

# POPULAR MECHANICS

## MAGAZINE

WRITTEN SO YOU CAN UNDERSTAND IT

REG. U. S. PAT. OFF.



Dr. Vannevar Bush  
top American scientist  
and photo-typesetting machine  
he helped develop

**INVENTING . . .**

*Hobby of Famous People*



Twain



Thurston



# Where are YOU in the Danger Zone

## The More You Delay—The More You Pay

There's always danger ahead when piston rings wear out—danger of much greater expense unless new rings are installed promptly.

But if you *do* install new rings at the first symptom of wear, you can protect your engine and insure its long and economical life.

Check your own situation on the Danger Zone chart, with the help of your service man. This simple precaution may save you both money and headaches. For the more you delay the more you pay. And when you need new piston rings, get Hastings, the rings designed for replacement service. It's the best money you can spend on your car.

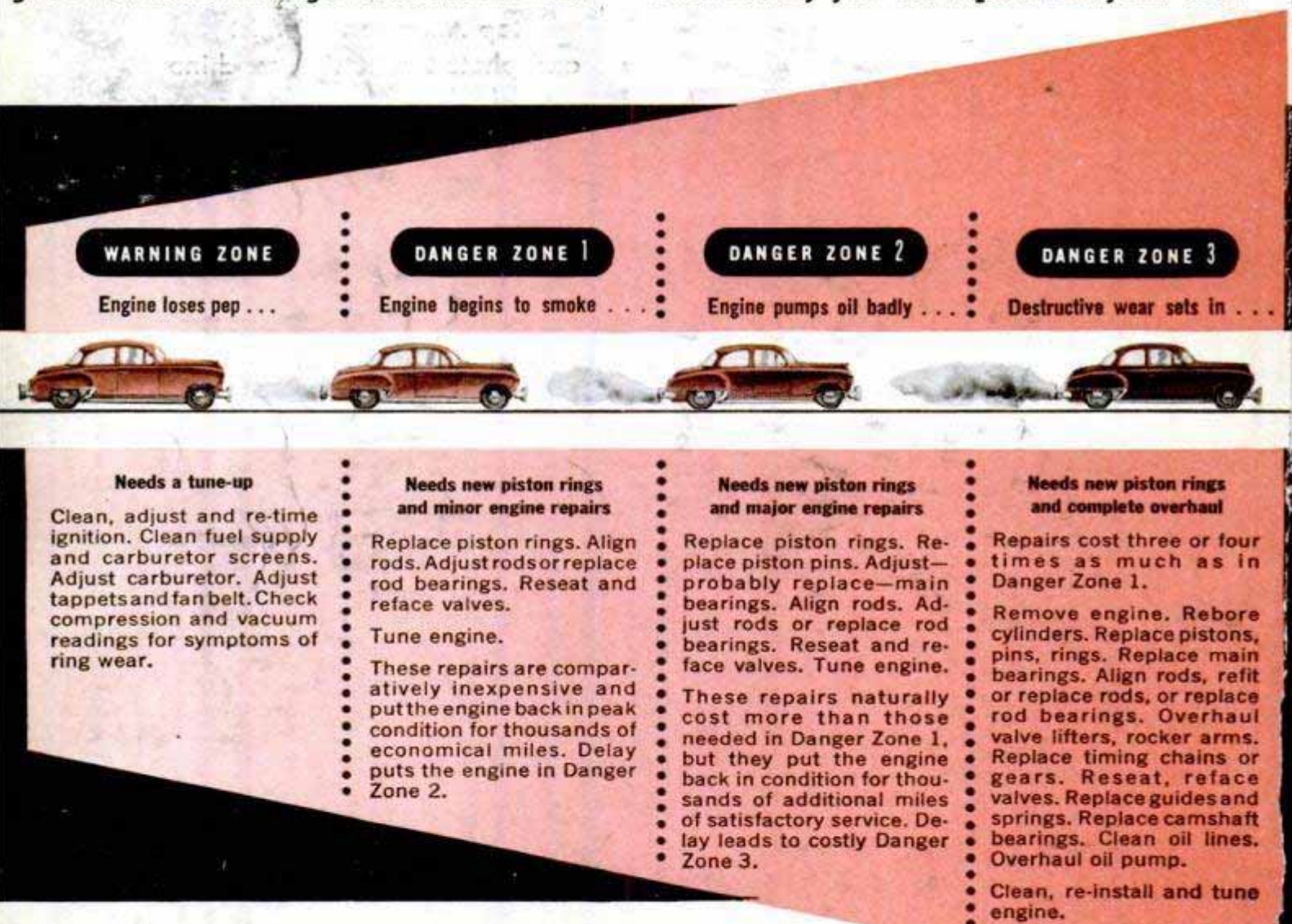

# HASTINGS

MANUFACTURING COMPANY  
HASTINGS, MICHIGAN  
HASTINGS LTD., TORONTO

## STEEL-VENT PISTON RINGS



TOUGH on Oil-Pumping • GENTLE on Cylinder Walls

How amazing tube  
discovery seals punctures  
while you ride!

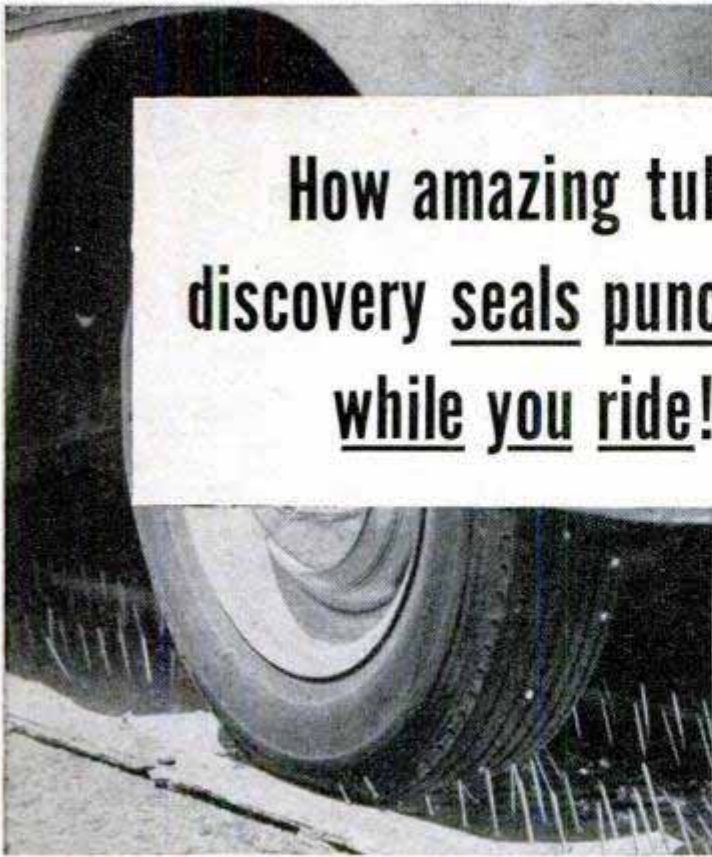

1. Sharp nails—*hundreds of them*—pierce deeply into this tire in grueling "Torture Test". What happens? Nothing! The tire does *not* go flat . . . the car keeps right on rolling!

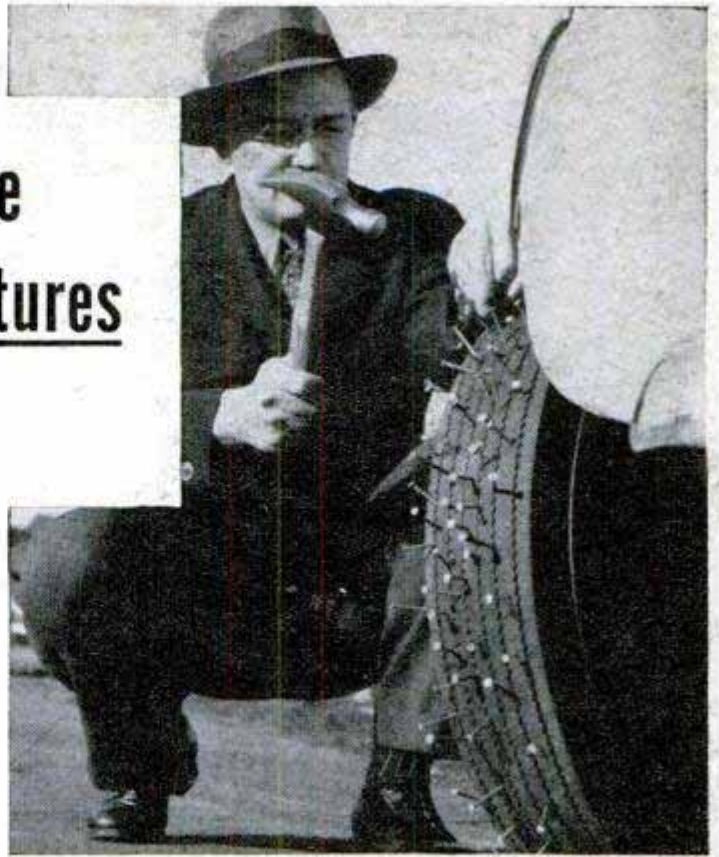

2. For good measure, *more* nails are pounded into the tire and through the tube. *Still no flat!* The secret lies in the amazing Sealed-Air Tube with patented Bulkheads perfected by Seiberling.



3. Here's how you "fix" a puncture when you have Seiberling Sealed-Air Tubes with patented Bulkheads. Just pull out the nail or other sharp object, and the tube seals itself *permanently!* No further repairs necessary!

How can this tube  
outlast four tires  
WITHOUT GOING FLAT?

How can this amazing Seiberling Sealed-Air Tube—the tube *no one* can imitate—actually outlast four tires, run as high as 300,000 miles—without even *one* flat? How can it save you many times its purchase price by eliminating the expense of tube repair bills and ruined tubes and tires? How can it make your driving immeasurably safer by protecting you from the dangers of sudden flats and blow-outs, and from the hazards of roadside tire changes? If you drive a car or truck, it will pay you many times over to fill in and mail the coupon below for the amazing story of what the Seiberling Sealed-Air tube can do for you.

**SEIBERLING**  
*Sealed-Air* TUBES  
WITH PATENTED BULKHEADS

**FREE!** Send coupon before you have another flat!

Learn more about the *only* tube built around the amazing Bulkheading principle. We'll send you, without obligation, our new book "10,189 PUNCTURES—AND NOT ONE FLAT!" Seiberling Rubber Company, Dept. PM-3, Akron 9, Ohio.

Name.....  
Address.....  
City.....State.....

This One



NEW FACTS FROM DU PONT HELP YOU

# SAVE MONEY ON ANTI-FREEZE

Instead of using expensive anti-freeze, most motorists can get complete winter protection from \$1.25-a-gallon "ZERONE"

This may surprise you—but here's what exhaustive winter road and laboratory tests made by Du Pont now prove about anti-freeze performance.

Du Pont "Zerone"\*—at only \$1.25 per gallon—will provide efficient, proper protection against cold weather, rust and corrosion for four out of five cars on the road today. These are the cars with low-opening thermostats, operating at normal altitudes, and requiring protection no lower than  $-30^{\circ}$  F.

If you've been overspending on anti-freeze in the past, you can save money with Du Pont "Zerone."

- With "Zerone," there is no evaporation problem—it needs only an occasional check-up.
- You buy less—3 quarts of "Zerone" do the work of 4 quarts of most other kinds of anti-freeze.
- "Zerone" has a chemical rust-inhibitor that helps keep a clean cooling system clean and won't attack rubber. Because it stays in solution, it can't clog the cooling system.

This winter, save good money on anti-freeze. Ask your service station attendant if you, too, can use inexpensive Du Pont "Zerone" in your cooling system.

\*REG. U. S. PAT. OFF.

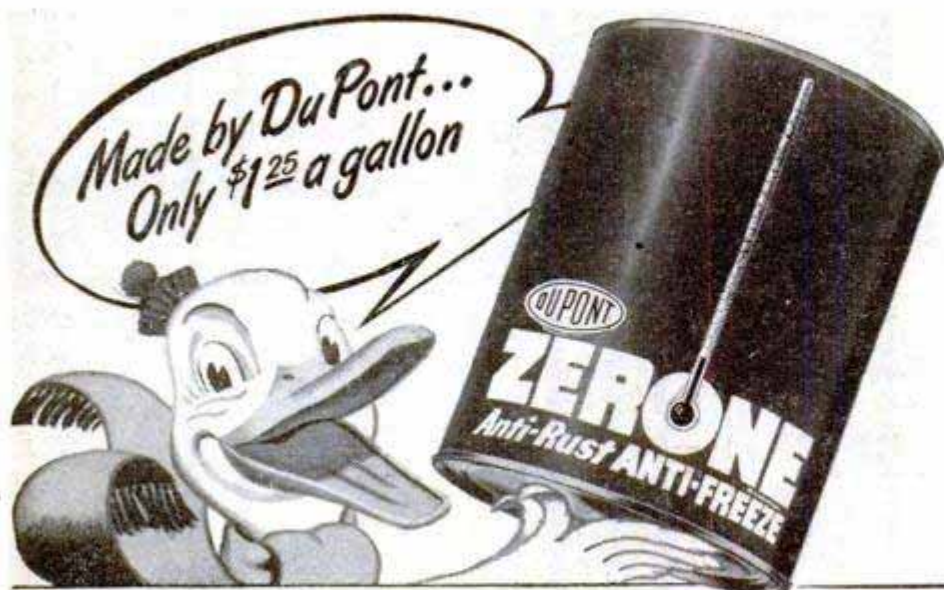

The dealer who displays this emblem offers you a special winter service. Make an early date with him for anti-freeze and for a thorough cooling system check-up—before the anti-freeze rush jams his driveway.



BETTER THINGS FOR BETTER LIVING  
... THROUGH CHEMISTRY

More motorists use Du Pont "ZERONE" anti-freeze than any other brand

# Popular Mechanics Magazine

Registered in U. S. Patent Office and Canada

H. H. WINDSOR, Founder

H. H. WINDSOR, JR., Editor and Publisher

Volume 94

OCTOBER 1950

Number 4

Managing Editor.....	Roderick M. Grant
Assistant Managing Editor.....	Wayne Whittaker
Shop Notes and Crafts Editor.....	James R. Ward
Radio-Television, Electronics Editor.....	Frank L. Brittin
Associate Editor, Aviation.....	Aubrey O. Cookman, Jr.
Associate Editor.....	Clifford B. Hicks
Automotive Editor.....	Siler Freeman
Art Director.....	Frank Beatty
Director, Bureau of Information.....	Allan Carpenter

**Assistant Editors**

Donald R. Brooks	Dorothy E. Hoffmann	Arthur R. Raiton
H. H. Windsor III		

**Assistant Editors, Shop Notes and Crafts**

W. Clyde Lamme	Wayne C. Lecky	Frank N. Stephany
Eastern Editor..... Richard F. Dempewolf		
Empire State Bldg., Room 2906, New York 1, N. Y.		

Western Editor..... Thomas E. Stimson, Jr.

Representative in Great Britain..... Douglas W. Wedderspoon  
77 Baker St., London W. 1, England



**this month's cover**

**DR. VANNEVAR BUSH**, distinguished director of the Carnegie Institution, is presented with considerable pride in our cover painting by Robert Korta. Doctor Bush, who ran the Office of Scientific Research and Development during the war, is shown with the new "typesetting" machine which he developed with associates at Carnegie and two French engineers who, he discovered, were working on the same idea. The machine makes a photographic record of letters on positive or negative film and this film is used to make engraving plates for printing — eliminating the need for typesetting machines which cast each line in metal. Aubrey D. McFadyen of the United States Patent Office tells more about the machine and the inventions of other famous persons in his entertaining and authoritative article beginning on page 106

**IN THIS ISSUE**

<b>It's 530 Degrees Cooler Inside</b>	<b>81</b>
<b>Treasure Hunt in a Lost World —Part II</b>	<b>88</b>
<b>The House That's Heated With "Mirrors"</b>	<b>97</b>
<b>Inventing—Hobby of Famous People</b>	<b>106</b>
<b>Suitcase Museum</b>	<b>114</b>
<b>Swords Without Rust</b>	<b>118</b>
<b>"Vest Pocket" Steel Mill</b>	<b>124</b>
<b>What's New for Your Home</b>	<b>128</b>
<b>The World's Favorite Sport</b>	<b>133</b>
<b>Funnels for a City's Freight</b>	<b>140</b>
<b>Harvest From Bearded Trees</b>	<b>154</b>
<b>Quest for a Galleon's Gold</b>	<b>159</b>

**For the Craftsman**

<b>Hobbies That Pay</b>	<b>166</b>
<b>Your Modern Kitchen—Part III</b>	<b>178</b>
<b>Modern Desk Features Built-In Wastebasket</b>	<b>190</b>
<b>Pointers on Remodeling an Attic</b>	<b>196</b>
<b>You're Missing Half the Fun</b>	<b>206</b>
<b>Curve It by Kerfing</b>	<b>211</b>
<b>Roofing Is Easy—Part II</b>	<b>217</b>
<b>Shopping for Tools</b>	<b>224</b>
<b>Radio-Television, Electronics</b>	<b>227</b>
<b>Clinic for Homemakers</b>	<b>236</b>

Other items, and manufacturers of available products described, are listed on pages 10, 14 and 16

Published monthly by Popular Mechanics Company, 200 E. Ontario St., Chicago 11, Ill. H. H. Windsor, Jr., president; William Harrison Fetridge, vice president; D. F. Windsor, vice president and secretary-treasurer; Clover L. Perkins, advertising manager; Alan M. Deyoe, circulation manager. Single copy in the United States and Canada, 35 cents; subscription rates in United States and possessions, Canada, Philippines and countries of the Pan-American Postal Union, 1 year \$3.50; 2 years, \$6.00; 3 years \$8.00. To all other countries add \$1.00 a year over United States prices for overseas postage. If you plan to move, notify us at least 30 days in advance so you will not miss an issue. Give both your old and new addresses.

Entered as Second Class Matter, September 15, 1903, at the Post Office at Chicago, Illinois, under Act of March 3, 1879. Entered as Second Class Matter at Post Office Dept., Canada. Registered as Second Class Matter at the Post Office at Mexico, D. F., Mexico, June 20, 1950.

Copyright 1950 by Popular Mechanics Company. Copyright under International Copyright Union. Copyright in France. All rights reserved under Pan-American Copyright Union. Printed in the United States of America.

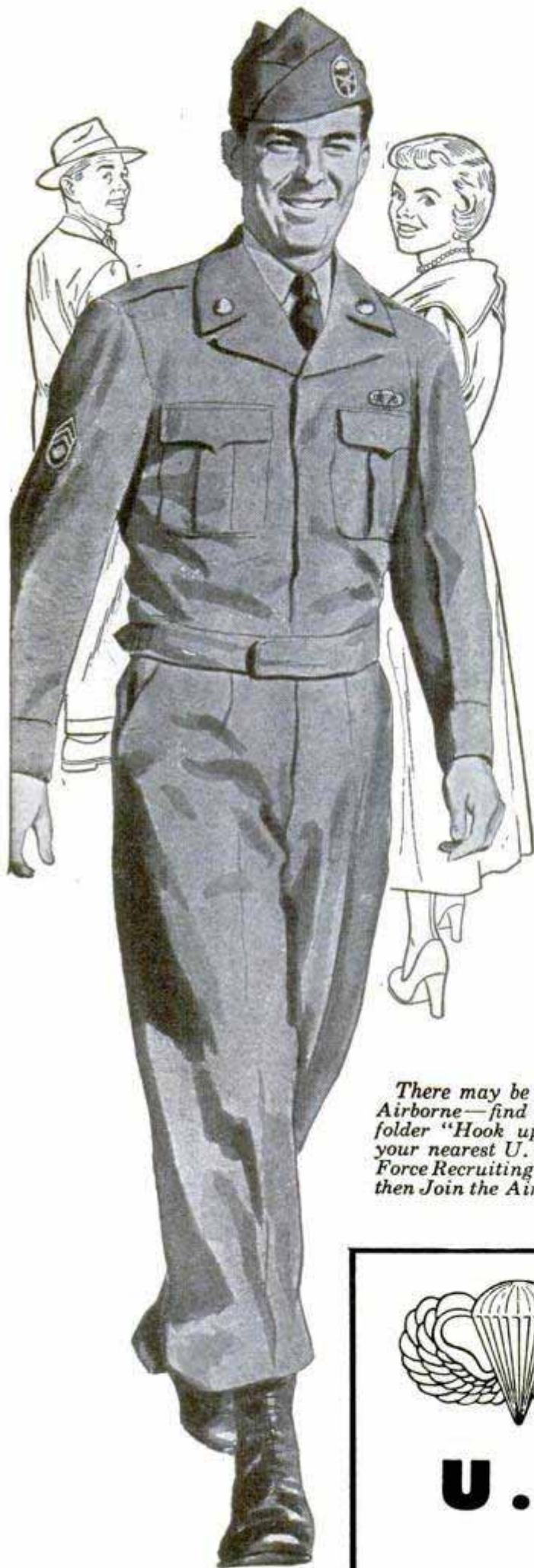

# Man Among Men!

***That's the Airborne Soldier for You***

Swift—Sudden—Strong—he comes out of the skies to fight on the ground . . . a volunteer and proud of it.

By the very nature of his work he must be a finished soldier—capable in every phase of his profession—ready and able to do anything from hand-to-hand combat to packing his chute or repairing a field radio.

This all contributes to the Airborne Soldier's outstanding characteristic—self-reliance. It shows in his walk—his talk—and in his work. The Airborne Soldier is truly "A Man Among Men"!

*There may be a place for YOU in the Airborne—find out today—pick up this folder "Hook up with the Airborne" at your nearest U. S. Army and U. S. Air Force Recruiting Station—Get all the facts, then Join the Airborne.*



**THE AIRBORNE**  
of the  
**U. S. A R M Y**

QUALITY CONTROLLED

**MA-TI-CO**  
ASPHALT TILE  
FLOORING

# Now! INSTALL YOUR OWN FLOOR!

## Cut Flooring Costs $\frac{2}{3}$ !



**IT'S LIKE EARNING  
\$40 IN A SINGLE  
EVENING**

New, perfected  
**MA-TI-CO**<sup>®</sup>  
install-it-yourself  
**METHOD**  
makes anyone a  
floor craftsman

### Create your own individual floor designs with MA-TI-CO's richer, clearer colors

You get a most durable serviceable, economical type of flooring for the price of the tile alone when you install MA-TI-CO yourself. The average 9' x 12' room costs as little as \$15. If you had the floor installed by a professional, it would cost you up to \$60. "Install-it-yourself" saves you more than  $\frac{2}{3}$  rds.

### IDEAL FOR EVERY ROOM IN YOUR HOME

... that's why Levitt and Sons, America's largest builder of private homes, selects MA-TI-CO for flooring every room in 4,000 new homes. MA-TI-CO is available in 27 sparkling colors, including five new pastel "Petal Tones". Get details today.



Mail Coupon for  
instruction booklet  
**NOW!**



MASTIC TILE CORP. OF AMERICA, Dept. M610  
P. O. Box 42, New York 10, N. Y.

Please send complete install-it-yourself instruction kit, illustrated literature and color charts. Enclosed is 10c to cover mailing.

NAME .....

ADDRESS .....

CITY..... ZONE.... STATE.....

QUALITY CONTROLLED

**MA-TI-CO**  
ASPHALT TILE  
FLOORING

### MASTIC TILE CORPORATION OF AMERICA

Member Asphalt Tile Institute

Factories:  
Newburgh, N. Y. • Long Beach, Calif.

For faster cleaning . . . more beautiful asphalt tile floors, always use MA-TI-CO Wax and MA-TI-CO Cleaner.

C10

# Why is Pyroil GOOD for my car?

## BECAUSE:

- Pyroil improves lubrication
- Pyroil removes sludge and gummy deposits
- Pyroil cleans your motor and keeps it clean
- Pyroil prevents damaging "dry starts"
- Pyroil maintains a constant film of protective oil between metal parts
- Pyroil reduces wear caused by friction
- Pyroil prevents rust and corrosion
- Pyroil protects your motor whether driving or idling

Pyroil is good for your car—and good to your budget. For Pyroil is the economical way of assuring you longer miles of smoother driving. When you add gas or oil, add Pyroil—add miles to your car.

### Pyroil for Aircraft Engines

Use Aircraft Pyroil B for lubricating oil, Aircraft Pyroil A for gasoline.

**GIVEN!** An attractive Pyroil metal savings bank, takes coins up to 50c pieces. **MOTORISTS**, it's yours for the asking—sent postage paid.



Manufactured and Guaranteed by  
Pyroil Company, 108 Pyroil Bldg.,  
La Crosse, Wisconsin

Canadian Distributors: Central  
Purchasing Agencies, Ltd.,  
Toronto, Ontario

**PYROIL COMPANY**  
108 Pyroil Bldg.,  
La Crosse, Wisconsin

I want my car to last and run properly. Please tell me more about Pyroil and how it can accomplish this for me.

Name \_\_\_\_\_

Address \_\_\_\_\_

City or Town \_\_\_\_\_ State \_\_\_\_\_



## in this corner..... **THE EDITORS**



### Letter to the Editor

Dear Sir:

As a reader of P.M. since I was knee-high-to-a-grasshopper (I'm 50 now and residing in this far-away land of the kiwi), I find your publication so full of informative matter that I often take a half day off to thoroughly digest the contents. Long live *Popular Mechanics*.

Your records show my name as a subscriber. But I have been taken off the list because the agent can get a license to import only so many, and the older subscribers have preference. However, I still get my copy but have to pay over six shillings a copy. In the old days . . . N. Z. currency was on a par with the American dollar; six shillings now would be about one dollar and fifty cents. But who cares so long as we get a copy monthly?

In a recent issue you showed a midget car called the "IMP" . . . may I have the name of the manufacturer? I am associated with an automotive engineering firm making farm tractors and am interested to know if we might obtain the manufacturing rights here under license. . . . Best wishes to *Popular Mechanics* and its staff of excellent editors.

Cordially yours,  
Hal Richardson,  
Wellington, New Zealand.

\* \* \*

### Letter to the Editor

Dear Sir:

On behalf of the Three-Quarter Midget Racing Association, Inc., I would like to thank you and your staff for the fine article on our cars in your June issue. We have received over 3000 letters in regard to them and the Post Office is very unhappy about the way they are coming in. Most of the letters are addressed either to the TQMRA or Mr. Cecil Buck, Sheriff, Norwalk, Calif. . . . He has received over 500 letters himself.

We will call our first TQMRA promoted track "Pop Corn Bowl."

Sincerely,  
Jerry Wright, President  
TQMRA

\* \* \*

☐ Carried 100 miles high by V-2 rocket, a photographic plate "snapped" an action shot of a cosmic ray smashing an atom.

(Continued to page 8)



# Why be a BOOKKEEPER?

... When Accountancy  
offers more Money  
and Success...

If you are a bookkeeper, you are right on the threshold of a profession that pays far above average—where there's real opportunity to get ahead and move up fast.

Why not step UP from bookkeeping—be an accountant—make *real* money!

You can learn Accountancy by the interesting LaSalle Problem Method—in your convenient spare time, at home, without losing a day from your work. You learn by *doing* . . . you study Accounting principles and solve Accounting problems under the clear guidance of experienced C.P.A.'s. You cover Accountancy from the basic principles right up through Accounting Systems and Income Tax Procedure—to advanced training for the C.P.A. degree if you so desire. And as you go along step-by-step, you master the principles of auditing, business law, statistical control, cost accounting, organization, management, finance, etc.

You go as fast or as slowly as you choose. And you may start "cashing in" on your new ability long before you complete the training—as thousands of others have proved. Many advance quickly to better positions, even before they are half way through. And that is only the *beginning* of a growing and continuing success for the rest of your business life.

Why remain "just a bookkeeper" when Accountancy holds so much for you? Our free 48-page booklet, "ACCOUNTANCY, THE PROFESSION THAT PAYS," tells you what you must know to be an Accountant, and how you can prepare in your

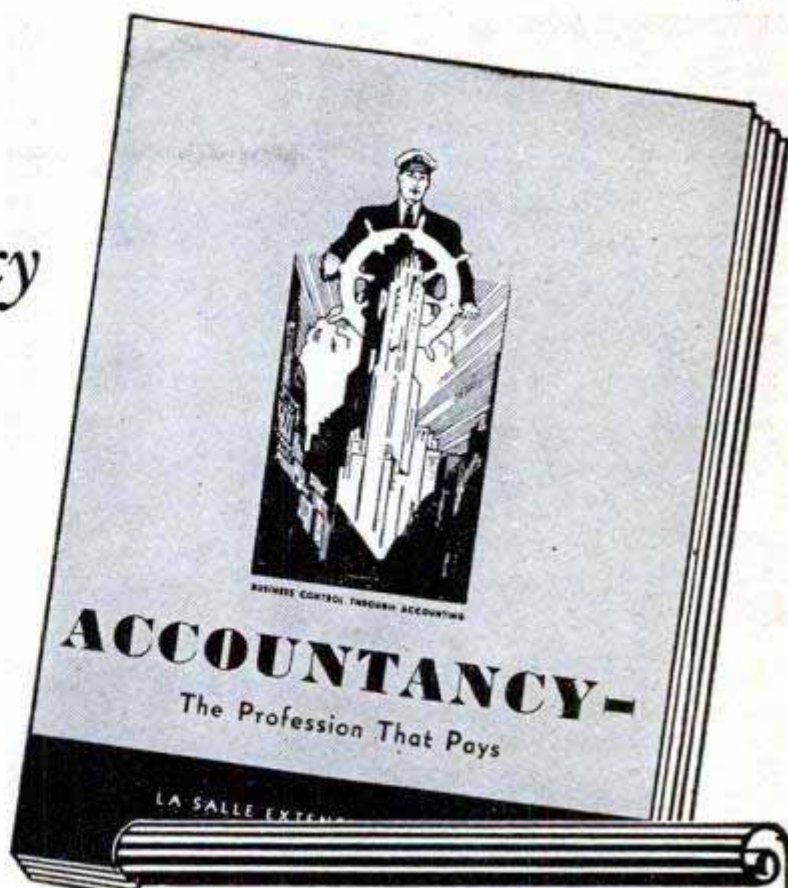

## LASALLE Extension University

*A Correspondence Institution*

Dept. 1064-HR • 417 S. Dearborn • Chicago 5, Ill.

Send me your free 48-page booklet, "Accountancy, the Profession That Pays"—plus "Ten Years' Promotion in One"—a book which has helped many men.

Higher Accountancy

Other LaSalle opportunities:

- |   |  |
|---|--|
| <input checked="" type="checkbox"/> C.P.A. Coaching | <input type="checkbox"/> Traffic Management            |
| <input type="checkbox"/> Bookkeeping                | <input type="checkbox"/> Foremanship                   |
| <input type="checkbox"/> Law: LL.B. Degree          | <input type="checkbox"/> Industrial Management         |
| <input type="checkbox"/> Business Management        | <input type="checkbox"/> Stenotypy (Machine Shorthand) |
| <input type="checkbox"/> Salesmanship               |  |

Name..... Age.....

Address .....

City, Zone, State.....

## LASALLE EXTENSION UNIVERSITY

*A Correspondence Institution*

Dept. 1064-HR 417 S. Dearborn St.  
Chicago 5, Illinois

leisure time, at moderate cost and on easy terms.

Send the coupon today and we'll include "Ten Years' Promotion in One"—a book which has helped many men. Get all the facts and judge for yourself. There is no obligation. You are already started in this field . . . find out how you can rapidly go to the top! Mail coupon NOW!

# AVIATION



# ESSENTIAL

## in peace or war

### A MESSAGE TO YOUNG MEN... AND PARENTS

We have an urgent demand for Embry-Riddle graduates. Aircraft manufacturers and operators need thousands of properly trained young men for essential positions in civilian aviation.

### SAVE TIME

Now, more than ever before, you need maximum school training in minimum time. Embry-Riddle offers complete eight-month to two-year aeronautical engineering, master A & E mechanic, flying and specialist courses, backed by a quarter-century experience in training today's aviation leaders.

### BE PREPARED

No one can safely predict the course of events today. Be assured, however, that no matter what happens, you will be one step ahead of the crowd with up-to-date, intensive Embry-Riddle aviation training. Write, wire or call today for catalog and full information.



## Embry Riddle

International

### SCHOOL OF AVIATION

RIDDLE-McKAY COLLEGE OF AERONAUTICS  
MIAMI 30, FLORIDA

Wherever planes fly, men know Embry-Riddle . . .  
A Famous Name in Aviation.

Dean of Enrollments - Dept. 99  
Embry-Riddle School of Aviation  
Miami 30, Florida

Please Print

NAME \_\_\_\_\_

ADDRESS \_\_\_\_\_

City \_\_\_\_\_

State \_\_\_\_\_ Age \_\_\_\_\_

I am interested in...

- A.&E. Mechanic
- Commercial Pilot
- Engineering
- A.&E. Combined with Commercial Pilot
- Flying Mechanic
- Drafting & Design

Check One  Veteran  Non-Veteran

**TRAIN IN MIAMI -- AIR CAPITAL OF THE WORLD**

(Continued from page 6)

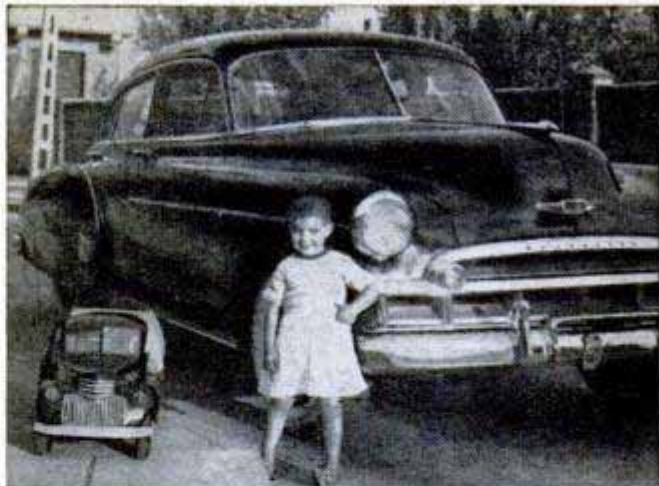

Above, realistic in all details, the tiny Chevrolet truck was built by a hobbyist in Chile. Below, the steering and driving motors are controlled remotely



### Chilean Hobbyist

National boundaries mean nothing in the hobby world, as a letter from Señor Jorge Petit of Santiago, Chile, proves. Señor Petit built a remote-controlled truck, a scale model of a popular General Motors product. Simply by pressing a button, he can make it go forward, backward or turn in either direction. It is battery-operated and even has sealed-beam headlights and a horn. On the wheels, he used the small tires that a U. S. manufacturer puts around his souvenir ash trays. Incidentally, Petit saved himself some money by reading *Popular Mechanics* advertisements. First, he bought a six-volt motor for the truck in Chile. It cost him \$21. Then he decided the truck needed a second motor and, seeing one advertised in our magazine, he sent for it. It turned out to be a duplicate of the one bought in Chile—exactly the same except for price. The second one cost him only \$5.95—so he came out \$15 ahead on the deal.

\* \* \*

TV's Little Brother makes his debut in the November issue. Don't miss it!

# HOW TO IMPRESS THE BOSS

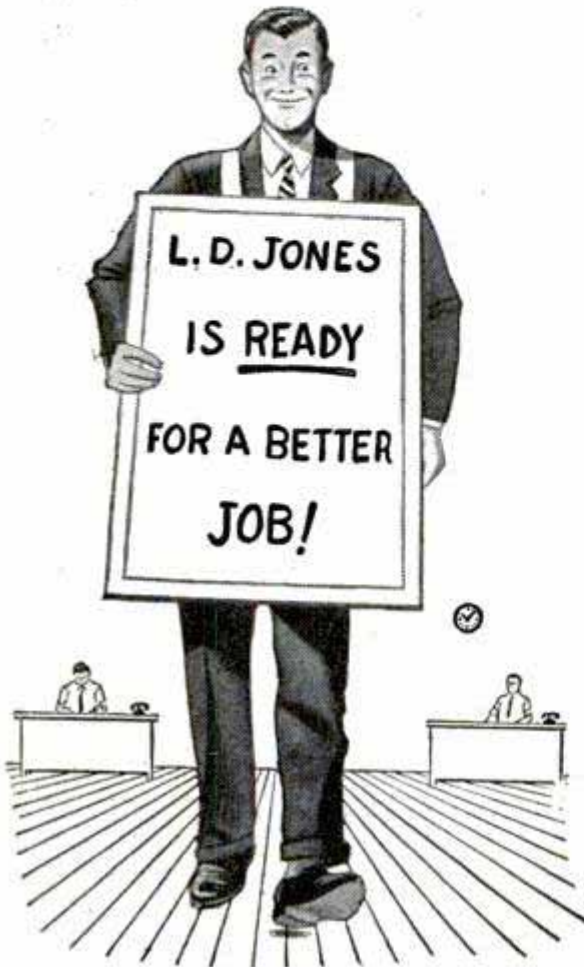

Suppose you do prepare for advancement in your spare time. Can you be sure news of it will reach the right ears? Will your boss be impressed?

I.C.S. regularly reports the progress of its students to their employers, regularly receives letters expressing appreciation of this service.

Typical of the many letters is one from an executive of a well-known oil company: "We want to thank you for your progress report on the above-named employee. It may interest you to know that he is being promoted, effective immediately."\*

YOU want your employer to know that you are ready for promotion. YOU want your training recognized and rewarded. Then act now to obtain that training. Sound, practical I.C.S. Courses cover more than 400 business and technical subjects. The coupon brings full information.

\*Name furnished on request.

## INTERNATIONAL CORRESPONDENCE SCHOOLS



BOX 5685-K, SCRANTON 9, PENNA.

Without cost or obligation, please send me full particulars about the course BEFORE which I have marked X:

- |  |  |   |   |
|--|--|---|---|
| <p><b>Business and Academic Courses</b></p> <ul style="list-style-type: none"> <li><input type="checkbox"/> Accounting</li> <li><input type="checkbox"/> App. Psychology</li> <li><input type="checkbox"/> Business Administration</li> <li><input type="checkbox"/> Bus. Correspondence</li> <li><input type="checkbox"/> Certified Public Accounting</li> <li><input type="checkbox"/> Commercial</li> <li><input type="checkbox"/> Commercial Art</li> <li><input type="checkbox"/> Cost Accounting</li> <li><input type="checkbox"/> Federal Tax</li> <li><input type="checkbox"/> First Year College</li> <li><input type="checkbox"/> Foremanship</li> <li><input type="checkbox"/> Good English</li> <li><input type="checkbox"/> Higher Mathematics</li> <li><input type="checkbox"/> Industrial Supervision</li> <li><input type="checkbox"/> Motor Traffic</li> <li><input type="checkbox"/> Retailing</li> <li><input type="checkbox"/> Salesmanship</li> <li><input type="checkbox"/> Sign Lettering</li> <li><input type="checkbox"/> Spanish</li> <li><input type="checkbox"/> Advertising</li> <li><input type="checkbox"/> Bookkeeping</li> <li><input type="checkbox"/> Bus. Law</li> <li><input type="checkbox"/> French</li> <li><input type="checkbox"/> High School</li> <li><input type="checkbox"/> Illustration</li> <li><input type="checkbox"/> Postal Civil Service</li> <li><input type="checkbox"/> Retail Bus. Management</li> <li><input type="checkbox"/> Secretarial</li> <li><input type="checkbox"/> Stenography</li> <li><input type="checkbox"/> Traffic Management</li> </ul> <p><b>Air Conditioning and Plumbing Courses</b></p> <ul style="list-style-type: none"> <li><input type="checkbox"/> Air Conditioning</li> <li><input type="checkbox"/> Heating</li> <li><input type="checkbox"/> Refrigeration</li> <li><input type="checkbox"/> Plumbing</li> <li><input type="checkbox"/> Steam Fitting</li> </ul> | <p><b>Chemical Courses</b></p> <ul style="list-style-type: none"> <li><input type="checkbox"/> Chemical Engineering</li> <li><input type="checkbox"/> Chemistry, Analytical</li> <li><input type="checkbox"/> Chemistry, Industrial</li> <li><input type="checkbox"/> Chemistry, Mtg. Iron &amp; Steel</li> <li><input type="checkbox"/> Petroleum Refining</li> <li><input type="checkbox"/> Plastics</li> <li><input type="checkbox"/> Pulp and Paper Making</li> </ul> <p><b>Civil Engineering, Architectural and Mining Courses</b></p> <ul style="list-style-type: none"> <li><input type="checkbox"/> Architecture</li> <li><input type="checkbox"/> Architectural Drafting</li> <li><input type="checkbox"/> Building Estimating</li> <li><input type="checkbox"/> Civil Engineering</li> <li><input type="checkbox"/> Coal Mining</li> <li><input type="checkbox"/> Contracting and Building</li> <li><input type="checkbox"/> Highway Engineering</li> <li><input type="checkbox"/> Lumber Dealer</li> <li><input type="checkbox"/> Reading Structural Blueprints</li> <li><input type="checkbox"/> Sanitary Engineering</li> <li><input type="checkbox"/> Structural Drafting</li> <li><input type="checkbox"/> Structural Engineering</li> <li><input type="checkbox"/> Surveying and Mapping</li> </ul> <p><b>Communications Courses</b></p> <ul style="list-style-type: none"> <li><input type="checkbox"/> Electronics</li> <li><input type="checkbox"/> Prac. FM and Television</li> <li><input type="checkbox"/> Prac. Telephony</li> <li><input type="checkbox"/> Radio Operating</li> <li><input type="checkbox"/> Radio, General</li> <li><input type="checkbox"/> Radio Servicing</li> <li><input type="checkbox"/> Telegraph Engineering</li> </ul> | <p><b>Electrical Courses</b></p> <ul style="list-style-type: none"> <li><input type="checkbox"/> Electrical Drafting</li> <li><input type="checkbox"/> Electrical Engineering</li> <li><input type="checkbox"/> Electric Light and Power</li> <li><input type="checkbox"/> Lighting Technician</li> <li><input type="checkbox"/> Practical Electrician</li> <li><input type="checkbox"/> Power House Electric</li> <li><input type="checkbox"/> Ship Electrician</li> </ul> <p><b>Internal Combustion Engines Courses</b></p> <ul style="list-style-type: none"> <li><input type="checkbox"/> Auto Technician</li> <li><input type="checkbox"/> Diesel-Electric</li> <li><input type="checkbox"/> Diesel Engines</li> <li><input type="checkbox"/> Aviation</li> <li><input type="checkbox"/> Gas Engines</li> </ul> <p><b>Mechanical Courses</b></p> <ul style="list-style-type: none"> <li><input type="checkbox"/> Aeronautical Engineer's, Jr.</li> <li><input type="checkbox"/> Aircraft Drafting</li> <li><input type="checkbox"/> Forging</li> <li><input type="checkbox"/> Heat Treatment of Metals</li> <li><input type="checkbox"/> Industrial Engineering</li> <li><input type="checkbox"/> Industrial Instrumentation</li> <li><input type="checkbox"/> Industrial Metallurgy</li> <li><input type="checkbox"/> Machine Shop</li> <li><input type="checkbox"/> Machine Shop Inspection</li> <li><input type="checkbox"/> Mechanical Drafting</li> <li><input type="checkbox"/> Mechanical Engineering</li> <li><input type="checkbox"/> Flight Engineer</li> <li><input type="checkbox"/> Foundry Work</li> </ul> | <p><input type="checkbox"/> Mold-Loft Work</p> <p><input type="checkbox"/> Patternmaking—Wood, Metal</p> <p><input type="checkbox"/> Reading Shop Blueprints</p> <p><input type="checkbox"/> Sheet-Metal Drafting</p> <p><input type="checkbox"/> Sheet-Metal Worker</p> <p><input type="checkbox"/> Ship Drafting</p> <p><input type="checkbox"/> Ship Fitting</p> <p><input type="checkbox"/> Tool Designing</p> <p><input type="checkbox"/> Toolmaking</p> <p><input type="checkbox"/> Welding Engineering</p> <p><input type="checkbox"/> Welding—Gas and Electric</p> <p><b>Railroad Courses</b></p> <ul style="list-style-type: none"> <li><input type="checkbox"/> Air Brake</li> <li><input type="checkbox"/> Diesel Locomotive</li> <li><input type="checkbox"/> Locomotive Engineer</li> <li><input type="checkbox"/> Locomotive Fireman</li> <li><input type="checkbox"/> Locomotive Machinist</li> <li><input type="checkbox"/> Railroad Section Foreman</li> <li><input type="checkbox"/> Steam and Diesel Loco. Eng.</li> </ul> <p><b>Stationary Engineering Courses</b></p> <ul style="list-style-type: none"> <li><input type="checkbox"/> Boilermaking</li> <li><input type="checkbox"/> Combust. Engrg.</li> <li><input type="checkbox"/> Marine Engineering</li> <li><input type="checkbox"/> Power Plant Engr.</li> <li><input type="checkbox"/> Steam Engineer</li> </ul> <p><b>Textile Courses</b></p> <ul style="list-style-type: none"> <li><input type="checkbox"/> Cotton Manufacturing</li> <li><input type="checkbox"/> Loom Fixing</li> <li><input type="checkbox"/> Rayon Weaving</li> <li><input type="checkbox"/> Textile Designing</li> <li><input type="checkbox"/> Woolen Manufacturing</li> </ul> |
|--|--|---|---|

Name \_\_\_\_\_ Age \_\_\_\_\_ Home Address \_\_\_\_\_

City \_\_\_\_\_ State \_\_\_\_\_ Working Hours \_\_\_\_\_ A.M. to \_\_\_\_\_ P.M.

Present Position \_\_\_\_\_ Employed by \_\_\_\_\_

Length of Service in World War II \_\_\_\_\_

Enrollment under G.I. Bill approved for World War II Veterans. Special tuition rates to members of the Armed Forces.  
Canadian residents send coupon to International Correspondence Schools Canadian, Ltd., Montreal, Canada.

# NEW LOW PRICE!

LARGE-SIZE TUBE

NOW ONLY

29¢



**MORE DOCTORS**  
Who Specialize in Care of the Skin  
**USE MENNEN LATHER**  
than any other brand

• Helps Make Beards Up to 47% Softer for Shaving

## WHERE-TO-BUY-IT INDEX

Source of supply appears after items commercially available

### AUTOMOTIVE

Detroit listening post	104
Kaiser's Henry J (Kaiser-Frazer Corp., Willow Run, Mich.)	105
Underwater truck (Reo Motors, Inc., Lansing, Mich.)	116
Rust remover protects engine (York-Rusgo Co., 1903 W. Market St., York, Pa.)	117
Adjustable overload springs (Laher Spring & Tire Co., 26th & Magnolia, Oakland, Calif.)	122
Revolving tire chains (Roll-O-Matic Chain Co., 200 Wyandotte, Kansas City, Mo.)	126
Test chart shows motorist when oil filter needs changing (Fram Corp., Pawtucket Ave., Providence, R.I.)	127
Auto runs on peat	138
Magnet holds utility tray (Glass Laboratories, Inc., 407 Douglass St., Brooklyn 17, N. Y.)	146
Car lighter puffs cigarette (Dow Products, Inc., 3724 N. Morris, Milwaukee, Wis.)	153
Hill holder (Berkeley Specialties Co., 899 Gilman St., Berkeley, Calif.)	157
Volkswagen, 1950 (Porsche K. G., Stuttgart-Zuffenhausen, Schwieberdingerstrasse, Germany, U. S. Zone)	163

### AVIATION

Britain's Brabazon—"Queen Mary of the Sky"	96
Doors shield jets from blowing dirt (Consolidated-Vultee Aircraft Corp., Fort Worth, Tex.)	117
Double-folding wings (Fairley Aviation Co., Ltd., Maidenhead, Berkshire, England)	122
Rain repellent (Fiberglas Canada, Ltd., Toronto, Canada)	123
Neptune adds power (Lockheed Aircraft Corp., Burbank, Calif.)	139
Torpedo-shaped airplane	163
Flying snow man	164

### FARM

Down-the-well pump (Sumo Pumps, Inc., One Atlantic St., Stamford, Conn.)	126
Food alarm	146
Long land leveler	152

### HOUSE AND HOME

Ranch-plank flooring (E. L. Bruce Co., Box 397, Memphis, Tenn.)	105
Insulating building material (Kaylo Division, Owens-Illinois Glass Co., Toledo 1, Ohio)	117
Moisture-sensitive plastic measures humidity in air (Humidial Co., 864 Edgemoor, Colton, Calif.)	123
Housewife's third hand (Grip-Tite Corp., 1488 Mdse. Mart Bldg., Chicago)	127
Bath pad (Luxury Gifts, Inc., 516 Fifth Ave., New York City 18)	128
Two-way heater (Salton Mfg. Co., Inc., 74 Reade St., New York City 7)	128
Roll cutter (Kesco, 5614 Blackstone Ave., Chicago 37)	128
Clothes sprinkler (Sprinkl-It Mfg. Co., 229 N. Muscatel Ave., San Gabriel, Calif.)	128
Indoor barbecue (Hoffritz for Cutlery, 331 Madison Ave., New York City)	129
Shoe shiner (Beck, Inc., Grafton, Wis.)	129
Aluminum spray (Chamberlain Metal Products Mfrs., 1466 W. Madison St., Chicago 7)	129
Plug-in thermostat (Electric Controls, Inc., Swan Island, Portland 18, Ore.)	129
Cook-and-carry pans (Ekeo Products Co., 1949 N. Cicero, Chicago)	130
Double-decker shelf (Space Saver Industries, 18370 Fitzpatrick, Detroit 28, Mich.)	130
Versatile table (Utilicrafts, Inc., 8-16 43rd Ave., Long Island City, N. Y.)	130
Safety plate (Hayman-Standard Products Co., Inc., 2022 Chancellor St., Philadelphia 3, Pa.)	130
Line lock (H. R. Rogant, 15 Second St., Willoughby, Ohio)	131
Travel crib (Bunny Bear, Inc., Everett, Mass.)	131
Shampoo spray (T & S Brass & Bronze Works, Inc., 121 E. 2nd St., Mineola, Long Island, N. Y.)	131
Garden fence (Eclipse Mfg. Co., 1360 Hird Ave., Cleveland, Ohio)	131
Triple-purpose table	132

### INDUSTRY

Hard coating for aluminum (Glenn L. Martin Co., Baltimore 3, Md.)	16
Plastic glasses (Dr. Robert Graham, College of Medical Evangelists, 312 N. Boyl Ave., Los Angeles, Calif.)	86
Truckers' Goliath (Walter Reddaway, Reddaway Truck Lines, Oregon City, Ore.)	87
Maze of steel pipe supports high Italian bridge	94
Automatic gate controls water (Thompson Pipe and Steel Co., 3001 Larimer St., Denver, Colo.)	94
Highway tanker	113
Plenty of oil and plenty of uses	116
Cotton-bale sampler	132
Trailer-type digger hooks to tractor (Badger Machine Co., Front St., Winona, Minn.)	147
Three blocks of radiators (Trane Co., La Crosse, Wis.)	147
Tailgate on truck forms electric lift (B. M. Quinn Co., Lebanon, Ind.)	152
Quick-change motor	158

### PHOTOGRAPHY

Diving cameraman	150
Superspeed camera films shock waves	158
Adjustable projector table (James H. Smith & Sons, Corp., Griffith, Ind.)	158

(Continued to page 14)

# WHAT **AUTO** MECHANIC Every Wants to Know

A motor vehicle is a machine of many parts, each part designed and constructed for its own special function.

All good mechanics, like good doctors, should know the working theory and operation of each part and understand what causes trouble and how to remedy it.

## LET AUDELS AUTO GUIDE SOLVE YOUR PROBLEMS

Every auto mechanic, helper, serviceman and operator can use AUDELS AUTO GUIDE. The information it gives saves time, money and worry. Highly endorsed by all users. It presents the whole subject of auto mechanics from A to Z in plain language and simple terms.

This Big Practical Book gives full information with working diagrams covering the principles, construction, ignition, service and repair of modern cars, trucks and buses.

A complete Guide of 1800 pages, with over 1500 illustrations showing inside views of the working parts, with instructions for service jobs. Diesel engines, Fluid and Hydra-matic drives fully explained.

### IT PAYS TO KNOW HOW TO

How to fit pistons—How to locate engine knocks—How to fit connecting rod bearings—How to service main bearings—How to recondition valves—How to time valves—How to adjust fan belts—How to adjust carburetors & chokes—How to rebuild a clutch—How to service automatic transmissions—How to service brakes—How to adjust steering gear—How to cope with ignition troubles—How to service distributors—How to time ignition—How to "tune up" an engine.

### INFORMATION IN A HANDY FORM

73 INTERESTING CHAPTERS—Read this partial list of subjects on which practical information is fully given for quick reference under the headings as shown below. Ready Reference Index.

All Parts of an Automobile—Automotive Physics—The Gas Engine—Gas Engine Principles—Multi-Cylinder Engines—Horse Power—Automobile Engines—Stationary Parts—Moving Parts—Pistons—Piston Rings—Connecting Rods—Crank Shafts—Valves—Valve Gear—Cams and Cam Action—Valve Timing—Cooling Systems—Fuel Feed Systems—Dual Fuel Feed—Mixture—Carburetors—Carburetor Service—Automatic Choke—Super-Chargers—Transmissions—Special Transmissions—Fluid and Hydra-matic Drives—Clutches—Universals and Propeller Shafts

A Ready Reference

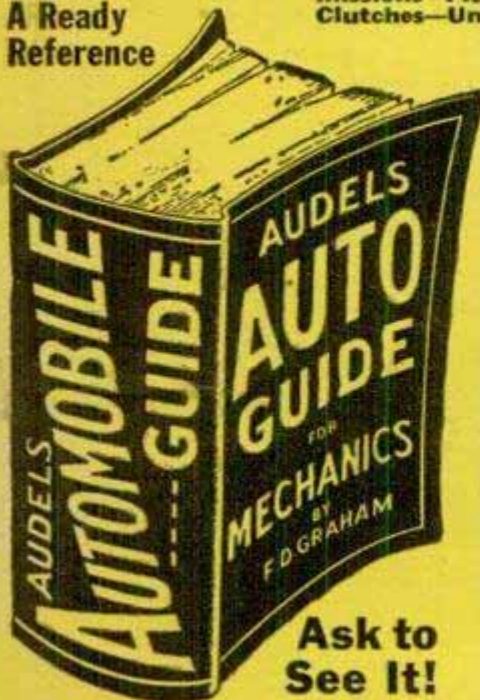

—The Differential—Rear Axles—Rear and Front Suspension—Running Gear—Brakes—Wheel Alignment—Knee Action—Steering Gear—Tires—Lubricants and Lubrication—Automotive Electricity—Ignition Systems—Magnet Ignition—Spark Plugs—Ignition Coils—Distributors—Automatic Spark Control—Ignition Timing—Generators—Starters—Generator and Starter Testing—Lighting Systems—Storage Batteries—Charging and Testing—Diesel Engines and Trouble Shooting.

**7 DAYS' FREE TRIAL**  
TO GET THIS ASSISTANCE FOR YOURSELF SIMPLY FILL IN AND MAIL COUPON TODAY.

**\$4 COMPLETE PAY \$1 A ONLY 1 MO.**



### Sent on 7 Days Approval

Step up your own skill with the facts and figures of your trade. Audels Mechanics Guides contain Practical Inside Trade Information in a handy form. Fully illustrated and Easy to Understand. Highly Endorsed. Check the book you want for 7 DAYS FREE EXAMINATION. Send No Money. Nothing to pay postman.

## CUT HERE MAIL ORDER

AUDEL, Publishers, 49 W. 23 St., NEW YORK 10, N. Y.

Please send me postpaid for FREE EXAMINATION books marked (x) below. If I decide to keep them I agree to mail \$1 in 7 Days on each book or set ordered and further mail \$1 monthly on each book or set until I have paid price, otherwise I will return them.

- AUTO GUIDE**, 1800 Pages **\$4**
- DIESEL ENGINE MANUAL, 400 Pages . . . . . 2
- WELDERS GUIDE, 400 Pages . . . . . 1
- MACHINISTS Handy Book, 1600 Pages . . . . . 4
- POWER PLANT ENGINEERS Guide, 1500 Pages. . . . . 4
- ENGINEERS & FIREMANS EXAMS, 528 Pages. . . . . 1
- PUMPS, Hydraulics & Air Compressors, 1658 Pgs. . . . . 4
- MARINE ENGINEERS Handy Book, 1280 Pages . . . . . 4
- ENGINEERS & Mechanics Guides (8 Book Set). . . . . 12
- Answers on Practical ENGINEERING, 254 Pages . . . . . 1
- ELECTRIC WIRING DIAGRAMS, 210 Pages . . . . . 1
- ELECTRICIANS EXAMINATIONS, 250 Pages. . . . . 1
- ELECTRICAL DICTIONARY, 9000 Terms . . . . . 2
- ELECTRIC MOTOR GUIDE, 1000 Pages . . . . . 4
- HANDY BOOK OF ELECTRICITY, 1440 Pages . . . . . 4
- ELECTRICAL POWER CALCULATIONS, 425 Pgs. . . . . 2
- RADIOMANS GUIDE, 914 Pages . . . . . 4
- ELECTRONIC DEVICES, 216 Pages . . . . . 2
- ELECTRIC LIBRARY, 7000 Pages (12 Book Set). . . . . 18
- Vols. I, II, III, IV, V, VI, VII, VIII, IX, X, XI, XII \$1.50 Ea. . . . . 1
- OIL BURNER GUIDE, 384 Pages . . . . . 1
- HOUSE HEATING GUIDE, 1000 Pages . . . . . 4
- CARPENTERS & Builders Guides (4 Book Set). . . . . 6
- PLUMBERS & Steamfitters Guides (4 Book Set). . . . . 6
- MASONS & Builders Guides (4 Book Set). . . . . 6
- BLUE PRINT READING, 416 Pages . . . . . 2
- PAINTERS & DECORATORS MANUAL, 450 Pgs. . . . . 2
- GARDENERS & GROWERS Guides (4 Book Set). . . . . 6
- REFRIGERATION & Air Conditioning, 1280 Pgs. . . . . 4
- SHEET METAL WORKERS Handy Book, 388 Pgs. . . . . 1
- SHEET METAL PATTERN LAYOUTS, 1100 Pgs. . . . . 4
- AIRCRAFT WORKER, 240 Pages . . . . . 1
- MECHANICAL DRAWING GUIDE, 160 Pages. . . . . 1
- MECHANICAL DRAWING & DESIGN, 480 Pgs. . . . . 2
- MATHEMATICS & CALCULATIONS, 700 Pgs. . . . . 2
- MECHANICAL Dictionary, 968 Pages . . . . . 4
- MILLWRIGHTS & Mechanics Guide, 1200 Pgs. . . . . 4

Name \_\_\_\_\_  
 Address \_\_\_\_\_  
 Occupation \_\_\_\_\_  
 Employed by \_\_\_\_\_

AUDEL, Publishers, 49 W. 23 St., New York 10, N. Y.



Makes \$10

Shop Specializes in Television



\$5 to \$8 Week In Spare Time



Calls N.R.I. His "Stepping Stone"

# BE A SUCCESS IN RADIO-

# RADIO- Learn by Practicing

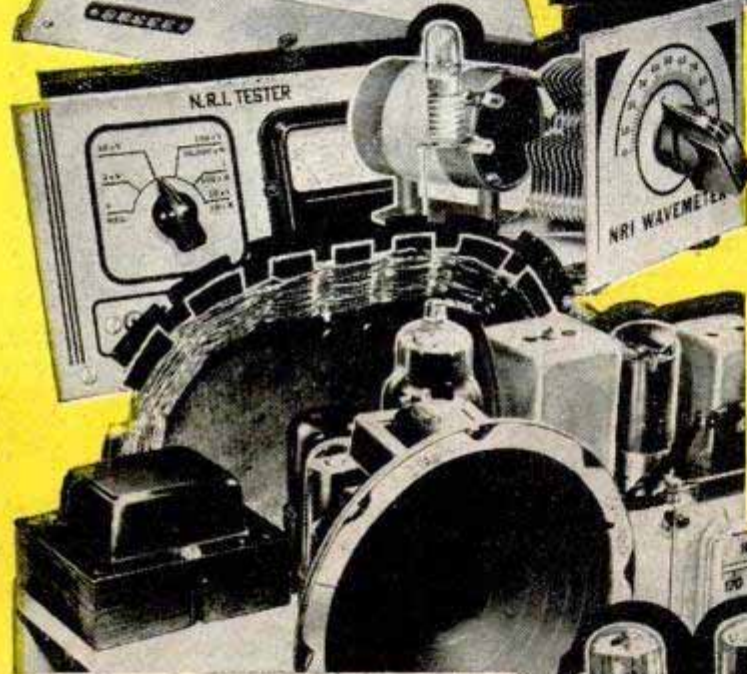

Build Radio Equipment Like This With Kits of Parts I Send

I give you PRACTICAL EXPERIENCE with many Valuable Kits I send that "bring to life" my illustrated texts. In my Servicing Course, you build a modern Radio, Set Tester, AM Signal Generator, etc. In my Communications Course, you assemble a low-power Broadcasting Transmitter, Wavemeter, Electronic Multitester, etc. Some equipment from both the courses is shown on this page. All of the equipment that you build is yours to keep.



## MAKE EXTRA MONEY WHILE LEARNING

I show you how to earn \$5, \$10 a week, or more, in spare time fixing Radios. I send you parts to build the SET TESTER you use to do it. Frank Lhotsky, Cicero, Ill., above, one of my many students who earned while training, writes, "when I enrolled, I didn't know the difference between a power transformer and a condenser. Your outstanding course made a new, prosperous man of me."





**NRI-  
Graduate  
Doubles  
Salary**

"I am employed by Station WKBO as transmitter operator. Have more than doubled salary since starting in Radio full time."—A. Herr, New Cumberland, Pa.



**Manager  
Radio and  
Television  
Dept.**

"From Radio and Television Technician... was promoted to Manager of Television Service and Installation. Thanks to N.R.I."—L. Hauger, San Bruno, Calif.



**Gets  
First Job  
Through  
N.R.I.**

"My first job was operator with KDLR, obtained for me by your Graduate Service Dept. Am now Chief Engineer Police Radio Station WQOX."—T. S. Norton, Hamilton, Ohio.



# TELEVISION

## at Home in Spare Time

**Get a Good Job--Have a Bright Future  
in America's Fast Growing Industry**

Do you want good pay, a job with a bright future and security? Would you like a profitable shop of your own? The fast growing, prosperous RADIO-TELEVISION industry is making these opportunities for you. Radio alone is bigger than ever. 81 million homes and auto Radios, 2,700 Broadcasting Stations, expanding use of Aviation and Police Radio, Micro-Wave Relay, Two-Way Radio for buses, taxis, etc., are making opportunities for Servicing and Communications Technicians and FCC-Licensed Operators.

**Television is TODAY'S Good  
Job Maker**

In 1946 only 6,000 TV sets sold. In 1949 almost 3,000,000. By 1954, 20,000,000 TV sets will be in use, according to estimates. 100 TV Stations are operating in 35 states. Authorities predict there will be 1,000 TV Stations. This means new jobs, more jobs, good pay for qualified men.



**HAVE A BUSINESS  
OF YOUR OWN**

Let me show you how to have a good, steady income from your own Radio-Television shop. Many N.R.I.-trained men each year start without capital, like Robert Dohmen, New Prague, Minn., above. He writes, "Am now tied in with two television outfits."

## VETERANS HURRY!

To get this valuable training under G. I. Bill. Time is running out.  
**Mail Coupon NOW!**

**Many Soon Make \$10 A Week  
Extra in Spare Time**

Keep your job while training at home. Hundreds I've trained are successful RADIO-TELEVISION TECHNICIANS. Most had no previous experience; many no more than grammar school education. Learn Radio-Television principles from illustrated lessons. Get PRACTICAL EXPERIENCE—build valuable multimeter for conducting tests; also practice servicing Radios or operating transmitters—experiment with circuits common to Radio and Television. You keep all equipment. Many students make \$5, \$10 a week extra fixing neighbors' Radios in spare time. SPECIAL BOOKLETS start teaching you the day you enroll.



**FREE  
ACTUAL LESSON  
AND 64 PAGE BOOK**

Act Now! Send for my FREE DOUBLE OFFER. Coupon entitles you to actual lesson on servicing; shows how you learn Radio-Television at home. You'll also receive my 64-page book, "How to Be A Success in Radio-Television." You'll read what my graduates are doing, earning; see photos of equipment you practice with at home. Send coupon in envelope or paste on postal. J. E. SMITH, President, Dept. OKP, National Radio Institute, Washington 9, D.C. OUR 37TH YEAR.

**MAIL  
THIS  
NOW**

**Good For 2 Books FREE**

**MR. J. E. SMITH, President, Dept. OKP  
National Radio Institute, Washington 9, D. C.**

Mail me Sample Lesson and 64-page Book about How to Win Success in Radio-Television. Both FREE. (No salesman will call. Please write plainly.)

NAME.....AGE.....  
ADDRESS.....  
CITY.....ZONE.....STATE.....  
 Check if Veteran. Approved Under G. I. Bill.

# NOW!

## BRIGGS SMOKES 3 WAYS BETTER\*



1. Stays lighted longer ... by 19%



2. Cleaner burning ... by 16.4%



3. Less tar ... by 21.6%

So today ...

Put this  
in your  
pipe

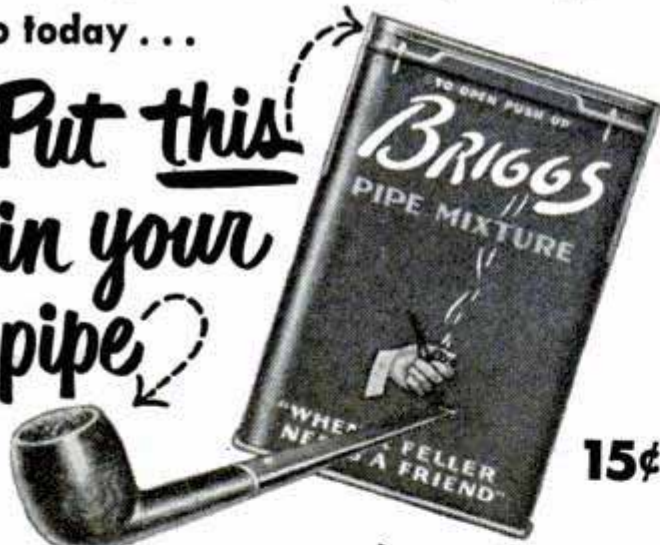

and smoke it!

\*Yes, our new process makes Briggs better by actual test! Better even than the swell-smoking Briggs that proved so fine and friendly in your pipe before. And remember this: when tobacco burns steady, free and clean, that's when you enjoy *all* the goodness of Briggs' fine tobacco, aged and mellowed in oaken casks. Today—try 3-ways-better Briggs!

Also available in Canada

(Continued from page 10)

### TOYS AND NOVELTIES

Mechanical elephant (Frank Stuart, Thaxted, Essex, England) .....	113
Goldfish clock .....	127
Flowers from tin cans (Mrs. Rosie Perdue, 1206 S. Waverly Drive, Dallas, Tex.) .....	138
Huge flower basket .....	138

### MISCELLANEOUS

"Seeding" of storm clouds decreases lightning .....	86
Air holds up tent (B. F. Goodrich Co., Akron, Ohio) .....	95
Interior of eye "shot" by camera (Bausch & Lomb Optical Co., 635 St. Paul St., Rochester 2, N. Y.) .....	95
"Atomic robot" locates brain tumor (Nuclear Instrument & Chemical Corp., 223-233 W. Erie St., Chicago 10) .....	116
Goose caller (Norm Thompson, Field and Stream Outfitter, 2728 S. E. Laurelwood, Portland 22, Ore.) .....	116
Gas can has flow control (Alva T. Smith Co., 161 W. Wisconsin Ave., Milwaukee 3, Wis.) .....	117
Washington's "diggings" .....	122
Dial-a-sign .....	122
Gearshift shoes for hill climbing .....	123
Squirt-on detergent speeds first aid (Gebauer Chemical Co., 9410 St. Catherine Ave., Cleveland, Ohio) .....	126
Don't shovel it—melt it! (A. J. Cayas, 117 Ethel St., Glendale, Calif.) .....	126
Piped oxygen system (Linde Air Products Co., Carbide & Carbon Bldg., 30 E. 42nd St., New York City 17) .....	139
Three-wheel taxi .....	139
Fisherman's "handcuff" (Better Fishing Products, 3622 W. Fullerton Ave., Chicago 47) .....	146
Patton tank .....	148
Railroad reservations made automatically (International Standard Trading Corp., 67 Broad St., New York City) .....	149
Pocket magnet (General Scientific Equipment Co., 27th & Huntington St., Philadelphia 32, Pa.) .....	152
Brush burner (Byron Lindstrom, Valparaiso, Ind.) .....	153
Tubular trestle (Bil-Jax, Inc., 100 Wyse Road, Archbold, Ohio) .....	157
Squeezable grease dispenser (Chaffee Distributing Co., 1410 Grand Ave., Kansas City 6, Kans.) .....	264

### Craftsman and Shop Notes Index

#### AUTOMOTIVE

Water-filled fender well provides tank for testing inner tubes .....	176
Tire chains held tightly in place with screen-door spring .....	185
Test lamp indicates spark position .....	216

#### FARM AND GARDEN

Ferretting predatory animals with gasoline fumes .....	176
Lean-to greenhouse .....	186
Flowerpots from eggshells .....	194
Vegetable washer utilizing car differential cleans root crops ready for market .....	215
Electric trailer-bed winch unloads chopped hay .....	215
Field waterer filled easily from large portable tank .....	216
Rear-view mirror on tractor permits checking implements .....	216
Hinged perches on poultry nests permit trapping new layers .....	220
U-shaped rods set in concrete form sliding-door guide .....	220
Stock supplied with clean water by damming spring flow .....	220
Divided door on brooder house facilitates inspecting chicks .....	222
Feeders mounted on wire fence are made from oil drums .....	226
Interchangeable trailer hitch .....	226

#### HOUSE AND HOME

Fruit-jar tops protected from chipping .....	174
Blocks aid in waxing floors .....	174
Glass baking dish keeps recipes clean .....	174
Comb helps remove stains from fabric .....	174
Curtain-rod holder makes ideal hook for keys .....	174
Picture frames held in place .....	175
Aluminum foil keeps bottle caps serviceable .....	175
Lighter fluid facilitates lighting candles .....	175
Extension opens and closes coalbin window .....	177
Wrapping linens in opaque paper prevents yellowing with age .....	177
Doorstops raise dining chair to seat child comfortably at table .....	184
Metal lath on porch canopy prevents snow slides .....	188
Pliers drive picture-frame brads .....	188
Furnace operation improved by basement-window vent .....	188
Weather stripping for garage door provided by old inner tubes .....	194
Steam iron perfumes garments .....	194
Slide-top roaster cabinet .....	195
Rheostat controls bed lamp .....	202
Clothes stored in shopping bags are suspended from rafters .....	202
Partially open window securely locked with door bolt .....	204

#### NOVELTIES

"Canasta" tray from scrap stock .....	176
Frying-pan kitchen clock .....	184
Inlaid photo frame .....	189
Attractive serving boards are fashioned from hardwood scraps .....	204

(Continued to page 16)

**IMPORTANT NOTICE**—It is the intention of this magazine to provide its readers with information regarding the latest developments in the mechanical arts. We take no responsibility as to whether the disclosures contained in our articles are covered by patents and advise readers to investigate this subject before making, using, or selling any of the products, machines, or processes described in order to avoid possible liability for patent infringements.





# INVENTORS

**L**earn how to protect your invention. The U. S. Patent Laws provide that any new and useful art, machine, article of manufacture, or composition of matter, or any new and useful improvement thereof, may be patented if the act of invention is involved. Therefore, every inventor with a valuable invention should take advantage of the Patent Laws and proceed for patent protection in order to safeguard his rights.

A patent gives the inventor the exclusive right to prevent others from making, using, or selling the invention claimed in the patent for a period of seventeen years.

The Patent Laws were enacted for the benefit of the inventor to give him protection for the features of his invention which are patentable. These features must be properly and concisely set forth and claimed in a formal application for patent, in order to comply with the requirements of the Patent Laws. For that reason, unless the inventor is familiar with patent matters, he should engage a competent registered patent attorney or agent to represent him. We are registered to practice before the U. S. Patent Office and are prepared to serve you in the handling of your patent matters.

A specially prepared booklet entitled "Patent Guide for the Inventor", containing detailed information with respect to patent protection and procedure, together with a "Record of Invention" form will be promptly forwarded to you without obligation upon request.

**CLARENCE A. O'BRIEN & HARVEY JACOBSON**

*Registered Patent Attorneys*

**01-K DISTRICT NATIONAL BUILDING**

**WASHINGTON 5, D. C.**

# BOY WANTED

To run errands,  
deliver parcels,  
keep healthy...  
and have fun

Apply to your parents.  
Tell Dad—and Mom too,  
that you want a good  
sturdy bike with a New  
Departure safety brake.  
The brake that affords  
constant control — the  
safe, powerful brake  
that brings any  
bike to a . . . .

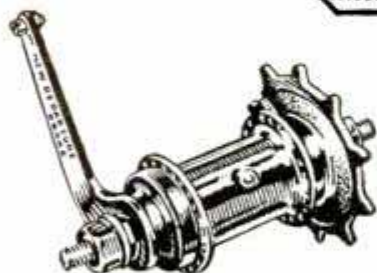

## New Departure

**SAFETY BRAKE**   
a product of

NEW DEPARTURE • DIVISION OF GENERAL MOTORS  
BRISTOL, CONNECTICUT

### PHOTOGRAPHY

Positive connectors for multiple flash units .....	205
Battery of flash gun tested with bayonet-base bulb .....	205
Keeping developer solutions fresh .....	205
Aluminum markings on film holders resist wear and are easily read .....	210
Comb removes lint from lenses .....	210
Pitcher doubles for mislaid funnel .....	210
Measuring bellows extension .....	210

### RECREATION

Indoor air-rifle target box retrieves BB shot .....	177
Pair of pliers mounted on base doubles as fly-tying vise .....	184
Fast "taxi service" on large skating ponds .....	185
Wooden marker buoy locates fishing hole .....	201

### TOOLS

Empty razor-blade dispenser makes handy sanding block .....	173
Rubber cushion on vise handle prevents pinching fingers .....	176
Screw eye holds hasp open .....	188
Slot covers for machine table .....	220
Electric oilstone for edge tools .....	221
Broken center drills removed with grease-gun pressure .....	222
Setting threading tool .....	222
Auxiliary polishing head .....	223
Multipurpose tool (Ritt Tool Corp., Box 1744, 123 E. 6th St., Cincinnati 2, Ohio) .....	224
Hand plane has simplified blade (Shelton Plane & Tool Mfg. Co., Shelton, Conn.) .....	224
Brake-shoe tool (B & B Mfg. Co., Oakland, Calif.) .....	224
Pillow-block bearings (Congress Drives Division, Tann Corp., 3750 E. Outer Drive, Detroit 34, Mich.) .....	224
Come-apart paintbrush (Wirthmore Division, Independent Brush & Specialty Co., 369 E. 200th St., Cleveland 19, Ohio) .....	225
Milling-machine clamp (Naper Clamp Co., Division Illinois Broach & Machine Co., Naperville, Ill.) .....	225
Magazine-loading screwdriver (Selecto Products Co., 740 Superior Ave., N.W., Cleveland 13, Ohio) .....	225
Guide for honing drill bits (R. J. Tingle, 8731 Orangelawn St., Detroit 4, Mich.) .....	225

### MISCELLANEOUS

Trouser flaps cover boot tops to prevent seepage of snow .....	173
Glasses case held in shirt pocket .....	184
Coating glass with lubricant foils Halloween pranksters .....	188
Removable toe rest on step ladder .....	193
Two C-clamps and scrap board support plywood when cutting .....	193
Handle for "hot shot" battery .....	194
Painting drawer pulls .....	194
Dishes facilitate layout work .....	194
Cookie cutters transfer designs .....	194
Air-lock in fuel-oil drum eliminated by special fitting .....	201
Pressure-type siphon connected to sill cock drains flooded basement .....	201
Preparing outboard motor for winter storage .....	202
Electric control for humidifier .....	203
Funnel forms nontip candleholder .....	204
Auxiliary fuse block for testing protects main circuit .....	204
Stopping leaks in pipe joints .....	216
Toxic liquids siphoned safely by blowing into container .....	222
Angle braces support shop bench .....	226
Magnet in bag picks up filings .....	226
Brake drums provide wheels for small caster truck .....	226

### Radio-Television, Electronics

Television in the theater (RCA Victor, Camden, N.J.) .....	227
"Handi talkie" pocket set for experimenters .....	228
How to build a multipurpose phototube relay .....	230
Television today (Giant mirror, American Optical Co., Southbridge, Mass.; adjustable TV antenna, Tricraft Products Co., 1535 N. Ashland, Chicago 22; twin-line connectors, Grayhill Co., 4524 W. Madison St., Chicago; twin-driven Yagi, Technical Appliance Corp., Sherburne, N.Y.; TV antenna mounting bracket, Kenwood Engineering Co., 265 Colfax Ave., Kenilworth, N.J.) .....	232

### Hard Coating for Aluminum

Hard coatings applied by a new process may qualify aluminum and other lightweight metals for roles now monopolized by steel alloys. The process has already been used on aluminum leg braces, helicopter blade tips and the leading edges of airplane wings. Developed by the Glenn L. Martin Company, it is applied by an electrochemical method and creates a nonmetallic, strongly bonded surface. Coating thicknesses range from .0001 to .006 inches, with abrasion-resistant uses generally calling for .002 inches. The coating is classed as "file hard."

# INVENTORS

If you believe that you have an invention, you should find out how to protect it. The first step is to have a search made of the prior pertinent U. S. patents. If a report on this search indicates that the invention appears patentable you can apply for a patent, and the specifications and claims should be prepared.

The firm of McMorrow, Berman & Davidson, with offices in Washington, D. C., is qualified to take the necessary steps for you. We can make a preliminary search on your invention, advise you whether we think it can be patented, and prepare your application for patent.

Unless you are fully familiar with the U. S. Patent Laws, we recommend that you engage the services of a Registered Patent Attorney to protect your interests. The patent laws are *your* laws. A patent gives you the right to prevent others from making, using or selling the invention claimed in your patent for a period of 17 years.

Use these patent laws for your protection. Investigate whether your invention can be patented. If you have what you believe to be an invention, we suggest that you have this firm make a search for you.

*Send for a copy of our Patent Booklet entitled "How To Protect Your Invention," containing information about patent protection and patent procedure. Along with this we will also send you an "Invention Record" form, for your use in writing down and sketching details of your invention. We will mail them promptly. No obligation. They are yours for the asking.*

**McMORROW, BERMAN & DAVIDSON**

*Registered Patent Attorneys*

**PATENTS • COPYRIGHTS • PATENTS**

**135-H VICTOR BUILDING, WASHINGTON 1, D. C.**

# Hunters! Anglers! You can learn Taxidermy

ISN'T THIS MALLARD A BEAUTY, BILL?

YES, IT'S A SHAME TO THROW AWAY SUCH GORGEOUS PLUMAGE. I'M GOING TO WRITE TO THE N.W. SCHOOL OF TAXIDERMY AND LEARN TO MOUNT AND SAVE MY TROPHIES.

HELLO, BILL—SAY, THOSE SPECIMENS ACTUALLY LOOK ALIVE!

YES, RAY, IT'S THE GRAND-EST HOBBY IN THE WORLD. COME UP AND SEE MY DEN.

I'VE DOUBLED MY FUN FROM HUNTING AND FISHING—AND HAVE MADE \$84 ALREADY MOUNTING TROPHIES FOR OTHER HUNTERS.

AND YOU TANNED THIS FOX SCARF YOURSELF? BILL, YOUR DEN LOOKS GREAT. I'M GOING TO START LEARNING TAXIDERMY RIGHT NOW!

## WE CAN TEACH YOU TO MOUNT BIRDS

**Great Fun and Profit. Send Coupon for marvelous Free Book.** It tells All about taxidermy — how you can Make Money and have great fun and fascination mounting Birds and Animals. Save your wild-game trophies — mount for others. Also Mount common specimens, pigeons, squirrels, rabbits, even frogs, into humorous and useful groups — highly interesting and sell at sight. Wild-game Not necessary. Men, Women, Boys learn quickly by Mail. Marvellous business, send coupon.

**BIG PROFITS!** Turn your spare time to Cash. Besides Taxidermy learn also to Tan Leather, Tan Fine Furs and make them into scarfs, etc. We teach you Genuine Chrome method—never before revealed. 250,000 students endorse this old reliable school. We offer you our marvelous Free Book. Send for your copy Today. In a few weeks we can teach you a New Trade that earns Cash in depression and good times, too. Then Taxidermy brings great fun and fascination. Investigate! Get the Free Book. Sign your name, state your AGE, and the FREE BOOK is yours. Send the coupon Today.

### FREE BOOK

Northwestern School of Taxidermy, 2510 Elwood Bldg., Omaha, Neb.

Gentlemen:—Please send me your free 48 page booklet explaining Taxidermy.

Name \_\_\_\_\_ Age \_\_\_\_\_

Address \_\_\_\_\_

Here's a fascinating, profitable hobby

# Command Bigger Money! STUDY LAW

STUDY AT HOME for BUSINESS SUCCESS and LARGER PERSONAL EARNINGS. 40 years expert instruction — over 114,000 students enrolled. LL.B. Degree awarded. All text material furnished. Easy payment plan. Send now for FREE BOOK — "Law and Executive Guidance." It explains the course — how you may enroll and the many ways you can profit from Law Study. Write TODAY to:

AMERICAN EXTENSION SCHOOL OF LAW  
Dept. 31-PM, 646 N. Michigan Ave., Chicago 11, Ill.

### Be an INVESTIGATOR

**RECOGNIZED & APPROVED SCHOOL OF INVESTIGATION**  
--Extension Training Division--

Learn a profitable and interesting profession while earning at home in your spare time. Free Placement Service assists graduates to obtain good positions. State your age. Write For Free Booklet

**NATIONAL DETECTIVE ACADEMY**  
239 SOUTH OXFORD AVENUE  
LOS ANGELES 4, CALIFORNIA

**GROW YOUR OWN** ... vegetables, flowers, house plants by hydroponics (without soil). It's easy to get big returns in a small space, indoors or outdoors. A clean pleasant way to grow any plant for fun or profit. Send postcard for free picture book.

GILBERT & CO., 3535f Enterprise, San Diego 10, Calif.

### BECOME A BETTER PAID MAN BY BEING A WELL TRAINED MAN

Learn a profitable trade—the Eastern Technical School way. Enroll now for an eight month course in Radio or Refrigeration. New classes beginning every April—August—December. Veterans — Nonveterans. Write for free catalogue. Graduates successfully placed from Coast to Coast.

**EASTERN TECHNICAL SCHOOLS**  
888 PURCHASE STREET NEW BEDFORD, MASSACHUSETTS

### GREAT PROFITS

MAKE YOUR OWN RUBBER MOLDS

will realize you great profits quickly!  
WRITE FOR NEW FREE CATALOG  
YOU can EASILY learn to cast thousands of perfect plaques, book ends, figurines, ash trays, etc. IT'S EASY, FUN, PROFITABLE!  
X.L. Rubber, Pts. \$2.00; Qts. \$3.50; Gallons \$8.95; Models and enough rubber for 3 molds \$1.30 postpaid.

**PLASTIC ARTS STUDIO** Address Dept. 2  
3403 S. Madison St. Muncie, Ind.

Say You Saw It in Popular Mechanics

### Want to Get Ahead in Business? Get A BUSINESS EDUCATION!

**THRU Hills TO SUCCESS...**

Regardless of whether your aim is to specialize or generalize in your business education, this nationally known and approved school will gladly counsel with you. We offer you nation wide recognition and placement service as secretary, stenographer, accountant or salesman. Hill's offer both Resident & Home Study Courses. Write **FREE**

Dept. PMQ today for Big 32 page SUCCESS BOOK

**Hills BUSINESS UNIVERSITY AND EXTENSION SCHOOL**  
619 W. MAIN ST. OKLAHOMA CITY 2, OKLAHOMA

### OUT OF PAWN GENUINE DIAMONDS

SAVE UP TO 50% AND MORE

Unmatched values in genuine blue white diamonds. Each diamond sold with a written iron-clad money back guarantee. All diamonds set in brand new mountings. Our reference—your own bank or any mercantile agency.

**BERMAN'S DIAMOND LOAN BANK**  
DEPT. P—BERMAN BLDG., BALTO. 1, MD.

Send for Illustrated FREE Catalog  
Values from \$10 to \$10,000

# YOU UNIVERSITY TRAINING

## KEY TO SUCCESS IN BUSINESS AND INDUSTRY

### Air Conditioning and Plumbing Courses

Air Conditioning  
Heating  
Refrigeration  
Steam Fitting

### Chemical Courses

Chemical Engineering  
Chemistry, Analytical  
Chemistry, Industrial  
and Steel  
Petroleum Refining  
Plastics  
Pulp and Paper Making

### Civil Engineering, Architectural and Mining Courses

Architectural Drafting  
Architecture  
Building Estimating  
Civil Engineering  
Coal Mining  
Contracting and Building  
Highway Engineering  
Lumber Dealer  
Reading Structural  
Blueprints  
Sanitary Engineering  
Structural Drafting  
Structural Engineering  
Surveying and Mapping

### Communications Courses

Electronics  
Practical Telephony  
Radio, General  
Radio Operating  
Radio Servicing  
Telegraph Engineering

### Electrical Courses

Electrical Drafting  
Electrical Engineering  
Electric Light and Power  
Lighting Technician  
Power House Electric  
Practical Electrician  
Ship Electrician

### Internal Combustion Engines Courses

Auto Technician  
Aviation  
Diesel-Electric  
Diesel Engines  
Gas Engines

### Mechanical Courses

Aeronautical Eng'r's, Jr.  
Aircraft Drafting  
Flight Engineer  
Forging Foundry Work  
Heat Treatment of Metals  
Industrial Engineering  
Industrial Instrumentation

### Industrial Metallurgy

Machine Shop  
Machine Shop Insp.  
Mechanical Engineering  
Mold-Loft Work  
Patternmaking—  
Wood, Metal  
Reading Shop Blueprints  
Sheet-Metal Drafting  
Sheet-Metal Worker  
Ship Drafting  
Ship Fitting  
Tool Designing  
Toolmaking  
Welding Engineering  
Welding—Gas and Elec.

### Railroad Courses

Air Brake  
Car Inspector  
Diesel Locomotive  
Locomotive Engineer  
Locomotive Fireman  
Locomotive Machinist  
Railroad Section Foreman  
Steam-Diesel Loco. Eng.

### Stationary Engineering Courses

Boilermaking  
Combustion Engineering  
Engine Running  
Marine Engineering  
Power Plant Engr.  
Steam Engineering

### Textile Courses

Cotton Manufacturing  
Loom Fixing  
Rayon Weaving  
Textile Designing  
Woolen Manufacturing

### Business and Academic Courses

Accounting  
App. Psychology  
Bookkeeping  
Business Administration  
Business Correspondence  
Business Law  
Cert. Pub. Accounting  
Commercial  
Commercial Art  
Cost Accounting  
Federal Tax  
First Year College  
Foremanship  
Good English  
High School  
Higher Mathematics  
Illustration  
Industrial Supervision  
Motor Traffic  
Postal Civil Service  
Retailing  
Retail Bus. Mgmt.  
Salesmanship  
Secretarial  
Sign Lettering  
Spanish  
Stenography  
Traffic Management

APPROVED UNDER THE G.I. BILL

IF YOU ARE AMBITIOUS AND  
WILLING TO STUDY . . .

**I. C. S. CAN TEACH YOU!**

• Special service and attention are  
always given to the student who may  
need extra help in order to understand.

Coupon Brings Full Information

**The successful man DOES today what the failure  
INTENDS to do tomorrow. Mail this coupon NOW!**

**INTERNATIONAL CORRESPONDENCE SCHOOLS**

BOX 5686-K, SCRANTON 9, PENNA.

Please send complete information on the following subject:

(Write above Technical, Business or Academic Subject in which you are interested.)

Name \_\_\_\_\_ Age \_\_\_\_\_

Address \_\_\_\_\_

City \_\_\_\_\_ State \_\_\_\_\_

Present Position \_\_\_\_\_ Working Hours \_\_\_\_\_ A. M. \_\_\_\_\_ P. M.

Employed by \_\_\_\_\_

Length of Service in World War II \_\_\_\_\_

Enrollment under G.I. Bill approved for World War II Veterans.  
Special tuition rates to members of the Armed Forces.

# INVENTORS

If you consider your invention to be something of importance—if you have invented any new and useful art, machine, manufacture or composition of matter or improvement thereof—you are advised to protect your invention by applying for a U. S. patent.

A patent is a valuable right. It grants you a monopoly—the right to exclude others from making, using or selling your invention as claimed for a term of seventeen years.

The specification and claims of a patent, particularly if the invention be at all complicated, constitute one of the most difficult legal instruments to draw with accuracy. Therefore, unless you are thoroughly familiar with such matters, you are advised to employ a competent registered patent attorney or agent.

This firm is registered to practice before the U. S. Patent Office and is available to assist in the preparation and prosecution of your patent application.

The "Evidence of Invention" form mentioned below is offered as a convenience to you in making your disclosure to us for search purposes.

You should date and sign your disclosure and have it witnessed by two or more persons who are capable of understanding your invention.

Your disclosure should be mailed to us together with a letter authorizing us to conduct a preliminary

search among previously granted U. S. patents for similar types of invention.

We then make this search and prepare a report of the probable patentability of your invention. If such report is favorable, we recommend the further course for you to take.

The "Evidence of Invention" form and booklet are suggested as conveniences to you and us in starting action on your invention.

**VICTOR J. EVANS & Co.** *Merlin M. Evans*  
REGISTERED PATENT ATTORNEY  
530-L MERLIN BUILDING, WASHINGTON 6, D. C.

We shall be glad to send you promptly and without obligation, an instructive booklet, "Patent Protection for Inventors", which was prepared to give inventors detailed information and steps to take toward patent protection—also our convenient "Evidence of Invention" form. Use address Victor J. Evans & Co., 530-L Merlin Building, Washington 6, D. C.

PATENTS

COPYRIGHTS

## ARC WELDING FOR PROFIT OR PLEASURE

60 LBS. OF READY MADE PARTS Only \$24.95

### BUILD YOUR OWN HEAVY DUTY WELDER

SAVE Buy Only NECESSARY PARTS

All necessary parts Ready-Made and easy to assemble. You can do all around welding on steel, cast iron and other metals after only a few hours practice. Illustrated instruction manual included. Sold on 30-Day Money-Back Guarantee!

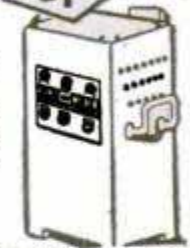

Gives 100% penetration. Welds are stronger than original metal. Operates on 110 or 220 AC.

**FREE:** Write today for fully illustrated Pamphlet P-10

**ATOMIC ARC WELDER CO.**  
1037 So. 19th St. OMAHA, NEBR.



### WOULD YOU \$400 PER MONTH INTEREST YOU?

It is easily possible to earn up to \$400 a month raising Guaranteed Thoroughbred ANGORA RABBITS. No experience required. Wool brings top price. Plenty of markets. WRITE TODAY for FREE INFORMATION, prices and where to sell.

**WHITE'S RABBITRY** NEWARK 10 OHIO

### Learn BAKING at home

Baking is one of America's high industries in wages. Not seasonal, but year 'round good field for trained and experienced men. Thorough basic spare time home study course lays solid foundation. If you have the aptitude for this type of work, send for FREE Booklet, "Opportunities in Commercial Baking."

**NATIONAL BAKING SCHOOL**  
1315 S. Michigan Ave., Dept. 1357, Chicago 5, Ill.

**FREE Bargain Book**

Packed with hundreds of sensational bargains—new and used—in still and movie photo equipment and accessories. Write for your free copy today to

**Central Camera Co.**  
Dept. 8-L, 230 S. Wabash, Chicago 4, Ill.

Photographic Headquarters Since 1899

### SAY YOU SAW IT IN POPULAR MECHANICS

**NEW! MINIATURE DUST MASK**

Wear when sanding, grinding, paint spraying, sweeping, dusting, furnace cleaning, etc. Handy as a pair of glasses. Just keep mouth closed and breathe through nose is all you do to operate. Protects against dusts, lint, coal, cement, grain dust. Has 9 sq. in. filter.

Order today.  
JERRY BRYANT, Dept. PM, 919 N. Michigan Ave., Chicago 11, Ill.

Order Today \$1.00 POST PAID

**A HIGH SCHOOL DIPLOMA the EASY WAYNE WAY**

• Many have learned from bitter experience that a high school diploma is necessary to get that better job. Why not improve your earning possibilities by enrolling with Wayne? No classes; spare time home study; standard texts; easy terms. Wayne training prepares you for college entrance exams. Take that first step now to bigger things—write for detailed information. Address

**WAYNE SCHOOL**  
2527 Sheffield Avenue  
Dept. HF-1 Chicago 14, Ill.

Prepare in our  
Big Training  
Shops for these

# GREAT OPPORTUNITY FIELDS!

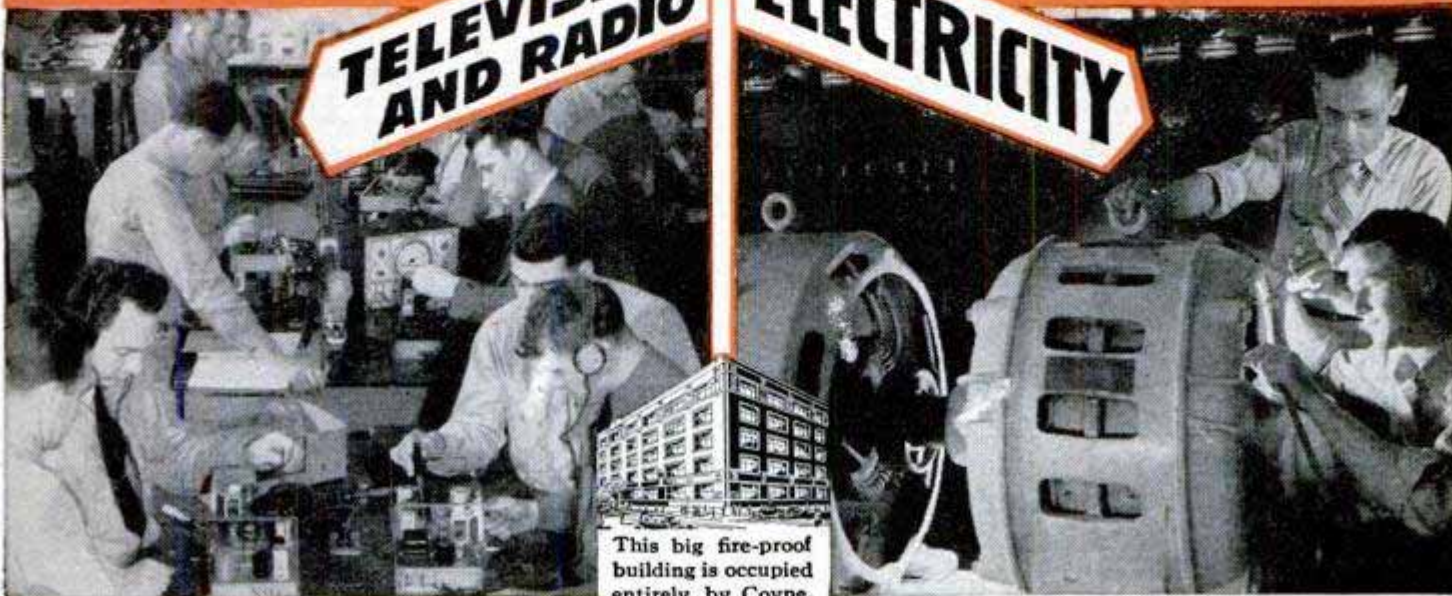

This big fire-proof building is occupied entirely by Coyne.

## FIVE BIG FLOORS PACKED WITH MASSIVE EQUIPMENT

Thousands of men and young men have come to our big training shops where we have floor upon floor packed with massive equipment. Here they prepare for good jobs and real futures in the opportunity fields of Television-Radio and Electricity. For many years, these fields have offered great opportunities to trained men. With new developments, including Electronics and Television, they will continue to grow and offer even greater opportunities. Why be satisfied with a "no future" job? Many "one operation" jobs that exist today will not last. Prepare for a good job with a real future for steady pay and advancement by training NOW in the great training shops of COYNE in Chicago.

### NOT "HOME-STUDY" COURSES

Our famous Television-Radio Practical-Technical method gives you practical experience on a massive outlay of equipment. Not by correspondence, but actual shop work plus necessary technical training. You are trained right here in the great Coyne shops that have been training men and young men for over 50 years.

## TELEVISION-RADIO ELECTRICITY

A great field now, even greater growth ahead. Here at COYNE you're trained for Construction, Testing, Trouble-Shooting on Radio, Public Address, Sound Units. Training includes FM, Television Servicing, etc. Many Coyne trained men in good jobs or own well paying Television-Radio businesses of their own.

### INCLUDING INDUSTRIAL ELECTRONICS

Big future in Power Plant Work, Motors, Armature Winding, Home and Factory Wiring, Appliances, Refrigeration, Maintenance, Illumination, etc. Electricians are in demand everywhere —lifetime job service to Coyne graduates. Send for BIG FREE BOOK.

### ELECTRIC REFRIGERATION

This valuable training now available with either course means added opportunities.

### G. I. APPROVED

NON-VETERANS who are short of cash can finance most of their tuition and pay in easy monthly payments. Many earn while learning.

B. W. COOKE, President

**COYNE** ELECTRICAL AND  
TELEVISION-RADIO SCHOOL  
500 So. Paulina St., Dept. 70-72H, Chicago 12, ILL.

## LARGEST, OLDEST, BEST EQUIPPED SCHOOL OF ITS KIND IN THE U.S.

Mail Coupon for  
Big FREE Book!

Whether you prefer Television-Radio or Electricity, train on actual equipment at Coyne. We have a big, fully illustrated book on each course, and we'll send you the one you want, or both if you want to consider both fields, without obligation. Mail coupon—TODAY.



B. W. Cooke, President  
COYNE ELECTRICAL AND TELEVISION-  
RADIO SCHOOL 500 S. Paulina St.,  
Dept. 70-72H, Chicago 12, Ill.

Send me the book, checked below and details of your training offer. This does not obligate me and no salesman will call.

TELEVISION-RADIO  ELECTRICITY

NAME.....

ADDRESS.....

CITY..... STATE.....

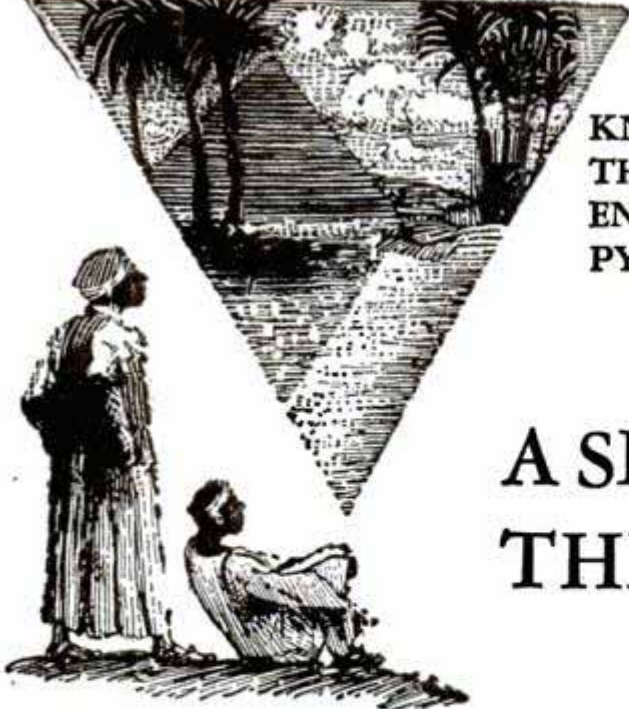

KNOWLEDGE  
THAT HAS  
ENDURED WITH THE  
PYRAMIDS

## A SECRET METHOD FOR THE MASTERY OF LIFE

**W**HENCE came the knowledge that built the Pyramids and the mighty Temples of the Pharaohs? Civilization began in the Nile Valley centuries ago. Where did its first builders acquire their astounding wisdom that started man on his upward climb? Beginning with naught they overcame nature's forces and gave the world its first sciences and arts. Did their knowledge come from a race now submerged beneath the sea, or were they touched with Infinite inspiration? From what concealed source came the wisdom that produced such characters as Amenhotep IV, Leonardo da Vinci, Isaac Newton, and a host of others?

Today it is known that they discovered and learned to interpret certain *Secret Methods* for the development of their inner power of mind. They learned to command the inner forces within their own beings, and to master life. This secret art of living has been preserved and handed down throughout the ages. Today it is extended to those who dare to use its profound principles to meet and solve the problems of life in these complex times.

### This Sealed Book—FREE

Has life brought you that personal satisfaction, the sense of achievement and happiness that you desire? If not, it is your duty to yourself to learn about this rational method of applying natural laws for the mastery of life. To the thoughtful person it is obvious that everyone cannot be entrusted with an intimate knowledge of the mysteries of life, for everyone is not capable of properly using it. But if you are one of those possessed of a true desire to forge ahead and wish to make use of the subtle influences of life, the Rosicrucians (not a religious organization) will send you A Sealed Book of explanation without obligation. This Sealed Book tells how you, in the privacy of your own home, without interference with your personal affairs or manner of living, may receive these secret teachings. Not weird or strange practices, but a rational application of the basic laws of life. Use the coupon, and obtain your complimentary copy.

## The ROSICRUCIANS

SAN JOSE

(AMORC)

CALIFORNIA



AMENHOTEP IV.  
Founder of Egypt's  
Mystery Schools

Use this  
coupon for  
**FREE**  
copy of book

SCRIBE V.X.L.  
The Rosicrucians (AMORC)  
San Jose, California

Please send free copy of Sealed Book  
which I shall read as directed.

NAME.....

ADDRESS.....

CITY.....



GET INTO

# DIESEL-AUTO MECHANICS

Master All Phases

**JOBS LIKE THESE ARE AVAILABLE TO TRAINED MECHANICS. CHOOSE THE FIELD YOU LIKE BEST**

### Get Complete Training

- Diesel Fuel Injection
- Automotive Motor Tune-up
- Diesel Engine Rebuilding
- General Garage Mechanic
- Agricultural Implements
- Auto Engine Rebuilding
- Auto Elec. Service
- Public Utilities
- Parts Dealers
- Bus & Truck Lines
- Industrial Maintenance
- Contracting & Excavating
- Business of Your Own
- AND MANY other similar openings

As a National Schools graduate, you are trained for ALL opportunities in the Diesel & Auto Industries

### EARN WHILE YOU LEARN

With our practical Master Shop-Method Home Training, you study at home in your spare time. You receive Spare Time Work Lessons, which show you how to earn while you Learn . . . for extra money and experience. You Learn by DOING.

### TOOLS AND EQUIPMENT

To make your training complete, we give you selected mechanic's tools and equipment, illustrated below, including all-metal toolbox — as a regular part of your instruction.



**WE GIVE YOU TOOLS OF YOUR TRADE**



### Shop-Method Home Training by an Established Resident School Prepares you for Many Good Jobs

Opportunity is everywhere for the trained Diesel-Auto Mechanic. Highways throng with cars, busses, trucks, tractors. Garages and Service Stations are kept busy. Factories, ships, farms, railroads, general industry, are dependent upon engine power. Here's a dynamic, fast-growing field that needs trained men who know ALL phases: installation, operation, maintenance and repair. Now—National Schools offers you a practical, all-embracing Diesel-Auto Mechanic's Course, including all of these advantages:

**Complete training, covering—Diesels, High Speed and Heavy Duty; Semi-Diesels, Gasoline and Special Fuel Engines AND Allied Mechanics.**

- Basic Lesson Texts
- Diesel Installation
- Operation-Maintenance
- Diesel Chart Manual
- Spare Time Lessons
- Engine Service Manuals
- Engine Repair
- Drive Systems
- Diesel Electric Power
- Thermodynamics

### TOOLS AND EQUIPMENT

#### INVESTIGATE

Secure Full Information

**NEW, ILLUSTRATED BOOK & SAMPLE LESSON SHOW HOW WE TRAIN YOU . . . SEND FOR THEM TODAY!**



**NO COST**

**NO OBLIGATION**

**APPROVED FOR VETERANS**

Check coupon below

## NATIONAL SCHOOLS

LOS ANGELES 37, CALIF. • EST. 1905



**FIND OUT NOW . . . MAIL COUPON TODAY**

NATIONAL SCHOOLS, DEPT. PMD-10  
4000 South Figueroa Street  
Los Angeles 37, California

(Mail in envelope or paste on penny postcard)

Mail me FREE the book, YOUR FUTURE IN DIESEL-AUTO MECHANICS, together with the Sample Lesson. I understand I may keep and use the information with no obligation.

Name \_\_\_\_\_ Age \_\_\_\_\_

Address \_\_\_\_\_

City \_\_\_\_\_ Zone \_\_\_\_\_ State \_\_\_\_\_

Check here if Veteran of World War II



**YOU  
can  
acquire**

## **LAW NIGHTS AT HOME! L. L. B. DEGREE**

LaSalle's famous Law Library—used as reference in many Law libraries and Law offices—has enabled thousands to master Law surprisingly fast, in spare hours at home, for business and professional advancement.

These 14 remarkable volumes, compiled by leading professors and lawyers, cover the whole basic field of Law in condensed, orderly, simplified manner.

You advance rapidly with this great library, plus special lectures furnished. We guide you step-by-step with personalized Problem Method of instruction . . . you learn by doing—handling legal problems—not by memorizing rules.

Send for two FREE 48-page booklets, "Law Training for Leadership," and "Evidence," answering questions about Law and its value to you, and telling how LaSalle Law graduates are winning rapid advancement in business and public life. Mail coupon below. No obligation.

### **LA SALLE EXTENSION UNIVERSITY A Correspondence Institution**

417 S. Dearborn St., Dept. 1064-L, Chicago 5, Ill.

Send me your two FREE booklets described above, without obligation.

Name.....Age.....  
Street.....  
City, Zone & State.....

## **ENGINEERING DEGREE IN 27 MONTHS**

### **Big Demand for Graduates**

**Aeronautical, Chemical, Civil, Electrical, Mechanical and Radio Engineering (including Television)**

Hundreds of young men are earning engineering degrees in this recognized institution each year—continuous operation. New terms start quarterly. Many students earn a major part of their college expenses in this large industrial center.

Low tuition. Competent instruction. Thorough, intense, practical program. Modern laboratory facilities including new physics lab, and modernized wind tunnel. Individualized instruction emphasized.

Approved for Veterans. Engineering preparatory courses. Students from 48 states and 21 foreign countries. Enter December, March, June or September. Send coupon for free catalog and full information. Enroll now.

**SEND COUPON TODAY**

## **INDIANA TECHNICAL COLLEGE**

5100 E. Washington Boulevard  
Fort Wayne 2, Indiana

Please send me free information on B.S. Engineering Degree in 27 months as checked.

Aeronautical,  Chemical,  Civil,  Electrical,  
 Mechanical,  Radio-Television.

Name.....

Address.....

## **LET ME PROVE I CAN MAKE YOU A NEW MAN**

Just tell me where you want handsome, powerful muscles. Are you fat and flabby? Or skinny and gawky? Are you short-winded, pepless? Then write for my 48-page FREE BOOK, about "Dynamic Tension", and learn how, in only 15 minutes a day, I can make you a healthy, confident, powerful HE-MAN.  
**CHARLES ATLAS,**  
115 E. 23rd St.,  
Dept. 810, New  
York, N. Y.



Charles Atlas  
winner of title  
"World's Most  
Perfectly De-  
veloped Man"

## **'How to Make Money with Simple Cartoons'**



A book everyone who likes to draw should have. It is free; no obligation. Simply address **FREE BOOK**

**CARTOONISTS' EXCHANGE**  
Dept. 910D Pleasant Hill, Ohio



## **Bar Bells**

Buy Direct From Factory

Write for free booklet  
and price list

**\$8.95**  
up

**INDEPENDENT IRON WORKS**

2416 East 23rd Street, Dept. B  
Los Angeles 58, Calif.

## **REAL ESTATE BE A BROKER**

**PAYS BIG! SEND FOR FREE, BIG, ILLUSTRATED CATALOG NOW!** No obligation. Graduates report making substantial incomes. Start and run your own business quickly. Men, women of all ages, learn easily. Course covers Sales, Property Management, Appraising, Loans, Mortgages, and related subjects. **STUDY AT HOME** or in our classrooms in big cities. Diploma awarded. G.I. approved. Nationally known.

**WEAVER SCHOOL OF REAL ESTATE (Est. 1936)**  
15 E. Pershing Road Dept. PM Kansas City, Mo.

**FREE  
BOOK  
TELLS  
HOW**

## **BE A NOTARY PUBLIC**

Old legal-supply house, 22 cities, guides you to quick official appointment, equips you fully. Pay after appointment (2 payments \$12.50 each). Lifetime public office, income. You notarize legal papers, using only your signature and official seal, receive your fees. Easy. Details free.

**STATIONERS EXCHANGE HELOTES 10, TEXAS**

**SAY YOU SAW IT IN POPULAR MECHANICS**

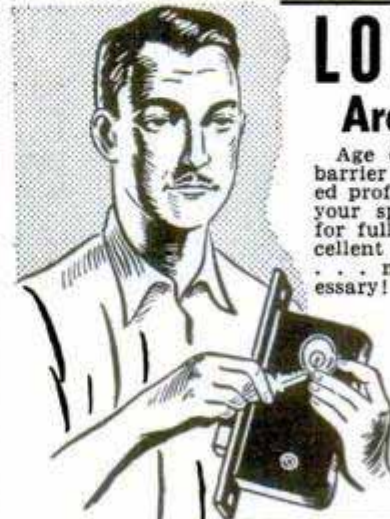

## **LOCKSMITHS Are Always Busy!**

Age or physical condition is no barrier to this good paying, respected profession! Learn it at home in your spare time. Uncrowded field for full or part-time business. Excellent profits and interesting work . . . no previous experience necessary!

Practical, illustrated lessons by professional locksmiths show you how to make money while learning. Special tools, materials, and practice locks without additional charge! Send for **FREE BOOKLET.**  
**Institute of Locksmithing**  
Dept. P-11, 55 Park Ave.,  
Rutherford, N. J.

# TELEVISION

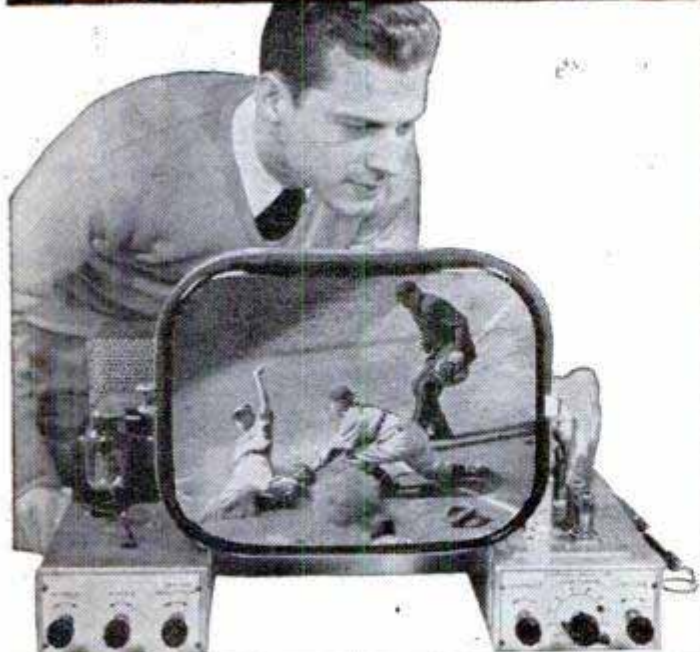

**RADIO and  
ELECTRONICS  
OFFER YOU**

**REAL MONEY and REAL  
JOB OPPORTUNITIES!**

**OPTIONAL  
FEATURE**  **BUILD AND KEEP FULL-VIEW 16-INCH  
RECTANGULAR "BLACK" PICTURE TUBE  
TELEVISION RECEIVER**

**PREPARE AT HOME . . . Become a  
TELEVISION · RADIO · ELECTRONICS  
TECHNICIAN! *No Previous Experience Necessary***

Here is everything you need to prepare you at home for FASCINATING WORK, GOOD MONEY and a THRILLING FUTURE in one of America's most promising fields. This includes the opportunity to build and keep the top-quality 16 inch rectangular picture tube television receiver shown above or a 10 or 12 1/2 inch ROUND picture tube set . . . if you choose. No matter which tube you select, you will get bright, sharp, steady pictures. This is an optional feature—available at slight additional cost when you complete your training described below. Get the complete facts. See how D.T.I.'s wonderfully practical method meets industry's needs. No previous experience needed. Mail coupon today!

**16 Big Shipments of Parts — Plus Lessons**  
Work over 300 electronic experiments and projects from 16 big shipments of parts. This includes building and keeping all test equipment and radio set shown at left side of page. Modern easy-to-read lessons with handy fold-out diagrams simplifies your entire training.

**You Also Use Home Movies**  
D.T.I., alone, includes the modern, visual training aid MOVIES to help you learn faster, easier at home. See electrons on the march and other fascinating "hidden action"—a remarkable home training advantage that speeds your progress.

**EMPLOYMENT SERVICE**  
When you complete your training, our effective Employment Service helps you get started toward a real future in Television-Radio-Electronics.

**Modern Laboratories**  
If you prefer, you can get All your preparation in our new, Chicago training laboratories . . . one of the finest of its kind. Ample instructors . . . modern equipment. Write for details!

**LEARN-BY-READING**  

**LEARN-BY-SEEING**  



**MAIL THIS COUPON TODAY!**

DeFOREST'S TRAINING, INC. Dept. PM-G-10  
2533 N. Ashland Ave.,  
Chicago 14, Illinois

Without obligation, give me complete facts showing how I may make my start in Television-Radio-Electronics.

Name..... Age.....  
Street..... Apt.....  
City..... Zone..... State.....

**DeForest's Training, Inc.**  
CHICAGO 14, ILLINOIS  
A DeVry Institution

\*\*\*\*\*

# TRAINED MEN SERVE BETTER



IN INDUSTRY  
AND IN  
THE SERVICE

★ ★ ★

## Learn a Trade Now!

Yes, it pays to be prepared! As a trained man with technical skill you serve your country better—and you do better—in industry or in the armed forces. Men who have trades earn more money, are in demand, enjoy greater security. *C.T.I. trains you either through home study or in our resident shops—within months. Over 12,000 graduates. One in 6 starts a business. Write for valuable free information today.*

### COMMERCIAL TRADES INST.

1400 Greenleaf, Dept. E2-10  
Chicago 26  Veteran  Non-Vet  
Name \_\_\_\_\_ Age \_\_\_\_\_  
Address \_\_\_\_\_  
City & State \_\_\_\_\_  
Course \_\_\_\_\_

- AUTO MECHANICS
- BODY-FENDER REPAIR
- DIESEL MECHANICS
- ELECTRICITY
- RADIO & TELEVISION
- REFRIGERATION
- MECHANICAL DRAFTING
- BUILDING CONSTRUCTION
- HIGH SCHOOL

# Do you want

- ..to go to College?
- ..or to enter a Profession?
- (Such as Accounting, Architecture, Nursing, Dentistry, Teaching, Social Work, Osteopathy, Beauty Culture, Optometry, Embalming, Chiropody, Law, Medicine, etc.)
- ..or get an Office Position?

To get anywhere, you practically MUST finish High School FIRST. You can complete our simplified High School Course in SPARE time at home, as FAST as your time and abilities permit. Equivalent to resident school work—prepares you for college, pre-professional examinations, business, industry. Standard texts furnished. Diploma. Credit for H.S. subjects already completed. Single subjects if desired. Low tuition, easy terms. American School, Chicago, est. 1897—endorsed by educators. Finish your high school education NOW. Write TODAY!

## High School Course at Home

Many Finish in 2 Years

American School, Dept. H745, Drexel Ave. at 58th St., Chicago 37, Ill.

Gentlemen: Send me FREE information covering special training in subjects checked below. No obligation on my part.

- |  |  |
|--|--|
| <input type="checkbox"/> High School Course          | <input type="checkbox"/> Diesel Engineering                  |
| <input type="checkbox"/> Architecture and Building   | <input type="checkbox"/> Drafting and Design for Men & Women |
| <input type="checkbox"/> Automotive Engineering      | <input type="checkbox"/> Plastics                            |
| <input type="checkbox"/> Business Management         | <input type="checkbox"/> Private Secretary                   |
| <input type="checkbox"/> Electrical Engineering      | <input type="checkbox"/> Mechanical Engineering              |
| <input type="checkbox"/> Elec. and Gas Refrigeration | <input type="checkbox"/> Aviation                            |
| <input type="checkbox"/> Air Conditioning            | <input type="checkbox"/> Salesmanship                        |
| <input type="checkbox"/> Railway Training            | <input type="checkbox"/> Radio                               |
| <input type="checkbox"/> Electronics, Industrial     |  |

Name.....

Address.....

# WANTED MAN WITH CAR

## NO TIME LIKE NOW TO GET IN McNESS BUSINESS

It's no trick to make good money when you use your car as a McNess "Store on Wheels." Farmers buy everything they can from McNess Men because McNess Products are tops in quality, represent extra values. Attractive business-getting prizes and premiums; also money-saving deals to customers make selling McNess daily necessities a snap.



### WE SUPPLY CAPITAL—START NOW!

There's no better work anywhere. Pays well, permanent, need no experience to start, and we supply capital to help you get started quick. You begin making money first day. Write at once for McNess Dealer Book. It's FREE. Tells all—no obligation. (15)

THE McNESS CO., 967 Adams St., Freeport, Ill.

## LEARN TO WRITE

*a Good Hand!*

### FOR BUSINESS AND SOCIAL SUCCESS!

Easy to improve your handwriting at home quickly with my new instruction books just off the press. Master all the secrets of better penmanship. Simple and easy, fully illustrated, highly endorsed. Begin today. Write for:  New Free Book, "How to Become a Good Penman," or check books wanted, \$1.00 each.  Business Writing  Artistic Writing  Card Writing  Engraving Alphabets  Bird and Design Flourishing  Complete Set \$4.50  Enclose 10c for your name beautifully written and special penpoint for shaded writing. S. A. Ziller, President, TAMBLYN SCHOOL OF PENMANSHIP, 441 Ridge Bldg. In Business Over 52 Years Kansas City, Mo., U.S.A.

## STAMMERER?

New booklet, "Stammering, and How to Stop It," sent free to any stammerer upon request. Write today. BENJAMIN N. BOGUE, Dept. 504, Circle Tower, Indianapolis 4, Ind.



## LABORATORY TECHNICIAN

BE A LABORATORY SPECIALIST! complete course. Big demand from hospitals, doctors, clinics. We teach all branches of medical laboratory work, including **Medical and Dental X-Ray**. Approved by American College of Medical Technologists. Co-educational. Free Placement Bureau.

Free Catalog

Accredited for "veteran" training

CHICAGO COLLEGE OF LABORATORY TECHNIQUE  
Dept. P.M., 431 S. Wabash Ave. Chicago 5, Illinois

## Attitude Tests

for men, women, boys, girls, discover the kind of work or studies best for your success! You get a personal report—a guide for life—more happiness—more prosperity. Write for complete facts. VOCATIONAL COUNSELORS, 5057 Woodward Avenue, Detroit

SAY YOU SAW IT IN POPULAR MECHANICS

## Be an INVESTIGATOR

JAMES S. BOLAN, FORMER NEW YORK CITY POLICE COMMISSIONER offers MEN & WOMEN an opportunity for a Professional Career in Modern Investigation & Criminology by comprehensive Home Study Course. Free placement service assists graduates to obtain jobs APPROVED FOR VETERANS. Licensed by State of New York. Write for Booklet P

THE BOLAN ACADEMY, INC.  
EMPIRE STATE BLDG., NEW YORK 1, N. Y.



"We have been using your book on Auto Repair for the past year and feel like it is a third man around the shop."—F. M. Scott, Stanwood, Wash.



"Fixed motor in 30 minutes another mechanic had worked on half a day."—C. Murfreesboro, Tenn.



"Instructions so clear, have no trouble learning anything about any car. Now working as mechanic in big plant."—S. Ordenez, San Francisco, Calif.



"So easy to understand—have done jobs with Manual I would not have attempted without it."—C. L. Vanerstrom, Hazel Park, Mich.



"I have found my MoToR Manual a wonderful help. It has put me in a position to do every job."—S. L. Sharpless, Los Angeles, Cal.

THOUSANDS OF MEN ARE RAVING ABOUT THIS GIANT GUIDE!

# Now YOU Can Be a "Cracker-jack" at Auto Repairs!

BRAND-NEW  
1950  
EDITION!

Thousands of Easy-to-Follow Step-by-Step Pictures

Easy-Step-by-Step Instructions Show How to do ANY Job on ANY Car—from 1935 through 1950!

THOUSANDS of men are raving about MoToR's BIG NEW ILLUSTRATED AUTO REPAIR MANUAL! It enables them to do any job FASTER and better; do MORE jobs; make MORE money!

Whether it's on a 16-year-old "jalopy" or a brand-new '50 beauty, YOU, too, can "breeze through" any repair job quickly, easily, right! Just look up the make, model, and job in the quick index—and go to it!

Everything You Need to Know to Repair Any Car!

This NEW, REVISED, edition has MORE REPAIR INFORMATION THAN EVER—right up to the minute! 740 big pages, 2180 "This-Is-How" pictures—clear drawings, diagrams, cut-away photos that lead you every step of the way. Over 200 "Quick-Check" charts containing more than 35,000 essential repair specifications. Over 200,000 service and repair facts. Clear, simple directions. You can't go wrong!

Any man—even a green beginner—can do a good job. If you're a top-notch mechanic, you'll find yourself tackling jobs now that you wouldn't touch before!

Earn More Money!  
Win Greater Prestige!

The editors of MoToR's Manual have put together all the "Know-How" from over 150 Official Factory Shop Manuals; "bolled it down" into one handy book!

Includes Automatic Transmissions and Semi-Automatic Transmissions. Covers the new GM Rochester Carburetor, Engines... Chokes... Carburetors... Fuel Pumps... Hydraulic Drives... Overdrives... Oil Filters... Starting Motors... Generators... Distributors... Clutches... Universals... Axles... Brakes... Steering Gears... Shock Absorbers, etc.

Valuable help in Body Service. Factory Specifications and Adjustment Tables. Tune-up Charts. Tables of Measurements and Clearances. Overhauling and Replacement Facts—AND MUCH, MUCH MORE.

Used by Armed Forces, hundreds of thousands of auto service men! YOU'LL want it, too, once you see its 740 giant pages—almost a foot high!—its 2180 close-up pictures! Try it on the following UNCONDITIONAL GUARANTEE:

Try Book for a Week FREE

Send No Money. Pay nothing to postman. Test book in your own garage or shop. It's GUARANTEED to pay for itself in 7 days. If it doesn't, just return the book, and owe nothing. You don't risk a penny. Rush coupon for your free-trial copy of this great money-saving Manual. MoToR Book Dept., Desk 1M, 250 West 55th St., New York 19, N. Y.

SEND NO MONEY!  
TRY BOOK FREE!  
FOR A WEEK FREE!

MAIL COUPON NOW FOR 7-DAY FREE TRIAL

MoToR Book Dept., Desk 1M,  
250 West 55th Street, New York 19, N. Y.

Rush to me at once: (Check box opposite book you want)

MoToR's New AUTO REPAIR MANUAL. If O.K. I will remit \$1 in 7 days (plus 35c delivery charge), then \$2 monthly for 2 months, and a final payment of 95c a month later. Otherwise I will return book postpaid in 7 days. (Foreign price, remit \$3 cash with order.)

MoToR's New TRUCK and TRACTOR REPAIR MANUAL. (Described at left.) If O.K. I will remit \$2 in 7 days, and \$2 monthly for 3 months, plus 35c delivery charge with final payment. Otherwise I will return book promptly. (Foreign price, remit \$10 cash with order.)

Print Name ..... Age .....

Print Address .....

City & Zone No..... State.....

SAVE 35c delivery charges by enclosing WITH COUPON check or money order for full payment of \$5.95 for Auto Repair Manual (or \$8.00 for Truck and Tractor Manual). Same 7-day return-for-refund privilege applies.

Same FREE 7-Day Offer on MoToR's NEW TRUCK and TRACTOR REPAIR MANUAL

BRAND-NEW! Covers EVERY job on EVERY gasoline-powered truck and farm tractor made from 1936 thru 1949! 1867 pictures, 963 big 8 1/2 x 11-inch pages, 300,000 facts. Used by Armed Forces. All types Gasoline Engines, Fuel Systems, Governors, Lubrication Systems, Ignition Systems, Starters, Generators, Clutches, Transmissions, Axles, Torque Dividers, Transfer Cases, Brakes, Steering, etc. Check proper box in coupon for free trial.



EVERY MODEL OF ALL THESE CARS COVERED:

- American
- Bantam
- Auburn
- Austin
- Buick
- Cadillac
- Chevrolet
- Chrysler
- Cord
- Crosley
- De Soto
- Dodge
- Ford
- Frazier
- Graham
- Hudson
- Hupmobile
- Kaiser
- Lafayette
- La Salle
- Lincoln
- Lincoln
- Zephyr
- Mercury
- Nash
- Oldsmobile
- Packard
- Pierce
- Arrow
- Plymouth
- Pontiac
- Reo
- Studebaker
- Terraplane
- Willys

USED BY U.S. ARMED FORCES

# Learn this Profitable Profession



**IN 90 DAYS AT HOME**

## Money-Making Career Open to Men and Women, 18 to 60

Hundreds of men and women between 18 and 60 make \$10 to \$20 in a single day giving scientific Swedish Massage and Hydro-Therapy treatments. There is big demand from doctors, hospitals, sanatoriums and clubs. Graduates earn large full time incomes from these or in private practice in their own offices. Others make good money from home treatments given in spare time. Learn this interesting, money-making profession in your own home, through our home study course. Same instructors as in our nationally known resident school. You can win independence and prepare for future security by qualifying for your Diploma. Course can be completed in 3 to 4 months. Many earn while they learn. Begin your training at once.



### Anatomy Charts & Booklet FREE

Enroll now and we will include, at no extra cost, many needed supplies. Fit yourself to help meet growing demand for Scientific Swedish Massage. Send the coupon at once for complete details. Anatomy Charts and 32-Page Illustrated Booklet, FREE, postpaid.

**THE COLLEGE OF SWEDISH MASSAGE**  
Dept. 064M, 41 E. Pearson, Chicago 11, Illinois

Please send me FREE and postpaid, Anatomy Charts, 32-page Booklet and complete details on Home Training.

Name \_\_\_\_\_ Age \_\_\_\_\_

Address \_\_\_\_\_

City \_\_\_\_\_ State \_\_\_\_\_

## The Steady Pay Profession Good Times or Bad!

### SCIENTIFIC CRIME DETECTION

FOLLOW THIS MAN

Operator No. 38



#### It Is Easy to Learn!

I will teach you this fascinating science during your spare time at home. It pays to be an expert in Finger Printing, Firearms Identification, Police Photography and Criminal Investigation. I have trained hundreds of men and women now successfully serving in identification bureaus throughout America. You, too, may quickly prepare yourself to become a well-paid valued officer of the law, often sharing in the generous rewards offered for wanted criminals.

**FREE! OVER 800**

#### "BLUE BOOK OF CRIME"

This book is full of exciting information on scientific crime detection. It will show how you can get started in a grand career. Now, at amazingly low cost. Clip coupon now... Mail it today.

Of all Identification Bureaus in the U.S. employ students and graduates of I.A.S. A majority of these men are heads of Bureaus. Many of them knew nothing about crime detection before training with me. Now they have steady jobs, good salaries and a fine future. Write today for full particulars and free book. Give age.

#### INSTITUTE OF APPLIED SCIENCE

1920 Sunnyside Ave., Dept. 1357, Chicago 40, Ill.

#### INSTITUTE OF APPLIED SCIENCE

1920 Sunnyside Ave., Dept. 1357, Chicago 40

Gentlemen: Without any obligation on my part, send me the "Blue Book of Crime," and complete list of Identification Bureaus employing your students or graduates, together with your low prices and Easy Terms Offer. (Literature will be sent ONLY to persons stating their age.)

Name \_\_\_\_\_ Age \_\_\_\_\_

Address \_\_\_\_\_

RFD or Zone \_\_\_\_\_ State \_\_\_\_\_

## PRINT YOUR OWN POST CARDS

COMPLETE OUTFIT only \$7.50



Amazing results in sales, inquiries and contacts... saves time and money... very easy to use GEM STENCIL DUPLICATOR is ideal for Advertising, Announcements, Notices, Labels, Forms, Price Lists—hundreds of uses for every type of business and organization. Comes complete with all supplies, instructions and 60-page Book of Ideas.

**FREE TRIAL OFFER:** Try it before you buy it! Write and a GEM OUTFIT will be sent you postpaid. After 10 days, send only \$7.50 or return the GEM, no questions asked. The GEM must sell itself: you be the judge.

**BOND EQUIPMENT CO. • Dept. 135**  
6633 Enright • St. Louis 5, Mo.

SEND NO MONEY • FREE TRIAL OFFER

## EASY TO LEARN CODE

Learn or increase speed with an Instructograph—the Radio-Telegraph Code Teacher that takes the place of an operator-instructor and enables anyone to master code without further assistance. Available tapes from beginners alphabet to typical messages on all subjects. Speed range 5 to 40 WPM. Always ready—no QRM. Thousands have "acquired the code" with the Instructograph System. Write today for convenient rental and purchase plans.



#### INSTRUCTOGRAPH COMPANY

4701-V Sheridan Road, Chicago 40, Illinois



## CARTOON SCHOOL

ONLY SCHOOL TEACHING CARTOONING EXCLUSIVELY Billy Hon nationally known cartoonist director. Draw comic strips, gag cartoons, editorials, sports, commercial cartoons and caricaturing. Cartoonists needed for television. Approved for Vets.

2921 Beverly Blvd. BILLY HON Los Angeles 4, Calif.

## FREE AMAZING NEW BOOK "HOW TO ANSWER ADS"



Never before have you seen anything like this. Tells you in simple language the correct way to answer ads. Gets you quicker replies—better results, and greater satisfaction. Will save you time and money and it's ABSOLUTELY FREE. No obligation whatever. Every reader of advertising should have this booklet. Send a postcard for your copy NOW. Advertising Department, Popular Mechanics Magazine, Room 600, 204 East Ontario Street, Chicago 11, Ill.

## LEARN WATCHMAKING JEWELRY REPAIRING

Start your training now for a better paying job or your own profitable business. Our training is nationally recognized, outstanding and supervised by expert craftsmen. Write for free catalogue.

APPROVED FOR VETERANS

### SCIENTIFIC SCHOOL OF WATCHMAKING, Dept. PM-10

3923 San Fernando Road

Glendale 4, California

## MAKE MONEY IN LANDSCAPING

Thorough training by Internationally known Landscape Architect to start your own business, improve your home or advance in this well paid field. Many Opportunities. Approved for Veterans. Send for FREE BOOK.



### NATIONAL LANDSCAPE INSTITUTE

Dept. P-10, 310 So. Robertson

Los Angeles 48, Calif.



## Thrilling Work COLORING PHOTOS

Fascinating vocation learned at home by those with aptitude. Thrilling pastime. National method brings out life-like colors. Free booklet.

#### NATIONAL PHOTO COLORING SCHOOL

1315 S. Michigan, Dept. 1357, Chicago 5



# Learn RADIO

## TELEVISION, ELECTRONICS

by

## SHOP METHOD HOME TRAINING

Let NATIONAL SCHOOLS, of Los Angeles, a practical Technical Resident Trade School for almost 50 years, train you for today's unlimited opportunities.

You receive all parts, including tubes, for building this fine, modern Superheterodyne Receiver. This and other valuable standard equipment becomes your property.

*these two FREE books will tell you how*



WE BRING  
NATIONAL  
SCHOOLS TO YOU!

### GOOD JOBS AWAIT THE TRAINED RADIO TECHNICIAN

You are needed in the great modern Radio, Television and Electronics industry! Trained technicians are in constant and growing demand at excellent pay—in Broadcasting, Communications, Television, Radar, Research Laboratories, Home Radio Service, etc. National Schools Master Shop Method Home Study Course, with newly added lessons and equipment, can train you in your spare time, *right in your own home*, for these exciting opportunities. Our method has been proved by the remarkable success of National Schools-trained men all over the world.

#### You Learn by Building Equipment with Standard Radio Parts We Send You

Your National Schools Course includes not only basic theory, but *practical training as well—you learn by doing*. We send you complete standard equipment of professional quality for building various experimental and test units. You advance step by step until you are able to build the modern superheterodyne receiver shown above, which is yours to keep and enjoy. You perform more than 100 experiments—build many types of circuits, signal generator, low power radio transmitter, audio oscillator, and other units. The Free Books shown above tell you more about it—send for them today!

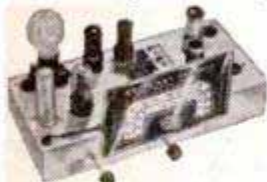

#### NOW! NEW PROFESSIONAL MULTITESTER INCLUDED



This versatile testing instrument is portable and complete with test leads. Simple to operate, accurate and dependable. You will be able to quickly locate trouble and adjust the most delicate circuits. You can use the Multitester at home or on service calls. It is designed to measure AC and DC volts, current resistance and decibels. You will be proud to own and use this valuable professional instrument.

**TELEVISION TRAINING** A complete series of up-to-the-minute Television lessons is an integral part of your course, covering all phases of Television repairing, servicing and construction.

Here are just a few of the interesting facts you learn with the  
**FREE SAMPLE LESSON**

1. How radio receivers operate.
2. How the antenna circuit is constructed.
3. Converting signal currents into sound.
4. How the R-F transformer handles the signal.
5. How the tuning circuit functions.
6. The Radio "bands."

**APPROVED  
FOR  
VETERANS**  
Check  
coupon below.

**NATIONAL SCHOOLS**  
LOS ANGELES 37, CALIFORNIA EST. 1905



#### MAIL OPPORTUNITY COUPON FOR QUICK ACTION

National Schools, Dept. PM-10, (Mail in envelope or  
4000 South Figueroa Street paste on penny postcard.)  
Los Angeles 37, California

Mail me FREE the book "Your Future in Radio-Television" and the sample lesson of your course. I understand no salesman will call on me.

NAME \_\_\_\_\_ AGE \_\_\_\_\_

ADDRESS \_\_\_\_\_

CITY \_\_\_\_\_ ZONE \_\_\_\_\_ STATE \_\_\_\_\_

Check here if veteran of World War II

GET THE DETAILS - SEND THE COUPON →

# 9 BIG BUILDING BOOKS

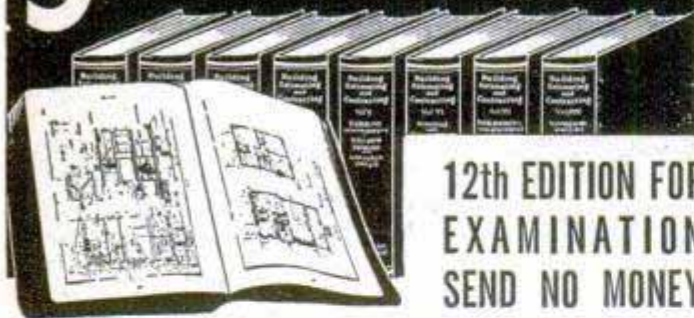

**12th EDITION FOR EXAMINATION SEND NO MONEY**

Learn to draw plans, estimate, be a live-wire builder, do remodeling, contracting. These 9 practical, profusely illustrated books cover subjects that will help you to get more work and make more money. Masonry, concrete forms, carpentry, steel square, roof framing, construction, plumbing, heating, painting, decorating and many other subjects. More than 4000 pages — 2750 illustrations.

## BETTER JOBS — BETTER PAY UP-TO-DATE EDITION

A nationwide building boom is in full swing and trained men are needed. Big opportunities are always for MEN WHO KNOW HOW. These books supply quick, easily understood training and handy, permanent reference information that helps solve building problems.

These books are the most up-to-date and complete we have ever published on these many subjects.

### Coupon Brings Nine Big Books for Examination

AMERICAN TECHNICAL SOCIETY—Publishers since 1898  
Dept. G719 Drexel at 58th Street Chicago 37, Ill.  
You may ship me the Up-to-Date edition of your nine big books, "Building, Estimating and Contracting," without any obligation to buy. I will pay the delivery charges only, and if fully satisfied in ten days, I will send you \$3.00, and after that only \$4.00 a month, until the total price of only \$34.80 is paid. I am not obligated in any way unless I keep the books.

Name \_\_\_\_\_  
Address \_\_\_\_\_  
City \_\_\_\_\_ State \_\_\_\_\_  
Please attach a letter stating your age, occupation, employer's name and address, and name and address of at least one business man as a reference. Men in service, also please give home address.

## Can a Man MY Age Become a HOTEL EXECUTIVE

**Even Though He Has No Previous Hotel Experience?**

Would you like to step into a well-paid position as Hotel, Club, Restaurant or Inn Manager, Purchasing Agent, Social Director or Assistant Manager? Would you like to look forward happily to the future? The success of Lewis graduates from 18 to 50 PROVES you can — though you have no experience in hotel work.



**W. Bradley Hall Becomes Hotel Manager Increasing His Income 50%, Although Without Previous Hotel Experience**

"When I enrolled in the Lewis School, I was a Railroad Conductor. Shortly afterwards I went to work in a Chicago hotel. Within 60 days I was made Superintendent of Service. Recently I took over the 'Y' cafe and am my own boss, thanks to Lewis Spare Time, Home Study Training."

## Step Into a Well-Paid Hotel Position FREE Book Gives Fascinating Facts

Our FREE Book, "Your Big Opportunity," explains how you can qualify for a well-paid position at home, in leisure time; tells how you are registered FREE of extra cost in the Lewis National Placement Service. Most important, it shows how you can be a Lewis Certified Employee—certified to "make good" when placed in a position. Mail the coupon NOW!

Course Approved for Veterans' Training

LEWIS HOTEL TRAINING SCHOOL  
Room SR-324, Washington 7, D. C. **35th** AN **SUCCESSFUL** YEAR

Send me the Free Book, "Your Big Opportunity," without obligation. I wish to know how to qualify for a well-paid position at home, in my leisure time.

Name \_\_\_\_\_  
(Please Print Name & Address)  
Address \_\_\_\_\_  
City \_\_\_\_\_ Zone \_\_\_\_\_ State \_\_\_\_\_  
 Check here if eligible under G. I. Bill of Rights.



# BE A JUGGLER

**Jugglers in Demand Now for Television, Shows and parties!**

For the first time you can get quick, easy instructions! Get on the Ball with Harry Moll. Send today for his amazing book, "The Art of Juggling" with Pro Juggling Balls. Secrets of famous Jugglers—clearly illustrated, an easy-to-follow manual—and 6 SUPER BOUNCE BALLS. Complete set, \$2.95—postpaid. A wow of a Christmas gift! No C.O.D.'s. ORDER TODAY.



**HARRY MOLL CO., Dept. P, 930 Grant — Box 29, Denver 1, Colo. DEALERS' Inquiries Invited**

# BECOME AN EXPERT IN TRAFFIC

Traffic men earn \$4,000 to \$10,000 and up. Thousands of firms need experts on rates, tariffs, regulations. We train you thoroughly in spare time at home for executive traffic jobs. Personal training under traffic authorities. Placement counsel and help. Write for free 48-page book "Traffic Management—the Fast Growing Profession."

**LASALLE Extension University, 417 So. Dearborn St. A Correspondence Institution Dept. 1064-T, Chicago 5, Ill.**

# FREE BARGAIN CATALOG of BOOKS

25,000 books of all publishers listed in our 56th Annual Bargain Catalog of 256 pages. Old-time favorites — latest "best sellers." Reference, Fiction, Juvenile, History, Scientific, etc. Supplying schools, colleges, libraries and thousands of individual customers. Send postcard today for our new 1951 catalog, "Bargains in Books."

**THE BOOK SUPPLY COMPANY, DEPT. 133 564-566 West Monroe St. Chicago 6, Ill.**

# THERE'S MONEY IN CARTOONS!

RAYE BURNS will teach you HOW to CREATE ORIGINAL CARTOONS at home that you may SELL! Course contains 26 lessons and over 600 illustrations. All for Only... **\$2.85**

Send name and address for free details.  
**RAYE BURNS SCHOOL, Dept. P, Box 3583, CLEVELAND, OHIO**



# RAISE HAMSTERS

The new wonder animals from Syria. Often called Toy Bears. Delightful pets. Everyone wants them. Laboratories need thousands. Clean, odorless. Raise anywhere. A profitable and interesting hobby or business. We furnish breeding stock with manual of instructions.

Write today for free illustrated literature.  
**GULF HAMSTERY, 1536 BASIL, MOBILE, ALA.**

## Say You Saw It in POPULAR MECHANICS

# Learn PHOTOGRAPHY at Home

Splendid opportunities. Prepare in spare time. Practical basic training. Long-established school. Send for free book, "Opportunities in Photography." No obligation.  
**American School of Photography, 1315 S. Michigan Ave., Dept. 1357, Chicago 5, Ill.**



# R·T·S - ORIGINATORS OF PRACTICAL HOME TRAINING

## IN TELEVISION RADIO AND ELECTRONICS

YOU BUILD THIS 23-TUBE TELEVISION RECEIVER



YOU KEEP ALL EQUIPMENT -it's Yours!

## ...GIVES YOU 11 BIG TELEVISION & RADIO KITS AT NO EXTRA COST!

Let RTS show you how to MAKE GOOD MONEY in Radio and Television. Learn NOW while Television is in its infancy. Be ready for the BIG BOOM in America's fastest growing Industry. You will work and learn with REAL TELEVISION and RADIO EQUIPMENT—RIGHT AT HOME! Study in spare time. You can EARN EXTRA MONEY while learning, like many RTS students.

Located in the heart of the Radio-Television capital of America—RTS has trained thousands during the past 28 years. RTS was FIRST to make practical TELEVISION training possible at home.

Opportunities are wide open! More than 3 and a half million TV receivers now in use! More than 60 million radios in the country! Daily the demand for TRAINED MEN INCREASES... EVERYWHERE!

Prepare NOW for these better jobs at GOOD PAY! INVESTIGATE! If you want a career in Radio-Television DON'T ACT WITHOUT GETTING THE FACTS FROM THE LEADER—RTS—ORIGINATORS OF PRACTICAL TELEVISION HOME TRAINING! Send coupon for Actual Lesson and BIG ILLUSTRATED BOOK — both sent to you FREE!

YOU BUILD THIS 6-TUBE SUPER HETERODYNE RADIO AND SHORT WAVE CONVERTER

Both Free! SEND FOR LESSON AND BIG ILLUSTRATED BOOK

### FOLLOW THE LEADER • GET THE FACTS

RADIO-TELEVISION TRAINING SCHOOL, DEPT. PM-10  
5100 South Vermont Avenue, Los Angeles 37, Calif., U.S.A.

Send FREE Illustrated Book showing how I can make good in TELEVISION and Radio through training under the guidance of expert RTS Technicians. No obligation. (No Salesmen will call).

NAME \_\_\_\_\_ AGE \_\_\_\_\_

ST. & NO. \_\_\_\_\_

CITY \_\_\_\_\_ ZONE \_\_\_\_\_ STATE \_\_\_\_\_

**RADIO-TELEVISION TRAINING SCHOOL**

5100 S. Vermont Ave., Los Angeles 37, Calif., U.S.A.

ESTABLISHED 1922 — 28 YEARS AGO

# I'LL TRAIN YOU for **RADIO**



**MEET  
A FEW OF MY  
GRADUATES**



**Appreciates Sprayberry  
Personal Interest**  
"Before completing  
your course I had  
a good paying job.  
I appreciate the per-  
sonal interest you  
gave me."—Leonard  
Petrus, Arkan-  
sas



**Best Investment  
He Ever Made**  
"Began fixing ra-  
dio sets after first  
few lessons. Your  
course is one of the  
best investments  
I've ever made."  
—A. R. Foronda,  
Hawaii

**I Send You  
18 BIG  
KITS  
OF RADIO-  
TELEVISION  
EQUIPMENT**

## **EXTRA MONEY**

**Earn While You Learn  
In Your Spare Hours!**

You do all your training  
with me AT HOME in  
spare hours. Keep right on  
with your present job and  
income while learning—and  
earn extra cash besides! The  
day you enroll I begin send-  
ing you plans and ideas for  
doing profitable spare time  
Radio-TV work. Many of  
my Sprayberry students  
pay for their entire Radio-  
TV training this way!

## **YOU KEEP THIS VALUABLE EQUIPMENT**

The many big kits of Radio-Television  
parts and equipment are sent to my  
students "for keeps." Nothing need be  
returned—it is YOURS! There is abso-  
lutely nothing else to buy!



# AT HOME IN SPARE TIME TELEVISION



**Training Leads To Good Radio Job**  
"Got a job in local radio shop soon after enrolling. Very satisfied with training"—Stanley Clemmons, Kansas



**Lucky To Be Sprayberry Trained**  
"I consider myself lucky I chose your training in preference to others I considered. Here's thanking you again."—Paul White, Ohio



**Radio Profits Pay Cost of Training**  
"I have more than taken in the cost of your training doing spare time radio repair work. See bright future ahead"—Thomas Shearer, N. Y.



**Earns Easy Spare Time Cash**  
"While training I made about \$180.00 in spare time. Thank you for wonderful Radio-TV training"—Herbert Burroughs, W. Va.

## My Proved Training System—Backed by a Quarter Century of Experience—Prepares You FAST for a Good Job or Your Own Profitable Radio-Television Business!

Radio-Television is now America's greatest opportunity field. Correctly trained men are needed NOW—more than ever—to fill good jobs and handle the profitable Radio-Television Service work. I have trained hundreds of successful men for Radio-Television—and I stand ready to train YOU too—even if you have no experience or knowledge of this field. My training is modern—right up to the second—with all the newest developments included! This is 100% practical training that eliminates the frills that only waste your time and progress. Sprayberry Training provides the all-important practical knowledge and skill you need to start making money in Radio-Television in the shortest possible time. You can start at once and be earning welcome spare time cash in a few short weeks. Upon completion of my Training you will be ready to handle any practical Radio-Television job.

You receive all the equipment I have illustrated on the opposite page—and MUCH MORE besides! In addition to your fascinating Sprayberry home study lessons, I send you a total of 18 kits of quality parts and equipment with which you do over 300 practical demonstrations, experiments and construction projects. You build a complete television set that you can use in your shop or at home—you build a powerful TWO-BAND superheterodyne radio set—a multi-range test meter—signal generator and other valuable test equipment—a cathode ray oscilloscope—everything needed to set up your own Radio-Television Service Shop! All equipment I send you is yours to keep. In addition I send you many valuable service manuals, books and reference material to help you in your day-to-day Radio-Television work. I firmly believe I offer the ambitious man the most outstanding training value of its kind in America today!



### Be Ready for Top Paying Radio-Television Jobs!

Radio-Television is growing with amazing speed. More than 2000 broadcasting stations PLUS an additional 102 Television stations are now on the air. Radio sets and TV receivers are being made and sold in record breaking numbers. If you enjoy working with your hands . . . if you like interesting and varied work . . . YOU BELONG IN RADIO-TELEVISION. But you MUST have good Training to "cash in" . . . the training that starts with basic fundamentals and carries through every circuit and problem of Radio-TV.

### No Previous Experience Needed to Succeed

My Training in Radio-Television is so complete, so down-to-earth that previous experience is not necessary. I start you with basic fundamentals and carry you in easy, practical steps through one Radio-Television subject after another. You will be amazed at your rapid progress and your knowledge of Radio-Television. Best of all, you put this knowledge to work making spare time cash soon after you enroll! You may train as fast or as slowly as suits your convenience. Each of my students receives individual training!

### VETERANS

You get my Radio Training without cost under the G. I. Bill. Check coupon.

### If you are Experienced . . .

In radio . . . I'll qualify you for Television in 4 to 8 weeks. Check coupon for special details.



## FREE 3 Big Radio and Television Books

I want you to have ALL the facts about my complete system of Radio-Television Training! Act now! Rush the coupon for my three big Radio-Television books: "How To Make Money in Radio-Television," PLUS my new illustrated Television bulletin PLUS an actual sample Sprayberry Lesson—all FREE with my compliments. No obligation and no salesman will call on you. Send the coupon in an envelope or paste on back of post card. I will rush all three books at once!

**Mail Coupon Today!**

**NO OBLIGATION  
No Salesman  
Will Call**

**SPRAYBERRY ACADEMY OF RADIO, Dept. 10-O**  
111 North Canal St., Chicago 6, Ill.

Please rush to me all information on your Radio-Television Training plan. I understand this does not obligate me and that no salesman will call upon me.

Name..... Age.....

Address.....

City..... State.....

Please Check Below About Your Experience

Are You Experienced?

No Experience

**Sprayberry Academy of Radio, Dept. 10-O**  
111 North Canal St., Chicago 6, Ill.

# "Cash In" On YOUR HIDDEN CREATIVE POWER

THOUSANDS of people have hidden creative power—but few know how to bring it out, and how to develop their ideas into *practical* form. Now you can "cash in" on your hidden creative powers, thanks to the more than 100 *tested* formulas revealed in a fascinating new book.

The author, Alex Osborn (of the advertising agency, Batten, Barton, Durstine & Osborn) discovered years ago that 90% of our time in school is spent learning facts. Only 10% is spent developing *imagination*. So for years he studied the idea-developing methods used by famous inventors, scientists, business men, and other successful people. Now he has put all his findings in a new book, "Your Creative Power." It is a simple, practical guide to getting and developing ideas.

## How to Think Up Ideas

Here are just a few of the things this book tells you:

- How some famous ideas were born
- How to think up ideas
- How to recognize good ideas
- How to develop big ideas step by step from little ideas
- How to present your ideas to others
- How to collaborate on ideas with others
- The 10 habits that kill ideas
- The 10 habits that breed ideas
- How a single idea made \$5,000,000

## What Well-Known People Say

**Dale Carnegie**—"I wish I had had the privilege of reading your book when I started my career. It should be used as a textbook in every college in the land."

**Dr. Waldo Semon**, Inventor of Koroseal, has recommended the book to fellow scientists.

**Arthur Nielsen**, President of world's largest research organization—"It is not only fascinating but absolutely sound. It's a veritable gold-mine of practical ideas."

**Dr. C. W. Fuller**, Inventor of Angle Tooth Brush—"This book is simply a knockout. It is so stimulating to the imagination that it should be adopted as a textbook and read by everybody."

**G. Lynn Sumner**, President, G. Lynn Sumner Co.—"The best, most helpful and most stimulating book on creative thinking I have ever read."

The president of a \$44,000,000 company was so excited about the book that he had parts of it reproduced and distributed to his associates. He reported that it worked miracles.

## Read It 10 Days FREE

The coupon (without money) will bring you a copy for 10 days' free reading. Unless convinced that its 355 pages will help you get more ideas and develop them into a practical form, return the book and owe nothing. Charles Scribner's Sons, Dept. 6810, 597 Fifth Ave., New York 17, N. Y.

**Charles Scribner's Sons, Dept. 6810**  
597 Fifth Ave., New York 17, N. Y.

Please send me YOUR CREATIVE POWER for 10 days' FREE examination. Within that time I will remit \$3.00 plus a few cents mailing charges, or return the book.

Name \_\_\_\_\_

Address \_\_\_\_\_

**SAVE!** If you enclose payment, publisher will pay mailing charges. Same return privilege; refund guaranteed.

# CARVE LEATHER

Easy to Learn in Spare Time.  
Fascinating, Profitable HOBBY.

Have fun and make money too! Carve handsome bags, billfolds, belts, moccasins, key cases, etc. from our huge and varied stock of Leather Projects that come **READY TO CARVE AND ASSEMBLE**. To select what you need, write for complete, fully-illustrated catalog. Contains over 200 photographs of projects, leathers, tools and accessories. Learn this fascinating hobby—start small and experiment. Write for catalog today, include 25c to cover printing and mailing.



**BURTONS LEATHERCRAFT**  
Dept. PM-10  
1755 1/2 Glendale Blvd.  
Los Angeles 26, Calif.

WRITE NOW FOR COMPLETE LEATHER-CRAFT CATALOG!

## "How to Make Money with Simple Cartoons"

A book everyone who likes to draw should have. It is free; no obligation. Simply address **FREE BOOK**

**CARTOONISTS' EXCHANGE**  
Dept. 910-A Pleasant Hill, Ohio

# TRI-STATE COLLEGE

**B. S. DEGREE IN 27 MONTHS**

Founded 1884

World-Wide Enrollment

Civil, Elect., Mech., Chem., Aero., Radio and Telev., Engineering; Bus. Adm., Acct. Visit Campus, see well equipped labs. Low cost. Prep. courses. Personalized instruction. Grads. successful. Enter Sept., Jan., March, June. Catalog 4100 College Ave., Angola, Ind.

# CARPENTRY BRICKLAYING

APPROVED FOR VETERAN TRAINING • FREE CATALOG

**PENNSYLVANIA INSTITUTE SCHOOL OF TRADES**  
30th & MARKET STS. PHILA. 4, PENNA.

## Learn WOOD PRODUCTION ENGINEERING At Home In Your Spare Time

**KLOK TRAINING** offers you exceptionally practical and fascinating instruction in the woodworking industry arts—Sketching—Drafting—Rod Making—Time Study—Cost and Production Scheduling in an 81-Lesson Home Study Course or through Resident Training at Grand Rapids. Enables you to attain a top woodworking position or to run your own shop more successfully. Free G. I. instruction. Money back trial offer to non-veterans. Write me—today for **FREE BOOKLET**. State age, veteran or non-veteran, Home Study or Resident Course, occupation.

from **THE ONLY SCHOOL OF IT'S KIND**

**FREE Booklet**



JOHN H. KLOK, President

## KLOK INSTITUTE

Woodworking Industry Training Since 1928  
K. Louis St., N.W. Grand Rapids 2, Mich.



**TO HELP YOU PREPARE FOR  
ONE OF THE BETTER JOBS  
IN BUSINESS or INDUSTRY**

**You can take subjects which have *Real Job Value*  
and still earn graduation!**

• This is *your* opportunity to make completion of high school *work* for you. Your AMERICAN SCHOOL home study course can include high school subjects closely related to your present job or the kind of work you want to do later. Not only can you qualify for your high school course diploma but you can benefit from course subjects that will aid greatly in winning promotions.

**50 Job Help Subjects  
from Which to Choose**

Our FREE, 44-page book of detailed information lists 100 high school subjects, of which 29 are technical and 21 are commercial. Whether you work in a shop, factory, garage or office you will find subjects of practical benefit in your climb toward better jobs at better pay. Some of these are Blueprint Reading, Mechanical and Machine Drawing, Tool Making, Foundry Work, four Automotive subjects, Electricity, Carpentry—and Bookkeeping, Accounting, Secretarial Practice, Office Machines, Salesmanship.

**Turn Spare Time Into Money**

During more than 50 years American School has helped thousands to reach higher job goals by profitable use of spare time at home—and it can help *you*. Others have prepared for college entrance. If you have not completed high school, check that subject on the coupon below, add your name and address and mail it *right now*. Or if you are a high school graduate and are ambitious to succeed in the vocation of your choice, check that subject. Your coupon will bring you the book of information, without obligation of any kind. Mail it *now*.

**HOME - STUDY TRAINING SINCE 1897**

**Take This First Easy Step**

**CHECK, CLIP AND MAIL COUPON NOW**

**AMERICAN SCHOOL, Dept. G745, Drexel at 58th, Chicago 37, Ill.**  
*Without obligation, please send me FREE information on training course checked below.*

<input type="checkbox"/> HIGH SCHOOL COURSES	<input type="checkbox"/> Bookkeeping	<input type="checkbox"/> Plastics Engineering
<input type="checkbox"/> Accounting	<input type="checkbox"/> Business Management	<input type="checkbox"/> Plumbing—Practical
<input type="checkbox"/> Air Conditioning	<input type="checkbox"/> Contracting	<input type="checkbox"/> Private Secretary
<input type="checkbox"/> Architecture & Building	<input type="checkbox"/> Diesel Engineering	<input type="checkbox"/> Radio Operating & Servicing
<input type="checkbox"/> Automotive Engr.	<input type="checkbox"/> Drafting & Design	<input type="checkbox"/> Railway Training
<input type="checkbox"/> Aviation—Practical	<input type="checkbox"/> Electrical Engineering	<input type="checkbox"/> Refrigeration
<input type="checkbox"/> Aviation Drafting & Design	<input type="checkbox"/> Electricity—Practical	<input type="checkbox"/> Sheet Metal Pattern Drafting
<input type="checkbox"/> Better Foremanship	<input type="checkbox"/> Electronics, Industrial	<input type="checkbox"/> Shop Management
	<input type="checkbox"/> Machine Shop Operations	<input type="checkbox"/> Tool Making
	<input type="checkbox"/> Mechanical Engineering	

**PRACTICAL, EFFECTIVE**

**AMERICAN SCHOOL**  
Dept. G745, Drexel at 58th Street, Chicago 37

Name \_\_\_\_\_ Occupation \_\_\_\_\_  
Address \_\_\_\_\_ Age \_\_\_\_\_  
City & Zone \_\_\_\_\_ State \_\_\_\_\_

# INVENTORS

Before you make any effort to market your invention, you should take the first steps toward proceeding for patent protection.

The usual first step is to have a search of the U. S. patent records conducted, so that I can report to you on the question of patentability.

I shall be pleased to furnish you with information relative to patent procedure, upon request from you, and this will be without any obligation on your part.

## PATRICK D. BEAVERS

(Formerly RANDOLPH & BEAVERS)

Registered Patent Attorney

934 Columbian Building Washington 1, D. C.

ARE YOU CROWNED  
WITH SUCCESS!



517-H  
W. Deming Place  
Chicago 14, Ill.



Let this New Science show you how to WIN WITH WORDS — financially, socially, culturally. Develop a MASTERFUL VOCABULARY. Influence others, improve your personality, manifest your latent ability. You are judged and rated by every sentence you utter. Start using the POWER of LEXIPOWER after the first Lesson. Write NOW for FREE details about LEXIPOWER Dime-a-Day LESSON CLUB.

LEXIPOWER LESSON CLUB

# INVENTORS

IF YOU WISH TO PROTECT YOUR INVENTION, You should take steps to protect it by a U. S. Patent. Write me for "RECORD OF INVENTION" form.

**CARL MILLER**  
REGISTERED PATENT ATTORNEY  
WOOLWORTH BLDG., 35th FLOOR, 100A  
NEW YORK CITY

# SHORTHAND IN

Famous Speedwriting system. No signs; no symbols; no machines. Uses ABC's. Easy to learn, write, transcribe. Low cost, 100,000 taught by mail. Also typing. 27th year. Write for FREE booklet to

**Speedwriting**  
Dept. 1510-A

55 W. 42 St., N. Y. 18, N. Y.

**6**  
WEEKS  
AT HOME

# PATENTS PATENT LAWYER

**GUSTAVE MILLER**  
REGISTERED  
PATENT ATTORNEY  
100-PM WARNER BLDG.  
WASHINGTON 4, D. C.

ASSOCIATE EXAMINER  
U. S. PATENT OFFICE 1922-1929  
Patent Attorney and Advisor  
U. S. NAVY DEPT. 1930-1947  
Send for  
PATENT INFORMATION book  
and "INVENTOR'S RECORD"  
without obligation

# INVENTORS

Whether an invention is patentable can be substantially determined by a search of the U. S. Patent records. Without obligation, write for information explaining the steps you should take to secure a patent.

**JOHN N. RANDOLPH**

Registered Patent Attorney

201 Columbian Building, Washington 1, D. C.

# INVENTING

**-FOR PROFIT!** If you have an inventive turn of mind, write for free 28-page booklet explaining how the Institute of American Inventors is helping inventors pre-test the profit possibilities of proposed devices to fill today's unprecedented demand for useful new inventions.

**INSTITUTE of AMERICAN INVENTORS**  
Dept. 4, 631-E St., N.W., Washington 4, D. C.

SAY YOU SAW IT IN POPULAR MECHANICS

# HIGHEST ROYALTIES and CASH

## FOR YOUR INVENTIONS

(Patented and Patent Pending Only)

Write for FREE booklet without obligation

**UNIVERSAL MARKETING CO.**

354 S. SPRING ST. (Suite M)

LOS ANGELES 13, CALIF.

**FREE-10 DAY TRIAL**

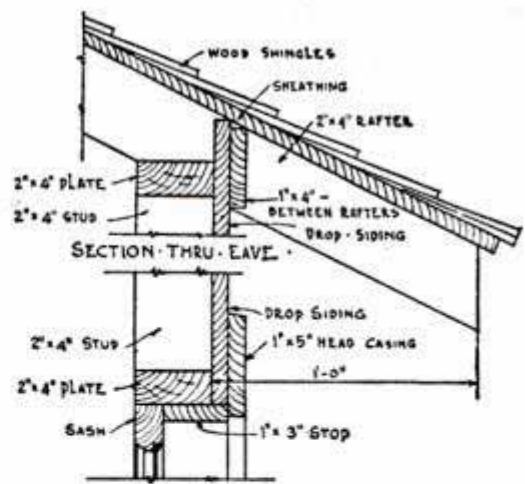
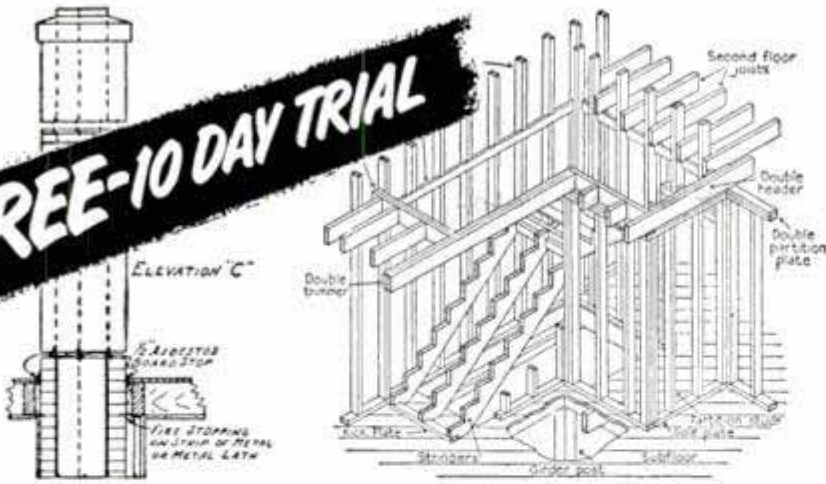

**NOW—Get the INSIDE FACTS on**  
**HOUSE CONSTRUCTION DETAILS**  
**Save Money and Time—Get Better Construction—**  
**with these Professional Methods**

Here, at last, is an exact working guide on every detail of house construction from foundation to finish. Tells you dimensions, materials, processes, step-by-step working methods. Hundreds of scale drawings and photographs make every step easy to follow. Can be used for alterations in a set of stock plans, for making additions or changes in a building, or for complete construction

of a dwelling. Conforms with modern practice and building regulations in all parts of the country. A book you will refer to for years! The professional guidance you get on even a single house construction detail can *repay you a hundred times the small cost* of this wonderful volume! Send for free-examination copy today. Mail coupon below.

**Every Step in House Construction Explained and Illustrated:**

- Excavations • Footings and drainage • Foundation forms • Sills • Girders • Joists • Sub-flooring • Exterior wall framing • Interior wall framing • Ceiling joists • Gable roof • Hip roof • Gambrel roof • Dormers • Siding and shingling • Cornices • Porches • Exterior walls of wood • Exterior walls of brick • Interior walls finished in plaster, in plywood • Wall panels • Mouldings for interior trim • Stair construction • Windows • Sash details • Window framing details • Doors and door trim • Hardware used in dwellings • Closets, shelves, built-in equipment • Breakfast alcove • Sewing room • Flooring • Chimneys and fireplaces • Mantels and seats • Outdoor fireplaces • Scaffolds • Garages • Electric wiring • Insulation • Arches and gates • Lattice porch and trellis • Picket fences • Log cabins, camps, cottages • Barns • Feeders and nests • Rabbit hutch • Septic tank • Painting and finishing • Heating systems • Air conditioning systems • Prefabricated houses • Useful information for home builders including architectural styles and data on modern building materials.

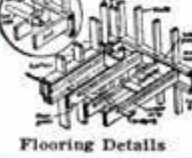
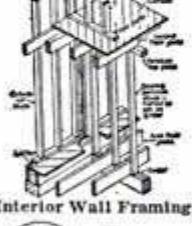
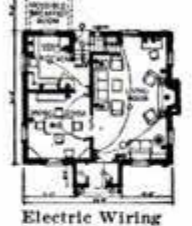

**313 PAGES, SIZE 8½ x 11. FULLY INDEXED. 1500 ILLUSTRATIONS.**

**The "How" Book of House Construction**

**Nothing Else Like It!** Other books may show you *what* to build, but this is the book that shows you *HOW* to build! Every detail in the construction of a house is clearly described — illustrated with large, easy-to-follow drawings — indexed for ready reference. Send coupon below to get your free-trial copy.

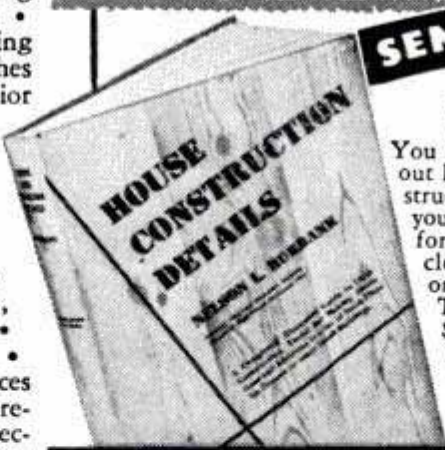

**SEND NO MONEY**

Examine  
**10 DAYS FREE**

You don't risk a penny to find out how valuable "House Construction Details" can be to you. Just mail coupon. See for yourself how you get clear, professional guidance on every building detail. Then either send only \$4.50 (plus postage) in full payment, or return the book and owe nothing. Mail free-examination coupon NOW!

**MAIL THIS COUPON**

Simmons-Boardman Publishing Corp., PM-1050  
 30 Church Street, New York 7, N. Y.

Rush to me at once, for 10 DAYS' FREE EXAMINATION, a copy of "House Construction Details." I will either return it in 10 days and owe nothing, or send only \$4.50 (plus shipping charges) in full payment.

Name.....  
 Address.....  
 City & State.....  
 Employed by.....  
 SAVE! Send \$4.50 with this coupon and we will pay postage. Same return and refund privilege.

# MACHINE SHOP MEN

*Needed Now!*



Learn to set up and run ANY kind of machine; **MAKE MORE MONEY NOW** by learning quickly **HOW TO DO THINGS** which usually take years of study and practice. The demand for **SKILLED** men offers excellent opportunities for men with "know how."

**Bigger Pay** Don't miss this chance to qualify for promotion, don't miss this Big Opportunity which is yours almost for the asking. Eight Big Books, 14th Edition, chockful of important mechanical facts told simply and clearly. Over 3000 pages, nearly 3000 illustrations cover every subject fully, including Tool Making, Pattern Making, Foundry Work, Mechanical Drawing, Forging, Machine Shop Practice and Management, and hundreds of other subjects. A big help to G. I. trainees and other ambitious men.

## 8 BIG BOOKS ON APPROVAL

With them we send a **Big Binder** of nearly 900 pages with 293 shop tickets and over 1300 illustrations. These show, step by step, how to set up and run almost any kind of job and are in addition to the 8 books. Note their great **MONEY MAKING** value, then, if you want to keep them, pay on the easiest kind of payments. A year's consulting privileges with our engineers now given with these books without extra charge.

AMERICAN TECHNICAL SOCIETY, PUBLISHERS SINCE 1898

American Technical Society, Dept. S-719-MSP  
Drexel at 58th St., Chicago 37

You may send me the 8 big books and binder of shop tickets on approval. I will pay the delivery charges only, unless I decide to keep them in which case I will send \$3.00 in ten days and \$4.00 per month until the total price of only \$34.80 is paid. If I return them in 10 days I will owe you nothing. You also agree to send me a certificate entitling me to consulting privileges with your experts for one year without extra charge.

Name \_\_\_\_\_

Address \_\_\_\_\_

Please attach a letter stating age, occupation, employer's name and address and name and address of at least one business man as reference. Men in service, also please give home address.

## In Industry and In Emergency TRAINED MEN ARE PREFERRED



**Jewelry- WATCHMAKING Engraving  
Stone Setting**

### "3 High-Paying Trades in 1 Career"

**Prepares You Now — Secures Your Future**

There are increasing needs in industry and the Jewelry Trade for thoroughly trained men.

Write for catalog and full information.

**MAIL THIS COUPON TODAY**

**KANSAS CITY SCHOOL OF WATCHMAKING**  
1218 Admiral Blvd.  
Kansas City 6, Missouri

Please send me, without obligation, complete information on training in the above courses.

Name \_\_\_\_\_

Street \_\_\_\_\_

City \_\_\_\_\_

State \_\_\_\_\_

Check if Veteran

G. I. Approved

## Are YOU the Man?

... if you are honest, willing to work to enjoy success—write today for details on how to Own a Business of Your Own. No experience necessary. You can have your business operating in a very few days.

### Clean and Mothproof Rugs and Upholstery

DuraClean cleans and sanitizes. Dura-proof protects against moths and carpet beetles. Furnishings are serviced right "in the home" or business building.

No overhead expense. Some dealers open a shop or an office . . . others operate from their own home. Profits up to \$20 a day on EACH of your service men.

DuraClean and DuraProof are Nationally Advertised in quality magazines to create voluntary orders for you in this year 'round, lifetime business of "your own."



Patented Equipment

**DURACLEAN CO., 0-160 Duraclean Bldg., Deerfield, Ill.**

## STUDY AT HOME

WITH AN EDUCATIONAL INSTITUTION

**Courses in ARTS AND SCIENCES:** Philosophy; Education; Letters; Public Health; Medical Jurisprudence; Psychology; Sociology; Physics; Chemistry; Geology; Pol. Science; Theology; Law; Business and Commerce; Accounting; Mathematics; Statistics; Agriculture. **Courses in ENGINEERING:** Electrical, Civil, Mechanical, Drafting, Architectural, Automotive, Steam, Diesel, Aeronautical, Radio, Structural, Mining, Industrial. Petroleum, Marine, Refrigeration, Air Conditioning, Chemical. Send for free catalog.

McKinley-Roosevelt Incorporated, 4610-K3, Sheridan Rd., Chicago 40, Illinois

## THE OPPORTUNITY OF A LIFETIME

### Export Promotion

Big Money  
Security  
Travel  
Own Business

At Last! A prosperous career, free from competition. AMERICAN EXPORTERS NEED TRAINED MEN TO BUILD FOREIGN MARKETS. This is the only course which trains you to set up your own business or become a HIGH-PAID EXPORT PROMOTER WITH SECURE FUTURE. Your Golden opportunity — SEND FOR OUR FREE BOOKLET TODAY.

AMERICAN EXPORT PROMOTION COUNSELORS  
Dept. A10, 366 Madison Ave., NEW YORK, N.Y.

## Learn CARTOONING

HAVE FUN! MAKE MONEY! Cash in on your sense of humor at HOME—BY MAIL. No experience needed to start. Write today for FREE TRIAL LESSON and full particulars.

Moon Gag Cartoon School, Dept. E, Fall Creek, Wis.



## A GOOD EDUCATION MEANS GOOD PAY

Lack of a high school diploma can stop you from getting a better job or promotion. You can complete high school in months thru C.T.I. guided study. Course equals resident work. College prep. Texts supplied. Easy terms. Credit for work elsewhere. Write for information today!

FINISH  
HIGH  
SCHOOL  
AT HOME

## COMMERCIAL TRADES INSTITUTE

1400 Greenleaf

Dept. H2-10

Chicago 26

**A famous book on a famous hobby,  
plus a copy of the Model Railroader  
for only 25c (a 45c value)**

Model railroading is more fun than you imagine. Here is an opportunity to get acquainted with the world's fastest growing hobby.

The book "Model Railroading for You" tells you how you can have your own railroad with little space and surprisingly little money. Picture-packed, this book explains all.

Send 25c today for this book, plus a recent copy of MODEL RAILROADER, the big magazine that is read by all the hobbyists. This introductory offer will open your life to a new exciting hobby that is enjoyed today by 250,000 fans from 7 to 70. Mail your 25c now to

## MODEL RAILROADER MAGAZINE

Dept. 1546B — Milwaukee 3, Wis.





# They Never Knew It Was SO EASY To Play

**Thousands Now Play Popular Songs  
Who Didn't Know a Note of Music Before**

**You, too, can learn your favorite  
instrument at home, without  
a teacher, this quick, easy,  
money-saving way**

**T**HINK of the fun YOU are missing! The popularity, friendship, good times! Why? Because you think it's *hard* to learn music. You have an idea that it's a slow, tedious task, with lots of boring drills and exercises.

That's not the twentieth-century way! Surely you've heard the news! How people all over the world have learned to play by a method so simple a child can understand it—so fascinating that it's like playing a game. Imagine! You learn without a teacher—in your spare time at home—at a cost of only a few cents a day! You learn by the famous print-and-picture method—every position, every move before your eyes in big, clear illustrations. You CAN'T go wrong! And best of all, you start playing real tunes almost at once, from the very first lesson.

No needless, old-fashioned "scales" and exercises. No confused, perplexing study. You learn to play by playing. It's thrilling, exciting, inspiring! No wonder hundreds of thousands of people have taken up music this easy way. No wonder enthusiastic letters like those reproduced here pour in from all over the world.

Sound interesting? Well, just name the instrument you'd like to play and we'll prove you CAN! (Instruments supplied when needed. Cash or Credit.) Mail the coupon or write. Do it now! 52nd year.

**U. S. SCHOOL OF MUSIC  
710 Brunswick Bldg.  
New York 10, N. Y.**



**Learned Quickly at Home.** "I didn't dream I could actually learn to play without a teacher. Now when I play for people they hardly believe that I learned to play so well in so short a time." \*H. C. S., Calif.

Music is the magic key to friendship, fun, romance. The person who can play a musical instrument is always sure of a welcome. Why not let music open up a new world for you. Thousands have discovered unexpected pleasure and profit in music, thanks to the unique method that makes it so amazingly easy to learn.

**Send for FREE Booklet and  
Print and Picture Sample**

See for yourself how this wonderful self-instruction method works. Sit down, in the privacy of your own home, with the interesting illustrated booklet, "How to Learn Music at Home." No salesman will call—decide for yourself whether you want to play this easy way.



**WELL WORTH MONEY**

"The course is fully self-explanatory. When one is finished with it there is little one need learn. It is well worth the money and I fully believe you have the finest course on the market today." \*R. E. G., Clarksburg, W. Va.



**INVITED TO PARTIES**

"Before I took your course I didn't know one note of music. Then three months later I started to play for dances. I've been invited to many parties. The course is easy and interesting." \*R.M., Vancouver, B.C.

\*Actual pupils' names on request.

Pictures by Professional models.

**U. S. SCHOOL OF MUSIC  
710 Brunswick Bldg., New York 10, N. Y.**

I am interested in music study, particularly in the instrument indicated below. Please send me your free booklet, "How to Learn Music at Home" and the free Print and Picture Sample.

- |                 |                  |                  |
|-----------------|------------------|------------------|
| Piano           | Pipe, Reed Organ | Modern           |
| Guitar          | Tenor Banjo      | Elementary       |
| Hawaiian Guitar | Ukulele          | Harmony          |
| Violin          | Clarinet         | Mandolin         |
| Piano Accordion | Trombone         | Practical Finger |
| Saxophone       | Flute            | Control          |
| Trumpet, Cornet | Piccolo          |                  |

Mr. \_\_\_\_\_ Have You  
Miss \_\_\_\_\_ This Instru.?  
Mrs. \_\_\_\_\_ (PLEASE PRINT)

Address \_\_\_\_\_

City \_\_\_\_\_ State \_\_\_\_\_

Note: If you are under 16 yrs. of age, parent must sign coupon.

SAVE 2c—Stick coupon on penny postcard.

**FREE** get it Now—

**ALLIED'S 1951 TV  
and RADIO CATALOG!  
212 Pages of BIG VALUES**

**EVERYTHING  
IN RADIO  
AND TV AT  
LOWEST PRICES**



**EVERYTHING FOR EXPERIMENTERS,  
BUILDERS, AMATEURS, SERVICEMEN,  
ENGINEERS, SOUNDMEN**

Save money on every Radio and TV need! Get the big 212-page 1951 ALLIED Catalog featuring the world's largest stocks of top-quality equipment at low, money-saving prices! See the latest TV releases, home radios, radio-phonos, Amateur equipment, P.A. systems and Hi-Fidelity Custom Sound, recorders, test instruments, builders' kits—plus thousands of parts, tools, books and diagrams. Get more for your money from the World's Largest Radio Supply House. Send today for your FREE new 212-page 1951 ALLIED Catalog!



P. A. SYSTEMS, RECORDERS

**ALLIED RADIO**.....

833 W. Jackson Blvd., Dept. 5-KK-0  
Chicago 7, Illinois  
 Rush FREE 212-Page ALLIED Catalog.

**FREE  
CATALOG**

Name.....  
Address.....  
City.....Zone.....State.....

**PLATING  
WITHOUT  
ELECTRICITY**



Now you can PLATE metals WITHOUT ELECTRICITY! No batteries, no rectifiers, no gadgets, no long waiting... plating takes only a few minutes! New book tells you how EASY it is to plate with GOLD, SILVER, PLATINUM, COPPER, TIN, ZINC, LEAD, etc. Also IRIDESCENT PLATING, antique finishes and many METAL-CHROMES—PLATING IN COLORS! Also make silver and copper mirrors! Full details, formulas and simplified instructions in SURPRISING new book—"PLATING WITH AND WITHOUT ELECTRICITY". Book also contains valuable section on PLATING WITH ELECTRICITY, building electroplaters and important section on plating BABY SHOES! POST-PAID, ONLY \$2.00

**FREE!**

A package of genuine 100% SILVERPLATING compound will be included FREE with each book to demonstrate the remarkable process described in part one, "PLATING WITHOUT ELECTRICITY".

BELLE HAVEN BOOK CO. (Dept. C-10), P.O. Box 606, Redwood City, Calif.

**New Way to Improve YOUR ENGLISH**



A command of effective English gives you added advantages and better opportunities. Poor English handicaps you more than you will ever realize. You can improve your English through Sherwin Cody's 100% self-correcting invention. If you are embarrassed by mistakes in grammar, spelling, punctuation, or pronunciation, this new free book "How You Can Master Good English in 15 Minutes a Day" will prove a revelation to you. Send for it now. It is free. No obligation. No agent will call. Address SHERWIN CODY COURSE IN ENGLISH, 510 B&O Building, Rochester 14, N. Y.

**BALL & BEARINGS DESIGNERS  
ROLLER HOBBYISTS**

3/16" to 9/16" Shaft Sizes—3/4" to 1 5/8" Outside Diam.

SMALL ASS'T—18 NEW BRGS. 2 or more each size. Original cost \$44.50.....	JUMBO ASS'T—100 New BRGS. 4 or more each size. Original cost \$247.....
<b>\$3.50</b>	<b>\$17.50</b>
P.Pd. cost \$247.....	P.Pd.

SPECIAL SIZES AVAILABLE ON REQUEST—LOW COST TO REPAIR SHOPS

**UNITED BEARING CO., INC.** 1407 THIRD AVE. SO. MINNEAPOLIS, MINN.

**K-R-O  
KILLS  
RATS**

• K-R-O BIS-KITS are ready-made, easy to use; containing fortified red squill, they're safer around livestock, pets, and poultry. K-R-O POWDER is 100% fortified red squill; economical to use in badly infested areas when mixed with natural baits. BIS-KITS, 35c and \$1.00; POWDER, 75c at drug, seed, and feed stores. Money-back guarantee. The K-R-O Company, Springfield, Ohio.

# Look what you can become IN 12 MONTHS



## In 12 months become an **ELECTRO TECHNICIAN**

You step into the vast electrical industry which anticipates **TRIPLING** its power load in 15 years. Thousands of qualified specialists have been trained here for specific occupations within this essential, fascinating field.



## In 12 months you become an **ELECTRONIC TECHNICIAN**

You enter a field of tremendous growing importance to the strength and welfare of the nation. This world-famous course specializes in Industrial Electronics. It can represent two-thirds of the Radio-Television\* program (below, left).

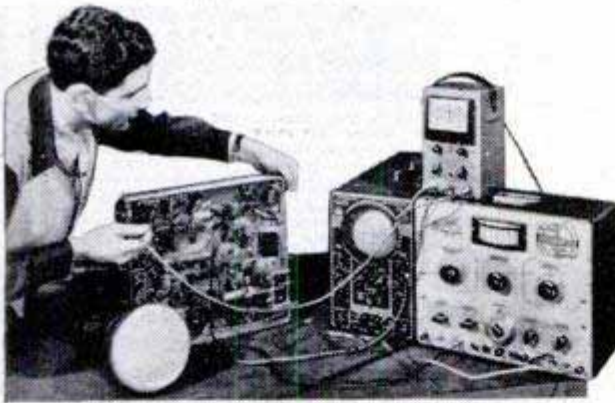

## \*In 6 additional months, become a **RADIO-TELEVISION TECHNICIAN**

TV requires men trained through an intensive, thorough course such as offered here, under the personal guidance of specialists. It is academically possible for the Electronic Technician to complete this course in six months of study.

Write today for the free "Combination Catalog and Occupational Guidance Manual".



## MILWAUKEE SCHOOL of ENGINEERING

Technical Institute • College of Electrical Engineering

**T**HE Technician courses described here are complete in themselves. If you must leave school after finishing these short courses, you are already equipped for important assignments and opportunities. Also, you can continue your Electrical Engineering studies in this College at any time. The Technician can achieve his B.S. degree in 24 additional months, majoring in Electronics or Electrical Power.



### OTHER COURSES

**IN 6 MONTHS** earn occupational certificates in • Practical Electricity • Practical Welding • Refrigeration or Heating Service

**IN 24 MONTHS** become a Refrigeration, Heating and Air Conditioning Technician

Faculty of 85 specialists.  
1555 enrolled from 48 states  
and 23 foreign countries.  
Alma mater of 35,000.

Military, practical or prior  
academic training evaluated  
for advanced credit.

**TERMS OPEN JANUARY,  
APRIL, JULY, OCTOBER.**

**MILWAUKEE SCHOOL OF ENGINEERING**  
Dept. PM-1050, 1020 N. Broadway, Milwaukee, Wis.  
Rush free "Combination Catalog and Occupational  
Guidance Manual" on the following course:

.....  
Name..... Age.....  
Address.....  
City..... Zone... State.....

Check if World War II Veteran

# Learn ELECTRIC APPLIANCE REPAIR IN YOUR SPARE TIME AT HOME



**ONE BUSINESS THAT IS NOT EFFECTED by STRIKES, DEPRESSIONS OR POLITICS**

## START YOUR OWN BUSINESS

WITH A POTENTIAL MARKET OF 50,000,000 CUSTOMERS

New shop-method, home-training system gives you electrical know-how that used to take years to learn. Learn at home by building valuable testing kits, repairing your own and neighbors' appliances. It is not unusual for appliance repairmen to charge on the basis of \$5.00-\$6.00 an hour.

### FREE ILLUSTRATED BOOK

Shows you how you learn every phase of electrical appliance. How to make money while you learn. Write today for your FREE copy.

**CHRISTY TRADES SCHOOL**  
Dept. D-8603  
4432 North Kedzie Ave., Chicago 25

# SPEED AND POWER Handbook

50 CHAPTER LIBRARY EDITION

Build Fast Stock Cars! California Roadsters! 160 MPH Rods! Covers Crosleys to Cadillacs—all makes—Authentic—Direct from California!



Photos Drawings 128 ENAMELED PAGES

## SAVE SAVE SAVE

Build your own Dual Manifolds! Superchargers! Hot Cams! Water Injectors! Hi-Compression Heads! Mileage Devices! Get up to ten more miles per gallon! Get racing speed, lightning acceleration, dynamic power increases from any make passenger automobile! Get construction drawings! Tuning techniques! Speed tricks! Economy secrets! Ingenious formulas! Covers "Racing Frames"—"Reciprocating Masses"—"Jet Engines"—"Wheel Geometry"—"Dynamometers"—"Dual Pipes, Gears, Fuels, Porting, Relieving, Lowering! Balancing—50 breathtaking chapters!



Includes "CALIFORNIA CUSTOMIZING"—Diagrams! Newest Ideas! Restyling all makes! Plus 1950 Racing Catalogue. Also, "Economy Manual" and "Alcohol Injection."

**5 ITEMS Postpaid \$1.98**

**SPEED SHOP METHODS**  
300 ILLUSTRATIONS

**NEWHOUSE AUTOMOTIVE INDUSTRIES**  
5805 EAST BEVERLY BLVD. DEPT. B4  
LOS ANGELES 22, CALIF.

## Play GUITAR in 10 DAYS

TRY IT ON MONEY-BACK OFFER!

Staff's Famous Charted Course for the beginner without previous musical knowledge. Popular music quickly learned. 52 Photographic chord charts, diagramed & in musical notation shows exactly how & where to place your fingers; plus 50 HIT SONGS. Play beautiful chords the very first day. Be playing beautiful music in 10 days or get your money back. Send check or money order for \$2.20 & your course will be sent to you postpaid by return mail. Fine Guitars. Free Folder. **STAFF SCHOOL OF MUSIC**, Dept. PM-10, Point Pleasant, N. J.

# LEARN MONEY-MAKING CARTOONING

**IN SPARE TIME—by Easy Picture Chart Method**  
Same Simplified Method that has helped train creators of "Terry & Pirates," "Freckles," "Out Our Way," "Winnie Winkle," "Reg'lar Fellers," "Strange As It Seems," "The Neighbors," and many others. Earn while learning. Send 10c for Picture Chart (to test your ability), and full details. (State age.)  
**THE LANDON SCHOOL**, 5010 Cleve. Transit Bldg., Cleveland, O.



# LEARN MEAT CUTTING At Home — In Spare Time



Get into the vital meat industry. Concise, practical Home Training based on 25 years proven instruction methods used at National's famous resident school. Prepares you for bigger pay as Meat Cutter, Supervisor, market manager or more money in your own store. Go as rapidly as your spare time permits. Diploma. Start NOW to turn your spare hours into money. Send for FREE bulletin today. No obligation.

**NATIONAL SCHOOL OF MEAT CUTTING, INC.**, Div. U-121, Toledo 4, Ohio

# Become a Doctor of PSYCHOLOGY

Win the degree of Ps.D. Teach the secret of contentment, happiness. Solve mental worries. Experience the revelation of truth. Chartered college. Individual help. Write for FREE book. **COLLEGE OF UNIVERSAL TRUTH**, 5153-B North Clark St., Chicago.

## SAY YOU SAW IT IN POPULAR MECHANICS



— the popular magazine of railroading!

Now you can get the story of America's most fascinating industry, told in words, maps and photos. At your news dealer...

or send 35c for current issue.

**TRAINS Magazine**

Dept. 1546A  
Milwaukee 3, Wis.

# Learn A Trade NOW! PRACTICAL SHOP TRAINING!

- In Our Chicago Shops**
- AUTO MECHANICS
  - DIESEL MECHANICS
  - REFRIGERATION
  - BODY-FENDER
  - WELDING—ARC and GAS
  - MACHINIST
  - PIANO TUNING

Above Approved For G. I.'s and Civilians  
One of America's Leading Practical Schools  
7 Floors of Fully Equipped Shops  
Over 50,000 Successful Graduates  
Expert Individual Instruction  
Learn by Doing—Low Living Expense  
Established 1902—Day and Evening Classes

## Also the following Home Study Courses

- PLASTIC
- REFRIGERATION
- DIESEL

— CALL IN PERSON OR MAIL THIS AD TO —

# GREER SHOP TRAINING

(Desk 10) 460 South State St., Chicago 5, Ill.

Please send without obligation free information regarding trade checked above. (Specify whether you are a Veteran  or Civilian )

Name \_\_\_\_\_ Age \_\_\_\_\_  
Address \_\_\_\_\_  
City \_\_\_\_\_ State \_\_\_\_\_

**MONEY BACK**  
If Not Delighted  
in 10 Days  
WEAR AT OUR RISK

**AMERICA'S BEST WATCH VALUES**  
PRACTICALLY WHOLESALE DIRECT TO USER

ORDER WITH CONFIDENCE  
**5 YEAR WRITTEN  
GUARANTEE**

**17 JEWEL SELF WINDING**  
ORIGINALLY \$71.95 WHILE STOCKS LAST  
NOW ONLY **\$24.95**

Watch that winds itself! Latest improved self winding lever movement. Keeps 40 hours reliable time after few hours wear. Waterproof. Shock built. Non-magnetic. Accurate. Professional sweep second hand. Now only \$24.95 plus \$2.50 tax. Order now. Lowest price in U.S.A. for a watch of this quality. Compare!



**BULOVA**  
MEN'S OR WOMEN'S

**15 or 17 JEWEL movement**



Originally Sold up to ~~\$59~~

OUR PRICE ONLY **\$16.95**  
Plus \$1.70 Tax

- Also
- BENRUS
  - GRUEN
  - WALTHAM
  - or ELGIN WATCHES

WAR OR NOT!  
WE'RE NOT RAISING OUR PRICES!

Genuine Bulova, Benrus, Gruen, Waltham, Elgin and other famous wrist watches in latest style Yellow Gold Cases. You get these unredeemed 5-year Guaranteed FAMOUS MAKE WATCHES now at truly enormous savings because we bought out SURPLUS STOCKS of leading New York and Maryland Jewelers. Order now while they last. State make preferred. Order men's or ladies'. Only \$16.95 plus \$1.70 tax. Order now.

**17 JEWEL 2 Push BUTTON CHRONOGRAPH**

Thousands Sold at \$71.50

- WRIST WATCH While Stocks Last.
- STOP WATCH NOW ONLY
- TELEMETER
- TACHOMETER **\$24.95**

Precision 4-in-1 timepiece for professional scientists, aviators, engineers, sportsmen, etc. Nationally advertised. 3 multi-function dials automatically coupled. 30 min. register. Synchronized for hrs., min., seconds, 1/5 seconds. Luminous. Instructions included. Unbreakable crystal. Only \$24.95 plus \$2.50 tax. Order now.



**2 PUSH BUTTON PLATED YELLOW GOLD CHRONOGRAPH**

LOOKS LIKE A \$25 WATCH

Sweep second hand. Measures speed of cars, planes, horses, heart, etc. Combined time-piece, stop-watch, telemeter, tachometer. Perfect for Sportsmen, Boys, Young men. Shock-Resist Movement. Radium Dial. Leather Strap. Instructions enclosed. Only \$6.95, plus 70c tax.



**17 JEWEL SHOCK PROTECTED WATER RESIST**

While Stocks Last.

ORIGINALLY \$59.00

OUR PRICE NOW ONLY

INCABLOCK Handsome, Accurate. **\$19.95**

Has Sweep Second Hand. Non-Magnetic. Passed 72 hour under water test and met rigid standards of Armed Forces during last war. Amazing value at \$19.95, plus \$2. Fed. Tax. Order now.



**FREE!** Handsome expansion band included free with your order.

War or No War, There's No Inflation in Our Prices.

Write for FREE Watch & Diamond Ring Catalog. Practically wholesale prices to user direct.

**TRIAL OFFER! WEAR AT OUR RISK! Money back if not delighted!** ORDER DIRECT FROM THIS AD, FOR SELF AND FOR THRILLING GIFTS. Lowest prices ever, for these guaranteed watches! Order now on famous 5-year written guarantee. Send only \$1 down payment with order. Pay balance to postman on arrival plus postage. Or we pay postage if you enclose full payment plus tax with your order.

MARYLAND DISTRIBUTORS, Dept. 176, 501 E. Baltimore St., Baltimore 2, Md.

**HOMESITES \$300 LOW TERMS**

In California's loveliest Garden Spot, on scenic shores of beautiful Morro Bay. Enjoy future independence with excellent soil, soft water, wonderful fishing, hunting, boating, bathing, etc. Grow fruits, vegetables, poultry. Perfect temperate climate. Congenial community. Finest investment. Free literature.

**RICHARD S. OTTO**

DEPT. M SAN LUIS OBISPO, CALIFORNIA

**LAW FREE BOOK**



Your FREE copy of "The Law-Trained Man" shows how to gain prestige and greater earnings through Blackstone home law study. All instruction material furnished including 18-volume Law Library written by 65 well-known law authorities. Lawyers, judges among our graduates. LL.B. degree. Low cost; easy terms. Write today.

**BLACKSTONE COLLEGE OF LAW** 225 N. Michigan Ave. Dept. 57, Chicago 1, Ill.

A Correspondence Institution Founded in 1890

SAY YOU SAW IT IN POPULAR MECHANICS

NEW  
**Penmanship**

HOME INSTRUCTOR

Shows step by step how you can learn to write. Also keeps record of your progress. Only \$2.00 for complete course. SEND TODAY!!!

The Zaner-Bloser Co.  
Columbus 8, Ohio

Please send a copy of L. O. P. Enclosed is \$2.00 in stamps, check or postal note.

Name \_\_\_\_\_  
Address \_\_\_\_\_  
City \_\_\_\_\_ State \_\_\_\_\_

**EARN SPARE CASH AT HOME!**

.. start up your own welding business

**BE THE WELDER IN YOUR NEIGHBORHOOD**

Cash in on profitable handy-man jobs like repairing torn fenders ... remodeling bodies for hot-rod fans ... also fix toys and garden tools ... braze and solder broken metal parts ... even charge batteries. It's easy now with the

**NEW "LINCWELDER 60"**

Low in price • Easy to use.  
Lincoln Arc Welder

- Plugs into 110 volt AC appliance socket.
- Easy to weld, cut, braze or solder.
- Approved by Underwriters Laboratories.
- Built by The Lincoln Electric Company, world leader in arc welding.



PRICE ONLY **\$48.00**

including freight in U. S. A.

Complete instructions furnished with each "Lincwelder 60"

Fill out order and mail to  
The Lincoln Electric Co., Dept. 195, Cleveland 1, O.

Ship me the "Lincwelder 60" with accessories \$48.00

Enclosed is  check  money order

Send me free bulletin on the new "Lincwelder 60"

Name \_\_\_\_\_  
Address \_\_\_\_\_  
City \_\_\_\_\_ State \_\_\_\_\_

# EARN MORE IN DRAFTING



More Opportunities for Employment and Promotion

"Here I am at work making good money as a draftsman. I'm glad I sent the coupon to Chicago Tech for that Free Trial Lesson and found out how easy it is to learn Drafting in spare time at home. Today I feel secure in my job because the draftsman's work comes first on any new project. And, in addition, draftsmen can't be replaced with machines. What's more, I feel I'm slated for promotion and more pay, because I see so many draftsmen advancing to high-pay jobs."

## LEARN IN SPARE TIME—AT HOME!

(or at the College in Chicago)

A few hours of pleasant home study every week—that's all. No interference with your present job. All the tools you need; drawing outfit included. With Chicago Tech's help, you train yourself step by step. This tested method—developed over 46 years of C.T.C. progress—prepares men quickly for good positions in industry.



### FREE INFORMATION—SEND COUPON

To prove to you how easy it is to learn Drafting at home by the Chicago Tech method, we will send you this FREE TRIAL LESSON. No charge for this lesson, now or later. Fill out and mail coupon, or send post card today.

## CHICAGO TECHNICAL COLLEGE

N-213 Tech Bldg., 2000 So. Michigan Ave., Chicago 16, Illinois

Mail me FREE Lesson with information about big opportunities in DRAFTING.

Name \_\_\_\_\_ Age \_\_\_\_\_

Address \_\_\_\_\_

City \_\_\_\_\_ Zone \_\_\_\_\_ State \_\_\_\_\_

## BIG PAY JOBS for men who qualify in DIESEL



**ASSURE YOUR FUTURE.** Steady, high-pay jobs await men qualified in Diesel, Tractor, and Heavy Equipment. Are you qualified for job and advancement opportunities in this fast-growing field? You can qualify!

**COMPLETE DIESEL COURSE NOW AVAILABLE.** If you are ambitious and want to get ahead in this big money field, you'll want to know about the complete Diesel home training course now offered by Interstate Training Service. Covers all phases of operation, repair, service. Easy to master in spare time. No interference with present job. Up-to-the-minute. Regularly revised to cover new developments. We invite comparison of material offered. Placement advisory service comes with course.

**PLANNING TO ENTER SERVICE?** I.T.S. home training can help you qualify for specialized military training and higher rating!

**YOU OWE IT TO YOURSELF** to investigate Interstate Training Service Diesel Training. Thousands agree it has helped them to better jobs... better pay. It can do the same for you!

WRITE FOR FREE INFORMATION TODAY

INTERSTATE TRAINING SERVICE, Portland 13, Ore.  
Please see that I receive FREE 24-page book, "Getting Ahead in Diesel." (3-K)

NAME \_\_\_\_\_ AGE \_\_\_\_\_

ADDRESS \_\_\_\_\_

CITY \_\_\_\_\_ ZONE \_\_\_\_\_ STATE \_\_\_\_\_

## CHRONOGRAPH WRIST WATCH

\$7.90

Plus Tax



Lifetime Guarantee

(EXCLUSIVE OF PARTS)

3 DIALS—5 HANDS—2 BUTTONS

Multi-purpose watch that measures distance, speed, time, moving objects. Used as Stop Watch or Timepiece. Has Sweep-Second Hand for full 60 Second count. Second Dial records up to 45 minutes. Third Dial then records up to 6 hours. Seconds—Minutes—Hours, all recorded automatically.

### INDEPENDENT MOVEMENTS

The movement of this fine Swiss Made watch continues to run when sweep hands are stopped. For sportsmen, professional men and women—time-keeper works when other hands and dials are stopped—separate movements permit dual use at same time.

### RUGGED CONSTRUCTION

Precision workmanship and shock resistant features are added to enhance the value of this watch. Sold elsewhere for as high as \$17.00. Our low introductory price is only \$7.90 plus 10% tax. (Total \$8.69). Send check or money order and we prepay postage. Or sent C.O.D. plus charges. LIMITED STOCK!

MARDO SALES CO., 480 Lexington Ave., Dept. C-118, N.Y. 17, N.Y.



## SILVER SOLDER TORCH & KIT \$6

JOINS ALL METALS PERMANENTLY

Do your own repairing. KIT includes one tube silver solder flux and 10 5-in. lengths silver solder alloy. Hottest ALCOHOL TORCH known. 2700° F. flame. Operates in any position, indoors or out. Torch alone \$5. KIT alone \$1.50. AMERICAN PRODUCTS CORP., 422 S. Dearborn St., Chicago 5, Ill.

## WHY DON'T YOU WRITE?

Writing short stories, articles on business, sports, homemaking, travel, shop crafts, local and club activities, etc., will enable you to earn extra money. In your own home, on your own time, the New York Copy Desk Method teaches you how to write the way newspaper men learn—by writing. Our unique "Writing Aptitude Test" tells whether you possess the fundamental qualities essential to successful writing. You'll enjoy this test. Write for it, without cost or obligation.

Veterans: Course approved for Veterans' Training.

### NEWSPAPER INSTITUTE OF AMERICA

SUITE 5590-S, ONE PARK AVENUE, NEW YORK 16, N. Y.



## This NEW TYPE ACCORDION

is much easier to play

You can even learn to play it by yourself. For free information write to:

HUNIBEL ACCORDIONS  
5154 N. Clark St., Chicago 40, Ill.

## TRADE MAGAZINES

BUSINESS, VOCATIONAL, DIVERSION

Current copies, all fields, through our easy-to-get-acquainted plan. Send now for List. It's free.

COMMERCIAL ENGRAVING PUBL. CO., 348 No. Ritter, Indianapolis 19, Ind.

it's fun to earn

### RAISING HAMSTERS

Cash in on the growing demand for SYRIAN GOLDEN HAMSTERS recently introduced into the U. S. Ideal pets... big laboratory demand. Hardy, clean, odorless. Easily and profitably raised anywhere.

### AKOPIAN HAMSTERY

the largest in the West

7358 H VARNA AVE. • NORTH HOLLYWOOD, CALIF.



write for FREE booklet

## SAY YOU SAW IT IN POPULAR MECHANICS

"It Measures As It Rolls"

### ROLLER RULE

HANDY MECHANICAL PENCIL

Measures Curves and Straight Lines. Any Shape. Any Distance. Any Surface.

\$1.00 POST PAID

Roll head over surface. Inches and fractions record accurately on "Inch-O-Meter". Excellent pencil too! Order Now! 10 Day Money Back Guarantee! C.O.D. (postage extra). In Calif. add 3% Sales Tax.

### PENCIL SALES CO., Dept. PM10

Room 6, 1213 E. Ocean Blvd., Long Beach, California

# STEVAN DOHANOS

FAMOUS COVER ILLUSTRATOR SAYS:

## "you can be a successful artist!"



### America's 12 Most Famous Artists Show You

Norman Rockwell • Al Parker • Jon Whitcomb  
 Ben Stahl • Stevan Dohanos • Robert Fawcett  
 Harold von Schmidt • Peter Helck • Austin Briggs  
 John Atherton • Fred Ludekens • Albert Dorne

It's just a question of training by professionals. Now America's 12 most famous artists have perfected a method of showing you our secrets and short-cuts at home, in your spare time.

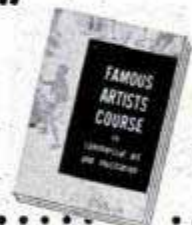

Send for FREE illustrated booklet—today!

### FAMOUS ARTISTS COURSE

Dept. J-6, Westport, Conn.  
 Please send book about Famous Artists Course.

FREE

Mr. Mrs. Miss .....  
 Street .....  
 City, Zone, State .....  
 Phone No. .... Age .....

## BE A PHOTO-ENGRAVER

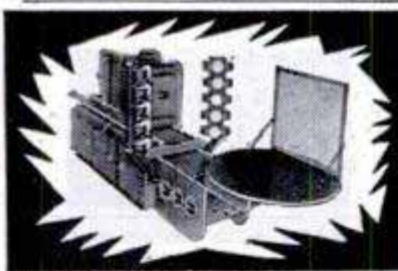

We furnish complete equipment and supplies. Learn at home or in our modern, friendly APPROVED school in MISSOURI. Get into this big demand, high profit, high wage field. You can start your own profitable, full time or part time PHOTO-ENGRAVING business right in your own home.

Be independent, be your own boss or pave the way to a high pay job with experience gained in your own shop.

TASOPÉ TRAINING and TASOPÉ EQUIPMENT has enjoyed world wide recognition since 1931. Write for descriptive literature today. No obligation.

THE AURORA SCHOOL OF PHOTO-ENGRAVING, DEPT. 9PM., TASOPÉ BLDG., AURORA, MO.

## LEARN MEAT CUTTING AT NATIONAL

Pay After Graduation



The steady dependable trade of Meat Cutting taught easily in 8 short weeks. YOU LEARN BY DOING under actual meat market conditions in big modern school at Toledo.

For beginners or men with experience. Get a profitable store of your own. Remember, PEOPLE MUST EAT! Big pay jobs. Free employment help. Thousands of successful graduates.

Buying, cutting, percentage, pricing, advertising, selling, etc. A complete retail meat education. National School established over 25 years. Get National training NOW. Pay your tuition in easy weekly payments

after you graduate. G. I. approved. Send coupon for FREE 52 page school catalog — TODAY.

National School of Meat Cutting, Inc., Dept. 50-K, Toledo 4, Ohio

Send me your FREE school catalog on National Training at Toledo in Meat Cutting, Meat Merchandising and Self Service Meats. No obligation. No salesman will call.

Name \_\_\_\_\_

Address \_\_\_\_\_

City \_\_\_\_\_ State \_\_\_\_\_

( ) Check here if Veteran of World War II



**Put your future  
in your own hands**

# BE AN ARTIST

**Here's the Amazing  
Way We Teach You  
Step-by-Step to Draw  
At Home in Spare Time**

Draw for money. You will enjoy W. S. A. training and can progress rapidly. **COMMERCIAL ART, DESIGNING, CARTOONING** — all in one complete, modern home study course. No previous art experience necessary. We start you from the beginning. Good art jobs available in advertising, television, newspaper and magazine publishing, department stores, art studios, etc. You can become your own boss. For 36 YEARS our graduates have been "making good" — WHY NOT YOU?

**Trained Artists Are Capable of Earning  
\$70-\$100 and MORE a WEEK**

Write for **FREE BOOK**, "Art for Pleasure & Profit" — tells about our course, instruction service, what our graduates say, and the many exciting commercial opportunities for you. **TWO ART OUTFITS** and other features included with training. *Low cost — only \$5 monthly.*

**VETERANS! Course G.I. Approved**

**FREE BOOK gives details!**

**WASHINGTON SCHOOL OF ART, Studio 1210W  
WASHINGTON 5, D. C.**

Please send information and Free Book, "Art for Pleasure and Profit" (Please print name) No salesmen will call.

Name \_\_\_\_\_ Age \_\_\_\_\_  
Street \_\_\_\_\_  
City \_\_\_\_\_ Zone \_\_\_\_\_ State \_\_\_\_\_

## AERONAUTICAL ENGINEERING

Design Aircraft & Components — Study with Jets & Rockets — Great Future — Advanced Aeronautical Subjects — World-Wide Enrollment — Fully Accredited — Established 1929 — Approved for Vets — CAL-AERO grads in heavy demand.  
**WRITE TODAY for Special Information, PM-10**

NAME \_\_\_\_\_ AGE \_\_\_\_\_  
ADDRESS \_\_\_\_\_  
CITY \_\_\_\_\_ ZONE \_\_\_\_\_ STATE \_\_\_\_\_

**CAL-AERO TECHNICAL INSTITUTE**  
GRAND CENTRAL AIR TERMINAL • GLENDALE 1, CALIFORNIA

**CORTINAPHONE Makes It EASY To:  
Speak FRENCH-SPANISH  
GERMAN — ITALIAN — BRAZILIAN**



Count Cortina

**Russian, Japanese**  
**BIG OPPORTUNITIES** await Americans who speak languages. Learn as a child learns—"by listening." The **CORTINA METHOD**, famous for 68 years, teaches you right at home to speak



**VETS**  
FRENCH or SPANISH course available under G. I. Bill State if Veteran

Listen to this Record! GERMAN, ITALIAN, BRAZILIAN, RUSSIAN or JAPANESE as a NATIVE speaks! **FREE BOOK** describes amazing "Cortina Short-Cut" Method, free approval offer. **WRITE TODAY.** State language interested in.

**CORTINA ACADEMY** Dept. 6410, 105 W. 40 Street, N. Y. C.

**YOU'RE THE WINNER!**  
with **POLICE JIU JITSU**



Learn every amazing trick from the man who has trained experts! Brute strength, giant size or bulging muscles will not beat you when the **COMMANDING** knowledge of "POLICE JIU JITSU" is yours!

A complete course, easy to read and master in one illustrated volume... Just pin \$1 to this ad and We will send Police Jiu Jitsu to you **POSTPAID.**

Satisfaction Guaranteed or money refunded.  
**BROOKS PUBLISHING CO.**  
56 W. 24th St., N. Y. 10, N. Y.

**RADIO ENGINEERING, Broadcasting, Television, FM, Servicing, Electronics, Aviation, Marine & Police Radio taught thoroughly.** Engineering course equivalent to 3 years' college radio work. Approved Veteran Training. Catalog free.  
**VALPARAISO TECHNICAL INSTITUTE, Dept. D, Valparaiso, Ind.**

**Watch Repairing Pays Big Money Learn at home**



Watchmakers in great demand. Train step-by-step under experts. We furnish all tools and 15 jewel watch and practice movement. Turn spare time into cash. 10 easy lessons. A licensed school. Low cost. Send for **FREE** book today.

**WATCH REPAIRING** Dept. PM10 2870 Elston Ave. Chicago 18, Ill.

**BE A CRIMINOLOGIST**  
**WORK HOME or TRAVEL. Experience unnecessary.**  
**CRIMINOLOGY** Particulars **FREE.** Write to **GEO. C. R. WAGNER, 125 W. 86th St., N. Y.**

**SHOE REPAIR OFFERS BIG INCOME**  
**LEARN IN 12 WEEKS TIME**

You can own your own shop or earn big income as skilled shoe repairman. Growing demand everywhere at top wages for men who know how. We teach you quickly by actually working on shoes and modern machines. School open to all from 18 to 60 years of age. **FREE BIG 20 PAGE BOOK** explains everything. Send for your copy today. Established 1927.

**MODERN SHOE REBUILDING SCHOOL**  
Chicago and Los Angeles only Approved for Vets Dept. PM  
2937 Belmont Ave., Chicago, Ill. 361-12th St., Oakland, Calif.  
806 So. Figueroa St., Los Angeles 14, Calif.

**ANALYZE Handwriting**

More and more men and women in home and various professions report greater earnings spare time. Home study. Test lesson, **YEAR BOOK** free. No children. **I.G.A.S.,** Witholt Bldg., 507. Springfield, Mo.

Famous Dan Lurie **BARBELLS**

**Only \$7.98**

**AMAZING SAVINGS**  
Free Color Catalog  
Low, low foundry prices! Mail orders filled same day. Write today!  
**DAN LURIE BARBELLS**  
1701-M 10 PITKIN AVE.  
BROOKLYN 12, N. Y. Dept. 159K



**New Advertising Machine**



**Prints & Illustrates 1¢ Post Cards**

**FREE** Learn how thousands of business men, in every line, are boosting sales in spite of conditions—with 1¢ messages—printed and illustrated in a few minutes on gov't post cards—with amazing new patented **CARDMASTER**. Your "today's" ideas, read by your prospects next morning. Not a toy, but a sturdy advertising machine, built to last for years. Low price, sold direct. Guaranteed for five years. Send name today. **SEND NAME** We'll send **FREE** illustrated book of money-making **IDEAS** for your business and complete, unique advertising plans. **RUSH YOUR NAME TODAY.** **CARDMASTER COMPANY** 1920 SUNNYSIDE, Dept. 1310, CHICAGO 40, ILL.

**WHAM-O SPORTSMAN\***

HITS LIKE A .22 RIFLE—KILLS RABBITS, SQUIRRELS. Powerful, silent, accurate. For hunting, target, routing pests. Dealers Write



**HUNTING SLINGSHOT**

Heavy ash hardwood stock. 40 steel balls, extra rubber straps GUARANTEED. Send \$1.00 today to

Wham-O Mfg. Co., Box 92, South Pasadena, Calif. \*The professional model of Nat'l Slingshot Assn.

**LOCKSMITHING & KEYMAKING**  
HOME TRAINING OUTFIT INCLUDES KEY MACHINE, SUPPLIES AND TOOLS TO GET STARTED IN BUSINESS

Professional outfit. Get practical training from Master Locksmiths. Learn to cut keys by code, master locks, change combinations, quickly identify key blanks, many profitable "tricks of the trade." Booklet of Information FREE. Write today. **UNITED SUPPLY & SERVICE, 3327 Madison St., Dept. PM-10, Chicago, Illinois.**



**ILLUSTRATED COMIC BOOKLETS**

THE KIND YOU LIKE!  
(VEST POCKET SIZE)

They are loaded with rare cartoons. Full of Fun and Humor. **20 DIFFERENT** booklets sent prepaid for \$1 in plain sealed wrapper. No C. O. D.'s.

GRAYKO, Dept. 2024, Box 520, G.P.O., N.Y.C. 1

**FIX ANY AUTO - EARN MORE MONEY**



**Get Drake's AUTO REPAIR Manual**

**Latest 1950 Edition Now Ready**

At last! Simplified, up-to-date instruction for tuning-up, adjusting, repairing and over-hauling all the popular makes of cars. Special emphasis on auto engines makes it easy to locate troubles and handle all kinds of ignition, fuel system and carburetor jobs. Get Drake's Automobile Repair Manual today. Thousands of copies of older editions in use everywhere. Newest edition has added pages, added illustrations and information never before in print.

An investment of only \$3.00 will save you time and trouble and make money for you. One repair job will pay for the book many times over. Hundreds of vital subjects covered and made plain as ABC. 439 Pages, 253 Illustrations.

Frederick J. Drake & Co., Dept. 17, 117 Green Bay Road, Wilmette, Ill.



**MONEY BACK IF NOT SATISFIED**

Clip this ad and mail with only \$3.00, currency, check or money order, or we will send C.O.D. Use the book for 5 days. See how easily you can make it pay for itself hundreds of times over. Then if you are not fully satisfied—send it back and we will refund your money quick. Rush your order today. Get started at once.

**PLASTICAST**

THE GREATEST THING IN PLASTICS!



**A NEW HOME INDUSTRY and HOBBY!**



We have started **THOUSANDS** of people in a wonderful new kind of business! Here are 4 reasons why: (1) The work is pleasant and very easy... actually as easy as pouring water out of a glass! (2) **VERY LITTLE** investment is required; imagine, less than \$5.00 is required in order to start you off in your own manufacturing business! (3) Can be started **ANYWHERE**... at home, garage, basement, etc. and most important (4) The things you can make in **QUANTITY PRODUCTION** are not only exceptionally attractive and useful but are always in big demand every season of the year!

**VAST QUANTITIES OF PLASTIC COMPONENTS NOW NEEDED BY ARMED SERVICES!**

**YOU CAN MAKE ANYTHING!**

What is this new business? It is **CASTING**... Casting with liquid plastics. **CASTING** is a method of production manufacturing **WITHOUT MACHINERY OR TOOLS!** **CASTING** is the exceedingly simple process of pouring liquids into molds... it is as simple as that: Like making Jello, only these liquid plastics **SOLIDIFY** in a few minutes after mixing into extremely **HARD, DURABLE** and **ATTRACTIVE** articles such as Jewelry, Novelties, Giftware, Figurines, Statuary, Knick-Knacks, Baby Shoes, Souvenirs, Ceramics, Imitation Marble, Bookends, Lamps, Pen sets, Cigarette Lighters, Toys, Dolls, Banks, Fishing Lures, Tools... **A THOUSAND USEFUL THINGS!** The field is really unlimited. We supply **EVERYTHING**... Casting Materials, Molds, Accessories and Instructions.



**1000 GOLDEN OPPORTUNITIES!**



Regardless what you are doing now you can get into the **CASTING BUSINESS** in your spare time or evenings. We assure you, once you do, you will be eagerly devoting all of your time to this very easy, fascinating and **HIGHLY PROFITABLE BUSINESS** until it leads into a dependable **OCCUPATION** all your own! **BUT LET US PROVE IT.** Send only 25¢ for our big 40 page Catalog of Casting Materials, hundreds of Molds, etc. We will also send you **FREE** an attractive **CASTING** to show you what can be done with liquid plastics in a few minutes! We will also send you **FREE** a valuable book giving you details on the **ART AND BUSINESS OF CASTING** which shows you how to cast and get started! All this for only 25¢, but write for it today. This may be the lucky coin that will start the most fascinating and profitable phase of your life!

**10 VALUABLE MOLDS FREE!**



If you want to get started at once without delay then send for our big **SENIOR PLASTICAST OUTFIT**... here is what you receive! **TEN VALUABLE MOLDS** for making extremely beautiful and useful **TRANSPARENT** crystal-clear or colored plastic articles as illustrated directly above! Make unusual Penholders, Cigarette Lighters, Ash Trays, Perfume Sets, Pendant Hearts, Imbedded Flowers and Photos, Buttons, Key Chain Fobs and countless other attractive items! Outfit also includes 1 qt. **PLASTICAST** liquid casting plastic and hardener which will make about \$100. worth of material, pipette, measuring glass, colorful imbedding material, polishing material, 2 dyes and Instruction Manual. **OUTFIT No. 645, price postpaid \$7.50**

Our **MASTER OUTFIT** contains 4 molds, pint of **PLASTICAST** and hardener, pipette, measuring glass, imbedding material and Manual. **OUTFIT No. 4 Price, postpaid... \$3.50** C.O.D. orders filled (not postpaid) if \$1.00 deposit sent with order.

**FREE**

An attractive Casting and valuable **BOOK** shown at the right sent **FREE** with our Catalog! See 3rd paragraph above.

**PLASTICAST COMPANY (DEPT. C)**  
170 N. Halsted St. (Write to P. O. Box 987  
Chicago 6, Ill. nearest address) Palo Alto, Calif.  
CANADIAN CUSTOMERS, please order directly from: **CANADIAN INDUSTRIAL PLASTICS, LTD.**, 1056 1/2 Pender West, Vancouver, B.C.

Have

# YOUR OWN BUSINESS

This New Easy Way



Real pansy embedded in Castolite



Real Ocean Crab embedded in Castolite



Child photo embedded in Castolite



Baby Shoe Set made of Castolite

## MAKE BIG PROFITS with New Wonder Plastic

With prices jumping—merchandise getting scarce again—now is the time for a smart fellow to start his own spare-time business. Instead of having "all your eggs in one basket," get going on a SECOND SOURCE OF INCOME. Begin at home making swell things with Castolite, the new wonder liquid plastic. Embed real flowers, photos, butterflies, etc. to make costume jewelry, hi-style buttons, fancy coasters, trays, baby shoe sets, book ends, desk accessories—other things that SELL ON SIGHT.

**Quits Job — Now Has Own Business**  
Pat Queen, Mt. Vernon, Wash., started making key chain tags (like one shown here). Queen writes: "My key chain tags have sold fast right from the beginning. I now make several times as much as when I had a job." Others also succeeding far better than they expected.

**Do Big Christmas Business**  
Get FREE Booklet  
Get our "Liquid Magic" folder showing things you can make with Castolite, and a new Booklet "How to Start a Plastic Products Business." Both FREE. Act NOW—to cash in big on orders for Christmas. Rush letter or post card to:  
**The Castolite Co., Dept. L-1, Woodstock, Ill.**

## RADIO ELECTRONICS TELEVISION LEARN AT HOME IN YOUR SPARE TIME!

NOW is the time to prepare for a BIG JOB in Radio-Television-Electronics. Outstanding opportunities for licensed Receiver Servicemen . . . Technicians . . . Airlines Radio Operators . . . Radio-Television Broadcast Operators . . . in America's fastest-growing industries!

YOU can qualify for a big-pay job in Radio-Television . . . have a business of your own . . . get your Federal Communications Commission 1st Class License . . . in your spare time—AT HOME—through Central training.

Find out today what Central can offer you . . . modern lessons prepared and kept up-to-date by RESIDENT SCHOOL INSTRUCTORS . . . big HOME LABORATORY EQUIPMENT KITS . . . free PLACEMENT SERVICE for graduates!

This valuable information costs you nothing. Fill in and mail this coupon today!

**CENTRAL RADIO AND TELEVISION SCHOOLS, INC.**  
Dept. PMO, 1644 Wyandotte St., Kansas City, Mo.

Tell me how I can qualify for a big job in Radio-Television-Electronics. No cost or obligation.

NAME \_\_\_\_\_ AGE \_\_\_\_\_  
ADDRESS \_\_\_\_\_  
CITY \_\_\_\_\_ STATE \_\_\_\_\_

# MAKE BIG MONEY Sharpening Lawn Mowers...

## SPARE OR FULL TIME

**PROOF** "I have had my Universal Grinder only 2 months. Live 1 1/2 miles from town. Yet have already made net profit of \$227." G. Spurlack, Arkansas. "I am doing a fine business with the Universal Grinder. One customer sends another. A 40c newspaper ad produced nearly \$500 worth of business." writes C. E. Hardy of Missouri. "A real machine, works fine on power mowers, too." This from J. H. Fisher, Pennsylvania.



## ONLY ON THE UNIVERSAL LAWN MOWER GRINDER

... can the inside face and edge of the stationary blade, as well as all the reel blades, be ground to proper clearance ALL IN ONE SET-UP, without removing any blade from either hand or power mower. Send today for FREE Facts.  
**ROGERS MFG. CO. Dept. M-100 LINDSEY, OHIO**

*Learn to Write at Home in spare time*

You can easily improve your writing and become an Expert Penman by my Simplified Method at home in spare moments, for your Social and Business Advancement. Write for my FREE BOOK, "How to Become an Expert Penman"—24 pages of information, photographs and specimens that tell how others learned.

**FREE SAMPLES** of Business and Ornamental Writing and Instructions that show how you can learn. Write for the Book, Samples and Details today. They are FREE for your information. Send 10c for Shading Penpoint and your name with flourished bird on a card.  
**T. M. TEVIS, BOX 25K, CHILLICOTHE, MO.**

## HOW to Make Your Own RUBBER MOLDS

Here's a quicker, easier way to make exact reproductions of an object in any quantity. No heat curing required; no shrinking of materials. Objects of clay, plaster, wood, metal, glass or stone-like ashtrays, book ends, medals, souvenirs, plaques, sculpture can be copied exactly right at home! Perfect for reproducing Dresden figurines. No previous experience needed. No special tools required. Our new Brochure 3210 gives exact, step-by-step instructions anyone can follow. Send 10c for it to **SCULPTURE HOUSE, 304 West 42 Street, New York 18, N. Y.**

## GETTING CUSTOMERS BY MAIL

easy when one knows how . . . Look this up. Revealing particulars free. Write today.  
**HOWARD HOUSE**  
Melrose 76-634 Massachusetts

**HOW TO BREAK and TRAIN HORSES**

**SEND FOR THIS FREE!**

Make money. Know how to break and train horses. Write today for this book FREE, together with special offer of a course in Animal Breeding. If you are interested in Galting and Riding the saddle horse, check here ( ) Do it today—now.

**BEERY SCHOOL OF HORSEMANSHIP**  
Dept. 11010-D Pleasant Hill, Ohio

## SCREWMIX—BEARINGS

Mixed screws & metal screws—30c Lb.	Bore	O.D.	Type	Price
Mixed wood screws—Mixed washers—Mixed cotter pins—30c Lb.	3/16"	1/2"	Needle	15c
Mixed nuts—Mixed aluminum rivets—50c Lb. Mixed steel rivets—20c Lb.	1/4"	5/8"	Needle	15c
<b>BARGAIN OFFER (\$2.40 value) one lb. each of above 7 mixtures—\$1.95</b>	5/16"	3/4"	Ball	22c
<b>POSTAGE Screw Mix, Add 5c per lb. POSTAGE Bearings, Add 10c per order, Minimum order \$1.00</b>	3/8"	7/8"	Ball	35c
	1/2"	1 1/4"	Ball	40c
	5/8"	1 1/2"	Ball	40c
	3/4"	1 3/4"	Ball	40c
	1"	1 3/4"	Needle	20c
	1 1/8"	1 3/4"	Needle	28c

**JAY-CEE SALES CO., 4517 Grand River Ave., Detroit 8, Michigan**

## SAY YOU SAW IT IN POPULAR MECHANICS

**LIKE SAWING A WOMAN IN HALF**

Here is a miniature version of that famous trick of sawing a woman in two, as performed by Thurston, Orson Welles, other magicians. This pocket-size illusion does the same with your finger. Apparently passing thru the finger and cutting a match or cigarette in two! Amazing trick, fools everybody. Simple, easy to do, no sleight of hand required. Colorful plastic. Have fun! Order today. Postpaid.

**\$1**

**SEDGHILL INDUSTRIES, 1120-B Sedgwick St., Chicago 10**

"I Have Earned an Average of  
**\$15<sup>20</sup> AN HOUR**"

with Science's New Midget Miracle,  
 the PRESTO Fire Extinguisher



Says William F. Wydallis, Ohio.  
 Many Others "Cleaning Up"—So Can YOU!



**A**MAZING new kind of fire extinguisher. Tiny "Presto" (about size of a flashlight!) does job of bulky extinguishers that cost 4 times as much, are 8 times as heavy. Ends fires fast as 2 seconds. Fits in pa'm of hand. Never corrodes. *Guaranteed forever!* Sells for only \$3.98!

Show it to owners of homes, cars, boats, farms, etc.—make good income. H. J. Kerr reports \$20 a day. C. Kama, \$1,000 a month. Write for FREE Sales Kit. No obligation. **MERLITE INDUSTRIES, Inc., Dept. 510, 201 East 16th St., New York 3, N. Y.** (If you want a regular Presto to use as a demonstrator, send \$2.50. Money back if you wish.)

Science's New Midget Miracle "PRESTO"

## DISTRIBUTORS—EXCLUSIVE for Amazing Talking Santa Claus

Exclusive territory will be allotted to reliable and responsible people. Send \$1.00 for sample. Start now for Christmas. *Big profits.* Write Calidor Products, Dept. P, 1585 Church St., San Francisco 14, Calif.

## WHEELS — WHEELS

5" Disc Wheel	5/8" Tire	5/16" or 3/8" sleeve	30c ea.
6" Disc Wheel	5/8" Tire	5/16" or 3/8" sleeve	35c ea.
7" Disc Wheel	3/4" Tire	3/4" sleeve	45c ea.
8" Disc Wheel	1 1/2" Tire	1 1/2" sleeve	70c ea.
7" Disc Wheel	1" Tire	1 1/2" ball bearing	80c ea.
8" Disc Wheel	1 1/8" Tire	1 1/2" ball bearing	\$1.00 ea.
8" Disc Wheel	2" semi-pneum.	T. 1 1/2" B.B.	\$1.35 ea.
10" Disc Wheel	1.75 semi-pneum.	T. 1 1/2" B.B.	\$1.50 ea.
12" Disc Wheel	1.75 semi-pneum.	T. 1 1/2" B.B.	\$1.85 ea.

Above wheel prices include hub cap  
 Plus postage. 20% — C.O.D.'s accepted

**UNITED WHEEL STAMPING CO., PM-10**  
 2756 W. 115th STREET CHICAGO 43, ILLINOIS

## Learn PHOTOGRAPHY

There's big money in PHOTOGRAPHY—and an action-packed career for you. Our HOME STUDY COURSE is your spare-time SHORT CUT TO SUCCESS! Or, if you wish—PERSONAL ATTENDANCE TRAINING at our famous New York School is available with subsistence under the G. I. Bill. Our 40th year Write immediately!

**NEW YORK INSTITUTE OF PHOTOGRAPHY**

Dept. "49," 10 West 33 Street, New York 1, N.Y.

## WATCH REPAIRING

### Be A Master Watchmaker

Large earnings and a steady secure future can be yours as a Master Watchmaker! The famous Sweazey System teaches you how . . . expertly, quickly, successfully . . . at home or in our modern, fully-accredited school. Also resident training in Engraving and Gem Setting.

#### FREE BOOKLET

Write today for your free copy of "Civilization's Debt to the Watchmaker." No obligation.

## CHICAGO SCHOOL OF WATCHMAKING

Famous Since 1908

Dept. 1100, 1608 N. MILWAUKEE AVE., CHICAGO 47

Hundreds of Ways for Mechanics and Car Owners to Save Money!

ALL POPULAR MAKES 1938 TO 1950 INCLUSIVE

**Auto Repair Kinks** by Bill Toboldt Editor Motor Service Magazine

Only \$3.00

## AUTO REPAIR KINKS

TIME AND MONEY-SAVING IDEAS

by Bill Toboldt

TUNE-UP TROUBLE-SHOOTING ALL POPULAR MAKES



FOR CAR OWNERS. MECHANICS

## NOW... Auto Tune-Up—Trouble Shooting—MADE EASY!

20 POPULAR CARS

Complete Mechanical and Tune-Up Specifications —1938 to 1950 Models Inclusive:

Buick	Cadillac	Chevrolet
Chrysler	Crosley	DeSoto
Dodge	Ford	Frazer
Hudson	Kaiser	Lincoln
Mercury	Nash	Oldsmobile
Packard	Plymouth	Pontiac
Studebaker	Willys	

Besides, there's a gold mine of information on How to Step up Speed and Power, How to Increase Fuel Economy, Causes and Cure of High Oil Consumption, Correcting Tire Wear and Steering Troubles, Locating Engine Knocks Quickly. **AUTO REPAIR KINKS** is crammed full of up-to-the-minute ideas, short cuts, professional secrets. As an editor for over 25 years, Toboldt has answered successfully, thousands of questions that have puzzled motor car men. Many of the answers to those puzzling questions are contained in this book. Only \$3.00.

## Other Money-Making Books

**AUTOMATIC TRANSMISSIONS SIMPLIFIED.** Right up to the minute. Covers Hydra-Matic, Dynaflo, Ultramatic, Powerglide, Gyro-Matic, Tip Toe Shift, Simplicomatic, Vacumatic and all other transmissions. Tells how transmissions work; how constructed; what goes wrong; how to locate trouble and service all types. Only \$4.00.

**AUTO REPAIR KINKS.** As described above.....\$3.00

Dyke's Auto Encyclopedia (New 1950 Ed.).....	\$7.50	Bailey's Handbook for Engineers and Firemen.....	2.00
Automotive Service Management.....	5.00	Vocational Mathematics (Shop Arithmetic).....	1.25
Dykes' Carburetor Book.....	3.50	Sheet Metal Die Design.....	2.25
Modern Electric & Gas Refrigeration (New 1950 ed.).....	5.00	Airplane Welding.....	3.50
Modern Welding Practice.....	4.00	Aircraft Flight Instructor.....	2.50
House Wiring.....	3.00	Electronic Television.....	2.50
D. C. Power Wiring.....	4.00	Electroplating.....	2.75
Plumbing and Pipe Fitting.....	2.50	Fractional Horsepower Motor Maintenance.....	3.75
Sheet Metal Layout.....	3.50	Upholstering Home Furniture.....	3.75
The Storage Battery Simplified.....	3.00	Standard Auto-Electrician's Manual.....	17.50
		40 Power Tools You Can Make.....	1.50

**SEND NO MONEY.** Use this ad as your order blank. Check titles wanted, clip and mail. Pay postman on delivery. If remittance is sent with order we will ship postpaid. Either way—your MONEY BACK if not satisfied.

**GOODHEART-WILLCOX CO.** Dept. 139, 1321 S. MICHIGAN AVE., CHICAGO 5

## DIESEL MECHANICS NEEDED BIG PAY . . . GOOD FUTURE



If you have no trade or profession that assures you steady employment and top pay through good times or bad, and regardless of whether you want to be a mechanic, technician, salesman, executive — or have your own profitable shop—you should investigate NOW this opportunity to enter world-famous Bailey Diesel Schools. Prepare yourself, this proven way, for an important place in the fast growing field of Diesel.

### Why Gamble With Your Future!

Your future success depends largely on the reputation of the school you attend. Don't take chances! Train at Bailey's—America's foremost school of diesel training. Approved by Missouri State Board of Education. Approved, also, for G. I. Training. Full details FREE. Return coupon below NOW.

### MAIL TODAY FOR FREE CATALOG

BAILEY DIESEL SCHOOLS  
1656 So. Grand Blvd., St. Louis, Mo.  
Please Send Me Your FREE Catalog.

Name .....

Address .....

Town ..... State .....

Veteran  Non-Veteran

Resident Training  Home Study



# Learn DRAFTING and BLUE PRINTING!

Both fields offer ambitious men remarkable opportunities for advancement. Neither profession will ever be replaced by machines. Before any production can start, plans must be drawn. Draftsmen are the first to be hired. Blueprints are essential in every shop.

#### CLEAR UNDERSTANDABLE TRAINING

Quickly you learn the hows and whys of successful production planning. You are sent professional drafting instruments, drafting table, equipment, etc., at no extra cost. Learn by making actual drawings.

#### BIG MONEY . . . ADVANCEMENT OPPORTUNITIES

Offered trained draftsmen. It is light, pleasant work paying big salaries. Drafting is the stepping stone to top managerial jobs. It is work that stimulates the mind . . . keeps one interested.

#### A BUSINESS OF YOUR OWN

Either as an independent drafting firm or as the operating head of a business firm producing products you created. Act now.

## MAIL THIS COUPON TODAY!

CHRISTY TRADES SCHOOL, Dept. DB-203  
4432 N. Kedzie Ave., Chicago 25

Mail me at once your big FREE book on Drafting and Blue Printing. Tell me how your Home Training and Professional Drafting Instruments, Drafting Table, Drafting Equipment, etc. can be had on PAY AS YOU LEARN plan.

Name ..... Age .....

Address ..... City ..... State .....

## PERSONAL RUBBER STAMP

YOUR NAME AND ADDRESS OR OTHER WORDING

PAD & HOLDER  
IN ONE UNIT!

Complete \$1

YOUR NAME AND ADDRESS, or any 3 lines of wording

If you want to fit space  $\frac{1}{2}$ " x  $2\frac{1}{4}$ ", on Rubber Stamp fitted in trim, all-enclosing case complete with ink pad, always ready for use. Handle lifts stamp out for easy use. Smart, flat case slips easily into pocket or purse. Perfect for business men, women, school children, service men and gifts! \$1 postpaid or \$1 C. O. D. plus postage. Satisfaction guaranteed.  
WESTERN STATIONERY CO., Dept. 7230, Topeka, Kansas

## ANEMOMETER ONLY \$29.50

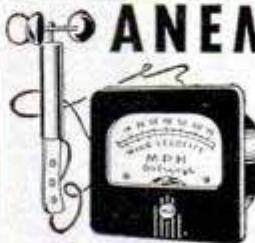

Shows wind velocity instantly! Accurate, precision built, weatherproof gauge operates on its own power. Mount whirler on roof, place meter anywhere, up to 50' away. Wire furnished. Ready to use, easy to install. Priced FOB Omaha. SEND NO MONEY . . . we ship COD. Order now for immediate delivery. Dealer inquiries invited.

BATSON ELECTRONICS, INC.  
Dept. A., 1031 S. 27th St., OMAHA, NEB.

## "SCOTIA" PLANS for 50¢



Build your own boat from Industrial Molded hulls and kits, sold and approved all over North America. Hulls for 14' "Scotia", shown above, and other beautiful models for immediate shipment. Rot, leak and fungus-proof; stronger, lighter than planked hulls. "Scotia" plans complete for 50c. Or send 25c for catalog.

INDUSTRIAL SHIPPING CO. LTD., Mahone Bay, N.S., Canada

# RUPTURE



### RELIEF...OR YOUR MONEY BACK

A simple . . . sturdy truss support built nature's way by old surgical appliance manufacturer. You risk nothing . . . relief or your money back. Send now for free booklet.

WEB TRUSS CO. Dept. M-10 Hagerstown, Md.

## EARN MONEY IN UPHOLSTERING

BUSINESS OF YOUR OWN OR A GOOD JOB

Learn at home from experts. Simplified, fully illustrated training program. Full plans for establishing your business—profits big. Fine earning opportunities also in good jobs. Upholster your own furniture at

PROFESSIONAL HOME TRAINING—TOOLS, SUPPLIES, EQUIPMENT INCLUDED

fraction of cost. Valuable booklet free. Write now.  
General Trades Schools, 3810 Broadway, Dept. PM-10, Chicago 13, Ill.

MAKE EXTRA MONEY

# PLASTICS

LEARN AT HOME

LEARN HOW TO MAKE fast selling PLASTIC NOVELTIES FURNITURE JEWELRY SIGNS TOYS LAMPS



There are RICH OPPORTUNITIES for MEN and WOMEN with "know-how" in Plastics. Interstate's amazing new Plastics course tells and shows how to make hundreds of fast selling items out of Plastics. Gives complete training in fabrication, casting, lamination, molding, etc., in simple, easy, step-by-step language and pictures.

START A PLASTICS BUSINESS OF YOUR OWN. No other industry holds such promise for the future. You can make big money manufacturing novelties, toys, signs, etc., in your own home in spare or full time. Don't wait! Learn NOW how Interstate's Plastics Training qualifies you for success in the plastics field.

Write for FREE Information Today!

## INTERSTATE TRAINING SERVICE

School of Plastics  
PORTLAND 13, OREGON

(Dept. 3-K)

# MEN...MAKE MORE MONEY BE YOUR OWN BOSS

## IN HIGHLY PROFITABLE SELF SERVICE LAUNDRY BUSINESS

We will handle all details . . . plans, maintenance training, construction, etc. Hundreds of locations in your neighborhood would make perfect spots for a "Lauderette". New apartment house developments, trailer camps, colleges, institutions, etc., offer opportunities for a profitable ROUTE OPERATION.

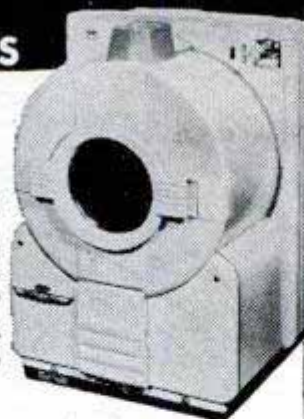

## EASY FINANCING OF COMMERCIAL BENDIX WASHERS

The only true COMMERCIAL MACHINE . . . and available only through Telecoin Corporation. Simple maintenance, trouble-free operation assured.

Write or Telephone **TELECOIN CORP.**  
12 East 44th St., New York City • MUrray Hill 7-7800  
1601 S. Michigan Ave., Chicago, Ill. • Wabash 2928  
35 Polk Street, San Francisco, Cal. • Market 1-5656

Originators and pioneers in the self service laundry system and owners of the name "Lauderette"

**YOU ARE  
IN DEMAND**  
*if you can draw!*



## ART INSTRUCTION, INC.

Dept. 10130 • 500 South 4th St.  
Minneapolis 15, Minn.

Please send me your FREE Talent Test.

Name \_\_\_\_\_

Address \_\_\_\_\_

Age \_\_\_\_\_ Phone \_\_\_\_\_

City \_\_\_\_\_ Zone \_\_\_\_\_

County \_\_\_\_\_ State \_\_\_\_\_

Occupation \_\_\_\_\_

Make money with your brush and pen! If you like to draw, sketch, or paint, take the FREE Talent Test. No fee. No obligation. Mail this coupon TODAY!

# WAR SURPLUS BARGAINS

**\$500,000.00 INVENTORY  
for QUICK LIQUIDATION**

Surplus items—hundreds of them for home, shop, factory, farm and outdoor use. New items, used items, reconditioned items—all at tremendous savings—all priced for quick sale.

**Page After Page of Values**

This big catalog shows page after page of amazing money saving values. Write for your copy today. Send 10c to cover postage, mailing, etc. Write today!

10c

SEND  
TODAY  
FOR YOUR  
COPY

**STARK'S**

Dept. 509 So. STATE STREET  
PMID CHICAGO 5, ILLINOIS



**FIX IT or FASTEN IT**  
*Better and Faster!*

## NEW TINNEMAN *Speed Nut*

**TINKER  
KIT**



**SPEED NUT**—the one-piece, self-locking, vibration-proof fastener—famous throughout industry... **NOW READY FOR HOME USE!** Handy assortment of 10 popular sizes of SPEED NUTS and matching screws. Over 100 home repair and hobbycraft uses. Once on—they stay on! Replace threaded nuts and lock washers.

**ONLY  
\$1.00**

POSTAGE  
INCLUDED  
SEND CASH OR  
CHECK—NO STAMPS

**TINNEMAN PRODUCTS, INC.**  
DEPARTMENT 13 • CLEVELAND 1, OHIO

**\$100.00 A DAY**  
*Yes! \$100<sup>00</sup> a day!*



Sensational "walk-in, walk-out" 10-second demonstration makes possible 30 to 50 calls a day. Sell 1 out of 3 for a daily profit of \$100 or more.

## Spectacular Invention

You write on glass in 5 colors with "Magic Crayon." Then watch letters "catch fire" and burn like brilliant Neon! Merchants amazed... snatch crayon out of your hand... start writing themselves! NOTHING BEFORE LIKE LITELITER PROFITS ever thrilled salesmen.

## Rush Coupon for FREE Offer on the most Breath-taking Money Maker of the Day!

Salesmen, Distributors, Crew Managers try out Litewriter for one day—then drop everything for this astounding money-maker. It's **patented**—hence **exclusive** with Maxilume men. No competition. Quick sales come easy. Many merchants buy three or four. Many salesmen close 1 out of 3 demonstrations. **Don't waste time.** Wire, phone or airmail name for facts. ALL FREE. If you have crew, ask for Exclusive Territory information. This is the biggest thing of the year. Don't miss it!

**L. B. Patterson, MAXILUME CO., Dept. L-810  
125 W. Hubbard St., Chicago 10, Illinois**

Rush complete information on Litewriter. Free Selling Kit, Free offer of Demonstrator and instructions for making "walk-in, walk-out" demonstration. No charge now or at any other time.

Name \_\_\_\_\_

Address \_\_\_\_\_

City \_\_\_\_\_ Zone \_\_\_\_\_ State \_\_\_\_\_

# NOW EASY TO START A Big Business ON A SMALL INVESTMENT



## WARNER SUCCESS PLAN Gives exact instructions showing you

- How to start in spare time
- How to use home as headquarters
- How to bring in the business
- How to do real METALIZING in genuine GOLD, SILVER, or BRONZE, by the easy Warner Method
- How to start without risking your job
- How to pyramid your profits
- How to be sure of steady, big income.

Don't turn this page until you've given serious thought to your future. In the uncertain years ahead, the men who own their businesses are the ones who will be happiest. A small start now easily can lead you to complete independence, freedom from time clocks, freedom from fear of lay-offs, freedom from the limits of a pay check.

Now, while you can do it without risk—now is the time to investigate the exceptional opportunity offered you by the Warner Success Plan. Looking into the market, checking up on the possibilities for big sales and big profits will not cost you anything. Isn't this the time to lay the foundation for a future of complete independence—a life of happiness—a steady, dependable income?

## METALIZING BABY SHOES AND OTHER KEEPSAKES

offers an exciting new opportunity to men or couples who want personal independence

If you'd like the feeling of being boss instead of being bossed—the Baby Shoe business is made to order for you. Just think of the appeal. A mother's love for her child—her desire to preserve forever the tiny shoes in which her baby took its first toddling steps. No wonder orders come easy and fast. No wonder profits are big. Then think of the Future. Fifteen Million babies in the last five years—three million last year—millions more next year. As long as babies are born, this business will prosper—in good times or bad. Think of the fun. Every job is different, interesting. And when you deliver a job and collect the money, you get a tremendous glow of satisfaction out of the mother's happy exclamations over your work. There's not another business I know of that offers you such big rewards in cash, in security, in a future, in independence that can be started on such a shoestring. You'll be glad you saw this ad—IF YOU SEND THE FREE COUPON.



## READ THE ENTIRE PLAN

### 7 DAYS AT MY RISK

#### DON'T SEND A PENNY NOW — Just Send Your Name

This is one of the most fascinating businesses you can imagine. There are 15 MILLION pair of baby shoes waiting right now to be METALIZED. The opportunities are unlimited. The future is very big. And it's a business in which the whole family can have fun helping. A perfect business for man and wife to start—or for two partners. And I want you to read the whole Plan at my risk. Don't spend a cent unless you go ahead.

I want every serious minded man to let me show what I've done in our own shops here in Chicago—reveal the exact facts about the profits to be made and the way to make them. I don't want you to spend a cent for supplies until you've studied the facts, talked them over with the family, and satisfied yourself that this is the ONE BIG OPPORTUNITY FOR YOU. That's why I allow you to read all trade secrets contained in the Warner Success Plan at My Risk. If you don't go ahead, you don't pay a cent.

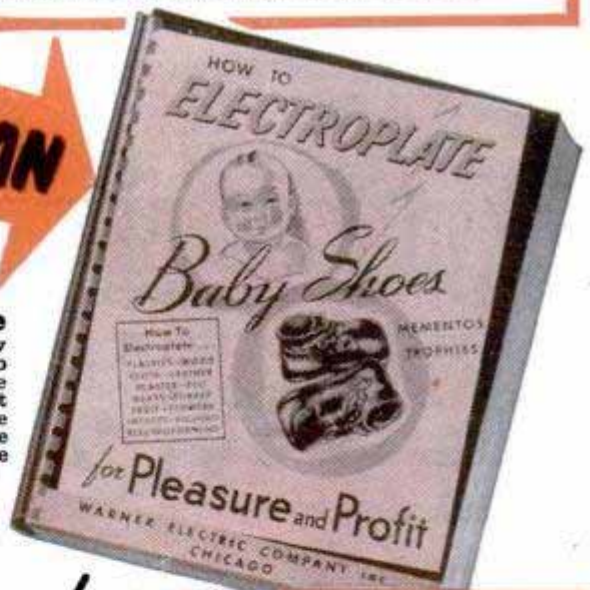

### ALL FACTS FREE! MAIL!

Raymond E. Brandell, Mgr., Warner Electric Co.,  
1512 Jarvis Ave., Dept. 3-S, Chicago 26, Ill.

As long as it doesn't cost me a cent, I am willing to read the facts, investigate, then give you my decision. Send the facts by next mail. No cost to me now or at any other time.

NAME \_\_\_\_\_

ADDRESS \_\_\_\_\_

CITY \_\_\_\_\_ Zone \_\_\_\_\_ STATE \_\_\_\_\_



### \$5.00 AN HOUR

Yes, it's possible for one man to turn out enough work to make \$5.00 an hour for his time. Think of how that pyramids when a partner or the whole family works.

#### Old Established Firm Backs You Up

The Warner Electric Company just celebrated its 26th year of success. You get a Real Start when you "join up with Warner"—you get real *Guidance to Success*.

**Warner Electric Co., Dept. 3-S**  
1512 Jarvis Ave., CHICAGO 26, ILL.

### WE SUPPLY EVERYTHING

You don't have to go "hunting" when Warner is behind you. We supply all materials, all mounts, chemicals, and metals. And you get the low prices made possible by our big quantity purchases and our own manufacture. You send for just what you need—and never have any big investment tied up in stock.

**WORLD'S  
BEST  
WANT AD  
MEDIUM**

# CLASSIFIED Advertisements



Advertisements in this section 75 cents per word, each insertion, minimum 10 words, payable in advance  
To be inserted under proper classification, copy must be in our office the 22nd of the  
second month preceding date of issue

F. W. Johnson, Manager, Classified Advertising  
Popular Mechanics Magazine, 200 East Ontario Street, Chicago 11, Illinois

## 1014 CLASSIFIED ADVERTISEMENTS 1014 OPPORTUNITIES FOR YOU

### AUTOMOBILES, MIDGET CARS

**HAND Wax** your car as easily as polishing. Use any paste wax. No equipment necessary. Complete instructions one dollar. C. L. Marshall, Oro Grande, Calif.

**1950 INDIANAPOLIS Race Official Yearbook** by Clymer. New, larger, better than ever. 112 pages, 300 photos. Articles by famous authorities, technical data, feature stories, driver histories, cartoons, newsy comments. The "bible" of Indianapolis racing. \$1.50 postpaid. Fabrikoid bound de luxe edition \$3.00. Catalog listing 75 books on automobiles, motorcycles free. Clymer Motorbooks, 1268A South Alvarado, Los Angeles 6, Calif.

**FREE Cash discount coupons** included with big 1951 hot rod and speed equipment catalog showing 1000 accessories, Hollywood mufflers, duals, manifolds, cams, heads, bargains! Complete 25c. Dealers wanted. Alquist Engineering, Milford 45P, Pennsylvania.

**SPEED And Power Handbook**, 128 enameled pages! Covers all makes of cars! Fifty breathtaking chapters. Including jet propulsion, racing frames, wheel geometry, dynamometers, reciprocating masses, gear ratios, dual pipes, fuel formulas, porting, balancing, lowering, relieving. Authentic, direct from California! Shows exactly how to build your own dual manifolds. Superchargers. Hot cams. Water injectors. Hi-compression heads. Mileage devices! Save, save, save! Get up to ten more miles per gallon, racing speed, lightning acceleration, dynamic power increases from any make passenger automobile! Build fast stock cars. California roadsters. 160 m.p.h. rods! Includes construction drawings! Tuning techniques! Speed tricks! Economy secrets! Ingenious formulas! Plus California Automobile Customizing. Photographs. Newest ideas. Conversions. Re-styling all makes. Also, 40 page speed equipment picture catalogue. Plus injection information. Plus new Economy Handbook. 300 illustrations. Five items \$1.98 postpaid. Newhouse Automotive Industries, 5805-B2 East Beverly, Los Angeles 22. (See page 42).

**MODERN Motor Car Magazine**—Covers all cars, new, old, American, foreign; all activities; shows, racing, clubs. Sample copy 25c; \$3.00 yearly. Crestline Publications, Box 581-A, Holliston, Mass.

**YOUR Car burn oil? Poor compression? Slow starting? Excessive cylinder wear?** Holt's Piston Seal restores compression! Cuts oil consumption! Checks piston slap! Lasts 10,000 miles! This amazing British product, now available, forms self-expanding pliable lubricating seal around pistons. Compensates for wear! Cannot harm finest engine. Easily installed; full directions enclosed. \$4.95 tube for 6 or 8 cylinders up to 240 cubic inches. Free details. Treglown Company, 200 West 7th Street, Plainfield 6, New Jersey.

**MIDGET Auto**, scooter plans \$3. 177 farm, home devices easily built from salvage. Descriptive handbook 25c (refundable). Free details. Kimo, Box 307-PM, New York 19.

**1951 SPEED Equipment bargains.** New dual manifolds \$9.95, adjustable tappets \$9.95, V-8 hi-compression heads \$23.50, Hollywood mufflers \$4.50, V-8 duals \$15.90, racing stacks 98c, camshafts \$29.95, chrome tailpipe megaphones \$1.55. All popular lines! Free premiums! Big speed equipment catalog 25c. Dealers wanted. Alquist Engineering, Milford 43P, Pennsylvania.

**SPEED And Mileage Manuals.** New deluxe 60th edition, world famous power book, endorsed by champions! Covers speed, power, economy, increasing for all passenger cars. Shows speed equipment construction, speed tuning, race car building, California hot rod plans, custom restyling, sports car conversions, etc. Double your power, gas mileage, acceleration. Get top racing performance from any car! Shows easy ways to build speed equipment, superchargers, dual manifolds, high compression heads, dual mufflers, racing cams, water injectors, economizers. Save 75%! Complete instructions with working diagrams on engine rebuilding, souping-up, restyling, gas saving, racing tricks, fuels, speed secrets, balancing, porting, jet, formulas, ratios, frames, Offys, Indianapolis methods! Also reveals 100 ways to save gas. Covers California customizing! Streamlining! Lowering! Sport changes! Roadster plans! Blueprints! 200 m.p.h. conversions, Fords, Chevs., Plys. All makes! 320 illustrations. Guaranteed finest! Worth \$10.00. Big Manual plus Speed Equipment Catalog, plus California Hot-rod Handbook, all three books \$1.98. Alquist Engineering, Milford 41P, Penna.

**TREASURY Of Early American automobiles.** New Floyd Clymer antique automobile book. Published by McGraw Hill, 224 large pages. 500 illustrations. New York-Paris, Indianapolis, Vanderbilt cup races, Glidden Tours information, cartoons, songs, early motoring styles, costumes. Gasoline, steam, electric, spring driven automobiles illustrated, described. 1600 makes American automobiles named. Clymer's latest, finest, largest most interesting book ever published on automobile history. Includes many illustrations never before shown. Beautiful cloth binding with attractive colored cover. Wonderful gift. \$5.00 postpaid. Clymer Motorbooks, 1268A South Alvarado, Los Angeles 6, Calif.

**SUPERCARGERS**, Safety belts, instruments, bucket seats. Karl Ort, Thomasville, Penna.

**RACING Equipment from California.** Speed-dress-up accessories for every make passenger automobile. Racing ignitions, carburetors, flywheels, camshafts, water injectors, mufflers, crash helmets, real jet engines. Thousands of items in stock! Dual manifolds for Jeeps to Rockets. Finned hi-compression heads, covering 155 makes and models. 1951 illustrated 40 page catalogue plus, Driving Economy 25c. Dealers, request wholesale catalogue. Newhouse Automotive Industries, 5805-B7 East Beverly, Los Angeles 22.

**ONE Cheap airplane tire** replaces two costly truck tires. Hauls same loads. Save. Walter, 1275 N.W. 33 St., Miami 42, Florida.

**STOP Excessive oil consumption.** Save money. Complete instructions for a dollar bill. Kerman Instrument Co., 407 S. Dearborn St., Chicago 5, Ill.

**HOT Rod**—The only monthly magazine about building roadsters, streamliners, etc. Sample copy 25c. \$3.00 yearly. Hot Rod, 1015 So. La Cienega, Los Angeles 35, Calif. Dept. PM.

**MOTOR Trend Magazine**—Custom, foreign, domestic, sports cars. Road testing, racing, auto shows, etc. Sample copy 25c. Full year \$3.00. Motor Trend, 1015 S. La Cienega, Los Angeles 35, Calif., Dept. PM.

**WIGLESWORTH**—Chasteen's Automobile History Scrapbook #1. Just published! Over 250 ads and illustrations of antique and vintage automobiles—all new material. \$1.50. Wiglesworth-Chasteen, 7134-P2 Alhambra, Mission, Kansas.

**"VAP-O" Water injector.** \$2.95, kit and instructions. Vap-O Mfg. Co., Box 3373, Los Angeles 54, Calif.

**SPEED Equipment for Fords, Chevrolts, Willys, Studebaker, Lincoln.** New illustrated literature and instructions \$1.00. R. & R. Mfg. Co., Box 546A, Anderson, Ind.

**1950 CADILLAC And Lincoln V-8 engines installed.** 1932 to 1950 Ford, Mercury, Lincoln, trucks using McBar Adaptors—housings. McBar Machine Shop, 65 N. Miami St., Peru, Indiana.

**SUPER Brake-Floaters** make Ford, Mercury, Chevrolet, Plymouth, Dodge, DeSoto and Chrysler brakes free floating and super powerful. Eliminate squeal, chatter, groan, fading brakes, "hard" pedal and scoring of drums. All models—\$4.00 to \$6.90. Make linings wear two to three times longer. Easily installed by yourself. Write for details. Super Brake-Floater Company, 4022 West Lake Street, Chicago 24, Illinois.

**WANT Better gas mileage?** Your car can attain it. Stamp brings details. Stan Stanton, Liberty, N. Y.

**"WATER Injection"**. Also speed, power, economy methods. Free illustrated information. Neher Industries, La Verne, California.

**CALIFORNIA Custom accessory headquarters.** Buy direct from original designers and save. Chrome dash panels, solid hood sides, grille panels, speed equipment, dual pipes, push button door conversions, chrome motor accessories, fender skirts. 34 page illustrated catalog 25c. Eastern Auto, 3319A South Grand, Los Angeles 7, Calif.

**CHEVROLET Owners**—Don't "Watch the Fords go by." Your Chevy can beat the Fords. Stamp brings particulars. Hi-Torque Speed Shop, Liberty, N. Y.

**AUTOMOBILE Racing**, sixth edition. 100 illustrations. Drawings, building instructions Ford-60 midget, California roadster, Offenhauser racer. World's record 158.5 m.p.h. car. \$2.00 postpaid; \$2.40 c.o.d. Popular Mechanics Press, 200 E. Ontario St., Chicago 11, Ill.

**SILENCE Overhead-valves**, attachments unnecessary. \$2.00. Derderian, Box 542, Sandston, Virginia.

**SMITHYS Mufflers** for all automobiles. Free list. Buck's Auto Parts, Box 1296H, Merced, California.

**FROM Speedway to roadway!** Track-proved hi-speed heads and manifolds now available for your passenger car! No special tools needed! Increase horsepower 25%! Astounding getaway! Free illustrated catalog. Speedsport, 6215P Diversey, Chicago 39.

### AUTO SUPPLIES AND EQUIPMENT

**AUTO Conversions and parts.** Marine manifolds for all engines. Your transmission converted to marine gear, propellers, shafts, struts, couplings, etc. Everything you need for your boat. Money back guarantee. Conversion Parts Co., 278 Adams St., Boston 22, Mass.

**BUICK Parts**—Enjoy new-car pep and power in your old Buick. Same day service from world's largest stock of new (not rebuilt) Buick parts and engines. Ship anywhere. Write today. Robertson Buick Co., 1001 S. Wabash Ave., Chicago 5, Ill.

making overrich mixtures. Fits all cars. For free particulars write Vacuumatic, Dept. 1653, Wauwatosa, Wis.

**JUST OUT!** Get the largest auto accessory and parts catalog in the world. Over fifteen thousand items, including Hollywood accessories, hi-speed equipment, rebuilt engines; all parts and accessories for all cars and trucks. New, used and rebuilt! We have that hard-to-get-part! Completely illustrated, jam-packed with bargains. Send 25c. J. C. Whitney & Co., 1919 Archer Ave., Chicago 16, Ill.

**GET Extra profits on repair work.** Do your own welding. Easy to use. Easy pays for itself terms. Catalog free. Hobart Welders, Box M-1005, Troy, Ohio.

**GENUINE Crosley parts.** Factory rebuilt engines \$109. Exchange. Packless water pump \$9.25. Clutch plates \$5.75. New Goodyear 4.50x12 tires \$7.50. Parts book \$1.25. Glenn Walraven Motors, "King of the Crosleys," Marion, Ohio.

**REBUILD Starters, generators, regulators, batteries.** Introductory manual \$1.00. Modern Technical Manuals, Box 4704, Kansas City, Mo.

**FUEL Pumps guaranteed, only \$1.00.** Ford, Chevrolet, Plymouth, rebuilt. Seal-test, 512 9th St., Brooklyn, N. Y.

**DeVILBISS Engine cleaners, only \$7.95 postpaid.** New, guaranteed. Limited supply. Reg. price \$12.90. Cross Tool Co., 6330 San Fernando Rd., Glendale 1, Calif.

**WHEEL Alignment and camber indicator.** Drive over. \$18.95. Particulars free. Align-A-Matic, Box 94B, West Orange, N. J.

**STOP Auto thieves!** With automatic alarm. 10 year guarantee. Was \$7.50, now \$5.00, postpaid. Crandall Supply, Rockville, Conn.

**LEOPARDSKIN Design blankets.** Excellent seat covers. Why pay \$30 to \$50 for leopardskin? Send \$7.25. Ippolito, 65 Brookside, Washington, Penna.

**CHAMPION, A-C, Auto-Lite spark plugs.** Rebuilt. Guaranteed 10,000 miles. 25c each. 23c sets of 6. Postpaid. State brand, type, quantity. Philip Minor, 5707 Arnsby Place, Cincinnati 27, Ohio.

**DRIVE Safely—Side-window wiper \$1.00 postpaid.** Agents wanted. Park Sales, P.O. Box 73, Forest Park, Illinois.

**NEW And used guaranteed parts** for civilian and army cars and trucks. Largest stock in America. Mail orders. Pioneer Auto Wrecking Co., 734 W. 13th Ave., Denver, Colorado.

**NEW "Economy and power" methods.** Free. Neher Industries, La Verne, Calif.

**LACHAPELLES Motor and motor fuel treatment (patented)** stops ping, gives more miles per gallon, more miles per motor. It puts bearings on the pistons. 100,000 miles treatment \$3.00 postpaid or c.o.d. Ferns Products, 8120 Walnut Dr., Los Angeles 1, Calif. (Data sheet on request.)

**NEW Government surplus.** Low voltage circuit tester in steel box cost \$202. Our price \$27.50. Will test batteries, starters, generators, voltage regulators, grounds, short circuits. Wilt Electrical Company, 7829 S. Racine Ave., Chicago 20, Ill.

**CHEVROLET Parts.** Scarce motor, body, sheet metal parts. Grossman Chevrolet, Minneapolis, Minnesota.

**AUTO And truck parts.** New and used. Lowest prices. Complete stock. Prompt replies. Babbitt Auto Parts, 2833 Chicago Ave., Chicago 22, Ill.

**BRUSH Plating outfits** connect to a battery. No tanks or shop required. Free particulars. Gunmetal Co., Avenue J, Decatur, Illinois.

#### AUTO TRAILERS

**BUILD Your own trailer!** Save money! Have every feature you want! Plans for house, sport, camp and utility trailers. Catalog describing 9 models 10c. 15c in Canada and overseas. Jim Dandy, Box 125-A, Wausau, Wisconsin.

#### MOTORCYCLES, BICYCLES, MOTORSCOOTERS AND SUPPLIES

**SPECIAL—1946 Whizzer in Schwinn bicycle \$20.** Also Cushman motorscooter (good tires and lights) \$15; Shaw bicycle motor \$15; midget car \$15. Rush 25c (35c for first class mail) for catalog #17 listing many other amazing postwar bargains in wheels, engines, motorscooters, midget cars, etc. Gail, 538 Erie, Toledo, Ohio.

**Doodlebug motor scooter \$15;** Salsbury \$35. Motorscooters less motors \$9 up; motors \$35 up. Power lawnmower \$12. Four balloon tires \$3. Mailorder only. Send 25c for catalogue Number Thirty-seven, just out, listing these and hundreds of other bargains in midget cars, motorscooters, parts, plans, transmissions, engines, war surplus, etc. (35c by first class mail.) Midget Motors Directory, Athens, Ohio.

**CYCLE—Monthly motorcycle enthusiasts' magazine.** Road tests, technical data, foreign and domestic. Many illustrations. Sample copy 25c. One year—\$3.00. Cycle, 1015 So. La Cienega Blvd., Los Angeles 35, California, Dept. PM.

**KNEEACTION Moto-Scout \$10;** motorbike (front and rear brakes) \$5; Whizzer motorbike with clutch and all attachments \$25; Indian motorcycle \$30; good midget car \$35; tire-wheel combination \$2.50. Rush 25c (35c for first class mail) for new catalog #946 listing sensational bargains in motors, motorscooters, midget cars, etc. Associated, Box 1764-CS, Toledo, Ohio.

**MOTORCYCLE Magazine—Worldwide coverage.** Yearly subscription \$1.00. Sample 15c. Motorcycle News, 5424-A Sawyer, Chicago 25.

**HARLEY-Davidson parts, accessories,** repair manuals on all models. 24 hour service. Authorized factory dealer. Philadelphia Harley-Davidson Company, 857 North Broad Street, Philadelphia 23, Penna.

**RECONDITIONED Motorcycles and motors.** Chromium accessories. Complete stock Indian parts. Expert rebuilding. Fast service. Indian Motorcycle Sales, Kansas City 1, Mo.

**TIRES And industrial wheels,** suitable for scooters, wheelbarrows, farm equipment, etc. All sizes. Bicycles and accessories. Send dime for list. Cycle Transport Company, 1241 So. Michigan Ave., Chicago 5, Illinois.

#### AVIATION

**LIGHTPLANE Gliders, motors, circulars** illustrated 20c. Craftsmann Books, Box 1153, Milwaukee 1, Wis.

**PROPELLERS, Plans, supplies, for ice** sleds, snow sleighs, air boats. Literature 20c. Banks-Maxwell, Box 3301E, Ft. Worth.

**PROPELLERS—For sleds, airdrive boats,** Literature. Standard Aerocraft, Box 387, Ft. Worth, Texas.

#### BATTERIES, GENERATORS

**EDISON Nickel storage batteries.** Long unconditional guarantee. Any voltage. Amperages from 37½ to 600. Interesting literature. Established 1919. Hawley Smith Co., Croton Falls 1, New York.

**GENUINE Edison batteries, fifteen year** life. Unconditionally guaranteed. Free literature. See-Jay Company, 300-12th Avenue, Paterson, N. J.

#### ELECTRICAL SUPPLIES

**LAMPS—Electrify oil lamps, vases, bottles,** etc. Instructions 10c. Fisher Lamp Supplies, 3825P Eastern Avenue 26, Cincinnati, Ohio.

**BE Independent, be secure, have your** own profitable business—earn \$20.00 and more a day making beautiful, fast-selling lamps at home. No equipment needed. Illustrated course teaches you quickly. Course, parts catalog, wholesale price list—only \$2. Gearon Co., Dept. 200-B10, 27 S. Desplaines, Chicago 6, Ill.

**LAMP Parts—Sockets, wire, harps, cords,** bases, pipes—all parts to build and repair. 60 page catalog with charts and instructions 25c. Gyro Lamps, 5402P Clark, Chicago 40.

**LAMPS—Build own originals, parts** wholesale, any amounts. Catalogue 10c. Brown Lamp Co., Box 501, Wellston, St. Louis 12, Mo.

**TRANSFORMER Lamination, magnet-** wire, insulation, supplies. Morton Electrical Service, Maywood, Ill.

**MOTOR Winders, free bulletins, wind-** ing and testing equipment. Motor Industries, Quincy, Illinois.

**BUILD Your own electric motors from** scrap automotive generators. Complete illustrated instructions for all makes. Only \$1.00. Autopower, Dept. PM, 918 South Theresa, St. Louis 3, Mo.

**ELECTRIC Pencil: Engraves all metals** \$1.25. Beyer Mfg., 10511-H Springfield, Chicago 43.

**32 VOLT Appliances—World's largest** line. Catalog free. Haines Corporation, Dept. N, Minneapolis, Minn.

**SET Up your own profitable welding** business. "Build Your Own" portable arc welder with low cost generator. Free book tells how. Hobart Welders, Box M-1002, Troy, Ohio.

**ACETYLENE Welding outfits new \$45.00,** used \$25.00, arcwelders \$46.50. Distributors wanted. Eagle Welding, Dept. PM, 5085 Broadway, Chicago 40, Ill.

**WELDERS—It's timely and profitable.** The versatile Atlas transformer welder, in portable metal case, 110V. a.c., develops to 75 amps; 9 heat stages. Welds, brazes, solders, cut all metals. Easy to use. Simple instructions. Special flame weld torch free. Splendid for shop, farm and home repairs. Saves hundreds of dollars yearly. Only \$38.50. Also other models. 10 day free trial. Magic Welder Co., 239 MB Canal St., New York, N. Y.

**A.C. Welders, four sizes. Lowest prices.** Holger's Service, Canton, Kans.

**BUILD Your own 100 ampere electro-** plating rectifier at a low cost. Starkweather, Ottawa, Kans.

**RADIATOR Repairing books, supplies,** equipment, gasoline torch. Write, Curfman Co., Maryville, Mo.

**BUY Direct from factory.** Welding and cutting equipment. All makes of equipment repaired. Established 1913. Box 331, Hamilton, Ohio.

**ELECTROPLATING Salts and rectifiers.** Mirror resilvering and chipped glass nameplate supplies. John Sprinkle, V55, Marion, Indiana.

**RADIATOR Repairing, cleaning, recor-** ing. How to equip small shop at low cost. Supply sources, trade secrets, instructions. Now only \$3.50 postpaid. Radiator Service, McBain, Mich.

#### MACHINERY, TOOLS, SUPPLIES

**IF You use micrometers, get a Mike-Lap.** Dress your micrometers to pinpoint accuracy using the Mike-Lap Patented Sleeve. Assures parallel planes at right angle to axis of spindle without disassembling micrometers. Handles 1" and 2" micrometers. Complete with charged lapping blocks and precision sleeve. Price \$7.50 postpaid. Easy to follow instructions. Satisfaction guaranteed. The Mike-Lap Company, Northboro, Massachusetts.

**NEW Power tools, accessories, hand** tools, kits, 500 items to make, books, bargains. New catalogue, send 3c stamp. Lloyd's Craftlines, 921-MA Cedar, Burbank, Calif.

**3M Sanding Belts, discs and paper for** wood working, automotive refinishing, glass grinding, and production work. 3M Scotch masking tapes, electrical tapes, 3M cements and adhesives. Write for catalogues and discounts. E. R. Bean Auto Supply, Danville, Illinois.

**CHUCKS, Independent, universal;** threaded 1½"-8, 1"-8, 1"-10, 1"-12, or with adapter recess. Other chucks to 16" diameter. Write for quotation and free literature. No obligation. Westcott Chuck Co., 3600 Walnut, Oneida, N. Y.

**BALL Bearings ¼ list price. Free list.** Burgess, Box 168, Ferguson, Mo.

**DIVIDING Head, rotary tables, etc.** For Atlas millers. Free machine tool accessories catalog. Montgomery, 49 Park Place, New York City.

**NEW A.A.F. surplus, mechanics hand** tools packed and sealed by A.A.F. in complete kits. 66 piece engine mechanic \$62.50. 55 piece armour mechanic \$50.00. F.O.B. Send money order only. J. F. Weatherly, 3510 Blodgett, #3, Houston 4, Texas.

**CONCRETE Block machines \$39.50.** Standard sizes. 400 daily. No expensive pallets needed. Free catalog. Concrete Appliance Co., 5129 S. Compton, St. Louis 11, Missouri.

**METALS For home workshops.** Aluminum, brass, copper, monel and steel. Bars, angles, channels, sheets and tubes. Write for small quantity price list. Cashmetals Co., 9 Arlington Park, Pittsburgh 34, Penna.

**ONLY \$3.95 For \$14.00 value 2" univer-** sal lathe chuck. Check or money order. Har-Mur, 2349 Devon, Chicago 45, Ill.

**DRILL Grinder for twist drills, \$2.95.** See ad on page 284.

**HYDRAULIC Cylinder double acting,** 2½ bore, 16½" travel, 1-3/16" shaft, brand new \$11.00. Discount ten or more. Spender Aircraft, 8410 Dallas, Seattle, Wash.

**RADIAL Arm saws, surplus, 2 h.p., single** phase, new, regular \$410. Special \$229.00. Iowa Machinery, Des Moines, Ia.



**POWER TOOLS.** Big savings when you build your own with Lewis castings. 23 wood and metalworking tools with blueprints. Most can be completed with lathe and drillpress. Commercial quality. Ideal for home shops, schools, small manufacturing. Catalog 10c. Lewis Machine Tool Co., 3217 Union Pacific Ave., Dept. M, Los Angeles.

### BOATS, OUTBOARD MOTORS

**BUILD A** better boat than you can buy for the money, with Ozarka's exclusive laminated-rib construction and carefully pre-formed and pre-fitted parts. Save to 55% on all popular types from simple car-top models to one-design knockabout sailboats, priced from \$39.50 to \$329.00. Shipped complete, ready for easy assembly. Send 25 cents for literature, refunded on first purchase. Ozarka, Inc., 6100 Borden Lane, Woodstock, Illinois.

**BUILD Your own**—Three point racing hydroplanes, others. Illustrated catalog 25c. Champion Boats, P.O. Box 7132 D, Long Beach, California.

**220 PAGE** Marine hardware catalog, beautifully illustrated for \$1.00. Money refunded with first order plus 10% discount. Marine Products, 7 Longfellow St., Baldwin Long Island, New York.

**FORD** And jeep marine conversion kits. Request catalog. Arthur Gershel, Dept. O, 51 Chambers St., New York 7, N. Y.

**TWENTY** Plywood boat plans \$1.00. Catalog boat building plans 10c. The Rudder, 15 Murray Street, New York 7.

**KNOCK-DOWN** Boat kits. Outboards, inboards, sails, hydroplanes. Easy to assemble. Minimum cost. Catalog with specifications, prices, 25c. Brooks Boat Company, Carrollton, PM, Michigan.

**SAVE 2/3** Cost. Assemble your own boat. Complete plans and boat parts machined ready for assembly. No experience necessary. Rowboats to cruisers. Illustrated catalog 25c. Midwest Boat Company, Menomonee Falls, Wisconsin.

**STEERING** Wheels, windshield brackets, from \$6.95. Modern fittings, water skis at lowest prices. Complete pre-cut plywood boats. Bargains galore. Folder 10c. Marine, Box 681, Mendota, Minnesota.

**REBUILT** Outboard motors at bargain prices! Late model Johnsons, Evinrudes, Mercury, etc. A 3c stamp brings list-new and used. Parts for all makes, including chain store brands. Write for prices, giving description of parts needed. Money back guarantee. When in Boston visit the largest outboard motor plant in the world. Outboard Motor Mart, Inc., 309B Atlantic Ave., Boston, Massachusetts.

**OUTBOARD** Motor bargains—\$35.00 up. Send for free list! Save big money! Used parts for most makes and models. Crandall-Hicks, 911 Commonwealth, Boston, Mass.

**CONVERT** Fords and Jeep to 100% marine engines with Osco's world famous Convo-Kits. Deluxe catalogue 25c (coin). Oscomotors, 3627B Lawrence, Philadelphia 40, Penna.

**P38 BELLY** Tanks, steel, \$9.95. Free picture. Bucks Auto Wrecking, Box 89, Merced, Calif.

**NEW, Used,** rebuilt marine motors. Marine conversions, fittings. Free catalog. Stokes Marine Supply, Dept. 24, Coldwater, Michigan.

**MARINE** Conversions for Ford and Jeep engines. Catalog 10c. Lehman Manufacturing Company, Department D, Newark 2, New Jersey.

**FULL** Size, cut to shape boat patterns, blueprints, 7 1/2-38 feet. Illustrated "Build a Boat" catalog, 25c (coin). "How to Build Boats" book, \$1.00. PolyWog houseboat plans \$10. Marine catalog \$1.00. Marine Specialty Mfg. Co., 3107 Detroit Ave., Cleveland 13, Ohio.

### ENGINES, MOTORS, DYNAMOS

**WELDING** Generators 150 amp. \$47.50. Motors 1/2 horse \$15; 3/4 \$22; 1 \$30. Compressors \$17.50. Butler, 1885 Milwaukee, Chicago 47.

**ICE-SLED** Engines, small airplane radial type. Write for descriptive literature. Gaare Supply Co., Box 277, Weatherford, Texas.

**WINDING** Data, listing 225 motors, single and three phase, \$1.00. Motor Data Co., Box 7631, Kansas City 3, Mo.

### TAXIDERMISTRY

**MODERN** Taxidermist Magazine, Greenfield Center 2, N. Y. Devoted entirely to taxidermy, photos, articles, methods. Trial year's subscription, \$1.00.

### AMMUNITION, American-foreign and obsolete. New guns. Dime for list. Central Sports, Delphos, Ohio.

**BARBELLS**—Finest quality \$7.98 up. Catalog free. Lurie Barbell Co., 1701-M7 Pitkin Avenue, Brooklyn, New York.

**FLORBALL**—New court sport. Most fun, most useful. Pictures \$2.00. Pictures 15c. Florball Inc., Colchester, Conn.

**STRENGTH** With stretchers. He-man cable course. Illustrated. \$1. Comborep, 79 Oakland Terr., Newark 6, New Jersey.

**GREAT** Strength easily obtained. Write Joseph Dryer, Box 5527-F, Chicago 80.

**TALLER!** Be one to three inches taller. A new scientific method for permanent height increase has now been developed. Free information. Natural Methods, Box 453, Briggs Station, Los Angeles.

**FREE** Illustrated catalogue—Books, magazines, photos, equipment, barbells, courses. Dr. Frank Thompson, Dept. 10, 919 Fourth, Manhattan, Kansas. World's Leading Dealer.

**DEADLY** Judo—Fiercest fighting technique. Trick knockouts. (Over 200 illustrated pictures.) Expert instructions; three volumes. Complete \$2.25. Variety House, Box 46-B Wall Station, New York 5.

**BARBELLS,** Exercise equipment, Courses. Free booklet. Good Barbell Co., Reading, Penna.

### BINOCULARS, TELESCOPES, MICROSCOPES, MAGNIFIERS

**NIGHTVISION** Tube \$14.95 with instructions. Sniperscope book \$1.50. Infrared filters 15c. Catalogue-data 10c. Precise, 942 Kings Hwy, Brooklyn 23, N. Y.

**6" ALUMINIZED** Parabolic mirrors. Performance guaranteed. \$25.00. Peninsula Optical, Box 212, Burlingame, Calif.

**FRENCH** Binoculars, slide rules, cameras, tripods, accessories. Bartro Importer, 26 Grenville Road, Watertown, Mass.

**REFLECTOR** Telescope kits, refractors. Free illustrated bulletin. Rake Instrument Laboratory, 612 Adams, Hoboken, N. J.

**WEATHER** Instruments for amateurs. Send 10c for catalog. Science Associates, Philadelphia 8, Penna.

**BINOCULARS**—Guaranteed repairs. Prompt service, estimates. Tele-Optics, Dept. B, 5514 Lawrence, Chicago 30, Ill.

**WAR** Surplus bargains, binoculars, telescopes, sextants, millions of lenses, prisms, reticles, eyepieces, objectives, etc. Mail 10c for big "Catalog CH." Send \$1.00 for Stock CH—10-piece lens kit and big instruction booklet. Edmund Salvage Co., Barrington, N. J.

**ASTRONOMICAL** Telescopes, binoculars, microscopes, bought, sold, repaired. Books. Lists 10c. Rasmussen-Reece, Amsterdam, N. Y.

**SAVE 50%** On new binoculars! Free catalog. Free book. "How to Select Binoculars." Write today! Bushnell Importers, 43-M8 East Green, Pasadena 1, California.

**BINOCULARS,** Telescopes, watches, guns. Buy, sell, trade. Schweer's, Donnellson, Iowa.

**GIANT** Astronomical telescope with 6 ft. tripod \$15.00, f.o.b. factory. 100 power. (10,000 area magnification). Clear vision, full power guaranteed. Ready for use. Suffolk Science Service, Dept. BT, Riverhead, N. Y.

**REFLECTING** Telescopes, 60X, completely assembled \$25.00. Guaranteed observatory clearness. Free information. Skyscope, 475 Fifth Avenue, New York 17.

**TELESCOPES,** Binoculars, microscopes, big bargain catalog free. Brownscope Company, 24 West 45th Street, New York.

**POWERFUL** Astronomical telescopes easily made. Perfect lenses and instructions; 100X \$3.00; 100X and 200X \$4.00; 100X, 200X and 400X \$6.00. Full power, clear vision guaranteed. Instructions alone 10c. Suffolk Science Service, Riverhead, N. Y.

### SPORTING GOODS, GUNS, FISHING TACKLE, ARCHERY, TRAPPING

**TENTS,** Camping equipment, tarpaulins; war surplus. Low prices, free catalogue. Morsan, 10-19R 50th Ave., Long Island City 1, N. Y.

**PISTOLS,** Firearms, ammunition. Complete list 25c. Frank Farish, Vicksburg, Miss.

**RIFLES**—303 British Enfield converted sporting models \$27.50; unconverted \$22.50. Write Sportsmen's Wholesale Supply, 2098 St. Catherine Street West, Montreal, Canada.

**AMMUNITION.** American-foreign and obsolete. New guns. Dime for list. Central Sports, Delphos, Ohio.

**LEARN** Gunsmithing! Details, copy "Guns and Gunsmithing," 25c. Gunsmith's Supply, Palatine 2, Illinois.

**MOLDS,** (For fisherman's sinkers, squids, jigs and lures.) Handled and hinged. Quality fishing tackle. Free catalogue. E. L. Sweet & Son., Tonawanda, New York.

**PERSONALIZE** Guns, equipment with nickel silver shield, 1 1/2" x 1 3/4", name, address hand-tooled, \$2.95. Catalog. Franklin Craftsmen, Wallingford, Penna.

**MOUNTED** Maine deer heads. Fine specimens for camp or den. \$30.00 each. Ed Howe, Coopers Mills 52, Maine.

**50 PAGE** New gun catalog, 50c. Yes, we trade. Gunsmith's Supply, Palatine 2, Illinois.

**SEND 10c** For list 150 used guns. Frayseth's, Wilmar, Minnesota.

**HUNTERS**—Legal allweather secret. 2000 got their buck 1949 using it. Method \$2. Info. free. Sabin's, Dalbo, Minn.

**FREE** Catalog—Glass fishing rod kits. America's largest selection. Anyone can build them. Simple illustrated instructions. Write today. Dept. Z, Trimline Tackle Co., 508 Tinton Ave., New York City 55.

**190 PROFUSELY** Illustrated pages antique and modern pistols, swords, daggers, armor, etc. 50c. Robert Abels, A860 Lexington Ave., New York 21.

**SHOTGUNS,** Rifles, revolvers, 500 modern, obsolete. Also cartridges. Each list 10c coin. Ed Howe, 62 Main, Coopers Mills, Maine.

**RIFLE** Stocks: Laminated and regular. Blanks, semi-finished, finished. Enfield, Springfield, Mauser, etc. Literature. Banks-Maxwell, Box 3301E, Ft. Worth.

**5000 BARGAINS.** Firearms, binoculars, war relics. Catalog 40c. Smith Firearms, Runnede, New Jersey.

### PETS—DOGS, BIRDS, RABBITS, HAMSTERS, ETC.

**SAINT** Bernards, Boxers. Schwarzwald Hof Kennels, 5136 Cascade Rd. S.E., Grand Rapids 6, Mich.

**RAISE** Guinea pigs. Money making business. Booklet free. Taylor, B426A, Hapeville, Georgia.

**SEE** Gulf Hamstery ad on page 30. Shows picture of Hamster.

**BEAUTIFUL** Pure white pedigreed police puppies. Ansonia Kennels, Mose, N. Dak.

**HAMSTERS.** Good breeding stock. Money-makers. Odorless. Big demand information. Folio. Twin-City Hamstery, 1145 Fauquier St., St. Paul 6, Minn.

**RAISE** Pedigreed rabbits for us. We buy all you raise. Literature free. Grinsteads, Edwardsville, Illinois.

**HAMSTERS**—Money making fast breeding virgin stock. Equipment. Dixie Hamstery, 502-C Trinity Lane, Nashville 7, Tenn.

**MAKE** Big money! Raise Chinchilla rabbits. Cash markets supplied for your production. Write today! Rockhill Ranch, Sellersville 15, Penna.

**EARN** Up to \$400 monthly. Raise Angora rabbits! Experience unnecessary. Wool brings \$5 pound. Plenty markets. Folder free. White's Rabbitry, Newark 31, Ohio.

**GOLDEN** Hamsters—Finest quality breeding and pet stock, \$2.50 pair, \$3.75 trio. Free folio. Valley Hamstery, 734 North Milam, San Benito, Texas.

**SPORTSMEN:** 200 Pointers, setters, straight cooners, combination hunters, rabbit and fox hounds. Reasonable. List free. Ramsey Creek Kennels, Ramsey, Illinois.

**A** Practical beginning to successful rabbit raising. 48 page illustrated booklet. Dime. American Rabbit Breeders Association, 36 AR & CBA Bldg., Pittsburgh, Penna.

**\$300 MONTHLY** Raising Angoras for our market. Particulars free. Wilson, Stanton 17, Calif.

**INCREASE** Your income by raising domestic rabbits. Small space needed. Ready market for delicious meat, fur and wool. Largest magazine in the industry tells you how. \$1.50 per year. Sample 15 cents. No stamps. Small Stock Magazine, Lamon 20, Iowa.

MINK Raising information free. Complete. Lake Superior Mink Farm, Superior, EEL, Wisconsin.

## FARMS, FARM LANDS, REAL ESTATE

**FREE** Fall catalog, farm bargains, many equipped, illustrated, pictures, many states! United Farm Agency, 1408-PM Consumers Bldg., 220 South State St., Chicago 4, Ill.

**GOVERNMENT** Lands \$2.00 acre up. Information all states twenty-five cents. National Tax Service, 901-A Majestic Bldg., Detroit.

80, SO. Missouri, 55 acre. Field, 112, Brooklyn 12, N. Y.

**\$3.75 PER Acre** Missouri "Ozark" land. Cash; terms. Free list, maps. Frederick Calvert, (owner), Winter Haven, Florida.

**WEST'S** New Digest of farms and country real estate—free! Values galore—Maine to Florida. West's, CK-9, Pittsburgh 17, Penna.

**STROUT'S** New fall catalog. Largest ever! 132 pages farm, home, country business bargains. Coast-to-coast. Mailed free. Strout, 7 So. Dearborn St., Chicago 3, Ill.

**FLORIDA.** Beautiful homesites in new Lake County development, \$245 at \$10 monthly. Near Ocala National Forest, many pretty lakes, streams, pavement. World's best bass fishing, wonderful hunting. Folder free. Howard Vernor, DeLand, Florida.

**\$5.00 MONTHLY** Buys 40 acres, near town. Price \$200. Free list. Box 425-P, Carthage, Mo.

**GOOD Farms—Ranches.** Washington, Minnesota, Montana, Idaho, Oregon, North Dakota. Dependable crops, favorable climate. Write for literature, lists describing typical farm opportunities. Specify which state. J. W. Haw, 119 Northern Pacific Ry., St. Paul 1, Minn.

**HOMESITES** \$300—Convenient payments. California's finest garden section. On Morro Bay's scenic shores. Wonderful fishing, hunting, boating, bathing. Fertile soil, softest water, temperate climate, congenial community. Free literature. Richard Otto, Department M, San Luis Obispo, California.

**FARM** Manual shows you how to make extra profits from your farm. 284 pages of farming lore, \$3.00. Popular Mechanics Press, 200 E. Ontario, Chicago 11, Ill.

## POULTRY, FARM SUPPLIES

**INCREASE** Your poultry income—Thorough knowledge means greater success. Our interesting, practical, home study course has trained thousands during past 29 years. Don't delay, write today for free booklet describing courses, methods, opportunities. National Poultry Institute, Dept. 50-C, Adams Center, New York.

**ATTENTION!** Farmers, homeowners! Interested in amazingly low-priced machinery? Get know-how handbook, 25c. Climax Products, 1324 S. Bond, Los Angeles 15, Calif.

**KNOW** How to raise poultry for profit. Read Poultry Industry. Every issue packed with helpful hints and practical suggestions. Latest articles on breeding, feeding and management. Subscribe now. 1 year 65c. 2 years one dollar. Foreign subscriptions \$1.00 a year. Poultry Industry, Dept. P.M., 376 Boylston St., Boston 16, Mass.

**RAISE** Fryers new easy way. One man home plan earns \$3000 yearly. Circular free. Poultryman's Institute, 1046 So. Olive, Los Angeles 15, Calif.

**EARN \$4 to \$12 hourly.** Chick sexing, turkey sexing, culling and caponizing. G.I. approved. Pilch's School, Box SSC-10, Thompsonville, Connecticut.

## PROFITABLE OCCUPATIONS

**LEARN** Arc welding at low cost in non-profit school. Easy to learn in short time. V-A contract. Write for free book. Hobart Trade School, Box M-1003, Troy, Ohio.

**CANDY-Making.** Well paying home business. Amazing instruction course with formulas. \$1.00 postpaid. Nelko, Box 3462-C, Chicago 54, Ill.

**MUSHROOMS** Grown boxes, barrels. Instructions 50c. Spawn \$1.00. Manureless process. \$2.00. Gordons, 553 William, Winnipeg, Manitoba.

**TURN** your spare time into cash! Make quick-selling, highly profitable lamps—every home a prospect. No experience or special tools required. New 1950 56-page illustrated catalog shows shades, shade frames, figurines and bases, oil lamp converters, boring compounds, and dozens of similar items. Also all kinds of sockets, cords, pipes, harps, finials, bases, and hundreds of other parts—everything you need. Special 8-page section shows 6 beautiful lamps in kit form ready to assemble. You buy wholesale, sell at retail—make big profits. Hundreds doing it. You can, too. Send 25c today for catalog and wholesale price list. Refundable first order. Gearon Co., Dept. 500-B10, 27 S. Desplaines, Chicago 6, Ill.

**"HOW To Make Money With Simple Cartoons"**—A book everyone who likes to draw should have. It is free; no obligation. Simply address Cartoonists' Exchange, Dept. 910CP, Pleasant Hill, Ohio.

**ALASKA!** Jobs! Nation wide authority on daily Alaskan employment. Unlimited opportunities booklet with map included. Also homesteading; government jobs. \$1.00 complete. Alaskan Opportunities (PM) 7512 - 18th N.E., Seattle 5, Wash.

**FREE** Book "How to Make Money With Home Workshop" describes amazing methods used by hundreds of successful craftsmen. Tells what to make, how to sell workshop output spare time. Write at once for details. Remember it's free! Craftsman, 115-A10 Worth St., New York City.

**FOREIGN** Employment. Construction men, building trades, mechanics, helpers. Office men. Good workers interested in foreign development projects. Pipe lines, dams, power plants, roadways, shipping, oil refineries, etc. Transportation and quarters furnished; high wages. Listings of firms actively working on projects in Arabia, Persian Gulf, Africa, Alaska, Canada, South American, Europe, etc. Send \$1.00 for foreign construction compendium and application forms. Foreign Service Bureau, Dept. PM-10, (Employment), P.O. Box 295, Metuchen, N. J.

**MAKE** Money raising golden hamsters. Easy; pleasant work. Literature free. Blackhawk Hamstery, 636-M Jackson, Ft. Atkinson, Wisconsin.

**TYPISTS,** Profitable business at home. Complete copyrighted information 50c. Rosdahl Industries, 4901 Elston Avenue, Chicago 30, Illinois.

**HAVE** Fun! Make money! "Working With Leather"—64-page booklet tells how. Send 25c for copy. Free catalog and valuable information included. Wilder-Craft, 1039 Crosby, Chicago 10.

**RAISE** Pheasants on the \$100 week plan. Little capital and space can make you independent. Free details. Great Central Game Management System, Columbus, Kansas.

**WANTED**—Purchasing agents. No money or experience required. Write Dept. C, Purchasing Manager, 2719 Lawrence, Chicago, Ill.

**MAKE** Flexible molds! Cast plaques, bookends, figurines! Free sample! H. Tooker, 630-M Chestnut, Hamilton, Ohio.

**LIFETIME** Income as notary public. Appointment assistance. Stationers, Helotes 50, Texas.

**RAISE** Fishworms. Easy, profitable. Send 25c in coin for complete instructions. Huffman Worm Ranch, Rives Junction 2, Mich.

**\$250 WEEK** Reported! Free illustrated book "505 Odd, Successful Businesses." Work home! Expect something odd! Pacific-E, Oceanside, California.

**INTERESTED** In Latin America and foreign employment? \$1.00 brings 1950 copyrighted "Foreign Service Directory" world wide listings in construction; oil; mining; aviation; steamships; manufacturers; transportation; exporters, importers. Hot list firms hiring. How-when-where to apply. Application form free. Global Reports, P.O. Box 883-P, Hollywood 28, Calif.

**BE** The Popular Mechanics representative in your neighborhood and earn big profits in your spare time. Write Popular Mechanics Magazine, Room 408M, 200 E. Ontario St., Chicago, Ill.

**\$46 FROM** Square foot plywood; jigsaw necessary. Write, Woodarts, P-38, Bridgewater, Mass.

**OWN** And operate mirror shop! Supplies for resilvering mirrors, making chipped glass nameplates and electroplating. John Sprinkle, V50, Marion, Indiana.

**\$40.00 WEEKLY** Made growing mushrooms, fresh, dried. Dominion patent 331583. Free spawn. North American, 169P Yonge, Toronto, Canada.

**ALASKA**—Last great American frontier. \$1.00 brings 1950 copyrighted directory and government map free. Big construction projects; fishing; mining; aviation; hunting-fishing-game rules; fur-farming; lumber; live stock; agriculture. Homestead land and highway information. Listing firms hiring. Application form, Alaska Opportunist, P.O. Box 883-P, Hollywood 28, Calif.

## BOOKS, PERIODICALS, PICTURES POSTCARDS

**SEND** 10c For catalogue. Hawaiian books, postcards. 10c refunded first order. Maui Book Store, Wailuku, Maui.

**USED** Books, low prices. Send wants. Free lists. David-Norman, Box 434M, Hempstead, N.Y.

**HOLLYWOOD** Movie star photos. Sample and list, 10c. M. Fortney, Dillsburg, Penna.

**BACK** Issues magazines, reasonable. Reedmore, 240 East 9th, New York, N. Y.

**SELF-Explaining Bible:** Illustrated circular free. Box 445-P, Minneapolis, Minn.

**USED** Correspondence courses. Bought. Sold. Rented. Free literature. Baker, 5509-B Winthrop, Chicago 40.

**LOW** Subscription prices. Free list. Rural Magazine Agency, Grenada, Miss.

**FARMERS** And owners of all livestock—Do you want to save money in taking care of your animals? Send for amazing new book Veterinary Guide for Farmers. New facts on the diagnosis, treatment and prevention of diseases of farm animals. Authoritative, easy-to-understand and guaranteed to satisfy you or your money back. Postpaid \$3.50. Windsor Press, 200 East Ontario Street, Chicago 11.

**NAME** The book—We'll get it! Chicago Book Mart-PBM, 3725 Southport, Chicago 13, Illinois.

**BOOKHUNTERS!** All subjects. Send wants! Jaher Book Service, 620-P East 178 Street, New York 57.

**BOOKFINDERS!** (Scarce, out-of-print, unusual books). Quickly supplied. Send wants. Clifton, Box 1377-PM, Beverly Hills, Calif.

**NATIONAL** Geographic Magazines 1888-1949. Any issue, Box 327-PM, Periodical Service, Swarthmore, Penna.

**HOW-To-do-it** books on every subject. Written in Popular Mechanics' famous easy-to-understand style and profusely illustrated. Subjects include workshop planning and practices, projects, hobbies, household repairs, motoring, outdoor sports, photography, home building and many others. Also booklets on specific topics. Write for free illustrated catalogue. Popular Mechanics Press, 200 E. Ontario, Chicago 11, Ill.

## MAGIC TRICKS, PUZZLES, JOKER NOVELTIES

**LEARN** Ventriloquism. Make money. Have fun. Big opportunity! Radio, television, stage appearances. Free information. Write, stating your age. Dummy catalogue 25c. Maher, Box 36-M105 Kensington Station, Detroit 24, Michigan.

**NICKELS** To dimes. Superb precision metal pocket magic. \$1.00. Fun Shop, Box VEE, Avalon, California.

200 **ELECTRIC** Stunts, 110 volts, \$1. Kutting Sons, Los Altos, Calif.

**JOIN** Our New Magic Club. Send 10c for illustrated catalogue and free particulars. Magic and Fun Mart, 55-L Prince St., New York.

**FREE!** 25 Jokes, tricks, with catalogue 25c. Finko, (1618-A), Philadelphia 5.

**FREE** Jokers' item with giant catalog, tricks, jokes, puzzles, 10c. Andersen's Fair, 6815-P Ardmore, Chicago 31.

**FREE** Hot toothpicks, 10 other tricks 25c. Catalogue. Coin slide trick 25c, yakkity yak talking teeth \$1.00. Laramie Sales, 4800 So. Laramie Ave., Chicago, Ill.

**LEARN** Magic, ventriloquism, mind-reading. Write for particulars. Fasick, Big Flats, N. Y.

500 **TRICKS,** New 1950 edition now ready! Send only 10c for your copy, containing latest in good magic for pocket, parlor, stage. Unequaled service to magicians for 30 years. Douglas Magicland, Dept. 1, Dallas, Texas.

**BIG** Magic catalog and book "102 Easy Tricks." Both only 50c. Robbins Co., 131-R West 42nd Street, New York.

**BE** A magician. Large professional magic catalog of latest tricks, 35c. Ireland, C-109 North Dearborn, Chicago 2.

PROFESSIONAL Catalog, 124 pages, 25c. Williams, 900 Plymouth, Ellwood City, Penna.

MAGIC Tricks, puzzles, books, cards, punch boards. Catalog 10c. Specialty, Box 671, St. Louis 1, Mo.

512-PAGE Catalogue of 2500 tricks, pocket, parlor, stage. World's finest magic. Send \$1.50 for catalogue (refunded first \$6.00 order). Kanter's, M-1311 Walnut, Philadelphia 7.

16 CARD Tricks and catalog 25c. Sterling Magic, Royal Oak, Mich.

WORLD'S Largest professional magic shop, keeps you in touch with latest tricks. To receive mailings, send 50c for new catalog. Holden's, M220 West 42nd St., New York.

VENTRILOQUISM Taught. 3c stamp bring particulars. Smith, 801 Bigelow, Peoria 5, Ill.

### COINS, TOKENS, CURRENCY

OLD Money wanted. Will pay fifty dollars for nickel of 1913 with liberty head (no buffalo). We pay cash premiums for all rare coins. Send 4c for large coin folder. May mean much profit to you. Numismatic Co., Dept. 20, Fort Worth, Texas.

SCARCE Lincoln pennies 1913S, 1914S, 1915S, 1915D, 1921S, 1923S, 1924S, 1926S, 1931D, 1932D, 1933D. 10c each. 11 for \$1.00. Reynolds Coins, Flint 13, Mich.

UNITED States rare coin value guide 50c; premium catalog of modern foreign coins 50c. Johnny Flood, 826-P So. Wabash Ave., Chicago.

FOR Pleasure and profit collect coins! Send 3c stamp for illustrated information folder. Hewitt, 5450-J Clark, Chicago 40.

1931-S LINCOLN Cent 65c. Pony Express medal 50c. both \$1.00. Giant bargain catalogue 15c. Bebee's, 1180 East 63rd, Chicago 37, Illinois.

100 COINS And bills \$1.00. Oddehon, Box 482, St. Louis, Mo.

30 DIFF., World coins \$1.00. 20 diff., 50c. Bishop, Box 2201, Kansas City, Mo.

FOREIGN Bills, 10 different 15c; foreign coins, 10 different 25c. Lists. O. Arnold, Macon, Mo.

FOR Pleasure and profit order, "world's greatest paper" for coin collectors, and two wooden nickels 10c. Lawrence Brothers, Anamosa, Iowa.

BARGAINS! Rare collection contains United States large cent over 90 years old. Flying Eagle cent, White Indian cent, 1881 cent, 1909VDB cent, 1912-D cent, 2c piece, 3c silver, 3c nickel, half dime, shield nickel, 1913 nickel, nickel without word cents, liberty seated dime, liberty seated quarter, large \$1.00 bill, Civil War cent, Confederate money, foreign coin, foreign bill and our complete buying-selling catalogue all \$3.00. 20 different dates Indian cents \$1.00. 18 different dates liberty head nickels \$2.00. 15 different dates large cents \$3.00. 1864-L cent \$2.00. Everything \$10.00. Catalogue 25c. Worthy Coin Corporation, 294 Washington, D-402, Boston, Mass.

MEXICAN Coins, 9 piece set \$1.50. 8 Reales \$1.75. 5 Pesos silver \$1.50. The Border Coin Co., Station A, Box 3535, El Paso, Texas.

4 BEAUTIFUL Whitman coin albums \$1.00. Giant bargain list 10c. Olson, 5800 Lake, Chicago 44.

ILL Buy your old coins. Send 50c for illustrated coin catalog listing highest prices paid. Jack Farrell, 19370 Stratford Rd., Detroit 21, Mich.

50 ASSORTED Indian pennies, \$1.50; 1892 Columbian half-dollar, 75c; Whitman coin album, 25c; 1863 Civil War cent, 15c; 25 foreign coins, \$1.00; check list, 3c; large catalog, 15c; 100 2 x 2 coin envelopes, 25c. Coin Shop, 31 North Clark, Chicago 2.

COINS Wanted: Itemized value list 20c. Eisholz, Box 9014M, Pittsburgh 24, Penna.

COINS Wanted, will pay up to \$2000 for certain coins, send 25c for catalogue. Burton's, 111 So. Third, Columbus, Ohio.

FREE! Foreign coin, banknote and coin collectors illustrated catalog to approval service applicants. Send 3c postage. Tatham Coinco, Springfield 30, Mass.

GET Profit and pleasure in collecting old coins. Send 10c for 56 page illustrated coin catalog. You'll be delighted with it. Send for it now. B. Max Mehl, 370 Mehl Bldg., Fort Worth, Texas. Largest rare coin establishment in U. S. Established 50 years.

COMMEMORATIVE \$1½, Oregon, Texas, Kentucky, Cleveland, Long Island, \$2.00 each. Illustrated catalogue 25c. Norman Shultz, Salt Lake 9, Utah.

### OLD STAMPS WANTED

I Will pay \$100.00 each for 1924 1c green Franklin stamps, rotary perforated eleven (up to \$1,000 each unused). Send 10c for large illustrated folders showing amazing prices paid for old stamps, coins and collections. Vernon Baker, PM-10, Elyria, Ohio.

### STAMP COLLECTING

1893 BALKANS Packet! Bonus approvals! Colonial, Box 326A, Passaic, N. J.

DIFFERENT, 25 Canada, 25 U. S., 25 Switzerland. All 3c with approvals. Alatel, Maynard, Massachusetts.

FREE! Scott's International albums, U.S. albums, catalogues. Particulars with approvals. Claire's, 7402 Bayparkway, Brooklyn 4, N. Y.

BAHAWALPUR Set 10c, attractive approvals. Rheume, 6591 11th Ave., Montreal 36, Canada.

5 SETS 5c. Sports, airplanes, pictures. Approvals. Wirth, Norwichtown, Conn.

LOOKING For bargains? Try our 1 and 2c approvals mounted in books of 1,000. We believe in both quantity and quality. First try will satisfy. Clark, Box 544P, Muskegon, Mich.

10 ASSORTED U. S. Commemorative 15c. Five U. S. Air Mail 15c. 10 Famous Americans 25c. All for 50c. Ideal Stamp, Box 179, Park Ridge, Illinois.

TRY "Gold Nugget" approvals: U. S., Americas, British Colonies, world. Nothing like them! 312 mixed U. S. only 10c to approval applicants. Kessel's, Palsom, California.

ZANZIBAR, Pitcairn Islands, Turks, Calcos, Gilbert, Ellice, Solomon, Borneo, Gambia, Tanganyika and others. Complete collection free. Send 5c for postage. Gray Stamp Company, Dept. PM, Toronto 5, Canada.

BIG Dollar value, 50 Italian commemoratives 25c with approval books. Profit sharing plan. Book Nook, Oronoco, Minn.

FREE—Ten different United States airmails with United States or British approvals. Gables Stamp Studio, Box 985, Coral Gables, Florida.

UNUSUAL—Unheard of. Cancelled sets of Roosevelts and Washington bicentennials complete. All yours for fifteen cents. Bargain approvals accompanying. Park Stamp Co., Box 191, New York 21, N. Y.

ALL Stamps at 1c each. Collection of 10,000 different, divided in 20 \$5 lots each containing 500 stamps. You just buy one lot at a time as often as you like. Each lot delivered as soon as paid for. No contract. No obligation. Real savings. N. V. Robillard, 812 West Vantrees Street, Washington, Indiana.

FREE 1300 Stamps, approval buyers only. Superior Stamps, 6908 Zoeter, Cleveland 3, Ohio.

100 DIFFERENT Stamps free with approvals at 60% discount. Martinsen, Box 115, Wash. Bridge Station, New York 33.

100 DIFFERENT U. S. commemoratives one dollar. Request approvals. Harold Holub, 18 East 198 Street, New York 58, N. Y.

FREE, Scott's International Album. Other big premiums. Full particulars with approvals. Raymax, 123-Z William St., New York City 7.

750 FRANCE And colonies stamps 10c. Littleton Stamp Co., Littleton 25, N. H.

WHOLESALE Lists to dealers. 3c postage. Grossman, 100 West 42nd, New York 18.

FREE! Canadian sets, royal visit, George VI, George V, coronation, jubilee, others to approval applicants. Ensign, Box 118-M, South Orange, N. J.

5 DIFFERENT Unused flag blocks (face) \$1.00. Approval applicants. North Andover Stamp, North Andover, Mass.

FREE—Famous Americans set, Flag set, National Parks set, and Presidential set to \$5.00. A total of 90 stamps free to customers for our unsurpassed U.S. and foreign selections. Send 3c for 15 of the above stamps and full particulars. Triboro Stamp Co., 145 Nassau St., Dept. 110, New York.

TOPS! Our book "How To Collect Stamps." Send for your free copy today! Littleton Stamp Co., Littleton 37, N. H.

EXCHANGE Stamps universe. Particulars free. "Exchangers," Bry 126, Seine, France.

FIFTY Different United States; commemoratives, dues, etc., 10c. Ed Keller, Library 1, Penna.

SAN Marino Collection free—25 different old and new issues. Airmails. Commemoratives. High values—Absolutely free with approvals. Viking, 130-ZZ Clinton St., Brooklyn, N. Y.

HOW To recognize rare stamps. Free book—Illustrated! Kenmore, Arlington 74-H8, Mass.

5000 DIFFERENT 1/5c Each. Bargain list gratis. Stamps, Box 1649P, Oakland 4, California.

10 AUSTRALIA Commemoratives in popular "111" packet. 10c. Approvals. Pleasure Stamps, 1865P - 52nd Street, Brooklyn 4, N. Y.

FREE Collection—Over 100 different stamps of the world—commemoratives, she-wolf, camels, giraffes, ships, rare Austria race horse, others all to approval buyers; also Scott International Albums, stamp catalogs. Bell Stamp Service, Dept. S-2, Box 190, Bell, California.

DEALERS Wholesale lists. Postage 3c. Transcontinental Commerce, 337 East 94th, New York 28.

TRY Hutch's approval service. Hutchinson's, 3463 "I" Street, Philadelphia 34, Penna.

FREE! 50 Different Japanese stamps! Approvals. Star Stamps, 225 Willard, Jamestown, New York.

GOYA Nude (2) 5c. Approvals. Han-nay's, 310 Quail, Albany 3, N. Y.

199 DIFFERENT—33 countries including 38 19th century diamonds, airmails, jubilees 10c. Approvals. Brooks, 2352B East 23rd Street, Brooklyn 29, New York.

STAMPS 100 Years old! Are usually expensive and hard to get. Yet we offer 10 very old 19th century foreign stamps plus the re-issue of the 100-year-old first U. S. stamp (No. 1), the famous 5c Franklin all for only 10c to new approval applicants. Please state whether approvals shall consist of U. S., or foreign or both. Globus Stamp Company, 268 Fourth Avenue, New York 10, N. Y., Dept. 212.

FREE! Monaco nude, Britain 2½ shilling, Mozambique bridge stamp, India peace, Gandhi and Independence stamps, plus 100 other good stamps. T. Moulblow, 740 Hegney, Bronx 56, New York.

REVOLUTIONARY! Complete miniature sheet free! Knott, 434 East 76th, New York 21, N. Y.

PENNY Approval bargains—Write Department PM, 1267 Tutwiler, Memphis 7, Tennessee.

FREE Duplicate exchange with approvals! Colonial, Box 326K, Passaic, N. J.

MONACO Nudes set 10c. Approvals accompany. Atlas, 3210-M Republic, Racine, Wisconsin.

FREE—25 Diff. Japan with approvals. Karl Scheerer, Box 301, Pottsville, Penna.

GIANT, Pigmy, triangle, other odd stamps free with bargain approvals. Niagara-on-the-Lake 11, Canada.

SENSATIONAL Offer! 50 different colorful San Marino pictorials 6c. Approvals. "PG," 195 Park, Lewiston, Maine.

FIRST Day covers on approval! Crum-rine, 6626 Lotus Road, Philadelphia 31, Pennsylvania.

POUR French Colony sets only 5c to approval applicants. Offer limited. Excel Stamps, 1241 Longfellow, South Bend 15, Indiana.

POSTAGE Stamps on approval. G. D. Ridings, Dept., Melvin Hill, N. C.

U.S. Illustrated price list free. DeLisle, 154 S. 2nd St., San Jose, Calif.

½c-1c APPROVALS! Bargains galore! Cole, 43-A Rinewalt, Buffalo 21, N. Y.

FREE! Scarce U.S. 5c and 10c coils. Approvals. "PG," 195 Park, Lewiston, Maine.

500 DIFFERENT Stamps only 25c to introduce our bargain approvals. Niagara Stamps, Niagara-on-the-Lake 30, Canada.

WANT Quality approvals? Try Roscoe's penny approvals. Roscoe Stamp, 1321 Roscoe, Chicago 13.

FLAG Stamp free with hydrade U.S. approvals. Wenigman, 1933 Patterson, Chicago 13.

FREE 10 Japan war stamps. Approvals. Schroeder, 636 Charles, St. Paul 4, Minn.

100 DIFFERENT Worldwide, 5c. Approvals. Stearns, 26970-B Princeton, Inkster, Michigan.

ILLUSTRATED Stamp magazine, 26 weeks 25c. Stamp Journal, Kalamazoo, Michigan.

STAMP Magazine! Free copy! "Stamp Post," South Catalina, Pasadena, Calif.

COMPLETE Mint foreign sets on approval. Hammell, Box 865-A, Waterbury 20, Conn.

500 MIXED Stamps and surprise packet for 10c, with approvals. Fahsing, Dept. PM, Atascadero, California.

100 DIFFERENT 10c With approvals. Jacobsen, 59 Nagle Ave., New York 34, N. Y.

POWERFUL Magnifying glass given to new customers for 5c postage and handling. Big bargain lists included. Jamestown Stamp Co., Dept. 207, Jamestown, New York.

UNITED States approvals complete coverage, fine quality, attractive prices. Seminole Stamps, Box 1138-P, Coral Gables, Florida.

FASCINATING Wonder packet 200 different China, 20c with approvals. Billingslea's, Gilmer, Texas.

FREE! Beginner's collection! With lists! Stampart, Box 2071, Hartford 1, Conn.

KOREA, Mongolia, Manchukuo, U.P.U., triangle; free packet to approval applicants. Worthmore, Box 156, Miami 45, Florida.

U.P.U. Issues, 10 different 10c, approvals. Hart, 3612 Darwin, Cincinnati 11, Ohio.

BARGAINS! 2,000 Foreign stamps \$1.00, 5,000 \$2.00, 2,000 U.S. \$1.00, 5,000 \$2.00. Postall Sales Company, Department 4128, Washington 13, D. C.

FREE! Exciting world wide collection. Triangles, pictorials, airmails, maps, natives, mountains, ships, jungles, kings. From Ceylon, Argentina, India, Holland, China, others. Everything free with approvals. Steiner, 330-F East 63rd, New York 21.

AMAZING "Queer Countries" packet—Free with approvals! Saxon, Escondido, California.

WHOLESALE Lists for junior dealers. Edward Hammond Company, Auburndale 66, Massachusetts.

OUTSTANDING Value 25c each. 25 Liechtenstein, 25 Morocco, 25 Canada, 25 Algeria, 25 airmails. Special all five \$1.00. Stuart, Box 72, Bowling Green Station, New York 4, N. Y.

307 ALL Different 15c. Beautiful collection of commemoratives, triangles, high values, bicolored stamps, etc., only 15c. Garcelon, Box 400, Calais, Maine.

U. S. Collection unbelievable! 300 different mostly commemoratives, \$1.10 post-paid. Franklin Stamp Co., 53 East Main St., Rochester, New York.

FREE! 25 Different Switzerland, with swell approvals. Kardell, 209 Bower, Santa Fe, New Mexico.

FREE! 100 Different world, approvals 1c up. Southworth, Weston, Mich.

110 DIFFERENT U.S. commemoratives \$1.00; 325 different \$3.00; 500, \$10.00. Bardsley, Roslyn, Penna.

BOY Scout set complete, Netherlands 1937, 10c with approvals. Vargo Stamps, 6044 South Fairfield, Chicago 29, Illinois.

GIGANTIC Bargain! Solomons, Caymans, Dominica, Grenada, Mauritius, Nauru, Gilberts, triangles and multitude others. Everything 10c with approvals. Seeley, Box 483P, Baytown, Texas.

50 DIFF. France, only 5c to new approval applicants. Bert Solka, Box 146M, Jackson Heights, N. Y.

FREE! United States, foreign price lists. Floyd Frederick, 513½ Green Street, Lancaster, Penna.

\$33.00 FOR 10c! Special bargain offer of eleven different used \$1.00 to \$10.00 United States stamps with a face value of \$33.00, seldom found in most collections and usually selling for far more, offered for only 10c to introduce our sparkling approvals. Money back if not delighted. D. M. Darling & Co., Dept. 403, Ridgway, Penna.

100 WORLD 10c. ¼c Approvals. Page-wold, 1355P No. Dearborn, Chicago 10, Ill.

222 DIFFERENT 10c. Foreign approvals. Co-op, 230 Ocean Parkway, Brooklyn 18.

HANDY, Valuable U. S. illustrated catalogue free. Stone, X-52, Dorchester 24, Mass.

FREE Stamp Finder. Tells instantly country to which any stamp belongs. 32 pages profusely illustrated. Garcelon, Calais 17, Maine.

10,000 PENNY Approvals waiting for you. Many from exotic countries, pictorials, airmails, new issues. Tilbury, Box 862, Newark 1, N. J.

WONDERFUL Offer 7 complete mint sets, Manchukuo, Bohemia and Moravia for only 10c with approvals. Reich Stamp Co., 4647 Kenmore, Chicago 40, Ill., Dept. M23.

100 OLD U. S. before 1935, 50c. Roush Stamps, 51 Chestnut, Mansfield, Ohio.

300 DIFFERENT Given free with approvals. Postage 3c. Windsor Stamps, 1435 East 67th Place, Chicago 37.

40 DIFFERENT, Liberia triangles 10c, approvals. Greenwood, 441 Washington, Miami Beach, Florida.

INDISPENSABLE U. S. list 10c. Stanley Gibbons, 38-P Park Row, New York.

GIFT—Tokelau Is. complete mint to approval applicants. Deane Stamps, Box 87, Miami 35, Florida.

50 DIFF. French Colonies, 10c with worldwide approvals. Fields, 1939 E. 85, Cleveland 6, Ohio.

FREE Gigantic beautiful bi-colored mint U. S. Yorktown stamp to approval applicants. Mohawk, Box 524, Albany, New York.

MAKE Money dealing in stamps! Free details. Lory's, Villa Park, Illinois.

APPROVALS Colorful foreign selected stamps. Complete sets, singles. Satisfaction assured. Ward, 241 So. Winchester, Campbell, Calif.

GRAND Value packet with five foreign sets, free. Stoll Stamp Service, 2632 Burnett, Louisville 10, Kentucky.

1000 WORLD Wide 67c. Pacific, P.O. Box 5704, Los Angeles, Calif.

FREE! Volcano pictorial! Madagascar! Nigeria! Chinese! Approvals. Keating, 637-P Bergen, Jersey City, New Jersey.

TWENTY Diff. 19th century given to approval applicants. Rossom, 218 West 59th St., Chicago 21, Ill.

110 DIFFERENT Hitlers, Roosevelt, Liberia, Haiti, etc. 10c. Buckley, 208 Ludlow Bldg., Dayton 2, Ohio.

LOOK—Gift of United States commemorative sets. Free premiums with each order. Approval applicants send 5c. Locust Stamp Co., Box 390T, Peekskill, New York.

50 DIFF. China 5c. Worldwide approvals sent. Holmes, 628 Connally Drive, East Point, Ga.

WORLDWIDE Stamps. All different. 200, 25c; 500, 50c; 1000, \$1.00; 2000, \$2.50; 5000, \$12.50. Beacon Sales, Northboro, Mass.

500 STAMPS For only 10c! This mammoth value includes airmails, pictorials; stamps from strange countries, cataloging up to 25c each! Also approvals. Mystic Stamp Company, Camden 80, New York.

500 JAPAN Stamps 10c. Kenmore, Arlington 74-J4, Mass.

FREE—Cuba Roosevelt issue and illustrated catalog. Littleton Stamps, Littleton 12, N. H.

50 DIFFERENT U. S. 10c. No approvals. Seidenberg, Box 944, Appleton, Wis.

10,000 DIFFERENT 1c Each! Gordon Davison, Box 1019S, Manchester, N. H.

AMAZING Offer! 500 United States stamps—including commemoratives, airmails, high values to \$5.00. Only 10c to approval applicants! Illustrated bargain lists free. Mystic Stamp Co., Dept. 80, Camden, New York.

FREE Philatelic supply list. Penny approvals on request. Reed, Box 980, Chicago 90, Illinois.

100 EXOTIC Japan—All different, 10c. Kenmore, Arlington, 74-K7, Mass.

GENUINE "Goya nude" set (catalogs 55c) 15c. Approvals. Royal Stamp Company, Tamaqua, Penna.

STAMPS Wanted. Collections, duplicates, surplus stock, mint and used. Trade for printing; buy outright if bargain. What have you, what's wanted. Vanroy Shirk, Lebanon, Penna.

PENNY Approvals that satisfy. Neil Gronberg, Box 5441-P, Philadelphia 43, Penna.

OLD Scarce U. S. seconds on approval. Slightly defective. Bargain prices. Hernefield, Clintonhill Station, Newark 8, N. J.

200 DIFFERENT Including Roosevelt triangle, 5c to approval applicants. M. Avalon Stamp Company, Springfield, Mass.

ARMENIA, Ten bicolored stamps, value 75c free to approval buyers. Apex Stamps, Box 2188, Miami 13, Florida.

FREE—Illustrated catalog! Kenmore Stamps, Arlington 74-C7, Mass.

200 BRITISH Empire stamps plus valuable publications only 3c. Kenmore Stamps, Arlington 74-B17, Mass.

MAGNIFIER, Big stamp magazine; first U. S. commemorative; plus unused \$5000 Foreign Legion, diamond, giant, and other worthwhile stamps. Everything free to approval buyers. Capital Stamp Company, Little Rock 2, Arkansas.

WORLD—500 Diff. 50c, 1000-\$1.00, 75 Canada 25c. Approvals, lists. Victoria Stamp Company, London 4, Canada.

200 DIFFERENT Stamps 10c with approvals. 500 mixed United States 25c. Carlton's, Tujunga, Calif.

DEALERS—Wholesale list. Postage 3c. Frank, 5031 Queensberry, Baltimore 15, Md.

U. S. Price list. Send postage. State Stamp Service, 1225 Park Building, Pittsburgh 22, Penna.

WOW! \$10.00 Worth of fun 10c! What a treasure hunt! Big package 500 foreign stamps, including airmails, pictorials and others from the world over; stamps worth up to 25c each. This offer sent for 10c to approval applicants only. Jamestown Stamp Co., Dept. 22, Jamestown, New York.

WORLD'S Largest stamp (7½x14 inches). A real curiosity! Retail for 50c, only 3c to approval applicants. Tatham Stamp Co., Springfield 30, Mass.

FREE! 100 Worldwide different stamps to approval buyers. Big U.S. and illustrated bargain lists sent with approvals. Bookman, Maplewood, N. J.

### ANTIQUES, RELICS, INDIAN GOODS, CURIOS

DECLARATION Of Independence, Lincoln's Gettysburg address, bill of rights. Authentic reproductions from Library of Congress on aged parchment paper. Appear hundreds of years old! All three for one dollar cash. Added; special premium free; copy of Constitution if you act promptly. Evelyn Bedard, 7416 Castor Ave. (15), Philadelphia, Penna.

INDIAN Relics. Old guns, minerals, frontier books. Illustrated catalog 25c. 8 arrows, \$1.00. Ed. Bartholomew, 8102 Lockheed, Houston, Texas.

### PRECIOUS STONES, MINERALS

TEN New Mexico mineral specimens \$1.50. Antique nails 25c. Fool's gold 25c. Free literature. Prospector, Winston, New Mexico.

ROSE Quartz, jasper, agate and catalogue. Quarter. Gemco, Elkhart Lake, Wisconsin.

MINERAL Specimens, cutting material, slabs, and gems. Send for free booklet. Warren's Minerals and Gems, 1969 Abbott St., San Diego 7, Calif.

MINERAL—Treasure locators — Geiger counters. Can be purchased on monthly payment plan. Free literature. Fisher Research Lab., Inc., Palo Alto, Calif.

GEMSTONES, Mineral specimens. Every variety. Lowest prices. Postcard brings free booklet. Plummer's, 2183C Bacon, San Diego 7, California.

METAL Detectors. The very latest circuit. Send 25c for literature. Hedden Metal Detectors, 3329 Liberty Ave., Pittsburgh 1, Penna.

### HOBBIES AND COLLECTIONS

50 DIFFERENT Army embroidered patches \$1. Other bargains. Insignia Mart, 703A Broadway, New York 3, N. Y.

KLONDIKE Novelty and jewelry findings! Novelty jewelry findings swept from manufacturers' tables. Parts for bracelets, pins, earrings, finished and unfinished chains, rings, stones, clips, beads, many others. Sample pound assortment \$2.00, 5-pound lots, \$5.00. Also unset stones, for rings, jewelry: all colors, sizes, designs, 1,000 assortment \$5.00, sample 100 assortment \$1.50. Also beads, assorted colors, sizes, 5-pound lots \$3.00, sample pound \$1.00. Prepaid only. Merchandise Distributing Company, 19 East 16th Street, Dept. J-2, New York 3, N. Y.

FOREIGN Medal ribbons packet. \$1.00. Free illustrated book. Browns, 3419 CenterB, Calgary, Canada.

NEW—15 Different match covers 10c. Box 202, Rochester 1, N. Y.

UNUSED Matchbook covers — 100 different \$1.00. Catalog 25c. Charles Edelman, 1311C East 84, Cleveland 3, Ohio.

INVENTING can be an interesting and profitable hobby. Write for complete particulars. Institute of American Inventors, Dept. 40-E 631-E St. N.W., Washington 4, D. C.

## CAMERAS, PHOTO SUPPLIES

**BASS** Says: Bargaingram 257 ready and waiting for you. The book which tells all. The finest in new and used camera equipment, a veritable encyclopedia. Write, phone or call the sign of the old "Horse Trader." 40th year of satisfaction or your money back dealing. Bass buys, sells and trades. Bass Camera Company, Dept. AG, 179 W. Madison St., Chicago 2.

**ADD "Spice"** to home projection shows with old-time Nickleodeon slides. 2x2. Kodachrome. Write for free list. Nickleodeon Co., New Fliedner Bldg., Portland 5, Oregon.

**NIGHTVISION Tube** \$14.95 with instructions. Snooperscope book \$1.50. Infrared filters 15c. Catalogue-data 10c. Precise, 942 Kings H'way, Brooklyn 23, N. Y.

**KODACHROMES**—Slides of Mexico on approval. Douglas Whiteside, Yosemite, California.

**PICTORIAL Figure photography**, 48 full page illustrations also a discussion of the human figure in art of all types. Send for free literature. Film Agency, 935 Cincinnati St., Dayton, Ohio.

**FREE Photographic bargain book** packed with hundreds of sensational values in still and movie cameras, lenses and latest accessories. Super savings for you in new and used equipment. Liberal trade-in allowances, too, on your equipment. Write now for your free copy to Central Camera Company, Dept. 9K, 230 S. Wabash Ave., Chicago 4. (Photographic headquarters since 1899.)

**PHOTOCOPY Anything**—Papers, books. No darkroom. 8½"x11" complete \$6.95. Fotoflek, 3751 St. John's Terrace, Cincinnati 36, Ohio.

## PHOTO FINISHING

**YOUR Films** carefully developed and enlarged to 3½"x5. Faster, finer quality service. Only \$1.25 for 36 exposures; 85c for 20 exp. Send films or write today for free mailers. Post Photo Service, Dept. A, 475 Fifth Avenue, New York City.

**OIL Coloring photographs** can be a fascinating hobby or profitable sideline for those with artistic talent. Learn at home. Easy simplified method. Send for free booklet. National Photo Coloring School, 1315 Michigan, Dept. 3437, Chicago 5, Ill.

**FOUR 8x10 Enlargements** \$1. Ten, \$2. Surgals, 3300 Beach, Chicago 51.

**FREE!** Trial offer. Extra set giant size prints with roll and this ad. 8 exp. 35c. 12—50c. 16—65c. Reprints 4c. Money-back guarantee. Send for mailing envelopes. Bonded Photo Service, Box 829-M, Hollywood 28, California.

**SPECIAL**, 10 Reprints 25c. 50—\$1.00. Roll developed and printed 25c. Dick's Photo, Louisville 12, Ky.

**MAIL Us your films.** Prompt service. 8 exposures developed and printed 30c. Free enlargements. Foto Art Studio, Box 406, San Francisco, Calif.

**TWO Beautiful prints** from each picture on 8 exposure roll 35c. 29 years of satisfied customers. Quick service. Lens Photos, Dept. J-4, Janesville, Wis.

**XMAS Cards** with envelopes, 18—\$1.00. Send negative. 5c for sample card, list of styles. Graphic Photo Service, 8 Saint John Street, Plains, Pennsylvania.

**BEAUTIFUL Enlargement** from each picture on 8 exposure roll 35c. Cut Rate Photos, Dept. B-4, Janesville, Wis.

**FREE Price list** on quality developing, printing, enlarging. Write for it today. Bryan's Photo Shop, Dept. M, Panama City, Florida.

**FREE 5 x 7 Enlargement** with each roll developed and printed, 6 or 8 picture roll 35c. 12 or 16 picture roll 55c. Send coin with roll. No c.o.d. If you fail to get pictures on your roll of film, we will mail a new roll to you at no additional cost. Overnight service. Mailers sent free on request. Deluxe Film Service, Box 1263, Shreveport, Louisiana.

**2 BEAUTIFUL Hi-Gloss prints** each good negative and enlarging coupon with each 8 exposure roll developed 28c. Free mailers. Owlphoto Co., Weatherford, Oklahoma.

**PHOTO Handbook** tells you how to take, develop and print your own pictures, build your own enlarger, etc. For the amateur and professional photographer. 160 pages, \$2.00. Popular Mechanics Press, 200-PF East Ontario, Chicago 11, Illinois.

## MOTION PICTURES AND SOUND EQUIPMENT

**BASS** Says: 40 years of leadership guarantees satisfaction. Finest cine equipment, 8mm., 16mm., and 35mm., silent and sound. Write the old "Horse Trader." Satisfaction or your money back always! Bass Camera Company, Dept. A, 179 W. Madison St., Chicago 2.

**SOUND Recording tape**—Leading manufacturer's surplus. Sold on money-back guarantee f.o.b. Opelika. 600' paper base 65c (plastic \$1.00). 1200' paper base \$1.00 (plastic \$1.50). Talking Tape Distributors, 506 North 3rd Street, Opelika, Alabama.

**"CINE-VOICE"** Sound-on-film camera shoots your own 16mm color talking-pictures. Write for free illustrated folder. Berndt-Bach, Inc., 7345 Beverly Blvd., Hollywood 36, Calif.

**BRAND New 16mm. sound one reel Castle Pictorial discontinued titles**, \$7.95; \$9.95 each, plus postage. Big list free. Blackhawk Films, Dept. PMG, Davenport, Iowa.

**16MM Sound movies; hundreds of titles:** bargains. Free gifts. Gaines, 639-PM Addison, Chicago 13, Ill.

**LOOK**—"The World's Greatest Passion Play," 8mm., 16mm. and 35mm. Mention sound or silent, purchase or rent. Hemenway Film Co., 33-F Melrose St., Boston 16, Mass.

**1000' 16MM. Silent-sound projection film** \$7.50. International, 2120 Strauss, Brooklyn 12, N. Y.

**MOVIES (8-16mm.)**. Enormous selection. Cameras, accessories, bargains, surprises galore! Big illustrated catalog. 25c; refunded first order. National Film Supply, Toledo 9-H, Ohio.

**SAVE 50%**—On movies. Free circulars. Fromaders, Box 637-A, Davenport, Iowa.

**NEW 16mm., 35mm. sound projectors.** Cine, 582 Ithaca, N. Y.

**WILD Game films**, 16mm, 8mm. Color, black-white. Sound, silent. Rare closeups taken in natural habitat by famed Eberhart organization. Send for free catalog. Wild Life Films, Dept. 9-PM, 6063 Sunset Boulevard, Hollywood, California.

**FREE MOVIES**. Thousands of subjects. Interesting. Entertaining. Fascinating. Latest directory—only 50c. National Cine Society, 126 Lexington Avenue, New York 16, N. Y.

**BETTER 8MM. and 16mm. movie camera film.** Free equipment catalog. Better Films, 742 New Lots, Brooklyn 7, N. Y.

**UNUSUAL 8 And 16mm. films**, used by many art students. Write for free catalogue. Send 25c for sample strip. Friart, 140-A-Liberty Street, New York 6.

**GUARANTEED Fresh anti-halo outdoor movie film!** Weston 16! Daylight loading! Processing free! Three spools double 8 mm. \$4.50! Six single 8 mm. for Univex, \$4.60! Postpaid! Catalog. Eso-S, 47th Holly, Kansas City 2, Missouri.

**RENT 16MM. sound films**, 50c reel. Large selection; free catalog. Film Service, 128 Chestnut St., Roselle Park, N. J.

**RENT 16MM. sound films**, 50c reel. Rogers Films, Box 26, East Atlanta, Ga.

**8-16MM. Silent-sound films.** Complete rental library. All latest subjects. Free catalogue, (sample film 10c). Garden Film, 317 West 50th, New York 19.

## MUSIC AND MUSICAL INSTRUMENTS

**ACCORDIONS**—All brands. New and used. Save 50%. Wholesale to every one. Del Principe, 307 So. Wabash, Chicago, Ill.

**REAL Composer of music** will co-operate in song production. Also master recordings under nationally advertised label. C. Isabel Mayer, Box 3896, Portland 8, Oregon.

**SHEET Music** 5c, 21 for \$1.00. Irving Siegel, Marshfield, Wis.

**BOOGIE Woogie piano** made easy. 14 lessons \$1.00. Miracle Series, Box 431-M, Pasadena 18, Calif.

**POEMS Wanted.** Percentage basis collaborations. Terry Tune Master, 709½ PM North Broadway, Oklahoma City 2.

**RECORDS**—Guaranteed new. Hillbilly, popular, spirituals, 4 for \$1.00. Free record with first order. Free catalog. Mailorc, Dept. 137, 570 N. Gay Street, Baltimore 2, Maryland.

**WRITE Songs.** Big money and reputation. Write for information. J. Gordon Pub. Co., 4700 South California Avenue, Chicago.

**POEMS Wanted** for musical setting. Send poems for free examination. Five Star Music Masters, 630 Beacon Bldg., Boston, Mass.

**MAKE Your own violin.** New book. You Can Make a "Stradivarius" Violin has eight full-size plans. Take the guesswork out of this fascinating project. Even tells how to fashion your own tools. Book and plans only \$3.50. Popular Mechanics Press, 200 East Ontario Street, Chicago 11.

**SONG Publication**—Royalty basis. Abbey Music, 242 West 10th, New York 14, N. Y.

**WANTED!** Poems for musical settings. Write Songwriters' Service, Clifton, N. J.

**POEMS Considered** for musical setting. Send poem for free examination and useful rhyming dictionary. Richard Brothers, 24 Woods Building, Chicago.

**SONGWRITERS!** Outstanding, ethical offer. Hibbeler, C-5, 2157 N. Avers, Chicago 47.

**SONGWRITERS!** Send poems, songs. Music Service, 243 West 72nd St., PM, New York 23.

**1950 ACCORDIONS**—Wholesale. Free catalog. American Accordion Center, 5329 Belmont, Chicago.

**POEMS Wanted** to be set to music. Free examination. Send poems. McNeil, Master of Music, 510-PM S. Alexandria, Los Angeles, California.

**MUSIC Arranged**, songs printed. Frank Wildt, Music Publisher, Lancaster, Penna.

## RADIO AND TELEVISION

**SPECIAL Bargain**—Selenium photo-electric cell rated at 500 microamperes per lumen. Generates ¼ volt in bright sunlight. Needs no batteries. Can be used in photo exposure meters and many other applications. No. 99-6810L. Each 95c plus postage. Send for free catalog and bargain bulletin on television, radio, electronic supplies. Concord Radio Corp., Dept. LK-50, 901 W. Jackson, Chicago 7, Ill.

**FIX Any radio.** Amazing new instrument locates radio troubles double quick. Simple instructions show you how. Thousands now in use. Free. Write today for 32-page illustrated technical manual, "The Inside Story." Feiler Engineering Co., Dept. 10PM5, 1601 S. Federal St., Chicago 16, Ill.

**BUILD Modern improved "diode detector radio."** Diode and complete illustrated instructions. \$1.00. New edition! "Five best tested circuits." 25c. Electronics, Dept. A100, Box 7101, Chicago 80, Illinois.

**BUILD Beginner's all-purpose tester.** Pictorial plans, 25c. Arthur Alena, Wall Street Station, Box 271, New York 5.

**RADIO Repair steps** 50c. Brown, 7818B Hampson St., New Orleans 18, La.

**24 PAGE Plans** "18 long distance crystal sets" 25c. Including "Radiobuilder," catalog. Laboratories, 578-C, San Carlos, California.

**FREE!** 212 Page radio and television catalog! World's largest stocks, lowest prices. Complete supplies for builders, experimenters, amateurs, servicemen. Latest radios, phonos, television, recorders, sound equipment. Thousands of parts, tubes, test instruments, books, diagrams. Top quality money saving values. Get it now! Allied Radio Corp., 833 W. Jackson Blvd., Dept. 34, Chicago 7, Illinois.

**TELEVISION And radio engineering** taught practically, also electrical engineering, armature winding, electrical drafting, Day and evening classes. Special correspondence courses. G. I. approved. Canadian School of Electricity, 282 Ontario W., Montreal.

**BUILD 15 Radios**, less than \$1.00 each. Experience unnecessary. Parts, tools, directions included. Free details. Federal Supply, 176-71 Union Turnpike, Flushing 2, New York.

**MAKE Simple, tubeless, batteryless, distance-getting crystal radios.** Crystal and illustrated instructions 25c postpaid. Allen, 427-P, Clinton, Mo.

## BUSINESS OPPORTUNITIES

**MAKE \$100/\$250 Weekly** installing, maintaining fluorescent lighting. Exclusive inexpensive illustrated instructions enables you to cash in on this fast growing billion dollar industry. Send for free facts on this proven business opportunity. "Fluorescent," 712-A State Tower Bldg., Syracuse 2, N. Y.

**BIG Money** in your own business. Sharp-en circular saws for builders, lumber yards, farmers, others—with new Belsaw complete circular saw shop. Low cost, no experience needed. Write Belsaw Machinery Co., 20 Field Bldg., Kansas City 2, Mo.

**BIG Money! Spare or full time in your home.** No selling! Spray new miracle finishes, plush and suede, on signs, radios, automobiles, figurines, lamps, toys, etc. Our business is booming. Help us fill huge demand. New easy Flok-Kraft methods. Material costs few pennies. You get dollars. Free samples, complete powerful money-making plan free. Write now! Coast, 1002N S. Los Angeles St., Los Angeles 15, Calif.

**BUILD Big business at home making hand soap, shampoo, polishes, washing powder, magic spot remover, amazing cleaners—Over 50 fast selling products. Easy to mix. No machinery needed. Only 1 and 2 ingredients. Complete set over 50 formulas only \$1.00 postpaid. Nelko Chemical Service, 3462-S Merchandise Mart Sta., Chicago 54, Ill.**

**YOUR Own profitable home business.** Preserve live flowers to last for years. New simple discovery. Enormous demand all year 'round. Tremendous profits! Light fascinating work. Send \$2.00 for working equipment, instructions, and valuable sales plans. Satisfaction guaranteed or money promptly refunded. Alfred Hermansen, 210 Fifth Ave., Suite 1102A, New York 10, N. Y.

**"WATERLESS (Lanolin) Hand Cleaner."** (Oil base.) Make, sell. No machinery. Build profitable business. Complete formula \$1.00. Ideal Service, Park Ridge 1, Ill.

**CAPITAL And facilities to market your product, send sample and fully describe benefits to buyer.** Maclean Company, 723 Citizens Building, Cleveland 14, Ohio.

**AMAZING New magazine.** No other magazine in the world like new "Here's How." Every page devoted to schemes, plans, ideas for making money—at home or outside, full or spare time. Tells how to start own business—how to sell personal service—how to make homecraft pay big profits—how to quickly win financial independence. Every story and article practical, stimulating, inspirational. Get copy of first issue of "Here's How" just off press for only 25c. One idea in this amazing new magazine may be worth \$1,000 to you. Be first in your locality to read "Here's How." Rush name and 25c today to Raymond Brandell, Publisher, 1512 Jarvis Avenue, Dept. CL-2, Chicago 26, Ill.

**START Your own business on credit.** Always your own boss. 1559 dealers sold \$5,000 to \$28,000 in 1949; their average \$6,834. We supply stocks, equipment on credit. 200 home necessities. Selling experience unnecessary to start. Wonderful opportunity to own pleasant profitable business backed by world-wide industry. Write Rawleigh's, Dept. J-U-PPM, Freeport, Ill.

**FABULOUS Earnings — Fascinating pastime growing genuine, living miniature (ming) trees.** New sensational business or hobby. Astounding information free. Dwarf Trees, Box 355 Briggs Station, Los Angeles 48, Calif.

**ACHIEVE Business and financial success in your own collection-credit agency business.** Home or office. Quickly learned. Free folder. Write Cole & Associates, Syracuse 2, N. Y.

**FRENCH Dry-clean yourself.** Send \$1.00, receive magic solvent and instructions. Vale Clo. Meriden, Conn.

**MAKE Tough, durable plastic—1c pound.** Makes attractive floors, walls, built-ins, roofs. Build good home, \$150.00 room. Bays Laboratory, Oklahoma City 9.

**BIG Money awaits you, if you follow practical, workable, profitable, ideas and plan in 10,000 word mail order booklet.** 25c. Ideal Sales, P.O. Box 1281, San Antonio 6, Texas.

**MIRROR Resilvering.** Wonderful home business. Complete formula 25c. Magic two-way mirrors. You can see out—no one can look in. Formula 50c. How to make coppered mirrors, vases, glasses. Formula 50c. All three \$1.00. Nelko Chemical Service, Box 3462-M, Chicago 54, Ill.

**LEARN Piano tuning, repairing — At home in 30 days.** Unlimited income. Phonograph recordings, tools and instructions furnished. Write Capitol City Tuning School, Department C-1034, 129 East Michigan, Lansing 16, Michigan.

**FREE "Inside" information.** 101 new successful home businesses. Unlimited possibilities. Research Bureau, Stanton 3, Calif.

**MAKE Rubber stamps, metalize baby shoes, repair dolls, silver mirrors, make beautiful figurines.** Catalogue of "30 ideas" free! Universal, Box 1076-A, Peoria, Ill.

**EASY To make expensive perfume with low cost "essential concentrate base."** Fast, tremendous profits. Write post card. H. May, Box 4473-PB, Coral Gables 34, Fla.

**SMALL Investment insures real profits—Your own mail order business.** 25c brings details. Humphrey, 905A Bellevue Court Bldg., Philadelphia, Penna.

**START Hosiery run mending service.** Home-office. Pleasant. Freed, Box 115, Chicago.

**OBTAIN Loans or capital for any purpose.** Details free. Rains Associates, Box 907, Station "A", St. Petersburg, Fla.

**SPECIAL Rubber for making molds.** Literature and sample free. Universal, Box 1076-A, Peoria, Ill.

**MAKE \$15.00 Easy: 101 ideas, full or spare time earnings.** Proven winners. Booklet 25c. Write F. Fiant, Duenweg, Mo.

**BUY Wholesale—Million articles.** Supply source directory, dime. Nelko, Box 3462-D, Chicago 54, Ill.

**GROW Plants, flowers.** Details free. Shiffers, Box 129, Millersburg, Penna.

**MONEYMAKING Opportunities,** propositions, magazine, catalog 25c. Dioplyco, 911-E California, Oklahoma City 4.

**WHOLESALE Baby shoe mountings, equipment, supplies.** Foster's, 1520 Ardmore, Chicago 26.

**RELAX! While mailman brings dollars in mail.** Magazine, revealing information, 25c. Panyko, 331 Townsend, New Brunswick, N. J.

**BOOKKEEPERS Earn \$100.00 weekly operating simplified "bookkeeping and tax service."** Details free. Universal Bookkeeping, Box 664-M, Springfield, Missouri.

**HAVE Your own mail order business.** Send now for free particulars. Charles H. Clum, 730-15th Street N.W., Washington 5, D. C.

**HOW And where to obtain capital.** Small and large loans. Free particulars. Star Service, Wapakoneta, Ohio.

**MAKE Perfumes, Men, women, write, "Carey Laboratories,"** 1914 Chouteau PM-10, St. Louis 3, Missouri.

**BIG Profits in mail order.** Write Mac's Service, 214B S. Broadway, Greensburg, Ind.

**ADVANCE In plating with "Electroplating-Know-How."** Free particulars. Joseph Kushner Electroplating School, Stroudsburg 70M, Pennsylvania.

**GET Into advertising for increased earnings—your own business; working for others.** Real future. Vincent Cremata, 1216 Washington, Key West 1, Florida.

**NEW Profitable home business repairing zippers.** Thousands of customers waiting. No experience required. We furnish everything. Write Texas Specialty Company, 204-B Texas, Texarkana, Texas.

**MAKE Perfume—men-women.** Write "International," 6347 Parnell PM-10, Chicago 21, Illinois.

**DESIGN, Model, mold new fast sellers from plasters, plastics, compositions, ceramics.** Amazing profits, quick returns. Details free. Plastics Digest, 2925-B7 Michigan, Kansas City 3, Mo.

**MINK Raising information free.** Complete. Lake Superior Mink Farm, Superior, EE1, Wisconsin.

**LIQUID Marble! Formula 25c.** Alpha Service, Box 3459, Rincon Annex, San Francisco, Calif.

**MADE Big money.** So can you. Wamsteker, Box 34-A, Wynberg, Cape, Africa.

**WIPE-ON Auto paint.** Make and sell this wonder. All colors. Complete formula 50c. Nelko Chemical Service, 3462 Merchandise Mart Sta., Chicago 54, Ill.

**REVOLUTIONARY Conception of public bookkeeping!** \$5.00 hourly. Simple instructions. Full, spare time. Systems, shortcuts, obtaining clients. Auditax, 10775-V Tabor, Los Angeles 34.

**EARN While you sleep.** Coin-radios. John Kratz, Grantham, Pennsylvania.

**MOLD Makers—Attention! Genuine natural latex for reproduction of figurines, statuary, plaques, etc.** Instructions free. B. M. Barron, 77 Francis St., Everett, Mass.

**PROFITABLE Mail selling propositions free!** Wehner, Box 142-A-10, Roxbury 19, Mass.

**HAVE Mailorder business.** Free details. Filey, 3519 St. Charles, Cincinnati 8, Ohio.

**COLLECTION Agency business easily learned by mail.** Highly profitable. Free bulletin. Franklin Credit School, Roanoke 7, Virginia.

**SAWDUST.** Turn it into cash. Six methods. Instructions 25c. Charles Co., 12-A-WV, Norwood, Ohio.

**MILLION Articles wholesale.** Directory 25c (refundable). Publishers, Box 1302, Detroit 31.

**NEW! "Simplified Manual of Modern Baby Shoe Plating"** for beginners, experts! Famous \$25 course by outstanding authority, plus new valuable developments! Includes complete shop, equipment plans; new rigidity, electropolishing techniques. Only \$4.95! For additional fresh income sources order, Manual of Modern Chrome Refinishing, Manual of Modern Brush Plating, \$4.95 each. Satisfaction guaranteed! Order today from Joseph Kushner Electroplating School, Stroudsburg 77M, Pennsylvania.

**INVISIBLE Reweaving—Big profit, big demand, easy to learn with low-cost complete course—nothing else to buy, ever.** Details free, write today; Fabricon, Rm. N-5, 8342 S. Prairie Ave., Chicago 19, Ill.

**OPPORTUNITIES For mail dealers.** Sent free. Volchok, 1098 Gerard, New York.

**TO \$35.00 Weekly.** Spare time, home operated mail order business. Successful small "beginners" plan. Everything supplied. Lynn, 5710-M Bankfield, Culver City, California.

**EARTHWORM Breeding illustrated.** Exclusive outline 3c stamp. Stoners, Chattanooga 4, Tenn.

**UNPAINTED Plaques, novelties, figurines.** Instructions dime. Perry Novelty Company, Perry, N. Y.

**SILICONE Auto polish—Make, sell this new wonder.** Amazing profits. Easily made. No machinery. Guaranteed formula \$2.00. Kemico, Park Ridge 21, Ill.

**ALL-Profit deal.** 25c. J. Faucher, Box 381, Fall River, Mass.

**LEARN Clock repairing.** All types. Illustrated manual \$1.00. Burnley & Co., Box 287, Dayton 1, Ohio.

**EXCEPTIONALLY Profitable making finest perfume.** Sample fragrance, particulars free. Torrey, 13 Sewallwoods, Melrose 76, Massachusetts.

**MAKE Money at home! 101 proven ideas.** All for 25c. Success Distributors, 903-PM Pine, Marshall, Ill.

**FIX Typewriters, full or part time.** Inexpensive copyrighted home study course quickly trains you for high earnings. Factory methods cover all phases with drawings and illustrations. No curiosity seekers. Typewriter Repair, 1015 Corbet, Tarentum, Pennsylvania.

**NEW, Different plan assures success in pleasant, profitable home-operated mail business.** Write: National, Box 88M, Boston 22, Mass.

**FORGE Ahead financially! Start profitable business; mail, locally!** Amazing invention. Free sample offer! Consolidated Equipment Corporation, 791 Guardian Bldg., Cleveland 14, Ohio.

**NEW Directories now out, list by address all U.S. and foreign manufacturers and their products.** Free use to interested persons. Send twenty five cents U.S. coin—your only cost. Cornwall Company, 200 Lumber Exchange Building, Minneapolis, Minn.

**\$7,200 YEARLY** Obtaining small-business clients for service, saving each approximately \$2,000 yearly. Send stamp for application. Box 5587, Washington 16, D. C.

**FOR More business, open New York office under your name—only \$12.00 yearly.** Established 1926. Co-operative Offices, PM-126 Lexington Avenue, New York 16.

**AWNINGS, Lawn umbrellas, aluminum, finest, colors, patented, users, dealers, assemblers.** Write Sundrella Mfg. Co., 5202 N. 22nd Ave., Phoenix, Arizona.

**YOU Can actually see the metal flow on with a Tyco Electro-Plater!** Portable. Inexpensive. Battery operated. High profits at home electroplating autoparts, bathroom fixtures, bicycles, baby shoes, mirrors! No experience necessary. Tyco Metals, Box 8535-D, Dallas 16, Texas.

**START Home manufacturing business making cleaning compounds, soaps, insecticides, cosmetics, polishes, food flavors.** No machinery. Literature free. Kemix, Park Ridge, Ill.

**I MAKE Big money in the mail-order business.** You can do the same at home with copyrighted system. Write me, I'll tell you how. F. Little, R.D. #1, Glenshaw, Penna.

**NEW Ideas—From other countries.** 5000 different magazines—in English. Many single copies available. Free descriptive list. Caron & Son, 45-A Fairview Ave., No. Plainfield, N. J.

**YOUR Sparetime, my ideas, with cash;** possibly fortune. Positively no selling, soliciting, embarrassment, or "bunk." Your residence, age or sex makes little difference. Permanent; pleasant. Free information. Sreka, North Hollywood, California.

**METALIZED** Baby shoe mountings \$1.00 each. Complete coppercote metalizing kit. Sample shoe, instructions \$1.00. Agents wanted. Metalcote, 3151-A Southport, Chicago.

**"HOW To Sell by Mail,"** 40 profitable pages, 25c. Send now! E. Lay, 3819 Kenmore, Chicago 13.

**OPPORTUNITIES!** Five mail order magazines, all different, 25c. Allens, Dept. PM, Box 543, Tallahassee, Fla.

**200 NEW Money** making plans, tips, ideas for increasing your income. Folio free. Reynard Pub., Smithfield 3, Ohio.

**MEN—Women.** Everybody likes candy. Learn to make professionally. Our 40th year. Ragsdale Candies, D5, East Orange, New Jersey.

**\$35 WEEKLY!** Home! Two hours daily! Particulars! Walsh, 894 Main St., Buffalo 2, N. Y.

**BRONZING** Baby shoes is big business. Start your own business for \$9.85. Includes all materials and instructions. Copyrighted "Metal Sealed" process requires no equipment. Particulars free. Box 2095, Wichita, Kans.

**\$1.00 PROFIT** Selling gallon upholstery cleaner—\$1.25. Stores sell \$1.69. Quart size sample, full details 25c. Kohne, 506 West 45th, Chicago 9.

**EARN** At home casting novelties. Free instructions using latex molds. Major Chemical Company, 164 Portland Street, Cambridge 39, Mass.

**BUILD** Home business by mail. Extra money. Future independence. Details free. Arnold, Butler Rd., R-11, Ft. Wayne, Ind.

**BE Independent** — Operate America's lowest price penny vending machine. Big profits. Immediate shipments. Write for bulletin and prices. Fielding Mfg. Co., Desk 90, Jackson, Mich.

**A Factory** in your home, garage! Mechanics' waterless hand cleaner, glass cleaner, auto cleaner-polish; many others. All formulas free, but if you also want free samples send 15c postage. Western Aircraft, Dept. B, Los Angeles 6.

**BRONZED** Baby shoe mountings, supplies wholesale. Box 2095, Wichita, Kans.

**DRESDEN** Craft figurine molds and many others, natural liquid rubber, statuary plasters, flock finishes, etc. Illustrated catalog and "Plastercraft" manual free. Blue Rapids Supply, Blue Rapids, Kansas.

**LIQUID Rubber,** make flexible molds. Free sample. Chaney, 1130 E. 16th St., Jacksonville 6, Fla.

**BUSINESS,** Vocational and diversion magazines. Profit by the help those in your field will give you. Send now for our easy-to-get-acquainted plan. It's free. Commercial Engraving Publishing Co., 34C North Ritter, Indianapolis 19, Indiana.

**EARN** Money at home with your typewriter! Spare time! Details free. Edwards, Publisher, 3915-PM 12th, Des Moines 13, Iowa.

**DOLLARS** Daily mailing postcards! Proof! Power Publishers (B-9), Cincinnati 36.

**VENDING** Machines earn big money! An investment as low as \$10.50 will start you in this fascinating, profitable business that can lead you to the road of success and independence. Routes can be established and operated in either full or spare time with no experience needed. Write for full details and our free catalog illustrating our nut, candy, gum and stamp vendors; also pin ball machines, music boxes, etc. Write immediately to Parkway Machine Corporation, Dept. 7, 715 Ensor Street, Baltimore 2, Maryland.

**ANNOUNCING** Home study course in commercial baking. Practical basic training. Good field for those with aptitude. Nearly depression proof. Send for free booklet, "Opportunities in the Baking Industry." National Baking School, 1315 Michigan Ave., Dept. 1346, Chicago 5, Ill.

**MAKE** Money at home as renewal headquarters for all magazines. Big Christmas sales profits now. Liberal commissions. Supplies furnished. Write for free catalog. McGregor Magazine Agency, Dept. 500B, Mount Morris, Ill.

**MAIL** Order opportunities galore. Sanchez, Box 66-P, Chelsea Station, New York 11.

**SECURITY!** Manufacture everyday demand products! Tremendous profits! Formula lists free! Thermolab, Peoria 4, Ill.

**1000 GOLDEN** Opportunities! Most amazing new money-making home occupations! 600 illustrations! Beautiful gold sample free! Stamp brings details. C. Bellehaven, P.O. Box 606, Redwood City, Calif.

**DOLLARS** Three ways with "Kitty-Kat" readi-cut baby shoes. Complete local and mail order plans. Write No-Co-Ro, Oakland 6-K, California.

**MAKE** More money with moneymaking secrets. Free facts. Service Bureau, Box 2625, Orlando 5, Fla.

**NEW** Industrial hand cleaner! Sensational product. Immense market. Tremendous possibilities. Unusual money-making plan free! Keenelo, 2438 Fifteenth, Denver 11, Colorado.

**\$46 FROM** Square foot plywood. Jigsaw necessary. Write, Woodarts, X-38, Bridgewater, Mass.

**MAKE** Money spare or full time casting metal toys and novelties. Big wholesale and chain store demand for autos, soldiers, ashtrays, banks, etc. keep manufacturers busy. Production moulds furnished for up to 100 and more castings per hour. No experience or special place necessary. "Cash-in" on holiday orders now being placed. Write for information and illustrations of patterns needed. Metal Cast Products Co., Dept. A, 1696 Boston Road, New York 60, N. Y.

**OWN** A printing business. Good profit printing cards, stationery, etc. in spare time. Easy rules furnished. Have home shop. Send dime for complete printer's supply book and samples. Kelsey, Inc., Z-24, Meriden, Conn.

**LEARN** Sewing machine repairing at home. Earn \$125.00 week spare time. Plus, new machines, motors, etc. wholesale. Free particulars. Taylor Service Co., Hamilton, Ohio.

**OPERATE** Profitable mailorder business. Particulars free. George Lenhoff, Lincoln 8, Nebraska.

**START** Mailorder business. Complete plan. Satisfaction or refund. Valuable sample 25c. Hughes, 4327 Dalton, Los Angeles 62.

**HOME** Business making statuettes, plaques, artificial marble, rubber molds. Silvering mirrors. Formulas. Folder free. Creative, 236-L, Winnetka, Illinois.

**LEARN** Gun repairing at home. Profitable. Modern Gun Repair School, Box 717, Dubuque, Iowa.

**SPIN** Angora wool into yarn. Interesting work. House of Angora, PM5, Springfield, Illinois.

**WEST** And northwest Canada. Tourist attractions, oil, mining, farming, trapping, hunting, Alaska highway. Land of opportunities. Booklets, maps. Any information. \$1.00. Box 354, Edmonton, Alberta, Canada.

**BUY** It wholesale! Manufacturers, distributors offer 850,000 items. Literature free. Olsen, 1231-A East Third St., Duluth 5, Minn.

**UNPAINTED** Figurines. Beautiful models. Write for new wholesale price list. Oman, 642J Broadway, St. Paul 1, Minn.

**COPUBLISH** Leading m.o. paper. Latest copy Mail Sale Advertiser, details, dime. Vanroy Shirk, Lebanon, Penna.

**MADE** \$24,500 Using money making plans from Schemer Magazine, world's oldest mailorder publication. Box 775M, Alliance, Ohio. Year \$2.00. Sample 20c.

**WRITE** For free booklet and catalog telling how to earn substantial profits in your spare time by forwarding new and renewal subscriptions to all magazines for your friends and neighbors. Oldest U. S. agency. Established 1869. Moore-Cottrell, North Cohocton, New York.

**MAKE** Flexible molds! Cast plaques, bookends, figurines! Free sample! H. Tooker, 630-R Chestnut, Hamilton, Ohio.

**BE** Appointed state notary public now! Details. Stationers, Helotes 50, Texas.

**COMMERCIAL** Deep frying course. Mock chicken legs, potatoes. New and proven methods. Learn about this money-making field. \$2.50 p.p. Concession, Toledo 13, Ohio.

**NATURAL** Molding Latex. Extra thick. Free sample. W. Wooley, 115-A Donald, Peoria, Ill.

**PROFITABLE** Business making and building with easy-laying interlocking building blocks. Rex Products, Dept. 10, Piqua, Ohio.

**\$250 WEEK** Reported! Free illustrated book "505 Odd Successful Businesses." Work home! Expect something odd! Pacific-E, Oceanside, California.

**\$25 WEEKLY** Working two hours daily. No canvassing. No manufacturing. Lycke, Box 2471-A, Cleveland 12, Ohio.

**POPCORN** And potato chip equipment. Long Eakins Company, 5060 High, Springfield 99, Ohio.

**WANTED** Unused U. S. postage stamps, small discount. Advance Stamp Co., 24 East 23rd St., New York.

**CO-PUBLISH** And advertise in The Central Mail Advertiser. Sample copy 10c. Low rates. Large circulation. Bagby Printing Co., Georgetown, Ohio.

**EARTHWORM** Breeding. Valuable bulletins on successful methods mailed free. Earthmaster Publications, Dept. 14, Sun Valley, Calif.

**LIQUID Marble**—Colorful, glossy! Molded, brushed, sprayed! Cast novelties, statuary, colored tiles. Flexible molds. Composition floors. Particulars free. Marbleizing Service, Edwardsville, Illinois.

**EXTRA** Money. No selling; operate vendors. Amazing profits, details free. Silver King, Suite B, 622 Diversey, Chicago 14.

**UNPAINTED** Bookends, plaques, statuettes, figurines. List. Haverty Products, 1219 8th Ave., Altoona, Penna.

**HOW** To set up and run a mirror shop! Resilver mirrors. Make chipped glass nameplates. Electroplating salts and rectifiers. John Sprinkle, V60, Marion, Indiana.

**MAKE** Money making new greaseload doughnuts at home on electric machine. Wholesale to grocers, drug stores, cafes, hamburger shops. Send for free recipes and plans. M. Ray Company, 3605 South 15 Ave., Minneapolis 7, Minnesota.

**RECAST** Old batteries into new. Latest achievements. Battery Laboratories, Minneapolis.

**READ** "Advance"—The voice of mail order. Offers money-making opportunities, sources of supply, personal guidance, etc. Issued monthly. Sample copy 25c. Yearly subscription \$2.00. Advance Publishing Company, 313 East 21st Street, Suite 450, New York 10, N. Y.

**START** Mailorder bookshop—Everything furnished. 25c brings booklet, samples, exciting ideas. General Publications, Ossining, N. Y.

**OPERATE** Profitable mail order business. Write Walter Service, 4159-A East 112th, Cleveland 5, Ohio.

**MAILING** Postcards selling repeat merchandise is profitable. Everything supplied. Details free. Gordan Publishers, Box 23, Pawtucket, R. I.

**137 WAYS** To make money, in home or office, business of your own. Full particulars free. Elite Co., 220 Grand St., New York 13.

**BRUSH** Plating outfits connect to a battery. No tanks necessary. Good paying business at home plating autoparts, bathroom fixtures, bicycles, reflectors, silvering mirrors. No shop or experience required. Outfits furnished. Free booklet. Gunmetal Co., Ave. H, Decatur, Ill.

**COLORGLAZED** Concrete pottery made without molds. Patented method. Cemetery products, novelties, tiles. Basement leak-sealing. Money-making projects. Booklet, details free. Men only. National Potteries Company, Grand Rapids, Minnesota.

## MONEYMAKING OPPORTUNITIES

**COLORLED** And light reflecting crystals, luminous pigments. Catalog and samples 25c. Glowell Co., 475-D, Fifth Ave., New York, N. Y.

**YOU** Can buy thousands of articles wholesale. "Supply Source Directory" 10c. Ideal Service, Park Ridge 40, Illinois.

**WINDSHIELD** Wiper rebuilding brings big profits. Free particulars. Arlington Products, 878 East Waterloo Road, Akron 19, Ohio.

**BARGAINS,** New and used arc welders. Electric or gas engine, a.c. or d.c., all sizes, portable or stationary. Write needs. Hobart Welders, Box M-1004, Troy, Ohio.

**MAKE** Money crinkle painting typewriters, sewing machines, etc., plans for crinkling outfit \$1.00. R. Mix, Box 394, Williamsport, Penna.

**SELL** By mail books, folios. Real money makers. Big profits. Write, Wolf's, 3240 Glenview St., Philadelphia 24, Penna.

**MAKE** Back-yard profits! Unusual opportunities! Interesting booklet free. Pickett's, Florence, Kentucky.

**6 DIFFERENT** Moneymaking mail-order magazines, \$1.00. Wilbur Erickson, Englishtown, New Jersey.

RESILVER Mirrors at home! Order 25c. Ideal Service, Park Ridge 8 Illinois.

WIN Cash, cars in prize contests! Write for copy filled with current contests, winning hints and tips. Send only 25c. Wright Contest Digest, Dept. 17-K, P.O. Box 2266, St. Louis 9, Mo.

WIN Contest money. General Contest Bulletin gives hundreds of tips. Lists current contests and rules. Sample 25c. General Contests, 1609½ East 5th, Duluth, Minn.

MANUFACTURE Own products. Any formula \$1. O. S. McCollum, 383 Miller, Vaux Hall, N. J.

EARN Money at home! Thousands do! "Home Worker Magazine" tells how. Sample, 25c. Sizemore, Box 7, 4917 Kostner, Chicago 30, Ill.

BOOKKEEPERS Boost income operating simplified bookkeeping service. Kern, 4942 Vineland Ave., No. Hollywood, Calif.

HOW To sell it—By mail. What have you? Personal reply free. Smith Advertising Co., PM, Excelsior Springs, Mo.

FREE Particulars "profitable home business enterprises." Cottage Industries, 2804-P Hanover, Omaha 12, Nebr.

RECEIVE Free merchandise! Postal brings items list. Athons, 2815-F Voughn, Ft. Worth 5, Texas.

MEN, Women—Start business at home. Easy. No cash needed. Trade? Send 25c deposit. Credited. For details and gift, Bishop Novelities, Box 877-1, Milwaukee 1, Wis.

ASSEMBLE And sell Swiss musical churches. Kit \$3.95 postpaid. Tremendous seller. Piltzcker Imports, Wood-Ridge, N. J.

SALESMEN—Sell 12 oz. bottle vanilla with premiums. Write, Economy Supply Service, 913 Asa St., Defiance, Ohio.

DOLL Repair book \$1.25 prepaid. Parts available. Grand Rapids Doll Hospital, 3824 South Division, Grand Rapids, Mich.

EARN Money evenings, copying and duplicating comic cartoons for advertisers. Adservice, Argyle 1, Wisconsin.

CLOSE-Out! Retractable ball point pens, gold colored metal, \$2.00 dozen. Watches, silverware, cookware, appliances, etc., lowest wholesale prices. Complete list 25c. Kriston Sales, Pemberville, Ohio.

CHURCHES, Organizations, agents sell candies. One pound tins only. Ralph Missimer, 251 Chelton, Philadelphia 20, Penna.

SCHOOL Seniors—Sell classmates America's most beautiful graduation name cards. Largest selection. Highest commission. Outsells all others. Free sample kit. Printcraft, Dept. M, 1425 E. Elm St., Scranton 5, Penna.

DOLLARS In personalized baby record books. Sell by mail. Use same literature we do. No-Co-Ro, Oakland 6, Calif.

INDEPENDENT Income! Make leather belts, billfolds, purses. Big catalog and genuine steerhide keyholder, 10c. Tandy Leather, Box 397E, Tulsa, Okla.

BUY Nylons direct from mill. Make good profits on fast selling nylons. Quick delivery on any quantity. Write for confidential wholesale price list. Joy Hosiery Mills, Delaware 13, New Jersey.

RAISE Your business value, standing, as state notary public. Information. Stationers, Helotes 50, Texas.

EASY Ways to earn extra income are described in Money-Making Hobbies, 132 projects you can make at home and sell anywhere. 160 pages, \$1.98. Popular Mechanics Press, 200-MH East Ontario, Chicago 11, Ill.

\$250 WEEK Reported! Free illustrated book "505 Odd Successful Businesses." Work home! Expect something odd! Pacific-E, Oceanside, California.

PUBLISH Your own magazine. Hand-some 52 page format, well edited, illustrated. Cost low as \$1.00 month. Brings you prestige, profits. 25c brings sample, details. National, Ord, Nebr.

READ Progressive Mailtrade, the magazine that tells how to make money by mail. Dime brings sample and special offer. Progressive Mailtrade, Box 357, Sheboygan, Wisconsin.

## CHEMISTRY

ATOMIC Calculator (Vinylite) — 96 elements. Atomic weights, valences, symbols, etc. Useful laboratory instrument. \$1.00. Slyd-Rul Company, Box 603, Brooklyn 1, N. Y.

Laboratories, 2849-A Birchwood, Chicago 45, Illinois.

NEW Idea chemical and apparatus outfits for home experimenting. Photo-scales, microscopes, chemicals, biological and laboratory supplies in small quantities. Catalog 15c. Established 1931. John H. Winn, 124A West 23rd Street, New York 11, N. Y.

ILLUSTRATED Catalog: Chemistry, mineralogy, biology. 10c. Tracey Laboratories, Evanston, Illinois.

CHEMICALS And apparatus for industrial, analytical, and private laboratories. Catalog 15c. Dept. M-56, Biological Supply Co., 1176 Mt. Hope Ave., Rochester, 20, N. Y.

## PLASTICS

AMAZING Liquid plastic kit \$3.25. Embed photographs, keepsakes, coins, make solid objects, clear, colors. Beautiful results in half hour. Easily tooled. Inexpensive hobby. Send 15 cents for catalogue. Kristalon Plastics, Dept. Z-100, Box 29, Wilmette, Illinois.

NEW Liquid plastic. Clear, colors. Cast without heat. Embed flowers, insects, coins. Saw, drill, carve. Send 25c for exciting new home project manual showing how to get started. Castolite, Dept. L-101, Woodstock, Illinois.

COMPLETE Line internally carved gifts and jewelry. Free catalogue. Pilot Plastics Co., 67C3 Fulton St., New York City 7.

PLASTICS—Our catalog lists the widest variety in the country stocked for immediate shipment. Wholesale, retail. Prices? You'll like them. Information? Furnished in catalog. Personal service? Try us. Catalog, bargain lists, 10c. Gem-O'-Lite, Box 686C, North Hollywood, Calif.

LEARN To cast plastic letters for personalizing gifts. Particulars and samples including your three initials, two dimes. A. H. Dreher, 2232 Brockway, Cleveland 18, Ohio.

PLASTIC: Sheets, cut pieces, and scrap in clear and colors. Rod, tubing, acetate, dies, jewelry findings. Send \$1.00 for 4 pound scrap assortment and fabricating manual. Regal Plastic Supply, 720 Main, Kansas City, Missouri.

LUCITE, Plexiglas, Any size sheets, masked. Square foot (12 x 12) cost, 1/16", 98c; 1/8", \$1.25; 3/16", \$1.52; 1/4", \$1.80. Colors add 10%. Include 10% postage. Almac Plastics, 230 Fifth Ave., New York 1, N. Y.

INTERNAL Carved roses, orchids, swans, goldfish, butterflies, etc. Jewelry and gifts. Crystal Floral Novelty Co., Bound Brook, New Jersey.

PLASTIC, Sheets, rods, tubes, etc. Free list. Plastic Supply Co., 2901 N. Grand Blvd., St. Louis 7, Mo.

## FORMULAS, PLANS, ETC.

ANY Formula \$1.00, or money refunded. Nelko Chemical Service, 3462-F Merchandise Mart Sta., Chicago 54, Ill.

BIG Profits manufacturing auto waxes, specialties. Seven formulas \$2.00. Plastics, Box 1574, Boston 4, Mass.

FREE Formula catalog, anything analyzed \$20.00. Western Chemical, Salem, Oregon.

10,000 FORMULAS And trade secrets. Free literature. Stillman, 555 Kingston Ave., Brooklyn 3, N. Y.

50 FORMULAS—Make soaps, polishes, cosmetics, etc. \$1.00. Star, Box 21, Brooklyn 14, New York.

PRODUCTS Analyzed. Improved. Guaranteed formulas. Consulting Scientific Company, Swarthmore, Pennsylvania.

MAKE—Sell cleaners, soaps, polishes, flavors, cosmetics. No machinery. Formula literature free. Kemico, Park Ridge 16, Illinois.

WATERLESS Hand cleaner. (No ammonia.) Easily made. Good profit. 2 dependable formulas \$1.00. Nelko Chemical Service, Box 3462, Chicago 54, Ill.

TESTED Formulas. Interesting descriptive booklet free. Pont, Box 635-PM, Terre Haute, Indiana.

FORMULAS For nearly everything. Catalog free. Write Creative, Winnetka, Ill.

REAL Manufacturing formulas. Lists free. Cummings, Chemist, Gordon Ave., Syracuse 4, N. Y.

## HELP WANTED

EARN Cash in kitchen. Special pleasant work at home. Good earnings. Send no money. Styleco, Dept. B155, Cincinnati 10, Ohio.

NEW Plastic rayon towels selling rapidly everywhere with spectacular demonstration. Large profits. Sample package \$1.00. Sunbeam Products, 634 4th St., South, St. Petersburg, Florida.

IMAGINE—Extra cash for you! Sell friends amazing value metallic, felt applique, comic, 50 for \$1.00 Christmas cards. Exclusive gift wraps. All-occasion assortments, scented stationery, animated books, gifts. Profits to 100%. Special offers. Bonus. Write today for free samples name imprinted Christmas cards, napkins, stationery, feature assortments on approval and free catalog. Elmira Greeting Card Co., C-2409 Elmira, N. Y.

SHINE Shoes without "polish." New invention. Lightning seller. Shoes gleam like mirror. Samples sent on trial. Kristee 157, Akron, Ohio.

BENTONIZE, The new wonder combination automobile and furniture polish sells fast. Steady repeat. 100% profit. Agents, dealers, distributors, write. Henry, 2815 Boulevard, Jersey City 6, N. J.

NEW Way to make money! Sell ladies' rain sandals to friends, others. Includes free carrying pouch. Spectacular \$1.00 seller. Amazing profits. Write for sample on approval and money-making details on complete line Christmas, everyday greeting cards, novelties. Experience unnecessary. Bargain offers. Hedenkamp, Dept. PM-44, 361 Broadway, New York.

YOUR Own business selling army surplus, new clothing. Lowest prices. Enormous profits. Catalog free. Moro, 558J Roosevelt, Chicago 7.

AMAZING Offer—\$40 is yours for selling only 50 boxes Christmas cards. And this can be done in a single day. Free samples. Other leading boxes on approval. Many surprise items. No experience needed. Free samples personalized Christmas cards, stationery, napkins. Write today. It costs nothing to try. Cheerful Card Co., 1688 White Plains, N. Y.

BRAND New! Amazingly different and smart Christmas cards bring you big money! Take easy orders for sensational new Christmas cards. Pays up to 100% cash profit. Christmas cards with name 50 for \$1, up. Big line. Personal stationery and book matches. Get sample assortments on approval. Imprints free. Write today. North Star, 31 Glenwood, Dept. M-18, Minneapolis, Minn.

SELL "Unilarm" fire detector. Protects homes, barns, stores. Easily installed. Liberal profits. Uses door-bell transformer. \$2.25 brings sample and proposition. Stoddard, Market St. National Bank Bldg., Philadelphia, Penna.

THERE'S Big money taking orders: Personal initialed buckles with belts, tie holders, choice of over 3,000 emblems, cap and breast badges for every purpose. Uniforms, work clothes, embroidered with company name, trademark, sales message, etc. Prospects everywhere. Latest styles, finest fabrics. Write for selling kit. Hook-Fast Co., Box 480PM, Roanoke, Virginia.

MEXICAN Feather pictures. Sell on sight; 200% profit! Free details; sample 10c stamps. Sylvia-PG, Apartado 9036, Mexico City.

BIG Money taking orders: Shirts, ties, Sox, pants, jackets, sweaters, shoes, uniforms, etc. Sales equipment free. Experience unnecessary. Nimrod, 4922-BG Lincoln, Chicago.

CASH In on tremendous demand for new low priced burglar alarm for cars, homes and farm building. Nothing like it. Everybody wants one. 286% profit. Unique sample offer. Northwest Electric Co., Dept. J-10, Pukwana, S. Dak.

ABSOLUTELY Free! Big package actual sample fabrics and style presentation of dresses, lingerie, hosiery, etc. Take orders. Commissions big. Send no money. Melville Co., Dept. 5625, Cincinnati 3, Ohio.

FREE Samples, and amazing plan giving you gorgeous dress without penny cost. Rush name today with dress size. Harford, Dept. C-435, Cincinnati 25, Ohio.

SELL DuPont nylon uniforms. Complete line famous exclusive Hoover styled nylon uniforms for beauty shops, nurses, doctors, waitresses, others. Best quality, splendid values. Exceptional income. Real future. Equipment free. Write fully. Hoover, Dept. J-100, New York 11, N. Y.

PHOTO-Salesmen, agents. Sell beautiful hand colored plastic enlargements and sensational new photo compacts, rings, bracelets, lockets, etc. Collect deposit, we deliver. Profitable sideline. Send card, for free sample kit. Novel Portrait Co., 3343 North Ave., Chicago, Ill.



business on credit. Sell some 200 farm-home products. Thousands our dealers now make quick sales, big profits. For particulars write Rawleigh's, Dept. J-192-PPM, Freeport, Ill.

AT Last! Something new and sensational in Christmas cards. Show gorgeous satins, velours and metallics never before offered. Gets easy orders fast! Pays up to 100% cash profit. Free samples of 30 Christmas cards with name, 50 for \$1.00 up. 80 assortments. Personalized book matches and stationery, gift items. 2 assortments on approval. Write Puro Co., 2801 Locust, Dept. 040-M, St. Louis, Mo.

NYLON Uniforms. Immediate delivery, immediate profits. Sell to doctors, dentists, nurses, waitresses, beauticians, housewives. Free sales kit. Superior Fabrics, Dept. P10, 3936 Market, Philadelphia 4, Penna.

NEW Eyeglass polisher. Amazing polishing cloth stops fogging, blurring. Cleans glasses beautifully. Samples sent on trial. Kristee 156, Akron, Ohio.

\$1.00 STARTS You in business. Sell men's neckwear full or part time. Low investment, big profits. Send \$1.00 receive sample tie, free color catalogue, selling plan, wholesale price list. Radio City Neckwear, Dept. M6, 112 W. 50th, New York City 19.

SELL Direct finest quality, fastest sellers in \$1.00 and \$1.50 neckwear. Hosiery. Lowest prices, top profits. Write: Wolfmark, 931-P West Roosevelt, Chicago, Ill.

MAKE \$20 A day! Sell Staybright brass name plates for front doors. Write Hubstamp, 357-E Congress, Boston, Mass.

MANUFACTURE Easy way. Add water our concentrates. Make flavors, lotions, perfumes, shampoos, cleaners, polishes. 125 products. Labels your name, bottles. Qualco, E20030 Russell, Detroit 3.

PERFUME—Sideline to independence. Learn all—free. "International," 6347 Parnell AM-10, Chicago 21, Illinois.

\$1 STARTS You in business. Sell fine \$1 ties. \$1.50 and up values only \$7.20 dozen, you make \$4.80. Send only \$1 for 2 sample ties. Catalog free. Philip's Neckwear, Dept. K-45, 20 West 22nd Street, New York 10.

SELL Gold embossed Christmas cards, napkins, matches, coasters. 50 for \$1 imprints. Samples free. Dunbar, New Brunswick 20, N. J.

FIRST Out—'51 models. Power mowers. Gas-electric. War "boom" demand. Rotacut, R-2010, Excelsior Springs, Mo.

IS \$210 A week worth a penny postcard to you? Then rush card with name and address for special free trial plan that sells amazing new automatic refrigerator defroster "like hot cakes!" Write to Mr. Lewis, D-Frost-O-Matic Corp., Dept. PMC-10, 6 N. Michigan, Chicago 2, Ill.

SELL The famous "Sunshine Line" greeting cards. New de luxe 21 card assortment with, or without. Scripture texts; fast selling religious plastics; brand-new gift wrap; Christmas notes; specialty items such as Christmas bell; holiday high lights; swing along; children's assortments; etc. Write for samples. Triumphant Art Publishers, Dept. G9, Anderson, Indiana or San Jose 6, Calif.

NYLONS Direct from mill. Sample free. Guaranteed against runs. No experience or money needed. Also Nylon slips, briefs. Earn big money spare or full time. Become manager, appoint agents. We pay you 40c for every \$1 your agents earn. Sell 14K neckchains "flat-curb" \$6, cost \$2.50. Ergim Co., 992 Columbus Ave., New York.

SELL Tax tables. Double your money bookkeeping, social security records. Details free. Goerke, 530 East 7th, Long Beach, Calif.

NEW Antifog prevents windshield fogging. Distributors, jobbers wanted. Sample 35c. Pankey Co., 3731 Wascanna, Hapeville, Georgia.

TIES Christmas boxed free. New patented tie and regular ties. Sensational Christmas gift line. Perma-Knot Tie Company, Dept. 101, Williamsville 21, New York.

\$184.00 CONTINUOUS Profit from every \$8.00 investment. Shampoo powders in bulk. Bottle yourself or sell powders. Request convincing facts. Moraal Manufacturing Company, 505-R Fifth Ave., New York City 17.

BE A money maker. Represent magazines year around. Wonderful home work. Big Christmas profits now. Liberal commissions. Everything furnished. Write for free catalog. McGregor Magazine Agency, Dept. 500A, Mount Morris, Ill.

only nationally advertised hosiery line actually guaranteed against runs, snags or excessive wear, regardless of cause! It's amazing but true. Every weight from sheerest 15 denier to heavy 70 denier—all gauges to luxury 60 gauge. Amazingly low prices, starting at \$1.08 prepaid for sheerest 15 denier 51 gauge. Not sold in stores. Good Housekeeping guarantee seal. Also complete line men's hosiery guaranteed one full year or replaced free. Full variety lingerie in crepe, satin and nylon, featuring all nylon slip at \$2.95, satin slip at \$1.58, etc. Housecoats and robes. Kendex sales people will earn one million dollars this year. Get your share. No money or experience needed. Pay nothing now or later. Just show free outfits. Write orders. We deliver and collect. Advance cash plus huge bonus. Earn money spare or full time. Become manager; appoint others to sell for you; earn steady income on their sales. Man or woman—young or old, you can earn more money than you ever thought possible. Everything you need is furnished free and prepaid, including nylon stocking, samples of materials, sales books, 36-page salesmanual, color cards, etc. Simply write your name and address on postcard and mail to Kendex Corporation, Babylon 73, N. Y.

FREE Literature—Thousands wholesale supply sources. Moneymaking business ideas. Wilkin Company, Hillsboro 4, Ohio.

NOVELTIES And household items! Fast sellers for agents, dealers, and gift shops. Write for 16-page Sunshine Catalog. Sunshine Sales, Dept. WP4, Loudonville, Ohio.

PROFITABLE Spare or full time selling NuSilver Polish and Plating Liquid, cloth applied products. NuSilver, 508-PM10, New York St., Aurora, Illinois.

AGENTS—Big line including food products. Fast selling premium and bargain deals. Low prices. Send card for big outfit offer with gift. Ho-Ro-Co, 2770 Dodier, St. Louis 7, Mo.

BUY Thousands of nationally advertised products direct from manufacturers and distributors. Write for "Buy Direct and Save." Service Publishing, 1420-A Investment Bldg., Pittsburgh 22, Penna.

MUSIC Greeting cards. Dorby Publications, P.O. Box 738, Morristown, New Jersey.

CASH In on plastics! Big profits with our 350 new plastic home needs. Perfect for party demonstrators, canvassers, stores. Lowest prices—highest quality. Write for free details. Durever, 2781-G Atlantic Ave., Brooklyn 7, N. Y.

SCHOOL Seniors! Your postal will bring our wonder, Kwick-Sell cardalog of popular graduation name cards. Biggest profits! Only firm giving free souvenir chest and card case. Don't miss out! Hurry that postal! Craftcards, Box 235 (L), Pittsburgh 30, Pennsylvania.

BIG Money selling tooth powder. J. Walker, 633 Plymouth Ct., Dept. 1, Chicago 5, Ill.

\$2 FIRE Extinguishers, locally, mailorder. Lorrac, Box 1086-X, Albany 1, N. Y.

SCHOOL Seniors—Earn sensational profits selling classmates America's most beautiful graduation name cards. Largest selection. Outsells all others. Free sample kit. Printcraft, Dept. M, 1425 E. Elm St., Scranton 5, Penna.

EARN Big money taking orders for attractive boxes of Xmas cards, 50 for \$1.00 up. Also metallics, plastics, wraps, children's cards and books, name-on stationery, napkins, etc. Samples on approval. Call, write or phone. Rainbow Greeting Cards, 38-T E. 1st St., New York 3.

BRITISH Imports—Sell world's most beautiful stationery (free samples), fine perfumes, etc. Kenneth Boyea, Indian Orchard, Mass.

MEXICAN Feather pictures. Unusual novelty \$1.00 (stamps) brings \$2.00 worth samples, details. Refunded if unsatisfied. Aztec Art-P, Apartado 762, Mexico City.

BIG Bargains for big profits. Over 100 sensational values. Men's used suits \$2, pants 35c, topcoats \$1.25, overcoats \$2, shoes 20c. Experience unnecessary. Free wholesale catalog. Superior, 1250-A Jefferson, Chicago.

QUICK Money—Sensational Christmas cards, plastics, metallics, stationery, napkins. 50 cards with name \$1. Approval sample. Torres, 373 A-Fulton St., Brooklyn 1, N. Y.

FREE Samples. Big profits showing amazing Glow-in-the-Dark specialties. House numbers, pictures, plastic novelties, ashtrays, keyholders, religious and nursery objects, etc. Madison Plastics, 303 Fourth Ave., New York 10, N. Y.

Hotter than a firecracker. Big profits. Sample free. Bestco, 4642 No. Central, Chicago.

CHRISTMAS Card agents. Sell America's only \$1.00 Gift wrap assortment containing 30 full size sheets; giant plastic pencil containing personalized pencils; Santa stocking with name; Rudolph, the red nosed reindeer assortment. Over 100 Christmas card box assortments and surprise items. Write today for five free portfolios of personalized Christmas cards. Elmcraft, Dept. 13, 5930 S. Western, Chicago 36.

1950 XMAS Card catalog ready! Earn more money as a wholesale jobber! Large selection of dollar box assortments, imprints, religious, personalized Christmas cards! Three dollar sample boxes \$1, postpaid! Write for free holiday bulletin. Elfko, 438 North Wells, Chicago 10.

DRESSES, 18c; Coats \$1.00, blouses 35c. Free catalog. Crown, 164-P Monroe Street, New York.

WRITE for free booklet and catalog telling how to earn substantial profits in your spare time by forwarding new and renewal subscriptions to all magazines for your friends and neighbors. Oldest U. S. agency. Established 1869. Moore-Cottrell, North Cohocton, New York.

SELL Balloons! Combs! Novelties! Excellent sideline. Carleton House, Texas City, Texas.

NEWEST Money making sensation. Sell personal initialed belts, buckles, cap and breast badges, tie holders, etc. Choice 2000 emblems. Write special outfit offer today. Hook-Fast, Box 1425PM, Providence, R. I.

JEWELRY Factory desires salesmen, distributors, jobbers. Pickcraft, 19 Bank Street, Attleboro, Mass.

SELL Big money-maker to men and women. Easy handwork makes fast-selling useful articles. Sunmade Company, Brockton 64, Mass.

GOLD Lacquered window sign letters. Large sizes penny each. New foils. Absolutely beautiful. Free samples. Atlas, 544 W. 79th, Chicago 20.

AGENTS: Stamping names on key protectors. Sample 25c. Stamping outfits, checks, social security and name plates. Hart Mfg. Co., 303 Degraw St., Brooklyn, N. Y.

EXCELLENT Sideline for printing and advertising salesmen. Decalomania name plates in small quantities. Great demand. Also, make money with our line of automobile initials and sign letters. Free samples. "Ralco" XL-Roxbury, Boston 19, Mass.

AGENTS—300% Profit selling genuine gold window letters; stores and offices. Free samples. Metallic Letter Co., 438-B North Clark, Chicago.

FAST Profits—No investment. Send for big, free catalog. Plastic aprons, tablecloths, etc. 150 sure-fire items. We guarantee sales. Write The Halliday Co., Dept. M-10, 15-19 Pennington, Passaic, N. J.

## HIGH-GRADE SALESMEN

IMMEDIATE Earnings as factory salesmen. Build your own permanent year-round repeat business. Sell patented air cushion shoes. Not available in stores. Complete family and work line. Dignified work calling at business places. Full time or side-line. Advance commissions up to \$25.00 per day. Free outfit. Chas. Chester Shoe Co., 80 Foundry St., Brockton, Mass.

AD Matches! Sell amazing designs—20, 30, 40 and 240-light book matches. Big spot cash commissions; every business a prospect. Low prices for high quality. Repeats. Start without experience; men, women; full, part time. Buy nothing! Sales kit furnished. Match Corp., Dept. PM-10, Chicago 32, Illinois.

EARN More with new family insurance—pays for disability, death, retirement. Costs only \$1.00 month. Reliance, Phoenix 5, Arizona.

ADVERTISING Book matches—Cash in on big demand; sell union label matches. Cuts for all businesses and political parties. Free powerhouse selling kit, low prices, protection guaranteed on repeat orders. Cash commissions. Superior Match Co., Dept. M-1050, 7530 Greenwood, Chicago.

A Fine income, your own nylons free! Show nylons, lingerie, men's socks with amazing free replacement guarantee against runs, snags, tears. Write for free sales kit. Group organizers invited. Rosalee Hosiery Co., Clifton 58, N. J.

**SELL** The fastest money maker out! Handy Hannah automatic wax dispenser pays you over 100%. Every housewife wants it. Saves time, labor, stooping, me.s, waste. Press button and wax is released. Sample and details write Everett Young Co., Whitman, Mass.

**POSITIVELY** New—Over 100% profit. Two sided reversible neckties. Free details. Farrell Company, Dept. P-15, 1377 Van Zandt, Cincinnati 31, Ohio.

**SALESMEN**. Earn \$50.00 weekly selling only three pairs shoes daily. Commission and bonus. Wide variety for men, women, children. No investment. Experience unnecessary. Free catalog. Tanners Shoes, 665 Boston, Mass.

**SALESMEN**—Sell America's finest, biggest line of advertising specialties. Sensational sellers to all types of business. Big commissions advanced. Sensational sales plan nets you top earnings. Free outfit. Charms & Cain, 407-PM South Dearborn, Chicago 5.

**FUR Coats**—As low as \$29. No experience necessary. Long established concern. Free catalogue. M. Seidel, 2067 - 82nd St., Dept. PM, Brooklyn 14, N. Y.

**NEW Jobs** open in selling! Send name, address for five free issues of Opportunity Magazine's money-making guide, listing hundreds of companies who'll pay you well, full or part-time. No experience needed. Opportunity, 28 E. Jackson, Dept. 17, Chicago 4, Ill.

**BIG Money** taking orders. Shirts, ties, sox, pants, jackets, sweaters, shoes, uniforms, etc. Sales equipment free. Experience unnecessary. Nimrod, 4922-AN Lincoln, Chicago.

### EDUCATIONAL AND INSTRUCTION

**LEARN** To play Scrimmage by correspondence. New football game sensation. Big demand for instructors. Write to-day. Fred Weina, 2220 North 33rd Avenue, Omaha 10, Nebraska.

**MAKE Up** to \$35-\$45 week as a trained practical nurse! Learn quickly at home. Booklet free. Chicago School of Nursing, Dept. M-10, Chicago.

**SEE** Our collection-credit business ad under Business Opportunities. Cole & Associates, Syracuse, N. Y.

**"HOW To Break and Train Horses"**—A book every farmer and horseman should have. It is free; no obligation. Simply address Beery School of Horsemanship, Dept. 1110-C, Pleasant Hill, Ohio.

**BE** A real estate broker through home study or classroom instruction. Write for free book. Approved for veterans. Weaver School of Real Estate, 15 E. Pershing Rd., Box CP-10, Kansas City 8, Missouri.

**WORK** For U. S. government! Start high as \$66.34 week. Men-women, qualify now for secure positions. Many openings expected soon. Don't delay. Free 40-page book shows jobs, salaries, sample tests. Write: Franklin Institute, Dept. K-24, Rochester, New York.

**MEDICAL** Laboratory Technicians in great demand. We train you in your own home. Catalogue free. Imperial Technical Institute, Box 973-J, Austin, Texas.

**CREATIVE** Behavior training at home wakes up your hidden success powers or no cost. Free brochure and details. Write to President Ballard, 1008 Washington Bldg., Louisville 2, Ky.

**LEATHER** Carving. Fascinating, highly-paid art; age-old secrets now taught for first time in home study course. For hobby, profession or profitable business, write: Baird School of Leather Carving, Box 1367-M, Dept. 11A, Manitou Springs, Colo.

**AIRBRUSH** Photo retouching simplified. 104 pages. \$1.75 postpaid. Harold Green, 117C East 60 St., New York, N. Y.

**USED** Correspondence courses bought, sold, rented. Write Tom Harrison, 726PM North Fifteenth, Waco, Texas.

**MANY** Who have answered our ads now have their names on office doors. See our ad under Business Opportunities. Franklin Credit.

**EXPORT!** Good jobs; travel abroad; world-wide business contacts. Free folder. Brooks, Export Counselor, P.O. Box 762, Washington 4, D. C.

**PREPARE** For career in private investigation or public law enforcement work. Write for free booklet. State age. National Detective Academy, P-239 So. Oxford Ave., Los Angeles 4, Calif.

**TYPING**, Home-study course. Easy, inexpensive. Free details. Hollowell, 1008 Muscatel, Rosemead, California.

**FOOT** Correctionists—Protect your rights. Join: American Pedoprotective Association, 235-S Brevard, Charlotte, N.C. Also, Pedoprotective courses offered.

**GET** Photographic mind with Super-memory. Write Thor Books, M-10, Box 1210, Chicago.

**READ** With speed! New amazing method! Save hundreds of hours yearly. Free test. Speed-Reading, 9111-a Hoyne, Chicago 20.

**USED** Correspondence courses and educational books bought, sold, rented, catalog free. Educational Exchange, Summer-ville, Ga.

**LEARN** Commercial deep sea diving. 20 week course. Veteran approved. Free booklet. Sparring Diving School, Dept. 10A, 1148 Wilmington Blvd., Wilmington, Calif.

**IT'S** Fun learning a language by Linguaphone. At home, in leisure time, quickly, easily, correctly master Spanish, French, Italian—any one of 29 languages through proved Linguaphone conversational method. Send for free book. Linguaphone Institute, 83-P Radio City, New York City.

**U.S. Gov't** jobs. Men, women qualify now. Study course, service helps you. Complete \$10. Wellwood Agency, Box 363, Oak Park, Ill.

**BE** A master salesman. Powerful secret key in new book, "How to Sell Faster." Send \$2.00 to Helpful Press, 2212 Cuming, Omaha, Nebr.

**FAMOUS** Singers; Secrets! Information! Free! Studio, 14356B Jersey, Norwalk, California.

**GUNSMITHING**—Learn for profit, pleasure! Practical residence course, day or eve, G.I. approved. Limited enrollment. Facts free! Pennsylvania Gunsmith School, 423 Federal, Pittsburgh.

**LEARN** Building design, or design your own home or cabin. Write Tech-Talk Design, 19375 Charleston, Detroit 3, Mich.

**STUDY** To be a doctor of psychology or metaphysics. Obtain Ps.D., Ms.D., D.D. or Ph.D. degree. Chartered by state. Write for free book telling how. The Neotarian Fellowship, Dwight Building, Kansas City 6, Missouri.

**USED** Correspondence courses and books sold and rented. Money back guarantee. Catalog free. (Courses bought.) Lee Mountain, Pisgah, Alabama.

**HOME** Study course, drugless therapy. Free literature. Institute of Drugless Therapy, Tama, Iowa.

**INVESTIGATOR** Training. Phillips Secret Service System, 1917-B North Kenneth, Chicago 39.

**BOOKKEEPERS!** Increase your earnings! Operate your own simplified "dollar-a-week" bookkeeping and tax service. Full or spare time. Details free. No obligation. Ellis, Box 200, Cedar Grove, N. C.

**PIANO** Tuning pays. Learn this profitable profession at home. Our Tonometer and mechanical aids make learning easy. No knowledge music necessary. Diploma granted. Largest and oldest school—52nd year. G.I. approved. Write for booklet. Niles Bryant School, 78 Bryant Bldg., Washington 16, D. C.

**SECRET** Investigation. Experience unnecessary. Investigators particulars free. George Wagner, M 125 West 86th, New York.

### PLAYS, STORIES, MANUSCRIPTS

**WRITERS**, Composers: Your name on penny card brings price list. Magdalene Kuhlman, 184 South Point Drive, Avon Lake, Ohio.

**MUSICAL** Comedy plays. Dorby Publications, P.O. Box 738, Morristown, New Jersey.

**I WANT** New writers to cash checks of \$1 to \$100 offered daily. The easiest way to write for pay. No previous experience necessary. Free details. Saunders M. Cummings, 468-11 Independence Bldg., Colorado Springs, Colo.

### INFORMATION

**WHERE** To buy most anything. We furnish supply sources. Single item, 50c. 3 for \$1.00. Service Bureau, Box 5053, Chicago 80, Ill.

### BUSINESS SERVICE

**AUSTRALIA!** Letters re-airmailed 3 for dollar bill. Comeadow, 5/239 Argent Street, Broken Hill, Australia.

### SPECIAL SERVICES

**DRAWINGS** To order, labels, trademarks, monograms, etc. \$15. c.o.d. Co-Op Art, Box 384, Madison, Wis.

**CALIFORNIA** Address! Receiving-forwarding. Letters remailed 25c. View-cards sent. Write Shanks Mail Service, Box 3110, San Francisco, California.

**MEXICAN** Mailing address, 25c each, \$3.00 monthly. Businesses, personal. Mexican matters reliably handled, confidential. Acuña, Box 25612, Mexico, 12, DF.

**INVESTIGATION** And cash liquidation—Old or recent stock certificates, bonds, bank books, promissory notes, deeds, wills, insurance policies, financial documents of every description. Send us your list for appraisal. National Evaluators, P.O. Box 5852, Cleveland 1, Ohio.

### CARTOONING, COMMERCIAL ART, SHOWCARD WRITING, SIGN PAINTING

**TRACING** Folios—Twelve alphabets, ten numerals, \$1.10. Three different \$3.00. Demonstrators, 639-P Paulina Street, Chicago, 12.

**9 ALPHABET** 3 Numeral pattern sets and catalog. \$1.00. Sign Letter Distributors, P.O. Box 101, Mineola, N. Y.

**CARTOONISTS** Make big money! Draw cartoons for money. Complete beginners course in cartooning at exceptionally low price. Write today for free details! R. M. Seward, 1340B Susquehanna Ave., Sunbury, Penna.

**HOW** To sell your cartoons. \$2.00. Lew Card, 16-13C, La Habra, California.

**DRAW** Beautiful human figures. 20 lessons. 147 pictures. \$1.00 complete. Aldcroft Studio, 1206 Maple, Los Angeles, California.

**ART**—Learn to draw in spare time. Commercial art, designing, cartooning all in one course. Write for free book "Art for Pleasure & Profit." Studio C129, Washington School of Art, 1115-15th St., Washington 5, D.C.

**TALENT** Test—Information. Give age. Art, Box 8066, Dallas 5, Texas.

**SIGN** Painting taught at home. Test lesson free. Ben Kerns, Box 812-T, Greenville, S. C.

**CHALK** Talks. Laugh producing program. \$1.00. Catalog 10c. Balda The Cartoonist, Oshkosh, Wisconsin.

### ADVERTISING AGENCIES, LETTER WRITERS, FOR ADVERTISERS

**WEEKLY** Mailing lists: Mailorder buyers, opportunity seekers, etc., 1,000, \$4.00; trial 250, \$1.00. Wright Publications, Memphis 8, Tennessee.

**MAILORDER** Advertisement, 2,000,000 nationwide circulation, \$32.90 inch. 24-word classified, 20 Sunday newspapers, \$25.00. Instructive Ad-Guide—ratebook magazines, newspapers, mailing-lists—10c. Ideas developed. Ads prepared free. Chicago Advertising Agency, (Established 1900), Chicago 4.

**24 WORDS** In 50 weeklies, \$4.96. J. Darnell, 730 Hays, Jackson, Tenn.

**FREE!** 1950 Advertisers Rate and Data Directory. 52 pages! E. H. Brown Advertising Agency, 20 N. Wacker, Chicago 6.

**CLASSIFIED** Mailing lists. Details on request. Service Sales, Box 188, Detroit Lakes, Minn.

**ADVERTISE:** 24 Words, 40 newspapers \$3.50. Lists free. Advertising Bureau, 10511-C Springfield, Chicago 43.

**MAILING** Lists; \$5.00-1000 up. Write Dixie Service, King, N. C.

**ADVERTISERS!** Reach nearly 18,000,000 readers. 25 Sunday national key newspapers, 18 words, \$51.50. "Terrific pullers." 20 popular newspapers, \$10.00. "Free booklet." Special—One inch display 2-821,198 circulation. \$48.30. Newmark's Advertising Agency, (Established 1893), 217-7th Ave., New York 11.

**ADS** Placed in out of town newspapers and magazines. Low rates. Catalogue free. Ideas that pay. Baker Advertising Agency, Successors Ankrum Agency, 189 W. Madison, Chicago 2.

### TYPEWRITERS, DUPLICATORS, OFFICE DEVICES

**PRINTOMATIC** Selffeeding post card printing duplicator \$13.50. Envelope addressing machines \$24.50. Pittsburgh Typewriter Company, 336-R Fourth Avenue, Pittsburgh 22, Penna.

TYPEWRITERS \$19.50. Duplicators \$9.95, adders \$12.50, addressers \$9.95. Meiers, 118 N. Spruce, Wichita, Kansas.

F & E Check protectors, recon'd. Price when new \$97.50. Series 1000 models. Amount visible. Impression made in one operation. Year guarantee. \$35.00. F. & E. Check Protector Company, 510 No. Dearborn Street, Chicago 10, Illinois.

RECONDITIONED Typewriters, printing devices. Write Dixie Service, King, N. C.

### RUBBER STAMPS AND OFFICE SUPPLIES

3 LINES 45c; Pads 35c; signature \$2. Stampright, Wauwatosa, Wis.

RUBBER Stamps, 3 or 4 line, \$1.00 postpaid. Dealer proposition. Smallwood Printery, 2715 Vine, Cincinnati 19, Ohio.

DELUXE Cushioned, indexed, knob handle; 3 lines 50c, 4-60c. Inked pads 40c. Free literature, 500 two color gummed stickers 3/4 x 2" \$1.00. Quick service. Warner Stationery, Havre de Grace, Maryland.

READY Made stamps, free list. Criterion, Box 2326, Denver 17, Colo.

LINE 20c; 2-35c; 3-50c. Stamp Works, Auburn, Nebraska.

### PRINTING, MULTIGRAPHING, MIMEOGRAPHING GUMMED LABELS

\$3.00 PRINTING Specials. Samples free. Travelonian Press, 55 South Tuxedo, Indianapolis 1, Indiana.

1000 BUSINESS Cards \$2.50. Printery, 1485 Cota, Long Beach 13, Calif.

BUSINESS Printing. Samples, prices free. Howprint, 721-23 Eunice, Webster Groves 19, Missouri.

PREPARE Circulars, letterheads, illustrations, quickly, easily, for reproduction by inexpensive offset printing. Folder, 3c. Pengad, Bayonne 4, New Jersey.

MIMEOGRAPHING—Free informative price list, samples. Anything legibly reproduced. Corley, P285 Carlton, E. Rutherford, New Jersey.

500 "EMBOSS" Letterheads \$3.95. Universal Printing—Multigraphing, 203 Avon Avenue, Newark 8, New Jersey.

MIMEOGRAPHING—Reasonable. Any copy. Mailers Service, Box 606-S, Chicago 90, Ill.

100-8 1/2 x 11 LETTERHEADS And envelopes (black or blue print). \$2.00. Birchfield Press, R. 5, Hendersonville, N. C.

100 BUSINESS Cards \$2.50 prepaid. Samples free. Reliable Print Shop, 905 East Jefferson, Louisville 6, Ky.

POSTCARD Brings free samples business cards. Mayfield, R-3, Chattanooga 9, Tennessee.

OFFSET Printing, mimeo prices! Samples. Athins, 2815-F Vaughn, Ft. Worth 5, Texas.

250 8 1/2 x 11 WHITE Bond letterheads \$2.00 postpaid. 5 lines. Envelopes same. Cards or statements 250-\$1.85. L. & F. Printers, Box 5531, Chicago 80, Ill.

AMERICA'S Best printing and offset values! Price list. Globe, 605 W. 151, New York City.

FINE Printing. Offset, letterpress. We specialize in booklets, folders, publications, office forms. Send copy for estimate. Quality Printing Company, Richmond 20, Virginia.

MIMEOGRAPHING And mimeograph supplies. Folder. Brown's Office Supply, Philadelphia 19, Penna.

100 LARGE Envelopes, 100 8 1/2 x 11 letterheads \$2. Crown Print, Adelphi, O.

DECALS Printed. Your copy. 28 colorful designs. Write for illustrated folder! Grand, 2506M-52nd, Kenosha, Wisconsin.

LETTERHEAD—Form letter combination, printed one operation. Inexpensive. Any quantity. Robbins, 415 20th, Baltimore 18.

OFFSET Printing, letterheads, letters, circulars, price lists, etc. 8 1/2 x 11; \$6.95 per 1000 delivered. Kale Bros., 2250 Milwaukee, Chicago 47.

100 8 1/2 x 11 HAMMERMILL Letterheads and 100 envelopes \$1.85. Herbert Hudson, Centredale, R. I.

MIMEOGRAPHING, Multigraphing. Like personal typing. Down low prices. Free samples. Packer, Box 1674, New Haven 7, Conn.

QUALITY Printing. We specialize in publications, newspapers, tabloids. Send copy for estimate. Bagby Printing Co., Georgetown, Ohio.

125 LETTERHEADS (8 1/2 x 11 Hammermill) \$1.00 postpaid. Envelopes same. Race Printers, Hudson, New York.

1000 6 3/4 WHITE Wove envelopes \$5.00; #10 \$6.50. Postage extra. Ideal Printing Company, Hudson 7, New York.

1000 QUALITY High gloss business cards printed, \$5.00. Postpaid. Arrow Printers, 2212 Cumings, Omaha, Nebr.

QUALITY Printing! Free price list. Nationwide Printing Company, 2337 Bath Avenue, Brooklyn 14, N. Y.

SEND 10c Now, for our 48 page 1950 price list—refunded first order. McCall Press, 1326 South 27th, Omaha, Nebraska.

500 3/4 x 2 1/4 FOUR Line gummed stickers 35c; red border 50c. Moritz Printery, Saginaw, Mich.

MIMEOGRAPHING—Letters, pricelists, formulas, instructions. Lowest prices. Lem's Letter Shop, 5710 Stanton, Detroit 8.

### PRINTING OUTFITS AND SUPPLIES

CAPABLE Home-built press, details free. Roberts, Box 184, Walpole, Mass.

PRESSES, Type, cabinets, supplies. List for stamp. Lincoln Press Company, 220-O Hartwell, Fall River, Mass.

MAKE Your own rubber printing cuts. Self-molding process. Plexirubber, Argyle 1, Wisconsin.

PRINT Your own cards, stationery, circulars, advertising. Save money. Simple rules. Print for others, nice profit. Raised printing like engraving too. Have home shop. Details free. Kelsey Presses, L-11, Meriden, Conn.

PRESSES, Supplies, paper. Catalog 10c. Printers Supply, 211, Springfield, Missouri.

PRINTING Presses, type, supplies. Lists 3c. Turnbaugh Service, Loysville, Penna.

### PATENT ATTORNEYS

INVENTORS—If you consider your invention to be something of importance, take steps to protect it with a United States Patent which gives you the right to exclude others from making, using and selling your invention as claimed. "Patent Protection for Inventors" outlines steps to take to secure patent protection. Mailed promptly without obligation. Victor J. Evans & Co., Merlin M. Evans, Registered Patent Attorney, 531-L Merlin Building, Washington 6, D. C.

INVENTORS—If you believe you have an invention, you should find out how to protect it. The firm of McMorro, Berman & Davidson with offices in Washington, D. C., is qualified to take the necessary steps for you. Send for copy of our patent booklet "How to Protect Your Invention." We will also send you an "Invention Record" form. No obligation. They are yours for the asking. McMorro, Berman & Davidson, Registered Patent Attorneys, 134-C Victor Building, Washington 1, D. C.

INVENTORS: Learn how to protect your invention. Unless the inventor is familiar with patent matters, he should engage a competent registered patent attorney or agent to represent him. We are registered to practise before the U.S. Patent Office and prepared to serve you in handling your patent matters. "Patent Guide for the Inventor" containing detailed information concerning patent protection and procedure with "Record of Invention" form will be forwarded to you upon request—without obligation. Clarence A. O'Brien & Harvey Jacobson, Registered Patent Attorneys, 01B-K District National Building, Washington, D. C.

HERMAN Lewis Gordon, registered patent attorney. Patent investigations and opinions. Warner Building, Washington, D. C.

REGISTERED Patent attorney offers services. Sanders, 6430 Evans, Chicago 37, Ill.

PETER Fries, Jr., Registered Patent Attorney. Patents, novelty searches, designs, copyrights. 110 East 42nd Street, New York City.

PATENTS. "Proof of Invention" folder mailed without obligation. E. E. Vrooman, Registered Patent Attorney, 507 McKim Building, Washington 5, D. C.

INVENTORS: When you are satisfied that you have invented something of value write me, without obligation, for information as to what steps you should take to secure a patent. Write Patrick D. Beavers (Formerly Randolph & Beavers) Registered Patent Atty., 935 Columbian Bldg., Washington 1, D. C.

PATENTS—Irving L. McCathran, 315 McLachlen Bldg., Washington 1, D. C. Registered Patent Attorney.

CANADA—Ramsay Company Registered, 273 Bank Street, Ottawa, Canada.

C. A. SNOW & Co.—M-427, Snow Building, Washington 1, D. C. Registered Patent Attorneys. Write for information.

"INVENTOR'S Guide" free on request. Frank Ledermann, Registered Patent Attorney, 154 Nassau St., New York 7, N. Y.

INVENTORS: Write for free brochure "Evidence of Invention." Labiner, World Building, New York 7.

INVENTORS: Without obligation, write for information explaining the steps you should take to secure a patent. John N. Randolph, Registered Patent Attorney, 203 Columbian Bldg., Washington 1, D. C.

PATENT Practice before U. S. Patent Office. Validity and infringement investigations and opinions. Booklet and form "Evidence of Conception" forwarded upon request. Lancaster, Allwine & Rommel, Registered Patent Attorneys, Suite 411, 815-15th Street, N.W., Washington 5, D. C.

INVENTORS. For "Record of Invention" form, contact Carl Miller, Registered Patent Attorney, Woolworth Building, New York.

### FOR INVENTORS

PATENT Searches \$5.00, including patent copies. Same reliable search as conducted for patent attorneys. Free protection forms, 48 hour service. Patent Service Institute, 945-A Pennsylvania Avenue, Washington 4, D. C.

INVENTORS—This firm is registered to practice before the United States Patent Office and is available to assist you in the preparation and prosecution of your patent application. "Patent Protection for Inventors" booklet containing detailed information and steps to take toward patent protection will be sent upon request. No obligation. Victor J. Evans & Co., 532-L Merlin Building, Washington 6, D. C.

INVENTORS—If you believe that you have an invention, you should find out how to protect it. The firm of McMorro, Berman & Davidson with offices in Washington, D. C., is qualified to take the necessary steps for you. Send for copy of our patent booklet "How to Protect Your Invention." We will also send you an "Invention Record" form. No obligation. They are yours for the asking. McMorro, Berman & Davidson, Registered Patent Attorneys, 134-B Victor Building, Washington 1, D. C.

INVENTORS: Learn how to protect your invention. Unless the inventor is familiar with patent matters, he should engage a competent registered patent attorney or agent to represent him. We are registered to practise before the U.S. Patent Office and prepared to serve you in handling your patent matters. "Patent Guide for the Inventor" containing detailed information concerning patent protection and procedure with "Record of Invention" form will be forwarded to you upon request—without obligation. Clarence A. O'Brien & Harvey Jacobson, Registered Patent Attorneys, 01A-K District National Building, Washington, D. C.

YOUR Ideas developed. Disclosure drawing \$5. Fast, accurate, helpful. E. Camporini, patent draftsman. (Estab. 1930). 412 W. 6th, Los Angeles 14.

PATENT Searches, including patent copies, patent drawings, invention marketing, protection forms free. For complete inventor's services write: Industrial Patent Reports, Box 1081, Massachusetts and North Capitol, Washington 13, D. C.

SEARCHES. Put your patent searches in the hands of a registered patent attorney. Don't take chances. All inventions kept in strict secrecy in my office. Lowest search fees. Record of Invention Form upon request and information on patent protection. Patrick D. Beavers, Registered Patent Attorney, 936 Columbian Bldg., Washington 1, D. C.

SELLING Your inventions made easier by our consulting, design and drafting services. Complete information—free. Machine Design Service, 416 Madison Avenue, Rahway, New Jersey.

PATENT Searches by former patent office examiners \$5.00. Protection forms free. Write Patent Engineering Service, 500 Walker Building, Washington 5, D. C.

PATENT Owner Representative. Years of experience. Can I help you? Charles A. Scott 773PM Garson Avenue, Rochester 9, N. Y.

mailed within 48 hours. Inventor protection forms free. Write Miss Ann Hastings, Patent Searcher, P.O. Box 176, Washington 4, D. C.

**PATENT Searches \$5.00, 48 hour service.** Patent copies included. Protection forms free. Write Raymond L. Smith, Patent Searcher, 410 Bond Building, Washington 5, D. C.

**SUCCESS Guaranteed.** Inventors with patented and patent pending inventions for sale or lease, request our free book. No obligation. Dept. 1-F, Universal Marketing Co., 354 South Spring St., Los Angeles 13, Calif.

**INVENTORS:** If you have an invention for sale, patented or unpatented, write Institute of American Inventors, Dept. 40A, 631-E St. N.W., Washington 4, D. C.

**INVENTIONS Wanted.** Prominent manufacturers and national distributors look to us for new products. You can also benefit by having us assist you with your invention from the idea stage through to the developed product, fully protected. Ask for Booklet "M." Elo Development Co., Chatham Phenix Bldg., Long Island City 1, New York.

**"INVENTOR'S Guide"** free on request. Frank Ledermann, Registered Patent Attorney, 154 Nassau St., New York 7, N. Y.

**INVENTORS:** Without obligation, write for information explaining the steps you should take to secure a patent on your invention. John N. Randolph, Registered Patent Attorney, 202 Columbian Bldg., Washington 1, D. C.

**INVENTORS.** For "Record of Invention" form, contact Carl Miller, Registered Patent Attorney, Woolworth Building, New York.

### INVENTIONS WANTED

**NATIONALLY Known manufacturer** wants new invention (pat. or unpat.) with wide demand. Give full details in first letter or save our time. Dean Studios, Dept. N.P.2, Des Moines, Iowa.

**"THE Inventor's Guide"** shows you how to develop, protect, sell your inventions for highest royalties and cash. Gives list of manufacturers, buyers. Send for details. Creative Service, 326 W. 3rd St., Los Angeles 13, Calif.

**INVENTORS Marketing assistance.** Circular free. Stanley Hull, 7829-K Euclid, Cleveland 3, Ohio.

**INVENTIONS Promoted.** Patented or unpatented. Write Adam Fisher Company, 61 Enright, St. Louis, Mo.

**INVENTORS:** Nationally-known manufacturer seeks new patented products suitable for manufacture by high production methods. Write P.O. Box #7312, Chicago.

**INVENTORS—What have you, patented, patent pending to offer manufacturers?** Our booklet free without obligation. Market Contacting & Data Service, 11106-A2 Longwood, Chicago 43.

**INVENTORS:** Hundreds of manufacturers have requested our assistance in locating marketable new products. Complete information free. Institute of American Inventors, Dept. 40-D, 631-E St. N.W., Washington 4, D. C.

**HIGHEST Royalties—Cash.** Patented and patent pending inventions only. Request our free book. No obligation. Dept. 1-W, Universal Marketing Co., 354 South Spring St., Los Angeles 13, Calif.

**INVENTIONS Wanted.** Patented or pending only. Inventors' Exchange-B, Hartford 1, Conn.

### PATENTS FOR SALE

**INVENTORS:** Test the commercial value of your patented or unpatented inventions, quickly and inexpensively. Write for free information. Institute of American Inventors, Dept. 40-B, 631-E St. N.W., Washington 4, D. C.

### MODELS, MODEL SUPPLIES

**GJOA Arctic sloop, and City of Pekin, steam canal barge.** Two new kits. Also Notebook For Shipmodel Builders, by Pratt, 32 pages, illustrated \$1.00 post paid. Send 25c for new 1951 catalog. Folio 60. Model Shipways, 476 Main St., Fort Lee, N. J.

**BUILD Historic ship models, complete kits 39c to \$9.00.** Catalog 10c. Ideal Models, 19 W. 18th, New York 11, N. Y.

**SHIP Models and yacht supplies complete.** Large 64 page catalogue 30c. Bill Wild's, 510 East 11 St., New York City 9.

**Model Magnesium for all model makers.** Rod, bar, sheet and scale structural shapes. The Craftsmiths, 15427 Robson, Detroit 27, Michigan.

**LIONEL Trains, accessories, switches.** Tremendous stock; fast delivery. Guaranteed repairs. Authorized Lionel Train Station, 72 West Washington, Chicago 2.

**SHIP And yacht model fittings; blueprints.** Send 25c for illustrated catalog No. 25—listing hundreds of items. A. J. Fisher, 1002-1 Etowah Ave., Royal Oak, Mich.

**STEAM Locomotives, 1 1/2", 3/4", 1/2", 1/4" scales.** Castings, parts, rail, steam fittings! Thorough drawings with instructions. Catalog 35c. Little Engines, Lomita, Calif.

### MANUFACTURING

**ENGRAVING Nameplates 40c, manufacturing small lot.** Tools, fixtures, models. Specialty Machine, 2821 Mitchell, Racine, Wis.

**MODELS—Small lot manufacturing.** Metals, plastics, etc. Milburn, Burlington, Kentucky.

### HOME CRAFTSMEN

**ANYBODY Can paint! Profitable! Fun!** America's largest unpainted home decorations, gifts. Catalog, complete instructions, 25c (Refunded first order). Buy direct, 50% discounts. Chetco Products, Wellsville 13, Penna.

**WHOLESALE Shellcraft Book 15c.** Large shellcraft kit \$1.69 postpaid. Shell-Art Novelty, Dept. PM, 5th and Moore, Philadelphia 48, Penna.

**LEATHERCRAFT Instruction book** one dollar postpaid. Leather list free upon request. Sam Tinnin, 213 East Walnut, Columbus 15, Ohio.

**VIOLIN Makers—Amateurs, professionals.** Fine tone European wood. Materials, supplies, catalogue 10c, refunded. Premier Violin Supplies, 430 S. Broadway, Los Angeles 13, California.

**ALL Leathercraft supplies! Catalogue 10c, refunded first order.** Rosenblum Leather, Box 507, Sheboygan, Wisconsin.

**LEATHERCRAFT.** Everything needed by beginners, advanced hobbyists and professional leatherworkers. Largest stock of supplies in U.S. Moderate-priced tooling leathers, top quality calfskins, tools, supplies, kits. Send 10c for big catalog. J. C. Larson Co., 820 S. Tripp, Dept. 375, Chicago 24.

**NEW 96 Page leather and craft catalog.** 1000's of items. Send 10c. Russo Handicraft Supplies, Dept. 10D, 245 South Spring, Los Angeles, California.

**JIGSAW Owners attention! Start earning money at home cutting out wooden novelties and souvenirs.** Write H. Cook, 4407 S. Normal Ave., Chicago 9, Ill.

**CACTUS Wood, lamp size sample, 60c postpaid.** 214B East Yavapai, Tucson, Arizona.

**NOVELTY Cedar chest.** Knocked down 31 1/2 x 5 wood and hardware. Instructions and price list included. 2 for \$1.00 postpaid. Jack Raybin, Dept. A-4, Portland, Tenn.

**SWISS Music movements, finest make, assorted tunes \$1.90.** Direct imports. Helaxe Company, 233 West 72 Street, New York.

**SHELLCRAFT Kit—Butterfly earrings and brooch \$1.00.** Value \$4.00. Money-making opportunity. Eagle, 6807 8th Avenue North, St. Petersburg, Fla.

**LEATHERCRAFTERS:** Big illustrated catalog of materials, tools, kits, 10c. Art Leather, 411 Joseph Ave., Rochester 5, N. Y.

**SHELLS, Plastics, findings.** Lowest prices. Catalog 5c. Frances Jones, Box 251, Sarasota, Fla.

**16 NEW Lawn chairs, 22 picnic tables, benches, trellises, etc.** All 38 plans with necessary full size patterns, \$1.00. Mastercraft 103M, 7041 Olcott, Chicago 31, Ill.

**GOLD-Plated jewelry supplies.** Rhinestones, pearls. Illustrated catalog, 10c. Barry's, 47-N Branford Place, Newark 2, N. J.

**90 ALL New, full size lawn ornament and novelty patterns, up to 20" high.** Only \$1.00. Mastercraft 102M, 7041 Olcott, Chicago 31, Illinois.

**INDIAN Style leather moccasin kits.** Pieces die cut. Sizes, small 1-5, medium 5-8, large 8-12. \$1.75 postage paid. Walter E. Berger, Atchison, Kansas.

**NEW Pantograph hand motor tool attachment; carves wood, engraves plastics.** Sample, details 25c. Desco Products Distr's., 6334-M Sepulveda, Van Nuys, Calif.

**LEATHERCRAFT Bargains!** Lacing, Francis Byrd, 3406 Montrose Ave., Richmond, Va.

**GARDEN Figures, lawn chairs, furniture, novelties, toys, etc.** 68 popular plans, with full size patterns, \$1.00. Mastercraft 101M, 7041 Olcott, Chicago 31, Illinois.

**BOOKLETS And catalog of figurines, paints, plastics, handcraft kits, details free.** Leisure Hour Products, 416 Rose, West Hazleton 3, Penna.

**COLLODION, Dope, cement, \$1.50 gallon.** Express, Box 103, Washington 4, D. C.

**89 FULL Size jig saw patterns of beautiful shelves, ornaments, toys, novelties.** Plus how, where to sell. Only \$1.00. Mastercraft 104M, 7041 Olcott, Chicago 31, Illinois.

**OLD West plywood moneymaker! Plan 25c.** Box 56-A, Braintree 84, Mass.

**BEAUTIFUL Lawn ornament patterns, ready cut, full size.** 20 assorted \$1.00 postpaid. Lincoln Craft Studio, Farmington, Conn.

**VELCOAT Makes any surface feel velvety.** 18 exciting colors. Easily sprayed on. Single color \$1; 6 color kit \$4.95. Velcoated samples free. Hobbies, 5172-K, Tulsa 16, Okla.

**MAKE Leather belts, billfolds, purses.** Big catalog and genuine steerhide keyholder, 10c. Tandy Leather, Box 397C, Tulsa, Okla.

**STAINLESS Steel sheets, 30 to 32 gauge, 15" x 36", postpaid only \$2.50 each.** Send check or m.o. to L. J. Michies, Fremont, Ohio.

**LEATHERCRAFT, Copper tooling, textile painting.** Make spare time, profitable time. Free illustrated catalog shows everything you need. Kit Kraft, 7377 Melrose, Hollywood 46, California.

**LEATHER, Tools, lacings, supplies.** Free catalog. National Handicraft, 199 William St., New York 7.

**SEA Shells, cut shells, oil colored shells at lowest prices.** Free illustrated catalogue showing many new jewelry designs with instructions. Southern Shellcraft Supply, Clearwater, Florida.

**OZARK Wood samples.** Eleven useful identified varieties. Prepaid \$1.25, check or cash to Davis Lumber, Cabool, Mo.

**8 BEAUTIFUL Full-size whatnot patterns 25c.** Joanes, P.O. Box 141-M, Omaha 7, Nebr.

**80 FULL Sized patterns.** Lawn ornaments, toys, novelties \$1.00. Modern Woodcraft, Saginaw, Mich.

**KNOCKDOWN Cedar chests.** Lumber and veneers. Free price list. Giles & Kendall Company, Huntsville, Ala.

**JEWELRY Findings, rhinestones, pearls, sequins, cameos.** J & M Novelties, Box 464P, Griffith, Ind.

### MAKE IT YOURSELF

**NEW Easy way to build your own modern webbed chair, armchair, lounge chair, rocking chair.** Send 25 cents for each pattern. Fabbrola, Box 17, New York 24, New York.

**BEARINGS—Ball and roller.** All new, 3/16" to 9/16" shaft sizes, 3/4" to 1 1/2" outside diameters. Small ass't—18 bearings \$3.50. Large ass't—100 bearings \$17.50. Postage prepaid. Special sizes also available. United Bearing Company, Inc., 1411 Third Avenue South, Minneapolis, Minnesota.

**\$50 BUILDS Large Zeolite water softener or automatic electric water heater.** Details free. 204 Carson Products, 2505 Benjamin, Minneapolis 18, Minn.

**ELECTRIC Clothes drier \$1.00, ceramics kiln \$1.00.** Furniture, electronics, machinery. Catalog 200 plans 25c (refunded). MD 34, East Rockaway, New York.

**MAKE Lumi-Brite house and lawn markers for home or for profit.** 15 designs plus alphabet and numerals ready to trace. Only \$1.50 postpaid. Smithcrafters, Dept. P.M.10, 6760 Stony Island Ave., Chicago 49, Illinois.

**GRANDFATHER Clock easily built.** Big savings. See ad on page 266.

**\$600 BUILDS Cozy 4 rooms and bath.** Concrete block, stuccoed. Instructions and blueprint \$1.00. Farrow, G-83, Box 645, Columbus 16, Ohio.

**"CONCRETE Block Homes."** 32 page booklet on how to build, \$1.00. H. C. Lightfoot, Civil Engineer, Richboro 1, Penna.

**STREAMLINED, Built-in kitchen cabinets to fit any kitchen.** Illustrated manual describes designing and construction. All for \$1.00. Thombert Company, Newton 10, Iowa.

**HEAT** Saving inside storm windows. Easy, proved method. 50c. Square, Excelsior, Minn.

**BUILD** Your own tractor. Plans, Walking, riding. Free information. Ellsworth Tractor Co., D-11, Camptonville, Calif.

**BUILD** Your own concrete blockmaker. Easy. Inexpensive. Motor or hand. Make block per minute. Write, C. Lee, Mountain View, Okla.

#### WATCHES, OLD GOLD, JEWELRY

10 HIGH Grade Swiss yellow and white wrist watches needing some repairs. \$15. B. Lowe, Holland Bldg., St. Louis 1, Mo.

**NEW**, Oxidized sterling silver wire kits, bracelet \$2.50, Earrings \$1.50. Pliers needed to finish. Burgess, 138 Pine St., Corning, N. Y.

**WATCHMAKERS'** Jewelers', hobbyists', tools—supplies. Catalogue! Bengal Company, Culver City, California.

**DIAMOND** Like zircons, alexandrites, rubies, star sapphires and other gems. Unmounted only. Free price list. Imhusex, Dept. P.M. Box 996, Dayton, Ohio.

**WATCHES** Cleaned, repaired. Maximum charge \$4.00! Year guarantee. National Watch Repair, Box 2414C, Cleveland 12, Ohio.

**HIGHEST** Prices paid for old gold, silver, platinum, diamonds, watches, gold teeth, spectacles. Cash immediately. Goods returned if offer unsatisfactory. Government licensed. United Smelting Works, (The Old Reliable), 39-B South State, Chicago 3.

**COSTUME** Jewelry makers illustrated parts list 10c. Conner, Box 188, National Park, N. J.

**WATCHMAKERS'** Journal contains instructive articles on watch repairing. \$1.00 year. Sample copy 20c. Dean Co., 116-K Nassau St., New York 7, N. Y.

**BEST** Prices paid for gold teeth, rings, broken jewelry, diamonds, platinum. Money mailed same day articles received. Licensed and bonded. Ship to Marko Loan Bank, 542 S. State St., Chicago 5, Ill.

**HIGHEST** Cash paid for old, broken jewelry, gold teeth, watches, silverware, diamonds, spectacles, platinum. Free information. Satisfaction guaranteed. Government licensed. Rose Smelting Company, 29-A East Madison, Chicago.

**GOLD** Plated jewelry supplies—Rhinstones, pearls. Illustrated catalog 10c. Barry's, 47-A Branford Place, Newark 2, N. J.

#### TOBACCO, SMOKERS' SUPPLIES

**PIPES**—Pipemakers' supplies. Kits \$1.00. Carvape, 2829-R Dixie, Hamilton, Ohio.

#### FOR THE HOME

**STEAM** Heat owners. Let us show you how to keep your house warmer this winter with less fuel by an amazing new vaporizing valve you can install yourself. Details free. Write Ralph M. Arato, 1651 East 14th Street, Brooklyn 29, N. Y.

**HAVE** Comfort. Weatherstrip your windows. Low cost. Illustrated circular from E-Z-On, 1009 Harvard, Evanston 9, Ill.

#### OF INTEREST TO WOMEN

**FLOWERMAKING** Supplies, wood fibre, chenille, 380 flower and animal cutouts. Crafts. Catalog 10c. Clevemodell, 4516K21 Lorain, Cleveland, Ohio.

**HANDS** Rough? Chapped? Savell Hand Lotion for "smoother hands." \$1.00 postpaid. Savell Sales Company, Maspeth 1, New York.

**EXCELLENT** Profits. Make fast-selling chenille Christmas poinsettias, corsages, Santas, monkey trees, dolls. Literature free. Velva, Dept. M, Bohemia, N. Y.

**SEW**—Our ready-cut line. Fast, easy, illustrated folders 10c. Liebig Industries, Beaver Dam 5, Wisconsin.

#### FOR SALE—MISCELLANEOUS

**DIVERS** Supplies. Largest stock of deep sea diving equipment in U. S. Free illustrated catalog. Divers' Supply, Dept. 10B, 1150 Wilmington Blvd., Wilmington, Calif.

**SAVE** Money on army, navy and factory surplus. Write today for new 60-page illustrated catalog. Tennusa Sales Co., Dept. AE, 1451 Market, Chattanooga, Tenn.

**GENUINE** Buckskin coin purse and illustrated buckskin catalogue, both only 15c. Berman Buckskin Co., 253 No. 1st, Minneapolis, Minn.

**BARGAIN**. Well established, equipped, metal specialty shop. Paying good profits. Wiebe, 1145 No. Liberty, Salem, Oregon.

**MICROSCOPES**, Pocket pen type. 20 power, \$2.95; 40 power, \$4.95 postpaid. Pocket pen telescope, 6 power, coated lens, \$9.95. New 1950 catalog of firearms, gov't surplus and sporting goods. Send coin 25c. Public Sport Shops, 11 S. 16th Street, Philadelphia 2, Penna.

**DRESSES** 18c; Coats \$1.00; blouses 35c. Free catalog. Crown, 164-PA Monroe Street, New York.

**HANDSIGHTING** Levels, improved, new model, used for grading land, contouring and laying out fences, piers, roads and gardens, price \$2.00 postpaid. New 1950 catalog of firearms, gov't surplus and sporting goods. Send coin 25c. Public Sport Shops, 11 S. 16th Street, Philadelphia 2, Penna.

#### WANTED—MISCELLANEOUS

**WILL** Buy patent outright, or royalty. Spector, 10 N. Clark St., Chicago, Ill.

**AUTOMOTIVE** And radio inventions, patented or pending. H. Boger, Waynesville, Ohio.

**QUICKSILVER** (Mercury) urgently needed! Immediate payment. Wholesale Terminal, Norwood, Massachusetts.

**WANTED**—Scrap mercury (quicksilver), tantalum, bismuth, tungsten. Metallurgical Products Co., Established 1909, 35th and Moore Sts., Phila. 45, Penna.

#### PERSONAL

**YOUR** Caricature, \$1.00. Pictures returned. Montague, Ad'mon 58, Mexico City.

**BORROW** By mail. Loans \$50 to \$300 to employed men and women. Easy, quick. Completely confidential. No endorsers. Repay in convenient monthly payments. Details free in plain envelope. Give occupation. State Finance Co., 210 State Finance Bldg., Dept. N-14, Des Moines 8, Iowa.

**LETTERS** Forwarded from Australia. Air 50c, surface 35c. Tipping, 61A Willington St., Arncliffe, N.S.W. Australia.

**VALUABLE** Big mails, four months listing, 25c. Wright Publications, Memphis 8, Tennessee.

**REVOLUTIONARY** Hearing device. No battery, no wires. Just a simple ear plug that carries sound to the ear drum. Beaudry, 4337—30th Avenue South, Dept. H, Minneapolis 6, Minn.

**MEXICAN** Law. General Practice Attorney, 1203 Arizona Street, El Paso, Tex.

**MEXICAN** Legal matters reliably handled. Box 263, El Paso, Texas.

"HOW Can I find out?" You can! Information discreetly developed. Any matter, person, problem, anywhere. Worldwide. Officially licensed, bonded service. Established 1922. Reasonable. Confidential. William Herman, 170 Broadway, New York.

#### MISCELLANEOUS

**RECEIVE** Hundreds of valuable items absolutely free. Supply source directory 25c. Neiko Service, 3462 Merchandise Mart Sta., Chicago 54, Ill.

**FORTUNE** May be yours. Detect uranium, gold, silver, precious metals, minerals. America's finest Geiger counters, metal and mineral detectors. None finer at any price. Factory guaranteed. Write manufacturer for free information. Detector Co., 5631 Cahuenga, Dept. B-11, North Hollywood, California.

**SAVE**—Make money. Buy merchandise wholesale. Free details. Orysen's, 1147 Sunkist, Waukesha, Wisconsin.

**SAVE** Money on paint brushes. Buy direct. Post card brings descriptions and prices. \$1.50 brings 3" brush, \$2.50 value. P.O. Box 53, Kenmore 17, N. Y.

**LUMINOUS** Reflective paints glow day and night in technicolor! New angle money-maker. Assorted color samples 25c. Research, 1842-PM Byron, Chicago 13.

**RECEIVE** Interesting mail and beautiful post cards from Mexico. Absolutely free. Send name and address. Letters received, forward service 25c. Universal Distributing, Apartado 10510, Mexico City.

**EARN** Up to \$200 month, inventing toys, games, gadgets. Write, Hendrickson, Argyle 1-A, Wisconsin.

**EXPLORE** Abandoned mines, hills, deserts, streams for natural gold, silver, other precious metals. Seek fabulous riches in buried treasures. Details free! Pathfinder Company, Dept. 10PM, 1726 Beverly Drive, Pasadena 7, Calif.

**CARTOONS**. The kinds you'll like. Samples 25c. Verret, Raceland, Louisiana.

**DOOR** Plate, solid nickel silver, name hand-tooled; 5½"x1½" \$3.95. Catalog. Franklin Craftsmen, Wallingford, Penna.

**INTERESTED** In football? Over 100 college schedules for 10c! Sports Calendar, 3625-K, Third, Detroit, Michigan.

**BABY** Shoes plated, free literature. "Precious Keepsakes," P.O. 133, Newark 2, New Jersey.

"INTERESTING Mails"—Details, 25c! Bentz, Pine Hill's House, (Desk C/12), Chatawa, Mississippi.

**SPANISH** Souvenirs, magazines, postcards. Catalog free. Cicerone, Hortaleza, 27, Madrid, Spain.

**DRESSES** 18c; Coats \$1.00; blouses 35c. Free catalog. Crown, 164-PM Monroe Street, New York 2.

**MILLION** Articles wholesale. Directory 25c (refundable). Publishers, Box 1302-P10, Detroit 31.

**USE** Best metropolitan address available! Business, personal. Metropole, Suite 3, 29 St. James East, Montreal 1, Canada.

**NO** Long courses! Learn touch typewriting in 4 hours at home. Guaranteed instructions, \$1.00. Lerner, 15 East 208 St., New York 67, N. Y.

**ATTENTION** Manufacturers—We have an ideal location for a factory. Ample water, rail facilities, low taxes, abundant labor. Contact Lions Club, Melvin, Texas.

"RECEIVE Mail." Moneymaking offers, opportunities, catalogs. Name listed 10c. Ideal Service, Park Ridge 10, Ill.

**MEXICAN** Jumping beans. For immediate shipment. The most original curiosity in the world. They attract universal attention. Joaquín Hernández, Exporter, Alamos, Sonora, Mexico.

**GEIGER** Counter Model C-18, fits coat pocket, 2 pounds weight, ultra sensitive, dependable, immediate shipment, only \$35.00. Fisher Research Lab., Inc., Palo Alto, Calif.

**TRADE!** Buy! Sell! In "Trading Post Magazine." Details. Thorne's, 525 Dewey, Jackson 15, Michigan.

**HAIRCUT** As you like it. New booklet tells how, 25c. Mastrolia, 5½ Jane, New York 14.

8x10 **OIL** Painting from any picture, any size \$1.95. Trueblood Studios, Wilson, N.C.

**PANNING** Gold — Beginners booklet 36 pages; catalogue, supplies, mining books, maps "where to go." 25c. Old Prospector, Box 729, Lodi, Calif.

**SQUARE** Dance instructions. Calls, 25 sets, \$1.00. Rayburne, Eureka Springs, Arkansas.

**INCREDIBLE!** Unprecedented! Become a mental superman overnight! Floor everybody! No studying! "Memoprop" does all your thinking! It's uncanny! Revolutionary! Write: Bijou, Box 1727-M4, Hollywood 28, California.

**SQUARE** Dance instructions. 40 dances. \$1.00. Wesley Rader, 1922 Grant, Denver 5, Colorado.

**YOUR** Leather jacket renovated by our craftsmen expertly, reasonably. Request free descriptive circular. Berlew Mfg. Co., Dept. 8, Freeport, N. Y.

**STOP** Toilet tank sweating—Save floors. Easy to install. \$10.95 postpaid. (Free literature). Arrow Sales, 2212 Cuming, Omaha, Nebraska.

**ELECTRIC** Paint remover from wood, plaster surfaces, curved or irregular. Safe, flameless. Precision built of chromeplated and stainless steels. Absolutely guaranteed. \$12.95. Your dealer or B & L Tool Company, 51 Pine St., Plainville, Conn.

**PROFESSIONAL** Secrets revealed. Send for your copy of "How to Trace Missing Persons." \$2.00 postpaid. Bonded Detectives, Omaha, Nebr.

**TATTOOING** Outfits, supplies. Illustrated list free. Zeiss, 728 Leslie, Rockford, Illinois.

**TREASURE**, Mineral locators. Goldak now offers treasure locators for \$75.00. Geiger counters reduced to \$95.00. Write the Goldak Co., 1541 West Glenoaks Blvd., Glendale 1, Calif.

**TREASURE**—Mineral locators — Geiger counters M-scope type for arctic-tropic use. Unsurpassed in efficiency. Factory guarantee. Lowest prices. Can be purchased on monthly payment plan. Free literature. Fisher Research Lab., Inc., Palo Alto, Calif.

**TATTOOING** Machines, outfits. Free catalogue. Jensen, 120 West 83rd Street, Los Angeles 3.

# I need 500 Men to wear SAMPLE SUITS



## Pay No Money— Send No Money

My values in made-to-measure suits are so sensational, thousands of men order when they see the actual garments. I make it easy for you to get your own suit to wear and show—**MAKE MONEY IN FULL OR SPARE TIME THIS EASY WAY!**

## My Plan is AMAZING!

Just take a few orders at my low money-saving prices—that's all! Get your own personal suit to wear and show—make money fast taking orders. No experience needed. Spare time pays big. You pay no money, now or any time.

### MAIL COUPON!

Rush this coupon today for full facts and **BIG SAMPLE KIT** containing more than 100 fine woollens in all popular weights and shades. Be one of the 500 top-notchers I need to wear, show, and take orders for my suits. Act now!

**W. Z. GIBSON**  
500 S. Throop St., Chicago 7, Ill.

**FREE**  
Costly Sample  
Kit containing  
over 100 actual  
fabric samples.

**W. Z. GIBSON**  
500 S. Throop St., Dept. K-516, Chicago 7, Ill.

Dear Sir: I WANT A SAMPLE SUIT TO WEAR AND SHOW, without paying 1c for it. Rush Valuable Suit Coupon and Sample Kit of actual fabrics, **ABSOLUTELY FREE.**

Name .....

Address .....

City ..... State .....

## MASTER MIND!

### Learn Short-Cut Mathematics

Juggle figures, do baffling number tricks. Make people gasp at your marvelous lightning-quick mind. Multiply 4 figures by 4 figures without using old-fashioned multiplication! Big cloth-bound volume; fully illustrated course. Includes worked-out problems, answers, etc. Sensational bargain, only \$1.49, postpaid—or OOD plus postage. Satisfaction guaranteed or refund. Order this amazing "Short-Cut Mathematics" today!

**NELSON-HALL CO., 210 S. Clinton St. \$1.49**  
Dept. 2K-2 Chicago 6, Ill. Complete



**NO BLURRING! NO STEAMING**

**NEW EYEGLASS POLISHER** Eyeglasses cleaned and polished—instantly! Amazing polishing cloth removes steam, mist, blur, dust, dirt specks, fingernails. Quick! Simply whisk over glasses. Stops fogging in changing temperatures. Sets like wild!

**SAMPLES FOR TESTING** Sample offer sent immediately to all who send name at once. Hurry—postcard will do. **SEND NO MONEY. KRISTEE CO., 676 Bar St., AKRON, OHIO**

## new, easy way to.. STRIPE with PAINT

### Do Perfect Paint Striping at Home with New Kind of PAINT STRIPING TOOL

This amazing new **Paint Striping Tool** makes it easy to do expert striping on furniture, bikes, model planes, autos, signs, toys, linoleum, wall board, etc. Makes plain, painted walls look like tile. Paint straight lines... curved... circular or evenly spaced parallel lines the same way a professional painter does. Simply fill **Tubular Glass Paint Fountain** with any color paint and wheel tip feeds paint evenly without spreading, or smearing—smudging. Tips interchangeable—jaws split apart for easy cleaning. Tool complete with tip for 1-16 in. stripe only \$1.09 postpaid. Other complete tools with 1-84, 1-32, 3-64, 1-16, 5-64, 3-32, 1-8 inch tips, \$1.50. Separate tips—75c each. **COMPLETE KIT** with tool and 7 tips, \$5.00. Here's the handiest tool in your whole painter's kit. Send for yours TODAY.

**DEALERS**  
Paint  
Striping Tool  
packed in attractive display cartons of 1 doz. Fast, profitable seller. Write for illus., circular, discounts.

**WENDELL MFG. CO., 4234 N. Lincoln Ave., Dept. 310, Chicago 18, Ill.**



**\$1 ONLY**  
**POSTPAID**  
**ATTENTION**  
Home Craftsmen  
and Hobbyists

Just the tool you've been waiting for! New **PAINT STRIPING** tool gives "professional" results every time, yet simple and easy to use as a fountain pen. Adjustable guide keeps lines straight as an arrow. Just as easy to make curves or free hand designs. Adds new beauty and finished look to everything you paint. Send dollar today.

## LEARN WATCH REPAIRING



**AT HOME.** By our modern and original system of instruction you can learn every part of the **WATCH REPAIRING TRADE AT HOME.** Prepare yourself for a well-paying position or start in business after completing our course of instruction. Good watch repairers are in demand and generally earn very good salaries. For particulars apply to the **WISCONSIN SCHOOL OF WATCH REPAIRING**, 759 North Milwaukee St., Milwaukee 2, Wis.



**NEW EASY WAY TO MAKE BIG MONEY FULL OR SPARE TIME**  
**COSTS YOU 5c—YOU MAKE \$5.00**

Make \$5 per hour right in your own home metalizing Baby Shoes in real Bronze, Silver, Gold, and Pearl. No experience needed. Start making money in one week—up to \$500-\$1,000 per month full time, up to \$75 per week spare time. Act at once—Send postcard for complete **FREE** details today!

**KIKTAVI CO., DEPT. P-5010**  
2111 W. MANCHESTER • LOS ANGELES 44, CALIFORNIA



### Easy Way to Practice Radio Code

NEW amazing Telegraph Code Practice Set. Light touch of **DUPLEX PRACTICODE** telegraph key produces **LOUD PROFESSIONAL "BEEP"** thru its large 4-inch Permanent Magnet Speaker. Works 6 months on only one 1 1/2 volt cell—No parts to burn out! **Safe! COMPLETE WITH REAL PROFESSIONAL TELEGRAPH KEY AND BATTERY—Nothing else needed!**

As many as 6 sets can operate on one line! Colorful Wood Cabinet, 3 1/2 x 5 x 10 1/2". In red, green, yellow or blue pastel. One-year factory guarantee. **\$5.95** complete plus 50c for shipping & handling.

Send M. O. or Check. Write for Catalog M  
**MARTIN MFG. CO., Dept. PM, 194 Gelston Ave., Brooklyn 9, N. Y.**

## BE A HIGH-PAID MAN IN YOUR COMMUNITY WITH THIS LONG NEEDED INVENTION

Earn up to \$10,000 or more per year! Nothing to invest! Be your own boss!

U.S. Pat.  
D 153853  
D 153854

A worldwide product needed by every home, business and farm... priced to sell quickly! **Automatic Red Comet** goes into action as soon as fire starts... smother's fire without human aid. It's a sales 'natural'!

### FREE SALES KIT

Demonstrator units, sales literature, etc., furnished you **FREE.** Handsome leather-type kit. Tried and proved, it will make you an independent businessman. **ACT NOW!** Someone in your community will be appointed soon. Write for details, today!



**RED COMET, INC.**  
735 R. C. Bldg. Littleton, Colorado

# Earn Big Money

# WRITING ORDERS

## AMAZING NYLONS

*Guaranteed Against*

### RUNS AND SNAGS

*Regardless of Cause!*

The world's ONLY complete, nationally advertised nylon hosiery line actually guaranteed against runs, snags or excessive wear, REGARDLESS OF CAUSE! It's amazing, but true! No matter what the cause—hard use or deliberate abuse—Kendex nylons are replaced FREE if they run, snag or become unfit for wear within entire guarantee period! Every weight from sheerest 15 denier to heavy 70 denier—all gauges up to luxury 60 gauge—all sizes, lengths, popular shades, fancy heels, black seams—full fashioned and seamless. Nothing is missing to make sure every woman is pleased. In spite of the amazing guarantee, retail postage prepaid prices start at \$1.08 the pair for sheerest 15 denier 51 gauge. Should free replacement be necessary, actual cost becomes 54¢ a pair! How could any woman possibly resist saving money and solving her hosiery problems? NOT SOLD IN STORES. Men and women wanted NOW, spare or full time, to write orders and earn big money. You can get orders even if you never sold a thing in your life!

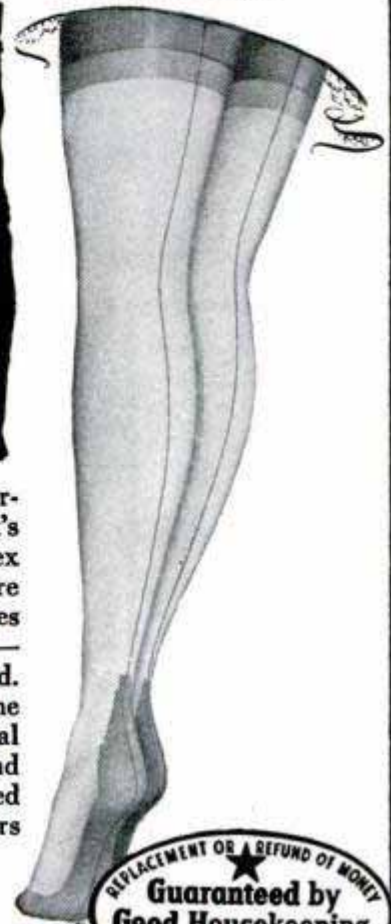

REPLACEMENT OR A REFUND OF MONEY  
**Guaranteed by**  
**Good Housekeeping**  
IF NOT AS ADVERTISED THEREIN

**MEN'S HOSE**  
**GUARANTEED 1 YEAR**

Kendex gives you FOUR complete lines, including sensational men's hosiery line actually guaranteed for ONE YEAR! Any pair not giving satisfactory wear within 12 months is replaced FREE without question. All styles, patterns, colors, yarns (including nylon) at lowest prices that mean steady income for you 52 weeks a year.

**LINGERIE**  
**HOUSECOATS - ROBES**

Full line of lingerie, housecoats and robes. Woven and knitted fabrics—rayon, cotton and NYLON. Nothing is lacking. Unbelievable prices that defy competition and make women eager to order. Imagine a beautiful all NYLON slip, with NYLON lace, at \$2.95 or a lace trimmed rayon satin slip at \$1.58! Kendex values sell themselves.

**NATIONALLY**  
**ADVERTISED**

Kendex has advertised in Life, Look, Collier's, McCall's, Saturday Evening Post, Ladies' Home Journal, Good Housekeeping, etc. Carries the Good Housekeeping Guarantee Seal. Thousands of orders shipped daily. Yearly volume in millions. A dependable responsible national organization.

## FREE NYLON STOCKING AND MONEY-MAKING OUTFITS

Man or woman — young or old, YOU can easily earn steady income, spare or full time. No money or experience needed. We supply EVERYTHING free and set you up in business at OUR expense. Nothing to buy or deliver. Write orders. we deliver and collect. Big advance pay plus huge cash bonus that increases your earnings up to 40%! Your name and address on postcard will bring you sample nylon stocking; samples of lingerie, hose, robe materials; self-selling sales books with FULL COLOR illustrations; 36-page sales manual showing you easy steps to success; color cards, free "door openers" worth \$1 each but which you give away free; special plan to have others sell for you, etc., etc. You can start making money the minute you receive the complete FREE outfits!

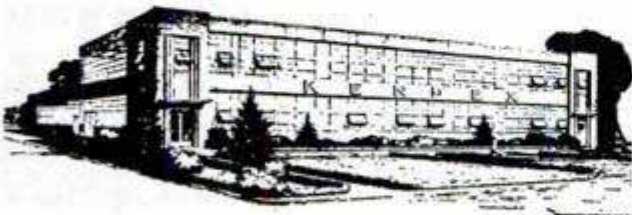

**YOUR COST ONE CENT!**

SEND NO MONEY. Pay nothing now or later. No obligation. Not even a promise to return outfits. Simply write your name and address on a penny postcard and mail to us. We'll immediately rush you everything you need FREE and postage prepaid. WRITE TODAY!

# KENDEX CORPORATION • BABYLON 346, N. Y.

# Don't Envy The PLUMBER-Be One

## Make \$15 to \$50 a Day

Every skilled workman will tell you Plumbers have the best of it. WINTER and SUMMER the Plumber is busy at top wages. No skilled Plumber is ever out of a job. Compare his opportunities with any trade. To the man with know how, Plumbing means profit. Investigate Universal Plumbing School. Not a "war born school," but a plumbing school developed and operated by plumbers since 1923.



The Plumber Protects the Health of the Nation

### Own Your Own BUSINESS

Have your own business and big profits with little other than training and a kit of tools.

### JOURNEYMAN Gets Good Salary

Master Plumbers own their own shop. A Journeyman works for a Master. With this training journeymen can depend on high wages.

G. I. Approved. Established 1923

## UNIVERSAL PLUMBING SCHOOL

877 Holmes Street

Kansas City, Mo.

### BE A PLUMBER IN JUST 32 WEEKS

Learn With Tools—Not Books

No need ever serve an apprenticeship. Don't envy the plumbers big profits—enjoy them. Learn every trick of the trade—Leadwork—Blueprint for plan reading, etc. under Licensed Master Plumbers.

### Over 7,000 Successful Plumbers Recommend This School

This system has made more than 7,000 plumbers. Investigate our past performance. If you like to work with tools this is your opportunity. Become a Plumber in America's largest and only school devoted exclusively to plumbing. Write today for FREE information.



## BE A DIESEL EXPERT

Training Books on Approval Send No Money

Prepare NOW for the BIG opportunities in Diesel Power—revolutionary power for railway trains, trucks, buses, tractors, boats, power plants, construction equipment, etc. Fit yourself for a better, more permanent, high pay job.

### Latest 6 Volume Edition

is packed full of essential and easy-to-learn facts about Diesel design, manufacture, operation and repairing. Written in simple language by prominent Diesel authorities. Over 3400 pages. Hundreds of illustrations and diagrams. Durably bound. Start at once to master this New, Big-Pay Profession. Send the coupon. Examine the books. If you are not thoroughly satisfied, return them and you'll not owe us a cent. Don't delay. Send today.

AMERICAN TECHNICAL SOCIETY, Publishers Since 1898  
Dept. 0719, Drexel at 58th Street, Chicago 37, Ill.

Send for 10 days' free trial, 6 volumes on Diesel Engineering. I will pay delivery charges only. If I decide to keep them I will send \$3.00 in 10 days, then only \$4.00 a month until \$29.80, total price, is paid. If not satisfied, I will return books in 10 days and owe you nothing. Include Consulting Service Privilege.

Name \_\_\_\_\_

Address \_\_\_\_\_

Please attach letter stating age, occupation, employer's name and address, and name and address of at least one business man as reference. Men in service, also please give home address.

# New! PRINT YOUR OWN ADVERTISING POST CARDS



ROTO-PRINT DUPLICATOR prints and illustrates your Advertising messages on 1c Government Post Cards. Also Club Notices, Announcements, Price Lists, Labels, Order Blanks, Forms, etc. Thousands surprised at great amount of extra business such low-cost Advertising brings—and great amount of money it saves on printing. Dozens of uses for business concerns, clubs, churches, etc. Professional machine—not a toy. Easy to use. Made of finest steel. Adjustable Card Guide assures even, uniform printing. Comes complete with necessary supplies, instructions, big Book of Money-Making Ideas.

Low Direct-To-You Price

16-DAY TRIAL OFFER

GUARANTEED FOR LIFETIME. U. S. defense program may limit number ROTO-PRINTs we can produce. So don't delay! Write today for FREE information—16-DAY TRIAL OFFER—and Low, Direct-to-You Price!

AGENTS WANTED

ROTO-PRINT CO.; 211 N. 7th St.; Dept. B-2, St. Louis 1, Mo.

## START YOUR OWN MONEY-MAKING BUSINESS

Clean painted walls for customers with highly efficient electric machine which is making BIG MONEY for others. No special skill or experience required. No shop or office needed. Operate business from your home. Write today for complete FREE information. Address:

VON SCHRADER MFG. CO. N66 PL. RACINE, WIS.

# REAL ESTATE

BE A BROKER

PAYS BIG! SEND FOR FREE, BIG, ILLUSTRATED CATALOG NOW! No obligation. Graduates report making substantial incomes. Start and run your own business quickly. Men, women of all ages, learn easily. Course covers Sales, Property Management, Appraising, Loans, Mortgages, and related subjects. STUDY AT HOME or in our classrooms in big cities. Diploma awarded, G.I. approved. Nationally known.

FREE BOOK TELLS HOW

WEAVER SCHOOL OF REAL ESTATE (Est. 1936)  
15 E. Pershing Road, Dept. PMB, Kansas City, Mo.

50,000 NOW LETTING THIS BOOK BUILD FOR THEM

## BUILD

HOW TO BUILD A BETTER HOME Here is the answer to how to build—The WORKS—how to plan, construct, supervise. Simply, clearly, explained step-by-step. Hundreds of clear-cut, complete diagrams. Only \$3.98. Post-Paid. Your money returned via AIR MAIL, if not completely satisfied. Order Now. The Westport Publishing Co., Dept. MP10, Westport, Conn.

### Learn a Highly Skilled Trade

Watch repairing is a specialized, technical, and highly skilled trade that pays well either as part time or full time work, and affords a great opportunity to build an independent business of your own. Both resident and home study courses. School catalog free. Address Dept. B-42.

American Institute of Specialized Watch Repair  
1012 Franklin, Southeast, Grand Rapids 7, Mich.

## NEW PLASTIC MODEL PLANE



that FLIES

Only \$1.50

Postpaid For COMPLETE KIT

including ALL parts & materials needed. Nothing else to buy.

### READ

About it in Aug. Pop Mech. Page 95

GUARANTEED TO FLY from the very first try. ASSEMBLED QUICKLY in "one sitting" even by youngsters. Made of new LIGHTWEIGHT plastic yet amazingly STRONG and flexible to take hardest landings. Rubber band motor fits in fuselage. Easily converted to gas motor. A SUPERIOR flying scale model plane—a sensational value. IDEAL XMAS GIFT. Send only \$1.50 (chk. or M.O.) NOW to:

THE KEMNITZ CORP., 1021 N. Water St., Milwaukee 2, Wisc.



# NOW READY! A Sensational New Line Of 1951 MIDWEST TELEVISION

**CONSOLES and  
COMPLETE CHASSIS**

Featuring the NEW MAMMOTH

**19½-Inch  
BLACK PICTURE TUBE**  
At Low Factory Prices



**DIRECT  
FROM  
FACTORY  
TO YOU**



"VIDEO GRAND"  
19½" Television-Radio-Phonograph Console

Never before have you seen such tremendously BIG clear pictures, such luxurious cabinets, such sensationally low Factory Prices as Midwest offers in its 31st Anniversary Line of 19½" and 16½" TV Consoles, TV - Radio - Phono Combinations, and complete TV Chassis.

Check these features: Mammoth 19½-Inch Picture Tube (225 sq. in. Image); Synchronized sound and picture; Simplified One-Knob Tuning; Big 12" Panasonic Speaker; Video-Sonic Tuner; and scores of other features.



"MIDWEST"  
19½" Television Chassis and Speaker

"CONSTELLATION"  
19½" Television Console



**\$44<sup>95</sup>** Will Put This Luxurious  
DOWN New 1951  
MIDWEST "VIDEO GRAND"  
**19½-Inch TELEVISION**

with AM-FM RADIO and 3-Speed  
Automatic Intermix Phonograph

In Your Own Home on

**30 DAYS TRIAL**

You Must Be Satisfied or Your  
MONEY BACK

Factory Authorized Service Available in Television Areas

Plus Powerful New 1951 World-Ranging 5-Band  
**MIDWEST** SERIES 16 **RADIOS**

In Beautiful Consoles and Complete Chassis



An entirely new line featuring the powerful Series 16 AM-FM Five-Band Radio Chassis and the magnificent Symphony Grand Radio-Phonograph with 3-Speed Automatic Intermix Record Player.

**EASY  
TERMS**

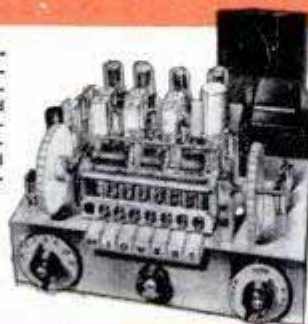

SEND COUPON TODAY  
For This NEW 1951 4-Color

**FREE** MIDWEST  
RADIO-  
TELEVISION  
CATALOG



• WRITE IN NAME AND ADDRESS (PLEASE  
PRINT) ON COUPON OR 1c POSTCARD

MIDWEST RADIO & TELEVISION CORP.  
Dept. 25C, 909 BROADWAY • CINCINNATI 2, OHIO

Please send me your new FREE 1951 Catalog.

NAME \_\_\_\_\_  
ADDRESS \_\_\_\_\_  
CITY \_\_\_\_\_ ZONE \_\_\_\_\_ STATE \_\_\_\_\_

**MIDWEST RADIO & TELEVISION CORP.**  
DEPT. 25C, 909 BROADWAY, CINCINNATI 2, OHIO

# Grow with Diesel

and SCIENTIFIC MOTOR TUNE-UP  
—One of America's Fast-Growing Big-Pay Industries!

• Lay the foundation now for something bigger and better—get into the fabulous Diesel industry. The U.E.I. Plan for learning Diesel and Scientific Motor Tune-Up is simple, practical and is based upon the principle of learning-to-do-by-doing. Essential fundamentals are gained through spare-time home-study, followed by actual shop practice. Competent instructors guide you step by step—you learn the HOW and WHY of Diesel operation, service and maintenance. Get all the facts—mail the coupon and we'll send you a free copy of "Earning Power in Diesel." Mail coupon today!



**UTILITIES ENGINEERING INSTITUTE**  
Chicago 14, Illinois Founded 1927

UTILITIES ENGINEERING INSTITUTE, Dept. DC-8  
2525 Sheffield Ave., Chicago 14, Illinois

Please send me, without obligation, your book "Earning Power in Diesel."

NAME (print).....AGE.....  
ADDRESS.....  
CITY..... Zone..... State.....  
 Check here for information if you are under 17



## SPEED & MILEAGE MANUAL

"DOUBLE the POWER and GAS MILEAGE of your Car..." World-famous POWER BOOK shows how you can easily get top racing performance with up to 100% more power and gas mileage! COVERS ALL MAKES — Shows simplified Speed Tuning, "Soup Up Methods", Racing Tricks, Economy Secrets, "Customizing Plans", etc. Tells how to BUILD YOUR OWN SPEED EQUIPMENT! FAST SPORTS CARS! "CALIFORNIA HOT RODS"! RACERS! 200 m.p.h. CONVERSIONS! Shows how to build inexpensive Superchargers, Dual Manifolds, High Compression Heads, Water Injectors, Cams, Dual Mufflers, Economizers—SAVE MONEY! Covers engine Rebuilding, Gas Saving, Fuel, Formulas, Ratios, Bodies, Frames, "Off's". Shows latest "CALIFORNIA CUSTOM RESTYLING"! Streamlining! Sport Changes! Lowering! Roadster Plans! Working Diagrams! Blueprints! Charted Color Photographs! Complete with 300 illustrations! "Satisfaction Guaranteed". YOU GET: "CALIFORNIA HOT ROD HANDBOOK" (plus SPEED CATALOG FREE with Manual. ORDER!

### FREE THESE BOOKS FREE

ORDER NOW by cash, check, or C.O.D.  
Big Manual plus 2 free books \$1.98  
1951 Speed Equipment Catalog showing 1000 items (without above books 25c) (Dealers send for wholesale catalog)  
Almqvist Engineering, Milford 42P, Pa.



### The Pencil With a Brain!



MEASURES EVERYTHING! An exciting Christmas Gift! Roll the top along any surface—Deluxe Roller Rule pencil measures road-map mileage and jobs beyond reach of rulers. Goes around curves, into corners, zigzags, etc. Perfect for carpentry, hobbycraft, blueprints; wife will want it for sewing, upholstery, etc. Get 'em and give 'em! Only \$1.95 each, ppd. XMAS SPECIAL: 3 for \$5. (No COD's) Satisfaction guaranteed.  
THE CROW'S-NEST, DEPT. P, 59 Park Ave., NYC 16, NY.

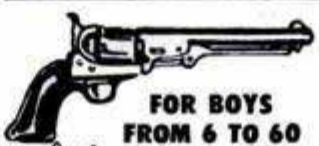

Start your collection of HISTORICAL WEAPONS with this ACCURATE SCALE construction Kit of an 1851 Colt Cap and Ball Pistol, truly representative of Frontier guns.

ONLY \$5.95  
SEND CHECK OR M. O. PREPAID

DEPT. A, 433 SO. PROSPECT AVE., PARK RIDGE, ILL.

Save time! Save money!  
SEND FOR THIS BIG NEW

# HUNT'S WOODWORKERS CATALOG NO. 17

NEW LOW PRICES

Greatest selection of fine domestic and imported woods—144 pages of real money-saving bargains

**QUICK DELIVERY**  
on maple, poplar, oak, mahogany, red cedar, cherry, walnut, and many others—all properly seasoned and kiln dried.

EVERY wood craftsman should have this big new catalog. Shows 32 rare and fancy woods in color... 43 veneer designs... multicolored bandings, inlays, overlays... 275 scroll patterns... all kinds of tools, machinery, cabinet hardware, ornaments, mouldings... plus... pages of ideas, hints, instructions, and information for beginner and advanced craftsman. You'll save time and money with this catalog. Yours for only 15 cents—refundable on first order. Use the coupon—send for your copy NOW.

ONLY 15c

Write Dept. A-10  
**CRAFTSMAN WOOD SERVICE CO.**  
2727 South Mary Street  
Chicago 8, Illinois

Please send me your big, new Catalog No. 17. Enclosed is 15c—to be refunded on my first order.

NAME.....  
ADDRESS.....  
CITY..... ZONE..... STATE.....

MAIL TODAY

## WAR BARGAINS

Over 200 terrific  
ALSO FACTORY SURPLUS VALUES!

# SURPLUS

SEND FOR FREE Catalog

SIoux FALLS SURPLUS STORE  
SIoux FALLS, S. DAK.

## BINOCULARS TELESCOPES

Big Bargain Catalog Free

BROWSCOPE CO., Dept. 10M, 24 West 45th St., New York 19, N.Y.

## PROTECT LIFE and PROPERTY!

Safety Master Switch shown above retails for only \$7.95.

Fire-proof and theft-proof your car. Simply pull the Safety Master Switch and the battery is completely disconnected. Increase battery life and eliminate dangers of fire. Simple to install.

Send for further information.

R & C OF PENN., INC. • RAMEY 1, PENNSYLVANIA

Transfer attractive designs onto Fabrics—Wood—Paper—Glass—Anything in only a few seconds . . . just by simple rubbing with . . .

# TRANS-ART

NO MORE HOT IRONS  
NO MESSY CARBONS  
NO CUTTING OF STENCILS NO MORE WATER

And each Trans-Art design can be used and re-used up to 10 times!

Bring new life and color into your home . . . for pennies! Convert drab tables, chairs, lamps, vases into decorative treasures. Make personalized gifts with your own two hands. YOU DON'T HAVE TO BE AN ARTIST! Anyone can do it with these amazing new TRANS-ART DESIGNS. Place a design face down on any surface. Rub gently. Lift . . . and there's the design stunningly outlined in full size . . . ready for hand painting, embroidering, leatherworking, stencilling, silk screening, block printing, etc., to satisfy every craft and decoration need. Each set contains over 200 designs: Penna. Dutch, Mexican, Nursery, Chinese, Floral, Birds, Alphabet, Borders, Etc. ALL SIZES. Only \$1.00 Postpaid

**HOW TO ORDER:** Send your order now. \$1.00 with order . . . sent postpaid. If C.O.D., \$1.00 plus postage. Immediate delivery. MONEY BACK GUARANTEE if not delighted. \*Pat. Pend.

**CRAFTMART CO.** 80 East 11th Street  
Dept. PM  
New York 3, N. Y.

## New Car?



## No, New Shocks

Don't buy a new car just to get a new car ride. Save your money and get new shock absorbers instead. It's thrifter and easier than you think to replace old, rough riding shock absorbers with new smooth riding MONROE Hydraulics.

Send 10¢ FOR INSTRUCTIONS ON HOW TO INSTALL SHOCK ABSORBERS

One thin dime brings you our A B C Manual and other valuable information on shock absorber installation and service . . . tells which shocks fit your car, takes you step by step over everything you need to know.

**MONROE SHOCK ABSORBERS** are Standard Equipment on more makes of new cars than any other brand.

MONROE AUTO EQUIPMENT COMPANY, MONROE, MICH.



## PREPARE NOW FOR A TV CAREER



AT LAST!

# The ABC's of TELEVISION

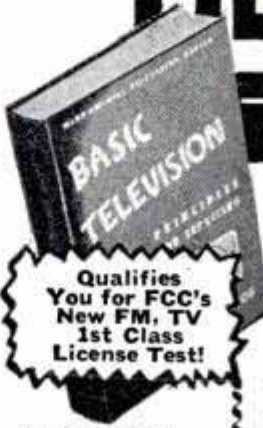

Qualifies You for FCC's New FM, TV 1st Class License Test!

Covers Every TV Installation, Service, Repair Job

Installation Made Easy • Repair of Circuit Troubles • Testing Equipment • Making the Switch To Color TV • Control Adjustments • Portable Field Equipment • Short Cuts to Proper Tuning • Trouble Shooting Transmissions • Amplifier Installation, Repair • Receiver Alignment • Tube Troubles and Their Cure • How To Get Rid of "Shadows," "Clouds," "Snow," "Bars," "Sound Signals," and "Hums" • Teleshooting Motion Picture Film • Solving Scanning Troubles • Synchronizing TV • AND MUCH, MUCH MORE!

"A 'must' for the video service technician."  
—RADIO NEWS

"As a comprehensive self-study course in television receiver servicing, this book can help anyone interested in knowing more about Television."  
—PRODUCT ENGINEERING

### ALL IN ONE BIG BOOK

NOW, you can do ANY TV installation, service, or repair job like an expert; operate field testing equipment; understand problems of TV broadcasting. Here's everything you want to know about TV theory, broadcasting, repairs, installation . . . a complete TV course in one GIANT manual—so that you can become a TV "whiz" at home . . . in your spare time!

### Almost 600 Pages — 400 Pictures

In 592 big pages, 401 pictures, diagrams, 14 tables, charts—"Basic Television" shows you how to install and service TV receivers expertly . . . how the video AM and audio FM signals originate . . . how each is transmitted . . . how each is received. Full directions for servicing each circuit block of receiver. How to read oscilloscope patterns in voltage, amplitude, frequency.

And, no matter what the repair problem is, at-a-glance trouble-shooting charts identify the symptoms, tell step-by-step how to "clear the picture."



At-a-glance charts show how to "clear" over 50 common troubles

### Prepares You For The Future

This book will pay for itself the first time you use it on a job. Contains more than enough material to qualify you for FCC's 1st Class License Test. Qualifies beginner for big-pay jobs—or own service business! Gives experienced technician more confidence, shows him new tricks!

### TRY BOOK Free FOR 10 DAYS!

Get ready now for a prosperous career in America's fastest growing industry. Be the TV expert of your neighborhood. SEND NO MONEY! Mail coupon below to try "Basic Television" FREE for 10 days. No obligation whatsoever. Mail it NOW. McGraw-Hill Book Co., Inc. Offer applies in U.S.A. only.

### Same 10-Day FREE TRIAL OFFER on "Elements of RADIO SERVICING"

A basic book on the principles and practice of radio servicing. Covers the superheterodyne A-M receiver, phonograph combination problems, push-button equipment, the auto radio, designs for your radio workshop. 475 pages, almost 400 illustrations. Only \$4.50 on easy terms. But examine it first without cost or obligation! Check box at right of coupon.

McGRAW-HILL BOOK CO., Inc., Dept. PM-10  
327 West 41st St., New York 18, N. Y.  
Send for 10 days' FREE EXAMINATION.

Basic Television (Grob). If not satisfied, I will return it, pay nothing. Otherwise I will keep it and send only \$2. then (plus shipping) and \$2.25 monthly for 2 months.

Elements of Radio Servicing (Marcus). If not satisfied, I will return it, pay nothing. Otherwise, I will keep it and send \$1.50 then (plus shipping) and \$1.50 monthly for 2 months.

WE'LL PAY POSTAGE if you enclose full payment WITH coupon.

Name \_\_\_\_\_  
Address \_\_\_\_\_  
City \_\_\_\_\_ State \_\_\_\_\_ PM-10

CHECK HERE TO GET INFORMATION ABOUT WEEKLY CASH COMMISSION PLAN, taking orders where you work for McGraw-Hill books like these. Easy, profitable, no obligation!

# Yes, More Brilliant Than a Diamond!



## Amazing New Discovery

Write today for the **FREE** illustrated booklet that tells the full story of the latest miracle of science—the story of a glorious jewel discovered in the laboratories of one of the world's largest corporations. Read all about the Kenya Gem that so closely resembles a diamond that only an expert can tell the difference.

## More Fire! More Brilliance!

Yes, this marvelous gem has more brilliance, more fire and more dazzling display of color than the finest diamond of equal size. And yet you can now own a brilliant one (1) carat uncut Kenya Gem for only \$24. Kenya Gems run from 1/2 carat to 8 carats, all expertly cut; also men's brilliant,

stylish rings of all sizes and ladies' rings, bar pins, brooches and earrings. If you wish, you can buy on **EASY PAYMENTS**.

## The Cinderella of Science

Kenya Gems are the sensational discovery that you read about in the Jewelers' magazine and The Sat. Eve. Post, "the only thing on earth more brilliant than a diamond." It is a true gem, crystallized by science instead of nature.



Write Today or Send Coupon for **FREE Illustrated Booklet**

**KENYA GEM CORPORATION, Dept. 28-W Philadelphia 44, Pa.**

### Mail This FREE Coupon Today

Kenya Gem Corporation, Dept. 28-W Philadelphia 44, Pa.  
Please send me, without obligation, the **FREE** illustrated booklet telling all about Kenya Gems.

Name.....  
Address.....  
City..... State.....

SAY YOU SAW IT IN POPULAR MECHANICS

# SANDEE

Mufflers—All Ford, Chev., Ply....\$4.45

All Buick, Pont., Olds., Chrys., Dodge, Hudson, K.F., Pack., etc....\$5.45

V-8 and Merc. Duals (32-50 incl.) \$15.95



DEALERS WANTED

Beautiful SANDEE Fender Skirts \$9.95

**DURABILITY**

Olds V-8 Duals \$35

A SANDEE Sportone will outlast two ordinary mufflers and give More Power! More Speed! More Mileage!—plus a tone quality unsurpassed.

Please ship (item): \_\_\_\_\_ Price \_\_\_\_\_  
Car and Year \_\_\_\_\_ Name \_\_\_\_\_  
Address \_\_\_\_\_

**SANDEE MUFFLER CO. 5643 Corryne Pl. Culver City, Calif.**

**SENSATIONAL BRAND NEW WORLD WAR II SOUVENIR**



**\$2.95**

postpaid, complete with official sheath

The Official British Commando Issue "FAIRBAIRN" FIGHTING KNIFE

**ORDER TODAY!** We have placed the entire available supply on sale. Here is another import scoop by R. H. Vazquez & Co. The "Fairbairn" is the actual knife used by British Commandos in hand-to-hand combat. Made of high quality steel. Blade length 7". Overall length 12". Genuine leather sheath with metal tip as issued. Absolutely the most beautiful knife of World War II, a rare and unusual bargain. \$2.95 Knives are brand new with blued finish. Postpaid...

**R. H. VAZQUEZ & CO., Dept. 10-PM 972 East Colorado Street, Pasadena 1, California**

## Learn CARPENTRY BRICK LAYING

Get into the billion dollar building trades. Learn now while opportunities are greatest. Train in our completely equipped shops under expert instructors. G.I. Approved. Enroll now. Limited classes. Write for **FREE** Catalog.

**MIDWEST SCHOOL OF BUILDING TRADES, Dept. PM-10 411 N. Center St. Bloomington, Ill.**

## A CAREER & INDEPENDENCE!

AT ANY AGE - IN GROWING PROFESSION



Train now in respected profession - Scientific CHARACTER ANALYSIS from HANDWRITING. Used by Armed Forces, Industry, Psychologists, private parties. DeWitt B. Lucas System - Famous for a Half-Century!

**THE ACCURATE, SCIENTIFIC SYSTEM**

Over Half a Century! • PLEASANT HOME STUDY can prepare you to Earn Real Money in growing field, full or part time. No educational requirements. Write today for **FREE BOOKLET "A"**!

**LUCAS FOUNDATION, 8844 Sunset Blvd., Los Angeles 46, Calif.**

## LOCKSMITHING & Key Making



**PRACTICAL UP-TO-DATE COURSE—ONLY \$3.95**

Easy-to-learn modern information for self-instruction. How to work on locks, de-code, make master-keys, repair, install, service, etc. For every handyman, home owner, carpenter, mechanic, service station operator, fix-it shop, hardware dealer, gunsmith. 53 plain illustrated lessons. **FULL PRICE ONLY \$3.95. SEND NO MONEY.**

Just pay postman plus C.O.D. postage. Or send \$3.95 with order, we'll ship postpaid. Satisfaction guaranteed or refund. **NELSON-HALL CO., 210 S. Clinton St., Dept. K-2, Chicago 6, Ill.**



18 Full Size Patterns to Make **WEATHERVANES**

Only \$1

24 Inches - 18 Full-Size Patterns ready to trace on plywood or sheet metal. (8 illustrated and 10 other novel designs) Make Weather vanes for fun or to sell. Construction is easy. Only simple hand tools needed. Full instructions in each big kit. Clip this ad and mail with Dollar Bill TODAY. Money back guarantee.



**CRAFTPLANS, Dept. 115, 1321 S. Michigan Ave., Chicago**

## PLEASURE! — PROFIT!

**LEARN AT HOME OUR EASY WAY:** Watch-Clock Repairing — BASIC TRAINING FOR AIRCRAFT INSTRUMENT WORK. Write for free information. **MODERN TECHNICAL SUPPLY CO. Dept. 10PM, 55 WEST 42nd STREET, NEW YORK 18, N. Y.**

## BIG MONEY AT HOME IN ELECTRONICS-TELEVISION FOR MEN OVER DRAFT AGE

You earn big money at home while learning; start your own business! Prepare now for high-pay jobs with SECURITY! Big demand for trained men! Get to the top faster through practical shop-training methods! You get 15 big television-radio kits at no extra cost! You build large screen television receiver. You keep all equipment! (No salesman will call)

**DRAFT AGE MEN!** Special "SPEED-UP" Radio Communications Program helps you get BETTER SERVICE RATING—BETTER PAY! Find out by return mail! Act now! Rush your name, address for **FREE TV** catalog and sample lesson!

**RADIO TELEVISION TRAINING ASSOCIATION 972 Broad Street, Dept. 2410 Newark 1, N. J.**

# Recipro Register CHRONOGRAPH

## WORLD FAMOUS SPLIT-SECOND TIMER



**10 DAY FREE EXAMINATION** A handsome wristwatch of incredible accuracy! Precision made in the highest traditions of Swiss craftsmanship. Thoresen's new RECIPRO-REGISTER CHRONOGRAPH automatically compensates speeds and distances down to 1/5th second tolerances! RECIPRO-REGISTER system HOLDS the result indefinitely. It remembers for you while movement continues to keep time. Compare with other stop-chronographs and you will never be satisfied with anything less than this truly precision timepiece.

**OVER 25 HIGH QUALITY FEATURES!**

- Times Planes
- Times Races
- Times Sports
- Times Photography
- Times Lab experiments
- Times Shop Work
- Shock-Resist
- It "remembers"
- 17 Ruby Jewels

Three multi-function dials automatically coupled and synchronized for hours, minutes, seconds & 1/5th seconds. Contact clutch to start computation and brake clutch to freeze Recipro-Register result. Erases back to zero. Hairline sweep-second. Radium-active dial. Unbreakable crystal. Sturdy, yet thin case with stainless steel back. Its 17 Jewel Ruby movement is electronically time tested for accuracy. A smart, thin timepiece of functional beauty. The pride of every owner. **SAVE \$50.00—ORDER YOURS DIRECT!** Recent list price 79.95. Now reduced for quick sales to \$29.95 tax paid. While supply lasts. Featured in Esquire and leading magazines. Instructions and gift case included. Price subject to change without notice because of international crisis. Remit 29.95, or order C.O.D. plus postage. Money back in 10 days if not delighted. **THORESEN DIRECT SALES, Dept. 6L-233, 131 West 33rd Street, (Phone: LA 4-5996 & 7) New York 1, N. Y.**

**5 YEAR GUARANTEE**  
Repairs if any are ever needed, will be made **ABSOLUTELY FREE!** Never a penny charge for handling, parts, labor, etc. Your time piece cheerfully cleaned and oiled every year **FREE!** Thoresen makes lifetime friends.

**Buy Direct**

# Send 10c Today for Your Copy of New, Mammoth 1951 Catalog of Nearly 8,000 Novelties---Nearly 600 Pages

Collier's, Coronet, New Yorker, Tide Magazine Write About This Amazing "World's Most Unusual" Catalog

More interesting than carnival, circus, world's fair & science exhibit rolled into one. Selling book. Costs us nearly \$1.00 a copy. You send only 10c for this big 600 page catalog—nothing more to pay or buy. Partial contents:

Accordions	Axes	Supplies	Cowboy Items	Flowers, Seeds	Home Expor.	Live Animals	Movies	Plating Equip.	Skirts, Kula	Thermometers
Address	Badges	Buyers' Guide	Crosses	Flying	Home Repair	Locks	Muscle Builders	Poker Items	Skull Novelties	Throwing Knives
Airplane Models	Balloons	Calculators	Crosses	Football	Horse Racing	Looms	Musical Items	Projectors	Skunk, Live	Tie Novelties
Air Rifles, Pistols	Banks	Calcs. Animal	Crystal Gazing	Forecasters	Houses, Model	Lovers' Items	Numerology	Purses	Slide Rules	Time Savers
Albums	Bar Novelties	Cameras	Crystal Radios	Formulas	Hunting	Lucky Novelties	Occult	Puzzles	Smokers' Items	Toys
Alligators	Barometers	Campers' Items	Cuckoo Clocks	Fortune Tellers	Hypnotism	Luminous Items	Office Supplies	Rackets, Auto	Snake Novelties	Trapping
Altars	Baseball Items	Caps, Guns	Dancing	Fun Makers	Imported Goods	Magic	Openers	Rockets	Sneezing Items	Treasure Finders
Animals, Live	Basketball Items	Card Tricks	Dice Items	Gadgets	Indian Novelties	Magnetic Items	Optical Goods	Radio Items	Soap Novelties	Tricks
Archery	Beard Looms	Cartoonist Items	Disguises	Gambling Items	Incor Games	Magazines	Oriental Imports	Records, Etc.	Spiritualism	Trunks
Artial Supplies	Beards	Cash Boxes	Dog Novelties	Games, Supplies	Ink Novelties	Magnifiers	Paints, Supplies	Stamps, Etc.	Sporting Goods	Trophies
Ash Trays	Beer Novelties	Chameleon, Live	Drawing Items	Garden Items	Insect Killers	Make Up Goods	Party Novelties	Recipes	Stag Novelties	Turtles
Astronomy	Belts	Charms	Electric Eye	Geiger Counter	Fishing Powder	Maps	Pennants	Religious Goods	Stamp Col. Items	Typewriters
Atomic Science	Betting	Chemistry Items	Electrical Goods	Girls, Pretty	Jewelry	Masks	Pens, Pencils	Rifles, Guns	Stationery Sup.	Vaults & Banks
Auto Items	Bibles	Chess	Electro-Platers	Glasses	Jobe Novelties	Massageurs	Personal	Sure-Winners	Tea Novelties	Ventriquoism
Awards	Bicycle Supplies	Chimes	Engines	Golf Items	Ju Jitsu	Medals	Photography	Seeds, Plants	Telescope Sets	Watches
Awls	Billboards	Cigar & Cigaret	Engraving Tools	Guitars	Key Chains	Microphones	Philatelic Sup.	Sewing Items	Telescopes	Wig
	Binoculars	Engines	Enlargers	Guns, Supplies	Keys, Master	Microscopes	Phones	Sharpeners	Television Items	Wigs & Many Others
	Blankets	Excercises	Engraving Tools	Gymnastic Items	Knives	Mirrors	Photograph	Shaving Goods		
	Boats	Explosives	Engraving Tools	Hardware	Labels	Model Supplies	Photography	Shaving Goods		
	Bodies, Shrunken	Field Glasses	Explosives	Harmonicas	Lamps	Money Savers	Ship Models	Shoekers		
	1000 Books	Fishing Itags	Explosives	Head, Shrunken	Lenses	Money Makers	Shoekers	Signs, Supplies		
	Boxing	Fireworks	Explosives	Height Builders	Lighters	Monkeys, Live	Signs, Supplies			
	Bracelets	Cosmetics		Hobbies		Motors				
	Bug Killers									

10c

**SEND 10c TODAY WITH YOUR NAME AND COMPLETE ADDRESS—NO LETTER NECESSARY**  
Big 600 page catalog of over 7000 novelties, 3500 pictures, 6-color cover, 1-inch thick. Sent 10c at once—no obligation. (Postage stamps accepted). **JOHNSON SMITH & COMPANY, DEPT. 276, DETROIT 7, MICHIGAN**  
Rush 10c with name & address today to:

## Introducing . . . "SNORKY"

### THE HOBBY HORSE THAT IS DIFFERENT!

Beautifully sculptured and entirely molded of durable Plastic. Hardwood rocking frame. Share your child's delight in the proud possession of "Snorky"!

**COMPLETE AS ILLUSTRATED IN NATURAL COLORS** Only **\$26.50**

Sent to you at our risk! If you aren't more than completely satisfied, simply return horse to us within ten days and money will be promptly refunded.

**OVERALL DIMENSIONS 33" LONG, 25" HIGH IDEAL FOR AGES 2 TO 6**

## ATTENTION HANDYMEN!

### THE HORSE ALONE IS ALSO AVAILABLE

For those Handymen that would wish to finish their own, we can furnish the Plastic Horse, primed but unfinished, ready for your own decorating. Horse equipped with bolt in each foot. Any good grade of enamels may be used. Patterns for the rocking frame furnished Free! Horse size 27" long by 21" high.

**UNPAINTED HORSE WITH-ONLY \$16.50 OUT ROCKING FRAME**

For Hobbyists with only limited time we can furnish the rocking frame, cut out and completely machined for easy assembly. For rocking frame kit, add \$2.50. CASH WITH ORDER. OR \$5.00 DOWN, BALANCE C.O.D. SHIPPED EXPRESS COLLECT.

**POSTAL TOY MART**  
Dept. A-1, MILNESVILLE, PA.

# TRAVEL FOR "UNCLE SAM"!

**AS HIGH AS \$3,450 FIRST YEAR**  
**RAILWAY POSTAL CLERKS**  
**Veterans Get Special Preference**



Many other Government Jobs, City and Rural Carriers—Postoffice Clerks—Meat Inspectors—Accountants—Stenographers—Typists—etc. Prepare now for next Examinations.

**FRANKLIN INSTITUTE, Dept. J-83, Rochester 4, N. Y. (Not Government Controlled)**

Sirs: Rush to me, without charge, copy of 40-page book, "How to Get a U. S. Government Job," list of positions, and full particulars telling how to qualify for them.

Name \_\_\_\_\_  
Street \_\_\_\_\_  
City \_\_\_\_\_ Vet? \_\_\_\_\_



**I HELPED T.E.H. MAKE \$14 A DAY WHILE STILL LEARNING!**

T. E. H.—West Virginia. "By the time I finished half your course, I was making \$14.00 per day. I have made enough on the side to more than pay for the course."

H. T. ARMSTRONG

# Learn **ELECTRIC APPLIANCE REPAIR & SERVICE**

## WE TEACH:

How to Repair  
Washing Machines  
Vacuum Cleaners  
Electric Ranges  
Lamps, Motors,  
Irons, etc.,

REFRIGERATION  
and  
House Wiring  
At Home  
In Your  
Spare Time!

For a man handy with tools, and happiest when working with his hands, OPPORTUNITY is Wide Open Today in this great and growing field. Everyone is a customer for the man trained to service electric appliances.

## Open Your Own Shop

Our practical HOME COURSE teaches you this business from A to Z—preparing you to take a well paid job or open your own shop. You can actually start in your basement or garage with the tools we send you . . . before finishing.

We  
Include An  
**ELECTRICAL APPLIANCE TESTER**

A Big Kit of Tools  
at NO EXTRA COST

**MAIL THIS COUPON for FREE BOOK**

H. T. ARMSTRONG  
**PACIFIC TRAINING SCHOOLS**  
7217 So. Broadway, Dept. P-5010, Los Angeles 3, Calif.

Dear Sirs: Please send me, without obligation, your free booklet and complete details.

Name \_\_\_\_\_

Address \_\_\_\_\_

City \_\_\_\_\_ Zone \_\_\_\_\_ State \_\_\_\_\_

# PEARL

FINISHING OFFERS YOU

# BIG MONEY

RIGHT AT HOME

AMAZING NEW PEARL FINISH can be instantly applied to any article—leather—wood—plastic—glass—metal, etc.

BABY SHOES preserved for life in beautiful Baby Pink, Blue, and Ivory thrill mothers and bring immediate sales.

Nothing else like it! Costume jewelry, buttons, earrings, treasured mementos, etc., etc., take on new splendor and beauty at once.

TREMENDOUS DEMAND—Help us fill it—Fantastic profits await those who act NOW. Be First! Scoop the market. Never before has such an opportunity been offered. Never before such Big Profits made so quickly.

DON'T PASS THIS UP—It costs Absolutely Nothing to get the FREE FACTS that show you the EASY WAY to QUICK, BIG MONEY overnight. Mail Coupon TODAY!

PEARL-KOTE CO., Dept. P-5010  
2111 W. Manchester Ave., Los Angeles 47, Calif.  
Okay! RUSH me FREE FACTS at once.  
Name \_\_\_\_\_  
Address \_\_\_\_\_  
City \_\_\_\_\_ Zone \_\_\_\_\_ State \_\_\_\_\_

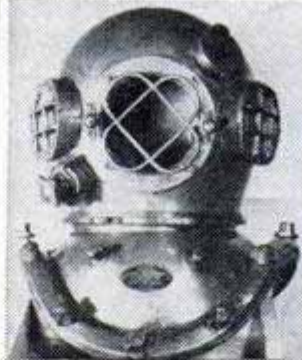

## LEARN Commercial DEEP SEA DIVING

High paying and fascinating profession. 20 week course. World famous school. Latest equipment. Specialized training in all underwater work. Write for FREE Booklet.

### SPARLING DIVING SCHOOL

Dept. PM-10  
1148 WILMINGTON BLVD.,  
WILMINGTON, CALIF.

## The SPORT DIVER



### NEWEST THING UNDER THE SEA FOR UNDERWATER SPORTS AND WORK

Enables swimmer to submerge for approximately 1 hour in shallow depths. Latest type regulators provide correct amount of air at all depths. Completely automatic — permits use of both hands. Simple to operate. Guaranteed.

ONLY \$59.50

Freight Collect

In Calif. Add 3% Sales Tax

## DIVE FOR EXTRA DOLLARS!

Commercial & Sports Divers, Diving Clubs, Boat Owners & Anchorage, Sea Scout Ships, Marine Research Groups, Others. We have the largest, most complete stock of surplus diving equipment in U.S.—ALL TESTED—EXCELLENT CONDITION. THE LAST OF SURPLUS EQUIPMENT!  
Send for FREE illustrated catalog, price list, decompression tables & job possibilities.

### DIVERS' SUPPLY, Dept. PM100

1150 WILMINGTON BLVD. WILMINGTON, CALIF.



10 Days Free Trial—Prepaid or C.O.D.  
8 Mile Range — High Grade **\$5.**  
**BINOCULARS**

Made in U.S. Optically accurate, center focusing, hinged body Binoculars, with high-powered 30 mm lenses, giving a clear, sharp field of vision of 100 yds. width at 1,000 yds. distance. Case & Straps included. Marvelous for hunting. All Sports or as a gift. Tax included. Money Refunded if dissatisfied.

BENNER & CO., PO Box 426-PM, Trenton 3, N. J.

## TRAIN



# Your VOICE!

### RESULTS GUARANTEED

STRENGTHEN your voice this tested, scientific way. Yes—you may now be able to improve the POWER of your speaking and singing voice . . . in the privacy of your own room! Self-training lessons, mostly silent. No music required. Write TODAY for Eugene Feuchtinger's great booklet "How to Develop a Successful Voice." It's absolutely FREE! You must state your age. Booklet mailed post-paid in plain wrapper. No salesman will call. Send your name and age RIGHT NOW! Perfect Voice Institute, 210 S. Clinton St., Studio K-2, Chicago 6, Ill.

## LEARN DRAFTING AT HOME

With a few hours effort each week, our practical comprehensive course in Engineering Drafting will prepare you for immediate employment in this highly paid profession. All books, equipment and supplies furnished.

VETERANS FREE UNDER G. I. BILL

## LAIN DRAFTING COLLEGE

601 N. DELAWARE • INDIANAPOLIS, IND.

Mail me FREE information about Engineering Drafting.

NAME \_\_\_\_\_

ADDRESS \_\_\_\_\_

CITY \_\_\_\_\_ STATE \_\_\_\_\_

Check if Veteran. Approved under G. I. Bill.

**NO PRICE RISE ON SCARCE ITEMS!**

**Send for this CATALOG TODAY!**  
**WAR SURPLUS BARGAINS**

**PRINTED BEFORE KOREA!**

Probably your last chance to buy SCARCE WAR SURPLUS at these low, low prices! Terrific savings for Sportsmen—Farm & Home. The greatest stock of gov't Surplus in America.

**JUST RELEASED!**

**New U.S. Navy 2-PIECE STORM SUITS**

Two-Piece suit, brand NEW, with parka hooded jacket, coverall bib-style pants. OD color. Waterproof, windproof, lightweight, rubberized coated fabric. Pants have zipper fly, button flap pocket. Sizes: Med., Lge., Ex. Lge. Excellent for sportsmen, hunters, fishermen, etc. SCARCE SURPLUS.



**NOW ONLY \$7.88 POSTPAID**

Parka Only ..... \$4.88  
Pants Only ..... \$4.49  
WGT. PER SUIT ONLY 3 1/2 LBS.

**Type A-6 Airforce Boot**  
Wear With or Without Shoes!  
Soft leather tops, rubber soles, sheep-lined for real warmth and walking comfort. Zipper closure, waterproof. Brand New!  
**Now Only STATE SHOE SIZE \$10.88**

**✓ CHECK THESE SURPLUS BARGAINS**

- \* U. S. A., 100% Wool BLANKETS. Olive Drab Wgt. 3 1/2 Lb. .... \$4.95
- \* U. S. 2-Pc. Wool SLEEP BAG. Poplin Cover. Used, Perfect Cond. .... \$5.95
- \* TANK CORPS O.D. JACKET, Wool Lined, 36-46, NEW. Knit Collar & Cuff ..... \$7.95

**500 SURPLUS BARGAINS** **Send 10¢ for Your Catalog Today!**

**FISLER SALES CO.** DEPT. D-1, 723 WALNUT STREET KANSAS CITY, MISSOURI

**LEARN RADIO-ELECTRONICS**



Train for an important job in Radio, Television and Radar—with unlimited future. Spartan resident study is backed with actual construction and operation. Write Department PM-100

**SPARTAN SCHOOL OF RADIO-ELECTRONICS**  
MUNICIPAL AIRPORT • TULSA, OKLAHOMA

**U. S. Approved TEXTBOOKS**

Get these handsome books, cloth bound, beautifully printed. Learn an important subject for ONLY ONE DOLLAR! Each a complete training course in fundamentals and advanced.



**\$1 EACH**

**Now Available**

**GOV'T.** selected. Authors and material very best. U.S. war time choice for vital training courses.  
**PROFUSELY ILLUSTRATED.** Fundamentals and practical usage. 100's excellent diagrams, photos. Study and review questions each chapter.  
**INTRODUCTORY GUARANTEE.** Complete satisfaction after 5 day inspection or full refund.  
**SHOP.** By Wicks, Poliak and Ellberg. Tools, Woodworking, Measuring and Gauging, Metalwork, Wire Splicing, Ropes, Splices, Knots. 160 pages, illustrated.  
**ELECTRICITY.** Developed for apprentices Carnegie-Illinois Steel. Magnetism, voltage, energy, power, motors, etc. Illustrated. 194 pages.  
**RADIO.** By Williams and Scarlott of Westinghouse. Terms, theory, currents, inductance, capacitance, resonance, triode, tubes, sound, microphones, loudspeakers, transmission, antennas, etc. Illustrated. 276 pages.

**ORDER ALL 3 • SAVE DOLLAR and HALF**

**Wilcox & Follett, 1255 S. Wabash, Dept. PM, Chicago**  
Please send the textbooks checked (each a regular \$1.50 value) at Special Price \$1:  COD  \$ enclosed (you pay postage)  
 SHOP  ELECTRICITY  RADIO

Name \_\_\_\_\_  
Address \_\_\_\_\_  
City \_\_\_\_\_ Zone \_\_\_\_\_ State \_\_\_\_\_



**Build "Old Timers" Antique Autos**

**RELIVE the Early Days of the Pioneer Auto!**  
WHAT A THRILL to build your collection of these famous antique cars — each one easy to assemble with pre-fabricated parts! Above we sketch the 13 cars of bygone days — so colorful, historical and authentic — actual 3/4 scale models! They range in length when complete from 6 1/4" to 10 1/2". A perfect gift for hobbyists this Christmas!

SEE them at your hobby, toy, or department store, or write to us. Add 25¢ for postage and handling; no C. O. D.'s, please.

**Hudson Miniatures' "OLD TIMERS"**  
SCRANTON HOBBY CENTER, Dept. 14, Scranton 10, Pa.  
SAY YOU SAW IT IN POPULAR MECHANICS

Which of these 2 one time **WEAKLINGS** PAID only a *Few Cents* to become an **All-Around HE-MAN** at Home?

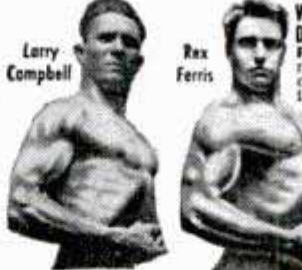

Which One Paid Hundreds Of Dollars To Train At My Side?  
Rex Ferris was a skinny weakling, paid a few cents to start building into a champion All-Around He Man!  
Larry Campbell paid me hundreds of dollars to train at my side years ago. Start to become an All-Around He Man at home with these same secrets for only a few cents — like Rex Ferris did!

**5 Great Body Building Picture Courses All Yours FOR ONLY 10¢ instead of \$1.00**

**Be a Winner at Anything YOU Tackle with Progressive Power SPORTS! JOB! SCHOOL! FRIENDS!**

**Let's Go, Pal! I'll prove I can make YOU an "ALL-AROUND" HE-MAN**  
FAST — OR NO COST! says George F. Jowett World's Greatest Body Builder

**JOWETT INSTITUTE, 230 Fifth Avenue, N. Y. 1, PM-010**

**FREE PHOTO BOOK of STRONG MEN**  
Dear George:—Please send by return mail, pre-paid, FREE Jowett's Photo Book of Strong Men, plus all 5 Muscular Building Courses. 1. Molding a Mighty Chest. 2. Molding a Mighty Arm. 3. Molding a Mighty Grip. 4. Molding a Mighty Back. 5. Molding Mighty Legs—Now all in One Volume "How to Become a Muscular He-Man." Enclosed find 10¢ for postage and handling. No C.O.D.'s.

Name \_\_\_\_\_ Age \_\_\_\_\_  
Address \_\_\_\_\_  
City \_\_\_\_\_ Zone & State \_\_\_\_\_



Blue Print

for **PROFIT**

Here's Your Success Plan



a few cents worth  
of materials  
**BRINGS YOU DOLLARS!!**

*Have* Your Own Lasting,  
Successful Business—Be Your  
Own Boss—Help Fill Huge Demand  
... No Experience Is Necessary

Rich profits are waiting to be tapped in this new field. New **MIRACLE** finish gives a velvety, luxurious surface to radios, lamps, toys, signs, store displays, figurines, auto dashboards, and hundreds of other items. Make old objects beautiful and saleable — make new things worth much more with this soft, rich covering that can be applied to any surface, even if old and worn.

**START RIGHT AWAY**

Yes, you can learn in a few days to start **MAKING MONEY!** Everything you need is furnished, including fully detailed, illustrated instructions that are complete and easy to understand. Every point is explained, to show you how to start on the road to big money, full or spare time, right in your own home.

**EVERYTHING COMPLETE**

In addition to full instructions, you get all materials that will enable you to start at once. A few cents worth of materials can mean many dollars in return. You can earn up to \$5.00 per hour and more spare or full time. Boost your present income or start your own profitable business. Our Business is Booming. Help us fill **HUGE DEMAND.**

**ACT NOW**

Grasp this opportunity **TODAY** — start your own business. It's too good to miss! **SEND NO MONEY** — fill out the coupon and stick it on a post card or in an envelope and mail today for full details, **FREE** sample of **FLOK-KRAFT** covered material, and hundreds of useful and profitable **IDEAS.** Do it **NOW** — be first!

**SEND NO MONEY**

Covers Wood,  
Fabric, Metal,  
Glass, Plaster,  
Plastic or any  
Surface

**FREE SAMPLE!**  
**MAIL COUPON**  
**NOW!**

It covers



**TOYS**  
old or new



**LAMPS**  
take on a new  
distinctive  
beauty



**JEWELRY  
BOXES**  
give perfect  
protection



**DISPLAY  
PIECES**  
become  
unusually  
eye-appealing



**CAR  
DASHBOARDS**  
made soft  
as velvet

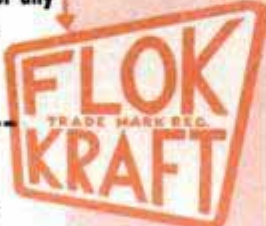

**COAST INDUSTRIES** Dept. 2-A

1004 So. Los Angeles St.,  
Los Angeles 15, Calif.  
Please rush me all the details **FREE!**

NAME.....

STREET.....

CITY.....STATE.....

**WANT TO  
SAVE GAS?**

**BE PREPARED IF RATIONING RETURNS**

**1/4 MILLION  
NOW IN USE**

**TRY FREE  
IT  
IN YOUR CAR**

**TEST FOR**  
✓MORE MILEAGE ✓FASTER PICK-UP  
✓EASIER STARTING ✓BETTER IDLING

You can install it easily in a  
few minutes.

**MANY GANE NEEDLE USERS  
REPORT up to 25% more mile-  
age, faster pick-up, easier start-  
ing and smoother idling.**

**TRY A GANE NEEDLE IN YOUR CAR** for ten days at our expense, then compare your mileage and performance. If fully satisfied, send only \$1.50 per needle (8 cylinder cars take 2). If not satisfied, just return it—**FAIR ENOUGH?** Since authorities differ on its merits and some users report no improvement, **TRY BEFORE YOU BUY!**

**FREE AUTO ECONOMY MANUAL**

Absolutely free to all who try Gane Needles, this manual tells how to save gas, tires, brakes, etc., tells how to get more power, speed and better performance from your car. Also introduces many new economy products.

**Write Today • Enclose No Money • Pay Postman Nothing**

Send your name, address, make and year of car—and the make of carburetor if convenient.

**NATIONAL AUTOMOTIVE RESEARCH CORP., Dept. J-10  
350 WEST WASHINGTON BLVD. VENICE, CALIF.**

THE AMAZING  
**GANE**

**AIR  
FLOW  
NEEDLE**

Gane  
replaces the  
idling  
adjustment  
screw in  
gasoline  
carburetors.



**OH! BOY! \$50 A DAY**

**Easy Sales! Easy Money!**



That's what you'll be shouting . . . when you line up with our sensational, fast selling item in your territory on a full time or spare time basis. Saves money for restaurants, lunch rooms, taverns, meat markets, food-beverage stores. Enormous field. No experience needed. **WRITE QUICK** for big money starting plan. **Hurry!**

**UTILITY CO., 53 W. Jackson Blvd., Dept. 2, Chicago 4, Ill.**

**BARBELLS**

Save Money — Buy the finest barbell equipment direct from our foundry — No other company can match our low price or value!  
**\$10.80 SET**  
Extra plates 10c lb.  
**BUR BARBELL CO.**  
Lyndhurst K22, New Jersey

**LEARN BY MAIL  
MATH-PHYSICS**

Practical simplified courses in **ALGEBRA** and **GEOMETRY**, **TRIGONOMETRY**, **INDUSTRIAL PHYSICS**, **ENGINEERING DRAFTING**

**VETERANS FREE UNDER G. I. BILL**

**MAIL COUPON TODAY** for free information about 30-lesson courses checked below:

- ALGEBRA and GEOMETRY
- TRIGONOMETRY
- PHYSICS
- ENGINEERING DRAFTING

NAME.....

ADDRESS.....

CITY.....STATE.....

Check If Veteran. Approved under G.I. Bill

**LAIN COLLEGE** 601 N. DELAWARE  
INDIANAPOLIS, IND.



# SALESMEN JAM POCKETS WITH \$10 BILLS



Taking  
orders for **KEY**  
expertly tailored  
auto seat covers

The "LEOPARD"  
selling sensation of the year

## BIG SEASON NOW STARTING!

Tremendous demand for Leopard auto seat covers built up overnight when Cadillac introduced a new 1950 model with Leopard Seat Covers. Car owners are paying \$50.00, \$60.00 and \$70.00 and more for car seat covers with Leopard design. Now you can serve that eager demand at a fraction of the cost your customers would expect to pay! Salesmen making money hand over fist.

### 4 STYLES

4 Price Ranges.  
A full line in  
addition to the  
leopard. Woven  
fiber. Woven  
Saran Plastic.

**FREE!**  
SALES KIT

Take orders from car owners everywhere. Year around income! A line of covers cut to accurate patterns like the finest suit of clothes. Add an accent of elegance to any car ... just like an original upholstery job! Full or spare time, you can realize big money in this business. *Every* car owner a prospect. Be the first in your territory to cash in. Get your free selling kit at once for some *real* money. **ACTUAL SEAT COVERS GIVEN FREE TO PRODUCERS FOR OWN USE!** Write for full details TODAY!

**KEY PRODUCTS CORP.**  
800 N. Clark St., Dept. 410, Chicago 10, Ill.



*Earn BIG PAY  
While learning*

VETERANS CAN EARN  
UP TO \$290.00 per  
month while training

Learn By Doing  
in Big Allied Shops

- MACHINIST TRADE.
- DRAFTING—ALL BRANCHES.
- TOOL, DIE MAKING & DESIGNING.
- TOOL ENGINEERING.
- PRODUCT ILLUSTRATION & DESIGN.

• BIG DEMAND FOR TRAINED MEN

Accredited by The  
American Society of  
Tool Engineers. En-  
dorsed by Leaders  
of Industry through-  
out U.S.A.

FREE Employment Service After Graduation

**ALLIED SCHOOL  
OF MECHANICAL TRADES, Inc.**

1338-1340-1342 S. MICHIGAN AVENUE  
410 ALLIED BUILDING, CHICAGO 5, ILL.

Write for  
**FREE BOOKS**  
A 1c Postcard  
will do

**\$15<sup>95</sup> BUYS THE  
ELECTRIC SHAVER  
THAT CONVINCED BARBERS**



*WhiskER*®

**COSTS LESS YET DOES MORE!**

Take the word of leading barbers—*WhiskER*'s new thin (.002") clipper blade cuts 1 to 7 day beards (even those other shavers will not touch) clean and close. Operates quietly on 110 v., 60 cycle AC; no TV or radio interference! Fast—14,400 shaving strokes per minute! Women like *WhiskER* for safely removing superfluous hair on legs and under arms. Get *WhiskER* at your Barber or Dealer. **ELECTRO TOOL CORPORATION**  
DEPT. 520-K • RACINE, WISCONSIN

If Your Barber or Dealer Cannot Supply You

**USE THIS COUPON TO ORDER**

ELECTRO TOOL CORP., Dept. 520-K, Racine, Wis.

- Encl. find \$15.95 (check, m. o.). Send *WhiskER* for 10-Day trial (money back if not delighted).
- Encl. find \$5. Send *WhiskER* C.O.D. for 10-day trial. I'll pay postman balance plus postage.

Name \_\_\_\_\_

Address \_\_\_\_\_

City \_\_\_\_\_ Zo. \_\_\_\_\_ State \_\_\_\_\_

## Amazing Attachment MAKES OLD REFRIGERATORS INTO MODERN Automatic Defrosters!

Thirty Million Prospects. Sell without "selling pressure" on sensational Free Trial Plan. Just plug it in and leave it. Frees women from drudgery and mess of defrosting. Saves electricity. Keeps food longer, better. Gives longer life to refrigerator. Secret "follow-up" Plan often brings five additional sales by making every user your agent. Big season now on!

**SENT FREE ... JUST SEND NAME!**

Don't send a cent—just your name on penny postcard. We'll send you the biggest money-maker you ever got your hands on and guarantee your sales at profits as high as \$5.00 on each sale. Rush your name!

**MAXILUME COMPANY, 125 West Hubbard Street, Dept. D-810, Chicago 10, Illinois**

**Women  
buying by the  
thousands!**

Salesmen Clean-  
ing up on "Free  
Trial" Sales Plan  
Sent Free with  
Instructions.

Make as high as  
\$5 on Every Sale!





He scores  
high...he's got

P.A.\*

R. J. Reynolds Tobacco Co., Winston-Salem, N. C.

P.A.\* means Pipe Appeal and Prince Albert

■ Her admiring glance shows he scores high with her. He's got Pipe Appeal! And you can just bet mild, rich-tasting Prince Albert scores high with him. It's America's largest-selling smoking tobacco.

Try P.A.! You'll enjoy the natural fragrance of P.A.'s choice, crimp cut tobacco—specially treated to insure against tongue bite.

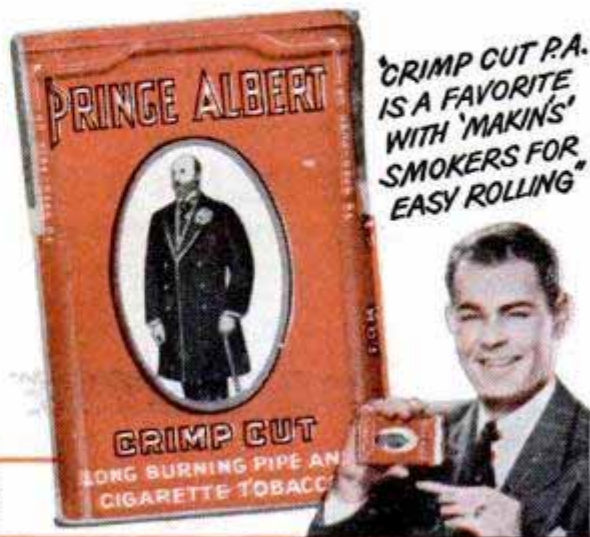

CRIMP CUT P.A. IS A FAVORITE WITH 'MAKIN'S' SMOKERS FOR EASY ROLLING\*

THE NATIONAL JOY SMOKE

# POPULAR MECHANICS

OCTOBER  
1950

WRITTEN SO YOU CAN UNDERSTAND IT  
VOL. 94 NO. 4

By Michael Day

**T**HERE was a time when 50 degrees below zero, Fahrenheit, was considered a fairly crisp temperature. And for all practical purposes you can still get your nose nipped by it, freeze your fingers and toes or crack the block of your car if you haven't enough antifreeze.

But up in Schenectady, N.Y., in a big new glassed-in laboratory sitting on a bluff overlooking the Mohawk River, Dr. Milan Fiske, General Electric scientist, will look you straight in the eye and state flatly that "50 below" is practically red hot. Here, in this "super deep freeze" plant, sit the reasons for his attitude—big metal containers with conical tops and long necks, shaped like the nickel-plated stacks on old-horse-drawn fire engines. They are filled with

Above, liquid air ( $-340$  degrees F.) is so "warm" that it makes liquid helium ( $-452$  degrees) boil when the two are mixed. Below, the G. E. laboratory

## IT'S 530 DEGREES COOLER INSIDE



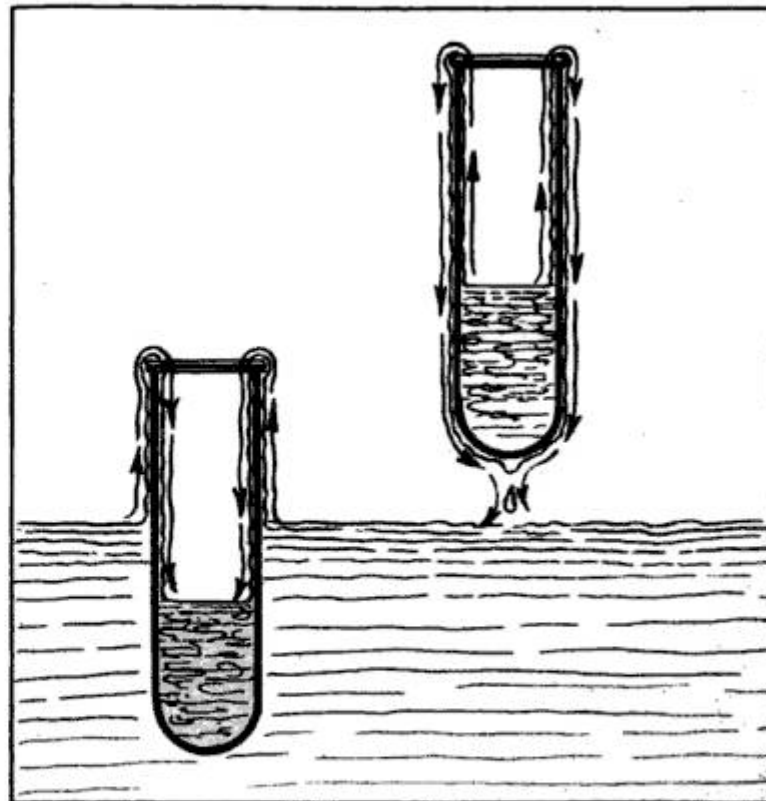
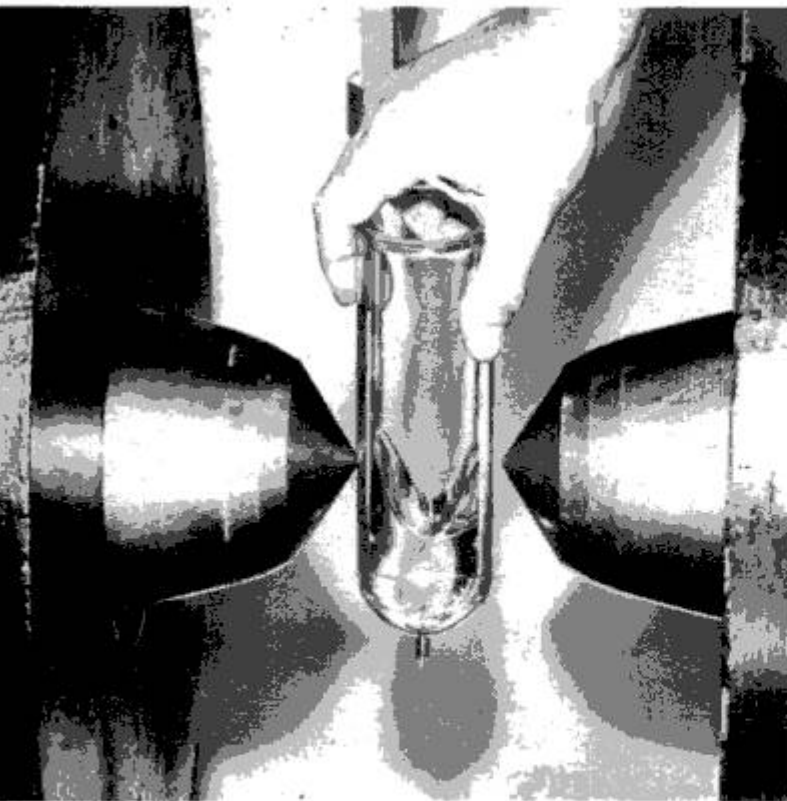

Left, liquid oxygen forms a U-shaped gully when held between magnets. Right, a hair's breadth from absolute zero, helium II flows up and into a partially submerged test tube, reverses its flow when held above surface

liquid frigidity: Hydrogen at minus 422 degrees Fahrenheit, nitrogen at minus 322 degrees Fahrenheit, air at minus 300 degrees Fahrenheit. There are frosted, steaming, multilayered flasks, too, containing the most frigid liquid of them all — helium, which boils at the near ultimate in cold — about 452 degrees below zero Fahrenheit or a scant four centigrade degrees from absolute zero. It will produce a burn like a white-hot poker if you spill any on your skin. Shake these containers and frosty white vapor puffs from the tiny pressure vent in their throats. Spill some of it on the cold concrete floor and it behaves like water spilled from a teakettle on the top of a red-hot coal range; it splatters into a hundred droplets that bounce around, sizzle and quickly evaporate.

"In normal room temperatures," explains Doctor Fiske, "these ultracold liquid gases are boiling continually. They evaporate at a rate of half a liter per hour and we have to keep making them as fast as they go."

For years, scientists have been experimenting with cooling processes and machines that will haul temperatures down to within thousandths of a degree of the fantastic, supercold world of absolute zero (about minus 459.69 degrees Fahrenheit), beyond which they now think there is nothing colder. No one can ever hit bottom, since there is no energy left to measure at absolute zero. At this point all thermal motion in matter ceases, the usually dancing molecules slow down and stop their gyrations in the frost of frozen space.

Down in this incredible range of ultimate frigidity, weird things happen to ordinary materials, and low-temperature scientists in some 35 laboratories around the country are trying to find out how they behave and why. Rubber refuses to bounce, for instance. A ball dunked in supercold will drop to the floor like a steel sphere and shatter like glass. Dip a banana in the frosty depths and you can "slice" it with a hammer. Some metals become brittle and you can crumble them with a tap. In other metals, electrical resistance vanishes; you can start a current going around a ring of pure metal, remove the source of power and the current will run forever. "A bar magnet dropped onto a superconducting tray," explains Doctor Fiske, "will be repelled by the tray and will hover above it in midair. The metal in the tray becomes a magnetic shield at near absolute zero."

Liquids behave oddly, too. Some lose all frictional resistance and, if set swirling like stirred coffee in a cup, would swirl until doomsday if they didn't evaporate. One will flow straight upward at eight inches per second on the sides of its container and will transmit heat just like sound waves.

"But," says Doctor Fiske, "we're not interested in the curiosities. By studying materials at near absolute zero we hope to find why they behave as they do at normal temperatures and perhaps improve them."

Already from low-temperature labs throughout the world have come better glass, longer-wearing rubber, cheaper fertilizer, stronger steel and better gasoline.

Right, this big cylinder is a super refrigerator for testing at near absolute zero. Helium gas is cooled until it liquefies by making it drive pistons. This work results in loss of heat. Repeating this process, the gas cools to almost absolute zero. Below, cut-away drawing shows how pistons are used to cool gas.

A miniature rocket engine at Ohio State University fueled by liquid hydrogen at about 425 degrees below zero and using liquid oxygen for the oxidizer has roared up the highest exhaust velocities ever obtained (15,000 miles per hour) and may well provide the pilot fuel for the first interplanetary rocket.

Scientists have been trying to out-frost each other ever since the 1700s when Gabriel Fahrenheit used combinations of snow, ice and salt in an ice-cream-freezer type of machine to achieve a minor chill. He thought, naively, that that was the bottom and set zero on his thermometer accordingly. It wasn't long before men found that it got colder than Fahrenheit's zero during Nature's own winter. But it was another century before European scientists discovered that by putting precooled gas under pressure, then letting it expand suddenly through a narrow opening, that its temperature would plummet to unheard-of depths. It was by this method that Sir James Dewar first liquefied hydrogen in 1898 and Kamerlingh Onnes made the first liquid helium in Holland in 1908.

The system is similar to that used today in the refrigerator in your kitchen. And it's the same basic pattern, with many embellishments, that will be used to produce the frigid liquid gases for deep-cold experiments at G.E.'s new Knolls Laboratory in Schenectady.

To facilitate their work, today's low-temperature scientists have abandoned the arbitrary scales of both the Fahrenheit and centigrade thermometers. They involve too many minus signs. Around low-temperature labs you may hear men muttering things about one, two or three degrees "K." This is the Kelvin or "absolute" scale, devised by Lord Kelvin when he determined back in 1848 that the rock bottom in fridity was about minus 460 degrees Fahrenheit. The Kelvin scale is graded in centigrade units of measurement, but it starts from absolute zero and works its way up. Naturally, normal thermometers are useless at ultralow temperatures. Mercury freezes solid at a mere minus 39 degrees Fahrenheit. Alcohol isn't much better. Even helium gas has limitations because it will not function below one degree absolute. So the professors of fridity use a gadget that measures the magnetic properties of the substance and translates these to its heat content.

When Drs. Fiske, Warren DeSorbo, F.

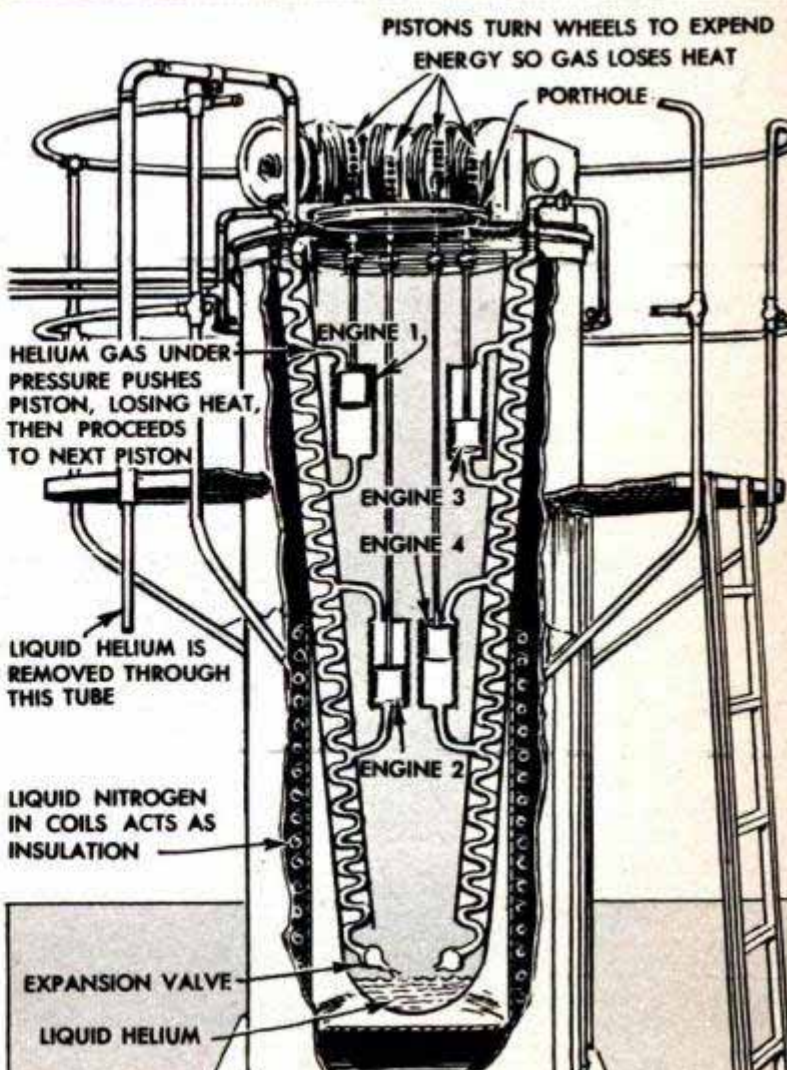
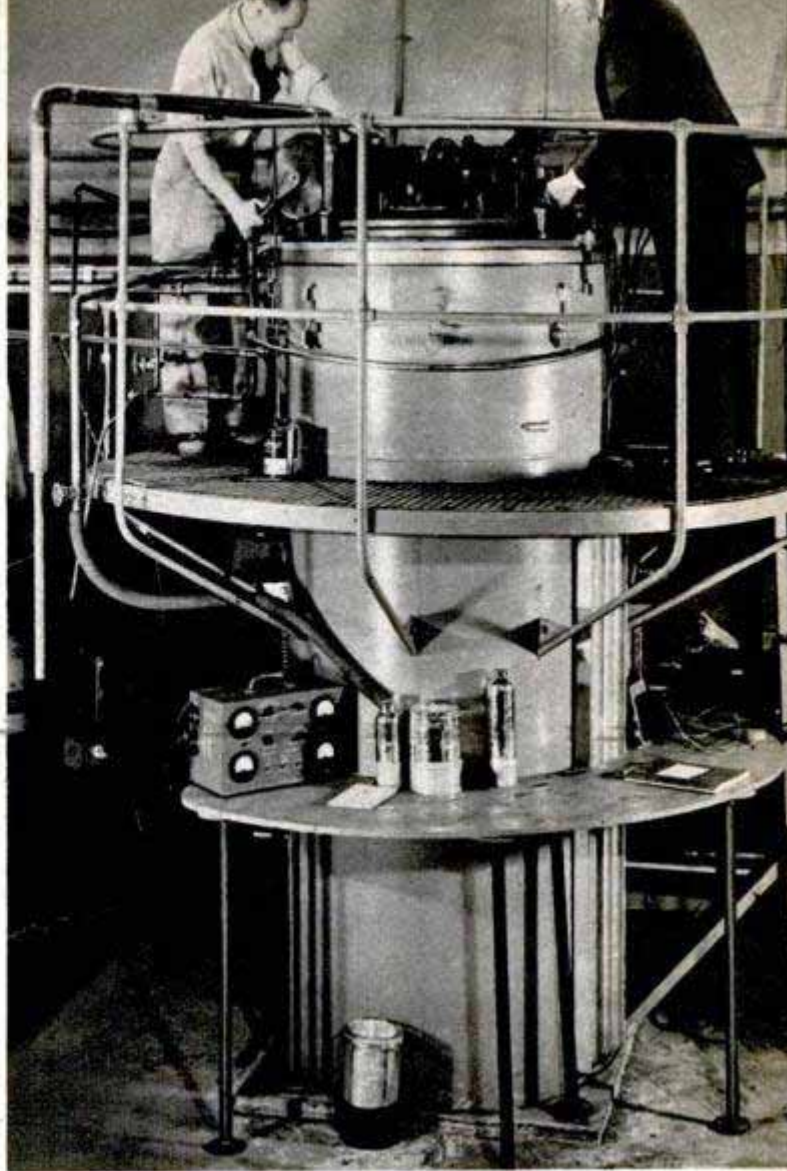

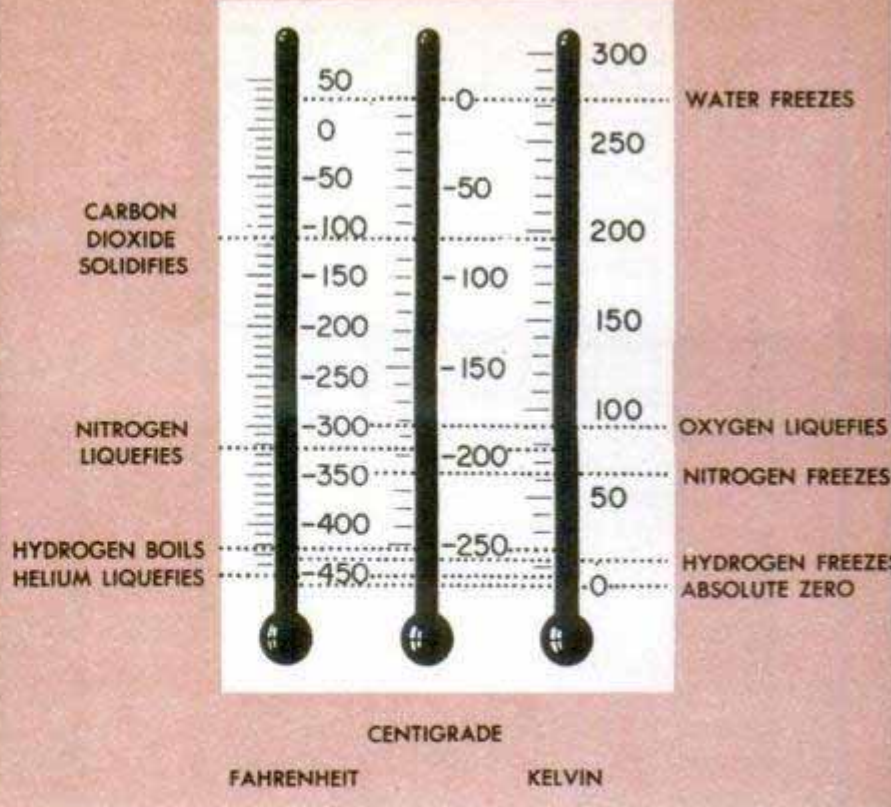

Left, liquid-helium flask is placed in container insulated with liquid nitrogen. The helium is kept in the dark, as light is warm enough to make it boil. Right, comparison of Kelvin, centigrade and Fahrenheit scales

Hubbard Horn and John F. Youngblood set out to design and build their lab, they spared no horses. Their \$250,000 super refrigerator is the first big laboratory tailor-made for low temperature in this country. The building is 60 by 70 feet, made of concrete and steel, with over 80 percent of the outer walls given over to explosion-venting sash.

Hydrogen, when mixed properly with oxygen, does explode. And though Doctor Fiske sneers at such a possibility, he took pains to divide the building with 12-inch concrete shields, separating personnel from liquefying machinery and stored gas and from the compressor room. "Mostly to deaden the racket," he says. Heavy-duty cranes for moving the equipment run on an overhead track with switches to route them from liquefying room or compressor room

Bouncing tennis ball, rear, is normal. At minus 340 degrees, front, ball has no more bounce than a brick

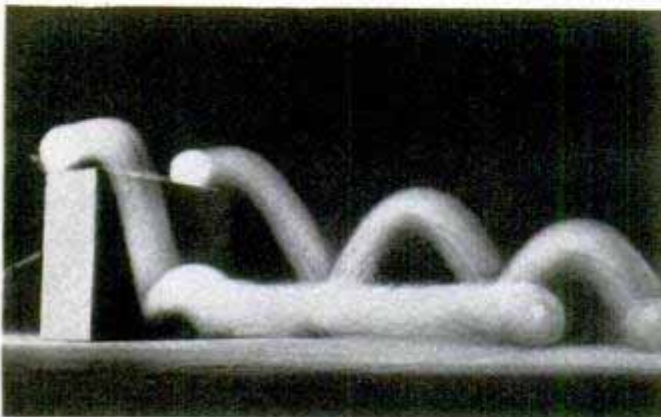

to the maintenance shop. They slide through the concrete walls via long, narrow steel doors.

No smoking is allowed in vital areas, all contact equipment is sealed against sparks and a hydrogen detector continually samples exhaust air from the building. When it hits more than .4 percent a double-barreled alarm goes off. But properly handled, hydrogen is harmless.

Actually the liquid hydrogen is not used for much real low-temperature work. "It's too hot," Doctor Fiske explains with a smile. "It becomes liquid at about 20 degrees Kelvin. We use it mostly as a coolant for the coils when we liquefy helium, which dribbles from the liquefiers at its boiling point of about four degrees absolute. When we're really rolling, we'll produce about seven gallons of liquid hydrogen or two of liquid helium per hour."

Producing the subchill fluids at G. E. is something like taking off for the moon in a rocket ship. The operator stands at an 11-foot double panel of dials behind the liquefiers. Beyond the thick concrete wall in the compressor room, a 60-horsepower electric motor whines as it starts the big hydrogen pump. A huge array of smaller ones pump helium. Multicolored pipes in the liquefier room grow a coating of frost. The operator's eyes flick from dial to dial. Occasionally, he peers through a thick glass porthole toward the gauges on the compressors. The gas is pouring down from big laboratory gas holders on the second



Experiment shows how supercold reduces electrical resistance. Bulb burns dimly, left, but when copper coil, carrying current to bulb, is dropped in some liquid nitrogen, right, the light output increases many times

floor. A hundred cubic feet of hydrogen per minute are pounding down to 2200 pounds per square inch. Helium, to 400 pounds. From the compressors the high-pressure gas feeds through purifiers, races through coils for cooling, roars into a chamber that is completely surrounded by a liquefied gas. The hydrogen chamber floats in liquid nitrogen at about 70 degrees absolute. The helium chamber is in liquid

hydrogen at about 15 degrees absolute. Now the roaring gases are cold enough to be on the verge of liquefying. All they need is a little push. They get it as they are rammed through pin-point nozzles and expand violently into the liquefying chamber. Twenty percent of them are chilled into liquid instantly by the expansion and rain to the bottom of the chamber to form a  
(Continued to page 244)

Chart of the hydrogen liquefier at the lab. Liquid hydrogen is "warm," being 20 degrees above absolute zero

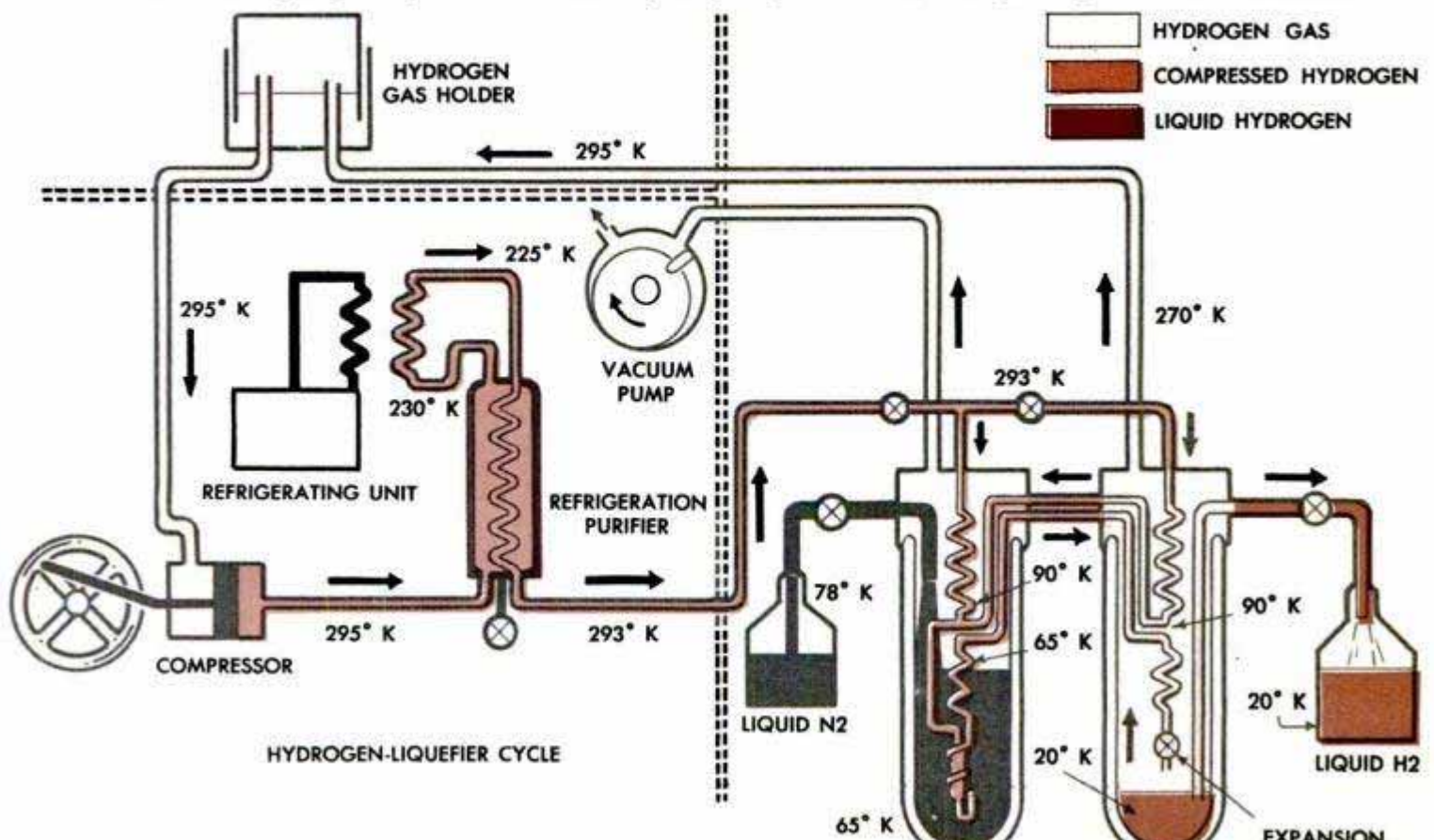

# Plastic Glasses



Above, welding splatter stuck to glass lens at left, but the plastic lens, right, is still in good condition

Right, two 1¼-pound steel balls were dropped on this pair of glasses to test impact resistance of lenses

Below right, when the balls hit the lenses the glass lens shattered while the plastic lens was undamaged

Below, dropped on a concrete floor and stepped on, the plastic lens was not broken or even scratched

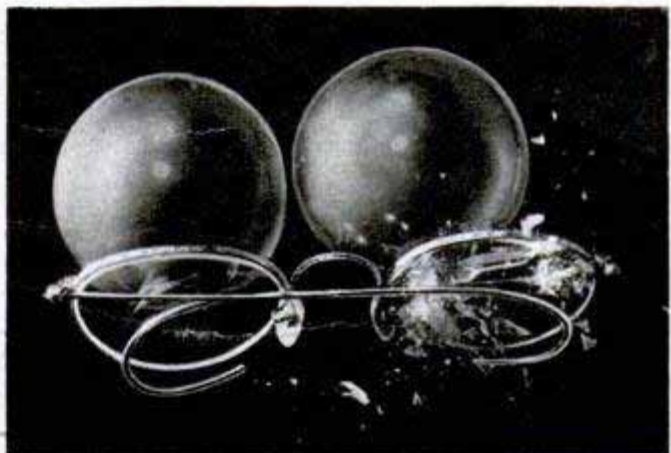

Worried about breaking your glasses? If so, your worry will be over when you get a pair of spectacles with plastic lenses that are virtually unbreakable and unscratchable. Forty times harder than previous plastic lenses, the new type won't scratch even when subjected to rough usage. Its impact resistance is several times greater than that of case-hardened glass. A 1¼-pound steel ball dropped on the plastic lens did not damage it. The lenses

were undamaged when placed on a concrete floor and walked on. Molten splatter and flying abrasives, always a problem for welders, did little damage to the spectacles, which weigh only half as much as regular glass lenses. The lenses are formed by pouring the plastic into molds, with each prescription requiring a different mold. They are heat-cured to prevent softening at high temperatures. Clear, flesh-colored and green-tinted lenses are produced.

## "Seeding" of Storm Clouds Decreases Lightning

Just as man has learned to produce rain artificially, scientists now believe the amount of lightning during thunderstorms can be decreased by using similar cloud "seeding" methods. Their hopes are based on the physical fact that when water freezes, as it does when moisture is carried into the upper level of a storm, electricity is generated. Researchers have found in

laboratory experiments that ammonia and some acids are able to limit the amount of electricity generated. Chemicals introduced into actual storm clouds on three occasions have decreased lightning. The U. S. Air Force project, headed by Prof. Horace Byers of the University of Chicago, is gathering the data to improve protection of power lines, buildings and airplanes.



# TRUCKERS' GOLIATH

WHEN a mammoth tractor-trailer rig rolls off the highway into a ravine, getting it back is often a major engineering feat. To speed salvage operations, Walter Reddaway of Oregon City, Ore., designed and built a powerful wrecker that bulges with mechanical muscles.

Weighing 36,500 pounds, the wrecker has four winches and a boom that extends to 62 feet. The one-inch steel cable that runs through the sheave on the boom tip winds up on a winch of 80,000 pounds' capacity. This Herculean tug can be increased by hooking on a second cable pulled by an auxiliary winch of 65,000 pounds' capacity. The boom, with three 14-foot girder sections that telescope for highway travel, is raised and lowered by a separate winch of 30,000 pounds' capacity. The fourth winch, mounted at the front end, develops a 45,000-pound pull.

All winches are driven by the truck's 265-horsepower engine and are controlled either from the cab or from a panel on one side of the vehicle. A broad anchor bar under the rear end is cranked down to provide solid support when a heavy load is being lifted.

The mechanical Goliath carries its own 110-volt lighting plant and six floodlights for night operations.



Coffee, brewed right in the cab, peeps up the crew



A steel bar at the rear adds stability for a hoist

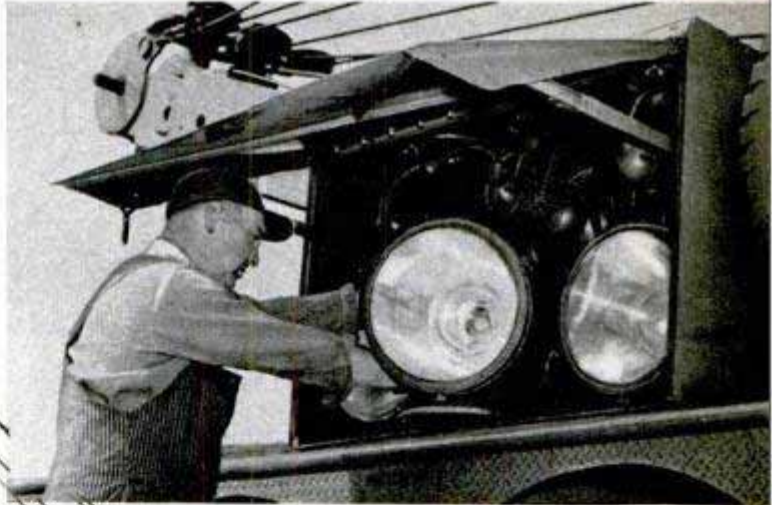

Six floodlights are part of the equipment. Below, this looks easy, but it is an 18,000-pound load



By Richard F. Dempewolff



Native crews helped build 32-mile railroad to move ore to Bethlehem Steel Co. barges (below) in Orinoco River

**I**T'S ONE THING to know there's a bunch of luscious blackberries in the middle of a mile-square brier patch, and quite another to go in, get them and haul them out. That's the way it is with Venezuela's fabulous wealth.

In a virtually roadless interior that varies from snow-capped Andean peaks, 20,000 feet high, to dense equatorial lowlands shot through with rivers, gorges, desert and impenetrable jungle, the simplest mission may take weeks and months of planning just to find what you're looking for, grab it and get out.

Ruth Robertson, veteran Caracas photographer, some of whose pictures accompany this article, saw Angel Falls from an airplane back in 1947. She decided to go in on foot as soon as she could arrange things, measure it (its actual height was then in question) and take pictures. Though it's only 300 miles

# Treasure Hunt in a

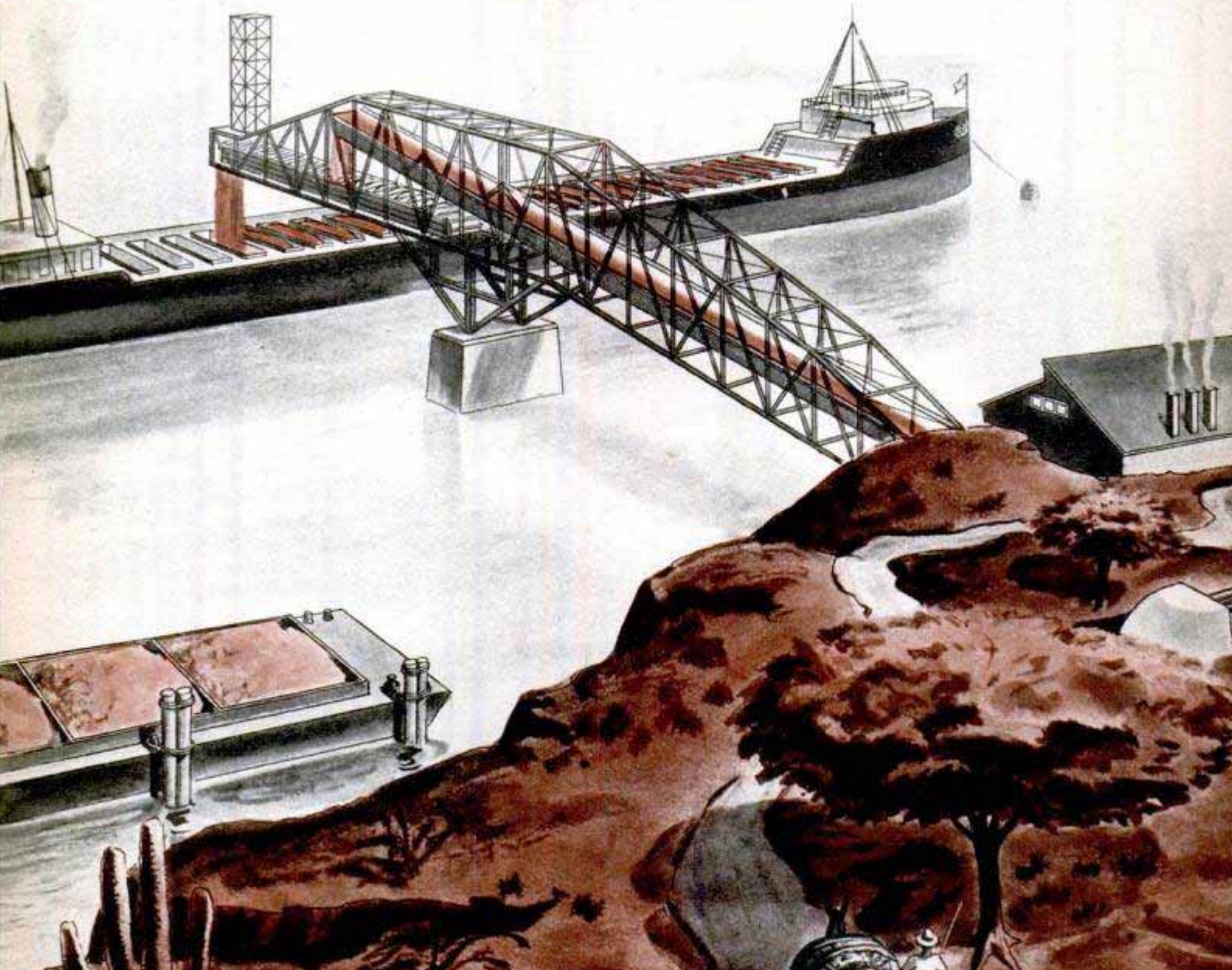

from Caracas, she finally made it last year. First a base-camp air strip had to be carved out of the jungle. Guide, radioman, supplies including waterproofing, jungle hammocks, snake-bite kits, compasses, machetes, rope, ammunition, guns, lamps—and a hundred other things had to be made ready. A DC-3 was to take the party of five into Uruyen, south of Ayuan-tepui. Small shuttle planes then would move them over the jungle one at a time to the advance strip, from which they would move up a Caroni River tributary into Churun Canyon by native dugout. The last 10 miles they would hack their way through deep jungle with machetes.

After all those plans, they got in to Uruyen but couldn't locate the advance strip. Their radio went on the "fritz" and they had to wait for a hand-crank set to be flown in. After days of battling with bugs, they took off by water all the way, supplementing their supplies with Indian fare and slogging it out through rains that pelted them

# Lost World

## Part II

When ore train from El Pao mine reaches the Orinoco the ore is dropped through chutes to conveyor-belt system which is partly underground. A cranelike loading bridge extends out over barge and is hinged at rear to accommodate river level in flood season



Ruth Robertson photo

Angel Falls, highest in the world, is hidden in the jungle and has been seen by only few white persons

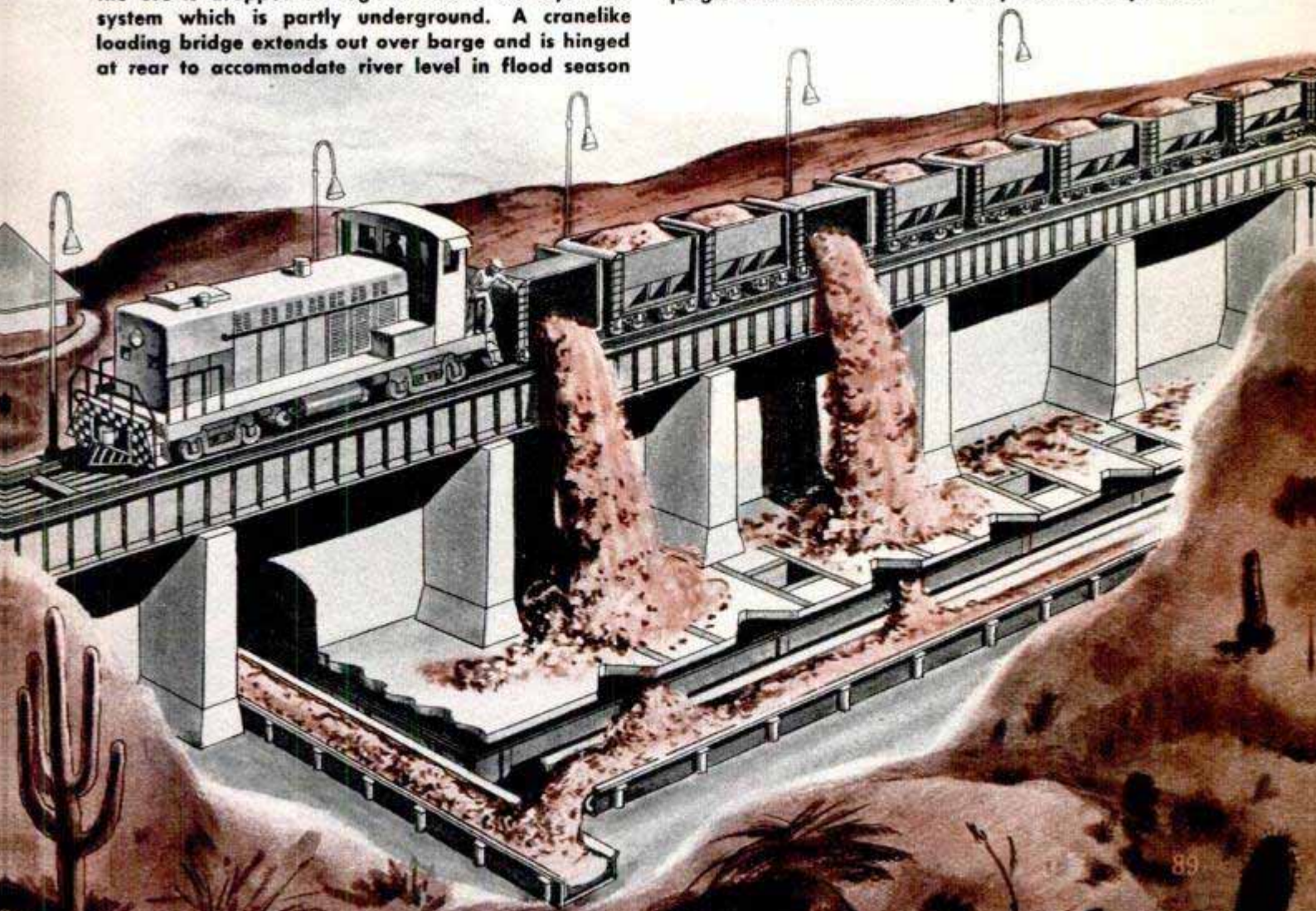



Oil wells along shore of Caribbean Sea as seen from air rival Oklahoma and are evidence of the oil boom in Venezuela

Oil rig (opposite page) is ablaze with lights at night to frighten Indians who attempt to shoot poison darts at the crew

Core drilling rig at right on opposite page penetrated 400 feet into mountain of iron to prove up vast reserve

daily. They made it all right. It took 19 days to get a matter of 20 air miles. The surveyors measured the falls (2648 feet for the first free drop, then a lower drop of 564 feet). "It's the most breath-taking sight in the world," recalls Ruth. "The wind blows spray in a half-mile semicircle around the base." She got her pictures, and off they went for home, returning a month after they'd started. And they weren't carrying anything but pictures, statistics, supplies and themselves!



"To date," says Ruth, "the only practical means of transportation in the interior is the airplane. Even that has its shortcomings. You can't set it down on jungle tree-tops, or river rapids. Furthermore, we saw several bucket seats adorning the sparsely furnished interiors of thatched roof native huts—a grim indication of what can happen when you try to."

Transportation is the toughest handicap facing men who would exploit Venezuela's vast wealth. On the plains and swamps of the vast llanos, oil companies like Creole, Standard Oil's Venezuelan subsidiary, have solved it by devising odd vehicles for their prospecting. There's the "marsh buggy," which looks like a big tent perched on a set of upended bass drums. The hollow-drum driving wheels up front are fluted for traction. Rear wheels are plain-surfaced. It will thump along smartly over swamps and shallow water, or dry grassy ground. The large riding surface of the drums keeps it from sinking into bogs and it will carry a respectable cargo of company explorers and well pipe.

Tiny Army surplus bulldozers, which can be flown anywhere in a DC-3, also show up in open country where they're used for road building, hill removing, or just riding through tough terrain on their wide steel Caterpillar treads. Jeeps are the modern burros of the Venezuelan prairies, used for hauling trailers and people through every

Pipe lines of the Creole Petroleum Corp. snake way through miles of rank jungle and must be patrolled

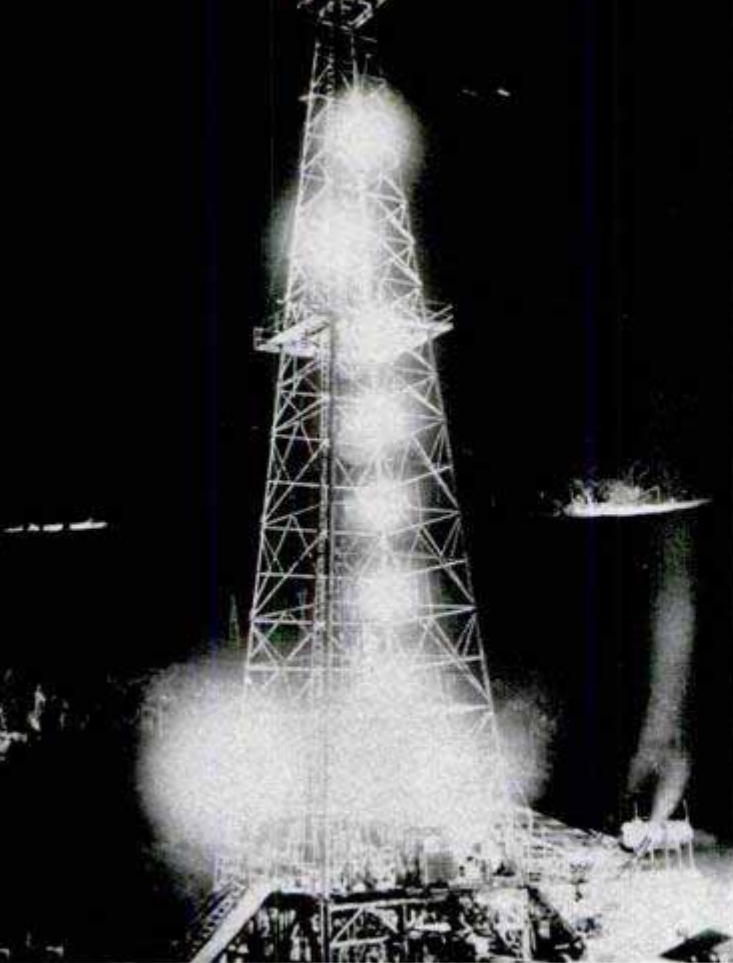

conceivable kind of country — not excluding rivers.

But how do you get oil, iron and other heavy raw materials out? By dint of incredible labor, ingenuity and expense. Oil companies' pipe lines snake through hundreds of miles of jungles, across plains and water to bring out more than a million barrels of black gold daily. Up in the northwestern jungles, Creole has more than pipe lines to worry about. Here are the little aboriginal Indians with six-foot blow-

pipes, who still plip their long, deadly, poison-tipped darts at strangers in their jungles. Time and again they have attacked Creole camps. Many a well digger has fallen victim to their arrows, many a camp has been disrupted by their onslaughts from the dense treetops.

To establish the most recent Creole wild-cat up there (Alturitas), Creole engineers first had to carve an 18-mile road through the jungle, clear a half-mile-square area around the rig to guard against attack, and

Map shows three major oil basins — Maracaibo Falcon, Apure and the Orinoco from which are flowing millions of barrels to create dizzy oil boom. Mountains of almost pure iron ore in the Gran Sabana region may start a second boom



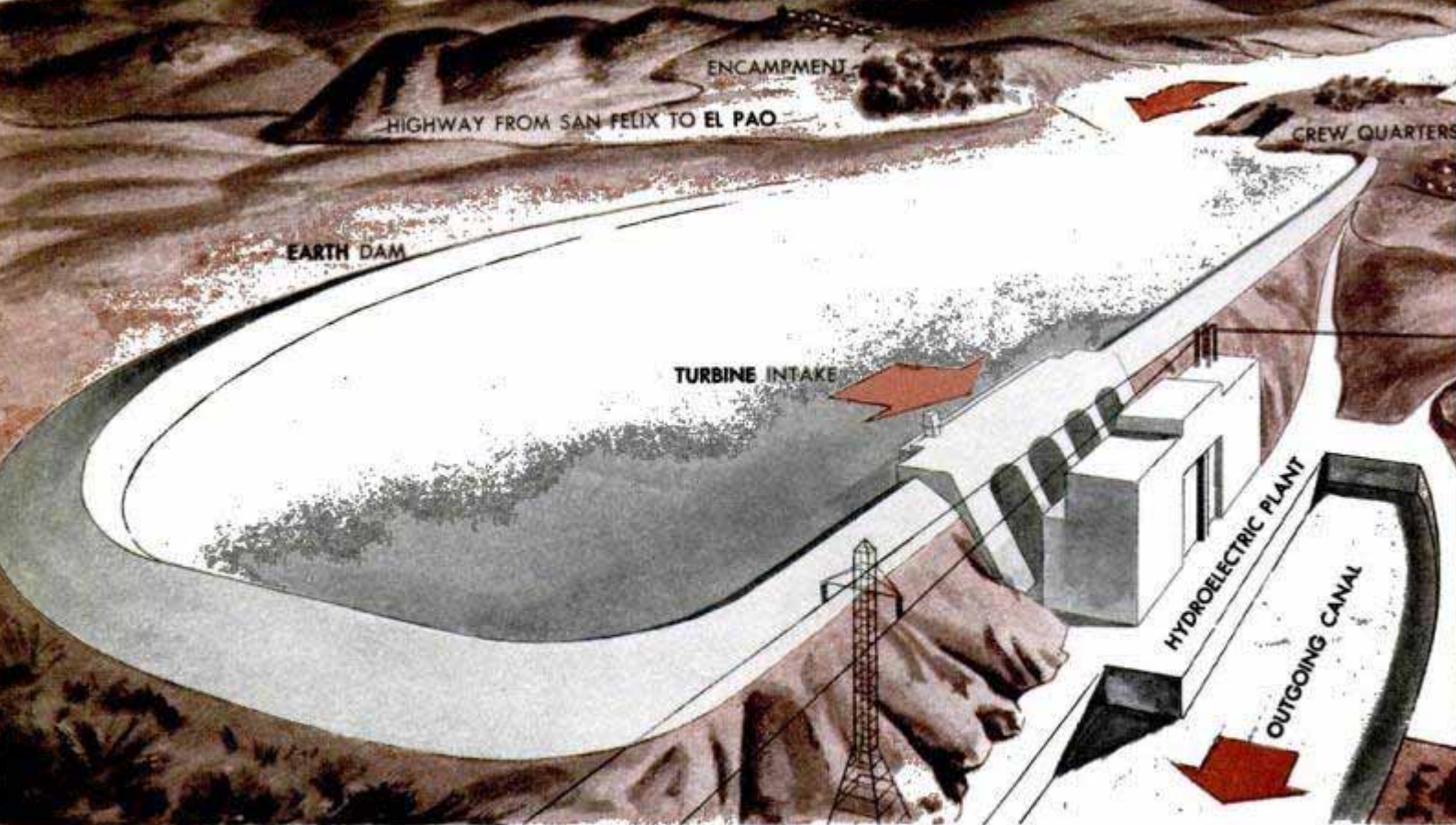

truck in the ponderous equipment on trailers drawn by rearing "cats." Medical men cleared the place of malaria; camps and schools had to be set up for workers.

Since the Indians in that area will attack only under cover of darkness, the Alturitas rig is kept ablaze with powerful lamps that light the entire clearing all night. Thus dazzled, the Indians have apparently decided to steer clear so far.

Not only does exploitation of Venezuelan oil cost lives, but heartaches and money—

like the 180-mile road and modern camps forged into wild central Venezuela to a territory that yielded exactly 11 dry holes! So far oil prospectors in "the land of opportunity" have spent half a billion dollars finding and getting out their black gold.

Today, acres of derricks out on the water of Lake Maracaibo in western Venezuela bring in 270 million barrels a year. Getting those wells drilled—some in water over 200 feet deep—seemed an impossible job. For shallow water, huge concrete piles were

Native huts and workmen's new homes rub elbows in mining town of El Pao

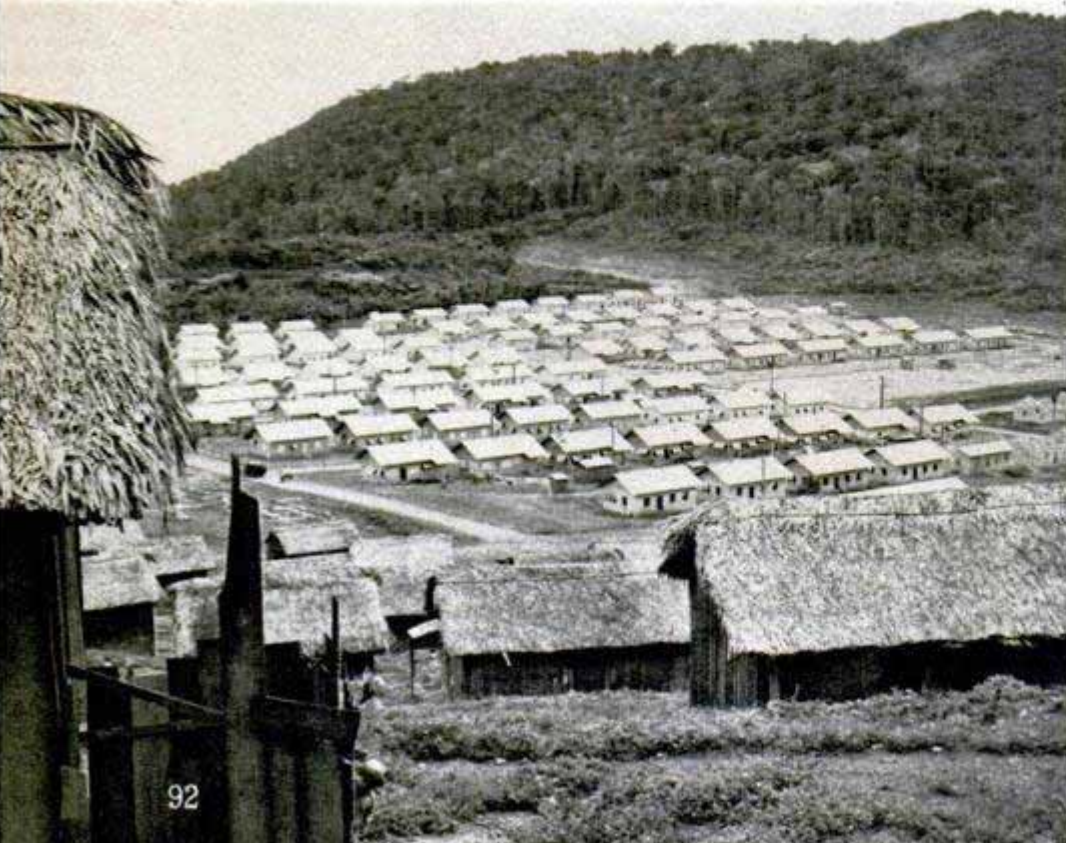

carried to location in barges, driven into the lake bottom for the rig platform. In depths over 80 feet, hollow concrete and steel caissons are now floated out on the lake in 100-ton, 185-foot lengths. The caissons are tipped up, filled with water and plunged nose first to the depths, where they drive themselves into the mud. Then 200-ton blocks of concrete are dropped on top of them to sink them in to final resting place. Platform, derrick, drilling rig are built on top; special drilling barges with built-in mud troughs, settling pits, pipe deck and a diesel power supply drop anchor alongside, and another shaft sinks into

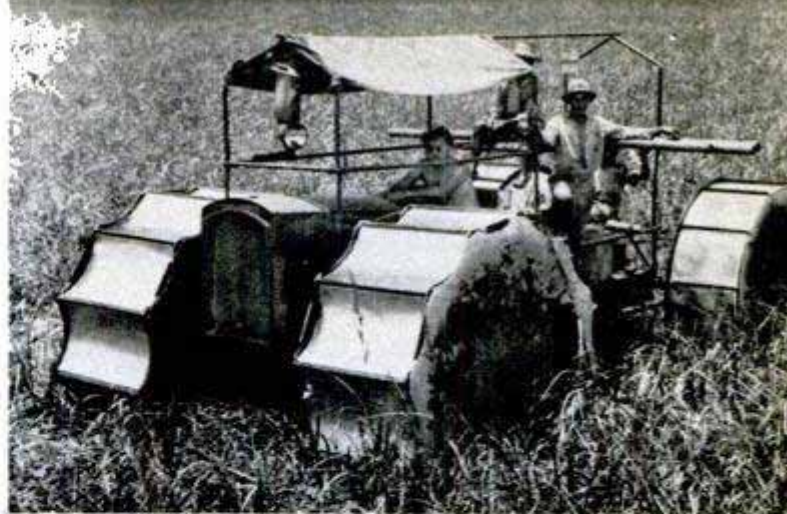
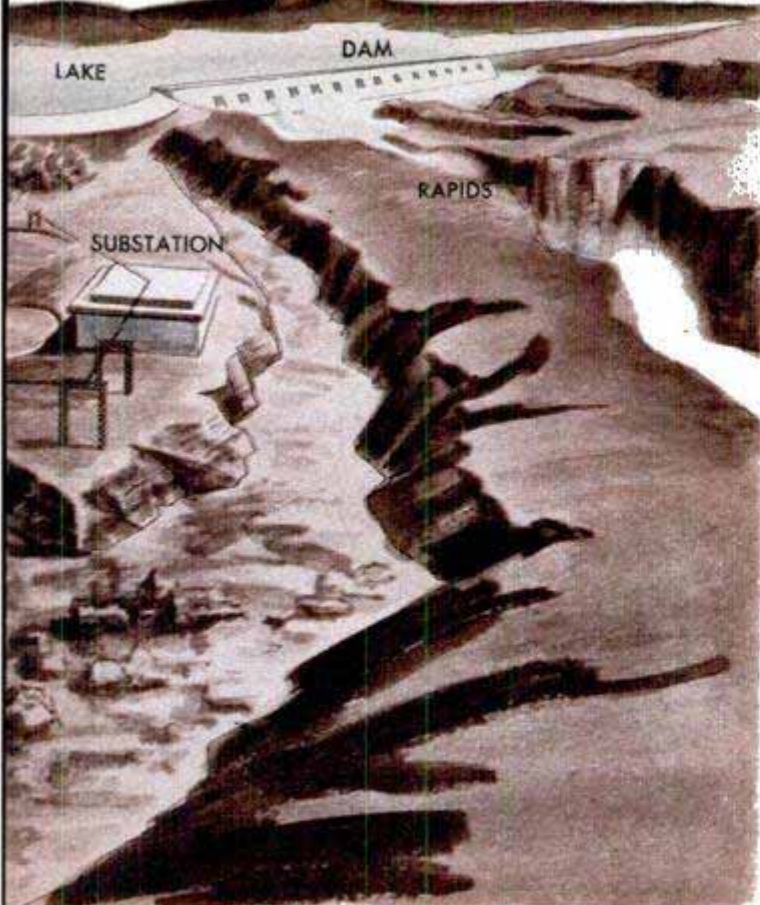

Oil-exploration crew moves over swampy parts of Gran Sabana in "marsh buggy" with drumlike wheels

←Caroni Dam will trap water from several streams of this branching river in a huge horseshoe-shaped earth dam. Big hydroelectric plant shown in center will provide needed power for many new industries

Below, one of many deserted ranchos which are boarded up because labor has left farms for oil fields

Maracaibo's bottom — not always without more grief. Some time ago, on the east side of the lake, a well "blew" in the course of drilling and made history by oiling the water and land in all directions with 100,000 barrels of crude in nine days before it "sanded in."

To facilitate lake-oil shipment, Creole has just had to build a fantastic 145-mile pipe line to Amuay Bay. Fifteen miles of it stretch across the wind-tossed Gulf of Coro —some of the roughest water in the world.

To do the job, pipe was assembled in two-mile lengths ashore, covered with spun glass, fiber felt and sprayed with concrete to prevent corrosion, sealed at each end and towed over whitecaps to the tie-in point at dead tide. As each section went out, huge cranes on barges picked up each butt and wiggled them together. Welders, in a swaying scaffold hung between the barges, made the joint. The pipe was then lowered between a "roadway" of pilings to keep it in place till the next section came out. Half-way through, wind and tide flipped a half mile of the pipe over the piles and bent it out across the bay like the hand of a big clock. Finally it was towed back and repaired. The bay link completed, the pipe



was pumped full of water and sank to the bottom intact—where it rests today, carrying 325,000 barrels of Venezuela crude per day to tanker-loading facilities at Amuay.

If oil's problems are tough in this rugged frontier, big steel's are practically a menace. The grim job of finding and removing heavy, unwieldy ore from the country is being tackled right now by Bethlehem and U. S. Steel in cooperation with the Venezuelan government.

For years it was known that somewhere on the Gran Sabana there was ore. The old

(Continued to page 256)

Cerro Bolivar is a mountain of almost pure iron ore discovered last year in the Gran Sabana of Venezuela



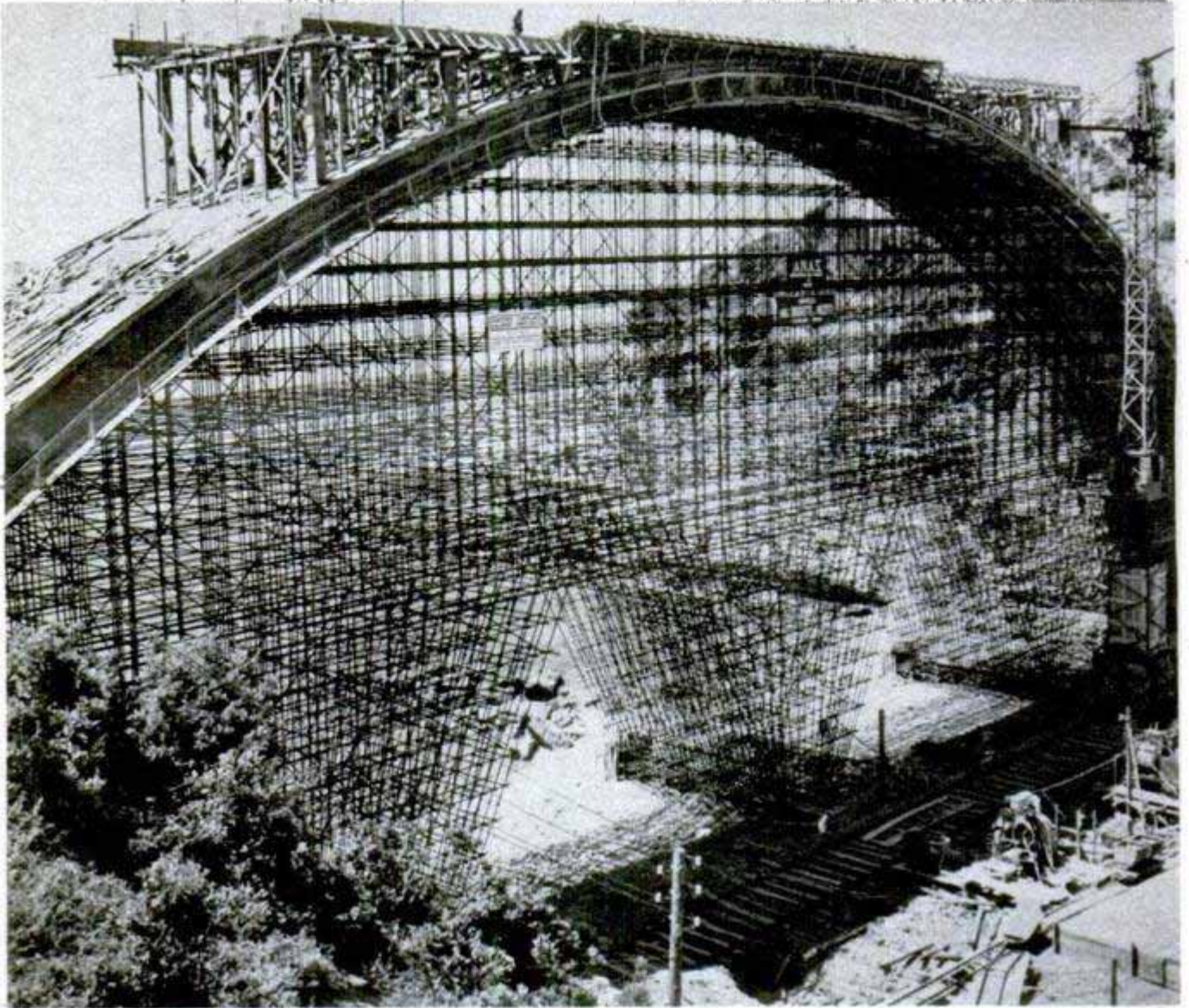

## Maze of Steel Pipe Supports High Italian Bridge

Steel pipe, built into an intricate maze, supports the roadway of a bridge spanning a deep valley near Leghorn, Italy. The

former bridge across the valley was destroyed during the war. The maze of pipe forms three supports for the new bridge.

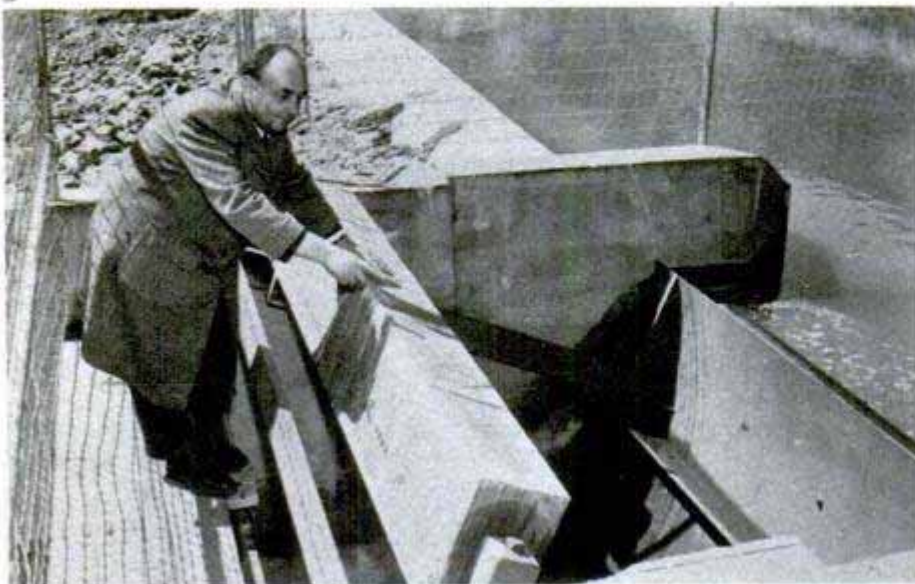

Counterbalanced, the automatic gate can be moved up and down with little effort. A float attached to the face of the gate controls its operation

## Automatic Gate Controls Water

Counterbalanced by a weighted arm, a steel gate automatically controls the flow of water from streams or reservoirs. A float attached to the face of the gate lifts the gate as the water level rises and lowers it when the water drops below any preset level. Trouble-free in operation, the gate maintains any level of water under all conditions, including flood. It was developed by a French hydraulic laboratory.





B. F. Goodrich Co. photo

## Air Holds Up Tent

Columns of air support an 80-foot-long tent that can be "erected" in six minutes. Its nine beams are made of rubberized Fi-

berglas-nylon and each takes three pounds of air to inflate. The waterproof tent weighs 740 pounds and can be deflated in 25 minutes. It was developed for the Air Force as a portable darkroom and briefing tent.

## Interior of Eye "Shot" By Camera

Doctors can now photograph the interior of the eye with a high-speed camera developed by Bausch & Lomb. The photographs, in color or black and white, show in microscopic detail the retina, nerve fibers and other structural elements within the eye. The camera is equipped with an extremely long focal length lens.

Telescopelike camera, right, photographs inside of the eye. Below, left, healthy eye. Center view shows start of optic atrophy. Right, degenerate eye

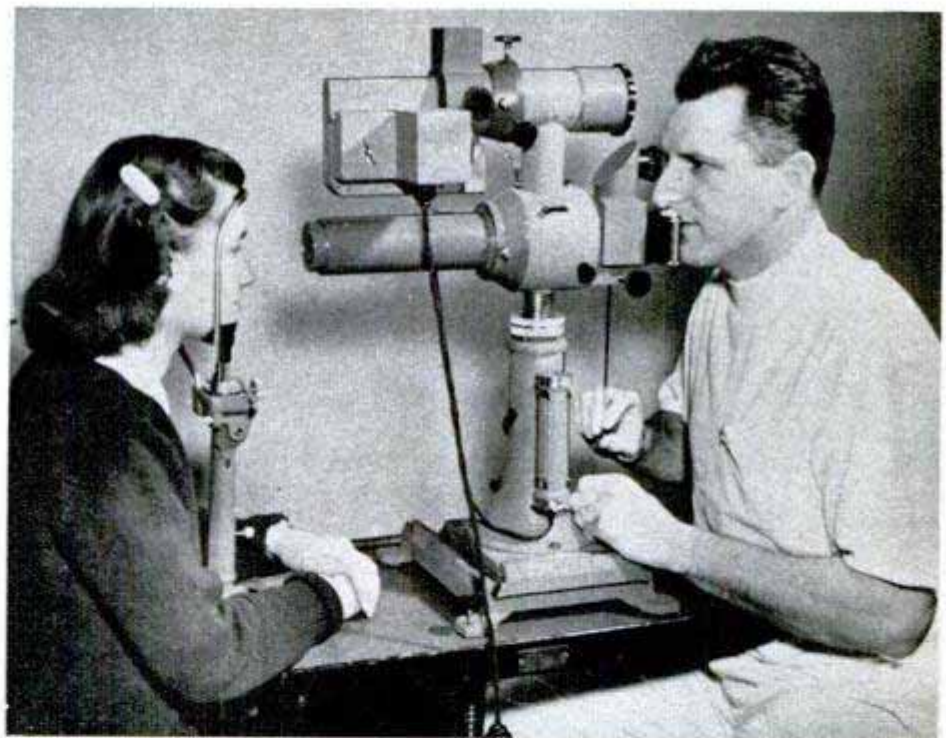

Popular Mechanics provides two sources of further information concerning articles published in each issue: the WHERE-TO-BUY-IT INDEX, page 10, and the WHERE-TO-FIND-IT LIST, available from Bureau of Information, 200 East Ontario Street, Chicago 11

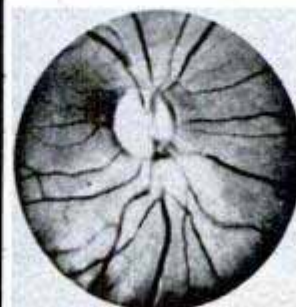
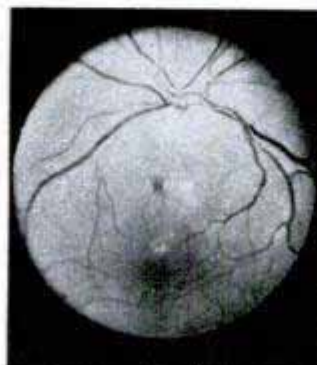

## BRITAIN'S BRABAZON— "Queen Mary of the Sky"



In addition to 38 seats in the main compartment, above, there will be first-class cabins with sleeping accommodations. A cocktail bar and aft lounge, with movies, provide ample room for 100 passengers, who would leave London at midnight and arrive in New York at 8 a.m.



Above, the engineers' room on the flight deck. Below, Brabazon I making its first landing at London airport

PASSENGERS won't play shuffleboard, but the flight from London to New York on the Bristol Brabazon will be as close to the luxury of an ocean liner as air travel can be. And the passengers, 100 of them, will enjoy the luxury as they speed 35,000 feet above the Atlantic at 350 miles an hour. For shorter flights, the plane could carry 224 persons in ample comfort.

Weighing 290,000 pounds, the "Brab" is the largest non-military landplane in the world. The B-36, with its 320,000 pounds, is the only landplane that tops it. Its 230-foot wingspan is equal to the B-36's and its 177-foot fuselage is 5½ feet longer.

Eight engines power the giant. To the uninformed, the Brabazon appears to be a four-engined craft because the engines are "buried" in the wing in pairs, driving four pairs of contrarotating propellers.

The Brabazon I, now being flown, is used only for research. Slated for 1951 completion and possible London-New York service is the Brabazon II. This newer model will be powered by Proteus gas turbines instead of the piston engines used in the original. These turbines will develop 30,000 horsepower.

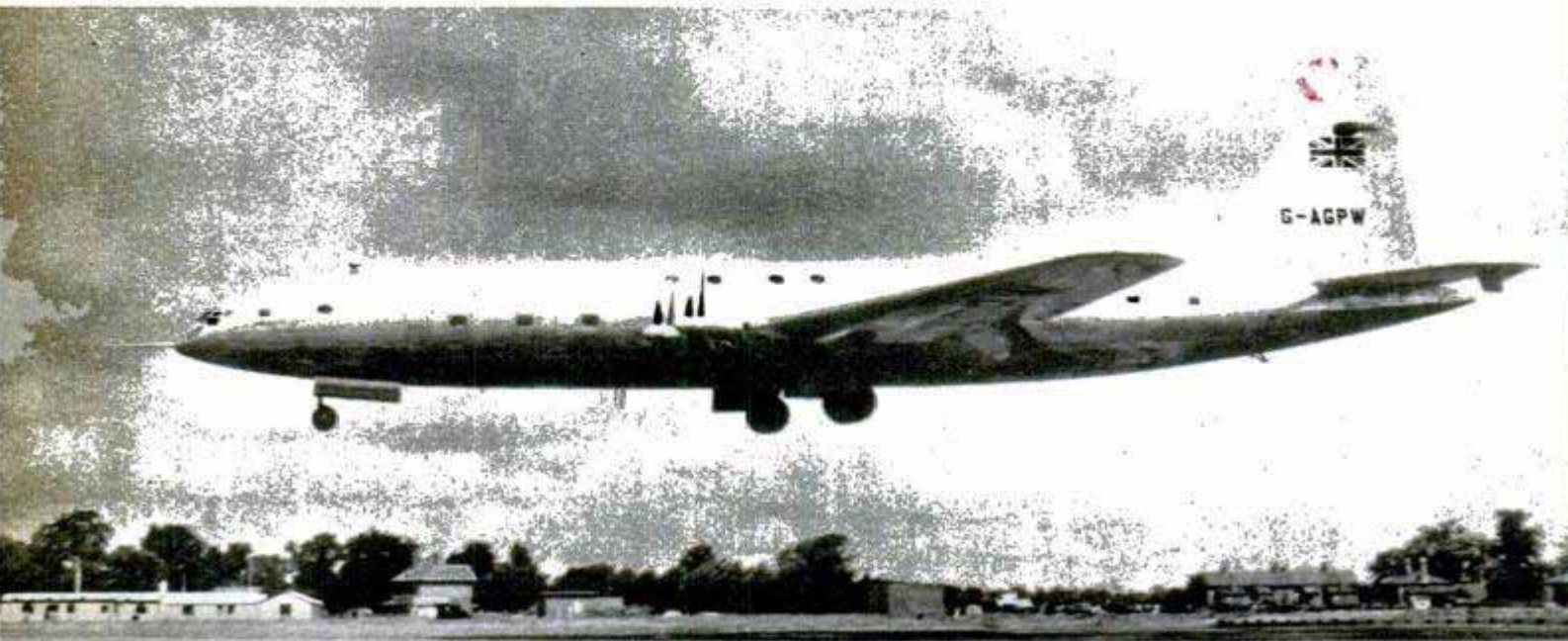

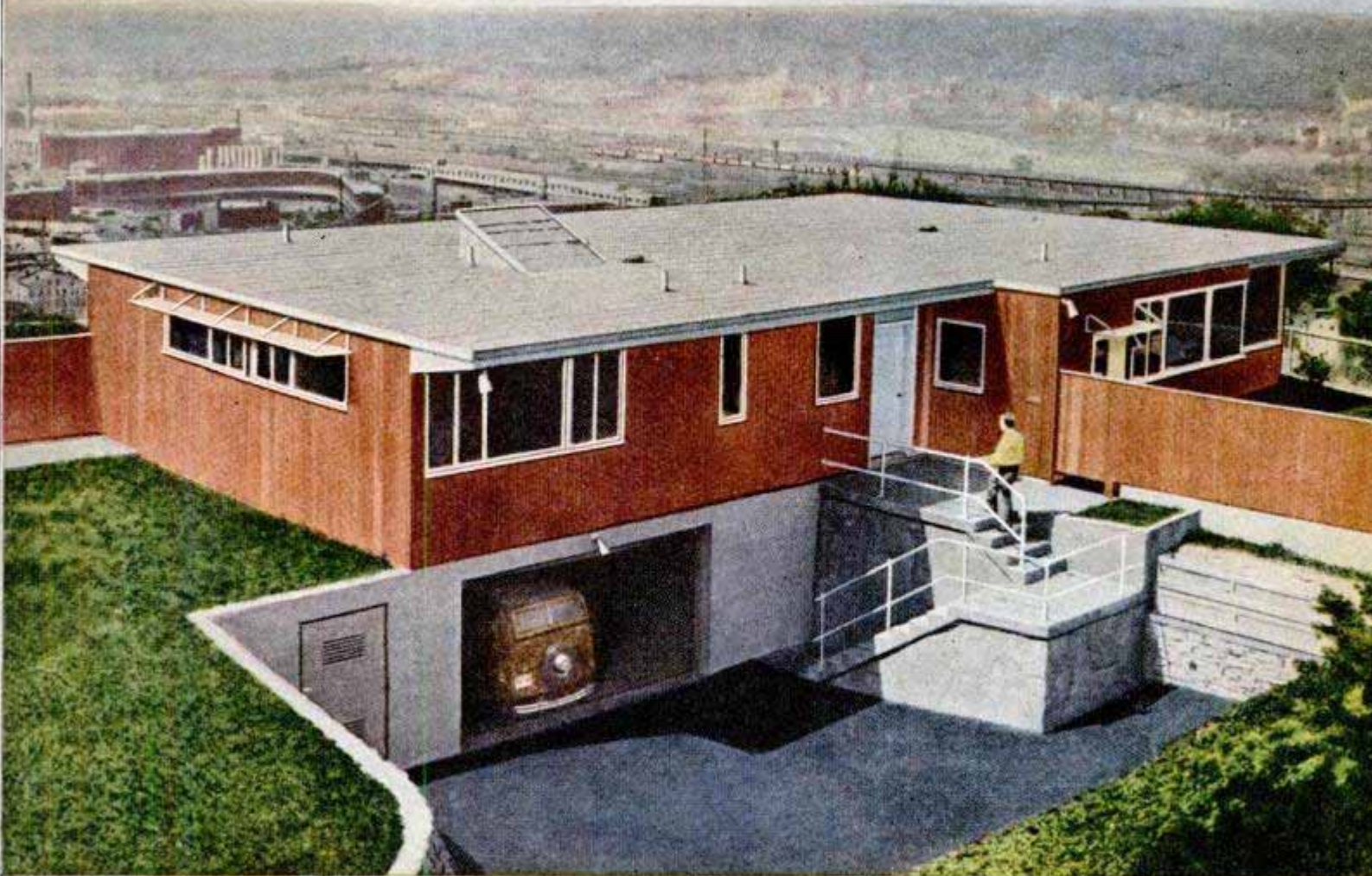

High on a bluff overlooking Cincinnati, the Mills house introduces reflective radiant heating and cooling

# The House That's Heated With "Mirrors"

By Wayne Whittaker

**Forget everything you ever knew about air conditioning. It's the body temperature and not the air that makes you comfortable, says a noted Cincinnati doctor who built this unique house to prove it**

**J**UST LIKE A MIRROR that reflects the sunlight, the foil-covered walls and ceilings of a revolutionary house in Cincinnati reflect heat. The air itself—neither its temperature nor humidity—is of little concern in either the heating or cooling of this amazing house. The same principle that enables a skier at Sun Valley to strip to the waist and be comfortable in freezing air temperature and winter sunshine warms this modern home.

Dr. Clarence A. Mills, professor of experimental medicine at the University of Cincinnati and author of "Climate Makes the Man" and other books, has developed what he calls reflective radiant heating and cooling. After 15 years of laboratory experimentation he has built a reflective radiant home on a bluff overlooking down-

town Cincinnati and the winding Ohio River just to prove what he has been preaching. He calls his home Reflection Point and believes that it may revolutionize the conditioning of houses and commercial buildings throughout the world.

In order to understand Doctor Mills' heating and cooling theory one must drop all thought of air conditioning. Reflective radiant conditioning is not concerned with the air but with man and the rate at which a person loses body heat. If a man is made comfortable by controlling the loss of his body heat, reasons Doctor Mills, the air temperature or humidity means nothing. In other words, you can sit in your shirt sleeves in air temperature of 32 degrees Fahrenheit or lower and be perfectly comfortable. The doctor admits it is a little

# HEAT WAVES FROM CEILING COVES REFLECT FROM

Perforated aluminum sheets form the ceiling of hall and let in forced filtered air at outside temperature. Reflected radiant heat controls body heat, ignores air temperature

Walls have no insulation. Roof is made of planking, four layers of roofing paper and two of aluminum foil to reflect heat waves

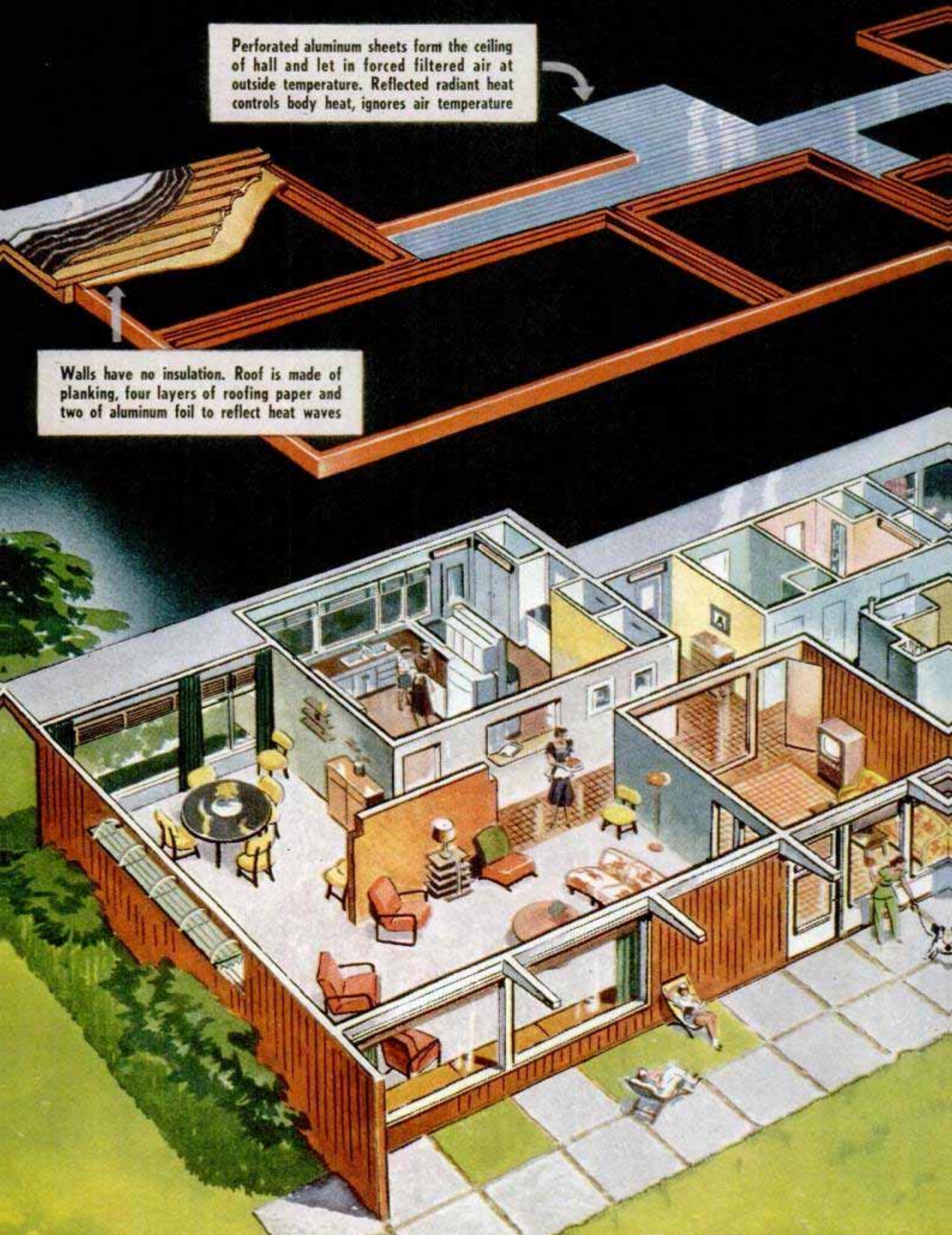

# FOIL-COVERED WALLS

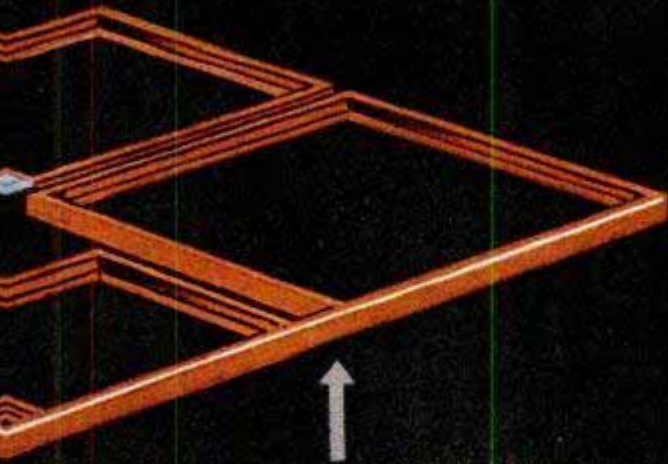

Coves hold both heating and cooling units. Original installation is electric rods for heating. The cooling tubes carry Freon gas

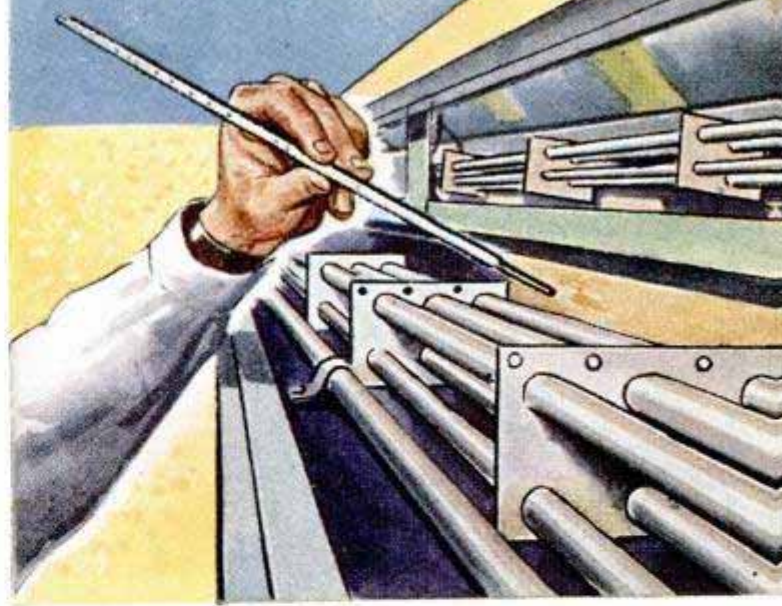
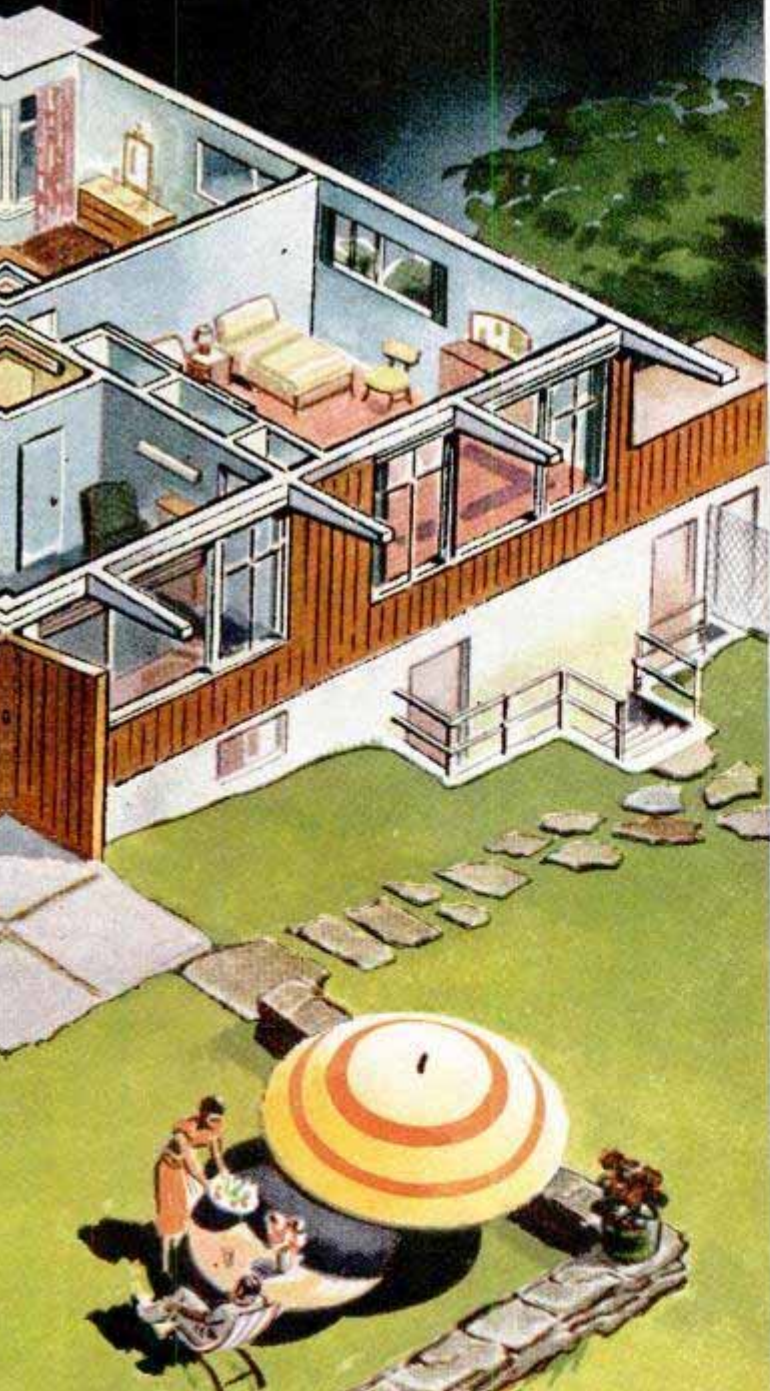

Thermometer registers low temperature in heating-cooling cove in summer. Lower pipes carry Freon gas. Electric current for heating passes through small rods at top. Cove is 12 inches below ceiling



Embossed aluminum foil paper pasted to plywood on side walls serves as passive reflector for heat or cooling waves. House has no insulation. Below, the perforated aluminum ceiling in hall lets in air

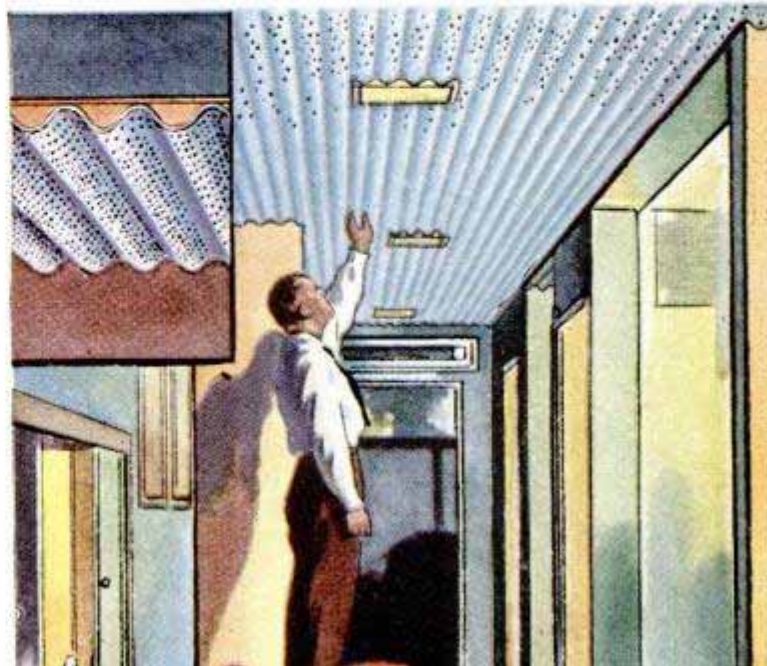



**Dr. Clarence A. Mills before picture window explains conditioning system to guest. The heating-cooling cove can be seen above window. Beneath carpet is aluminum foil which reflects heat waves like side walls**

disconcerting to see your breath freezing in front of you under such circumstances, but he contends that people will get used to the idea.

"The story behind Reflection Point starts back in 1930," says Doctor Mills. "I had long been dissatisfied with our antique heating systems and felt that our best answer lay in the radiant control of body heat loss. I made a long study of radiant heating—but that was only part of the answer. Do you know that only one fourth of the human race needs heating compared with

three fourths that need cooling? For health reasons there has been a great need to get away from the sharp contrast between inside and outside air. What I have sought is a combined system."

In his early research, the doctor discovered that Westinghouse had had a laboratory at New Kensington, Pa., which demonstrated that it was possible to make a person comfortable in air from zero to 120 degrees Fahrenheit. Westinghouse used metal walls with hot or cold air behind them, but the experiment was abandoned.

**Left, this end of living room leads to enclosed porch with sliding glass door. Right, long terrace at rear**



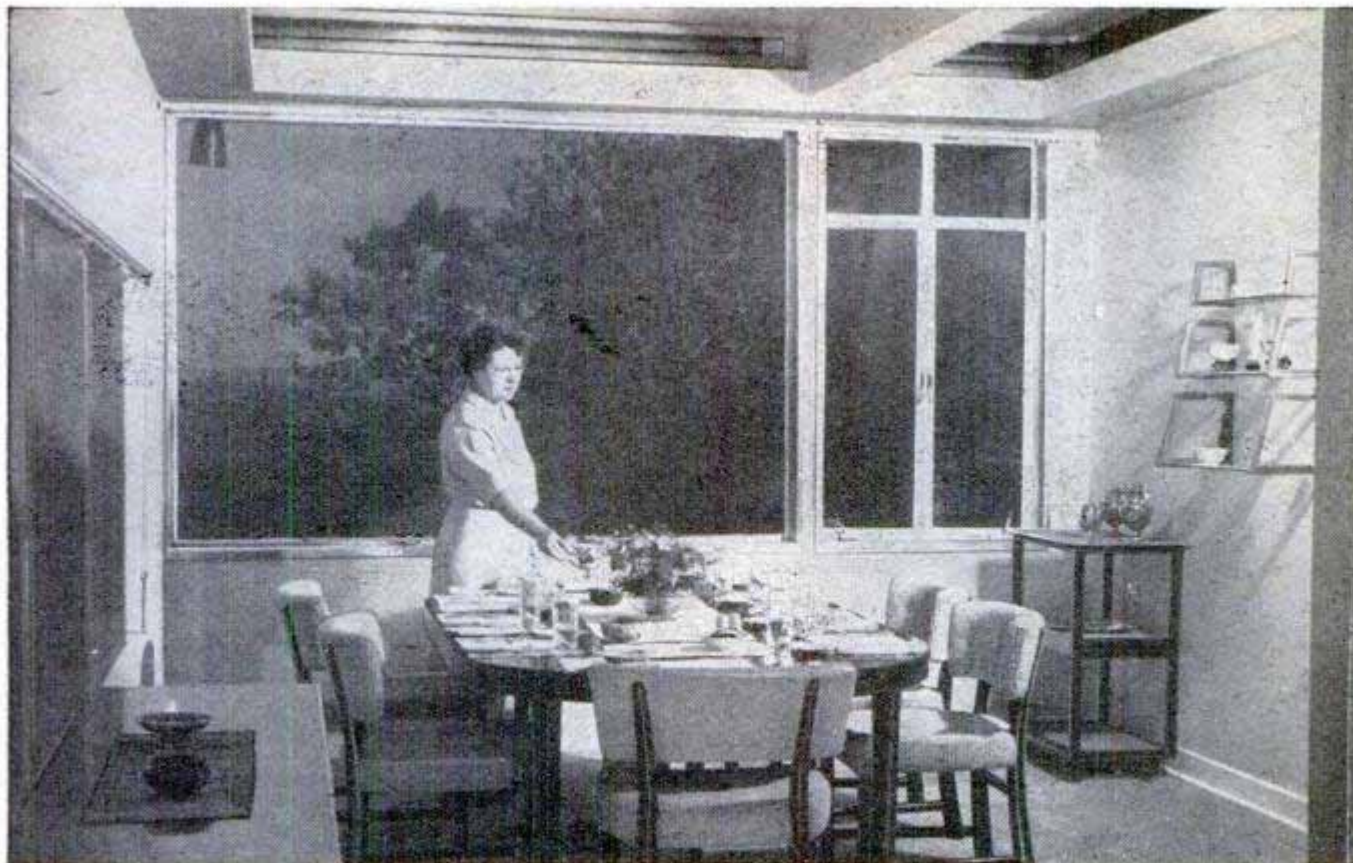

Small dining-room window at right is one of few that open. Aluminum Venetian blinds were installed later

"I have merely gone a step further," he explains. "One of the great difficulties with the cold metal wall was that it dripped constantly in summer under direct radiant cooling. I hit upon the idea of lining the inside walls with aluminum foil to obtain a reflective surface. Also, if you use hot or cold surfaces direct for radiant conditioning, air currents are started which result in actual air conditioning."

Doctor Mills' wall covering of aluminum foil serves as what he calls a "passive reflector." That is the key to his "mirror" heating. The walls themselves do not absorb the heat waves any more than a mirror absorbs the sunlight which it reflects. Both are passive reflectors. In the Mills system the heating or cooling source is pocketed in a cove or trough near the ceiling. The heat waves bounce off the ceiling to the side walls and into the human body or any other material which will absorb them. In this way the walls are kept at air temperature in both heating and cooling operations and during the latter there is no condensation of moisture.

"After getting the theory ironed out," he continued, "I built four experimental rooms in the Cincinnati General Hospital. Two of the rooms I lined with foil, one for heat tests and the other for cold. The two other rooms were not lined with foil but were kept at identical temperatures and humidity (one hot and one cold) for the tests. We used rats in the experiments and the temperatures ranged from 35 to 95 degrees

Fahrenheit in very moist air. In the non-reflective rooms the animals became weak and stopped growing. But in the foil-lined rooms, under reflective radiant conditioning, the animals thrived at identical air temperatures and humidity. Both rats and people did well at 35 degrees Fahrenheit when radiant heat was reflected on their skin to keep them warm. These experiments spread out over a number of years and finally convinced me that I really had something."

There were also hints in the early experiments, Doctor Mills recalls, that it might be possible to "spot heat" various parts of a house. This was not to be proved until Reflection Point was completed last summer. The living room and dining room of the house are connected with a wide opening, yet it is possible to spot heat—or cool—the dining room and not the living room and vice versa. This is done by the flip of a switch, much as you would turn on a light. Spot heating is made possible because the air is not concerned in the heating system—a radical idea which is hard to grasp in our "air minded" generation. Doctor Mills believes that spot heating or cooling may eventually bring down heating or cooling costs near what we pay today for light.

One problem during the early experiments was that with the use of smooth foil there were cold spots or hot spots in a room. What was needed was a surface that would break up the heat or cold waves and send them out at every angle. An embossed

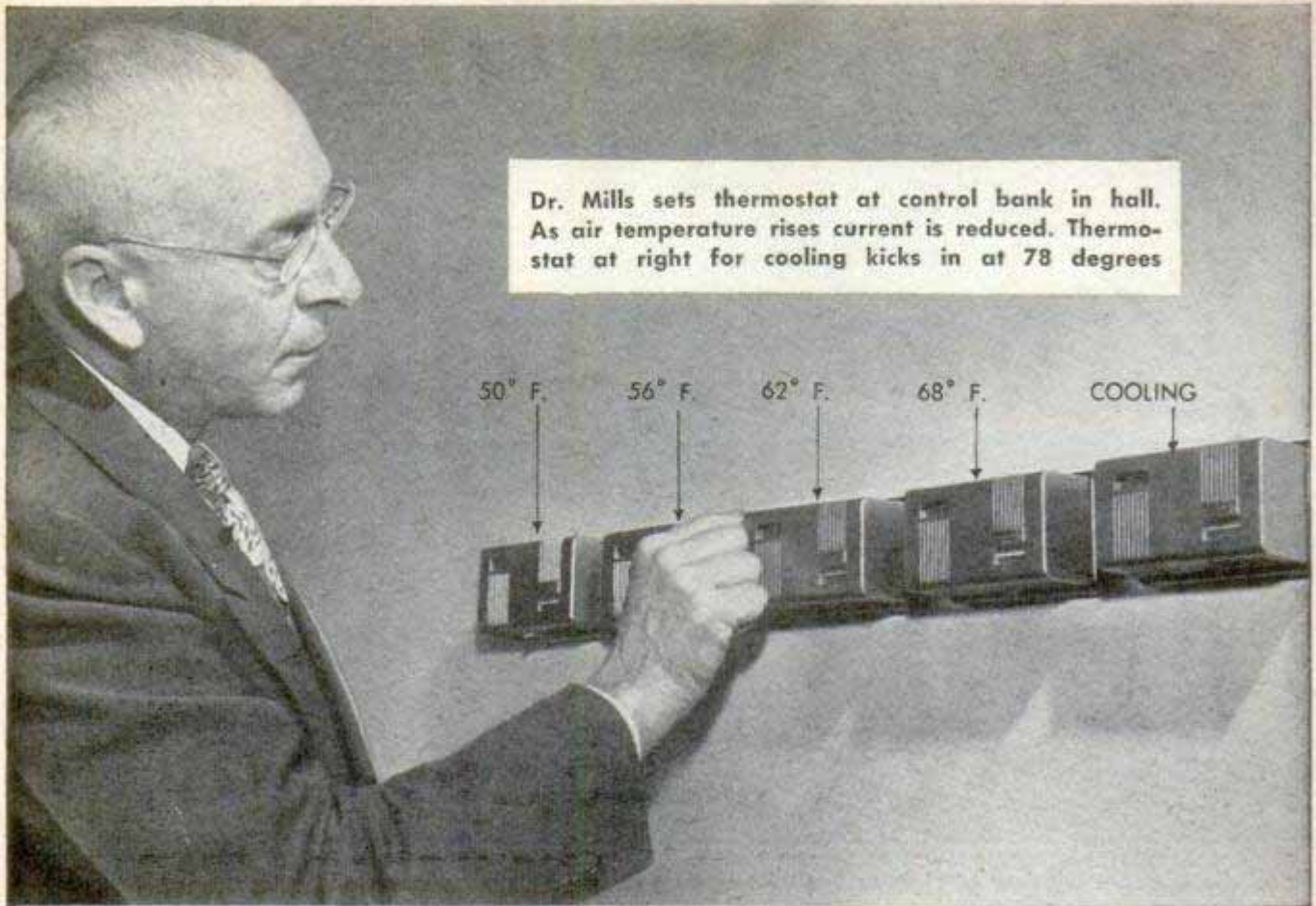

Dr. Mills sets thermostat at control bank in hall. As air temperature rises current is reduced. Thermostat at right for cooling kicks in at 78 degrees

paper was the answer. Doctor Mills discovered that one company made such a paper in attractive designs and colors for Christmas-package wrapping. And so, the handsome wallpaper in Reflection Point, which ranges in color from bronze, green and yellow to a neutral light gray, was originally made for wrapping gifts.

The house was designed and decorated by two other teachers at the University of Cincinnati, Robert A. Deshon of the department of architecture, and Robert J.

Lines show indirect or reflected path of all heat waves which start in cove and bounce off ceiling

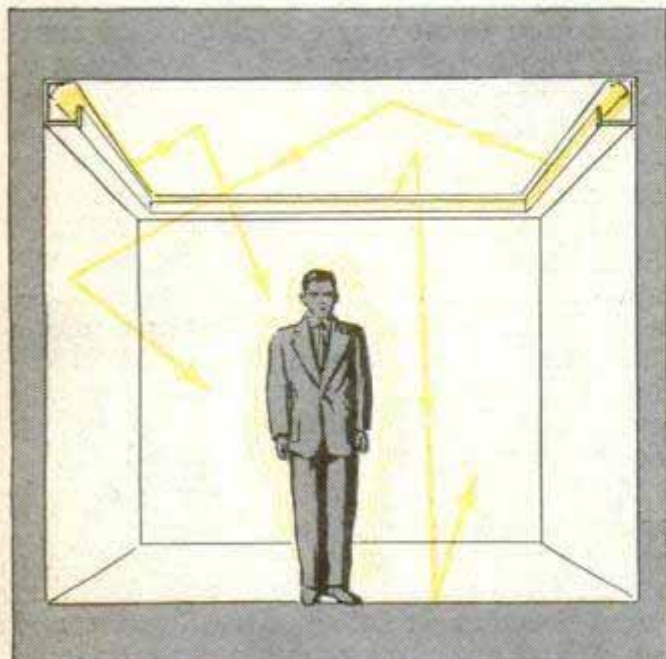

Stevens, decorations architect. Reflection Point is "conservative modern" with flat roof, wide picture windows and every inch of space utilized. There is a large living-dining room area, combined kitchen and utility room, two bedrooms, two baths, a study, and enclosed porch which adjoins the living room, entrance hall and long central hallway. The basement harbors a two-car garage and three rooms for storage and service equipment.

The ceiling of the central hallway is cov-

Bedroom rug is rolled back to show waffle-design rubber mat, aluminum foil and cork floor covering







Night scene taken from rear terrace shows the open arrangement of rooms and glowing foil-covered walls

ered with corrugated and perforated aluminum through which outside air is brought into the house via an electrostatic air filter in the basement. One thousand cubic feet of clean air a minute can be pumped into the house without perceptible draft. This air system serves for ventilation and for maintaining an outward air current through all cracks or any openings, such as a door or window. Incidentally, there are only five windows in the house that open. They were put in to satisfy some conventional members of the family, says the doctor, and not because they were necessary. Next time, all windows would be fixed plate glass.

The house sits on a reinforced-concrete slab and is of wood construction with vertical redwood siding. There is no insulation in the walls, ceiling or floor construction. The sidewalls consist merely of ½-inch Gypsum wallboard on the inside of the studding and a layer of plywood for rigidity and the redwood outside. The roof is made of 7 by 12-inch built-up beams, spaced every eight feet to carry the planking and surface roofing. The entire roof is covered with aluminum foil. The concrete slab is heavily reinforced over the basement areas but otherwise lies directly over gravel-covered rocky earth and contains no

insulating material. Heat loss downward is minimized by aluminum foil (facing upward) directly over the concrete. A waffle-design foam-rubber mat which gives point contacts is placed over the foil and finally nylon carpeting in the living room, dining room, den and one of the bedrooms.

(Continued to page 234)



"Accordion" doors of bedroom and hall closets are made of corrugated plastic resembling gray leather



# **Detroit Listening Post**

*By Siler Freeman*

**S**TUDEBAKER is on schedule to come out with its 1951 models. It is expected to go into production on the new cars early this month.

There will be few changes outwardly, mainly a face-lifting job with most of the differences being found in the grille and trim. Maintaining its pioneering in the so-called postwar design, present Studebaker styling is considered good enough to keep the South Bend firm in an enviable position in the automotive field. Use of its automatic transmission will be extended.

The new Nash, now in production, shows considerable styling revisions. It has new rear fenders and a different deck shape as well as a new grille. The exterior trim is also new and different.

The 1951 Nash Ambassador and Statesman lines went on display in September. Principal change from 1950 models is the elongated rear fenders which come with streamlined vertical fins. Tail and directional-signal lamps are moved from the trunk lid to the rear fenders. The airline-lounge type rear seat is retained in the club coupe. The Ambassador has a 115-horsepower engine with a compression ratio of 7.3 to 1. The Statesman uses an L-head, 85-horsepower engine with a 7 to 1 ratio.

The new Ford, due later in the year, will feature many engine and transmission refinements. It will also have improved shock absorbers. The new automatic transmission, with which the company has been concerned for some time, will show up in the 1951 cars.

The auto industry is still going heavily to new engines, despite the threat of allocations and war orders. Studebaker has one, an overhead-valve job that resembles the Cadillac's V-8. It will be given to the Commander and Land Cruiser for 1951. The engine has been tested and shows much of Cadillac's economy as well as power. It is slightly smaller however, having a cubic-inch displacement of about 280 against Cadillac's 331.

Lincoln-Mercury engineers have been driving around behind their new V-8, high-compression power plant, equipped with

the new automatic transmission. The combination is reported to be hard to beat on getaway and high-speed driving, as well as terrific power.

Kaiser-Frazer is also working on a new engine, or rather two engines. One is a six cylinder with a seven-bearing crankshaft and the other is a V-8 with a five-bearing crankshaft. Because of the long testing period plus the huge investment in an engine program, K-F is probably two years away from production of the new engines.

General Motors' new-model program was somewhat in the balance only a couple of months ago. Although the 1951 lines have been finalized, a big difference of opinion came up at one of the policy-committee meetings on how the corporation should go.

Several wanted to halt all preparations for new models this year, as well as 1952 and 1953 planning, until the government came to a decision on its defense program and its effect on the auto industry. But Harlow H. Curtice, executive vice-president, led the group which urged the corporation to keep on as usual until all-out war was in the offing. He won out so GM customers will have their new cars, a bit late perhaps but nevertheless as planned.

GM is already committed to its annual showing of new models at the Waldorf-Astoria in New York in January. What worries the top GM executives is the inroads the government may make on its engineers who are already packed to move into its new \$600,000,000 technical center in Centerline, Mich.

If anything, GM has planned a larger staff of research and lab experts when it finally completes its new center. The defense program's extent and needs will determine it, however. Fisher Body is taking over the research center's old quarters, behind the GM Building in Detroit.

Production, kept high since last February by the huge demand for new cars, will probably start sliding the other way this quarter. Changeovers by those companies which have not yet brought out new models for 1951 will keep output lower than for the past six months.

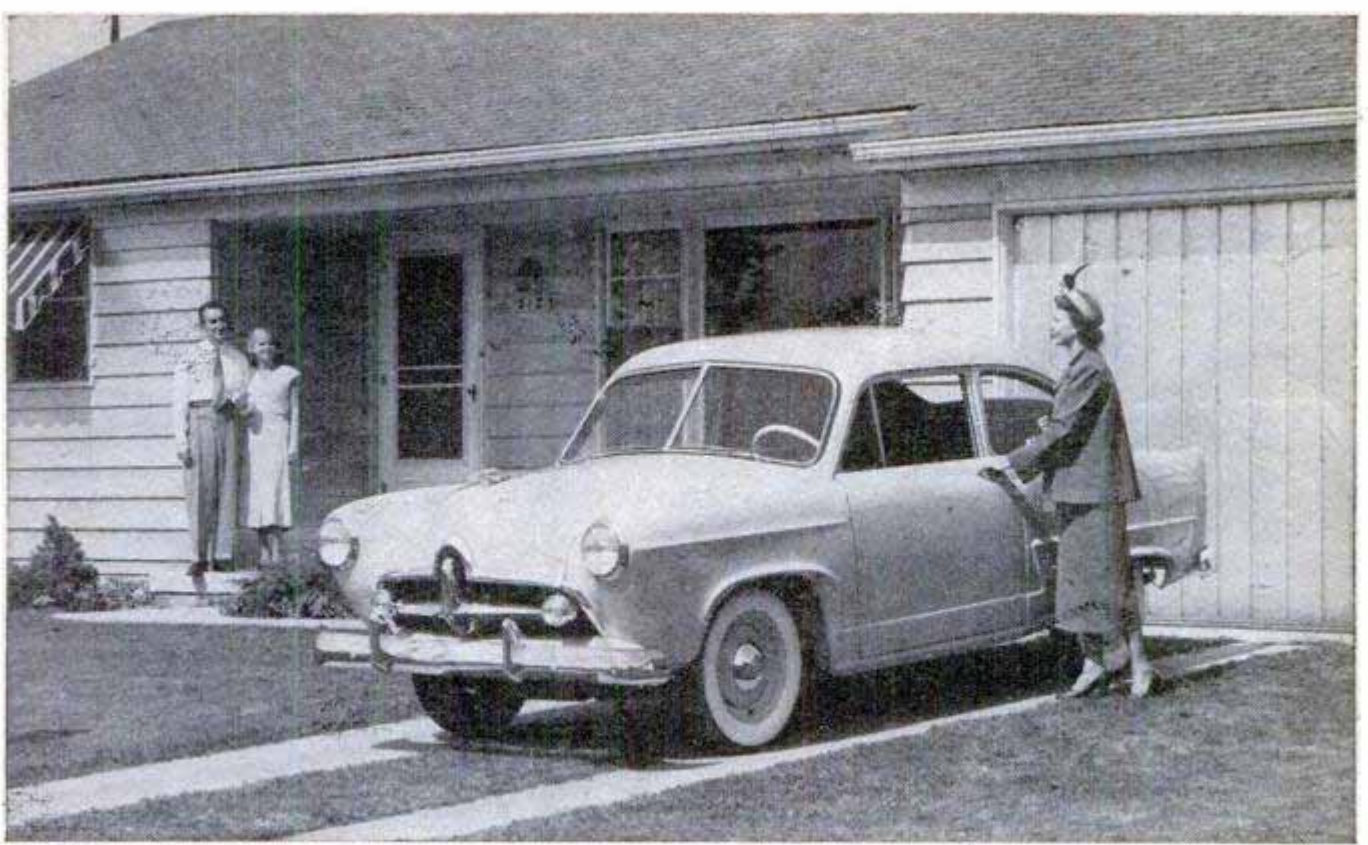

## Kaiser's Henry J

Coincident with the showing of the highly publicized Henry J, the Kaiser-Frazer Corp. has released specifications for the first time. The low-priced offering of the Willow Run company is being shown only in the six-cylinder models but the four will be put on the assembly line shortly. The six is rated at 80 horsepower, while the four is 68. Both are L-head high-compression types, made by Willys-Overland for K-F. The Henry J has an over-all length of 174½ inches. The tread is a standard 54-inch front and rear and its turning radius is 17½ feet. It is less than five feet high but has a road clearance of 7½ inches. Great power is claimed for the engine, as well as smooth operation through use of a counterbalanced crank-

shaft with a stroke of only 3½ inches. A ventilation system, which pipes clean air for the crankcase through the carburetor air filter and exhausts it through the manifolds, is another feature. The company tests have shown the car goes from zero to 50 miles an hour in 10 seconds, to 60 in 14 and 70 in less than 20 seconds. Gas mileage between 30 and 35 miles to the gallon is claimed. The car was put through grueling tests before being put on the market, according to company officials. Back-country roads of Arkansas, reputed to be the worst in the country, were selected for the tests, which ran up 5000 miles. A team of five specialists accompanied a production model to Jonesboro, Ark. Experts computed that each 100 miles on the twisting, tortuous terrain would equal 5000 miles of normal driving.



## Ranch-Plank Flooring

Plank flooring especially designed for ranch-style homes has a typically Western appearance. Walnut pegs are glued into the random-length planks at the factory. The oak flooring is laid in alternate strips, 2¼ and 3¼ inches wide. Prefinished with a penetrating seal, the planks can be nailed in place by the homeowner himself.

☐ Lubricating-oil stocks are shipped hot from Houston to New Orleans in a 240-foot barge heavily insulated to reduce heat loss.

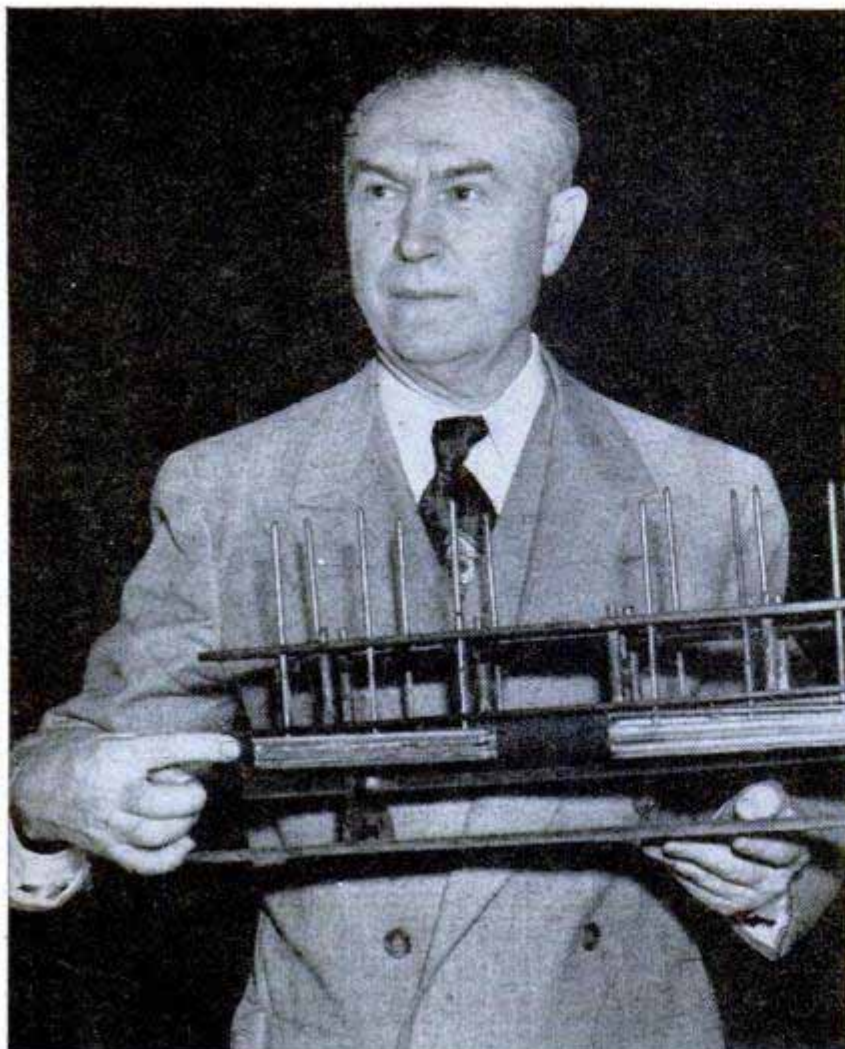

The author holds boat model made by Lincoln and points to bellowslike affair on side which could be filled with air by pumps to lift a boat off sand bar. Patent drawing below

# INVENTING— Hobby of Famous People

By Aubrey D. McFadyen

**J**AMES BRYANT CONANT, president of Harvard University, was a young man just out of college when he patented two of his pet ideas for manufacturing benzoic acid. With Stanley Pennock, all-American guard at Harvard, he ventured into production. The commercial practice of Conant's idea proved tricky and misfortune plagued the enterprise. Twice their plant was destroyed by fire. Pennock was killed in an explosion which started the second fire. Finally, Conant sold his patent rights and became a chemistry professor at Harvard.

Like Conant, nearly everybody, from presidents to prisoners, has been inventing. It excites little wonder when a noted pianist patents automobile parts, or when a world's champion pugilist patents a monkey wrench, or when a scion of one of the nation's wealthiest families patents a shoe-polishing device. The name of Albert Einstein is so much in the public

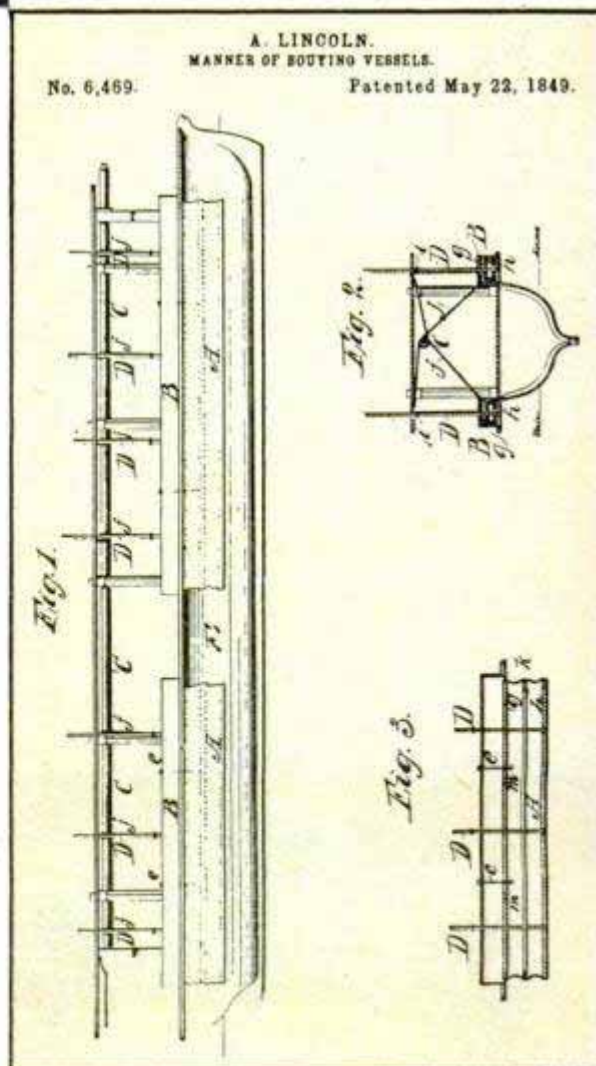

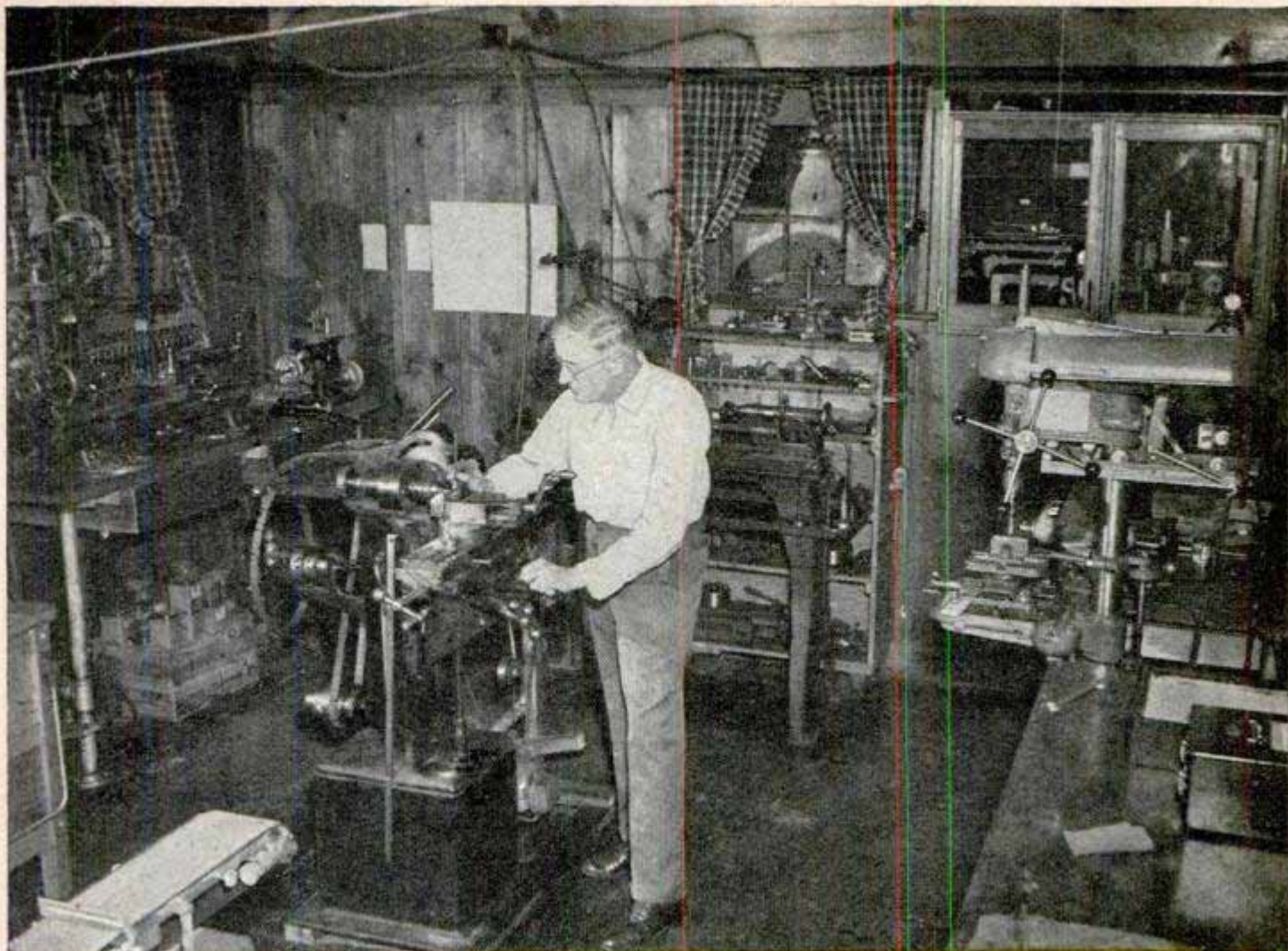

print in connection with atomic energy that his patenting a new refrigerator, or a novel camera structure goes unnoticed.

Of the 2,500,000 patents granted to date by the United States Patent Office, approximately a million of the inventors are alive today. Win or lose, not one of them is likely to deny that his fling at inventing was an exhilarating adventure. These inventors represent a true cross section of our population and include names few of the public will recognize as inventors.

Take Abraham Lincoln, for example. As a young man, working along the Mississippi and Ohio Rivers, Lincoln noticed that steamboats frequently became grounded on the shoals and flats. He designed a system of inflatable bellowslike gadgets for attachment to the hulls

Dr. Vannevar Bush, director of the Carnegie Institution, in his well-equipped workshop where he has turned out many inventions. Below is newest invention he has been instrumental in developing, an automatic typewriter which can photograph type to speed printing. The film is transferred directly to engraving plates, eliminating the need for casting each line in metal by Linotype

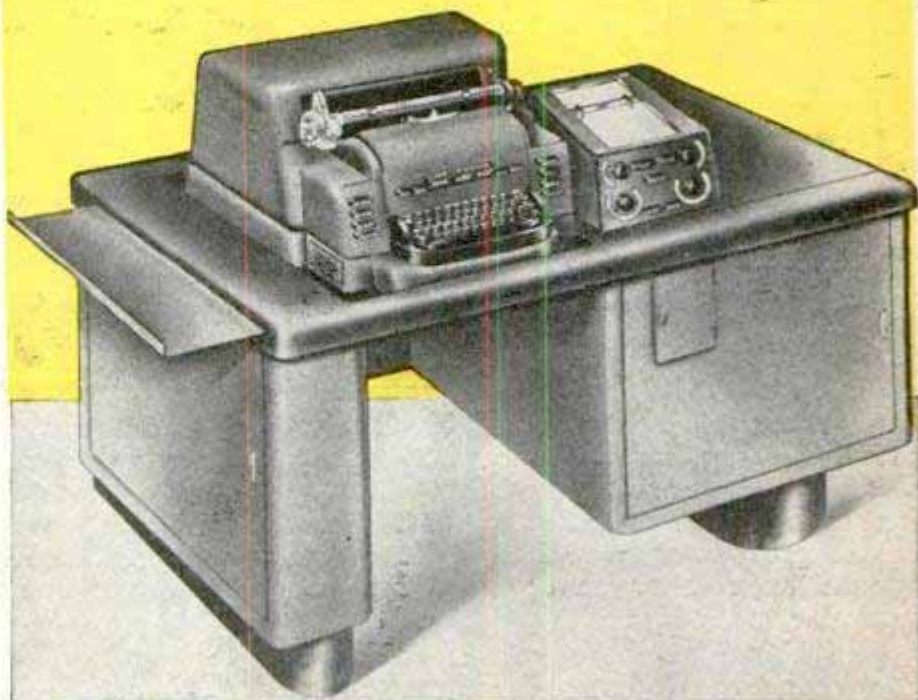



Josef Hofmann, the noted pianist, at left, with compressed-air shock absorber; right, his key-action device

of boats. In case a boat were grounded, or had to traverse shallow water, the bellows could be expanded to lessen the draft of the ship.

While Lincoln is the only one of our presidents who received a patent on an invention, others have made inventions. George Washington invented a wine coaster, a seeding plow and other farm devices, all of which are recorded in his diary. Thomas Jefferson originated, among other things, the folding buggy top, lap desk, modern plowshare, one-arm lunchroom chair, and swivel chair, the latter now in use all over the world.

Lincoln's trips up and down the Mississippi recall the patents of another famous character who used to be a steamboat pilot—Samuel L. Clemens, better known as Mark Twain. Clemens patented three inventions—an adjustable strap for gentlemen's vests, a game to assist in memorizing historical dates and a self-pasting scrapbook. In the scrapbook, blank pages were provided with spaced patches of dried glue. Clemens made money out of his scrapbook, which, he admitted, "was pretty good for a book that contained not a single word for criticism"; but he lost all the profits from the scrapbook and his accumulated fortune besides, on the inventions of another man. He staked his entire fortune on an invention of James W. Paige, of Rochester, N.Y., an oil prospector, who had an idea for a typesetting machine that promised to revolutionize the industry.

The Paige machine was designed for composing the individual characters and

justifying the lines to duplicate hand composition. After a decade of intense work—four years on the keyboard alone—the idea was ready for patent application and manufacture. In the Patent Office the Paige patent is still known as the "whale," because of the 176 sheets of mechanical drawings necessary to portray the invention, for the machine included more than 18,000 parts.

Just when the Paige enterprise seemed to be going to town, Otto Mergenthaler brought out his relatively simple and cheap Linotype, which, in addition to eliminating the handling of small pieces of type and returning the same to their cases after use, made a fresh cast each time. The Paige machine was so complicated and costly that it could not compete.

Though misfortune plagued Clemens and Paige in their development of a typesetting machine, another famous man recently achieved spectacular results in the same field. Dr. Vannevar Bush, wartime director of the Office of Scientific Research and Development, has announced a photo-typesetting machine which may make obsolete the process by which this page was printed. The machine, about the size of a desk, has an ordinary typewriter keyboard. When the operator presses a key the machine photographs a letter either on positive or negative film. The film is transferred directly to engraving plates for printing, thereby eliminating the need for casting each line in metal. An electronic "brain" justifies the lines as they are set. The material also is typed on a sheet of

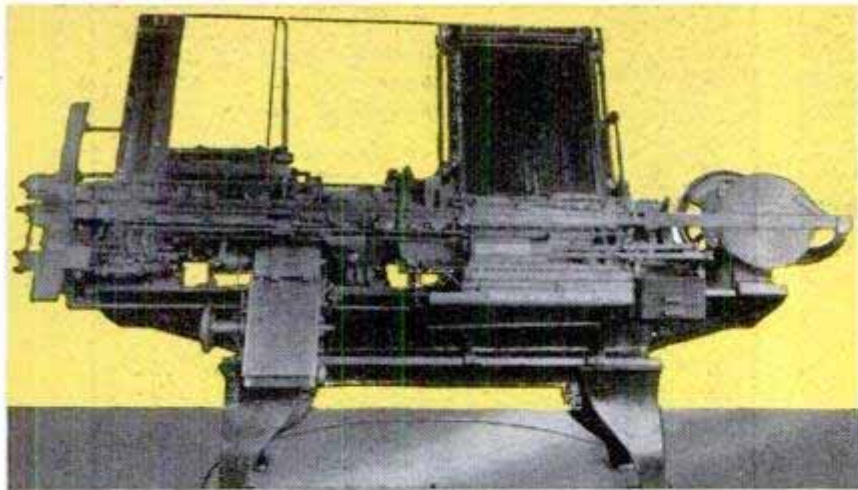

paper, enabling the operator to proofread his work as he proceeds. He can make corrections by pushing a button which "erases" erroneous letters and brings the machine into position to type the correct letter. The machine "sets type" four to five times faster than modern Linotype machines. It was developed by Doctor Bush, his associates at the Carnegie Institution of Washington, and two French telephone engineers who were doing independent work in the same field.

In general, inventions are the by-products of one's occupation and contacts. Thus, Bernarr MacFadden, of physical-culture fame, was granted a patent on a practice golf range. Walter Hagen, one-time champion of the fairways, patented a golf ball which, his patent states, is "accurate in flight as well as in putting and rolling." Glenn S. Warner, football coach, patented improved shoulder protectors for his players. Charles Brickley, famous Harvard drop kicker of 30 years ago, whom sports writers described as having an "educated" toe, wore a patented shoe which was his own invention.

Other sports celebrities who have patented inventions include René LaCoste, French tennis star; Eugen Sandow, once the "strong man" who patented apparatus for measuring his strength; and Max Carey, one-time star of the Pirates, who patented the special pad he wore to save his hide when sliding into a base. The Shibes—Benjamin, Thomas and John—names long synonymous with baseball in Philadelphia, hold more than two score patents on baseballs and apparatus for making them. Gertrude Ederle, who in 1926 gained renown as the first woman to swim the English Channel, holds design patents for a doll in a bathing suit, and goggles for swimmers.

Of the heavyweight-champion prize fighters, Bob Fitzsimmons and John Arthur "Jack" Johnson are listed as inventors. Fitzsimmons invented a punching-bag support and Johnson patented an automobile lock and a monkey wrench.

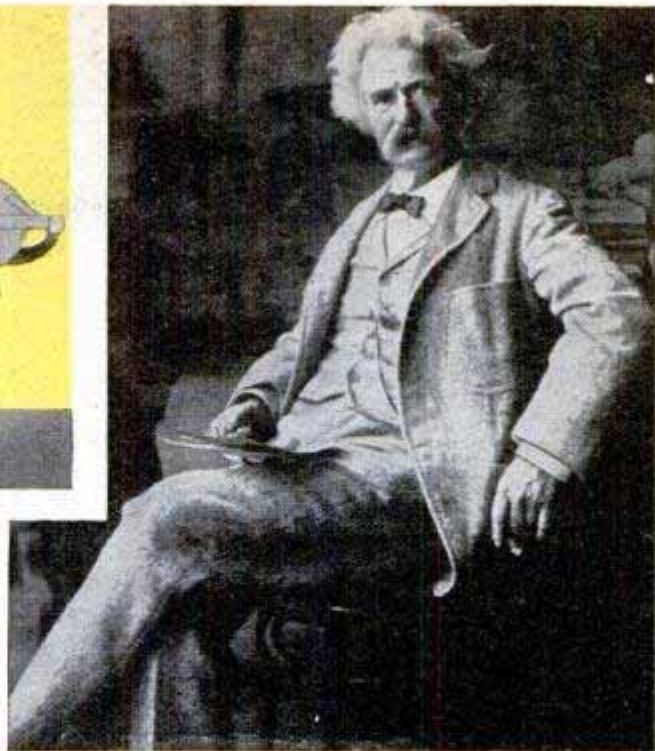

Mark Twain, author and inventor, lost a fortune on another man's brainchild—the Paige typesetter, at left above, which was extremely complicated and outmoded by Otto Mergenthaler's more practical Linotype



Gertrude Ederle invented a pair of goggles which she wore when she swam the English Channel. Below, Miss Penny Pendleton and her holder for spectacles



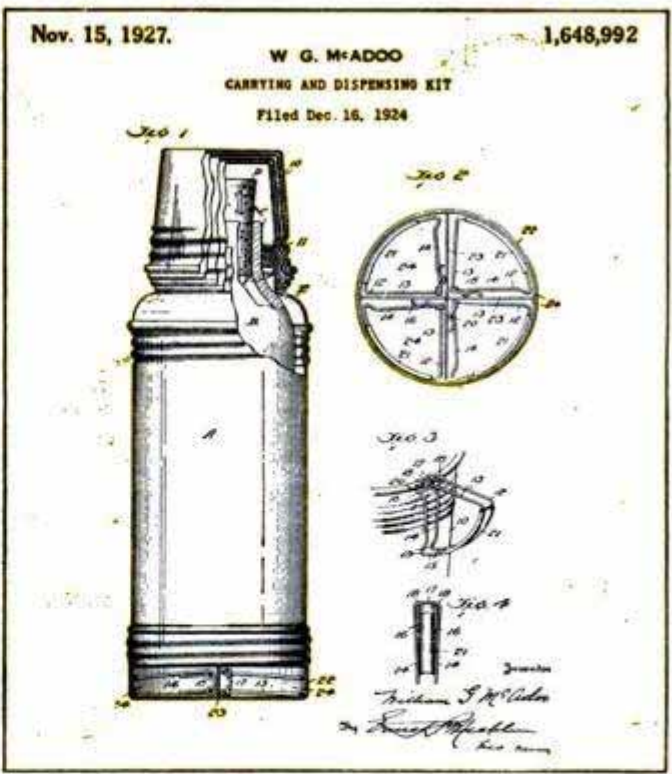

Left, the author holds lap desk invented by Thomas Jefferson. Right, William G. McAdoo's vacuum-flask cups

It is a long jump from Jack Johnson to the Astors, Vanderbilts and royalty, but all are in the same boat as amateur inventors. Col. John Jacob Astor, who went down with the Titanic, patented a road-cleaning machine operating on the principle of a vacuum cleaner.

Three of the four men to bear the name Cornelius Vanderbilt have made inventions. The present Cornelius Vanderbilt, the journalist, patented a shoe polisher in which a cloth unrolls from a penlike barrel. His father, Gen. Cornelius Vanderbilt, invented a locomotive firebox that was long standard equipment on railroads.

Lord Louis Mountbatten, who served Great Britain as Viceroy of India and is a British Navy officer, has patented several inventions pertaining to gunfire and ship control.

In the field of entertainment, dozens of patents were granted to the magicians, Harry Houdini and Howard Thurston. Oscar Hammerstein, theatrical magnate and opera impresario, patented some 30 inventions on cigar-making machines. Cigar-making was Hammerstein's first occupation and provided much of the fortune he invested in theatrical productions.

Edgar Bergen, radio and screen star, has taken out several design patents on doll heads invented by him. Charles Ray, movie idol of the early '20s, is found in the Patent Office index as a pioneer inventor of electrical automobile turn signals. In general, the movie colony has left the matter of improving their art to its skilled technicians. However, David W. Griffith was granted

five patents and the name of William Fox appears three times as a patentee. Jimmy Durante holds a trademark registration on his profile, with the word "schnozzle."

Col. Charles A. Lindbergh invented a navigation wrist watch, which permits direct reading of the hour angle, necessary in determining longitude. This instrument was used by the Lindberghs in their early intercontinental flights.

While Wiley Post and Harold Gatty were making their round-the-world flight, Gatty thought up a gadget by which he could determine, while in flight, the stratum offering most favorable tail winds.

When the patent law was broadened in 1930 to allow granting of patents on new plants and flowers, Harold Ickes, long-time Secretary of the Interior and flower fancier, was one of the first to apply. He was granted patent No. 19, covering a dahlia of coral-red color. Only one plant patent was issued to Luther Burbank, the noted horticulturist, and that posthumously.

Two members of Woodrow Wilson's cabinet also took out patents. Newton D. Baker, Secretary of War, patented a special brush for dusting shelves and books. William Gibbs McAdoo, Secretary of the Treasury and later senator from California, burned his hand on a hot Thermos-bottle cap and invented the familiar cap-and-cup arrangement. The second patent to McAdoo covered a safety razor in which new blades could be inserted without taking the razor apart. This invention set the present trend in safety razors.

Josef Hofmann, concert pianist, has taken





Harold Gatty invented a device for world-girdling Winnie Mae that told wind force at various levels

out a dozen or more patents, several for automobile steering mechanisms and stabilizers. Before coming to this country, he built one of the first steam-propelled cars.

The joint inventions of the sons of two famous musicians made possible present-day amateur color photography, both movies and prints. These men are: Leopold Godowski, Jr., son of the pianist-composer; and Leopold Damrosch Mannes, now successor to his father as director of the David Mannes School of Music in New York.

These inventors became acquainted during childhood. Both manifested an early interest in photography and in time they conceived the idea that color photography was possible by the use of multilayer coatings. They communicated their idea to the Eastman Kodak Company, and in turn were invited to join the Eastman staff in Rochester. Godowski and Mannes spent 10 years at the Eastman laboratories exploring their idea. While their first basic concept turned out not to be novel, they did develop the basic color sensitizers upon which Kodacolor and Kodachrome photography are based.

Jumping to the other extreme in music, we find that Borrah Minevitch, the harmonica king, has confined his inventions to his business, all his patents relating to harmonica construction.

It is not surprising to find patents to Ardé Bulova on watch improvements, nor to the late Henry Ford, who made and patented more than a hundred inventions. But it is surprising to find that the name of André Dubonnet, probably the most famous wine producer and merchant of France, appears six times in the Patent Office records as

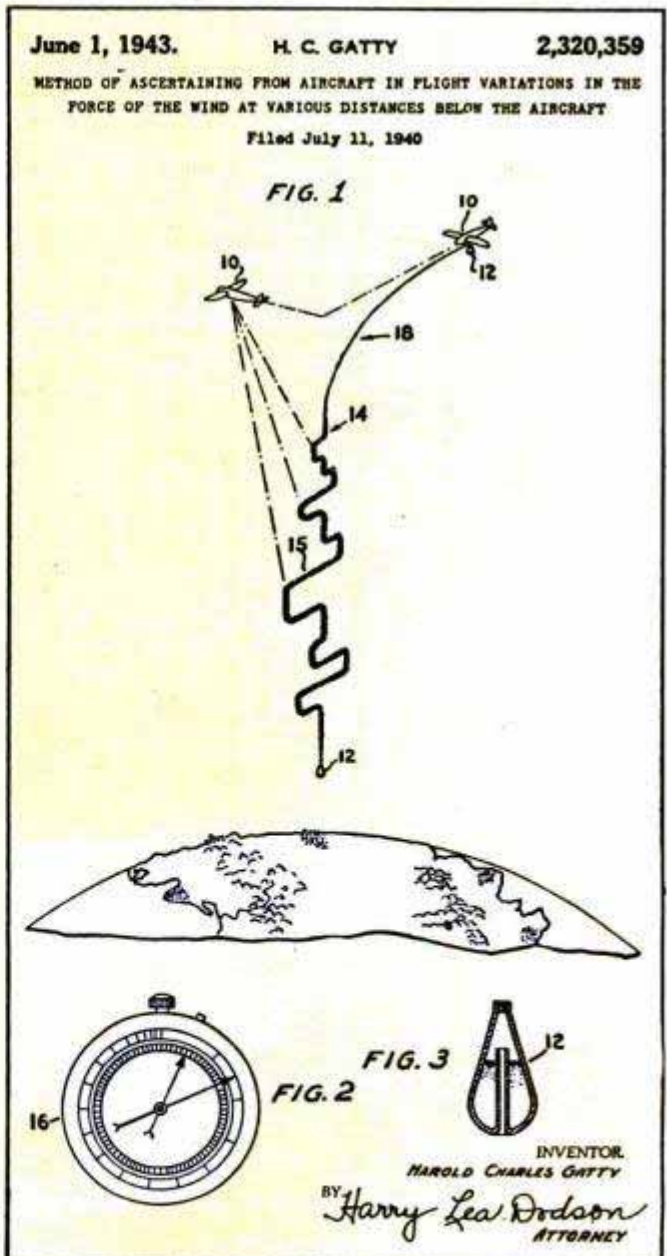

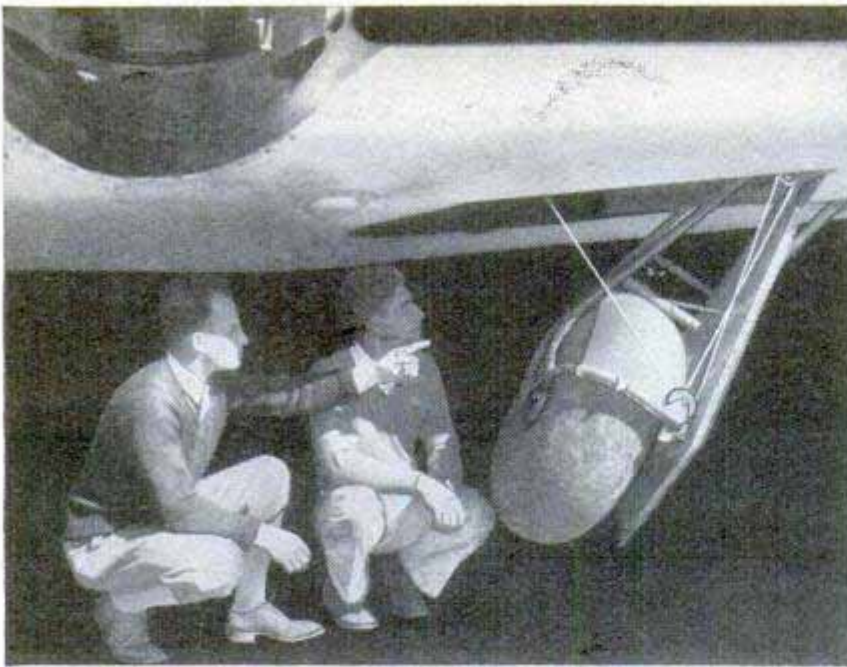

Disappearing landing gear of Sirius monoplane was invented by Col. Charles A. Lindbergh. Most of his ideas are given to public domain

inventor of various knee-action arrangements for automobiles. When knee-actions were introduced in 1935, Dubonnet began collecting royalties far exceeding the yield from his wine business.

Another executive who struck it rich with his invention is Sanford L. Cluett, president of the Cluett, Peabody Company, shirt manufacturers of Troy, N. Y. During manufacture, fabrics are stretched, and Cluett devised a process and apparatus for

crowding the fabric back together again, leaving small residual shrinkage. Today, Sanforizing is a commonly used process for preventing shrinkage of many fabrics.

While many celebrities have dabbled in inventing, with varying success, other persons have become celebrities by reason of making but a single invention. For instance, Samuel F. B. Morse and Robert Fulton were well-known portrait painters of their day, but now are known almost exclusively for their work on the telegraph and steamboat, respectively. Both Alexander Graham Bell and Eli Whitney probably would have remained obscure teachers save for their inventions. Charles

Goodyear was a physician; Eli H. Janney, inventor of the railway-car coupler, was a clerk; George M. Pullman, inventor of the sleeping car, was a street contractor; George Westinghouse, a 23-year-old carpenter-machinist, invented the modern air brake. The world has about forgotten that the Wright brothers operated a bicycle business in Dayton, Ohio. King C. Gillette, of safety-razor fame, was a hardware

(Continued to page 264)

Howard Thurston, the magician, held dozens of patents. He never told how he kept a man alive underwater



## Highway Tanker

It takes a crew of six to operate a giant French tank truck that has a capacity of more than 44,000 gallons. The crew includes a chief driver, front and rear drivers, a mechanic and two helpers who ride on outriggers at the rear to watch clearances on each side. Designed to cut petroleum-transportation costs, the 56-ton vehicle travels between Bordeaux and Le Havre.

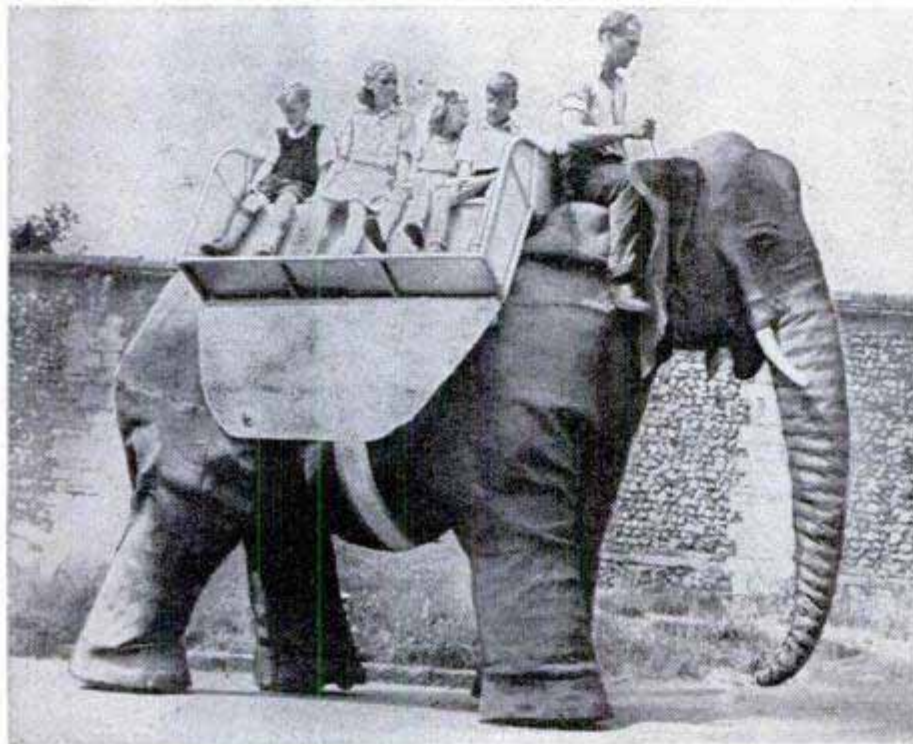

## Mechanical Elephant

Walking, waving its trunk and flapping its ears in a realistic fashion, a mechanical elephant may soon be popular at amusement centers because its "feed" bill is small. An attendant sits on the robot's neck, operating the controls. The 8½-foot model is powered by an 8-horsepower engine and has a ½-inch-thick "hide" of toughened paper. The exhaust pipe is hidden in the trunk. Made in England, the elephant contains 9000 parts and walks on a set of wheels concealed in the hollow feet. The elephant's leg "bones" are filled with compressed air to add a natural "spring" to the ride.

Above left, this elephant lives on a gasoline diet. It can step along at 27 miles an hour with its load of thrilled youngsters. Left, stripped of its tough skin, it looks like a plumber's nightmare

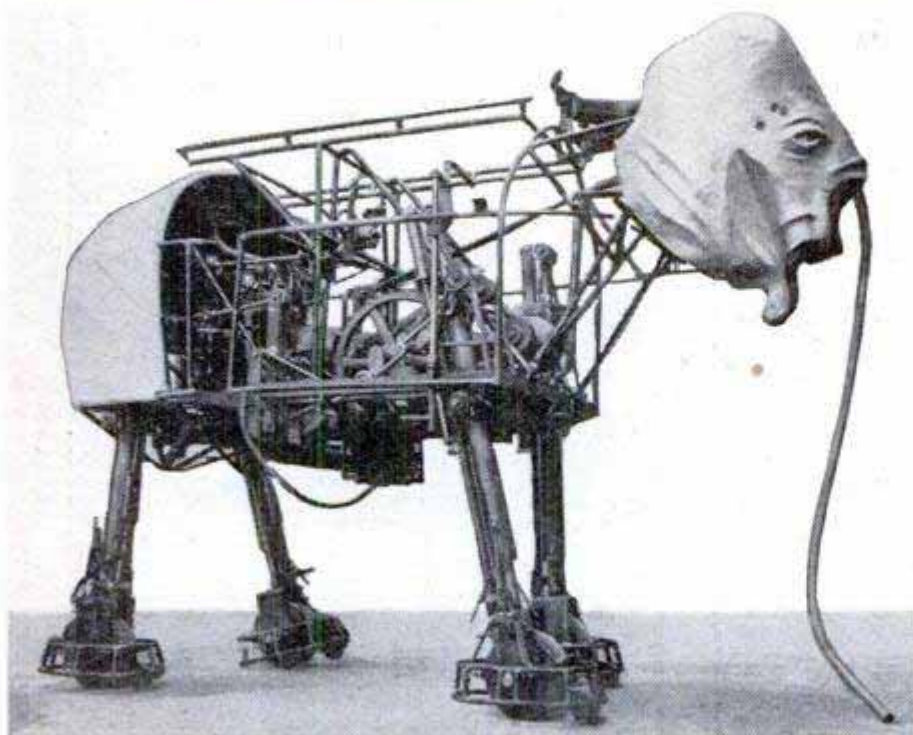

Sources of available products described in this issue are listed in the index, starting on page 10. Sources of further information on other articles are listed in the WHERE-TO-FIND-IT LIST, which is available to readers without charge from Bureau of Information, Popular Mechanics Magazine, 200 East Ontario Street, Chicago 11

# SUITCASE MUSEUM

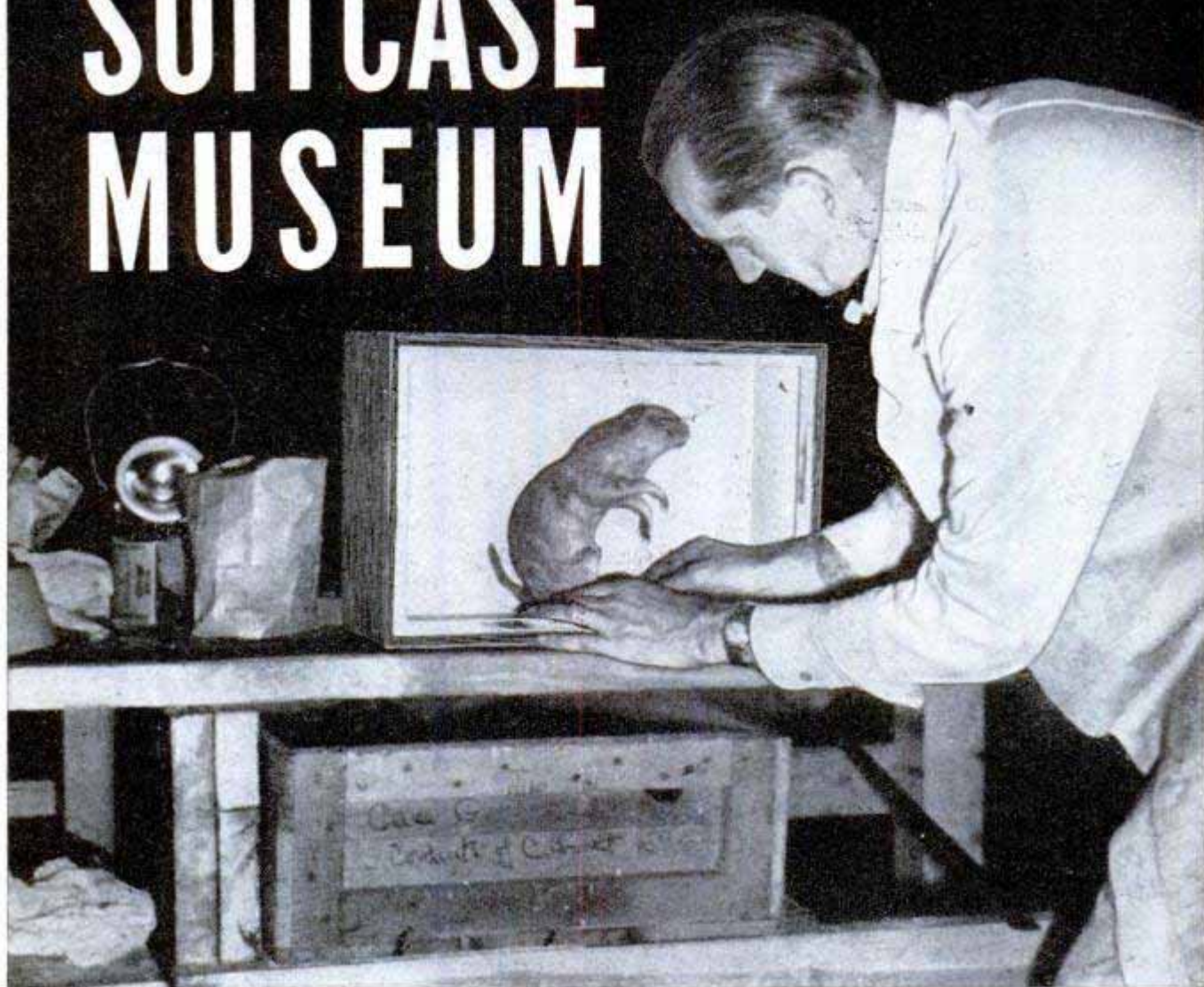

Staff member poses a lifelike muskrat in case. Background will be painted, then animal mounted permanently

Dury, who cooked up the suitcase-museum idea, tells a class how to tell mushroom from poisonous fungi



Worker puts finishing touches on a portable showcase which shows how the early Ohio mound builders lived

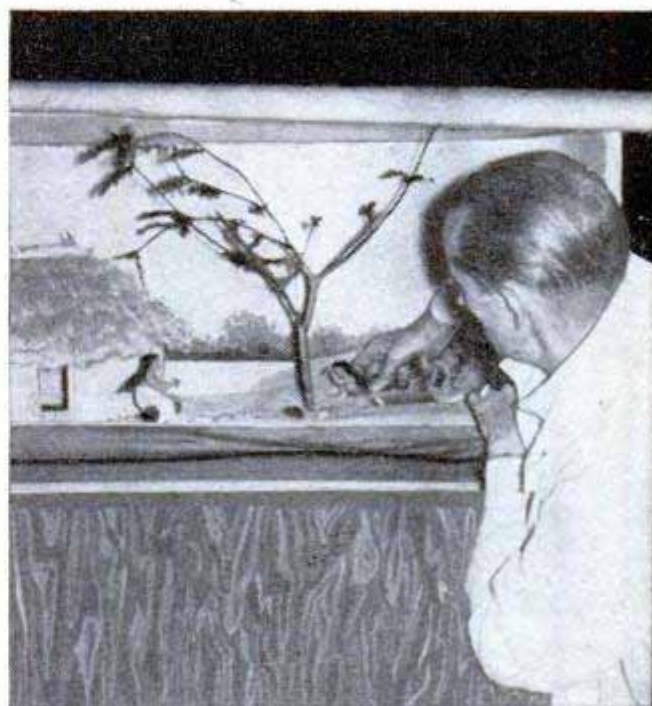

**I**N CINCINNATI they carry museums around in suitcases.

It isn't just a local peculiarity, but a novel idea for bringing educational exhibits to school children who otherwise might not have an opportunity to see them. Visual-education authorities across the country are enthusiastic about the plan. Furthermore, the head of the American Museum Association recently stated that very few museums in the United States are giving as much service per dollar spent as the Cincinnati Museum of Natural History, despite its cramped quarters.

Those cramped quarters originally inspired the plan. One day Ralph Dury, director of the museum, sat in his piano-box office and tried to unravel the problem of exhibiting a good deal of valuable nature material packed away in the basement because there was no room for it in the exhibit cases. The schools could make good use of the birds, insects, stones and shells if there were some way to show them off. That started him thinking about the suitcases.

His small staff went to work making cases of plywood fitted with handles and glass windows. Backgrounds were painted inside the boxes, and everything from fossils to feathers was mounted properly behind the glass. Within a few days the first suitcases went out to Cincinnati schools.

The response was immediate. Calls came in to the museum for the traveling exhibits so fast that a waiting list developed. In less than three months 60 of the portable museums were completed, and Dury says that eventually he'll have 500 of them making the rounds. The plan is to give every school child in the city a chance to study nature exhibits. In the first three months of its existence the suitcase museum brought natural history right up to the desks of 35,000 school children, who now know what a fossil is, can identify a good many birds and have seen with their own eyes a stone

Off goes another suitcase museum to a school. It's a better teaching aid than a textbook and a lot more fun for kids



ax and bone awl made by some primitive man before recorded history.

Dury points out that the success of the traveling museum is not in the cases but in their contents. The museum contains one of the most valuable shell collections in the country.

How do the kids like it? One of them recently wrote the director a letter which stated emphatically: "Dear Mr. Dury: You have taught us all about everything."



### "Atomic Robot" Locates Brain Tumor

Doctors can diagnose and locate brain tumors within a few minutes with the aid of an "atomic robot" which detects radioactivity. In the past such diagnosis often required hospitalization of the patient and incisions in the skull. In the new method, the patient is given an injection of a radioactive isotope. If tumor tissue is present, the "tracer" accumulates in it. Two arms of the instrument are placed against the skull and readings are taken in 32 places. Geiger counters detect radioactivity to indicate location of the tumor tissue.

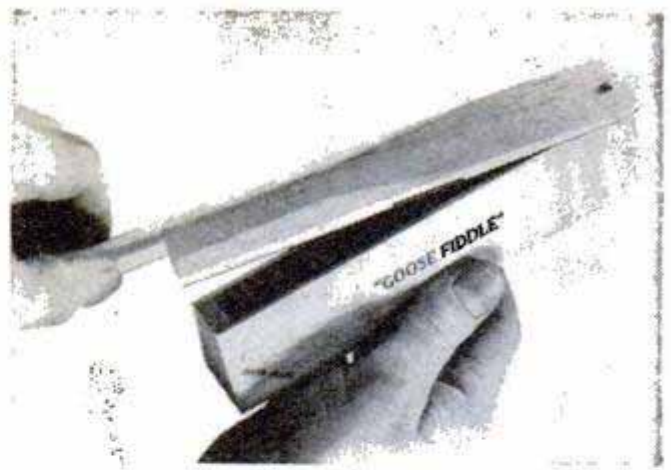

### Goose Caller

Realistic imitations of a goose call are made with a new device for hunters. Made of six kinds of woods selected to give accurate tones, it gives the call when the handle is rubbed across the sound box.

### Year A.D. 2000— Plenty of Oil and Plenty of Uses

Despite gloomy predictions that our oil reserves will soon be exhausted, Dr. Gustav Egloff of the Universal Oil Products Company believes that in the year 2000 we will be refining 16,000,000 barrels of petroleum daily. The present rate of production is 6,000,000 barrels per day. Furthermore, he believes natural gas production in 50 years will be 21,000 billion cubic feet per year compared with the present 6,000 billion cubic feet. Today, about 12 billion pounds of chemicals are made from petroleum each year; Doctor Egloff says in the year 2000 the production will have quadrupled. He predicts that most of our clothing in the next half century will be made basically from petroleum.

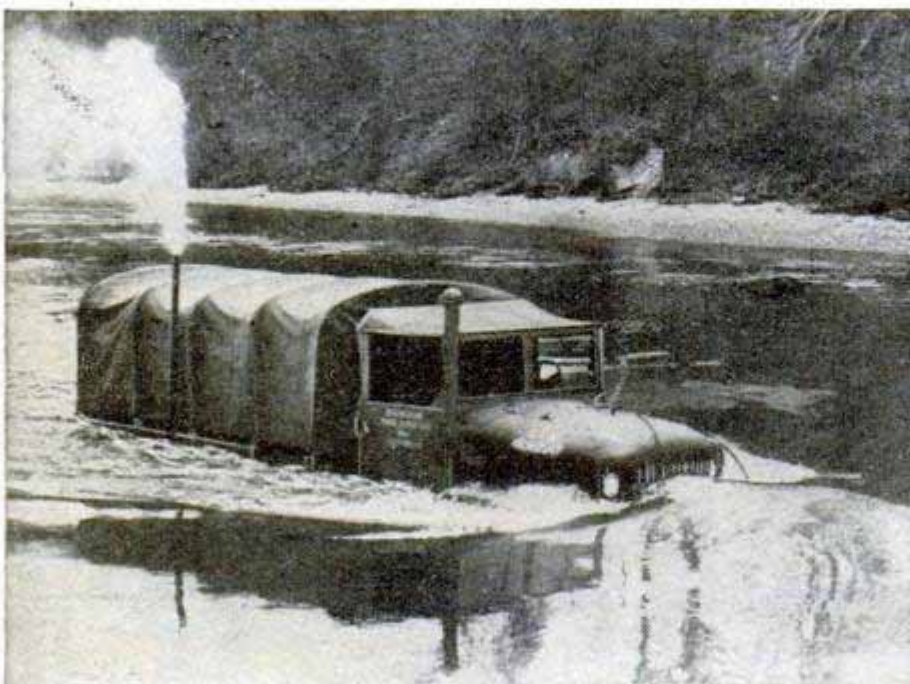

### Underwater Truck

Swimming may soon be a requirement for Army truck drivers and mechanics. In addition to operating in subzero cold and blistering heat, the new "Eager Beaver" 1½-ton truck travels underwater. All the driver has to worry about is keeping his head above the surface, one foot on the accelerator and his hands on the wheel. A "schnorkel" extension pipe brings air to the submerged engine and the exhaust is emptied out a similar "snorter" tube.

## Doors Shield Jets From Blowing Dirt

To keep dust out of the jet engines when the plane is on the ground, "doors" are being put across the air intakes of the B-36's four units. The doors are operated by an actuator switch in the pilot's compartment when the jets are to be started. They are also kept closed in flight to reduce drag when the plane is relying entirely on its six piston engines for power. Largest bomber in the world, the B-36 has a range of over 10,000 miles and is also being used extensively by the U. S. Air Force for long-range reconnaissance missions.

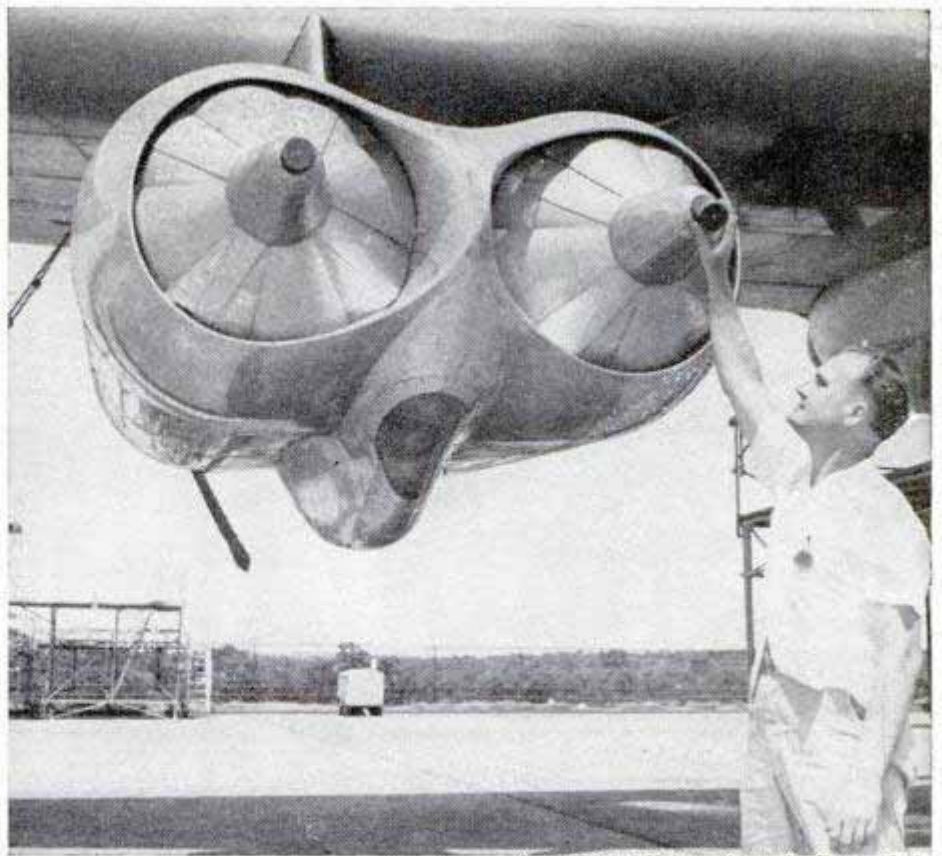

Consolidated-Vultee Aircraft Corp. photo

## Insulating Building Panel

Providing more insulation than a 16-inch concrete wall, a new laminated building panel less than two inches thick can be used for either exterior or interior walls. The core of the panel is a calcium-silicate insulating material which is faced with cement-asbestos boards. Each panel, 4 by 8 feet, weighs 200 pounds and will withstand an hour's exposure to fire.

## Rust Remover Protects Engine

By pulverizing and trapping rust particles suspended in the water of a car's cooling system, a rust remover protects the radiator and prevents overheating due to poor circulation. No chemicals are used in the trap; the swirling path of the water as it passes through a screen pulverizes the particles which are trapped by a series of baffles.

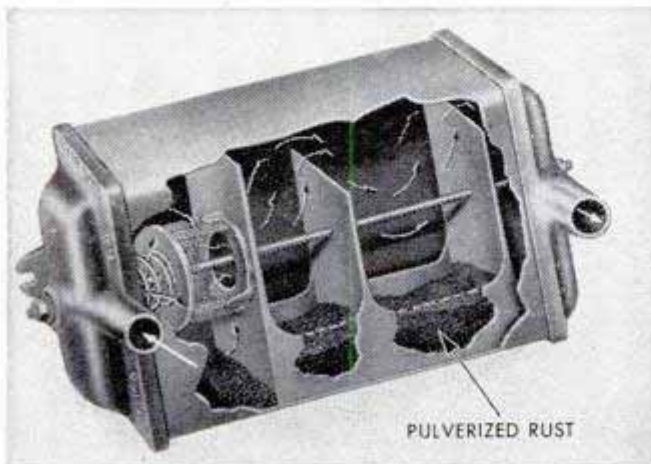

## Gas Can Has Flow Control

Simply by pressing a button on the top of the can, you control the flow of gasoline from a fuel container that eliminates spillage. Available in several sizes, the container is designed to solve the pouring problem on outboard motors, power mowers and other small gasoline engines. The flexible hose is attached to a reversible screw cap and is stored inside the can when not in use. The push button regulates the flow of air into the can, controlling 99 percent of the flow.

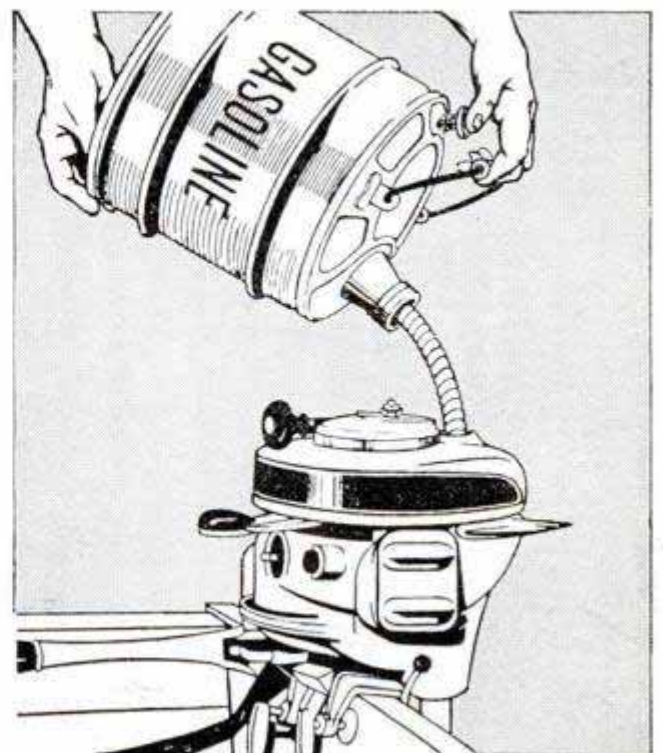

# SWORDS

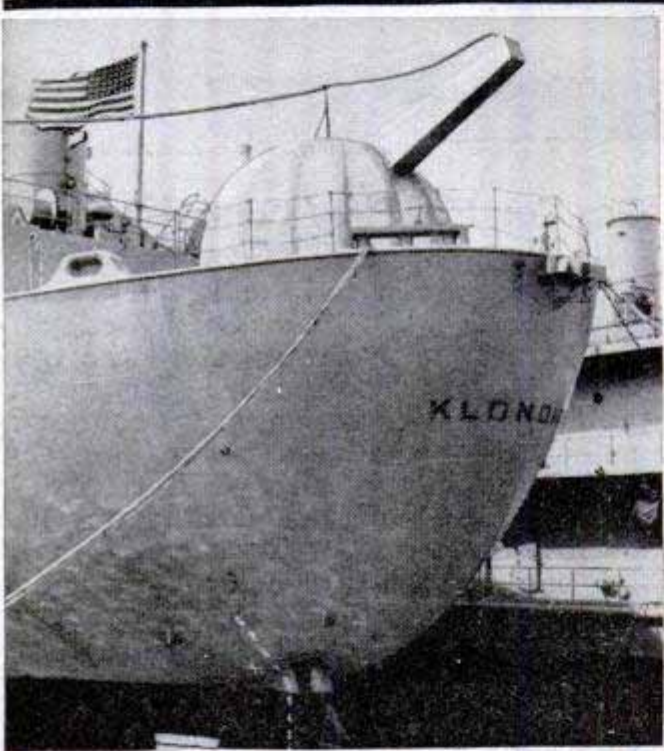
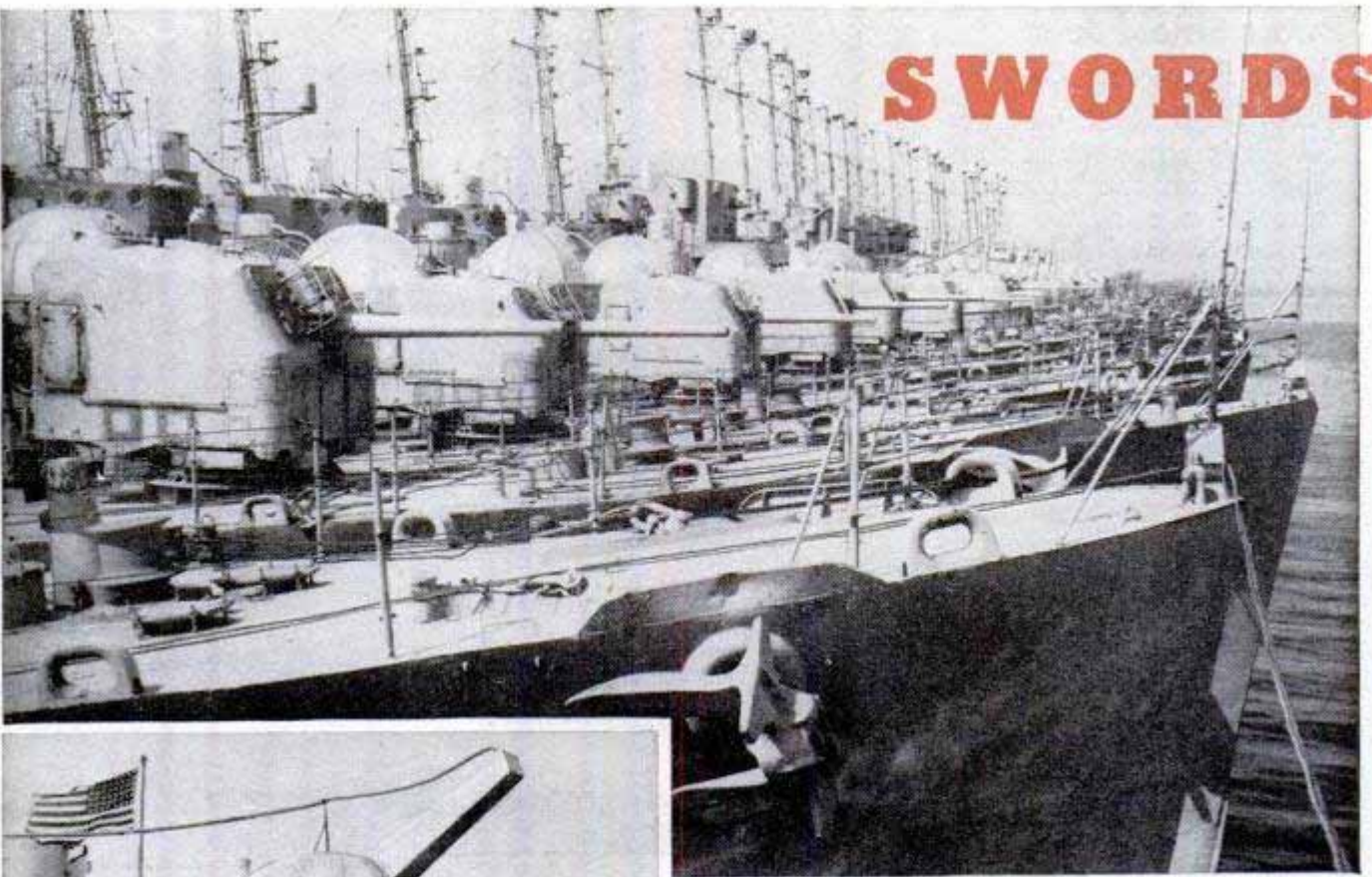

Line of escort vessels awaits resurrection from the "moth ball" fleet. Deck gear is protected with "liquid envelopes" and compartments are sealed and kept dry

← Igloo over the stern gun of a naval auxiliary is sealed to the deck and fitted with a pipe through which dry air flows to prevent formation of rust

Below, sailors peel the protective covering off the flight deck of an escort carrier. Close examination showed that the deck was still in perfect condition

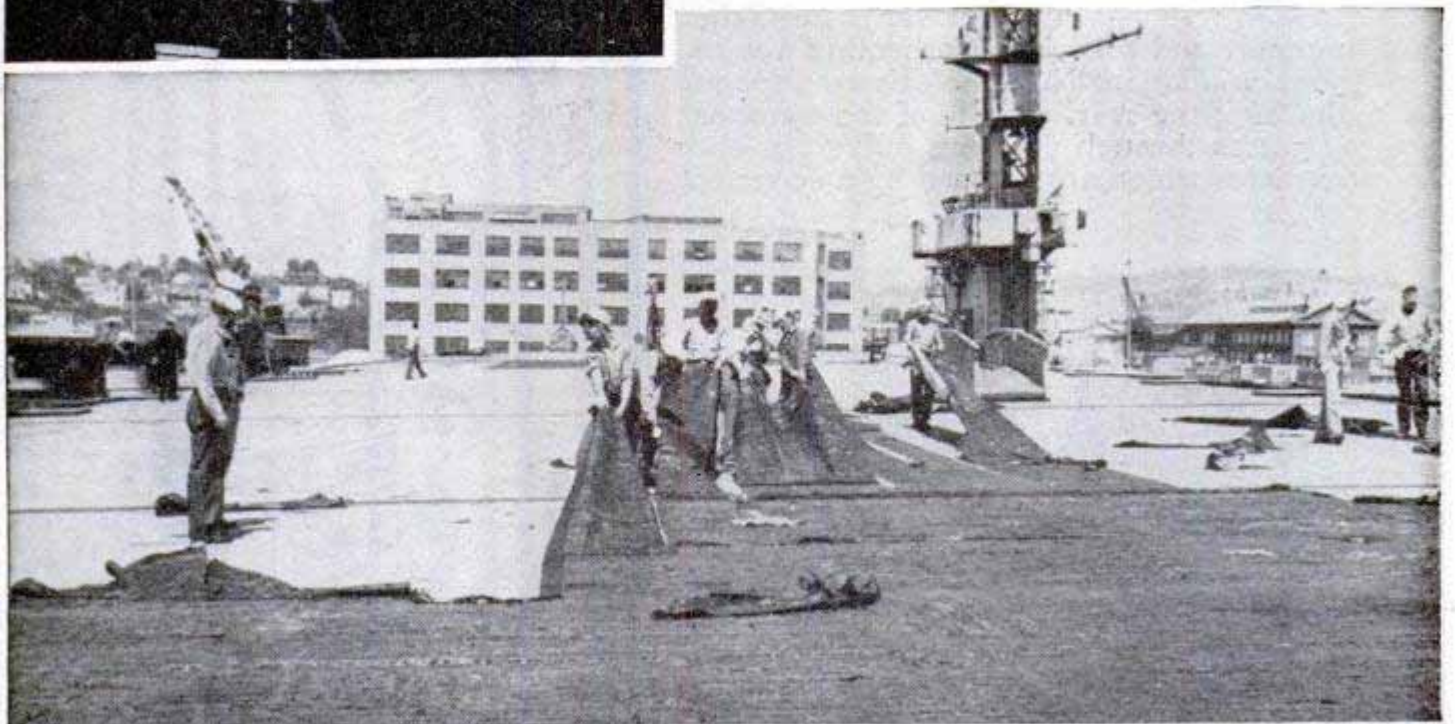



# WITHOUT RUST



**I**NSTEAD OF beating his sword into a plowshare after the last war, Uncle Sam wisely laid it away for future use. It was a farsighted move, for now he is reaching into the cupboard and there is his sword, ready for action. Translated into battle lingo, this means that thousands of tanks and guns, ships and aircraft are being unwrapped for use again. When workmen began unwrapping planes and ships, after being stored about four years, they found Uncle Sam's sword in fine condition.

"Canned" plane is exposed to the air once more after several years of storage inside an airtight steel box

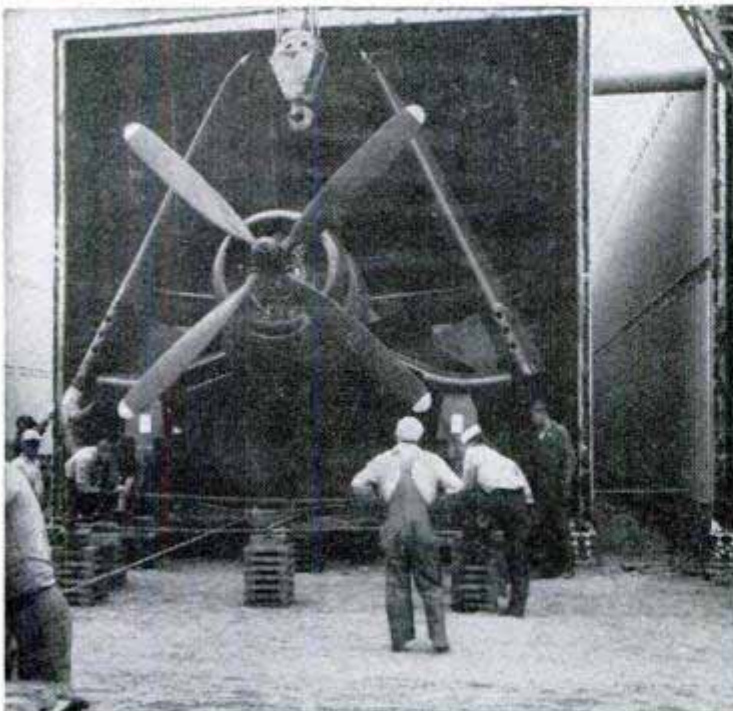

Once these warbirds haunted Tokyo and Berlin. Then they hibernated for a time on acres of desert. Now they are coming to life once more to arm Uncle Sam

Thoroughly tested and refitted for service, a plane is hoisted aboard a waiting carrier for sea duty again





U. S. Air Force photos

**Plastic-coated plane is towed along a desert road to the Tucson airport where it will be unwrapped and test-flown**

**← First step in taking the big "butterfly" out of its cocoon is to tear the sprayed-on coating off the propeller hubs**

**Chemicals loosen the rubberlike coating from the skin of the aircraft. Cocoon material then is ripped off by hand**



A veteran of the Pacific war, with a record of 36 bombing strikes painted on its fuselage, emerges from its desert cocoon

Below, metal igloo that had been welded to ship deck around an anti-aircraft gun is raised after weld was broken

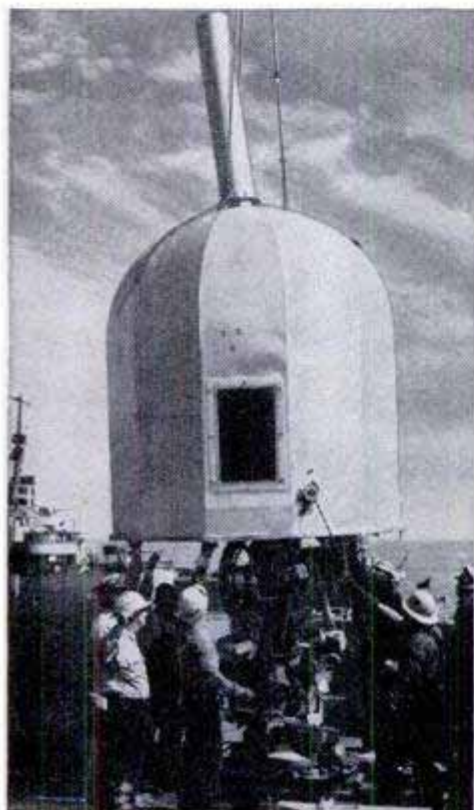

Hundreds of millions of dollars worth of equipment—everything from radar instruments to automatic weapons—is being withdrawn from storage under the terms of the MDAP, the Mutual Defense Assistance Program, under which the United States is arming other nations. And now Uncle Sam is reaching into his arsenal himself. Aircraft are being flown to active duty from one to three days after they are taken from desert storage. Ships are readied for a cruise 45 days after sailors begin peeling away deck coatings. Most of the planes have been sprayed with a plastic coating and stored on the desert or have actually been “canned” inside hermetically sealed steel boxes. Ships were sealed and their interiors kept dry by machines that constantly pumped dry air through them.

Deck gear is covered with oil and oxide paint. Here a sandblaster removes the paint from deck stanchion

Two sailors rip the plastic sheeting from a piece of deck gear. Ship can be ready for sea in 45 days

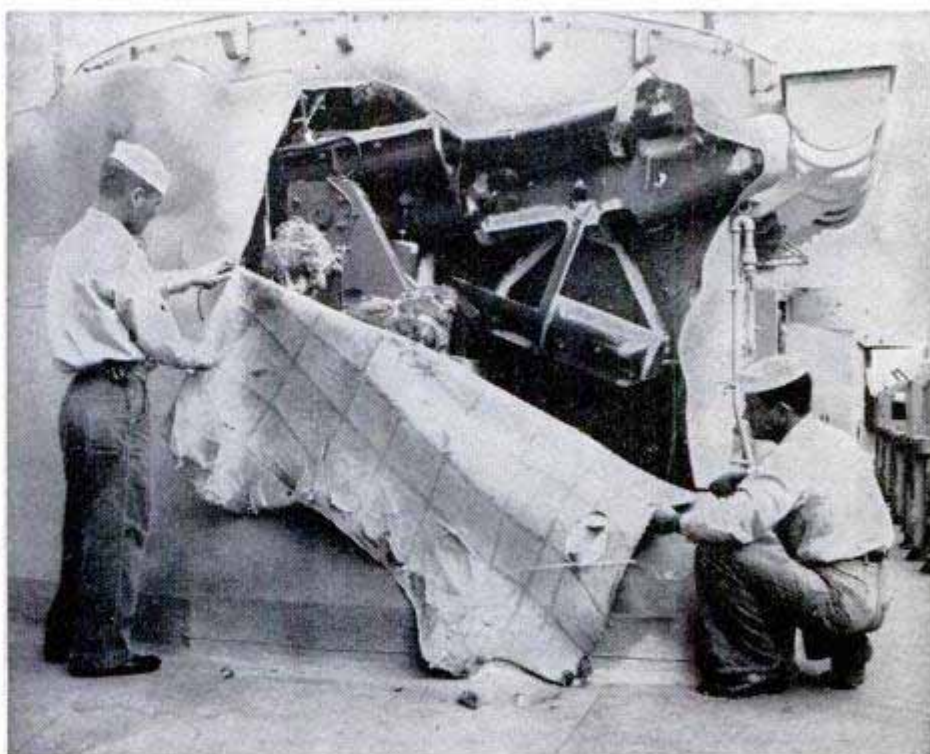

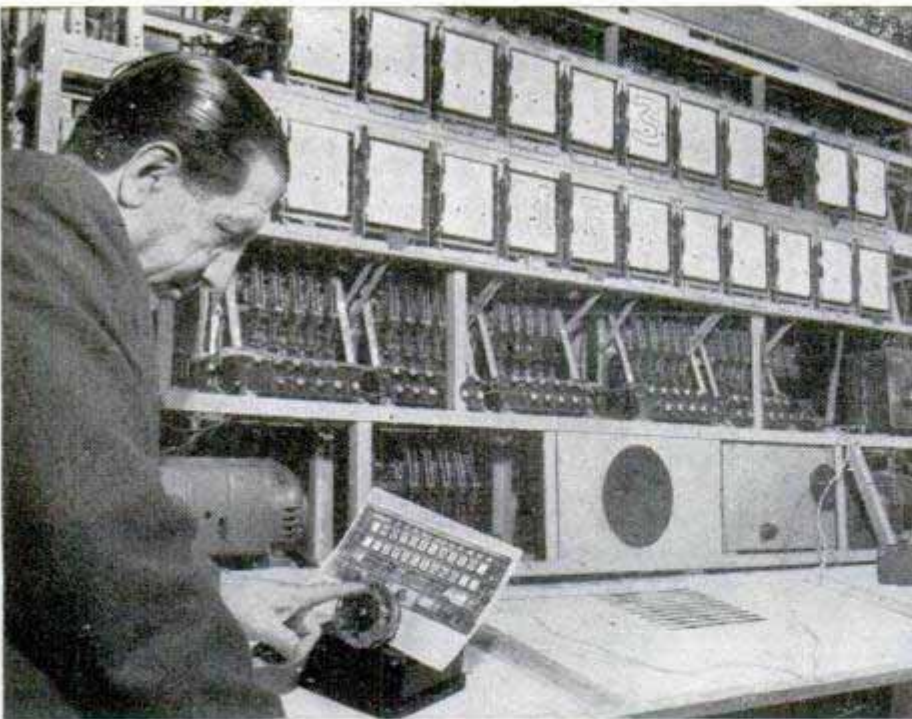

## Dial-A-Sign

Something new in signs has been invented by an Italian radio engineer who can "write" any message simply by dialing a series of impulses on a standard telephone dial. This remote-control system will make it possible to write messages simultaneously on display signs scattered all over the country from a central dial station. The letters of the alphabet are printed on paper rolls and the dialed impulses cause the rolls of paper to rotate until the correct letter appears on the face.

## Adjustable Overload Springs Protect Autos and Trucks

Protection against overloading of automobiles or light trucks is provided with adjustable overload springs designed in two models, for cars with either coil or underslung rear springs. The springs do not change the riding characteristics of a car under normal loads and support the standard car springs only when a vehicle is overloaded. By simply loosening or tightening four nuts, the springs can be adjusted for different loads or to counteract spring sag due to constant flexing. Overload springs for coil-spring suspension are of the cantilever type and are mounted at the rear end of the frame behind the differential. The over-

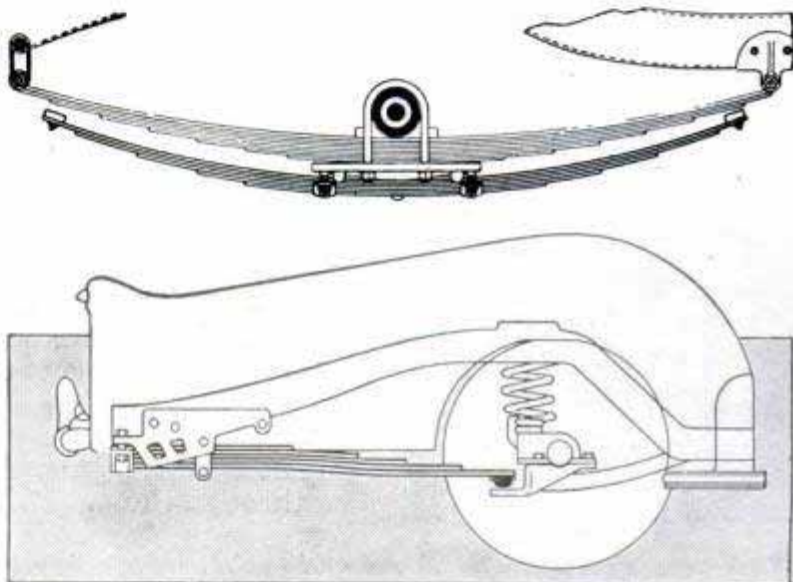

load unit for leaf springs is mounted beneath the regular spring and can be put on or taken off in a few minutes.



## Double-Folding Wings

Double-folding wings that reduce their width to 19½ feet ease the shipboard storage problem for Britain's big Fairey 17s. The twin-turbine submarine hunters have a wingspan of over 54 feet.

## Washington's "Diggings"

Washington, D. C., may become a mining town now that rich deposits of the vital war material, germanium, have been discovered in the Capitol's parks. Germanium is a semiconductor, essential in the manufacture of radio and other electronic devices.

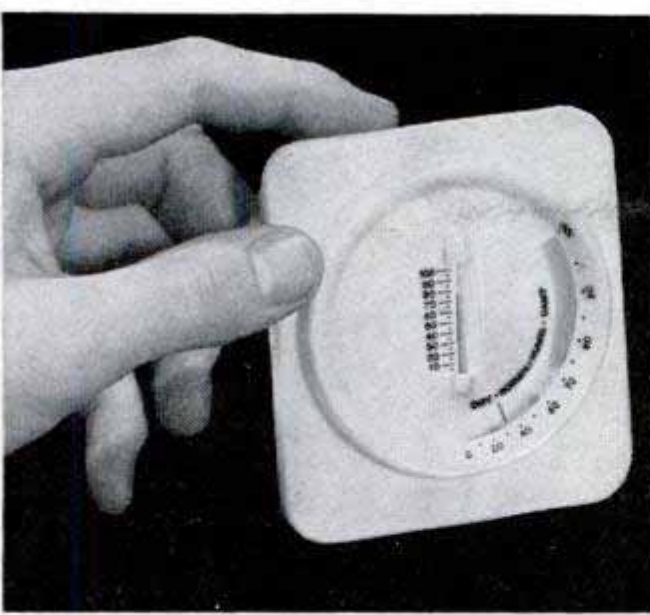

### Moisture-Sensitive Plastic Measures Humidity in the Air

Homeowners, who are anxious to maintain the proper humidity inside their houses for comfort and health, will be aided by a new hygrometer or humidity-measuring device which uses a moisture-sensitive plastic pointer. The pointer consists of two plastic strips that are bonded together. One strip is not affected by moisture and the other is. Changes in the moisture content of the air cause the needle to bend, showing the relative-humidity reading on a scale. Also incorporated in the device is a small thermometer.



### Rain Repellent

Heavy rains that normally obscure and distort a pilot's vision are harmlessly shed from aircraft windshields sprayed with a new wax repellent. Developed by Dr. D. F. Stedman of the National Research Council of Canada, it forms a film that does not become wet. In flight tests through storms there was less than 300 feet of visibility through the untreated portion of the windshield and three to five miles through the treated section.

### Gearshift Shoes For Hill Climbing

Doctors are studying a French invention that makes it easier for invalids to walk up and down hills. The invention is a pair of shoes, worn like snowshoes, which provides a horizontal platform for the feet despite the slope of the ground. When the wearer is descending a hill, the toe is elevated. When walking uphill, the heel elevates to maintain the level platform.

☐ America's sweet tooth certainly will be satisfied this year since the amount of sugar available will average about 110 pounds per person, a larger supply than we have had in any other year in history.



# "VEST POCKET" STEEL MILL

IMAGINE a steel mill—with complete equipment from furnace to rolling mill—so small the works would fit into one open hearth with plenty of room to spare. Such a mill is in full production today, turning out new metals and alloys at the Westinghouse Research Laboratories. Daily production isn't measured in thousands of tons, but in miniature ingots and test pieces weighing less than 25 pounds. The purpose of the little mill is to find new alloys for industrial and military use—metals with exactly the right degree of hardness or ductility, better electrical conductivity or the ability to withstand extremely high temperatures. Technicians "cook" each experimental batch in an electric furnace not much larger than a Thermos jug. Each new test metal is checked in a "torture chamber" where torsion machines twist it until it breaks and other instruments subject it to hardness, heat and fatigue tests. The "Tom Thumb" mill may produce new alloys which will make possible more powerful jet engines and gas turbines.

New ingot is suddenly plunged into an oil quenching bath to cool the metal without destroying its ductility

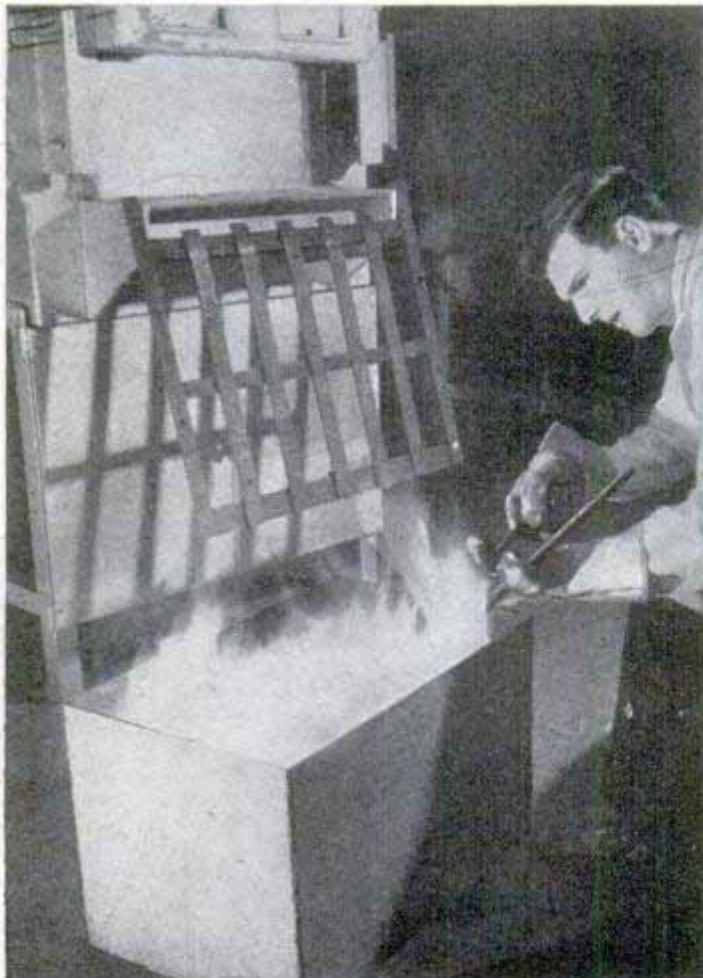

Metallurgist weighs out ingredients of a new alloy with the precision of a chef mixing a special dish

Next the ingot is rolled out in a miniature mill. Variety of rolls produces bars of different sizes

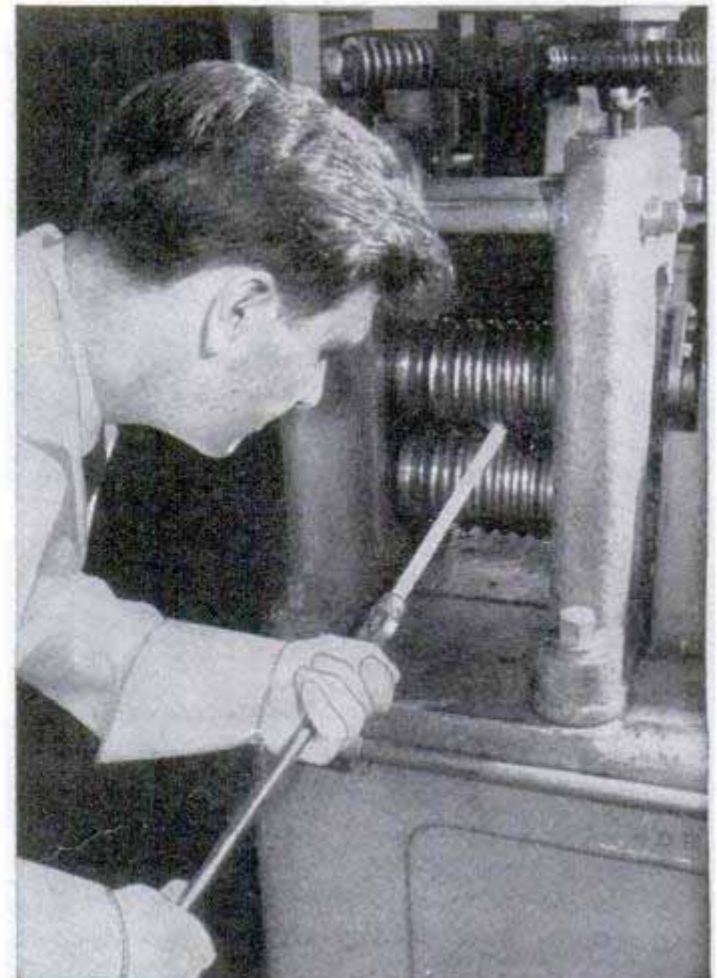



**Will this new alloy have the needed characteristics? Molten metal is poured into a casting mold**

**Test piece is removed from an oven in which it has been "aged" to increase hardness of the metal**



**White-hot ingot is lifted from the mold. Entire process from mixing to final casting takes less than an hour**

**Grain-size comparator shows the nature of a new alloy by comparing its grain with standard grain structure**

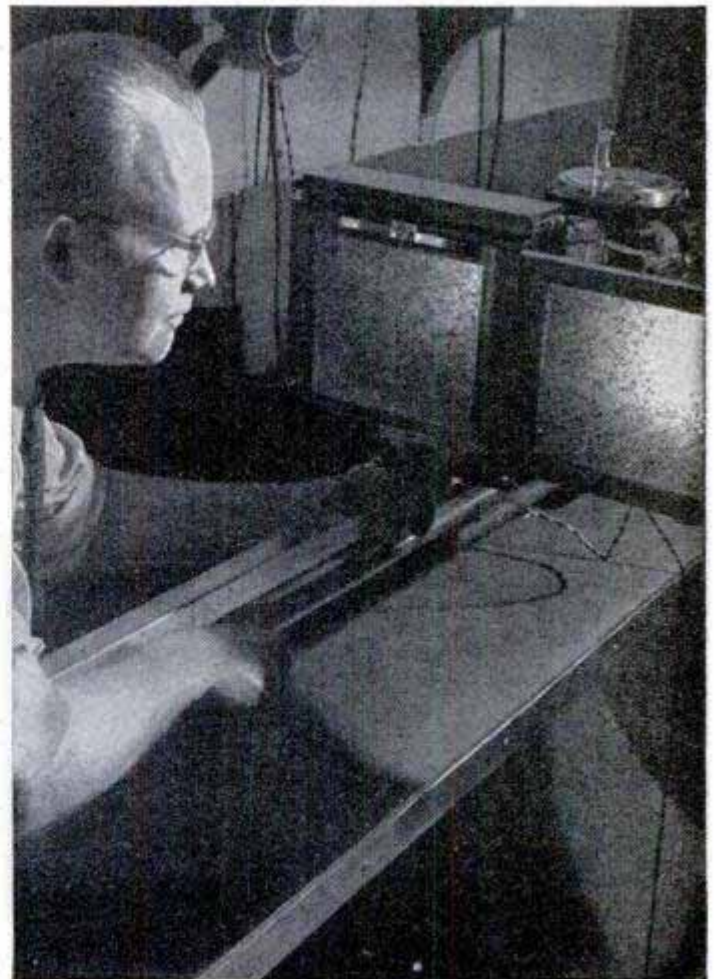
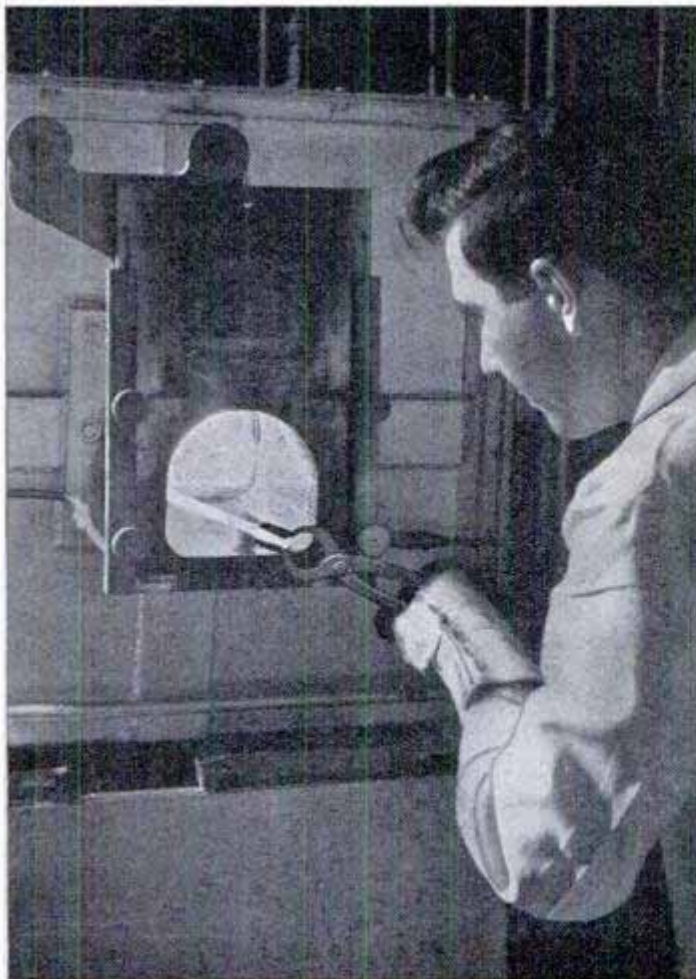

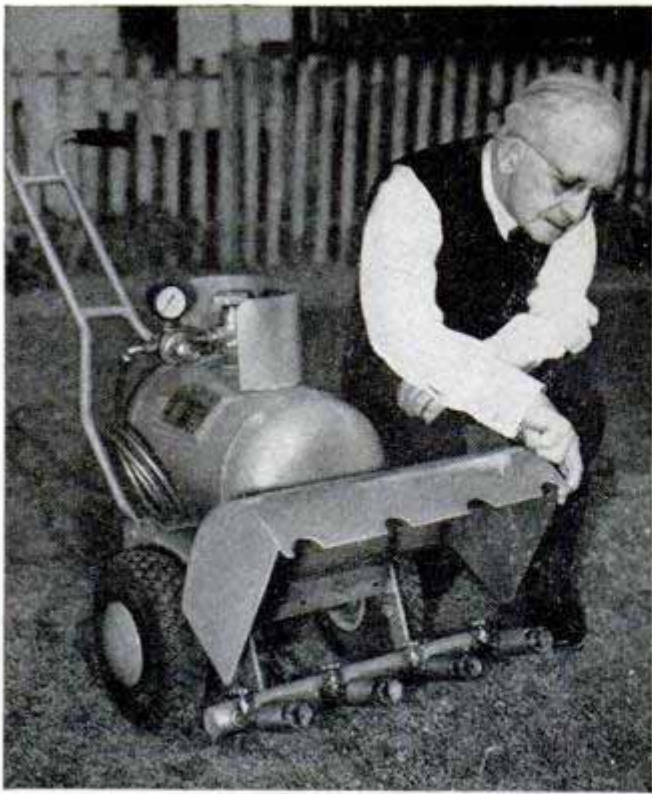

### Don't Shovel It — Melt It!

Backaches resulting from snow shoveling are no more when you use a snow-removal machine that melts away the ice and snow with four butane-gas flames. The machine is mounted on two rubber-tired wheels and its tank holds enough fuel to operate for 10 hours. It was invented by a man in Glendale, Calif., and why he needs such a machine is not clear!

### Squirt-On Detergent Speeds First Aid

Oil and grease are quickly washed from cuts and burns by a nonirritating detergent designed for factory first-aid stations. The detergent is sealed against contamination in its bottle and is dispensed by pressure when needed. No water is required as the detergent produces a lather as it is sprayed on the flesh. It is also used for removing ointment dressings and as a cleanser for soap-sensitive skins.

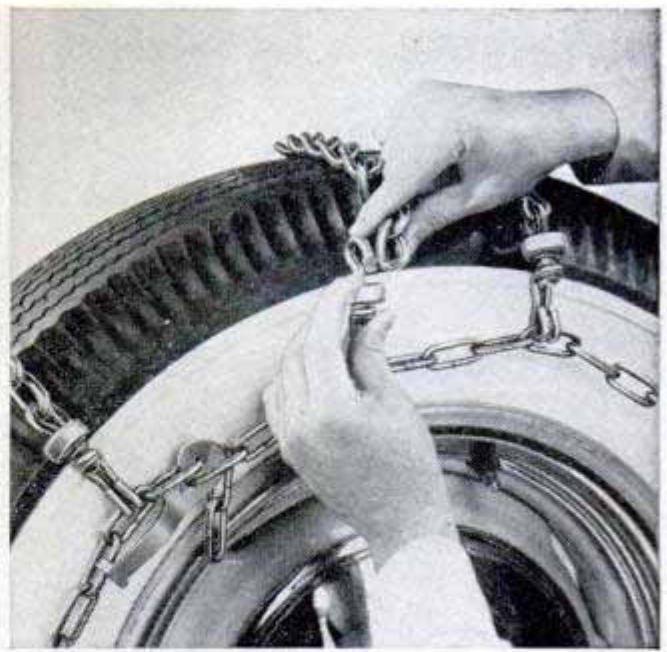
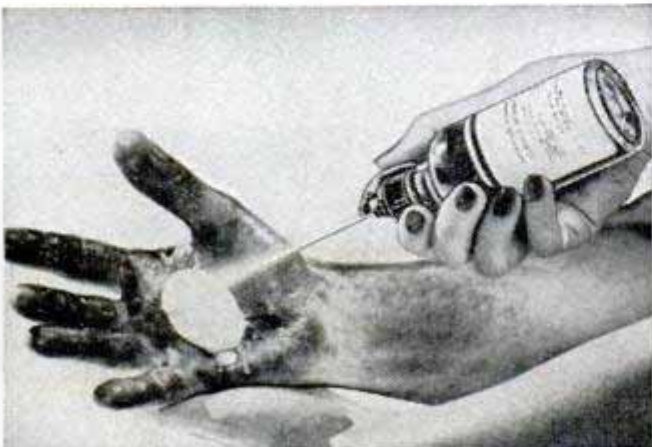

### Revolving Tire Chains

Cross links of a new tire chain slowly revolve, distributing wear on two sides of the chain instead of one. The revolving action prolongs the life of the cross links. Small rollers on both sides of the tire snap on the ends of the cross links, permitting them to turn. In addition, the snap-on rollers make it possible to replace worn cross links without tools. The chains can be used on cars of different wheel and tire sizes by snapping on longer or shorter cross links.

### Down-the-Well Pump

Supplying water to homes and farms, submersible electric pumps are simply lowered into wells and suspended under water by their own piping. No pump house and no pits are required, and the pump is noiseless because it is inside the well. The electric motor—a part of the underwater unit—is designed to use water as a lubricant. Only the field windings and the cable connections are protected in a hermetically sealed tube. All the pump components are made of bronze or stainless steel to resist corrosion. A heavy-duty submersible cable runs down the well shaft and is held to the pump's piping with clips to carry current to the motor.

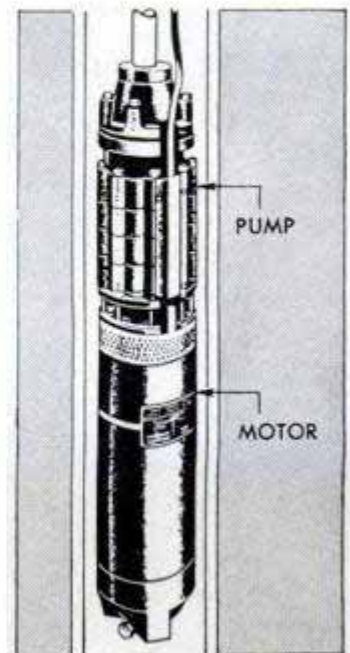





### Housewife's Third Hand

Just like a third hand, a double suction cup grips a mixing bowl tightly so the housewife can use both hands for pouring and mixing ingredients. One giant rubber suction cup forms the base, anchoring the

device to the table or cabinet top. The upper half holds the mixing bowl at any angle by suction. A release valve instantly breaks the vacuum so the bowl can be picked up whenever desired. A similar base is available for "nailing down" the baby's dish to eliminate spillage.



### Goldfish Clock

There are novelty clocks of all kinds and one of the newest combines a goldfish bowl and a timepiece. Made in Japan, the clock tells time by means of a circular scale that rotates behind a pointer on the lid of the bowl. Suspended from the clock mechanism are two artificial goldfish and, as the clock rotates, the fish "swim" slowly around the bowl. Live goldfish can be placed in the bowl if desired.

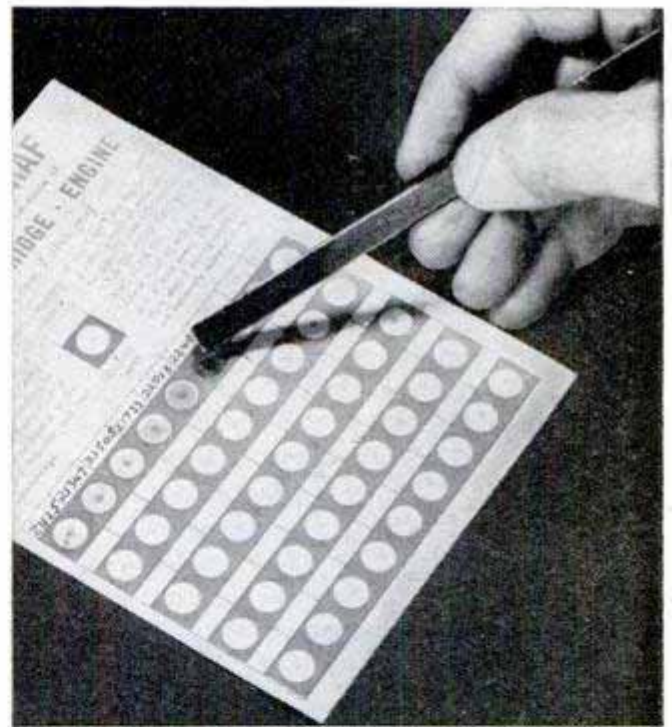

### Test Chart Shows Motorist When Oil Filter Needs Changing

Taking the guesswork out of oil-filter changes, a test chart on which a drop of oil from the crankcase is placed shows the motorist when the filter is dirty enough to replace. The dipstick is touched to an indicator spot on the card. If the oil obscures the color dot, it's time to replace the filter cartridge. The chart is designed to fit in the glove compartment.

# WHAT'S NEW

## For Your Home

A four-page "shopping section"  
dedicated to modern homemakers



**BATH PAD**, above, makes lounging in the tub just as comfortable as it is relaxing. The inflatable pad is made of Vinylite plastic and is held to the tub by suction cups, providing a seat, back and headrest

**TWO-WAY HEATER**, left, can be used to take the chill off a cool room or to keep food hot alongside the table. Turned up to high heat, it fries eggs or hamburgers. The radiant-glass panel is shatterproof

**ROLL CUTTER**, bottom left, adds a professional touch to your rolls and eliminates hand shaping of the dough. You simply press the cutter into the dough. One end makes clover-leaf, the other fan-tan rolls

**CLOTHES SPRINKLER**, below, has gone modern to make bottle-shaking obsolete. Connected to a faucet by a long hose, the sprinkler produces a fine mist at the touch of a button, dampening clothes evenly

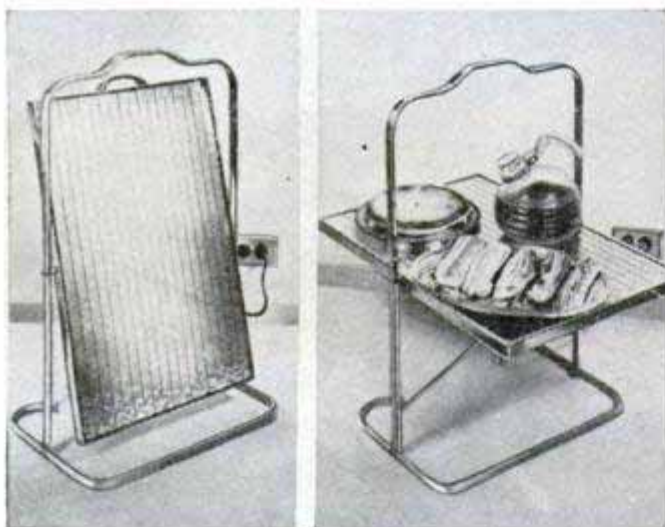



**INDOOR BARBECUE**, above, broils meatballs or cube steaks and toasts marshmallows on your dinner table. It burns alcohol and a filling will last for hours

**SHOE SHINER**, above right, takes work out of the polishing chore. Electric powered, it has a wool-pile buffer that can be removed easily for dry cleaning

**ALUMINUM SPRAY**, right, is ready to use at the touch of a button. Pressure packed, the paint is a combination of aluminum and plastic for long outside wear

**PLUG-IN THERMOSTAT**, below, makes a portable electric heater automatic. Connect heater and thermostat cords, set a dial and presto — controlled heat

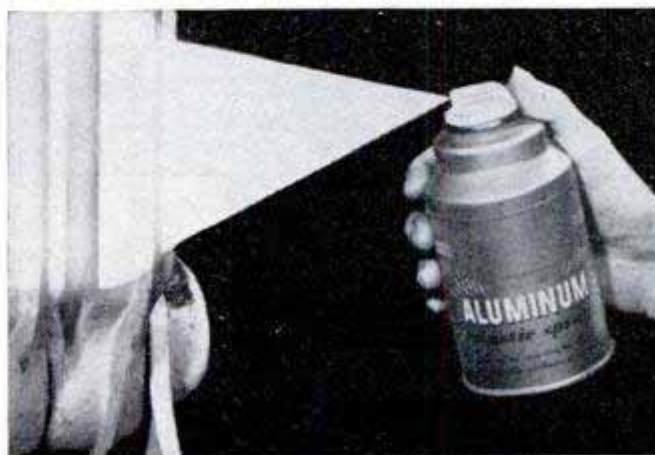
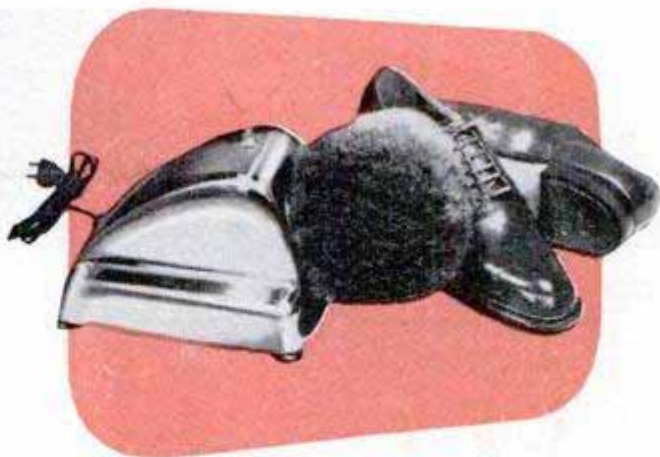



PRESENT SHELF

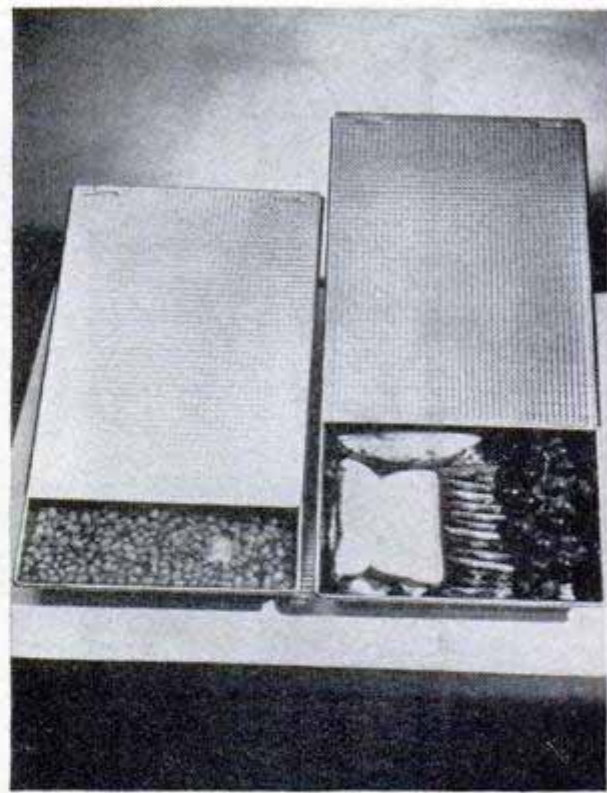

**COOK-AND-CARRY PANS**, above, are just right for use at church suppers or picnics. Tight-fitting covers prevent any spillage

**DOUBLE-DECKER SHELF**, left, for a crowded closet, swings forward and down, bringing it within easy, convenient reach

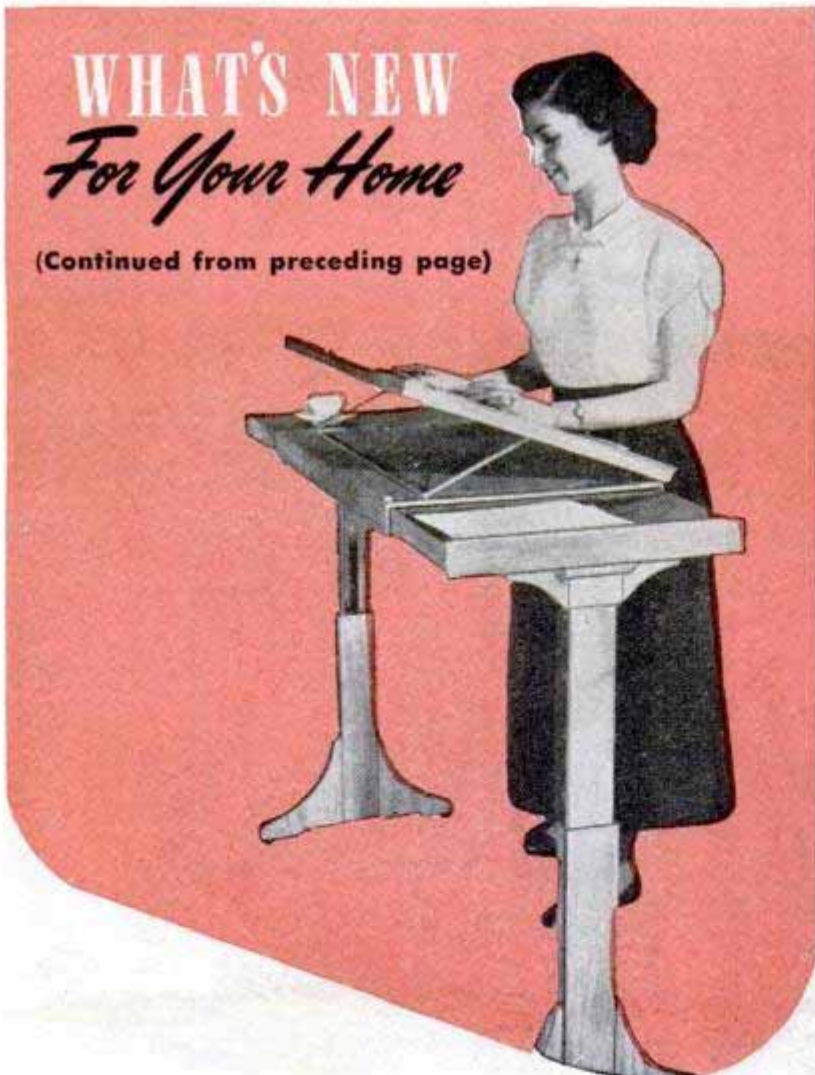

**WHAT'S NEW**  
*For Your Home*

(Continued from preceding page)

**VERSATILE TABLE**, left, stretches vertically and horizontally to perform many jobs. Here, it's used as speaker's table

**SAFETY PLATE**, below, fastens over any outlet. Holes are covered to prevent shocks. Sliding button opens them for use

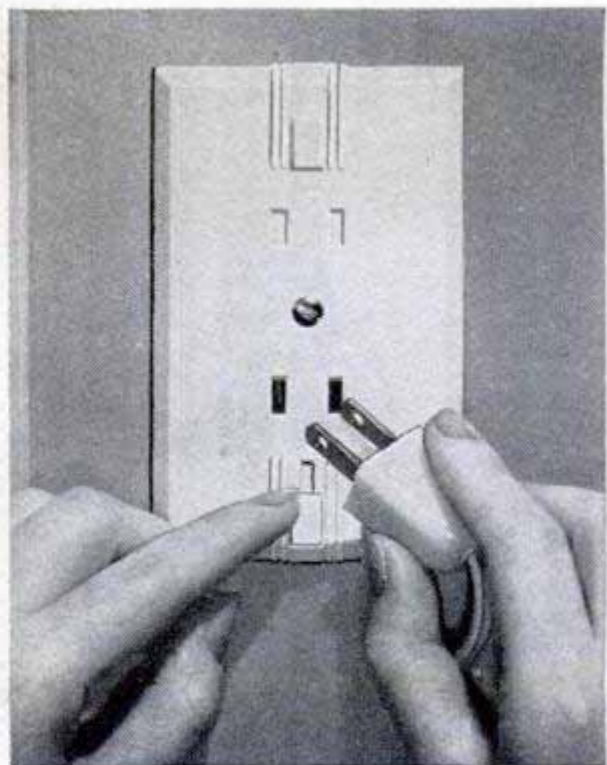

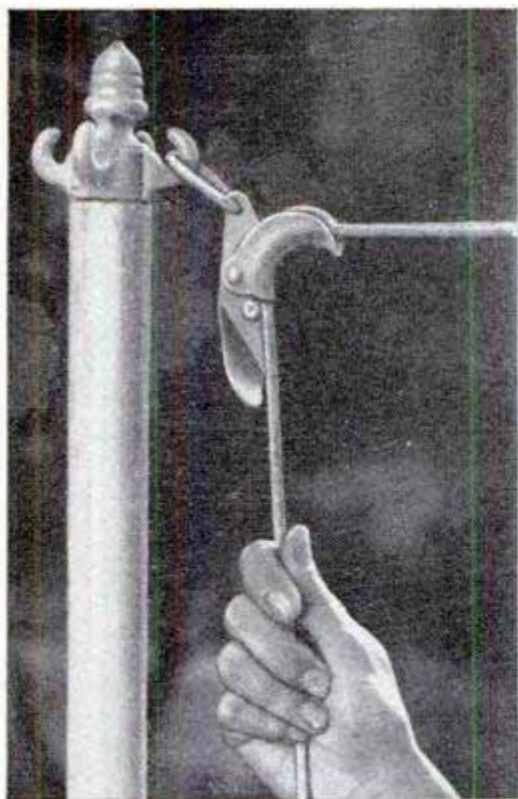

**LINE LOCK**, above, requires no knots to keep clothesline tight. Used on any line, it won't slip

**TRAVEL CRIB**, right, is light and folds to fit in the trunk of a car. Screening protects baby from bugs

**SHAMPOO SPRAY**, below right, is a permanent installation. Its flow is controlled from the washbasin

**GARDEN FENCE**, below, is all aluminum, has 8-inch pickets. It can be bent around circular beds

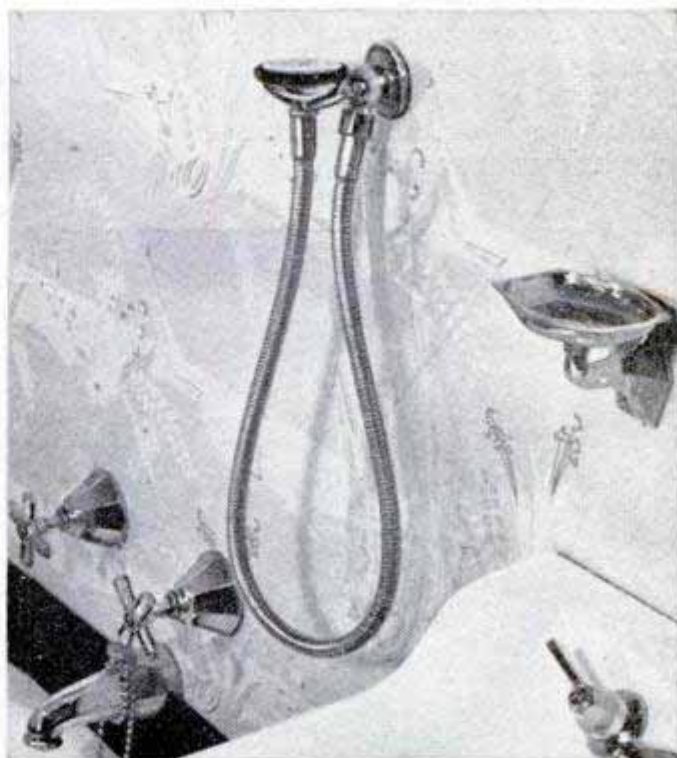
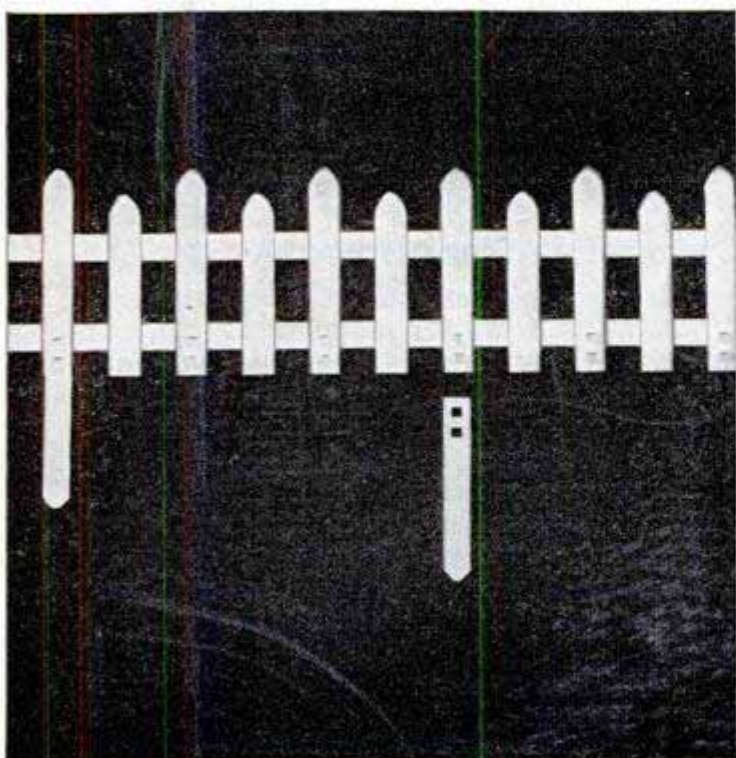

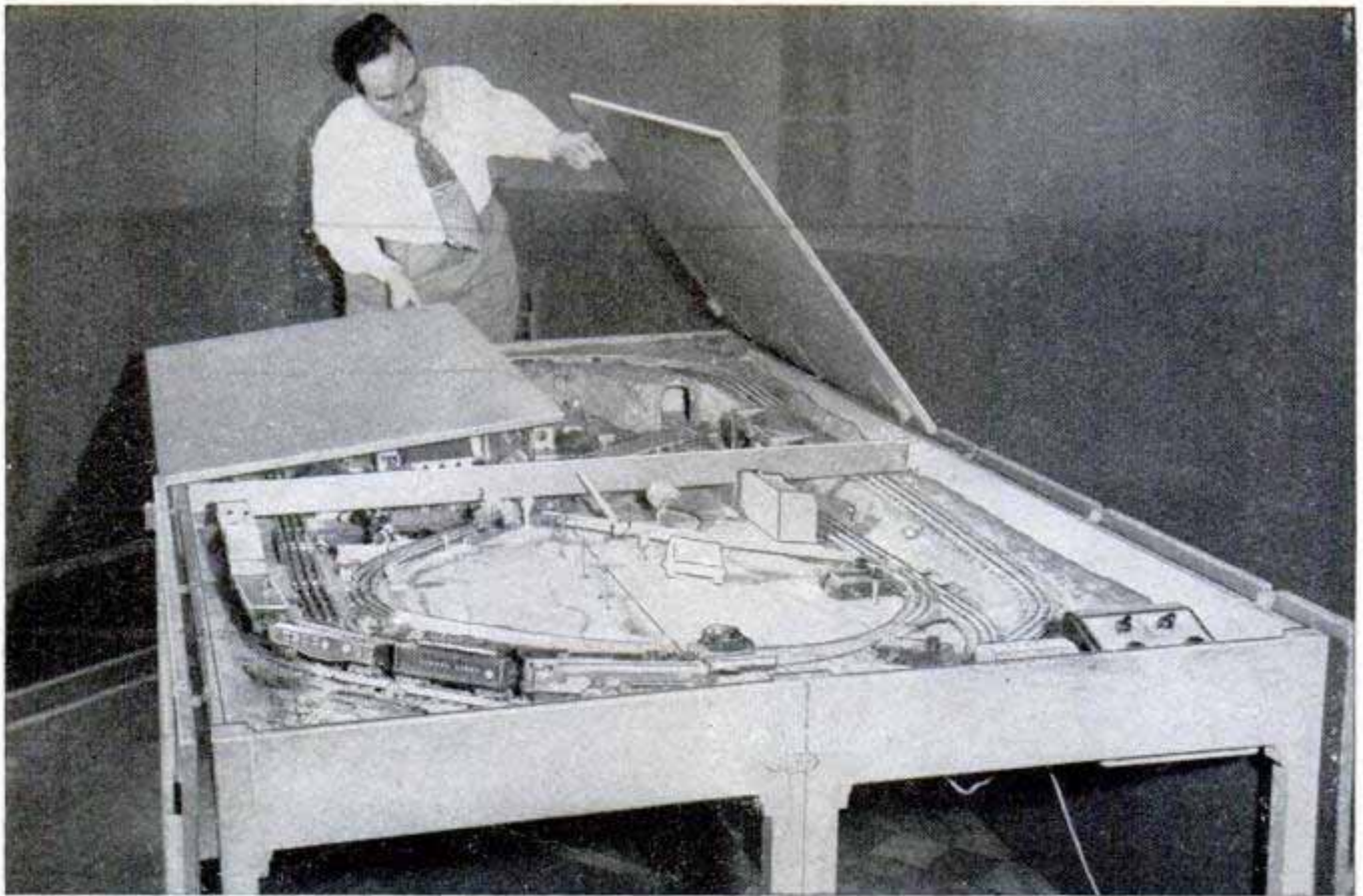

## Triple-Purpose Table

Model-railroad layouts usually take up a lot of space, but a Brooklyn hobbyist, Bernard C. Eisenberg, made this space do triple duty by setting up the track inside a ping-pong and party table. The hinged top pieces fit over the railroad, protecting it from dust and damage when the table is used for ping-pong. With the top open, Eisenberg simply plugs in the electric cord and the railroad is ready to operate. The table also divides to form two party tables. Hinged sidepieces swing up to enclose the fourth side when the two halves are used separately.

Hinged covers, above, protect the train layout and convert it into a regular ping-pong table, below. For parties in the game room, the table splits lengthwise into two refreshment tables



## Cotton-Bale Sampler

Cotton samples are cut from bales quickly and uniformly by a portable electric saw with a toothless, razor-sharp blade. This new technique, developed in a New Mexico cotton gin, replaces the slower method of slicing into the bale by hand. Every one of the millions of bales produced annually is sampled three or four times and the power-saw method saves money by eliminating frequent honing and replacement of hand knives.

☐ Candy and gum can be given a licorice flavor with an oil that is distilled from the familiar yellow goldenrod.

# THE WORLD'S *favorite* SPORT

Clever headwork by a German soccer star. Timing is more important than brawn in this international game

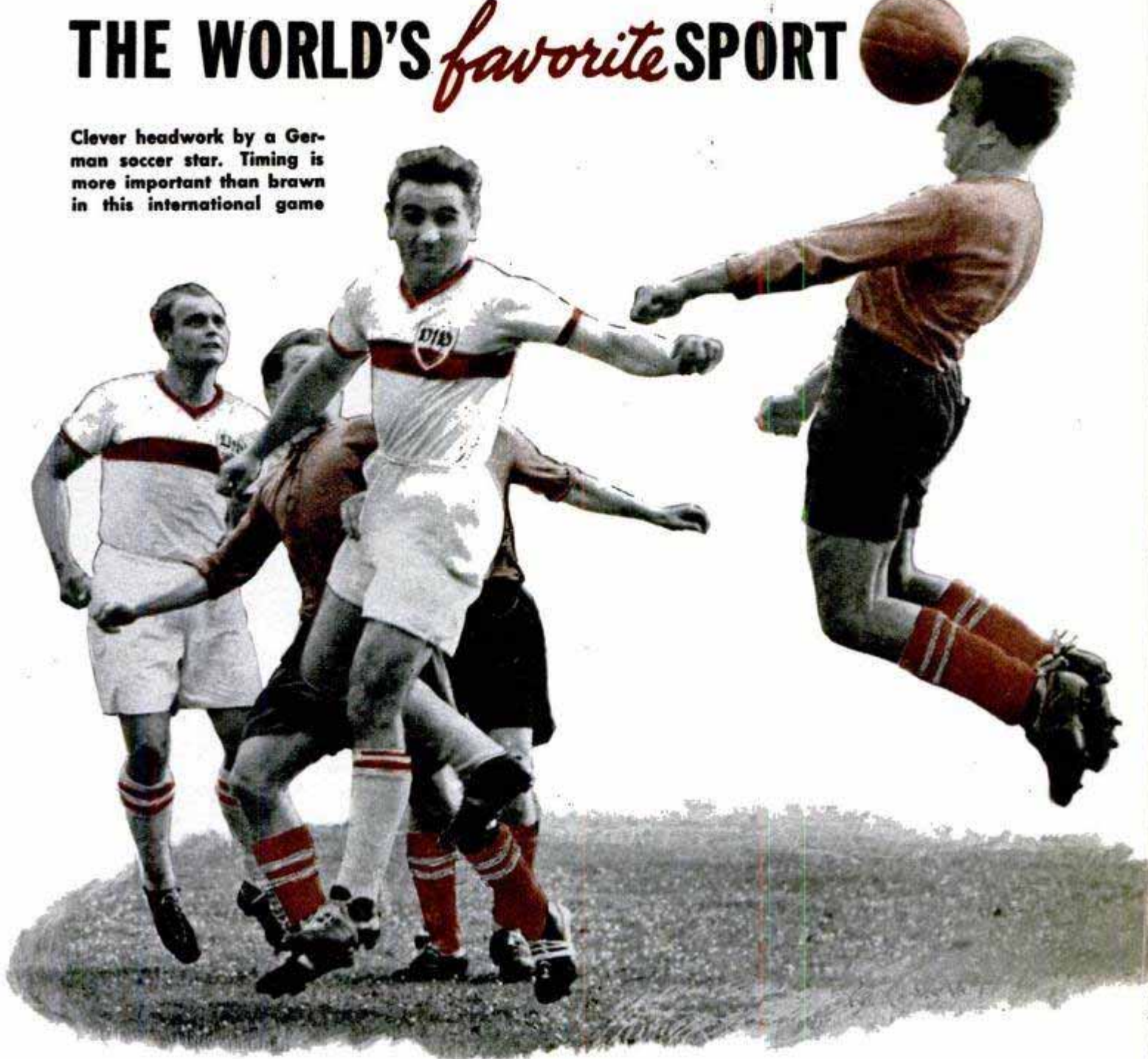

**W**HETHER moved by anger, curiosity, jubilation or the spirit of competition, man has always evidenced a great urge to kick things, which explains why soccer is the world's most widely played game, as well as one of the oldest. It is the national sport of 54 nations, and 68 nations are affiliated with the Federation Internationale de Football Association, with headquarters in Paris.

There is documentary evidence that this ancestor of American football and English rugby was a great favorite with the Greeks, Romans, Saxons and Danes. Even then it appealed to the masses, with whole communities sometimes comprising "teams"

Goalies lunging through space to stop balls headed for scores provide some of soccer's most thrilling sights. They are only players allowed to use hands

**By John W. Wood**

*Soccer player and coach for 57 years, coach for the last 25 years at Oak Park and River Forest (Ill.) High School, the author was president in 1949 of the National Soccer Coaches Association of America*





Coach John Wood, the author, shows a student how to "trap" a moving ball with the bottom of his foot

and endeavoring to kick a sphere through the gates of neighboring cities, defended by town teams.

History doesn't definitely record when soccer was first played. However, Chester, England, claims it originated there in Saxon times in A.D. 217 from gleeful kicking through the streets of heads of conquered Danes. Histories of London tell of school-boys playing soccer in the city in 1175.

One of Wood's high-school players demonstrates how soccer ball is kicked with the instep, not the toe

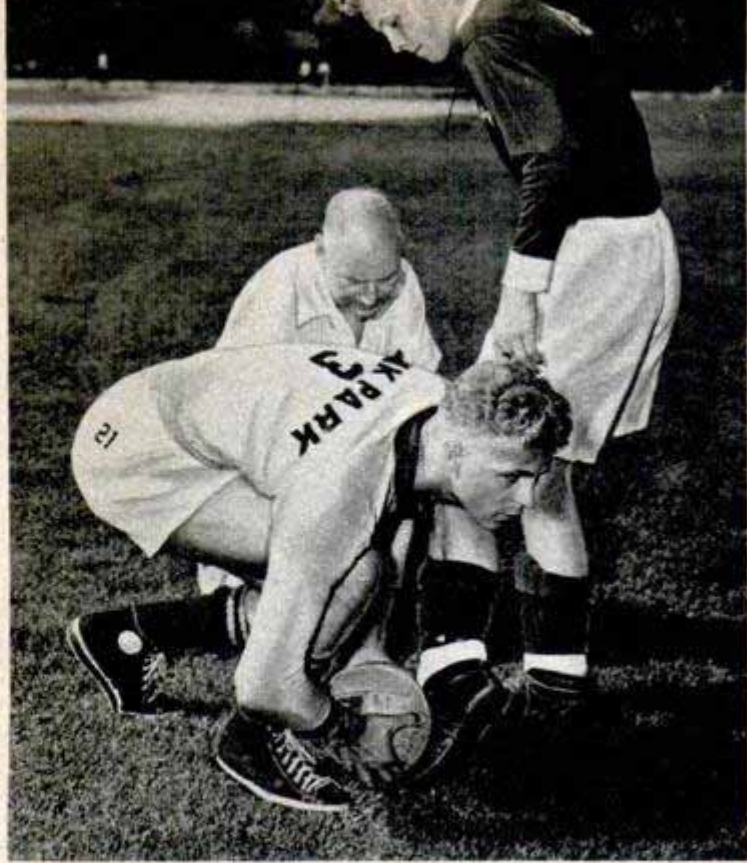

Goalie is being coached in technique of charging in to take ball off opponent's foot before he can kick

Edward II forbade it altogether in 1314 and Edward III enacted a law against football and similar "foolish games," stating the young men took greater delight in animal pursuit of a bladder than in fitting preparation in arts of war. He felt that at all costs he must have a nation trained to archery and not to useless games. Scottish kings also forbade it.

Oliver Cromwell played football. The

Passing is the key to good soccer. Player is flicking ball to man at his right, using outside edge of foot





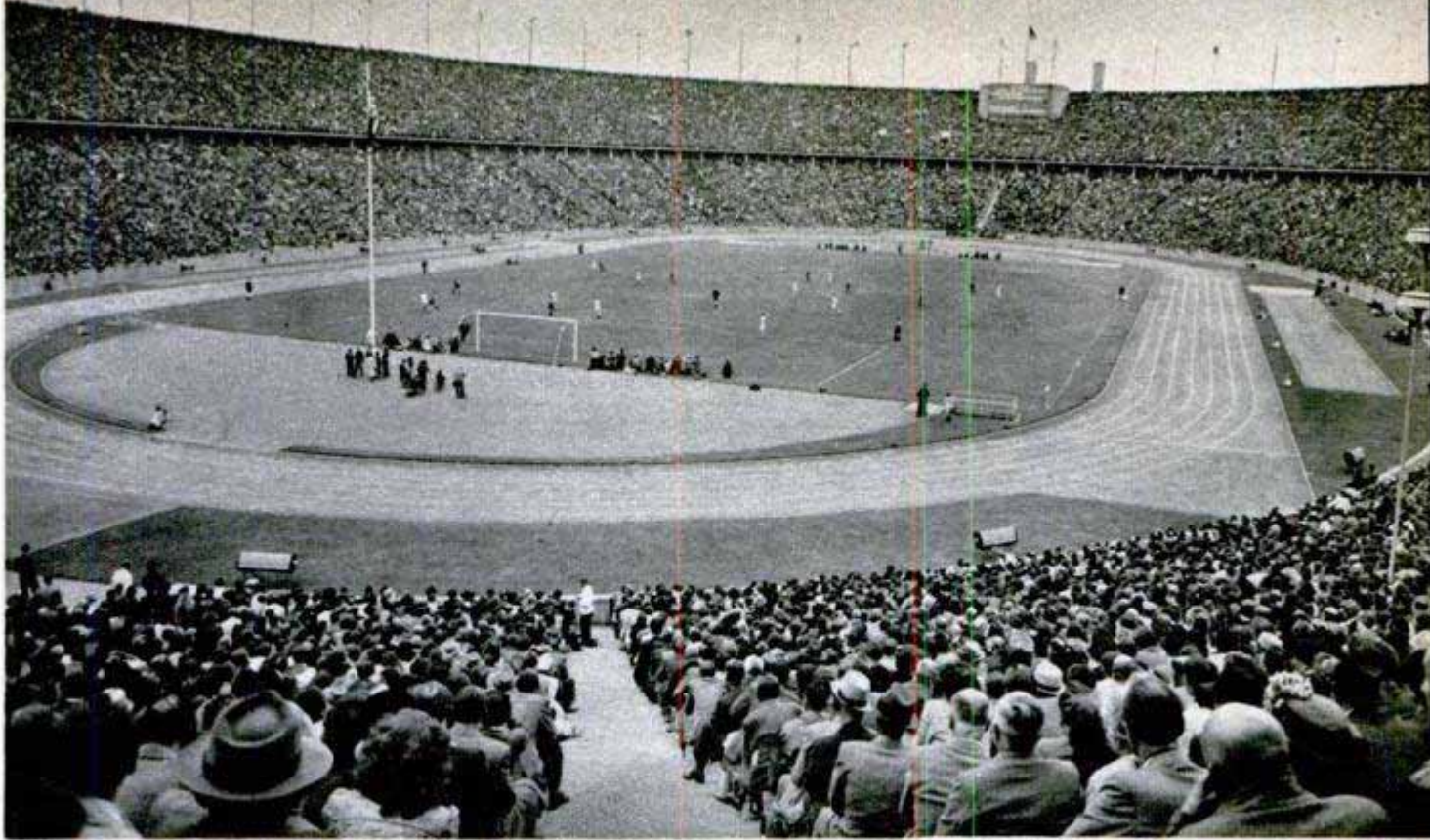

There were no vacant seats in Berlin's vast Olympic Stadium as teams from Offenbach and Stuttgart met for the German championship. Crowds of 125,000 have seen big games in Glasgow and Buenos Aires

Reverend John Wheelwright, a noted wrestler, declared he would rather do anything than meet Cromwell on a football field, because he was sure to be tripped up by him.

There were no strict playing rules in these earlier times. The ball was frequently stuffed with corks and there were any number of players on a team. Kicking an opponent was considered only slightly less laudatory than kicking the ball.

Another way to stop the ball, with knees and shins. This is particularly effective against very long kicks

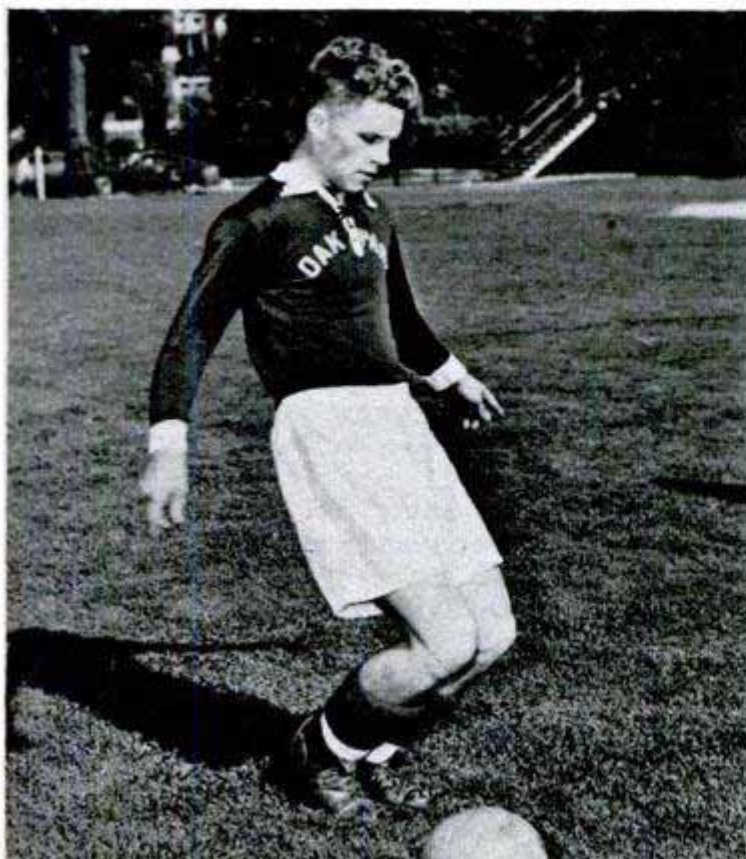

In 1823 William Webb Ellis, a player for Rugby School, disregarding custom, picked up the ball and ran with it. That was the inception of the present rugby game, from which our American football came. There is a tablet at Rugby School commemorating the occasion.

In England, the Ellis-originated style of football was called rugby football, and soccer is called "association football." Soccer came from "association" when the Londoners abbreviated the word "association" to "soccie"—soccer. The game is called football in every country except in the United States, where it is known as soccer.

No country or continent outdistances the world in soccer, as the Americans do in baseball and the Scandinavians in skiing and skating. Since 1906, for example, the Olympic championship has shifted from Denmark, to England, to Belgium, to Uruguay, to Italy and to Sweden in 1948.

The Indians are reported to have played something resembling soccer before Columbus arrived. Yale, Harvard and Princeton took a fling at the game in 1840, with the first two barring it in 1862 as "too rough." Soccer was played at the University of Virginia in 1875. About 80 years ago Irish, Scotch and English immigrants formed the first real soccer clubs in the United States, but not until 1913 did the sport gain national recognition. That year the United States Soccer Football Association was organized and affiliated with the international governing body.

Now there are over 3000 teams listed in



All of India's Olympic team, except the goalie, play in stocking feet. They are clever ball manipulators

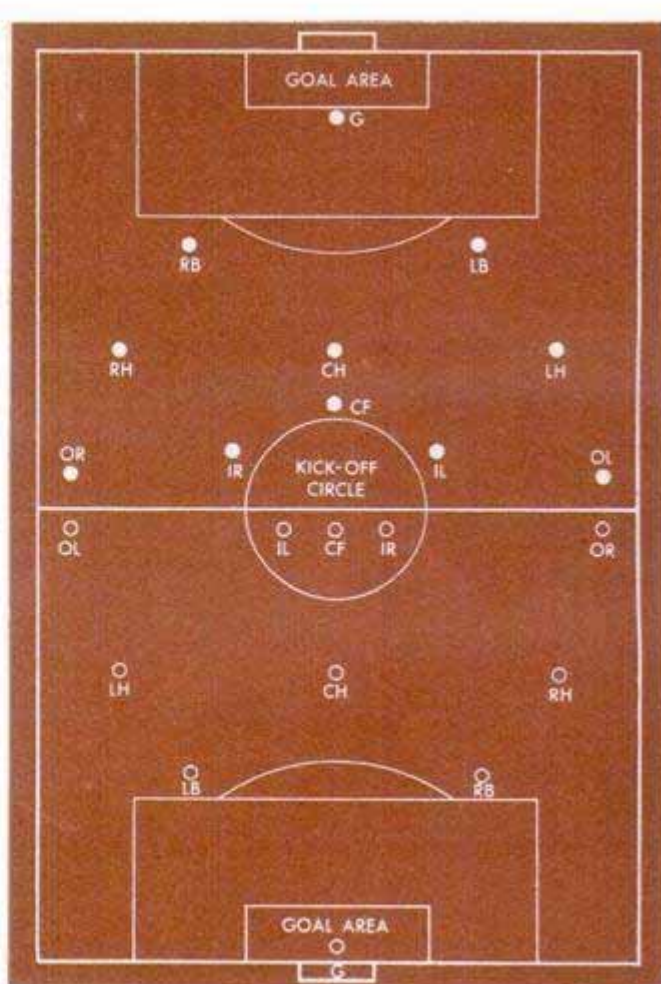

Players' positions at kickoff. The field's size can be from 100-130 yards long and 50-100 yards wide



the United States alone, with more than 60,000 players on their squads. Thousands more play on informal playground and school teams.

Most Eastern and Southeastern high schools and colleges and universities play intercollegiate soccer. The National Soccer Coaches Association of America, with a membership of about 500 high-school and college coaches, selects an all-American team every year. The first Soccer Bowl game took place in Sportsman's Park, St. Louis, Jan. 1, 1950, when undefeated Penn State and the undefeated University of San Francisco played a 2 to 2 tie. This will now be an annual affair.

Several all-American collegiate soccer players played on the U. S. A. team that surprised sports fans by upsetting England in the world's championships in Rio de Janeiro in July. Little Uruguay won the title. International championships are scheduled for 1954 in Switzerland and 1958 in Sweden.

Soccer crowds dwarf all other sports spectacles in size. Nearly 137,000 saw a game in Glasgow, and in Buenos Aires, a city of 2½ million, almost five million tickets were sold for games in one season. Two clubs in the latter city, incidentally, main-

With a well-directed punch, the Australian goalie, in the air at right, bats ball away from the danger area



At the start of a back flip, Brazilian in striped shirt grabs ball from Mexican opponent with his toe and kicks it in opposite direction. At the end of this acrobatic maneuver he landed on his hands and knees

tain stadiums seating 80,000 and 125,000 respectively—larger than our biggest major-league baseball parks.

Much of the game's worldwide appeal can be laid to the fact that it requires little equipment and the rules for playing are simple; also to the fact that all action of the game is easily seen by the spectators. Most people can grasp the essentials of soccer after watching a single game, at least well enough to play it in a simple, inexpert way, even though it is a very scientific game, really billiards with the feet and head. Kicking, a familiar motion, is soccer's basic offensive action.

All sorts of kickable objects were used from ancient times until today's inflated ball, with a leather casing between 27 and 28 inches in circumference, was adopted. At the start of the game, before becoming water-soaked or mud-caked, it has to weigh between 15 and 16 ounces.

(Continued to page 254)



At a glance this looks like the finish of a long field-goal try in American football, with the ball holder still kneeling in the background. Actually it is a soccer player getting off a long downfield boot

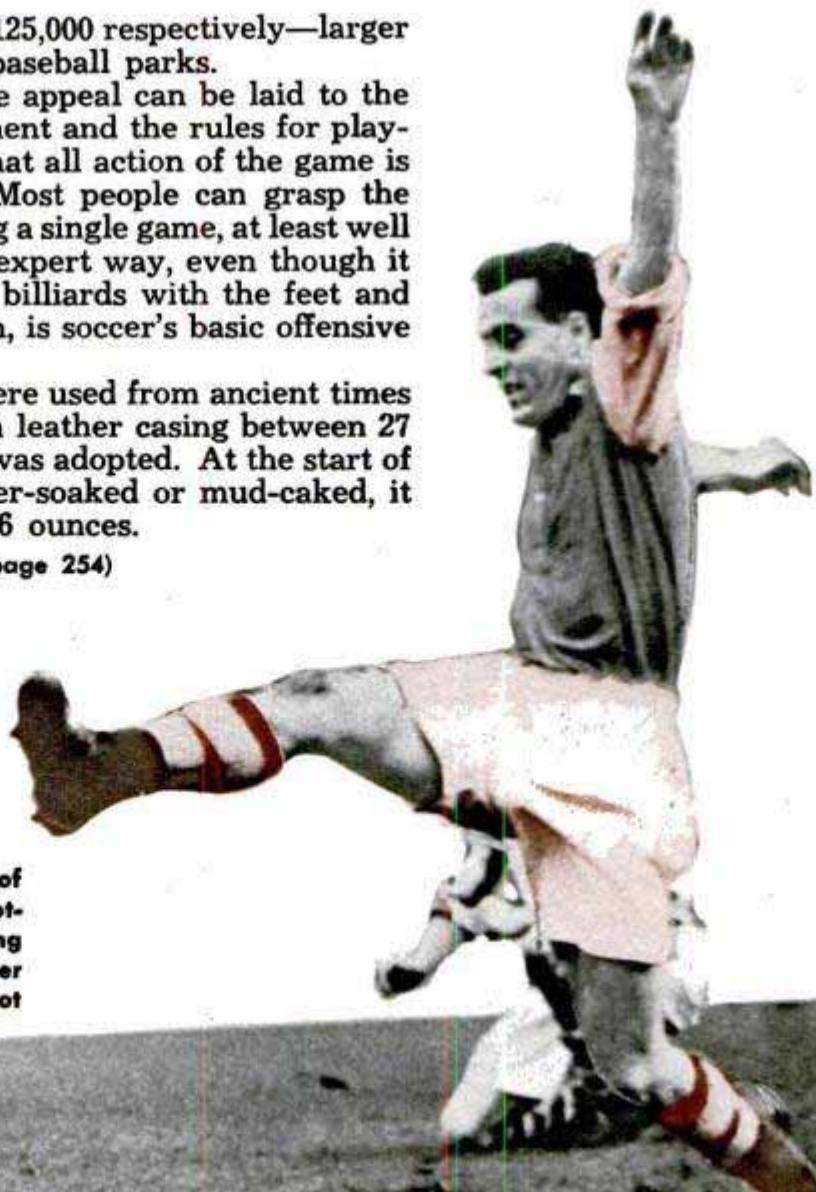

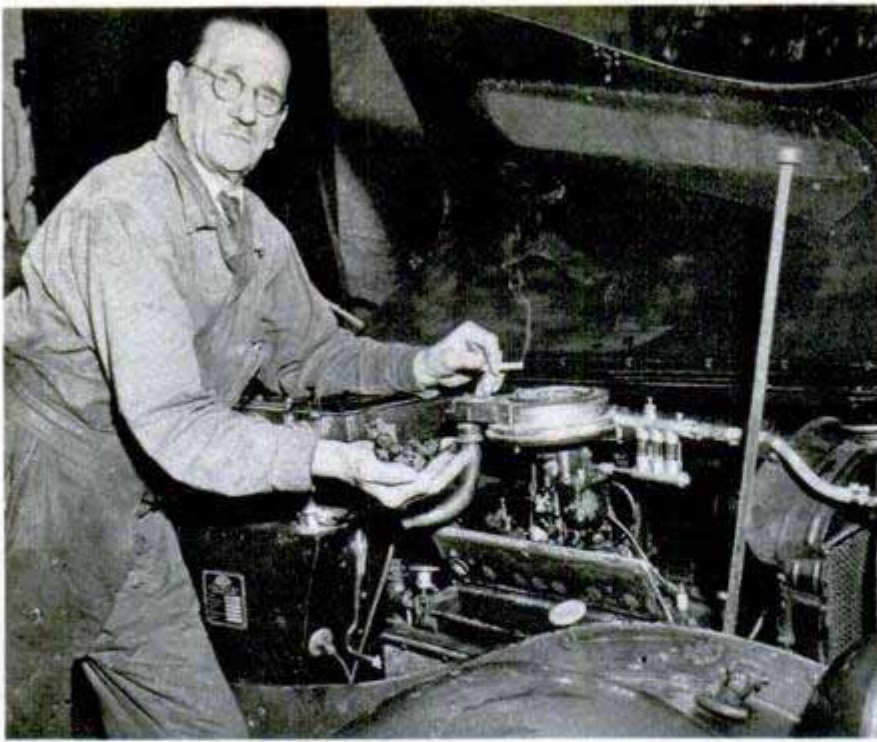

### Auto Runs on Peat

Peat serves as the fuel for a new auto engine invented by Hans Gebhardt, a German engineer. Gebhardt says his engine's operating costs are only a third those of a gasoline engine, but the driver must stop

every 65 miles to refuel. The engine runs that distance on a mixture of peat, a few pounds of carbide and three gallons of water. One advantage of the engine, he says, is that the driver can stop along the road, feed the gas generated by the engine into a small stove and cook a meal.

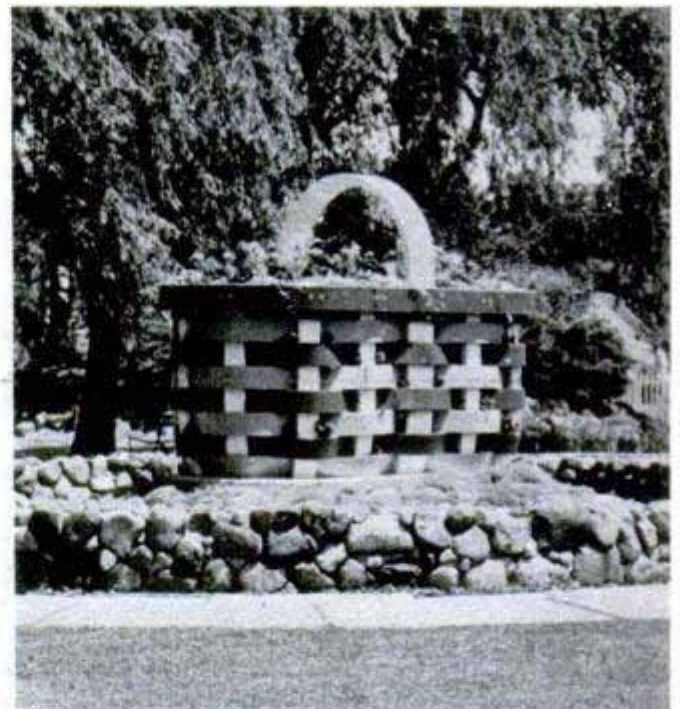

### Flowers From Tin Cans

Converting old tin cans into beautiful bouquets is the hobby—and part-time business—of Mrs. Rosie Perdue, Dallas, Tex. Mrs. Perdue first shreds a tin can and makes the stems for an entire bouquet out of one can. The bottom of the can is left intact. Artificial blossoms of paper and cloth are attached to the stems. Mrs. Perdue can make a dozen bouquets in a day.

### Huge Flower Basket

Center of attraction in a Lorain, Ohio, park is a giant flower basket, so large it dwarfs the near-by benches. The basket is woven from long, brightly painted boards. Flowers cover the top of the basket and grow out through openings in the sides.

☞ Butyl inner tubes have now been improved for use in subzero temperatures.

### Three-Wheel Taxi

Small enough to scoot in and out of city traffic, a three-wheel motorcycle taxi, built by a British cabbie, still is roomy enough to seat three persons. The passengers sit backward in the "rumble seat" body. Economical to operate, the taxi does 80 miles to a gallon with its two-stroke motorcycle engine, mounted over the front wheel.

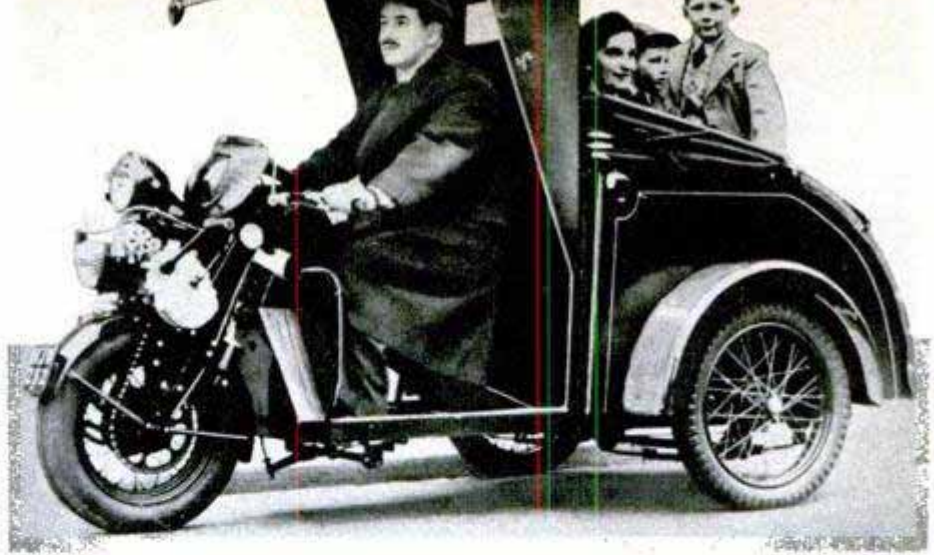

### Neptune Adds Power

Compound power plants—two sets of three turbines driven by exhaust gases from a pair of piston engines—have lengthened the range of Navy Neptunes 20 percent. They are used for long-range antisubmarine patrol and one now holds the world's distance record of 11,236 miles. The force of the gases drives the turbine wheels, which are geared to the crankshaft through a series of gears and fluid couplings that transmit the extra power to the engines. The new combination provides 6500 horsepower at take-off and also lessens engine noise, reducing crew fatigue on long trips.

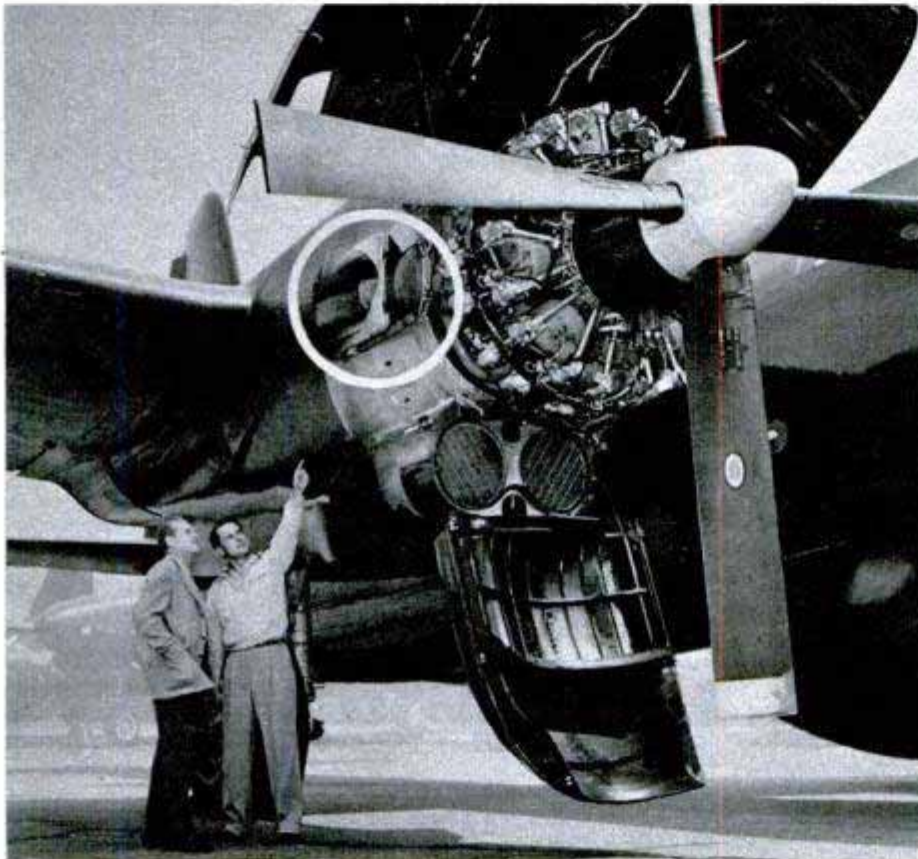

Lockheed Aircraft photo

### Piped Oxygen System In Hospitals

Liquid oxygen is stored in a low-pressure cold converter at the University Hospitals of Cleveland and piped to the users. The new system is less costly and more convenient than hauling heavy cylinders of gas to the points where needed. About 50,000 cubic feet of gaseous oxygen are stored in liquid form in a 440-gallon tank at minus 297 degrees Fahrenheit. Automatic controls and low pressure eliminate the possibility of explosion.

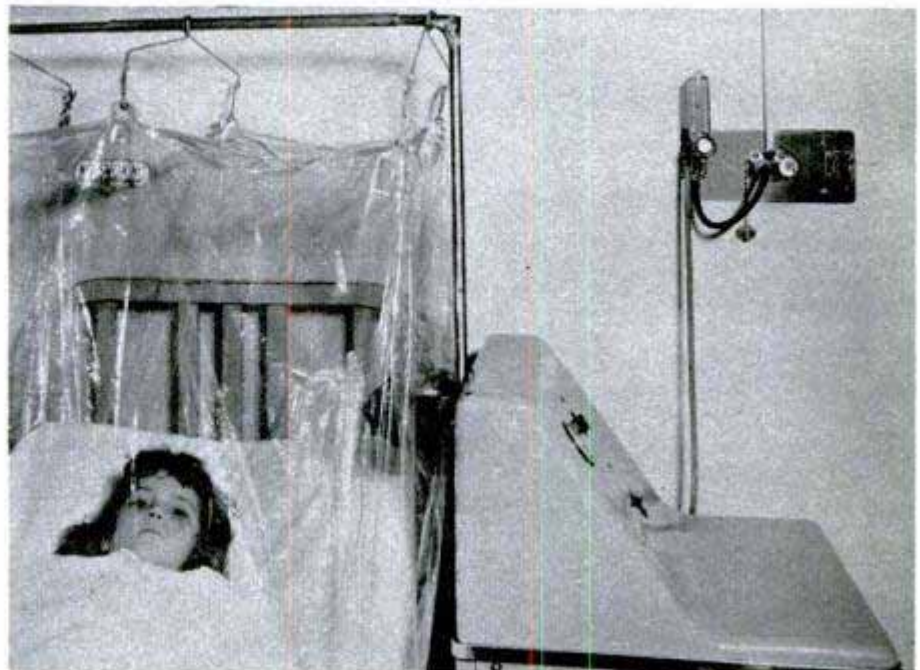



Here's a familiar sight in Manhattan—a truck traffic snarl. Terminal takes 25 percent of long-haul trucks off streets, eliminates 12 percent of "mosquito" fleet

← Model of efficiency is the loading platform. Freight is being shifted from hand trucks to highway trucks

Cutaway shows facilities of the vast terminal. Highway trucks pull in on one side of four-block-long building. Workers sort freight on hand trucks which move by conveyor to delivery trucks across platform

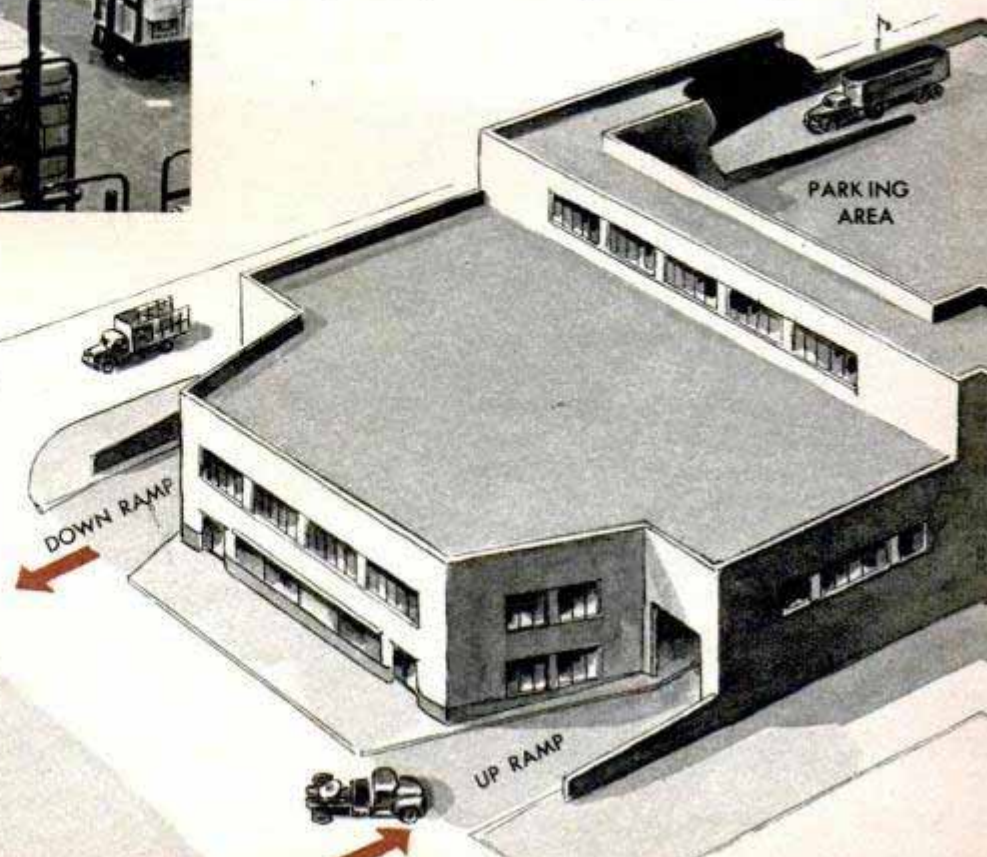

Steel beams and safety pins, potatoes and people in an endless procession of trucks and busses stream into two vast new terminals that serve as

# FUNNELS FOR A CITY'S FREIGHT

By Clifford B. Hicks

**B**ILL EGAN waited 10 minutes, finally saw his chance and pulled his big semi-trailer truck out of the alley into the snarl of Manhattan traffic. One wide swing didn't do it, so he ground to a halt, whipped the wheel around and started to back up.

That's when he clipped the fender of the motorist who had crawled up behind him. And behind that car were a hundred others, scores of trucks and busses, all blaring the lid off Manhattan. A traffic cop worked 10 minutes untying the knot. Worst of all, Bill knew he'd likely get tangled up again when he made his next delivery.

Thousands of trucks like Bill's are at once a lifeline and a garrot for New York. But the big rigs are just one of the factors

in the traffic troubles that plague Manhattan Island. Another is the 2500 intercity busses which each day shuttle some 65,000 people to and from the terminals scattered across the city.

Now New York is whipping the problem with a one-two punch which will give the city top terminal facilities for handling freight and human beings. One blow is a cavernous truck terminal, recently completed, which serves as a "post office" for the common carrier, mixed freight carried by Bill Egan and his fellow drivers. Officials estimate the terminal will remove 25 percent of the long-distance trucks and 12 percent of the local "mosquito" trucks from the jammed streets. The other punch is a walloping bus terminal, to be completed in mid-December, which will keep about 2500

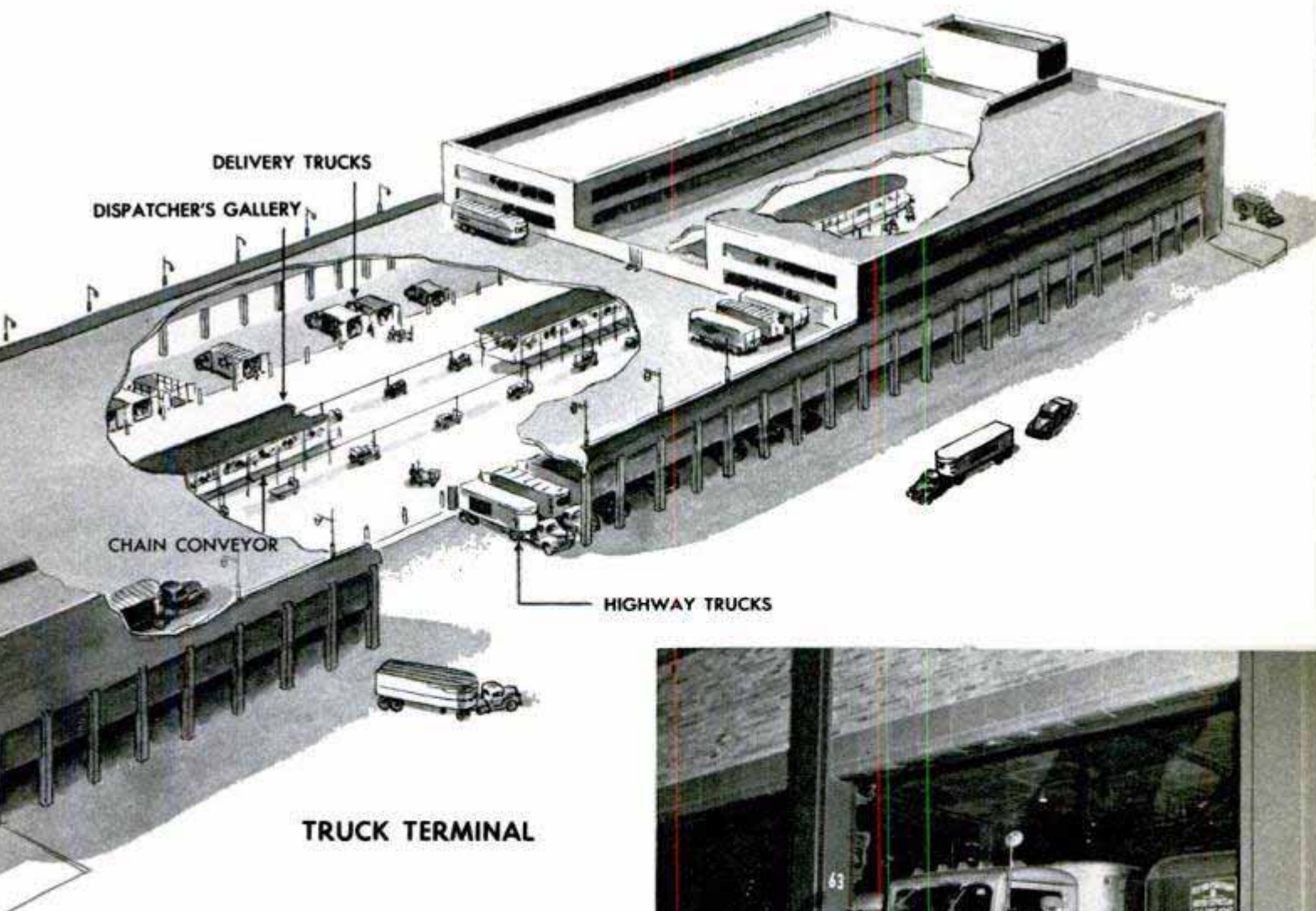

Right, drivers never had it so good—no unloading, no reloading. Here a driver backs in to pick up his preloaded trailer for a long haul out of New York

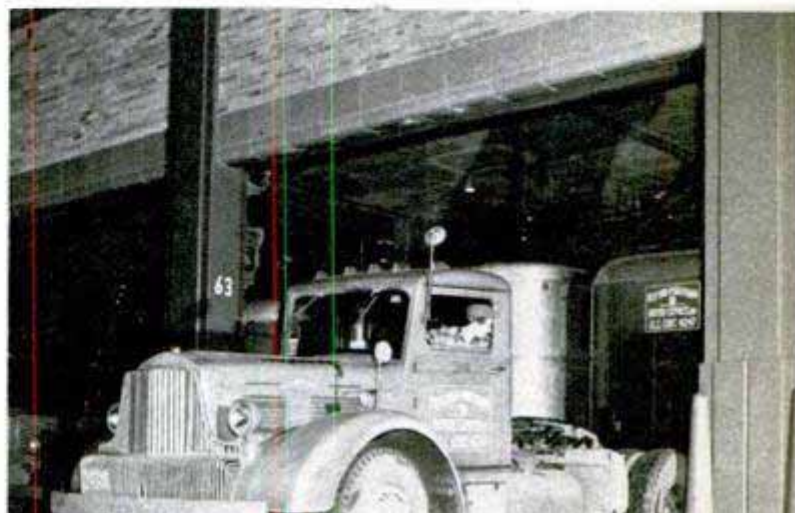



Platform worker shoves loaded hand truck into position so conveyor "fingers" will snap around its mast

busses out of the island's troubled traffic.

The two projects are ripples in a stream, for they already are serving as patterns for similar proposals in other cities. Both are built and operated by the Port of New York Authority, which does its job without levying a penny against the taxpayer. Operating expenses are paid by the truck and bus lines which lease the terminal facilities.

Bill Egan is one of the 7256 drivers who roll their big rigs onto the island of Manhattan each day. Like Bill, about 65 percent of these drivers haul hodge-podge loads that must be dropped piecemeal at various destinations. In the past, Bill sometimes operated this delivery route himself; at other times he unloaded at his company's makeshift terminal in lower Manhattan,

where the mosquito-fleet drivers took over the freight. Bill knows from hectic experience that the average truck with a mixed load rumbles 50 or 60 miles through New York streets, making an average of 40 sporadic stops before the run is completed.

The truck terminal has changed Bill's life. The \$9,000,000 building is a vast cavern four blocks long equipped with countless robots from a merry-go-round freight carrier to pneumatic tubes that swish paper work from one end of the building to the other. Inside this "post office," men and machines manhandle huge freight shipments, sorting, routing and reloading them for delivery. The terminal will clip an estimated 945,000 truck-miles from the budgets of long-distance operators each year, saving them about 238,000 gallons of gasoline. Mosquito-fleet operators will whittle their expenses accordingly. The total saving to truckers will be somewhere around a million dollars a year.

Gone are Bill Egan's delivery worries. Today he rolls his rig through the Holland tunnel, then rumbles only four blocks to the terminal. Swinging the semi backward through one of the 40 broad doors, he inches into one of the 142 big, floodlighted truck berths. This entire side of the vast freight platform is reserved for over-the-road trucks. Bill switches off his engine, climbs down, unlocks the trailer and ambles over to the registration room where he checks in the papers which cover the mixed shipments in his truck. Then he's through for a while. No irritating paper work. No unloading. No responsibility until he climbs into a loaded truck a few hours, a day or two later. Bill wanders up to the neat locker room, stores his road clothes and takes a quick shower. Spruced

In platform control section, operators trace movement of every box in the building by watching numbers flash on panels. Below right, cylinders which hold shipping papers drop out of pneumatic tubes onto a moving belt

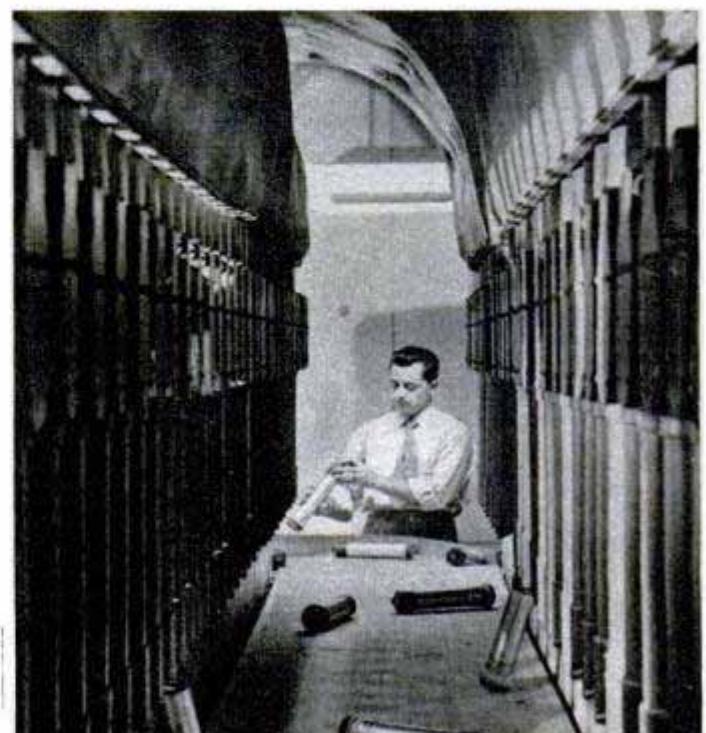



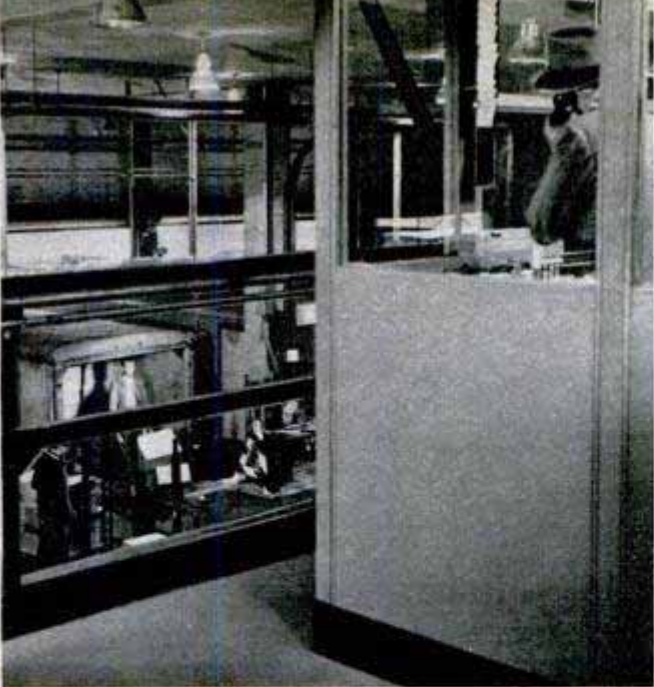

From a long gallery high above the loading platform a dispatcher checks on a shipment. Right, other dispatchers see that local trucks are loaded in street-address sequence, give drivers instructions on their local pickups

up, he heads for the truckers' restaurant inside the terminal, eats and strikes north for a night in New York. Bill never had it so good.

An hour before, as soon as Bill unlocked the trailer, the platform workers plunged into the big truck and started wrestling the packages out onto the platform. High overhead, running like a balcony above the center of the 800-foot platform, is the dispatcher's gallery—the link between the paper work and the big, crated shipments. And down at one end of the gallery is the central control room, the nerve center of the building, where operators determine the destination of each bundle in Bill's mixed load, then send instructions down to the platform workers on how to sort the stuff for reloading. Three communications

systems link the room with the big bay where Bill's truck is parked—an intercom system, a telephone and a pneumatic tube.

The platform workers have a wide variety of hand trucks and machines to help them sort and stack the freight for reloading. Ordinary flat trucks carry standard-shaped crates; motorized lift trucks scoop up heavy shipments; barrel trucks cradle cylindrical objects. If the worker finds a shipment of long pipe inside the semi, he merely hitches little trailers to a flat truck, stretching it out until it will hold the pipe. If there is a mountain of small bundles, all going to the same destination, he erects a portable roller conveyor in a couple minutes and sends the bundles shooting down the line to the trucks.

Circling the center of the big platform is

In truck bay, a worker signals the control room his disposal of a particular shipment. Right, freight handler chalks number on hand truck. Carried around platform by conveyor, truck will be picked off by another man





the merry-go-round conveyor—an overhead chain almost a third of a mile long. At 16-foot intervals along the endless chain, metal fingers gape open. The conveyor has but one purpose—to haul the loaded platform trucks from one side of the big concrete slab to the other. To do this job, it moves them at the rapid rate of 148 feet per minute down the length of the platform, around the corner and down the other side. Each little truck has a tall mast on one end. When the workman has loaded the flat truck, he chalks its code number (received from the platform control room) on the truck's blackboard. Then he wheels it over to the belt conveyor, lining up the top of the mast with the open metal fingers. When the fingers strike the mast, they lock around it and the conveyor spins the shipment around the platform to the other side, where a designated workman recognizes the code number and unclips the truck. If he misses the first time, the truck will always be around again. The conveyor eliminates the need for pushing the trucks clear across the platform, and the endless confusion that might result if they were delivered by hand.

Meanwhile, paper work on Bill's truckload is fanning out through the building along the 6½ miles of pneumatic tubing. Carriers zoom through the tubes to each operating section and every important room in the terminal. Each destination has a code number.

Up in the routing section, one of the operators rifles the manifests which are to be sent down to the unloading berth. He glances at the huge blackboard

lining one wall and decides the proper route for one shipment. Slipping that manifest into a carrier, he turns a disk on the cylinder until it shows the proper code number, then inserts it into the tube. It is sucked immediately to the tube control room, where it is deposited on a moving belt, swung around and dumped in front of the router. He glances at the code number and inserts it into one of the 65 tubes for delivery to the truck bay.

One room in the vast building is lighted like a pinball machine. In the platform control section, big electronic panels with flashing code numbers show the movement of every item of freight in the terminal from a box of pins to a shipment of steel beams. Down on the platform, the worker turns a dial as he unloads or reloads each shipment. Numbers instantly pop up on the panel in the room, and the operator processes and sends out the papers covering that shipment.

Each dispatcher has 20 telephone lines at his command for ordering deliveries and pickups. He prepares each load in street-address sequence, then sends out the mosquito-fleet trucks on their delivery runs. When a driver telephones that his truck is empty, the dispatcher routes him for pick-

ups on his return trip to the terminal.

Just about every known device for jockeying freight from one point to another is built into the terminal. A cruising overhead crane zips tonnage shipments from one side of the platform to the other. Four big scales, including a 10-ton job, are spotted along the platform. In the recoopering shop, complete power equipment turns out new crates to replace those that have burst their seams. There are an in-bond room, short-term storage room and a special room for the storage of valuable merchandise. Automatic sorting machines and punch cards keep the paper work flowing. Topside, on the roof of the terminal, there are two fire stations and parking berths for 115 trucks. And spotted through the structure are banking facilities, a doctor's office and various conference rooms.

Across the river, in Newark, N. J., a twin terminal has been completed. Similar in  
(Continued to page 240)

Busses will roll into new bus terminal every five seconds during peak periods. Located near Times Square, terminal will handle 130,000 passenger movements each day. Four-level building accommodates both suburban and highway busses. Ramps are radiant-heated to melt snow as it falls. Arrows show traffic patterns busses will use to and from Lincoln tunnel

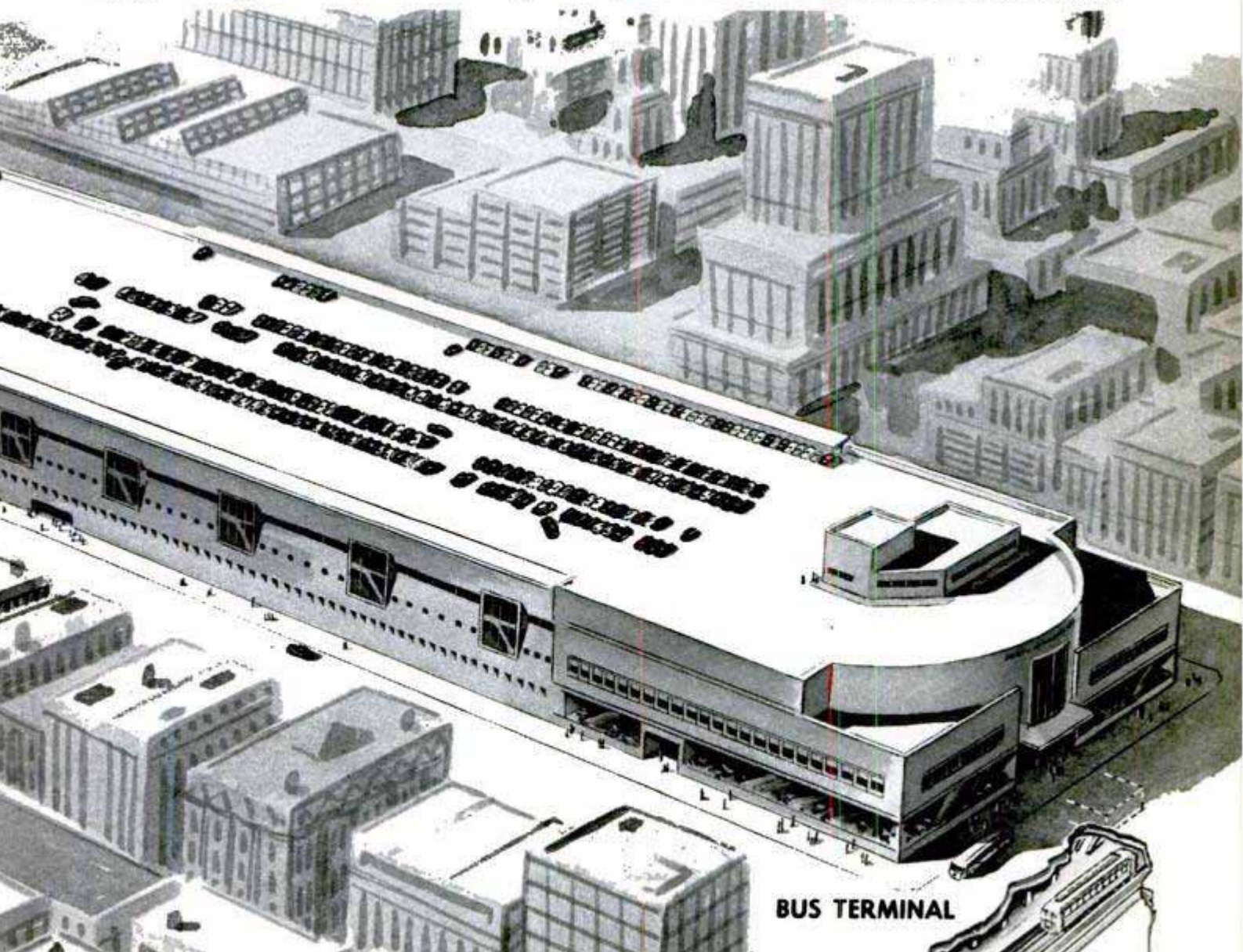



## Food Alarm

Timed feeding, which has become traditional for infants, is extending to the poultry world. An Englishman has invented an



Mirrorpics

alarm-clock controlled device which releases food from a hopper into a container at a preset time. The owner can leave for the day and know the chickens will be fed on time.

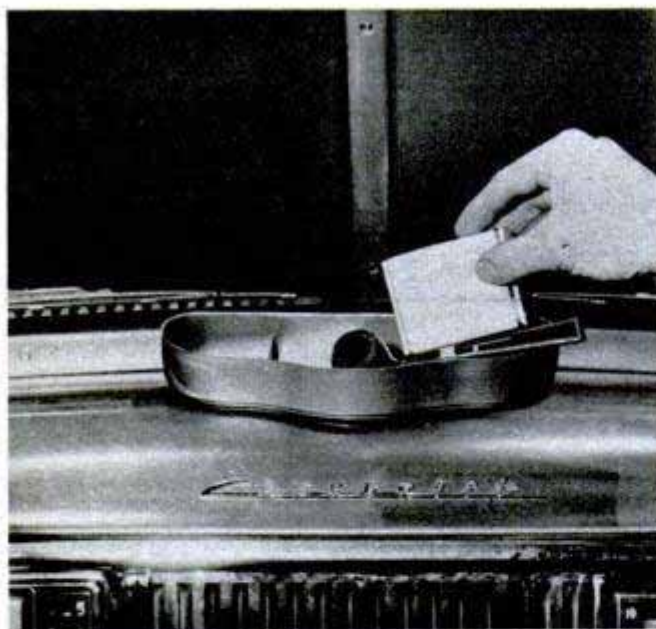

## Magnet Holds Utility Tray On Car Dashboard

There's no installation problem with a new utility tray for motorists—you simply place it on the dashboard and a strong magnet holds it there. The tray is large enough to hold smoking supplies, parking-meter coins, keys and other items. The permanent magnet, cemented to the base of the tray, is coated to prevent scratching.

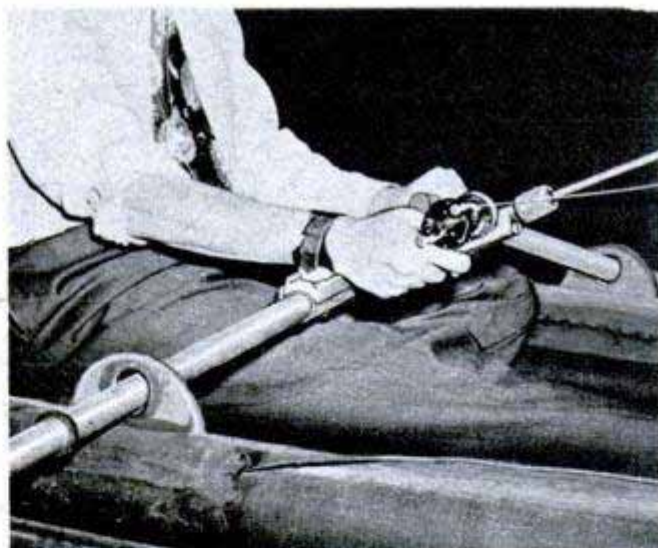

## Fisherman's "Handcuff"

You can fish and row at the same time with a "handcuff" that straps to your wrist and fastens to the end of the oar. When a fish strikes, you can release the oar instantly by a sidewise motion of the arm. The slow movement of the arm in rowing gives the lure a better action in the water.

☐ Cooking doesn't affect the taste of a synthetic noncaloric sweetener, Sucaryl, which has a more natural sweetness than saccharin.

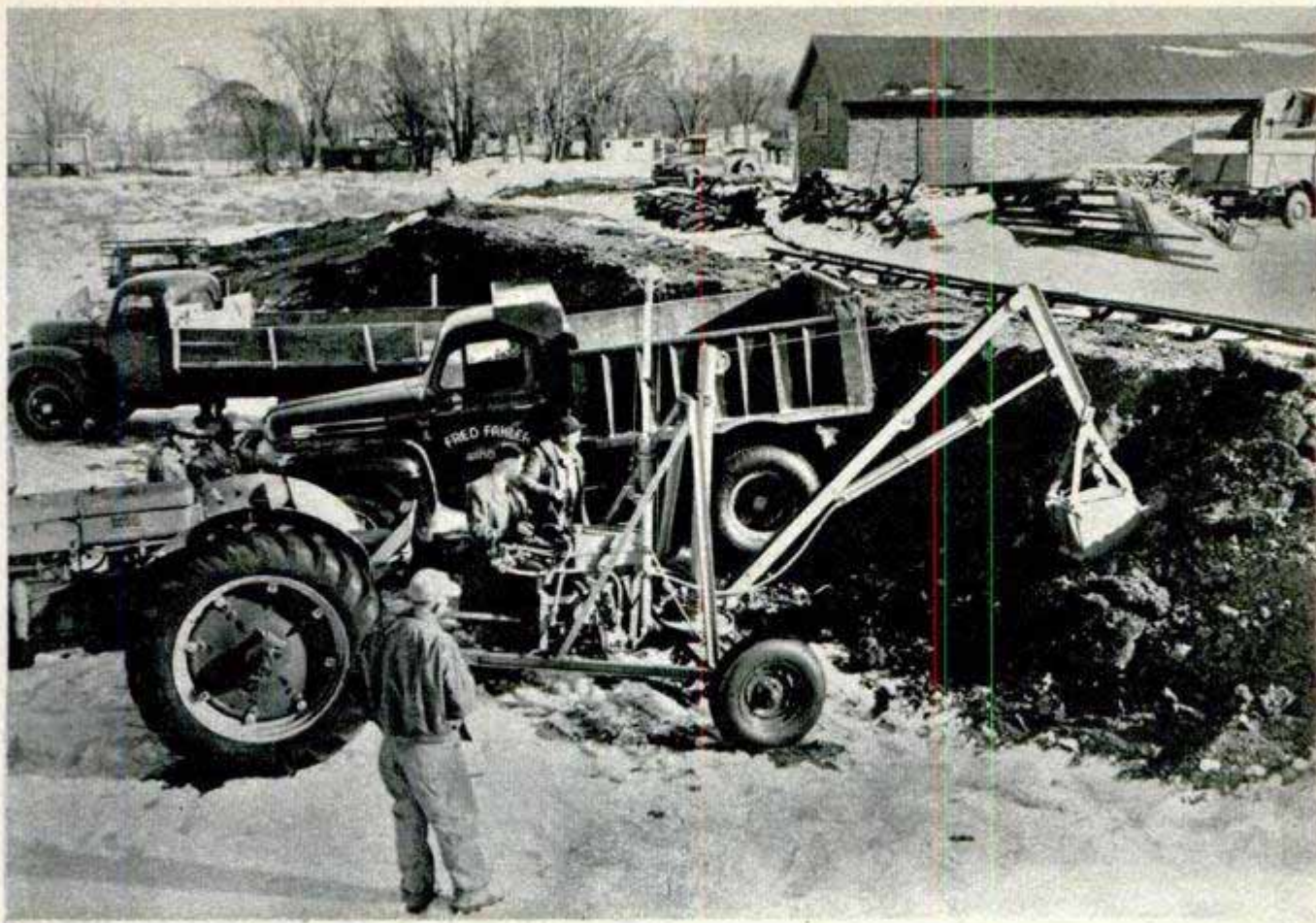

## Trailer-Type Digger Hooks to Tractor

Attached to the power take-off of a tractor, Jeep or truck in less than a minute, a trailer-type digger has a capacity up to 30 yards an hour. Because the unit supplying the power acts as a counterbalance, swinging counterweights are unnecessary, enabling the machine to work in close quar-

ters. Three controls operate the hydraulic cylinders that actuate the swing, boom and dipper-stick mechanisms. The digger works down to a depth of 9 feet and its shovel can be raised to 14 feet for easy loading into any truck. Shovel buckets for the machine vary in width from 14 to 24 inches.

## Three Blocks of Radiators

It's always warm along a three-block-long bank of giant radiators that cool the 120 engines of the largest internal-combustion power plant in the world at Port Lavaca, Tex. The large radial engines drive 120 direct-current generators, each turning out 1000 kilowatts for the aluminum reduction works of the Aluminum Company of America. Each radiator is over 11 feet tall and has a six-bladed fan 7 feet in diameter. Both water and oil are cooled in the radiators. The total heat dissipated is 317,700,000 BTUs an hour.

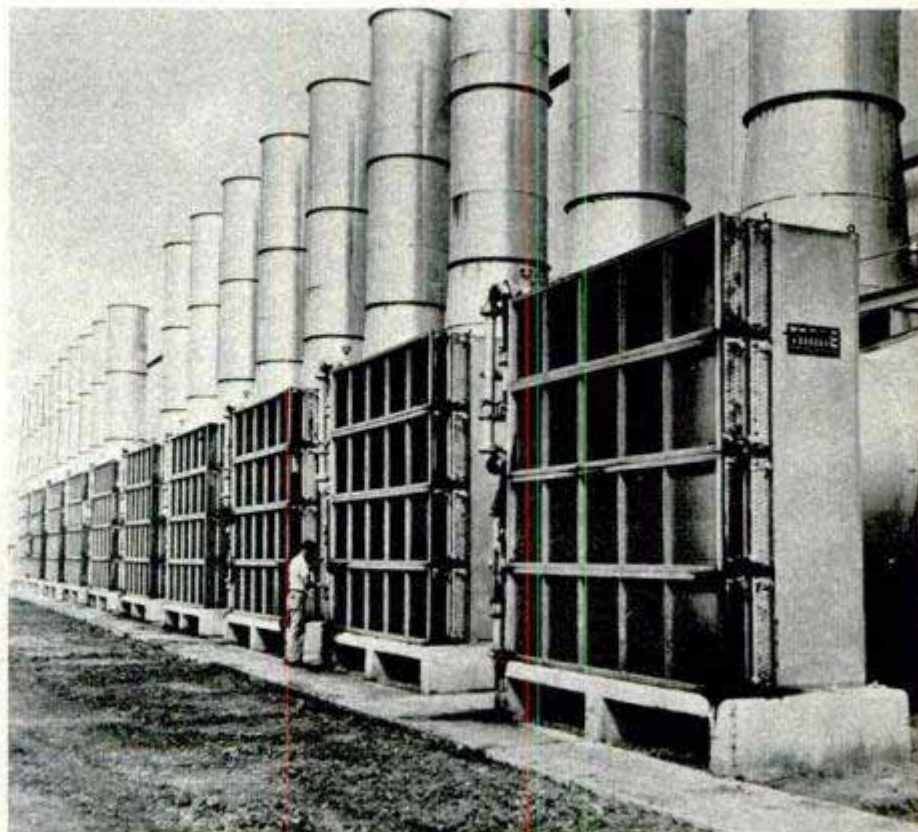

# Patton Tank M-46

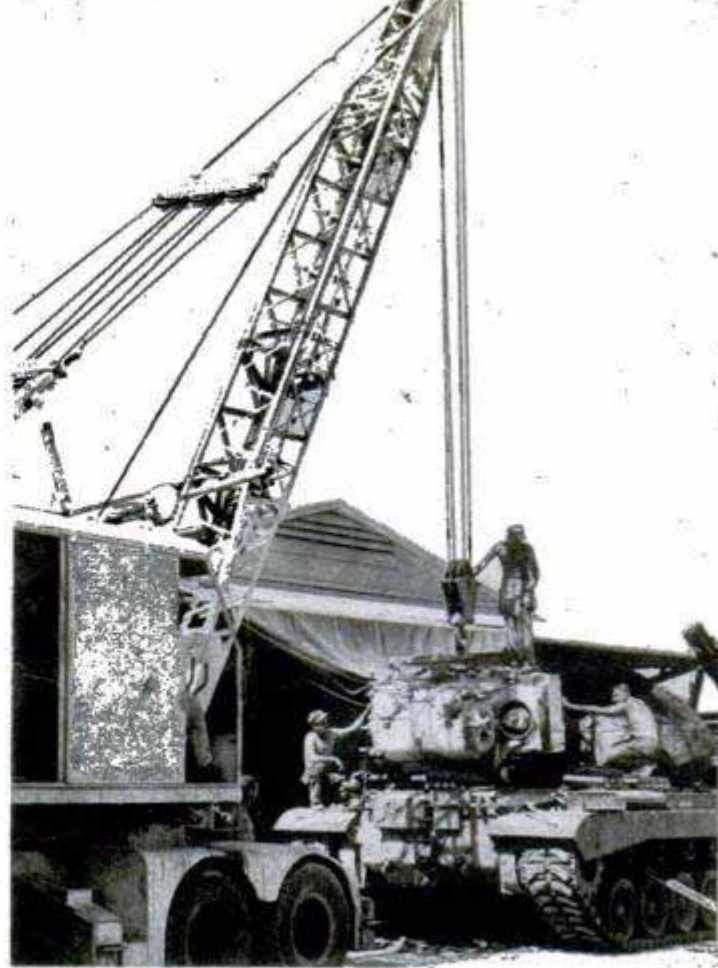
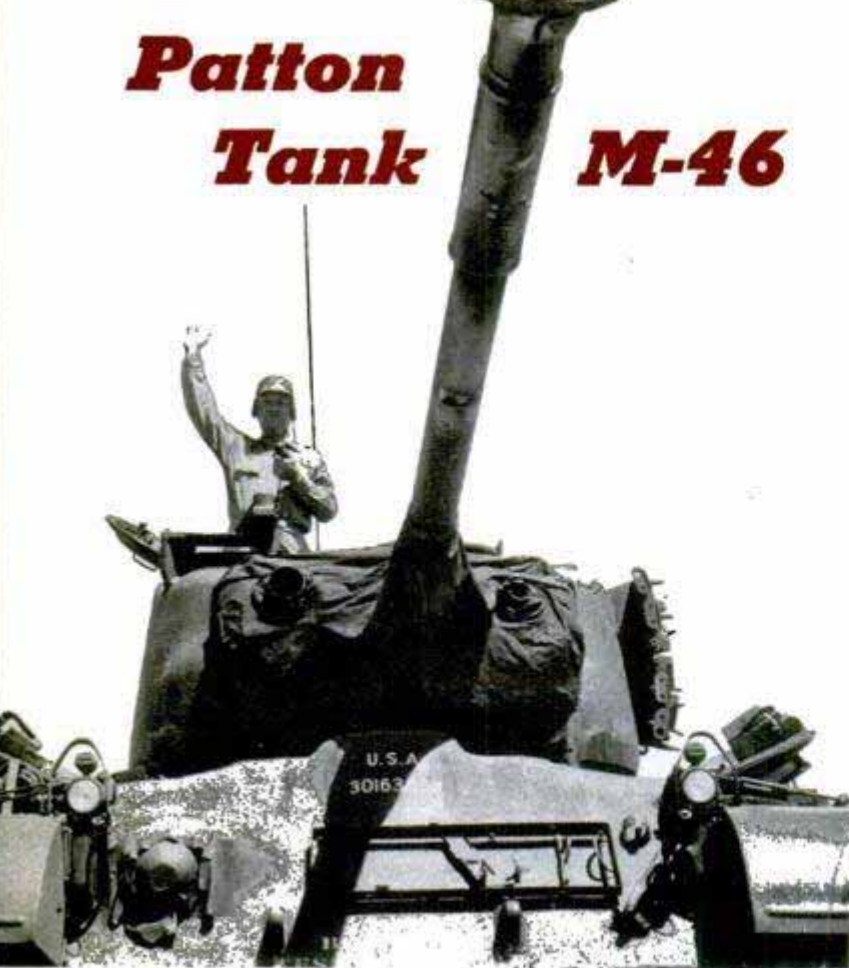

U. S. Army photos

Muzzle brake on 90-mm. cannon helps eliminate dust when firing, preventing the tank's position from being given away. Right, engine and transmission can be lifted out as a unit for quick change if power plant fails

AGILITY and heavy fire power are combined in an improved version of the General Patton medium tank, now receiving exhaustive field tests. The 48-ton armored monster, with a 90-mm. cannon, can speed at 40 miles per hour across level ground. Its driver steers with a short wobble stick that also serves as the gearshift and with which he can spin the tank around in its own length. Designated the M-46, the Patton tank has a 12-cylinder, 810-horsepower air-cooled engine. Semi-air-conditioning is provided by fans that drive hot fumes aft, out of the engine compartment, away from the driving compartment and the turret. The engine has mufflers to silence the exhaust noise and pads of cold rubber fixed

to the track cleats permit travel over good highways without damage to the road surface. Part of the field testing of the Patton and other redesigned track and wheel vehicles was conducted at El Centro, Calif., at temperatures that ran as high as 120 degrees in the shade.

Among them were improved Jeeps and various sizes of military trucks, all of which could run circles around their World War II counterparts. They all have 24-volt electrical systems and low-pressure tires for better flotation in mud and sand. Their engines are waterproofed and all can be changed quickly. Also under test are an 18-ton light cargo tractor and a 49-ton heavy cargo tractor.

Patton can travel over rough ground at 40 miles an hour. Gun muzzle is turned and shrouded when traveling over dusty terrain. Right, looking down at driver, holding wobble stick used to shift gears and steer



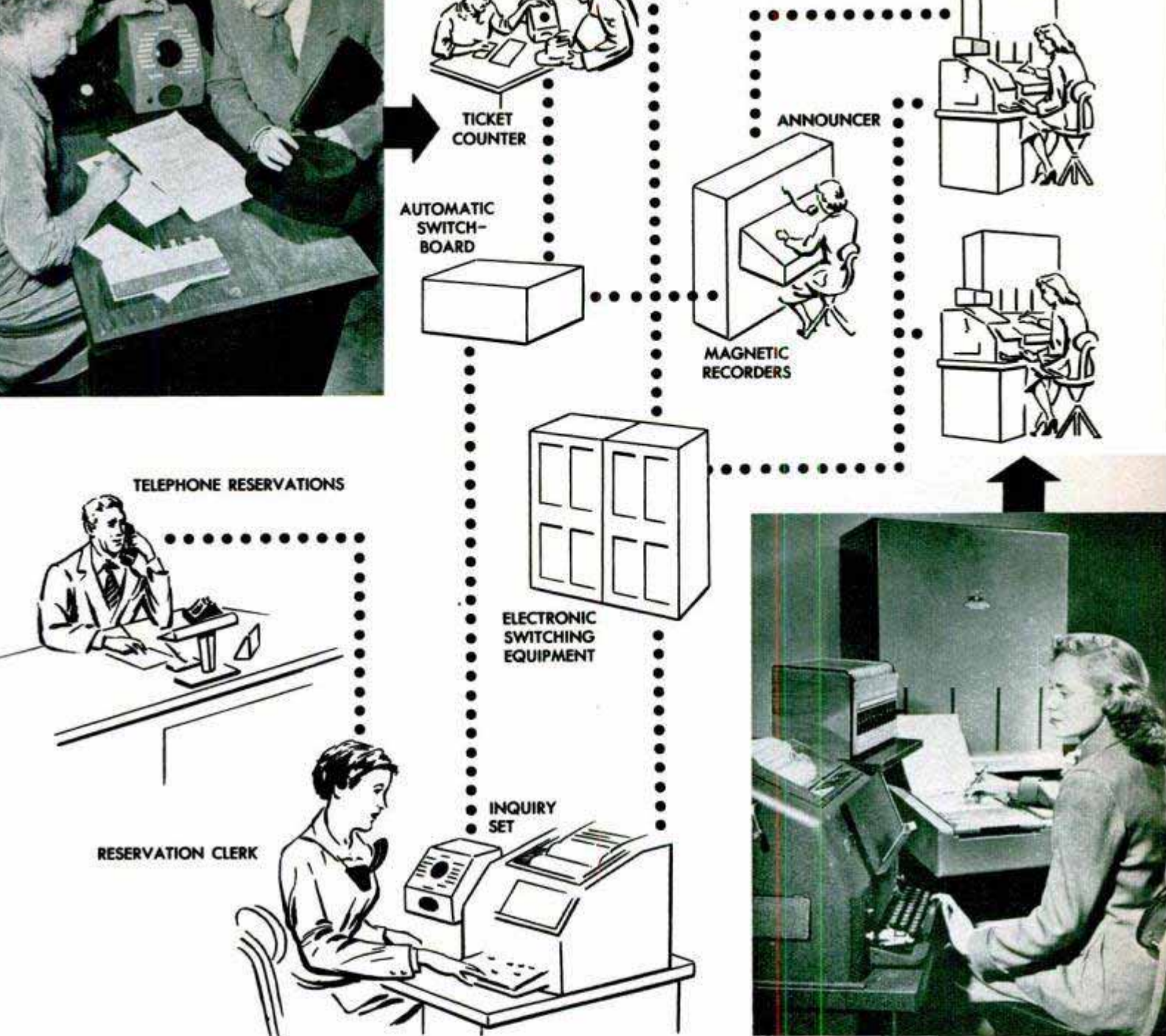

Diagram of Pennsylvania Railroad's speedy reservation system. Ticket agent, top left, or reservation clerk, lower center, uses electronic equipment to make your reservation with clerk at automatic file, lower right

## Railroad Reservations Made Automatically

IF YOU'VE ever waited impatiently in line at a ticket window, you'll welcome an automatic railroad-reservation system that cuts handling time by 70 percent. Accomplishing this long-needed miracle is an electronic system that eliminates all usual conversation between the ticket agent and reservation file clerks.

When a customer comes in for a reservation, the ticket agent simply dials a code number denoting the destination and date of departure on an inquiry set beside her. This code number connects the inquiry set to a magnetic recording which announces all accommodations available on that date for that destination. The recordings, a different one for each day and destination, are

kept up to date by an announcer who makes a new one whenever the last unit of any type of space is sold.

Learning the available accommodations, the customer selects the space he wants for his trip. The agent then "types" the order to the space-control unit, an automatic book-keeping machine. This machine "reads" the order as it comes in over the wire and automatically selects the proper train file, ejecting it on the desk in front of the clerk. She looks over the diagram, assigns the space and types a confirmation to the ticket agent, which usually requires less than 30 seconds. During busy periods, the machine automatically "stacks" messages, handling them in order.



# DIVING

# CAMERA- MAN

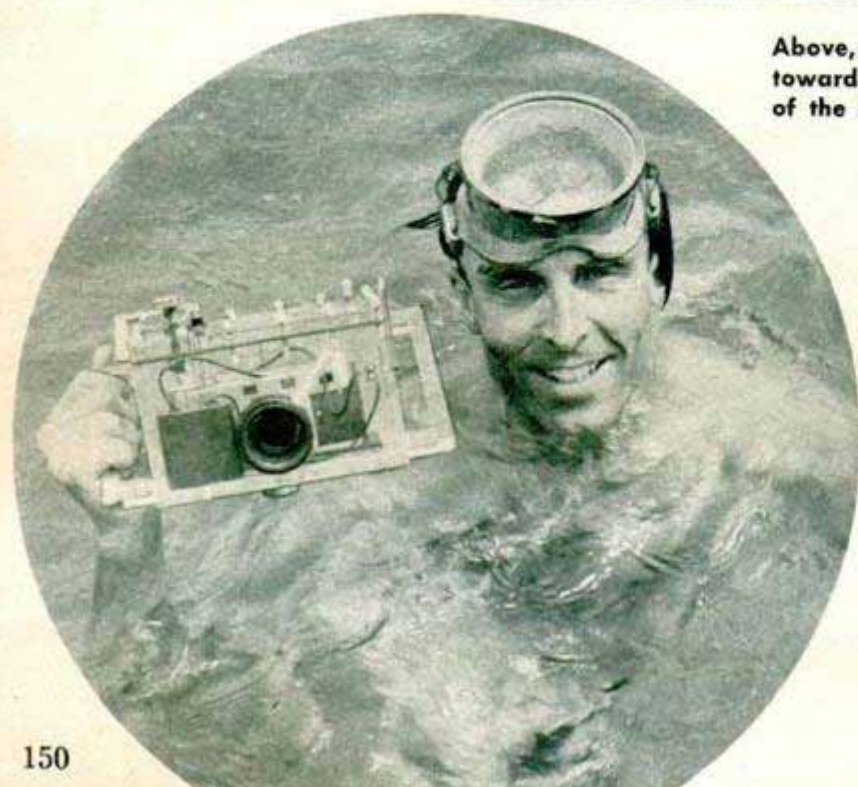

Above, aiming his camera, photographer swims toward a subject. Left, Howard Deichen, designer of the box, comes up from a picture-taking dive

PENS that write underwater have nothing on Roy Pinney's camera. Sealed snugly inside a plastic box, it takes pictures as easily underwater as it does on land. Extension shafts, sealed by waterproof packing, allow the photographer to focus, cock and trip the shutter and wind the film while swimming far below the surface. There's even a flash synchronizer for use when lighting is poor. Ten pounds of air pressure are maintained inside the box to keep water out should a small leak develop.



This action shot of an underwater "hunter" is typical of the photos Pinney takes with his plastic-encased camera



Spear fishing, popular at Nassau and other island resorts, provides excellent action shots for submarine camera



Sportsman Roy Halvorson uses a Pinney camera on visits to the ocean bottom. Motor-driven compressor enables him to stay down over half an hour

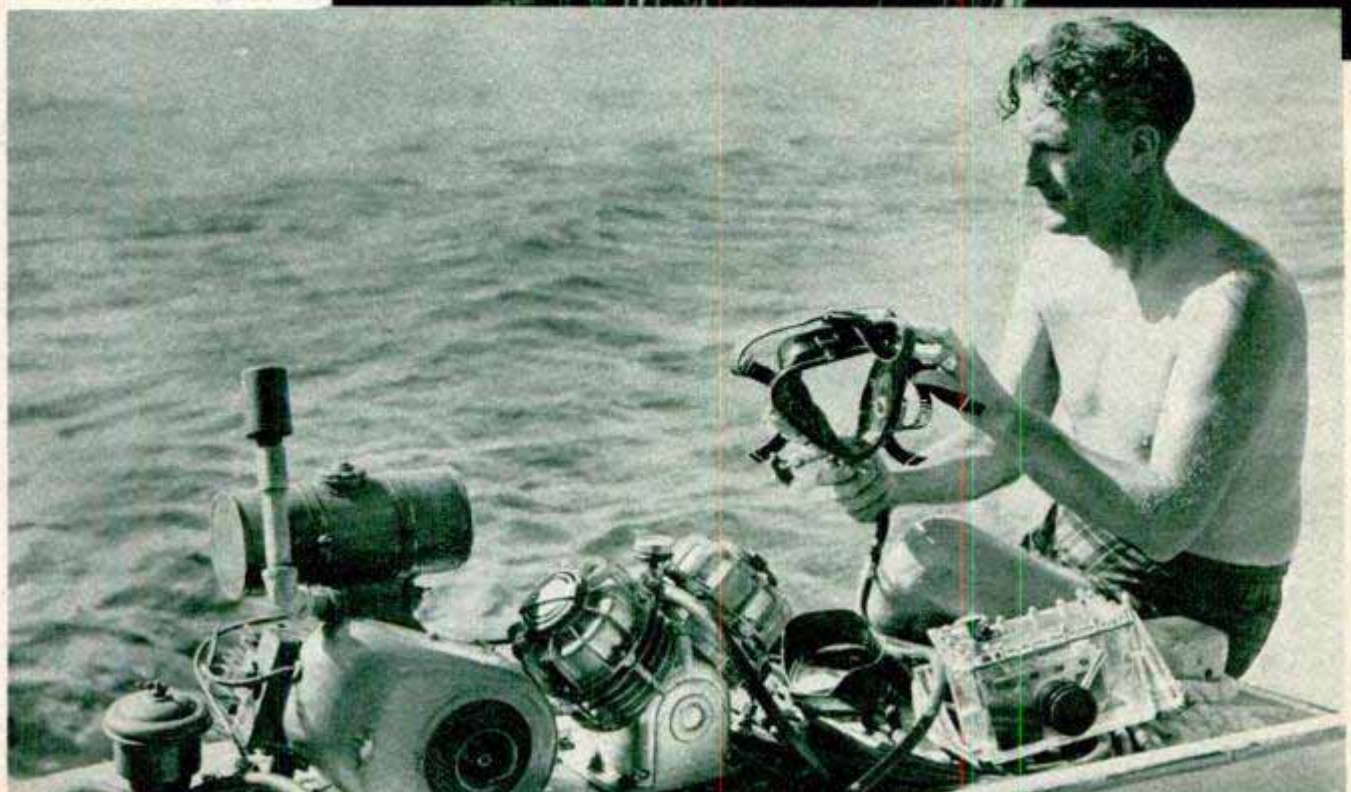

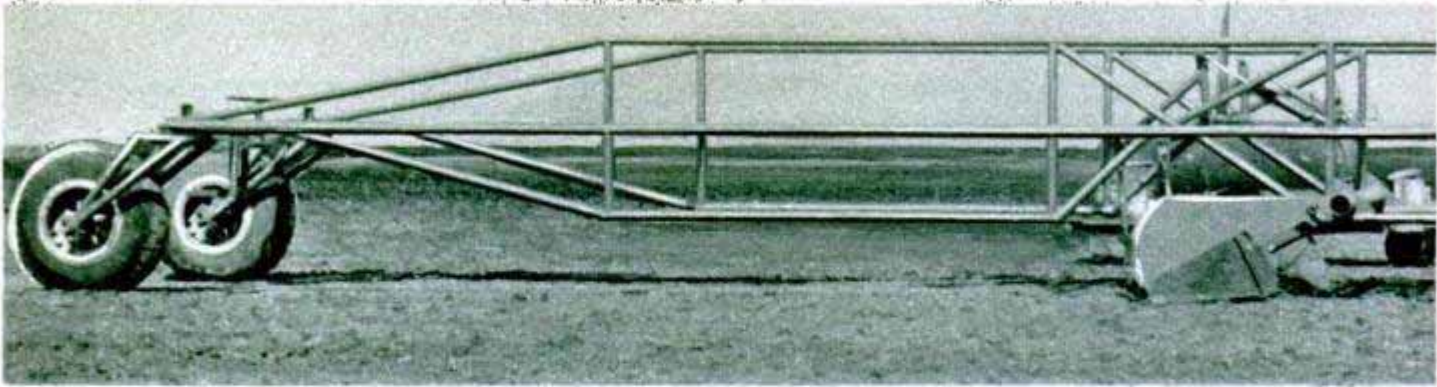

## Long Land Leveler

With a 60-foot-long machine they built from surplus equipment, two enterprising brothers of southeast Texas can level four acres of ground in an hour. Howard and



## Tailgate on Truck Forms Electric Lift

Hard-to-handle shipments are easily loaded aboard any truck equipped with a new electric lift. The lift platform replaces the conventional tailgate on the truck. A winch and cable, powered by the truck battery, draw the platform up to the truck body level. After the load is inside, the gate closes automatically. A portable switch controls the winch, and the operator can ride up with the load if he desires. The lifts are made in a variety of sizes.

## Pocket Magnet

Small metal pieces dropped in hard-to-get-at places are quickly retrieved by a powerful magnet that moves in and out of its plastic case like the lead in a mechanical pencil. A spring clip on the barrel of the magnet makes it convenient to carry in the shirt pocket. It is especially useful in factory first-aid stations where it safely removes steel splinters from the eyes or flesh of workers.

Information not listed on articles in the index, starting on page 10, frequently is listed in the WHERE-TO-FIND-IT LIST, available to readers without charge from Bureau of Information, Popular Mechanics, 200 E. Ontario Street, Chicago 11

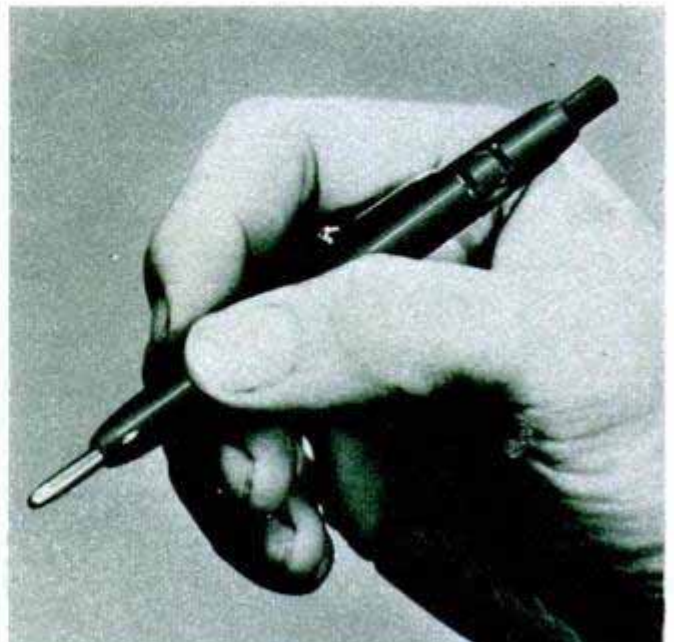

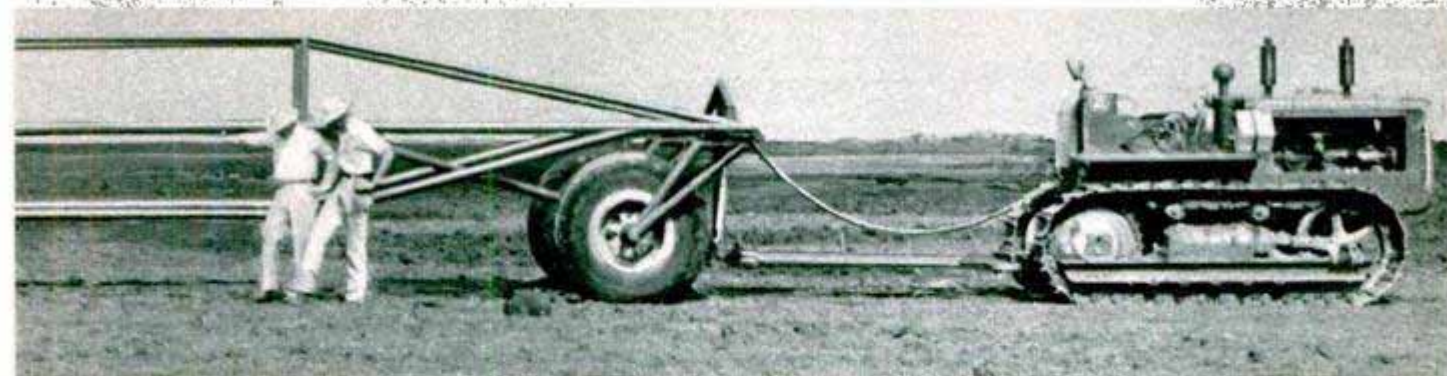

William Clayton built the tractor-drawn leveler to slice humps off their rice fields, making possible efficient irrigation. They made the frame from three-inch refinery

pipe, welded at the joints. Under each end they placed two surplus bomber wheels. In the center of the frame is a 16-foot blade controlled by hydraulic lifts.

### Brush Burner

Brush trimmers along Indiana highways and power lines get rid of green branches quickly and completely in a portable furnace mounted on a two-wheeled trailer. Once a bed of hot coals is formed in the firebox, the green branches burn quickly with a minimum of smoke. The smokestack, which folds down for traveling, carries the smoke high enough so that it does not bother highway traffic. The front end of the furnace is thickly insulated to protect the tow truck from the heat.

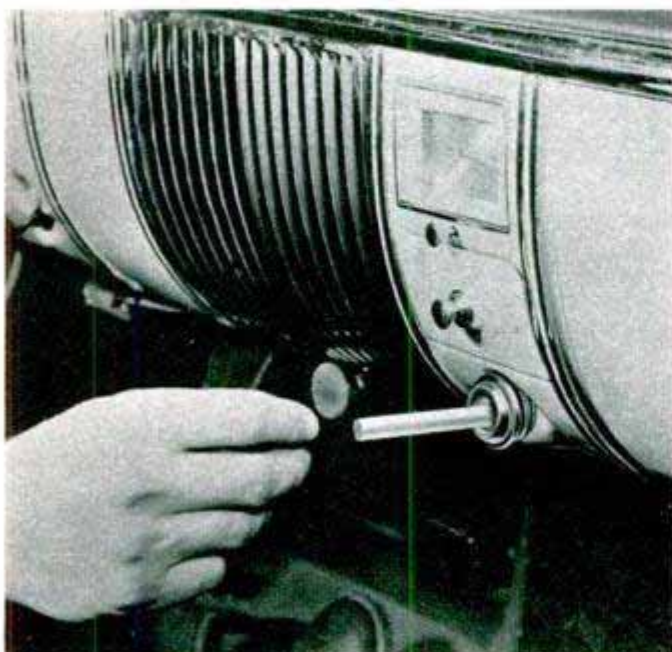
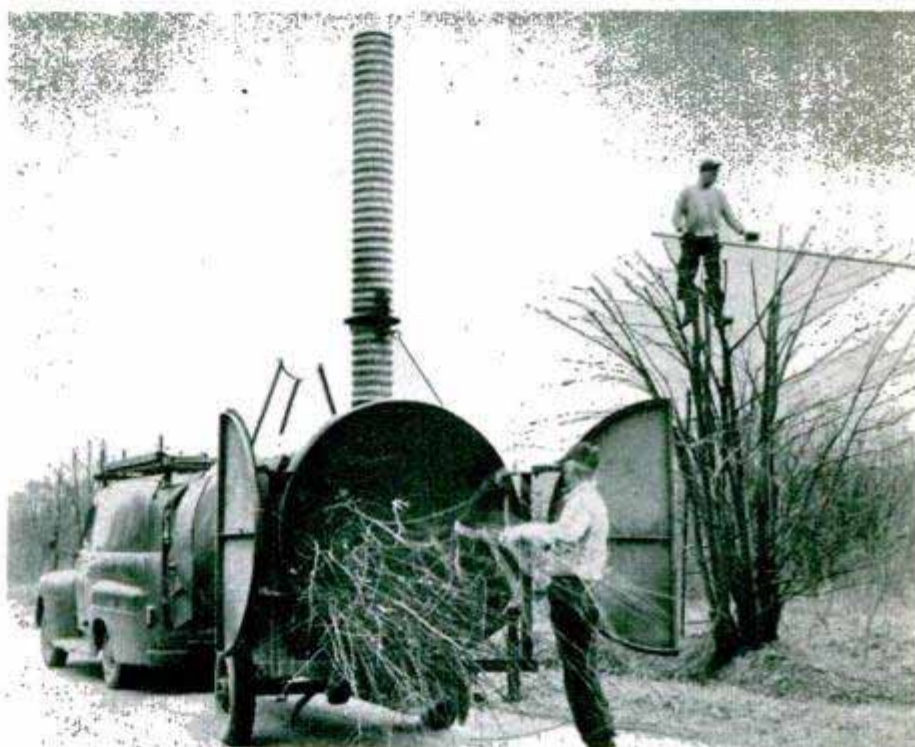

### Car Lighter Puffs Cigarette

Cigarettes are lighted automatically for the motorist by a new car lighter that is never removed from the dashboard. Instead, the motorist inserts the cigarette into a socket and pushes in a metal ring. A few seconds later the ring pops back out and delivers the lighted cigarette. A hose connects the lighter with the windshield-wiper vacuum line to provide air for the light. Electric current is supplied through a connection to an ignition-switch terminal.

¶ Although chemical industries in this country extract 5,000,000 tons of nitrogen from the air each year, life processes replace almost that amount; and even if the nitrogen were not replaced, the supply would last about 930,000,000 years.



# HARVEST

**A**SK ANY FARMER to describe the perfect crop and he'll probably say it's one that would require no plowing, no planting, no cultivating, no fertilizing, yet could be harvested all year 'round!

Strangely enough, there is such a crop. However, you won't see farmers rushing to produce it because, compared with such money-makers as corn, wheat and oats, it's just a poor relative. You'd better not plan to grow it because Nature can do it cheaper. It is Spanish moss, the gray plant that hangs like a shaggy beard from the trees in the South. Growing wild and in great abundance, it has a steady but low-priced demand.

The inner fiber of the plant somewhat resembles horsehair and it is commercially valuable as stuffing for upholstered furniture, mattresses and other items. For many Southern workers, Spanish moss is a form of unemployment insurance provided by Mother Nature. During periods of seasonal unemployment, the worker can always go out and collect a load of moss to be sold at the nearest buying yard.

To some folks, it's picturesque and to others it's weird, but there are many persons to whom this dangling Spanish moss is a crop that pays the food bill

During seasonal unemployment periods, trucks and cars pour into Southern moss yards bringing tons of moss. It is piled on the ground and soaked until it's cured

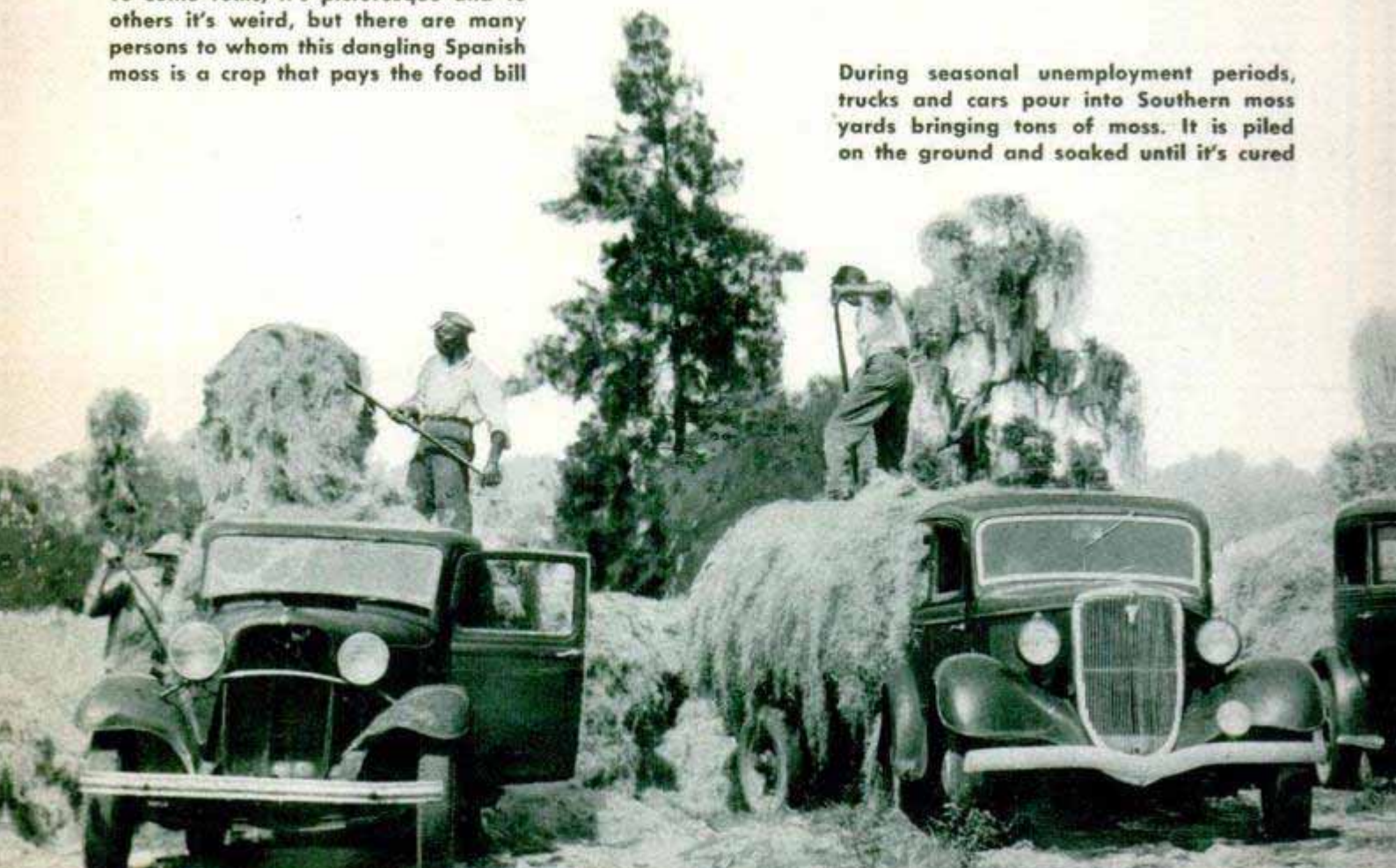

# FROM BEARDED TREES

Spanish moss is an excellent example of misnomers in nature, for it is neither moss nor Spanish. Instead it is an air plant, or epiphyte (the opposite of parasite), belonging to the pineapple family. Its lengthy strands seen growing along Atlantic and Gulf Coast states from Virginia to Florida and westward to Texas, take no nourishment from the tree on which they grow. All the plant needs is a place to anchor its seeds. Food is supplied by the air and by moisture.

The feathery, wind-blown seeds frequently find anchorage in rough-barked trees, though if they happen to land on wires with worn insulation, they will start growth there as readily as on a tree, demonstrating that they are a true air plant and not a parasite which needs nourishment from its host. The only harm that Spanish moss can do is to become so dense on a tree that leaf growth is smothered. When frequently harvested, it does not damage the host tree in any way.

Close inspection of the twisted strands of Spanish moss in springtime reveals a tiny three-petaled, greenish blossom. When the seed pod ripens it is much more conspicuous than the minute bloom. It contains numerous feathery seeds with tiny barbs which cling to any rough surface wherever they are blown by the wind.

Finding an anchoring place, the tiny seed grows into a twisted, pendant plant. Normally, the moss is gray, but during heavy showers it becomes greenish for as long as the rain lasts. Like a camel it seems to store up enough moisture until the next rain. On the day following the shower, the green disappears and the plant becomes a drab gray again.

In regions bordering streams, lakes or swamps, Spanish moss reaches its greatest abundance. It knows no seasons and can be harvested any time of the year. Spanish moss is one crop of which it can be said that "money does grow on trees." It is usually possible to harvest it free of charge wherever it grows, for the owner of the place is generally happy to have it removed from his trees—that is, unless he wishes to harvest it himself.

To harvest the crop, a long bamboo pole is used. This is studded on one end with nails that are hooked over the strands to pull them loose. Sometimes entire families work at the harvest. The adults work on the ground while the younger and more agile members climb into the trees to tear the moss free.

The load of moss is hauled to the nearest moss yard in whatever conveyance is available. Anything from an ancient wagon to a modern automobile serves as a carrier. It is even brought in on bicycles by youngsters anxious to earn spending money.

Arriving at the moss yard, the load is weighed and the pickers are paid for their crop. When the moss is unloaded it is piled up to five or six feet high around the yard. During periods when the moss is being harvested steadily, there are often acres of ground covered with it. After large heaps have accumulated, the plant is thoroughly soaked until it settles to less than half the height of the original heap. It is then left exposed to the elements for about 60 days for curing. Since only the inner fiber of the plant is used, the outer covering must be removed. Therefore, much of this covering is allowed to rot away before the moss is ginned.

Left, frequent wettings speed the curing. Right, when cured, the moss is transferred to these drying racks



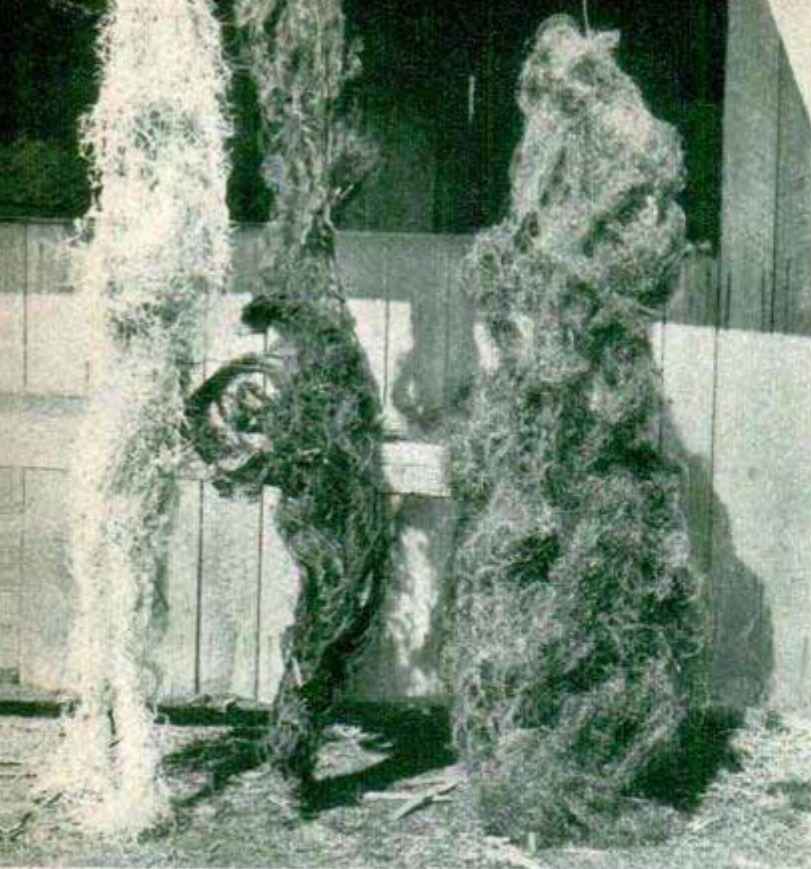

Above, from left to right, three stages of Spanish moss: freshly harvested moss; cured moss, and the valuable hairlike fiber that is removed by the gin

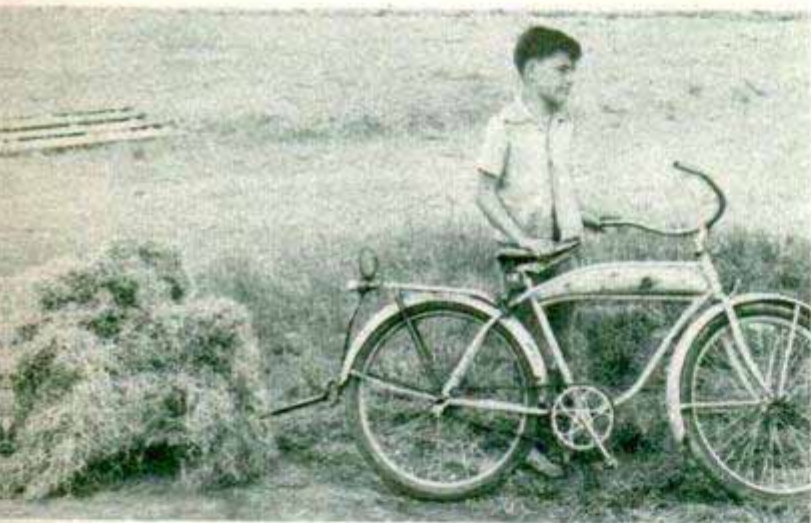

Above, even youngsters find moss-harvesting profitable. Below, moss is used here to shade shuffleboard fans



After lengthy exposure to weather, the color of the moss turns from its original gray to dark brown. It is then loaded on trucks and transferred to the drying racks.

Next the moss is piled in sheds to keep it dry until the ginning. The machinery that gins the moss is often homemade by the owner of the plant, based on his own ideas. Ginning removes the remaining outer covering of the plant, also taking out twigs or other foreign matter which may be mixed in with the moss. This waste material accumulates at the gin and it is sold at bargain prices as fertilizer. The valuable inner fiber resembles horsehair both in appearance and in toughness.

Before ginning, the moss is often separated into different grades, each grade being run through separately. The highest quality fiber is used for better grades of upholstered furniture and for mattress making. The poorest quality may be used for stuffing horse-collar pads.

Strands of moss are used to shade newly set-out plants and to protect tender plants from freezing. Moss is woven into the mesh of wire fences along the sidewalls of plant sheds. City residents hang strands of the material over wires to make a back-yard screen for more privacy.

Strands of moss have been used to provide a temporary sun shelter over Florida shuffleboard courts. Moss has been hung over the frames of window awnings after a storm destroyed the canvas, providing shade until a permanent covering could be provided.

It is truly a plant of many uses. The best part of it all is that it is almost always available for harvesting without cost to the individual. Only the necessary time to harvest it and haul it to the moss yard is needed. No other crop requires so little effort to convert it into cash. It is truly the "perfect" crop.

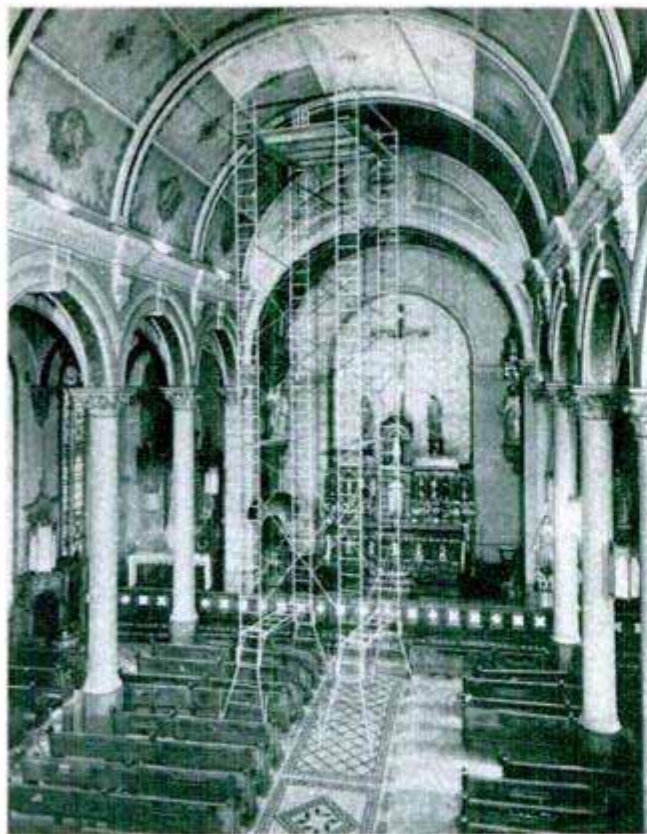

## Tubular Trestle

Virtually unlimited combinations are possible with a tubular-steel trestle that can be assembled in a variety of shapes to provide safe scaffoldings for maintenance crews. The basic trestle unit is designed to



permit passage underneath and to bridge obstacles such as desks, church pews, furniture and aisles. The vertical members serve as ladders and make it possible to add working platforms at each rung level. The caster stems are adjustable to permit level erection on steps or uneven floors.

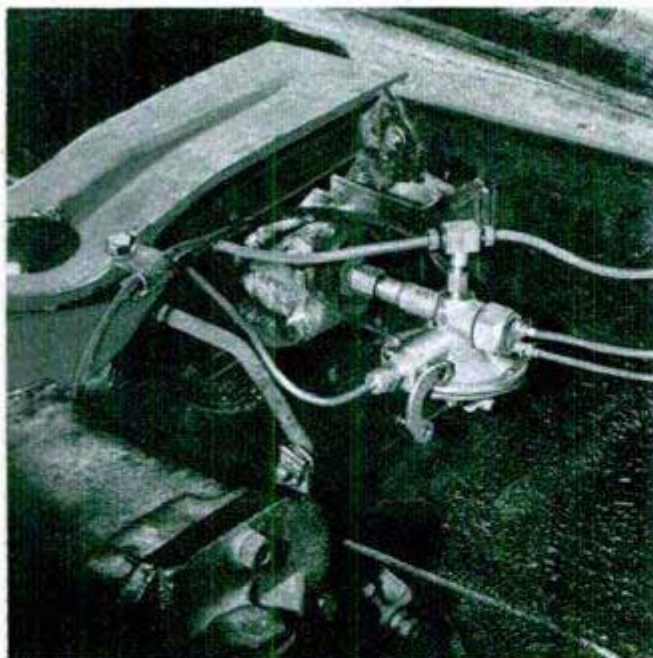

## Hill Holder

Cars are held motionless even on steep grades by a mechanical hill holder. The attachment, which fits any hydraulic brake system, can also be installed on trucks and industrial lift trucks. It is a casting with connections to fit the master cylinder, the brake line and the intake manifold. When



the engine is turned off and the foot pedal depressed, the hill holder automatically retains pressure in the brake system to hold the car in place. Flipping a lever and inserting the car key releases the pressure. When the engine is running, a knob on the dash is pulled out to hold the car. Pushing in the knob returns the brake system to normal operation.

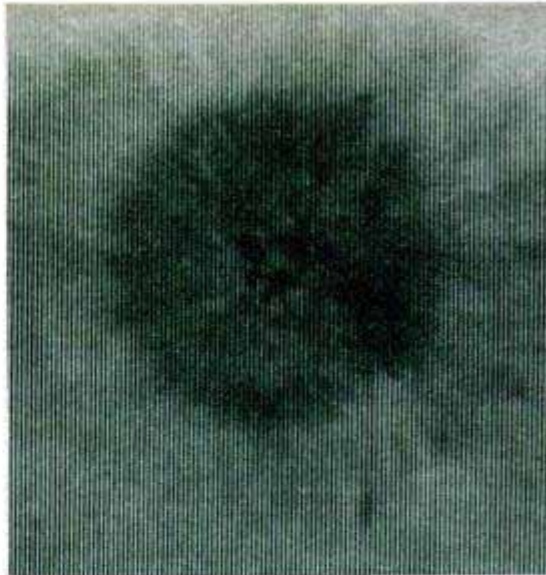
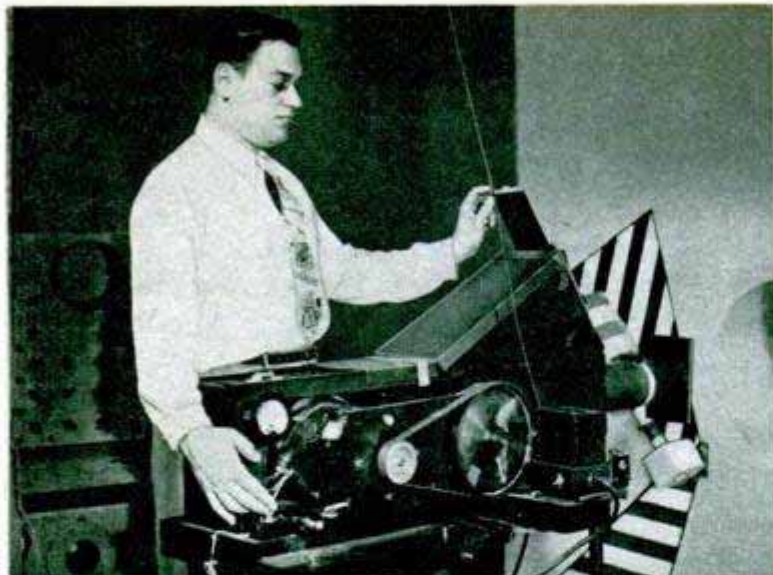

Dept. of Defense photo

Left, inventor pulls slide on superspeed camera. Left, shock-wave photo shot at 100-millionth of a second

## Superspeed Camera Films Shock Waves

By crowding as many as 300 exposures on a single film, a new high-speed camera developed by Army Ordnance takes pictures at a rate of 100 million a second. Designed by Morton Sultanoff of the Aberdeen Proving Ground, the camera can record shock and detonation waves during explosions and other high-velocity phenomena. Sultanoff first thought of the unusual shutter system when he saw an animated greeting card on which a moving picture is produced by sliding a transpar-

ent grid across a composite picture. A framing grid, actually a focal-plane shutter with a series of narrow slits across it, and a rotating mirror break down each exposure into a series of parallel lines. During the filming of the explosion, the mirror moves the grid image rapidly across the film, sandwiching the grids of 300 pictures on a single film. The resulting picture, really 300 in one, is meaningless unless viewed through another grid which permits the eye to see only lines forming an individual picture.

## Adjustable Projector Table Folds Into Small Space



Adjustable to any height from two to more than three feet, a folding table is designed for slide or movie projectors. Its broad tripod legs provide a firm base, assuring vibration-free pictures. When collapsed, it can be stored in a small space.

## Quick-Change Motor

One small electric motor in a "giant brain" electronic computing machine can be stopped and started again in the reverse direction in four thousandths of a second. It is relatively easy to stop a motor rapidly with brakes, but rapid starts either in the same direction or in reverse are limited if electromagnetic means alone are used. In the National Bureau of Standards' new rapid-reversal motor, the energy of the rotor which would be dissipated as heat during braking is stored in a spring for use in restarting. The reversal spring consists of a steel torsion bar 31 inches long and less than  $\frac{1}{2}$  inch in diameter.

☐ Throughout the country, the average worm population is estimated at 53,767 worms per acre.



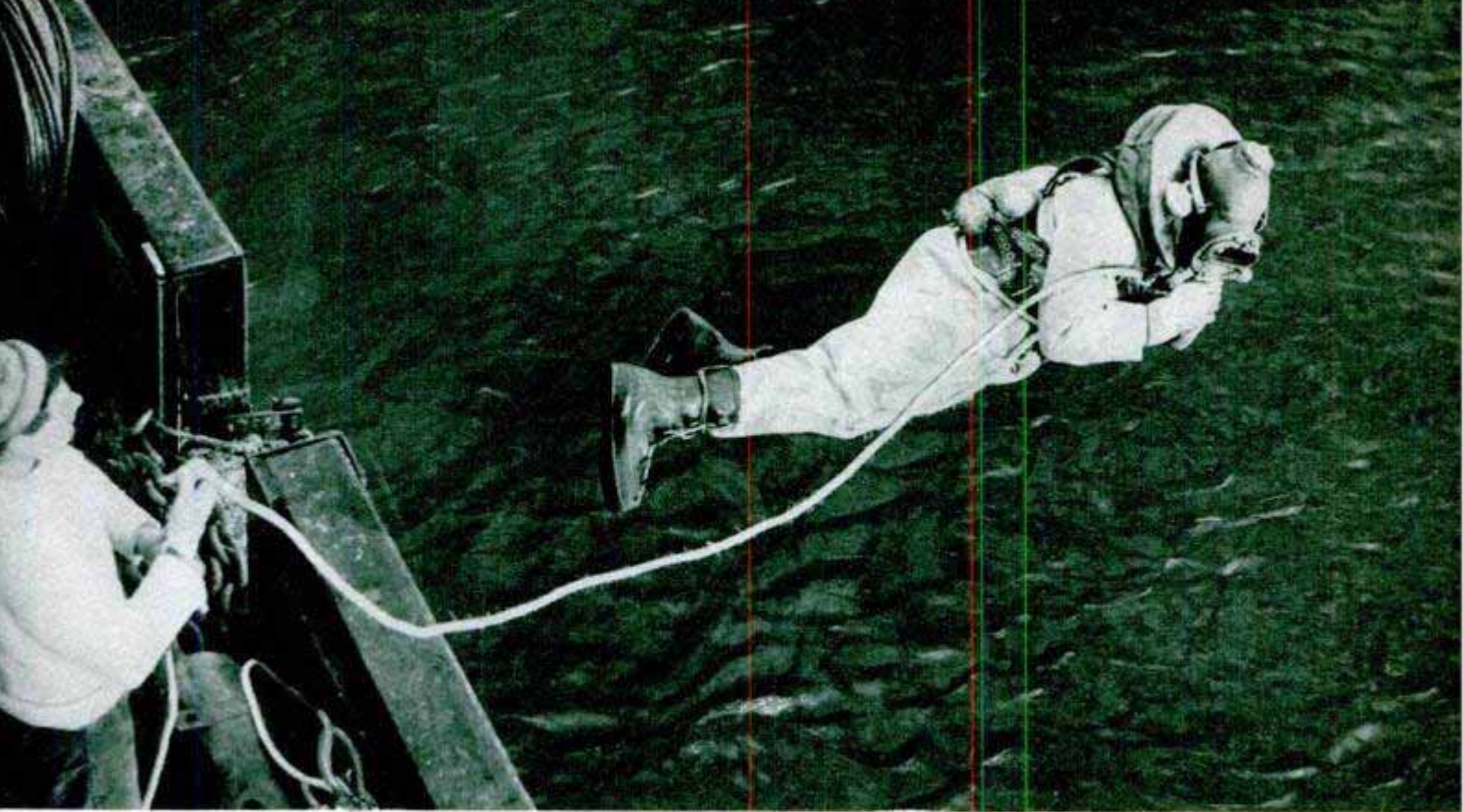

British naval diver leaps into waters of Tobermory Bay in search for sunken Spanish Armada treasure ship

## QUEST FOR A GALLEON'S GOLD

THE SHIP lies sunck off the Shore about one finger-stone-cast, her sterne lyes into the Shore norwest and her head to the southwest she lyes under ye water at ye deepest nine fatham at a low water and 12 fatham at ye high water. In the forepart lyes great ballast stones. We got within the ship a pretty distance and saw a great gunn and other brass gunns. We lifted the kempstone (capstan) of curious worke pauled with a spring at every inches."

This report, written by a Scottish diver in 1683, was recently reaffirmed by 10 British naval divers at Tobermory Bay, Island of Mull, Scotland. Since 1588, a Spanish treasure ship, believed to be the *Florenzia* or the *San Juan de Sicilia*, has lain under some 70 feet of water in the bay. The *Florenzia*, a four-masted galleon, was reported to be carrying the pay of the entire Spanish Armada and even a crown to be placed on the Spanish king's head in London. Both ships carried large amounts of gold from the coffers of Spain's King Philip II—the amount has been reputed to be as high as \$84,000,000. The ship was a survivor of the ill-fated Armada and had fled north along the coast to escape the Royal Navy. It was blown up in Tobermory Bay and for nearly 400 years the dukes of Argyll, whose castle overlooks the bay and

who were granted the rights to the treasure by Charles I, have tried at intervals to recover the gold.

Attempts through the centuries—dwarfed by the 1950 recovery effort—have been unsuccessful in locating the treasure. By 1665 the diving bell had been invented and a major expedition was organized. A year later, a search headed by James Mauld raised three large guns, two of bronze and one of iron. In the next few years, six more guns were recovered and added to evidence of the ship's armament.

Archibald Miller, the Scottish diver

After treasure hunt on floor of sea, diver comes to surface for a rest and clings to the "blob" float

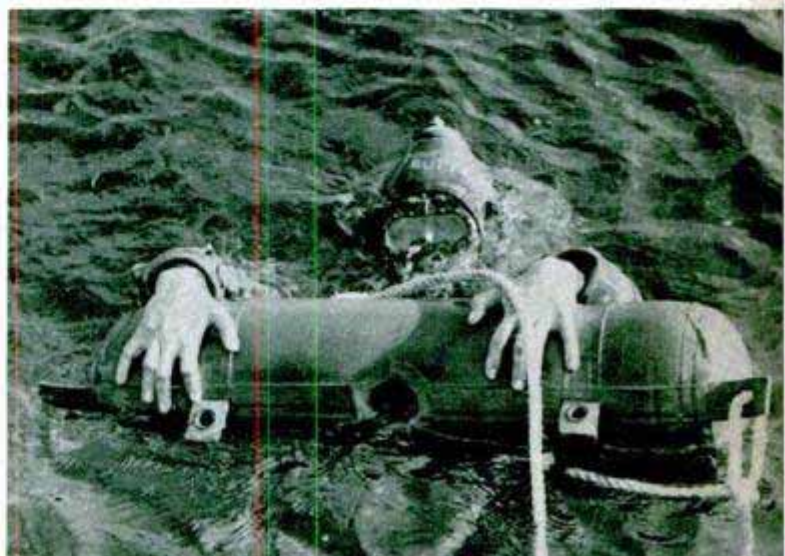

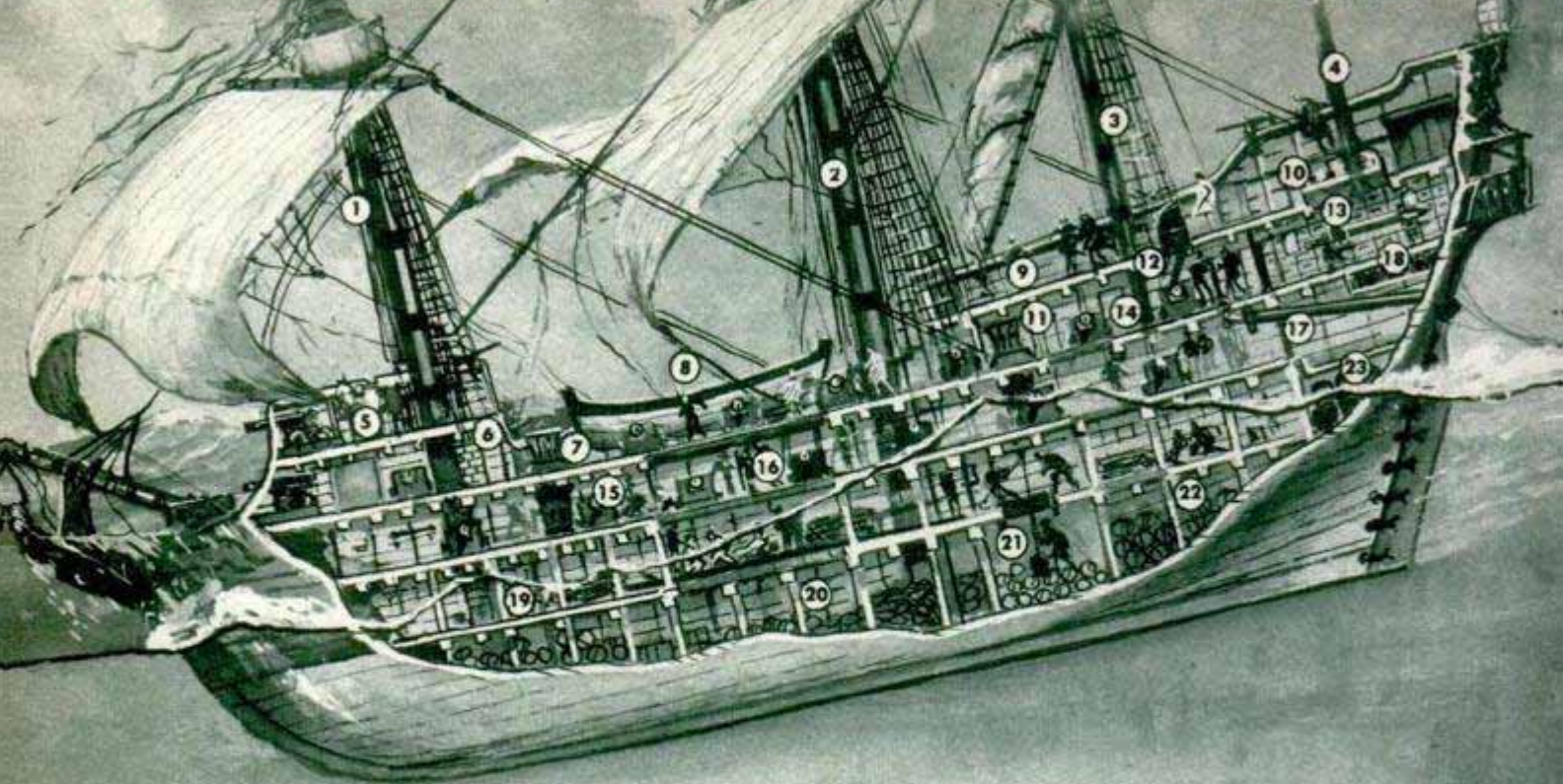

1—FOREMAST. 2—MAINMAST. 3—MIZZENMAST 4—BONAVENTURE MAST (BROKEN OFF). 5—FORECASTLE. 6—COOKING STOVE. 7—UPPER DECK. 8—LONG BOAT. 9—HALF DECK. 10—QUARTER DECK. 11—MAIN CAPSTAN. 12—HELMSMEN AT THE WHIPSTAFF. 13—GREAT CABIN. 14—DEMI-CULVERINS (CANNON, 45-LB. SHOT). 15—LOWER DECK WITH CULVERINS (34-LB. SHOT). 16—MAIN HATCH. 17—TILLER. 18—POSSIBLE POSITION OF TREASURE. 19—ORLOP (LOWEST) DECK, CREW SPACE, SPARE ROPES OR SPARS. 20—HOLD. 21—MAGAZINE. 22—WINE STORE. 23—PROBABLE POSITION OF TREASURE

### PRELIMINARY SEARCH FOR THE TREASURE IN TOBERMORY BAY

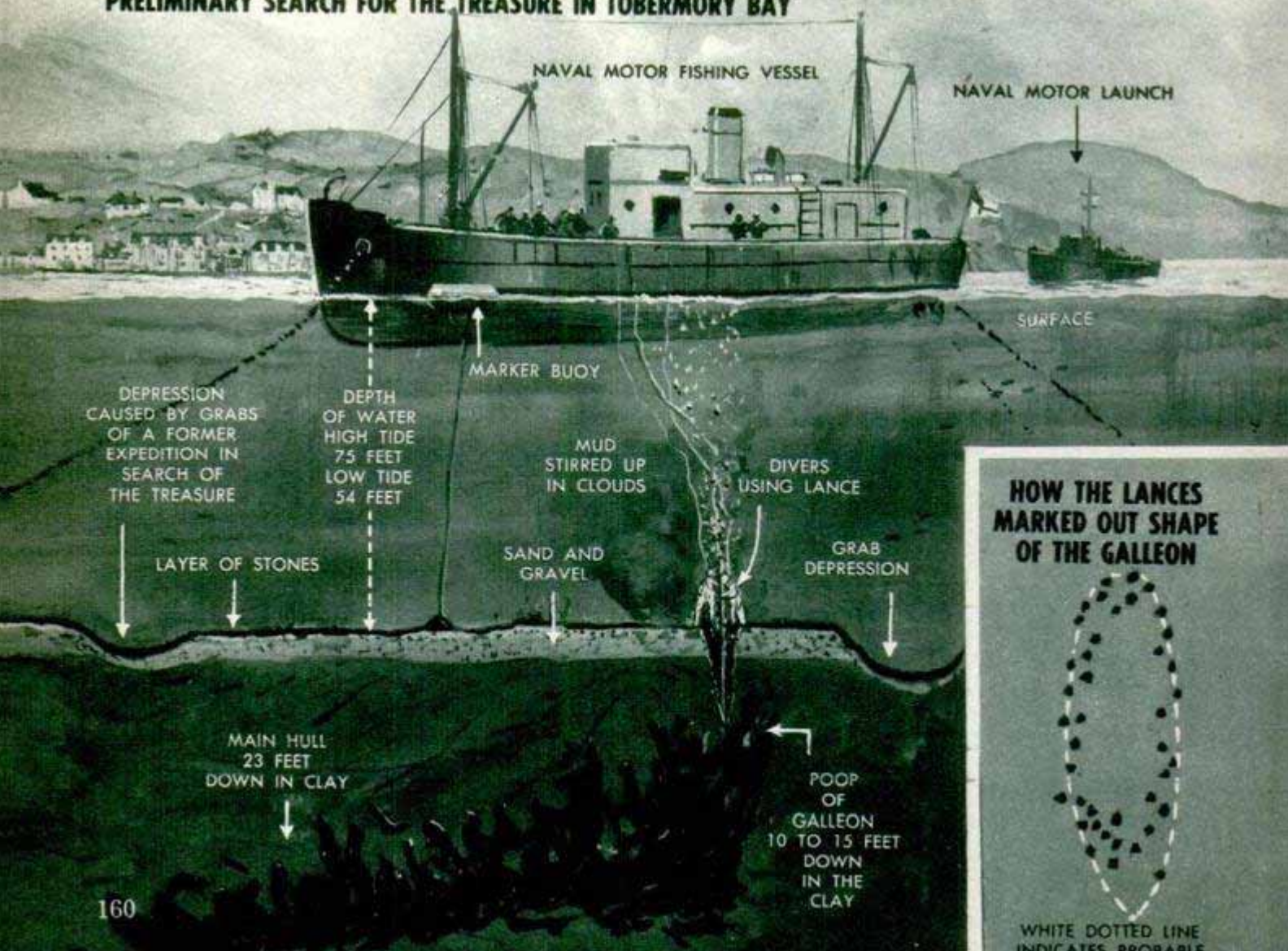

**FOR THE SUNKEN GALLEON**



**AIR LIFT FOR DRAWING OBJECTS TO THE SURFACE**

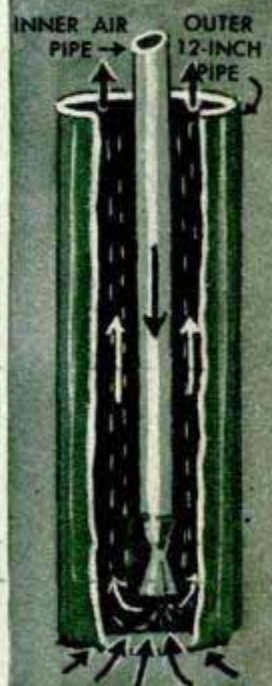
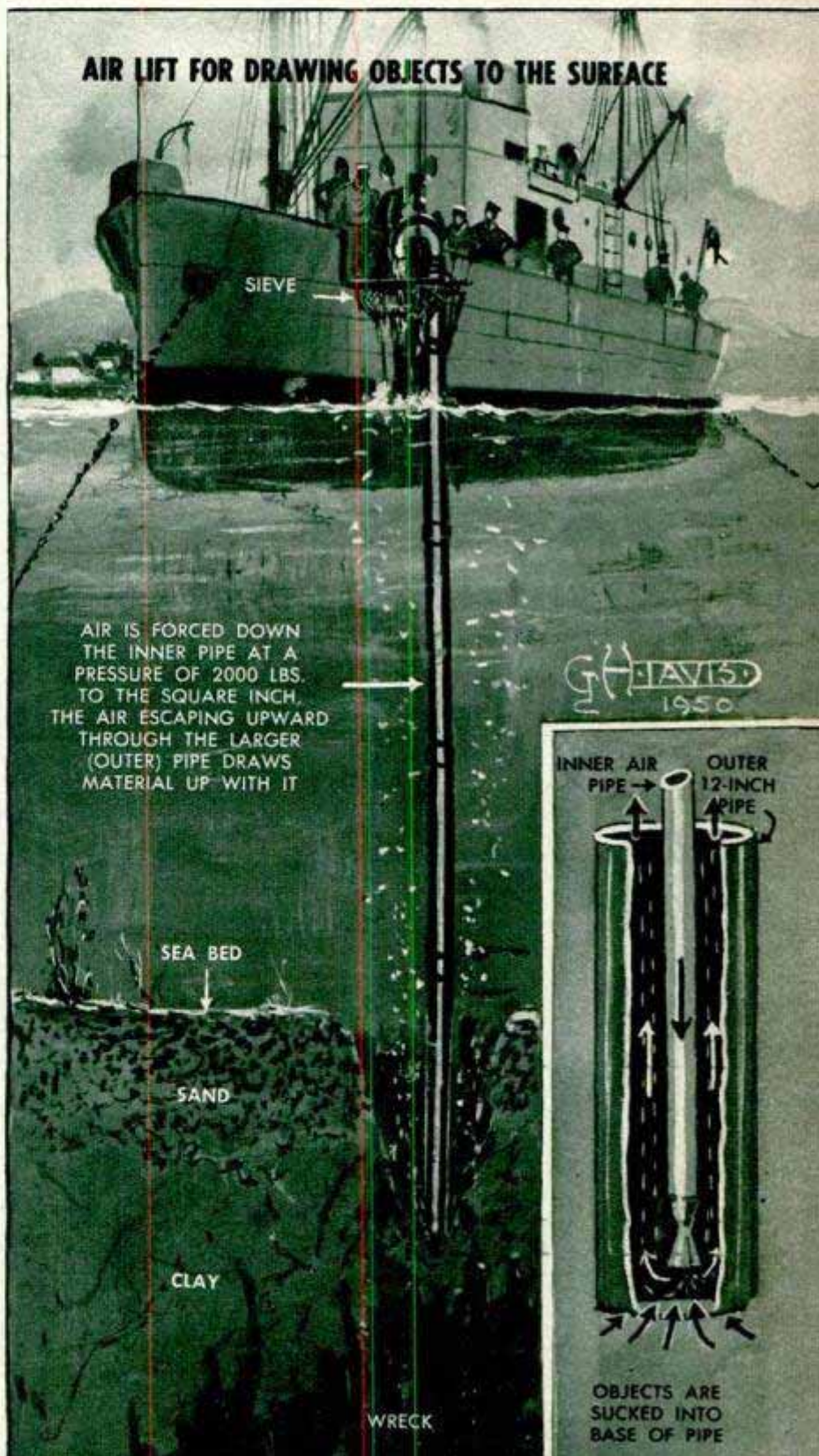

**HIGH-PRESSURE AIR FLOW**



THE AIR HELPS DIVERS TO PUSH THE LANCE DOWN THROUGH SAND AND CLAY



Diving crew examines piece of wood brought to surface and believed to be a timber from lost galleon

quoted above, raised nine guns, all made of bronze, three anchors, a 28-foot-high rudder and a silver bell. A major expedition in 1912 brought historical relics to the surface valued at several thousand dollars.

Early this year the present Duke of Argyll made a deal with the British Admiralty to locate the galleon and mark out its position. The expert diving crew, using self-contained suits which free the diver from air tubes, has pin-pointed the wreck. In this work they used specially designed

lances and probes that are forced through the sand and clay of the sea bed under high air pressure. Working in pairs, the divers would place the pipe against the sides of their helmets and by listening carefully could tell when they struck a timber of the sunken galleon.

In addition to the probes, an experimental air lift was employed. This consists of a series of lengths of pipe screwed together and lowered from the ship to the bottom. The outer pipe of 12-inch diameter has an inner pipe with about a one-inch bore. Through the smaller pipe air was forced at 2000 pounds' pressure to create a suction within the big pipe and draw up any loose objects. Several coins and two medallions were brought up by this method. Since the success of this experimental suction pipe a larger one is being made for final operations to be resumed late this year.

The concluding phase of the quest is expected to bring to the surface many stern timbers (which are nearest to the surface), old guns of various types, cannon balls and scores of fascinating historical items. It will also reveal once and for all time whether there is a fabulous treasure hoard on the ship and fix the identity of the vessel. Everything that is recovered from the treasure ship will be exhibited at the Festival of Britain Exhibitions next year.

Between the two naval vessels and 70 feet below surface lies the sunken Spanish galleon in Tobermory Bay

Copyright, The Evening Citizen, Glasgow



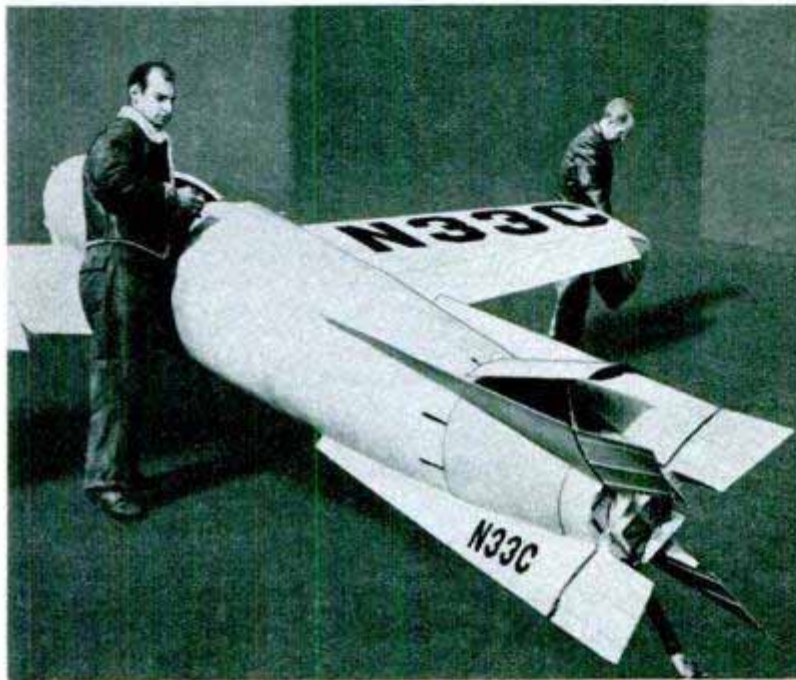
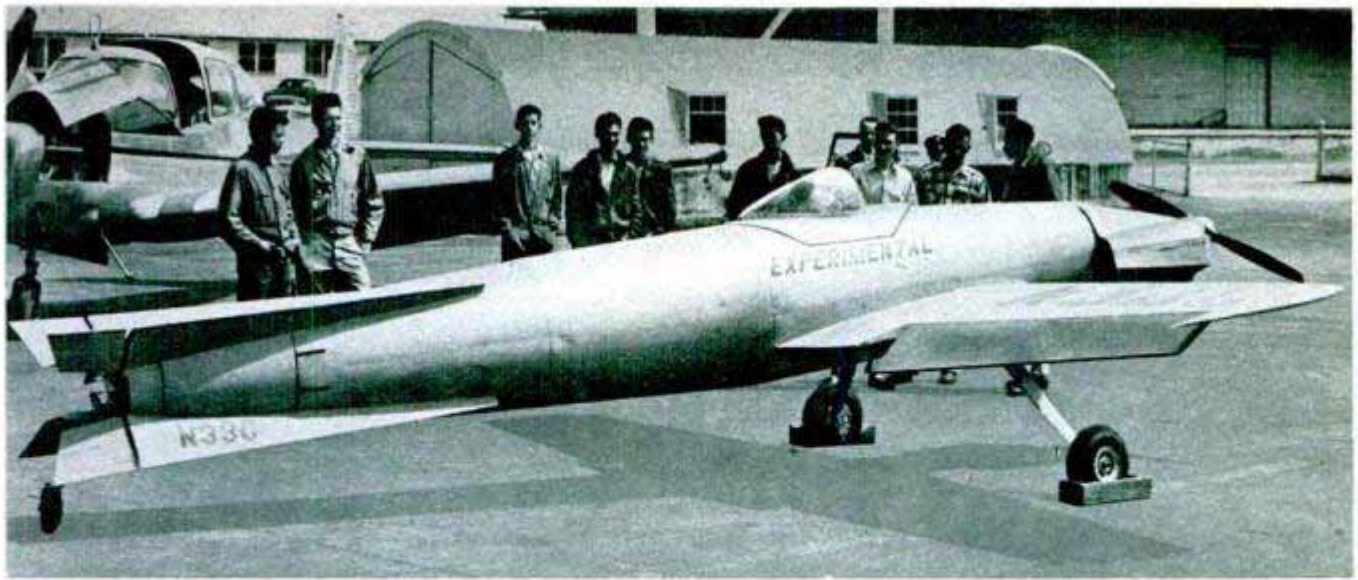

When its wheels are retracted in flight, airplane built by Cliff Kysor resembles a torpedo. Below, top control raised from normal flush position to lower the tail

### Torpedo-Shaped Airplane

Resembling a torpedo when aloft, an airplane designed by Cliff Kysor of Alameda, Calif., has tail controls built flush with the fuselage. The conventional elevators and rudder were eliminated to minimize air drag and permit greater speed. The four control surfaces, at the top, bottom and sides of the tail section, are operated by a stick and by rudder pedals. Small tabs at the trailing edge of the fins are used only to trim the aircraft.

### Volkswagen, 1950

Low-slung and racy in appearance, a new German automobile, the Porsche 356, makes 30 miles to a gallon of gas. The car is a streamlined version of the Volkswagen which was designed for mass production during the Hitler regime. It has an engine similar to that in the original Volkswagen and is equipped with twin carburetors. Top speed of the car is 90 miles an hour.

◻ Marks of varying shapes and sizes have been painted on a runway on Long Island to help pilots judge distance and altitude during landings.





In the Cascades, this ski-equipped helicopter reaches the highest peaks to survey snow depth and moisture

## FLYING SNOW MAN

WANT TO KNOW about snow conditions in Washington state's towering Cascade Mountain Range? Ask Vern Montgomery—it's his job to know. Montgomery uses a ski-equipped helicopter to reach remote elevations and measure moisture and depth of snow fields. His information helps forecast stream flow to power plants and irrigation projects, and to control floods. Previously, the snow surveying was done by

parties of seasoned mountaineers, traveling through the frozen wilderness for days with bedrolls, food and equipment strapped to their backs. The helicopter does the job in a few hours. Four ski-shoes enable the craft to land and take off in deep snow, with the front two maneuverable from the cockpit to aid in taxiing. The rear two have retractable plunger spikes to pierce the ice crust and hold the ship fast when parked.

Retractable spike plunger, left, pierces ice crust when craft is parked. Right, measuring snow's water content

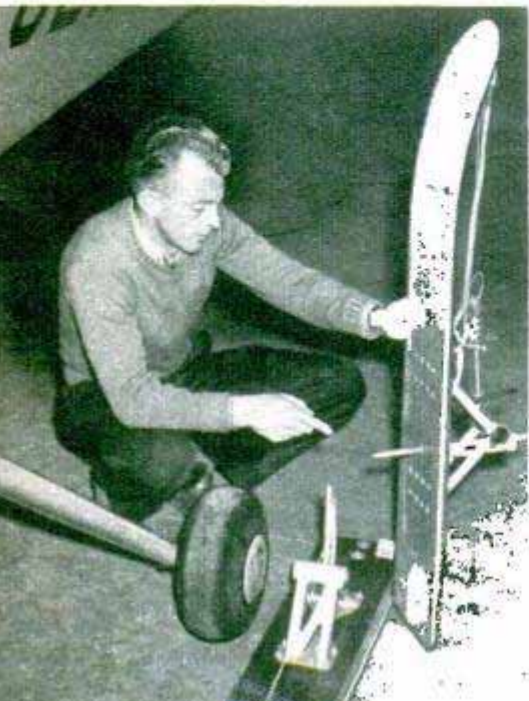

*the* **POPULAR MECHANICS** **CRAFTSMAN**



Spare rooms to spare in your attic. Remodeling story, page 196, tells how

*In This Issue—*

- Tooled-Leather Projects . . . . . 166**
- Lean-To Greenhouse . . . . . 186**
- Electric-Roaster Cabinet . . . . . 195**
- A Darkroom for Everyone . . . . . 206**
- Saw Kerfing Know-How . . . . . 211**



*Korta*

Spinet-size desk has unique built-in wastebasket. Turn to page 190





# Hobbies

## LEATHER GOODS

### FLORAL PICTURES

A HOBBY that is not only fascinating, but profitable as well, is that of drying flowers and framing them in beautiful floral displays as pictured above. Anyone can do it at practically no cost and, according to Mrs. Mae Delano of Los Angeles, Calif., nearly all small flowers such as larkspurs, pansies, delphiniums, cockscombs, etc., can be dried. The flowers are picked at full bloom and immediately buried in processed sand, such as that obtainable for a child's sand pile. Place about 2 in. of sand in a tight box and arrange the freshly cut blooms face down on the sand. Then sprinkle more sand around the blooms to cover them, taking special care not to crush them. The sand must be sprinkled under and around each individual petal so that the flower is supported in a lifelike position. Finally, add about 1 in. of sand on top and place the box in a warm, dry room or closet for about two weeks. At the end of this time the dry sand is carefully poured off and the dried blooms are left exposed for at least six hours. To arrange the flowers in an attractive display they are mounted with transparent glue on a backing of heavy cardboard, as pictured below. Although the bouquets can be arranged and mounted in rectangular picture frames without glass, the best mounting is in an oval frame under curved glass.



*Mrs. Mae Delano  
2719 Alsace St  
L.A., Calif.*

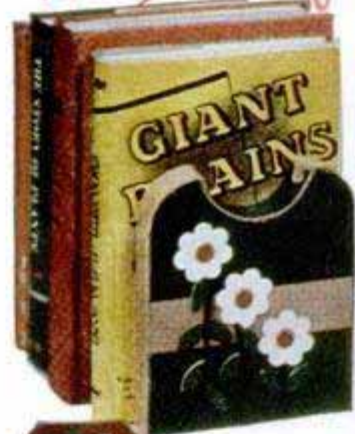



2322 Bury  
Albert P. Belanger

# That Pay!

## SELL READILY

**VIBRATOR-TYPE** tools make leather tooling as easy as writing with a pen so that attractive projects can be produced in a fraction of the time required by hand. Mr. Albert P. Belanger, noted craft authority, in this informative article on leathercraft, shows a number of beautiful projects that he has made and tooled, and he takes you through the steps of making a few of them.

**Selecting leather:** Steer and cowhide generally are used for heavy projects, such as large handbags, while calfskin is used for billfolds, small purses, key cases, book covers, etc. While some sheepskin can be tooled if it is tanned, it is mainly used to line bags, boxes, and the like. Dyed sheepskin can be obtained in a finish which closely resembles grained leather and alligator skin. However, the dye is not too permanent and will fade if exposed to strong sunlight. Goatskin cannot be tooled and is used mostly for lacing.

Leather should always be stored flat, if possible, or rolled with the finish side out. Never roll leather with the finished side in as this will cause wrinkles and spoil the tooling surface. In salvaging a skin that has been folded, it can be grained all over by folding it with the finished side in and then pressing it evenly while rolling it back and forth. This will produce a long-grained finish and, if you wish to make the grain even finer, fold the leather at right angles to the grain and roll the leather the same as before.

**How patterns are made:** While full-size patterns for the tooling designs can be purchased, you can make your own by enlarging the squared drawings given. Some of the designs presented require only a half section to be enlarged; others require laying out a complete

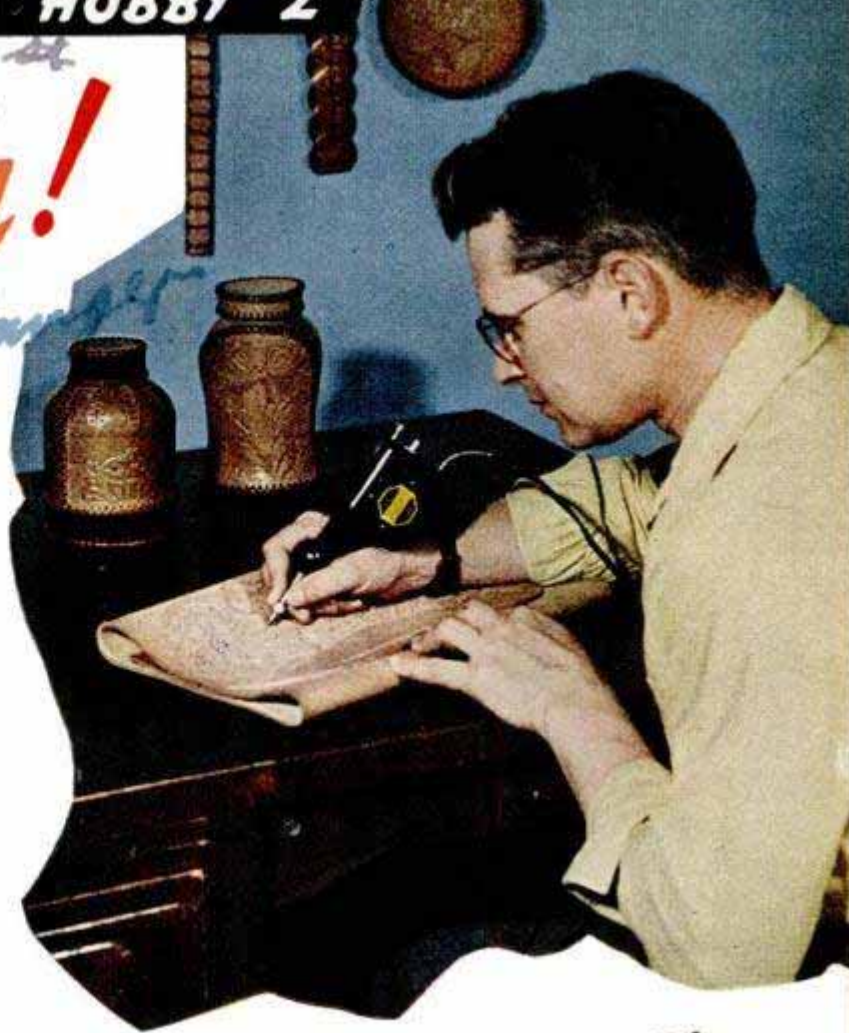



pattern. Where only half of the design need be drawn, carbon paper is used to duplicate the opposite half to form the complete pattern. A final pattern is made from this by laying tracing paper over it. This is done to avoid the possibility of getting ink on the leather from the carbon transfer when tracing the pattern onto the work.

**Transferring pattern to leather:** Before the pattern is transferred, the leather must be dampened. Avoid getting it too wet as it will not hold the tooling. Excess moisture can be removed, however, by placing the leather between blotters or newspapers. Spring paper clamps are excellent for holding the paper pattern to the leather, small pieces of cardboard being placed under the clamps to prevent marring the leather. A ball-point stylus is the best tool to use in tracing the pattern, although a medium-hard lead pencil can be used. To make sure that no part of the pattern is skipped, it is a good plan to lay tracing paper on top of the pattern. Then if any part of the de-

sign has been missed, it can be readily noted. After the design has been transferred, the light impression in the leather is deepened by going over the lines with the stylus. This step can be done also with a vibrator tool, using the smallest ball tip.

**Steps in tooling:** The first step in tooling leather after it has been dampened is to go over all the lines as mentioned, and then work in any background before tooling the design. Tooling by machine is done in much the same manner as with hand tools, except that ball tips are used extensively and, of course, the tool is held like a pen or a wood-burning tool. For flat tooling, the flat diamond point is used. For cutting and punching leather, a cutter set such as pictured in Fig. 15 is very useful.

**Small handbag:** The attractive handbag shown in Fig. 1 requires a minimum of material. It is made of two kinds of leather, each of a different shade. The tooled front is cowhide and the back, including the flap, is calfskin. The squared drawing incorpo-

## Handbag

1

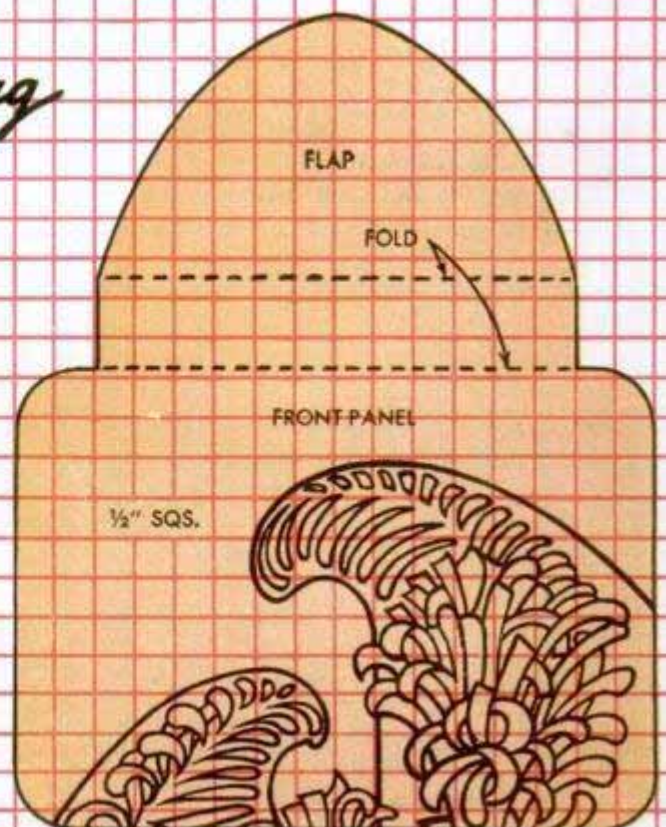

1" X 20" STRIP

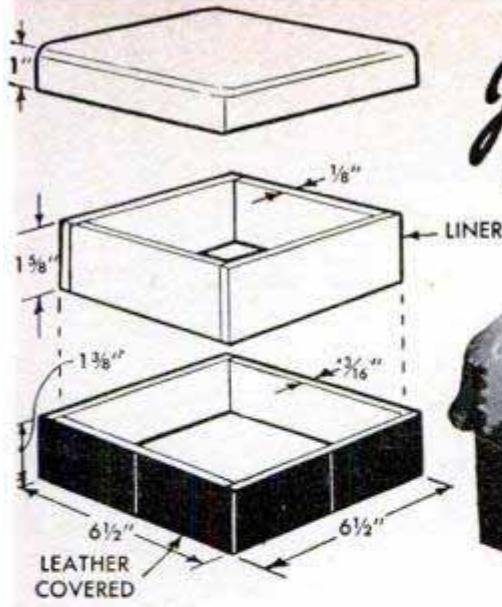

## 2 Jewel Box

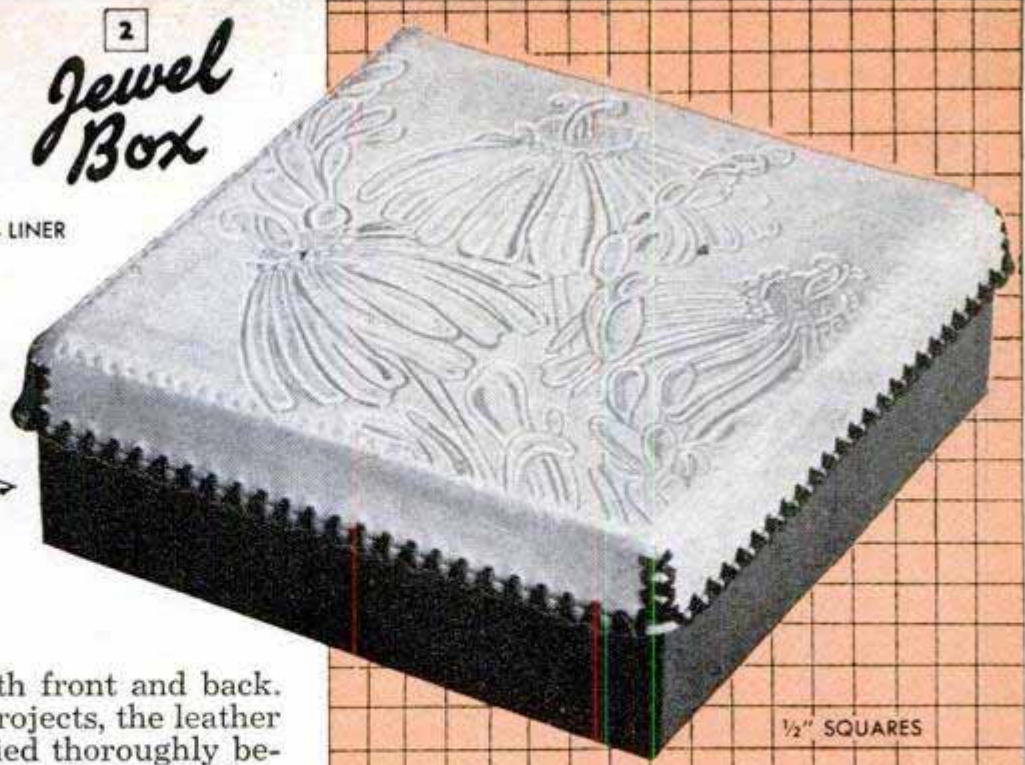

1/2" SQUARES

rates patterns for both front and back. As in the case of all projects, the leather is tooled and then dried thoroughly before it is cut to shape. Being softer than cowhide, calfskin must be lined to stiffen it. Cement a sheepskin lining to the calf portion of the purse before lacing together. The lining is applied in three separate pieces, the lining for the top being cut 1/4 in. narrower than the width of the top. The handle is made from a scrap piece of leather 1 x 8 in. and is covered with calfskin before being laced. The calfskin is cemented to the handle and brought around to meet on the underside. The edge banding requires a piece of leather approximately 1 x 20 in., although the actual length should be determined by the bag itself.

In lacing a curved and straight piece of leather together, a spacing punch cannot be used to punch the holes in both pieces because the distance between the

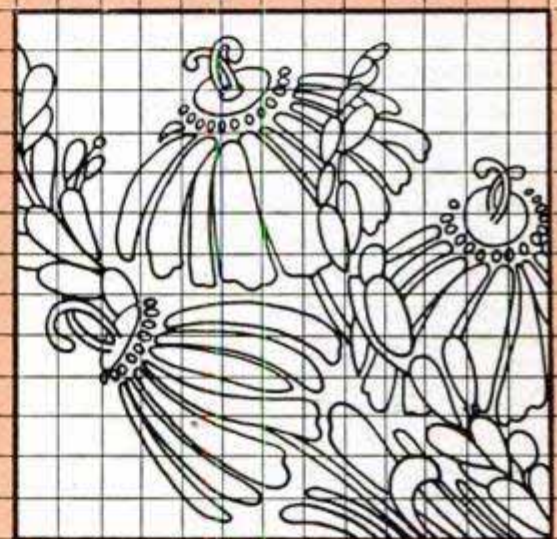

## 3 Glass Jar Humidor

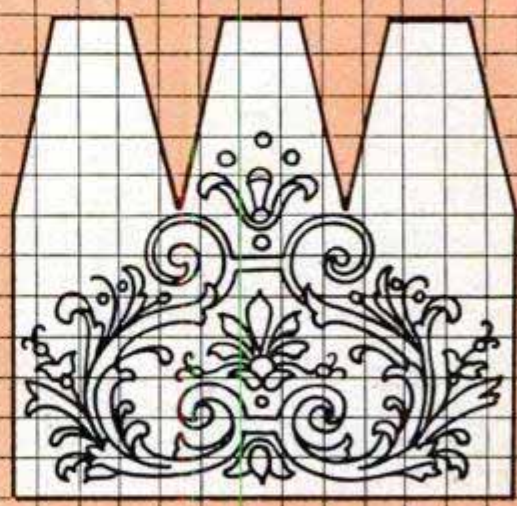
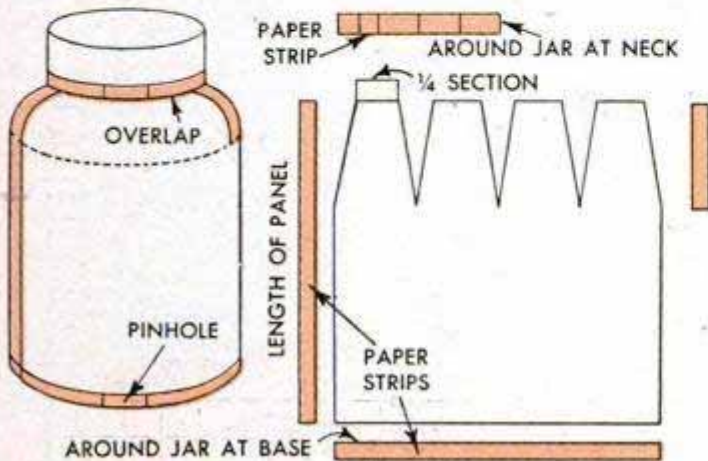

holes on the curved piece must vary in order to round the curve. Therefore, the straight piece must be punched first, using equal spacing between the holes, and the curved piece is punched three or four holes at a time as you progress with the lacing in order to prevent bunching of the straight piece. On this project, punch the banding strip for the sides of the purse, spacing the holes  $\frac{1}{4}$  in. apart and  $\frac{1}{8}$  in. in from the edge. The back and front pieces and flap are punched as the lacing progresses. Method of lacing is shown in Fig. 10.

To determine the amount of lacing required for any project, punch and lace together two pieces of scrap leather at least 3 in. long, using the same stitch and spacing you plan to use. Then remove the lacing and measure. This will give you the amount of lacing required for a given distance. If you are lacing the edge of a single thickness, do your trial lacing along only one edge of a piece, as less lacing is required in finishing an edge than in joining two pieces together.

To join the back and the handle to the side and front, start at one of the upper corners of the back and lace down the side, across the bottom and up the other side, continuing around the flap and joining the handle to the top part of the purse as you lace. Close with a fastener.

**Jewel box:** To cover a wooden box such as the one shown in Fig. 2, the leather is first tooled and allowed to dry thoroughly, then cut to fit the box top snugly. You will note that the cover is laced at the corners and all around the edge, and that a round plastic lace is inserted in the lacing to strengthen the edge. To lace the cover, start at one corner and lace down to the edge. Continue across the edge to the next corner, cut off the extra length of lacing and tuck the ends under, securing with a bit of cement. Lace the remaining corners and edges as just described and then cement the cover to the box top. The bottom half of the box may be covered in the same way as the top or smaller pieces of leather may be used, as on the original box. Here there are no joints at the corners. Instead, the pieces are butted together at the center of the sides and glued in place. See detail, Fig. 2. The remaining leather is then brought down and cemented to the underside of the box, mitering the corners.

**Glass-jar humidior:** First find the circumference and height of the jar by using narrow strips of paper and punching them with a pin, as shown in Fig. 3. When the strips are laid flat, the distance between the pinholes is the exact



5 Photoalbum

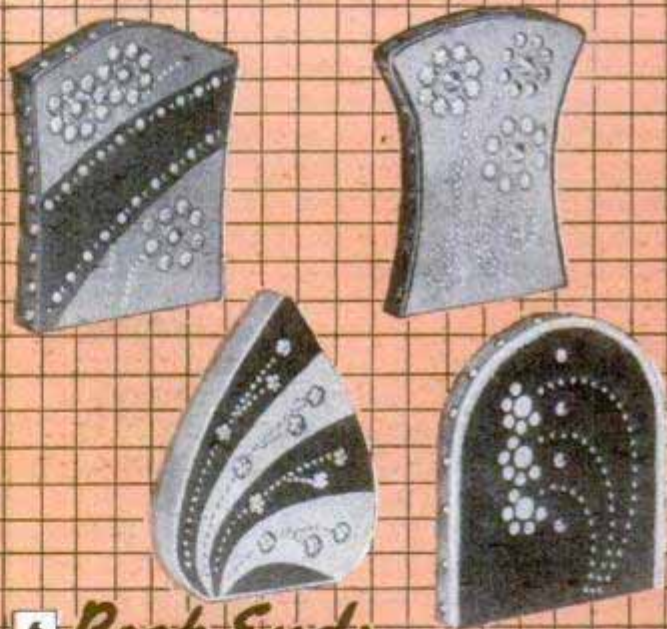

6 Book Ends



7 Checkerboard

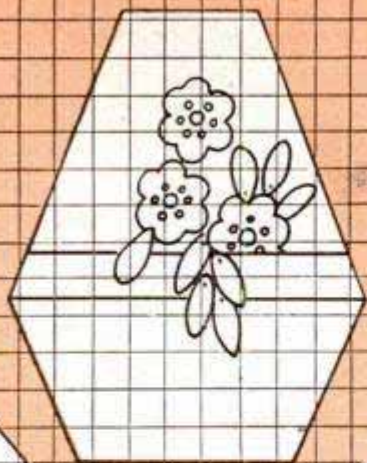

8

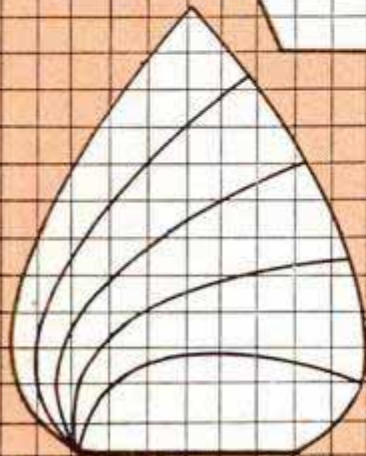

9 *Purse*

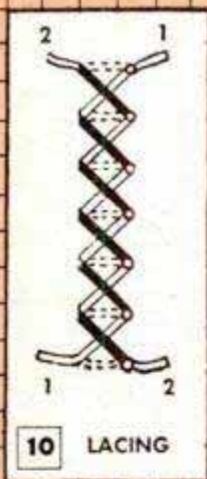

10 LACING

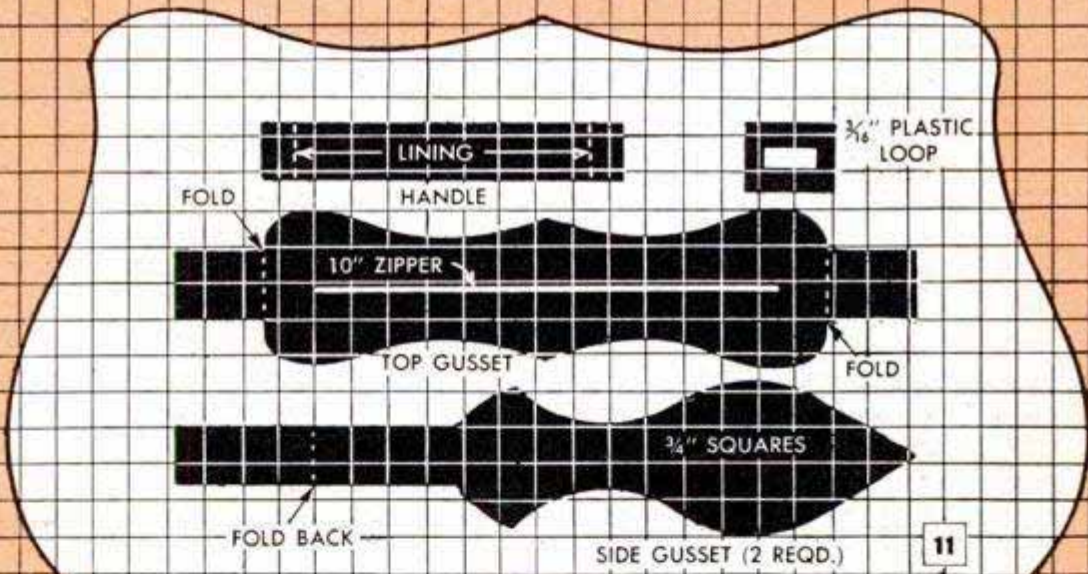

11

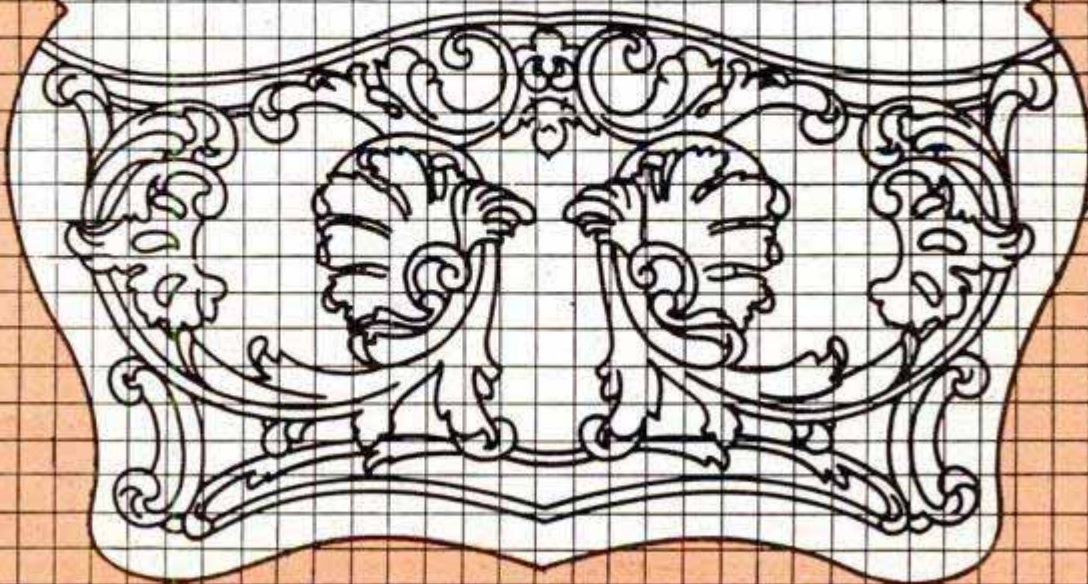

1/2" SQUARES

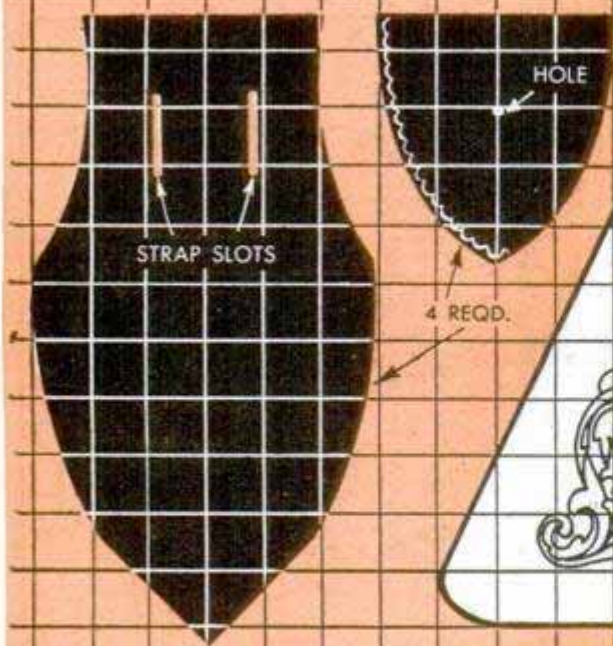

12 *Handbag*

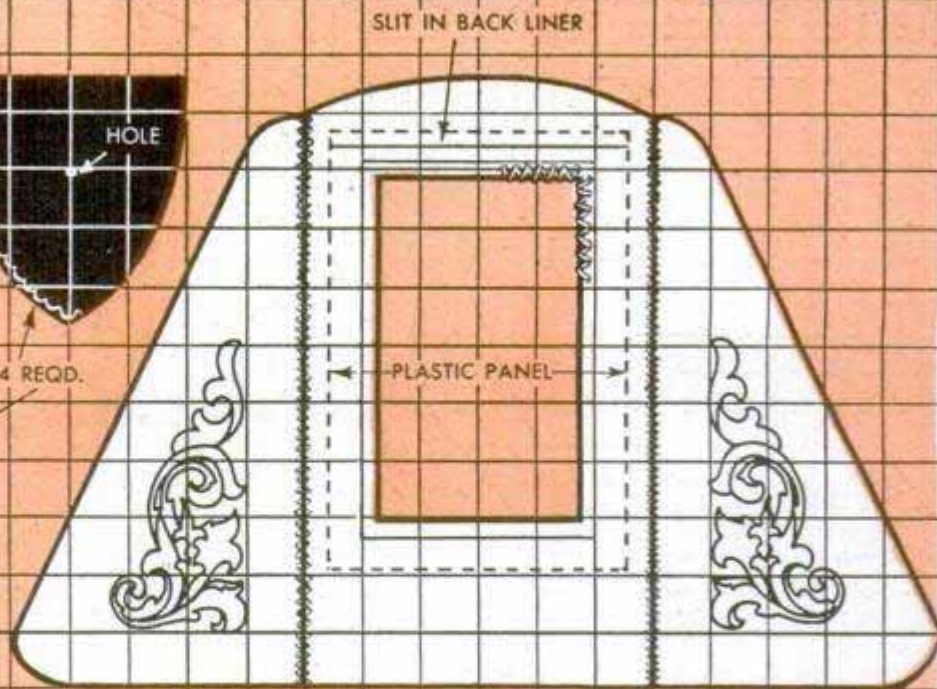

13 *Photo Frame*

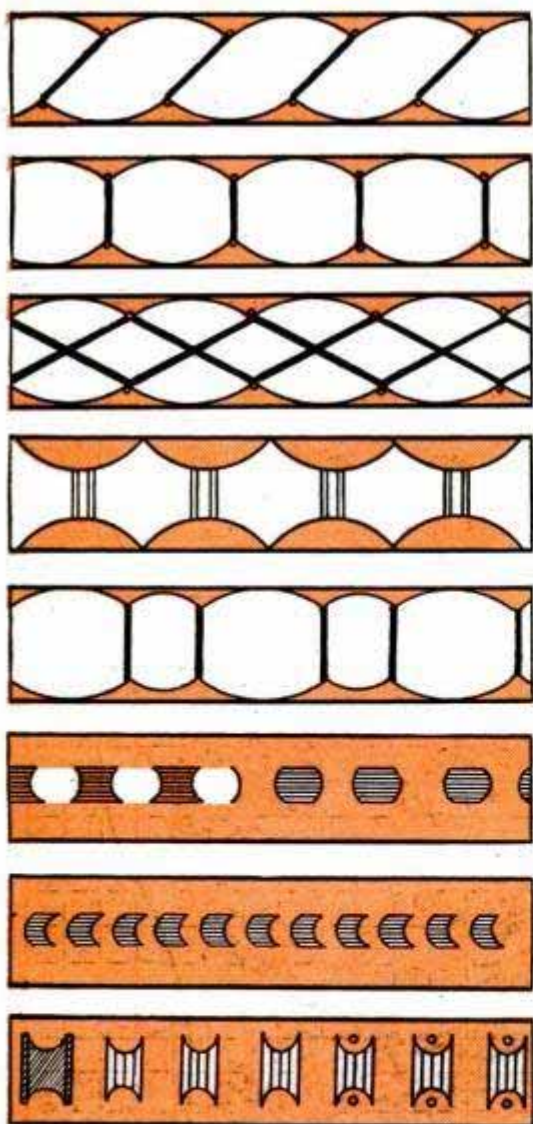

14 *Belt Designs*

length for use in making the paper pattern. The circumference of the jar may be divided equally into three or four parts. If three sections are used, each section should have four tapered tabs cut at the top as shown. After the design has been traced and tooled on the sections and the pieces allowed to dry, cut the leather according to the pattern. If a contrasting band is desired at the bottom of the jar, as on one of the models shown, be sure to make allowance for it. Now, punch the sections, making the holes  $\frac{1}{4}$  in. apart and  $\frac{1}{8}$  in. in from the edges. Punch the meeting edges of the tabs also, using the same spacing. Now, join the side sections, lacing only up to the tapered tabs at the top, using the stitch illustrated in Fig. 10. Insert the jar and lace the edges of the tabs together around the neck. This is done with a single strand approximately six times as long as the circumference of the jar. Fasten one end of the strand under a tab and lace the strand in and out the first row of holes completely around the jar, pulling it tight. Then proceed to the next row of holes and repeat the step. The rest of the holes are laced in the same manner. Cut a disk the same diameter as the bottom of the jar but do not punch it until you begin to join it to the sides. Then, do not space the holes the same distance apart as on the sides but locate them so that the sides and bottom can be joined without bunching or buckling of either piece. For the cap, cut a disk equal to the outside diameter of the mouth of the jar and a strip long enough to encircle the cap. Join these pieces in the same fashion as the sides and bottom.

**Purse:** The purse shown in Fig. 9 was made of cowhide. Accompanying patterns in Fig. 11 give the dimensions. The edges of the gussets are beveled 45 degs. for a distance of about 7 in. on each

side and the edges of the bag where the gussets fit are likewise beveled. The beveling makes a square corner when the bag is laced together. Punch lacing holes in the front and back of the purse, spacing them  $\frac{1}{4}$  in. apart and  $\frac{1}{4}$  in. in from the edge. Punch the gussets as they are joined to the main part of the bag, spacing these holes to allow a smooth join of the parts. The gusset for the top of the purse is fitted with a 10-in. zipper attached by sewing through holes made along the edges of the opening with an awl. The tabs that extend from the ends of this gusset are bent down and cemented to the side gussets after lacing. The handle of the bag is lined with thin leather which is cemented in place before the handle is punched for lacing. The upper end of each side gusset is turned back through a plastic loop and punched and laced to hold the loops in place. The ends of the center portion of the handle are secured in the same way. See Fig. 9. Finish the purse by attaching a leather button to a loop on the zipper pull.

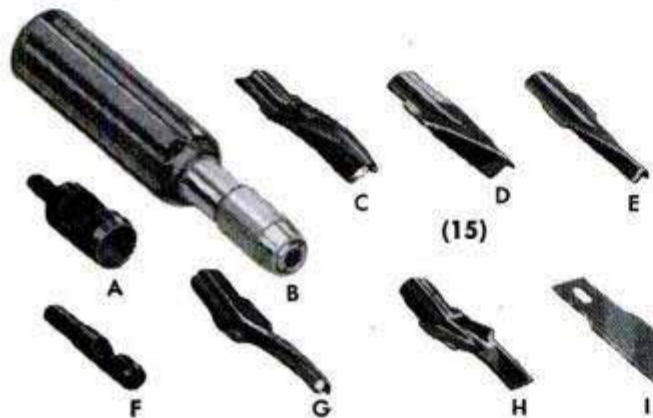

A.  $\frac{7}{16}$ -in. punch. B. Tool handle. C.  $\frac{1}{4}$ -in. gouge. D.  $\frac{1}{4}$ -in. V-gouge. E.  $\frac{1}{8}$ -in. V-gouge. F.  $\frac{1}{8}$ -in. punch. G.  $\frac{1}{8}$ -in. round gouge. H. Flat chisel. I. Knife blade

**Photo frame:** To make the photo frame shown in Fig. 13, you'll need a piece of cowhide 6 x 10 $\frac{1}{2}$  in. for the center panel and two pieces 5 x 10 in. for the side panels. The center panel is backed up with light-weight cardboard and then covered with a piece of light leather or cloth, such as is used in bookbinding. After the tooling has been done, the panels are laced, a round plastic lace being first placed against the edge of the leather. The lacing joining the sides to the front forms a hinge for adjusting the wings of the frame. The center panel is laced around the inside.

**Other projects:** Figs. 5, 6, 7, 8 and 12 show other projects that can be made. The book ends consist of wood covered with leather and decorated with fancy upholstery nails. Sheet-metal bases, about 5 in. long, are attached to the bottom edge of the wood. The patterns for the pouch-type handbag are given in Fig. 12. Four pieces are cut from each pattern and laced to-

gether, a strap being used to draw the bag shut at the top. A bright red button adds a touch of color to each side flap of the bag. Study the color photo on page 166. A number of suggestions for overlay and pierced belts are given in Fig. 14. A common wood gouge is used to cut the repeat design of the scalloped edges and the pierced patterns shown.

## Trouser Flaps Cover Boot Tops To Prevent Seepage of Snow

Farmers and laborers who work in low-cut boots or overshoes during the winter can keep snow from seeping into the tops of the boots by flaps that are sewed to the trouser legs. The flaps, which are made of material cut from old trousers, are sewed a few inches above the trouser cuffs so that they will overhang the boot tops when the cuffs are tucked into the boots.

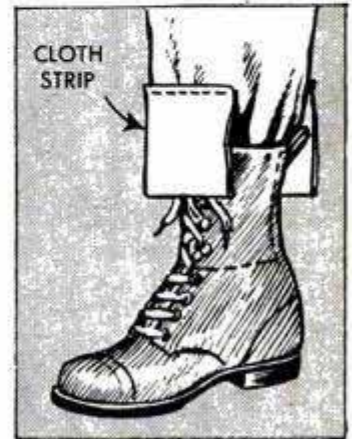

## Empty Razor-Blade Dispenser Makes Handy Sanding Block

Here is an idea for those of you who are model builders and have been looking for a small but adequate sanding block. Take an empty plastic double-edge razor-blade dispenser and open the case very carefully, removing the metal spring. Then lay a piece of sandpaper on the outside of the bottom of the case and fold the ends of the paper over the edge so that they extend a short way within the case. Replace the spring and snap the lid back in place.

Robert Kan, Plattsburg, N.Y.

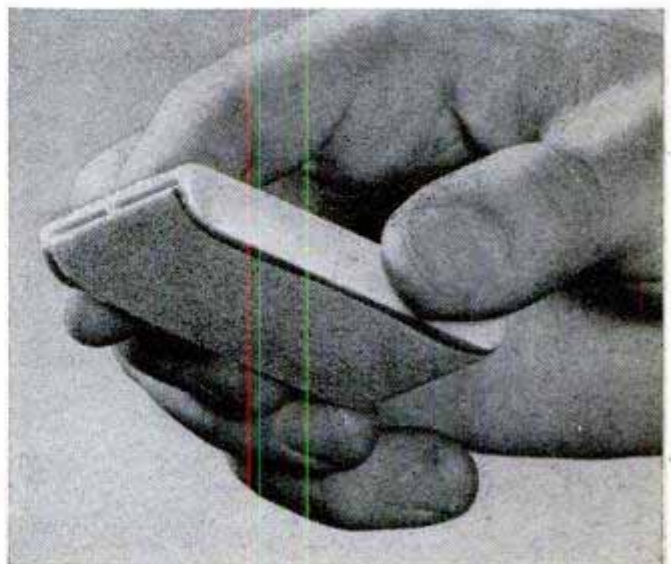

# Solving

—1—

**FRUIT-JAR TOPS ARE PROTECTED** from chipping if the threaded portion of the metal cap is turned on each jar as soon as it is emptied and washed. Then, when the jars are taken out of storage for the next canning season, all the tops will be in good shape

—2—

**WHEN WAXING FLOORS** in a room where furniture makes it impractical to roll back the rug, the edges of the rug can be held off the floor by propping them up with children's building blocks or pieces of wood. These are left in place until the wax dries

—3—

**RECIPE CARDS AND CLIPPINGS** won't be soiled by spilled batter if they are placed beneath an inverted glass baking dish while being used. Although the glass shields the recipe from drippings, the type can be read easily through the bottom of the dish

—4—

**STUBBORN STAINS IN FABRIC** can be cleaned quickly by using the teeth of a comb as a miniature washboard. You will find that rubbing the material along the comb removes the stain with a minimum of effort and also requires less cleaning fluid than usual

—5—

**WHERE TO HANG THE KEYS** for the garage and basement was solved neatly by one homeowner who fastened a curtain-rod holder to the trim of the kitchen door. The key ring slips over the hook with little danger of the keys accidentally falling to the floor

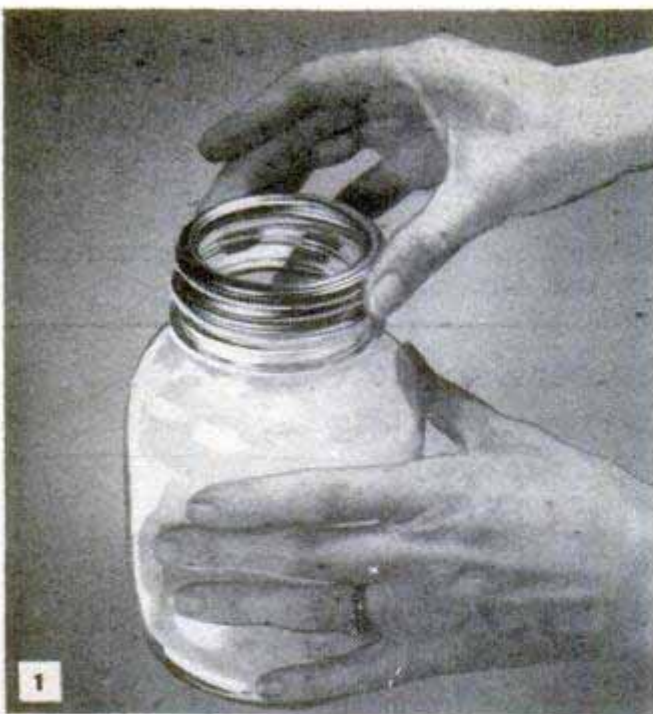



# HOME PROBLEMS

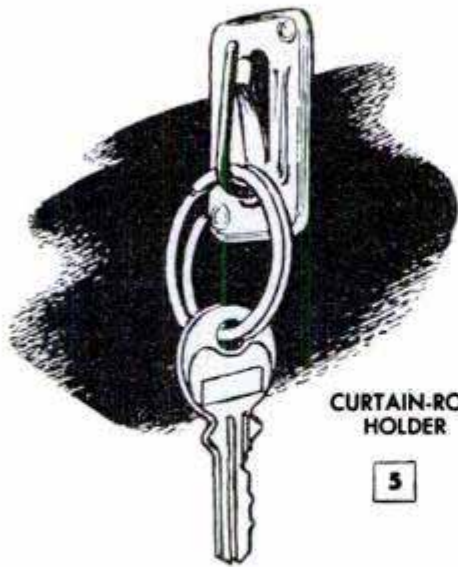

CURTAIN-ROD  
HOLDER

5

— 6 —

**STRAIGHTENING PICTURE FRAMES** is a thing of the past if two-pointed tacks are used to hold the frame level. Just drive the tacks into the lower corners of the frame and hang the pictures in the usual way

— 7 —

**IF METAL BOTTLE CAPS TEND TO RUST** and stick tightly to the glass, the trouble can be corrected by placing a small square of aluminum foil over the neck of the bottle before screwing the cap in place

— 8 —

**TO ASSURE FAST IGNITION OF CANDLES** and avoid delaying a party or perhaps burning your fingers, dip the wicks in lighter fluid. Don't wait too long before lighting the candles, as the fluid evaporates

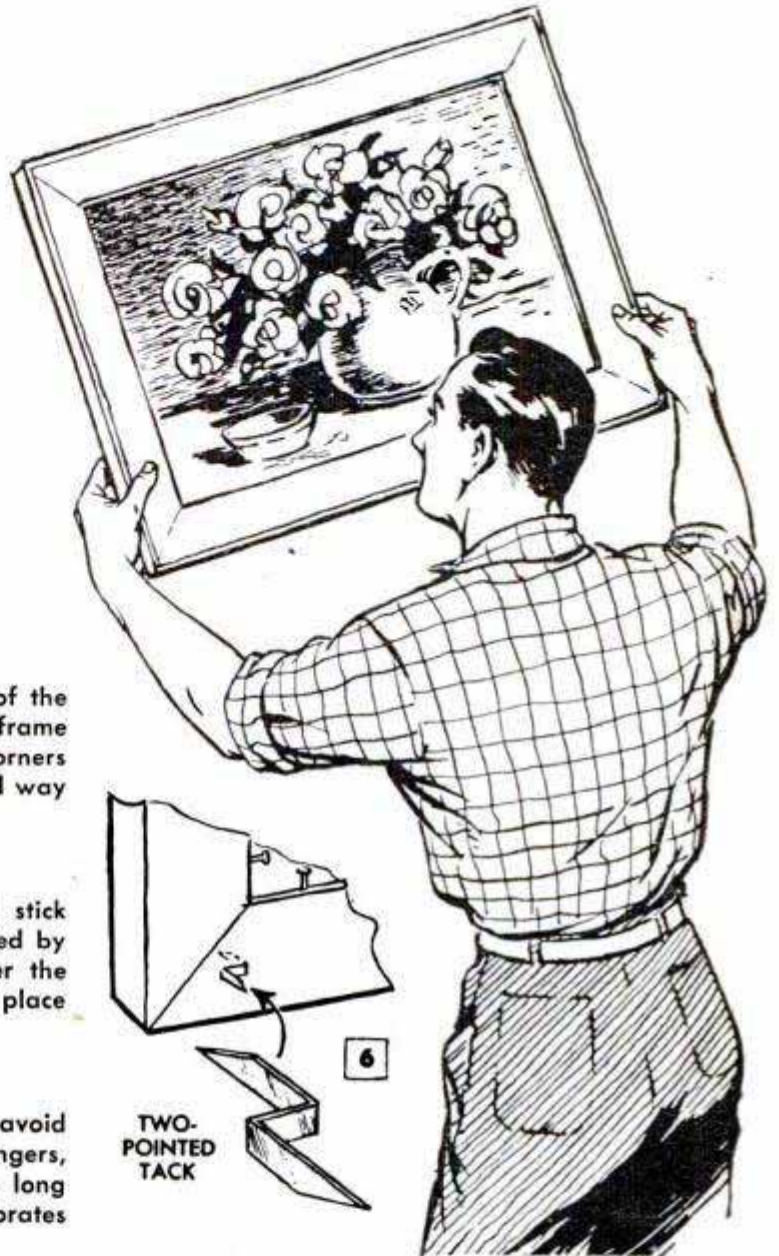

6

TWO-POINTED  
TACK



7



8

## Water-Filled Fender Well Provides Tank for Testing Inner Tubes

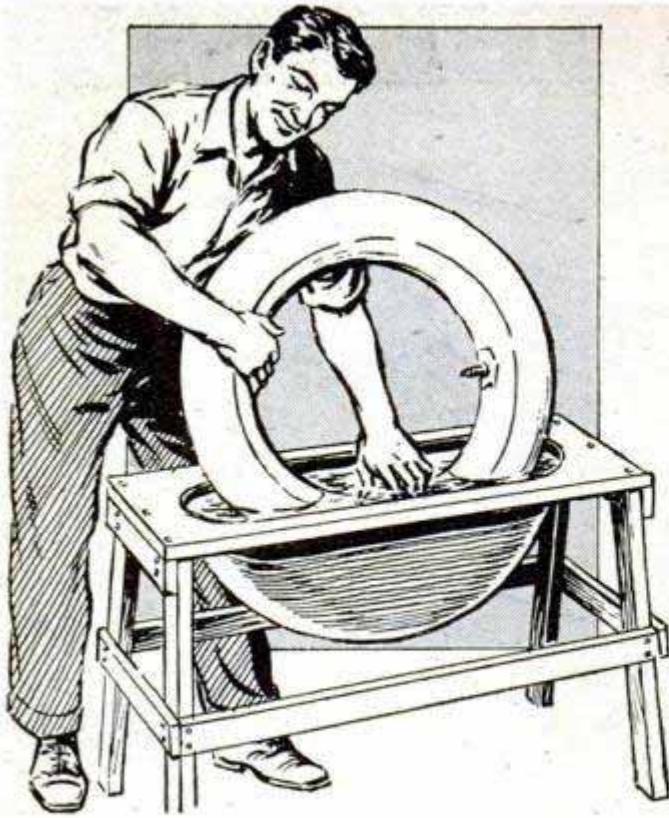

Testing inner tubes for leaks is quick and easy if they are submerged in a water tank improvised from an old fender well. Holes in the bottom of the well are patched and soldered to make it watertight and the well is mounted on a wooden frame. The top of the frame consists of a board which has been cut out for the fender well, and the sheet metal is nailed or screwed to the board.—Victor H. Lamoy, Upper Jay, N. Y.

## Rubber Cushion on Vise Handle Prevents Pinching Fingers

Pinching the fingers between the shaft of a vise and the knob on the end of the handle can be prevented by fitting each end of the handle with a rubber cushion. Use a split washer or slit a short length of rubber hose and place it around the handle shank just below the knob.—Joseph Osborne, Milwaukee, Wis.

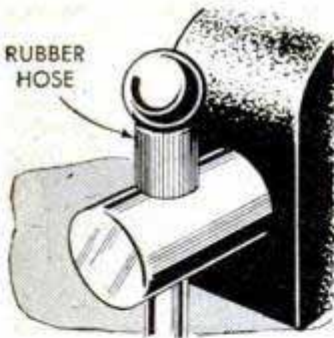

## "Canasta" Tray From Scrap Stock

This neat Canasta tray is a one-evening project that not only provides a useful item for the home but also forms a gift that will be greatly appreciated. The sides of the tray, which are of  $\frac{1}{2}$ -in. stock, are beveled on the inner surface and mounted on the  $\frac{1}{4}$ -in. base with glue and brads. The pegs are glued in holes which are drilled through the base at a slight angle. After the tray has been stained or painted, felt is glued to the underside. Although only one tray is pictured, it is best to make two of them to a set, one for the draw pile and the other for the discard pile. If desired, the base can be made approximately twice the width indicated and the two trays combined, using a dividing strip across the center. Also, an opening can be made in one side of the tray to permit placing a card crosswise when "freezing" the deck.

J. S. Turnbull, Seattle, Wash.

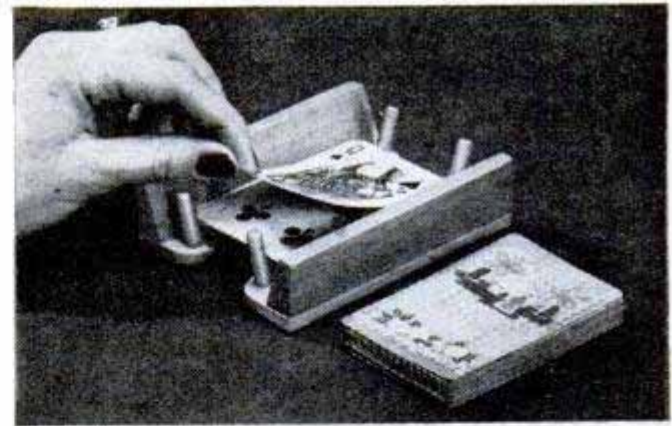

## Ferretting Predatory Animals With Gasoline Fumes

Fumes from gasoline will drive foxes, coyotes and other predatory animals from their dens and into traps set at the entrances. Just soak a piece of burlap in gasoline, and then with a long pole push the burlap as far into the den as possible. Set a trap just inside the den entrance and plug up the entrance tightly with leaves covered with dirt so that none of the fumes will escape. No animal can withstand the gas fumes for long and, when it comes up for fresh air, it will be caught in the trap.

R. A. Jenkins, St. Louis, Mo.

Plain vinegar is an excellent cleaner for windows. Wipe dry with a clean cloth.

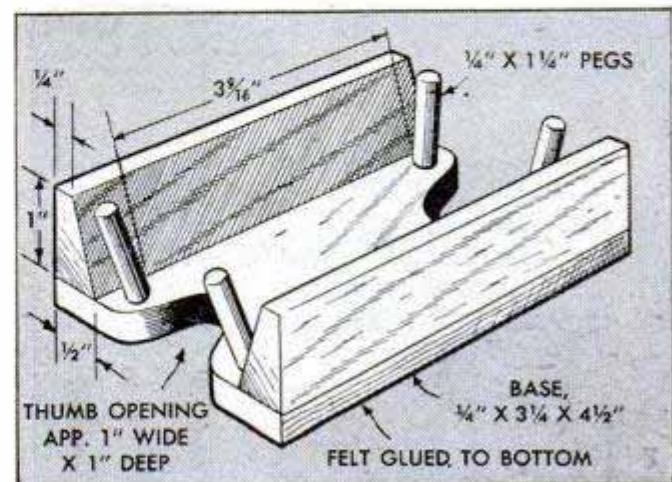

# Extension Opens and Closes Coalbin Window

Scrambling over the coal pile to open and close the bin window will be a thing of the past if the window is fitted with this toggle latch and extension arm. The combination permits the window to be pulled open or to be locked shut from outside the bin. Make the toggle from hardwood as shown in detail A, varying the dimensions to suit. Then, using angle-iron brackets, loosely bolt one end of the toggle to the bottom of the hinged sash and the other end to the edge of one of the ceiling joists. Note that when the window is tightly closed, the pivoted toggle arm rests against the beveled face of the stop, thus providing a lock that prevents pushing the window open. The extension handle is a strip of wood (doorstop will do) pivoted to the toggle. A notch cut in the lower edge of the

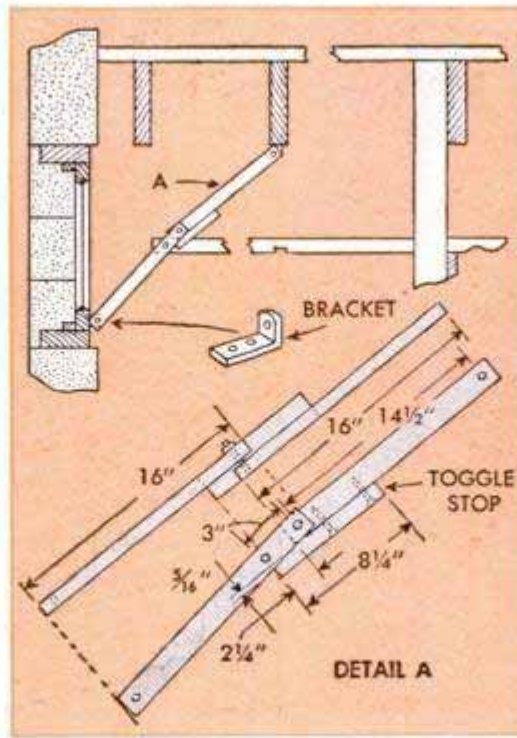

arm engages the edge of the coalbin to hold the window in the open position. If the bin is enclosed all the way up to the ceiling, an opening for the extension arm can be cut as pictured in the illustration.

W. Arthur Lofft, Collingswood, N. J.

## Wrapping Linens in Opaque Paper Prevents Yellowing With Age

When linens are stored over long periods of time they are likely to become yellow unless protected from light. However, they can be kept white and new looking indefinitely if they are wrapped in opaque paper before storing. Dark-blue paper is best, al-

though several layers of ordinary heavy wrapping paper will serve the purpose. To prevent breaking the fibers of the cloth, roll the linens in the paper instead of folding and creasing them.

Nina Kay Morris, Norman, Okla.

## Indoor Air-Rifle Target Box Retrieves BB Shot

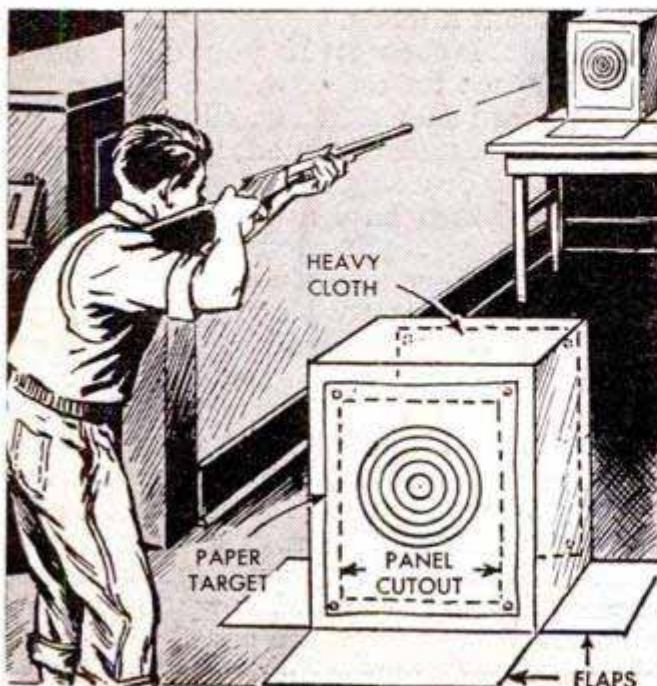

In addition to retrieving BB shot for use over and over again, this indoor target box for a low-powered air rifle or pistol prevents ricocheting of the pellet when it strikes the target. To make the box, cut a hole in one side of a large cardboard carton, the opening being slightly smaller overall than the dimensions of a paper target. Then tack a piece of heavy cloth or canvas to the inside of the box opposite the cutout panel. This will keep the BB shot from embedding in the cardboard after passing through the target. Stand the target box, open end down, on a table or on the floor and fasten the paper target over the cutout panel with thumbtacks. If the box is set up on a rough wooden floor or other surface which might cause the BB shot to be lost, spread a piece of cloth under the box to catch the pellets.

Charles H. Hardy, Los Angeles, Calif.

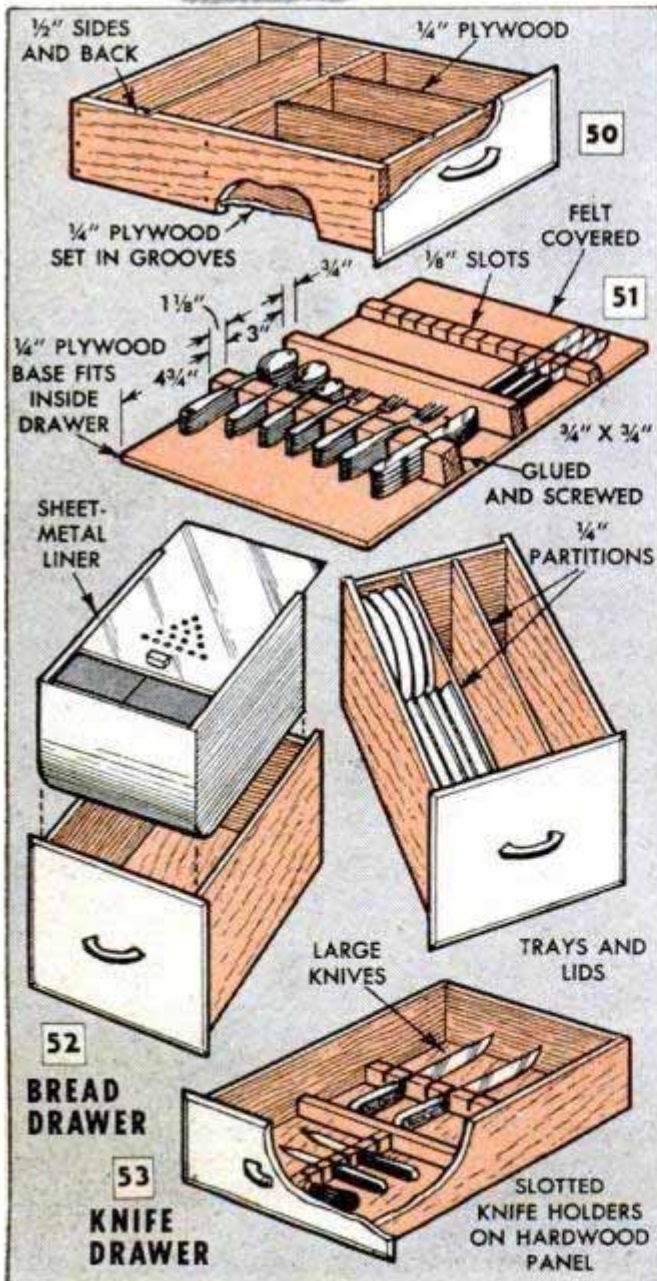
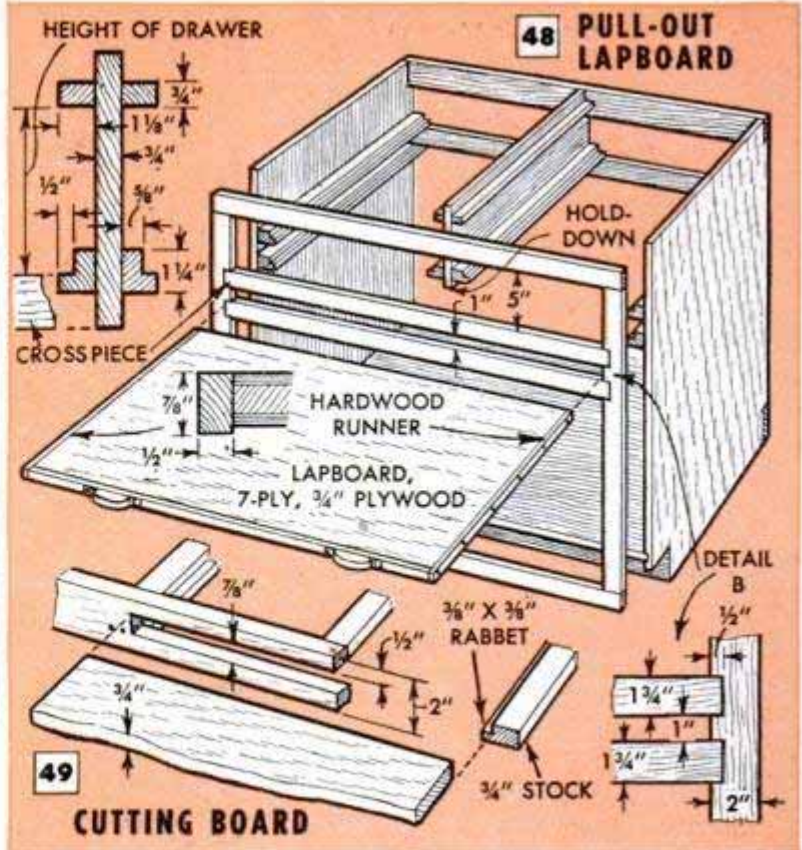

# Your MODERN

Practical arrangements to ease kitchen chores and provide convenient storage

By E. R. Haan

THERE ARE many minor yet important things that you can do to get extra convenience and efficiency from your kitchen without taking on major remodeling jobs as described in the two preceding articles. Adding a few improvements here and there will perform stepsaving miracles in your present kitchen.

**Pull-out lapboard:** If you don't have enough space for an extra table, the pull-out lapboard shown in Fig. 48 may be just the thing you need. Located right under two top drawers or a single long one, the board is installed in a base cabinet 26 to 28 in. from the floor. If you are building the cabinets yourself as explained in Part II of this series, and you wish to include a lapboard, the cabinet front should have two crossrails instead of one, with sufficient space between them to accommodate the lapboard. Hardwood runners screwed to the ends slide on hardwood guides that are made just like regular drawer runners and are installed below them. The runners extend  $\frac{1}{8}$  in. below the panel and a clearance of  $\frac{1}{16}$  in. above and below the runners is required to prevent the board from rubbing against or binding between the cross-

## 54 SLIDING TOWEL RACK

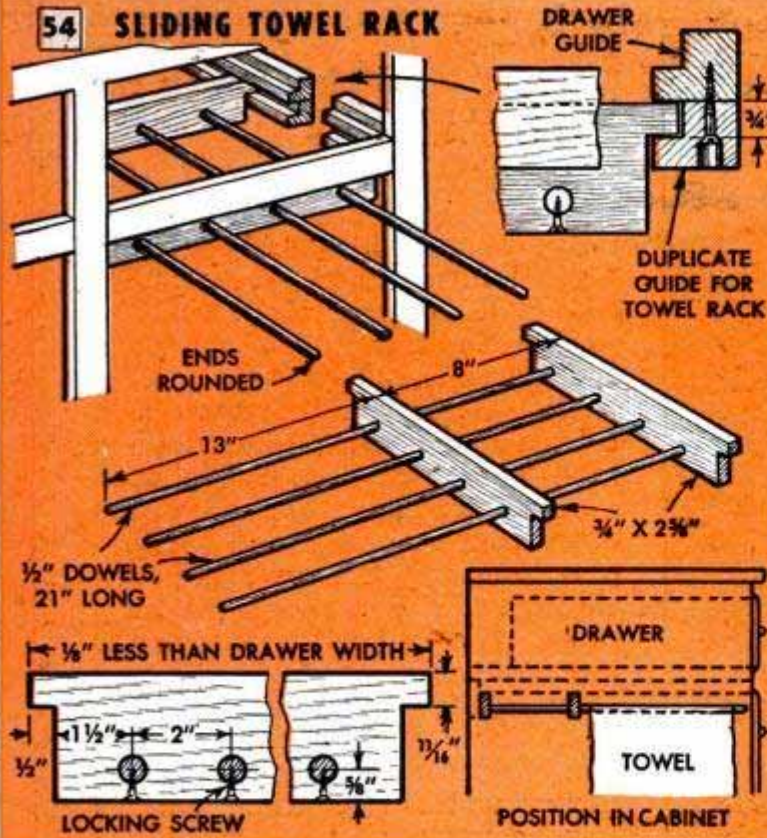

# KITCHEN PART III

*Kitchen Plans 50*

rails. The partition between two drawers above a lapboard should be wide enough to serve as a hold-down for the board to prevent its tipping down when pulled out. The guides and hold-downs of the drawers above the board are screwed to the partition. Note how the front crossrails are mortised into the side rails as in detail B, Fig. 49, which provides maximum resistance to downward pressure.

**Drawer arrangements:** Partitioned drawers, Fig. 50, are convenient for storing everyday silverware, but the felt-covered holder shown in Fig. 51 offers better protection against scratching. Blocks slotted to hold the silverware are attached to a removable panel that fits inside the drawer. The felt is glued on, even in the knife, fork and spoon slots, but on the steak-knife rack, the felt is just slit down the slots with a razor blade. Carving and paring knives can be stored in drawers with less risk of getting their sharp edges nicked and with less danger of cutting fingers if they are set with their sharp edges down in slotted holders as in Fig. 53. The holders are screwed to a removable panel of plywood or hardboard.

A deep drawer can be partitioned for storage of tins and lids. The partitions are held in grooves, metal channels or between lengths of 1/4-in. quarter-round molding. Fig. 52 shows a sheet-metal bread-drawer

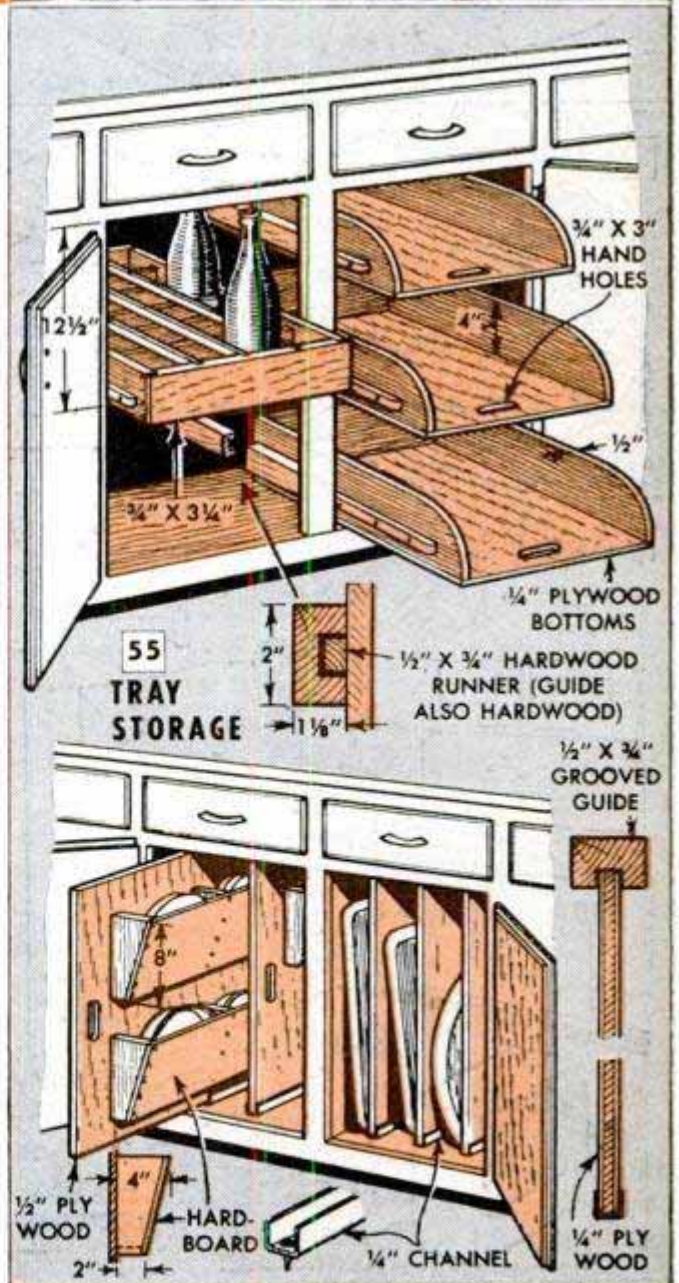

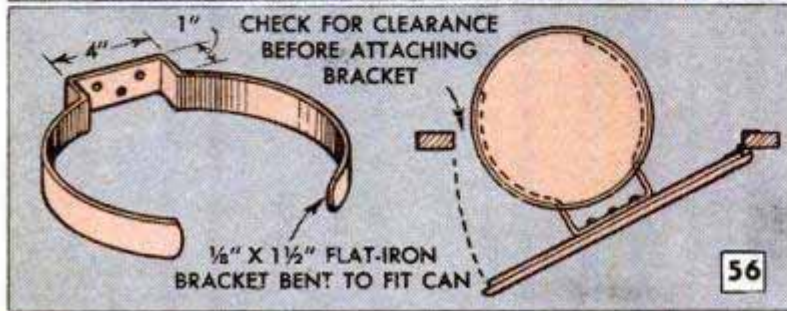

liner which can be purchased ready-made.

**Sliding towel rack:** Towels can be kept at hand but out of sight on a sliding towel rack in a base or sink cabinet, as in Fig. 54. The rack consists of a number of hardwood dowels fitting snugly in holes drilled in two crosspieces that slide on drawer guides. The guides of a drawer above the towel rack serve as hold-downs. In case there is no drawer above the rack, as in a sink cabinet, you will need rack guides having a U-shaped cross section. The front ends of the dowels are rounded and sandpapered smooth. Screws are driven through the crosspieces to keep the dowels in position and make the assembly rigid. Ventilation through the towel-rack compartment is highly desirable. Some manufacturers provide an electric heater and a circulating fan for towel compartments.

**Other storage facilities:** Vegetables and heavy cooking utensils such as skillets, and also empty beverage bottles, can be kept in orderly fashion if you provide sliding units in base cabinets as shown in Fig. 55. Hand holes are cut in the bottom of sliding shelves that have no front. For vegetables, you may prefer a drawer having a front, in which case a row of holes for air circulation should be bored in the sides near the lower edge just above the bottom. Hardwood strips on the sides of the units fit grooved hardwood guides as shown in the detail. Use of roller bearings on sliding shelves, as described in Part II of this series, will greatly reduce friction. Divider strips on the unit for empty bottles provide individual wells for holding them.

To keep trays out of sight, set them vertically between partitions in a base cabinet as in Fig. 55. The partitions may be held in channels or between molding strips. Shallow pans, lids and tins can be kept in pockets attached to vertical panels that slide in channels. The pockets can be attached to both sides of the panels. Hand holes are provided as shown.

**Waste-disposal methods:** One of the handiest places to hold a container to take table scraps, vegetable peelings, etc., is the cabinet door under a sink. It saves steps

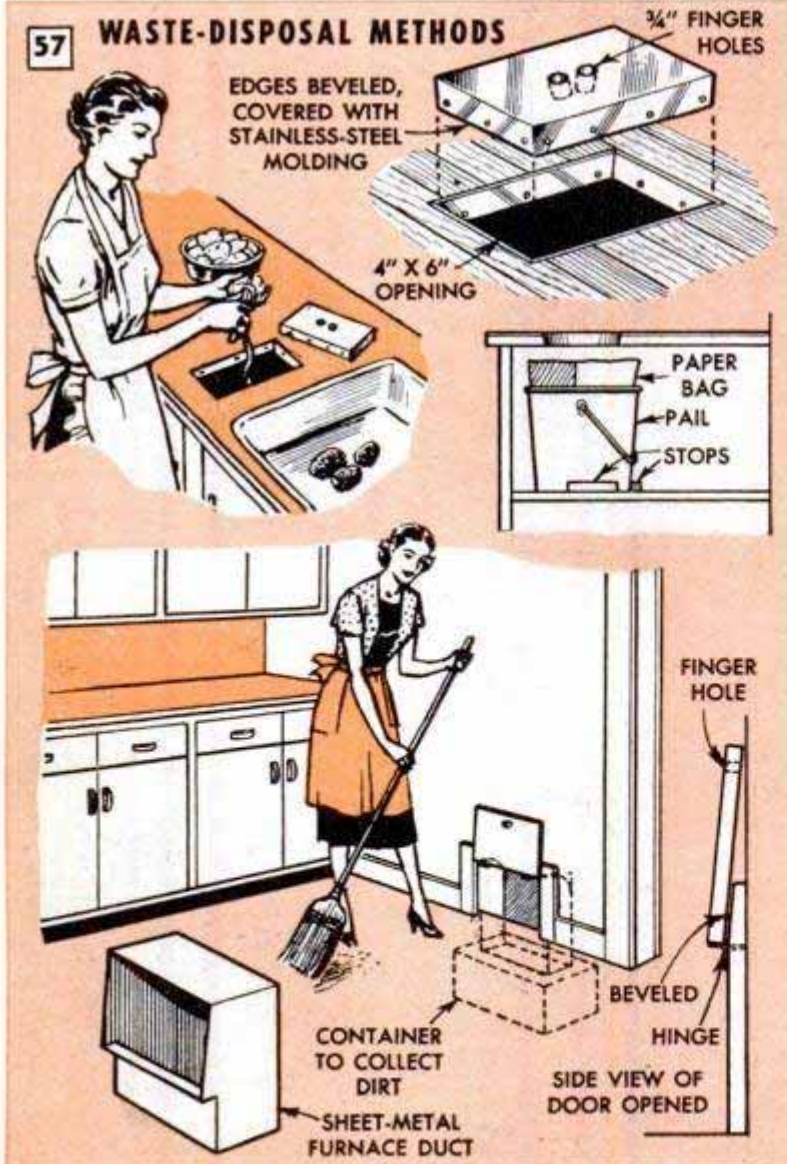

and avoids stooping. A simple arrangement consists of a rimmed container that can be held by a bracket bent to fit as in Fig. 56. Three screws hold the bracket to the cabinet door. Before attaching it, check for clearance when opening the door. Keep a waxed bag in the container for easy removal of contents to the outside waste can. The bag also eliminates constantly washing the container.

A somewhat similar idea is shown in the two upper details of Fig. 57. An opening is cut in a counter top to center directly over the container, which is set on a shelf below and is held in the proper position by stops nailed to the shelf. The edges of the opening are lined with stainless steel, which also is used on the edges and top surface of the hardwood-block cover. It fits flush with the counter surface and has two finger holes drilled at a slight angle toward each other. Cutting and chopping of vegetables, meat, etc., should be done on a hardwood board unless the counter itself is laminated hardwood.

Floor sweepings simply drop into a pan hung on the basement ceiling if you install a dust chute in the kitchen wall at floor level as shown in the detail below Fig. 57. Cut out the plaster, baseboard, floor boards in the partition, part of the sole plate, and a section of the basement ceiling to install a wall-register fitting of a warm-air furnace duct. Finish the job with a neat frame and provide a door, hinged at the top. By beveling the top of the frame, the door can swing back far enough to prevent it from dropping down of its own weight. A wall chute of this kind is preferable to an opening in the floor which entails accident risk.

**Extra storage space:** A separate shelf to store cups makes more space available for other dishes. The cup shelf has a cleat at each end so that it is held by four shelf brackets which can be adjusted for height, Fig. 58. Similar narrow shelves can be used for tumblers.

Another convenience is a plate rail on a cabinet shelf, as in Fig. 59, for large serving dishes that cannot be stacked. The rail is merely a strip of wood nailed to the shelf. A long one can be located near the rear edge, and short ones at the

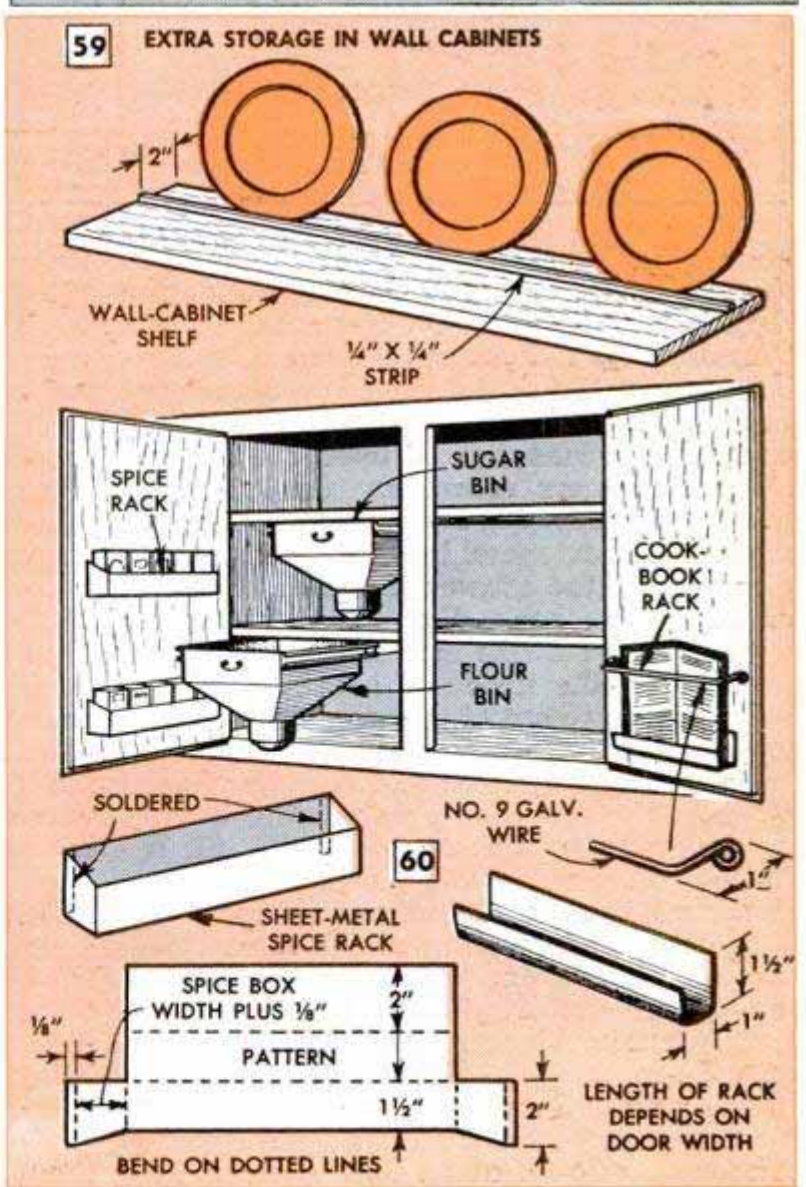
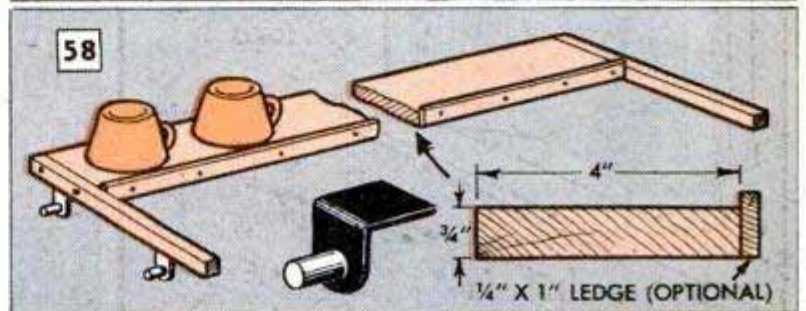

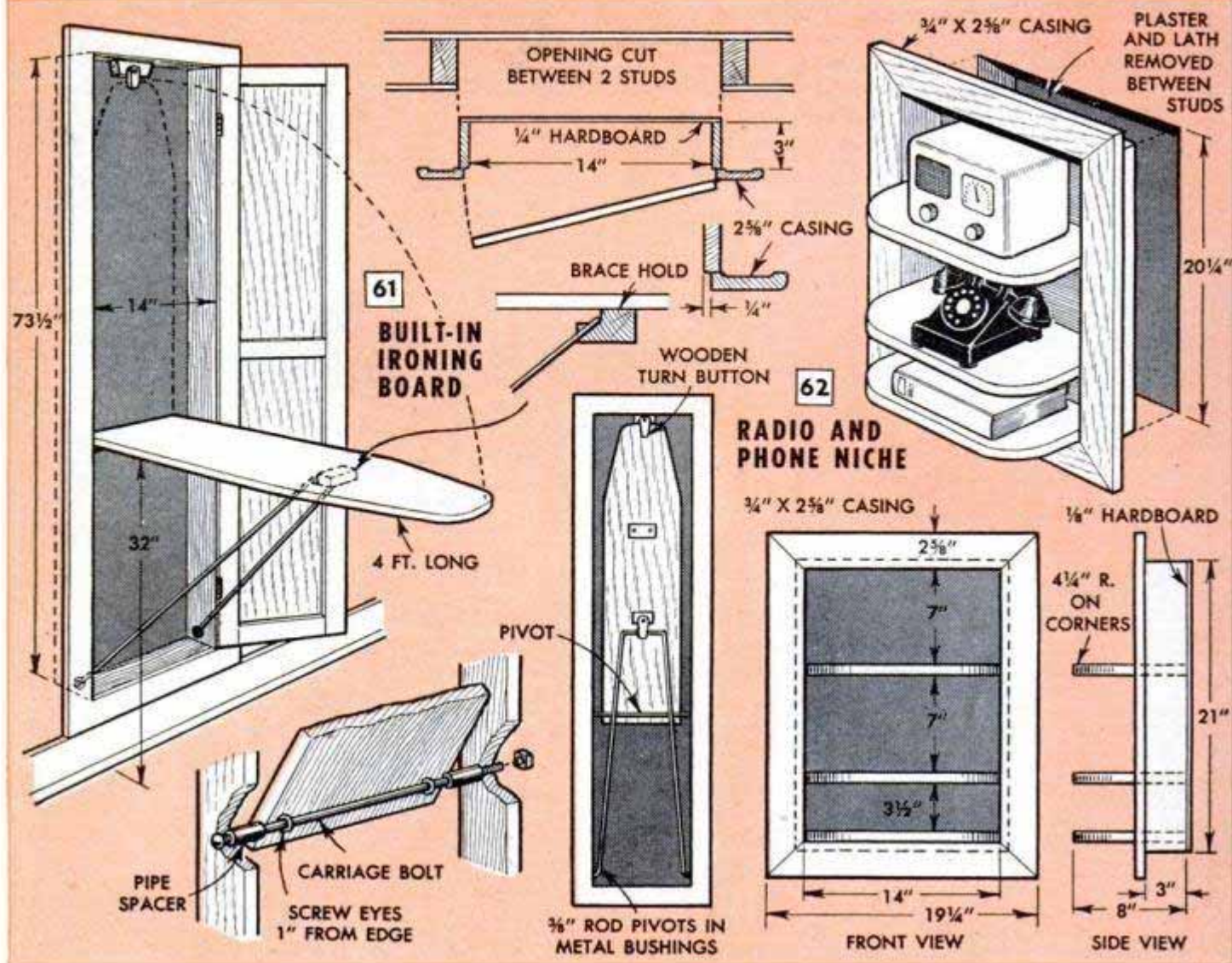

ends of a shelf. Ready-made flour and sugar dispensers can be attached to the underside of wall-cabinet shelves as in Fig. 60. This drawing also shows easily made spice-box racks which are attached to the doors between the shelf positions. Because the exact dimensions depend upon the size of spice containers commonly used in the kitchen, the drawing does not give all sizes. A piece of sheet metal is cut and bent as indicated and the tabs at the ends are soldered to the back. By the simple rack shown, recipe books can be held in open position on the inside of a cabinet door, where they are out of the way and not apt to be soiled, yet easily read while at work.

**Built-in ironing board:** You can purchase a ready-made cabinet-type ironing board or you can build one as shown in Fig. 61. It fits above the baseboard to avoid removing or cutting the board. Cut plaster from the wall between two studs at the most convenient location and then install the cabinet, nailing it through the casing to the studs with finishing nails. The board pivots on a 3/8-in. carriage bolt slipped through large screw eyes or eyebolts installed about 1 in. in at the wide end of the board. Although a 14-in. dimension is given for

the width of the cabinet, this will vary as the distance between wall studs is not always the same. Therefore, the opening in the wall should be cut first and the cabinet made to fit. If you find the studs to be 16 in. on centers, the cabinet will have to be made narrower than indicated. In some cases, where existing studs are not located where you prefer the ironing board, it may be necessary to straddle a stud and install headers and vertical members to provide the necessary framework for the cabinet. Pipe spacers on the bolt keep the board centered. After the nut is turned on,peen the ends of the thread to lock the nut in place. Allow just enough clearance to permit the board to be raised and lowered without rubbing against the back of the cabinet.

A wooden turn button prevents the raised board from falling unexpectedly. A 3/8-in. steel rod, bent to a U shape as shown in the detail, provides sturdy bracing for the board when in use. The ends of the brace are bent outward to fit in metal bushings or sleeves in the cabinet sides at the bottom. The natural spring of the brace keeps the ends in place. The other end of the brace butts into a notched block on the



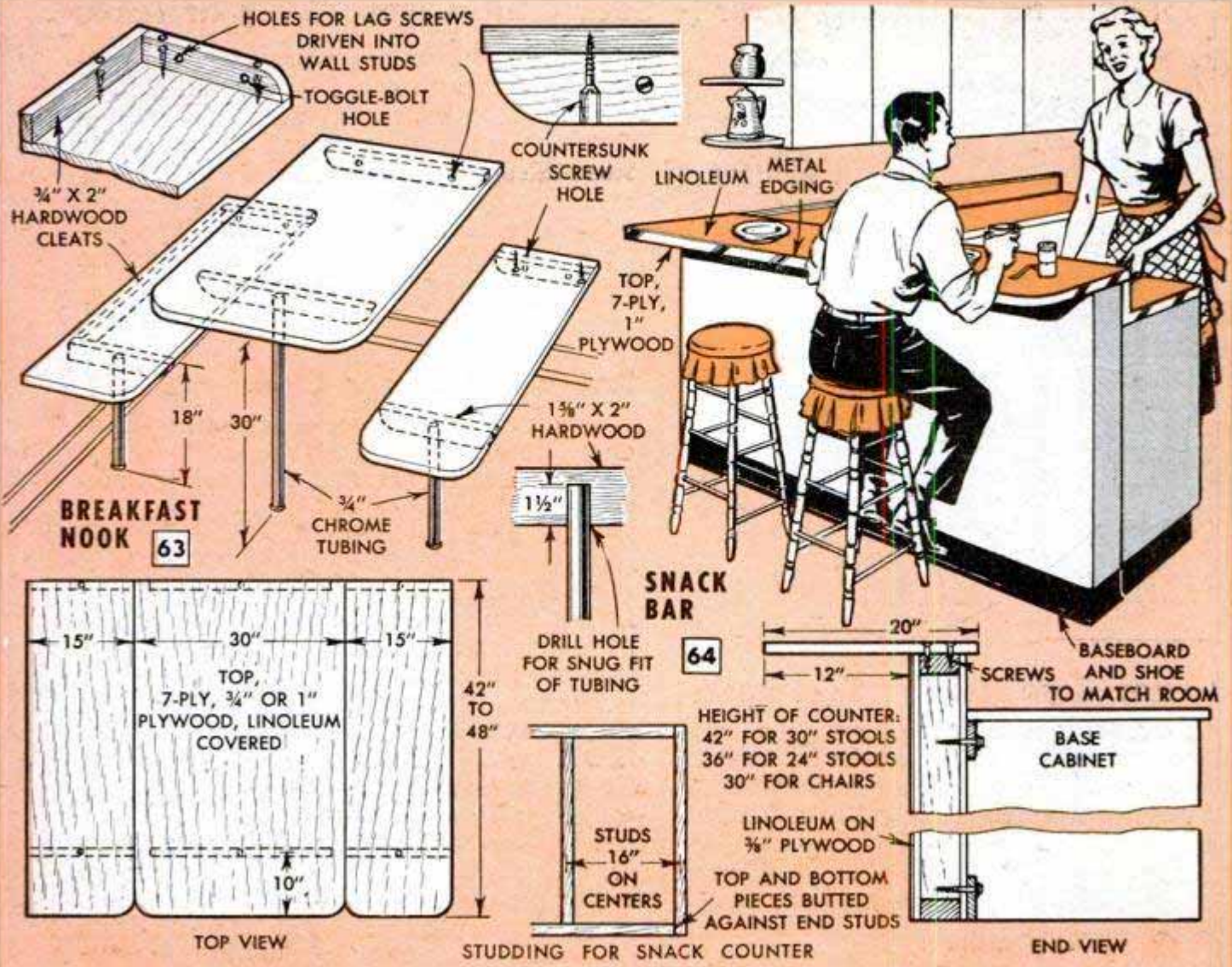

underside of the board. When not in use, a wooden turn button on the board keeps the brace from falling. An electric outlet should be provided in the inside of the cabinet at the top so that the ironing cord hangs out of the way.

**Built-in radio and phone niche:** Installed like the ironing-board cabinet, a wall niche as shown in Fig. 62 keeps a radio and phone out of the way, yet convenient. Install it at the right height for dialing. The shelves must extend beyond the casing to provide the necessary space and the corners are all rounded the same radius for good appearance. The niche should have an electric outlet for the radio, preferably at the top.

**Breakfast nook:** About the simplest construction for an attractive breakfast nook is shown in Fig. 63. Table and backless benches are cut from a single 4 x 5-ft. plywood panel. Hardwood cleats on the underside provide a means of sturdy support. The cleats used for attachment to walls are flush with the edges and are drilled for lag screws driven into wall studs. Bench cleats are attached with one lag screw and one toggle bolt as they are not wide enough to pass two studs. Where one bench fits against an end wall, a cleat is provided at

this wall edge also. A seat corner adjoining a wall is not rounded. Wider cleats located about 6 or 8 in. from the other end of table top and benches are bored centrally to take chrome legs. Since there are only three legs, floor cleaning is easy. Benches are simply enameled and the table top may be either painted or covered with linoleum.

**Snack bar:** Even though space is at a premium, you may still be able to install a three or four-stool snack bar. It can be attached to a wall with brackets or may extend into the room, backing against a base cabinet or range as in Fig. 64. For good support, build a wall of regular studs, including sole and top plate. Flat-headed wood screws, 3 in. long and spaced about 12 in. apart, hold the counter to the top plate. Studs are covered with plywood, and linoleum may be cemented over it on the counter side. The wall end of the counter is screwed to a cleat fastened to the wall with a lag screw and toggle bolt. The height of the counter may be varied according to the height of the stools. These, when not in use, are pushed under the counter.

(The End)

## Doorstops Raise Dining Chair to Seat Child Comfortably at Table

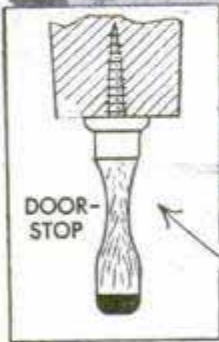
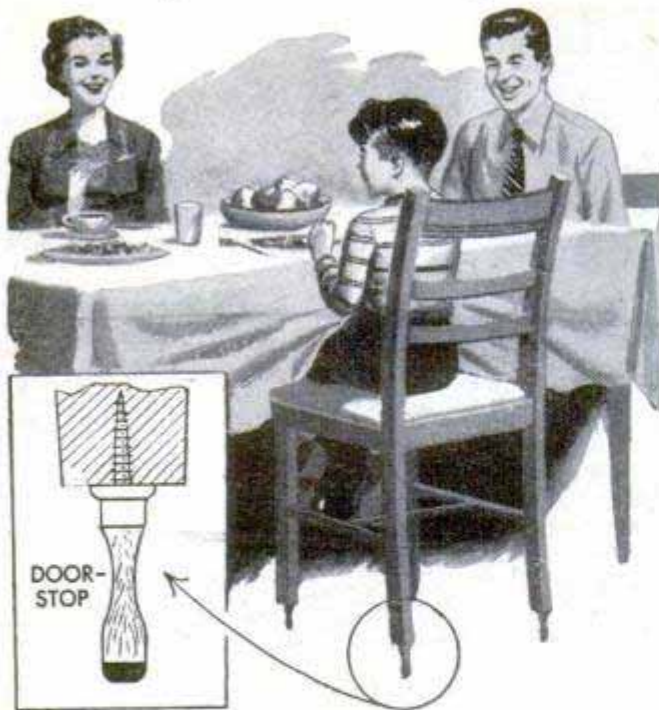

One family, whose youngster has outgrown his youth chair but is still a little too small to be seated comfortably in a regular dining chair, used doorstops to raise the chair instead of resorting to books and other props. The doorstops are screwed into the ends of the legs and, as they are tipped with rubber, they do not mar the floor or damage the rug.

Jos. E. Ciboch, North Judson, Ind.

## Frying-Pan Kitchen Clock

By combining an electric or spring-driven clockwork with a frying pan you can fashion an attractive and appropriate timepiece for the home kitchen or small restaurant. Polish the bottom of the frying pan with steel wool and coat it with clear lacquer or varnish to preserve the shiny finish. Drill a hole for the clock shaft centrally through the bottom of the pan and then drill two smaller holes near the outer edge for stove bolts which anchor the clock mechanism. Mark off twelve equal sections around the face of the pan and paint dots to represent numerals. If desired, metal furniture glides can be used to provide a modern clockface, the necessary mounting holes being drilled through the pan. Still another way is to buy a paper or cardboard clockface ready-made and glue it to the bottom of the pan.

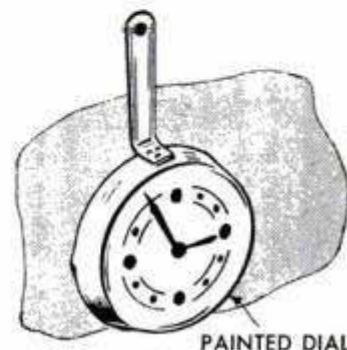

George J. Berkwitz, New York City.

## Glasses Case Held in Shirt Pocket

If a glasses case is too large to allow a shirt-pocket flap to be buttoned over it, the case can be held in the pocket with a rubber band which is slipped over the button. The rubber band is placed around one end of the case lid so it can be pulled over the edge of the pocket, thus making removal of the case merely a matter of disengaging the rubber band from the button.

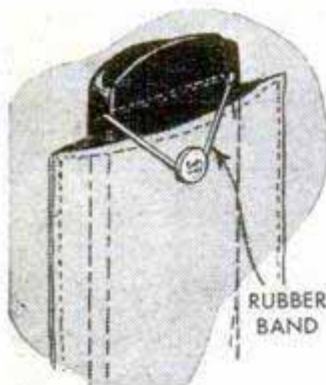

## Pair of Pliers Mounted on Base Doubles as Fly-Tying Vice

Mounting a pair of ordinary pliers on a wooden base provides an excellent vise for tying fishing flies. Aligning holes are drilled through both handles of the pliers to take a bolt, a compression spring being slipped over the bolt so that it holds the handles of the pliers apart. A wing nut which is turned on the bolt locks the pliers closed. Blind holes drilled in the wooden base receive the ends of the handles to hold the pliers upright. Tightening the wing nut clamps the jaws of the pliers over the hook and, as soon as the wing nut is loosened, the compression spring automatically spreads the jaws to release the hook. Be sure that the bolt used is of as small a diameter as possible so that the holes in the pliers handles will not be large enough to weaken them for ordinary uses. A C-clamp can be used to fasten the block to a table.

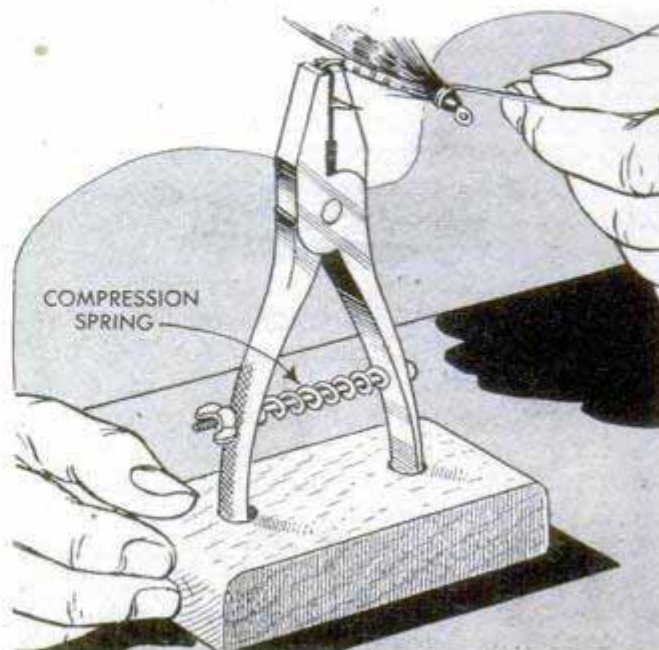

# Fast "Taxi Service" on Large Skating Ponds

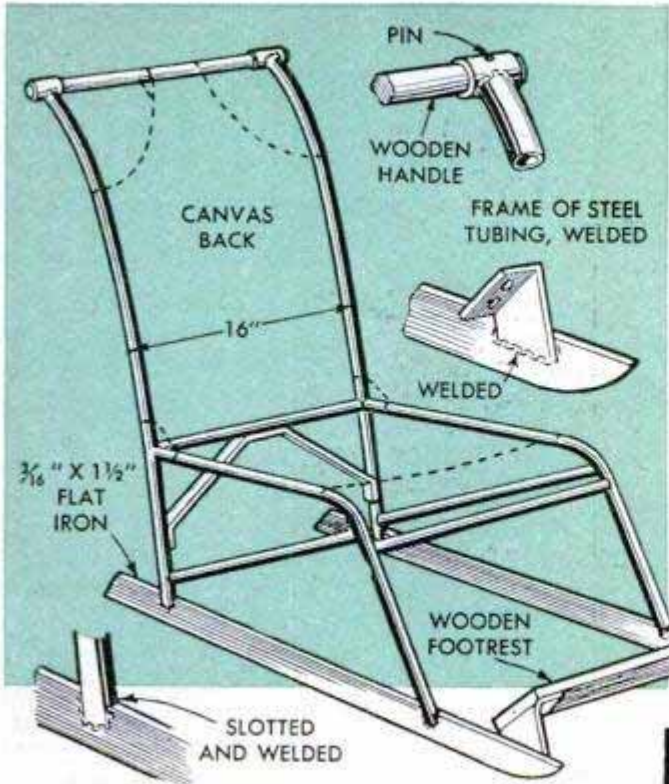

It's no trick for a good skater to handle this ice taxi, even though it's only skate-driven, as it glides easily over the ice on polished runners. The light, tubular frame of the chair is of all-welded construction. Only the handle and footrest are of wood. The seat and backrest are formed from one piece of canvas with all edges folded once and hemmed. The part of the fabric forming the seat is cut wide enough to allow for hemming the edge and looping the flaps around the tubular frame members on both sides. The looped flaps are sewed with two seams each. On the back section of the canvas, flaps fold around the frame uprights and over the handle. Grommets spaced along the edges of the fabric permit lacing the edges together as shown at the right. If desired, this same construction can be used across the bottom. The bottom edges of the runners are filed to a wide

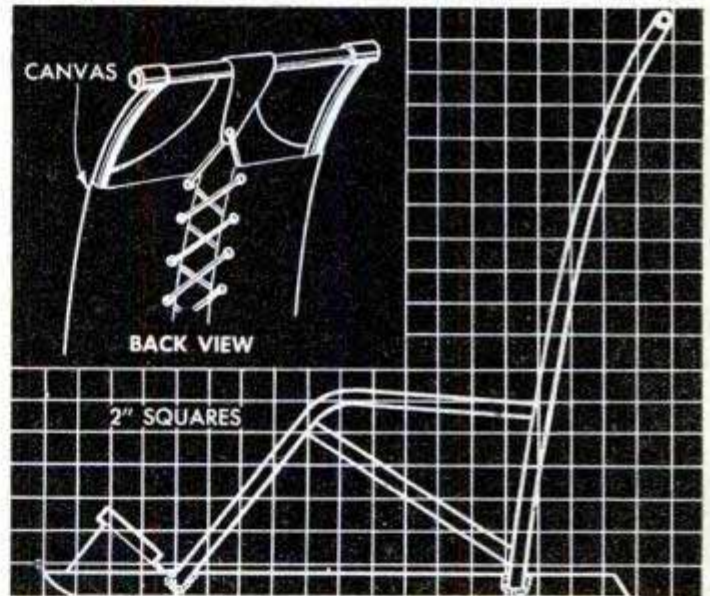

V-shape and polished smooth with fine emery cloth. Filing the runners to the V-shape makes the taxi steer easier, as the runners slide freely, without cutting the ice as a hollow-ground skate runner would. Smooth the runner edges with an oilstone.

## Tire Chains Held Tightly in Place With Screen-Door Spring



Tire chains that fit loosely can be kept from slipping by drawing them tight with a screen-door spring. The spring is stretched over the side wall of the tire and fastened to the chains with S-hooks at three or four points. Tension can be increased by fastening the spring to the chain at additional points around the tire.

□ Paper shopping bags can be waterproofed to a certain extent by coating them with shoe polish of a neutral shade.

# LEAN-TO

**You can have cut flowers out of season and start seedlings early by building this walk-in greenhouse against a side of your home**

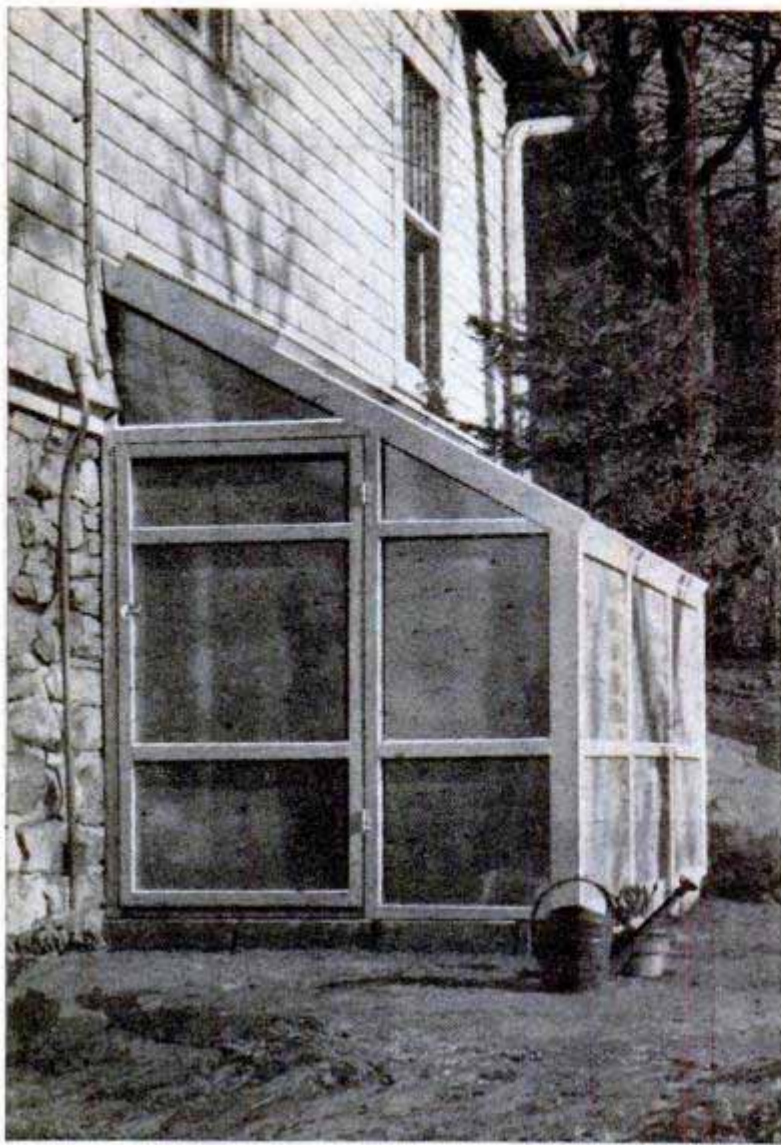

Above, this lean-to greenhouse, covered with plastic-sheeted screening is the place to start seedlings for early plantings. Below, there's plenty of room for seed flats and potted plants



**T**HERE'S no need to clutter up the window sills with seed flats or freeze your fingers breaking out snowbound cold frames in late winter in order to get seedlings started in time for transplanting when warm weather arrives. A lean-to greenhouse is the answer to this perennial problem of gardeners. Moreover, by timing greenhouse plantings you can have cut flowers out of season. The lean-to greenhouse pictured is covered with plastic-sheeted screening and gives you a floor space 5 x 9 ft. Of course, the length of the structure can be increased as much as desired simply by adding studs and rafters on a uniform 3-ft. spacing.

Locate the greenhouse unit on the south side of the house or other suitable building where it will be exposed to late winter and early spring sunlight during the greater part of the day. In severely cold weather, heat can be piped from the furnace or supplied by a small space heater. Use concrete blocks or flat stones for the foundation. Lay the first foundation course of either blocks or stones on a concrete footing below the normal frost line. Half-lap the sills at the outer corners as in Fig. 2 and be sure that the sills are level before setting up corner posts and studding. It will pay to notch, or house, the ends of the braces, or nailing strips, into studs and corner posts as detailed in Fig. 2. This results in a much more durable structure. Because of the high humidity always present in a greenhouse, redwood is the best material for framing. Cypress and white pine are a good second choice.

As the construction of the frame proceeds, plumb all vertical members and check corners for squareness. Note that the eave strip is beveled on the lower edge so that it will fit flush against the outside edge of the plate. The weather stripping over which the ventila-

# GREENHOUSE

By  
Richard F. Dempewolff

tors fit is beveled slightly on the outside edges to permit the ventilator frames to close without binding. Set the weather strip in nonhardening mastic before nailing to the rafters. The doorframe is made up as detailed with half-lapped corner joints and housed center cross members. Use screws in assembling the joints of both the door and ventilator frames.

After hinging the door and ventilator frames in place the job is ready for the plastic-sheeted covering. Apply mastic to all surfaces which the covering will join, then tack it in place with screen staples spaced about 3 in. apart. Then apply a second coat of mastic over the joints as in Fig. 1 and nail trim strips over all joints. That finishes the job except, perhaps, for a line of calking run in at the joint where the structure joins the house foundation and across the roof joint back of the ventilators. Paint all interior woodwork with two coats.

[Design and photos courtesy Celanese Corp. of America]

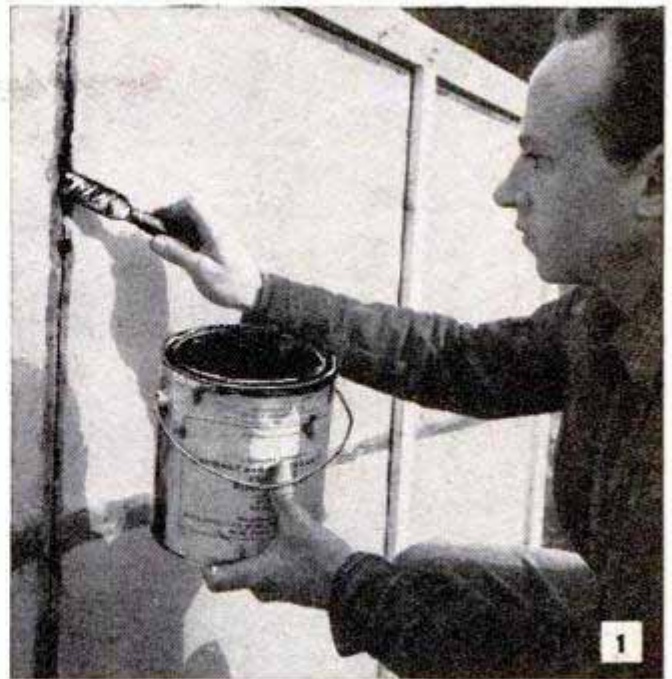

Mastic applied under and over plastic-covering joints makes tight, waterproof job on walls and roof

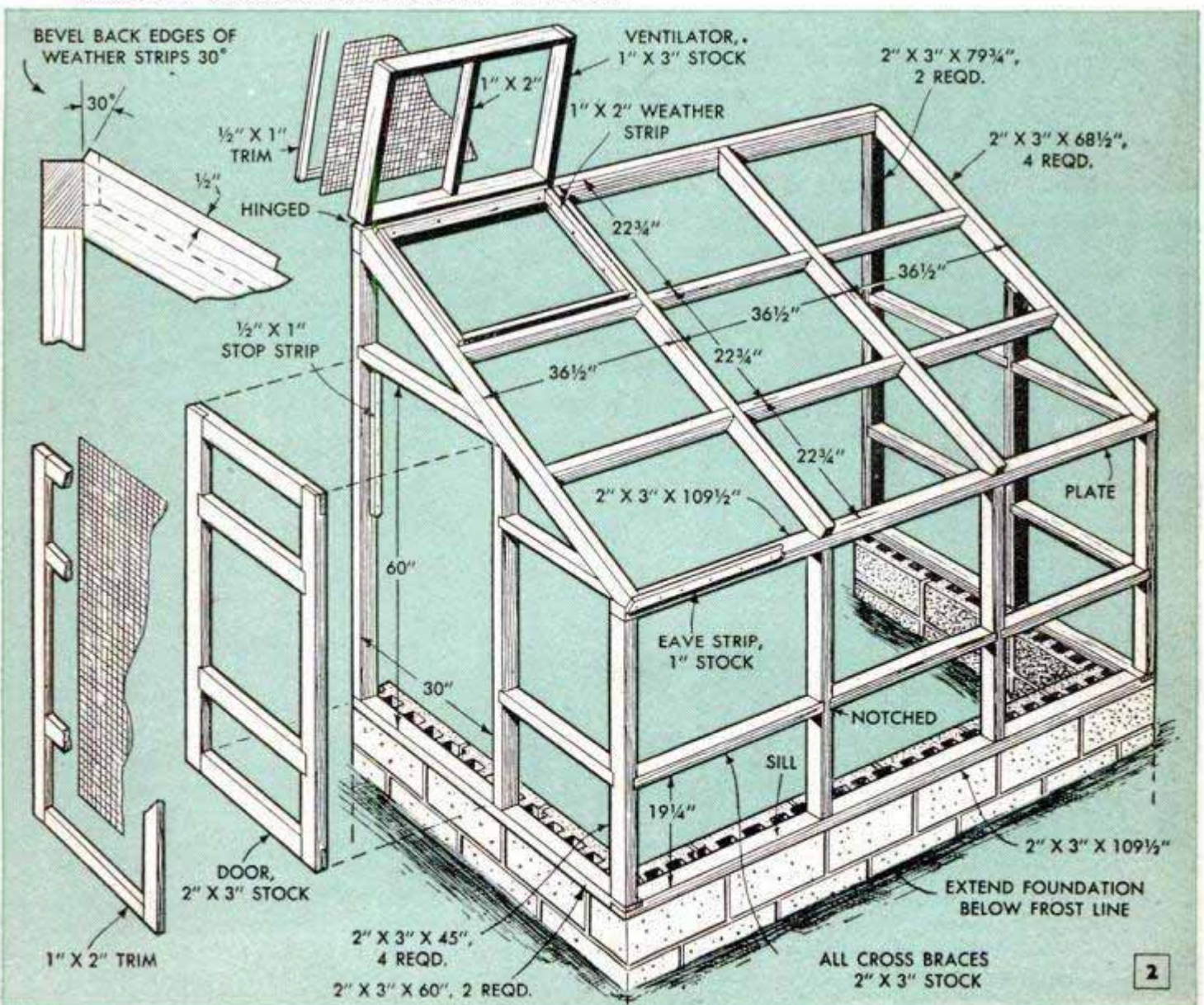

## Metal Lath on Porch Canopy Prevents Snow Slides

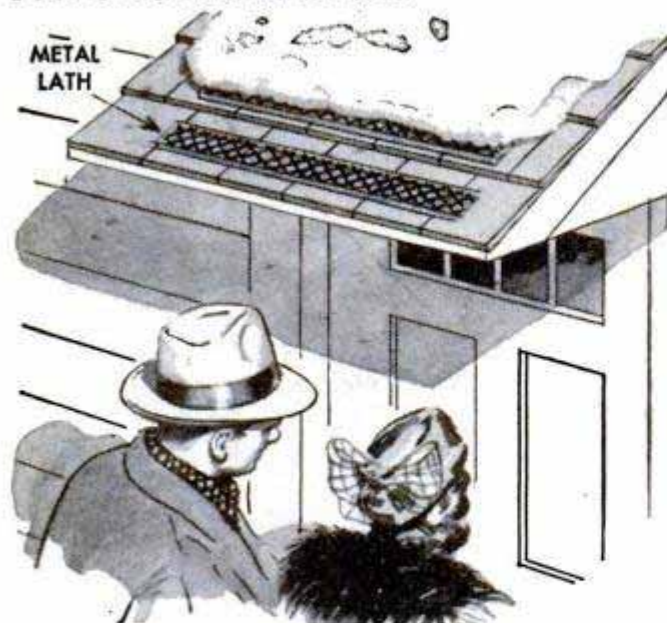

Melting snow that slides off a porch canopy is not only annoying but may prove embarrassing if it should fall on guests. To prevent such an accident, tack two or three strips of metal lath to the lower portion of the canopy as shown. The lath will retain the bulk of the snow until it has had a chance to melt. Paint the lath to minimize rusting and tack it in place lightly so it can be removed in the spring.

## Pliers Drive Picture-Frame Brads

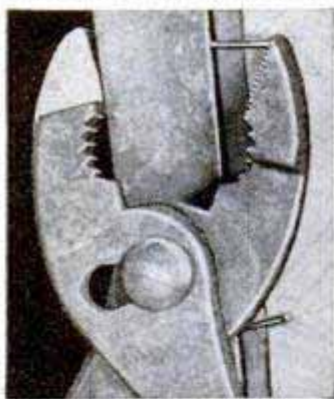

Framing pictures with a hammer often results in damage to the frame or the glass. However, on smaller frames, this difficulty is easily overcome by using pliers to drive the brads. Use brads short enough so that the

jaws of the pliers will fit over the head of the brad and the edge of the frame. Simply force the brads into the wood by squeezing the pliers. Tape the surface of one jaw of the pliers to prevent marring the frame.

Virginia Hanson, Santa Monica, Calif.

## Coating Glass With Lubricant Foils Halloween Pranksters

If you expect the youngsters to "decorate" your windows with wax or soap this Halloween, much troublesome cleaning-up can be saved by coating the outer surface of the glass with petroleum jelly or lubricating oil. Spread the oil in a thin film, applying it with a soft cloth, and later remove

the oil and any markings with a soap-and-water solution. Although the oil will not cause appreciable interference with vision through home or store windows, it is best not to coat the car windows until it has been parked for the night. If soap markings have already been made on an unprepared window, they can be removed with hot water and a scrub brush. Marks from wax crayons or candles can be cleaned off with an organic solvent such as gasoline or turpentine. This should be followed by washing the glass with soap and water.

## Furnace Operation Improved By Basement-Window Vent

From the poor operation of his gas-fired furnace, one homeowner discovered that weather stripping can be too thorough. To remedy this difficulty, he fitted a basement window with a permanent air intake.



Selecting a three-paned window about four feet from the furnace, he removed one of the panes and replaced it with an L-shaped vent frame. The latter was made of outdoor plywood and contained a screen to keep out insects. The top front panel overhangs the lower panel and the opening between them provides the air intake. The overhanging construction prevents driving rain and snow from entering. Robert Hertzberg, Jackson Heights, N. Y.

## Screw Eye Holds Hasp Open

When a tool chest or storage bin is locked with a padlock, it is often convenient if the hasp can be kept from falling over the staple, particularly when you are carrying

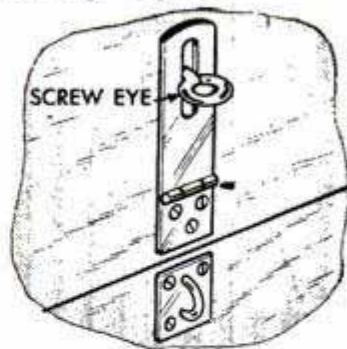

an armload of tools or other items to be placed in the chest. A screw eye turned into the lid is just the thing to hold the hasp open when you do not want to lock the chest. Turn the screw eye into the front of the lid so that the slot in the hasp fits over it, and merely turn the screw eye at right angles to the slot in order to hold the hasp open.

Use a dampened wad of cotton or tissue paper to wipe up fragments of glass.

# Inlaid Photo Frame

By Benjamin Nielsen

THIS turned photo frame features an unusual segment inlay of contrasting woods. First, turn a disk to the outside dimensions of the frame and face off. Next, turn inlay rings from walnut and maple disks as in Fig. 3. You will need three rings of each wood of the sectional size given in section A-A, Fig. 1. Now, turn a  $\frac{1}{16}$  x  $\frac{5}{32}$ -in. groove into the face of the disk from which the frame will be cut later. Be careful to make an exact layout to assure precise fitting of the inlay. Cut the inlay rings into segments and fit these into the groove in the pattern shown in Fig. 1 and the photo below. Glue the segments in place and face off after the glue is dry. Now, reverse the disk on the faceplate and recess the back so a small undercut can be made as in section A-A, Fig. 1. A suitable tool for undercutting the  $\frac{3}{8}$ -in. groove can be made from an old file. Bend a short length of the shank at a right angle and grind a cutting edge on the end. After running in the undercut to width and depth, reverse the disk on the faceplate and cut off the frame. Run the cut straight in but stop just before the tool breaks through. Remove the work from the faceplate and finish the cut with a sharp knife, then trim off any remaining waste from the inside edge of the frame. Now, drill the two holes indicated in the section A-A, Fig. 1. These are for hanging the frame on a small L-hook screwed into the wall. Turn the backing disk as in Fig. 2, cutting the rabbet as in section B-B. Sand off the shoulder as indicated by the dotted lines, split the disk and fit the sliding dowel and stop as shown in the lower detail. To assemble the frame and picture, cut a circular piece of glass to fit in the rabbet in the inner edge of the frame. Place the picture back of the glass, lay the backing over it and then force the two halves open so that the shouldered segments of the backing enter the undercut groove in the frame. A snug fit will keep the segments in place.

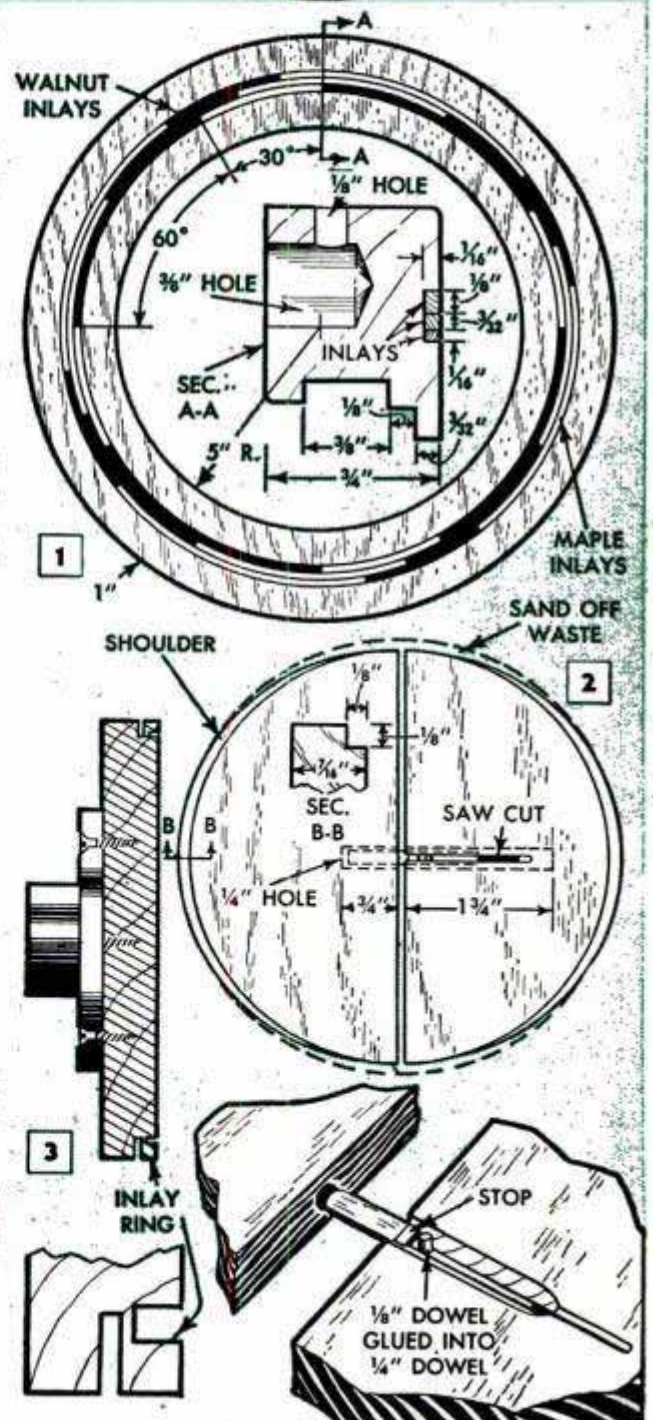

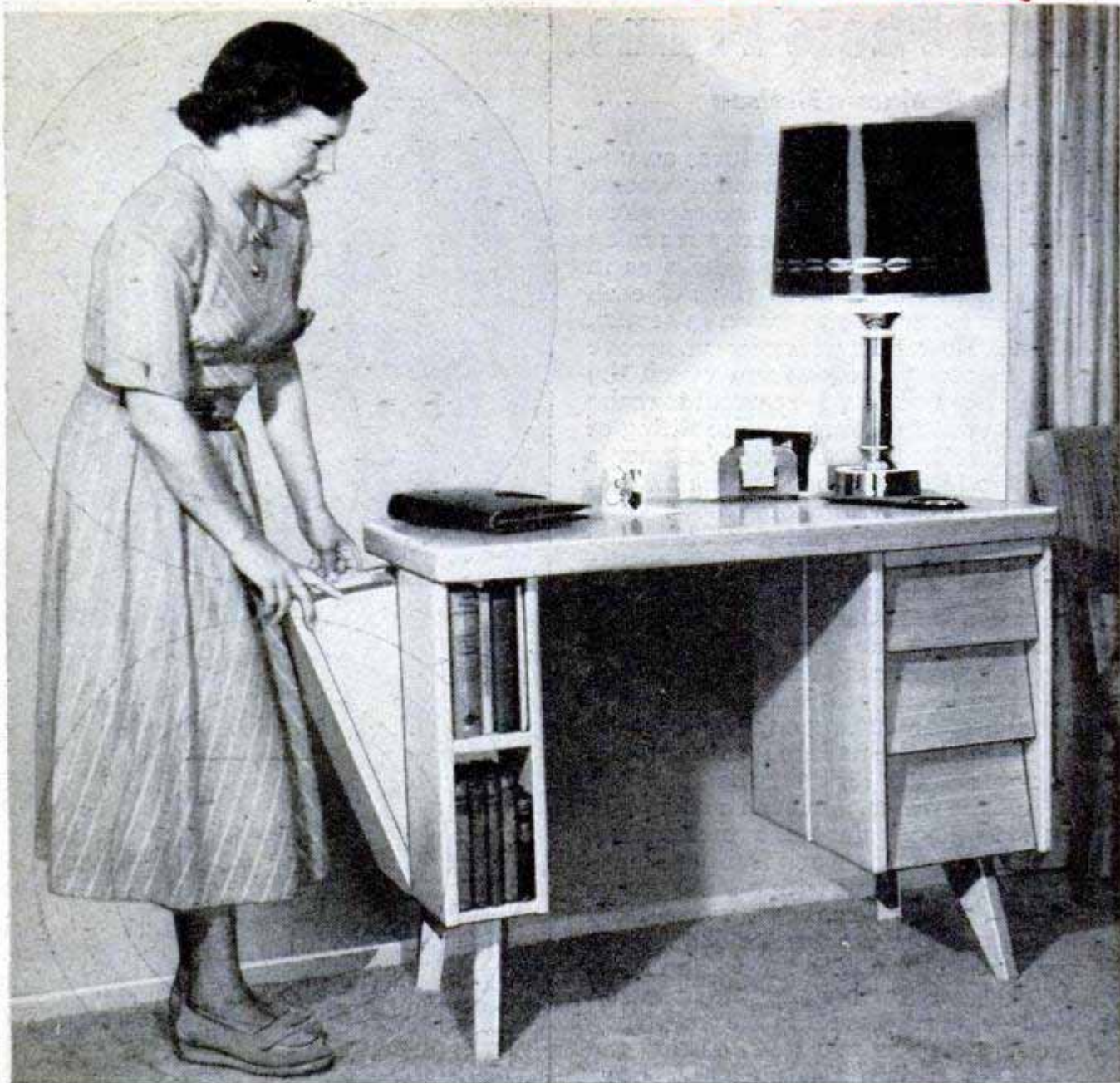

### By Robert Hoppough

**T**HIS MODERN DESK combines good design with several interesting and useful features that adapt it exclusively to home use. One pedestal provides ample drawer space and the other one consists of a small open-front bookcase and a built-in wastebasket. The latter is a feature of special decorative and practical value in small homes where space is limited. The construction of each pedestal is almost as simple as that of a box and, owing to the type of assembly, nearly all joints and fastenings are concealed. Begin construction by making the top first. The edges of the top are curved as in Fig. 2 and the first thing to do is rip out the edging strips from

striated, or "comb surfaced," plywood. Then lay off the length and the three widths of the top from a center line drawn directly on the sheet of plywood from which the top is to be cut. Now, lay out the curved edges, using the plywood edging strips to strike the arcs. Drive brads into the plywood just outside the ends of the 16 and 18-in. dimension lines of the layout. Place the ends of the edging strip against the projecting brads and draw the strip outward until the curvature is slightly past the end of the 20-in. dimension line, as in Fig. 2. Then strike the arc with a pencil point held against the inner edge of the strip. Do the same on the opposite edge of the top. Saw outside the layout lines along the curved sides and across the ends, and then true the edges with a plane to the layout lines. Note that the trim pieces on the ends are of  $\frac{3}{4}$ -in. striated plywood while those along the sides are only  $\frac{1}{4}$ -in. plywood. Note also that these parts overlap at the corners. Attach the endpieces



first, using glue and finishing nails. Set the nailheads below the surface and fill the holes with wood putty. Then bevel the projecting ends of each endpiece so that the thinner sidepieces fit neatly over them. Glue and nail the side strips in place. Then sand all exposed edges and round them slightly.

Both the drawer pedestal and the open bookcase are of simple box construction with butt joints fastened with glue and screws. The back panel of the drawer pedestal fits into  $\frac{1}{4}$ -in. grooves cut in the inner and outer side panels. Cleats are attached to both side panels with glue and screws to serve as braces and drawer runners. A  $\frac{1}{4}$ -in. groove about  $\frac{1}{8}$  in. deep divides the inner and outer panels vertically so that the effect is that of two separate panels on each side.



Back view of desk shows how built-in wastebasket tilts outward. It is easily removed from the desk for emptying and cleaning.

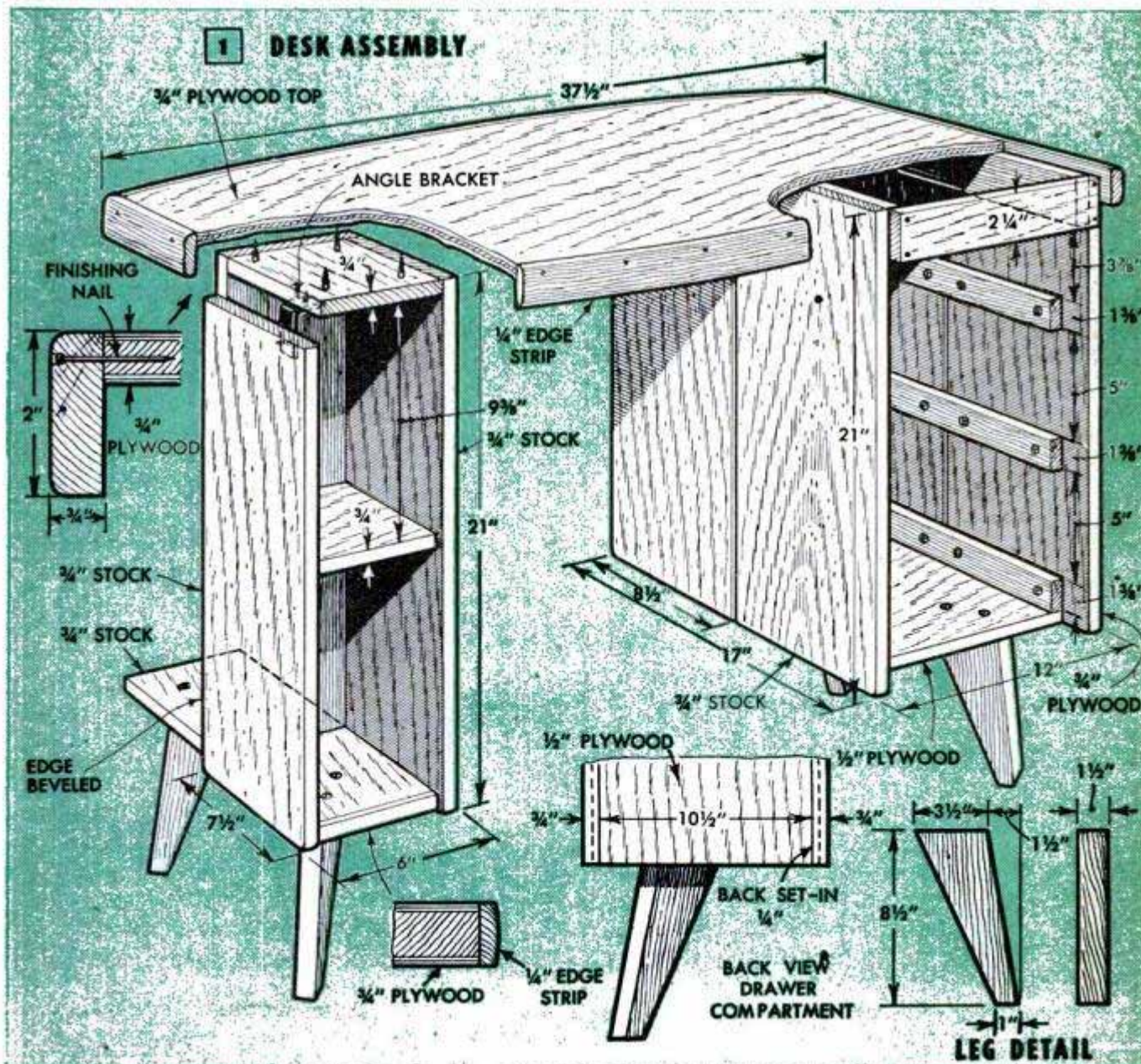

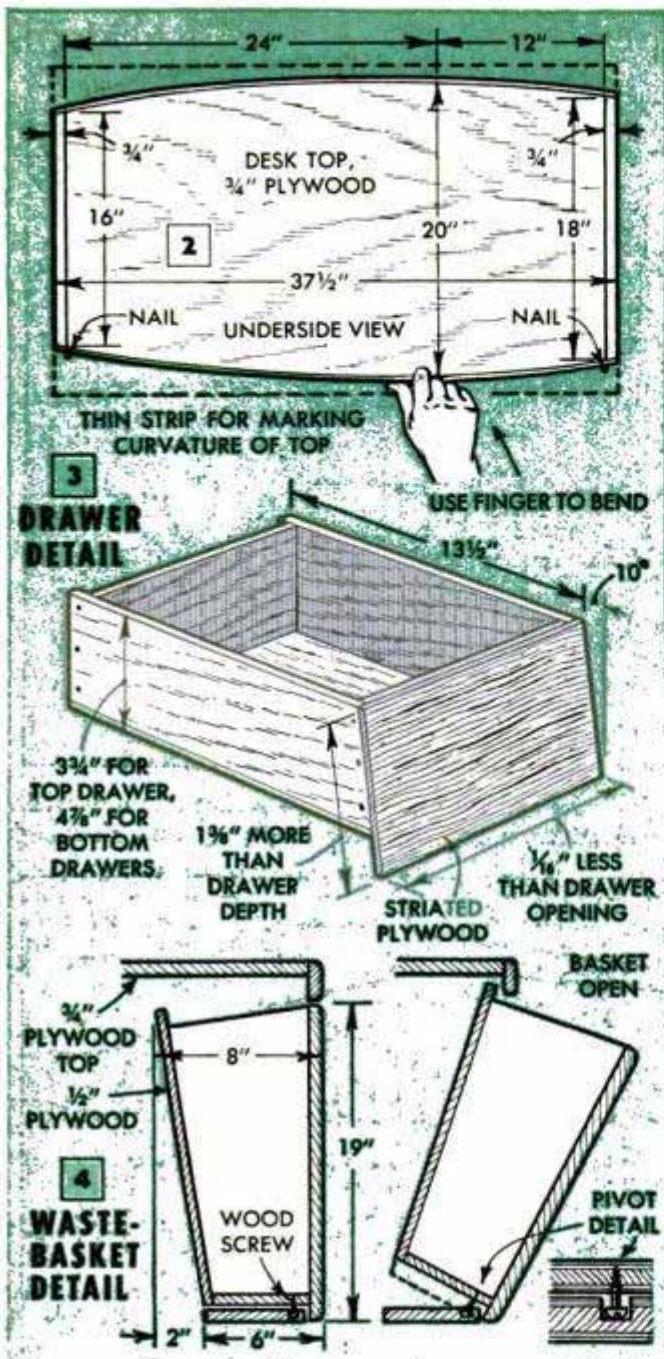

Drawer fronts of striated plywood are inclined at an angle of 10 deg., making rails unnecessary



Edges of the groove are rounded slightly before assembly of the parts. Another important design detail is the manner of attaching the top rail, Fig. 1. The ends of the rail are attached to cleats screwed to the side panels and the ends of these cleats come within  $\frac{3}{8}$  in. of the front edges of the side panels. Thus when the rail is screwed in place the corners project about  $\frac{3}{8}$  in. The corners are then rounded as in the photo below Fig. 4. No bottom rail is necessary because of the design of the drawers, Fig. 3.

Now, note the short outer panel which forms one side of the bookcase, Fig. 1. The outer edge of the panel is supported by an angle bracket and the corner is rounded. This also is a design detail as it gives the effect of separation which you will note in the photo above Fig. 1. This simple design motif is characteristic of modern furnishings of this type. Invert the top on a table or bench and attach the pedestal and bookcase with screws. Be careful to get the parts correctly positioned. Make and attach the four legs in the positions shown. Glue strips of matching wood to the front edges of the bookcase shelf and bottom.

Next, make the wastebasket to the dimensions given in Fig. 4, using  $\frac{1}{2}$ -in. plywood for the back and sides and  $\frac{3}{4}$ -in. plywood for the front. Round the edges of the front panel to match the corner contours of the outer bookcase panel. Note in Fig. 4 that the back of the wastebasket is extended so that it engages the edging strip across the end of the desk top when it is tipped forward. The basket pivots on the heads of screws which are driven about half their length into the bottom of the basket at points equally spaced from the

End view of the desk with wastebasket removed. End panels of basket and bookcase are shaped to match



front panel. Registering holes are drilled part way through the extended bottom of the bookcase as shown in the sectional view, Fig. 4. The basket is removed from the desk by simply tilting it forward about halfway, then raising it slightly and pulling out the bottom until the screwheads clear. Construction of the drawers is pretty well covered in Fig. 3. Note that the drawer fronts are of striated plywood and that the sides are fitted into rabbets cut in the ends of the frontpieces. The ends of the drawer sides are cut at an angle of 10 deg. Assemble with screws and glue and then sand all corners slightly rounded.

The type of finish applied depends on the kind of wood used. Fir plywood is the most inexpensive and is easily available, but oak, birch or maple-faced plywoods make the best job. Fir plywood can be given an attractive finish by first applying a white filler and immediately wiping the coating so the prominent grain of the wood shows through. Allow the filler to dry, sand lightly and follow with a sealer. Sand this when dry and finish with clear varnish or water-white lacquer. Maple or birch can be given the same treatment with good results. Oak can be finished in the same way, but will require careful sanding of the filler in order to high-light the grain. If a painted finish is desired, use fir plywood and apply the filler first. Sand lightly when dry and apply an enamel undercoater. Follow this with one or two coats of enamel in the color desired. Of course, only the flat surfaces can be sanded. Parts made from striated plywood are smoothed with steel wool.

### Removable Toe Rest on Stepladder

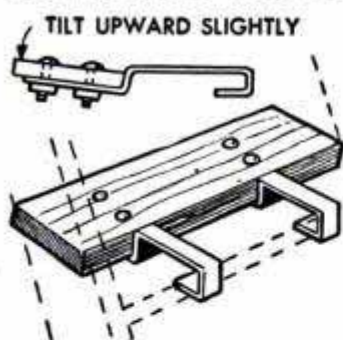

When working from a stepladder for hours at a time, standing on the narrow step is less tiring if the step is fitted with a toe rest. The rest is simply a length of wood bolted to two flat-iron brackets which slip over the ladder step. The ends of the brackets are bent to engage the front edge of the step, permitting the rest to be moved from one step to another in a moment. Note that the portions of the brackets to which the toe rest is bolted are bent upward slightly to give better support.

☛ Particles left on the skin by adhesive tape can be removed by rubbing with acetone and rinsing with water. Use absorbent cotton to apply the acetone to the skin.

### Two C-Clamps and Scrap Board Support Plywood When Cutting

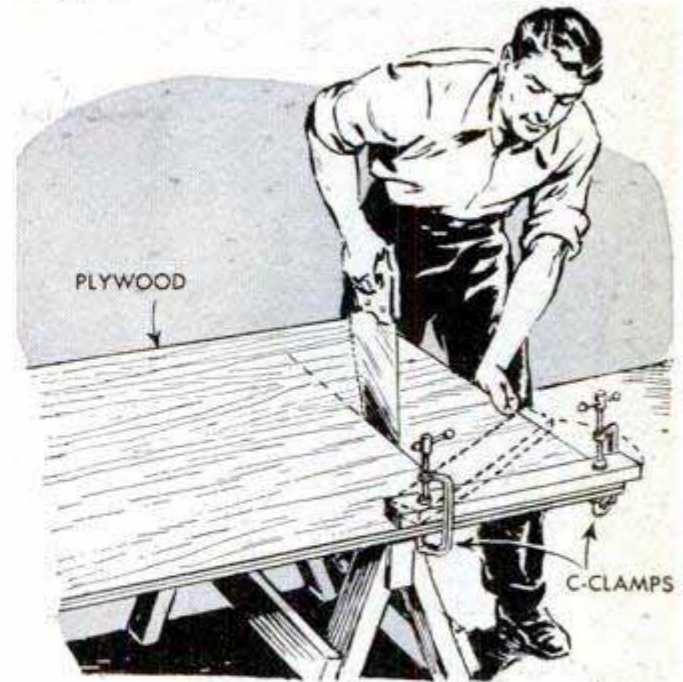

Cutting a piece off the overhanging end of a large plywood panel usually is an awkward task. Trying to hold the piece and saw at the same time usually results in the saw binding and the piece cracking off before the cut is completed. To overcome this, Herbert E. Fey of New Braunfels, Tex., supports the work in the manner illustrated. He first saws the panel for a distance of about 12 in. Then, using two C-clamps, he clamps a scrap board across the end of the unsupported piece, attaching one clamp to the plywood at the right side of the line and the other to the outer edge of the piece being cut. This keeps the end from dropping down. The sawing is continued to a point about 12 in. from the rear edge and then the board clamped across the edge is swung down, as indicated by the dotted lines, to give support to the work as the sawing is completed.

### Handle for "Hot Shot" Battery

Dry cells wired in series may be easily carried if you merely connect a metal screen-door handle to opposite poles on two of the dry cells. Fasten the handle to the terminals with the terminal nuts and wrap friction tape around the cells to hold them together. The handle doubles as a connector and a carrier.



Arthur Trauffer, Council Bluffs, Iowa.



## Weather Stripping for Garage Door Provided by Old Inner Tubes

Cold air, rain and snow are kept from blowing under swinging or sliding garage doors by tacking strips of inner-tube rubber to the lower edges of the doors. The strips are tacked on the outside so that they rub against the ground, thus providing an effective seal. If desired, additional strips may be fastened vertically to one of the doors so they cover the joint between the doors when the latter are closed.

## Painting Drawer Pulls



Several drawer pulls can be painted at the same time and without handling by first mounting them on a cardboard box. This permits the job to be done quickly and neatly as the box also serves as a drying rack. Attach the pulls to the box by passing the bolts from the inside through holes which have been punched in the cardboard.

Benj. Nielsen, Aurora, Neb.

## Steam Iron Perfumes Garments

Linens, lingerie, dresses and the like, which often take on a slightly unpleasant odor when finished with a steam iron, can easily be given a delicate scent while ironing. Simply mix a few drops of perfume with the water before filling the iron. Mrs. Margaret A. Brokop, Alhambra, Calif.

## Flowerpots From Eggshells

To start seedlings, try using eggshell halves filled with loam as individual flowerpots. The shells can be stored in egg cartons and moved easily to

EGGSHELL HALVES

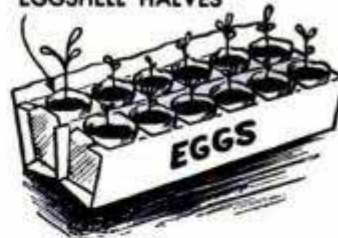

any sunny window sill. Later, the seedlings can be transplanted right in the shells as the roots will break through and will be supplied with fertilizer as the shell decomposes.—LeRoy J. Hebert, Lexington, Mass.

## Dishes Facilitate Layout Work

Kitchen utensils, dishes and ordinary cans readily available around the house provide suitable curves for quickly laying out repeat designs. These are particularly handy when marking a scalloped window valance or cornice board prior to sawing the decorative edge. Just experiment with dishes and cans of various sizes and shapes until the desired effect is attained.

Harrison Neustadt, Miami Beach, Fla.

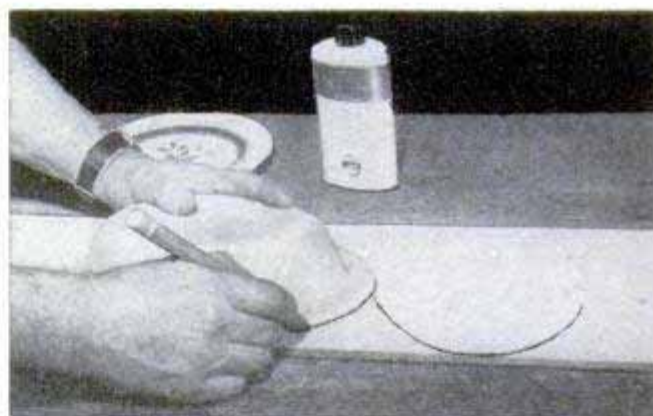

## Cookie Cutters Transfer Designs

Standard designs such as stars and hearts are quickly transferred to paper or wood surfaces by using an ordinary cookie cutter to stamp them on the surface. Press a narrow strip of masking or friction tape tightly over the edge of the cutter all the way around and then ink the tape with a stamp pad. Press the cutter over the spot where you want the design and then fill in with the desired color. The cutters also come in handy to make a number of outlines for coloring by children.

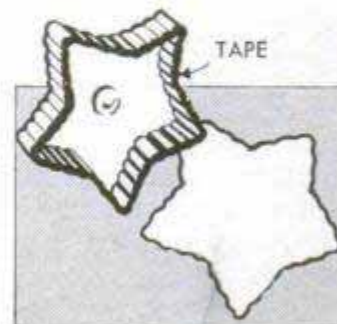

John J. Rea, Urbana, Ill.

# Slide-Top ROASTER CABINET

By Richard L. Smith

SEVERAL unusual features adapt this roaster cabinet to use in small kitchens where space is limited. The pivoted top slides sidewise to open and tilts to a vertical position as pictured. This releases the hinged front panel which drops down on the open cabinet doors to form a service shelf. The lower doors are opened by pulling on a single knob which projects from the left side of the cabinet as in the detail A below. This operates the cam mechanism shown in the lower right-hand detail and pictured in position in the center detail. Detail B, upper right, shows how the sliding top is pivoted. The pivot pins slide in grooves cut in the back rail and the inner face of the front panel. Registering grooves also are cut in the front and back facing strips on the edge of the side panel. After the top has been pushed to the left as far as it will go, the pins enter these grooves and permit the top to swing to the vertical position, as in the photo. With the exception of the base, top and bottom rails at the back and the facing strips, all parts are made from plywood. Strip C serves as a spacer between the front panel and the top edges of the doors when the panel is dropped to the horizontal position.

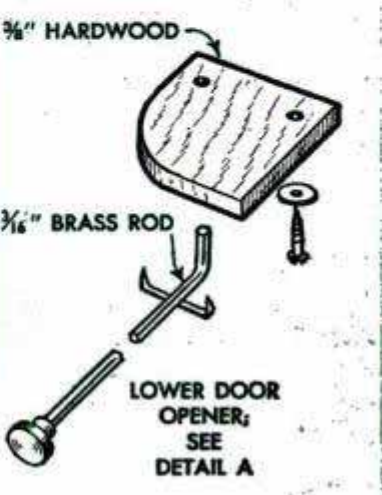
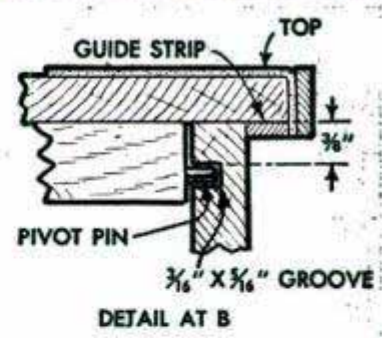
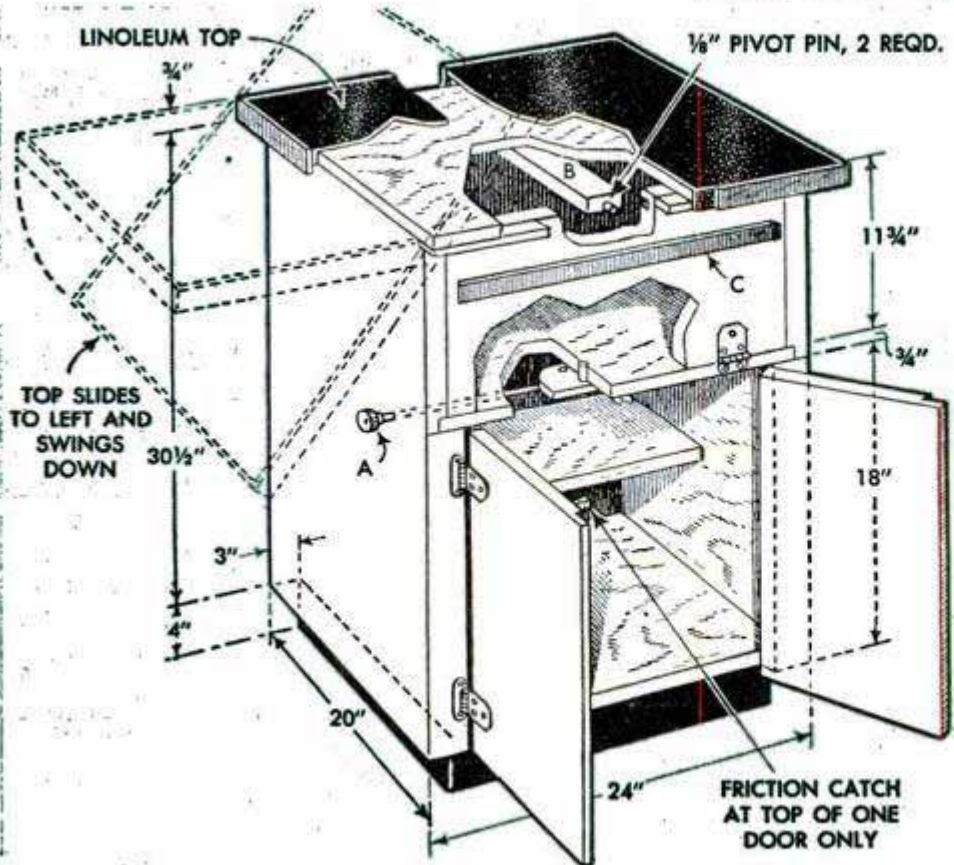
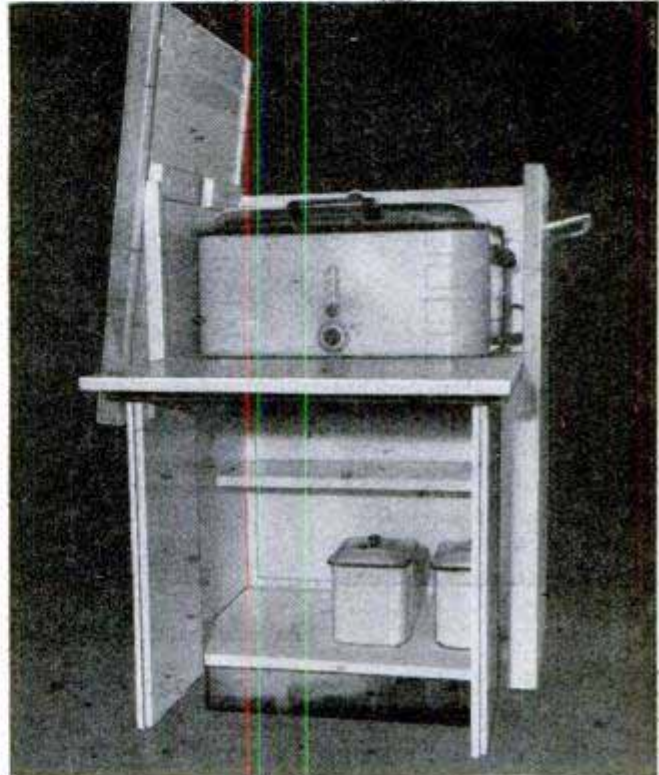

# POINTERS ON REMODELING

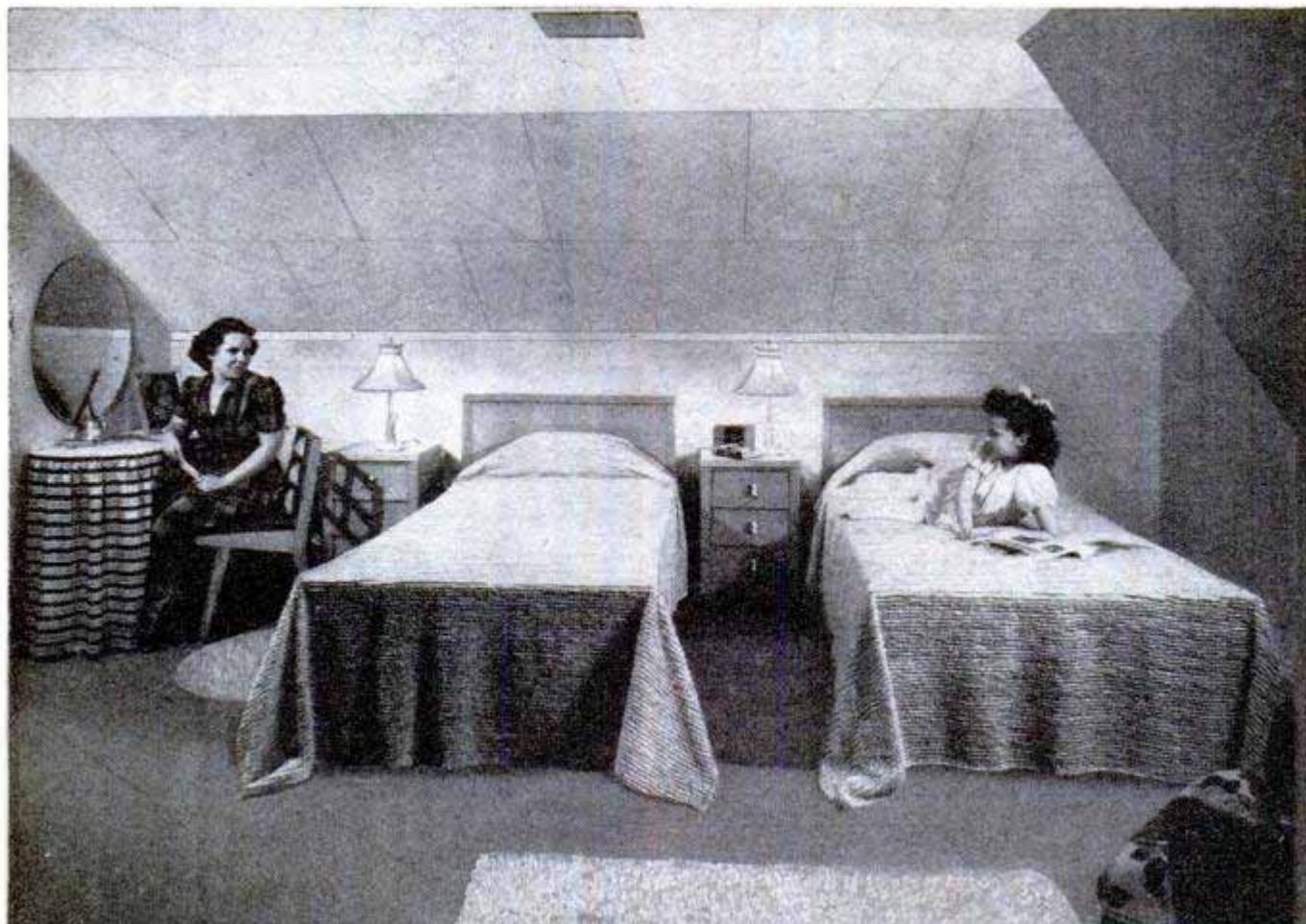

Article courtesy of Douglas Fir Plywood Association

**I**F YOU ARE crowded for space in your home, how about the attic? In most houses the attic can be converted into two large rooms that can be used as extra bedrooms with bath, or even one large recreation room. With new wall coverings which are available, particularly plywood, you

can do most of the work yourself. After the walls have been framed in, the job is half done because the big sheets of plywood build a solid wall quickly. After nailing in place, they are ready for finishing. Just how you proceed depends first on the type of attic that is to be remodeled,

whether it is long and rectangular under a low-pitched gable roof or whether it is more nearly square and the roof is high-pitched. Because of the limited height available in relation to the over-all size in the smaller home, it may be necessary to include the entire attic space along the length and slant a portion of the walls along one or both sides. The alternative is the installation of a Dutch-type dormer along one side, preferably across the back of the house. Fig. 1 shows a typical floor plan of an attic-remodeling job requiring the construction of a dormer. Figs. 3 and 4 detail the framing of this job and Fig. 2 is an exterior view of the finished dormer.

Unless one is familiar with the type of carpentry required in framing a dormer, it's a good idea

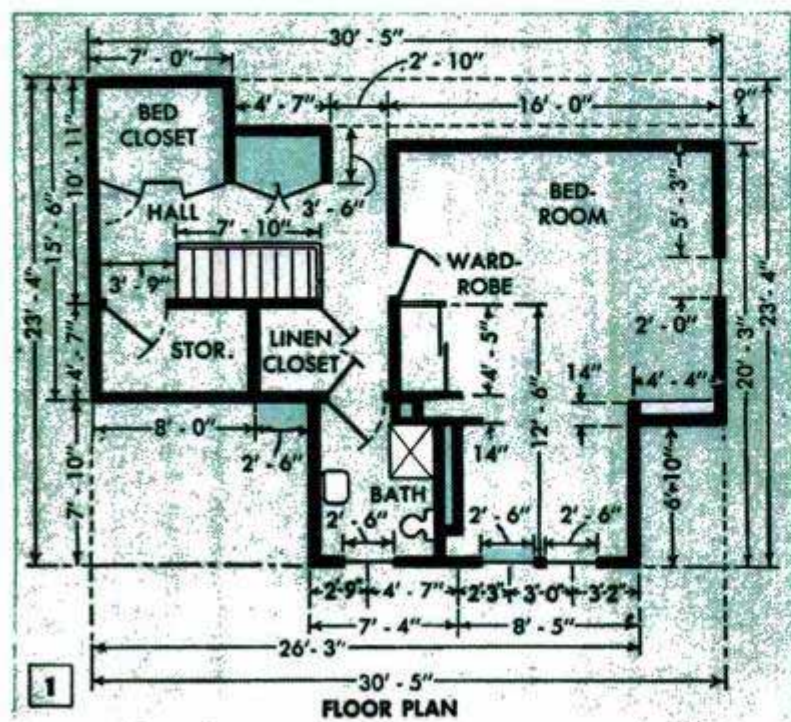

# AN ATTIC

to have this part of the job done by an experienced carpenter. As soon as the dormer is enclosed you can take over and finish the job. However, unless the attic is already completely floored, sub-flooring comes first, as the dormer sills are placed on top of the sub-floor. New subflooring should be of  $\frac{5}{8}$ -in. plywood. Then, after the dormer is framed, and all other wall studding is in place, the top floor is laid. Sound-deadening felt is placed between the top floor and the subfloor as in the left-hand



Here's how the finished dormer looks from the outside. Adding a dormer greatly increases the usable area of attic rooms under a low-pitched roof. Double windows admit light and air

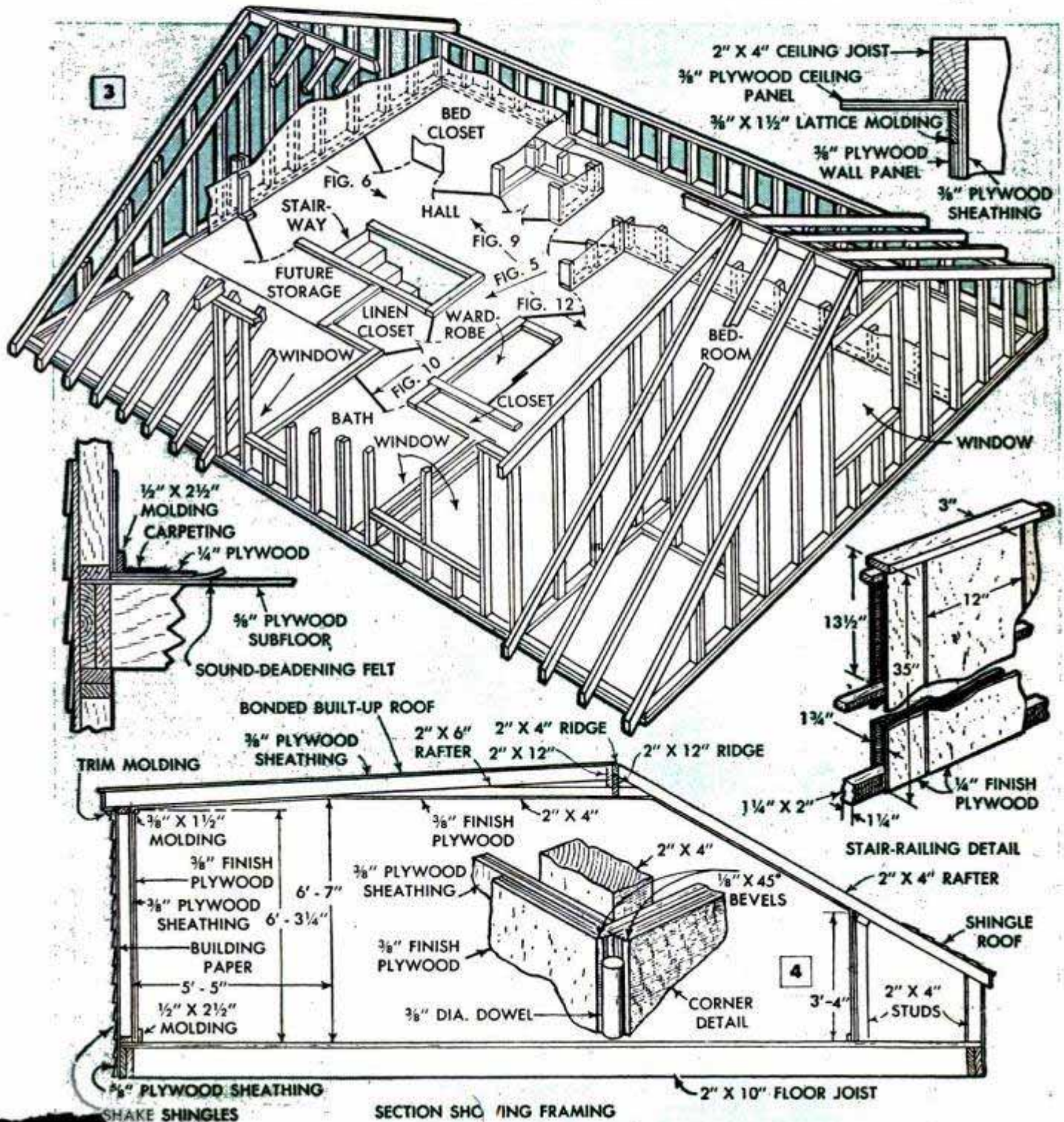



Ample linen storage is provided by closets opening onto hallway. Closets are fitted with plywood doors

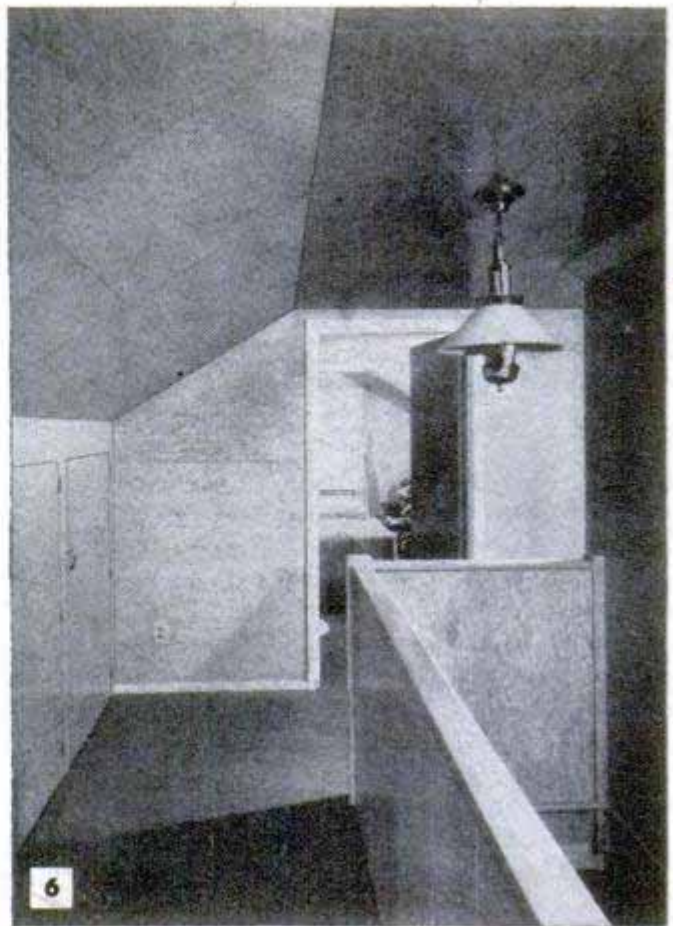

Hallway walls, ceilings and stair rail are finished in plywood paneling with horizontal grain on the walls

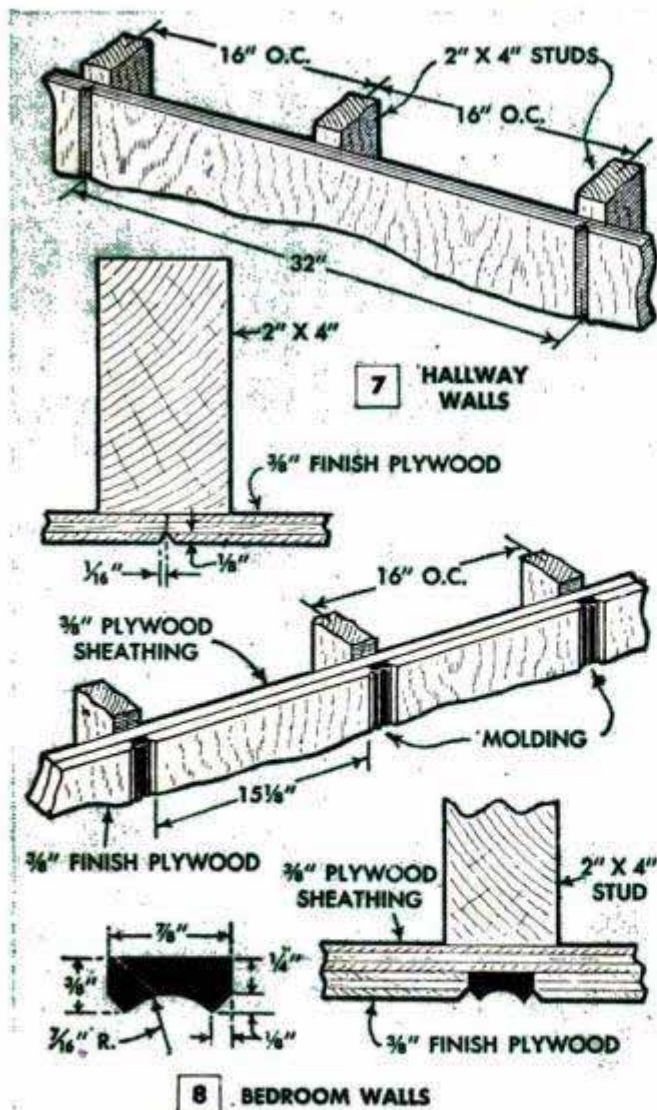

sectional detail, Fig. 3. With the dormer framed and the subfloor and top floor laid, you're ready to tackle the interior walls, cabinets and other fittings. Many homeowners now favor plywood ceilings and the material is available in 1/4-in. thickness and cut into pieces 20 x 32 in. and 32 x 32 in., especially for this purpose. The small panels are beveled on all four edges and are applied to rafters or ceiling joists with 4d finishing nails spaced 6 in. apart. The nailheads are set about 1/16 in. below the surface and the holes are filled with wood-putty compound. The joint pattern of the smaller ceiling panels can be anything that suits your fancy, but breaking the joints as in the photo above Fig. 1 simplifies the job somewhat and results in a very attractive ceiling. When applying the smaller panels to rafters on a sloping ceiling it probably will be necessary to add extra 2 x 4s or 2 x 6s to provide nailing strips under the plywood joints. Now, note the upper right-hand detail in Fig. 3. As a rule, where only one thickness of plywood is applied to walls and ceilings, it's the practice to put on the ceiling first. But in this case, a sheathing plywood is first nailed to the walls, then the ceiling is put on and, finally, the finish plywood is applied to the walls. The detail referred to shows how the corner joint is made.

Details in Figs. 7 and 8 show methods of applying finish plywood to walls. In



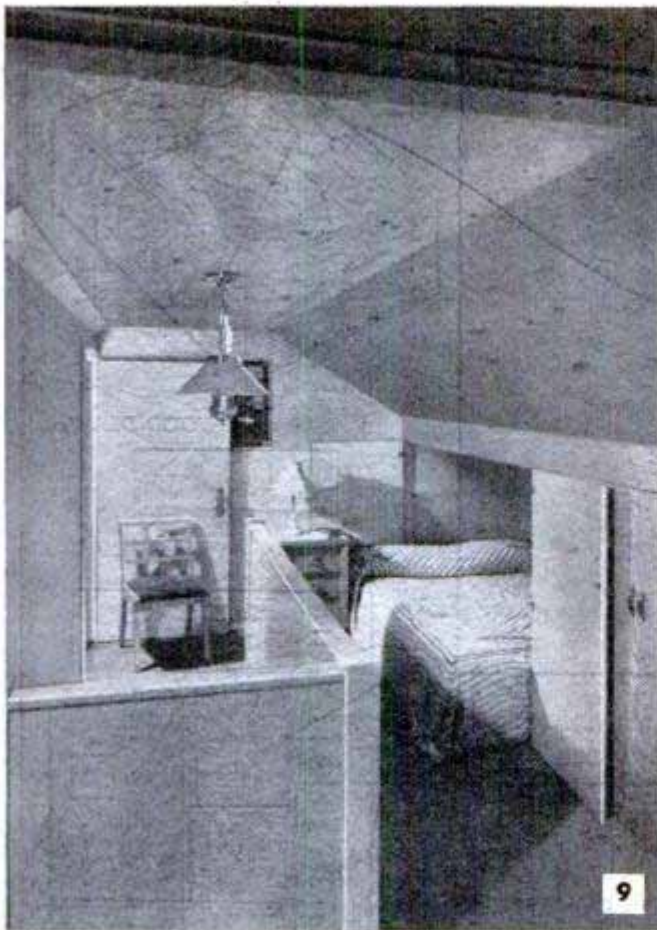

9

Slide-away double bed at the head of the stair is enclosed by two plywood doors and removable panel



10

Bathroom has plywood walls and ceiling finished in gloss enamel. Note neat job on the plywood walls

7 the panels span three studs as in the upper detail. This type of panel is suitable for hallways and it can be installed with the grain running vertically, as shown, or with the grain running horizontally, whichever you prefer. Fig. 6 shows the large panels installed in a hallway with the grain of the wood running horizontally. In inside corners the panels are cut to meet in a tight lap joint, but on the outside corners the ends are cut to fit corner-to-corner and the vee is filled and rounded with a length of dowel as in the corner detail in Fig. 4. This detail, of course, shows sheathing plywood under the finish plywood but the procedure in either case is the same. The lower right-hand detail in Fig. 3 shows how to frame and cover a stair railing, or balustrade with plywood. Fig. 6 pictures the finished job. On a stair rail of this type the grain of the panels should always run vertically.

Built-ins in the hallway are two simple storage cabinets with doors of  $\frac{3}{4}$ -in. interior plywood, Fig. 5, and a slide-away double bed which is stored in a closet when not in use, Figs. 8 and 9. The bed closet is closed with two doors

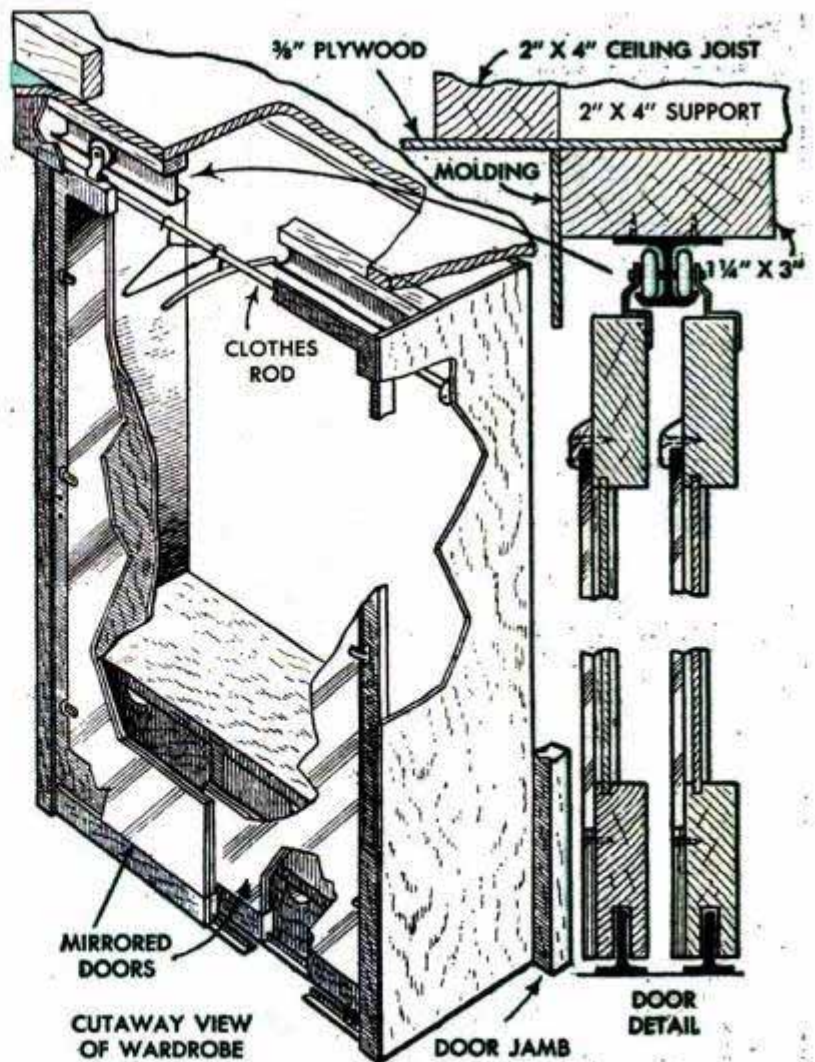

11 WARDROBE DETAILS

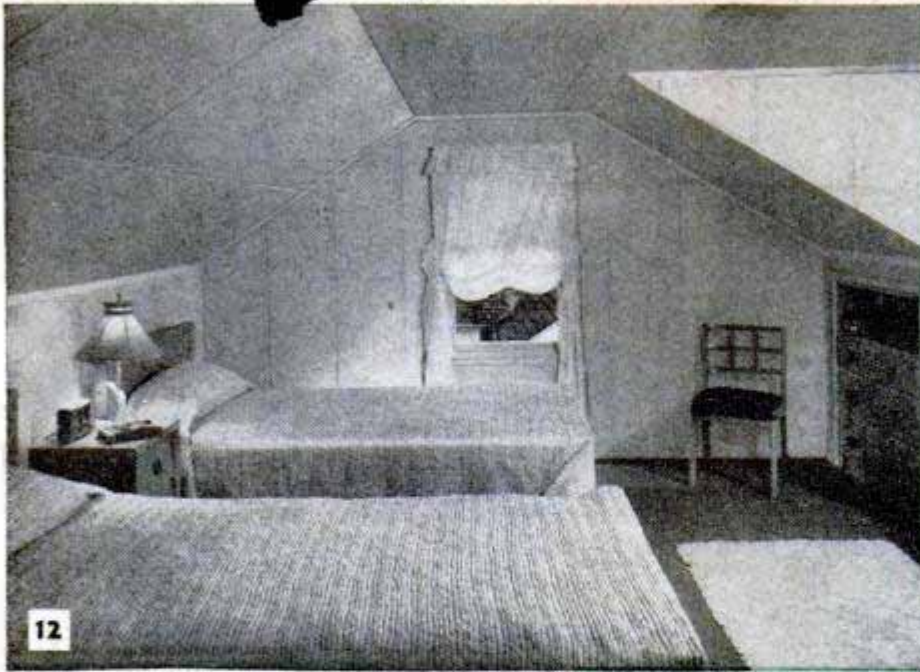

Here's a view of the finished bedroom with a built-in chest of drawers. Plywood can be finished natural or with enamel

of plywood and a removable panel shown in the plan, Fig. 1, and also in Fig. 3. This panel is fastened at the bottom by means of dowels driven into holes drilled in the end. The dowels project about  $\frac{1}{2}$  in., the ends entering registering holes drilled in a base strip when the panel is set in place. The panel is fastened at the top with two throw-type door bolts. Walls and ceiling of the bathroom, Fig. 10, are covered with  $\frac{3}{8}$ -in. plywood. On the ceiling the plywood is applied at right angles to the rafters and on the walls the panels are placed with the grain running horizontally. All panels are beveled at the edges.

Because of the low ceilings, the paneling in attic bedrooms generally is applied vertically, using narrow panels and molding spacers as in Fig. 8. Note in the upper detail, Fig. 8, that the panels are only  $15\frac{1}{8}$  in. wide and that they are beveled only on two edges. At the top end the panels butt against a  $\frac{3}{8} \times 1\frac{1}{2}$ -in. lattice strip as in the upper right-hand detail in Fig. 3. Fasten the panels with 4d finishing nails spaced 6 in. apart. The bedroom wardrobe is built-in in addition to a closet, Figs. 1 and 3, and is fitted with sliding doors of plywood to which full-length mirrors are attached. Note that the doors are framed with rails and stiles as in the sectional detail, Fig. 11, which also shows the installation of the top and bottom door tracks. A low cabinet containing deep storage drawers is built into the wardrobe. The door to the bedroom closet is made from a single panel of  $1\frac{1}{8}$ -in. plywood. The bed-

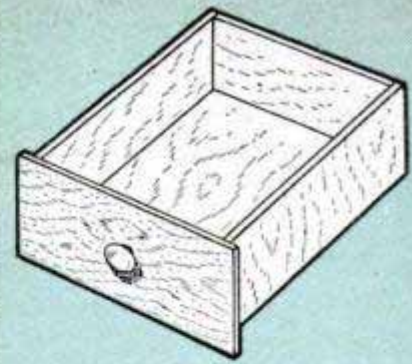

$\frac{3}{8}$ " PLYWOOD DRAWER



$\frac{5}{8}$ " PLYWOOD

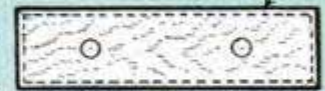

DETAIL OF MIDDLE DRAWER

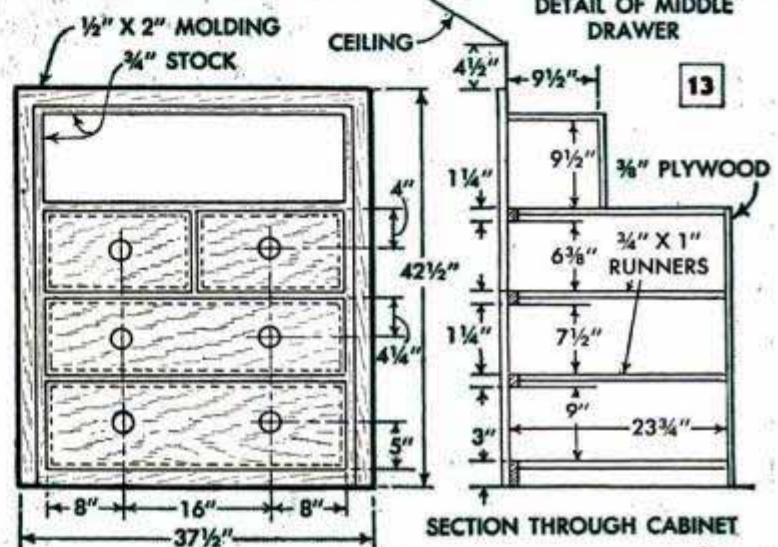

room door opening onto the hall also is made from the same material. The remodeling job finishes up with a built-in chest of drawers which is located on a low wall in a corner of the bedroom. The cabinet is detailed in Fig. 13 and shown in place in Fig. 12. The dimensions given on the chest are suited to the representative job pictured and described. They probably will have to be altered to suit variations.

Panels in the hall and bedroom were given a light natural finish. First, a coat of white resin sealer was applied and wiped to the desired grain show-through. This was then sanded lightly after drying. Next, a coat of shellac was applied and sanded lightly when dry. The job was finished with one coat of high-grade varnish of the non-rubbing type. The bathroom was finished with one coat of resin sealer, one coat of enamel undercoater and a third coat consisting of one half undercoater and one half white enamel. The final finish coat of white enamel was applied.

# Wooden Marker Buoy Locates Fishing Hole

Trying to bring your boat back over the spot where you were pulling in the big ones last time out is no cinch, especially if the check points on the shore are somewhat vague. To make sure that the fishing hole will be easy to find, carry along several small wooden marker buoys whenever you go out in the boat, and then set one of the buoys before leaving a good spot. The buoy consists of a length of dowel pressed into a hole drilled through the center of a wooden float. A white flag is tacked to the top of the dowel and a chalk line is tied to the lower end. The dowel should project below the underside of the float and this portion is drilled to permit tying

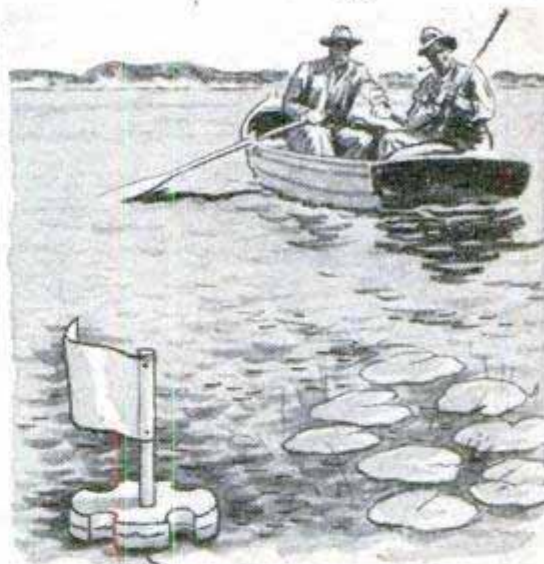
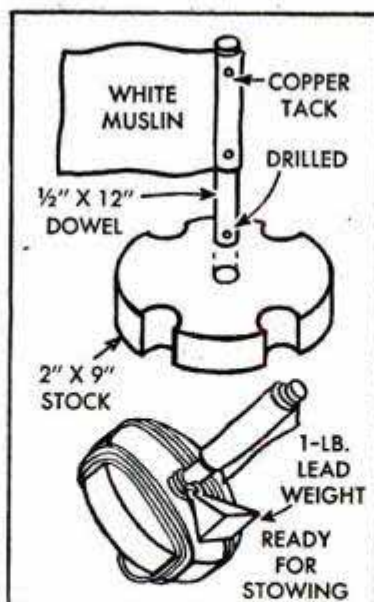

the line. A 1-lb. lead weight will hold the buoy in most lake water, and enough line should be carried to reach bottom even in the deepest parts of the lake.

Hi Sibley, Nuevo, Calif.

## Air-Lock in Fuel-Oil Drum Eliminated by Special Fitting

By fitting the bung of a fuel-oil drum with an air intake, air-lock is completely eliminated making it unnecessary to remove the bung each time fuel is dispensed. Drill and tap a hole through the center of the bung to receive a length of 1/8-in. pipe threaded at one end. If the bung is in the end of the drum, bend the pipe to an L-shape, as in detail A, or thread the pipe and fit it with an elbow. Should the bung be on the side of the drum, bend the pipe to

an inverted U-shape or use two elbows and a nipple as shown in detail B. This will keep rain water from entering the drum through the air intake.—Jerry Pokorny, Kewanawana, Ind.

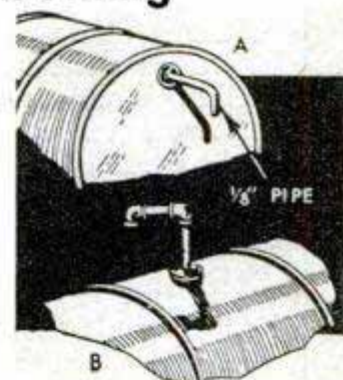

## Pressure-Type Siphon Connected to Sill Cock Drains Flooded Basement

If water pressure is available, it is easy to drain water from a flooded basement. Connect a pressure siphon of the type used on low-priced washing machines to a length

of hose. Place the other end of the hose in the flooded basement. Then attach the garden hose to the siphon and connect it to the sill cock. To prime the siphon, turn on the water and plug the siphon outlet with your finger until the length of hose running from the basement fills with water. When the siphon is working properly, a heavy loose stream of water will flow from the outlet. A solid, thin stream indicates that the siphon is not operating. It is necessary, of course, to keep debris from plugging the siphon intake hose.

Clinton R. Hull, Costa Mesa, Calif.

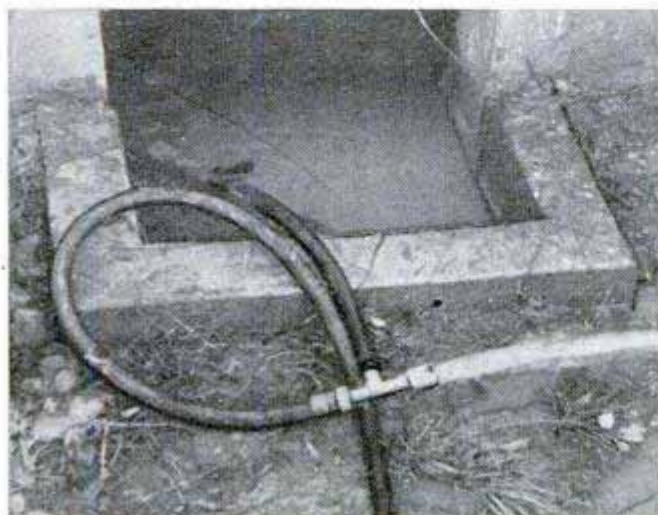

Gold-plated belt buckles and other jewelry can be kept from tarnishing for a period of several weeks by coating the surface of the metal with colorless fingernail polish. The polish will not harm the finish and will protect it from scratches.

## Rheostat Controls Bed Lamp

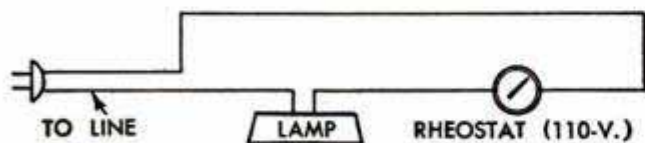

If one of the occupants of a double bed prefers to read while the other wants to sleep, a rheostat wired into the bed-lamp circuit can be used to soften the light. In this way, adequate light for reading may be had without disturbing the sleeper. The rheostat allows the lamp to be used at its full brilliance or turned down to the point where it will just cast a soft glow similar to a night light.

## Preparing Outboard Motor For Winter Storage

When preparing an outboard motor for winter storage, these few necessary steps are important to make sure that the engine will be in top operating condition for that early spring fishing trip. The first step is a thorough cleaning with a cloth dampened with a little motor fuel. This will reveal any minor exterior defects in the motor and simplify the succeeding operations. Completely drain the water jacket, as severe damage to the motor is likely to result if the water freezes. Many motors have a drain plug on the lower unit, and this should be removed as well as the vent and grease plugs. To expel all the water, including any that may have worked into the gear case, rock the flywheel back and forth a few times and turn the motor from side to side. Fresh grease in the gear case will protect all working parts in the lower unit from corrosion and also will expel the last of any water which has collected there. Use the grade of grease recommended by the motor manufacturer. At this time, inspect all parts of the motor and gear case carefully, and have any necessary repair

work completed before storing the motor. The fuel tank should be drained and rinsed with a little fuel mixture to eliminate formation of any gummy deposits. Fuel lines can be disconnected and blown out to free them from sediment. Be sure to clean the sediment bowl. The carburetor requires draining and the fuel screen cleaning with compressed air. When replacing the parts, use only a wrench on fuel-line fittings, as pliers will deeply burr the soft metal. Cover the vent in the fuel-tank cap with adhesive tape. To protect the interior of the motor from corrosion, remove the spark plugs and place about two table-spoonfuls of oil in each cylinder. Then ground the spark-plug wires on any part of the motor and turn the flywheel slowly several times. This will coat the piston and cylinder walls with oil. Put the spark plugs back in the motor to keep dampness out of the cylinders. After this has been done, wipe the entire motor with an oily cloth. Store the motor in an upright position and in a dry place.

## Clothes Stored in Shopping Bags Are Suspended From Rafters

Storing old clothes in the attic is done neatly by placing each type of article in an individual shopping bag and hanging the bag from a rafter or stud. This keeps the floor clear to facilitate cleaning and allows use of available space to the best advantage. Label the bags to indicate the contents and hang them from nails driven at convenient intervals. After placing a sheet of newspaper or wrapping paper over the contents of the bag to protect them from dust, hang the bag by interlocking the handles. This is done by passing one loop through the other before slipping it over the nail.—Paul Will, Chicago.



# ELECTRIC CONTROL FOR HUMIDIFIER

By R. Boettinger

FLOAT CONTROLS on furnace humidifiers that depend solely on evaporation of water to actuate the float-controlled valve often give trouble because of sediment collecting in the valve. Since the water in the humidifier pan, or tank, evaporates slowly, the valve generally is slightly open for long periods of time, permitting water to drip. Because of this condition, sediment and lime deposits build up on the valve seat, preventing complete closure. This sometimes results in flooding. To solve this problem one homeowner designed and built the all-electric control detailed below. Power to operate the solenoid valve is taken off the blower control box by connecting leads to the terminals in the manner shown. The advantage of this type of control is that it can function only when the heating unit is in operation. Lowering of the water level in the pan closes the circuit through the mercury switch and opens the solenoid valve, permitting water to flow into the evaporating pan from the hot-water heater. When the float rises sufficiently to open the mercury switch, the solenoid valve closes tightly. This cycle continues as long as water is required in the evaporating pan. Note that the solenoid-valve circuit is provided with a summer switch, which also serves as an emergency switch should it be necessary to adjust the float mechanism.

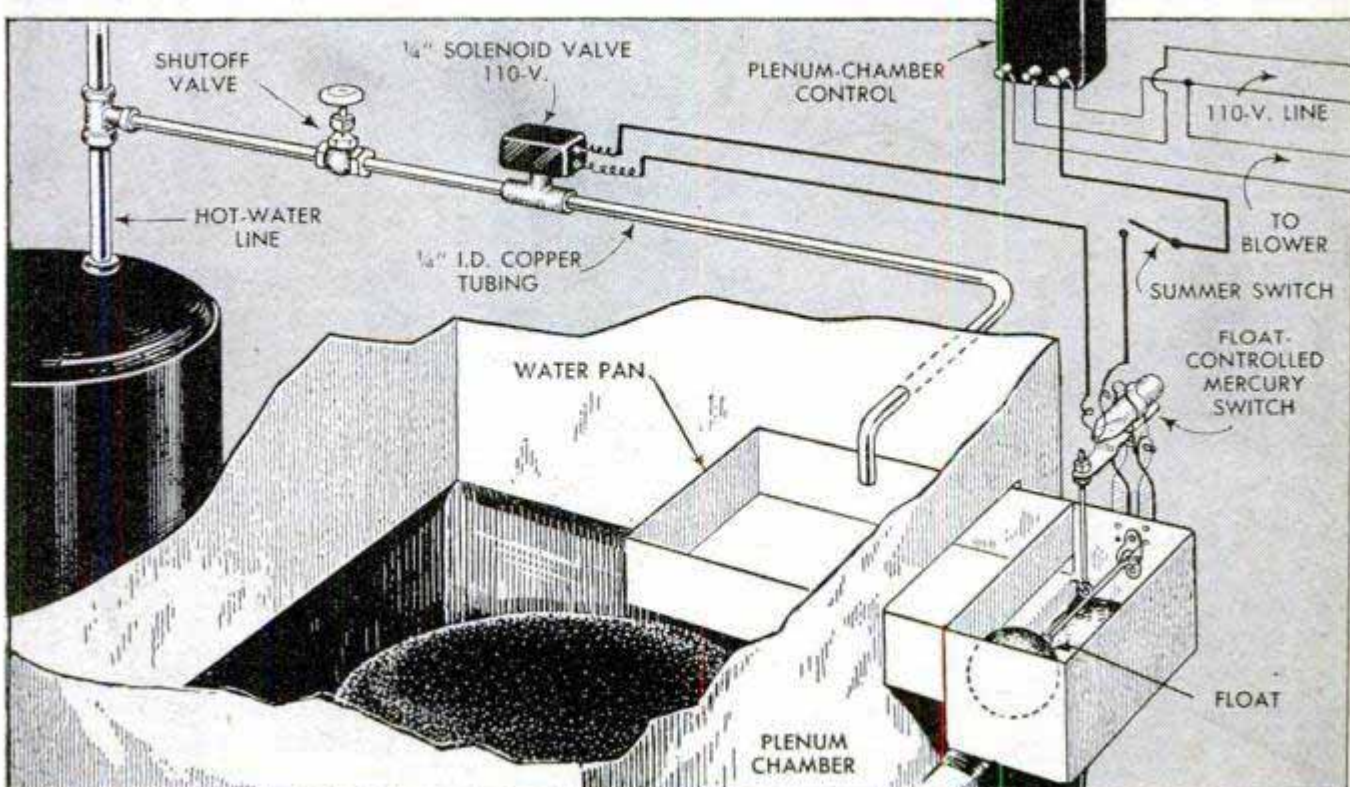
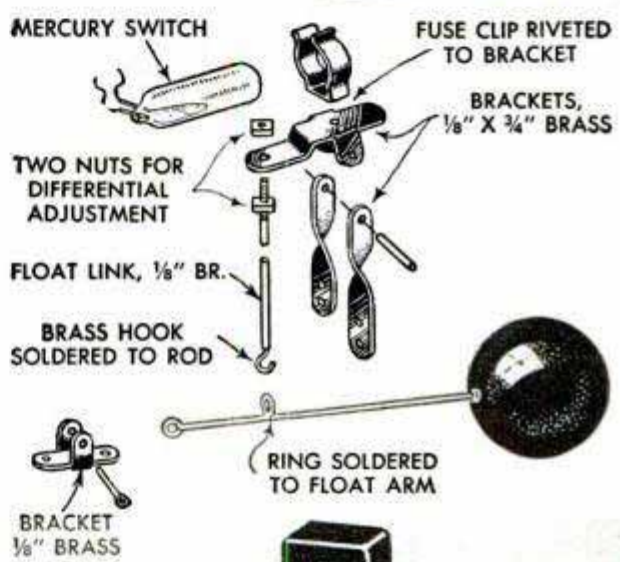
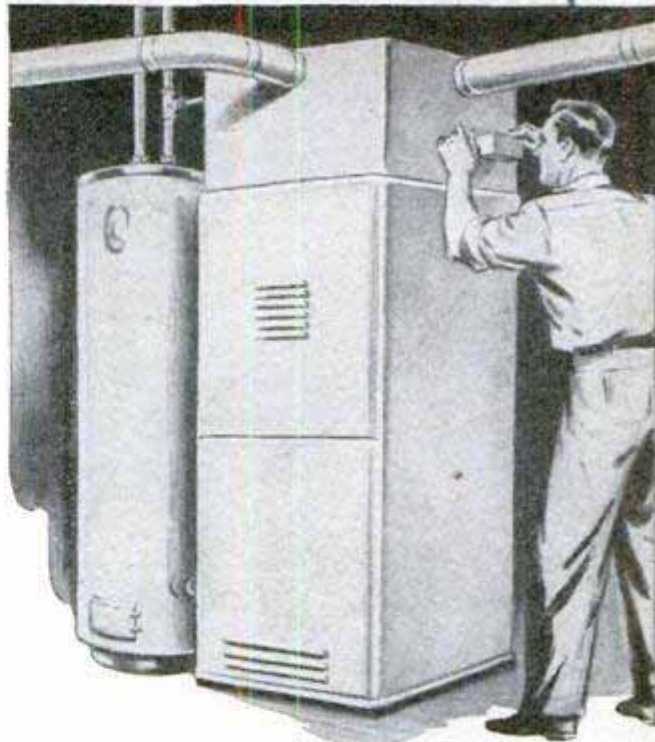

## Attractive Serving Boards Are Fashioned From Hardwood Scraps

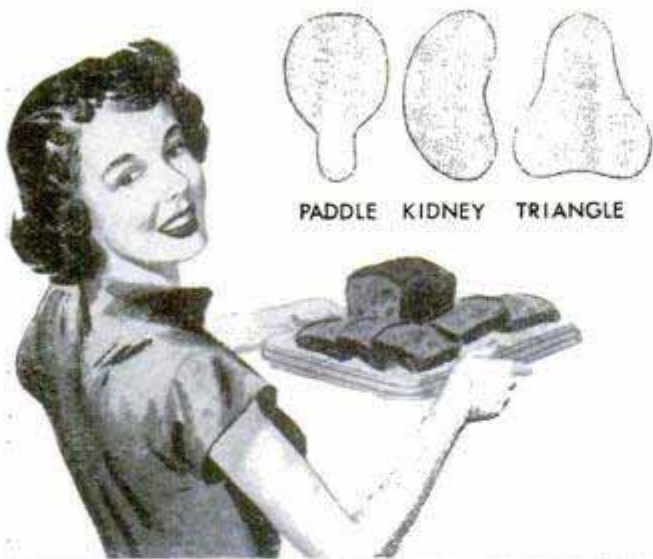

Scraps of hardwood that you may have in your basement will provide all the raw material necessary for several cutting boards of attractive design. They can be turned on the lathe or cut into any of various patterns, such as pear and kidney shapes, or in rectangles, triangles and squares. Sand the board smooth and finish in a natural color, applying two or three coats of clear shellac. Use the underside of the board for slicing, mincing and chopping, and the finished top for serving.

Norbert Engels, South Bend, Ind.



## Funnel Forms Nontip Candleholder

When power fails and a candle must be used to make emergency repairs, an old metal funnel is just the thing to use for a candleholder that will not tip over. The candle is pressed into the end of the funnel spout, the bottom of the candle being tapered slightly with a knife if it is too large to fit in the opening.

T. P. Ilari, Louisville, Ky.



## Auxiliary Fuse Block for Testing Protects Main Circuit

There is no danger of blowing the main fuse if electrical equipment is tested by plugging it into this auxiliary fuse block. The setup consists of a one-branch, two-wire entrance fitting, the two outlets being wired in series, and an extension to the line connected to the terminals as shown. A fuse of less capacity than the one in the main line is inserted in one of the outlets and a plug base is turned in the other outlet. If the appliance being tested is defective, the auxiliary fuse only will blow and it can be replaced in a moment.

Edward A. Mendyk, Chicago.

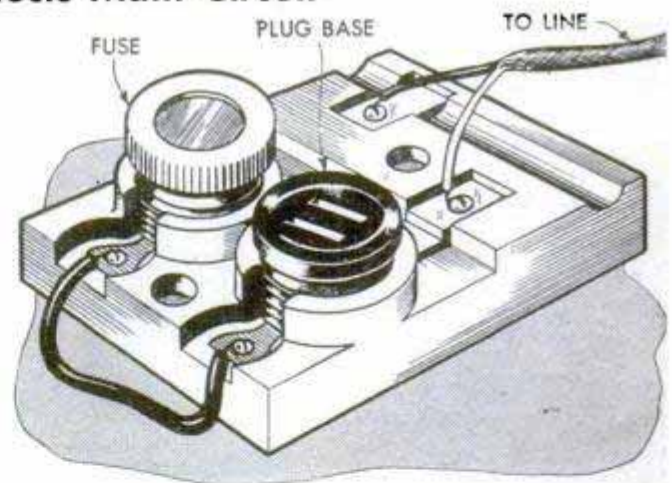

## Partially Open Window Securely Locked With Door Bolt

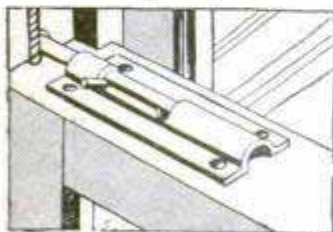

To keep your window partially open during warm nights without fear of burglars, use this simple but sturdy lock made from a hook and

eye and a barrel-type door bolt. Secure the upper sash to the top of the window frame with the hook and eye and fasten the bolt to the top of the lower sash. Then drill a

hole for the bolt pin in the sash channel, locating it about 8 in. above the top of the lower sash when the latter is in the closed position. Press a short length of tubing into the hole to improve the action of the bolt and also to keep from wearing away the wood by the end of the bolt.

Floyd V. Bookout, Kansas City, Mo.

☞ The problem of a sweating bathroom flush box can be solved by covering it with a slip cover of terry cloth or toweling.

# Positive Connectors for Multiple Flash Units

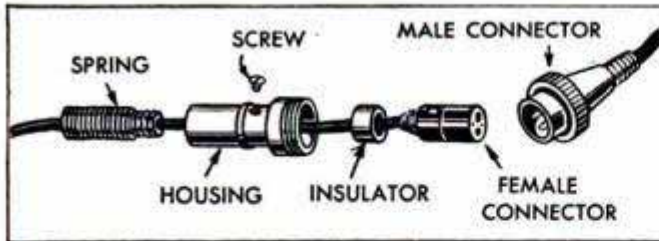

Professional photographers and others who shoot pictures in difficult settings with multiple flash equipment often experience trouble with poor electrical contacts in the wiring harness used with synchronous flash units. This usually is due to breakage of plugs or bending of the copper contact strips. Also the weight of the cords frequently causes worn contacts to pull apart easily. Positive electrical connections that do not pull apart or wear rapidly can be maintained by using Series 80 double-pole connectors of the type used on micro-phones. As shown in the detail above and also in the photo at the right, the male and female sections of this connector are held together by a screw collar. Three jack sections are connected to one cord for three side-light extensions from the gun, or two side-light extensions and a solenoid tripper. The plug sections are attached to one end of each light cord and the shutter trip cords. In this way, all the "hot" lines are permanently attached to the gun and need never be removed. Taping the cords at the point where they are attached to the gun and also at the bottom of the gun will prevent the cords from pulling out. This pre-

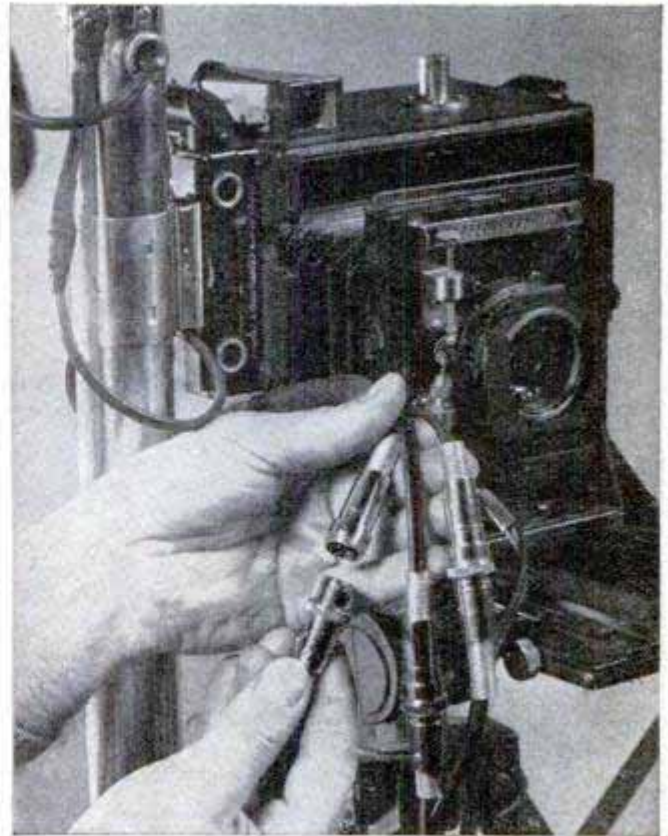

caution also will prevent the cords from pulling in front of the lens when shooting from a high position. The extra lengths on the tripper cords resulting from this type of hookup permit the photographer to remove the gun from the camera and shoot the flash high off the camera when it is necessary to avoid flat-lighting the subject.

Frank P. Fritz, Bensenville, Ill.

## Battery of Flash Gun Tested With Bayonet-Base Bulb

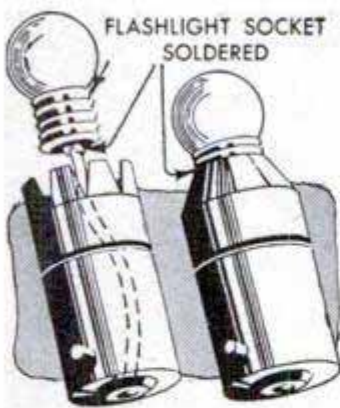

You won't waste film as a result of battery failure of your miniature flash gun if you test the battery with this bayonet-base test lamp. After breaking away the glass and cement from an auto taillight bulb, cut notches

around the top of the base. Melt or drill a hole through the contact in the center of the base and insert a short length of insulated wire through the base, soldering the end in this hole. Then solder the other end of the wire to the center contact of a flashlight-bulb receptacle, being careful not to damage the insulation around either of the contacts or to short-circuit them with the solder. Crimp the notched end of

the taillight base around the flashlight receptacle and solder the joint. Turn a flashlight bulb of the correct size for your flash gun into the receptacle and insert the test lamp in the gun. If the battery is in good shape, the bulb will light.

## Keeping Developer Solutions Fresh

If kept in partly filled bottles, developer solution soon loses its strength. However, your solutions can be kept fresh for several months by storing them in completely filled bottles which are tightly capped. Use 12-oz. beverage bottles for print developer and 1-qt. bottles for film developer. The corks can be made airtight by dipping them in melted paraffin before pressing into the bottles.

☞ When a kitchen serves as a darkroom, easily cleaned sheet plastic protects furniture from scratches and chemical stains.



*Elaborate or Simple*



## YOU'RE MISSING HALF THE FUN

**I**F YOUR PART in making a snapshot ends with the clicking of the shutter, you're missing the biggest thrill of this fascinating hobby—processing your own photos. There's a definite feeling of excitement at catching the first glimpse of a newly developed roll of film as it comes from the fixing bath. And, it's fascinating, too, to watch a picture suddenly spring into being from a blank sheet of paper. There's nothing really difficult about processing photos, anyone can do it, and in almost every home there is space somewhere for you to set up shop and really enjoy the hobby.

If you can't find permanent quarters, there are a number of temporary spots that can be used. For a short session of developing and printing you could simply take over the kitchen for a few hours, or you might very easily set up your trays and chemicals in the bathroom, or in some little-used closet, using a simple darkroom kit. Of these possible locations, the kitchen is wonderfully convenient for temporary quarters. Water and electricity are handy and usually there is plenty of working space for your trays and equipment. It is

No great outlay of cash is required to get started. You can begin with an inexpensive kit like the one above which includes all the basic items needed. In time you can graduate to a more elaborate darkroom

required, of course, that the room be made lighttight. This is especially important with film because it is much more sensitive to light than printing paper. Some fans utilize roll-film developing tanks which, after being loaded in darkness, can be processed in full daylight. The tank can be loaded in a small closet which is easy to darken, and then all subsequent operations can be carried out in some convenient spot like the kitchen sink without further darkening. With printing paper, you don't have to be quite so careful about extraneous light, and a brighter darkroom working light can be used without fear of fogging your work.

If you are interested in setting up quarters of a more permanent nature, possibly you can take possession of a closet seldom used. It may mean that you will have to



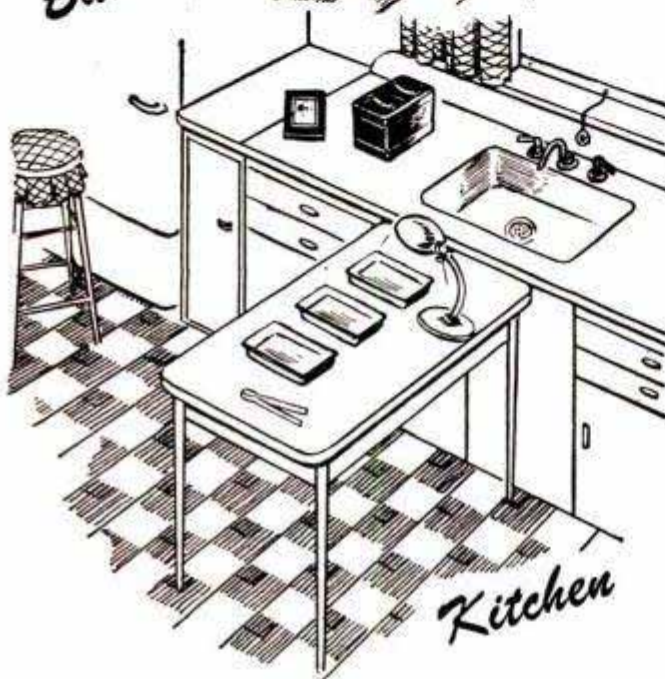

Tray development of roll film proceeds in a left-to-right sequence. In each case, the film is developed, rinsed and fixed by dipping it with a seesaw motion

carry in a water supply each time and run a few extension cords to get electricity, but these are minor inconveniences. Fundamentally, you will require two working areas. One shelf should be installed about 36 in. from the floor to hold trays. Another one, at the same height and a little wider, will hold the contact printer and enlarger and furnish additional working space. A

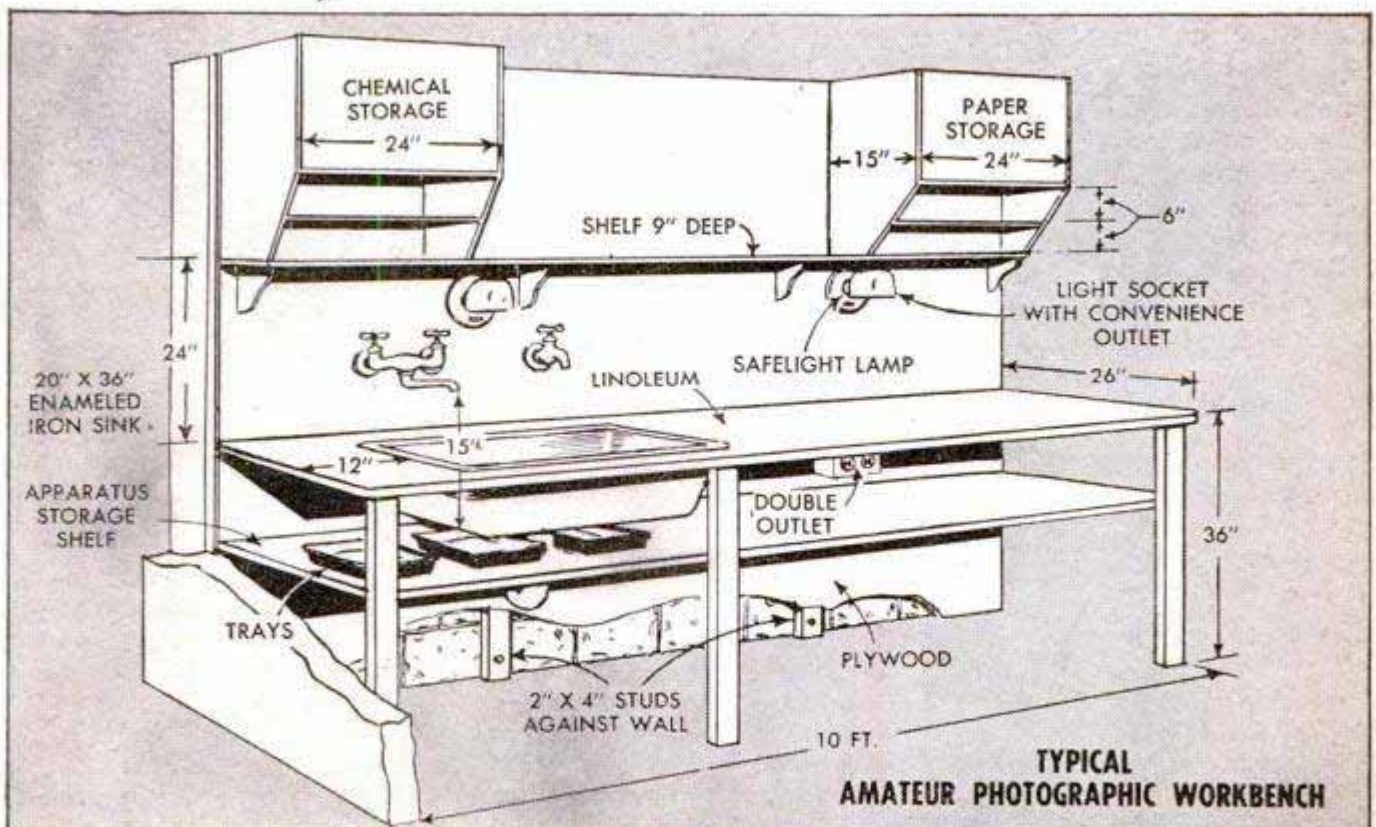

## DEVELOPING

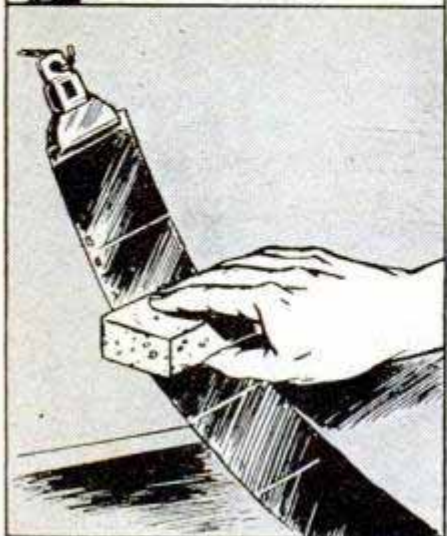
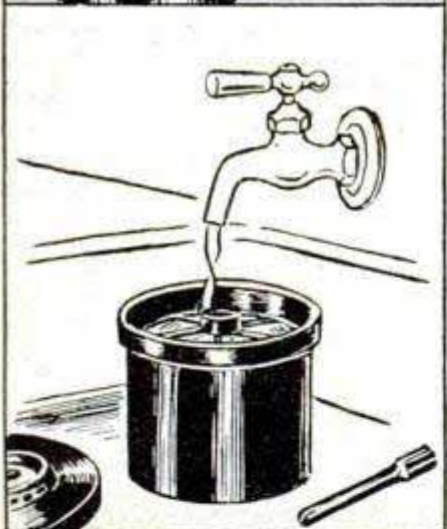

◆ A roll-film tank makes developing a matter of time and temperature. Once film is loaded in tank, it is not touched again until ready for drying. Except for loading, all operations may be done in daylight which makes it ideal when a closet is used

Printing can be done with either a contact printer or a printing frame. As printing paper is sensitive only to blue and white light, you can work with a fairly bright orange safelight. Place the negative on the printer dull side up and the paper on top

◆ Time and temperature are very important, so follow directions that come with the developer. Mix enough chemicals to fill the tank completely and pour it in the filler hole. Then insert the agitator rod and twirl the reel a few times during development

Exposure is timed with a clock ◆ having a second hand. Try an interval of five seconds, the first time, then vary it, if necessary, to obtain the correct exposure. After a few seconds in developer, image will begin to appear and develop fully in 60 seconds

◆ Time the period accurately and then pour off the developer, flush with clear water and add fixative (hypo). After 15 min., pour off hypo and wash. Washing is done right in the tank, setting it under a running faucet for approximately a half hour

To avoid contaminating hypo ◆ bath, the print is removed from the developer and placed in water and rinsed. From here it is transferred to hypo. After 10 min., the print is fixed. Then it is placed in tray and washed in running water for one hour

◆ After film has been washed, a spring clip is attached to each end and the film is hung up to dry. Water spots are eliminated by gently wiping both sides of the wet film with a wet sponge wrung nearly dry. Hang the film in a dust-free place to dry

For a glossy finish the prints ◆ are dried on a ferrotype tin; for a matte finish they are dried in a blotter book. The prints are placed face down on ferrotype and rolled flat. When dry, the prints will fall off by themselves or are easily peeled off the tin

## PRINTING

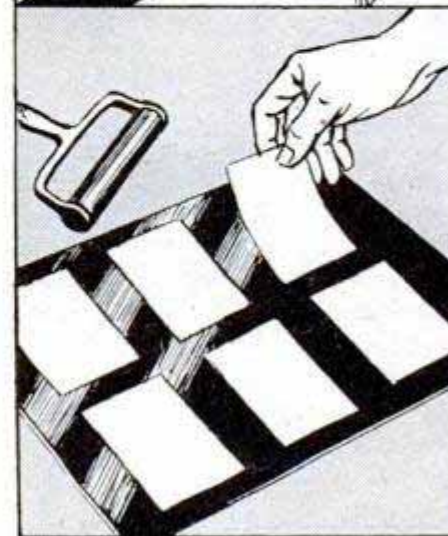
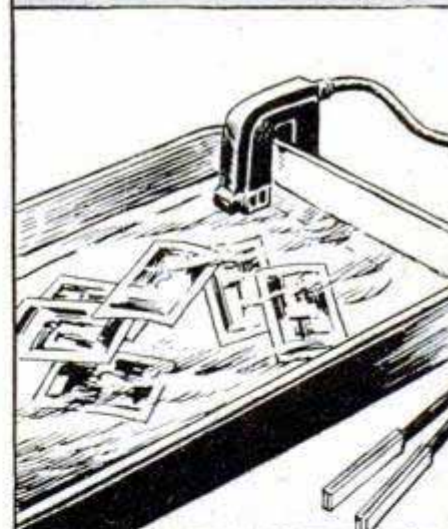
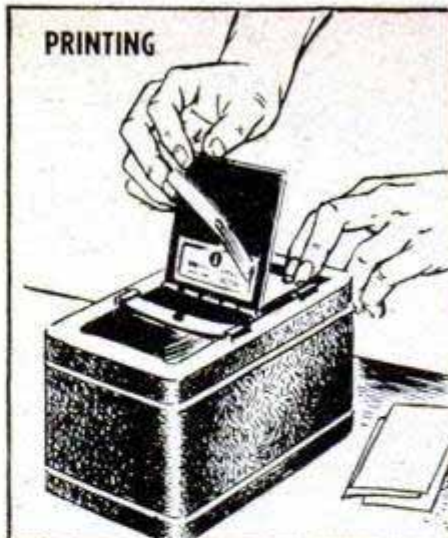

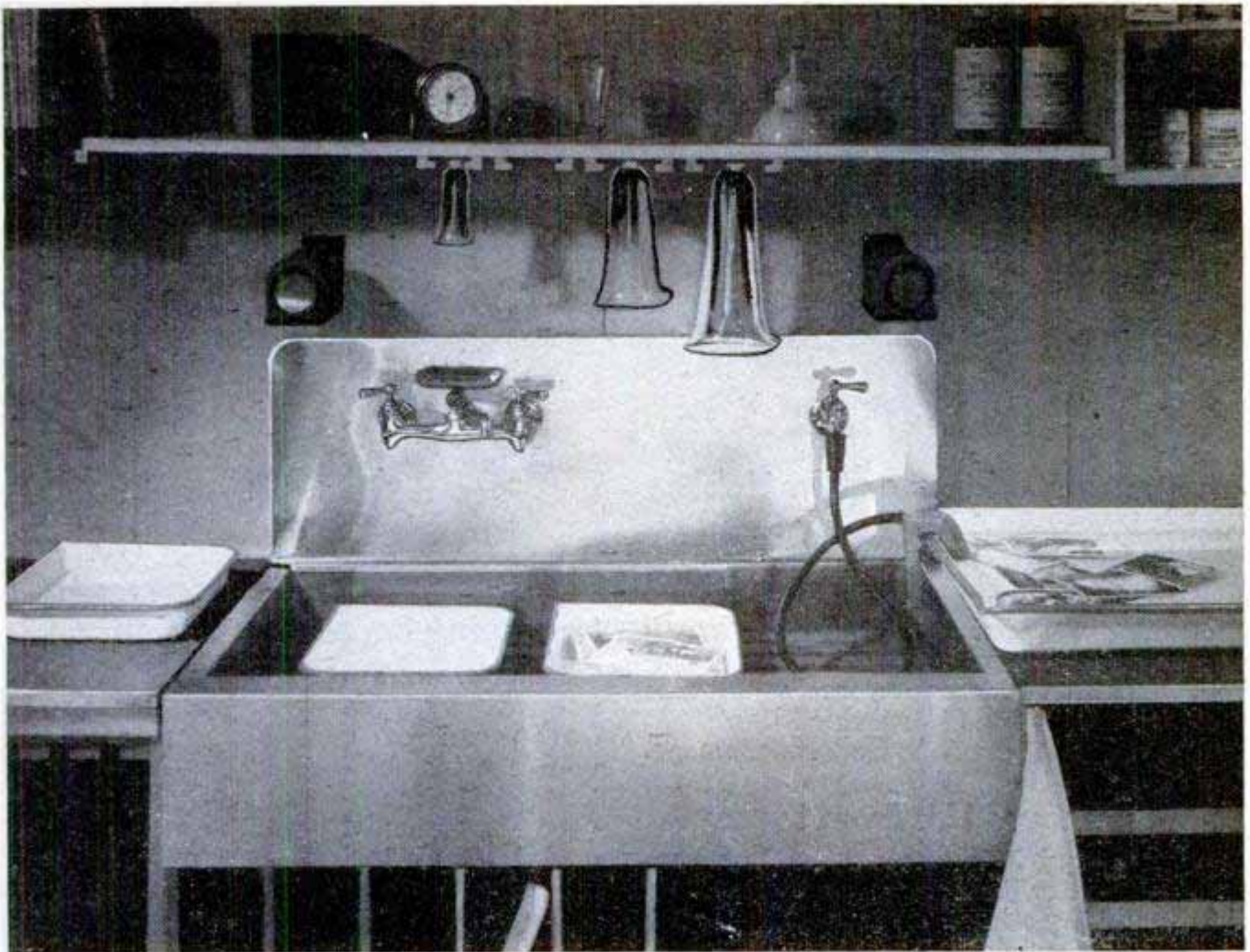

**This is the processing or wet area of the darkroom, located around the sink. Prints go from left to right through printing solutions and finally to washing tray**

smaller shelf 2 ft. above the tray shelf will be needed to hold bottles of solutions. Above the printing or enlarging shelf, smaller shelves and a cabinet can be added to hold paper and other supplies.

If it is not too damp, a basement makes an excellent location for a darkroom. Dampness is a factor to be considered because photographic materials tend to deteriorate more rapidly under damp conditions. A simple solution to this problem, however, is to store your supplies elsewhere when they are not being used. For the most efficient layout, the floor area should not be less than 5 x 6 ft. and not more than 10 x 12 ft. A darkroom such as this is usually built with specific space for dry work (the printing and enlarging) and the wet work (processing the film or paper through the solutions). The wet-side operations lead finally to the sink where the material is washed. It will be convenient if there are both hot and cold-water faucets at the sink, for this will allow you better temperature control of various solutions.

A good working height for the shelves for the wet and dry areas is about 36 in., and 26 in. for width. The surfaces should be covered with a waterproof covering,

such as linoleum, and waxed. Trays, when not in use, can be stored under the working shelves, as can larger pieces of equipment. It is very convenient to have graduates and thermometers and also cut-film holders hanging in their own racks above the working space.

The wiring in your darkroom should be adequate to provide for safelights over each working area, a general room light and, of course, outlets for the printer and enlarger. All the electrical and plumbing work should be done carefully and should comply fully with local building codes.

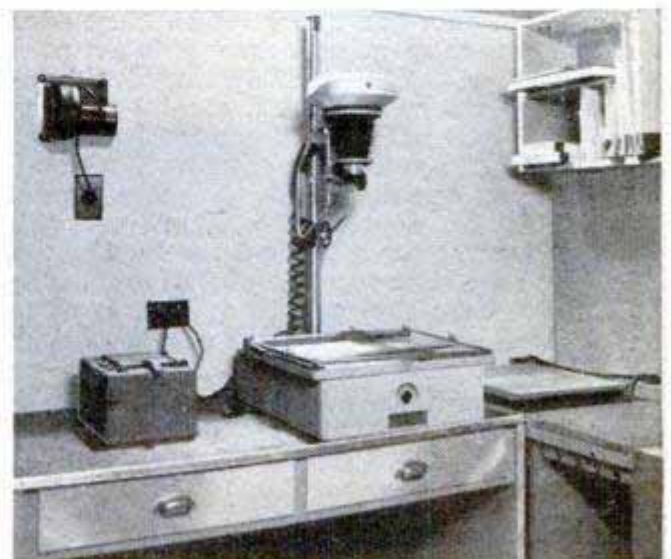



### Aluminum Markings on Film Holders Resist Wear and Are Easily Read

To identify your cut-film holders quickly, number each one with aluminum paint applied to an upper corner with a small brush. Unlike paper or cloth tabs, the aluminum paint will last for years, and it also is easy to read even in subdued light.

Frank T. Sokolik, Chicago.

### Comb Removes Lint From Lenses

Here's a quick way to remove lint from camera lenses without danger of scratching. After rubbing a hard rubber comb briskly with a woolen cloth, pass the comb over the lens, coming close to the glass but not touching it. Static electricity will cause the lint to jump to the comb where it will remain until wiped off. The same procedure can be used for removing lint from negatives.—Robert C. Aughtry, Ware, Mass.

### Pitcher Doubles for Misplaced Funnel

If you have to pour a photo solution from one small-necked bottle into another and can't find your darkroom funnel, use a small cream pitcher as an emergency substitute. Hold the pitcher in pouring position with the end of the spout inserted in the neck of the bottle to be filled, and then pour the solution into the pitcher.



P. R. Wilson, Brooklin, Ont., Can.

### Measuring Bellows Extension

For close-up photography, the extension of a view-camera bellows can be measured at a glance, if a dressmakers' tape is glued to the bed of the camera. Position the "zero" mark of the tape directly beneath the center of the lens barrel and run it straight back to the end of the bed. The length of the extension can be read below the camera back.

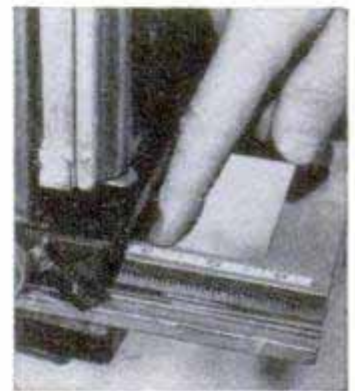

## Books That Help You Make and Save Money

The first in a series of books to be published by *Popular Mechanics* for the car owner, the **MANUAL FOR PLYMOUTH OWNERS** will enable you to save its cost the first day. Every part of the Plymouth car is explained in nontechnical language so that any owner can understand it. The book shows how to make adjustments to get peak performance at all times and thus avoid unnecessary wear and tear. A careful study of the book may not make you a mechanic, but it will enable you to be your own "doctor" so that you can detect and diagnose trouble before it can develop into a major repair bill. All garage owners and mechanics, too, will find the book most helpful as practically all the information can be applied to other makes of cars. A remittance of \$3.50 brings the book to your door.

For the craftsman and hobbyist, there is nothing quite like *Popular Mechanics* book, **MONEY-MAKING HOBBIES**. Here you will find hundreds of ways of not only furthering

your hobby, but also many ways of making it pay. The entire contents of the book consists of a collection of articles written by widely known authors who have made their hobbies pay at least a small income. The book contains 132 projects featuring techniques for the beginner as well as the experienced craftsman in plastics, leather, woodworking, ceramics, metalworking, weaving, etc. The book is available for \$2.00.

If you have an inventive trend of mind, you cannot spend \$2.50 to a better advantage than to send for *Popular Mechanics* book, **MONEY FROM IDEAS**, which is a primer of inventions and patents. Written by M. Penn Laughlin, talented engineer, inventor and patent lawyer, this book is a gold mine of information to every man who believes he has ideas that can be patented. With the book, one may determine what inventions are needed, how to go about inventing them, how to get a patent, protect it and sell it.

All books are available from **Popular Mechanics Book Dept., 202 E. Ontario St., Chicago 11, Ill.**

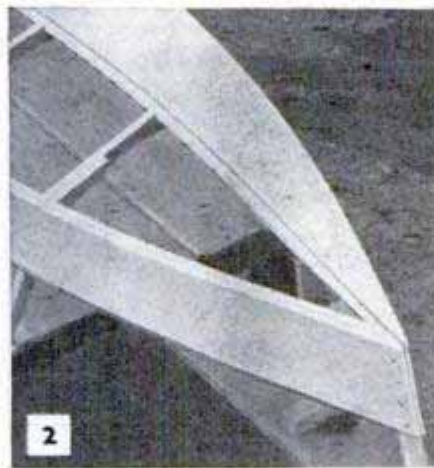

## Curve it by **KERFING**

By Sam Brown

**K**ERFING provides a simple and practical method of bending wood without steaming, and consists of running in a number of saw cuts (kerfs) across the wood to reduce its mechanical thickness. Once used extensively in wooden casket construction, the operation is sometimes referred to as an "undertaker's bend."

The craftsman's usual approach to a kerfing job is to space the kerfs close together and cut the wood as thin as practical. For average work,  $\frac{1}{4}$ -in. center-to-center spacing of kerfs is used, while the uncut portion of wood can be as thin as  $\frac{1}{16}$  in. The job is set up as shown in Figs. 3 and 4, with a nail driven into the miter-gauge facing to space the cuts exactly. A thin-gauge saw is preferable, but good work can be done with any bench-saw blade.

Kerfing also can be done on the bandsaw, Fig. 6, a method which has the advantages of being faster and producing a narrower kerf than a bench saw. The advantage of the narrow kerf is that it can be closed completely when the work is bent and will make the job stronger. When bandsaw kerfing, you cannot make use of the spacing pin, but you can make an equally accurate measure by advancing each kerf as it is cut to a mark on the miter-gauge facing, as shown in Fig. 5. Note that the miter gauge is rotated about 6 deg. to allow the work to clear the bandsaw arm. A stop clamped to the saw table assures cuts of equal depth.

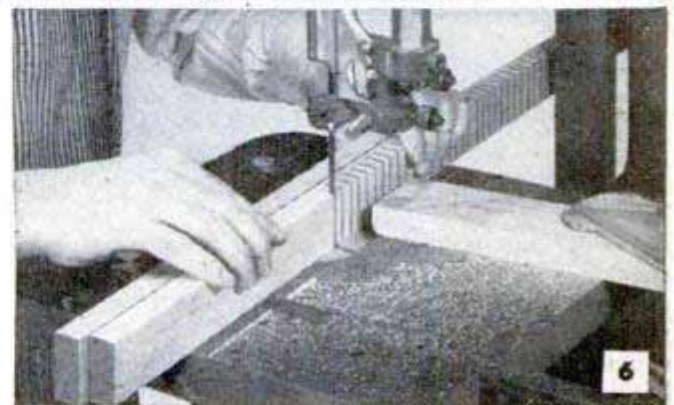
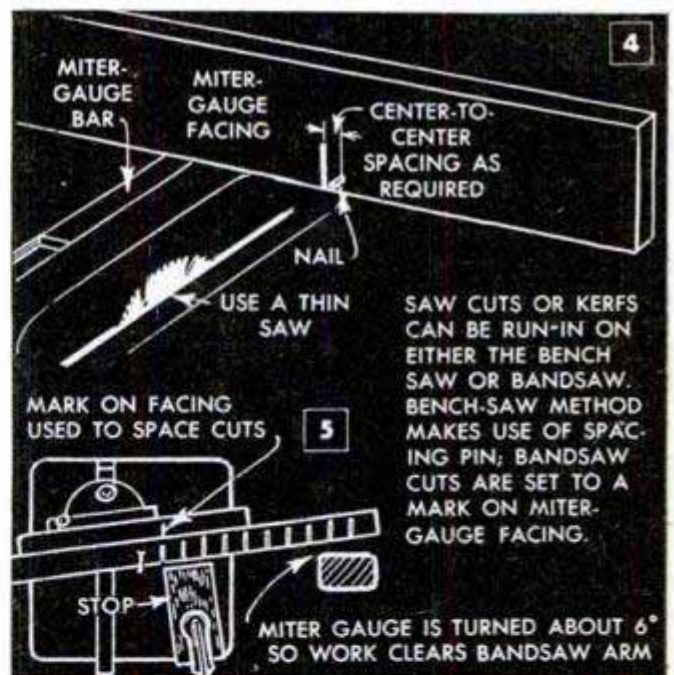
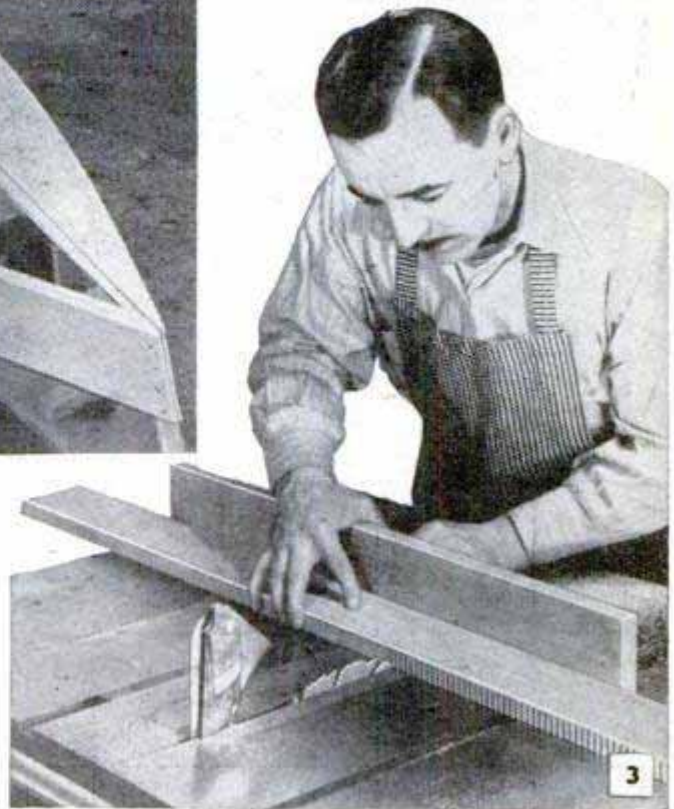

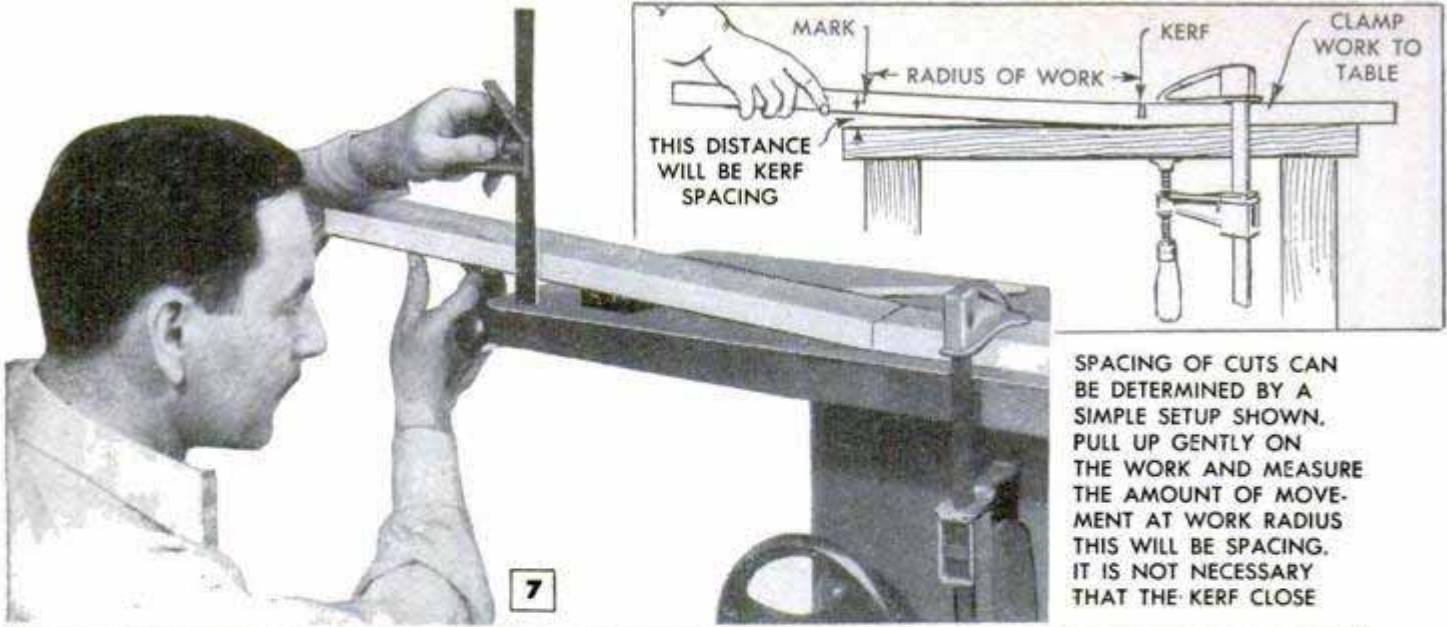

7

**8 KERFING TABLE**

① TEST BEND	② NUMBER OF CUTS IN CIRCLE	③ KERF TO CLOSE	SPACING OF CUTS ④													
			RADIUS OF WORK IN INCHES													
			3	4	5	6	7	8	9	10	11	12	13	14	15	16
1/8"	258	.018 (1/64)	1/16	3/32	1/8	3/32	3/32	3/16	7/32	1/4	1/4	9/32	5/16	5/16	3/8	3/8
3/16"	171	.027 (1/32)	3/32	1/8	3/16	7/32	1/4	9/32	3/16	3/8	3/8	7/16	7/16	1/2	9/16	9/16
1/4"	129	.036 (1/32)	1/8	3/16	1/4	1/4	3/16	3/8	7/16	1/2	1/2	9/16	5/8	11/16	3/4	3/4
5/16"	100	.047 (3/64) (AV. BAND SAW)	3/16	1/4	3/16	3/8	7/16	1/2	9/16	5/8	11/16	3/4	13/16	7/8	15/16	1
3/8"	83	.056 (1/16)	3/16	1/4	3/8	7/16	1/2	9/16	5/8	3/4	13/16	7/8	15/16	1	1 1/8	1 3/16
7/16"	72	.065 (1/16)	1/4	3/16	7/16	1/2	9/16	11/16	3/4	7/8	15/16	1	1 1/8	1 3/16	1 5/16	1 7/8
1/2"	63	.074 (3/64)	1/4	3/8	1/2	9/16	11/16	3/4	7/8	1	1 1/16	1 3/16	1 1/4	1 3/8	1 1/2	1 9/16
5/8"	56	.084 (3/64)	3/16	7/16	9/16	5/8	3/4	7/8	1	1 1/8	1 3/16	1 5/16	1 7/16	1 9/16	1 11/16	1 3/4
⑤ 3/4"	50	.094 (3/32) (AV. CIRC. SAW)	3/8	1/2	5/8	3/4	7/8	1	1 1/8	1 1/4	1 3/8	1 1/2	1 5/8	1 3/4	1 7/8	2
1 1/16"	46	.102 (7/64)	3/8	1/2	1 1/16	1 3/16	1 5/16	1 1/16	1 3/16	1 5/16	1 7/16	1 9/16	1 3/4	1 7/8	2 1/16	2 3/16
3/4"	42	.112 (1/8)	7/16	9/16	3/4	7/8	1	1 3/16	1 5/16	1 1/2	1 5/8	1 3/4	1 15/16	2 1/16	2 3/16	2 3/8

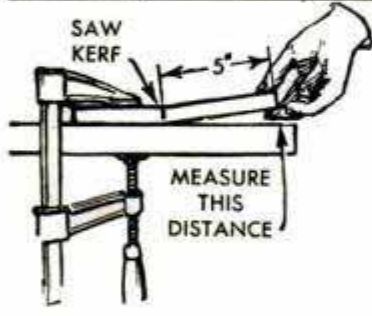

1. Test bend is made on scrap piece being worked. Amount of lift at end is value used in first column.
2. This gives number of cuts in a circle. Half circle requires half as many cuts.
3. Width of saw kerf.

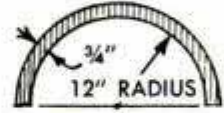

**HOW KERFING TABLE IS USED**

Make a test bend as shown in drawing at extreme left. For maximum strength, leave as much uncut wood as possible. Gradually deepen cut until test piece can be bent 1/8 in. Then find 1/8 in. in column 1. On same line, column 2 shows 258 cuts needed for full circle, or 129 cuts for half circle. Under 12-in. radius column, 9/32 in. is the spacing required. Note in column 3 that the kerf needed to close is 1/64 in. wide. As this is not practical, a wider kerf is used, even though it will not close tightly when stock is bent. **Second example of same job:** If you want the kerf to close, start with the .047-in. bandsaw kerf in column 3. Then all the figures on this line will apply. Test bend must be 5/16 in. and spacing will be 3/4 in. Kerfing is done on the bandsaw as pictured in Fig. 5

This column applies only to 3/4-in. stock. Kerf can be wider but will not close. 4. Center-to-center spacing of kerfs. Cuts can be spaced closer but not wider. 5. Spacing in this line works out exactly and values are used to check work sizes not listed. A 6-in. radius needs twice the spacing of 3-in. radius. If test bend is 5/16 in., a 12-in. radius requires 3/4-in. spacing

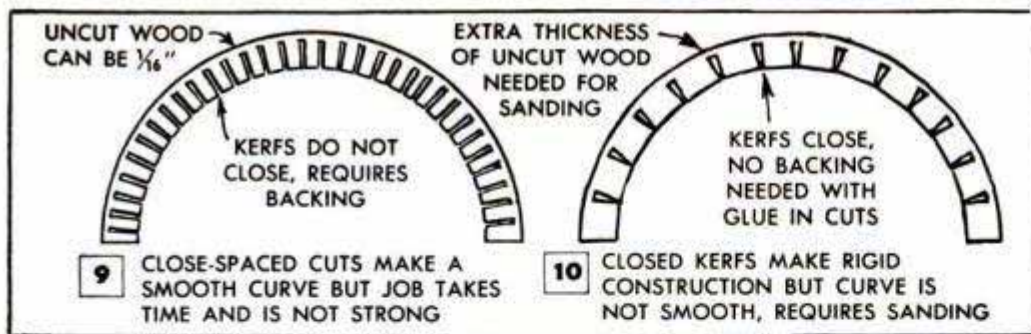

Sanding work is required when kerfs are wide-spaced

A scientific approach to a kerfing job calls for spacing the cuts exactly as required to make a specified bend. One method to determine the spacing is shown in Fig. 7. First, a test kerf is cut on a scrap board and the board is clamped to a level surface. Then the board is lifted and the amount of lift at the work radius is measured to determine the spacing required. While exact, this method is subject to considerable variance, for the deeper the kerf is made, the more the wood will bend and the wider the spacing will be. You are assured in all cases, however, that if one kerf allows the wood to bend a certain distance at the radius, further cuts will allow the same bend all around and will ultimately make a circle of the specified radius.

All of the various factors in kerfing are brought under control by the use of the kerfing table shown in Fig. 8. By referring to the table, you can control any of the factors which may be needed for a certain job. You can make the kerfs close for maximum flexibility, or determine the maximum thickness of uncut wood which can be left and still permit the bend. Any allowance made should lean to closer spacing than the table shows. The fault of wide spacing is that, while it permits the bend, the curve will form in a series of flat faces, Fig. 10, and may require sanding to bring it to a smooth curve. The advantage of wide spacing is that it allows the kerfs to close; if you run glue into the cuts before bending, the final product will be a bent piece of wood capable of standing alone. On the other hand, close-spaced kerfs, Fig. 9, consume time and the job is not strong. They must always be backed by a number of glue blocks as shown in Fig. 12.

After the kerfing is completed, the actual bending of the wood should be done gradually to avoid any danger of splitting. Give the work a comfortable bend and span a piece of wood across it to hold the shape, Fig. 13. After setting to this curve for an hour or two, the work can be given another bend. Sometimes it is necessary to sponge the work for about five minutes with warm water, as shown in Fig. 14. This will allow nearly double the bend possible with dry wood, a fact which should be kept in mind when determining the kerf spacing.

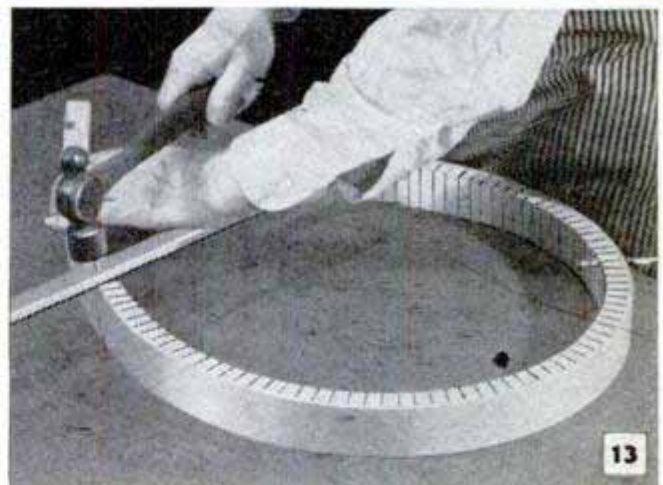
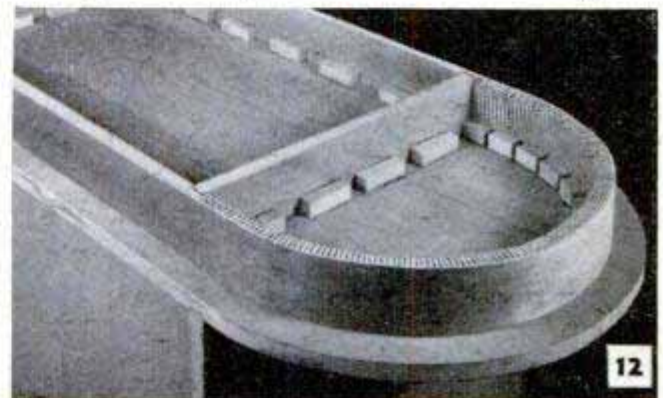

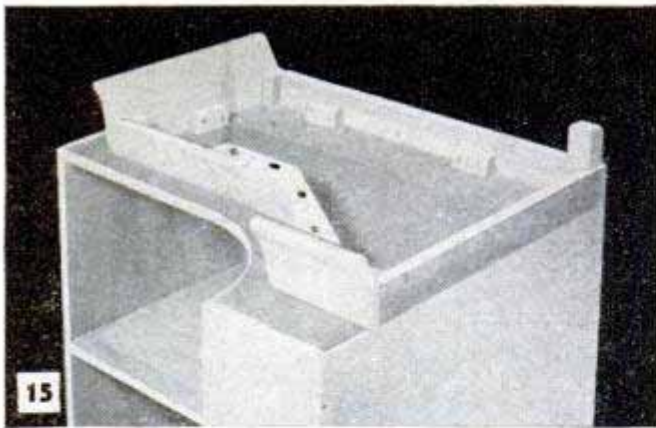

The thin-section method of producing bent work can be used for forming both inside and outside curves

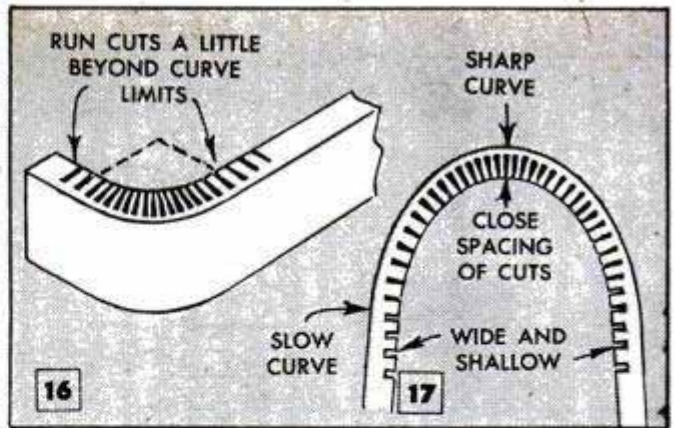
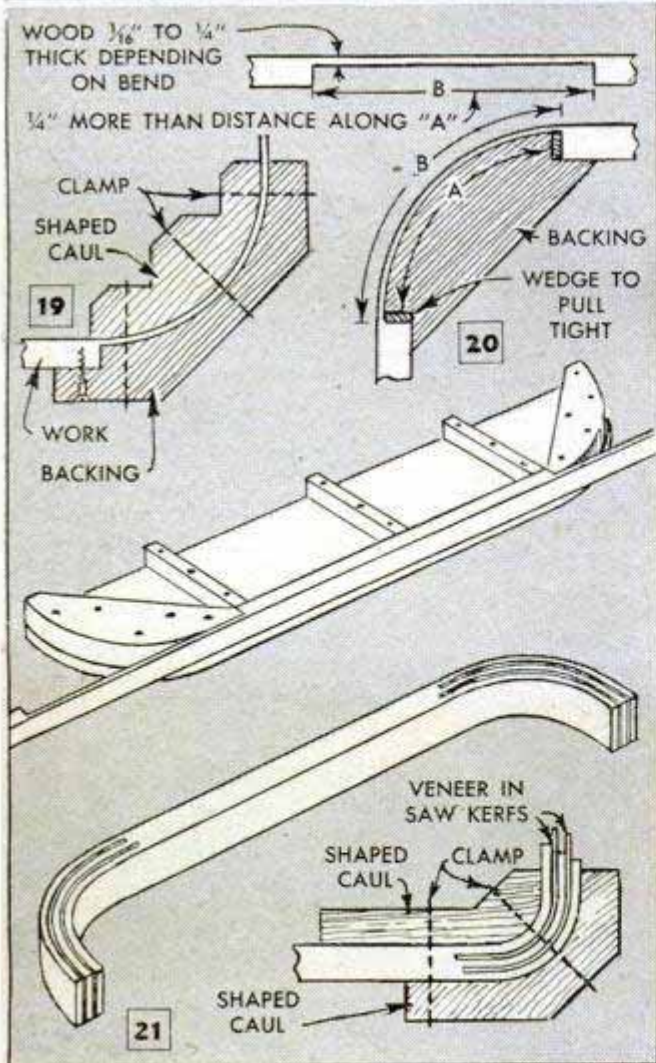
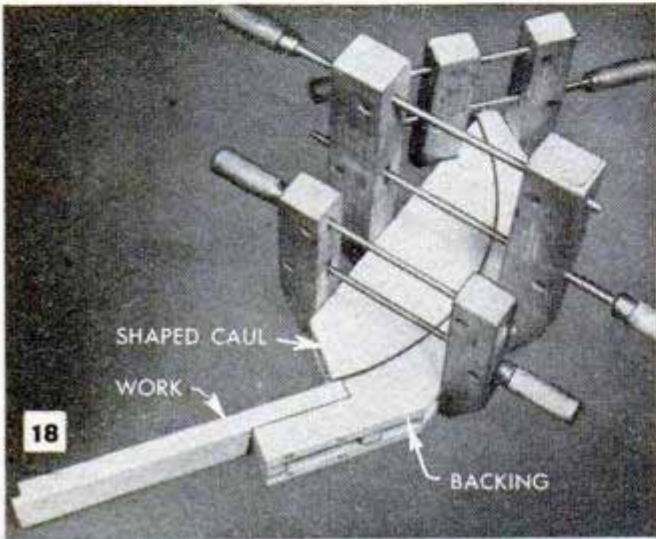

Kerf spacing is always uniform if the curve is uniform. On slight bends, however, the spacing may vary. Fig. 17 is an example—closely spaced cuts are used to make the sharp bend, while a few widely spaced cuts serve for the flat curve. Fig. 1 is an example of a flat bend where two or three cuts about halfway through the wood are enough to take the strain off the wood. The job shown in Fig. 2 makes use of a number of uniform and closely spaced kerfs cut very shallow; the idea is to reduce the effective thickness of the wood to make a more comfortable bend. Fig. 16 shows a quarter-round curve with kerfing extending beyond the curve limits.

An alternate to kerfing for most bent work is the technique of thinning the wood, as shown in Figs. 15 and 18 to 20 inclusive. Like close-spaced kerfing, this work always requires a backing, which, in this case, must be a solid block of wood or an equivalent built-up backing. The thin section is glued to the backing, necessitating the use of a shaped caulk or pressure block in the clamping operation, as shown in Fig. 18. This is an example of an inside curve; Fig. 20 is an example of an outside curve. When one end of the thinned section is free, the shoulder is butted tightly against the backing block; when the work does not have a free end, it is more practical to cut the thinned section a little overlength to permit stretch-fitting with wedges.

Still another technique used for bent work is kerfing lengthwise with the work, as shown in Fig. 21. The cuts should be run in on the bandsaw with the use of a ripping fence and can be spaced to suit. Dependent on the sharpness of the curves and the number of kerfs, work of this kind may require some steaming. Strips of veneer are placed in the saw kerfs and the work is clamped without glue, using hot-water sponging or steam if needed. After the work has dried, the clamps are released and the permanent assembly made with glue. Although this method of bending is more work than the other systems, it has advantages in that the work will stand alone and the edge can be exposed.



Market gardeners who specialize in root crops will find this inexpensive washer just the thing for cleaning freshly dug carrots, radishes and beets. It will thoroughly wash 15 bushels of carrots in 20 minutes. The container is a wooden tank of the type used for watering livestock and measures 30 in. deep and 60 in. in diameter. A false bottom installed in the tank is raised on 1-in. blocks so that dirt washed from the vegetables can collect underneath. An agitator consisting of two arms of pipe turned into a cross fitting is driven by one axle extending from a car differential as shown in the illustration. Note that the axle housings have been cut off near the differential housing. The other axle turns in a bearing improvised from a short length of pipe and a floor flange. The latter is attached to the ceiling and the lower end of the pipe telescopes over the axle. A hole is drilled through the pipe and shaft to permit the insertion of a pin to prevent the axle from turning. After the drive has been assembled to this stage, a lower bearing consisting of a floor flange and a sheet-metal plate,  $\frac{1}{8}$  in. thick and about 5 in. square, is attached to a block screwed to the bottom of the tank. The metal plate is placed under the flange and both

## Vegetable Washer Utilizing Car Differential Cleans Root Crops Ready for Market

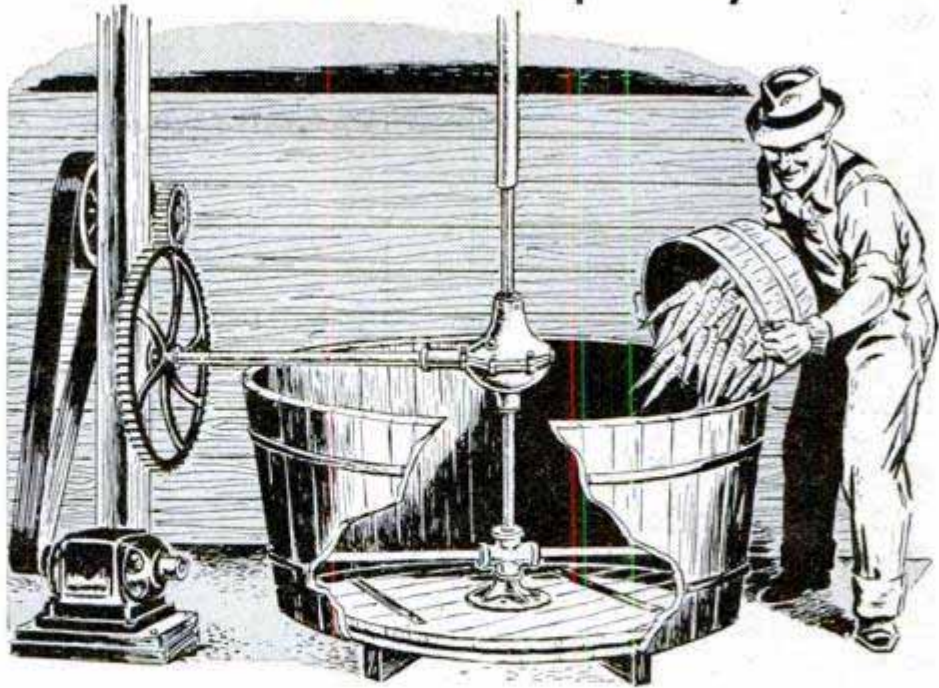

are attached to the block with screws. Then a short length of pipe is threaded at one end and turned into the lower opening in the pipe cross. The lower end of this pipe bears on the metal plate under the pipe flange. If desired, the threads can be reamed out of the pipe flange to make a somewhat more durable bearing. Any spur gear giving about 10 to 1 reduction will serve as a driving jack, and a  $\frac{1}{2}$ -hp. motor will furnish power for average work. In use, place vegetables in the tank, then fill the tank with sufficient water to cover the tops. Although not shown, the false bottom is made in two removable sections for cleaning, one on each side of a permanently attached center section.

are attached to the block with screws. Then a short length of pipe is threaded at one end and turned into the lower opening in the pipe cross. The lower end of this pipe bears on the metal plate under the pipe flange. If desired, the threads can be reamed out of the pipe flange to make a somewhat more durable bearing. Any spur gear giving about 10 to 1 reduction will serve as a driving jack, and a  $\frac{1}{2}$ -hp. motor will furnish power for average work. In use, place vegetables in the tank, then fill the tank with sufficient water to cover the tops. Although not shown, the false bottom is made in two removable sections for cleaning, one on each side of a permanently attached center section.

## Electric Trailer-Bed Winch Unloads Chopped Hay

Unloading chopped hay or grass silage from a trailer into a blower hopper is a slow, tiring job by hand methods. Some farmers have used elevator jacks to dump the trailer load with fairly satisfactory re-



sults, but the best method of unloading this material is by means of a trailer-bed winch driven by a detachable motorized jack like the unit pictured. It's farm-built from scrap farm-machine parts, standard roller chain, sprockets, and angle and flat iron. A spur gear and pinion taken from an old manure spreader provide the necessary gear reduction. The completed drive unit attaches to a corner of the trailer bed as pictured. The drive shaft of the unit has a squared end which engages a square socket welded into the end of the windlass barrel. Wire cables run from the barrel to a high endgate at the forward end of the trailer bed. As the cables are wound on the windlass by the drive unit, the endgate is drawn to the rear of the bed, carrying the load with it. The slow backward movement of the load causes the material to drop into the blower hopper in a uniform stream.

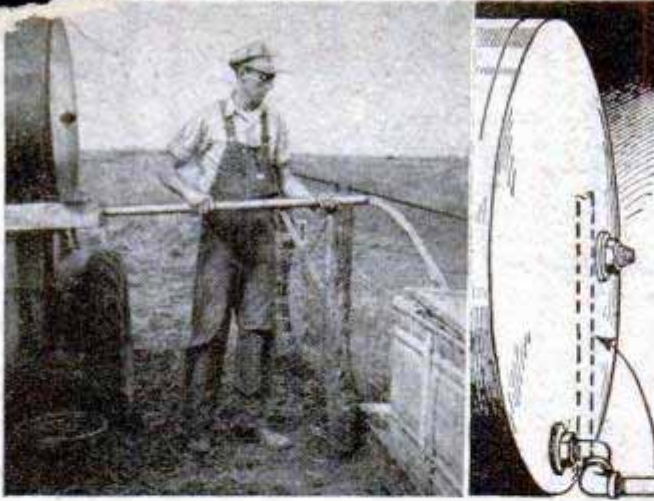

## Field Waterer Filled Easily From Large Portable Tank

When hogs or other livestock are placed on newly fenced pastures, a permanent water supply is not always at hand. One large hog raiser makes hauling water an easy chore by mounting a 250-gal. tank on a trailer and providing the tank with a handy turn-down spigot. This is the feature that saves time, as all that is necessary is to drive the trailer close to the field waterer and turn down the long spout. Raising the spout shuts off the water. Two pipe elbows, a short nipple and a 36-in. length of pipe are assembled to form the spigot. The first nipple is screwed into a reducer which is turned into the threaded plug opening in the tank. Turn this one up tightly. Draw the nipple tight also, but turn the second elbow on loosely as it must turn easily to allow the pipe, or spout, to swing down. Plumber's pipe-thread compound will prevent leaks at the threaded joints.

A. M. Wettach, Mt. Pleasant, Iowa.

## Stopping Leaks in Pipe Joints

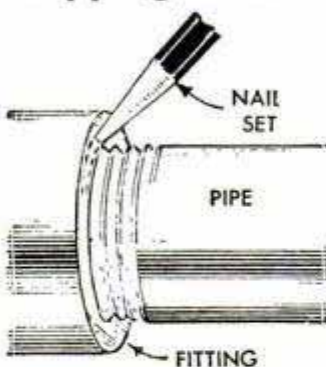

Especially where an iron pipe is connected to a brass fitting, leakage between the threads can be stopped in a jiffy by using a nail set to form a slight lip around the threaded end of the fitting. With the nail set or a countersink having a somewhat rounded point, tap completely around the end of the fitting about  $\frac{1}{32}$  in. from the pipe threads. This will form a continuous line of indentations resembling a shallow groove and will upset the metal to reduce the inside diameter at the end of the fitting, thus sealing the leak.

Edmund C. Biggin, Philadelphia, Pa.

## Test Lamp Indicates Spark Position

Frequently it is necessary for the auto mechanic to know precisely the time a spark occurs at the plug with respect to the position of the piston in that particular cylinder. A small test lamp placed in the circuit will show when current is flowing and also when the distributor points open, or break.

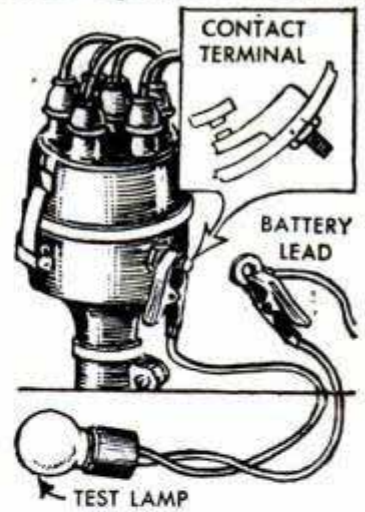

The leads from the test-lamp socket are provided with clips and the lamp is placed in the circuit by detaching the battery lead from the distributor terminal and clipping the test-lamp leads to the terminal and battery wire as shown. When current is flowing, the lamp burns. Breaking of the points is indicated when the lamp goes out.

## Rear-View Mirror on Tractor Permits Checking Implements

So that the work of a breaking plow or rear-mounted cultivator can be checked frequently without turning around in the tractor seat, one farmer fastened a rear-view mirror to the transmission housing. He used a large, truck-type mirror and positioned it so he can glance down from his seat and obtain a clear view of the operation of the drawn implement.

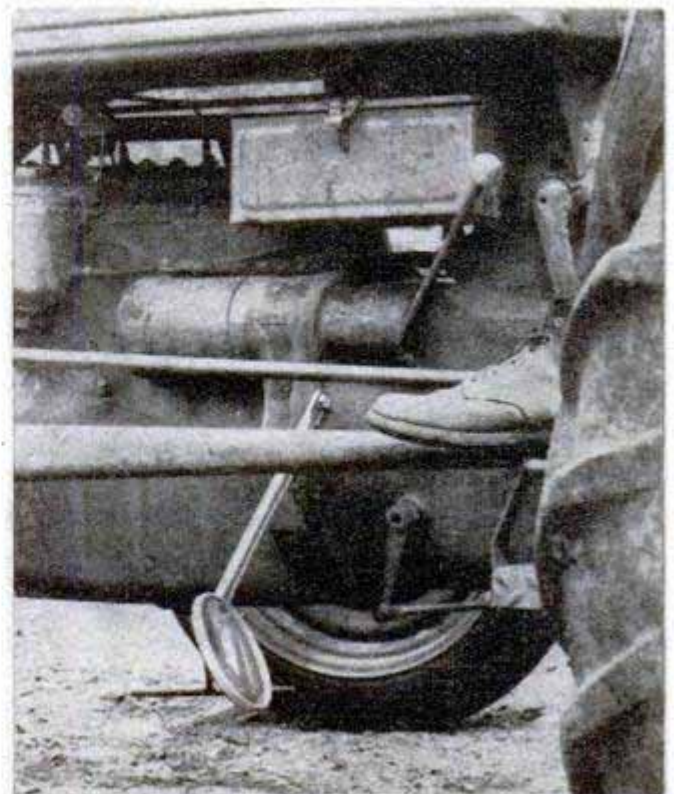



# ROOFING IS EASY

## Application of Roll Roofing



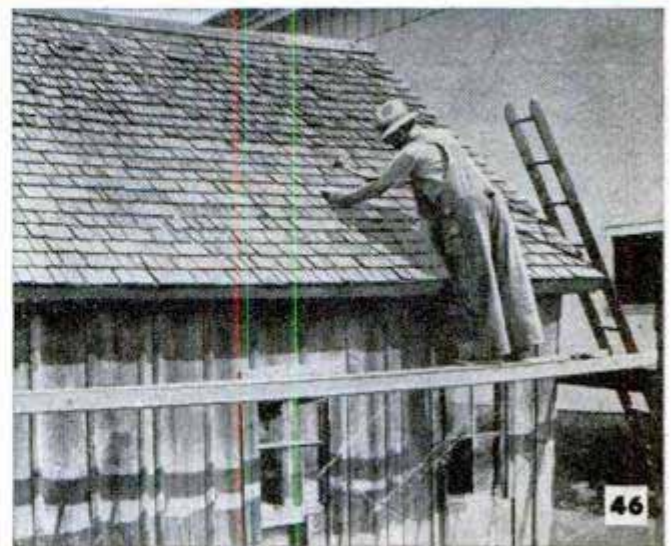
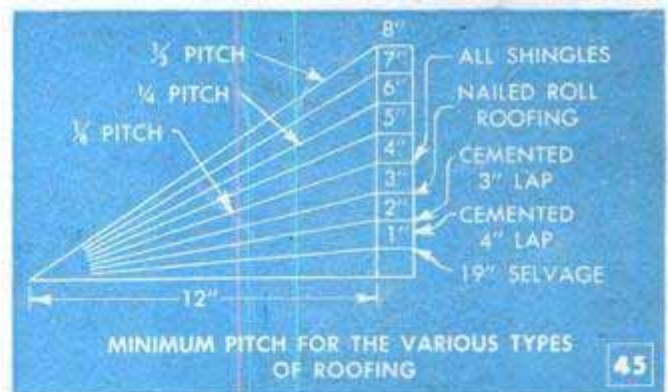

### Part II

AS DESCRIBED in Part I last month, laying composition shingles is one of the easiest home repair jobs, but laying roll roofing is even simpler as it comes in continuous rolls of a uniform width and length. You simply unroll the covering, cut it to the lengths required and nail it down. It's less expensive than shingles and where appearance is not of the first importance it has a wide application.

**Mineral-surfaced roll roofing:** This probably is the most popular type as it can be applied either vertically or horizontally and with exposed or concealed nails, Figs. 48 and 58. The edges of the roofing should overhang slightly at the eaves and along the rise, Fig. 49. Another method is to turn down the edge and nail it, Figs. 44 and 50. Old shingled roofs are prepared for reroofing by nailing down loose shingles, Fig. 46, and applying drip boards at eaves and gable ends



To prepare old shingled roofs, nail down loose shingles and apply drip boards at eaves and gable ends

Roll roofing	Weight Per Square	Unit Size	Nails Per Square	Coverage Per Roll	Remarks
 SATURATED FELT	15 LBS. 30 LBS.	36" X 144' 36" X 72'	½ LB., 1" 6" SPACING	400 SQ. FT. 200 SQ. FT.	15 LB. WEIGHT IS CALLED No. 15. 30 LB. IS No. 30. No. 15 IS COMMONLY USED FOR UNDERLAY ON NEW WORK
 SMOOTH SURFACE	45 LBS. 55 LBS. 65 LBS.	36" X 36'	1¼ LB., 1" OR 1¾ LB., 1¾" (2" SPACING)	100 SQ. FT. (1 SQUARE)	INEXPENSIVE ROOFING FOR BARNs, GARAGES, ETC. WEIGHTS ARE SOMETIMES CALLED MEDIUM, HEAVY AND EXTRA-HEAVY
 MINERAL SURFACE	90 LBS.	36" X 36'		100 SQ. FT. (1 SQUARE)	MOST POPULAR ROLL ROOFING FOR ALL PURPOSES. CAN BE APPLIED WITH EXPOSED OR CONCEALED-NAILING METHOD
 PATTERN EDGE	105 LBS.	36" X 42' 32" X 48'	1¾ LB., 1" OR 2¼ LB., 1¾"	100 SQ. FT. (1 SQUARE)	AN ATTRACTIVE YET INEXPENSIVE ROOFING. CAN BE APPLIED WITH EXPOSED OR BLIND NAILING CLIPS
 19" SELVAGE	140 LBS.	36" X 36'	1 LB., 1" OR 1¼ LB., 1¾"	50 SQ. FT. (½ SQUARE)	THE BEST ROOFING FOR LOW PITCHES. CAN BE USED ON ROOFS HAVING AS LITTLE AS 1" RISE PER FT. (CEMENT REQ'D)

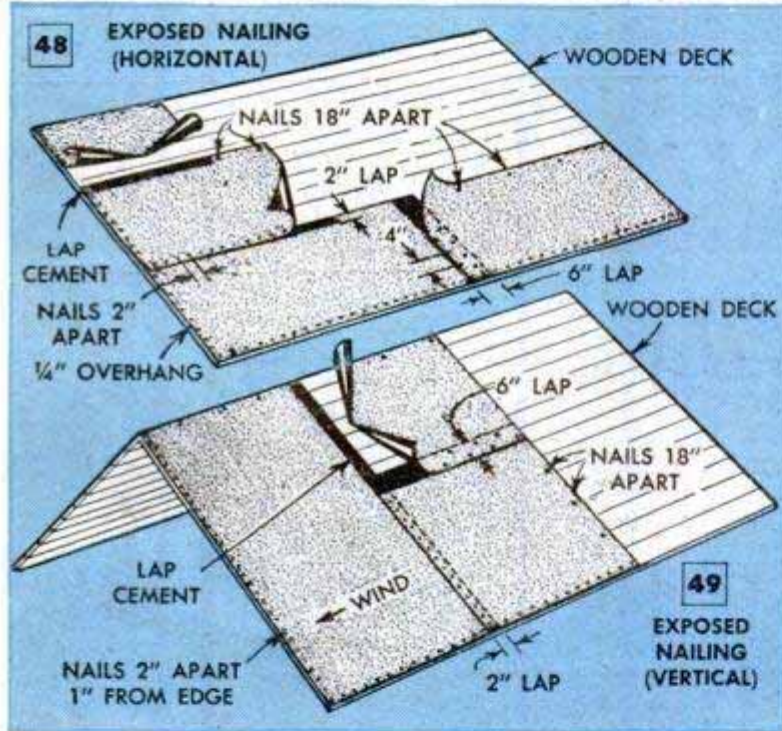

roofs require wider laps, Fig. 45. The second sheet is held in place with widely spaced nails along the top edge while cement is spread on the lapped area. Then the lower edge is pressed into firm contact with the cement and nailed, the nails being spaced about 2 in. apart. If concealed nailing is desired, the roof edges are fitted with strips of roofing, Fig. 55, and the roofing is applied with a 3-in. head lap and 6-in. end lap, all cemented.

**Pattern-edge roofing:** This can be had in a variety of edge patterns, Figs. 47, 54 and 56, and makes an attractive, inexpensive roof. Concealed nailing, Fig. 55, is recommended although exposed nails can be used if desired. Pattern-edge roofing must be unrolled to break



Edges of the roll roofing can be folded over and nailed as in Fig. 50. Measure and snap a chalk line to show the amount of lap as in Fig. 51. Finish the ridge as in Fig. 52, using a 10 or 12-in. strip of roll roofing



the tabs which hold the strips together. Allow them to flatten for several hours before laying. The strips are then loosely rerolled for application as in Fig. 53. Valleys, Fig. 59, are treated in the same manner as described in Part I. Ridges can be covered with a single strip of roll roofing 9 to 12 in. wide, Fig. 52, or with individual short strips as in Figs. 56 and 57.

**Wide-selvage roll roofing:** If you are covering a roof that is nearly flat, 19-in. selvage roofing makes a tight double-coverage job with laps cemented the full 19-in. width, Fig. 58. The 19-in. lap is smooth surfaced for easy application of the cement. Only the exposed surface is mineral coated. Note that the starter course is a strip of the unsurfaced portion. This type of roofing usually is laid over sheathing paper.

(The End)



Pattern-edge roll roofing is available in a variety of patterns and makes an attractive, inexpensive roof

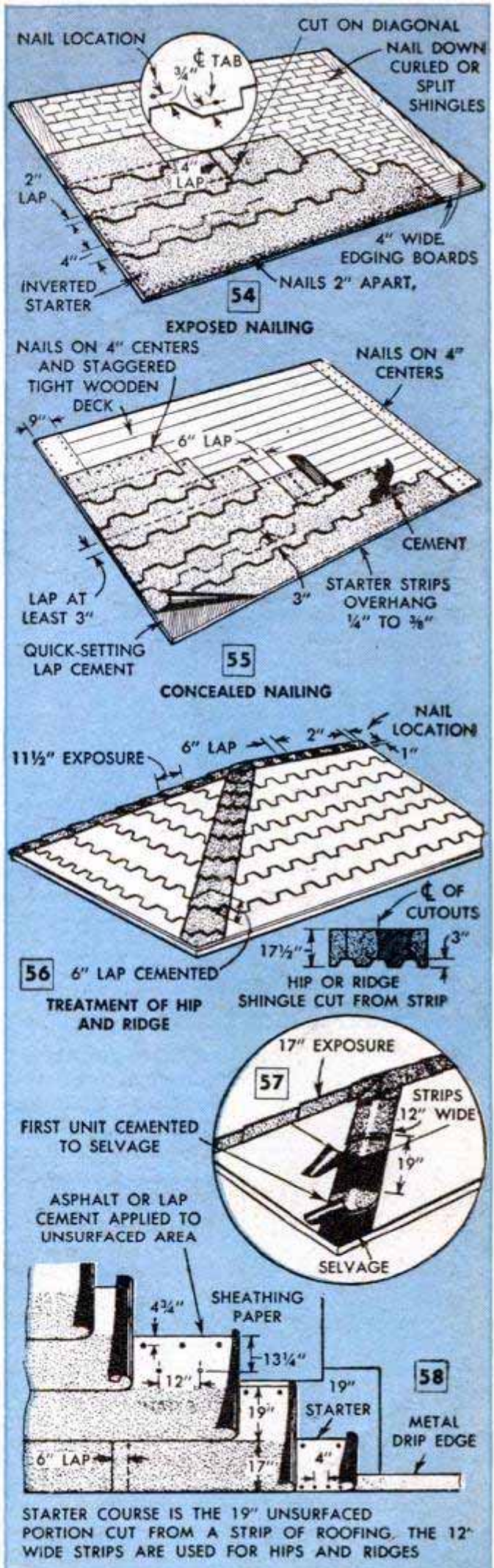

## Hinged Perches on Poultry Nests Permit Trapping New Layers



For culling laying flocks of pullets many poultrymen use trap nests of various types. One poultryman built his own trap nests in portable units of six compartments each and in the construction he hinged the perches in such a way that they can be made to serve a two-fold purpose, that of trapping the layers during the day and preventing the birds from roosting on the perches at night by simply raising them to the closed position at the end of the day. The nest units are made from ordinary pine lumber and the hinged perch design has the added feature of providing easy access to the interior of the nests for cleaning.

## U-Shaped Rods Set in Concrete Form Sliding-Door Guide

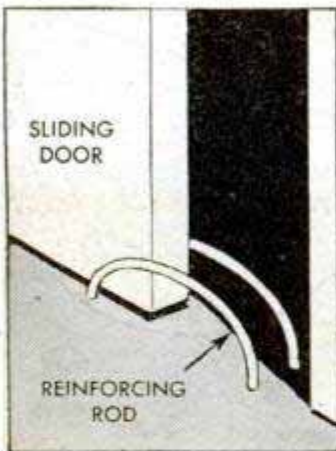

When pouring concrete ramps leading to sliding corncrib or barn doors, farmers usually install braces to hold the leading edges of the doors firmly closed at the bottom. The brace protects the doors from damage by wind or crowding livestock. At the

same time, the two-member brace serves as a guide for closing the doors by keeping the meeting edges in line and preventing damage to the weatherboard which covers the narrow crack between the doors when they are fully closed. The braces are bent to a wide U-shape from 1/2-in. iron rods and

are placed in the cement before it hardens. When installing the braces it's a good idea to drop a plumb line from the door track so that you are sure to get them located an equal distance on each side of the center line of the doors. Be sure that the braces are the correct distance apart so that the doors will close without binding.

## Slot Covers for Machine Table

If you would like to eliminate the job of digging chips out of the T-slots in a machine table, try covering the slots with T-shaped inserts. Cut from wood, metal or plastic in a variety of lengths, inserts are easily selected to cover completely all the exposed slots after setting up a job.

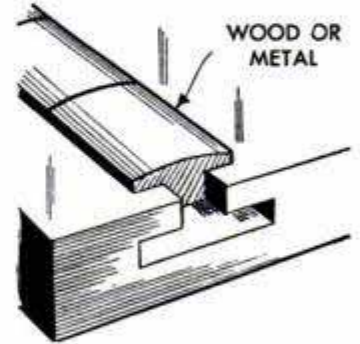

Laurence H. Seibert, Little Silver, N. J.

## Stock Supplied With Clean Water By Damming Spring Flow

Water from boggy open springs is readily impounded and piped to a livestock watering tank by constructing a small dam of concrete or field stone on the downgrade side of the spring. If the spring opens into a fairly steep gully or natural waterway, the dam should be wide and high enough to prevent water from flowing over the top or around the ends. When the dam is laid up of field stone, or poured, as the case may be, a length of pipe large enough to take the normal flow of the spring is installed in the masonry as shown in the illustration. The pipe is inclined slightly to discharge into a steel or concrete tank which is located below the dam. Backfill the dam with field stone and gravel, then with sand and finally cover with sod.

G. E. Hendrickson, Argyle, Wis.

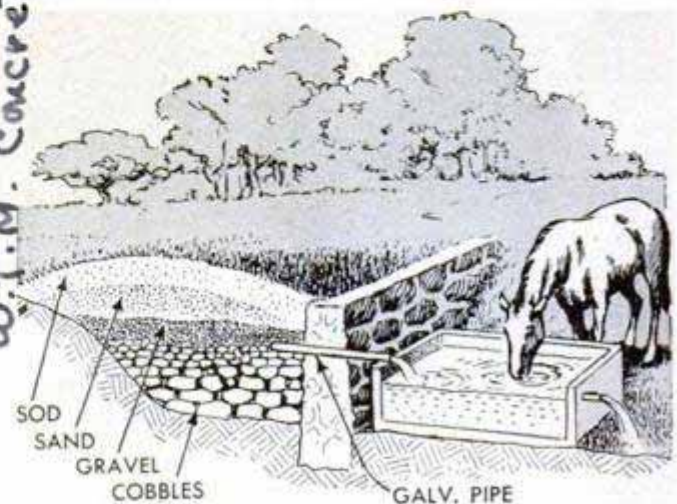

W.T.M. Concrete

W.T.M. Concrete

# Electric Oilstone for Edge Tools

By Hi Sibley

IF YOU experience trouble in honing edge tools, such as knives and chisels, because it is difficult to stroke them across an oilstone without distorting the bevel, this electrically driven oilstone may solve your problem. Here, the stone moves instead of the tool, and the tool can be held against the stone at the correct angle. All you need to make the outfit is an old phonograph motor, either electric or spring-wound. Just make a box in which to house the motor as in Fig. 1. Mount the motor on the underside of the box top and drill the top for the turntable shaft. Then thread a short piece of tubing to take a cast-iron flange and slip this over the shaft, shimming it if necessary. The turntable is turned from wood and screwed to the flange as indicated in Fig. 2. It may be necessary to bevel the inner sides of the table slightly to hold the stone firmly and yet allow it to be removed and turned over. If you use an electric motor, a toggle switch can be mounted in one side of the box. When a spring-wound motor is used, provision should be made for winding.

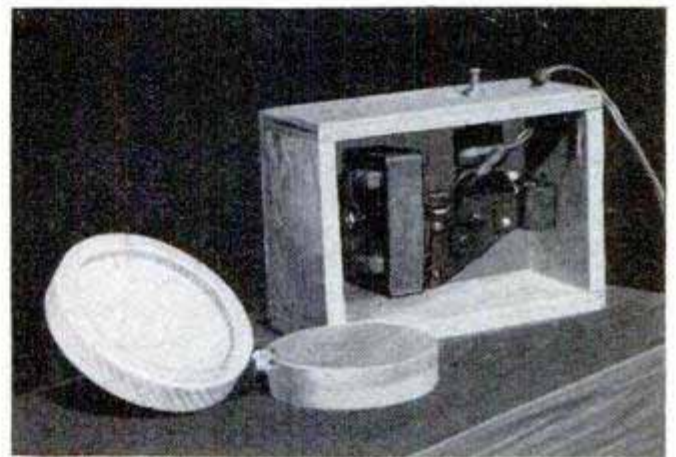
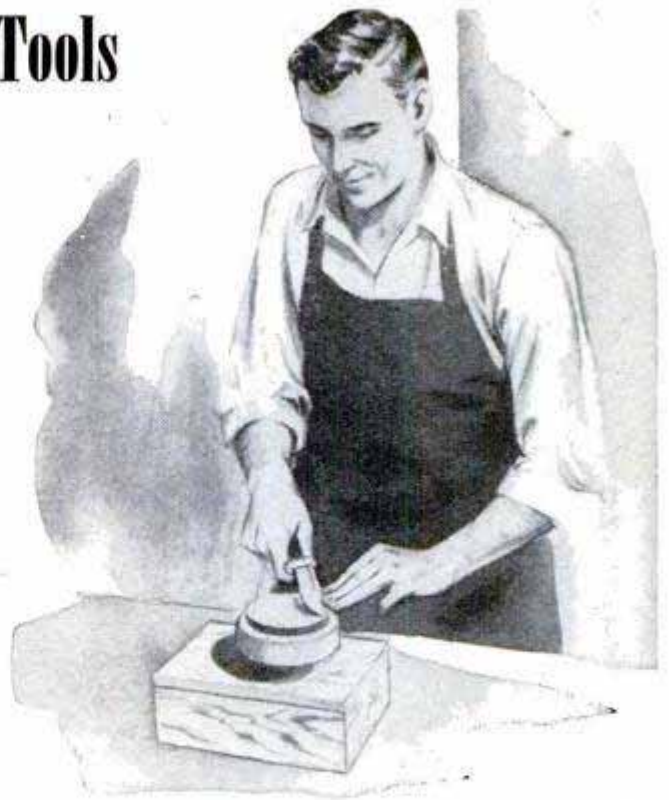

Motor is mounted with screws on inside of box as above and controlled from outside by toggle switch

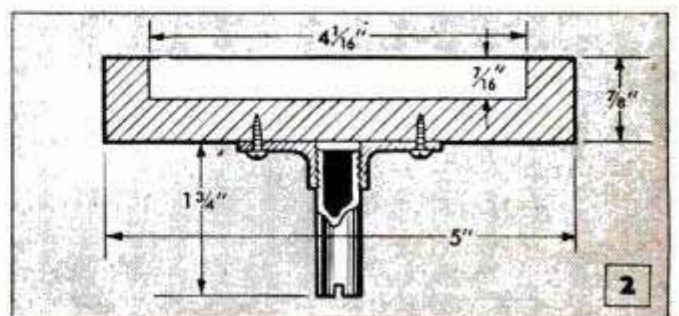
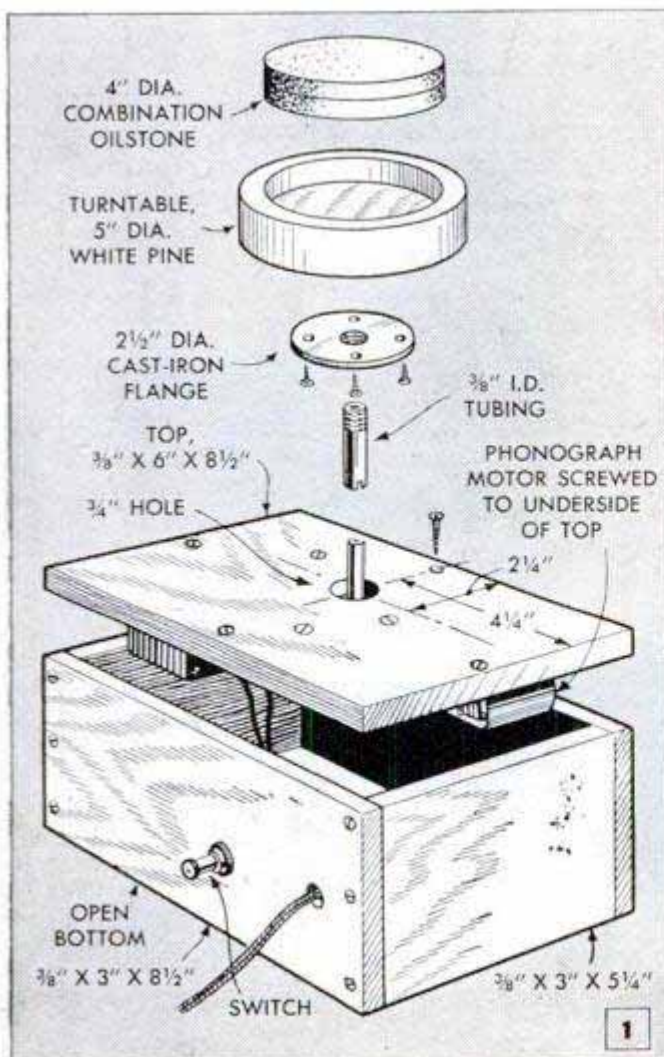
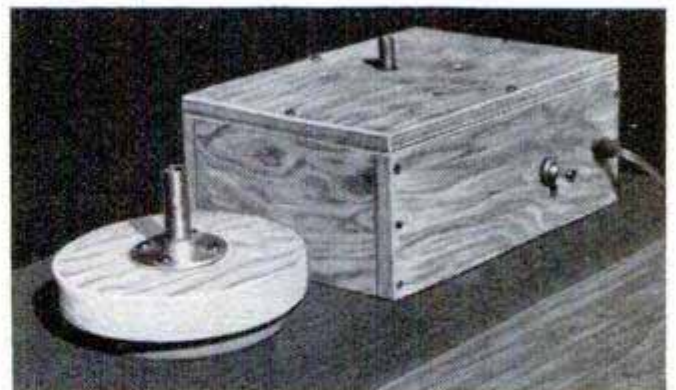

## Toxic Liquids Siphoned Safely By Blowing Into Container



When siphoning liquids such as chemical solutions or gasoline from one container to another don't chance getting a mouthful of the harmful or distasteful liquid by drawing it through the hose in the usual way. Instead fit the storage jar or tank with a special stopper that allows you to blow into the container to start the siphoning action. To do this, drill two holes through a cork or rubber stopper and press short lengths of glass tubing through the holes. A rubber hose for blowing air into the jar is pressed over the outside end of one of the tubes, and a length of hose is attached to each end of the other tube. The hose on the inside of the second tube should reach the bottom of the jar while the hose on the outside leads to the container to be filled. After the siphon has been started by blowing into the container, the flow of liquid will continue until the level in both containers is the same. It can be shut off at any time by placing your thumb over the end of the tube through which you blew.

## Broken Center Drills Removed With Grease-Gun Pressure

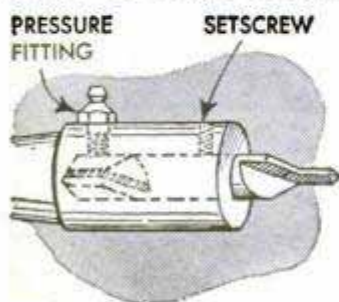

In many machine shops shell-reamer arbors are adapted to hold center drills for center-drilling work in the lathe or drill press. In order to do an accurate job, the center drill must be a light press fit in the arbor and when it breaks, as it sometimes does, trouble is had in removing the broken section from the arbor. To overcome the

difficulty, one mechanic drilled and tapped the arbor transversely for an ordinary pressure grease fitting which is installed as shown in the detail. Then, when the drill breaks, he applies the shop grease gun to the fitting. One stroke of the gun usually builds up sufficient pressure to remove the broken section of the drill.

## Setting Threading Tool

This thread-tool setting gauge is always ready because it's part of the lathe. To make it, simply remove the tailstock quill and turn and grind a 60-deg. chamfer on the outer end.

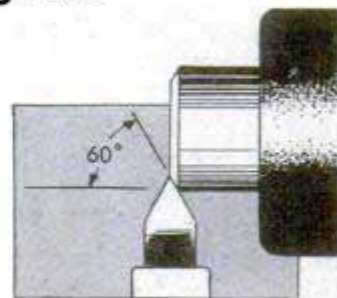

Then replace it and run the threading tool up against the chamfer as in the detail. Setting the tool to the chamfer automatically squares it with the work.

Robert J. Lemp, Woodhaven, N.Y.

## Divided Door on Brooder House Facilitates Inspecting Chicks

To aid in inspecting young chicks, one poultryman fitted the brooder house with a split door, the top half of which can be swung wide open while the bottom half is tightly closed. This feature also comes in handy for ventilating the house on warm clear days while still keeping the chicks safely enclosed. Each half of the door is hung with two hinges and fastened with a separate latch.





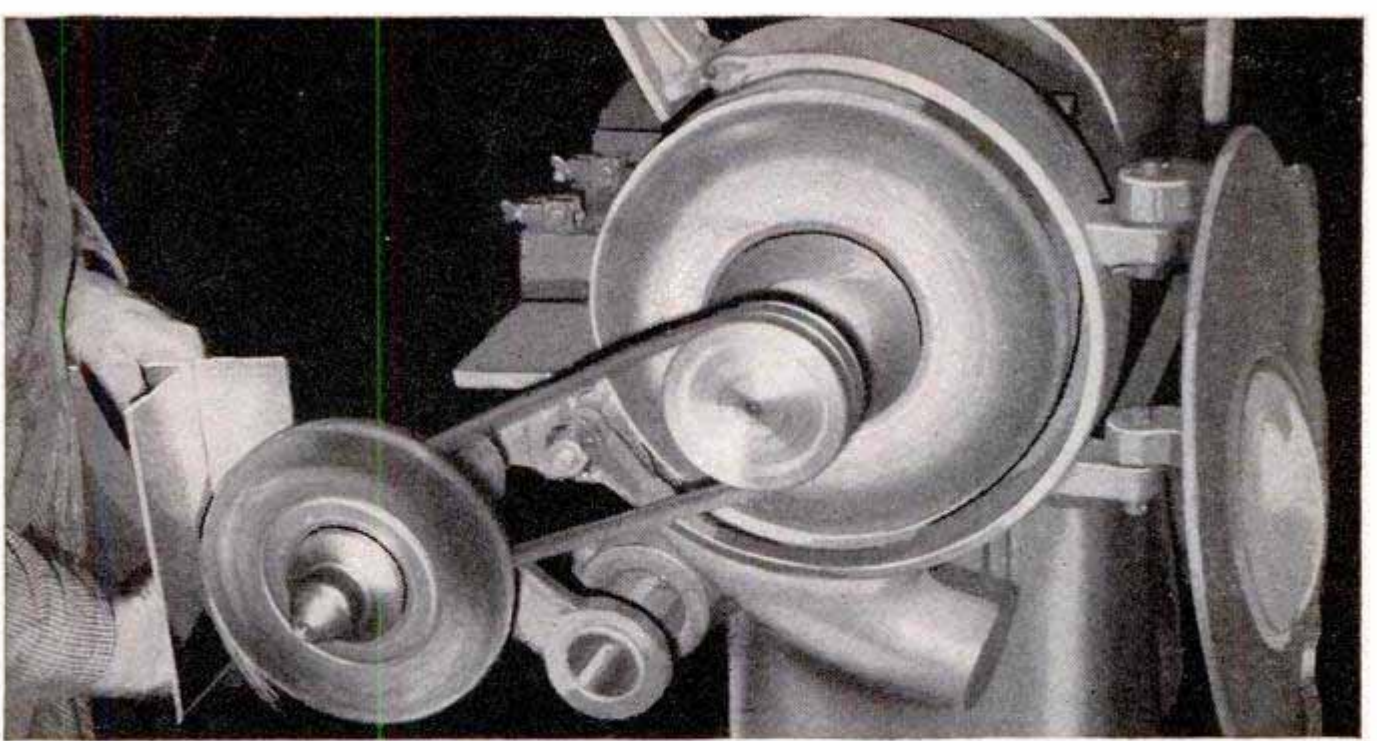

# Auxiliary Polishing Head

By Don Pittwood

THIS AUXILIARY polishing head is just the thing for the small shop having one grinder, either of the bench type or pedestal type. It saves the time and inconvenience of changing the grinding wheel when polishing and buffing are to be done. The polishing head is driven from a short spindle mounting two V-pulleys and internally threaded to screw onto the end of the grinder shaft in place of the nut, which normally turns up against the wheel flange. The head, Fig. 2, is supported in a jig clamp attached to the grinder pedestal. A jig clamp for the bench-type grinder is made from a pipe tee and a short length of angle iron as in Fig. 1. The head, Fig. 2, is a machined and welded job mounting ball bearings to carry the high-speed polishing spindle, which is shouldered and threaded at both ends for washers and a castle nut which provides bearing adjustment.

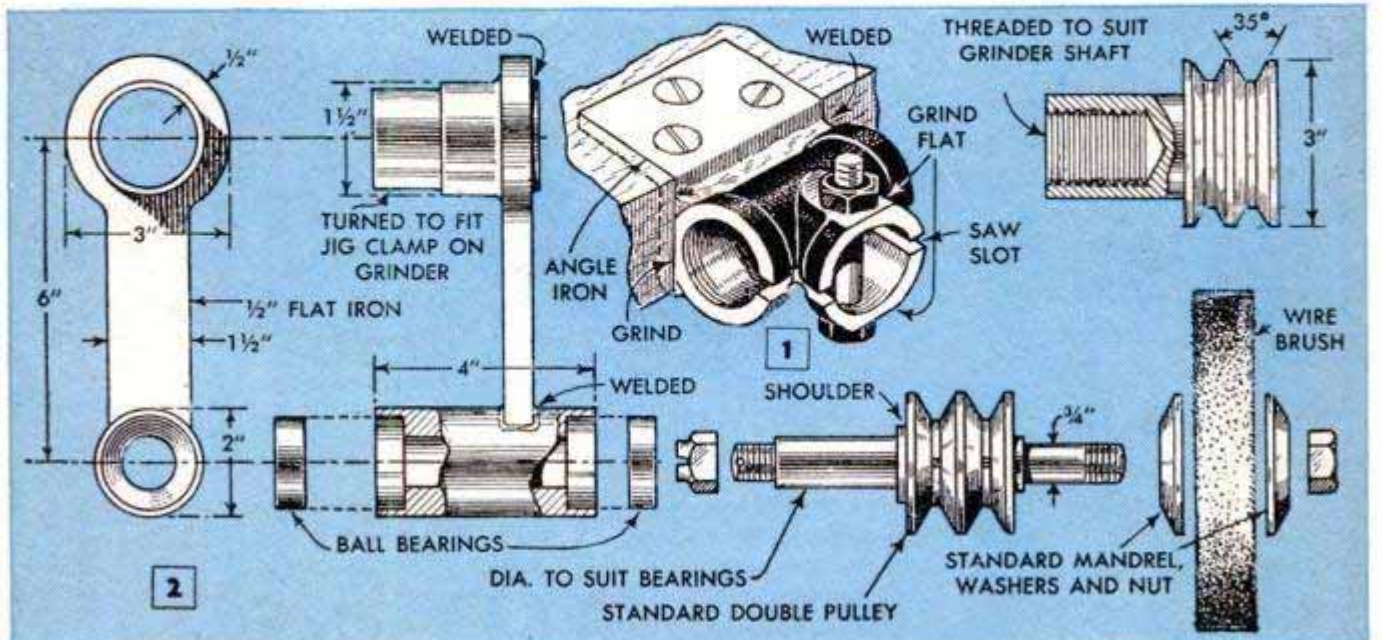
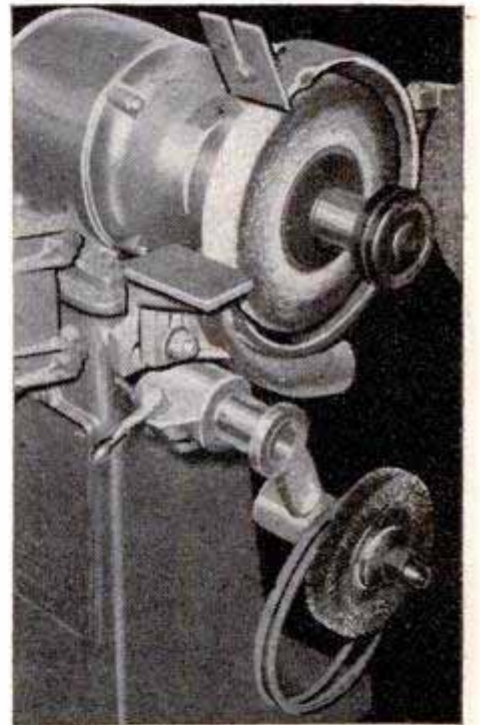

# SHOPPING

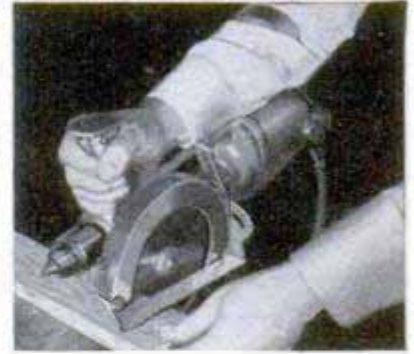
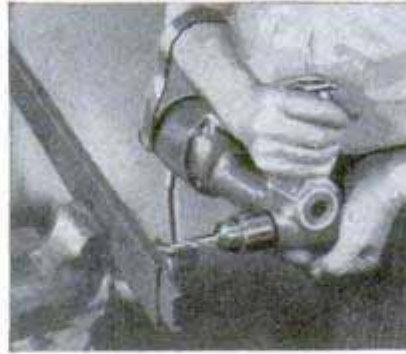
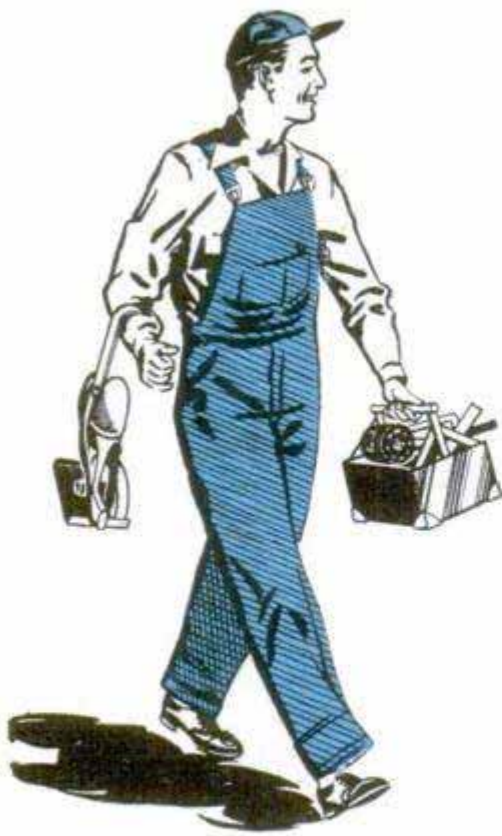

**ELECTRICALLY DRIVEN MULTIPURPOSE TOOL** now available to carpenters, plumbers, electricians and home craftsmen has several new and novel features. It consists of an a.c.-d.c. motor of portable-drill size driving a two-speed angle head fitted with two threaded sleeves for mounting accessories for sawing, drilling, sanding and grinding. Angle head is fitted with a handle and the motor is supported by a metal sling over the forearm

**THIS HAND PLANE** has a simplified blade adjustment which completely replaces the conventional frog, chip breaker and lever construction that has been standard for so long. New plane is fitted with screw-type blade lock having fine-thread screw which acts directly on the blade. The depth-adjusting screw also is direct-acting and is located at the top of the blade for convenient operation. The plane is chatterproof and chip-breaker action is automatic with blade settings

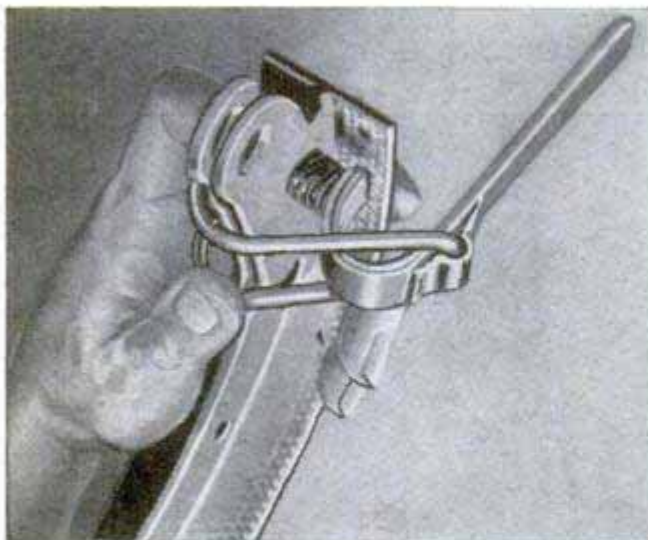
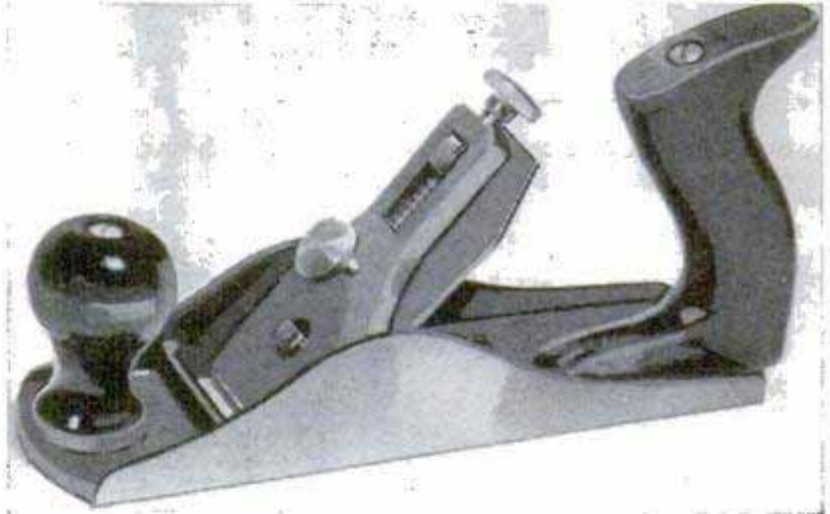

**SIMPLE BRAKE-SHOE TOOL** for quickly removing and installing the friction-pin lock on Chevrolet brakes saves time and prevents injury to the hands. With this tool at hand it is not necessary to dismount the brake shoe as the troublesome friction pin can be quickly removed or installed right at the car

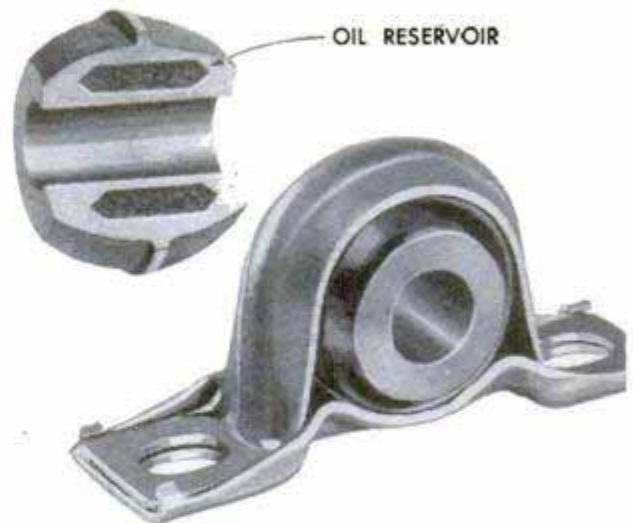

**PILLOW-BLOCK BEARINGS** which will withstand heavy loads and speeds up to 4000 r.p.m. now are used in many installations to replace ball bearings. The bearing sleeve is formed from sintered metal and contains a cavity which is filled with sponge iron that will retain lubricant for the life of the bearing

# FOR TOOLS

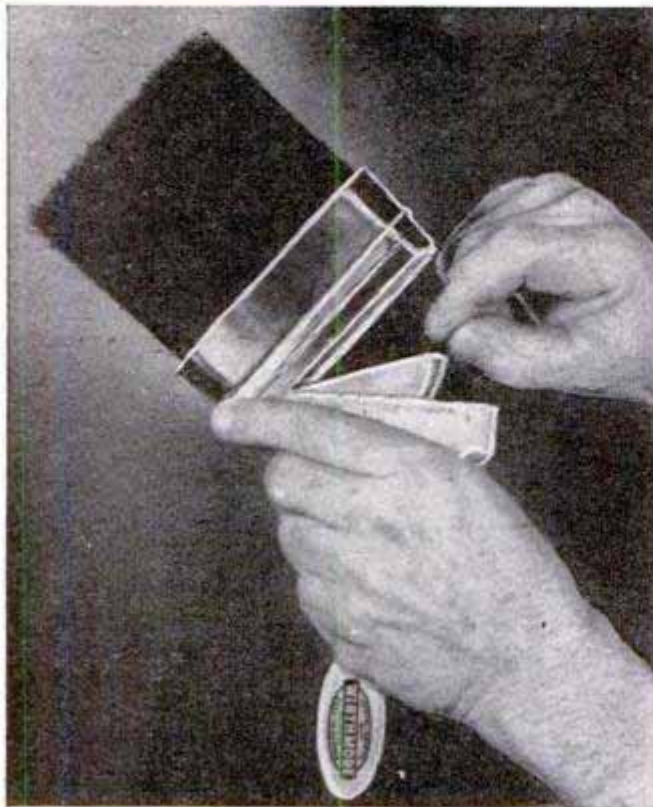

**THERE'S A NEW COME-APART PAINTBRUSH** now available which is designed to eliminate paint dripping from brush when painting ceilings. Paint which runs from bristles is trapped and funneled into a cup fitted in a recess in the handle under the metal ferrule. A simple thumb catch releases the ferrule from the handle, permitting easy access to the metal cup

**A NEW MILLING-MACHINE CLAMP** designed to speed repetitive operations has a straight-line clamping bar actuated by a cam lock instantly released by lever action. The locking mechanism can be fixed at any height by means of teeth milled in the cam unit which mesh with teeth on the locking post. Once set, the clamp can be adapted to various operations

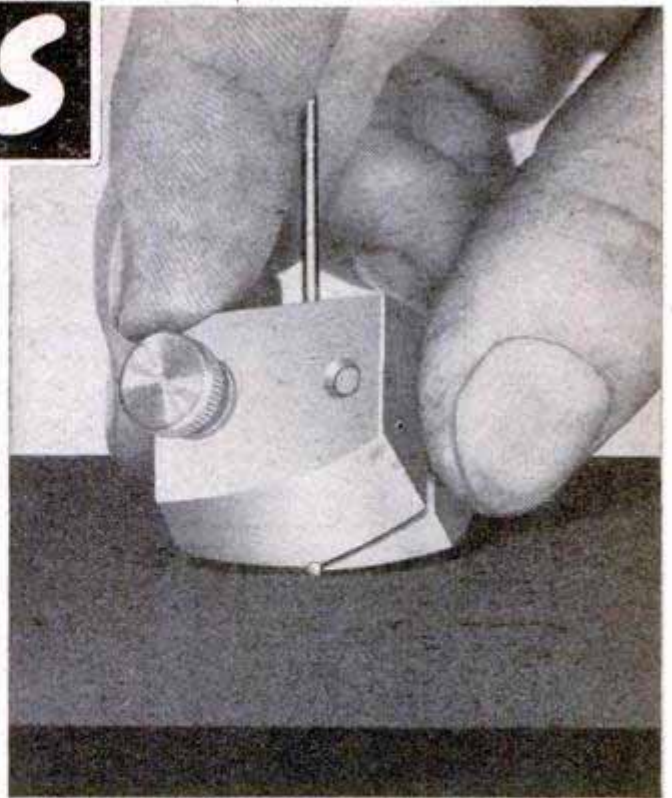

**THIS GUIDE** for honing drill bits in the number sizes holds the drill at just the right angle to the oil-stone. Honed drill bits, especially those in the smaller sizes, cut clean, true holes in either wood or metal

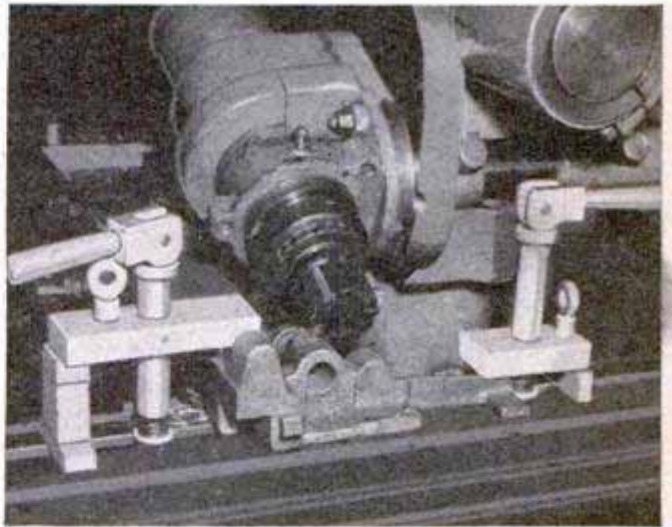

**MAGAZINE-LOADING SCREWDRIVER** can prove to be one of the handiest tools in the kit for electricians, auto mechanics and home craftsmen, especially if it has been designed to permit quick changes from one type of bit to another. The one pictured above and detailed at the right does just that. It comes with three special bits which are fed to the chuck from a magazine built into the handle. There's one bit for No. 2 Phillips-head screws and also 9/32 and 3/16-in. flat bits for driving round and flat-headed screws in several sizes. Handle is of tough plastic

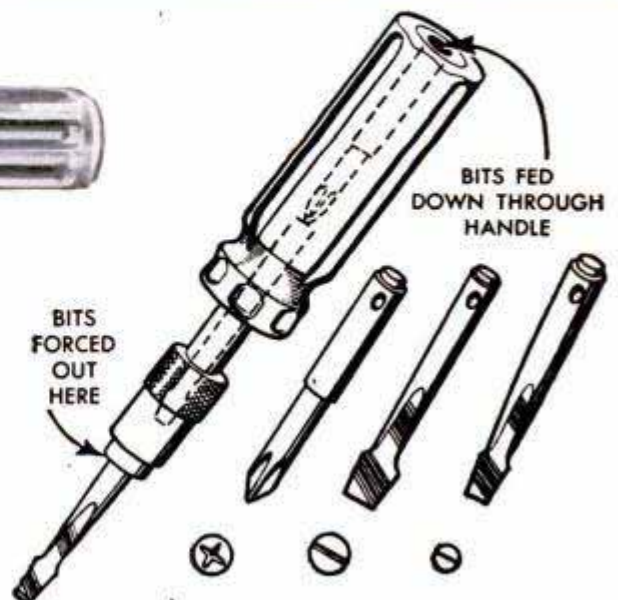

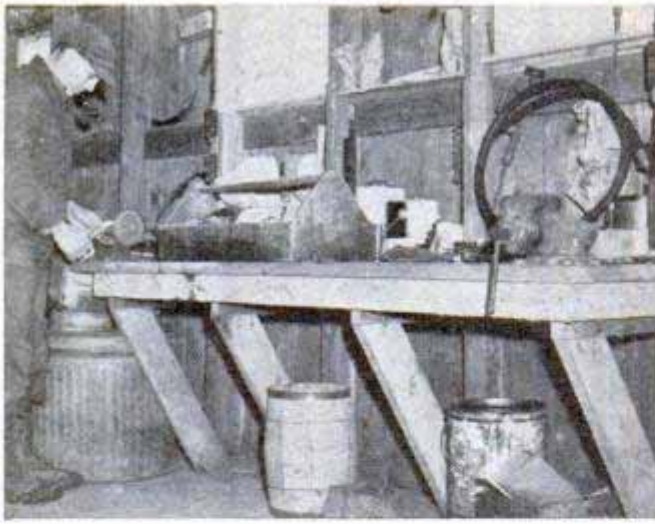

### Angle Braces Support Shop Bench

By using angle braces instead of the standard vertical legs to support his shop bench, one farmer found that storage space under the bench could be used to better advantage. The angle braces of 2 x 6-in. stock are nailed to the wall studs and to individual horizontal members which support the bench top as shown in the photo.

### Feeders Mounted on Wire Fence Are Made From Oil Drums

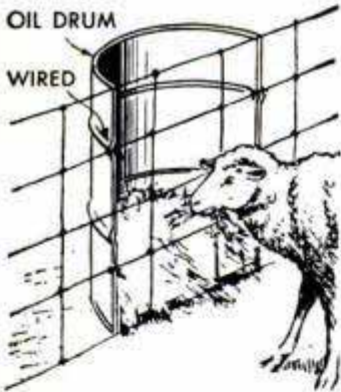

Small racks for feeding roughage to sheep or goats without waste are easily made by attaching halves of oil drums to a woven-wire fence. After one end has been removed from the drum, the latter is cut in half lengthwise to

provide two feeders. Holes drilled near the front edges of the feeder allow it to be wired to the fence, and hay placed in the feeders is easily pulled through the fence wire. If using a torch to cut the oil drum, be sure that the inside of the drum has been thoroughly steam-cleaned to prevent any possibility of explosion.

Albert H. Blackmon, Neeses, S.C.

### Magnet in Bag Picks Up Filings

A quick and easy way to pick up iron filings and shavings is to use a strong magnet placed in a paper bag. The filings which cling to the outside of the bag can be discarded by holding the bag over a trash can and removing the magnet. In this way, the filings will drop into the can and the magnet will still be clean.

Warren Norcross, Philadelphia, Pa.

### Brake Drums Provide Wheels For Small Caster Truck

Old brake drums in various sizes make good wheels for small special-purpose carts, caster trucks and any other application where a sturdy, small-diameter wheel will serve. Note the neat swivel truck in the



illustration. Here, long wheel hubs are welded on and the wheels are fitted onto a short axle which is pivoted on a kingpin by means of a special yoke. This construction permits the truck to swivel and the axle to oscillate. Wheels can be mounted with the flange in or out as desired.

### Interchangeable Trailer Hitch

The difficulty of hooking the same trailer to tractors having different types of drawbars led one farmer to devise this handy interchangeable hitch. The arrangement permits using both wide and narrow yoke, or clevis-type, hitches and also the ball-joint car hitch on the same drawbar. One is quickly substituted for the other simply by removal of two bolts. The center detail shows the clevis hitch adapted for a tractor having a U-type drawbar of thin cross section. The adaptation is made by removing the two bolts and turning the lower bent member over. In the top view the clevis is adapted for a swinging drawbar of a thicker cross section. This change is made by placing the lower half of the clevis with the bend down as indicated.

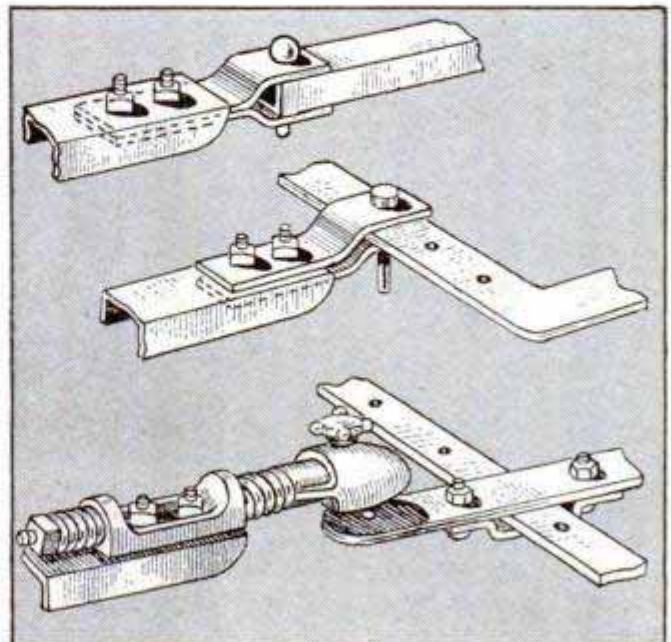

## TELEVISION IN THE THEATER

THERE ARE two basic RCA systems for theater television, one is the "intermediate film system" and the other is an "instantaneous projection system." In the instantaneous-projection system, shown in Fig. 1, a television picture is created on the face of a special high-brilliance kinescope "picture tube." This bright picture is then projected directly to the theater screen by means of a highly efficient reflective optical system. In this way, the audience sees the action at the exact instant that it is taking place.

In the intermediate-film, or "kinescope photography" system (sometimes called the film-storage system), Fig. 2, the television picture is again produced on the face of a special kinescope picture tube. This image is photographed by a 35-mm. motion-picture camera. The accompanying sound is simultaneously recorded directly on the film by a film-recorder attachment. The exposed film is then run into a high-speed developer where it is developed, washed and dried. It is then fed directly to a standard motion-picture projector in the projection room which projects it onto the theater screen. The whole process, from photographing to final projection, takes approximately one minute.

A typical theater instantaneous-projection installation is illustrated in Fig. 3. The operating station and control rack are mounted in the projection room; the power-supply rack may be installed in this or an adjacent room. The high-voltage supply is in a vault, or generator room. The TV projector is mounted out in the auditorium, as shown in photo A, about 75 feet from the screen in such a manner that the light beam passes through the center of the screen. This equipment projected a 15 x 20-ft. picture at the projection throws indicated.

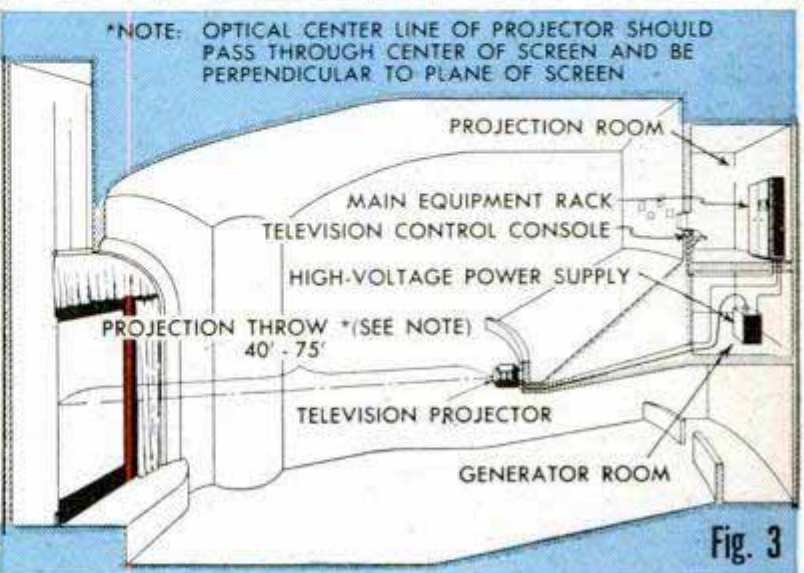
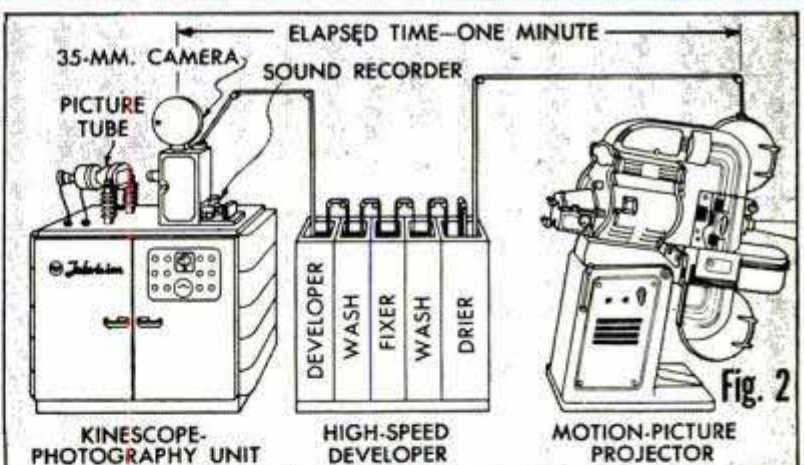
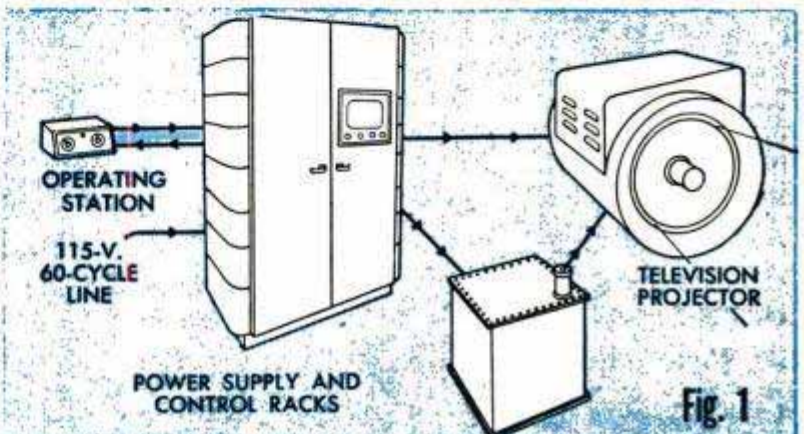
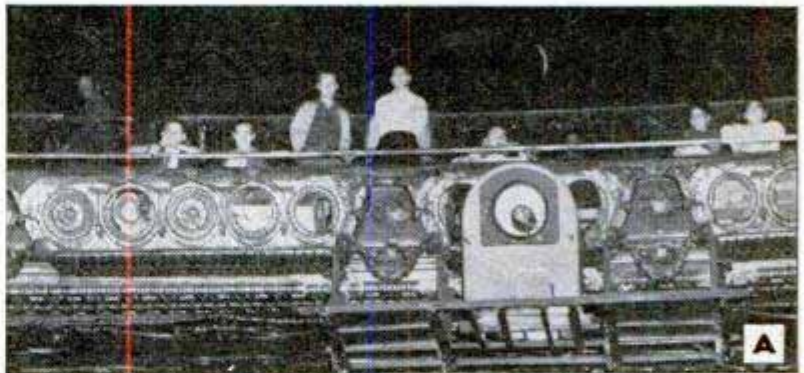

# "HANDI TALKIE" POCKET SET FOR EXPERIMENTERS

By S. A. Johnson



ONLY ONE miniature tube is used in this "handi talkie" type pocket receiver. It is so compact it will slip into a coat pocket—yet sensitive enough to bring in strong local broadcasting stations with only an emergency antenna. The short antenna lead shown in photo A terminates in a spring clip which may be clipped to the metal finger stop on a dial telephone, a metal lamp base as illustrated in photo C, bedsprings, window screen, or any similiar metal object in the home. Out of doors, practically any metal railing, wire fence, downspout, bicycle frame, or other metallic object will provide a suitable emergency antenna.

All parts are inexpensive standard materials. The case is made of 1/4-in. pine or plywood, and the top and bottom covers are made of 1/8-in. hardboard. The over-all dimensions of the case are given in photo D. Most of the parts are mounted directly on the hardboard front panel as shown in photos B and E. The single earphone, which is from a 2000-ohm headset, should be a type which has outside terminals. It is mounted on the back panel by means of its terminal screws.

The coil for the set is hand-wound on a cardboard case from a "C" size of flashlight cell, see Fig. 3. Coils L1 and L2 are both close-wound in the

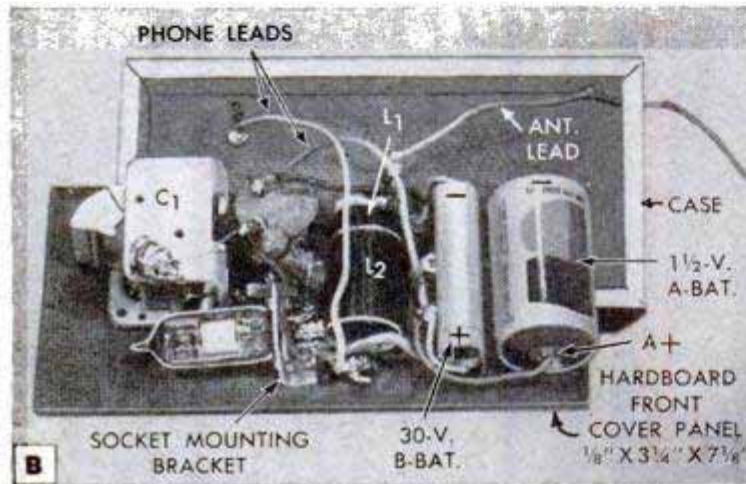

The coil for the set is hand-wound on a cardboard case from a "C" size of flashlight cell, see Fig. 3. Coils L1 and L2 are both close-wound in the

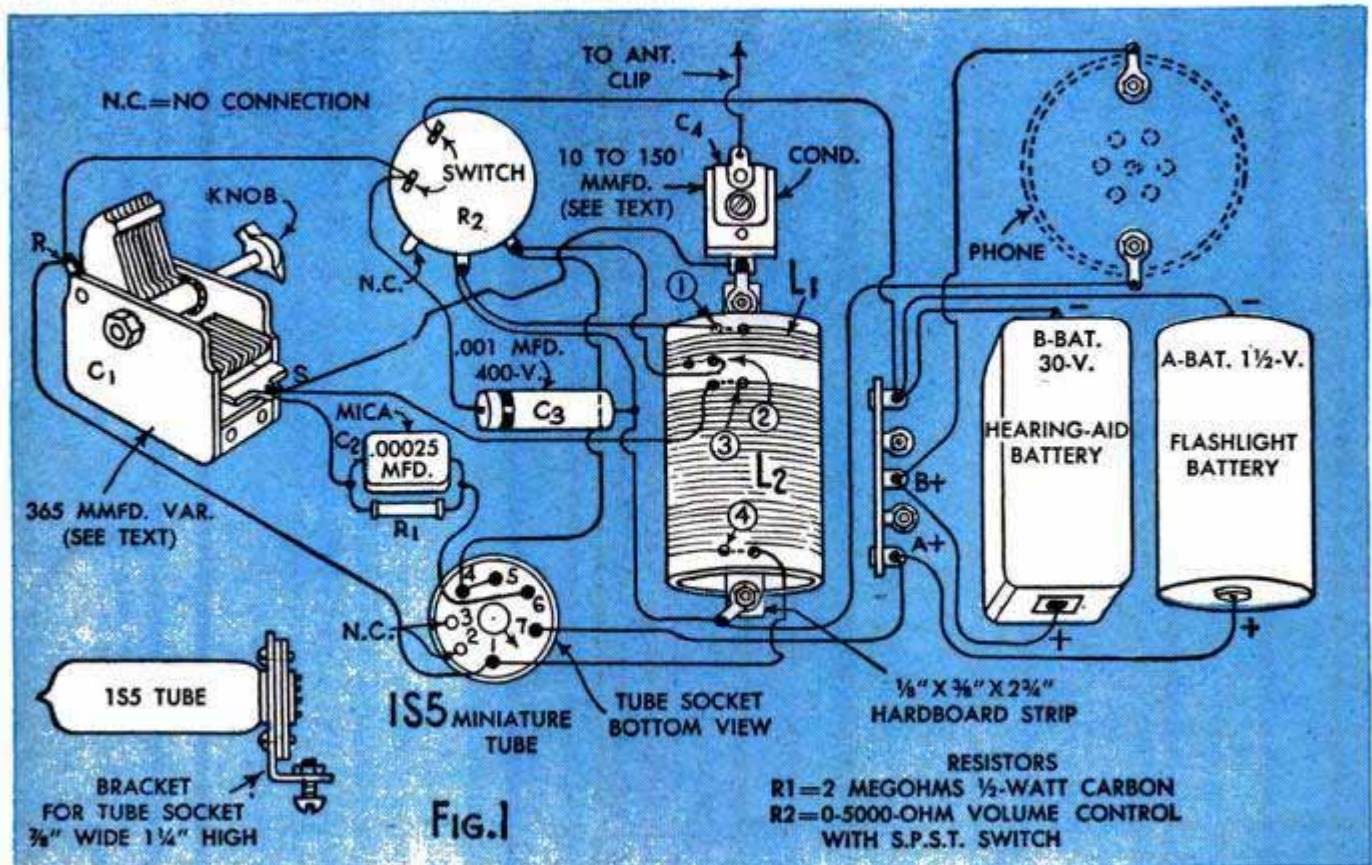

same clockwise direction as shown in pictorial diagram Fig. 1 and diagram Fig. 3. Two small holes are punched in the cardboard form to anchor the wire at the start and finish ends of each coil. The schematic circuit diagram appears in Fig. 2; No. 18 or 20 flexible insulated hookup wire is used for all connections except those to the coil, which are made with the coil-wire ends. The rotor plates of condenser C1 are common with the condenser frame. This is the terminal R. Power for the set is provided by one standard-size flashlight cell and a 30-volt hearing-aid battery.

Test the set first with a standard outdoor antenna or a long indoor wire. Assemble it in the case temporarily and open the setscrew on the small trimmer condenser C4 as far as it will go. The on-off switch is combined with the volume control. Turn this control "full on" and rotate the variable condenser until you hear a whistle indicating a station. Now back off the volume control very slowly until the whistle disappears and the station comes in clear. After the set is in working order with a standard antenna, connect it to any convenient emergency antenna and adjust condenser C4 until it is closed as much as possible without eliminating the oscillation whistle at the low (550 kc.) end of the band. The case cover can now be closed with two small brads or wood screws to complete the assembly. The detailed student material list for this article is R-394.

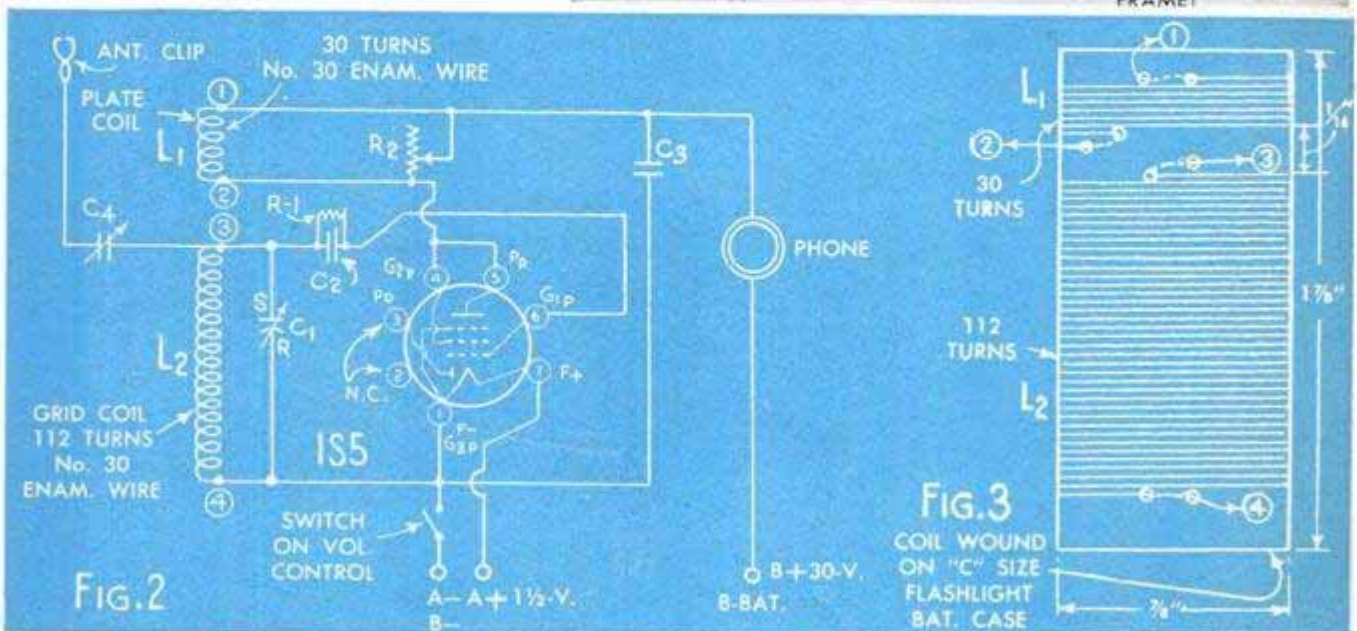
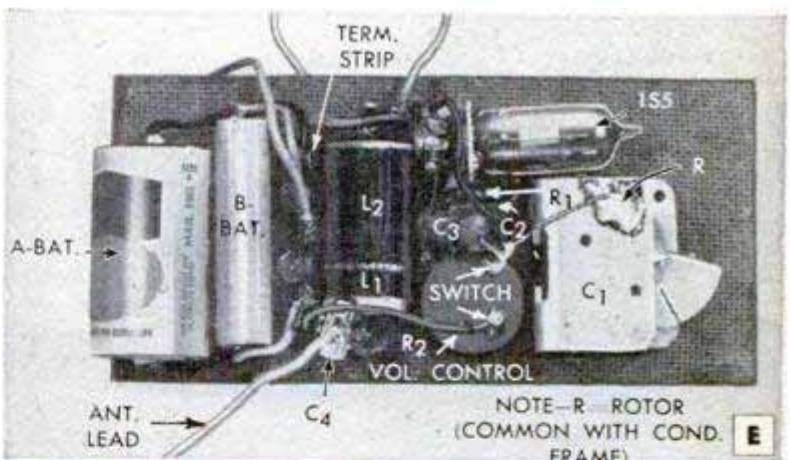
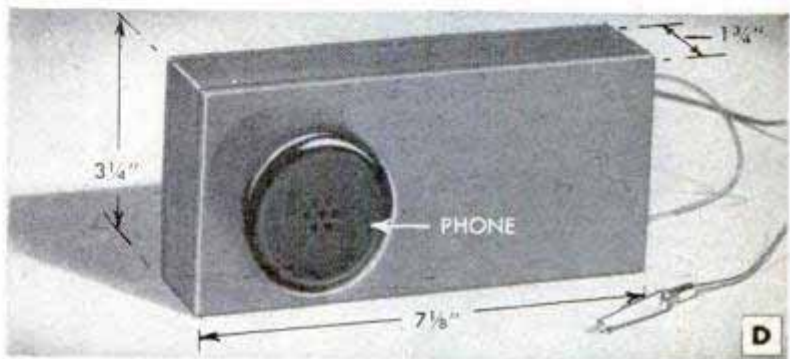

# HOW TO BUILD A MULTI-

By L. M. Dezettel

**T**HIS MODERN phototube circuit will permit you to turn your lights or other electrical appliances on or off by either shining a light beam onto the phototube, or breaking a light beam that is shining on the tube. It has many applications, such as counting items going down a conveyor belt, announcing the entrance of a customer passing through a doorway, etc. By adding an infrared filter, available from any photographic supply house, to the light source, it can be converted into a "black light" burglar-alarm system. The unit may also be made into an intermittent, electronic light flasher.

A sensitive s.p.d.t. relay is employed in the plate circuit of a 50L6-GT tube. The type 918 RCA phototube anode and cathode are connected in the grid circuit of the 50L6-GT tube so as to cause the grid voltage to vary with the light that falls on the phototube. Decrease of negative bias on the 50L6-GT causes a flow of plate current in this tube through the relay and closes the armature. The contacts on the armature supply 115 volts a.c. to a light or other appliance, or disconnect the a.c. from it, depending upon the terminal connections made on the unit.

Photos A, B, C and E show various views of the completed relay; the simple base and panel construction is detailed in Fig. 1. The use of a double-pole, single-throw toggle switch disconnects the entire circuit from the house line. While the unit is operating, precaution should be taken not to touch any of the unit wires or clips. Disconnect the unit from the wall socket, or throw the toggle switch to "off" before making connections to the clips. The sensitivity control is a 4-watt wire-wound potentiometer. The phototube faces the light source, as indicated in photo A. A schematic circuit diagram is given in Fig. 3. Fig. 2 shows pictorial bottom views of the tube sockets. Use rosin-core solder for all connections, and be sure to observe the polarity of the electrolytic condenser C1.

After completing the wiring, experiment with proper sensitivity control by playing a flashlight beam across the phototube. The click of the relay will indicate proper action as it closes and opens. Adjustment of the sensitivity control is determined by experience. A slight adjustment of the relay spring may be necessary. A good source of light can be made with an automobile headlight bulb operated from a 6.3-volt filament-type transformer. A suitable inexpensive lens for focusing the light in

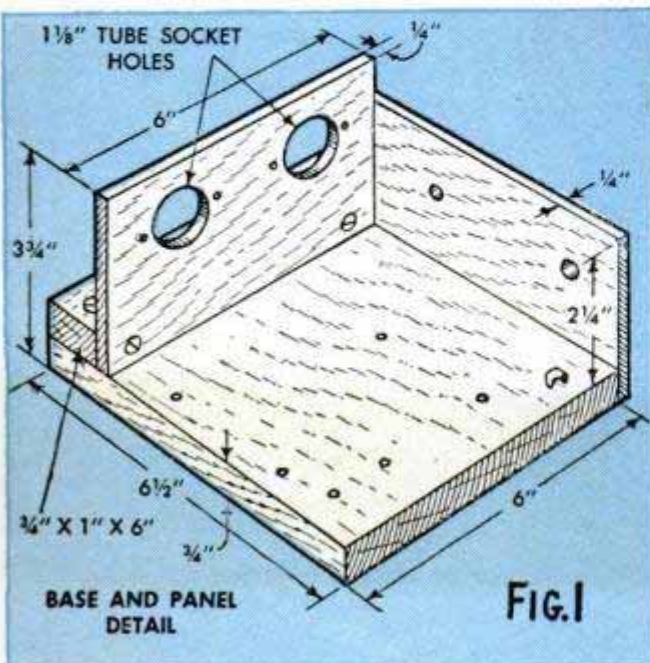
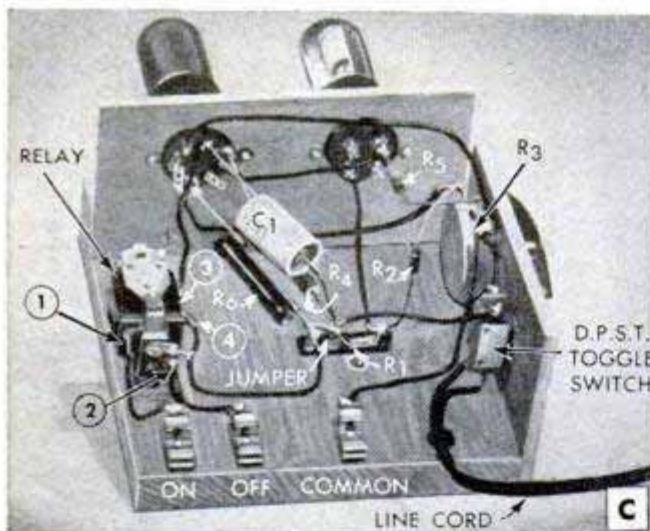
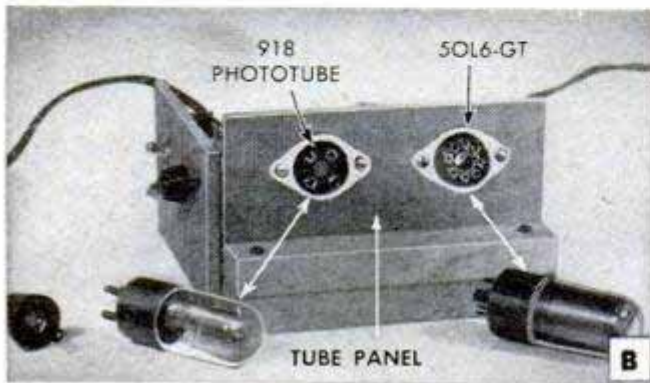
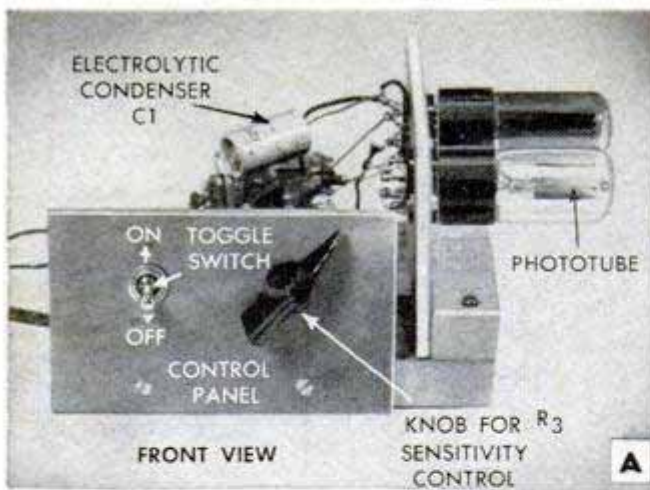



# PURPOSE PHOTOTUBE RELAY

a beam can usually be purchased in a local dime store. Installation can be made in a lighttight box (except for the beam opening); provide a frame or slot in front of the lens for the infrared filter, if desired.

As an experimental start, for a light to be controlled by the relay, mount a 115-volt light bulb in a base-mount type of socket with wires about 3 to 5 ft. long as shown in photo D. The leads may be connected to the Fahnestock clips marked "common" and "on," or "common" and "off," depending upon the type of operation desired. When connected to "common" and "off," the light will be off until the beam from the light source falls on the phototube; this is the connection for opening doors and similar applications. When connected to "common" and "on," the lamp is off when a steady beam of light is on the phototube, and comes on when the beam is broken. This is the hookup for counting articles on a conveyor belt, for a burglar alarm, etc. By connecting the lamp to "common" and "on," and placing the controlled light in front of the phototube, the relay will turn on and off at a moderate rate, and you have an electronic flasher. Detailed student material list R-395 is available from Popular Mechanics Radio and Electronics department upon receipt of ordinary letter postage.

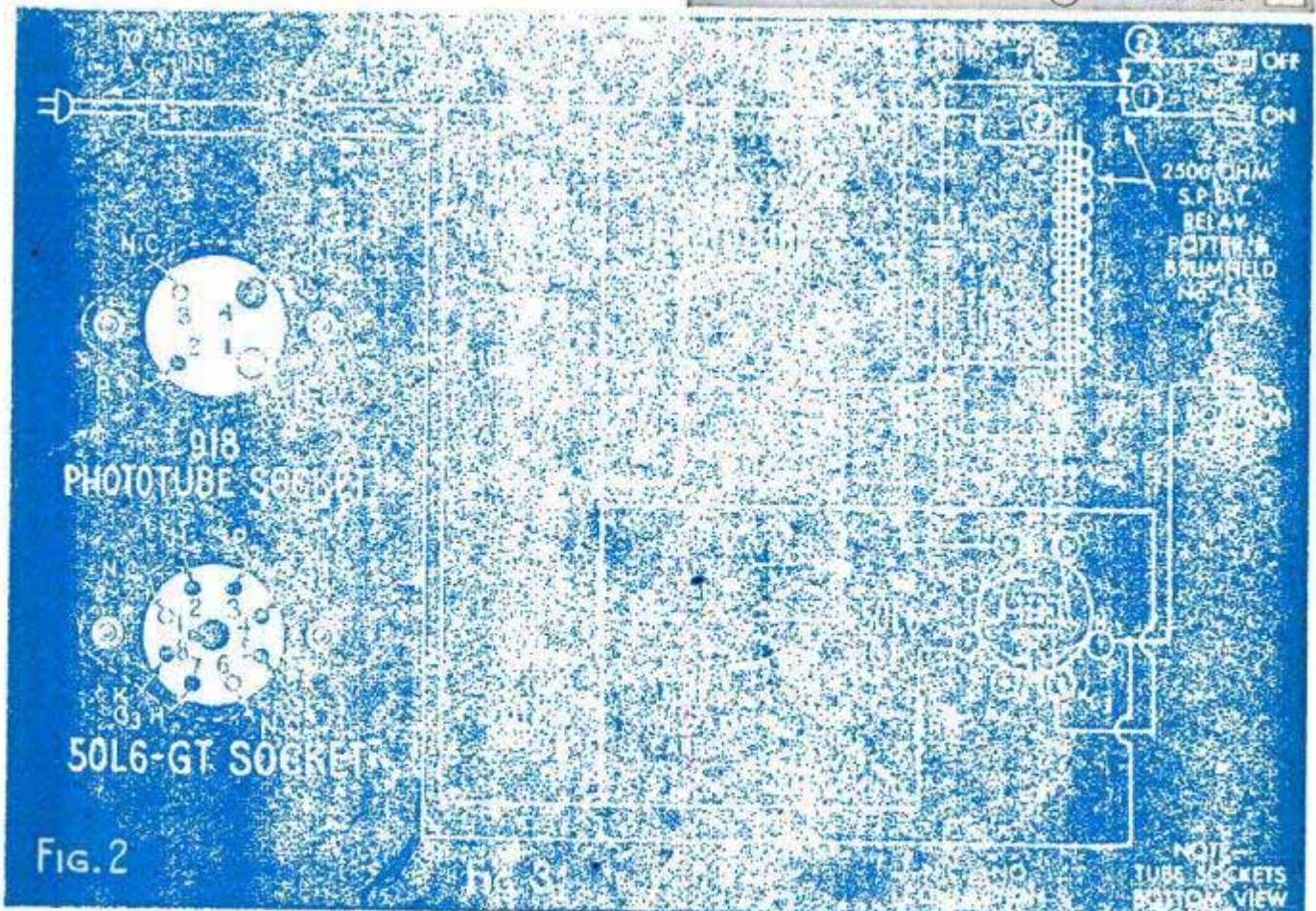
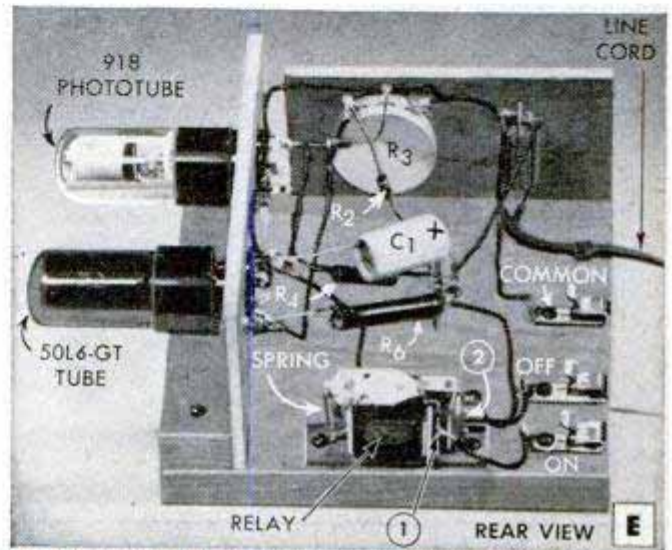
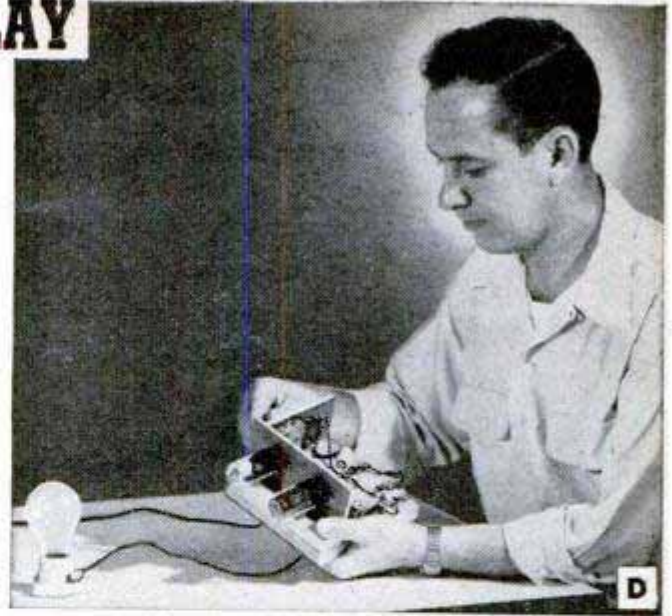

# TELEVISION TODAY



A

**A**—Giant spherical mirror designed for use in a reflecting-type of optical projecting system which allows a small bright picture on the face of a special cathode-ray television picture tube to be greatly magnified and projected to fill a large theater screen. The mirror is 26 inches in diameter and it weighs 90 pounds. Rigid tolerances are met in producing these giant mirrors. Following the grinding and polishing, they receive a special aluminized coating



B

**B**—Indoor TV antenna of unusual design employs no rods or external elements to be adjusted. It is claimed to receive signals on all channels and is finished to harmonize with any type home furnishings. A switch adjusts the device to the channel desired and the antenna is electrically tuned to the station

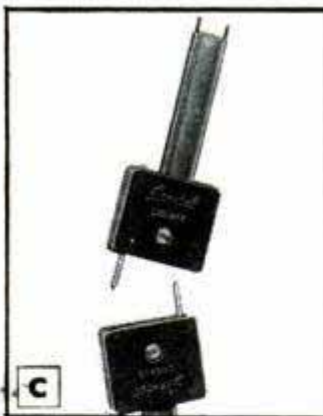

C

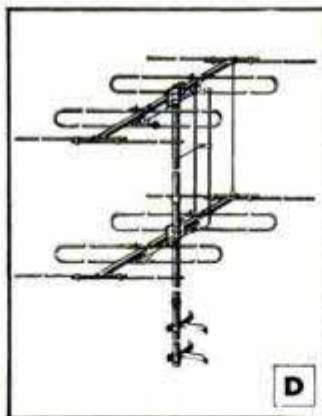

D

**C**—One of the most needed and convenient devices for the TV set owner is this connector for the 300-ohm twin-lead transmission line that connects the TV receiver to the receiving antenna. It provides a speedy means for connecting accessory equipment into a television receiver circuit as different combinations are required by varying conditions. Such accessories as inside and outside antennas, boosters, matching stubs and matching devices can be quickly connected. Added lengths of 300-ohm line can be inserted for standing wave correction. TV sets may be moved to different locations if they are of the small table type since the connectors provide instant antenna connections for an emergency installation

**D**—Twin-driven Yagi-type TV antenna is stagger-tuned for channels 4 and 5. With this new design, it is now claimed that it is possible to achieve the unusual gain heretofore possible on only one channel with this type of high-gain directional antenna. In fringe areas, or where signals are weak, this improved Yagi is claimed to bring in signals and at the same time not require the mast height necessary for comparable signals with other antenna types. The Yagi type of high-gain directional single-band antenna system is well-known to many amateur radio operators all over the world for efficiency

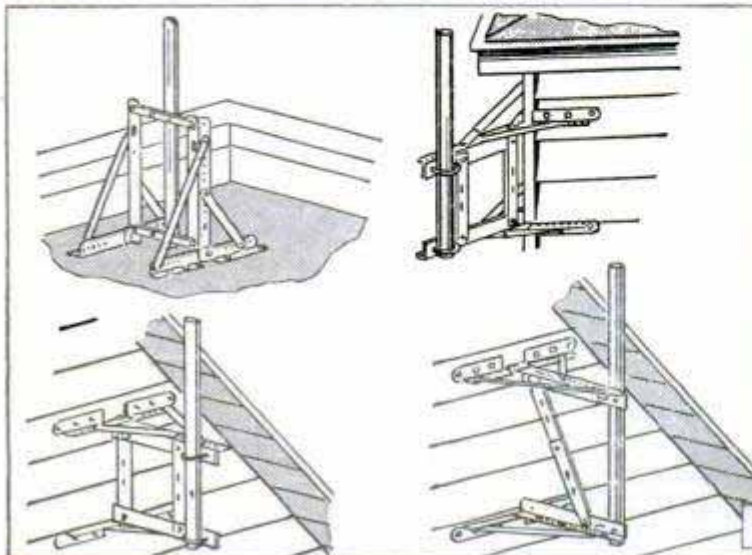

E

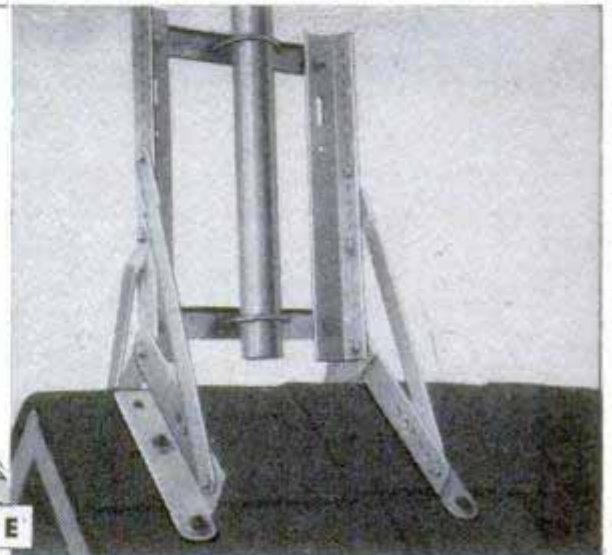

**E**—All-position antenna mount adjusts to any position on a roof, parapet, side wall or corner of a building, as illustrated in the sketches. It is pre-assembled for quick and easy service installations

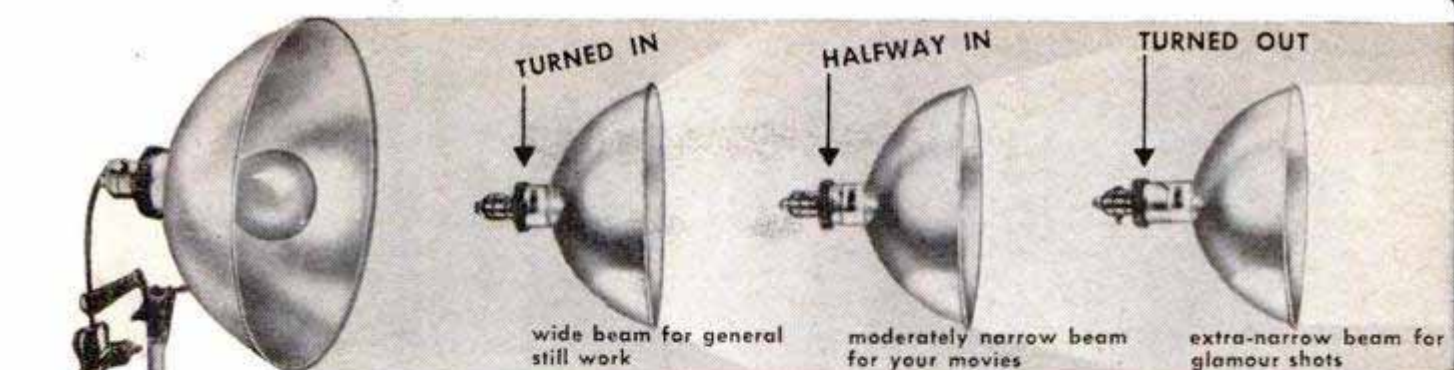

## For "on-the-beam" flood shots **KODAK VARI-BEAM**



**Kodak Vari-Beam Standlight—**  
12-inch reflector with a #2 flood lamp gives powerful illumination . . . convenient handle aims the lamp . . . telescopic column adjusts height from 3 to 5½ ft. . . special rubber rim on heavy base protects furniture. \$15.

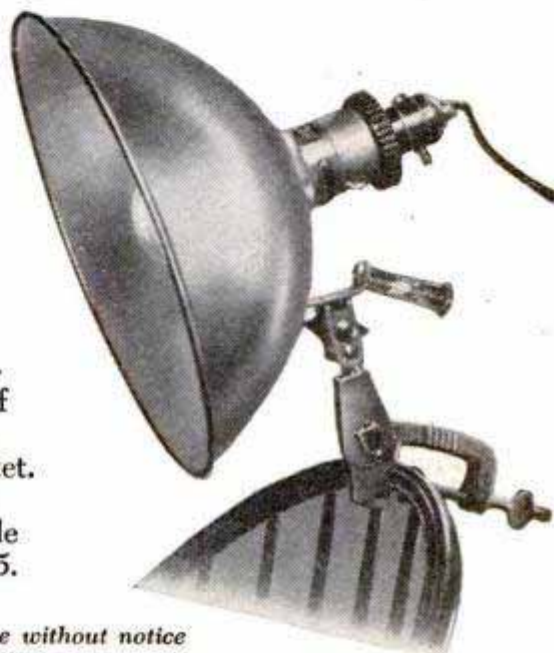

**Kodak Vari-Beam Clamplight—**  
lamp unit has all the features of the Vari-Beam Standlight unit, but is mounted on flexible bracket. Padded clamp attaches quickly and securely to chair backs, table tops, and tubular surfaces. \$9.75.

*Prices on this page are subject to change without notice*

## For sparkling flash shots—**MULTIPLE flash**

**Flash pictures** taken with multi-unit flash illumination have a more pleasing, natural look. You eliminate possibility of burned-out highlights and dense shadows in flash shots this easy way:



**Start with the KODAK FLASHHOLDER** with *Flash-guard* connected to camera—easy to attach. Exposure data on back of reflector. \$11.50.

**Then connect a KODAK FLASHHOLDER EXTENSION UNIT, MODEL B.** Attach to a chair for side lighting. More than one unit can be used. \$12.75.



*List prices include Federal Tax where applicable*

**Your Kodak dealer will be glad to demonstrate this equipment—see him today . . . EASTMAN KODAK COMPANY, ROCHESTER 4, N. Y.**

**Kodak**  
TRADE-MARK

(Continued from page 103)

The most intriguing part of the house is the heating-cooling cove with turned-up edge which extends outward from each sidewall 12 inches below the ceiling. In this aluminum-lined trough are the Freon cooling coils, or pipes, so placed that no part of them extends above the edge of the cove. In the present arrangement, the heating elements are in a smaller cove nearer the ceiling. For experimental purposes and ease of metering, the present heat system is electric. Doctor Mills expects eventually to convert the system to hot water (with a small gas heater), using the same pipes as are now used for cooling. Bathrooms, hallway and kitchen have small direct radiant-heating units.

In severe winter weather or extreme summer heat, window draperies will be pulled over the large glass surfaces. All curtain and wall draperies in the house are woven from nylon and foil yarns so the surface presents at least 90 percent foil exposure for reflective purposes. Venetian blinds made of aluminum are also used for reflection.

In reflective radiant conditioning any type of fuel can be used so long as the heat is introduced in the living space in radiant form and not as hot air. Hot water or steam radiators can be used but should be so placed as to emit heat rays freely toward the reflective wall and ceiling surfaces.

To understand the reflective radiant cooling system, all you do is reverse the heat procedure. Excess heat from your body is reflected to the walls and the ceiling and then to the cold pipes in the cove. The doctor insists that the air temperature in a room can be at 90 or 100 degrees and you will be perfectly comfortable due to your body heat loss to the reflective surfaces. On one 96-degree July day of muggy heat, perfect comfort in the entire house cost only two kilowatts of current per hour—25 cents a day at Cincinnati power rates.

A legion of automatic devices controls the reflective radiant heat input in winter and its removal in summer. A 25-kilowatt industrial-type transformer feeds 240 and 120-volt alternating current to a large panel board in the basement. Part of this current is used directly for hot-water heater, kitchen range, household utilities and lighting. The balance feeds into a transformer through four contactors, each of which is operated by its own air thermostat in the central hall upstairs. These four

(Continued to page 240)



# Care and Feeding of Engines

BY S. P. CORP

## ONE CAUSE OF STARTING TROUBLE

So it gets cold. So you have starting trouble. So you hunt and hunt to find what's wrong. Early in your hunting, it may pay you to check on the heat control valve in the exhaust manifold. This is a little gadget that either diverts hot gases over and around the intake manifold or passes them on through the muffler.

There are two types of these heat control valves, manual and automatic. The manual type has a cam lever with a dial marked "Summer" and "Winter." As of now, the lever should be set at "Winter" and the lock bolt set for that position until next spring. If you have already had a cold snap, and starting trouble, make sure the dial is set correctly. Such a simple matter may solve your starting problem in a jiffy.

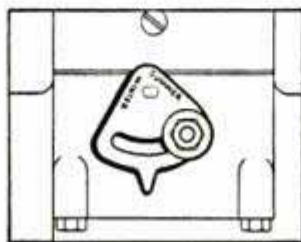

MANUAL VALVE

## AUTOMATIC CONTROL IS TOUGHER

Proper working of the automatic control depends on the thermostatic spring. If there is too little tension, the valve won't open, no heat gets to intake manifold, and you have starting trouble. Check while your

engine is cold. Check the valve shaft to be sure it turns freely. Check the spring to be sure it has enough tension to open the valve.

Why? Because, if the valve doesn't open, your engine is bound to be slow in warming up, with a lot of coughing and spitting. On the other hand, if the valve stays open in warm weather, the trouble can

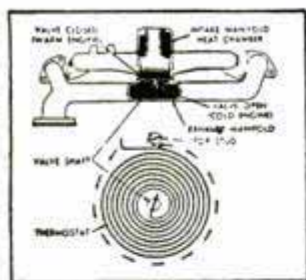

AUTOMATIC CONTROL

be serious. Your car will lack power, and the engine will have a tendency to cut out at high speed because the mixture is too hot and too lean—and your exhaust valves may even become burned!

## RINGS IMPORTANT IN ALL WEATHER

Winter and summer, you need good piston rings. Starting trouble is only a very minor result of rings that don't seal the cylinders properly. For top performance, get the best rings made—Sealed Power Piston Rings. There is a Sealed Power Ring set specifically engineered to do the best possible job in your engine, whatever the make, model, or wear condition. The best oil control ring in the world is the Sealed Power MD-50 Steel Oil Ring, the only ring with the Full-Flow Spring. It helps you save oil, save gas, and restore original engine power, even in badly tapered or out-of-round bores. Ask for the free booklet, "7 Ways to Save Oil." Just address a postal card to Sealed Power, Dept. G-10, Muskegon, Mich.

# LIONEL presents the most sensational advance in model railroading

## MAGNE-TRACTION

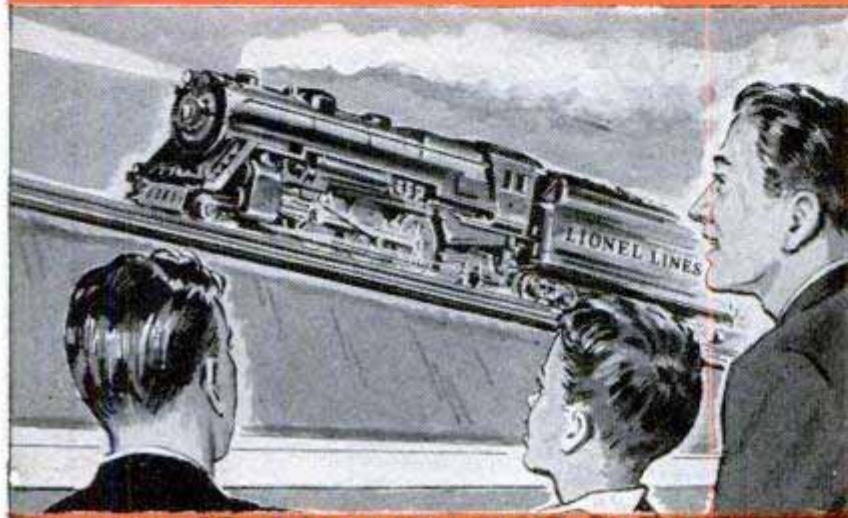

LIONEL LOCOMOTIVES NOW CLIMB 20% GRADES!

MORE SPEED

MORE PULL

MORE CLIMB

MORE CONTROL

ALL and ONLY  
LIONEL TRAINS  
HAVE MAGNE-TRACTION

Grand climax to Lionel's 50-year leadership! MAGNE-TRACTION makes wheels grip rails with permanent, motor-shielded magnetic force. Trains take curves at top speed, climb amazing grades, stop on a dime. It's the practical equivalent of a real locomotive's massive *weight!* And it's in all 1950 Lionel locomotives...exclusively Lionel. See MAGNE-TRACTION work. Free catalog at your dealer's, or send coupon for special offer.

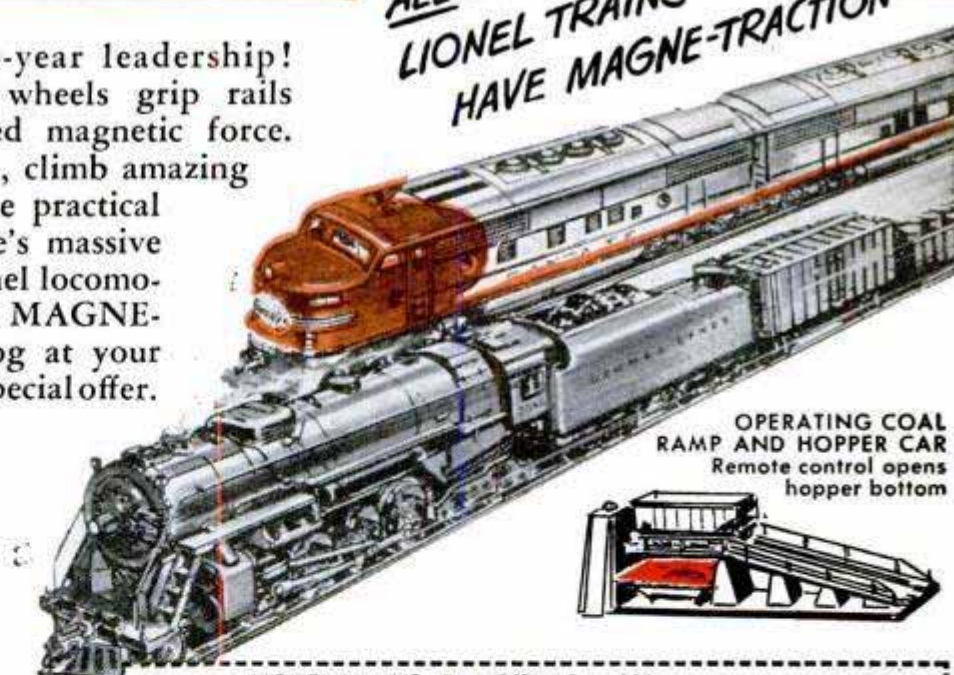

OPERATING COAL RAMP AND HOPPER CAR  
Remote control opens hopper bottom

LIFT BRIDGE  
Raises center span;  
automatic  
or remote control.



OIL DERRICK & PUMP  
Motor-operated beam;  
illuminated oil column.



LIONEL TRAINS, Post Office Box 466  
Madison Square Station, N. Y. 10, N. Y.  
I enclose 25c. Please send me special Lionel Train Catalog offer postage prepaid.

1. The Big New Lionel 44-page full-color catalog.
2. The "Magic of Magne-Traction Book" with new track layouts, scenic effects, landscaping, etc.
3. The Lionel "Portfolio of 19th Century Locomotive Art Prints" —in color—suitable for framing.

**SPECIAL COUPON OFFER**  
**ALL FOR 25¢**

Name \_\_\_\_\_  
Address \_\_\_\_\_  
City \_\_\_\_\_ Zone \_\_\_\_\_ State \_\_\_\_\_

News for model railroaders—a new handbook on Model Railroading published by Bantam Books is now on sale for 25c.



# New Tricks You Can Do

with these **Wizards with Wood**

Do you get a kick out of making things with wood? You'll rave about the dandy new effects you get with these time-tested products. . . .

## A MUST for Finishing Fir Plywood



Tame that wild grain with FIRZITE. It tight-seals the pores . . . virtually prevents grain rise or checking . . . readies the surface satin-smooth for paint, stain or enamel. (For blond, pickled, wiped or tinted effects use White Firzite).

### FIRZITE

## Newer than Shellac or Varnish



Pints, Quarts, Gallons

For "natural wood" finishes on furniture or woodwork, there's nothing like Satinlac. Brings out the natural grain and color beauty of any plywood or solid wood. Avoids that "built-up" look, and will never turn yellow or darken with age. "Water-white", easy to brush or spray, dries ready for next coat in 2 or 3 hours.

### SATINLAC

## Strongest Wood Glue Ever Made



To make things or fix things, use Weldwood Glue for all wood-to-wood bonds. Makes joints stronger than the wood itself. Mixes easily with water. Stain-free, rot-proof . . . highly water-resistant! 15¢, 35¢, 65¢, 95¢ and larger sizes.

### WELDWOOD PLASTIC RESIN GLUE

Ask for Weldwood Glue, Firzite and Satinlac at hardware, paint or lumber dealers.

Send post card for interesting glue and finishing leaflets.

**UNITED STATES PLYWOOD CORPORATION**  
Dept. 119, 55 West 44th St., New York 18, N.Y.

## Clinic



## for Homemakers

As a service to our readers in solving the hundreds of problems pertaining to a home—inside or out—the editors of *Popular Mechanics* invite you to present your problems to The Clinic Editor for help and advice. Address your questions to The Clinic Editor, *Popular Mechanics Magazine*, 200 East Ontario Street, Chicago 11, Ill.

### Painting Gutters



**Q**—Recently I had new galvanized gutters and downspouts installed. I painted them immediately for added protection, but only lately the paint has peeled badly, more especially at the gutter joints and on the downspouts. What causes this and can anything be done to prevent it?

W.M., Superior, Wis.

**A**—Many tinsmiths recommend that galvanized gutters and downspouts be allowed to "weather" for a period of from two to six months before painting, as certain residues from the galvanizing process, as well as soldering salts at the joints, affect the bonding properties of paint. You did not say whether you used a metal primer, but a common procedure is to allow two to six months for the parts to weather, then apply a metal primer and follow with outside paint in the desired color. Some primers used by builders are said to contain ingredients which tend to neutralize the lifting action of the acids remaining from the galvanizing and soldering processes. However, we believe that where the owner does the painting himself it is advisable to wait the specified time before applying primer or paint. In your own case, where the paint has already been applied, there is little you can do except to scrape off all loose paint and apply a fresh coat in the color desired. You probably will have no further trouble, provided, of course, the old paint remaining after scraping is bonded solidly to the metal.

### Waxing New Furniture

**Q**—I have new living room and bedroom furniture in a blond finish. I would like to wax this furniture to preserve the finish, but I have been told this is not advisable. Why?

D. W., Sacramento, Calif.

**A**—We know of no reason why you should not wax your new blond-finished furniture if you prefer, except perhaps that in normal use the surfaces will require rewaxing and polishing periodically and this requires considerable labor and time to produce a first-class job with non-liquid wax. We would not advise the application of self-polishing wax on finely finished furniture, not because these waxes will cause harm, but because of the difficulty of obtaining a uniform coating by ordinary

(Continued to page 238)

# Whiz-Master

## 10-inch BAND SAW

**Sensational, New, LOW Priced Saw does anything that any other band saw on the market will do**

One of the most versatile saws ever produced. For cross-cutting, ripping or on complicated curves and circular cuts, it performs with remarkable efficiency. Table tilts to 45° and has miter gauge slot. All mechanism fully enclosed but readily accessible. Adjustable blade guard allows cuts up to 3¾" thick. Top wheel adjustable for tension and tilt. Rip Fence and Miter Gauge furnished at small additional cost.

All parts except blade and mechanical units are made of wood . . . birch plywood and hardwood, guaranteed against warping.

### No. 10 Whiz-Master Band Saw SPECIFICATIONS

Capacity in Depth, 9" . . . Capacity in Height, 3¾" . . . Saw Blade Length, 60" . . . Table Size, 10" x 10" . . . Blade Size, 3/16" . . . Bearings, Chrysler Oilite . . . Height of Saw, 25½" . . . Length of Saw, 17½" . . . Width of Saw, 10" . . . Recommended Motor, 1750 RPM, ½ HP . . . Recommended Pulley on Motor 2½" . . . Table Tilt 45°.



*The ideal, efficient, economical saws for the home shop or any shop*

**MONEY BACK GUARANTEE if not satisfied**

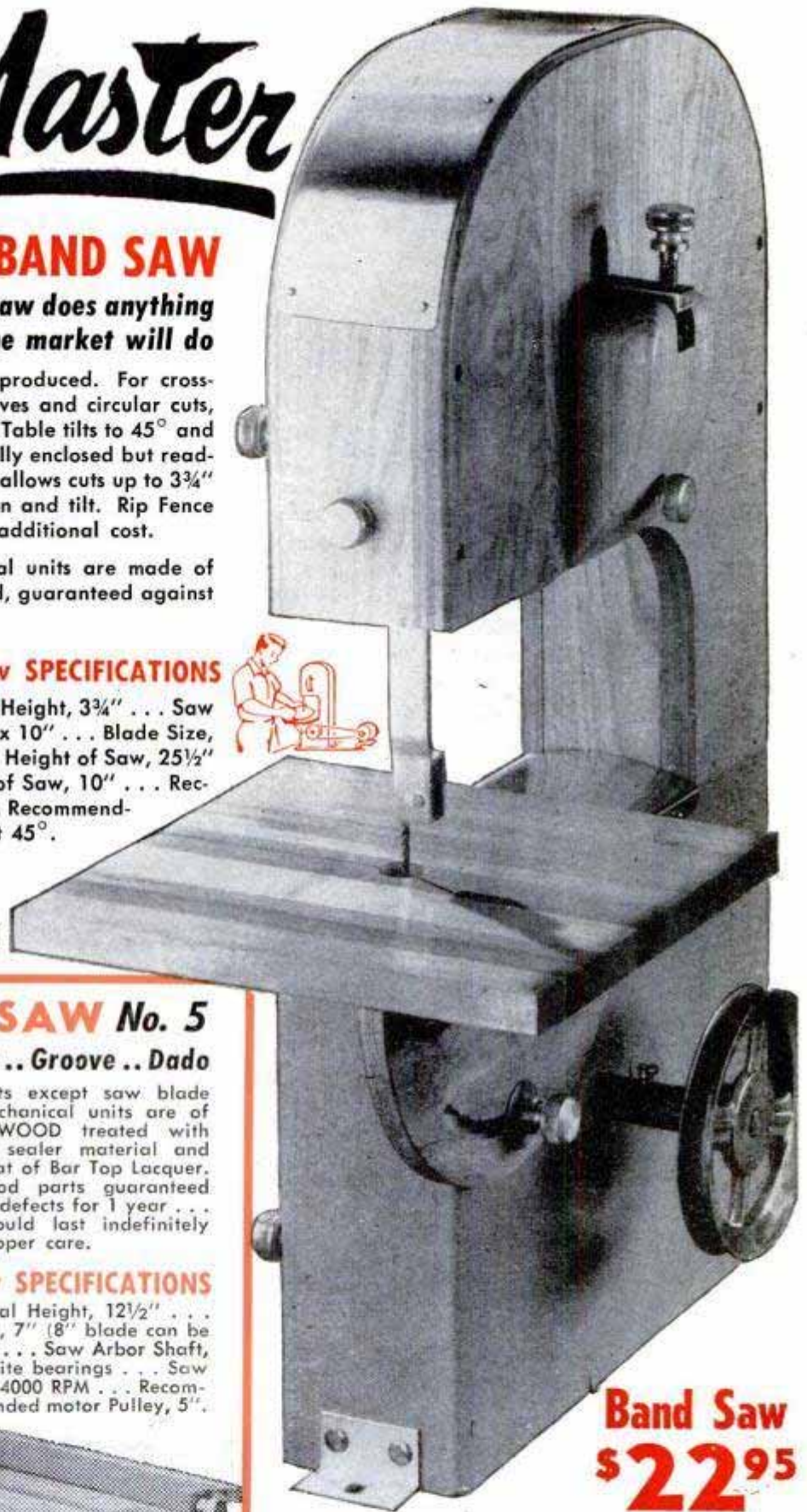

**Band Saw  
\$22.95**

Shipping Weight 24 lbs.

Parcel Post Prepaid

Extra Band Saw blades, each . . . . . **\$1.25**  
Miter Gauge calibrated to 45° each way . . . . . **1.50**  
Band Saw Rip Fence, complete . . . . . **1.75**  
Quick Change Mounting Board with motor bracket bolts and nuts for either Whizmaster Band Saw or Table Saw. Board 7x2x¾" . . . . . **\$2.50**

## Whiz-Master TABLE SAW No. 5

**For Cross Cut .. Ripping .. Miter .. Groove .. Dado**

Performance matches that of saws costing several times this price. The ideal table saw for the home shop. Fence extends full length of table. . . Saw can be used on either side of blade. . . Miter gauge graduated for 15° - 30° - 45° cutting.

All parts except saw blade and mechanical units are of HARD WOOD treated with specific sealer material and final coat of Bar Top Lacquer. All wood parts guaranteed against defects for 1 year . . . and should last indefinitely with proper care.

### No. 5 Whiz-Master Table Saw SPECIFICATIONS

Table Size, 18x20" . . . Total Height, 12½" . . . Size of Saw Blade Furnished, 7" (8" blade can be used) . . . Depth of cut 1¾" . . . Saw Arbor Shaft, ½" . . . Oil-Lite bearings . . . Saw Speed, 4000 RPM . . . Recommended motor Pulley, 5".



**Table Saw**

**\$16.95** Parcel Post Prepaid

7" Combination Saw Blade \$2.75

Shipping Weight 20 lbs.

Telephone Victor 5592

**W. R. VERMILLION CO.**

2201 Grand Ave. Kansas City, Mo.

# Give your son a gun he'll be proud of

No other name in firearms says "quality . . . dependability . . . craftsmanship" so surely as Winchester. This single-shot, bolt action Winchester Model 67 is a truly fine 22, designed as a beginner's rifle . . . yet its high accuracy has won the admiration of experts.

The Model 67 shoots 22 Short, Long, and Long Rifle cartridges interchangeably. It is a light, finely-balanced rifle with a full man-sized stock and sporting type forearm of genuine American walnut. Extra safe . . . the Model 67 does not cock upon opening or closing the bolt; it must be cocked manually. See it at your dealer's.



**FREE!** Folder giving full details of all Winchester 22 caliber sporting and target rifles. Address: Dept. 342-D, Winchester Repeating Arms Co., Division of Olin Industries, Inc., New Haven 4, Conn.



The World Famous Model 67  
**WINCHESTER**  
TRADE-MARK  
SPORTING RIFLE

(Continued from page 236)

means of application. We believe you would find it more satisfactory to use an ordinary furniture polish to brighten up the finish when the luster becomes dulled by finger marks and dust. Make it a rule to use only a high-grade polish and be sure to follow the manufacturer's directions in every detail. You can then be assured of consistently good results. Many manufacturers of high-grade furniture make specific recommendations for the care of the finish. It's a good idea to follow these instructions.

## Roof Leaks

*Q—My home is over-roofed with composition shingles which are now about 15 years old. I've noticed lately, during hard rainstorms, that the roof leaks in several places. The roof is quite flat and the leaks seem to be mostly in the lower half of the roof above the eaves. How does one locate these leaks so that they may be repaired?  
I.D., Jacksonville, Fla.*



*A—If you go into the attic during a hard rainstorm, it will be easy to locate and mark the spots where the water drips from the rafters or roof boards. When marking, use colored chalk or a lumber crayon so that the marks are readily seen. Then, later on when weather permits, drive nails through the roof from inside the attic at the points marked. Use nails long enough to pass clear through the boards and shingles so the nail points will be visible from the top side of the roof. The projecting nail points will enable you to spot the location of the leaks and repair the roof at these points. One thing to keep in mind when locating the leaks in the attic: It often happens that water from a leak will run for some distance down a rafter before it finally drips onto the attic floor. If you discover water dripping from a rafter examine the area carefully to determine just where the water is coming through the roof boards. The actual leak may be some distance above the point where the water drips from the rafter.*

## Moths in Piano

*Q—We have an old piano of rather ornate design and on opening it recently for cleaning we found that moths had damaged a lot of the felt facings on the parts which strike the notes. How does one go about repairing this damage? Is there a moth proof felt available? Will moth balls prevent damage after repair?  
D.T., Bay City, Mich.*

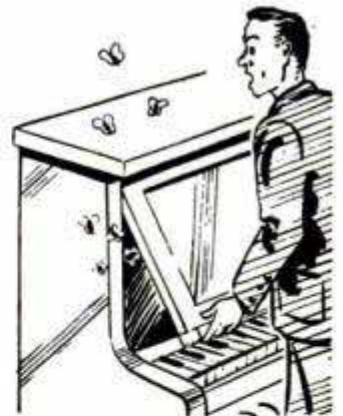

*A—You probably mean that the felt linings on such parts of the action as the checks, backstops, damper blocks and perhaps the hammer heads and rails have been damaged by moths to such an extent that the hammer action has been affected. While you probably could tackle this type of repair job yourself with a fairly good chance of success, we believe that where one is inexperienced in this particular work it would be more satisfactory to call in a local piano tuner. After an examination of the damage to the action of the instrument, he will know what to do. Preventing moth damage in older pianos is not so much a matter of keeping the moths out of the instrument as getting rid of them entirely by using approved methods. While moth balls placed in a suitable container located inside the piano case might be effective in preventing a new moth infestation, it is likely that the odor would be objectionable. There are other types of repellents in use which are more satisfactory.*



# "They showed me,"

says Mike  
(FROM MISSOURI)

## "How to give my faithful Ford a new future!"

WHEN I VISITED ONE OF THE FORD-AUTHORIZED RECONDITIONING PLANTS

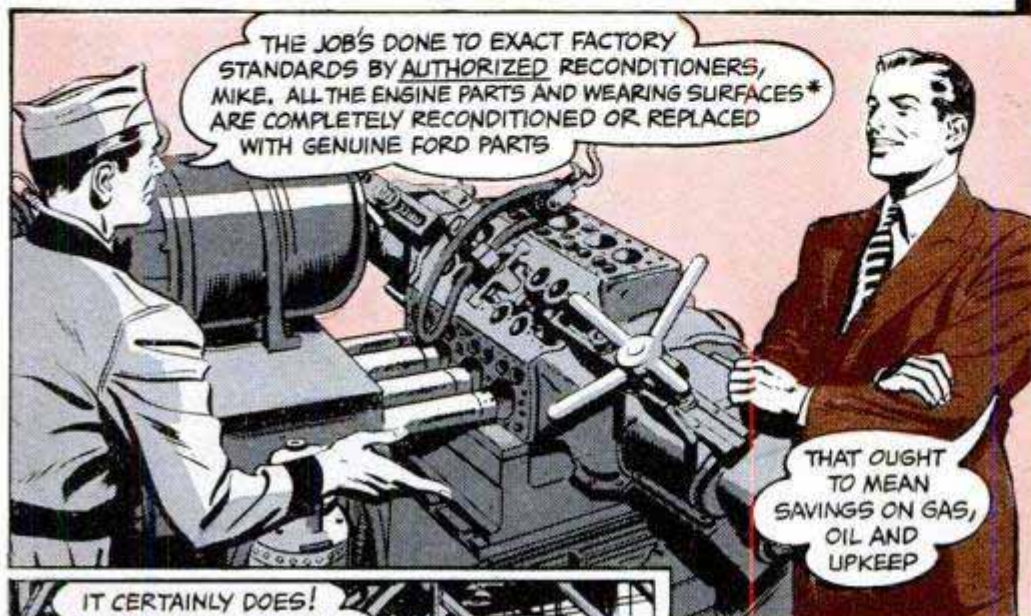

\*CRANKSHAFTS, CAMSHAFT, BUSHINGS, VALVE GUIDES, TIMING GEARS, PISTONS, RINGS, BEARINGS, RODS, VALVES, GASKETS, STUDS, NUTS

— ALL COMPLETELY RECONDITIONED OR REPLACED WITH THE PARTS THAT ARE MADE RIGHT, FIT RIGHT, LAST LONGER....

**GENUINE FORD PARTS**

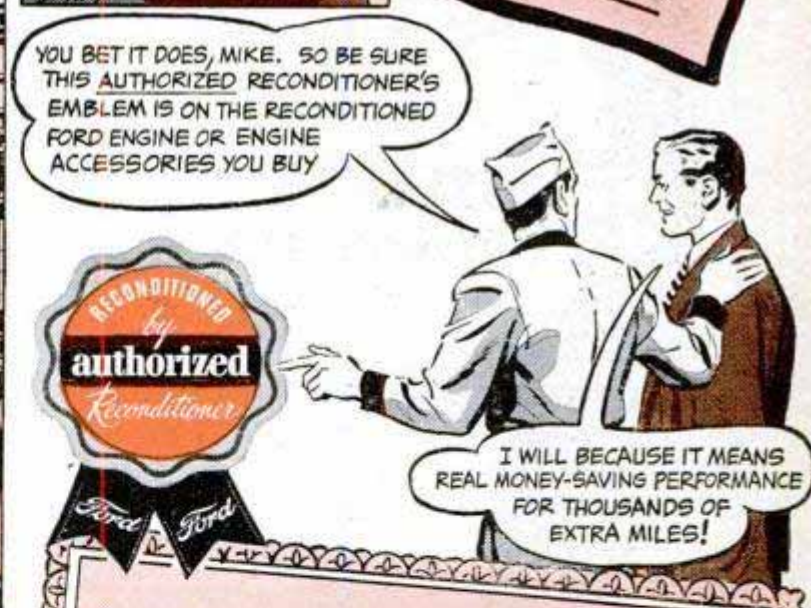

**AUTHORIZED RECONDITIONED FORD ENGINES AND ENGINE ACCESSORIES**

GIVE "LIKE NEW" PEP AND POWER....  
SAVE ON GAS, OIL AND REPAIRS

**RECONDITIONER'S GUARANTEE**

90 DAYS OR 4,000 MILES

Costs only a few dollars per week

No. 1950

\$4<sup>50</sup>\*  
10-INCH  
SWEEP

Outstanding  
**NEW  
VALUE!**

High on looks . . . low in price — you'll like this new Millers Falls Ratchet Brace with head and handle of glossy red unbreakable "TENITE"

It's the new No. 1950 — latest addition to Millers Falls famous line of fine braces. Jaws of forged steel and rugged ratchet mechanism assure long service. Ball bearing head gives smooth, easy operation. Heavy nickel finish keeps it shining. Best of all — it's Millers Falls quality throughout and priced at only \$4.50.\* See it soon at your hardware dealer's. In looks, in performance, in price — it's the biggest bit brace value on the market.

\*Price slightly higher in the West

**MILLERS FALLS  
TOOLS**

SINCE  
1868

MILLERS FALLS  
COMPANY

GREENFIELD  
MASS.

thermostats are set to cover air-temperature ranges from 50 to 68 degrees. At the lowest air temperature, full heating power is available to the heating elements in any room whenever the wall switch in that room is in the "on" position. As the air temperature rises, the amount of heating power is reduced.

A fifth thermostat cuts the current to the Freon compressor on and off. This makes hot-weather cooling available to any room whenever the wall switch in that room is turned on. The thermostat is set for 78 degrees Fahrenheit.

Among the advantages of reflective radiant conditioning, Doctor Mills points out, is the fact that it can be applied to old houses without expensive insulation or sealing of windows. He warns, however, that the system must include cooling facilities. Foil coverings on walls, ceilings and floors make any room uncomfortably warm in summer weather without a cooling unit. He believes the system is also applicable to factories, office buildings, hotels, theaters, airplanes, Army tanks, or military barracks in arctic or tropical regions.

"The possibilities are tremendous," says the doctor, "because the system frees man from his age-old dependence on air temperature for the comfort of his body."

Anyway, reflective radiant conditioning is just what the doctor (Mills) ordered.

## Funnels for a City's Freight

(Continued from page 145)

plan, the New Jersey terminal is even larger than the Manhattan building, and is expected to receive, sort and deliver some 2500 tons of freight each day when it achieves full operation.

Whereas these terminals are built for the unbelievably fast handling of freight, the bus terminal up in the center of Manhattan is designed for just as efficient traffic in human beings. Located smack in the center of the world's busiest business district, connected by direct ramp to Lincoln tunnel, the bus terminal will be a great new landmark only a block from Times Square. About 130,000 passenger movements will be funneled through the \$24,000,000 structure each day. Virtually all of the 2500 busses which roll into the city each 24-hour period will wind up in the new terminal instead of the present terminals spotted around the island. In a peak period they'll roll in at the rate of 750 each hour and depart just as frequently.

The four-level building, which will be completed this fall, will blanket an entire

(Continued to page 244)

# New World's Speed Record

160.323 M. P. H.

set with Dependable

## CHAMPION

### Spark Plugs

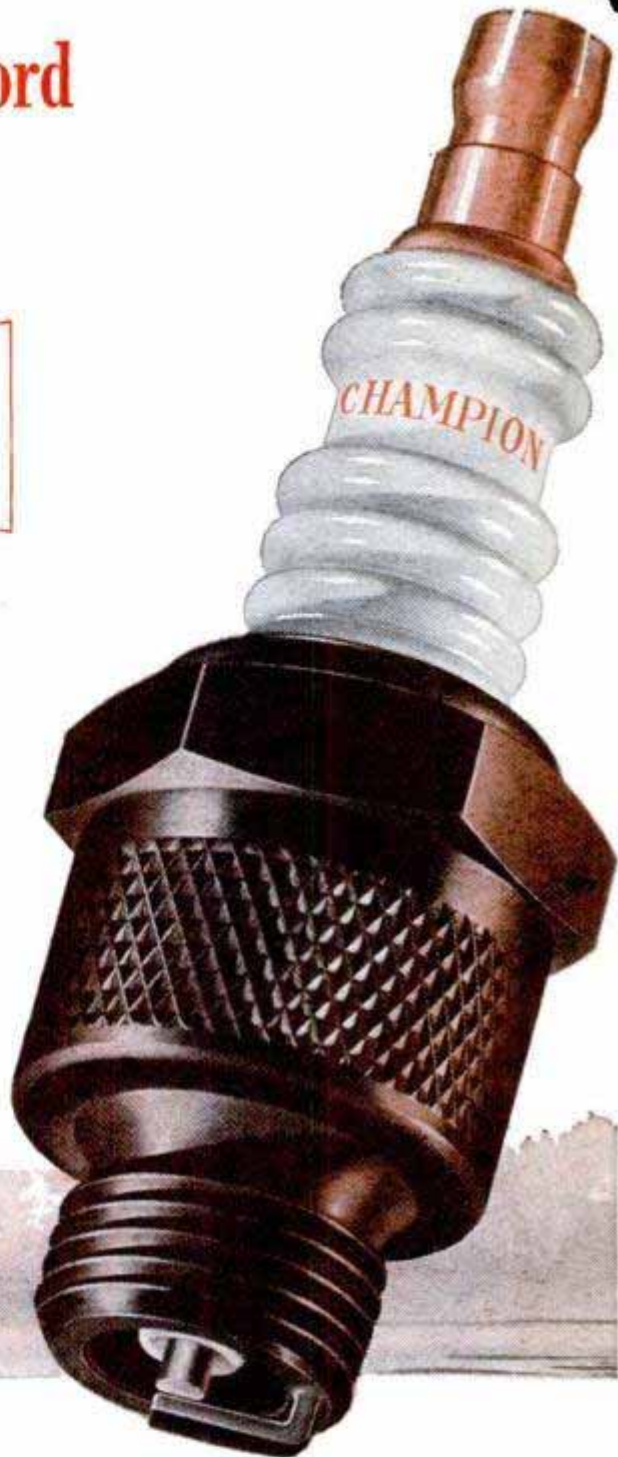

#### FLASH:

Detroit, Mich. July 22. Slo-Mo-Shun IV Also Wins 1950 Gold Cup Race in Record Time!

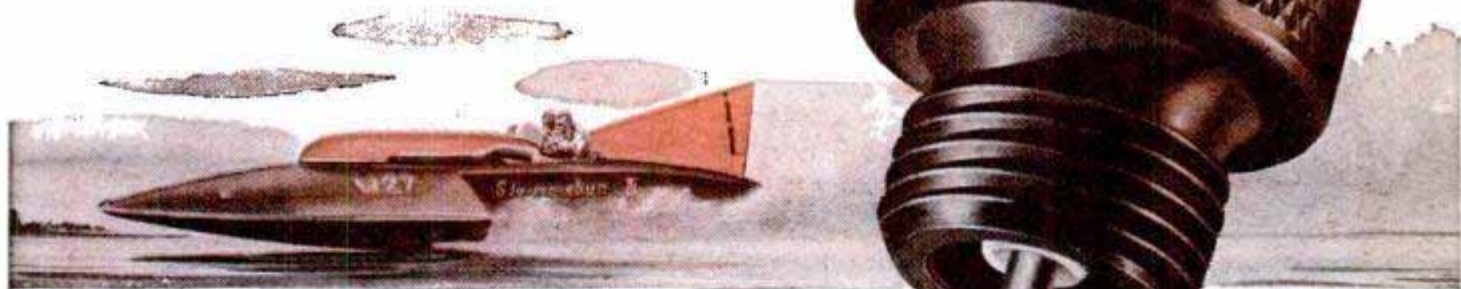

**BE A CHAMPION DRIVER...** Get this extra performance for Your engine!



Here is the news that electrified the speedboat world recently. The new record broke the old mark, which has stood since 1939, by over 18 miles per hour.



Mr. S. S. Sayres, owner and driver of Slo-Mo-Shun IV, is a qualified expert on engine performance, and his choice of dependable Champion Spark Plugs for his world's record speed run speaks for itself.



Follow the experts, who in overwhelming majority choose Champion Spark Plugs for their outstanding performance and dependability. That's what has made Champion America's Favorite for over a quarter century.

CHAMPION SPARK PLUG COMPANY, TOLEDO 1, OHIO

Listen to the CHAMPION ROLL CALL . . . Harry Wismer's fast sportscast every Friday night, over the ABC network



# America's most complete line Big! Accurate! Priced to give

Here's why Sears quality power tools are a "better buy"! They're deliberately designed with the plus-performance and features professional craftsmen want. Precision-built by the most expert, efficient manufacturing methods known. Laboratory-tested... and **GUARANTEED** for your complete satisfaction, or your money back! Big, in size and capacity! Accurate for faster, better work! Rugged, to serve you longer under hard use! Handsome, streamlined beauties that you'll be proud of!

**CRAFTSMAN 8-inch  
Electric Hand Saw**



**\$100<sup>00</sup>\***  
Cash  
Without case  
\$10 Down

**CRAFTSMAN 1/2-H.P. 1750 R.P.M.  
Ball Bearing  
Capacitor Motor**



**\$2295\***  
Cash  
1/2-H.P.  
\$2.50 Down

**DUNLAP 1/4-inch  
ELECTRIC DRILL**



**\$1395\***  
Cash

**CRAFTSMAN  
3-Drum  
Belt Sander**



**\$5895\***  
Cash  
Without case  
\$6 Down

**DUNLAP 1/2-inch  
Electric Drill**



**\$2995\***  
Cash  
\$3 Down



**CRAFTSMAN  
Wood Shaper**

**\$4795\*** Without motor  
Cash \$5 Down



**CRAFTSMAN Disc Sander-Polisher**

**\$3695\*** Without case  
Cash \$4 Down



**CRAFTSMAN Rotary Tool Outfit**

Complete 54-piece set  
**\$2895\***  
Cash  
\$3 Down

**CRAFTSMAN Sander-Polisher**



**\$1095\***  
Cash  
Complete

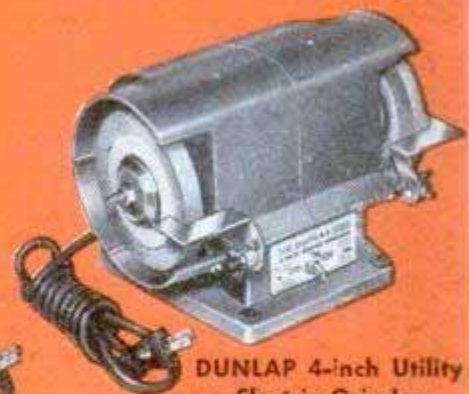

**DUNLAP 4-inch Utility  
Electric Grinder**

**\$1495\***  
Cash

\*Prices slightly higher south of the Ohio and west of the Mississippi rivers

**CRAFTSMAN** and **DUNLAP** Tools by **SEARS, ROEBUCK and CO.**  
REG. U.S. PAT. OFF.

# of fine quality Power Tools! you more for your money!

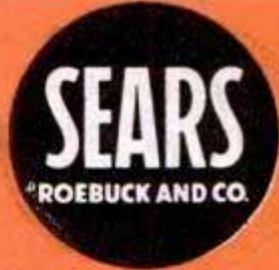

Sears famous power tools are the finest that can be made for the money . . . at the lowest possible price to you! And Sears complete range of tool-types and sizes is an extra convenience. See these sensational extra-value tools at your nearest Sears Retail Store TODAY! Note how completely equipped each is (not always true of others). Compare them feature for feature with ANY others! Prove to yourself Sears tools are a "better buy"!

**CRAFTSMAN 8-inch  
Tilting-Arbor Bench Saw**



**\$54.50\*** Without motor  
Cash \$5.50 Down

**CRAFTSMAN Ball Bearing  
Drill Press**



**\$64.95\*** Cash  
Without motor  
\$6.50 Down



**CRAFTSMAN  
3-wheel Band Saw**

**\$46.95\*** Cash  
Without motor  
\$5 Down



**CRAFTSMAN  
18-inch Jig Saw**

**\$29.95\*** Cash  
Without motor  
\$3 Down

**CRAFTSMAN  
Metal Turning Lathe**

**\$43.50\*** Cash  
Without motor  
\$4.50 Down



**CRAFTSMAN Ball Bearing Wood Turning Lathe**

**\$39.95\*** Cash  
Without motor  
\$4 Down

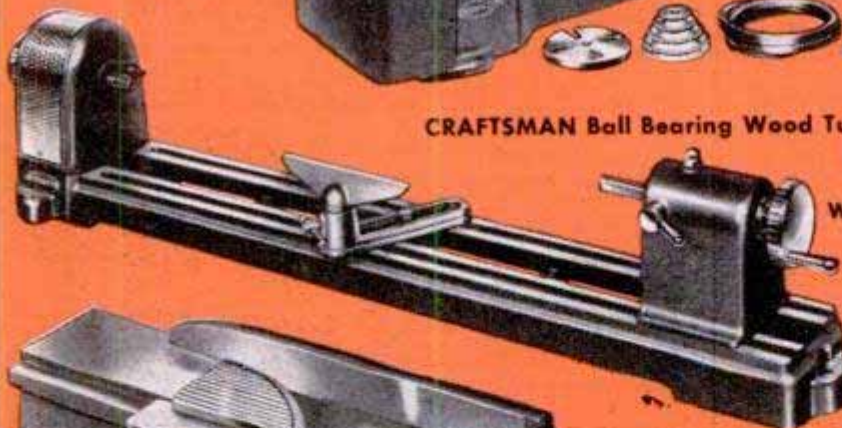

**CRAFTSMAN 4 1/2-inch  
Jointer-Planer**

**\$44.95\*** Cash  
Without motor  
\$4.50 Down

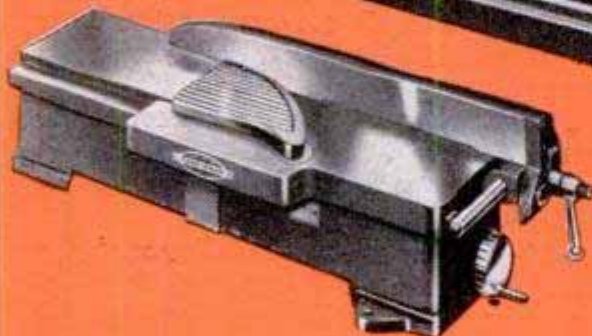

**Free!**

SEARS new 1951 Power Tool Catalog free! Get yours NOW, at the Hardware Dept. of your nearest SEARS Retail Store!

Sears Easy Terms make it easier to own the tools you need NOW . . . pay while you enjoy using them!

**Famous for fine quality . . . precision performance . . . low price!**

# Make Big Money!



## Be Your OWN BOSS In Building Field



**NO SCHOOLING!**

**STEADY WORK!**

**BIG MONEY!**



Stake your claim now to a money-making future—get started in a good, respectable, solid business of your own as a floor surfacing contractor!

This is not difficult—no schooling—no experience needed. Sanders are easy to operate—and you can start making money the first day your machines arrive! Earnings of \$25 and more a day are not uncommon! Hundreds of prospects everywhere in your community—new and old homes. Original investment small—no large overhead—you need no elaborate offices, workshop, storeroom or heavy trucking equipment. Many men operate from their own homes and use regular passenger car to transport equipment from job to job. Pleasant indoor work—steady year 'round—a real opportunity to **MAKE MONEY** and be your own boss! Send for "money-making" booklet entitled "Opportunities in Floor Surfacing"—use coupon and enclose 25c in coin or stamps to cover handling.



# AMERICAN

**FLOOR MACHINES  
PORTABLE TOOLS**

**SEND COUPON  
TODAY**

The American Floor Surfacing Machine Co., 535 So. St. Clair St., Toledo, Ohio  
Enclosed find 25c in stamps or coin for booklet "Opportunities in Floor Surfacing", telling me how I can start sanding business.

my own floor sanding business.

Name \_\_\_\_\_

Street \_\_\_\_\_

City \_\_\_\_\_

State \_\_\_\_\_

city block. Two of the floors actually will be constructed on a slant, making the building itself a huge ramp for the busses. Long-distance busses will roll into the bottom floor, which tilts downward to make more overhead room for the vehicles. Passengers will step off the busses and take one of the terminal's 30 broad escalators up to the second floor, where they will find waiting rooms, shops from a beauty parlor to a hardware store and the main concourse. Suburban busses, on the other hand, will roll up an outside ramp, radiant-heated to melt snow as soon as it falls, and into the top floor of the terminal. Passengers will move down the automatic stairs to the suburban concourse on the third floor. The vast building will be a boon to motorists, too; there will be parking spaces for 450 private autos on the roof.

Every five seconds a huge bus will roll into the completed terminal. The driver will glance above the doorway where an indicator will tell him which dock his bus is to occupy.

Not only will the passengers have the facilities of a brand-new building, the biggest bus terminal in the world, but they will save from 6 to 20 minutes of travel time on each trip.

Transporting freight and human beings into a big city is only half the problem today. Shipments, whether inside crates or walking on two legs, must be unloaded swiftly and dispatched immediately to make room for the inexorable stream of similar shipments on the way to the city. Other cities now are looking to the New York terminals as one solution to this perplexing problem of mass movement.

## It's 530 Degrees Cooler Inside

*(Continued from page 85)*

puddle. The rest recirculate, cooling the coils on their return, and are run through the system again in a never-ending cycle of faster and faster frigidity.

Out in the liquefier room, attendants busily set their big, long-necked, insulated containers on tiny hydraulic floor elevators which lift them until the long needlelike liquid-gas spouts are sunk deep in the necks. The strange fluids dribble into their storage tanks.

These metal cans are not good enough for liquid helium, though. To protect this liquid, laboratories use a device invented by Sir James Dewar, the man who first liquefied hydrogen. Besides keeping helium cold, Dewar flasks keep coffee hot. The Thermos bottle you take on picnics is the same thing

*(Continued to page 248)*

Tomorrow's battery is here TODAY—

# it's the GREAT NEW EXIDE!

A NEW HIGH IN STARTING POWER  
LONGER LIFE THAN EVER BEFORE  
MORE BATTERY FOR YOUR MONEY

Outstanding improvements! Amazing performance! This is the result of ceaseless development by the largest research-engineering staff in the battery industry, plus 62 years of battery-making experience.

Ask your service station about the new Exide. And remember—you can depend on the Exide Dealer for good products, good service.

THE ELECTRIC STORAGE BATTERY COMPANY  
Philadelphia 32

*Exide Batteries of Canada, Limited, Toronto*

*"Exide" Reg. Trade-mark U.S. Pat. Off.*



WHEN IT'S AN  
Exide  
YOU START

## Exide has EVERYTHING

# SHOPSMITH OUTPERFORMS SAWS, SANDERS, LATHES, DRILL PRESSES COSTING \$500<sup>00</sup>

It's a performance-proved fact! With SHOPSMITH you can do more jobs, actually do better work, than with any \$500 combination of single-purpose tools with motors. And here's why:

**SHOPSMITH IS VERSATILE!** It converts into five big, heavy-duty power tools. Takes all standard accessories. Can do 116 wood, plastic and metal working operations.

**SHOPSMITH IS EASY TO OPERATE!** Even without practice you can change it from tool to tool in less than sixty seconds.

**SHOPSMITH TAKES BIG WORK!** Its effective table width is so great you can saw to center of 8-foot plywood panels, sand and drill room-length pieces—with no interference from other tools. Lathe turns work bigger than a nail keg.

**SHOPSMITH IS PRECISION-BUILT!** It combines features found only in the finest tools. Grease-sealed ball-bearing action. Induction hardened spindle tip. Centerless ground steel ways. A score of precision features that assure hairline accuracy, lifetime service.

**SEE SHOPSMITH DEMONSTRATED!** At any Montgomery Ward, leading hardware or department store. And write for free 16-page, fact-packed illustrated booklet.



## \$169.50

complete except for motor. With special, 1/2-hp., capacitor type motor (shown). \$199.50

**CONVENIENT TERMS**

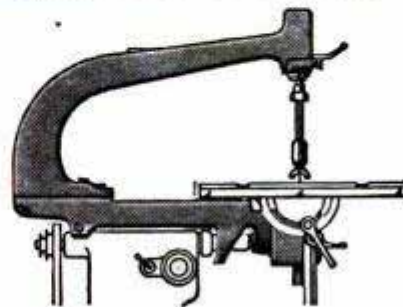

## JIGSAW FOR SHOPSMITH

*The finest precision jigsaw you could own*

Rugged construction. 18" throat. Large tilting table. Built-in blower. Attaches quickly with one bolt. Can be used also for saber sawing, machine filing. Complete attachment, \$34.50



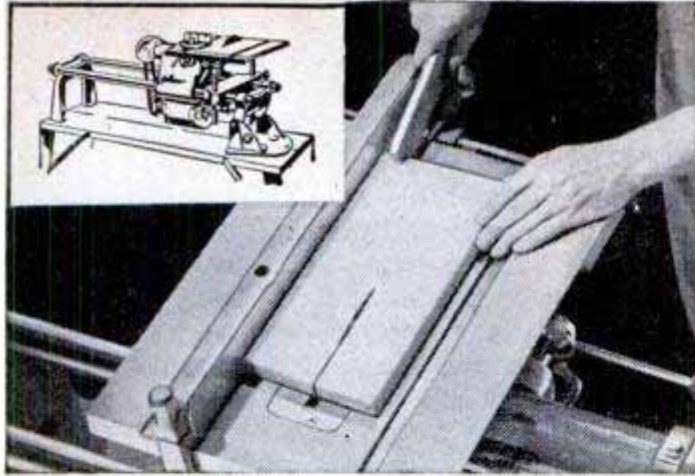

**1 8-inch Circular Saw.** You'd pay \$120 for a saw of equal quality, equal capacity. Effective table width, fence to blade, up to 48". Depth of cut 2 1/4". Sturdy tilting table with ball-crank raiser. Precision-tooled miter gauge with automatic stops. Self-aligning rip-fence.

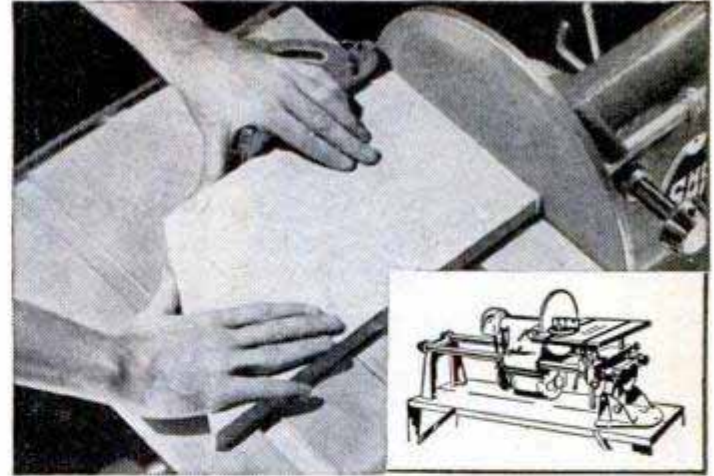

**2 12-inch Disc Sander.** No other disc sander can match it. None has 12" precision balanced disc, 14 1/2" x 17" tilting table, both miter gauge and fence. And with SHOPSMITH you can feed disc into workpiece with feed lever for greater accuracy, speed and safety.

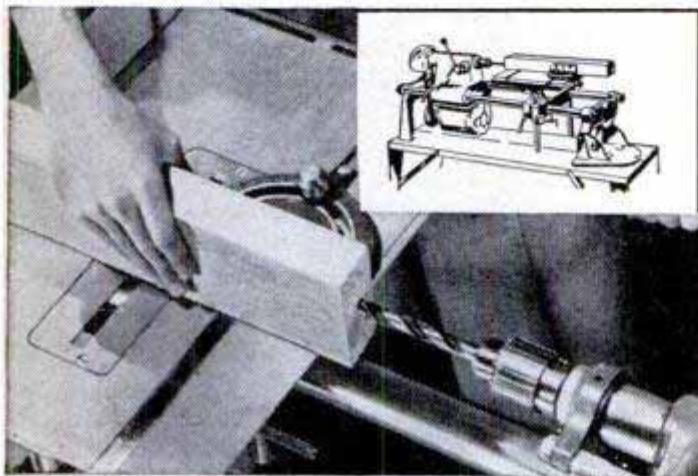

**3 Horizontal Drill Press.** Ever try to drill the end of a table leg? Dowel stock for table tops? Mortise doors for locks? You can do it quickly and easily with SHOPSMITH. Work lies flat on table, no special jigs needed. Speeds from 875 to 3500 rpm. 4" quill feed.

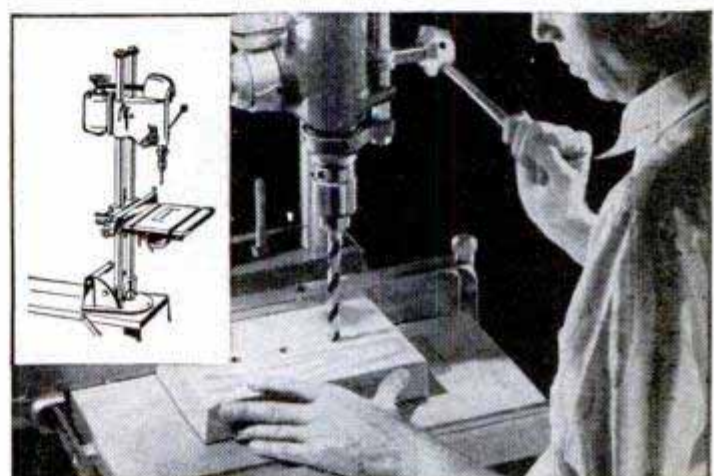

**4 Vertical Drill Press.** In vertical position, SHOPSMITH is both a bench and floor-type drill press. Drills to center of 15" circle. Has 4" spindle feed with right or left hand feed lever. Jacobs key chuck takes drills from 5/64" to 1/2" in diameter. Extra-large table.

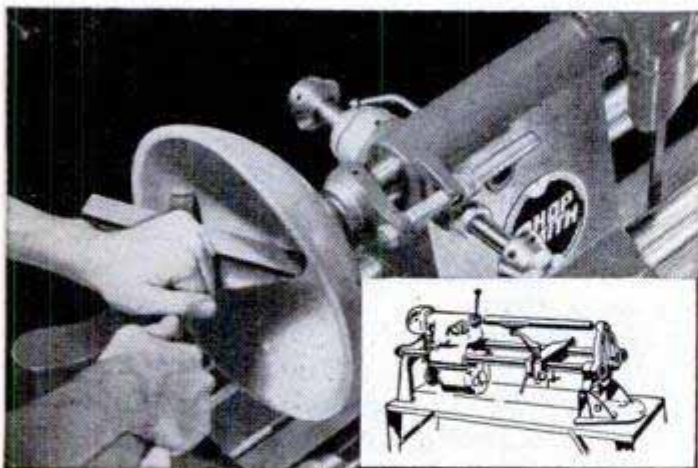

**5 33-inch Wood Lathe.** Turns stock up to 15" in diameter, 3" more than most heavy-duty lathes. Swivel-arm tool rest slides parallel to ways, lever-locks in position. Absolutely rigid lathe bed assures maximum accuracy—tubular steel ways each take over one-ton stress.



**FREE**

**GET ALL THE FACTS!** Compare before you buy! Fact-packed, 16-page booklet brings you detailed specifications, describes SHOPSMITH'S many operations. Send for it! It's FREE!

Address:

**SHOPSMITH**

Dept. 145-B, at factory nearest you:  
12819 Coit Rd., Cleveland 8, Ohio, OR  
417 Montgomery St., San Francisco, Calif.

Name \_\_\_\_\_

Address \_\_\_\_\_

City \_\_\_\_\_ Zone \_\_\_\_\_ State \_\_\_\_\_



Always

**Fresher**

**Flashlight  
Batteries**



**BURGESS BATTERIES** surge to life at the flick of your flashlight switch. **BURGESS** power is kept fresh and ready because Chrome Protection curbs internal action when your flashlight is idle, and allows more complete battery recovery between uses to give you longer, more dependable service.

- SEALED IN STEEL AND PLASTIC
- MODERN STYLING
- PLAINLY DATED
- IMPROVED ENGINEERING DESIGN
- GUARANTEED

**BURGESS** *Flashlight*  
**BATTERIES**

**BURGESS BATTERY COMPANY**  
FREEPORT, ILLINOIS

—a double thickness of silvered glass surrounding a vacuum. Helium is kept in a small one that fits in a bigger one, with an insulating chill of 80-degree-absolute liquid air between them.

Since helium boils at 4.2 degrees absolute, and is continually boiling away inside its little Dewar refrigerator, special tricks must be used to reduce the temperature further. If you've boiled eggs at sea level and at high mountain altitudes, you know that the mountain eggs take longer to cook. It's because the water boils at lower temperature in the rare mountain air where atmospheric pressure is less. Scientists have found that by putting a vacuum pump on a Dewar flask and reducing the pressure over the liquid helium, the same thing will happen. The boiling point drops as low as one degree absolute.

But even that isn't cold enough. The final chill is achieved by a magnetic process devised by Dr. William Giauque of the University of California. By applying magnetism to bodies of salt immersed in a Dewar and already chilled to about one degree Kelvin by helium boiling under reduced pressure, the temperature of the salt can be made to plummet even more. Recently, one low-temperature laboratory achieved the sublime frigidty of .0015 degree above zero.

Supercooled helium is full of surprises. It shimmers like faint heat waves as you view it through the tiny observation slit in the silvered glass. "Turn it toward the dark," the scientist will tell you. "Don't let it see that 'hot' wall or it will evaporate." Mere light has heat, so liquid helium is kept in total darkness. Its behavior is preposterous. At 2.19 degrees Kelvin it produces a "superfluid," helium II, which scientists think may contain particles that have actually reached the bottom hole. Some of the most recent discoveries about it have been made by Dr. John Pellam of the U. S. Bureau of Standards. It is neither solid, liquid nor gas, though it has properties of all three. Baffled scientists call it the quantum fluid, or "the fourth state of matter." It can flow through almost anything, and readily finds its way through airtight seals. For some reason, it will flow up the sides of an open container and drop to the bottom of the outer insulating container until the level in both is the same. Drop the level of the inner container, and the superfluid outside will climb back in until the level is reached again. Give it a shot of heat, and it will geyser up through a tiny tube of tightly packed emery in a spectacular 12-inch fountain effect. Heat travels through it in

(Continued to page 250)

# Now 2 great SAVAGE hi-power rifles

## FAMOUS MODEL 99

### HI-POWER LEVER ACTION REPEATING RIFLE

Two cal. — Savage .300 and Savage .250-3000. Three great models: 99EG (illus.) Standard, 99R — same but with longer stock and higher comb. Semi-beavertail fore-end. Screw eyes for carrying strap. Receiver tapped for Weaver top mount telescope sight. Model 99RS — same as Model 99R, but fitted with No. 31 Lyman front sight, middle sight slot blank and Redfield No. 70 LH receiver sight with elevation and windage adjustment knobs.

## NEW MODELS 340-342

### BOLT ACTION REPEATING RIFLES

Model 340 — .30-30 cal. Model 342 — .22 Hornet cal. Newly designed, improved bolt handle, larger stock of selected American walnut. "Hornet" receiver tapped for scope mount and micro peep sight. Ramp front sight and new type disc elevator rear sight, standard. *Deluxe Grade* — Models 340-342 available with micro rear peep sight; hooded front sight; checkering on grip and forearm and screw eyes for carrying strap.

The SAVAGE MODEL 99 is the world's most famous lever action repeating rifle. The "smashing power" of the Savage .300 cartridge and the flat trajectory and extreme accuracy of the Savage .250-3000 cartridge, have made and kept the "99" "First in the Field" among big game hunters everywhere.

The SAVAGE MODEL 340 is a compact, fast handling bolt action rifle priced within the reach of every shooter. It is chambered for the ever popular, dependable, widely available .30-30 cartridge. Model 342 is chambered for the hi-speed, flat trajectory .22 Hornet cartridge. Ideal for varmints and small game.

For "hi-power action" buy a Savage. At your dealer's. Write for free catalog.

SAVAGE ARMS CORPORATION  
Firearms Division      Chicopee Falls, Mass.



First in the Field



# SAVAGE

SAVAGE • STEVENS • FOX Rifles and Shotguns

REG. U.S. PAT. OFF.

SAVAGE • WORCESTER Power and Hand Lawn Mowers



## HAVE FILING JOBS GOT YOU CORNERED?

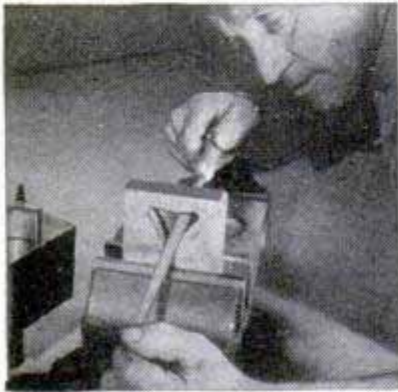

**C**ROSS-SECTIONWISE, you're looking at twelve basic file shapes used by amateur and professional craftsmen. They're shapes that operate in almost every kind of slot, corner, hole or curve (not to mention flat surfaces); file shapes that come in many kinds of cuts—like single, double, curved-tooth, shear-tooth, rasp—and in various degrees of coarseness. Many also, in Nicholson and Black Diamond brands, have special cuts for use on brass, aluminum, lead and babbitt, stainless steel, plastics, lathe work\*.

All of which leads to the conclusion that the best results and half the satisfaction of filing come from using *The right file for the job*—especially when it's a high-quality Nicholson or Black Diamond. These world-famous brands are sure to heighten your satisfaction by their trueness and uniformity. Both these important file qualities are reflected in Nicholson's sweeping guarantee of *Twelve perfect files in every dozen*.

They're brands which also give you the feeling that hardware stores selling them are good places for obtaining dependable merchandise and sound values.

\*Write us for your free copy of the famous Nicholson Book, "FILE PHILOSOPHY"—48 interesting, informative, illustrated pages on kinds, use and care of files.



**NICHOLSON FILE COMPANY**  
22 Acorn St., Providence 1, R. I.  
(In Canada, Port Hope, Ont.)



# NICHOLSON FILES

FOR EVERY PURPOSE

waves similar to sound waves. A shot of heat at the bottom is quickly transmitted directly to the top. Scientists have called this phenomenon "second sound."

So far, the small area inside the Dewar which can be kept at a fairly constant chill between zero and two degrees absolute has been a handicap. Only tiny bits of things could be tested. But at M.I.T., Dr. S. C. Collins has just built a new liquid-helium producer that will refrigerate an area bigger than your home refrigerator. It's a cylindrical affair standing about 12 feet high, looking for all the world like the conning tower of a dry-land submarine. The scientist stands on a circular deck atop the machine and can see his supercold materials down below through a big porthole.

The Collins machine produces liquid helium by an entirely different system from that used by G. E., Doctor Giauque and others.

Collins' machine utilizes the fact that if you make a gas do work, it gives off some of its heat in the energy it produces. The water vapor exhausted from a locomotive cylinder, for instance, is much colder than the steam that shoved the piston a second before. His helium gas feeds through coils and into a series of pistons so minutely machined that they are frictionless and need no lubricant beyond the helium itself. The engines turn wheels outside the machine, thus performing work. The cylinders are so arranged that the exhaust gas from one cools the intake of another in a perpetual cycle that makes the gas get colder and colder (without the aid of liquid hydrogen) until it finally liquefies and drops to the conical bottom of the big tank and can be drawn off. The compactness of Collins' unit is amazing and already, with the aid of H. O. McMahan, a former student now working with the Arthur D. Little Company a few blocks away in Cambridge, 29 two-cylinder machines the size of your console TV set have been manufactured and sold to laboratories throughout the country. You can buy one yourself for \$22,000.

Collins' big baby has four pistons, and a man could climb into the frigid compartment and frost himself to an instantaneous lump if he wished. In four hours it starts producing liquid helium.

"The big samples which have been quickly removed from the Collins cryostat," says Doctor Collins, "are so cold that the room-temperature air sits right down on them. It liquefies before your eyes. If you held a pan under such a test sample you'd have a panful of liquid air instantly."

(Continued to page 252)

What's **NEW**  
in Batteries?

**AUTO-LITE Sta-ful**  
**BATTERY...needs water**  
**only 3 times a year**  
IN NORMAL CAR USE

A revolutionary new development, the Auto-Lite "Sta-ful" Battery, protects you against a major cause of battery failure . . . damage to plates due to liquid loss. This new "Sta-ful" Battery Design permits a liquid reservoir with more than 3 times the reserve capacity of ordinary batteries . . . keeps plates fully covered and active months longer in normal car use.

In addition, "Sta-ful" gives you 70% longer average life\* than batteries without Sta-ful features. Fibre-glass retaining mats protect every positive plate and keep the power producing material in place for maximum dependability. Get more for your battery dollars—replace with an Auto-Lite "Sta-ful" Battery. See your Dealer today.

**AUTO-LITE BATTERY CORPORATION**

Toledo 1

Ohio

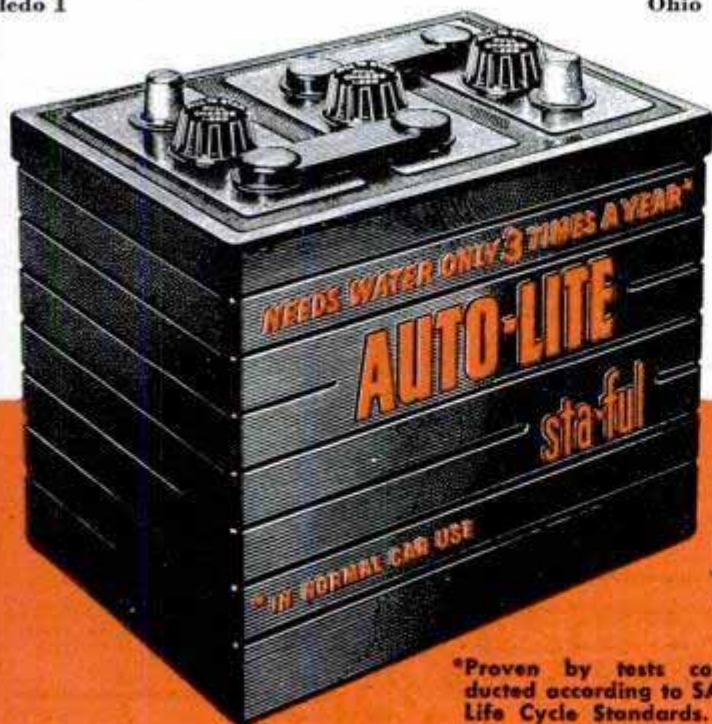

\*Proven by tests conducted according to SAE Life Cycle Standards.

Because of its unique design and construction, the new Auto-Lite "Sta-ful" Battery holds more than 3 times the liquid reserve of ordinary batteries.

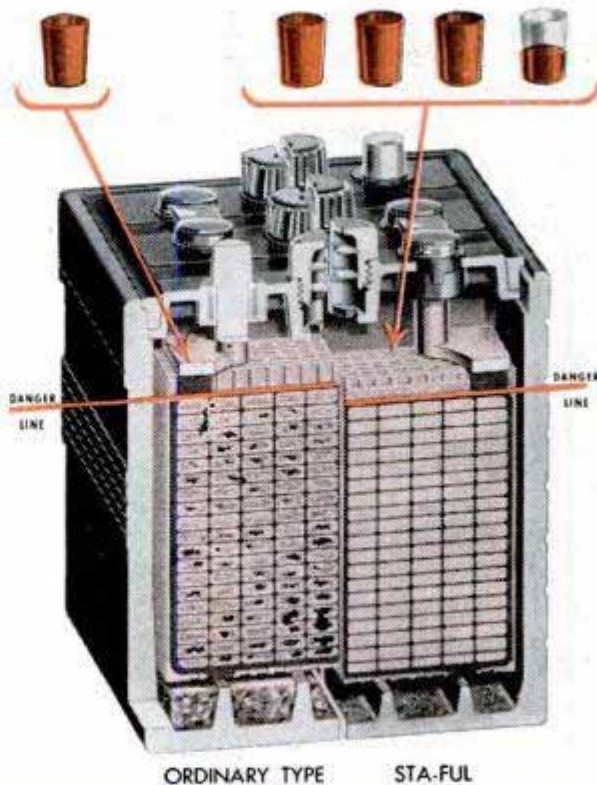

Note how the protective Fibre-glass mat retains the power-producing material in the positive plate while ordinary battery plates shed the active material until it fills the sediment well.

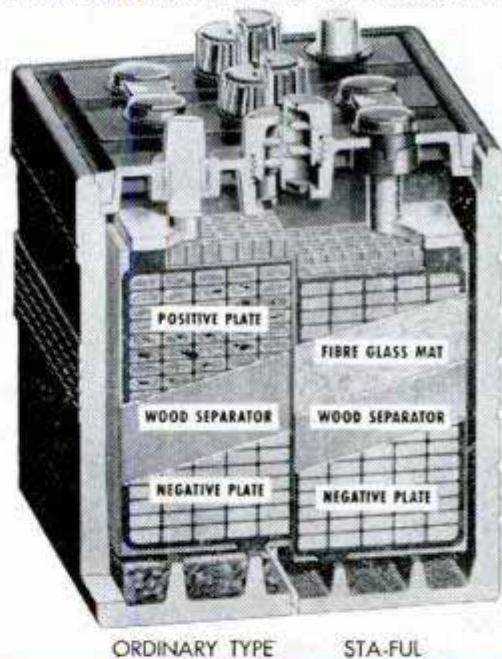

**AUTO-LITE**  
**Sta-ful BATTERIES**

With such a machine, great blocks of metal can be tested. "We expect to gain a better understanding of 'creep' in steel," says Doctor Collins. "Certainly we'll have a better laboratory to investigate the behavior of all kinds of things at near absolute zero."

A host of secrets about matter and its properties are gradually being let out of the bag by the shimmering liquids of our low-temperature labs. And they're finding their way toward practical usage.

When the first liquid oxygen drizzled into a container, no one guessed it would provide a fuel for torches that cut through steel like a hot knife through butter or for the oxidizer that would burn fuel fast enough to send a rocket through space at twice the speed of sound. Its compact lightness is already a boon to industry. One tank car of liquid oxygen equals 11 freight cars of the tanked gas.

Today, liquid nitrogen is the best "shrink fitter" known. When a metal worker wants a tight fit, he sprays the inner piece under a withering blast of minus 320 degrees Fahrenheit, inserts it immediately in place and as it warms up it expands into as tight a fit as you'd care to find.

Already there are inklings of what will come from the depths of near absolute zero.

Scientists are excited about the superconducting qualities of metals at liquid-helium temperature levels. Not long ago, a ring of columbium nitride immersed in frigidty at Johns Hopkins for experiments in the weird perpetual current phenomenon suddenly began to broadcast music from a local radio station. It was acting as a superdetector of radio waves. Visionary low-temperature men can see in the future ultrasensitive radio sets that will pick up fantastically faint signals. The crystal for the set will simply be refrigerated. Since all thermal motion of molecules is stilled by the cold in the crystal, there will be no hum in such radios.

Such crystals will also pick up infrared light signals and work is afoot to develop a detector that might pin-point the heat from exhaust stacks of enemy sea or air craft at great distances.

"We've only begun," the frosty fellows will tell you. "We haven't even done more than look at the new world we've reached down there in the subcold."

But they're still not content. Already they're talking about using powerful nuclear magnetism to wring the heart out of that last degree. This may bring them within a millionth of a degree of absolute zero. "Think what that would mean to science," they sigh.

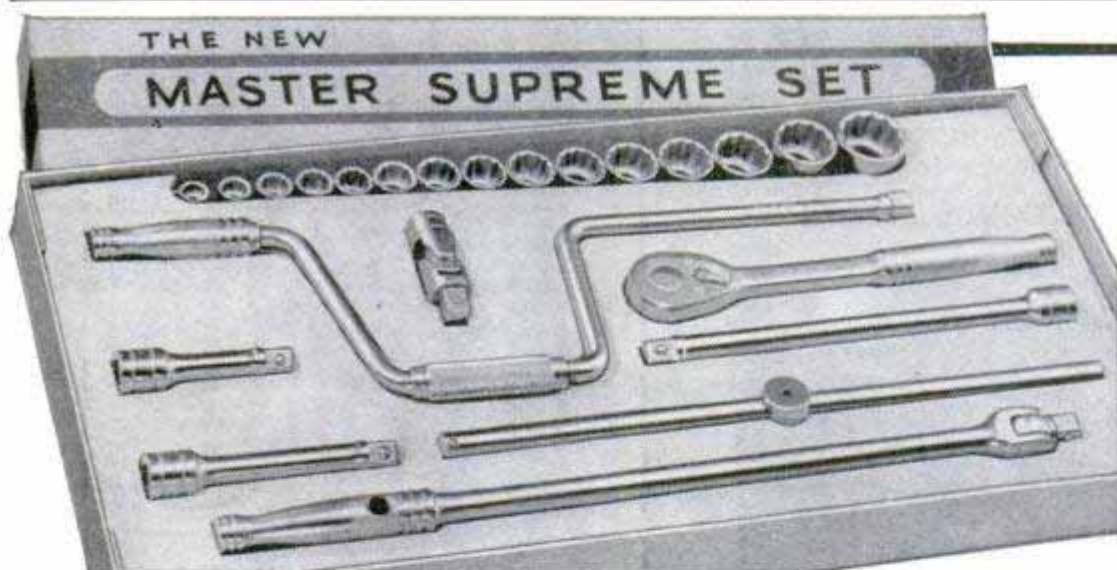

**Snap-on**

**MASTER SUPREME  
23-PC. SOCKET SET**

**\$36<sup>50</sup>**  
Plus  
Local  
Tax

In this 1/2" sq. drive set, you will find highly engineered design, accurate balance, perfect fit, and a comfortable grip that results in faster, safer, more satisfactory work. Full chrome finish.

- ★ Patented Palm-Grip handles give a secure grip.
- ★ 32-tooth ratchet action. Double-tooth contact gives added strength.
- ★ Easily removed Welch plugs for servicing friction-grip device.
- ★ Four-way socket grip for faster interchange of various units.
- ★ Hot broached, chip-curved openings give you smooth, strong socket walls.
- ★ Controlled heat-treating for skin-to-core toughness.

SNAP-ON TOOLS CORP., 8062-J 28th Ave., Kenosha, Wis.

Please send me the Master Supreme Socket Set.

I enclose  Check,  Money Order,  
 Company Purchase Order.



Name.....  
Address.....  
City.....State.....

\*Snap-on is the trademark of Snap-on Tools Corporation.

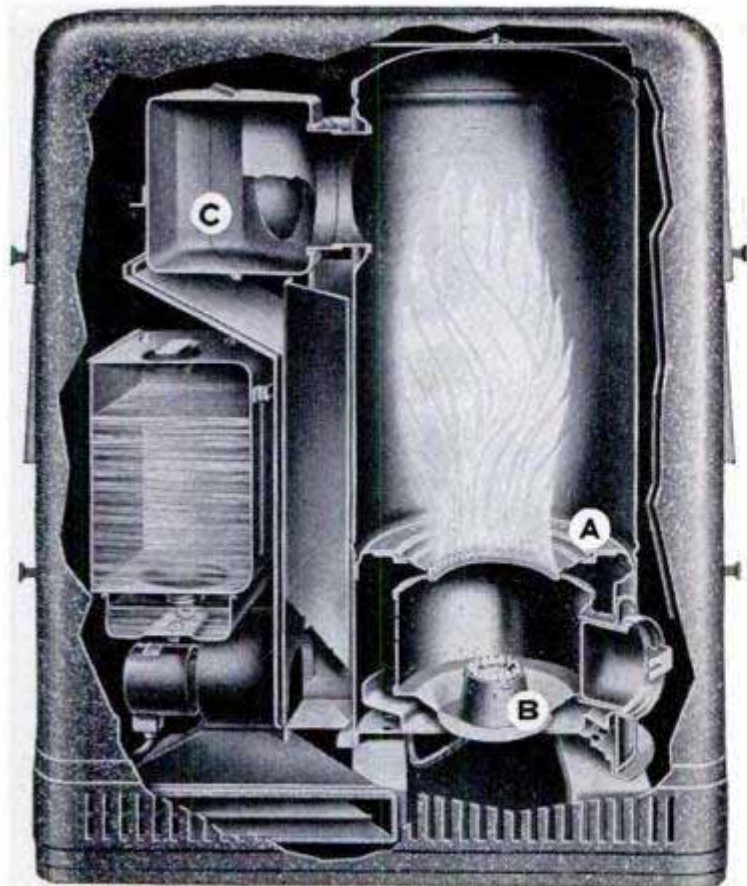

# New Burner-Pilot Principle Gives Perfection Oil Heater Greater Efficiency

Too much fuel oil was being wasted with heaters having only one burner. In cold weather, the burner needed constant adjustment from high to low heat. And, during mild weather when only low heat was needed for a few minutes at a time, it was necessary to light it, turn it off and then relight it. So, because of this inconvenience, many times the burner was left on longer, causing unnecessary fuel waste.

So Perfection Stove Company engineers designed a "Multi-Heat" burner (A) which had a high and a low burner-fire. This took care of the cold-weather problem—but left the mild-weather problem unsolved, until . . . an actual pilot (B) was made and installed, too. This pilot did a great deal to help "kill the chill" and at the same time "cut the bill"! And, it saves bothersome relighting, because, coupled with thermostatic controls, the burner cuts back automatically from low burner speed to money-saving, labor-saving pilot!

## "Heat Extractor" Prevents Heat Loss

Inefficient use of fuel cropped up in another way, too . . . heat which could be used to an advantage in the room was going up the chimney instead. So for better efficiency, a "Heat Extractor" (C) was designed to catch this surplus and use it to warm the home.

## No More Cold Feet

The age-old problem of getting the heat distributed properly was solved by a quiet-blower—not merely a fan. Heat is distributed over the floor, into the farthest corners. This Perfection feature has the additional advantage of bringing comfort in summer as well as winter by its continuous circulation of air.

## Money Spent is Money Earned

A lot of experimenting went into this project of getting more efficiency from a heater . . . but Perfection found it paid for itself finally . . . because, of course, their "exclusives" made the demand for their heaters really great.

### AND HERE'S THE HANDIEST PORTABLE MADE



Over ten million safe, convenient Perfection Portables in use! Ideal for workshops, camps, cottages, recreation and laundry rooms.

For additional information see your dealer or write:

**PERFECTION STOVE COMPANY**  
7206-A PLATT AVENUE  
CLEVELAND 4, OHIO



(Continued from page 137)



## How to get smoothest jobs ever with wonderful new NYLON paint brushes!



Dip only half the length of the bristles in paint—on overhead work dip to only one inch. Tap off the excess paint. Don't scrape off on edge of can.

Nylon brushes hold a full load of paint. And they are ideal for nearly all finishes.



To get the best results, use a long, steady, even stroke, painting toward the surface already coated.

Durable nylon bristles don't break off and mar your work, and an independent research laboratory has found that nylon brushes paint smoother.



Use correct brush for each job. Poking large brushes into corners causes "fingering."

You can get a set of nylon brushes for every job, from touch-up work to wall and roof painting. They're made by leading manufacturers.

The next time you paint, try a smooth-painting, easy-to-clean nylon paint brush. You will never use any other kind. They're sold in paint, hardware and variety stores everywhere in all types and sizes.

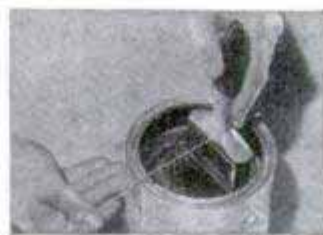

Clean thoroughly, suspend brush on wire in turpentine or linseed oil for storage between jobs. Resting bristles on bottom of can deforms them.

Nylon brushes clean quickly and easily. Work out paint on newspaper, clean with thinner, rinse with soap and water. Then comb the bristles and wrap the brush for storage.



Better Things for Better Living  
... through Chemistry



Considerable leeway is permitted in the size of the playing field, or "pitch"—as the British call it. It can be from 100 to 130 yards long and 50 to 100 yards wide, with small variations in size for amateur and college games. The goals at each end of this rectangle are marked by uprights eight yards apart and eight feet high, usually backed by a netting to stop the ball after a score.

Eleven players, including a goalkeeper, form a team. He is the only one permitted to touch the ball with his hands or arms, and then only in the penalty area, which extends 18 yards out from the goal line through the center 44 yards of the field's width. Within that space he can also run with the ball, provided he bounces it at least once every four steps. To distinguish his eligibility to handle and run with the ball, the goalkeeper has to wear different colors from his teammates, who can only kick or "head" the ball.

Soccer is a rugged, "he man's" game, requiring and developing great stamina, coordination, initiative and endurance, but is more a scientific game than a rough game, when properly played. It is a game particularly suited to the slightly built boy—the wiry type, as well as to his sturdily built brother.

The action of a soccer game is almost constant, requiring much running and the use of every muscle of the body. The ball may be headed or played with any part of the body except hands or arms, with the exception of the goalie. A game has two 45-minute periods, broken only by a five-minute intermission when the teams change goals. No time-outs are allowed for rest and in most international matches substitutions are not even permitted for injured players. When permitted, the limit is two who cannot be resubstituted.

The game can be played where teams and officials do not understand each other's language. The officials are one referee and two linesmen.

Experts, using only their feet, can pass precisely, feint and dribble the ball almost as cleverly as star cagers can manipulate a basketball with their hands. Some can move the ball along almost as fast with short, light kicks as they can run when there is no ball in sight. Propelling the ball with the head is another offensive maneuver that requires long practice to master. Most goals are scored by power shots to the corners of the goal.

(Continued to page 256)



**GREATER THAN EVER!**

*The new 1951*

# HARLEY-DAVIDSON

**HYDRA-GLIDE**

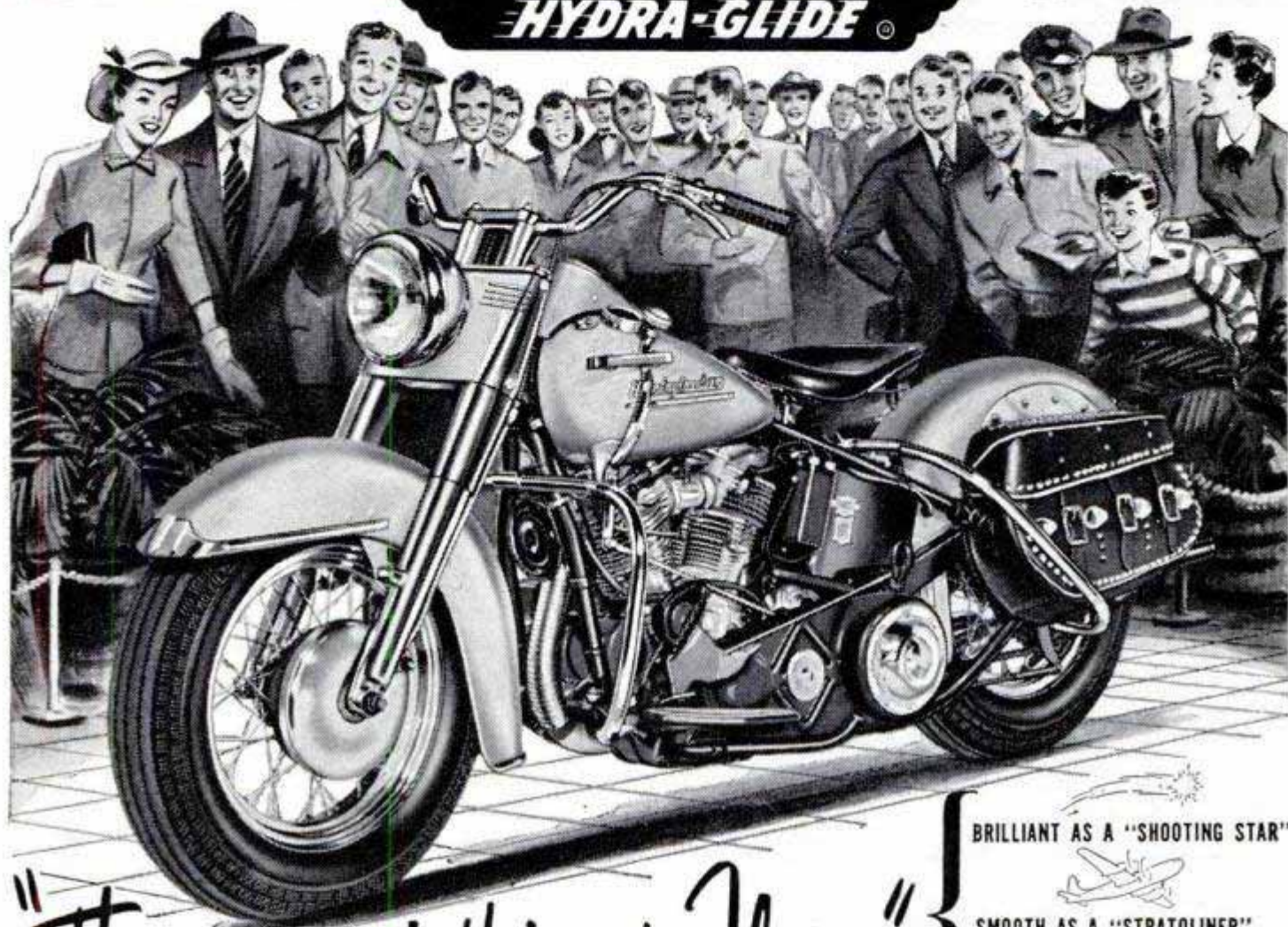

*"The nearest thing to flying"*

BRILLIANT AS A "SHOOTING STAR"



SMOOTH AS A "STRATOLINER"



MODERN AS A "SPACESHIP"

Take off to thrill-land! Ride the perform-  
in'est motorcycle of all time . . . the 1951  
Harley-Davidson Hydra-Glide! Every mile  
is a new sensation! Hills melt away like  
magic! Rough roads level out like boulev-  
ards. Straightaways make you feel you're  
flying! And you steer and hold the road so

easily that even day-long touring leaves you  
fresh and untired. You're ever-ready for fun  
as you take in exciting races, hillclimbs, en-  
durance runs, sightseeing trips and special  
club events of every kind. Get your share of  
the world's greatest sport. Phone or see your  
dealer today. Mail coupon now.

HARLEY-DAVIDSON MOTOR CO., Dept. P, Milwaukee 1, Wisconsin

Send for free copy of ENTHUSIAST Magazine filled with motor-  
cycle action pictures and stories; also literature on new models.



Name.....

Address.....

City..... State.....

**OPPORTUNITY:** Valuable franchises available for full line of Big Twins and 125 Model. Write today.

# PEEL OFF PAINT

WITH KLEAN-STRIP

**Amazing new-type remover  
is fast, safe, easy-to-use**

Klean-Strip changes any finish into loose, wrinkled film. Use only a brush or putty-knife to peel off all layers of the old finish at one time.

Klean-Strip leaves the surface clean, smooth and dry. No sticky mess to wash off, no waxy residue to scrape. And Klean-Strip is absolutely safe: will neither burn nor explode.

Klean-Strip is brand new . . . not like any paint remover you've ever used. Takes all the danger and drudgery out of refinishing. Buy Klean-Strip whenever you buy paint. Available at better paint, hardware and department stores, everywhere.

Product of  
W. M. BARR & CO.  
2352 S. Lauderdale  
Memphis, Tennessee



**New! No-Wash!  
Non-Inflammable!**

*"I'll take the WHITE one  
every time!"*



WYTEFACE Steel Tapes, with their jet black markings on a white background, are easier to read in any light. They are rust-resisting, hard to kink and easy to clean.

Protected by U. S. Patent 2,089,209

## WYTEFACE

TRADE MARK

### STEEL TAPES

KEUFFEL & ESSER CO.

The three men stationed closest to their own goal, the goalkeeper and the right and left fullbacks who flank him, in addition to the center halfback, are defensive specialists, adept at stopping opposing kicks and passing the ball forward to their teammates. Three halfbacks—right, center and left—switch their roles from offensive to defensive play. The center half is the key man in all plays, defensive and offensive.

The remaining five—center forward, inside left, inside right, outside left and outside right—comprise the front line. They are usually the fastest, shiftiest players and score most of the goals.

Soccer is a fall and spring sport, except in warmer countries where it can be played the year 'round. An indoor version, with seven-man teams, is spreading fast in the big-city arenas.

Much of soccer's current popularity boom here was generated by Americans who first played it or saw it played overseas during the war. In a nationwide poll, 41 percent of the public and 68 percent of the sports-writers questioned voted soccer as the sport with the best prospects of catching on as a major attraction.

Soccer embodies the science of football, the speed of ice hockey, the grace of tennis, the thrills of baseball and the scoring accuracy of basketball.

## Treasure Hunt in a Lost World

(Continued from page 93)

Indian tales of mountains that attracted lightning, attracted prospectors. Back in 1945, big steel faced the dilemma of depletion of the Mesabi ore reserves by 1970 at present consumption. John G. Munson, vice-president of U. S. Steel, decided to look around. He searched from Sweden to Brazil, finally wound up in Venezuela. A year later, Mack C. Lake, long-time geologist, and two young men, set to work taking aerial pictures of the area west of the Caroni.

For a year Lake's planes circled the Gran Sabana, photographing the entire country. Steel men's eyes popped at the mosaic. In the area west of the Caroni and south of the Orinoco, where no ore ever had been found before, the pictures showed formations indicating high-grade ore, and huge geologic folds to show it was near the surface, permitting open-pit operations. The mountain, 11 miles long and a mile wide, was known as La Parita.

Lake borrowed a magnetometer. In Jeeps, planes, on horseback, the men swarmed in. The magnetometer readings

(Continued to page 258)

# It's BIG... It's HUSKY

Ready To Save You Hundreds of Dollars!

**Atlas 10" TILT/ARBOR SAW**

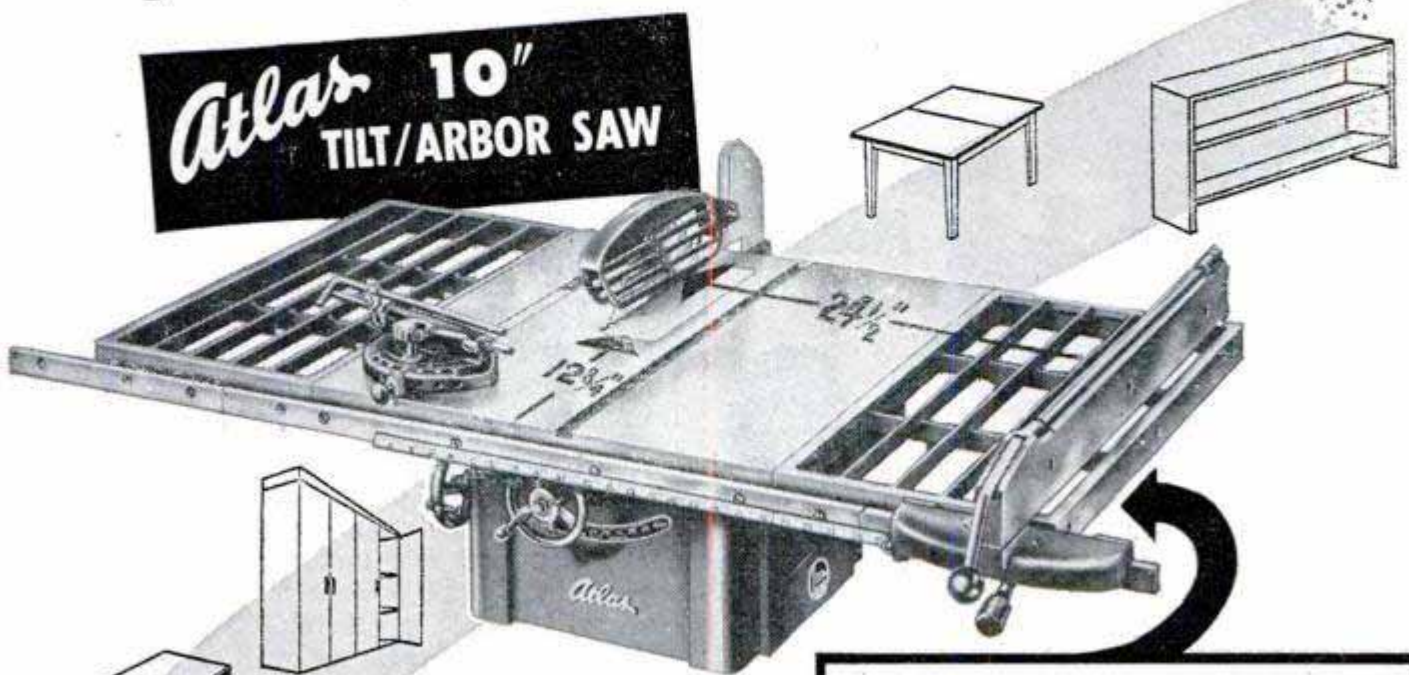

Finest Rip Fence On Any Saw! Vernier control for fine adjustment . . . positions smoothly and easily . . . locks at BOTH ENDS . . . LIFTS OFF!

You are equipped to handle *every* table sawing need for a *lifetime* with this big Atlas saw in your shop. It has the capacity to help you build a garage, utility buildings, a house . . . or to finish off a recreation room or attic. It has the accuracy for "factory-quality" work on fine cabinets and furniture and saves you money on shelves, cupboards, bookcases, and home repairs. You'll like every feature: The big *precision-ground grey-iron* table (25" x 45 1/2" with extensions as shown) with its *super smooth* surface; the quiet smoothness of its *large sealed-for-life ball bearings*; the easy, accurate operation of the rip fence; the smooth-working blade height and angle controls. Blade cuts 3 1/4" deep — tilts to 45° — table is always flat. Yes — this Atlas is big, and rugged, and fast, and dependable — sure to make your shop and your work outstanding in the neighborhood. See it at your Atlas dealers today!

SEE *Atlas* 8" SAWS, TOO!



Same fine construction as the 10" saws.



MATCHED PRECISION TOOLS FOR WOODWORKING AND METALWORKING

**FREE — Woodworking Tool Catalog**

ATLAS PRESS CO., 1043 N. Pitcher St., Kalamazoo, Mich.

Please send your woodworking tool catalog.

NAME \_\_\_\_\_

ADDRESS \_\_\_\_\_

CITY, STATE \_\_\_\_\_



**Model  
80**

**\$72.95  
less  
guarantee**

**8-INCH  
TILTING ARBOR SAW  
at a  
HOME WORKSHOP PRICE**

*Darra-James* Model #80 is the *only 8"*  
Tilting Arbor Saw that has

ALL these features:

- ★ Cast Aluminum Motor Mount
- ★ Cast Iron Ribbed Table
- ★ Steel Base with Cast Iron Sub Base
- ★ 2 5/8" depth of cut
- ★ Self-Aligning Touch-Control Fence
- ★ Ball Bearing 45° Tilt Arbor

Compare the FEATURES! . . . and then  
— Compare the PRICE! You will  
agree that Darra-James, makers of  
over 200 Professional Power Tools,  
Accessories and Motors, of-  
fers more for the professional  
woodworker, and for the  
home craftsman.

**FREE** Mail Coupon to-  
day for Darra-  
James Catalog #14 and  
Literature on America's  
fastest growing Power  
Tool Line.



*toolcraft* CORPORATION  
SPRINGFIELD, MASSACHUSETTS

SEND me Darra-James Catalog #14

Name.....  
Address.....  
City..... State.....

were submitted to a California geophysicist. "They're fine," he said. "But your decimal points are in the wrong places." What the instrument showed was the highest reading ever recorded — and the decimal points were right!

La Parita, renamed Cerro Bolivar by the steel company, turned out to be a mountain of solid ore—ranging to the almost unbelievable purity of 72 percent pure iron.

Lake's men rushed to file claims. Drills were flown in to Cerro Bolivar, only 60 miles south of the Orinoco port of Bolivar City. Ninety holes drilled to 400-foot depth proved up the incredible reserves—more than half a billion tons of ore purer than big steel's fabulous Hull-Rust-Mahoning mines in Minnesota! Enough to supply U. S. Steel's hungry furnaces with 10 million tons a year for half a century.

But to get it home the company will have to spend \$900,000,000 in the next 10 years. A four-foot, two-mile conveyor belt will carry the ore a quarter mile down the mountain. On its journey, the descending iron will generate electricity to serve the entire village now being built at the mountain's base. Once down, it must be carted away. This will be done in one of two fiendishly expensive ways: either by building a 274-mile railroad to the Caribbean coast, with a ticklish bridge across the Orinoco high enough to allow for the whimsical river's rise of 65 feet in rainy season, or a 90-mile railroad to the Orinoco, and barges. But if the latter plan is carried out, U. S. Steel plans on a fleet of monster 45,000-ton ore boats, as big as the battleship Missouri. This will mean dredging some 70 miles of the big river to a depth of 34 feet to accommodate the ocean-going monsters that will ferry the ore to Mobile, Trenton and Baltimore. Right now, the latter plan is favored. Venezuela would love to have the Orinoco deepened for ocean-going traffic, for it would open up the whole interior of the country.

Furthermore, across the Caroni, lies Bethlehem's mountain of ore, which is producing this year for the first time. Already, four big electric shovels are chewing at the mountain, dumping each mouthful into monster trailer trucks that haul it to one of four big trains tugged by 1500-horsepower diesel locomotives.

The trains run it 32 miles over narrow-gauge track to the Orinoco, where it is emptied into a vast pit. Under the pit is a row of trap doors, which open as the ore is required, dropping it through funnel-shaped chutes onto an underground conveyor belt. The ore is then carried up to a

(Continued to page 260)

Repair Electrical Appliances and Utilities with the aid of  
THE NEW MODEL 50

# UTILITY TESTER



Compact—Measures 3 1/8" x 5 7/8" x 2 1/4"

A NEW KIND OF INSTRUMENT FOR TESTING ALL ELECTRICAL CIRCUITS AND APPLIANCES SUCH AS—

- RANGES
- SHAVERS
- HEATERS
- IRONERS
- WASHERS
- FANS
- VACUUM CLEANERS
- AIR CONDITIONERS
- REFRIGERATORS
- SUN LAMPS
- TOASTERS
- WASHING MACHINES and MOTORS

[ALL MOTORS—single phase, multi-phase, universal, squirrel cage, induction, in fact every type of motor from fractional H.P. to 2 H.P.]

## THE MODEL 50 UTILITY TESTER:

- Will measure the actual current consumption of any appliance or utility either A.C. or D.C. and will measure it while the unit is in operation. The reading will be direct in amperes. The appliance or utility may be plugged directly into the front panel receptacle. A special pair of insulated clip-end leads is included for motors, etc.
- Will measure the actual voltage and indicate whether the current is A.C. or D.C. and if the frequency is 25 cycles or 60 cycles.
- Incorporates a sensitive direct-reading resistance range which will accurately measure all resistances commonly used in electrical appliances, motors, etc. This range will enable continuity checks and tests for shorts and opens.
- Will indicate excessive leakage between a motor and a line up to 10 Megohms.
- Will indicate when a three phase motor is running erratically due to a "blown" fuse
- Will test Thermostats under actual working conditions.
- Is the ideal trouble-shooter as it will instantly locate opens, shorts and grounds.
- Will test all bulbs, radio tube filaments, pilot light lamps, all fuses including cartridge, screw, etc., fluorescent bulbs, etc.

- Will test condensers for both opens and shorts.
- Will accurately check and locate the exact cause of failure in 3 way heat control switches.
- Will check field coils for opens and shorts.
- Will indicate when one side of an appliance or motor connected to the line under test is "grounded".

## SHIPPED ON APPROVAL NO MONEY WITH ORDER—NO C.O.D.

**TRY BEFORE YOU BUY!** Yes, you need send no money with order or pay anything on delivery. Simply fill out this order form and mail it today. Try the Model 50 for 10 days. If completely satisfied, remit \$13.90. If not, return the instrument—no explanation necessary.

The Model 50 Utility Tester comes housed in a round cornered molded bakelite case. Complete with all test leads and operating instructions—only.....

# \$13<sup>90</sup>

GENERAL ELECTRONIC DISTRIBUTING CO.  
98 PARK PLACE, NEW YORK 7, N. Y.

PM-10

Please rush one Model 50 Utility Tester. I will either remit \$13.90 after a 10-day trial or return the instrument via Parcel Post.

Name \_\_\_\_\_

Address \_\_\_\_\_

City \_\_\_\_\_ State \_\_\_\_\_

### FREE PREMIUM!!

Check here if you include \$13.90 payment with order. In return for saving due to bookkeeping, we will include a set of 6 assorted key chains with your Model 50. If the Model 50 does not meet with your wholehearted approval after a 10-day trial, return it for full immediate refund of \$13.90—keep the premium for your trouble.



**FROM OUT OF THE NORTH  
Comes an AMAZING  
HEAT INVENTION**

**South Dakota Man Turns Coal,  
Wood Stoves and Furnaces into Oil  
Burners ECONOMICALLY.**

**BIG SELLER FOR DISTRIBUTORS, SALESMEN, AGENTS.**

**NOW Sensational  
CHEAP OIL BURNER**

**For Cooking & Heating Stoves - Furnaces**



**COOK YOUR MEALS HEAT YOUR HOME**

**with Cheap, Furnace Oil**

**No Coal to Carry In • No Chopping Kindling  
No Ashes to Carry Out • No Slow Fires to Build**

**Read How You Can Test This Amazing QUIK-HEAT Oil Burner in Your Own Home for 30 Days—Then MAIL COUPON for Full Details.**

Here's an oil burner entirely different—easy to install—easy and economical to operate. It sets in the fire or ash box of your coal or wood range, cook stove, heating stove, laundry stove—larger size for furnaces and boilers. Makes one of the quickest, hottest, cheapest fires from No. 1 Furnace Oil, Distillate, Diesel, Range, Heater Oil and Kerosene. A great convenience by simply turning a valve and lighting the Fuelizer Starter—great heat for cold winter, moderate heat or just a simmering heat for slow cooking or chilly fall and spring weather.

**USERS SAY:** "A wonderful burner and a money saver—easy on fuel" says Clarence Gothe. "Started selling yesterday, sold six. Send me 5 more," says J. Klappenstein. "No trouble to keep house warm even at 8 below zero," says Harold H. Bumer.

**FITS INTO COAL,  
WOOD STOVES,  
FURNACES**



**DISTRIBUTORS  
Agents  
Salesmen  
BIG  
MONEY**

**30 DAY TRIAL OFFER**

The QUIK-HEAT Oil Burner carries our famous Iron Clad LIFETIME GUARANTEE. So confident are we of the unusual satisfaction given by the QUIK-HEAT that we make \$1.00 BONUS OFFER FOR TESTING and let you try it in your own stove or furnace for one month. You can get yours for introducing—big profits QUICK. Be first. MAIL COUPON for details and cash in on the tremendous demand for this amazing invention. DO IT NOW.

**NORTHWEST MFG. CO.  
Dept. 834-M, Mitchell, S. Dak.**

**MAIL COUPON NOW**

**Northwest Mfg. Co., Dept. 834-M, Mitchell, S. Dak.  
Without cost or obligation send TRIAL OFFER and  
details about your amazing QUIK-HEAT Oil  
burner.**

Name \_\_\_\_\_

Address \_\_\_\_\_

City \_\_\_\_\_ State \_\_\_\_\_

Check here if interested in our REAL money making offer.

long steel loading track, that extends out over the river's edge like half a steel bridge. Out over this rig the rich ore slides, dumping off the end into shallow river barges that will float it to the delta for loading on big ore carriers.

Odd part of the loading bridge is that it raises and lowers like a drawbridge to accommodate the 65-foot rise or fall of the Orinoco in wet or dry seasons.

So far, the system has been successful. But if Bethlehem could move its big ore boats all the way up the river, immense sums of money and time could be saved.

How does all this activity on the Gran Sabana affect the rest of Venezuela? Economists are scratching their heads. Already the country's economy is a list under an oil boom that has been booming for 20 years, pouring \$180,000,000 a year into the government till through taxes and royalties—and untold millions into workers' salaries. And that's the trouble. Everyone is out working on the oil fields. What will happen, they wonder, when the iron mines begin to tap the long-depleted labor ranks?

Throughout the once great cattle ranges and agricultural farms on the rich plains, big old ranchos are boarded up. No one in Venezuela needs to be out of work. In a country a little larger than Texas, there are only a third as many people to be found. There is no one to take care of the home industries. Everything from butter and eggs to automobiles is imported from outside.

The government is working like fury to arouse interest in home industries. Much of the oil money is being plowed back into experimental farms and industrial projects.

Like every boom frontier, Venezuela is popping, and probably will continue to pop. Vast projects are afoot. Caracas, the capital city of 300,000, nestled in a cool valley atop the coastal ranges, is a boom town "busting its seams." Its new modern buildings are stretching down the valley and climbing precipitous mountainsides. The city is a bedlam of clattering machinery building higher structures, tearing down old colonial streets, boring vast multilayered traffic tunnels under the streets. Out along the coasts, the four major oil companies have built or are building mammoth refineries to handle the ever-increasing abundance of black gold. Below Caracas, on the Caribbean coast, a mighty seaport is being constructed to provide docking facilities for a dozen big ships. Out where the Caroni River tumbles over a ledge and joins the Orinoco, work is progressing to harness the massive falls with a huge earth dam, and a

(Continued to page 262)



# FREE . . . WARDS 1950-51

## POWR-KRAFT POWER TOOL AND WELDING BOOK

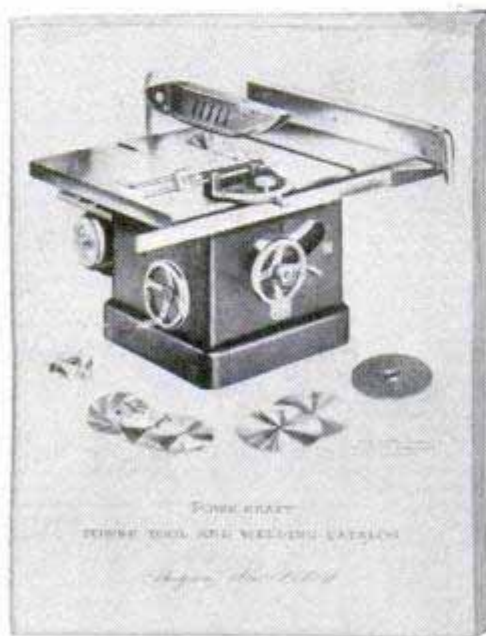

48 PAGES FOR CRAFTSMEN—Beginner, hobbyist or production shop will find this complete catalog of power tools and accessories indispensable, with its helpful information and money-saving prices. Use the coupon below—today!

FOR A FIRST-CLASS WORKSHOP—This book lists wood and metal working tools, portable electric tools, welding equipment, electric motors, etc.—most of the equipment you need to set up a fine workshop. Also production shop woodworking power tools, metal lathes and accessories.

CHOOSE FROM FAMOUS NAME BRANDS—You'll see the full line of Wards Powr-Kraft tools, plus nationally known brand names such as Mall, Logan, Beaver, Burke, Shopsmith, etc.—all pictured and described.

### Montgomery Ward

Chicago • Albany • Baltimore • Denver • Ft. Worth  
Kansas City • Oakland • Portland, Ore. • St. Paul

Mail coupon to nearest city above—NOW!

MONTGOMERY WARD, Dept. PM-10  
Rush me your 1950 Powr-Kraft Power Tool and  
Welding Book.

Name \_\_\_\_\_  
(PRINT Plainly)

Street Address,  
Route, Box \_\_\_\_\_

Post Office \_\_\_\_\_ State \_\_\_\_\_

power plant capable of producing 1,000,000 kilowatts an hour—second greatest producer of electrical energy in the world.

On a square mile of land north of Caracas sits what will be the biggest educational institution in South America—University City. Its medical-school hospital alone, with room for 1000 beds, can be emptied in seven minutes in case of fire. Beds on casters are simply rolled to a series of ramps from each floor and coast to the wide outdoors.

Most of this is happening under the guiding hand of a Venezuelan government department known as the Ministerio de Fomento. Its job is to foment, and it does it well.

Other government projects include a vast road-building program which will double the present mileage. There are 38 new airports under way throughout the country, half a dozen major domestic airlines, a cattle program with slaughterhouses and breeding stations to revive the fallow industry. One irrigation project will reopen 250,000 acres of forgotten farmland. In cooperation with Nelson Rockefeller's Venezuelan Basic Economy Corp., the government is also creating markets in the interior for the big fishing industry, through the introduction of refrigeration.

There's plenty of opportunity in Venezuela. But if you're planning to hop a freighter, think it over. Where there's gold there are high prices. In Caracas, orchids, gold, diamonds and gasoline are cheap, but they are the only cheap products to be found anywhere in the country. A nickel candy bar is thirty cents. Cheap shoes are \$20. U. S. cigarettes are almost a dollar a pack. Americans working for U. S. companies get "cost of living" bonuses up to 100% of their salaries and continually scream "poor."

Before you go to Venezuela there are several things you should know: Spanish, a U. S. employer who'll backstop you with a job, and enough to go there with the idea of staying. What's more, the ground is Venezuela's. All mines are on government mineral reserves, to which rights must be leased on percentage. Taxes are low, but anybody in business must hire 75 percent Venezuelan labor—which is hard to find. What's more, the government isn't interested in buying tickets back home for people who flop. Venezuelans are friendly. But they don't like foreigners who plan to grab a fortune and run back home with it. Nine times out of ten it won't pan out like that anyway.

☐ Aureomycin, the antibiotic drug, is now being used to treat sinusitis in turkeys.



# WHAT LASTS FOREVER?

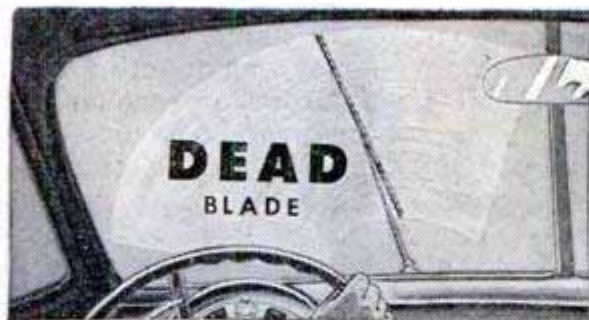

**THIS DEAD BLADE** still looks new but it blurs rain, smears muck, streaks glass. DEAD blades make dead drivers!

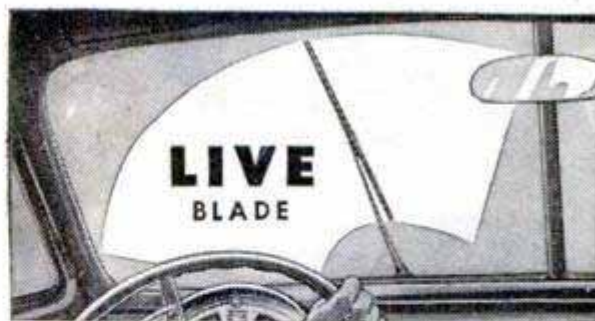

**THIS LIVE ANCO BLADE** wipes clean, clears rain, clears road muck . . . lets you SEE. Protects your loved ones.

**WHAT LASTS FOREVER?** Nothing does. This is especially true with Windshield Wiper Blades—even though made of finest natural rubber. Corrosive windshield film, wind burn and hot sun BAKE the life out of wiper blades, often in six months or less. DEAD blades cause dangerous windshield smear. DEAD blades make dead drivers. Make sure your car has live, new windshield wipers.

## Change Your Wiper Blades

Next time you buy gas, change to LIVE,

NEW ANCO BLADES . . . RAIN-MASTER for Flat windshields . . . CLEAR-FLEX for Flat or Curved windshields. They fit all cars—wipe quicker and cleaner than any other blades.

**Mr. Dealer:** Ask your ANCO Distributor about the sensational new ANCO Wiper Motor. A quick, easy replacement for lazy vacuum motors. Gives lots more power . . . lots less stall. Compensates for linkage wear to control wiping arc. Eliminates blade slap.

**THE ANDERSON COMPANY**  
GARY, INDIANA

# DON'T WORK HARD SCRAPING PEEL PAINT TO BARE WOOD WITH ONE EASY STROKE

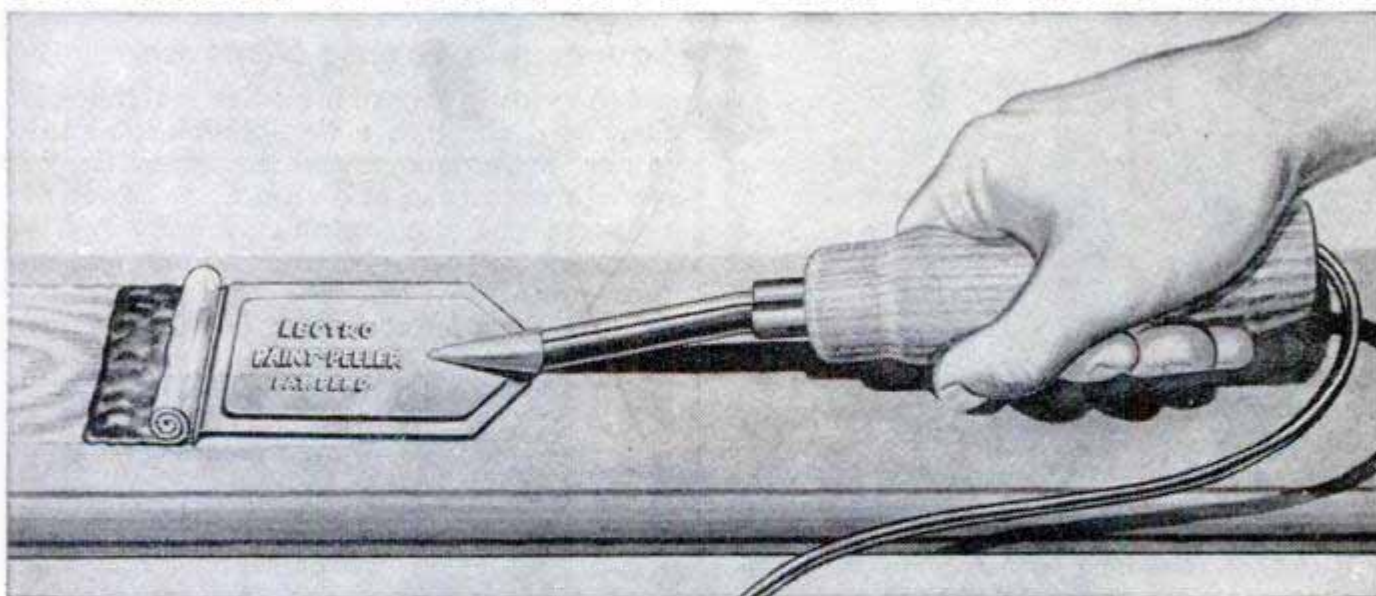

## NO CHEMICALS — NO FLAME

With one easy stroke, the Lectro Paint Peeler removes any number of coats of paint right down to bare wood. No danger of fire. Will not scorch or burn delicate wood surfaces. No messy chemicals. Crisp paint curls that you remove are dry, won't stick to rugs or furniture. Removes paint, enamel, flat or semi-gloss from wood surfaces. Nothing else to buy. Complete instructions included. Just plug in any 115 AC or DC outlet, heat, and go to it. Will pay for itself in a few hours in savings of your time, materials, and

**YOU MUST BE SATISFIED OR YOUR MONEY BACK**

## ORDER NOW!

**LECTRO WELD, INC.**  
5700 Detroit Ave., Dept. PM-10  
Cleveland 2, Ohio

I want to peel paint to bare wood in 1 easy stroke. Rush my Lectro Paint Peeler at \$4.95 postpaid.

NAME \_\_\_\_\_  
ADDRESS \_\_\_\_\_  
CITY \_\_\_\_\_ STATE \_\_\_\_\_

# New Allen-A Sensation!

## "LIVE-RUBBER" Action-Fit!

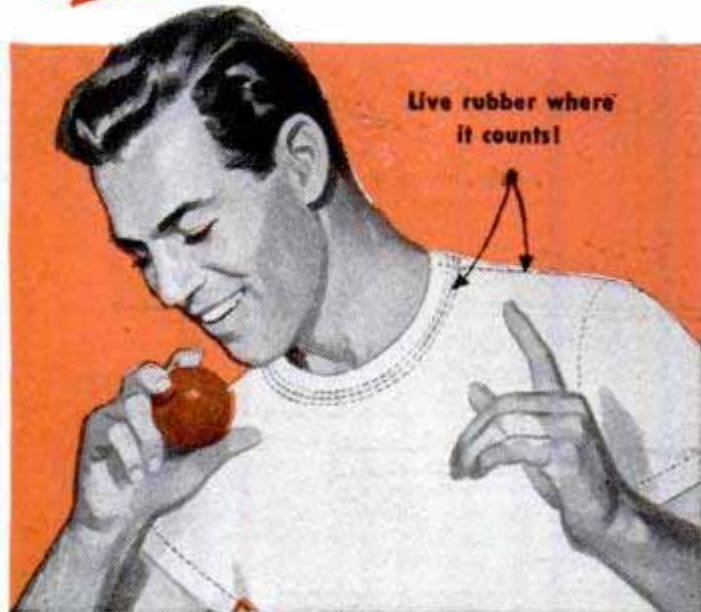

Like comfort in action? This new Allen-A Atlastic\* T-Shirt has live-rubber s-t-r-e-t-c-h in shoulder seams and collar for *permanent* shape-holding fit—both in action and at ease!



These new Allen-A Atlastic\* Briefs have live-rubber s-t-r-e-t-c-h at legs and waistband, naturally. But their new live-rubber and combed-yarn knit fly is Allen-A's alone. It gives you permanent fit *plus* mild support. Ask for this newest Allen-A "wonder-wear" today!



**Atlatic\***  
**UNDERWEAR**

engineered with "live rubber"

—fits like your own skin!

\*Reg. U. S. Pat. Off.—Pat. No. 2,282,217

# Inventing—Hobby of Famous People

(Continued from page 112)

salesman. And, while their inventions are not known by the name of the inventor, the vacuum cleaner was invented by a department-store janitor, a preacher invented photographic film and a barber invented the power loom. The dial telephone is an outgrowth of the work of an undertaker who thought that a rival mortician had bribed the operators to bungle his calls!

Even those who have not sought fame and fortune in inventions, often have found Lady Fortune at their elbow. This is illustrated by the invention of Miss Penny Pendleton, of St. Louis, and United States patent No. 2,481,946 issued to her on September 13, 1949. Miss Pendleton's invention is a holder for spectacles and consists of a piece of ribbon or chain long enough to be hung about the wearer's neck. Each end of the ribbon is provided with an elastic socket into which the ends of the bows of the spectacles may be inserted and retained. Though Miss Pendleton intended the device for her personal use, friends soon were pleading with her to duplicate the holder for them. In a matter of a few months she had launched a business that now embraces a million users.

Casual inventors, such as Miss Pendleton, continue to far outnumber professional inventors. This year one out of each thousand persons in the United States will take a fling at **inventing**. Perhaps this will be your turn—or that of your neighbor.

## Squeezable Grease Dispenser

Lubricating grease for office machines is dispensed through a flexible-plastic container that combines the characteristics of a toothpaste tube and an oilcan. Made of polyethylene, the container is squeezed to force grease through either a long flexible nozzle or a short tip. The dispenser can be refilled like a fountain pen.

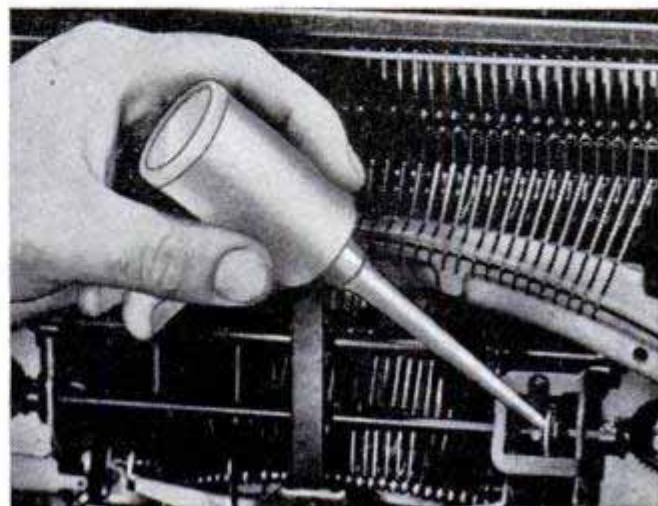

# Stucco Spraying Can Be Your Opportunity



You can build a profitable, lifetime business with Colorcrete. Large waiting market. Work is easy and interesting. Moderate investment; high return. Large waiting market. Full instructions and liberal co-operation.

## Sprayed-On Beauty

Colorcrete is modern beauty treatment for masonry surfaces — exterior and interior. Fuses to concrete, stucco, etc. Applied by air pressure. Range of many smart colors. Proven by 20 years of use on all kinds of buildings.

Write or wire for Opportunity Book.

**COLORCRETE INDUSTRIES, INC.**

570 Ottawa Ave.,  
Holland, Mich.



## FINE TOOLS NEED FINE OIL!



• Lubricates



• Prevents Rust

• Cleans • Polishes

SOLD EVERYWHERE

## 3-IN-ONE Oil



## Easy To Build

### U-MAK-IT BOAT KITS

8 FT. PRAMS  
ROWBOATS

OUTBOARDS



INBOARDS &  
CRUISERS



SEND 25c (coin)  
NEW CATALOG  
ORDER YOURS TODAY

**U-MAK-IT PRODUCTS** 703P-WHITTIER ST.  
New York 59, N. Y.

# HANDY RULES

## FOR HOME AND SHOP

In the complete line of Stanley Rules there's a wide assortment of styles, sizes, and markings. See them on display at your local dealer's.



**STANLEY NO. 346 PULL-PUSH RULE.** Rust-resistant spring steel blade — nickel plated or white enamel face. Large Gothic numerals — easy to read. Flexible-rigid blades for measuring straight, curved and angular surfaces. 6, 8, 10 ft. lengths.



**STANLEY NO. 106 ZIG-ZAG RULE.** All the features of 227 but without extension. White enamel finish.



**STANLEY NO. 227 EXTENSION RULE.** Solid brass extension for inside measuring. Selected sticks with new protective plastic finish. Coal black Gothic numerals. Graduated in 16ths — all edges. Rustproof nickel silver joints — "ball socket" action.

## 30 PRACTICAL PROJECTS

### FOR YOUR WORKSHOP

Early American Designs — easy to make with hand or power tools. Two packets with 15 designs in each, 25c per packet, postpaid.

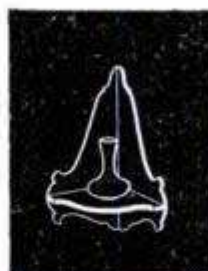

THE TOOL BOX OF THE WORLD

**STANLEY**

Reg. U.S. Pat. Off.

Hardware • Tools  
Electric Tools  
Steel Strapping • Steel

## TEAR OUT AND MAIL

Stanley Tools, 1100 Elm. St., New Britain, Conn.  
(In Canada: Send to Stanley Tool Co. of Canada, Ltd., 112 Stanley St., Roxton Pond, Quebec.)

Please send me Series A ( ) and Series B ( ) of the new Early American Project Plans. I enclose 25c for each set.

Name.....

Street.....

City..... State.....

Announcing the New CUSHMAN

# EAGLE

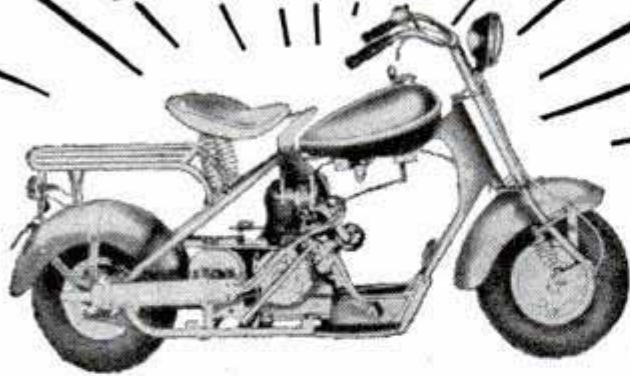

The sensational New Cushman EAGLE is ready! And, Boy! O Boy!—how you'll enjoy this entirely new thrill in motoring pleasure! It's big, husky, powerful, speedy! Has you moving at high speed within yards! Cruises up to 50 miles an hour out on the open road! Amazing fuel economy—up to 75 miles to the gallon! Luxurious comfort—big motor-bike saddle seat mounted on double coil springs . . . shock-absorbing springs on front wheel . . . big balloon tires designed for comfortable riding as well as easy steering and long life. Powerful 2-wheel brakes. 2-gallon (plus) fuel tank. Brilliant headlight, tail-light. Nothing else like it—and it's yours for only \$282.50 f.o.b. factory.



Long-time favorite for lowest cost motoring! Thousands in use. Cheaper than bus fare or operating your car. Handles easy. Slips through traffic, parks anywhere. Wonderful for getting to work, school or market—making deliveries. Famous Husky engine.

**WRITE**

See your Cushman dealer for the New EAGLE and regular Cushman Scooter. Or send for Folder M10.



Rider Agent Plan Available

DEALER INQUIRIES INVITED

**CUSHMAN MOTOR WORKS, Inc**  
LINCOLN, NEBRASKA USA

## MAKE EXTRA MONEY with Larson Leathercraft

### Easy-To-Assemble Kits No Experience Needed

Get started now. LARSON Beginners' Kits of ready-cut projects require no tools or experience. Free instructions included. Make belts, gloves, moccasins, billfolds, woolskin animals and mittens, other attractive leather items. Also America's most complete stock for advanced hobbyists and professional craftsmen. SEND 10c TODAY for newest 24-page catalog. **J. C. LARSON CO., 820 So. Tripp Ave., Dept. 218, CHICAGO 24, ILLINOIS**

## MODERN LAWN MOWER SHARPENER

FOR LAWN MOWER SHOPS  
FIX-IT SHOPS

GOLF COURSES • PARKS  
101 OTHER JOBS

Sharpens All Reel Type Mowers • Hand, Power or Gang • 10 to 20 Minutes • No Dismantling • No Extra Attachments Needed.

All reel type mowers, from 5-inch edgers to 36-inch power mowers, are quickly sharpened to extreme ends of both left and right twist blades.

**ORDER NOW**

Immediate Delivery

Handle, wheels, roller and motor remain in place when sharpening is in process. Bed knife is sharpened in same brackets. Grinding head rides on five ball bearing races. Easy to operate.

Also sharpens chisels, joiner knives, planer blades. Big profit maker. Own your own business. Send Today for FREE Illustrated Bulletin No. 10-C

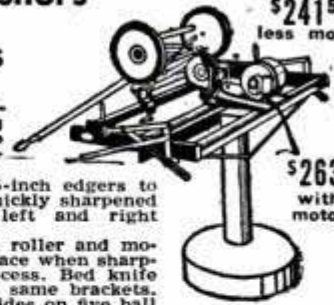

PRICE \$241.50 less motor

\$263.00 with motor

**MODERN MFG. CO.** 160 N. FAIR OAKS AVE. PASADENA, CALIFORNIA

## 100,000 WASHER REPAIR PARTS

Start Your Own Washing Machine Repair Business

RETAIL CUSTOMERS MAIL IN OLD PARTS OR MODEL NO. AND SERIAL NO.

Tremendous field, excellent profits! Get our large complete wholesale catalogue showing thousands of repair parts illustrations; wringer rolls, V-belts, motors, gears, etc. Price \$2.00 per copy postpaid in U.S. Send check or money order today—Established 20 years

**WESTERN APPLIANCE CO., Inc.**  
5650 GRAND RIVER AVE., DETROIT 8, MICH.



## FREE AMAZING NEW BOOK "HOW TO ANSWER ADS"



Never before have you seen anything like this. Tells you in simple language the correct way to answer ads. Gets you quicker replies—better results, and greater satisfaction. Will save you time and money and it's ABSOLUTELY FREE. No obligation whatever. Every reader of advertising should have this booklet. Send a postcard for your copy NOW. Advertising Department, Popular Mechanics Magazine, Room 602, 204 East Ontario Street, Chicago 11, Ill.

**BUILD FINE GRANDFATHER CLOCK NOW**  
The simple sensible Red-i-Kut way as thousands have—SAVE HALF. SHOP TESTED PLANS "SPIRIT OF THE CENTURY" Narrow waist 83" tall or stately straight side "SPIRIT OF AMERICA." EASY-TO-FOLLOW photopack PLANS tell all—plus BROCHURE of heavy brass weight Westminster, tube chime, movements, gorgeous dials, 3/4" solid mahogany case kits. Send \$1.00 today—Both Plans \$1.50 NOW. **KUEMPEL CHIME CLOCK CO., #8 Kuempel Bldg., Minneapolis 16, Minn.**

## WANT \$10,000?

Earn the govern- Super Sensitive P.R.I. ment bonus. Locate Uranium with a **GEIGER COUNTER**

Find gold, silver, and other valuable ores with a P.R.I. Treasure Locator. World's finest instruments. FREE catalog.

Write today.

**PRECISION RADIATION INSTRUMENTS, Inc.** Dealer Inquiries Invited  
5478PM Wilshire Blvd., Los Angeles 36, Cal.



SAY YOU SAW IT IN POPULAR MECHANICS

## RUPTURED?

Get Relief This Proven Way

Why try to worry along with trusses that gouge your flesh—press heavily on hips and spine—enlarge opening—fail to hold rupture? You need the Cluthe. No leg-straps or cutting belts. Automatic adjustable pad holds at real opening—follows every body movement with instant increased support in case of strain. Cannot slip whether at work or play. Light. Waterproof. Can be worn in bath. Send for amazing FREE book, "Advice To Ruptured," and details of liberal truthful 60-day trial offer. Also endorsements from grateful users in your neighborhood. Write:

**CLUTHE SONS, Dept. 31, Bloomfield, New Jersey**



The Right Tool for  
a Right Job  
IN YOUR WORKSHOP  
**EMPIRE LEVELS**



Get more value  
for less money! Make  
Your Choice an Empire Level

No. 151 Aluminum Level. Extremely accurate with adjustable-interchangeable vials. Has 2 levels, 2 plumbs, and a choice of 2 45° vials or 2 additional plumbs. Beautifully finished, easy to work with. A tool you can be proud to own.

18" ... \$6.40 24" ... \$6.80 28" ... \$7.80

Order EMPIRE Levels from your local dealer, or write for complete information.



**EMPIRE LEVEL  
MFG. COMPANY**

Dept. PM

10930 W. Potter Rd., Milwaukee 13, Wis.



**\$2.95**  
EACH

**NOW! FILE YOUR OWN SAWS**

Do expert saw filing at home. Precision filing easy without experience. Two simple adjustments. Keeps any hand saw extra sharp and true-cutting. Complete with file. Money back guarantee. Cash with order, prepaid. (COD postage extra.) Order today, \$2.95.

ANOTHER SPEEDCOR TOOL  
**THE SPEED CORP. PM-10**

512 N.E. 73 Ave., Portland 16, Oregon

**MONEY for MEN ALL DATA FREE**

THE PLASTEX Industry needs manufacturers on small scale and for big production of Lamp and Clock Stands, Art Goods and Novelties in Plastex and Marble imitation. Experience unnecessary. 1/2¢ material makes regular 10¢ store sellers. Rubber moulds furnished for speed production. Small investment brings good returns. We are now placing big Chain Store Orders with manufacturers. Ambitious men have chance for real prosperity. Our Free booklet will interest and benefit you.

**PLASTEX INDUSTRIES, Dept. A**  
3400 Third Ave. New York 56, N. Y.

**Big Savings on Quality Ball Bearing Wheels**

6 x 1.50	.....1.50	10 x 2.00	.....2.45
8 x 1.75	.....1.80	10 x 2.75	.....4.65

Take advantage of these big savings on quality ball bearing wheels. Every wheel has the Bilt-Rite guarantee. 10 Day RETURN PRIVILEGE. WRITE FOR PRICES ON OTHER SIZE WHEELS.

**BILT-RITE WHEEL CO.** Missouri Ave. and Cherry St. KANSAS CITY 6, MISSOURI

**10 SHELF PLANS**  
NEW FULL SIZE

New, full size, easily built, beautiful wall shelf plans ready to trace on lumber, cut out and assemble. Corner and wall racks with 1 to 3 shelves. Stores charge about \$75.00 for these shelves. Make money selling them. Finest selection available. PLUS BONUS of 48 other novel cut-outs, Dutch Boys, Girls, Toys, etc., etc. PLUS FREE latest Handicraft Catalog. Send only \$1 to

**JACKSON, Dept. 19**  
7927 MILWAUKEE AVE.  
MILWAUKEE, WIS.

**\$1**



**THE HANDIEST HAND TOOL  
FOR THE WORK SHOP**

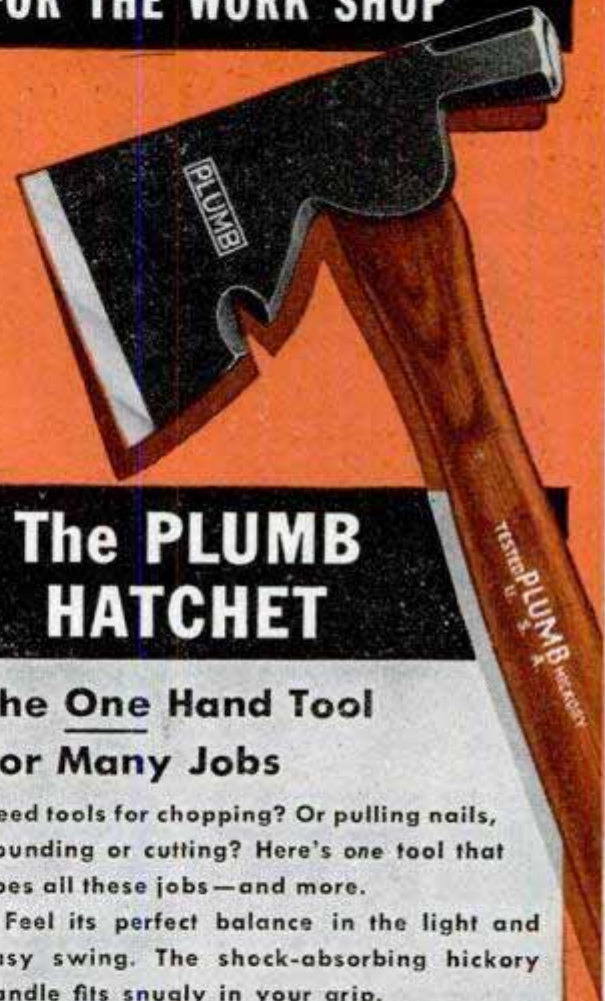

**The PLUMB HATCHET**

**The One Hand Tool  
For Many Jobs**

Need tools for chopping? Or pulling nails, pounding or cutting? Here's one tool that does all these jobs—and more.

Feel its perfect balance in the light and easy swing. The shock-absorbing hickory handle fits snugly in your grip.

The special analysis steel head is expertly made from the long-lasting cutting edge to the tough striking head.

Get a Plumb hatchet and have a time-saving, all-purpose tool handy.

The red handle and the black head  
—exclusively Plumb

**PLUMB**

HAMMERS • HATCHETS • AXES • FILES

# THROW AWAY NICOTINE

When the Filter in Medico Pipes or Cigarette Holders turns brown, throw it away with the nicotine, tars, juices and flakes it has trapped. Insert a fresh Filter for cooler, cleaner, dryer, purer smoking!



Real Filters  
...not mere hollow tubes!

10  
for  
10¢

**MEDICO V. F. Q. (VERY FINE QUALITY)**

Pipes of specially selected imported briar. \$2  
Wide variety of shapes. With 10 filters... 2

Also Frank Medico "Standard"...

America's Outstanding Dollar (\$1) Pipe

Frank Medico Cigarette Holders \$1 & \$2

## MEDICO FILTERED SMOKING

Write to S. M. Frank & Co., New York 22, for booklet M

ALL MEDICO PIPES NOW MADE OF PRE-WAR QUALITY IMPORTED BRIAR

**NEW! SPECIAL TYPE**

*Eklind*

**EMERGENCY BRAKE SIGNAL-LITE**

- Red plastic shield escutcheon. • Warns driver when emergency brake is on.
- Fits all cars including '50 models.

Install this handy signal-lite that glows red when ignition key is turned on, with emergency brake set. The red cap also removes for handy map reading light.

If your dealer cannot supply you, order direct (No C. O. D.'s)

**EKLIND TOOL & MFG. CO.** 2623 N. Western Chicago 47, Ill.



\$2.50 postpaid

Complete instructions for easy installation with each lite.

SAVE TIME, WORK, MONEY!

**SHAW "DU-ALL"**  
and "PEPPY PAL" TRACTORS

Easy and Cheap to Operate

**PLOW**  
These rugged walking or riding tractors are ideal for farm, truck garden, orchard, poultry farm. Operate on a few cents an hour. A child can handle them.

**CULTIVATE**  
DO DOZENS OF JOBS Both riding and walking tractors quickly and easily plow, cultivate, harrow, disk, bulldoze, spray, haul, grind, saw wood, etc.

**LOW FACTORY PRICES** Buy direct or through your dealer. Year's guarantee!

**RIDING TRACTORS** 4 models from 5 to 12½ H.P., 58 in. wheelbase, 36 to 52 in. wide, 24 in. plant clearance. Hand or electric starter. Walking Tractors 1½ to 5 H.P.

**FREE** Illustrated folders giving complete details and price lists—write today!

**SHAW MFG. CO.** 4510 FRONT ST., GALESBURG, KANS. 668G NORTH 4TH ST., COLUMBUS, O.

**GERSTNER Tool Chests**  
Every Gerstner Chest embodies high quality workmanship. Longer life is assured. Free catalog for machinists and toolmakers.

**GERSTNER TOOL CHESTS**  
450 Columbia St. Dayton 7, Ohio

## How To Hold FALSE TEETH More Firmly in Place

Do your false teeth annoy and embarrass by slipping, dropping or wobbling when you eat, laugh or talk? Just sprinkle a little FASTEETH on your plates. This **alkaline** (non-acid) powder holds false teeth more firmly and more comfortably. No gummy, gooey, pasty taste or feeling. Does not sour. Checks "plate odor" (denture breath). Get FASTEETH today at any drug store.

**DRAINS CELLARS, WASH TRAYS CIRCULATES OIL**

Pumps 1800 GPH 300 gal. 30' high, use 1/8 to 1/2 HP motor. Will not clog. **\$6.50**

Postpaid if cash with order. (Add 50c for west of the Mississippi.)  
Thousands in use since 1936

**LABAWCO PUMPS, BELLE MEAD 7, N. J.**

**QUICKLY REPAIRS Chipped PORCELAIN**  
NO BAKING required... anyone can repair Stoves, Refs., Sinks, Tubs, etc. Home-Size (up to 3 repairs) 50c; Economy size \$1.50 prepaid. (No C.O.D.'s).

**PORCELENE**  
Dept. M SHEBOYGAN, WIS.

SAY YOU SAW IT IN POPULAR MECHANICS

**BRUSHES ONLY 4¢ EA.**

Suitable for

- PAINT, ENAMEL
- LACQUER
- GLUE, PASTE
- OIL & CHEMICALS

Ideal for  
**WORKSHOP use, HOUSEHOLD, FACTORY and HOBBYISTS**

100 Assorted Brushes ..... \$4.00  
50 Assorted Brushes ..... 3.00  
25 Assorted Brushes ..... 2.00  
Minimum Order \$2.00 Postpaid. No C.O.D.

**N. ELGENE MFG. CO.** Box 147, FT. HAMILTON STA. BROOKLYN 9, N. Y.



*Hi-level needs water  
only 3 times a year!*  
In Normal Car Use

# prest-o-lite hi-level

70% longer average life\*!

**A**VOID battery failures, get longer battery life, with the new Prest-O-Lite Hi-Level Battery that needs water only 3 times a year in normal car use. Helps prevent a major cause of battery failure. In addition, Hi-Level gives you Fibreglass mats to keep power-producing material in the plates for longer life. Make your next battery a Prest-O-Lite Hi-Level.

**PREST-O-LITE BATTERY COMPANY, INC.**  
Toledo 1 Ohio



\*In tests conducted according to S.A.E. Life Cycle Standards.

## PROFESSIONAL TYPE BUFFING WHEELS

**KIT OF 5  
COMPOSITIONS**  
by Mail  
**\$1.75**  
(Reg. Val. \$1.95)



### AND COMPOSITIONS

For best buffing results, depend on DICO — by the world's leading producer of buffing wheels for industry. Whatever your buffing job, you'll find the right DICO wheel and composition to do it. For free Buffing Manual, write Dept. B-1050.

**DIVINE BROTHERS CO.**

**UTICA, N. Y.**

ASK FOR **Dico**

**AT YOUR  
HARDWARE  
STORE**

Contains 5-inch tubes of Dico genuine Jewelers Rouge, Emery, Tripoli, Rouge and Stainless. Instructive Buffing Manual included. MAILED POSTPAID if dealer cannot supply.

**HANDEE-DAPTOR**

**CONVERT YOUR 1/4" DRILL TO 1/2"**  
Simply insert adaptor shank in 1/4" chuck. HANDEE-DAPTOR chuck takes all bits to 1/2", incl. . . . . **\$2.95**  
Send 25c for Bargain Motor & Power Tool catalog. Refund on 1st. Order. Handee-Daptor postpd. exc. on C.O.D.  
**DANIELS PRODUCTS CO.**  
2224 N.E. 18 St., Oklahoma City, Okla.



**PISTON TYPE COMPRESSOR**



### EASY PROFIT IN PAINT SPRAYING

Paints walls, ceilings, screens, furniture and machinery faster, better. All complete as shown less motor. Carry anywhere. Fully guaranteed. Could be used with 1/4 H.P. motor or less. Price **\$35.00** less motor F.O.B. Chicago. \$5.00 deposit balance C.O.D. or see your dealer. With motor \$55.00.

**IDEAL AUTOMATIC PUMP CO., Dept. P.M.8**  
801 W. Washington Blvd. Chicago 7, Ill.

**M-SCOPE TREASURE-MINERAL LOCATORS**

WRITE FOR FREE, ILLUSTRATED 16-PAGE BOOKLET

M-Scope Treasure-Mineral Locators, Geiger Counters. New Low Prices, unsurpassed in efficiency. Full factory guarantee. Immediate shipment.

YOU CAN PURCHASE THESE INSTRUMENTS ON A MONTHLY PAYMENT PLAN

**URANIUM** **FISHER RESEARCH LAB, INC., PALO ALTO, CALIF.** **GOLD**



# Pep-Up That Sluggish Engine



*Before it Shakes You Down!*

## Add **BARDAHL** to Your Crankcase Oil

GIVE your cranky engine the sure-fire lubrication treatment it needs! Simply add one quart of BARDAHL to regular oil.

BARDAHL wakes up tired, sluggish engines. Quickly penetrates metal surfaces, cleans out carbon, forms a thin protective film at all friction points.

Best of all—BARDAHL cuts repair bills in half by stopping needless cylinder wear before it starts.

Ask the best mechanic in town about BARDAHL. He's been using it for years!

## **BARDAHL OIL**

*Reduces Friction to a Fraction*

BARDAHL OIL COMPANY  
Seattle • St. Louis

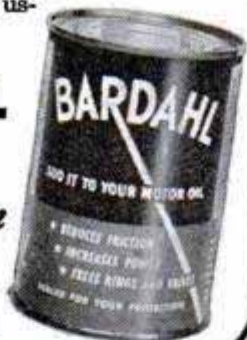

## **HOLLYWOOD MUFFLER** THE TONE YOU LOVE TO HEAR

### MORE SPEED—POWER—MILEAGE

are yours with a Hollywood Muffler . . . plus a tone you'll love to hear! Not a gutted muffler. Easy to install.

Hollywood Mufflers  
Trade-mark Reg.  
U. S. Pat. Off.

IMPROVED DESIGN  
PRECISION MADE  
ELECTRIC WELDED!

Outlasts ordinary mufflers 3 to 1

Ford, Chevrolet, Plymouth \$6.00  
All other cars . . . . . \$8.00

Duals, Ford & Merc. \$24.50. 3" Chrome Barker Tip, \$3.25. Order direct. Send check or M.O. and save postage.

Dealers Write **WILKINSON MUFFLER CO.** 811 WILT STREET FT. WAYNE, IND.

## An Outstanding **METAL HAND PUNCH** with unusual performance

Needed by every Mechanic in every Shop . . . . .

### No. 5 Jr. HAND PUNCH

CAPACITY—1/4" THRU 16 Ga. Mild Steel. 3/32" — 1/8" — 5/32" — 3/16" — 7/32" — 1/4" — 9/32" — Punches and Dies Furnished.



Weights 2 3/4 lbs.

THROAT DEPTH 2 inches

only **\$8.75**

ORDER YOURS TODAY!

Write for FREE Catalog on other tools.

Postpaid in U.S.A.

**WHITNEY METAL TOOL CO., Dept. P-10, Rockford, Ill.**

## **MAGNETS** OF ALL TYPES—10c UP AMAZINGLY POWERFUL!!

4 oz. Alnico Magnet, lifts 10 lbs. \$1.00. Our Leader, 15 oz. Magnet, lifts 40 lbs. \$2.50. New alloy—will not weaken! Useful for lifting valuables from tanks, lakes, or rivers easily! 7 small magnets \$1.10 with list of many shop and home uses. Satisfaction guaranteed. R. EYRICH, 2566 N. 49TH ST., MILWAUKEE 10, WIS.

BRAND NEW



## 30 DAY FREE TRIAL 7x50 Prism BINOCULARS

Finest Precision Optics  
Buy Direct From Importer  
Money Back Guarantee

7x50 \$36\* with leather case

Many other models AS LOW AS \$6.00\* (\*plus Fed. Tax)

FREE Illustrated Catalog & Book, "How To Select Binoculars"  
Dealers: Write for discounts.

**BUSHNELL Importers**

43 E. Green St., Dept. M-10  
Pasadena 1, California

## **LAWN ORNAMENT—NOVELTY PATTERNS**

28 Lawn Ornament Patterns, 25c. Other patterns; 15-20" high; Dutch Girl, Dutch Boy, Pirate, Bull Terrier, Mexican Girl, Mexican Boy, Dwarf, Penguin, Flower Girl, 10c each. 25 Novelty Patterns, 30c. All 62 Full Size Patterns, \$1.00 Postpaid. Strother Pattern Service, Dept. BX-8, Box 128, Belington, W. Va.

### Find HIDDEN TREASURES



**GEIGER COUNTERS** for Uranium Detection. (see at left). **TREASURE DETECTORS** for gold, silver, etc. Lightweight, ultra sensitive. None finer at ANY PRICE. Information FREE.

Detection Co. Dept. 10-B  
5631 Cahuenga, No. Hollywood, Calif.

SAY YOU SAW IT IN POPULAR MECHANICS

## **ONAN Portable ELECTRIC PLANTS**



FOR CABINS, TRAILERS, CONTRACTORS, BOATS

Light weight, compact, air-cooled, engine-driven. Furnish regular city-type A.C. electricity for lights, appliances, radios, etc. Can be carried by hand. Fits trunk of car. Plug-in receptacles on plant. Larger models for farms, homes, businesses beyond highlines. Catalog shows over hundred models. 400 to 55,000 watts.

**GASOLINE OR DIESEL POWERED**  
Prices begin at \$169.50

**WRITE FOR CATALOG**  
**D. W. ONAN & SONS INC.**  
5838 Royalston Ave., Minneapolis 5, Minn.





For Pleasure and Profit . . . . . in Shop and Home

# PUT THESE DREMEL TOOLS TO WORK!

PRACTICALLY DESIGNED . . . EASILY OPERATED . . . QUALITY BUILT . . . FULLY GUARANTEED

## DREMEL *Electric* SANDERS

**STRAIGHT-LINE RECIPROCATING ACTION  
GUARANTEES SCRATCH-FREE SURFACES**

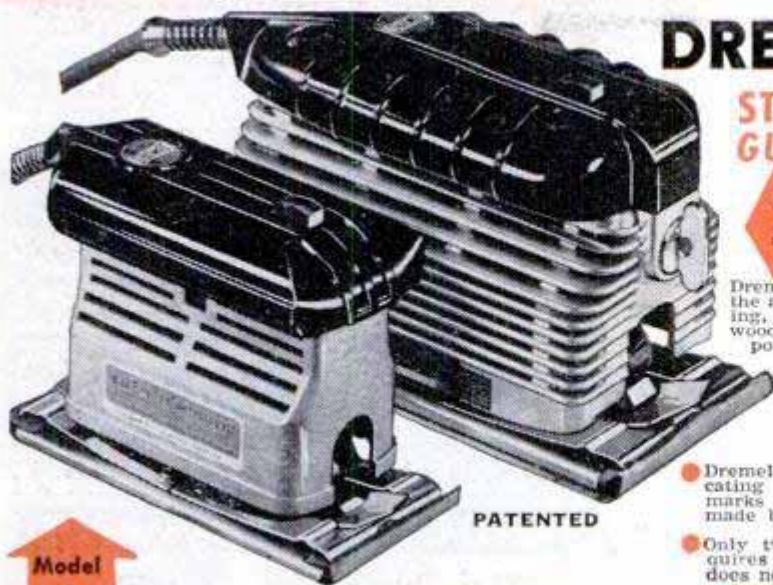

PATENTED

Model 2000  
**\$24.50**

**FOR HEAVY-DUTY CRAFT AND  
WOODWORKING PROJECTS**

Dremel's new Model 2000 is a fast-cutting, production sander. It has the added stroke and extra power required for furniture and cabinet making, boat building or refinishing. Great for building operations, sanding woodwork, dry wall joints, siding and other surfaces. Does a superb wax polishing job, too. Weighs only 5 pounds yet has 21 sq. in. sanding surface. Over-all size 3 1/4" x 4 1/2" x 7". Complete with steel carrying case, 25 asstd. sheets sandpaper, polishing pad. \$24.50.

### LOOK FOR THESE DREMEL FEATURES

(IN MODEL A AND MODEL 2000 SANDERS)

- Dremel's Straight-Line Reciprocating Action leaves no sanding marks . . . removes scratches made by other type sanders.
- Only two moving parts . . . requires no oiling . . . sanding dust does not affect action.
- 14,400 cutting strokes per minute assure faster sanding-polishing.
- Cam-type holder permits changing paper in seconds.
- 8 ft. Underwriter's approved cord . . . operates on 110-120 volt, 60 cycle A.C. . . . fully guaranteed.

Model A  
**\$14.85**

**FOR HOBBY WORK, REFINISHING  
AND REDECORATING . . . . .**

Dremel Model "A" Sander is a time and labor saver for hobbyists, homeowners and housewives. Over a quarter million now in use. Like Model 2000, its straight-line reciprocating action will not leave cross-grain scratches and abrasive marks made by other type sanders. Ideal for sanding woodwork, cabinets, unfinished furniture, workshop projects, etc. Weighs only 2 1/2 lbs. Takes the drudgery out of polishing waxed surfaces—furniture, woodwork, etc. Sanding pad 2 1/4" x 5 1/2". Furnished with 6 sheets sandpaper, 1 sheepskin, 1 felt pad \$14.85.

## DREMEL MOTO-TOOL

**THE POCKET-SIZE MACHINE SHOP**



**MOTO-TOOL KIT NO. 2**  
With 23 Accessories  
(High Speed Steel Cutters, Grinding Wheels)  
**\$23.50**

**MOTO-TOOL NO. 2** (only) with one emery wheel point — **\$16.50**  
Moto-Tool is the most versatile tool you can own—grinds, routs, drills, carves, engraves, polishes, etc. Look at these features: Approx. 27,000 R.P.M. • Dynamically balanced armature eliminates vibration. Oilless (oil-sealed) bearings • Dust-filtered air-cooling system • Weighs 13 oz. • Uses 110-120 v. AC • Used in plants of General Electric, Ford, Remington Arms, Nash-Kelvinator, etc.

Don't confuse Moto-Tools and Accessories with so-called "bargain offers". Compare Dremel feature for feature with competitive tools. If our products are not superior in every way, we don't want you to buy.

Portable  
**DRILL  
PRESS**

Only  
**\$9.95**

(Less  
Moto-Tool)



## DREMEL *Electric* COPING SAW

**CUTS SCROLLS LIKE MAGIC—SANDS AS IT SAWS**



BLADE  
FACES  
4 WAYS

JUST  
GUIDE IT!

Only  
**\$5.85**  
with 3 new blades

**SAFE! AS A HANDSAW**

For home, hobby, repair work—no other tool pleases so much for so little cost. Works in any direction—delivers 7,200 strokes per minute smoothly, effortlessly. Saws through 3/4" medium-hard wood at a foot-a-minute speed. Touch-of-the-trigger, foolproof action. Only 2 moving parts, never needs oiling. Uses 110-120 v. A.C.

. . . for 6 useful projects packed with each saw



### WHERE TO BUY DREMEL TOOLS



Dremel Tools are sold everywhere. If your dealer cannot supply you, send remittance in full and we will ship postpaid. Or send only \$2, and pay postman balance plus postage and fee. Money back if not delighted after 5 days' trial.

**DREMEL MFG. CO., DEPT. 110-K, RACINE, WIS.**

## BIG VALUE!

### MOTO-TOOL KIT NO. 1

Moto-Tool Kit No. 1 contains the lighter Model No. 1 Moto-Tool and 34 practical accessories (steel cutters, grinding wheels, etc.) in an attractive lacquer-finish wood case. It's the biggest value in the field. With 34 Accessories Only . . . **\$17.50**

**MOTO-TOOL NO. 1** with one emery wheel point . . . . **\$9.85**



### ROOM FOR TWO

### CHILD'S DUO-DRIVE SPORT CAR

ORDER BY MAIL

HIT OF THE YOUNGER SET

**\$24.95**

Seats two (Age 2 to 8 yrs.) Steers and pedals easily, either or both sides. Red enamel steel with varnished wood side panels. Big 8"x1.25 tires. 40" long x 22" wide x 20" tall — 45 lbs., shipping wt. Durable. Store price up to \$35. Mail price only \$24.95. Enclose payment or \$5.00 deposit. Balance C. O. D. on arrival. Free catalog.



**ESHELMAN, Dept. 19, 119 Light Street, Baltimore 2, Md.**



### HANDY CALCULATOR FOR WOODWORKERS.. ONLY 10c

Just set dial, quickly solves countless problems. Converts linear to board feet, compares workability of various woods, shows bit sizes, nail specifications. Also tool sharpening tips, etc. 6" diameter heavily varnished cardboard. Send 10c to Greenlee Tool Co. 2110 Columbia Av., Rockford, Ill.

FREE  
BOOKLET

Tells how  
YOU can be

almost 2 inches  
**TALLER**



Simply by changing  
your shoes

You're sure of yourself  
when you're TALLER.  
Be taller instantly in  
these amazing shoes.  
As smart and  
comfortable as any  
shoes you ever wore,  
they make you almost

2 inches TALLER instantly . . . "confidentially".  
Your shoe dealer has them in stock in your size.

\$16.95  
and  
\$19.95

Write for  
FREE  
BOOKLET  
Today.



STONE-TARLOW CO., INC., Dept. M10-50, Brockton GR, Mass.  
Please send me Free Booklet and name of nearest dealer.

NAME \_\_\_\_\_ PLEASE PRINT

ADDRESS \_\_\_\_\_

CITY \_\_\_\_\_ STATE \_\_\_\_\_



Look - ONLY \$39.95  
for This 5-in-1 Machine

Wonderful  
Christmas  
Gift

DRILL  
PRESS

LATHE

GRINDER

SANDER

SAW  
ARBOR

**Have Fun While You Save Money**

MUCH FOR LITTLE . . . an Emrick includes Lathe, Drill Press, Saw Arbor, Sander, Grinder — all in ONE machine, using only ONE motor. Equals in performance equipment costing 8 times more. You can work in wood, metals, plastics; make useful articles and splendid gifts; handle home repairs; operate profitable business. Fun for entire family — Marvelous gift for Dad!

● Direct factory-to-you price for everything pictured above still only \$39.95 cash, or on Easy Pay Plan. 63 pounds of REAL machinery. Thousands of delighted customers — our 52nd year. 10-Day Free Trial, Money-Back GUARANTEE. Write today for FREE literature.

**EMRICK, Inc., 1562 Clinton, Kalamazoo, Mich.**

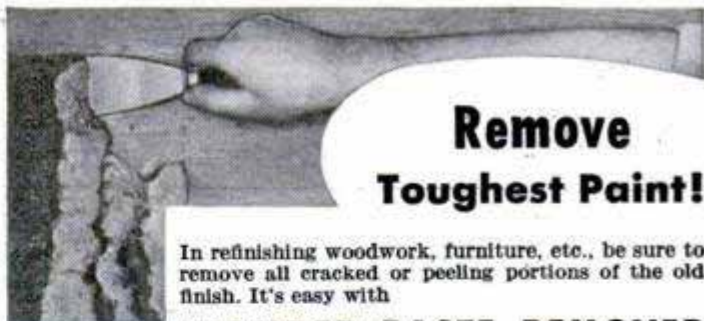

**Remove  
Toughest Paint!**

In refinishing woodwork, furniture, etc., be sure to remove all cracked or peeling portions of the old finish. It's easy with

**WONDER-PASTE REMOVER**

WRITE FOR  
Wonder-Paste  
leaflet and  
advice on  
your remov-  
ing problem.

Applied with a paint brush, this remarkable solvent softens up the toughest finish—paint, varnish, enamel, shellac, etc. Turns it into a soft sludge that comes off easily. Long a favorite with painters.

Get Wonder-Paste at paint and hardware stores

Wilson-Imperial Company, 119 Chestnut Street, Newark 5, N. J.

**GARAGEMEN** . . . Write for the new  
K. R. WILSON Catalog  
of Garage Tools and Equipment. Lowest Prices.  
K. R. WILSON, 213 Main Street, Buffalo 3, N. Y.

**KING MIDGET** Home Assembled Auto

**WORLD'S LOWEST PRICED CAR!**

Drive this car for as low as 50c per week. Precision built parts direct from factory with beautiful all steel body. Get the facts on this amazing small auto—send 25c for detailed circular with large picture, 3 view drawings and price of all parts, or send \$1 (refunded first order) for this plus actual assembly book with 42 photos, drawings; blueprints of snow, ice conversions. Ideal for micro-midget racing — Get this information.



MIDGET MOTORS MFG. CO.  
ATHENS 1, OHIO

**ROTARY FILES**



Special Assortment of 10—\$19.95 Value, now ONLY \$9.95. Ground from the solid and hand cut—1/4" shanks. We also offer a complete regrinding service—SATISFACTION GUARANTEED. Inquiries invited.

INDEPENDENT TOOL CO., 6007 Euclid Ave, Cleveland 9, Ohio

**BOYS-IT'S FREE!**

**"THE WONDERS OF CHEMISTRY"**

This exciting new book shows how to amaze your friends with chemical magic, describes many fascinating home experiments, tells of fun, thrills and big future opportunities for boys who know chemistry. Special atomic energy feature. Send today!

THE PORTER CHEMICAL COMPANY  
41 Prospect Avenue, Hagerstown, Maryland



SAY YOU SAW IT IN POPULAR MECHANICS

**NOW  
DADO ANY WIDTH**

**WITH DA-DALL!**

Pat. Pend U.S.A. & For

A simple turn of a screw adjusts your saw to any desired Dado cut! DA-DALL cannot slip, is self-tightening, self-adjusting, of all-steel construction does a clean, true job!

**ONLY \$4.95**

DA-DALL cuts hard or soft wood, plywood, without chipping! No blades or complicated dials. All arbor sizes

**RULE-WAGNER CO**

Box 694, Dept. D-6  
Walnut Creek, Calif.

Dealers, Jobbers Write for Information



# GET THIS 1950 CAR ENGINE PROTECTION

## the new **MARVEL** **INVERSE OILER**

### FOR CONSTANT UPPER CYLINDER LUBRICATION

Here's the famous auxiliary lubricating oil system—in a sensational new, low cost, 1 Quart size—that meters MARVEL Mystery Oil to critical upper cylinder engine parts precisely in accordance with the demands of your engine under load. This new, compact OILER, with visible oil supply, functions on the same exclusive MARVEL principle—inversely to manifold vacuum—retarding feed when throttle is closed or at engine idle. You'll keep ring, piston and valve wear down and performance way UP with the MARVEL INVERSE OILER on your car.

#### MARVEL MYSTERY OIL

Learn about MARVEL Mystery Oil too—the nationally recognized leader among oil improving additives. Added to your regular motor oil, it shields vital parts from excessive frictional wear with its great film strength—produces a slow idle, faster engine pick-up and an even power pull.

**EMEROL MANUFACTURING CO., INC.**

244 WEST 69th ST.

NEW YORK 23, N. Y.

**WRITE  
FOR THE  
FACTS—  
NOW!**



**SENSATIONAL NEW  
MODEL Q, 1 QUART  
VISIBLE RESERVOIR  
UNIVERSAL  
BRACKET  
SIMPLE TO INSTALL**

YOU'LL ENJOY

## LEATHERCRAFT

THE KIT KRAFT WAY

AND COPPER TOOLING OR  
TEXTILE PAINTING, TOO



**FREE!**  
ILLUSTRATED  
CATALOG

It's fun and it can be profitable! You can make fine leather goods, do beautiful copper tooling or decorative textile painting. Kit Kraft's big new catalog shows all supplies, tools, instructions, books, designs, everything you need, makes it easy, even for beginners. Write today for free catalog.

**KIT KRAFT** 7377 MELROSE AVE., DEPT. M-10  
HOLLYWOOD 46, CALIFORNIA

## SHARPEN SKATES!

**NEW ICE  
SKATE GRINDER**  
grinds all makes and  
types of ice skates!

Here's a speedy way to make extra money all winter! Sharpen ice skates of any type on the new Iceal Model 50 Bench Grinder, with skate grinder attachment. It's the finest—and FASTEST!—method. Write TODAY for free folder with complete money-making facts!

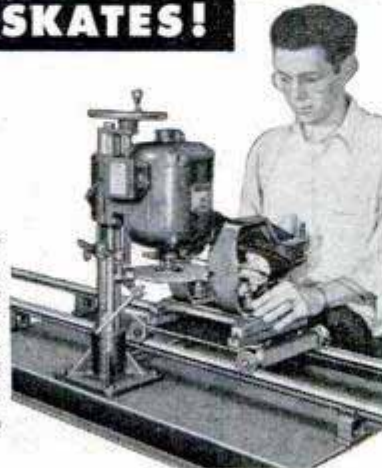

**THE FATE-ROOT-HEATH CO., Dept. J-3, Plymouth, O.**  
OCTOBER 1950

## SMALL BALL BEARING

**ASSORTMENT  
100 POPULAR  
SIZES & MAKES  
IN PARTITIONED  
PLASTIC BOX**



**NEW - PRECISION** { **FACTORY LIST PRICE ON  
BEARINGS OVER \$250.00**

Bearings are SKF—FAFNIR—MRC—NEW DEPARTURE—NORMA—FEDERAL and others. Sizes from 2mm to 8mm inside diameter, and 4mm to 24mm outside diameter. MECHANICS—TECHNICIANS—HOBBYISTS—just the thing for servicing small machines such as Washing Machines, Vacuum Cleaners, Home Appliances, Cameras, Toys, Instruments, Automotive and equipment of all kinds.

No. MA-1  
Assortment of  
100 Ball Bearings  
in Plastic  
Box complete  
as shown,  
postpaid

**ONLY  
\$15.95** **ORDER  
Now**

No. MA-2  
Junior Assort-  
ment of 50 Ball  
Bearings in  
Plastic Box  
complete,  
postpaid

**ONLY  
\$7.95**

**MEDALLION MFG. CO., 25 E. 25th St., Chicago 16, Ill., PM 10**

Send me postpaid, Ball Bearing Assortment

No. \_\_\_\_\_ in Plastic Box. I enclose  
check (or Money Order) for \$ \_\_\_\_\_

Name \_\_\_\_\_

Street \_\_\_\_\_

City \_\_\_\_\_ State \_\_\_\_\_

**SAY YOU SAW IT IN POPULAR MECHANICS**

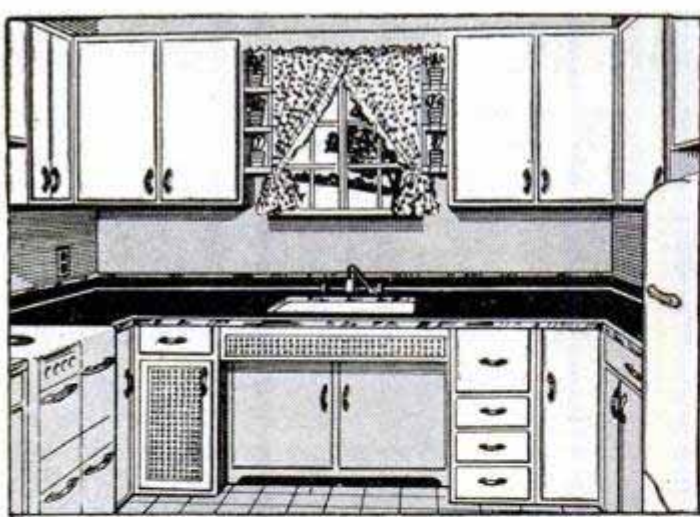

## MAKE YOUR KITCHEN MODERN

... this low-cost easy way  
 ... including today's new counter top

To help you modernize your kitchen the easiest possible way—and save up to 75%—we offer the famous Easi-Bild Build It Yourself\* patterns for base and wall cabinets. By this method, we help you discover the miracle counter top: Micarta . . . the plastic surface so smooth, so tough and lustrous, it resists any scratching, denting, or chipping—can't be stained or discolored by boiling fats, alcohol, fruit juices, greases or oil—so beautiful and colorful it's the choice of today's leading architects.

You can buy Micarta at your local lumber yard, already mounted on  $\frac{3}{4}$ " waterproof Weldwood plywood. Ask for Micarta panels. They can be sawed, trimmed, planed and drilled by ordinary hand tools.

## DO IT YOURSELF... SAVE BIG MONEY

And, to take all the mystery out of building Base and Wall Cabinets for your kitchen, child's room, playroom or bedroom, send for the patterns below. With them you buy only the materials the patterns clearly specify—at your local lumber dealer. You cut each piece exactly as the easy-to-follow, step by step directions indicate, then fasten into the positions shown by the "easy-as-pie" assembly illustrations. No special tools or skill are required.

Over a million Easi-Bild Patterns have been sold because they make your project easy, inexpensive and professionally perfect. Buy them at your lumber or hardware dealer or order them in the coupon below.

\*TRADE MARK, Easi-Bild Pattern Company



MICARTA is manufactured by WESTINGHOUSE and sold for decorative purposes only, by UNITED STATES PLYWOOD CORP.



UNITED STATES PLYWOOD CORPORATION  
 PATTERN DEPT. P.O. Box 215, Pleasantville, N. Y.

Enclosed is \$\_\_\_\_\_ for items checked below.

- Send FREE sample of Micarta
- Kitchen Base and Wall Cabinet Patterns No. 201 at \$1.00
- Service Counter Pattern No. 80 at 60c
- Easi-Bild Pattern Catalogue illustrating over 100 other "Build It Yourself" projects at 20c

Name \_\_\_\_\_

Address \_\_\_\_\_

City \_\_\_\_\_ State \_\_\_\_\_

P.M. 10-50

## HYDRAULIC Power Transmission WITH Infinitely VARIABLE SPEEDS, Clutch and INSTANT REVERSE—OUTPUT TORQUE ADJUSTMENT UP TO 180 inch POUNDS

This positive displacement Hydraulic Torque Converter is the ideal fluid drive with thousands of uses . . . Output Speeds Infinite .0 to 550 R.P.M. . . . in either direction . . . Change Speeds WHILE RUNNING . . . Control and Transmit your power this SMOOTH Oil-Way . . . Will handle  $\frac{1}{4}$  H.P. to  $1\frac{1}{2}$  H.P. Motor, Industrial or Home & Farm Use . . . Cost government \$300. High Quality Precision Workmanship. Buy this unit to get the most for your money. Case measures  $7\frac{1}{2}$ " long 7" high  $6\frac{1}{2}$ " wide. Input & Output Shafts  $5\frac{1}{8}$ " dia. Beautiful Red Crackle Finish Case.

FINGER TIP CONTROL

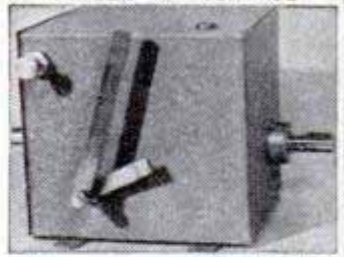

Shipping Wght. 25 pounds

Only \$54.50

If C.O.D. is requested a 10% Deposit must accompany order and we ship F.O.B. Chicago.

$1\frac{1}{2}$ "-8 thread lathe Chuck Adapter, \$3 extra

Prepaid in U.S.A. 2 quarts oil included FREE

DIRZIUS MACHINE SHOP "G" 1423-25 So. 52nd Ave., Cicero 50, Ill.

## Plane it square with **SQUAR-EZY.**



• The new attachment that makes your woodworking plane an accurate edging and joining tool. Fits all standard planes—Quickly attached or removed—Rugged malleable iron, accurately machined and cadmium plated. Order direct or ask your dealer. Model 7 for Block planes and Nos. 2-3-4, \$1.98. Model 11 for No. 5 Jack and larger, \$2.49. Satisfaction guaranteed.

The BRATTON COMPANY  
 Dept. 123 Edwardsville, Kansas

## LIQUID MARBLE

COMPOSITION FLOORS

FLEXIBLE MOLDS

Mold, Brush, Trowel, Spray It!

MOLD novelties, Statuary, Art Goods in Flexible Plastic Molds; 5c

material makes \$1 seller. Make Marbleized floors, Tile Walls. Colorful, glossy, amazing! Easily learned; start in garage or basement. Particulars free.

MARBLEIZING SERVICE, Dept. 10-F, Edwardsville, Ill.



## ONE-MAN SAWMILL LOW \$50.00 DOWN AS... \$50.00



Take BELSAW Portable Sawmill right to the trees—turn out valuable lumber for local yards—do "custom sawing" for neighbors. BELSAW lasts a lifetime. No crew needed. Power with old auto engine. Beginners get excellent results. Send postcard for FREE BOOK, "How To Make Lumber."

BELSAW MACHINERY CO  
 8111 Field Bldg, 315 Westport Rd, Kansas City 2, Mo.

## Aptitude Tests

for men, women, boys, girls, discover the kind of work or studies best for your success! You get a personal report—a guide for life—more happiness—more prosperity. Write for complete facts.

VOCATIONAL COUNSELORS, 5059 Woodward Avenue, Detroit

SAY YOU SAW IT IN POPULAR MECHANICS

## OIL FILTER REFILLS... 10c



Filters Oil the full length of the Pack

10,000 Sq. In. of Filtering Surface

Plates Last Indefinitely

Here's News! Ordinary toilet paper makes an ideal oil filter. Laboratory tests prove it cleans oil faster and better than popular makes of filter elements. All you need is a simple set of Retlif Adapter Plates... and you can start using toilet paper rolls (costing about 10¢) in your present oil filter. For proof and descriptive literature, send name and address to:

RETLIF CORPORATION, Dept. 57  
 1239 No. Highland Ave., Los Angeles 38, Calif.  
 DISTRIBUTOR INQUIRIES INVITED

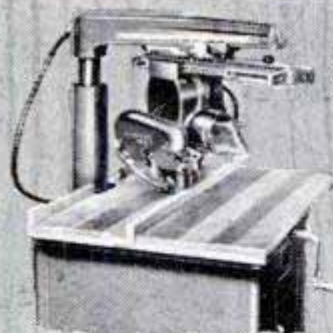

Delta Multiplex®  
Radial Arm Saw —  
one of four models.

Delta Crescent  
Planer — one of  
three Delta  
Crescent planers.

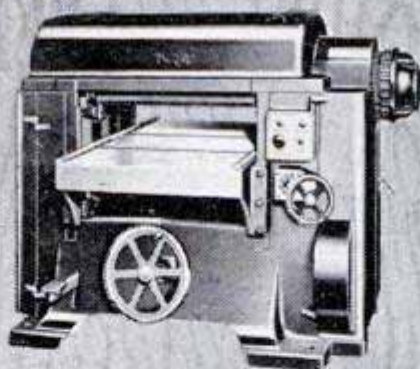

Delta-Milwaukee  
Tool Grinder —  
one of five Delta  
grinders.

**DELTA**  
**MILWAUKEE**  
®

*Power Tools*

**cut wood — cut metal — cut costs!**

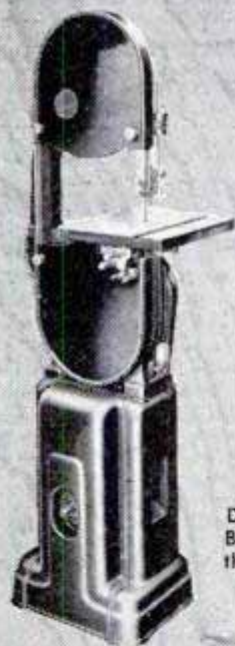

Delta-Milwaukee 14"  
Drill Press — one of  
11 Delta drill presses.



Delta-Milwaukee 14"  
Band Saw — one of  
three Delta band saws.

Delta-Milwaukee  
10" Tilting-Arbor  
Saw — The famous "Uni-  
saw"® — one  
of six Delta cir-  
cular saws.



**Talk about selection!**

53 machines  
246 models

More than 1300 accessories

— plus 14 Delta Ho-necraft®  
tools and accessories

**Get the right tool for every job,  
in the *complete* line, the  
*quality* line, the *leading* line**

Whether you work in wood or metal, whether your shop is big or little, Delta tools offer you: low first cost, low upkeep, high output. The reason? Quantity production of quality tools, backed by years of safe and successful operation in schools, industrial plants, commercial shops, and homes.

See for yourself how these tools can help you cut costs. Ask your Delta dealer for a demonstration. And send the coupon today for the complete catalog, showing and describing the tools that fit your job and budget best. Time payments available.

**DELTA POWER TOOL DIVISION**



**Rockwell**

Manufacturing Company

MILWAUKEE 1, WISCONSIN

**Send coupon today for free catalog**

Delta Power Tool Division, Rockwell Manufacturing Company  
802L E. Vienna Avenue, Milwaukee 1, Wisconsin

Send me your catalog on the complete  
Delta line. I am interested in tools for:

Business       School       Home

Name.....

Address.....

City..... (.....) State.....

B-5A



## OWN YOUR BUSINESS

### Start in Spare Time with a FOLEY SAW FILER

Here is a steady repeat CASH business you can start at home in your basement or garage, while you are working at your regular job. No experience is necessary to turn out perfect cutting saws—"the first saw I sharpened came out 100%. I think the Foley Saw Filer is a marvel of perfection," writes Clarence E. Parsons. Every saw you sharpen will bring you new customers. You will find you can make up to \$2 or \$3 an hour—\$20 to \$30 a week in your spare time as a starter.

With a Foley Saw Filer you can file all hand saws, also band and cross-cut circular saws. It is easy to operate—simple adjustments—no eye-strain. Patented jointing principle evens up all irregular teeth and makes an old saw cut just like new.

#### This Free Book Shows How to Start

"INDEPENDENCE AFTER 40!" shows you how to get plenty of saws to file without canvassing, and how you can develop into a general repair shop that will be your own business. This is a helpful, practical book that tells just what to do—send for your free copy today. No salesman will call.



Send For FREE BOOK

FOLEY MFG. CO., 1016-O Foley Bldg. Minneapolis 18, Minn.

Send me free book "INDEPENDENCE AFTER 40!"

Name \_\_\_\_\_

Address \_\_\_\_\_

## Own The Genuine VISE-GRIP WRENCH

Low as \$1.65



Ton-Pressure LOCKED grip enables VISE-GRIP to do jobs no other tool can do! No job too tough! Wonderful in close quarters. Easily turns battered nuts, bolts, worn screws—holds the smallest parts for grinding, sawing, etc. Insist on the Genuine VISE-GRIP with Involute Jaw Curve that holds all shapes. Knurled Jaw Tips that grip to the very tip. Thin Nose, Super Wire-Cutter. With cutter—No. 7W, 7", \$2.25; No. 10W, 10", \$2.50. Without cutter—No. 7C, 7", \$1.85; No. 10C, 10", \$2.25; No. 7, 7", \$1.65; No. 10, 10" \$1.95. If not at your dealer's, order direct.

PETERSEN MFG. CO., Dept. P-10, DeWitt, Nebr.

## CARBURETOR TOO RICH MAKES MOTORIST TOO POOR



Car owners who are wasting money and not getting proper gas mileage due to over-rich mixtures will be pleased to learn how to save gasoline by VACU-MATING over-rich mixtures. VACU-MATIC fits all cars, trucks and tractors. It is automatic and operates on the supercharge principle. Easily installed in a few minutes.

**SALESMEN WANTED!** Big Profits! Send name, address on penny postcard for free particulars and how to get yours for introducing.

VACU-MATIC CO., 7617-1651 W. State St., WAUWATOSA, WIS.

## Have fun! BUILD YOUR OWN CHAMPION



Build your own 3 point racing Hydroplane or Runabout! Complete plans available for fastest boats in the world. Send 25c now for new illustrated catalog to CHAMPION BOATS, P. O. Box 7132 M, Long Beach 7, California

## Free Book on CUSTOM-BUILT HIGH FIDELITY RADIO

by DAVID RANDOLPH  
CONTENTS: How to assemble connoisseur's radio-phonograph for as little as \$121.50. How to select components. How to save money by installing system in existing furniture. Glossary of hi-fi terms. . . . Assemble your own hi-fi set. It's easy. Send today for FREE copy of David Randolph's "High Fidelity Guide"

WRITE: LAFAYETTE RADIO, Dept. LJ  
100 Sixth Avenue, New York 13, N. Y.

## Sensational Double-Value!

PLATED METAL FRAME

GRAIN FINISH HEAVY WOOD STOCK

**BORNEO**

**DART GAME and SLING SHOT**

New JET-LIKE PROPULSION for Fun or Hunting

Amazing new principle! Convert from exciting dart game to most powerful, long range sling shot in seconds. Includes gun, 3 rugged arrow darts with safe rubber cups, sling shot band and extra rubber strands.

**\$1.00** POST PAID

Wes-ko Products 6057 W. Adams Blvd. Los Angeles 34, California

# HERE IT IS!

## A New, Improved, Better Handling

# CRESCENT ROUND NOSE LINEMAN'S PLIER

Grasped by any experienced hands, this new Crescent Round Nose Plier immediately impresses the user with its feel and balance. The rounded nose enables it to be used in places where the conventional type will not reach...lets it slip easily in and out of loops on tool belts.

The new #2150 is lighter and thinner than the conventional pattern... actually two ounces lighter but with the same characteristics of strength and toughness that feature other CRESTOLOY pliers. Its cutting edges are carefully hand-honed to give them lasting sharpness. The milled teeth in the nose take a sure, non-slip hold on the wire or other work. The handles, while smooth to the touch, are not slippery. Head is polished, handles are black. Each plier carries the CRESTOLOY tag.

**LIGHTER**  
Thinner, stronger than conventional pliers.

**No. 2150-8"**  
Also available with insulated handles.

**NON-SLIP**  
Handles smooth to touch but not slippery to hold.

**CRESTOLOY TAG**  
is your best guarantee of individually tested quality.

**HAND-HONED**  
cutters for lasting sharpness.

**CRESCENT TOOLS**

**STREAMLINED**  
Easy to get in or out of tight spots and tool belts.

**MILLED TEETH**

in the nose mean a firm grip on the work.

## SHOW YOUR COLORS!

*Miniature*  
**CRESCENT WRENCH**  
*Tie Clasp*

### BE PROUD OF YOUR CRAFT OR HOBBY!

A \$2.00 value anywhere! This beautiful chain-type Tie Clasp is the latest style... a miniature Crescent Wrench of Jeweler's bronze suspended on a gold-plated chain. This Crescent Tie Clasp keeps tie in place but allows normal upward and downward movement. Mail coupon with 50¢ (coin only).

Crescent Tool Co., Jamestown, N. Y.

Gentlemen: Enclosed find 50¢ (coin). Please send me a Crescent Tie-Clasp prepaid.

Name.....

Address.....

City.....State.....

"Crescent" is our trademark, registered in the United States and abroad, for wrenches and other tools. Sold by leading distributors and retailers everywhere. Made only by Crescent Tool Company, Jamestown, N. Y.

**FREE**

**ALLIED'S  
NEW 1951  
RADIO and  
TV CATALOG**



**SEND FOR THIS  
212-PAGE BOOK**



**SAVE ON EVERYTHING  
IN RADIO AND TV**

**Get Radio's Leading Buying Guide!**

Save money on every purchase you make from the world's largest radio supply house! Send for ALLIED'S new 212-page 1951 Catalog packed with *everything* in Radio and Television. Widest selections of home radios, TV equipment, phonoradios, Amateur equipment, P.A. systems, Hi-Fidelity music systems, recorders, test equipment, builders' kits—plus thousands of parts, tubes, tools, books and diagrams. Get more for your money—send today for your **FREE** 1951 ALLIED Catalog, the preferred Buying Guide to *everything* in Radio, TV and Electronics.

**BUILDERS' KITS • TELEVISION  
HI-FIDELITY CUSTOM SOUND  
AMATEUR GEAR • THOUSANDS  
OF PARTS, TUBES, TOOLS,  
TESTERS, BOOKS, DIAGRAMS**

Everything for:  
Servicemen  
Engineers  
Experimenters  
Builders  
Amateurs

**ALLIED RADIO**

**FREE  
CATALOG**

ALLIED RADIO CORP., Dept. 5-K-0  
833 W. Jackson Blvd., Chicago 7, Ill.

Rush **FREE** 212-Page ALLIED Catalog

Name.....

Address.....

City.....Zone.....State.....

**NEW! "VIOLIN FINISH"  
WOOD CLARINET**

**EASY  
TO PLAY**

**WILL NOT CRACK**

Amazing new Pan-American wood clarinet in beautiful "violin finish," guaranteed *not to crack!* No other clarinet like it. Musically and mechanically superior. See it and other fine Pan-Americans at dealers everywhere, or write for free literature. Mention instrument. Address Dept. 1003.

*Write  
FOR FREE  
FOLDER on  
instrument of  
your choice*

**PAN-AMERICAN  
BAND INSTRUMENTS**  
Division of C. G. CONN Ltd., Elkhart, Ind.

**BIG MONEY FOR YOU  
Selling Mechanical Trades**

**\$9.00**  
Prepaid

It saws all Metals, Bolts, Asbestos, Rivets, Wood, Fibre, Pipe and Tubing. Invest only \$9 in demonstrating sample. You can make over \$50 daily. Write for details.



**E. H. STACKHOUSE**  
219 N. 63rd St.  
Dept. PM9-S  
PHILA., PA.

**Rupture Troubles Ended**

Advanced method has healed thousands. No leg straps, no elastic, no plasters. No pressure on hips or spine. Flexo-pad. Entirely different. Endorsed by doctors, mechanics, clerks. Very light. **INEXPENSIVE. GUARANTEED.** Write for information and trial.

**SMITH MANUFACTURING COMPANY**  
EST'D 1893 DEPT. PM PRESTON, ONTARIO



**FREE SAMPLES!  
GLOW IN THE DARK!**

**BIG PROFITS** showing amazing Luminous Specialties—house numbers, pictures, plastic novelties, religious and nursery objects, ash trays, key-holders, etc. Large manufacturer. Enormous demand. Sell on sight. **WRITE AT ONCE** for **FREE** samples, Madison Mills, 303 4th Ave., Dept. P-4, New York 10, N.Y.

BeMaCo Dependable

**AUTOMATIC  
SAW SET**

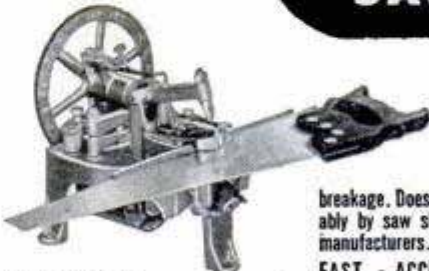

Sets 400 teeth per minute on hand or band saws 4 to 16 point. Hammer and anvil action sets teeth accurately and uniformly... No tooth breakage. Does a perfect job. Used profitably by saw shops everywhere and saw manufacturers. Every machine guaranteed!

**FAST - ACCURATE - DEPENDABLE**

★ **INCREASES PROFITS**  
**BEAVER MFG. CO.**  
Saw Machine Div. #2M  
800 SO. ISIS AVE. • INGLEWOOD, CALIF.



BEAUTIFIES natural wood, pine paneling

POLISHES furniture, woodwork

NET CONTENTS ONE QUART

**Pol-mer-ik** SUPERTREATED  
**LINSEED OIL**  
FOR BETTER PAINTING

ARCHER QUALITY

AND 101 HANDY HOME USES

IMPROVES paint jobs

PROTECTS wood and metal surfaces

49¢ 89¢  
PINT QUART

**101 HANDY HOME USES!**  
Every home, every workshop, needs Pol-mer-ik BOILED Linseed Oil. Free folder tells you how to use it. Write . . .

ARCHER-DANIELS-MIDLAND CO., Minneapolis 2, Minn.

**HIGH SPEED STEEL ROTARY CUTTERS**  
1/8" Shanks

SET No. 18 . . . \$6.85 POST PAID

Send check or money order today.

This set of 18 cutters consists of the most popular shapes and sizes used by individuals throughout the country. Due to the high quality workmanship, these cutters are unsurpassed for performance and efficiency. Packed in sturdy case as illustrated. Dealer inquiries invited.

**RICO SUPPLY COMPANY**  
P. O. Box 828 Dept. C Saginaw, Mich.

**THAT'S RIGHT, YOU'RE WRONG**

This isn't a fountain pen. It won't write, but it's always right about your tire pressure! Introducing the new

**1950 WONDER IN TIRE GAUGES**

Absolutely nothing like the Fletcher tire gauge for accuracy! Light as a feather! Clips on your pocket like a fountain pen. You'll never part with it . . . greatest boon to safe motoring . . . saves on tires. Calibrated from 16 to 42 lbs. Extremely durable, nothing to wear out. Made of crystal clear plastic and aluminum. \$3.50 post-paid. Order today. No C.O.D.'s.

**FLETCHER MFG. CO., P. O. Box 2072**  
1050 SHERMAN ST., DENVER, COLO.  
Dealer's Inquiries Invited.

That horrible stuff in our car?

Horrible, is right. If you want your car to run better, last longer, and cost less for repairs, get a new Purolator Refill for your oil filter—quick!



If you've been neglecting to have your oil filter checked, chances are there's horrible muck like this in your car. So when you change your oil this fall, start fresh with a new filter refill.

Be sure you get a Purolator\* Refill—the accordion type that filters more completely, hence saves more substantially on repair bills. Costs only \$1.38 to \$3.00, depending on make of car. Inserted in a few minutes.

P. S. If your car has no oil filter, a complete Purolator, both housing and refill, costs only \$6.50 or a bit more, depending on make of car. Purolator Products, Inc., Rahway, N. J., and Toronto, Ontario, Canada.

**Purolator**

**MICRONIC OIL FILTER**

\*Reg. U. S. Pat. Off.

*Only* **STRYPEEZE**  
PAINT REMOVER  
is **GUARANTEED**



**STAYS WET LONGER**  
**REMOVES MORE COATS**  
**CLINGS TO**  
**UPRIGHT SURFACES**

**GUARANTEE**

STRYPEEZE is guaranteed to stay wet longer and remove more coats of finish per application, indoors or out, than any other remover, or your money back.

*Write for  
Free Circular*

**TRY STRYPEEZE!**

Harmless to hands and surfaces. Only 65¢ a pint where you buy paints.

**SAVOGRAN**

DEPT. 38, BOSTON 16, MASS.

**Better, Easier, Quicker**  
**GROOVE CUTTING or**  
**CABINET-MAKING**

with *Warren* DADO SAWING WASHERS

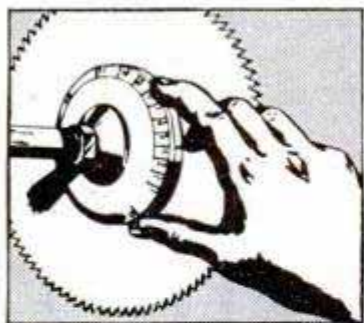

*Just dial*  
**DESIRED CUT**

Cut accurate, parallel grooves—any width, any angle. Just dial desired width with Micromatic adjustment. Cuts smooth

and clean—no burning or chewing to mar fine wood. Just four simple washers. Available in 5 sizes— $\frac{1}{2}$ " ,  $\frac{3}{4}$ " ,  $\frac{5}{8}$ " , 1" ,  $1\frac{1}{8}$ ". Free booklet on request. See your dealer or write direct. Absolutely guaranteed! In Canada, send money order for \$4.95 (duty and sales tax extra).

**\$4.95**  
A SET

Dealers, Jobbers, Write for Information!

**WARREN DADO SAWING WASHERS CO.**  
70 Medbury, Dept. 30, Detroit 2, Michigan

**MAKE YOUR OWN!**  
WITH



**Griffin READYCUT LEATHER PROJECTS**

Over 100 KITS in every kind of Tooling and Carving Leather, accurately cut, all parts included. Only Top Grade Leathers used. You do the choosing. You do the tooling, carving, stamping, the punching and assembling.

SEND FOR COMPLETE CATALOG  
Please send 10¢ to cover mailing.

**EVERYTHING FOR THE LEATHER WORKER**

Largest, most complete stock of Leathercraft Tools and Accessories in U.S.A.



**HIDES AND SKINS** of Craft Leathers of every kind if you prefer to cut your own.

SINCE 1924  
OUT OF THE WEST, THE HOME OF LEATHER CARVING

**Griffin CRAFT SUPPLIES**  
5626-A TELEGRAPH AVE.  
OAKLAND 9, CALIFORNIA

*Now* . . . **MEASURE CURVED LINES!**

Simply hold instrument vertically and trace line or distance to be measured. The index hand on dial shows exact length of measured distance in centimeters or inches. (Multiply for feet, yards or miles).



**IDEAL FOR:** Motorists, architects, draftsmen, engineers, craftsmen, machinists, engravers, artists, photographers, teachers, students, decorators, hobbyists, designers, textile men, etc.

- Watch type. Has 2 faces—1 on front, 1 on back.
- Precision made (Imported)
- Highest quality material
- Chrome finish
- Unbreakable lenses

**\$3.75**  
ea.

GUARANTEE Dealers Inquiries Welcome

Send Check or Money Order to:  
**ALVIN CO. Importers, Windsor, Conn.**  
"QUALITY AT THE RIGHT PRICE"

**MARCOT KEY MACHINE**

Immediate Delivery



- MARCOT No. 8 KEY MACHINE,** mounted on Cabinet, less motor. \$ 95.00  
Auto Code Book and Depth Keys. 12.50  
100 Dz. Popular Key Blanks. . . . . 60.00  
Set — Key File, Follow-Through Rods, Lock Picks, Bit Key Gauge, Thimble, Pins, Springs. . . . . 10.50  
"Locksmith Trade Books". . . . . 6.75  
How to Open Locks without Keys or Picks; Secret of Locksmithing; How to Make Keys by the Impression Method; Master Key Systems.  
**TOTAL COST. . . . . \$184.75**

A. J. MARCOTTE CO., 1200 N. Kedzie Ave., Dept. PM, Chicago 51, Ill.

**NEW 'S' LINE!** **PAGE GARDEN TRACTORS**

LOW PRICES  
EASY TERMS  
Benefit from our 25 years' experience

**RIDING AND WALKING MODELS**  
2 to 6 HP with . . . complete gear drive and reverse. Dozens of attachments available

**PAGE FARM EQUIPMENT**  
1904 S. 81st ST. • MILWAUKEE 14, WIS.

SAY YOU SAW IT IN POPULAR MECHANICS

**ACE TOOLS**



Be permanently toolled-up for every operation on your Metal Cutting Lathe.

No. 8-A Ace Tool Set for 9" and 10" Swing Lathes—fits shank size  $\frac{3}{8}$ " x  $\frac{3}{4}$ ". Includes Turning, Cutting-off, Boring, Knurling and Threading Tools with high speed cutters, blades and wrenches. 8 complete tools in fitted steel case—nothing else to buy. See your local dealer or order direct.

**ARMSTRONG BROS. TOOL CO.**  
5268 W. Armstrong Ave., Chicago 30, Ill.

**\$24.25**

## You Can Have Local Manufacturing Rights

Here's an outstanding manufacturing opportunity for men with vision, energy and a little capital. Brikcrete is sweeping the country because it has beauty, long life and ultra comfort. Truly the world's most modern masonry. Distinctively different. Yet costs less than lumber because it is locally manufactured of local materials by local labor for local building needs.



### 100%-150% Mark-Up on Costs

You can be one of a national chain of local plants. High income potentials. Can be started on moderate investment. Wide-open market. Requires no experience; no skilled labor. We supply all equipment. Easy terms, if necessary. We work with you to put it across. Write for Brikcrete Book No. 2 today... free.



**Brikcrete Associates, Inc.**  
4679 Division Ave., S.  
Grand Rapids 8, Mich.

**BRIKCRETE**

### IMPORTED FROM ENGLAND FINEST QUALITY NEEDLE FILES for the HOME MECHANIC

Here are the famous P. S. Stubs Needle Files, used and preferred by highly skilled watch makers, tool and die makers. Now available for the Hobbyist who works on Railroad, Airplane, Ship Models, etc. Ideal for shaping any type of material, such as wood, plastic, steel, aluminum, etc. Truly the finest in perfect, fine Needle Files. 5 1/2" long. Cut #2—Packed 1 doz. Assorted shapes to a box. \$4 prepaid. Send check or money order Now. Sorry, no C.O.D.'s.



1 Doz. assorted  
**\$4 PREPAID**  
Money Back  
Guarantee

**STUB SALES** 20 VESEY ST.  
N. Y. 7, N. Y.

### GENSCO *Swedish* WOOD CHISELS

Finest Imported Swedish Steel Blades

- Prices Now Lower than Most American Chisels.
- Hand-Honed and Polished.
- Unbreakable machined plastic handles.

Fine Swedish quality in accurate cutting chisels that every craftsman will appreciate. Gensco chisels take and hold the finest edge for better work.



**PROTECTIVE PLASTIC COATING**

keeps blades clean and sharp. Strip it off when ready for use.

The GENSCO LINE also includes **BUSHMAN**

Swedish Hand, Bow and Pruning Saws

See Your Dealer or Write Direct

11 SIZES  
FROM 1/4" to 2"

**GENSCO TOOL DIVISION**

General Steel Warehouse Co., Inc.

1832 North Kostner Avenue • Chicago 39, Illinois

# New!

## The Safe Saw that Cuts One Inch Wood 50% Faster and with 70% Less Noise!



ARM  
ADJUSTS TO  
PERMIT SAWING  
ANY LENGTH  
MATERIAL

NOW ONLY  
**\$17.50**

New No. 201

# SYNGRO ELECTRIC JIG SAW

Ideal for Dad's workshop—safe for children! Largest, most powerful of its kind! Quiet operation. Cuts any length 1" wood, thin metal, plastic. Portable. 14,400 Safety Strokes a minute: Entire Saw approved by Underwriters' Laboratories, Inc. Power Unit **GUARANTEED** against Burn-out all during your ownership.

No. 401  
**\$12.50**

Complete with Built-In Motor, \$17.50



**SYNGRO ELECTRIC HONE**

**Greatest Sharpening Development Since Invention of the Hone!**

Buy With Confidence!

SYNGRO's stone-that-moves-240 strokes a second enables you to hone SHARP almost anything—tools, knives—easier and in your favorite honing style! Safe to use. With Built-In Motor, 4 Stones — **\$12.50**



That's the Name to Ask For!

# SYNGRO

**QUALITY TOOLS**



Operate on 60 cycle, 110-120 volt. AC only. Buy at dealers. If none near, send article price, we'll ship POSTPAID. (Dealers write!)

**SYNGRO CORPORATION**  
Dept. D-100A, Oxford, Michigan, U.S.A.

**You own the BEST money can buy... when it's P & C**

SMOOTH handles  
DEEP grooves give a better grip  
UNBREAKABLE plastic  
SWAGED blades will not turn  
SPECIAL alloy forged steel, chrome plated  
GROUND, polished bits fit screw slots perfectly

There is a P & C tool for every job. Ask your hardware dealer for the finest wrenches, sockets, punches, pliers and screwdrivers made—P & C—"the BEST tools money can buy".

FREE FOLDER shows the right size blade for every screw you use. Send for your copy.

**P & C** P & C HAND FORGED TOOL COMPANY  
PORTLAND 22, OREGON

**STOP FURNACE LEAKS**  
*Save Fuel Costs*

Seal up every heat-wasting crack, opened seam and other leak in your furnace, boiler, tank, radiators and piping tight — as professional repair men do — with Smooth-On No. 1 Iron Cement. Do it yourself—now—and cut this winter's fuel bills. You apply Smooth-On like putty, it hardens like metal, and stays tight, because it expands slightly as it sets. Buy Smooth-On No. 1 in 1 3/4-oz., 7-oz., 1-lb., 5-lb., 20 or 100 lb. size at your hardware store. If they haven't it, write us.

**FREE Repair Handbook**  
40 pages of ingenious, tested, short-cut repairs. Simple directions. 170 illustrations. Write today for YOUR free copy of the Smooth-On Handbook.  
SMOOTH-ON MFG. CO., DEPT. 37K,  
570 Communipaw Ave., Jersey City 4, N. J.

**Do it with SMOOTH-ON**  
THE IRON CEMENT OF 1 000 USES

**ELECTRIC SIREN** \$10.95  
6 volt. Complete with push button...

**"HOT ROCKET" Illuminated Ornament** Chrome Plated Terrific Value at \$6.50  
Five Red luminous Plastic fins whirl, looking like jet propulsion in action. 9 inches long, has internal lights. Metal parts are gleaming chrome. Fits all cars.

**ILLUMINATED CHROME PLATED DELUXE FENDER FINS** \$9.95  
Get that Cadillac Look! For 1949-50 Chev., Ford, Pontiac, 1950 Plymouth, Dodge, Chrysler, DeSoto. Red reflector lens. Contoured to fit rear fenders perfectly. PAIR

**HOLLYWOOD MUFFLERS** FOR ALL CARS \$4.45  
Gives that Motorboat Tone. Universal type to fit all cars, ea...

**NEW CONVERTIBLE TOPS & REBUILT MOTORS** for all Cars. Write for Prices.  
Send 25% Cash With Orders, Balance C.O.D.

**JUST OUT!** Get the largest Auto Accessory & Parts Catalog in the world. Over fifteen thousand items, including Hollywood Accessories, Hi-Speed Equipment, Rebuilt Engines, all parts & accessories for all cars & trucks. We have that Hard-to-Get-Part! Completely illustrated. Jam packed with bargains. Send 25c.

**J. C. WHITNEY & CO.**  
1917GA ARCHER AVE. CHICAGO 16, ILL.

**STUDENTS! — They're here ... IMPORTED DRAWING SETS**  
Compare our prices with these features:  
• 12 Instruments and Parts \$7.50  
• Fine Nickel Polish  
• 3 Free Action Bows  
• 5 1/2" Compass and Divider with  
• Special Bearing in Head for lasting service  
• 2 Flap Velvet-lined Button Case  
**FREE CATALOG UPON REQUEST**  
10 Day Money Back Guarantee  
Send check or money order to:  
**MODERN SCHOOL SUPPLIES**  
Box 958 High St. Hartford, Conn.  
"Savings For Student America"

**BRUSH PLATING OUTFITS**  
• for re-plating articles in the home and shop. No tanks necessary. Free particulars. •  
**GUNMETAL CO., AVE. M, DECATUR, ILLINOIS**

**SAW SHARPENER**  
Table model, gums and sharpens rip saws, combination saws & cut-off saws. Ideal for "Skill-saw" blades. Cap. 4" to 20" diam. Complete with 1/4 h.p. motor & 1 grinding wheel & cord — \$64 f.o.b. Portland. Shipping weight, 63#. SEND FOR FREE LITERATURE.  
**P. T. HOBBS MACHINERY**  
8375 N. Interstate, Dept. 57, Portland 17, Ore.

**OWN A Printing Business**  
Cards, Tickets, Stationery, etc. Good profit in spare time. PRINT YOUR OWN greeting cards, movie titles, church work, etc. Save money. Easy rules applied. Raised printing like engraving too. Have home shop. Sold direct from factory only. Pays for itself in short time. Write for free catalog of outfits, and all details.  
**KELSEY PRESSES, 0-37, MERIDEN, CONNECTICUT**

**NEW PACKAGED BOATS**  
17 models. 8'-16': Tredronic racers, cruisers: Outboard, inboard, skiffs. Assembled frames: Tri-Keel construction: Tredronic bottom: spray rails: easy to build!  
**SEND 25c FOR CATALOG!**  
Catalog and booklet "Plywood Boats", \$1.00

**BOAT PATTERNS-BLUE PRINTS**  
1950 Catalog—100 designs by naval architects. Racing classes, cruisers, inboard, outboard, sail, 6 to 35 ft. Plywood—Steel—Plank. Construction plans, full-size patterns. SEND 35c FOR CATALOG or \$1.00 for catalog and booklet on "Boat Building."  
**MARINE MART-DEPT. 24-BUFFALO 7, N. Y.**

# WAR SURPLUS BARGAINS!

ALL ITEMS BRAND NEW — UNCONDITIONALLY GUARANTEED

NEW! STATIONARY OR PORTABLE

## D.C. ARC WELDER

250 AMPS. MODEL 252  
FOR ANY WELDING JOB,  
LIGHT OR HEAVY

Stop Costly Repair Bills,  
Weld It Yourself and Save

Designed for many years of trouble-free service. This precision engineered Direct Current ELECTRIC ARC WELDER is offered at but a fraction of its original value. It can be mounted permanently or easily transported for portable use. Does the job instantly where and when you need it. Has dial type rheostat for easy pinpoint control and a high-low range switch. Run welder at 2500 RPM from drive pulley or power take-off of tractor, a 7 1/2 HP electric motor or a 10 HP gas engine. Use two V belts or flat belt (on pulley). Now ... AT A FRACTION OF ITS VALUE. Price includes double V or flat belt pulley and instruction book. Shipping wt. 107 lbs. F.O.B. Chicago. **99.50**

ACCESSORY KIT including welding helmet, electrode holder, two 10 ft. cables with clamp and 5 lbs. of assorted welding rods. (ITEM #65) Shpg. wt. 17 lbs. F.O.B. Chicago. **10.50**

IF MORE INFORMATION IS DESIRED, write for WELDER CIRCULAR.



(ITEM #65)

Only one or two jobs will pay for entire welder.

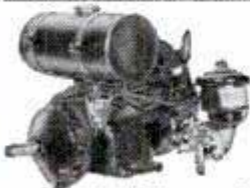

## SURPLUS SPECIAL! CONTINENTAL RED SEAL 1 1/2 H.P. ENGINE

1 cylinder, 4 cycle gas engine with 6:1 gear reducer for 300 to 400 RPM output. For Lawn Mowers, Garden Tractors, Light Farm machinery, Feed Mills. To drive Pumps, Compressors, Generators. Engine rated 1800 to 2400 RPM. Complete with starter rope, muffler, oil bath air cleaner. Shpg. wt. 60 lbs. A \$74.00 VALUE. NOW ... WHILE THEY LAST. (F.O.B. Chicago) **39.50**

(ITEM #97)

oil bath air cleaner. Shpg. wt. 60 lbs. A \$74.00 VALUE. NOW ... WHILE THEY LAST. (F.O.B. Chicago)



## G-1 STAINLESS STEEL TANK

Use these tanks on compressors, for tire inflators, pulsation chambers, floats, buoys, hydraulic reservoirs, fluid and milk containers, fuel containers, etc. Tough, light, shatterproof, 450 P.S.I. Aviator's Breathing Oxygen bottles, type G-1, 2100 cu. in. (approx. 9 gallons) int. vol. 24"x12", 1/4 threaded openings at ea. end. Wt. 19 lbs. F.O.B. Chicago. **5.95**

(ITEM #63)

## SELF-PRIMING ELECTRIC PUMP

APPLICATIONS: Oil burners, aquariums, fluid metering, fuel pump, tool post grinder, coolant pump, pressure lubricating pump, general industrial, etc. Motor Mfd. by Black & Decker: Double ball bearing series wound, continuous duty 1/30 H.P. electric motor, rated 12,000 R.P.M. Transformer included for use on 110 V AC current. Also applicable for 24-32 V DC. Pump Mfd. by Weldon Tool Co. with standard 1/4" tubing ports; rated 2 G.P.H.; remove pump and use motor as high speed grinder. Overall Dimensions: 7 3/4" long x 3 1/4" wide x 3 1/4" high. Approx. wt. 5 lbs. \$51.00 value. (Item #1) postpaid. **12.95**



## Hydraulic Cylinders-Air or Oil

Large supply of new labor-saving, economical hydraulic equipment in many types and sizes. Use these positive, highly efficient, smooth pressure hydraulics on presses, arbors, lifts, loaders, power control, positioning, brakes, plastic dies, auto frame alignment, etc., etc. ITEM #4—All steel double action hydraulic cylinder, 1 1/2" bore, 2 3/8" stroke. Clevis mounting. Will lift 1000 lbs. with 1000 P.S.I. line pressure. Perfect for positioning and feeding movements. Shpg. wt. 4 lbs. F.O.B. Chicago. **4.95**



(ITEM #42)

ITEM #33C—Double action hydraulic cylinder, 1 1/2" bore, 4 1/2" stroke. Clevis mountings at both ends. Uses 1/4" pipe fittings. Postpaid. **8.95**

ITEM #32—Double action, 1 1/2" bore, 9" stroke, will lift 1760 lbs. with 1000 P.S.I. line pressure. Wt. 4 lbs. A \$45.00 value. Postpaid **10.95**

ITEM #41—Double action hydraulic cylinder, 2" bore, 6" stroke, clevis mounting at base end of shaft. Overall length closed 12 1/2". Has 3/8" stainless steel shaft, uses 3/4" tubing fittings. Will lift up to 3100 lbs. with 1000 P.S.I. line pressure. Weight 7 lbs. Postpaid. **12.50**

ITEM #16—Double acting cylinder, 1 1/2" bore, 27" stroke. Will lift 1760 lbs. with 1000 P.S.I. line pressure. Wt. 8 lbs. A \$55.00 hydraulic cylinder value for only Postpaid. **12.95**

ITEM #15—Double acting cylinder, 3" bore 10 1/2" stroke. All steel hydraulic cylinder, will lift up to 7000 lbs. with 1000 P.S.I. line pressure. Wt. 12 lbs. A \$78.00 value, Postpaid **19.50**

ITEM #40—Double action, 3 1/2" bore, 20" stroke. Rated lift capacity 9600 lbs. with 1000 P.S.I. line pressure. Clevis mounting, aluminum alloy barrel with 1 1/2" stainless steel shaft and piston. Wt. 20 lbs. A \$25.00 value. F.O.B. Chicago. **25.00**

ITEM #6A—Double action hydraulic cylinder, 3" bore, 25" stroke, will lift 7070 lbs. with 1000 P.S.I. line pressure. Steel barrel, 1 1/2" stainless steel shaft. Gov't. acq. cost. \$178.00. Shpg. wt. 26 lbs. F.O.B. Chicago. **28.00**

ITEM #42—Double action hydraulic cylinder, 4" bore, 18" stroke. Rated lift capacity with 1000 P.S.I. line pressure is 12,560 lbs. Ship. wt. 30 lbs. AN EXCELLENT BUY for F.O.B. Chicago. **32.50**

HI-PRESSURE FITTINGS for cylinders and valves available at 50c ea. for 3/8" pipe and 65c ea. for 1/2" pipe.

FREE: 44-PAGE CATALOG — WRITE TODAY

ORDER DIRECT FROM AD — SEND PAYMENT OR PURCHASE ORDER TODAY — SATISFACTION GUARANTEED

GROBAN SUPPLY CO. 1507 SOUTH MICHIGAN AVE. Chicago 5, Ill. Dept. PM 10

Brand New



(ITEM #88)

## AUXILIARY ELECTRIC A.C. GENERATING PLANT

FOR GENERAL UTILITY AND EMERGENCY USE  
2500 WATTS - 115 VOLTS A.C.  
60 CYCLES

Plenty of current to operate your: Oil Burner, Sump Pump, Refrigerator, Home Freezer, Power Saw, Lights, Radio and Television, Home Water System Pumps.

Complete integrated heavy duty electric power plant. Signal Corps Model PE-75, driven by Briggs & Stratton, one cylinder 6 1/2 H.P. Model ZZ, 4-cycle engine with killer button, oil bath air cleaner, governor, muffler, starting rope, and radio interference filter. The self-excited Leland or Westinghouse generator is rated 2500 Watts, 115 Volts, 60 Cycle A.C. single phase, belt driven, with guard and duplex receptacle. When generator is not in use, you can use the engine separately to power other equipment. Mounted on adjustable steel skids, notched for carrying poles. Net wt. 310 lbs. Shpg. wt. 440 lbs. Dimen. 36"x19 1/2"x24". 12 month guarantee. \$726.00 value. NOW **295.00**

F.O.B. Chicago

## UTILITY PUMP ROTARY VANE TYPE

Perfect For Water, Oil or Insecticides  
Sprays DDT, 2-AD, sulphur compounds, etc. Pressures to 150 lbs., 15 gals. per min. at 1200 RPM using 2 HP. As vacuum pump for milking machines: lab use, etc., delivers 26" vacuum, 4.5 cu. ft. per min. at 1500 RPM using 3/4 HP. Rotate either direction, 1/2" pipe thread ports, 1/2" standard shaft, 4 ball bearings. Easy to mount — Ready to run. Shpg. wt. 13 lbs. (ITEM #51) F.O.B. Chicago. **16.50**



(ITEM #51)

## DIRECT CURRENT GENERATORS



For welders, plating, truck and marine use, D.C. appliances, lights, etc. Aircraft quality—lifetime grease sealed ball bearings. Heavy duty.

ITEM #89—Type M-2, rated 50 Amps.—24 Volts. Mfd. by Leecce-Neville Co. Shpg. wt. 32 lbs. Gov't. Acq. Cost \$178.00. F.O.B. Chicago. NOW ONLY **16.50**

ITEM #90—Type P-1, rated 100 Amps.—28 Volts, 2500 RPM. Mfd. by General Electric, Ford, Delco-Remy and Westinghouse. Gov't. Acq. Cost \$300.00. Shpg. wt. 70 lbs. F.O.B. Chicago. **22.50**

ITEM #91—Type R-1, rated 300 Amps.—30 Volts. Mfd. by Jack & Heintz. Gov't. Acq. Cost \$380.00. Shpg. wt. 70 lbs. F.O.B. Chicago. **35.00**



(Item #99)

## D.C. GENERATOR FOR 12 VOLT SYSTEMS

BRAND NEW. Rated 15 Volts at 50 Amps. Use on 12 Volt circuits on trucks, tractors, ships, planes, battery chargers, auxiliary lights, etc. Base mounting with 4 bolt holes. 5/8" threaded shaft with keyway. Mfd. by Bendix-Eclipse. Gov't. acq. cost \$136.00. Shpg. wt. 53 lbs. F.O.B. Chicago. **21.50**

LOGAN HEAVY DUTY

## HYDRAULIC PUMP

For operating hydraulic cylinders and hydraulic motors on tractors, bulldozers, construction machinery, lift trucks, industrial applications, etc. Delivers 10 GPM at 1200 RPM at 1000 P.S.I. using 6 HP. Has a 3/4" inlet, 1/2" outlet, 3/4" shaft with flat and keyway for direct or pulley drive. Has flange with 4 bolt holes for convenient mounting. Ship. wt. 22 lbs. Overall dimen.: 7" L. x 5 1/2" H. x 5 1/2" W. A \$105.00 value. FOR ONLY. **22.50**



(ITEM #29)

## VICKERS HYDRAULIC TRANSMISSION

MODEL AA16801A  
Ideal for lathe drive, miniature cars, power machinery, gearing, etc. Rated 2 HP maximum input at 3750 RPM. Output speed continuously variable from 0 to 1/2 of input speed in either direction. Self contained reservoir. All controls external. Even power at all speeds. Complete with two 1/2" shafts with flat for pulley attachment. Ship. wt. 20 lbs. Gov't acquisition cost \$325.00. A tremendous value at. **25.00**

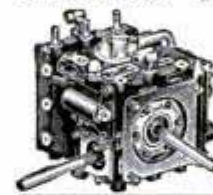

F.O.B. Chicago (ITEM #85)

## HYDRAULIC CONTROL VALVES

ITEM #24. Four-way control valve with built-in relief valve, for use with one double action hydraulic cylinder, may be used with 1500 P.S.I. hydraulic system to open and close hydraulic cylinders. Ship. wt. 8 lbs. A \$38.00 value. **7.95**

ITEM #26. Four-way control valve for use with two hydraulic double-action cylinders. Each cylinder may be operated independently of the other or in conjunction with the other. Oil may be locked in any of the cylinders to hold the piston at any required position. Ship. wt. 6 lbs. A \$60 value. **10.95**



(ITEM #24)

# You can build this SINK ENCLOSURE



## from full-size patterns

Famous Easi-Bild\* Pattern Method of Construction shows you the simplified way to save many, many dollars in your "homework"... by doing it yourself.

Send 50¢ for Easi-Bild Pattern #41, and dress up your sink with this convenient, modern cabinet-work. Another 20¢ brings you the Easi-Bild Pattern Book, illustrating over 100 other "Build It Yourself" patterns.

\*T. M. Easi-Bild Pattern Co.

## UNITED STATES PLYWOOD CORPORATION

Dept. PM, P. O. Box 215, Pleasantville, N. Y.

### The JIFFY metal CABINET

**YOUR ANSWER TO  
SMALL ITEMS STORAGE**  
at home, office, and shop  
(IDEAL GIFT, TOO)

So handy to keep nuts,  
bolts, screws, nails,  
parts, washers, stamps,  
hobbyists' needs, etc.,  
at your fingertips.



THIS 32 DRAWER UNIT ONLY \$8.95 POSTPAID

Stop searching, get a 32 or 64 drawer Jiffy to keep those small items that usually get mislaid. Spot welded steel, gray enamel finish, metal drawer guides. Dividers included with aluminum drawers make possible three compartments per drawer. Looks good anywhere. Send check or money order, please—no C. O. D.'s. Prices below. Your money refunded if not satisfied. Dealers write for quantity discount.

**SPECIFICATIONS**  
**32 Drawer Unit**  
6" Deep  
12 3/4" Wide  
15 1/4" High  
**64 Drawer Unit**  
6" Deep  
25 1/2" Wide  
15 1/4" High  
**Drawer Size**  
1 1/4" Deep  
2 3/4" Wide  
6" Long

**WITH ALUMINUM  
DRAWERS**  
**Dividers and Index  
Cards Included**  
One piece rustproof aluminum drawers for heavy service—good for work bench and industry use.  
**32 drawer - \$8.95**  
**64 drawer - \$15.95**  
OHIO ORDERS ADD 3% SALES TAX  
Marproof Rubber Feet included with all cabinets  
POSTAGE PAID

**NEW SPECIAL!**  
**ONLY \$2.95**  
**8 DRAWER UNIT**  
(24 compartments)  
**16 Drawer Unit \$4.95**  
(48 compartments)  
**SPECIFICATIONS**  
6" Deep—8 1/4" High  
8 Drawer 6 3/4" Wide  
16 Drawer 12 3/4" Wide  
POSTAGE PAID

KAYTEE PRODUCTS, Dept. M, Box 588, Canton, O.

## NEW PRICE REDUCTIONS

on all Crosley Cars!



Crosley announces sweeping price reductions on all Crosley cars. Even the new Super models, recently introduced, now sell at a much lower price—\$63 to \$86 less. Now a Crosley costs less to buy—still costs less to drive—up to 50 miles on a gallon of regular gasoline. See the latest Crosley Super Station Wagon at your dealer's. New roll-down windows. Smart chrome trim. Fender ornaments. Tailored upholstery, door linings and interior body lining. Rear seats can be folded against the back of the front seat. Get the price on this beautiful Station Wagon—get all the new low prices on all Crosley cars—Super and Standard.

**FREE!** 1950  
Crosley Catalog!  
Write Crosley  
Motors, Inc., 2530-HW  
Spring Grove Ave., Cincinnati 14, Ohio

**CROSLLEY**  
A FINE CAR

You see them everywhere!

### NONE BETTER! SUPER DRILL GRINDER



Sharpens round shank drills from 3/32" to 1/2" in diameter, up to 6" long. Grinds old drills like new in 4 different point angles, using hand or power grinding wheels. Money-back guarantee.

Price only \$2.95

At Dealers or Postpaid

CRANDALL MFG. CO. 1512 W. Slauson, Dept. FA-52, Los Angeles 44, Calif.

**make your own Gems** 29.50 F.O.B.

All necessary lapidary equipment is furnished, including a super-charged diamond blade for sawing, and all wheels for grinding, shaping and polishing also complete instructions. The complete equipment as shown, less motor and belt, for only \$29.50, f.o.b., Burlington, Wisconsin. Write today for information and literature.

**B&I MANUFACTURING CO.**  
Dept. S Burlington, Wis.

### Build your own JET ENGINE!

**Order these plans today**

1. JET PROPELLED BICYCLE. Assemble your own. Photo and instructions, \$1.00.
2. HOW TO MAKE EXPERIMENTAL JET ENGINES. Seven sheets drawings with information and instructions \$2.95.
3. BOTH OF ABOVE in one order \$3.75. SEND NO MONEY. Order both at once \$3.75 C.O.D. in USA plus c.o.d. postage. Send check or Money Order and we pay postage. Get other information too. Rush Order.

**J. HOUSTON MAUPIN, Dept. 55, Tipp City, Ohio**

**STARRETT "Tools and Rules" BOOK**

Describes and illustrates the precision methods skilled mechanics use. Only one dime. Write Dept. AP.

THE L. S. STARRETT CO., Athol, Mass., U. S. A.

### NEW Lightweight, Single Unit GEIGER COUNTER

Earn Big Govern.  
\$10,000  
Bonus



Low Price—  
High Sensitivity,  
2 ranges,  
neon & head  
phone indicator.

Write for FREE FS 1 Bulletin.  
Dealer Inquiries Invited

**Beck Instrumentation Co.**

310-17th ST.

OAKLAND 24, CALIF.

Pat. Pend.



Not a toy! A perfectly balanced small arm for sport and small game! Special introductory offer: "Powr-Pak" Pistol Sling, 50 "Tru-Flite" 23 gr. pellets, extra sling, 10 "Red Dot" targets, postpaid, \$2.25 cash, check or money order. No COD's! Money back guarantee. Order yours today from Baron Industries, Box 3578P, Cleveland 18, Ohio. Order extra supply 23 gr. "Tru-Flite" Pistol Sling pellets with your Powr-Pak. 250 for \$1.00.

## Save HALF! Slight Factory Imperfect Dress PANTS

Genuine 100% GABARDINE

Imperfections very slight — positively do not affect wear. Ideal for dress, school, play, work. Firm hard finish. Wrinkle and shine resistant. Retains neat press. Zipper front. Roomy pockets. Blue, Tan, Gray, Sand, Lt Brown, Dk. Brown, Blue-Gray or Green. Waist: 28-42.

SEND NO MONEY Send name, waist size, 1st, 2nd and 3rd color choice. Pay postman only \$4.95 plus small postage. Or send money and save postage. Money Back Guarantee.

LINCOLN TAILORS Dept. PM-2 Lincoln, Nebr.



Worth \$10  
**\$4.95**

## LIFETIME CHRONOGRAPH, STOP-WATCH CALENDAR WATCH



**NEW LOW PRICE**  
**8.95**  
with Steel Expansion Band Plus 10% Tax (90c)

FULLY GUARANTEED for One Year

Plus Lifetime Service Certificate 5-Day Free Trial.

31-Day Calendar Changes dates automatically! For Sportsmen, Scouts, Photographers, Engineers, Chemists, Navigators, Doctors.

Remarkable Import Buy—these ideal all-around timepieces and chronographs at an unbelievable low, low price. Imported Swiss jeweled movement, Radium Glow 1" dial, red sweep-second hand, shock-resistant case, unbreakable crystal. And—included is the handsome, rich-looking steel expansion wristband. Complete instructions included together with guarantee and service certificate. White, Pink or Black dial face, specify color.

**GAYLORD** Dept. PK-7, Fifth & Hamilton, Pittsburgh 6, Pa.  
I enclose  Check  Money Order  Send C.O.D.  
Send..... Chronograph watches at 8.95 (Postpaid), plus 10% tax on 5-day free trial. Money Back Guarantee, Name & Address on Margin.

### UP TO 25% MORE MILEAGE ON CARS, TRUCKS & TRACTORS

QUICKER PICK-UP . . . BETTER MILEAGE WITH ECONOMICAL NEW VAPORIZER

Drivers claim up to 25% savings with new water Vaporizer operating on fighter plane principle. Eliminates carbon and "pinging". Get faster pick-up, better performance. NOW, for first time, fully automatic unit available at LOW COST! For cars, trucks & tractors. Won't harm engine. Water vapor improves efficiency. Easily installed. Give make, year, no. cylinders of car. ONLY \$5.95 Postpaid. Send Money Order.

**AUTOMATIC VAPORIZER MFG. CO.**  
Box 7033, Station G Los Angeles 37, California

SAY YOU SAW IT POPULAR MECHANICS

### BUILD YOUR OWN ARC-WELDER

For Light or Heavy Work

No rewinding necessary—use coils taken from old auto generators. Works on 110 or 220 A.C. Has 20 different heats. Complete plans and BIG Catalog 35c.

**LEJAY MFG. CO.** 3347 LeJay Bldg. Minneapolis, Minn.

### ELECTRIFY your SEWING MACHINE

**NEW LOW PRICE! \$11.50 1 YR. GUARANTEE**

Buy direct from manufacturer and save! Kit comes fully wired, installed in a jiffy. Fits all machines! You get these all-new parts:

- Motor & Bracket
- AC-DC 115v 60c
- Multi-speed foot control
- Cord set & block
- Easy instructions
- Steel pulley & belt

**FREE . . . reg. \$2.95 chrome SEWLITE given with every kit.**

**10 DAY FREE TRIAL — ORDER NOW!** Send no money, pay COD or send money order and we'll pay postage. Please state whether wheel on your machine turns toward you or away from you. Shipping wt. 6 lbs.

**CONTINENTAL SALES CO.**  
1046 BEDFORD AVENUE Dept. PM-20 BROOKLYN 5, N.Y.

## CHRONOMETRIC TACHOMETER

U. S. NAVY SURPLUS—ACCURACY—PRECISION—GUARANTEED

For PRECISION timing of all rotating mechanisms. Incomparable GUARANTEED ACCURACY of 1/10 of 1%. An RPM counter and surface speed indicator combined with chronometric operation which AUTOMATICALLY computes period of test in EXACTLY 6 SECONDS. No stop watch or personal equation necessary. UNSURPASSED for cameras, projectors, generators, motors, sanders, turbines, saws, shafts, looms, fans, lathes, etc. Packed in plush-lined, simulated leather case. UNCONDITIONALLY GUARANTEED subject to your inspection and approval. Manufactured by JAEGER and TOTCO, leaders in field of exacting measuring devices. Only \$19.75 Shipped postpaid in U.S.A. on cash orders.

**TEST EQUIPMENT**  
Dumont—R.C.A.—Hickok Weston  
World's Largest Selection of: Electronic Test Meters, Signal Generators, Oscilloscopes, Bridges, etc. Just purchased from U.S. Army. Send for latest catalog with low prices that will frighten you.

**COMPASS**  
Mark IV Self-Compensating Floating Compass. U.S. Navy. 3 1/4 x 3 1/2 x 3 1/4" For car, plane, or boat. Govt. Cost \$72.00 Now \$4.95

**A-10 Bubble SEXTANT**  
Never before at this price! Complete with hardwood case. Gov't cost. \$300. Now..... **\$7.95**

**Kohlsman ALTIMETER**  
Ideal for Auto or Airplane. Used but GUARANTEED accurate. Don't wait. Order NOW! Original gov't cost, \$168. Each **\$10.95**

**NOW \$19.75**

Order these surplus bargains today. We pay postage on cash tachometer orders. Add postage to other items. 20% dep. on C.O.D.'s

**Semlers' ASSOCIATED SURPLUS** Dept. PM-10 5720 WILSHIRE BLVD., LOS ANGELES 36, CALIF.



**METALS FOR YOUR CRAFTWORK ...OR METAL WORK!**

**AT WAREHOUSE-TO-YOU PRICES**

Now ... from **one** convenient and economical source you can get these high quality metals for your needs, pre-cut to your specifications.

**ALUMINUM, BRASS, COPPER, STAINLESS STEEL in RECTANGULAR SHEETS**

Easy to work, adaptable to hundreds of uses such as lamp shades, serving trays, wall brackets, etc. Ideal for modern silhouette cut-outs.

**CIRCLES of ALUMINUM and COPPER** Perfect for shaping and forming into useful items, and for perforated design work.

Write for price lists and complete information



**FREE BOOKLETS** tell how YOU can use these metals—easily and quickly. Write for your free copies today.

**METAL GOODS CORPORATION**

628 Rosedale Ave., St. Louis 12, Mo.

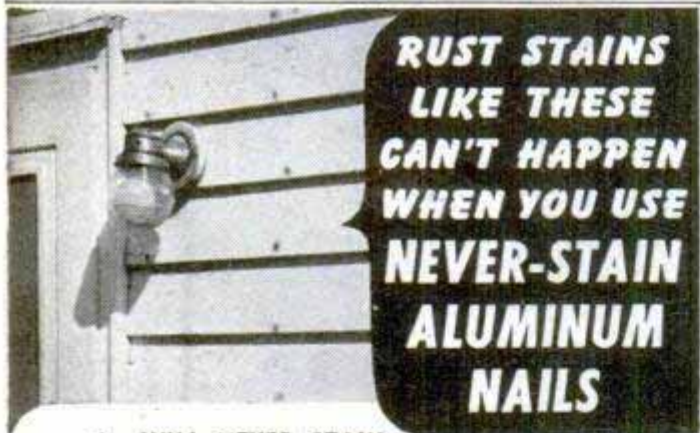

**RUST STAINS LIKE THESE CAN'T HAPPEN WHEN YOU USE NEVER-STAIN ALUMINUM NAILS**

- ★ WILL NEVER STAIN OR STREAK PAINTED SIDING OR COLORFUL ROOFING
- ★ COST LESS TO APPLY—NO PUTTYING OR COUNTER-SINKING NECESSARY
- ★ ALMOST 3 TIMES AS MANY PER LB.

They pay for themselves in the savings they make—and they may save you a \$300 repaint job! Now packaged for the job in different colored boxes, each with quantity, size and type clearly indicated.

**THERE IS NO SUBSTITUTE FOR ALUMINUM!**

Write for FREE Samples. Address Dept. PM.



**NICHOLS WIRE & ALUMINUM CO.**  
DAVENPORT, IOWA



**STOPS LEAKS PERMANENTLY**

Cut your fixture replacement, water and fuel bills with Economy Renewable Seats. Make economical, permanent repairs quickly and easily with the Junior Kit (illus.). Repair bathroom, kitchen and laundry fixtures. Everything you need included in steel box. This is a natural for the "Fixit" shops—get extra income from making permanent repairs on your customers' faucets.

Senior Master Kit also available—repairs faucets and valves up to 1" pipe. Write for illustrated circular and prices.

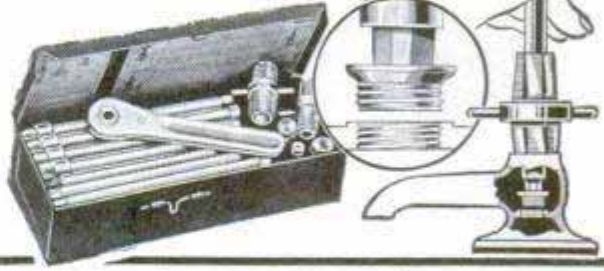

**ECONOMY VALVE SEAT CO.**

3122 N. California Ave. Chicago 18, Ill.

**CASH IN YOUR SPARE TIME**

**BIG MONEY IN OWN BUSINESS**

YOU CAN MAKE UP TO \$40 A DAY sharpening and setting circular saws for factories, builders, lumber yards — with **NEW BELSAW COMPLETE CIRCULAR SAW SHOP**. LOW COST, Sharpens 4 to 5 saws per hour, no experience needed, complete instructions. Send today for **FREE** Catalog.

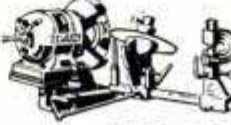

**BELSAW MACHINERY CO**

3701 Field Bldg.

Kansas City 2, Mo.

**TREASURE -- \$10,000**

New locator detects metals, valuable minerals and buried treasure. Money-back guarantee of superiority.

Also geiger counters. Govt. reward of \$10,000 for uranium discovery. Write for **FREE** information.



**THE GOLDAK COMPANY**

1542 W. GLENOAKS BLVD., GLENDALE 1, CALIF.

Only \$498



**OTTAWA Mule Team Tractor**

Finest low-cost tractor. Costs too little to do without. Engines burn gasoline. **Seven models.** Starter and lights available. Other larger Models to choose from. Over 4,000 in world-wide use. Time-proved and tested. At low cost they easily mow, plow, disc, harrow, plant, cultivate, etc. Sold only direct to user. Write for **FREE** details.

**OTTAWA MFG. CO., 2-027 Garden St., Ottawa, Kansas**

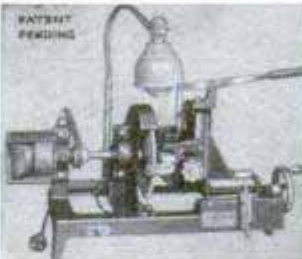

**Start a NEW BUSINESS!**

or Add to your present Repair Business

**SHARPEN DULL PIPE WRENCHES**

PIPE TAPS & DIES "GUM" CIRCULAR SAWS

Write for Information

**J. C. MOORE INDUSTRIES**  
BOX M 276 FREDONIA, PA.

**SHINE WITHOUT 'POLISH'**

New Invention! • Sells Like Wild



Replaces messy pastes, liquids. Simply glide over shoes—and **PRESTO!**—you have a lustrous, long-lasting shine. No mess. No muss. No soiled hands. Clean. Handy. **WORKS LIKE MAGIC!** For Men's, Women's and Children's Shoes. Low priced. Lightning seller!

**SAMPLES FOR TESTING** Sample offer sent immediately to all who send name at once. A penny postal will do. **SEND NO MONEY**—Just your name. **KRISTEE CO., 677 Bar Street, AKRON, OHIO**



# SCRATCHES VANISH!

LOOK AT YOUR FURNITURE EVERYONE ELSE DOES

**KIT RESTORES ORIGINAL FURNITURE BEAUTY**



Remove ugly scratches without paying for costly re-finishing. New instant FINISH-FIX restores beauty to chipped veneer; marred, scratched, or burned finish (antique or modern).

It's easy! Touch on like nail polish. It's done—dry in seconds. BRUSH IN EACH CAP. No mess! Transparent—wood grain beauty shows through . . . permanent color & finish in one step. No harm to old finish. Thousands now in use. Try it TODAY!

\*KIT—contains 6 natural wood colors (blendable): Walnut, Deep Red Mahogany, Maple, Brown Mahogany, Blonde, Cherry Mahogany. \$2.50

\*CHOICE of 2 Colors (above) \$1.00

\*PINT JAR (no brush) of above colors. Adapted for fast finishing of new woods. Covers blemishes . . . adds new life to old finishes. \$1.20

## 10 DAY FREE TRIAL

Send for kit today COD (plus postage). Keep it 10 days . . . if not delighted, return for full refund. Or —SAVE! Send payment now and we pay postage (same guarantee).

DEVELOPED BY PROFESSIONAL RETOUCHERS

# FINISH-FIX

DEALER • JOBBER INQUIRIES INVITED SENIOR CHEMICAL CO. Dept. M2, White Plains, N.Y.

## Electric HOME-UTILITY Tools

for HOMES • FARMS • WORKSHOPS

HOME-UTILITY Division — BLACK & DECKER Mfg. Co.

UP TO 35 MILES PER GAL. ON YOUR CAR WITH — "MILE-O-METER"



REGISTERS MILES PER GALLON AT EVERY SPEED Checks Spark Plugs, Carburetor, and 31 other Adjustments.

- Simple 5 Minute Installation—No Holes To Drill.
- 4 Color Easy Reading Dial—Complete Instructions Furnished.
- Fits All Cars—Permanently Mounted.
- 1,000,000 In Use—By World's Largest Mfgs.
- Works By Manifold Pressure.
- Saves 1 Gallon in 4. Makes A Perfect Gift.

Deluxe Chrome Model 3 3/8" Dial \$12.95, Std. 2 3/8" Dial \$7.50 P.P.D. GALE HALL ENGINEERING CORP., Boston 18, Mass.

# MILLER ROTARY

IT'S SPEED / OPE-SAW / DRILL-BIT  
IT'S SAWS / CUTS / REAMS



SAWS, CUTS, REAMS . . . Sheet metal, angle iron, pipe, wood, plastic, Transite, etc. Amazing high-speed combination bit and saw fits any 1/4" or 1/2" electric drill or slow drill press. Drills own starting hole to quickly cut, saw or ream opening. Easy to operate. Ideal for carpenters, auto mechanics, electricians, plumbers, hobby workers, many others. Abrasive resistant high speed steel. No breaking. Will withstand severe continuous use. Resharpener at no charge. 1/4" diameter, over-all length 3 1/2", cutting section 2" long with flutes ground from solid. Shipped same day—money back guarantee.

Discounts on quantity orders from dealers Takes place of up to \$50 in tools. SEND CASH, CHECK OR M.O.

Manufactured and distributed by: INTERNATIONAL TWIST DRILL CORP. 624 Wyandotte, Rm. 638, Kansas City 6, Mo.

only \$3.95 POST-PAID

## THE COMPLETE LINE OF TOOLS FOR HOME AND INDUSTRY

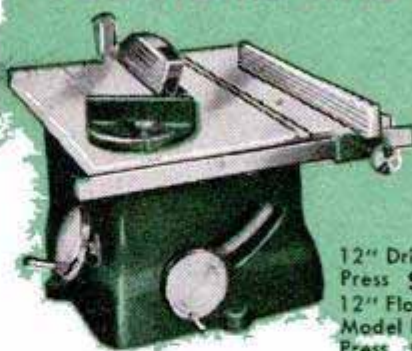

12" Drill Press \$44.95  
12" Floor Model Drill Press \$54.00



8" Tilting Arbor Bench Saw . . . \$69.95

Also

7" Tilting Arbor Bench Saw . . . \$42.95

8" Tilting Table Bench Saw . . . \$51.50

10" Tilting Arbor Bench Saw . . . \$82.45

10" Floor Model Tilting Arbor

Saw . . . \$99.95

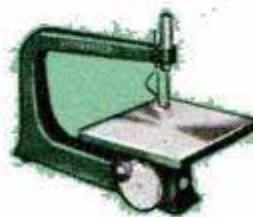

15" Jig Saw (Tilting Table) \$27.95



Saber Saw. \$16.95



12" Band Saw . . \$71.45  
10" Band Saw . . \$43.95

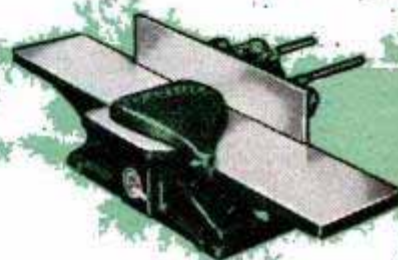

6" Jointer-Planer . \$73.45  
4" Jointer-Planer . \$44.95

Belt and Disc Sander . \$51.50



Spindle Shaper . . \$45.95

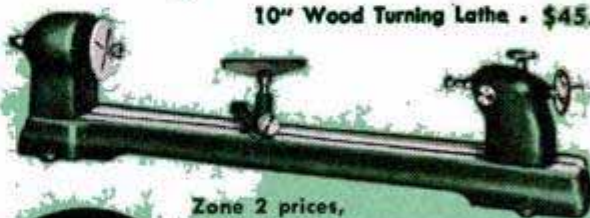

10" Wood Turning Lathe . \$45.95

Zone 2 prices, slightly lower in Zone 1.

Write today for full color catalog.



**SHOPMASTER, INC.**

1214 Third St. S., Minneapolis, Minn.

"SAVE IT AND  
FIX IT"



# FIXES

FURNITURE, DISHES, TOYS  
BOOKS AND GLASSWARE

It's transparent, waterproof,  
flexible and durable.  
Get a tube  
today.



# DUCO CEMENT

REG. U. S. PAT. OFF.



FOR  
**CRAFTSMEN**  
ACCURACY NOW  
WITHOUT  
EYESTRAIN

No bending . . . No squinting  
with the Tufboy Brite Blade. The  
snow white tape pops the large black  
numbers right out at you.

Extremely flexible . . . Tufboy's spring steel  
blade can't chip, crack or peel . . . works with a  
smooth push-pull action.

Tufboy's chrome case is specially treated to keep  
its lustre through years of hard wear.

The handy ten foot Brite Blade costs only \$2.25.  
Buy it at your nearest hardware dealer, or mail us  
this ad and your remittance. Also available in 6'  
lengths at \$1.75 or 8' lengths at \$1.90.

MASTER RULE MFG. CO., INC.  
MIDDLETOWN, N. Y.

# MASTER

REG. U. S. PAT. OFF.

WOOD AND STEEL TAPE RULES



## 2 DRILLS IN 1

This at-  
tachment gives  
you two drills in one. It  
converts any 1/4 inch electric  
drill to 1/2 inch capacity.  
Reduction gears reduce the drill speed 5  
to 1, the average speed of a 1/2 inch drill,  
and thereby increases the power. Absolu-  
tely indispensable for all shop work  
and home craftsmen. Satisfaction guaran-  
teed. Order yours now.

Send check or Money Order with order.  
Jobbers write for special information.

**\$11.95**  
post  
paid

G. M. CO. MANUFACTURING, INC.  
1308 43rd AVE. LONG ISLAND CITY 1, NEW YORK

## NOW YOU TOO CAN BUILD 15 RADIOS

COMPLETE  
KIT  
\$14.75



Progressive Radio "Edu-Kit" is prac-  
tically a radio course. No knowledge of  
radio required. Excellent background for  
television. Instructive quizzes included. Used  
by Radio Schools and Veterans Administra-  
tion. Free Electrical and Radio Tester and  
tools. Postage prepaid on cash orders; COD  
orders accepted in U.S.A. Order now from  
this ad, or write for further information.

PROGRESSIVE ELECTRONICS CO.  
497 Union Ave., Dept. P.M.1, Brooklyn 11, N.Y.

## POWER HACKSAW \$47.25

LESS MOTOR  
F. O. B. Benton Harbor

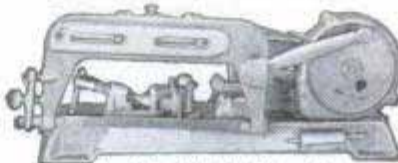

● Rugged cast iron con-  
struction. Wt. 56 lbs.  
bronze bearings. Draw  
cut. Auto. return lift.  
Auto. shut-off. Vise  
swivels 45°. Cap. 4"x4".

Send for full details and  
name of nearest dealer.

EXCEL MACHINE TOOLS Dept. PM-100  
BENTON HARBOR, MICHIGAN

## ADJUSTABLE HOLLOW AUGER



USUAL \$2.00  
\$7  
VALUE

YES. We said \$7 VAL-  
UE. CUTS TENONS or  
wheel spokes. Adjusts 1/4 to 1 1/4"  
Diam. Send cash, check or  
money order, plus 25c for mailing to  
E. G. HOWARD, 80 Washington St., Boston 8, Mass.

Longer  
Lasting  
Jobs at  
Trifling  
Cost

Use  
**E-L-A-S-T-I-C "33"**

Unlike putty, "33"  
Glazing Compound stays  
E-L-A-S-T-I-C. Won't  
crack or crumble. Never  
gets rock-hard. Use it on  
wood or metal windows  
for LASTING protec-  
tion. Get "33" from your  
hardware or lumber  
dealer. Try it! ARM-  
STRONG CO., Chicago 9.

## DUST-O-VAC FOR ALL MACHINES



For Home Workshops & Indus-  
try. DUST-O-VAC collects &  
bags wood & plastic chips,  
wood & metal dust, wood  
shavings. Free Bag. Attaches  
to circular saw, planer, band  
saw, grinder, belt or disc sander,  
shaper, drill press with shaper  
or sander attachment, spindle  
shaper, wood lathe, jig saw. 110  
A.C., D.C. Send for mounting  
instr. for all machines.

**\$19.95**

Free Ship.  
cost of  
Miss.  
West of  
Miss., add  
\$1. Check,  
M.O.

HEAVY CAST ALUMINUM BLOWER — ONLY \$11.25  
For Workshop, lab., kitchen, cellar, app. 100 CFM. Send for circular.  
UNIVERSAL YONKERS CORP., 137 Alexander St., M-10, Yonkers 2, N. Y.

# Jig Saw Patterns

## Big Bargain Packet

62 SQUARE FEET — Full Size  
50 AMAZING PROJECTS —  
ONLY \$3.00 Complete

Every pattern full size ready to paste on wood and cut out. No tracing, no graph square enlarging. It's the new simplified way of making projects in half the time it took you before.

Packet contains Dutch Windmill Ivy Bracket plus 49 other exciting things to make. Cradle, Waddling Duck, Pot Holder, Snack Tray, Wall Plaques, Elopant Shelf, Bunny Cart, Beverage Server, Costume Jewelry, Seahorse Bracket, Bird Garden Cutouts, Airy Wall Shelves, Scottie House Marker, Whisk Broom Holder, Oval Mirror Bracket, Tooth Brush Holder, Wind-Operated "Dog Chases Cat," Stairway to Stars, Lotus Flower Bracket, Swan Plant Bracket, Wall Plaques, many other profitable patterns.

Amazing value. Worth \$10. Send \$3.00 now, or we send COD if you pay postage. HURRY! Order Jig Saw Packet No. 2 now from

**CRAFTSMAN PATTERN CLUB**  
117-M2 Worth St., New York 13, N.Y.



## New! Electric Motors

New General Electric 1/2 H.P. Induction Type 3450 RPM 110 V. 60 cy. 1 Ph. A.C. Motor. **GEH-5, ONLY \$19.75**

New Delta 3/4 H.P. Cap/Ind. Ball Brg. 3450 RPM. 110 V. 60 cy. 1 Ph. A.C. Motor. **\$29.75** (specify rotation desired) **DH-34.**

New Emerson 1 H.P. Heavy Duty, Repulsion Induction 3450 RPM. 110/220 V. 60 cy. 1 Ph. A.C. Motor. **\$37.50**

New Eicor 1 H.P. Capacitor Induction 1750 RPM 110/220 V. 60 cy. 1 Ph. A.C. Motor. **\$38.50**

New "B" Line 2 H.P. Repulsion Induction 1750 RPM 110/220 V. 60 cy. 1 Ph. A.C. Motor. **\$75.00**

New 3 Phase Motors 1 H.P. Ass't Makes, 1750 RPM 220 V. 60 cy. **A34, only \$37.50**



ALL PRICES ARE FOB. CHICAGO

WRITE FOR BARGAIN MOTOR CIRCULAR—SPECIAL MOTORS D.C. & 3 PHASE—ALL SIZES AND SAVE  
C. MARSHALL SALES, 3546 W. Fullerton Av., Dept. P-10, CHICAGO 47

Pioneers

Leaders

**AIR RIFLES**

**BENJAMIN**

**AIR PISTOLS**

SHOOT WITH SAFETY

BE SAFE—SHOOT WITH COMPRESSED AIR—ALWAYS READY No Cartridges or Tanks to Replace or Recharge. If you want the most PRACTICAL GUN to use anywhere—inside or outdoors—get a SAFE—CLEAN—ECONOMICAL BENJAMIN with Adjustable Power and Amazing Accuracy. Send for Free Folder of Latest Models Today. BENJAMIN AIR RIFLE CO., 890 MARION ST., ST. LOUIS 4, MO.

**8-inch Ball Bearing Tilting Arbor—Only \$69<sup>95</sup>**

Price includes One-Half HP Motor, 8-inch Rip and Cross-Cut Saw Blade, Miter Gauge, Rip Fence and Steel Stand.

Never before so much saw for so little money! Absolutely complete—just plug it into your lighting circuit, snap switch and operate. Nothing else to buy!

EMRICK KWIK-SAW is Tilting Arbor type. You can cut 2 3/4" at 90°; 2 1/8" at 45°. Depth and angle of cut instantly adjustable. Only blade tilts—work stays level. Ball bearings protect all moving parts. Big Saw Performance at small saw cost.

Sold on 10-day FREE Trial, MONEY-BACK Guarantee. Our 52nd year. Easy pay plan available. Write for FREE literature. EMRICK, Inc., 1583 Clinton, Kalamazoo, Michigan.



100 lbs. of Real Machinery

Wonderful Christmas Gift

## SELF-CONTROL STARTS HERE



and to restore

**CAR PERFORMANCE**

## OIL-CONTROL STARTS HERE

To stop oil-pumping, replace worn engine connecting rod bearings

Like the small-fry "family terror", worn engine bearings can cause real trouble! Worn engine bearings can't meter oil for proper lubrication. Excess oil reaches combustion chambers, burns to performance-stealing carbon on spark plugs, valves, pistons and rings. PERFORMANCE GOES UP IN SMOKE!

With sluggish engine performance . . . high oil consumption . . . excessive, oily exhaust—check for worn engine bearings! Replace, in sets, with Genuine Federal-Mogul Bearings, engineered for the job of oil control. They restore the power, pep, economy. Ask your mechanic!



**FEDERAL-MOGUL SERVICE**  
(Division of Federal-Mogul Corporation)  
DETROIT 13, MICHIGAN

control oil-pumping  
where it starts—REPLACE WITH

**FEDERAL-MOGUL**

**OIL CONTROL BEARINGS**



# WORK-SAVERS OF THE WORKSHOP - "ARCO" QUALITY TOOLS AT BETTER HARDWARE STORES EVERYWHERE

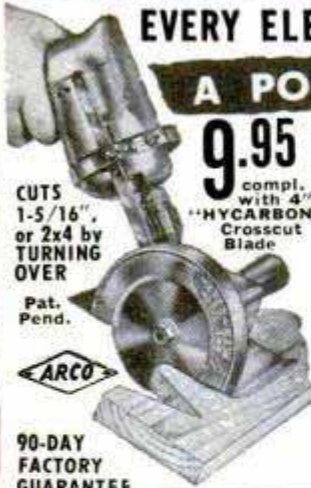

## EVERY ELECTRIC DRILL A PORTABLE SAW



**9.95** CAN BE USED WITH ONE HAND

CUTS  
1-5/16",  
or 2x4 by  
TURNING  
OVER  
Pat.  
Pend.

compl.  
with 4"  
"HYCARBON"  
Crosscut  
Blade

Any 1/4" or 3/8" Drill a Powerful Saw in ONE MINUTE  
"ARCO-SAW" is a rugged tool with right angle gear drive (no clumsy, dangerous, direct drive with drill sideways). Works like a high priced Portable Saw.

Only ARCO Gives You All These Features:  
Safety-yoke assures rigid connection and absolute safety—Big handle affords firm grip for two-hand operation—Precision one-piece gear box—Self-lubricating lifetime bearings—Wide shoe-plate for straight, square cuts—Lowest priced, quality Replacement Blades.

"HYCARBON" Crosscut Blade ..... \$1.60  
"HYCARBON" Combination Blade ..... \$1.60

90-DAY  
FACTORY  
GUARANTEE

## NOW! EVERY "ARCO-SAW" AN ANGLE SANDER & POLISHER

Your "ARCO-SAW" becomes a powerful right angle sander & polisher in just a few minutes. Ideal for removing paint from cars & walls, simonizing cars, polishing linoleum & furniture. Swivel action between drill chuck & gear box permits new freedom of use at any angle on every surface, or when necessary safety-yoke can be used to hold unit rigid. No need to buy an expensive special angle gear drive. New ARCO "SAND-N-POLISH" Attachment consists of flexible molded rubber head, sanding disc, lambswool polisher, bottom plate, hexagon adaptor, & also 1/4" adaptor for use in drill chuck



**\$1.95**

## BETTER BLADES AT LESS ARCO "HYCARBON" SAW BLADES



Made of finest, heavy gauge, TEMPERED TOOL STEEL, HANDFILED.  
Unexcelled Workmanship.

For top-notch quality and performance you can rely on these famous precision-made ARCO "HYCARBON" CIRCULAR SAW BLADES. Designed especially for long and rugged use, they cut cleaner and faster.

## ARCO QUALITY AND PRICE CAN'T BE BEAT

- 4" Crosscut, or Combination ..... \$1.60 each
- 6" Crosscut, Rip or Combination .... 2.00
- 7" Crosscut, Rip or Combination .... 2.50
- 8" Crosscut, Rip or Combination ... 3.00

All Blades Supplied with 1/2", 5/8" or 3/4" Bore (Bore for Mail, Skil, Black & Decker Saws 30c more)

ORDER TODAY at your dealer or send us check or M.O. (Postpaid). C.O.D.'s — postage extra.

UNCONDITIONAL 10-DAY MONEY BACK GUARANTEE

DEALERS—Write for nearest jobber.

## ARROW METAL PRODUCTS CO.

Dept. PM-10, 140 WEST BROADWAY, NEW YORK 13, N. Y.



## EASY TO INSTALL LOW-COST TELEPHONE SYSTEMS Save Time & Steps With ARMY FIELD TELEPHONES & WIRE

### Ring and Talk Any Distance Up To 17 Miles!

Hundreds of uses around ranches, industrial projects, anywhere. You can install Field Telephones and have communication in a matter of minutes. They'll save you time and work which means money. Walking or driving short distances to talk is unnecessary. Just string this low-cost, 2-conductor, weatherproof wire, attach to phone terminals and you just ring and talk. Simple as that. You can use from 2 to 8 phones—any number you may require—on the same line for a complete inter-com system. Performance guaranteed to equal present day commercial telephones. Powered by flashlight cells. No maintenance required.

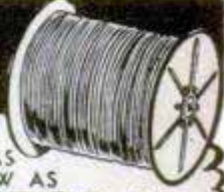

AS LOW AS  
**\$10.50** PER MILE

**EES FIELD TELEPHONES**  
Factory Reconditioned —  
New \$15.00 Per pair \$29.50  
Used, excellent condition \$10.00 Per pair \$19.50  
Each

### ACT NOW NEW LOW PRICES

W110B 2-CONDUCTOR, TWISTED PAIR, WEATHERPROOF FIELD TELEPHONE WIRE—NEW, unused, excellent condition.  
NEW, unused, good serviceable condition.....

### ORDER TODAY

PER MILE (wt. 160 lbs.) \$13.50  
PER MILE \$10.50

Write for FREE FOLDER Telephone Specialties  
1/2 MILE (wt. 80 lbs.) \$7.00  
1/2 MILE \$5.50

All prices FOB Sacramento. No C.O.D. (Calif. residents add 3% for sales tax.) Small orders sent postage collect. Heavy orders freight.

Send check or money order **LORIS SALES** P. O. BOX 1896-B10, SACRAMENTO, CALIF.

**DON'T MISS IT! ONLY 10¢**  
**BIG CATALOG**  
WAR SURPLUS  
**OPTICAL BARGAINS**  
LENSES! PRISMS! INSTRUMENTS!

## Build Your Own RIFLESCOPE, BINOCULARS, TELESCOPE, ETC.

We Furnish Optics and Instructions

- LENSES, PRISMS & RETICLES
- EYEPIECES and OBJECTIVES

Send \$1.00 for Stock #2-H 10-Piece Lens Kit and Big Instruction Booklet.

CHECK OUR BARGAINS . . . MAIL 10c FOR CATALOG H  
**EDMUND SALVAGE CO., BARRINGTON, N. J.**

## The Chief WORK BENCH

*Built to Last a Lifetime!*

With Bottom Shelf and 18" Sq. Drawer. 2"x6", Solid Plank, Grooved and Dovetailed Top and 1"x8" Back Rail, Shellacked to a Smooth, Satiny Finish.

MOHAWK LUMBER CO. Dept. 33  
14525 W. Chicago Blvd. Detroit 27, Mich.  
Enclosed  Check  Money Order for \$.....  
Ship.....CHIEF WORK BENCHES at  
Quantity  
\$19.95 each, F.O.B. Detroit, Mich.  
 Send C.O.D., \$5 Deposit Enclosed.

NAME.....  
ADDRESS.....  
CITY.....STATE.....

• 6 Ft. Long • 34" High • 26" Deep. Shipped Knock-down, with Bolts, Nuts and Screws and ABC Chart for Quick, Simple Assembly.

*Prompt Delivery*  
**MOHAWK LUMBER CO.**  
14525 W. Chicago Boulevard  
DETROIT 27, MICHIGAN



**\$19.95**  
F.O.B. DETROIT

Send Check or Money Order, or Will Ship C. O. D. (\$5 Deposit)

# STOP CHANGING MOTOR OIL!

End this needless expense forever with

## RECLAIMO Today's Most Advanced OIL RE-REFINING filter FOR CARS, TRUCKS, TRACTORS & DIESELS

Continuously cleans and RE-REFINES motor oil as you drive (by utilizing motor heat)—keeps oil in high grade lubricating quality at all times!

### "RECLAIMO"

- REMOVES SOLIDS (by filtration)
- REMOVES WATER (by distillation)
- PREVENTS Excess Fuel Dilution
- PREVENTS Acid and Sludge Formation
- ADDS Thousands of Miles to Engine Life

### MAINTAINS Stable Viscosity ELIMINATES All Oil Changes

FREE 32-PAGE BOOK "OIL FACTS" (with bonafide \$1000.00 offer on page 30), gives you the complete "Reclamo" story and details of our extraordinary 90-DAY NO-RISK TRIAL OFFER! Write for your copy TODAY!

Reclamo Sales Div., Inc.

4508 S. Logan, Dept. M-2, Lansing, Mich.

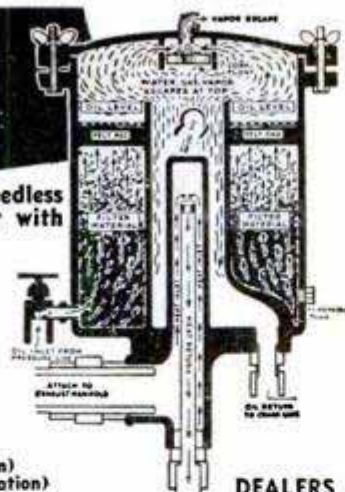

DEALERS WANTED

U.S. BUREAU OF STANDARDS, Bul. 86 States, "Oil does not wear out - mechanically."

MONEY-BACK GUARANTEE

# OVER 100 PROJECTS that YOU can build

Illustrated here are just two of the many practical projects in our catalog that you will enjoy building for pleasure or profit.

Our scale drawn, detailed plans make it easy to build these projects. Knockdown kits with perfectly cut parts, ready to assemble, are also available for every item.

Full size pattern for novel scrollwork necktie holder, shown at left, ONLY 35c.

The charming Dutch windmill shown here is 40" high, wings operate on roller bearings—just the thing to dress up your garden. Fully detailed plans and instructions only 75c. **FALL SPECIAL!** Knockdown kit of this beautiful Dutch windmill, \$14.75 VALUE, ONLY \$13.50.

Send 10c for fully illustrated CATALOG

CRAFTSMAN'S MODEL CO. DEPT. P21 DELAFIELD, WIS.

Finger test proves it!

**Scrum\*** in your radiator means **DANGER AHEAD!**

\*clogging accumulation of scale, rust and oil muck

SCRUM\* strangles your cooling system, overheats your engine, costs you money! Now, before adding anti-freeze, remove all SCRUM\* with

**Warner RADIATOR CLEANER**



Warner-Patterson Co., Chicago 5

At service stations, car dealers, auto supply stores everywhere.

OCTOBER 1950

# SpeedWay Speed Sander



**Sands Cleans**

**Smooths Polishes**

Designed for industry, for professional work, this light, beautifully balanced, orbital-motion, SpeedSander is rapidly becoming a standard home appliance. With its powerful electric motor and all-ball-bearing construction, anyone can easily re-surface and refinish furniture, woodwork, metal surfaces or walls. It will quickly remove old paint, stain, or enamel down to the bare wood or metal; will sandpaper to a "piano finish," remove rust and corrosion or "feather edge" a scraped fender. It will burnish pots and pans or with lambs wool bonnet, delicately polish fine furniture. It makes tedious, tiresome jobs fun—saves hands! In design, convenience and efficiency it is today's finest sander regardless of price. Ask your local dealer to demonstrate it.



No. 400  
1/2" (in steel)  
\$34.95

# SpeedWay Speed Drills



No. 79  
3/8" (in steel)  
\$19.95



No. 200  
1/4" (in steel)  
\$14.95

Far advanced in design and construction these new SpeedDrills are lighter, handier, yet more powerful and faster-drilling than more costly old type drills. Drill steel, wood or concrete. Quality built for lifetime service, of die-cast aluminum with cast-in air cooling system and self-lubrication. Heavy cut-steel gears. Ball thrust bearings. Your SpeedWay Dealer will point out the many other superior features.

## Kits Make Ideal Christmas Gifts

Any craftsman or "Mr. Fix-it" will be thrilled with a SpeedDrill Kit that drills, grinds, sands, buffs, polishes.

**No. 79 Kit** provides a No. 79 3/8" capacity (in steel) SpeedDrill, a SpeedStand, wire brush, sanding discs and backer plate, cloth and lambs wool polishers, paint stirrer and 5 steel drills—31 pieces in all in fitted steel carrying case, complete \$29.95



GA Kit



No. 128

Bench Speed-Grinders

**No. 200 Kit.** (Not illustrated) Similar to No. 79 Kit but with No. 200 1/4" capacity (in steel) SpeedDrill and 28 accessories in fitted case, complete \$19.95

**GA Kit.** 20,000 r.p.m. SpeedWay No. 129 Hand Grinder with 16 mounted cutters, brushes, and wheels, complete in leatherette case. \$13.95

**Bench SpeedGrinders—\$14.95 to \$29.95**—Ask your dealer to show them to you.

**SpeedWay MANUFACTURING CO.**  
1863 SO. 52nd AVE., CICERO 50, ILL.

# Buy the Best... WISS!



for all sheet metal cutting

## WISS Metal Master Compound Action Snips

#M-3. Easily cuts 18 gauge sheet metal. Cuts curves and circles as well as straight. Ideal for the home workshop. \$4.25. Rubber grips recommended, 60¢ extra.

## WISS Straight Cut Snips

#9. Crucible steel inlaid blades. The basic snips for straight metal cutting. Gun metal handles. Overall length 12½". \$4.25.

## WISS Combination Snips

#V-13. Solid steel, gray japanned handles. Cuts curves and irregular shapes with ease. Handy pocket size, 7" long. Accurately tempered jaws and strong bolts. \$1.75.

Prices slightly higher  
Denver and West



Quality for more than a Century

J. WISS & SONS CO. • NEWARK 7, N. J.

## Keep Brushes like New

BEFORE

AFTER

• 10c  
• 25c

**DICA-DOO  
PAINT  
BRUSH  
BATH**

*Clean and Restore  
PAINT BRUSHES*

Keeps brushes springy and  
ready for use

Perfect for  
**NYLON BRUSHES, too!**  
At Paint, Hardware, Dept., and 5 & 10c Stores  
Patent Cereals Co. Geneva, N. Y.

## AMAZING TOOL BARGAINS!



### SURPRISE VALUE

100 Pieces \$1.00

FOR ELECTRIC GRINDERS

Post Paid in U.S.A.

Grinding Wheels, Cut-off Wheels, Sanding Discs, Mounted Stones, Sharpening and Honing Stones, Rotary Cutting Burs, Abrasive Cartridges, and many other items. Rush check or Money Order.



### 2 CIRCULAR SAWS

ON 2 MANDRELS— ALL AT ONE LOW PRICE \$1.50

Post Paid in U.S.A.

1" diameter saws on 1/4" Mandrels. For cutting wood, plastic, or soft metals. Order at once! Send Check or Money Order.



### 2 DRUM SANDERS \$1.50

With 12 Bands in Assorted Grits. 1/2" dia. x 1" long on 1/8" arbor with 12 bands..

1" dia. x 1" long on 1/4" arbor with 6 extra sleeves.. \$1.00

SCHUPACK SUPPLY CO., 7331 Cottage Grove, Dept. M-10, Chicago 19, Ill. ILLUSTRATED BARGAIN CATALOG 10c

## END GENERATOR REGULATOR BATTERY TROUBLE

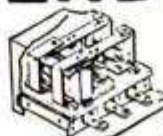

REPLACE VOLTAGE REGULATOR WITH AMAZING NEW WATTAGE REGULATOR GREATEST ADVANCEMENT IN AUTO IGNITION SINCE THE SELF-STARTER DRIVE WITH OR WITHOUT BATTERY 100,000 MILE MONEY BACK GUARANTEE

STATE MAKE AND MODEL OF CAR AND SEND FOR FREE CATALOG SCIENTIFIC ELECTRIC CO. P.O. BOX 2162-G STA-H Cleveland, OHIO

**THE IDEAL WOODWORKER'S VISE!**  
Whatever any vise can do with wood—Versa-Vise does it better, easier. There's nothing like it. Vertical work? Just lay it on its side on the permanently attached post. Horizontal? Place it upright on the same post! Turns a full circle in either position. Tightens automatically on the post when you tighten the jaws. Beautifully machined 2½x3¾" jaws open to full 5". 16 lbs., finest cast semi-steel. Only \$8.95 f.o.b. Orrville. Buy it from your dealer, or send \$8.95 now and pay small shipping cost on delivery (Ohio residents add 3% sales tax). Handiest woodworking vise you ever used. Money-back guarantee. Thousands sold. Made by makers of the famous Will-Burt stoker. Ask any bank. The WILL-BURT Company Dept. PM-1 Orrville, Ohio

## Tub-tite PLASTIC CEMENT

Fills cracks between bathtub and tile walls—around kitchen sink. Tub-tite adheres tightly to tile, wood, glass, linoleum; even cements metal and glass together. Ideal for calking boats, filling plaster cracks and for general plumbing use. Alkali, acid, water and oil proof. Easily applied; stays white and elastic. Secret formula. At stores: \$1.00; mailed postpaid: \$1.25. THE AMERICAN FLURESIT CO., 4003 Red Bank Road, Cincinnati 27, Ohio.

**WE FIT THE BIG MAN**

**SIZES 48 to 66**  
**at LOW PRICES!**

CLOTHING and HABERDASHERY  
**FREE New Winter CATALOG**

**BURNS MARTIN** Dept. 65  
147 SUMMER St., Boston, Mass.

## SPECIAL OFFER!

**LOCK-STITCH SEWING AWL**

Famous, patented lock-stitch sewing awl complete with needles, waxed thread and direction folder. Hundred uses — sewing, repairing leather goods, canvas, belting, harness, saddles, gun cases, awnings, golf bags. Extra needles and thread available. Satisfaction guaranteed or money back. Send currency, check or money order. Yates Mfg. Co., 611-H Main St., Lake Geneva, Wisconsin

**\$1.**  
Postpaid

**5 BIG POWER TOOLS**  
in ONE



RETAIL PRICE \$125.00  
**FACTORY TO YOU \$59<sup>95</sup>**

**SUPERSHOP** the PRECISION BUILT WORKSHOP Lifetime lubricated BALL BEARINGS. All running parts precision GROUND. Compare finest production tools. BIG capacity. Amazing VALUE. Write for FREE catalog, full details, trial plan.

**POWER TOOLS, INC.** 116 YATES AVENUE  
BELOIT, WISCONSIN

**TIMERS** Now only \$4<sup>95</sup> postpaid

Precision Electric Timer has many uses. Ideal for shop work, home craftsmen, photo darkrooms, etc. Sturdy construction. Automatically controlled fine clock machine for any pre-determined time in seconds. Satisfaction guaranteed. Originally sold for \$12.25. Now only \$4.95. Postpaid if cash with order, or will ship C.O.D.



**CRESCENT MFG. CO.,** 1839 S. Pulaski Road, Chicago 23, Ill.

**DUAL CROSS and ROTARY FEED**

**PALMGREN** ROTARY, INDEX, MILLING TABLE No. 83

Has 8" table, 360° movement and 4" cross feed travel. Adjusting wheels and dials graduated in degrees and thousands. Slotted for bolting to table. No. 83 Priced \$49.50. No. 82 without rotary feed \$39.75.

Write for Circular No. 10  
**CHICAGO TOOL and ENGINEERING CO.**  
8365 South Chicago Ave., Chicago 17, Ill.



**\$ RETOOTHING SAWS PAYS BIG \$**

**RETOOTH HAND SAWS IN 60 SECONDS.** Increase your income with automatic retooth that cuts 4 to 16 point rip or cross-cut teeth in hand saws. Requires less space, less time and less effort . . . while doing a perfect job. Gives a lifetime of service and has a 1 year guarantee. Free folder on request.

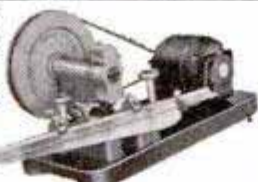

**SAW SHOP CHARGES COAST TO COAST**

**WRITE FOR VALUABLE BOOK** Automatic Retoother

Send 25c in coin for Burr's Blue Book of saw shop charges and other valuable information.

**BURR MFG. CO., Dept. 10, 8933 Venice Blvd., Los Angeles 34, Calif.**

**No — NOT JUST A PIPE CUTTER — But — A New Improved "Patented" KUICK KUT METHOD OF pipe cutting**

With a flick of the thumb knob . . . This PATENTED RELEASE NUT PIPE CUTTER is ready for cutting instantly . . . No need having two or three tools on hand . . . This one tool alone cuts 3/8", 1/2", 3/4", 1", 1 1/4", 1 1/2" and 2" pipe . . . The real thing for the handy man, to make those minor pipe repairs and changes about the home, garage, etc. . . .

A TRULY COMPACT "BUNCH OF VALUE." Send check or money order. We pay postage. **\$7.45** YOU JUST CAN'T GO WRONG

WILL PAY FOR ITSELF TIME AND TIME AGAIN

**ALCO**

473 Vine Street Engineering Bethlehem, Pa.



*Handy Hank says:*  
"Every man's a handyman with **PLASTIC WOOD**"

Reset loose drawer pulls—

Replaces splintered wood . . . makes loose screws firm!



Seal drafty cracks—

Fills openings easily . . . dries tight and hard! Resists weather!

Repair loose tiles—

Holds tiles firm on wall! Easy!



Also useful in filling cracks in floors, nail and screw holes, repairing broken toys. Handles like putty . . . hardens into wood!

**PLASTIC WOOD**

A CELLULOSE FIBRE FILLER

IN CANS OR TUBES



WEATHER RESISTANT

NOW YOU CAN  
INSTALL YOUR OWN



Nothing to it for the average handy man. You need only seven tools to put in the astonishing new forced-hot-water system:

# COPPERHEAT

- BOILER:** Choose from gas, bottled-gas, or oil-fired.
- PUMP:** (patent pending) circulates water fast for speedy heat and economy.
- COPPER TUBING:** You can "fish" it through the walls.
- WALLRADS:** Flush-with-wall radiators, each with a blower. Easily inserted and assembled.

For Old House or New—  
For Store or Small Factory—

## THE COPPERHEAT SYSTEM

gives you

- 1—FORCED HOT WATER HEAT at the cost of warm air.
- 2—FASTEST HEAT EVER: Automatic blower-action gives heat shot out across the floor in 30 seconds.
- 3—EASE OF INSTALLATION: Dealers reported that in early Copperheat sales, 25% to 33% were owner-installations, all 100% satisfactory.

Send for illustrated folder and name of the COPPERHEAT dealer near you, if any. Tell us whether you will fire your boiler with gas, bottled-gas, or oil.

### COPPERHEAT INDUSTRIES, Inc.

20211 LIVERNOIS, DETROIT 21, MICHIGAN

Inquiries for Dealers will receive prompt attention

## PARTS FOR MILITARY TRUCKS

At Big Savings For Jeep, Dodge, Chevrolet, G.M.C., Studebaker New FREE Catalog

Brand New — Weatherizing Kits — Complete  
**JEEP TOPS and SIDE CURTAINS**  
Fits all Military Jeeps. Also adaptable to Civilian Jeep. Waterproof O.D. . . . . \$59.50

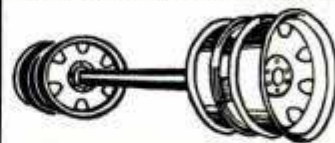

### TRAILER AXLE

Heavy duty trailer axle suitable for many types of trailer construction. Also excellent for building of heavy farm trailers and wagons. It is a 12,000 lb. capacity square type straight

trailer axle complete with Timken roller bearings, hubs, and 6 hole 750 x 20 Budd Wheels. Without brakes. Axle is 2 inches square and 69 inches between wheel mounting flanges. Std. width.

With Single Wheels. \$59.50 With Dual Wheels. \$69.50

### NEW STEEL WHEEL With Solid TIRE



Complete With Shaft. 12 1/4 x 5 5/8 inch tire size. Shaft size 1 3/4 x 2.165. Equipped with two bearings. Suitable for Trailers, Dollies, Belt Drives and many other uses. Weight 67 lbs. Priced at a fraction of government cost. Each . . . . . \$9.95

Hundreds of Other Truck & Jeep Parts and Supplies  
All prices quoted good 30 days FOB, Kansas City

## American AUTO PARTS CO. INC.

1830 LOCUST—DEPT. PM  
KANSAS CITY, MISSOURI



**MASTER CHAMPION  
LAWN MOWER SHARPENER**  
IMMEDIATE DELIVERY—PARTS SERVICE  
(Agents Wanted)

**FRANK'S MFG. CO.**  
Dept. H, 2501-3-5 E. Imperial Hwy.  
Los Angeles 2, Calif.

### LATHE GRINDING ATTACHMENT

The New "HURON CHIEF"—A Wet Grinder For 8" to 18" metal lathes! BUILD IT YOURSELF from our semi-machined castings and save \$8. Grinds with coolant on wheel and work. Controls dust and heat. Will grind with the finish and precision of a specialized grinding machine. Does both external and internal work, valve and piston grinding, cutter and tool sharpening, production grinding, etc. WRITE for FREE illustrated folder and price list of castings, parts, grinding wheels, coolant, etc. Mention your lathe.

HURON MACHINE AND TOOL CO.  
Dept. B Yale, Michigan



**WELD**  
BRAZE, SOLDER, CUT  
quickly...easily

The FOUR-WAY  
PORTABLE ARC-WELDER

COMPLETE ONLY \$11.95  
10 DAY TRIAL F.O.B.

YOU'LL BE AMAZED by the work you can do on your first job! Plugs into any convenient properly wired 110 volt A.C. or D.C. line. Follow simple directions. Work on iron, steel, bronze, brass, aluminum and other metals. Save money doing own repairs. Make money repairing for others.

Thousands of users among maintenance and repair men, farmers, tinsmiths, engineers, home and auto owners, etc. Pays for itself over and over. Order on ten-day trial or send for details.

FOUR-WAY WELDER CO., Dept. F2-KA  
2326 So. Michigan Avenue, Chicago 16, Ill.

FREE Full Details SEND TODAY



OF ALL FINE SAWS...THE FINEST ARE "SILVER STEEL" SAWS



only **ATKINS** makes

*"Silver Steel"*

**SAWS**

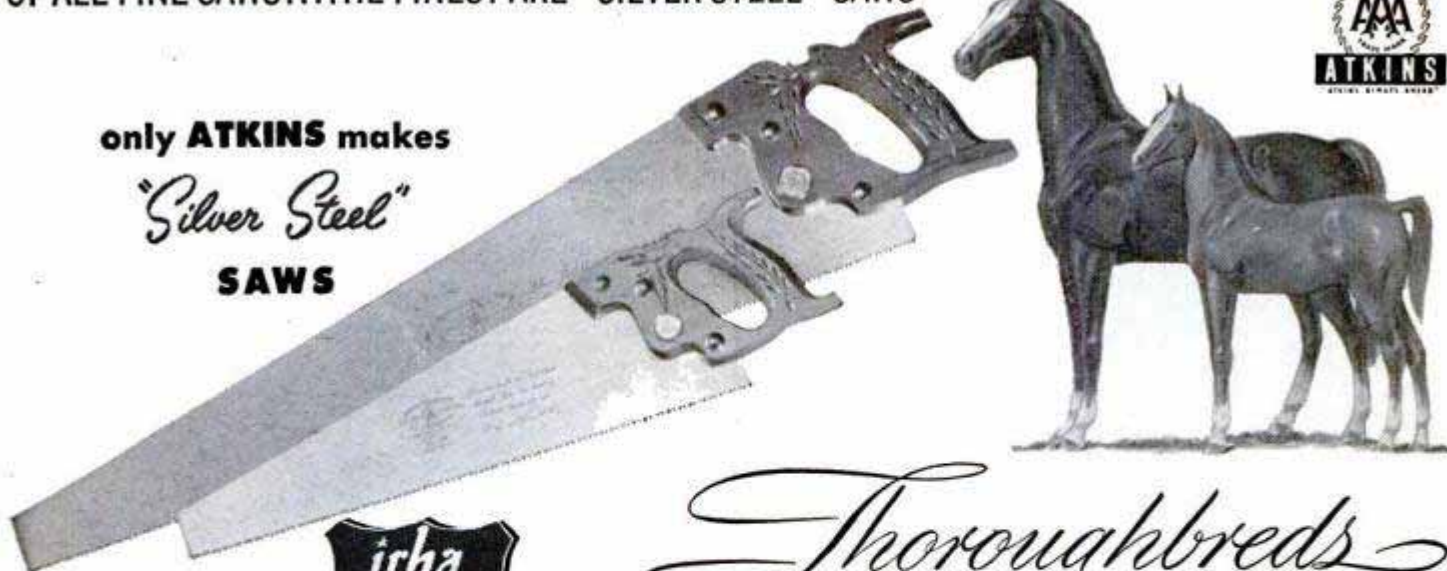

Buy at hardware retailers displaying this emblem and at other hardware stores.

*Thoroughbreds*



ATKINS "Silver Steel" files designed for every filing need.

Here's the famous son of a famous father—a "chip off the old block!"... Atkins No. 65 saw has a running mate—for craftsmen, their sons, their wives—for countless jobs around the home. It's a saw for particular jobs—for small hands (and for big ones, too)—for painstaking workmanship. Ask for it by name—ATKINS JR.-65. 16" blade, but otherwise the counterpart of America's most popular saw!... See it at your local hardware store.

**ATKINS**

**E. C. ATKINS AND COMPANY**

Home Office and Factory: 402 S. Illinois St., Indianapolis 9, Ind.  
Branch Factory: Portland, Oregon  
Branch Offices: Atlanta • Chicago • New Orleans • New York

*Protect It!*

**FREE BOOK TELLS HOW**

New free 24-page illustrated booklet tells how you can add years of life to fences, trellises, all weather-exposed wood—with a coat of the *right* aluminum paint. Oil-rich Aluminum *House Paint* seals out moisture, says **NO** to wood deterioration. Dozens of helpful painting tips like this—secrets of master painters—in this free booklet. Send for your copy today! And be sure to get the brand that bears the Alcoa symbol of quality when you buy aluminum paint from your dealer.

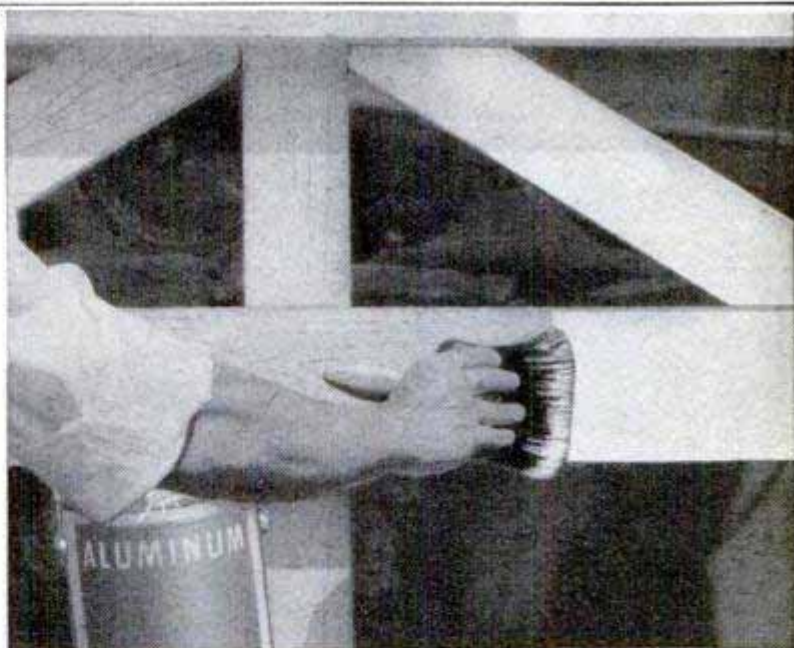

**MAIL COUPON TODAY!**

Paint Service Bureau, ALUMINUM COMPANY OF AMERICA,  
1718K Gulf Building, Pittsburgh 19, Pa.  
Please send me free copy of "Paint It Bright".

Name (please print) \_\_\_\_\_

Address or RFD No. \_\_\_\_\_

City \_\_\_\_\_ State \_\_\_\_\_

I want to paint the following: \_\_\_\_\_

Look for this shield on aluminum paints made by many paint manufacturers using **ALCOA PIGMENTS**



# ADJUSTABLE WRENCHES THAT LAST 10 TIMES AS LONG

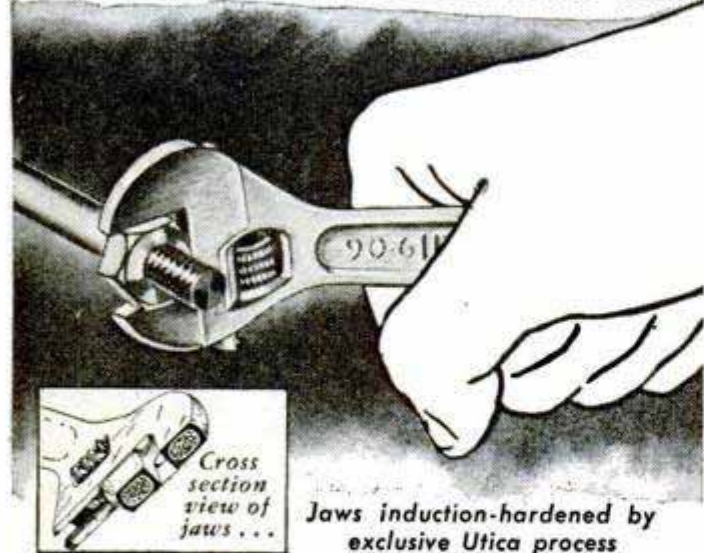

Jaws induction-hardened by exclusive Utica process

Now you can have adjustable wrenches engineered to take tremendous wear and tear exactly where most wrenches fail first—along the jaw edges.

By an exclusive electronic process Utica, and only Utica, hardens these edges to prevent burring over. They give you up to 10 times longer wear.

It will pay you many times over to insist on Utica Adjustable Wrenches. Your hardware dealer or tool supplier has them, or can get them for you. Or write us.

**FREE** Send for interesting folder describing Utica Adjustable Wrenches and other hand tools.

Utica Drop Forge & Tool Corporation, Utica 4, N.Y.



And the world's best tools are made in U. S. A.

## 15 ESSENTIAL OPERATIONS ON ANY DRILL PRESS

● Spark your hobby or manufacturing operations with the most complete line of all-purpose drill press tools and accessories. Barron Tools make any drill press your most economical, versatile workshop machine. You can surface-plane woods and plastics, tenon, rabbet, panel, groove, mortise, rout, dovetail, bead, shape contours and moldings, vein, sand surfaces, drum sand, grind, and drill.

The Barron Workshop Guide tells how. Sent free on request with catalog and prices.

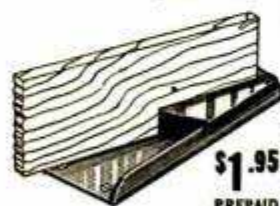

### ALL-PURPOSE BENCH VISE

Holds workpieces up to 3 1/2" wide—solid and secure—for planing, sawing, drilling, sanding, filing.

\$1.95  
PREPAID

BARRON TOOL CO., INC.  
315 Architects Bldg., Detroit 1, Mich.



Drill Press Planer \$7.50



Rotary Surface Sander \$5.95



Safety Shaper Cutter and Blades \$9.00

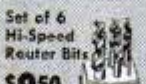

Set of 6 Hi-Speed Router Bits \$9.50

## BARRON PRECISION WORK SHOP TOOLS

# HANDEE

tool of 1001 Uses

- Handicraft Hobbies
- Household Repairs
- Auto Maintenance

**Everyone Needs a Handee!**  
Absolutely the finest in hand power tools. Cool running, controlled power for those countless small jobs. A whole toolbox in your hand... grinds, drills, engraves, cuts, polishes, saws, routs, sands... pays for itself quickly!

**HANDEE with 51 accessories, in fitted steel case \$27.50**  
**HANDEE with 7 basic accessories \$19.95**

**MONEY BACK GUARANTEE!** Liberal 10-day free trial offer. Get HANDEE at your dealer's today, or order direct postpaid.

**FREE!** New HANDEE Catalog... shows a host of practical applications. Write today!

**CHICAGO**  
**WHEEL & MFG. CO.**  
Dept. PM, 1101 West Monroe Street, Chicago 7, Ill.

**POSTPAID ANYWHERE IN U.S.A.** WE FURNISH ALL MACHINED METAL PARTS, EVERY SCREW, NUT, BOLT, WASHER, AND COMPLETE PLANS FOR THIS...

## BIG 10" POWER SAW

**\$10.95** FULL REFUND IF LESS GUARD NOT SATISFIED & WOOD IN 10 DAYS

COMPLETE PLANS 10c  
**MARCUS-POLLAk**  
DEPT. N, ROYERSFORD, PA.

ASSEMBLE IT YOURSELF WITH SIMPLE HOUSEHOLD TOOLS!

## SHEET METAL BRAKES

Forms angles, flanges and Pittsburgh locks. 26 gauge steel, heavier aluminum. Cam locking. Portable, can be bolted to bench, or clamped to edge of truck. All steel, reinforced. Shipped Exp. Coll. 30" size, Wt. 42 lbs., \$26.50. 36" Wt. 52 lbs. \$31.00. 48" Wt. 45.00. Floor mountings, portable, 32" high, \$7.00.

12" BRAKE. Fits in vise to form difficult compound bends, up to 20 gauge steel. Not illustrated... \$12.50 PP.

18" CURVE FORMER, Capacity —16 gauge steel... \$10.00

SHEET METAL PLIERS, 2 1/2" wide, \$2.00; 5" \$2.50. Immediate delivery. Order direct, cash or C.O.D. or send for folder.

**YKKE BRAKE CO., P-1116 So. 27th St., Omaha 5, Nebr.**

## SAVE MONEY

Build this 18 ft. House Trailer yourself \$286.00. Blueprints, Building instructions and 1950 parts catalog 50c. Don't Delay, Write Today

**NATIONAL TRAILER EQUIPMENT COMPANY**  
Dept. PM-10, 431 W. MITCHELL ST., MILWAUKEE 4, WISCONSIN

## HULL AUTOMOBILE COMPASS

**OWNERS KNOW WHICH WAY TO GO... SAVING MILES OF WRONG WAY TRAVEL**

The ONLY Automobile Compass with 16 years' proof of constant dependability. At your dealer's. Write for literature.

**HULL MFG. CO. P. O. Box 246-D10, Warren, Ohio**

## AVIATION SURPLUS MATERIALS

- Pilot's Breathing Oxygen set; lightweight 6"x24" steel bottle, 0-500# gauge, "demand" regulator, mask and hose, carrying case. All unused AAF surplus, now only... \$7.95. Refill hose and valve (for filling)... \$2.00.
- Navigator's Sextant, AAF type A10, w/wood carrying case, used condition, not collimated or checked... \$5.95. (A10-A with automatic averager, case—\$7.95)
- Instruments and meters, Airplane; assortment 10, used condition, electric-pressure types, our choice... \$7.95
- Rubber tired wheels; 8x1.75", new, 1/2" axle hole, Bronze bushings... four for \$3.95 (for ball bearings add \$1.00 extra per set)
- Food and liquid warmer, portable oven, 110V and 28V power; Size 17"x17"x12", 23 lbs. Fine for bread, buns, food, sandwiches, all liquids. Use home, shop, office, airplanes, boats, trailers, etc. In good used condition, F.O.B... \$6.95
- AAF Parachutes w/harness; app. 60 sq. yds. pure silk; for decorations, drapes, clothing, etc. Limited! F.O.B... \$12.95
- AAF Generators, P-1, 200 amp. 28V; for welding, etc., used, F.O.B... \$13.95
- AAF Radio headphones, good used condition, postpaid... \$1.25

Items 1, 2, 3, 4 not postpaid; add 10% to price  
SEND CHECK, CASH OR MONEY ORDER  
**AERO PARTS SUPPLY, Dept. PM-9**  
8102 LOCKHEED HOUSTON 17, TEXAS

**Portable LIGHT PLANT**  
(ITEM 24)



500-700 watts 110-120 v. — 60 cyc. A.C. Powered by a sturdy dependable easy starting air cooled 2 hp. gas engine. No wiring necessary, just plug in and operate. Plenty of current for oil burner, emergency lights, freezer, radio, incubator, etc. Complete protection against current failure. Ideal for hunting or camping. Complete with Voltmeter and built-in winding to charge 6 v. auto batteries. Fully guaranteed. Reg. \$275.00 value. Only **\$129.50**.

**GAS ENGINE**  
(Item 25) Air-cooled, 1 1/2-2 h.p. Complete with gas filter, air cleaner, governor, fuel tank. Ready to run. Speed range 2000-3600 r.p.m. 3/8" shaft. Rope start. Ideal for pumps, air compressors, power tools, generators, etc. One of the best made. Wt. 40#. Worth \$62.50. Spec. **\$38.50**.



**PARTS WASHER**  
(Item 20) Store gas or carbon tet. in 5 gal. safety can. Valve releases just the right amount into washing compartment. Parts are washed and drained on a "dunking" screen — no fishing for parts. Eliminates fire-danger, waste, spillage, evaporation. Wt. 8 lbs. Reg. \$19.50—Special **\$4.95**.



**GAUGE TESTER**  
(Item 27) Precision made of solid bronze by Star Brass Co. Calibrated weights acting against hydraulic piston, provides quick, accurate testing of all pressure gauges up to 3000 lbs. per sq. in. Brand new in hardwood cases. Wt. 100#. Reg. \$435.00. Our Spec. **\$125.00**.



**EXTENSION CORD**  
(Item 16) 40 ft. heavy duty, made of specially insulated No. 14 2-conductor wire. So tough that you can drive over it and yet amazingly flexible and easy to handle. Resists oil, grease or water. Extend electricity up to 400 ft. without voltage drop. Use indoors or out. Complete with heavy rubber plug and outlet. Wt. 2 1/2 lbs. Usually \$4.50—Special 40 ft. **\$1.95**. Comb: 2-40 ft. and 1-20 ft. (total 100 ft.) **\$4.75**.



**FRAM OIL FILTER**  
(Item 12), Model F21. Big 73 cu. in. size. Ample capacity for all cars, trucks, tractors. Universal bracket, standard openings. Fram filters are tops. Easy to install. Wt. 8 lbs. Usually \$7.95—now **\$3.75**.



**HYDRAULIC HOSE**  
High pressure, heavy duty, compl. with swivel fittings. Pipe thread connections. Ideal for farm equip., bulldozers, grease guns, etc. Any length. Minimum order **\$2**. **INSIDE DIAMETER** 1/4" 40c per ft. 3/8" 50c. 1/2" 70c. 5/8" 90c.



**HOT WATER HEATER**  
(Item 26) Immersion type, heavy duty. 115v. A.C. 300w. Does not require watching. Thermostat shuts off at 165°. Keeps water hot for shaving, washing, dishes, etc. Also good for keeping water from freezing in big troughs or tanks. Made by Cities Service. Wt. 4#. Worth \$9.50. Our Spec. **\$4.50**.



**RUBBER HOSE**  
New genuine Neoprene Hose —outlasts ordinary rubber 3 to 1. Reinforced with super tough cotton cord plies. Flexible. Easy Flo brass couplings with standard pipe threads for quick connections, included. Pump water for irrigation, stock, tanks, home, barn, fire fighting, etc. Pump Gas or Fuel Oil. Save more than 60%. (Inside Diam.) 1 1/4" 11 1/4" 11 1/2" Length 25 ft. 40 ft. 30 ft. Price \$8.75 13.75 13.75 If specified we will send special hose for gas or oil at same prices.



**TERRIFIC VALUES!**

**ANGLE DRILL**  
(Item 23) Fits into chuck of any electric or pneumatic drill or flex. shaft. Operates at any angle in a full 360° arc. Makes possible drilling, grinding, carving, routing, etc. in close cramped quarters. Makes impossible jobs easy. Made by Kett Tool Co. Complete with built-in chuck and adjusting key. Lists at \$39.95—while they last **\$9.95**.



**5 GAL. STRAINER FUNNEL**  
(Item 28) Made of heavy galv. steel. Fine brass strainer built into neck. Perfect for straining milk, gas, diesel fuel, spray mixes, etc. Includes 10" flex. extension hose (not illus) for hard to reach spots. Wt. 4#. Worth \$5.95. Our Spec. **\$2.25**. 2 for **\$3.95**.



**WELDING HELMET**  
(Item 29). Hand type, complete with medium filter lens. Made by Hobart. Best quality. Wt. 3#. Reg. \$6.95. Spec. **\$2.35**.



**HEATING & VENTILATING FAN**  
(Item 10) Easily installed in furnace pipes. Forces even heat to all rooms. Over range, removes kitchen smoke and odors. Powerful continuous duty motor, 110-120 V. A.C. Quiet, super efficient fan moves huge volume of air (400 to 600 c.f.m.) 8" Fan **\$5.95**, 10" Fan **\$7.95**, 12" Fan **\$8.95**.



**CLIP BOARD**  
(Item 17) Heavy Masonite, with self-adjusting spring hinge to hold up to 100 sheets of 8 1/2 x 11 paper. Push back cover for instant release. Flip cover shut and notes or drawings are protected. Perfect for pilots, engineers, students, artists, truck drivers. Wt. 2 1/4#. Usually \$2.95. Spec. **\$1.10**, 2 for **\$2.00**.



**All items brand new surplus. Prices f.o.b. Chicago area. Money back guarantee. Send check or M.O. The A & K EQUIPMENT & SUPPLY CO., Dept. 50, Burlington, Wis.**

**JUNIOR ENGINEERS! — MAKE YOUR OWN REAL ELECTRIC MOTOR!**

**A V-4 ELECTRIC ACTION-PACKED MOTOR —**

**EXPERIENCE the Thrill of actually Constructing — Using**

Have FUN putting it together! Then—have MORE FUN watching it WORK! And then—have STILL MORE FUN using it to Power your mechanical sets! The V-4 Motor is NEW! It's ACTION-PACKED! Every MOTION is Clearly Visible! That's why you will be Fascinated by its ACTION!

FEEL the Complete Control you have over The Motor with the Master Control Lever—Continuously Variable Speed Control from Full Speed Forward-to-Full Speed Reverse! Run it on SAFE—Low-voltage A.C. or D.C. 18 volts, 60 cycles from a Transformer—Or, 6 volts from a Battery or Rectifier.

**The "V-4 ACTION MOTOR" is "MORE than a MOTOR"**

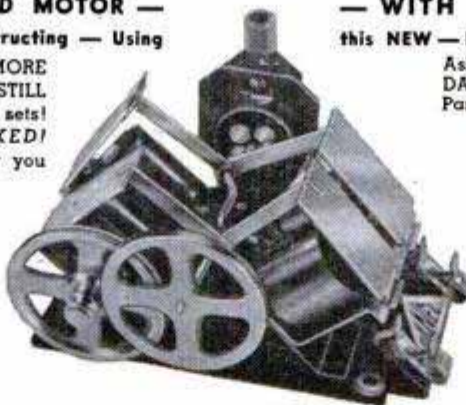

**— WITH THE DANEL 400-K MOTOR KIT!**

**this NEW — REVOLUTIONARY — ACTION-PACKED MOTOR!**

Ask your Toy or Hobby Dealer for the DANEL 400-K Motor Kit complete with all Parts—full—easy-to-follow Instructions. **\$5.95**

Or—the Completely Assembled Model 400 V-4 Motor (Illustrated) Ready to Operate **\$6.95**

If your Dealer is unable to supply you, either the Kit or Assembled Motor can be ordered directly from—

**DANEL, INC.-BOX 49M-RADNOR, PA.**

Write for Free Descriptive Folder  
**\$1.00 Deposit Required for C.O.D.'s**  
**DEALERS — JOBBERS!**  
**WRITE FOR INFORMATION**

**Aladdin Tools**

**Make These Cuts—And Hundreds More—with Aladdin Shapers for Circle Saw and Drill Press!**

**CIRCLE SAW WOODSHAPER, MODEL #5A-10.** (left) Solid steel. Absolutely safe—blades locked in position with screws all the way through. In ordering, state diameter of your circle saw shaft. Complete, as pictured, with 6 pair blades and tool rack. **\$14.95**

**DRILL PRESS WOODSHAPER MODEL #60.** (right) Heavy-duty shaper. Exclusive pilot bearing eliminates side thrust, chatter, vibration — assures smooth cutting action. Complete, as pictured with 6 pair blades. **\$12.95**

**ALL ALADDIN TOOLS ARE GUARANTEED**  
At your dealer, or send cash, check or money order for prepaid shipment

Nationally Distributed by

**BERTRAM B. ENGINEERING & SUPPLY COMPANY**  
3121 MAIN STREET KANSAS CITY, MO.



**WIND SPEED?**  
**WIND DIRECTION?**  
**TEMPERATURE?**

Know all the answers, INSTANTLY, with an **A-C-I WINDOMETER**

complete as illustrated **89.50**

**FOR AIRPORTS, BOATS, HOMES, INDUSTRY, FARMS!**

Know the important facts about outside weather instantly—and have them right at your fingertips, in one compact unit!

**WIND VELOCITY**—calibrated in leading University Lab. Wind Tunnel, for extreme accuracy.

**WIND DIRECTION**—built to aviation standards.

**OUTSIDE TEMPERATURE**—precision made, aircraft quality. All instruments and transmitters are highest quality precision aircraft type, with Gold-palladium and Silver contacts. Completely self-contained unit—use anywhere—easily installed.

NEVER BEFORE such quality and precision at this amazing price!

**AIRCRAFT COMPONENTS, INC.**

1212 Woodland Avenue, Benton Harbor, Mich.

Please send me one WIND-OMETER complete as illustrated. My Check/Money Order for \$89.50 enclosed.

Name \_\_\_\_\_  
Street \_\_\_\_\_  
City \_\_\_\_\_ State \_\_\_\_\_

## AIRCRAFT INVENTION

### ROLLS YOUR CAR INTO THE AIR

**LIFTS AND LIFTS—**  
There is no other automobile jack like it. This Saginaw super-jack literally rolls a car into the air. Ball-bearings, rolling between the raceway-shaped threads, reduce effort through increased efficiency—give you remarkable lifting power.

**EXTRA SENSIBLE—**  
There's common sense in buying a Saginaw jack. Added to safety and ease of operation, there is real economy in a jack built to last for years. One good jack is worth more—costs less—than several poor ones.

**GET YOURS NOW—**  
See your nearest United Motors service station.

**UNITED MOTORS SERVICE, DEPT. S-31**  
General Motors Building, Detroit 2, Michigan  
Send me more information about the new Saginaw jack and where I can buy it.



## SAGINAW

### Recirculating-Ball BUMPER JACK

**LASTS AND LASTS—**  
Tested and proved, this exclusive principle actuated bomb bay doors and wing flaps in thousands of warplanes. The heavy base is permanently attached—can't come loose. The rugged steel construction is built to outlast your car.

**EXTRA SAFE—**  
Won't slip, won't spin, no fluid to leak, no notches to wear. Recirculating balls hold your car where you want it. No kneeling or stretching to prop it under your car. It fits every bumper. Safety like this can mean more than money to you.

# BINOCULARS

**BRAND NEW.** Quality glasses. Achromatic lens! Have precision ground optics. Light weight metal bodies. Moisture-Dust proofed.



**16 x 50 COATED \$69.50**  
**CENTER FOCUS**

Lightweight. Superb craftsmanship. Combines tremendous power, instant center focusing plus magnificent light transmission. Objective lens is 2 inches in diameter.

6x Coated (Pocket model).....	\$19.50
6x25 Regular .....	26.00
7x35 Coated (Center Focus).....	49.50
7x40 Coated (Center Focus).....	52.50
7x50 Coated .....	49.50
8x40 Coated .....	49.50
10x50 Coated .....	62.00
12x50 Coated .....	65.00



**COATED — FEATHERWEIGHT**  
**6 x 30 \$24.95**

6 Power is the UNIVERSAL POWER preferred by top U. S. Army field strategists. FEATHERWEIGHT weighs only 15 ounces. COATED for clear, sharp images. Measures in compact 4 1/2" x 6". Has field of 390 ft. at 1000 yds. 8x30 COATED (as above) \$29.50

**UNCONDITIONALLY GUARANTEED TRY FOR 20 DAYS AT OUR RISK!**

If not fully satisfied return for full refund! Cash orders rushed postpaid. On C.O.D.'s include \$2.00 deposit. Add Federal tax. Prices include handsome genuine leather case and straps.

**UNITED BINOCULAR CO.**

9043 S. WESTERN DEPT. ARF-1908 CHICAGO, 20

## AGENTS 300% Profit SIGN LETTERS

For Store Fronts and Office Windows. Anyone can put them on. Free samples. Liberal Offer to General Agents.

**METALLIC LETTER CO., 430 N. Clark, Chicago 10**

## Drill any masonry CONTINUOUSLY

### ... with new CARBOLOY "LIVE-SPIRAL" Masonry Drill

No packing or stalling. Spiral wire lifts dust as it drills. Tipped with Carboloy Cemented Carbide. Fits any rotary drill or hand brace. 1/4" drill—\$1.40. Also 1/4", 3/8", 1/2" in Kit C. Free folder at dealer's or write.

"Carboloy" and "Live-Spiral" are trademarks of **CARBOLOY COMPANY, INC., 11185 E. 8 Mile Ave., Detroit 32, Mich.**

## SHARPEN CIRCULAR SAWS LIKE AN EXPERT



**THE SUPER GADGET FOR HOME WORKSHOP**

Two simple adjustments. Gets hollow-ground, cross-cut or combination saw blades true and sharp. Fits 6" to 12" blades 1/2" to 13/16" centers. Includes file, complete instructions. \$6.95 postpaid. (C.O.D. postage extra.) Guaranteed—Money back if not satisfied after 10-day trial. Soon pays for itself. Order today. Free Folder.

**SURE SHARP MFG. CO., Dept. M-100**  
P. O. Box 24 Santa Ana, Calif.



## MACHINE SHOP EQUIPMENT

The No. 49 edition of the famous Center Tool Co. Catalog is now ready! Every workshop owner should have a copy. 240 pages full of illustrations, descriptions, and prices of the latest tools made by best-known manufacturers in U. S. You pay the cost of printing—50c. We refund your 50c with your first order of \$10.00 or more. Prompt delivery on most tools. Send check or money order today!

**CENTER TOOL CO.**

153 Centre Street, Dept. C, New York 13

## Your YOUNGSTER WILL LOVE IT!



Give your youngster a TRACTALL for the joy-ride of a lifetime! Looks just like a man-size Tractor. The perfect gift for boys, girls, up to 12 years old. Chain Drive. Sold only direct from factory. Write for Literature, FREE trial offer.

**INLAND MFG. CORP., Dept. PM-10 164 Ellicott St., Buffalo 3, N. Y.**

**ARMY ORDNANCE AIRBRAKE SPECIAL**

WESTINGHOUSE AIRBRAKE CO.

**PORTABLE AUTOMATIC AIR COMPRESSOR UNIT**

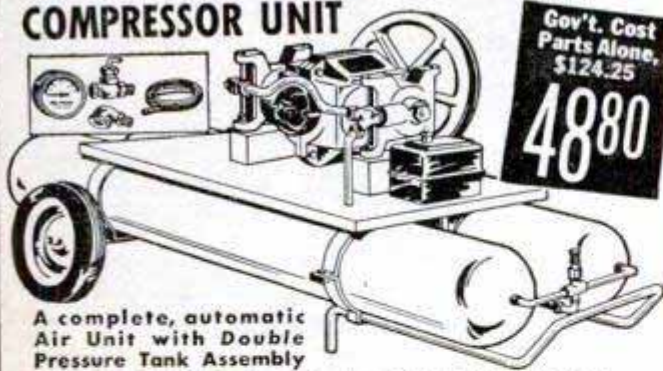

Gov't. Cost Parts Alone. \$124.25  
**4880**

A complete, automatic Air Unit with Double Pressure Tank Assembly

Terrific Value in this Large Capacity Unit for Farm, Home, Industry, Painting, Air Tools, etc.

**INCLUDES:** • **COMPRESSOR:** horizontally opposed, 2 cylinder piston type, huge volume, 6.54 CFM, 2" bore, 1 1/2" stroke. • **TANKS:** 6" x 45", 400 PSI test, heavy gauge steel, 1000 cu. in. capacity each tank, pressure capacity—13.8 cu. ft. each tank. • **PLATFORM:** 12" x 32" for easy mounting of electric motor or gas engine. • **WHEELS:** 10 x 1.75, full ball bearing with semi-pneumatic, puncture proof tires, can be drawn as a trailer. • **PRESSURE SWITCH:** Cutler-Hammer, adjustable automatic motor control, with overload protection for motor. • **PETCOCK:** for air shut-off and water drainage. • **SAFETY RELIEF VALVE:** adjustable. • **GAUGE:** by U. S. Gauge Co. • **HOSE:** 25 ft., 2 braid, high pressure, with fittings and tire chuck. • **CHECK VALVE:** seals air in tanks. Shipping wt. 85 lbs.

**COMPLETE ASSEMBLY WITHOUT COMPRESSOR \$29.50**

All prices FOB Pittsburgh, Pa. Send Check or Money Order

**NATIONAL EQUIPMENT CO.**

929 Fifth Avenue Dep't. MY Pittsburgh 22, Pa.



"I'm making our new kitchen cabinets with SKIL Home Shop Tools"

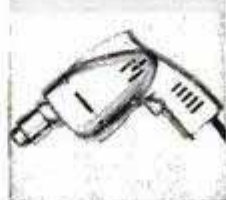

**SKIL Home Shop 1/4 inch Drills**

For home repairs, hobby work. Drills 1/4 in. in steel, 1/2 in. in wood.

Model 518 (hex key chuck) \$19.95

Model 549 (geared chuck) \$22.95



**SKIL Home Shop 8 1/4 inch Saw**

Bevel-cuts. Adjustable for cuts—0" to 2 3/8".

Rips, cross-cuts, bevel-cuts 2x4's, 2x6's, 2x8's in a few seconds.

Model 565, \$84.50



**SKIL Home Shop Oscillating Sander**

Sands! Rubs! Polishes! 10 times faster than by hand. \$64.50

Products of the Home Shop Division

**SKILSAW, INC.**

5033 Elston Ave. Chicago 30, Ill.

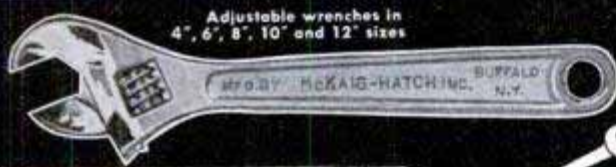

Adjustable wrenches in 4", 6", 8", 10" and 12" sizes

**OUR FINEST MECHANICS TOOLS**

Now Priced for Every Pocketbook

McKaig-Hatch Superior Design In Polished-Chrome, Forged Tools

Exact design in these tools does faster, better work on every job. Every tool is forged of finest alloy steel, heat treated and carefully finished in gleaming polished chromium. Now you can own tools that mechanics have preferred for years—at prices you'd expect to pay for ordinary tools.

- Every tool fully guaranteed for material and workmanship.
- Thinner design—increased strength.
- High tensile strength and hardness.

There is no substitute for a McKaig-Hatch Tool

SEE YOUR TOOL DEALER

Dealers and Jobbers Write for New Literature

Open end 5 and 6 wrench sets 3/8" to 1"

Combination 5 & 6 wrench sets 3/8" to 3/4"

12 pt. Box End 5 & 6 wrench sets 3/8" to 1"

Slip Joint Pliers 5" to 10" sizes

5 styles of Claw Hammers

Pipe Wrenches 10", 14" and 18" sizes

**McKAIG-HATCH INC.**

125 Skillen Street • Buffalo 7, New York

They're easy to use . . . economical to own

Build cabinets, tables, lawn furniture . . . dozens of other things for your home right now. It's easy, it's inexpensive, it's fun. Plan a "do-it-yourself" project now. Ask your dealer about SKIL Home Shop Tools.

ASK YOUR DEALER ABOUT THESE OTHER SKIL HOME SHOP TOOLS

Sander-Polisher • Belt Sander • Saws Saw Table • Bench Stands • SKIL Trimmer



SKILSAW, INC., Home Shop Division 5033 Elston Ave., Chicago 30, Ill.

Please send me full information on SKIL Home Shop Tools and the name of my nearest dealer. C10

Name .....

Address .....

City ..... Zone ..... State .....

SEND COUPON TODAY FOR FULL INFORMATION

# NEW B-T HACK SAW!

Fits any 1/4" electric drill



For  
Home  
Craftsmen  
Farmers  
Carpenters  
Plumbers  
Mechanics  
Electricians  
Contractors

**POWERFUL ...  
PORTABLE ...  
POCKET-SIZE ...**

**\$4.95!**

- SAWS WOOD, PLASTIC, STEEL & SHEET METAL, PIPE, PLASTER BOARD, CELOTEX!
- 2-1 reduction prevents burning saw teeth on metal!
- NO GEARS, NO BEARINGS—ABSOLUTELY NOTHING TO WEAR OUT!
- LIFETIME GUARANTEE—At any time, we'll put this tool in perfect working order for only 50c!

*Prices subject to change without notice after November 1, 1950*

At Your Dealer or Order Direct

**BERTRAM B. ENGINEERING & SUPPLY CO.**  
3121 MAIN ST. KANSAS CITY, MO.

# BRAND NEW SURPLUS BARGAINS

Make Your Own  
**POWER LAWN MOWER**  
Cutter Assembly

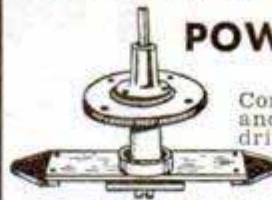

Complete with 18" blade and double ball bearing drive, only... **\$11.95**

Add 50c for shipping charges

**GAS ENGINE \$39.50**

1 1/2-2 hp. 4 cycle. A special. now. Add \$1.00 for shipping charges. Thousands of other items. Tell us your needs. Write for list.

All Prices FOB. K.C.  
Send Chk. or M.O. for immediate shipment

**ATLAS EQUIPMENT CO.**

229 S.W. Blvd. Dept. PM10 Kansas City, Mo.

## NEW HIGH-SPEED ROTARY CUTTERS

For Those Who Want the Best!

FULL SET OF 15 CUTTERS

only **\$9**

SET "A"  
8 CUTTERS

\$5.25

HIGH SPEED STEEL  
(\$1/2" Shafts)

SET "B"  
7 CUTTERS

\$4.60

WILL OUTLAST ORDINARY CARBON STEEL CUTTERS MANY TIMES

A SHAPE FOR EVERY PURPOSE. Made of high speed steel. Cut metal, plastic, wood and most materials except stone and glass.

Brass and nickel-silver for model makers—gold silver, amateur jewelers supplies. 68-page illustrated catalog of burs, cutters, stones, polishing supplies, hand grinders, flexible shaft equipment and small tools—only 25c. Write Dept. P.M.

**SCHRADER INSTRUMENT CO.**  
INDEPENDENCE, IOWA

# BE INDEPENDENT!

**START YOUR OWN BUSINESS** installing the lifetime **BELCO BALL BEARING FAUCET WASHER**. Every home, apartment, factory, public building and all types of institutions are prospects. Satisfied customers because you save them money on water, fuel and costly maintenance. Start small with a modest investment, expand on your earnings. Steady profits. Light weight **BELCO CONVERTER MACHINE** makes short work of converting standard faucets to BELCO.

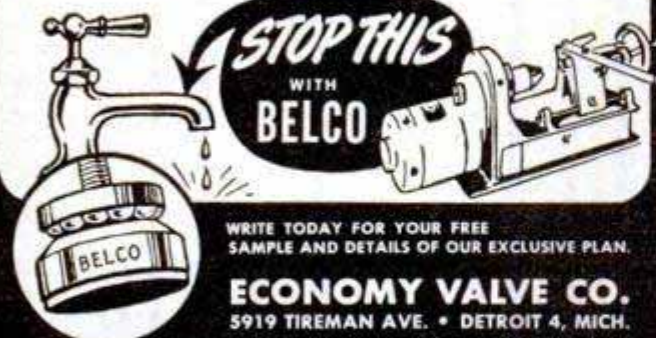

WRITE TODAY FOR YOUR FREE SAMPLE AND DETAILS OF OUR EXCLUSIVE PLAN.

**ECONOMY VALVE CO.**  
5919 TIREMAN AVE. • DETROIT 4, MICH.

**SEND THIS COUPON NOW!**

**ECONOMY VALVE COMPANY**  
5919 TIREMAN AVE. • DETROIT 4, MICH.

NAME \_\_\_\_\_  
ADDRESS \_\_\_\_\_  
CITY \_\_\_\_\_ STATE \_\_\_\_\_

## SELLS FAST

The new necklace and Miraculous Medal encased in permanent, transparent plexiglas. 18" gold plated chain with safety lock. Blue, red, gold or clear backing. Individually packed in gift boxes. Sell direct to wearer and to churches and religious groups. High discounts. Write for details at once, and send \$1.00 for sample, postpaid.

**STEPHENS PRODUCTS CO.**

1947 BROADWAY, Dept. "P", New York 23, N.Y.

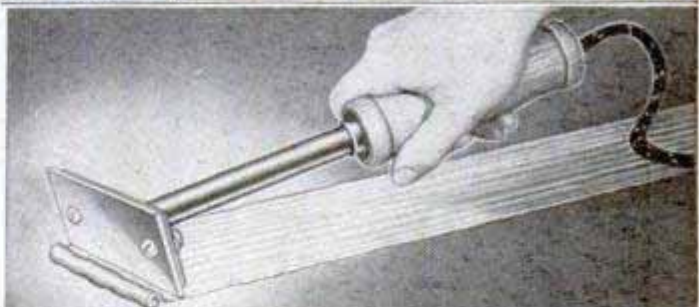

## REMOVE PAINT ELECTRICALLY From Any Wood Surface Fast!

**NEW SCIENTIFIC ELECTRIC PAINT REMOVER TOOL** takes off any number of coats of paint, enamel, varnish clean to the fresh wood grain in one simple forward stroke. "Heet Kleen" removes paint fast—safe—quick eliminating burning, marring, scraping, sanding, chemicals, danger of fire.

**4 CASE HARDENED STEEL BLADE-EDGES PEEL ROUND-FLAT-CURVED SURFACES**—300% more peeling surface than any other tool. Cool handle, replaceable heating element. Uses A.C. or D.C. current to curl paint or varnish continuously forward clean to the fresh wood grain on siding, woodwork, floors, cupboards, furniture, windows, doors, boats—hundreds of other uses.

**1 YEAR WARRANTY AGAINST MECHANICAL DEFECTS** A tool not a gadget. Price \$4.95 complete—postpaid. Unconditionally guaranteed to be the finest or your money back. For immediate shipment send check, cash or money order to:

**HEET KLEEN, INC., Dept. PM-10**

1426 W. 3rd ST. CLEVELAND 13, OHIO

# REAL DIESEL ENGINE!

## \$2.95

You just can't beat this price for a completely assembled precision diesel engine!

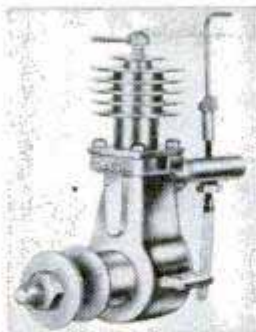

- Ideal for planes, boats, midget cars
- Actually runs at 7500 RPM, produces 1/7 HP
- Height a full 3 1/2 inches; weight 5 ounces
- Comes to you completely assembled, ready for operation

**MAYBE WE'RE CRAZY**, giving away a precision diesel engine, complete with cylinder and piston, carburetor, crankshaft, connecting rod, etc. for **ONLY \$2.95**. But we're selling thousands of DEEZILS all over the world, and that keeps our production costs down. DEEZIL is streamlined, compact, rugged. Starts quickly, easy to install, runs for years! Fast delivery if you **ORDER DEEZIL TODAY!**

Send \$2.95 plus 25c postage

**GOTHAM HOBBY CORP.** 107 E. 126th ST., NEW YORK 35, N. Y.

## DU-FAST OSCILLATING MOTION SANDER



### ... BEST VALUE BAR NONE!

Where in the world can you get FULL 1/2" OSCILLATING MOTION . . . LARGE 3-2/3" x 7" FAST-WORKING SURFACE THAT USES INEXPENSIVE STANDARD CUT PAPERS . . . LIGHT WEIGHT FOR EASY CONTINUOUS USE?

Where in the world can you get the economy and convenience of a powerful sander and polisher that attaches in 10 seconds to any Home Utility Black & Decker 1/4" Electric Drill? Or (another Du-Fast model) that attaches just as easily to any Skil Home Shop 1/4" Electric Drill?

Where can you get the safety that permits you to sand or polish with absolutely no chance of gouging, marring, swirling or burning? YET GIVES A PERFECT FINISH EVERY TIME?

See your nearest hardware dealer carrying either Skil or Black & Decker tools. **ASK TO SEE AND TRY A DU-FAST UNIT . . . YOU'VE GOT A PLEASANT SURPRISE COMING!**

DU-FAST OSCILLATING SANDER powered by Home Utility E & D 1/4" Electric Drill.

ONLY **\$14.95**

FOR ATTACHMENT!

DU-FAST OSCILLATING SANDER powered by Skil Home Shop 1/4" Electric Drill.

ONLY **\$14.95**

FOR ATTACHMENT!

\*Pat. Applied For

MANUFACTURED BY

## DU-FAST, INC.

32 East Fourth Street

New York 3, N. Y.

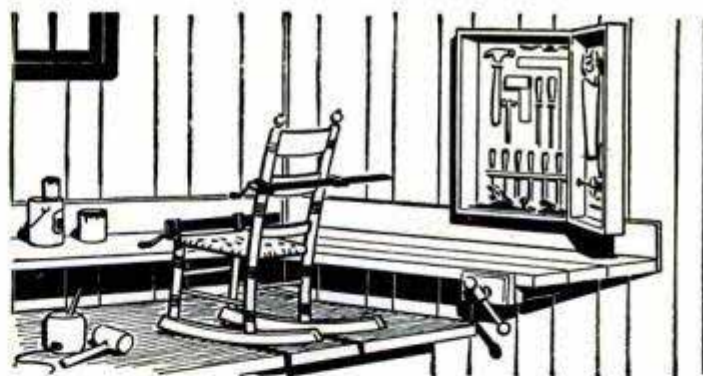

## BUILD YOUR OWN PRIVATE WORKSHOP

**H**OW'D you like to have a snug basement workshop all your own? One where you can hammer and putter to your heart's content without disturbing the family. Build one at low cost with Gold Bond Insulation Board. It deadens noise *and* insulates against cold. Comes in big ivory-colored Panels as well as Tiles and random-width planks. Tile and planks are finished in harmonizing variegated blends with tongue-and-groove edges to hide nails and staples. Ideal for an attic bedroom, gameroom or any extra room!

Available at your local Gold Bond lumber and building materials dealer!

**NATIONAL GYPSUM COMPANY**  
BUFFALO 2, NEW YORK

## CASH IN ON THE BUILDING BOOM!

### MAKE BUILDING BLOCKS RIGHT IN YOUR OWN BACKYARD AMAZING GENERAL BLOCK MACHINE

CAPACITY 1000 BLOCKS PER DAY

ONLY **\$199** LESS MOTOR  
F.O.B. PLANT  
SHIPPING WEIGHT 400 lbs.



Cinder and Concrete Blocks in big demand. Sell all you produce, to contractors and builder supply yards, at 15c to 25c each. Easy to start your own profitable business.

GENERAL BLOCK MACHINE can be operated indoors or out, in floor space 9 ft. x 10 ft. All steel construction. Vibrator mounted in sealed ball bearings. Simple to run. Powered by 1/2 H.P. electric motor or 1 H.P. gas engine. Produces up to 1,000 8x8x16 blocks in 8 hour day. Superior 3-core type, meeting all building code requirements. Produces 4x8x16, 8x8x16, 12x8x16 blocks. Material for blocks, cinders; cement; and sand; obtainable anywhere. Full instructions and mixing formulas with each machine. Immediate Delivery. Mail coupon at once for full details, sent free without obligation.

**HOW TO BUILD YOUR OWN CONCRETE BLOCK HOME**  
Only 1 Prepaid

Wonderful book written and illustrated by our staff of experts.

## GENERAL ENGINES CO.

DEPT. P13 307 HUNTER ST. GLOUCESTER, N. J.

Shows you 8 ways to save money and how to make and lay blocks, laying out building lines, mixing your own concrete, building steps, porches and concrete floors, includes floor plans for 6 beautiful easy to construct concrete block bungalows. Mail coupon at once with \$1.

Name .....

Address .....

City..... Zone... State.....

# SAVE UP TO 60%! GIGANTIC MAIL SALE!

COMPLETE BARGAIN CATALOG  
Order from ad. Satisfaction guar.  
Or, rush card for big free catalog.

## Power Plants • Welders • Pumps • Compressors • Tools

WE PAY SHIPPING COSTS

- Select from many hundreds of pieces of new equipment—yours at a fraction of the original cost.
- Order direct from this ad — your complete satisfaction guaranteed — or write for full details.

### A-C POWER PLANTS (2500 watt)

Brand New 110-volt 60-cycle. Army's finest plant. Real buy. Ideal for farmers, contractors, camps, emergency city power.

• Briggs 6.5 h.p. engine. Leland self excited gener. Automatic voltage regulation. Easy starting.

• Kit of tools, spare parts, full instruction manual. \$279.00

• Also bargains 3,000 & 5,000 watt plants. Write for full details power plant sale.

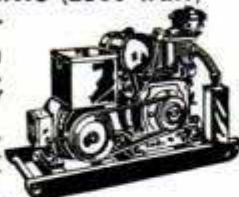

### D-C ARC WELDER

0-250 amps. \$300.00 value. Outstanding welding unit. Easy to drive with tractor, engine, etc. Excellent control. Complete unit with G.E. helmet, electrode holders, cables, rod asst., etc. Guaranteed.

Brand New..... \$104.50

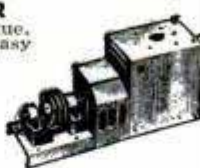

### D-C 200-Amp. GENERATOR

Excellent direct current generator with full instructions for use as welder. Includes heat control, cooling fan, etc. Type P-1 Delco-Remy. 30 V. Cost \$296.00

\$31.95

### WATER PUMPS and SYSTEMS

Genuine brand new Burdex bronze self priming all purpose water pumps. Std. pipe threads. Will lift up to 22 ft. Pressures to 60 lbs. Up to 22 g.p.m.

- 1/2" BRONZE..... \$12.79
- 3/4" BRONZE..... \$15.99
- 1.0" BRONZE..... \$19.49
- 3/4" CENTRIFUGAL..... \$6.50

### GENUINE HYPRO WATER SYSTEMS

Automatic 110-v. 60-c running water system. For wells with lifts up to 22 ft. Easy to install. Turns on-off automatically. Pressure water in every home..... \$59.50

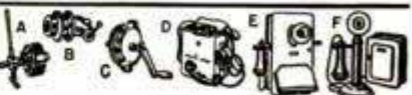

### MISCELLANEOUS BARGAINS

- "We pay shipping costs on everything"
- A. Utility Clutch up to 6.5 h.p. \$13.95
  - B. V-belt Clutch up to 1.5 h.p. \$ 7.49
  - C. Hand Gas Pump 10 g.p.m. \$13.90
  - D. Army Field Telephone EE-8 \$11.25
  - E. Rural Phones (1600 ohm 5-bar) \$12.40
  - F. City Desk Phones (Com. Batt.) \$ 4.99
  - G. Briggs 3.5 h.p. Engine..... \$75.50
  - H. 2-sta. phone inter com..... \$11.60

### AIR COMPRESSOR KIT

Assemble own unit. Consists of finest one cyl. piston compressor (see below), stainless steel 2100 cu. in. tank, 160 lb. gauge, safety valve, paint spray gun, blow gun, 15 ft. hose, assembly instructions, tire chuck, fittings. Drive with engine or motor. \$80.00 Value (Brand New) SALE \$36.90

• Quincy One-Cyl. Compressor Top quality. 150 lbs. pressure, 2.88 c.f.m. \$25.00 Value (Brand New) SALE \$18.15

• Quincy Two-Cyl. Compressor Nation's best. 150 lb. up to 9 c.f.m. \$80.00 Value (Brand New) SALE \$42.80



### POWER & HAND WINCHES

• Amazing Values. Jeep winch 80 to 1 ratio, 5,000 lb. capacity. Mounts on front trucks, jeeps, cars. Cost over \$150.00 (New) SALE \$21.95

• Finest Steel Hand Winch. Powerful unit complete with 50 ft. 3,000 lb. cable. Complete with crank. \$50.00 Value (New) SALE \$29.95



- Hundreds electronic mechanical, power plant, tool, radio bargains.
- Order from ad. Satisfaction guaranteed.
- Send card for amazing bargain catalog.

## BURDEN PREPAYS ALL SHIPPING CHARGES!



## BURDEN SALES COMPANY

812 "O" St. LINCOLN, NEBR.

**Clark EXPANSIVE BIT**  
CUTS BETTER • COSTS LESS! Accurate, fast; cuts smooth holes in hard or soft wood Chrome vanadium steel blades, all chrome body No. 250, 9/16" \$1.69; No. 251, 1/2" \$1.89 GUARANTEED At your dealer or write  
★ ROBERT H. CLARK COMPANY Beverly Hills, Calif.

**Foredom offers a**  
**POWER-PACKED 14000 RPM 1/15 H.P.**  
**FLEXIBLE SHAFT MACHINE**  
YOU can afford  
**ONLY \$27.95**  
including 6-STEP FOOT RHEOSTAT

**3-WAY USEABILITY**  
• Hang it up • Set it on Bench • Mount under Bench

Foredom's Model 9050 gives you industrial quality at a popular price. Here is what you get: • 14000 rpm 1/15 H.P., air-cooled universal motor • precision-made pencil-size, quick-detachable handpiece • flexible shaft of extra good flexing qualities running in a metal sheath covered with tough, long-lasting Neoprene. Here's a small power grinder with the kind of power, speed, stamina and all-around versatility you have been waiting for. TOP'S THEM ALL. For commercial users and home users who insist on industrial quality in their tools.

Use it to grind, polish, drill, saw, sand, carve, mill, clean, rout, etch, engrave, etc. on all metals, wood, plastics, glass and linoleum.

Includes your choice of 3/32" or 1/8" capacity collet. Add 85c if you want both.

Backed by Foredom's 28-year old reputation for quality and workmanship. Other motor-driven models for as little as \$16.95, all precision-made.

Catalog 1134E on request.

**FOREDOM ELECTRIC CO.**  
27 PARK PLACE Dept. 1134E NEW YORK 7, N.Y.

**FREE • PLASTICS • FREE**

Learn plastics at home. Make useful and attractive articles. KIT of 15 different kinds of plastics: Lucite, Saran, Nylon, Bakelite, etc., with complete supplies, accessories. ALSO Complete new book — "INTRODUCTION TO PLASTICS" — describing many fascinating experiments and projects. \$4.98 Post Paid

WRITE for FREE SAMPLE PLASTIC 3 experiments and complete details

**PLASTIC PROJECT ASSOCIATION**  
Box 5151 Southfield Station, Detroit 35, Michigan

**STOP-LIGHT FLASHER** MAKES STOPLIGHT FLASH ON and OFF AUTOMATICALLY

LIKE FIRE AND POLICE DEPTS. FITS ANY CAR. BOTH POP-OUT LIGHTER AND FLASHER (TO INTRODUCE) ONLY \$1.00 POSTPAID

**ALCO MFG. CO.**  
937 ARGENTINE BLVD.  
DEPT. M KANSAS CITY, KANSAS

GIVEN! EXTRA \$1.50 CIGAR LIGHTER FOR CAR

**1951 BUZZ MASTER**  
8 MODELS — \$99 up

More cutting — "Tomorrow's BUZZ MASTER Today!" See the deluxe riding model. Nothing else like it. Made by the oldest firm in the business—now in our 47th year. There is a model to meet all needs at lowest prices. FREE DETAILS.

**OTTAWA MFG. CO., 1-027 Brush Ave., OTTAWA, KANSAS**

**HOT RUNNING WATER!**

Attaches easily, quickly to any standard faucet. Regulates temp. by turning faucet. Operates AC or DC. Comes with 8-ft. rubber cable and plug. Our DELUX heater has delighted many thousands of users. Send \$3.95 cash, check, or M.O.—we will ship prepaid or, if you wish, we will ship C.O.D.—you pay postman \$3.95 plus few cents postage. Order 3 for \$10—save \$1.85.

**METROPOLITAN ELECTRONICS CO.**  
Dept. 164, 106 Fifth Ave., New York 11, N.Y.

**POPULAR MECHANICS**





**BETTER MEASURE  
WITH LUFKIN**

**NEW MEASURING EASE—  
FAMOJS MEZURALL AND  
WIZARD, JR. TAPE-RULES  
WITH CHROME-CLAD  
BLADES!**



**CHECK THESE  
OUTSTANDING FEATURES**

- 1—Exclusive Lufkin Chrome-Clad satin finish blades.
- 2—Black markings razor-sharp against chrome white background.
- 3—Rust and corrosion resistant.
- 4—Will not crack, chip, or peel.
- 5—Self-adjusting hook permits accurate butt-end and hook-over measuring.
- 6—Replaceable blades.
- 7—Smooth manual blade operation.
- 8—Improved heavily plated cases.

**Easy to  
Read Markings  
That Are Durable**

**ASK FOR THEM BY NAME—ASK FOR A MEZURALL  
OR WIZARD, JR. CHROME-CLAD TAPE-RULE**

**Buy LUFKIN**

**THE LUFKIN RULE CO. • TAPES • RULES • PRECISION TOOLS  
SAGINAW, MICHIGAN • NEW YORK CITY • BARRIE, ONTARIO**

**LOCKS  
onto the work  
"HOLDS ON,"  
after you let go.**

**Finest locking  
plier because...**

Clamps on better with patented swivel jaw which adapts itself to shape being held. Faster working because of patented jaw size indicator; you pre-set jaw size to approximate size of object. Easier opening with patented lock release; finger-operated lever readily releases 2000 pound bite.

**\$1.75  
7" size  
10" — \$2.25  
Both bright  
nickel finish**

At your dealer's. Send for **FREE** folder.

**SEYMOUR SMITH  
"Snap-Lock"  
PLIER - WRENCH**

**SEYMOUR SMITH & SON, INC.  
1210 Main St., Oakville, Conn.  
100 years of quality tools**

**SEYMOUR SMITH  
The Line of Quality  
SINCE 1850**



**AFFORDS A  
FIRM GRIP  
ON SHORT  
ENDS**

**REMOVES  
STUBBORN  
STUDS AND  
THEN  
RESETS  
THEM**



**Earn \$250<sup>00</sup> to \$350<sup>00</sup>  
EXTRA PROFIT monthly  
with your own  
Arc Welding Business!**

**LOWEST PRICED  
200 amp. D.C. arc  
welder on market**



**You need but little cash** to start a profitable welding business. Be sure of success with full capacity "professional" arc welders of the size and type best fitted to your plans. Turn out better work and more of it with HOBART "Simplified" Arc Welders.

**"BUILD-YOUR-OWN" ... save \$\$\$**

**"Bantam Champ"  
complete, less drive**



**A road trailer welder** is a big asset to the average welding business. Now you can have your own at far less cost than complete factory-built outfits. Let Hobart show you how it can be done, using one of their welding generators.



**"Build-Your-Own"  
D.C. Generator only**

**COMBINATION WELDER—POWER UNITS**

A big advantage on high pay emergency jobs is to have a welder which also generates A.C. or D.C. power. Run lights, power tools, appliances, etc. Ask about them. They're part of the complete HOBART line.

**A.C. Welder—  
A.C. Power**

**NOW  
is the time to  
START  
a profitable  
welding shop.  
WRITE!**

**A.C. or D.C. arc welders** in all types and sizes are available now for prompt shipment.



**FREE** Catalog on complete line mailed with no obligation. Write today.

**A.C. Transformer  
Type Portable  
Shop Welder**

**HOBART BROTHERS CO., Box M-100, Troy, Ohio**  
"One of the world's largest builders of arc welders."

**Now, a G-E sealed beam  
type headlamp for BIKES!**

*Gives more  
light, does not  
grow dim!*



Brings the same advantages to bikes as the famous General Electric "all-glass" sealed beam headlamp has brought to automobiles! Has own built-in reflector. Does not grow dim with age. Beam is five feet wide—thirty feet long. Operates on 5-volt hand-lantern battery or electrical generator used on bicycles. Now on sale at hardware and bicycle stores.

**GENERAL ELECTRIC**

# New, High-Speed ELECTRIC PLANE



PORTER-CABLE  
**Guild**

Weights  
8 lbs.



WORKS AS  
A JOINTER



FITS DOORS  
AND SASHES

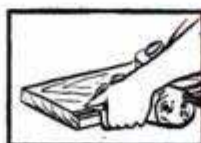

SHAPES EDGES,  
MOULDING

## A Work-Horse For Any Home Shop Only \$65.00

Try it. You'll agree that as a labor-saving device it's more than the equal of any tool in your shop. It does jobs your other tools cannot do, in real professional manner. And the hardened, razor-sharp spiral cutter is F-A-S-T—20,000 rpm. Zips off the shavings, leaving a straight, smooth, non-fuzzy surface with or against the grain, with no bumps, no gouges. Enables you to do perfect surfacing, fit doors, windows, drawers, screens, storm sash, trim of every kind. Ideal for hobby projects—built-in furniture, cabinets, bookcases, benches.

### Special Jointer-Shaper Cutters

Yes, you can even use this plane as a bench jointer-shaper, or as a moulding plane. Spiral cutter for jointing work; variety of shaper cutters for decorative edging, grooving and channeling. Optional Sharpener (extra) puts keen edge on plane cutter in 3 minutes.



**Same Motor Powers 2 Other Guild Tools:** Motor of your Guild Power Plane is interchangeable with the versatile new Guild Router—one of the most valuable tools for advanced home-craft projects; also with the Guild Shaper, adapted from the Router. Router base only (using Plane motor), \$7.50. Router complete, \$47.50. Shaper Table only, \$24.00; complete with Router, \$71.50.

At your dealer's—or mail coupon.

Send me full information about the Guild Power Plane and attachments . . . Also name of nearest Guild Tool dealer.

Name .....

Street .....

City..... State .....

PORTER-CABLE MACHINE COMPANY  
2290 N. Salina St. Syracuse 8, N. Y.

# Make MORE Things EASIER...

## With This Value-Packed **SAW!**

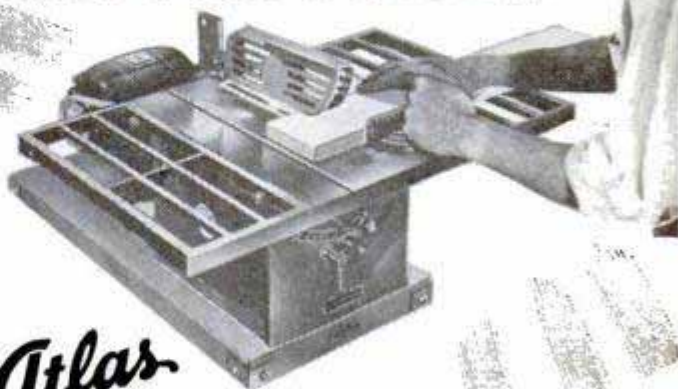

*Atlas*

## POWER KING 3001 Saw

### CHECK THESE OUTSTANDING FEATURES!

- ★ **TILT/ARBOR CONSTRUCTION**—table and work are always flat for safe angle sawing.
- ★ **BALL BEARINGS**—sealed from dirt and dust, assure smooth running and lasting accuracy.
- ★ **BIG CAPACITY.** 2 1/4" depth of cut. 12" x 16" table has 7 1/8" work area ahead of blade. Greater capacity than any other low-cost saw.
- ★ **PRECISION-GROUND GREY-IRON TABLE.** Heavy table is rib-braced for absolute rigidity. Work slides smoothly on its accurate precision ground surface.
- ★ **RIGID RIP FENCE**—extends full length of table, locks at both ends, lifts off.
- ★ **TABLE EXTENSIONS.** Add a low-cost precision-ground table extension to right side and you can rip to center of 24" panel. Add one to each side (as shown) for big 25 1/2" x 16" work area.

*It's a saw that's fun to operate!*

Every feature you need for fine sawing is built into the Atlas-Power King No. 3001. It's fun to operate it. You'll value its dependable accuracy, the way it speeds up your work on shelves, cupboards, bookcases, tables, furniture, and home repairs—it's a real money-saver! Best of all the Atlas-Power King is the only saw on the market today that gives you all the outstanding features listed above at low cost. See it today at your Power King dealers.

**NEW  
FREE  
CATALOG**

Name \_\_\_\_\_

Address \_\_\_\_\_

City, State \_\_\_\_\_



**ATLAS PRESS CO.**

1035 N. Pitcher St., Kalamazoo, Mich.



**MATCHED PRECISION TOOLS FOR  
WOODWORKING AND METALWORKING**



# "ONE-STOP SHOPPING"

for ALL electric drill accessories — ORDER TODAY!



**NEW BULL "200"**  
1/4" ELECTRIC DRILL  
A PORTABLE POWERHOUSE!  
only **\$14.95**

WE GUARANTEE YOUR MONEY BACK if it isn't more powerful than any 1/4" electric drill at ANY price!



## AUTOMATIC SCREWDRIVER

for any electric drill, drill press or flexible shaft. When ordering, specify standard or Phillips head. **\$4.95**



## NEW PORTABLE BELT SANDER

Fits any 1/4" elec. drill; does every job from roughing to finishing. Complete with 3 pressure pads and 2 sanding belts. **\$19.95**

Send 10c for catalog of other new drill accessories

AT YOUR DEALER OR SEND CASH, CHECK, OR M. O. FOR IMMEDIATE, PREPAID, SHIPMENT

**BERTRAM B. ENGINEERING & SUPPLY CO.**  
3121 MAIN STREET KANSAS CITY, MO.



**BULL BUFFER**  
complete with sheepskin bonnet, rubber pad, 2 sanding discs. **\$9.95**



## Portable BULL MORTISING KIT

For on-the-job mortising with elec. drill or drill press. Complete with adapter and 1/4", 3/8" and 1/2" chisels and corresponding bits. **\$23.90**

**BULL MORTISING ADAPTER** only, **\$6.95**  
Fits any 1/4" elec. drill and any standard shank chisel. (Bit and chisel prices on request.)



**BULL MANDREL KIT**  
includes mandrel, 2 1/2" grindstone, 3" wire brush, 4" cloth buffing wheel. **\$2.19**



**NEW BULL SAW**  
Fits any 1/4" electric drill. Powerful, portable, easy one-hand operation. Complete with saw blade. **\$9.95**



**BULL High Speed JITTER SANDER**  
For 1/4" drill. Makes perfect, flawless finishes; one-hand operation. **\$9.95**



**4-IN-1 HOLE SAW!**  
For any 1/4" electric drill or drill press. Complete with arbor and 1", 1 1/2", 2" and 2 1/2" blades. **\$4.95**

## Take along COMFORT and SAFETY

For Every Hour in the Open

### MARBLE'S OUTING EQUIPMENT



**Marble's Waterproof Match Box**  
Keeps matches dry, even under water. Price 75c



**Marble's Woodcraft No. 49**  
Beautiful leather handle. Extra keen 4 1/2 in. forged steel blade, with sheath. **\$3.00.**



**Marble's Expert No. 545**  
Hunters' and Trappers' favorite. 5 in. blade. With sheath, **\$3.50.** No. 60 Sport Knife—4 in. blade. With sheath, **\$2.50.**



**Marble's Compasses**  
Pin-or, Pocket and Wrist models. No. 182—1 in.-on show. Price **\$2.00**



**Marble's Ideal No. 45**  
All-purpose for field, forest and camp. Extra sturdy. With sheath, 5 in. blade, **\$3.50;** 6 in. blade, **\$4.00.**

Ask your Dealer, or write for Catalog (252)

**Marble Arms & Mfg. Co.** 578 Delta Ave. Gladstone, Mich., U.S.A.

## RELIEVES PAIN OF HEADACHE · NEURALGIA NEURITIS

# FAST

The way thousands of physicians and dentists recommend



Anacin® relieves headache, neuralgia, neuritis pain fast because Anacin is like a doctor's prescription—that is, Anacin contains not just one, but a combination of medically proven, active ingredients in easy-to-take tablet form. Thousands have been introduced to Anacin through their own dentist or physicians. If you have never used Anacin, try these tablets yourself for incredibly fast, long-lasting relief from pain. Don't wait. Buy Anacin today.

# SURPLUS MACHINE SHOP TOOLS

## HIGH SPEED STRAIGHT SHANK DRILLS



**SET 1E** 30 Selected High Speed Straight Shank Drills from 1/8" to 1 1/2" \$15 value. New and slightly used surplus. Priced at only..... **\$2.95**

**SET 2E** 10 Different Size High Speed Straight Shank Drills from 1/4 to 1". Extra Long Drills. \$40 value. New and slightly used surplus. Priced at only..... **\$5.95**

## HIGH SPEED MORSE TAPER SHANK DRILLS



**SET 3E** 15 Different Size High Speed Morse Taper Shank Drills up to 9/16" with No. 1 and 2 tapers. \$50 value. Priced at only..... **\$6.49**

**SET 4E** 20 Different Size High Speed Morse Taper Shank Drills from 1/4 to 1". \$70 value. Priced at only..... **\$12.95**

**SET 5E** 10 Different Size High Speed Morse Taper Shank Drills from 1/2 to 1 1/4". \$50 value. Priced at only..... **\$9.95**

**SET 6E** 10 Different Size High Speed Morse Taper Shank Drills from 1 to 2" with No. 3, 4 and 5 tapers. \$180 value. Priced at only..... **\$39.95**

## HIGH SPEED TAPER SHANK CHUCKING REAMERS



**SET 7E** 20 Different Size High Speed Morse Taper Shank Chucking Reamers up to 1 1/2" with No. 1 and 2 tapers. Priced at only..... **\$6.95**

**SET 8E** 8 Different Size High Speed Morse Taper Shank Chucking Reamers from 1/4 to 1". Priced at only..... **\$4.95**

**SET 9E** 10 Different Size High Speed Morse Taper Shank Chucking Reamers from 1/2" to 1 1/8". \$65 value. Priced at only..... **\$9.95**

**SET 10E** 20 Different Size High Speed Morse Taper Shank Chucking Reamers from 1/4 to 1". Priced at only..... **\$9.98**

**SET 11E** 6 Different Size High Speed Morse Taper Shank Chucking Reamers from 1 to 1 3/8" with No. 3 and 4 tapers. Priced at only..... **\$17.95**

## HIGH SPEED STRAIGHT SHANK CHUCKING REAMERS



**SET 12E** 20 Different Size High Speed Straight Shank Chucking Reamers up to 1 1/2". Priced at only..... **\$6.95**

**SET 13E** 10 Different Size High Speed Straight Shank Chucking Reamers from 1/2 to 1 1/8". Priced at only..... **\$9.95**

**SET 14E** 15 Different Size High Speed Straight Shank Chucking Reamers from 1/4 to 1". Priced at only..... **\$6.95**

## HIGH SPEED HAND TAPS



**SET 15E** 10 Different Size High Speed Standard Thread Hand Taps up to 7/8". Priced at only..... **\$2.49**

## HIGH SPEED MILLING CUTTERS



**SET 16E** 4 High Speed Milling Cutters. Set consists of two side milling cutters, size 2x1 3/8x3 3/8" arbor and two side milling cutters, size 2x3/16x3 3/8" arbor. Set of four priced at only..... **\$3.95**

**SIDE MILLING CUTTERS**

Dia.	Width	Arbor Hole	Price Ea.	Quantity
6	3/4	1 1/4	7.00	none

**PLAIN MILLING CUTTERS**

1 3/4	1/8	5/8	1.00	none
1 3/4	1/2	3/4	1.05	none
2	1/4	1	1.00	none
2 1/2	2	1	3.50	6/\$16.00
3 3/4	7/8	1	3.00	6/\$15.00
4	3/4	1 1/4	2.95	6/\$14.00

**STAGGER TOOTH CUTTERS**

4	1/2	1 1/4	3.00	6/\$15.00
6	5/8	1 1/4	5.95	6/\$25.00

## SLITTING SAWS

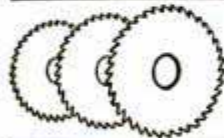

**SET 17E** 7 Different Size High Speed Slitting Saws 2 3/4" dia. x 1" arbor. Thickness from .040 to .071. Cuts wood, aluminum, brass, steel, etc. \$25 value. Priced at only..... **\$4.95**

## BRAND NEW HIGH SPEED COMBINATION DRILL AND COUNTERSINKS



**SET 18E** 8 Different Size from C2 to M1 (1/16 drill x 13/64 body to 7/32 drill x 5/8 body) 60 degree countersink. These new countersinks sell new from 75c to \$2.50 each. Your price for this set of 8, while they last, only..... **\$3.95**

# WANTED!

## MEN AND WOMEN TO EARN SPARE TIME MONEY

Many Popular Mechanics neighborhood representatives are making extra cash for easy, after-hours work. A few more are needed.

For details, write:

**POPULAR MECHANICS**  
ROOM 408  
200 E. ONTARIO STREET  
CHICAGO 11, ILLINOIS

## NEW CARBON STEEL MORSE TAPER SHANK DRILLS

1-9/32...\$1.95    1-11/32...\$2.39    1-7/16...\$2.69  
1-5/16...\$2.29    1-3/8...\$2.49    Discounts on quantity.

## HYDRAULIC DEPARTMENT

### LARGE VOLUME PUMP



Capacity 400 GPH @ 1750 RPM, 1/2" drive spline. Maximum head pressure 30 PSI. 3/4" pipe inlet and outlet. Rotate either direction. Built-in relief valve. Ideal for all types of sprayers, etc. Reconditioned guaranteed. Priced at only..... **\$4.98**

Discounts on quantity.

### VICKERS HYDRAULIC PUMP OR MOTOR, Mod. PF2

This brand new, compact, powerful pump is rated at 1000 PSI, 507 Cu. In. per Rev., 8 G.P.M. at 3750 R.P.M. Delivers up to 6 H.P. Requires 1/3rd to 6 H.P. to drive directly. Change rotation by reversing flow, 3/8" drive spline and 1/2" pipe ports. Wt. 4 lbs. Priced at only **\$8.96**



### BRAND NEW HYDRAULIC UNIT

Pesco 1P203 Hydraulic Pump rated at 3 G.P.M. @ 3750 R.P.M. and 1000 P.S.I. Attached to 2 1/4 H.P. 24 volt D.C. electric motor. Pump priced at only \$9.95. Motor Free. Price F.O.B. Tulsa. Discounts on quantity.



**\$9.95**

### Master Hydraulic Control Valve

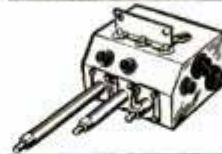

Will operate 1 or 2 hydraulic cylinders independently of each other or together by means of 3 control handles. Valve made of heavy steel with standard pipe ports. Cost new over \$125. Priced to you at only..... **\$7.95**

Discounts on quantity.

**PARKER CONTROL VALVES** 200 to 500 lb. regulators and 300 regulators. Price, each only..... **\$2.50**

### ASTRO COMPASS

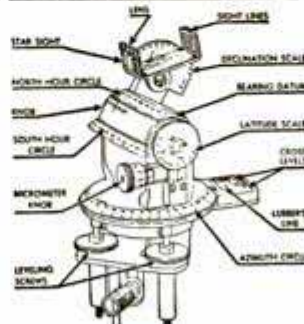

Brand New Mark II Airforce navigation instrument. Excellent for schools, math classes, etc. Can be adapted for transit or level. Precision built throughout. Government cost over \$125.00. Comes complete in wood carrying case and web strap. Weighs only 6 lbs. Priced at only..... **\$9.95**

Discounts on quantity

All merchandise is sold with money back guarantee of satisfaction and is shipped postpaid unless otherwise stated.

**T & T TOOL**

101 WEST ARCHER  
TULSA, OKLAHOMA



# The Only SANDER with POWER UNIT **GUARANTEED** ALL DURING YOUR OWNERSHIP AGAINST **BURN-OUT OR REPLACED FREE!**

SYNCR0 is the only sander of its kind that *guarantees* its Power Unit—heart of ANY sander—against burn-out *all during your ownership*—or replaces it FREE! And *only* SYNCR0 gives you a magnetic-electric SANDER *approved* ENTIRELY to be free from shock and fire hazards by UNDERWRITERS' LABORATORIES, INC.—not just the cord but the ENTIRE Tool! This Power Unit GUARANTEE—and Seal of Approval from internationally-famous "UL" *plus* the exclusive SYNCR0 DOUBLE ARC MOTION makes SYNCR0 your safest and best buy. For all light sanding, high polish jobs in tight places, corners and on flat or curved surfaces. A marvelous massager. 240 Strokes Per Second! Just guide it. Get this safe, GUARANTEED POWER UNIT, UL-Approved, at your hardware store! All Chrome body, bakelite top.

With BUILT-IN POWER UNIT, 10 sandpapers, lamb's wool and fabric pads — \$14.50. If Dealer hasn't it, send \$14.50 direct, we'll ship postpaid.



## WARNING!

BUY ONLY ELECTRIC SANDERS TESTED AND APPROVED BY UNDERWRITERS' LABORATORIES, INC. "UL" has *approved* the complete SYNCR0 Sander to be free from shock and fire hazard. Always look for the UL Label in advertisements — and on the product — before you buy!

SYNCR0 CORPORATION, Dept. D-100, Oxford, Mich., U.S.A.

That's the Name  
to Ask For!



# SYNCR0

ELECTRIC  
 SANDER-MASSAGER-POLISHER



## BUILD YOUR OWN TILTING ARBOR SAW!

Exclusive GIL-BILT Build-It-Yourself Features

- No machining—build easily with hand tools only
- No blueprint reading—step-by-step pictorial plans, full scale patterns, actual photographs
- Sturdy wood, aluminum, and steel construction
- Capacity and performance of commercial saws selling for \$60 and up

SAVE  
**\$50**  
 OR MORE

### GIL-BILT 10-INCH TILTING ARBOR SAW



- 27x28 in. table, 13 1/2 in. capacity in front of blade
- 10 in. blade cuts 3 1/4 in. deep, tilts full 45 degrees
- Floor model 34" high, table always stays level
- New Departure ball bearing arbor, 3/4" precision shaft turned down for 5/8" bore blades, alum. housing, shipped ready to run
- Jackscrew and 4 1/2 in. dia. handwheel lowers and raises blade
- Cast aluminum miter gauge and self-aligning rip fence guide

GIL-BILT Metal Parts Kit includes Plans, ball bearing arbor, miter gauge and bar, rip fence guide, dado insert, lock knobs, jack screw mechanism and handwheel, and all other metal parts (less blade)..... \$20.95  
 Same Kit with 10" Combination Blade \$24.90  
 Same Kit with 8" Combination Blade \$23.90

### GIL-BILT 12-INCH BAND SAW

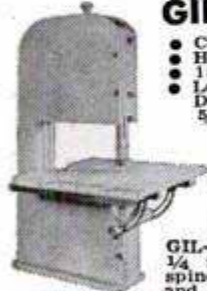

- Cuts to center of 24 inch circle
- Handles stock up to 6 inches thick
- 18x18 inch table tilts 45 degrees
- Lower wheel and drive pulley runs on sealed New Departure Ball Bearings; Upper wheel runs on two 5/8" bore Oillite Bronze bearings.
- Upper wheel tension and tilt mechanism of cast aluminum, completely assembled.
- Upper and lower blade guides. Each has ball thrust bearing, self-lub bronze jaws
- Rubber tired wheels. Choice of cast aluminum or make-your-own wood wheels on metal hubs.
- Uses standard 78 inch blades up to 3/8 in. wide.
- Fully enclosed mechanism for utmost safety.

GIL-BILT Metal Parts Kit includes Plans, rubber tires, 1/4 inch blade, hubs for wood wheels, ball bearing spindle, tilt mechanism, guides, table tilt segments and all other metal parts..... \$16.95  
 Same Kit with two machined ready-to-install 12" cast aluminum wheels..... \$20.95

Return Kits in 10 days for refund if not satisfied.  
 (Prices include postage within 600 miles. Over 600 add 5%)

Also available—Plans and Parts Kit for 8" Tilt/Table saw. Order Plans at \$1.00 each—sent postpaid anywhere in the world or write for FREE descriptive catalog.

GILLIOM POWER TOOLS P. O. Box 1-PK, Lambert Field St. Louis 21, Missouri



DO EVERY JOB

*better-faster-  
cheaper-*

WITH

**COMPRESSED AIR**

Paint Buildings, boats, tractors, trucks; refinish furniture and fenders; inflate tires; grease and lubricate motors, engines, implements. Destroy weeds. Rid livestock, poultry and pens of pests with portable air power.

Free Literature explains relative advantages of 4-cylinder **PRESSURE QUEEN** and single-cylinder **PRESSURE PRINCESS** spray painting outfits. Tells how to save material, time and money by using the proper outfit at the right price.

It Is Yours For The Asking  
 Write Today

**THE CAMPBELL-HAUSFELD CO.**  
 1046 RAILROAD AVE. HARRISON, O.

# ROLLS PAINT ON Like MAGIC

No Spilling! No Dripping!



With **MAGIKOTER** You  
Paint Like An Expert!

● **MAGIKOTER** is sensational! You simply pour paint into sleeve-covered cylinder, then just *roll* the paint on! No laps, no runs, no brush marks! You get a beautiful finish, a professional-looking job. Endorsed by paint manufacturers — ASK FOR **MAGIKOTER** BY NAME at leading department, hardware, and paint stores.

**THE KENWILL CORPORATION**  
P.O. Box 845, Dept. L, Cleveland 22, Ohio

For oil paints and enamels

Precision  
Built



\$4.95  
Fair Trade.

SAY YOU SAW IT  
POPULAR MECHANICS

## MAKE THESE WOOD SHAPES

With Your Drill Press and  
This LOW COST TOOL

Your drill press and this tool does all types of wood shaping—Routing, Tongue and Groove, Fluting, Notching, Inlay and any type of joint. Make window sashes, cabinets, doors, grooved sash, etc.

Complete with fence and platform to run professional work without slipping.

Write today for FREE facts about this unit, and special offer.



Complete with 3 blades



T & H MFG. CO., 811 E. 31 St., Dept. SPB 10, Kansas City, Mo.

**REMEMBER** it's dangerous to Pay LESS if you want finest matched, used tires. Positively not Recaps.

**GOOD YEAR**  **Firestone** 

GOODRICH, U.S. & others. FREE TUBE WITH EVERY TIRE.

Our policy is to select your tires so carefully, as if our very future depended on the service given by that particular tire.

ONE TOP GRADE, 26 MONTHS GOLDEN RULE GUARANTEE BOND. THIS GRADE MADE THE "BLATT" NAME "WORLD" FAMOUS.

**TAKE \$2** off the price of each of these tires if you do not wish the tube.

600-16 \$7.35		650-15 \$7.75		MATCHED BALANCED TRUCK TIRES	
600-16 (6)	8.95	670-15	7.75	600-20	\$10.95
650-16	7.95	700-15	7.95	650-20	11.25
700-16	7.95	710-15	7.75	700-20	11.95
750-16	8.75	760-15	8.35	32x6(8)	12.50
550-16	7.25	820-15	8.00	32x6(10)	13.75
550-17	7.75	875-19	7.45	750-20	13.50
525-18	7.35	550-19	7.95	825-20	17.50
				900-20	\$16.75
				1000-20	17.50
				1100-20	18.50
				1200-20	19.50
				1000-22	16.75
				1100-22	18.50
				750-15	15.95

**MILITARY REG. GUAR. 14 Mos. (Rugged 45,000 Miles)**

EXTRA DEEP- END TREAD FOR EXTRACTION	750-16 Reg. \$10.95 Rugged 12.22	900-16 Reg. \$9.65 Rugged 12.50	750-20 Reg. \$10.45 Rugged 16.40
--	--	---------------------------------------	--

**BLATT** BLATT BLDG., GIRARD & LANCASTER AVES., DEPT. PM, PHILADELPHIA 31, PA.  
Send check or money order and this ad for rush shipment. We won't ship a tire we wouldn't use. The name to trust in rubber.



**GIANT ELECTRIC STEAM ENGINE**

WAS \$18.95  
NOW \$9.95  
POST PAID  
MONEY BACK  
GUARANTEE

Develops 1/20 HP 3200 RPM. Piston driven, has nickel-plated steel boiler, automatic safety valve, throttle control, water level gauge, pulley attachment, electric cord. UL appr. 9" long, 6" wide, 9" high. Powers all models.

ORDER TODAY.

SEND CHECK OR MONEY ORDER.  
**STANLEY AND CO.** 1613 SOUTH ORANGE GROVE AVENUE  
LOS ANGELES 35, CALIF.

**SAVE MONEY ON CHRISTMAS PRESENTS**

Popular Mechanics CHRISTMAS HANDBOOK shows you how to save many dollars on Christmas presents. Colorful, fascinating articles you can make at home quickly and easily in your spare time including beautiful Christmas cards, gift wrappings, candles, toys, for children of all ages and Xmas tree ornaments. Also tells how to select a tree, helpful hints on home decorating, tips for the holiday hostess, centerpieces, Xmas customs and Xmas celebrations in other countries. 144 pages. Cloth bound.

**POPULAR MECHANICS PRESS \$2.00**

200 E. Ontario Street, Chicago 11



low cost complete **Dynamic**  
**MULTI-METALCRAFT-WORKSHOP**  
12 tools in 1!

Over 50,000 Satisfied users! Here's the biggest shop value offered. Now you can make or repair 1001 useful auto & home appliances, farm and shop equipment. Fabricate anything of iron, steel, brass, bronze and other metals. Can pay for itself on first job or project. No experience needed. Complete instructions furnished. Works on any properly wired 110 Volt 50/60 cycle A.C. line. **Everything Included. Complete, ready-to-use.** You get Power Unit, Electric Torch, Etching & Soldering Tool, Headshield, Electrode Holder, Welding ground and power cables, Ground clamp, Simplified instruction manual, Metal fabricating rods, Flux, Etc.

Gift  
Accessories  
Worth \$8.30  
Included  
For  
Prompt  
Action  
At No  
Extra Cost

**FREE** Complete Illustrated Descriptive Literature. Write Today for Details on Money-Back Guarantee. 10 Day Trial Offer!

SOLDERING METAL CUTTING ARC WELDING TOOL MARKING

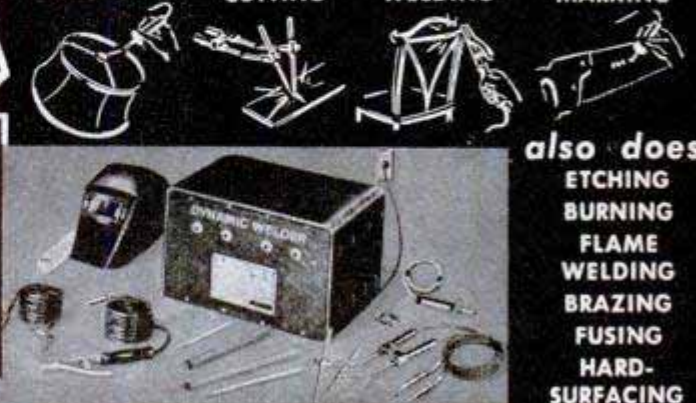

also does  
ETCHING  
BURNING  
FLAME  
WELDING  
BRAZING  
FUSING  
HARD-  
SURFACING  
SWEATING &  
PREHEATING

**DYNAMIC WELDER CO.**  
15 E. 23rd St.

Dept. D2-KA6  
Chicago 16, Ill.

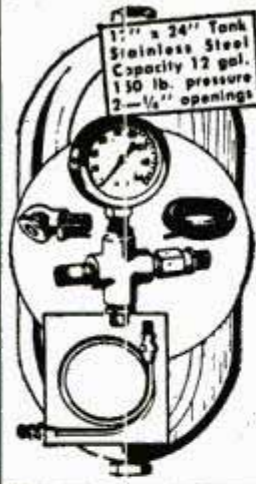

# WESTINGHOUSE Air Compressor

Reg. \$60.50 . . . Only

Model T-1 Brand New — 2 CYLINDER \$21.50 PISTON TYPE.

Operates with 1/2 H.P. Motor or equivalent gas engine.

Compressor has 2" bore, 1 1/2" stroke, ball bearing, 3.27 CFM at 600 R.P.M. Capacity up to 6.54 CFM. Size 9" x 11 1/8" x 6 5/8". Wt. 26 lbs.

Compressor, pressure tank, air gauge, air chuck, 20-ft. hose, pop valve, copper tubing with 4 brass flared fittings for connecting compressor to tank, 4-way cross and 3 nipples.

COMPLETE OUTFIT, wt. 52 lbs. . . . . \$32.50  
EQUIPMENT LESS COMPRESSOR, \$12.50  
COMPRESSOR SEPARATELY, \$21.50—TANK ONLY \$5.95

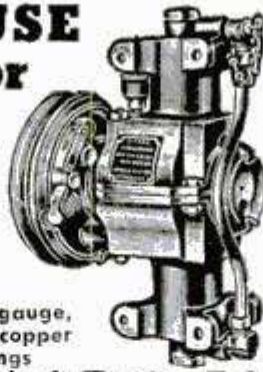

# 140 CFM "WELLWORTH" BLOWER

3 1/2"x4" mounting flange with 2 1/2" square discharge, 3 1/2" dia. blower wheel powered by direct-connected 1/15 H.P., 110 V., 60C., A.C. motor with conduit box and 20" leads, 7 1/2" wide less flange by 7 1/4" H. x 6 3/4" D. Shpg. wt. . . . . \$14.20



# "Wellworth" BLOWER

Quiet operating. Double wheel inlet, double width blower. For heating, ventilating, cooling, air washing, exhausting and forced draft. DIMENSIONS: 10" wheel; outlet 1 3/8" x 1 3/8"; inlet 8 3/4". Height 10"; width 18"; Depth 16 1/2". C.F.M. 1/4" S.P. 1600; outlet vel. 1575; motor 1/4 H.P. with overload relay, cord & plug, 110 v. 60 cy. A.C. Ship. wt. 67 lbs. Special price . . . \$39.50

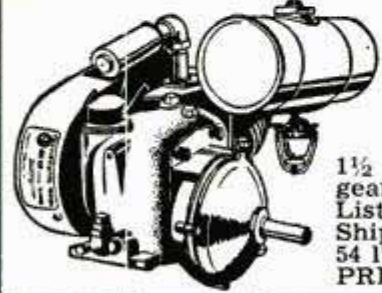

# Red Seal Continental GAS ENGINE

6 to 1 Reduction Gear

1 1/2 HP with 6 to 1 reduction gear. Operates at 450 R. P. M. List Price \$79.50 Shipping weight \$39.50 54 lbs. SPECIAL PRICE . . . . .

# AUTOMATIC COMPRESSOR UNIT

1/2 H.P. heavy duty capacitor motor. AC 110/220 volt, 60 cycle, 2x1 1/4 inch piston type compressor, splash feed lubrication. 12x24 inch tank, automatic pressure switch. CFM 2.8 at 100 lb. pressure, or 150 lbs. pressure for intermittent duty. Check valve, safety valve, air regulator with gauge and filter, 20 ft. air hose with air chuck for inflating tires. V. belt drive. Mounted on 2 wheels, ball bearing, with 2"x10" pneumatic tires. Portable with handle. Shipping wt. 90 lbs.

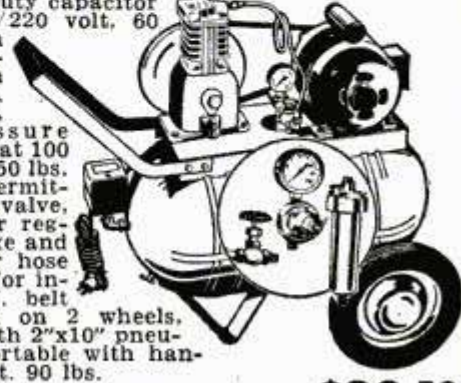

SPECIAL PRICE . . . \$89.50

# WELLWORTH V-BELT CLUTCH

Takes starting load off engines or motors. When speed is reached, a flip of handle shifts clutch from idling to driving position. Handles "A" belts, 2.35" pitch diameter, 5/8" bore. Ideal for use with lawn mowers, garden tractors, home workshop motors, etc. 3 1/4" long. Safe, easy to mount, sealed bronze bearings, positive action. Shpg. wt. 3 lbs. \$7.50



SAME CLUTCH FURNISHED WITH 3/4" BORE \$8.50

Prices f. o. b. Chicago. Money back guarantee. Send check or money order today. Prompt shipment.

# NEW CATALOG

Motor guide, air compressors, home and factory workshop tools. Also big bargains in luggage. Send 10c for postage.

# WELLWORTH TRADING CO.

1831 S. STATE ST., DEPT. D-10, CHICAGO 16, ILL.

# SAVE \$150 MAKE YOUR OWN 3-Dimensional Camera ALL YOU NEED IS YOUR OLD CAMERA AND THE STEREO-TACH

No costly stereo camera is needed to take realistic 3-D slides and prints. Use your present camera and a Stereo-Tach outfit. Changes practically any camera to a 3-D camera instantly. See your dealer or write ADVERTISING DISPLAYS, INC. Dept. PM1C COVINGTON, KY.



For 35 MM cameras, outfit #101 (Stereo-Tach & 3-D slide viewer) 17.70\* For larger cameras #100 or for Polaroid Cameras #100 PL (Stereo-Tach and print viewer) 16.25\* plus 2.09 Fed. tax

# SAY YOU SAW IT IN POPULAR MECHANICS

# WAR SURPLUS AND OTHER BARGAINS

**PNEUMATIC RIVETER & CHIPPING HAMMER**  
Pistol grip. Ideal for fender, brake lining, concrete breaking work. Weight 5 lbs. Like new. Price each... 2X - \$6.95 3X - \$7.50 4X - \$8.50



# HELPFUL BOOKS

Send post card asking for FREE catalog Popular Mechanics Press, 200 E. Ontario, Dept. 601, Chicago 11

# 5-IN-1 SAW

FOR ONLY \$2.95! A Sensational Offer to acquaint you WITH BULL TOOL VALUES! Made by Swedish Craftsmen



**SET INCLUDES—**  
5 INTERCHANGEABLE BLADES OF HIGH CARBON TEMPERED STEEL  
16" Hand Saw Blade 16" Pruning Saw Blade  
12" Back Saw Blade 14" Nail Cutting Blade  
12" Key Hole Cutting Blade  
PLUS handle in rose wood finish and hardware, ALL FOR \$2.95!  
SEND CASH, CHECK OR M. O. FOR REPAID SHIPMENT TO

**BERTRAM B. ENGINEERING & SUPPLY CO.**  
3121 MAIN ST. KANSAS CITY, MO.

**QUANTITY LIMITED**  
We guarantee to fill orders in the order received and to maintain the price quoted in this ad for thirty days after date of this publication. ORDER YOURS NOW!

# INSIDE MICROMETER 2" to 8"

Precision made of tool steel. Hardened tips on all six measuring rods. One 1/2" spacer. Chrome finish. Complete with case. \$6.95



**MICROMETERS**  
Chrome plated, precision engineered and carefully tooled to give long life. All new. 0-1" capacity . . . ea. \$2.25. 1-2" cap. \$3.50. 2-3" cap. \$5.50. 3-4" cap. \$6.50.

# HIGH SPEED DRILLS

All New. Fractional & numbered. Orig. Val. \$15. Nationally known brand. Asst. sizes Set 30 \$3.50

# EXTENSION DRILLS

High Speed Steel, like new. Asst'd sizes from No. 1/4 to 40. Lengths from 6" to 12". Approximately \$20 value. Set of 12 . . . . . \$3.75



**ELECTRIC BELLS**—Vibrating type, high pitch. 115 V., 60 Cycle. Ideal for use indoors or outdoors—on ranches, for schools, plant installations, as signal systems, burglar alarm systems, etc. Nationally known Mfr. ALL NEW in orig. Pkgs. Solid brass clapper & 8 1/2" gong. Wt. 8 lbs. Govt. cost about \$67.50. Close out at . . . \$7.95  
Send check, money order or cash. 25% deposit required on C.O.D. orders. All prices F.O.B. Culver City, Calif.  
Send 25c for Illustrated Catalog.

**AIRBORNE SALES CO., INC.** DEPT. PM 10-0 CULVER CITY, CALIF.

# WAR SURPLUS SPECIAL

## NEW! STATIONARY or PORTABLE D.C. ARC WELDER

300 Amps Continuous. 350 - 400 Amps Intermittent. For ALL WELDING - LIGHT or HEAVY!!

This rugged air-cooled precision built electric ARC WELDER - designed to weld for hours comes complete with pulley reactor, output controls, Hi-Lo switches, rheostat. The heart of this unit is the famous R-1 generator, specially developed for B-29 Bombers, and with features no other generator has. Heavy steel frame, easily adapted to mounting on Jeep, Tractor or other power supply (10 H.P. gas or electric). Never before offered at this low price.

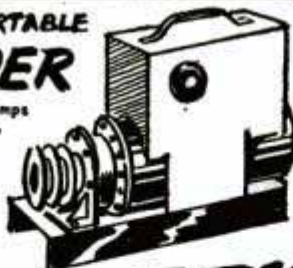

**97<sup>50</sup>**

**Ellinwood "44"** Here's a Real BUY!! This engine is rated from 4.4 to 5 HP. Has optional power take-off of 1 to 1 from crankshaft or 2 to 1 reduction from camshaft. Makes an ideal auxiliary power plant or can be used to drive pumps, generators, compressors, small boats, etc. Lightweight rugged and contains such fine component parts as Bendix-Timken-Air Maze, etc. . . . . ONLY



**57<sup>95</sup>**

**CONTINENTAL** The famous 4 cycle, air-cooled "L" head gas engine, 1 1/2 to 2 HP. Cheap power for Farm, Factory, Shop.

**37<sup>50</sup>**

NEW  
READY  
TO RUN

### PNEUMATIC AND AIR TOOLS

**7500 RIVET GUNS** Pistol & Gooseneck Type \$55 **\$8.95**

10,000 in various popular makes, sizes, types, Cleco, Aro, Ingersoll Rand, Chicago, Pneumatic Buckeye, etc.

### MANUFACTURERS!

We stock 1000's Tons of NEW BEARINGS, BOLTS, NUTS, SCREWS, RIVETS and other small hardware. These were purchased in the past 5 years from ARMY, NAVY, War Assets Administration, Aircraft Factories, and other Govt. agencies. We are selling these at a fraction of their original cost. Most of the stock is in their original packings. All is new and clean. Please write us for particulars based on your requirements.

## 3/4" HEAVY DUTY - 2 SPEED Portable DRILL



Never before such a value. Converted from aircraft starter-energizer. Ideal for all types heavy drilling. Has 2 speed control for 200 RPM low, or 275 RPM high. Heavy duty gear box gives extremely high torque. 3/4" Std. Jacobs Chuck. Universal ball bearing motor - 110 - 115 volt AC or DC. 32" Length 32 inches. tric cable.

**Only  
62<sup>50</sup>**

Equipped  
with  
50ft.  
Electric cable

### CHEMISTRY SET

Made for Chemical Warfare Division for testing water, etc. A handy addition to the chemistry lab. or an exciting experiment for the amateur. Set includes test tubes, complete instructions, 15 different items. Packed in attractive lucite box with cover & dividers. Set

**\$1.39**

**Plexiglass & Noscolite clear plastic sheets.**

NASCOLITE - Full sheets app. 1/8" x 37 1/2" x 49 1/2", app. 10 1/2 lbs. each **\$12.50**

PLEXIGLASS - Full Sheet 5/16" x 36" x 24" ... Per Sheet... **\$13.00**

5/16" x 36" x 48" ... Per Sheet... **\$25.00**

Fabricators write in for our special quantity prices. All above are new & marked. Also inquire about other large stocks of Plastics.

### NEW ELECTRIC MOTORS

No. 500 - New 1/2 HP - 27 Volt DC-AC. This motor can be readily adapted to deliver up to 1/2 HP on 110 Volts AC by the simple method of rearranging armature brush-leads. Free diagram with each order. A sensational value . . . . **\$5.95**

No. 500-A - Converted to 110 Volts-AC Equipped with plug and 3 1/2 ft. Heavy Duty Cord . . . . . **\$8.49**

### NEW TARPS - HEAVY CANVAS

Mildew & Flame Resistant. Cheap outside storage! They are really moving at these prices.

9' x 16' . . . . . **\$11.95**

5' x 7' . . . . . **3.95**

16' x 33' . . . . . **39.95**

Rubberized Nylon Tarp 7' x 11' . . . . . **6.95**

New Rubberized Linen Tarp - 7' x 11' Waterproof, weighs only 3 lbs. **5.95**

Ideal for outside car storage . . . . .

18 OZ. TARP - 6' x 6' - O.D. Duck. Can be used as a tent floor covering or storage protector. A terrific buy! Used - but in excellent condition . . . . . **3.95**

### New SUN VISOR

Stop That Glaring Sun! Here is a Visor made of clear Green Plastic. Has swivel lead and adjustable arm. Can be swung in any direction. Made for the USAAF. SPECIAL **\$1.29**

Order from this ad. All sales final. All prices F.O.B. Glendale. Pay by M.O. or check. P.O.'s accepted from D & B firms. 1/3 deposit with C.O.D. orders.

## FOR ALL-AROUND UTILITY . . .

No need to hire a handyman when you have a Bernz Torch for the job. Complete line fits every need.



### . . . LP GAS TORCH

Weights just 2 1/2 lbs. Burns in any position, any climate—even at minus 40° F. Ideal for brazing, soldering, thawing frozen pipes. Pencil flame and utility burner heads. Re-fill cylinder only \$1.00.

### ALUMINUM TORCH . . .

40% lighter weight. New, stronger tank design increases fuel capacity. Safety lock on needle valve. Faster pumping. No-leak joints. New low price.



### . . . WEED BURNER

Completely portable. No hose or extra tanks. Seamless steel tank with spun-sealed ends. Removable burner block. For killing weeds, disinfecting poultry houses, melting ice and snow, killing garden pests.



**OTTO  
BERNZ**

"Always Reliable"

**OTTO BERNZ CO., Inc.**  
280 LYELL AVE., ROCHESTER 6, N. Y.

## NEW BULL PORTABLE ROUTER!

only **\$9.95**

Fits any  
1/4" electric drill



- Now your electric drill converts into a portable router that grooves, rabbets, tenons, engraves, mortises!
- Depth gauge automatically permits routing to a uniform depth!
- Use it as a jig saw on wood of any dimension!
- You can rout "free hand" . . . follow a pattern line . . . or use the adjustable fences for perfect parallel inside routing!
- Two-handed grip gives you perfect control!

Complete as shown with 3/16" router bit, stand and guides, only **\$9.95**. (Extra routing bits, 1/8", 3/16" or 1/4", \$2.25 ea.) At your dealer or send cash, check or M. O. for prepaid shipment to

**BERTRAM B. ENGINEERING & SUPPLY CO.**  
3121 MAIN ST. KANSAS CITY, MO.

**PALLEY  
SUPPLY CO**

5321 SAN FERNANDO RD.  
Dept. PM-10  
GLENDALE 1, CALIF.



**SAVE UP TO 85%**

**IN WAR SURPLUS from "MAGNETEERS" HEAVEN**

**NEW 1950 TOOL CATALOG**  
72 pages of Machine Tools (taps, drills, dies, reamers, etc.) Hydraulic cylinders Air tools. Send 25¢ for your copy today.

**B-15 Style JACKET**

That "HOT" JACKET You'll be proud to wear! Water repellent, wind resistant, Nile Green cambed Gov't. Zealan sanforized Poplin. Full sturdy zippered front with 100% wool pile lined sleeves & body. Two slash pockets & large Mouton Fur Collar. Ribbed cuffs and bottom. Sizes: 36 to 46 . . . . **\$11.95**



**Sleeping Bag**

**MUMMY BAG** Has outer cover of forest green, water repellent balloon cloth. Filled with 15% Duck Down and 85% Chicken Feathers. 1/2 length zipper. Size 34" x 84" . . . . . **12.95**  
**KAPOK BAG** -Here's real warmth and comfort. Has special water-repellent, olive green, heavy duty cover. Filled with 4 lbs. of 100% imported Kapok. Stays soft - will not mat down, 3/4 length zipper. Head flap makes dust cover when rolled. Full length mattress pocket. Size 34" x 77" . . . . . **13.50**



**16 mm MOVIE CAMERA** Has semi-telephoto 1 3/8" (35mm) lens with yellow filter - 3 shutter speeds: for normal (16 frames) semi-slow motion (32 frames) and slow motion (64 frames per second). Uses any standard Eastman film magazine or Type 'G' AAF magazine. Takes Black & White or Full Color pictures. Operates on 24V (dry cell batteries) & requires slight conversion for hand use. Diagram furnished. Cost Gov't \$235.00. NOW **\$24.50**  
**CONVERTED GUN CAMERA** - Fully reconditioned with start switch on front. Choice of finishes - Grey, Black, Blue . . . . . **\$33.95**

**EISENHOWER JACKET**

Trim, smart military cut jacket for sports and outdoor wear. Warm and comfortable. Has 2 patch pockets, 2 inside pockets, & adjustable side straps. Waist belt with buttons and snaps. **ONLY 5.95 EA.**



**FLYING HELMET**  
Fine grade leather - Chamouis lined with chin cup on strap. Intermediate weight - Ideal for summer wear. **NEW ONLY 1.59**



**NAVY WADING SUIT**

Here's a suit that will make surf fishing a pleasure. Made of rubberized canvas, with vulcanized seams. It will keep you absolutely dry. Has built in rubber gloves and 1/2 length rubber boots. Air tight Buoyancy pockets inside keep you balanced in deep water. Has 100% waterproof liner. **16.95** Guaranteed condition.



**NEW WATCH**  
Here's a real Shock Absorbing watch. Has jewel movement, Sweep second hand, luminous dial, chrome case. Guaranteed for one year. Ideal for young and old. . . . . **16.95**

**ELGIN 7 JEWEL TIMER** Pocket type. 60 second dial divided into 5th's of second. Also 30 minute recorder dial, shatterproof crystal. This genuine Bureau of Ordnance watch has \$35.00 value. Shipped in steel, shock-absorbing suspension case. **15.95** Plus tax

**17 JEWEL Chronograph**. One of the finest made anywhere. Cased in Switzerland. Sweep second hand, stop and re-set buttons. Measures distance, air speed, ground-speed, races. Ideal for the sportsman. **\$21.95** Plus tax

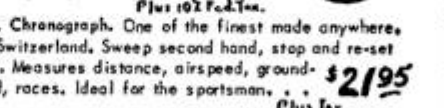

All New! Winter type with fleece or chamouis lining. Has ear puffs & chin cup. Ideal for pilots, cycle - drivers, sportsmen, etc. **1.95**

**RUBBER BOOTS**  
A Sturdy Boot of finest pliable Rubber. Completely Waterproof with adjustable strap. Wear with or without shoes. **3.95 PR**  
Felt Inner-Shoe & Shoe Pad Insert - for Cold Weather. (sold only with boots.) Set complete, **1.50 PR**

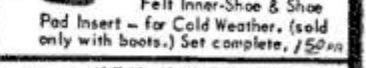

**AAF CASE**  
Genuine top grade leather. Multi-compartment. Lock and Straps. Ideal for Artists, Students, Salesmen, etc. Used, good condition. . . . . **7.95**

**AIR CORPS BRIEF CASE**  
This is a genuine piece of AAF equipment. Made of best grade Brown Leather in a handsome Pebble finish with a light canvas liner. Has two full length map or paper compartments and three smaller pockets. An ideal case for students, salesmen, artists, etc. Full heavy duty zipper closure. 12" x 16". Shpg. Wt. 3 lbs. **ONLY 2.95**

**Loose Leaf BINDER**  
3 metal post. Cylindrical locking heavy duty 3/16" fabricated hinged cover. End identification window. Ideal for price books, salesmen catalogues, photoalbums, students, publications, Reference books, etc. Will hold 500 sheets, 8" x 11". **59c ea**

**PLEXI DOME**  
Overall length 21" - Width at widest point 11" - at base 4". 6" deep. For Fish & Flower Bows - Cab Roof - Lights. **1.89**

**GOOSENECK LAMP**  
Consists of 24 volt control box with dimmer switch, 18" flexible extension & frosted glass shade. Can be used on 110 volt current. **2.49**

**NAVIGATORS LAMP**  
A handy light for desk, work bench, chart table, engine room, etc. Can be used on 6-12-24-110 V by changing bulb. 3 ft. shaft has 4 joints to adjust position. . . . . **2.95**

**NAVY Sealed Beam LAMP**  
U.S. Navy Portable Pistol Grip light. Has sealed beam and aiming sight. Ideal for search, spot or Emergency light on auto, boat, farm etc. . . . . **2.95**  
12 Volt light, 4" lens . . . . . **2.95**  
24 Volt, 5" lens & carry case . . . . . **3.49**  
Set of 3 filters, Red, Grn, Amber (specify type lamp) . . . . . **99¢**

**Genuine ARMY AIR FORCES SUNGLASSES**  
HERE'S THE REAL MCCOY!  
**ARMY AIR FORCE - 6 base.** Precision Polished & Ground. Glare-Free caliber lenses. Leather case to be attached to belt. Gold plated adjustable frame. Pearlloid sweat bar and pads. \$17.50 Palley value for **ONLY \$13.95**

**NIGHT DRIVING GLASSES**  
With 57mm yellow, amber, 6 base lenses. Optically precision ground and polished! Your doctor will recommend these. Not a cheap "Process" lens. Reduces headlight glare and sharpens 'object focus' during night driving. Men's size or Ladies Harlequin style. ND-1, \$16.00 VALUE. **14.29**  
SAME GLASSES but clip-on's. **\$3.95** Fit-over style without temple bars.

**Aviators (AN-6530)** Windproof & Dustproof **GENUINE GOGGLES**  
Rubber or chamouis covered frame. Clear or Green **GROUND LENSES** are inter-changeable. Adjustable nose bar. Ideal for flying, motor cycling, etc. . . . . **\$1.69**

**GO-1 GOGGLE KIT**  
NEW! U.S. Navy - Has soft sponge rubber frame. 4 Polaroid lenses. 2 green, 1 red, 1 clear. Perfect for racing, cycling, etc. **89¢**

**JEEP CANS 5 GALLON**  
For reserve gas & water. Top condition. . . . . **1.95**  
**ARMY PUP TENTS** - 2 Man. Used. Perfect . . . . . **5.95**  
**MESS TRAY** - Stainless Steel . . . . . **79¢**  
**HUNTING KNIFE** - 6" polished blade, leather sheath. **1.69**  
**BOLO KNIFE** - 10" Parkerized blade, with case. **1.19**

**15 MONKEY WRENCH**  
Adjustable Jaw - Opens to 4"  
Drop Forged. . . Auto Type. Cadmium Plated **89c** Black **79c**

**U.S. SIGNAL CORPS MICROPHONE**  
Telephone type - Highly Sensitive with excellent, clear tone. This was the Signal Corps favorite. An ideal instrument for the radio 'ham' and professional recording studio, broadcasting, home recording, public address, etc. A Sensational Buy! Complete with cord and plug. . . . . **2.29**

**RADIO HEADSET**  
Low Impedance. Ideal for amateur radio, crystal sets, or professional use. Adjustable ear phones. Used and in excellent condition. . . . . **1.59**  
**HS-300** - Two Magnetic Type receivers in watertight brass case. Soft rubber inserts in each receiver to fit into wearers' ear. Pliable steel head band. Ideal for communications, divers, workers in noisy compartments, etc. **NEW 1.59**

**FIELD TELEPHONE**  
A private phone or intercom. system - Easy to operate. Reception up to 20 miles. Uses 2 standard flashlight batteries. Several phones can be used on same line. Set contains generator for ringing, leather carrying case & phone. **7.95 PER UNIT**  
**COMPLETE SYSTEM OF two generators & two phones. PER SET 15.50**

**CAMPING SPECIALS**  
**HYLON FISHLINE** - 25 lb. Test - 100 ft. Green . . . **1.59**  
50 lb. Test - 400 ft. Green . . . **1.19**  
72 lb. Test - 300 ft. blk. & grey. **3.49**  
45 lb. Test - 750 ft. Tan . . . . . **2.69**  
**COMPASSES** - Match Box . . . . . **39¢**  
Jeweled Watch - Pocket . . . . . **1.59**  
Wrist Strap Type . . . . . **69¢**  
Pocket Card Type . . . . . **89¢**  
**OCEAN CITY FISHING REEL**  
For Fly Casting . . . . . **1.25**

**PLASTIC PARALLEL STRAIGHT EDGE**  
with knees and rubber pads for non slipage on each section. A must for navigators, mechanics, draftsmen, and engineers . . . . . **97¢ ea.**

**NEW NAVIGATORS MAGNETIC COMPASS**  
D-12 Type. Rotating verge range ring, calibrated in 1 degree increments from 0 to 360°. Two parallel grid wires for N-S line alignment. . . . . **14.95**

**B4 TRAVEL BAG**  
Servicemen's Buddy. 2 large outside pockets. Snap down panel for folding clothes. Canvas divider. Heavy duty zipper. Bag opens flat for packing. You can't abuse this bag on trips, vacation or camping. Reconditioned and ready to go. **ONLY 6.49**

**NEW PRESSURE TANKS**  
Stainless Steel, Shatterproof & Rustless. Ideal for painting, cooking, spraying, ocean buoys, underwater fishing, or diving.  
G-1-12 1/2 x 24 inches. 2100 Cu. In. capacity . . . . . **4.75**  
F-1-10 x 18 inches. 1000 Cu. In. capacity . . . . . **USED 4.19**  
F-2-6 x 45 inches. 1000 Cu. In. capacity . . . . . **NEW 3.95**  
D-2-6 1/2 x 24 inches. 500 Cu. In. capacity. Stainless Steel Construction . . . . . **USED 3.49**  
D-2A-Corrosion resistant steel. Same as D-2 . . . . . **NEW 2.49**  
A-4-5 1/2 x 15 inches. 280 Cu. In. capacity . . . . . **USED 2.25**  
A-4-5 x 8 inches. 104 Cu. In. capacity . . . . . **NEW 1.35**  
NOTE: All tanks listed as used are guaranteed serviceable and free from leaks or dents.

**TANK** Dural with welded seams, 2" filler with cap, two standard pipe ports for hookup. Visible liquid level gauge on side. Ideal for Gas, Oil, Water, or "spare" on auto, tractor, truck or boat. Sturdy, light. Capacity 6 gal. . . . . **14.95**

**NEW TANK**  
For Gas, Oil, Water, etc. Seamless, welded tank made of aluminum with filter screen and Pack. Has stick level gauge. 19 gal. capacity . . . . . **16.95**

Order from this Ad. All sales final. All Prices F. O. B. Glendale. Pay by M.O. or Check. P.O.'s Accepted. from D & B. firms. 1/2 deposit with C.O.D.'s.

**PALLEY SUPPLY CO**  
DEPT. PHO GLENDALE 1, CALIF.

# SOUTH BEND

## Precision Lathes

# For Better Machining

Whether you are doing production, maintenance, service or experimental work, you have need for South Bend Lathes. They produce better machining efficiently—especially when close tolerances are specified. Consequently, their use often results in appreciable savings in machining costs. And, being reasonable in price, they do not require heavy capital investment.

South Bend Lathes are your best buy. They're designed right—built right. Check coupon for complete information.



Building Better Tools Since 1906

**SOUTH BEND LATHE**  
SOUTH BEND, INDIANA

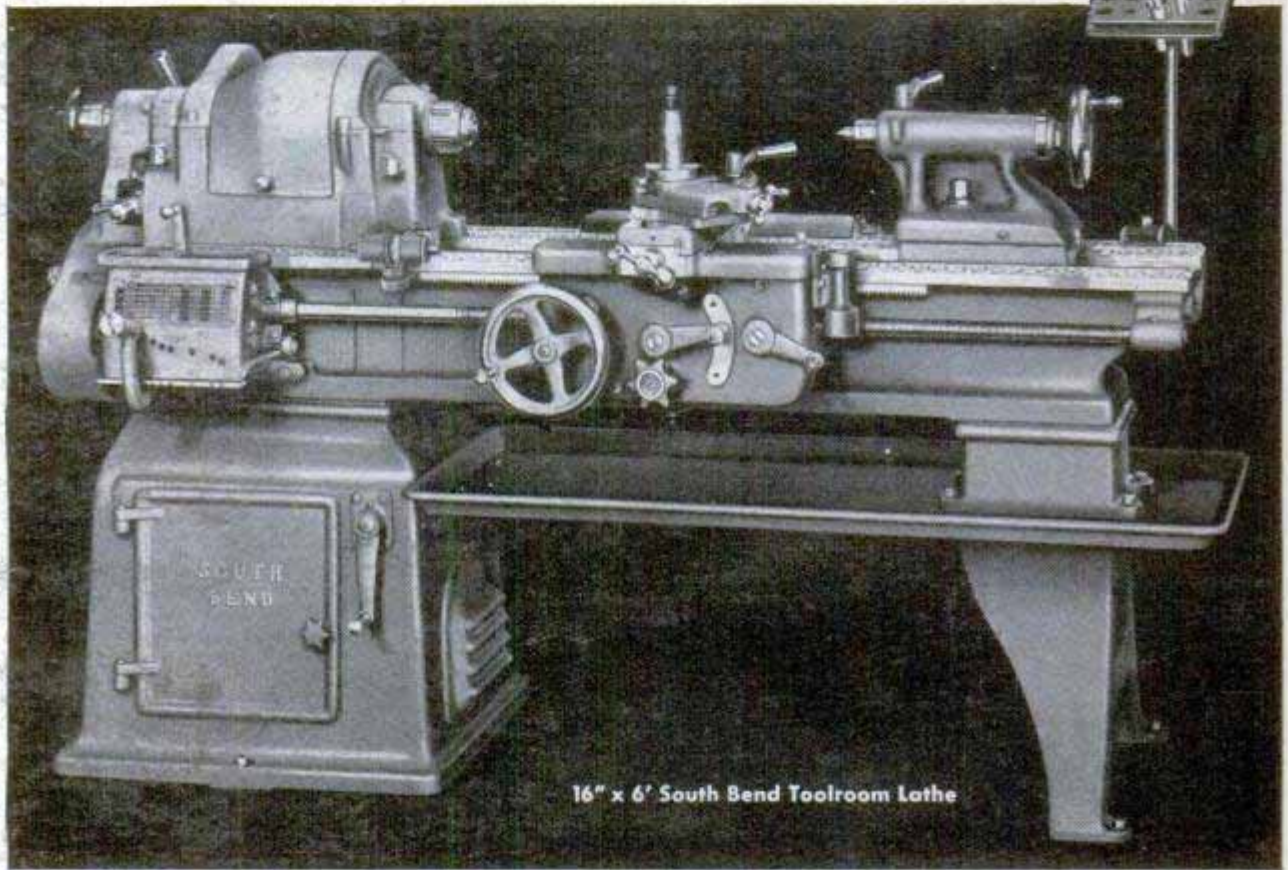

16" x 6' South Bend Toolroom Lathe

### PRICES OF SOUTH BEND LATHES

LATHE SIZE	16" x 6'	14-1/2" x 5' ~ 13" x 5'	10" x 3' 1" Collet Cap.	10" x 3' Light Ten	9" x 3'
QUICK CHANGE GEAR MODEL	\$1902.90	\$1613.90	\$1350.90	\$1017.40	\$464.70
TOOLROOM MODEL	2360.90	2033.90	1748.90	1355.40	663.70
					555.70

Above prices include 3 phase, 60 cycle motor and drum switch, f.o.b. factory.

\*9" Standard Change Gear Models priced from \$176.00, less motor and switch.

### Send Information Checked:

16" TOOLROOM LATHES

LATHE TOOLS AND ATTACHMENTS

TIME PAYMENT PLAN



9" and 10" BENCH LATHES

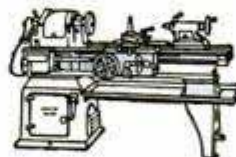

10" TO 16-24" FLOOR LATHES



14" DRILL PRESSES

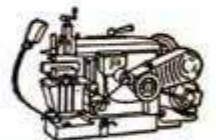

7" BENCH SHAPER

Name \_\_\_\_\_

Street \_\_\_\_\_

City \_\_\_\_\_ Zone \_\_\_\_\_ State \_\_\_\_\_

TURRET LATHES  
1/2" and 1" Collet



Printed by Popular Mechanics Company, Chicago, Ill., U. S. A.

**NOW** MAKE HUNDREDS OF USEFUL THINGS FOR YOUR HOME with this Amazing **NEW Low-Priced**



GUARANTEED BY BURGESS

CREATIVE FUN FOR FATHER OR SON

PRECISION-BUILT: STEEL AND ALUMINUM CONSTRUCTION

A POWERFUL BUILT-IN ROTARY MOTOR

JUST PRESS THE BUTTON AND SAND, SAW OR FILE

(Larger, Sturdier — 3" x 7 7/8" x 11 3/4")

**BURGESS**

*Electric*  
**JIG SAW SANDER FILER**  
WITH BUILT-IN AUTOMATIC  
**BLOWER**

**\$14.75**  
ONLY COMPLETE

with POWERFUL BUILT-IN MOTOR, "Every Direction" Saw Blade Adjustment, Selector Blade Guide, Built-In Cooling Fan, Air Vent, 3 Saw Blades, 3 Sanding Discs — FULL-SIZE project pattern.

Complete Portable Home Power Tool at Sensational Low Price!

**BUILT-IN AUTOMATIC BLOWER** — To clear away sawdust and filings.

**POWERFUL BUILT-IN ROTARY MOTOR** — Means fast, easy sawing or filing.

**"EVERY DIRECTION" JIG SAW** — Special blade guide faces any direction to cut extra long pieces.

**LARGE CUTTING TABLE** — Large, firm, working surface tilts 45°.

**BUILT-IN COOLING FAN WITH AIR VENT** — Cool, efficient operation.

**3400 R.P.M. SANDING DISC WITH ADJUSTABLE TABLE** — Revolves at constant high speed. Table tilts 45°.

**PORTABILITY** — Used in kitchen, study, garage or workshop. Cushioned base protects working surface and provides quiet operation.

**UL APPROVED 6-FOOT PLASTIC CORD SET** — Plug into 115-125 Volt AC outlet.

**BURGESS GUARANTEE** — Manufactured and guaranteed by Burgess Vibrocrafter, Inc., Chicago 1, Illinois.

Sold by Leading Hardware and Department Stores. If not available at your store, MAIL COUPON TODAY

**It's Easy and Fun to Make Many Attractive, Useful Things!**



Make hundreds of useful things with this New 1951 Burgess Electric Home Workshop. A powerful tool for your home projects, yet completely safe for the youngster to use. Make many decorative things with the skill of an expert. A full-size shoeshine box pattern comes with the saw and other patterns as shown are available.

Your Burgess Electric Jig Saw need not be bolted to a work bench. It's a complete portable home power tool in itself. And, what could be a more perfect gift for a friend or relative? Now is the time to place your order — Today!

**READ THESE AMAZING FEATURES AND ORDER YOUR BURGESS ELECTRIC JIG SAW TODAY!**

Yes, now you can have this wonder tool of the year. A highly functional, precision-built tool, portable for use in any room. Get one for your home and saw, sand and file wood, metal, plastic and many other materials. This sturdy tool saws wood up to 1/2 inch and light metals up to 1/8 inch. Use it anywhere you want without worry of marring the working surface.



**BURGESS HANDICRAFT STORES**  
182 North Wabash Avenue • Chicago 1, Illinois

**BURGESS HANDICRAFT STORES, Dept. PM-10**  
182 North Wabash Avenue • Chicago 1, Illinois

Send me my Burgess Electric Jig Saw, Sander, Filer with automatic blower, built-in rotary motor, 3 saw blades, 3 sanding discs and FULL-SIZE project pattern.

I enclose Check  or Money Order  for \$14.75. Burgess will pay delivery and handling charges.

Send C.O.D. . I will pay postman \$14.75 plus delivery charge. (Illinois residents add 2% sales tax.)

Name \_\_\_\_\_

Address \_\_\_\_\_

City \_\_\_\_\_ Zone \_\_\_\_\_ State \_\_\_\_\_



NOW...LIGHT  
WHEN YOU NEED IT!  
because...



**They're sealed in steel  
to stay fresh and usable!**

Above, new Ray-O-Vac "Billioneer" 2-cell flashlight . . . now at your favorite dealer.

Here's the battery that won't swell or stick in your flashlight . . . that will stay fresh and usable longer . . . that doesn't have to be "dated." Only genuine Ray-O-Vacs are sealed in steel . . . top, bottom, and all around. You get . . .

1. A steel top.
2. Powerful battery.
3. Multi-ply insulation.
4. Steel jacket.
5. Steel bottom.



Each battery carries this guarantee: "If your flashlight is damaged by corrosion, leakage or swelling of this battery, send it to us with the batteries and we will give you FREE a new, comparable flashlight with batteries."

*Over a Billion Sold*

**Buy Spares . . . they stay fresh**