



# POPULAR MECHANICS

## MAGAZINE

MEMBER OF THE NATIONAL ASSOCIATION OF PUBLISHERS

REG'D. TRADE MARK, GREAT BRITAIN, No. 41037

REG. U.S. PAT. OFF.



What, no crankshaft?—Turn to page 114 for the story of the

**REVOLUTION OF THE FREE-PISTON ENGINE**

A LITTLE SOMETHING

EXTRA . . .



*CORALOX* is AC's patented spark plug Insulator. It gives you that "something extra" which is always vital to outstanding performance.

*CORALOX* gives you many extras. It has 4 times greater heat conductivity—10 times greater electrical resistance at high temperatures—is 3 times stronger—than the best ceramic insulator material in use before *CORALOX*.

What do these extras mean in terms of service to you? Easier starting—better idling—no misfiring under heavy loads—no failure due to heat shock—little or no accumulation of combustion deposits.

For better year-round performance in your car, truck or tractor, use AC Spark Plugs with patented *CORALOX* Insulator.



PATENTED

*CORALOX*

INSULATOR

# Think of the fishing you'd be missing

## IF A FLAT TIRE LET YOU DOWN



Far from  
the beaten path,



a nail . . .



broken  
glass . . .



any sharp  
object . . .

and your vacation  
may suddenly go **FLAT!**



Make sure you enjoy your vacation

WRITE FOR THIS BOOK NOW

**"10,189 PUNCTURES — AND NOT ONE FLAT"**

But you'll fly right to your destination with Sealed-Air, world's most trouble-free tube. Pick up a dozen nails and never know the difference.

These tubes outlast set after set of tires. That's because they're the world's only puncture-sealing tube with Bulkheads . . . your *extra protection* against costly punctures and dangerous blowouts.

# SEIBERLING

## Sealed-Air Tube WITH PATENTED BULKHEADS

*It's Free*

Learn the secret of patented bulkheading . . . and how this puncture-sealing tube will save you time, trouble . . . AND MONEY. No obligation. Simply mail this coupon now to Seiberling Rubber Co., Dept. PM-2, Akron 9, Ohio.

Name .....

Address .....

City ..... State .....

This One



Mounting Bell's new microwave lens in a horn-lens antenna. Other blocks will complete the lens.

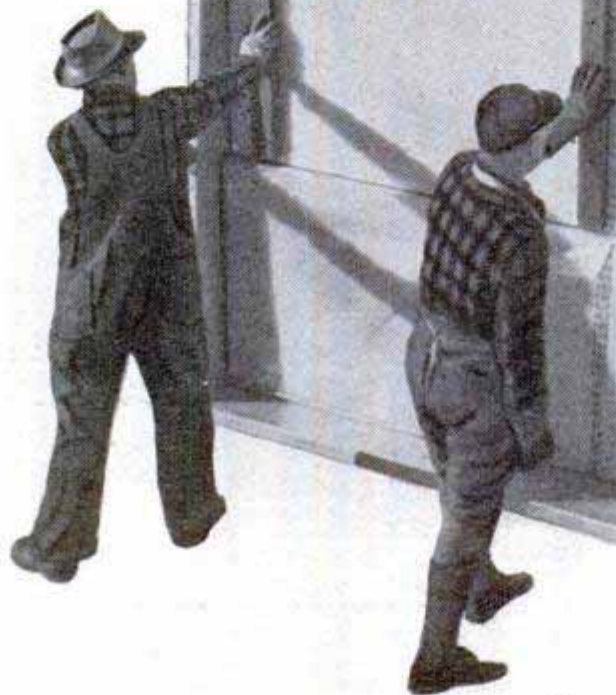

## A focus on better, low-cost telephone service

In the new microwave radio relay system between New York and Chicago, giant lenses shape and aim the wave energy as a searchlight aims a light beam.

Reasoning from the action of molecules in a glass lens which focuses light waves, Bell Laboratories scientists focus a broad band of microwaves by means of an array of metal strips. To support the strips these scientists embedded them in foam plastic which is rigid, light in weight, and virtually transparent to microwaves.

This unique lens receives waves from a wave guide at the back of the horn. As they pass across the strips, the waves are bent inward, or focused, to form a beam like a spotlight. A similar antenna

at the next relay station receives the waves and directs them into a wave guide for transmission to amplifiers.

This new lens will help to carry still more television and telephone service over longer distances by microwaves. It's another example of the Bell Telephone Laboratories research which makes your telephone service grow bigger in value while the cost stays low.

Laboratory model of the new lens. A similar arrangement of metal strips is concealed in the foam plastic blocks in the large picture.



# BELL TELEPHONE LABORATORIES

Working continually to keep your telephone service big in value and low in cost.

# Popular Mechanics Magazine

Registered in U. S. Patent Office and Canada

H. H. WINDSOR, *Founder*

H. H. WINDSOR, JR., *Editor and Publisher*

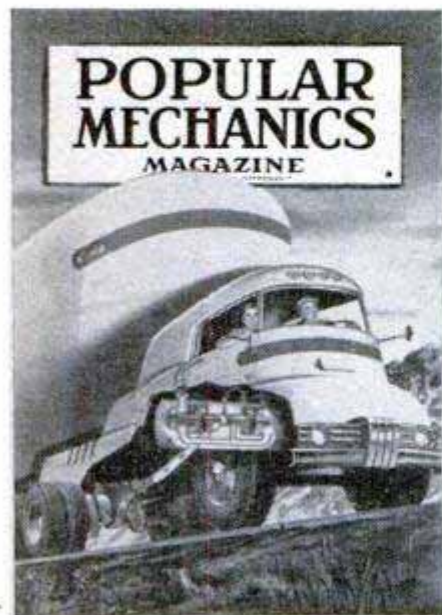

## this month's cover

FROM A DEAD STOP that truck on our cover can take off with the pick-up of a scared Arizona jack rabbit. It can scoot up a Rocky Mountain with the zip of a motorcycle. Of course, it hasn't been built yet, and neither has the passenger car that will roll you 50 or 60 miles on a gallon of cheap kerosene—but both these developments are theoretically possible as the result of a revolutionary engine so simple you'll wonder why it wasn't dreamed up back in the days of the Model-T. It's the free-piston engine, consisting of two pistons connected to absolutely nothing. The pistons slide back and forth in a chamber, burning fuel and compressing air. Hot gases from the engine flow through a turbine to power most anything. J. D. Ratcliff, noted science writer, gives you the details on the newborn but power-packed youngster, on page 114

Published monthly by Popular Mechanics Company, 200 E. Ontario St., Chicago 11, Ill. H. H. Windsor, Jr., president; William Harrison Petridge, vice president; D. F. Windsor, vice president and secretary-treasurer; Clover L. Perkins, advertising manager; Alan M. Deyoe, circulation manager. Single copy in the United States and Canada, 35 cents; subscription rates in United States and possessions, Canada, Philippines and countries of the Pan-American Postal Union, 1 year \$3.50; 2 years, \$6.00; 3 years \$8.00. To all other countries add \$1.00 a year over United States prices for overseas postage. If you plan to move, notify us at least 30 days in advance so you will not miss an issue. Give both your old and new addresses.

Entered as Second Class Matter, September 15, 1903, at the Post Office at Chicago, Illinois, under Act of March 3, 1879. Entered as Second Class Matter at Post Office Dept., Canada. Registered as Second Class Matter at the Post Office at Mexico, D. F., Mexico, June 20, 1950.

Copyright 1950 by Popular Mechanics Company. Copyright under International Copyright Union. Copyright in France. All rights reserved under Pan-American Copyright Union. Printed in the United States of America.

Volume 94 SEPTEMBER 1950 Number 3

Managing Editor.....Roderick M. Grant  
 Assistant Managing Editor.....Wayne Whittaker  
 Shop Notes and Crafts Editor.....James R. Ward  
 Radio-Television, Electronics Editor.....Frank L. Brittin  
 Associate Editor, Aviation.....Aubrey O. Cookman, Jr.  
 Associate Editor.....Clifford B. Hicks  
 Automotive Editor.....Siler Freeman  
 Art Director.....Frank Beatty  
 Director, Bureau of Information.....Allan Carpenter

### Assistant Editors

Donald R. Brooks      Dorothy E. Hoffmann      Arthur R. Railton  
 H. H. Windsor III

### Assistant Editors, Shop Notes and Crafts

W. Clyde Lamme      Wayne C. Leckey      Frank N. Stephany      A. E. Youngquist  
 Eastern Editor.....Richard F. Dempewolf  
 Empire State Bldg., Room 2906, New York 1, N. Y.

Western Editor.....Thomas E. Stimson, Jr.

Representative in Great Britain.....Douglas W. Wedderspoon  
 77 Baker St., London W. 1, England

## IN THIS ISSUE

Treasure Hunt in a Lost World—Part I	- - -	73
What's New for Your Home	- - -	80
Galloping Gold	- - -	84
Doctor for Old Timers	- - -	89
Engine With a Built-In Tornado	- - -	94
I Flew Thirty-One Hours in a B-36	- - -	98
Packard '51 Takes a Bow	- - -	104
Revolution of the Free-Piston Engine	- - -	114
The Campus is "On the Air"	- - -	125
Look What's Happened to the Little Old Schoolhouse	- - -	132
Mayhem on Wheels	- - -	148

## For the Craftsman

Your Modern Kitchen—Part II	- - -	158
Pine-Needle Baskets	- - -	173
Wood-Finishing Facts and Formulas	- - -	178
Longer Life for Fence Posts	- - -	188
Adapt Your Camera to Copy Work	- - -	195
Mower-Snowplow All In One	- - -	199
Precision Measuring—Part III	- - -	204
Shopping for Tools	- - -	210
Roofing is Easy—Part I	- - -	212
Radio-Television, Electronics	- - -	219
Clinic for Homemakers	- - -	228

Other items, and manufacturers of available products described, are listed on pages 14, 16 and 18

# The Greatest Adventure Awaiting Mankind!



**SEE** the pull of gravity crush them deep into their crash-couches as the space-ship takes off at 32,000 feet a second.



**SEE** the flyers risk death as they crawl outside the space-ship to repair their short-wave aerial—their only link with Earth.



**SEE** the slip that sends a crew member adrift in space—facing the doom of floating forever in the vast black universe.



**SEE** Man's greatest thrill as he finally sets foot on the Moon! Now, at last, his age-old dream of conquering space comes true!



## It's closer than you Think!

Be there! Be with the first men to ride a space-ship to the Moon! It's spine-tlingling, perilous adventure!

See how the greatest news story of all time will actually happen! Share this adventure into tomorrow!

Two years in the making, this is the picture you have heard about and have been reading about in LIFE, THIS WEEK, PARADE, the popular science magazines, New York Times and many more.

It's a prophecy—not a fantasy! Watch for it at your favorite theatre!



COLOR BY

## TECHNICOLOR

# DESTINATION MOON

Produced by GEORGE PAL. Directed by IRVING PICHEL. Screenplay by RIP VAN RONKEL, ROBERT HEINLEIN and JAMES O'HANLON

# Big Wheel

IN ANY LEAGUE!

In baseball, as in every other sport, the star performer, the big wheel, is the fellow with *constant control*.

In bicycling, the "big wheel" is the one that has a New Departure Safety Brake, the lightest, strongest, most powerful brake ever built. The brake that gives you *constant control* at all times. It brings any bike to a ...

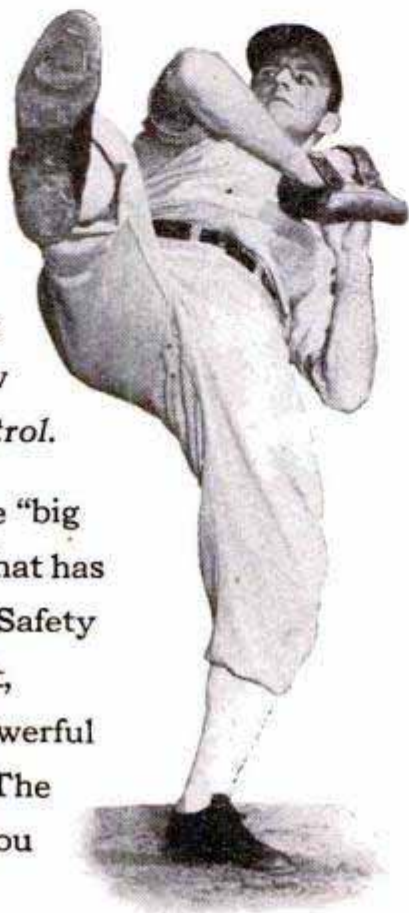

1884



Be sure your new bike has a

**New Departure**  
SAFETY BRAKE   
a product of 

New Departure • Division of General Motors • Bristol, Connecticut

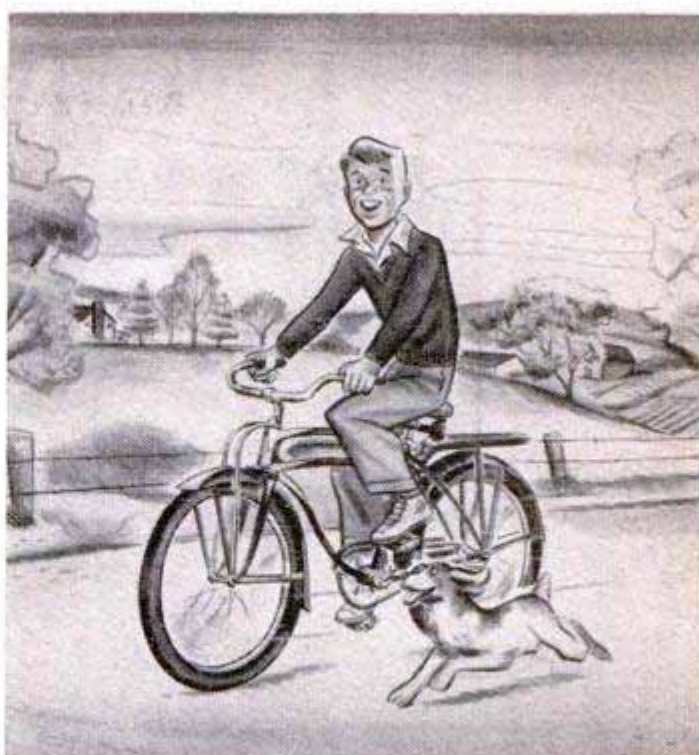

## A Boy, a Dog... and a Bike

A gleesome threesome if there ever was one! You're really going places, you're really doing things when you and your pup roll out the bike to see what's going on down the road.

Fun? You just know you'll have barrels of it, and so does Dad—good safe fun, too, because the New Departure safety brake affords constant control.

It brings any bike to a ...



**New Departure**  
SAFETY BRAKE   
a product of  1876

New Departure • Division of General Motors • Bristol, Connecticut

# it's cheaper to buy PYROIL

Yes, PYROIL is much cheaper than repairs and much more convenient than having your car in the shop when you want to use it. PYROIL adds efficiency to your lubrication. It gives oil the property of adhering to cylinder walls—reducing friction wear between piston rings and cylinder. It also prevents gumming and corrosion.

Ask the attendant at your favorite gas station to add PYROIL — and add miles to your car.

## Pyroil for Aircraft Engines

Use Aircraft Pyroil B for lubricating oil, Aircraft Pyroil A for gasoline.

**GIVEN!** An attractive Pyroil metal savings bank, takes coins up to 50c pieces. **MOTORISTS**, it's yours for the asking—sent postage paid.

Manufactured and Guaranteed by Pyroil Company, 107 Pyroil Bldg., La Crosse, Wisconsin

Canadian Distributors: Central Purchasing Agencies, Ltd., Toronto, Ontario



### PYROIL COMPANY

107 Pyroil Bldg., La Crosse, Wisconsin

I want my car to last and run properly. Please tell me more about Pyroil and how it can accomplish this for me.

Name \_\_\_\_\_

Address \_\_\_\_\_

City or Town \_\_\_\_\_ State \_\_\_\_\_



in this corner.....

## THE EDITORS



## Atomic Golf Ball

We told you it was coming—the atomic golf ball that you couldn't lose in the rough. In Wayne Whittaker's article (October 1949) about the Nuclear Instrument and Chemical Corporation, the "Million Dollar Baby of the Atom Age," he told of the inquiry for 200,000 portable Geiger counters to be used for hunting atomic golf balls. Well, here it is—the radioactive golf ball—produced experimentally at the B. F. Goodrich Research Center in Brecksville, Ohio. And Geiger counters are getting down in weight and price so you might save money by toting one around the course to retrieve "slices" from the neighboring wheat field. The radioactive ball is not yet being manufactured, however. There are problems. The radioactivity of the ball is low enough to avoid danger to its user, but in wholesale lots they might prove dangerous to the handler. For the time being, just stay out of the rough.

\* \* \*

## But Will It Get You Up?

One of General Electric's latest products is introduced as a "triumph of science over human nature." Well, it does have some admirable and amazing characteristics, but

(Continued to page 8)



# 5 reasons why ACCOUNTANCY

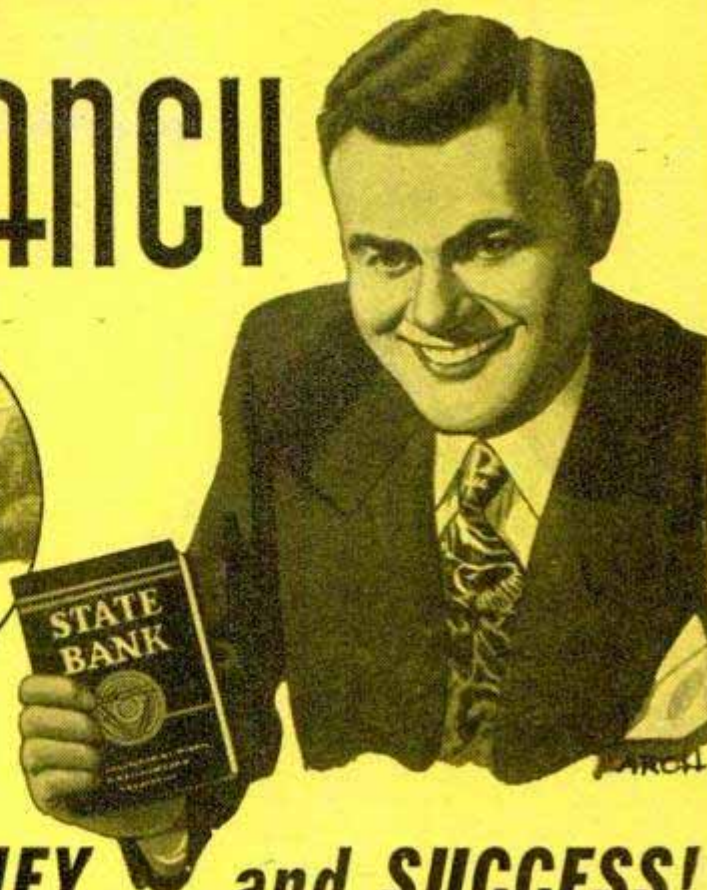
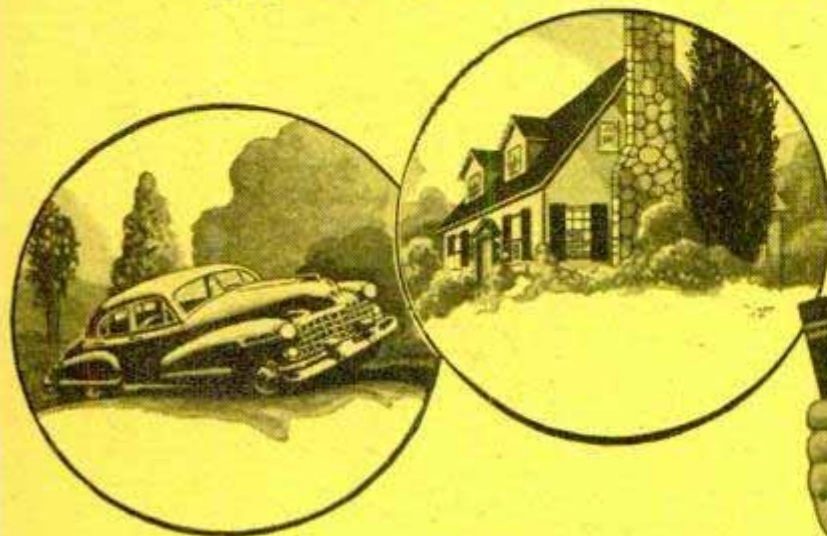

offers you **MORE MONEY . . . and SUCCESS!**

**REASON #1.** If you were an expert accountant right now, chances are you would find yourself among the highest-paid of all professional men and women. Even back in "depression years," surveys showed that accountants earned more on the average than men in other major professions.

**REASON #2.** The demand for accountants is great—everywhere. All businesses must have trained accountants to cope with ever-growing requirements. It's a profession offering wide opportunity—always—to the man who knows.

**REASON #3.** You can fit into any business, anywhere in the country—because accounting principles are universal. Think what this means in terms of security and independence!

**REASON #4.** Accountancy is open to all. Any man or woman of good intelligence, who enjoys figure work and is willing to follow LaSalle's systematic "problem method" plan, can rapidly qualify for a highly profitable, enjoyable

lifetime career . . . and he doesn't have to finish his training before beginning to "cash in."

**REASON #5.** Without losing a day from your present work, you can prepare in spare hours at home, at low cost, under LaSalle's step-by-step "Problem Method" of "learning by doing." This famous plan accounts for LaSalle's remarkable record of having trained nearly 10 per cent of all Certified Public Accountants in the U. S. . . . and of having put many thousands of others into high-paying careers.

Send today for LaSalle's interesting booklets, "Accountancy, the Profession That Pays," and "Success Reports." Learn about the five great fields of opportunity . . . and LaSalle's time-tested plan for helping men and women to rapid advancement, higher income, greater prestige and professional standing. The coupon below will bring these fact-filled booklets to you—without cost or obligation. Mail the coupon NOW.

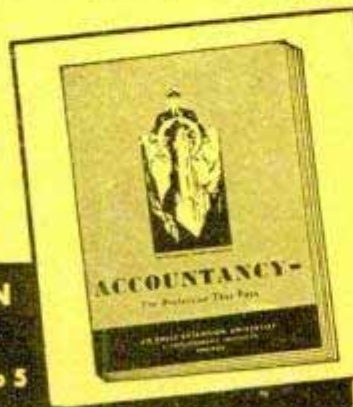

## LaSalle Extension University A Correspondence Institution

Dept. 964-H, 417 S. Dearborn St., Chicago 5, Ill.  
Please send me, free of all cost or obligation, your 48-page illustrated book "Accountancy, the Profession That Pays," and the booklet "Success Reports"—send also "Ten Years' Promotion in One"—a book which has helped many men.

Name . . . . . Age . . . . .  
Address . . . . .  
City, Zone, State . . . . .

**LASALLE EXTENSION  
UNIVERSITY**  
417 S. Dearborn St., Chicago 5

# Build your Aviation Career



## Start Now — Earn Good Money in Two Years or Less

There's a bright future ahead for you in Aviation. In fact, no other career field today can possibly offer you so much opportunity. The aviation industry urgently needs men with skilled minds and hands to build, fly and maintain the giant aircraft of this great new Air Age.

The properly trained man climbs faster and higher in Aviation, just as in law, medicine, engineering or any other profession. Embry-Riddle training, backed by a quarter-century of aviation school knowledge and experience, makes the strongest possible foundation for your aviation success.

In a few short months Embry-Riddle prepares you for engineering, master mechanic, flight or combined pilot and mechanic positions. All courses stress thorough, practical study including work on live aircraft in Embry-Riddle's airline-size hangars.

Enjoy Florida's unexcelled year-round climate, its wealth of aviation and recreational facilities. Live, work and play on Embry-Riddle's modern campus—the most complete aviation school plant in America. Save time, earn good money faster . . . send coupon today for full information.

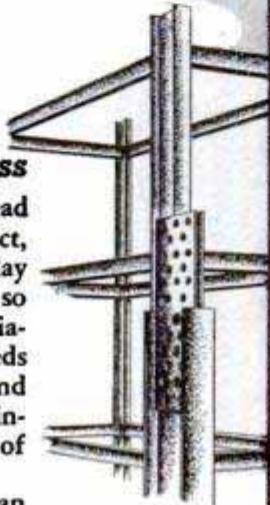

Dean of Enrollments - Dept. 99  
Embry-Riddle School of Aviation  
Miami 30, Florida

Please Print

NAME \_\_\_\_\_

ADDRESS \_\_\_\_\_

City \_\_\_\_\_

State \_\_\_\_\_ Age \_\_\_\_\_

I am interested in...

- A.&E. Mechanic
- Commercial Pilot
- Engineering
- A.&E. Combined with Commercial Pilot
- Flying Mechanic
- Drafting & Design

Check One  Veteran  Non-Veteran

TRAIN IN MIAMI—AIR CAPITAL OF THE WORLD

(Continued from page 6)

on the other hand—it's an alarm clock. Set it for the hour you want to be awakened and it will reset itself to ring at that hour every day until you shut it off. This ruins that "I forgot to set the alarm" alibi. But if you forget to turn it off on week ends, blame nobody but yourself.

\* \* \*

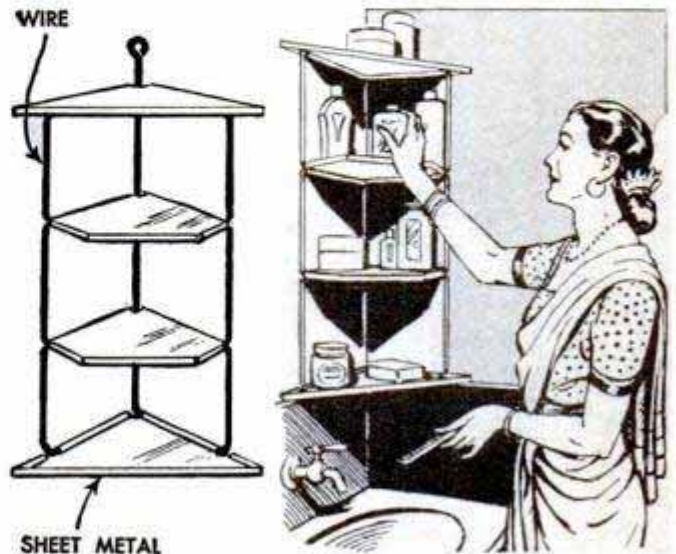

## Round-the-World Idea

To the Editor:

Please turn to page 195, April '47 issue of your esteemed magazine. We wonder how many Americans thanked P.M. for the idea . . . "Single-Board Bathroom Cabinet." But we have every reason to thank you sincerely . . . It struck us that a "corner cabinet" will be useful not only in a bathroom but in almost every room . . . The immediate result . . . was translation of this idea into a sheet-metal corner shelf . . .

It suited local city market best. But gradually when demands poured in from neighboring cities we began scratching our heads, the worst snag being the packing problem . . . We were already in possession of an Indian patent . . . for a novel method of manufacturing improved metal furniture by eliminating . . . bolts, nuts, rivets, screws or springs . . . The same method was applied to make the corner shelf portable . . .

Even though we have improved and adapted the information provided by you to suit our own needs . . . for the basic idea underlying all this development we heartily say "thank you" to *Popular Mechanics*. Now we leave it to you to make the best use of the information contained herein in your future issues.

Yours faithfully,  
Allied Engineering Industries,  
Bangalore 3,  
South India.

(Continued to page 10)

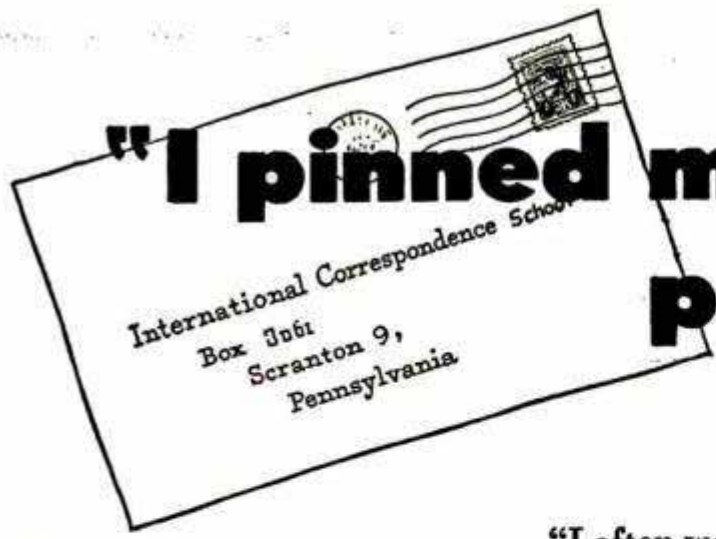

# "I pinned my hopes to a penny postal"

**JESSE K. KIMBALL**  
Chief Building Inspector, Washington, D. C.



"I often wonder what sort of job I'd have now if it were not for a penny postal and the International Correspondence Schools.

"Today I'm Chief Building Inspector for the District of Columbia. It's a good job and pays a good salary. Just recently, I got another \$600-a-year raise. I. C. S. instruction made it all possible."

THE coupon you mail today might very well start a chain reaction that could change your entire future. For it brings you information about successful careers and how to prepare for them. It puts you in touch with the world's largest educational institution. It starts you off the way hundreds of today's leaders in business and industry started. Why not mail it today?

## INTERNATIONAL CORRESPONDENCE SCHOOLS



BOX 5683-K, SCRANTON 9, PENNA.

Without cost or obligation, please send me full particulars about the course BEFORE which I have marked X:

- |   |   |   |  |
|---|---|---|--|
| <p><b>Air Conditioning and Plumbing Courses</b></p> <ul style="list-style-type: none"> <li><input type="checkbox"/> Air Conditioning</li> <li><input type="checkbox"/> Heating</li> <li><input type="checkbox"/> Refrigeration</li> <li><input type="checkbox"/> Plumbing</li> <li><input type="checkbox"/> Steam Fitting</li> </ul> <p><b>Chemical Courses</b></p> <ul style="list-style-type: none"> <li><input type="checkbox"/> Chemical Engineering</li> <li><input type="checkbox"/> Chemistry, Analytical</li> <li><input type="checkbox"/> Chemistry, Industrial</li> <li><input type="checkbox"/> Chemistry, Mfg. Iron &amp; Steel</li> <li><input type="checkbox"/> Petroleum Refining</li> <li><input type="checkbox"/> Plastics</li> <li><input type="checkbox"/> Pulp and Paper Making</li> </ul> <p><b>Civil Engineering, Architectural and Mining Courses</b></p> <ul style="list-style-type: none"> <li><input type="checkbox"/> Architecture</li> <li><input type="checkbox"/> Architectural Drafting</li> <li><input type="checkbox"/> Bridge and Building Foreman</li> <li><input type="checkbox"/> Building Estimating</li> <li><input type="checkbox"/> Civil Engineering</li> <li><input type="checkbox"/> Coal Mining</li> <li><input type="checkbox"/> Contracting and Building</li> <li><input type="checkbox"/> Highway Engineering</li> <li><input type="checkbox"/> Lumber Dealer</li> <li><input type="checkbox"/> Reading Structural Blueprints</li> <li><input type="checkbox"/> Sanitary Engineering</li> <li><input type="checkbox"/> Structural Drafting</li> </ul> | <ul style="list-style-type: none"> <li><input type="checkbox"/> Structural Engineering</li> <li><input type="checkbox"/> Surveying and Mapping</li> </ul> <p><b>Communications Courses</b></p> <ul style="list-style-type: none"> <li><input type="checkbox"/> Electronics</li> <li><input type="checkbox"/> Practical Telephony</li> <li><input type="checkbox"/> Radio, General</li> <li><input type="checkbox"/> Radio Operating</li> <li><input type="checkbox"/> Radio Servicing</li> <li><input type="checkbox"/> Television</li> <li><input type="checkbox"/> Telegraph Engineering</li> </ul> <p><b>Electrical Courses</b></p> <ul style="list-style-type: none"> <li><input type="checkbox"/> Electrical Drafting</li> <li><input type="checkbox"/> Electrical Engineering</li> <li><input type="checkbox"/> Electric Light and Power</li> <li><input type="checkbox"/> Lighting Technician</li> <li><input type="checkbox"/> Practical Electrician</li> </ul> <p><b>Internal Combustion Engines Courses</b></p> <ul style="list-style-type: none"> <li><input type="checkbox"/> Auto Technician</li> <li><input type="checkbox"/> Diesel-Electric</li> <li><input type="checkbox"/> Diesel Engines</li> <li><input type="checkbox"/> Gas Engines</li> <li><input type="checkbox"/> Aviation</li> </ul> <p><b>Mechanical Courses</b></p> <ul style="list-style-type: none"> <li><input type="checkbox"/> Aeronautical Engineer's, Jr.</li> <li><input type="checkbox"/> Aircraft Drafting</li> <li><input type="checkbox"/> Flight Engineer</li> <li><input type="checkbox"/> Forging</li> <li><input type="checkbox"/> Foundry Work</li> <li><input type="checkbox"/> Heat Treatment of Metals</li> <li><input type="checkbox"/> Industrial Engineering</li> <li><input type="checkbox"/> Industrial Instrumentation</li> </ul> | <ul style="list-style-type: none"> <li><input type="checkbox"/> Industrial Metallurgy</li> <li><input type="checkbox"/> Machine Shop</li> <li><input type="checkbox"/> Mech. Drafting</li> <li><input type="checkbox"/> Mechanical Engineering</li> <li><input type="checkbox"/> Mold-Loft Work</li> <li><input type="checkbox"/> Patternmaking—Wood, Metal</li> <li><input type="checkbox"/> Reading Shop Blueprints</li> <li><input type="checkbox"/> Sheet-Metal Drafting</li> <li><input type="checkbox"/> Sheet-Metal Worker</li> <li><input type="checkbox"/> Ship Drafting</li> <li><input type="checkbox"/> Ship Fitting</li> <li><input type="checkbox"/> Tool Designing</li> <li><input type="checkbox"/> Toolmaking</li> <li><input type="checkbox"/> Welding Engineering</li> <li><input type="checkbox"/> Welding—Gas and Electric</li> </ul> <p><b>Railroad Courses</b></p> <ul style="list-style-type: none"> <li><input type="checkbox"/> Air Brake</li> <li><input type="checkbox"/> Car Inspector</li> <li><input type="checkbox"/> Diesel Locomotive</li> <li><input type="checkbox"/> Locomotive Engineer</li> <li><input type="checkbox"/> Locomotive Fireman</li> <li><input type="checkbox"/> Locomotive Machinist</li> <li><input type="checkbox"/> Railroad Section Foreman</li> <li><input type="checkbox"/> Steam-Diesel Loco. Eng.</li> </ul> <p><b>Stationary Eng'r's Courses</b></p> <ul style="list-style-type: none"> <li><input type="checkbox"/> Boilermaking</li> <li><input type="checkbox"/> Combustion Engineering</li> <li><input type="checkbox"/> Engine Running</li> <li><input type="checkbox"/> Marine Engineering</li> <li><input type="checkbox"/> Power Plant Eng'r's</li> <li><input type="checkbox"/> Steam Engr.</li> </ul> | <p><b>Textile Courses</b></p> <ul style="list-style-type: none"> <li><input type="checkbox"/> Cotton Manufacturing</li> <li><input type="checkbox"/> Loom Fixing</li> <li><input type="checkbox"/> Rayon Weaving</li> <li><input type="checkbox"/> Textile Designing</li> <li><input type="checkbox"/> Woolen Manufacturing</li> </ul> <p><b>Business and Academic Courses</b></p> <ul style="list-style-type: none"> <li><input type="checkbox"/> Accounting</li> <li><input type="checkbox"/> Advertising</li> <li><input type="checkbox"/> App. Psychology</li> <li><input type="checkbox"/> Bookkeeping</li> <li><input type="checkbox"/> Business Administration</li> <li><input type="checkbox"/> Bus. Management</li> <li><input type="checkbox"/> Bus. Correspondence</li> <li><input type="checkbox"/> Bus. Law</li> <li><input type="checkbox"/> Certified Public Accounting</li> <li><input type="checkbox"/> Commercial Art</li> <li><input type="checkbox"/> Commercial</li> <li><input type="checkbox"/> Cost Accounting</li> <li><input type="checkbox"/> Federal Tax</li> <li><input type="checkbox"/> First Year College</li> <li><input type="checkbox"/> Foremanship</li> <li><input type="checkbox"/> French</li> <li><input type="checkbox"/> Good English</li> <li><input type="checkbox"/> High School</li> <li><input type="checkbox"/> Higher Mathematics</li> <li><input type="checkbox"/> Illustration</li> <li><input type="checkbox"/> Industrial Supervision</li> <li><input type="checkbox"/> Motor Traffic</li> <li><input type="checkbox"/> Postal Civil Service</li> <li><input type="checkbox"/> Retailing</li> <li><input type="checkbox"/> Retail Bus. Management</li> <li><input type="checkbox"/> Salesmanship</li> <li><input type="checkbox"/> Secretarial</li> <li><input type="checkbox"/> Sign Lettering</li> <li><input type="checkbox"/> Spanish</li> <li><input type="checkbox"/> Stenography</li> <li><input type="checkbox"/> Traffic Management</li> </ul> |
|---|---|---|--|

Name \_\_\_\_\_ Age \_\_\_\_\_ Home Address \_\_\_\_\_

City \_\_\_\_\_ State \_\_\_\_\_ Working Hours \_\_\_\_\_ A.M. to \_\_\_\_\_ P.M.

Present Position \_\_\_\_\_ Employed by \_\_\_\_\_

Length of Service in World War II \_\_\_\_\_ Enrollment under G.I. Bill approved for World War II Veterans. Special tuition rates to members of the Armed Forces. Canadian residents send coupon to International Correspondence Schools Canadian, Ltd., Montreal, Canada.

# Let us send you this book of PROFESSIONAL SHORT CUTS IN HOME BUILDING, REMODELING AND REPAIR for FREE 5-day trial

If you're handy with tools, like to save money, enjoy doing home carpentry and "fix-up" jobs yourself, here are professional *job simplifiers* and *speed ups* that save time and money.

"Practical Job Pointers" wasn't written by one man, but by hundreds of highly skilled contractors, job superintendents, shop foremen, journeymen carpenters, cabinet makers and others—who share with you their pet "pointers", "short cuts" and private "trade secrets."

These tried-and-proven *job simplifiers* and *speed ups*, selected as prize winners from thousands of contributions for originality, practicality and usefulness are an education in themselves for any man who works with tools.

**OVER 800 BETTER WAYS TO DO IT—OVER 700 PICTURES AND DIAGRAMS**

This big 211 page book gives you over 800 of these useful job pointers with over 700 easy-to-follow illustrations and diagrams. Whether you're building a house or a china closet . . . repairing a roof or putting a new handle in a tool . . . flashing a chimney or laying linoleum . . . making a septic tank grease trap or planing a warped board . . . YOU'LL WANT THIS BOOK!

You'll find pointers and short-cuts not only for the big jobs but for countless little jobs that are always turning up, such as: How to paint the inside of a downspout—How to remove oil and grease from cement—How to fit a window casing to a wall that's out of plumb—How to repair and caulk steel windows—How to level up an oil stone—How to cut circles with a table saw—How to stop drips from cold water pipes—How to sharpen a hollow chisel—How to replace broken asbestos shingles—How to raise a sagging beam without a jack—How to repair a sunken floor board without ripping up the floor. And these are only a sample. Remember there are over 800 such time-saving ideas that give you the know-how of the expert. All indexed so the one you need can be located instantly.

**SEND NO MONEY  
Examine 5 Days FREE**

Just fill in and mail coupons below to get your copy of "Practical Job Pointers" for 5 DAYS FREE TRIAL. If not fully satisfied, return the book and owe nothing. If you keep it, send only \$3.98 plus few cents postage in full payment. You take no risk. Mail coupon below, now.



### THIS BOOK BRINGS YOU:

88 handy and unusual ways to use tools; 37 novel ideas for work benches and attachments; 39 suggestions on excavations, foundations and forms; 49 short cuts on exterior and interior wall construction; 19 tips on making cornices and porches; 54 ideas for interior wall covering and trim; 27 pointers on stair construction; 37 window suggestions; 54 ideas for installing doors; 29 pointers on closets, shelves and built-in equipment; 24 flooring pointers; 35 aids in installing sanitary equipment; 44 short cuts in laying out work, etc., etc., etc.

**FREE TRIAL COUPON** MAIL TODAY

Simmons-Boardman Publishing Corp., PM-950  
30 Church Street, New York 7, N. Y.

Send me for 5 DAYS FREE TRIAL, "Practical Job Pointers". I will either return it in 5 days and owe nothing, or send only \$3.98, plus few cents postage, in full payment.

Name \_\_\_\_\_

Address \_\_\_\_\_

City \_\_\_\_\_ State \_\_\_\_\_

Employed by \_\_\_\_\_

### Letter to the Editor:

Not often does *Popular Mechanics* make a blunder, but here is one for the book. Page 143, July 1950 issue, "Siamese Twins" bulldozer: "Two tractors hitched in tandem . . . made by joining two conventional Caterpillar tractors *side by side*." If they are "tandem" hitched, they just can't be "side by side," or if they can, please show us how!

Cordially,  
G. A. Lechliter, D.D.,  
South Florida Baptist Hospital,  
Plant City, Fla.

We've ordered another dictionary for one of the editors.

\* \* \*

### Knothole for a Gnat

Department of Defense officials, who normally point with pride to the development of bigger bazookas or more titanic tanks, announce a recent accomplishment—a hole. Believed to be the smallest ever drilled in a piece of metal, it is only 60/100,000 inch in diameter, about the size of the thinnest invisible strand of silk spun by a spider. It can't be seen without the aid of a high-powered microscope. The hole, drilled through a piece of platinum with a standard jeweler's lathe, will be an essential part of the hydraulic system of one of the Navy's new weapons.

\* \* \*

### It's a Rough Trip to the Moon

Volunteers for rocket trips to the moon had better have seasickness pills ready, according to Dr. William Kellogg of the University of California at Los Angeles. Just finishing a study of upper-air atmosphere, he reports an area 50 to 60 miles above the earth with storms that dwarf the most violent Atlantic hurricanes or Pacific typhoons. The winds sometimes reach velocities of 600 miles an hour. Doctor Kellogg believes the high turbulence results from the rapid exchange of heat between a layer of atmosphere that absorbs large amounts of ultraviolet radiation from the sun and a cooler layer just above it.

\* \* \*

### Children of the Dawn

In China two years ago scientists discovered seedlings of the Dawn Redwood, previously believed to be extinct for millions of years. They planted 66 of the seedlings in Alaska. Latest report: 46 of the little fellows are known to be alive and may flourish into forest giants that would make their age-old forefathers proud.

# WHAT **AUTO** MECHANIC Every Wants to Know

A motor vehicle is a machine of many parts, each part designed and constructed for its own special function. All good mechanics, like good doctors, should know the working theory and operation of each part and understand what causes trouble and how to remedy it.

## LET AUDELS AUTO GUIDE SOLVE YOUR PROBLEMS

Every auto mechanic, helper, serviceman and operator can use AUDELS AUTO GUIDE. The information it gives saves time, money and worry. Highly endorsed by all users. It presents the whole subject of auto mechanics from A to Z in plain language and simple terms.

This Big Practical Book gives full information with working diagrams covering the principles, construction, ignition, service and repair of modern cars, trucks and buses.

A complete Guide of 1800 pages, with over 1500 illustrations showing inside views of the working parts, with instructions for service jobs. Diesel engines, Fluid and Hydra-matic drives fully explained.

## IT PAYS TO KNOW HOW TO

How to fit pistons—How to locate engine knocks—How to fit connecting rod bearings—How to service main bearings—How to recondition valves—How to time valves—How to adjust fan belts—How to adjust carburetors & chokes—How to rebuild a clutch—How to service automatic transmissions—How to service brakes—How to adjust steering gear—How to cope with ignition troubles—How to service distributors—How to time ignition—How to "tune up" an engine.

## INFORMATION IN A HANDY FORM

73 INTERESTING CHAPTERS—Read this partial list of subjects on which practical information is fully given for quick reference under the headings as shown below. Ready Reference Index.

All Parts of an Automobile—Automotive Physics—The Gas Engine—Gas Engine Principles—Multi-Cylinder Engines—Horse Power—Automobile Engines—Stationary Parts—Moving Parts—Pistons—Piston Rings—Connecting Rods—Crank Shafts—Valves—Valve Gear—Cams and Cam Action—Valve Timing—Cooling Systems—Fuel Feed Systems—Dual Fuel Feed—Mixture—Carburetors—Carburetor Service—Automatic Choke—Super-Chargers—Transmissions—Special Transmissions—Fluid and Hydra-matic Drives—Clutches—Universals and Propeller Shafts

A Ready Reference

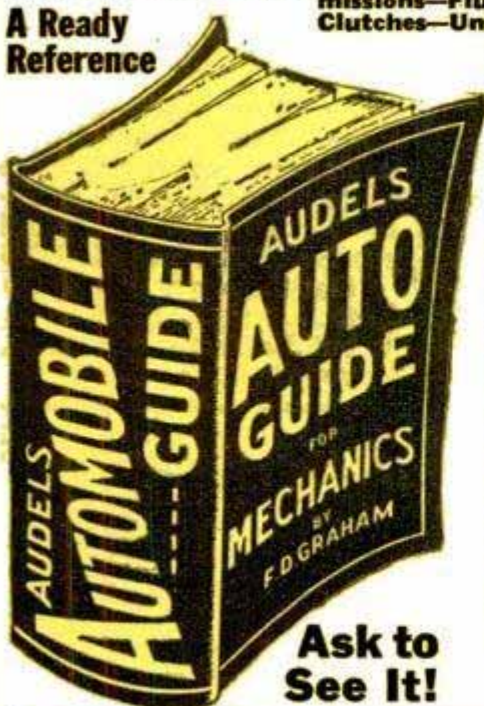

Ask to See It!

—The Differential—Rear Axles—Rear and Front Suspension—Running Gear—Brakes—Wheel Alignment—Knee Action—Steering Gear—Tires—Lubricants and Lubrication—Automotive Electricity—Ignition Systems—Magneto Ignition—Spark Plugs—Ignition Coils—Distributors—Automatic Spark Control—Ignition Timing—Generators—Starters—Generator and Starter Testing—Lighting Systems—Storage Batteries—Charging and Testing—Diesel Engines and Trouble Shooting.

**7 DAYS' FREE TRIAL**  
TO GET THIS ASSISTANCE FOR YOURSELF SIMPLY FILL IN AND MAIL COUPON TODAY.

**\$4 COMPLETE PAY \$1 A ONLY 1 MO.**



## Sent on 7 Days Approval

Step up your own skill with the facts and figures of your trade. Audels Mechanics Guides contain Practical Inside Trade Information in a handy form. Fully illustrated and Easy to Understand. Highly Endorsed. Check the book you want for 7 DAYS FREE EXAMINATION. Send No Money. Nothing to pay postman.

## CUT HERE MAIL ORDER

AUDEL, Publishers, 49 W. 23 St., NEW YORK 10, N. Y.

Please send me postpaid for FREE EXAMINATION books marked (X) below, if I decide to keep them I agree to mail \$1 in 7 Days on each book or set ordered and further mail \$1 monthly on each book or set until I have paid price, otherwise I will return them.

- AUTO GUIDE**, 1800 Pages . . . \$4
- DIESEL ENGINE MANUAL, 400 Pages . . . 2
- WELDERS GUIDE, 400 Pages . . . 1
- MACHINISTS Handy Book, 1600 Pages . . . 4
- POWER PLANT ENGINEERS Guide, 1500 Pages. 4
- ENGINEERS & FIREMANS EXAMS, 528 Pages. 1
- PUMPS, Hydraulics & Air Compressors, 1658 Pgs. 4
- MARINE ENGINEERS Handy Book, 1280 Pages 4
- ENGINEERS & Mechanics Guides (8 Book Set). 12
- Answers on Practical ENGINEERING, 254 Pages 1
- ELECTRIC WIRING DIAGRAMS, 210 Pages . . . 1
- ELECTRICIANS EXAMINATIONS, 250 Pages. 1
- ELECTRICAL DICTIONARY, 9000 Terms . . . 2
- ELECTRIC MOTOR GUIDE, 1000 Pages . . . 4
- HANDY BOOK OF ELECTRICITY, 1440 Pages 4
- ELECTRICAL POWER CALCULATIONS, 425 Pgs. 2
- RADIOMANS GUIDE, 914 Pages . . . 4
- ELECTRONIC DEVICES, 216 Pages . . . 2
- ELECTRIC LIBRARY, 7000 Pages (12 Book Set). 18
- Vois. I, II, III, IV, V, VI, VII, VIII, IX, X, XI, XII \$1.50 Ea.
- OIL BURNER GUIDE, 384 Pages . . . 1
- HOUSE HEATING GUIDE, 1000 Pages . . . 4
- CARPENTERS & Builders Guides (4 Book Set). 6
- PLUMBERS & Steamfitters Guides (4 Book Set). 6
- MASONS & Builders Guides (4 Book Set) . . . 6
- BLUE PRINT READING, 416 Pages . . . 2
- PAINTERS & DECORATORS MANUAL, 450 Pgs. 2
- GARDENERS & GROWERS Guides (4 Book Set). 6
- REFRIGERATION & Air Conditioning, 1280 Pgs. 4
- SHEET METAL WORKERS Handy Book, 388 Pgs. 1
- SHEET METAL PATTERN LAYOUTS, 1100 Pgs. 4
- AIRCRAFT WORKER, 240 Pages . . . 1
- MECHANICAL DRAWING GUIDE, 160 Pages. 1
- MECHANICAL DRAWING & DESIGN, 480 Pgs. 2
- MATHEMATICS & CALCULATIONS, 700 Pgs.. 2
- MECHANICAL Dictionary, 968 Pages . . . 4
- MILLWRIGHTS & Mechanics Guide, 1200 Pgs. 4

Name \_\_\_\_\_  
Address \_\_\_\_\_  
Occupation \_\_\_\_\_  
Employed by \_\_\_\_\_ 42

AUDEL, Publishers, 49 W. 23 St., New York 10, N. Y.

## I Trained These Men



**E. J. STREITBERGER**, New Boston, O., says, "After completing a six-week course, I made a week fixing sets in my spare time. Now set Television sets."



**PHILLIP G. K.**, Louisville 8, Ky., says, "I have been operating a Servicing business for 14 years I did \$14,000 business; net profit \$1,000."



**S. W. DINWIDDIE**, Chicago, Ill., writes, "After finishing course, I opened a servicing shop. Now I am Engineer of WCUN Police Radio Installation."



**A. HERR**, New Castle, Pa., writes, "I have doubled my salary since starting in Radio full time. Am employed by Station WKBO as transmitter operator. Future looks bright to me."



**L. HAUGER**, San Bruno, Calif., tells us, "I accepted a position as Radio and Television Technician. I was promoted to manager of Television Service and Installation."



**LEANDER ARNOLD**, Pontiac, Mich., says, "While learning, made \$5 to \$10 a week repairing Radios in my spare time. Now I have a spare time shop in my home."



**NORMAN H. WARD**, Ridgefield Park, N. J., writes, "4 years ago, I was a bookkeeper with a hand-to-mouth salary. Now I am employed by a key ABC station."



**H. B. MILLS**, Washington, Ohio, finds, "Word traveled fast in regard to my N.R.I. training. Have been doing Television installation and servicing, tracing out and eliminating interference, etc."



**C. STAETH**, Fort Madison, Iowa, informs us, "Do Radio Servicing full time in my own shop and am making more money than ever before. I owe this to N.R.I."



**T. S. NORTON**, Hamilton, Ohio, says, "My first job was obtained for me by your Graduate Service Department. Am now Chief Engineer, Station WQOX."



**W. R. NICHOLSON**, writes from Chicago, "I am in control of a Radio Servicing business."

# I'll Train You RADIO-

## PRACTICE SERVICING OR COMMUNICATIONS with Radio Kits I Send

For both my Servicing Course and my NEW Communications Course, I send you many Valuable Kits of Parts for PRACTICAL EXPERIENCE. They "bring to life" theory you learn in my illustrated texts. Some equipment from both courses is shown below. As part of my Servicing Course, you build a complete, powerful Radio Receiver, a Set Tester useful in earning extra spare time money, an A. M. and F. M. Signal Generator, etc. In my Communications Course, you assemble a low-power Broadcasting Transmitter that shows how to put a station "on the air," a Wavemeter, an Electronic Multitester for measuring voltage, current, resistance, impedance, etc. This and other equipment you build with Kits I send is yours to keep.

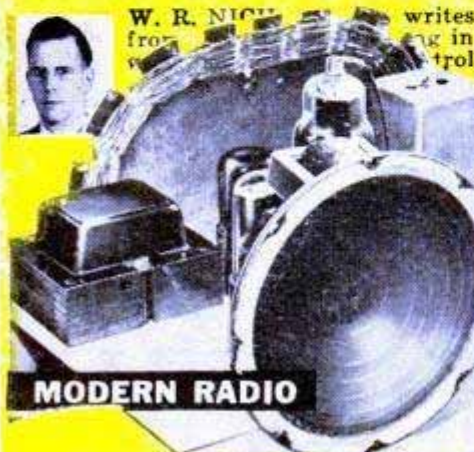

## Make Extra Money in Spare Time While Learning

Many of my students earn money fixing neighbors' Radios in their spare time while learning, often average \$5, \$10 a week. I send you SPECIAL BOOKLETS that show you how to do it... and I send parts to build a Tester that helps you do it.



# AT HOME for Good Jobs in TELEVISION

## There is Success--Good Pay--Security for You in America's Fast Growing Industry

### VETERANS HURRY!

To get this valuable training under G. I. Bill. Time is running out. **Mail Coupon NOW!**

### Want Your Own Business?

Many N.R.I. trained men operate successful Radio-Television sales and service businesses. Let me show you how, starting with spare time earnings as their capital, they build good incomes from their own shops.

Do you want good pay, a bright future, and security? Want your own profitable shop? Get into fast growing, prosperous **RADIO-TELEVISION!** Radio alone is bigger than ever. 81 million home and auto Radios, 2,700 Broadcasting Stations, expanding Aviation and Police Radio, Micro-Wave Relay, Two-Way Radio are making opportunities for Servicing and Communications Technicians and FCC-Licensed Operators.

#### Television is TODAY'S Good Job Maker

In 1949, almost 3,000,000 TV sets sold. By 1954, 20,000,000 TV sets estimated. 100 TV Stations now operating. Authorities predict 1,000 TV Stations. This means more jobs, good pay for qualified men all over United States and Canada.

#### No Previous Experience Needed

Keep your job while training. Hundreds of successful **RADIO-TELEVISION TECHNICIANS** I trained had no previous experience, some only a grammar school education. Learn Radio-Television principles from illustrated lessons. Get **PRACTICAL EXPERIENCE**. See on the opposite page some of the devices my students build from Kits of Parts I furnish; also practice servicing Radios or operating transmitter

... experiment with circuits common to Radio and Television. Many of my students make \$5, \$10 a week extra fixing neighbors' Radios in spare time while training. Many start their own profitable Radio-Television sales and service business, using these earnings as capital.

**Send Now for 2 Books FREE -- Mail Coupon**

Send now for my **FREE DOUBLE OFFER**. You get actual Servicing lesson to show how you learn at home. Also my 64-page book, "How to Be A Success in Radio-Television." Read what my graduates are doing, earning; see equipment you practice with at home. Send coupon in envelope or paste on postal. **J. E. SMITH, President, Dept. OJP, National Radio Institute, Washington 9, D. C. OUR 37th YEAR.**

## Actual Lesson and 64 page Book BOTH FREE

The ABC's of SERVICING

### Mail Coupon Now!

**MR. J. E. SMITH, President, Dept. OJP National Radio Institute, Washington 9, D. C.**

Mail me Sample Lesson and 64-page Book, "How to Win Success in Radio-Television"—both **FREE**. (No salesman will call. Please write plainly.)

NAME.....AGE.....

ADDRESS.....

CITY.....ZONE.....STATE.....

Check if Veteran  Approved Under G. I. Bill

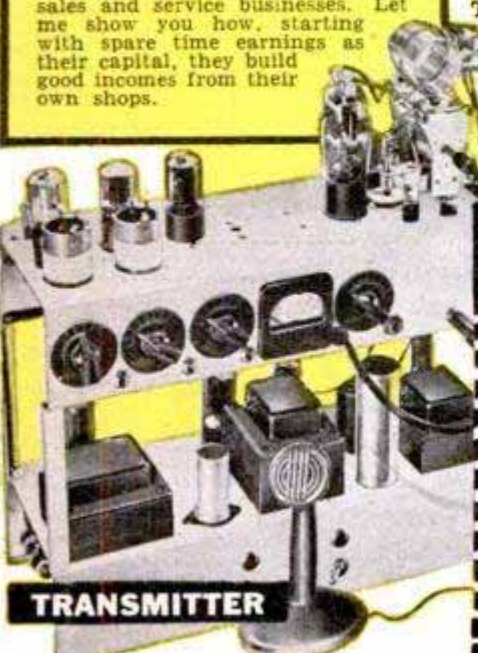
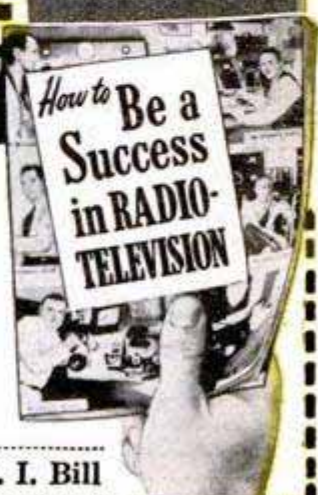

**TRANSMITTER**

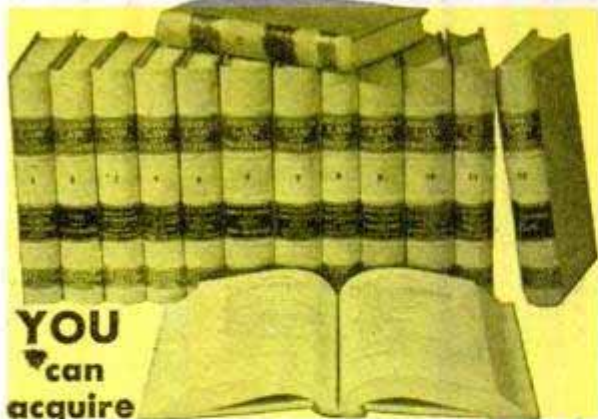

YOU  
can  
acquire

## LAW NIGHTS AT HOME! L. B. DEGREE

LaSalle's famous Law Library—used as reference in many Law libraries and Law offices—has enabled thousands to master Law surprisingly fast, in spare hours at home, for business and professional advancement.

These 14 remarkable volumes, compiled by leading professors and lawyers, cover the whole basic field of Law in condensed, orderly, simplified manner.

You advance rapidly with this great library, plus special lectures furnished. We guide you step-by-step with personalized Problem Method of instruction . . . you *learn by doing*—handling legal problems—not by memorizing rules.

Send for two FREE 48-page booklets, "Law Training for Leadership," and "Evidence," answering questions about Law and its value to you, and telling how LaSalle Law graduates are winning rapid advancement in business and public life. Mail coupon below. No obligation.

### LA SALLE EXTENSION UNIVERSITY

A Correspondence Institution

417 S. Dearborn St., Dept. 944-L, Chicago 5, Ill.

Send me your two FREE booklets described above without obligation.

Name.....Age.....

Street.....

City, Zone & State.....

## ENGINEERING DEGREE IN 27 MONTHS

### Big Demand for Graduates

Aeronautical, Chemical, Civil, Electrical, Mechanical and Radio Engineering (including Television)

Hundreds of young men are earning engineering degrees in this recognized institution each year—continuous operation. New terms start quarterly. Many students earn a major part of their college expenses in this large industrial center.

Low tuition. Competent instruction. Thorough, intense, practical program. Modern laboratory facilities including new physics lab. and modernized wind tunnel. Individualized instruction emphasized.

Approved for Veterans. Engineering preparatory courses. Students from 48 states and 21 foreign countries. Enter September, December, March or June. Send coupon for free catalog and full information. Enroll now.

SEND COUPON TODAY

## INDIANA TECHNICAL COLLEGE

590 E. Washington Boulevard  
Fort Wayne 2, Indiana

Please send me free information on B.S. Engineering Degree in 27 months as checked.

Aeronautical,  Chemical,  Civil,  Electrical,  
 Mechanical,  Radio-Television.

Name.....

Address.....

## WHERE-TO-BUY-IT INDEX

Source of supply appears after items commercially available

### AUTOMOTIVE

British car has built-in jacks (Ford Motor Co., Ltd., Dagenham, Essex, England).....	79
Car screen (Mocar Products Co., Box 2375, Dearborn, Mich.).....	82
Quick wheel fastener.....	83
Detroit listening post.....	93
Protector for truck-tire fixer (Ralph E. Titus, 7111 E. Lawn Drive, Cincinnati, Ohio).....	111
Gasoline injector for cars (Seaport Corp., 1821 Egbert, San Francisco 24, Calif.).....	129
Desk for drivers (Travis W. Kendall, Greenup, Ky.).....	143
Tip to Moscow: You can do it better with gasoline.....	143

### AVIATION

Drone plane lays wire.....	96
Explosion to high altitude.....	108
Midget autopilot light enough for fighters (Marvin Ruffin, Lear, Inc., 110 Ionia Ave., N.W., Grand Rapids 2, Mich.).....	112
Italian helicopter.....	129
Fastest plane increases power.....	142
Bomber carries spare engines (Consolidated-Vultee Aircraft Corp., Ft. Worth, Tex.).....	146
Steep-climbing "air horse" for farmers (Piper Aircraft Corp., Lock Haven, Pa.).....	156

### BOATS

"Big Mo"—sample size.....	103
Glass-bottom pedal boat.....	119
Keel beams cut 97 feet long.....	131
Householder's ark.....	156

### FARM AND GARDEN

Foot-operated grass catcher (Burbank Wire & Metal Mfg. Co., 229 W. Orange Grove Ave., Burbank, Calif.).....	111
Timer for sprinklers (Technical Services, 750 Station M., Pasadena 19, Calif.).....	124
Spreader-sprinkler (Misch Mfg. Co., 317 Capital Ave., Mishawaka, Ind.).....	124
Bodyless wheelbarrow (Bathey Mfg. Co., 100 S. Mill St., Plymouth, Mich.).....	147
Rosier cheeks for apples.....	147
Berry farmers sit down at work (Mov-n-Bench Mfg. Co., Kenmore, Wash.).....	152

### HOUSE AND HOME

Self-honing shears (Marvel Shear Corp., 4811 S.E. Powell Blvd., Portland, Ore.).....	79
Container slices, serves and stores cheese (Kenneth E. Luger Co., 3017 S. Lyndale Ave., Minneapolis 8, Minn.).....	80
Two-piece "kitchen" (Ideal Steel Products, Inc., 666 Lake Shore Drive, Chicago 11).....	80
Carpets dyed at home (T. R. Conway & Co., 55 E. Washington St., Chicago 2).....	80
Candles with wax refills (Robert K. Hartman, 5857 W. Third St., Los Angeles 36, Calif.).....	80
Tub sealer (Keller Products, Inc., 7039 Superior Ave., Cleveland 3, Ohio).....	80
Removable card-table top (The Tuco Work Shops, Inc., Lockport, N. Y.).....	81
Spout cover for screw-top jars (Kaye Plastics Co., New Brunswick, N. J.).....	81
Shallow-well pump (Fadden Pump Co., 740 N. Washington Ave., Minneapolis 15, Minn.).....	81
Dry defroster (The Marion Glass Mfg. Co., Marion, Ohio).....	81
Spud baker (William Hungate, 5207 Harrisburg Blvd., Houston 11, Tex.).....	81
Oil-and-coal furnace (R. L. Peters, 420 8th Avenue, South, St. Cloud, Minn.).....	110
Swedish prefabs keep workers comfortable on the job.....	120
Tile-laying kit (David E. Kennedy, Inc., 58 2nd Ave., Brooklyn 15, N. Y.).....	142

### INDUSTRY

"Sardine" pack for car bodies doubles flat-car capacity (Kaiser-Frazer Corp., Willow Run, Mich.).....	88
Powerful betatron for atom research.....	107
Freight car hits the road.....	110
Earth-and-metal alloys may solve jet-engine problem.....	120
Angledozer (Peterson Equipment Co., San Leandro, Calif.).....	131
Gears made of plastic outlast steel in test.....	139
Vibration detector.....	143
Push-button coalyard.....	144
Carbon dioxide injected into mine kills stubborn coal fire.....	152

### MODELS, NOVELTIES AND TOYS

Miniature motorcycle.....	88
Wheel converts trike to bike.....	124
Art is a shell game to this artist.....	130

### OUTDOOR RECREATION

Ski-bob.....	87
Golf aid controls swing (Groovemaster, 3333 N.W. North River Drive, Miami, Fla.).....	97
Plug records water depth (Bornemann Products Co., 929 S. 5th St., Aurora, Ill.).....	111
Lightweight waders worn inside shoes (Seal-Dri Sports-wear Co., 2514 Kilburn Ave., Rockford, Ill.).....	112
Robot booter tests soccer goalies.....	113
Practice "guard" simulates game conditions.....	113

### PHOTOGRAPHY

Battery-capacitor flash gun (Busch Precision Camera Corp., 411 S. Sangamon St., Chicago 7).....	112
Movie projector helps grid coach (Eastman Kodak Co., Rochester 4, N. Y.).....	119

(Continued to page 16)



# INVENTORS

**L**earn how to protect your invention. The U. S. Patent Laws provide that any new and useful art, machine, article of manufacture, or composition of matter, or any new and useful improvement thereof, may be patented if the act of invention is involved. Therefore, every inventor with a valuable invention should take advantage of the Patent Laws and proceed for patent protection in order to safeguard his rights.

A patent gives the inventor the exclusive right to prevent others from making, using, or selling the invention claimed in the patent for a period of seventeen years.

The Patent Laws were enacted for the benefit of the inventor to give him protection for the features of his invention which are patentable. These features must be properly and concisely set forth and claimed in a formal application for patent, in order to comply with the requirements of the Patent Laws. For that reason, unless the inventor is familiar with patent matters, he should engage a competent registered patent attorney or agent to represent him. We are registered to practice before the U. S. Patent Office and are prepared to serve you in the handling of your patent matters.

A specially prepared booklet entitled "Patent Guide for the Inventor", containing detailed information with respect to patent protection and procedure, together with a "Record of Invention" form will be promptly forwarded to you without obligation upon request.

---

**CLARENCE A. O'BRIEN & HARVEY JACOBSON**

*Registered Patent Attorneys*

**01-J DISTRICT NATIONAL BUILDING**

**WASHINGTON 5, D. C.**

# Become an ELECTRICAL ENGINEER

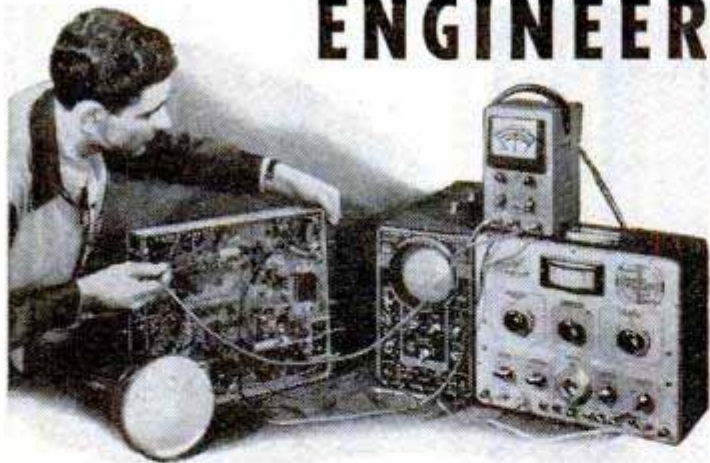

## Major in Electronics or Power ... B. S. Degree in 36 Months

Important advantages are yours at this nonprofit Technical Institute and College. A valuable year is saved by gaining your B. S. degree in 36 months of continuous study. You get both practical, specialized training in well-equipped laboratories—and a solid education in Electrical Engineering and related arts.

Choose the Course  
That Interests You Most

### SERVICE

6 to 12 months

- Electricity
- Welding
- Refrigeration
- Heating

### TECHNICIAN

12 to 24 months

- Radio and Television
- Electronics
- Electrotechnics (Power)
- Refrigeration, Heating, Air Conditioning

### PROFESSIONAL

36 months

- Electrical Engineering — B.S. Degree Major in Electronics or Electrical Power

## A Radio-Television Technician's Certificate can be yours in 18 months

Technicians are needed throughout this fastest-growing of America's industries. All technician courses are credited toward the B. S. degree.

Practical, military or academic training will be evaluated for advanced credit.

Faculty of 85 specialists. Over 1500 currently enrolled. 35,000 former students.

## MILWAUKEE SCHOOL of ENGINEERING

Technical Institute • College of Electrical Engineering

Terms open Oct., Jan.,  
April, July

Write for free catalog  
and 44-page pictorial  
booklet, "Your Career"



MILWAUKEE SCHOOL OF ENGINEERING  
Dept. PM-950, N. Broadway & E. State, Milwaukee, Wis.

Without obligation send catalog and "Your Career" bulletin plus details on course in \_\_\_\_\_

NAME \_\_\_\_\_ AGE \_\_\_\_\_

ADDRESS \_\_\_\_\_

CITY \_\_\_\_\_ ZONE \_\_\_\_\_ STATE \_\_\_\_\_

Check if World War II Veteran

(Continued from page 14)

Plastic base on photo film (Du Pont Co., Wilmington 98, Del.)	124
Three-in-one photo accessory (Utilitron, Inc., 30 Church St., New York City 7)	129
Lens holder for close-ups (Hollywood Cine Products, Lakeland Village, Elsinore, Calif.)	130

### TELEVISION

TV for deep-sea divers	79
Prisms for color TV	82
Three's no crowd in TV filming	97

### MISCELLANEOUS

Automatic anesthesia	18
Pneumatic stamp mill designed for prospectors (Beam Smelters, 10535 Buford Ave., Inglewood, Calif.)	82
Magnetless atom smasher	83
Aquarium in submarine takes fish for ride	85
Portable black-light source	87
Motor bike fits in back pack	87
Training leash "spanks" dog when he fails to obey orders (Tut, Inc., Dept. 36, Auburn, N. Y.)	88
Magnet flips pages for violinist	103
Dreaded quicksand debunked in tests	103
More potent fly killer	107
Newest and heaviest element is californium	113
Loop the looper	121
Sifting the story of an ancient race	122
Midget typewriter	130
Knockout punch (Blackhawk Mfg. Co., Milwaukee 1, Wis.)	139
Swinging lamp exposes film to photograph sound waves (Bell Telephone Laboratories, 463 West St., New York City 14)	139
When the earth shakes—you're safer in your car	140
Mechanical "thinking turtles"	146
Store's information booth has an electronic "clerk" (Electronic Engineering Co., 362 W. Bowery St., Akron 7, Ohio)	147
Rolling truck doors (Normand Ltd., Cumberland Ave., Park Royal, London, N.W. 10, England)	147
Part-time traffic cop	152
Prefab aluminum garage (Lennox Furnace Co., Marshalltown, Iowa)	153
Painting in three dimensions	154
Record cleaner dissipates static (Minnesota Electronics Corp., 97 E. 5th St., St. Paul 1, Minn.)	242

## Craftsman and Shop Notes Index

### AUTOMOTIVE

Rope expands car-trunk gasket to renew watertight seal	166
Convenient key and license holder from small fountain pen	168
Mirror mounted on garage door affords view of driveway	169
Matching upholstery on car door	209

### FARM

Foot scraper utilizing pipe lengths has handhold for better support	186
Novel flag arm on mailbox trips when lid is opened	192
Slat sides of turkey feeder adjusted to suit birds	203
Board wedged between wheels to block tractor for belt work	208

### FISH AND FISHING

Loop tied at end of fishline facilitates attaching leader	168
Fish-pole holder of bent wire is set up quickly	172
Separating fishing-rod ferrules without damage	184

### HOUSE AND HOME

Polishing door-chime plunger increases volume	165
"Baby proof" lock for cabinet safeguards inquisitive child	166
Storing croquet wickets facilitated by garden-hose section	166
Indoor drying rack for baby clothes suspended over heater or register	168
Glove finger tips mended quickly	169
Sandpaper sharpens scissors	170
Storing yarn remnants safely	170
Wax paper restores stiffness to dressmaker's tape	170
Slip covers held in place with sponge-rubber pads	170
Foil aids in growing African violets	170
Kitchen ventilation without drafts	171
Paper sack catches excess oil from fan	171
Replacing clothesline on high pulleys	171
Toothpicks locate nail holes when repapering walls	171
Garments steamed over bathtub	175
Magnetic toothbrush rack sticks to metal door	176
Multiple clothes-hanger rack conserves closet space	181
Seating your TV audience	187

### MODELS, NOVELTIES AND TOYS

Model-railroad water tank	167
Miniature clockcase	176
Speed of battery-operated toys controlled by high-low circuit	181
Intriguing fruit bowl	182
Two shelves or one	185

### OFFICE, SHOP AND STORE

Paper plate tacked to shop wall provides sanding-disk holder	165
Motor-oil cans form parts rack	165
Extension on hand truck permits carrying skids	208
Opening in floor near store window affords view of basement display	218

(Continued to page 18)

**IMPORTANT NOTICE**—It is the intention of this magazine to provide its readers with information regarding the latest developments in the mechanical arts. We take no responsibility as to whether the disclosures contained in our articles are covered by patents and advise readers to investigate this subject before making, using, or selling any of the products, machines, or processes described in order to avoid possible liability for patent infringements.

# INVENTORS

If you believe that you have an invention, you should find out how to protect it. The first step is to have a search made of the prior pertinent U. S. patents. If a report on this search indicates that the invention appears patentable you can apply for a patent, and the specifications and claims should be prepared.

The firm of McMorrow, Berman & Davidson, with offices in Washington, D. C., is qualified to take the necessary steps for you. We can make a preliminary search on your invention, advise you whether we think it can be patented, and prepare your application for patent.

Unless you are fully familiar with the U. S. Patent Laws, we recommend that you engage the services of a Registered Patent Attorney to protect your interests. The patent laws are *your* laws. A patent gives you the right to prevent others from making, using or selling the invention claimed in your patent for a period of 17 years.

Use these patent laws for your protection. Investigate whether your invention can be patented. If you have what you believe to be an invention, we suggest that you have this firm make a search for you.

*Send for a copy of our Patent Booklet entitled "How To Protect Your Invention," containing information about patent protection and patent procedure. Along with this we will also send you an "Invention Record" form, for your use in writing down and sketching details of your invention. We will mail them promptly. No obligation. They are yours for the asking.*

## McMORROW, BERMAN & DAVIDSON

*Registered Patent Attorneys*

PATENTS • COPYRIGHTS • PATENTS

135-G VICTOR BUILDING, WASHINGTON 1, D. C.

# Lend Me 15 Minutes A Day



*..and I'll prove  
I can make you  
a NEW MAN*

I'M trading in old bodies for new! I'm taking men who know that the condition of their arms, shoulders, chests and legs—their strength, "wind," and endurance — is not 100%. And I'm making NEW MEN of them!

If you can simply raise your arm and flex it, I can add SOLID MUSCLE to your biceps—yes, on each arm—in double-quick time! I can broaden your shoulders, strengthen your back, develop your whole muscular system INSIDE and OUTSIDE!

## What Only 15 Minutes a Day Can Do

I can add inches to your chest, give you a vise-like grip, make those legs of yours lithe and powerful. I can shoot new strength into your old backbone, exercise those inner organs, help you cram your body so full of pep, vigor and red-blooded vitality that you won't feel there's even "standing room" left for weakness and that lazy feeling! Before I get through with you I'll have your whole frame "measured" to a nice, new, beautiful suit of muscle!

## I Was a 97-lb. Weakling

All the world knows I was ONCE a skinny, scrawny 97-pound weakling. And NOW it knows that I won the title, "The World's Most Perfectly Developed Man." Against all comers! How did I do it? How do I work miracles in the bodies of other men in only 15 minutes a day? The answer is "Dynamic Tension," the amazing method I discovered and which changed me from a 97-pound weakling into the champion you see here!

## My Illustrated Book Is Yours —Not for \$1.00 or 10c—But FREE

Send NOW for my famous book, "Everlasting Health and Strength," 48 pages, packed from cover to cover with actual photographs and valuable advice. Shows what "Dynamic Tension" can do, answers vital questions. Page by page it shows what I can do for YOU.

This book is a real prize for any fellow who wants a better build. Yet I'll send you a copy absolutely FREE. Just glancing through it may mean the turning point in your whole life! So don't put it off—send the coupon to me personally: Charles Atlas, Dept. 89, 115 East 23rd St., New York 10, N. Y.

*Charles Atlas*

Actual photo of the man who holds the title, "The World's Most Perfectly Developed Man."



**CHARLES ATLAS, Dept. 89,  
115 East 23rd St., New York 10, N. Y.**

Send me—absolutely FREE—a copy of your famous book, "Everlasting Health and Strength"—48 pages, crammed with actual photographs, answers to vital health questions, and valuable advice to every man who wants a better build. I understand this book is mine to keep, and sending for it does not obligate me in any way.

Name \_\_\_\_\_ Age \_\_\_\_\_  
(Please Print or Write Plainly)  
Address \_\_\_\_\_  
City \_\_\_\_\_ State \_\_\_\_\_

(Continued from page 16)

## OUTDOOR RECREATION

Duck decoy controlled from blind looks like feeding bird...166  
Portable open-fire cooking grill swings meal clear of flames 184  
Rifle supported against car fender with suction-cup bracket...183

## PHOTOGRAPHY

Photos through a microscope...193  
Lamp stand fitted with novel clamp supports reflector near floor...194  
Handle steadies candid camera...194  
Inventory kept on film-box cover...194  
Light trap for darkroom window permits passage of air...194  
Wooden "safe" for photo paper has self-closing door...197  
Switch added to movie projector prolongs life of lamp...198  
Adhesive labels for transparencies...198  
Tape guards box-camera shutter...198

## TOOLS

Variable taper-cutting jig for bench saw...169  
Blocks lower hacksaw blade for flush cutting...172  
Toe clamps salvaged from skates hold small work for gluing...183  
Bolt supports plane blade for sharpening edge...184  
Hand-drill depth stop...191  
Puller for flywheel bearing improvised from bolts...203  
Brace chuck fitted with adapter holds twist drills securely...208  
Handy cutter speeds trimming building paper...209  
Slotting with hacksaw improved by blade alteration...209  
Easy-to-read micrometer (Central Tool Co., Cranston, R.I.)...210  
Emergency power-line generator (Wincharger Corp., Sioux City 6, Iowa)...210  
Speed changer features variable-pitch sheaves (Speed Selector, Inc., 118 Noble Court, Cleveland 13, Ohio)...210  
Bottled-gas torch (Precision Engineering & Mfg. Co., 330 Center St., Saginaw, Mich.)...210  
Folding bucksaw (Peters Enterprises, 362 Great Kills Road, Staten Island 8, N. Y.)...210  
Metal paintbrush holders (Acorn Mfg. Co., 1207 Keosauqua Way, Des Moines, Iowa)...211  
Portable tool for cutting wire rope and chain (Manco Manufacturing Co., Bradley, Ill.)...211  
Soldering iron heats in 30 seconds (Dickson Engineering & Sales Co., 4701 Townes Road, Minneapolis 10, Minn.)...211  
Gauges aid in sharpening drills (R. J. Tingle, 8731 Orange-lawn St., Detroit 4, Mich.)...211

## MISCELLANEOUS

Dusting with pigment colors putty...166  
Soldering iron polishes leather to obtain smooth edges...168  
Emergency service from "dead" flashlight battery...169  
Dowels indented with pliers strengthen glued joints...172  
Novel method simplifies making soldered connections...172  
Fitting mitered baseboard around irregular corners...175  
Wooden box supports door for planing edge...176  
Picket "basket" protects shrubs...181  
Washers protect hydrometer glass...183  
Loose-pin hinge forms door bolt...183  
Simulated-leather table tops improvised from hardboard panels...184  
Discoloration of steamed wood prevented by cloth wrapping...186  
Estimating hip-roof area...186  
Checking for water in fuel-oil drum...191  
Stepladder serves as glazing easel when fitted with folding arms...192  
Silk hose tests sanded surface...192  
Improvised aquarium thermometer...192  
Handy lifter for thumbtacks formed from picture hook...192  
Renewing bolt threads after cutting...208  
Muffler for service-station lift improvised from oilcan...209  
Drawing board hung from ceiling occupies minimum space...218  
Ladder lashed to truck top with spring-fitted chain...218  
Waterproof patch for masonry wall...218

## Radio-Television, Electronics

Television today (Electron gun tube, General Electric Co., Schenectady 5, N. Y.; 24-in. picture tube, General Electric Co., Electronics Park, Syracuse, N. Y.; aluminum tower, Tabet Mfg. Co., Tazwell St., Norfolk 10, Va.; antenna rotating device, U. S. Devices Corp., South Plainfield, N. J.; television set assembled in units, Setchell-Carlson, Inc., New Brighton, Minn.)...219  
High-fidelity frequency-modulated tuner unit (Allied Radio Corp., 833 W. Jackson Blvd., Chicago 7)...220  
Ten-meter transmitter features air-cooled final...223

## Automatic Anesthesia

By harnessing the patient's brain waves to regulate the amount of anesthetic being given him, an electronic control enables the patient to put himself to sleep. Brain waves are the fluctuations in electrical potential that accompany brain activity. As the anesthesia deepens, brain waves decrease and the electronic control cuts down the flow of ether or other anesthetic. As the anesthesia wears off, the brain waves increase and the device increases the ether flow.

# Is High School High enough?

**I**F YOU were smart enough to finish high school, you already know the answer. A high school diploma is a *must* if you want a decent job at a decent wage. But it's *not* enough if you want more: Real security. Responsible positions. Big rewards.

I. C. S. training is *specialized* training that helps you go farther, *faster*. It supplements your high school education with the practical, working knowledge you need for immediate as well as future advancement. Equally important, it gives you the confidence and self-assurance so characteristic of competent, well-trained, *successful* men.

The courses of these famous schools are designed so you can *learn* while you *earn*. You study in your spare time. At work you prove and apply what you learn.

This system of training is backed up by 58 years of I. C. S. experience. It is success-proved by thousands of students reporting promotions and pay increases. It can mean the difference between "halfway" and "headway" *for you*.

Job competition is getting stiffer every day for high school graduates. Mark and mail the coupon **NOW!**

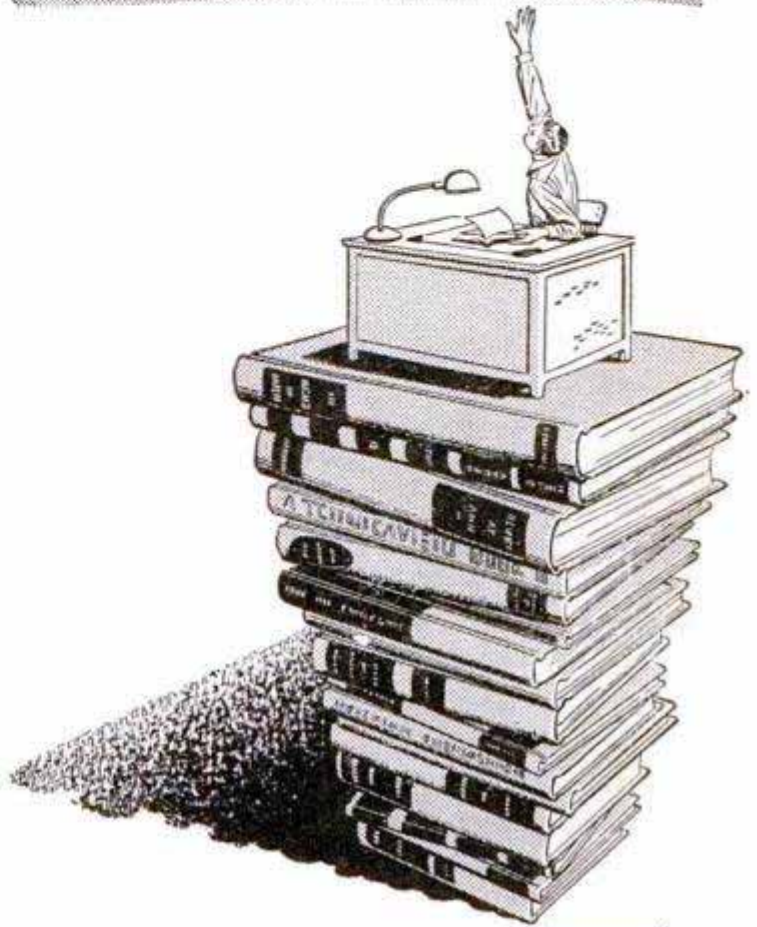

**APPROVED**  
under the  
**G.I. BILL**

## INTERNATIONAL CORRESPONDENCE SCHOOLS

BOX 5684-K, SCRANTON 9, PENNA.

Without cost or obligation, please send me full particulars about the course BEFORE which I have marked X:

- |   |   |   |   |
|---|---|---|---|
| <p><b>Business and Academic Courses</b></p> <ul style="list-style-type: none"> <li><input type="checkbox"/> Accounting <input type="checkbox"/> Advertising</li> <li><input type="checkbox"/> App. Psychology <input type="checkbox"/> Bookkeeping</li> <li><input type="checkbox"/> Business Administration</li> <li><input type="checkbox"/> Bus. Correspondence <input type="checkbox"/> Bus. Law</li> <li><input type="checkbox"/> Certified Public Accounting</li> <li><input type="checkbox"/> Commercial</li> <li><input type="checkbox"/> Commercial Art</li> <li><input type="checkbox"/> Cost Accounting</li> <li><input type="checkbox"/> Federal Tax</li> <li><input type="checkbox"/> First Year College</li> <li><input type="checkbox"/> Foremanship <input type="checkbox"/> French</li> <li><input type="checkbox"/> Good English <input type="checkbox"/> High School</li> <li><input type="checkbox"/> Higher Mathematics <input type="checkbox"/> Illustration</li> <li><input type="checkbox"/> Industrial Supervision</li> <li><input type="checkbox"/> Motor Traffic <input type="checkbox"/> Postal Civil Service</li> <li><input type="checkbox"/> Retailing <input type="checkbox"/> Retail Bus. Management</li> <li><input type="checkbox"/> Salesmanship <input type="checkbox"/> Secretarial</li> <li><input type="checkbox"/> Sign Lettering <input type="checkbox"/> Stenography</li> <li><input type="checkbox"/> Spanish <input type="checkbox"/> Traffic Management</li> </ul> <p><b>Air Conditioning and Plumbing Courses</b></p> <ul style="list-style-type: none"> <li><input type="checkbox"/> Air Conditioning</li> <li><input type="checkbox"/> Heating <input type="checkbox"/> Plumbing</li> <li><input type="checkbox"/> Refrigeration <input type="checkbox"/> Steam Fitting</li> </ul> | <p><b>Chemical Courses</b></p> <ul style="list-style-type: none"> <li><input type="checkbox"/> Chemical Engineering</li> <li><input type="checkbox"/> Chemistry, Analytical</li> <li><input type="checkbox"/> Chemistry, Industrial</li> <li><input type="checkbox"/> Chemistry, Mfg. Iron &amp; Steel</li> <li><input type="checkbox"/> Petroleum Refining <input type="checkbox"/> Plastics</li> <li><input type="checkbox"/> Pulp and Paper Making</li> </ul> <p><b>Civil Engineering, Architectural and Mining Courses</b></p> <ul style="list-style-type: none"> <li><input type="checkbox"/> Architecture <input type="checkbox"/> Architectural Drafting</li> <li><input type="checkbox"/> Building Estimating</li> <li><input type="checkbox"/> Civil Engineering <input type="checkbox"/> Coal Mining</li> <li><input type="checkbox"/> Contracting and Building</li> <li><input type="checkbox"/> Highway Engineering</li> <li><input type="checkbox"/> Lumber Dealer</li> <li><input type="checkbox"/> Reading Structural Blueprints</li> <li><input type="checkbox"/> Sanitary Engineering</li> <li><input type="checkbox"/> Structural Drafting</li> <li><input type="checkbox"/> Structural Engineering</li> <li><input type="checkbox"/> Surveying and Mapping</li> </ul> <p><b>Communications Courses</b></p> <ul style="list-style-type: none"> <li><input type="checkbox"/> Electronics</li> <li><input type="checkbox"/> Prac. FM and Television</li> <li><input type="checkbox"/> Prac. Telephony <input type="checkbox"/> Radio Operating</li> <li><input type="checkbox"/> Radio, General <input type="checkbox"/> Radio Servicing</li> <li><input type="checkbox"/> Telegraph Engineering</li> </ul> | <p><b>Electrical Courses</b></p> <ul style="list-style-type: none"> <li><input type="checkbox"/> Electrical Drafting</li> <li><input type="checkbox"/> Electrical Engineering</li> <li><input type="checkbox"/> Electric Light and Power</li> <li><input type="checkbox"/> Lighting Technician</li> <li><input type="checkbox"/> Practical Electrician</li> <li><input type="checkbox"/> Power House Electric</li> <li><input type="checkbox"/> Ship Electrician</li> </ul> <p><b>Internal Combustion Engines Courses</b></p> <ul style="list-style-type: none"> <li><input type="checkbox"/> Auto Technician <input type="checkbox"/> Aviation</li> <li><input type="checkbox"/> Diesel-Electric</li> <li><input type="checkbox"/> Diesel Engines <input type="checkbox"/> Gas Engines</li> </ul> <p><b>Mechanical Courses</b></p> <ul style="list-style-type: none"> <li><input type="checkbox"/> Aeronautical Engineer's, Jr.</li> <li><input type="checkbox"/> Aircraft Drafting <input type="checkbox"/> Flight Engineer</li> <li><input type="checkbox"/> Forging <input type="checkbox"/> Foundry Work</li> <li><input type="checkbox"/> Heat Treatment of Metals</li> <li><input type="checkbox"/> Industrial Engineering</li> <li><input type="checkbox"/> Industrial Instrumentation</li> <li><input type="checkbox"/> Industrial Metallurgy</li> <li><input type="checkbox"/> Machine Shop</li> <li><input type="checkbox"/> Machine Shop Inspection</li> <li><input type="checkbox"/> Mechanical Drafting</li> <li><input type="checkbox"/> Mechanical Engineering</li> </ul> | <ul style="list-style-type: none"> <li><input type="checkbox"/> Mold-Loft Work</li> <li><input type="checkbox"/> Patternmaking—Wood, Metal</li> <li><input type="checkbox"/> Reading Shop Blueprints</li> <li><input type="checkbox"/> Sheet-Metal Drafting</li> <li><input type="checkbox"/> Sheet-Metal Worker <input type="checkbox"/> Ship Drafting</li> <li><input type="checkbox"/> Ship Fitting <input type="checkbox"/> Tool Designing</li> <li><input type="checkbox"/> Toolmaking <input type="checkbox"/> Welding Engineering</li> <li><input type="checkbox"/> Welding—Gas and Electric</li> </ul> <p><b>Railroad Courses</b></p> <ul style="list-style-type: none"> <li><input type="checkbox"/> Air Brake <input type="checkbox"/> Car Inspector</li> <li><input type="checkbox"/> Diesel Locomotive</li> <li><input type="checkbox"/> Locomotive Engineer</li> <li><input type="checkbox"/> Locomotive Fireman</li> <li><input type="checkbox"/> Locomotive Machinist</li> <li><input type="checkbox"/> Railroad Section Foreman</li> <li><input type="checkbox"/> Steam and Diesel Loco. Eng.</li> </ul> <p><b>Stationary Engineering Courses</b></p> <ul style="list-style-type: none"> <li><input type="checkbox"/> Boilermaking</li> <li><input type="checkbox"/> Combust. Engrg. <input type="checkbox"/> Engine Running</li> <li><input type="checkbox"/> Marine Engineering</li> <li><input type="checkbox"/> Power Plant Engr. <input type="checkbox"/> Steam Engineer</li> </ul> <p><b>Textile Courses</b></p> <ul style="list-style-type: none"> <li><input type="checkbox"/> Cotton Manufacturing <input type="checkbox"/> Loom Fixing</li> <li><input type="checkbox"/> Rayon Weaving <input type="checkbox"/> Textile Designing</li> <li><input type="checkbox"/> Woolen Manufacturing</li> </ul> |
|---|---|---|---|

Name \_\_\_\_\_ Age \_\_\_\_\_ Home Address \_\_\_\_\_

City \_\_\_\_\_ State \_\_\_\_\_ Working Hours \_\_\_\_\_ A.M. to \_\_\_\_\_ P.M.

Present Position \_\_\_\_\_ Employed by \_\_\_\_\_

Length of Service in World War II \_\_\_\_\_

Enrollment under G.I. Bill approved for World War II Veterans. Special tuition rates to members of the Armed Forces.

Canadian residents send coupon to International Correspondence Schools Canadian, Ltd., Montreal, Canada.

# INVENTORS

If you consider your invention to be something of importance—if you have invented any new and useful art, machine, manufacture or composition of matter or improvement thereof—you are advised to protect your invention by applying for a U. S. patent.

A patent is a valuable right. It grants you a monopoly—the right to exclude others from making, using or selling your invention as claimed for a term of seventeen years.

The specification and claims of a patent, particularly if the invention be at all complicated, constitute one of the most difficult legal instruments to draw with accuracy. Therefore, unless you are thoroughly familiar with such matters, you are advised to employ a competent registered patent attorney or agent.

This firm is registered to practice before the U. S. Patent Office and is available to assist in the preparation and prosecution of your patent application.

The "Evidence of Invention" form mentioned below is offered as a convenience to you in making your disclosure to us for search purposes.

You should date and sign your disclosure and have it witnessed by two or more persons who are capable of understanding your invention.

Your disclosure should be mailed to us together with a letter authorizing us to conduct a preliminary

search among previously granted U. S. patents for similar types of invention.

We then make this search and prepare a report of the probable patentability of your invention. If such report is favorable, we recommend the further course for you to take.

The "Evidence of Invention" form and booklet are suggested as conveniences to you and us in starting action on your invention.

**VICTOR J. EVANS & Co.** *Merlin M. Evans*  
REGISTERED PATENT ATTORNEY  
530-K MERLIN BUILDING, WASHINGTON 6, D. C.

We shall be glad to send you promptly and without obligation, an instructive booklet, "Patent Protection for Inventors", which was prepared to give inventors detailed information and steps to take toward patent protection—also our convenient "Evidence of Invention" form. Use address Victor J. Evans & Co., 530-K Merlin Building, Washington 6, D. C.

PATENTS

COPYRIGHTS

SAY YOU SAW IT IN POPULAR MECHANICS

# Command Bigger Money! STUDY LAW

STUDY AT HOME for BUSINESS SUCCESS and LARGER PERSONAL EARNINGS. 40 years expert instruction — over 114,000 students enrolled. LL.B. Degree awarded. All text material furnished. Easy payment plan. Send now for FREE BOOK — "Law and Executive Guidance." It explains the course — how you may enroll and the many ways you can profit from Law Study. Write TODAY to:

AMERICAN EXTENSION SCHOOL OF LAW  
Dept. 30-PM, 646 N. Michigan Ave., Chicago 11, Ill.

**STAMMERER?** GET THIS FREE BOOK!  
New booklet, "Stammering, and How to Stop It," sent free to any stammerer upon request. Write today. BENJAMIN N. BOGUE, Dept. 504, Circle Tower, Indianapolis 4, Ind.

## BECOME AN EXPERT IN TRAFFIC

Traffic men earn \$4,000 to \$10,000 and up. Thousands of firms need experts on rates, tariffs, regulations. We train you thoroughly in spare time at home for executive traffic jobs. Personal training under traffic authorities. Placement counsel and help. Write for free 48-page book "Traffic Management—the Fast Growing Profession."

LASALLE Extension University, 417 So. Dearborn St.  
A Correspondence Institution Dept. 964-T Chicago 5, Ill.



## Bar Bells

Buy Direct From Factory \$8.95 up  
Write for free booklet and price list

INDEPENDENT IRON WORKS

2416 East 23rd Street, Dept. B  
Los Angeles 58, Calif.



## CARTOONING

HAVE FUN! MAKE MONEY! Cash in on your sense of humor AT HOME—BY MAIL. No experience needed to start. Write today FOR FREE TRIAL LESSON and full particulars.

Moon Gag Cartoon School, Dept. D, Fall Creek, Wis.

## REAL ESTATE BE A BROKER

PAYS BIG! SEND FOR FREE, BIG, ILLUSTRATED CATALOG NOW! No obligation. Graduates report making substantial incomes. Start and run your own business quickly. Men, women of all ages, learn easily. Course covers Sales, Property Management, Appraising, Loans, Mortgages, and related subjects. STUDY AT HOME or in our classrooms in big cities. Diploma awarded. G.I. approved. Nationally known.

WEAVER SCHOOL OF REAL ESTATE (Est. 1936)  
15 E. Pershing Road Dept. PM Kansas City, Mo.

FREE BOOK TELLS HOW



## IT'S EASY TO MAKE MONEY NOW TO CHRISTMAS

Sell FRIENDSHIP Christmas Cards Turn your spare time into QUICK EXTRA CASH! Gorgeous 21-Card \$1 Christmas Card Assortments sell on sight. You make up to 50c ON EACH BOX. Extra earnings with Metallics, Religious, Gift Wraps, All-Occasion, other boxes. EMBOSSED Christmas Cards Name-Imprinted — 50 for \$1. Assortments On Approval, FREE Imprint Samples. Write! FRIENDSHIP STUDIOS, Inc. 195 ADAMS STREET, ELMIRA, N.Y.

FREE IMPRINT SAMPLES  
NO EXPERIENCE NEEDED

THESE MEN ARE GETTING PRACTICAL TRAINING

# IN **ELECTRICITY**



*On Real:*

**A.C. and D.C. MOTORS  
GENERATORS  
SWITCHBOARDS  
CONTROLLERS  
WIRING JOBS  
APPLIANCES  
ELECTRONIC UNITS**

*(Shown at left—Instructor explaining operation and testing of a large Motor Generator in our A.C. Department.)*

# AND **TELEVISION-RADIO**

*On Real:*

**TELEVISION SETS  
RADIO RECEIVERS  
F.M.  
(Frequency Modulation)  
RECORD CHANGERS  
AUTO RADIOS  
PUBLIC ADDRESS Systems**

*(Right—Instructor helping students check the wiring and trace-circuits of television receivers.)*



## Just Like YOU Can Get in the Great SHOPS of COYNE

Prepare NOW for a real future the quick, practical way. Come to the Great Shops of COYNE in Chicago. Largest and best equipped school of its kind—now in our 51st Year GI approved. Finance plan for non-veterans. Mail coupon.

**NOT "HOME-STUDY" COURSES!** At Coyne you learn on real, full-size equipment. Trained instructors show you how, then you do typical jobs yourself. We don't teach by mail.

**CLIP COUPON NOW** for big new illustrated Coyne book on either **ELECTRICITY** or **TELEVISION-RADIO** or both. No obligation; no salesman will call. Get the facts now!



# COYNE

**B. W. COOKE, Pres.  
ELECTRICAL & TELE-  
VISION-RADIO SCHOOL  
500 S. Paulina St., Dept. 60-72H  
Chicago 12, Ill.**

**Mail Coupon for  
FREE BOOKS!**



**B. W. COOKE, President  
COYNE ELECTRICAL &  
TELEVISION-RADIO SCHOOL  
500 S. Paulina St., Chicago 12, Ill. Dept. 60-72H**

Send FREE, the book checked below, and details of your training offer. This does not obligate me and no salesman will call.

**ELECTRICITY**       **TELEVISION-RADIO**

NAME .....

ADDRESS.....

CITY.....STATE.....

# In Your Mind's Eye

## The Secret of MENTAL CREATING

**I**F you just like to dream, read no further. There comes a time when your fancies *must be* brought into light—and stand the test of every-day, hard realities. Are you one of the thousands—perhaps millions—whose thoughts never get beyond the stage of *wistful wishing*? Do you often come to from a daydream with the sigh, "If only I could bring it about—*make it real*?"

All things begin with thought—it is what follows that may take your life out of the class of those who hope and dream. Thought energy, like anything else, can be dissipated—or it can be made to produce actual effects. *If you know how to place your thoughts* you can stimulate the creative processes within your mind—through them you can assemble things and conditions of your world into a happy life of accomplishment. *Mental creating* does not depend upon a magical process. It consists of *knowing how* to marshal your thoughts into a power that draws, compels and organizes your experiences into a worth-while design of living.

### ACCEPT THIS *Free* BOOK

Let the Rosicrucians tell you how you may accomplish these things. The Rosicrucians (not a religious organization), a world-wide philosophical fraternity, have preserved for centuries the ancients' masterful knowledge of the functioning of the inner mind of man. They have taught men and women how to use this knowledge to *recreate their lives*. They offer you a free copy of the fascinating book, "The Mastery of Life." It tells how you may receive this information for study and use. Use coupon opposite.

*The* **ROSICRUCIANS**  
(AMORC)

SAN JOSE

CALIFORNIA

SCRIBE: V.F.Z.

The Rosicrucians (AMORC),  
San Jose, California.

Please send free copy of "The Mastery of Life,"  
and I shall read it as directed.

Name.....

Address.....

City.....



GET INTO

# DIESEL-AUTO

## MECHANICS *Master All Phases*

**JOBS LIKE THESE ARE AVAILABLE TO TRAINED MECHANICS. CHOOSE THE FIELD YOU LIKE BEST**

### Get Complete Training

Diesel Fuel Injection  
 Automotive Motor Tune-up  
 Diesel Engine Rebuilding  
 General Garage Mechanic  
 Agricultural Implements  
 Auto Engine Rebuilding  
 Auto Elec. Service  
 Public Utilities  
 Parts Dealers  
 Bus & Truck Lines  
 Industrial Maintenance  
 Contracting & Excavating  
 Business of Your Own  
 AND MANY other similar openings.

**As a National Schools graduate, you are trained for ALL opportunities in the Diesel & Auto Industries**

### EARN WHILE YOU LEARN

With our practical Master Shop-Method Home Training, you study at home in your spare time. You receive Spare Time Work Lessons, which show you how to earn while you Learn . . . for extra money and experience. You Learn by DOING.

### TOOLS AND EQUIPMENT

To make your training complete, we give you selected mechanic's tools and equipment, illustrated below, including all-metal toolbox — as a regular part of your instruction.

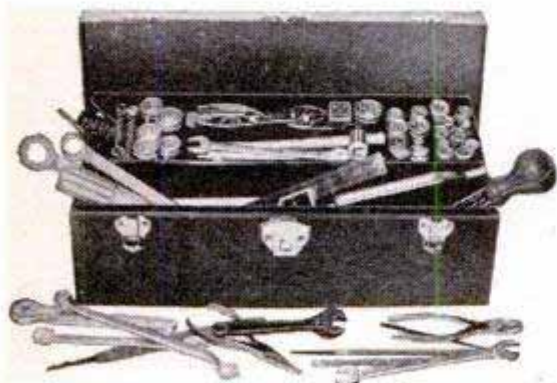

**WE GIVE YOU TOOLS OF YOUR TRADE**



### Shop-Method Home Training by an Established Resident School Prepares you for Many Good Jobs

Opportunity is everywhere for the trained Diesel-Auto Mechanic. Highways throng with cars, busses, trucks, tractors. Garages and Service Stations are kept busy. Factories, ships, farms, railroads, general industry, are dependent upon engine power. Here's a dynamic, fast-growing field that needs trained men who know ALL phases: installation, operation, maintenance and repair. Now—National Schools offers you a practical, all-embracing Diesel-Auto Mechanic's Course, including all of these advantages:

### Complete training, covering—Diesels, High Speed and Heavy Duty; Semi-Diesels, Gasoline and Special Fuel Engines AND Allied Mechanics.

- Basic Lesson Texts
- Diesel Installation
- Operation - Maintenance
- Diesel Chart Manual
- Spare Time Lessons
- Engine Service Manuals
- Engine Repair
- Drive Systems
- Diesel Electric Power
- Thermodynamics

### TOOLS AND EQUIPMENT

**INVESTIGATE**  
Secure Full Information

**NEW, ILLUSTRATED BOOK & SAMPLE LESSON SHOW HOW WE TRAIN YOU . . . SEND FOR THEM TODAY!**

**NO COST**  
**NO OBLIGATION**

**APPROVED FOR VETERANS**

Check coupon below

## NATIONAL SCHOOLS

LOS ANGELES 37, CALIF. • EST. 1905



### FIND OUT NOW . . . MAIL COUPON TODAY

NATIONAL SCHOOLS, DEPT. PMD-9  
4000 South Figueroa Street  
Los Angeles 37, California

(Mail in envelope or paste on penny postcard)

Mail me FREE the book, YOUR FUTURE IN DIESEL-AUTO MECHANICS, together with the Sample Lesson. I understand I may keep and use the information with no obligation.

Name \_\_\_\_\_ Age \_\_\_\_\_

Address \_\_\_\_\_

City \_\_\_\_\_ Zone \_\_\_\_\_ State \_\_\_\_\_

Check here if Veteran of World War II

# Are You REALLY Ready for a Better Job?

HOW long is it since YOU had a raise or a good promotion? Thousands of men wait and wait and wait—and then are angry and discouraged if the "job ahead" is handed to someone else. But, frankly, most of them did nothing to rate it; they didn't do a thing to prepare themselves for it!

Advance preparation—beyond the duties of your present job—is the big secret of getting ahead faster. The Business Management Library will give you that advance preparation—get you really ready for a bigger job—and help you do such outstanding work on the new job that further promotions will come along regularly and automatically. Here is a very condensed outline of what these six practical, fact-filled books contain:

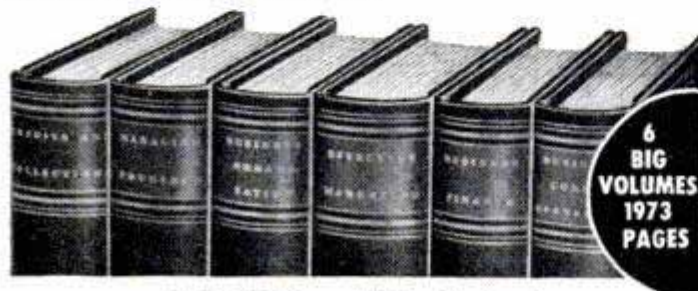

6  
BIG  
VOLUMES  
1973  
PAGES

## A Brief Idea of The Contents

- |  |   |
|--|---|
| <p><b>1) BUSINESS ORGANIZATION</b> — how to organize a dept. or business; control its operation efficiently; set it up on a profitable basis.</p> <p><b>2) BUSINESS FINANCE</b> — where and how to get capital; how to use it effectively; establish sound controls; pyramid your profits and build surplus.</p> <p><b>3) CREDIT AND COLLECTIONS</b> — how to reduce credit losses; modernize a credit system; build up a high percentage of prompt collections.</p> | <p><b>4) EFFECTIVE MARKETING</b> — how to streamline a sales organization; develop advertising and merchandising ideas; handle mail order selling.</p> <p><b>5) BUSINESS CORRESPONDENCE</b> — how to write letters that get results; retain good will; increase sales; answer complaints; win new customers.</p> <p><b>6) MANAGING YOURSELF</b> — how to do more work in less time; manage other people; think straight; overcome tensions; use your imagination to increase profits.</p> |
|--|---|

## Free... "How To Get Publicity"



A book every man should have. In 226 pages, it tells how to get business or personal publicity through magazine, newspaper, radio. How to get your "story" or picture in print. 11 big chapters. Regular price \$2.00. YOURS FREE for sending coupon below.

## Try Books FREE 10 Days

Prepare NOW—to be worth more money and to step right into that better job. Mail coupon. Examine The Business Management Library FREE and without obligation. Then decide for yourself whether this practical 6-volume Library will be worth to you many times its low price. Mail Free-Examination Coupon TODAY!

McGraw-Hill Book Co., Inc., Dept. PM-9,  
327 West 41st Street, New York 18, N. Y.

Send me the McGraw-Hill Library of Business Management, 6 volumes, for 10 days' FREE trial. In ten days, I will either return books or send \$2.50, plus postage and packing charges; then \$4 a month until \$18.50 is paid. With my shipment, I will receive FREE, "How To Get Publicity"—which I may keep whether or not I keep the books.

Name \_\_\_\_\_

Address \_\_\_\_\_

PM-9

City, Zone, State \_\_\_\_\_

**SAVE POSTAGE, PACKING CHARGES.** Enclose first payment (\$2.50) with this coupon and we'll prepay all postage and packing costs. Same 10-Day Return-For-Refund Privilege.

# LET US TEACH YOU TO Mount Birds

SEND FOR FREE BOOK



Animals, Fish, Heads; to TAN. Hunters, Trappers, be a Taxidermist. Let this old reliable school teach you—at home, in spare time. Our school has over 300,000 students. Save your fine trophies. Mount and keep ducks, deer, ALL wild-game. Tan skins, make robes and rugs, double your interest in HUNTING AND FISHING. Have a home museum.

## Free Book

Yes, FREE, this great strange book, with 100 fine wild-game pictures. Tells how YOU can become a real TAXIDERMIST, easily and quickly. It is amazing, thrilling, and may bring you a lifetime of PLEASURE and PROFIT. SPORTSMEN, grasp this opportunity. SEND NOW. A postal will do. But WRITETODAY—don't fail. State your age. N. W. SCHOOL OF TAXIDERMISTRY DEPT. 2509 OMAHA 2, NEBR., U. S. A.



# TRI-STATE COLLEGE

**B. S. DEGREE IN 27 MONTHS**

Founded 1884

World-Wide Enrollment

Civil, Elect., Mech., Chem., Aero., Radio and Telev., Engineering; Bus. Adm., Acct. Visit Campus, see well equipped labs. Low cost. Prep. courses. Personalized instruction. Grads. successful. Enter Sept., Jan., March, June. Catalog 490 College Ave., Angola, Ind.

## EASY EXTRA-MONEY



### SELL CHRISTMAS CARDS

to friends, clubs, neighbors, and fellow workers. It's Easy! The country's outstanding line. 6 FREE SAMPLES of name-on cards (low as 50 for \$1.00), stationery, napkins. Box samples on approval. Prompt service. LIBERTY BELL STUDIOS—Dept. B-2, 1013 Filbert St., Phila. 7, Pa.

FREE Bargain Book

Packed with hundreds of sensational bargains—new and used—in still and movie photo equipment and accessories. Write for your free copy today to

**Central Camera Co.**  
Dept. 8-K, 230 S. Wabash, Chicago 4, Ill.,

Photographic Headquarters Since 1899

# EASTERN COLLEGE OF COMMERCE AND LAW. ACCOUNTING—

2 years, Day; 3 years, Night. Preparing for C.P.A. and Executive positions. Also Bus. Admin., Pre-Law, & Law (LL.B. degree). Veterans admitted. Chances for part-time employment. M. A. CLEMENS, DEAN, 9 W. FAYETTE ST., BALTIMORE 1, MD.

# RUPTURED?

## Get Relief This Proven Way

Why try to worry along with trusses that gouge your flesh—press heavily on hips and spine—enlarge opening—fail to hold rupture? You need the Cluthe. No leg-straps or cutting belts. Automatic adjustable pad holds at real opening—follows every body movement with instant increased support in case of strain. Cannot slip whether at work or play. Light. Waterproof. Can be worn in bath. Send for amazing FREE book, "Advice To Ruptured," and details of liberal truthful 60-day trial offer. Also endorsements from grateful users in your neighborhood. Write:

**CLUTHE SONS, Dept. 31, Bloomfield, New Jersey**

Now IN YOUR OWN HOME Learn

# TELEVISION RADIO

*the Amazingly Effective*

## D.T.I. WAY

**—with the aid of BOTH  
HOME EQUIPMENT  
and HOME MOVIES**

What will mailing the coupon below do for YOU? Just this! You'll find out about one of today's most remarkable... practical ways to prepare to get into America's amazing billion dollar opportunity field of TELEVISION-RADIO-ELECTRONICS. You'll see how to get into fascinating work that pays well... that offers one of America's most promising futures... that enables you to start your own business almost "on a shoe string," if you prefer this to a job opportunity.

And above all, you'll get some GOOD NEWS especially welcomed by men anxious to earn REAL MONEY in this thrilling field. For you'll see that NOW you can get the kind of practical, laboratory-type training so desirable for making real progress in Television-Radio-Electronics... and WITHOUT LEAVING HOME.

You'll see that DeForest's Training, Inc. sends everything needed to set up your own HOME LABORATORY. You get and keep the same type of basic electronic equipment used in our modern Chicago Training Laboratories. You get home training that includes the knowledge and experience gained from training thousands of students first hand in Chicago. And to top it all, you use DTI's amazingly effective and exclusive home training aid—INSTRUCTIVE MOVIES. But why not get the complete story? Mail coupon today for information-packed literature.

### MODERN LABORATORIES

If you prefer, get all your preparation in our new Chicago Training Laboratories—one of the finest of its kind. Ample instructors, modern equipment. Write for details!

**NO PREVIOUS EXPERIENCE NEEDED**  
**NOW...get EVERYTHING YOU NEED**  
for real Laboratory-Type training  
**AT HOME**

Above:  
Work over  
**300**  
fascinating  
experiments  
with this  
equipment

You  
KEEP  
all test  
equip-  
ment

**1. Build over 300 fasci-  
nating experiments  
from 16 BIG SHIPMENTS  
of Electronic-Radio parts  
which you KEEP.**

**2. Build valuable commer-  
cial-type test equipment—as  
shown to the left—which you  
KEEP. This includes a quality  
OSCILLOSCOPE—a must for  
Television work.**

**3. Use a 16 mm. movie projector  
and new series of Hollywood pro-  
duced instructive movies—a wonder-  
ful aid to help you grasp important  
fundamentals faster...easier...better.**

**4. Enjoy well-illustrated, easy-to-read  
lessons with handy FOLD-OUT diagrams.**

**5. Get an honest-to-goodness EMPLOY-  
MENT SERVICE to help you get a good job  
after graduating—or assistance in starting  
your OWN SALES AND SERVICE BUSINESS.  
Mail coupon today for the complete details.**

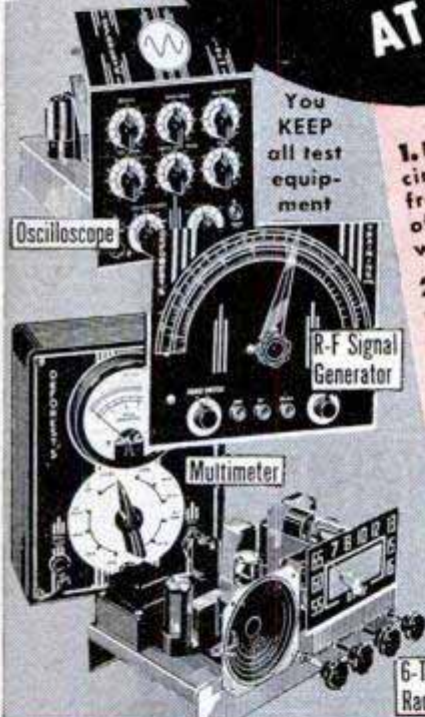

New "black"  
RECTANGULAR  
TUBE

**Get BOTH of these  
colorful, information-  
packed folders FREE**



**SEE FOR  
YOURSELF**  
*Mail  
Coupon  
Today*

DeFOREST'S TRAINING, INC. Dept. PM-G9  
2533 N. Ashland Avenue, Chicago 14, Ill

Without cost or obligation, I would like valuable, information-packed folders showing how I may get started toward a good job or my own business in Television-Radio-Electronics.

Name..... Age.....  
Street..... Apt.....  
City..... Zone..... State.....

**DeFOREST'S TRAINING, INC.**

Chicago 14, Illinois

A DeVry Institution

# Lots of DIESEL

IN THE PACIFIC NORTHWEST



Yes, DIESEL is BIG business in Oregon, Washington, and adjoining states where industries and populations are growing so incredibly fast.

**DIESEL IS THE KING OF POWER** . . . on our railroads, highways, waterways and in our industries.



L. L. ADCOX, President

**MEN WHO ARE** equipped with the thorough training they get at the ADCOX SCHOOL, are prepared for a splendid future in the great Northwest. A fine place to live and enjoy life.

I PRODUCE DIESEL MEN IN 3 SHORT MONTHS

**NEWEST FACILITIES AND EQUIPMENT**, Advanced Instruction Methods by highly paid, Expert Instructors, combined with my 40 YEARS of trade school experience, enable me to turn out **REAL DIESEL ENGINE TROUBLE SHOOTERS**. When you receive your Adcox Diploma you are ready to begin your career in Diesel.

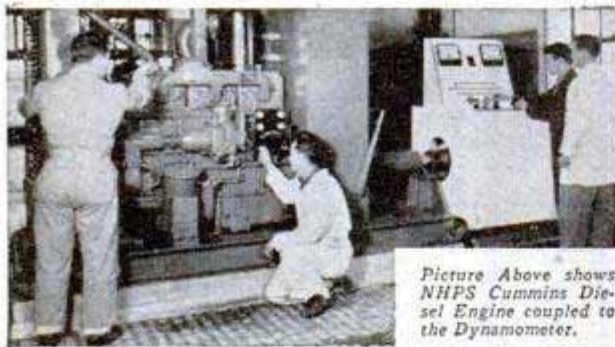

Picture Above shows NHPS Cummins Diesel Engine coupled to the Dynamometer.

YOU LEARN ENGINE CONSTRUCTION FROM THE GROUND UP. Special laboratory for Injection, Fuel Pumps, Nozzles and Governors. Trouble Shooting under full Dynamometer Load (as shown in picture).

This kind of training puts ADCOX out in front!

**CLASSES LIMITED** — Latest type equipment (no obsolete engines). Skilled Instructors — combine to insure best possible training. You learn Diesel **RIGHT**, and you learn it **FAST** . . . in this Nationally Famous School!

**DIESEL SCHOOL CATALOG FREE** APPROVED FOR VETERANS

L. L. ADCOX, President  
**ADCOX SCHOOL**  
237 N. E. Broadway, Portland 12, Oregon  
Without obligation, send FREE Catalog No. PM.

Name \_\_\_\_\_  
Address \_\_\_\_\_  
Town \_\_\_\_\_ State \_\_\_\_\_  
If World War II Veteran, Check Here



SAY YOU SAW IT IN POPULAR MECHANICS

## WANTED MAN WITH CAR



No Time Like Now to Get In **McNess Business**

It's no trick to make good money when you use your car as a McNess "Store on Wheels." Farmers buy everything they can from McNess Men because McNess Products are tops in quality, represent extra values. Attractive business-getting prizes and premiums; also money-saving deals to customers make selling McNess daily necessities a snap.

**We Supply Capital—Start Now!**

There's no better work anywhere. Pays well, permanent, need no experience to start, and we supply capital to help you get started quick. You begin making money first day. Write at once for McNess Dealer Book. It's FREE. Tells all — no obligation. (1)

**THE McNESS CO., 966 Adams St., Freeport, Ill.**

Use Your CAR to Raise Your PAY

## FALSE TEETH

**KLUTCH** holds them tighter

**KLUTCH** forms a comfort cushion; holds dental plates so much firmer and snugger that one can eat and talk with greater comfort and security; in many cases almost as well as with natural teeth. Klutch lessens the constant fear of a dropping, rocking, chafing plate. 25c and 50c at druggists . . . If your druggist hasn't it, don't waste money on substitutes, but send us 10c and we will mail you a generous trial box. © I. P. INC.

**KLUTCH CO. Box 5093-I ELMIRA, N. Y.**

## LAW FREE BOOK



Your FREE copy of "The Law-Trained Man" shows how to gain prestige and greater earnings through Blackstone home law study. All instruction material furnished including 18-volume Law Library written by 65 well-known law authorities. Lawyers, judges among our graduates. LL.B. degree. Low cost; easy terms. Write today. **BLACKSTONE COLLEGE OF LAW 225 N. Michigan Ave. Dept. 56, Chicago 1, Ill.**

A Correspondence Institution Founded in 1890

## LEARN WATCH REPAIRING



**AT HOME.** By our modern and original system of instruction you can learn every part of the **WATCH REPAIRING TRADE AT HOME.** Prepare yourself for a well-paying position or start in business after completing our course of instruction. Good watch repairers are in demand and generally earn very good salaries. For particulars apply to the **WISCONSIN SCHOOL OF WATCH REPAIRING 759 North Milwaukee St., Milwaukee 2, Wis.**

**Aptitude Tests** for men, women, boys, girls, discover the kind of work or studies best for your success! You get a personal report—a guide for life—more happiness—more prosperity. . . . Write for complete facts. . . . **VOCATIONAL COUNSELORS, 5057 Woodward Avenue, Detroit**

## Be an INVESTIGATOR



**RECOGNIZED & APPROVED SCHOOL OF INVESTIGATION**

--Extension Training Division--

Learn a profitable and interesting profession while earning at home in your spare time. Free Placement Service assists graduates to obtain good positions. State your age. Write For Free Booklet P

**NATIONAL DETECTIVE ACADEMY**

239 SOUTH OXFORD AVENUE  
LOS ANGELES 4, CALIFORNIA

# Now Any AUTO REPAIR JOB Can Be a "Push-Over" for You!

**IN LESS TIME—WITH LESS  
WORK—AND MORE PROFITS!**



**Free  
7-DAY OFFER!**

**N**OW, tackle anything from carburetor to rear end on ANY car built from 1935 thru 1950. And fix it quick, easy, right the FIRST time! Just look up make, model, and job in quick index of MoToR's brand-new AUTO REPAIR MANUAL. Clear, illustrated instructions lead you step by step all the way. Covers automatic and semi-automatic transmissions; the new GM Rochester carburetor.

**ONLY Manual of Its Kind!**

The engineer-editors of MoToR Magazine condensed all the meat of over 150 official factory manuals for you. They dug out all the information you need—made sure every word and picture is crystal clear—and put the whole "works" into this one big 750-page book. Contains 200,000 service, repair, tune-up facts. 35,000 essential dimensions! More than 2100 cut-away photographs, diagrams, charts show what the clear text tells.

Used by  
U. S. Army  
and Navy

**Win Prestige! Earn More Money!**

MoToR's Manual makes every operation so easy that you'll find yourself tackling jobs you wouldn't think of doing before. And you'll win added prestige and more money in the bargain.

Beginners will find usable helpful guidance on every kind of repair and service job imaginable. Experts will be amazed by the time and labor-saving short cuts.

This GIANT Manual is used by Army, Navy, Technical Schools, and thousands of successful auto-repairmen. Now YOU can try it FREE—for 7 days. Learn firsthand how it can pay for itself the first few times you use it!

**SEND NO MONEY**

Mail coupon below — without money! When your book arrives — make it show you what it's got! Unless you agree it's the greatest time and work saver you've ever seen—return book in 7 days and pay nothing. Mail coupon NOW! MoToR Book Department, Desk 1K, 250 West 55th St., New York 19, N. Y.



**Just 2 of the Many  
Letters of Praise**



"MoToR's Manual paid for itself on the first 2 jobs, and saved me valuable time by eliminating guesswork." — W. SCHROP, Ohio



"Instructions so clear have no trouble learning anything about any car. Now working as mechanic in big plant." — SAM ORDONEZ, California

**MOTOR'S  
AUTO  
REPAIR  
MANUAL**

**COVERS ANY CAR  
BUILT SINCE 1935!**

- Auburn Frazer
- Austin Graham
- Buick Hudson
- Cadillac Hupmobile
- Chevrolet Kaiser
- Chrysler Lafayette
- Cord La Salle
- Crosley Lincoln
- De Soto Mercury
- Dodge Nash
- Ford Oldsmobile
- Packard
- Pierce
- Arrow
- Plymouth
- Pontiac
- Reo
- Studebaker
- Terraplane
- Willys



ABOVE: Showing operation of Buick Dyna-Flow — and, BELOW: How to adjust Ford Clutch. Every moving part is covered in simple words and BIG, CLEAR Pictures.

**Same FREE Offer  
on MoToR's TRUCK &  
TRACTOR MANUAL**

Brand - new! Covers EVERY job on EVERY popular make gasoline truck and farm tractor built from 1936 thru 1949! 1400 pictures, 961 pages, 300,000 facts. All types Gasoline Engines, Fuel Systems, Governors, Lubrication, Ignition, Starters, Clutches, Axles, Brakes, etc., etc.

ALSO covers many buses, contractor and road building equipment, stationary power machinery. Check box in coupon at right for 7-day FREE trial.



Published by MoToR, The Leading Automotive Business Magazine.



**MAIL COUPON NOW FOR 7-DAY FREE TRIAL**

MoToR BOOK DEPT.  
Desk 1K, 250 West 55th St., N. Y. 19, N. Y.

Rush to me at once (check box opposite book you want):  
 MoToR's New AUTO REPAIR MANUAL. If O.K., I will remit \$1 in 7 days (plus 35c delivery charges), \$2 monthly for 2 months and a final payment of 95c one month after that. Otherwise I will return the book postpaid in 7 days. (Foreign price, \$2 cash with order.)

MoToR's New TRUCK & TRACTOR REPAIR MANUAL. (Described at left.) If O.K., I will remit \$2 in 7 days, and \$2 monthly for 3 months, plus 35c delivery charges with final payment. Otherwise I will return book postpaid in 7 days. (Foreign price, remit \$10 cash with order.)

Print Name.....Age.....

Address .....

City..... State.....

Check box and save 35c delivery charge by enclosing WITH coupon entire payment of \$5.95 for Auto Repair Manual (or \$8 for Truck & Tractor Repair Manual). Same 7-day return-refund privilege applies.

# Do you want

→ ..to go to College?

→ ..or to enter a Profession?

(Such as Accounting, Architecture, Nursing, Dentistry, Teaching, Social Work, Osteopathy, Beauty Culture, Optometry, Embalming, Chiropody, Law, Medicine, etc.)

→ ..or get an Office Position?

To get anywhere, you practically MUST finish High School FIRST. You can complete our simplified High School Course in SPARE time at home, as FAST as your time and abilities permit. Equivalent to resident school work—prepares you for college, pre-professional examinations, business, industry. Standard texts furnished. Diploma. Credit for H.S. subjects already completed. Single subjects if desired. Low tuition, easy terms. American School, Chicago, est. 1897—endorsed by educators. Finish your high school education NOW, Write TODAY!

## High School Course at Home

Many Finish in 2 Years

American School, Dept. H645, Drexel Ave. at 58th St., Chicago 37, Ill.

Gentlemen: Send me FREE information covering special training in subjects checked below. No obligation on my part.

- |  |  |
|--|--|
| <input type="checkbox"/> High School Course          | <input type="checkbox"/> Diesel Engineering                  |
| <input type="checkbox"/> Architecture and Building   | <input type="checkbox"/> Drafting and Design for Men & Women |
| <input type="checkbox"/> Automotive Engineering      | <input type="checkbox"/> Plastics                            |
| <input type="checkbox"/> Business Management         | <input type="checkbox"/> Private Secretary                   |
| <input type="checkbox"/> Electrical Engineering      | <input type="checkbox"/> Mechanical Engineering              |
| <input type="checkbox"/> Elec. and Gas Refrigeration | <input type="checkbox"/> Aviation                            |
| <input type="checkbox"/> Air Conditioning            | <input type="checkbox"/> Salesmanship                        |
| <input type="checkbox"/> Railway Training            | <input type="checkbox"/> Radio                               |
| <input type="checkbox"/> Electronics, Industrial     |  |

Name.....

Address.....

AT HOME IN SPARE TIME

LEARN

WATCH REPAIRING

CLOCK REPAIRING

JEWELRY REPAIR & DESIGN

For FREE literature, check course of your choice—NOW!

Get into one of these top pay, easy to learn fields quickly through our unique home-study plan. Nothing mysterious about any of these courses—almost anyone can become proficient in a short time and start making money quickly.

Courses written in simple, non-technical language that most any one can understand. And you train under experts. Professional tools included with each course.

See how easy it is to turn spare time into money. Check the course of your choice, send us your name and address, and we will send you without obligation, the literature you want. A licensed school.

ILLINOIS SCHOOL OF WATCH REPAIRING PM 90  
2870 Elston Avenue, Chicago 18, Ill.

Send me at once free literature on the course I have checked above.

Name.....

Address.....

City, Zone & State.....

## PRINT YOUR OWN POST CARDS



COMPLETE OUTFIT only \$7.50



Amazing results in sales, inquiries and contacts... saves time and money... very easy to use GEM STENCIL DUPLICATOR is ideal for Advertising, Announcements, Notices, Labels, Forms, Price Lists—hundreds of uses for every type of business and organization. Comes complete with all supplies, instructions and 60-page Book of Ideas.

FREE TRIAL OFFER: Try it before you buy it! Write and a GEM OUTFIT will be sent you postpaid. After 10 days, send only \$7.50 or return the GEM, no questions asked. The GEM must sell itself; you be the judge.

BOND EQUIPMENT CO. • Dept. 135  
6633 Enright • St. Louis 5, Mo.

SEND NO MONEY • FREE TRIAL OFFER

NATION'S LARGEST EXCLUSIVE ELECTRICAL SCHOOL

"LEARN-BY-DOING"

## ELECTRICITY

PRACTICAL TRAINING NOT "HOME STUDY"

Get actual experience in great shops of M.T.I. Learn all phases Practical Electricity; Housewiring, Motors, Const., Maintenance, etc. Living arrangements, Part-time jobs, etc. Pay after graduate plan.

A post card brings the story.

MICHIGAN TECHNICAL INSTITUTE, Dept. PM-9  
2281 W. Fort St., Detroit 16, Michigan

## LEARN TO WRITE



FOR BUSINESS AND SOCIAL SUCCESS!

Easy to improve your handwriting at home quickly with my new instruction books just off the press. Master all the secrets of better penmanship. Simple and easy, fully illustrated, highly endorsed. Begin today. Write for:  New Free Book "How to Become a Good Penman," or check books wanted, \$1.00 each.  Business Writing  Artistic Writing  Card Writing  Engraving Alphabets  Bird and Design Flourishing  Complete Set \$4.50  Enclose 10c for your name beautifully written and special penpoint for shaded writing. S. A. Ziller, President, TAMBLYN SCHOOL OF PENMANSHIP, 441 Ridge Bldg. In Business Over 52 Years Kansas City, Mo., U.S.A.

Is Your Life Crowned With Success?

## LEXIPOWER



WE THINK IN WORDS. THOUGHT IS POWER. Let this New Science show you how to WIN WITH WORDS—financially, socially, culturally. Develop a MASTERFUL VOCABULARY. Influence others, improve your personality, manifest your latent ability. You are judged and rated by every sentence you utter. Start using the POWER of LEXIPOWER after the first Lesson. Write NOW for FREE details about LEXIPOWER. Dime-a-Day LESSON CLUB.

LEXIPOWER LESSON CLUB

517-G W. Deming Place Chicago 14, Illinois

## HOLLYWOOD MUFFLER

THE TONE YOU LOVE TO HEAR



### MORE SPEED—POWER—MILEAGE

are yours with a Hollywood Muffler... plus a tone you'll love to hear! Not a gutted muffler. Easy to install.

Hollywood Muffler: Trade-mark Reg. U. S. Pat. Off.

IMPROVED DESIGN PRECISION MADE ELECTRIC WELDED!

Outlasts ordinary mufflers 3 to 1

Ford, Chevrolet, Plymouth \$6.00

All other cars . . . . . \$8.00

Duals, Ford & Merc. \$24.50. 3" Chrome Barker Tip, \$3.25. Order direct. Send check or M.O. and save postage.

Dealers Write WILKINSON MUFFLER CO. 811 WILT STREET FT. WAYNE, IND.



# Learn RADIO

## TELEVISION, ELECTRONICS

by

## SHOP METHOD HOME TRAINING

Let NATIONAL SCHOOLS, of Los Angeles, a practical Technical Resident Trade School for almost 50 years, train you for today's unlimited opportunities.

You receive all parts, including tubes, for building this fine, modern Superheterodyne Receiver. This and other valuable standard equipment becomes your property.

*these two FREE books will tell you how*



WE BRING  
NATIONAL  
SCHOOLS TO YOU!

### GOOD JOBS AWAIT THE TRAINED RADIO TECHNICIAN

You are needed in the great modern Radio, Television and Electronics industry! Trained technicians are in constant and growing demand at excellent pay—in Broadcasting, Communications, Television, Radar, Research Laboratories, Home Radio Service, etc. National Schools Master Shop Method Home Study Course, with newly added lessons and equipment, can train you in your spare time, *right in your own home*, for these exciting opportunities. Our method has been proved by the remarkable success of National Schools-trained men all over the world.

#### You Learn by Building Equipment with Standard Radio Parts We Send You

Your National Schools Course includes not only basic theory, but *practical training as well—you learn by doing*. We send you complete standard equipment of professional quality for building various experimental and test units. You advance step by step until you are able to build the modern superheterodyne receiver shown above, which is yours to keep and enjoy. You perform more than 100 experiments—build many types of circuits, signal generator, low power radio transmitter, audio oscillator, and other units. The Free Books shown above tell you more about it—send for them today!

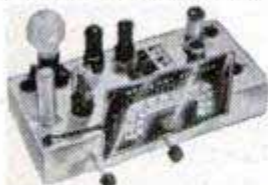

#### NOW! NEW PROFESSIONAL MULTITESTER INCLUDED



This versatile testing instrument is portable and complete with test leads. Simple to operate, accurate and dependable. You will be able to quickly locate trouble and adjust the most delicate circuits. You can use the Multitester at home or on service calls. It is designed to measure AC and DC volts, current resistance and decibels. You will be proud to own and use this valuable professional instrument.

GET THE DETAILS — SEND THE COUPON →

**TELEVISION TRAINING** A complete series of up-to-the-minute Television lessons is an integral part of your course, covering all phases of Television repairing, servicing and construction.

Here are just a few of the interesting facts you learn with the **FREE SAMPLE LESSON**

1. How radio receivers operate.
2. How the antenna circuit is constructed.
3. Converting signal currents into sound.
4. How the R-F transformer handles the signal.
5. How the tuning circuit functions.
6. The Radio "bands."

**APPROVED  
FOR  
VETERANS**  
Check  
coupon below.

**NATIONAL SCHOOLS**  
LOS ANGELES 37, CALIFORNIA EST. 1905



#### MAIL OPPORTUNITY COUPON FOR QUICK ACTION

National Schools, Dept. PM-9,  
4000 South Figueroa Street  
Los Angeles 37, California

(Mail in envelope or  
paste on penny postcard.)

Mail me FREE the book "Your Future in Radio-Television" and the sample lesson of your course. I understand no salesman will call on me.

NAME \_\_\_\_\_ AGE \_\_\_\_\_

ADDRESS \_\_\_\_\_

CITY \_\_\_\_\_ ZONE \_\_\_\_\_ STATE \_\_\_\_\_

Check here if veteran of World War II

Have

# YOUR OWN BUSINESS

This New Easy Way



Real pansy embedded in Castolite



Real Ocean Crab embedded in Castolite



Child photo embedded in Castolite



Baby Shoe Set made of Castolite

## Make Big Profits with Magic Liquid Plastic

STRIKES, LAY-OFFS, having to deal with Pinch-Penny Bosses—these things often hit some of us mighty hard. But there may be a way out for you like many others. Here's your chance to see about having a business of your own. Instead of "having all your eggs in one basket," get going on a SECOND source of income. Begin at home in spare time. Make swell things with Castolite, new, magic liquid plastic. Profits run 300% to 700% above material cost. Make \$3.00 to \$5.00 an hour in your extra time. Exciting, interesting, different. Embed real flowers, photos, shells, butterflies, coins, medals, to make distinctive costume jewelry pieces, hi-style buttons, coasters, baby shoe sets, wall plaques, book ends, lamp-bases, desk accessories—other things that SELL ON SIGHT.

### Quits Job — Now Has Own Business

Pat Queen, Mt. Vernon, Wash., quit his job and started making key chain tags (like one shown here). Queen writes: "My key chains have sold fast right from the beginning. I now make several times as much as when I had a job." Others also succeeding far better than they expected. Start small. Grow big. Use your home as headquarters. Proved Success Methods bring business fast. Start now. Do fine business before Xmas. New book shows how to make things; how to sell at big profit. Send 25c today for your copy of "A Way to Success."

### THE CASTOLITE CO.

Dept. K-1, Woodstock, Ill.



## Learn this Profitable Profession

IN 90 DAYS AT HOME

## Money-Making Career Open to Men and Women, 18 to 50

Hundreds of men and women between 18 and 50 make \$10 to \$20 in a single day giving scientific Swedish Massage and Hydro-Therapy treatments. There is big demand from doctors, hospitals, sanatoriums and clubs. Graduates earn large full time incomes from these or in private practice in their own offices. Others make good money from home treatments given in spare time. Learn this interesting, money-making profession in your own home, through our home study course. Same instructors as in our nationally known resident school. You can win independence and prepare for future security by qualifying for your Diploma. Course can be completed in 3 to 4 months. Many earn while they learn. Begin your training at once.



### Anatomy Charts & Booklet FREE

Enroll now and we will include, at no extra cost, many needed supplies. Fit yourself to help meet growing demand for Scientific Swedish Massage. Send the coupon at once for complete details. Anatomy Charts and 32-Page Illustrated Booklet, FREE, postpaid.

#### THE COLLEGE OF SWEDISH MASSAGE

Dept. 064L, 41 E. Pearson, Chicago 11, Illinois

Please send me FREE and postpaid, Anatomy Charts, 32-page Booklet and complete details on Home Training.

Name \_\_\_\_\_ Age \_\_\_\_\_

Address \_\_\_\_\_

City \_\_\_\_\_ State \_\_\_\_\_

## SOLVE REAL CRIMES!



Yes, YOU may be the one to lead the thrilling chase.

There IS satisfaction in bringing a crook to justice through SCIENTIFIC CRIME DETECTION. The thrill of solving the mystery may be yours.

We can teach you Finger Printing and Criminal Investigation; teach you quickly and easily in your own homes.

HUNDREDS OF IDENTIFICATION BUREAUS employmen trained by I.A.S. You too, may work for these Crime Detection Bureaus. Let us show you how we can prepare you for this exciting, well-paid profession in your spare time. Write today . . . NOW. No salesman will call. (Be sure to state your age.)

### INSTITUTE OF APPLIED SCIENCE

(A Correspondence School Since 1916)

Dept. 1356, 1920 Sunnyside Ave., Chicago, 40, Ill.

Be A FINGER PRINT Expert

FREE!

Send for thrilling "BLUE BOOK OF CRIME" which tells how Criminal Investigators work.

## SHINE WITHOUT 'POLISH'

New Invention! • Sells Like Wild



Replaces messy pastes, liquids. Simply glide over shoes—and PRESTO! —you have a lustrous, long-lasting shine. No mess. No muss. No soiled hands. Clean. Handy. WORKS LIKE MAGIC! For Men's, Women's and Children's Shoes. Low priced. Lightning seller!

### SAMPLES FOR AGENTS

Sample offer sent immediately to all who send name at once. A penny postal will do. SEND NO MONEY—just your name. KRISTEE CO., 675 Bar Street, AKRON, OHIO

## BECOME A BETTER PAID MAN BY BEING A WELL TRAINED MAN

Learn a profitable trade—the Eastern Technical School way. Enroll now for an eight month course in Radio or Refrigeration. New classes beginning every April—August—December. Veterans—Nonveterans. Write for free catalogue. Graduates successfully placed from Coast to Coast.

### EASTERN TECHNICAL SCHOOLS

888 PURCHASE STREET NEW BEDFORD, MASSACHUSETTS

## LEARN POULTRY BUSINESS AT HOME!

Thorough knowledge can mean greater success in this \$3½ billion business. Our interesting, practical, home-study courses have trained thousands during past 29 years. For full information on courses, methods, opportunities—Write Today to Dept. 50



NATIONAL POULTRY INSTITUTE Adams Center, N.Y.

### Learn Watch Repairing

Fascinating, dignified, and highly skilled trade that pays exceptionally well over more years of your life. Study in spare time in your own home or attend our resident school. School catalog sent free by return mail. Address Dept. B-32.

American Institute of Specialized Watch Repair  
1012 Franklin, Southeast, Grand Rapids 7, Mich.

## Want to Get Ahead in Business? Get A BUSINESS EDUCATION!



Regardless of whether your aim is to specialize or generalize in your business education, this nationally known and approved school will gladly counsel with you. We offer you nation wide recognition and placement service as secretary, stenographer, accountant or salesman. Hill's offer both Resident & Home Study Courses. Write FREE

Dept. PMP today for Big 32 page SUCCESS BOOK

### Hills BUSINESS UNIVERSITY AND EXTENSION SCHOOL

619 W. MAIN ST. OKLAHOMA CITY 2, OKLAHOMA



# R·T·S - ORIGINATORS OF PRACTICAL HOME TRAINING

## IN TELEVISION RADIO AND ELECTRONICS

**YOU BUILD THIS 23-TUBE TELEVISION RECEIVER**



**YOU KEEP ALL EQUIPMENT - it's Yours!**

## ...GIVES YOU 11 BIG TELEVISION & RADIO KITS AT NO EXTRA COST!

Let RTS show you how to **MAKE GOOD MONEY** in Radio and Television. Learn **NOW** while Television is in its infancy. Be ready for the **BIG BOOM** in America's fastest growing Industry. You will work and learn with **REAL TELEVISION** and **RADIO EQUIPMENT—RIGHT AT HOME!** Study in spare time. You can **EARN EXTRA MONEY** while learning, like many RTS students.

Located in the heart of the Radio-Television capital of America—RTS has trained thousands during the past 28 years. RTS was **FIRST** to make practical **TELEVISION** training possible at home.

Opportunities are wide open! More than 3 and a half million TV receivers now in use! More than 60 million radios in the country! Daily the demand for **TRAINED MEN INCREASES... EVERYWHERE!**

Prepare **NOW** for these better jobs at **GOOD PAY! INVESTIGATE!** If you want a career in Radio-Television **DON'T ACT WITHOUT GETTING THE FACTS FROM THE LEADER—RTS—ORIGINATORS OF PRACTICAL TELEVISION HOME TRAINING!**

Send coupon for Actual Lesson and **BIG ILLUSTRATED BOOK** — both sent to you **FREE!**

### FOLLOW THE LEADER • GET THE FACTS

**RADIO-TELEVISION TRAINING SCHOOL, DEPT. PM-9  
5100 South Vermont Avenue, Los Angeles 37, Calif., U.S.A.**

Send **FREE** Illustrated Book showing how I can make good in **TELEVISION** and Radio through training under the guidance of expert RTS Technicians. No obligation. (No Salesmen will call).

NAME \_\_\_\_\_ AGE \_\_\_\_\_

ST. & NO. \_\_\_\_\_

CITY \_\_\_\_\_ ZONE \_\_\_\_\_ STATE \_\_\_\_\_

**RADIO-TELEVISION TRAINING SCHOOL**

5100 S. Vermont Ave., Los Angeles 37, Calif., U.S.A.

ESTABLISHED 1922 — 28 YEARS AGO

**Both Free!** SEND FOR LESSON AND BIG ILLUSTRATED BOOK

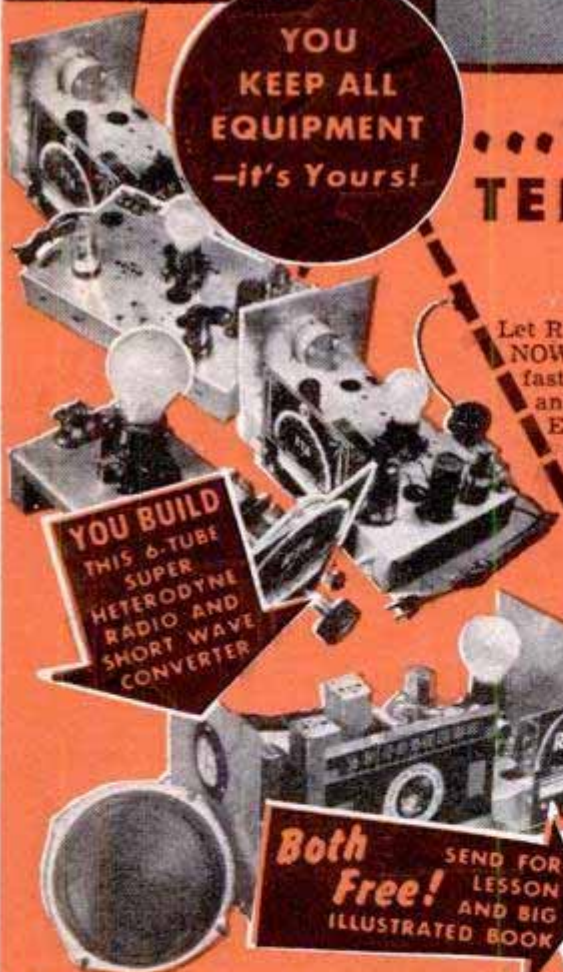

**YOU BUILD THIS 6-TUBE SUPER HETERODYNE RADIO AND SHORT WAVE CONVERTER**

# I'LL TRAIN YOU for **RADIO**



**MEET  
A Few of My  
GRADUATES**



**Appreciates Sprayberry  
Personal Interest**  
"Before completing  
your course I had  
a good paying job.  
I appreciate the per-  
sonal interest you  
gave me."—Leonard  
Petrus, Arkan-  
sas



**Best Investment  
He Ever Made**  
"Began fixing ra-  
dio sets after first  
few lessons. Your  
course is one of the  
best investments  
I've ever made."  
—A. R. Foronda,  
Hawaii

**I Send You  
18 BIG  
KITS  
OF RADIO-  
TELEVISION  
EQUIPMENT**

## **EXTRA MONEY**

**Earn While You Learn  
In Your Spare Hours!**  
You do all your training  
with me **AT HOME** in  
spare hours. Keep right on  
with your present job and  
income while learning—and  
earn extra cash besides! The  
day you enroll I begin send-  
ing you plans and ideas for  
doing profitable spare time  
Radio-TV work. Many of  
my Sprayberry students  
pay for their entire Radio-  
TV training this way!



### **YOU KEEP THIS VALUABLE EQUIPMENT**

The many big kits of Radio-Television parts and equipment are sent to my students "for keeps." Nothing need be returned—it is **YOURS!** There is absolutely nothing else to buy!

# AT HOME IN SPARE TIME TELEVISION



**Training Leads To Good Radio Job**  
 "Got a job in local radio shop soon after enrolling. Very satisfied with training"—Stanley Clemmons, Kansas



**Lucky To Be Sprayberry Trained**  
 "I consider myself lucky I chose your training in preference to others I considered. Here's thanking you again."—Paul White, Ohio



**Radio Profits Pay Cost of Training**  
 "I have more than taken in the cost of your training doing spare time radio repair work. See bright future ahead"—Thomas Shearer, N. Y.



**Earns Easy Spare Time Cash**  
 "While training I made about \$180.00 in spare time. Thank you for wonderful Radio-TV training"—Herbert Burroughs, W. Va.

## My Proved Training System—Backed by a Quarter Century of Experience—Prepares You FAST for a Good Job or Your Own Profitable Radio-Television Business!

Radio-Television is now America's greatest opportunity field. Correctly trained men are needed NOW—more than ever—to fill good jobs and handle the profitable Radio-Television Service work. I have trained hundreds of successful men for Radio-Television—and I stand ready to train YOU too—even if you have no experience or knowledge of this field. My training is modern—right up to the second—with all the newest developments included! This is 100% practical training that eliminates the frills that only waste your time and progress. Sprayberry Training provides the all-important practical knowledge and skill you need to start making money in Radio-Television in the shortest possible time. You can start at once and be earning welcome spare time cash in a few short weeks. Upon completion of my Training you will be ready to handle any practical Radio-Television job.

You receive all the equipment I have illustrated on the opposite page—and MUCH MORE besides! In addition to your fascinating Sprayberry home study lessons, I send you a total of 18 kits of quality parts and equipment with which you do over 300 practical demonstrations, experiments and construction projects. You build a complete television set that you can use in your shop or at home—you build a powerful TWO-BAND superheterodyne radio set—a multi-range test meter—signal generator and other valuable test equipment—a cathode ray oscilloscope—everything needed to set up your own Radio-Television Service Shop! All equipment I send you is yours to keep. In addition I send you many valuable service manuals, books and reference material to help you in your day-to-day Radio-Television work. I firmly believe I offer the ambitious man the most outstanding training value of its kind in America today!



**Be Ready for Top Paying Radio-Television Jobs!**  
 Radio-Television is growing with amazing speed. More than 2000 broadcasting stations PLUS an additional 102 Television stations are now on the air. Radio sets and TV receivers are being made and sold in record breaking numbers. If you enjoy working with your hands . . . if you like interesting and varied work . . . YOU BELONG IN RADIO-TELEVISION. But you MUST have good Training to "cash in" . . . the training that starts with basic fundamentals and carries through every circuit and problem of Radio-TV.

### No Previous Experience Needed to Succeed

My Training in Radio-Television is so complete, so down-to-earth that previous experience is not necessary. I start you with basic fundamentals and carry you in easy, practical steps through one Radio-Television subject after another. You will be amazed at your rapid progress and your knowledge of Radio-Television. Best of all, you put this knowledge to work making spare time cash soon after you enroll! You may train as fast or as slowly as suits your convenience. Each of my students receives individual training!

### VETERANS

You get my Radio Training without cost under the G. I. Bill. Check coupon.

### If you are Experienced...

In radio . . . I'll qualify you for Television in 4 to 8 weeks. Check coupon for special details.



## FREE 3 Big Radio and Television Books

I want you to have ALL the facts about my complete system of Radio-Television Training! Act now! Rush the coupon for my three big Radio-Television books: "How To Make Money in Radio-Television," PLUS my new illustrated Television bulletin PLUS an actual sample Sprayberry Lesson—all FREE with my compliments. No obligation and no salesman will call on you. Send the coupon in an envelope or paste on back of post card. I will rush all three books at once!

**Mail Coupon Today!**

**NO OBLIGATION No Salesman Will Call**

SPRAYBERRY ACADEMY OF RADIO, Dept. 10-N  
 111 North Canal St., Chicago 6, Ill.

Please rush to me all information on your Radio-Television Training plan. I understand this does not obligate me and that no salesman will call upon me.

Name..... Age.....

Address.....

City..... State.....

Please Check Below About Your Experience

Are You Experienced?  No Experience

**Sprayberry Academy of Radio, Dept. 10-N**  
 111 North Canal St., Chicago 6, Ill.

# How to Write

## Short Stories, Mysteries, Articles



A. E. Van Vogt

**For Part-Time or Full-Time Income, Learn at Home. Free Lesson Shows How**

**H**AVE you ever had an urge to write? Have you or your friends had interesting experiences or ideas about people, places, hobbies, sports, business or social activities, that might make interesting stories or articles for general magazines, trade and technical journals, fraternal publications, etc.?

Editors agree: the demand for new writers is greater than ever, and you don't have to be a genius to make money. Many Palmer beginners earn while learning, receiving small but welcome checks for material that may be turned out quickly once you acquire the technique. And now it's easier to learn than you may imagine, through Palmer's unique method of training—for not just one field of writing, but for all: Fiction, Article, Radio. Endorsed by famous authors—including Rupert Hughes, Gertrude Atherton, Katharine Newlin Burt, Keith Monroe, and by hundreds of successful graduates.

### Graduate Now Famous Author

A. E. Van Vogt, leading science fiction writer, says, "Your course is excellent. It was a milestone in my career."

You get practical writing assignments to do at home, saving time, effort and money. Your work is individually handled by professional writers.

FREE sample lesson and free book, "The Art of Writing Salable Stories" shows how you may earn extra income or make writing a full-time career. Be independent—work where, when, how you please. Send today! Palmer Institute of Authorship, Since 1917, Desk T-90, 1680 N. Sycamore, Hollywood 28, Calif.

**APPROVED FOR VETERANS**



### Palmer Institute of Authorship, Desk T-90

1680 N. Sycamore Hollywood 28, Calif.

Please send me free sample lesson and illustrated book explaining how your home-study training helps new writers get started. This is confidential. No salesman will call.

Mr. \_\_\_\_\_  
Mrs. \_\_\_\_\_  
Miss \_\_\_\_\_

Address \_\_\_\_\_

City \_\_\_\_\_ Zone \_\_\_\_\_ State \_\_\_\_\_

Please print clearly. Veterans:  Check here

**FREE**

## NEW! MINIATURE DUST MASK

Wear when sanding, grinding, paint spraying, sweeping, dusting, furnace cleaning, etc. Handy as a pair of glasses. Just keep mouth closed and breathe through nose is all you do to operate. Protects against dusts, lint, coal, cement, grain dust. Has 9 sq. in. filter.

Order today.

JERRY BRYANT, Dept. PM, 919 N. Michigan Ave., Chicago 11, Ill.



Order Today \$1.00 POST PAID

**At Last... A Practical, Up-to-date Book on All Types of A. C. Windings!**

## WINDING A. C. MACHINES

By Michael Liwshitz-Garik, consulting engineer to Westinghouse Electric Corp., assisted by C. Gentilini, assistant chief engineer, National Electric Coil Co.

Organized for instant fingertip reference, this authoritative new book covers in full detail every type of windings used on A.C. machines. Simple, specific directions show every step in installing and connecting both lap and wave windings, balanced and unbalanced fractional-slot windings, and integral-slot and (integral + 1/2) slot-wave windings. This brand-new work contains complete information on insulation, and includes large numbers of practical reference tables which show all possible series and parallel connections for all pole numbers between 2 and 30.

**WINDERS, REPAIRMEN, AND DESIGNERS OF ELECTRIC MACHINES EXAMINE THIS GREAT BOOK FREE**

Mail This Free Examination Coupon

D. Van Nostrand Company, Inc.  
250 Fourth Ave., New York 3, N. Y.

Please send me a copy of "Winding Alternating Current Machines". Within ten days I will either return the book or send you \$8.50 plus a few cents postage.

NAME \_\_\_\_\_

ADDRESS \_\_\_\_\_

CITY \_\_\_\_\_ ZONE \_\_\_\_\_ STATE \_\_\_\_\_

# WHAT IS YOUR IDEA OF A GOOD JOB?

Do you want independence . . . good pay . . . a chance to become one of your town's most respected citizens? Would you like to know that your skill is your security as long as you live? These are a few of the advantages of Watchmaking, the mechanical profession that has been called "depression-proof" by unbiased national authorities.

Don't wait for "breaks" that never come, learn the facts now about real opportunities ahead for our skilled graduates. Our 32-page catalog will tell you all about outstanding GI-approved courses in master watchmaking, chronograph watch repair and jewelry engraving. Write today!

**Western Pennsylvania Horological Institute, Inc.**  
Desk B-43, 706 Smithfield St., Pittsburgh 19, Pa.

## Play GUITAR in 10 DAYS

**Try It On Money Back Offer!**

Staff's Famous Charted Course for the beginner without any previous musical knowledge. Popular music quickly learned. 52 Photographic chord charts, diagramed and in musical notation shows exactly how and where to place your fingers; plus 50 HIT SONGS. Play beautiful chords the very first day. Be playing beautiful music in 10 days or get your money back. Send check or money order for \$2.20 and your course will be sent to you postpaid by return mail. **STAFF SCHOOL OF MUSIC, Dept. PM-9, Point Pleasant, N. J.**

## LEARN AERONAUTICAL ENGINEERING

### Aircraft and Engine Mechanics (A & E)

Train at the Flying Wing school—New classes starting soon. Write for illustrated catalog.

**Northrop Aeronautical Institute**  
APPROVED FOR VETERANS DIVISION OF NORTHROP AIRCRAFT, INC.  
1527 E. Broadway, Hawthorne, Los Angeles County, California

## BE A NOTARY PUBLIC

Old legal-supply house, 22 cities, guides you to quick official appointment, equips you fully Pay after appointment (2 payments \$12.50 each). Lifetime public office, income. You notarize legal papers, using only your signature and official seal, receive your fees. Easy. Details free.

**STATIONERS EXCHANGE HELOTES 10, TEXAS**

## FREE AMAZING NEW BOOK "HOW TO ANSWER ADS"



Never before have you seen anything like this. Tells you in simple language the correct way to answer ads. Gets you quicker replies—better results, and greater satisfaction. Will save you time and money and it's ABSOLUTELY FREE. No obligation whatever. Every reader of advertising should have this booklet. Send a postcard for your copy NOW. Advertising Department, Popular Mechanics Magazine, Room 600, 204 East Ontario Street, Chicago 11, Ill.

Say You Saw It in Popular Mechanics

## Model Railroading is more fun than you imagine, and less expensive than you think!



● 250,000 people can't be wrong. They are having real fun with the world's fastest growing hobby. Get this picture-packed book that tells how simple it is to start . . . and how surprisingly little money is needed.

Fully illustrated, this book tells how constructive this hobby is. Enjoyed by anyone from 7 to 70. Send 10c today

for your copy of "Model Railroading for You," written by a well-known authority.

## MODEL RAILROADER MAGAZINE

Dept. 1545 — Milwaukee 3, Wis.

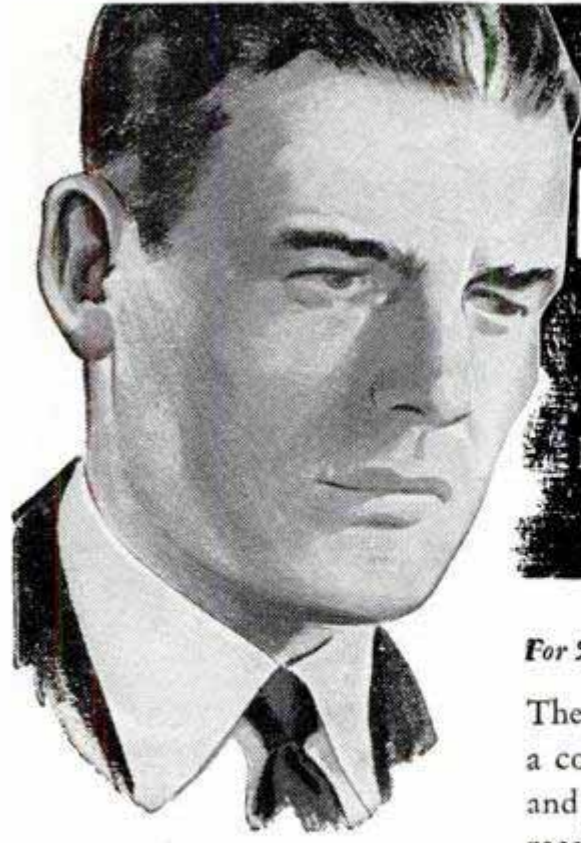

*What's the matter...*  
**NOT SATISFIED WITH  
 YOUR PAY CHECK?**

Home study training, in spare time, can increase your earnings!

*For 52 years we've been training men for BETTER JOBS AT BIGGER PAY*

The successes of thousands of today's money-makers started in a coupon similar to the one below, which they checked, signed and mailed to AMERICAN SCHOOL. The information they received opened doors of real opportunity, and steps upward which brought promotions and better living through bigger pay checks.

● Who earns promotions — more money — security? It's the ambitious man with know-how and the self-confidence that comes from training. It's the man who looks far beyond the next pay day and sets his goal. He is determined to merit responsibility and its rewards, and is willing to devote some of his spare time to acquiring the knowledge that will give him the power to climb. For over half a century American School has provided specialized training for commercial and technical advancement. It has enabled men to *earn* more while they *learned* more and win promotions. In almost every business field you'll find highly paid leaders whose success began with American School training.

**IT COSTS SO LITTLE — PROVIDES SO MUCH**

At a cost you can afford and in hours you might otherwise waste you can prepare to climb in the field of work you prefer. American School, an educational institution *not for profit*, offers you a wide choice of training opportunities. Give serious thought to the list in the coupon, then check one or more subjects, add your name and address and mail it. You will receive full information, without obligation of any kind. Do it now. You'll be glad you did.

**HOME - STUDY TRAINING SINCE 1897**

**Take This First Easy Step**

**CHECK, CLIP AND MAIL COUPON NOW**

**AMERICAN SCHOOL, Dept. G645, Drexel at 58th, Chicago 37, Ill.**  
*Without obligation, please send me FREE information on training course checked below.*

<input type="checkbox"/> Accounting	<input type="checkbox"/> Business Management	<input type="checkbox"/> Plastics Engineering
<input type="checkbox"/> Air Conditioning	<input type="checkbox"/> Contracting	<input type="checkbox"/> Plumbing—Practical
<input type="checkbox"/> Architecture & Building	<input type="checkbox"/> Diesel Engineering	<input type="checkbox"/> Private Secretary
<input type="checkbox"/> Automotive Engineering	<input type="checkbox"/> Drafting & Design	<input type="checkbox"/> Radio Operating & Servicing
<input type="checkbox"/> Aviation—Practical	<input type="checkbox"/> Electrical Engineering	<input type="checkbox"/> Railway Training
<input type="checkbox"/> Aviation Drafting & Design	<input type="checkbox"/> Electricity—Practical	<input type="checkbox"/> Refrigeration
<input type="checkbox"/> Better Foremanship	<input type="checkbox"/> Electronics, Industrial	<input type="checkbox"/> Sheet Metal Pattern Drafting
<input type="checkbox"/> Bookkeeping	<input type="checkbox"/> High School Courses	<input type="checkbox"/> Shop Management
	<input type="checkbox"/> Machine Shop Operations	<input type="checkbox"/> Tool Making
	<input type="checkbox"/> Mechanical Engineering	

Name \_\_\_\_\_ Occupation \_\_\_\_\_  
 Address \_\_\_\_\_ Age \_\_\_\_\_  
 City & Zone \_\_\_\_\_ State \_\_\_\_\_

**PRACTICAL, EFFECTIVE**

**AMERICAN SCHOOL**  
 Dept. G645, Drexel at 58th Street, Chicago 37

# INVENTORS

Before you make any effort to market your invention, you should take the first steps toward proceeding for patent protection.

The usual first step is to have a search of the U. S. patent records conducted, so that I can report to you on the question of patentability.

I shall be pleased to furnish you with information relative to patent procedure, upon request from you, and this will be without any obligation on your part.

## PATRICK D. BEAVERS

(Formerly RANDOLPH & BEAVERS)

Registered Patent Attorney

934 Columbian Building Washington 1, D. C.

## Be an INVESTIGATOR

JAMES S. BOLAN, FORMER NEW YORK CITY POLICE COMMISSIONER offers MEN & WOMEN an opportunity for a Professional Career in Modern Investigation & Criminology by comprehensive Home Study Course. Free placement service assists graduates to obtain jobs. APPROVED FOR VETERANS. Licensed by State of New York. Write for Booklet P

THE **BOLAN ACADEMY, INC.**  
EMPIRE STATE BLDG., NEW YORK 1, N. Y.

# INVENTORS

IF YOU WISH TO PROTECT YOUR INVENTION, You should take steps to protect it by a U. S. Patent. Write me for "RECORD OF INVENTION" form.

**CARL MILLER**  
REGISTERED PATENT ATTORNEY  
WOOLWORTH BLDG., 35th FLOOR, 90A  
NEW YORK CITY

# SHORTHAND IN

Famous Speedwriting system. No signs; no symbols; no machines. Uses ABC's. Easy to learn, write, transcribe. Low cost. 100,000 taught by mail. Also typing. 27th Yr. Write for FREE booklet to:

**Speedwriting**  
Dept. 1509-A

55 W. 42 St., N. Y. 18, N. Y.

**6**  
WEEKS  
AT HOME



# PATENTS

## C. A. SNOW & CO.

REGISTERED PATENT ATTORNEYS  
WRITE FOR INFORMATION TO  
428 SNOW BUILDING, WASHINGTON 1, D. C.



# INVENTORS

Whether an invention is patentable can be substantially determined by a search of the U. S. Patent records. Without obligation, write for information explaining the steps you should take to secure a patent.

## JOHN N. RANDOLPH

Registered Patent Attorney

201 Columbian Building, Washington 1, D. C.

# INVENTING

**-FOR PROFIT!** If you have an inventive turn of mind, write for free 28-page booklet explaining how the Institute of American Inventors is helping inventors pre-test the profit possibilities of proposed devices to fill today's unprecedented demand for useful new inventions.

## INSTITUTE of AMERICAN INVENTORS

Dept. 4, 631-E St., N.W., Washington 4, D. C.

SAY YOU SAW IT IN POPULAR MECHANICS

# PATENTS PATENT LAWYER

**GUSTAVE MILLER**  
REGISTERED  
PATENT ATTORNEY  
90-PM WARNER BLDG.  
WASHINGTON 4, D. C.

ASSOCIATE EXAMINER  
U. S. PATENT OFFICE 1922-1929  
Patent Attorney and Advisor  
U. S. NAVY DEPT. 1930-1947  
Send for  
PATENT INFORMATION book  
and "INVENTOR'S RECORD"  
without obligation

# PATENTS "Proof of Invention" Folder mailed without obligation.

**E. E. VROOMAN, Registered Patent Atty.**  
505 McKim Building, Washington 5, D. C.

# HIGHEST ROYALTIES and CASH

## FOR YOUR INVENTIONS

(Patented and Patent Pending Only)

Write for **FREE** booklet without obligation

## UNIVERSAL MARKETING CO.

354 S. SPRING ST. (Suite M)

LOS ANGELES 13, CALIF.

# IMAGINE THEIR JOY

## WHEN THEY FOUND THEY COULD PLAY

This easy as A.B.C. way!



### LEARNED QUICKLY AT HOME

"I didn't dream I could actually learn to play without a teacher. Now, when I play for people they hardly believe that I learned to play so well in so short a time."

\*H. C. S., Calif.

### INVESTMENT PAID BACK A THOUSAND FOLD

"Anyone with musical ability should make good with your course. My little investment paid back a thousand fold. I have been playing for 4 years now. Today I play in one of our top bands."

\*J. M., San Juan, P. R.



### PLAYS AT DANCES

"I have completed your course and your lessons have been most satisfactory. I can play all of the popular songs. I have also earned money playing at dances."

\*E. N. J.  
New York.

### PLAYS ON RADIO

"As a proud student I can't keep from telling you that as a result of my course I have a good position playing from KTHS, Hot Springs, Ark., every morning."

\*J. S., Okla.



### INVITED TO PARTIES

"I enjoyed taking this course and I get a lot of pleasure out of it. I have made much progress and have many invitations to play at parties. I owe you much for making this possible."

\*K. U., N. Y.

## Thousands Have Learned to Play Quickly, Easily At Home

WHAT instrument would you like to play? We'll show you how you can learn to play it—quickly, easily, in spare time at home for only a FEW CENTS A DAY! Never mind if you don't know one note of music from another—don't worry about "special talent." The truth of the matter is that thousands now play who never thought they could! Yes, men and women everywhere are enjoying the thrilling satisfaction of playing the piano, violin, guitar, saxophone or other favorite instrument. Some of them are playing in orchestras and over the radio; others are teaching music, making money in spare or full time. And thousands are playing for their own enjoyment

and the entertainment of their friends. It all came about when they wrote to the U. S. School of Music for the Free Booklet that shows you how EASY it is to learn music at home this modern way. No tedious scales, no tiresome exercises. You learn to play by playing—start right in almost at once with the melody of a simple tune! It takes only a few minutes a day and the cost is trifling; you save the expense of a private teacher. Does it sound too good to be true? Mail the coupon and get the FREE PROOF! No salesman will call. (Our fifty-second year—Est. 1898.) U. S. School of Music, 79 Brunswick Bldg., New York 10, N. Y.

### NOTICE

Please don't confuse our method with any systems claiming to teach "without music" or "by ear." We teach you easily and quickly to play real music, any music, by standard notes... not by any trick or number system.

### SEND TODAY FOR COMPLETE DETAILS

You'll open your eyes when you find how quickly and easily you can learn to play your favorite instrument. Don't doubt; don't hesitate. Send for the fascinating illustrated booklet that answers all your questions; let the free Print and Picture Sample show you how this method actually works. If interested, mail the coupon NOW.

\*Actual pupils' names on request. Pictures by professional models.

### FREE! Print and Picture Sample

#### U. S. SCHOOL OF MUSIC

79 Brunswick Bldg., New York 10, N. Y.

I am interested in music study, particularly in the instrument checked below. Please send me your free illustrated booklet, "How to Learn Music at Home."

Piano	Saxophone	Modern Elementary
Guitar	Trumpet, Cornet	Harmony
Hawaiian Guitar	Pipe, Reed Organ	Clarinet
Violin	Tenor Banjo	Practical Finger
Piano Accordion	Mandolin	Control
		Other Instrument

Have you instrument? \_\_\_\_\_  
Mr. \_\_\_\_\_  
Miss \_\_\_\_\_  
Mrs. \_\_\_\_\_  
(Please Print)

Address \_\_\_\_\_

City \_\_\_\_\_ State \_\_\_\_\_

NOTE: If you are under 16 years parent must sign coupon.

Save 2c—Stick coupon on penny postcard.

# C. T. C. TRAINING IN DRAFTING

PREPARES FOR  
PROMOTION  
•  
MORE MONEY  
•  
SUCCESS



"Here I am at work making good money as a draftsman. I'm glad I sent the coupon to Chicago Tech for that Free Trial Lesson and found out how easy it is to learn Drafting in spare time at home. Today, I feel secure in my job. What's more, I feel I'm slated for promotion and more pay."

## LEARN IN SPARE TIME—AT HOME! (or at the College in Chicago)

A few hours of pleasant home study every week—that's all. All the tools you need; drawing outfit included. This tested method—developed over 46 years of C.T.C. progress—prepares men quickly for good positions in industry.



**FREE INFORMATION — SEND COUPON**  
To prove to you how easy it is to learn Drafting at home, we will send you this **FREE TRIAL LESSON**. Mail coupon or send post card today.

## CHICAGO TECHNICAL COLLEGE

M-213 Tech Bldg., 2000 So. Michigan Ave.,  
Chicago 16, Illinois

Mail me **FREE** Lesson with information about big opportunities in **DRAFTING**.

Name \_\_\_\_\_ Age \_\_\_\_\_  
Address \_\_\_\_\_  
City \_\_\_\_\_ Zone \_\_\_\_\_ State \_\_\_\_\_

## BIG PAY JOBS for men who qualify in DIESEL



**ASSURE YOUR FUTURE.** Steady, high-pay jobs await men qualified in Diesel, Tractor, and Heavy Equipment. Are you qualified for job and advancement opportunities in this fast-growing field? You can qualify!

**COMPLETE DIESEL COURSE NOW AVAILABLE.** If you are ambitious and want to get ahead in this big money field, you'll want to know about the complete Diesel home training course now offered by Interstate Training Service. Covers all phases of operation, repair, service. Easy to master in spare time. No interference with present job. Up-to-the-minute. Regularly revised to cover new developments. We invite comparison of material offered. Free placement advisory service.



**YOU OWE IT TO YOURSELF** to investigate Interstate Training Service Diesel Training. Thousands agree it has helped them to better jobs... better pay. It can do the same for you!

**WRITE FOR FREE INFORMATION TODAY**

INTERSTATE TRAINING SERVICE, Portland 13, Ore.  
Please see that I receive **FREE** 24-page book, "Getting Ahead in Diesel," K-9

NAME \_\_\_\_\_ AGE \_\_\_\_\_  
ADDRESS \_\_\_\_\_  
CITY \_\_\_\_\_ ZONE \_\_\_\_\_ STATE \_\_\_\_\_

# SPEED AND POWER Handbook

50 CHAPTER LIBRARY EDITION  
Tens of thousands have been sold!  
Build Fast Stock Cars! California Roadsters! 160 MPH Rods! Covers Crosleys to Cadillacs—all makes—Authentic—Direct from California!



Photos  
Drawings  
128  
PAGES

## SAVE MANY DOLLARS

Build your own Dual Manifolds! Superchargers! Hot Cams! Water Injectors! Hi-Compression Heads! Mileage Devices! Get up to ten more miles per gallon! Get racing speed, lightning acceleration, dynamic power increases from any make passenger automobile! Get construction drawings! Tuning techniques! Speed tricks! Economy secrets! Ingenious formulas! Covers "Racing Frames"—"Reciprocating Masses"—"Jet Engines"—"Wheel Geometry"—"Dynamometers"—"Dual Pipes, Gears, Fuels, Porting, Relieving, Lowering! Balancing—50 breathtaking chapters!



SPEED SHOP  
METHODS

Includes "CALIFORNIA AUTOMOBILE CUSTOMIZING"—Diagrams! Photographs! Newest Ideas! Restyling all makes! Including 1950 Racing Equipment Catalogue. Also, "Economy Manual" and "Injection Information," 300 illustrations. Five items, complete—\$1.98 post-paid. Racing Equipment Catalogue without book—50c.

**NEWHOUSE AUTOMOTIVE INDUSTRIES**  
5805 EAST BEVERLY BLVD. DEPT. B4  
LOS ANGELES 22, CALIF.



Free  
Book

## RAISE HAMSTERS

The new wonder animals from Syria. Often called Toy Bears. Delightful pets. Everyone wants them. Laboratories need thousands. Clean, odorless. Raise anywhere. A profitable and interesting hobby or business. We furnish breeding stock with manual of instructions.

Write today for free illustrated literature.  
**GULF HAMSTERY, 1536 BASIL, MOBILE, ALA.**



## LABORATORY TECHNICIAN

**BE A LABORATORY SPECIALIST:** complete course. Big demand from hospitals, doctors, clinics. We teach all branches of medical laboratory work, including Medical and Dental X-Ray.

Approved by American College of Medical Technologists  
Co-educational Free Placement Bureau  
Free Catalog

Accredited for "veteran" training  
**CHICAGO COLLEGE OF LABORATORY TECHNIQUE**  
Dept. P.M., 431 S. Wabash Ave. Chicago 5, Illinois

## GETTING CUSTOMERS BY MAIL

easy when one knows how... Look this up. Revealing particulars free. Write today.  
**HOWARD HOUSE**  
Melrose 76-634 Massachusetts

## WHY DON'T YOU WRITE?

Writing short stories, articles on business, sports, homemaking, travel, shop crafts, local and club activities, etc., will enable you to earn extra money. In your own home, on your own time, the New York Copy Desk Method teaches you how to write the way newspaper men learn—by writing. Our unique "Writing Aptitude Test" tells whether you possess the fundamental qualities essential to successful writing. You'll enjoy this test. Write for it, without cost or obligation.

**Veterans: This course approved for Veterans' Training.**  
**NEWSPAPER INSTITUTE OF AMERICA**  
SUITE 5590-P, ONE PARK AVENUE, NEW YORK 16, N. Y.

## SAY YOU SAW IT IN POPULAR MECHANICS

## Learn WOOD PRODUCTION ENGINEERING At Home In Your Spare Time

KLOK TRAINING offers you exceptionally practical and fascinating instruction in the woodworking industry arts—Sketching—Drafting—Rod Making—Time Study—Cost and Production Scheduling in an 81-Lesson Home Study Course or through Resident Training at Grand Rapids. Enables you to attain a top woodworking position or to run your own shop more successfully. Free G. I. instruction. Money back trial offer to non-veterans. Write me—today for **FREE BOOKLET**. State age, veteran or non-veteran, Home Study or Resident Course, occupation.



JOHN H. KLOK, President

## KLOK INSTITUTE

Woodworking Industry Training Since 1928  
J. Louis St., N.W. Grand Rapids 2, Mich.





**MONEY BACK**  
if Not Delighted  
in 10 Days  
WEAR AT OUR RISK

**AMERICA'S BEST WATCH VALUES**  
PRACTICALLY WHOLESALE DIRECT TO USER

ORDER WITH CONFIDENCE  
**5 YEAR WRITTEN  
GUARANTEE**

**17 JEWEL SELF WINDING**

ORIGINALLY \$71.95 FACTORY SURPLUS

Watch that winds itself! Latest improved self-winding lever movement. Keeps 40 hours reliable time after few hours wear. Waterproof. Shock built. Non-magnetic. Accurate. Professional sweep second hand. Now only \$24.95 plus \$2.50 tax. Order now.

NOW ONLY  
**\$24.95**



MEN'S OR WOMEN'S **BULOVA**

**15 or 17 JEWEL**  
movement



Originally Sold up to ~~\$59~~

OUR PRICE ONLY  
**\$16.95**  
Plus \$1.70 Tax

Also

- BENRUS
- GRUEN
- WALTHAM
- or ELGIN WATCHES

TRIAL OFFER!  
Wear At Our Risk!

Genuine Bulova, Benrus, Gruen, Waltham, Elgin and other famous wrist watches in latest style Yellow Gold Cases. You get these unredeemed 5-year Guaranteed FAMOUS MAKE WATCHES now at truly enormous savings because we bought out SURPLUS STOCKS of leading New York and Maryland Jewelers. Order now while they last. State make preferred. Order men's or ladies'. Only \$16.95 plus \$1.70 tax. Order now.

**17 JEWEL 2 Push BUTTON CHRONOGRAPH**

Thousands Sold at \$71.50

- WRIST WATCH Factory Surplus
- STOP WATCH NOW ONLY
- TELEMETER
- TACHOMETER **\$21.95**

Precision 4-in-1 timepiece for professional scientists, aviators, engineers, sportsmen, etc. Incablock shock resistant feature. 3 multi-functional dials automatically coupled. 30 min. register. Synchronized for hrs., min., seconds, 1/5 seconds. Luminous. Instructions included. Unbreakable crystal. Only \$21.95 plus \$2.20 tax. Order now.



**2 PUSH BUTTON PLATED YELLOW GOLD CHRONOGRAPH**

LOOKS LIKE A \$25 WATCH

Sweep second hand. Measures speed of cars, planes, horses, heart, etc. Combined time-piece, stop-watch, telemeter, tachometer. Perfect for Sportsmen, Boys, Young men. Shock-Resist. Movement. Radium Dial. Leather Strap. Instructions enclosed. Only \$6.95, plus 70c tax.

NOW ONLY  
**\$6.95**



**17 JEWEL SHOCK PROTECTED WATER RESIST**

Factory Surplus Sacrificed!  
ORIGINALLY \$59.00

OUR PRICE NOW ONLY  
INCABLOCK **\$16.95**  
Handsome accurate.

Has sweep second hand. Non-magnetic. Kept accurate time after 72-hour test under water. Amazing value at \$16.95 plus \$1.70 tax. Order now.



**FREE!** Handsome expansion band included free with your order.

Write for FREE Watch & Diamond Ring Catalog. Practically wholesale prices to user direct.

ORDER DIRECT FROM THIS AD, FOR SELF AND FOR THRILLING GIFTS. Lowest prices ever, for these guaranteed watches! Order now on famous 5-year written guarantee. Send only \$1 down payment with order. Pay balance to postman on arrival plus postage. Or we pay postage if you enclose full payment plus tax with your order.

MARYLAND DISTRIBUTORS, Dept. 116, 501 E. Baltimore St., Baltimore 2, Md.

**BE A PHOTO-ENGRAVER**

We furnish complete equipment and supplies. Learn at home or in our modern, friendly APPROVED school in MISSOURI. Get into this big demand, high profit, high wage field. You can start your own profitable, full time or part time PHOTO-ENGRAVING business right in your own home.

Be independent, be your own boss or pave the way to a high pay job with experience gained in your own shop.

TASOPÉ TRAINING and TASOPÉ EQUIPMENT has enjoyed world wide recognition since 1931. Write for descriptive literature today. No obligation.

THE AURORA SCHOOL OF PHOTO-ENGRAVING, DEPT. 9PM., TASOPÉ BLDG., AURORA, MO.

**LEARN MEAT CUTTING AT NATIONAL**  
Pay After Graduation



The steady dependable trade of Meat Cutting taught easily in 8 short weeks. YOU LEARN BY DOING under actual meat market conditions in big modern school at Toledo.

For beginners or men with experience. Get a profitable store of your own. Remember, PEOPLE MUST EAT! Big pay jobs. Free employment help. Thousands of successful graduates.

Buying, cutting, percentage, pricing, advertising, selling, etc. A complete retail meat education. National School established over 25 years. Get National training NOW. Pay your tuition in easy weekly payments

after you graduate. G. I. approved. Send coupon for FREE 52 page school catalog — TODAY.

National School of Meat Cutting, Inc., Dept. 50-J, Toledo 4, Ohio

Send me your FREE school catalog on National Training at Toledo in Meat Cutting, Meat Merchandising and Self Service Meats. No obligation. No salesman will call.

Name \_\_\_\_\_

Address \_\_\_\_\_

City \_\_\_\_\_ State \_\_\_\_\_

( ) Check here if Veteran of World War II

# FREE

## ALLIED'S NEW 1951 RADIO and TV CATALOG



### SEND FOR THIS 212-PAGE BOOK



### SAVE ON EVERYTHING IN RADIO AND TV



### Get Radio's Leading Buying Guide!

Save money on every purchase you make from the world's largest radio supply house! Send for ALLIED'S new 212-page 1951 Catalog packed with *everything* in Radio and Television. Widest selections of home radios, TV equipment, phonoradios, Amateur equipment, P.A. systems, Hi-Fidelity music systems, recorders, test equipment, builders' kits—plus thousands of parts, tubes, tools, books and diagrams. Get more for your money—send today for your FREE 1951 ALLIED Catalog, the preferred Buying Guide to *everything* in Radio, TV and Electronics.

BUILDERS' KITS • TELEVISION  
HI-FIDELITY CUSTOM SOUND  
AMATEUR GEAR • THOUSANDS  
OF PARTS, TUBES, TOOLS,  
TESTERS, BOOKS, DIAGRAMS

Everything for:  
Servicemen  
Engineers  
Experimenters  
Builders  
Amateurs

## ALLIED RADIO

FREE  
CATALOG

ALLIED RADIO CORP., Dept. 5-J-O,  
833 W. Jackson Blvd., Chicago 7, Ill.

Rush FREE 212-Page ALLIED Catalog

Name.....

Address.....

City.....Zone.....State.....

## OWN Your Own Business

### Lifetime Income

Clean and Mothproof rugs and upholstery "in the home" or public buildings. Start full or part time. Gross profits up to \$15 and \$20 a day on EACH of your service men. Easy to learn . . . quickly established.



PATENTED PORTABLE EQUIPMENT

**DURACLEAN** cleans by absorption! No scrubbing, soaking or shrinkage. Dirt and grease vanish . . . matted pile rises . . . colors revive. Furnishings used again same day.

**DURAPROOF** resists moths and carpet beetles. Your service backed by a National Money Back 4 Year Warranty.

We furnish enough material to return your total investment. **EASY TERMS.** Territories limited. Send for **FREE** booklet . . . full details.

**Duraclean Co.** 0-169 Duraclean Bldg. Deerfield, Ill.

### Easy Way to Practice Radio Code



NEW amazing Telegraph Code Practice Set. Light touch of **DUPLEX PRACTICODE** telegraph key produces **LOUD PROFESSIONAL "BEEP"** thru its large 4-inch Permanent Magnet Speaker. Works 6 months on only one 75 volt cell—No parts to burn out! Safe! COMPLETE WITH REAL PROFESSIONAL TELEGRAPH KEY AND BATTERY—Nothing else needed!

As many as 6 sets can operate on one line! Colorful Wood Cabinet, 3 1/2 x 5 x 10 1/4", in red, green, yellow or blue pastels. One-year factory guarantee. **\$5.95** complete plus 50c for shipping & handling

Send M. O. or Check. Write for Catalog M  
**MARTIN MFG. CO., Dept. PM, 194 Gelston Ave., Brooklyn 9, N. Y.**

### make MONEY CASTING AT HOME



Make your own rubber molds quickly, cheaply with **X.L. RUBBER**. Cast thousands of perfect figurines, book ends, plaques, ornaments, ash trays, etc. **GREAT PROFITS!** Write for **NEW Catalog**. X.L. Rubber, Pts. \$2.00; Qts. \$3.50; Gallons \$8.95; Models and enough rubber for 3 molds \$1.30 postpaid.

**PLASTIC ARTS STUDIO** Dept. 2, 3403 S. MADISON ST., Muncie Ind.

50,000 NOW LETTING THIS BOOK BUILD FOR THEM

## BUILD

Here is the answer to how to build—The **WORKS**—how to plan, construct, supervise. Simply, clearly, explained step-by-step. Hundreds of clear-cut, complete diagrams. Only \$3.98, Post-Paid. Your money returned via AIR MAIL, if not completely satisfied. Order Now. The Westport Publishing Co., Dept. MP9, Westport, Conn.

## ELECTRICAL TRAINING

Intensive 32 weeks' residence course in fundamentals of industrial electrical engineering, including radio, electronics. Prepares for technician, engineering aides. Approved for veteran training. 57th year. Enter November 6. Catalog.

**BLISS ELECTRICAL SCHOOL**  
7640 TAKOMA AVENUE  
WASHINGTON 12, D. C.



### WOULD UP TO \$400 PER MONTH INTEREST YOU?

It is easily possible to earn up to \$400 a month raising Guaranteed Thoroughbred **ANGORA RABBITS**. No experience required. Wool brings \$5.00 per pound. Plenty of markets. **WRITE TODAY** for **FREE INFORMATION**, prices and where to sell.

**WHITE'S RABBITRY**  
NEWARK 10 OHIO



### OH! BOY! \$50 A DAY

**Easy Sales! Easy Money!**  
That's what you'll be shouting . . . when you line up with our sensational, fast selling item in your territory on a full time or spare time basis. Saves money for restaurants, lunch rooms, taverns, meat markets, food-beverage stores. Enormous field. No experience needed. **WRITE QUICK** for big money starting plan. Hurry!

**UTILITY CO., 53 W. Jackson Blvd., Dept. 1, Chicago 4, Ill.**

# Norman Rockwell

WORLD'S MOST FAMOUS COVER ARTIST SAYS . . .

## "you can be a successful artist!"



America's 12 Most Famous Artists Show You

Norman Rockwell • Al Parker  
Jon Whitcomb • Ben Stahl • Stevan Dohanos  
Robert Fawcett • Harold von Schmidt  
Peter Helck • Austin Briggs • John Atherton  
Fred Ludekens • Albert Dorne



Every famous artist was once an amateur. The difference between "doodling" and a well-paid art job is training by professionals. Now, you can get that know-how quickly, at home, in your spare time. I have worked with America's 11 most famous artists to perfect new and faster methods of teaching you our secrets and short cuts. Get started today. Write for big illustrated brochure. It's FREE!

### FAMOUS ARTISTS COURSE

Dept. I-6, Westport, Conn.

**FREE**

Please send book about Famous Artists Course.

Mr. Mrs. Miss \_\_\_\_\_

Street \_\_\_\_\_

City, Zone, State \_\_\_\_\_

Phone No. \_\_\_\_\_

Age \_\_\_\_\_

# CHARCOAL-BROIL FOOD, INDOORS!

MAKES LUSCIOUS CHARCOAL-BROILED FOOD RIGHT AT YOUR TABLE

Bring Outdoor Living Indoors!

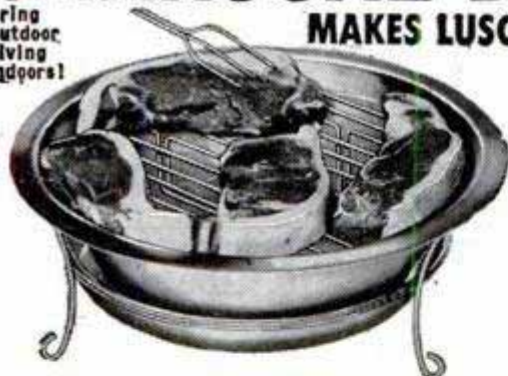

For the most lip-smacking eating you've ever known, charcoal broil steaks, fish, fowl, etc., on CHARCOOK! Proved over 90% smokeless. Self-sterilizing. Made of nickel-plated steel with 10 1/2" grill. Ash and drip pan eliminates dirt and grease. Requires no kindling—lights over gas or electric stove in seconds, then burns for hours without attention. Also ideal for gardens, picnics. Large bag of finest hickory and hardwood charcoal included free. Price, only \$4.95 complete, plus 25¢ postage. Or, sent C.O.D. \$4.95 plus postage. Money back if not delighted. Order now!



**FOSTER PRODUCTS, Inc.** 659 Main St., Dept. CK-20, New Rochelle, N. Y.

### HAD A PAY RAISE RECENTLY?

You need a high school diploma to assure faster promotions or to land a better job! Earn yours at home in spare time—within months—not years. Texts supplied. Guided study. College prep. Credit for work elsewhere. Easy terms. Write for valuable free booklet today.



### COMMERCIAL TRADES INSTITUTE

1400 Greenleaf

Dept. H2-9

Chicago 26

### THE OPPORTUNITY OF A LIFETIME

#### Export Promotion

At Last! A prosperous career, free from competition. AMERICAN EXPORTERS NEED TRAINED MEN TO BUILD FOREIGN MARKETS. This is the only Course which trains you to set up your own business or become a HIGH-PAID EXPORT PROMOTER WITH SECURE FUTURE. Your Golden opportunity—SEND FOR OUR FREE BOOKLET TODAY.



AMERICAN EXPORT PROMOTION COUNSELORS  
Dept. A9, 366 Madison Ave., NEW YORK, N.Y.

# NEON SIGN SCHOOL

G.I. APPROVED

Learn Neon. Interesting, clean work, BIG PAY—\$1.50 to \$2.00 an hour to start. 12 1/2 week Job-Practice Course gives you training in Glass Blowing, Neon Tube Bending, Color Gassing, other branches. FREE FOLDER explains. Write today.

### ACME NEON INSTITUTE (Write Nearest Office)

330 S. PAULINA ST., Dept. K2  
CHICAGO 12, ILL.  
G. I. Approved

418 1/2 W. Olympic Blvd., Dept. K2  
Los Angeles 15, Calif.  
Write for G.I. Information

LEARN IN 12 1/2 WEEKS

# Learn ELECTRIC APPLIANCE REPAIR IN YOUR SPARE TIME AT HOME



**ONE BUSINESS THAT IS NOT EFFECTED BY STRIKES, DEPRESSIONS OR POLITICS**

## START YOUR OWN BUSINESS

**WITH A POTENTIAL MARKET OF 50,000,000 CUSTOMERS**

New shop-method, home-training system gives you electrical know-how that used to take years to learn. Learn at home by building valuable testing kits, repairing your own and neighbors' appliances. It is not unusual for appliance repairmen to charge on the basis of \$5.00-\$6.00 an hour.

### FREE ILLUSTRATED BOOK

Shows you how you learn every phase of electrical appliance. How to make money while you learn. Write today for your FREE copy.

**CHRISTY TRADES SCHOOL**  
Dept. D-8503  
4432 North Kedzie Ave., Chicago 25

# 9 BIG BUILDING BOOKS



**12th EDITION FOR EXAMINATION SEND NO MONEY**

Learn to draw plans, estimate, be a live-wire builder, do remodeling, contracting. These 9 practical, profusely illustrated books cover subjects that will help you to get more work and make more money. Masonry, concrete forms, carpentry, steel square, roof framing, construction, plumbing, heating, painting, decorating and many other subjects. More than 4000 pages — 2750 illustrations.

## BETTER JOBS — BETTER PAY UP-TO-DATE EDITION

A nationwide building boom is in full swing and trained men are needed. Big opportunities are always for MEN WHO KNOW HOW. These books supply quick, easily understood training and handy, permanent reference information that helps solve building problems.

These books are the most up-to-date and complete we have ever published on these many subjects.

### Coupon Brings Nine Big Books for Examination

**AMERICAN TECHNICAL SOCIETY—Publishers since 1898**  
Dept. G619 Drexel at 58th Street Chicago 37, Ill.

You may ship me the Up-to-Date edition of your nine big books, "Building, Estimating and Contracting," without any obligation to buy. I will pay the delivery charges only, and if fully satisfied in ten days, I will send you \$3.00, and after that only \$4.00 a month, until the total price of only \$34.80 is paid. I am not obligated in any way unless I keep the books.

Name \_\_\_\_\_

Address \_\_\_\_\_

City \_\_\_\_\_ State \_\_\_\_\_

Please attach a letter stating your age, occupation, employer's name and address, and name and address of at least one business man as a reference. Men in service, also please give home address.



# SPEED & MILEAGE MANUAL

**Easily Get Super Speed, Acceleration, Mileage—Top Racing Performance From Any Automobile!**

Famous New Book shows simplified Soup-up Methods—Speed Tuning—Economy Secrets—"Customizing Plans"—Latest Track Proven Methods for all cars! Tells how to build your own SPEED EQUIPMENT! FAST SPORT CARS! "CALIFORNIA HOT RODS"! 200 H.P. ROAD & TRACK CONVERSIONS! Complete Instructions on building inexpensive Superchargers! Dual Manifolds! "Water Injectors"! High Compression Heads! Twin Mufflers! Economizers! All about—Fast Engines, Gas Saving, Restyling, "Cam Secrets," Multiple Carburetion, Fuels, Porting, Ratios, Frames, "OHV's"! BRAND NEW METHODS, Plans, Formulas, "Racing Tricks"—STOCK CAR SPEED SECRETS! Reveals 100 Ways to save gas! Shows latest "HOLLYWOOD CUSTOM STYLING"! Streamlining! Sport Changes! Lowering! Speed Conversions! Including—California Roadster Plans! Racer Diagrams! Working Drawings! Performance Charts! Graphs! Beautiful Photographs! Etc.!

Large manual (plus) "California Equipment Catalog" and Hot Rod Handbook.  
**BIG SPEED EQUIPMENT CATALOGS**  
(without above books 25 cents)  
**ALMQUIST AUTOMOTIVE ENGINEERING**  
Milford 32P, Pa.



ALL \$1.98  
THREE—P.P.

## NEW! DURABLE! 7 JEWELS! 3 YEAR SERVICE GUARANTEE

- Shock Resist.
- Dust Proof
- Radium Dial
- Sweep Second Hand
- Chromed Case
- Leather Band

**\$6.95**  
Post Paid  
Plus 70c tax



Refund if not satisfied. Special! Order Now! Sorry, no C.O.D.'s.  
LADIES Watch, as above, smaller Size \$7.95 plus 80c tax.

**ELCO PRODUCTS CO., Dept. 15 166 W. WASHINGTON CHICAGO 2, ILL.**

# ARTISTS MAKE MONEY

Do you like to draw? Send name, address, age and occupation for FREE ART TEST, to find out your ability.

**ART INSTRUCTION, Inc.**

9130 ART INSTRUCTION BLDG., MINNEAPOLIS 15, MINN.

# MAGIC LIGHT BULB

Amaze your friends! Mystify them with a magic bulb that lights up in the mouth, ear or hand.



No wires attached! It's easy to do, and you'll get plenty of laughs. Sent post-paid for only \$2.00.

**DIME SILVER CLUB 935 W. Peachtree Atlanta, Georgia**

## Find HIDDEN TREASURES



**GEIGER COUNTERS** for Uranium Detection. (see at left). **TREASURE DETECTORS** for gold, silver, etc. Lightweight, ultra sensitive. None finer at ANY PRICE.

Information FREE.

*Detection Co.* Dept. 9-B  
5631 Cahvenga, No. Hollywood, Calif.



**IS \$10.00 A DAY WORTH A ONE CENT STAMP ?**

### NO EXPERIENCE OR INVESTMENT NEEDED

Let me show you how YOU can make as high as \$10 a day, without previous experience, by showing Merit Christmas & Everyday Cards, Stationery & Napkins to your friends, neighbors, relatives and others. We print your customers' names at no extra cost. No risk or investment. Drop me a penny postcard TODAY and I'll send you complete Selling Plan and samples on approval by return mail.

**MERIT GREETING CARD CO.**

370 PLANE ST.

Dept. 46

NEWARK, N. J.

# MEN! WOMEN!

## New Car given as Bonus!



### TAKE ORDERS for Nationally Advertised NYLONS

#### GUARANTEED NINE MONTHS

Sensational Guarantee creating a tremendous demand for Wilknit Nylons! If they run, wear out or evensag from any cause whatever... within NINE MONTHS... depending on quantity... they are replaced FREE OF CHARGE. No wonder it's easy to quickly build up fine, steady, year-round income. Earnings start immediately. Look at these exceptional figures—Ralph Shearer made \$67.11, first week—Mrs. Paul Estes, \$42.92—Mrs. Ivey Gentry, \$43.37. Doris Jensen in addition to making as much as \$17.00 in a single day, earned two cars as EXTRA BONUSSES. Learn how you can make money in your full or spare time without a bit of previous experience.

### SEND NO MONEY... Just Hose Size

When you send for Selling Outfit, I also send your choice of Nylons or Socks for your personal use. Don't lose a minute. Rush name on penny postcard for full money-making facts on Sensational Sales Kit. Send hose size, too. **Lowell Wilkin, WILKNITHOSIERY CO., 309 Midway, Greenfield, Ohio**

### EARNED TWO NEW CARS

#### ... and as much as \$120.00 in one week

That's the exceptionally fine record of Chas. Mills with the famous Wilknit hosiery line. Offer of New Chevrolet as a bonus open to EVERYONE. Send name for facts FREE.

## LEARN DIAMOND CUTTING

America needs Diamond Cutters. Big opportunity for men, women with special training. In only 14½ months Stewart prepares you to step into an important job at high pay. You "learn by doing" Personal instruction by skilled craftsmen. You work with actual diamonds. You learn to master every phase of this fascinating art.

Only Diamond Cutting School in U.S. Approved for Veterans. Start at once.

Send today for free catalog:

**STEWART GEM & DIAMOND CUTTING Institute**  
(Dept. 73) 565 Main Avenue, Passaic, N. J.



### Save Time!!! Save Money!!!

#### SEND FOR THIS BIG, NEW

## Woodworkers Catalog No. 17

ONLY 15c New low prices...great selection of fine domestic and imported woods...bargains in hard to get supplies--144 pages of items and ideas for woodworkers. Quick delivery on mahogany, walnut, maple, cherry, poplar, oak, red cedar, and others properly seasoned, kiln dried. Send 15c for your copy--TODAY. Dept. A-9



**CRAFTSMAN WOOD SERVICE CO.**

2729 S. MARY STREET-CHICAGO 8, ILLINOIS

## GO PLACES

### LEARN ANOTHER LANGUAGE

by the ONE and ONLY

# Linguaphone

METHOD

IN 20 MINUTES A DAY

Are you letting interesting job opportunities and a whole new world of social advantages pass you by because you speak only one tongue? Speak French, Spanish, German — any of 29 languages — quickly, easily by the one and only LINGUAPHONE CONVERSATIONAL METHOD. You listen—you learn—you understand—you SPEAK. World-wide educational endorsement; over a million delighted home-study students. FREE BOOK gives fascinating facts. Write TODAY!

**LINGUAPHONE INSTITUTE**

Dept. 98-P RADIO CITY, NEW YORK 20, N. Y.

FRENCH  
SPANISH  
GERMAN  
or any of 29  
Different  
Languages

# PLASTICAST

## THE GREATEST THING IN PLASTICS!



## A NEW HOME INDUSTRY AND HOBBY!

We have started THOUSANDS of people in a wonderful new kind of business! Here are 4 reasons why: (1) The work is pleasant and very easy... actually as easy as pouring water out of a glass! (2) VERY LITTLE investment is required; imagine, less than \$5.00 is required in order to start you off in your own manufacturing business! (3) Can be started ANYWHERE... at home, garage, basement, etc. and most important (4) The things you can make in QUANTITY PRODUCTION are not only exceptionally attractive and useful but are always in big demand every season of the year!

## YOU CAN MAKE ANYTHING!

What is this new business? It is CASTING... Casting with liquid plastics. CASTING is a method of production manufacturing WITHOUT MACHINERY OR TOOLS! CASTING is the exceedingly simple process of pouring liquids into molds... it is as simple as that! Like making Jello, only these liquid plastics SOLIDIFY in a few minutes after mixing into extremely HARD, DURABLE and ATTRACTIVE articles such as Jewelry, Novelties, Giftware, Figurines, Statuary, Knick-knacks, Baby Shoes, Souvenirs, Ceramics, Imitation Marble, Bookends, Lamps, Pen sets, Cigarette Lighters, Toys, Dolls, Banks, Fishing Lures, Tools... A THOUSAND USEFUL THINGS! The field is really unlimited. We supply EVERYTHING... Casting Materials, Molds, Accessories, Instructions and LISTS OF BUYERS!

## 1000 GOLDEN OPPORTUNITIES!

Regardless what you are doing now you can get into the CASTING BUSINESS in your spare time or evenings. We assure you, once you do, you will be eagerly devoting all of your time to this very easy, fascinating and HIGHLY PROFITABLE OCCUPATION until it leads into a dependable business all your own! BUT LET US PROVE IT. Send only 25c for our big 40 page Catalog of Casting Materials, hundreds of Molds, etc. We will also send you FREE an attractive CASTING to show you what can be done with liquid plastics in a few minutes! We will also send you FREE a valuable book giving you details on the ART AND BUSINESS OF CASTING which shows you how to cast and get started! All this for only 25c, but write for it today. This may be the lucky coin that will start the most fascinating and profitable phase of your life!

## 10 VALUABLE MOLDS FREE!



If you want to get started at once without delay then send for our big SENIOR PLASTICAST OUTFIT... here is what you receive! TEN VALUABLE MOLDS for making extremely beautiful and useful TRANSPARENT crystal-clear or colored plastic articles as illustrated directly above! Make unusual Penholders, Cigarette Lighters, Ash Trays, Perfume Sets, Pendant Hearts, Imbedded Flowers and Photos, Buttons, Key Chain Fobs and countless other attractive items! Outfit also includes 1 qt. PLASTICAST liquid casting plastic and hardener which will make about \$100. worth of material, pipette, measuring glass, colorful imbedding material, polishing material, 2 dyes and Instruction Manual. OUTFIT No. 646, price postpaid \$7.50  
Our MASTER OUTFIT contains 4 molds, pint of PLASTICAST and hardener, pipette, measuring glass, imbedding material and Manual. OUTFIT No. 4 Price, postpaid... \$3.50  
C.O.D. orders filled (not postpaid) if \$1.00 deposit sent with order.

# FREE

An attractive Casting and valuable BOOK shown at the right sent FREE with our Catalog! See 3rd paragraph above.

## PLASTICAST COMPANY (DEPT. C)

170 N. Halsted St. (Write to P. O. Box 987  
Chicago 6, Ill. nearest address) Palo Alto, Calif.  
CANADIAN CUSTOMERS, please order directly from: CANADIAN INDUSTRIAL PLASTICS, LTD., 1056 1/2 Pender West, Vancouver, B.C.

# Learn A Trade NOW! PRACTICAL SHOP TRAINING!

## In Our Chicago Shops

- |   |  |
|---|--|
| <input type="checkbox"/> AUTO MECHANICS   | <input type="checkbox"/> WELDING—ARC and GAS |
| <input type="checkbox"/> DIESEL MECHANICS | <input type="checkbox"/> MACHINIST           |
| <input type="checkbox"/> REFRIGERATION    | <input type="checkbox"/> PIANO TUNING        |
| <input type="checkbox"/> BODY-FENDER      |  |

Above Approved For G. I.'s and Civilians  
One of America's Leading Practical Schools  
7 Floors of Fully Equipped Shops  
Over 50,000 Successful Graduates  
Expert Individual Instruction  
Learn by Doing—Low Living Expense  
Established 1902—Day and Evening Classes

## Also the following Home Study Courses

- |                                  |  |                                 |
|----------------------------------|--|---------------------------------|
| <input type="checkbox"/> PLASTIC | <input type="checkbox"/> REFRIGERATION | <input type="checkbox"/> DIESEL |
|----------------------------------|--|---------------------------------|

— CALL IN PERSON OR MAIL THIS AD TO —

## GREER SHOP TRAINING

(Desk 10) 460 South State St., Chicago 5, Ill.

Please send without obligation free information regarding trade checked above. (Specify whether you are a Veteran  or Civilian )

Name \_\_\_\_\_ Age \_\_\_\_\_  
Address \_\_\_\_\_  
City \_\_\_\_\_ State \_\_\_\_\_

# MOTOR TUNE-UP MANUAL

For the best job  
in the shortest time

You can do quicker, cheaper, better tune-up and repair jobs if you FULLY UNDERSTAND your motor. This book gives you that *thorough* understanding.

**Complete instruction in auto electricity**  
Besides complete step-by-step instruction in all tune-up jobs, this book clearly explains the *function* of every part of the battery, generator, voltage regulator, ignition system, etc. as well as all other parts of the motor. You will understand each part of the timing devices, how to locate trouble quickly, how to test for perfect adjustment, and how to be sure the adjustments you make achieve the results you want.

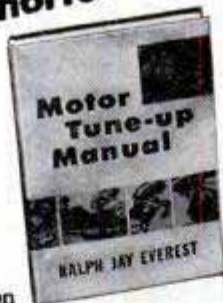

**A COMPLETE  
COURSE FOR  
ONLY \$5.50**

Fully illustrated

Handy lists of  
trouble symptoms  
and all possible  
causes.

## SEE IT ON APPROVAL

The Macmillan Co., 60 Fifth Ave., New York 11

Please send me Motor Tune-Up Manual on approval. I will either remit \$5.50 or return the book in 10 days.

Signed \_\_\_\_\_

Address \_\_\_\_\_

# BUILD THIS HOUSE Yourself



The Famous  
Popular Mechanics  
House  
The picture below is from an actual photograph of the Build-It-Yourself House with breezeway and garage, as built by Jack Brownson, 23-year-old veteran, in Aurora, Illinois.

Designed by Popular Mechanics and Famous Architects. Every Detail Simplified and Explained. No Previous Experience Needed!

Can you use everyday tools as well as the average Popular Mechanics reader? Then you, too, can easily build this modern house in any of its five designs, doing every part of the job yourself. The new Popular Mechanics Book, "Your Home—How to Build It Yourself" will show you how.

### Space for Living and Family Growth

This beautiful, modern house is 1½ stories, with basement, living room, kitchen, dining nook, two bedrooms, bath, plenty of closets and space for two additional bedrooms on second floor. The house itself is 35' 9" x 28' 11"; breezeway 20' 10" x 8'; garage 20' 10" x 12'.

### The House That Has Everything

Designed for easy construction and the most living space for the least cost, the Build-It-Yourself House is also most attractive and suitable for any community and most income groups. The basic plan is adaptable to four other exterior designs.

### Get Book and Plans Now—Build When You Can

You may never have thought about actually building a house yourself, but now that building restrictions have been lifted, it is easier than you think. So order book and plans today. Even if you engage a contractor to build for you, you will need the plans. And you certainly will want the book which can easily save you hundreds of dollars, whether you build this or any other house.

## Mail Coupon for New Book and Plans!

Build It Yourself  
or Have It Built  
—Save Hundreds  
of Dollars!

### PLANS YOU CAN READ AND FOLLOW

Plans consist of ten working-size blueprints—floor plans, elevations, construction notes, framing, joints, lumber and mill list, specifications, plumbing and wiring diagrams. Every measurement is marked—every detail made clear as ABC. Book has 100 pages—three-fifths are photographs and drawings. Some sections in colors, showing just how your house will look when finished.

**BIG BOOK**  
8½ x 11 inches



## MAIL COUPON FOR BOOK AND PLANS

POPULAR MECHANICS PRESS

200 E. Ontario St., Chicago 11

I enclose \$\_\_\_\_\_. Send me the items checked at once.

- |   |         |
|---|---------|
| <input type="checkbox"/> Your Home and How to Build It Yourself.....        | \$ 3.00 |
| <input type="checkbox"/> Complete set of plans for Popular Mechanics Home.. | 12.50   |
| <input type="checkbox"/> Book and plans at reduced price.....               | 14.00   |
| <input type="checkbox"/> Duplicate sets of plans.....                       | 5.00    |

Name \_\_\_\_\_

Address \_\_\_\_\_

City \_\_\_\_\_ Zone \_\_\_\_\_ State \_\_\_\_\_

## IT MAKES CENTS—

and it makes sense—advertisers who want to increase their business (their reason for advertising) seldom will risk losing your good will by delayed replies or poor service. That's why—when you write to them and want a prompt reply—check for a slip-up on your part before you mail your letter.

Was the address on the envelope correct and legible—did you send it to the right concern—did you use enough postage—did you tell the advertiser exactly what you want?

It's good business for advertisers to answer your letters promptly, to fill your orders correctly, or to tell you where you can buy their products locally. So remember—a delay in reply often means there's been a mistake somewhere—and not a lack of interest on the part of the advertiser!



Put your future  
in your own hands

# BE AN ARTIST

Here's the Amazing  
Way We Teach You  
Step-by-Step to Draw  
At Home in Spare Time

Draw for money. You will enjoy W. S. A. training and can progress rapidly. **COMMERCIAL ART, DESIGNING, CARTOONING**—all in one complete home study course. No previous art experience necessary. We teach you step-by-step and prepare you for good art jobs in advertising, newspaper and magazine publishing, department stores, printers, engravers, or in art studios, etc. You can become your own boss. For 36 years our graduates have been "making good"—**WHY NOT YOU?**

Trained Artists Are Capable of Earning  
**\$75-\$100 and MORE a WEEK**

Write for **FREE BOOK**, "Art for Pleasure & Profit"—tells about our course, instruction service, material furnished, what our graduates say, and commercial opportunities for you. **TWO ART OUT-FITS** and other features included with training.

**VETERANS! Course G.I. Approved**

**FREE BOOK** gives details!

**WASHINGTON SCHOOL OF ART, Studio 129W**

1115—15th St., N.W., Washington 5, D.C.

Please send me full information and your Free Book, "Art for Pleasure and Profit." (Please print name, etc.)

Name \_\_\_\_\_ AGE \_\_\_\_\_  
Street \_\_\_\_\_  
City \_\_\_\_\_ Zone \_\_\_\_\_ State \_\_\_\_\_

SAY YOU SAW IT IN POPULAR MECHANICS

**RADIO ENGINEERING.** Broadcasting, Television, FM, Servicing, Electronics, Aviation, Marine & Police Radio taught thoroughly. Engineering course equivalent to 3 years' college radio work. Approved Veteran Training. Catalog free. **VALPARAISO TECHNICAL INSTITUTE, Dept. D, Valparaiso, Ind.**

## Complete and Practical DRAWING OUTFIT at a Real Saving

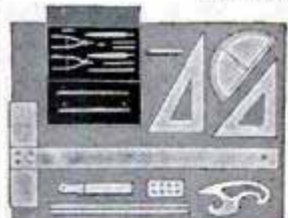

for Students, Professionals, and Non-Professionals at prices to fit every budget.

Contains:  
10 piece Imported Drawing Set  
1—12" x 17" Drawing Board  
1—T-Square, Maple 15"  
1—45° Plastic Triangle 4"  
1—30° x 60° Plastic Triangle 6"  
1—Scale Triangular Ruler  
1—Protractor 4" 1—French Curve  
1—Pencil Pointer  
2—Pencils 2H and 4H  
1—Eraser and set of thumb tacks  
Packed in a strong, easy-carrying Paste Board Box... **\$12.00**  
in all for only.....

Other Complete Drawing Outfits from \$3.75 for Scholastic Students to \$28.00 for College Students.

### FREE ILLUSTRATED CATALOG

Send Check or Money Order; on C.O.D.'s we add postage. 10 Day Money Back Guarantee If You Are Not Completely Satisfied.

**MODERN SCHOOL SUPPLIES**

BOX 958 HIGH ST., HARTFORD, CONN.  
"Savings For Student America"

# Watchmakers MAKE MONEY!

Large earnings, professional dignity and a steady, secure future can be yours as a Master Watchmaker! You can choose a fine job or go into business for yourself.

The nationally-known Sweazey System teaches you in the shortest allowable time . . . at home or in our modern, fully-accredited resident school.

**SEND FOR FREE PAMPHLET and Information NOW!**

Since 1908, Chicago School of Watchmaking graduates have been in constant demand. Big opportunities for trained workers. Resident courses in watch repairing, gem setting, and engraving. Home Study Course in Master Watchmaking.

**CHICAGO SCHOOL OF WATCHMAKING, 1608 Milwaukee Avenue Chicago 47, Illinois, Dept. 190**

Please send copy of "Civilization's Debt to the Watchmaker" and information on courses without cost or obligation.

I am interested in

Resident School  
 Home Study

Veteran  
 Non-Veteran

NAME \_\_\_\_\_  
ADDRESS \_\_\_\_\_  
CITY \_\_\_\_\_ ZONE \_\_\_\_\_ STATE \_\_\_\_\_

# ELECTRICAL BOOKS

shipped for  
**EXAMINATION**



**8**

**BIG BOOKS**

SEND NO MONEY  
**APPLIED  
ELECTRICITY  
INCLUDING RADIO  
AND REFRIGERATION**

Here's great news for anyone interested in Electricity. NEW, up-to-date 19th Edition of Applied Electricity with new subjects fully covered, including blueprint reading, electronics, P. M. radio, fluorescent lighting, 8 Big Books sent for examination!

## NEW Edition for Beginners and Experts

Over 3700 pages, 2700 illustrations and 134 tables in most complete electrical work we have published. Dynamos, motors, diesel plants, power stations, transmission - everything explained for easy understanding.

## BIG FIELD! Big Demand! Big Pay!

Men who understand electricity are needed now in all kinds of industries. Practically every business depends on electrical knowledge, and men who know this subject make big money. Learn easily with these new, interesting books. Send coupon for a set of books on approval. See how they will help you to get ahead faster.

**SEND  
NOW**

[A year's consulting privileges with our engineers now given to all buyers of this famous Cyclopedia of Electricity.]

**AMERICAN TECHNICAL SOCIETY**  
Vocational Publishers Since 1898

American Technical Society, Dept. E619, Drexel at 58th St., Chicago 37 Send for 10 days' free use, 8 volume set of New 19th Edition, Applied Electricity, including a certificate entitling me to consulting privileges for one year. I will pay the delivery charges only on the books. If I wish I may return them in 10 days and owe you nothing, but if I keep them, I will send \$3.00 after 10 days, then \$4.00 a month until the total price of only \$34.80 is paid.

NAME \_\_\_\_\_

ADDRESS \_\_\_\_\_

CITY \_\_\_\_\_ STATE \_\_\_\_\_

Please attach letter stating age, occupation, employer's name and address, and name and address of at least one business man as reference. Men in service, also please give home address.



No doubt about it!—There are plenty of splendid "blue-ribbon" jobs waiting in industry for trained men! They pay well, are more secure, offer real chances for advancement. C.T.I. trains you either at home in spare time, or in our resident school, in months. Over 12,000 graduates. One of every 6 starts a business. Mail coupon for valuable free booklet today. (State course.)

## COMMERCIAL TRADES INST.

1400 Greenleaf, Dept. E 2-9  
Chicago 26  Veteran  Non-Vet.  
Name \_\_\_\_\_ Age \_\_\_\_\_  
Address \_\_\_\_\_  
City & State \_\_\_\_\_  
Course \_\_\_\_\_

**AUTO  
MECHANICS**

**BODY-FENDER  
REPAIR**

**DIESEL  
MECHANICS**

**ELECTRICITY**

**RADIO &  
TELEVISION**

**REFRIGERATION**

**MECHANICAL  
DRAFTING**

**BUILDING  
CONSTRUCTION**

**FACTORY  
MANAGEMENT**

**HIGH SCHOOL**

# OUT OF PAWN GENUINE DIAMONDS

SAVE UP TO 50% AND MORE

Unmatched values in genuine blue white diamonds. Each diamond sold with a written iron-clad money back guarantee. All diamonds set in brand new mountings. Our reference—your own bank or any mercantile agency.

**BERMAN'S DIAMOND LOAN BANK**  
DEPT. P—BERMAN BLDG., BALTO. 1, MD.

Send for  
Illustrated  
**FREE  
Catalog**

Values from  
\$10 to \$10,000

## MAKE MONEY with Bostonian SHIRTS

TAKE orders for old, reliable line finest quality dress and sport shirts. All styles... fabrics... colors... sizes. Sensational LOW PRICES. No experience needed. FREE Samples of actual fabrics and big Style Kit waiting for you! Send no money, but rush name NOW! **BOSTONIAN MFG. CO.**  
89 Bickford St., Dept. J-40, Boston 30, Mass.



## BE AN INVESTIGATOR

WORK HOME or TRAVEL. Experience unnecessary.

**CRIMINOLOGY** Particulars FREE. Write to **GEO. M. P. WAGNER**, 125 W. 86th St., N. Y.

## HOMESITES \$300 LOW TERMS

In California's loveliest Garden Spot, on scenic shores of beautiful Morro Bay. Enjoy future independence with excellent soil, soft water, wonderful fishing, hunting, boating, bathing, etc. Grow fruits, vegetables, poultry. Perfect temperate climate. Congenial community. Finest investment. Free literature.

**RICHARD S. OTTO**

DEPT. M

SAN LUIS OBISPO, CALIFORNIA



## CARTOON SCHOOL

ONLY SCHOOL TEACHING CARTOONING EXCLUSIVELY Billy Hon nationally known cartoonist director. Draw comic strips, gag cartoons, editorials, sports, commercial cartoons and caricaturing. Cartoonists needed for television. Approved for Vets.  
2921 Beverly Blvd. **BILLY HON** Los Angeles 4, Calif.

## ELECTRICIANS' SCHOOL

HOUSE AND COMMERCIAL WIRING • MOTOR REPAIR  
AND REWINDING • ELECTRIC REFRIGERATION

Approved for Veterans Training

## PENNSYLVANIA INSTITUTE SCHOOL OF ELECTRICITY

42nd and SPRUCE STS.

PHILADELPHIA 4, PENNA.

## Say You Saw It in POPULAR MECHANICS

## GUARANTEED TO INCREASE POWER

**RetMahr** Automatic

**GASOLINE  
INJECTOR**



More power, quicker starting, faster acceleration and greater mileage! It atomizes fuel for the fullest power. Dynamometer tests show power increases up to 15%.

**\$9.95**

SOLD ON MONEY BACK GUARANTEE  
Send Postcard for Information

**WESCO** Box D, 1665 Mission,  
San Francisco 3, Cal.

Easily  
Installed



**DON'T RISK YOUR LIFE**—on tires of inferior quality. We handle perfect, dependable tires—only one grade: the best!

**NOT VULCANIZED • NOT RECAPPED**  
**10% OFF ON TWO OR MORE TIRES**  
**NO SECTIONAL OR SPOT REPAIRS OF ANY KIND**



**GUARANTEED** perfect used tires. Tread deepened for longer wear, added protection. Drive with confidence—equip your car with triple inspected **SAFTYRES**. Every **SAFTYRE** carries a liberal **2 YEAR GUARANTEE**—every passenger tire, an additional 30-day absolute replacement clause. You can't buy better used tires if your life's at stake—and it is!

**2 Year Guarantee — Free Tube With Each Tire**

600-16	5.50	700-16	7.40	750-16	10.45
600-16(6)	6.50	650-15	5.65	550-16	5.50
650-16	6.25	700-15	5.75	550-17	6.95

**BEST GRADE MILITARY MUD AND SNOW**  
 600-16.....6.75

**EVERY TIRE PERFECT, A GENUINE VALUE**  
**LO-PRESSURE TIRES FOR THAT SOFTER RIDE**

670-16	5.95	670-15	5.75	760-15	7.35
760-16	7.95	710-15	6.96	820-15	7.95

**TRUCK TIRE VALUES**

Truck Owners — Get more loads per tire, more miles per tire dollar. Tires to suit your needs at prices to suit your pocketbook.

600-20	10.95	750-20	12.45	825-20	19.95	1100-20	26.95
650-20	11.95	32x6(8)	11.95	900-20	20.95	1000-22	18.95
700-20	11.95	32x6(10)	14.95	1000-20	21.50	1100-22	24.50

Top quality military tires.....750-20 15.95 — 900-16 12.75

**The SAFTYRE CO.** MAIL ORDERS PROMPTLY  
 "FOR THAT SAFE TIRE" FILLED. Send check or  
 920 W. CARY ST., RICHMOND, VA money order with this ad.

**STUDY AT HOME**  
**WITH AN EDUCATIONAL INSTITUTION**

**Courses in ARTS AND SCIENCES:** Philosophy; Education; Letters; Public Health; Medical Jurisprudence; Psychology; Sociology; Physics; Chemistry; Geology; Pol. Science; Theology; Law; Business and Commerce; Accounting; Mathematics; Statistics; Agriculture. **Courses in ENGINEERING:** Electrical, Civil, Mechanical, Drafting, Architectural, Automotive, Steam, Diesel, Aeronautical, Radio, Structural, Mining, Industrial. Petroleum, Marine, Refrigeration, Air Conditioning, Chemical. Send for free catalog.

McKinley-Roosevelt Incorporated, 4610-K3, Sheridan Rd., Chicago 40, Illinois

**YOU'LL ENJOY**

**LEATHERCRAFT**

**THE KIT KRAFT WAY**

**AND COPPER TOOLING OR TEXTILE PAINTING, TOO**

It's fun and it can be profitable! You can make fine leather goods, do beautiful copper tooling or decorative textile painting. Kit Kraft's big new catalog shows all supplies, tools, instructions, books, designs, everything you need, makes it easy, even for beginners. Write today for free catalog.

**FREE! ILLUSTRATED CATALOG**

**KIT KRAFT** 7377 MELROSE AVE., DEPT. M 9  
 HOLLYWOOD 46, CALIFORNIA

**BE A HIGH-PAID MAN IN YOUR COMMUNITY WITH THIS LONG NEEDED INVENTION**

Earn up to \$10,000 or more per year! Full or part time! Be your own boss!

U.S. Pat. D 153853  
 D 153854

A worldwide product needed by every home, business and farm... priced to sell quickly! Automatic Red Comet goes into action as soon as fire starts... smotherers fire without human aid. It's a sales 'natural'!

**SALES KIT FURNISHED**

Demonstrator units, sales literature, etc. Handsome leather-type kit. Tried and proved, it will make you an independent business man. **ACT NOW!** Someone in your community will be appointed soon. Write for details today!

**RED COMET, INC.**  
 720 R. C. Bldg. Littleton, Colorado

**"I Wanted SECURITY I Became a REAL ESTATE BROKER!"**

**HOWARD S. WEAVER**  
 The man who made this training possible. Founder of the **WEAVER SCHOOL** of Real Estate.



**Mr. Weaver Says:**  
 "I can show you how to start YOUR OWN BIG PAYING REAL ESTATE BUSINESS!"

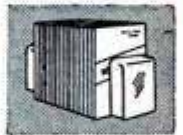

Easy to Understand Text Material—to add to your Reference Library.



Nationally Recognized Diploma Awarded.



Free Consultation as long as you want.

**BE YOUR OWN BOSS!** Operate your own Real Estate business. Be a broker. Use our FREE consultation service as long as you need it. Our files are full of testimonial letters from graduates who praise my system of instruction. They say they couldn't have done it without the **WEAVER SCHOOL OF REAL ESTATE** training. Real Estate offers you exceptional money-making opportunities. Act now! Fill out and mail the coupon to me today!

**YOU CAN MAKE BIG MONEY** in Real Estate. Since 1936 our graduates have been making good incomes in top real estate positions and in their own profitable real estate businesses. Real Estate offers you unlimited opportunities for big money, rapid advancement and lifetime security. I can show you how to get all of this. But act now.

**STUDY AT HOME** in your spare time—or in the classes of our franchise schools in leading cities. The Weaver School of Real Estate course teaches you everything you need to know to make a high income in Real Estate. It's easy. I send you lessons in easy-to-learn forms. You learn quickly and thoroughly. My instructors personally grade your papers. Try me at one hour a week, and I'll teach you Real Estate in a very short time.

Approved for Veterans' Training

**FREE BOOK TELLS HOW**

Established 1936

**WEAVER SCHOOL of REAL ESTATE**  
 15 E. Pershing Rd., Dept. K, Kansas City, Missouri

Name.....  
 Address.....  
 City..... State.....

**HOW to Make Your Own RUBBER MOLDS**

Here's a quicker, easier way to make exact reproductions of an object in any quantity. No heat curing required; no shrinking of materials. Objects of clay, plastic, wood, metal, glass or stone-like ashtrays, book ends, medals, souvenirs, plaques, sculpture can be copied exactly right at home! Perfect for reproducing Dresden figurines. No previous experience needed. No special tools required. Our new Brochure 329 gives exact, step-by-step instructions anyone can follow. Send 10c for it to **SCULPTURE HOUSE**, 304 West 42 Street, New York 18, N. Y.



**BECOME A JET ENGINE EXPERT**

**BE READY Start NOW**

Aviation's NEWEST OPPORTUNITY — Study with LIVE JETS at CAL-AERO only — AERONAUTICAL ENGINEERING & MASTER AVIATION MECHANIC training since 1929 — Approved for VETERANS.

**WRITE TODAY for Special Information.**

NAME..... AGE.....  
 ADDRESS.....  
 CITY..... ZONE..... STATE.....

**CAL-AERO TECHNICAL INSTITUTE**  
 GRAND CENTRAL AIR TERMINAL • GLENDALE 1, CALIFORNIA



# Learn DRAFTING and BLUE PRINTING!

Both fields offer ambitious men remarkable opportunities for advancement. Neither profession will ever be replaced by machines. Before any production can start, plans must be drawn. Draftsmen are the first to be hired. Blueprints are essential in every shop.

### CLEAR UNDERSTANDABLE TRAINING

Quickly you learn the hows and whys of successful production planning. You are sent professional drafting instruments, drafting table, equipment, etc., at no extra cost. Learn by making actual drawings.

### BIG MONEY . . . ADVANCEMENT OPPORTUNITIES

Offered trained draftsmen. It is light, pleasant work paying big salaries. Drafting is the stepping stone to top managerial jobs. It is work that stimulates the mind . . . keeps one interested.

### A BUSINESS OF YOUR OWN

Either as an independent drafting firm or as the operating head of a business firm producing products you created. Act now.

**MAIL THIS COUPON TODAY!**

CHRISTY TRADES SCHOOL, Dept. DB-103  
4432 N. Kedzie Ave., Chicago 25

Mail me at once your big FREE book on Drafting and Blue Printing. Tell me how your Home Training and Professional Drafting Instruments, Drafting Table, Drafting Equipment, etc. can be had on PAY AS YOU LEARN plan.

Name \_\_\_\_\_ Age \_\_\_\_\_  
Address \_\_\_\_\_ City \_\_\_\_\_ State \_\_\_\_\_



## HIGH PAY • SECURITY

When You

## LEARN A TRADE



Get ready for a well-paid, lifetime job or a business of your own in one of these FIVE ESSENTIAL TRADES. Complete training under expert instructors with practical experience prepares you to step into a good paying job with a future and security.



**ELECTRICITY:** Basic electricity, Residential and Industrial Wiring and Appliance Repair.



**PLUMBING:** Every phase — pipe cutting and threading to complete installations, blue print reading.



**MASTER AUTOMOTIVE TECHNICIAN—INCLUDING BODY AND FENDER:** Engine overhaul, Transmissions, Carburetion, Generator-Ignition Systems, Tune Up.

**DRAFTING:** College level training in general Machine and Architectural Drafting.

**SHOE REPAIRING:** Complete practical training includes reconditioning and rebuilding.

Approved For Veteran's Training

## NATIONAL TRADE SCHOOL

2610 Grand • Kansas City 8, Mo.

Without obligation to me please send full information on the course checked.

.....Master Automotive Technician Including Body & Fender  
.....Drafting .....Plumbing .....Electricity .....Shoe Repairing

Name \_\_\_\_\_ Age \_\_\_\_\_

Address \_\_\_\_\_

City \_\_\_\_\_ State \_\_\_\_\_

Veteran? \_\_\_\_\_

# PLYMOUTH SAVE MONEY!

Owners



Learn How to Make Your Car Run Better . . . Last Longer . . . and Save Hundreds of Dollars!

Get this book, written especially for you, without one penny of risk and get more out of your car. Mail coupon for MANUAL FOR PLYMOUTH OWNERS today. When the book comes, skip through the pages and see how your investment in one of America's most popular automobiles can be even a better investment than you thought. If you don't agree, send the book back and you'll get your money back.

### A Popular Mechanics Book Written Just for You

Not a re-hash of service manuals. A complete new Popular Mechanics book written for the Plymouth owner by an outstanding automotive authority with the full cooperation of Plymouth engineers and service directors. It will save you money on repairs and service; make your Plymouth last longer; give you safe, economical and trouble-free motoring. And this is true whether you take your Plymouth to a regular service station or service it at home.

### Prevents Trouble. Cuts Down on Repair Bills

Nothing like this manual anywhere. It covers all phases of operation, service and maintenance. It has entire chapters on the individual parts of your Plymouth—battery, ignition, starter, generator, regulator, lighting, fuel system, engine, lubrication, gasoline qualities, cooling systems, transmission, differential, rear axle, brakes, wheel alignment, tire care, body maintenance, trouble shooting on the road, etc. It covers your Plymouth, new and older models, step by step—bumper to bumper—showing you how parts operate; what can go wrong; how repairs and adjustments should be made and how to avoid all types of troubles.

### Money Back if Not Satisfied

Mail the coupon today. Send only \$3.50 or you can pay postman. Money back guarantee protects you.

### Official, Authoritative, Practical Information

Written by C. E. Packer, formerly service school instructor and auto show lecturer for automobile manufacturers, Member Society of Automotive Engineers, Editor of Automobile Digest, contributor to leading magazines, author of some of the biggest selling books on Automotive subjects. Prepared with the full authority and active cooperation of the Plymouth Division of the Chrysler Corporation.

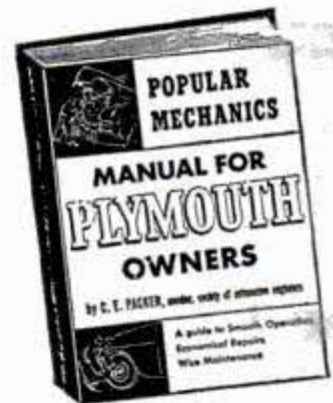

288 Pages. Hundreds of How-To-Do-It Illustrations and Diagrams

The entire book follows Popular Mechanics famous easy-to-read and easy-to-understand style. While primarily intended for the Plymouth owner, to help him get more out of his car at lower cost, it can be worth its weight in gold to the auto mechanic and service station operator who works, not only on Plymouths, but on all other makes as well, to which the information in the book can be easily applied.

## Order on this Handy Coupon

POPULAR MECHANICS PRESS, Dept. A  
200 E. Ontario St., Chicago 11, Ill.

Send Manual for Plymouth Owners at once. If not satisfactory I will return it within 5 days and you will refund full purchase price.

Remittance for \$3.50 enclosed.  Send C.O.D.

Name \_\_\_\_\_

Address \_\_\_\_\_

City \_\_\_\_\_ State \_\_\_\_\_

# LOCKSMITHS

## Are Always Busy!

Age or physical condition is no barrier to this good paying, respected profession! Learn it at home in your spare time. Uncrowded field for full or part-time business. Excellent profits and interesting work . . . no previous experience necessary!

Practical, illustrated lessons by professional locksmiths show you how to make money while learning. Special tools, materials, and practice locks without additional charge! Send for **FREE BOOKLET**.

**Institute of Locksmithing**  
Dept. P-10, 55 Park Ave.,  
Rutherford, N. J.

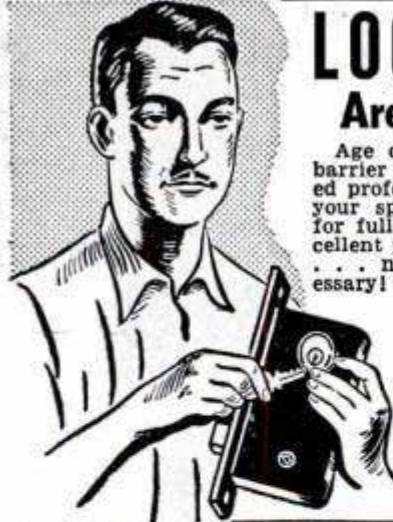

# Wear Sample Suit NOT 1¢ TO PAY!



Here's an amazing plan! Write me today and I'll show you how to get a fine, all-wool made-to-measure suit for yourself—to wear and show to friends. Just take a few orders, that's all! Here's an easy way to get your own suit without paying 1¢, and also make fine cash profit on every order you take. You send no money, now or ever. Just rush name and address for Sample Woolens and Valuable Sample Suit Coupon. Act now.

**W. Z. GIBSON, 500 S. Throop Street**  
Dept. J-516, Chicago 7, Illinois

**FREE**  
Costly Sample  
Kit containing  
over 100 actual  
fabric samples.

# Free Book on CUSTOM-BUILT HIGH FIDELITY RADIO

by **DAVID RANDOLPH**  
**CONTENTS:** How to assemble connoisseur's radio-  
phono for as little as \$111. How to select components.  
How to save money by installing system in existing fur-  
niture. Glossary of hi-fi terms. . . . Assemble your  
own hi-fi set. It's easy. Send today for **FREE** copy of  
David Randolph's "High Fidelity Guide"

**WRITE: LAFAYETTE RADIO, Dept. LI**  
100 Sixth Avenue, New York 13, N. Y.

Make  
Extra  
Money

# SELL CHRISTMAS CARDS

Show friends, neighbors, etc. finest Christmas assort-  
ments. Also beautiful All Occasion cards, Gift Wrapp-  
ings and Religious Cards. Write for **FREE SAMPLES**  
imprinted Christmas cards and stationery. **MITCHELL**  
**GREETINGS, Dept. P-9, 76 W. Adams, Detroit 26, Mich.**

# PIPE BENDING MADE EASY

New pocket-size disc computer plots en-  
tire pipe bending operation instantly on  
pipe diameters up to 6". Money-back guar-  
antee if returned within seven days.  
\$1.25 postpaid. C.O.D. charges extra.

# COMPUTERS

**BOX 193-E C. G. STA. SHREVEPORT, LA.**

Say You Saw It in  
**POPULAR MECHANICS**

# FOR BIG MEN ONLY!

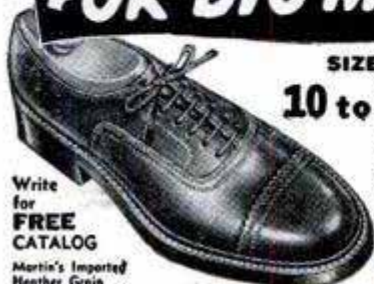

Write  
for  
**FREE**  
**CATALOG**  
Martin's Imported  
Heather Grain

**SIZES 10 to 16**      **WIDTHS AAA to EEE**

We **SPECIALIZE** in large sizes  
only—sizes 10 to 16; widths  
AAA to EEE. Loafers, Wing Tips,  
Moccasins, Dress Oxfords, High  
and Low Work Shoes, House  
Slippers, Rubbers, Overshoes,  
Socks. Extra quality at popular  
prices. Satisfaction guaranteed.  
Sold by mail only. Write for  
**FREE Catalog.**

**KING-SIZE, Inc., 979, Brockton, Mass.**

# International Harvester \$2<sup>95</sup>

1910 PASSENGER CAR MODEL

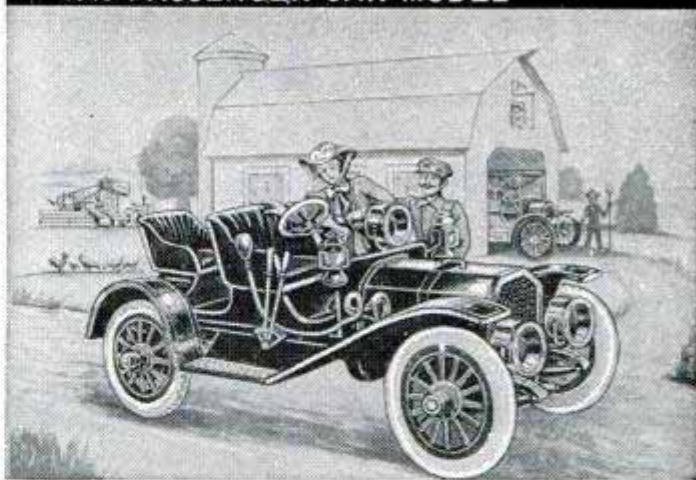

It may come as a surprise to you, but International Harvester did make a passenger car in 1910. They ceased production after two years—and that's what makes this antique auto such a rarity! Our scale model is from James Melton's Harvester Auto—one of his most prized museum cars! Pre-fabricated parts, easy to assemble. Length 8½". Only \$2.95. Also 12 other famous antique auto sets!

**FREE!**  
Write for  
Your Copy of  
Our 4-Color  
FOLDER!

1911 Maxwell . \$2.50	1910 Model "T"
1903 Model "A"	Ford . . . \$2.50
Ford . . . \$2.50	1903 Rambler . \$2.50
1904 Olds . . \$1.95	1909 Model "T"
1909 Stanley	Ford . . . \$2.95
Steamer . \$2.95	1900 Packard . \$2.50
1911 Buick . . \$2.50	1903 Cadillac . \$2.50
1914 Stutz	1911 Mercer
Bearcat . . . . \$3.95	Raceabout . . . \$3.95

SEE them at your hobby, toy, or department store, or write to us  
Add 25¢ for postage and handling; no C. O. D.'s, please.

**Hudson Miniatures' "OLD TIMERS"**  
SCRANTON HOBBY CENTER, Dept. 14, Scranton 10, Pa.



# "GET ON" Uncle Sam's PAYROLL

**START**  
as high as  
**\$3,450.00 Year**  
Prepare **NOW** For  
Next Examinations

**VETERANS GET  
SPECIAL PREFERENCE**  
Railway Postal Clerks  
City Mail Carriers  
City Postoffice Clerks  
Stenographers-Typists  
Liquor Inspectors  
Messengers, Etc.

**40-Page Book  
on Civil Service  
FREE.**

**Mail  
Coupon  
today—  
SURE**

# FRANKLIN INSTITUTE

(Not Government Controlled)  
Dept. H-83

Rochester 4, N. Y.

Rush to me, entirely free  
of charge, 40-page book  
with: (1) A full description  
of U. S. Government jobs;  
(2) A list of U. S. Government  
jobs; (3) Tell me how to qual-  
ify for a job.

Name \_\_\_\_\_

Street \_\_\_\_\_

City \_\_\_\_\_ Vet? \_\_\_\_\_

COUPON



# AIR FORCE JOBS



## *And How They Lead to* **CAREER OPPORTUNITIES**

### *In the Air Force and in Civilian Life*

Airmen are select men—selected for intelligence, and high moral and physical qualifications.

Airmen are select men in another way too—selected for Air Force careers on the basis of individual aptitudes.

Most Air Force jobs have counterparts in civilian life. Your training in the Air Force—with pay and all advantages—fits you for responsible jobs in the Air Force or in civilian life as well.

Learn the Air Force way. For full details, visit your nearest U. S. Army and U. S. Air Force Recruiting Station today.

***Airmen are Select men!***



## **U. S. AIR FORCE**



Here are just a few of the 42  
**AIR FORCE CAREER FIELDS**  
Now Open to You

RADIO AND RADAR MAINTENANCE  
AIRCRAFT AND ENGINE MAINTENANCE  
AIRCRAFT ACCESSORIES MAINTENANCE  
INTRICATE EQUIPMENT MAINTENANCE  
WEATHER  
ARMAMENT SYSTEMS  
FOOD SERVICE  
TRAINING DEVICES MAINTENANCE  
AIR TRAFFIC CONTROL AND WARNING  
WIRE MAINTENANCE  
MISSILE GUIDANCE SYSTEMS  
COMMUNICATIONS  
OPERATIONS  
PHOTOMAPPING

**WORLD'S  
BEST  
WANT AD  
MEDIUM**

# CLASSIFIED Advertisements



Advertisements in this section 75 cents per word, each insertion, minimum 10 words, payable in advance  
To be inserted under proper classification, copy must be in our office the 22nd of the  
second month preceding date of issue

F. W. Johnson, Manager, Classified Advertising  
Popular Mechanics Magazine, 200 East Ontario Street, Chicago 11, Illinois

## 1032 CLASSIFIED ADVERTISEMENTS 1032 OPPORTUNITIES FOR YOU

### AUTOMOBILES, MIDGET CARS

**YOUR** Car burn oil? Poor compression? Slow starting? Excessive cylinder wear? Holt's Piston Seal restores compression! Cuts oil consumption! Checks piston slap! Lasts 10,000 miles! This amazing British product now available, forms self-expanding pliable lubricating seal around pistons. Compensates for wear! Cannot harm finest engine. Easily installed; full directions enclosed. \$3.98 tube for 6 or 8 cylinders up to 240 cubic inches. Free details. Treglown Company, 200 West 7th Street, Plainfield 1, New Jersey.

"GENUINE Crosley parts." Factory rebuilt engine with cast block \$109 exchange. Block kits \$77.15. Water pumps, packless \$9.25. Hydraulic brake kits \$75. Clutch plates \$5.75. Parts books \$1.25 postpaid. Glenn Walraven Motors, "King of the Crosleys," Marion, Ohio, Phone 2-4135.

HOW To cut garage bills, increase power and acceleration, save gas, have a smoother engine: Check the ignition efficiency of your car, truck, tractor or plane with amazing new 5" Framco testing screwdriver. Shockproof glow-handle indicates weak plugs, leaky ignition wires, cracked distributor caps, and other points of high frequency electrical loss. Strongly made with pocket clip, tool steel shank and bit. Always carry it. Astonish friends by accurately diagnosing their ignition troubles. Unconditionally guaranteed. Makes wonderful gift. Educational. Rush order today and we will include tune-up hints and additional 3" Framco screwdriver for small work. Send only \$1.45 for both fine tools postpaid. Save double that amount first week. Frank Morgan Company, Marysville, California.

**AUTOMOTIVE** Trouble shooting. 500 questions and answers. \$1.00 post paid. Charles Nelson, 2908 Washington Ave., Santa Monica, California.

**SPEED** — Equipment. Lowest prices. Handbook, catalog 25c. Speed-O-Motive, Covina 3, California.

1950 **CADILLAC** And Lincoln V-8 engines installed. 1932 to 1950 Ford, Mercury, Lincoln, trucks using McBar Adaptors—housings. McBar Machine Shop, 65 N. Miami St., Peru, Indiana.

**SAVE** Gasoline, oil, tires, brakes—New illustrated economy manual. Get more power, speed, better automobile performance. Introduces 17 new economy products—super sparkplugs, water-oil injector, rocket booster, mileage meter, etc. Special 50c. National Automotive Research Corporation, Venice 29, California.

**NEW** Book, "The Sports Car Engine." Complete information speed tuning, design, maintenance all sports cars. Postpaid, \$1.50. Clymer, Dept. A-9, 1268 So. Alvarado, Los Angeles 6, Calif.

**SUPER** Brake-Floater make Ford, Mercury, Chevrolet, Plymouth, Dodge, DeSoto and Chrysler brakes free floating and super powerful. Eliminate squeal, chatter, groan, fading brakes. "hard" pedal and scoring of drums. All models—\$4.00 to \$6.90. Make linings wear two to three times longer. Easily installed by yourself. Write for details. Super Brake-Floater Company, 4022 West Lake Street, Chicago 24, Illinois.

**SPEED** Equipment—Road, track, marine racing. Fords A V8-6-4; Chevrolet, 6; 4 Willys, Studebaker, Lincoln. New illustrated literature and instructions \$1.00. R. & R. Mfg. Co., Box 546A, Anderson, Ind.

1950 **INDIANAPOLIS** Race Official Yearbook by Clymer. New, larger, better than ever. 112 pages, 300 photos. Articles by famous authorities, technical data, feature stories, driver histories, cartoons, newsy comments. The "bible" of Indianapolis racing. \$1.50 postpaid. Fabrikoid bound de luxe edition \$3.00. Catalog listing 75 books on automobiles, motorcycles free. Write. Clymer Motorbooks, Dept. A-9, 1268 S. Alvarado, Los Angeles 6, Calif.

**NEW** Book, "Special Racing Cars and Hot Rods of the World." 160 photographs, charts, drawings. Complete mechanical information cars of all nations. Supercharging, engines, suspension, transmissions. A "must" for every race car enthusiast. Postpaid, \$1.50. Clymer, Dept. A-9, 1268 So. Alvarado, Los Angeles 6, Calif.

1951 **HOT** Rod & Racing catalog plus "Speed Secrets" handbook (1000 items, pictures, instructions—all cars). Both 25c. Alquist Engineering, Milford 35P, Penna.

"**SPEED & Mileage**" Manuals — "New deluxe 60th edition, world famous power book, endorsed by champions!" Covers speed, power, economy, increasing for all passenger cars. Shows speed equipment construction, speed tuning, race car building, California hot rod plans, "custom restyling," sports car conversions, etc. Easily get super speed, mileage, acceleration, top racing performance from any car! Shows inexpensive ways to build speed equipment, superchargers, dual manifolds, high compression heads, twin mufflers, racing cams, water injectors, economizers. Save 75%! Complete instructions with working diagrams on engine rebuilding, "souping-up," restyling, "customizing," gas saving, racing tricks, fuels, cam secrets, balancing, porting, "jet," formulas, ratios, frames, "Offys"! Learn 100 ways to save gas! Reveals stock car speed secrets! California speed shop methods! California custom styling! Streamlining! Lowering! Sport changes! Roadster plans! Blueprints! 200 M.P.H. Conversions—Fords, Chevs., Plys. — all makes! 320 illustrations. Guaranteed finest! (Worth \$10.00). Big Manual plus equipment catalog, plus Hot Rod Handbook—all three books \$1.98. Alquist Engineering, Milford 31P, Pennsylvania. (See display ad page 42.)

**SAVE** Gasoline! Sensational Gane needles. Free trial. See page 260.

"**SPEED** Equipment" bargains — Hollywood mufflers \$4.50, V-8 duals \$15.90, V-8 high compression heads \$23.50, chrome carburetor stacks 98c, dual manifolds \$9.95, chrome tailpipe megaphones \$1.55, racing camshafts \$29.95, water injectors \$12.95. All popular brands—Big illustrated catalog 25c. (Dealers wanted.) Alquist Engineering, Milford 33P, Pennsylvania.

**PLYMOUTH** Owners. At last a book for you and your car! Just published. Gives every detail from bumper to bumper, explaining how parts operate, what can go wrong, what repairs are necessary. Only \$3.50. Guaranteed to save you large repair bills. Popular Mechanics Press, 200 East Ontario Street, Chicago 11.

**ANTIQU** Auto Scrapbook, just published—all new material. Over 250 ads and illustrations of antique and vintage automobiles dating back to 1901. \$1.50. Wiglesworth-Chasteen, 7134-P2 Alhambra, Mission, Kansas.

**WANT** Better gas mileage? Your car can attain it. Stamp brings details. Stan Stanton, Liberty, N. Y.

**NEW** Sensational seat cover. Mono, 6545 Santa Monica Blvd., Hollywood, California.

"**SPEED** And Power" Handbook — 128 enameled pages! Covers all makes of cars! Sixty breathtaking chapters. Including jet propulsion, racing frames, wheel geometry, dynamometers, reciprocating masses, gear ratios, dual pipes, fuel formulas, porting, balancing, lowering, relieving. Authentic—by automotive engineers. Shows exactly how to build your own dual manifolds. Superchargers. Hot cams. Water injectors. Hi-compression heads. Mileage devices! Save many dollars! Get up to ten more miles per gallon, racing speed, lightning acceleration, dynamic power increases from any make passenger automobile! Build fast stock cars. California roadsters. 160 m.p.h. rods! Includes construction drawings! Tuning techniques! Speed tricks! Economy secrets! Ingenious formulas! Includes, "California Automobile Customizing"—Photographs. (Newest ideas.) Conversions. (Re-styling all makes.) Also, "Speed Equipment Picture Catalogue." Plus new "Economy Handbook." Plus "Injection Information." 300 illustrations. Five items \$1.98 postpaid. Newhouse Automotive Industries, 5805-B2 East Beverly, Los Angeles 22. (See page 38.)

"**WATER** Injection". Also speed, power, economy methods. Free illustrated information. Neher Industries, La Verne, California.

**CALIFORNIA** Custom accessory headquarters. Buy direct from original designers and save. Chrome dash panels, solid hood sides, grille panels, speed equipment, dual pipes, push button door conversions, chrome motor accessories, fender skirts. 34 page illustrated catalog 25c. Eastern Auto, 3319A South Grand, Los Angeles 7, Calif.

**RACING** Equipment from California. Speed-Dress-up accessories for every make passenger automobile — Racing ignitions, carburetors, flywheels, camshafts, water injectors, mufflers, crash helmets. Thousands of items in stock! Dual manifolds (for Willys Jeeps to Oldsmobile Rockets). Finned hi-compression heads, covering 155 different makes and models. "1950 Illustrated Equipment Catalogue" plus, "Driving Economy" 25c. (Dealers, request wholesale catalogue.) Newhouse Automotive Industries, 5805-B7 East Beverly, Los Angeles 22.

**CHEVROLET** Owners—Don't "Watch the Fords go by." Your Chevy can beat the Fords. Stamp brings particulars. Hi-Torque Speed Shop, Liberty, N. Y.

**AUTOMOBILE** Racing, sixth edition. 100 illustrations. Drawings, building instructions Ford-60 midget, California roadster, Offenhauser racer. World's record 158.5 m.p.h. car. \$2.00 postpaid; \$2.40 c.o.d. Popular Mechanics Press, 200 E. Ontario St., Chicago 11, Ill.

**SILENCE** Overhead-valves, attachments unnecessary. \$2.00. Derderian, Box 542, Sandston, Virginia.

**SMITHYS** Mufflers for all automobiles. Free list. Buck's Auto Parts, Box 1296H, Merced, California.

**FROM** Speedway to roadway! Track-proved hi-speed heads and manifolds now available for your passenger car! No special tools needed! Increase horsepower 25%! Astounding getaway! Free illustrated catalog. Speedsport, 6215P Diversey, Chicago 39.

## AUTO SUPPLIES AND EQUIPMENT

GET Extra profits on repair work. Do your own welding. Easy to use. Easy pays for itself terms. Catalog free. Hobart Welders, Box M-905, Troy, Ohio.

MOTORISTS Save gasoline by Vacuumating overrich mixtures. Fits all cars. For free particulars write Vacuumatic, Dept. 1637, Wauwatosa, Wis.

FREE! "The flash that may save your life!" Levin Accessories, 720 Princeton Ave., Trenton, N. J.

ONLY \$1.25 Ea. \$5.00 value. 6 volt motors with fan blade, 3 for \$3.00. Check or money order. Har-Mur, 2349 Devon Ave., Chicago 45, Ill.

VAPOR Injector \$8.00. You can install. Why pay more? Vapor injection automatically balanced to engine work load and radiator water temperature. Save car life, gas and oil. Tenco, Box 5528, Washington 16, D. C.

CHAMPION, A-C, Auto-Lite spark plugs. Rebuilt. Guaranteed 10,000 miles. 25c each, 23c sets of 6. Postpaid. State brand, type, quantity. Philip Minor, 5707 Arnsby Place, Cincinnati 27, Ohio.

SEND Old carburetors. Rebuilt like new. Any car. Fords \$3.45; Plymouth, Chevrolet, \$4.95. Guaranteed. Rebuilt Exchange, 846 Blue Island, Chicago.

CHEVROLET Speed catalog (illustrated). Finest proven equipment for increasing mileage, power and all-round performance. '37 thru '50 models. Only 25c. California Bill, 4411 York (Dept. B-9), Eagle Rock, California.

STOP Wasting money! On unburned gasoline. The amazing, patented, Turb-O-Vane vaporizer, atomizes and whirrs the mixture with centrifugal force, giving greater mileage, easier starting, more power, pep and pick-up. Like magic for car, truck or tractor. Realize again the new car feel. Easy installed, no adjustments. Order to-day, \$3.50 each. Send make, model, year and number of cylinders. Turb-O-Vane Distributors, P.O. Box 1167, Stockton, California.

WHEEL Alignment recorder. Drive-over. \$18.95. Guaranteed. Particulars free. Salesmen wanted. Align-A-Matic, Box 94B, West Orange, N. J.

WAR. No brake cables protect yours. 50c each. Williams Oilers, 1404 E. 19th Ave., Columbus 11, Ohio.

DRIVE Safely—Side-window wiper \$1.00 postpaid. Agents wanted. Park Sales, P.O. Box 73, Forest Park, Illinois.

SAVE Gasoline! Sensational Gane needles. Free trial. See page 260.

NEW And used guaranteed parts for civilian and army cars and trucks. Largest stock in America. Mail orders. Pioneer Auto Wrecking Co., 734 W. 13th Ave., Denver, Colorado.

NEW "Economy and power" methods. Free. Neher Industries, La Verne, Calif.

LACHAPELLES Motor and motor fuel treatment (patented) stops ping, gives more miles per gallon, more miles per motor. It puts bearings on the pistons. 100,000 miles treatment \$3.00 postpaid or c.o.d. Ferns Products, 8120 Walnut Dr., Los Angeles 1, Calif. (Data sheet on request.)

JUST Out! Get the largest auto accessory and parts catalog in the world. Over fifteen thousand items, including Hollywood accessories, hi-speed equipment, rebuilt engines; all parts and accessories for all cars and trucks. New, used and rebuilt! We have that hard-to-get-part! Completely illustrated, jam-packed with bargains. Send 25c. J. C. Whitney & Co., 1919 Archer Ave., Chicago 16, Ill.

BUICK Parts—Enjoy new-car pep and power in your old Buick. Same day service from world's largest stock of new (not rebuilt) Buick parts and engines. Ship anywhere. Dime brings catalog. Write today. Robertson Buick Co., 1001 S. Wabash Ave., Chicago 5, Ill.

NEW Government surplus. Low voltage circuit tester in steel box cost \$202. Our price \$27.50. Will test batteries, starters, generators, voltage regulators, grounds, short circuits. Wilt Electrical Company, 7829 S. Racine Ave., Chicago 20, Ill.

CHEVROLET Parts. Scarce motor, body, sheet metal parts. Grossman Chevrolet, Minneapolis, Minnesota.

AUTO And truck parts. New and used. Lowest prices. Complete stock. Prompt replies. Babbitt Auto Parts, 2833 Chicago Ave., Chicago 22, Ill.

BRUSH Plating outfits connect to a battery. No tanks or shop required. Free particulars. Gunmetal Co., Avenue J, Decatur, Illinois.

## AUTO TRAILERS

MODERN Trailer coach. Designing, building, traveling. Bookstores everywhere. Postpaid \$4.00. Craftsmann Books, Box 1153, Milwaukee 1, Wis.

TRAILER Coaches. Save money. Buying? Building? Sound engineering construction, chassis, bodies, furnishings. Travel, dwelling, trailer plans, \$1.50 postpaid. Popular Mechanics Press, 200 E. Ontario St., Chicago 11, Ill.

BUILD Your own trailer! Save money! Have every feature you want! Plans for house, sport, camp and utility trailers. Catalog describing 9 models 10c. 15c in Canada and overseas. Jim Dandy, Box 125-A, Wausau, Wisconsin.

STREAMLINED Family trailer—Build it yourself. Includes all conveniences—cook-stove, sink, ice box, electric lights, closets, cupboards, sleeping accommodations for four. Fifteen feet long. Weighs 1400 lbs. Complete set of 6 blueprints only \$1.50. Ask for Plans No. 937-942. Popular Mechanics Press, 200 East Ontario Street, Chicago 11, Illinois.

## MOTORCYCLES, BICYCLES, MOTORSCOOTERS AND SUPPLIES

WHIZZER, Cushman, Salsbury, Powell parts, accessories. Ship anywhere. Ray George, 3322 South Grand, Saint Louis 18, Missouri.

MOTORCYCLE Pistons and parts, new, used. Harley, Indian, Henderson, Super-X. List 10c. Ballak, 811 N. 9th, St. Louis 1, Missouri.

1930 INDIAN Twin \$10; Harley 61 \$35; Doodlebug motorscooter \$15; Salsbury \$35. Motorscooters less motors \$9 up; motors \$3 up. Power lawnmower \$12. Four balloon tires \$3. Mailorder only. Send 25c for catalogue Number Thirty-seven, just out, listing these and hundreds of other bargains in midget cars, motorscooters, parts, plans, transmissions, engines, war surplus, etc. Midget Motors Directory, Athens, Ohio.

AMAZING New motorbike. Many big features. Costs only \$199.50. Literature for 10c. Joe G. Young, Route Three, Elba, Alabama.

KNEEACTION Moto-Scout \$10; motorbike (front and rear brakes) \$5; Whizzer motorbike with clutch and all attachments \$25; Indian motorcycle \$30; good midget car \$35; tire-wheel combination \$2.50. Rush 25c (35c for first class mail) for new catalog #945 listing sensational bargains in motors, motorscooters, motorcycles, Servicycles, midget cars, etc. Associated, Box 1764-CS, Toledo, Ohio.

SPECIAL—1946 Whizzer in Schwinn bicycle \$20. Also Cushman motorbike (good tires and lights) \$15; Shaw bicycle motor \$15; midget car \$15. Rush 25c (35c for first class mail) for new catalog #17 listing many other amazing postwar bargains in wheels, engines, motorscooters, midget cars, monocytes, motorettes, etc. Gail, 538 Erie, Toledo, Ohio.

MOTORCYCLE Magazine—Worldwide coverage. Yearly subscription \$1.00. Sample 15c. Motorcycle News, 5424-A Sawyer, Chicago 25.

HARLEY-Davidson parts, accessories, repair manuals on all models. 24 hour service. Authorized factory dealer. Philadelphia Harley-Davidson Company, 857 North Broad Street, Philadelphia 23, Penna.

RECONDITIONED Motorcycles and motors. Chromium accessories. Complete stock Indian parts. Expert rebuilding. Fast service. Indian Motorcycle Sales, Kansas City 1, Mo.

TIRES And industrial wheels, suitable for scooters, wheelbarrows, farm equipment, etc. All sizes. Bicycles and accessories. Send dime for list. Cycle Transport Company, 1241 So. Michigan Ave., Chicago 5, Illinois.

## AVIATION

LIGHTPLANE Gliders, motors, circulars illustrated 20c. Craftsmann Books, Box 1153, Milwaukee 1, Wis.

PROPELLERS, Plans, supplies, for ice sleds, snow sleighs, air boats. Literature 20c. Banks-Maxwell, Box 3301E, Ft. Worth.

PROPELLERS—For sleds, airdrive boats. Literature. Standard Aircraft, Box 387, Ft. Worth, Texas.

## BATTERIES, GENERATORS

GENUINE Edison batteries, fifteen year life. Unconditionally guaranteed. Free literature. See-Jay Company, 300-12th Avenue, Paterson, N. J.

12 VOLT, 55 ampere Auto-Lite Jeep generators and regulators. Surplus; excellent condition. \$45.00 f.o.b. Robert Cromwell, 103 Mulberry Avenue, South San Francisco, Calif.

EDISON Nickel batteries, 37 to 600 ampere. Also kits with Edison plates; make your own. Interesting literature. Hawley Smith Co., Croton Falls 1, New York.

## ELECTRICAL SUPPLIES

LAMP Parts—24 hour service from most complete stock in country. 25c brings 60 page catalog with charts and instructions for building and repairing. Discount to dealers. Gyro Lamp, 5402-P Clark, Chicago 40.

LIGHT Plants. 2½ and 5 k.w. Army surplus bargain. Write for 68 page catalog. Wellworth Trading Co., 1831 S. State St., Dept. 30, Chicago 16, Illinois.

HOME Owners! Mechanics! Builders! Send \$1.00, refundable first order, for big buyer's discount catalogue; Westinghouse, General Electric, Delco, Dayton appliances, motors, blowers, fans, air conditioning supplies, electric controls, tools, 1000 other items. Not war surplus! New, fresh stock. Unconditionally guaranteed. Ralph Nichols Co., Suppliers, Montvale Ave., Woburn, Mass. Reference, Woburn National Bank.

BUILD Your own electric clock or electrify wind-up clocks easily with guaranteed motor and movement unit. Complete with three hands, cord, connectors. Only \$4.95, postpaid. Scott Industries, Box 373-A, Coral Gables, Florida.

BE Independent, be secure, have your own profitable business—earn \$20.00 and more a day making beautiful, fast-selling lamps at home. No equipment needed. Illustrated course teaches you quickly. Course, parts catalog, wholesale price list—only \$2. Gearon Co., Dept. 200-B9, 27 S. Desplaines, Chicago 6, Ill.

BUILD Your own electric motors from scrap automotive generators. Complete illustrated instructions for all makes. Only \$1.00. Autopower, Dept. PM, 918 South Theresa, St. Louis 3, Mo.

LAMPS—Build own originals, parts wholesale, any amounts. Catalogue 10c. Brown Lamp Co., Box 501, Wellston, St. Louis 12, Mo.

ELECTRIC Pencil: Engraves all metals \$1.25. Beyer Mfg., 10511-H Springfield, Chicago 43.

32 VOLT Appliances—World's largest line. Catalog free. Haines Corporation, Dept. N, Minneapolis, Minn.

## WELDING, SOLDERING, PLATING

A.C. Welders, four sizes. Lowest prices. Holgerson's Service, Canton, Kans.

P-1 Aircraft generator, 28 volts, 200 amps. Welder conversion instructions Science and Mechanics magazine. Good used condition, gross 50 lbs, \$13.95 f.o.b. Aero Parts Supply, 8102 Lockheed, Houston, Texas.

SET Up your own profitable welding business. "Build your own" portable arc welder with low cost generator. Free book tells how. Hobart Welders, Box M-902, Troy, Ohio.

ELECTRIC Welder plans \$3.00. 178 farm, home equipment easily built from salvage materials. Descriptive handbook 25c (refundable) free details. Kimo, Box 307-PM, New York 19.

ACETYLENE Welding outfits, new. \$45.00, used \$25.00; arcwelders \$46.00. Eagle Welding, Dept. PM, 5085 Broadway, Chicago 40, Ill.

THERMASOL Magic solder outfit. Solders without iron, flux, cleaning. Suitable 1001 jobs. Anyone can use. \$1.00 complete, postpaid. Keystone, Box 4770, Johannesburg, South Africa.

BUILD Your own 100 ampere electroplating rectifier at a low cost. Stark-weather, Ottawa, Kans.

RADIATOR Repairing books, supplies, equipment, gasoline torch. Write, Curman Co., Maryville, Mo.

BUY Direct from factory. Welding and cutting equipment. All makes of equipment repaired. Established 1913. Box 331, Hamilton, Ohio.

ELECTROPLATING Salts and rectifiers. Mirror resilvering and chipped glass nameplate supplies. John Sprinkle, V55, Marion, Indiana.

RADIATOR Repairing, cleaning, recoring. How to equip small shop at low cost. Supply sources, trade secrets, instructions. Now only \$3.50 postpaid. Radiator Service, McBain, Mich.

## MACHINERY, TOOLS, SUPPLIES

HYDRAULIC Cylinder double acting, 2 1/2 bore, 16 1/2" travel, 1-3/16" shaft, brand new \$11.00. Discount ten or more. Spencer Aircraft, 8410 Dallas, Seattle, Wash.

CLOTH Sanding discs—4 1/4", 4 1/2", 5", 6". Fits all drills. 1 each 40c, 2 each 60c, 4 each \$1. Postage paid. General Supply, 19-6 Franklin, St. Louis 5, Mo.

POWER Tools, equipment wholesale prices. Free bulletin. Homecrafters Cooperative, Grand Rapids 6, Michigan.

ONE Dozen high speed tool steel drills for \$2.50. Assorted sizes, 5/16" to 3/4". Used, in good condition. Also turnbuckles, welding tips, pumps. Send for list. Acme Tool Co., 229 78 St., Brooklyn 9, New York.

NEW U.S.A.F. surplus, Plumb and Snap-On, 120 piece crew chief tool kit. Packed and sealed in original government chest. \$68.00 f.o.b. Send money order only. J. F. Weatherly, 3510 Blodgett, #3 Houston, Texas.

MACHINES For your shop, 14" lathe \$150. Milling machine \$260. Drill press \$100. Shaper \$220. 300 amp. welder \$125. Good condition, money back guarantee. Conversion Parts Co., 278 Adams St., Boston 22, Mass.

ONLY \$3.95 For \$14.00 value. 2" precision universal lathe chuck. Check or money order. Har-Mur, 2349 Devon Ave., Chicago 45, Ill.

THOUSANDS Of bargains in used, rebuilt, surplus, electrical and power equipment. 132 page monthly magazine. Current issue 25c. Subscription \$2 year. Resale, Wheaton, Illinois.

DIVIDING Head, rotary tables, etc. For Atlas millers. Free machine tool accessories catalog. Montgomery, 53 Park Place, New York City 7, N. Y.

RADIAL Arm saws, surplus, 2 h.p., single phase, new, regular \$410. Special \$229.00. Iowa Machinery, Des Moines, Ia.

CONCRETE Block machines. Standard sizes. \$39.50. Average 400 dally. Free catalog. Concrete Machine Company, 5129 South Compton, St. Louis 11, Mo.

POWER Tools. Big savings when you build your own with Lewis castings. 23 wood and metalworking tools with blueprints. Most can be completed with lathe and drillpress. Commercial quality. Ideal for home shops, schools, small manufacturing. Catalog 10c. Lewis Machine Tool Co., 3217 Union Pacific Ave., Dept. M, Los Angeles.

## BOATS, OUTBOARD MOTORS

BUILD A better boat than you can buy for the money, with Ozarka's exclusive laminated-rib construction and carefully pre-formed and pre-fitted parts. Save to 55% on all popular types from simple car-top models to one-design knockabout sailboats, priced from \$39.50 to \$329.00. Shipped complete, ready for easy assembly. Send 25 cents for literature, refunded on first purchase. Ozarka, Inc., 690 Borden Lane, Woodstock, Illinois.

OHIO River handbook—400 pages, 600 pictures. Complete charts of Ohio River; "Nothing like it ever attempted before," says river authority. Steamboats, diesels, racing, dams, TVA, navigation, canals, Civil War gunboats, history, statistics. \$2.00 copy. Young & Klein, Inc., 5137 Vine Street, Cincinnati 17, Ohio.

TWENTY Plywood boat plans \$1.00. Catalog boat building plans 10c. The Rudder, 15 Murray Street, New York 7.

BOAT Plans, including full size templates and complete instructions. Also precision cut to fit boat kits. Outboard speedsters, sailboats, rowboats, skiffs. Illustrated literature 10c. Schneider Boats, Dept. P, 1913 W. Vliet, Milwaukee 5, Wis.

KNOCK-DOWN Boat kits. Outboards, inboards, sails, hydroplanes. Easy to assemble. Minimum cost. Catalog with specifications, prices, 25c. Brooks Boat Company, Carrollton, PM, Michigan.

SAVE 2/3 Cost. Assemble your own boat. Complete plans and boat parts machined ready for assembly. No experience necessary. Rowboats to cruisers. Illustrated catalog 25c. Midwest Boat Company, Menomonee Falls, Wisconsin.

STEERING Wheels, windshield brackets, from \$6.95. Modern fittings, water skis at lowest prices. Complete pre-cut plywood boats. Bargains galore. Folder 10c. Marine, Box 681, Mendota, Minnesota.

P38 TWIN Tank boat, free picture, plan \$3.00. Twin Tank, Box 89, Merced, Calif.

REBUILT Outboard motors at bargain prices! Late model Johnsons, Evinrudes, Mercury, etc. A 3c stamp brings list—new and used. Parts for all makes, including chain store brands. Write for prices, giving description of parts needed. Money back guarantee. When in Boston visit the largest outboard motor plant in the world. Outboard Motor Mart, Inc., 309B Atlantic Ave., Boston, Massachusetts.

OUTBOARD Motor bargains—\$35.00 up. Send for free list! Save big money! Used parts for most makes and models. Crandall-Hicks, 911 Commonwealth, Boston, Mass.

CONVERT Fords and Jeep to 100% marine engines with Osco's world famous Convo-Kits. Deluxe catalogue 25c (coin). Oscomotors, 3627B Lawrence, Philadelphia 40, Penna.

P38 BELLY Tanks, steel, \$9.95. Free picture. Bucks Auto Wrecking, Box 89, Merced, Calif.

NEW, Used, rebuilt marine motors. Marine conversions, fittings. Free catalog. Stokes Marine Supply, Dept. 24, Coldwater, Michigan.

MARINE Conversions for Ford and Jeep engines. Catalog 10c. Lehman Manufacturing Company, Department D, Newark 2, New Jersey.

FULL Size, cut to shape boat patterns, blueprints, 7 1/2-38 feet. Illustrated "Build a Boat" catalog, 25c (coin). "How to Build Boats" book, \$1.00. PolyWog houseboat plans \$10. Marine catalog \$1.00. Marine Specialty Mfg. Co., 3107 Detroit Ave., Cleveland 13, Ohio.

## ENGINES, MOTORS, DYNAMOS

MOTORS—1 Horse, \$35; 3/4, \$24; 1/2, \$15. Twin cylinder compressors \$17.50. Fans, 32 volt \$3.75. Butler, 1885 Milwaukee, Chicago 47.

MOTOR Winders, free bulletins, winding and testing equipment. Motor Industries, Quincy, Illinois.

WINDING Data, listing 225 motors, single and three phase, \$1.00. Motor Data Co., Box 7631, Kansas City 3, Mo.

## ATHLETIC EQUIPMENT, BODY BUILDING COURSES

TALLER! Be one to three inches taller. A new scientific method for permanent height increase has now been developed. Free information. Natural Methods, Box 453, Briggs Station, Los Angeles.

BARBELLS—Finest quality, \$7.98 up. Free catalog. Lurie Barbell Co., 1729-M8 Rockaway Parkway, Brooklyn, New York.

FREE Illustrated catalogue—Books, magazines, photos, equipment, barbells, courses. Dr. Frank Thompson, Dept. 10, 919 Fourth, Manhattan, Kansas. World's Leading Dealer.

DEADLY Judo—Fiercest fighting technique. Trick knockouts. (Over 200 illustrated pictures.) Expert instructions; three volumes. Complete \$2.25. Variety House, Box 46-B Wall Station, New York 5.

BARBELLS, Exercise equipment. Courses. Free booklet. Good Barbell Co., Reading, Penna.

## TAXIDERMISTRY

MODERN Taxidermist Magazine, Greenfield Center 2, N. Y. Devoted entirely to taxidermy, photos, articles, methods. Trial year's subscription, \$1.00.

## BINOCULARS, TELESCOPES, MICROSCOPES, MAGNIFIERS

BINOCULARS — Guaranteed repairs. Prompt service, estimates. Tele-Optics, Dept. B, 5514 Lawrence, Chicago 30, Ill.

350 POWER Precision reflecting telescope; equatorial mounting. Simple illustrated instructions describing their construction. \$1.00. Prof. Cram, Westmar College, LeMars, Iowa.

IMPORTED Quality French binoculars, monoculars. Bartro, 6605 Telegraph, Oakland, Calif.

WAR Surplus bargains, binoculars, telescopes, sextants, millions of lenses, prisms, reticles, eyepieces, objectives, etc. Mail 10c for big "Catalog CH." Send \$1.00 for Stock CH—10-piece lens kit and big instruction booklet. Edmund Salvage Co., Barrington, N. J.

ASTRONOMICAL Telescopes, binoculars, microscopes, bought, sold, repaired. Books. Lists 10c. Rasmussen-Reece, Amsterdam, N. Y.

SAVE 50% On new binoculars! Free catalog. Free book, "How to Select Binoculars." Write today! Bushnell Importers, 43-M8 East Green, Pasadena 1, California.

BINOCULARS, Telescopes, watches, guns. Buy, sell, trade. Schweer's, Donnellson, Iowa.

GIANT Astronomical telescope with 6 ft. tripod \$15.00, f.o.b. factory. 100 power. (10,000 area magnification). Clear vision, full power guaranteed. Ready for use. Suffolk Science Service, Dept. BT, Riverhead, N. Y.

REFLECTING Telescopes. 60X, completely assembled \$25.00. Guaranteed observatory clearness. Free information. Skyscope, 475 Fifth Avenue, New York 17.

TELESCOPES, Binoculars, microscopes, big bargain catalog free. Brownson Company, 24 West 45th Street, New York.

POWERFUL Astronomical telescopes easily made. Perfect lenses and instructions; 100X \$3.00; 100X and 200X \$4.00; 100X, 200X and 400X \$6.00. Full power, clear vision guaranteed. Instructions alone 10c. Suffolk Science Service, Riverhead, N. Y.

## SPORTING GOODS, GUNS, FISHING TACKLE, ARCHERY, TRAPPING

CROSSBOWS: \$39.95 Up. Free literature. Schmidt, 1511 Gardner, Hollywood, Calif.

ANTIQUA, Modern guns. Bargain list 10c. Martin Rywell, Harriman, Tenn.

SEND 10c For list 150 used guns. Frayseth's, Wilmar, Minnesota.

HUNTERS. Foreign ammunition available. Mauser's, Mannlicher's, Steyr's, others. Write needs. Ashton Company, 1511 Gardner, Hollywood 46, California.

WRITE For your new Rado Spinning Reel with these exclusive features: Loop pickup snaps in any position; handle does not spin; reversible for right or left hand use; weighs only 6 ounces. \$11.95 list, prepaid (or C.O.D. plus postage and fee). Order today! Rado Manufacturing Company, 314 South Leroy St., Fenton, Mich.

HUNTERS—Legal allweather secret. 2000 got their buck 1949 using it. Method \$2. Info. free. Sabin's, Dalbo, Minn.

FREE Catalog—Glass fishing rod kits. America's largest selection. Anyone can build them. Simple illustrated instructions. Write today. Dept. Z, Trimline Tackle Co., 508 Tinton Ave., New York City 55.

LEARN Gunsmithing! Details, copy "Guns and Gunsmithing," 25c. Gunsmith's Supply, Palatine 2, Illinois.

GATHER Fishing worms without digging. Details. Box 474, Great Neck, N. Y.

22 CAL. Power from pellet guns. No altering of weapon. 50 shots 1c. Guaranteed results. Instructions 50c. F. Kemp, 3607 South St., Wesleyville, Penna.

KNIVES, Marine Corps surplus, 6" parkerized steel blade, leather handle, sheath, \$2.00 ppd. Money back guarantee. Kabal, Box 757, Church, New York 8.

50 PAGE Catalog new guns 25c. Gunsmith's Supply, Palatine 2, Illinois.

RELOAD Used rifle and pistol cartridges, or shotshells at savings up to 80%. Produce safe, accurate loads, using 144 page Ideal Reloading Handbook #36. Send 10c. (Limited offer). Lyman Gun Sight Corporation, Dept. 7, Middlefield, Conn.

SLINGSHOT Pellets: For best results use "Tru-Flite" 23 grain lead pellets. 250 for \$1 postpaid. Send cash with order. Baron Industries, Box 3578-A, Cleveland 18, Ohio.

NIGHT Vision tube \$14.95 with instructions. Snooperscope book \$1.50. Catalogue free. Infrared filter 10c. Precise, 942 Kings Highway, Brooklyn 23, New York.

TENTS. All types and sizes, vast selection, camping equipment; war surplus. Lowest prices. Free catalogue. Morsan, 10-19R 50th Avenue, Long Island City 1, N. Y.

FIREARMS, Ammunition; foreign-American. List 25c. Frank Farish, Vicksburg, Miss.

190 PROFUSELY Illustrated pages antique and modern pistols, swords, daggers, armor, etc. 50c. Robert Abels, A860 Lexington Ave., New York 21.

ENJOY Fishing as never before! Amazing new Kel-O-Bob automatic fishing float measures water automatically. You can cast with it, reel fish all the way. No knots to clog your reel. Satisfaction guaranteed. Order today, one for 60c, two for \$1.00. Keller Laboratories, Oneida, N. Y.

**SHOTGUNS, Rifles, revolvers, 500 modern, obsolete. Also cartridges. Each list 10c coin. Ed Howe, 62 Main, Coopers Mills, Maine.**

**RIFLE Stocks: Laminated and regular. Blanks, semi-finished, finished. Enfield, Springfield, Mauser, etc. Literature. Banks-Maxwell, Box 3301E, Ft. Worth.**

**FISHERMEN—Make your own sinkers with our molds. Free illustrated booklet. Reading Instrument Co., Box 78, Reading, Penna.**

**5000 BARGAINS. Firearms, binoculars, war relics. Catalog 40c. Smith Firearms, Runnemed, New Jersey.**

### **PETS—DOGS, BIRDS RABBITS, HAMSTERS, ETC.**

**MAKE Big money! Raise Chinchilla rabbits. Cash markets supplied for your production. Write today! Rockhill Ranch, Sellersville 15, Penna.**

**EARN Up to \$400 monthly. Raise Angora rabbits! Experience unnecessary. Wool brings \$5 pound. Plenty markets. Folder free. White's Rabbitry, Newark 38, Ohio.**

**HAMSTERS—Good breeding stock. Money makers, odorless. Big demand. Information folio 25c coin. Twin-City Hamstery, 1145 Fauquier St., St. Paul 6, Minn.**

**GOLDEN Hamsters—Finest quality breeding and pet stock, \$2.50 pair, \$3.75 trio. Free folio. Valley Hamstery, 734 North Milam, San Benito, Texas.**

**MAKE Money raising golden hamsters. Easy, pleasant work. Literature free. Blackhawk Hamstery, 636-M Jackson, Ft. Atkinson, Wisconsin.**

**SEE Gulf Hamstery ad on page 38. Shows picture of Hamster.**

**SPORTSMEN: 200 Pointers, setters, straight cooners, combination hunters, rabbit and fox hounds. Reasonable. List free. Ramsey Creek Kennels, Ramsey, Illinois.**

**BEAUTIFUL Pure white pedigreed police puppies. Ansonia Kennels, Mose, N. Dak.**

**RAISE Guinea pigs. Money making business. Booklet free. Taylor, B426A, Hapeville, Georgia.**

**NEW Profits from hamsters! Easily raised. Small space. Odorless. Rapid breeders. Sell laboratories, people, pet shops. Pair \$3.00. Trio (1M-2F) \$5.00. Literature free. American Hamstery, 3826-C Lemmon Avenue, Dallas, Texas.**

**A Practical beginning to successful rabbit raising. 48 page illustrated booklet. Dime. American Rabbit Breeders Association, 36 AR & CBA Bldg., Pittsburgh, Penna.**

**\$300 MONTHLY Raising Angoras for our market. Particulars free. Wilson, Stanton 17, Calif.**

**MINK Raising information free. Complete. Lake Superior Mink Farm, Superior, EE1, Wisconsin.**

**GRINSTEAD'S Famous Angoras! Giant Chinchillas! World's most profitable rabbits. Finest pedigreed, heavy-producing, prize-winners. Literature free. Grinsteads, Edwardsville, Illinois.**

**INCREASE Your income by raising domestic rabbits. Small space needed. Ready market for delicious meat, fur and wool. Largest magazine in the industry tells you how. \$1.50 per year. Sample 15 cents. No stamps. Small Stock Magazine, Lamoni 20, Iowa.**

### **FARMS, FARM LANDS, REAL ESTATE**

**WEST'S New Digest of farms and country real estate—free! Values galore—Maine to Florida. West's, CK-9, Pittsburgh 17, Penna.**

**STROUT'S New fall catalog. Largest ever! 132 pages farm, home, country business bargains. Coast-to-coast. Mailed free. Strout, 7 So. Dearborn St., Chicago 3, Ill.**

**FREE Fall catalog, farm bargains, many equipped, illustrated, many states! United Farm Agency, 1406-PM Consumers Bldg., 220 South State St., Chicago 4, Ill.**

**RAYBURN'S Ozark Guide, Eureka Springs, Arkansas. Homeseekers, tourists magazine. Year, \$1.50.**

**FLORIDA. Beautiful homesites in new Lake County development. \$245 at \$10 monthly. Near Ocala National Forest, many pretty lakes, streams, pavement. World's best bass fishing, wonderful hunting. Folder free. Howard Vernor, DeLand, Florida.**

**SAFETY In Ozarks, \$5 acre. Free lists. Write Armstrong, Shook 34, Mo.**

**\$5.00 MONTHLY Buys 40 acres, near town. Price \$200. Free list. Box 425-P, Carthage, Mo.**

**GOOD Farms—Ranches. Washington, Minnesota, Montana, Idaho, Oregon, North Dakota. Dependable crops, favorable climate. Write for literature, lists describing typical farm opportunities. Specify which state. J. W. Haw, 119 Northern Pacific Ry., St. Paul 1, Minn.**

**HOMESITES \$300—Convenient payments. California's finest garden section. On Morro Bay's scenic shores. Wonderful fishing, hunting, boating, bathing. Fertile soil, softest water, temperate climate, congenial community. Free literature. Richard Otto, Department M, San Luis Obispo, California.**

**FARM Manual shows you how to make extra profits from your farm. 284 pages of farming lore, \$3.00. Popular Mechanics Press, 200 E. Ontario, Chicago 11, Ill.**

### **POULTRY, FARM SUPPLIES**

**RAISE Fryers new easy way. One man home plan earns \$3000 yearly. Circular free. Poultryman's Institute, 1046 So. Olive, Los Angeles 15, Calif.**

**EARN \$4 To \$12 hourly. Chick sexing, turkey sexing, culling and caponizing. G.I. approved. Pilch's School, Box SSC-10, Thompsonville, Connecticut.**

**KNOW How to raise poultry for profit. Read Poultry Industry. Every issue packed with helpful hints and practical suggestions. Latest articles on breeding, feeding and management. Subscribe now. 1 year 65c. 2 years one dollar, foreign subscriptions \$1.00 a year. Poultry Industry, Dept. P.M., 376 Boylston St., Boston 16, Mass.**

### **PROFITABLE OCCUPATIONS**

**PROFITABLE Fascinating hobby. Complete ming tree kit \$1.00. Oriental Gardens, 181 So. Rosemead, Pasadena, Calif.**

**MEN—Women. Everybody likes candy. Learn to make professionally. Our 40th year. Ragsdale Candies, D6, East Orange, New Jersey.**

**LEARN Arc welding at low cost in non-profit school. Easy to learn in short time. V-A contract. Write for free book. Hobart Trade School, Box M-903, Troy, Ohio.**

**TURN Your spare time into cash. Make quick-selling, highly profitable lamps—every home a prospect. No experience or special tools required. New 1950 56-page illustrated catalog shows shades, shade frames, figurines and bases, oil lamp converters, boring compounds, and dozens of similar items. Also all kinds of sockets, cords, pipes, harps, finials, bases, and hundreds of other parts—everything you need. Special 8-page section shows 6 beautiful lamps in kit form ready to assemble. You buy wholesale, sell at retail—make big profits. Hundreds doing it. You can, too. Send 25c today for catalog and wholesale price list. Refundable first order. Gearon Co., Dept. 500-B9, 27 S. Desplaines, Chicago 6, Ill.**

**FOREIGN Employment. Construction men, building trades, mechanics, helpers, office men. Good workers interested in foreign development projects. Pipe lines, dams, power plants, roadways, shipping, oil refineries, etc. Transportation and quarters furnished; high wages. Listings of firms actively working on projects in Arabia, Persian Gulf, Africa, Alaska, Canada, South America, Europe, etc. Send \$1.00 for foreign construction compendium and application forms. Foreign Service Bureau, Dept. PM-9 (Employment), P.O. Box 295, Metuchen, N. J.**

**FREE Book "How to Make Money With Home Workshop" describes amazing methods used by hundreds of successful craftsmen. Tells what to make, how to sell workshop output spare-time. Write at once for details. Remember it's free! Craftsman, 115-A9 Worth St., New York City.**

**RAISE Giant frogs. Breeders for sale. Vol Brashears, Berryville, Ark.**

**\$28.95 RETURNS You \$105.00. Big profit; no selling. Every \$10.00 invested thereafter returns \$52.50. Here's how. Rush your order for Silver King Ball Gum Vendor and 10,500 balls of gum, place in store, gas station, profits start at once. Send \$10.00 deposit, machine and 50 lbs. of gum will be shipped express, you pay \$18.95 plus express charges on delivery, or write for free details on starting a route of these fast money makers. Silver King Corp., Dept. C, 622 Diversey, Chicago.**

**HOW To make transparent mirrors, in booklet form, 8½x11, sent postpaid, \$1.00. Dougherty, Box 12, Phillipsburg, N. J.**

**TYPISTS. Profitable business at home. Complete copyrighted information 50c. Rosdahl Industries, 4901 Elston Avenue, Chicago 30, Illinois.**

**FOREIGN Jobs! South America, Asia, Africa, Europe, Alaska! How, when, where to apply. Latest foreign opportunities report. \$1.00. Money back guarantee. Christopher Publications, Dept. PMF-1, Holtsville, N. Y.**

**FULLFASHION Nylons when available. Socks 95c doz., combs 20c doz., rayon panties \$3.50 doz., men's underwear \$3.50 doz., chenille spreads \$2.50, quilt tops 39c. Sample razor blades, complete stock list, 25c. Sibert Company, Chattanooga 4, Tenn.**

**DOMESTICATED Earthworms convert leaves, garbage into huge profits. Details 10c. 300 worms \$2.00. (Instructions.) Avery, 112-S Elizabeth, Wichita 12, Kans.**

**START Profitable business; paint figurines; full instructions. Ray Art Industries, 314 Westport, Kansas City, Mo.**

**HAVE Fun! Make money! "Working With Leather"—64-page booklet tells how. Send 25c for copy. Free catalog and valuable information included. Wilder-Craft, 1039 Crosby, Chicago 10.**

**OUTDOOR Work for extra income. Information free. Morris, 328-A Parkway NE, Atlanta 5, Georgia.**

**RAISE Pheasants on the \$100 week plan. Little capital and space can make you independent. Free details. Great Central Game Management System, Columbus, Kansas.**

**WANTED—Purchasing agents. No money or experience required. Write Dept. C, Purchasing Manager, 2719 Lawrence, Chicago, Ill.**

**MAKE Flexible molds! Cast plaques, bookends, figurines! Free sample! H. Tooker, 630-M Chestnut, Hamilton, Ohio.**

**LIFETIME Income as notary public. Appointment assistance. Stationers, Helotes 50, Texas.**

**RAISE Fishworms. Easy, profitable. Send 25c in coin for complete instructions. Huffman Worm Ranch, Rives Junction 2, Mich.**

**\$250 WEEK Reported! Free illustrated book "505 Odd, Successful Businesses." Work home! Expect something odd! Pacific-E. Oceanside, California.**

**INTERESTED In Latin America and foreign employment? \$1.00 brings 1950 copyrighted "Foreign Service Directory," world wide listings in construction; oil; mining; aviation; steamships; manufacturers; transportation; exporters, importers. Hot list firms hiring. How-when-where to apply. Application form free. Global Reports, P.O. Box 883-P, Hollywood 28, Calif.**

**BE The Popular Mechanics representative in your neighborhood and earn big profits in your spare time. Write Popular Mechanics Magazine, Room 408M, 200 E. Ontario St., Chicago, Ill.**

**\$46 FROM Square foot plywood; jigsaw necessary. Write, Woodarts, P-38, Bridgewater, Mass.**

**OWN And operate mirror shop! Supplies for resilvering mirrors, making chipped glass nameplates and electroplating. John Sprinkle, V50, Marion, Indiana.**

**\$40.00 WEEKLY Made growing mushrooms, fresh, dried. Dominion patent 331583. Free spawn. North American, 169P Yonge, Toronto, Canada.**

**ALASKA—Last great American frontier. \$1.00 brings 1950 copyrighted directory and government map free. Big construction projects; fishing; mining; aviation; hunting-fishing-game rules; fur-farming; lumber; live stock; agriculture. Homestead land and highway information. Listing firms hiring. Application form. Alaska Opportunist, P.O. Box 883-P, Hollywood 28, Calif.**

### **BOOKS, PERIODICALS, PICTURES POSTCARDS**

**BOOKHUNTERS! All subjects, all languages. Send wants! Atlantic Book Service, Lawrence Avenue, Charlestown 29, Massachusetts.**

**BOOKS. Out-of-print. Hard-to-find. Any subject. Banker Book Co., Dept. 24, Sherman Oaks, Calif.**

**ENCYCLOPAEDIA And dictionary catalog available. Rare books located. Encyclopaedia Outlet, 8 East 33rd, New York 16.**

**SELF-Explaining Bible: Illustrated circular free. Box 446-P, Minneapolis, Minn.**



USED Correspondence courses. Bought, Sold, Rented. Free literature. Baker, 5509-B Winthrop, Chicago 40.

LOW Subscription prices. Free list. Rural Magazine Agency, Grenada, Miss.

"98 DANCING Lessons," \$1.00! "Jiu-Jitsu," 50c! 130 Main, Spring Valley, N. Y.

FARMERS And owners of all livestock—Do you want to save money in taking care of your animals? Send for amazing new book Veterinary Guide for Farmers. New facts on the diagnosis, treatment and prevention of diseases of farm animals. Authoritative, easy-to-understand and guaranteed to satisfy you or your money back. Postpaid \$3.50. Windsor Press, 200 East Ontario Street, Chicago 11.

NAME The book—We'll get it! Chicago Book Mart-PBM, 3725 Southport, Chicago 13, Illinois.

THE World in color. Sensational 35mm slides, 10 for \$1.00. C.O.D. or send \$1.00 for sample set. Money back guarantee. Free list, Evan J. Anton Productions, Dept. B, 20 East 42 Street, New York 17, N. Y.

HOW-To-do-it books on every subject. Written in Popular Mechanics' famous easy-to-understand style and profusely illustrated. Subjects include workshop planning and practices, projects, hobbies, household repairs, motoring, outdoor sports, photography, home building and many others. Also booklets on specific topics. Write for free illustrated catalogue. Popular Mechanics Press, 200 E. Ontario, Chicago 11, Ill.

BOOKHUNTERS! All subjects. Send wants! Jaher Book Service, 620-P East 178 Street, New York 57.

BOOKFINDERS! (Scarce, out-of-print, unusual books). Quickly supplied. Send wants. Clifton, Box 1377-PM, Beverly Hills, Calif.

NATIONAL Geographic Magazines 1888-1949. Any issue, Box 327-PM, Periodical Service, Swarthmore, Penna.

### MAGIC TRICKS, PUZZLES, JOKER NOVELTIES

LEARN Magic, ventriloquism, mind-reading. Write for particulars. Fasick, Big Flats, N. Y.

FREE! Pepper gum, 24 other tricks, with catalogue 25c. Fink Co. (B-1618), Philadelphia 5.

FREE Big fun-making catalog—Novelties, magic tricks, etc. Write Andersen's Novelty Fair, 6815-P Ardmore, Chicago 31.

500 TRICKS, New 1950 edition now ready! Send only 10c for your copy, containing latest in good magic for pocket, parlor, stage. Unequaled service to magicians for 30 years. Douglas Magicland, Dept. 1, Dallas, Texas.

LEARN Ventriloquism. Make money. Have fun. Big opportunity! Radio, television, stage appearances. Free information. Write, stating your age. Dummy catalogue 25c. Maher, Box 36-M95 Kensington Station, Detroit 24, Michigan.

BIG Magic catalog and book "102 Easy Tricks." Both only 50c. Robbins Co., 131-R West 42nd Street, New York.

ONE-WAY Glass, any size, 2x2 sample and details 25c. Magiglass, 7154 Linsdale, Detroit 4.

BE A magician. Large professional magic catalog of latest tricks, 35c. Ireland, C-109 North Dearborn, Chicago 2.

JOIN Our New Magic Club. Send 10c for illustrated catalogue and free particulars. Magic & Fun Mart, 53-A Prince St., New York.

PROFESSIONAL Catalog, 124 pages, 25c. Williams, 900 Plymouth, Ellwood City, Penna.

MAGIC Tricks, puzzles, books, cards, punch boards. Catalog 10c. Specialty, Box 671, St. Louis 1, Mo.

512-PAGE Catalogue of 2500 tricks, pocket, parlor, stage. World's finest magic. Send \$1.50 for catalogue (refunded first \$6.00 order). Kanter's, M-1311 Walnut, Philadelphia 7.

200 ELECTRIC Stunts, 110 volts, \$1. Kutting Sons, Los Altos, Calif.

16 CARD Tricks and catalog 25c. Sterling Magic, Royal Oak, Mich.

WORLD'S Largest professional magic shop, keeps you in touch with latest tricks. To receive mailings, send 50c for new catalog. Holden's, M220 West 42nd St., New York.

VENTRILQUISM Taught. 3c stamp bring particulars. Smith, 801 Bigelow, Peoria 5, Ill.

### COINS, TOKENS, CURRENCY

WHAT Are your coins worth? Amazing Fell's United States Coin Book by Jacques DelMonte. Everything on every single coin minted—Worth, value, how to sell, speculating, investment; other valuable facts on coins. Clothbound, 150 illustrations. Send no money. Pay postman only \$1.50 (plus postage) or \$1.50 postpaid (refundable). Order now! Fell Publ., 386E 4th Avenue, New York City 16.

4 BEAUTIFUL Whitman coin albums \$1.00. Giant bargain list 10c. Olson, 5800 Lake, Chicago 44.

I'LL Buy your old coins. Send 50c for illustrated coin catalog listing highest prices paid. Jack Farrell, 19370 Stratford Rd., Detroit 21, Mich.

OLD Money wanted. Will pay \$100.00 for 1894 dime, S. mint. \$50.00 for 1913 Liberty head nickel (not buffalo). Big premiums paid for all rare coins. Send 4c for large coin folder. May mean much profit to you. Numismatic Co., Dept. 20, Fort Worth, Tex.

50 ASSORTED Indian pennies, \$1.50; 1892 Columbian half-dollar, 75c; Whitman coin album, 25c; 1863 Civil war cent, 15c; 25 foreign coins, \$1.00; check list, 3c; large catalog, 15c; 100 2 x 2 coin envelopes, 25c. Coin Shop, 31 North Clark, Chicago 2.

COINS Wanted: Itemized value list 20c. Elsholz, Box 9014M, Pittsburgh 24, Penna.

25 COINS and bills, 25c. Oddehon, Box 482, St. Louis, Mo.

BARGAINS—Large \$2 bill \$2.60; 20 different Indian cents \$1.00. 4 coin albums \$1.00. 256 page guidebook \$1.50. Giant bargain catalogue 15c. Bebee's, 1180 East 63rd, Chicago 37, Illinois.

COIN Collectors greatest paper and two wooden nickels 10c. Huge bargains listed in every issue. Lawrence Brothers, Anamosa, Iowa.

CANADA, Newfoundland coins. List 10c. Coin Exchange, Box 35, Toronto A, Canada.

COINS Wanted, will pay up to \$2000 for certain coins, send 25c for catalogue. Burton's, 111 So. Third, Columbus, Ohio.

ANCIENT Roman coins 2000 yrs. old—2 small, \$1.00; 1 large, \$1.00; 10 diff., \$4.00; 33 diff. foreign, \$1.00; 100 diff. foreign, \$3.00. Chelsea, 26 W. 18, New York City 11.

FREE! Foreign coin, banknote and coin collectors illustrated catalog to approval service applicants. Send 3c postage. Tatham Coinco, Springfield 30, Mass.

GET Profit and pleasure in collecting old coins. Send 10c for 56 page illustrated coin catalog. You'll be delighted with it. Send for it now. B. Max Mehl, 370 Mehl Bldg., Fort Worth, Texas. Largest rare coin establishment in U. S. Established 50 years.

COMMEMORATIVE \$½. Oregon, Texas, Kentucky, Cleveland, Long Island, \$2.00 each. Illustrated catalogue 25c. Norman Shultz, Salt Lake 9, Utah.

### STAMP COLLECTING

10,000 PENNY Approvals waiting for you. From exotic countries, pictorials, airmails, new issues. Tilbury, Box 862, Newark 1, N. J.

WONDERFUL Offer 7 complete mint sets, Manchukuo, Bohemia and Moravia for only 10c with approvals. Reich Stamp Co., 4647 Kenmore, Chicago 40, Ill., Dept. M23.

250 STAMP Hinges—Free with bargain approvals (beginners' or advanced). Niagara Stamps, Niagara-on-the-Lake 31, Canada.

100 OLD U. S. before 1935, 50c. Roush Stamps, 51 Chestnut, Mansfield, Ohio.

PENNY Approval bargains—Write Department PM, 1267 Tutwiler, Memphis, Tennessee.

FINE Approvals. Fast, personal service. What countries do you prefer? I'll send their stamps. Skinner, 438 Locust, Long Beach 12, Calif.

100 DIFFERENT Worldwide, 5c! Approvals. Stearns, 26970-B Princeton, Inkster, Michigan.

PENNY Paradise, U. S., foreign approvals. Sparta, Box 426, Dansville, New York.

FREE Sample newsy, informative stamp weekly. Southern Philatelist, Box 1948, Miami 35, Florida.

STAMP Magazine! Copy free! "Stamp Post." South Catalina, Pasadena, Calif.

LARGE Illustrated world stamp map—10c. Kenmore, Arlington 74-D6, Mass.

POWERFUL Magnifier given approval buyers! Passaic, Box 326A, Passaic, N. J.

SNAKES! Leopard! Rhinoceros! Big stamp zoo free with bargain approvals. Niagara Stamps, Niagara-on-the-Lake 10, Canada.

100 DIFFERENT U. S. commemoratives, one dollar. Request approvals. Harold Holub, 18 East 198th Street, New York 58, N. Y.

300 DIFFERENT Given free with approvals. Postage 3c. Windsor Stamps, 1435 East 67th Place, Chicago 37.

40 DIFFERENT, Liberia triangles 10c, approvals. Greenwood, 441 Washington, Miami Beach, Florida.

500 MIXED Stamps and surprise packet for 10c, with approvals. Fahsing, Dept. PM, Atascadero, California.

FREE Surprise packet; also premiums to approval applicants. Frogness, Box 620, R-3, McHenry, Ill.

REVOLUTIONARY! Complete miniature sheet, mixture samples, perfectogauge, free with approvals. Knott, 434 East 76th, New York 21, N. Y.

FREE, Scott's International Album. Other big premiums. Full particulars with approvals. Raymax, 123-Z William St., New York City 7.

FREE! 10 Different Congo pictorials with approvals. L. Moublow, 740 Hegney, Bronx 56, New York.

FLAG Stamp free with your request for U. S. approvals. Wenigman, 1933 Patterson, Chicago 13.

FREE—Famous Americans set, Flag set, National Parks set, and Presidential set to \$5.00. A total of 90 stamps free to customers for our unsurpassed U.S. and foreign selections. Send 3c for 15 of the above stamps and full particulars. Triboro Stamp Co., 145 Nassau St., Dept. 109, New York.

INDISPENSABLE U. S. list 10c. Stanley Gibbons, 38-P Park Row, New York.

POUND Stamps containing thousands \$1.00. Longacre Shop, 108 West 42nd, New York 18.

PAY Less, buy more, books of 1,000 at 1c and 2c each. Very good fillers. Attractive stamps. Adults only. Daniel Grave-line, 14702 Troester, Detroit, Michigan.

BELIEVE It or not: 25 different British, West Indies stamps are yours for the asking. Beautiful pictorials, 19th and 20th century, including free monthly magazine. Send only 5c for postage. Empire Stamp Company, Dept. PM, Toronto 5, Canada.

ABSOLUTELY Free—Gilbert Ellice, Cook Islands, Tonga, Seychelles, Ascensions. Free to approval applicants. Viking, 130-Z Clinton St., Brooklyn, N. Y.

GIFT—Tokelau Is. complete mint to approval applicants. Deane Stamps, Box 87, Miami 35, Florida.

½c-1c APPROVALS! Bargains galore! Cole, 43-A Rinewalt, Buffalo 21, N. Y.

SERBIA! Silesia! Wurttemberg! Free! Approvals. Colonial, Box 326A, Passaic, N. J.

TRIANGLE Assortment, airmail assortment, U. S. packet. Everything 5c with approvals. Alatelo, Maynard, Mass.

50 DIFF. French Colonies, 10c with worldwide approvals. Fields, 1939 E. 85, Cleveland 6, Ohio.

300 DIFFERENT With approvals 25c. Robert Hovell, 209 Maple, Lansdowne, Penna.

BOMBING Pearl Harbor! Scarce Bataan! 6 Barcelona. 3c. Approvals. Grabin, Box 1111, Sioux City 6, Iowa.

FREE Gigantic beautiful bi-colored mint U. S. Yorktown stamp to approval applicants. Mohawk, Box 524, Albany, New York.

500 DIFFERENT World 25c. Approvals. Ginther, 3711 Deodar, East Chicago, Ind.

FREE "Stamp Finder." Tells instantly country to which any stamp belongs. 32 pages profusely illustrated. Garcelon, Calais 17, Maine.

100 WORLD 10c. ¼c Up approvals. Pagewood, 1355 North Dearborn, Chicago 10, Ill.

SPECIAL Bulgaria set, catalogue \$1.87, for 10c, with approvals. Kingman, High-bridge, Box 42, New York 52.

FIVE Mint Camerouns free with approval request. Brown, 106 Center, Staten Island 6, New York.

150 DIFFERENT U. S. 1886 to date \$1.00, 240 different \$2.00, 325 different \$3.00. M & G Stampco, Swanton, Ohio.

VALUABLE Illustrated U. S. catalogue free. Stone, Box 52-P, Dorchester 24, Mass.

**FREE!** 50 Different Japanese stamps! Approvals. Star Stamps, 225 Willard, Jamestown, New York.

**MOZAMBIQUE** Triangulars, unused set 10c with approvals. Vargo Stamps, 6044 South Fairfield, Chicago 29, Illinois.

307 ALL Different 15c. Beautiful collection of commemoratives, triangles, high values, bicolored stamps, etc., only 15c. Garcelon, Box 400, Calais, Maine.

**TWENTY** Stamps for ten cents. Each stamp fifty years old and over, if you ask for our wonderful bargain approvals. Park Stamp Co., Box 191, New York 21, N. Y.

**MAKE** Money dealing in stamps! Free details. Lory's, Villa Park, Illinois.

**PAYING** High prices for approvals? If your collection numbers under 15,000 try our 1c and 2c approvals. In books of 1000 different. Lots to choose from at lowest prices. Also special offer to customers. Clark, Box 544-P, Muskegon, Michigan.

**\$10,000 CHINESE** Air mail; also 100 different world wide, 5c with approvals. Andrews, 112 So. Main, Room 304, Decatur, Illinois.

**FAMOUS** American set (21 var.) for 25c coin with United States or British approvals. Gables Stamp Studio, Box 985, Coral Gables, Florida.

110 DIFFERENT U. S. commemoratives \$1.00; 300 different U. S. \$3.00; 500 different U. S. \$10.00. Bardsley, Roslyn, Penna.

**JUMBO** World wide approvals 1/2c to 5c, about 500. Mounted by countries. Hi-land De Luxe Stamps, 945 37th, Des Moines, Iowa.

**APPROVALS** Colorful foreign selected stamps. Complete sets, singles. Satisfaction assured. Ward, 241 So. Winchester, Campbell, Calif.

**GRAND** Value packet with five foreign sets, free. Stoll Stamp Service, 2632 Burnett, Louisville 10, Kentucky.

10 ASSORTED U. S. Commemorative 15c. Five U. S. Air Mail 15c. 10 Famous Americans 25c. All for 50c. Ideal Stamp, Box 179, Park Ridge, Illinois.

1000 WORLD Wide 67c. Pacific, P.O. Box 5704, Los Angeles, Calif.

**FREE!** Volcano pictorial! Madagascar! Nigeria! Chinese! Approvals. Keating, 637-P Bergen, Jersey City, New Jersey.

**TWENTY** Diff. 19th century given to approval applicants. Rossom, 218 West 59th St., Chicago 21, Ill.

**GERMANY!** Mint Hitlerheads (12) free. Interesting, exciting approvals. William Deems, Ravenswood, West Virginia.

1111 DIFFERENT Including 100 China \$1. Bargain list gratis. Stamps, Box 1649P, Oakland 4, California.

100 DIFFERENT U. S. commemorative stamps. \$1.00. Historical Stamp, 110 West 42nd St., New York City.

**DEALERS**—Illustrated wholesale bargain catalogue free. Liss, Box 184, Coral Gables 34, Florida.

**BELGIAN** Colonies 50 different. Send \$1.00. Stampico, Box 988, Brussels (Belgium).

**YOUR** Money's worth in good packets! Write for free bulletins. E. Myers, Box 122, Lansdowne, Penna.

110 DIFFERENT Hitlers, Roosevelt, Liberia, Haiti, etc. 10c. Buckey, 208 Ludlow Bldg., Dayton 2, Ohio.

300 FOREIGN Stamps plus 50 all different United States plus watermark detector and perforation gauge. Everything 10c to approval applicants. Jerry Whitehead, 315M South Fifth Avenue, Canton, Illinois.

**LOOK**—Gift of United States commemorative sets. Free premiums with each order. Approval applicants send 5c. Locust Stamp Co., Box 390T, Peekskill, New York.

**SMALL** Collection U.S. stamps \$1.00. Law, Box 725, Lynn, Mass.

50 DIFF. China 5c. Worldwide approvals sent. Holmes, 628 Connally Drive, East Point, Ga.

**WORLDWIDE** Stamps. All different. 200, 25c; 500, 50c; 1000, \$1.00; 2000, \$2.50; 5000, \$12.50. Beacon Sales, Northboro, Mass.

500 STAMPS For only 10c! This mammoth value includes airmails, pictorials; stamps from strange countries, cataloging up to 25c each! Also approvals. Mystic Stamp Company, Camden 80, New York.

500 JAPAN Stamps 10c. Kenmore, Arlington 74-J4, Mass.

**FREE**—Cuba Roosevelt issue and illustrated catalog. Littleton Stamps, Littleton 12, N. H.

**AMAZING** Offer! 500 United States stamps—including commemoratives, airmails, high values to \$5.00. Only 10c to approval applicants! Illustrated bargain lists free. Mystic Stamp Co., Dept. 80, Camden, New York.

50 DIFFERENT U. S. 10c. No approvals. Seidenberg, Box 944, Appleton, Wis.

10,000 DIFFERENT 1c Each! Gordon Davison, Box 1019S, Manchester, N. H.

**SCARCE** Atomic bomb airmail and 100 all different war-issues, airmails, etc. 10c to approval applicants! Star Stamp Company, Jamestown, New York.

**FREE** Philatelic supply list. Penny approvals on request. Reed, Box 980, Chicago 90, Illinois.

100 EXOTIC Japan—All different, 10c. Kenmore, Arlington, 74-K7, Mass.

**GENUINE** "Goya nude" set (catalogs 55c) 15c. Approvals. Royal Stamp Company, Tamaqua, Penna.

**STAMPS** Wanted. Collections, duplicates, surplus stock, mint and used. Trade for printing; buy outright if bargain. What have you, what's wanted. Vanroy Shirk, Lebanon, Penna.

**FREE** Collection—Over 100 different stamps of the world—commemoratives, she-wolf, camels, giraffes, ships, rare Austria race horse, others all to approval buyers; also Scott International Albums, stamp catalogs. Bell Stamp Service, Dept. S-2, Box 190, Bell, California.

**PENNY** Approvals that satisfy. Neil Gronberg, Box 5441-P, Philadelphia 43, Penna.

**FREE!** Beginner's packet! With lists! Stampmart, Box 2071, Hartford 1, Conn.

"HOW To recognize rare stamps." Book profusely illustrated. Only 10c! Kenmore, Arlington 74-H8, Mass.

**OLD** Scarce U. S. seconds on approval. Slightly defective. Bargain prices. Herfield, Clintonhill Station, Newark 8, N. J.

200 DIFFERENT Including Roosevelt triangle, 5c to approval applicants. M. Avalon Stamp Company, Springfield, Mass.

**ARMENIA**, Ten bicolored stamps, value 75c free to approval buyers. Apex Stamps, Box 2188, Miami 13, Florida.

**FREE**—Illustrated catalog! Kenmore Stamps, Arlington 74-C7, Mass.

**TOPS!** Our book "How To Collect Stamps." Send for your free copy today! Littleton Stamp Co., Littleton 37, N. H.

200 BRITISH Empire stamps plus valuable publications only 3c. Kenmore Stamps, Arlington 74-B17, Mass.

**MAGNIPIER**. Big stamp magazine; first U. S. commemorative; plus unused \$5000 Foreign Legion, diamond, giant, and other worthwhile stamps. Everything free to approval buyers. Capital Stamp Company, Little Rock 2, Arkansas.

**WORLD**—500 Diff. 50c. 1000-\$1.00. 75 Canada 25c. Approvals, lists. Victoria Stamp Company, London 4, Canada.

**FREE!** Powerful magnifying glass—To approval applicants; also big bargain lists. Jamestown Stamp Co., Dept. 207, Jamestown, New York.

200 DIFFERENT Stamps 10c with approvals. 500 mixed United States 25c. Carlton's, Tujunga, Calif.

**DEALERS**—Wholesale list. Postage 3c. Frank, 5031 Queensberry, Baltimore 15, Md.

**U. S. Price** list. Send postage. State Stamp Service, 1225 Park Building, Pittsburgh 22, Penna.

**WOW!** \$10.00 Worth of fun 10c! What a treasure hunt! Big package 500 foreign stamps, including airmails, pictorials and others from the world over; stamps worth up to 25c each. This offer sent for 10c to approval applicants only. Jamestown Stamp Co., Dept. 22, Jamestown, New York.

**WORLD'S** Largest stamp (7 1/2 x 14 inches). A real curiosity! Retail for 50c, only 3c to approval applicants. Tatham Stamp Co., Springfield 30, Mass.

**FREE!** 100 Worldwide different stamps to approval buyers. Big U.S. and illustrated bargain lists sent with approvals. Bookman, Maplewood, N. J.

### ANTIQUES, RELICS, INDIAN GOODS, CURIOS

**INDIAN** Relics. Send \$10.00 for 150 small genuine tools. D. J. McKillop, 2136 Smith St., Regina, Sask, Canada.

8 ANCIENT Indian arrowheads \$1.00. tomahawk \$1.00. 4 fine bird arrows \$1.00. list free. Lear's, Glenwood, Arkansas.

### PRECIOUS STONES, MINERALS

**ROSE** Quartz, jasper, agate and catalogue. Quarter. Gemco, Elkhart Lake, Wisconsin.

"GENUINE" Deep red Arizona rubies (garnets). Send quarter for packet. Box 724, Scottsdale, Arizona.

**MINERAL** Specimens, cutting material, slabs, and gems. Send for free booklet. Warren's Minerals and Gems, 1969 Abbott St., San Diego 7, Calif.

**DIAMONDS** For industry. 2 carats weight \$10. No duty. Brilliant halfcarat \$100. Duty 10%. Airmail. Joachim Goldenstein, Diamondclub, Antwerp.

**AGATES**, Cutting machines, mountings. Free list. North West Gems, Box 305, Tacoma 1, Wash.

**MINERAL**—Treasure locators—Geiger counters. Can be purchased on monthly payment plan. Free literature. Fisher Research Lab., Inc., Palo Alto, Calif.

**GEMSTONES**. Mineral specimens. Every variety. Lowest prices. Postcard brings free booklet. Plummer's, 2183C Bacon, San Diego 7, California.

**METAL** Detectors. The very latest circuit. Send 25c for literature. Hedden Metal Detectors, 3329 Liberty Ave., Pittsburgh 1, Penna.

### HOBBIES AND COLLECTIONS

**WANTED** To contact hobbyist who makes miniature mechanical circuses. George Lambert, Wyalusing, Penna.

**NEW**—15 Different match covers 10c. Box 202, Rochester 1, N. Y.

**WANTED**—Cigarette, tobacco cards. Write Charles Bray, East Bangor, Penna.

**UNUSED** Matchbook covers—100 different \$1.00. Catalog 25c. Charles Edelman, 1311C East 84, Cleveland 3, Ohio.

**TRANSPARENT** Plastic boxes; ideal for keeping small parts in order, completely visible. 10 boxes, 3 sizes, transparent case, complete \$1.00. Wonderful time savers. Money back guarantee. Cargille, 114-A Liberty St., New York 6.

**INVENTING** Can be an interesting and profitable hobby. Write for complete particulars. Institute of American Inventors, Dept. 40-E 631-E St. N.W., Washington 4, D. C.

### PHOTO FINISHING

**EMBOSS** Christmas cards from your own negative. For samples, send negative and 25c. Film Capital Service, 818 Dewey Avenue, Rochester 13, N. Y.

**SPECIALIZING** 35MM. fine grain developing. 36 big 3 1/2 x 5 enlargements \$2.00; 20, \$1.50. Photoshop, Linton 3, Ind.

**MAIL** Us your films. Prompt service. 8 exposures developed and printed 30c. Free enlargements. Foto Art Studio, Box 406, San Francisco, Calif.

16 FOR 25c. Any standard 8 exposure roll developed with 16 velox decklegrade prints 25c. 10c package mounting corners and enlargement coupon free with this ad. Skrudland, 6444-W Diversey, Chicago, Ill.

**FREE** Album and 5 x 7 enlargement with every 8 exposure roll, developed and oversized printed, 35c. Caron Photo Service, Box 6399P, Chicago 80, Illinois.

**GIANT** Size prints. 8 exposure roll 35c. 12-50c, 16-65c. Cain's, Box 4872 Florence Branch, Los Angeles, Calif.

**FREE!** You get extra set of giant prints with each roll and this ad. Introductory offer. 8 exp. roll. 25c. Moneyback guarantee. Bonded Photo Service, Box 829-M, Hollywood 28, California.

16 CONTACT Prints from 8 exposure roll 35c. Reprints 3c; 40, \$1.00. Double size prints in album book. 8 exposure roll 30c; 12, 45c; 16, 60c. Reprints 4c; 30, \$1.00. Apex Photo Service, Box 197, Bronx 51, N. Y.

**TWO** Beautiful prints from each picture on 8 exposure roll 35c. 29 years of satisfied customers. Quick service. Lens Photos, Dept. J-4, Janesville, Wis.

**ROLL** Developed and 4x6 or 3 1/2 x 4 1/2 oversized glossy Velox prints. 8 exposure 35c. 12 exposure 55c. 16 exposure 70c. Clemet Photo Service, 1318 W. Columbia Avenue, Philadelphia 22, Penna.

**SOMETHING** New. 8 exposure roll developed and printed \$1.00 per roll. Trueblood Studios, Wilson, N. C.

**LOW** Cost vacation special! Roll developed, 8 giant (enlarged) prints only 35c; 12 or 16 for only 50c. 8 giant reprints 32c. Quick service. Valuable premium coupons. Free mailers. Willard Studios, Box 3518G, Cleveland, Ohio.

**XMAS Cards** with envelopes, 18—\$1.00. Send negative. 5c for sample card, list of styles. Graphic Photo Service, 8 Saint John Street, Plains, Pennsylvania.

**EIGHT 4x6 Enlargements** 50c or eight 5x7s 79c from roll or negatives. Artshop, PM46, Sweetwater, Texas.

**BEAUTIFUL Enlargement** from each picture on 8 exposure roll 35c. Cut Rate Photos, Dept. B-4, Janesville, Wis.

**8 HOUR Service.** Your 8 exposure roll printed jumbo or regular size 30c; 12 exposures 35c; 16 exposures 50c; 20 exposures 75c; 36 exposures \$1.00. Reprints 3c. Fine grain developing. Send for mailers. Quality Photo Service, Box 468A, San Francisco 1, Calif.

**GRAPHIC For quality!** 8 exposure roll printed regular size, 25c. Oversize 35c. 12, 55c; 16, 65c. Reprints 4c. 35mm 36 exposure fine grained, enlarged 3 1/4 x 4 1/2, \$1.25, 20 \$1.00. Fast service. Satisfaction guaranteed. Price list, mailers on request. Graphic Photo Service, Dept. M, 8 Saint John Street, Plains, Pennsylvania.

**ROLL Developed,** 16 prints 25c. Reprints 2c. Dick's Photo, Louisville 12, Ky.

**GREAT NEWS!** New low price on our famous jumbo oversize finishing. New Chicago plant with latest, exclusively improved equipment produces new high-quality work. 8-exp. roll deluxe finish only 30c. 12-exp. 45c. 16-exp. 55c. 36-exp. \$1.25. Oversize reprints 4c. Send us your next order, magnificent results will delight you. Century Photo Service, Box 5208, Chicago 80, Ill.

**FREE Price list** on quality developing, printing, enlarging. Write for it today. Bryan's Photo Shop, Dept. M, Panama City, Florida.

**UNBEATABLE For quality and price.** You will be surprised and pleased with the beautiful results from our celebrated jumbo oversize finishing. New low prices, same as contact. 8-exp. roll superfine finish only 30c. 12-exp. 45c. 16-exp. 55c. 36-exp. \$1.25. Oversize reprints 4c each. Send us your order, you will be delighted. Free mailers. Mailbag Film Service, Box 5440A, Chicago 80, Ill.

**OIL Coloring photographs** can be a fascinating hobby or profitable sideline for those with artistic talent. Learn at home. Easy simplified method. Send for free booklet. National Photo Coloring School, 1315 Michigan, Dept. 343B, Chicago 5, Ill.

**MOEN'S New equipment,** better prints quick as a flash. 8 exposure rolls developed and printed contact size 30c, reprints 3c each; 8 supersize genuine Moentone prints 35c. Mailers free. Moen Photo Service since 1898, 41 Moen Bldg., LaCrosse, Wis.

**FREE 5 x 7 Enlargement** with each roll developed and printed. 6 or 8 picture roll 35c. 12 or 16 picture roll 55c. Send coin with roll. No c.o.d. If you fail to get pictures on your roll of film, we will mail a new roll to you at no additional cost. Overnight service. Mailers sent free on request. Deluxe Film Service, Box 1268, Shreveport, Louisiana.

**2 BEAUTIFUL Hi-Gloss prints** each good negative and enlarging coupon with each 8 exposure roll developed 28c. Free mailers. Owipphoto Co., Weatherford, Oklahoma.

**PHOTO Handbook** tells you how to take, develop and print your own pictures, build your own enlarger, etc. For the amateur and professional photographer. 160 pages, \$2.00. Popular Mechanics Press, 200-PF East Ontario, Chicago 11, Illinois.

## CAMERAS, PHOTO SUPPLIES

**GLOW Label equipment** decals make panchromatic film loading, developing in total darkness easy! Luminous titles, triangles, dots, etc. put darkroom equipment at your fingertips! Non-fogging, permanent. Easy to apply. Complete set \$1.00 each. Dealers: write on letterhead! Tekni-Labels Company, 732-MS S. Victory, Burbank, California.

**LARGEST Selection** exclusive original art slides for Stereo Realist. Sample slides \$1.75 five assorted \$7.00. 2 1/4 x 2 1/4 slide sample \$1.50, five assorted \$4.98. Special—25-35mm. slides with free viewer \$6.75. Send for free film catalogue. 25c for film strip sample. Friart Camera Exchange, Inc., 140A Liberty St., New York 6.

**FREE Photographic bargain book** packed with hundreds of sensational values in still and movie cameras, lenses and latest accessories. Super savings for you in new and used equipment. Liberal trade-in allowances, too, on your equipment. Write now for your free copy to Central Camera Company, Dept. 9K, 230 S. Wabash Ave., Chicago 4. (Photographic headquarters since 1899.)

**PHOTOCOPY Anything—Papers, books.** No darkroom. 8 1/2 x 11" complete \$6.95. Fotoflek, 3751 St. John's Terrace, Cincinnati 36, Ohio.

**35MM. Owners.** Develop, reverse slides yourself in one hour. Thrilling, easy! Black or color. Sample free. Write: Lake Camera Exchange, Drawer 842D, Gary, Indiana.

**BASS Says: Bargaingram** 257 ready and waiting for you. The book which tells all. The finest in new and used camera equipment, a veritable encyclopedia. Write, phone or call the sign of the old "Horse Trader." 39th year of satisfaction or your money back dealing. Bass buys, sells and trades. Bass Camera Company, Dept. AG, 179 W. Madison St., Chicago 2.

## MOTION PICTURES AND SOUND EQUIPMENT

**SPECIAL 3600 r.p.m.** 1/40 h.p. synchronous motor. 110 volt, 60 cycle a.c. Special price \$59.50. Standard Sales, Box 7525, North Kansas City, Mo.

**MOVIE Film 8mm. roll,** guaranteed, process included, \$1.25, 50 ft., Hollywoodland Studios, "Since 1934," Box 33F, South Gate, Calif.

**1000' 16MM. Silent-sound film** \$7.50. International, 2120 Strauss, Brooklyn 12, N. Y.

**SAVE 50%—On movies.** Free circulars. Fromaders, Box 637-A, Davenport, Iowa.

**BRAND New 16mm. sound one reel** Castle, pictorial discontinued titles, \$7.95, \$9.95 each, plus postage. Big list free. Blackhawk Films, Dept. PMF, Davenport, Iowa.

**NEW 16mm., 35mm. sound projectors.** Cine, 582 Ithaca, N. Y.

**MOVIE Film 16mm. MAG, guaranteed,** process included \$1.75, 50 ft., Hollywoodland Studios, "Since 1934," Box 33F, South Gate, Calif.

**DYNAMIC Films for artists.** Free catalogue. Gotham Films, 383 East 48 Street, Brooklyn 3, N. Y.

**16MM. Hobbyists—Send 10c stamps** for illustrated list of well known manufacturer's slight seconds of sprockets, rollers, shafts, etc. Post Office Box 962, Mission, Kansas.

**WILD Game films.** 16mm, 8mm. Color, black-white. Sound, silent. Rare closeups taken in natural habitat by famed Eberhart organization. Send for free catalog. Wild Life Films, Dept. 9-PM, 6063 Sunset Boulevard, Hollywood, California.

**FREE MOVIES.** Thousands of subjects. Interesting. Entertaining. Fascinating. Latest directory—only 50c. National Cine Society, 126 Lexington Avenue, New York 16, N. Y.

**BETTER 8MM. and 16mm. movie camera** film. Free equipment catalog. Better Films, 742 New Lots, Brooklyn 7, N. Y.

**MAGAZINES, 16MM., new!** Empty, 50c. Loaded fresh film, \$1.25! Processing service. 10% discount six lot! Catalog. Eso-S, 47th Holly, Kansas City 2, Missouri.

**UNUSUAL 8 And 16mm. films,** used by many art students. Write for free catalogue. Send 25c for sample strip. Friart, 140-A-Liberty Street, New York 6.

**GUARANTEED Fresh anti-halo outdoor** movie film! Weston 16! Daylight loading! Processing free! Three spools double 8 mm. \$4.50! Six single 8 mm. for Univex, \$4.60! Postpaid! Catalog. Eso-S, 47th Holly, Kansas City 2, Missouri.

**RENT 16MM. sound films,** 50c reel. Large selection; free catalog. Film Service, 128 Chestnut St., Roselle Park, N. J.

**"THE World's Greatest Passion Play,"** 8mm., 16mm. and 35mm. Specify silent or sound. Rent or purchase. Hemenway Film Co., 33-F Melrose St., Boston 16, Mass.

**SNOW White movie screen paint.** Free literature. 126 1/2 West Main, Danville, Illinois.

**RENT 16MM. sound films,** 50c reel. Rogers Films, Box 26, East Atlanta, Ga.

**8-16MM. Silent-sound films.** Complete rental library. All latest subjects. Free catalogue, (sample film 10c). Garden Film, 317 West 50th, New York 19.

**BASS Says: 39 years of leadership** guarantees satisfaction. Finest cine equipment, 8mm., 16mm., and 35mm., silent and sound. Write the old "Horse Trader." Satisfaction or your money back always! Bass Camera Company, Dept. A, 179 W. Madison St., Chicago 2.

## MUSIC AND MUSICAL INSTRUMENTS

**SWISS Music movements,** finest make, assorted tunes \$1.90. Direct imports. Helaxe Company, 233 West 72nd Street, New York.

**NEW, Interesting recording deal.** Turner, P.O. Box 2201-M, Bridgeport 8, Conn.

**SWISS Musical movements.** Retail, wholesale. Spielman, 131 West 42nd, New York 18.

**POEMS Wanted.** Percentage basis collaborations. Terry Tune Master, 709 1/2-PM North Broadway, Oklahoma City 2.

**GUARANTEED.** Quality instruments. Bargains by mail catalog 10c. Harden's, Marion, M., Ohio.

**RECORDS—Guaranteed new.** Hillbilly, popular, spirituals. 4 for \$1.00. Free record with first order. Free catalog. Mallorc, Dept. 137, 570 N. Gay Street, Baltimore 2, Maryland.

**LEARN Song writing!** Fun-profitable. Wonder Wheel jiffy composer, perfect harmony, any note, any chord. Folders free. Barnes, Box 490, Times Square Station, New York 18, N. Y.

**ACCORDIONS—All brands.** New and used. Save 50%. Wholesale to every one. Del Principe, 307 So. Wabash, Chicago.

**SONGWRITERS,** Collaboration, details. Newark Publications, G.P.O. Box 1226, Syracuse, New York.

**UKULELE—Learn to play popular songs** in 12 lessons, only \$2.95 complete. Gelb Studios, 2707 37th Ave., San Francisco, Calif.

**SONG Publication—Royalty basis.** Abbe Music, 242 West 10th, New York 14, N. Y.

**PLAY In any key.** Amazing new "Kord-Key" transposing guide. Complete with chord structure chart. Only \$2.95 c.o.d. or money order. Creative Harmony, Box 3366, Glendale, Calif.

**MAKE Your own violin.** New book. You Can Make a "Stradivarius" Violin has eight full-size plans. Take the guesswork out of this fascinating project. Even tells how to fashion your own tools. Book and plans only \$3.50. Popular Mechanics Press, 200 East Ontario Street, Chicago 11.

**WRITE Songs.** Big money and reputation. Write for information. J. Gordon Pub. Co., 4700 South California Avenue, Chicago.

**POEMS Wanted for musical setting.** Send poems for free examination. Five Star Music Masters, 630 Beacon Bldg., Boston, Mass.

**WANTED! Poems for musical settings.** Write Songwriters' Service, Clifton, N. J.

**POEMS Considered for musical setting.** Send poem for free examination and useful rhyming dictionary. Richard Brothers, 24 Woods Building, Chicago.

**SONGWRITERS! Outstanding, ethical** offer. Hibbeler, C-5, 2157 N. Avers, Chicago 47.

**SONGWRITERS! Send poems, songs.** Music Service, 243 West 72nd St., PM, New York 23.

**1950 ACCORDIONS—Wholesale.** Free catalog. American Accordion Center, 5329 Belmont, Chicago.

**POEMS Wanted to be set to music.** Free examination. Send poems. McNeil, Master of Music, 510-PM S. Alexandria, Los Angeles, California.

**MUSIC Arranged, songs printed.** Frank Wildt, Music Publisher, Lancaster, Penna.

## RADIO AND TELEVISION

**FIX Any radio.** Amazing new instrument locates radio troubles double quick. Simple instructions show you how. Thousands now in use. Free. Write today for 32-page illustrated technical manual, "The Inside Story." Feiler Engineering Co., Dept. 9PM5, 1601 S. Federal St., Chicago 16, Ill.

**FREE! 212 Page radio and television** catalog! World's largest stocks, lowest prices. Complete supplies for builders, experimenters, amateurs, servicemen. Latest radios, phonos, television, recorders, sound equipment. Thousands of parts, tubes, test instruments, books, diagrams. Top quality money saving values. Get it now! Allied Radio Corp., 833 W. Jackson Blvd., Dept. 34, Chicago 7, Illinois.

**TELEVISION And radio engineering** taught practically, also electrical engineering, armature winding, electrical drafting, Day and evening classes. Special correspondence courses. G. I. approved. Canadian School of Electricity, 282 Ontario W., Montreal.

DESIGN Your own TV antennae. Made to order. 95c foot aluminum. Includes postage and accessories. Ra-Vi-Dio Co., Simpson, Penna.

**SPECIAL Bargain**—Selenium photo-electric cell rated at 500 microamperes per lumen. Generates 1/4 volt in bright sunlight. Needs no batteries. Can be used in photo exposure meters and many other applications. No. 99-6810L. Each 95c plus postage. Send for free catalog and bargain bulletin on television, radio, electronic supplies. Concord Radio Corp., Dept. LJ-50, 901 W. Jackson, Chicago 7, Ill.

**BUILD 15 Radios**, less than \$1.00 each. Experience unnecessary. Parts, tools, directions included. Free details. Federal Supply, 176-71 Union Turnpike, Flushing 2, New York.

**AMAZING Distance reception** on one tube radio. Pictorial plans 25c. Arthur Alena, Wall Street Station, Box 271, New York 5.

**MAKE Simple, tubeless, batteryless, distance-getting crystal radios.** Crystal and illustrated instructions 25c postpaid. Allen, 427-P, Clinton, Mo.

## BUSINESS OPPORTUNITIES

**200 NEW Money making plans, tips, ideas for increasing your income.** Folio free. Reynard Pub., Smithfield 3, Ohio.

**MEN—Women.** Everybody likes candy. Learn to make professionally. Our 40th year. Ragsdale Candies, D5, East Orange, New Jersey.

**FRENCH Dry clean yourself** with marvelous solvent. Cleans eighteen garments. Receive outfit and information. Send \$1.00. Yale Clo, Meriden, Conn.

**\$35 WEEKLY! Home!** Two hours daily! Particulars! Walsh, 894 Main St., Buffalo 2, N. Y.

**MANUFACTURE Easy way.** Add water our concentrates. Make flavors, lotions, perfumes, shampoos, cleaners, polishes. 125 products. Labels your name, bottles. Qualco, E20030 Russell, Detroit 3.

**FIX Typewriters**, full or part time. Inexpensive copyrighted home study course quickly trains you for high earnings. Factory methods cover all phases with drawings and illustrations. No curiosity seekers. Typewriter Repair, 9915 Corbet, Tarentum, Pennsylvania.

**BRONZING Baby shoes** is big business. Start your own business for \$9.85. Includes all materials and instructions. Copyrighted "Metal Sealed" process requires no equipment. Particulars free. Box 2095, Wichita, Kans.

**GET Quick profits.** Make your own jewelry. Send for free catalog with complete instructions on making beautiful rhinestone and pearl jewelry that sells on sight. Immerman & Sons, 1814-D East 13th St., Cleveland 14, Ohio.

**MAKE — Sell sensational new product.** 300% profit. No machinery, just add water. Everything supplied. National, Box 88-P, Boston 22, Mass.

**BETTER Jobs in electroplating!** Free particulars. Joseph Kushner Electroplating School, Stroudsburg 775, Penna.

**\$1.00 PROFIT Selling gallon upholstery cleaner—\$1.25.** Stores sell \$1.69. Quart size sample, full details 25c. Kohne, 506 West 45th, Chicago 9.

**LEARN Typing, bookkeeping, business plans, mail order schemes, formulae, postal data, miscellaneous tables.** Reliable old book. Details free. Lackey, 1128 Delaware, Detroit 2, Michigan.

**START Own profitable mailorder business.** "Natural" money-makers revealed! Free folder. E. Lay, 3819 Kenmore, Chicago 13.

**EARN At home casting novelties.** Free instructions using latex molds. Major Chemical Company, 164 Portland Street, Cambridge 39, Mass.

**OPERATE Profitable mail order business.** Write Macs Service, 214B S. Broadway, Greensburg, Ind.

**START Your own business on credit.** Always your own boss. 1554 dealers, sold \$5,000 to \$26,500 in 1948; their average \$6,742. We supply stocks, equipment on credit. 200 home necessities. Sales experience not needed to start. Wonderful opportunity to own pleasant, profitable business backed by world-wide industry. Write Rawleigh Co., Dept. I-U-PPM, Freeport, Ill.

**EASY To make expensive perfume** with low cost "essential concentrate base." Fast, tremendous profits. Write post card. H. May, Box 4473-PA, Coral Gables 34, Fla.

**AMAZING New magazine.** No other magazine in the world like new "Here's How." Every page devoted to schemes, plans, ideas for making money—at home or outside, full or spare time. Tells how to start own business—how to sell personal service—how to make homecraft pay big profits—how to quickly win financial independence. Every story and article practical, stimulating, inspirational. Get copy of first issue of "Here's How" just off press for only 25c. One idea in this amazing new magazine may be worth \$1,000 to you. Be first in your locality to read "Here's How." Rush name and 25c today to Raymond Brandell, Publisher, 1512 Jarvis Avenue, Dept. CL-2, Chicago 26, Ill.

**IMPORT-Export! Men, women.** Learn from established world trader. Your own profitable world-wide business by mail order from home without capital; or travel abroad. Experience unnecessary. Free details. Mellinger, C-2, Los Angeles 24.

**BIG Money! Spare or full time** in your home. No selling! Spray new miracle finishes, plush and suede, on signs, radios, automobiles, figurines, lamps, toys, etc. Our business is booming. Help us fill huge demand. New easy Flok-Kraft methods. Material costs few pennies. You get dollars. Free samples, complete powerful money-making plan free. Write now! Coast, 1002M S. Los Angeles St., Los Angeles 15, Calif.

**BUILD Home business by mail.** Extra money. Future independence. Details free. Arnold, Butler Rd., R-11, Ft. Wayne, Ind.

**LEARN Piano tuning, repairing — at home** in 30 days. Unlimited income. Phonograph recordings, tools and instructions furnished. Write Capitol City Tuning School, Department C-934, 129 East Michigan, Lansing 16, Michigan.

**BE Independent — Operate America's lowest price penny vending machine.** Big profits. Immediate shipments. Write for bulletin and prices. Fielding Mfg. Co., Desk 90, Jackson, Mich.

**MAKE Tough, durable plastic—1c pound.** Makes attractive floors, walls, built-ins, roofs. Build good home, \$150.00 room. Bays Laboratory, Oklahoma City 9.

**A Factory in your home, garage!** Mechanics' waterless hand cleaner, glass cleaner, auto cleaner-polish; many others. All formulas free, but if you also want free samples send 15c postage. Western Aircraft, Dept. B, Los Angeles 6.

**SLUSH Cast flexible toys fast** with solventless rubber. \$6.50 gallon. Boruski, 505 Fifth Ave., New York City.

**LEARN Home mail order business.** Details free! Walter Bevil Publications, 3408 Avenue G, Fort Worth 5, Texas.

**ACHIEVE Business and financial success** in your own collection-credit agency business. Home or office. Quickly learned. Free folder. Write Cole & Associates, Syracuse 2, N. Y.

**DRESDEN Craft figurine molds** and many others, natural liquid rubber, statuary plasters, flock finishes, etc. Illustrated catalog and "Plastercraft" manual free. Blue Rapids Supply, Blue Rapids, Kansas.

**BRONZED Baby shoe mountings,** supplies wholesale. Box 2095, Wichita, Kans.

**BABY Shoe mountings—Book ends, 75c each.** Ash trays, \$1. Picture frames, \$1.35. Unbronzed metal. Felt bottoms. Cal-Bronze, Culver City, California.

**25 TIN Can projects; drawings, directions,** 50c. Dowels Krafters, Route 2, Box 210-A, Hampton, Virginia.

**GET Into advertising** for increased earnings—your own business; working for others. Real future. Vincent Cremata, 1216 Washington, Key West 4, Florida.

**LIQUID Rubber, make flexible molds.** Free sample. Chaney, 1130 E. 16th St., Jacksonville 6, Fla.

**BUSINESS, Vocational and diversion magazines.** Profit by the help those in your field will give you. Send now for our easy-to-get-acquainted plan. It's free. Commercial Engraving Publishing Co., 34C North Ritter, Indianapolis 19, Indiana.

**LOOKING For business? Open New York office—only \$12.00 yearly.** Co-operative Office Service, PM-126 Lexington Avenue, New York 16.

**MAKE Perfumes.** Men, women, write "Carey Laboratories," 1914 Chouteau PM9, St. Louis 3, Missouri.

**EARN Money at home** with your typewriter! Spare time! Details free. Edwards, Publisher, 3915-PM 12th, Des Moines 13, Iowa.

**DOLLARS Daily mailing postcards!** Proof! Power Publishers (B-9), Cincinnati 36.

**VENDING Machines** earn big money! An investment as low as \$10.50 will start you in this fascinating, profitable business that can lead you to the road of success and independence. Routes can be established and operated in either full or spare time with no experience needed. Write for full details and our free catalog illustrating our nut, candy, gum and stamp vendors; also pin ball machines, music boxes, etc. Write immediately to Parkway Machine Corporation, Dept. 7, 715 Ensor Street, Baltimore 2, Maryland.

**"HOW To Make Money With Simple Cartoons"**—A book everyone who likes to draw should have. It is free; no obligation. Simply address Cartoonists' Exchange, Dept. 99CB, Pleasant Hill, Ohio.

**ANNOUNCING Home study course** in commercial baking. Practical basic training. Good field for those with aptitude. Nearly depression proof. Send for free booklet, "Opportunities in the Baking Industry." National Baking School, 1315 Michigan Ave., Dept. 1346, Chicago 5, Ill.

**100 MARKETS For handicrafts.** Wood, crochet, novelties, etc. Big buyer's bulletin \$1.00. Free details. Research, 2409 12th Ave., Los Angeles 18, California.

**MAKE Money at home** as renewal headquarters for all magazines. Big Christmas sales profits now. Liberal commissions. Supplies furnished. Write for free catalog. McGregor Magazine Agency, Dept. 500B, Mount Morris, Ill.

**THOUSAND Articles wholesale.** "Supply Source Directory" 10c. Ideal Service, Park Ridge 30, Illinois.

**SCRAP Wood, sawdust, etc.** Over 150 cash uses. Booklet 25c. Lee Books, Box 502, Chicago 90.

**I Make big money in the mail-order business.** You can do the same at home with copyrighted system. Write me, I'll tell you how. F. Little, RD #1, Glenshaw, Penna.

**START A home business** in spare time. Make extra money. Experience not essential. Free information. Cherre, 5106 Armenia, Tampa, Florida.

**SAWDUST.** Turn it into cash. Six methods. Instructions 25c. Charles Co., 12-AWT, Norwood, Ohio.

**START Home manufacturing business** making cleaning compounds, soaps, insecticides, cosmetics, polishes, food flavors. No machinery. Literature free. Kemix, Park Ridge, Ill.

**WITH An Acme Flyer,** 40 hand saws can be sharpened per day. At \$1.00 per saw that could be \$40.00 in your pocket. Send for free literature. Max Mfg. Co., 138 Stockton Ave., San Jose 26, California, makers of nationally famous Acme sharpeners for circular saws.

**PROFITABLE Mail selling propositions free!** Wehner, Box 142-A9, Roxbury 19, Mass.

**MAIL Order opportunities galore.** Sanchez, Box 66-P, Chelsea Station, New York 11.

**NEW!—"Simplified Manual of Modern Baby Shoe Plating"**—Incorporates original \$25 course by Joseph Kushner Ch.E. (who originated teaching this by correspondence)—plus many new valuable helps for beginner and expert. Only \$4.95! For additional fresh income sources order "Manual of Modern Chrome Refinishing," "Manual of Modern Brush Plating," \$4.95 each. Satisfaction guaranteed! Order today from Joseph Kushner Electroplating School, Stroudsburg, Pennsylvania.

**FORGE Ahead financially!** Start profitable business; mail, locally! Amazing invention. Free sample offer! Consolidated Equipment Corporation, 791 Guardian Bldg., Cleveland 14, Ohio.

**MILLION Articles wholesale.** Directory 25c (refundable). Publishers, Box 1302, Detroit 31.

**10 NOVELTY Plans, 25c.** Valcal Service, Box 1506, Vallejo, Calif.

**SECURITY! Manufacture everyday demand products!** Tremendous profits! Formula lists free! Thermolab, Peoria 4, Ill.

**"WATERLESS (Lanolin) Hand Cleaner."** (Oil base.) Make, sell. No machinery. Build profitable business. Complete formula \$1.00. Ideal Service, Park Ridge 1, Ill.

**COIN Operated telescopes** produce high earnings. Ideal full or part time business wherever there are scenic views and pedestrian traffic. Telescopes sold, rented, leased or operated with you on fifty-fifty basis. Write or wire American Telescope Company, Evansville 8, Indiana.

**PROFITABLE Business** at home mimeographing letters. Proven plans. Carlson Letter Service, Mankato, Minnesota.

1000 GOLDEN Opportunities! Most amazing new money-making home occupations! 600 illustrations! Beautiful gold sample free! Stamp brings details. C. Bellehaven, P.O. Box 606, Redwood City, Calif.

DOLLARS Three ways with "Kitty-Kat" readi-cut baby shoes. Complete local and mail order plans. Write No-Co-Ro, Oakland 6-K, California.

ENORMOUS Profits and fun galore making sensational new glass ornaments. Huge demand. Samples, diagrams, easy-to-follow instructions \$1.00. Hobby, 243 S. Lexington, St. Paul 5, Minn.

MAKE More money with moneymaking secrets. Free facts. Service Bureau, Box 2625, Orlando 5, Fla.

MAKE Perfume at home—Men, women. Write International, 6347 Parnell-PM-9, Chicago 21, Illinois.

MAKE Real money selling all-metal interlocking weatherstrip, wire sweater blocker, or caulking compounds. Liberal commissions to good man. For details write E-Z-On, 1009 Harvard, Evanston 2, Ill.

EARN \$100/\$250 Weekly, installing, maintaining fluorescent lighting. Proven business opportunity. Free facts. "Fluorescent," 712-A State Tower Bldg., Syracuse, N. Y.

WANTED. Men to operate profitable electroplating and mirror shops at home, part time or full time. We furnish electroplating equipment and training. Write Tyco Metals, Box 12008C, Houston 17, Tex.

NEW Industrial hand cleaner! Sensational product. Immense market. Tremendous possibilities. Unusual money-making plan free! Keenelo, 2438 Fifteenth, Denver 11, Colorado.

MAKE Big money selling by mail. I do, everyday, from my home. You can too. Write me today, I'll tell you how. Superior, 48D, Englewood, Colorado.

BABY Shoe mountings. Bookends, frames, etc. St. Albans Plating and Casting, 135-17 135 Ave., So. Ozone 20, N. Y.

\$46 FROM Square foot plywood. Jigsaw necessary. Write, Woodarts, X-38, Bridgewater, Mass.

\$200 WEEKLY Reported! No selling. Free booklet. T. J. Surface, Roanoke 4, Virginia.

FOR Pleasure or profit. Make inexpensive gorgeous Simplex plastic statuettes and costume jewelry. Sell to stores or friends. Complete illustrated instructions only one dollar. Thermal Company, 17 Guilford Avenue, Baltimore, Maryland.

EXTRA Money at home casting silver rings? Details free. Western Silvercraft, Box 574-I, Great Falls, Montana.

FREE Details! "The Magic Formula for Mailorder Success." Mailord Company, 204-C9 East 81, New York 28, N. Y.

MEN — Women, sell money-making household items from fully illustrated catalog. Sales outfit free. National, Box 88, Boston 22, Mass.

MAKE Money spare or full time casting metal toys and novelties. Big wholesale and chain store demand for autos, soldiers, ashtrays, banks, etc. keep manufacturers busy. Production moulds furnished for up to 100 and more castings per hour. No experience or special place necessary. "Cash-in" on holiday orders now being placed. Write for information and illustrations of patterns needed. Metal Cast Products Co., Dept. A, 1696 Boston Road, New York 60, N. Y.

OWN A printing business. Good profit printing cards, stationery, etc. in spare time. Easy rules furnished. Have home shop. Send dime for complete printer's supply book and samples. Kelsey, Inc., Z-24, Meriden, Conn.

MAKE Products yourself. No machinery needed. Work at home. Build big business. One and two ingredient formulas. Over 50 fast sellers. Just package and label. Complete set only \$1.00. Nelko Chemical Service, 3462-F Merchandise Mart Sta., Chicago 54, Ill.

LEARN Sewing machine repairing at home. Earn \$125.00 week spare time. Plus, new machines, motors, etc. wholesale. Free particulars. Taylor Service Co., Hamilton, Ohio.

BOOKKEEPERS Earn \$100.00 week up-erating your "bookkeeping service." Simplified plan. Information free. Bookkeeping Service, Box 664-M, Springfield, Missouri.

SOMETHING New — Preserving baby hand and foot prints with life like relief as beautiful wall plaques. Complete course, equipment and material offered. Details. Steepleton, 3136 Walnut Street, Huntington Park 2, California.

OPERATE Profitable mail order business. Particulars free. George Lenhoff, Lincoln 8, Nebraska.

START Mailorder business. Complete plan. Satisfaction or refund. Valuable sample 25c. Hughes, 4327 Dalton, Los Angeles 62.

BRONZED Baby shoe mountings, equipment and supplies. Buy wholesale from world's oldest and largest manufacturers of all metal mountings. Sales Dept., Hollywood Bronze Supply, 6141 S. Wentworth Ave., Chicago 21, Illinois or 1766-70 North Vermont Avenue, Hollywood 27, Calif.

LEARN Gun repairing at home. Profitable. Modern Gun Repair School, Box 717, Dubuque, Iowa.

SPIN Angora wool into yarn. Interesting work. House of Angora, PM5, Springfield, Illinois.

HOME Business making statuettes, plaques, artificial marble, rubber molds. Silvering mirrors. Formulas. Folder free. Creative, 236-L, Winnetka, Illinois.

MIRROR Resilvering. Wonderful home business. Complete formula 25c. Magic two-way mirrors. You can see out—no one can look in. Formula 50c. How to make coppered mirrors, vases, glasses. Formula \$1.00. All three \$1.50. Nelko Chemical Service, Box 3462, Chicago 54, Ill.

WEST And northwest Canada. Tourist attractions, oil, mining, farming, trapping, hunting, Alaska highway. Land of opportunities. Booklets, maps. Any information, \$1.00. Box 354, Edmonton, Alberta, Canada.

SEND For "1001 Ways to Make Money," 25c (refundable). 1001 Opportunities Club, 1495 Westchester Ave., New York 59.

BUY It wholesale! Manufacturers, distributors offer \$50,000 items. Literature free. Olsen, 1231-A East Third St., Duluth 5, Minn.

UNPAINTED Figurines. Beautiful models. Write for new wholesale price list. Oman, 642J Broadway, St. Paul 1, Minn.

SPECIAL Rubber for making molds. Literature and sample free. Universal, Box 1076-A, Peoria, Ill.

COPUBLISH Leading m.o. paper. Latest copy Mail Sale Advertiser, details, dime. Vanroy Shirk, Lebanon, Penna.

MADE \$24,500 Using money making plans from Schemer Magazine, world's oldest mailorder publication. Box 775M, Alliance, Ohio. Year \$2.00. Sample 20c.

WRITE For free booklet and catalog telling how to earn substantial profits in your spare time by forwarding new and renewal subscriptions to all magazines for your friends and neighbors. Oldest U. S. agency. Established 1869. Moore-Cottrell, North Cohocton, New York.

MAKE Flexible molds! Cast plaques, bookends, figurines! Free sample! H. Tooker, 630-R Chestnut, Hamilton, Ohio.

BE Appointed state notary public now! Details. Stationers, Helotes 50, Texas.

COMMERCIAL Deep frying course. Mock chicken legs, potatoes. New and proven methods. Learn about this money-making field. \$2.50 p.p. Concession, Toledo 13, Ohio.

MAKE Rubber stamps, metalize baby shoes, repair dolls, silver mirrors, make beautiful figurines. Catalogue of "30 ideas" free! Universal, Box 1076-A, Peoria, Ill.

NATURAL Molding Latex. Extra thick. Free sample. W. Wooley, 115-A Donald, Peoria, Ill.

PROFITABLE Business making and building with easy-laying interlocking building blocks. Rex Products, Dept. 10, Piqua, Ohio.

POPCORN Poppers, peanut roasters, copper candy, caramelpopcorn kettles. Northside Co., Indianola, Iowa.

\$250 WEEK Reported! Free illustrated book "505 Odd Successful Businesses." Work home! Expect something odd! Pacific-E, Oceanside, California.

YOUR Own profitable home business. Preserve live flowers to last forever. New simple discovery. Enormous demand all year 'round. Tremendous profits! Light fascinating work. Send \$2.00 for working equipment, instructions, and valuable sales plans. Satisfaction guaranteed or money promptly refunded. Alfred-Hermansen, 210 Fifth Ave., Suite 1102A, New York 10, N. Y.

\$25 WEEKLY Working two hours daily. No canvassing. No manufacturing. Lycke, Box 2471-A, Cleveland 12, Ohio.

POPCORN And potato chip equipment. Long Eakins Company, 5060 High, Springfield 99, Ohio.

WANTED Unused U. S. postage stamps, small discount. Advance Stamp Co., 24 East 23rd St., New York.

CO-PUBLISH And advertise in The Central Mail Advertiser. Sample copy 10c. Low rates. Large circulation. Bagby Printing Co., Georgetown, Ohio.

EARTHWORM Breeding. Valuable bulletins on successful methods mailed free. Earthmaster Publications, Dept. 14, Sun Valley, Calif.

LIQUID Marble—Colorful, glossy! Molded, brushed, sprayed! Cast novelties, statuary, colored tiles. Flexible molds. Composition floors. Particulars free. Marbleizing Service, Edwardsville, Illinois.

EXTRA Money. No selling; operate vendors. Amazing profits, details free. Silver King, Suite B, 622 Diversey, Chicago 14.

UNPAINTED Bookends, plaques, statues, figurines. List. Haverly Products, 1219 8th Ave., Altoona, Penna.

RESILVER Mirrors at home. Formula 25c. Ideal Service, Park Ridge 8, Illinois.

HOW To set up and run a mirror shop! Resilver mirrors. Make chipped glass nameplates. Electroplating salts and rectifiers. John Sprinkle, V60, Marion, Indiana.

CASH For your idea, 280 manufacturers need inventions, patented or unpatented. List free. Invention Bureau, 208M Clinton, Oak Park, Illinois.

MAKE Money making new greaseless doughnuts at home on electric machine. Wholesale to grocers, drug stores, cafes, hamburger shops. Send for free recipes and plans. M. Ray Company, 3605 South 15 Ave., Minneapolis 7, Minnesota.

RECAST Old batteries into new. Latest achievements. Battery Laboratories, Minneapolis.

READ "Advance"—The voice of mail order. Offers money-making opportunities, sources of supply, personal guidance, etc. Issued monthly. Sample copy 25c. Yearly subscription \$2.00. Advance Publishing Company, 313 East 21st Street, Suite 450, New York 10, N. Y.

START Mailorder bookshop—Everything furnished. 25c brings booklet, samples, exciting ideas. General Publications, Ossining, N. Y.

OPERATE Profitable mail order business. Write Walter Service, 4159-A East 112th, Cleveland 5, Ohio.

WHOLESALE baby shoe mountings, equipment, supplies. Foster's, 1520 Ardmore, Chicago 26.

MAILING Postcards selling repeat merchandise is profitable. Everything supplied. Details free. Gordan Publishers, Box 23, Pawtucket, R. I.

137 WAYS To make money, in home or office, business of your own. Full particulars free. Elite Co., 220 Grand St., New York 13.

BRUSH Plating outfits connect to a battery. No tanks necessary. Good paying business at home plating autoparts, bathroom fixtures, bicycles, reflectors, silvering mirrors. No shop or experience required. Outfits furnished. Free booklet. Gunmetal Co., Ave. H, Decatur, Ill.

COLORGLAZED Concrete pottery made without molds. Patented method. Cemetery products, novelties, tiles. Basement leak-sealing. Money-making projects. Booklet, details free. Men only. National Potteries Company, Grand Rapids, Minnesota.

MONETARY OPPORTUNITIES

EARN Money by mail like I do. Literature free. Satterfield, Box 345-C, Mansfield, Ark.

BECOME A mail order specialist. Write J. M. Stenger, 500-20th St., Rock Island, Ill.

BARGAINS, New and used arc welders. Electric or gas engine, a.c. or d.c., all sizes, portable or stationary. Write needs. Hobart Welders, Box M-904, Troy, Ohio.

NEW—Different plan assures success in pleasant, profitable home-operated mail business. Write: National, Box 83-H, Boston 22, Mass.

MAKE Money in mailorder. Beginner's guide 25c. Ad-Man Dankmeyer, 2631B Guilford, Baltimore 18, Maryland.

CHURCHES, Organizations, agents sell candies. One pound tins only. Ralph Missimer, 251 Chelton, Philadelphia 20, Penna.

MAKE Back-yard profits! Unusual opportunities! Interesting booklet free. Pickett's, Florence, Kentucky.

\$50,000 RADIO Jackpot, other fabulous prizes anyone can win! 3c stamp. National Contest Bulletin, Box 2685-P, Miami 16, Florida.

SEPTEMBER 1950

**WIN** Contest money. General Contest Bulletin gives hundreds of tips. Lists current contests and rules. Sample 25c. General Contests, 1609½ East 5th, Duluth, Minn.

**NEW** Profitable home business repairing zippers. Thousands of customers waiting. No experience required. We furnish everything. Write Texas Specialty Company, 204-B Texas, Texarkana, Texas.

**EARN** Money evenings, copying and duplicating comic cartoons for advertisers. Adservice, Argyle 1, Wisconsin.

**EARTHWORMS**. Complete culture, 150 hybrids and free plans Allweather Worm House, \$1.60 postpaid. William Barnard, 2121 Vanderbilt Lane, Redondo Beach, Calif.

**CANDY-Making**. Well paying home business. Amazing instruction course with formulas. \$1.00. Nelko, Box 3462-C, Chicago 54, Ill.

**SCHOOL Seniors**—Sell classmates America's most beautiful graduation name cards. Largest selection. Highest commission. Outsell all others. Free sample kit. Printcraft, Dept. M, 1425 E. Elm St., Scranton 5, Penna.

**DOLLARS** In personalized baby record books. Sell by mail. Use same literature we do. No-Co-Ro, Oakland 6, Calif.

**LEARN** The profitable and fascinating art of electroplating baby shoes at our expense! Write for details to manufacturers of world's largest assortment of plating mounts, equipment and supplies. Dept. W1, Hollywood Bronze Supply, 6141 So. Wentworth Ave., Chicago 21, Illinois or 1766-70 North Vermont Ave., Hollywood 27, Calif.

**CONCRETE** Birdbath, metal molds. New high daily production system. Gardenware, 404 Stiltz, Louisville, Ky.

**HOW** To sell. What have you? Enclose \$1.00 for personal report. 35 years experience. Smith Advertising Company, Excelsior Springs, Mo.

**EARN** Big profits in mail-order. Let our long experience show you how. Small cost. No experience necessary. Lucious, P608 So. 18th St., Philadelphia 46, Penna.

**MEN'S** Ties \$2.50 dozen. Watches, jewelry, cookware, silverware, appliances, etc., lowest wholesale prices. Complete list 25c. Kriston Sales, Pemberville, Ohio.

**NEW** Fountainflow toothbrush. Jewelry, leather goods. Free wholesale list other hot sellers. C & C Sales, Box 578-P, Chicago 90, Ill.

**START** Own business, spare time, home or shop, make polishes, soaps, cosmetics, etc. Dollar brings fifty formulas. Star Enterprises, Box 21, Brooklyn 14.

**BOOKKEEPERS** Boost income operating simplified bookkeeping service. Kern, 4942 Vineland Ave., No. Hollywood, California.

**BUY** Wholesale—Million articles. Supply source directory, dime. Free samples, hundreds of advertised items. Supply Source Directory 25c. Nelko, Box 3462, Chicago 54, Ill.

**CHURCHES**, Ladies' clubs receive \$130.00. 12 tables. You sell advertisements for tables. Unique Gift Club Plan, Pine Hill, New Jersey.

**INDEPENDENT** Income! Make leather belts, billfolds, purses. Big catalog and genuine steerhide keyholder, 10c. Tandy Leather, Box 397E, Tulsa, Okla.

**QUICK** Profits taking magazine subscriptions, handling greeting cards. Cassell Publishers Service, Westfield, N. J.

**BUY** Nylons direct from mill. Make good profits on fast selling nylons. Quick delivery on any quantity. Write for confidential wholesale price list. Joy Hosiery Mills, Delawanna 13, New Jersey.

**MAKE** And sell a proven item welcomed by smokers like I do. Details free. Thos. W. Mogck Laboratories, 40 Wood St., Camden 2, N. J.

**RAISE** Your business value, standing, as state notary public. Information. Stationers, Helotes 50, Texas.

**EASY** Ways to earn extra income are described in Money-Making Hobbies. 132 projects you can make at home and sell anywhere. 160 pages. \$1.98. Popular Mechanics Press, 200-MH East Ontario, Chicago 11, Ill.

**\$250 WEEK** Reported! Free illustrated book "505 Odd Successful Businesses." Work home! Expect something odd! Pacific-E, Oceanside, California.

**DOLLARFUL** Ideas for you every month in advance—"Voice of Mail Order." Leads the field in exclusive supply sources. Plans for mail order operation; new products, etc. Details free. Advance Publishing Company, Suite 350, 313 East 21st Street, New York 10.

**PUBLISH** Your own magazine. Hand-some 52 page format, well edited, illustrated. Cost low as \$1.00 month. Brings you prestige, profits. 25c brings sample, details. National, Ord, Nebr.

**READ** Progressive Mailtrade, the magazine that tells how to make money by mail. Dime brings sample and special offer. Progressive Mailtrade, Box 357, Sheboygan, Wisconsin.

## FORMULAS, PLANS, ETC.

**PRODUCTS** Analyzed. Improved. Guaranteed formulas. Consulting Scientific Company, Swarthmore, Pennsylvania.

**MAKE**—Sell cleaners, soaps, polishes, flavors, cosmetics. No machinery. Formula literature free. Kemico, Park Ridge 16, Illinois.

**AUTO** Liquid wax, costs 14c pint. Money maker. Formula \$1. Plastics, Box 1574, Boston 4, Mass.

**WATERLESS** Hand cleaner. (No ammonia.) Easily made. Good profit. 2 dependable formulas \$1.00. Nelko Chemical Service, Box 3462, Chicago 54, Ill.

**10,000** FORMULAS And trade secrets. Free literature. Stillman, 555 Kingston Ave., Brooklyn 3, N. Y.

**TESTED** Formulas. Interesting descriptive booklet free. Pont, Box 635-PM, Terre Haute, Indiana.

**FORMULAS** For nearly everything. Catalog free. Write Creative, Winnetka, Ill.

**REAL** Manufacturing formulas. Lists free. Cummings, Chemist, Gordon Ave., Syracuse 4, N. Y.

## PLASTICS

**PLASTIC** Consulting services to small businesses. Inquiries welcomed and answered promptly. 65 East Rich Street, Columbus 15, Ohio.

**LEARN** To cast plastic letters for personalizing gifts. Particulars and samples including your three initials, two dimes. A. H. Dreher, 2232 Brockway, Cleveland 18, Ohio.

**NEW** Liquid plastic. Clear, colors. Cast without heat. Embed flowers, insects, coins. Saw, drill, carve. Send 25c for exciting new home project manual showing how to get started. Castolite, Dept. K-101, Woodstock, Illinois.

**NU FLEX** Heavy duty molding compound, new, plastic compound makes molds overnight. Economical. Plastercraft, 359 Third St., San Bernardino, California.

**PLASTIC**: Sheets, cut pieces, and scrap in clear and colors. Rod, tubing, acetate, dies, jewelry findings. Send \$1.00 for 4 pound scrap assortment and fabricating manual. Regal Plastic Supply, 720 Main, Kansas City, Missouri.

**AMAZING** Liquid plastic kit \$3.25. Embed photographs, keepsakes, coins, make solid objects, clear, colors. Beautiful results in half hour. Easily tooled. Inexpensive hobby. Send 15 cents for catalogue. Kristalon Plastics, Dept. Z-90, Box 29, Wilmette, Illinois.

**MOLD** Makers—Attention! Genuine natural latex for reproduction of figurines, statuary, plaques, etc. Instructions free. B. M. Barron, 77 Francis St., Everett, Mass.

**LUCITE**, Plexiglas, acetate. 85 different colors, thicknesses. Immediate shipment from stock. Rod, tube, casting plastic. Wholesale, retail. Catalog, instructions, bargain lists, 10c. Gem-O'-Lite, Box 686S, North Hollywood, Calif.

**LUCITE**, Plexiglas. Any size sheets, masked. Square foot (12 x 12) cost, 1/16" .96c; 1/8", \$1.25; 3/16", \$1.52; 1/4", \$1.80. Colors add 10%. Include 10% postage. Almac Plastics, 230 Fifth Ave., New York 1, N. Y.

**INTERNAL** Carved roses, orchids, swans, goldfish, butterflies, etc. Jewelry and gifts. Crystal Floral Novelty Co., Bound Brook, New Jersey.

**EARN** Money with plastics. New book, "Money-Making Hobbies," shows you how. 160 pages, \$1.98. Popular Mechanics Press, 200 E. Ontario, Chicago 11, Ill.

**PLASTIC**, Sheets, rods, tubes, etc. Free list. Plastic Supply Co., 2901 N. Grand Blvd., St. Louis 7, Mo.

## CHEMISTRY

**COMBINATION** Offer: Chemical balance, experiment book, catalog of laboratory supplies, \$1.00. Catalog only, 10c. Rex Laboratories, 2849-A Birchwood, Chicago 45, Illinois.

**ATOMIC** Calculator (Vinylite) — 96 elements. Atomic weights, valences, symbols, etc. Useful laboratory instrument, \$1.00. Slyd-Rul Company, Box 603, Brooklyn 1, N. Y.

**NEW** Idea chemical and apparatus outfits for home experimenting. Photo-scales, microscopes, chemicals, biological and laboratory supplies in small quantities. Catalog 15c. Established 1931. John H. Winn, 124A West 23rd Street, New York 11, N. Y.

**NEW** Catalogue of laboratory chemicals and apparatus 10c. Luther Laboratories, New Britain, Connecticut.

**ILLUSTRATED** Catalog: Chemistry, mineralogy, biology. 10c. Tracey Laboratories, Evanston, Illinois.

**CHEMICALS** And apparatus for industrial, analytical, and private laboratories. Catalog 15c. Dept. M-50, Biological Supply Co., 1176 Mt. Hope Ave., Rochester, 20, N. Y.

## AGENTS WANTED

**MAKE** Money easy. \$5.00 for selling only ten 21 Christmas card boxes. Also metallic and plastic cards, personalized cards and stationery, note paper and wrappings. Send for samples. Howard P. Ellis, Dept. PM-9, Pitman, N. J.

**BE** A money maker. Represent magazines year around. Wonderful home work. Big Christmas profits now. Liberal commissions. Everything furnished. Write for free catalog. McGregor Magazine Agency, Dept. 500A, Mount Morris, Ill.

**NEW** Antifog prevents windshield fogging. Distributors, jobbers wanted. Sample 25c. Pankey Co., 3731 Wascanna, Hapeville, Georgia.

**\$50.00** EASILY Made in spare time. Sell sensational new name-imprinted Christmas cards. 50 sell for only \$1.00. Not obtainable elsewhere. Big profit. Write for free samples. Kit on approval. Regal Greetings, Hazel Park 76, Michigan.

**FOUND!** Over 100 ways to make extra money and friends. Sell metallic Christmas cards, wrappings, children's books, gifts. Big profits. Bonus. Request feature samples on approval, free samples name imprinted Christmas cards, stationery, napkins, free catalog and free selling guide. New England Art Publishers, North Abington 257, Mass.

**CASH** In on plastics! Big profits with our 350 new plastic home needs. Perfect for party demonstrators, canvassers, stores. Lowest prices—highest quality. Write for free details. Durever, 2781-G Atlantic Ave., Brooklyn 7, N. Y.

**SELL** Watches. Free details. Saro Watch, AB-1674 Broadway, New York 19.

**PERFUME** At less than wholesale. Write "Imco," 6347 Parnell PMA, Chicago 21, Illinois.

**SHINE** Shoes without "polish." New invention. Lightning seller. Shoes gleam like mirror. Samples sent on trial. Kristee 154, Akron, Ohio.

**AT** Last! Something new and sensational in Christmas cards. Show gorgeous satins, velours and metallics never before offered. Gets easy orders fast! Pays up to 100% cash profit. Free samples of 30 Christmas cards with name, 50 for \$1.00 up. 80 assortments. Personalized book matches and stationery, gift items. 2 assortments on approval. Write Puro Co., 2801 Locust, Dept. 040-L, St. Louis, Mo.

**BRAND** New! Amazingly different and smart Christmas cards bring you big money! Take easy orders for sensational new Christmas cards. Pays up to 100% cash profit. Christmas cards with name 50 for \$1, up. Big line. Personal stationery and book matches. Get sample assortments on approval. Imprints free. Write today. North Star, 31 Glenwood, Dept. L-18, Minneapolis, Minn.

**FAST** Profits—No investment. Send for big, free catalog. Plastic aprons, tablecloths, etc. 150 sure-fire items. We guarantee sales. Write The Halliday Co., Dept. M-9, 15-19 Pennington, Passaic, N. J.

**AMAZING** Offer—\$40 is yours for selling only 50 boxes Christmas cards. And this can be done in a single day. Free samples. Other leading boxes on approval. Many surprise items. No experience needed. Free samples personalized Christmas cards, stationery, napkins. Write today. It costs nothing to try. Cheerful Card Co., 1617 White Plains, N. Y.

TO \$35.00 Weekly. Spare time, home operated profitable mail order business. Successful small "beginner's" plan. Lynn, 5710-M Bankfield, Culver City, California.

SELL "NuSilver Plating Liquid." Cloth applied. Renews silverware like new. Silverplates brass, copper, NuSilver, 508-PM9 N.Y. Street, Aurora, Illinois.

**BARGAINS!** Save up to 50%. Hosiery, lingerie, toys, school supplies, blades, novelties, carded goods, drygoods, cosmetics, stationery, jewelry, notions, perfume, soaps, etc. Send 10c for illustrated 1000 bargain catalog. Valuable surprise gift free with first order. Reliable Jobbers, 311-B North Desplaines, Chicago 6.

**NYLON Uniforms.** Immediate delivery. Immediate profits. Sell to doctors, dentists, nurses, waitresses, beauticians, housewives. Free sales kit. Superior Fabrics. Dept. P9, 3936 Market, Philadelphia 4, Penna.

**EARN \$3 Hour spare time—Sell Sunshine's beautiful, exclusive Christmas cards.** 21 nationally famous French folders, \$1.00; 24 evergreen cards, 24 lined envelopes \$1.00; 50 imprints \$1.25. Many more. Samples on approval. Write for Sunshine's complete sales kit, free imprint folders. Sunshine Art Studios, Dept. PM-9, 115 Fulton Street, New York 8, N.Y.

**LOOK Here! Wanted—Men to start in business on credit.** Sell some 200 farm-home products. Thousands our dealers now make quick sales, big profits. For particulars write Rawleigh's, Dept. I-192-PPM, Freeport, Ill.

**IMAGINE—Extra cash for you!** Sell friends amazing value metallic, felt applique, comic, 50 for \$1.00 Christmas cards. Exclusive gift wraps. All-occasion assortments, scented stationery, animated books, gifts. Profits to 100%. Special offers. Bonus. Write today for free samples name imprinted Christmas cards, napkins, stationery, feature assortments on approval and free catalog. Elmira Greeting Card Co., C-2309 Elmira, N. Y.

**ANYONE Can sell Hoover DuPont Nylon Uniforms for beauty shops, waitresses, doctors, nurses, others.** In white and colors. Exclusive styles. Top quality. Low priced. Exceptional income. Real future. Equipment free. Write fully. Hoover, Dept. H-100, New York 11, N. Y.

**ABSOLUTELY Free!** Big package actual sample fabrics and style presentation of dresses, lingerie, hosiery, etc. Take orders. Commissions big. Send no money. Melville Co., Dept. 5624, Cincinnati 3, Ohio.

**MEN Over 40.** Sell guaranteed family shoe line direct from Brockton factory. Immediate commissions. Bonuses. Free selling outfit teaches you how to build permanent income. Mench Shoes, ME-27, Brockton, Mass.

**\$50 YOURS.** Sell only 100 boxes beautiful Xmas cards; also 50 and 25 for \$1 imprinted; others: novelties, metallics; stationery, write now for approval samples, cost nothing to try. Pen-'n-Brush, PM-9, 139 Duane St., New York City 13.

**SCHOOL Seniors!** Your postal will bring our wonder, Kwick-Sell cardalog of popular graduation name cards. Biggest profits! Only firm giving free souvenir chest and card case. Don't miss out! Hurry that postal! Craftcards, Box 235 (L), Pittsburgh 30, Pennsylvania.

**MAKE Money for yourself or organization.** Sell big value Christmas, everyday assortments, wrappings, stationery, gifts, deluxe personals to friends, others. 100 items. Amazing profit. No experience necessary. Special offers. Extra cash bonus plan. Write today for samples on approval and exciting details. Hedenkamp, 361 Broadway, Dept. PM-9, New York.

**SELL Ultra-blue stock signs to stores.** 1000 slogans, comedy, general, religious. "7x11" cost 6c, sells 35c. Make money. 15 samples \$1.00 postpaid. Lowy, 812 Broadway, Dept. 561, New York City 3.

**CALL On friends with sensational Christmas cards in handy assortments.** Sell for \$1.00. Profit up to 50c. Also popular-priced personal Christmas cards, everyday assortments, stationery, gift items. Samples on approval. Wallace Brown, Dept. N-4, New York 10, N. Y.

**CASH In on tremendous demand for new low priced burglar alarm for cars, homes and farm building.** Nothing like it. Everybody wants one. 286% profit. Unique sample offer. Northwest Electric Co., Dept. I-10, Pukwana, S. Dak.

**NEW Bathroom deodorizer.** Hangs on wall. Banishes odors bathroom, kitchen. Lightning seller. Samples sent on trial. Kristee 155, Akron, Ohio.

**BIG Money selling tooth powder.** J. Walker, 633 Plymouth Ct., Dept. 1, Chicago 5, Ill.

**SELL Gold embossed Christmas cards, napkins, matches, coasters.** 50 for \$1 imprints. Samples free. Dunbar, New Brunswick 1, N. J.

**FREE Samples, and amazing plan giving you gorgeous dress without penny cost.** Rush name today with dress size. Harford, Dept. C-335, Cincinnati 25, Ohio.

**MEN! Say good bye to money worries.** It's easy to sell tested merchandise with money-back guarantee. No high pressure. No novelties. No gadgets. Take orders for things everyone wants and needs: Men's shirts guaranteed to wear a full year. Men's pants. Women's slips with laboratory-tested seams. Lingerie. Uniforms. Nylon hosiery. Men's and women's raincoats—All guaranteed! Make quick profits with America's fastest-growing agents' line. You keep commissions. We deliver and collect. Get immediate cash, extra gifts and big Christmas bonus. No experience necessary! Big free sample catalogue. Rush name on penny postcard to Crane Tested Fashions, 547-M Broadway, New York 12, N. Y.

**CASH Waiting for you!** Collect big advance commissions selling exclusive cork-cushioned shoes. Free outfit and selling guide. Concordian Shoes, G-4, West Concord, Mass.

**SILICONE Auto polish—Make, sell this new wonder.** Amazing profits. Easily made. No machinery. Guaranteed formula \$3.00. Kemico, Park Ridge 20, Ill.

**NYLONS Direct from mill.** Sample free. Guaranteed against runs. No experience or money needed. Also nylon slips, briefs. Earn big money spare or full time. Become manager, appoint agents. We pay you 40c for every \$1 your agents earn. Sell 14K neckchain "Curbflat" \$6, cost \$2.50. Ergim Co., 992 Columbus Ave., New York.

**\$2 FIRE Extinguishers, locally, mail-order.** Lorrac, Box 1086-X, Albany 1, N. Y.

**BUY Thousands of nationally advertised products direct from manufacturers and distributors.** Write for "Buy Direct and Save." Service Publishing, 1420-A Investment Bldg., Pittsburgh 22, Penna.

**WAR Boom demand. Power mowers.** '51 models. Gas-electric. Rotacut, R-2019, Excelsior Springs, Mo.

**MEXICAN Feather pictures.** Sell on sight; 200% profit! Free details. Sample 10c stamps. Sylvia-PF, Apartado 9036, Mexico City.

**SELL New automatic floor waxer.** Trigger on handle. Hands never touch floors or wax. Retail \$2.95. Profit 125%. Write Smith, Inc., Greenfield 34, Mass.

**NOVELTIES And household items!** Fast sellers for agents, dealers and gift shops. Write for 16-page Sunshine catalog. Sunshine Sales, Dept. WP4, Loudonville, Ohio.

**NEW Items! Fast sellers! Big profit!** Large selection includes: Men's wallets, ladies' wallets, carry-alls, costume jewelry, cigarette lighters, handbag atomizers. Perfect gift items for men, women, children. Write for free illustrated catalog. Ermo, Dept. M, 507 5th Ave., New York 17, N. Y.

**BUSINESS Cards \$1.60 thousand postpaid.** William F. Maloney, 91 Avondale, Rochester 7, N. Y.

**SCHOOL Seniors—Earn sensational profits selling classmates America's most beautiful graduation name cards.** Largest selection. Outsell all others. Free sample kit. Printcraft, Dept. M, 1425 E. Elm St., Scranton 5, Penna.

**EXCELLENT Sideline—No selling.** Inquire Modern Technical Supply, Dept. PMA, 55 West 42nd Street, New York 18.

**CHRISTMAS Cards:** Sell personalized cards, 50 for \$1.00 up. If you live west of Mississippi write for sales kit on approval. 100 assortments to make money. Imperial, 406 So. Main, Dept. P-11, Los Angeles 13, Calif.

**EARN Big money taking orders for attractive boxes of Xmas cards, 50 for \$1.00 up.** Also metallics, plastics, wraps, children's cards and books, name-on-stationery, napkins, etc. Samples on approval. Call, write or phone. Rainbow Greeting Cards, 38-T E. 1st St., New York 3.

**BRITISH Imports—Sell world's most beautiful stationery (free samples), fine perfumes, etc.** Kenneth Boyea, Indian Orchard, Mass.

**FREE Catalog, fast selling novelties, lowest prices.** Hansen Sales, Dept. P-1, 2851 Madison, Chicago 12.

**NEW Plastic rayon towels selling rapidly everywhere with spectacular demonstration.** Large profits. Sample package \$1.00. Sunbeam Products, 634 4th St., South, St. Petersburg, Florida.

**FREE Sample nylon stocking of world's only nationally advertised hosiery line actually guaranteed against runs, snags or excessive wear, regardless of cause!** It's amazing but true. Every weight from sheerest 15 denier to heavy 70 denier—all gauges to luxury 60 gauge. Amazingly low prices, starting at \$1.08 prepaid for sheerest 15 denier 51 gauge. Not sold in stores. Good Housekeeping guarantee seal. Also complete line men's hosiery guaranteed one full year or replaced free. Full variety lingerie in crepe, satin and nylon, featuring all nylon slip at \$2.95, satin slip at \$1.58, etc. Housecoats and robes. Kendex sales people will earn one million dollars this year. Get your share. No money or experience needed. Pay nothing now or later. Just show free outfits. Write orders. We deliver and collect. Advance cash plus huge bonus. Earn money spare or full time. Become manager; appoint others to sell for you; earn steady income on their sales. Man or woman—young or old, you can earn more money than you ever thought possible. Everything you need is furnished free and prepaid, including nylon stocking, samples of materials, sales books, 36-page salesmanual, color cards, etc. Simply write your name and address on postcard and mail to Kendex Corporation, Babylon 63, N. Y.

**FAST Profits—No investment.** Send for big, free catalog. Plastic aprons, tablecloths, etc. 150 sure-fire items. We guarantee sales. Write the Haldiday Company, Dept. M-7, 15-19 Pennington, Passaic, N. J.

**AS Seen in Popular Mechanics August issue—Amazing! New!** Clip-on screw driver; holds the screw; demand is terrific! Low prices insure fast sales. Big profits. Write B. J. Johnson Co., 848 Wood Ave., Bridgeport 4, Conn.

**SELL Dress fabrics to friends, neighbors.** Stylish, beautiful materials. Year round profits. No experience needed. Free details. National, 640 Broadway, Dept. M, New York 12.

**MEXICAN Feather pictures.** Unusual novelty \$1.00 (stamps) brings \$2.00 worth samples, details. Refunded if unsatisfied. Aztec Art-P, Apartado 762, Mexico City.

**AMAZING 1950 Personalized 50 for \$1.** Christmas cards, Everyday cards, stationery, napkins, dolls. Other wonderful values. Samples on approval. Plateless, 392 Broadway, N. Y.

**BIG Bargains for big profits.** Over 100 sensational values. Men's used suits \$2, pants 35c, topcoats \$1.25, overcoats \$2, shoes 20c. Experience unnecessary. Free wholesale catalog. Superior, 1250-A Jefferson, Chicago.

**SAVE—Make money.** Buy merchandise wholesale. Free details. Orysen's, 1147 Sun-kist, Waukesha, Wisconsin.

**MAGIC Cleaner—Laundry soap deal.** Hotter than a firecracker. Big profits. Sample free. Bestco, 4642 No. Central, Chicago.

**QUICK Money—Sensational Christmas cards, plastics, metallics, stationery, napkins.** 50 cards with name \$1. Approval sample. Torres, 373 A-Fulton St., Brooklyn 1, N. Y.

**\$85 WEEKLY Selling 4 pair shoes daily direct.** Free outfit. Samples. No investment. Experience unnecessary. Advance commissions, bonus. Paragon Shoes, 739 Columbus, Boston, Mass.

**REPEAT Sellers.** Big demand. Profitable. Parker Drug Co., Hoboken 8, N. J.

**FREE Samples.** Big profits showing amazing Glow-in-the-Dark specialties. House numbers, pictures, plastic novelties, ashtrays, keyholders, religious and nursery objects, etc. Madison Plastics, 303 Fourth Ave., New York 10, N. Y.

**CHRISTMAS Card agents.** Sell America's only \$1.00 Gift wrap assortment containing 30 full size sheets; giant plastic pencil containing personalized pencils; Santa stocking with name; Rudolph, the red nosed reindeer assortment. Over 100 Christmas card box assortments and surprise items. Write today for five free portfolios of personalized Christmas cards. Elmcraft, Dept. 13, 5930 S. Western, Chicago 36.

**1950 XMAS Card catalog ready!** Earn more money as a wholesale jobber! Large selection of dollar box assortments, imprints, religious, personalized Christmas cards! Three dollar sample boxes \$1, postpaid! Write for free holiday bulletin. Elfko, 438 North Wells, Chicago 10.

**DRESSES, 18c; Coats \$1.00, blouses 35c.** Free catalog. Crown, 164-P Monroe Street, New York.

**FREE** Outfit, write today! Sell em-broidered advertising uniforms and work clothes, initial buckles, belts, badges, 2000 emblems. Hook-Fast Co., Box 480PM, Roanoke, Virginia.

**DRAW** Side income under notary public appointment. Stationers, Helotes 50, Tex.

**WRITE** for free booklet and catalog telling how to earn substantial profits in your spare time by forwarding new and renewal subscriptions to all magazines for your friends and neighbors. Oldest U. S. agency. Established 1869. Moore-Cottrell, North Cohocton, New York.

**SELL** Balloons! Combs! Novelties! Excellent sideline. Carleton House, Texas City, Texas.

**NEWEST** Money making sensation. Sell personal initialed belts, buckles, cap and breast badges, tie holders, etc. Choice 2000 emblems. Write special outfit offer today. Hook-Fast, Box 1425PM, Providence, R. I.

**JEWELRY** Factory desires salesmen, distributors, jobbers. Pickcraft, 19 Bank Street, Attleboro, Mass.

**SELL** Big money-maker to men and women. Easy handwork makes fast-selling useful articles. Sunmade Company, Brockton 64, Mass.

**GOLD** Lacquered window sign letters. Large sizes penny each. New fols. Absolutely beautiful. Free samples. Atlas, 544 W. 79th, Chicago 20.

**AGENTS:** Stamping names on key protectors. Sample 25c. Stamping outfits, checks, social security and name plates. Hart Mfg. Co., 303 Degraw St., Brooklyn, N. Y.

**EXCELLENT** Sideline for printing and advertising salesmen. Decalcomania name plates in small quantities. Great demand. Also, make money with our line of automobile initials and sign letters. Free samples. "Ralco" XL-Roxbury, Boston 19, Mass.

**PHOTO-Salesmen-agents.** Sell beautiful hand-colored plastic enlargements. Collect deposit, we deliver. Profitable sideline. Send card, for free sample kit. Novel Portrait Co., 3343 North Ave., Chicago, Ill.

**AGENTS—300% Profit** selling genuine gold window letters; stores and offices. Free samples. Metallic Letter Co., 438-B North Clark, Chicago.

### HIGH-GRADE SALESMEN

**MEN, Women—Wonderful career opportunity** with leading advertising line. New calendars, specialties, signs. Continuous selling season. Daily commissions. Re-orders credited. Deluxe sample outfit. Selling experience essential. Established 1892. Highly rated. The Harrison Company, Union City, Indiana.

**REPRESENT** America's finest and largest line of personalized gift and advertising specialty good will builders—Includes the best in calendars, pencils and specialties of all types. LeRoy representatives are big money makers. We want a man in this area who likes and knows selling and wants to represent a company known for its fair treatment of field men. Write giving age, experience, etc. LeRoy, Inc., 2109-P Summit Ave., Union City, N. J.

**CAN** You use \$20 extra next week? Many make much more right around home, part-time. Get free outfit, tested comfort shoe selling methods. Write today, give shoe size. Mr. N. Lee, Desk CS-55, Consolidated Shoe System, Chippewa Falls, Wisconsin.

**SALESMEN—Sell** America's finest, biggest line of advertising specialties. Sensational sellers to all types of business. Big commissions advanced. Sensational sales plan nets you top earnings. Free outfit. Charms & Cain, 407-MP South Dearborn, Chicago 5.

**EASY** Dollar plan—Quick success. Sell exclusive advertising address books, card cases, combs, emery boards, handy purse kits, pencils, rulers, salad sets and thumbtacks. Highest commissions. Instant cash. Free sample kit. Lederer Ad Gifts, 125C W. 33 St., New York.

**SALESMEN.** Earn \$50.00 weekly, selling only three pairs shoes daily. Commission and bonus. Wide variety for men, women, children. No investment. Experience unnecessary. Free catalog. Tanners Shoes, 665, Boston, Mass.

**MAKE** \$3,000 Next 90 days—Nationally advertised item. Price protected. Merchants need, increases business 60%. Commissions advanced. Outfit free. Schubert, 330-A South Wells, Chicago.

**I'LL** Send you a fine suit and start you in a big money business in your home or office. Get your made-to-measure suit without cost taking orders at direct-from-factory prices. Big commissions. Splendid outfit with samples. Tested plans. Top men make up to \$9,000 in a year. Write Manager, Dept. 27, Box 23, Cincinnati 6, Ohio.

**DISTRIBUTORS** Wanted! Sell Lazy Man's Polish, the world's best for autos, furniture, windows. Everybody a prospect. Send \$1.00 for two full size containers with complete money making sales plan. C. F. Lusk Co., 5921 Bonna Ave., Cleveland 3, Ohio.

**ADVERTISING** Book matches—Cash in on big demand; sell union label matches. Cuts for all businesses and political parties. Free powerhouse selling kit, low prices, protection guaranteed on repeat orders. Cash commissions. Superior Match Co., Dept. M-950, 7530 Greenwood, Chicago.

**SOUVENIR** Giveaway—Salt shakers. Terrific for drive-ins, taverns. Imprinted 2c. Full size. Ellswood's, Pueblo, Colorado.

**HOTTEST** Money-maker out! New idea ironing pad pays you up to 100% profit. Saves housewives time, labor, money. Sells on minute demonstration. Fully guaranteed. Other sensational selling new household aids. Free sample offer. Sheldon, 1223 South 23rd, Dept. 507, Milwaukee, Wis.

**\$6.00 CASH** Every hour showing our sensational 3 in 1 deluxe folding shopping bag and purse. Women buy several. Commissions advanced daily. Sample furnished. LeNard, 179-D Washington, Chicago 2.

**CALENDARS** And advertising novelties. Full time or side line. Every business wants them. Few calendar salesmen are on the road now which means more sales for you. Fleming Calendar Co., 6539 Cottage Grove, Chicago 37, Ill.

**POSITIVELY** New—Over 100% profit. Two sided reversible neckties. Free details. Farrell Company, Dept. P-15, 1377 Van Zandt, Cincinnati 31, Ohio.

**ADVERTISING** Book matches \$6.95 per case. New sales plan sells every store! Regular commissions. Advertising specialties too! Morris Distributors, 404 North, Morris, Illinois.

**SALESMEN—Sideline.** Earn \$3,000 next 5 months selling calendars, advertising specialties. Buyers everywhere. Big commissions advanced. Samples free. Continental Calendar, 542-A South Dearborn, Chicago.

**NEW** Jobs open in selling! Send name, address for five free issues of Opportunity Magazine's money-making guide, listing hundreds of companies who'll pay you well, full or part-time. No experience needed. Opportunity, 28 E. Jackson, Dept. 17, Chicago 4, Ill.

**EXCEPTIONAL** Earnings selling famous Bostonian shirts. Spare time, full time, sideline. Sales kit, actual fabrics, free. Bostonian, 89 Bickford, Dept. A-10, Boston 30, Mass.

**BIG** Money taking orders. Shirts, ties, socks, pants, jackets, sweaters, shoes, uniforms, etc. Sales equipment free. Experience unnecessary. Nimrod, 4922-AN Lincoln, Chicago.

### EDUCATIONAL AND INSTRUCTION

**IT'S** Later than you think! G.I. training will soon be over. Inquire about training for job opportunities to make your future secure. Don't risk losing your veteran's entitlement. Factual information free. Write Box B4393, W.P.H.I., Chamber of Commerce Building, Pittsburgh 19, Penna.

**BECOME** A Doctor of Psychology or Metaphysics. Teach secret of contentment, happiness. Win degree of Ps.D. or Ms.D. Solve mental worries. Free book. College of Universal Truth, 5153-C North Clark, Chicago.

**GRADUATE** Watchmakers! Reach an untapped source of profitable new business in chronograph watch repair. Easy step-by-step Esembl-O-Graf method taught in GI-approved 22 week resident course or by low-cost home study plan. Be the first in your community to display the handsome Certified Chronograph Technician's diploma. Complete information on request. Western Pennsylvania Horological Institute, Desk B-93, 706 Smithfield Street, Pittsburgh, Penna.

**BE** A real estate broker through home study or classroom instruction. Write for free book. Approved for veterans. Weaver School of Real Estate, 15 E. Pershing Rd., Box CP-9, Kansas City 8, Missouri.

**GOOD** Jobs and a sound substantial future await in hotel and institutional field. Men and women, all ages, needed for well-paid positions that offer color, excitement, ever-new and fascinating duties. Record-breaking travel means even greater opportunities for trained men and women in hotels, clubs and institutions. Lewis School receiving calls for managers, assistant managers, stewards, hostesses, purchasing agents and 55 other types of important positions! From coast to coast there are important positions that offer splendid opportunities for advancement in a business where you are not dropped because you are over 40. Previous experience proved unnecessary! No need to leave your job to qualify. A good grade school education, plus Lewis Training qualifies you at home, in spare time. Our National Placement Bureau helps to place you—and our amazing Certified Job Plan—actually certifies you will "make good" when placed. Write today for free book! Veterans: Course approved for veteran's training. Lewis Hotel Training School, Room SO-368, Washington 7, D.C. (First and only School of its kind—now in its 34th year.)

**INVESTIGATORS** Trained, men-women, learn fascinating profession. Spare time study. Big pay. Folders free. Investigator, Box 490, Times Square Station, New York 18, N. Y.

**AIRBRUSH** Photo retouching at home. Send 25c for catalog. N. Y. School of Airbrush Art, 117 C East 60 St., New York, N. Y.

**"HOW** To Break and Train Horses"—A book every farmer and horseman should have. It is free; no obligation. Simply address Beery School of Horsemanship, Dept. 1108-C, Pleasant Hill, Ohio.

**LEATHER** Carving. Fascinating, highly-paid art; age-old secrets now taught for first time in home study course. For hobby, profession or profitable business, write: Baird School of Leather Carving, Box 1367-M, Dept. 19, Manitou Springs, Colo.

**MAKE** Up to \$35-\$45 week as a trained practical nurse! Learn quickly at home. Booklet free. Chicago School of Nursing, Dept. M-9, Chicago.

**SEE** Our collection-credit business ad under Business Opportunities. Cole & Associates, Syracuse, N. Y.

**AMAZE** Your friends: Produce oil paintings at home. \$5 brings complete ten lesson course. Prickett's Petrel Studios, Box 49, San Diego 12, California.

**READ** With speed! New amazing method! Save hundreds of hours yearly. Free home test. No obligation. Rush postcard. Brownson, 9111 S. Hoyne, Chicago 20.

**USED** Correspondence courses and educational books bought, sold, rented, catalog free. Educational Exchange, Summer-ville, Ga.

**DENTAL** Technician's supplies. Artificial teeth, plastic, etc. Technician's manual. Grant Laboratory, 219 W. 7th, Los Angeles 14, Calif.

**U. S. Civil service jobs!** Start high as \$3,450.00 year. Secure positions. Men—women. Qualify now for many expected openings. Experience usually unnecessary. Free 40-page book shows jobs, salaries, sample tests. Write: Franklin Institute, Dept. J-24, Rochester, N. Y.

**IT'S** Fun learning a language by Linguaphone. At home, in leisure time, quickly, easily, correctly master Spanish, French, Italian—any one of 29 languages through proved Linguaphone conversational method. Send for free book. Linguaphone Institute, 83-P Radio City, New York City.

**U. S. Gov't. jobs.** Men, women qualify now. Study course, service helps you. Complete \$10. Wellwood Agency, Box 363, Oak Park, Ill.

**BE** A master salesman. Powerful secret key in new book, "How to Sell Faster." Send \$2.00 to Helpful Press, 2212 Cuming, Omaha, Nebr.

**GET** Photographic mind with Super-memory. Write Thor Books, M-9, Box 1210, Chicago.

**IMPORTED** Quality slide rules, log-log., decl.-trig. Barttro, 6605 Telegraph, Oakland, Calif.

**NATIONAL** Detective Academy. See our advertisement on page 26.

**WORRY,** Tension and fears knocked out or no cost. Free brochure and details. Write President Ballard, 1008 Washington Blvd., Louisville 2, Ky.

**FAMOUS** Singers; Secrets! Information! Free! Studio, 14356B Jersey, Norwalk, California.



**GUNSMITHING**—Learn for profit, please! Practical residence course, day or eve, G.I. approved. Limited enrollment. Facts free! Pennsylvania Gunsmith School, 423 Federal, Pittsburgh.

**LEARN** Building design, or design your own home or cabin. Write Tech-Talk Design, 19375 Charleston, Detroit 3, Mich.

**STUDY** To be a doctor of psychology or metaphysics. Obtain Ps.D., Ms.D., D.D. or Ph.D. degree. Chartered by state. Write for free book telling how. The Neotarian Fellowship, Dwight Building, Kansas City 6, Missouri.

**USED** Correspondence courses and books sold and rented. Money back guarantee. Catalog free. (Courses bought.) Lee Mountain, Pisgah, Alabama.

**HOME** Study course, drugless therapy. Free literature. Institute of Drugless Therapy, Tama, Iowa.

**INVESTIGATOR** Training. Phillips Secret Service System, 1917-B North Keneth, Chicago 39.

**BOOKKEEPERS!** Increase your earnings! Operate your own simplified "dollar-a-week" bookkeeping and tax service. Full or spare time. Details free. No obligation. Ellis, Box 200, Cedar Grove, N. C.

**PIANO** Tuning pays. Learn this profitable profession at home. Our Tonometer and mechanical aids make learning easy. No knowledge music necessary. Diploma granted. Largest and oldest school—52nd year. G.I. approved. Write for booklet. Niles Bryant School, 78 Bryant Bldg., Washington 16, D. C.

**SECRET** Investigation. Experience unnecessary. Investigators particulars free. George Wagner, M 125 West 86th, New York.

**MEDICAL** Laboratory Technicians in great demand. We train you in your own home. Catalogue free. Imperial Technical Institute, Box 973-J, Austin, Texas.

### PLAYS, STORIES, MANUSCRIPTS

**ORIGINAL** Musical comedy production. Three acts, twelve songs. Hilarious, unique. Suitable church or other organizations. Dorby Publishers, P.O. Box 738, Morristown, New Jersey.

**I WANT** New writers to cash checks of \$1 to \$100 offered daily. The easiest way to write for pay. No previous experience necessary. Free details. Saunders M. Cummings, 468-11 Independence Bldg., Colorado Springs, Colo.

### INFORMATION

**WHERE** To buy most anything. We furnish supply sources. Single item, 50c. 3 for \$1.00. Service Bureau, Box 5053, Chicago 80, Ill.

### BUSINESS SERVICE

**INCORPORATE** Your business. Delaware laws. Free details. Tax Research Bureau, Inc., Box 710, Wilmington, Del.

**COMMERCIAL** Representation New York vicinity. Personal commissions undertaken. Purchasing assignments handled. Manufacturers outlets available. Agency facilities maintained. Herman Brown Enterprises, 116 Mill St., Brooklyn 31, N. Y.

**WHERE** To buy it information, almost anything. Write, listing items. Kelly, 9544-D Whitecomb, Detroit 27, Michigan.

### SPECIAL SERVICES

**FIVE** Letters remailed from Daytona Beach for one dollar and source of supply furnished for Eremochloa Ophiuroides the new lawn grass for southern lawns that never needs mowing. T. Rule, PM 2240 South Peninsula Drive, Daytona Beach, Florida.

**PHILADELPHIA**, Pa. postmark! Letters and cards remailed from famous historic city. Intrigue your friends. Send 25c cash. (Also I sell beautiful original color postal cards of historic Philadelphia scenes, 10c each, 3 for 25c.) Evelyn Bedard, 7416 Castor Ave., Philadelphia 15, Penna.

**FLORIDA**—Reliable information any locality. Present facts on facilities, living costs, business, income possibilities. Write Charnell Information Service, 1843 First Ave., So. St. Petersburg, Florida.

**INVESTIGATION** And cash liquidation—Old or recent stock certificates, bonds, bank books, promissory notes, deeds, wills, insurance policies, financial documents of every description. Send us your list for appraisal. National Evaluators, P.O. Box 5852, Cleveland 1, Ohio.

**MECH.** Designing, drafting; from your sketch, machine, instruction. Professional work. Designers of America, Box 661, Lynbrook, New York.

**PRODUCT** And package design at unbelievable low cost! A complete art service, products, packages, labels, letterheads, layouts, etc., created. Make your product and merchandising material salable with finest and lowest cost design service in country. Write for free details. Products & Package Designers, 627 Grove, Evanston, Ill.

**MECHANICS**, Inventors, toolmakers. Prepare for coming production push. Get expert assistance with your metal problems. Heat treating information any type steel \$1.00. G. Firk, Metallurgist, 138 Thomas St., Utica 3, N. Y.

**PHOTOGRAPHIC** Missions accomplished. New York City. Confidential. Negative, print \$5.00. Anthony Todaro, Box #1096 G.P.O., New York 1, N. Y.

### CARTOONING, COMMERCIAL ART, SHOWCARD WRITING, SIGN PAINTING

**ART**—Learn to draw in spare time. Commercial art, designing, cartooning all in one course. Write for free book "Art for Pleasure & Profit." Studio C129, Washington School of Art, 1115-15th St., Washington 5, D. C.

**AIRBRUSH** Photo retouching simplified. 104 pages. \$1.75 postpaid. Harold Green, 117-C East 60 St., New York, N. Y.

**FAMOUS** \$75 Lockwood art course now only \$6 postpaid. Other smashing art bargains. Catalog 10c. Art Book Shop, Arnold 8-I, Missouri.

**CARTOON** Your way to success! Internationally known instructor, Raye Burns, will personally teach you to create salable, original cartoons at home. Course of 26 lessons only \$2.85. Send remittance with order or write for free details and addresses of successful students. Raye Burns School, Box 3583-M, Cleveland 18, Ohio.

**ADVERTISING** Artist teaches by mail. Particulars free. Joseph Bolger, 148 Concord, River Edge, N. J.

**TALENT** Test—Information. Give age. Art, Box 8066, Dallas 5, Texas.

**CARTOONISTS** Make big money! Draw cartoons for money. Complete beginners course in cartooning at exceptionally low price. Write today for free details. R. M. Seward, 1340A Susquehanna Ave., Sunbury, Penna.

**ARTISTS**, Sell your drawings. Informative booklet 50c. Box 2055, Colonial Heights, Virginia.

**CARTOON** Course—Monthly, 50c. Free details. 1437 North Highland, Los Angeles 28.

**COMPLETE** Course in cartooning. Simplified, easily followed instructions. Costs less than 8 cents a lesson. No money risk offer. Circulars, details free. Write Progressive Enterprises, 237 Bridge Street, Struthers, Ohio.

**9 ALPHABET** 3 Numeral pattern sets and catalog. \$1.00. Sign Letter Distributors, P.O. Box 101, Mineola, N. Y.

**SIGN** Painting taught at home. Test lesson free. Ben Kerns, Box 812-T, Greenville, S. C.

**CHALK** Talks. Laugh producing program. \$1.00. Catalog 10c. Balda The Cartoonist, Oshkosh, Wisconsin.

### ADVERTISING AGENCIES, LETTER WRITERS, FOR ADVERTISERS

**WEEKLY** Mailing lists: Mailorder buyers, opportunity seekers, etc., 1000, \$4.00; trial 250, \$1.00. Wright Publications, Memphis 8, Tenn.

**MAILORDER** Advertisement, 2,000,000 nationwide circulation, \$32.90 inch. 24-word classified, 20 Sunday newspapers, \$25.00. Instructive Ad-Guide—ratebook magazines, newspapers, mailing-lists—10c. Ideas developed. Ads prepared free. Chicago Advertising Agency, (Established 1900), Chicago 4.

**CIRCULARS**—Mailed first class mail 25c per 100. Israel Company, 6051-Y, Washington 5, D. C.

**24 WORDS** In 50 weeklies, \$4.96. J. Darnell, 730 Hays, Jackson, Tenn.

**FREE!** 1950 Advertisers Rate and Data Directory. 52 pages! E. H. Brown Advertising Agency, 20 N. Wacker, Chicago 6.

**TRADEMARKS** Designed complete with cut, \$10.00. Rough sketch, \$1.00. Catalog free. Burke, 3208 McKinney, Dallas.

**CLASSIFIED** Mailing lists. Details on request. Service Sales, Box 188, Detroit Lakes, Minn.

**ADVERTISE:** 24 Words, 40 newspapers \$3.50. Lists free. Advertising Bureau, 10511-C Springfield, Chicago 43.

**MAILING** Lists; \$5.00-1000 up. Write Dixie Service, King, N. C.

**ADVERTISERS!** Reach nearly 18,000,000 readers. 25 Sunday national key newspapers, 18 words, \$51.50. "Terrific pullers." 20 popular newspapers, \$19.00. "Free booklet." Special—One inch display 2,-821,198 circulation. \$48.30. Newmark's Advertising Agency, (Established 1893), 217-7th Ave., New York 11.

**ADS** Placed in out of town newspapers and magazines. Low rates. Catalogue free. Ideas that pay. Baker Advertising Agency, Successors Ankrum Agency, 189 W. Madison, Chicago 2.

### TYPEWRITERS, DUPLICATORS, OFFICE DEVICES

**TYPEWRITERS** \$17.50, Adders \$12.50, duplicators \$9.95; addressers \$9.95. Typewriters, 118N Spruce, Wichita, Kansas.

**REVOLUTIONARY** Portable addresser. No plates. New! Sensational! Only \$9.95 complete! Fully guaranteed. Pru-A-Ex, Kingsport, Tennessee.

**PRINTOMATIC** Selffeeding post card printing duplicator \$13.50. Envelope addressing machines \$24.50. Pittsburgh Typewriter Company, 336-R Fourth Avenue, Pittsburgh 22, Penna.

**RECONDITIONED** Typewriters, printing devices. Write Dixie Service, King, N. C.

### RUBBER STAMPS AND OFFICE SUPPLIES

**RUBBER** Stamps, 3 or 4 line, \$1.00 postpaid. Dealer proposition. Smallwood Printery, 2715 Vine, Cincinnati 19, Ohio.

**3 LINES** 45c; Pads 35c; signature \$2. Stamp-Right, Wauwatosa, Wis.

**DELUXE** Cushioned, indexed, knob handle; 3 lines 50c, 4-60c. Inked-pads 40c. Free literature, 500 two color gummed stickers 3/4 x 2" \$1.00. Quick service. Warner Stationery, Havre de Grace, Maryland.

**READY** Made stamps, free list. Critterion, Box 2326, Denver 27, Colo.

**LINE** 20c; 2-35c; 3-50c. Stamp Works, Auburn, Nebraska.

### PRINTING, MULTIGRAPHING, MIMEOGRAPHING, GUMMED LABELS

**MIMEOGRAPHING**, Multigraphing. Like personal typing. Down low prices. Free samples. Packer, Box 1674, New Haven 7, Conn.

**BUSINESS** Printing. Samples, prices free. Howprint, 721-23 Eunice; Webster Groves 19, Missouri.

**100 8 1/2 x 11 HAMMERMILL** Letterheads and 100 envelopes \$1.85. Herbert Hudson, Centredale, R. I.

**100 EACH** Noteheads, envelopes, printed name, address, \$1.15. Gooch, 202PM, Hernando, Miss.

**MIMEOGRAPHING** By experts. Post cards, catalogs, circulars, etc. Free samples. R. Lasko, 6235R Chestnut, Philadelphia 39, Penna.

**YOUR** Printing our specialty. LaNan Press, 502 West Main Street, Richmond, Virginia.

**MIMEOGRAPHING**—Reasonable. Any copy. Mellers Service, Box 606-A, Chicago 90, Ill.

**100 ENVELOPES**. Printed 2-colors \$1.25. Samples. Box 523, Rochester 2, N. Y.

**PHOTO-Offset** special, 5000-8 1/2 x 11 \$14. Samples free. Reiffe, 160-P Monroe St., New York 2.

**FINE** Printing. Offset, letterpress. We specialize in booklets, folders, publications, office forms. Send copy for estimate. Quality Printing Company, Richmond 20, Virginia.

**125 LETTERHEADS** (8 1/2 x 11 Hammermill) \$1.00 postpaid. Envelopes same. Race Printers, Hudson, New York.

**DISTINGUISHED** Embossed business cards, 1000 \$3.00 postpaid. Elmer Griffith, Seiotoville, Ohio.

**\$5.95 THOUSAND** Delivered. Letterheads, envelopes, statements. Honest service. Send your copy and remittance to Bixler, 754 Benson, Frankfort, Kentucky.

**OFFSET** Printing, 8 1/2 x 11—\$6.95 per 1000 delivered. Letterheads, letters, circulars, price lists, etc. Kale Bros., 2250 Milwaukee, Chicago 47.

1000 6 3/4 WHITE Weave envelopes \$5.00; #10 \$6.50. Postage extra. Ideal Printing Company, Hudson 7, New York.

1000 QUALITY High gloss business cards printed, \$5.00. Postpaid. Arrow Printers, 2212 Cuming, Omaha, Nebr.

PRINTING! 1000 3x6 Colored circulars \$3.50; 3000 \$10. 1000 4-page folders \$12.50. Postpaid. Estimates free. Hanna, 1518 Miles, Logansport, Indiana.

100 8 1/2x11 LETTERHEADS And envelopes. (Black or blue print.) \$2.00. Birchfield Press, R. 5, Hendersonville, N. C.

1000 BUSINESS Cards \$2.95. Jose Ortiz, 1050 Fox Street, New York.

SPECTACULAR Letterheads styled by nationally-famed typographer. McKeown, 107 S. Capitol, Indianapolis 25.

OFFSET—Planograph bargains. 1000—8 1/2x11—\$6.56. Submit your specifications, samples. Dauphin, Rockland, R.F.D., Mass.

MIMEOGRAPHING—Letters, forms, artwork, anything. Salem Print, 3131 Salem, Dayton 6, Ohio.

1000 EMBOSSED Business cards \$3.00. Tucolor \$4.25. Agents discount. Averi, 112-Z Elizabeth, Wichita 12, Kansas.

QUALITY Printing! Free price list. Nationwide Printing Company, 2337 Bath Avenue, Brooklyn 14, N. Y.

BUSINESS—Personal printing. Your requirements? Dauph, Box 219, Cambridge 39, Mass.

MULTIPAGE Vartyping, printing, multigrating; cost-pairing arrangements. U-Tel-M. 252 8th S.E., Washington, D. C.

1000 3x6 Circulars printed, \$1.95. Farley Printery, Box 15, Everts, Ky.

1000 BUSINESS Cards \$2.50 prepaid. Samples free. Reliable Print Shop, 905 East Jefferson, Louisville 6, Ky.

QUALITY Printing. We specialize in publications, newspapers, tabloids. Send copy for estimate. Bagby Printing Co., Georgetown, Ohio.

SEND 10c Now, for our 48 page 1950 price list—refunded first order. McCall Press, 1326 South 27th, Omaha, Nebraska.

500 3/4x2 1/4 FOUR Line gummed stickers 35c; red border 50c. Moritz Printery, Saginaw, Mich.

MIMEOGRAPHING—Letters, pricelists, formulas, instructions. Lowest prices. Lem's Letter Shop, 5710 Stanton, Detroit 8.

## PRINTING OUTFITS AND SUPPLIES

MAKE Your own rubber printing cuts. Self-molding process. Plexirubber, Argyle 1, Wisconsin.

PRINT Your own cards, stationery, circulars, advertising. Save money. Simple rules. Print for others, nice profit. Raised printing like engraving too. Have home shop. Details free. Kelsey Presses, L-11, Meriden, Conn.

PRESSES, Supplies, paper. Catalog 10c. Printers Supply, 211, Springfield, Missouri.

PRESSES, Type, cabinets, supplies. List for stamp. Lincoln Press Company, 220-M Hartwell, Fall River, Mass.

PRINTING Presses, type, supplies. Lists 3c. Turnbaugh Service, Loysville, Penna.

## PATENT ATTORNEYS

HERMAN Lewis Gordon, registered patent attorney. Patent investigations and opinions. Warner Building, Washington, D. C.

INVENTORS—If you believe that you have an invention, you should find out how to protect it. The firm of McMorrow, Berman & Davidson is qualified to take the necessary steps for you. Send for copy of our patent booklet "How to Protect Your Invention" and "Invention Record" form. No obligation. McMorrow, Berman & Davidson, Registered Patent Attorneys, 134-A Victor Building, Washington 1, D. C.

INVENTORS—If you consider your invention to be something of importance, take steps to protect it with a United States Patent which gives you the right to exclude others from making, using and selling your invention as claimed. "Patent Protection for Inventors" outlines steps to take to secure patent protection. Mailed promptly without obligation. Victor J. Evans & Co., Merlin M. Evans, Registered Patent Attorney, 531-J Merlin Building, Washington 6, D. C.

CANADA—Ramsay Company Registered, 273 Bank Street, Ottawa, Canada.

REGISTERED Patent attorney offers services. Sanders 6430 Evans, Chicago 37, Ill.

INVENTORS: Learn how to protect your invention. Unless the inventor is familiar with patent matters, he should engage a competent registered patent attorney or agent to represent him. We are registered to practise before the U.S. Patent Office and prepared to serve you in handling your patent matters. "Patent Guide for the Inventor" containing detailed information concerning patent protection and procedure with "Record of Invention" form will be forwarded to you upon request—without obligation. Clarence A. O'Brien & Harvey Jacobson, Registered Patent Attorneys, 01B-G District National Building, Washington, D. C.

PETER Fries, Jr., Registered Patent Attorney. Patents, novelty searches, designs, copyrights. 110 East 42nd Street, New York City.

PATENTS—Irving L. McCathran, 315 McLachlen Bldg., Washington 1, D. C. Registered Patent Attorney.

PATENTS. "Proof of Invention" folder mailed without obligation. E. E. Vrooman, Registered Patent Attorney, 507 McKim Building, Washington 5, D. C.

INVENTORS: When you are satisfied that you have invented something of value write me, without obligation, for information as to what steps you should take to secure a patent. Write Patrick D. Beavers (Formerly Randolph & Beavers) Registered Patent Atty., 935 Columbian Bldg., Washington 1, D. C.

C. A. SNOW & Co.—M-427, Snow Building, Washington 1, D. C. Registered Patent Attorneys. Write for information.

"INVENTOR'S Guide" free on request. Frank Ledermann, Registered Patent Attorney, 154 Nassau St., New York 7, N. Y.

INVENTORS: Write for free brochure "Evidence of Invention." Labiner, World Building, New York 7.

INVENTORS: Without obligation, write for information explaining the steps you should take to secure a patent. John N. Randolph, Registered Patent Attorney, 203 Columbian Bldg., Washington 1, D. C.

PATENT Practice before U. S. Patent Office. Validity and infringement investigations and opinions. Booklet and form "Evidence of Conception" forwarded upon request. Lancaster, Allwine & Rommel, Registered Patent Attorneys, Suite 411, 815-15th Street, N.W., Washington 5, D. C.

INVENTORS. For "Record of Invention" form, contact Carl Miller, Registered Patent Attorney, Woolworth Building, New York.

## FOR INVENTORS

PATENT Searches \$5.00. Includes patent copies. Reliable, accurate results. Free protection forms, 48 hour service. Patent Service Institute, 945-A Pennsylvania Avenue, Washington 4, D. C.

SEARCHES. Put your patent searches in the hands of a registered patent attorney. Don't take chances. All inventions kept in strict secrecy in my office. Lowest search fees. Record of Invention Form upon request and information on patent protection. Patrick D. Beavers, Registered Patent Attorney, 935 Columbian Bldg., Washington 1, D. C.

INVENTORS—If you believe that you have an invention, you should find out how to protect it. The firm of McMorrow, Berman & Davidson is qualified to take the necessary steps for you. Send for copy of our patent booklet "How to Protect Your Invention" and "Invention Record" form. No obligation. McMorrow, Berman & Davidson, Registered Patent Attorneys, 1349 Victor Building, Washington 1, D. C.

INVENTORS—This firm is registered to practice before the United States Patent Office and is available to assist you in the preparation and prosecution of your patent application. "Patent Protection for Inventors" booklet containing detailed information and steps to take toward patent protection will be sent upon request. No obligation. Victor J. Evans & Co., 532-K Merlin Building, Washington 6, D. C.

PATENT Searches by former patent office examiners \$5.00. Protection forms free. Write Patent Engineering Service, 500 Walker Building, Washington 5, D. C.

SELLING Your inventions made easier by our consulting, design and drafting services. Complete information—free. Machine Design Service, 416 Madison Avenue, Rahway, New Jersey.

PATENT Owner Representative. Years of experience. Can I help you? Charles A. Scott 773PM Garson Avenue, Rochester 9, N. Y.

PATENT Searches \$5.00. Reports airmailed within 48 hours. Invention protection forms free. Write Miss Ann Hastings, Patent Searcher, P.O. Box 176, Washington 4, D. C.

PATENT Searches \$5.00. 48 hour service. Patent copies included. Protection forms free. Write Raymond L. Smith, Patent Searcher, 410 Bond Building, Washington 5, D. C.

INVENTORS—Honest marketing assistance and services, patented, patent pending inventions. Write for our free booklet without obligation. Market Contacting & Data Service, 11106-A3 Longwood, Chicago 43.

SUCCESS Guaranteed. Inventors with patented and patent pending inventions for sale or lease, request our free book. No obligation. Dept. 1-F, Universal Marketing Co., 354 South Spring St., Los Angeles 13, Calif.

INVENTORS: Learn how to protect your invention. Unless the inventor is familiar with patent matters, he should engage a competent registered patent attorney or agent to represent him. We are registered to practise before the U.S. Patent Office and prepared to serve you in handling your patent matters. "Patent Guide for the Inventor" containing detailed information concerning patent protection and procedure with "Record of Invention" form will be forwarded to you upon request—without obligation. Clarence A. O'Brien & Harvey Jacobson, Registered Patent Attorneys, 01A-G District National Building, Washington, D. C.

COMPREHENSIVE Inventors services by patent research organization: Patent searches, including patent copies, patent drawings, invention marketing, protection forms free. Industrial Patent Reports, Box 1081, Massachusetts and North Capitol, Washington 13, D. C.

INVENTORS: If you have an invention for sale, patented or unpatented, write Institute of American Inventors, Dept. 40A, 631-E St. N.W., Washington 4, D. C.

INVENTIONS Wanted. Prominent manufacturers and national distributors look to us for new products. You can also benefit by having us assist you with your invention from the idea stage through to the developed product, fully protected. Ask for Booklet "M." Elo Development Co., Chatham Phenix Bldg., Long Island City 1, New York.

INVENTORS: Without obligation, write for information explaining the steps you should take to secure a patent on your invention. John N. Randolph, Registered Patent Attorney, 202 Columbian Bldg., Washington 1, D. C.

CASH For your idea. 280 manufacturers need inventions, patented or unpatented. List free. Invention Bureau, 208M Clinton, Oak Park, Illinois.

"INVENTOR'S Guide" free on request. Frank Ledermann, Registered Patent Attorney, 154 Nassau St., New York 7, N. Y.

INVENTORS. For "Record of Invention" form, contact Carl Miller, Registered Patent Attorney, Woolworth Building, New York.

## INVENTIONS WANTED

INVENTORS Marketing assistance. Circular free. Stanley Hull, 7829-K Euclid, Cleveland 3, Ohio.

INVENTIONS Promoted. Patented or unpatented. Write Adam Fisher Company, 61 Enright, St. Louis, Mo.

INVENTORS: Nationally-known manufacturer seeks new patented products suitable for manufacture by high production methods. Write P.O. Box # 7312, Chicago.

INVENTORS—What have you, patented, patent pending to offer manufacturers? Our booklet free without obligation. Market Contacting & Data Service, 11106-A2 Longwood, Chicago 43.

INVENTORS: Hundreds of manufacturers have requested our assistance in locating marketable new products. Complete information free. Institute of American Inventors, Dept. 40-D, 631-E St. N.W., Washington 4, D. C.

HIGHEST Royalties—Cash. Patented and patent pending inventions only. Request our free book. No obligation. Dept. 1-W, Universal Marketing Co., 354 South Spring St., Los Angeles 13, Calif.

CASH For your idea. 280 manufacturers need inventions, patented or unpatented. List free. Invention Bureau, 208M Clinton, Oak Park, Illinois.

INVENTIONS Wanted. Patented or pending only. Inventors' Exchange—B, Hartford 1, Conn.

## PATENTS FOR SALE

**PENDING;** Electric, remote controlled lawn mower. Should retail for \$100 or less. Leslie Dooley, 5515 N.E. 28th Ave., Portland, Oregon.

**AUTOMOBILE** Hand accelerator. (patented). Eliminates leg, back, foot fatigue on long drives. Transcontinental, Box 3812, Kirkwood, Mo.

**INVENTORS:** Test the commercial value of your patented or unpatented inventions, quickly and inexpensively. Write for free information. Institute of American Inventors, Dept. 40-B, 631-E St. N.W., Washington 4, D. C.

## MANUFACTURING

**MODELS —** Manufacturing, designing, machine work, special parts. Henry, Engineer, 2815 Boulevard, Jersey City, N. J.

**ENGRAVING** Nameplates, manufacturing small lot. Tools, fixtures, models. Specialty Machine, 2821 Mitchell, Racine, Wis.

**METAL** Stampings. Tools, dies and fixtures. Send drawings or sample for estimate. Sterling Manufacturing Company, Davison, Michigan.

**MODELS —** Small lot manufacturing. Metals, plastics, etc. Milburn, Burlington, Kentucky.

## MODELS, MODEL SUPPLIES

**DOWMETAL** Magnesium for all model makers. Rod, bar, sheet and scale structural shapes. The Craftsmiths, 15427 Robson, Detroit 27, Michigan.

**LIONEL** Trains, accessories, switches. Tremendous stock; fast delivery. Guaranteed repairs. Authorized Lionel Train Station, 72 West Washington, Chicago 2.

**POWER** Models. Unusual steam, gasoline and traction engines. Metals, tools, accessories. Catalog 50c. Chas. Cole, Ventura, Calif.

**25** MINIATURE Bridge kits, PM9, London Bridges, 2146 Barnes, New York City 60.

**JUST** Published! Notebook for Ship-model Builders, by W. Pratt. 32 pages including 14 plates of drawings and sketches. At dealers, or send \$1.00. Ship model catalog, 25c. Model Shipways, 476 Main Street, Fort Lee, N. J.

**KING** Of hobbies—Bottled models. Boat kit A—\$1.00. No c.o.d.'s. Particulars. Fregoe, 28 Park, Massena, N. Y.

**BUILD** Historic ship models, complete kits 39c to \$9.00. Catalog 10c. Ideal Models, 19 W. 18th, New York 11, N. Y.

**SHIP** And yacht model fittings; blueprints. Send 25c for illustrated catalog No. 25—listing hundreds of items. A. J. Fisher, 1002-1 Etowah Ave., Royal Oak, Mich.

**STEAM** Locomotives, 1<sup>st</sup>, 2<sup>nd</sup>, 3<sup>rd</sup>, 4<sup>th</sup>, 5<sup>th</sup> scales. Castings, parts, rail, steam fittings! Thorough drawings with instructions. Catalog 35c. Little Engines, Lomita, Calif.

**SHIP** Models and yacht supplies complete. Large 64 page catalogue 30c. Bill Wild's, 510 East 11 St., New York City 9.

## HOME CRAFTSMEN

**ALL** Leathercraft supplies! Catalogue 10c, refunded first order. Rosenblum Leather, Box 507, Sheboygan, Wisconsin.

**WOODCRAFTERS.** New realistic light-house or Dutch mill plans \$1.00 each. Fred J. Frey, 2229 Faws St., Jacksonville 7, Fla.

**FIX-O-STRIPS.** Flexible metal repair strips, pictured Popular Mechanics, July 1950, page 122. Send \$1.10 for six strips, metal file free. Jaysen Strips Co., 157 Adelphi St., Brooklyn 5, New York.

**16** NEW Lawn chairs, 22 picnic tables, benches, trellises, etc. All 38 plans with necessary full size patterns, \$1.00. Mastercraft 93M, 7041 Olcott, Chicago 31, Ill.

**89** FULL Size jig saw patterns of beautiful shelves, ornaments, toys, novelties. Plus "How, Where to Sell." Only \$1.00. Mastercraft 94M, 7041 Olcott, Chicago 31, Illinois.

**90** ALL New, full size lawn ornament and novelty patterns, up to 20' high. Only \$1.00. Mastercraft 92M, 7041 Olcott, Chicago 31, Illinois.

**OLD** West plywood money-maker! Plan 25c. Box 56-A, Braintree 84, Mass.

**JIGSAW** Owners attention! Start earning money at home cutting out wooden novelties and souvenirs. Write H. Cook, 4407 S. Normal Ave., Chicago 9, Ill.

**BEAUTIFUL** Lawn ornament patterns, ready cut, full size. 20 assorted \$1.00 postpaid. Lincoln Craft Studio, Farmington, Conn.

**VELCOAT** Makes any surface feel velvety. 18 exciting colors. Easily sprayed on. Single color \$1; 6 color kit \$4.95. Velcoated samples free. Hobbies, 5172-K, Tulsa 16, Okla.

**LEATHERCRAFT** For pleasure or profit. Make easy-to-assemble purses, belts, gloves, woolskin toys, 100 other items for gifts or to sell. Send 10c today for big catalog. Largest leathercraft stock in U. S. J. C. Larson Co., 820 S. Tripp, Dept. 275, Chicago 24

**NATIONAL** Emergency may bring your home metal or woodworking shop profitable jobs. Mail \$1.00 for list items needed, procurement offices nearest you. Shopplan, 1122 Stanfield, South Bend, Indiana.

**CACTUS** Wood, lamp size sample, 60c postpaid. 214A East Yavapai, Tucson, Arizona.

**SEND** For details about bulletins, and figurines, paints, plastics, handcraft supplies catalog. Leisure Hour Products, 416 Rose, West Hazleton 3, Penna.

**MAKE** Leather belts, billfolds, purses. Big catalog and genuine steerhide keyholder, 10c. Tandy Leather, Box 397C, Tulsa, Okla.

**LEATHERCRAFT** Tools, accessories, bargains! Francis Byrd, 3406 Montrose Ave., Richmond, Va.

**STAINLESS** Steel sheets, 30 to 32 gauge. 15" x 36", postpaid only \$2.50 each. Send check or m.o. to L. J. Michles, Fremont, Ohio.

**LEATHERCRAFT,** Copper tooling, textile painting. Make spare time, profitable time. Free illustrated catalog shows everything you need. Kit Kraft, 7377 Melrose, Hollywood 46, California.

**LEATHERCRAFT** Supplies, leather, tools, lacing. Catalogue 10c. Mail orders. Crown Leather Co., 22 Spruce Street, New York 7.

**LEATHER,** Tools, lacings, supplies. Free catalog. National Handicraft, 199 William St., New York 7.

**SEA** Shells, cut shells, oil colored shells at lowest prices. Free illustrated catalogue showing many new jewelry designs with instructions. Southern Shellcraft Supply, Clearwater, Florida.

**OZARK** Wood samples. Eleven useful identified varieties. Prepaid \$1.25, check or cash to Davis Lumber, Cabool, Mo.

**NEW** 96 Page leather and craft catalog. 1000's of items. Send 10c. Russo Handicraft Supplies, Dept. 4D, 245 South Spring, Los Angeles, California.

**8** BEAUTIFUL Full-size whatnot patterns 25c. Joaness, P.O. Box 141-M, Omaha 7, Nebr.

**80** FULL Sized patterns. Lawn ornaments, toys, novelties \$1.00. Modern Woodcraft, Saginaw, Mich.

**KNOCKDOWN** Cedar chests. Lumber and veneers. Free price list. Giles & Kendall Company, Huntsville, Ala.

**JEWELRY** Findings, rhinestones, pearls, sequins, cameos. J & M Novelties, Box 464P, Griffith, Ind.

## MAKE IT YOURSELF

**SAFETY** Lawn mower Brush cutter. Small timber saw. Free plans. Eltraco, 11 Valdrive, Camptonville, California.

**BUILD** Your own tractor. Plans, Walking, riding. Free information. Ellsworth Tractor Co., D-11, Camptonville, Calif.

**NEW** Easy way to build your own modern webbed armchair, lounge chair, rocking chair. Send 25 cents for each pattern. Fabbrola, Box 17, New York 24, New York.

**FULL** Size plans to build working model of Amusement park roller coaster, metal construction. \$2.00. Ideal for Christmas platforms. Dan Schultz, 1024 So. 7th St., Allentown, Penna.

**BRICKLAYING**—Anyone can with the Roger Briktool. Present price \$1.30 postpaid. Briktool Distr., 942 Monroe, Eugene, Oregon.

**BUILD** Your own concrete blockmaker. Easy. Inexpensive. Motor or hand. Make block per minute. Write, C. Lee, Mountain View, Okla.

**GARDEN** Tractor. Make it yourself. Used car parts. See page 265.

**BLUEPRINTS** And plans — all kinds: Furniture, radio, boats, equipment, model building and trailers. Catalog free. Popular Mechanics Blueprint Department, 200 East Ontario, Chicago 11.

**GRANDFATHER** Clock easily built. Big savings. See ad on page 267.

**SAVE** 50%-75% Building automatic electric water heater or Zeolite water softener. Particulars free. 226 Carson Products, 2505 Benjamin, Minneapolis 18, Minn.

**FREE** Handbook, build sawmill, block machines, freezers, tractors, scooters, 250 shop, farm, home machines. Nichols Co., Dept. C-1001, Purvis, Miss.

**STREAMLINED,** Built-in kitchen cabinets to fit any kitchen. Illustrated manual describes designing and construction. All for \$1.00. Thombert Company, Newton 10, Iowa.

**OVER** 300 Plans and blueprints in Popular Mechanic's big 32 page Plan Catalog. Furniture, boats, trailers, tools, toys, gun rack, home freezer, many more. Send 3c stamp for copy. Popular Mechanics Press, 200 East Ontario Street, Chicago 11, Ill.

**SOLAR** Water heater systems efficient any locality. Standard materials, low cost. Free facts. Solar Water Company, Box 175, Coral Gables, Florida.

## WATCHES, OLD GOLD, JEWELRY

**MAKE** Big money! No investment. Send us discarded jewelry, watches, spectacles, dental gold, etc., from friends, relatives, others. You receive 20% of cash we send them. Free shipping containers sent to you on request. Lowe's, Dept. A-11, Holland Bldg., St. Louis 1, Mo.

**COSTUME** Jewelry makers illustrated parts list 10c. Conner, Box 188, National Park, N. J.

**WATCHMAKERS'** Journal contains instructive articles on watch repairing. \$1.00 year. Sample copy 20c. Dean Co., 116-K Nassau St., New York 7, N. Y.

**WATCHMAKERS.** Beginners, watches, movements, descriptive list. Box 150, Chicago 90, Illinois.

**WATCHES** Cleaned, repaired. Maximum charge \$4.00! Year guarantee. National Watch Repair, Box 2414B, Cleveland 12, Ohio.

**BEST** Prices paid for gold teeth, rings, broken jewelry, diamonds, platinum. Money mailed same day articles received. Licensed and bonded. Ship to Marko Loan Bank, 542-S. State St., Chicago 5, Ill.

**WATCHMAKERS'** Tools, materials, sold-bought. Catalogue! Bengal Company, Culver City, California.

**HIGHEST** Cash paid for old, broken jewelry, gold teeth, watches, silverware, diamonds, spectacles, platinum. Free information. Satisfaction guaranteed. Government licensed. Rose Smelting Company, 29-A East Madison, Chicago.

**GOLD** Plated jewelry supplies—Rhinestones, pearls. Illustrated catalog 10c. Barry's, 47-A Branford Place, Newark 2, N. J.

## OF INTEREST TO WOMEN

**BAKER'S** Recipes—Sugar, Scotch cookies, two dollars. Addressed stamped envelope. Lee Marley, 2706 Winthrop Avenue, Indianapolis 5, Indiana.

**EXCELLENT** Profits. Make fast-selling chenille Christmas poinsettias, corsages, Santas, monkey trees, dolls. Literature free. Velve, Dept. M, Bohemia, N. Y.

**SEW—**Our ready-cut line. Fast, easy illustrated folders 10c. Liebig Industries, Beaver Dam 5, Wisconsin.

**1000** WAYS To save time, money, labor. Amazing new book "Short-Cuts to Better Housekeeping." 160 pages packed with ideas every housewife will appreciate. Well illustrated. Only 60c postpaid. Popular Mechanics Press, Dept. SC, 200 E. Ontario St., Chicago 11, Illinois.

## FOR SALE—MISCELLANEOUS

**SAVE** Money on army, navy and factory surplus. Write today for new 60-page illustrated catalog. Tennasa Sales Co., Dept. AE, 1451 Market, Chattanooga, Tenn.

**MICROSCOPES.** Pocket pen type, 20 power, \$2.95; 40 power, \$4.95 postpaid. New 1950 catalog of firearms, gov't. surplus and sporting goods. Send coin 25c. Public Sport Shops, 11 S. 16th Street, Philadelphia 2, Penna.

**FREE** Catalog! War surplus clothing. Amazing bargains. N. Y. Clothing Co., New York 29.

**DRESSES** 18c; Coats \$1.00; blouses 35c. Free catalog. Crown, 164-PA Monroe Street, New York.

**HANDSIGHTING** Levels, improved, new model, used for grading land, contouring and laying out fences, piers, roads and gardens, price \$2.00 postpaid. New 1950 catalog of firearms, gov't. surplus and sporting goods. Send coin 25c. Public Sport Shops, 11 S. 16th Street, Philadelphia 2, Penna.

GENUINE Buckskin coin purse and illustrated buckskin catalogue, both only 5c. Berman Buckskin Co., 253 No. 1st, Minneapolis, Minn.

**WANTED—MISCELLANEOUS**

WILL Buy Stanley steam engine in any condition. P.O. Box 4296, Philadelphia, Penna.

WANTED: Saw filing machines. Box 194, Park Ridge, N. J.

WANTED—Scrap mercury (quicksilver), tantalum, bismuth, tungsten. Metallurgical Products Co., Established 1909, 35th and Moore Sts., Phila. 45, Penna.

**PERSONAL**

REAL Authentic western brand registered in your name. Meet cowboys and ranchers on equal terms. Send only \$1.00. Western Brand Registry, Room 10, Brand Bldg., Colorado Springs, Colo., for your brand certificate and book on How to Read Brands and Story Behind Them. Branding iron available to registered brand owners.

VALUABLE Big mails, four months listing, 25c. Wright Publications, 2270 Hubbard, Memphis 8, Tennessee.

MEXICAN Law. General Practice Attorney, 1203 Arizona Street, El Paso, Tex.

BORROW By mail. Loans \$50 to \$300 to employed men and women. Easy, quick. Completely confidential. No endorsers. Repay in convenient monthly payments. Details free in plain envelope. Give occupation. State Finance Co., 210 State Finance Bldg., Dept. M-14, Des Moines 8, Iowa.

"INTERESTING Mails" — Details, 25c! Bentz, Pine Hill's House, (B/86), Chatawa, Mississippi.

REVOLUTIONARY Hearing device. No battery, no wires. Just a simple ear plug that carries sound to the ear drum. Beaudry, 4337-H—30th Avenue South, Minneapolis 6, Minn.

MEXICAN Legal matters reliably handled. Box 263, El Paso, Texas.

"HOW Can I find out?" You can! Information discreetly developed. Any matter, person, problem, anywhere. Worldwide. Officially licensed, bonded service. Established 1922. Reasonable. Confidential. William Herman, 170 Broadway, New York.

**MISCELLANEOUS**

MAKE Changeable shoe tops. Patterns, instructions \$1.00. Imports catalogue, Brokerage, Milbank, South Dakota.

SAVE Money on paint brushes. Buy direct. Post card brings descriptions and prices. \$1.50 brings 3" brush, \$2.50 value. Kenmore Brushes, P.O. Box 53, Kenmore 17, N. Y.

FOUNTAIN pen repairing. Send 35c for Penkit; includes sac, point with instructions for repairing. Penmart, 297, Henderson, Nevada.

SQUARE Dance instructions. 40 dances, \$1.00. Wesley Rader, 1922 Grant, Denver 5, Colorado.

"OPPORTUNITIES Galore" — Interesting profitable mailing, 10c. Valles, Box 242-BK, Brooklyn 1, New York.

PANNING Gold — Beginners booklet 36 pages; catalogue, supplies, mining books, maps "where to go." 25c. Old Prospector, B-441, Dutch Flat, Calif.

14,000 NEW Schatz commercial ball bearings, 3/8 x 1/4 x 1/4. Make offer. Lieber & Son, 802 Forestdale, Royal Oak, Mich.

OLD Toy trains bought. List dime. Kowal, 1846 Cullerton, Chicago.

USE Best metropolitan address available! Business, personal, Metropole, Suite 3, 29 East St. James, Montreal 1, Canada.

YOUR Leather jacket renovated by our craftsmen expertly, reasonably. Request free descriptive circular. Berlew Mfg. Co., Dept. 8, Freeport, N. Y.

ADD "Spice" to home projection shows with old-time Nickleodeon slides, 2x2. Kodachrome. Write for free list. Nickleodeon Co., New Fliedner Bldg., Portland 5, Oregon.

SENSATIONAL New line of Geiger counters for uranium detection. All types, all prices. No finer selection. Also mineral rights and new gold, silver and mineral detectors. Complete information free. Detector Co., 5631 Cahuenga, Dept. B-9, North Hollywood, California.

INCREDIBLE! Unprecedented! Become a mental superman overnight! Floor everybody! No studying! "Memoprop" does all your thinking! It's uncanny! Revolutionary! Write: Bijou, Box 1727-M3, Hollywood 28, California.

EARN Up to \$200 month, inventing toys, games, gadgets. Write Hendrickson, Argyle 1-A, Wisconsin.

MILLION Articles wholesale. Directory 25c (refundable). Publishers, Box 1302-P9, Detroit 31.

FREE Hearing aid "A" battery. Box M51, York, Penna.

STOP Toilet tank sweating—Save floors. Easy to install. \$10.95 postpaid. (Free literature). Arrow Sales, 2212 Cuming, Omaha, Nebraska.

EXPLORE Abandoned mines, hills, deserts, streams for natural gold, silver, other precious metals. Seek fabulous riches in buried treasures. Details free! Pathfinder Company, Dept. 8PM, 1726 Beverly Drive, Pasadena 7, Calif.

ELECTRIC Paint remover from wood, plaster surfaces, curved or irregular. Safe, flameless. Precision built of chromeplated and stainless steels. Absolutely guaranteed. \$12.95. Your dealer or B & L Tool Company, 51 Pine St., Plainville, Conn.

PROFESSIONAL Secrets revealed. Send for your copy of "How to Trace Missing Persons." \$2.00 postpaid. Bonded Detectives, Omaha, Nebr.

GENUINE Lucky stone. Rare stone found only in the Archosargus, 50c. Erie Novelty, Box 81, Huron, Ohio.

NEON House numbers, any color \$14.95 complete. LuxArt, Box 15597, Los Angeles 8, Calif.

HAIRCUT As You Like It. New booklet tells how, 25c. Mastrolia, 5 1/2 Jane, New York City, 14.

TATTOOING Outfits, supplies. Illustrated list free. Zeiss, 728 Leslie, Rockford, Illinois.

GEIGER Counter model C-18, fits coat pocket, 2 pounds weight, ultra sensitive, dependable, immediate shipment, only \$35.00. Fisher Research Lab., Inc., Palo Alto, Calif.

"RECEIVE Mail." Moneymaking offers, opportunities, catalogs. Name listed 10c. Ideal Service, Park Ridge 10, Ill.

TREASURE, Mineral locators. Goldak now offers treasure locators for \$75.00. Geiger counters reduced to \$95.00. Write the Goldak Co., 1541 West Glenoaks Blvd., Glendale 1, Calif.

FREE—Amazing new book, "How to Answer Ads." Never before have you seen anything like this. Tells you in simple language the correct way to answer ads. Gets you quicker replies—better results, and greater satisfaction. Will save you time and money and it's absolutely free. No obligation whatever. Every reader of advertising should have this booklet. Send a postcard for your copy now. F. W. Johnson, (Room 600), 200 East Ontario Street, Chicago 11, Ill.

TREASURE—Mineral locators — Geiger counters M-scope type for arctic-tropic use. Unsurpassed in efficiency. Factory guarantee. Lowest prices. Can be purchased on monthly payment plan. Free literature. Fisher Research Lab., Inc., Palo Alto, Calif.

TATTOOING Machines, outfits. Free catalogue. Jensen, 120 West 83rd Street, Los Angeles 3.

REACH Spanish-speaking mail-order buyers. Great new market for your merchandise. Your classified ad in the Spanish Edition of Popular Mechanics will bring you some nice business from this new field. Rate only 25c per word. Circulation 100,000 copies. Mail a trial ad right now. Popular Mechanics Magazine (Spanish Dept.), 200 E. Ontario Street, Chicago 11, Ill.

**Learn PHOTOGRAPHY**

There's big money in PHOTOGRAPHY—and an action-packed career for you. Our HOME STUDY COURSE is your spare-time SHORT CUT TO SUCCESS! Or, if you wish—PERSONAL ATTENDANCE TRAINING at our famous New York School is available with subsidistence under the G. I. Bill. Our 40th year. Write immediately!

**NEW YORK INSTITUTE OF PHOTOGRAPHY**

Dept. "49," 10 West 33 Street, New York 1, N.Y.

**LEARN MEAT CUTTING**

At Home — In Spare Time



Get into the vital meat industry. Concise, practical Home Training based on 25 years proven instruction methods used at National's famous resident school. Prepares you for bigger pay as Meat Cutter, Supervisor, market manager or more money in your own store. Go as rapidly as your spare time permits. Diploma. Start NOW to turn your spare hours into money. Send for FREE bulletin today. No obligation.

**NATIONAL SCHOOL OF MEAT CUTTING, INC., Div. U-120, Toledo 4, Ohio**

**Send 10c Today for Your Copy of New, Mammoth 1951 Catalog of Nearly 8,000 Novelties—Nearly 600 Pages**

**Collier's, Coronet, New Yorker, Tide Magazine Write About This Amazing "World's Most Unusual" Catalog**

More interesting than carnival, circus, world's fair & science exhibit rolled into one. Selling book. Costs us nearly \$1.00 a copy. You send only 10c for this big 600 page catalog—nothing more to pay or buy. Partial contents:

Accordions	Ades	Badges	Balloons	Banks	Air Rifles, Pistols	Albums	Alligators	Animals	Archery	Artist Supplies	Ash Trays	Books	Atomic Sciences	Auto Items	Awards
Buttons	Calendars	Calculators	Cameras	Camper's Items	Caps, Guns	Card Tricks	Cartoonist Items	Cash Boxes	Chameleons, Live	Chimes	Chemistry Items	Chess	Cigarettes	Cigar & Cigaret	Novelties
Clairvoyance	Clocks, Watches	Code Maker	Coin Items	Compasses	Contest Winning	Bug Killers	Cosmetics	Crosses	Cowboy Items	Flowers, Seeds	Flying	Football	Forecasters	Formulas	Fortune Tellers
Fun Makers	Gadgets	Gambling Items	Games, Supplies	Garden Items	Geiger Counter	Girls, Pretty	Jobe Novelties	Ju Jitsu	Key Chains	Kids, Hobby	Keys, Master	Knives	Labels	Lamps	Lenses
Letter, Sweater	Lighters	Microscopes	Mirrors	Model Supplies	Money Savers	Money Makers	Monkeys, Live	Mobers	Movies	Muscle Builders	Musical Items	Numerology	Occult	Office Supplies	Openers
Optical Goods	Oriental Imports	Paints, Supplies	Party Novelties	Pennants	Pens, Pencils	Personals	Magnesium	Pets, Supplies	Philatelic Sup.	Phones	Mirrors	Model Supplies	Money Savers	Money Makers	Monkeys, Live
Plating Equip.	Poker Items	Printing Items	Projectors	Purses	Puzzles	Razors, Auto	Rockets	Radio Items	Hazors, Etc.	Recipes	Religious Goods	Rifles, Guns	Stationsery Sup.	Swim Items	Surprise Package
Rulers & Rules	Scientific App.	Seeds, Plants	Sewing Items	Sharpeners	Shaving Goods	Ship Models	Shockers	Signs, Supplies	Television Items	Thermometers	Throwing Knives	Yo Novelties	Time Savers	Tools	Traps
Treasure Finders	Tricks	Trophies	Turtles	Typewriters	Vaults & Banks	Vendors	Ventri-liquam	Waists	Water Novelties	Weird Articles	Western Goods	Whips	Whistles	Wigs	Wrestling Items
Many Others															

**SEND 10c TODAY WITH YOUR NAME AND COMPLETE ADDRESS—NO LETTER NECESSARY**

Big 600 page catalog of over 7000 novelties, 3500 pictures, 6-color cover, 1-inch thick. Send 10c at once—no obligation. (Postage stamps accepted). Rush 10c with name & address today to: **JOHN-SMITH & COMPANY, DEPT. 269, DETROIT 7, MICHIGAN**

# Earn Big Money

# WRITING ORDERS

## AMAZING NYLONS

*Guaranteed Against*

### RUNS AND SNAGS

*Regardless of Cause!*

The world's ONLY complete, nationally advertised nylon hosiery line actually guaranteed against runs, snags or excessive wear, REGARDLESS OF CAUSE! It's amazing, but true! No matter what the cause—hard use or deliberate abuse—Kendex nylons are replaced FREE if they run, snag or become unfit for wear within entire guarantee period! Every weight from sheerest 15 denier to heavy 70 denier—all gauges up to luxury 60 gauge—all sizes, lengths, popular shades, fancy heels, black seams—full fashioned and seamless. Nothing is missing to make sure every woman is pleased. In spite of the amazing guarantee, retail postage prepaid prices start at \$1.08 the pair for sheerest 15 denier 51 gauge. Should free replacement be necessary, actual cost becomes 54¢ a pair! How could any woman possibly resist saving money and solving her hosiery problems? NOT SOLD IN STORES. Men and women wanted NOW, spare or full time, to write orders and earn big money. You can get orders even if you never sold a thing in your life!

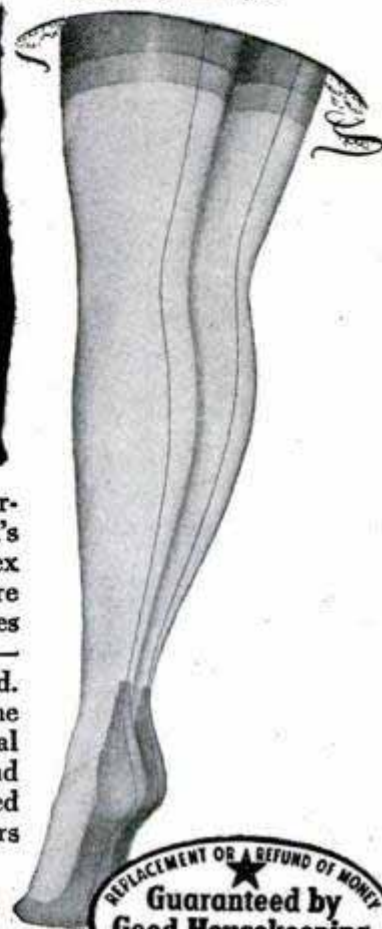

**MEN'S HOSE  
GUARANTEED 1 YEAR**

Kendex gives you FOUR complete lines, including sensational men's hosiery line actually guaranteed for ONE YEAR! Any pair not giving satisfactory wear within 12 months is replaced FREE without question. All styles, patterns, colors, yarns (including nylon) at lowest prices that mean steady income for you 52 weeks a year.

**LINGERIE  
HOUSECOATS — ROBES**

Full line of lingerie, housecoats and robes. Woven and knitted fabrics—rayon, cotton and NYLON. Nothing is lacking. Unbelievable prices that defy competition and make women eager to order. Imagine a beautiful all NYLON slip, with NYLON lace, at \$2.95 or a lace trimmed rayon satin slip at \$1.58! Kendex values sell themselves.

**NATIONALLY  
ADVERTISED**

Kendex has advertised in Life, Look, Collier's, McCall's, Saturday Evening Post, Ladies' Home Journal, Good Housekeeping, etc. Carries the Good Housekeeping Guarantee Seal. Thousands of orders shipped daily. Yearly volume in millions. A dependable responsible national organization.

## FREE NYLON STOCKING AND MONEY-MAKING OUTFITS

Man or woman — young or old, YOU can easily earn steady income, spare or full time. No money or experience needed. We supply EVERYTHING free and set you up in business at OUR expense. Nothing to buy or deliver. Write orders. we deliver and collect. Big advance pay plus huge cash bonus that increases your earnings up to 40%! Your name and address on postcard will bring you sample nylon stocking; samples of lingerie, hose, robe materials; self-selling sales books with FULL COLOR illustrations; 36-page sales manual showing you easy steps to success; color cards, free "door openers" worth \$1 each but which you give away free; special plan to have others sell for you, etc., etc. You can start making money the minute you receive the complete FREE outfits!

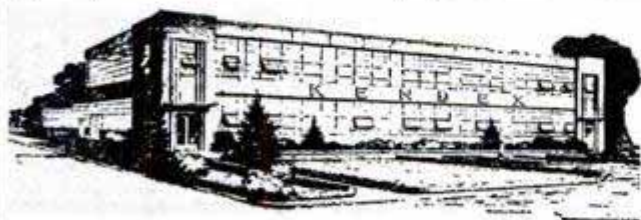

**YOUR COST ONE CENT!**

SEND NO MONEY. Pay nothing now or later. No obligation. Not even a promise to return outfits. Simply write your name and address on a penny postcard and mail to us. We'll immediately rush you everything you need FREE and postage prepaid. WRITE TODAY!

# KENDEX CORPORATION • BABYLON 246, N. Y.

# CORTINAPHONE

makes it FUN to Learn

## French-Spanish

### GERMAN - ITALIAN - BRAZILIAN RUSSIAN - JAPANESE

**BIG OPPORTUNITIES and JOBS** await Americans who speak a foreign language. Millions being spent in Europe, Latin America. Travel booming.



**Only 15 Minutes a Day** Listen to

Speak **FRENCH, SPANISH, German, Italian, Brazilian, Russian or Japanese** like a native! **CORTINAPHONE METHOD**, famous for 68 years, teaches you—**BY LISTENING**. Right in your own home, relaxed, at ease.



Count Cortina

**Sent on 5 Days Approval**  
THOUSANDS have learned a second language this quick, easy way for **PLEASURE and BUSINESS!** FREE 32-page book describes famous method; tells how you can try it at home for 5 days. **NO COST IF NOT DELIGHTED.** Send for free book NOW!

### VETS! FRENCH OR SPANISH COURSE AVAILABLE UNDER G. I. BILL

**CORTINA ACADEMY** (Language Specialists for 68 Years)  
Dept. 649, 105 W. 40th St., New York 18, N. Y.

Please send me—without obligation—your free book. I am interested in (check language interested in)

- French  Spanish  German  Italian  
 Brazilian  Russian  Japanese

Name \_\_\_\_\_

Address \_\_\_\_\_

Check here if you are a VETERAN

## START A WELDING BUSINESS AT HOME

turn your spare time to spare cash

### MAKE WELDED REPAIRS FOR NEIGHBORS

Repair Torn Fenders . . . Fix Toys Braze and Solder Broken Parts . . . Charge Batteries with the

### NEW "LINCWELDER 60"

Low in price • Easy to use  
Lincoln Arc Welder

- Plugs into 110 volt AC appliance socket.
- Easy to weld, cut, braze or solder.
- Approved by Underwriters Laboratories.
- Built by The Lincoln Electric Company, world leader in arc welding.



Complete instructions furnished with each "Lincwelder 60"

PRICE ONLY  
**\$48.00**

including freight in U. S. A.

Fill out order and mail to

The Lincoln Electric Co., Dept. 194, Cleveland 1, O.

- Ship me the "Lincwelder 60" with accessories \$48.00  
Enclosed is  check  money order  
 Send me free bulletin on the new "Lincwelder 60"

Name \_\_\_\_\_

Address \_\_\_\_\_

City \_\_\_\_\_

State \_\_\_\_\_

BRAND NEW **30 DAY FREE TRIAL**  
**7x50 Prism BINOCULARS**  
Finest Precision Optics  
Buy Direct From Importer  
Money Back Guarantee  
Many other models AS LOW AS \$6.00\*  
(\*plus Fed. Tax)  
FREE Illustrated Catalog & Book,  
"How To Select Binoculars"  
Dealers: Write for discounts.  
43 E. Green St., Dept. M-9  
Pasadena 1, California

**BUSHNELL Importers**

**I'LL SEND YOU A FINE SUIT AND START YOU IN BUSINESS**

Get your made-to-measure suit without cost taking orders from friends at direct-from-factory prices. Pocket big commission on all orders. Get splendid demonstration outfit and tested plans FREE. Work from home or office, full or spare time. Top men make up to \$12,000 in a year. Famous 37-year-old firm. Write.

**BUSINESS MANAGER, Dept. 7, Box 23, Cincinnati 6, Ohio**

## WATCHMAKING

**Be a Watchmaker — Be Independent**  
Get practical training in Chicago's first accredited watchmaking school.  
Day and Evening Classes—Approved for Veterans  
Write today for free information  
**CHICAGO INSTITUTE OF WATCHMAKING**  
6 EAST LAKE STREET Dept. PM-9 CHICAGO, ILLINOIS

**TOOTHACHE?** TOOTH GUM  
Ask your Druggist for **DENT'S** TOOTH DROPS  
POULTICE

## EARN MONEY IN UPHOLSTERING

**BUSINESS OF YOUR OWN OR A GOOD JOB** Learn at home from experts. Simplified, fully illustrated training program. Full plans for establishing your business—profits big. Fine earning opportunities also in good jobs. Upholster your own furniture at fraction of cost. Valuable booklet free. Write now.

**PROFESSIONAL HOME TRAINING—TOOLS, SUPPLIES, EQUIPMENT INCLUDED**

**General Trades Schools, 3810 Broadway, Dpt. PM-9, Chicago 13, Ill.**

## SHOE REPAIR OFFERS BIG INCOME

**LEARN IN 12 WEEKS TIME**  
You can own your own shop or earn big income as skilled shoe repairman. Growing demand everywhere at top wages for men who know how. We teach you quickly by actually working on shoes and modern machines. School open to all from 18 to 60 years of age. **FREE BIG 20 PAGE BOOK** explains everything. Send for your copy today. Established 1927.

**MODERN SHOE REBUILDING SCHOOL**  
Chicago and Los Angeles only Approved for Vets Dept. PM  
2937 Belmont Ave., Chicago, Ill. 361-12th St., Oakland, Calif.  
806 So. Figueroa St., Los Angeles 14, Calif.

## Learn CARPENTRY BRICK LAYING

Get into the billion dollar building trades. Learn now while opportunities are greatest. Train in our completely equipped shops under expert instructors. G.I. Approved. Enroll now. Limited classes. Write for FREE Catalog.

**MIDWEST SCHOOL OF BUILDING TRADES, Dept. PM-9**  
411 N. Center St. Bloomington, Ill.

**Thrilling Work COLORING PHOTOS**

Fascinating vocation learned at home by those with aptitude. Thrilling pastime. National method brings out life-like colors. Free booklet.

**NATIONAL PHOTO COLORING SCHOOL**  
1315 S. Michigan, Dept. 1356, Chicago 5

**EASY TO LEARN**

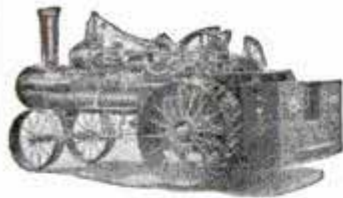

# MINIATURE ENGINES

## The World's Most Fascinating Hobby

Send 25 cents (refunded with first \$1.00 purchase) for our illustrated catalogue of the WORLD'S LARGEST SELECTION of model engine castings and drawings—Models of every type and for every purpose including steam, gasoline, traction and live steam 1/4", 1/2", 3/4" & 1" scale locomotives.

## Miniature Engine Laboratories

200 CEMENT AVENUE SANDUSKY, OHIO

## PAY-UP ALL YOUR BILLS!

EARN BIG MONEY-SPARE TIME  
SELL LEATHER JACKETS NOW



Every Outdoor Worker A Prospect!

Sell them all! Telephone linemen, building workers, hikers, hunters, demand snug warmth, free-action comfort, sturdy construction. Write today! COMPLETE LINE Jackets, shirts, raincoats, PLUS 151 comfort shoe styles for men, women. Liberal Comm., no experience or investment. Write TODAY for FREE SELLING OUTFIT!

CONSOLIDATED SHOE SYSTEM, Dept. GS-54, Chippewa Falls, Wisc.

Reduced from \$7.90

Imported Swiss Stop **CHRONOGRAPH** multi purpose **WRIST WATCH \$5.90**

2 PUSH BUTTONS



1 YR. WRITTEN GUARANTEE

Plus 59c Fed. Tax WITH INSTRUCTIONS GIVEN—washable, ventilated plastic band "Wonder" Watch. Used to time autos, airplanes, horse races, athletic events. • Tachometer • Telemeter • Hands & Nos. Glow in Dark • Unbreakable Crystal • Large Red Sweep Hand • Tells Time • Measures Speed & Distance • Stop Watch • Precision Made

Send money order for \$6.49. For C.O.D.'s enclose \$1.00 with order for Fed. Tax, postage, handling.

THE JEWELBOX, Dept. YJ, 1674 Broadway, N.Y. 19, N.Y.



You can easily improve your writing and become an Expert Penman by my Simplified Method at home in spare moments, for your Social and Business Advancement. Write for my FREE BOOK, "How to Become an Expert Penman"—24 pages of information, photographs and specimens that tell how others learned. FREE SAMPLES of Business and Ornamental Writing and Instructions that show how you can learn. Write for the Book, Samples and Details today. They are FREE for your information. Send 10c for Shading Penpoint and your name with flourished bird on a card.

T. M. TEVIS, BOX 25K, CHILLICOTHE, MO.

## FREE TO RUPTURE SUFFERERS

Penny post-card brings free information on newly invented three-contact, painless pad that holds hernia at upper break thru, center and point of swelling. Safe! Comfortable! Write Dept. PM-9.

ACTIVE MAN APP., 549 W. Randolph, Chicago 6

## 100,000 WASHER REPAIR PARTS

Start Your Own Washing Machine Repair Business  
RETAIL CUSTOMERS MAIL IN OLD PARTS OR MODEL NO. OR SERIAL NO.

Tremendous field, excellent profits! Get our large complete wholesale catalogue showing thousands of repair parts illustrations: wringer rolls, V-belts, motors, gears, etc. Price \$2.00 per copy postpaid in U.S. Send check or money order today—price of catalogue refunded on first \$20.00 order. Established 20 years.

WESTERN APPLIANCE CO., Inc.  
5650 GRAND RIVER AVE., DETROIT 8, MICH.



# ELECTRICIANS

Get this Great Book **FREE**  
For Merely Examining  
Coyne's NEW Pay Raising

## 8 Volume Set APPLIED ELECTRICITY

Here's a brand new set of electrical books to give you the "know how" on all branches of electricity from Appliance Repairing to D.C. and A.C. equipment, Electrical Refrigeration, Industrial Electronics, etc. 3,400 subjects, 11,500 facts, latest methods explained in easy to follow instructions. To prove how valuable and Practical this set can be to you, I'll give you a FREE copy of my book "150 Shop Prints and How to Read Them" just for looking over this set. Written by the Coyne Staff and backed by 31 years' experience, this set has helped many ambitious electrical workers to bigger pay and added opportunity.

**OFFER LIMITED • ACT NOW!** If you act promptly, I'll send you the 8 volume set Applied Practical Electricity for 7 days FREE examination... together with the 150 Shop Prints Book. Look the set over 7 days. If you like it send only \$3.00 after 7 days and \$3.00 per month until \$25.50 plus postage is paid. Or \$23.75 cash now. If you don't want the set, return it and YOU OWE NOTHING. Either way you keep the 150 Shop Prints Book absolutely FREE. Coupon below is just a request to see the books free and to get my gift book for doing it. ACT—Send coupon Today!

Book Div., COYNE ELECTRICAL & RADIO SCHOOL  
500 S. Paulina St., Dept. 90-R6, Chicago 12, Ill.



B. W. Cooke, Director COYNE ELECTRICAL & RADIO SCHOOL  
500 S. Paulina St., Dept. 90-R6, Chicago 12, Ill.  
O. K. send me, postpaid, Coyne's new 8 volume, "Applied Practical Electricity" for 7 Days FREE TRIAL per your offer. Also send, absolutely FREE, the book of 150 Shop Prints as a gift.

Name \_\_\_\_\_ Age \_\_\_\_\_  
Address \_\_\_\_\_  
Town \_\_\_\_\_ Zone \_\_\_\_\_ State \_\_\_\_\_

## Learn All About

**Hydra-Matic—Dynaflo, Ultramatic, Powerglide, Gyro-Matic, Tip-Toe Shift, Simplicomatic, Drive-Master, Vacomatic, Fluid Flywheels, Torque Converters, Overdrives, Hydraulic Servos, Syncro-Mesh, Free Wheeling, Vacuum Boosters, Electric Solenoids, etc. New and Complete. Describes, illustrates and explains every detail of every transmission in simple, understandable form.**

Newly written, planned encyclopedia of information on all past, present and some future features of auto power transmission.



## Automatic Transmissions Simplified

No engineering terms. No mathematical formulae. Over 175 photos, sectional views, exploded pictures, drawings, diagrams and charts. Many in colors. Written by famous service authority with help of factory engineers. Only \$4.00. See below.

## Other Money-Making G-W Books

Dyke's Auto Encyclopedia (New 1950 ed.)	\$7.50	Vocational Mathematics (Shop Arithmetic)	1.25
Automotive Service Management	5.00	Sheet Metal Die Design	2.25
Dyke's Carburetor Book	3.50	Airplane Welding	3.50
Modern Electric & Gas Refrigeration (New 1950 ed.)	5.00	Aircraft Flight Instructor	2.50
Modern Welding Practice	4.00	Fundamentals of Industrial Arts	1.50
House Wiring	3.00	Electronic Television	2.50
D. C. Power Wiring	4.00	Electroplating	2.75
Plumbing and Pipe Fitting	2.50	Fractional Horsepower Motor Maintenance	3.75
Sheet Metal Layout	3.50	Upholstering Home Furniture	3.75
The Storage Battery Simplified	3.00	Standard Auto-Electrician's Manual	17.50
Bailey's Handbook for Engineers and Firemen	2.00	40 Power Tools You Can Make	1.50

**SEND NO MONEY.** Use this ad as your order blank. Check titles wanted, clip and mail. Pay postman on delivery. If remittance is sent with order we will ship postpaid. Either way—your MONEY BACK if not satisfied.

GOODHEART-WILLCOX CO. Dept. 137, 1321 S. MICHIGAN AVE., CHICAGO 5

# New Advertising Machine



## PRINTS and ILLUSTRATES

1¢ Post Cards

**FREE** Learn how thousands of business men, in every line, are boosting sales in spite of conditions—with 1¢ messages—printed and illustrated in a few minutes on gov't post cards—with amazing new patented **CARDMASTER**. Your "today's" ideas, read by your prospects next morning. Not a toy, but a sturdy advertising machine, built to last for years. Low price, sold direct. Guaranteed for five years. Send name today.

We'll send **FREE** illustrated book of money-making **IDEAS** for your business and complete, unique advertising plans. **RUSH YOUR NAME TODAY.**  
**CARDMASTER, COMPANY**  
 1920 SUNNYSIDE, Dept. 139, CHICAGO 40, ILL.

### WHAM-O SPORTSMAN\*

HITS LIKE A .22 RIFLE—  
 KILLS RABBITS, SQUIRRELS.  
 Powerful, silent, accurate.  
 For hunting, target,  
 routing pests.

Dealers  
 Write



#### HUNTING SLINGSHOT

Heavy ash hardwood stock.  
 40 steel balls, extra rubber straps.  
**GUARANTEED.** Send \$1.00 today to

Wham-O Mfg. Co., Box B2, South Pasadena, Calif.  
 \*The professional model of Nat'l Slingshot Assn.

# Photography

for

PLEASURE or PROFIT

Learn at home. Spare time. Practical basic training. Long-established school. Many have earned while learning. Send coupon below for free booklet, "Opportunities in Modern Photography" and full particulars.



**AMERICAN SCHOOL OF PHOTOGRAPHY**  
 1315 Michigan Avenue Dept. 1356 Chicago 5, Illinois  
 Send booklet, "Opportunities in Modern Photography," full particulars and requirements. No salesman will call.

Name \_\_\_\_\_ Age \_\_\_\_\_  
 Address \_\_\_\_\_  
 City \_\_\_\_\_ Zone \_\_\_\_\_ State \_\_\_\_\_

# BE AN AUTO MACHINIST



Draw Top Pay • No Job Worries

Earn more money in auto mechanics—Specialize! New **FREE** booklet tells how to prepare for good jobs with high pay and job security. Our modern equipment and practical instructions make it easy to learn—get experience in

**ENGINE REBUILDING or GENERAL AUTO MECHANICS**

**Practical Shop Training**  
 Learn to operate the very latest shop machinery. Friendly instructors take a real interest in preparing you for a good job.

**VETERANS**  
 American is a G.I. approved school

Job Placement Service **FREE**

WRITE TODAY FOR **FREE BOOKLET**

**AMERICAN TRADE SCHOOL**  
 2417E McGee Kansas City, Mo.

PLANNING YOUR FUTURE IN AUTO MECHANICS



## Happy Highways Ahead!

With Popular Mechanics new **MOTORIST'S HANDBOOK**. 160 pages of authoritative advice to keep your car rolling smartly—longer. Brakes, body, spark plugs, battery, starter—every automotive part is covered in this up-to-the-minute manual of year 'round driving pleasure.

Your news dealer has the 60c paper edition. Order the clothbound \$2.00 volume from

**POPULAR MECHANICS PRESS**

200 E. ONTARIO ST. CHICAGO 11



## BINOCULARS MADE IN GERMANY

Precision ground lenses & center focusing give exact eye adjustment, large 42MM objectives, 8 mi. range. Strongly built. Wgt. 10 oz. Extra wide field of view. Satisfaction guaranteed or money refunded. Send check or money order to Dept. PMB2.

**\$3.95**  
 Post Paid

**CRITERION CO., 438 Asylum St., Hartford, Conn.**



## BARBELLS

Save Money — Buy the finest barbell equipment direct from our foundry — No other company can match our low price or value!

95 lb. SET  
**\$10.80**  
 Extra plates 10c lb.

Send to-day for our **FREE Barbell Catalog**

**BUR BARBELL CO.**

Lyndhurst K21, New Jersey

**MAKE MONEY at Home**

With Easy-to-Assemble Leathercraft Kits

**YOU** will be amazed at how easy it is to make attractive leather articles, for gifts or to sell, with **LARSON Ready-cut Leathercraft Kits**. **FREE** instructions, no experience or tools needed. Make purses, belts, billfolds, woolskin toys, gloves, etc. Send 10c Now for newest 24-page illustrated catalog of complete supplies, top quality leathers for beginners and advanced leatherworkers.  
**J. C. LARSON CO., 820 S. Tripp Ave. DEPT. 118 • CHICAGO 24, ILLINOIS**

**LARSON** Leathercraft Kits for the **BEGINNER**

## HELPFUL BOOKS

Send post card asking for **FREE** catalog

Popular Mechanics Press, 200 E. Ontario, Dept. 601, Chicago 11

### \$100 "MIRACLE" CAMERA

can be Yours for **\$3.95** Only



Make your own High-Speed Camera—Enlarger—Slide Projector—Movie Film Viewer—Shadowgraph—Burglar Alarm Lights—Engraving Spot—Telescope—Signal Light—Magnifier—Code Blinker Light.

ALL OF THESE and many more useful things can be made with this fine precision made piece of optical equipment.

Contains color corrected anastigmat lens 2 1/4 inches in diameter, 5 1/2 inch focal length, Cast Aluminum Case, Water-Tight Cover Glass, Front Surface Reflecting Mirror, Reticule, Lamp Socket, 28-Volt Lamp Bulb, Micrometer Adjustment of Socket, Bull's-Eye, etc. Booklet of instructions showing how to make many of the above items included. This offer may never be repeated. Rush check or money order today to

**ELECTRONIC PRODUCTS CO., Dept. PM, St. Charles, Ill.**





# Earn **BIG PAY** while learning

**VETERANS CAN EARN UP TO \$290.00** per month while training  
**Learn By Doing in Big Allied Shops**

- MACHINIST TRADE.
- DRAFTING—ALL BRANCHES.
- TOOL, DIE MAKING & DESIGNING.
- TOOL ENGINEERING.
- PRODUCT ILLUSTRATION & DESIGN.

• **BIG DEMAND FOR TRAINED MEN**

Accredited by The American Society of Tool Engineers. Endorsed by Leaders of Industry throughout U.S.A.

**FREE Employment Service After Graduation**

**ALLIED SCHOOL OF MECHANICAL TRADES, Inc.**  
 1338-1340-1342 S. MICHIGAN AVENUE  
 429 ALLIED BUILDING, CHICAGO 5, ILL.

Write for **FREE BOOKS**  
 A 1c Postcard will do

## **NEW! CHEAP! OIL BURNER** SWEEPING THE COUNTRY!

**SALESMEN BIG MONEY** SLIPS INTO ANY COAL RANGE, STOVE OR FURNACE  
 Amazing quick, intense heat. By finger-tip control. Cheaper than coal. No more shoveling coal or ashes. **SENT ON TRIAL.** Prove it pays for itself quickly by what it saves. \$1 bonus for testing. We'll let you try one in your own home for one month. Write for details today. Northwest Mfg. Co., Dept. 833-L, Mitchell, S. Dak.

## **MAKE MONEY IN LANDSCAPING**

Thorough training by Internationally known Landscape Architect to start your own business, improve your home or advance in this well paid field. Many Opportunities. Approved for Veterans. Send for **FREE BOOK**.



**NATIONAL LANDSCAPE INSTITUTE**  
 Dept. P-9, 310 So. Robertson Los Angeles 48, Calif.

## **'How to Make Money with Simple Cartoons'**

A book everyone who likes to draw should have. It is free; no obligation. Simply address **FREE BOOK**  
**CARTOONISTS' EXCHANGE**  
 Dept. 99D Pleasant Hill, Ohio

## **LOCKSMITHING & KEYMAKING**

HOME TRAINING OUTFIT INCLUDES KEY MACHINE, SUPPLIES AND TOOLS TO GET STARTED IN BUSINESS  
 Professional outfit. Get practical training from Master Locksmiths. Learn to cut keys by code, master locks, change combinations, quickly identify key blanks, many profitable "tricks of the trade." Booklet of information **FREE**. Write today. **UNITED SUPPLY & SERVICE, 3327 Madison St., Dept. PM-9, Chicago, Illinois.**

## **New Sensational Discovery for**

## **WRINKLES, BLACKHEADS, ENLARGED PORES**

**Not a Cream or Mask! A Revolutionary New Home Device!**  
**MILLIONS OF PROSPECTS BIG QUICK PROFITS**

Internationally-famous Skin Specialist makes greatest Beauty Aid Discovery in years. Nothing like it ever seen before. Produces startling results. Amazing appeal to girls, women and men with wrinkles, blackheads, enlarged pores, dry or oily skin, other skin blemishes. Virgin territory. Prospects galore. Get in on ground floor of fast profits. Write today!



**MIDWEST INTERNATIONAL PRODUCTS CORP.**  
 1148 W. CHICAGO AVE., Dept. 804  
 CHICAGO 22, ILL.

# **Yes, More Brilliant Than a Diamond!**



## **Amazing New Discovery**

Write today for the **FREE** illustrated booklet that tells the full story of the latest miracle of science—the story of a glorious jewel discovered in the laboratories of one of the world's largest corporations. Read all about the Kenya Gem that so closely resembles a diamond that only an expert can tell the difference.

## **More Fire! More Brilliance!**

Yes, this marvelous gem has more brilliance, more fire and more dazzling display of color than the finest diamond of equal size. And yet you can now own a brilliant one (1) carat unset Kenya Gem for only \$24. Kenya Gems run from 1/2 carat to 8 carats, all expertly cut; also men's brilliant, stylish rings of all sizes and ladies' rings, bar pins, brooches and earrings. *If you wish, you can buy on EASY PAYMENTS.*

## **The Cinderella of Science**

Kenya Gems are the sensational discovery that you read about in the Jewelers' magazine and The Sat. Eve. Post, "the only thing on earth more brilliant than a diamond." It is a true gem, crystallized by science instead of nature.



Copyright 1950 Kenya Gem Corp.

**Write Today or Send Coupon for FREE Illustrated Booklet**

**KENYA GEM CORPORATION, Dept. 289 Philadelphia 44, Pa.**

### **Mail This FREE Coupon Today**

Kenya Gem Corporation, Dept. 289 Philadelphia 44, Pa.  
 Please send me, without obligation, the **FREE** illustrated booklet telling all about Kenya Gems.

Name .....

Address .....

City ..... State .....

# **SANDEE**

Mufflers—All Ford, Chev., Ply....\$4.45

All Buick, Pont., Olds., Chrys., Dodge, Hudson, K.F., Pack., etc....\$5.45

V-8 and Merc. Duals (32-50 incl.)  
**\$15.95**



**DURABILITY**  
 Olds V-8 Duals \$35

Beautiful **SANDEE** Fender Skirts **\$9.95**

A **SANDEE Sportone** will outlast two ordinary mufflers and give More Power! More Speed! More Mileage!—plus a tone quality unsurpassed.

Please ship (item): \_\_\_\_\_ Price \_\_\_\_\_  
 Car and Year \_\_\_\_\_ Name \_\_\_\_\_  
 Address \_\_\_\_\_

**SANDEE MUFFLER CO. 5643 Corryne Pl. Culver City, Calif.**

**"TOOK IN \$217  
FIRST 10 DAYS"**

**Some Make More,  
Some Less... We Help  
You to Start Your  
Own All-Year  
Business, Make  
Big Money!**



With our easily operated, highly efficient wall washer, Chas. Stelle took in \$217 gross in first ten days. E. L. Goss took in more than \$10,000 in one year. E. C. Taber wrote, "I made \$400 gross in two weeks." And no wonder — this machine washes walls 6 times faster and better than by hand.

**Your Money-Making Opportunity**

We want more men to go into this profitable business for themselves and enjoy independence. There are customers everywhere—homes, offices, schools, churches, hotels, stores, etc. What you take in is mostly profit, for material costs are low. And there's no need to rent a shop or office. Operate your business from your home.

Lose no time. Get all facts without obligation. **WRITE FOR FREE INFORMATION.** Ask for Wall Washer Details at once.

**VON SCHRADER MFG. CO., 966 PL, RACINE, WIS.**

**3 TRADES IN 1 CAREER**

**Secures Your Future**



**WATCHMAKING • JEWELRY- ENGRAVING  
STONE SETTING**

**TRAINED MEN** in these Trades have Priority in Industry and Emergencies. Each trade a full-time job; together the 3 assure numerous high-paying opportunities.

Profit by the **Nationally Recognized Training Methods of the K. C. School of Watchmaking.** — MAIL THIS COUPON TODAY.

**KANSAS CITY SCHOOL OF WATCHMAKING**  
1218 Admiral Blvd.  
Kansas City 6, Missouri

Please send me, without obligation, complete information on training in the above courses.

Name \_\_\_\_\_  
Street \_\_\_\_\_  
City \_\_\_\_\_ State \_\_\_\_\_  
 Check if Veteran G. I. Approved

**Christmas  
Handbook**

144 PAGES  
CLOTH  
\$2.00

**A Wonderful Collection of  
Ideas, Gifts, Decorations,  
Toys—You Can Make!**

Popular Mechanics new Christmas Handbook is certain to fill a long felt Christmas-time need in thousands of American homes, and to be cherished as a practical, useful gift. There are articles on entertaining and decorations for Christmas-time hostesses—and how-to-do-it instructions for the making of beautiful greeting cards and gifts of all kinds.



**Partial Contents**

How to Select a Xmas Tree, Exterior and Interior Lighting, Rotating Xmas Trees, How to Make Your Own Greeting Cards, Helpful Hints on Home Decoration, Tips for the Holiday Hostess, How to Make Gifts for All Ages, The Story of Christmas, Christmas in Other Lands, Centerpieces, etc., Gift Wrappings, Christmas Games, How to Make Candles, Xmas-Tree Ornaments.

**Order From**

**POPULAR MECHANICS PRESS**

200 East Ontario Street Chicago 11, Illinois

**Got an Idea? An Inventive Mind? . . .  
Want to Cash In on It? . . .**

**THEN GET**

CLOTH  
BINDING  
**\$2.50**

**MONEY  
from IDEAS**

**MONEY FROM IDEAS** by Myron P. Laughlin, is a down to earth, informative and useful book for every man with an active, inventive mind, who believes he has ideas that can be patented.

Get this book to determine what inventions are needed for today's market, and how to go about inventing them; how to get a patent, protect it, sell it and make money out of it.

144 pages, well illustrated, indexed, and contains an appendix of patent forms, most valuable for the sale, assignment or licensing of patents.

**Vital, Informative and Practical Help!**

Inventions and How They Are Patented—What Inventions Can Do For You—The Growth of an Idea—Let Others Experiences Guide You—An Invention, How It Was Developed—An Invention, How It Was Protected—An Invention, How It Paid Its Way in the World—How to Make Money From Inventions—Invention is a Business—Specialization—Sources of Information, A Where-to-Find-It Index—Records of Progress—Development Work—Starting a Business—Selling Patent Rights—Selecting a Patent Attorney—Patent Forms—Form of Assignment and Royalty Agreement—Form of License—Helpful Books.



**POPULAR MECHANICS PRESS**  
200 E. ONTARIO ST.  
CHICAGO 11, ILL.

FIX ANY AUTO • EARN MORE MONEY

Get Drake's **AUTO REPAIR Manual**

**Latest 1950 Edition Now Ready**

At last! Simplified, up-to-date instruction for tuning-up, adjusting, repairing and over-hauling all the popular makes of cars. Special emphasis on auto engines makes it easy to locate troubles and handle all kinds of ignition, fuel system and carburetor jobs. Get Drake's Automobile Repair Manual today. Thousands of copies of older editions in use everywhere. Newest edition has added pages, added illustrations and information never before in print.

An investment of only \$3.00 will save you time and trouble and make money for you. One repair job will pay for the book many times over. Hundreds of vital subjects covered and made plain as ABC. 439 Pages. 253 Illustrations.

Frederick J. Drake & Co., Dept. 16, 117 Green Bay Road, Wilmette, Ill.



**MONEY  
BACK  
IF NOT  
SATISFIED**

Clip this ad and mail with only \$3.00, currency, check or money order, or we will send C.O.D. Use the book for 5 days. See how easily you can make it pay for itself hundreds of times over. Then if you are not fully satisfied—send it back and we will refund your money quick. Rush your order today. Get started at once.

**New Way to Improve YOUR ENGLISH**

A command of effective English gives you added advantages and better opportunities. Poor English handicaps you more than you will ever realize. You can improve your English through Sherwin Cody's 100% self-correcting invention. If you are embarrassed by mistakes in grammar, spelling, punctuation, or pronunciation, this new free book "How You Can Master Good English in 15 Minutes a Day" will prove a revelation to you. Send for it now. It is free. No obligation. No agent will call. Address **SHERWIN CODY COURSE IN ENGLISH, 59 B&O Building, Rochester 14, N. Y.**

**TRAIN Your VOICE!**

**RESULTS GUARANTEED**  
STRENGTHEN your voice this tested, scientific way. Yes—you may now be able to develop the POWER of your speaking and singing voice in the privacy of your own room. Self-training lessons, mostly silent; no music required. Write TODAY for Eugene Feuchtinger's great booklet "How to Strengthen Your Voice." It's absolutely FREE! You must state your age. Booklet mailed in plain wrapper. No salesman will call. Send your name and age RIGHT NOW! Perfect Voice Institute, 1141 S. Wabash Ave., Studio J-2, Chicago 5, Ill.

**SAY YOU SAW IT IN POPULAR MECHANICS**

**125 NEW HOME DESIGNS**  
SENSATIONAL NEW BOOK \$1.00  
**125 DESIGNS for CONVENIENT LIVING**  
—by Richard B. Pollman, nationally famous home designer — Outstanding Value! — 128 big 9x12 pages! 75 pages designs and floor plans — 50 pages home planning help! Module-Rule! Module-Graph! Scale Furniture Cut-outs! Send \$1.00 at once for your copy. Postpaid. **DELIGHTED**  
**HOME PLANNERS' INC. 18600 SCHOOLCRAFT DETROIT-23-MICHIGAN**

**Rupture Troubles Ended**

Advanced method has healed thousands. No leg straps, no elastic, no plasters. No pressure on hips or spine. Flexo-pad. Entirely different. Endorsed by doctors, mechanics, clerks. Very light. **INEXPENSIVE. GUARANTEED.** Write for information and trial.

**SMITH MANUFACTURING COMPANY**  
EST'D 1893 DEPT. PM PRESTON, ONTARIO

**SILVER SOLDER TORCH & KIT \$6**  
JOINS ALL METALS PERMANENTLY  
Do your own repairing. KIT includes one tube silver solder flux and 10 5-in. lengths silver solder alloy. Hottest **ALCOHOL TORCH** known. 2700° F. Same. Operates in any position, indoors or out. Torch alone \$5. KIT alone \$1.50. **AMERICAN PRODUCTS CORP., 422 S. Dearborn St., Chicago 5, Ill.**

**UP TO 25% MORE MILEAGE ON CARS, TRUCKS & TRACTORS**  
QUICKER PICK-UP . . . BETTER MILEAGE WITH ECONOMICAL NEW VAPORIZER  
Drivers claim up to 25% savings with new water vaporizer operating on fighter plane principle. Eliminates carbon and "pinging". Get faster pick-up, better performance. NOW for first time, fully automatic unit available at **LOW COST!** For cars, trucks & tractors. Won't harm engine. Water vapor improves efficiency. Easily installed. Give make, year, no. cylinders of car. **ONLY \$5.95 Postpaid. Send Money Order.**  
**AUTOMATIC VAPORIZER MFG. CO.**  
Box 7033, Station G Los Angeles 37, California

**SALESMEN!**

**WRITE  
THREE  
WORDS  
COLLECT  
\$7.65**



**SENSATIONAL NEW ADVERTISING SIGN**

**YES, MAKE \$7.65 on 10-second demonstration to merchants. Write on glass with amazing magic crayon and presto—a 5-color advertising message takes fire and glows like a brilliant neon sign! Three sales a day and \$22.95 profit is for "lazy" men. Workers can double to triple that amount. FREE SALES KIT. Don't wait. Rush your name and address on a penny postcard for full details and complete sales kit—ALL FREE.**

**MAXILUME CO., 125 W. Hubbard DEPT. L-89 CHICAGO 10, ILLINOIS**



**Start As High As \$3,450 YEAR**

**MEN — WOMEN** **FRANKLIN INSTITUTE**  
(Not Government Controlled)  
Dept. H-84  
Rochester 4, N. Y.

Postoffice Clerks-Carriers  
Railway Postal Clerks  
Stenographers  
Accountants  
Statistical Clerks  
Typists  
Liquor Inspectors  
Many Other Jobs  
Veterans Get Preference

Gentlemen: Rush to me, FREE of charge, list of U. S. Government big pay jobs. Send FREE 40-page book describing salaries, vacations, hours, work, etc. Tell me how to qualify for one of these jobs.

**COUPON**

Name \_\_\_\_\_  
Street \_\_\_\_\_  
City \_\_\_\_\_ Vet? \_\_\_\_\_

**MAIL COUPON TODAY SURE**

# \$175<sup>00</sup> PROFIT IN MY FIRST FIVE DAYS!

With PRESTO, Science's New  
Midget Miracle Fire Extinguisher



"Easiest Money I Ever Made," says  
C. S. Melious. Many others "cleaning  
up" — so can YOU!



Science's New  
Midget Miracle  
"PRESTO"

**A**MAZING new kind  
of fire extinguish-  
er. Tiny "Presto" (about size of a flash-  
light!) does job of bulky extinguishers  
that cost 4 times as much, are 8 times  
as heavy. Ends fires fast as 2 seconds.  
Fits in palm of hand. Never corrodes.  
Guaranteed for 20 years! Sells for only  
\$3.98!

Show it to owners of homes, cars,  
boats, farms, etc. — make good income.  
H. J. Kerr reports \$20 a day. C. Kama,  
\$1,000 a month. Write for FREE Sa'es  
Kit. No obligation. MERLITE INDUS-  
TRIES, Inc., Dept. 59, 201 East 16th St.,  
New York 3, N. Y. (If you want a regu-  
lar Presto to use as a demonstrator,  
send \$2.50. Money back if you wish.)

Earn BIG MONEY in

## RADIO TELEVISION ELECTRONICS!

**QUALIFY NOW — IN YOUR OWN HOME!**

YOU can be a success in America's fastest-growing  
industries! You can get a Government First Class  
Radio-Television Broadcast Operator's License in  
your spare time—at home! Unlimited opportunities  
for the licensed man in Radio-Television Servicing  
. . . Public Address System work . . . Police, Fire,  
Emergency Radio . . . Airlines Radio . . . Radio and  
Television Broadcast Engineering. No previous  
training or experience is required. Prepare for a  
good job with BIG PAY and a bright future in an  
exciting career field. Find out now how YOU can  
make your start to SUCCESS! Fill in and mail this  
coupon today!

**GET FULL INFORMATION — FREE!**

CENTRAL RADIO AND TELEVISION SCHOOLS, INC.  
Dept. B, 1644 Wyandotte, Kansas City, Mo.

I want complete information on how I can succeed in  
Radio, Television and Electronics. This does not obligate  
me in any way.

Name \_\_\_\_\_  
Address \_\_\_\_\_  
City \_\_\_\_\_ Zone \_\_\_\_\_ State \_\_\_\_\_  
Age \_\_\_\_\_ Vet? \_\_\_\_\_

## 14K GOLD PLATED CHRONOGRAPH WRIST WATCH

LOWEST  
MARKET  
PRICE  
\$6.75

(Formerly Priced at \$9.95)



Sweep Second Hand; Precision Work-  
manship; Rugged Shock-resistant case;  
Radium hands and numerals; Leather  
strap. It measures distance, speed of cars,  
planes, horses and other moving objects.  
It's a time keeper, stop watch, telemeter,  
tachometer. ONE YEAR WRITTEN  
GUARANTEE and full operating instruc-  
tions enclosed with each watch. SEND  
NO MONEY. Mail your order today.  
Pay postman \$6.75 plus 10% Federal  
tax. Total \$7.43 plus postage. Or send  
cash (money order or check) with your  
order and save postage charge. CHROME  
CASE MODEL \$6.50 Plus Tax. Total  
\$7.15.

MARDO SALES CO., Dept. 1712

480 LEXINGTON AVE.

NEW YORK 17, N. Y.

## Learn ELECTRIC APPLIANCE REPAIR AND SERVICE

FREE! PLAN FOR YOUR SUCCESS

BIG PROFITS — BIG DEMAND for qualified men in field of  
Home Freezers, Washing Machines, Dishwashers, House wir-  
ing, Auto electricity, etc. Learn at home — start your own  
business. NO PREVIOUS EXPERIENCE NEEDED. Special  
tools & equipment furnished. Earn while learning. Write for  
YOUR FREE SUCCESS PLAN — ACT NOW!

PACIFIC TRAINING SCHOOL Dept. P-509

7217 South Broadway

Los Angeles 3, California

FREE  
BOOK

## ROOM CHILD'S DUO-DRIVE SPORT CAR

FOR 2

HIT OF THE YOUNGER SET

\$24.95

ORDER  
BY MAIL

Seats two (Age 2 to 8 yrs.) Steers and  
pedals easily, either or both sides. Red  
enamel steel with varnished wood side  
panels. Big 3"x1:25 tires. Ball bearing  
drive. Size 20" H. x 22" W. x 40" L. — 45  
lbs., shipping wt. Durable. Store price up  
to \$35. Mail price only \$24.95. Enclose  
payment or \$5.00 deposit. Balance C.O.D. on arrival. Free catalog.



ESHELMAN, Dept. 18, 119 Light Street, Baltimore 2, Md.

AMAZING  
SAVINGS  
Free Color  
Catalog

## BARBELLS

Only

\$7.98



Famous Dan Lurie

Low, low foundry prices! Mail  
orders filled same day. Write  
today!

DAN LURIE BARBELL COMPANY  
Dept. 159J, 1701-M9 Pitkin Ave.,  
Brooklyn 12, N. Y.

## LOCKSMITHING & Key Making

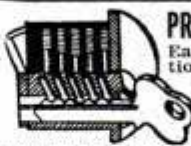

PRACTICAL UP-TO-DATE COURSE—ONLY \$3.95

Easy-to-learn modern information for self-instruc-  
tion. How to work on locks, de-code, make master-  
keys, repair, install, service, etc. For every  
handyman, home owner, carpenter, mechanic,  
service station operator, fix-it shop, hardware  
dealer, runsmith. 53 plain illustrated lessons.  
FULL PRICE ONLY \$3.95. SEND NO MONEY.

Just pay postman plus C.O.D. postage. Or send \$3.95 with order,  
we'll ship postpaid. Satisfaction guaranteed or refund.  
NELSON-HALL CO., 1139 S. Wabash Ave., Dept. J-2, Chicago 5, Ill.



**GROW YOUR OWN . . .** vegetables, flowers, house  
plants by hydroponics  
(without soil). It's easy to get big returns in a small space,  
indoors or outdoors. A clean pleasant way to grow any plant  
for fun or profit. Send postcard for free picture book.

GILBERT & CO., 3535f Enterprise, San Diego 10, Calif.



EXTRA LOUD  
**TWANGERS**  
GENUINE MUSIC WIRE  
EXTRA HEAVY

EASY TO  
INSTALL  
NO DRILLING



Protects Car Fenders — Doors — White Sidewalls!  
Deluxe Quality! Sensational  
Value!

Send \$1.00 (postpaid)

Address: Lumidor Co., Los Angeles 58, Calif.

\$1.00  
PR.  
BOXED

Make Use of  
**POPULAR  
MECHANICS  
BOOKS**

# STREAMLINED HELP



**BETTER JOBS  
HOBBIES  
AND PASTIMES  
HOME AND FARM  
WORK SHOPS  
HOME REPAIRS-  
IMPROVEMENTS**

## THE INEXPENSIVE PRACTICAL BOOKS WITH A MILLION READERS!

Want help on your job—extra knowledge that brings extra pay? Want to save money on home repairs? Want practical information to better enjoy hobbies and home and farm workshop projects? Then get a Popular Mechanics Book. These easy-to-use books, written in plain, everyday how-to-do-it English, and extravagant with pictures, plans, diagrams, etc., will give you the practical help you need. Full library size, cloth bound book unless otherwise described. Rush order on coupon today. Money back if not satisfied.



### FORTY POWER TOOLS YOU CAN MAKE

Have your own powered workshop at low cost. Tells how to make forty different machines such as lathes, drill press, jig saw, band saw, circular saw, sanders, from pipe fittings, old auto parts, wood, etc. New 1948 edition. \$1.50

### POPULAR MECHANICS PHOTO HANDBOOK

An entirely new and different book from our popular Photo Guide. It's a complete guide to better pictures and darkroom technique, and features dozens of handy gadgets you can make yourself. \$2.00

### 23 BOATS YOU CAN BUILD

Brand New! More than 500 photographs, plans, drawings and diagrams with step-by-step instructions for building rowboats, runabouts, sailboats, a sloop and even a 25-foot cabin cruiser which sleeps four people. Makes building easy for men with limited tools and no experience. \$2.00

### WHAT TO MAKE FOR CHILDREN

A Popular Mechanics book for Dad, Mother and the whole family. Shows how to make toys, dolls, doll houses, slides, see-saws, rocking horses, furniture. 175 projects to make from discarded or inexpensive materials. \$2.00

### THE GARDEN BOOK

How to build your own trellises, fences, lawn furniture, outdoor fireplace, attractive ornaments and other things for your yard and garden. Beautify your grounds—enjoy attractive equipment—at low cost. \$1.50

### OUTDOOR SPORTS MANUAL

220 helpful articles and hints for fishermen, hunters, campers, trappers, archers and boatmen. If you love the outdoors, double your enjoyment with the help of this new book. Contains 334 illustrations. \$2.00

### WHAT TO MAKE. 12 Volumes



The famous annual craftsman's guide. Shows what to make and how to make hundreds of things in spare time for fun or profit. Novelties, gifts, toys, games, furniture, etc. Cloth bound and filled with instructive pictures. Single volumes each \$1.75. Save money on 12 volume set, complete only \$18.00

### MONEY MAKING HOBBIES

Your hobby can pay its own way and produce a profit. A selection of craft articles written by widely known, expert craftsmen, and designed to produce extra income as well as pleasure and recreation. Contains 46 comprehensive projects (132 different things to make!) for both the beginner and the experienced craftsman. \$2.00

### POPULAR MECHANICS MOTORIST'S HANDBOOK

For every man who drives a car and wants to do his own servicing and simple repairs. A money-maker for the professional auto repairman. Hundreds of ideas, helps, and kinks you can use every day. \$2.00

### CONCRETE HANDBOOK

How to do all types of concrete work and make ornamental things of cement—walks, driveways, foundations, steps, vases, benches, etc. Ideal book for home owner, handyman and construction men. \$2.00

### WELDING, BRAZING AND SOLDERING

How to construct welding equipment and use it effectively—small arc welder, spot welder, arc torch. Best approved methods, tricks and kinks to use in soldering, brazing, heat treating iron and steel. \$1.75

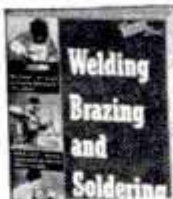

### YOUR HOME AND HOW TO BUILD IT YOURSELF

Step by step instruction by which anyone with ordinary knowledge of use of hand tools can build a five-room house complete. Every detail is shown in pictures with amazing clarity. Will save hundreds of dollars building any house. Spiral bound. \$3.00. Complete set regular builders plans \$12.50. Book and plans \$14.00.

### FARM MANUAL

Hundreds of articles on making farm implements and equipment, maintaining the home, farm workshop, live stock and poultry, many farm hints and kinks. A book for every member of every farm family. 284 pages. Hundreds of illustrations. \$3.00



### THE BOY MECHANIC

One of the most popular and best known Popular Mechanics publications. Describes hundreds of things for boys to do and make. Develops natural talents and industry. Crammed with how-to-do-it illustrations. The perfect gift for every boy. \$2.00

### PLANNING YOUR HOME WORKSHOP

By Sam Brown, a recognized authority on home workshops. Now you can have the kind of home workshop you've always dreamed of having with this book to show you how! Covers shop layout, maintenance, shop furniture, projects and sources of supply. Actual photos of famous workshops you can use as a guide. \$2.50

## USE THIS HANDY COUPON • Mail Today

POPULAR MECHANICS PRESS, Dept. 950, 200 E. Ontario St., Chicago 11

Send Popular Mechanics books checked.  I will pay postman, plus charges (U.S.A. only).  Remittance enclosed—send fully prepaid. I will return books in five days for return of money if not satisfactory. Outside U.S.A. please add 15% for postage and wrapping.

Forty Power Tools . . . . .	\$1.50	What to Make (Children) . . . . .	\$ 2.00	Boy Mechanic . . . . .	\$ 2.00
Home Workshop . . . . .	2.50	Garden Book . . . . .	1.50	Concrete Handbook . . . . .	2.00
Motorist's Handbook . . . . .	2.00	What to Make (1 Vol.) . . . . .	1.75	Welding, Brazing . . . . .	1.75
Photo Handbook . . . . .	2.00	12 Volumes . . . . .	18.00	Your Home . . . . .	3.00
23 Boats . . . . .	2.00	Money Making Hobbies . . . . .	2.00	Book with Plans . . . . .	14.00
Sports Manual . . . . .	2.00			Farm Manual . . . . .	3.00

Name \_\_\_\_\_

Address \_\_\_\_\_

City \_\_\_\_\_ State \_\_\_\_\_

Check for FREE Catalog

# Don't Envy The PLUMBER • Be One

## Make \$15 to \$50 a Day

Every skilled workman will tell you Plumbers have the best of it. WINTER and SUMMER the Plumber is busy at top wages. No skilled Plumber is ever out of a job. Compare his opportunities with any trade. To the man with know how, Plumbing means profit. Investigate Universal Plumbing School. Not a "war born school," but a plumbing school developed and operated by plumbers since 1923.



### Own Your Own BUSINESS

Have your own business and big profits with little other than training and a kit of tools.

### JOURNEYMAN Gets Good Salary

Master Plumbers own their own shop. A Journeyman works for a Master. With this training journeymen can depend on high wages.

### BE A PLUMBER IN JUST 32 WEEKS

Learn With Tools—Not Books  
No need ever serve an apprenticeship. Don't envy the plumbers big profits—enjoy them. Learn every trick of the trade—Leadwork—Blueprint for plan reading, etc. under Licensed Master Plumbers.

### Over 7,000 Successful Plumbers Recommend This School

This system has made more than 7,000 plumbers. Investigate our past performance. If you like to work with tools this is your opportunity. Become a Plumber in America's largest and only school devoted exclusively to plumbing. Write today for FREE information.

G. I. Approved. Established 1923

## UNIVERSAL PLUMBING SCHOOL

877 Holmes Street

Kansas City, Mo.



**SURPLUS STOCK FROM MID-WEST SUPPLY FIRM!**

# 69¢

What a buy! These sturdy, serviceable work shirts, though used, have been washed, sterilized and put in perfect condition. Every shirt is cut from durable wash materials, choice of blue or tan. Well made with reinforced stitching at strain points. Order today at our risk! Money-back guarantee!

3 for \$1.79

**SEND NO MONEY!** Just send name, address, neck size and color choice. Pay postman plus postage or send cash and we ship prepaid. Inspect 10 days. Return for refund if not delighted!

**WORK PANTS TO MATCH . . . . . 99¢**

Send waist measure and leg length

**COVERALLS . . . . . \$1.49**

Send chest measurement

**MILCO SALES, Dept. P-264, 9350 Roselawn, Detroit 4, Mich.**

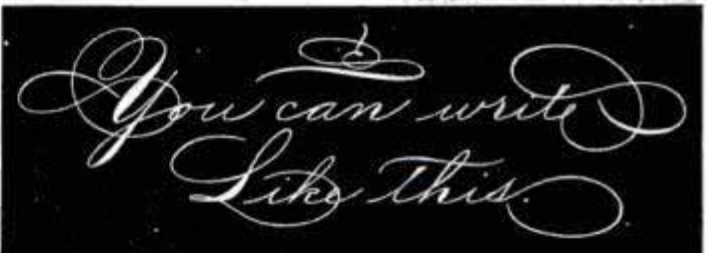

### INCREASE YOUR BUSINESS and SOCIAL PRESTIGE

Yes—you too can write like this and improve your business ability and chances for advancement. Just a few minutes a day is all it takes to become an expert penman using C. P. Zaner's **Ornamental Penmanship**—96 pages of instructions, diagrams and illustrations that show how to improve your writing. Send in for your copy of **Ornamental Penmanship** today and begin improving your writing and increasing your business and social prestige. Quantity limited. **\$1.50.**

**POPULAR MECHANICS PRESS, 200 E. Ontario St., Chicago 11, Ill.**

**SAY YOU SAW IT IN POPULAR MECHANICS**



**READ ABOUT TRAILERS BEFORE YOU BUY**

## TRAILER TOPICS MAGAZINE

Brings you the latest in Trailer Coaches—Equipment—Accessories—Trailer Trips—Trailer Parks and many other interesting features at only—\$3.00 for 2 years.

**(6 month trial subscription \$1.00)**

Send your subscription to

**TRAILER TOPICS MAGAZINE, (Room 1510B) 28 EAST JACKSON BLVD. CHICAGO 4, ILL.**

## LIFETIME CHRONOGRAPH, STOP-WATCH CALENDAR WATCH

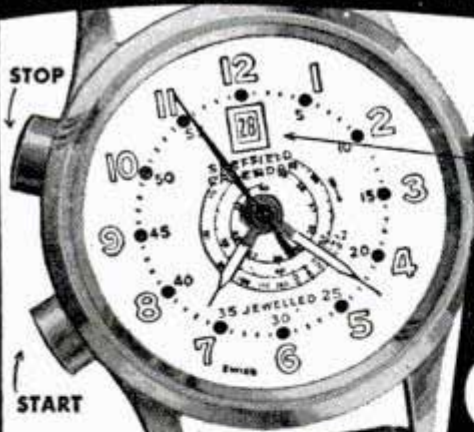

It's also a **TELEMETER & TACHOMETER**

CALENDAR

WINDER

NEW LOW PRICE

# 895

with Steel Expansion Band Plus 10% Tax (90c)

### 31-Day Calendar

Changes dates automatically! For Sportsmen, Scouts, Photographers, Engineers, Chemists, Navigators, Doctors.

**FULLY GUARANTEED for One Year**

**Plus Lifetime Service Certificate. 5-Day Free Trial.**

**Remarkable Import Buy**—these ideal all-around timepieces and chronographs at an unbelievable low, low price. Imported Swiss jeweled movement, Radium Glow 1" dial, red sweep-second hand, shock-resistant case, unbreakable crystal. And—included is the handsome, rich-looking steel expansion wristband. Complete instructions included together with guarantee and service certificate. White, Pink or Black dial face, specify color.

**GAYLORD** Dept. PJ-7, Fifth & Hamilton, Pittsburgh 6, Pa.

I enclose  Check  Money Order  Send C.O.D.  
Send \_\_\_\_\_ Chronograph watches at 8.95 (Postpaid), plus 10% tax on 5-day free trial. **Money Back Guarantee.** Name & Address on Margin.

*NOW READY! A Sensational New Line Of*  
**1951 MIDWEST TELEVISION**

*Complete CHASSIS and BEAUTIFUL CONSOLES*  
*Featuring the New MAMMOTH* **19 1/2** Inch *PICTURE TUBE*

**FACTORY-TO-  
 YOU on  
 30 DAYS  
 TRIAL**



**"VIDEO GRAND**  
 19 1/2-Inch Picture (225 sq. in. image) Television-Radio-Phonograph Console

**EASY  
 TERMS**



**"CONSTELLATION"**  
 19 1/2" Television Console with BIG 12" Panasonic Speaker

**NOT A KIT!**  
 This is A Completely Assembled Receiver

Never before have you seen such tremendously BIG clear pictures, such luxurious cabinets, such sensation-ally low Factory Prices as Midwest offers in its 31st Anniversary Line of 19 1/2-Inch and 16 1/2-Inch Television receivers. They are available in complete ready-to-use chassis for custom installation in your own cabinet...or in luxurious console cabinets with Television only or in TV-Radio-Phonograph combinations. All are offered on Midwest's famous 30 Days Trial right in your own home.

Plus Powerful New 1951 World-Ranging 5-Band  
**MIDWEST** SERIES 16 **RADIOS**  
 In Beautiful Consoles and Complete Chassis



An entirely new line featuring the powerful Series 16 AM-FM Five-Band Radio Chassis and the magnificent Symphony Grand Radio-Phonograph with 3-Speed Automatic Intermix Record Player.

**EASY  
 TERMS**

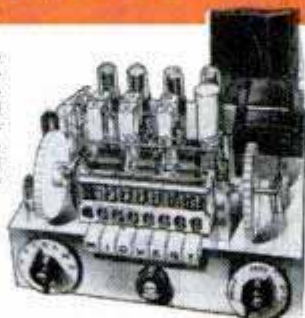

**SEND COUPON TODAY**  
 For This NEW 1951 4-Color

**FREE** MIDWEST  
 RADIO-  
 TELEVISION  
 CATALOG



• WRITE IN NAME AND ADDRESS (PLEASE PRINT) ON COUPON OR 1c POSTCARD

MIDWEST RADIO & TELEVISION CORP.  
 Dept. 25B, 909 BROADWAY • CINCINNATI 2, OHIO  
 Please send me your new FREE 1951 Catalog.

NAME \_\_\_\_\_  
 ADDRESS \_\_\_\_\_  
 CITY \_\_\_\_\_ ZONE \_\_\_\_\_ STATE \_\_\_\_\_

**MIDWEST RADIO & TELEVISION CORP.**  
 DEPT. 25B, 909 BROADWAY, CINCINNATI 2, OHIO

# How to **IMPORT!** For Profit and Pleasure

A ONCE-IN-A-LIFETIME OPPORTUNITY

World Trade boom offers new, big money opportunities for men and women! Now you can learn how to import at low foreign prices for buyers in your locality at high United States prices.

## BUY-SELL, WORLD-WIDE WITHOUT CAPITAL

Big profits possible, no investment in goods, operating world-wide business from your own home by mail order, spare or full time. (See examples of recent prices in other countries, at left.) Also big savings on clothes, tools, gems, antiques, watches, cameras, china, silk, toys, etc., for your own use. Get FREE list of over 1000 low priced products for import from Europe, the Orient and other parts of the world. It makes no difference where you live. World Trade can be carried on in or near small towns or large cities—anywhere. World travel opportunities. Practical, low-cost World Trade Course teaches you quickly at home in spare time.

## WORLD TRADE GROUP HELPS YOU START

Membership in International Traders Guild included with course. Helps you get samples and prices and get after big profits NOW Importing and Exporting. No previous special experience or schooling required. World Trade Certificate awarded. There is no obligation when you send for FREE details and list of Imports. (No salesman will call on you.) Write today. Airmail reaches us overnight.



The Mellinger Co., Exporters-Importers  
1418 DQ Westwood Blvd., Los Angeles 24, Calif.



# MAKE BEAUTIFUL TRAYS, COASTERS, PLATTERS, OTHER ITEMS

OF ALUMINUM,  
COPPER, BRASS

—Quickly, Easily, at Low Cost!

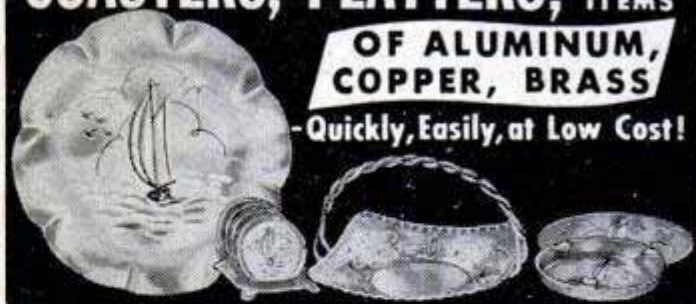

LOW, WAREHOUSE-TO-YOU PRICES ON PRE-CUT METALS!

FREE  
DIRECTIONS

You don't have to be an experienced metal craftsman to learn this easy, profitable hobby! Make beautiful metal Serving Trays, Coasters, Platters, Ash Trays, Ornaments, etc.—for your home, gifts, or Big Profits. No previous experience necessary. Our FREE Instructions explain how. We supply pre-cut metals.

OUR LOW, DIRECT-FROM-WAREHOUSE-TO-YOU PRICES—ON COMPLETE SIZE RANGE OF PRE-CUT CIRCLES, SQUARES AND RECTANGLES—OF ALUMINUM, BRASS, COPPER—MEAN BIG SAVINGS! Highest-quality, easy-to-work sheet metals. Die-cut—no burrs. Paper interleaved—no scratches. Wide range of sizes. Also other items of highest quality: Flat Sheet, Tooling Copper, Bracelet Blanks, Wire, Rod, Bar, Tube, Angles, Fastenings. Write today for full information—FREE Instruction Literature—and money-saving, Warehouse-to-You Prices!

## BRASS & COPPER SALES CO.

2817 Laclede Ave. Dept. PM-1 St. Louis 3, Mo.

## PLEASURE! — PROFIT!

LEARN AT HOME: Watch-clock repairing — Basic Training for Aircraft Instrument Work

## MODERN TECHNICAL SUPPLY CO.

Dept. 9PM, 55 WEST 42nd STREET, NEW YORK 18, N. Y.

FREE TV

RTA

CATALOG & SAMPLE LESSON

RADIO  
TELEVISION  
TRAINING  
ASSOCIATION

Dept. 249  
972 BROAD ST.  
NEWARK 1, N. J.

Rush me your FREE Catalog "How to Make Money in Television," in spare time, AT HOME, while learning; details FREE round trip to N. Y. C.; together with FREE Sample Lesson. I am under no obligation.

Name.....Age.....  
Address.....

# BAKING

— a Sound Trade  
or Business



Baking is one of America's high industries in wages. Not seasonal, but year 'round good field for trained and experienced men. Thorough basic spare time home study course lays solid foundation. If you have the aptitude for this type of work, send coupon below for FREE Booklet, "Opportunities in Commercial Baking."

NATIONAL BAKING SCHOOL  
1315 S. Michigan Ave., Dept. 1356, Chicago 5, Ill.  
Send free booklet "Opportunities in the Baking Industry" and full particulars.

Name.....  
Address.....  
City..... State.....

HOW TO  
BREAK  
and  
TRAIN  
HORSES



SEND  
FOR THIS  
**FREE!**

Make money. Know how to break and train horses. Write today for this book FREE, together with special offer of a course in Animal Breeding. If you are interested in Gaiting and Riding the saddle horse, check here ( ) Do it today—now.

BEERY SCHOOL OF HORSEMANSHIP  
Dept. 1109-D Pleasant Hill, Ohio



## Boy! What a Picture!

And boy, what a book is Popular Mechanics new PHOTO HANDBOOK. Gives you the big three of superior photography:

1. The secret of taking better shots.
2. The technique of clearer developing.
3. The way to build better photo equipment.

Be an expert! Have fun! Save money!  
Paper covered edition on all newsstands... 60c  
Order colorfully bound library volume from  
**POPULAR MECHANICS PRESS... \$2.00**  
200 E. ONTARIO ST. CHICAGO 11

SAY YOU SAW IT IN POPULAR MECHANICS



- Row Boat—12 Foot
- Dinghy—8 Foot
- Dinghy—14 Foot Sailing
- Training Ship—6 Foot
- Sea Sled—9 Foot
- Outboard—12 Foot
- Cruiser—18 Foot
- Bicycle Boat—Kayak
- Row Boat—Sectional
- Dinghy—Sailing
- Canoe—16 Foot
- Sailing—12 Foot
- Outboard—Runabout
- Pontoons Ice Yacht

FOR PLEASURE OR PROFIT  
DESCRIBES 17 LOW COST BOATS  
Get this outstanding book and build a boat at home for your own use or to sell at a profit. You can do it. Just the boat you've always wanted—power, sail or row boat—17 different kinds and sizes.  
Order BUILD A BOAT on postal card and pay only \$2.00 plus postage on delivery. Return in 5 days if not pleased and get money back. Or send \$2.00 with order and we'll pay postage. (Outside U. S. \$2.25 with order.) Order today.  
**POPULAR MECHANICS PRESS**  
Dept. 598, 200 E. Ontario, Chicago 11



# Recipro Register CHRONOGRAPH

## WORLD FAMOUS SPLIT-SECOND TIMER



**10 DAY FREE EXAMINATION** A handsome wristwatch of incredible accuracy! Precision made in the highest traditions of Swiss craftsmanship. Thoresen's new RECIPRO-REGISTER CHRONOGRAPH automatically computes speeds and distances down to 1/5th second tolerances! RECIPRO-REGISTER system HOLDS the result indefinitely. It remembers for you while movement continues to keep time. Compare with other stop-chronographs and you will never be satisfied with anything less than this truly precision timepiece.

**OVER 25 HIGH QUALITY FEATURES!**

- Times Planes
- Times Races
- Times Sports
- Times Photography
- Times Lab experiments
- Times Shop Work
- Shock-Resist
- It "remembers"
- 17 Ruby Jewels

Three multi-function dials automatically coupled and synchronized for hours, minutes, seconds & 1/5th seconds. Contact clutch to start computation and brake clutch to freeze Recipro-Register result. Erases back to zero. Hairline sweep-second. Radium-active dial. Unbreakable crystal. Sturdy, yet thin case with stainless steel back. Its 17 Jewel Ruby movement is electronically time tested for accuracy. A smart, thin timepiece of functional beauty. The pride of every owner. **SAVE \$50.00—ORDER YOURS DIRECT!** Recent list price 79.95. Now reduced for quick sales to \$29.95 tax paid . . . while supply lasts. Featured in Esquire and leading magazines. Instructions and gift case included. Price subject to change without notice because of international crisis. Remit 29.95, or order C.O.D. plus postage. Money back in 10 days if not delighted. **THORESEN DIRECT SALES, Dept. 6K-233, 131 West 33rd Street, (Phones: LA 4-5996 & 7) New York 1, N. Y.**

**5 YEAR GUARANTEE**

Repairs if any are ever needed, will be made **ABSOLUTELY FREE!** Never a penny charge for handling, parts, labor, etc. Your time piece cheerfully cleaned and oiled every year **FREE!** Thoresen makes lifetime friends.

**Buy Direct**

## MEN! A Blue Print For YOUR SUCCESS!



Here is your opportunity for Success An amazing new finishing system that will start you in your own profitable business. No experience necessary—up to \$10 an hour easy Spare or full time in your own home or garage Start small—grow big fast. We will guide you every step of the way This is BIG—don't miss your chance. Send name now for FREE SAMPLE and booklet of my complete, easy, profit plan for your success ACT NOW

Coast Industries Dept. 29, 1004 So. Los Angeles St. • Los Angeles 15, Calif

PROFITABLY COVERS. TOYS, RADIOS, LAMP SHADES, AUTO TRUNKS & DASHBOARDS PLUS HUNDREDS OF OTHER ITEMS



**DON'T MISS IT! ONLY 10¢**

## BIG CATALOG

WAR SURPLUS OPTICAL BARGAINS

LENSES! PRISMS! INSTRUMENTS!

## Build Your Own RIFLESCOPE, BINOCULARS, TELESCOPE, ETC.

We Furnish Optics and Instructions

- LENSES, PRISMS & RETICLES
- EYEPIECES and OBJECTIVES

Send \$1.00 for Stock #2-H 10-Piece Lens Kit and Big Instruction Booklet.

CHECK OUR BARGAINS . . . MAIL 10¢ FOR CATALOG H EDMUND SALVAGE CO., BARRINGTON, N. J.

## "SEA CRAFT" BLUEPRINTS READY NOW!

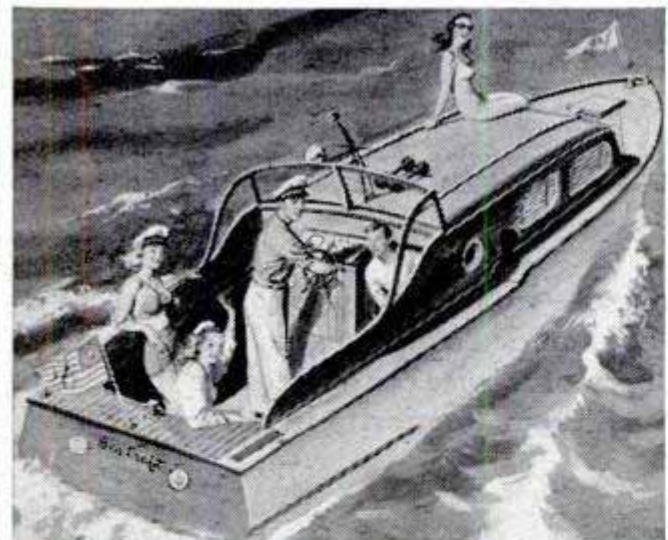

Build this luxurious cabin cruiser yourself and save money. What a beauty it is! A 25-foot boat readily adaptable as a sport fisher, express cruiser, or utility boat. Cruises effortlessly at 15 knots with a marine engine or converted auto motor. Its spacious cabin sleeps four and has a galley complete with fresh-water tank, sink, and cook stove. Has open cockpit large enough for fishing, lounging, etc.

During war the Coast Guard used "Sea Craft" for ship-to-shore travel. Order today your complete set of seven large-size blueprints scaled 1 inch to the foot. These, plus a 40-page two-color illustrated booklet giving step-by-step instructions, only \$10.00.

**POPULAR MECHANICS PRESS**  
200 EAST ONTARIO ST. CHICAGO 11, ILL.

## Say You Saw It in POPULAR MECHANICS

Which of these 2 one time WEAKLINGS PAID only a Few Cents? to become an **All-Around HE-MAN** at Home!



Larry Campbell Rex Ferrus

### WHICH ONE PAID HUNDREDS OF DOLLARS TO TRAIN AT MY SIDE?

Rex Ferrus mailed a coupon and paid only a few cents. Larry Campbell paid me hundreds of dollars.

**LET ME PROVE I CAN MAKE YOU TOO an "ALL-AROUND" HE-MAN FAST — or it won't cost you a cent — says George F. Jowett—World's Greatest Body Builder**

Just as I did Rex Ferrus, I'll teach you, at home, the "Progressive Power Method" through which I rebuilt myself from a wreck at 15, to holder of more strength records than any other living teacher!

### BUILD A BODY YOU WILL BE PROUD OF . . .

Send only 10¢ for my 5 easy-to-follow, picture-packed courses now in 1 volume, "How to Become a Muscular He-Man."

**10 DAY TRIAL!** IF these 5 courses do not PRODUCE results in ONE WEEK, send them back and I'll return your dime.

**FREE! Jowett's Photo Book of Famous Strong Men!**

**JOWETT INSTITUTE, Dept. PM-09**  
230 Fifth Avenue, New York 1, N. Y.

Dear George: Please mail to the prepaid FREE Jowett's Photo Book of Strong Men, plus all 5 Muscle Building Courses, "How to Become a Muscular He-Man." ENCLOSED FIND 10¢ in complete payment for EVERYTHING.

NAME \_\_\_\_\_ AGE \_\_\_\_\_  
(Please Print Plainly, Include Zone Number)  
ADDRESS \_\_\_\_\_ NO C.O.D.'s  
CITY \_\_\_\_\_ ZONE & STATE \_\_\_\_\_



**JOWETT GEORGE**  
"Champion of Champions"



Illustrated — GX Steel Oil Ring, one of 62 types of Perfect Circle Piston Rings for Custom Made Engines

# Perfect Circle

*THE MOST HONORED NAME IN PISTON RINGS*

Honored by  
Automotive  
Engineers



Perfect Circle Piston Rings—honored by Doctors of Motors for their dependability . . . by America's foremost automotive engineers for their design . . . and by motor-wise car owners for their economy. Perfect Circles have proved their superiority in millions of successful installations!

Honored by  
Doctors of Motors



Look for this sign. It identifies a place where your car will receive expert attention. Your local Doctor of Motors knows your car, knows the value of honest workmanship and reliable parts. He will install a set of Perfect Circles Custom Made for your car to restore power, save gas, stop oil pumping.

*Perfect Circle Corporation. Offices: Hagerstown, Indiana, and Toronto, Canada. Plants: Hagerstown, Richmond, New Castle and Tipton, Indiana, and Toronto,*



**The DOCTOR OF MOTORS**

Honored by





Along a remote tropical stream in Venezuela natives pan for gold and diamonds with cone-shaped wood dishes

# Treasure Hunt in a Lost World

By Richard F. Dempewolf

Part I

**T**ALK OF GOLD RUSHES, boom towns where eggs cost \$1.20 each and coffee a dollar a cup, natural wonders like sheer mile-high cliffs with waterfalls to dwarf Niagara, the greatest ore deposits ever discovered, oil seeping from the sand at your feet, diamonds lying in surface silt to be dug by the shovelful—and it sounds like a wild-eyed saga of the '49ers.

Yet, today that saga is being repeated with flourishes. Airplanes are the "prairie schooners" that bring prospectors to their fabulous diggings. Weird "marsh buggies" with buoyant metal drums for wheels thump and splash over mushy hummocks of the 3000-foot-high plateau swamps, carrying cargoes of geologists and explorers into new unexplored regions in search of more oil, gold, diamonds and ore. Planes equipped with magnetometers comb the air and startle their owners with readings higher than any ever recorded. Jeeps, trucks and baby bulldozers flown into boom

towns that mushroom overnight on jungle-swathed river shores, are used to push through rivers that never saw a bridge, forests that never saw a white man. Many, like the covered wagons of the '49ers, bog down and are left to rot beside the trail while their owners forge ahead on foot in search of the "bomba," or strike, that will make them rich.



Miner wears his diamond-panning dish, or batea, on his head over his hat as he dreams of a big strike



**Native woman tries her luck. One lad found diamonds worth \$5000 in five buckets of sand alongside river**

The scene of 1950's glittering frontier encompasses thousands of square miles of Bolivar State in that mysterious, remote corner of South America where the Lost World mesas of Conan Doyle rear their mile-high cliffs from equatorial jungles on the southeastern edge of Venezuela, near the Brazilian border.

Along the Rio Caroni, which has its



**These friendly Kamarakota Indians in eastern Venezuela have salvaged bucket seat of wrecked airplane**

golden source in the clouds atop the southernmost mesas, and flows northward through jungle, across the Gran Sabana—as the Lost World highlands are called—out over the low-lying llanos grasslands and into the Orinoco, is without question one of the richest, most fantastic unexploited areas the world has known. When the conquistadores came there 400 years

**While a pump sucks water out of a stream natives shovel muck from old potholes where diamonds are found**





The Lost World region in southeastern Venezuela is one of the few unexplored or "white" spots left on map

ago, they found, besides jungles and snakes, Asiatic slant-eyed, squarely built highland Indians, with sturdy mountain legs set far apart. These were Taurepanes, and they told the ancient Spaniards wild tales of "little men" and strange beasts who lived atop the mesas, isolated there for centuries by the sheer walls. They told, too, of tremendous waterfalls born in the clouds, of rivers of gold and acres of glittery pebbles in the northern jungle river beds. On the llanos, they said, thick black water oozed from the ground, and some mountains spouted fire when the lightning came.

Jungle lore? Today, nearly every one of those tales is being proved a fact. From the side of Ayuan-tepui's (Devil Mountain's) sheer Lost World cliffs, almost a mile above a tangle of jungle, spurts Angel Falls, the world's highest waterfall, plunging more than twice the height of the Empire State Building for a total 3212 feet into the humid green vegetation below. Hidden deep in an eroded canyon, it has seldom been viewed by white men, and its source, a few feet below the mesa rim, is nearly always hidden by clouds.

What about the little men and strange beasts? "For all we know," says a Venezuelan who just returned from the area, "they may be. The Gran Sabana is studded with monster mesas, one to two

miles high, some of them 20 miles across and utterly unscalable. Who knows what's up there?"

Ayuan-tepui and Mount Roraima on the Brazilian border have been scaled by a few hardy souls. But the strange mountain tops are scarred with fissures from centuries of erosion that has carved them into weird shapes and made travel across the tops impossible. Jimmie Angel, veteran Venezuelan pilot and explorer who gave his name to the falls, flew his plane to the top of Ayuan-tepui in 1937, crash landed in a swamp near the rim and was unable to travel more than a few hundred yards in any direction. Angel and his party were rescued over the side with ropes. His plane is still there.

Aside from mesa-top fauna, the Indian tales are bearing furious fruit. Northward

Street scene in frontier boom town. A smart pilot flew in a generator and wire and now charges the miners \$6 per month for each light bulb





Here are 400 carats of Venezuela's finest diamonds under critical eye of appraiser for New York firm

along the Caroni and its tributaries, in primitive unexplored jungles, the gold is there—big nuggets and placer deposits which today are being by-passed for the more exciting glittery pebbles—diamonds—so profuse that little ones are thrown away by prospectors.

For 100 miles north along the golden river, where it meanders over the low-lying grasslands, are the black-water oil seepages. The fire-shooting mountains were discovered in the last two years, by both Bethlehem and U. S. Steel, to be huge mountains of the richest iron ore in the world, ranging from 55 to 72 percent pure. Lightning indeed strikes fire from these magnetic humps, which diamond drill cores have shown to contain a billion tons of ore.

Besides all this, the rich land, which produces basketball-size pineapples and range land to feed a world stock of cattle, hides tremendous deposits of bauxite that have never been touched.

Most recent and dramatic rush to Venezuela's fabulous frontier occurred this year, for diamonds. Last fall three Italian prospectors paddled a native dugout up and down Caroni tributary rapids, probing the ledges where jungle streams cut through eroded Sabana plateaus. Finally, one day in January, ragged, tired and ready to quit, they beached their boat on a sandy ledge. Compulsively, they trotted out their suruku—a circular, three-screened panning tray—and sifted a shovelful of stream-bed gravel. The top, coarse screen held a four-carat diamond! Between them, the other finer screens held 140 diamonds ranging to one-half carat in size. It was a \$4000 haul. Excitedly they stored the stones in empty pulverized milk tins and kept digging. When food gave out, they ate fish and game brought to them by friendly Indians from near-by grass-hut villages.

To catch fish, the ingenious natives take the stalks of native barbasco bushes, fray the ends like a whisk broom until the poisonous milky sap flows freely. With these they swish the water until it becomes cloudy with the poison. The fish are stunned, float to the surface and are shot by red-loin-clothed Indian boys with bows and arrows.

By March, the three prospectors had cleared \$120,000. As the news spread, the Uriman, as the area is known, swarmed with people pouring up the Caroni in small

The Gran Sabana—two-mile-high mesas rise from almost impenetrable jungle floor. Ayuan-tepui is at right



Sketches show different ways diamonds occur in Africa and Venezuela. African diamonds are found in lava plugs of long extinct volcanoes while in Venezuela the gems are scattered widely in alluvial soil

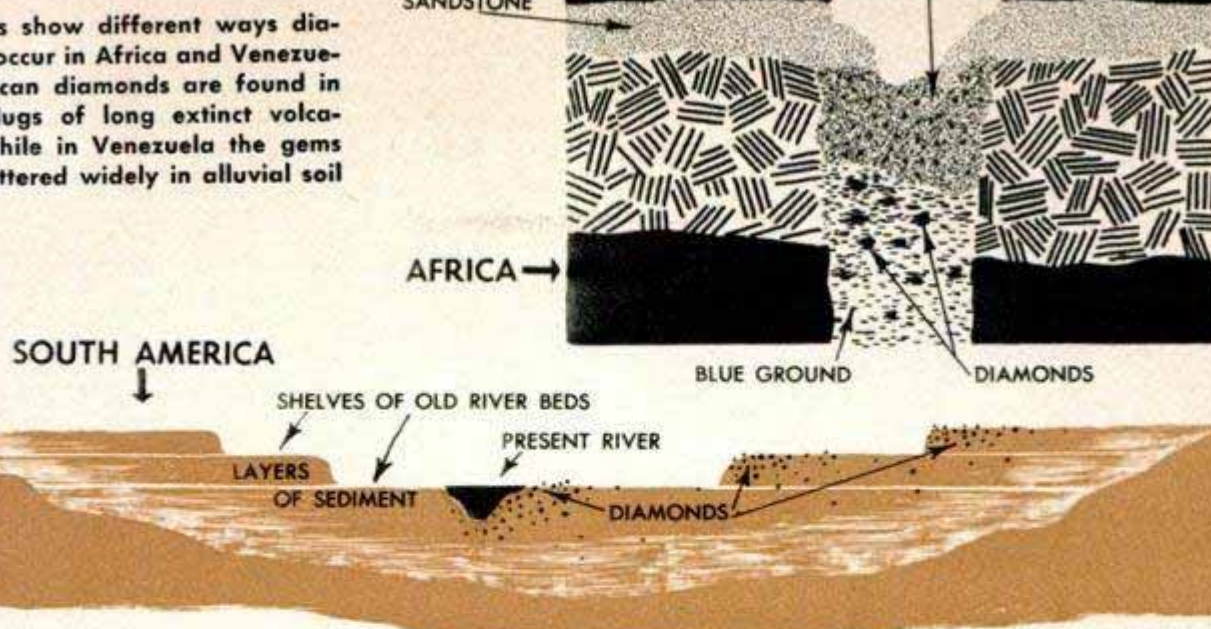

boats and rafts from outpost towns of Icaburu (which didn't exist last year, but now numbers 6000 souls), Guasipati, Peru, El Dorado. Wealthy folk flew in via Linea Aeropostal Venezolana from Caracas, Barcelona and even Brazil. A rickety boom town rose by the riverside, frontier gambling dens opened up, men went about armed but there was no thievery. Planes charged \$175 for the half-hour hop from Bolivar City on the Orinoco. Incredible strikes were made. "One 15-year-old boy," recalls a Caracan, "took five buckets of sand from a Caroni tributary and came up with \$5000 worth of diamonds in an hour."

Oddly, geologists don't know where Venezuelan diamonds come from. "In Africa," explains Dr. Frederick H. Pough, curator of mineralogy and geology for the American Museum of Natural History, "they are

in diamond 'pipes'—the feeder tubes of long-extinct volcanoes plugged with ancient lava. The diamonds are embedded in the lava plug, where they either crystallized as the lava cooled, or were carried up in crystal state by molten lava—no one knows which. As eons passed, the lava altered to a serpentine, then oxidized to blue clay and finally to yellow clay."

African prospectors look for these "blue ground" or "yellow clay" plugs by tracing diamonds up stream beds where they have been washed from their source.

But no one has ever found one of those old plugs in South America. Geologists assume that they must long have eroded away, for the diamonds are scattered all over the country in alluvial soil so near the surface that a shovel and suruku screen are all that's needed to dig them out in most

Cargo plane dumps out vital equipment and food on dirt airstrip at Icaburu during the recent "diamond rush"

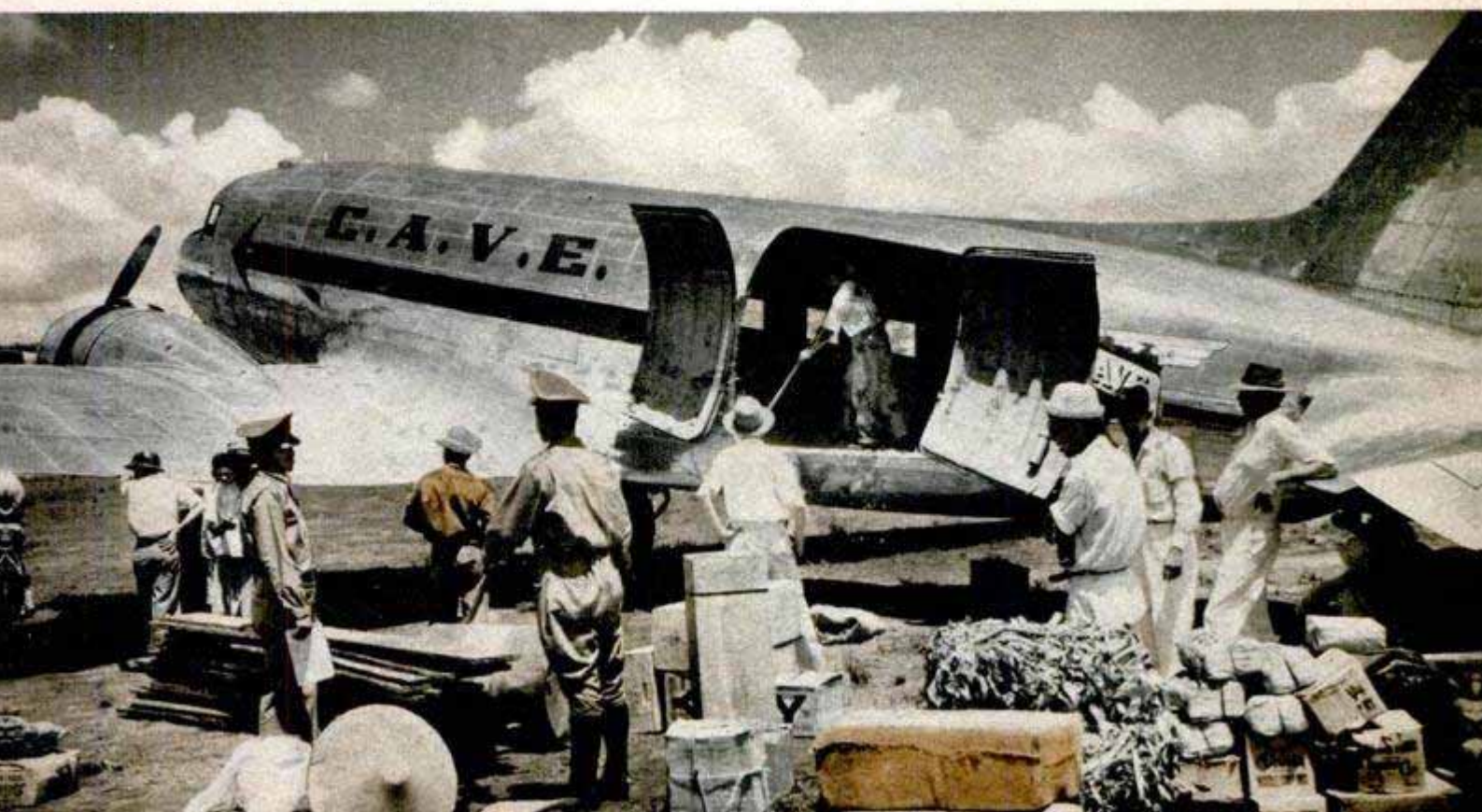



**Jeeps perform the jobs of bridges, busses and railroads in frontier country and command fancy prices**

cases. Ancient beds of long-dried rivers have them; they are laid down in ledge after ledge of old peneplains carved by centuries of meandering streams. And every place you find diamonds, you find gold—not in veins, but in sediments. Even the great rearing mesas are not basaltic or crystalline rock, but tough sedimentary rock from which the softer sediments around them have eroded away.

But some people, like Jimmie Angel, gaze at those mesas with sharp eyes. "The rivers are carrying the gold and diamonds to the valleys from someplace higher up," they point out—"and that someplace must have a higher concentration of them." Angel has been flying in and around the Lost World for years looking for a lost river deposit of gold nuggets, which he swears an old prospector led him to many years ago on a mystery flight. Nobody laughs at him.

**Exquisite gold work is a native Venezuelan craft. The orchid pin here is made of 22-karat Caroni gold**



In any case, there are enough gold and diamonds on the 4000-foot-high Gran Sabana to keep up a steady stream of frontier "strikes" and rushes. The headwaters of the precipitous Caroni, weaving and rushing down from the highlands over rapids, has created numerous potholes—ideal catch basins for diamonds and nuggets. As the river has changed its course, these potholes have filled with silt. A "strike" is usually the discovery of a collection of such old potholes. It was in a similar place farther south, on the "River of Hell" in Brazil, that diamond-drunk prospectors once hauled a total of 23,000 carats of the stones in one afternoon. The place had been worked before, but the ancient potholes lay hidden beneath a concretelike conglomerate. A careless workman dropped a crowbar, broke the sediment and revealed the big find.

Few modern pieces of mining equipment have found their way into the jungle-bound Gran Sabana. The going is too tough. One New York diamond merchant lost a fortune trying to fly in a huge sifting plant. Native methods, some of them four centuries old, still are in use. Each miner stakes a claim, and starts carrying away the "overburden" or topsoil in big wooden bowls. When he hits diamond or gold-bearing strata, he gets out his batea—a wooden dish about three feet in diameter, shaped like an inverted Chinese hat. This is filled with a load of silt, and swished about in typical "panning" procedure. Lighter sand and gravel wash over the rim, while heavier gold and diamonds sink to the conelike bottom of the batea. Naturally, a lot of perfectly good gold and diamonds spill over, too, and are lost. "There's a curious superstition among natives," explains one old hand, "that it's unlucky to find both gold and diamonds in a batea. I've seen plenty of gold deliberately thrown back."

More modern and efficient than the batea is the suruku, a circular nest of three sieves, coarse, medium and fine mesh. The prospector shovels 30 pounds of sand and gravel into the topmost coarse screen, spins it in the water until all small grains of silt and gravel have washed through to lower screens. It is then denested and set aside, and the process repeated with the finer screens. The pebbles in each screen are picked over, and diamonds or gold nuggets are retrieved by hand. It's a long, grueling process, but men with diamond glitter in their eyes will work at it from sun to sun.

A few larger, more ingenious machines have been shipped in. On one Gran Sabana claim a group of men devised a big drum into which sand and water are thrown. The drum spins, by gasoline motor, churns

(Continued to page 240)



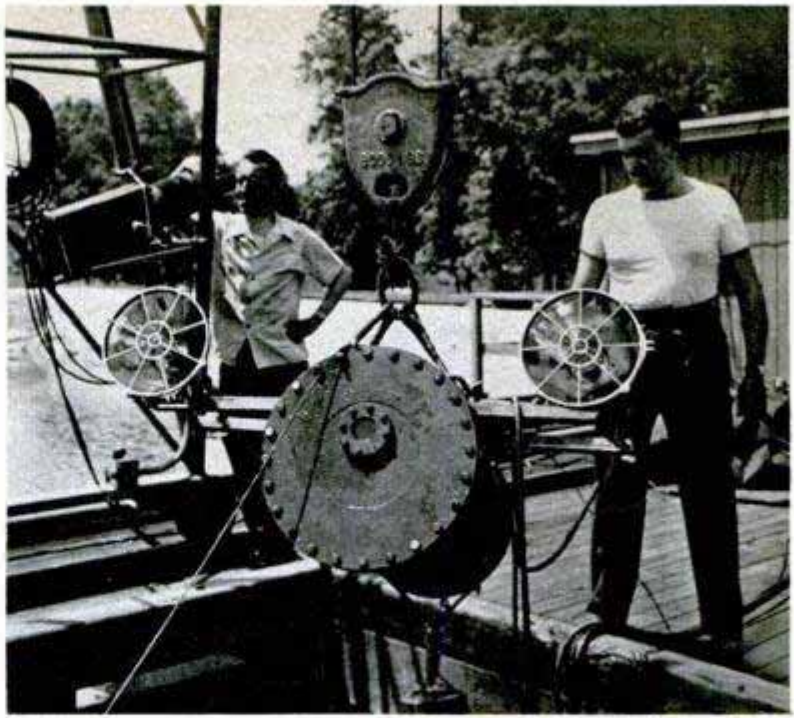
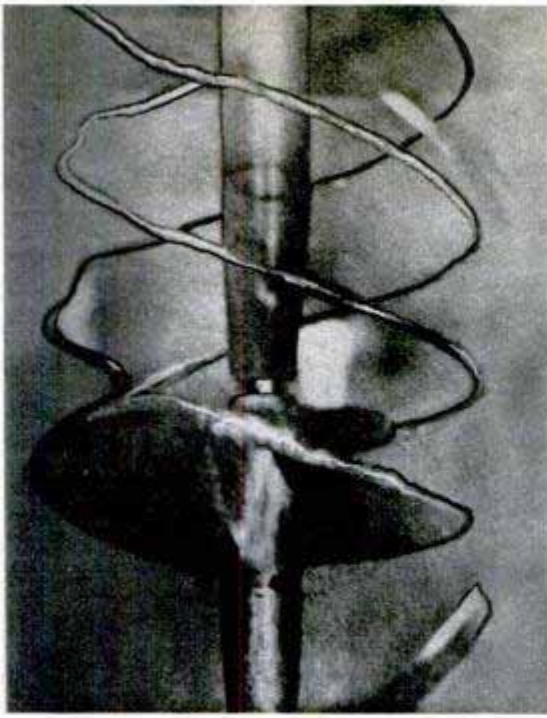

Department of Defense photos

## TV for Deep-Sea Divers

Deep-sea diving operations can now be speeded and documented by means of a television technique developed by the U. S. Navy. The camera, inside a steel casing flanked by stroboscopic lights for underwater illumination, is lowered to the work-

ing area by cable. A relief diver on deck can follow the previous diver's progress and doesn't have to waste time orienting himself to the situation. Films made of the television, which is distinct enough to show the shock waves caused by a revolving ship propeller, preserve the operation for study at a later date.



## Self-Honing Shears

Every cutting stroke rehones the blades of a new-type scissors. The shears are held together by a spring-action pin which guides the blades so they hone each other. Several sizes are available from four-inch embroidery scissors to 10-inch shears.

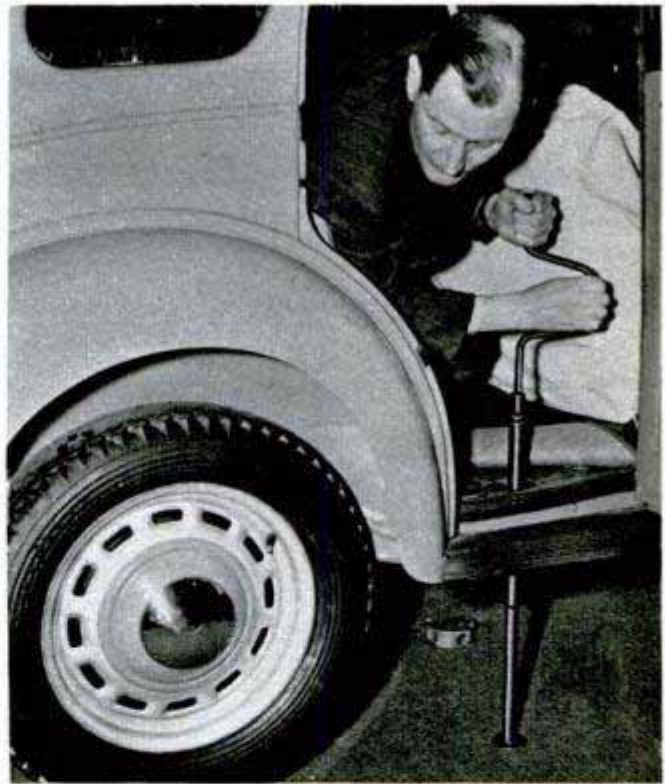

## British Car Has Built-In Jacks

You can jack up a new British Prefect without stepping outside. Apertures near each wheel allow you to insert the jack handle through the floor and raise the wheel. The Prefect is manufactured by the Ford Motor Company of England.

# WHAT'S NEW

## For Your Home

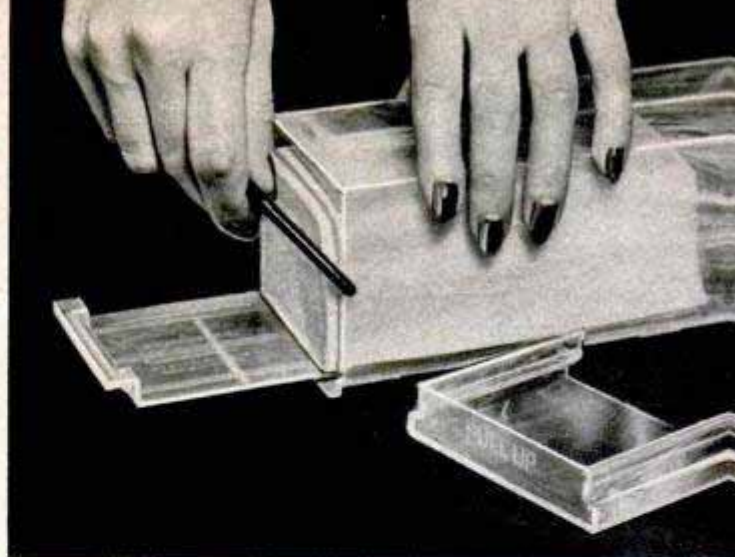

**SERVING CHEESE?** You can slice, serve and store it in this plastic container. The wire knife slips in the lid for storage. Sliding tray is used for serving



**TWO-PIECE "KITCHEN"** adds cooking and eating facilities to any room. Included are a refrigerator and electric stove, built as a unit, and a folding dinette set. The door of the refrigerator has a lock and key

**CARPETS** get fresh color right on the floor with a dye that you just brush in

**CANDLES** with wax refills are always tall, graceful and dripless. A spring raises the refill as it's burned away

**TUB SEALER** is flexible plastic in strip form. It eliminates water leakage around the tub and washbowl

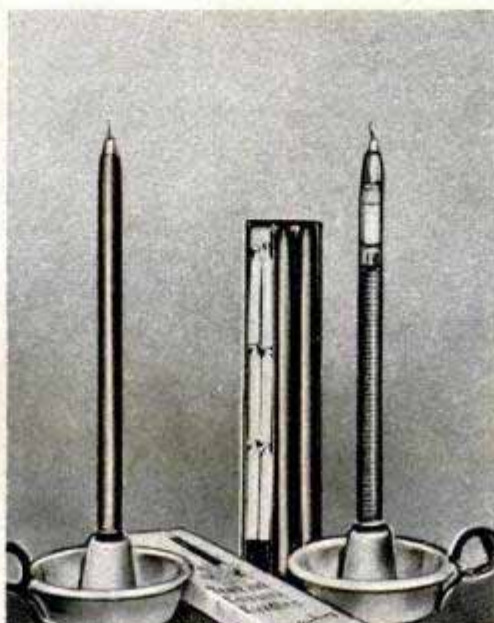



**SPOUT COVER** fits standard screw-top jar for storing pantry supplies. Plastic lid seals tightly when spout is closed



**DRY DEFROSTER** scrapes frost from a home freezer, making melting unnecessary

**SPUD BAKER** holds potatoes on prongs that carry heat inside for faster baking

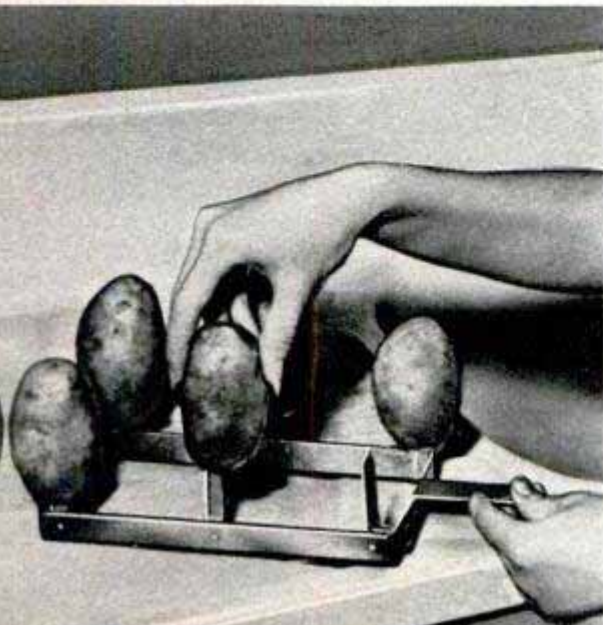

**CARD TABLES** are protected by a removable top that is washable and scuff resistant. It's reversible, both sides being finished with a colorful lacquer



**SHALLOW-WELL PUMP** is automatic yet so small it fits under the sink. No large storage tank is used. It lifts water 25 feet





Dr. Geer demonstrates his TV system with enlarged model of screen. The prisms break light into colors

### Prisms for Color Television

Color television of a new type has been developed by Dr. Willard Geer, director of physics laboratories at the University of Southern California. The system is based on the ability of prisms to break up light beams. Doctor Geer's television screen consists of a large number of tiny prisms. Three electronic "guns" beam the primary colors onto the prisms, which superimpose the colors on each other to give the viewer a natural color picture. The receiving tube can be installed in present black-and-white television sets, and will receive color televised by any of the systems that are now under consideration by the Federal Communications Commission.

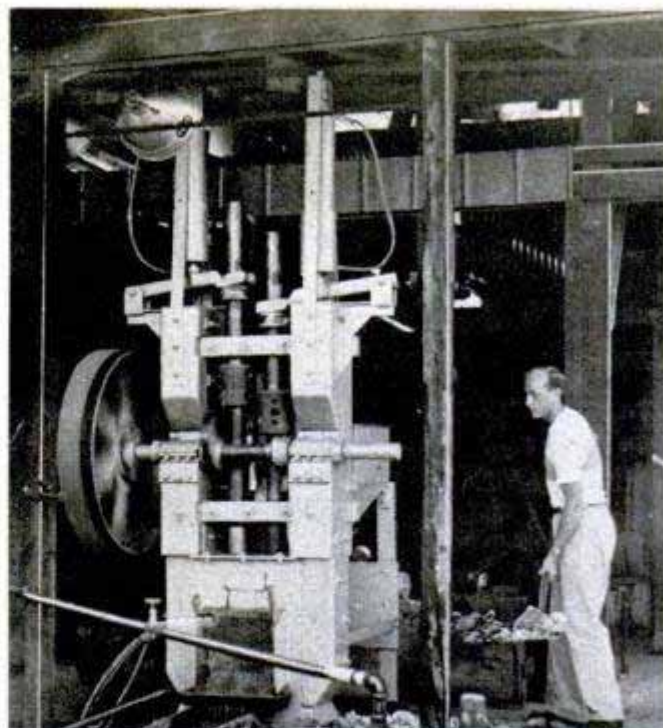

### Pneumatic Stamp Mill Designed for Prospectors

Although compressed air is used to boost the crushing action of a stamp mill, no compressor is needed. A small air tank is pumped to about 50 pounds pressure by an ordinary tire pump. This is enough air to operate the stamp mill for a week. The air simply acts as a booster for the stamps, eliminating the need for tremendous weight. There is only a slight loss of air because the up-and-down action of the stamps also acts as a compressor, returning air to the tank after each stroke. The advantage of the air-operated mill is its light weight and fast action. The small mill weighs only 500 pounds and a larger model weighs 1500 pounds, permitting transport into the mining area. The mills operate at 200 blows a minute for each stamp. The prospector mill will handle six tons of ore in 24 hours at 35-mesh screen. A five-horsepower gasoline engine runs the smaller model and a 15-horsepower engine the larger one.

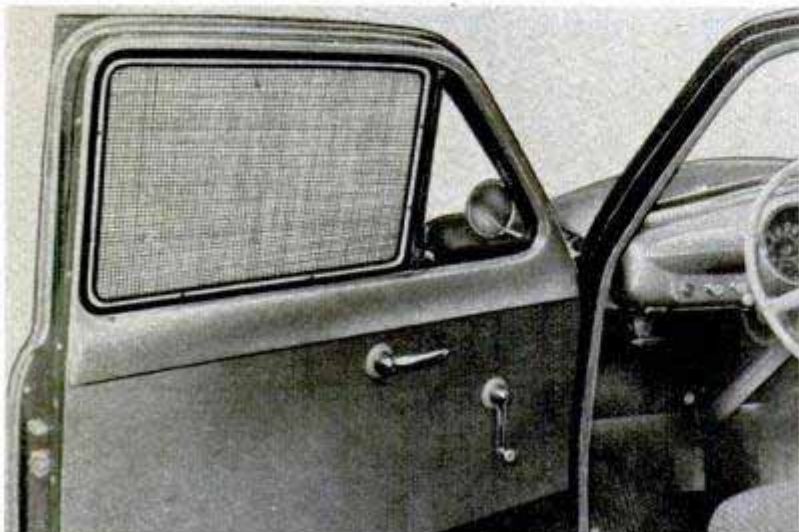

### Car Screen

Sportsmen and tourists who sleep in their cars will appreciate the value of an adjustable screen that fits any car window. Mosquitoes and other insects are kept out without interfering with ventilation. No bolts or fastening devices are used, the screen being held in the window channels by means of three adapters.

☞ Only two states, Massachusetts and Rhode Island, are considered to be adequately mapped.

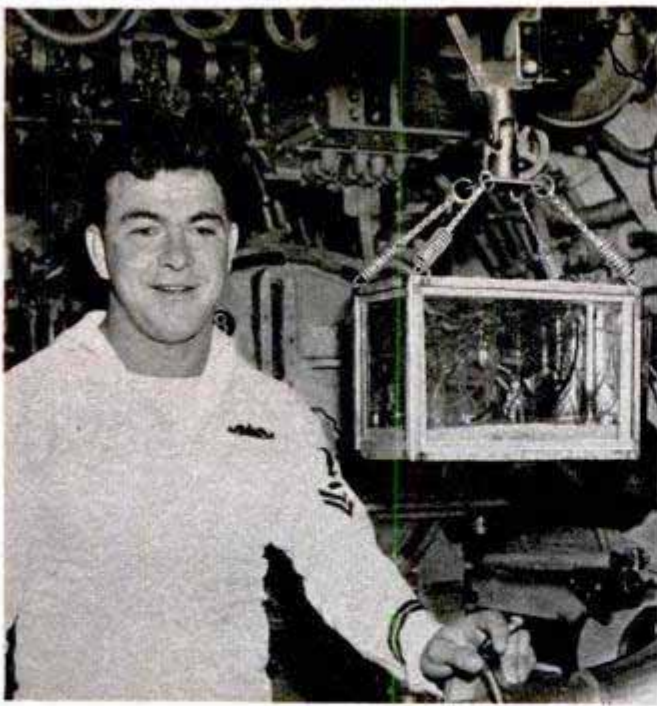

### Aquarium in Submarine Takes Fish for Ride

Probably the world's most traveled tropical fish belong to Torpedoman William H. Jones of the U. S. Navy submarine Pickrel. The fish go wherever the Pickrel goes. Recently, they "swam" from Hong Kong to Honolulu, a distance of 5200 miles, in 21 days when the Pickrel completed the longest undersea voyage ever made. Jones' hobby is collecting tropical fish and he designed and built a seagoing suspension system for his aquarium. Rough water makes no difference to the tropical fish as they swim in their own quiet pool, thanks to a universal joint, coil springs and chains which keep the aquarium on an even keel.

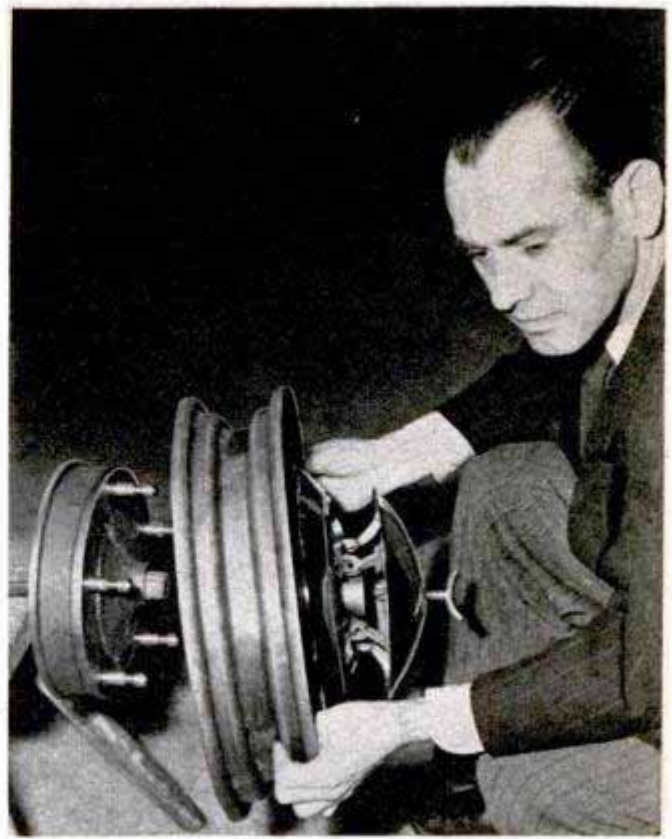

### Quick Wheel Fastener

Even a child could change an auto wheel when it is secured by a new hub. The fastening has no lugs to tighten and requires no tools, once the wheel has been lifted off the ground. Developed by a German refugee, the wheel hub has five tweezerlike levers which clamp around five projections on the brake drum. The wheel is locked in place by pushing in the hubcap. The inventor says the faster the wheel moves the safer it is, because centrifugal force increases the grip of the lever arms.

### Magnetless Atom Smasher

In this atomic age, new models of atom smashers come out as frequently as new automobile models and the latest is a non-ferromagnetic synchrotron that is expected to produce X rays of 300 million volts. This new particle accelerator has no huge iron-core electromagnet. Necessary magnetic fields are produced by coils of wire, carrying heavy current. The electrons move in a vacuum between the inner and outer coils, which accelerate them to generate the X rays when they strike the target.

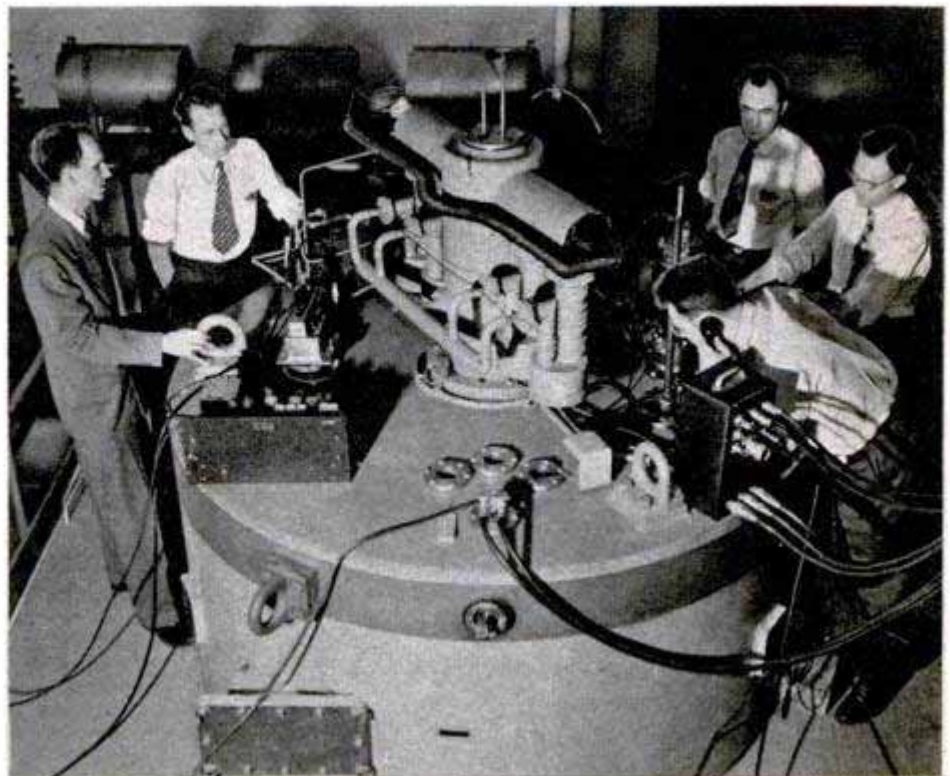

General Electric photo



Golden palominos are leading the popularity parade and these two are trained to support a standing rider

# *Gallop* **GOLD**

By Andrew Hamilton

Photos by Lucille Stewart

**T**HERE'S a New Look in horseflesh—a color as rich and dazzling as a well-polished \$20 gold piece. Horses that sport these high-fashion, honey-colored coats, trimmed with white manes and tails, are palominos.

Beautiful color and shapeliness make the palomino a natural for leading parades adorned like royalty



You've seen them in parades, rodeos, fiestas and horse shows. In the middle 1930s, only a few such magnificent animals existed—but today the upsurge in interest among American horse breeders, fanciers and hobbyists has increased their numbers to approximately 10,000.

The palomino is a golden horse in more ways than one. Colts sell for \$500 and up. Mares bring \$1000 to \$5000. A fine stallion is worth \$10,000 or more and is difficult to purchase at that price. Even the matter-of-fact Western rancher, who has long operated on the theory, "We don't care about color if it's a good horse," has been compelled to recognize the current popularity of the palomino.

The golden palomino is often called "the most beautiful horse in the world." In recent years this superlative has been applied not only to his brilliant coat, but also to his carriage. He sometimes used to be jug-headed, raw-boned and as graceful as a milk-wagon nag. But careful breeding has developed in this animal gentle manners, a shapely head and a well-proportioned body. Leading a parade or prancing in a horse show, he's a sight not easily forgotten.

Perhaps the best-known palomino in the world is Roy Rogers' famous horse, Trigger. The movie-going public doesn't know it, but the Trigger you see on celluloid may be any one of Rogers' string of six or eight golden horses. Other members of the

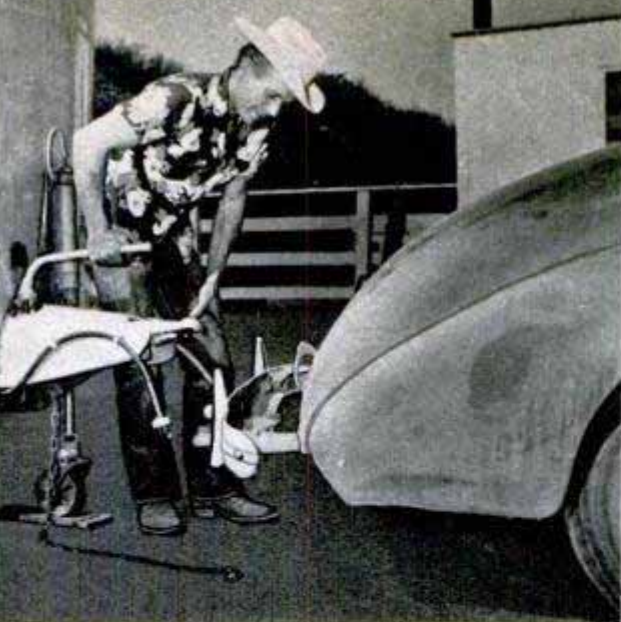

Hydraulic lift eases horse-owner's job of raising or lowering heavy trailer hitches



Desert Gold, prize palomino of the Flying W Ranch, Pacoima, Calif., gets his valuable mane shorn with electric clippers

Hollywood horsy set who own palominos include Gene Autry, Alan Ladd, Spike Jones, Leo Carrillo and Bob Burns.

Many breeders are convinced that the palomino coat was developed by nature on the Arabian and African deserts thousands of years ago as protective coloring against the hot sun. When the Moors overran Spain, they brought golden horses with them—ancestors of the famous yellow Ysabellas of the 15th century and the golden horses of early Spanish California. During World War II, the Coast Guard used palominos to patrol the beaches because their light colors blended harmoniously with sand and rock.

There are many explanations for the origin of the word palomino. Perhaps the simplest and most logical is this: In the early days of California, one of De Anza's soldiers, Juan Palomino by name, owned a magnificent golden stallion. This animal was called el caballo de Palomino, "Palomino's horse."

In spite of their Arabian-Moorish-Spanish ancestry, the palomino today is bred and raised most extensively in the United States. Increasing interest in palominos is also shown by horse raisers in England, Canada, Mexico, Argentina, Venezuela, India, New Zealand and Australia.

The two American breeding centers are California and Texas. On the West Coast, palomino ranches are located principally in



Desert Gold prepares to enter the streamlined aluminum van in which he rides around country to shows. He wins many ribbons. Below, palomino proves that he can do more than look pretty





**This palomino mare presented owner with golden colt which only happens about 50 to 85 percent of time**



**Power buggy for removing straw and debris from the stable travels 18 m.p.h. and carries 13 cubic feet**

the misty coastal valleys of San Diego, Los Angeles and Santa Barbara counties. In Texas they are found in all parts of that huge state where horses are raised.

About 3000 American horse breeders belong to the Palomino Horse Association with headquarters in Reseda, Calif. One hundred Texans have their own Palomino Horse Breeders Association at Mineral Wells, Tex.

How does one get started as a palomino breeder?

Many horsemen do it the way Jim and Edna Fagan of Reseda did it. Jim saw his first golden horse leading a parade at the annual Santa Barbara fiesta in 1929. "I knew then that I wouldn't be happy until I had a string of palominos," he said. It was not until 1935, however, that the Fagans were able to purchase their first mare.

(Continued to page 234)

**Below, Jim Fagan demonstrates intelligence of his palomino with a balancing act at night horse show**

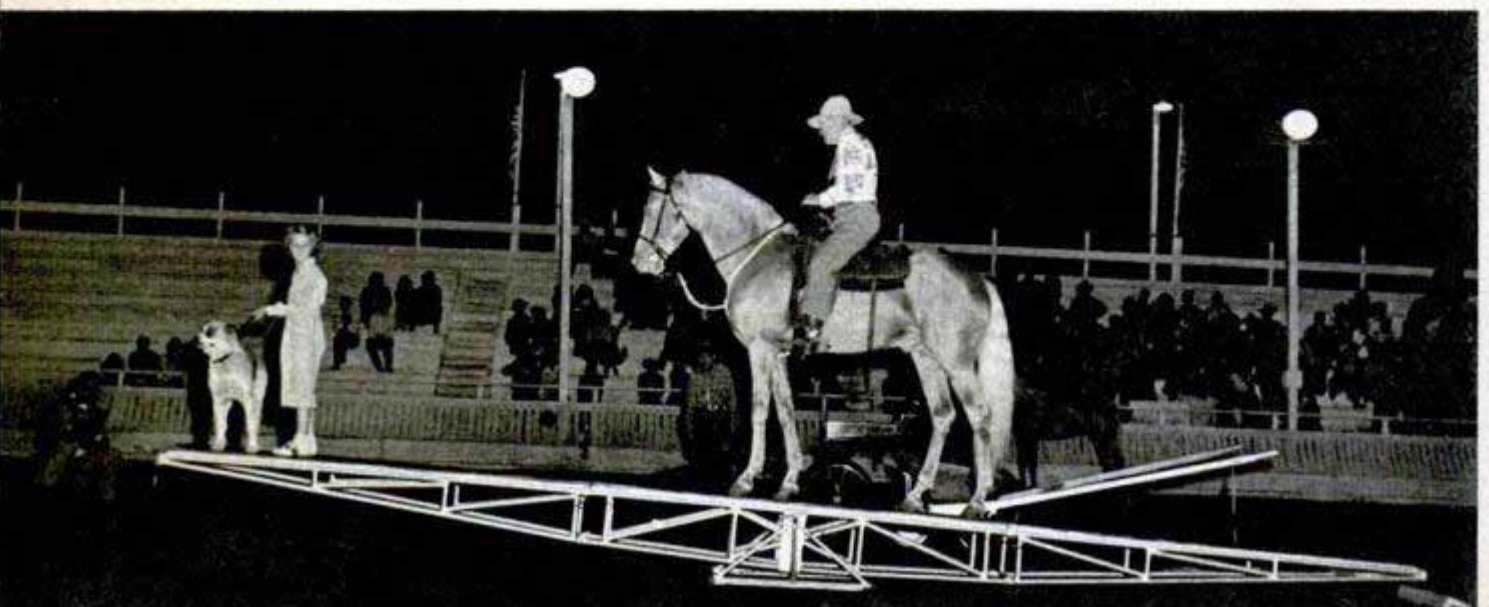





### Motor Bike Fits in Back Pack

If a German motor bike breaks down along the road, you just fold it up, tuck it in a sack and carry it to the nearest garage!

It weighs only 15 pounds and is full size in every detail except the undersize motor. Hinged in the center, the bike folds into a compact package. The seat and handle-bar supports telescope for packing.

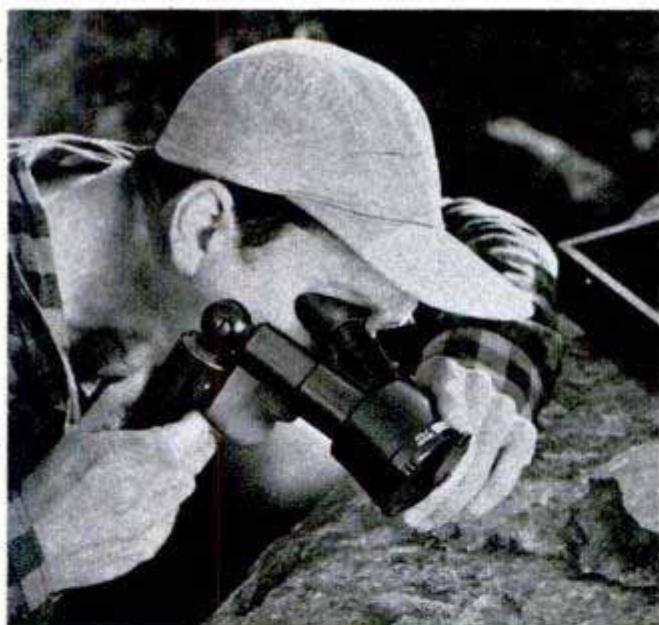

### Portable Black-Light Source

Collectors of minerals, stamps and other objects can examine materials under ultraviolet light in broad daylight with a battery-operated black-light source that weighs less than two pounds. The instrument permits on-the-spot identification of minerals. Stamp collectors use it to study printing ink and postal cancellations. Gem quality can be determined by a study of fluorescence. Two standard flashlight batteries power the mercury-vapor tube.



### Ski-Bob

Offering users the thrills of two sports is a combination ski and bobsled invented by a Bavarian. The frame is mounted on skis and steered by a crossbar. It is six feet long, with an ordinary bicycle seat about 14 inches above the ground.

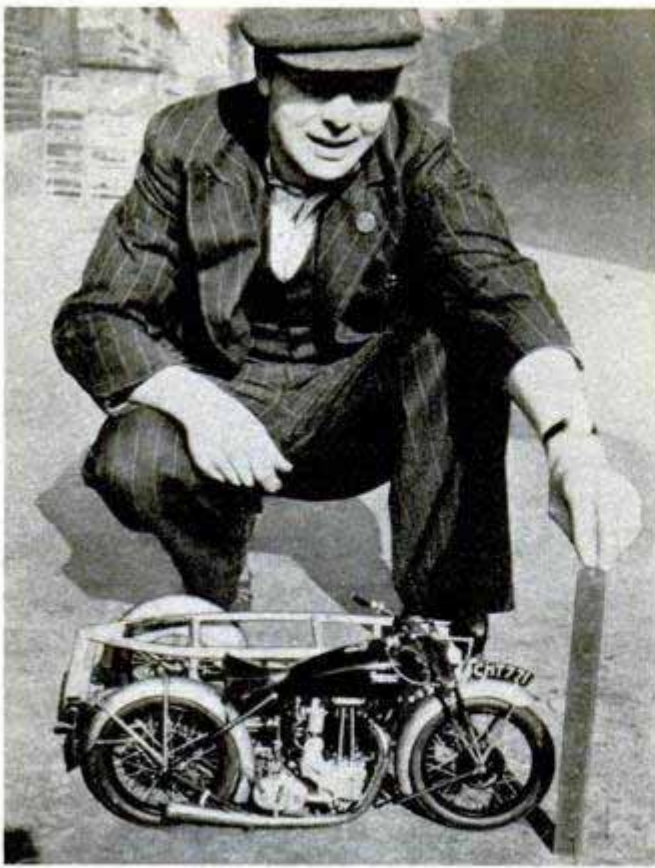

### Miniature Motorcycle

Utilizing all his spare time during the past four years, an English engineer has built a five-inch-high gasoline-powered replica of his own motorcycle. It has a spring frame, two gears, a handle-bar twist throttle and lights that work. The machine is 12 inches long and weighs 15 pounds.

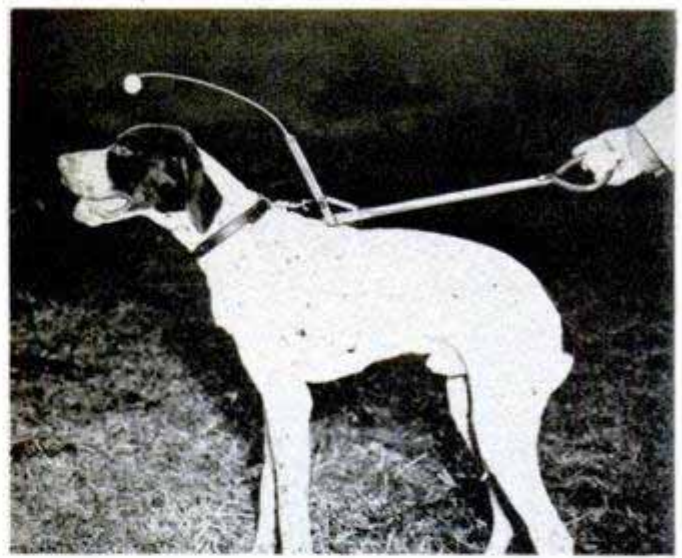

### Training Leash "Spanks" Dog When He Fails to Obey Order

Dogs quickly learn to heel when trained with a new leash that taps the dog on the head as he tries to break away. The leash is a short length of aluminum tubing with a stout leather handle. Attached to the base of the leash is a short extension on the end of which is fastened a length of spring wire terminating with a hollow ball positioned just above the dog's head. As the dog lunges forward to break away, the ball is jerked downward tapping the animal on the head and causing him to stop the forward motion. In a short time, the dog learns to remain beside the trainer even when the leash is removed.

### "Sardine" Pack for Car Bodies Doubles Flatcar Capacity

By packing automobile bodies as compactly as sardines in a can, Kaiser-Frazer Corp. has doubled the number of units that can be shipped on a railroad car. The bodies are loaded horizontally on special

"pinwheel" racks which pivot to hold the 16 bodies vertically in two rows. The technique, developed in cooperation with the Union Pacific Railroad, not only cuts shipping costs, but reduces loading time.

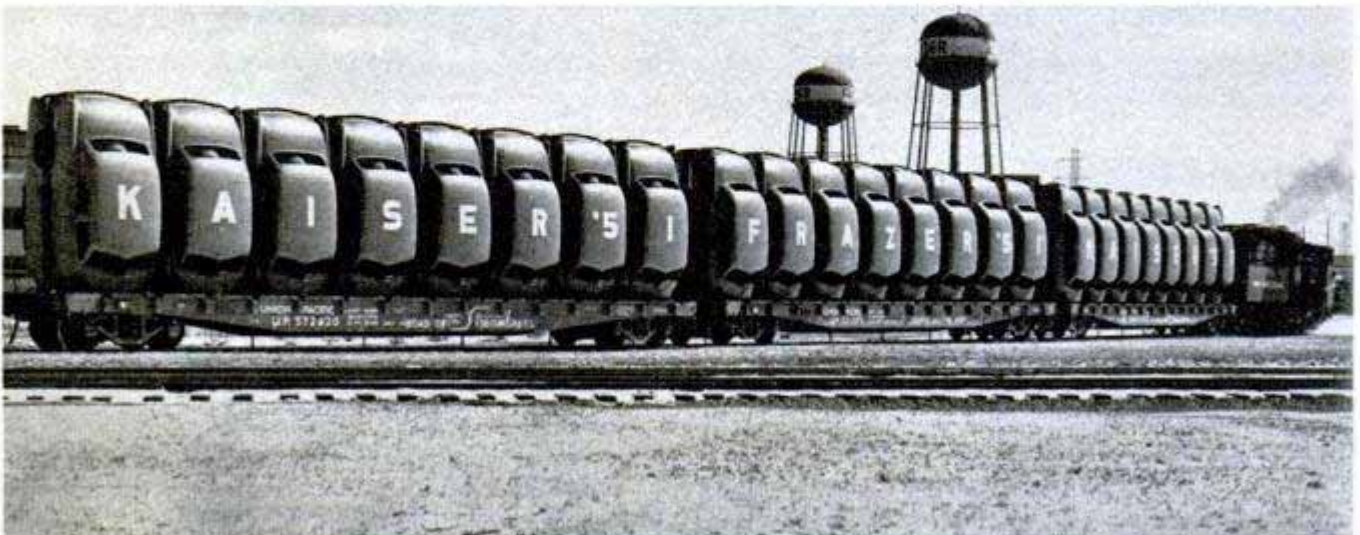

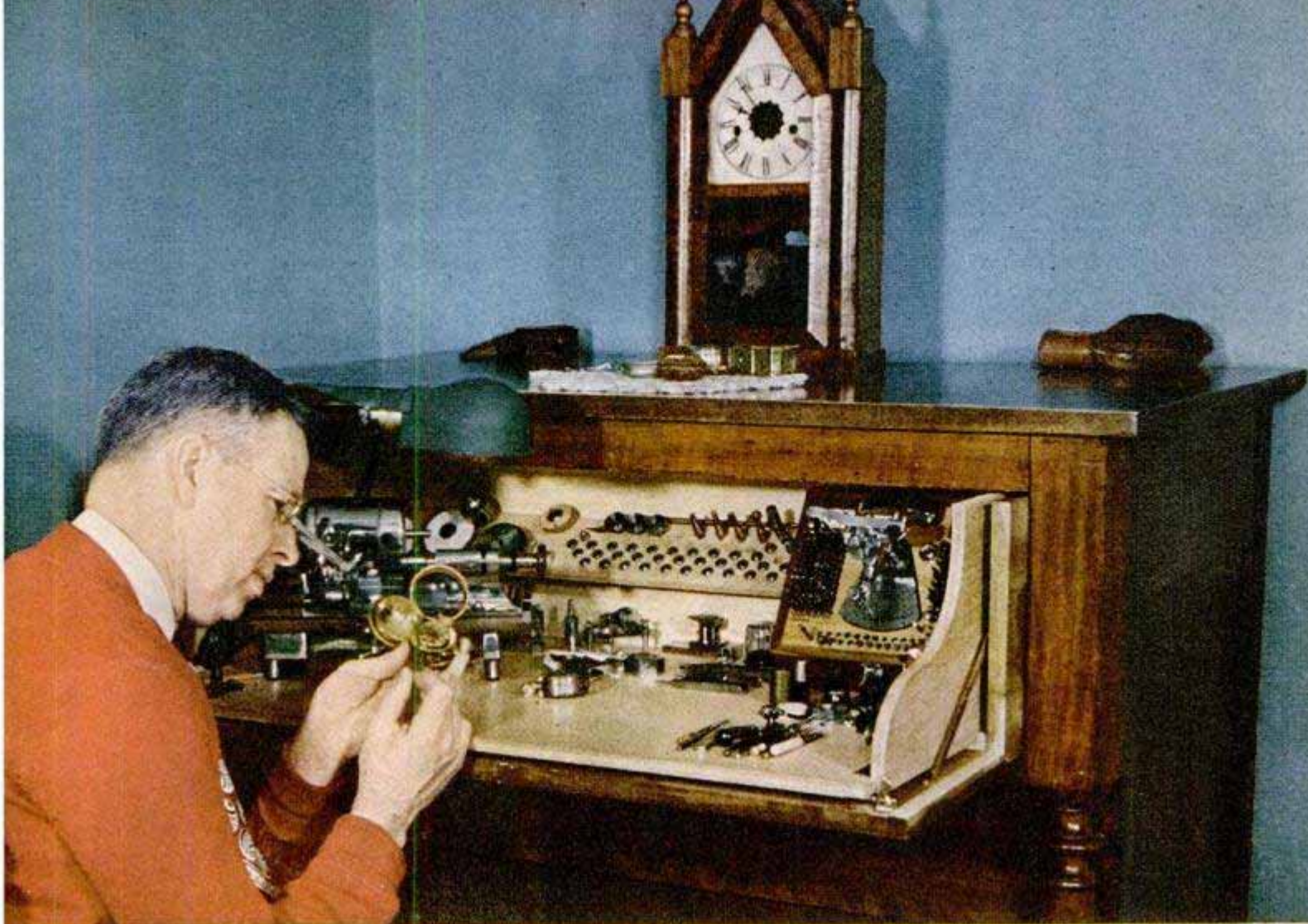

Marvel of spacesaving is Dick Cole's "shop" in a bureau drawer. Watch-repair tools are at his finger tips. Below, musical roller plays five tunes in an old clock. Cole plans to put 18 tunes on one roller

## DOCTOR FOR OLD TIMERS

By Merle E. Dowd

**B**ACK IN 1610—340 years ago—a now-nameless European with a flair for fine craftsmanship fashioned a watch from whatever materials he could find. By present standards it was a crude mechanism. Only one hand swung around the face, for in those days time was not considered a priceless commodity and a watch that gained or lost only an hour a day was a miraculously accurate timepiece.

In the three centuries and more that have passed since the watch was assembled, the European craftsman has been forgotten but his work has ticked out the time of the ages. At some point in the world's history the mechanism broke down. A few years ago the watch fell into the hands of Dick Cole, a painstaking craftsman. Thanks to Cole, the old timer is ticking again.

To Cole, an assistant professor of mechanical engineering at Northwestern



University, time and its measurement have become a fascinating hobby. It is the centuries-old watch that intrigues him; a broken antique timepiece is a challenge. Putting a 300-year-old watch into operation somehow gives a man a new perspective on the tensions and worries of our own short days.

For years Cole has been rebuilding antique watches. Two years ago, though, destiny seemed to take a hand in his hobby when he crossed the path of a man named Leopold Metzenberg. For a lifetime Metzenberg, a Chicagoan, had been collecting old and valuable watches. On 40 trips to Europe he collected 570 watches, each a beautiful antique work of art. Trouble was, some of them wouldn't run.

Since then Cole has been busy rebuilding timepieces of all kinds: watches made almost entirely of wood; watches with striking bells and moving figures; diamond and ruby-studded watches built for royal families; complicated automatons; calendar and moon-phase indicators; watches that play tunes. Each is a different problem, and in each case Cole has worked with the same materials the original watchmaker used, or modern substitutes that have the same appearance.

In many of the timepieces, parts are missing. Then Cole searches through his library of rare books on timekeeping to discover how the watch originally looked and what materials were used. In some cases, he first has to make tools and dies, often more difficult to fashion than the parts themselves. Through his long association with watches, Cole has come to see time as an endless stream—he may take months or years to complete his work on one of the old timers. There's no feeling of hurry in Cole's workshop.

The shop itself is a miniature work of art. When Cole first started repairing old watches, he and his family lived in an apartment where there was no room for a conventional shop. Cole talked his wife out of one drawer of an old bureau, which he converted into a marvel of space-planning. The drawer pulls out and the hinged front drops down level with the bottom. Fluorescent tubes along the sides and back flood the workshop with light. Miniature racks hold the tools at finger-tip reach. When Cole finishes work for the night, he merely swings up the front of the drawer and shoves it into the bureau.

One of the craftsman's first projects was

Many of the ornate and valuable watches of the Metzenberg collection wouldn't run until Cole went to work on them. Here are just a few of the antique timepieces. Black line in photos represents one inch to show comparative size. 1—Carved gold watch, made in Madrid about 1850, strikes the time with a gong; 2—Bug watch for the lapel has black wings which fold over the face; 3—"Cuckoo watch" whistles a tune while bird moves; 4—French watch, made about 1800, is model of a medieval harp; 5—Figures on automaton watch keep time to a striking gong; 6—Large timepiece is one of few remaining watches fashioned by a master French watchmaker

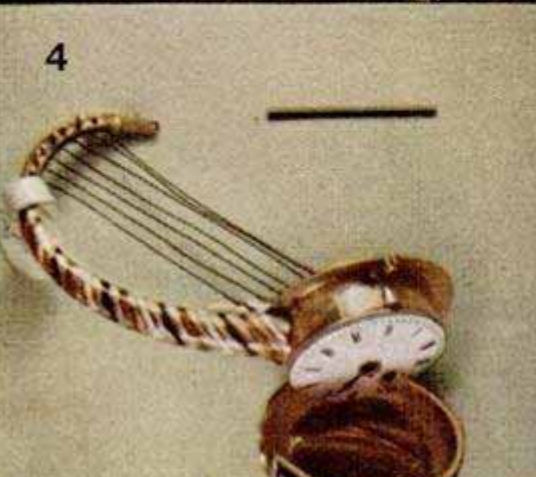
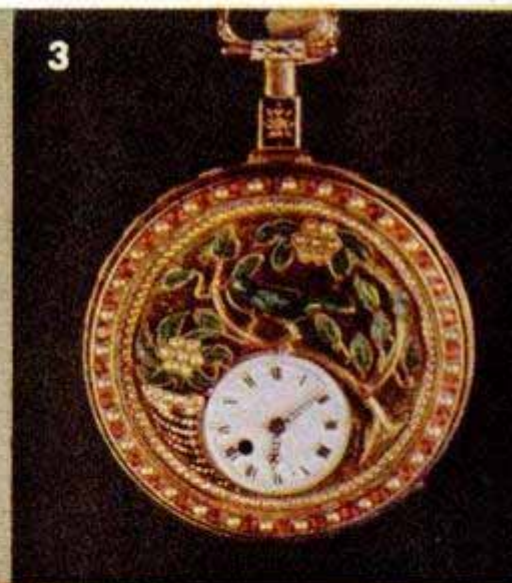

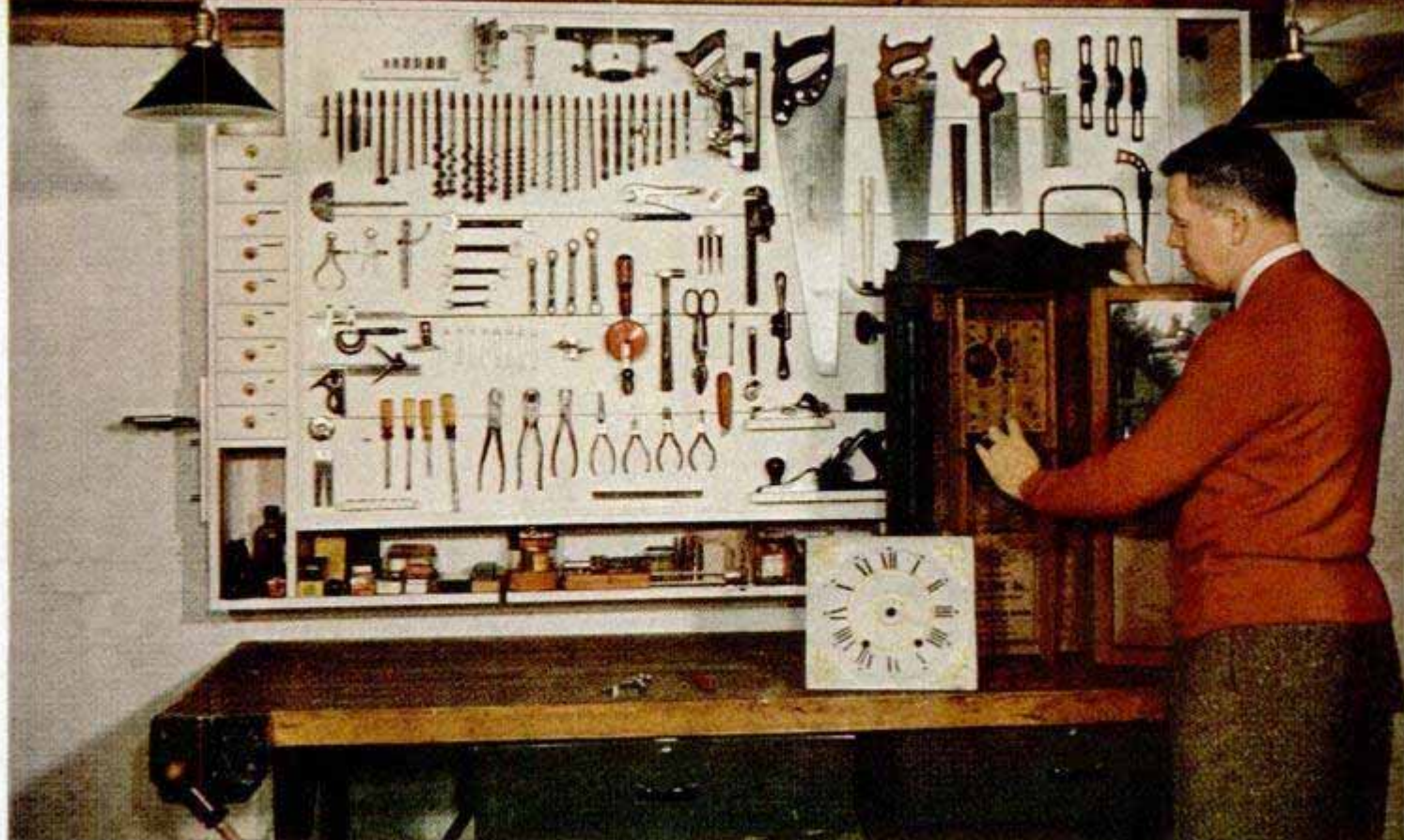

In his neat-as-a-pin basement shop, Cole works on antique clock mechanisms and their carved wood cases

7—Bug, controlled by watch movement the size of a penny, pivots about ornate dial to show the time; 8—One of earliest German watches, made about 1600, has only one hand and looks like a miniature book; 9—Ornate watch has three cases to protect the fragile enameling, though the additional cases also are enameled; 10—Each number on this heavily carved gold watch is enameled on an individual plaque; 11—Floral enameling for man's pocket watch, so bright it almost seems luminous, is surrounded by a ring of tiny matched pearls; 12—Gold and rococo watch, made in Germany about 1785, is raised in relief and has a tortoise-shell case



7



8



9



10



11



12



Cole, at his shop drawer, has the patience of Eternity. He may work weeks over small part of casing

Music watch, rebuilt by Cole, has figure of a dancing girl, moving between two animated figures at sides

a wooden pocket watch. The main driving wheel was broken, though years before it had been patched with extra teeth. Links were missing from the driving chain, one of the few metal parts. The watch was originally carved from a dense, brittle wood with virtually no grain. Cole tried to match it for months without any luck, then finally hit on the idea of using a coconut shell. His library yielded a picture of the watch and he proceeded to carve a new back cover.

face of the watch presents a surprisingly animated scene—a man strums a mandolin, a woman claps her hands in time with the music and a girl dances between them. All the figures actually move and all are synchronized with the music from five bells inside the watch—real bells, not wire gongs.

Inside, some of the gear teeth were missing from the main driving wheel, carved from wood. He decided to use a plastic material the same color as the wood for repairs. Cutting the teeth exactly right so they would mesh with the wooden works required new tools, so he built a gear-tooth-cutting fixture for his jeweler's lathe.

When Cole took over the job the silver dancing girl was missing, the striking works had disappeared and two of the five bells were lost. He carved and hammered the figure of the girl out of bright silver, designed and built a mechanism for playing the bells and actuating the figures. He tuned two new bells to harmonize with the old ones, then rebuilt the mechanism to play a traditional tune. Now the figures come to life at the touch of a finger.

Next came a new driving chain, with links the size of a fine pencil lead. Each link had to be made by hand and drilled with holes so small it is difficult to see them. After nearly a year of part-time work the wooden watch was ticking again.

According to Cole there has been no major mechanical improvement in watches since way back in 1756. Our modern split-second timing is a result of improvement made in mechanisms known 200 years ago. The hairspring on the balance was the last major improvement. By the style and workmanship on a watch, Cole can tell approximately when it was built.

One of Cole's most difficult jobs was rebuilding an automaton watch, which has moving figures plus five striking bells. The

(Continued to page 226)

13—Magnified view of floral case shows detailed enameling. Gold wire outlines each petal and leaf to form a dam for the enamel; 14—Tulip-bulb watch, made about 1810; 15—Same watch, with bulb open to show dial

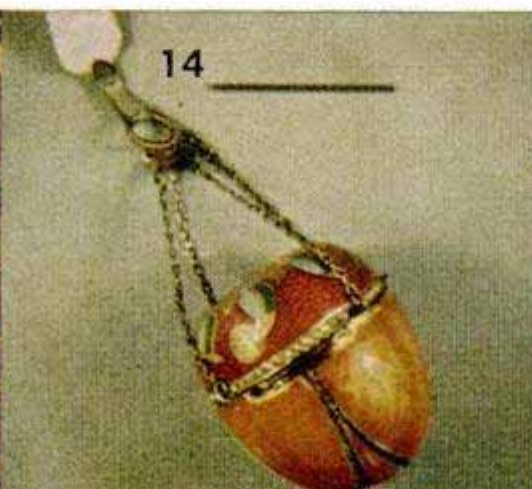



# Detroit Listening Post

*By Siler Freeman*

**T**HIS IS NEW-MODEL season in the automobile industry. Some of the new cars are ready for introduction, and but for the uncertainty of the international situation would shortly be riding the double-deck trailers to dealers' show windows around the nation.

What long-range effect the Korean war will have on the change-over to new models is impossible to gauge at this writing.

Designers and engineers have finished their work on the '51 lines. But the shot-in-the-arm which automobile sales departments call for may not be needed this year—demand has quickened tremendously because of the fear of shortages, first of steel, and then of finished automobiles—and it is quite possible that the manufacturers will avoid any shutdown of production for retooling so long as they can sell all the '50 models they can make.

Packard is already out with its offerings. The 1951 models, described more fully elsewhere in this issue, show a complete break with most of the traditions of the oldest company making cars, in looks, styling and even price class. Its three-passenger coupe in the lowest priced line, the 200, will seek business from not only other independents but will try to crash the barriers of the biggest producers.

Nash planned to introduce in late September its new offerings in the Ambassador and Statesman lines, and the Rambler sedan and coupe were due in December.

Pre-Korea calendars called for the big new-model shows late this year. If the major companies do go forward with the change-over, it is likely the 1951 cars will not be radically different in appearance.

At the recent tremendous rate of production, some buying resistance might eventually have been reflected in a downturn of prices. Car buyers have lost any hope for a reduction in the foreseeable future now, and the industry is watching the price of steel for a guide to the next trend in automobile prices.

With automatic transmissions showing little change in principle and design, the auto makers plan to concentrate on new engines for their next big drive. The en-

gine program has taken two paths, the first beaten by General Motors with high compression through V-type power plants of entirely new design, and the other as illustrated by Packard's new motor, using most of the old tools and attaining high compression through new heads.

The two trends are dictated primarily by economics. GM will have as disciples both Chrysler and Ford, as well as Studebaker. All of the latter have the money to put into new facilities and tooling.

The others, not so well financed that they can lay out many millions to bring out an entirely new engine, are following Packard. But the object of both programs is to give the customer the smoothness and power of high compression.

Chrysler is so enthused about its V-8 engine that even before it is in production, schedules have been doubled on it. Originally scheduled for 20 an hour, plans now call for 40 an hour. It will be made in the East Jefferson plant, with the DeSoto-engine production now housed there being moved to the DeSoto plant.

Meanwhile, the evident success of its Rocket engine has moved Oldsmobile to drop its 76, the six-cylinder model, from its schedule as of October 1. This has been coming for a long time. The 88 model, with its Rocket engine, has about cornered the market among Oldsmobile buyers and while schedules have been raised and raised, demand has been staying ahead. Even the 98 line has been cut back to make room for more 88s.

Oldsmobile's new assembly plant, opened only last spring, is being pushed to its utmost, even with the most modern equipment. Its original schedule of 80 cars an hour has jumped to 85 and S. E. Skinner, general manager, is eyeing the possibility of getting a few more out of the plant.

Kaiser-Frazer is watching the reception its Henry J. is getting from the public. It now has one line on its Kaisers, which are selling well, and the other turning out the smaller, low-priced car. If orders keep piling up, another line is available for the Henry J. A convertible will follow later in the same line.

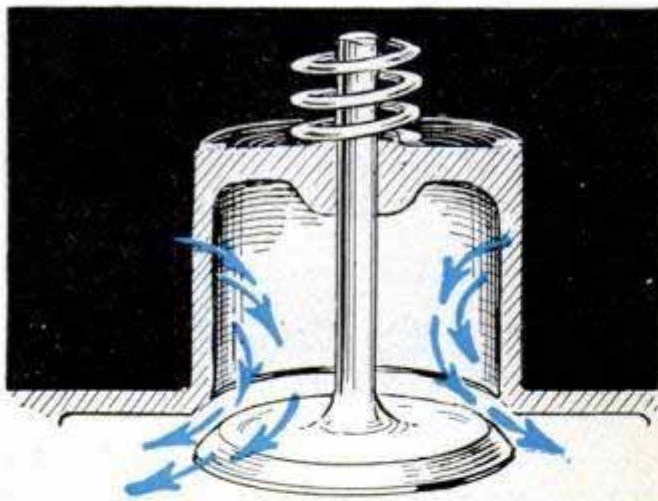

VALVE WITHOUT SHROUD—AIR ENTERS COMBUSTION CHAMBER, MOVING IN ALL DIRECTIONS



SHROUDED VALVE—AIR MOVES IN ONE DIRECTION ONLY

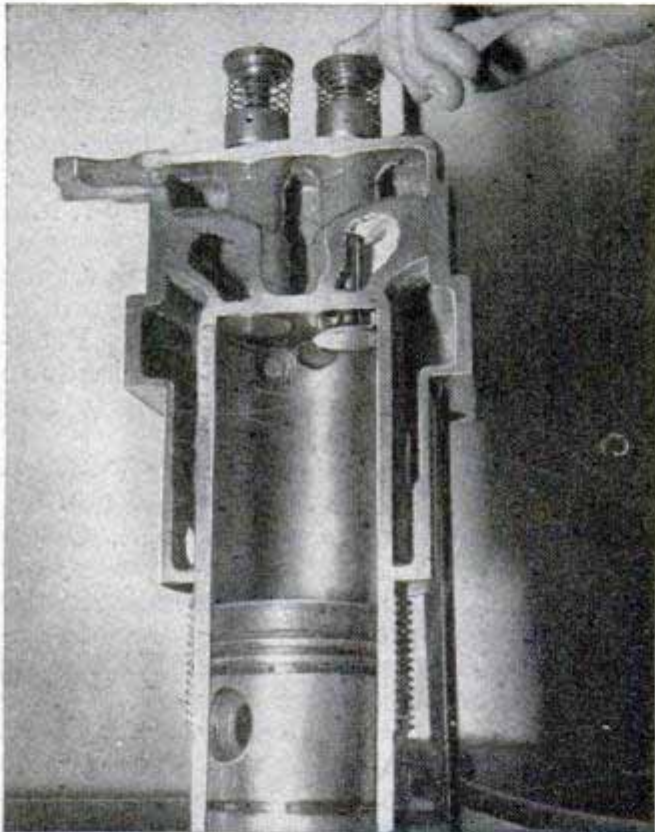

Cutaway shows no-ping engine cylinder. Below, tiny valve shroud creates a whirlwind inside the cylinder

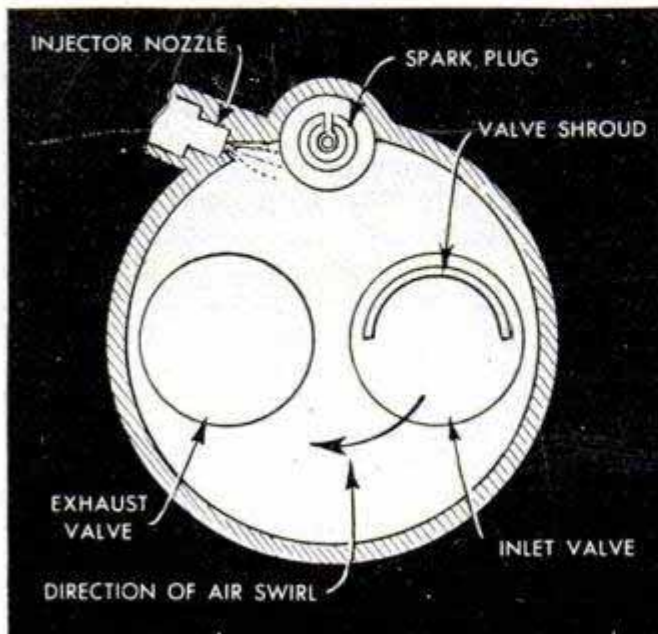

# Engine With a Built-In Tornado

**I**MAGINE RUNNING out of gas on a country road, hiking to the nearest general store for a can of kerosene, then dumping the kerosene in the tank of your shiny new car with its high-compression engine, stepping on the starter and taking off like a jack rabbit.

Don't try it on your present car. You won't go anywhere. Even if you could get it started, the inside of your engine would look like the deserted end of a blackened, pock-marked battlefield after a few minutes of running. But in a few years, that dream may come true. Hidden up in the wooded hills above the Hudson River town of Beacon, N. Y., in the laboratories of The Texas Company, several models of an experimental cylinder sit on test blocks thrumming an almost unbelievable story.

"Alcohol, kerosene, benzine, motor oil, tractor fuel and many other fuels will work as well in it as high-octane gasoline," point out the engineers who designed the engine. "... almost anything from 90 octane to 90 proof," is the way one man cheerfully puts it, and he adds, "you might even get a sputter out of the engine using a high grade of after-shave lotion."

The engine is knockproof, and it is so



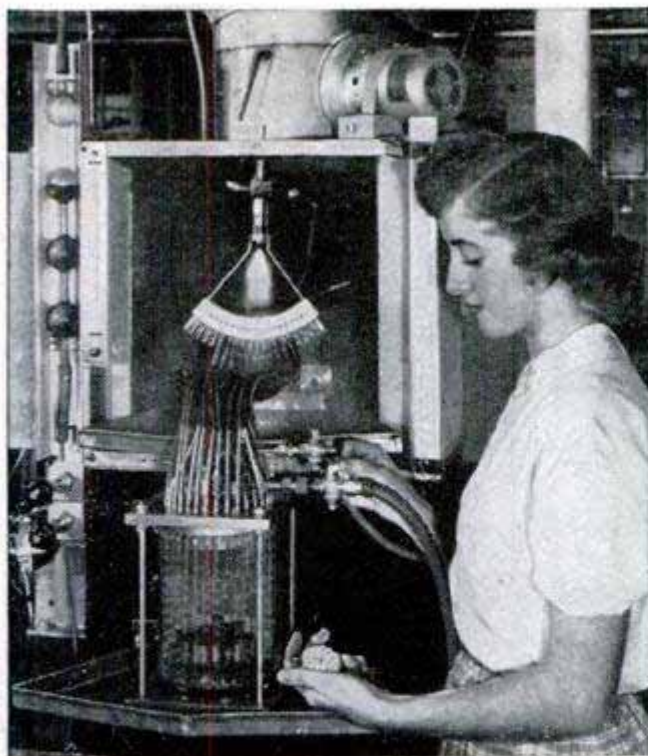

Laboratory technician tests various spray nozzles for the new engine. Fuel collects in test tubes and is measured to determine the efficiency of the nozzles

efficient that it will deliver an average of 30 percent more miles per gallon. With it, New York City taxi operators would save \$2,000,000 a year. The average car owner, driving 10,000 miles a year, would save about \$50 on fuel alone.

Secret of the new engine—called T.C.P. (for Texaco Combustion Process—is a built-in tornado inside the cylinder, and a radical fuel injection and firing system. It all started about eight years ago when Texaco top brass set Everett M. Barber, a brilliant, husky young engineer, to work on the big bugaboo of the oil industry—engine knock, which has resulted in an ever-spiraling race to keep octane numbers ahead of higher and higher compression engines. “Every time the octane goes up a point,” they explain, “it costs the industry more than half a billion dollars. Since the war, oil companies have parted with more billions to boost octane than it has cost to finance the Marshall Plan to date.”

The ping and knock you hear on hills is what happens when the octane number is too low for your engine. And it can be more harmful than you think. It can send a spark plug up through the hood of your car if it's bad enough. A walk through the test stands where knock is investigated at the Beacon Labs sounds like a day at a gunnery range. They ran a high-compression truck cylinder for three minutes on a grade of fuel five numbers too low, one of the engineers reports, and at the end of that time it stopped dead, pitted and charred beyond repair. You can imagine what

(Continued to page 264)

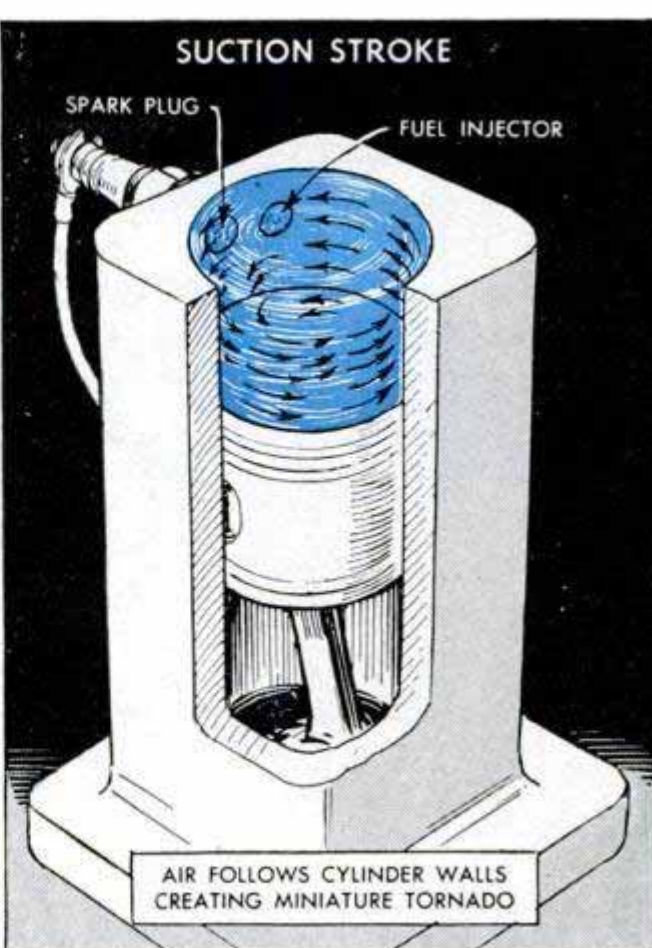

Two strokes show action of the new cylinder, which operates even on kerosene. Above, as piston moves down, air swirls into cylinder. Below, at top of stroke fuel-air mixture ignites and burns completely

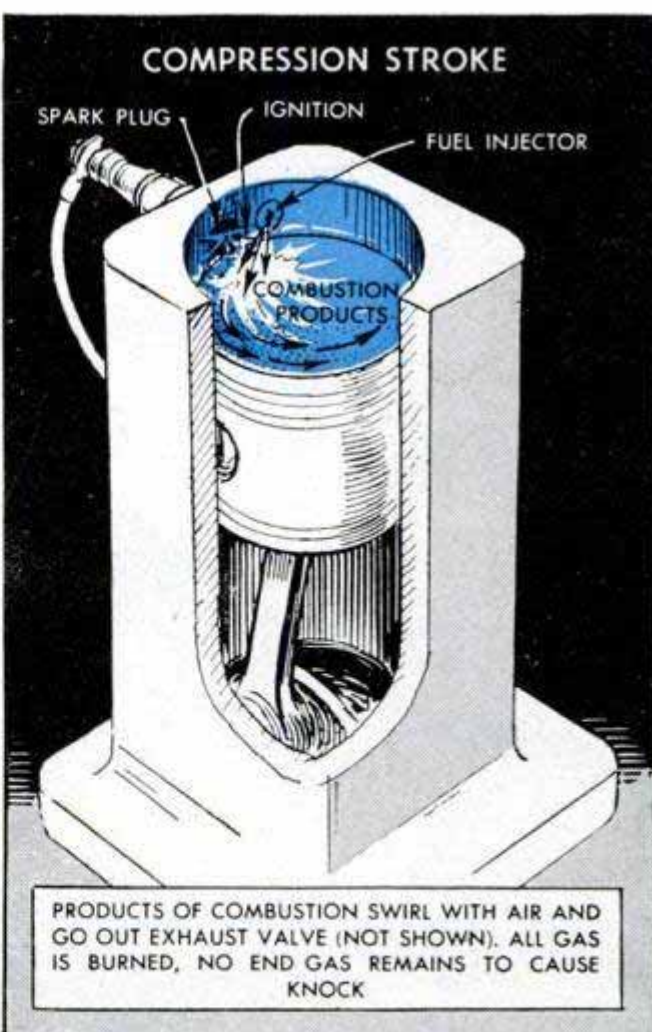

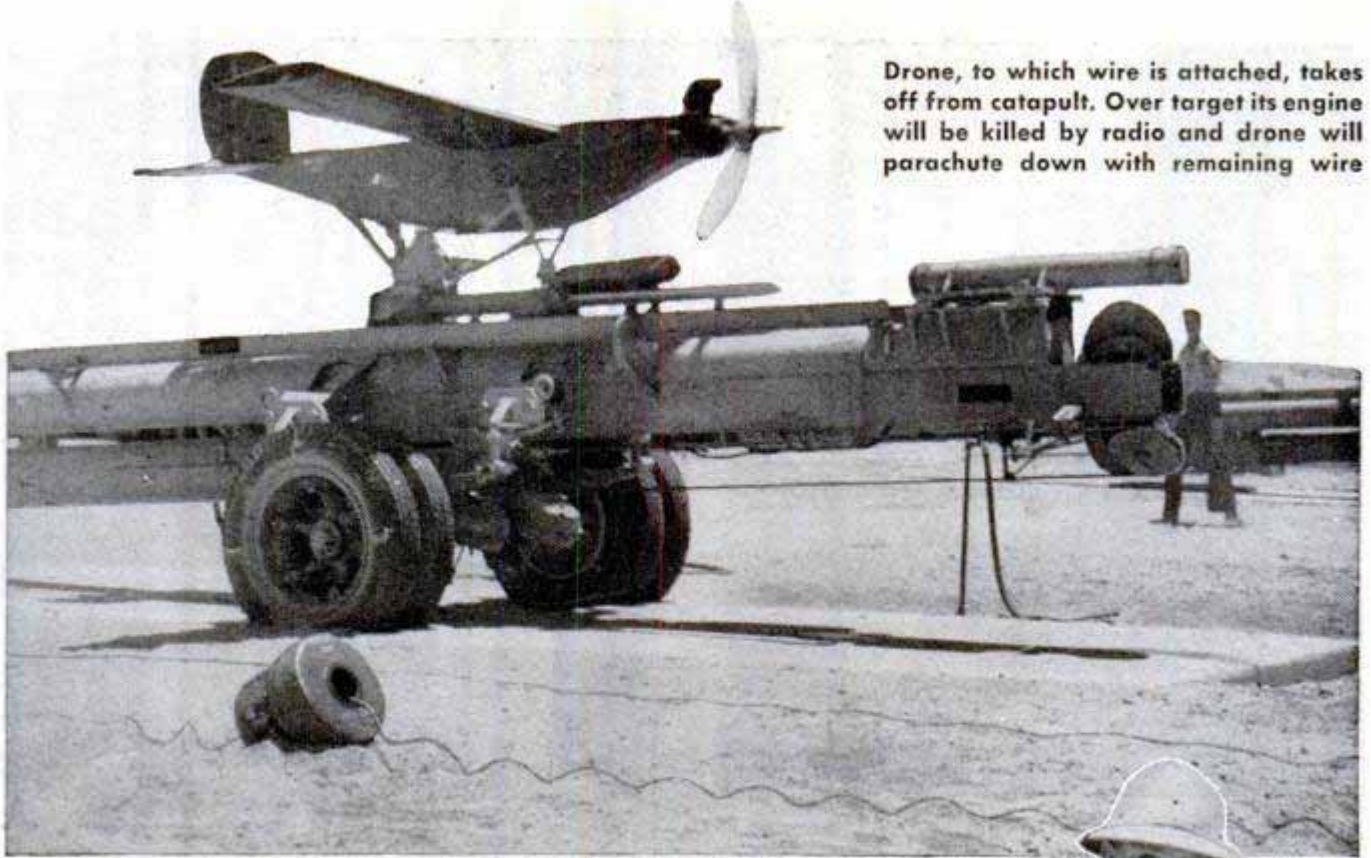

Drone, to which wire is attached, takes off from catapult. Over target its engine will be killed by radio and drone will parachute down with remaining wire

## Drone Plane Lays Wire

SMALL radio-controlled drone aircraft are being used experimentally by the Army for laying communication wire, the idea being that the drones could do the job faster and more safely than a crew of soldiers in a front-line area. The wire used by the drones weighs one third less than World War II field wire and is coiled inside light canvas containers instead of on heavy metal reels. Each container holds half a mile of wire and the wire in separate containers can be joined. The containers may be carried on a Jeep for laying wire at high speed on the ground.



Canvas container holds a half mile of lightweight wire which unreels as the drone zooms toward target



Free end of wire is attached to the robot aircraft. A small radio-control box guides the plane



### Three's No Crowd in TV Filming

By using three cameras simultaneously to photograph half-hour shows for television broadcasts, the Jerry Fairbanks studio cuts production time down to three days. Two days are used for rehearsals and the third for shooting. Because the three cam-

eras are spotted for close-up, medium and long-shot views, the show is given variety by splicing the films. Once the film has been made, it can be shown over any number of stations, reducing the cost per showing considerably. Quality is said to be superior to the method of filming live programs from a TV tube for rebroadcasting.

### Golf Aid Controls Swing

Golf players can improve their swing with a pendulumlike guide rod that controls movement of the club through the entire arc of the swing. The guide rod attaches to the club head on a ball-socket swivel and to a bracketed arm extending out from a wall or tree. Tests in a Miami, Fla., golf school revealed that the device helps the golfer bring the club head back low and straight along the intended line of flight, stresses the importance of a straight left arm and proper wrist breaking.

☐ When the dentist drills away on one of your molars, the tooth enamel undergoes an average temperature rise of 100 degrees.

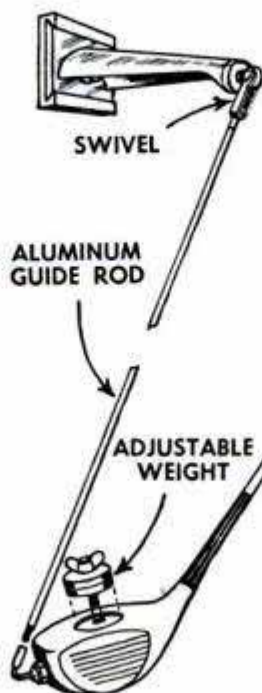



U. S. Air Force photo

Triple-deck bunks gave the crew much-needed rest during a flight that lasted through two nights and a day

# I Flew Thirty-One Hours

By Lt. Edward A. Timmins

1st Strategic Reconnaissance Squadron, USAF



I SPENT two nights and a day several miles high in the air, on the first extreme-range reconnaissance mission to be flown in a Strategic Air Command B-36.

For 31 hours we crossed and recrossed the country without landing. Our giant six-engined plane flew some 7100 miles as we completed more aerial and radar photographic projects in one flight than could have been attempted in a fortnight just five years ago.

As radar bombing and photo specialist, I was just one of a crew of 22 aboard the huge aircraft, including extra men carried in several positions for training purposes.

Our route stretched from Fairfield-Suisun Air Force Base in California to the

The author, a radar bombing and photo specialist, flew on the first extreme-range reconnaissance flight

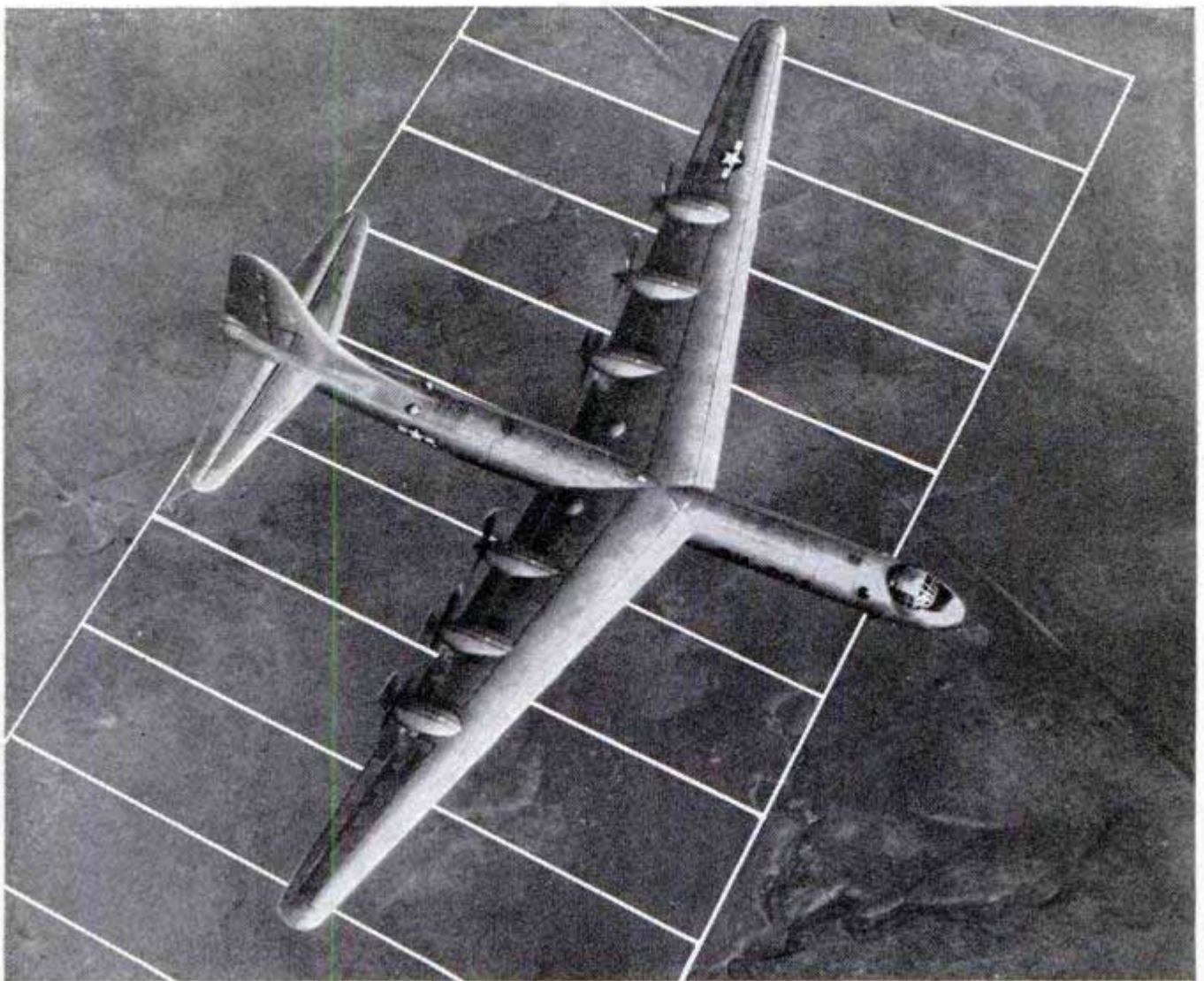

Consolidated-Vultee photo

Overhead view of the big B-36 shows how its dimensions compare with superimposed 100-yard football field

# in a B-36

Georgia coast; then to the southern tip of Texas, to the Colorado mountains and back to our base near Sacramento.

The crew was composed of officers and airmen of the First Strategic Reconnaissance Squadron, the oldest unit of Ameri-

can air power. This outfit was organized as the First Aero Observation Squadron in 1913 and pioneered many of the reconnaissance procedures in use today.

This flight was not the longest we could have flown, but it was long enough to reveal some of the problems we will meet if called upon to fly 10,000-mile missions.

The B-36, to begin with, is a high-altitude, long-range plane, which is at its best at nearly double the heights which were considered high in the last war.

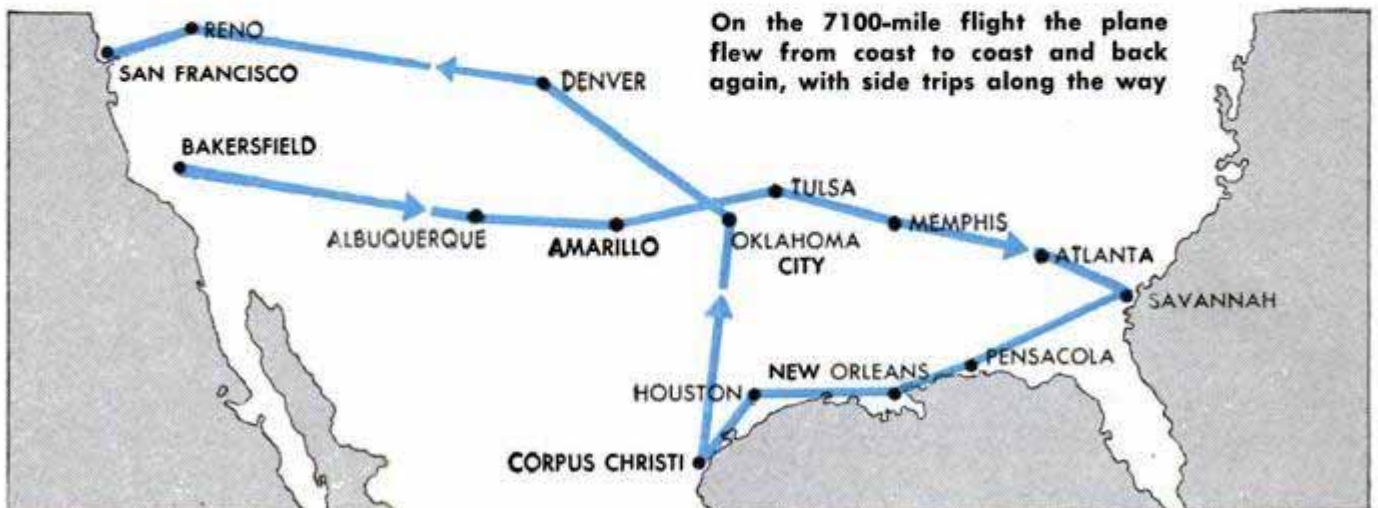

On the 7100-mile flight the plane flew from coast to coast and back again, with side trips along the way

Its wing stretches some 80 yards from tip to tip, being so thick that engineers can make inspections of engines from within, even in flight.

The wing is nearly twice the length of the Wright brothers' first flight at Kittyhawk. The pilot, sitting high in the nose, can hardly hear the engines, much less see them. Only the extremities of the wing are easily within sight from his seat.

Lateral spread of the tail assembly almost overlaps the wings of a Flying Fortress, which was the backbone of the bombing of Europe.

The rudder fin is so high that, to open

plates for inspection of control cables, our ground crews have resorted to ingenious stunts. I've seen them hoist a man to the top of a 50-foot crane, using an empty oil drum as a crow's-nest from which to work on rudder hinges.

From nose to tail-gun turret, the B-36 measures better than 50 yards, much of this distance being devoted to four bomb bays.

Total weight of the empty plane approximates 80 tons, and it can carry upwards of 60 tons of fuel plus bombs, ammunition and crew members.

It is advertised to carry this load nearly half around the world.

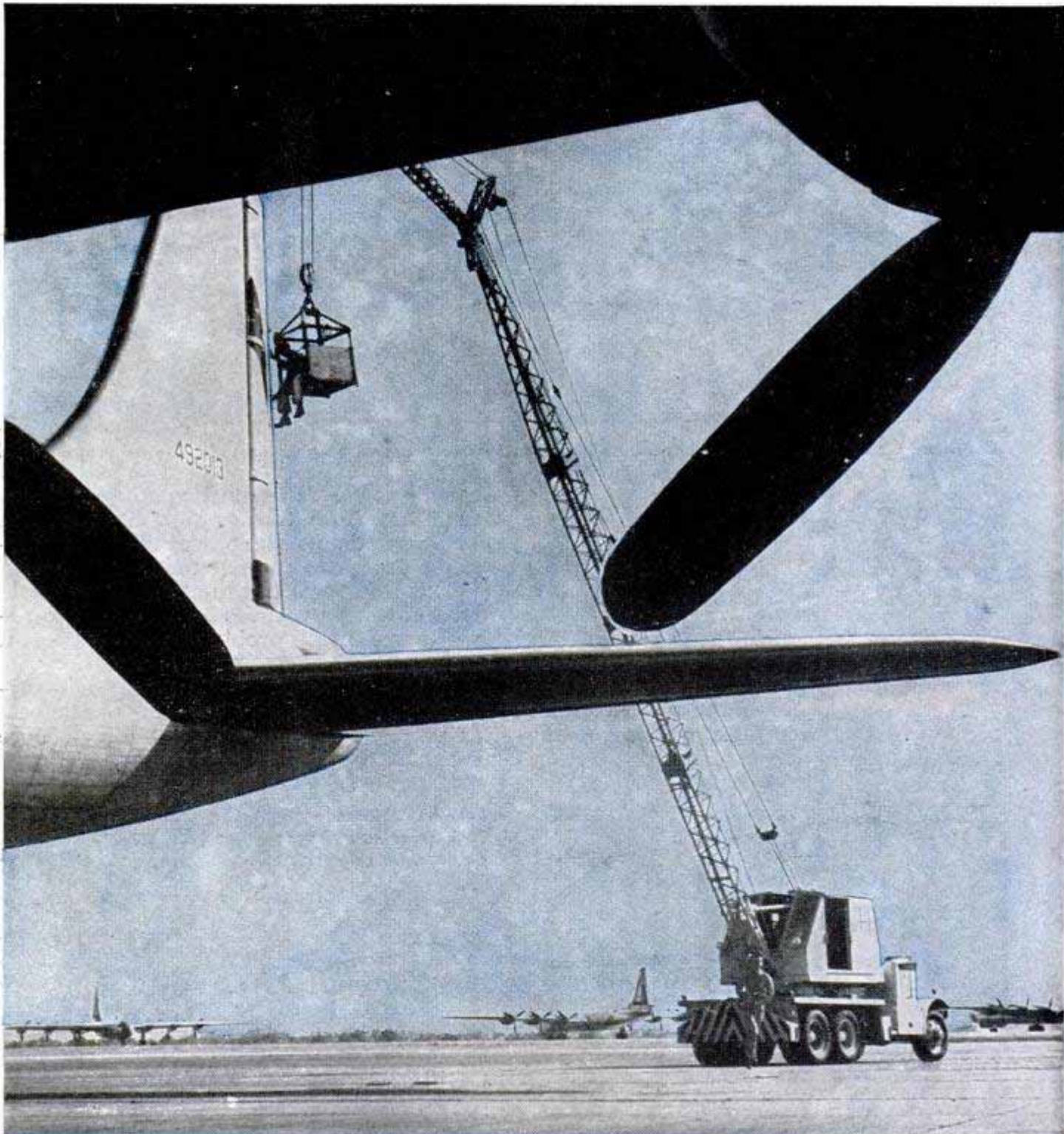

U. S. Air Force photo

Airman in a makeshift crow's-nest is hoisted toward the sky to inspect the towering 46-foot 7-inch tail

The big birds are powered with six 3500-horsepower engines with a total of 21,000 horsepower, 2½ times that of a Superfort B-29. These engines are mounted aft of the wing to push the behemoth instead of being mounted in the usual pulling position. This mounting gives them a peculiar and easily identifiable sound.

The propellers, having a diameter nearly that of the screws of the Queen Mary, all may be reversed in pitch. When the blades are twisted from their normal angle they hold back the big craft, a feature which allows landing in a shorter space than many airliners.

Literally, the landing wheels are "trucks." Four oversize wheels combine to make up each of the main gear. With two more wheels in the nose gear, the ship stands on 10 wheels, each bearing less weight than a wheel on a B-29.

First of the B-36 types to be equipped with supplementary jet pods will be reconnaissance models. This hints at the importance of reconnaissance in the estimate of Lt. Gen. Curtis E. Lemay's Strategic Air Command — America's "cocked fist."

These jets will furnish additional power for extremely heavy loads and help lone planes to return pursuit more easily. Many reconnaissance missions will be single-ship sorties.

The problems involved in planning, preparing and executing an extreme-range mission keep the flight crew busy for many hours before and after the flight itself.

In the air, efficiency requires the staggering of duty time, sleeping time and meal periods, in addition to the teamwork vital to top-rate accomplishment for the many hours of flying. Some of the unexpected situations we met were indeed amusing.

Even before take-off, we got a bewildered feeling as we realized we would cover a route equivalent to flying nonstop from Boston to Tokyo, and that when we landed, it would be right back at our starting point.

As radar specialist, I was required to help plan the route at a conference beginning at nine o'clock in the morning. The rest of the day would be used in preparation for the flight which would



U. S. Air Force photos

Crewman lies on dolly and pulls himself through 80-foot tunnel connecting fore and aft compartments. Below, aircraft commander and pilot take time out for cake and coffee during flight





Crewman squeezes through air intake to work on engine while plane is on ground. In the air, the crewmen can crawl along narrow catwalks in wings to inspect any of the six engines



With an auto-type wheel, commander steers plane along runway. Below, scanner watches flaps and landing gear for the pilot

U. S. Air Force photos



begin at six o'clock that evening.

Every step had to be planned: turning points; altitudes on various camera and radar photographic projects; weather conditions to be met or avoided; timing of our arrival at other sites with advantageous sun angles.

The flight engineers, intelligence officers, navigation officers and operations specialists all collaborated in the plans and the general and specialized briefings which followed later in the day.

After early supper, the crew reconvened at the plane for crew inspection under the wing of the big bird. Each man was checked for oxygen mask, warm clothing in the event of heat failure, parachute, one-man life raft, "Mae West" life preserver and technical equipment.

Each laid out his equipment for inspection by the aircraft commander who was also chief pilot. Besides myself there were pilots, navigators, flight engineers, gunners, scanners, photographers, weather observers and electronic experts. Almost every man was qualified for more than one duty.

Loading our gear in the B-36 was a job in itself. Each of us carried some 50 pounds in bulky equipment. Besides, there were half a dozen huge Thermos jugs of water and coffee, about four boxed lunches per man and cases of milk and soup.

Once aboard, first of the standard procedures was to "check in" with the pilot on each of the two interphone systems, reporting position, emergency oxygen supply and readiness for starting engines.

The double interphone system on the B-36 is an innovation, designed to eliminate confusion and interruption of important reports. Gunners can collaborate on one system while the bombing team uses the other without mutual interference at critical moments.

Next thing to be heard on the "hook up" was the voice of the ground crew chief talking with the pilot and flight engineer. The engines are so far back, and behind the wind as well, that the crew chief on the ground outside acts as eyes for the men in the cockpit.

Engines are started with current

(Continued to page 254)



## Dreaded Quicksand Debunked in Tests

That old bugaboo, quicksand, isn't nearly as dangerous as most people think, according to Prof. J. O. Osterberg of Northwestern University, who has been making measured tests of the stuff. Quicksand is mostly water with sand floating in it. Because it has a higher specific gravity than water, a person can float in it with greater ease than in water. What makes it seem dangerous, Osterberg says, is that it is thick, hampering the movement of arms or legs. Osterberg proves his point with the aid of Willie, a toy rabbit which he has weighted to equal the specific gravity of a human being. Only the tips of



Willie's ears stick out when he is dropped in a tube of water. In quicksand, Willie stays out from his waist up.



## "Big Mo"—Sample Size

Ever hear of the flea that wanted to be an elephant? Now we have a ferryboat that tries to emulate a battleship. Not long after the "Big Mo" was pulled off her mudbank, the little ferryboat Dutchess steamed out of her slip at Beacon and headed for Newburgh, N. Y. The pride of the U. S. fleet had nothing on the Dutchess, for the ferry promptly ran aground on her own mudbank. A day later she was refloated with the aid of two tugboats, a flood tide—and, presumably, the plans for floating the battleship Missouri.

## Magnet Flips Pages For Violinist

Violinists turn the pages of the musical score without missing a beat by means of magnetism. A short length of wire tipped with a small magnet is attached to the violin scroll. At the lower right-hand corner of each sheet of music a small metal tab is clipped. When the violinist swings the scroll down toward the music, the magnet attracts the metal tab, raising the sheet.



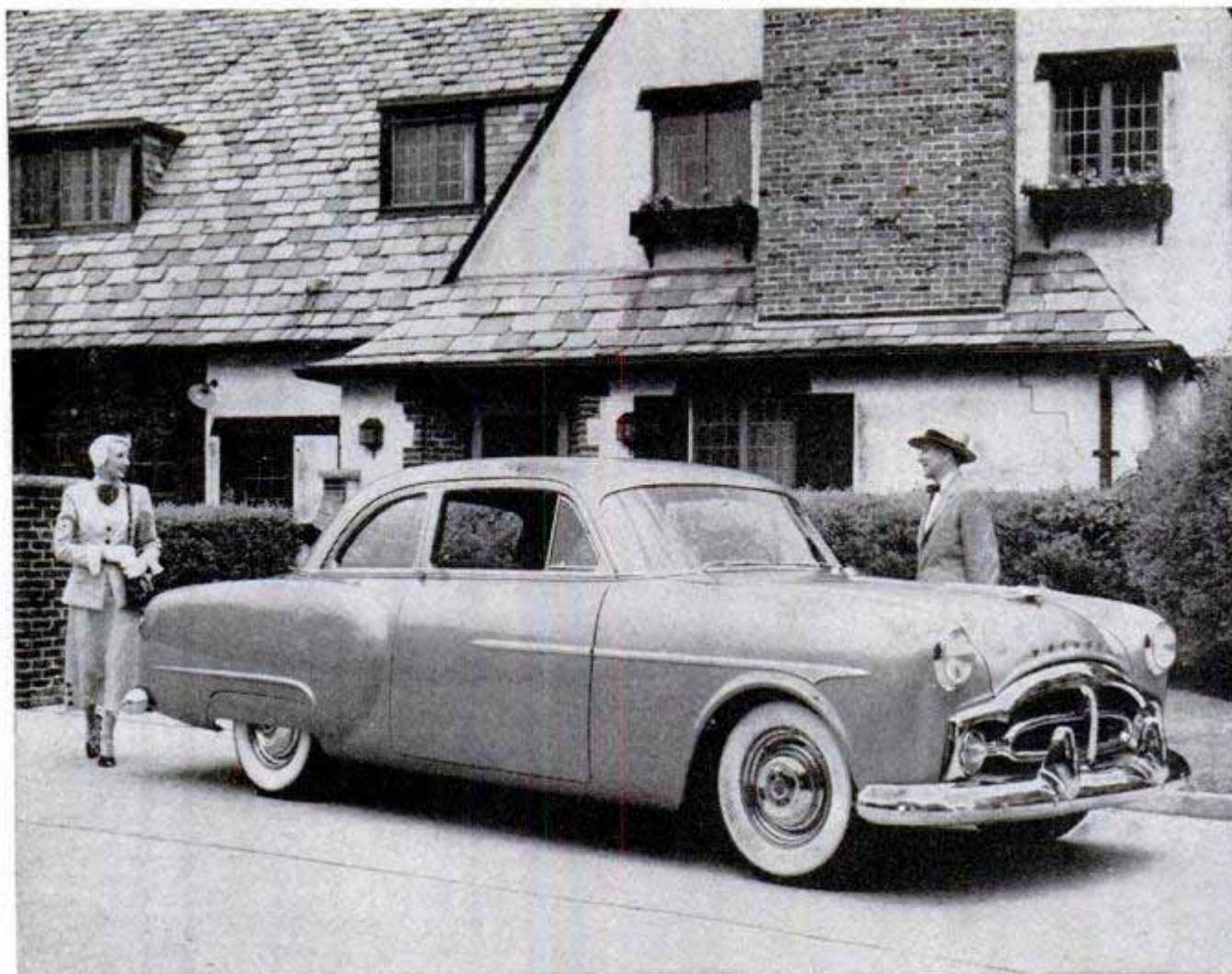

From sleek grille to long rear fenders the '51 Packard is an all-new car. This is the 200 series two-door sedan

## PACKARD '51 TAKES A BOW

**By Siler Freeman**  
*Automotive Editor*

**P**ACKARD dealers are displaying the 1951 line of cars, just brought out by the company, which represents an almost complete break with all Packard traditions. The models are completely new, outside and in, including styling and a new power line-up.

Except for an adaptation of the familiar Packard radiator lines in the 1951 car and retention of the hexagonal hub caps which always distinguished the company's products, the new models have gone all the way to join the low-silhouette, wide and streamlined trend in the industry. The car has been lowered two inches and the rear seats moved forward to add 12 inches in width to the seating room in the back.

Also showing the trend in the industry is the fact that Packard has gone to the notch-back styling, which adds trunk space.

Packard has also joined the high-compression engine advocates. It has two new engines, one of 288-cubic-inch displace-

ment and the other 327 cubic inch. It develops what it announces is the highest compression in the industry, 7.8 to 1, by using a cast-iron high-compression head.

The high-compression head is not new to the industry. Pontiac has offered one for some time and, with the emphasis on higher compression and better fuels, it is now starting to sell a lot of cars to customers. Pontiac would sell many more if it would emphasize this feature, but for some reason or other the division has been loath to talk about the head, which gives 7.5 to 1 without changing the engine. Hudson some time ago also demonstrated how it could step up its regular engine to almost 9 to 1 with an aluminum head, using aviation-type gasoline.

Packard's new Thunderbolt engine with its high-compression ratio is teamed with the Ultramatic Drive. On one model the combination is standard; on the rest it is optional.

The smaller engine is rated at 135 horsepower regularly and develops 7 to 1 compression ratio. With the Ultramatic, the

engine is equipped with the high-compression head and develops 7.5 to 1.

The big engine is 150 horsepower but teamed with the new head and Ultramatic, it goes up to 155 and 7.8 to 1 compression ratio. The engine powering the 400 has a nine-bearing crankshaft for quiet operation. Premium fuel is recommended.

Both engines have new mounts with re-located three-point suspension to minimize vibration. The new power plants are equipped with hydraulic vibration dampers. The big engines have hydraulic valve tappets and larger spark plugs.

Ultramatic, which Packard developed, is unchanged in principle but has been improved in performance, the company states.

Other improvements announced in the 1951 models are a new frame assembly, a water pump which delivers adequate cool-

ing pressure even when the level is low, larger brakes, a clutch pedal on models not equipped with Ultramatic which requires only 16 pounds of foot pressure, asbestos-lined muffler on the custom series for quietness, wider rear springs and a gas tank that holds 20 gallons.

As a "first" Packard points with pride to new shock absorbers. They are direct action with special valving which adjusts automatically for all types of road shock.

The 1951 Packard comes in three series, the 200, 300 and 400. The 200 is on a 122-inch wheelbase, while the other two are on a 127-inch wheelbase. The 300 and 400 differ principally in interior fittings and trim.

The 200 series comes in the standard and de luxe lines. This series will offer later a sports coupe, which joins the parade of so-called "hardtops." It offers the customer the

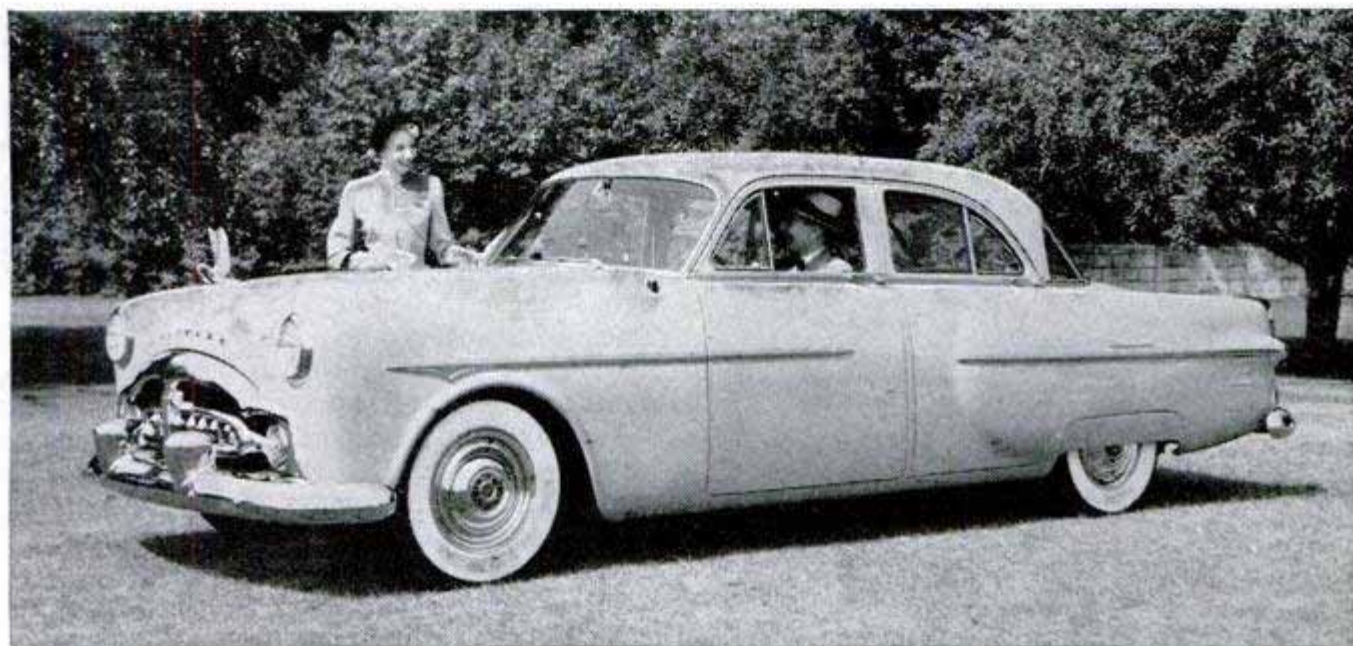

Luxuriously finished, the 300 series four-door is two inches lower than its predecessor and has a rear seat 12 inches wider. The sweep-around rear window increases visibility, and bustle back yields more trunk space





No "Fibber's closet" is this glove compartment—it pulls out like a drawer. Below, new direct-action front shock absorbers are placed inside coil springs

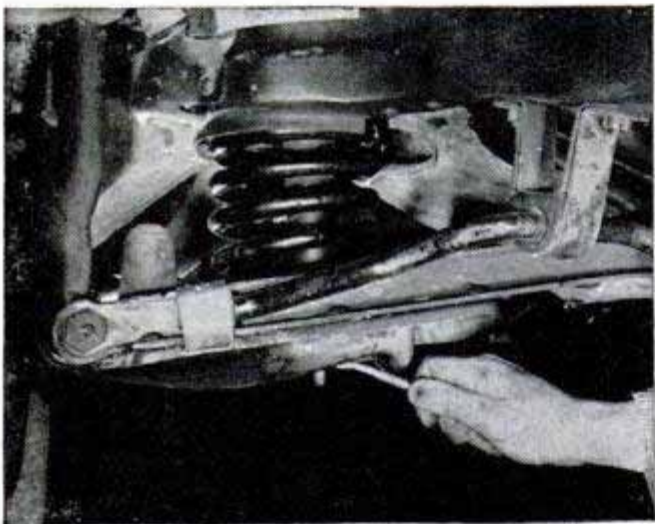

choice, however, of either of the engines. In the 200 standard line, the company has a sedan, club sedan and business coupe. The latter is a very evident price leader, designed to compete against the medium-price cars.

In the 200 de luxe line, besides the hard-top, the models include a sedan, club sedan and convertible. The 300 and 400 series will only offer sedans.

Outwardly, the new Packard is distinguished by its low silhouette and sweeping fender lines; the fenders are higher than the bonnet, with the hood lowered by five inches. The over-all height of the car is 62 inches but the road clearance has been kept the same. The over-all length has been increased five inches.

The 1951 Packard has a one-piece, curved windshield and the defroster opening is clear across for better vision in winter. The rear windows are swept back and vision has been increased 96 percent.

As said before, the rear seats have been made 12 inches wider by moving the wheel housings out and relocating the seats. Front seats have been widened two inches.

The 1951 line has a new dash instrument, with red lights flashing when oil pressure gets low or the generator fails to charge. The radio antenna is operated electrically instead of by vacuum. A rear-compartment loudspeaker is provided.

Packard has made wide use of plastics in its new models. On the 200 series, plastics are used at scuff points and door panels, and in the 400 it is used in combination with fabrics for rich effects.

The Packard "family" expects big things from its new offerings. The models have many points of interest that may appeal to auto buyers during the fall market season.

Packard 300, completely redesigned, poses with last year's model. Note lower hood, wider body, higher fenders



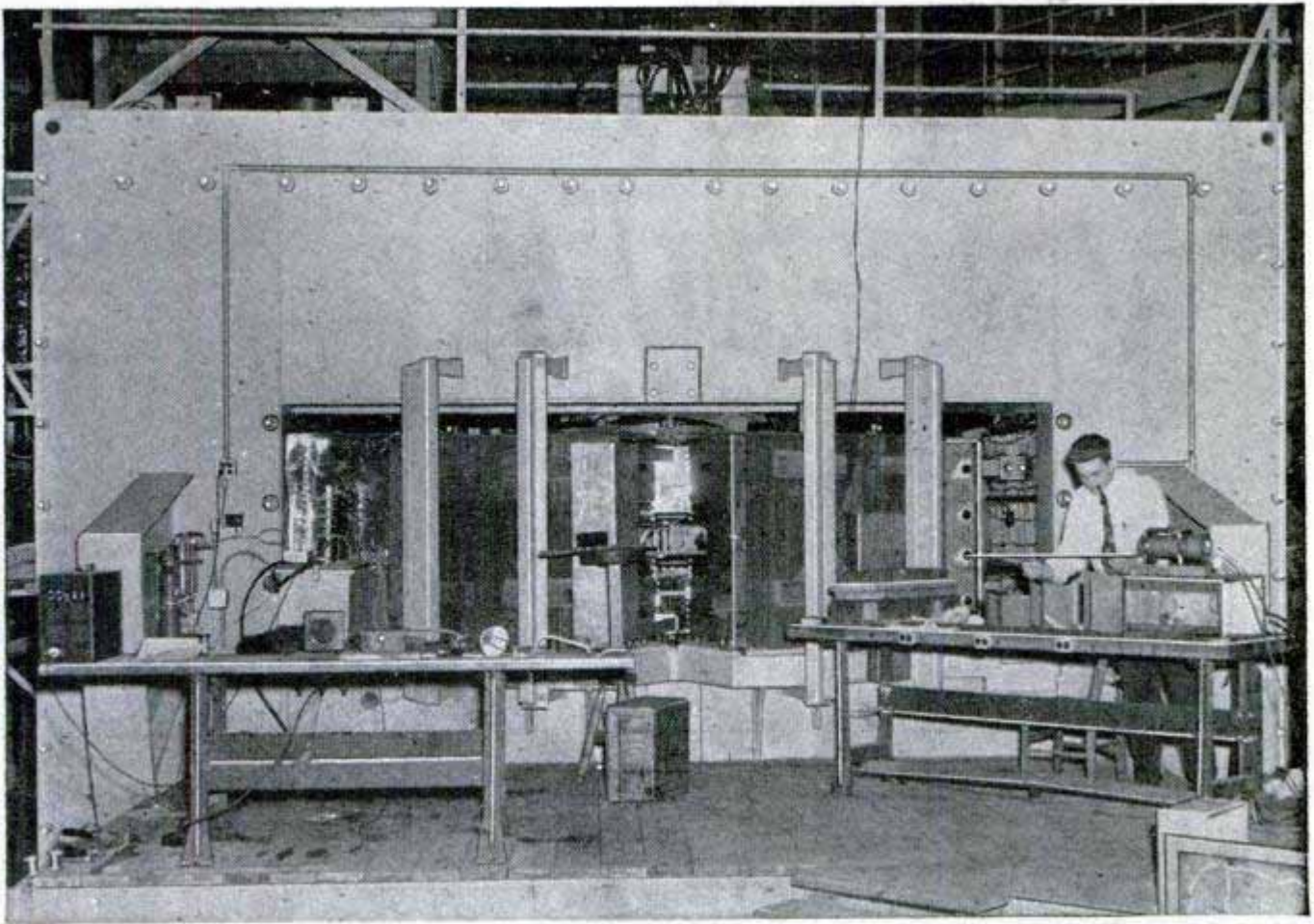

Rays from the 300-million-volt betatron, above, leave the center opening and are measured by instruments on table at the right of photo. Right, Prof. Kerst, inventor of the betatron, at control panel

## Super Betatron

Mesons, believed to be the "something" that holds the atom together, have been produced artificially by the new 300-million-volt betatron at the University of Illinois. The machine, designed by Prof. Donald W. Kerst, inventor of the betatron, develops radiations 20 times greater than any other similar machine. This radiation is 14 billion times the concentration of energy showered upon the earth from outer space in cosmic rays, the natural source of mesons. The Illinois mesons were produced when 300-million-volt X rays smashed into the atoms of a carbon stick. The X rays, rushing at the speed of light, bombard atoms,

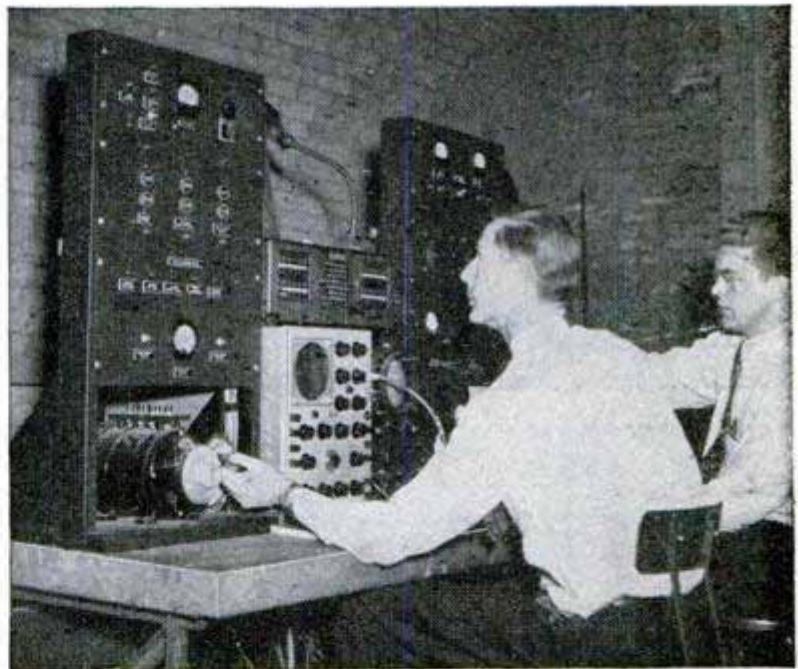

exploding them and knocking loose particles such as mesons. Research with the betatron may help reveal whether there are particles in the atom more fundamental than is now known.

## More Potent Fly Killer Extracted From Weed Root

From a weed root has come another potent fly-killing insecticide. A chemical called scabrin, it is so toxic that the Department of Agriculture thinks it may supplant pyrethrum, the knockdown agent in most sprays containing DDT. Scabrin oc-

curs in the roots of oxeye, a cousin of the sunflower, and could be cultivated and harvested mechanically with greater ease than pyrethrum, which requires hand-picking. Tests are being made to determine whether it is safe for general use.

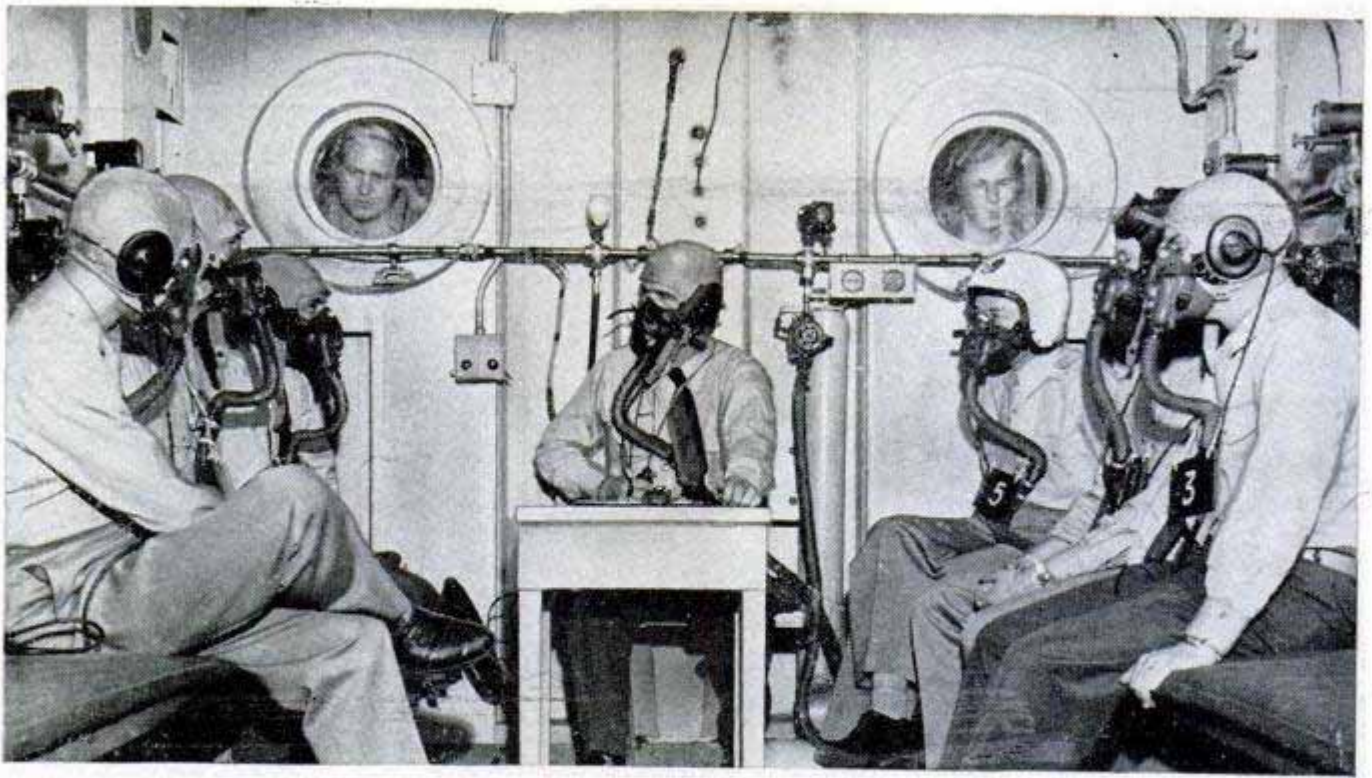

↑ While the "altitude" inside the chamber is raised, an aviation physiologist briefs pilots on what symptoms they may experience when pressure is "blown out"

← Watched and timed by the observer at left, a pilot blacks out in 45 seconds at 35,000 feet. Coordination board shows other pilots how he loses muscular control

↓ During the "flight," observers keep a wary eye on occupants of the chamber through portholes, ready to rush inside if needed. Man at left controls altitude

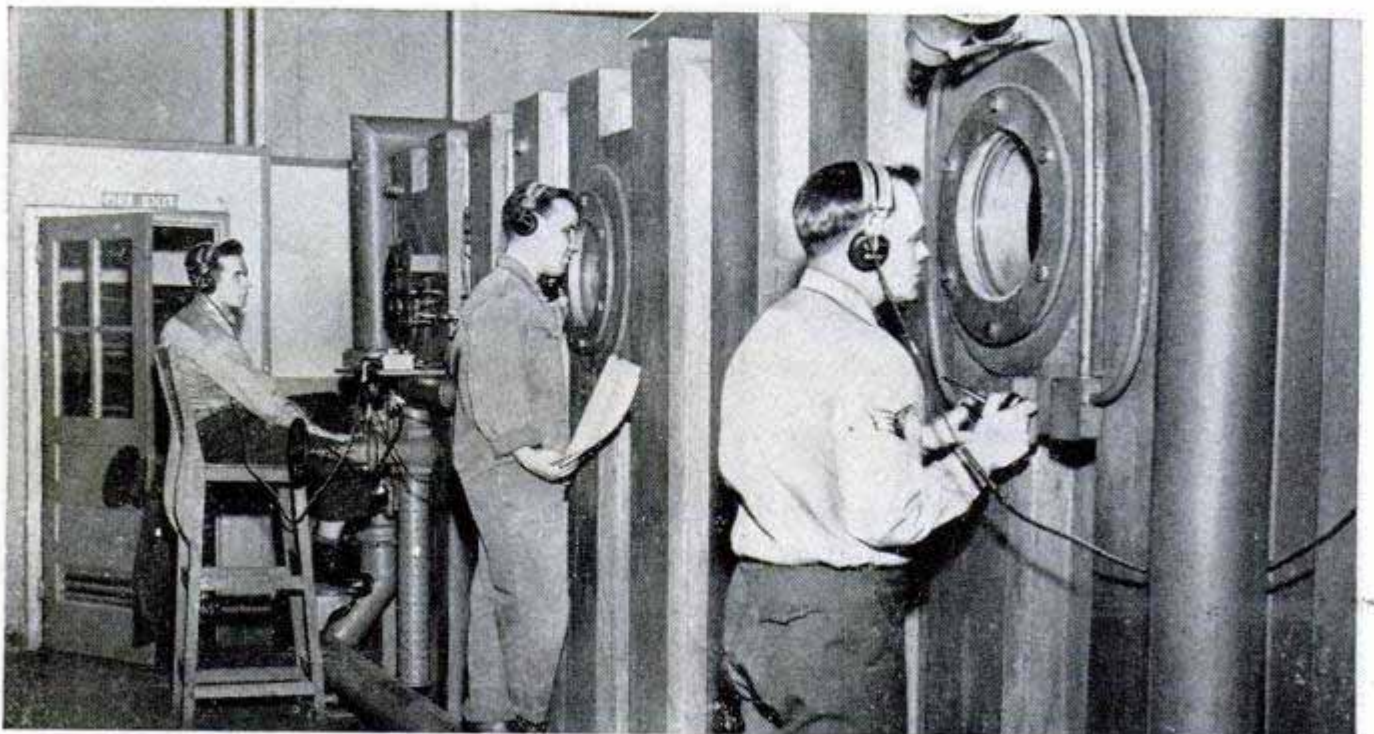

# Explosion to High Altitude

A SQUADRON of Thunderjets stretched long white trails from their wing tips as they roared over Langley Field at 35,000 feet recently. Suddenly one of the planes wobbled. The pilot, semiconscious from lack of oxygen, accidentally released the emergency catch on his canopy. With a resounding pop, the Plexiglas hood flew into space. Jolted by the explosion and exposure to thin, icy air five miles above the earth, the frightened pilot peeled off, dove for the earth and landed safely but badly shaken from his experience.

In peacetime, such action is commendable, but in war, planes can't always desert the mission whenever cabins are shattered by gunfire, or canopies pop off. To familiarize pilots with sudden exposure to high altitude, the Air Force has built an "explosive decompression chamber" at the Mitchel Air Force Base on Long Island. Under the direction of Capt. William T. Larkin and six technicians, groups of 16 pilots at a time are put through the jolt of exposure to a sudden five-mile height.

In a 19-ton chamber of ¼-inch steel, 20 feet long, nine feet wide and seven feet high, the helmeted and masked pilots sit in a simulated altitude of 10,000 feet, apprehensively eyeing the aeromedical technician as he prepares to catapult them to the rigors of a quick 22,000 to 25,000 feet. There is no sound except the hiss of air being pumped out of the adjacent antechamber—creating a semivacuum there. In the steel wall separating the two chambers is a six-inch porthole, sealed with three layers of celluloid film. The technician watches a gauge telling him the air pressure in the antechamber is gradually approaching the necessary level. At the crucial moment, he reaches for a poker, jabs and ruptures the film seal over that porthole. With a roar, air gushes from the personnel chamber into the semivacuum in the outer room. Air, sucked from the lungs and stomachs of the men, burbles around the edges of their masks as pressure plummets. Their lungs feel as though they've been bathed in ice water. Fog forms momentarily in the thin air, then vanishes. In less than a second it's all over.

"Explosive decompression is an unknown quantity to most flyers," explains Sgt. Glenn H. Crittenden, Mitchel's aeromedical technician. "They've heard of it but they don't know what to expect. The constant worry affects their efficiency. So we show them, here in the chamber, that it won't hurt them."

The chamber is made of 12-inch-wide

channel-iron strips electrically welded with a two-inch lap at the web. Set in the walls are eight observation ports. Trained observers watch through these to notice reactions. Besides explosive decompression, various altitudes can be simulated in the big chamber by removing air with a vacuum pump powered by a 15-horsepower electric motor. An oil-seal pump is used instead of a water-seal pump, because the water seal will leak air at 60,000 feet. The oil-seal pump permits chamber altitudes of 100,000 feet, although personnel are not taken over 35,000 feet.

Hypoxia results from lack of enough air pressure to force sufficient oxygen into the blood stream. It's usually evident about 10,000 feet, and it's insidious. Most pilots are too busy flying to notice the symptoms—a slight headache or dizziness, nausea or panting. Their lips or finger tips turn blue, but are too well covered to be noticed. When they've passed out, it's too late.

To acquaint pilots with their hypoxia symptoms is part of Captain Larkin's job. Sixteen flyers at a time are "flown" to 18,000 feet where the effect of hypoxia on vision is demonstrated. Then, after everyone has gone on oxygen, the altitude is raised to 25,000 feet where a volunteer removes his mask. He usually stays conscious about three minutes.

At 35,000 feet another volunteer takes off his mask. At this altitude he rarely stays conscious more than one minute.

Hypoxia victims have no memory of unconsciousness, and when revived they'll continue to do whatever they were doing when they passed out. To prove to volunteers that they were unconscious they are asked to keep writing their name until the instructor tells them to stop. Before they've stopped hypoxia develops and they are no longer writing, just making short strokes or jabbing the pencil lightly at the paper.

The pencil is then turned around and the victim given oxygen. Upon reviving he continues to write his name with the pencil upside down. He's always surprised to discover the eraser on the paper instead of the lead. One first lieutenant became hypoxic at 25,000 feet while writing his name, rank and serial number. He started promoting himself. First he was a first lieutenant, then captain, then major and then chief of staff of the Air Force.

But whatever his rank might be when flying at 35,000 feet, the decompression chamber at Mitchel Field has made a better pilot of him by acquainting him with high-altitude problems and how to handle them.

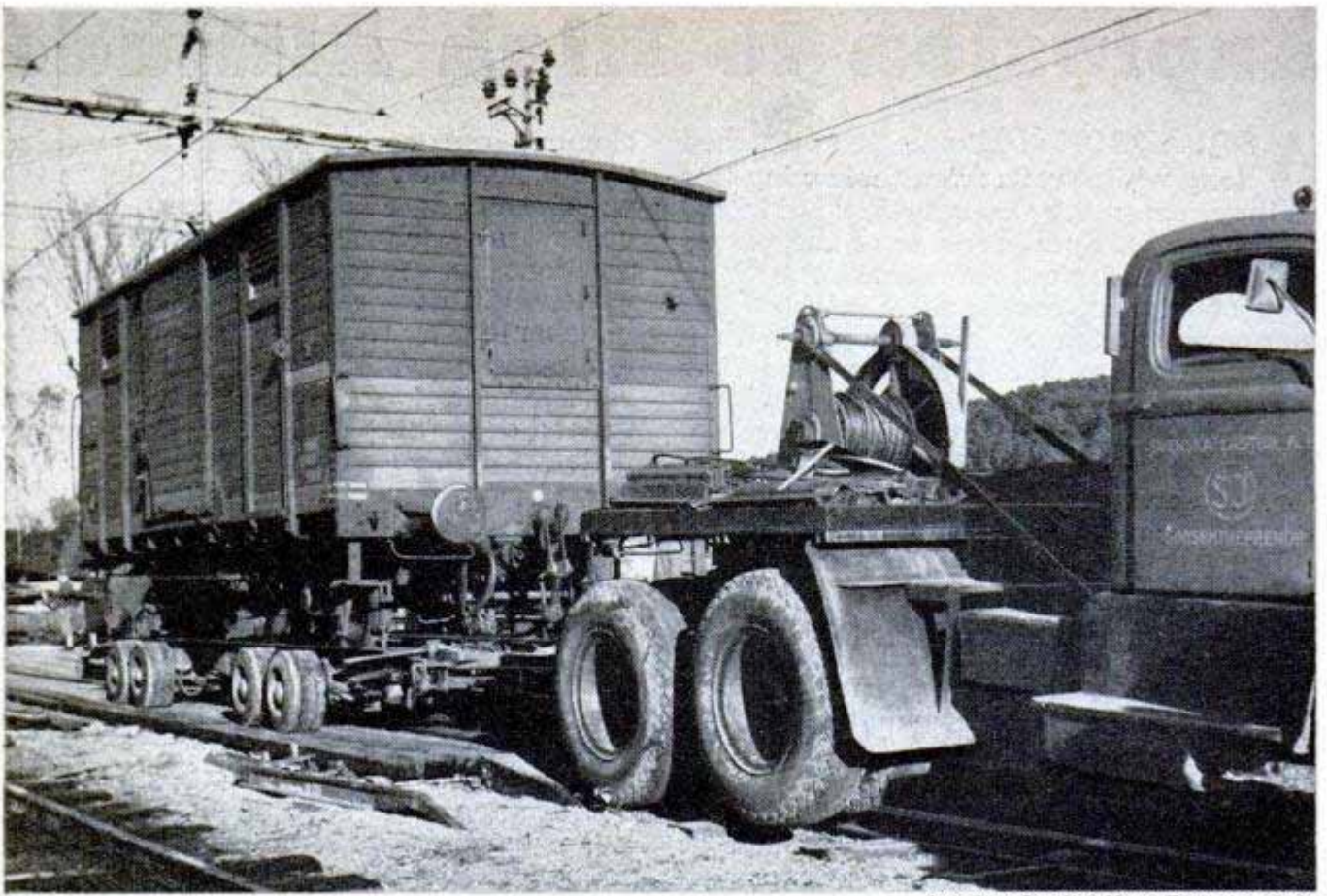

American-Swedish News Exchange photo

## Freight Car Hits the Road

Freight cars leave the tracks and are hauled right to your door by means of a special trailer developed by the Swedish

State Railways. The trailer has 16 wheels to distribute the load evenly over the pavement. A winch on the tractor pulls the freight car onto the low, flat trailer bed for over-the-highway travel.

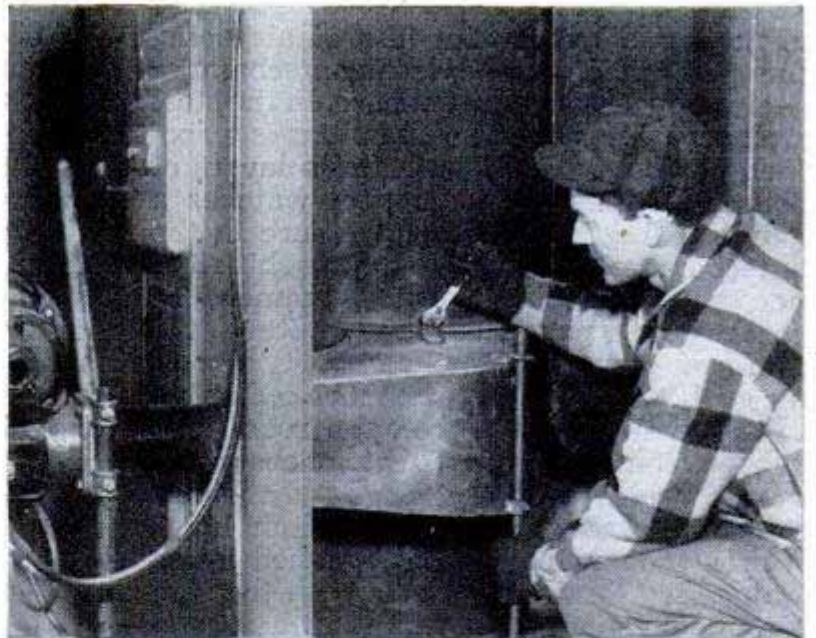
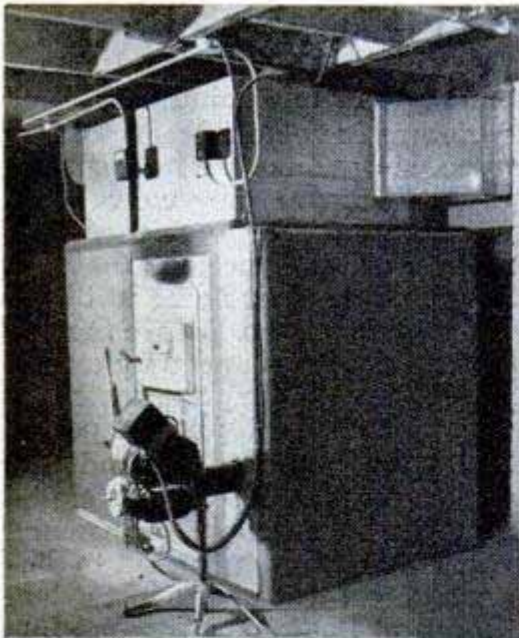

## Oil-and-Coal Furnace

Oil and solid fuel can be burned at the same time or at different times when a special combustion unit is added to a conventional coal furnace. If the furnace is hand-fired at a temperature above the setting on the thermostat, the oil burner does not operate. When the solid fuel burns down,

the oil burner comes on to boost the heat and aid in burning any solid fuels which remain. An opening from the oil combustion chamber enters the solid-fuel chamber on a level with the grates to utilize the greatest heating capacity of the furnace. The unit can be installed in coal furnaces which have all-steel bodies and supply gravity or forced-air heat.



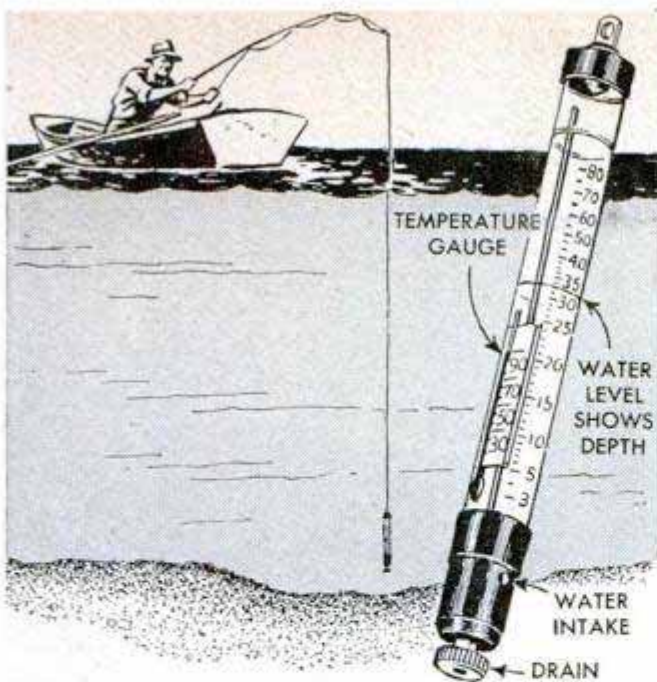

### Plug Records Water Depth

Cast like a plug, a new fishing instrument tells the angler the temperature and depth of the water. The transparent-plastic cylinder is scaled from zero to 70 feet and contains a thermometer. When the fisherman casts the instrument, it settles through the water until it rests on the bottom. Water pressure at that depth forces a sample of water to a corresponding height inside the instrument, where it is trapped until the fisherman releases it. The temperature of this water is read on the thermometer. By casting the instrument several times, the fisherman can find holes or underwater springs where fish are likely to be found during certain seasons.



### Protector for Truck-Tire Fixer

Truck drivers and repairmen are protected from serious accidents while inflating tires by a tool which holds the lock ring in place in the event of a blowout. One arm of the tool locks under the edge of the rim. Another arm then is slipped across the front of the tire, preventing the lock ring from flying off. If the lock ring is distorted or out of place after the tire is inflated, the tool cannot be removed, thereby warning the truck driver that the tire has been mounted incorrectly.

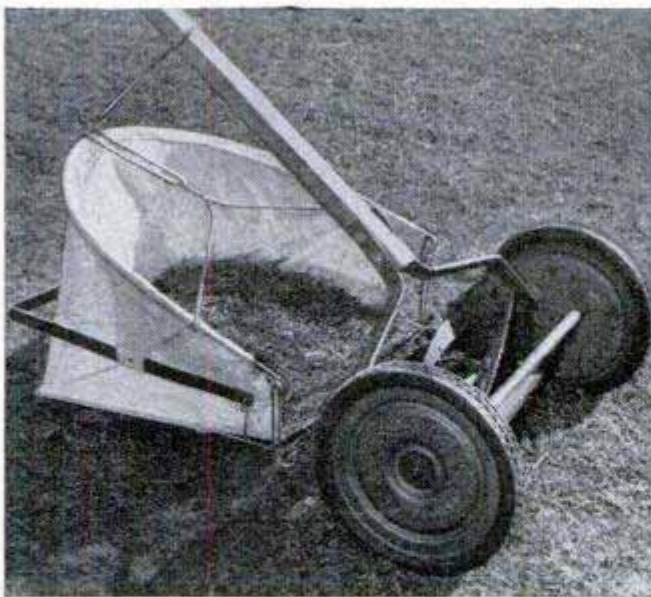

### Foot-Operated Grass Catcher

Cut grass is flipped to the back of a new grass catcher for lawn mowers when the operator steps on a pedal. Grass which sometimes tends to gather near the front of

a catcher is moved to the rear by a hinged plate. The plate swings up when the foot bar is pressed down, shoving the grass deep into the catcher. The attachment is made in two sizes to fit all hand mowers and some power mowers.



One small battery and a capacitor, shown at right, operate all the flash equipment in the left-hand photo

## Battery-Capacitor Flash Gun

It takes only one tiny battery, small enough to fit in your watch pocket, to fire up to seven flash guns using as much as 100 feet of wire when the flash system is capacitor operated. The capacitor is charged automatically just before each exposure and it releases 15 times the voltage of regu-

lar flash-gun batteries. In normal operation, the battery, a 22½-volt B-battery, has a life of about two years! Current flows from the battery to the capacitor only when a flash bulb is in the socket. As soon as the bulb is fired, the circuit is broken. It takes only a second or two to recharge the capacitor. Solenoids work briskly even in zero weather with the system.

## Midget Autopilot Light Enough for Fighters

More compact and less than half the weight of previous models, a new automatic pilot is small enough to be produced for fighter planes. The complete unit weighs only 52 pounds. Its working parts are

sealed in hydrogen to provide better heat transfer from the gyro to the surrounding air. Controls are simplified to include a switch, three buttons and a release button that is usually mounted on the stick.



## Lightweight Waders Worn Inside Shoes

For fishermen there is a new lightweight wading outfit with all the seams welded electronically to make it completely waterproof. The Vinylite material won't mildew and resists acids, oils, grease and food stains. It is a stocking-foot wader and is worn inside tennis or gym shoes, or boots.

Popular Mechanics provides two sources of further information concerning the articles published in each issue: the WHERE-TO-BUY-IT INDEX, starting on page 14, and the WHERE-TO-FIND-IT LIST, which may be obtained without charge by writing Bureau of Information, Popular Mechanics Magazine, 200 East Ontario Street, Chicago 11, Illinois

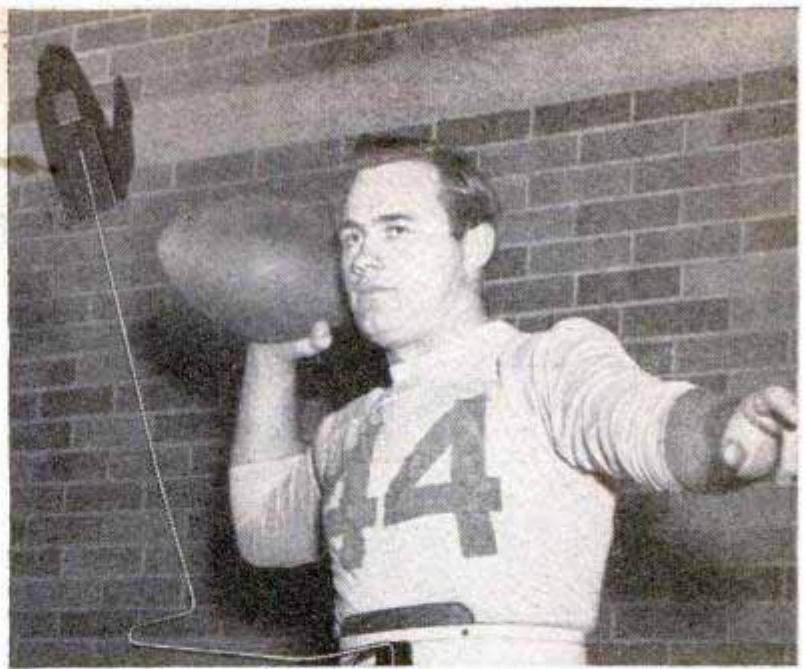
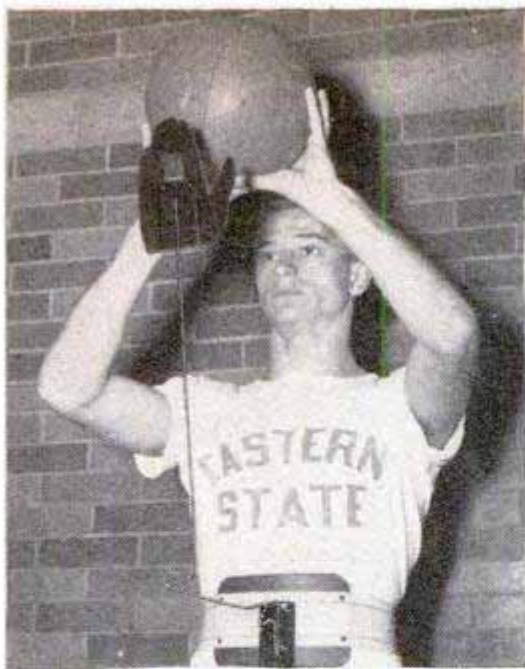

## Practice "Guard" Simulates Game Conditions

Even the cleverest basketball and football players cannot escape a self-imposed practice "guard." It is a simulated hand supported by a flexible arm attached to a

belt around the user's waist. In basketball the upraised hand hinders a player shooting, and in football it plays the part of a lineman attempting to block a pass.

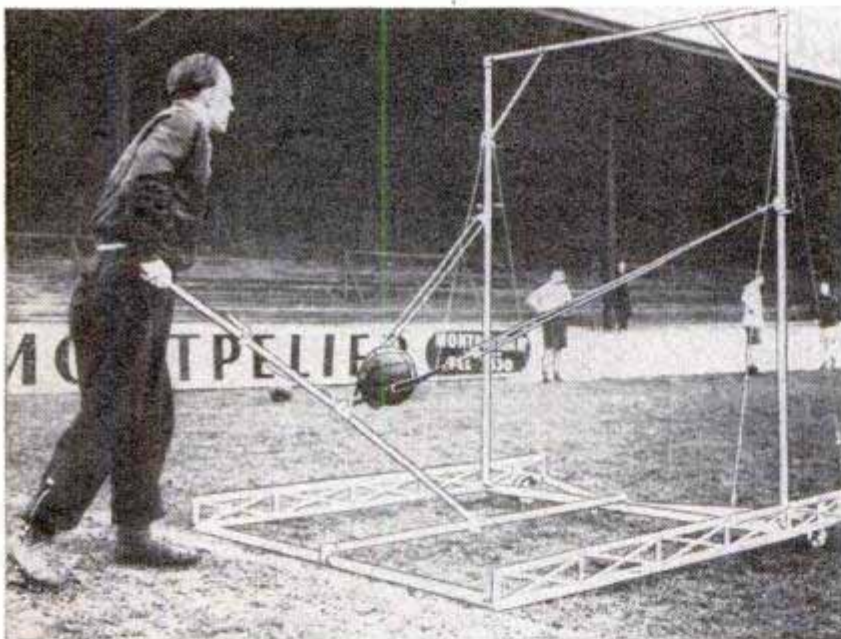

## Robot Booter Tests Soccer Goalies

Soccer goalkeepers get precision practice against their defensive weaknesses with a new automatic ball kicker. It can propel

balls at the rate of one every 10 seconds and can be adjusted to boot them from different angles and at varying heights.

## Newest and Heaviest Element Is Californium

Scientists at the University of California have created another new element, this one being element 98, the heaviest atom ever known. Named after the university and its state, the element is called californium and is six steps up the periodic table from uranium, the most massive element in nature. Element 98 is actually a synthetic unit of

matter, which does not exist in nature and has never before been observed on earth. It is so intensely radioactive that it has a half life of only 45 minutes. Produced by bombarding curium (element 96) with 35-million electron-volt alpha particles fired from a 60-inch cyclotron, the new element has no practical value in atomic energy.

Cars without crankshafts, trucks and busses that climb hills at top speed—these are what the engineers see in the promised . . .

# REVOLUTION OF THE FREE-PISTON ENGINE

By John D. Ratcliff

WRAPS are about to be removed from a new engine which looks like an inventive milestone. The engine promises busses and trucks which will climb hills at top speeds—instead of creeping up them to present prime traffic hazards. It offers a more economical source of power for long-range planes. One railroad, the Pennsylvania, sees it as a step beyond the diesel in locomotives. In time, it may even find its way into automobiles, giving 50 to 60 miles on a gallon of low-cost kerosene!

These are the things promised by the free-piston engine, a radical new power concept. As the name implies, pistons are not connected to anything. In your present auto engine there are masses of moving metal—connecting rods, crankshaft, flywheel. The new engine eliminates these parts. Two pistons slide freely in a horizontal cylinder. As they come together at the center they compress air so that the fuel injected will burn. In this respect the engine is like a diesel, requiring no spark plugs. As the free pistons fly apart, they compress air at the other end of their stroke. Air compressed in the "bounce chamber" acts as a springy cushion, driving the pistons back to the center again. Flying back and forth, the pistons do useful work all the time, generating hot gases in the center of the cylinder, compressing air at the ends. These gases are drawn off, run through a conventional gas turbine where they give up their power.

Thus, the engine is a kind of hybrid, a cross between a diesel and a gas turbine—combining the best features of both. It eliminates most of the diesel's moving parts and does away with the gas turbine's

Panel at right shows, from top to bottom, one cycle of a free-piston engine. Drawings have been simplified for clarity and only the major parts are shown

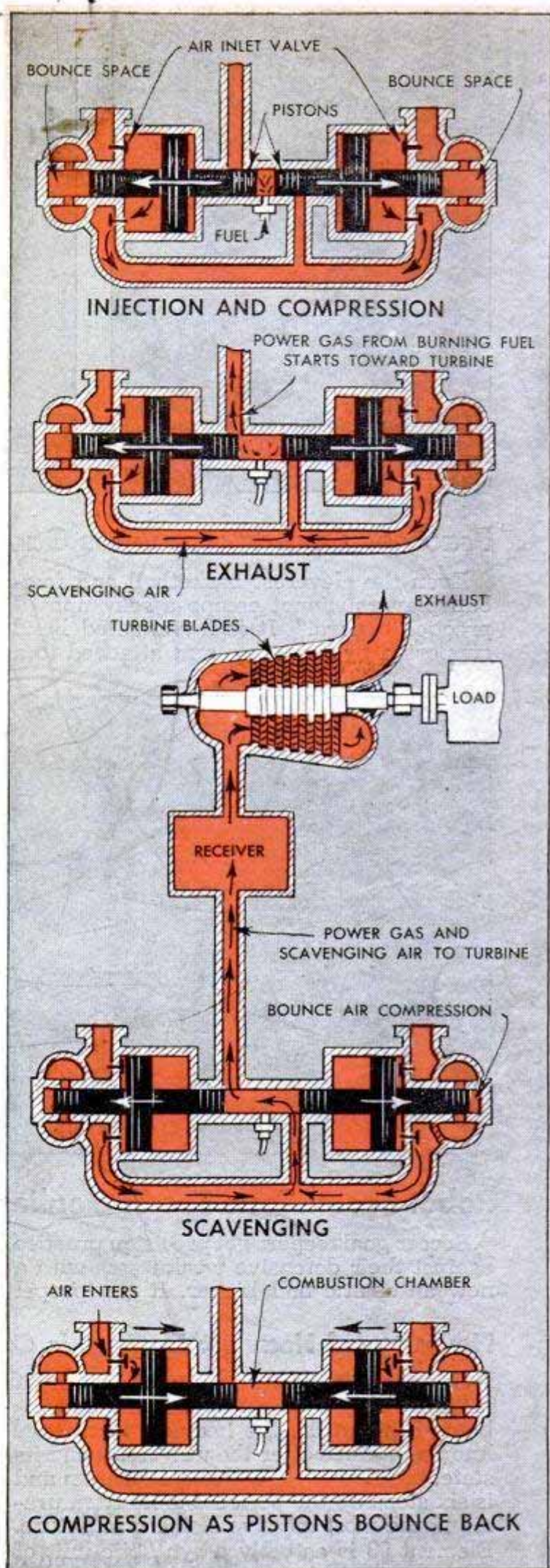

further info S. Buraya, Transmitter, New Rochelle, N. Y.  
 229 Eastchester Rd.

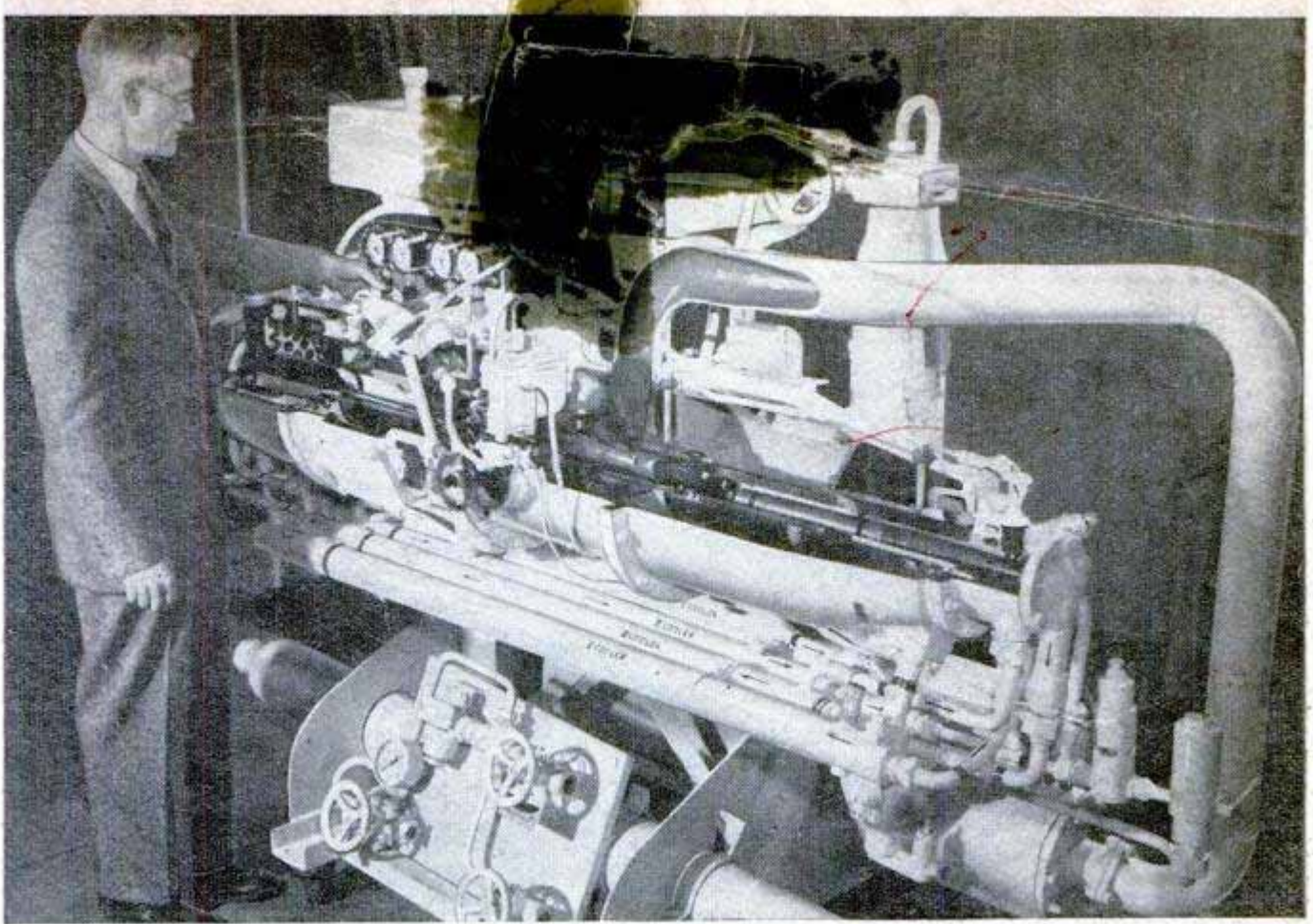

**This free-piston air compressor was used on a Nazi submarine to provide high-pressure air for the torpedoes. It was cut away for classroom study**

**Free-piston engines may soon power heavy-duty trucks. No transmission or drive shaft is needed. The cover painting shows front view of truck**

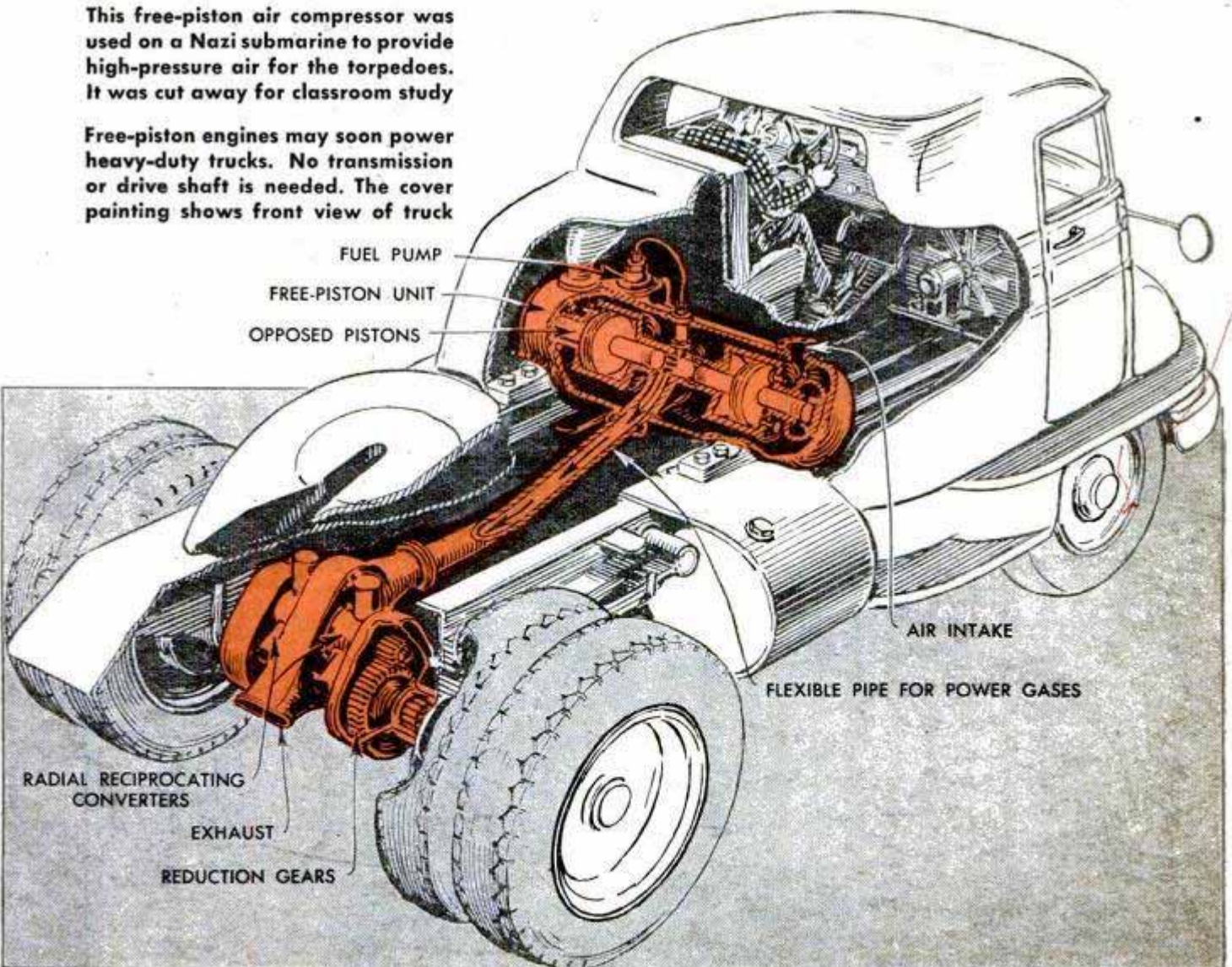

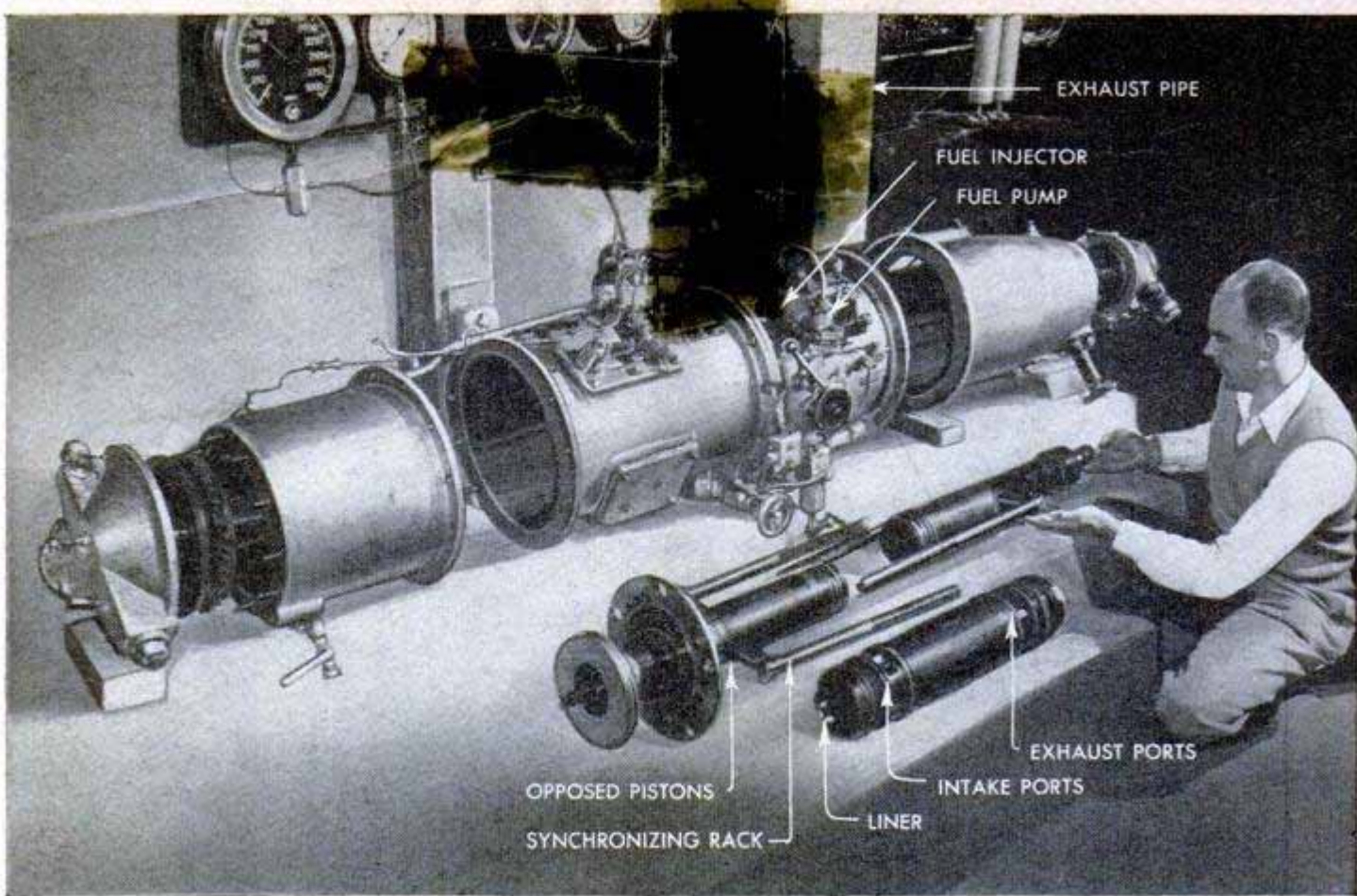

Stanford University is testing this German free-piston air compressor for the Navy. Here it has been taken apart and its inner workings exposed

Below, an artist's impression of how a ship could be driven by free-piston units, giving compact, vibrationless power

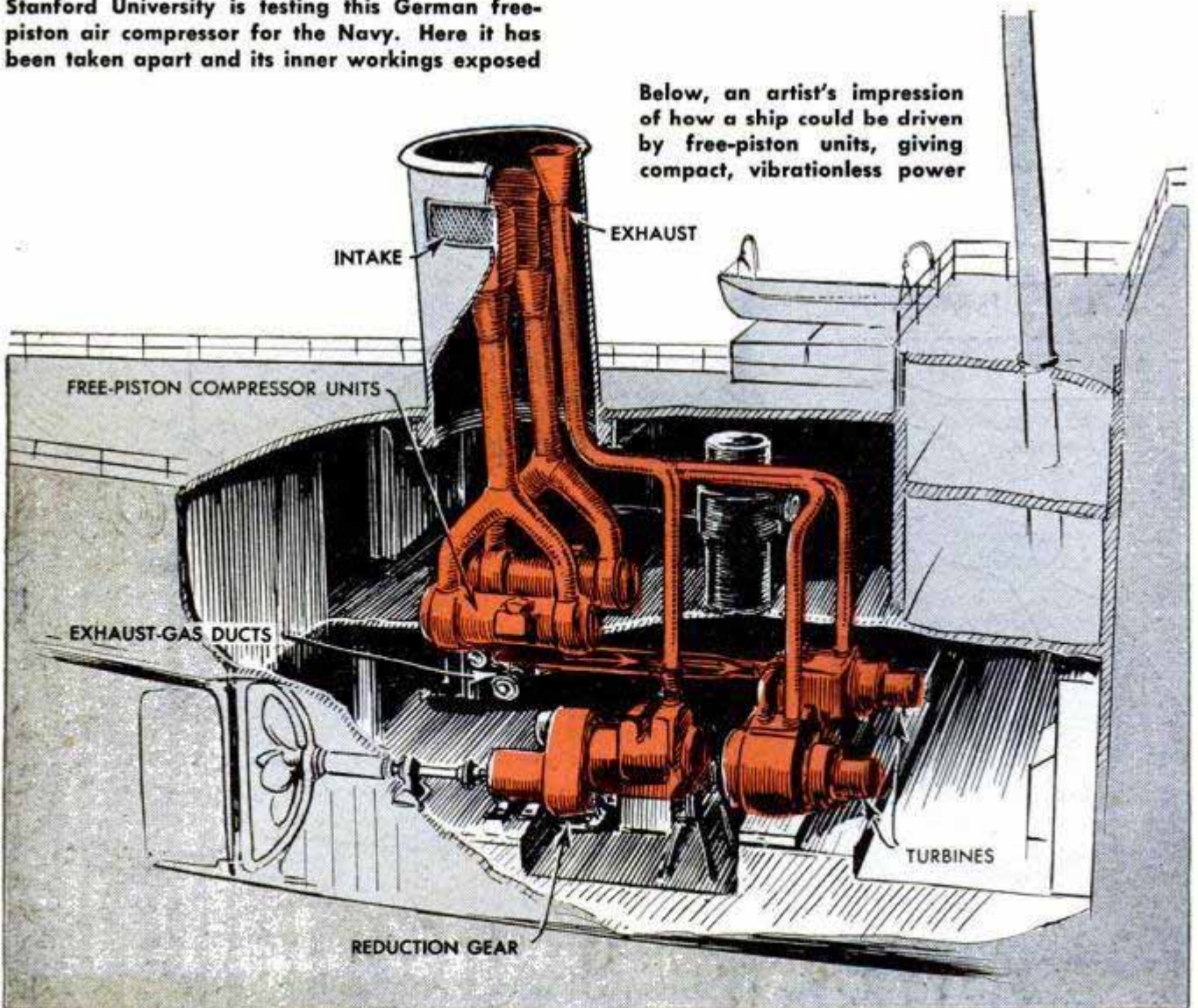

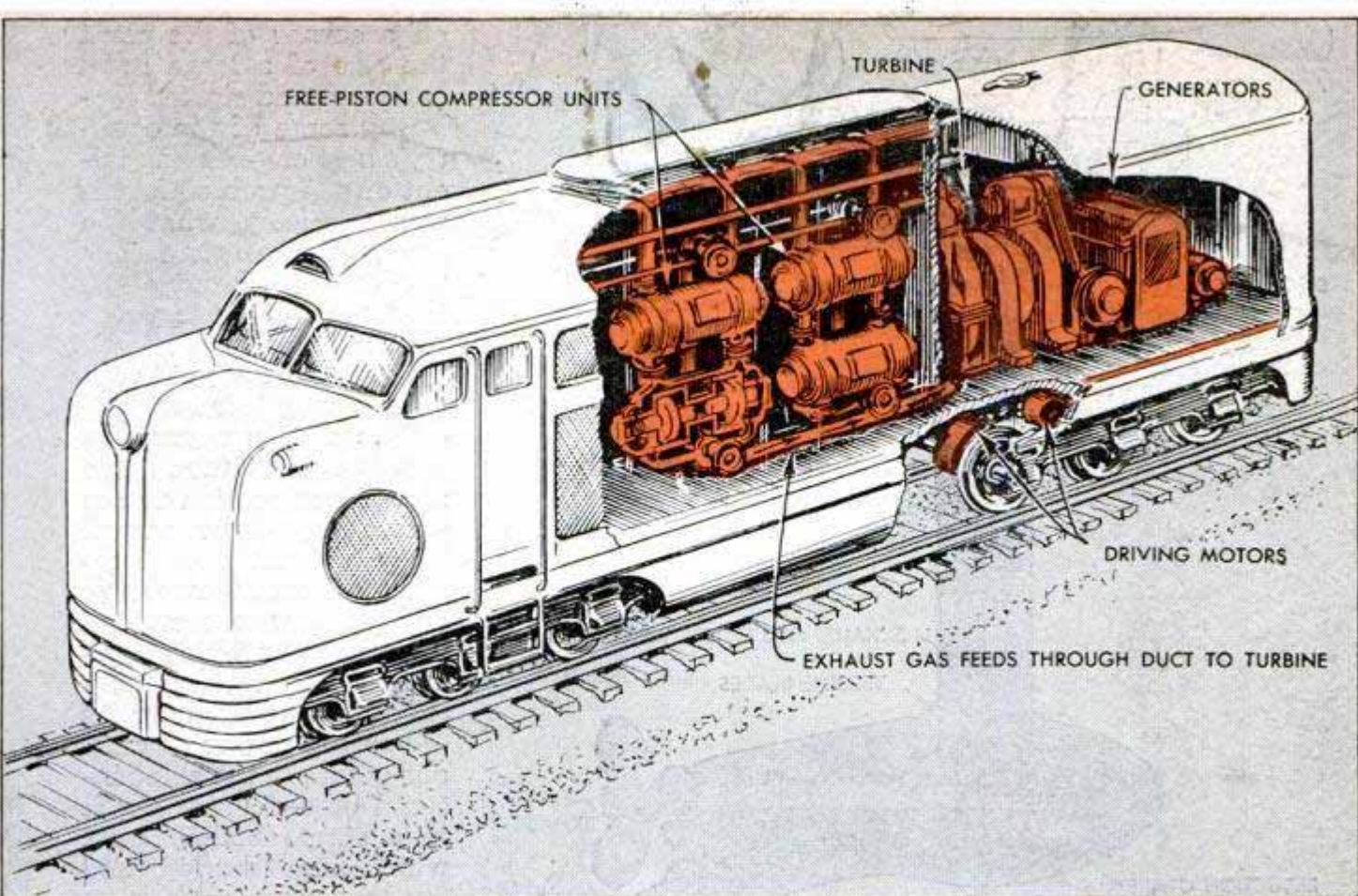

Engineer's conception of a free-piston locomotive such as is being developed for the Pennsylvania Railroad

open combustion chamber and compressor. In essence, it has but three moving parts: the two pistons and the revolving fan blades in the turbine. The engine is quiet, vibration-free, light. Aircraft engineers estimate that such an engine applied to aircraft would weigh less than a pound per horsepower. Today's best radial aircraft engines weigh about the same, but require three times as much weight in fuel.

Further, the free-piston engine is by all odds the most efficient power plant ever developed — an important point since the world stock pile of fuels is steadily dwindling. It is 40 to 45 percent efficient—which is to say that it converts this percentage of the fuel it burns into useful energy. Its nearest competitor, the orthodox type of diesel, is around 35 percent efficient.

The free-piston engine will operate on almost any fuel—natural or manufactured gas, diesel oil or other petroleum products. It can operate on the cheap oils that any diesel engine in service uses today. It can do this because it can be designed to breathe large quantities of excess air, an essential in burning low-grade fuels.

As is the case with almost any new development, the free-piston engine has gone through a long period of evolution. Nearly a century ago two Italian inventors developed a crude model in which a heavy piston was fired upward in an open-ended cylinder. It was like a cannon in which the

ball never emerged from the barrel. The rising and falling piston contained a slotted rack which turned a toothed gear, thereby giving up its power.

The Swedes got closer to the idea in the early '20s when they took exhaust gases from a diesel engine, piped them to the stern of a ship and ran them through an engine connected directly to the propeller. Clumsy and inefficient as this arrangement was it did eliminate shafting and boilers.

In the years just preceding World War II several groups were attracted by the free-piston idea. At Belfort, France, a brilliant inventive genius named Pateras Pescara conceived the idea of hooking a gas turbine onto such a machine. His company, Als-Thom, had made only a bare start on the idea when the Germans swept over Belfort and all work stopped. Immediately after the war ended, the S. I. G. M. A. works, an affiliate of Als-Thom, started again. It has built several thousand free-piston air compressors to be used in highway construction and other applications. Meanwhile, in Winterthur, Switzerland, a group of engineers at Sulzer Brothers, Ltd., also started building free-piston gas-turbine machines.

Real work in the United States didn't get underway until the middle of the war. In 1943 the Navy captured several German submarines. On them they found compact, efficient, free-piston air compressors—used

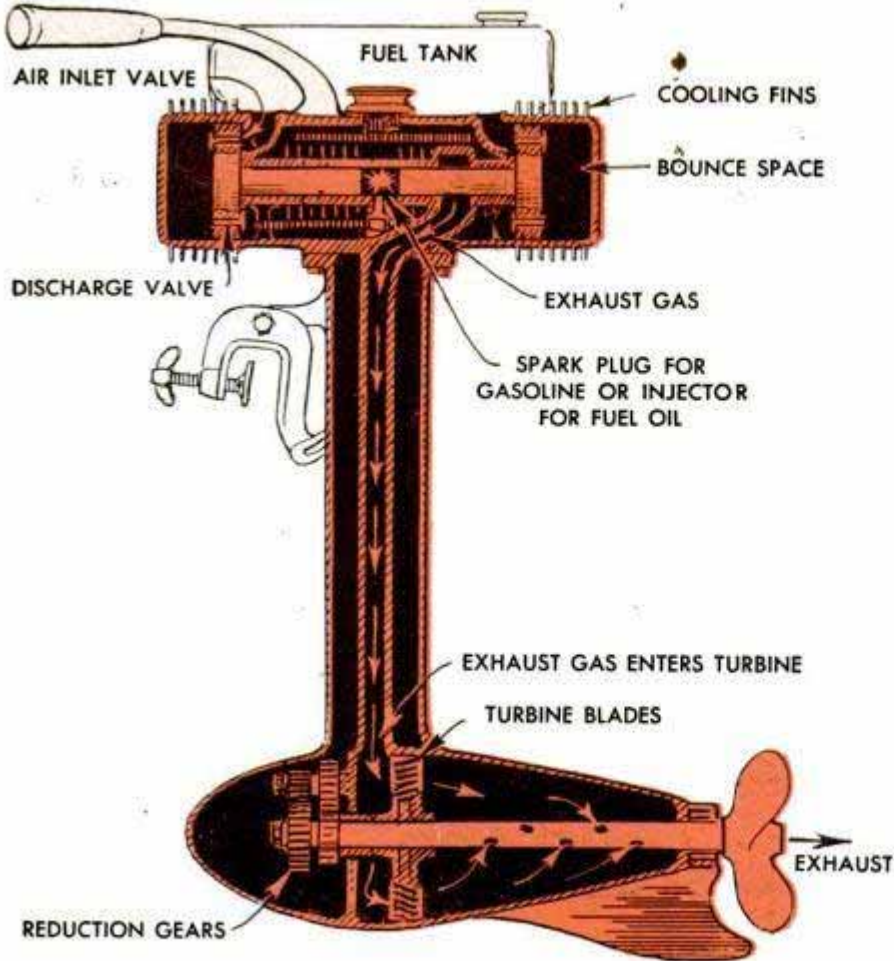

There are endless applications for the free-piston unit. A small version could be designed to make a quiet-running 20-horsepower outboard motor

to charge the air bottles which fire torpedoes. This engine burned diesel oil, drew off air compressed on the outward stroke of the pistons. It was, in other words, an air compressor, not a new engine. But alert Navy men were quick to see possibilities.

Three of the captured compressors were shipped to the General Machinery Corporation, Hamilton, Ohio, makers of half the engines used on Liberty ships, plus a complete line of diesels and other heavy engines for ships, power plants and other uses. Would General Machinery undertake a large-scale research project, hooking a free-piston engine to a turbine, and seeing if a revolutionary new power plant couldn't be developed?

The company blocked out the task, fenced

off a corner of the plant the size of a large hotel ballroom and started lavishing some of the country's best engineering talent on the problem. This was precisely what the free-piston engine idea needed—an all-out effort to solve the basic problems involved.

The Navy has yet to announce why it is interested in free-piston engines. But it doesn't take a too active imagination to see where they might be used. They would give submarines greater range and greater fuel economy. They might provide power for such vulnerable ships as aircraft carriers—spacing power at various points in the ships instead of concentrating it in a single boiler room, which might be knocked out by torpedo attack.

Civilian applications of the free-piston engine are barely getting underway. The Lima-Hamilton Corporation, which resulted from a merger of General Machinery and Lima Locomotive, has under construction a 4000-horsepower locomotive for the Pennsylvania Railroad.

Use of the new engine in locomotives has a number of attractive features. With fewer moving parts than other engines it should cut service bills. Its higher efficiency will

slash fuel costs. Further, the engine might be adapted to run on coal derivatives, either liquid or gaseous. Many railroads, deriving a major portion of their income from hauling coal, like to patronize their customers.

Adapted for coal derivatives, the engine would work this way: Coal would be converted to gas or liquid fuel. Experimental "gas generators" are already available. In them, steam combines with burning coal to produce inflammable hydrogen and carbon monoxide. One such generator is little larger than a big barrel. Fed powdered coal and operated continuously, it would produce enough gaseous fuel to feed a 4000-horsepower free-piston engine. Such liquid-fuel generators are being developed

(Continued to page 248)





### Glass-Bottom Pedal Boat

From odds and ends, Fleet White of Honolulu built a glass-bottom pedal boat in which to pursue his spear-fishing hobby. A pair of surplus belly tanks, each about 3½ feet in width, is connected at the front and rear by welded pieces of sheet steel. The two occupants, sitting on what was once an automobile seat, pump pairs of bicycle pedals that turn a partially submerged paddle wheel at the rear of the craft. White cut a hole in the bottom of the deck, which clears the surface by just a few inches, and slid in a watertight glass-bottom box through which he looks in his searches for the best fishing sites. The boat is steered by a lever and will do five knots.



### Movie Projector Helps Grid Coach

Movies are shown in daylight with a projection viewer that can be set up on a desk, eliminating the necessity for darkening the room and setting up a full-size screen. Designed especially for the use of football coaches, the viewer allows the coach to point to details in the picture without throwing a shadow on the screen because the image is projected from the rear. The viewer is equipped with a reversing switch which enables the coach to repeat important plays.



American-Swedish News Exchange photos

Above, left, a section of the Swedish prefab arrives by flatcar and will be loaded on this truck. Above, right, workmen lift an electric range into the building. Wiring is done during the trip. Below, left, a crane lifts the section onto its foundation. Below, right, the completed building, ready for occupancy

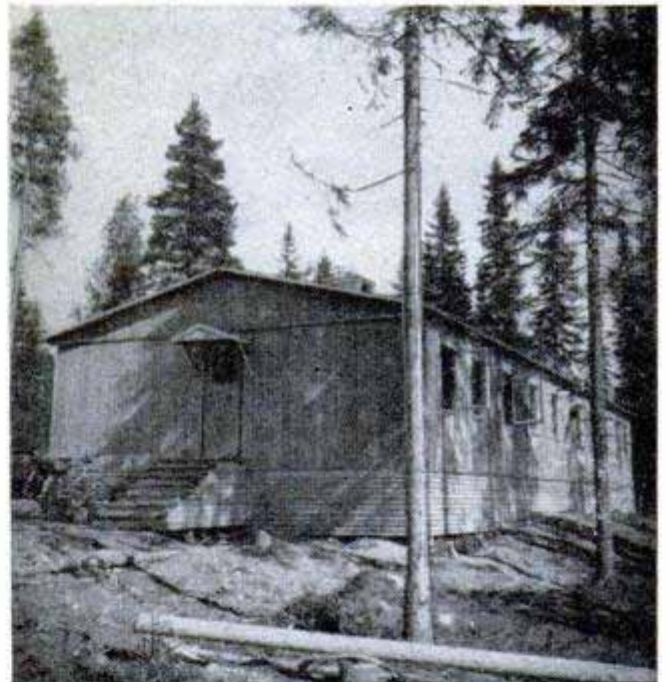

## Swedish Prefabs Keep Workers Comfortable on the Job

Swedish workers who construct electric power plants for the government live in comfortable prefabricated houses that can be hauled into rough country and put up in a day. The houses come in three sections and are factory made, with windows, doors

and cupboards fitted and painted by mass production. The sections are shipped by rail and transferred to special trucks at the destination. When the power-plant construction is completed, the houses can be taken down quickly and moved.

## Earth-and-Metal Alloys May Solve Jet-Engine Problem

Earthy substances combined with metal may provide the heat-resistant alloys needed for tomorrow's jet aircraft engines. Research by the National Advisory Committee for Aeronautics indicates the most promising is titanium carbide with 20 per-

cent cobalt, which bonds well with cemented-carbide tool compositions. It has been tested at 2400 degrees Fahrenheit. Metal alloys now used in turbine blades are close to their temperature limits and ceramics have shown a tendency to fracture.

# Loop-the-Looper

DURING working hours C. C. Beckett is a maintenance man at Constitution Hall in Washington, D. C. On his own time he's a daredevil who dances a jig at dizzying heights aboard a sky swing he made himself. The contraption is a huge revolving arm with a circular cage at each end. By shifting his weight, Beckett starts swinging the big arm in a circle. Then as it gyrates like a windmill he strolls around the cage or does a jig at the top of each loop. Attached to the same framework is another arm which terminates in a swing. Beckett straps his feet to the swing and, with a 100-pound weight on the other end of the arm, starts pumping the swing into a great loop. Eventually, he is hanging upside down 50 feet above the ground with his arms outstretched. So far the apparatus has cost him about \$3000 including the metal, welding and \$10 monthly rental for the site along the Marlboro Pike at Hillside, Md. Maintenance man Beckett, who once worked as a carnival juggler, hopes to land a spot in a carnival or circus with his sky-swing act.

While the big blade whirls, he strolls around the wire cage on one end, or does a jig atop the loop. His safety depends upon his ability to anticipate and counteract the pendulumlike swing of the blade

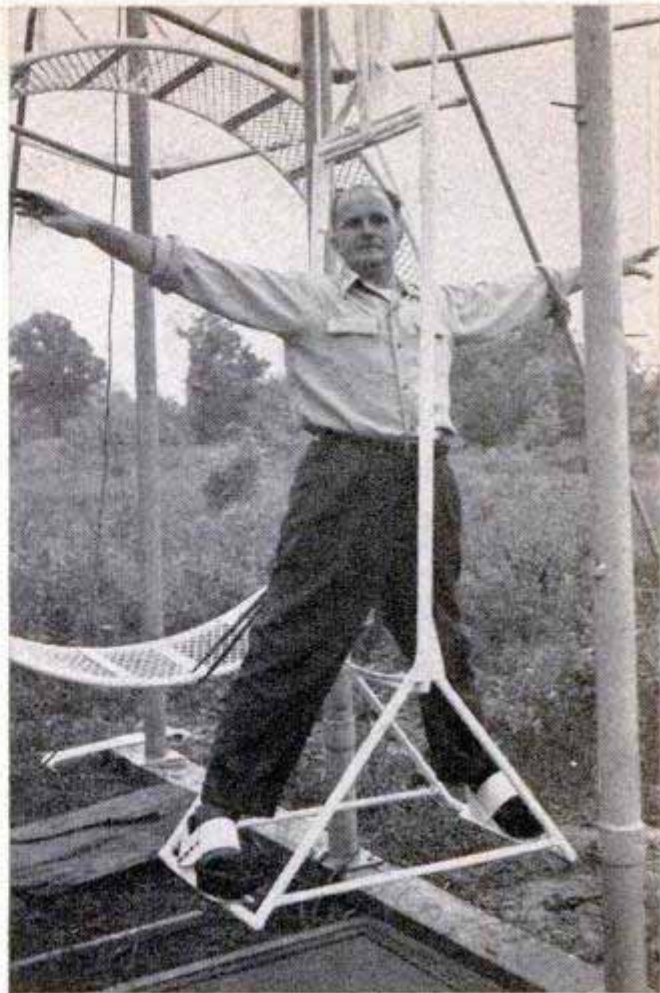

Daredevil Beckett straps his feet into his gigantic sky swing and prepares to loop the loop. Below, by shifting his weight he moves the swing in a big circle until he's standing on his head 50 feet above ground

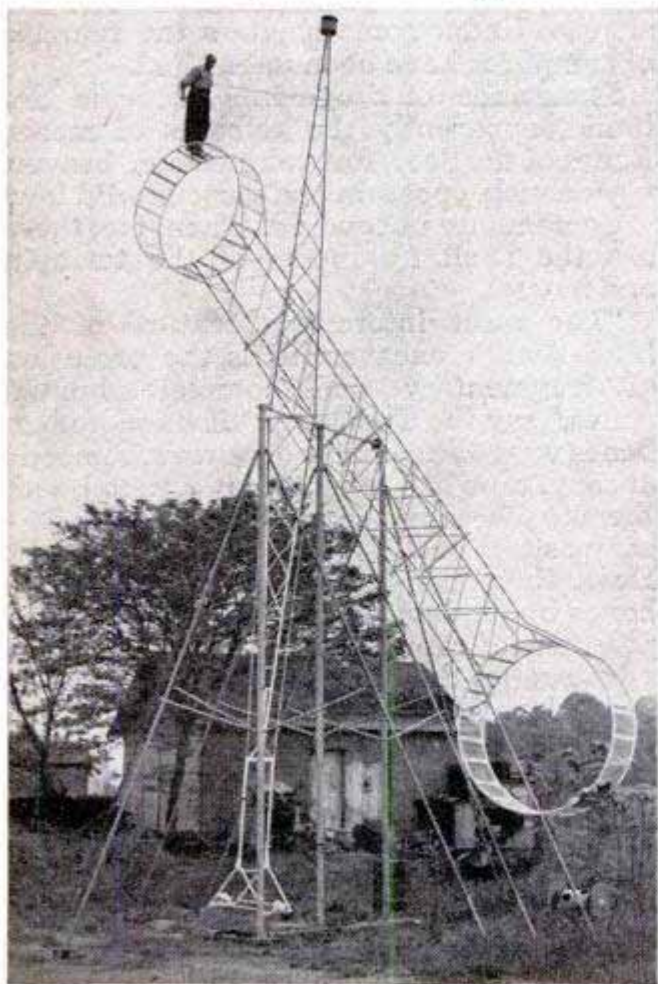

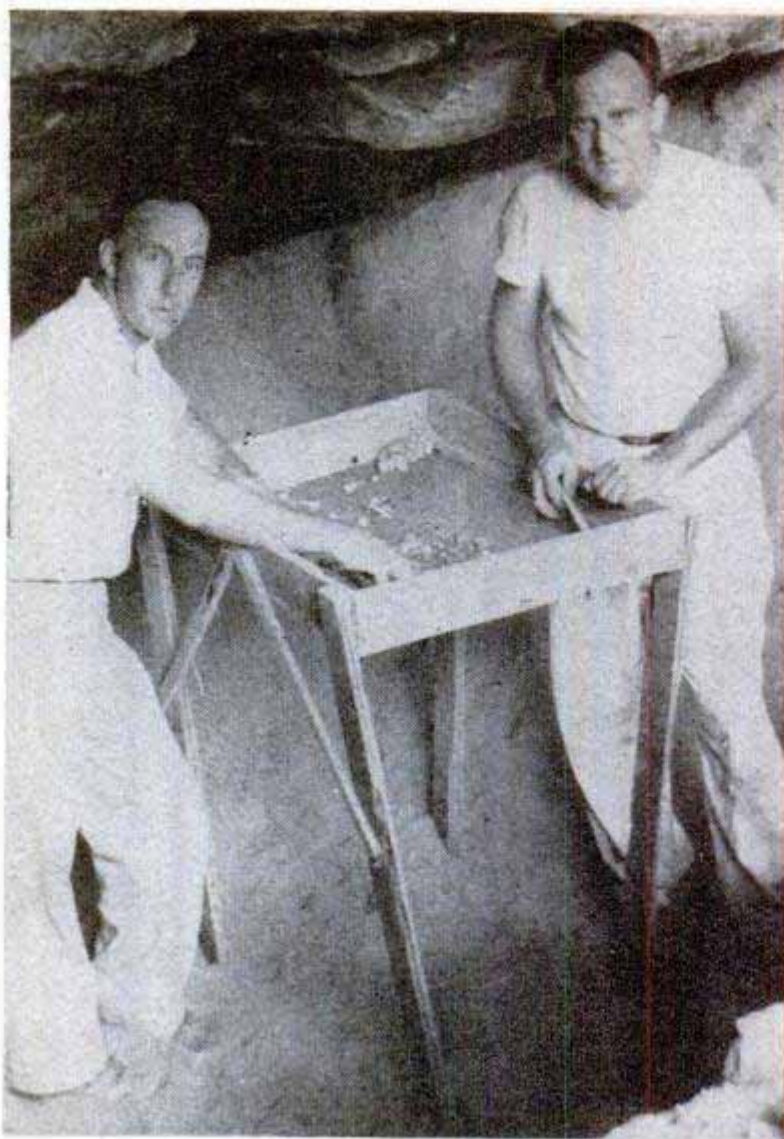

# Sifting the Story of an Ancient Race

By Norman E. Moore

Charles and Joe Thomas, amateur archaeologists, search for secrets of an ancient age in the dust found in bluff shelters of the Illinois Ozarks. They sift excavated dust in homemade screen

**A** MYSTERY story of the past, to which a long-dead race holds the key, is slowly being revealed bit by bit from under the dust of the sandstone-bluff shelters of the Midwest. Within a radius of 20 miles of their home, Charles and Joe Thomas, amateur archaeologists, have found more than a million pieces of pottery, bone, stone, shells and other artifacts of an ancient people who at one time lived in the caves and cliffs of the Illinois Ozarks.

The Thomas brothers operate out of the village of Cobden, Ill. For years their pastime on Sundays, after a week wielding painters' brushes, has been to roam the region searching for clues which might have some bearing on this prehistoric race—the Bluff Shelter people.

All this means laborious digging and the meticulous sifting of debris by hand. Sometimes it means using needlelike instruments to pick out specimens from dirt-filled pits. The earth beneath the bluff shelters is dry and the accumulated dust and debris is usually from five to six feet deep. From this dust are reclaimed numerous pottery fragments, war points, rough arrows and spears, awls and bone drills. Several sandstone mortars have been found with cooking stones and hammer-

stones. Under some shelters the remains of campfires have been unearthed.

Thousands of fragments of bone are found, apparently the remains of meals. Bones of the deer, fox, rabbit, coon, beaver, woodchuck, opossum and various wild fowl are commonly uncovered. Then, too, there are the shell fragments of the terrapin and mussel.

"The most interesting feature of the bluff-shelter excavations is the profusion of fragmentary and complete human bones," say the Thomases. "If these human bones were the remains of burials, someone at some time had taken great care to break them to pieces and scatter them about. Decomposition had affected them very little. How, then, can the presence of human bones be explained? To us, it has the appearance of cannibalism."

The relics they find, at least those in the lower levels of the dust, are of great antiquity. The bulk of them, it is believed, are of pre-Columbian origin while some of them may antedate the Christian Era. The Thomases are of the opinion that the sandstone-bluff shelters of the Mississippi Valley were occupied by all types of prehistoric men native to the area.

(Continued to page 244)



Fragments of bones, flint weapons and crude tools are examined by the Thomases and a friend, Joe Karstater (center). The collection includes both human and animal bones and shell fragments of turtles. Below, some of the thousands of relics gathered by the Thomases—arrowheads, pottery, ancient tools and odd broken pieces

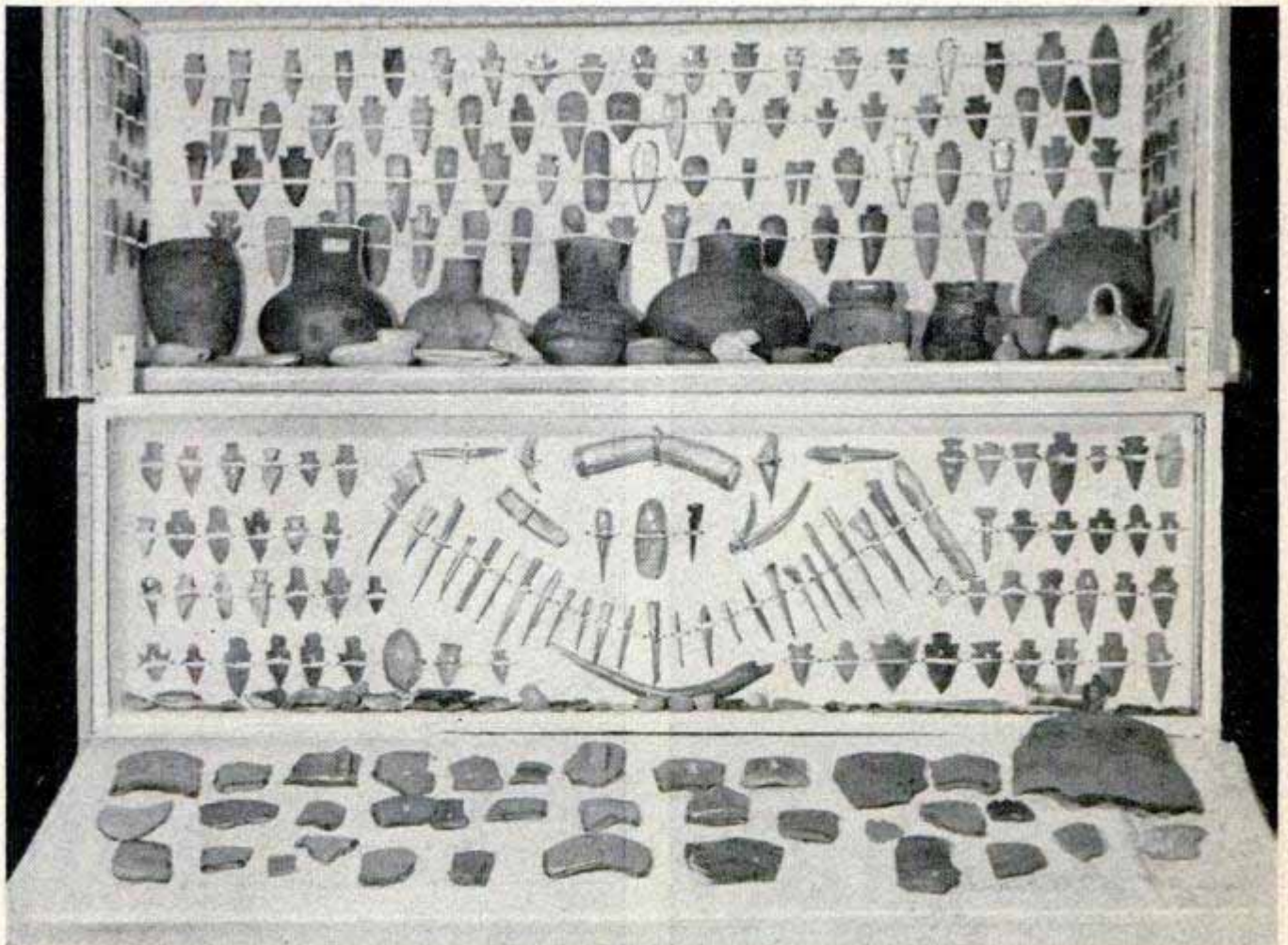



## ← Wheel Converts Trike to Bike

Bicycle and tricycle are combined in a new vehicle designed for the 'tween-age child. The sidewalk runabout looks like a conventional tricycle except that it has a fourth wheel between the two rear wheels. Lowering this wheel makes the vehicle a bicycle, as the other two wheels then are raised off the ground.

## Plastic Base on Photo Film

Photographic films may soon be made with synthetic-plastic emulsion instead of the gelatin emulsion generally used today. A new color film, developed by Du Pont, which uses a synthetic polymer to replace both the gelatin emulsion and the color former, may forecast a changeover for all films. Because the synthetic emulsion can be made under controlled conditions, it can be kept uniform, thus assuring constant quality. The gelatin emulsion in use today is made from the skin of calves and the quality of the gelatin varies with the diet of the animals.

## Spreader-Sprinkler

Attached below the head of a new-type sprinkler, a quart-size Tenite plastic jar that can be filled with liquid fertilizer, weed killer or insecticide simplifies lawn care. Turning the jar lid regulates the amount of the solution mixed with the water and the spray covers a 60-foot circle. A hand spray at the end of six feet of hose can be substituted for the sprinkler head in killing insects and weeds.



## Timer for Sprinklers

Water waste from forgotten sprinklers is done away with by an automatic device that shuts off the flow at a preset time. It couples to any standard threaded faucet before the hose is attached. The timer measures a factory preset amount of water and then turns off the flow. It is available in three cycles, running approximately ½, 1 and 1½ hours respectively, depending upon the water pressure.



## "ON THE AIR"

By Rafe Gibbs

YOU ARE FAMILIAR with NBC, ABC and CBS, but unless you live in a college town you may never have heard of IBS. These letters, referring to the Intercollegiate Broadcasting System, stand for a touch of Rube Goldberg, a heaping cup of youthful enthusiasm and a dash of genius.

Celebrating its tenth anniversary this year, IBS is now composed of 73 stations at universities and colleges across the nation. Working at these stations are more than 3500 students. Listening are several hundred thousand fans—rabid fans. Leaders of commercial radio are watching IBS stations like Tabby does a goldfish bowl, and are annually reaching in to scoop up more than 100 graduates.

Seeking first-hand knowledge of the inner workings of a typical collegiate radio station, we visited KUOI at the University of Idaho.

KUOI was born in 1945 when Glenn Southworth, engineering student, flicked off a radio program in the lounge of

the Student Union. "What this campus needs," he said, "is a good five-watt radio station that gives with plenty of music and a little drama that doesn't take three months to get some place."

So Southworth, who started taking the family radio apart—critically and mechanically—at the age of 10, got busy with several fellow students, and came up with a radio station. Its first equipment was a midget marvel.

The transmitter was made out of an old receiver, held together with baling wire and chewing gum. The main coil was wound around an oats box. The base was that of an old battery radio salvaged from a fraternity-house attic.

The station's present equipment, vastly improved with new parts, is still a student-assembly job. The station is also unusual in the fact that technically it never goes

Students like these, at 73 colleges across the U. S., foreshadow better commercial radio for the future





Student actors and musicians put on a show at Creighton University. University of Idaho's KUOI, like most campus stations, is student-maintained. At right, instructor explains technique of making transcriptions

on the air. All broadcasts travel to radios on the campus via the local electrical power line.

By the end of this year, KUOI will have strictly modern quarters in a new addition being built to the Student Union. But our visit to present quarters necessitated going through the university's ivy-clad engineering building, passing through two electrical-engineering laboratories and climbing two flights of stairs to an attic cranny that nobody seemed to want for anything else except a radio station.

We found eight students, all busy at work, in the 8 by 10 room. A coed, twice as pretty as her horn-rimmed glasses indicated at first glance, picked up a script and we were treated to an unusual women's fashion broadcast.

The program started off with the usual style chatter, but then came the piece de resistance — an interview with a male student. He thought the rolled-up levi fad was something that "shouldn't happen to a dog." And over a thousand coeds, mind you, were listening.

"Slacks? Well, they're different. It all depends on the chassis."

During a transcribed musical interlude, we remarked that the studio seemed a





little crowded. "If you think this is crowded," grinned an amiable student, "you should see it when we do a play. Sometimes the sound effects get bumped at the wrong time. We got in an unexpected clap of thunder at an inopportune moment one night."

From time to time, listeners call the station with requests—and critical comments. It is difficult for commercial stations to find out what their listeners want by calling them on the telephone and asking if they are listening to a certain program. But a college station is so close to its listeners that it can feel their pulse.

Harold Hough, general manager of commercial Station WBAP at Fort Worth, Tex., commented at a convention of the National Association of Broadcasters that "radio producers must do something about the forgotten man of radio—the listener." In college, the listener can't be forgotten. The broadcasters have to live with him. And college stations have another advantage over the big stations and networks. They can experiment—such as staging three-act plays with one act per night or holding a dance orchestra practice with all its chatter on the air—and have nothing to lose.

Ann Pike, who holds the position of assistant in radio education at Ohio State University, phrased it this way:

"Campus radio is frankly experimental radio. It need not be tied to conventional techniques for fear of miscarriage. It is a seedbed for new ideas."

Action was put to her words at Ohio Wesleyan University, where WES decided to try out a one-man horror show. A professor with a good story-telling voice recited original horror tales to the accompaniment of music and sound effects, complete with squeaking stairs. The experts who had predicted the show would be monotonous

sat on the edge of their chairs and ate their words.

The stations of 5 or 10 watts, broadcasting either through a common-carrier power line or through privately owned wires strung all over the campus, are of the peanut variety. But their possibilities are of the giant goober type.

First of the peanut parade was Station WBRU at Brown University, started in 1936. Like all pioneers, the experimenting students at Brown found the going tough. Use of the common-carrier power line was not practicable at Brown. That meant stringing wires from dormitory to dormitory. Fearing disapproval of their work by college officials, the students decided to do the stringing first, and talking afterward. There was plenty of talk.

When thousands of feet of wire added an unattractive droop to Brown's elms, the dean's office complained; the bursar's office warned that the insurance company wouldn't like it because of added hazards. The argument went on for two years, then came the intervention of nature, with whom one does not argue. A hurricane ripped up most of the trees in question, tore down the wires. The wires were then strung through heating tunnels, and everybody was happy.

The collegiate stations throughout the nation today enjoy a maximum of administrative backing and a minimum of interference. Because technically they do not go on the air, the stations have not been required to obtain FCC licenses. They have had to register with the FCC, but, within the limits of common good sense and taste, they have generally been masters of their own fate.

Last spring, however, the FCC proposed applying standard broadcast rules to the stations. The students groaned louder than

Coeds at St. Lawrence's Station KSLU practice art of control-room signaling. Performers are behind a window





Transcribing a "Voice of America" program at the University of Virginia for the United Nations to air to South America, Europe and the Far East



How does a sound effect sound? Stephens College girls do some experimenting. At all schools the broadcasts travel to campus radios via the local electrical power line. Below, actors on the air at the University of Southern California, with only listeners and no sponsors to satisfy



they do at the announcement of a quiz, for their stations are simply not designed to comply with the rigid regulations. Radio was about to "flunk out" of college.

The groans were heard — and echoed. Forty three congressmen, four state governors, 52 standard broadcasting stations, the National Association of Broadcasters, the National Association of Educational Broadcasters and dozens of other organizations, leading educators and radio executives speeded telegrams and letters to the commission. The FCC is preparing special regulations for collegians.

Unlike its big-brother systems, IBS does not broadcast programs nationally. Primarily, IBS serves as a clearing house for the scattered collegiate-radio empire. It is a nonprofit organization supported by its dues-paying members, with executives serving as nonsalaried volunteers.

Dramatic proof of the listening strength of IBS stations was provided when Station WPRU at Princeton University received a tip that a convoy of University of Pennsylvania students was headed for the Princeton campus, presumably to do a little painting job before the Princeton-Penn football game. Princeton students had decorated the Penn campus the night before, and a venging horde was riding the highways.

Station WPRU's announcer, a modern Paul Revere, warned the Princetonians over

(Continued to page 232)



## Italian Helicopter Is One of World's Smallest

One of the world's smallest helicopters is being flight tested in Italy. With its odd tail assembly and double rotor, the craft weighs only about 1100 pounds. Known as the

B.G.M. 2, it has a four-cylinder, 80-horsepower engine and a maximum range of 400 miles. The streamlined craft was built by Italian engineer Frederico Brondetti.

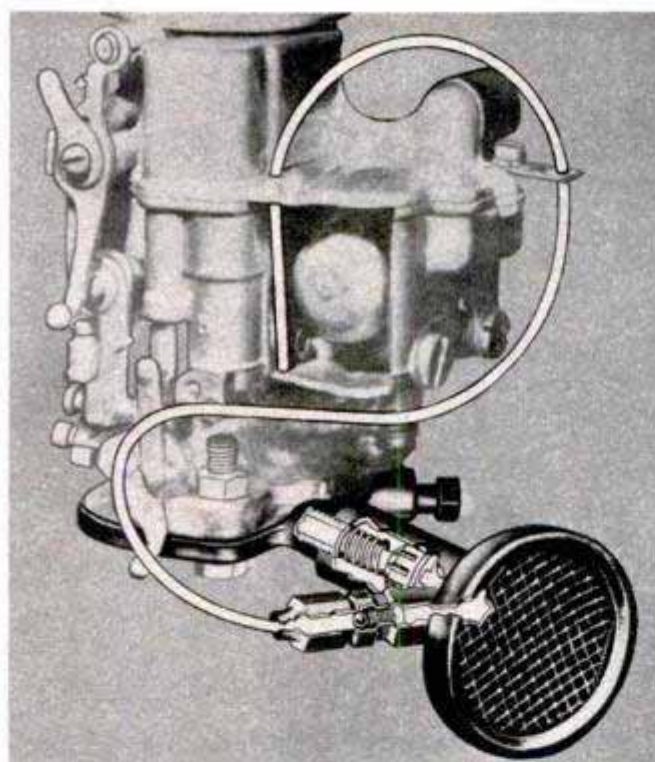

## Gasoline Injector for Cars

Installed on the carburetor of any automobile, a gasoline injector is said to yield greater mileage and power. The accessory operates by using the manifold vacuum and thus is coordinated to the motor's demands. A high-speed stream of air from the air intake mixes with gasoline in a ratio of 15 to 1. The fuel then is atomized. The injector goes into operation only when demands are made on the motor; at cruising speed, the carburetor functions normally.



## Three-In-One Photo Accessory

Combined in one compact instrument are a range finder, flash calculator and exposure meter to provide the photographer with all the data necessary for a good picture. The flash calculator and range finder are linked so that you read the correct diaphragm opening instantly after finding the range. The extinction-type exposure meter is designed to give simultaneous reading of "f" numbers as the photographer measures the light intensity.

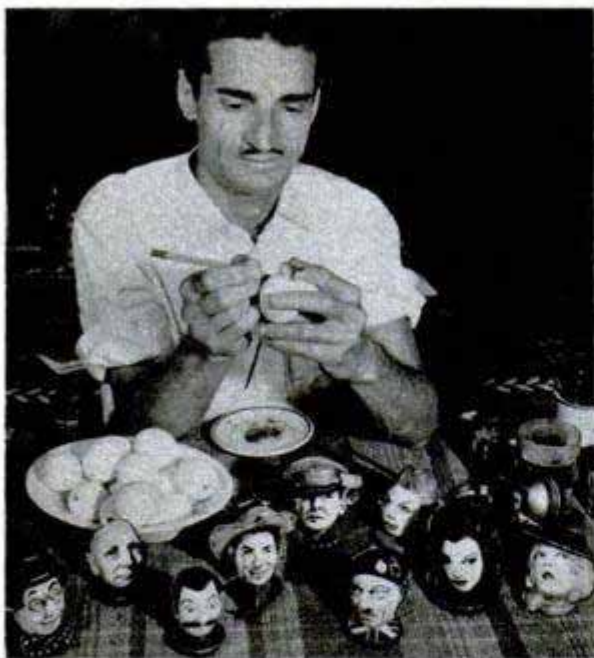

## Art Is a Shell Game to This Artist

Egg shells are the canvas on which Graham Dale, Hollywood artist, paints "portraits" of well-known persons. There are more than 100 personalities in his collection already and it's still growing. He drains the shell by punching a hole in the end.

Then he paints on the face, using a special acid paint. Hair, hats, neckties, ears and other characteristics of his subjects are made of paper, cloth, beads and wire. These are glued to the shell, producing an amazingly realistic "portrait."

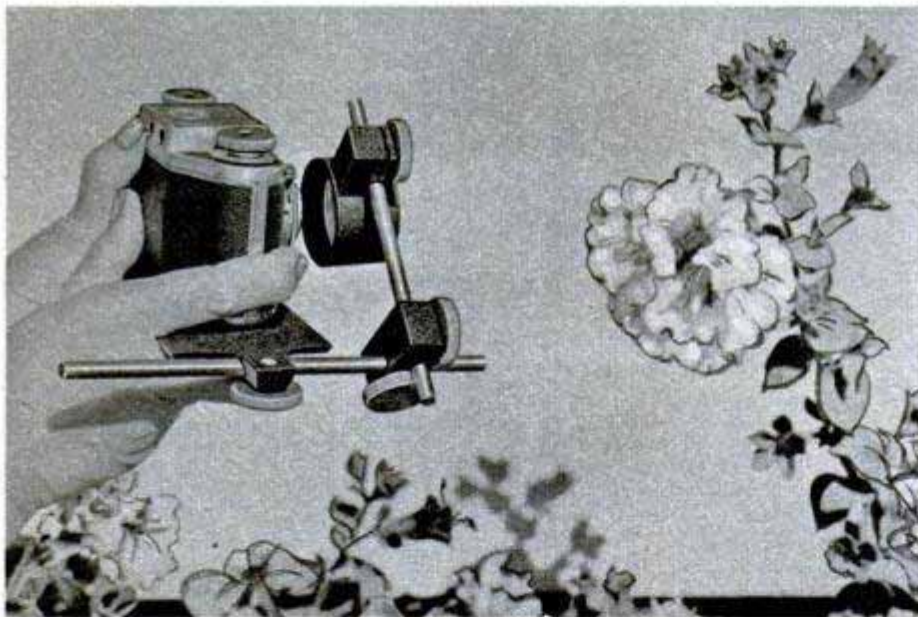

## Lens Holder For Close-Ups

Simplifying the task of adding a supplementary lens to your camera for extreme close-ups, a convenient holder can be used with lenses of any focal length. The entire device, which consists of a support plate and two arms, attaches to the camera-tripod socket. The supplementary lens is snapped into place in the lens holder. The device can be used with either still or movie cameras.

## Midget Typewriter

Virtually pocket-size is a midget typewriter developed by the Zeuzem brothers of Frankfurt, Germany. The midget, weighing only 2½ pounds, can be carried in a lady's handbag. There's one major difference between it and the conventional typewriter — the keyboard serves as the carriage.

☛ Tests show that inaudible sound waves do not have a harmful effect on the human body.



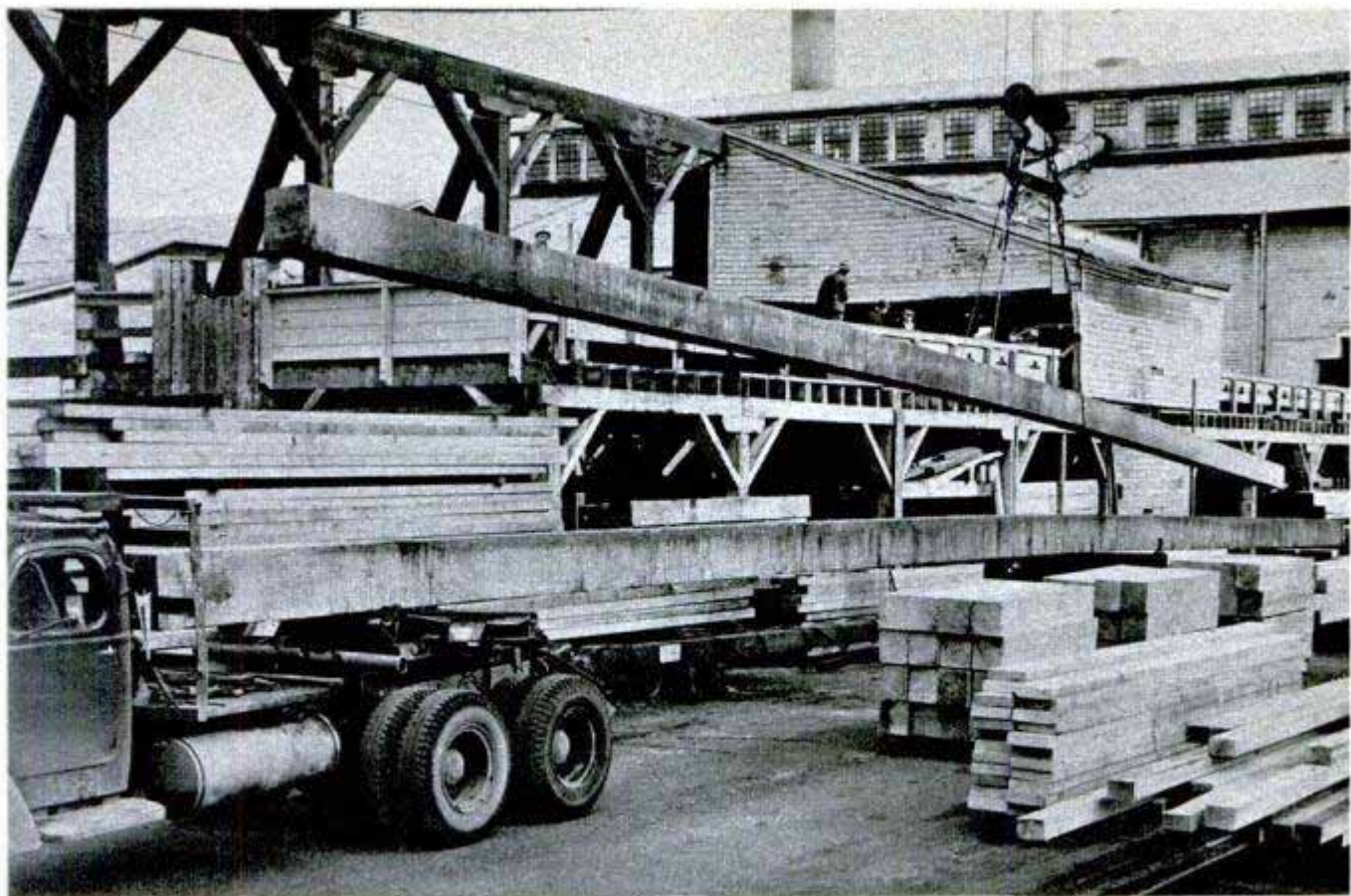

## Keel Beams Cut 97 Feet Long

Two of the longest timbers ever handled by an old-time Washington sawmill recently were cut to size for tuna-clipper keels. The big beams were fashioned from

Douglas fir trees felled near Mount Rainier. They measured 97 feet long, 18 inches wide and 20 inches thick. The sticks were so long the sawmill operator had to cut a hole through one end of his big building before they could be finished and shipped.

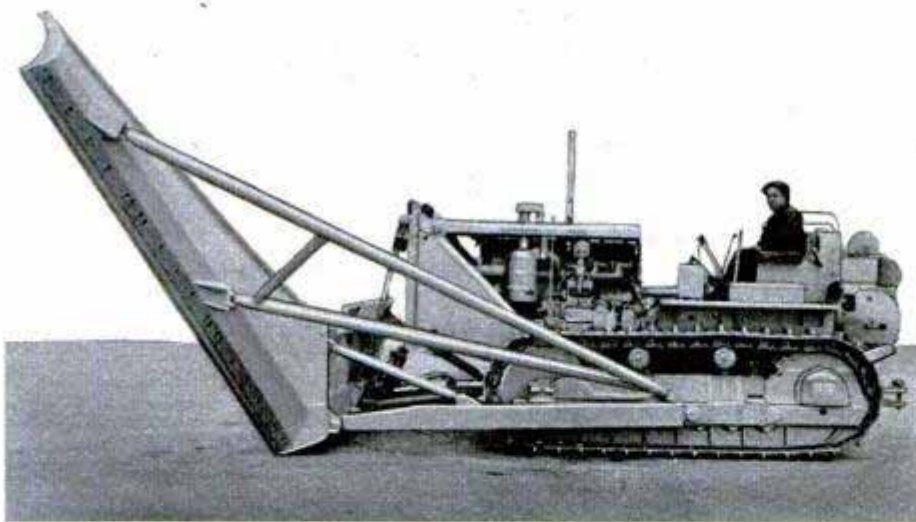

## Angledozer

Ditch sides are scraped at the proper angle by a tilting blade attached to a bulldozer. The blade is being used to trim the sides of the Friant-Kern irrigation canal in California's San Joaquin Valley. The offset blade is used in conjunction with a conventional blade, and runs out from the bulldozer for 16 feet. The operator can adjust the angle of the blade.



Popular Mechanics provides two sources of further information concerning articles published in each issue: the WHERE-TO-BUY-IT Index, starting on page 14, and the WHERE-TO-FIND-IT LIST, which is available to readers without charge from Bureau of Information, Popular Mechanics Magazine, 200 East Ontario Street, Chicago 11

# Look What's Happened to the Little Old

By Clifford B. Hicks

**T**ROUBLE is brewing in the nation's school system and it's a lot more serious than pigtailed inkwells.

At the core of the problem are seven million war babies who now are answering school bells to spill through our jam-packed classrooms like a tidal wave. The problem is swirled to a crisis by the United States birth rate. Before Pearl Harbor about 2,300,000 babies joined us each year; now the rate has swelled to about 3,500,000, who annually begin their surge toward an already shaky educational system.

Faced with the problem of educating this wave of kids, old-timers are likely to look back on the days of the little old schoolhouse with nostalgia. That's the answer, they say. The old schoolhouse hammered out an education in the three Rs as solid as its bolted-down desks. What's become of the little one-room school?

Unfortunately, it's still with us. In the United States there remain more than 75,000 one-room schools, many of them dispensing a 50-year-old brand of education. More than 20 percent of our school buildings were erected before the Spanish-American War. These obsolete mind-factories are a dangerous problem in themselves.

What's to be done? The Federal Security Agency says we must build 300,000 new classrooms during the next 10 years to siphon off the wave of war babies, and at the same time replace 200,000 classrooms which will become obsolete during

One classroom for kids of all ages, and only a baseball for recreation—that was yesterday's school. Example of a beautiful modern building is Blythe Park School, Riverside, Ill., within a baseball-throw of a city park that is used as a playground. Low wall forms an amphitheater scaled to size of a six-year-old

Hedrich-Blessing photo

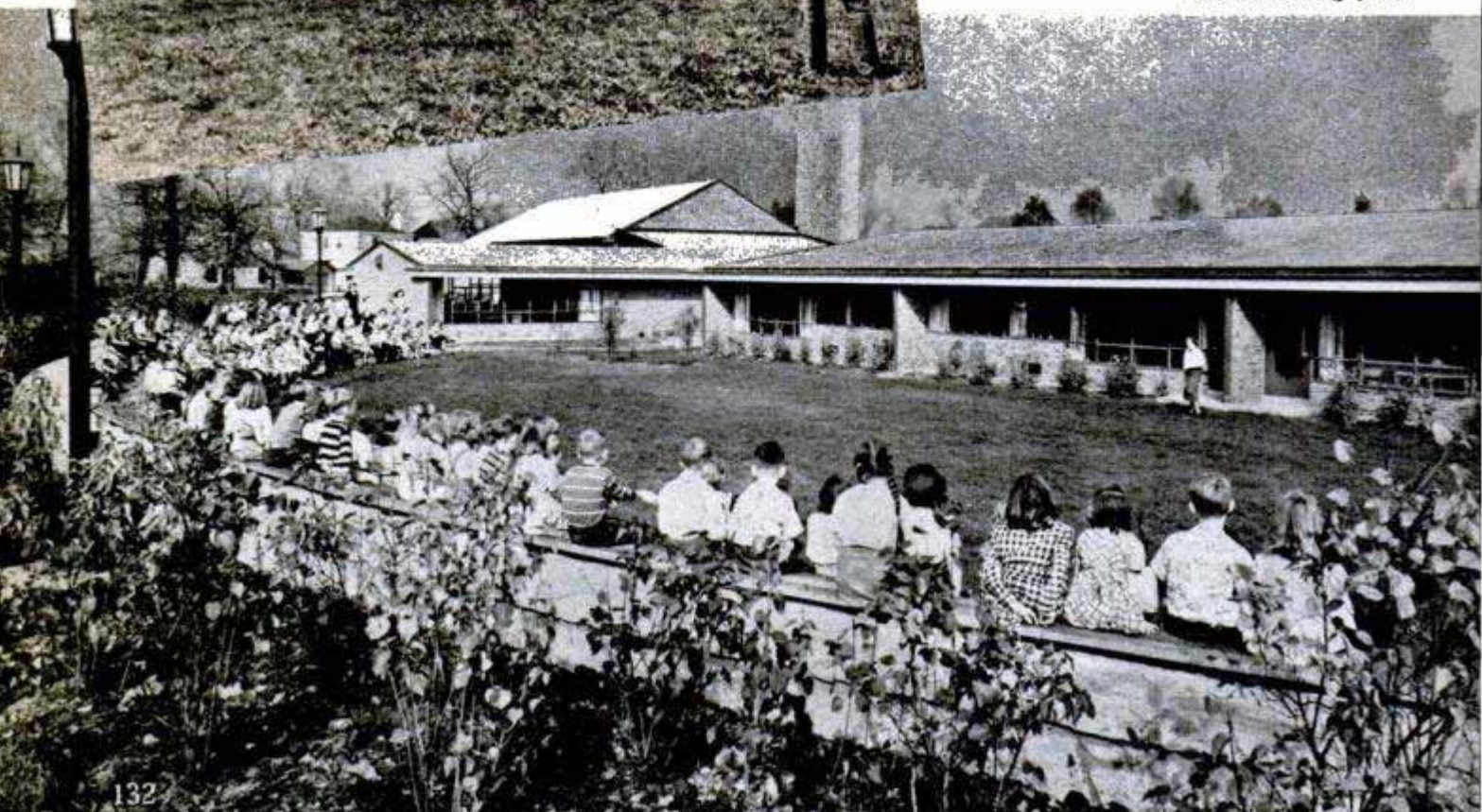

# Schoolhouse!

as guideposts for the many classrooms soon to be built.

Today, Johnny learns by action instead of by rote, and it takes a versatile building indeed to keep out of Johnny's way during his rip-roaring bursts of activity. Why shouldn't he read about Indians, then seize some poles and canvas to build a wigwam? Why shouldn't Sarah learn to add and multiply by dickering over prices in a schoolroom store? A dozen lectures by the teacher on traffic safety will never equal one 15-minute period with a make-believe traffic light and a pack of frisky children serving as cruising motorists while others cross a "street" chalked on the floor.

To carry out such a philosophy the classroom must be big, and about as changeable as a set of kindergarten building blocks. For too long we have tailored an educational program to the school building; now we must fit the building to the program.

One of the most advanced of these adaptable new schools is Blythe Park School, Riverside, Ill., which was designed by Larry Perkins after he had given every person in the community right down to the last freckle-faced kindergartner an opportunity to expound pet ideas on what the building should contain.

Blythe Park School looks like a

Teacher's dress seems odd today—and so does the crowded, muddy-brown classroom with its bolted-down desks. Contrast it with the big classroom of the Clyde L. Lyon School, Glenview, Ill., with its fireplace, light from both sides, pine walls that serve as tackboards and blond woodwork. Movable furniture can be shoved into one corner to increase play area

Hedrich-Blessing photo

that period. To do the job, the nation's 103,000 independent school districts will have to spade up a walloping nine billion dollars, four times the sum spent on school structures during the past 10 years.

There are bright spots, though. More than a few progressive communities already have tackled the problem with such enthusiasm that school buildings of a refreshing new type dot the countryside. Designed by such architects as Lawrence B. Perkins, Ernest Kump and Richard Neutra—the men who combine imagination with common sense—these schools reflect a revolution in education. They are serving





Hedrich-Blessing photo

Every classroom of this school has its own outside entrance, cutting down the noise and increasing fire safety. When the windows are open, the baffles on the outer wall isolate the noises of each classroom

sprawling ranch-style house on the edge of a big green park. That's exactly what it is—a home away from home for the school kids, with a city park less than a baseball-throw away. When the community started searching for a site, the school board and the park commissioners came up with an ideal solution. The site is small and in a built-up area, but the kids have acres of playground in the neighboring city park. The park officials profit through use of the school for indoor programs and evening projects. Service clubs meet in the music room, the library serves the whole town and staid businessmen can use the big playroom for much-needed exercise with a volleyball or basketball. It's truly a community building, and it's just plain uneconomical not to use it when it stands available 'round the clock.

Because kindergartners are leaving their mothers for the first time, their room is

**New educational tool teaches student to read faster. Screen slides down a page at a predetermined speed**



especially homelike. Drapes hang from windows, rugs provide a soft sure footing and over in one corner there's a real fireplace. Best of all there's plenty of space for roughhouse, balanced by a quiet corner in the sun for the story hour.

Each classroom has 30 square feet of area per child, more than twice as much as the old schoolmaster calculated as adequate in the little red schoolhouse. Walls of glass stretch from floor to ceiling. Perkins believes it's just as important to let vision out as to let light in. "When a kid's vision roams outdoors," he says, "his young mind goes along to the horizon and then right on around the world. This wandering of attention would have seemed idiotic a few years ago. But schools now try to do more than chain a child to a book—they develop his imagination."

Adjoining each classroom is a playroom where kids splatter paint without reprisal,

**Another instrument increases student's speed of perception. Numbers appear on screen for split second**





where paste is paste instead of a nuisance, and where movies are screened. Each class has its own sink, drinking fountain and rest room. Tables with odd, trapezoidal tops can be shoved together in endless geometric patterns, thus providing a common table top for 2, 6 or 30 students.

The famed Crow Island School, Winnetka, Ill., which also bears Perkins' fine hand, probably did more to revolutionize school architecture than any building of the century. Winnetka children don't absorb the three Rs in predetermined doses. They learn from books, but they also learn from creative play, which whets their appetites for more "book learnin'." They soon discover that they must know how to read and write before they can learn more about aviators or firemen or how to take care of a baby. Ceilings are low, colors bright. Most of the walls are pine, soft enough so that the whole room becomes a tackboard. And outside each room is a walled-in outdoor classroom where lessons become fun on warm days.

Inside the little old schoolhouse, the tools of learning consisted of 35 screwed-down desks, a blackboard, a box of maps and an American flag. Woodwork and floors, desks and doors were stained a muddy "school brown" on the theory that dirt would match the background.

In the modern school, about all that's left of this traditional equipment is the American flag. Desks and tables can be shoved anywhere in the big classroom. Education finally has realized that the left-handed student is no freak, and permits him to turn his desk to obtain



General Electric photo  
 "Ceiling of light" sheds an even, almost natural light over the entire classroom, yet none of the fluorescent tubes can be seen. "Egg carton" panels made of metal do the trick. Below, modern high schools have several up-to-date kitchens where future homemakers learn to prepare meals  
 St. Charles Manufacturing Co. photo

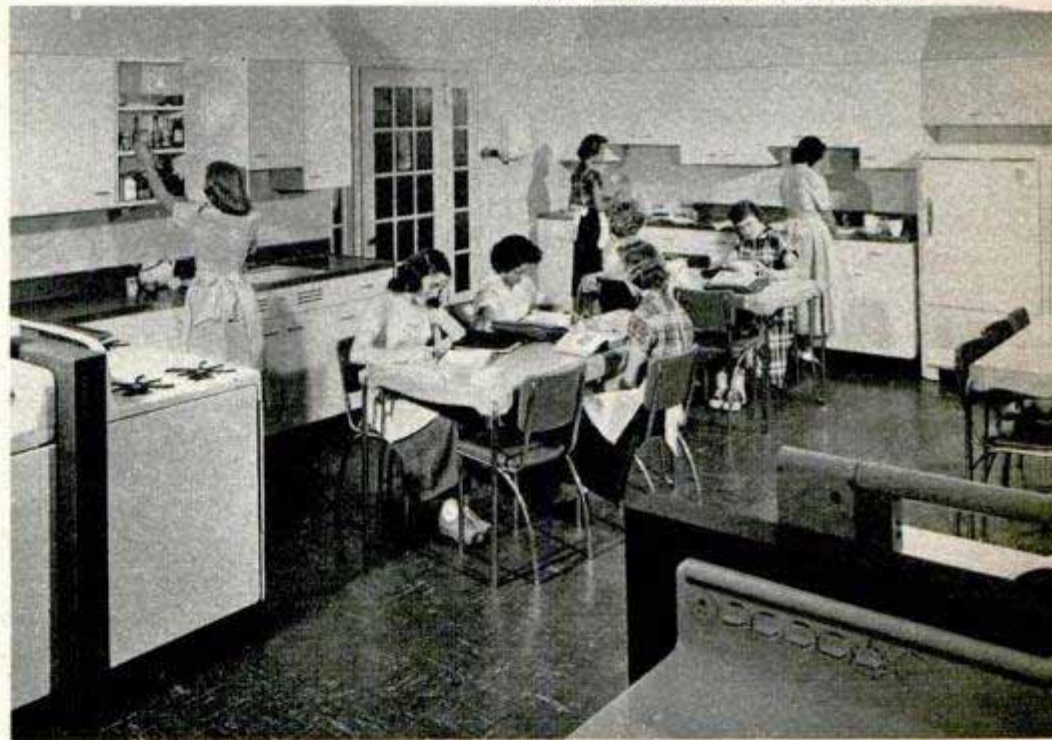

Baffle above the windows helps solve the problem of casting light to the inside desks. Light bounces against ceiling, then deep into the room

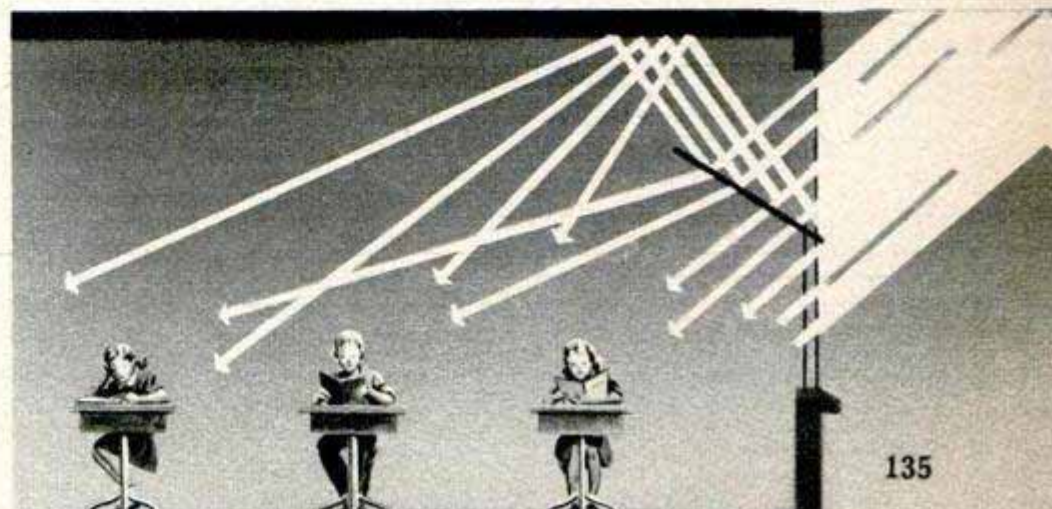



Turnabout in Pittsburgh schools: boys learn to cook while girls, in a shop course, learn to repair furniture, fix leaky faucets and bad electric fixtures

Pittsburgh Press photos



Modern school desk is movable and adjustable for various kinds of work, molds student into good posture

American Seating Co. photo



light. He doesn't usually have to turn it, though, for light streams into the room from both sides.

In the typical old schoolroom, by actual measurement, the students near the wall received only one hundredth the light of the student next to the window. In a before-and-after experiment at an old-style school in Austin, Tex., 396 youngsters were examined and more than half were found to have visual trouble of one kind or another. The classrooms then were redecorated, relighted and the arrangement of seats changed. Six months later squinting had practically disappeared and the number of students afflicted with eye difficulties had been cut in half.

Architects use ingenious ways to pump light from one side of the classroom to the other. Directional glass blocks, installed just above the windows of Progress School, Ogallala, Neb., bend the light rays up to throw them far into the corners. Reflecting shades at the windows of other schools bounce the light against the ceiling where it is diffused throughout the room.

Every stick of wood in the modern classroom has a light, nonglare finish, for educators and architects have learned that too much contrast can do just as much damage to the eyes as too little light. The blackboard no longer is a board or a slate, and it isn't black—it's a textured green glass. Experiments have proved that white against green is easier to read, with less eyestrain, than white against black.

Teaching aids and play equipment are everywhere in the new school—movies and textile colors, stainless-steel jungle-gyms and finger paints, indoor fireplaces and out-

Small site dictated a two-story building here, so the upper corridor was placed outside the new school

Kump & Falk, architects; Roger Sturtevant photo

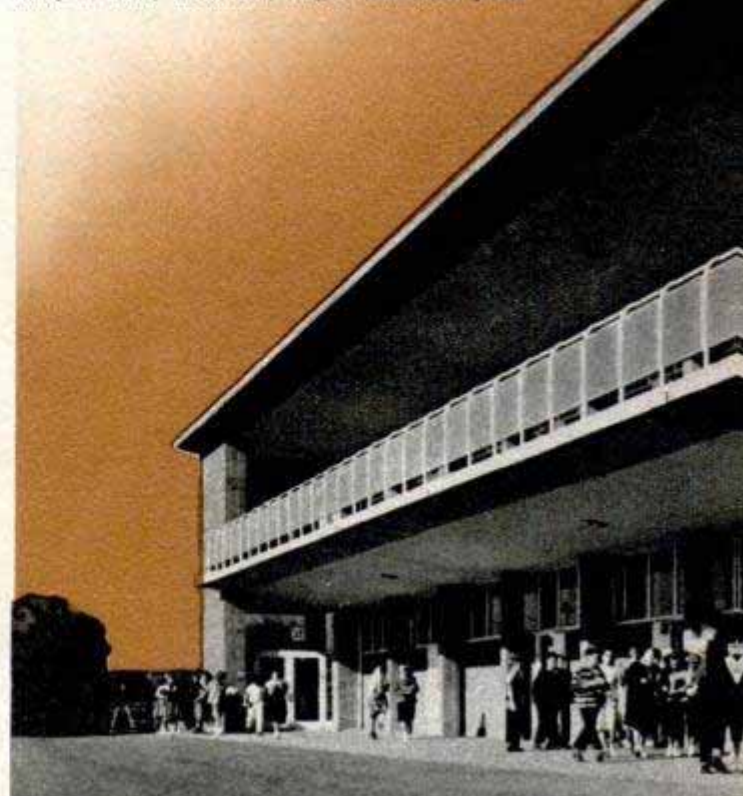

door wading pools. Even television.

Two new educational tools—the tachistoscope and the reading-rate controller—are finding widespread use in modern schools. The tachistoscope increases the speed of perception. An object, which may be a group of numbers, words or pictures, is flashed in front of the student for a split second. As he learns to see faster, the exposure time is shortened. After practice, some students can develop their speed of perception remarkably. One student learned to see and repeat a group of seven figures after they appeared for only one thousandth of a second. The other instrument speeds the student's rate of reading without any reduction in comprehension. A printed page is placed in the instrument. Then a screen moves down the page, covering up the text line by line at a predetermined speed. As the student becomes more adept, the screen is set to move faster. Practice with the instrument has speeded some students' reading rates as much as 300 percent with no loss in comprehension.



Hedrich-Blessing photo

Trapezoidal tables can be shoved together in endless patterns to provide a common table top for any number of children. Below, at the touch of a button a big automatic door slides across a gymnasium to separate it into two private play areas.



Richards-Wileox photo

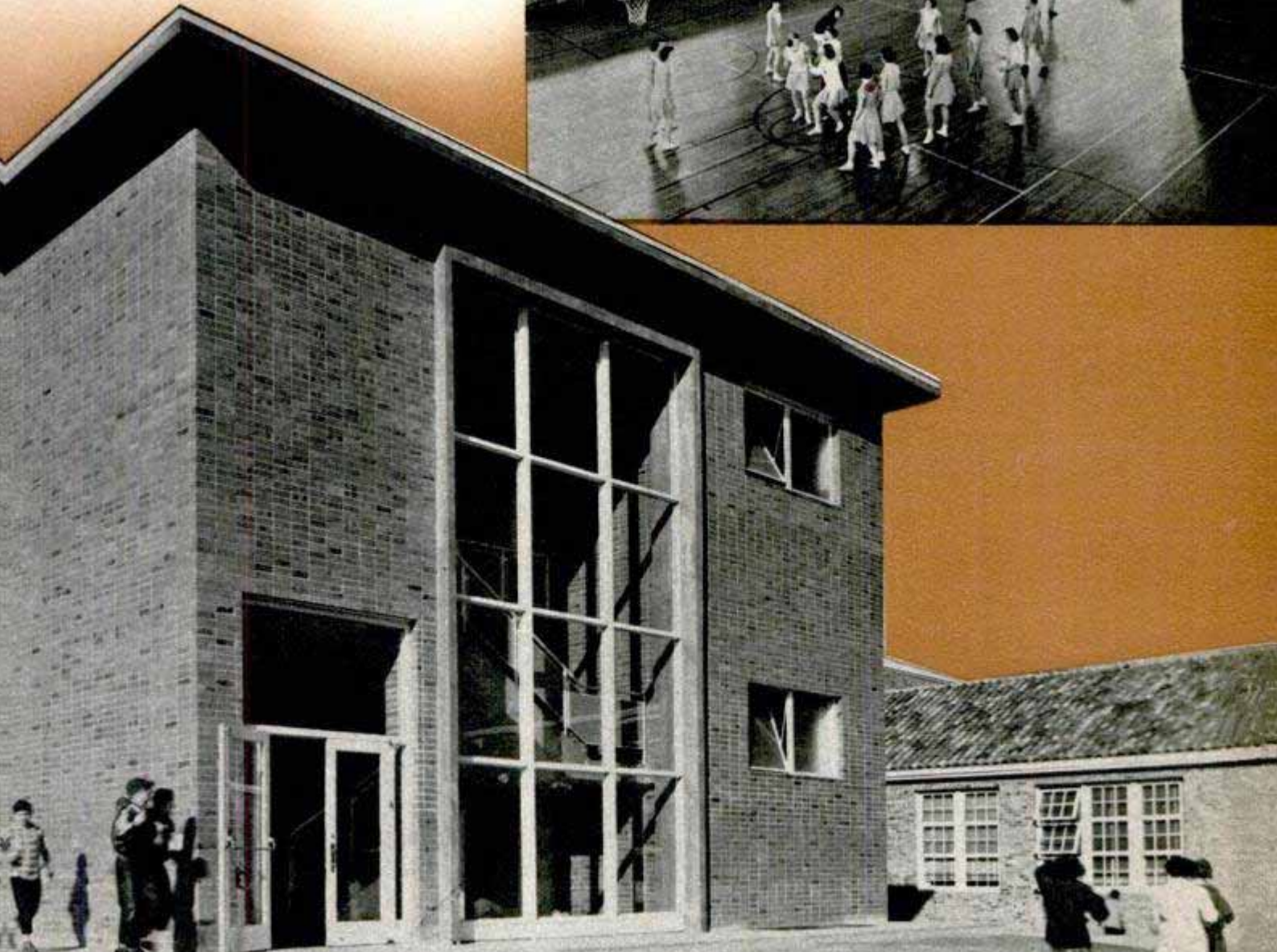

Folding tables and benches in some new schools appear from the walls of gyms or school corridors to convert them to lunch-rooms. Bleachers in gyms disappear at the touch of a finger, making twice as much room for play. At the Downers Grove, Ill., high school, huge automatic doors glide across the big basketball floor to split the area into two separate courts for boys and girls. Concealed irrigation systems keep athletic fields green despite the pounding of cleated shoes.

In many of the new schools each classroom has its own exit, reducing fire hazards and muffling the commotion generated by several hundred young dynamos. At the Consolidated School, Palatine, Ill., baffles on exterior walls stand out a few feet, dividing off the classrooms and soft-pedaling the group sounds of each room.

A half-dozen or more kitchens, complete with refrigerators and stoves, are built into modern high schools. In Pittsburgh the board of education has gone even further—boys are turned loose in the kitchens to learn how to prepare meals, while girls are given a special “how to do it” course in the shops to prepare them for the day when they can’t persuade a tired husband to do a lick of work around the house.

Some communities, watching the flood

of war-born kids lapping up around the foundations of their school systems, have come up with novel emergency measures. Tacoma called in architects Mock and Morrison and had them design movable classrooms, bright and airy, warm in winter and cool in summer. When a particular school needs more space and needs it fast, the classroom rolls up to the door. It is lowered to the ground and utilities are piped in from the existing building. Next year, if some other school district starts popping its seams, the building will be hoisted and trundled across town again.

When the school superintendent today looks over a diagram of his city he sees nothing but headaches. There are population lumps and sags all over the map. Since the war more than 17,200,000 new American families have been started, and a good many of them have settled—with kids the same age—in new housing areas. On the map they pop up as those 500 new families out on the edge of the city on a site that was an open field three years ago.

Selecting the right site for a new school thus is all-important. Even the finest building erected on the wrong site can become obsolete surprisingly fast.

Among trends in modern school design: Smaller “play sheds” are replacing huge

spectator-type gyms. The theory is that it’s better for every kid in the school system to have adequate physical training than to provide one big building where 5000 people can watch five local athletes swish a ball through a basket. Auditoriums, too, are smaller today. In one of Perkins’ schools, the stage apron is made of big movable blocks, so the stage floor can assume any of countless shapes and sizes.

Most new schools are one-story buildings, and many are so designed that new classrooms can be added later. In some buildings a large-roofed play porch gets the kids outside even on rainy days.

Although some furniture and shelving is “built in,” there is a trend toward making almost every piece of furniture movable. Book-cases and cabinets are on easy-rolling wheels so the room arrangement can be changed within a few seconds. Movable metal walls make the entire floor area fluid. Two men can move a new 21-foot partition to another location in less than an hour.

These facilities, which weren’t even thought of when the little old

(Continued to page 242)

Playroom, just off classroom, provides area where enthusiastic young artists can splatter paint and paste without reprisal

Hedrich-Blessing photo



## Gears Made of Plastic Outlast Steel in Test

So tough that it outlasts steel when formed into gears, a new plastic, developed by United States Rubber Co., can be produced with varying degrees of flexibility. In one application, a drive gear on a heavy-duty lathe was molded of the plastic, called Enrup, and after more than six months of use it showed no signs of wear. Because it can be molded to close tolerances, the plastic eliminates many finishing operations. It will bridge the gap between brittle hard rubber and elastic soft rubber and can be produced to match the flexibility of either of these extremes as well as the varying degrees between them. Enrup is fire resistant and a good electrical insulator. It is expected to be used for battery cases, gears, water-pump and fuel-pump parts and many other items.

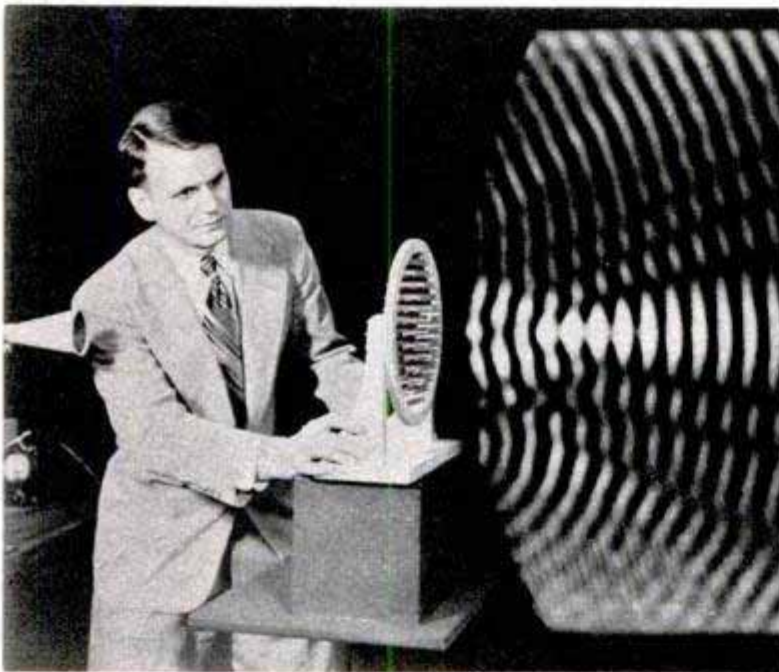
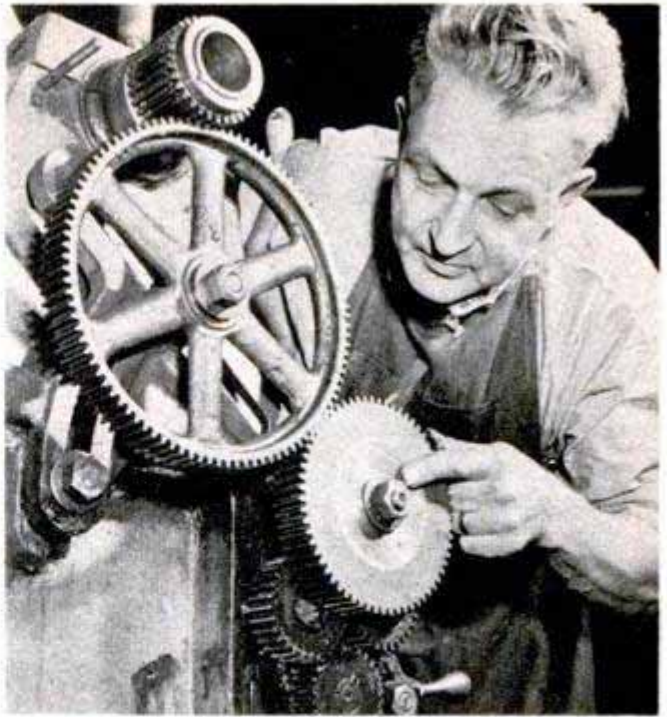

## Swinging Lamp Exposes Film To Photograph Sound Waves

Actual patterns created by waves of sound have been recorded on film at the Bell Telephone Laboratories. The equipment consists of a tiny microphone and a neon lamp, both mounted on a swinging beam which scans the wave field. It is this scanning which builds up a picture during a time exposure, in much the same way television images are formed. One of the first uses of the equipment was to test the focusing effect of an acoustic lens on waves emitted from a horn. Sound was broadcast from the horn through the lens. The waves beyond the lens then were photographed.

## Knockout Punch

Electricians pack a powerful punch that speeds the work of cutting holes in control boxes when they use a portable hydraulic ram with a 10-ton capacity. The ram can be used with hand punches or, if desired, complete punch kits can be purchased that are designed for the tool. The hydraulic unit and punch are connected by a flexible hose, enabling the punch to be used in places that would be inaccessible to more bulky equipment. It is also easier to use in awkward positions because there is no wrench or hammer to swing.

Probably the world's deepest laboratory is 7000 feet underground in a South African gold mine where doctors study the effect of subterranean heat on the workers.

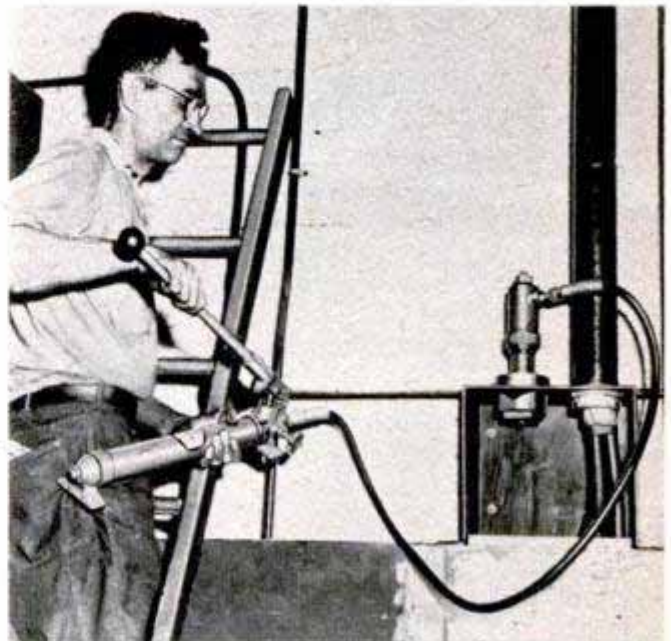

# when the earth shakes— You're Safer in Your Car

By Juan Pastor

I COVERED the disastrous earthquake that hit Ecuador last year, a devastating horror that killed over 10,000 and left at least 100,000 homeless. Fifty-three towns and villages were badly damaged and some were totally destroyed.

Pelileo was struck the hardest, as this thriving town seemed to be the exact epicenter of the quake, and not one building was left standing. No atomic bomb could have wrought greater structural damage than Pelileo suffered. I searched in vain for a building that might have, somehow, escaped the ravages of this trembling terror which killed more than 90 percent of the inhabitants who were indoors or standing within range of the crashing walls.

Having lived in Ecuador for more than a decade, I was not unfamiliar with earth tremors and had been told, repeatedly, that the best spot to go at the first indication of a quake, assuming you are not well clear of buildings, was in an archway—the theory being that while the walls might crumble, the arch supports of stone, cement or heavy beams would very likely afford sufficient protection to save your life. Don't you believe it, unless, of course the quake is a slight one.

The safest place to be when the earth shakes violently is somewhere else—the farther the better! But assuming that this is impossible, that circumstances—call it luck—put you on the spot, then let me give you some advice based on my inspection of several towns and villages immediately after the quake:

Get into your car. If it has an all-steel body, it's your safest bet by all odds. Most earthquakes do give a moment's warning. This one opened at 2:10 p.m., with a slight tremor. All survivors state that they felt this initial movement. Some paid little or no attention since mild temblors are frequent in some sections of the Andean slopes and highlands. Others either went out into the open street or sought shelter under an arch. Only a very few of these lived and those who pulled through, did so through sheer good fortune. Exactly 45 seconds after the warning tremor, the entire valley in which Pelileo is located dropped from six to ten feet and this was followed at once by a shaking so violent that absolutely



While several persons were killed by falling rubble on this street, the passengers in this truck were unhurt. Below, workers begin removing the ruins of a church where 85 persons, most of them children, died



nothing in town except the cars and trucks held together.

In many places, earth cracks opened, swallowing people and livestock, then closed again. But none of these crevices was more than three to five feet wide. No one knows how deep. One truck actually straddled such a crack, its occupants screaming in fright as they saw the ground open up.

One of my photographs shows a sedan. A man and his wife were sitting in the front seat when the quake occurred. At the first slight tremor, the woman opened the door on her side and started to get out. Her husband yanked her back, slamming the door after her, and seconds later the car was buried under tons of rubble, stone and beams from the building next to which it stood. Neither of them was injured though they spent 34 hours trapped in the car without food or water before being dug out by a rescue party.

A truck driver tells of his freakish experience: "I was driving along at 25 or 30 miles an hour, going up a long grade. I did not feel the first slight tremor, probably because of the motion of the truck. Suddenly, the whole truck leaped upwards, how far I do not know, and then turned turtle, falling upside down. One man riding behind was thrown clear. There were three of us in the cab and we suffered slight head contusions and bruises, nothing more."

Another truck, driving slowly along a

narrow Pelileo street, was stopped short by the cave-in of houses on both sides. Fortunately, they were low, one-story dwellings, with the result that the truck was not completely covered (see photograph). But three bodies were unearthed in this same short street, evidence that these people had run out of their homes seeking sanctuary in the open and, having no protection such as those in the truck, they were knocked down and engulfed by the rubble.

Not one person who was in an all-steel body of either car or truck was seriously injured, and I saw at least 15 cars in various stages of burial, most of which had been occupied at the time of the quake.

I have said that every building and house in Pelileo was destroyed, and this is quite true. Yet it was not infrequent to find roofs still intact even though the walls had crashed in or out. This was probably due to the initial dropping of the valley which caved in the walls but occasionally left the roof sitting there, virtually level with the ground.

During the four days that I spent in Pelileo, Ambato and other quake-ridden towns, I slept in my car, for recurring slight tremors kept up at the rate of 15 to 20 a day for several days after the disaster and none of us knew, from one moment to the next, when another major quake would come. I had learned, not as a scientist, but by simple observation, that my car was the safest place to be.

Shown here partly uncovered, this car was completely buried in the quake, but its occupants were unscratched

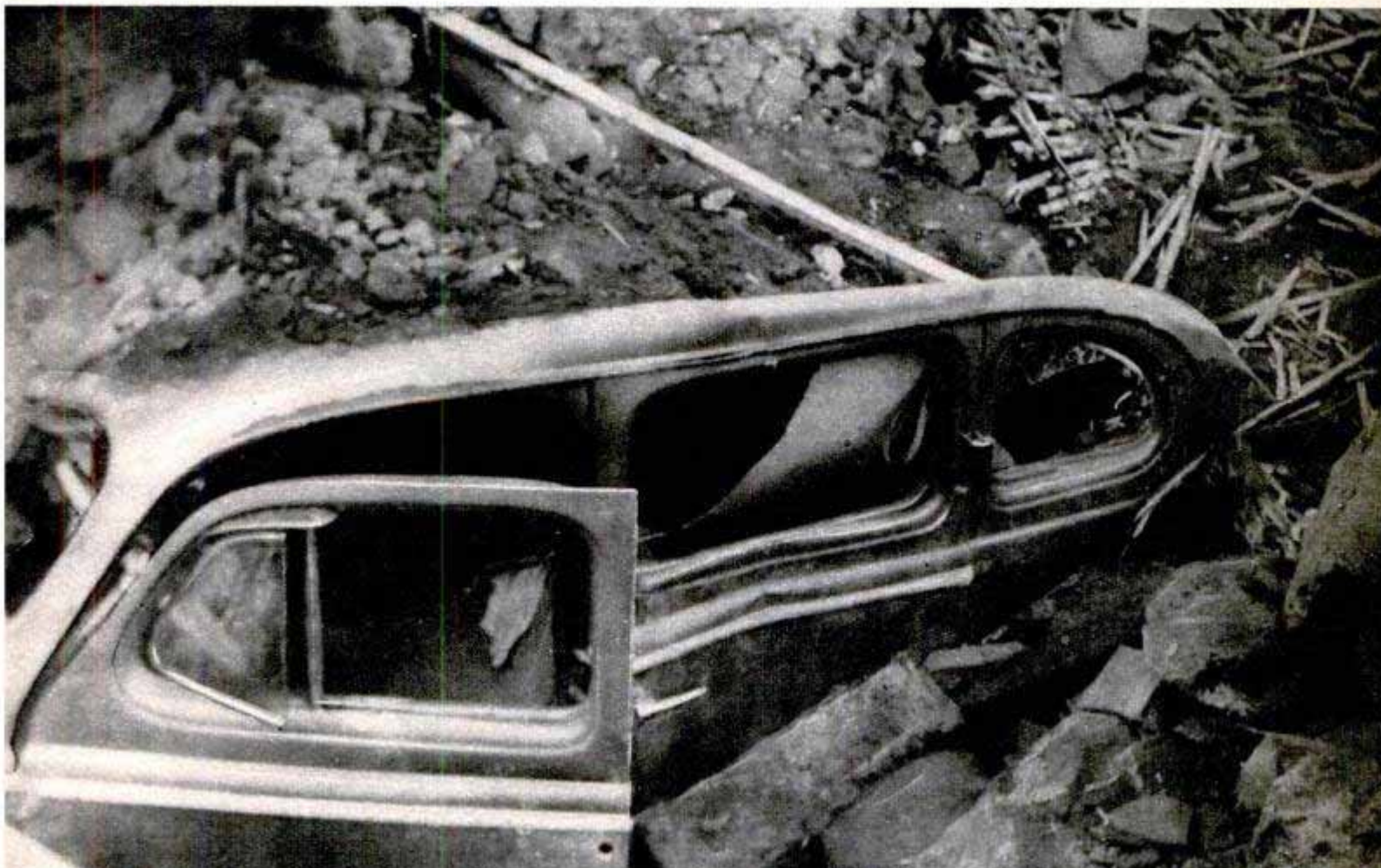

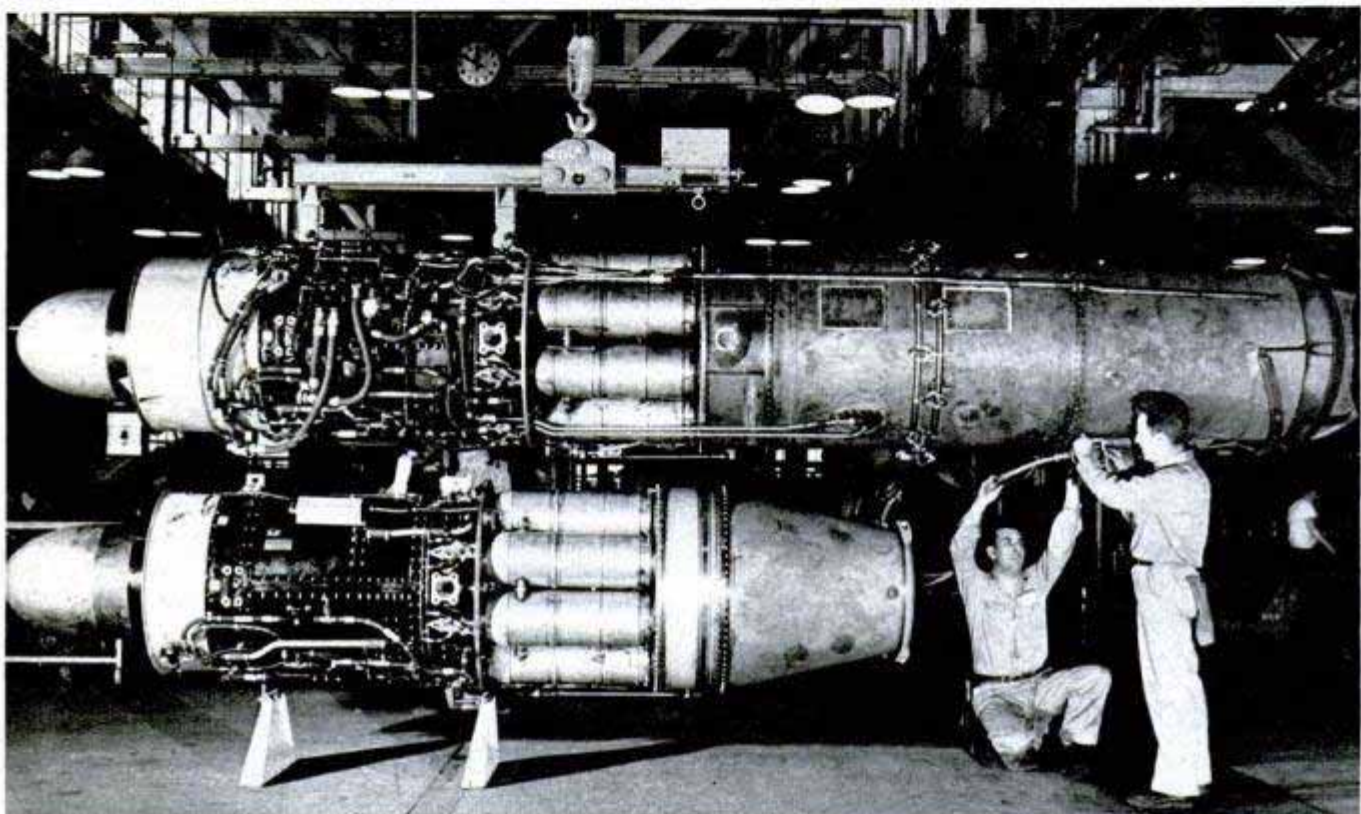

Top photo courtesy North American Aircraft Co.

## Fastest Plane Increases Power

Burning of additional fuel in the tailpipe of its General Electric jet engine gives added power to the F-95A, newest version of the fighter holding the world's speed rec-

ord of 670 miles an hour. Automatically controlled "lips" in a nozzle at the end of the pipe gain maximum performance from the engine under varying flight and power conditions by changing the area through which the hot gases must escape.

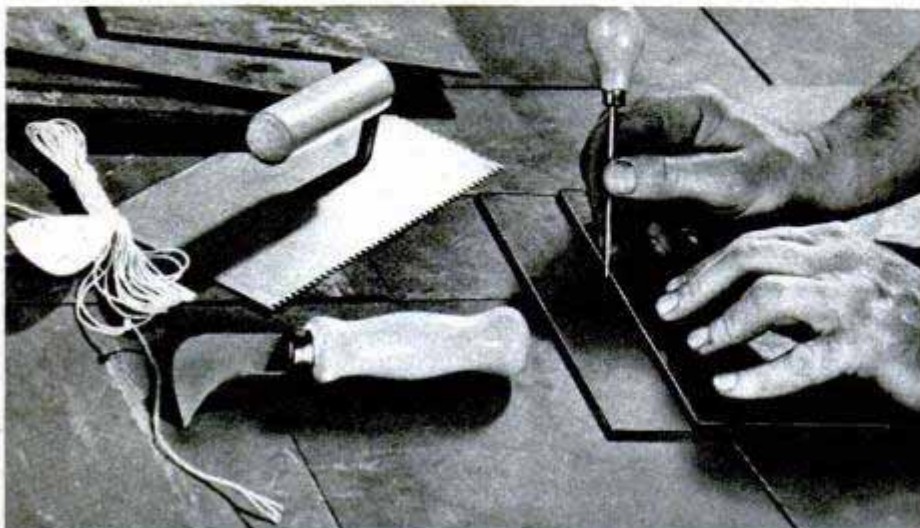

## Tile-Laying Kit

All the tools needed in laying an asphalt or rubber-tile floor are included in a new kit. The tools consist of a knife, notched adhesive spreader, awl, chalkline and chalk. The kit also contains step-by-step instructions for laying the tile, including diagrams showing how the tile should be arranged and applied to rooms of various shapes.



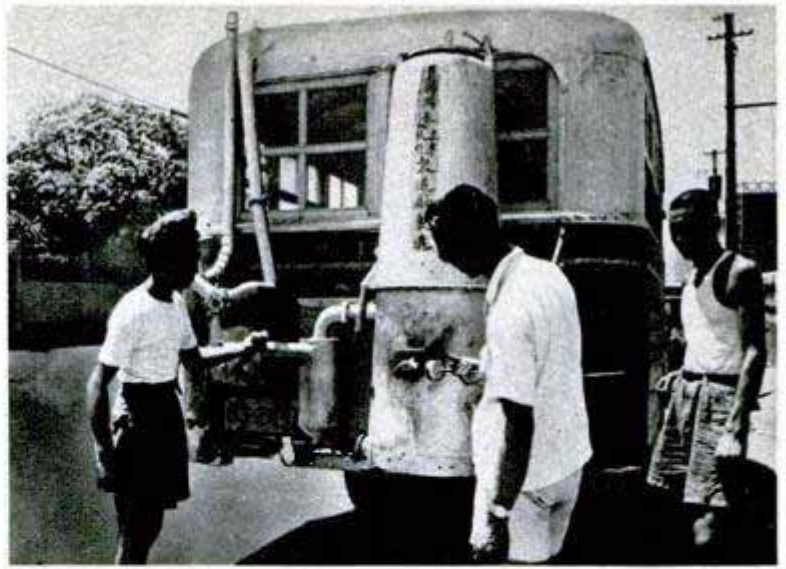

## Tip to Moscow: You Can Do It Better With Gasoline

When the Nationalist coastal blockade cut off gasoline imports into Communist China, the Chinese resorted to charcoal as a fuel for thousands of their vehicles.

Busses which were converted to use of charcoal sported big burners behind the rear panel. Tubes ran up over the bus to a feed-in mechanism for the carburetor.

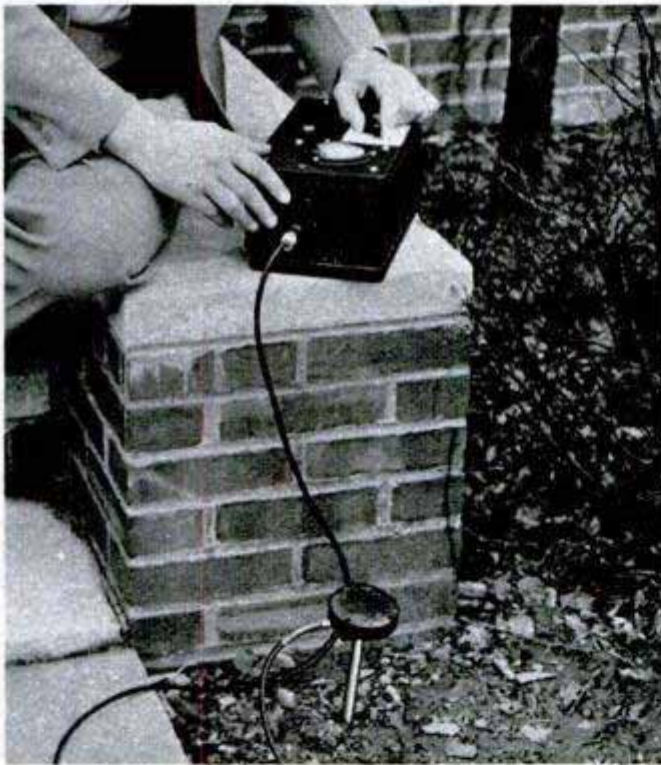

## Vibration Detector

Invented by a 22-year-old undergraduate at John Carroll University, a portable vibration detector provides a simple means of measuring vibrations in buildings and other structures. It weighs only six pounds and is essentially a small version of the seismograph. Its basic parts include a pick-up mechanism, an amplifier and recording circuit. The circuit "holds" the peak impulse on the dial, assuring the operator that he reads the most intense vibration. The inventor, Edward F. Carome of Cleveland Heights, Ohio, worked on the detector's design for eight months before perfecting it.



## Desk for Drivers

Salesmen and other motorists who must use their cars as offices can jot down notes on a desk that fits over the steering wheel. The portable desk slips into place and is held at a convenient height and angle. Inside the desk are compartments for stationery, stamps, order books, pencils and other supplies. It can be carried like a briefcase with a handle on the top.

Escape holes can now be cut through the walls of crashed airplanes by a new-type explosive, specially shaped to concentrate its punch in one direction.

RAILWAY COAL CARS

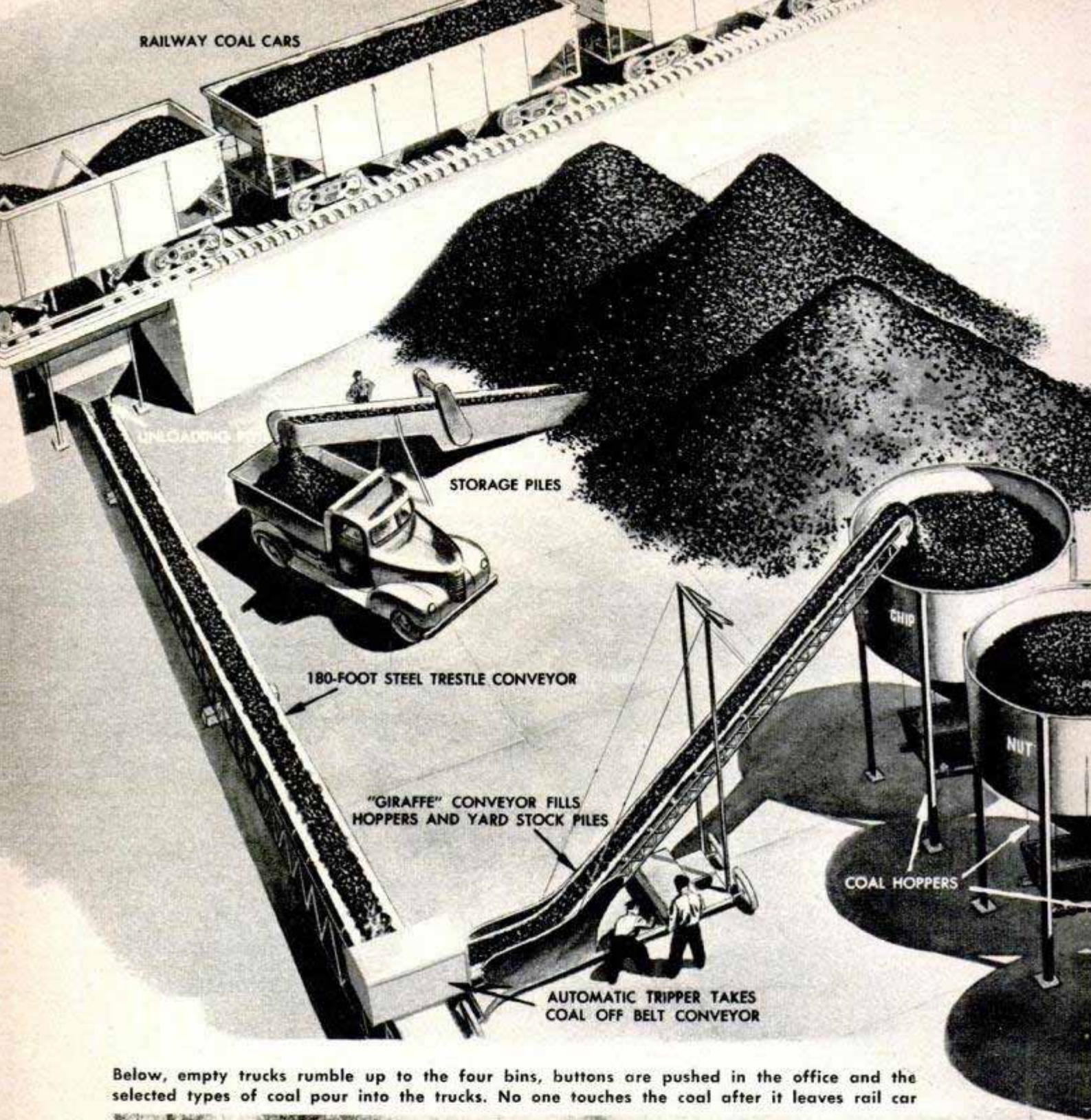

Below, empty trucks rumble up to the four bins, buttons are pushed in the office and the selected types of coal pour into the trucks. No one touches the coal after it leaves rail car



# Push-Button Coalyard

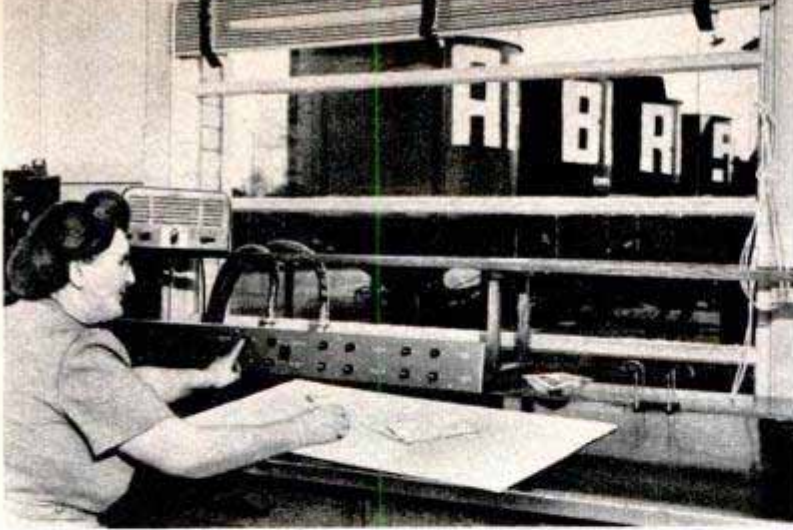

Spic 'n span as a grocery store is a coalyard in Tacoma, Wash., where weird machines automatically unload the fuel from rail cars, sort and grade it, deposit it in bins and then load it on trucks when it's needed. One operator, above, can run the entire coalyard with push buttons. The coal drops into an unloading pit from the rail cars. It then is moved by a conveyor belt to a point opposite the bins, where a mobile "giraffe" hoists it into the proper bin. Loading conveyors siphon it out of the bins and into waiting trucks. Coal of other types or sizes is stored in separate piles and loaded by a second mobile giraffe

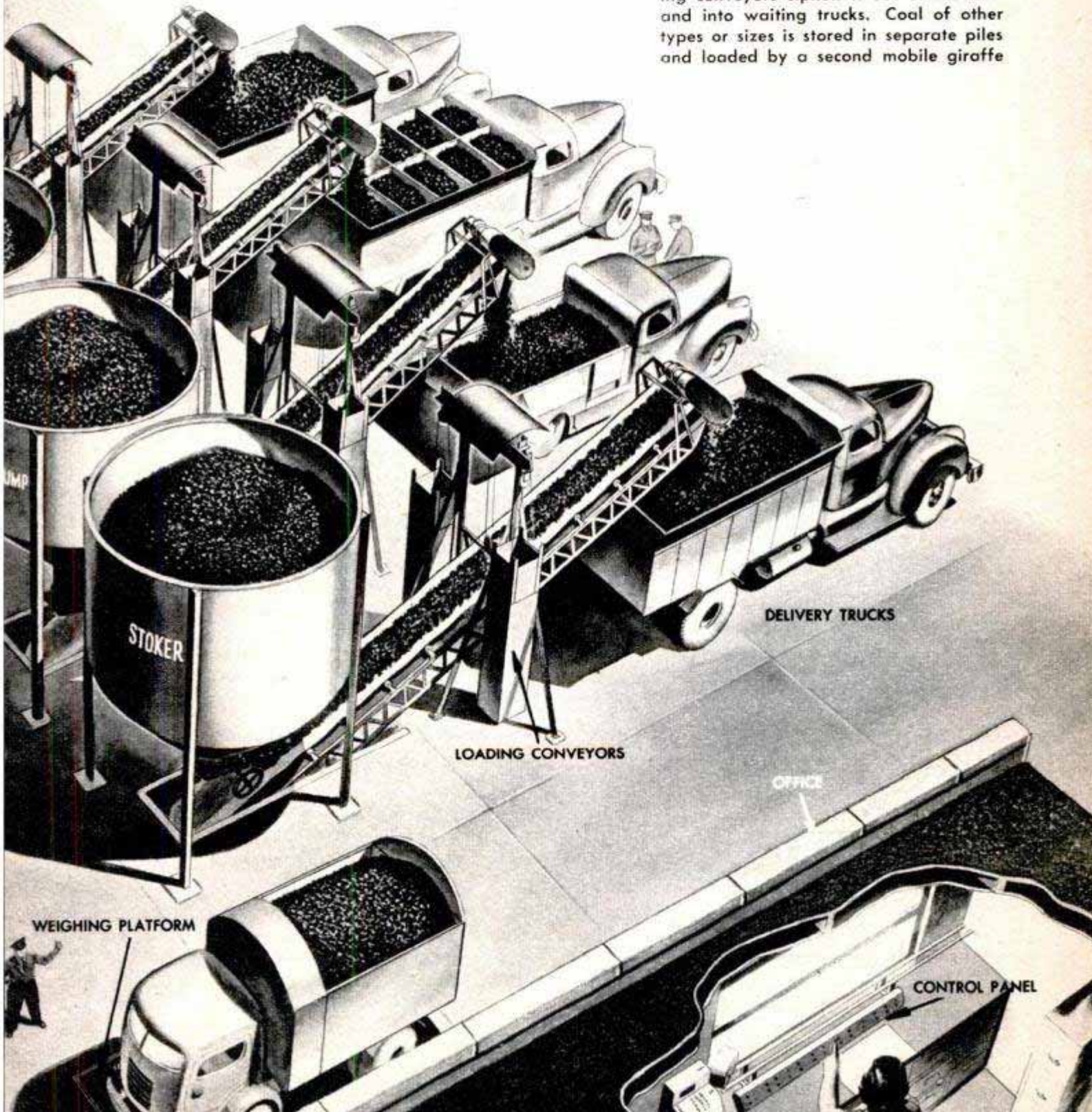

STOKER

DELIVERY TRUCKS

LOADING CONVEYORS

OFFICE

WEIGHING PLATFORM

CONTROL PANEL



Consolidated-Vultee photo

## Bomber Carries Spare Engines

Four spare engines can be hauled by a giant B-36 in two streamlined pods that hang from its bomb bay. Each is 32 feet

long and 8 feet in diameter and together they weigh 25,000 pounds when loaded with engines. Increasing the utility of the bomber, the carriers can be quickly removed and placed inside the airplane.

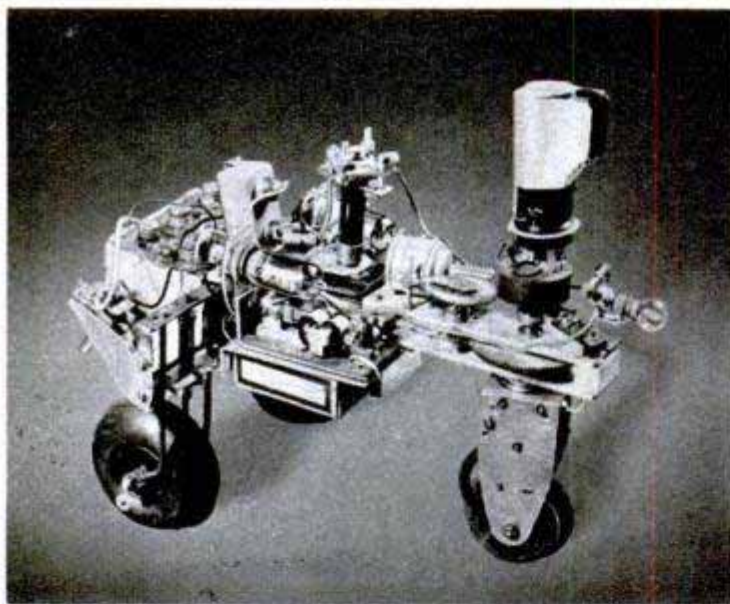

## Mechanical "Thinking" Turtles

With a couple of old gas meters, some batteries and electrical parts, a scientist has built a pair of unpredictable mechanical turtles which are aiding in a study of how animal and human brains work. Dr. Grey Walter of the Burden Neurological Institute, Bristol, England, made the robot tortoises. Each has a snout on its back containing a photoelectric cell. When the batteries are turned on, the snout slowly revolves, searching for the strongest source of light in the room. This action also revolves the front wheel of the tricycle un-

dercarriage, and the turtle wanders from side to side. As soon as it "sees" the light, the snout stops revolving and the rear wheels start turning to move the turtle forward toward the light until it strikes a piece of furniture or some other obstacle. Then with a growling of machinery it moves at random from side to side until it once more "sees" a clear path to the light. The two turtles now have two simple reactions—response to light and avoidance of obstacles. Doctor Walter plans next to give them a 15-minute electronic memory, and a primitive learning ability. He won't predict exactly what they'll do then!

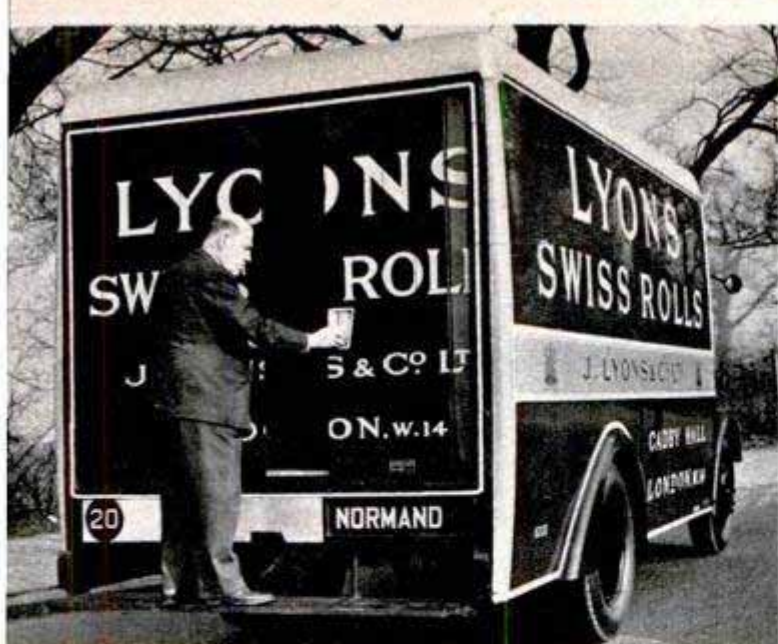

### Rolling Truck Doors

Particularly adapted to delivery trucks in congested areas, rolling doors that disappear into the body sides are making their appearance in London. Vehicles using them in place of outward-opening hinged doors require less parking space for loading and unloading. The risk of accident from doors opening outwards onto the street or sidewalk is also eliminated.

### Rosier Cheeks for Apples

Treatment with a new spray solution gives apples 40 percent more color, Cornell University experiments indicate, and the red is more intense than on untreated fruit. The spray, which is not commercially available as yet, doesn't add the extra color, but it increases the output of red pigment in the apple.

### Store's Information Booth Has An Electronic "Clerk"



SEPTEMBER 1950



### Bodyless Wheelbarrow

Because it has no body to limit its uses, a steel wheelbarrow chassis will haul just about anything from storm windows to ash cans. It will carry garbage cans, lumber, firewood, grain sacks and many other items of all sizes and shapes. Weighing only 12½ pounds, the wheelbarrow can be hung on a nail in the wall when not in use.

Shoppers, looking for a certain item in a large store, get quick, accurate information from any of several wall-mounted communication units scattered throughout the building. These units, parts of a two-way communications system, are hooked up to the store's information center. When the customer wants some information, she presses a button to call the operator and asks the question into the built-in microphone. The operator, who knows where the customer is because each unit is identified on the control panel, gives her exact instructions over the two-way system.

☐ Forest fires in the U. S. last year burned over more square miles than the combined land areas of Massachusetts, Connecticut, Rhode Island, New Jersey, Delaware and the District of Columbia.

ons usually get there too late for the excitement. Those who pack the stadium for the stock-car races are sure to eyewitness the wreck. It's

# MAYHEM ON WHEELS

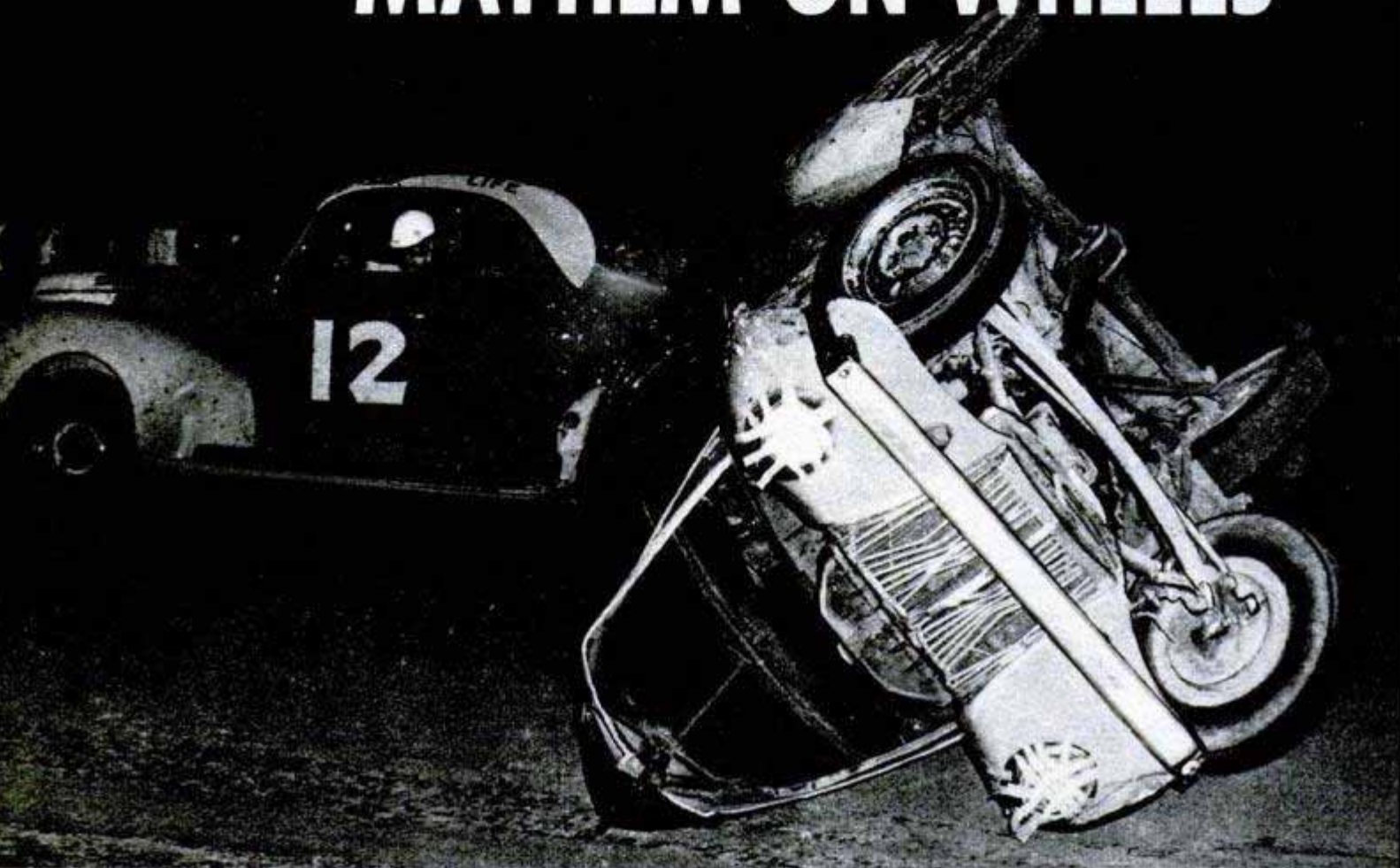

Over he goes! Thrills like this are packing in the customers at stock-car race tracks all over the country

By John Christy

**T**AKE THIRTY-ODD passenger cars of varying ages, put them on a quarter-mile track and turn the drivers loose with instructions to "put on a show for the folks." The resulting mayhem, a cross between a legitimate auto race and a thrill show, is a stock-car race.

Although not a new phenomenon, stock-car racing during the past year has taken an upswing in popularity, surpassing such drawing cards as hot rods and midgets for crowd appeal.

The main crowd appeal seems not to be so much an interest in speed as in the urge for some kind of destruction, the more violent the better.

Perhaps another big reason for the record attendance lies in the fact that here at last is a race car that the people can understand. There is no secret about these cars. There are no special engines, no talk of overhead cams, tube frames, quick-change rear ends and other unintelligible equip-

ment. These are just cars like John Q. drives to work.

Modern family buggies were never designed as race cars. With their slow steering and soft suspension, they have about as much stability as a camel on a log jam. That's why there's excitement at the track!

On a track designed for midget racing, these erstwhile family busses handled by eager young race drivers anxious to prove their driving ability or lack of it, keep the crowd on edge all night. The ripped fenders, spins, rolls and general destruction make even a tough cab driver shudder. When the natural talent of these incipient Barney Oldfields for slashing and plain and fancy "boogering," or power sideswiping, is compounded by an offer of repair money, the mass destruction would delight a lunatic with a wolverine complex.

The races, staged along the traditional lines of the sprint programs of the midgets and hot rods, are run off in a series of heats,



After an end-for-end flip, this stock car slid more than 50 feet on its nose. The driver? Not a scratch!

a consolidation race for the slower qualifiers and two feature events. Occasionally, there is a culminating "super feature." The same rules that apply to other types of racing apply to the stock cars with the exception, at least in the midwestern circuits, of the flag regulation.

The big difference is that at no time during the race is the yellow or "no passing" flag displayed. This, in other races, is used when a spin or other mishap partially blocks the track. In stock-car races, if the track becomes so cluttered with debris that it is completely impassable, the red or "stop" flag is displayed. When the track is cleared, the race continues with the cars in the order in which they were stopped.



The '39 Ford has been a favorite stocker. This one lasted an entire season, winning two championships

The only other time an event is halted is in case of injury or fire.

In some races, particularly the consolation, this produces the effect of an obstacle course as the drivers worm their way at top speed through the torn fenders, bumpers and wrecks of their less fortunate competitors. Some don't quite make it and the course gets tougher as the race proceeds.

At many tracks the pit area is continually bathed in the blue light of a welder's arc. A welder is in constant attendance to nurse the cars through the race. It is quite common for a car to become so battered that it could model for an insurance-company advertisement, but it still bounces back in competition for the feature event.

Nobody won this argument. Both cars went through the fence and out of the race. Crash helmets, safety belts and luck kept the drivers unhurt

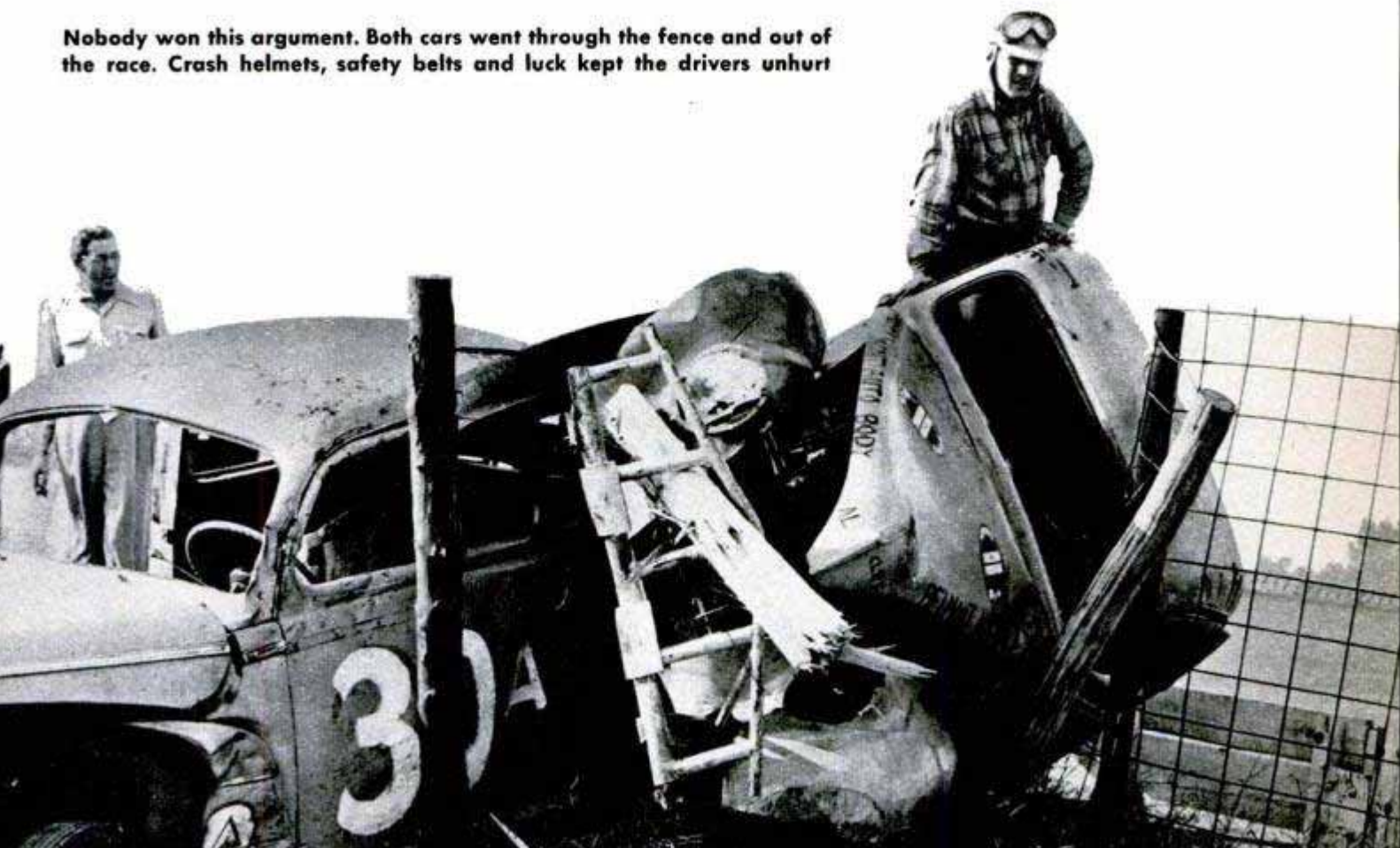



Its radiator smashed, this wrinkled racer filled up with steam as the driver exits through a glassless window

Pit mechanics are expected to do in minutes what the ordinary garage mechanic would not try to do in days.

Stock-car drivers, like their more conservative brethren of the hot rods and midgets, follow a circuit of tracks. One night they'll be in Chicago, the next night they run in Milwaukee, then Rockford. After that there is another dash across country to another town. In some cases, the haul from one track to another is 100

miles or more. Much the same schedule is followed all over the country.

Traveling the circuit is not easy. Since the cars require constant service, the hauls are usually made at night, after the evening race. Repair work is done in the next town before the race. One driver was asked if he ever got a chance to get a full night's rest. "Oh, sure," he answered. "We sleep Mondays."

Since the hot rods went big-time the

Rolling over so violently that he lost his goggles (left), this driver and car still raced again that night







Soldier Field Stock-Car Racing photo

Expectantly, the crowd watches two drivers desperately try to avoid a collision as they skid around the turn

"stockers" remain the last chance of the amateur driver to prove his stuff. Some of the screwball tactics designed by over-eager young chauffeurs to make an impression give officials the howling jitters.

Main danger in this type of competition is fire. A fuel explosion can turn one of these heaps into a rolling crematorium if care isn't taken to prevent it. Promoters and officials grow ulcers like mushrooms worrying about this but some drivers don't bother about such minor details.

One enthusiastic newcomer, noted for driving "over his head," discovered that he wasn't getting enough fuel through to the engine. After considerable thought he came to the conclusion that an auxiliary fuel supply was what he needed. Taking a five-gallon can of 91-octane aviation fuel cut with methanol, he connected it to his fuel pump and wired it firmly in place.

He had completed two laps of the consolation when his car erupted like a miniature Bikini. After a seemingly interminable struggle with his safety belt, the young Vulcan finally emerged, singed but perversely pleased at the effect of the whole thing, to watch his charred chariot towed away by the track crew. What gave officials rise to doubt the compos of his mentis was the location of his extra fuel tank—on the frame, wired to the exhaust manifold.

Although it would seem to the uninitiated that the damage to life and limb would be in direct proportion to the automotive damage, injury is extremely light, bruises and an occasional sprain being the most common.

Steel tops, safety belts and the use of crash helmets are strictly required. Glass is removed or taped to prevent shattering

and shatterproof goggles must be worn. In spite of this, insurance companies are reluctant to cover the participants.

The automotive-casualty figure is terrific. After a few weeks' competition, the cars are a mass of welding beads and baling wire. Fenders are pared to the minimum. Some of the cars have crumpled tops while nearly all have at least one door so badly battered that it will not open. Average life expectancy of a stock car is six to eight weeks. Before a car can enter a night's racing, it is inspected and has to have all fenders, doors and other major parts in place. It must look like a normal car when the racing begins—after that anything goes!

From time to time new cars make their way into competition. One such, a brand new Chevrolet, made its appearance late last season. The pretty little job was in perfect shape. It was immaculate, without even a scratch on the finish. The audience, stunned by its appearance, became absolutely still. Then, as with one voice, they let out a mighty cheer.

The other drivers, feeling that here was either a complete idiot or a rank amateur, undertook to warn the newcomer with gentle bumps and near misses as the race proceeded. But when the driver showed up for the next heat in spite of these warnings, the boys took no pity. He was slammed from one side of the track to the other; he was ground against the wall; he was spun out on the turns and broadsided not once, but four times and he still came back for more.

By the end of the evening, one door was battered shut, the rear bumper was missing, both front fenders were ripped and

(Continued to page 236)



### Part-Time Traffic Cop

Traffic during rush-hour peaks and at school crossings is directed effectively by a portable automatic signal. The signal cylinder is moved by a coil spring 11 feet long



that will operate for 24 hours when fully wound. An adjustable time clock controls the time interval for signals. When not in use, one man can move the signal stand on retractable rubber rollers that are concealed within its base.

### Carbon Dioxide Injected Into Mine Kills Stubborn Coal Fire

Carbon-dioxide gas has extinguished a stubborn fire in an Illinois coal mine, according to the U. S. Bureau of Mines. The successful battle will lead to the use of CO<sub>2</sub> in fighting other mine fires, the bureau indicates. In the Valier, Ill., mine, temporary seals to prevent air from reaching the fire

were blown out twice by gas explosions. Flooding was impractical because of the height of the airway. Eight days after the fire had started new seals were erected and carbon-dioxide gas was injected into the fire area. Temperature tests indicated that 11 hours later the fire was out.



### Berry Farmers Sit Down at Work

Farm laborers, working on strawberry plants, sit down in the shade as they work, thanks to a rubber-tired, hand-propelled cart. The cart also provides space for carrying seedlings during transplanting and baskets during harvesting. An umbrellalike cover protects the plants and berries as well as the worker from the hot sun. Power is transmitted to the rear wheel by a hand lever and ratchet. There is even a spot for a portable radio to entertain the worker.

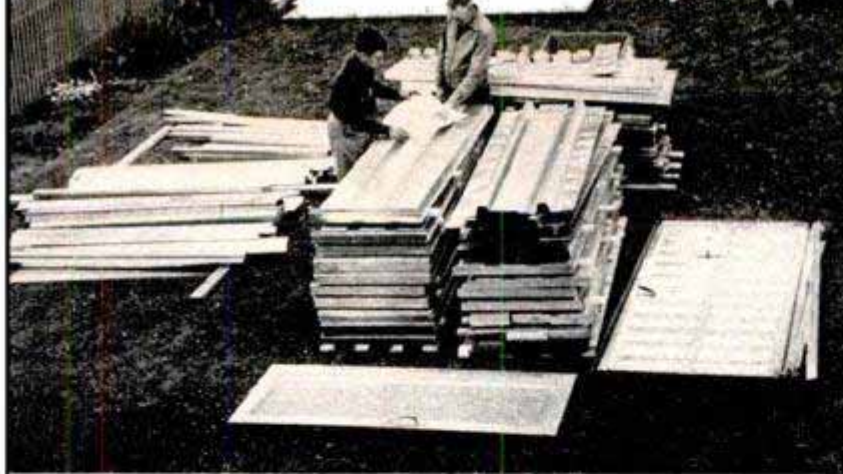

↑ Stacked here are all the parts needed to make the garage. The structure can be built on a concrete slab or set on cedar posts

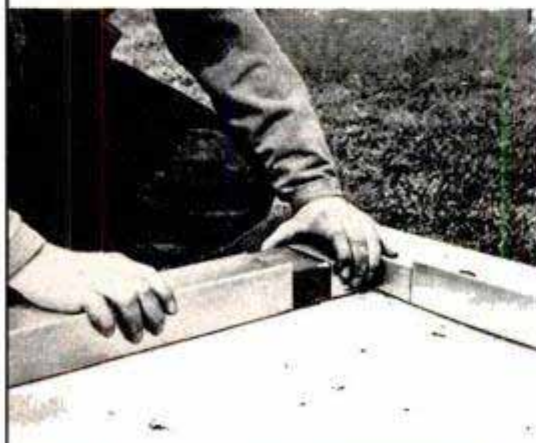

← Base rail is a rectangular aluminum tube just the size to take a two-by-four. Short lengths of wood are installed at joints



← After walls are up the roof panels are slipped into place on strong ridge member. Tension cleats hold the panels together

Below, left, heavier beam slips into sockets in the sidewalls, thus making the opening for the door exactly the right size

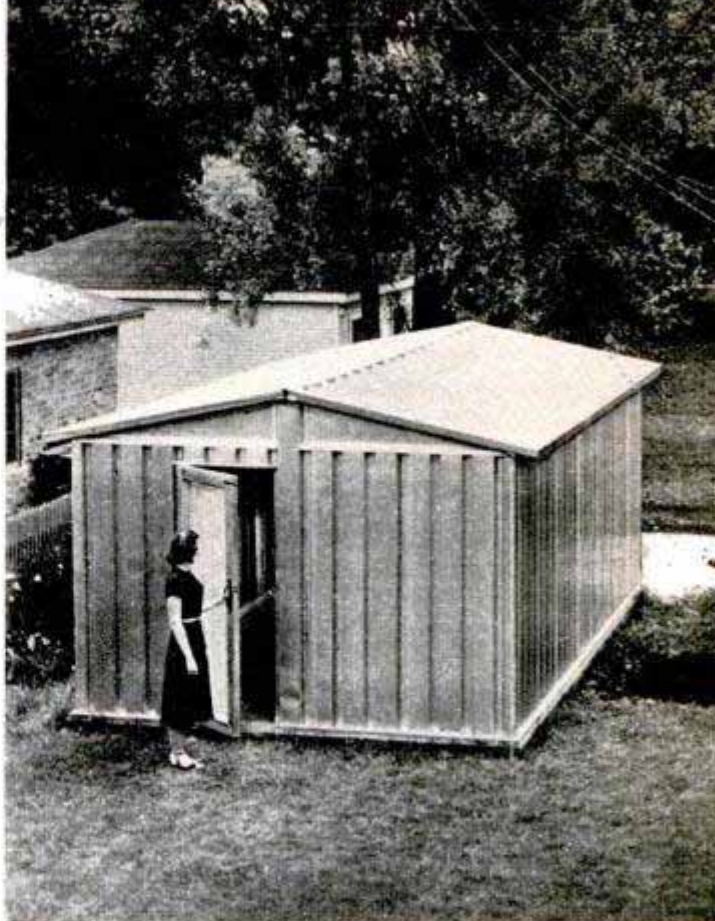

Garage, built of panels held together with cleats, is strong and can be made any length

## PREFAB ALUMINUM GARAGE

Overhead door has spring that works like curtain shade to raise door at touch of a finger



With quick strokes Pearson completes another unique landscape which combines painting and woodworking

## Painting in Three Dimensions

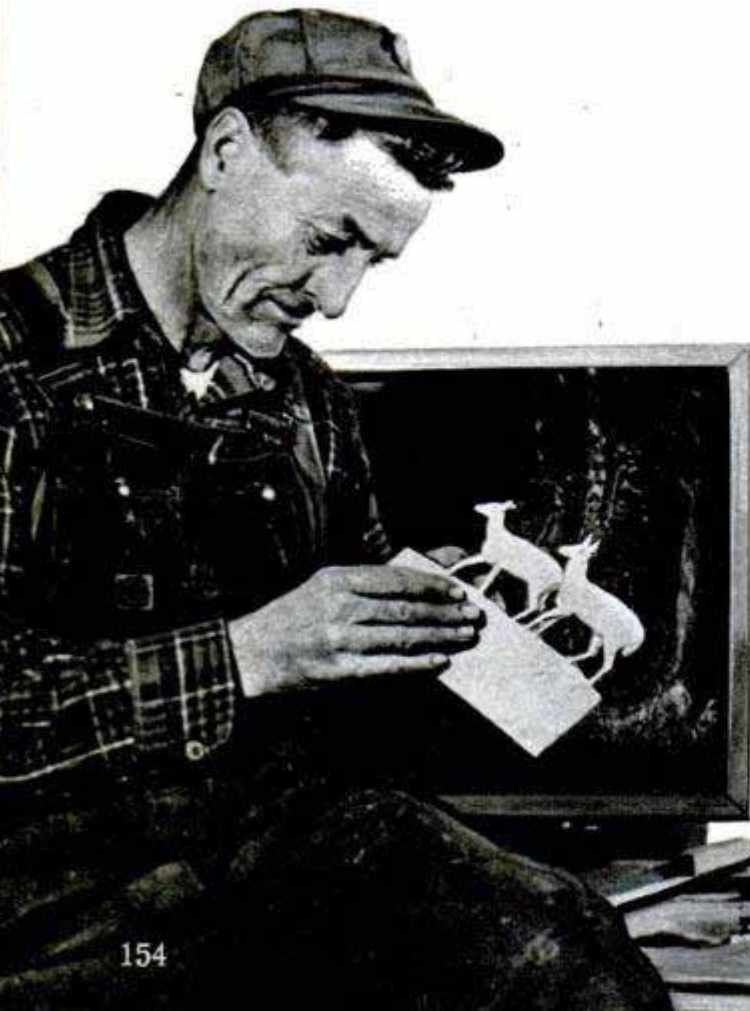

**W**ITH a jackknife and an artist's brush Bill Pearson of Sartell, Minn., can create a three-dimensional picture that seems to pop out of the frame toward the observer. Pearson, a carpenter, has combined his trade with his talent for painting. His unique forest landscapes are made of carved wooden figures which are blended into a painted background. In creating a picture, he paints the scene on a piece of cardboard with ordinary oil paints. Then, using small bits of shrubbery, he "plants" trees and underbrush on the painting. Bears, deer, duck, large trees and other foreground figures are carved or jigsawed from pine boards, then shaped with a knife and chisel. The finished figures are worked into the picture so that they stand well away from the background. To make the picture even more unique, Pearson paints shadows of the wooden figures on the background. His three-dimensional paintings have sold for as much as \$200.

Artist carves wooden deer which will be foreground figures, mounted well in front of the painted background



In the finished painting the deer and the foreground setting seem to jump out of the picture to give an illusion of depth. Below, drawing shows how landscape is built in layers, with large trees carved from wood





## Steep-Climbing "Air Horse" for Farmers

Designed to carry heavy loads out of rough, "postage stamp" size fields, the new Piper Super Cub is airborne after a run five times its own length. A novel tandem-wheel landing gear allows operation on rocky terrain, soft sand and mud. The front tires are inflated to only four pounds, permitting them to climb up and over obstacles that would stop a conventional landing gear. For its primarily agricultural role, the plane can carry 1000 pounds of crop dust or 80 gallons of liquid spray, and "hover" safely at just over 30 miles an hour.

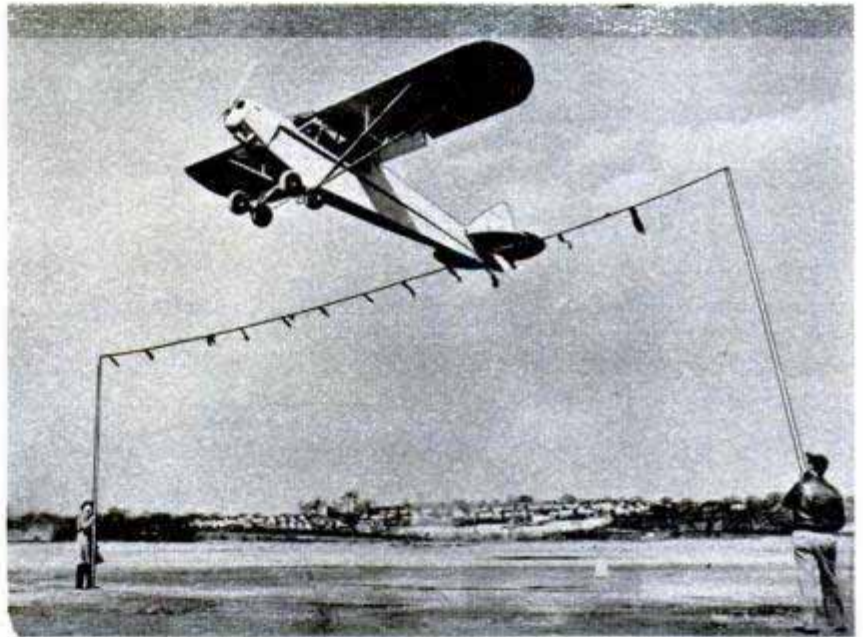

## Householder's Ark

Pontoons that the British used as temporary bridge supports during the war are being made into dwellings for house-hungry Londoners. Some are being put on lots, others used as houseboats and the remainder are being converted into pleasure craft. The pontoons are 20 feet long.

Information not listed on articles in the index frequently is listed in the WHERE-TO-FIND-IT LIST, available without charge from Bureau of Information, Popular Mechanics Magazine, 200 East Ontario Street, Chicago 11, Illinois



Twin-blade, rotary mower converts quickly to power snowplow to give year-round duty. Construction story on page 199 presents complete details for building it yourself



General Electric Co. photo

### Building your own cabinets and special built-in fixtures

JUST AS in any home-remodeling job, a major saving in the cost of converting your present kitchen into a modern, streamlined one can be had if you are able to pitch in and do most of the work yourself. This is especially so when it comes to making the cabinets, the built-in fixtures and other labor-saving features. Even though these are fairly simple to build, having them made up special at a mill is expensive and sends your remodeling bill soaring. However, the home craftsman with a basement workshop, or, for that matter, any homeowner with hand tools, can turn cabinetmaker and do the work at half the cost. If metal cabinets are

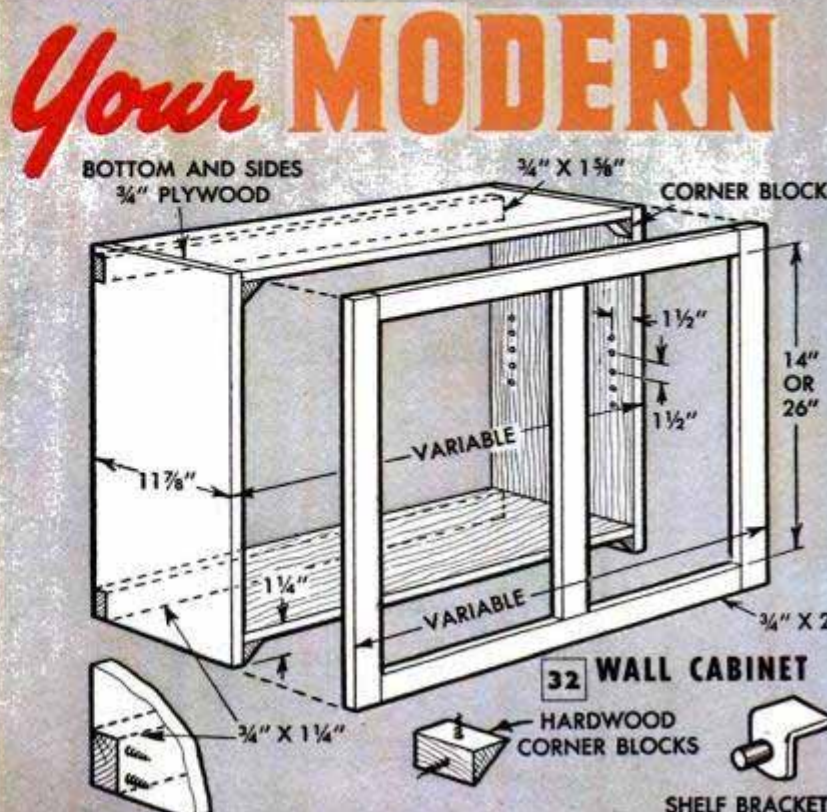



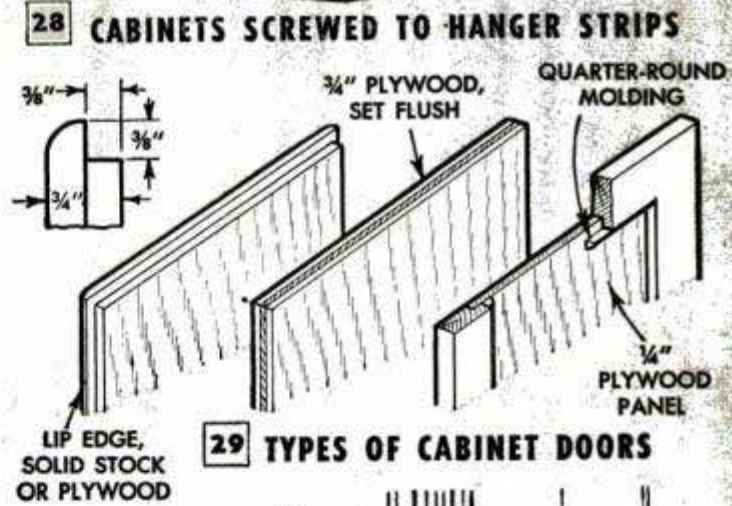
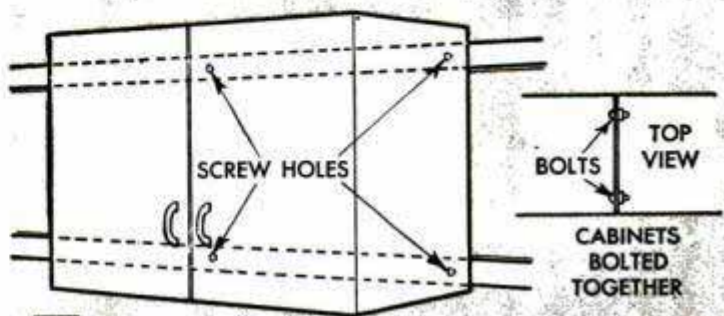
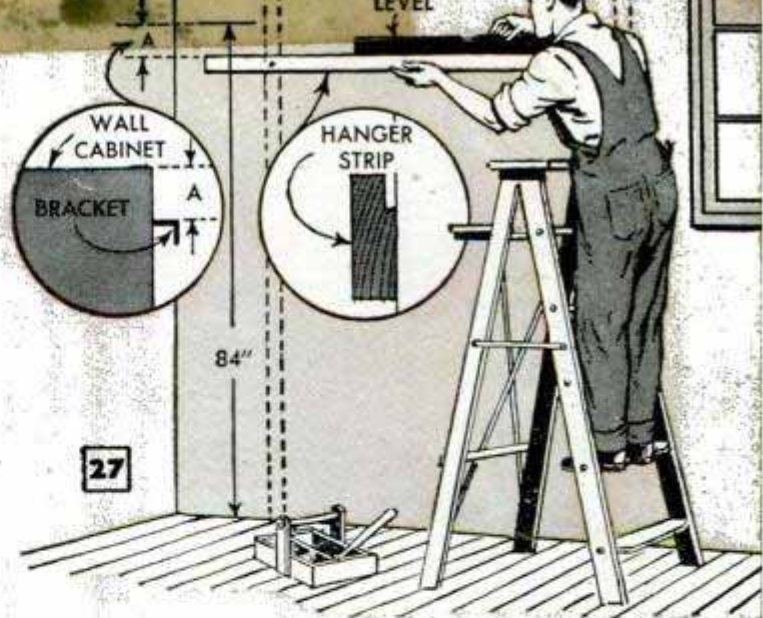
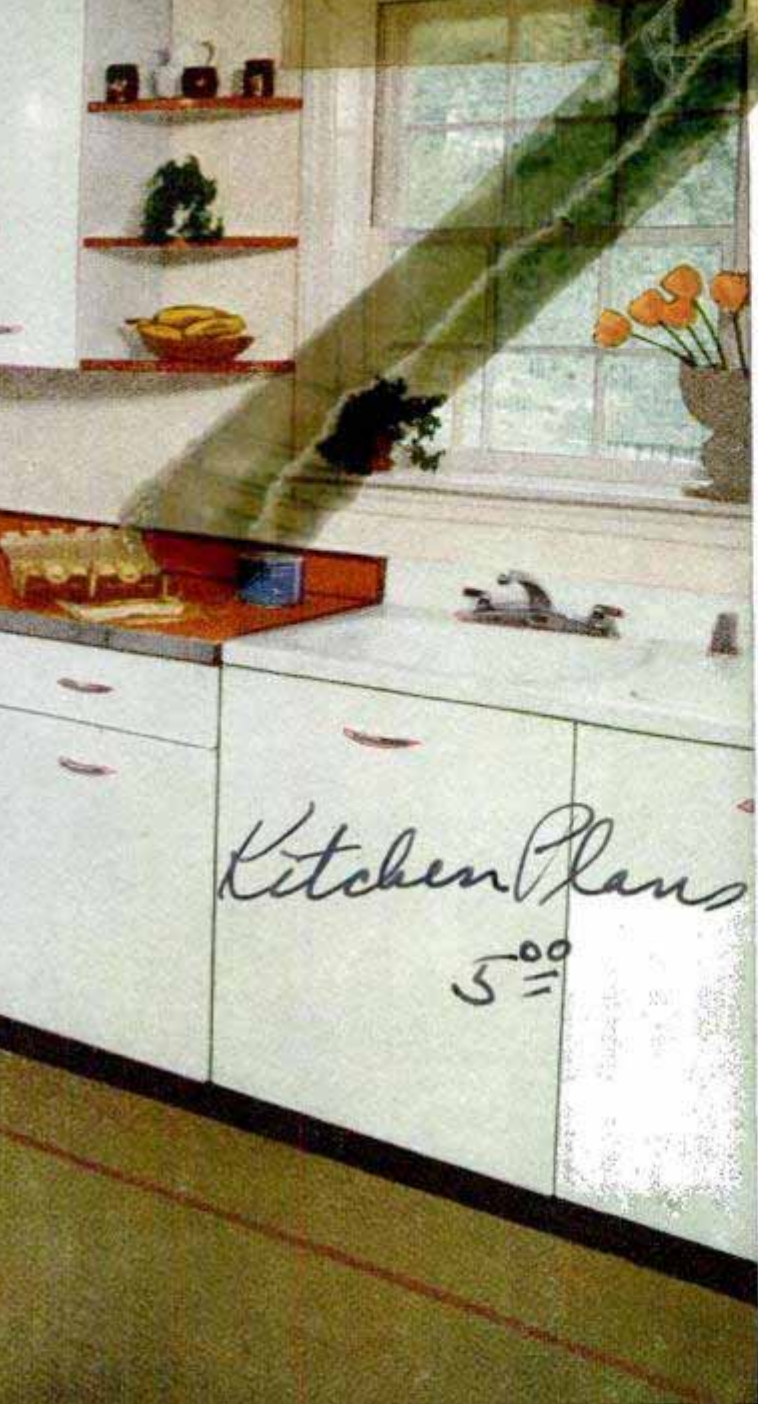

# KITCHEN

PART II  
By E. R. HAAN

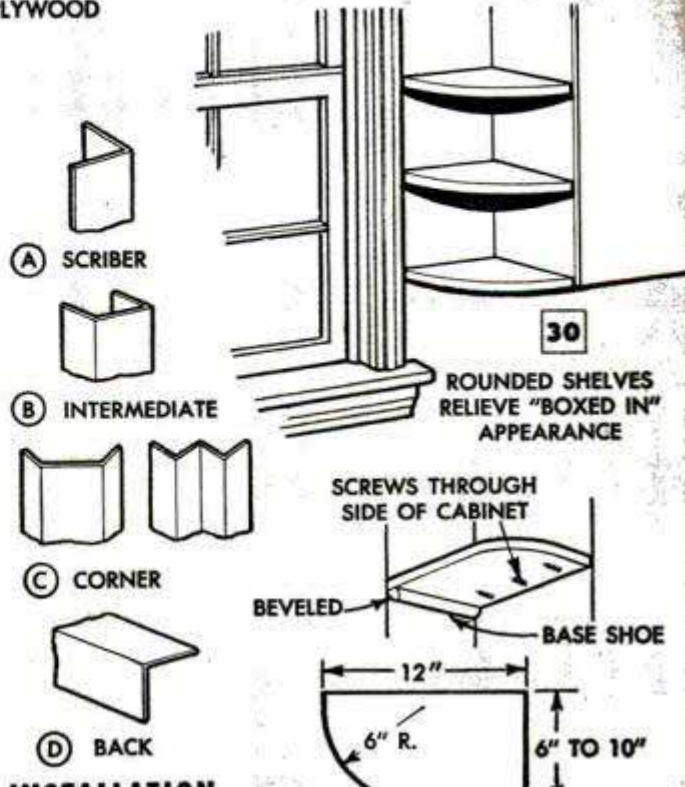
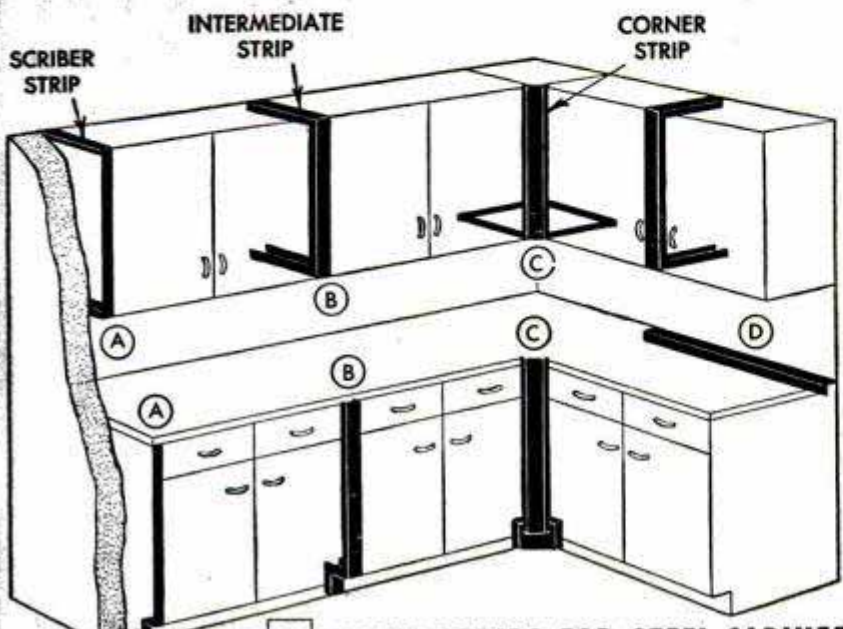

21 FULLER STRIPS FOR STEEL CABINET INSTALLATION

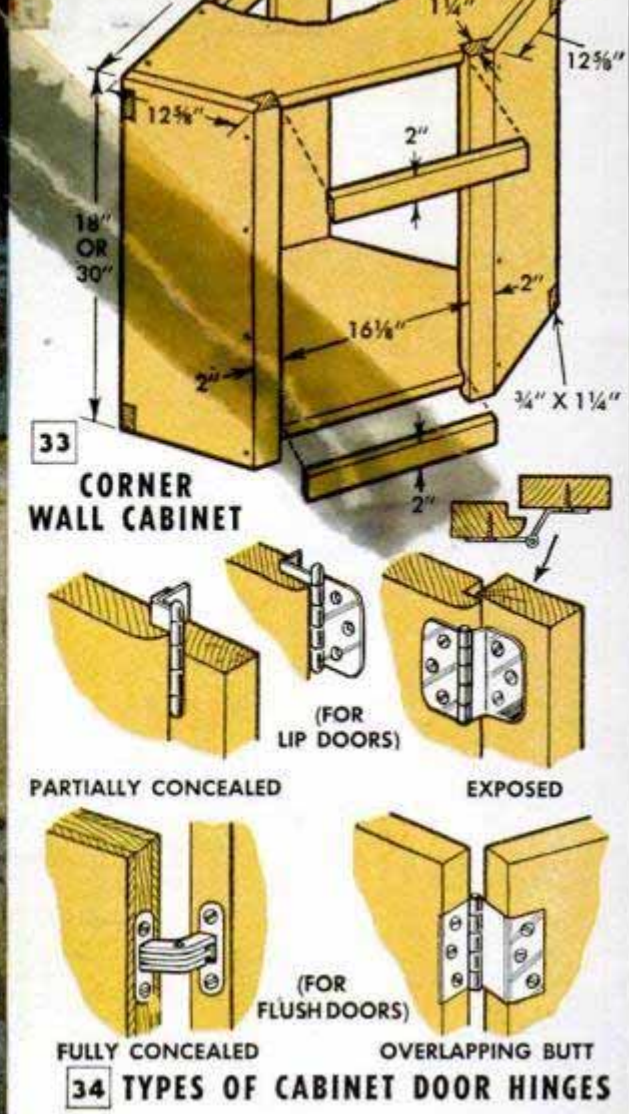

preferred, there's money to be saved by hanging them yourself and, for the man who doesn't want to build from scratch, there are ready-made units and kits on the market which can be assembled right on the job at a considerable saving. This, the second in a series of three articles, treats cabinet construction in detail, including the hanging of both metal and wooden units.

**Installing wall cabinets:** Before purchasing ready-made cabinets, have a dealer go over your plans and check all dimensions so that the units will fit properly. You can purchase "packaged" units from dealers or mail-order houses and installation instructions generally are provided. Wall cabinets of the standard 30-in. height usually are hung so their tops will come 84 in. above the floor. Most steel cabinets are attached



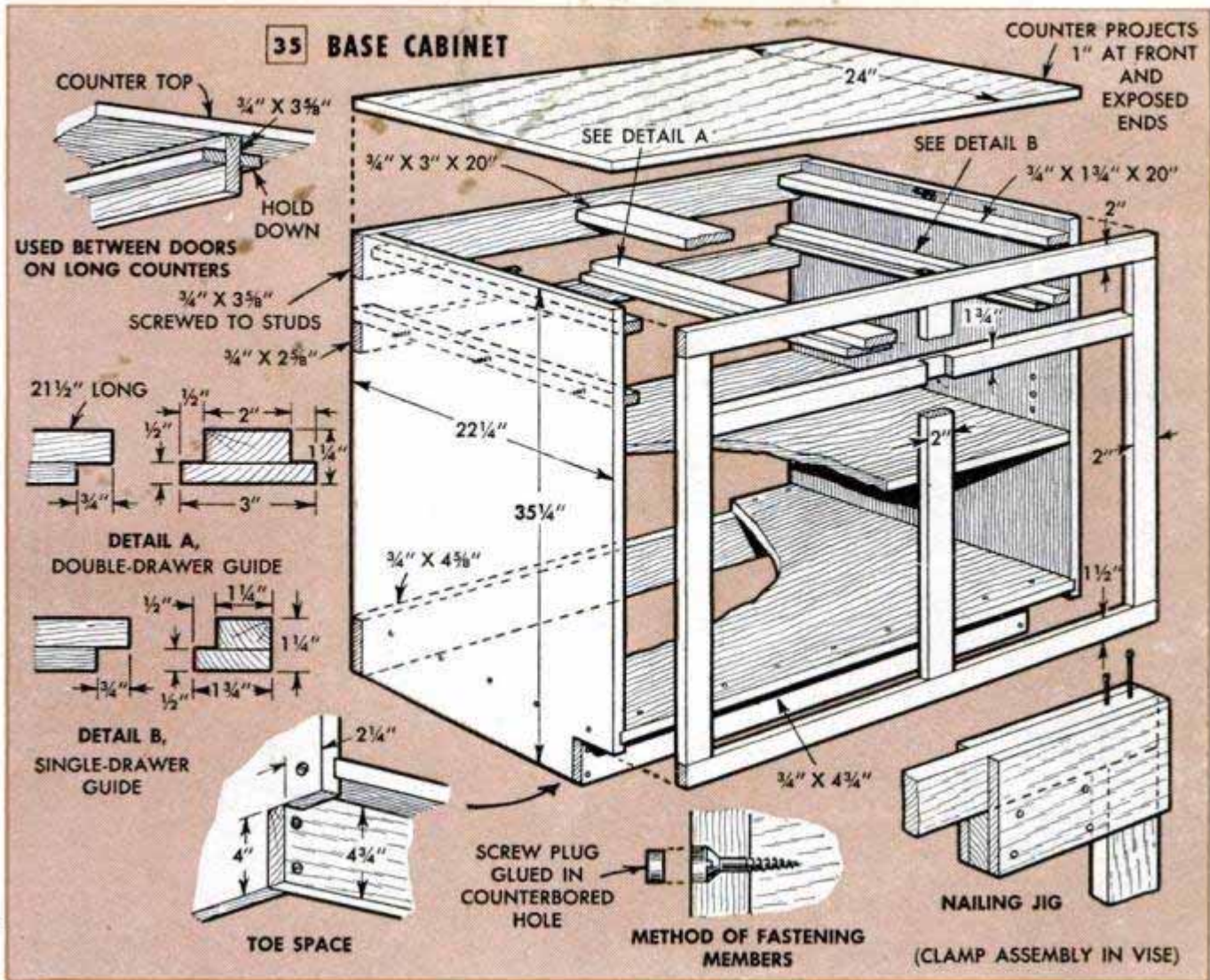

to wooden or metal hanger strips which are fastened horizontally and nailed or screwed into wall studs. The hanger strips, particularly the upper one if two are used, must be absolutely level, Fig. 27. In some cases, hanger strips are used individually on the cabinets; in other cases they extend, as in Fig. 28, to hold more than one cabinet. In still other installations, the cabinets are screwed directly to the walls with the screws driven into studs. On hollow tile walls, toggle bolts are used for fastening, whereas brick walls require screws and expansion sleeves.

When hanging metal wall cabinets, and also when installing base cabinets, the usual procedure is to start from a corner. If your installation does not include corner cabinets having 45-deg. doors, fasten two standard straight cabinets to a metal "corner" filler strip, Fig. 31, C, and to a corner bottom plate. Next, bolt several cabinets together before screwing them to hanger strips or wall. Steel cabinets are sometimes provided with removable knockouts for bolts used to fasten the cabinets together. If not, holes must be drilled. Wooden cabinets generally are fastened together with screws. Before screwing the cabinets permanently, check with a level to see that the

front and sides are plumb. Often it is necessary to use shims behind the cabinets where plastered walls are uneven.

Avoid locating a refrigerator next to a corner wall cabinet as it will interfere with opening the cabinet door. Avoid having a cabinet butt tightly against an end wall, as this would interfere with the operation of doors. This also applies to base cabinets. The needed clearance space between cabinet and wall is concealed by using a "scriber" filler strip, Fig. 31, A. If the wall is uneven, the strip is held in position, scribed to conform to the wall surface and then cut accordingly with tin shears and fastened in place. On metal wall cabinets having sides that do not conceal the hanger strips, "back" filler strips, Fig. 31, D, are added for concealment. A spacing of 6 to 10 in. is recommended between wall cabinets and windows where rounded shelves, Fig. 30, are used. When it is necessary to fill a gap of a few inches between cabinets to stretch them, an "intermediate" filler strip, Fig. 31, B, is used. These strips come in various widths.

**Base cabinets and counters:** Installation of base cabinets is started at corners the same as with wall cabinets. If the corner space is not to be used, two straight-type

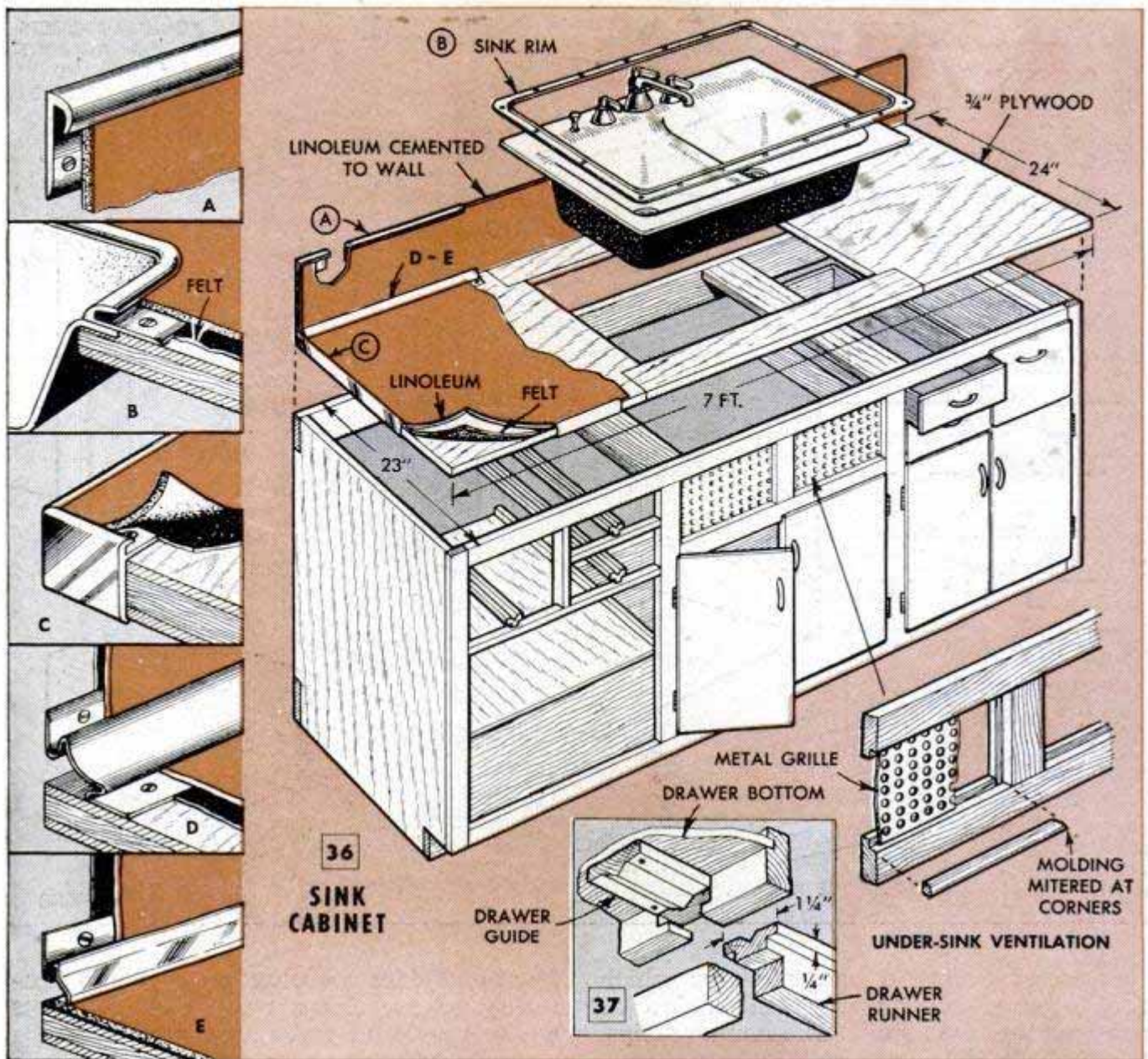

cabinets can be butted together at right angles and a corner filler strip added at the front. Then a counter support cleat is nailed or screwed to the wall studs. Corner space can be utilized with special cabinets having parallel-to-wall or 45-deg. fronts, in which case no corner strips are needed. The cabinets are fastened together, shimmed with wooden wedges to get them perfectly level on uneven floors, then screwed to wall studs. A base shoe will hide the exposed crack where the cabinet is raised above the floor.

A base-cabinet assembly also can be "stretched" to desired length by either inserting a narrow tray cabinet or else using one or more "intermediate" filler strips between the cabinets. A single counter can extend over the entire assembly although, in some packaged units, individual cabinet counters are provided. Where counters butt against sinks, wedge-shaped filler strips coated with sealing compound assure waterproof joints. Backsplash on sinks and counters may be integral with them, may be attached as separate units, or may be

provided by covering wall with linoleum.

**Building your own:** Cabinet construction is simplest if  $\frac{3}{4}$ -in., 7-ply plywood is used together with solid stock lumber. White pine is good, and so is birch or gum. Thin plywood or hardboard requires additional framework and entails considerable joinery. Simple screwed or nailed joints, coated with glue where possible, give adequate strength, although dowels produce stronger joints where narrow stock is butted together. Flat-headed screws are concealed in holes counterbored and drilled for the screw body. A pilot hole should be drilled for the thread portion of the screw, and the screw coated with soap for easy driving. Plugs, cut from dowels that fit the holes tightly, are glue-coated and driven to come flush with the surface. Crack filling, sanding and painting will conceal them entirely.

**Making wall cabinets:** The top, bottom and sides of wall cabinets, Fig. 32, are  $1\frac{7}{8}$  in. wide to get four widths, including waste for saw cuts, out of a standard 48-in. plywood panel. Before assembling, the inner faces of the side members are drilled for

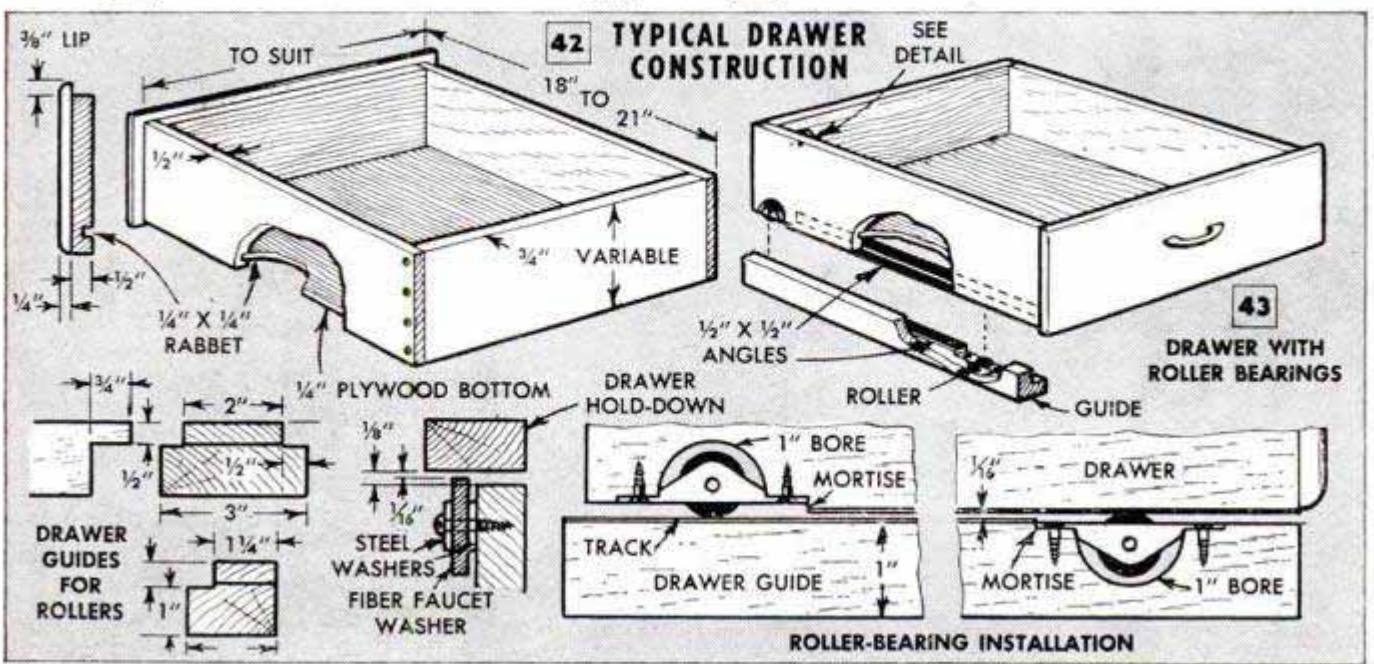
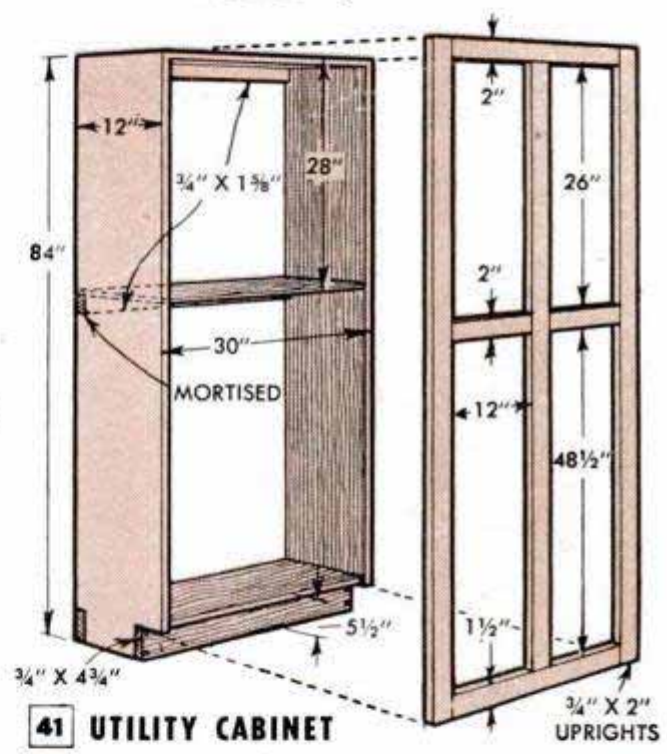
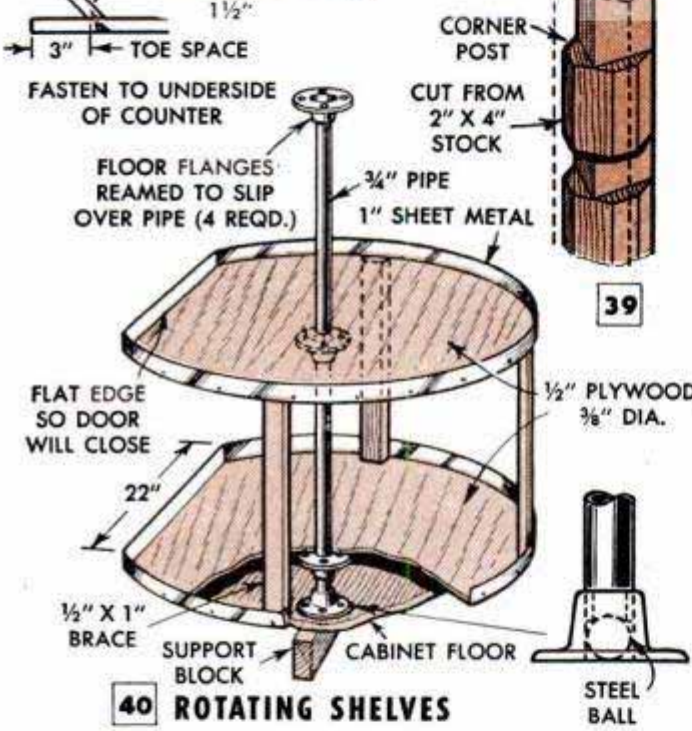
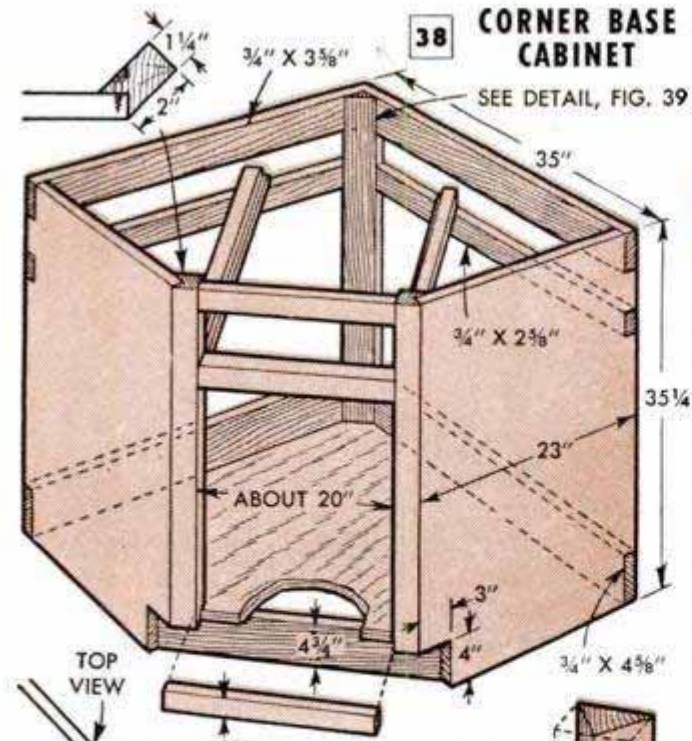

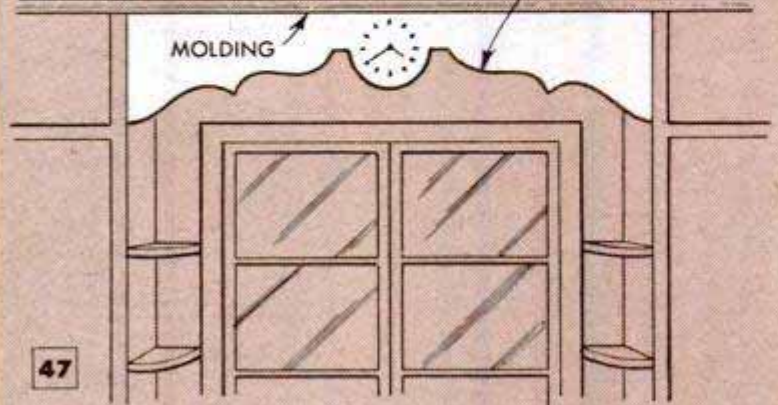
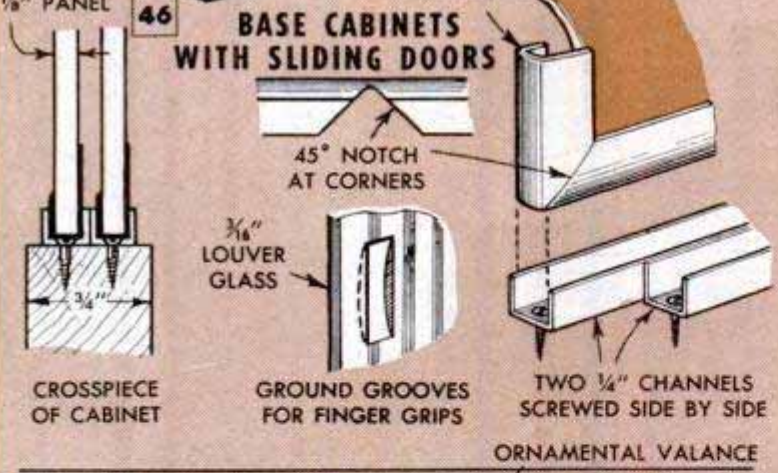
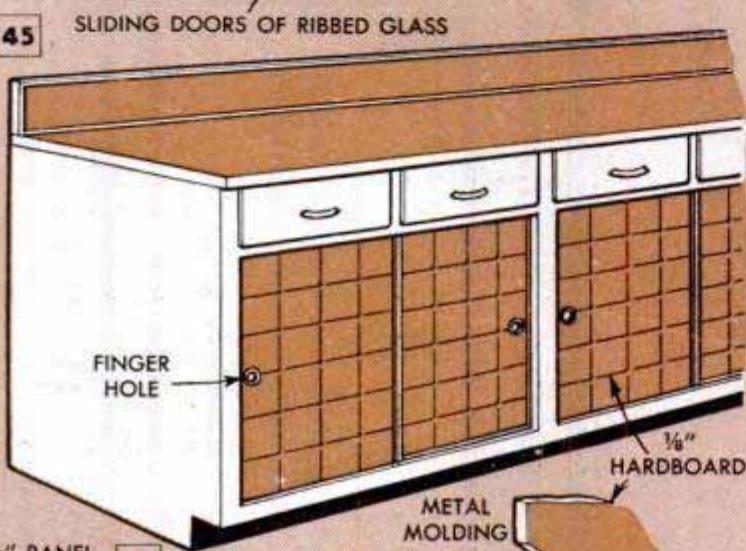
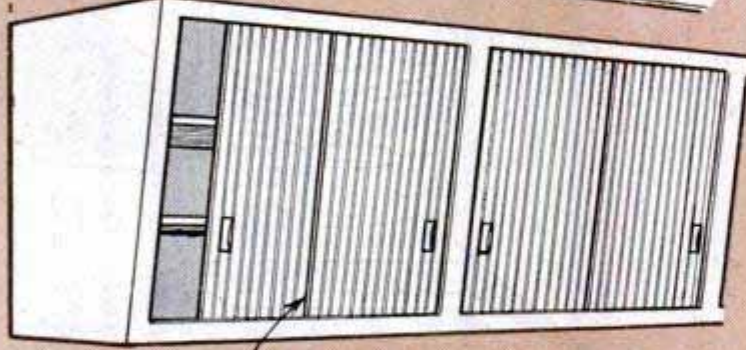
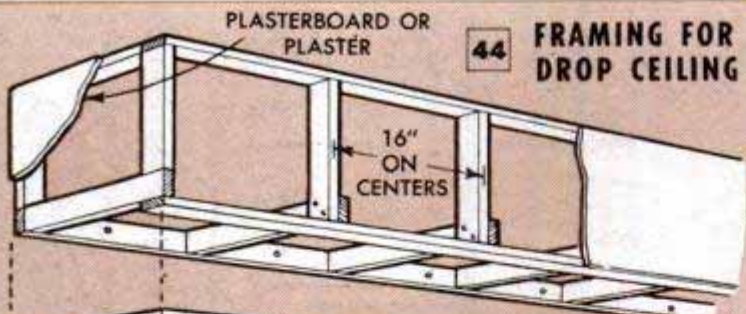

47 VALANCE USED WHEN CABINETS EXTEND TO CEILING

shelf brackets. Note that the front framework is made separately of solid stock and fastened with glue and 6 or 7d finishing nails. Butt joints of narrow stock can be assembled flush at the sides with the nailing jig shown in Fig. 35, using a C-clamp to hold the joining pieces together tightly. Then two 10d finishing nails are driven in, slightly toed toward each other, and the heads are sunk about 1/2 in. deep with a nail set. For extra rigidity, hardwood corner blocks are glued and screwed in place. When cabinets extend to the ceiling, the portion above the 84-in. height should have separate doors.

In the corner wall cabinet shown in Fig. 33, the sidepieces of the doorframe are hardwood, rabbeted, glued and screwed to the side panels. Corner posts for wall and base cabinets are made as shown in Fig. 39. Top and bottom of the cabinet extend 1 in. into the doorframe so that 3/4-in. inserts will fit flush with the front.

Rounded shelves to flank windows are detailed in Fig. 30. Three types of modern cabinet doors are shown in Fig. 29 and five types of hinges are shown in Fig. 34. In fitting the doors, allow 1/16 in. all around the opening for clearance.

**Construction of base cabinets:** Baseboards are removed for installing base cabinets detailed in Figs. 35 and 38. Toe space should be 4 in. high and 3 in. deep. If desired, the cabinet floor may be set into 1/8-in. grooves in the sides for added rigidity, the floor being glued and screwed through the sides. As with wall cabinets, the front framework is made separately and, after it is attached, the drawer guides, hold-downs and counter-support crosspieces are installed. An alternate arrangement for drawer guides, using a single V-shaped guide for each drawer, is shown in Fig. 37. For ventilation under a sink, metal grilles are advised, and counters can be screwed to base units with angle brackets.

As corner base cabinets, Fig. 38, are too large to pass through doors, they must be assembled in the kitchen. Note that the doorframe is similar in construction to that of the corner wall cabinet. Rotating-shelf units, called Lazy

Susans, Fig. 40, are labor-savers. Floor flanges, reamed out to slip over  $\frac{3}{4}$ -in. pipe, serve as bearings and the weight is carried by a steel ball in the lower flange. Three or four braces between the shelves and a block under the cabinet floor are required.

Drawer construction is shown in Fig. 42. A clearance of  $\frac{1}{16}$  in. should be allowed at the top, bottom and each side of a drawer to avoid binding in the frame and guides. Utility cabinets usually extend to the top of wall cabinets. Fig. 41 gives construction.

**Roller drawer bearings:** If you want easy-action drawers at moderate extra cost, install rollers and tracks as shown in Fig. 43. A roller is recessed in each side of a drawer at the back and another roller is recessed in the front end of each guide. The guides must be hardwood and at least  $1\frac{1}{2}$  in. thick. A metal track of  $\frac{1}{2}$ -in. angle is screwed to each side of the drawer and to each guide. The rollers project slightly beyond the track surfaces to prevent the tracks from rubbing against each other. Fiber washers, arranged to rotate on screws, minimize friction against the hold-downs.

**Counter covering:** Linoleum is widely used for counter tops, although plastics and tile have been found suitable. Linoleum is laid over felt, Fig. 36, both being cemented with moisture-repellent cement. There are many varieties of linoleum edging in anodized aluminum, stainless steel and plastics. Details A to E, Fig. 36, show the various types which are used.

**Sliding cabinet doors:** To make sliding doors of  $\frac{1}{8}$ -in. tile-effect hardboard, cement them in stainless-steel linoleum edging, Fig. 46. By making 45-deg. cutouts, the edging can be brought around corners neatly. The doors slide in metal channels screwed side by side, while bezels frame finger-grip holes.

Sliding doors of  $\frac{3}{16}$ -in. "louver" glass are attractive for wall cabinets, Fig. 45. A  $\frac{3}{16}$ -in. channel is cemented to top and bottom edges of the glass. The side edges of the glass are smoothed with emery cloth and the doors slide in  $\frac{3}{8}$ -in. channels. Shallow grooves are ground for finger grips.

**Valances and drop ceilings:** When cabinets extend to a ceiling on either side of a window, a valance, Fig. 47, greatly improves the appearance. A drop ceiling or soffit, to close waste space over wall cabinets, should be installed before they are mounted. A sturdy framework, Fig. 44, is attached to ceiling joists and wall studs. Front and bottom are covered with plaster-board and plaster, not extending beyond the front edge of the wall cabinets. The plaster should be bonded to the ceiling plaster after chiseling off some of the latter alongside the joint to prevent a crack.

(To be continued)



### Motor-Oil Cans Form Parts Rack

This novel small-parts rack made from motor-oil cans holds a quantity of nails and screws in individual containers for easy selection. The cans, from which the tops have been removed, are set on a board nailed to the shop wall. The board is nailed at a slight angle to tilt the cans upward, and the oil remaining in the cans helps to keep the contents from rusting.

Harry W. Strand, Evanston, Ill.

### Paper Plate Tacked to Shop Wall Provides Sanding-Disk Holder

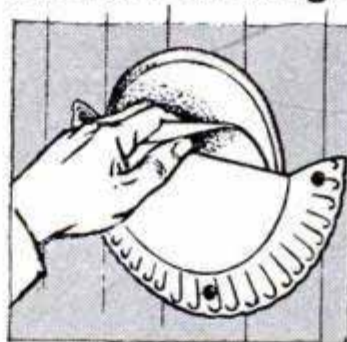

Utilizing a holder improvised from a paper plate, a number of sanding disks can be stored at your finger tips. Cut the plate in half and mount one of the halves on the shop wall near the sander.

Use thumbtacks to tack the rim to the wall so the dished portion of the plate will serve as a pocket. The holder is replaced easily when it becomes worn.

### Polishing Door-Chime Plunger Increases Volume

Finding that my door chimes were not loud enough to be heard in every room of the house while the radio was playing, I increased their volume by polishing the plunger. I removed the plunger, buffed it to a mirrorlike finish and then replaced it in the solenoid. This reduced friction to the point where the plunger now travels extremely fast, thus striking the chimes with greater force.—Jules Rafalow, New York City.

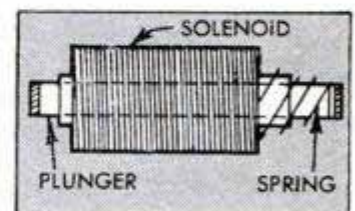

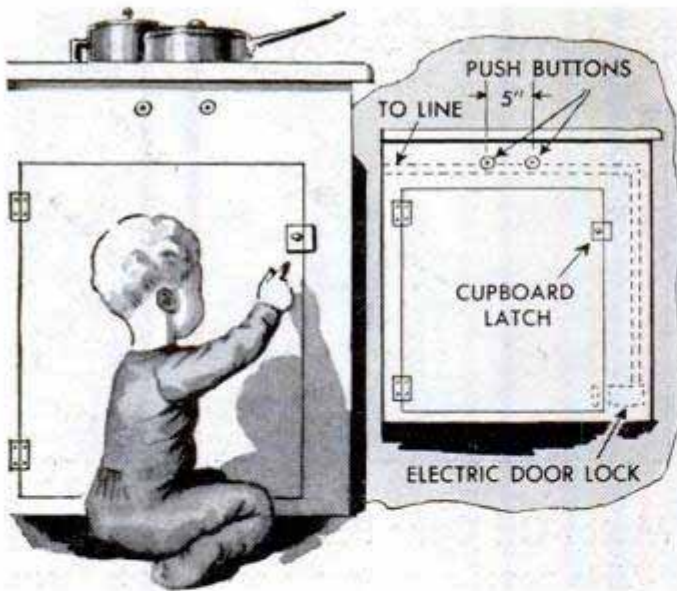

### "Baby Proof" Lock for Cabinet Safeguards Inquisitive Child

One of the most distressing problems of parents who have a curious toddler investigating every nook and cranny in the house is that he might sample bleach, lye or some other poisonous cleaning solution. To set his mind at ease, one parent installed a "baby proof" lock on the door of the storage cabinet in which cleaning materials are kept. In addition to the regular cupboard latch, he fitted an electric lock on the cabinet door, using a standard electric door lock. Two push buttons, wired in series, must be depressed simultaneously to open the lock, and these are spaced 5 in. apart—too far for the spread of the tiny fingers of a baby's hand. If the child uses both hands to depress the push buttons, the cupboard latch still keeps the door closed. An adult can depress both buttons with one hand while opening the latch with the other.

A. J. Seymour, Jr., Salmon Falls, N. H.

### Storing Croquet Wickets Facilitated By Garden-Hose Section

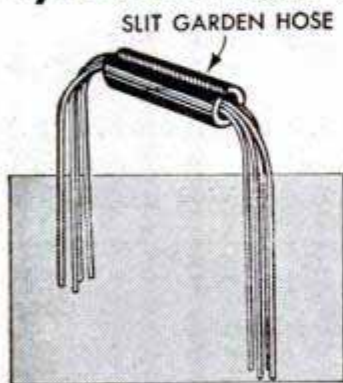

Croquet wickets are stored with less danger of loss if they are held together with a short length of garden hose. The hose is slit lengthwise and, as the wickets are collected after a game, the top portion of each

wire is pressed into the slit. Because of the bends in the wires, the wickets cannot slip from the ends of the hose.

Colored fingernail polish can be used to paint wooden buttons to suit any costume.

### Duck Decoy Controlled From Blind Looks Like Feeding Bird

As ducks which are apparently feeding undisturbed will attract immediate attention from incoming flocks, rig up the two decoys nearest the blind so they can be made to dive and dip realistically to simulate feeding. To do

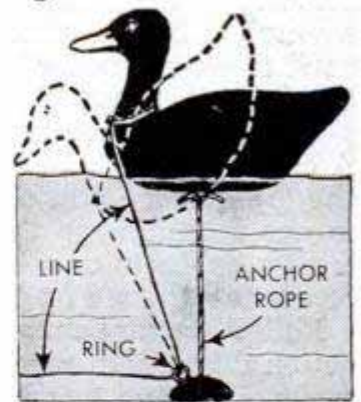

this, fasten a long, strong cord to the neck of each of the two decoys. Run the cord through a ring or screw eye attached to the decoy anchor, and then bring the end of the cord into the blind. When a flock of ducks is sighted, draw them closer with the feeding call on your duck caller and simultaneously pull the lines leading to the decoys. Attracted by the motion of the decoys, the flying flock will circle and come in.—R. A. Jenkins, St. Louis, Mo.

### Dusting With Pigment Colors Putty

A quick way to paint putty is to dust a little lampblack or other dry color over the surface of the putty before the putty has had time to harden. The pigment will absorb enough oil from the putty to form a glaze over the surface.

### Rope Expands Car-Trunk Gasket To Renew Watertight Seal

In some older cars, trouble with leaking trunk-compartment gaskets can be corrected in a jiffy by inserting a length of small-diameter rope or cord between the fold of the rubber gasket. Braided cotton cord of the type used as pull cords on Venetian blinds usually will expand the gasket sufficiently to provide a watertight seal between the car body and trunk door.

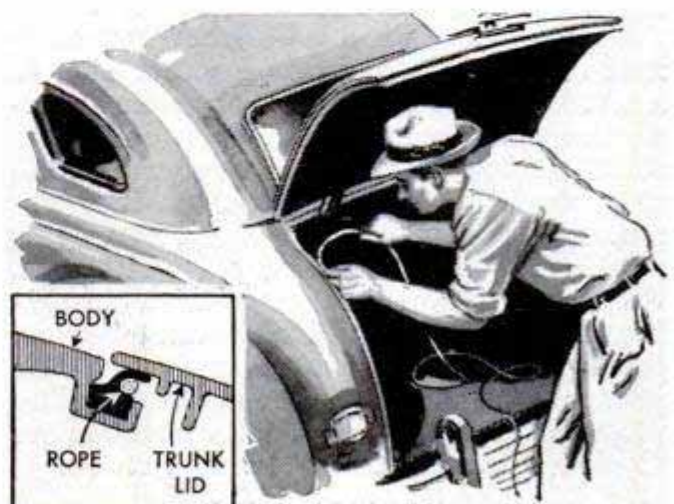



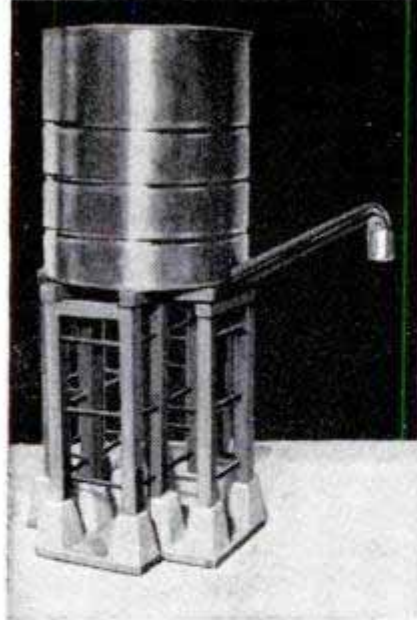

# MODEL-RAILROAD WATER TANK

By Webster P. Taylor

AS A FAST FREIGHT grinds to a stop at the station, the push of a button lowers the nozzle of this realistic water tank. When the button is released, the counterbalanced spout is raised automatically. The dimensions are easily altered to suit your particular setup, and the length of the spout is governed by the size of the train.

The dummy tank is a fruit-juice can supported by a timber framework. The timbers are glued to wooden footings mounted on a plywood base. Ripped from scrap stock, the timbers are drilled for matchstick cross braces which are glued in place when the framework is assembled.

The wooden spout is fitted with a sheet-metal nozzle and pivoted to the timber framework. The spout is counterbalanced to return it to the raised position, the edge of the can being notched if necessary to provide clearance. The weight is suspended from one end of a length of string, and a nail, which enters a solenoid, is suspended from the other end. The string is tied to the spout arm and passed over two brads which are supported by wooden crosspieces nailed to a center upright. The solenoid consists of a coil of No. 22 cotton-covered wire wound between two faucet washers on a 1-in. length of  $\frac{1}{4}$ -in. dowel. The coil is mounted on a wooden block, and both dowel and block are drilled lengthwise to receive the shank of the nail. When current passes through the solenoid, the nail is drawn downward, thus pulling on the string and lowering the spout. The position of the nail must be determined by experiment.

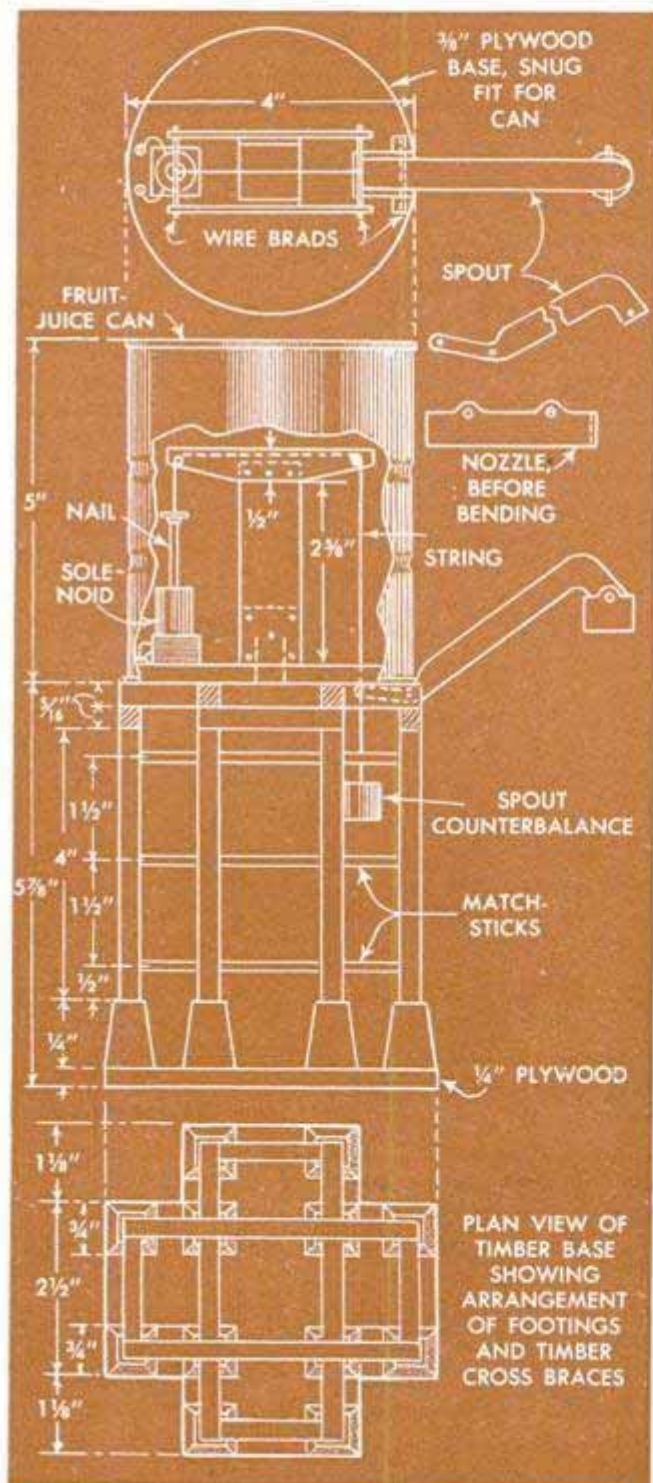

## Indoor Drying Rack for Baby Clothes Suspended Over Heater or Register

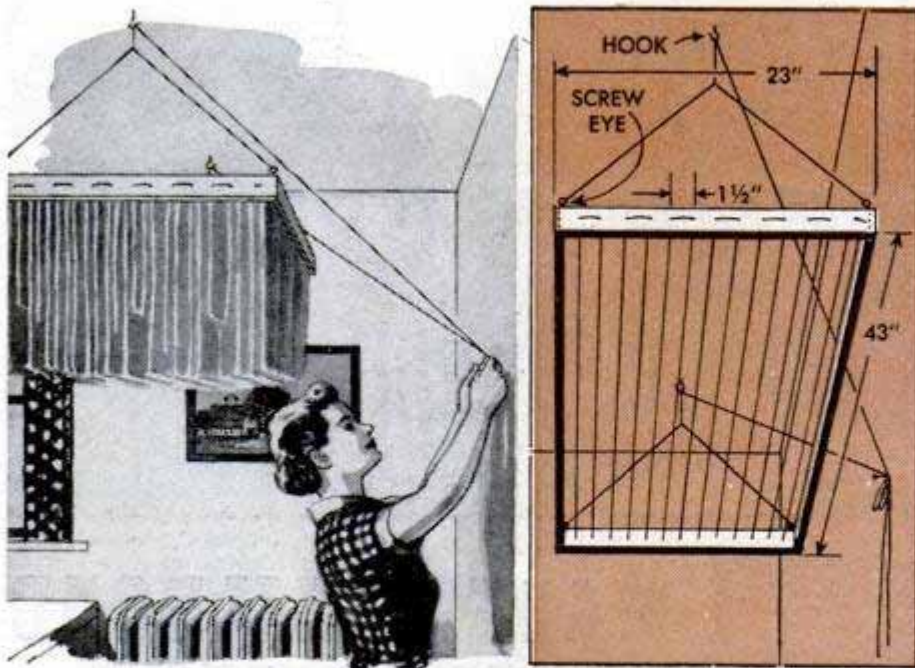

If there is no room to hang the baby's clothing and diapers indoors, the things can be dried quickly during cold weather by using this compact rack, which is suspended from the ceiling near the source of heat. The wooden frame is strung with 100 ft. of clothesline, and lines for raising or lowering the rack are tied to screw eyes turned into the four corners. The lines are then passed over screw hooks driven into the ceiling joists. When the rack is raised, the lines are made fast to a hook which is fastened to a near-by wall.—Bob Pilkington, Grinnell, Iowa.

## Soldering Iron Polishes Leather to Obtain Smooth Edges

Craftsmen who work in leather frequently find it difficult to obtain a smooth, clean edge when finishing the project. This can be done easily by first shaping the edge as carefully as possible with a knife and then heat-polishing it with a soldering iron. Using a small iron, heat it to the point where it will melt solder. Then run the iron along the edge of the leather, keeping it moving with a light pressure on the work.

After the entire edge has been treated with the soldering iron, it should be rubbed briskly with a coarse cloth to remove any charred particles. This will result in a fine edge which, after the application of a little saddle soap, will look like a professional job. When using the soldering iron, be especially careful not to burn the leather, as this will detract from the appearance of the work.—John M. Avery, Dexter, N.Y.

## Loop Tied at End of Fishline Facilitates Attaching Leader

Attaching a leader to a fishline is done in a jiffy and there's no chance of its slipping off, if a permanent loop is made at the end of the line. To form the loop, bring the end of the line back against itself and

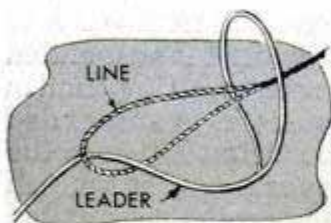

whip the two strands together with light sewing thread. Then seal the joint with clear fingernail polish. The leader is attached by passing the loop of the

leader over the end of the line and bringing the other end of the leader through the loop in the line as shown in the drawing.

Robert K. Ungemah, White Plains, N.Y.

☐ Curled rug corners can be straightened by dampening them with water and weighting with a heavy object until dry. Place cloths or newspapers under the rug to protect the floor from the moisture.

## Convenient Key and License Holder From Small Fountain Pen

When, after starting the car, you remember something that was left in the house, it means turning off the ignition if both car and house keys are kept on an ordinary ring. However, if a discarded short-barreled fountain pen is used to form a two-piece key holder, the portion from which the house keys are hung is unfastened from the other part of the pen, and the motor can be left running while you go back into the house. In addition, the pen provides a container for your auto identification. To adapt the pen for a key holder, remove the point and sack from the barrel and drill holes for key chains through the barrel and the cap. Then string the house keys on one chain and the car keys on the other.—Richard Theis, Tiffin, Ohio.

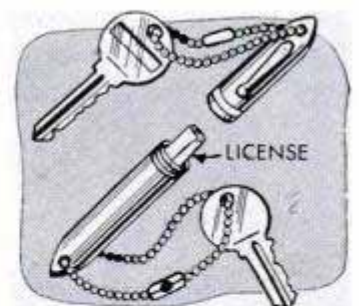

# VARIABLE TAPER-CUTTING JIG FOR BENCH SAW

Especially handy for cutting long tapers when building furniture, this hardwood jig allows the work to be cut at a wide variety of angles. One corner of the work is placed against the end block of the jig and the edge of the work is held against a movable slide, the location of which determines the angle of cut. Then the jig is pushed along the rip fence. Note that the movable slide is clamped to the guide strip with a bolt and wing nut, and that the end block has two steps to permit increasing the range of cutting angles.—L. F. Stephan, Homestead, Pa.

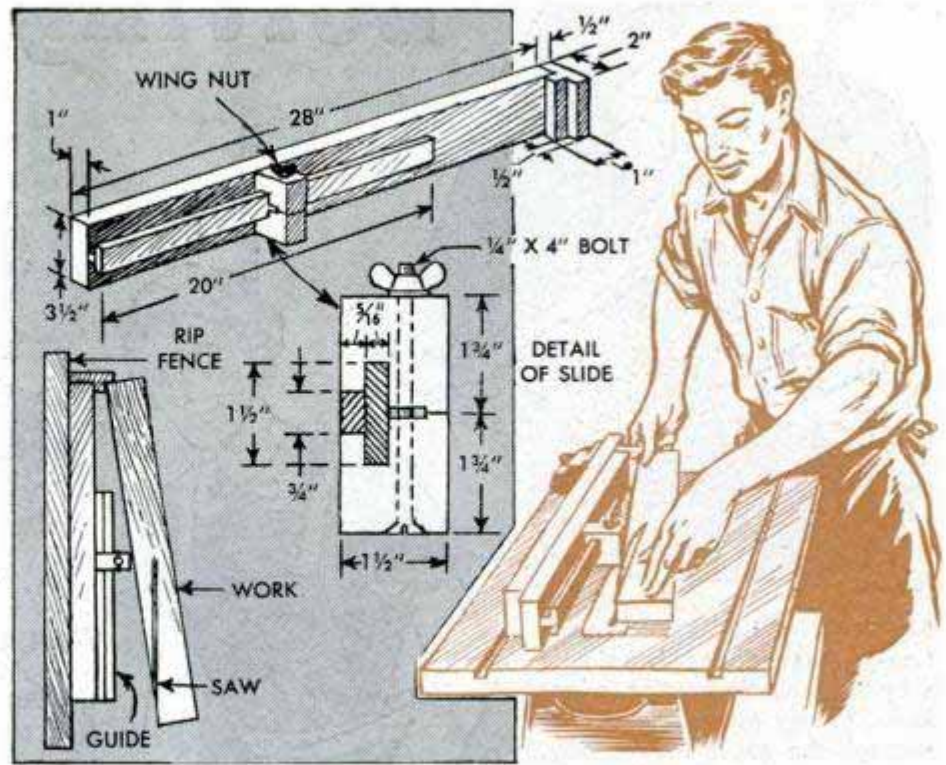

## Emergency Service From "Dead" Flashlight Battery

If the battery of your flashlight wears out and you cannot get to a store to buy new cells, here's how you can obtain another eight or ten hours of emergency use from the "dead" cells. If there is not a corrosion hole in the side of the cell jacket, punch a small hole through

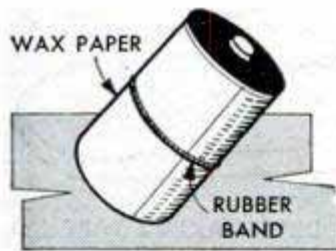

the casing with an ice pick or knife. Then soak the cells in water or vinegar for about an hour. After removing the cells from the

bath, dry them and wrap wax paper tightly around each one, fastening it in place with a rubber band. Simply replace the cells in the flashlight case in the usual way.

Jack Casper, Brooklyn, N.Y.

## Glove Finger Tips Mended Quickly

Mending the finger tips of woolen or fabric gloves can be done quickly by slipping a glass or plastic toothbrush container into the tips of the finger to be repaired. When mending dark-colored gloves, stuff white tissue paper in the end of the container so the thread will be clearly visible.

## Mirror Mounted on Garage Door Affords View of Driveway

To make sure that neither the children nor their toys were in the driveway when backing his car out of the garage, one homeowner fastened a mirror to the inside of the swinging garage door. The mirror is located so that it gives a clear view of the driveway when the door is fully open, thus overcoming the blind spots in the rear-view mirror of the car. If the garage has an overhead door, a mirror can be mounted on a bracket which is fastened to the inside of the door casing. However, this can be done only if there is enough clearance to allow the car to pass.—Jim Forrest, Winston, Ore.

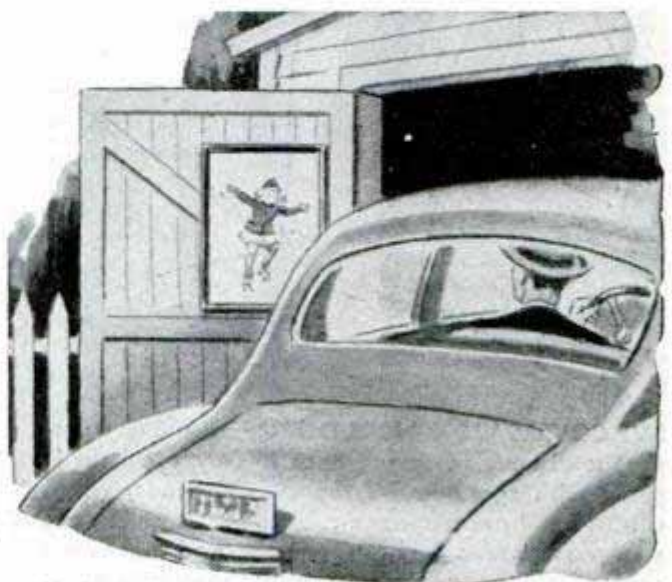

☐ Boiling new clothespins for 15 minutes before they are used will make them stronger and prolong their life.

# Solving HOME

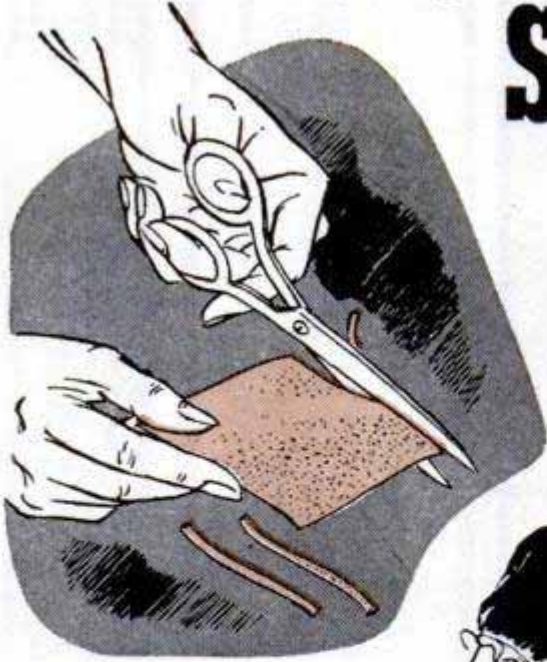

**SHARPENING SCISSORS** with fine-grade sandpaper is a simple way to keep the cutting edges keen. Merely make several cuts through the paper occasionally, and abrasive action will whet the edges of the scissors blades



**YARN REMNANTS ARE STORED** safely by wrapping them around ordinary moth balls. The latter will afford maximum protection from moths in addition to providing handy cores around which to wind the remnants



**IRONING A CRUMPLED DRESSMAKER'S TAPE** between two sheets of wax paper will restore original stiffness to the tape. The heat from the iron melts the wax which is transferred from the paper to the fibers of the tape where it solidifies when cooled



**SLIP COVERS WON'T PULL OUT OF SHAPE** and present a disheveled appearance if they are held in place with sponge-rubber pads. The pads, which can be cut from a sponge-rubber seat cushion, are wedged between the arms, or back, and seat of the chair after the slip-cover fabric has been pulled taut



**LARGER, STURDIER BLOOMS** will be had from African violets if the stems of the outer leaves are protected from contact with the rim of the flower-pot. Covering the rim of the pot with decorative aluminum foil will not only protect the stems from damage but also will add to over-all appearance

# PROBLEMS

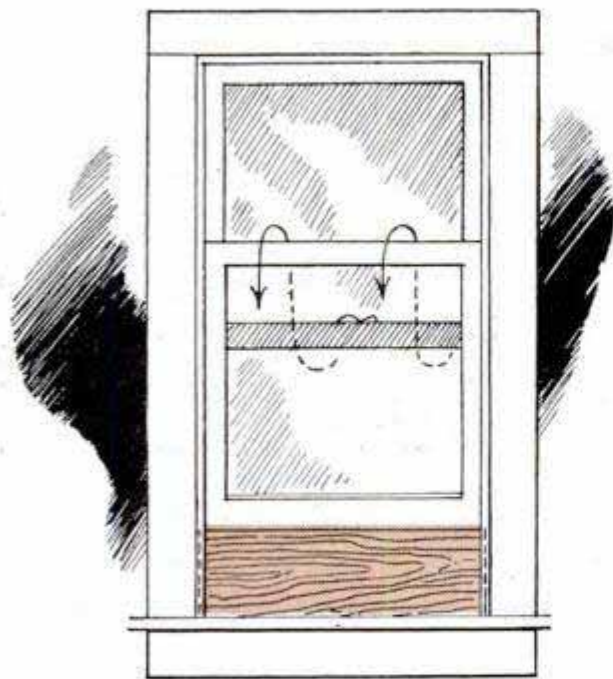

**KITCHEN VENTILATION** without direct drafts can be achieved by opening a lower sash and placing a board under it. The board, which is cut to fit between the sash channels, allows air to enter only through the space between the upper and lower sash



**AFTER OILING AN ELECTRIC FAN**, slip a large paper sack over the blade guard to catch any excess oil that otherwise would be likely to splatter walls, furniture and draperies. Turn on the fan and allow it to run for a few minutes before removing the sack

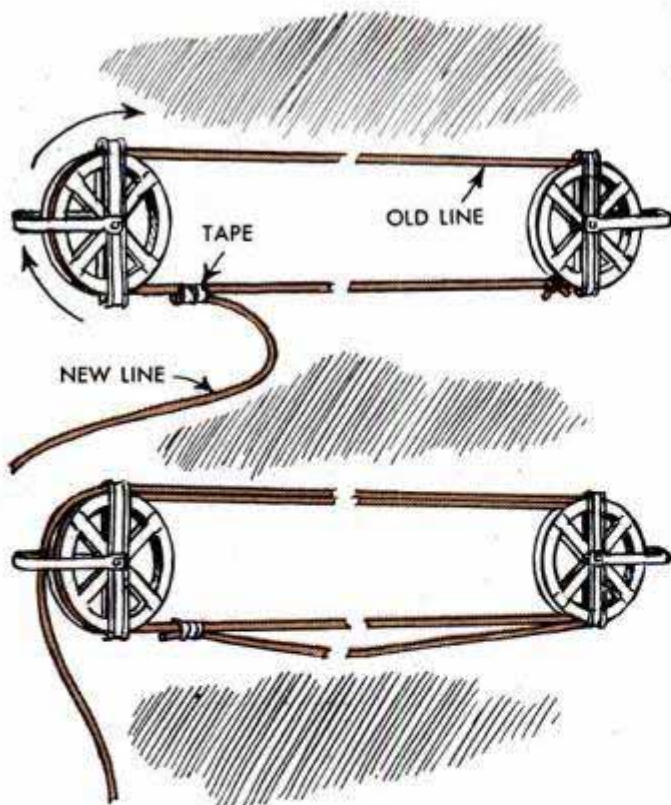

**WHEN REPLACING CLOTHESLINE** on high pulleys, it isn't necessary to climb a ladder if you use the old line to pull the new one in place. Just tape the end of the new line to the old one and pull it around until the ends can be tied. Then cut the old clothesline free

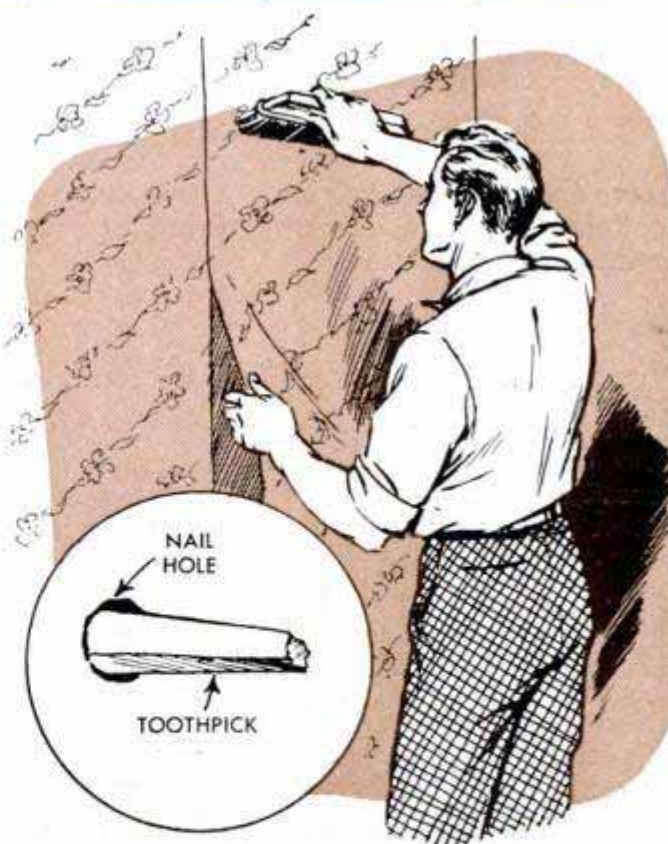

**TOOTHPICKS LOCATE NAIL HOLES** in newly papered wall, thus eliminating the necessity of drilling additional holes when rehangng pictures. A toothpick driven into each hole so that it projects about  $\frac{1}{4}$  in. will puncture the new paper when it is pasted down

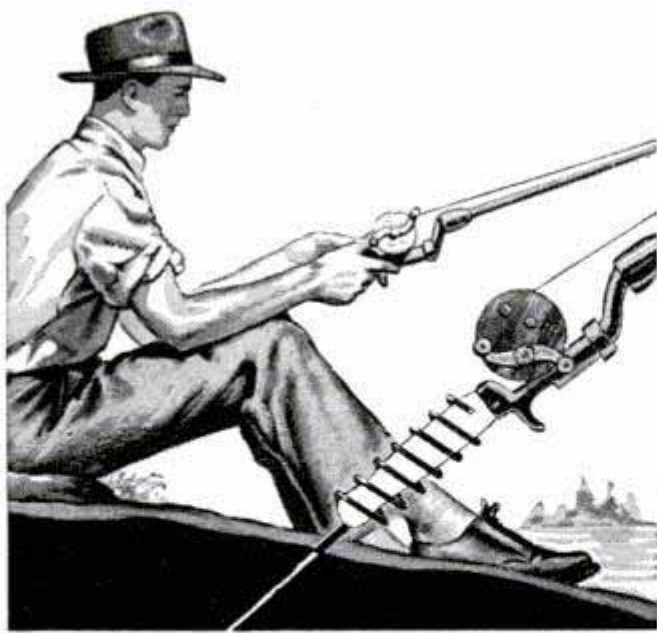

## Fish-Pole Holder of Bent Wire Is Set Up Quickly

Anglers who prefer to still-fish from shore will appreciate this wire fish-pole holder which is set up by simply pressing it into the ground. One end of the wire is formed into a spiral slightly larger in diameter and almost as long as the rod handle, and the other end of the holder is left straight. The spiral can be formed around a length of pipe, but it should be remembered that the rod handle must fit loosely enough to permit quick removal from the holder when a fish takes the bait. Although coat-hanger wire can be used for the holder, heavy-gauge steel clothesline wire will give more spring to the rod.

William B. Eagan, Louisville, Ky.

## Dowels Indented With Pliers Strengthen Glued Joints

When using dowels and glue to join cabinetwork, the strength of the joint can be increased considerably by indenting the dowel with a pair of pliers. Squeeze the dowel between the jaws of the pliers, as shown, to make indentations all the way around and the full length of the dowel. This will slightly reduce the diameter of the dowel and also provide pockets for the glue.

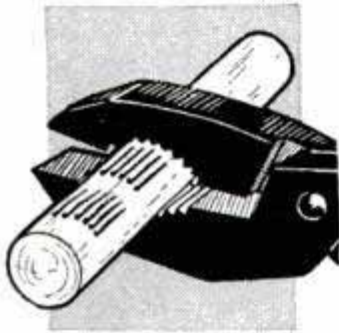

After the dowel is in place, it will have a tendency to expand, thus resulting a tighter and stronger joint.

Wm. A. Novak, Maywood, Calif.

## Blocks Lower Hacksaw Blade For Flush Cutting

If it is necessary to cut off a bolt or stud flush with a concrete floor or other surface, the job can be done easily with an ordinary hacksaw. The blade is simply turned at right angles to its normal cutting position and two wooden blocks are wedged between the blade and the saw frame. The blocks should be of a length necessary to bend the blade downward sufficiently to clear the brackets on the frame. With the blocks in place, the saw is held as for vertical sawing with the blade against the surface. Pressure is applied sideways to saw through the bolt.

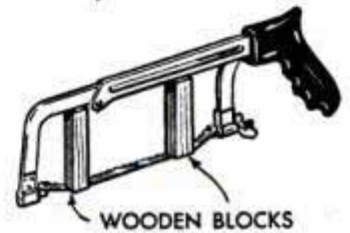

Hugh Lineback, Stillwater, Okla.

## Novel Method Simplifies Making Soldered Connections

With this easy method, even the man who has never handled a soldering iron before can join two wires with a well-soldered connection. After the insulation has been removed, the ends of the wires are twisted together and dipped in flux. Then, the hot soldering iron is touched against the bar or coil of solder, allowing a drop of solder to fall onto a hard, smooth surface. The drop, which flattens out on the surface, is picked up and wrapped around the twisted wires. Finally the tip of the soldering iron is held against the wrapping, thus melting the solder which flows through the strands of wire.

Carter Robertson, Franklin Park, Ill.

☐ A stiff wire brush about 6 in. long is a handy tool for scaling fish.

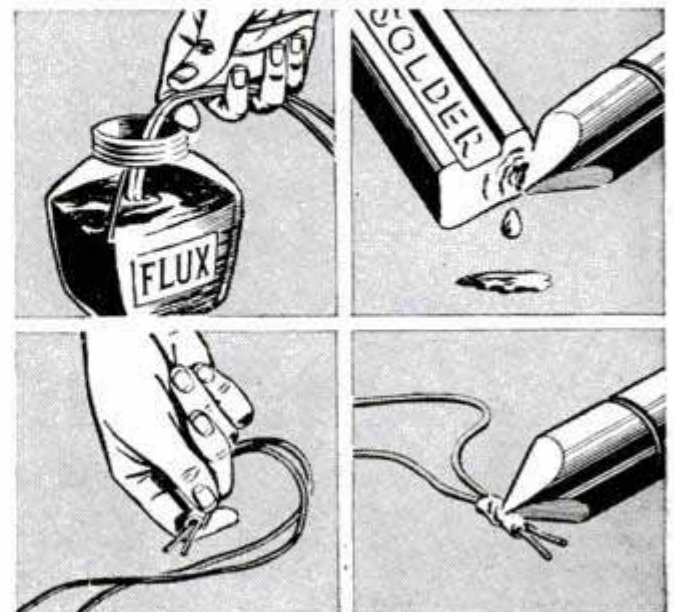

# PINE-NEEDLE BASKETS

*By Ed Lundburg*

**F**ASHIONING artistic baskets from pine needles and raffia is a hobby that not only affords countless enjoyable hours to young and old alike but results in an item that is readily sold through a variety of home-town outlets. The present popularity of the hobby is due in no small part to such organizations as the Recreation Commission of Long Beach, Calif., which conducts classes in pine-needle basketry. Although this article takes you through the basic steps of making the baskets, you can probably receive first-hand instruction on the more advanced designs from a similar organization in your own community. However, the procedure is not complicated and, after practicing on a few simple baskets, you will no doubt be able to progress without difficulty.

The pine needles, which can be found carpeting the floors of forests in many parts of the country, range in length from 6 in. on up, and a pound or two will be sufficient for a beginner's basket. These are formed in coils and bound with either plain or colored raffia. The most practical type of basket to start with is one having a base cut from  $\frac{3}{16}$ -in. plywood, although the more elaborate designs are made entirely of pine needles. After sawing the plywood to the desired disk or oval shape, mark it as shown in Fig. 1, for drilling  $\frac{1}{8}$ -in. holes  $\frac{1}{2}$  in. apart to permit binding the first coil of pine needles to its edge.

Before beginning the basket, soak the raffia in cool water for 10 minutes, and then



You will be surprised at how easily handsome baskets like these are fashioned from pine needles and raffia

wrap it in a damp cloth to keep it moist. Soak the pine needles in hot water for 20 minutes or in cold water for about an hour and also wrap the needles in a cloth until you are ready to use them. The soaking removes the brittleness from the needles. Note that each cluster of needles has a "boot" covering the base as in Fig. 2. To facilitate splicing the needles in the coil, allow the boot to remain intact until the cluster is to be used.

Splicing the coil is done by adding several needles at a time continually during the progress of the work, Fig. 8. This keeps the coil uniform in thickness and, of course, increases its length. After a No. 16 tapestry needle has been threaded with raffia

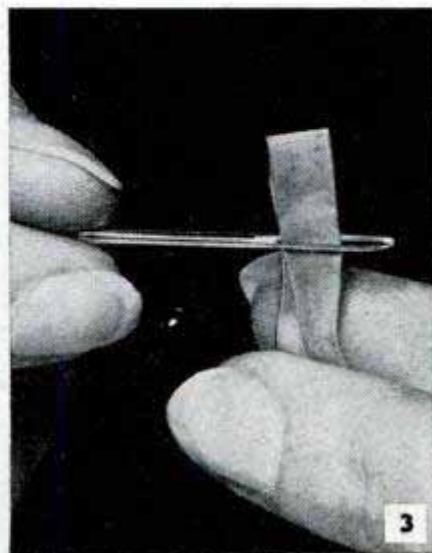
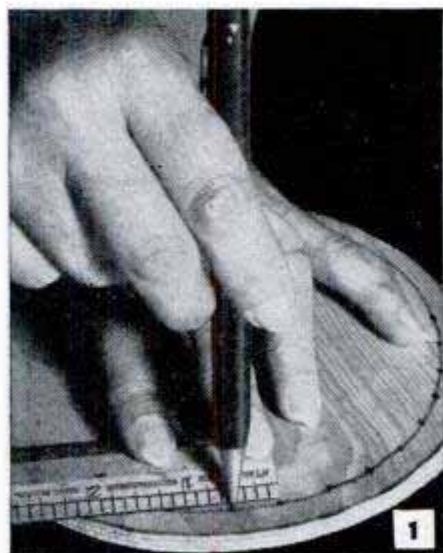

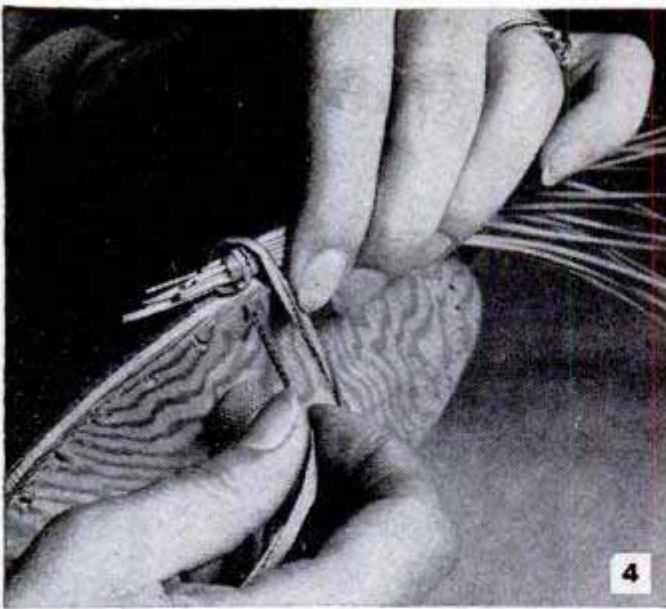

Start the coil of pine needles by binding the end to the plywood base with several wrappings of raffia

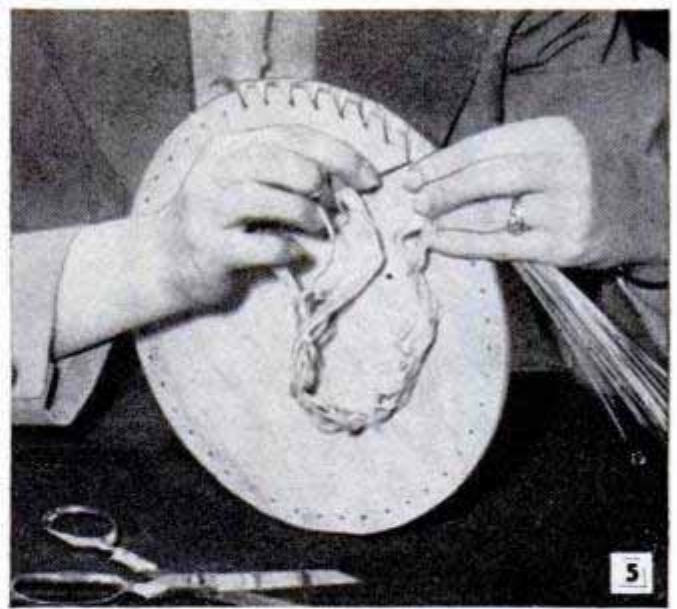

This is how the starting coil will look after a few stitches have been made and before splicing needles

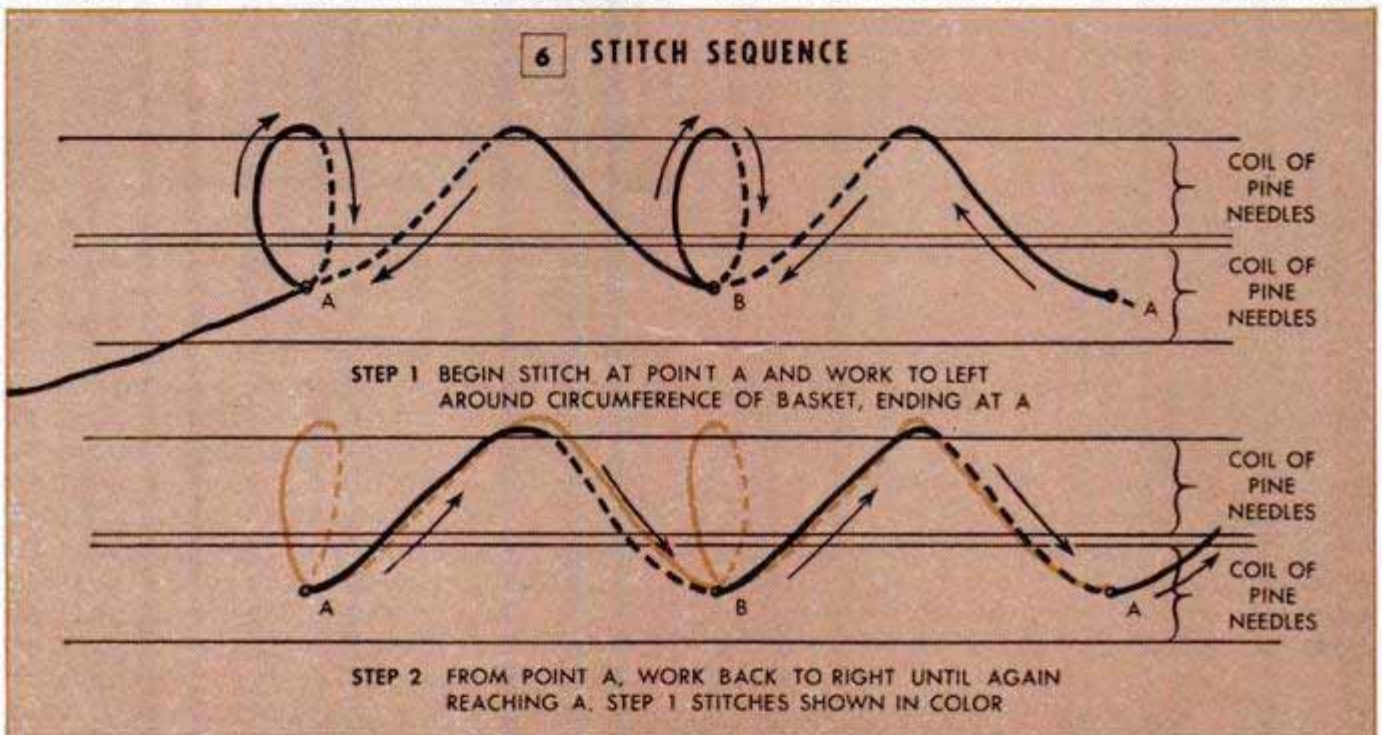

Note how left hand is used to hold raffia taut. Work is done on the side of the basket away from the body

As work progresses, needles are spliced into the coil to keep it uniform in diameter and increase its length

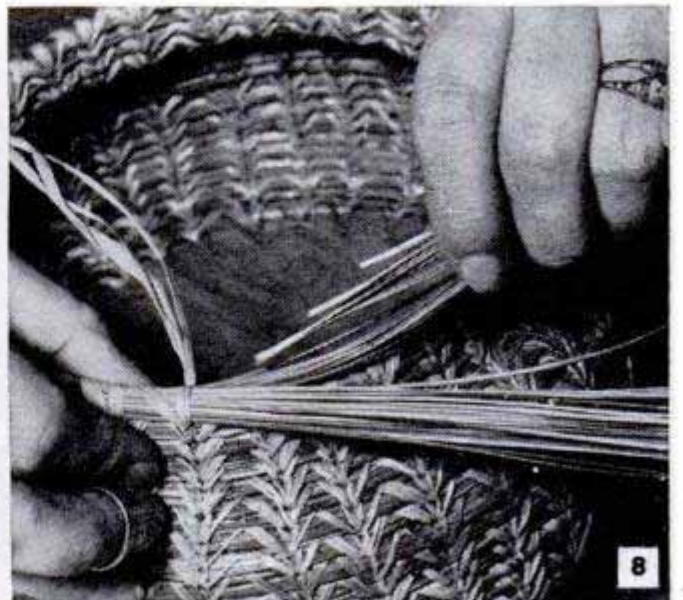



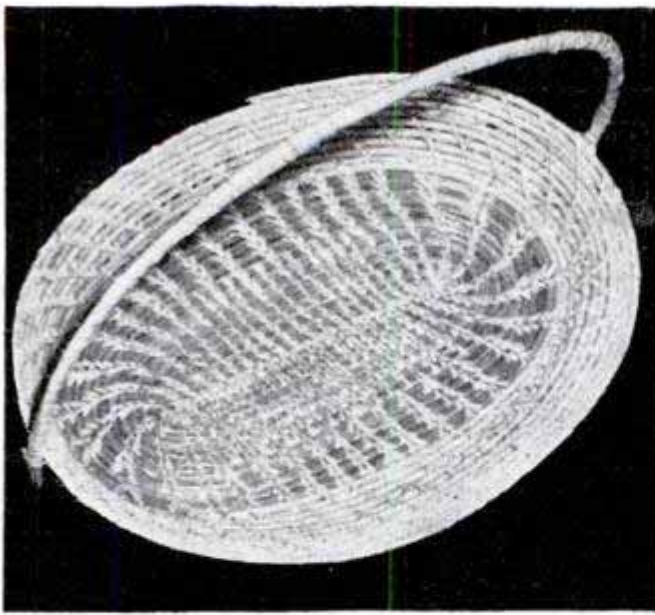

The advanced basket design shown above is made entirely of pine needles instead of having a wooden base. Handy sewing basket is pictured at the right

as in Fig. 3, the first coil of needles is bound to the plywood base with a simple over-and-under stitch, Figs. 4 and 5. Subsequent coils are held in place by passing the stitches through the center of the coil below, as in Fig. 7. The stitch sequence is begun as in Fig. 6, step 1, by working to the left from the starting point, A, around the entire circumference of the coil, stitch B, and back to A. Upon reaching point A, work to the right, step 2, adding the slanting stitch until again reaching A. Then proceed to the left on the next coil. Study Fig. 7 which illustrates the technique.

It is recommended that five or six three-pronged pine needles be used to build up the thickness of the coil. However, if a larger coil is desired, remember that a 1/2-

in. diameter is considered the maximum for satisfactory results. The basket is completed by tapering the coil of needles and turning the end of the raffia back under the coil so that it is hidden. Instead of knotting the ends of the raffia while binding the basket, always fold them to the left and conceal them within the coil, locking them in place with following stitches. To give the desired shape to the basket, simply turn the coil of needles inward or outward during the course of the work. The needles should be held in a firm coil and each stitch of raffia drawn tightly. You will enjoy the work more and finish with a better looking basket if you take your time, grasping the work firmly but not tiring yourself by clutching it in a viselike grip.

## Fitting Mitered Baseboard Around Irregular Corners

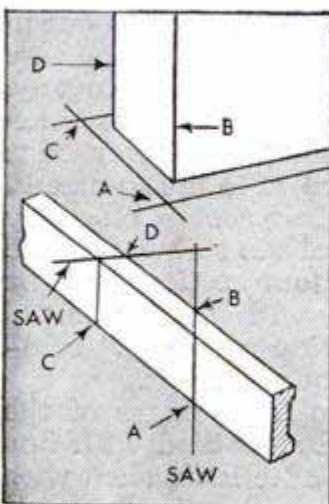

transferred to the work from a layout made on the floor. For example, when fitting baseboard around the edges of an archway, as in the drawing, hold a short length of the baseboard against the three faces of the

In many cases, mitering baseboard 45 deg. to fit it around corners will not result in perfect-fitting joints because of the fact that the wall corners are not true right angles. However, it is easy to cut baseboard to fit neatly around irregular corners if the cutting points are

archway and draw lines on the floor. Next, set in place the board which is to fit across the edge of the arch and transfer points A and C. Then, without moving the board, transfer points B and D. Using a try square, extend A and C to the top of the board and join them with B and D as shown. This will indicate the correct angle of cut for both ends of the work. Simply repeat this procedure for marking the baseboard running along both sides of the wall.

Verne E. Enz, Jeannette, Pa.

## Garments Steamed Over Bathtub

Steaming wrinkles from wool or crepe garments can be done right in the bathroom. Hang the garments over the bathtub on coat hangers and then run hot water into the tub until the room is filled with steam. Air the clothes overnight.

# MINIATURE CLOCKCASE

By M. B. Birge

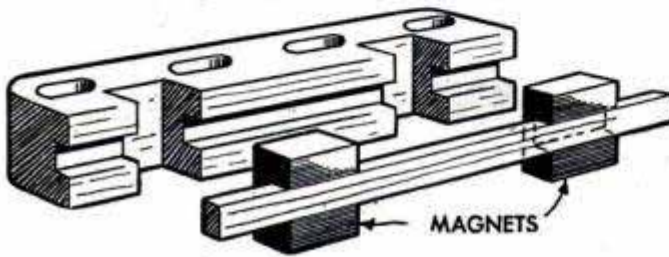
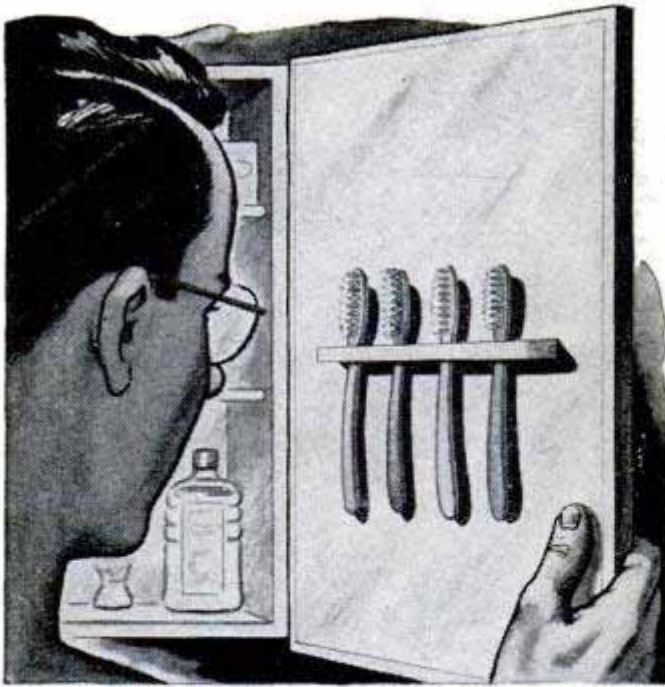

## Magnetic Toothbrush Rack Sticks to Metal Door

The inside of a medicine-cabinet door is probably the handiest place in the bathroom for mounting a toothbrush rack, except that if the door is of metal, the rack cannot be fastened with screws or glue. If this is the case, make this neat hardwood rack, fitting it with two permanent magnets which will hold it securely to the inside of the door and yet permit easy removal for cleaning. The rack is drilled for the brush handles and notched on the rear face to receive the magnets. A spline glued in a groove holds the magnets in place.

David B. Thoms, Winchester, Mass.

## Wooden Box Supports Door For Planing Edge

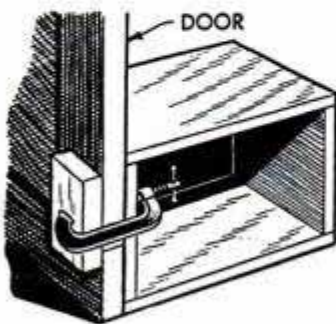

Elaborate bracing setups to support a door on edge for planing and setting hinges are not necessary if a heavy wooden box is available. Just use a C-clamp to fasten the door to the side of the box,

inserting a wooden block between the clamp and the door so that the surface is not marred by the clamp jaw.

Robert Hoppough, Encino, Calif.

REPRODUCED in miniature, this authentic replica of the quaint double-steeple clock makes a handsome desk accessory or wall-shelf ornament. If made proportionately larger, it is also an interesting piece for the fireplace mantel. The clock works are taken from an alarm clock and bolted to a sheet-metal mounting plate which is set against cleats glued to the inside surfaces of the case. The face of the clock is carefully drawn on white paper and cemented to the front of the mounting plate, the latter being drilled for the shaft. The front of the clockcase is covered with two glass panels. These are held between  $\frac{1}{8}$ -in. frames glued to the sidepieces and the slanted top. Decorative pictures or paintings are applied to the glass except for the section directly in front of the clock face, as shown in the photo.

Note that the  $\frac{3}{8}$ -in. base and the  $\frac{3}{16}$ -in. shelf are grooved to receive tenons on the ends of the sidepieces. These grooves terminate  $\frac{1}{16}$  in. from the front edges of both the base and shelf so that the sidepieces are set back from the front edges. In addition, the groove must be located  $\frac{1}{4}$  in. from the edge of the work to allow  $\frac{1}{8}$  in. overhang at the sides.

The steeples are  $\frac{7}{16}$  in. square and  $1\frac{1}{2}$  in. long, having the upper half tapered to a sharp point. This can be done by cutting and sanding to shape or by turning the steeples two at a time in the lathe. The steeples are glued to the front corners of the shelf and in  $\frac{1}{4} \times \frac{1}{4}$ -in. notches cut in the edges of the roof. The back of the case consists of two sections of  $\frac{1}{8}$ -in. mahogany, plywood or hardboard. The upper section is fitted with pins along the lower edge which engage holes drilled in the shelf, and the peak is held against a stop block by means of a sheet-metal tab screwed to the roof panels. The bottom section may be mounted permanently with glue or hinged on the inside to provide a "secret" compartment for storage of valuables.

After assembly, the front edges of the case are rounded and smoothed with fine sandpaper. Then the case is finished with a dark stain or simply finished in the natural color with several applications of paste wax. Take special care in fitting the joints, as good joinery in this instance is particularly important to the appearance and craftsmanship of the finished product.

100 W.P.

100 W.P.

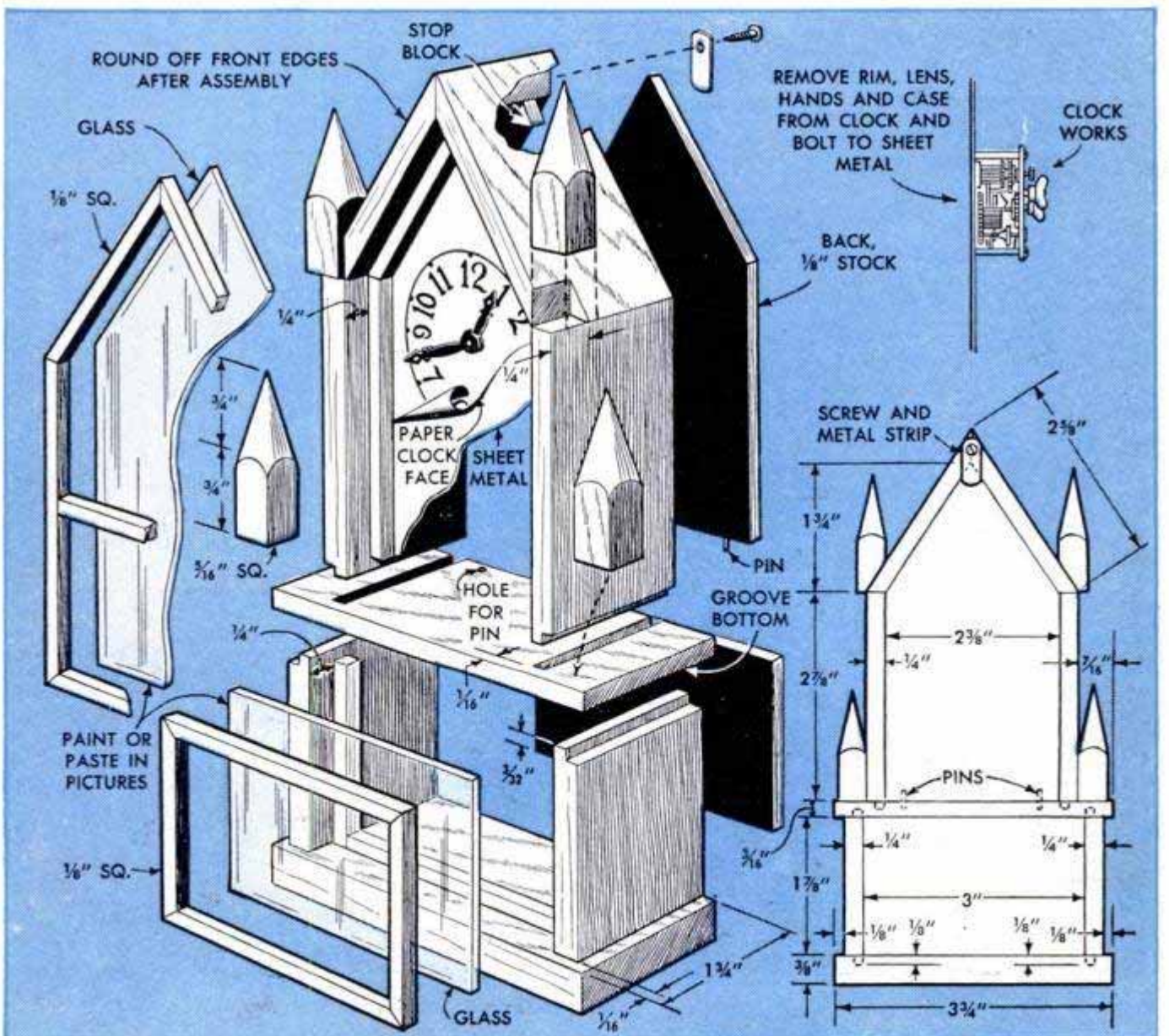
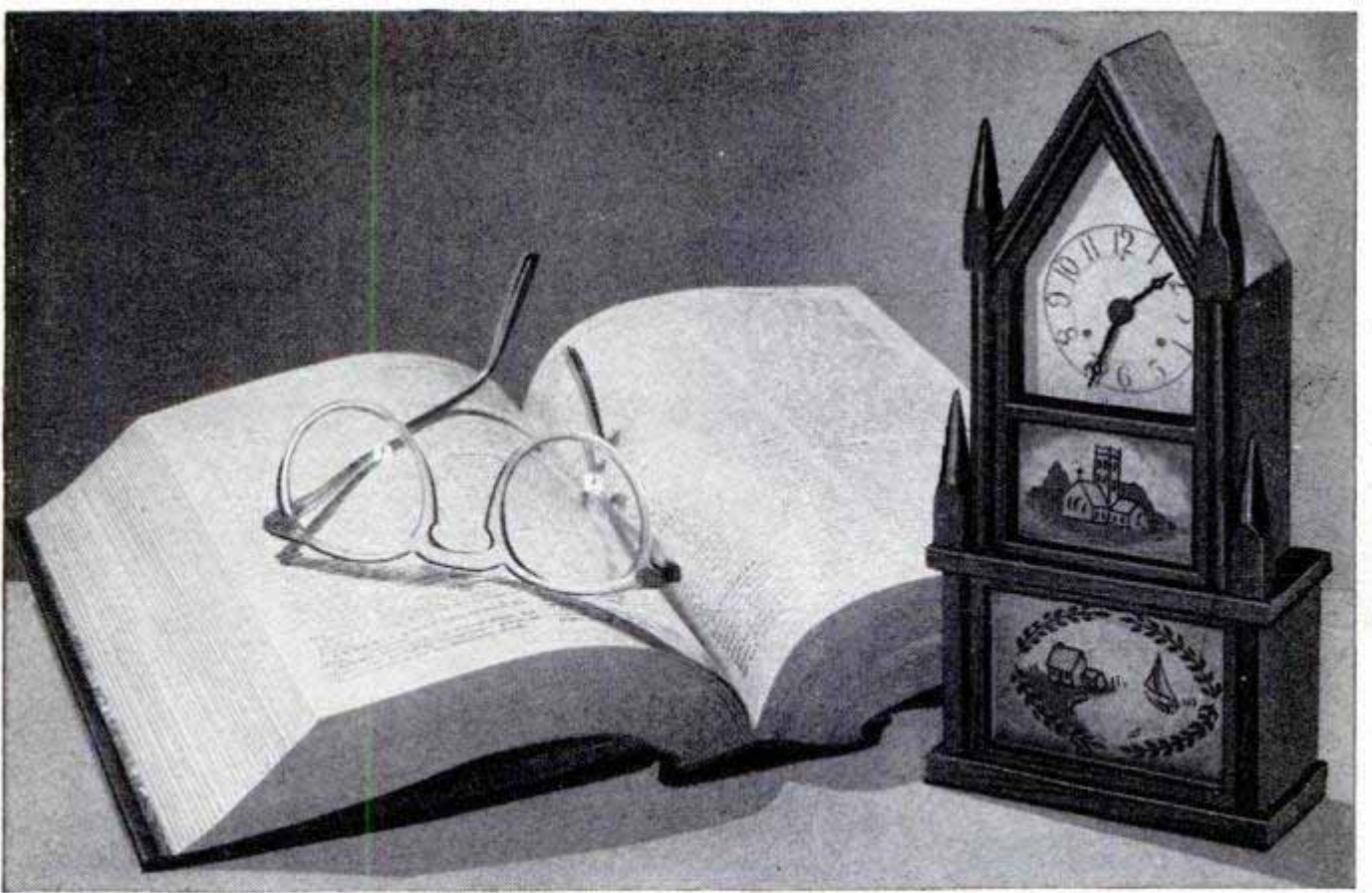

# WOOD-FINISHING

By Edward R. Lucas



**A**FTER you've finished building that homeshop project from fine woods and have spent a little time admiring the design and workmanship, you'll probably be all set to tackle the job of applying a suitable finish. It's likely you've already visualized the type of finish you want. This may require reproducing the aged patina of some museum piece, or perhaps you will require the light colors and grained wood of up-to-the-minute modern. Either finish can be made up to suit your taste simply by mixing and blending the finishing materials yourself from separate ingredients.

First, the wood must be thoroughly sanded to produce a smooth surface free from scratches, ripples, dents or other irregularities. From there on the procedure depends on the color desired and the kind of wood used. Open-grained woods, such as oak, walnut, mahogany and ash will require a filler. On some woods this should be applied before staining. A good general-purpose filler is mixed according to formula No. 1, Fig. 6. On open-grained woods, such as oak and ash, which are to be finished in a light color, this filler can be used without the addition of oil colors. Mix the ingredients in a clean container, Fig. 1, and stir until the mixture is of a creamy consistency. Then apply with a brush, Fig. 2, and when the filler has set, rub off the excess across the grain with a coarse cloth, Fig. 3. When the filler is applied to turnings, use the cloth as in Fig. 4. After the filler is completely dry, sand it lightly and dust thoroughly. A painter's tack rag is best for picking up dust. Even though grained woods are to be finished in a light color, or natural, it is best to apply a light stain to serve as a means of uniforming the



Many finishers prefer to mix their own wood fillers from separate ingredients. Mix in a clean container

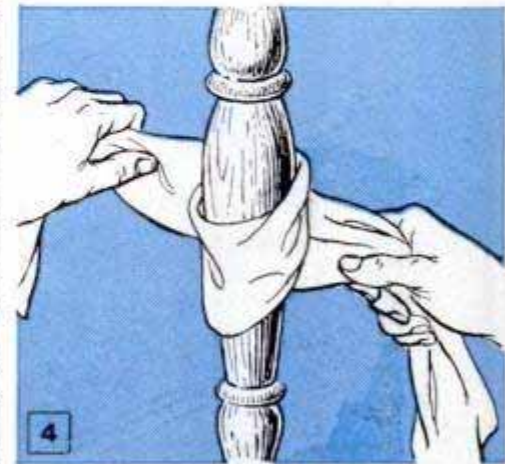
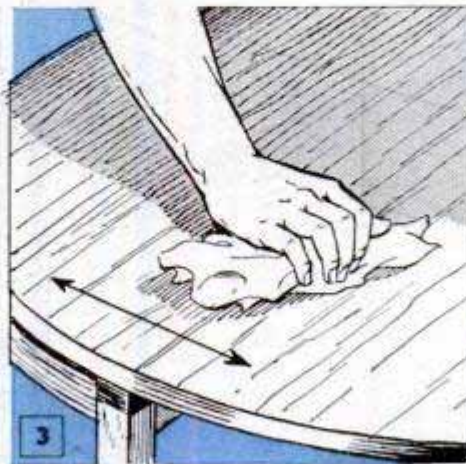

Mix the filler to the consistency of cream and apply to the wood with a brush. Allow to set, then rub across the grain with a coarse cloth. When rubbing turnings, wrap cloth around work and pull back and forth

# FACTS AND FORMULAS

natural color of the wood. A stain made up as in Fig. 7, formula No. 5, with just enough raw sienna in oil to color the mixture, results in a beautiful natural finish on oak and ash, as well as on the close-grained woods such as birch and maple. The thing to do, if you are working for a specific color or shade, is to try the stain on a test panel of the same wood, as in Fig. 5. Several tests may be necessary before you get just what you want.

On the darker woods such as walnut and mahogany, the No. 1 or No. 2 formula, Fig. 6, will make a satisfactory filler but it will be necessary to add a small amount of either raw or burnt umber to the mixture so that the filler will blend with the natural color of these woods. If the finish is to be red mahogany, then add to the filler the same stain that is to be used in coloring the wood. As a rule, it is best to use filler formula No. 2 when the wood is to be finished in the darker colors, although this filler is much slower in drying. Because of the fine "grain" of the filler mixed as in the No. 2 formula, it is necessary to wet-sand it after application, continuing the sanding with fine-grit sandpaper until the liquid disappears from the surface. Then rub across the grain with the palm of the hand until the excess filler rolls and bunches under the palm. Remove this with a fine-mesh cloth and wipe the surface lightly until it is dry. After the filler is thoroughly dry, sand again with fine-grit paper until the surface is glass-smooth to the touch. Then, unless the wood is to be stained, finish with two coats of white shellac, the first coat being diluted 50 percent with alcohol. This method results in a clear-toned sheen comparable to results obtained by French polishing. The same methods can be used in finishing woodwork which will be exposed to weathering, as it is one of the most durable of all natural finishes. When finishing an outside door, rub petroleum jelly into the end grain at the top and bottom as in Fig. 10.

On nearly all close-grained woods a sealer is substituted for the filler and where a stained finish is desired, the two colors of automobile lacquer, Fig. 7, formula No. 3, are all that are needed, as these two colors can be used in varying proportions to give almost any shade desired from light red cherry to dark mahogany and brown or dark walnut. Any stain mixed from the ingredients listed dries very fast; final finishing coats can be applied in from 30 minutes to one hour after applying the stain. The body of the stain, that is, its coloring

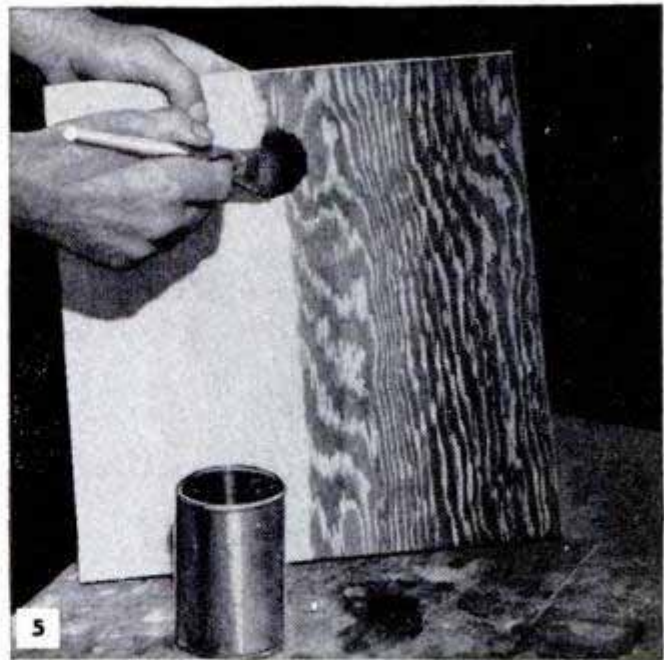

When working with stains that penetrate quickly and dry fast, always check results on test panels cut from the same wood as that which is to be finished

6

## FILLERS

### Formula #1\*

1/3 pint linseed oil  
2/3 pint turpentine  
Tablespoon Japan driers  
Household cornstarch thickener  
(add to suit)

### Formula #2\*

1/2 pint mineral turpentine  
1/2 pint linseed oil  
Heaping teaspoon litharge

7

## STAINS

### Formula #3

Black automobile lacquer  
Cardinal red automobile lacquer  
Lacquer thinner

### Formula #4

1/2 pint hydrochloric acid  
1/2 pint acetic acid  
Wad of fine steel wool  
Dilute with water as needed  
after steel wool has dissolved

### Formula #5\*

1/8 pint linseed oil  
1/8 pint turpentine  
Japan driers  
Colors in oil (raw sienna,  
burned sienna, raw umber)  
Small amount flat white paint

\*Caution: Always burn rags immediately after using. Driers are extremely liable to spontaneous combustion.

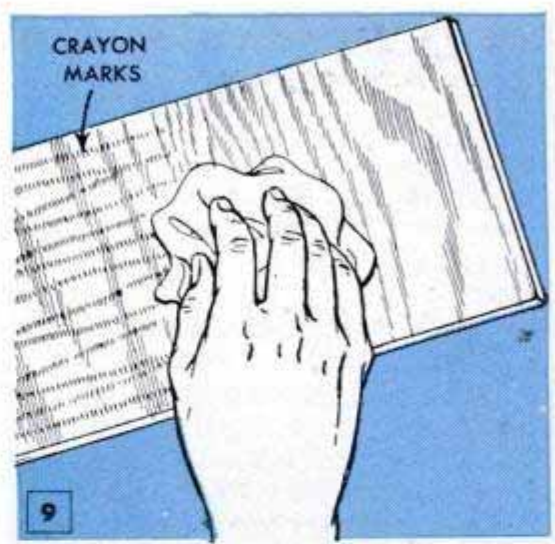
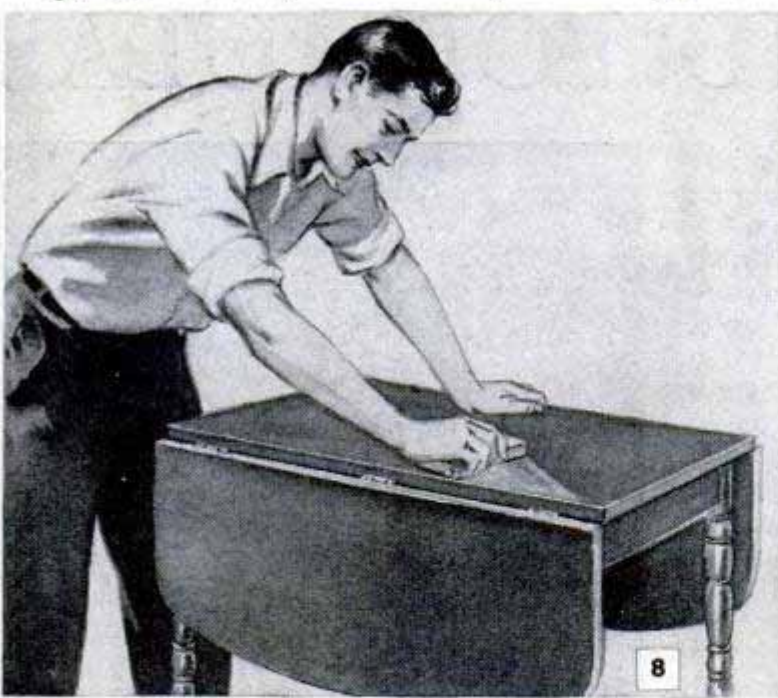

A novel and useful method of staining native woods is to make spaced marks across grain with a wax crayon, then spread color with cloth dampened in lacquer solvent



capacity, can be varied from opaque through various degrees of shading stain to a very light tint suitable for light finishes. The variations are accomplished by changing the proportions of the body colors and increasing or decreasing the amount of thinner as required. Before applying this type of stain, check results on test panels.

Formula No. 4, Fig. 7, produces what might be called an aging stain on most of the common native cabinet woods but it also is very effective on certain imported woods which will not accept ordinary stains satisfactorily owing to the high oil content. This is a water stain and, in order to produce desired results, it must be applied with care. Try it on test panels first to be sure you have the required shade. (Caution: In the undiluted form hydrochloric acid is a violent poison. It also causes severe burns on coming in contact with the skin. The fumes are toxic. Destroy all unused portions of the acid or acid solution.) By adding a small amount of ni-grosine (soluble in water) to the stain solution given in formula No. 4, close-grained woods such as poplar, birch, maple and basswood can be stained an ebony black which is very attractive on certain types of woodwork such as picture frames and

shadow boxes. The regular solution is especially effective in staining woods to obtain the effect of age. Shading of the stain is done merely by changing the proportions of stain and water. By making tests on small panels of the same wood as that to be finished, you can get almost any effect.

Another rather novel method of staining which is quite attractive on both the open-grained and close-grained domestic woods is the use of wax crayons. Simply make spaced marks across the grain with a crayon of the color desired, then rub with the grain using a cloth dampened in a lacquer solvent, Fig. 9. The solvent dissolves the crayon marks and spreads the color evenly over the surface. The depth, or body, of the color is determined by the spacing of the marks on the wood. Close spacing produces a heavy-bodied color, wide spacing a light, thin stain.

Top finishing materials most commonly used after filling and staining, or staining and sealing, as the nature of the work may require, are shellac, varnish of various kinds and clear lacquer. Spraying lacquers can be applied only with a spray gun, but brushing lacquers are laid on with a well-filled brush, just as varnishes are applied. Drying time ranges from 10 to 30 min. Shellac takes from 1 to 3 hrs. to dry ready for a second coat, although it is dry to the touch in 15 to 20 min. Drying time for varnish depends on the type used, but it may range from 4 to 48 hrs. All these materials will require light sanding between coats in order to produce a first-class surface. The final coat usually is rubbed to a dull gloss with rubbing compound, Fig. 8. On certain native woods, some finishers prefer a wax finish. Two coats of shellac will form a good base for applying the wax.

## Picket "Basket" Protects Shrubs

Individual shrubs and flowers can be protected from damage by pets and romping children and made much more attractive if they are ringed with a picket basket. For a basket approximating the size of the one pictured, use 17 pickets,  $1\frac{3}{8}$  in. wide by 14 in. long. Drill  $\frac{1}{16}$ -in. holes through the edges of the pickets near the top and bottom and counterbore larger-diameter holes partially through the two end pickets. Use two lengths of galvanized wire to string the pickets, the bottom length being  $27\frac{1}{4}$  in. long and the top length  $32\frac{1}{2}$  in. long. After stringing all the pickets on the wire, twist it an inch or so from the end so that it will not pass through the smaller hole in the starting pickets but can be inserted in the counterbored portion of the hole. Then twist the two ends together and move the finish picket so that the twisted ends are hidden in the counterbored holes. Space the pickets about  $\frac{1}{2}$  in. apart along the upper wire and  $\frac{1}{4}$  in. apart along the bottom wire to attain the tapered effect.



Before assembling the basket, paint the pickets with two coats of the desired color.  
Dick Hutchinson, El Monte, Calif.

## Speed of Battery-Operated Toys Controlled by High-Low Circuit

Often it is desirable to operate battery-driven toys, which are powered by two or more cells, at a speed lower than normal.

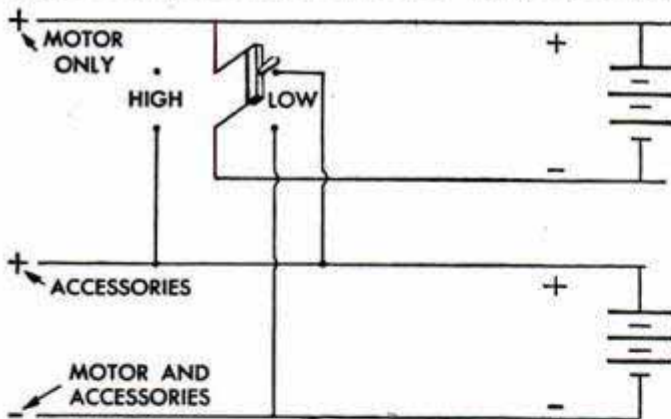

This can be done by arranging the wiring as in the diagram, using two dry cells, or groups of dry cells. A d.p.d.t. (double-pole, double-throw) switch is placed in the circuit as shown. Throwing the switch to the high position connects the cells in series, making the full voltage available. When the switch is thrown to the low position, the cells are connected in parallel and the voltage is reduced by one half. This reduces the speed of the model and also conserves the batteries. If there are accessories, such as lights, which require the same voltage at all times, connect these to terminals on the leads as indicated.

Charles Erwin Cohn, Chicago.

## Multiple Clothes-Hanger Rack Conserves Closet Space

To conserve space in a small closet or to hang several suits or coats in the car while traveling, bend this multiple hanger rack from a wire coat hanger. Just straighten out the wire, bend it into several loops as shown, and slip the hook of a coat hanger through each loop. Be sure to make the rack from a heavy-wire hanger so that it will withstand the excessive weight.

John Torhan, Yonkers, N.Y.

☐ If you want to read the voltage and wattage of a light bulb without turning it off, just hold a sheet of white paper against the end of the bulb. The numbers on the glass will be legible through the paper.

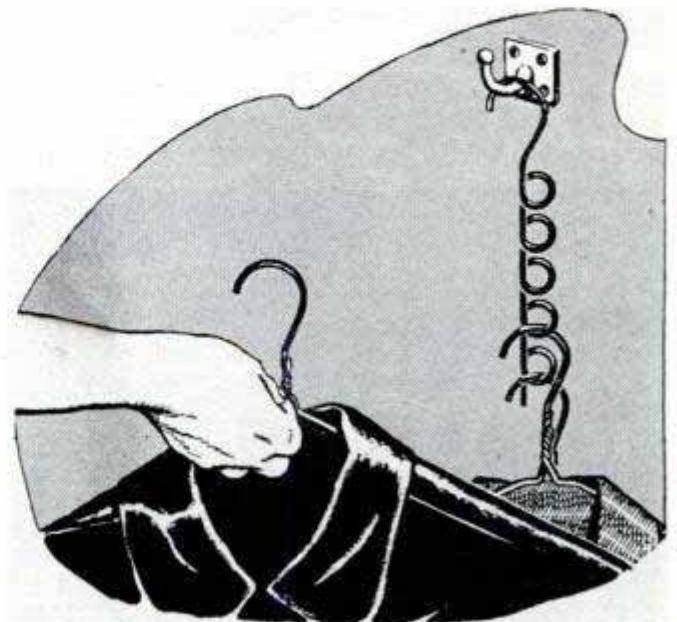

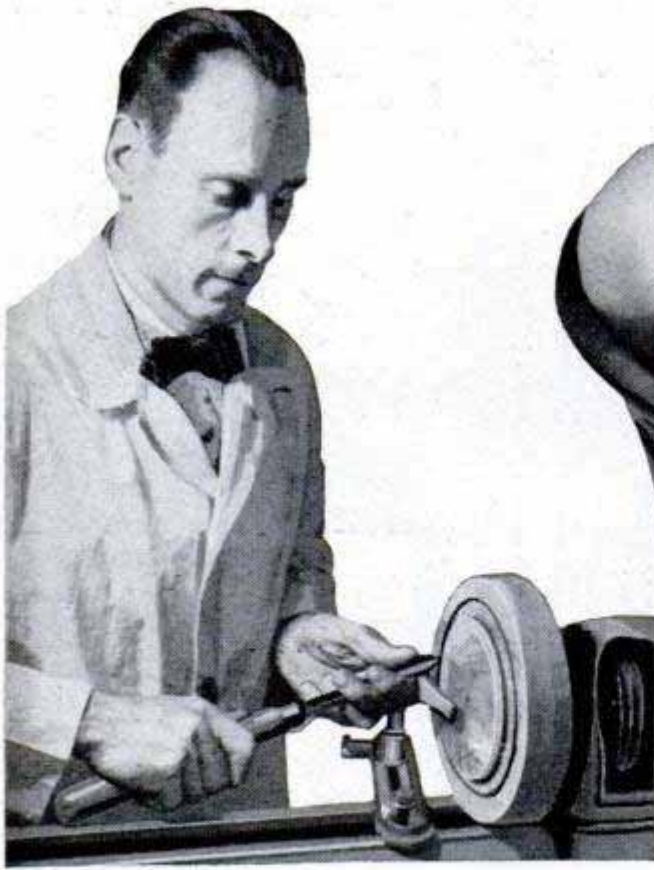

A tenon is formed around the edge of the bottom disk to fit a matching groove turned in the second piece

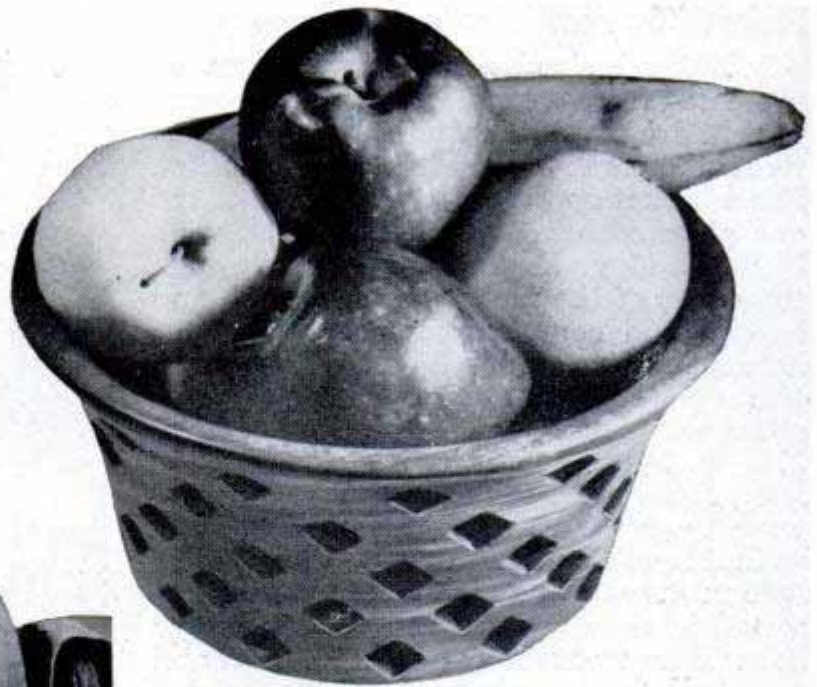

## INTRIGUING

**H**OW DID YOU make it? That's the first question your craft friends will ask when they examine this unique fruit bowl. They'll see right away that it was first turned, but how the square holes were formed usually will keep them guessing. Oddly enough, the piercing of the bowl is actually the easiest part of the whole job for it's done merely with a mortising chisel in the drill press. The bowl itself is a typical turning job, being turned from either a solid block or three separate pieces glued and clamped together as shown in Figs. 1 and 3. Note in Fig. 1 that the bottom section of the built-up block is glued to a waste block for attaching a faceplate. The outside of the bowl is turned to final size and sanded smoothly at this time but, on the inside, the wall thickness is left about  $\frac{1}{8}$  in. oversize. This is done to provide waste to take care of any chipping that occurs when piercing the bowl. Fig. 3 shows how the outside of the bowl is marked off to locate the points for piercing. A  $\frac{1}{2}$ -in. mortising chisel is used, as well as a jig to support the bowl. This is made of wood as in Fig. 4 and is clamped to the drill-press table as shown in Fig. 5. Ease the chisel through the work slowly in making each hole to prevent excessive chipping. After the piercing is completed, the bowl is remounted in the lathe and the inside is turned down. This operation requires extreme care and the use of a very sharp, pointed tool. Finish by touching up the holes with a square file, sanding and giving the bowl a French polish of shellac and sweet oil while it is still mounted in the lathe.

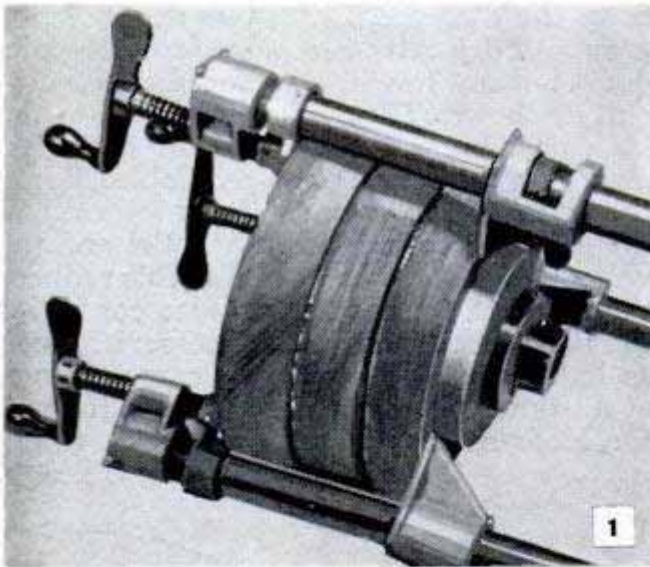

Above, built-up assembly with faceplate attached is glued and clamped. Center of two disks is removed beforehand. Below, the inside is turned after piercing

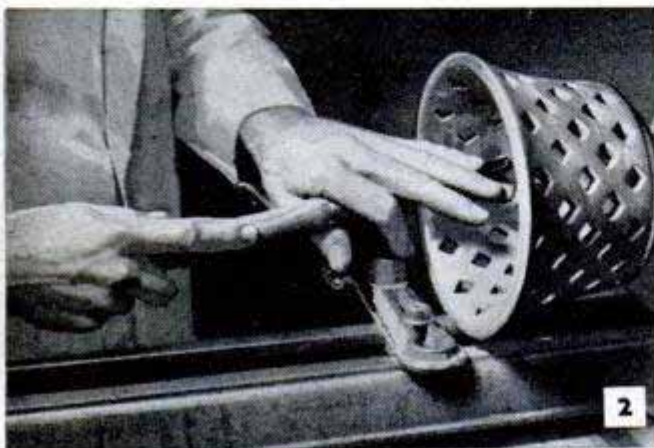



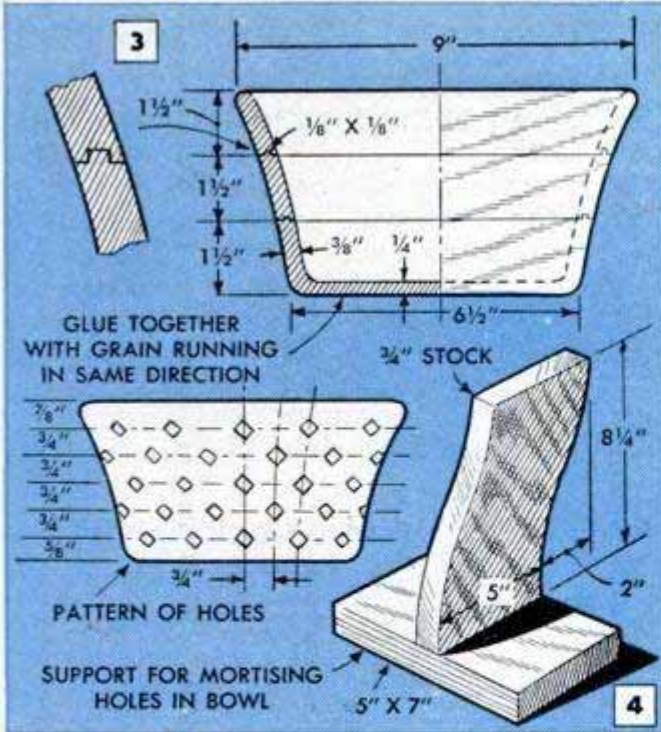

## FRUIT BOWL

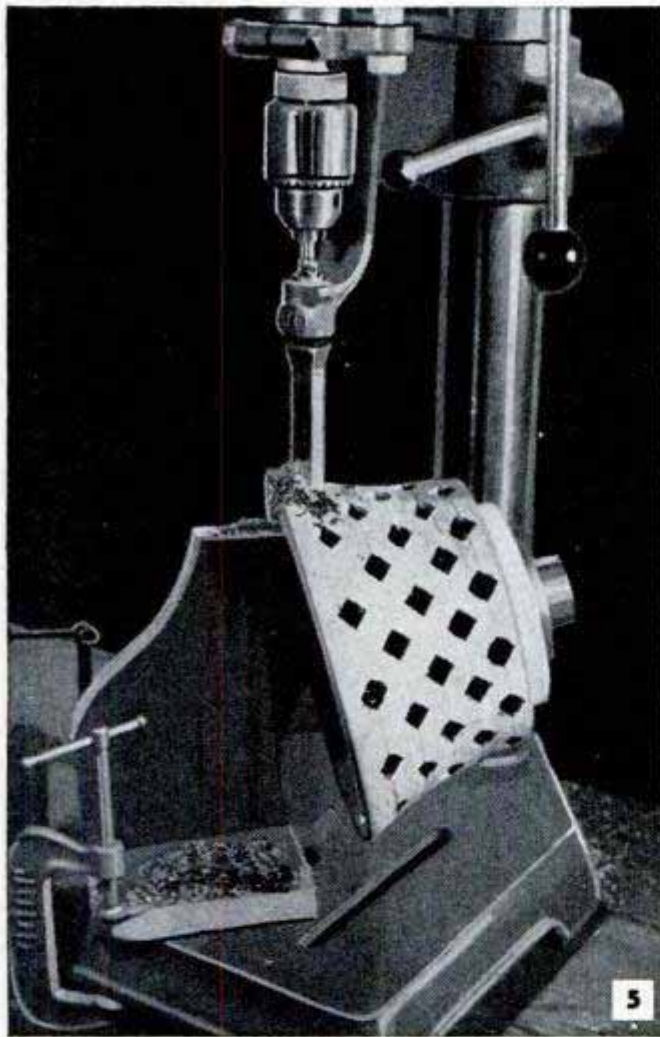

In piercing the bowl, it is held on a wooden standard. Note that this is clamped to the base of the drill press at a 45-deg. angle. Ease the mortising chisel through the work and hold the bowl firmly when the chisel begins to break through. The faceplate is left in place so that the bowl can be replaced for final turning

## Toe Clamps Salvaged From Skates Hold Small Work for Gluing

Before throwing away an old pair of roller skates, remove the clamps and save them. They will come in handy as gluing clamps for small work and turnbuckles when gluing larger work. Although pliers can be used to tighten the clamp, a roller-skate key is more convenient.

Edward F. Kmiec, Flushing, N. Y.

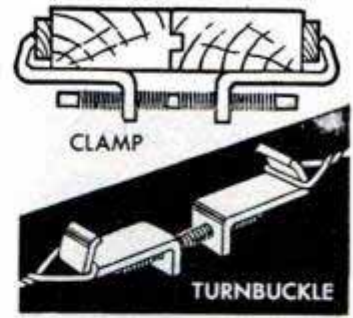

## Washers Protect Hydrometer Glass

To minimize the danger of breaking the glass cylinder of a hydrometer when it is accidentally bumped or dropped a short distance, slip several rubber garden-hose washers over the gauge glass. This, of course, is not foolproof protection, but it will prevent damage from minor accidents.

Victor H. Lamoy, Upper Jay, N. Y.

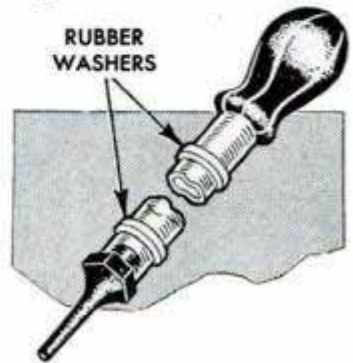

## Loose-Pin Hinge Forms Door Bolt

Suitable for a garage or shop door, this sturdy bolt can be made quickly from a large loose-pin hinge and a length of rod. The original pin is removed from the hinge and the leaves are aligned side by side and screwed in place. The decorative pin button on one leaf can be left in place or removed as desired. Then the rod, which should be slightly smaller in diameter than the hinge pin, is chamfered at one end, to facilitate sliding it in place, and bent at right angles at the other end to provide a handle.

A drop or two of oil applied to the bolt will improve operation. To assure perfect alignment, it is best to screw the hinge parts in position with the sliding bolt in place.

Warren W. Howe, Longview, Wash.

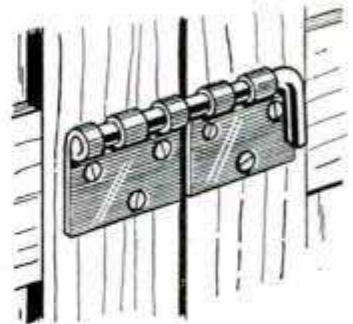

☐ A cake of soap provides a handy pin-cushion for baby's bathinette and at the same time will keep the pins lubricated.

## Simulated-Leather Table Tops Improvised From Hardboard Panels



Hardboard panels having a leatherlike finish are just the thing to simulate expensive leather table tops. Fitted carefully into the recessed top of a cocktail or occasional table, the hardboard panels are difficult to distinguish from real leather. The panels are practically unbreakable, quickly removed for dusting and easy to wipe off. The hardboard can be sawed, the edges sanded like plywood and the surface finished with paste wax.

Edward L. Fisher, Milwaukee, Wis.

## Portable Open-Fire Cooking Grill Swings Meal Clear of Flames

Built from scrap pipe and iron rod, this portable campfire grill is quickly set up and has the advantage of allowing the entire meal to be swung on or off the fire. A length of pipe or  $\frac{1}{2}$ -in. rod about 3 ft. long is embedded in the ground to support the movable grill, and a collar clamped to the upright by means of a thumbscrew permits the grill to be set to any desired height. The grill itself is a frame of  $\frac{1}{4}$ -in. rod welded to a 12-in. length of pipe which fits loosely over the upright.

Perry E. White, Oklahoma City, Okla.

## Bolt Supports Plane Blade For Sharpening Edge

To do a good job of sharpening the blade of a plane on an oilstone, it is important to support the blade at the proper angle to the stone. This can be done easily by using a long, roundheaded bolt to hold the cutter

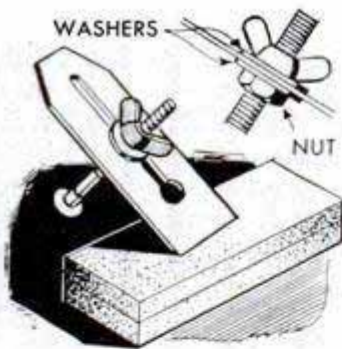

at a constant angle. Fasten the bolt in the blade slot with a nut, two washers and a wing nut, as shown. Set the oilstone on a flat surface, such as a bench top, and place the edge of the blade on the stone. Then adjust

the blade to the desired angle by turning the nut down the bolt threads or backing it off and then locking in place with the wing nut. After the correct angle is attained, sharpen the blade in the usual manner.—Ted J. Kubit, Detroit, Mich.



## Separating Fishing-Rod Ferrules Without Damage

Ferrules of fishing rods that have not been taken apart before storing often corrode, making separation difficult without exerting pressure that might damage the rod. To separate the corroded ferrules, apply a few drops of carbon tetrachloride in and around the joint, and allow it to remain for a half hour so that it penetrates and dis-

solves the corrosion. After this, the rod sections will come apart easily. Remove the rust spots with fine emery cloth and coat the ferrules with a light oil before putting the rod sections back together.

☐ An electric baby-bottle sterilizer is just the thing for sterilizing jelly glasses.

# TWO SHELVES OR ONE

By  
Benj.  
Nielsen

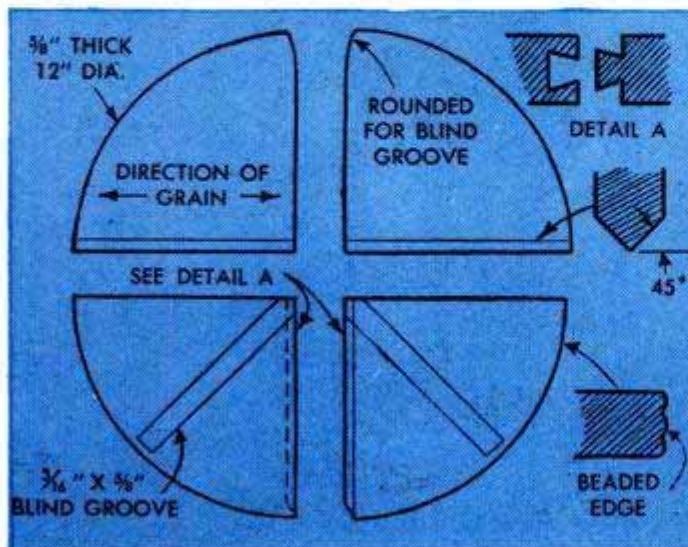
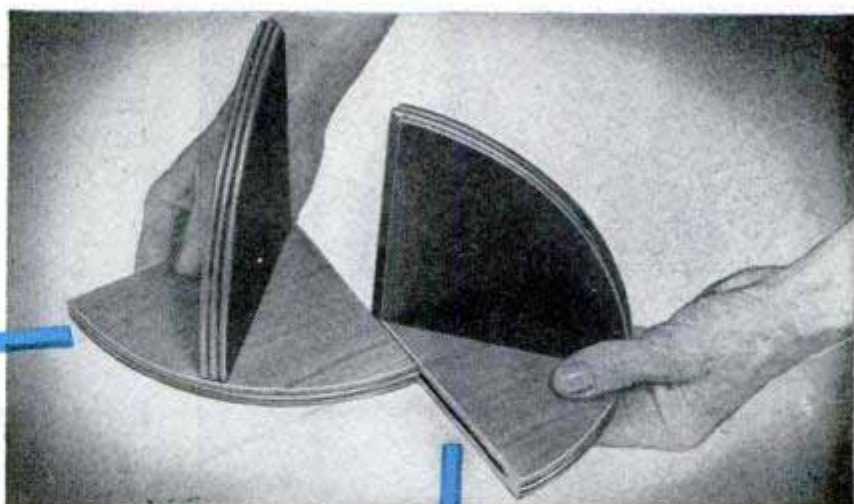
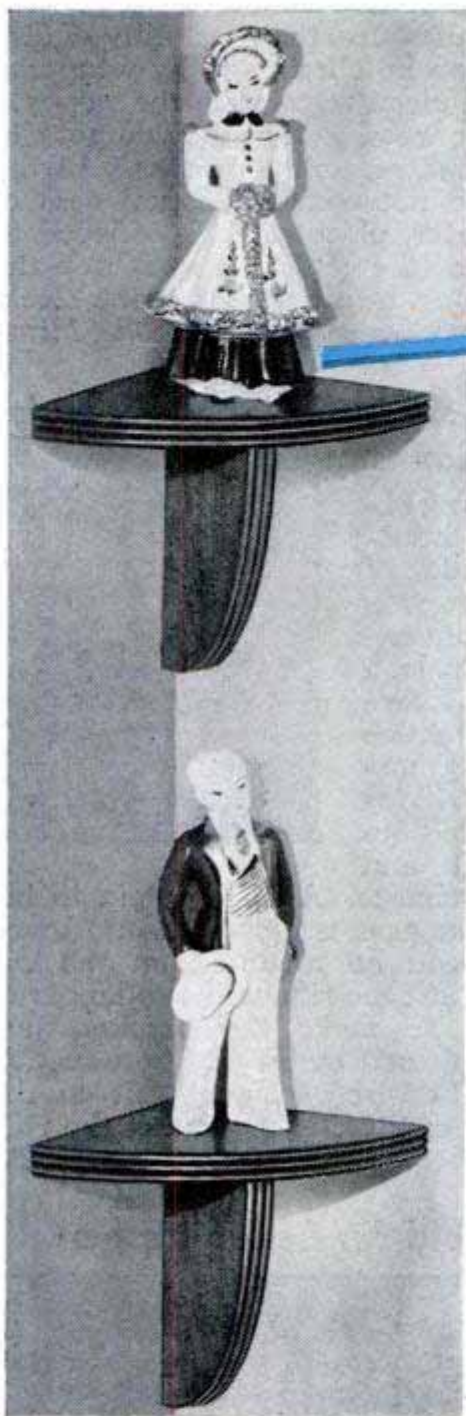

You're in for a change with this novel two-in-one shelf for, when you are tired of using it as a plain wall shelf, it can be slipped apart and used as two separate corner shelves. Primarily, it's a lathe job, although a power saw is needed to form the dovetail joint which locks the two shelves together. Both shelves are made from a 12-in. disk which is faced 5/8 in. thick and beaded around the edge. The disk is cut into four equal segments, producing two brackets which are beveled along one edge as shown, and two top pieces which are dovetailed along the end grain. The brackets are glued in shallow grooves routed or dadoed in the underside of the top pieces. Note that these are made blind at the front

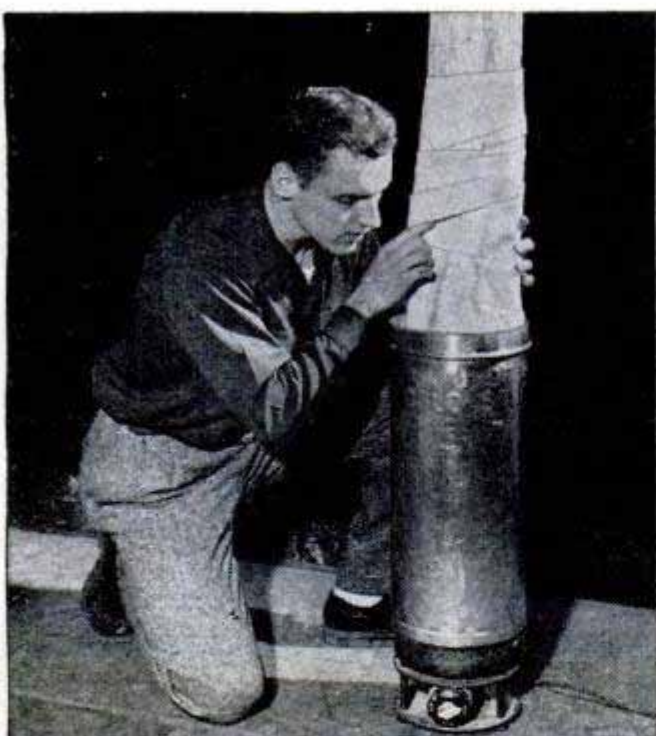

## Discoloration of Steamed Wood Prevented by Cloth Wrapping

When it is necessary to steam wood in order to bend it to suit the design of a boat or piece of furniture, the possibility of discoloration can be eliminated by wrapping the wood in clean rags. Tie the rags securely to the wood so that they do not slip off during the steaming process. As the wood should not come in actual contact with the water, place a block of wood at the bottom of the container and keep the water level just below the top of the block.

Sherwood Benson, Minneapolis, Minn.

## Rifle Supported Against Car Fender With Suction-Cup Bracket

While target-shooting or hunting, the fender of your car often is the most convenient place to lean the rifle. However, this practice is extremely unsafe, as the rifle is likely to fall to the ground and possibly discharge.



A handy item to include in your gear is a suction-cup bracket which can be mounted on the car body to support the rifle without danger of its falling. To make the bracket, just screw a U-shaped metal clip to a suction cup and, if desired, cement felt to the inner edges of the clip to protect the rifle barrel.—Robert P. Arce, Hawthorne, Calif.

## Estimating Hip-Roof Area

Here is a simple way to find the total area of a hip roof when determining the amount of shingles or roll roofing it will take.

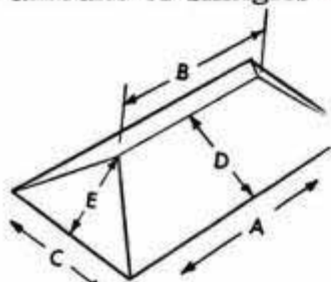

First, add the length of eave, A, to the length of ridge, B, and multiply the sum by the slope, or rafter length, D. Then multiply the eave, C, by the slope, E.

Merely add the two answers in order to obtain the total roof area.

A. L. Kaser, Niles, Mich.

## Foot Scraper Utilizing Pipe Lengths Has Handhold for Better Support

An efficient foot scraper is a must on the farm and in newly built suburban communities where sidewalks are scarce and the mud is thick. This scraper has a handhold across the top so that you can grasp it while cleaning the shoes, thus gaining the balance necessary to do a thorough job. Two pieces of pipe several feet long are joined at one end by welding a short length of pipe across the ends. Then a piece of flat iron, which forms the scraper, is welded between the vertical pipes 18 in. or so from the top. The pipes are driven into the ground until the flat-iron scraper rests on the surface.

A. M. Wettach, Mt. Pleasant, Iowa.



☐ To remove a paint spot from fabric, saturate the spot a few times with a solution consisting of equal parts of turpentine and household ammonia. Then wash the area with soap and water.

# SEATING YOUR TV AUDIENCE

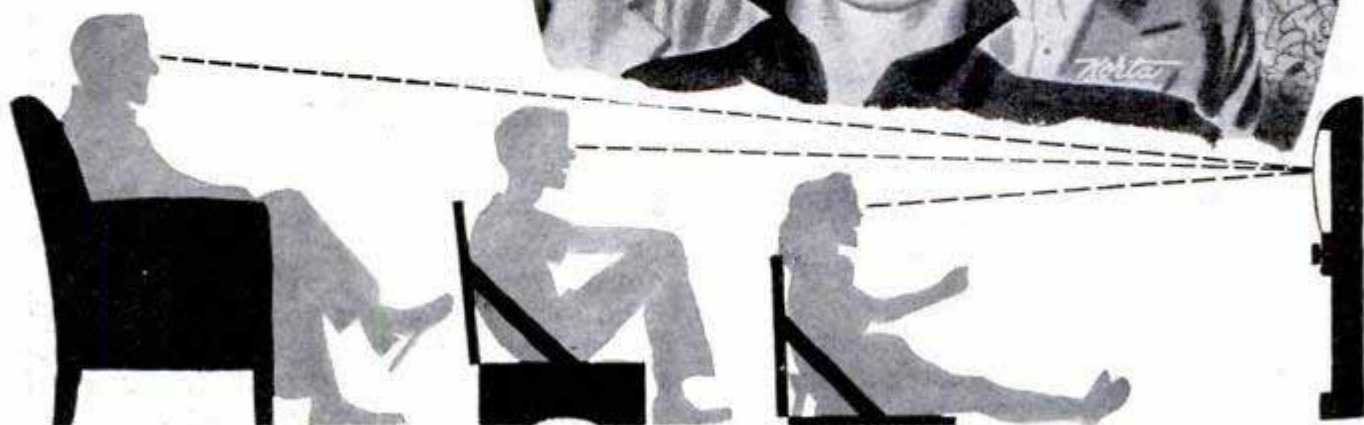

WHEN a group of friends and their children drop in for an evening of TV, the smart host takes the seating problem in stride and brings out these novel "down in front" chairs to give everyone a box seat. Reserved for young Hopalong fans and teen-agers, the chairs augment the regular room furnishings and also permit the audience to be seated on three levels so that all can see without craning. Made in two sizes, the chairs are used down front—the low seats for small fry, with older children

being ushered to the higher ones. Several of each type can be made and, as they fold, they can be tucked away in a closet. Both chairs, which are detailed below, are made from solid stock and plywood. Style B is a duplicate of style A, except that a hinged base is added to bring the seat about 7 in. above the floor. The hinged backs are supported when open by strips of upholstery webbing. The webbing is fastened in place with short roundheaded screws and washers.—Hi Sibley, Nuevo, Calif.

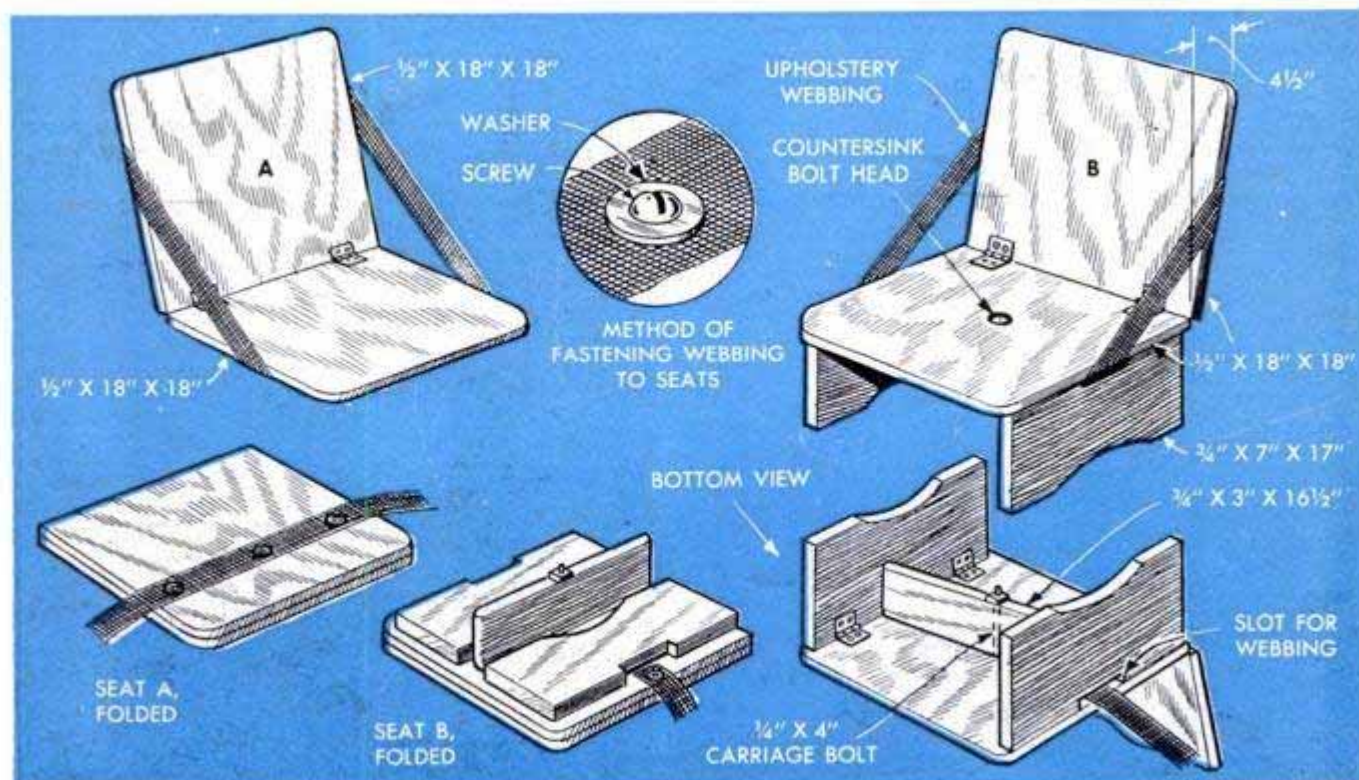

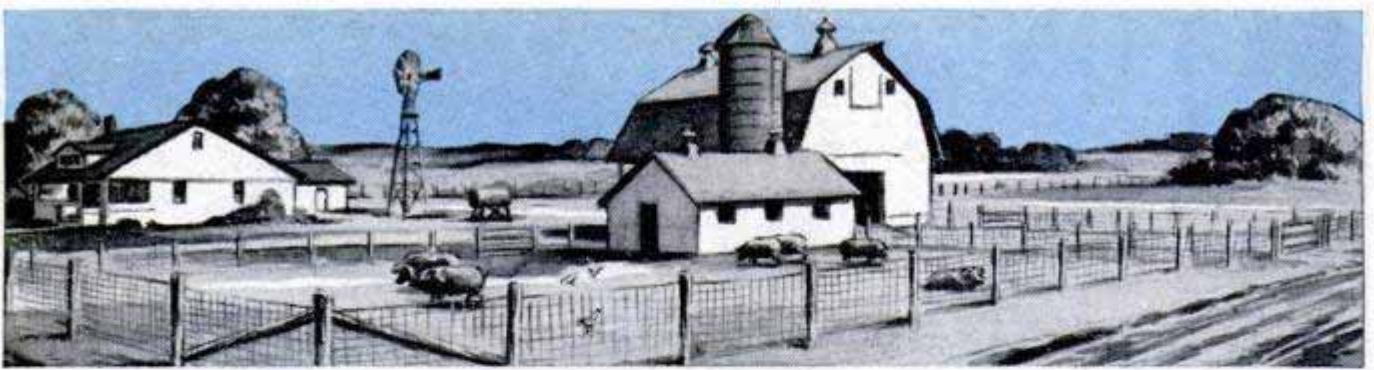

# LONGER LIFE FOR FENCE POSTS

**Preservative treatments for prolonging the life of fence posts can be carried out on the farm or in the wood lot at a minimum cost in time, labor and equipment**

**By Robert Donald Sawyer**

ACCORDING to Richard W. Abbott, assistant extension forester at the University of Wisconsin, simple preservative treatments now are being carried out which will lengthen the life of wooden fence posts from 8 to 15 years. Wood of the different tree species suitable for fence posts varies greatly in durability. As shown in the table, Fig. 5, some durable woods such as cypress, Osage orange, black locust and redwood have a serviceable life as fence posts ranging from 15 to 25 years without any protection other than the natural oils contained in the wood itself which are toxic to ordinary wood-rotting organisms. Other less durable woods, widely used because of the high cost and relative scarcity of the durable varieties and also because they are readily available locally,

are destroyed in a relatively short time unless protected by preservative treatments. Compare the condition of the posts in Figs. 2 and 6. The post in Fig. 2 has been treated; the other (untreated) post shows the progress of decay through the sapwood after only a few years of service. Note also from the table that after treatment with a preservative the serviceable life of the less durable woods compares favorably with that of the most durable varieties.

Posts selected for treatment with preservatives should be round and about 4 to 5 in. in diameter at the top end. In the non-pressure method of treatment, the heartwood of most varieties will resist the penetration of the preservative and it is for this reason that only round, unsplit posts are used. In treating with the common chemicals it generally is recommended that the bark be peeled immediately after cutting, Fig. 1, and that the posts be stacked to season as in Fig. 3. However, some treatments can be carried out without removal of the bark, as will be noted later. Bark of most of the common trees suitable for fence posts peels most easily in the early

**Bark should be peeled from each post immediately after cutting and while the sap is still fresh**

**Treated post shows no signs of decay after several years of service. Note smooth surface below ground**

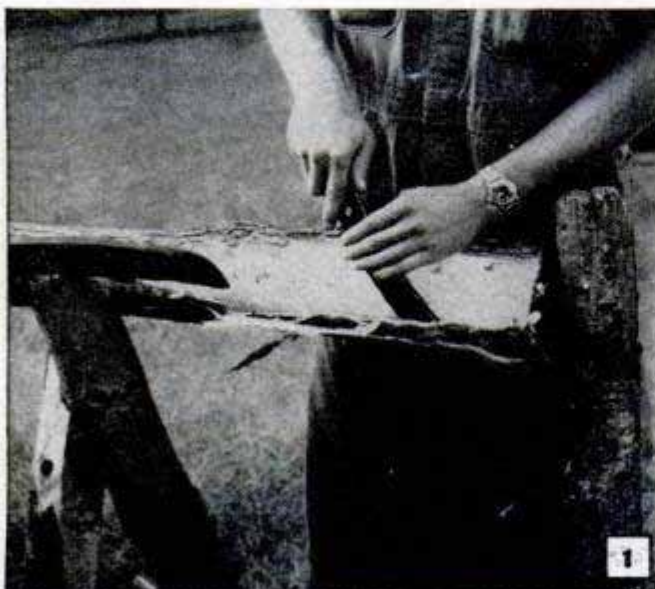

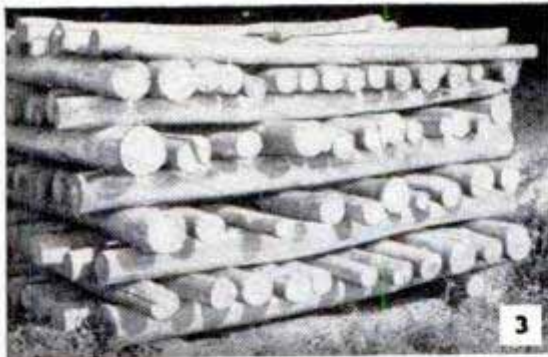

3

After peeling, posts are stacked to season thoroughly before treating by cold soaking

spring when the sap begins to rise. That's why farmers plan to cut the season's replacement posts at this time. Before cutting post timber, it's a good idea to go over the wood lot and mark trees suitable for cutting during that season. When cutting, special attention should be given to removal of interfering growth, Fig. 4.

In general, there are three methods of nonpressure treatment, the open-tank, or "cold soaking" method, being the easiest and simplest, using as a preservative a mixture of equal parts of creosote and crankcase oil. Various tanks can be used but the setups pictured in Figs. 7 and 8 have proved the most satisfactory. In the first system a pump is used to draw the preservative solution from the drums and force it into the sheet-metal vat. The latter is specially made for the purpose and is generally designed to hold at least 12 posts submerged for treatment at one time. Special hold-downs are provided to force

Decay of some untreated posts progresses to this stage in three to five years' time



6



4

When cutting posts, good forestry practices should be observed by removing interfering growth and thinning wood lot uniformly

5 EXPECTED LIFE AND RECOMMENDED TREATMENT FOR FENCE POSTS OF DIFFERENT SPECIES						
Species	Round Only	Split	Expected Life Without Treatment (In Years)	Recommended Treatment		Expected Life After Treatment (In Years)
				Cold Soaking	Hot and Cold Bath	
Aspen (poplar)	X		2-3		X	15-20
Basswood	X		2-3		X	15-20
Beech	X		3-5		X	15-20
Birch, river, yellow	X		2-4		X	15-20
Black Cherry	X		6-9		X	15-20
Black Gum	X		3-5		X	15-20
Black Walnut	X		10-20		X	15-20
Buckeye	X		3-5		X	15-20
Butternut	X		6-9		X	15-20
Catalpa	X		10-20		X	15-20
Cedar, red	X	X	15-20		butts only	20-25
Cedar, white	X	X	15		butts only	20
Chestnut	X		10-20		X	15-20
Cottonwood	X		3-5		X	15-20
Cypress	X	X	20-25	not necessary		
Douglas Fir	X		10-20		X	15-20
Elm	X		4	72 hrs.		15
Fir	X		3-5		X	15-20
Hemlock	X		6-9		X	15-20
Hickory	X		5	72 hrs.		15
Honey Locust	X		10-20		X	15-20
Hornbeam	X		3-5		X	15-20
Loblolly Pine	X		6-9	X		15
Locust, black	X	X	20-25	not necessary		
Longleaf Pine, dense	X		10-20	X		15-20
Longleaf Pine, nondense	X		6-9	X		15
Maple, hard, soft	X		2-4		X	15-20
Mulberry	X	X	20-25	not necessary		
Oak, red, black	X		5	72 hrs.		15
Oak, white, bur	X	X	10	72 hrs.		15-20
Osage Orange	X	X	20-25	not necessary		
Pine, white, red, jack	X		3-5	48 hrs.		15-20
Red Gum	X		6-9		X	15-20
Redwood	X	X	20-25	not necessary		
Rock Oak	X		6-9	X		15
Shortleaf Pine	X		6-9	X		15
Spruce	X		3-5		X	15-20
Sugar Maple	X		3-5		X	15-20
Sycamore	X		3-5		X	15-20
Tamarack	X		7-10		X	15-20
White Ash	X		3-5		X	15-20
Willow	X		2-3		X	15-20
Yellow Poplar	X		3-5		X	15-20

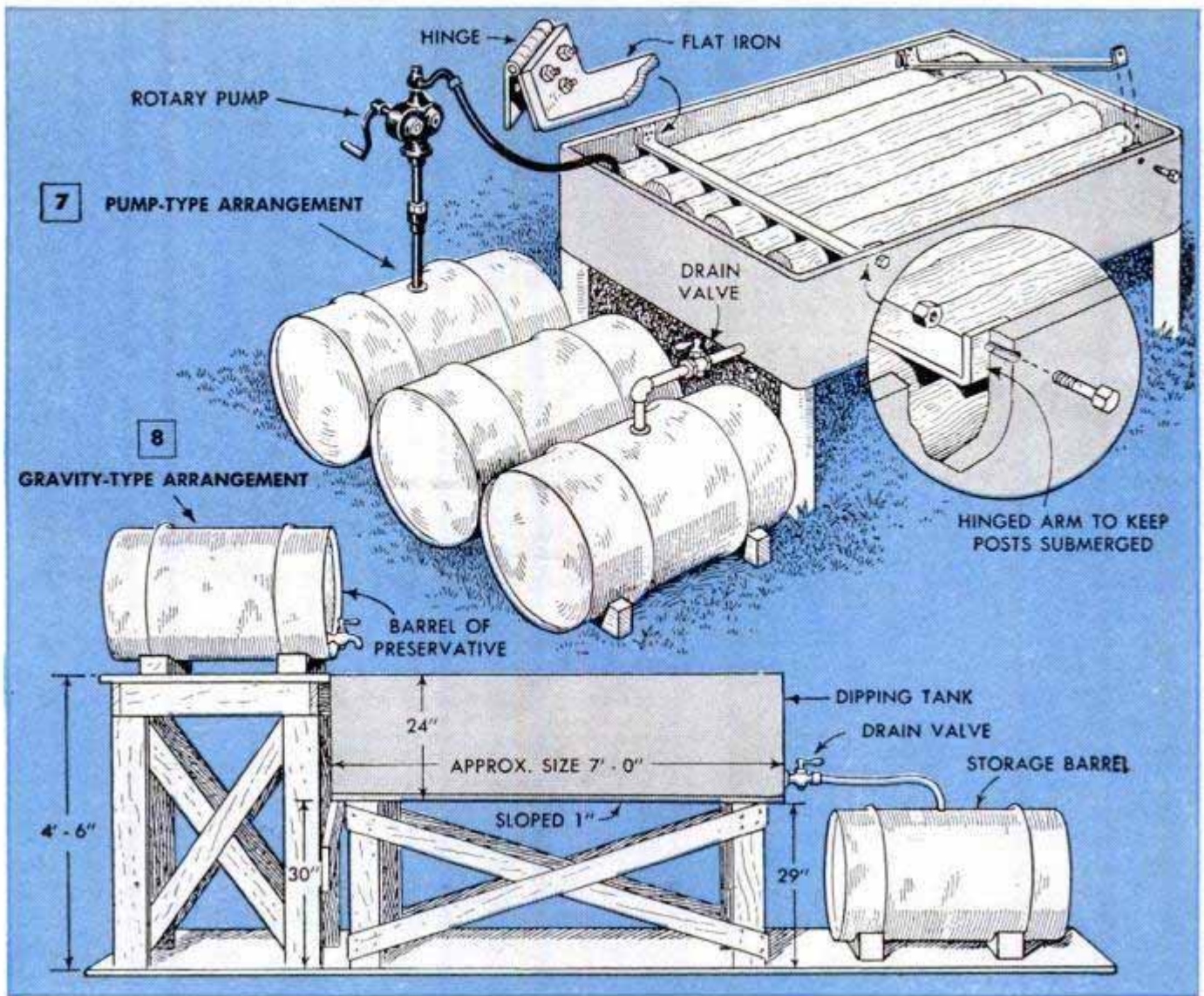

the posts below the level of the solution and hold them in position. The vat is elevated sufficiently so that the solution will drain off into an empty drum through a drainpipe fitted with a shutoff valve as shown. In the gravity system, Fig. 8, the supply tank is located above the vat which also is elevated so that the solution can drain off into a storage drum. Either arrangement performs satisfactorily when used with the creosote-oil solution or with the new preservative consisting of a 5 percent solution of pentachlorophenol (pronounced "penta-klor-fee-nol") and oil. This newer solution is available ready-mixed for treating fence posts. *Caution:* Care should be taken in handling either the creosote-oil or pentachlorophenol-oil solutions. Wear rubber gloves when handling posts wet with the solution and take special precautions against a splash which might throw the liquid into the eyes or onto the bare skin. The treating unit should be located in the open away from buildings to reduce the fire hazard to the minimum, as the solutions used are flammable.

The amount of solution required will average about  $\frac{1}{2}$  gal. per post. This will vary somewhat with the kind of wood.

Treatment should be carried out only during the summer months when the temperature remains above 60 deg. F. As noted in the table, Fig. 5, the duration of the single treatment ranges from 48 to 72 hrs. for the common woods. At the end of this time the solution is drained off and the posts removed. If there are more posts to be treated, the tank is refilled with a new solution and the process repeated.

A second method, which is the most effective of all treatments practicable on the farm, requires that the solution be heated to about 200 deg. F. The equipment required is essentially the same as that used in cold soaking, except that some provision must be made for heating the preservative in the tank. Usually it is possible to mount the tank over a firebox of brick or stone in which a controlled fire can be maintained for the time necessary to bring the solution to the required temperature. A half-and-half solution of creosote and oil is recommended for the hot-bath method. Use caution in heating this solution as it is highly flammable. The procedure is quite simple: Place the posts in the tank, pump in the preservative, bring it to the required temperature and



maintain it at this level for 3 hrs., then pull the fire. Allow the posts to remain in the solution at least 12 hrs. or overnight.

The third method of treatment, known as the tire-tube method, has lately come into favor because of the simple equipment required. However, it is not suitable for all woods used for fence posts. Only the fast-growing, nondurable woods are recommended for treatment by this method, as the posts must be treated while still green and without being peeled. The first requirement is a rack long enough to support several posts laid side by side with the large end (butt) about 18 in. higher than the small end. Place two uprights in line with the large ends of the posts to support a bar about 18 in. above the ends. In use, the free ends of the inner-tube sections are attached to the bar to hold them in a vertical position when filled with treating solution. Peel the bark from the large end of each post for a distance of 4 or 5 in. Cut an ordinary tire tube into 20-in. lengths and double one end of each length back about 2 in. Slip it over the peeled end of the post and bind tightly with a piece of twisted wire. Then rack the posts and tie the free ends of the inner-tube sections to the crossbar.

Chromated zinc chloride is the recommended solution for treating posts by the tire-tube method. This is available ready for mixing with water and complete directions are furnished for preparing the solution. The amount of solution required for each individual post ranges from  $\frac{1}{2}$  to  $\frac{3}{4}$  gal., depending on the diameter and length of the post. A post 3 in. in diameter and 6 ft. long will require about  $\frac{1}{4}$  gal., while a post 6 in. in diameter and the same length will require  $1\frac{1}{4}$  gal. of solution for thorough treatment. Increase or decrease the amounts proportionately for longer or shorter posts, and those of varying diameters. Pour measured amounts of the solution into the open ends of the inner tubes and allow to stand until the preservative drips from the lower end of each post. Impregnation is accomplished by displacement of the moisture and sap present in the wood by the zinc-chloride solution. The pressure exerted by the head of liquid in the tire tube is sufficient to accomplish this in a comparatively short time, which, of course, will vary with the condition, or treatability, of the wood and the dimensions involved. Place a length of gutter under the lower ends of the posts to catch the drippings. In some cases, farmers mix a coloring agent, such as egg dye, with the solution in order to make it easier to determine when penetration is complete.

Photos and certain technical information courtesy University of Illinois and University of Wisconsin

## Checking for Water in Fuel-Oil Drum



If you've been wondering just how much water has collected in a fuel-oil storage drum as a result of condensation and seepage through the vent, you can find out quickly with a piece of red litmus paper and a long stick. The litmus paper, which usually can be purchased in the drugstore, is tacked to the lower end of the stick as in the detail. Then the stick is held vertically and inserted through the bung until it touches the bottom of the drum. Any water in the drum will have settled to the bottom and will turn the litmus paper blue. Thus, the amount of water can be estimated by the depth of the color change in the paper. If the entire piece of paper should change color, use a longer piece and check again. Be sure that there is no sidewise movement when lowering the stick, and hold it against the bottom of the drum momentarily.

Jerome Toomey, Long Beach, Calif.

## Hand-Drill Depth Stop

When drilling blind holes with a hand drill, it is next to impossible to gauge the depth exactly by eye. If you want to be sure that all the holes are just the right depth,

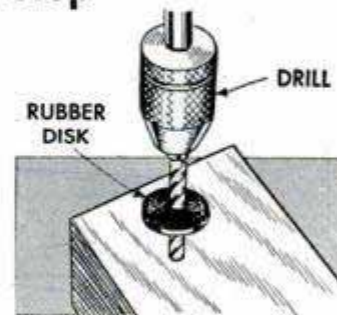

slip a rubber disk over the bit so that the tip projects the desired distance. Stop drilling when the disk contacts the surface of the work. The disk can be cut from  $\frac{1}{16}$  to  $\frac{1}{8}$ -in. sheet rubber and the center of the disk is slit to receive the bit.

Paul Woodruff, Chicago.

## Stepladder Serves as Glazing Easel When Fitted With Folding Arms



If a hook-shaped wooden arm is screwed to each leg of a stepladder, it takes only a moment to transform the ladder into a convenient easel for glazing window sash. The hooks are pulled outward when needed and pushed up along the leg when not in use. Stop blocks along the rear edge of the leg keep the hooks from dropping when the sash is rested on them.

## Silk Hose Tests Sanded Surface

After sanding a wooden surface prior to painting, you can check the smoothness of the surface with an old silk stocking. Slip the stocking over your hand and rub it lightly over the sanded area. If the surface snags the stocking, further sanding is necessary for a smooth finish.

David Deutsch, Brooklyn, N.Y.

## Improved Aquarium Thermometer

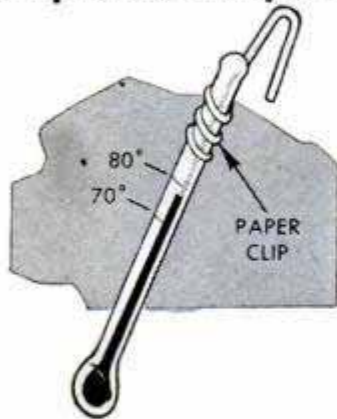

A suitable thermometer for a tropical-fish aquarium can be made in a few minutes from an inexpensive wall-type thermometer. Mark the thermometer tube with dots of black paint to indicate the upper and lower temperature limits to be maintained in the aquarium. Then remove the tube from the backboard and paint a thin stripe around the tube at each dot. After straightening a paper clip, bend one end

in a spiral to fit snugly around the thermometer tube and bend the other end of the wire to hook over the edge of the aquarium. Even though the thermometer is easily read, it is not noticeable enough to mar the appearance of the aquarium.

Willard M. Burton, Miami, Fla.

## Handy Lifter for Thumbtacks Formed From Picture Hook

Changing shelf paper and other jobs that require removing thumbtacks are speeded by using this convenient little tool which is made from a picture hook. Just notch the small end of the hook and file the edge sharp. To use, slip the sharp edge under the head of the tack and pry up by rocking the large end of the hook.



William Swallow, Brooklyn, N. Y.

## Novel Flag Arm on Mailbox Trips When Lid Is Opened

To make sure that the mailbox flag was lowered each time outgoing mail was removed from the box and thus save the mail carrier unnecessary stops, one man devised this novel flag arm which is tripped by opening the lid of the box. The arm consists of a length of rod bent so that it passes through a length of tubing and then down and in front of the mailbox lid, as shown in the drawing. The tubing, which is soldered to the top of the box, provides a pivot for the arm, and the portion of the arm which hooks over the lid of the box is bent slightly less than 90 deg. so that it is forced upward when the box is opened. The long upright portion of the rod is bent somewhat forward to keep the flag from falling before the arm is tripped. The flag is of sheet metal soldered to the top of the arm.

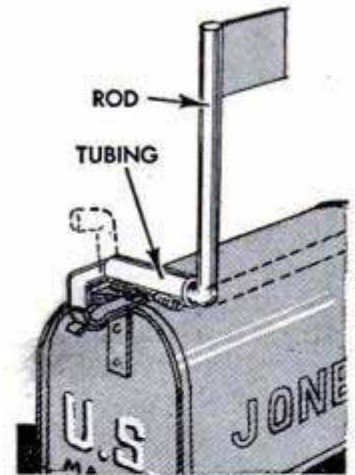

Vincent Serecin, Williamsport, Pa.

Creasing the edges of a necktie too sharply when pressing it can be prevented by cutting cardboard to the desired shape and inserting it between the folds of the tie.

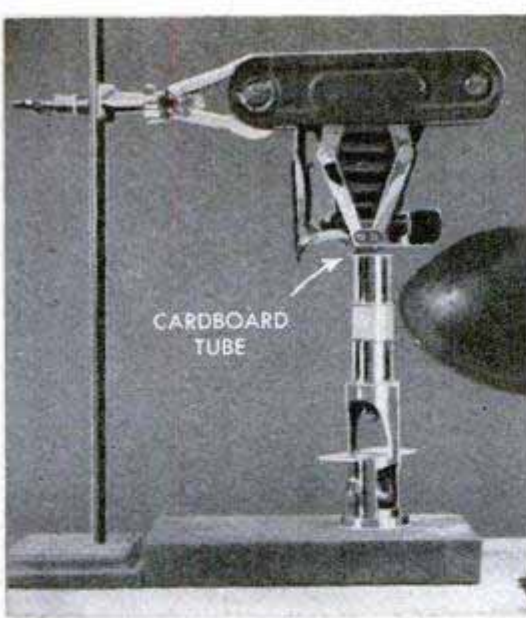

## PHOTOS THROUGH A MICROSCOPE

By Victor Rodwell and Selwyn A. Marks

INTERESTING and informative photos can be made of minute objects by shooting them through a microscope. Any camera will do the trick, even a box camera, and your laboratory can be any convenient table top. Cameras of the bellows type or box type are preferable to the 35-mm. miniature, which would produce negatives so small as to require enlargement. A low-power microscope is best for most subjects, and a desk lamp of the adjustable type shown in the photos above is just the thing for lighting. The camera must be supported rigidly in the vertical position so that it overhangs the eyepiece of the microscope and at the same time is adjustable up and down. A laboratory ring stand like that shown is best, of course, but if this unit is not available, a suitable stand is easily improvised.

After setting up the microscope and focusing it on the subject, hold a sheet of thin white paper over the eyepiece and move it upward until the light disk projected on the paper is reduced to the minimum diameter. The camera lens must be placed at this point and directly above the microscope eyepiece so that the subject will be in sharp focus. Fit a small cardboard tube between the lens and the eyepiece to form a light-tight connection. Test shots for the purpose of correcting any chance errors in focusing or timing can be made on fine-grade printing paper. Remember that the image projected onto the film through the eyepiece is circular. To determine the size of the circular area, remove the back of the camera and substitute a piece of ground glass or wax paper. Then open the shutter and measure the diameter of the circle of light on the ground glass. Make a holder by cutting two pieces of masking paper to fit the ground-glass opening. Cut a square opening in one piece. Sandwich the printing paper between. Place in the camera and close the back to retain the improvised holder. Make several exposures, then develop and check results. Once the setup is proved correct, regular film can be used.

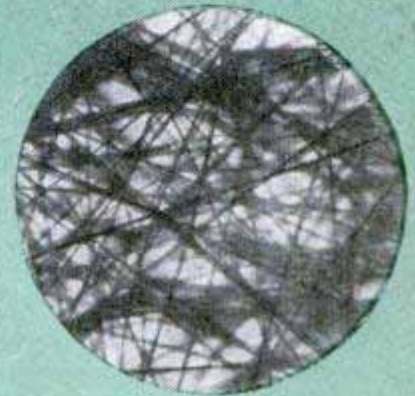

You wouldn't guess it, perhaps, but this is glass cloth, highly magnified



A mountain range, or what? It's part of the letter "K" on an engraving



Fine printing not ordinarily noticed on postage stamps looks like this

## Lamp Stand Fitted With Novel Clamp Supports Reflector Near Floor

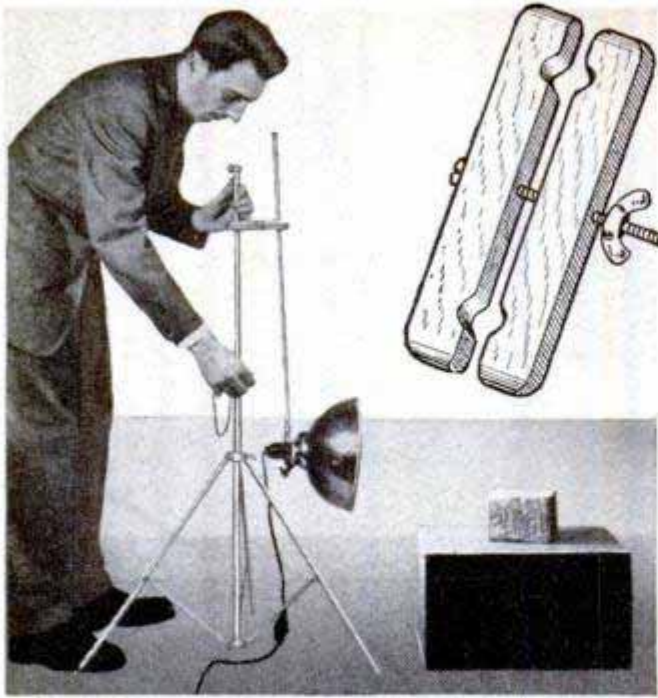

A photoflood reflector mounted on a light stand in the usual manner sometimes cannot be positioned near enough to the floor for desired lighting effects. In this case, use a wooden clamp to permit adjusting the reflector from a height of approximately 2 ft. down to floor level. The clamp is made from two pieces of hardwood notched near both ends to clamp over the light-stand shafts and drilled for a bolt and wing nut. To lower the reflector, remove the upper telescoping rod from the stand, invert the rod and clamp the end to the tripod standard as shown in the photograph.

Frank T. Sokolik, Chicago.

## Handle Steadies Candid Camera

If difficulty in holding a candid camera steady sometimes spoils otherwise perfect shots, try fitting the camera with a wooden handle which can be made at a cost of only a few cents. After

cutting the head from a  $\frac{1}{4}$ -in. stove bolt, insert the threaded portion into a wooden chisel handle, using plastic wood to anchor the bolt in place. Be sure that the bolt is aligned with the handle, and allow the threads to project

about  $\frac{3}{16}$  in. from the top of the handle. To attach the handle to the camera, just turn the bolt threads into the tripod socket.

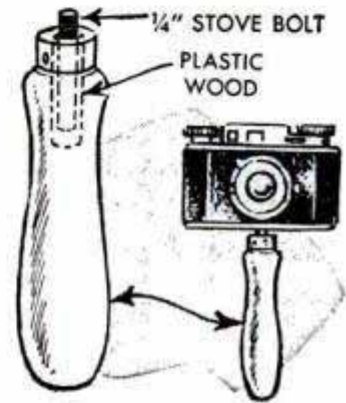

## Inventory Kept on Film-Box Cover

When cut film is purchased in boxes of 25 or 100 sheets, it is easy to forget just how many sheets remain in the box after loading the film holders. To prevent the inconvenience of starting to load the holders and finding that there are only two or three sheets of film left in the box, keep an inventory on the



box cover by marking down the number of sheets remaining each time a portion of the film supply is removed from the box.

## Light Trap for Darkroom Window Permits Passage of Air

One of the major problems confronting the amateur photographer who sets up a basement darkroom is how to ventilate the room and still keep it lightproof. An easy way to do this is to build a light trap, like the one shown, that will fit an open window or an opening cut in an inside wall or door. The trap consists of two baffle sections held apart by wooden side members. The baffles are staggered so that light will not pass through them even though they are separated sufficiently to allow passage of air. Plywood, hardboard or cardboard can be used for the baffles which should be painted flat black to prevent any light reflection. If possible, mount one light trap near the floor of the darkroom and another near the ceiling. This will provide excellent ventilation, especially if a fan is used to help circulate the air.

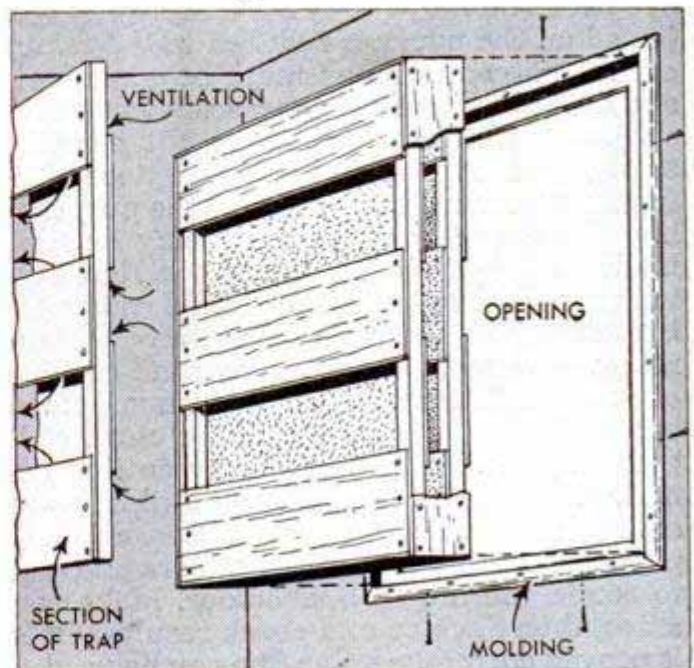

# ADAPT YOUR CAMERA

## to copy work

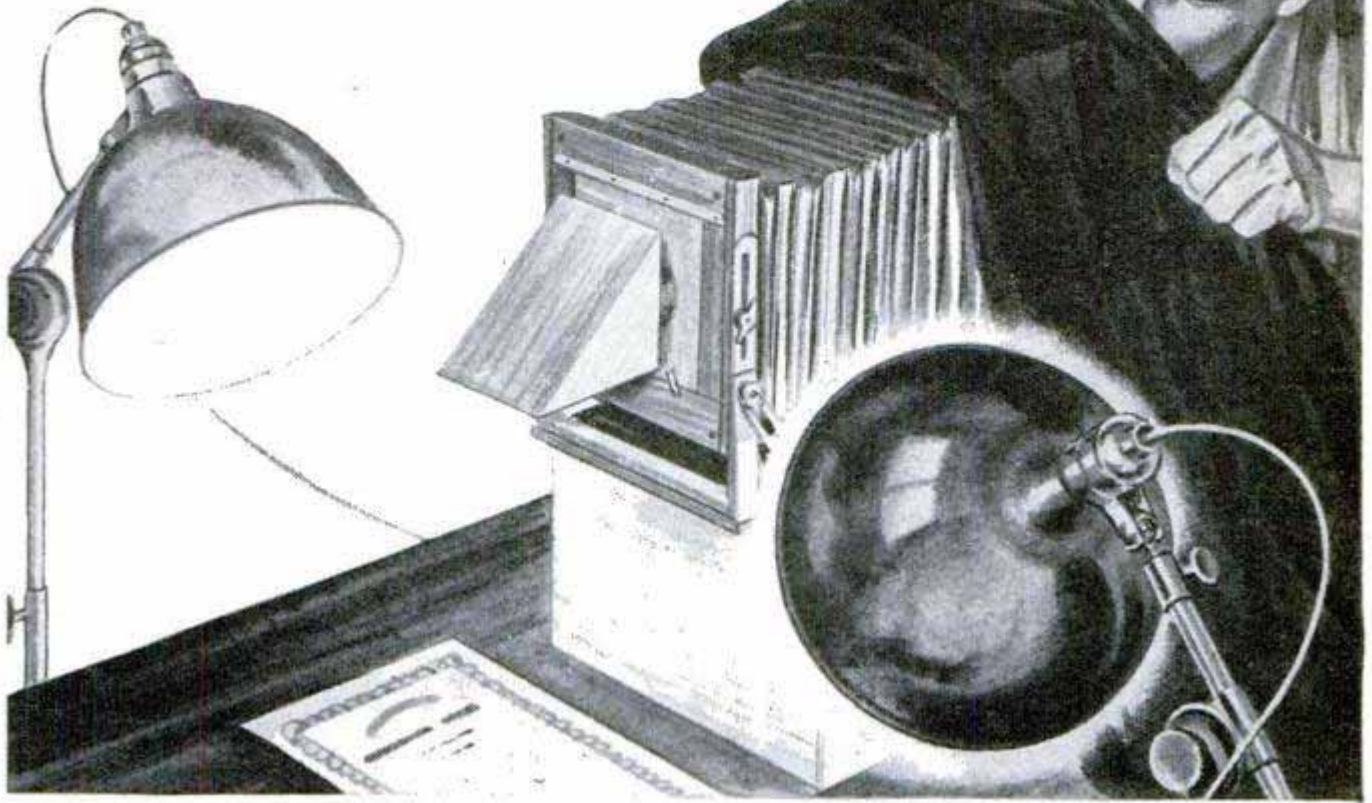

By Roland Wolfe

BY FITTING the lens of your camera with what is known to the trade as a "first surface" mirror you can make photocopies—'stats for short—of such original subjects as manuscript pages, letters, business and legal forms, line drawings and any similar printed matter. The purpose of the mirror is to reverse the image of the subject before it is recorded on the sensitized copy paper so that the 'stat reads correctly from left to right. The process simply reverses the black-and-white tone values of the original, making the print appear like a negative, as you can see from the several examples shown at the bottom of the following page.

An ordinary mirror, silvered on the back, cannot be used, as it produces double images and considerable distortion. The first-surface mirror is silvered on the face, or front, of the glass and serves the same purpose in photocopy work as a prism. The mirror is held in front of the lens at a 45-deg. angle by means of a special holder made as detailed at the right. Reflected light from the subject is deflected by the mirror into the camera lens at an angle of 90 deg. For this reason, the copy must be placed in a plane at right angles to the camera lens, either on a table top directly

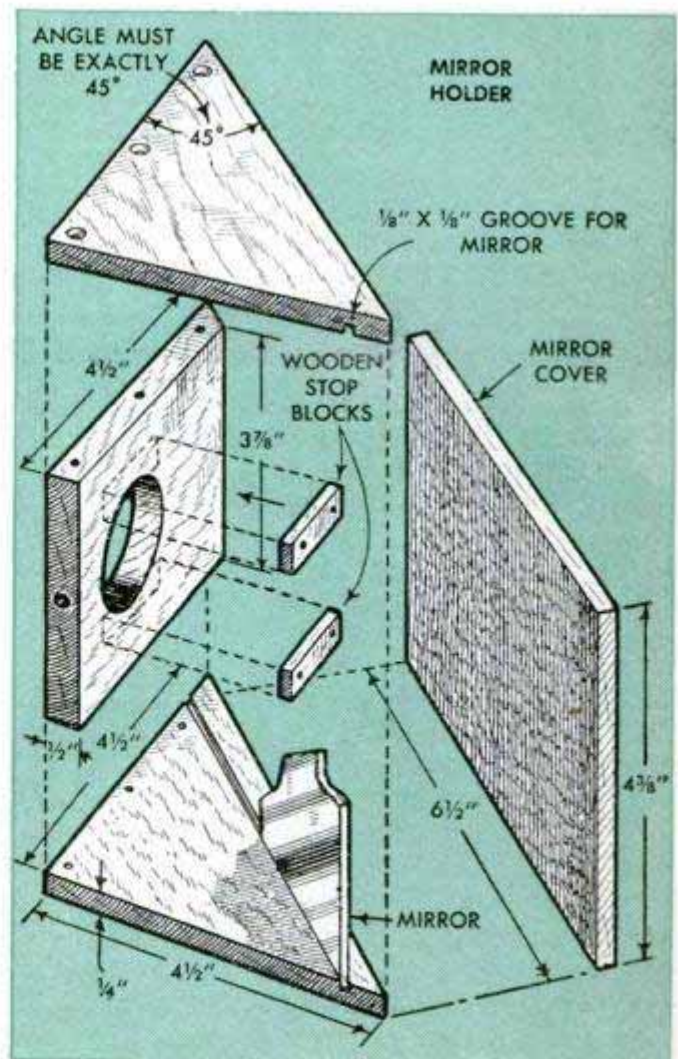

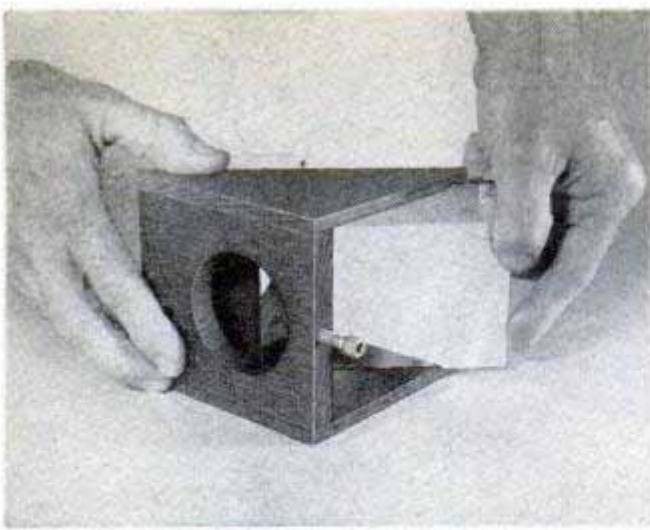

The mirror holder completed with the mirror being inserted in the grooves cut into the sides. Thin felt is glued to the edges of the lens opening to prevent marring lens barrel. Note locking thumbscrew

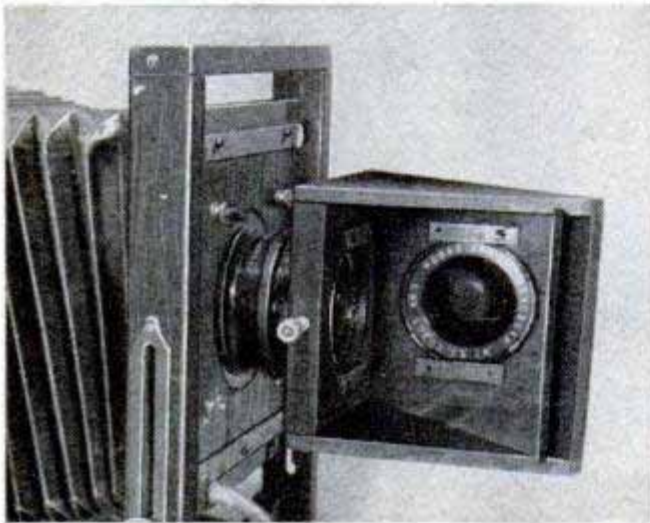

Above, holder in position on lens. Here it is turned for photographing subject on an easel. Below, samples of negative prints produced by the one-step process. First and third from the left are originals

below the camera or on an easel at one side. Although most cameras taking the larger film sizes will serve the purpose, a view camera is best, as this type permits making all focusing adjustments from the back, thus making it unnecessary to move the copy in or out as the lens board and bellows are moved.

The mirror holder, detailed on the preceding page and pictured at the left, can be made either of hardwood or plywood. Care must be taken in its construction and assembly, as it is important that the mirror be supported at an angle of exactly 45 deg. with the axis of the lens. As dimensioned, the holder takes a mirror measuring 4 x 5 in. Before boring the hole for the lens, measure the lens barrel and make allowance for a thin strip of felt to be glued to the edges of the hole after boring. This will protect the lens barrel from scratches. It is necessary that the opening be of the correct size so that it fits the lens barrel tightly after the felt has been glued in place. Note that a locking screw is pictured at the left. Although not essential, this can be added if desired. Use an ordinary thumbscrew and simply bore an undersized hole in the wood so that when the screw is turned into the hole it will cut its own threads. Glue a disk of felt to the end of the screw so that it does not mar the lens when tightened. Finish the inside of the holder with a flat-black paint of the type supplied for photographic equipment.

Although a rigid tripod of the adjustable type can be used for certain types of work, it is seldom satisfactory for general use owing to the 90-deg. angle of light travel from the subject to the camera lens. For occasional copy work it will suffice to place



the camera on a box and then raise it to the required position by blocking up either the camera or the box. It is necessary that both the camera and the table top be leveled in two directions as otherwise it is difficult to bring all parts of the flat copy into sharp focus without some distortion. On the other hand, if you plan to do considerable copy work, it will pay to make the simple copying stand pictured at the right. Here the camera is located in a stationary position at right angles to an easel, which is movable along an improvised track. Both methods have certain advantages and the individual must decide which best suits his purpose.

Where only a limited number of photocopies are made at a time, ordinary cut-film holders may be used for holding the special copy paper. Otherwise, it is best to purchase or build a special camera back to accommodate copy paper in rolls. It should be remembered that one-step copy work eliminates the usual method of negative-positive printing and gives you a reverse print which is suitable for record files at a very low cost per print, as elimination of the film negative cuts both cost and time. If you wish to go one step further, it is possible to rephotograph the negative print and produce a positive print. Since photocopy paper is available with

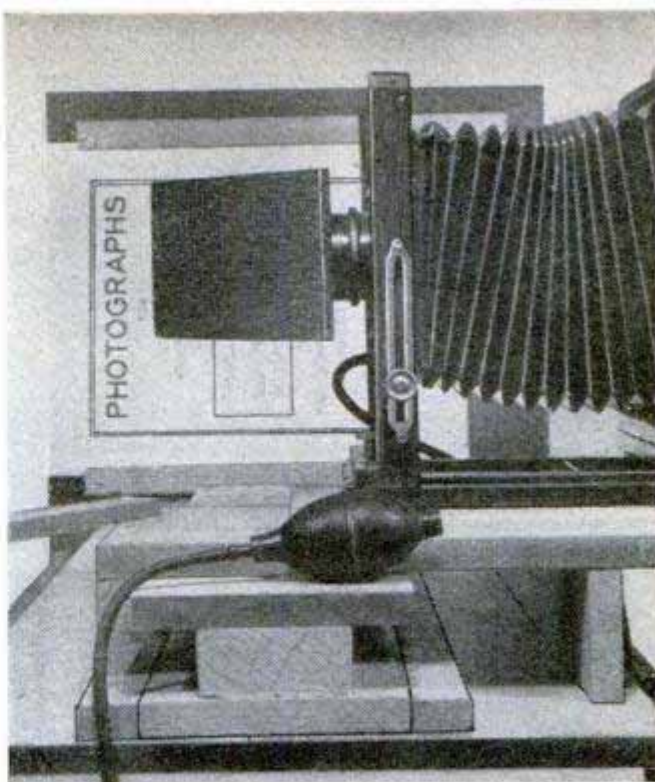

Here the subject is mounted on a movable easel with the camera placed at right angles to the easel track

both orthochromatic and panchromatic emulsions, the tonal values of the original copy can be reproduced as faithfully as they are with film negatives simply by rephotographing the negative print.

## Wooden "Safe" for Photo Paper Has Self-Closing Door

There's no need to worry about accidentally exposing your supply of photo paper when the darkroom light is turned on or the door is opened if the paper is stored in this lightproof paper safe. Although the paper is kept right at your finger tips, it is always protected from light, as the front of the cabinet is fitted with a spring-hinged door which closes tightly after each sheet has been removed. The door swings up-

ward and out of the way when the hand is inserted. A turn button installed directly beneath the door provides a safety lock to keep the door from being opened accidentally. If made to the dimensions given, the cabinet is suitable for sheets up to 4 x 5 in. but, of course, it can be made considerably larger if desired. The cabinet itself is of simple box construction, the parts being carefully fitted and joined with glue and nails so that the cabinet is absolutely lightproof. The slotted panel which contains the spring-hinged door is rabbeted on two sides to fit snugly into the front of the cabinet, and the sheet-metal doorframe is screwed to the inside of the front panel so that it is centered over the 3 x 6-in. slot. A two-piece door, carefully cut to fit the stepped edges of the frame, is riveted together and the rivets are filed flush on both sides. After the door has been riveted to one leaf of the spring hinge, the other leaf is fastened to the doorframe over the center of the opening. The spring on the hinge should be just strong enough to close the door tightly when the hand is removed from the opening. Punch or file a reference mark on the safety-lock knob to indicate when the door is locked.

James W. Thetford, Philadelphia, Pa.

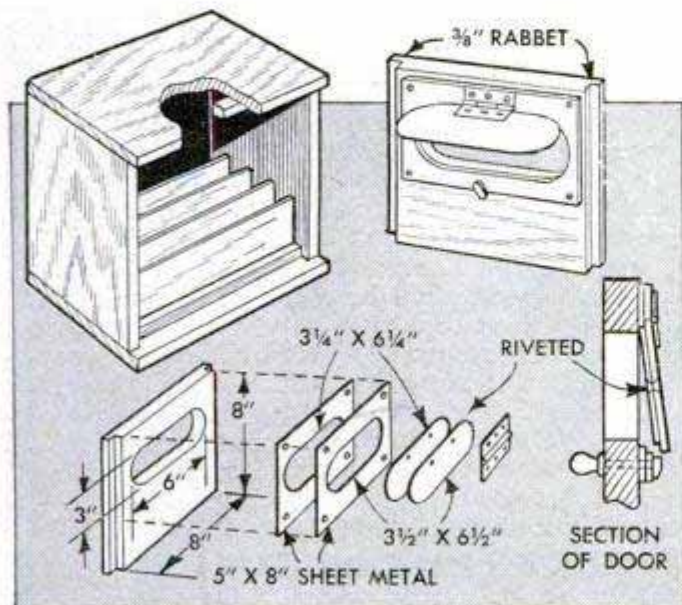

## Switch Added to Movie Projector Prolongs Life of Lamp

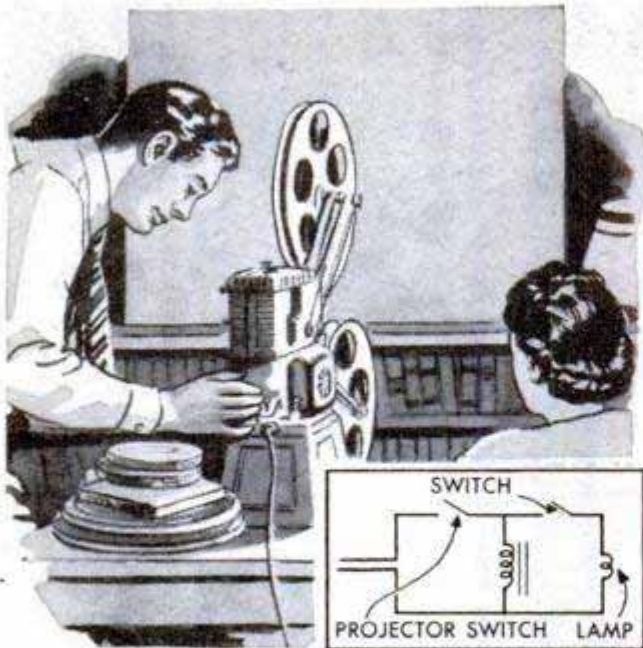

If your movie projector is equipped with only one switch which turns on motor, blower and lamp, you can obtain longer life from the lamp by fitting the projector with an independent switch for turning off the lamp while rewinding the film. Simply wire a toggle switch into the lamp circuit as shown in the diagram, and drill a hole through the projector base to permit mounting the switch at a convenient spot,

preferably directly above or below the present switch. After installing the lamp switch, check the circuit to be sure that the blower operates when the lamp is turned on.—J. T. Gataldo, Brooklyn, N. Y.

## Adhesive Labels for Transparencies

Adhesive labels of the type which require no moistening are just the thing for identifying color transparencies. The labels adhere readily to the acetate sleeves or cardboard mounts of the transparencies and yet can be removed without leaving marks. These labels are obtainable in most stationery stores and may be purchased in convenient roll form for use with a typewriter.



## Tape Guards Box-Camera Shutter

When the film in a box camera has been only partially used and you wish to save the rest of the roll until a later date, use a piece of cellulose tape to prevent accidental tripping of the shutter. Place the tape over the trigger slot so the trigger cannot be moved and simply remove the tape when you again want to use the camera.—Jackson Pratt, San Jose, Calif.

## Books That Every Home Craftsman Needs

With the arrival of cool autumn days, every home craftsman and would-be craftsman is thinking about getting his workshop ready for the winter when he plans to do all the work that he put off last summer. Also, it's time to think of that near teen-age son in your family. There is no better way to keep him busy and teach him to concentrate and be neat and careful in all of his work than to start him out in his own home workshop. Besides, he can pick up some spending money by making and selling items to his friends. Training obtained in this kind of work will be invaluable to him in later years when he goes out into the world on his own.

*Popular Mechanics* book "POWER TOOLS AND HOW TO USE THEM" by W. Clyde Lammey, who is a recognized authority on the use of small power tools, will be invaluable to any craftsman, young or old. It covers workshop layout, workbenches and tool storage as well as basic woodworking joints, moldings, mitered work, jointing, turning and drilling in addition to sanding, shaping and mortising. You will find also various woodworking projects that tie in the use of power tools in construction.

Metalworking is covered, too. Here you

will find the fundamentals of lathe work, measuring with rules, calipers and micrometers, grind finishes, milling, etc. Also included is information on how to run milling cuts, cut threads and operate a drill press. Publication date, Oct. 15; price \$2.50.

*Popular Mechanics* book entitled "100 BEAUTIFUL PIECES OF FURNITURE YOU CAN BUILD" will solve the problem of every craftsman who wants to make furniture of which he and his family can be proud. The book shows furniture for every room in your home, either as occasional pieces or in complete suites, such as a living-room suite, a dining-room suite or a suite for a bedroom. In fact, an owner of a new home can furnish it completely with furniture described in this book, in either modern or period style. Every piece is pictured and completely detailed in addition to having a thorough text that tells how to build it step by step. There are 48 pages in full color that enable you to view the furniture in its natural beauty. Most of the suites were designed exclusively for *Popular Mechanics* by John Bergen who styled them to be made easily with tools owned by the average home craftsman. Publication date, Oct. 15; price \$3.00.

Both books are available from *Popular Mechanics* Book Dept., 200 E. Ontario St., Chicago 11





# Shop Notes



## MOWER-SNOWPLOW ALL IN ONE

NOT LIKE most lawn mowers that go into retirement during winter, this double-duty machine earns its keep the year 'round. Featuring two intersecting rotary blades, it serves as an efficient power mower in summer, and a scoop attachment converts it in winter to an excellent rotary snowplow. Powered by a 1½-hp. Briggs and Stratton gasoline engine, the machine

is self-propelled by a chain-belted drum. Power transmission to the mower and the snowplow is provided by a V-belt drive.

Designed and built by L. O. Hansen of Waterloo, Iowa, the original mower pictured above was assembled from odd parts, welded together. The cutaway drawing, Fig. 2, gives a general idea of the arrangement of the V-belt drive, and also shows how

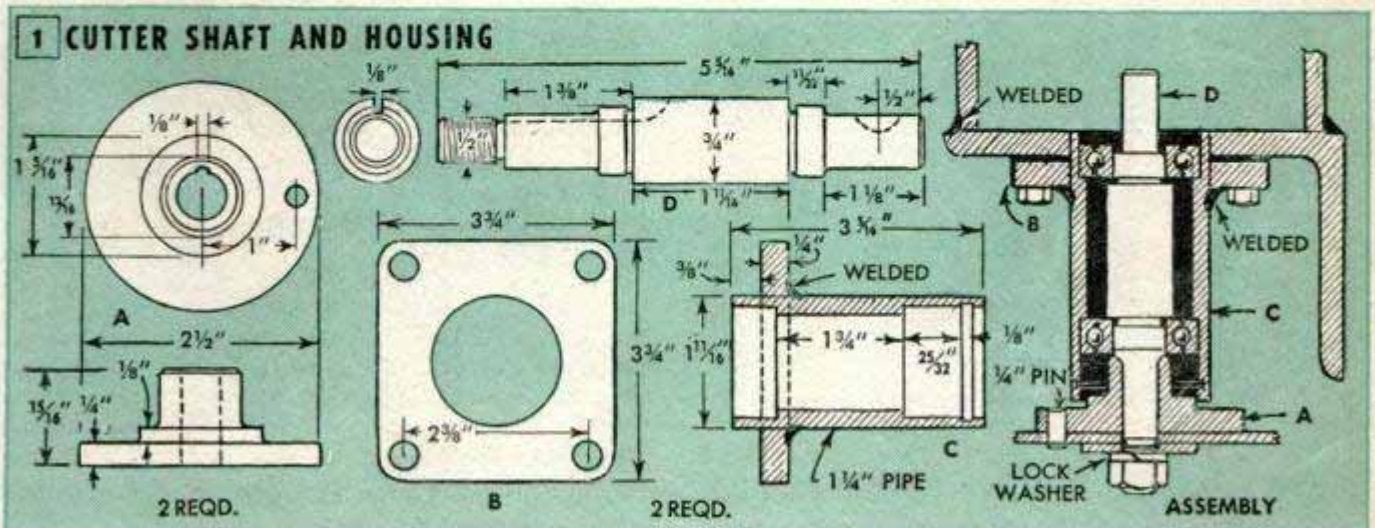

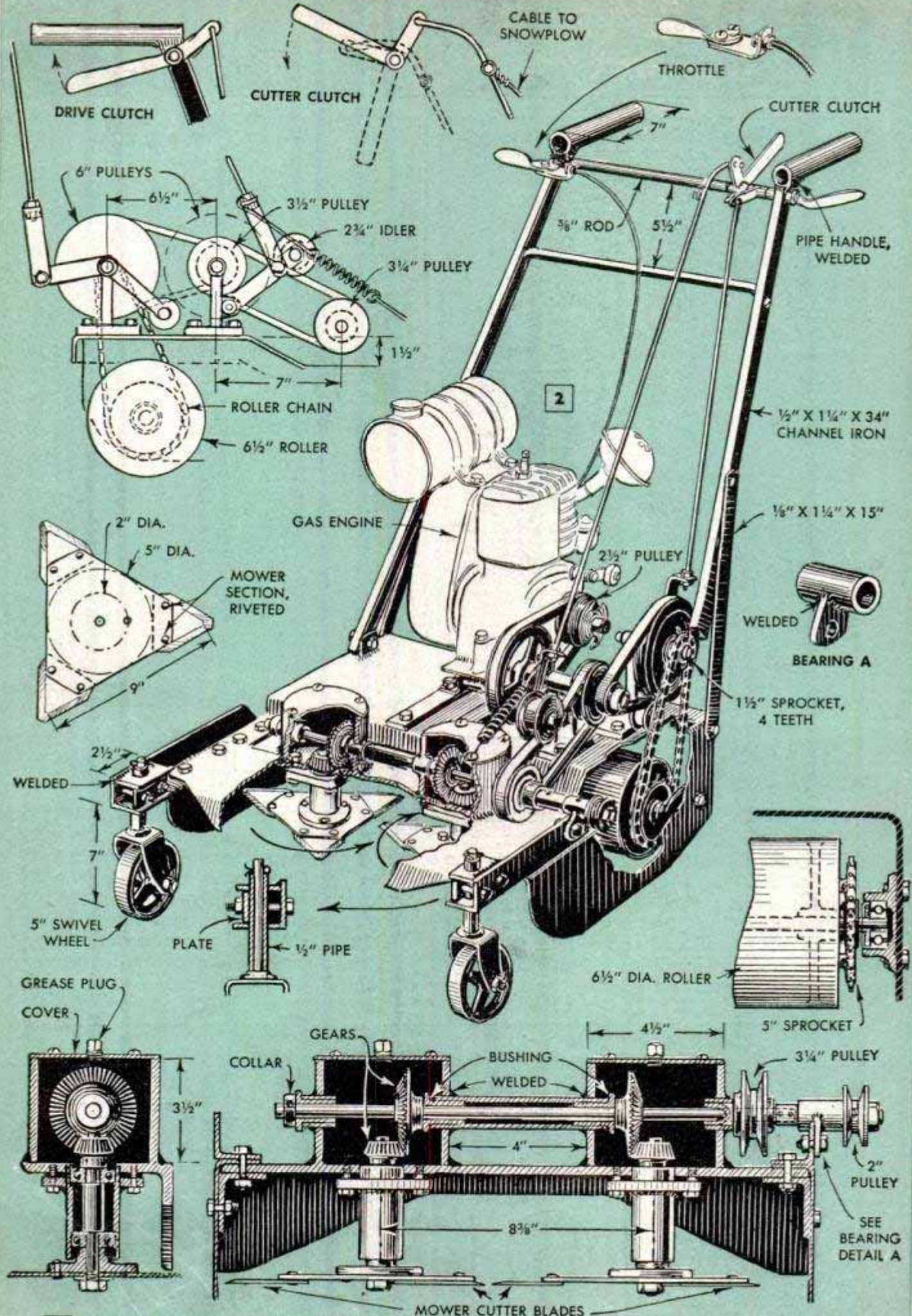

**3** SECTION THROUGH GEAR HOUSING

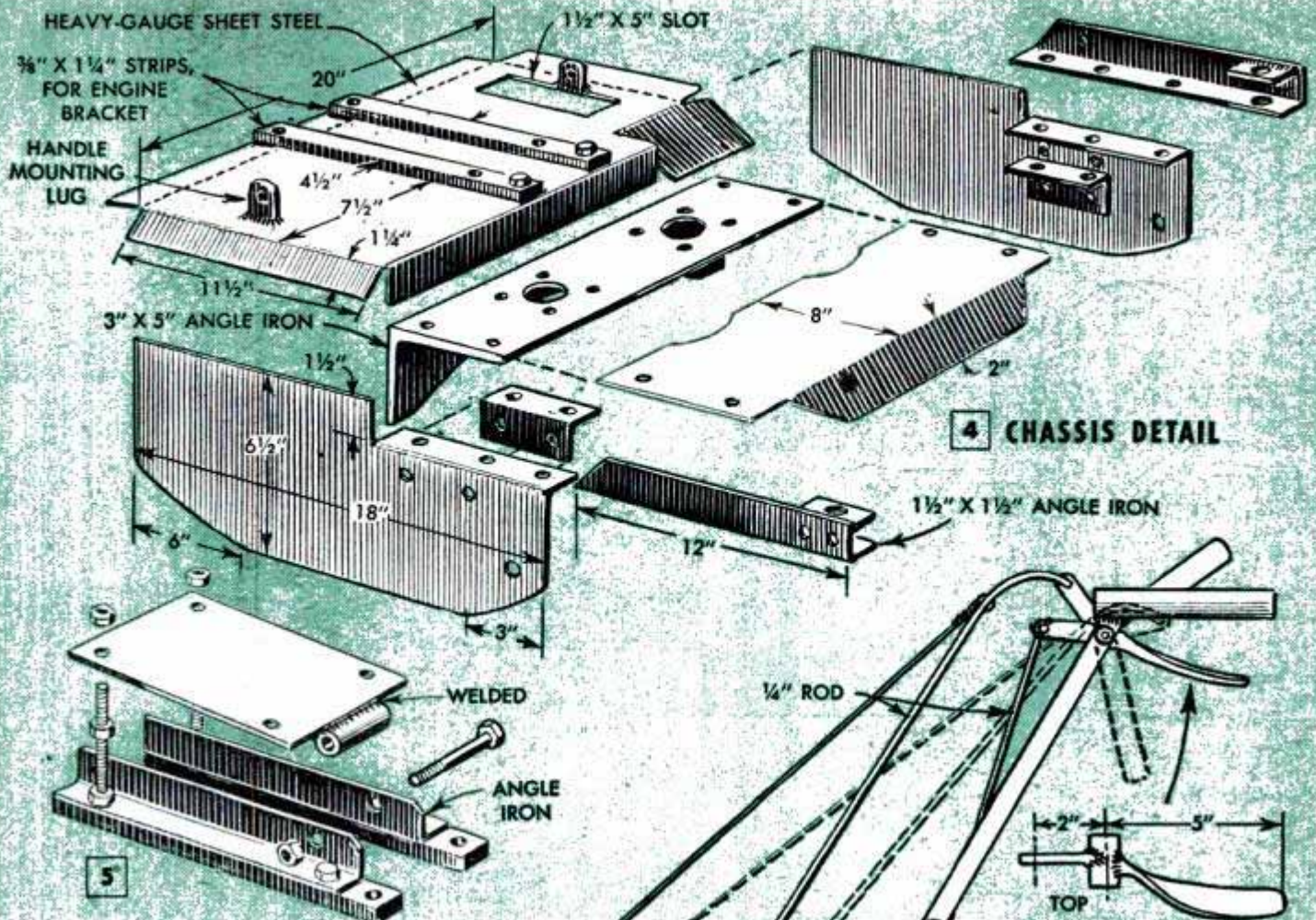

**4 CHASSIS DETAIL**

**5 ENGINE-MOUNTING BRACKET**

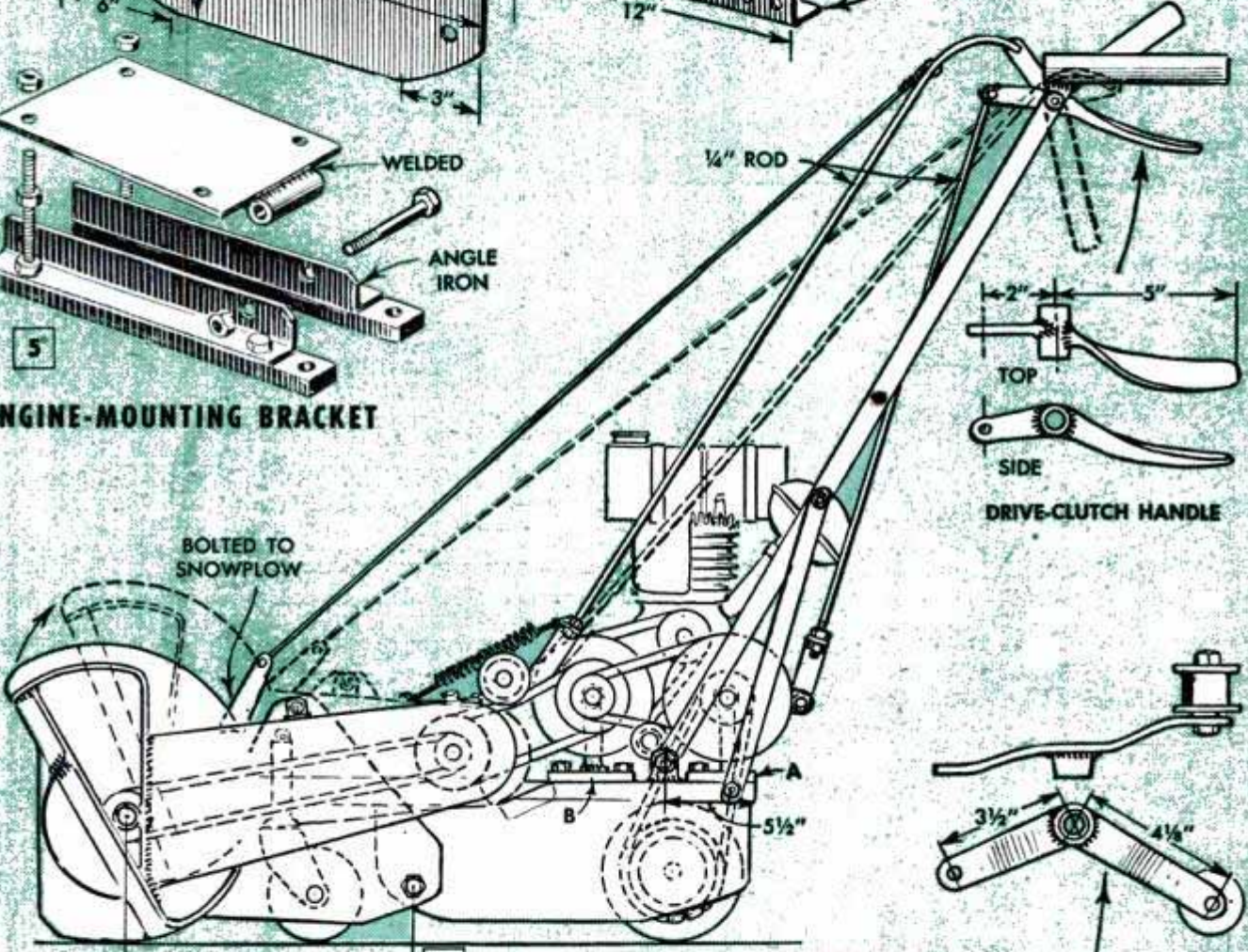

**6 SIDE VIEW (SNOWPLOW ATTACHED)**

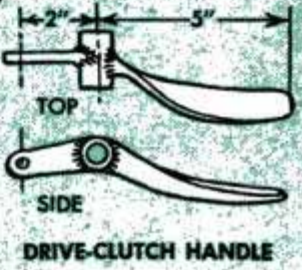

**TOP**  
**SIDE**  
**DRIVE-CLUTCH HANDLE**

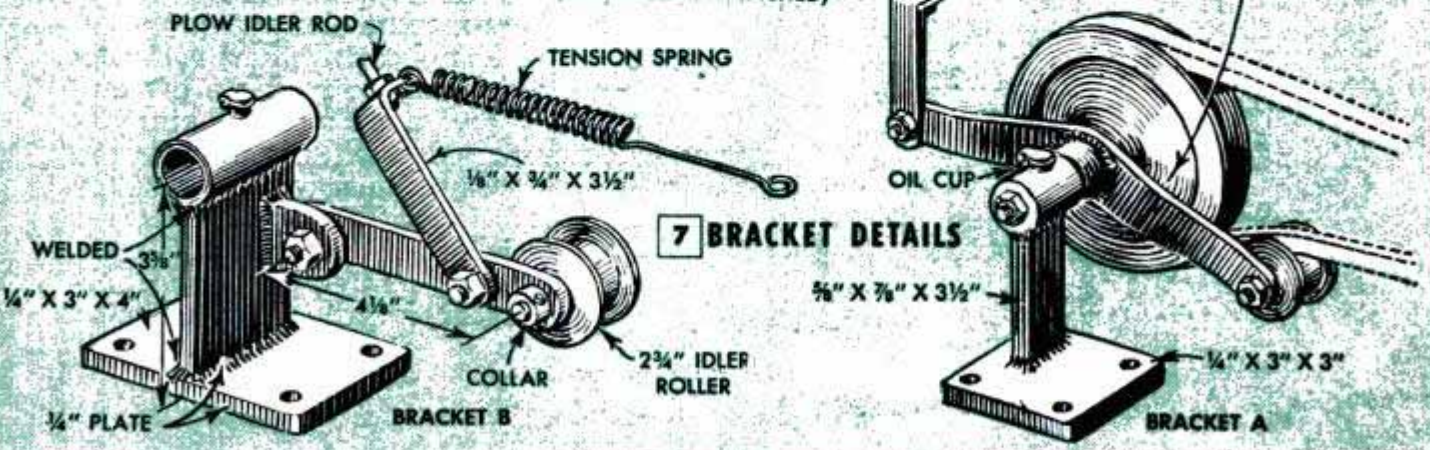

**7 BRACKET DETAILS**

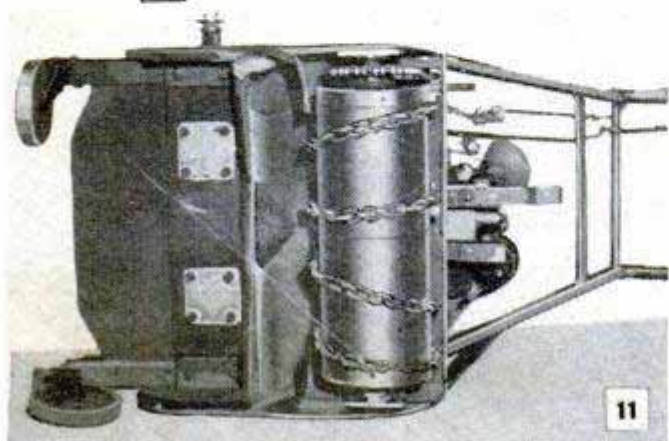
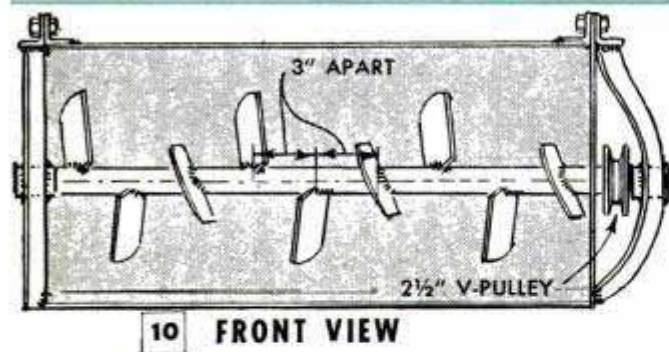
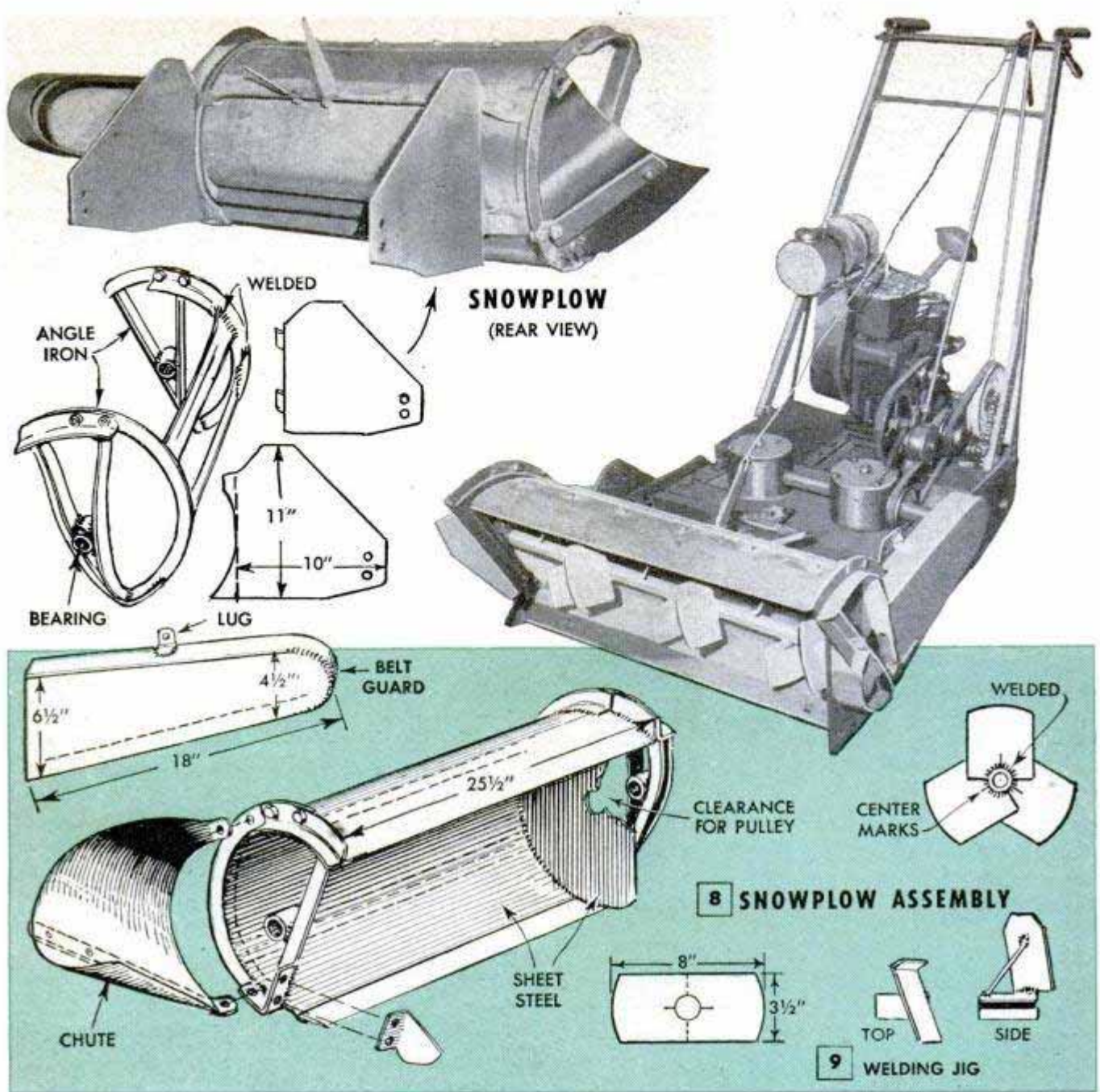

bevel gears are used to spin the twin mower blades. The original machine used an old golf-green roller to provide the driving drum that propels the mower. If such a roller cannot be obtained, you can substitute several wide flat-belt pulleys for this part. A 5-in., 15-tooth sprocket is welded to one end of the drum and the axle is housed at each end in ball bearings held in special castings machined for a press fit. Sleeves which form bearings for the swivel casters are adjustable to regulate the cut.

A study of Figs. 1 and 3 will acquaint you with the parts needed and assembly of the twin pipe sleeves that carry the shafts for the blades. Notice in Fig. 3 that each set of bevel gears is installed in a circular gear-box. The latter are fitted with bushings and coupled together with a length of pipe through which a  $\frac{5}{8}$ -in. drive shaft is inserted. The outboard end of the shaft carries a 2-in. pulley which operates the snowplow. Each vertical shaft unit, Fig. 1, is

held in place with four, short cap screws, thus permitting both units to be removed temporarily when the mower is changed over to a snowplow. Two ball bearings seated in the ends of each unit result in a free-running shaft. The matched bevel gears provide a 3-to-1 speed ratio, a 16 pitch, 3-in. P.D., 48-tooth gear being used on the drive shaft and a 1-in., 16-tooth pinion being keyed to the blade shaft.

The side-view drawing in Fig. 6 shows where pulley brackets A and B are mounted, and also illustrates, as indicated by the dotted lines, how the snowplow attachment is automatically raised when power to the snowplow is cut off. Traction, as well as power to the mower blades and snowplow, is controlled by slippage of the V-belt drive. As shown in the construction details in Fig. 7, idler pulleys are used to take up slack in the belts. Assembly of the chassis, Fig. 4, centers around a heavy piece of angle iron which forms the backbone to which the rest of the parts are welded and bolted. The pipe gearboxes for the bevel gears are tack-welded to this angle iron and holes are drilled and tapped in it for attaching the blade-shaft assemblies. The two triangular mower blades consist of 1/8-in.-thick steel plates equipped with three razor-sharp mower sections riveted to the ends. Besides being accurately centered and drilled for mounting, each blade is drilled for a 1/4-in. locking pin which engages a corresponding hole in the backing plate, part A, Fig. 1. Fig. 5 details the engine mounting bracket.

The snowplow attachment, Fig. 8, is pivoted to the side of the chassis (see Fig. 6) and is fitted with a belt guard. A wire cable, which is connected to the cutter clutch rod, is attached to an upright arm fastened to the snowplow and permits raising the latter to clear obstructions. The plow features a screw impeller which throws the snow to one side through a chute. The screw consists of nine vanes of 1/8-in. sheet steel welded to a 1-in. shaft which is machined down at the ends to rotate freely in bushings welded to the ends of the scoop. The vanes are spaced 3 in. apart, Fig. 10, and are welded equidistantly around the shaft as indicated in the detail above Fig. 8. The vanes are welded in place at a 30-deg. pitch and are held at the correct angle by means of a special jig, Fig. 9. The jig consists of a split sleeve tack-welded to a sheet-metal plate. In use, the sleeve fits over the shaft and is moved along it to the point of weld. A vane is simply leaned against the plate which supports it at the proper angle while it is being welded. Fig. 11 shows the mower blades removed and a chain wrapped around the drum to provide traction on ice.

## Slat Sides of Turkey Feeder Adjusted to Suit Birds

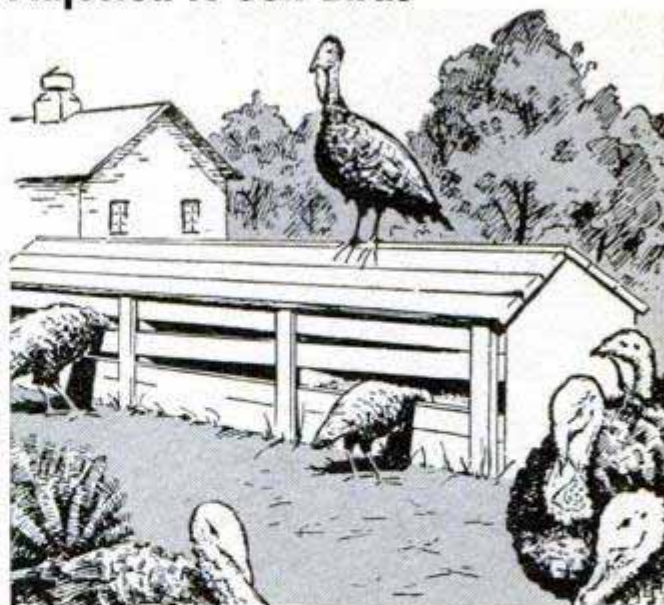

Varying the position of the slat sides on this turkey feeder permits the height of the feeder to be increased as the birds grow. When the turkeys are small and first put on the range, the slats are lightly nailed near the top so the birds have easy access to the feed. When the turkeys become larger, the slats are lowered, thus raising the height of the opening and increasing the capacity of the feeder. The drawing shows a slat nailed in place diagonally to illustrate both upper and lower positions.

## Puller for Flywheel Bearing Improved From Bolts

When it is necessary to remove a flywheel pilot bearing and a puller is not to be had, one can be improvised in a few minutes from two long bolts and an iron bar. The bolts should be of a size which permits the head of one and

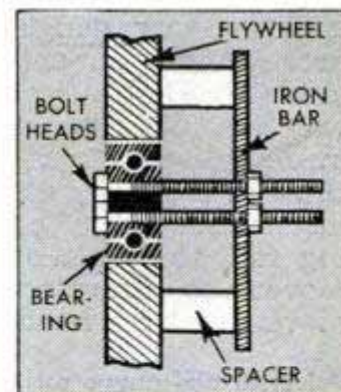

the shaft of the other to be passed through the hole in the bearing simultaneously. However, the heads must be large enough so that both of them will not pass through the hole at the same time. After both bolts have been pushed through the bearing, the bolt heads are positioned side by side to engage the edge of the bearing hole. Then the iron bar, which has been drilled for both bolts, is slipped over the threads and a nut is turned on each bolt. A spacer is placed under each end of the bar and the nuts are gradually tightened to pull the bearing from its seat.



# PRECISION With Verniers

brated dial. The movement of the hand is easily read in thousandths or in ten-thousandths of an inch. In this respect, dial gauges differ from all other types of measuring instruments covered in Parts I and II.

Some gauge dials made for specialized work, such as comparative inspection, are fitted with tolerance hands which may be set to indicate plus and minus limits in thousandths or tenths. On other special types designed for a spindle travel up to 1 in., the dial is fitted with a short telltale hand which registers the number of revolutions of the master hand when the spindle is moved. Gauge dials also are regularly calibrated for continuous readings from 0 to 10, 0 to 50, etc., and for balanced, or plus-and-minus readings such as 0-5-0, 0-25-0 and so on, depending on the requirements of the job in hand.

Figs. 28 to 34 inclusive show various applications of the universal type of dial gauge, the complete gauge set being shown in Fig. 32. The set is furnished with contact points A, B and C, Fig. 32, a hole attachment, clamp and tool-post holder. The clamp, tool-post holder and hole attachment permit the instrument to be used on large lathes and planers, milling machines of the vertical and horizontal type and also for certain setup work on shapers. A helpful feature of this particular type of gauge is the adjustable dial. By simply turning the knurled rim, the dial may be moved to bring the zero mark to any point desired in relation to the hand. Usually the circumference of the dial is divided into 100 equal divisions, each representing a movement of the contact point .001 in. One complete revolution of the hand adds up to .1 in. on this particular type of dial. Fig. 28 pictures

## Part III

*By W. Clyde Lamme*

**D**IAL INDICATORS, or dial gauges as they are often called, are widely used in industry for checking the accuracy of machine-tool setups and sizes of parts, in the inspection of duplicate parts and in various other gauging operations where precise measurements must be made consistently. Dial gauges look something like watches and the best-grade instruments are made with watchlike precision. Basically, the dial unit consists of a rack-and-pinion mechanism connected to a gear train having ratios capable of translating a slight movement of a spindle to a much greater movement of a hand swinging on a cali-

Universal dial gauge set up for direct contact with the work when checking accuracy of facing cut

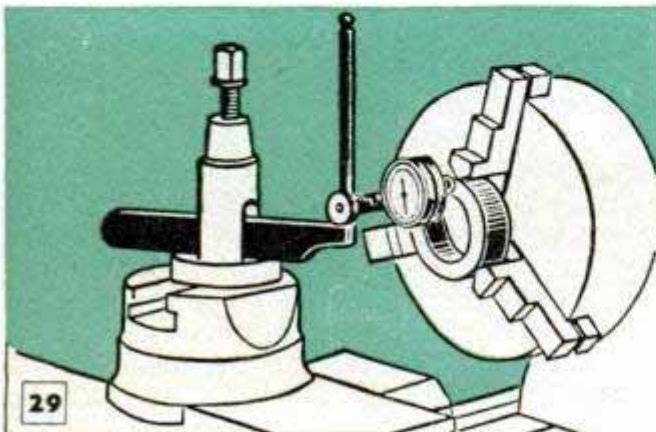

When checking the accuracy of bores, the hole attachment is used. Contact is made through a pivoted arm

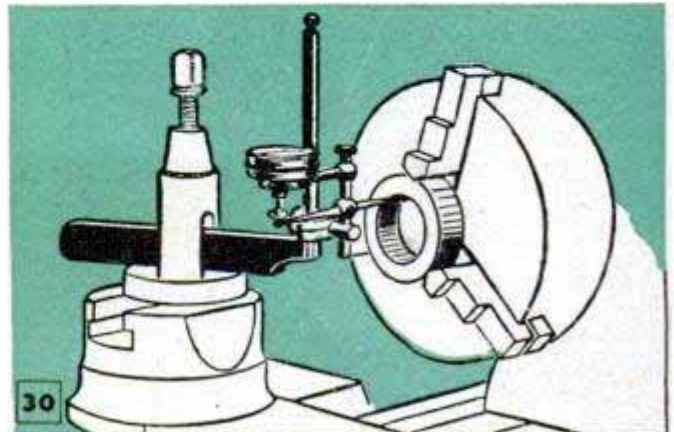

# MEASURING and Dial Gauges

the universal indicator being used to check the runout of a lathe chuck before setting up a small job on which the machine work will be quite exacting. Fig. 29 shows the same instrument set up to check on the accuracy of a facing cut. In Figs. 30 and 33 the instrument is assembled with the hole attachment, Fig. 32. The arm, having two ball-shaped ends, is pivoted below the dial in such a position that one ball end bears on the contact point of the dial spindle when the other end of the pivoted arm contacts the inside of the bore in the work. After the parts are placed in contact and the dial is adjusted to the zero reading, the lathe is turned slowly by hand. Any slight errors in the bore diameter will register on the dial. Setting the ball end of the actuating arm at the outer edge of the bore and running the lathe carriage slowly forward will enable the machinist to detect errors in the bore in the axial plane. In Fig. 33 the hole attachment is used to reach over the blocking on the faceplate, as here it would not be possible to use the dial alone as in Figs. 28 and 29. Figs. 31 and 34 show how the dial is mounted with the special clamp on machine parts for making critical accuracy checks. The inside of the clamp frame is machined to a right angle and the jaw is "veed" so that it may be attached to parts of almost any size or shape within its capacity. Note that when the unit is assembled as in Fig. 32 the movement of the dial is universal. It can be placed in practically any position that the nature of the work requires. When locating the dial to take an important reading, be sure that all binding screws are tightened before running the test. It should be kept in mind that Fig. 32 pictures only one of

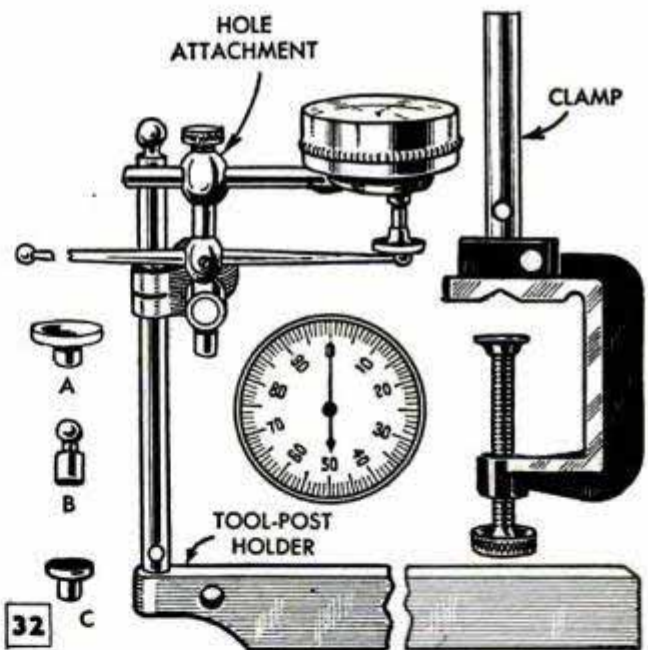

Here the hole attachment gives clearance over faceplate lugs or blocks. The lathe is turned by hand

In this setup, the dial is attached to the special clamp for checking the alignment of machine parts

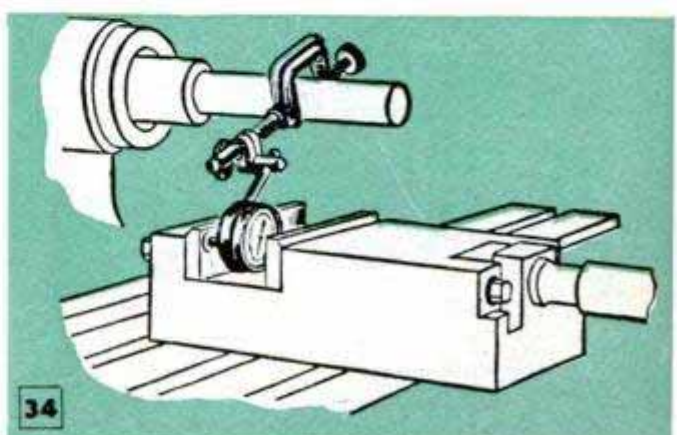
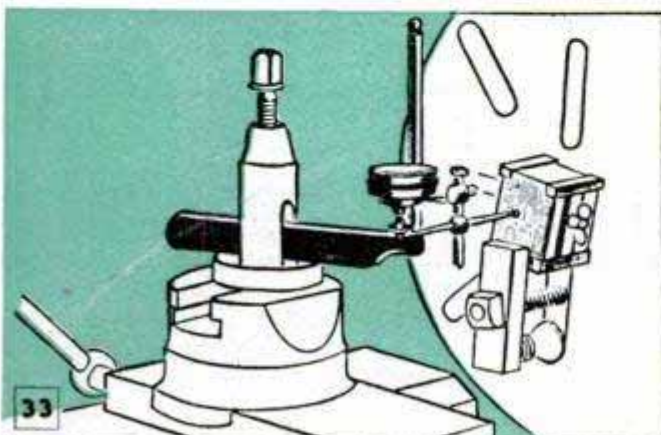

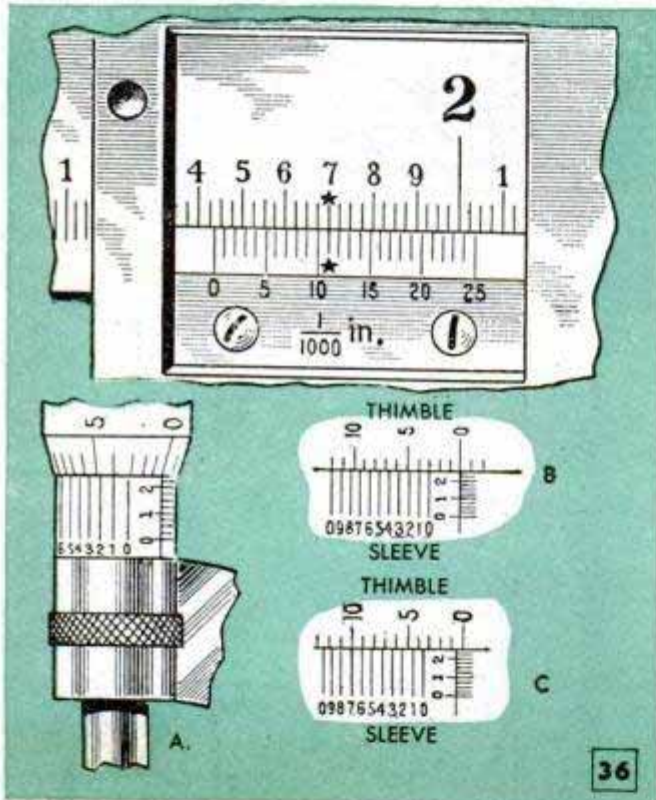
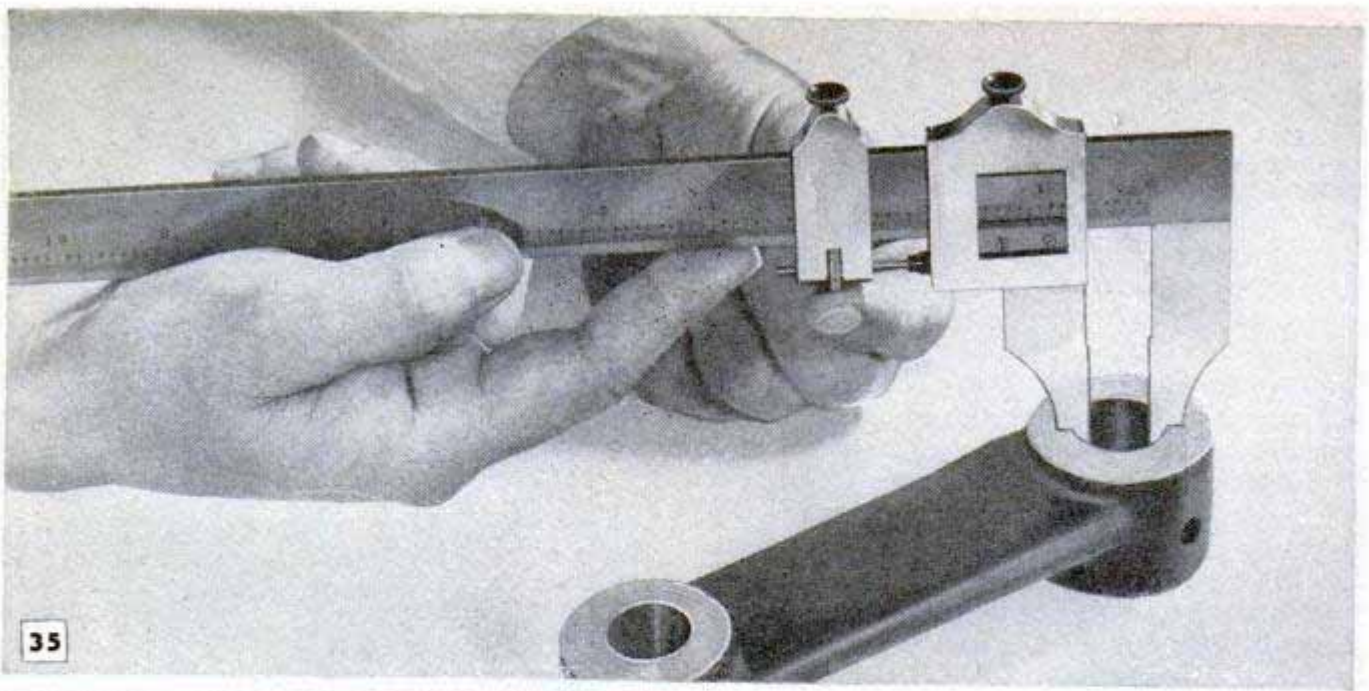

the many types of fixtures in which dial gauges are used.

The inside-outside vernier, or vernier caliper, and also the vernier height gauge, are units which, in effect, are simply combinations of steel rules that permit exceedingly accurate measurements. The vernier caliper, Figs. 35 and 37, consists of a graduated steel rule, generally called the bar, on one end of which is a fixed jaw, or contact point. A movable jaw sliding on the bar and controlled by a slow-motion screw, which may be locked at any point along the length of the bar, carries a graduated rule, or plate, arranged so that it may be compared with the fixed scale on the bar. The fixed scale is graduated in fortieths of an inch (.025) and every fourth division representing one tenth of an inch is numbered, Fig. 37 and the upper detail in Fig. 36. The plate (vernier) is graduated into 25 divisions and the space, or total span, of the 25 divisions is equal to 24 divisions on the fixed scale. Thus, each graduated space on the plate is one twenty-fifth of one fortieth

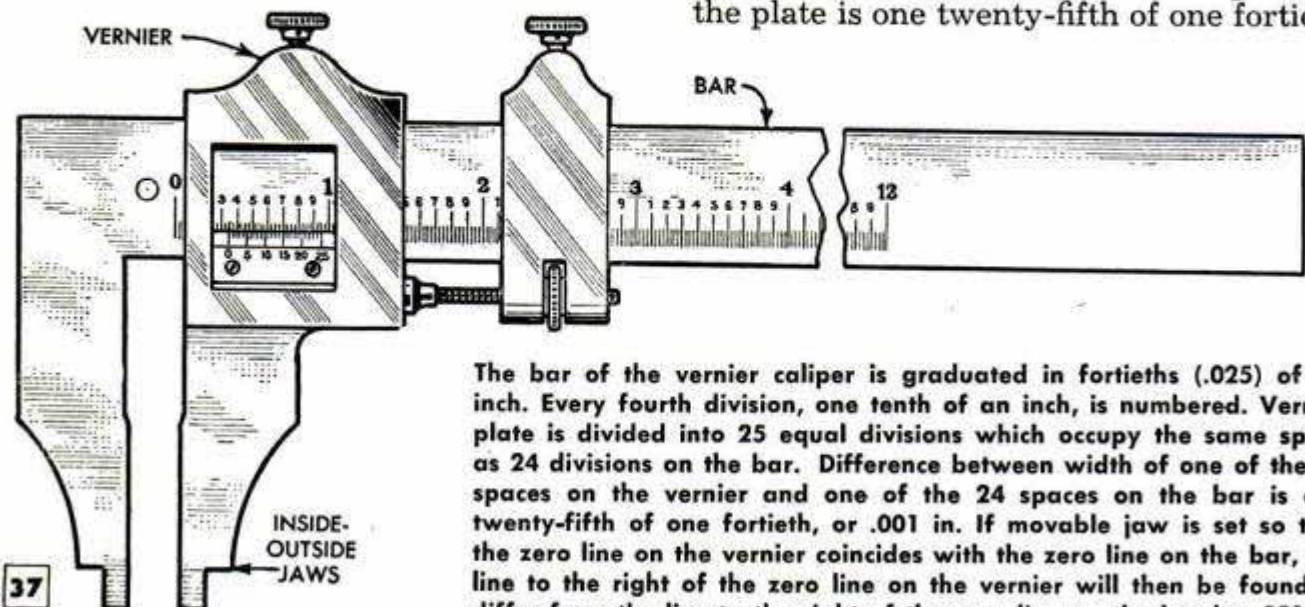

The bar of the vernier caliper is graduated in fortieths (.025) of an inch. Every fourth division, one tenth of an inch, is numbered. Vernier plate is divided into 25 equal divisions which occupy the same space as 24 divisions on the bar. Difference between width of one of the 25 spaces on the vernier and one of the 24 spaces on the bar is one twenty-fifth of one fortieth, or .001 in. If movable jaw is set so that the zero line on the vernier coincides with the zero line on the bar, the line to the right of the zero line on the vernier will then be found to differ from the line to the right of the zero line on the bar by .001 in.



of an inch (.001) less than a corresponding space on the fixed scale. Although this seems a little involved, it will be greatly simplified by remembering that, if the zero marks on the bar and plate are exactly aligned, the first marks to the right on the bar and plate will be .001 in. out of line. The second marks will be .002 in. out, and so on. Now, if the slide is adjusted to bring the first two marks precisely in line, the jaws will have opened .001 in., and, if the slide is moved to bring the fourth pair of marks into line, the jaws will have opened .004 in., and so on.

Once this progression is understood, the principle can be used to read the instrument with the vernier in any position on the bar. For example, looking through the "window" in the movable jaw, as shown in the upper detail in Fig. 36, the vernier has been moved to the right one and four tenths and one fortieth inches, or 1.425 in., as shown on the bar. It also will be noted that the eleventh line on the vernier coincides with a line, indicated by stars, on the bar. Thus eleven thousandths of an inch must be added to the reading on the bar, making the total reading 1.425 plus .011 in., or 1.436 in. It should be noted in the upper detail in Fig. 36 that the offsets and spacings of the lines on the plate and bar have been exaggerated somewhat. Essentially the same principle applies to the vernier height gauge, Figs. 38 and 39. This instrument is designed for measuring or laying off vertical distances where a high degree of accuracy is required.

Details A, B and C in Fig. 36 show sample readings of a vernier micrometer graduated to read in ten-thousandths. Otherwise the instrument is the same as the ordinary mike graduated to read in thousandths. The difference is that on the vernier mike there are ten divisions marked on the sleeve occupying the same space as nine divisions on the edge of the thimble. The thimble is graduated to read in thousandths, thus one tenth of a division would be one ten-thousandth of an inch. To make the reading, first read to thousandths as with the regular mike, then note which of the lines on the sleeve coincides with a line on the thimble. In Fig. 36, B, a zero line on the thimble coincides with an axial line on the sleeve and the vernier zero on the sleeve coincides with a line on the thimble. The reading would be .2500 in. But in detail C it will be noted that the zero line on the thimble indicates a value greater than .2500 in. Note that the seventh vernier line on the sleeve coincides with a line on the thimble, making the total reading .2507 in. Mikes graduated to read in tenths are now widely used by machinists.

(The End)

[Certain technical information courtesy L. S. Starrett Co.]

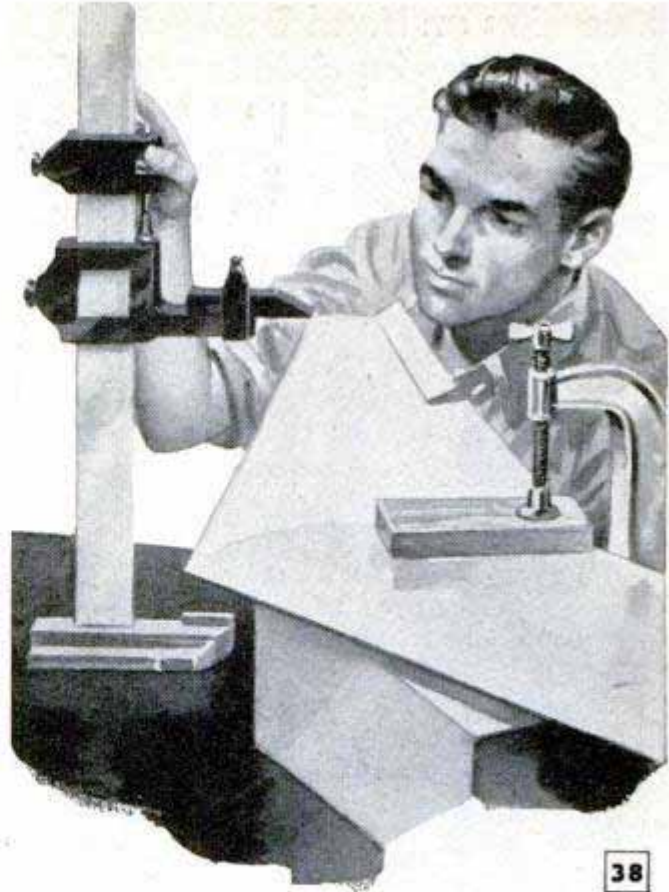

38

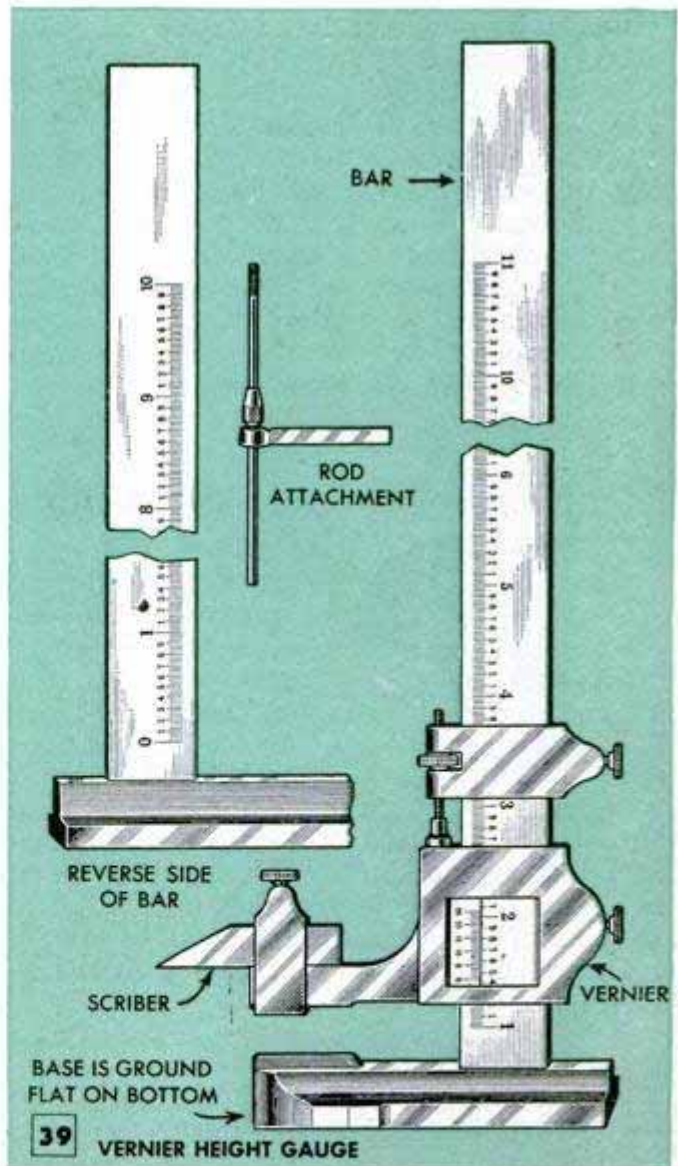

39

VERNIER HEIGHT GAUGE

## Extension on Hand Truck Permits Carrying Skids

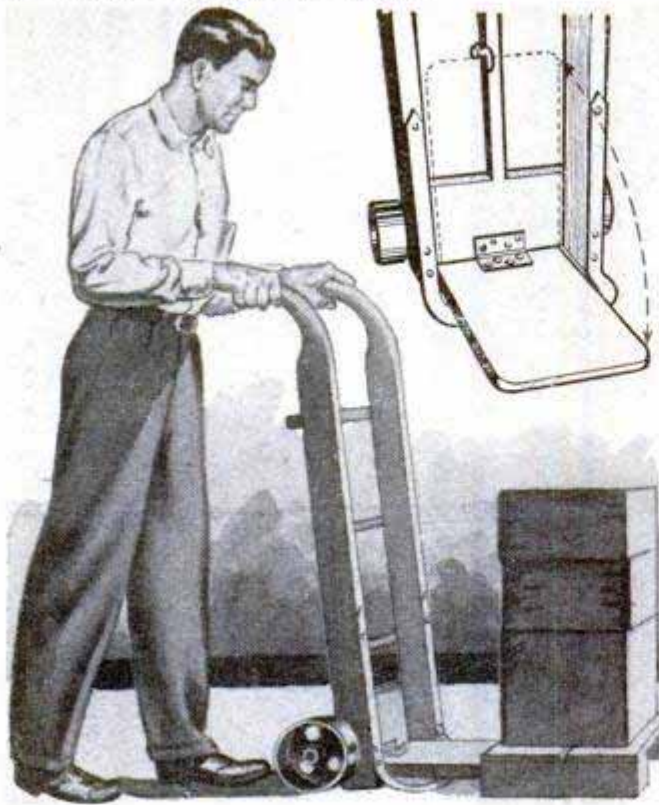

Because it is easy to handle in narrow aisles, a two-wheel hand truck is often preferred to the larger platform truck even though the size of its load is limited. Fitting the nose of the hand truck with a hinged wooden extension will permit picking up skids which will handle a more sizable load than the nose plate itself. When not in use, the extension is hooked in the upright position. The skids can be made from waste lumber, 16 x 16 in. being a convenient size, and should be high enough to allow the extension to slide under them easily.—J. A. Richards, Saco, Me.

## Renewing Bolt Threads After Cutting

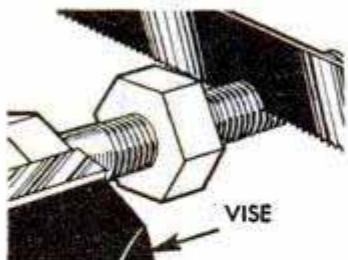

When a bolt or machine screw must be cut off either with a hacksaw or snips, the threads are likely to be damaged at the point of cut.

To renew the threads, turn a nut well onto the bolt before cutting and, after the bolt has been severed, back off the nut. If the bolt has been snipped with cutters instead of sawed, it is best to round the end on a grinder before backing off the nut.

W. H. McClay, Pasadena, Calif.

☐ A hot-water bottle filled with scalding water will often thaw a frozen car-door lock when other methods fail.

## Brace Chuck Fitted With Adapter Holds Twist Drills Securely

Frequently it is advantageous to drive small twist drills with a hand brace, but most hand-brace chucks will not hold small straight-shank drills securely. Adapters for the most-used drill sizes are easily made from short lengths of steel rod. Square one end of each length of rod and drill a hole in the squared end to a depth of about  $\frac{3}{4}$  in. with the same drill which is to be used in the adapter. Be sure that the hole is centered. Then slot the rod at right angles with a hacksaw to a depth of roughly  $1\frac{1}{2}$  in. The slots form four jaws which close on the drill shank in the same manner as the jaws of a collet. To use, insert the adapter in the hand-brace

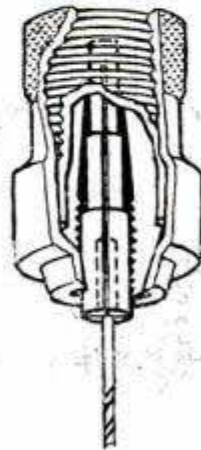

chuck, insert the drill and tighten the chuck. In some hand-brace chucks the jaws are tapered, or are pivoted at the inner ends. In this case, it will be necessary to shoulder the adapters as in the detail so that the chuck jaws will close fully.

W. F. Schaphorst, Newark, N. J.

## Board Wedged Between Wheels To Block Tractor for Belt Work

Four-wheeled tractors having rear-mounted belt pulleys are quickly blocked for belt work by placing a board behind the front wheel and over the rear wheel as illustrated. In some cases, it may be necessary to use two boards, placing one back of each front wheel to prevent the tractor from creeping sidewise when driving a long belt. The boards are easily placed in position by the operator as the belt is tightened.—John Evritt, Vandalia, Ohio.

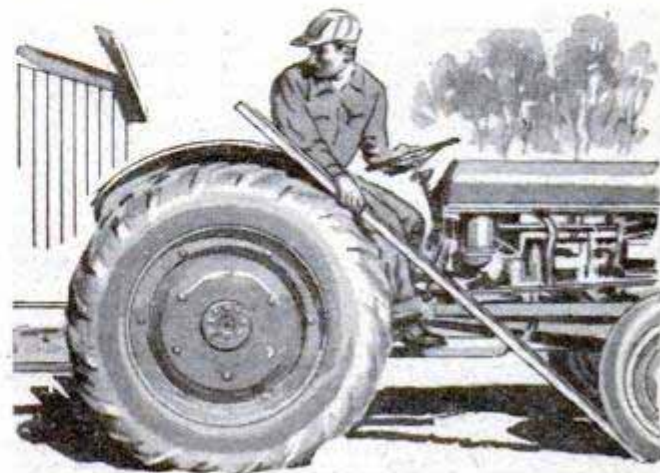

# Handy Cutter Speeds Trimming Building Paper

When it is necessary to cut building paper into narrow strips, one carpenter uses this simple cutter to rip the paper to size quickly. Razor blades fastened at an angle provide the cutting edges, and the roll of paper rotates on a length of  $\frac{1}{2}$ -in. pipe. Note that the paper is pulled under a guide board so that it is held tightly against the blades, the latter being screwed to cleats which are nailed or screwed to the front edge of the cutter frame. One, two or more blades may be used and spaced to suit the desired widths. — Hi Sibley, Nuevo, Calif.

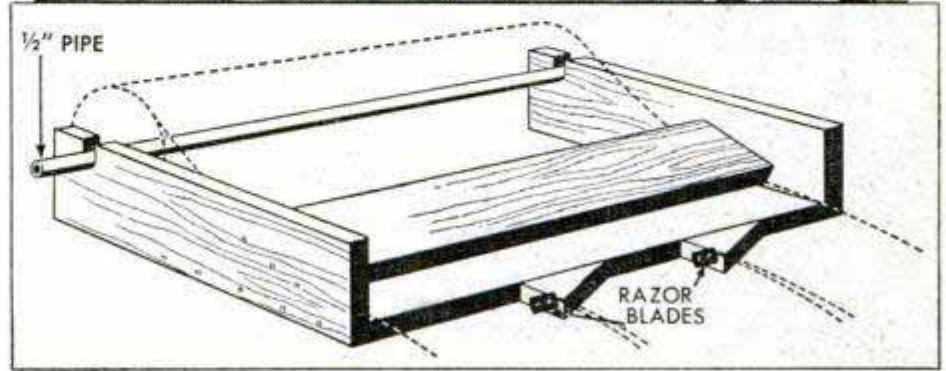
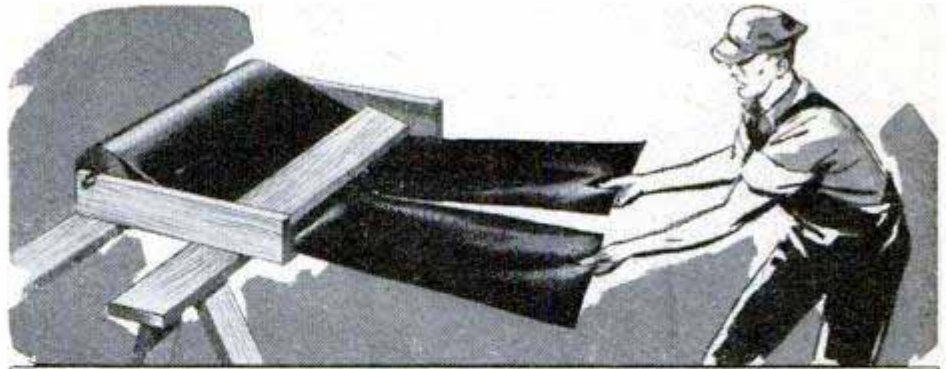

## Slotting With Hacksaw Improved by Blade Alteration

If two or three hacksaw blades are used side by side in the standard hacksaw frame for cutting slots, the tension on the blades

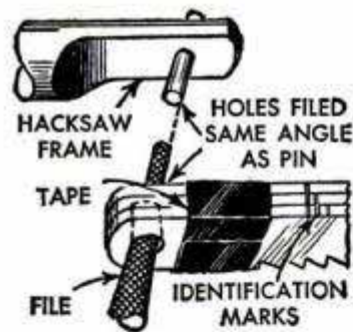

is never equal because of the angle of the pins in the holders. This frequently causes one of the blades to buckle and bind, resulting in inaccuracies and possible breakage. To correct this tendency, tape the blades together at each end and then file the registering holes at an angle corresponding to that of the pins in the holders. This assures that when the blades are

placed in the frame they will be drawn to the same tension when the frame is tightened. File identifying marks on the blades as shown so that when removed from the frame they can be reassembled in the same order. — Earl R. Goddard, Denver, Colo.

## Matching Upholstery on Car Door

Having to repair a small hole in the upholstery of a car door and finding that no matching fabric was available, one auto trimmer removed an armrest and cut out a piece of the material directly under the rest. The patch, which was slightly larger than the hole to be repaired, was cemented inside the opening. The armrest covered the hole left by cutting away the patching fabric. — Russell L. Card, Tweed, Ont., Can.

## Muffler for Service-Station Lift Improvised From Oilcan



To eliminate the ear-splitting sound of air being exhausted from a hydraulic car lift, one service-station owner fitted the lift exhaust with a muffler made from a 1-qt. oilcan filled with steel wool. Instead of opening the can in the conventional way, a hole was punched in the center of the top end and the oil drained out. After the can was packed with steel wool, a few vent-holes were punched in the bottom and sides with a nail. Then, the muffler was mounted on the outlet valve of the lift by means of a short length of  $\frac{3}{4}$ -in. pipe soldered in the hole at the top of the can.

George Boyer, East Pepperell, Mass.

# SHOPPING

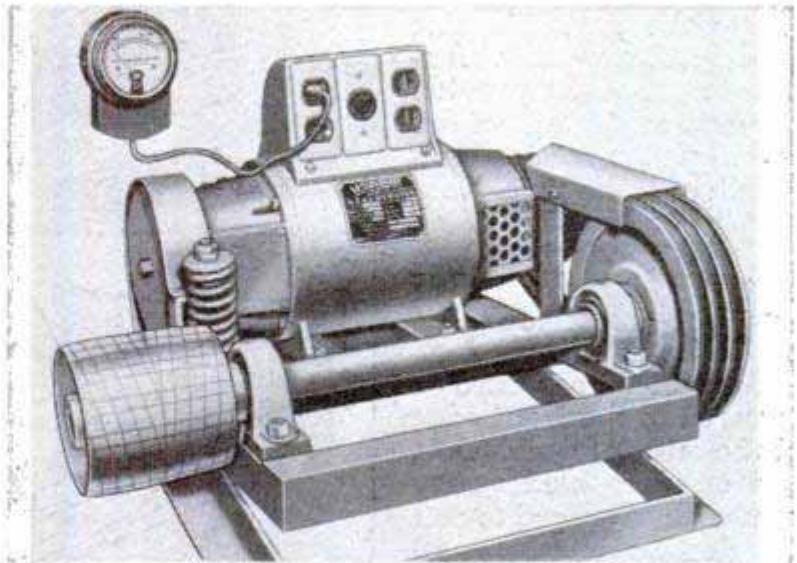

**NEW DIRECT-READING MICROMETER** is adjusted to the work in the same way as conventional mike, but the readings appear in openings, or windows in the thimble, thus making usual computations unnecessary

**STAND-BY A.C. GENERATOR** is now available to farmers and dairymen for use when rural power lines fail. Farm tractor is hooked to generator, furnishing power for lights, milking machines and pumps

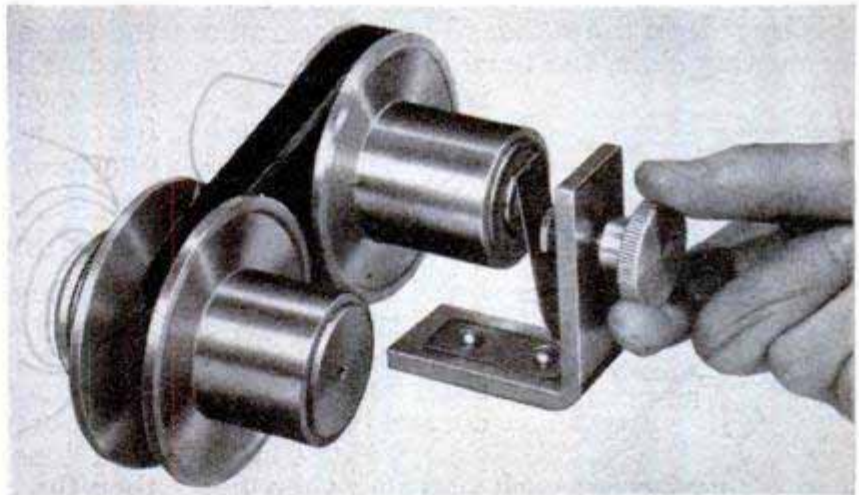

**NEW SPEED CHANGER** that features two variable-pitch sheaves is now available. One sheave is spring-loaded and mounted on motor shaft. Other is controlled manually and is mounted on driven shaft

**THE BOTTLED-GAS TORCH** pictured at the left is suitable for work requiring temperatures up to 2200 deg. F. Flame is adjustable to pin-point size and the torch is charged from a bottled-gas tank

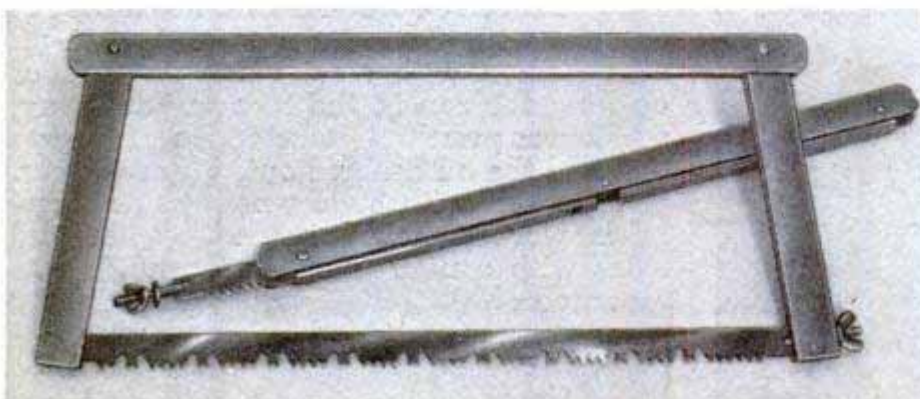

**FOLDING BUCKSAW**, or bow saw as it is often called, is a new item in trail equipment for campers and outdoorsmen. Note how saw folds to compact unit with teeth covered to prevent injury when handling or carrying in a pack. It comes in two sizes with blade lengths of 20 and 24 in. In the larger size, it is suitable for cutting logs up to 10 in. in diameter. Weighing only 2½ lbs., it carries easily on the trail

# FOR TOOLS

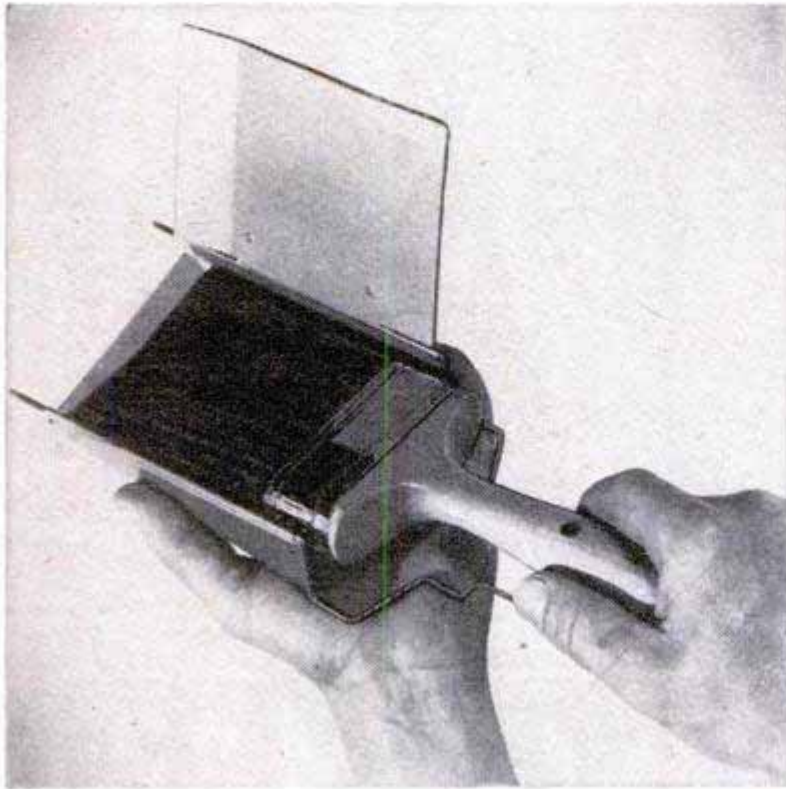

**METAL PAINTBRUSH HOLDERS**, or jackets, that keep brushes soft and ready for use have been made available. Holder supports the brush in a solvent with the bristles compressed slightly, thus retaining the chisel edge and preventing bristles from spreading. Two short legs on lower end of each holder prevent brush from touching bottom of container. Furnished in five sizes



**A PORTABLE TOOL**, which is hydraulically operated, is now supplied for cutting wire rope, round steel, chain and power cables. Hydraulic mechanism is operated by a built-in hand pump capable of exerting a 22½-ton thrust. Cuts 1¼-in. wire rope in 20 seconds

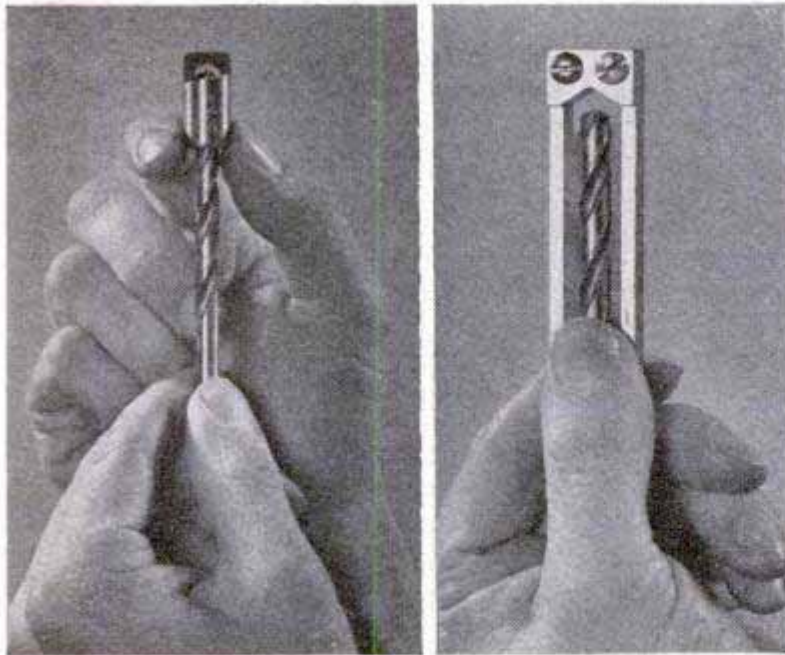

**TWO NEW GAUGES** that aid in sharpening drills up to ½ in. in diameter are pictured above. Left, this gauge slips over end of drill bit which projects through to a 118-deg. profile, or gauge. When drill point has been ground to the correct angle light cannot be seen between profile and cutting edges. Right, this gauge has a 90-deg. V-groove for holding drills up to ½-in.

**THIS NEW SOLDERING IRON** heats to soldering temperatures in 30 seconds and "idles" at 500 deg. F. with current consumption of about 25 watts. When booster switch is closed, current consumption is increased and temperature at tip is raised 400 percent





# ROOFING IS EASY

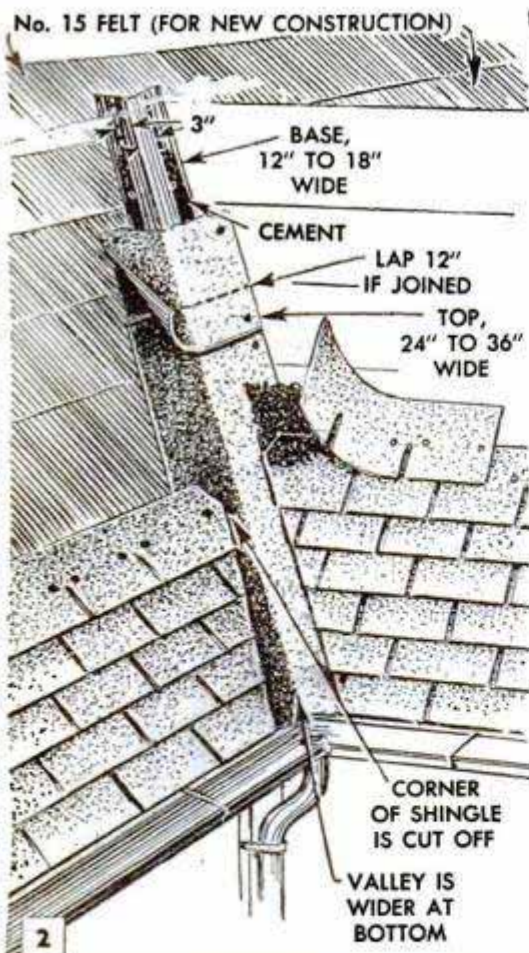

VALLEYS ARE COVERED WITH DOUBLE THICKNESS OF MINERAL-SURFACE ROLL ROOFING









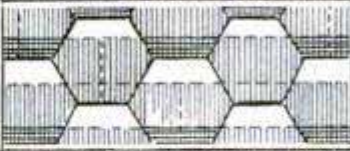

## How To Apply Asphalt Shingles

*By Sam Brown*

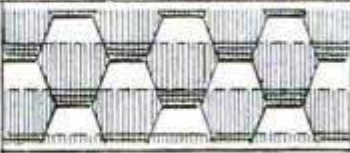
### Part I

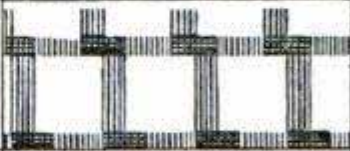
**R**OOFING is the simplest of all the major repair jobs that the homeowner can tackle himself without professional help. It's easier to do than painting, except that you have to climb a little higher, work in a somewhat less comfortable position and swing a hammer instead of a paintbrush. Because of the mechanical features of the various asphalt-shingle patterns, the shingles practically lay themselves. If the first course is started correctly, you can't very well go wrong.

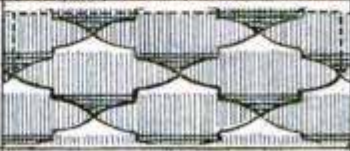
**Selecting the shingle pattern:** Data on several of the more popular shingle patterns, or types, is given at the top of the opposite page. The individual shingle is pretty much the same product in any type or style. It averages about the same weight per unit and has essentially the same proportions in the mineral covering. The difference in the style of modern roofing and the cost of the job depends on whether the shingles are laid single thickness, double thickness or triple thickness. Probably the most popular choice is the double thickness, or double coverage roof, and in this class the three-tab square butt and the three-tab hex strip shingles are leaders, especially on new work. Single-coverage shingles, such as Dutch lap, and interlocking

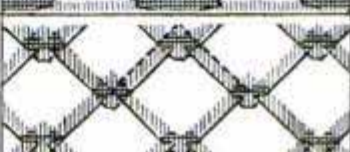
<i>Asphalt shingles</i>	WEIGHT PER SQUARE	UNIT SIZE	NAILS PER SQUARE	COVERAGE		
				PER BUNDLE	X-RAY VIEW	PERCENT
 <b>3-TAB SQUARE</b>	210 LBS.	12" X 36"	1.9 LB., 1" OR 3.2 LB., 1 3/4"	33 SQ. FT. (2/3 SQUARE)		1 PLY—2% 2 PLY—59% 3 PLY—39% <hr/> 100%
 <b>2-TAB HEX</b>	167 LBS.	11 1/3" X 36"	1.3 LB., 1" OR 2.3 LB., 1 3/4"	50 SQ. FT. (1/2 SQUARE)		1 PLY—22% 2 PLY—63% 3 PLY—15% <hr/> 100%
 <b>3-TAB HEX</b>	167 LBS.	11 1/3" X 36"	1.3 LB., 1" OR 2.3 LB., 1 3/4"	50 SQ. FT. (1/2 SQUARE)		1 PLY—22% 2 PLY—63% 3 PLY—15% <hr/> 100%
 <b>DUTCH LAP</b>	162 LBS.	12" X 16"	0.9 LB., 1" OR 1.5 LB., 1 3/4"	50 SQ. FT. (1/2 SQUARE)		1 PLY—61% 2 PLY—29% 3 PLY—10% <hr/> 100%
 <b>THATCH</b>	172 LBS.	10" X 36"	1.2 LB., 1" OR 2 LB., 1 3/4"	50 SQ. FT. (1/2 SQUARE)		1 PLY—14% 2 PLY—72% 3 PLY—14% <hr/> 100%
 <b>INTERLOCK</b>	138 LBS.	16" X 16"	0.6 LB., 1" OR 1.1 LB., 1 3/4"	50 SQ. FT. (1/2 SQUARE)		1 PLY—60% 2 PLY—31% 3 PLY— 9% <hr/> 100%

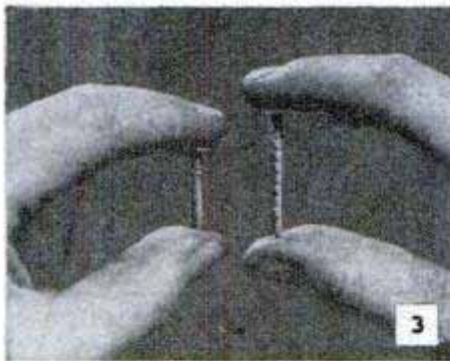

3 NAILS SHOULD BE 1" LONG FOR NEW WORK, 1 3/4" FOR REROOFING



4 GOOD BASE IS ESSENTIAL. SPLIT AND NAIL DOWN WARPED SHINGLES



5 STARTER COURSE CAN BE INVERTED SHINGLES OR ROLL ROOFING



6 ROOF CEMENT IS VERY ESSENTIAL FOR TIGHT FLASHINGS AND VALLEYS



7 RIDGES CAN BE FINISHED WITH CUT SHINGLES OR ROLL ROOFING



8 DRIP EDGE OF 26-GAUGE SHEET METAL GIVES PROTECTION AT EAVES AND RAKE

## *Basic operations common to all jobs*

This page pictures and details nearly everything you need to know about a common roofing job. It's important to note the length of the nails recommended for new and old work, Fig. 3, and in over-roofing it's equally important to avoid driving the nails too far down, as expansion and contraction of shingles may cause breaks

# Methods of Laying 3-Tab. Square-Butt Shingles

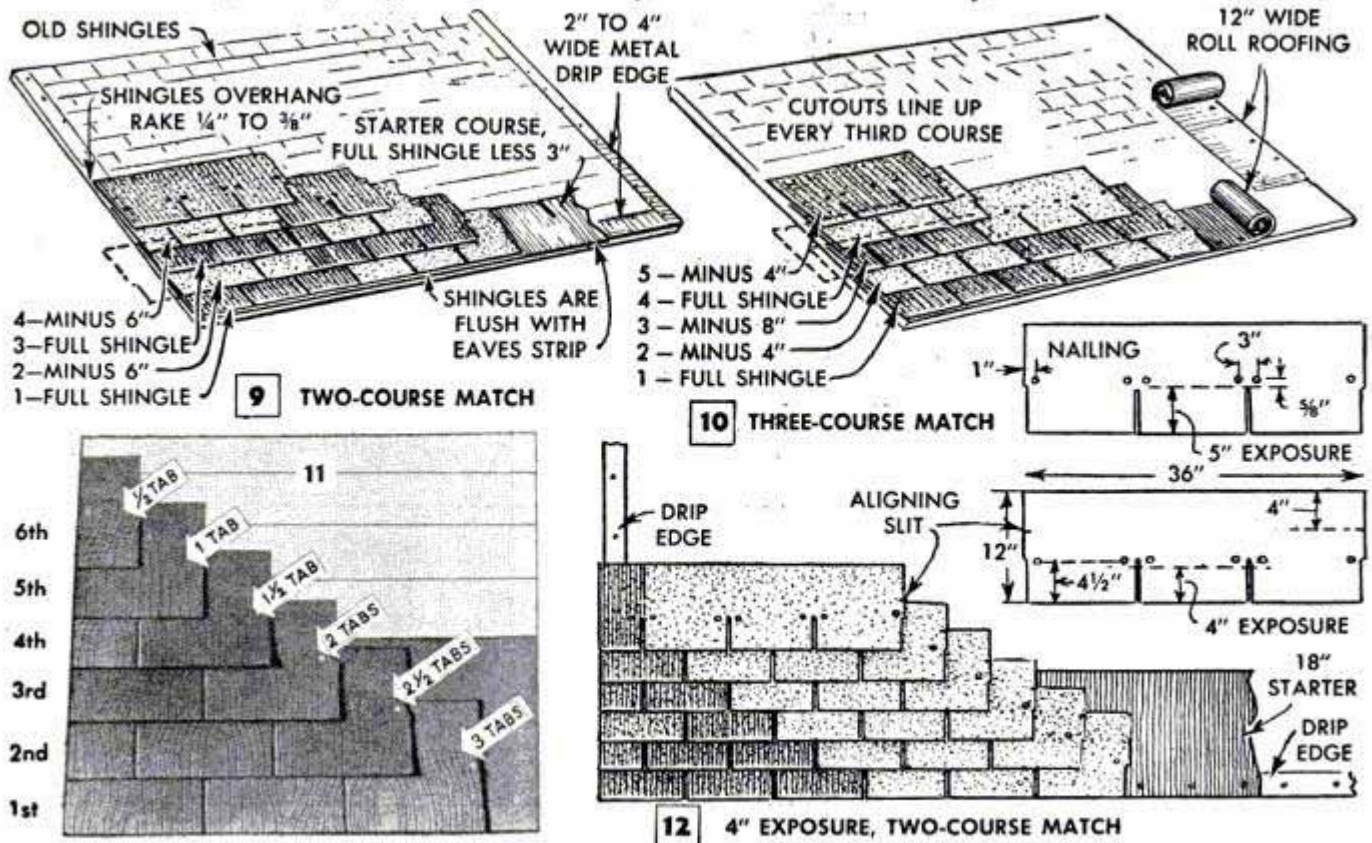

types, cost much less per job and make an excellent roof, especially when used for overroofing, that is, laying new shingles over an old roof in good condition. Shingles are sold by the bundle, each bundle containing enough units to cover from  $33\frac{1}{3}$  to 50 sq. ft., which is  $\frac{1}{3}$  to  $\frac{1}{2}$  of a square, the square being an area measuring 10 x 10 ft., or 100 sq. ft. After measuring the roof and determining the total area in square feet, it's easy to figure the number of bundles required for the job.

**Treatment of roof edges:** The terms "eaves" and "rake" are used by builders to refer to the edges of the roof, eaves meaning the lower edges and rake indicating the run from the eaves to the ridge. If the old roof is in good condition to start with, it is unlikely that the edges will need any special treatment, but if the shingles are in poor shape then some preparatory work may be necessary. Figs. 3 to 8 inclusive picture roofing steps common to all jobs and Figs. 13 to 24 inclusive picture the step-by-step procedure, including the regular valley treatment, Figs. 2, 18, 19, 20 and 21. As a rule, the first step is to prepare the roof edges. Rake boards or metal drip edges are installed, the boards being installed in the same positions as indicated for the drip edges in Figs. 8 and 9. When overroofing a wood-shingle roof it is the usual practice to use rake boards of beveled siding, 4 to 6 in. wide, to form a drip edge along the rake. It also is good practice to cut away the shingles along the rake so that the board bears directly on the roof

boards with the thicker edge out. This has the effect of tilting the shingles slightly away from the edge, forming a watershed which prevents water from running down the edge of the roof and dripping from the fascia board. Some builders may even use 12-in. strips of roll roofing as in Fig. 10. It is a common practice to set the drip edges in roofing cement to prevent seepage of water under the shingles. On new roofs, Fig. 25, felt uncovering goes on first, then the drip edges and finally the shingles.

**Preparing valleys:** Figs. 18 to 21 inclusive show how the valley is prepared on old work. First a narrow strip of roll roofing is cut and laid in the space between the shingle ends to build up level. Then the full-width valley strip of roll roofing goes in, Fig. 18. Next, chalk lines are snapped to indicate the taper of the valley width, Fig. 19. Finally, lay a line of lap cement outside the chalk lines from top to bottom on both sides of the valley as in Fig. 20. Don't be confused by the forked arrow in Fig. 21. During heavy rainstorms when even a steep valley runs full from a point well up near the ridge, some water may take the direction of the small arrow, which makes it necessary to take the precaution of cutting the corner of each shingle and bedding the exposed edge in roofing cement or lap cement. Full-length valleys, such as those formed where the ridges meet at right angles at the same level, should be 6 in. wide at the top and should widen at the rate of about  $\frac{1}{8}$  in. to the foot down to the eaves. Note that the chalk lines, Figs. 19 and 20,



# Here's a Picture Story Showing Application of Square-Tab Shingles



STANDARD

THICK

THE BUTT



13

Lay a row of inverted shingles at eaves to form the starter course



14

First course starts with full shingle with the edge flush at eaves



15

Begin second course with full shingle less 6 in. Cut shingle from back



16

Four nails fasten each shingle. Nail straight to avoid cutting



17

Shingles are cut and flashed to all parts projecting above roof



18

Two layers of roll roofing used in valley, same color as shingles



19

Chalk lines are snapped on valley to indicate trim line for shingles



20

Shingle ends at valley are bedded in roofing cement to turn water

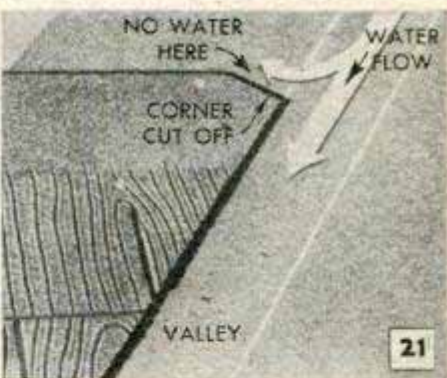

21

Top edge of each shingle at valley is cut off diagonally as shown



22

Plastic roof cement assures tight joints at vent pipes and chimney

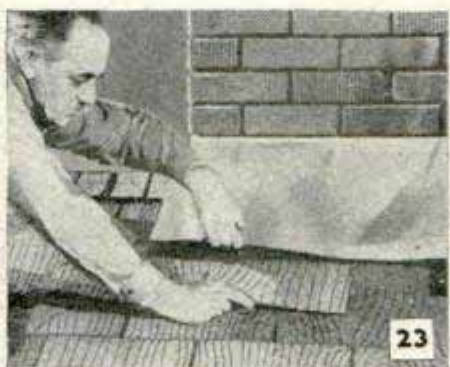

23

On overroofing jobs shingles often are fitted under old flashing



24

Ridges and hips can be finished with 12-in. strips of roll roofing

# shingles

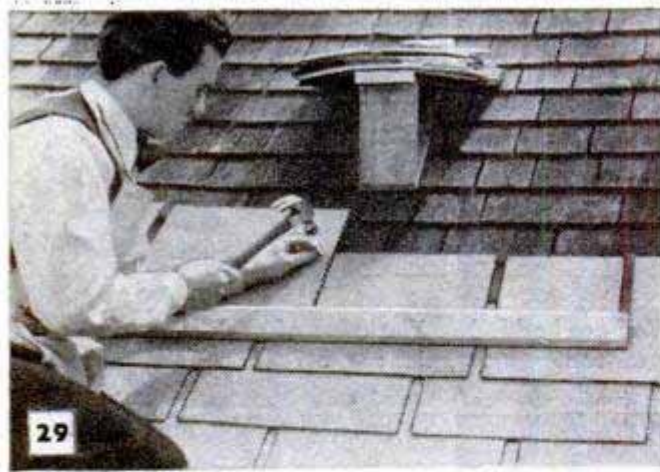
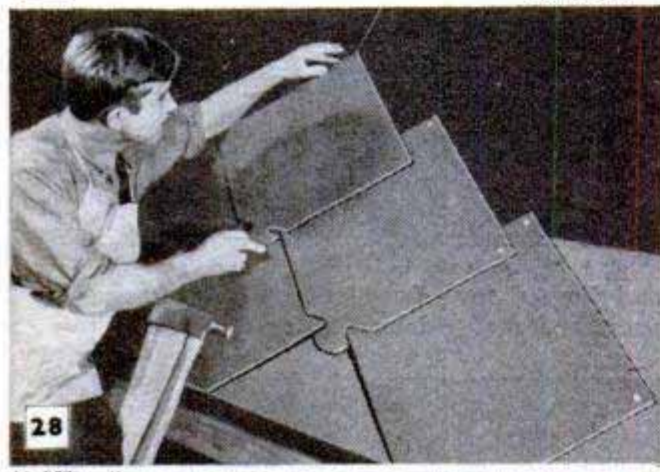
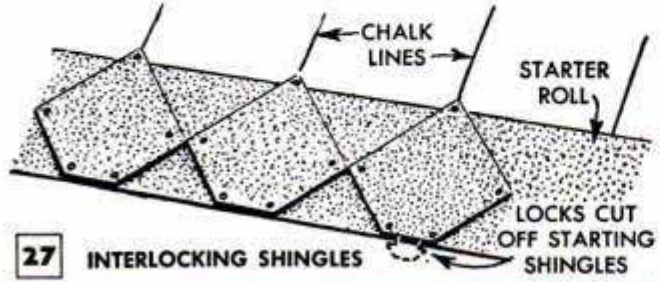
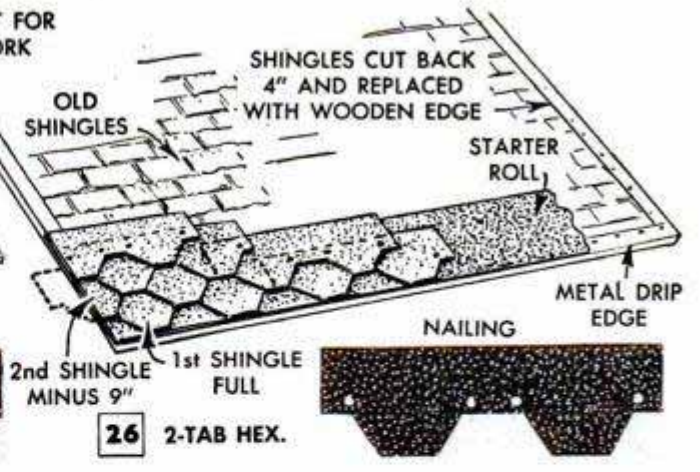
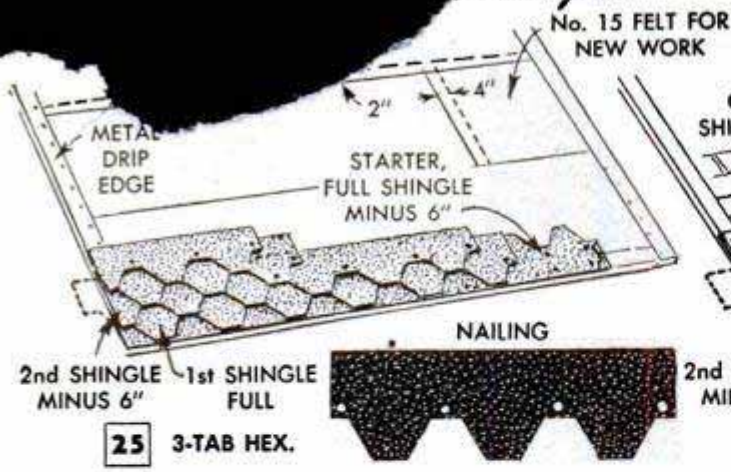

widen in about this relative proportion.

**Laying shingles:** With the drip edges and valleys completed, the rest is plain sailing on an ordinary roofing job. *Caution:* On a steep roof, Fig. 1, don't take chances! See that all ladders reaching to the eaves stand solidly and make sure that scaffolding and footboards are anchored securely before trusting your weight on them. Some roofers, working on high, steep roofs, take the added precaution of tying a light rope loosely about the waist or under the arms. The free end of the rope is thrown over the ridge and tied securely to a tree or some other solid anchorage on the opposite side of the building. Then, if you slip, or something lets go, the rope will save you from a possible serious injury. The starter course, pictured in Fig. 5, is a row of inverted shingles, Figs. 13 and 25, or a roll of roofing 12 to 18 in. wide as in Figs. 5, 10, 26 and 27. In ordinary roofing practice, the shingles overhang  $\frac{1}{4}$  to  $\frac{3}{8}$  in. at the rake edge and  $\frac{1}{8}$  in. at the eaves when applied over old shingles. These overhangs can be slightly less over metal drip edges. Nearly all shingle units are self-spacing, that is, one butts against the other, and the head-lap and alignment are more or less automatically taken care of by cutouts, slits or other mechanical features of the individual shingle units. However, it's a good idea to snap a chalk line occasionally as the work progresses to check the horizontal alignment. An example of how the head-lap and alignment are governed by the cutouts and aligning slits provided on each

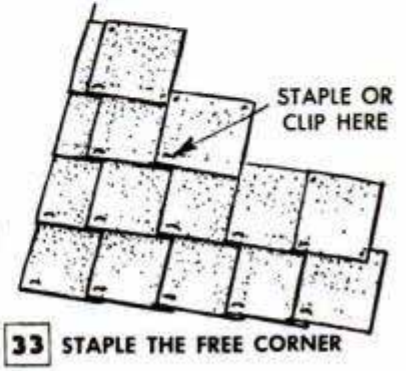
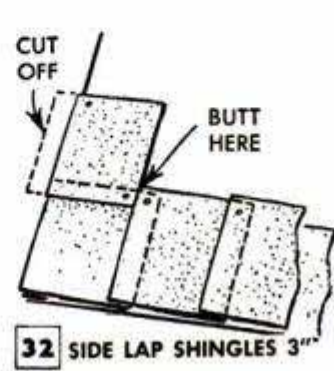
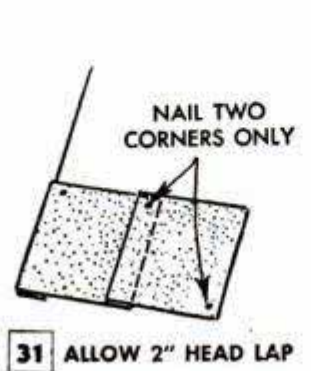
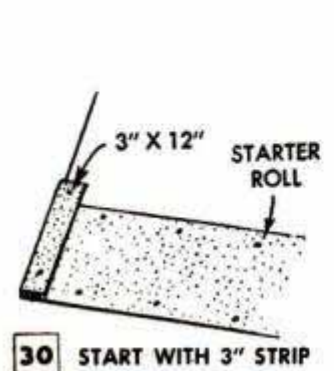

## Three ways to join sidewalls



34

PLAIN BUTT SHINGLES ARE PRACTICAL WHEN ROOFING CAN BE NAILED INTO RECESS OF SIDING. ALSO GOOD ON SLOPES WHEN CEMENTED

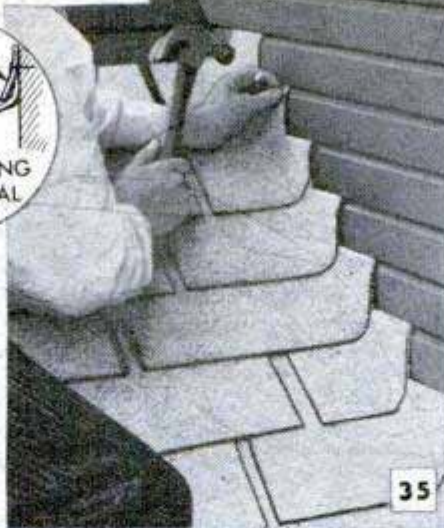

35

STEPPED SHINGLES MAKE A TIGHT FITTING JOB, ESPECIALLY WHEN CEMENT IS LIBERALLY APPLIED TO THE JOINT UNDER THE SHINGLES



36

METAL FLASHING WITH PREPARED FLASHING TIN IS GOOD STANDARD METHOD. EXPOSED FLASHING TIN IS PAINTED COLOR OF HOUSE

unit is the three-tab hex shingle. The usual exposure, or lay, is 5 in. to the weather. This means that after the first course the succeeding courses are set flush with the cutouts. Also, it is common to break the cutouts every second course, as in Fig. 25. This is done by alternating a full shingle unit and another with 6 in. cut off the outer end. This forms the starting shingle on the succeeding course. An alternate method is detailed in Fig. 26. Matching the cutouts on square butt shingles can be done by several methods as detailed in Figs. 9 to 12 inclusive. Other methods of laying different types are detailed and pictured in Figs. 27 to 33 inclusive.

**Flashing to sidewalls, vent pipes and chimneys:** Figs. 34 to 43 inclusive detail and picture the procedures in flashing the roof to various parts of the house structure to prevent leakage. Three methods of joining to side walls are pictured in Figs. 34, 35 and 36. How to flash to a vent pipe projecting through the roof is detailed clearly in Figs. 37, 38 and 39. Both metal flashings and self-flashings are used, the latter being made either from the shingles or from roll roofing. On chimneys that project from a steep roof at some point below the ridge, it is customary to fit a watershed, or cricket, on the upper side of the chimney as in Fig. 40. The cricket can be made of wood as suggested, but for maximum durability it should be made of galvanized sheet metal or copper. All flashings, except metal, should be coated liberally at the joints with roofing cement carefully knifed into all openings and well smoothed on the exposed surfaces.

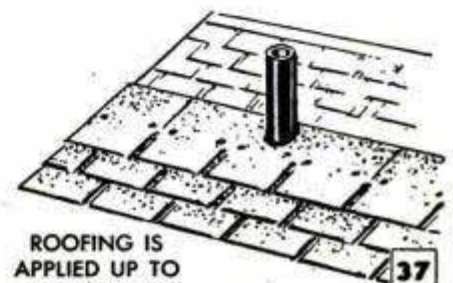

ROOFING IS APPLIED UP TO AND AROUND PIPE

37

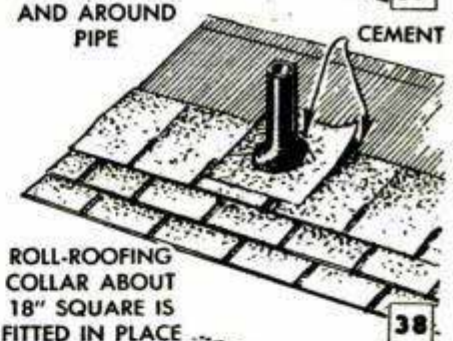

ROLL-ROOFING COLLAR ABOUT 18" SQUARE IS FITTED IN PLACE

38

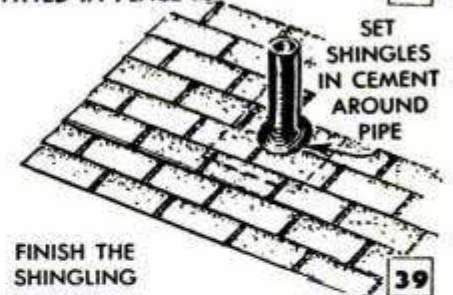

SET SHINGLES IN CEMENT AROUND PIPE

39

FINISH THE SHINGLING

### Pipe flashing

### Chimney flashing

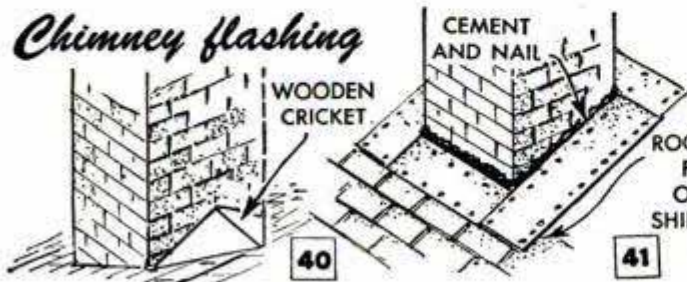

40

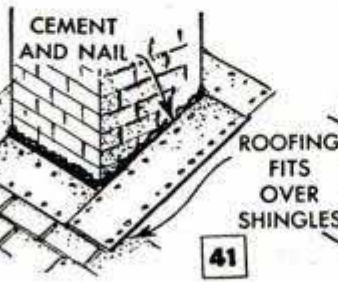

41

ROOFING FITS OVER SHINGLES

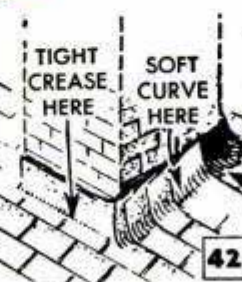

42

TIGHT CREASE HERE

SOFT CURVE HERE

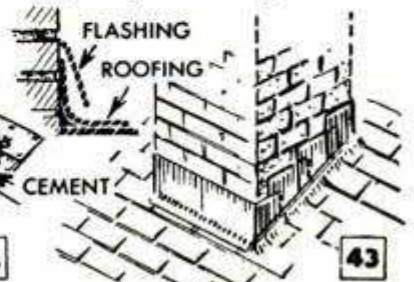

43

FLASHING ROOFING

CEMENT

Here's the way to flash a chimney on an overroofing job. On steep roofs a wooden or metal cricket usually is fitted above the chimney as in Fig. 40. New shingles are then brought up to the chimney and roll-roofing strips are nailed and cemented in place as in Fig. 41. Job is then completed with shingles and cap flashing

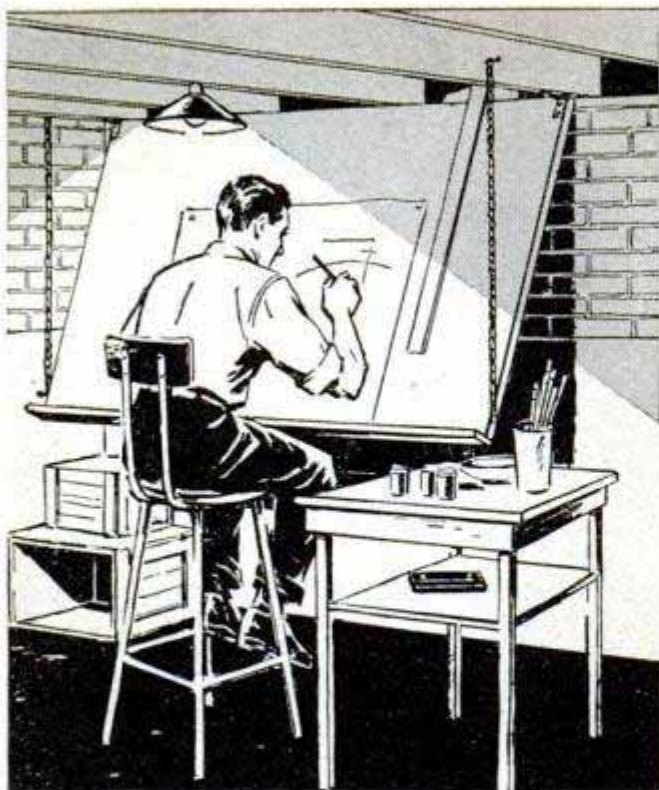

## Drawing Board Hung From Ceiling Occupies Minimum Space

Free-lance artists who use a corner of the basement as a home studio will appreciate this large drawing-board easel which is hinged from the ceiling and folds flat against the wall for compact storage. Lengths of chain suspended from screws or nails driven into the ceiling joists hold the lower edge of the board away from the wall and permit easy adjustment of its angle. Storage space against the wall can still be used as the easel has no lower framework to interfere. A sheet of plywood, a drawing board fitted with extension arms or a large board built up of pieces doweled and edge-glued together, is hinged to two of the ceiling joists at the top corner of the wall. The chain links engage nails driven into the edges of the board. When folded flat against the wall the easel also serves as a mounting board for photocopy work.

Paul Will, Chicago.

## Ladder Lashed to Truck Top With Spring-Fitted Chain

By anchoring each end of a ladder with two lengths of chain and a tension spring, the ladder is easy to fasten to the top of a truck and can be taken off in a jiffy, without the necessity of untying ropes. In addition, this method prevents rattling and keeps the ladder from working loose even on long hauls. Use two lengths of chain at each end of the ladder, connecting the lengths together with a tension spring as shown in the detail. Hooks at the ends of the chain engage the ladder rung and the truck bumper. The important point to remember is to use tension springs of sufficient strength to hold the ladder in place.

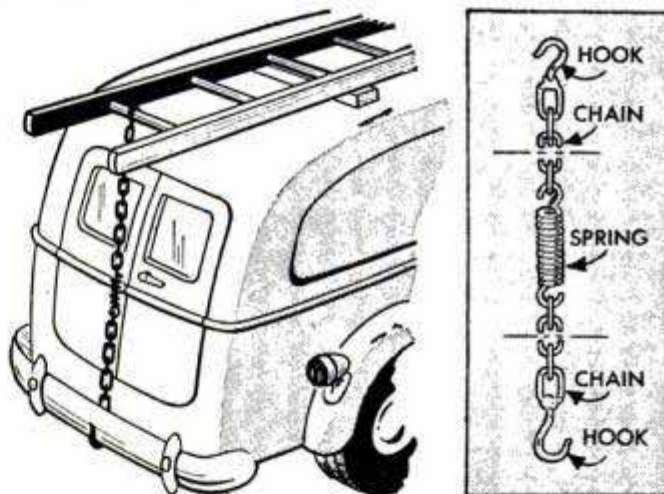

## Opening in Floor Near Store Window Affords View of Basement Display

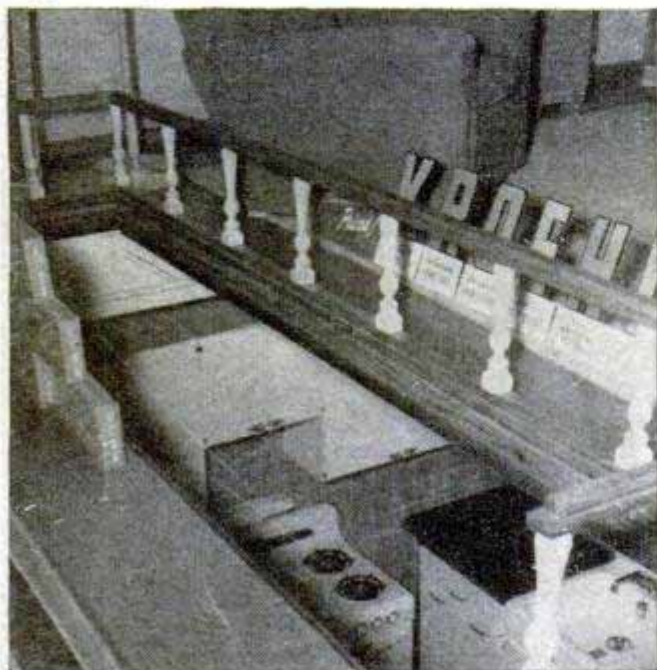

Their interest aroused by a gaping hole in the floor of one furniture store, many passing shoppers paused for a second look and went in to buy the merchandise so unusually displayed. The opening, which is cut through the floor just inside the show window, is large enough to afford a clear view of the basement showroom. A decorative railing around three sides of the opening doubles as a guardrail.

Grover Brinkman, Okawville, Ill.

## Waterproof Patch for Masonry Wall

If the joints in a masonry wall begin to leak, it is easy to seal them with a waterproof patch of asphalt calking compound. Just remove the old mortar to a depth of 2 in., force the calking compound into the joint and then cover with new mortar.

## TELEVISION TODAY

WHEN color television comes into common use, weird-looking vacuum tubes like this electron gun, photo A, may come into their own. An electron beam is fired through the tube, and action of the beam on current flowing through the spiral (coiled spring in a vacuum) causes a large increase in the power of the current. Color TV will have to be broadcast at very high frequencies over a wide band, and this "traveling wave" high-power amplifier tube is claimed to meet these special requirements.

Aluminum towers for TV antenna systems are to be seen in many fringe areas near cities where television broadcasting stations are located. The one shown in photo B comes in 10-ft. sections; it is made of lightweight structural aluminum.

The TV antenna rotating device, illustrated in photo C, operates on 110 volts a.c., 60 cycles, with an input of 25 watts. It rotates 370 degrees clockwise or counterclockwise, being instantly reversible from any point. The plastic control box operated at the TV receiver is color-toned to blend with most home furnishings.

Photo D shows a new 24-in. picture tube which will produce a direct-view picture almost as large as your daily newspaper page. It is shown mounted on a glass-to-metal cone sealer on the assembly line.

A new idea in television engineering is illustrated in photo E. It features an entire TV chassis organized into eight plug-in units, each performing its separate and distinct function. For repair and replacement, each unit can be removed without interfering with the rest of the set.

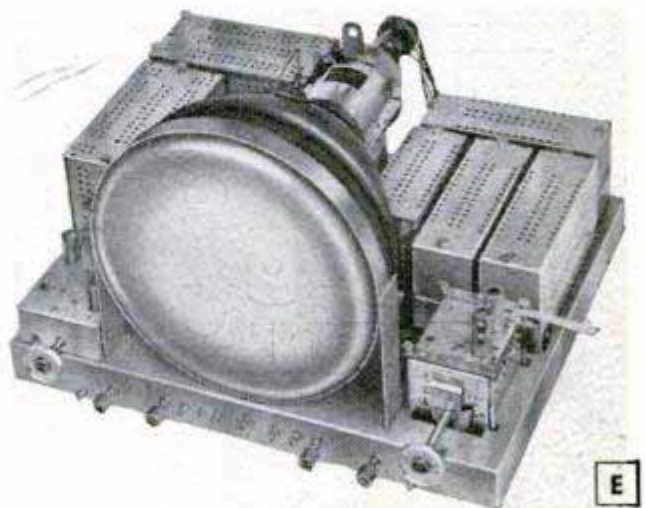
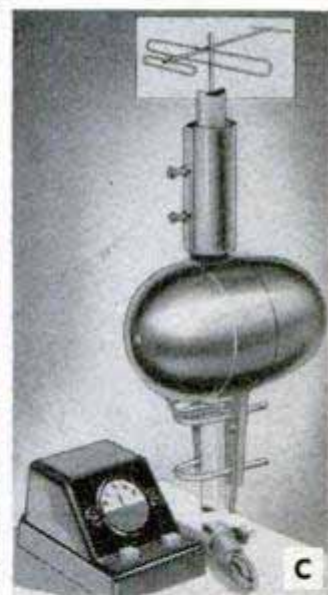

# HIGH-FIDELITY FREQUENCY-

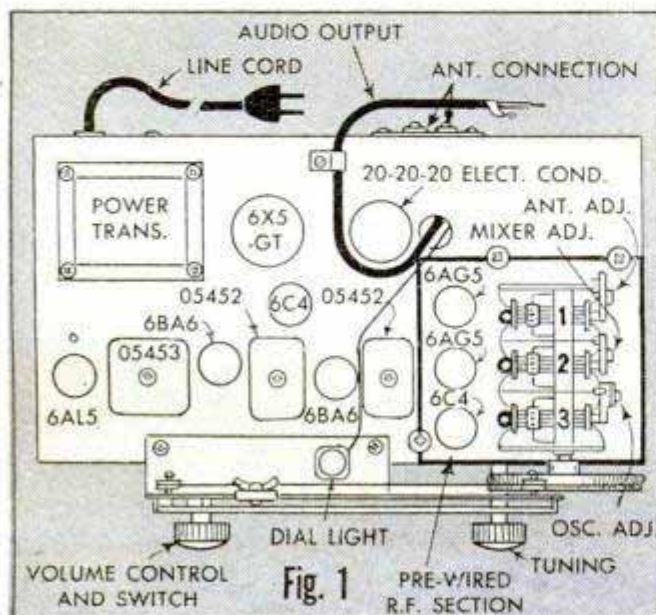
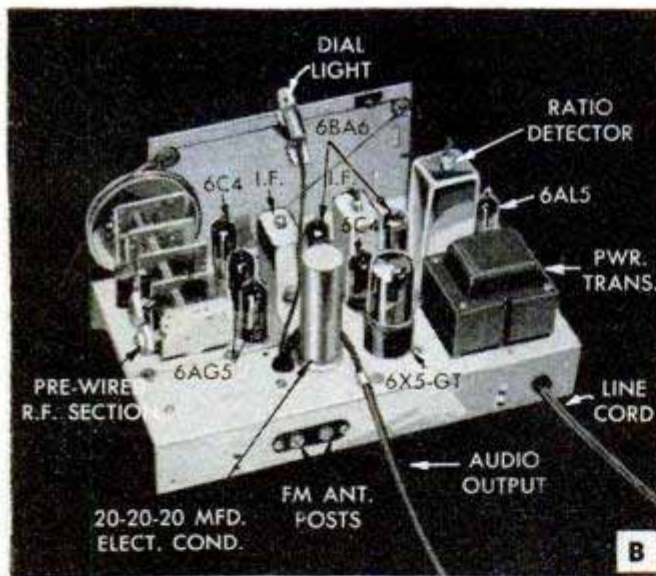

HERE IS an excellent FM tuner of advanced design that can be used with any good audio amplifier. It is easy to build as the r.f. front end is assembled and the i.f. coils are prealigned. This r.f. section comes in a compact prewired unit that mounts on the chassis base which is available cut, drilled and ready for mounting all parts just as shown in the photos.

The parts are available in complete kit form from radio-parts houses and are standard in every respect. Although not intended for beginners, the construction is not difficult for experienced builders, and the results when used with a good audio amplifier are highly satisfactory even to critical music lovers. Photo A shows the completed tuner connected to an audio amplifier, and a good loudspeaker in an adequate enclosure. Photo B is a rear view of the chassis showing the binding post strip for an FM dipole antenna, and the audio output cable which is fastened to the chassis base by means of a clamp. A front view of the completed FM tuner appears in photo C. It may be housed in a standard stock cabinet or installed in a custom-made or home-built console combination. The chassis layout is shown in Fig. 1 and the dial-string detail in Fig. 2. A complete schematic circuit diagram appears in Fig. 3. All coils are of the reliable Meissner type, and every part is carefully selected to insure maximum results. Very little leeway in specifications can be tolerated in high-frequency FM circuits and the parts specifications given in Fig. 3 are those that are supplied in the complete kit shown in photo D. Those who do not wish to purchase the complete Meissner T-8CK kit shown in photo D can buy foundation parts which consist of the essential Meissner units. These are as follows: FM tuning assembly (catalog number 13-7628) with dial parts and hardware; main chassis base (No. 05965-A); power transformer (No. 29501); FM-i.f. transformers (No. 05452), and the ratio detector coil (No. 05453). The i.f. coils and the ratio detector, when supplied separately, are not prealigned.

A bottom view of the completed FM tuner unit is shown in photo E. Before the operation of an FM receiver is described, it is well to review briefly the theory of FM transmission. Unlike amplitude-modulated (AM) transmission in which the r.f. wave varies in amplitude to correspond with the impressed audio signal, frequency-modulated transmission does not affect the amplitude of the wave. It permits the wave amplitude to remain constant but varies

# MODULATED TUNER UNIT...

wave frequency in accordance with the modulated signal, as illustrated in Fig. 4. If the carrier frequency of an FM broadcast station is, for example, 88 megacycles, its frequency under modulation may shift as high as 88,075 kc. and as low as 87,925 kc., a swing above and below 88 megacycles (88,000 kc.) of 150 kc. From this it can be seen that a single FM broadcasting station may cover a band width in the radio-frequency spectrum of as much as 150 kc. This is why FM broadcasting stations are located in the ultra-high frequency bands where there is a great deal more room for wide-range high-fidelity transmission than in the regular broadcast band.

Designed by well-known radio engineers especially for students and experimenters, this FM tuner circuit employs a double converter system which greatly reduces image response. The detector circuit, built around the 6AL5 tube, is called a "ratio detector." It develops an audio voltage that is proportional to the ratio of the swing in frequency above and below the average frequency, during frequency-modulation (FM). It responds only to FM signals, not to amplitude-modulated (AM) signals and, since static and other electric disturbances

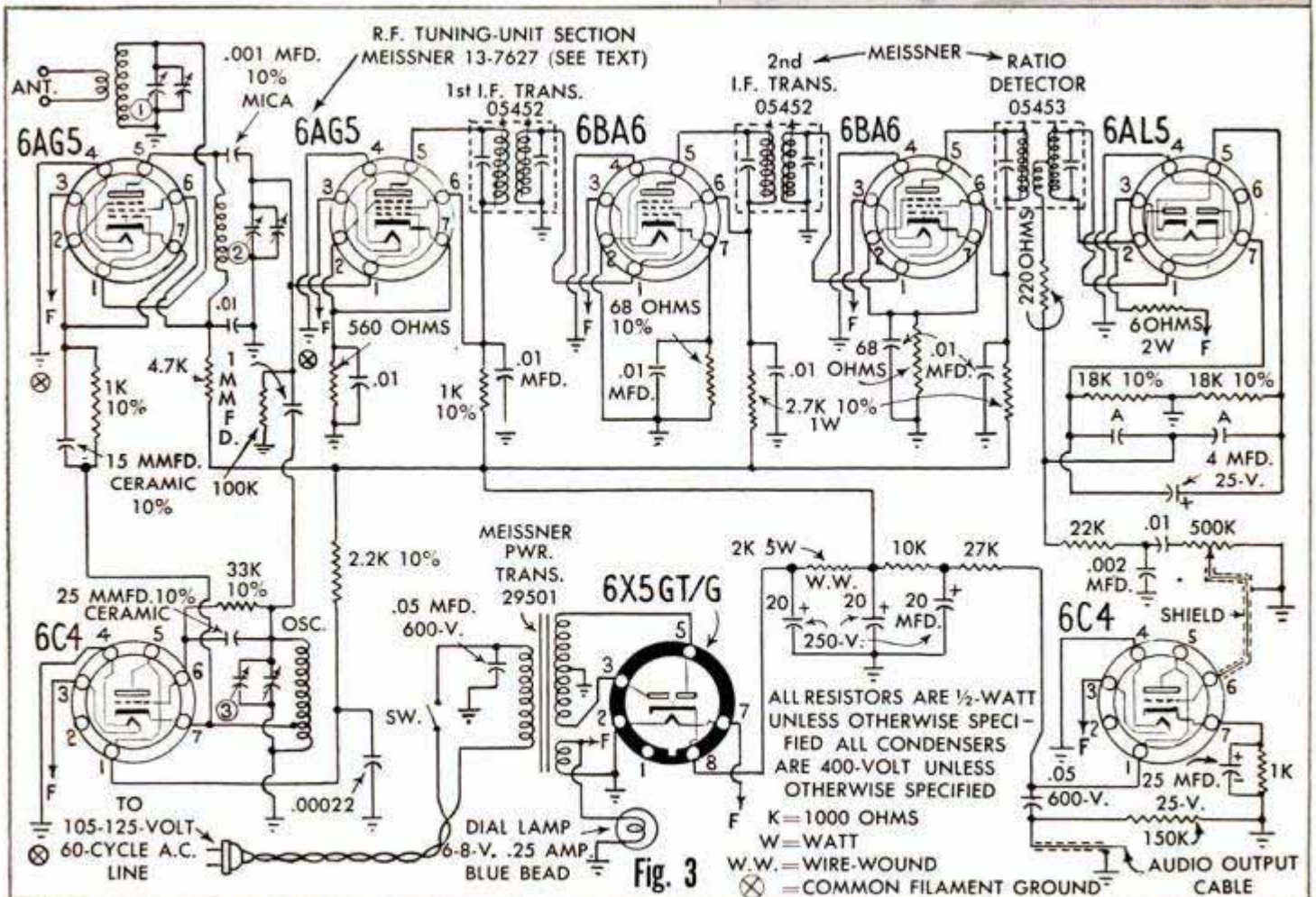
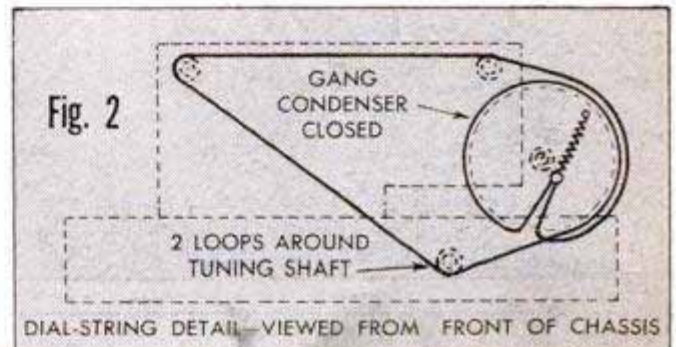
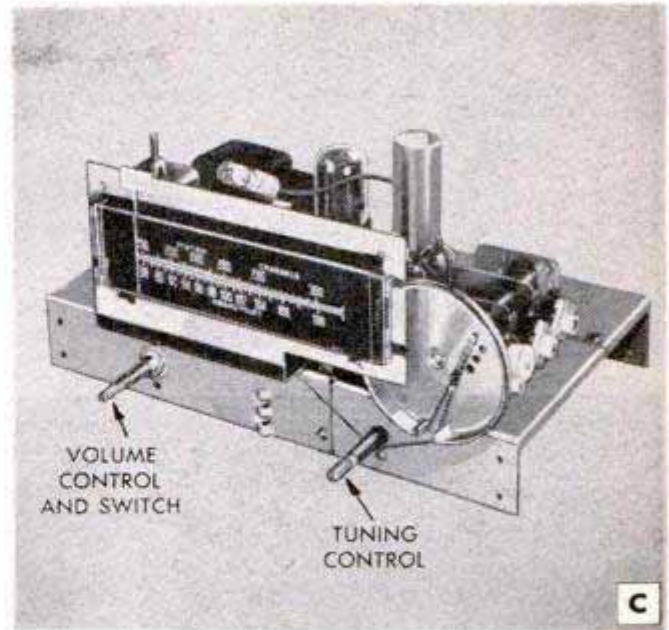

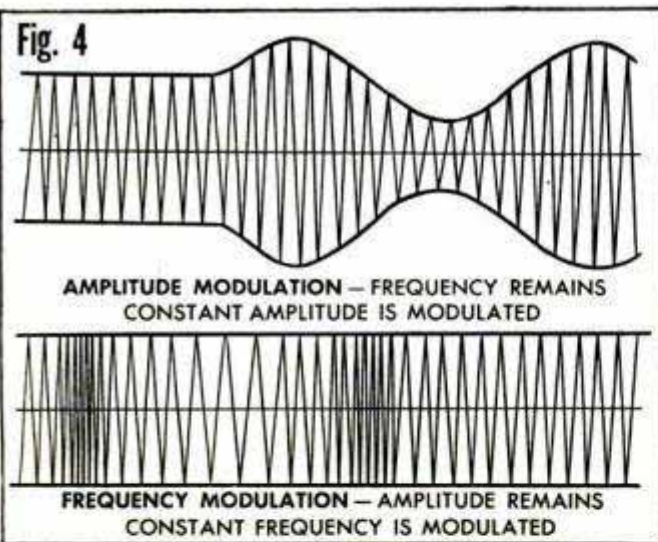
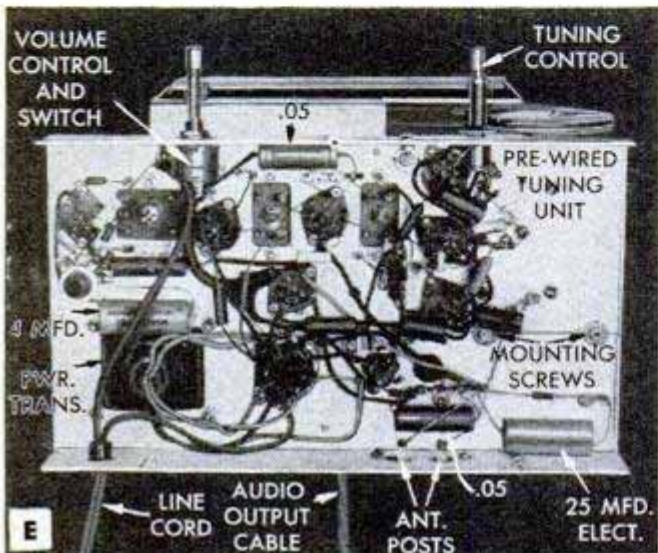
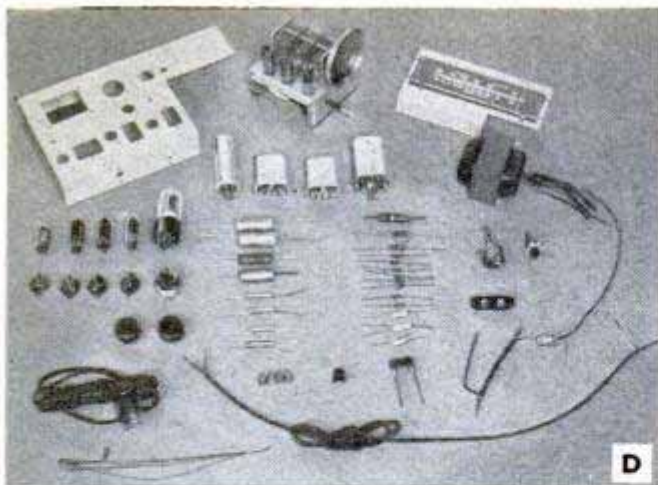

are principally amplitude modulated, they are not reproduced, thus the performance of the FM receiver is noise-free.

The input or antenna coil tunes the entire FM band from 88 to 108 megacycles. The oscillator involving the 6C4 tube, shown at lower left in the circuit diagram, beats with the incoming signal to produce a lower frequency signal. The oscillator voltage is fed into the main receiver circuit at two points, in series with the cathode of the first 6AG5, and in shunt with the input grid of the second 6AG5 tube. After the second 6AG5, the signal is at 10.7-megacy-

cle frequency and is amplified by the two following 6BA6 i.f. tubes.

Just above and to the left of the 6C4 audio-amplifier tube, shown at lower right in the circuit diagram, is a 22,000-ohm resistor and a .002-mfd. condenser. This is the de-emphasis circuit of the FM receiver. FM signals are transmitted by the station with the higher frequencies accentuated. At the receiver these higher frequencies must be attenuated to provide a perfectly flat response. Any noise in the circuit is also reduced at this point.

A full-wave rectifier is employed in the a.c. power supply, and the filter circuit is a resistor-condenser type. The output of the 6C4 amplifier tube is approximately 7 volts maximum. This is just right for use with any phono amplifier, power amplifier or good radio set having phono input terminals. Because of the high frequencies involved in FM reception, it is desirable to use a standard outdoor FM antenna, which should be mounted as high as possible. Those who wish to make an indoor FM dipole antenna that will give good results in strong FM signal areas can do so by using a short length of 300-ohm Amphenol twin lead. This is the same transmission line material that is used for both FM and TV antenna lead-ins. Cut off a 57-in. length of the twin lead and bare the wires at each end just enough to twist them together and then solder these ends. Then lay the twin lead out flat and cut the lower wire in the exact center; bare the ends of this wire about 1/2-in. and tin them for soldering to the twin-lead transmission line to the receiver. This transmission line can be any length up to about 100 ft. You can fasten the antenna to any table or baseboard with the dipole broadside to the station.

This is often a good solution for the antenna problem when a roof installation is not practical; the twin-lead dipole can be tied with string to a horizontal collar beam in the attic. A twin-lead dipole of this description makes a good emergency FM antenna in an apartment house where roof antenna systems are not permitted. Merely fasten it to the picture molding with thumbtacks on the wall of the room that is broadside to the FM station. In some cases on upper floor apartments it can even be placed under a rug if there are powerful FM stations broadcasting in the vicinity. The length of the dipole is cut to 56 1/2 in. as this is about the center of the FM band. All parts for this model T-8CK FM tuner are supplied with the complete kit, with exception of the wire and rosin-core solder. A detailed material list is furnished with the kit and also with the essential parts, when they are supplied separately by parts houses.



# Ten-Meter Transmitter Features Air-Cooled Final

By Stan Johnson W0LBV

DESIGNED especially for those who built the 160-meter phone transmitter, R-386, which appeared in the January and March 1950 issues of *Popular Mechanics Magazine*, this unit can be operated from the same power-supply and modulator units. The two transmitters together provide the amateur radio operator, having a "B" ticket, with a highly effective pair of moderate power transmitters to work the two most important Class "B" phone bands. Like the 160-meter rig, this 10-meter transmitter section handles a full 120-watts input.

The 829-B final amplifier tube is an excellent high-frequency tube and performs on 10 meters as a pair of triodes on 160 meters. This is owing to a simple forced-air cooling system using a tube-cooling fan available from radio-parts houses.

Photo A shows the new 10-meter transmitter installed in the top section of the wooden rack above the original modulator unit. A complete circuit diagram of the 10-meter transmitter unit appears in Fig. 1. Various views of the completed unit are shown in photos B, C, D and E. The standard chassis base is 3 x 7 x 15 in.

Excitation for the 829-B is provided by a two-stage exciter. The 6V6 crystal oscillator uses a grid-plate oscillator circuit instead of more common tri-tet. This

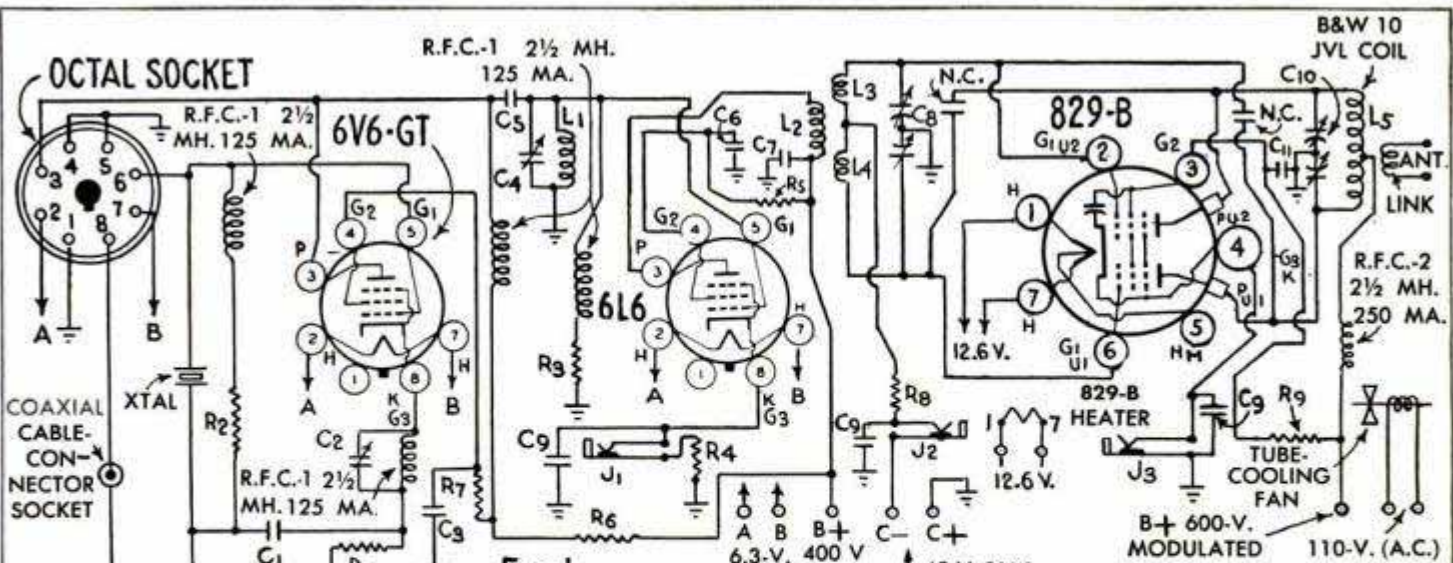
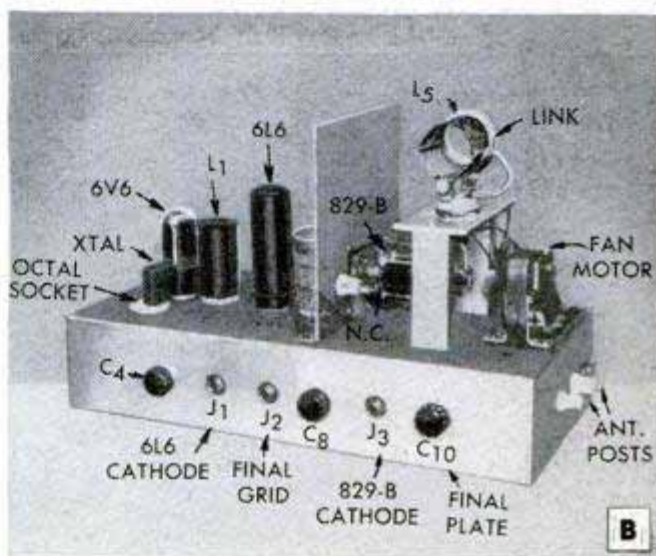

- RESISTORS**
- R1—300 ohms, 10-watt wire-wound
  - R2—47,000 ohms, 1-watt carbon
  - R3—33,000 ohms, 1-watt carbon
  - R4—400 ohms, 10-watt wire-wound
  - R5—15,000 ohms, 10-watt wire-wound
  - R6—10,000 ohms, 20-watt wire-wound
  - R7—25,000 ohms, 10-watt wire-wound
  - R8—4000 ohms, 1-watt carbon
  - R9—10,000 ohms, 20-watt, wire-wound

- CONDENSERS**
- C1—1 mfd. 400-volt paper type
  - C2—100 mmfd. air trimmer condenser
  - C3—.002 mfd. mica 600-volt d.c.
  - C4—50 mmfd. variable
  - C5—100 mmfd. mica 600-volt d.c.
  - C6—.002 mfd. 600-volt d.c.
  - C7—.002 mfd. 600-volt d.c.
  - C8—Dual 35 mmfd. variable
  - C9—1 mfd. 600-volt d.c.
  - C10—Dual 50 mmfd. variable (National TMC-50)
  - C11—.0005 mfd. mica 1000-volt rating

NOTE—SOCKETS BOTTOM VIEW.  
N.C. = NEUTRALIZING CONDENSERS  
(SMALL WIRES MOUNTED ON  
STAND-OFF INSULATORS; SEE TEXT)

NOTE—XTAL PLUGS  
INTO NO. 4 AND NO. 6  
ON OCTAL SOCKET



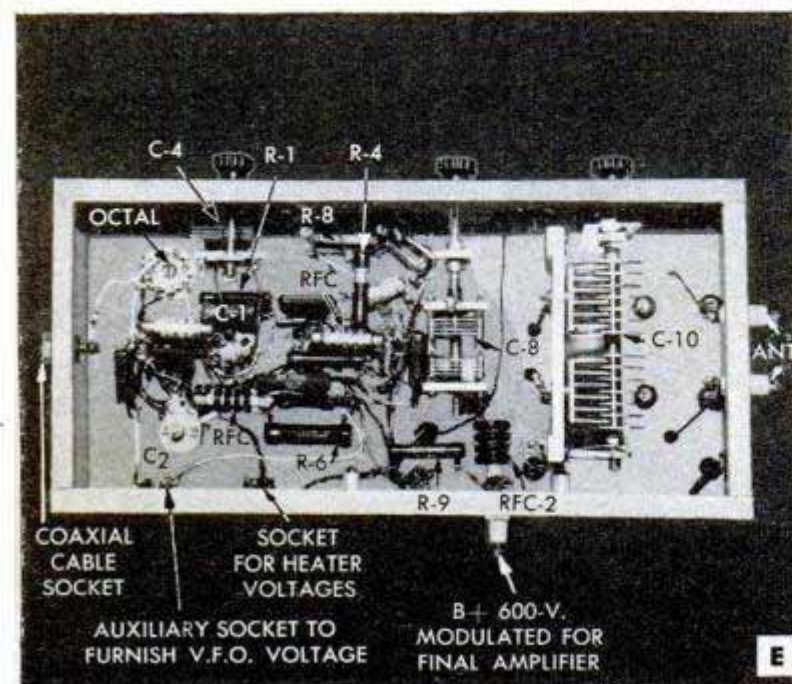
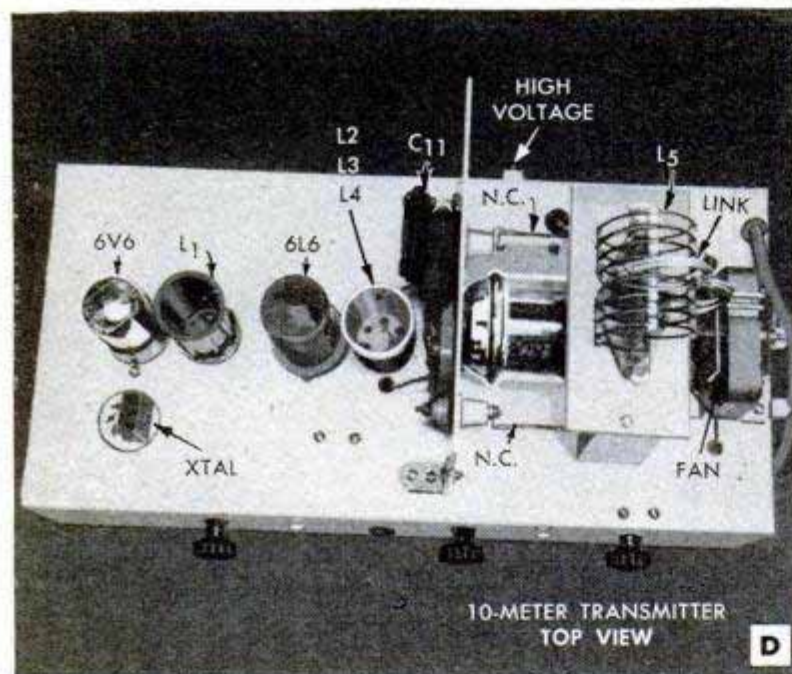
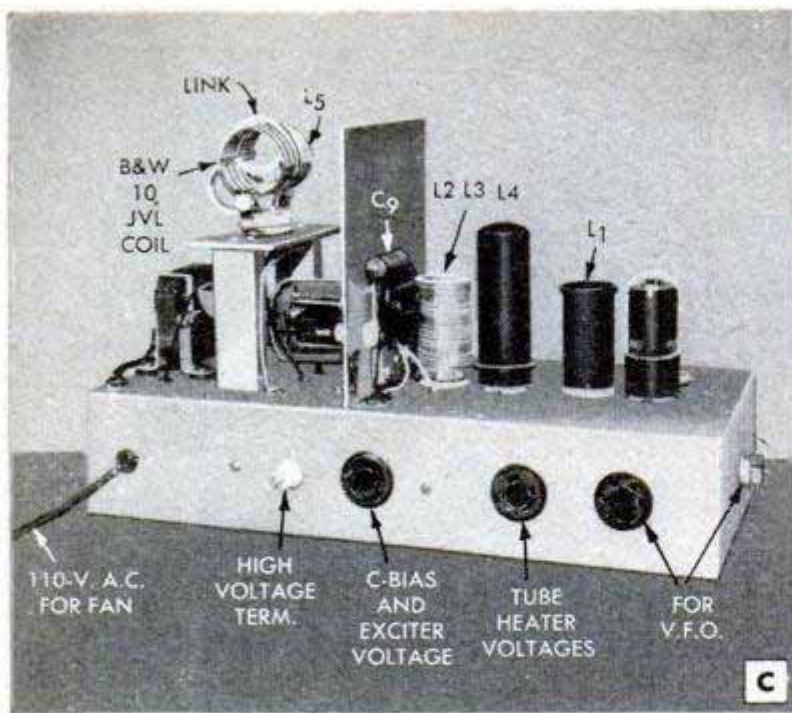

utilizes W6YVO's input arrangement which greatly simplifies coupling the oscillator to an external variable-frequency oscillator (VFO). The crystal oscillator tube is simply shifted to the octal tube socket normally used for the crystal—and the VFO (which should have the type of output in which one side of the output coil is ground) is plugged into the coaxial cable socket on the chassis.

The buffer circuit is conventional, except that the output side is untuned and tightly coupled to the tuned circuit in the grid circuit of the final amplifier. This arrangement eliminates one tuning control. All metering for the transmitter is provided for by closed-circuit jacks inserted at points in the circuit which allow the jack frame to be grounded. The 829-B is mounted horizontally on a shield which separates the input and output circuits. Neutralization of this tube is provided by small wires mounted on stand-off insulators. Starting with the wires close to the plates, they are gradually pushed away from the plates and, if necessary, clipped off, until there is no evidence of grid current change when the plate tank condenser C10 is rotated through resonance (with plate voltage on the final off, of course). The plate coil for the final is mounted on a hardboard strip mounted on two small blocks of wood. Coil L5 is a small variable-link type that plugs into a five-prong tube socket. Coil L1 consists of seven turns of No. 22 enameled wire wound on a standard plug-in 1¼-in.-dia. form, and the winding is spaced out to ⅝ in. Coils L2, L3 and L4 are wound on a six-prong 1¼-in.-dia. form. L2 is 4¾ turns of No. 22 wire spaced to ⅝ in. and L3 and L4 are each three turns of No. 22 wire wound on either side of L2 and are spaced ¼ in. from it. Have the exciter portion working before applying plate voltage to the final. The cathode current for the buffer will be approximately 40 ma., grid current to the final 12 ma., and the cathode current of the final 240 ma.

Detailed student material list R-393 for this Ten-Meter Transmitter is available from Popular Mechanics Radio and Electronics department upon receipt of ordinary letter postage.

# IT'S KODAK FOR BRILLIANT COLOR SHOWS

Everything you need for the finest miniature slide projection . . . for unequalled brilliance on the screen . . . unmatched protection for your precious transparencies. Your Kodak dealer now has a complete line to show you. Visit him today.



**A**

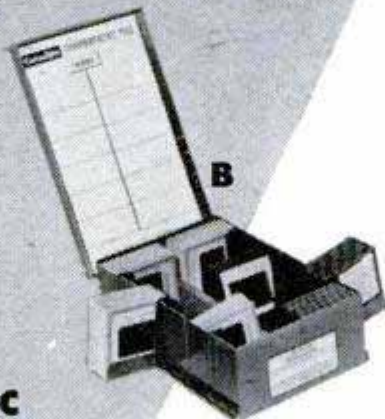

**B**

**A Kodaslide Projector, Model 2A**—Medium-priced—with sparkling performance. Heat-absorbing glass protects slides. Lumenized optics, including Kodak Ektanon Lens, 5-in. f/3.5. \$49.50.



**D**



**B Kodaslide Compartment File**—Each of the 12 compartments swings out for easy access. Index inside cover. Holds 240 cardboard or 96 glass slides. Ideal for group filing. \$3.75.

**C Kodaslide Projector, Model 1A**—A great performer at a low price. Projects bright images up to 7 ft. wide. Lumenized optical system steps up screen brilliance 50%. \$29.50.

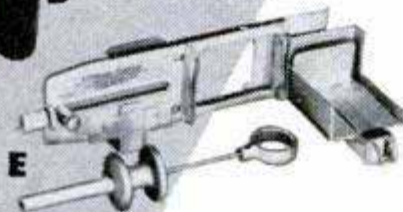

**E**

**D Kodaslide Projector, Master Model**—Thousand-watt lamp delivers more light than any other 2 x 2 projector. Turbine-type fan cools slides on both sides. Choice of 5 superb Kodak Ektar and Ektanon Lenses. \$150 to \$225, depending on lens choice.

**E Kodaslide Changer**—Attaches to a Model 1A or a Model 2A for smooth, simple changing of slides. Takes up to 46 cardboard mounts. \$17.50.

**F Kodaslide Table Viewer**—Projector, screen, and changer in a single unit. Always set up and ready to go. Gives a brilliant image even in a fully lighted room. \$95.

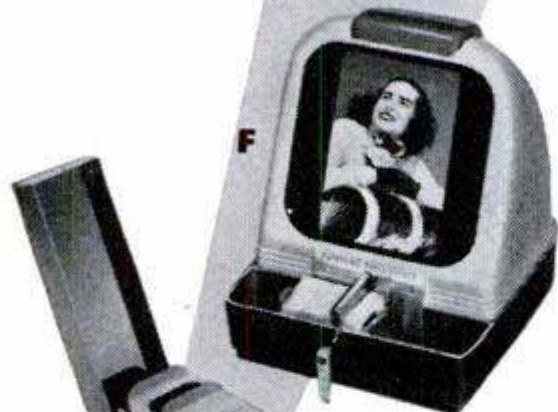

**F**

**G Kodaslide File Box**—Protects 140 cardboard slides, 55 glass slides. Keeps them organized for easy handling in darkened room. Sturdy metal construction. \$1.15.

**G**



**EASTMAN KODAK COMPANY**  
**ROCHESTER 4, N. Y.**

**Kodak**  
 TRADE-MARK



A "COMPLETE HOME WORKSHOP" IN ONE COMPACT UNIT!

Cuts 1/2" wood, 1/4" plywood, thin metal, plastic.

NEW and IMPROVED

**atkins** ELECTRIC MOTOR DRIVEN  
**3 in 1** JIGSAW! SANDER! FILER!

ONLY \$14.95 POST PAID

Complete with built-in Motor — 3 Project Patterns — 3 Blades — 2 (4" x 9") Pieces of Wood and Allen Wrench!

**POWER PLUS—ABSOLUTELY SAFE—MADE OF LIGHT WEIGHT CAST ALUMINUM!**

**POWERFUL ELECTRIC MOTOR** (do NOT confuse with ordinary, less powerful vibrator type motors.) 3000 revolutions per minute! **SAW** cuts to center of 16" circle . . . adjustable **SAW GUIDE** permits cutting ANY length material. Strokes 3000 per minute. 110 V - A.C. **TILTING** and **ROTATING TABLE TOP** (6"x8") cuts at any angle. **SANDING TABLE** tilts through 45°. **FOR FAST, EASY FILING** simply remove saw blade, chuck and saw guide . . . insert 1/4" diameter standard file.

Guaranteed 1 Year against defects in materials and workmanship

Try it FREE for Five Days—Money Back if Not Satisfied!

Wonderful PROJECT PATTERNS. It's Simple To Make Most Anything! Household Items, Toys and Many Others!



All pattern parts are actual size for finished projects. All you do is paste them down or trace them right on the wood! **10 \$1 FOR**

GROUP 1 . . . 10 patterns for beginners  
GROUP 2 . . . 10 patterns for the advanced  
GROUP 3 . . . 10 patterns for the skilled

Sold in leading Department, Hardware and Hobby Stores.

If your dealer cannot supply, send coupon direct:  
**FREE 5 day trial... MONEY BACK if not satisfied!**

**atkins INDUSTRIES INCORPORATED Dept. PM9—5823 N. Ravenswood Ave., Chicago 26, Ill.**

- Enclosed is \$14.95 (check or M.O. in full.) Rush, 3-in-1 Jig Saw POST PAID.
- Enclosed is \$2.00 part payment. I will pay postman balance plus postage on C.O.D. delivery.
- Enclosed is \$.....(check or M.O. in full.)  
Rush Group Nos. ....Project Patterns at \$1.00 each POST PAID.

Name.....  
Address.....Zone.....  
City.....State.....

## Doctor for Old Timers

(Continued from page 92)

Most of the beautiful antique watches require new crystals; modern crystals could be made to fit, but many of the originals had high crowns. So that's the way Cole makes them. With the help of James Morris, a glassblower at Northwestern University, Cole has developed a method for making these high-crown crystals. The two men soften heat-resistant glass in a flame, supporting it around the edge. At the right temperature the glass sags in the center. Presto—they have a high-crown crystal.

Cole doesn't restrict himself to work on watches alone—he also is an expert on old clock mechanisms. One of his prize jobs was the rebuilding of an 18th-century grandfather clock which now stands in the hallway of his new home. The clock is a complicated mechanism which shows the date and moon phase as well as the time. A 55-pound weight keeps it going for a full month without rewinding.

But most fascinating of all is the musical ability of the old clock. Behind the face are 25 bells which are actuated by a roller mechanism to play 18 different tunes, each tune lasting about 45 seconds. Rows of small pins, precisely set on the roller, trigger tiny hammers to play the tunes. When Cole started working on the clock, so many of the pins were bent, broken or missing that he decided to get a fresh start by removing the ones which remained. Then watchmaker Cole became musician Cole. He searched for old German tunes of the period when the clock was made, worked out the timing and harmony of the tunes, then set 600 pins in the roller to play the music. To date he has put five tunes on the roller.

Now that he has a house of his own, Cole has an immaculate basement workshop equipped with razor-sharp tools where he repairs or duplicates the hand carving on antique clock cases.

His latest project is a fascinating little "cuckoo watch" with a saucy bird that bobs back and forth to the music played by a "miniature slide trombone." Actually the music comes from a tiny whistle which plays an entire octave of notes. A slide in the whistle slips back and forth to play either of two tunes. Air for the whistle? A tiny goatskin bellows, operating through an ingenious arrangement of four compartments, furnishes a steady supply.

Cole is an inventor, too. He's working on a watch without a dial which shows time directly, like some electric clocks. Similar watches have been designed, but Cole will

(Continued to page 232)

Only wide-gap Auto-Lite Resistor Spark Plugs give you

# SMOOTHER PERFORMANCE DOUBLE LIFE and GREATER GAS SAVINGS

**M**ILLIONS of car owners from coast to coast are switching from narrow-gap spark plugs to the sensational new wide-gap Auto-Lite Resistor Spark Plug. They want smoother performance—money-saving gas economy—improved starting in extreme cold weather. They want the spark plug with the *Built-in Resistor* that doubles spark plug life and reduces interference with radio and television reception.



To get these remarkable benefits for your car, see your Auto-Lite Spark Plug Dealer today. You're always right . . . with Auto-Lite.

Auto-Lite Spark Plugs Patented U.S.A.

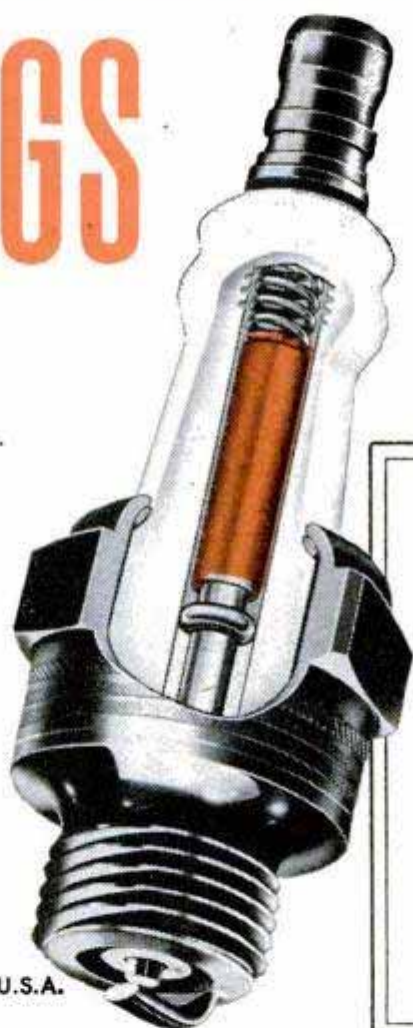

Cut-away view shows the 10,000 ohm Resistor which permits wider initial gap settings and makes these advantages possible. *Double life under equal conditions as compared to spark plugs without the built-in Resistor.*

The wide-gap Auto-Lite Resistor Spark Plug is the newest addition to the complete line of Transport, Aviation, Marine and Regular Automotive spark plugs—ignition engineered by Auto-Lite.

# AUTO-LITE Resistor SPARK PLUGS

Tune in "Suspense!" . . . CBS Radio Thursdays . . . CBS Television Tuesdays



# Care and Feeding of Engines

BY S. P. CORP

## TIME TO CHECK THERMOSTAT

Winter is coming. You'll be putting in anti-freeze. Do you realize that different types of anti-freeze call for different thermostat adjustments? Alcohol boils at 180° F. If your thermostat is set higher than 165°, you will lose alcohol fast. But—if you use a permanent type anti-freeze—which boils at 223° F.—you will lose a lot of benefit unless your thermostat is set between 180°-200°. The best way is to decide which type anti-freeze you are going to use, and check your thermostat. Put thermostat in water with a thermometer and heat water. Note temperature as thermostat opens. If it opens too soon, or too late, for the anti-freeze you will use, get another thermostat! Also—be sure to check all hose lines and water connections. Replace hose that has begun to deteriorate!



## FIX WATER PUMP LEAKS

Pump leaks generally occur at the bottom of the pump housing. Such a leak means that you need to recondition the sealing surfaces of the pump. If you are using a water pump repair kit, be sure the machined surface against which the seal bears is smooth and true. Here is one design. If surface "X" is rough, pitted, or grooved, the seal will not hold. Tight seals are also required around the shaft on this particular design. There are several pump designs. The important thing is to know your pump before you start to fix it. Then be sure you have taken care of every seal. You may need to replace fan hub or impeller. Loss of anti-freeze can be both costly and dangerous.

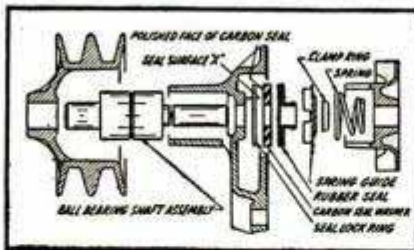

## ABOUT THAT RING JOB

Loss of power is costly, too. If you need a re-ring job before winter, be sure to use the best rings—Sealed Power Piston Rings. There is a Sealed Power Ring Set specifically engineered to do the best possible job on your engine, whatever the make, model, or wear condition. The best oil control ring ever made is the Sealed Power MD-50—the only ring with the Full-Flow Spring. It controls oil even in badly tapered and out-of-round bores. Write Sealed Power, Dept. G-9, Muskegon, Mich., for the free booklet, "7 Ways to Save Oil."

# Clinic



## for Homemakers

As a service to our readers in solving the hundreds of problems pertaining to a home—inside or out—the editors of *Popular Mechanics* invite you to present your problems to The Clinic Editor for help and advice. Address your questions to The Clinic Editor, *Popular Mechanics Magazine*, 200 East Ontario Street, Chicago 11, Ill.

### Defective Shade Roller



**Q**—I have a roller shade over a large single-pane window which lately has refused to lock in the down position. I suppose this is due to a defective roller as the shade flies up as soon as it is released. The shade is nearly 5 ft. wide. Can the roller be repaired by the installation of new parts and, if so, how does one go about it?  
C. G., York, Pa.

**A**—As a rule it does not pay to attempt the repair of a shade roller so badly worn that the ratchet no longer holds. Shade rollers of the spring type, even large ones, are quite inexpensive. However, there is one simple repair that sometimes effects a cure of the trouble you describe, at least for a time. The chances are, if the roller mechanism has not been damaged in some other way, that the shaft has become so badly worn that the ratchet dogs cannot engage and hold. On most shade rollers it is possible to slip a bushing cut from thin sheet metal over the shaft to take up the excessive play due to wear. You might try out this suggestion but, if it does not work satisfactorily, then the installation of a new roller is the only effective remedy.

### Water Damage



**Q**—Recently my home caught fire in the attic and considerable damage resulted from the water used to extinguish the blaze. Paint has peeled from the ceilings and plaster seems to be loose in places and in general is badly discolored. Do you think it is necessary to replaster?  
A. D., Milwaukee, Wis.

**A**—It is, of course, difficult for us to make a long-range appraisal of damage to walls and ceilings from water used to extinguish a fire. However, judging from your description of the condition of the ceilings and walls we would be doubtful about

(Continued to page 230)

# Never before - SO MUCH SAW for SO LITTLE MONEY!

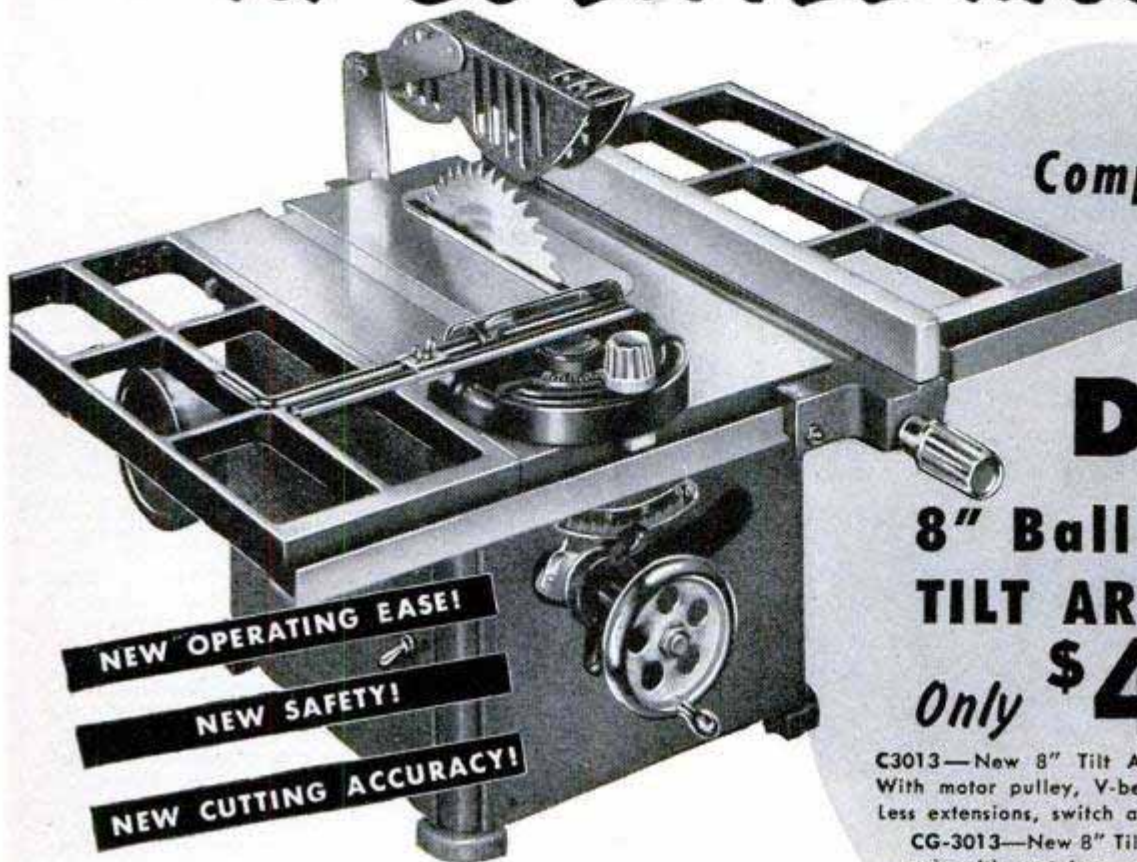

Completely  
**NEW**

## DURO

**8" Ball Bearing  
TILT ARBOR Saw**  
Only **\$43<sup>95</sup>**

C3013—New 8" Tilt Arbor Bench Model saw. With motor pulley, V-belt and 8" comb. blade. Less extensions, switch and motor, \$43.95 retail.  
CG-3013—New 8" Tilt Arbor Bench Model saw with cast iron gridded extensions, as shown. With motor pulley, V-belt, 8" comb. blade. Less motor and switch . . . \$49.95

**NEW OPERATING EASE!**

**NEW SAFETY!**

**NEW CUTTING ACCURACY!**

**AS EASY TO BUY AS IT IS TO USE!**

*Today's Greatest Saw Value*

Now you can enjoy the thrill of working with a husky, extra-capacity *tilting arbor design* saw . . . for little more than you'd expect to pay for an ordinary table saw! This smooth-running new ball bearing saw is **BIG** in everything but price. There is a full  $7\frac{3}{8}$ " ahead of the blade . . . you can make cuts up to  $2\frac{3}{8}$ " in depth. With gridded extensions the work table measures  $26"$  x  $17\frac{1}{8}"$ —large enough to make big cuts with ease. The new Duro arbor lock tilts and locks the blade just where you want it . . . instantly, safely.

**There is a full line of Duro Precision Power Tools** including band saws, lathes, sanders, shapers, jointers, jig saws and drill presses. See them at your dealer.



WRITE TODAY for details and specifications on this new Duro 8" Tilt Arbor Saw. Or, if you would like to order and your dealer cannot supply you, send check or money order for \$43.95 or \$49.95 and your saw will be shipped prepaid promptly. (Illinois shipments, add 2% Retail Sales Tax.)

### EXCLUSIVE NEW DURO MOTOR PULLEY

This new Duro tilting arbor design saw features an exclusive "wide range" motor pulley which allows the belt to adjust itself to the angle of the saw blade. You get more positive drive . . . less belt twist . . . longer belt life. In addition, an interchangeable sleeve permits use of this new pulley on either  $\frac{1}{2}"$  or  $\frac{3}{8}"$  motor shafts.

### DURO METAL PRODUCTS CO.

2670 N. KILDARE AVE., CHICAGO 39, ILL.

Duro Metal Products Co.  
2670 N. Kildare Ave., Chicago 39, Ill.

Please send me: Full details about the new Duro 8" Tilt Arbor Saw . I'd like to order a saw right now . . . I enclose check  money order  for \$\_\_\_\_\_

Name \_\_\_\_\_

Address \_\_\_\_\_

City \_\_\_\_\_ Zone \_\_\_\_\_ State \_\_\_\_\_

Dealer's Name \_\_\_\_\_



# POINTERS FOR HOME PAINTERS

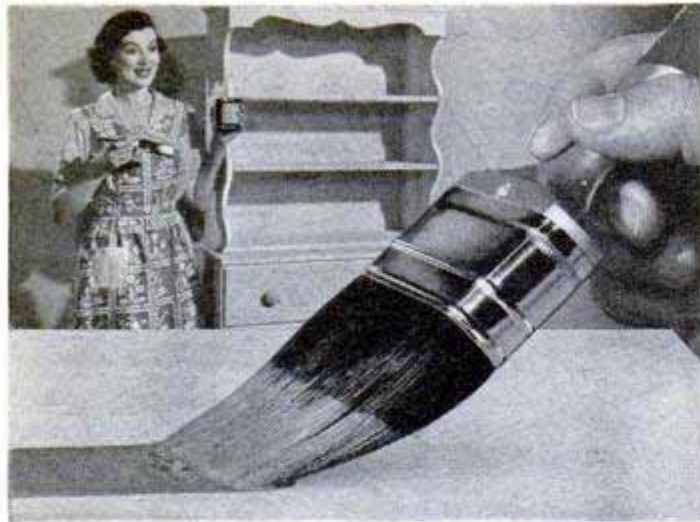

How to get smoothest jobs ever with wonderful new NYLON paint brushes!



Dip only half the length of the bristles in paint—on overhead work dip to only one inch. Tap off the excess paint. Don't scrape off on edge of can.

Nylon brushes hold a full load of paint. And they are ideal for nearly all finishes.



To get the best results, use a long, steady, even stroke, painting toward the surface already coated.

Durable nylon bristles don't break off and mar your work, and an independent research laboratory has found that nylon brushes paint smoother.



Use correct brush for each job. Poking large brushes into corners causes "fingering."

You can get a set of nylon brushes for every job, from touch-up work to wall and roof painting. They're made by leading manufacturers.

The next time you paint, try a smooth-painting, easy-to-clean nylon paint brush. You will never use any other kind. They're sold in paint, hardware and variety stores everywhere in all types and sizes.



Clean thoroughly, suspend brush on wire in turpentine or linseed oil for storage between jobs. Resting bristles on bottom of can deforms them.

Nylon brushes clean quickly and easily. Work out paint on newspaper, clean with thinner, rinse with soap and water. Then comb the bristles and wrap the brush for storage.



Better Things for Better Living  
... through Chemistry

**NYLON  
PAINT BRUSHES**

for smooth painting... easy cleanup

(Continued from page 228)

the advisability of painting them. Rather we believe it will be necessary to replaster, at least the areas where you say the plaster seems to be loose. In any case, if the plaster has been loosened it cannot be considered permanent. Minor discolorations on the walls probably would be covered satisfactorily by paint but, if any areas of the ceilings or walls have been soaked sufficiently to crack and loosen the plaster from the lath, then it will be necessary either to patch the damaged parts or replaster the entire wall or ceiling. Replastering generally is advisable if the damage includes more than one fourth of the total area. Otherwise patch-plastering will probably prove satisfactory in a room of average size. Be sure that both the old and new plaster are thoroughly dry before applying paint.

## Making Compost Pile

Q—I have available grass clippings and other materials for making a compost pile. But how to do it? One adviser says to excavate and pile the refuse in layers below ground level. Another maintains that the stuff will decompose just as effectively if piled above grade. Who's right? T. R., Rock Island, Ill.



A—In this case both your mentors are right, at least partially. The essential difference between the two methods is the matter of time. Obviously, all things considered and depending to some extent on the kind of material used, it will take longer for equal decomposition of composted material piled above ground as compared with that placed in an excavation. Where an excavation is objectionable, composting of such materials as you list above the ground level will be satisfactory but decomposition will take longer by natural processes. Decomposition can be hastened if desired by the addition of chemicals specially prepared for this purpose. When making the pile, either above or below ground level, select a low spot protected from drying winds by shrubbery or other barriers. Pile the fine and coarse material in alternate layers 3 to 5 in. thick, keeping the pile rectangular in shape with the edges higher than the center so that the depression will catch and retain both rain and snow. If chemicals are added, sprinkle the mixture on each layer so that it is equally distributed through the pile. During the drier summer months soak the pile periodically with water from the hose. Keep the sides of the pile vertical, as otherwise the pile will shed water. Some gardeners repile the material after a time and add new chemicals, but ordinarily this is not necessary.

## Surfacing Driveway

Q—I need a hard-surfaced driveway from the street to my new garage which has just been completed. Length of the driveway will be about 50 ft. I will have to break the curb and install a ramp from the curb to the property line. What surfacing material should I use for the driveway and ramp—concrete, blacktop or flagstones set in cement?—S.M., Columbus, Ohio.

A—So far as permanence is concerned there is little choice between these materials, provided, of course, the work is properly done. Most recommendations call for a tamped gravel fill in an excavation 4 to 6 in. deep and, of course, a form will be required above ground for cement. Although there are various methods in use, flagstones are commonly laid on tamped gravel and the joints (spaces between the individual stones) are filled flush with cement mortar and brushed lightly before the cement sets. This makes a satisfactory driveway surface for light traffic and it is especially attractive for a winding driveway. Blacktop surfacing also is widely favored because of its durability and probably because the driveway is less conspicuous on a small lot when surfaced with this material. Don't forget that most municipalities require you to obtain a permit before breaking the curb and installing a ramp.



IF YOUR FIREPLACE ACTS  
LIKE THIS... IT'S TIME TO  
CLEAN THE CHIMNEY...

*and*

IF YOUR CAR FEELS LIKE THIS  
...IT'S TIME FOR MARFAK  
CHASSIS LUBRICATION



THAT CUSHIONY FEELING LASTS LONGER WITH MARFAK!

You get driving that's "cushiony" as a hayride when *Marfak* lubrication guards the chassis. *Marfak* is tough and stretchy—sticks to wear points and bearings for a thousand miles and *more*. Rough roads can't jar out *Marfak*. It resists wash-out and squeeze-out. You can feel its longer-lasting protection in that "cushiony" driving ease that *lasts*. Get *Marfak* lubrication today! See your Texaco Dealer, *the best friend your car ever had*.



**THE TEXAS COMPANY**  
**TEXACO DEALERS IN ALL 48 STATES**

*Texaco Products are also distributed in Canada and in Latin America*



# Tired of Raking Leaves?

--- then

## PULVERIZE them

with

# MOW-MASTER

## Grind-a-Leaf



### The NEW

### Easy Way . . . .

## TO RID YOUR LAWN OF DRIFTING LEAVES

Here is the fast, effortless way to a beautiful, clean lawn through the autumn season. MOW-MASTER Grind-a-Leaf pulverizes leaves instantly—completely eliminates the need for raking, hauling or burning.— And in the summer time MOW-MASTER mows lawns velvety smooth or cuts tall grass and weeds by simply removing the Grind-a-Leaf attachment.

Write for FREE literature and name of nearest dealer.

**PROPULSION ENGINE CORP., Dept. PM-9**

7TH STREET & WHITE EAGLE ROAD, KANSAS CITY 15, KANS.

### TRIPLE DUTY MOW-MASTER

1—Mows Lawns    2—Cuts Tall Grass and Weeds  
3—Pulverizes Autumn Leaves

have a moon-phase indicator and a mechanism that will show the daily time of the moon's rising and setting.

As you might suppose, Cole's own pocket watch is no ordinary timepiece. There's no face and you can look right through the glass case to see every cog in the mechanism. How does he tell time? When he pushes the stem, gongs strike the hour from one to 12, pause, strike the quarter-hour, pause again, then strike from one to 15 to indicate the exact minute.

"Takes several seconds to learn what time it is," Cole says happily.

## The Campus Is On the Air

(Continued from page 128)

the microphone of the Penn menace. The words had no more than been spoken, when hundreds of Princeton students began to pour out of houses all over the campus. Every jalopy that could be coughed into action was soon bulging with students, who raced to block all approaches to the campus. Princeton was not painted that night.

The average college station has a staff of about 45 students, and they all get in plugs for their station at their respective dormitories, fraternities and sororities.

College radio stations usually broadcast all day Saturday and from 3 to 11 p.m. other week days. While the campus microphones are warm, the stations expect students to keep dialed to them except when switching to a commercial station to listen to some particular program. Broadcasts are even geared so that the students can listen while they study. The latter part of the evening is usually devoted to classical music.

College students would be expected to favor mostly popular music, but the stations receive as many requests for classical pieces as they do popular.

In a nation-wide survey conducted by its stations, IBS found that 45.8 percent of the students polled liked opera and operatic music. In the voting, opera ranked just between jazz (hot!) and spirituals, but ahead of quiz shows. Particularly significant was the higher cultural level of preferences by upperclassmen.

WKCR at Columbia has helped to educate its listeners to a type of drama as far removed as possible from soap operas. Historical dramas and fantasies have attracted big listening audiences. Other successful programs have used adaptations of stories by William Saroyan, Dorothy Parker and Stephen Vincent Benet.

College radio, as might be expected, is often spotty, amateurish. But there are flashes of brilliance, too. And those flashes rate an "A plus" in any grade book.

# All-Steel Bodies Stronger Than Steel



Chevrolet all-steel Bodies by Fisher not only have all the strength that is inherent in this strongest of metals, but *extra* strength due to advanced engineering design and precision manufacturing methods.

Take the center body pillar as an example of how Fisher design makes steel parts stronger than steel. The pillar is a self-reinforcing flanged double box girder—a structural form having far greater strength than a solid steel pillar of equal weight. (See illustration at the right.)

Look at the floor, too. It's a single piece of steel, made vastly stronger and more rigid by deep ribs, channels, and buttress-

like brace, formed directly in the metal.

And so it goes throughout the body, as the larger view shows. It's a picture worth studying—for it tells clearly why *Body by Fisher* means *better by far*. That, of course, is another reason why Chevrolet is first and finest—for Chevrolet alone in the low-price field has this world's best body.

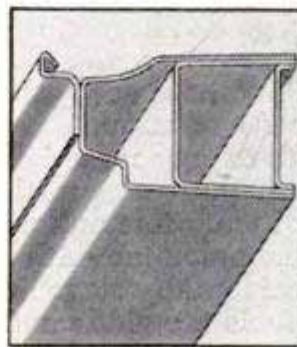

Your Chevrolet dealer invites you to see and drive the new Chevrolet. Make it a point to do it today!

Flanged double-box-girder body pillar—light, but exceedingly strong. (Left)

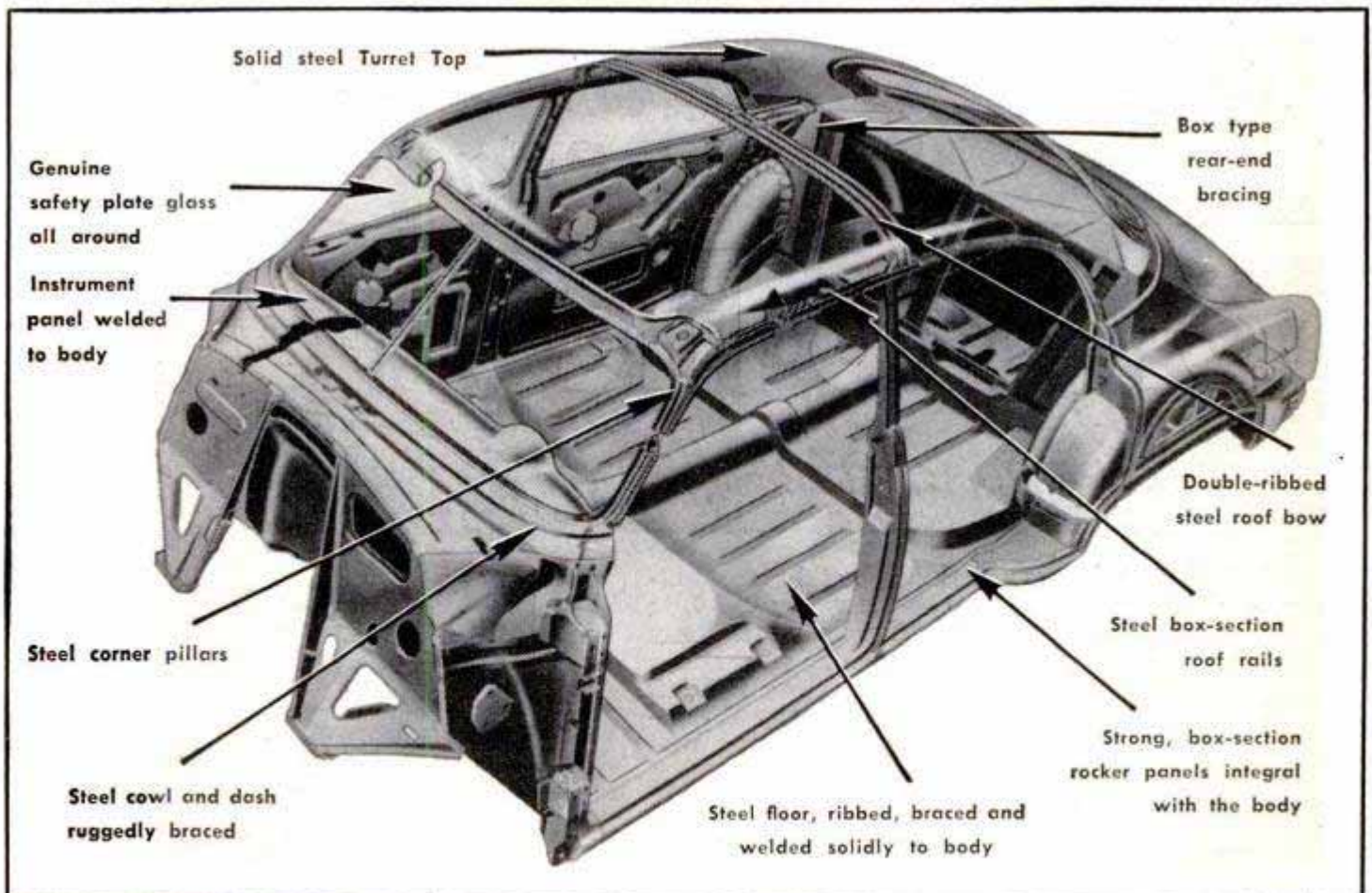

CHEVROLET MOTOR DIVISION, General Motors Corporation, DETROIT 2, MICHIGAN

## Galloping Gold

(Continued from page 86)

They looked around to find the best possible stallion. Finally they chose Cream of Wheat, a splendid animal belonging to the Tom Goodnight and Roy Wayland ranch in Phoenix, Ariz. Out of this mating came the Fagan's first and most famous colt, Harvester, a stallion who has won a whole sheaf of ribbons, does tricks like a well-trained dog, and has sired about 50 registered palomino progeny.

The Fagan's proudest boast about Harvester, however, is that "former Secretary of Agriculture Clinton P. Anderson tried to buy him for his New Mexico ranch—but we wouldn't sell."

Today the Fagans have one of the largest palomino strings in the San Fernando Valley. Breeding and buying stock, they now own about 20 registered golden horses. Recently, Jim and Edna acquired the Bob Burns ranch at Reseda and both are active in the Palomino Horse Association.

Sometimes it's difficult to purchase high-grade palominos even if you possess the wherewithal. Owners of truly fine animals are reluctant to sell. The palomino enthusiast, therefore, who accidentally stumbles upon a promising colt feels the giddy sensation of a gold-hunting prospector chanc-

ing upon precious nuggets in a stream.

The ideal color of a palomino's coat is described by that very apt phrase, "the color of a newly minted U. S. gold coin." Variations up to five shades lighter and five shades darker are allowed in palomino horse shows.

In California they like their palominos a solid color—an orange or a coppery hue. In Texas, the preference runs to a golden dapple. Manes may be silver, ivory or snowy white. Four stockings and a blaze or star on the forehead are allowed, but color on any other part of the body disqualifies the animal as a true palomino. Eyes should be brown or hazel.

You can frequently tell a palomino by his name alone, for the suggestion of gold carries over into the names of many registered animals: Sunny Gold, Golden Eagle, Harvest Sun, My Buck O' Gold, Banana Peavine, Nugget, King Midas, Casey's Champagne Blonde, Mustard, Desert Sunshine, Yellow Tack, Poppy de Oro, Taffy, Honey Harvest and Amber Boy.

Although golden horses have been known and valued for thousands of years, geneticists declare that palominos today are not a breed, in the strictest sense, but a color type. In other words, you cannot expect to mate a palomino mare and a

(Continued to page 236)



*Hi-level needs water  
only 3 times a year!*  
In Normal Car Use

# prest-o-lite hi-level

*70% longer average life\*!*

**A**VOID battery failures, get longer battery life, with the new Prest-O-Lite Hi-Level Battery that needs water only 3 times a year in normal car use. Helps prevent a major cause of battery failure. In addition, Hi-Level gives you Fibreglass mats to keep power-producing material in the plates for longer life. Make your next battery a Prest-O-Lite Hi-Level.

**PREST-O-LITE BATTERY COMPANY, INC.**  
Toledo 1 Ohio



\*In tests conducted according to S.A.E. Life Cycle Standards.

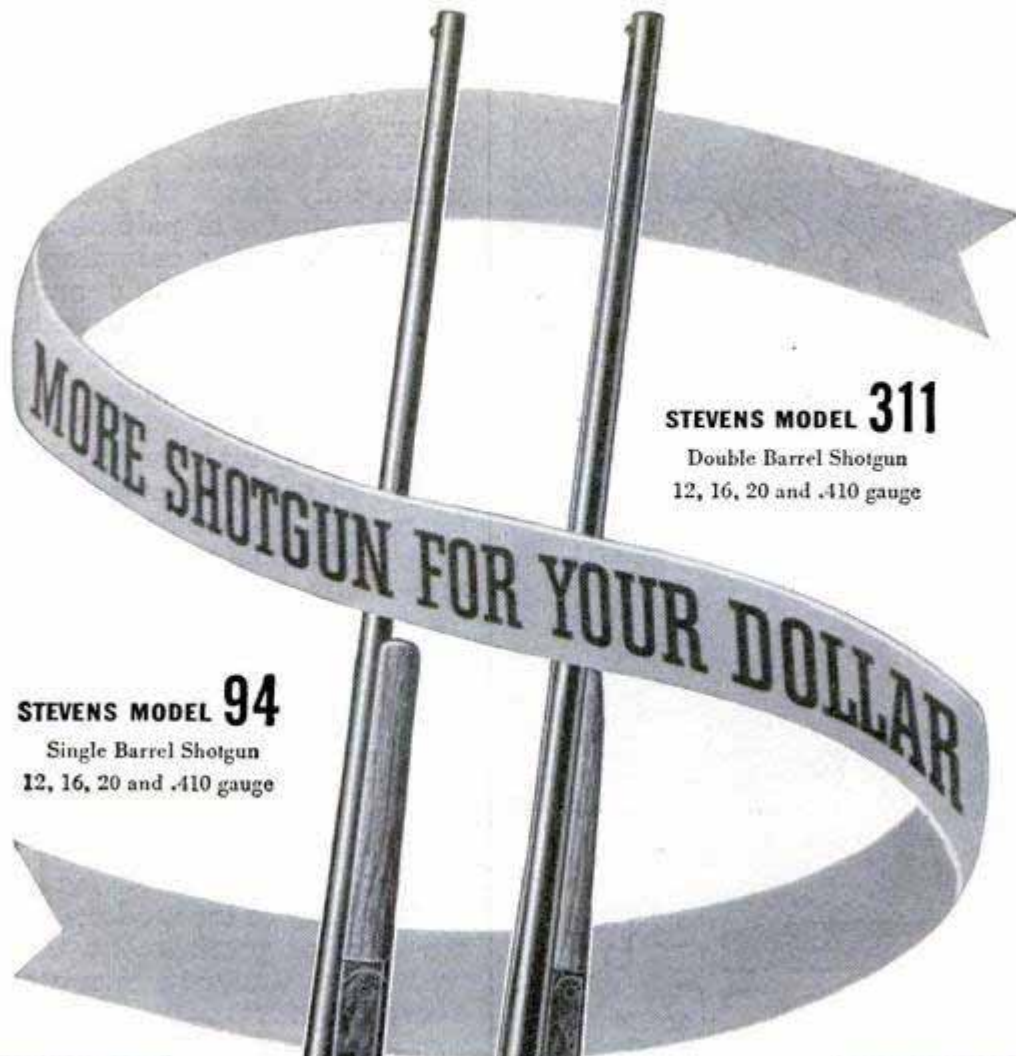

**STEVENS MODEL 94**  
Single Barrel Shotgun  
12, 16, 20 and .410 gauge

**STEVENS MODEL 311**  
Double Barrel Shotgun  
12, 16, 20 and .410 gauge



Two-way, top snap action for either right or left hand shooters, is a feature of the Stevens Model 94 "single." Lock-up is positive and rigid — can't shoot loose. Unbreakable coil springs . . . chrome molybdenum firing pins and *positive automatic* ejector are other quality features.



There's no better, more reliable double barrel shotgun action, *regardless of price* than in the Stevens Model 311 "double." The coil spring—hammer—sear mechanism of proven design (used in most expensive double guns) gives clean, crisp, trigger pulls—split second hammer fall.

You get more shotgun for your dollar, *plus* more fine gun features, when you buy a Stevens double or single barrel shotgun. That statement has been proved by the tens of thousands of shooters, over the years, who have made these guns their first choice. And, by the fact that Savage is the world's largest builder of single and double barrel shotguns.

**STOCKS**—New redesigned wood stocks and fore-ends, walnut finish, on both Model 94 and 311.

**MORE FINE GUN FEATURES**



Barrel and Lug forged in one piece — one of many fine gun features found in these low priced Stevens models . . . features which mean unfailing dependability . . . top shooting qualities.

Plan right now to own a Stevens "double" or "single" this year — for pest and sports shooting. See these "first in the field" values at your dealer's. Write for free catalog describing the complete line of Savage, Stevens and Fox Shotguns and Rifles.

**SAVAGE ARMS CORPORATION**  
Firearms Division, Chicopee Falls, Mass.

**SAVAGE**  
SAVAGE · STEVENS · FOX Rifles and Shotguns

SAVAGE · WORCESTER Power and Hand Lawn Mowers

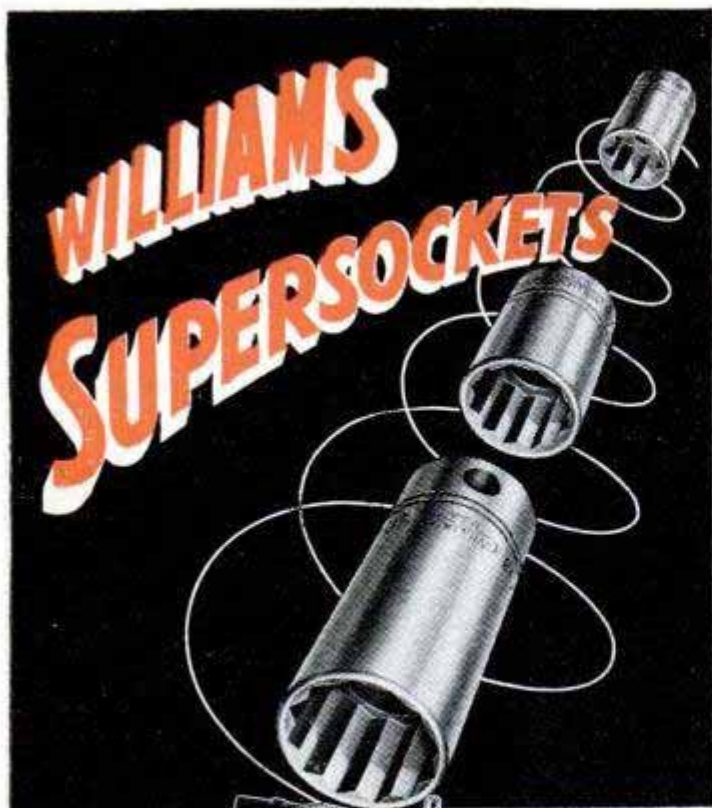

Set No. S-10  
21 Sockets  
and 15 Attach-  
ments.

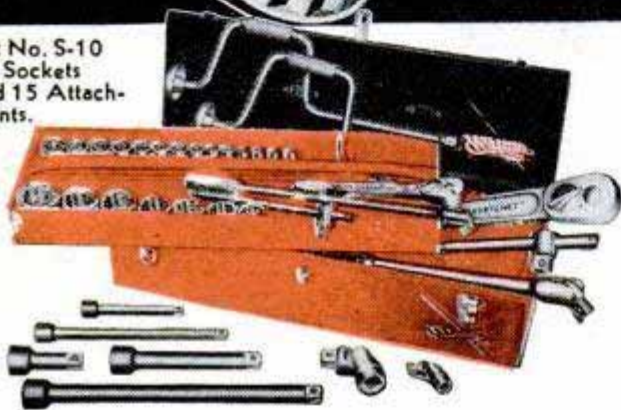

## WORLD'S MOST FLEXIBLE WRENCH SYSTEM

The engineered flexibility of Williams "Supersockets" permits the combining of sockets, handles and accessories to create special wrenches for special jobs. Available in five different patterns, with drives ranging from 1/4" to 1" square, and with socket openings from 3/16" to 3/8". Sold by Hardware Dealers, Automotive and Industrial Distributors. Write for "Supersocket" Catalog A-50.

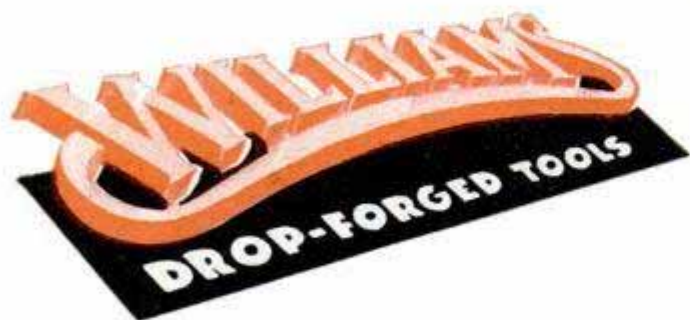

J. H. WILLIAMS & CO., Dept. M, BUFFALO, N. Y.

palomino stallion and always get one of the golden-colored colts. He may be a taffy blond, but he also may be an albino or a sorrel. Breeders say that colts come out about 85 percent true palominos some years, only about 50 percent others.

Some strains of palominos have already indicated that the palomino breed is on its way. The Pirate Gold and Golden Don strains of Texas, the Harvester and Pal-O-Mine blood of California are all prepotent lineages whose stallions sire a high percentage of true palomino colts.

At the present time, interest in palominos is growing like bluegrass in the spring. More breeders are acquiring golden horses every day. The two-toned pinto, the spotted appaloosa, the snowy albino and other horses that feature color all have their devotees. But the golden palomino seems to be leading the popularity parade at the moment.

## Mayhem on Wheels

(Continued from page 151)

the rear quarter panel was caved in. Such is the ability of the modern car to take huge amounts of punishment that this wreck went home under its own power and raced every week from then until the end of the season.

This sort of thing is the exception, however, as the usual stock car starts its competitive life as a junked or burned-out wreck. After being put in near-perfect mechanical shape, the car is given a flashy paint job and is ready for the slaughter. The paint job usually outlasts the car.

Stock cars are just that—strictly stock. No racing parts may be added, especially insofar as the engine is concerned. Some alterations may be made though, in line with safety requirements and better handling. Excess tin is trimmed from the fenders; bumpers are replaced with channel iron and heavy steel grilles, in some cases.

Special racing tires may be used, especially on asphalt tracks. Asphalt is a tricky surface, according to the drivers. It wears a tire to a peculiar shape, with a round shoulder on the right side and a sharp one on the left. Consequently, tires for use on this surface are capped with a special thick tread without grooves. The cap is molded in the shape in which the asphalt would ordinarily wear the tread. This causes the tire to wear evenly and enables it to get full traction at all times even under the screeching stress of a racing turn. An ordinary stock tire wouldn't hold up for one full event.

Extra shock absorbers are essential as

(Continued to page 238)

# Wonderful fun — ENDLESS GOOD TIMES



## RIDE A HARLEY-DAVIDSON *HYDRA-GLIDE*

**N**EW pleasures await you in motorcycling, world's greatest sport! Adventure, travel, thrills, fascinating friends! Every trip is delightfully different, every moment one to be remembered as you take in exciting races, hillclimbs, endurance runs and go on gypsy tours, sightseeing trips and other club events.

And what a difference it makes when you're riding a Harley-Davidson *Hydra-Glide*! Roughest roads smooth out like magic, hills fade away, day-long riding is really comfortable! Get your share of this exhilarating fun. You can own a Harley-Davidson on easy terms. See your dealer today.

HARLEY-DAVIDSON MOTOR CO., Dept. P, Milwaukee 1, Wis.

Send me *free* copy of ENTHUSIAST Magazine filled with motorcycle action pictures and stories, also literature on latest models.

Name.....

Address.....

City..... State.....

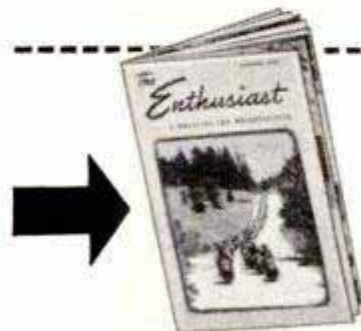

**DEALERS:** Valuable franchises are now available for the full line of famous Big Twins and the 125 Model. This is your opportunity to line up with the greatest name in motorcycles. Write or wire for complete information today.



## THAT MUCK —not in my car?

YES, mister, two pounds of the horrible stuff. After 5,000 miles, that's about average. But your repair bills may be way above average—if you don't get a new **PUROLATOR Refill** for your oil filter—quick!

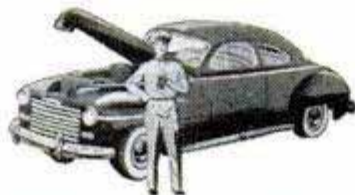

If you've been neglecting to have your oil filter checked, chances are there's horrible muck like this in your car. So when you change your oil this fall, start fresh with a *new filter refill*.

Be sure you get a Purolator\* Refill—the accordion type that filters more *completely*, hence saves more substantially on repair bills. Costs only \$1.38 to \$3.00, depending on make of car. Inserted in a few minutes.

P. S. If your car has no oil filter, a *complete* Purolator, both housing and refill, costs only \$6.50 or a bit more, depending on make of car. Purolator Products, Inc., Rahway, N. J., and Toronto, Ontario, Canada.



\*Reg. U. S. Pat. Off.

are sway bars and stabilizers. The left front spring is usually fastened down to prevent loss of control on the turns.

Cars range from the biggest to the smallest. Cadillacs and Crosleys have appeared several times. These extremes don't work out too well however; the big heavy cars are too clumsy for the short turns while the little jobs don't have the power to pull out of trouble.

Fords are the perennial favorite. Up to the present, the '39 coupe was considered tops for racing. Promoters are now insisting on later models, however, preferably '46 and later. The later the better.

The reason for this, according to Andy Granatelli, Chicago promoter, is that the '39s threatened to make the "stocks" a one-design race. This, he says, is sure death as far as audience appeal goes. The thing that is causing other types of racing to drop off in popularity is the uniformity of looks and performance of the racing cars. This makes for "parades," changing the races into a game of follow the leader with the first car into the stretch leading the rest like the fabled piper of Hamelin.

Age limitations and other restrictions will, the promoters believe, tend to alleviate this problem for the stock cars. Newer cars coupled with slam-bang driving should produce a nearly irresistible show.

People often wonder what makes a fellow want to go into this sort of thing. Most of the drivers and owners claim it's the money. This is in large part true. But there is another big reason and that is the urge to get into a car and go a little faster than the law deems proper and at the same time work off a head of steam. Many of us have, at one time or another, had the itch to relieve some of life's frustrations by plowing through traffic with a total disregard of consequences. In a stock-car race you can do just that.

The money, though, remains the big attraction for the drivers. The pay is good—for the top drivers. The others barely make expenses, if that. All hope eventually to walk off with a feature win and carry off some of the heavy sugar. It's an all or nothing proposition. Since the purses in these events run anywhere from \$2000 to \$10,000 it is obvious that even with a large field of cars the top positions can pay off several months' salary in one night.

"A sharp-looking car, license to push said car to its limit and a crack at more 'geetus' than can ordinarily be made in months! What more could a guy ask? If you don't win now, there's always the next track," was the way one driver put it.

Anybody know where there's a burned-out '46 coupe?



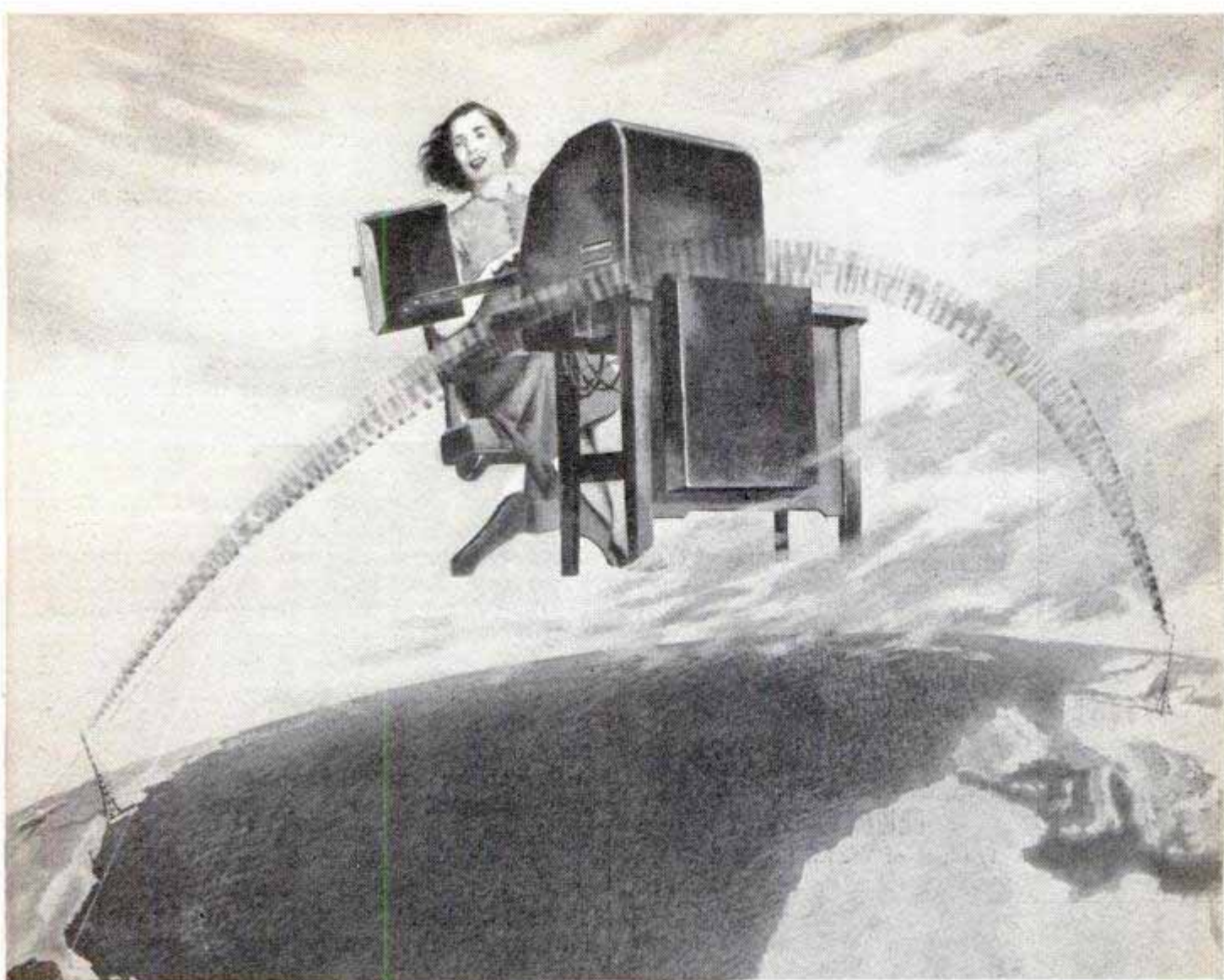

New RCA overseas teleprinter service by radio, first open to the public, now links New York and Holland.

## Now "Flying Stenographers" span the sea!

You are familiar with *teleprinter* service which delivers a typed message, by wire, at high speed. Now this useful service takes to the air on a person-to-person basis, and is spanning the Atlantic Ocean by radio!

This new achievement, called TEX, was developed by RCA engineers and European experts. Its heart is an amazing machine that thinks in code, detects errors which may have come from fading

or static—and automatically insists on a correction!

If, when RCA's "TEX" is at work, a letter becomes distorted, the receiving instrument rejects the character and sends back a "Repeat, please" signal in fractions of a second—until a correct signal is received. Like other RCA advances in radio, television, and electronics, RCA's TEX system helps make radio waves more useful to all of us—and in more ways!

See the newest in radio, television, and electronics at RCA Exhibition Hall, 36 West 49th St., N. Y. Radio Corporation of America, Radio City, New York 20.



RCA Research and pioneering provide a firm basis for the superiority of RCA Victor home television receivers—the best buy on the 1950 market.



**RADIO CORPORATION of AMERICA**  
*World Leader in Radio — First in Television*



**Peels  
Off  
Paint**

**New!**

**NO WASH!**

**Non-Inflammable!**

Now you can "strip off" any finish safely, easily, without mess.

Old-fashioned, inflammable solvents work by "dissolving," leaving a sticky, waxy surface that must be carefully washed, or "neutralized." But Klean-Strip penetrates all layers of old paint and actually "breaks" the bond between the bottom layer and the surface to be stripped.

Klean-Strip changes any finish into a wrinkled film that is easily peeled off with brush or putty knife. Leaves surface smooth, clean and dry.

Buy Klean-Strip whenever you buy paint. At better paint, hardware and department stores.

**KLEAN-STRIP  
REMOVER**

Product of W. M. BARR & CO.  
2350 S. Lauderdale, Memphis, Tenn.

**Treasure Hunt in a Lost World**

(Continued from page 78)

the mud like a cement mixer and drops it in metal boxes which jiggle. Water pouring into the boxes from the drum keeps flushing silt out, while gold and diamonds settle to the bottom of the boxes. At day's end, the jiggle boxes are sealed and hauled away to a safe place for inspection.

Most such contrivances are jerry-built. One old jungle gold prospector rigged a crude head frame of saplings over a deep excavation and dropped a bucket from a pulley. He hauls his pay dirt up and down with an antique Model-T Ford engine.

Occasionally, groups of men get together and build three or four cascades, lined with clay. Water, fed in from the river, splashes over each level. Pay dirt thrown in every few minutes is automatically washed down, leaving the gold and stones.

But in all the systems there is great wastage. "Just let me at the tailings of all the old workings down there, and I'll make a fortune out of what's been left behind," says a Caracas gem merchant.

Primitive though their methods may be, there's nothing cowardly about the prospectors when it comes to the risky business of diverting a river to get at its bed. In valleys it's easy to dig a ditch, dam the stream and sluice it out the new canal. But up in the jungle gorges, the stream must be dammed, lifted on a flume and carried away overhead. Such fluming, made of riverside timber lashed together with liana vine and calked with the bark of a native tree, is rickety and dangerous. One of these affairs collapsed under the weight of the river it carried, and killed 70 men in a claim just as the prospector's pay dirt had been uncovered, and "the diamonds," he said, "lay gleaming like stars in the skies."

But gold and diamonds are not the only prizes on the Venezuelan frontier. There are the fabulous recent finds of iron ore up near the Orinoco. And oil, coming out of coastal areas at the rate of half a billion barrels yearly makes the country the world's second largest petroleum producer. And the surface hasn't been scratched. Every city is a boom town, huge construction projects are under way. But you don't rush in with a suruku, or a drilling rig and start digging. You begin to realize that a frontier is no Yellowstone picnic park when you know that oil prospectors must guard their jungle wildcats against the poison blowguns of Indians; or when you hear the story of Big Steel's hunt across roadless wilderness for iron, and the problem of getting ore out once it was found.



**Snap-on\***

**ANGLE HEAD  
WRENCHES**

**\$9.55**

Postpaid  
Add Local Tax

7 Sizes 3/8" to 3/4"

**FOUR USABLE WRENCH POSITIONS  
IDEAL FOR USE IN CLOSE QUARTERS**

Heads are set at 30° and 60° angles. Both openings are same size. By switching ends you can turn nuts in narrow swing areas where standard wrenches cannot operate. Hammer forged from finest alloy steel. Special Snap-on heat treating process toughens and hardens wrench from skin to core. Thin blade. Heavy chrome plated. Satisfaction guaranteed or your money back.

\*Snap-on is the trade-mark of the Snap-on Tools Corp.

**ORDER  
NOW!**

**SNAP-ON TOOLS CORPORATION**  
8062-I 28th Ave. Kenosha, Wisconsin

I enclose ( ) Check, ( ) Money Order for one set of angle head wrenches V-807K \$9.55 postpaid.

NAME .....

ADDRESS .....

CITY ..... STATE .....

# "Under Construction"

To all of us, those are stirring words. They signify Americans . . . forever building, developing, improving, for the future.

To roadbuilder Edward D. Eveleth of Arcadia, California . . . they mean ribbons of smooth highway, from coast to coast.

But to *Army Reservist* Edward D. Eveleth, those words apply as well to the defense forces of his country. He realizes that these forces must be continuously improved . . . constantly revitalized.

That's why Sgt. Eveleth devotes two nights and one weekend a month to his local unit of the U. S. Army Organized Reserve Corps. If and when . . . he is determined that he and his unit will be ready.

Find out how you can serve your country and yourself in the Army's Organized Reserve Corps. Visit your nearest U. S. Army and U. S. Air Force Recruiting Station or call your local ORC Unit Instructor.

Sgt. Eveleth Directing Bulldozer Operator at Fort MacArthur, California

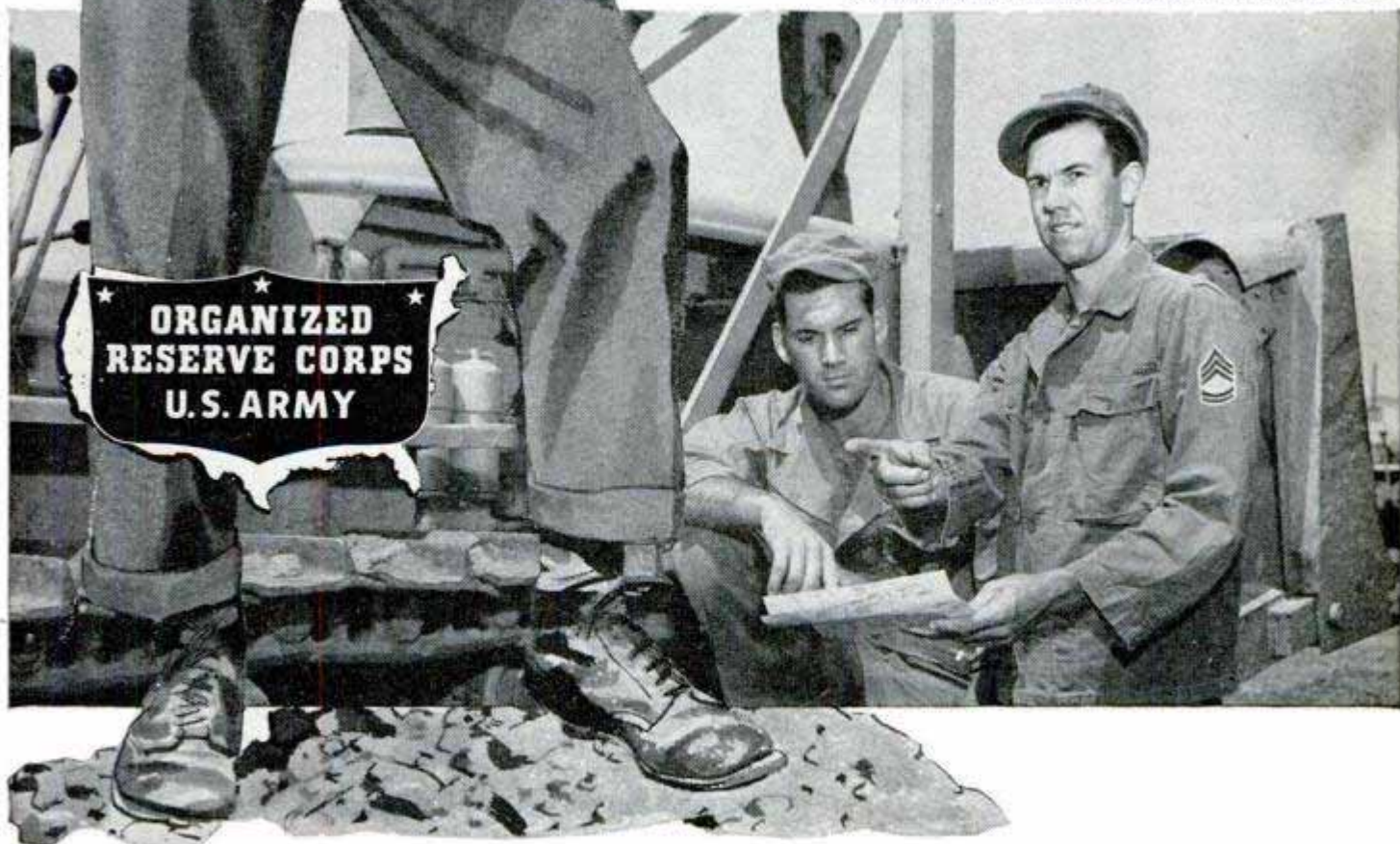

★ ORGANIZED RESERVE CORPS ★  
U. S. ARMY

Make \$20 to  
\$30 a Week  
**EXTRA  
MONEY**



## MACHINE SAW FILING PAYS UP to \$2 or \$3 an HOUR

Turn your spare time into CASH—sharpening saws with a Foley Automatic Saw Filer pays up to \$2 or \$3 an hour. You will find you can make \$20 to \$30 a week in your spare time as a starter.

You can work in your basement or garage—no experience necessary. "The first saw I sharpened with my Foley Filer came out 100%"—writes Clarence E. Parsons. No canvassing—"I advertised in our local paper and got in 93 saws"—says M. L. Thompson. The Foley is the only machine with which you can file all hand saws, also band saws and cross-cut circular saws.

## SEND FOR FREE BOOK "INDEPENDENCE AFTER 40!"

Shows how you can get business from home owners, farmers, carpenters, schools, factories, etc. With a small investment, no overhead, no stock of goods to carry, you can get right into a cash business—and possibly later on develop into a full-time repair shop. Send coupon today for Free Book. No salesman will call.

"Each saw I filed got me six more and business has been picking up that way since a year ago. If it keeps up I will have to buy another Foley Saw Filer." — William C. Baldwin

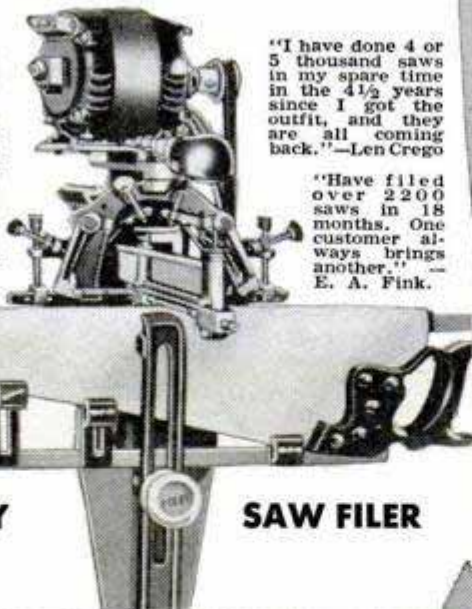

"I have done 4 or 5 thousand saws in my spare time in the 4 1/2 years since I got the outfit, and they are all coming back."—Len Crego

"Have filed over 2200 saws in 18 months. One customer always brings another." — E. A. Fink.

FOLEY

SAW FILER



**SEND COUPON FOR FREE BOOK**

**FOLEY MFG. CO.**

916-O Foley Bldg., Minneapolis 18, Minnesota

Send FREE BOOK — "Independence After 40."

Name \_\_\_\_\_

Address \_\_\_\_\_

## Look What's Happened to the Little Old Schoolhouse!

(Continued from page 138)

schoolhouse was built, are expensive during an era of high building costs. But the modern architect is paring big chunks off the cost of his buildings by eliminating all the marble slabs and expensive gingerbread which once served as a symbol of community pride.

But still some cities feel they just can't afford new buildings. Though such communities can't increase the number of classrooms, they can modernize old schools on a small budget.

Walls and woodwork can be painted bright, flat colors to increase the light and make school a truly colorful experience. In poorly lighted rooms a "ceiling of light" or "egg crate ceiling" can be installed. Perkins was the first architect to install such a ceiling, at Lincoln School, Park Ridge, Ill. Long bands of fluorescent lights were fastened to the ceiling of the room. Then a false ceiling—a virtually uninterrupted area of honeycomb metal louvers—was suspended just below the lights. The result: you can't see a bulb anywhere in the room, yet the entire ceiling is aglow.

For more money the community can re-equip its classrooms with movable, non-glare desks, designed to mold the student into the correct posture. Tanbark and sand can be spread over playgrounds to minimize broken arms and skinned knees. Black slates can be repainted a soft green with a new surfacer. And why can't fathers who enjoy woodworking spend a few nights in the manual-training shop turning out attractive bookshelves, storage cabinets and play blocks for every school in town?

The work can be an exciting community experience, with results just about as sparkling as a new school building. Parents will relish the job and youngsters may find school more of an adventure than playing hookey. Perkins' biggest compliment came from a wild-eyed little boy who had just spent a few days in one of his buildings: "You know, school can be more fun than a Hopalong movie!"

## Record Cleaner Dissipates Static

Static charges built up in the handling and playing of phonograph records are eliminated by a cleaning agent which is applied to the grooved surface. Such charges attract and hold dust and dirt to the surface of the record, creating noise and causing excessive wear. The cleaner leaves an extremely fine antistatic film which adheres to the surface for several months.

Columbia Records, Inc.  
POPULAR MECHANICS

(dealers can handle it)



# CRAFTSMAN Tilting-Arbor Saw

REG. U. S. PAT. OFF.

## More Saw for less money!



**CRAFTSMAN**  
8-in. Tilting-Arbor  
Bench Saw

Only **\$54.50\*** Cash

Complete with blade, guard, splitter, non-kickback pawls, rip fence, miter gauge, two pulleys, and V-belt

\$5.50 Down; \$5 Monthly on Easy Terms

Complete outfit **\$108.95\*** Cash  
as shown

With motor, bench, front and 2 side table extensions  
\$11 Down

\* Prices slightly higher south of the Ohio and west of the Mississippi rivers

Sears Easy Terms make it easy to buy your bench saw NOW... pay as you enjoy using it!

**These Accessories will make your saw more useful!**

**\$8.95**  
1/2 or 5/8-in. hole

**DADO SET.** 6-in. Dados, rabbets, grooves, etc., with 1/2 or 5/8-in. arbor bench saws.

**\$1.39**

**CUT-OFF WHEEL** 8-in. Cuts tile, concrete, stone, metals. 1/2, 5/8 or 3/4-in. arbor.

**\$4.50**

**NAIL-CUTTING SAW.** 8-in. For rough work (rips; crosscuts). For 1/2 and 5/8-in. saw arbors.

**Look at these superior features!**

**Work stays level!** Blade and guard (not table and work) tilt any angle up to 45°, for much faster, easier and more accurate operation!

**Exclusive Tilting,** raising and lowering blade are all controlled by a single hand wheel... at front of saw!

**Floating motor mount** fastens to bench for easier tilting. Controls belt tension; reduces saw vibration; lessens strain on saw frame!

Sears Bench Saws are completely equipped; NOT stripped models, as are some saws on the market!

**We know of NO finer, more complete Outfit at anywhere NEAR this low price!**

Big, accurate, precision-built, and low priced... this superb, heavy duty CRAFTSMAN tilting-arbor saw outfit meets the most rigid requirements of professional and amateur craftsmen! Many exclusive features! Large smooth-ground table of cast semi-steel (20x17 in. without side extensions; 34x20 in. with extensions), has insert removable for dadoing. Depth of cut up to 2 1/2 in. Saw has automatic leveling guard, non-kickback pawls, splitter, accurate miter gauge and rip fence, 2-in. machine and 2 1/2-in. motor pulleys, 1/2x40-in. V-belt, motor mount, and 8-in. combination blade (1/2-in. bore). Complete outfit includes 1/2-H.P. 3450 R.P.M. ball bearing capacitor motor (110-120-volt, 60-cycle A.C.); two side table extensions; front roller extension; and steel power tool bench (height adjusts 22 to 32 in.). See this sensational CRAFTSMAN outfit at your nearest Sears Retail Store TODAY!

**CRAFTSMAN Top Quality Circular Saws in 6, 7, 8, 10 and 12-inch sizes**

	Crosscut (Cut-off) Saws <b>\$229</b> 8-in.		Rip Saws <b>\$229</b> 8-in.		Flat-ground Combination Saws <b>\$229</b> 8-in.		Hollow-ground Combination Saws <b>\$389</b> 8-in.
--	--	---	-----------------------------------	---	---	---	---

**CRAFTSMAN** Hand and Power Tools by **SEARS, ROEBUCK and CO.**  
Famous for fine quality... precision performance... low price!

**Eyes  
Tired?**



**Two  
Drops**



**Quick  
Relief!**



**MURINE  
FOR YOUR EYES**

## CLEAN PAINT BRUSHES

in Minutes with NEW

# Kwikeeze

- SOFTENS hardest brushes—usually less than 30 minutes.
- CLEANS OUT fresh paint instantly!
- DISSOLVES all paint finishes easily.
- HARMLESS to hands and brushes.

Pint Can only 50c  
CLEANS SEVERAL  
BRUSHES

For  
Free  
Circular  
Write

# SAVOGRAN

25 HUNTINGTON AVENUE, DEPT. 28, BOSTON 16, MASS.



## Sifting the Story of an Ancient Race

(Continued from page 122)

Down through the ages how many dusky aborigines had made the bluff shelters at least a temporary abode? How did the first human being, whose shadow fell across the threshold of these shelters, look, and in what dim period had he lived? All these questions and more have spurred the Thomases on to countless discoveries.

By how many centuries are those artifacts that lie nearest the surface separated from those which are unearthed at a depth of five or six feet? They are not certain, neither are other archaeologists who have examined the remains of this ancient race.

Low-level excavations have revealed no implements used by an agricultural race, and flint weapons unearthed at the bottom of the debris-filled pits are noticeably inferior in quality and workmanship to those found near the surface. Evidence points to the fact that the bluff shelters in the Illinois Ozarks were occupied for short periods by two distinct cultures or by a single culture acquiring certain characteristics of the other through trade, warfare or some like manner. It is quite likely that the shelters were used more as a place of transient habitation rather than as a permanent home. The scarcity of burned bone in the bluff shelters seems to indicate this, the Thomases believe.

One of the cultures that occupied the shelters used a grit-tempered pottery and had crude chipped-stone artifacts; the other culture is characterized by shell-tempered pottery and finely made triangular projectile points.

Buried treasure, the quest for the unknown and the effort to recreate ancient civilizations have always intrigued mankind—thus it is with Charles and Joe Thomas. They'll never be satisfied until they can unearth the complete story of the Bluff Shelter people who inhabited the caves and cliffs of the Illinois Ozarks.

## CHAMPION V-GLOW PLUGS

for model engines only

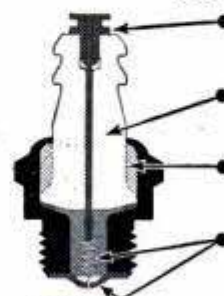

- CHAMPION TERMINAL—assures better center electrode seal and provides sturdier electrical connection.
- CHAMPION-CERAMIC INSULATORS—proved dependable in millions of Champion Spark Plugs.
- CHAMPION SILLMENT SEAL—prevents excessive compression leakage between insulator and shell.
- CHAMPION "THERM-O-FLEX" CONSTRUCTION—longer element life, more dependable performance.

Follow recommendations of plug types and fuels approved by engine manufacturer.

**CHAMPION SPARK PLUG COMPANY, TOLEDO 1, O.**

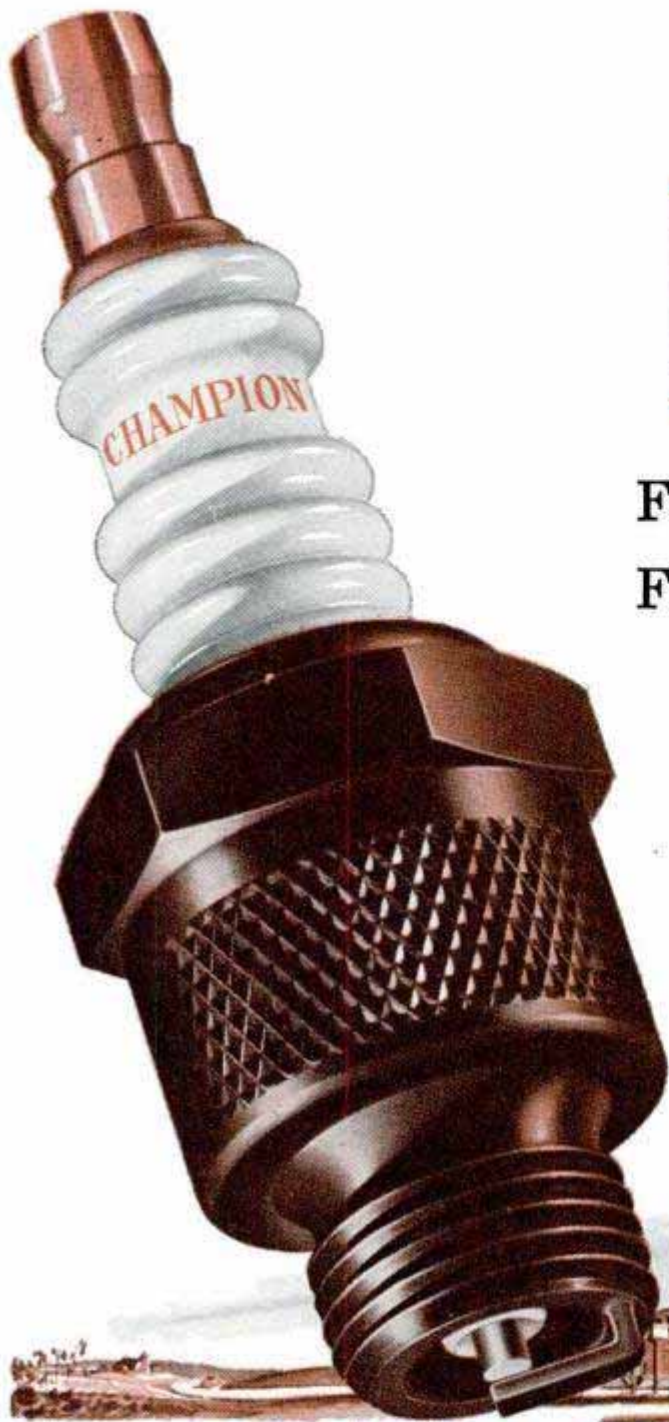

Dependable

**CHAMPION**

First Choice in Spark Plugs  
For Over a Quarter Century



**BE A CHAMPION DRIVER**

*... It's Schoolltime Again—Be Extra Cautious!*



"School" signs call for extra caution. Stop for children boarding or unloading from school buses; watch for them getting in or out of private cars, crossing streets!



Obey Safety Patrol boys. These youngsters save hundreds of lives and shoulder a great responsibility. They need your cooperation in observing signals.



Safe driving depends in great measure on a quick, responsive engine. That's why champion drivers everywhere have stamped Champion as America's Favorite!

**CHAMPION SPARK PLUG COMPANY, TOLEDO 1, OHIO**

*Listen to the CHAMPION ROLL CALL . . . Harry Wismer's fast sportscast every Friday night, over the ABC network*

# BIG WORK SAWED, SANDED, DRILLED, TURNED—WITH HAIRLINE ACCURACY

**Rugged, Multi-Purpose  
SHOPSMITH is complete  
power workshop in one  
compact unit**



61,000 SHOPSMITH owners wholeheartedly agree—you can't beat SHOPSMITH for accuracy, capacity, all-around utility. It does the work of *five* heavy-duty single-purpose tools—actually does it *better*.

SHOPSMITH has precision features found only in highest priced saws, drill presses, lathes and sanders. Four grease-sealed ball bearings in headstock. Induction hardened spindle tip. Centerless ground steel ways. Built-in quality through and through. So compact it fits any 2' x 5' space. So ingeniously engineered you can convert from tool to tool *in less than 60 seconds*.

Takes all standard accessories including shaper-cutters, drum sander, jointer fence and cutter, flexible shaft, dado heads, etc. See SHOPSMITH demonstrated at any Montgomery Ward, leading hardware or department store. And write for *free* 16-page booklet.

**\$169.50**

complete except for motor.  
With special ½-hp., ball-bearing, capacitor-type motor  
(shown) **\$199.50**

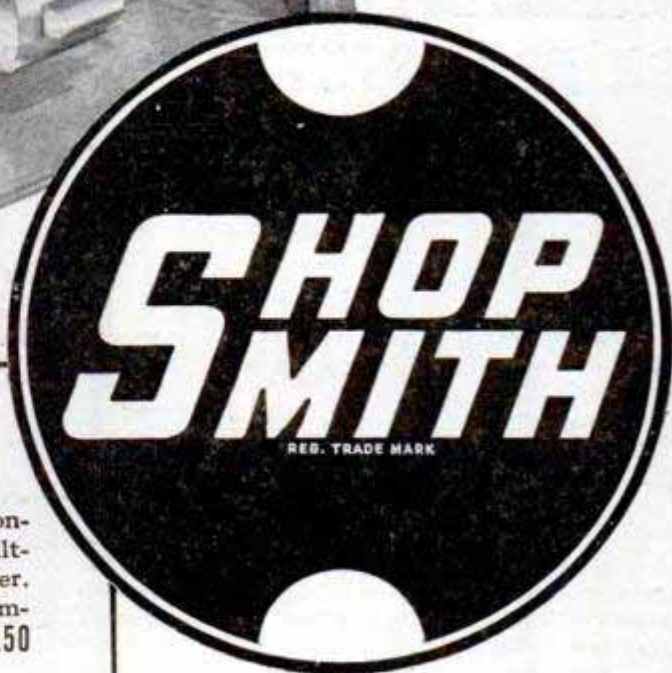

## **JIGSAW for SHOPSMITH**

Heavy-duty, precision construction. 18" throat. Tilting table. Built-in blower. Attaches quickly. Price complete..... **\$34.50**



# 1. 8" CIRCULAR SAW

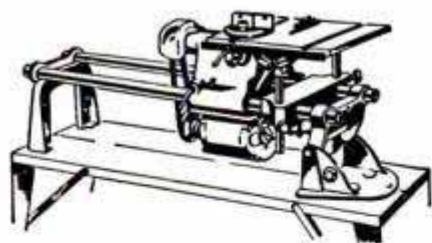

SHOPSMITH saw has capacity and performance equal to or greater than most cabinet shop models. Can cut to center of 8' plywood panels. Effective table width up to 56". Depth

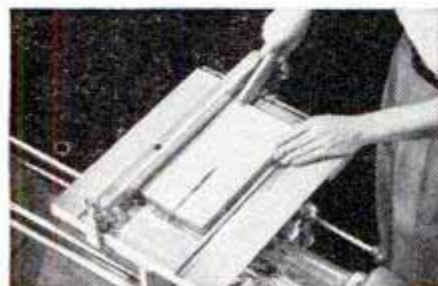

of cut 2 1/4". Sturdy tilting table with ball-crank raiser for precise settings. Precision-tooled miter gauge and self-aligning rip fence.

# 2. 12" DISC SANDER

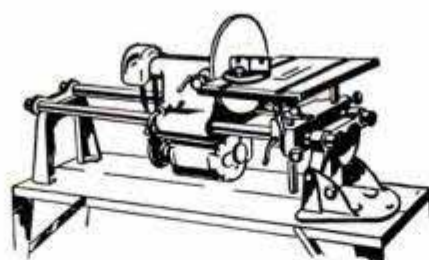

With extendable quill, 12" cast-aluminum disc can be fed into workpiece for safety and accuracy. Extra-large adjustable table measures 14 1/2" x 17". Use miter gauge for accurate



squaring and mitering; rip fence for super-smooth jointing; tilting table for compound-angle sanding. Operator can face work or work from side.

# 3. 33" WOOD LATHE

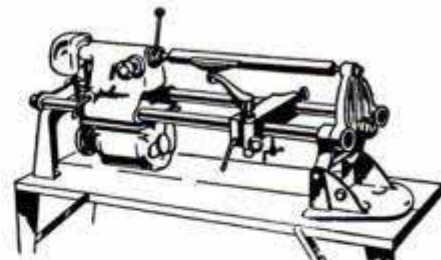

Greater capacity than most other heavy-duty lathes. 15" swing. 33" between centers. 4" quill feed. Swivel-arm tool rest always parallel to ways —no need for constant adjusting.

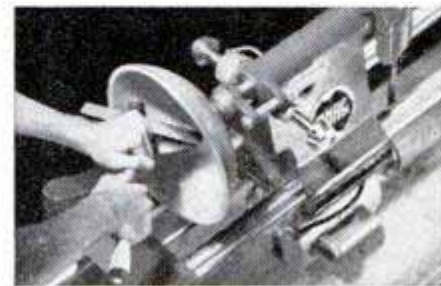

Quickly adaptable for face plate work. Fine-grain cast-iron headstock slides with fingertip pressure, locks in any position.

# 4. VERTICAL DRILL PRESS

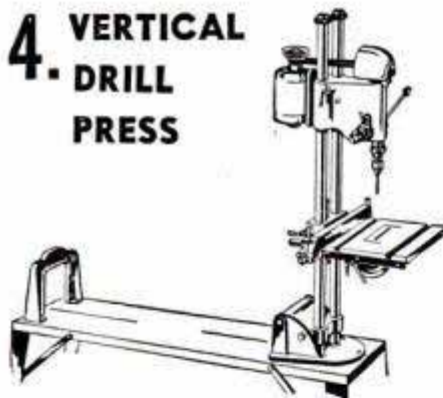

SHOPSMITH drills to center of 15" circle, has a maximum clearance table to chuck of 27". floor to chuck of 55". Jacobs key chuck takes straight shank drills from 5/64" to 1/2" diameter.

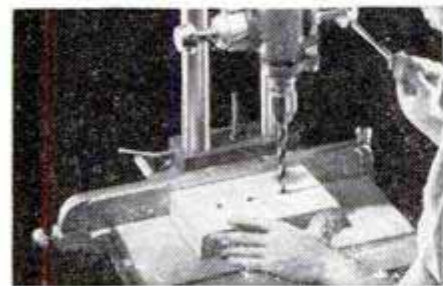

Rugged, 6-spline spindle floats on 4 lifelong, grease-sealed ball bearings. 4" quill feed. Lever fits either side of driving head for right- or left-hand operation. Speeds from 875 to 3500 rpm. Use with or without fence.

# 5. HORIZONTAL DRILL

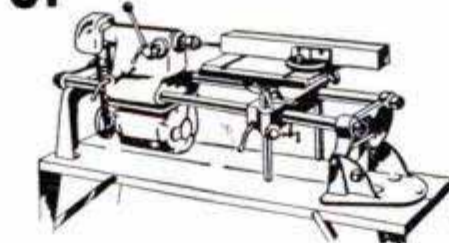

Extremely useful operation possible only with SHOPSMITH. Quill feeds up to 4" with adjustable stops. Permits large, heavy pieces to be drilled or mortised quickly, accurately. Handy,



too, for doweling tops for tables. Miter gauge and fence eliminate need for jigs. 36" effective table support. Length of work limited only by size of room.

## SHOPSMITH TAKES ALL STANDARD ACCESSORIES



Fact-packed, 16-page illustrated booklet. Send for it!

Address:

SHOPSMITH, Dept. 143-B, at factory nearest you:  
12819 Coit Rd., Cleveland 8, Ohio, OR  
417 Montgomery St., San Francisco, Calif.

Name \_\_\_\_\_

Address \_\_\_\_\_

City \_\_\_\_\_ Zone \_\_\_\_\_ State \_\_\_\_\_

When you use pliers...

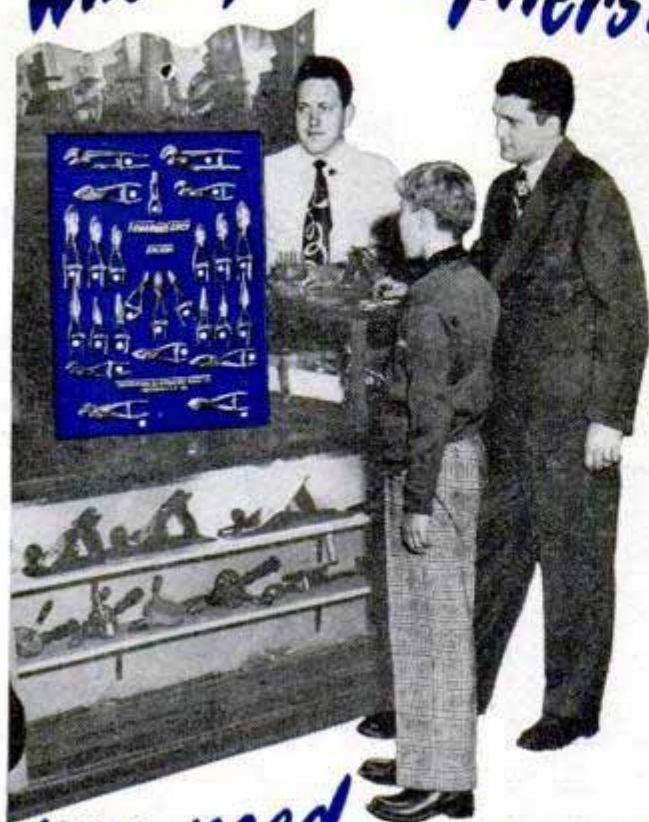

You need  
**CHANNELLOCK**

There are lots of "fussy fix-it" jobs around the house that Dad, Mom or the kids can easily do when Channellock pliers are handy. No matter what—electrical, automotive, plumbing, battery, or anything mechanical—you need Channellock pliers.

Channellock's patented tongue and groove joint gives you these "plus" features: Greater Strength, Longer Wearing, Self-Cleaning, Closely-spaced Adjustments, Visible Adjustment, No Wear on Joint Bolt.



Send for Catalog  
C-14 today.

**CHAMPION DE ARMENT TOOL CO.**  
MEADVILLE, PA.



*Channellock*

**CHAN NEL LOCK**

## Revolution of the Free-Piston Engine

(Continued from page 118)

now. The Pennsylvania locomotive will operate on diesel oil. Preliminary estimates indicate that it will be, by a wide margin, the most efficient locomotive ever built. The most immediate application of the idea is in the compressor fields—for instance pushing gas through pipe lines now spreading over the country. Compressors must be spaced every few miles along the network to push billions upon billions of cubic feet of gas through the lines. From present evidence, the free-piston engine is ideal for this use. It would operate as the air compressors worked on German submarines. The machines would feed on the fuel they were pumping. They would burn gas at the center of the cylinder, compress it at the ends. There would be no turbine in such a setup—the free-piston engine would spend all its energy compressing gas, pushing it through the pipe-line network.

Several major truck and bus companies see the free-piston engine as the solution to some of their greatest problems. For all practical purposes the 300-horsepower engine seems to be about the upper limit for trucks and busses. Beyond this point gears and transmissions become too heavy. And with the massive trucks now on highways, a 300-horsepower engine isn't powerful enough to get them up hills without stalling long lines of traffic behind them. In addition, time lost on hills increases costs to bus and truck operators.

Since a free-piston engine requires no conventional transmissions—it would be connected to wheels with a hydraulic coupling—there is no upper limit to its size. It has, in effect, all the flexibility of the old steam auto engine without that engine's greatest drawback. It doesn't blow up. As more fuel is shot into the cylinder the pistons are driven farther apart, developing greater compression and more power. A truck with a free-piston engine could make a jack rabbit start at a traffic light, getting away as fast as a motorcycle.

Applications to automobiles appear to be well in the future, but such applications have dazzling appeal. A free-piston engine would be unbelievably quiet and vibrationless. It would be so small that it could be placed anywhere in a car and so economical that it would give 50 to 60 miles per gallon of fuel—diesel oil or kerosene. It also has drawbacks. First, the great U. S. auto industry has hundreds of millions of dollars invested in engine plants and would be hesitant about scrapping them to build a revolutionary new engine, no matter how

(Continued to page 250)



## Delta long-life quality features:

- Pre-loaded ball bearings.
- Precision-ground arbor.
- Precision-bored bearing seats.
- Ball bearings are lubricated for life.

No. 34-405

**\$234<sup>00</sup>**

(subject to change without notice)

Motor and switch extra

Low down-payments, easy terms

Delta is the *complete* line: 53 machines — 246 models. Over 1300 accessories. Plus a complete line of 14 Homecraft® machines.

**DELTA**  
**MILWAUKEE**  
®

# More saw for the money!

## Compare what you get!

- ✓ Double-faced rip fence — locks front and back.
- ✓ Exclusive Auto-set miter gage.
- ✓ 5/8" arbor.
- ✓ Diameter of saw blade, 10".
- ✓ Blade tilts 45°.
- ✓ Cross-cut capacity, 12".
- ✓ 3-belt Texrope drive.
- ✓ Graduated front guide bar.
- ✓ Fence can be used on either side of blade.

## Famous Delta Unisaw®

Compare this rugged 10" tilting-arbor saw alongside *any* saw *anywhere* near its price. Then you can see why the Delta Unisaw is first choice of schools, industry, commercial shops, home shops.

It's got big capacity — rips to center of 50" panel, cuts stock up to 3 1/8" thick. It has heavily-ribbed cast-iron table, 36" x 27", with ground surface; massive, smooth-operating trunnions; steel cabinet base. It's safe and convenient — has saw guard that really protects . . . fast, handy controls.

See the Delta Unisaw in operation today. See why it's more saw for the money.



Look for the name of your Delta dealer under "Tools" in the classified section of your telephone directory.

**DELTA POWER TOOL DIVISION**



**Rockwell**  
Manufacturing Co.

**MILWAUKEE 1, WISCONSIN**

**FREE** get it Now—

**ALLIED'S 1951 TV  
and RADIO CATALOG!  
212 Pages of BIG VALUES**

**EVERYTHING  
IN RADIO  
AND TV AT  
LOWEST PRICES**



**EVERYTHING FOR EXPERIMENTERS,  
BUILDERS, AMATEURS, SERVICEMEN,  
ENGINEERS, SOUNDMEN**



**TV, HOME RADIOS  
& RADIO-PHONOS**



**SERVICE SUPPLIES  
BUILDERS' SUPPLIES**



**AMATEUR GEAR**



**P. A. SYSTEMS, RECORDERS**

**ALLIED RADIO**.....

833 W. Jackson Blvd., Dept. 5-JJ-O

Chicago 7, Illinois

Rush FREE 212-Page ALLIED Catalog.

Name.....

Address.....

City.....Zone.....State.....

**FREE  
CATALOG**

Save money on every Radio and TV need! Get the big 212-page 1951 ALLIED Catalog featuring the world's largest stocks of top-quality equipment at low, money-saving prices! See the latest TV releases, home radios, radio-phonos, Amateur equipment, P.A. systems and Hi-Fidelity Custom Sound, recorders, test instruments, builders' kits—plus thousands of parts, tools, books and diagrams. Get more for your money from the World's Largest Radio Supply House. Send today for your FREE new 212-page 1951 ALLIED Catalog!

good. Further, thousands of garage mechanics are trained to service traditional engines and might have a hard time learning a new art.

Engineers think that on a real mass-production basis free-piston engines would cost far less than engines in use today. They would solve the service problem by eliminating service. If mechanical difficulties arose a car owner would drive to a garage, trade the ailing engine in on a new one or a factory-rebuilt job. This idea has been gradually creeping up on the auto industry. Today, we exchange faulty carburetors, generators, timers and other engine parts. Tomorrow, a mechanic may simply hoist out an old engine and bolt a new one into place in a few minutes.

Today, many aircraft engineers think free-piston machinery will pick up where the jets leave off. Present-day jets appear to be reaching the upper limits of their effectiveness. For one thing, their efficiency is directly related to the temperature at which they operate. The problem is to get metals for turbine blades which will withstand the inferno heat from the combustor. Right now, metallurgists feel that they have about reached the peak at 1800 degrees Fahrenheit.

The free-piston engine, on the other hand, operates at temperatures which power plants have used in steam turbines for some time—around 1000 degrees Fahrenheit. Metals which will operate at this temperature and give years of faithful service are readily available.

This low temperature in free-piston machinery is accounted for by several things. At the moment of explosion the temperature is about what it is in other internal-combustion engines—around 3000 degrees. But as explosive gases expand they lose heat rapidly. Further cooling is achieved by compressed air from the outward stroke of pistons.

For these various reasons, there is no road block in the way of applying the free-piston engine to aircraft. Its high efficiency—nearly double that of the best jets—would be translated into greater range, greater fuel economy. Its light weight and fuel economy would give it a tremendous advantage over traditional radial engines. Potentially, at least, it opens the way for world plane travel cheap enough to be within almost everyone's reach.

Free-piston machinery should find application wherever power is needed. It compresses air for drilling machinery, and can provide energy to move gas through pipe lines. It would be an ideal machine for giant shovels and other earth-moving

(Continued to page 252)

"MY CAR'S GOT  
TWO  
MUFFLERS?"



"I'M PUTTING TWO MUFFLERS ON YOUR CAR," THE MECHANIC TOLD ME. "TWO?" I SAID, "ALL I SEE IS ONE!"



HE EXPLAINED THAT THE GENUINE FORD MUFFLER HAS TWO SKINS FOR EXTRA QUIET AND LONGER LIFE...



AND HE TOLD ME IT HAS SAFETY-LOCKED SEAMS, TOO, AT BOTH ENDS TO ELIMINATE GAS SEEPAGE.



ITS FREE-FLOW DESIGN GIVES BETTER GAS MILEAGE. IT'S THE LOWEST COST QUALITY MUFFLER WITH THESE QUIET, SAFETY, LONG-LIFE FEATURES.



YOU'LL FIND IT'S THE SAME WITH ALL GENUINE FORD PARTS. THEY'RE BUILT TO SAVE TIME, MONEY AND MEAN REAL SATISFACTION

AVAILABLE WHEREVER YOU SEE THIS SIGN AT ALL FORD DEALERS AND SELECTED INDEPENDENT GARAGES

KEEP YOUR FORD

ALL FORD!



*Stuck up?*



*Cleaned up!*



## CASITE *Frees* STICKY VALVES

Get rid of engine coughs, jerks, roughness. Chances are, it's caused by sluggish or sticky valves.

Casite through the air-intake quickly frees sticky valves, lets the engine *breathe*, lets the power zoom through. A second pint of Casite, in the crankcase, keeps the engine clean and free-running. Cuts engine wear by speeding lubrication... Get a Casite Treatment for your car today from your garage, service station or car dealer.

THE CASITE CORPORATION • HASTINGS, MICHIGAN  
Casite Division, Hastings Ltd., Toronto



75¢ A PINT  
95¢ in Canada

BETTER AND SMOOTHER  
PERFORMANCE OR  
*double-your-  
money-back*

equipment. Engineers have rough designs for a compact outboard motor. The torpedo-shaped power unit rides under the water, eliminating the noise that makes this type of engine a nuisance to people who live along rivers and lakes. The engine develops 20 horsepower, weighs 80 pounds.

In the power field, the new engine offers more economical production of electricity—a saving which will be passed along to consumers in lowered electric bills. It should chalk up savings on a number of scores. First, it is light, vibration-free. Hence, it requires no heavy foundations.

Free-piston machinery has another advantage in the power field. Fuel markets fluctuate constantly—strikes shut off coal, winter cold spells strain natural gas, war creates petroleum shortages. The engineers contend that any power plant built today should be designed to operate on any fuel. Free-piston machinery answers this requirement. Equipped with a gas generator, it can operate on coal. It can be designed to use natural gas or any of the light oils.

The free-piston engine will find greatest usefulness in the power field in medium-size cities. These engines could be used up to 25,000 horsepower. Giant steam-turbine plants are firmly entrenched above 50,000. Present engineering data indicate that 5000 horsepower may be the upper limit for a single-cylinder engine. Multiple-cylinder units will take care of power requirements above this point.

In sum, there is hardly a place where fuel is converted into energy that the new engine won't find application. It is more versatile than the diesel, three times more economical than the open-cycle gas turbine, cheaper than the steam plant. Prophecy is never completely safe with any development as new as this. But everything indicates that the free-piston engine will have quite as large an impact on all our lives in the second half of the 20th Century as the conventional internal-combustion engine had during the first half.

### Cold-Weather Antidote

Survival time in cold weather is increased 54 percent by dosage of a thyroid compound called endothyrin. Army and civilian researchers found that when thyroid activity was suppressed with doses of another chemical, thiouracil, larger numbers of the animals used in the test died and they died sooner. A dose that raised the basal metabolic rate by 30 to 50 percent was found to be most effective. Given orally the compound took four to five days to produce the cold-resisting effect, while it acted within eight hours when given by injection.

**LOGAN HEAVY DUTY  
HYDRAULIC PUMP**



For operating hydraulic cylinders and hydraulic motors on tractors, bulldozers, construction machinery, lift trucks, industrial applications, etc. Delivers 10 GPM at 1200 RPM at 1000 P.S.I. using 6 HP. Has a 3/4" inlet, 1/2" outlet, 3/4" shaft with flat and keyway for direct or pulley drive. Has flange with 4 bolt holes for convenient mounting. Ship. wt. 22 lbs. Overall dimen.: 7" L x 5 1/2" H x 3 1/2" W. A \$105.00 value. FOR ONLY.....

(ITEM #29)  
**22.50**

**VICKERS HYDRAULIC TRANSMISSION**

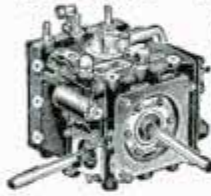

**MODEL AA16801A**  
Ideal for lathe drive, miniature cars, power machinery, gearing, etc. Rated 2 HP maximum input at 3750 RPM. Output speed continuously variable from 0 to 1/3 of input speed in either direction. Self contained reservoir. All controls external. Even power at all speeds. Complete with two 1/2" shafts with flat for pulley attachment. Ship. wt. 26 lbs. Gov't acquisition cost \$325.00. A tremendous value at.....

(ITEM #85)  
**25.00**

**HYDRAULIC CONTROL VALVES**

**ITEM #24.** Four-way control valve with built-in relief valve, for use with one double action hydraulic cylinder, may be used with 1500 P.S.I. hydraulic system to open and close hydraulic cylinders. Ship. wt. 8 lbs. A \$38.00 value  
**7.95**

**ITEM #26.** Four-way control valve for use with two hydraulic double-action cylinders. Each cylinder may be operated independently of the other or in conjunction with the other. Oil may be locked in any of the cylinders to hold the piston at any required position. Ship. wt. 6 lbs. A \$60 value.....  
**10.95**



**Hydraulic Cylinders-Air or Oil**

Large supply of new labor-saving, economical hydraulic equipment in many types and sizes. Use these positive, highly efficient, smooth pressure hydraulics on presses, arbors, lifts, loaders, power control, positioning, brakes, plastic dies, auto frame alignment, etc., etc.

- ITEM #4-**All steel double action hydraulic cylinder, 1 1/2" bore, 27" stroke. Clevis mounting. Will lift 1000 lbs. with 1000 P.S.I. line pressure. Perfect for positioning and feeding movements. Ship. wt. 4 lbs. F.O.B. Chicago..... **4.95**
- ITEM #33C-**Double action hydraulic cylinder, 1 1/2" bore, 4 1/2" stroke. Clevis mountings at both ends. Uses 1/2" pipe fittings. Postpaid..... **8.95**
- ITEM #32-**Double action, 1 1/2" bore, 9" stroke, will lift 1760 lbs. with 1000 P.S.I. line pressure. Wt. 4 lbs. A \$45.00 value. Postpaid..... **10.95**
- ITEM #41-**Double action hydraulic cylinder, 2" bore, 6" stroke, clevis mounting at base end of shaft. Overall length closed 12 1/2". Has 3/8" stainless steel shaft. Uses 1/2" tubing fittings. Will lift up to 3100 lbs. with 1000 P.S.I. line pressure. Weight 7 lbs. Postpaid..... **12.50**
- ITEM #16-**Double acting cylinder, 1 1/2" bore, 27" stroke. Will lift 1760 lbs. with 1000 P.S.I. line pressure. Wt. 8 lbs. A \$55.00 hydraulic cylinder value for only Postpaid..... **12.95**
- ITEM #15-**Double acting cylinder, 3" bore 10 1/2" stroke. All steel hydraulic cylinder, will lift up to 7000 lbs. with 1000 P.S.I. line pressure. Wt. 12 lbs. A \$78.00 value, Postpaid..... **19.50**
- ITEM #42-**Rated lift capacity 9600 lbs. with 1000 P.S.I. line pressure. Clevis mounting, aluminum alloy barrel with 1 1/2" stainless steel shaft and piston. Wt. 20 lbs. A \$125.00 Value. F.O.B. Chicago..... **25.00**
- ITEM #42-**Double action hydraulic cylinder, 4" bore, 18" stroke. Rated lift capacity with 1000 P.S.I. line pressure is 12,560 lbs. Ship. wt. 30 lbs. AN EXCELLENT VALUE for..... **32.50**

**HI-PRESSURE FITTINGS** for cylinders and valves available at 35c ea. for 3/8" pipe and 50c ea. for 1/2" pipe.

**UTILITY PUMP ROTARY VANE TYPE**  
Perfect For Water, Oil or Insecticides

Sprays DDT, 2-4D, sulphur compounds, etc. Pressure to 150 lbs., 15 gals. per min. at 1200 RPM using 2 HP. As vacuum pump for milking machines, lab use, etc., delivers 26" vacuum, 4.5 cu. ft. per min. at 1500 RPM using 3/4 HP. Rotate either direction. 1/2" pipe thread ports, 1/2" standard shaft, 4 ball bearings. Easy to mount-Ready to run. Ship. wt. 13 lbs. (ITEM #51) F.O.B. Chicago



(ITEM #51)  
**16.50**

**G-1 STAINLESS STEEL TANK**

Use these tanks on compressors, for tire inflators, pulsation chambers, floats, buoys, hydraulic reservoirs, fluid and milk containers, fuel containers, etc. Tough, light, shatterproof. 450 P.S.I. Aviator's Breathing Oxygen bottles, type G-1, 2100 cu. in. (approx. 9 gallons) int. vol. 24"x12". 1/4" threaded openings at ea. end. Wt. 19 lbs. (ITEM #63) Price..... F.O.B. Chicago



(ITEM #63)  
**4.95**

**FREE: 44 PAGE CATALOG— Full of unsurpassed War Surplus "buys" including generators, pumps, welders, double action hydraulic cylinders, control valves, tanks, pumps, hose, fittings and data on hydraulic applications. Write today!**

**ORDER DIRECT FROM AD — SEND PAYMENT OR PURCHASE ORDER, TODAY — SATISFACTION GUARANTEED**

**GROBAN SUPPLY CO., 1507 SOUTH MICHIGAN AVE. Chicago 5, Ill. Dept. PM-9**

**Brand New AUXILIARY ELECTRIC A.C. GENERATING PLANT**



**FOR GENERAL UTILITY AND EMERGENCY USE  
2500 WATTS - 115 VOLTS A.C.  
60 CYCLES**

Plenty of current to operate your: Oil Burner, Sump Pump, Refrigerator, Home Freezer, Power Saw, Lights, Radio and Television, Home Water System Pumps.

Complete integrated heavy duty electric power plant. Signal Corps Model PE-75, driven by Briggs & Stratton, one cylinder, 6 1/2 H.P. Model ZZ, 4-cycle engine with killer button, oil bath air cleaner, governor, muffler, starting rope, and radio interference filter. The self-excited Leland or Westinghouse generator is rated 2500 Watts, 115 Volts, 60 Cycle A.C. single phase, belt driven, with guard and duplex receptacle. When generator is not in use, you can use the engine separately to power other equipment. Mounted on adjustable steel skids, notched for carrying poles. Net wt. 310 lbs. Shpg. wt. 440 lbs. Dimen. 66"x19 1/2"x24". 12 month guarantee. \$726.00 value.....**NOW**

**295.00**  
F.O.B. Chicago

**NEW STATIONARY OR PORTABLE D.C. ARC WELDER**

**250 AMPS. MODEL 252  
FOR ANY WELDING JOB, LIGHT OR HEAVY**



**Stop Costly Repair Bills, Weld It Yourself and Save**

Designed for many years of trouble-free service. This precision engineered Direct Current ELECTRIC ARC WELDER is offered at but a fraction of its original value. It can be mounted permanently or easily transported for portable use. Does the job instantly where and when you need it. Has dial type rheostat for easy pinpoint control and a high-low range switch. Run welder at 2500 RPM from drive pulley or power take-off of tractor, a 7 1/2 HP electric motor or a 10 HP gas engine. Use two V belts or flat belt (on pulley). Now... AT A FRACTION OF ITS VALUE. Price includes double V or flat belt pulley and instruction book. Shpg. wt. 107 lbs.

**99.50**

**ACCESSORY KIT** including welding helmet, electrode holder, two 10 ft. cables with clamp and 5 lbs. of assorted welding rods. (ITEM #66) Shpg. wt. 17 lbs. F.O.B. Chicago

**10.50**

**IF MORE INFORMATION IS DESIRED, write for WELDER CIRCULAR.**

**Brand New! SURPLUS SPECIAL! CONTINENTAL RED SEAL 1 1/2 H.P. ENGINE**

1 cylinder, 4 cycle gas engine with 6:1 gear reducer for 300 to 400 RPM output.

- For Lawn Mowers, Garden Tractors, Light Farm Machinery, Feed Mills.
- To drive Pumps, Compressors, Generators.

Engine rated 1800 to 2400 RPM, complete with starter rope, muffler, oil bath air cleaner. \$74.00 Value. Shpg. wt. 60 lbs. NOW...**WHILE THEY LAST**.....



**39.50**  
F.O.B. Chicago

**EMERGENCY ELECTRICITY! 750 WATT • 115 VOLT • 60 CYCLE**

**A.C. LIGHT PLANT**

**USE FOR:** Home lighting, trailers, tourist cabins, hunting lodges, fire truck lighting, emergency standby units. Plenty of power for home freezer, oil burners, incubator, radio or lights.

**GENERATOR:** Manufactured by Elecor, rated 750 Watts, 115 Volts A.C., 60 cycles at 1800 R.P.M. Complete with volt meter regulator. \$249.00 value. (ITEM #86) These generators built to exacting Signal Corps specifications, are the answer to your lighting needs.

**GASOLINE ENGINE:** Briggs & Stratton, Model BP, 3 H.P., 1800 R.P.M. Completely radio shielded, full accessories including air cleaner, muffler, starting rope, killer button, remote control wire. Shpg. wt. 165 lbs. Complete unit, \$249.00 Value. NOW ONLY.....



**139.00**  
F.O.B. Chicago

**DIRECT CURRENT GENERATORS**

For welders, plating, truck and marine use, D.C. appliances, lights, etc. Aircraft quality—lifetime grease sealed ball bearings. Heavy duty.

**ITEM #89—Type M-2,** rated 50 Amps.—24 Volts. Mfd. by Leece-Neville Co. Shpg. wt. 22 lbs. Gov't. Acq. Cost \$176.00. F.O.B. Chicago

**NOW ONLY 16.50**

**ITEM #90—Type P-1,** rated 200 Amps.—28 Volts, 2500 RPM. Mfd. by General Electric, Ford, Delco-Remy and Westinghouse. Gov't. Acq. Cost \$300.00. Shpg. wt. 70 lbs.

**F.O.B. Chicago, 22.50**

**ITEM #91—Type R-1,** rated 30 Amps.—30 Volts. Mfd. by Jack & Heintz. Gov't. Acq. Cost \$380.00. Shpg. wt. 70 lbs. F.O.B. Chicago

**Each individually packed in wooden box. 35.00**



# Announcing the New CUSHMAN

# EAGLE

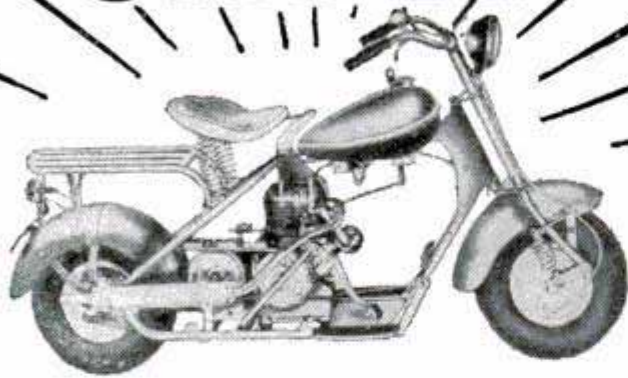

The sensational New Cushman EAGLE is ready! And, Boy! O Boy!—how you'll enjoy this entirely new thrill in motoring pleasure! It's big, husky, powerful, speedy! Has you moving at high speed within yards! Cruises up to 50 miles an hour out on the open road! Amazing fuel economy—up to 75 miles to the gallon! Luxurious comfort—big motor-bike saddle seat mounted on double coil springs . . . shock-absorbing springs on front wheel . . . big balloon tires designed for comfortable riding as well as easy steering and long life. Powerful 2-wheel brakes. 2-gallon (plus) fuel tank. Brilliant headlight, tail-light. Nothing else like it—and it's yours for only \$282.50 f.o.b. factory.



Long-time favorite for lowest cost motoring! Thousands in use. Cheaper than bus fare or operating your car. Handles easy. Slips through traffic, parks anywhere. Wonderful for getting to work, school or market—making deliveries. Famous Husky engine.

### WRITE

See your Cushman dealer for the New EAGLE and regular Cushman Scooter. Or send for Folder M9.



**85**  
MILES  
PER  
GALLON

Rider Agent Plan Available

DEALER INQUIRIES INVITED

**CUSHMAN MOTOR WORKS, Inc**  
LINCOLN, NEBRASKA USA

# 10 SHELF PLANS

NEW FULL SIZE

New, full size, easily built, beautiful wall shelf plans ready to trace on lumber, cut out and assemble. Corner and wall racks with 1 to 3 shelves. Stores charge about \$75.00 for these shelves. Make money selling them. Finest selection available. PLUS BONUS of 48 other novel cut-outs, Dutch Boys, Girls, Toys, etc., etc. PLUS FREE latest Handicraft Catalog. Send only \$1 to

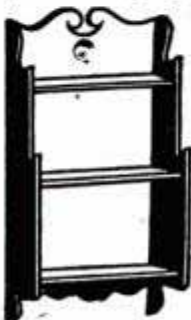

**\$1**



**JACKSON, Dept. 18**  
1426 S. MAIN ST.  
RACINE, WIS.

# I Flew Thirty-One Hours in a B-36

(Continued from page 102)

from outside the ship, furnished by power units similar to those which run contracting equipment. Use of external power adds to the pay load of the B-36 by eliminating the weight of the power unit.

The ground crew chief plugged this starter into the electric system, cleared the propellers of obstructions and reported symptoms of engine performance in starting.

He also directed the parking of fire engines near the mammoth power plants as a precaution against fires. The hand equipment which stands by at starting of engines of other planes could not effectively reach a fire in the lofty engines of a B-36.

Soon the words "starting number six" were heard, a rather startling announcement when you are used to flying planes with only four, or even two, "fans."

After a run-up period, number five was started, and the others in order until all six of the three-bladed props were spinning. The pitch of the blades was checked carefully during the hour-long testing of controls, switches and synchronization.

If one or more propellers should be in reverse pitch on take-off, that is, in a position to hold back rather than push the plane, the big aircraft might drop off on one side and crash with full power applied.

This precaution taken, we taxied out to take-off position. With wings stretching 120 feet to either side, we had to avoid narrow taxi strips and virtually weave our way between other parked planes.

The pilot has a simpler job of steering a B-36 on the ground than in most other planes. He does not use his regular controls, but turns to a special nose steering wheel much like those in city busses.

Just at dark, everyone buckled into position as the pilot called a readiness warning on the interphone. Seconds later the giant engines roared to full power as two pilots held back on the brakes.

Greater and greater became the surge as the 130-ton titan struggled against the brakes. Then suddenly pressure was released and we charged down the runway.

Before half the runway was used we were airborne and climbing much faster than we did in Superforts. Within a mile we were well aloft as our landing gear stowed itself amid the opening and folding of wheel-well panels.

Once out of the Fairfield traffic pattern, we headed south between the coastal mountain ranges and the Sierras. We stayed low as long as possible before turning east to climb over the mountains.

(Continued to page 256)



# SAVE UP TO 60%! GIGANTIC MAIL SALE!

**COMPLETE BARGAIN CATALOG**  
Order from ad. Satisfaction guar.  
Or, rush card for big free catalog.

## Power Plants • Welders • Pumps • Compressors • Tools

**WE PAY SHIPPING COSTS**

- Select from many hundreds of pieces of new equipment—yours at a fraction of the original cost.
- Order direct from this ad — your complete satisfaction guaranteed — or write for full details.

### A-C POWER PLANTS

Brand New  
110-volt, 60-cycle  
2500-watt  
Army's finest plant.  
Ideal farmers, camps,  
contractors, etc.

- Briggs 6.5 h.p. engine. Leland generator.
- Full kit spare parts, tools, instructions.
- Cost over \$700.00

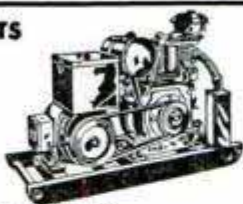

SALE **\$279.00**

### PORTABLE AIR UNIT

Briggs 1.5 h.p. engine. Bendix 2 cyl. ball bearing \$194.00 compressor in portable wheeled frame. Comes with hose, gauge, regulator, valves, unloader, tire chuck, instructions. Over 4.5 c.f.m. Pressures to 125 lbs. Excellent for farms, painters, shops, contractors.

- Slightly used. Factory rebuilt. Like new.
- Cost over \$275.00

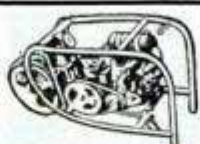

SALE **\$99.50**



### MISCELLANEOUS BARGAINS

"We pay Shipping Costs on everything"

- A. Utility Clutch up to 6.5 h.p. \$13.95
- B. V-belt Clutch up to 1.5 h.p. \$ 7.49
- C. Hand Gas Pump 10 g.p.m. \$13.90
- D. Army Field Telephone EE-8 \$11.25
- E. Rural Phones (1600 ohm 5-bar) \$12.40
- F. City Desk Phones (Com. Batt.) \$ 4.99
- G. Navy-Type Binoculars 7x50 \$39.00
- H. Complete 110-volt Water System \$59.50

### AIR COMPRESSOR KIT

Assemble own unit. Consists of finest one cyl. piston compressor (see below), stainless steel 2100 cu. in. tank, 160 lb. gauge, safety valve, paint spray gun, blow gun, 15 ft. hose, assembly instructions, tire chuck, fittings. Drive with engine or motor. \$60.00 Value

(Brand New) SALE **\$36.90**



- Quincy One-Cyl. Compressor  
Top quality. 150 lbs. pressure, 2.88 c.f.m. \$25.00 Value  
(Brand New) SALE **\$18.15**



- Quincy Two-Cyl. Compressor  
Nation's best, 150 lb. up to 9 c.f.m. \$60.00 Value  
(Brand New) SALE **\$42.80**

### D-C WELDING GENERATOR

Outstanding Welding Generator. 0 to 250 amperes. Easy to drive with tractor, engine, etc. Complete welding unit with helmet, holders, cables, rods, etc.



Cost over \$250.00 (Brand New) SALE **\$104.50**

### WATER PUMPS

Genuine New Burdex Bronze self-priming all-purpose water pumps. Lift water up to 25 ft. Pressures to 60 lbs. Up to 22 g.p.m.



- 1/2" Model . . . . . \$12.79
- 3/4" Model . . . . . \$15.99
- 1" Model . . . . . \$19.49
- 3/4" Aqua Centrifugal . . . . . \$6.50

### POWER & HAND WINCHES



- Amazing Values. Jeep winch 80 to 1 ratio. 5,000 lb. cap. Mounts on front trucks, jeeps, cars.
- Cost over \$150.00 (New) SALE **\$21.95**
- Finest Steel Hand Winch. Powerful unit complete with 50 ft. 3,000 lbs. cable. Complete with crank. \$50.00 Value (New) SALE **\$29.95**

- Hundreds electronic mechanical, power plant, tool bargains.
- Order from ad. Satisfaction guaranteed.
- Send card for amazing bargain catalog.

**BURDEN PREPAYS ALL SHIPPING CHARGES!**

FREE CAT. ALDG.

**BURDEN SALES COMPANY**

811 "O" ST. LINCOLN, NEBR.



**\$300 to \$500 EXTRA PROFIT MONTHLY with ARC WELDING**

"BUILD YOUR OWN" portable gasoline engine driven welder. It's easy and profitable. Same type full capacity generator as used in newest HOBART arc welders. Start now. Get the big pay outside jobs. Be independent of power supply. FOR WELDING AND RUNNING MOTORS, LIGHTS, ETC.

HOBART BROTHERS CO.

EASY . . .  
PAY OUT OF PROFITS TERMS  
as low as  
**\$12 monthly**

GAS DRIVE combination A-C Welder and A-C Power Unit. Actually two machines in one. Change from welder to power unit by flip of switch. Lets you cash in on high pay emergency service and many important repair jobs. Ask Hobart how easy you can start a welding business of your own. Free book.



BOX M-901, TROY, OHIO **Write for FREE Catalog.**

## DID YOU KNOW?

THAT YOU CAN BUY LAND WHOLESALE  
**\$3 to \$5 acre full price -**

Farm, Timber, Ranch Lands in California, Oregon and Washington. Send 10c for prices, photos, full information about amazing buys YOU can make.

COAST LAND CLUB, Dept. 29  
5291 Fountain Avenue, Los Angeles 27, Calif.

## NEW SELF-DRIVE B-M POWER MOWER!

For Modern Lawn Care

Why waste energy pushing a Power Mower when a new self-propelled B-M Mower can be had at our low factory cost? Available in 20" or 22" sizes with 2 or 3 h.p. Clinton engines. Send for our FREE literature showing four models in three sizes including the new direct blade drive with vertical shaft motor. Prompt shipment.

LOW FACTORY PRICE

FULLY GUARANTEED

Write For FREE Literature



MODEL PD1

B-M MOWER CO., Box 66-PM, Blue Mound, Kansas

## Make all your tools more useful with a DESMOND-SIMPLEX VISE

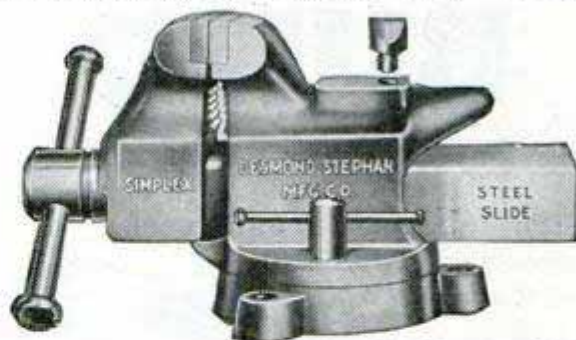

### Enclosed Screw . . . Steel Channel Slide

Here's your best vise value by far. And at a surprisingly low price. Steel slide encloses screw; prevents damage from falling chips. Swivel base for maximum convenience. Non-pinching type handle. Pipe jaws part of vise. Replaceable hardened steel jaw inserts fit snugly on heavy shoulder, withstand heaviest blows from any angle. Hardened steel cut-off tool on anvil. Get a Desmond-Simplex Vise from your hardware store. Write us direct for valuable folder on your basic shop tool.

**The Desmond-Stephan Mfg. Co.**  
Walnut Street, Urbana, Ohio

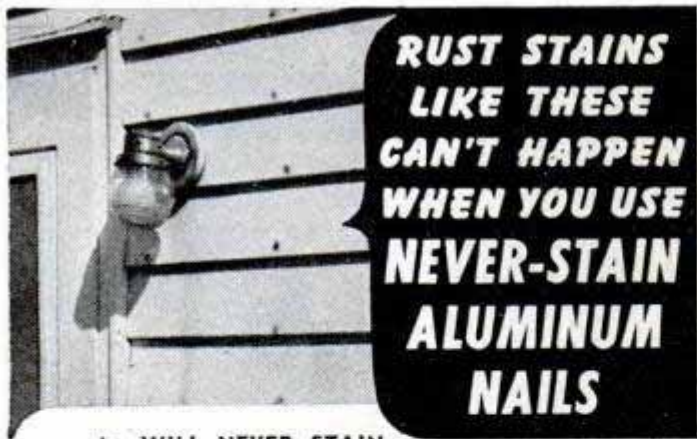

**RUST STAINS  
LIKE THESE  
CAN'T HAPPEN  
WHEN YOU USE  
NEVER-STAIN  
ALUMINUM  
NAILS**

- ★ WILL NEVER STAIN OR STREAK PAINTED SIDING OR COLORFUL ROOFING
- ★ COST LESS TO APPLY—NO PUTTYING OR COUNTER-SINKING NECESSARY
- ★ ALMOST 3 TIMES AS MANY PER LB.

They pay for themselves in the savings they make—and they may save you a \$300 repaint job! Now packaged for the job in different colored boxes, each with quantity, size and type clearly indicated.

**THERE IS NO SUBSTITUTE FOR ALUMINUM!**  
Write for FREE Samples.  
Address Dept. PM.



**NICHOLS WIRE & ALUMINUM CO.**  
DAVENPORT, IOWA

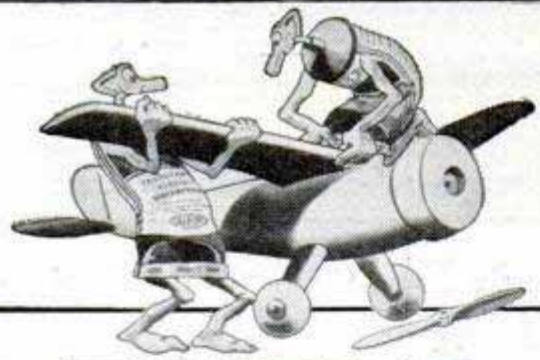

**BUILD  
STRONGER MODELS**

It's transparent, waterproof flexible and durable.  
Get a tube today.



**DU PONT  
DUCO CEMENT**

REG. U. S. PAT. OFF.

Each hour at low altitude meant a lighter load to be lifted when it came time to climb. Had we been flying out over the Pacific, chances are we'd have stayed on the deck for many hours before calling on the big bird to produce the extra energy to get "way up in the blue."

This phase of planning comes under the jurisdiction of the flight engineer, whose position is truly important in that he has complete charge over the power plants and the many smaller motors and controls necessary to its performance.

The pilot is relieved of much of the important responsibility of engineering problems. Much as aboard ship, the power plants are separated from the piloting and navigating problems.

These technicians figure in such details as fuel-consumption variation, the weight of the plane at any given time, its changing center of gravity and its effect on performance during various climb and descent phases. They predict how fuel will be used in future hours in each of the six engines, taking into account the varying weight of the plane as hours of flying use up gas. Each thousand gallons used lessens the weight by three tons.

Though we took off from California at dusk, it was already daylight by the time we roared over central Georgia, our engines throbbing with a peculiar beat typical of the B-36, often described as the sound of an outboard motor echoing across the lake.

We had zigzagged across the southwest and delta states performing certain phases of our mission during the night. The period of darkness was three hours shorter because we had flown east across three time zones.

Our tasks all fitted into the function of reconnaissance, which is charged with obtaining information of every possible kind with such accuracy that it can be used as basis for strategic bombardment.

The First Strategic Reconnaissance Squadron and its sister units will be airborne intelligence for Strategic Air Command and, in the event of emergency, will obtain information used to support strategic bombing.

These crews are training to fly solo to any target in the world to perform such tasks as photography, target study, feeling out of lines of communication, and weather analysis, all simultaneously.

By dawn we had accomplished several assignments and had shifted several times at controls and instruments. Most of us had

(Continued to page 258)

# GET THIS 1950 CAR ENGINE PROTECTION

## the new **MARVEL** **INVERSE OILER**

### FOR CONSTANT UPPER CYLINDER LUBRICATION

Here's the famous auxiliary lubricating oil system—in a sensational new, low cost, 1 Quart size—that meters MARVEL Mystery Oil to critical upper cylinder engine parts precisely in accordance with the demands of your engine under load. This new, compact OILER, with visible oil supply, functions on the same exclusive MARVEL principle—inversely to manifold vacuum—retarding feed when throttle is closed or at engine idle. You'll keep ring, piston and valve wear down and performance way UP with the MARVEL INVERSE OILER on your car.

#### MARVEL MYSTERY OIL

Learn about MARVEL Mystery Oil too—the nationally recognized leader among oil improving additives. Added to your regular motor oil, it shields vital parts from excessive frictional wear with its great film strength—produces a slow idle, faster engine pick-up and an even power pull.

**WRITE  
FOR THE  
FACTS—  
NOW!**



**EMEROL MANUFACTURING CO., INC.**

244 WEST 69th ST.

NEW YORK 23, N. Y.

**SENSATIONAL NEW  
MODEL Q, 1 QUART  
VISIBLE RESERVOIR  
UNIVERSAL  
BRACKET**

**Only \$11.20**  
SIMPLE TO INSTALL

**BASS  
IS BEST  
WEEJUNS  
LEISURE  
COMFORT**



**BASS  
IS BEST  
QUAIL  
HUNTERS  
FIELD and STREAM**



**BASS  
IS BEST  
SKI BOOTS  
EXTRA  
CONTROL**



**BASS IS BEST  
SPORTCASINS  
GOOD GOLF STRATEGY**  
G. H. BASS & CO.  
60 MAIN STREET  
WILTON, MAINE



## PROFESSIONAL TYPE **BUFFING WHEELS**

### AND COMPOSITIONS

For best buffing results, depend on DICO — by the world's leading producer of buffing wheels for industry. Whatever your buffing job, you'll find the right DICO wheel and composition to do it. For free Buffing Manual, write Dept. B-950.

**DIVINE BROTHERS CO.**

**UTICA, N.Y.**

#### INTRODUCTORY KIT by Mail

Contains 2 big 6" Dico Buffing Wheels, 2 tubes of Dico Composition and Buffing Manual, MAILED POSTPAID if dealer can't supply. Give spindle diameter of your power unit.

**\$2.59**  
(Reg. Val. \$2.85)

ASK FOR

**Dico**



**AT YOUR  
HARDWARE  
STORE**

## M-SCOPE TREASURE -MINERAL LOCATORS

WRITE FOR FREE, ILLUSTRATED 16-PAGE BOOKLET

M-Scope Treasure-Mineral Locators, Geiger Counters. New Low Prices, unsurpassed in efficiency. Full factory guarantee. Immediate shipment.

YOU CAN PURCHASE THESE INSTRUMENTS ON A MONTHLY PAYMENT PLAN



URANIUM

**FISHER RESEARCH LAB., INC., PALO ALTO, CALIF.**

GOLD



## POWER KING #3001

The Lowest-Priced Ball-Bearing Tilt/Arbor Saw

Yes, now you can get real "production" on your shop projects — at low cost! — zip through your saw work in a tenth the time . . . make important savings on shelves, cupboards, cabinets, furniture, home repairs, and remodeling!

The Power King #3001 — built by Atlas — has many features of high-priced saws: tilt/arbor (table *always* flat), cuts 2 1/4" deep, sealed ball bearings, precision-ground grey-iron table (16" x 25 1/2" with two low-cost extensions), full length double-locking rip fence. You can't beat its value—see it today!



**PK 4 1/2" Jointer-Planer**  
For "Factory-Smooth" Finishes

Your projects can have the smartness of professional furniture with this Power King 4 1/2" Ball Bearing Jointer-Planer in your shop. Saves you time and work in planing, rabbeting, tonguing, beveling. It's built extra heavy, with grey-iron base and table — precision-ground table surface—tilting fence—3-blade steel cutter head — plus other outstanding features. A good companion tool for your circular saw.

**NEW  
FREE  
CATALOG**

Name \_\_\_\_\_

Address \_\_\_\_\_

City, State \_\_\_\_\_



**ATLAS PRESS CO.**

935 N. Pitcher St., Kalamazoo, Mich.



**MATCHED PRECISION TOOLS FOR  
WOODWORKING AND METALWORKING**

stayed awake during our relief shifts, but now, after many hours, "sack time" had priority.

Our B-36 was equipped with two triple tiers of bunks, six in all, located aft of the bomb bays in the scanner-gunners' compartment. These had been assigned specifically to various crew positions by the plane commander; one for pilots, one for gunners, one for engineers, one for observers and so on.

To get to these, the tunnel from the nose compartment was in almost constant use. This tunnel, some 80-odd feet in length and 30 inches in diameter, connects the forward and aft compartments, crossing the length of the four bomb bays.

A cart similar to an auto-mechanic's dolly travels the length of the tube on rails. Its rider lies prone and pulls himself through on cables as in a horizontal dumb-waiter.

The two crew compartments were pressurized when the plane climbed two miles or more above sea level. At its designed altitude, air pressure is less than a quarter as dense as on the ground. If the cabins were not kept at relatively high pressure, the crews would have had to breathe pure oxygen for the entire time.

By using engine power to keep air pumped to nearly normal density, we did not have to wear oxygen masks constantly. We had no fear of bends, the disease so common to divers who have suddenly been zoomed from one pressure to one much less dense.

Such a possibility is always an added danger, for a "blister" or window might suddenly give way or be shot out. Such a gap would cause the more compressed air to rush for the opening, sweeping all loose objects in its way.

Should a man be caught in the tunnel at such a crisis, he would likely be blown through like a pea in a beanshooter. Safety hatches at both ends of the tunnel are a safety precaution against this possibility.

We all carried heavy flying clothing in case of such a blowout and in the event of failure of the heating system. Outside air temperature during the night dropped to 30 and 40 degrees below zero. However, no mishaps occurred and we worked with only flying suits over our uniforms.

As all servicemen are "chow hounds," off-duty time was also mealtime. Crew members carried up to five lunches apiece, including sandwiches, canned fruit, oranges, relishes, hard-boiled eggs, cakes and chocolate bars. These were supplemented by the milk, hot coffee and soups.

(Continued to page 260)

**ELECTRIC SIREN**

6 volt. Complete with push button... **\$10.95**

**"HOT ROCKET" Illuminated Ornament**

Chrome Plated  
Terrific  
Value at  
**\$6.50**

Five Red luminous Plastic fins whirl, looking like jet propulsion in action. 9 inches long, has internal lights. Metal parts are gleaming chrome. Fits all cars.

**Illuminated Chrome Plated DELUXE FENDER FINS**

Get that Cadillac Look! For 1949-50 Chev., Ford, Pontiac, 1950 Plym., Dodge, Chrysler, DeSoto. Red reflector lens. Contoured to fit rear fenders perfectly.  
**\$9.95**  
PAIR

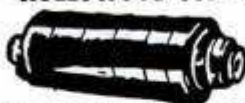
**HOLLYWOOD MUFFLERS**

FOR ALL CARS

Gives that Motorboat Tone. Universal type to fit all cars, ea... **\$4.45**

**NEW CONVERTIBLE TOPS & REBUILT MOTORS** for all Cars. Write for Prices.

Send 25% Cash With Orders, Balance C.O.D.

**JUST OUT!** Get the largest Auto Accessory & Parts Catalog in the world. Over fifteen thousand items, including Hollywood Accessories, Hi-Speed Equipment, Rebuilt Engines, all parts & accessories for all cars & trucks. We have that Hard-to-Get-Part! Completely illustrated, Jam packed with bargains. Send 25c.

**J. C. WHITNEY & CO.**  
1917GA ARCHER AVE. CHICAGO 16, ILL.

**4000 WATTS**

from this compact, low-cost Witte Dieselectric Plant

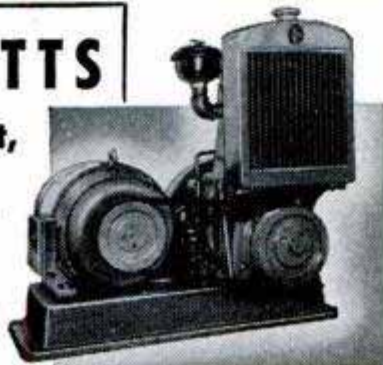

Model ADRBA  
Witte Dieselectric Plant



**WITTE ENGINE WORKS**  
KANSAS CITY 3, MISSOURI  
Division of Oil Well Supply Company

**UNITED STATES STEEL**

**Swedish WOOD CHISELS**

Finest Imported Swedish Steel Blades

- Prices Now Lower than Most American Chisels.
- Hand-Honed and Polished.
- Unbreakable machined plastic handles.

Fine Swedish quality in accurate cutting chisels that every craftsman will appreciate. Gensco chisels take and hold the finest edge for better work.

**PROTECTIVE PLASTIC COATING**

keeps blades clean and sharp. Strip it off when ready for use.

The GENSCO LINE also includes **BUSHMAN**

Swedish Hand, Bow and Pruning Saws

See Your Dealer or Write Direct

11 SIZES FROM 1/4" to 2"

**GENSCO TOOL DIVISION**

General Steel Warehouse Co., Inc.  
1832 North Kostner Avenue • Chicago 39, Illinois

**"NEW" Better-Than-Ever DRILL PRESSES***Atlas*

★ **NEW**  
4 Ball Bearing Equipped Head

★ **NEW**  
Direct Reading Depth Stop

★ **NEW**  
Extra Heavy Construction

★ **NEW**  
Operating Smoothness

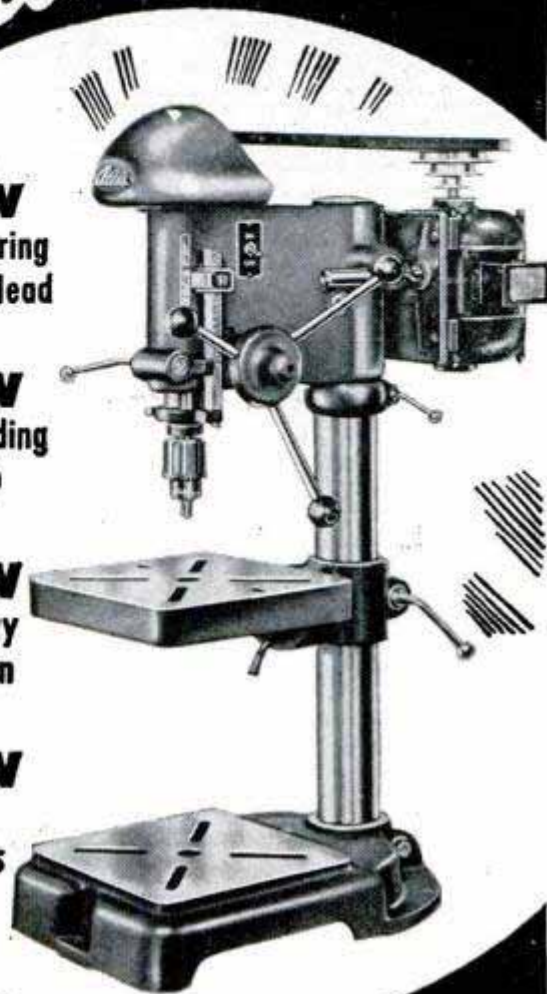

**7 TOOLS IN 1**  
For Your Shop

Add those new advancements to the known quality features of Atlas drill presses and you'll quickly see why you get *more value today in an Atlas*. With low-cost attachments it drills, taps, routs, sands, carves, mortises, shapes... gives you clean, precision workmanship on metals, woods, and plastics... makes your workshop hours more productive than ever. Write for full details.

SEND A POSTCARD FOR LATEST CATALOG

**ATLAS PRESS COMPANY**  
843 N. Pitcher St., Kalamazoo, Mich.



**MATCHED PRECISION TOOLS FOR METALWORKING AND WOODWORKING**

**NEW AUTOMOTIVE DISCOVERY**  
**FREE TRIAL**  
 IN YOUR CAR!

REPLACES  
 IDLE ADJUSTMENT  
 SCREW IN YOUR CARBURETOR  
 HOLES FOR AIR FLOW



THE OBJECTIVE IS  
 TO GIVE YOUR CAR

- ⚡ MORE MILEAGE
- ⚡ FASTER PICK-UP
- ⚡ EASIER STARTING
- ⚡ BETTER IDLING

INSTALL IT  
 YOURSELF  
 in a Few  
 Minutes

Patent Pending

THE AMAZING NEW GANE "air-flow" NEEDLE

ABOUT 1/2 MILLION NOW IN USE!

Up to 25% MORE MILEAGE, EASIER STARTING, FASTER PICK-UP and SMOOTHER IDLING are reported by many users of this new SENSATIONAL Automotive Product. (Hundreds of such letters have already been received.) However, they do not show improvement in some cars—Therefore we want you to try them in your car AT OUR EXPENSE. TRY BEFORE YOU BUY.

Just mail card or coupon below and TRY THEM FREE for 10 days. Then check your mileage and engine performance. If satisfied, send only \$1.50 per needle (8 cyl. cars take 2). If not entirely satisfied—just return them and YOU OWE US NOTHING—FAIR ENOUGH? - TRY BEFORE YOU BUY

**MAIL TODAY**  
**SEND NO MONEY**  
**PAY POSTMAN**  
**NOTHING**

**NATIONAL AUTOMOTIVE RESEARCH CORP.**  
 Dept. J-9, Venice, California

RUSH Gane "Air-Flow" Needle for my FREE TRIAL. I SEND NO MONEY—I PAY POSTMAN NOTHING. I will try them for 10 days in my car. Then, if satisfied, I will send only \$1.50 per needle (8 cyl. cars take 2). If NOT SATISFIED, I will return them and I OWE YOU NOTHING.

Name \_\_\_\_\_

Address \_\_\_\_\_

City \_\_\_\_\_ State \_\_\_\_\_

Make of Car \_\_\_\_\_ Year \_\_\_\_\_

No. of Cylinders \_\_\_\_\_ Make of Carburetor \_\_\_\_\_

**SAVE WATER!**  
 No more scalding or splashing



FITS ALL SPIGOTS

**Adjustable WATER MIXER**

You can now have a modern "Combination Faucet" in seconds by just slipping this adjustable water mixer on your old spigots. Have water always at the right temperature, eliminate annoying scalding and splashing. Easily installed, of glistening chrome-plated solid brass with hold-tite faucet adapters that fit round or oval faucets. Comes with removable anti-splasher. Save water, time and temper. Money Back Guarantee!

**1.59**  
 Plus 11c Handling

**GAYLORD** Dept. PM-3 Fifth & Hamilton, Pittsburgh 6, Pa.  
 Send . . . Water Mixers at \$1.59 plus 11c postage.  Check  M.O.  C.O.D.

Hot cups to warm soup were plugged into several different outlets in our B-36. Steaming soups are always favorite fare among flight crews. In older types of planes, the crewmen used to warm the individual serving cans on radar sets and other hot electronic equipment.

Relief time was also wash-up time, and wash basins and reservoirs of water earmarked for the purpose were available both fore and aft. Nobody risked shaving amid the vibration and possibility of a sudden turn!

"Off time" was also visiting time, and crew members stopped by at other duty stations to watch goings-on and learn duties and problems of other specialists firsthand. Cross-training in the interests of teamwork is greatly encouraged on all "Sac" (Strategic Air Command) crews. Favorite spots for "goofing off" were the pilots' topside cockpit, the engineers' dome looking aft over the engines, the navigation section on the lower deck in the nose and the gunners' sighting stations in the strategically placed blisters fore and aft.

Our daylight photographic assignments brought us down to lower altitudes than the eight-mile altitude for which the B-36 was designed. We performed several photomapping projects in as many states, flying within a few hundred yards of a designated line for many miles in each instance.

The planners of the mission had calculated many hours before that we would be at each of these projects at certain times of day, even taking into account that on our way westward we'd have additional daylight for the more western assignments.

On several occasions other planes flew near us to look us over. Even in the Air Force the six-engined global bomber is a curiosity. In one case a fighter made several long-range "passes" at us, with the permission of our pilot.

Though his attacks were made when we were far below the altitude at which we would have been flying in the event of hostile attack, it afforded our gunners some practice in tracking incoming aircraft.

The B-36 is the most heavily armed aircraft ever to fly, all its heavy-bore guns being controlled from any one of several sighting positions, many yards from the guns themselves.

In case of attack, the gunners snap a few switches to raise the turrets from their normal stowage hatches inside the body of the plane. More circuits serve the sighting computers which aim, lead, fire and stow the turrets after use.

Strange as it might seem, the pilots did  
 (Continued to page 262)

# Turn Spare Time into Profit Time with Home Workshop Tools by SHOPMASTER



**12" TILTING TABLE BAND SAW** Table work surface 12"x18" Cutting depth 6 1/2" Table tilts to 45° Ball bearings  
**\$69.95\***  
 Also available in 10" size, \$41.50\*



**10" FLOOR MODEL TILTING ARBOR SAW** Table size 26"x20" Depth of cut 2 1/2" Arbor tilts 45° Heavy construction plus ball bearings for accuracy. Complete with Stand  
**\$98.50\***

**12" DRILL PRESS** Bolt thrust bearing Jacobs Chuck, 3-spoke feed wheel, plus many accessories make this a most versatile tool. Also available in a floor model, \$54.00\*



**10" WOOD TURNING LATHE** Co. swing, 31" center to post, 10" wide, 45" long. Rugged frame, sealed-for-life ball bearings.  
**\$42.50\***



**SABER SAW** Table size 10" x 10" Depth of cut 1 1/2" Table tilts to 45°  
**\$15.75\***



**BELT AND DISC SANDER** Belt 6" wide, 45" long. Disc diameter 10". Adjustable table tilts to 45°  
**\$49.95\***



**15" TILTING TABLE JIG SAW** Table size 10"x10" Cutting depth, 2 3/4" Table tilts 45°  
**\$25.50\***



**8" TILTING ARBOR BENCH SAW** Table size 16"x20" Depth of cut, 2 1/2" Blade tilts to 45°. Includes Rip Fence, Mitre Gauge, Guard  
**\$68.50\***



**6" JOINTER-PLANER** Overall table length 34" Sealed-for-life ball bearings. Advanced design cut-ting head. Also available, 4" jointer-Planer \$41.50\*  
**\$71.50\***



**7" TILTING ARBOR BENCH SAW** Ball bearing arbor. Heavy cast construction. Depth of cut, 2 1/2" Blade tilts to 45°. Ideal for small shop.  
**\$41.50\***



**SPINDLE SHAPER** Table size 14"x18" Spindle travel (up and down) 1/2"  
**\$44.50\***



**8" TILTING TABLE BENCH SAW** Table size 14"x18" Depth of cut, 2 1/2" Sealed-for-life ball bearings  
**\$47.95\***



\*Prices as illustrated, Zone 2, less motor (Slightly lower in Zone 1)

It's easy to be a skilled craftsman when you use SHOPMASTER Power Tools

It doesn't require woodworking experience to do creditable work with SHOPMASTER Power Tools. You learn as you enjoy this profitable hobby. With SHOPMASTER Power Tools you eliminate tedious hand operations and soon achieve work of professional quality.

Start your shop with a single SHOPMASTER Power Tool. Built to meet professional standards, all are moderately priced. With the available accessories, each will handle many tasks. Then add new tools from the complete SHOPMASTER line.

SHOPMASTER Power Tools are the finest tools available for your shop. They are accurately machined to close tolerances for fine work. They are adjustable to all sizes of work and adaptable for many odd operations. There is a complete line of accessories which, with repair parts, are available nationally.

Write today for full color catalogue and price list, and the name of your nearest dealer.



**SHOPMASTER INC.**  
 1214 Third St. S., Minneapolis, Minn.

There is also a complete line of accessories for SHOPMASTER TOOLS

# FREE . . . WARDS 1950-51

## POWR-KRAFT POWER TOOL AND WELDING BOOK

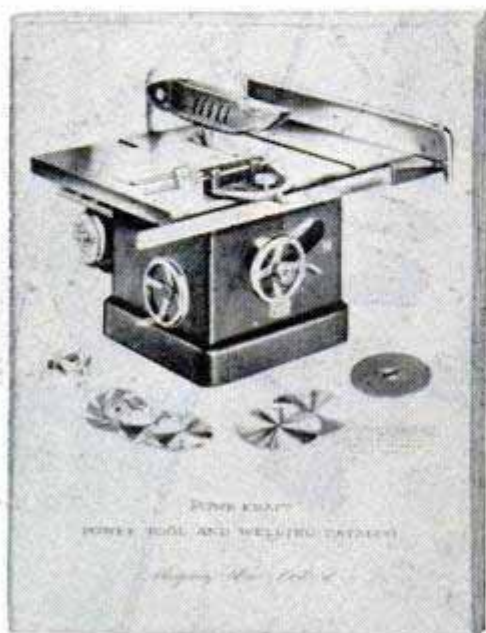

48 PAGES FOR CRAFTSMEN—Beginner, hobbyist or production shop will find this complete catalog of power tools and accessories indispensable, with its helpful information and money-saving prices. Use the coupon below—*today!* •

FOR A FIRST-CLASS WORKSHOP—This book lists wood and metal working tools, portable electric tools, welding equipment, electric motors, etc.—most of the equipment you need to set up a fine workshop. Also production shop woodworking power tools, metal lathes and accessories.

CHOOSE FROM FAMOUS NAME BRANDS—You'll see the full line of Wards Power-Kraft tools, plus nationally known brand names such as Mall, Logan, Beaver, Burke, Shopsmith, etc.—all pictured and described.

*Montgomery Ward*

Chicago • Albany • Baltimore • Denver • Ft. Worth  
Kansas City • Oakland • Portland, Ore. • St. Paul

Mail coupon to nearest city above—NOW!

MONTGOMERY WARD, Dept. PM-9  
Rush me your 1950 Powr-Kraft Power Tool and  
Welding Book.

Name \_\_\_\_\_  
(PRINT Plainly)

Street Address,  
Route, Box \_\_\_\_\_

Post Office \_\_\_\_\_ State \_\_\_\_\_

not have to use more strength to control our king-sized plane, despite the huge areas of aileron, elevator and rudder.

Though the cockpit controls moved in standard fashion, they did not directly move these broad surfaces but swung only small panels of these, and in the opposite direction from normal at that.

When the pilot wanted to move the rudder right, he swung his wheel over as usual. The effect was to move the trim tab panel to the left. The slip stream of air against this tab had a resulting effect of pushing the main surface over where the pilot wanted it to be. In all movements, the pilot really uses the slip-stream pressure to move his controls for him.

As we came closer to our home base, the power settings of the engines became less and less as the 60-odd tons of fuel were used up. The throb and noise of the propellers became more and more relaxed.

It was dark for the second time in the flight as we flew over Denver on our last project before turning home. It was past midnight when we finally set down again at Fairfield, 31 hours older than when we took off.

Our plane was more than 60 tons lighter than when we left and, even at a gross weight remaining of over 80 tons, practically "floated" in comparison with its original tendencies.

We were all glad the flight was nearing an end as the aircraft commander made his "final approach," touched down and reversed his props to slow us down almost to walking speed. We had landed and stopped in a shorter distance than many airliners a fraction of our size.

Though it was now 40 hours since we had reported for work, we were not yet through. It was nearly three more hours before we were dismissed to go home.

All performances of mechanical and electrical equipment had to be written up on maintenance reports. Our personal equipment had to be checked in, lunches and debris collected, cameras and film unloaded and other recording apparatus and technical equipment had to be processed. Then the crew had to be "debriefed."

Debriefing included all reports of the projects assigned and training accomplished, turning in of navigation and other logs, reports of unassigned and special observations and the crew commander's criticism of the mission as it was flown.

Then they let us go home with the promise of a day off—and a warning, "Remember, when you report back, you still have to vacuum-clean your compartments . . . no crumbs allowed."



# Brighten Up!

## TURN DIM CELLAR CORNERS INTO BRIGHT SPOTS

Get more light to work by—see how easy it is to brush aluminum metal and masonry paint on basement walls. You'll be amazed at how this specially-formulated aluminum paint covers, how much brighter your basement walls will be.

### FREE BOOK TELLS HOW

Free 24-page illustrated booklet, "Paint It Bright", tells how to choose and use aluminum paints, provides pages of helpful painting tips. Remember, there's a right kind of aluminum paint for every job around your house—get it from the dealer who displays the Alcoa symbol of quality on the brand he sells.

Look for this shield on aluminum paints made by many paint manufacturers using **ALCOA PIGMENTS**

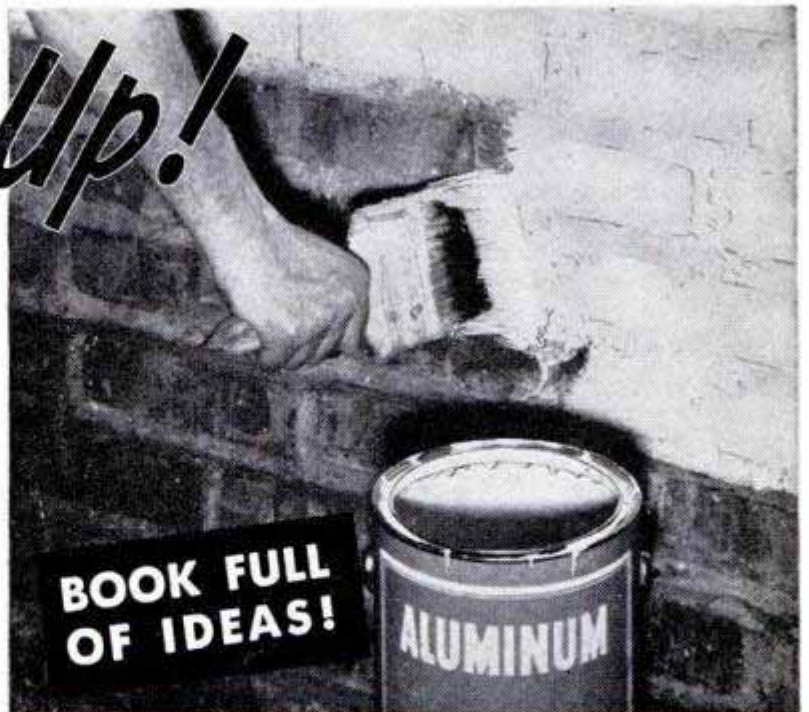

### MAIL COUPON TODAY!

Paint Service Bureau, ALUMINUM COMPANY OF AMERICA, 1718J Gulf Building, Pittsburgh 19, Pa.

Please send me free copy of "Paint It Bright".

Name (please print) \_\_\_\_\_

Address or RFD No. \_\_\_\_\_

City \_\_\_\_\_ State \_\_\_\_\_

I want to paint the following: \_\_\_\_\_

## KING MIDGET Home Assembled Auto

### WORLD'S LOWEST PRICED CAR!

Drive for as low as 50c per week. Precision built parts direct from factory with beautiful all steel body. Get the facts on this amazing small auto—send 25c for detailed circular with large picture, 3 view drawings and price of all parts, or send \$1 (refunded first order) for this plus actual assembly book with 42 photos, drawings: blue-prints of snow, ice conversions. Ideal for micro-midget racing — Get this information.



ATHENS MOTORS MFG. CO.  
ATHENS 1, OHIO

WHITNEY-JENSEN

## "NO-CREEP" NOTCHER



32° Notch

Hardened Steel Hook Jaw Prevents Creep... Cuts Smooth, Clean Notches up to 13/16"

### VERSATILE HAND TOOL FOR WORKSHOP OR TOOL KIT

Save time and effort with this handy, popular tool designed for fast, accurate, clean cuts. Easy to use. Quick, one-hand operation. Smooth, shaped, polished handle grips. Spring-return jaws. Hook-type upper jaw bites notch apex first, holding exact desired depth of notch without slip or creep. Maximum notching depth: 13/16". Made for 32° notch. Capacity: 20 ga. mild steel.

Only \$6.10

Postpaid

WEIGHS ONLY 1 LB. — LENGTH 9"

Send cash, money order, or check

ORDER TODAY... POSTAGE PAID IN U. S. A.

WHITNEY METAL TOOL CO., DEPT. P-9, ROCKFORD, ILL.

## IT'S A PISTOL Lighter with Real Trigger Action!

IT'S NEW! Only

\$2.00

prepaid



AS A TABLE LIGHTER

Be the first in your crowd to have one. Looks just like a real little pistol! Pull the trigger and it's a fully automatic lighter (3" x 2 1/2"). Works every time. Polished chrome finish, will not tarnish... black bone-like handle. Good protection for ladies! Removable table stand included. Ideal as a GIFT! Order Yours today—send \$2.00—full refund if not satisfied in 5 days. Note the unusual low price!

## GOLDMAN JEWELRY EST. 1886

Dept. PM, 1103 Walnut, Kansas City, Missouri

# IT'S THE NEW STARRETT UNIVERSAL PRECISION GAGE

Designed for machinists, tool and diemakers and inspectors, Starrett No. 995 Universal Precision Gage combines the unique features of fine adjustment with universal adaptability to countless gaging, scribing, measuring and leveling operations.

**With Fine  
Adjustment**

Patented



## PLUS MORE THAN 60 OTHER NEW STARRETT TOOLS

Ask your distributor to show you these and many more important new tools — or write for Starrett New Tools Booklet.



**No. 354**  
Vernier Height  
Gage With  
Slotted Base.  
Reads Direct  
0-6"

**No. 449** Micrometer  
Depth Gage  
With Flat Rods

**No. 1010** Pocket  
Dial Indicator.  
Reads in .001"

**No. 231** Satin  
Chrome Micrometer.  
No Glare Readings

**No. 11** Improved  
Combination Square  
With Reversible  
Lock Bolt

**No. 1025** Pocket  
Slide Caliper—  
Stainless Steel

Satin Chrome Inside Micrometers

**No. 823** With Tubular Rods **No. 124** With Solid Rods

Get Your FREE Copy

**STARRETT NEW TOOLS BOOKLET**

Describes, illustrates and prices these and over 60 more important new Starrett Tools. Write for your copy today.

Address Department AP.

THE L. S. STARRETT CO. • ATHOL, MASS., U. S. A.

TRADE MARK  
**Starrett**  
REG. U.S. PAT. OFF.

Since 1880... Standard of Precision

MECHANICS' HAND MEASURING TOOLS AND PRECISION  
INSTRUMENTS • DIAL INDICATORS • STEEL TAPES • HACKSAWS  
BAND SAWS AND BAND KNIVES • PRECISION GROUND FLAT STOCK

Buy Through Your Distributor

## Engine With a Built-in Tornado

(Continued from page 95)

would have happened if they had used a low-grade fuel like the light oil—20 numbers off—that the new engine laps up.

To understand what Barber did, you have to know what makes a standard engine knock. As a piston in your car moves down, air and fuel whoosh into the cylinder in just the right amounts to make a mixture that will burn. Then the valves close, the piston moves up, compressing the mixture, and the spark plug fires. The result is not an explosion, as many people think, but a burning process. The flame moves from the plug, usually on one side of the cylinder, toward the other side quickly—but not quickly enough. Over on the far side is some of the mixture, getting hotter and hotter as the flame gets closer and the rising piston compresses it more and more. Suddenly, before the flame can get to it, that isolated mixture or "end gas" gets so hot that it ignites spontaneously before the flame front can reach it. Result: a minor explosion that detonates against the walls of its steel cell—ping. The shock of that explosion persistently banging away gradually pits and scars the walls of your cylinders. Pretty soon a carbon-valve job doesn't help anymore, and your engine sounds like a coffee grinder.

Fuel engineers in laboratories across the country have kept ahead of the ping by forever hunting up new ways to crack their crude oil. They often have to settle for less gasoline from every barrel of crude in order to produce gasoline with higher resistance to spontaneous ignition—or higher octane number. Every time they boost it another number, engine manufacturers boost compression a notch, raising the cylinder heat, and the pinging starts all over again.

That was the situation when the knock problem at Texaco landed in Ev Barber's lap. Barber, who started as a research engineer and has worked his way up to supervisor of the engineering research department, refused to be trapped in the merry octane spiral.

"I figured," he says, "that the whole thing might be solved if you could just burn up the fuel immediately as it entered the cylinder. Then there wouldn't be any 'end gas' to detonate."

That's not as easy as it sounds. Fuel needs oxygen in order to burn. The big problem was how to get the fuel to mix with the air so it would burn a split second after it entered the cylinder.

(Continued to page 266)



# "ONE-STOP SHOPPING"

for ALL electric drill accessories — ORDER TODAY!



## Polish, Sand 'n Save with the BULL BUFFER



Polish and sand the easy, right angle way. Gear reduction, swivel action. Over 100,000 now in use. Complete with sheepskin bonnet, rubber pad, 2 sanding discs.

**\$9.95**

## A PORTABLE POWERHOUSE!

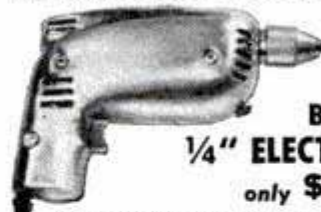

NEW BULL "200" 1/4" ELECTRIC DRILL only **\$14.95**

WE GUARANTEE YOUR MONEY BACK if it isn't more powerful than any 1/4" electric drill at ANY PRICE.

Runs at 1500 r.p.m. under heaviest hand pressure! Designed for use with drill accessories. New specially wound AC-DC motor! A man-sized drill for man-sized jobs—at an unheard of price. **\$14.95**

It's new! "The Mighty Little Midget"

## BULL HACK SAW, only \$4.95

Fits any 1/4" electric drill or drill press. Weighs only 11 ozs.; small in size—easy to carry, easy to use. 2-to-1 ratio of drill speed to saw speed for extra power! No gears, no bearings, nothing to wear out. Full chip clearance on any wood, metal or plastic stock up to 3/4". Powerful, portable, pocket-size — a must for every home craftsman, only....

**\$4.95**



## HIGH SPEED JITTER SANDER

for those professional finishes on wood or metal. Ideal for furniture, fenders, etc. Easy one-hand operation.

**\$9.95**

## NEW BULL SAW

**\$9.95**

Converts any 1/4" electric drill into a portable saw. One-hand operation. One-piece safety guard; visual guide. Depth of cut: 1 1/2". Complete with high carbon saw blade.

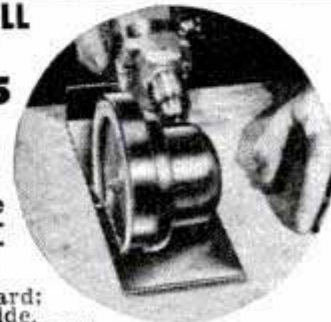

**\$9.95**



## AUTOMATIC SCREWDRIVER

for any electric drill, drill press, or flexible shaft. When ordering specify standard or Phillips head.

**\$4.95**



## 4-IN-1 HOLE SAW

Cuts 1", 1 1/2", 2", 2 1/2" holes in any 3/8" stock. Fits any 1/4" drill or drill press. Complete with arbor and 4 blades.

**\$4.95**

All Bull Tools are Guaranteed

ORDER TODAY — WHILE THESE LOW PRICES ARE STILL IN EFFECT!

# BERTRAM A. ENGINEERING & SUPPLY CO.

3121 MAIN STREET

Dealers — Write today for 1950 catalog

KANSAS CITY, MO.



Three Authoritative Books Every Fan Needs!

## AUTOMOBILE RACING

Famous for authoritative, detailed information on auto racing, every type race car, rules, specifications, working drawings, plans, etc. No duplication. Every book is different. Money back if not satisfied.

### AUTOMOBILE RACING, 6th Ed.

\* Championship cars, big cars, midgets, roadsters, Offenhauser dirt track car. Specifications on Indianapolis cars, four-wheel drive details, front drive drawings. Plans for Ford 60 midget, roadster racer, data on engines, gear boxes, clutches, axle ratios, compression ratios, etc. Indianapolis rules and regulations. More than 100 illustrations. Only \$2.00.

Fast—How to Make Them Fast—How to Build Engines—How to Build Chassis—How to Build Bodies—Who Holds What Records—What the International Formula Is — What Midget Racing Rules Are—How World's Record Cars are Built—How to Speed Up Ford V8 Cars! Only \$1.00.

### AUTOMOBILE RACING, 4th Ed.

\* Gives information on midgets, including three sets of working drawings and complete building instructions. Miller-Ford V8 Front Drive Racers are illustrated and described, also other big-time data featured. Only \$1.00.

### AUTOMOBILE RACING, 5th Ed.

\* Tells you—Why the Fast Ones are POPULAR MECHANICS PRESS, Dept. 350, 200 E. Ontario St., Chicago

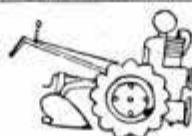

## YOU BUILD IT GARDEN TRACTOR

From used Ford parts. Plans \$1.00. Free info. PAUL'S TRACTOR CO., 1301 W. Arrow, Fontana, Cal.

Say You Saw It in Popular Mechanics



## DUST-O-VAC FOR ALL MACHINES

For Home Workshops & Industry. DUST-O-VAC collects & bags wood & plastic chips, wood & metal dust, wood shavings. Free Bag. Attaches to circular saw, planer, band saw, grinder, belt or disc sander, shaper, drill press with shaper or sander attachment, spindle shaper, wood lathe, jig saw. 110 A.C., D.C. Send for mounting instr. for all machines.

**\$19.95**

Free Ship. east of Miss. West of Miss. add \$1. Check. M.O.

HEAVY CAST ALUMINUM BLOWER — ONLY \$11.25 For workshop, lab., kitchen, cellar, etc. App. 100 C.F.M. Send for circular.

UNIVERSAL YONKERS CORP., 137 Alexander St., M-9, Yonkers 2, N. Y.

GOVT. COST

~~\$87.25~~



NOW **\$19.75**

## CHRONOMETRIC TACHOMETER

U. S. NAVY SURPLUS—ACCURACY—PRECISION—GUARANTEED

For PRECISION timing of all rotating mechanisms. Incomparable GUARANTEED ACCURACY of 1/10 of 1%. An RPM counter and surface speed indicator combined with chronometric operation which AUTOMATICALLY computes period of test in EXACTLY 6 SECONDS. No stop watch or personal equation necessary. UNSURPASSED for cameras, projectors, gen-

erators, motors, sanders, turbines, saws, shafts, looms, fans, lathes, etc. Packed in plush-lined, simulated leather case. UNCONDITIONALLY GUARANTEED subject to your inspection and approval. Manufactured by JAEGER and TOTCO, leaders in field of exacting measuring devices. Only \$19.75 Shipped postpaid in U.S.A. on cash orders.

### TEST EQUIPMENT

Dumont—R.C.A.—Hickok Weston World's Largest Selection of: Electronic Test Meters, Signal Generators, Oscilloscopes, Bridges, etc. Just purchased from U.S. Army. Send for latest catalog with low prices that will frighten you.

### COMPASS

Mark IV Self-Compensating Floating Compass. U.S. Navy. 3 1/4 x 3 1/4 x 3 1/4" For car, plane, or boat. Govt. Cost \$72.00 Now **\$4.95**

### A-10 Bubble SEXTANT

Never before at this price! Complete with hardwood case. Gov't cost, \$300. Now **\$7.95**

### Kohlsman ALTIMETER



Ideal for Auto or Airplane. Used but GUARANTEED accurate. Don't wait. Order NOW! Original gov't cost, \$168. Each **\$10.95**

Order these surplus bargains today. We pay postage on cash tachometer orders. Add postage to other items. 20% dep. on C.O.D.'s

Semlers' ASSOCIATED SURPLUS Dept. PM-90 5720 WILSHIRE BLVD., LOS ANGELES 36, CALIF.

# "44" CRATEX WHEELS and POINTS

## Plus "3" Sturdy Mandrels



CRATEX (rubberized abrasive) wheels cut as they polish... Sturdily built for lasting top performance... Fine Tool Quality backed by over 25 years of industrial, professional and technical use. Use CRATEX wheels on your most difficult finishing and polishing applications—Models, Instruments, Guns, Plastic Articles, Costume Jewelry, Molds, Dies and Small Castings... You will be amazed at what you can accomplish.

Send for this Special CRATEX Assortment Today  
Guaranteed to Please or Your Money Refunded

CRATEX MFG. CO., 88 Natoma St., San Francisco 5, Calif.

## AUTO MECHANICS! BOOST YOUR EARNINGS



# AUTO ELECTRICAL SERVICE

*made easy!*

**JUST OFF THE PRESS**

**Contains technical information**

Only **\$2.00**  
Over **200** pages

The finest, most completely illustrated full color book on the complete automotive electrical system. Includes full information on the seven basic electrical circuits built by Auto-Lite... Starting—Charging—Ignition—Horns—Windshield Wipers—Instruments—Lighting. Plus Trouble Shooting Charts worth many times the price of the book. Gives you the answer every time.

... packed with latest service methods.

### SPECIAL! NO MONEY COUPON

THE ELECTRIC AUTO-LITE COMPANY—Toledo 1, Ohio

Yes, send me your "Maintenance and Operation Manual" by return mail. I will pay the postman when he delivers my copy \$2.00 plus postage. (If \$2.00 is enclosed with this coupon, the book will be sent postpaid.) If after 10 days I am not satisfied I may return the book and my money will be refunded.

NAME \_\_\_\_\_

ADDRESS \_\_\_\_\_

In the machine shops of the Beacon Labs, Barber and two other young engineers, Blake Reynolds and Bill Tierney, set to work designing and grinding parts and assembling cylinders, valves and fuel jets that might do the job. Today, the results of their persistence sit on test blocks beating out a steady, knockless tattoo that is music in the ears of their bosses.

They solved the big problem of air mixture by creating a miniature tornado inside the cylinder. This whirling air whips into the entering fuel and makes it beautifully combustible almost the instant it gets inside the cylinder. To do this, the men devised a "shroud" or semicircular shield around the upper lip of the air-intake valve. So, when the valve drops open, the air rushes into the cylinder in one direction. The apron prevents it from going elsewhere. In effect, it's a jet of air, which hits the cylinder wall and follows it around, setting up a powerful swirl.

Instead of using a standard automobile fuel feed system, the engineers used a fuel jet (like the diesel system), which spurts fuel into the cylinder at an angle—downwind into the whirling air stream.

What happens, then, inside the cylinders which are pounding in the Beacon Labs today? Briefly, it is like this: as the piston moves downward on the suction stroke, the air-intake valve pops open and into the cylinder rushes a tiny typhoon. As the piston moves upward on the compression stroke, the intake valve claps shut, trapping the swirling air. Then, fuel jets downwind into the battering air stream, mixing with it. At the same time, the spark plug fires and ignites the mixture as it goes past. Firing and squirting last until the top of the piston stroke and all the fuel is burned as it goes by the spark plug. Hence, there is no "end gas" or unexploded mixture in the cylinder to ignite spontaneously as the temperature rises. And, hence, the cause of ping or knock is gone. Combustion products are ejected on a normal exhaust stroke.

"With the bugaboo banished," explains Blake Reynolds, "octane no longer matters. Low-octane fuels are as good as high, as long as they can be made to burn cleanly and efficiently—which they can. We've got ourselves an engine that will operate on practically anything but wishful thinking. And corrosive carbon deposits will be a thing of the past."

What does it all mean? With octane out of the picture, Barber and Reynolds estimate that the oil industry will be able to produce about 30 percent more automotive

(Continued to page 268)

## DREMEL'S STRAIGHT-LINE ACTION

# GUARANTEES SCRATCH-FREE SURFACES

Here's fast cutting, finish sanding at its best. Dremel introduces a new electric sander, sturdily built to withstand hours of continuous use. It is light in weight... will not tire operator. Its straight-line (non-rotary) action leaves no scratches, no rotary marks—just satin-smooth surfaces ready for any type finish. Here, for the first time, is an electric sander built for years of faithful service—all at the remarkably low price of only \$24.50.

### A POWERFUL, FAST CUTTING TOOL FOR CRAFTSMEN, HOME and INDUSTRIAL USERS

Craftsmen find this new Dremel model has the extra stroke and power needed for heavier woodworking projects such as cabinet-making, boat building and re-finishing, garden furniture, etc. Home-owners say it's just the tool for preparing surfaces for painting and varnishing—for refinishing walls, woodwork, furniture, dry wall joints, siding and other surfaces. The Model 2000 also does a professional job of polishing waxed surfaces—eliminating all the back-breaking labor on cars, furniture, floors, stairways, etc. Industrial users likewise find this new Dremel Sander a faithful performer in furniture, cabinet, building and body shop operations.

#### RUGGED DESIGN and PERFORMANCE FEATURES

- Only two moving parts — requires no oiling.
- Reciprocal (straight-line—non-rotary) action leaves no marks... cannot burn surface.
- 21 square in. sanding surface speeds production... 14,400 cutting strokes per min.
- Cam-type holder permits changing paper in seconds.
- Die-cast aluminum housing with moulded Bakelite cover... Light weight, only 5 pounds... Over-all size 3 1/8" wide x 4 1/2" high x 7" long.
- 8 ft. Underwriter's Approved cord... operates on 110-120 v. A.C.

### DREMEL Model "A" SANDER-POLISHER

Over 200,000 Now in Use!

A lighter-capacity Sander that takes all the work out of home or hobby projects. Popular with women for polishing furniture, etc. Same design and construction features as larger model. Furnished in attractive cardboard box. If your dealer can't supply, order direct from factory.



\$14.85

## DREMEL Electric COPING SAW

CUTS SCROLLS LIKE MAGIC—SANDS AS IT SAWS



BLADE FACES 4 WAYS

Only \$5.85 with 3 saw blades

#### SAFE! AS A HANDSAW

For home, hobby, repair work—no other tool pleases so much for so little cost. Works in any direction—delivers 7,200 strokes per minute smoothly, effortlessly. Saws through 3/4" medium-hard wood at a foot-a-minute speed. Touch-of-the-trigger, foolproof action. Only 2 moving parts, never needs oiling. Uses 110-120 v. A.C.

... for 6 useful projects packed with each saw

FREE PROJECT PLANS

## New DREMEL Electric SANDER · POLISHER

MODEL 2000

ONLY \$24.50

WITH STEEL CARRYING CASE AND COMPLETE ACCESSORIES

14,400 Sanding Strokes per Minute



(Patented)

#### PRICE INCLUDES STURDY CARRYING CASE

Perfect portability of Sander, cord, abrasives, and polishing pads is provided in this sturdy, 3-shelf metal storage case. Price also includes 25 assorted sheets abrasive paper and a high-grade sheepskin polishing pad.



## MOTO-TOOL — THE POCKET-SIZE MACHINE SHOP



Don't confuse Moto-Tools and Accessories with so-called "bargain offers". Compare Dremel feature for feature with competitive tools. If our products are not superior in every way, we don't want you to buy.

Portable DRILL PRESS Only \$9.95 (Less Moto-Tool)



MOTO-TOOL KIT NO. 2 With 23 Accessories (High Speed Steel Cutters, Grinding Wheels, Polishers) — \$23.50  
MOTO-TOOL NO. 2 (only) with one emery wheel point — \$16.50  
Moto-Tool is the most versatile tool you can own—grinds, routs, drills, carves, engraves, polishes, etc. Look at these features: Approx. 27,000 R.P.M. • Dynamically balanced armature eliminates vibration. Oilless (oil-sealed) bearings • Dust-filtering air-cooling system • Weighs 13 oz. • Uses 110-120 v. A.C. • Used in plants of General Electric, Ford, Remington Arms, Nash-Kelvinator, etc.

## WHERE TO BUY DREMEL TOOLS



Dremel Tools are sold everywhere. If your dealer cannot supply you, send remittance in full and we will ship postpaid. Or send only \$2, and pay postman balance plus postage and fee. Money back if not delighted after 5 days' trial.

DREMEL MFG. CO., Dept. 110-J, Racine, Wis.

## BUILD FINE GRANDFATHER CLOCK NOW

The simple sensible Reg-i-Kut way as thousands have—SAVE HALF. SHOP TESTED PLANS "SPIRIT OF THE CENTURY". Narrow waist 83" tall or stately straight side "SPIRIT OF AMERICA." EASY-TO-FOLLOW photomockt PLANS tell all—plus BROCHURE of heavy brass weight Westminster, tube chime, movements, gorgeous dials, 3/4" solid mahogany case kits. Send \$1.00 today — Both Plans \$1.50 NOW. KUEMPEL CHIME CLOCK CO., #8 Kuempel Bldg., Minneapolis 16, Minn.

SAY YOU SAW IT IN POPULAR MECHANICS

## FREE AMAZING NEW BOOK "HOW TO ANSWER ADS"

how to answer ads

Never before have you seen anything like this. Tells you in simple language the correct way to answer ads. Gets you quicker replies—better results, and greater satisfaction. Will save you time and money and it's ABSOLUTELY FREE. No obligation whatever. Every reader of advertising should have this booklet. Send a postcard for your copy NOW. Advertising Department, Popular Mechanics Magazine, Room 602, 204 East Ontario Street, Chicago 11, Ill.

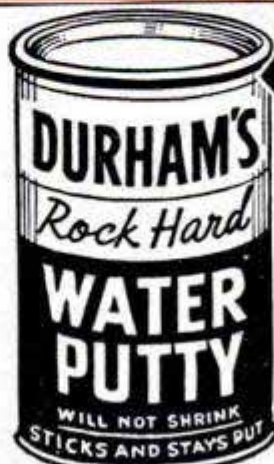

## The Modern PLASTIC for lasting Home Repairs

PERMANENTLY mends cracks or holes in wood, tile, stone or plaster. Sticks and stays put—Does not chip, shrink or fall out. Easy to use. Economical. Mold it, chisel it, polish or paint it. If unobtainable from your lumber, paint or hardware dealer, the big 4-lb. can will be sent you postpaid (in U.S.) for only \$1. Full money-back guarantee, order now.

DONALD DURHAM CO. Box 804-U, Des Moines, Iowa

# NEW PRICE REDUCTIONS

## on all Crosley Cars!

Crosley announces sweeping, across-the-board reductions for all Crosley cars. Every model, including the recently introduced Super models, will now sell at a much lower price—\$63 to \$86 less. Now a Crosley costs less to buy—still costs less to drive—up to 50 miles on a gallon of regular gasoline. See the latest Crosley models at your dealer's. Get the new low prices on all Crosley cars, Super and Standard.

### NEW SUPER STATION WAGON

Roll-down windows, folding rear seats. Seats 4, or 2 with 1/2 ton load. Standard also available.



### NEW SUPER SEDAN DELUXE

New tailored upholstery, smart door linings, roll-down windows. Standard also available.

### NEW SUPER CONVERTIBLE

Folding rear seats, roll-down windows. First with now-imitated safety rail. Standard also available.



### NEW SUPER SPORTS

New folding top, zipper side curtains. Hotshot also available. (First prize winner Tangier Stadium, Sports Roadster Class.)



**FREE!** 1950 Crosley catalog! Write Crosley Motors, Inc., 2530-HV Spring Grove Ave., Cincinnati 14, Ohio

## CROSLLEY

a FINE CAR

You see them everywhere!



AS LOW AS \$950

## "Brownlee" SECTIONAL LOG CABINS

### Easy to Erect, Saving Labor Costs!

Save money on your log cabin! Get a "Brownlee"—the cabin that you can erect yourself! Shipped in sections, with doors and windows installed. White cedar logs, pre-treated. Impervious to moisture. Termite resistant. Weather-proof. Factory-caulked exterior walls. Complete materials furnished for erection. A variety of attractive designs—two to five rooms—as low as \$950. Also lodges, camp buildings and tourist cabins. Send 25c today for catalog. (Some territories still open to dealers.)

Send 25¢ for CATALOG!

**THE BROWNLEE CO.**

10164 W. Jefferson  
Detroit 18, Mich.

fuel from a barrel of crude. Today your car can go 315 miles on the motor fuel from a barrel of crude—tomorrow it will go 490.

It would be a boon to the military, they point out. The Navy hates lugging hazardous high-test gas around on their warships and touchy aircraft carriers. It would give all the military services a single type of safer fuel that would work equally well in tanks, trucks, jet planes, liaison planes, Jeeps, command cars, landing craft—or practically anything else on wheels.

When will you be able to buy an automobile with this new wonder engine in it? It may be several years, though one report says that a big automobile manufacturer is considering mass production of an engine using the new combustion system.

Before it can happen, there's plenty to be done. Barber, Reynolds and Tierney still must hand-build a multicylinder unit. So far, units on the test blocks are single-cylinder affairs. Plans for the big engine are under way at Beacon now. When it's completed in 1951, the engineers will install it in a standard automobile chassis and give it a road test behind closed doors.

This is accomplished in a neat way at Beacon—on a two-story machine known as the "basement speedway." Its technical name is a chassis dynamometer. The car rolls into the second floor. Its front wheels sit in chocks, and the drive wheels rest on the top of a huge drum, suspended on a truck axle in the basement. "We've driven a million miles on it," grins Tierney, "and never left home."

A drive shaft from the drum axle goes through an electric generator, which supplies power or resistance to the drum—simulating all sorts of road conditions. The car can be tested for uphill, downhill, stop, start, fast, slow or endurance phenomena. The car engine roars; its rear wheels spin like mad, but it goes no place.

The drive shaft also drives a fan that blows air up through a tunnel and out across the front of the car, simulating highway breeze for cooling and road resistance effects. A tube, leading from the exhaust, carries fumes out of the building so they won't be trapped in the blower system and asphyxiate the car testers. Thermocouples and wires lead from the engine to the test meters on a swivel platform beside the driver's side of the car, so the "driver" can read what's happening inside his engine at all times and under all conditions.

When the new engine gets through with its multicylinder shakedown on the basement speedway next year, you should be hearing a lot more about it. But don't count on riding behind it until late in the 1950s.



# The Only SANDER with POWER UNIT GUARANTEED ALL DURING YOUR OWNERSHIP or Replaced FREE!

SYNCR0 is the only sander of its kind that guarantees its Power Unit—heart of ANY sander—all during your ownership—or replaces it FREE! And only SYNCR0 gives you a magnetic-electric SANDER approved ENTIRELY to be free from shock and fire hazards by UNDERWRITERS' LABORATORIES, INC.—not just the cord but the ENTIRE Tool! This Power Unit GUARANTEE—and Seal of Approval from internationally-famous "UL" plus the exclusive SYNCR0 DOUBLE ARC MOTION makes SYNCR0 your safest and best buy. For all light sanding, high polish jobs in tight places, corners and on flat or curved surfaces. A marvelous massager. 240 Strokes Per Second! Just guide it. Get this safe, GUARANTEED POWER UNIT, UL-Approved, at your hardware store! All Chrome body, bakelite top.

With BUILT-IN POWER UNIT, 10 sandpapers, lamb's wool and fabric pads — \$14.50. If Dealer hasn't it, send \$14.50 direct, we'll ship postpaid.



That's the Name  
to Ask For!



## SYNCR0

ELECTRIC  
SANDER-MASSAGER-POLISHER



**WARNING!**  
BUY ONLY ELECTRIC SANDERS TESTED AND APPROVED BY UNDERWRITERS' LABORATORIES, INC. "UL" has approved the complete SYNCR0 Sander to be free from shock and fire hazard. Always look for the UL Label in advertisements — and on the product — before you buy!

SYNCR0 CORPORATION, Dept. D-90, Oxford, Mich., U.S.A.

## SHOOTS LIGHT 1/4 MILE!

12-VOLT

It's brand new—powerful (12-volt, 1500 ft. beam). Adjustable, all-chrome head. Uses two 6-volt lantern batteries. Total weight only 5-1/4 lbs.! At hardware, sport, and electrical stores.



**Delta** ELECTRIC CO.  
Marion, Ind.

**POWER-KING** 12-VOLT ELECTRIC LANTERN

## MAKE BIG MONEY

Sharpening Lawn Mowers...

SPARE OR FULL TIME

**PROOF** "I have had my Universal Grinder only 2 months. Live 1 1/2 miles from town. Yet have already made net profit of \$227." G. Spurlock, Arkansas. "I am doing a fine business with the Universal Grinder. One customer sends another. A 40c newspaper ad produced nearly \$500 worth of business." writes C. E. Hardy of Missouri. "A real machine, works fine on power mowers, too." This from J. H. Fisher, Pennsylvania.



ONLY ON THE **UNIVERSAL** LAWN MOWER GRINDER

... can the inside face and edge of the stationary blade, as well as all the reel blades, be ground to proper clearance ALL IN ONE SET-UP, without removing any blade from either hand or power mower. Send today for FREE Facts. **ROGERS MFG. CO.** Dept. M-90 **LINDSEY, OHIO**

## low cost complete Dynamic MULTI-METALCRAFT-WORKSHOP

12 tools in 1!

Over 50,000 Satisfied users! Here's the biggest shop value offered. Now you can make or repair 1001 useful auto & home appliances, farm and shop equipment. Fabricate anything of iron, steel, brass, bronze and other metals. Can pay for itself on first job or project. No experience needed. Complete instructions furnished. Works on any properly wired 110 Volt 50/60 cycle A.C. line. **Everything Included. Complete, ready-to-use.** You get Power Unit, Electric Torch, Etching & Soldering Tool, Headshield, Electrode Holder, Welding ground and power cables, Ground clamp. Simplified instruction manual, Metal fabricating rods, Flux, Etc.

Gift  
Accessories  
Worth \$8.30  
Included  
For  
Prompt  
Action  
At No  
Extra Cost

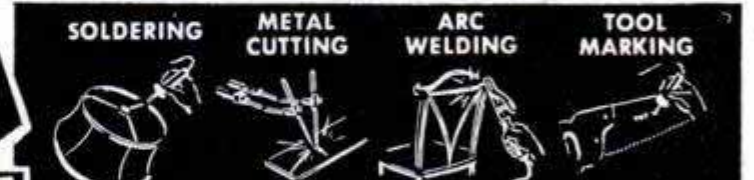

also does  
ETCHING  
BURNING  
FLAME  
WELDING  
BRAZING  
FUSING  
HARD-SURFACING  
SWEATING &  
PREHEATING

**DYNAMIC WELDER CO.**  
15 E. 23rd St.

Dept. D2-JA6  
Chicago 16, Ill.

**FREE** Complete Illustrated Descriptive Literature. Write Today for Details on Money-Back Guarantee. 10 Day Trial Offer!

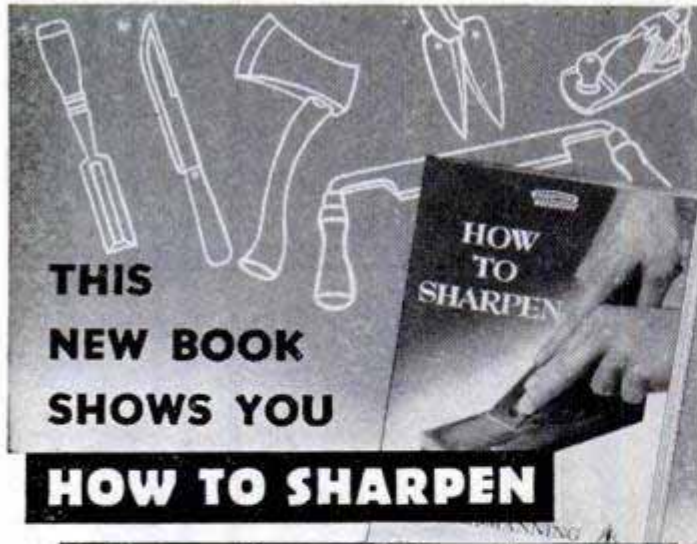

**THIS  
NEW BOOK  
SHOWS YOU**

## **HOW TO SHARPEN**

**Knives, Shop and Garden Tools**

— with clear pictures and easy-to-follow directions for each sharpening job, including the right **NORTON abrasives** sharpening stone to use. For your Copy send 10c to Dept. PM-9.

**BEHR-MANNING**  
TROY, N. Y.  
Also Mfrs. of Abrasive Paper and Cloth

## **Keep Brushes like New**

**BEFORE** **AFTER**

• 10c  
• 25c

**DICA-DOO  
PAINT  
BRUSH  
BATH**

*Clean and Restore  
PAINT BRUSHES*

Perfect for  
NYLON BRUSHES, too!

**At Paint, Hardware, Dept., and 5 & 10c Stores**

Patent Cereals Co. Geneva, N. Y.

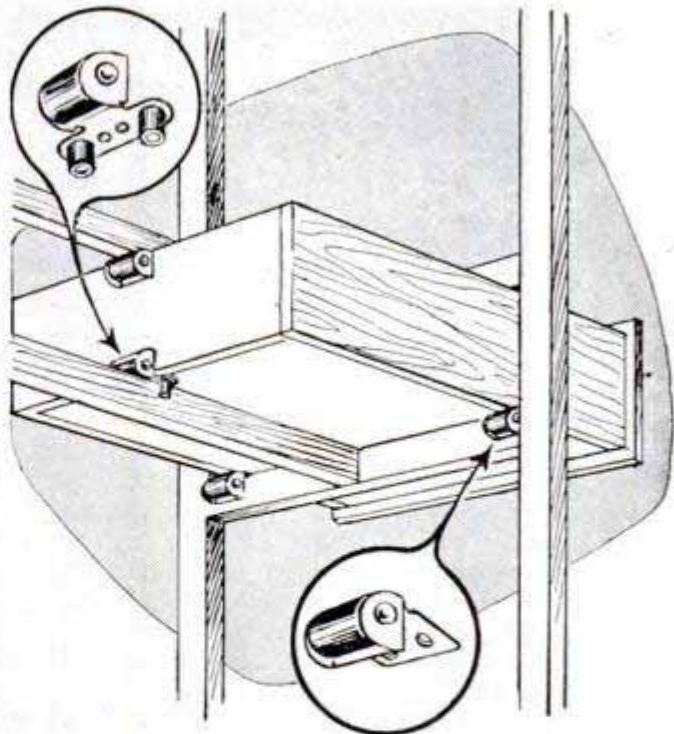

## **Plastic Rollers For Wooden Drawers**

Wooden drawers slide in and out with finger-tip pressure when they are equipped with a set of plastic rollers. Easy to install, the rollers are mounted in steel frames that are nailed in place. Two rollers are nailed to the bottom rail of the drawer opening. A third roller is attached to the drawer back to run along the upper center runner. The fourth roller unit consists of three rollers and it is nailed to the bottom of the drawer on the back edge so it straddles the lower center runner. The rollers not only provide a roller-bearing action for the drawer, but also keep it in alignment.

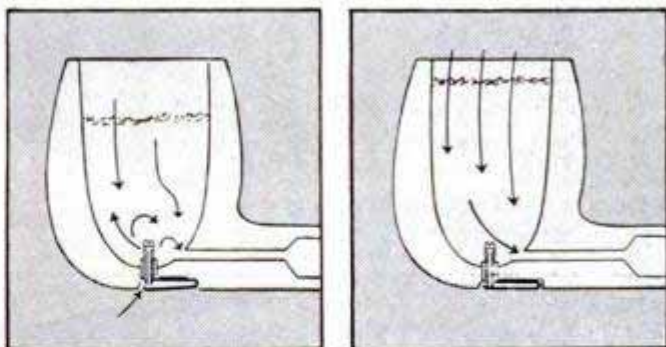

## **Thermostatic Valve Cools Pipe Smoke**

Cooler smoking results from a thermostat-equipped pipe that feeds cool air into the base of the bowl as the pipe gets hot. The bimetal thermostat spring, set into the bowl, operates like a valve, opening and closing a small air inlet. The additional air also makes the tobacco burn better, eliminating many relighting operations, and stops the formation of a soggy "heel."



## DIRECT CURRENT GENERATORS



FOR ANY WELDING JOB, LIGHT OR HEAVY, PLATING, truck, or D.C. Appliances. PORTABLE AND RURAL LIGHTING, or

power plant. Heavy duty, aircraft quality, air cooled commutator, and lifetime grease sealed ball bearings.

Stock No. 535 - Type P-2, rated 200 amps. 28 Volts. Mfg. by Eclipse-Bendix. Gov't. acq. cost approx. \$300

NEW, ONLY..... \$21.50  
Used, but in guaranteed condition - ONLY..... \$15.50

Build your own light plant (cap. load 5,000 watts) the easy inexpensive way. Simple instructions included for P-2 generator.

Stock No. 537-Type R-1, rated 300 amps. 30 Volts. Mfg. by Jack & Heintz. Gov't. acq. cost over \$350. New, only..... \$32.50

Used, but in guaranteed condition - ONLY..... \$25.50

Make your own ARC HEAVY DUTY WELDER the easy inexpensive way of continuous welding, rating 200-300 amps. Simple instruction included, for P-2 and R-1 types. Prices f.o.b. K.C. Ship. wt. approx. 70 lbs.

DYNAMOTORS. Input 28V. 19 amps. Output 1000 V. D.C. 35 Amps. Base mounting G. E. Model PE-73\*CM. \$4.95

DYN. #23350. Input 27 V. D.C. Output 285 V. D.C. \$1.95 postpaid

## WEAVERS HYDRAULIC HAND PUMP



BRAND NEW. For hydraulic jacks, presses, hoist, etc. For operating hydraulic cylinders to pump oil or hydraulic fluid under pressure. Has built in check valve, and is capable of delivering 1000 lbs. pressure. Wt. 10 1/2 lbs. A \$50.00 value. \$7.50 Post-Instructions incl. Price..... \$7.50 paid

## ROMEC WOBBLE PUMP

Hand lever operated. Ideal for camp, farm, ranch, for fuel transfer to boat, etc. Connections are 1/2" I.P.S. New. \$8.50 postpaid.



VALUABLE GEARS BARGAINS SPEED REDUCER 10-1 or 5-1 ratio. 90 degree angle. Shaft driven 1/2" spline shaft with 3 mounting holes 5/16". Gears held in forged and machined aluminum housing with two needle bearings, one bronze bearing, and three high speed shielded bearings. Sealed self lubricating chamber. \$4.95

## AMPLIDYNE MOTOR GENERATOR

#5AN31N18A-Use as 24/32 Volt D.C. motor, pulls 1 1/2 H.P. or 0/60 V. D.C. Can be adapted to 110 V. A.C./D.C. 10,000 R.P.M. 1/2 H.P. by simple changes in connections. Unused, instructions incl. (Stock #790). Gov't cost \$140.00. Wt. 30 lbs. Only \$5.50

## SENSATIONAL FASCINATING SELSYNS

Two or more connected together, work perfectly on 110 V. A.C. For weather vanes, rotating directional antennas or controlling distance operations. Complete with diagram and instructions. Wt. 3 1/2 lbs. PER PAIR..... \$4.50 (plus 35c postage)



## THOMPSON MOTOR DRIVEN BOOSTER PUMP

Including Built in Motor. Applicable for 24 V. D.C./A.C. or 110 V. A.C. The motor is explosion proof constructed, making it ideal for pumping GASOLINE, FUEL TRANSFER, HOT WATER HEATING CIRCULATOR. USE IT AS COOLANT PUMP, FUEL BOOSTER, OIL PUMP, etc. Discharge connection is for 1" hose. Rated Capacity 300 G.P.H. Directions & Engineering data incl. A tremendous bargain! Stock No. 1200-Only..... \$7.95

## New Purolator GASOLINE FILTER

Aircraft type. Today's advanced gasoline Re-refining filter for all cars, Trucks, Tractors and all Motor Boats. Removes solids, water and prevents sludge formation. Install at home in a few minutes. STOP GASOLINE WASTE AND EXPENSE. Instructions incl. Permanent, needs no replacement. Stock No. 2725. Ea..... \$4.95 Postpaid



## CUNO OIL FILTER - Brand New

Aircraft type. Filters oil without cartridge replacements. Just turn handle and cartridge is clean. Standard 3/8" inlet and outlet ports to accommodate 12 gallons per minute. STOP CHANGING OIL. Instructions incl..... \$4.95 Postpaid

## ELECTRIC MOTOR 1/2 H.P. 27 V. D.C. R.P.M. 4000 No. 750

For Intermittent or Continuous Duty. 5 1/2" SHAFT VARIABLE SPEED MOTOR CAN BE ADAPTED TO 110 V. A.C. OR R.E.A. line by simple arranging armature brush leads. UNUSED. Instructions incl..... \$5.50

ELECTRIC MOTOR 1/2 H.P. 24 Volt D. C. Amp. 22 #HCA24. Gov't cost \$75.00. Brand New..... \$4.50

ELECTRIC MOTOR 1/4 H.P. 28 Volt D. C. #2832 with simple instructions to convert to 28-32 Volt A.C. Gov't cost \$82.84. Brand New..... \$3.50

## 6 VOLT D. C. DELCO MOTOR

Handles 6" fan blade. Use as windshield wiper motor, hot water car heater motor, commercial or toy applications. 1 1/2" Dia. 1 1/8" long shaft. Size 5" long X 3". 2 mounting studs. 1200-2000 R.P.M. NEW Only..... \$2.35 paid

## BRAND NEW PESCO GEAR TYPE HYDRAULIC FLOW EQUALIZER AND PRESSURE BALANCER.

No. 1-D-397. Guarantees equal flow and equal pressure for 2 cylinders or 2 systems. Has 1-inlet and 2 outlets. Pressure limits 1500 P.S.I. Capacity 360 G.P.H. Accurate to less than 2% variation in flow from outlet ports. Engineering data incl. Now \$14.50 postpaid



## ECLIPSE MOTOR & GEAR UNIT

Brand New. This is a 24 V. D.C. motor with built in planetary and bevel gear reduction. Has 1- horizontal and 1- vertical take off shaft. Overall gear ratio to motor is 40-1 can be adapted for 2-1 or 20-1 ratio. Unit can be operated from 32 D.C. Farm light plant. Ideal as OVERHEAD GARAGE DOOR OPERATOR. DRIVE FOR SMALL ROIST, WELL PUMP JACK, LAWN MOWER DRIVE, DRIVE FOR POST DRILL, etc. Wt. 23 lbs. Gov't. cost \$221.00. Instructions incl. Only \$12.50

## Pesco Vacuum Air-General Purpose Pump

Here is a pump for air, fluid, pressure or vacuum. Standard 1/2" pipe thread. Delivers 300 G.P.H. at 2000 R.P.M. Runs forward or reverse. Self aligning shaft. Spline terminal for direct drive, readily replaced with a pulley. Use them for oil burners, MILKING MACHINES, COMPRESSORS, VACUUM PUMP, etc. Engineering report and instructions incl. \$8.50 Post-Now only..... \$8.50 paid



## Brand New Wonderful ROTATOR MOTOR

For rotating Ham, FM Antennas, Turntables, Telescopes, etc. Applicable for 110 V. A.C. 60 cycles or for 24 V. D.C. as reversible motor. Approx. 7 R.P.M. Free Swing, Reversible, Light Weight, Rugged, quiet, Motor & Gear oil sealed. Including 3 mounting lugs on motor. Simple instructions & diagram incl. Wt. approx 3 1/2 lbs. Stock No. 572. \$75.00 Value. Now Only..... \$6.50 Postpaid

## Adel Self-Priming ELECTRIC PUMP

For pumping light oils, oil burners, fluid metering, fuel pump, tool post grinder, coolant, pressure lubricating pump, etc. Double ball bearing series wound motor, continuous duty. 1/30 H.P. rated 12000 R.P.M. Applicable for 24 V. D.C./A.C. or use on 110 Volt A.C. Size 6 3/4" x 3 1/2" x 5 1/4". Rated 3 G.P.H. Remove pump and use motor as high speed grinder, etc. Diagram and instructions incl. \$50.00 value. \$7.95 Post-Only..... \$7.95 paid



## Pesco Centrifugal Heavy Duty Electric Pump

With built in 1/2 H.P. MOTOR included. BRAND NEW COMPLETE. Self Contained, Explosion proof. Ideal for pumping Gasoline, Oils, Water and non-corrosive liquids. Applicable for 24 V. D.C./A.C. or on 110 Volts A.C. The Discharge is for 3/4" hose connection. Capacity 400 G.P.H. Use them for Cottages, Basements, Laboratories, Boats, etc. Here's your Greatest PUMP VALUE IN YEARS. Engineering data and instructions incl. \$85.00 value. Stock #659 \$8.95 f.o.b. Only..... \$8.95

All Items Guaranteed as represented. Send check or Money Order. Prices f.o.b. K. C. except when marked postpaid U.S.A. only

## STRATOPOWER CONSTANT DISPLACEMENT HEAVY DUTY PUMP



For operating Hydraulic cylinders, hydraulic motors on tractors, Bulldozers, Construction machinery, Lift trucks. For fuel or oil transfer. Industrial Applications, etc. Delivers up to 400 G.P.H. at 3750 R.P.M. Rated 1250 to 1400 P.S.I. 3750 to 4500 R.P.M. HAS BUILT IN RELIEF AT HEAD. Rotation either direction without adjustment. Can be used as hydraulic motor. \$85.00 value. Engineering data & instructions incl. Stock #37. Wt. 8 lbs. \$12.50

## Hydraulic Cylinders

### AIR OR OIL HYDRAULIC CYLINDERS

Here's a double action 1" Bore, 3" Stroke, 3/8" Shaft, Clevis mounting. Overall length 9". Capacity 700 lbs. with 1000 P.S.I. input. Has a capacity of 6800 lbs. with our STRATOPOWER PUMP 1400 P.S.I. It's perfect for applications such as door openers, positioners, small loaders, control units, etc. A REAL TERRIFIC VALUE. Stock No. 10 \$4.50



Stock No. 25 is double action, Bore 2 1/4", Stroke 6", Shaft 3/8". Has a capacity of 7850 lbs. with our STRATOPOWER PUMP 1400 P.S.I. Delivers 1199 lbs. with our strato-power pump Postpaid..... \$7.50

Stock No. 27..... operated, Bore 2 1/2", Shaft 2 1/4", Stroke 6", one way Stroke. Can be used as snubber or Brake. Length 15" Wt. 11 lbs. f.o.b. \$6.50 K.C., Mo. Now..... \$6.50

Stock No. 11 Double Action 1 1/2" Bore, 6" Stroke, 5/8" Dia. Shaft, Clevis mounting base and shaft end. Capacity 1160 lbs. with 1000 P.S.I. input. Has a capacity of 1625 lbs. with our STRATOPOWER PUMP 1400 P.S.I. A \$50.00 value. Postpaid Only..... \$9.50

## HYDRAULIC CYLINDER SPECIAL

Stock No. 12 Gives 12560 lbs. with 1000 P.S.I. input. Capacity 17584 lbs. with our STRATOPOWER PUMP 1400 P.S.I. or will produce 34168 lbs. with 3000 line pressure. Can also be operated on low pressure system. 4" Bore, 8 1/4" Stroke, 1-5/16" Shaft, Clevis mounting O. Gov't cost \$300 A tremendous Bargain only..... \$19.50

## HYDRAULIC VALVES

### BRAND NEW Hydraulic CONTROL VALVES

Four way control for use with two hydraulic double action cylinders. Each cylinder may be operated independently of the other or in conjunction with the other. Oil may be locked in any of the cylinders to hold the piston at any required position. Brand New. \$60.00 \$8.95 Post-value. Only..... \$8.95



## Adel HEAVY DUTY VALVE #D-8660

Here's your four way hydraulic control valve for use with 2 double action cylinders. Each cylinder may be operated independently of the other or in conjunction with the other. 3/8" pipe thread connections with mounting brackets attached to body of valve. A \$60.00 \$8.95 Post-value. Brand new..... \$8.95

## ADEL PRECISION #10086 Brand New.

controlling 2 single action cylinders or one double action cylinder. When pressure is applied to one cylinder the return to the opposite cylinder is opened. Connections are for 3/8" pipe thread. Including operating lever 6" long and has quadrant for locking in either position. A tremendous bargain \$8.95 Post-only..... \$8.95

## Hydraulic Accumulators—Vickers Ball Type

Dia. 5 1/2". Built to stand 2000 P.S.I. Stock #A-65. Wt. 4 lbs. only. \$5.50 VICKERS ACCUMULATOR. Ball Type. Dia. 10". Built to stand 2000 P.S.I. Wt. 15 lbs. Stock #A-85. Only..... \$15.50

## VICKERS CONSTANT DISPLACEMENT HIGH PRESSURE PUMP

Use it for any type liquid pumping job 375 gal. per hr. at 3750 R.P.M. 1000 pounds pressure per sq. in. Can be used as hydraulic motor. O. Acq. \$100.00. Brand new directions \$8.95 post-incl. Wt. 7 lbs. \$8.95 paid



## HYDRAULIC Check & Relief VALVE \$2.50 postpaid

## VICKERS UNLOADING VALVE

Brand New—By passes full amount output of the pump while the cylinder is not in operation. Takes starting load off of electric motor driving the pump. 1 1/2" AC TUBE PORTS (3/4"-18) thread. \$7.50 post-paid

GENERAL SALVAGE CO.  
2922 E. 27 ST. DEPT. 179  
KANSAS CITY, MO.

**HOBBYISTS!**  
 YOU ASKED FOR IT! **HERE IT IS!**

ONLY **\$295**  
 POSTPAID IN U.S.A.

**ROTARY POWER PLANE**  
 SLIP ON TABLE SAW ARBOR—USE AS JOINTER

**THROW AWAY THAT HAND PLANE!**

At last! The answer to the hobbyist-craftsman's prayer...a sensational, time-saving rotary power plane that gives wood a smooth, glass-like finish in seconds! Just slip on table saw arbor—go to work! Perfect for hard wood. Made with top-grade hardest tool steel yet you can sharpen in 2 minutes! We know you'll be amazed and satisfied... order now!

State hole size and send cash, check or money order today!

• DOES THE WORK OF AN EXPENSIVE JOINTER  
 • NO ADJUSTING OR ASSEMBLY  
 • FITS 6"–8"–10" POWER SAWS  
 • SURFACES UP TO 1½"

**RABY MFG. CO.** 1123 LILLIAN WAY PM9  
 HOLLYWOOD 38, CALIF.



### Paint for Flagstones

Flagstone walks and concrete steps now can be painted bright colors. The plastic rubber base of a new paint is weather and water resistant. Available in red, green and two shades of gray, the paint also can be used on playroom and patio floors, bird-baths, stone benches and other masonry or concrete surfaces.

### Underwater Amplifier

#### Boosts Trans-Atlantic Cable Traffic

Increasing the capacity of the trans-Atlantic cable system more than 100 million words a year, a submerged amplifier will operate on the ocean bottom 1800 feet below the surface. Sealed in a steel case about five feet long and a foot square, the amplifier is a three-stage tube instrument that will get its electrical power from the mainland over the same conductor on which the signals are transmitted. An electrically operated switch, controlled from Western Union's mainland cable station at Bay Roberts, Newfoundland, will change tubes remotely in the event of a tube failure. The steel case is filled with oil which is automatically kept at a pressure equal to that of the sea water, nearly 800 pounds per square inch. Spliced in the cable about 165 miles northeast of Bay Roberts, the amplifier will boost signals which have become weak in traveling across the ocean.

☐ Since May 1947, the United States Air Force has flown more than 300 missions over the North Pole without a single loss.

**BE INDEPENDENT!**

**START YOUR OWN BUSINESS** installing the lifetime **BELCO BALL BEARING FAUCET WASHER**. Every home, apartment, factory, public building and all types of institutions are prospects. Satisfied customers because you save them money on water, fuel and costly maintenance. Start small with a modest investment, expand on your earnings. Steady profits. Light weight **BELCO CONVERTER MACHINE** makes short work of converting standard faucets to **BELCO**.

**STOP THIS WITH BELCO**

WRITE TODAY FOR YOUR FREE SAMPLE AND DETAILS OF OUR EXCLUSIVE PLAN.

**ECONOMY VALVE CO.**  
 5919 TIREMAN AVE. • DETROIT 4, MICH.

**SEND THIS COUPON NOW!**

**ECONOMY VALVE COMPANY**  
 5919 TIREMAN AVE. • DETROIT 4, MICH.

NAME \_\_\_\_\_  
 ADDRESS \_\_\_\_\_  
 CITY \_\_\_\_\_ STATE \_\_\_\_\_

## You Can Have Local Manufacturing Rights

Here's an outstanding manufacturing opportunity for men with vision, energy and a little capital. Brikcrete is sweeping the country because it has beauty, long life and ultra comfort. Truly the world's most modern masonry. Distinctively different. Yet costs less than lumber because it is locally manufactured of local materials by local labor for local building needs.



### 100%-150% Mark-Up on Costs

You can be one of a national chain of local plants. High income potentials. Can be started on moderate investment. Wide-open market. Requires no experience; no skilled labor. We supply all equipment. Easy terms, if necessary. We work with you to put it across. Write for Brikcrete Book No. 2 today . . . free.



Brikcrete Associates, Inc.  
4679 Division Ave., S.  
Grand Rapids 8, Mich.

**BRIKCRETE**

**WELD**  
BRAZE, SOLDER, CUT  
*quickly . . . easily*

The **FOUR-WAY**  
PORTABLE ARC-WELDER

COMPLETE ONLY **\$9.95**  
10 DAY TRIAL F.O.B.



YOU'LL BE AMAZED by the work you can do on your first job! Plugs into any convenient properly wired 110 volt A.C. or D.C. line. Follow simple directions. Work on iron, steel, bronze, brass, aluminum and other metals. Save money doing own repairs. Make money repairing for others.

Thousands of users among maintenance and repair men, farmers, tinsmiths, engineers, home and auto owners, etc. Pays for itself over and over. Order on ten-day trial or send for details.

MAKE  
OR REPAIR  
HOME & FARM  
APPLIANCES  
FENDERS  
BICYCLES  
METAL  
FURNITURE  
& 1001 ITEMS

**FREE** **FOUR-WAY WELDER CO., Dept. F2-JA**  
2326 So. Michigan Avenue • Chicago 16, Illinois  
**Full Details SEND TODAY**

*Easy To Build*

**U-MAK-IT  
BOAT KITS**

ROWBOATS

OUTBOARDS

INBOARDS &  
CRUISERS



SEND 25c (coin)  
**NEW CATALOG**  
ORDER YOURS TODAY

**U-MAK-IT PRODUCTS** 703P-WHITTIER ST.  
New York 59, N. Y.

**10 Times Faster**  
than hand sawing



PORTER-CABLE  
**Guild**

ELECTRIC

**SAW**

*A Professional Carpenter's Saw*

6" model cuts 2" — Only **\$65.**  
8" model cuts 2 7/8" — Only **\$87**

Wait till you guide one of these smooth working Guilds through lumber . . . or plywood, compo-board, even aluminum siding! Then you'll know what *cutting speed* is! . . . and what the powerful Guild motor can do. You'll be amazed how easy it is to rip with one of these saws—how easily you can cross-cut, dado, plough or groove, Guild Saws are light and perfectly balanced—they've full safety protection—and they're extremely accurate. Best of all, they're THE BUYS OF THE YEAR IN POWER SAWS.

No other saw offers all the value-features of Guild: the new built-in tilting adjustment with easy-to-read quadrant giving angle setting up to 45°; new quick depth regulator which allows base to be raised or lowered by a mere twist of the knob; efficient helical gear drive; precision ball bearings; retractable safety guard; polished aluminum frame.

Look over both saws—decide which best suits your purpose—then take advantage of one of the most sensational value offers ever made. **MAIL COUPON TODAY.**

Please send me full information on the Guild 6" and Guild 8" Saws — also name of my nearest dealer.

Name.....

Address.....

City..... State.....

**PORTER-CABLE MACHINE CO.**

2289 N. Salina St.

Syracuse 8, N. Y.

# COMPLETE LOCKSMITH SHOP \$99.00

**NEW POPULAR STANDARD EQUIPMENT**  
**START YOUR SHOP NOW!** AT HOME, GARAGE, BASEMENT, OR RENT A SMALL STORE, OR ADD A KEY DEPARTMENT TO YOUR PRESENT BUSINESS

- 1 Precision key machine complete with three cutters
- 1 Heavy plywood key display board with 100 hooks
- 1000 Popular key blanks and cut keys
- 3 Locksmith instruction books
- 1 Automotive lock manual
- 1 Assortment of pins and springs
- 1 Assortment of disc tumblers and springs
- 1 Misc. set of locksmith tools

**ALL FOR ONLY \$99.00 — EASILY WORTH \$130.00!**

Slightly higher out of U. S. A. 25% deposit on C.O.D. orders.  
 Start making money at once! Order your outfit today! Complete satisfaction guaranteed.  
 Write for FREE Catalog today!

REPAIR SHOP SERVICE • Box 264-D • Skokie, Illinois



**Save \$250 to \$450 - Build Your Own ARC WELDING BUSINESS**

It's easy. Just decide on the type and capacity generator you need and hook up to a used auto engine. Generators are same as used in newest HOBART "Simplified" Arc Welders. Connect to electric motor, gasoline engine, power shaft or other available power. Makes ideal shop welder—or generator can be mounted with gas engine on trailer to make portable outfit. Handle the big pay outside jobs. Easy pay-for-itself terms as low as \$12 monthly. Write today, FREE book tells how.

**"Build your Own" AC Welder! Power for tools, lights. All in one low-cost unit.**

**HOBART BROTHERS COMPANY • BOX M-90, Troy, O. • Write for FREE Catalog**

**BUY a Gear Driven RED-E-TRACTOR**

**No Belts! No Chains!**  
**Does More Jobs Easier, Quicker**  
 You'll like the smooth, powerful, gear-driven action of the "RED-E" with clutch for each wheel. Dozens of attachments for plowing, sowing, fertilizing, raking, harrowing, wood-sawing, snow-plowing, etc.

**4 Styles!**  
 2-Wheel and 4-Wheel Fully Guaranteed

**EASY TERMS** — with Pays-For-Itself-Plan.  
**SPECIAL:** Discount to User Agents.

**RED-E TRACTOR CO. Richfield, 27 Wis.**

**GRIP-R**  
 A VERSATILE HANGER. HOLDS ANYTHING WITH OR WITHOUT HANDLES.

Quality spring holds items firmly. Adjustable clips make room for large or small items. Tools, brushes, etc., may also be easily slipped in from bottom, making them accessible for fast manipulation. 18" long X 2 3/4" wide. Red-white baked enamel or cadmium plated. At your dealer or mail \$1.50 postpaid. Dealers-Agents invited.

**MACHINISTS • ROBBYFUTS • KITCHENS • ARTISTS • DOCTORS • SUPPLY STORES • BARRS • REPAIR SHOPS • FARMERS • ETC.**  
**HOBBY HILL • 14 N. MICHIGAN AVE. • CHICAGO 2, ILLINOIS**

**EVERY ELECTRIC DRILL A PORTABLE SAW**

**9.95** Can Be Used With One Hand!  
 Any 1/4" or 3/8" Drill a Powerful Saw in ONE MINUTE

"ARCO-SAW" is a rugged tool with right angle gear drive (no clumsy, dangerous, direct drive with drill sideways). Works like a high priced Portable Saw.

**CUTS 1-5/16", or 2 x 4 by turning over ONLY ARCO GIVES YOU ALL THESE FEATURES:** Safety-yoke assures rigid connection and absolute safety—Big handle affords firm grip for two-hand operation—Precision one-piece gear box—Self-lubricating lifetime bearings—Wide shoe-plate for straight, square cuts—Lowest priced, quality Replacement Blades.

"HYCARBON" Crosscut Blade ..\$1.60  
 "HYCARBON" Combination Blade \$1.60  
**90-day Factory Guarantee**

**NOW! EVERY "ARCO-SAW" AN ANGLE SANDER & POLISHER**

Your "ARCO-SAW" becomes a powerful right angle sander & polisher in just a few minutes. Ideal for removing paint from cars & walls, simonizing cars, polishing linoleum & furniture. Swivel action between drill chuck & gear box permits new freedom of use at any angle on every surface, or when necessary safety-yoke can be used to hold unit rigid. No need to buy an expensive special angle gear drive. New ARCO "SAND-N-POLISH" Attachment consists of flexible molded rubber head, sanding disc, lambswool polisher, bottom plate, hexagon adaptor, & also 1/4" adaptor for use in drill chuck.

**1.95**

ORDER TODAY at your dealer or send us check or M.O. (Postpaid).  
 C.O.D.'s—Postage extra

**UNCONDITIONAL 10-DAY MONEY BACK GUARANTEE**

**ARROW METAL PRODUCTS CO.**  
 DEPT. PM-9, 140 WEST BROADWAY, NEW YORK 13, N. Y.

**WHEELS - WHEELS**

5" Disc Wheel 5/8" Tire 5/16" or 3/8" sleeve	30c ea.
6" Disc Wheel 5/8" Tire 5/16" or 3/8" sleeve	35c ea.
7" Disc Wheel 3/4" Tire 3/8" sleeve	45c ea.
8" Disc Wheel 1 1/8" Tire 1/2" sleeve	70c ea.
7" Disc Wheel 1" Tire 1/2" ball bearing	80c ea.
8" Disc Wheel 1 1/8" Tire 1/2" ball bearing	\$1.00 ea.
8" Disc Wheel 2" semi-pneum. T. 1 1/2" B.B.	\$1.35 ea.
10" Disc Wheel 1.75 semi-pneum. T. 1 1/2" B.B.	\$1.50 ea.
12" Disc Wheel 1.75 semi-pneum. T. 1 1/2" B.B.	\$1.85 ea.

Above wheel prices include hub cap  
 Plus postage, 20% — C.O.D.'s accepted

**UNITED WHEEL STAMPING CO., PM-9**  
 2756 W. 115th STREET CHICAGO 43, ILLINOIS

**BARGAIN! BRAND NEW! SPINNER!**

only **\$42.50** Save **\$40!** REG. \$82.50  
 7-in. disc

Direct From Manufacturer—

Uses 7-in. or 9-in. disc—Sands, grinds, wire brushes, etc. Makes tough jobs easy. 3/4 h.p., Heavy Duty Motor. 10-day, money-back guarantee. No C.O.D. Send check or M.O. TODAY—while they last! Californians add 2% State Sales Tax

**HOLT MFG. CO.** 651 20th Street Oakland 12, Calif. | 272 Badger Avenue Newark 8, New Jersey

**NEW PACKAGED BOATS**

17 models, 8'-16'; Tredonic racers, cruisers; Outboard, inboard, skiffs. Assembled frames; Tri-Keel construction; Tredonic bottom; spray rails; easy to build!

**SEND 25c FOR CATALOG!**  
 Catalog and booklet "Plywood Boats", \$1.00

**BOAT PATTERNS-BLUE PRINTS**

1950 Catalog—100 designs by naval architects. Racing classes, cruisers, inboard, outboard, sail, 6 to 35 ft. Plywood—Steel—Plank. Construction plans, full-size patterns. SEND 35c FOR CATALOG or \$1.00 for catalog and booklet on "Boat Building."

**MARINE MART-DEPT. 24-BUFFALO 7, N. Y.**

# BUILD MODEL HOMES

FOR FUN OR PROFIT!

It's so easy with low cost ARCHITECTURAL MODEL MATERIALS

If you want to build all kinds of model homes, doll houses, etc.-- $\frac{1}{4}$ ",  $\frac{1}{2}$ ", and  $\frac{3}{4}$ " scale--you can do so with Architectural Model Materials. Everything you need--siding, roofing, windows, doors, etc. in wood and plastic. Send 25c TODAY --for samples and details.

Write Dept. A-950

**ARCHITECTURAL MODEL MATERIALS, INC.**  
4339 Diversey Ave., Chicago 39, Ill.

SEND 25c FOR DETAILS AND SAMPLES



## SHEET METAL BRAKES

Forms angles, flanges and Pittsburgh locks, 26 gauge steel, heavier aluminum. Cam locking. Portable, can be bolted to bench, or clamped to edge of truck. All steel, reinforced. Shipped Exp. Coll. 30" size, Wt. 42 lbs., \$26.50. 36", Wt. 52 lbs. \$31.00. 48", \$45.00

Floor mountings, portable, 32" high, \$7.00

12" BRAKE. Fits in vise to form difficult compound bends, up to 20 gauge steel. Not illustrated. . . . \$12.50 PP.

18" CURVE FORMER, Capacity --16 gauge steel. . . . \$10.00

30 AND 36 IN.

SHEET METAL PLIERS, 2 1/2" wide, \$2.00; 5" \$2.50

Immediate delivery. Order direct, cash or C.O.D. or send for folder.

WISE BRAKE MFG. CO., P-1116 So. 27th St., Omaha 5, Nebr.



## HANDEE-DAPTOR

CONVERT YOUR  $\frac{1}{4}$ " DRILL TO  $\frac{1}{2}$ "

Simply insert adaptor shank in  $\frac{1}{4}$ " chuck. HANDEE-DAPTOR chuck takes all bits to  $\frac{1}{2}$ " incl. . . . \$2.95

Send 25c for Bargain Motor & Power Tool catalog. Refund on 1st. Order. Handee-Daptor postpd. exc. on C.O.D.

DANIELS PRODUCTS CO.  
2224 N.E. 18 St., Oklahoma City, Okla.



## BUILD YOUR OWN TRAILER

### LINCO Level-Load AXLE

One-piece solid forging steel SAE 1040. Heavy springs coiled around axle cushions shock. Distributes load evenly. No swaying. Safety through even load and low center of gravity. Guaranteed. Write for details of our complete line of axles.

**\$34.50**

Includes axle hubs & bearings. 1-ton capacity. Shipping weight 105 lbs. Prices f.o.b.

E. B. MORITZ FOUNDRY,  
628 E. Wash., Santa Ana, Calif.



## MODERN LAWN MOWER SHARPENER

FOR LAWN MOWER SHOPS  
FIX-IT SHOPS

GOLF COURSES • PARKS  
101 OTHER JOBS

Sharpens All Reel Type Mowers • Hand, Power or Gang • 10 to 20 Minutes • No Dismantling • No Extra Attachments Needed.

All reel type mowers, from 5-inch edgers to 36-inch power mowers, are quickly sharpened to extreme ends of both left and right twist blades.

Handle, wheels, roller and motor remain in place when sharpening is in process. Bed knife is sharpened in same brackets. Grinding head rides on five ball bearing races. Easy to operate.

Also sharpens chisels, joiner knives, planer blades. Big profit maker. Own your own business. Send Today for FREE Illustrated Bulletin No. 10-C

PRICE \$241.50 less motor

\$263.00 with motor

ORDER NOW  
Immediate Delivery

MODERN MFG. CO., 160 N. FAIR OAKS AVE PASADENA 3, CALIFORNIA



Our 305th Advertisement

# REAL DIESEL ENGINE!

## \$2.95

You just can't beat this price for a completely assembled precision diesel engine!



- Ideal for planes, boats, midget cars
- Actually runs at 7500 RPM, produces 1/7 HP
- Height a full 3 1/2 inches; weight 5 ounces
- Comes to you completely assembled, ready for operation

MAYBE WE'RE CRAZY, giving away a precision diesel engine, complete with cylinder and piston, carburetor, crankshaft, connecting rod, etc. for ONLY \$2.95. But we're selling thousands of DEEZILS all over the world, and that keeps our production costs down. DEEZIL is streamlined, compact, rugged. Starts quickly, easy to install, runs for years! Fast delivery if you ORDER DEEZIL TODAY!

Send \$2.95 plus 25c postage

GOTHAM HOBBY CORP. 107 E. 126th ST., NEW YORK 35, N. Y.

## PUT LIGHT IN YOUR CLOSETS

### Automatic CLOSET LIGHT

ANYONE CAN INSTALL KLOZ-A-LITE IN A FEW MINUTES

LIGHT GOES ON WHEN CLOSET DOOR OPENS

Ideal for Tool Cabinet, Attic, Cellar, etc. Stop fumbling in the dark . . . stop tripping over brooms, rubbers, etc. Open door and brilliant light reaches every corner. Fully automatic KLOZ-A-LITE is "on" only when needed; goes out when door is closed.

COMPLETE ONE-PIECE FIXTURE includes socket, automatic switch and 12 feet of UL approved cord. Fastens to door frame with two screws. Absolutely safe! Plug into any wall outlet. At low price of \$1.98, you can afford one of these for every closet in the house--and an extra one for the cellar stairway. Postage paid when money is sent with order. Send check or money order today. C.O.D. orders shipped plus postage. Martin Products Co., Dept. 28P, 804 Rhode Island Ave., N.E., Washington 18, D. C. KLOZ-A-LITE® - Patent Pending

ONLY \$1.98

MONEY BACK IF NOT COMPLETELY SATISFIED

MARTIN PRODUCTS CO. Dept. 28P  
804 Rhode Island Ave., N.E.  
Washington 18, D. C.

Please send me more information.  
 Please send me . . . . . KLOZ-A-LITES.  
 Enclosed is \$ . . . . . postpaid.  
 Send C.O.D. plus postage.

NAME.....  
ADDRESS.....  
CITY..... STATE.....

# Tighten Loose Handles TO STAY



Use the "repairman's standby" — Smooth-On No. 1 Iron Cement — to anchor loose tool and cutlery handles, knobs, pulls, casters, clothes-hooks, bolts, screws, etc. You apply it like putty — no heat required. It hardens like metal. And because Smooth-On expands slightly as it sets, your repairs *stay tight*. Buy Smooth-On No. 1 in 1¾-oz., 7-oz. or 1-lb. size at your hardware store. If they haven't it, write us.

## FREE Repair Ideas

40 pages of time-saving, money-saving ways to stop leaks, seal cracks, tighten loose parts. 170 illustrations. Clear, simple directions. Send now.

SMOOTH-ON MFG. CO., Dept. 37J,  
570 Communipaw Ave., Jersey City 4, N. J.

Do it with

# SMOOTH-ON

THE IRON CEMENT OF 1000 USES



# So easy TO REMOVE PAINT

## The modern Wonder-Paste way

Don't spend hours scraping off old finishes. Do it the quick, easy WONDER-PASTE way. Apply with a paint brush, and the toughest, thickest paint, varnish, shellac, enamel, or lacquer can be cleanly peeled off with a putty knife. Leaves surface in perfect condition—no sanding needed. At paint and hardware stores.

Write for  
**WONDER-  
PASTE  
leaflet**

Wilson-Imperial Company, 119 Chestnut Street, Newark 5, N. J.

**AGENTS** 300% Profit **SIGN LETTERS**  
For Store Fronts and Office Windows. Anyone can put them on. Free samples. Liberal Offer to General Agents.  
**METALLIC LETTER CO., 430 N. Clark, Chicago 10**

Pioneers **BENJAMIN** Leaders  
**AIR RIFLES** **AIR PISTOLS**  
**SHOOT WITH SAFETY**  
BE SAFE—SHOOT WITH COMPRESSED AIR—ALWAYS READY  
No Cartridges or Tanks to Replace or Recharge. If you want the most PRACTICAL GUN to use anywhere—inside or outdoors—get a SAFE—CLEAN—ECONOMICAL BENJAMIN with Adjustable Power and Amazing Accuracy. Send for Free Folder of Latest Models Today.  
**BENJAMIN AIR RIFLE CO., 890 MARION ST., ST. LOUIS 4, MO.**

**LAWN ORNAMENT-NOVELTY PATTERNS**  
28 Lawn Ornament Patterns, 25c. Other patterns; 15-20" high; Dutch Girl, Dutch Boy, Pirate, Bull Terrier, Mexican Girl, Mexican Boy, Dwarf, Penguin, Flower Girl, 10c each. 25 Novelty Patterns, 30c. All 62 Full Size Patterns, \$1.00 Postpaid.  
Strother Pattern Service, Dept. BW-8, Box 128, Belington, W. Va.

**BALL & ROLLER BEARINGS** DESIGNERS HOBBYISTS  
3/16" to 9/16" Shaft Sizes—3/4" to 1 1/8" Outside Diam.  
SMALL ASS'T—18 NEW BRGS. | JUMBO ASS'T—100 New BRGS.  
2 or more each \$3.50 | 4 or more each \$17.50  
size. Original cost \$44.50. . . . . P.P.d. cost \$247. . . . . P.P.d.  
SPECIAL SIZES AVAILABLE ON REQUEST—LOW COST TO REPAIR SHOPS  
**UNITED BEARING CO., INC. 1407 THIRD AVE. SO. MINNEAPOLIS, MINN.**

**Aptitude Tests** for men, women, boys, girls, discover the kind of work or studies best for your success! You get a personal report—a guide for life—more happiness—more prosperity. Write for complete facts.  
**VOCATIONAL COUNSELORS, 5059 Woodward Avenue, Detroit**

## Say You Saw It in Popular Mechanics

Easy and Cheap to Operate  
**SAVE TIME, WORK, MONEY!**  
**SHAW DU-ALL**  
and "PEPPY PAL" TRACTORS

**PLOW**  
**CULTIVATE**

These rugged walking or riding tractors are ideal for farm, truck garden, orchard, poultry farm. Operate on a few cents an hour. A child can handle them.  
**DO DOZENS OF JOBS** Both riding and walking tractors quickly and easily plow, cultivate, harrow, disk, bulldoze, spray, haul, grind, saw wood, etc.  
**LOW FACTORY PRICES** Buy direct or through your dealer. Year's guarantee!  
**RIDING TRACTORS** 4 models from 5 to 12½ H.P., 58 in. wheelbase, 36 to 52 in. wide, 24 in. plant clearance. Hand or electric starter. Walking Tractors 1½ to 5 H.P.  
**FREE** Illustrated folders giving complete details and price lists—write today!  
**SHAW MFG. CO. 4509 FRONT ST., GALESBURG, KANS. 668G NORTH 4TH ST., COLUMBUS, O.**

## HOME CRAFTSMEN AND HOBBYISTS!

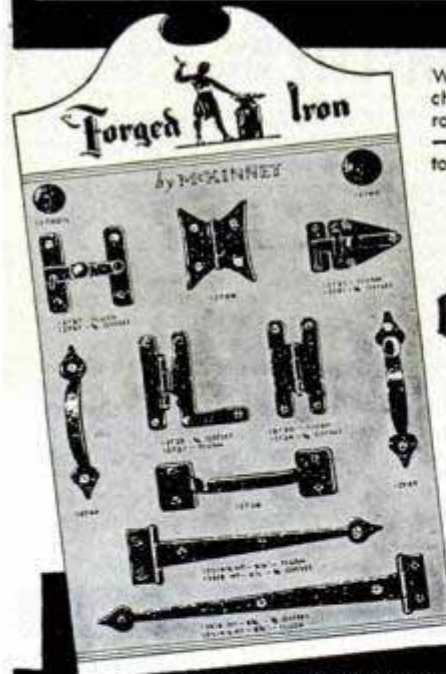

When you build cabinets, chests, furniture, remodel rooms, redecorate your home—add the distinctive finishing touch by using

## McKINNEY Forged Iron Cabinet hardware

Attractive authentic Heart pattern strap hinges, H and L hinges, latches, drawer pulls and knobs, etc. in dull black or Swedish Iron finish. Buy them at your local hardware, lumber or paint dealer. Look for the McKinney display.

SEND FOR FREE FOLDER

SHOWING McKINNEY PERIOD PATTERNS AND SUGGESTED USES.

McKinney Manufacturing Company  
1400 Metropolitan Street, Pittsburgh 33, Pa.  
Please send free folder on McKinney Forged Iron Hardware to:

NAME \_\_\_\_\_  
ADDRESS \_\_\_\_\_  
CITY \_\_\_\_\_ STATE \_\_\_\_\_ PA \_\_\_\_\_

# MILLER ROTARY

Hi-SPEED (PIPE-SAW) DRILL-BIT  
IT SAWS CUTS REAMS



SAWS, CUTS, REAMS . . . Sheet metal, angle iron, pipe, wood, plastic, Transite, etc. Amazing high-speed combination bit and saw fits any 1/4" or 1/2" electric drill or slow drill press. Drills own starting hole to quickly cut, saw or ream opening. Easy to operate. Ideal for carpenters, auto mechanics, electricians, plumbers, hobby workers, many others. Abrasive resistant high speed steel. No breaking. Will withstand severe continuous use. Resharpener at no charge. 1/4" diameter, over-all length 3 1/2", cutting section 2" long with flutes ground from solid. Shipped same day—money back guarantee.

Discounts on quantity orders from dealers. Takes place of up to \$50 in tools. SEND CASH, CHECK OR M.O.

Manufactured and distributed by:  
**INTERNATIONAL TWIST DRILL CORP.**  
624 Wyandotte, Rm. 637, Kansas City 6, Mo.

only  
**\$3.59**  
POST-PAID



"It Measures As It Rolls"

## ROLLER RULE

HANDY MECHANICAL PENCIL

Measures Curves and Straight Lines. Any Shape. Any Distance. Any Surface.

**\$1.00**  
POST PAID

Roll head over surface. Inches and fractions record accurately on "Inch-O-Meter". Excellent pencil tool! Order Now! 10 Day Money Back Guarantee! C.O.D. (postage extra). In Calif. add 3% Sales Tax.

**PENCIL SALES CO., Dept. PM9**

Room 6, 1213 E. Ocean Blvd., Long Beach, California

## D. C. ARC WELDER

\$300 VALUE — ONLY \$97.50

200 Amperes Continuous Duty. Up to 250 amps. intermittent duty. Easily mounted on your tractor. Welding range from 0-up by dial type control. 1-yr. guarantee with money back 10-day trial period. Write for FREE literature. OR send 35c for PLAN "Build Your Welder from Aircraft Generator" literature included.

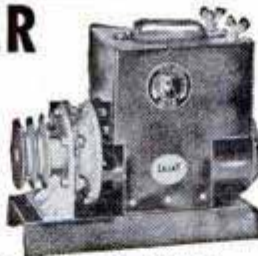

**LEJAY MFG., 847 LeJay Bldg., Minneapolis 8, Minn.**

SAY YOU SAW IT IN POPULAR MECHANICS

Pat. Pend.

## POWR-PAK

EXTRA HEAVY PURE GUM RUBBER (600% ELONGATION)



Not a toy! A perfectly balanced small arm for sport and small game! Special introductory offer: "Powr-Pak" Pistol Sling, 50 "Tru-Flite" 23 gr. pellets, extra sling, 10 "Red Dot" targets, postpaid, \$2.25 cash, check or money order. No COD! Money back guarantee. Order yours today from Baron Industries, Box 3578P, Cleveland 18, Ohio. Order extra supply 23 gr. "Tru-Flite" Pistol Sling pellets with your Powr-Pak. 250 for \$1.00.

## CASH IN ON THE BUILDING BOOM!

MAKE  
**BUILDING BLOCKS**  
RIGHT IN YOUR  
OWN BACKYARD  
AMAZING GENERAL  
**BLOCK MACHINE**

CAPACITY 1000 BLOCKS PER DAY

**\$199** LESS MOTOR  
F.O.B. PLANT  
SHIPPING WEIGHT  
400 lbs.



Cinder and Concrete Blocks in big demand. Sell all you produce, to contractors and builder supply yards, at 15c to 25c each. Easy to start your own profitable business.

GENERAL BLOCK MACHINE can be operated indoors or out, in floor space 9 ft. x 10 ft. All steel construction. Vibrator mounted in sealed ball bearings. Simple to run. Powered by 1/2 H.P. electric motor or 1 H.P. gas engine. Produces up to 1,000 8x8x16 blocks in 8 hour day. Superior 3 core type, meeting all building code requirements. Produces 4x8x16, 8x8x16, 12x8x16 blocks. Material for blocks, cinders, cement, and sand, obtainable anywhere. Full instructions and mixing formulas with each machine. Immediate Delivery. Mail coupon at once for full details, sent free without obligation.

**HOW TO BUILD YOUR OWN CONCRETE BLOCK—HOME**  
Only 1 Prepaid

Wonderful book written and illustrated by our staff of experts.

## GENERAL ENGINES CO.

DEPT. P12 307 HUNTER ST. GLOUCESTER, N. J.

Shows you 8 ways to save money and how to make and lay blocks, laying out building lines, mixing your own concrete, building steps, porches and concrete floors. Includes floor plans for 6 beautiful easy to construct concrete block bungalows. Mail coupon at once with \$1.

Name .....

Address .....

City..... Zone... State.....

## Build a super-sensitive Tubeless Radio Receiver

... and other efficient, low-cost instruments with the amazing new *Sylvania Germanium Diodes*.

This book gives full information... shows detailed diagrams with easy-to-follow instructions for 40 germanium diode circuits... receivers, amplifiers, transmitters. A real treasury of new hook-ups and time-saving ideas for hobbyists, hams, and engineers.



Mail \$1.00 for your copy TODAY!

**SYLVANIA ELECTRIC PRODUCTS INC.**  
Advertising Dept. E-1609, Emporium, Pennsylvania  
Enclosed please find \$1.00 for copy of "40 Uses of Germanium Diodes."

Name \_\_\_\_\_

Address \_\_\_\_\_

City \_\_\_\_\_ State \_\_\_\_\_

# WAR BARGAINS

Over 200 terrific  
ALSO FACTORY  
SURPLUS VALUES!

**MAIL ORDERS**  
Please remit with order. Include postage. You will also receive FREE SURPLUS CATALOG.

**Surplus O. D. WOOL MELTON PANTS \$10.00 Val. 4.99**

NEW 20 oz all wool. Price drastically reduced due to limited sizes 28 to 34.

Add 25c postage.

**WATCH CAPS 77c**

NEW All wool Navy blue Ideal for sports, outdoor wear. Add 5c postage.

**Surplus on ALL WOOL SHIRTS**

SIZES 15-21

**1.66**

**PANTS**

SIZES 27-32

**1.99**

**CLOSE OUT 16,000 GARMENTS**

Used, cleaned and pressed by the Q. M. Corp., ready to wear 100% all wool serge. Prices slashed on account of limited sizes. Add 15c postage per garment.

**OFFICERS PINKS**

NEW Just like the officers wore. Elegantly tailored. 17 oz. elastic material. All sizes. Add 25c postage.

**9.95**

**COMBAT BOOTS 6.55**

NEW Sturdy, comfortable. About 12" high. Reversed uppers, oak leather sole with composition outer sole. Add 27c postage.

**FIELD SHOES 4.55**

NEW Reversed uppers, oak leather sole with composition outer sole. Add 20c postage.

**DUST MASKS 33c**

5 for \$1.50

NEW Ideal for spraying, for millers, etc. \$1.50 Val. Add 5c postage.

**Officer type OXFORDS \$6.88**

NEW Top grain uppers and oak leather sole. Comfortable. Excellent quality. Add 17c postage.

**BOMBER JACKET 12.99**

NEW Made identical to the regulation jacket. 4 pockets, mouton collar, full pile lining, wool knit wristlets. Add 25c postage.

**all wool WRISTLETS 13c**

NEW Worth 75c per pr Ideal for liners, wristlets, etc. Add 3c post.

**BARGAINS**

- NAVY WADERS 8.99
- SADDLES \$60.00 Val. 12.99
- CUSHION FOOT SOCKS 49c

**NAVY WHITE T-SHIRTS 55c**

NEW Full cut. Fine combed yarn. Add 3c postage.

**ORDER NOW! Sioux Falls Surplus Store 113 N. PHILLIPS SIOUX FALLS, S. D.**

**PISTON TYPE COMPRESSOR**

**EASY PROFIT IN PAINT SPRAYING**

Paints walls, ceilings, screens, furniture and machinery faster, better. All complete as shown less motor. Carry anywhere. Fully guaranteed. Could be used with 1/4 H.P. motor or less. Price \$35.00 less motor F.O.B. Chicago. \$5.00 deposit balance C.O.D. or see your dealer. With motor \$55.00.

**IDEAL AUTOMATIC PUMP CO., Dept. P.M.8 801 W. Washington Blvd. Chicago 7, Ill.**

**PET PORTABLE HAND SAW... Fits Any 1/4" Electric Drill**

Light weight, safe, easy to use on any trimming, rip or cross-cut sawing or dado cutting. 4" saw blade, adjustable depth 0" to 1". Ideal for farmers, craftsmen, electricians, mechanics, plumbers, others. Immediate delivery. Write for literature and name of nearest dealer.

**Only \$795**

**PORTABLE ELECTRIC TOOLS, INC. 324 West 83rd Street, Chicago 20, Illinois In Canada: 369 Danforth Rd., Toronto 13, Ont.**

**NEW WAY to clean CLOGGED SEWERS WITHOUT DIGGING**

to make **BIG PROFITS—QUICK, EASY**

• BIG BUSINESS EVERYWHERE • Positive Chain Drive

Nowhere can you start such a **BIG BUSINESS** for so **LITTLE COST**. Complete, Compact and Portable, Ready for the job anywhere. Sturdily built, fully welded frame. Reel holds up to 150 ft. of cable. Longer sewers can be cleaned by using additional cable. High Carbon Steel Cutters for cleaning inside surface of pipe. 1/2 H.P. Single Phase A. C. Motor. Shipping Weight approx. 200#. On C.O.D. orders we require 25% deposit. We Pay Freight when the purchase price accompanies order. HERE IS A REAL OPPORTUNITY. A few jobs STARTED pay for this TODAY equipment.

Operates in Forward or Reverse to Go Through T Fittings

for 3" 4" 5" 6" pipe

Ready to Run complete with 100 Ft. Flexible Cable **\$354.95**

**Grove Machine Works, BOWLING GREEN, OHIO**

**16 x 50 COATED \$69.50**

**CENTER FOCUS**

Lightweight. Superb craftsmanship. Combines tremendous power, instant center focusing plus magnificent light transmission. Objective lens is 2 inches in diameter. UNCONDITIONALLY GUARANTEED. Satisfaction or your money back. Price of \$69.50 includes genuine leather case and straps. Add tax. Send \$2 deposit on C.O.D.'s. Cash orders prepaid. **UNITED BINOCULAR CO., 9043 S. Western, Dept. ARF-1808, Chicago 20**

**FREE SAMPLES! GLOW IN THE DARK!**

**BIG PROFITS showing amazing Luminous Specialties—house numbers, pictures, plastic novelties, religious and nursery objects, ash trays, key-holders, etc. Large manufacturer. Enormous demand. Sell on sight. WRITE AT ONCE for FREE samples. Madison Mills, 303 4th Ave., Dept. N-4, New York 10, N.Y.**

**Print Your Own**

Cards, stationery, circulars, tags, labels, photo and movie titles, advertising, etc. Save money. **Print for Others, Good Profit!** easy rules sent. Raised Printing like Engraving, too. Sold direct from factory only. Write for free catalog of outfits and all details. **KELSEY PRESSES, M-37, Meriden, Conn.**

**CASH IN YOUR SPARE TIME**

**MAKE BIG MONEY IN OWN BUSINESS**

**EXPERT SAW GRINDERS Earn BIG MONEY.** Easy to learn. No experience required. All instructions furnished. Sharpen circular saws for woodworkers, lumber yards, farmers, others. New BELSAW Powered Saw Gunning Machine does fast, precision work on all saws 6 to 48-in. diameter with 1-2 to 2-in. arbor holes. Quickly pays for itself, lasts a lifetime. Send postcard for FREE Catalog.

**BELSAW MACHINERY CO 6372 Field Bldg., 315 Westport Road, Kansas City, Mo.**

**NOW DADO ANY WIDTH**

**WITH DA-DALL!**

Pat. Pend. U.S.A. & For

A simple turn of a screw adjusts your saw to any desired Dado cut! DA-DALL cannot slip, is self-tightening, self-adjusting, of all-steel construction. does a clean, true job!

**ONLY \$4.95**

DA-DALL cuts hard or soft wood, plywood, without chipping! No blades or complicated dials. All arbor sizes

**RULE-WAGNER CO**

Box 694, Dept. D-5 Walnut Creek, Calif.

**Dealers, Jobbers Write for Information**





# Honestly now— would you prefer a shrinking violet?

The advertisers in this magazine all claim their products are “tops.” They are full of pride in their brand names.

Every so often you meet someone who objects to what he calls the “boastfulness” of advertising, but *most* of us Americans like it.

We like it because we know that deep *pride* in things well made goes way back into the factories and is reflected in the fine products we have to choose from when we go to buy the things we use in our homes or on our persons.

We like it because we know that pride is a spur to make better merchandise; and that it is the driving power that keeps men striving each to outdo the other in new ideas, new and better ways of doing things. The end result is a steady stream of new and better means to make life comfortable; more and better jobs for us to earn the means of buying them.

We will take the *Proud* ones—and let some other land cultivate the shrinking violets.

*Brand Names Foundation*  
INCORPORATED

*A non-profit educational foundation* • 119 West 57th Street, New York 19, N. Y.

# AMAZING TOOL BARGAINS!

## 300 PIECE ELECTRIC GRINDER OUTFIT

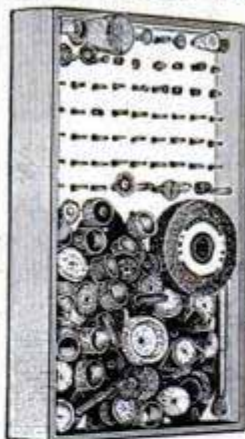

**THE MASTER KIT** \$9.75  
fits all hand grinders for CUTTING, SHAPING, GRINDING, POLISHING Wood, Metal or Plastic  
\$50 VALUE  
Post Paid in U.S.A.

- 1 High Speed Steel Rotary File
- 3 Grinding Wheels 1 to 3" in diameter
- 12 Mounted Stones 1/8, 3/32, 1/4 Shanks
- 9 Rotary Cutters 1/8 and 3/32 Shanks
- 30 Miniature Rotary Cutters 3/32 Shank
- 10 Cut off Discs and Grinding Wheels
- 1 Drum Sander 1/8" Shank
- 15 Abrasive Bands for Drum Sander
- 15 Leather and Felt Polishing Wheels 1/2 to 1" in diameter
- 15 Felt Polishing Cylinders with Mandrel
- 25 Abrasive Sanding Discs 1 1/2 to 2" dia.
- 3 Rubber Wheels 7/8" Diameter
- 2 Speed Drills 3/32 Shank
- 2 Mandrels 1/8 and 3/32" Shanks
- 3 Bristle Brushes
- 1 Rotary Wire Wheel Brush
- 1 Circular Saw on Mandrel 1/8" Shank
- 2 Rubber Cylinders with 3/32" Mandrels
- 150 other items—all new and valuable



**2 CIRCULAR SAWS** \$1.50  
ON 2 MANDRELS—ALL AT ONE LOW PRICE \$1.50  
1" diameter saws on 1/8" Mandrels. For cutting wood, plastic, or soft metals. Order at once! Send Check or Money Order for this big bargain.  
Post Paid in U.S.A.

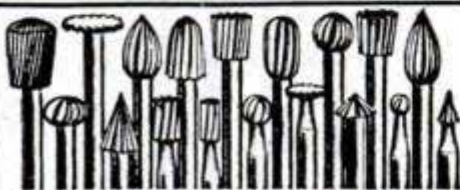

**18 ROTARY CUTTERS** \$5.85  
\$13.50 Value  
Post Paid in U.S.A.

Assorted sizes cutter on 1/8" or 3/32" shank. Will fit all hand grinders. Ideal for cutting wood, metal, or plastic. Brand new.  
Send check or money order today for these Big Bargains.  
SCHUPACK SUPPLY CO., 7331 Cottage Grove, Dept. M-9, Chicago 19, Ill.  
ILLUSTRATED BARGAIN CATALOG 10c

SAY YOU SAW IT IN POPULAR MECHANICS

## Better, Easier, Quicker GROOVE CUTTING or CABINET-MAKING

with *Warren* DADO SAWING WASHERS

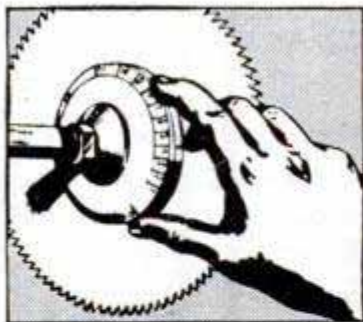

*Just dial*  
DESIRED CUT

Cut accurate, parallel grooves—any width, any angle. Just dial desired width with Micromatic adjustment. Cuts smooth and clean—no burning or chewing to mar fine wood. Just four simple washers. Available in 5 sizes—1/2", 3/4", 5/8", 1", 1 1/8". Free booklet on request. See your dealer or write direct. Absolutely guaranteed! In Canada, send money order for \$4.95 (duty and sales tax extra).

\$4.95  
A SET

Dealers, Jobbers, Write for Information!

**WARREN DADO SAWING WASHERS CO.**  
70 Medbury, Dept. 29, Detroit 2, Michigan



## IDEAL LAWNMOWER SHARPENER

Saves work, saves time, helps you earn extra dollars! Sharpens hand, power mowers without disassembling. Complete shop in one machine — equipped with Bed Knife Grinder and "lapping-in" Reconditioner. Home owners, parks, clubs, cemeteries pay good money for efficient sharpening; get your share!

WRITE NOW FOR FREE CATALOG

THE FATE-ROOT-HEATH CO., Dept. I-3, Plymouth, Ohio

**MONEY for MEN ALL DATA FREE**

THE PLASTEX Industry needs manufacturers on small scale and for big production of Lamp and Clock Stands, Art Goods and Novelties in Plastex and Marble imitation. Experience unnecessary. 1/2c material makes regular 10c store sellers. Rubber moulds furnished for speed production. Small investment brings good returns. Big chain store orders now being placed. Ambitious men have chance for real prosperity. Our Free booklet will interest and benefit you.

**PLASTEX INDUSTRIES, Dept. A**  
3400 Third Ave. New York 56, N. Y.



## ELECTRIC WELDER

AC or DC 110 Volts

"The Little Marvel" All-Metal welder. 5-year written guarantee. Welds 1/8" thick metal or money back. Repairs tanks, tools, fenders, machine parts, etc. Comes complete with everything — rods, unit, eye shield, and directions. We also make a welder for 16 to 22 gauge metal . . . \$3.95 complete. On C.O.D., postage extra.

\$6.45  
Complete

ESSAY MFG. CO., Inc., Dept. 51, Quincy 69, Mass.



## TRAILER PARTS



**BULL DOG** Hitches, Parking Jacks and Axles for all types of trailers!

Write for FREE Catalog

**Hammer Blow Tool Company**  
Wausau 13, Wisconsin



## GERSTNER Tool Chests

Every Gerstner chest is built for maximum service — for longer life. Free catalog for machinists and toolmakers.

**GERSTNER TOOL CHESTS**  
450 Columbia St. Dayton 7, Ohio

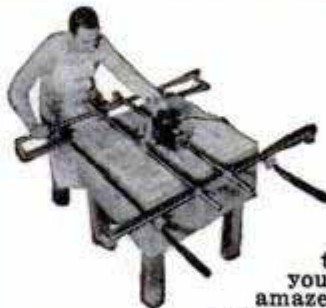

## REFINISH BUTCHER BLOCKS

Our new machine can easily pay for itself in one month. From then on, all the profit is yours. Profit possibilities will amaze you. Every butcher and restaurant owner within driving distance is a good prospect. Resurface his block for him right in his shop. Machine is light, easy to set up on any size block, does a superior job of resurfacing. You can work days or evenings to suit your customers' convenience. Steady repeat business. It is a neglected field with wide-open opportunities. Write today for complete information. Ask for Model C Circular. Hill Machine Company, Box 677Q, Rockford, Illinois.

## WHEN YOU BUY BY MAIL

Every issue of POPULAR MECHANICS contains many products and services which you can obtain by mail. However, there are important points to check on to make sure you get quick and satisfactory service.

In writing to an advertiser:

Be sure your address and the advertiser's are correct and readable . . .

Tell the advertiser exactly what you want — include size, number, color, etc., if required . . .

Send the correct remittance — however, don't send cash through the mails — use a check or money order.

Taking time to check these points will help you get quicker replies and better results — and will make it well worth your while if you buy by mail!

## OXYGEN BREATHING SET ORIGINALLY COST \$100—NOW ONLY \$7.95!

**BRAND NEW SURPLUS.** Ready to use. Portable with Automatic "Demand" type valve. The type set our Air Force depended on! A must for airman, mountaineers, firemen, paint shop workers and others who on occasion need extra oxygen. This popular "demand" type oxygen outfit requires no technical knowledge for use—just breathe into the mask provided and the regulator automatically delivers the oxygen you need as you breathe into the mask! Complete set includes D-2 type shatter-proof steel bottle 6x24 inches; demand type regulator AN-6022-1; 6-500 lb. oxygen gauge and type A-10 demand oxygen mask with hose. Net weight 7 lbs. Shipping weight 10 lbs. Outfit as described above but with empty tank shipped parcel post each \$7.95. With oxygen filled tank (available by express only) \$9.95. Refiller hose, orifice and valve for charging tank with oxygen \$2.00. 6 foot flexible extension hose with fittings \$2.00. **PORTABLE AIR SUPPLY OUTFIT:** Oxygen set minus mask only \$6.95. By adding hose and air chuck (not furnished) you have portable source air for auto tires, garden sprayers, etc. F.O.B. Houston.

**SPECIAL DISCOUNT** Lots of 6—20% Lots of 12—25%  
Lots of 24—33 1/3%

Send check, money order

**AERO PARTS SUPPLY CO.**

Dept. PM-8 8102 Lockheed, Houston, Texas

SAY YOU SAW IT IN POPULAR MECHANICS



## New MODELS EASIER TO PLAY

Find out about these sensational new Conn Band Instruments. Many wonderful, exclusive features! Today, *more than ever*, Conns are the "Choice of the Artists." You'll advance faster and take more pride in a genuine Conn—made by the world's largest manufacturer. See your dealer or write us for free literature. Mention instrument. Conn Band Instrument Division, C. G. Conn Ltd., 931 Conn Building, Elkhart, Indiana.

Write  
FOR FREE FOLDER



SEPTEMBER 1950

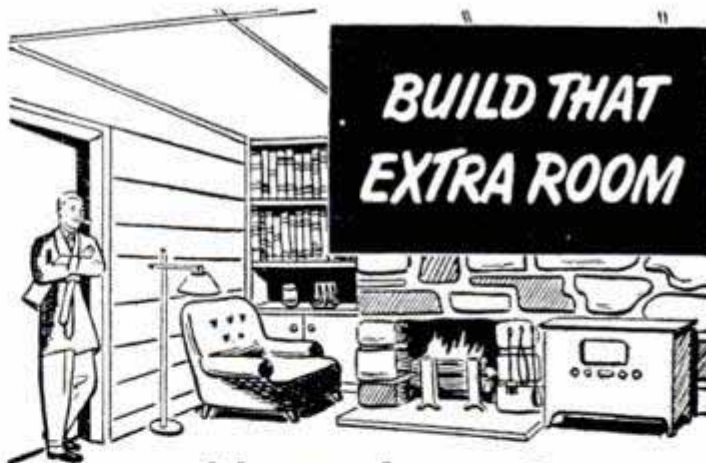

with new, low-cost  
**Gold Bond Insulation Board!**

**G**RAB your hammer and start building that extra attic bedroom you've been needing. You'll be surprised how little it costs with new Gold Bond Insulation Board. It comes in Tiles, random width Planks and big lightweight Panels. Tiles and Planks come with interlocking edges that hide nails or staples and are finished in ivory and harmonizing variegated blends—large Panels in ivory. You can get any number of eye-pleasing color combinations without any further decoration. You'll not only have an attractive room but one that's insulated against heat and cold. Gold Bond Insulation Board is perfect for game rooms, dens, or for any kind of interior modernizing.

Available at your local Gold Bond  
lumber and building materials dealer!

**NATIONAL GYPSUM CO., BUFFALO 2, N. Y.**

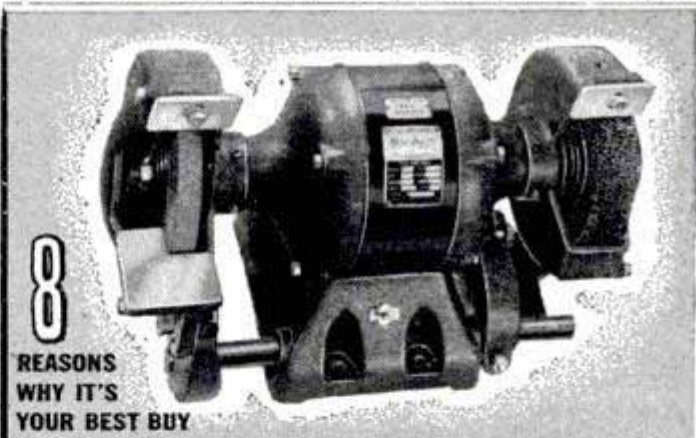

8

REASONS  
WHY IT'S  
YOUR BEST BUY

## Snap-on\* BENCH GRINDER

- Completely enclosed motor.
- Oversize ball bearings throughout.
- Large wheel guards.
- Rugged base. Rubber feet provide solid mounting free from vibration.
- Induction run motor
- develops less heat in winding.
- Adjustable tool rests.
- Capacitor start motor — uses low starting current.
- Many special models are available for use with different voltages and currents.

MAIL  
TODAY!

\* SNAP-ON is the Trade-mark of SNAP-ON TOOLS CORP.

**SNAP-ON TOOLS CORPORATION**  
8062-1 28th Ave., Kenosha, Wis.

Send me 104-page Snap-on Tools Catalog.

Name .....

Address .....

City .....State .....

281



**NOW!**

**EVERYONE CAN MAKE TRAYS..COASTERS..GIFTS OF BEAUTY**

with **PRE-FORMED METAL CIRCLES**

Pre-cut, pre-formed circles of Aluminum and Copper — ready to transform quickly and easily into colorful trays, coasters and other items with the Metal Goods Dek-AllColorKit. No cutting or forming. IT'S EASY—JUST TRACE ON DESIGN... THEN PAINT WITH "DEK-ALL" COLOR SET. The brilliant colors are chip-resistant, will not wash off.



**WRITE TODAY** for literature and price list

**METAL GOODS CORPORATION**

628 Rosedale Ave. St. Louis 12, Mo.

**NEW..**  
first time ever available...



**3-shot shotguns with VARIABLE "C-LECT-CHOKE"\***

Model #185K  
20 ga.  
\$26.95

\$27.80 West of Rockies

\*Patent pending

Model #190  
16 ga.  
\$28.95  
\$29.95 West of Rockies

SEE THEM AT YOUR DEALER'S

No sales at factory

Instantly, with twist of fingers, positive, visual setting at Full, Modified or Improved Cylinder choke—or any point in between.

"C-LECT-CHOKE"\* is not a separate device to be mounted on the gun. Choke and gun are a unit, precision engineered and perfectly coordinated.

Many other de luxe features, including ventilated barrel, thumb-operated safety, custom-type Monte Carlo stock of genuine walnut.

FREE—Catalog on request



9709 St. John St., New Haven 5, Conn.

**WAR SURPLUS BARGAINS!**

**STARK'S**

**WAR SURPLUS BARGAINS**

**\$500,000.00 INVENTORY for QUICK LIQUIDATION**

Surplus items—hundreds of them for home, shop, factory, farm and outdoor use. New items, used items, reconditioned items—all at tremendous savings—all priced for quick sale.

**Page After Page of Values**

This big catalog shows page after page of amazing money saving values. Write for your copy today. Send 10c to cover postage, mailing, etc. Write today!

**SEND TODAY FOR YOUR COPY**

**10c**

**STARK'S** Dept. PM9 509 So. STATE STREET CHICAGO 5, ILLINOIS

**WRITE FOR FREE Building Instructions**

**The Rite-Way Mower Attachment**

**BUILD YOUR OWN POWER LAWN MOWER**

**WHY PAY MORE FOR FACTORY BUILT MOWERS?**

Now anyone can save time and effort mowing field or lawn by building their own whirl type Power Mower. Build it in a short time with parts and instructions we furnish. Requires no special tools.

Write Today for Free Building Instructions

**T & H MFG. CO., INC.**  
Dept. M-PB9, 811 E. 31st St. Kansas City, Mo.

**END GENERATOR TROUBLE**

**REPLACE VOLTAGE REGULATOR WITH AMAZING NEW WATTAGE**

**GREATEST ADVANCEMENT IN AUTO IGNITION SINCE THE SELF-STARTER**

**DRIVE WITH OR WITHOUT BATTERY 100,000 MILE MONEY BACK GUARANTEE**

STATE MAKE AND MODEL OF CAR AND SEND FOR FREE CATALOG

**SCIENTIFIC ELECTRIC CO. P.O. BOX 2162-G STAH CLEVELAND, OHIO.**

**LIQUID MARBLE** COMPOSITION FLOORS FLEXIBLE MOLDS

Mold, Brush, Trowel, Spray It!

MOLD novelties, Statuary, Art Goods in Flexible Plastic Molds; 5c

material makes \$1 seller. Make Marbleized floors, Tile Walls. Colorful, glossy, amazing! Easily learned; start in garage or basement. Particulars free.

**MARBLEIZING SERVICE, Dept. 10-F, Edwardsville, Ill.**

**MARCOT KEY MACHINE**

Immediate Delivery

**MARCOT No. 8 KEY MACHINE, mounted on Cabinet, less motor. \$ 95.00**

Auto Code Book and Depth Keys. 12.50

100 Dz. Popular Key Blanks. . . . 60.00

Set — Key File, Follow-Through Rods, Lock Picks, Bit Key Gauge, Thimble, Pins, Springs. . . . . 10.50

"Locksmith Trade Books" . . . . . 6.75

How to Open Locks without Keys or Picks; Secret of Locksmithing; How to Make Keys by the Impression Method; Master Key Systems.

**TOTAL COST. . . . . \$184.75**

**A. J. MARCOTTE CO., 1200 N. Kedzie Ave., Dept. PM, Chicago 51, Ill.**

**ARC WELDING FOR PROFIT OR PLEASURE**

**60 LBS. OF READY MADE PARTS**

**Only \$24.95**

**BUILD YOUR OWN HEAVY DUTY WELDER**

**SAVE Buy Only NECESSARY PARTS**

All necessary parts Ready-Made and easy to assemble. You can do all around welding on steel, cast iron and other metals after only a few hours practice. Illustrated instruction manual included. Sold on 30-Day Money-Back Guarantee!

**FREE:** Write today for fully illustrated Pamphlet P-9

**ATOMIC ARC WELDER CO.**  
1037 So. 19th St. OMAHA, NEBR.

*Gives 100% penetration. Welds are stronger than original metal. Operates on 110 or 220 AC.*

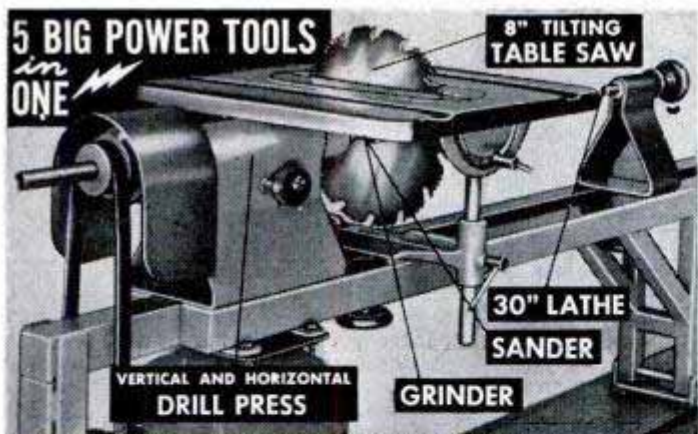

RETAIL PRICE \$125.00  
**FACTORY TO YOU \$59.95**

**SUPERSHOP** the PRECISION BUILT WORKSHOP Lifetime lubricated BALL BEARINGS. All running parts precision GROUND. Compare finest production tools BIG capacity Amazing VALUE. Write for FREE catalog, full details, trial plan.

**POWER TOOLS, INC.** 115 YATES AVENUE  
 BELOIT, WISCONSIN

## CARBURETOR TOO RICH MAKES MOTORIST TOO POOR



Car owners who are wasting money and not getting proper gas mileage due to over-rich mixtures will be pleased to learn how to save gasoline by VACU-MATING over-rich mixtures. VACU-MATIC fits all cars, trucks and tractors. It is automatic and operates on the supercharge principle. Easily installed in a few minutes.

**SALESMEN WANTED!** Big Profits! Send name, address on penny postcard for free particulars and how to get yours for introducing.

**VACU-MATIC CO.,** 7617-1635 W. State St., WAUWATOSA, WIS.

## BOYS-IT'S FREE!

**"THE WONDERS OF CHEMISTRY"**  
 This exciting new book shows how to amaze your friends with chemical magic, describes many fascinating home experiments, tells of fun, thrills and big future opportunities for boys who know chemistry. Special atomic energy feature. Send today!

**THE PORTER CHEMICAL COMPANY**  
 40 Prospect Avenue, Hagerstown, Maryland

## Electric HOME-UTILITY Tools for HOMES • FARMS • WORKSHOPS

HOME-UTILITY Division — BLACK & DECKER Mfg. Co.

## MAKE YOUR OWN!

WITH

### Griffin READYCUT LEATHER PROJECTS

Over 100 KITS in every kind of Tooling and Carving Leather, accurately cut, all parts included. Only Top Grade Leathers used. You do the choosing. You do the tooling, carving, stamping, the punching and assembling.

SEND FOR COMPLETE CATALOG Please send 10¢ to cover mailing.

SINCE 1924  
 OUT OF THE WEST, THE HOME OF LEATHER CARVING

**Griffin CRAFT SUPPLIES**  
 5626-A TELEGRAPH AVE.  
 OAKLAND 9, CALIFORNIA

**EVERYTHING FOR THE LEATHER WORKER**  
 Largest, most complete stock of Leathercraft Tools and Accessories in U.S.A.

HIDES AND SKINS of Craft Leathers of every kind if you prefer to cut your own.

# Speedy Sprayer

New! 1/4 h.p. professional type  
 paint sprayer \$18.95\*  
 only



Now for home owners, mechanics, hobbyists — a real professional quality Speedy Sprayer at amazing low cost! Thoroughly atomizes any material and gives your handiwork a mirror-smooth finish. Quickly pays for itself in savings of time, labor and paint. Portable! Never needs oiling! Ask your paint, hardware, lumber, or auto supply dealer for Speedy Sprayer. Model 750 outfit with 1-pint gun, less motor, only \$18.95

**W. R. BROWN CORP.,** FREE! Write for literature and booklet "How to Spray!"  
 5717 W. Armitage Ave., Chicago 39, Ill.

Specialists in Portable Sprayers for over 20 Years

Adjustable wrenches in 4", 6", 8", 10" and 12" sizes

## OUR FINEST MECHANICS TOOLS

Now Priced for Every Pocketbook

McKaig-Hatch Superior Design In Polished-Chrome, Forged Tools

Exacting design in these tools does faster, better work on every job. Every tool is forged of finest alloy steel, heat treated and carefully finished in gleaming polished chromium. Now you can own tools that mechanics have preferred for years—at prices you'd expect to pay for ordinary tools.

- Every tool fully guaranteed for material and workmanship.
- Thinner design—increased strength.
- High tensile strength and hardness.

There is no substitute for a McKaig-Hatch Tool

**SEE YOUR TOOL DEALER**  
 Dealers and Jobbers  
 Write for New Literature

Open end 5 and 6 wrench sets 3/8" to 1"

Combination 5 & 6 wrench sets 3/8" to 3/4"

12 pt. Box End 5 & 6 wrench sets 3/8" to 1"

Slip Joint Pliers 5" to 10" sizes

5 styles of Claw Hammers

Pipe Wrenches 10", 14" and 18" sizes

**MCKAIG-HATCH INC.**  
 125 Skillen Street • Buffalo 7, New York

# PRESSURE PRINCESS

Makes every job *EASIER*

**YOU** have never seen a single cylinder portable air compressor that packs so much power as this one. Built by the makers of the famous 4 cylinder Pressure Queen, the Princess will do any job, from inflating tires to painting buildings. Compact, simple and rugged, it will last your lifetime and pay for itself over and over again.

Powered by electric motor or gas engine.

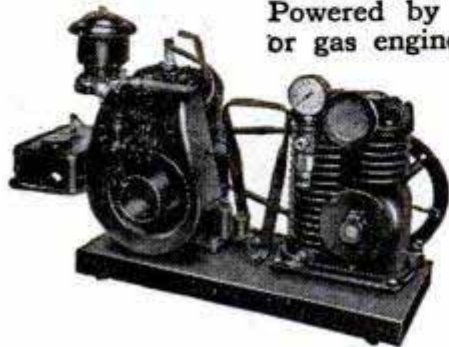

Write for Literature and Prices

## THE CAMPBELL-HAUSFELD CO.

1046 Railroad Avenue

Harrison, Ohio

# BUILD 'EM YOURSELF

IT'S EASY - - - IT'S FUN!

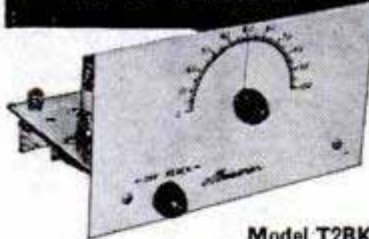

Model T2BK

You'll have a world of fun assembling a MEISSNER Radio Kit, and what's more you'll have a REAL radio at an amazing low cost.

Step-by-step instructions with pictures and diagrams make it easy as ABC. All you need is a screw driver and soldering iron.

MEISSNER Radio Kits carry a written guarantee — your assurance of complete satisfaction!

## Meissner RADIO KITS



Model T6BK

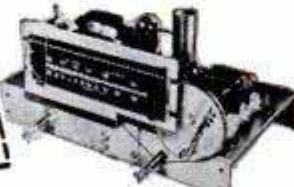

Model T8CK

Write Today for Free Kit Catalog

You'll Be Glad You Did!

**MEISSNER** MFG. DIVISION  
Maguire Ind., Inc.  
Mt. Carmel, Illinois

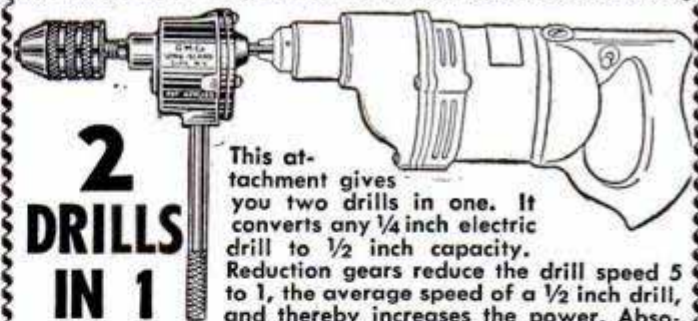

**2 DRILLS IN 1**

This attachment gives you two drills in one. It converts any 1/4 inch electric drill to 1/2 inch capacity. Reduction gears reduce the drill speed 5 to 1, the average speed of a 1/2 inch drill, and thereby increases the power. Absolutely indispensable for all shop work and home craftsmen. Satisfaction guaranteed. Order yours now.

Send check or Money Order with order. Jobbers write for special information. **\$11.95** post paid

G. M. CO. MANUFACTURING, INC.  
1308 43rd AVE. LONG ISLAND CITY 1, NEW YORK

## NEW BATHROOM DEODORIZER



Secret chemical invention automatically banishes unpleasant odors in bathroom, kitchen, anywhere. Gives off refreshing fragrance. Just hang on wall. No liquids, sprays, or wicks. Needs no attention. Beautifully designed!

**SAMPLES for AGENTS** Sample offer sent immediately to all who send name at once. Hurry—postcard will do. SEND NO MONEY—just your name.  
KRISTEE CO., 674 Bar St., Akron, Ohio



## PUT HYDRAULIC BRAKES ON YOUR MODEL A-B OR V-8 FORD!

Install them yourself with Ansen's complete conversion kit. All parts and instructions furnished. Price—with exchange on backer plates and shoes... \$65.00 (F.O.B. Los Angeles, Calif.) 1950 "Insert-type" catalog available. Includes Speed Tuning Info., Hot Rod and Midget Racing Histories, etc. 35c.

WRITE: ANSEN AUTOMOTIVE ENGINEERING INC.  
3801-PM WEST JEFFERSON - LOS ANGELES 16, CALIFORNIA

**GARAGEMEN**... Write for the new K. R. WILSON Catalog of Garage Tools and Equipment. Lowest Prices. K. R. WILSON, 213 Main Street, Buffalo 3, N. Y.

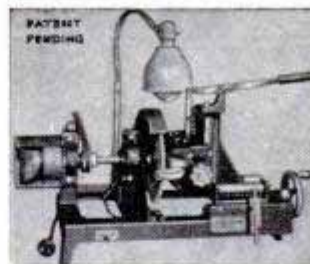

## Start a NEW BUSINESS!

or Add to your present Repair Business

### SHARPEN DULL PIPE WRENCHES

PIPE TAPS & DIES  
"GUM" CIRCULAR SAWS

Write for Information

J. C. MOORE INDUSTRIES  
BOX M 276 FREDONIA, PA.



## ONAN Portable ELECTRIC PLANTS

FOR CABINS, TRAILERS, CONTRACTORS, BOATS

Light weight, compact, air-cooled, engine-driven. Furnish regular city-type A.C. electricity for lights, appliances, radios, etc. Can be carried by hand. Fits trunk of car. Plug-in receptacles on plant. Larger models for farms, homes, businesses beyond highlines. Catalog shows over hundred models. 350 to 75,000 watts.

GASOLINE OR DIESEL POWERED  
Prices begin at \$169.50

WRITE FOR CATALOG

D. W. ONAN & SONS INC.  
5837 Royalston Ave., Minneapolis 5, Minn.



**Extra Value!**

Here are terrific **BARGAIN VALUES**— Outstanding specials for experimenters, engineers and inventors—Offered at these prices only while our present stock lasts.

**ALL ITEMS ARE BRAND NEW AND IN PERFECT CONDITION.**

**Double Voltage Output Generator—Type NEA7** made by Eclipse. Here is a unit that is 2 generators in one, adaptable to a lighting plant and excellent for welding, etc. Produces 21.8 Amps at 115 Volt, 880-2000 cycle. (Excellent for lighting or any AC-DC resistance type application) The second winding puts out 28 volts DC and is rated at 125 Amps. Will produce both currents at once or separately. Size 15" x 6" dia. Shipping weight. 50 lbs. **Only \$19.75**

**Special Offer — 3 HP - 4 cycle brand new, factory guaranteed GAS ENGINES.** Model U23 with ball bearing shaft. \$84.50 value **Now only \$59.50 complete.** Shipping weight 50 lbs. Model U23R6 with 6-1 gear reducer — **Now \$69.50** (regularly \$96.50).



**Jack & Heintz Aircraft Starter No. 950R.** Brand New in original cartons. Shipping weight 30 lbs. **Only \$19.50 each.**

**Bell & Howell Light Projector** - Contains 4 big precision lenses, including a 91 mm dia. Plano-Convex with 9" F.L. A component of navy's skip bomb sight. **Only \$3.75** (add postage for 8 pounds)

**Universal Electric Fuel Pump** - Made for 12 volt DC - will operate on 6 volt as well as on AC. Tapped for 1/4" pipe fittings. Plenty of uses for this big value! Size 7" x 3" x 3". **Only \$7.50 each postpaid.**

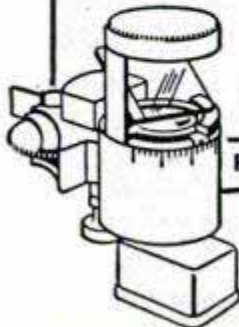

**Reflex Sight Projector - Type X-1** - contains valuable parts including 8 miniature instrument bearings 1/8" I.D. x 3/8" O.D., concave 1st surface mirrored optic with 5-1/2" F.L., light and switch assembly with rheostat, etc. Unit is 8-1/2" high. A good buy for the ball bearings alone. **Only \$2.95 each -- 3 for \$7.50 postpaid.**

**Stainless Steel Tanks** - This is type D2 tank made to supply breathing oxygen in aircraft. 1/4" pipe fitting with brass plug in each end. Ready to use for all sorts of shop and laboratory uses. Ideal for storage and reservoirs for liquids and gases. Excellent for compressors, portable compressed air storage, hydraulic reservoirs, etc. **Only \$2.50 each, 4 for \$9.20** 5-1/2" dia. 23" long. — Add postage for 6 pounds each.

**Motor and Gear Actuator Assembly** - Made by Foote Bros. for Lockheed. This is a Flap Actuator, adaptable to many shop, laboratory and experimental uses. Can be used for both rotary or thrust motion - up to 1,000 lbs. Thrust can be increased for lighter loads with a bell crank. Ball bearing shaft has 5-1/2" travel. Powered by ball bearing reversible 1/6 HP 24 volt motor with built in brake. Operates on 6 volt battery or on AC current with the solenoid brake out of play. Extent of travel is controlled by 2 Micro limit switches in the junction box mounted on gear reduction housing. Overall size 12" x 11" x 4". **Only \$9.75 each postpaid.**

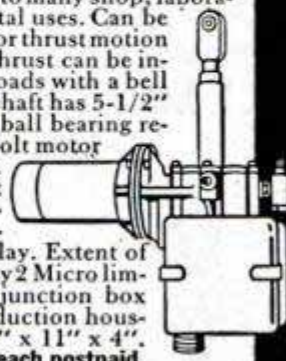

You may send only 20% with order. We will ship COD for balance but suggest you include full amount and save COD fees. We **Guarantee** prompt shipment and full satisfaction or your money back on any item returned within 15 days.

**DIRECT SYSTEM CORP. 62 GILL • BUFFALO 22, N. Y.**

**CAST your own LEAD HAMMERS**



**1000 USES AROUND SHOP OR FARM** Simple, easy, quick. Use short length of pipe for handle and this accurately finished, cast iron mold. Lasts a lifetime. Also makes brass faced hammers. Available two sizes: 3 1/4 lb. \$3.50; 1 3/4 lb. \$3.00. Order both for \$6.00. Postpaid if cash with order, otherwise C.O.D. plus postage. Send check or money order TODAY

DEALERS WRITE FOR OUR OFFER

AIR CAPITAL PATTERNS • 1612 S. ST. FRANCIS • WICHITA 11, KANS.

**HIGH POWER TELESCOPE**

**60 POWER - ALUMINUM TUBES - OPENS TO 33"**

Variable Power Eyepiece Adjustable to 15X, 30X and 60X. Made in U.S.A.

**\$4.50** Case Included

5 Sections. 4 Ground & Polished Lenses. Also used as 50X Microscope. Ready to use. **only \$4.50 POSTPAID.**

**BROWSCOPE CO.** Dept. 9M, 24 W. 45th St. NEW YORK 19, N. Y.

**KEEP YOUR TOOLS SHARP!**

The revolving Oilstone Tool Dresser offers an oilstone with a continuous motion. The accepted method of putting a keen edge on a sharp cutting edge is to oilstone it. Round carving tools and gouges, the most difficult tools to oilstone by hand, can be rolled back and forth over the revolving oilstone and sharpened as easily as a flat tool. Write for circular.



**CLAUSING MANUFACTURING CO.** 235 RICHMOND AVE. OTTUMWA - IOWA

**WANT \$10,000?**

Earn the government Super Sensitive P.R.I. ment bonus. Locate Uranium with a **GEIGER COUNTER**

Find gold, silver, and other valuable ores with a P.R.I. Treasure Locator. World's finest instruments. **FREE** catalog. Write today.

**PRECISION RADIATION INSTRUMENTS, Inc.** 5478PM Wilshire Blvd., Los Angeles 36, Cal.



Dealer Inquiries Invited

**CRESCENT TOOLS**

*Give Wings to Work*

ASK YOUR HARDWARE DEALER

**Look! \$74.95 Buys ALL This!**

**10-Day FREE TRIAL** Cash or Easy Time Pay Plan



**EMRICK 5-in-1 MACHINE Complete** with 1/3 H.P. Motor, Drive Pulley, V-belt, 7" Saw Blade, 5 Wood Drills, 6 Best Quality Lathe Turning Tools, 2 Steel Bench Legs, Buffing Wheel, 6 Abrasive Discs and Distic.

**5 Complete POWER TOOLS for TURNING DRILLING SAWING SANDING GRINDING**

**EMRICK All PURPOSE SPECIAL**

Includes every item shown here except bench lumber

**WONDERFUL CHRISTMAS GIFT** 115 pounds of REAL machinery. Complete, ready-to-run workshop. Biggest Bargain in power tool history. Have fun; save money on home repairs; operate profitable woodworking business; handle big jobs. Thousands of delighted customers — our 52nd year. **MONEY-BACK GUARANTEE.** Write for **FREE** literature on this \$74.95 Special, our famous 5-in-1 Machine still only \$39.95, and **MONEY-SAVING** Christmas Lay-Away Plan. **EMRICK, INC., 1552 Clinton, Kalamazoo, Mich.**

# U.S. KOYLON LATEX Foam Rubber

Now you can enjoy the comfort of the most modern cushioning known... soft, luxurious foam rubber. Re-upholster your furniture, automobile or aircraft seats, or design furniture to suit your particular needs.

## FLAT STOCK      CORED STOCK

Sheet Size	Net Price Per Sq. Ft.	Net Price Per Sheet	Sheet Size	Net Price Per Sq. Ft.	Net Price Per Sheet
1/4" x 34" x 60"	\$.34	\$3.97	1" x 24" x 60"	\$.95	\$7.92
3/8" x 34" x 60"	.46	5.37	1 1/2" x 24" x 60"	1.35	10.65
1/2" x 34" x 62"	.56	6.47	2" x 24" x 60"	1.59	13.30
3/4" x 34" x 62"	.77	8.97	2 1/2" x 24" x 60"	1.80	15.10
1" x 34" x 62"	.98	11.50	3" x 24" x 60"	2.00	16.65
1 1/4" x 34" x 62"	1.20	14.10	4 1/4" x 24" x 48"	2.20	17.35

ANY SHEET SIZE CAN BE FURNISHED

## CLEAR PLEXIGLAS RODS



MINIMUM ORDER \$1.00

Dia.	Price/Ft.	Approx. Lbs./Ft.	Approx. Ft./Lb.	Max. Lgth.
1/8"	\$.05	.0068	147	72"
1/4"	.10	.026	38	72"
3/8"	.30	1/10	9 1/2	72"
1/2"	.60	1/4	4 1/3	72"
3/4"	.84	1/3	3 1/3	72"
1"	1.25	1/2	2 1/3	60"
1 1/2"	2.90	1	1	60"
2"	5.80	2	1/2	60"

## CLEAR PLEXIGLAS SHEETS

Std. Thick.	Approx. Fractional Equiv.	Price 24"x18" Sheets	Price 24"x36" Sheets	Price 36"x48" Sheets	Price 20"x50" Sheets	Price 36"x72" Sheets	Approx. Wt. per Sq. Ft.
.060"	1/16"	\$ 3.48	\$ 6.26	\$12.53	\$ 7.26	\$18.79	.37 lb.
.080"		3.86	6.94	13.89	8.04	20.83	.49 lb.
.100"	3/32"	4.20	7.46	14.93	8.65	22.39	.62 lb.
.125"	1/8"	4.55	8.20	16.39	9.49	24.59	.77 lb.
.150"	5/32"	4.95	8.87	17.75	10.28	26.62	.92 lb.
.187"	3/16"	5.45	9.97	19.94	11.54	29.91	1.15 lb.
.250"	1/4"	6.55	11.74	23.49	13.61	35.23	1.54 lb.
.312"	5/16"	8.10	14.56	29.13	16.87	43.69	1.93 lb.

## A M C SUPPLY

P. O. Box 1440 Fort Worth, Texas  
a division of air accessories, inc.

## \$ RETOOTHING SAWS PAYS BIG \$

EARN \$15.00 HOURLY... as automatic retoothers cut new 4 pt. to 16 pt. rip or cross-cut teeth on hand saws in 50 seconds. Requires less space, less time and less effort... while doing a perfect job. Gives a lifetime of service and has a 1 year guarantee. Free folder on request.

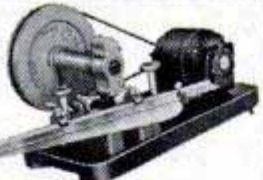

SAW SHOP CHARGES COAST TO COAST

WRITE FOR VALUABLE BOOK Automatic Retoother  
Send 25c in coin for Burr's Blue Book of saw shop charges and other valuable information.

BURR MFG. CO., Dept. 9, 8933 Venice Blvd., Los Angeles 34, Calif.

## HYDRAULIC Power Transmission WITH Infinitely VARIABLE SPEEDS, Clutch and INSTANT REVERSE—OUTPUT TORQUE ADJUSTMENT UP TO 180 inch POUNDS

This positive displacement Hydraulic Torque Converter is the ideal fluid drive with thousands of uses... Output Speeds Infinite .0 to 550 R.P.M. in either direction... Change Speeds WHILE RUNNING... Control and Transmit your power this SMOOTH Oil-Way... Will handle 1/4 H.P. to 1 1/2 H.P. Motor. Industrial or Home & Farm Use... Cost government \$300 High Quality Precision Workmanship. Buy this unit to get the most for your money. Case measures 7 1/2" long 7" high 6 1/2" wide. Input & Output Shafts 5/8" dia. Beautiful Red Crackle-Finish Case.



Shipping Wght. 25 pounds      Only \$54.50

If C.O.D. is requested a 10% deposit must accompany order and we ship F.O.B. Chicago.

1 1/2"-8 thread lathe Chuck Adapter, \$3 extra

Prepaid in U.S.A. 2 quarts oil included FREE

DIRZIUS MACHINE SHOP "F" 1423-25 So. 52nd Ave., Cicero 50, Ill.

## Ball-Bearing SPEED WHEELS



### JUVENILE WHEELS (No bearing, solid tires)

4"	40c	6"	65c
5"	45c	7"	75c

(Semi-pneumatic tire, ball bearing)

8 x 1.25	1.85	10 x 1.25	2.20
8 x 1.75	1.95	10 x 1.75	2.30
8 x 2.00	2.20	10 x 2.00	2.65
12 x 1.75	3.45		

### INDUSTRIAL WHEELS

Lug Base, Semi-Pneumatic tire

5 x 1.75	3.65	10 x 2.00	6.10
6 x 2 SW	3.45	10 x 2.75	5.15
8 x 2.00	4.00	12 x 2.00	6.90
8 x 2.00	5.20	12 x 3.00	9.20
8 x 2.50	5.40	16 x 4.00	15.15

Smooth Base, Pneumatic tire and tube

8 x 3.00	11.00	12 x 4.00	12.10
10 x 2.75	6.80	4.00 x 8	13.10
10 x 3.50	10.55	14 x 4.50	13.40

Dealers, Jobbers, and Manufacturers! Our new prices will interest you.

Available Now—CASTERS Write for circulars on all wheels. No c.o.d. orders. Prices F.O.B. our plant.

## JIM BROWN TOY COMPANY

1093 HOME AVENUE AKRON 10, OHIO



## CAPE COD CHAIRS TRELLISES • ARBORS DUTCH WINDMILLS

Chairs style B-C-A PLANS 50c Ea., all 3 only \$1.00. 12 different trellis designs PLAN of all 12 only 50c. Authentic 40" high Dutch Windmill Detailed PLAN only 75c. Unique 40" high Light-house having copper lantern, ideal for garden or on lake shore of summer home. Large detailed PLAN 75c. SPECIAL ALL PLANS ABOVE \$3.00 VALUE ONLY \$2.50

SEND 10c for catalogue of many fine projects. Dept. P20 CRAFTSMAN'S MODEL CO. DELAFIELD, WISCONSIN

QUICKLY REPAIRS Chipped PORCELAIN NO BAKING required... anyone can repair Stoves, Refers., Sinks, Tubs, etc. Home-Size (up to 3 repairs) 50c; Economy size \$1.50 prepaid. (No C.O.D.'S).

**PORCELENE**  
Dept. M SHEBOYGAN, WIS.

## Have fun! BUILD YOUR OWN CHAMPION

## SPEEDBOAT

Build your own 3 point racing Hydroplane or Runabout! Complete plans available for fastest boats in the world. Send 25c now for new illustrated catalog to CHAMPION BOATS, P. O. Box 7132 M, Long Beach 7, California

## BRUSH PLATING OUTFITS

for re-plating articles in the home and shop. No tanks necessary. Free particulars. GUNMETAL CO., AVE. M, DECATUR, ILLINOIS

## SAY YOU SAW IT IN POPULAR MECHANICS

## MORE STATIONS—LESS STATIC NEW AERIAL INTENSIFIER

## ENDS FADING ON YOUR CAR RADIO OR TV SET

BRILLIANTLY IMPROVED Auto Radio or Television reception. The new Electronic AERIAL INTENSIFIER for greater distance, improved reception, less radio static and clearer, brighter TV pictures. One screw installation, no wires. Sharpens car appearance, too. Send now! Money-Back Guarantee.

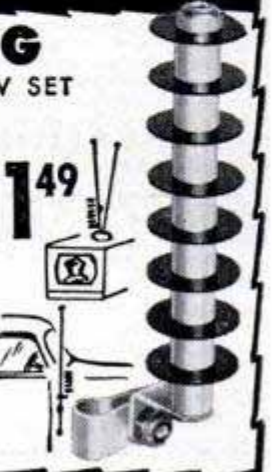

**GAYLORD** Dept. PJ-8  
Fifth & Hamilton, Pittsburgh 6, Pa.  
Send...intensifiers @ 1.49 ea. + 11¢ hndlg.  Check  M. O.  C. O. D.



# Build This 5-Room Concrete Block House Yourself - Complete for less than \$3650

**Popular Mechanics  
Home of the Year**

**Has All These Features**

- ★ Five Finished Rooms plus Bath and Three Closets
- ★ Concrete Block Walls—Poured Concrete Floors—Vapor-Sealed Walls Stuccoed Outside—Fully Plastered Inside
- ★ Complete Heating and Plumbing Equipment and Electric Wiring
- ★ Modern Cabinet Kitchen
- ★ Insulated Ceiling

**Build-It-Yourself Book and Set of Building Plans, Only \$12.50**



**Beat the High Cost of Home Owning!  
No Experience Needed! Follow Book  
and Plans! Save Thousands of Dollars!**

If you can mix a batch of concrete following simple instructions, and saw a board straight you can build this new Popular Mechanics concrete block house yourself. Yes Sir! In a few months of spare time you can laugh at the housing shortage and save several thousand dollars while acquiring a home you will be proud to own.

Like Popular Mechanics' famous Build-It-Yourself frame house introduced in 1947, a new BUILD-IT-YOURSELF BOOK for this five room Concrete Block House is now ready, along with a full size set of building blueprint plans. The book covers every construction detail and the plans are so simplified, so easy to follow, that you need have no experience to do a fine workman-like job. On the other hand, if you want to hire a contractor or an ordinary builder, have him follow these plans and still enjoy a tremendous saving. Read further about this fine permanent type house. See how easy you can build it and own it yourself. Order book and plans on coupon below.



**Start Planning Now!**

**It's Easier Than You Think  
to Own Your Home**

**IDEAL FOR FAMILY OF FOUR**

Popular Mechanics Build-It-Yourself Concrete Block House is 26'-8" deep by 32'-8" wide. It has 675 square feet of comfortable living space — living room, two bed rooms, cabinet kitchen, utility room, bath and three closets. Built in a Chicago suburb, a relatively high price region, in a high price year, its total cost was less than \$3650.00 including all material, heating, plumbing and electrical equipment and outside labor for installing the equipment and plastering all rooms. In many localities it can be built for even less and additional savings can be made by using less expensive bath and kitchen equipment.

**LONG LIFE MATERIALS —  
EASY UPKEEP**

Construction is concrete throughout —poured concrete floors and concrete block walls—both vapor sealed for insulation—construction that requires no special skill. Walls are furred-out and plastered inside, stuccoed outside. Ceiling is insulated. Only a very minimum of carpentry is required—

simple shingled hip roof, door frames and trim, which almost anyone can do. Interior doors are new flush type. Hot air heating plant may be gas, oil or coal-fired. Hot air ducts terminate in ceiling, cold air ducts are tile laid under the floor.

**EASY TO BUILD — EASY TO OWN**

Every part of the construction is simplified and thoroughly explained in the BUILD-IT-YOURSELF Book, from the turning of the first shovel full of earth to the last flick of the paint brush. It is written in plain, understandable terms and packed with pictures and diagrams that make every construction detail simple as ABC. The book also tells how to make your own concrete blocks, how to select and buy a lot and how to build a house of bricks. Book and set of ten working blueprint plans are all you need to get started and enjoy the thrills of home owning, doing the job yourself and saving money too. Book, \$2.00. Set of plans, \$12.00. See coupon for special money-saving offer when both are ordered together.

**USE THIS COUPON TO GET  
BUILD-IT-YOURSELF BOOK AND PLANS**

**Popular Mechanics Press, Dept. 600  
200 East Ontario Street, Chicago 11**

Send postpaid, the items checked. Remittance for

- \$ \_\_\_\_\_ enclosed.
- Build-It-Yourself Concrete Block House Book \$ 2.00
  - Set of 10 Builders Blueprint Plans . . . . . 12.00
  - Book and Plans ordered together (Save \$1.50) . . . . . 12.50
  - Extra sets of plans—each . . . . . 5.00

Name \_\_\_\_\_

Address \_\_\_\_\_

City \_\_\_\_\_ Zone \_\_\_\_\_ State \_\_\_\_\_

# PARTS FOR MILITARY TRUCKS

At Big Savings New FREE Catalog  
For Jeep, Dodge, Chevrolet, G.M.C., Studebaker

Brand New JEEP TOP and CURTAINS  
Fits all Military Jeeps. Also adaptable to Civilian Jeep. **\$49.50**

**TRAILER AXLE**  
Heavy duty trailer axle suitable for many types of trailer construction. Also excellent for building of heavy farm trailers and wagons. It is a 12,000 lb. capacity square type straight trailer axle complete with Timken roller bearings, hubs, and 6 hole 750 x 20 Budd Wheels. Without brakes. Axle is 2 inches square and 69 inches between wheel mounting flanges. Std. width.

With Single Wheels. \$59.50 With Dual Wheels. \$69.50

**NEW STEEL WHEEL With Solid TIRE**  
Complete With Shaft. 12 1/4 x 5 5/8 inch tire size. Shaft size 1 1/4 x 2.165. Equipped with two bearings. Suitable for Trailers, Dollies, Belt Drives and many other uses. Weight 67 lbs. Priced at a fraction of government cost. Each **\$9.95**

**American AUTO PARTS CO. INC.**  
1830 LOCUST—DEPT. PM  
KANSAS CITY, MISSOURI

**HOW To Get MULTIPLE UTILITY When You Buy a SMALL GRINDER**

**BUY THE FOREDOM MODEL 100 FLEXIBLE SHAFT MACHINE**

For \$16.95, no more than most ordinary grinders cost, you get PLUS VALUES galore. With machine (or later) you can buy Drill Press Attachment, for only \$4.95 extra, quickly converting to power drill press, or the B-R-S Attachment, only \$3.50 more, which makes it serve as bench grinder, router and shaper. Pencil-size handpiece gives utmost handling ease—Chuck guard protects fingers, gives sensitive, finger-tip control. Foot Rheostat \$4.85 extra. Motor not dwarfed to fit hand so—more power, longer motor life.

Grind, Polish, Drill, Saw, Sand, Carve, Etch, Clean, Engrave, etc., on all Metals, Wood, Plastics, Glass, Leather, Linoleum, etc.

Since 1922 **FOREDOM ELECTRIC CO., Dept. 1133-E**  
27 Park Place, New York 7, N. Y.



35" Flexible Shaft  
**\$16.95**  
Complete With Motor

MODEL 100

## RUBBER HOSE SALE



Brand new genuine Neoprene Hose—outlasts ordinary rubber 3 to 1. Reinforced with super tough cotton cord piles. Flexible, easy to handle. Easy Flo brass couplings with standard pipe threads for quick connections, included. Pump water for irrigation, stock, tanks, home, barn, fire fighting, etc. Pump Gas or Fuel Oil. Save more than 60%.

(Inside Diam.) 1 1/4 in. 1 3/4 in. 1 1/2 in.  
Length 25 ft. 40 ft. 30 ft.  
Price \$8.75 13.75 13.75

If specified we will send special hose for gas or oil at same prices.

## HYDRAULIC HOSE

High pressure, heavy duty, complete with swivel fittings. Pipe thread connections. Any length desired. Minimum order \$2.00.

INSIDE DIAMETER  
1/4"—40c per ft., 3/8"—50c per ft., 1/2"—70c per ft., 5/8"—90c per ft.



**EXTENSION CORD** 40 ft. heavy duty, insulated No. 14 2-conductor wire. So tough that you can drive over it and yet amazingly flexible and easy to handle. Resists oil, grease or water. Extend electricity up to 400 ft. without voltage drop. Use indoors or out. Complete with heavy rubber plug and outlet. Wt. 2 1/2 lbs. Usually \$4.50—Special 40 ft. **\$1.95.** Comb: 2-40 ft. and 1-20 ft. (total 100 ft.) **\$4.75.**

All prices f.o.b. Chicago area. Satisfaction guaranteed. Send ck. or M.O.  
**MASTER MECHANIC CO., Dept. 29, BURLINGTON, WIS.**

MAKE A "Stradivarius" **VIOLIN**  
—For Pleasure  
—For Profit  
—For Your Own Use

BOOK AND PLANS ALL YOU NEED

You Can Do It at Little Cost! It's Easy! It's Fun!

Here is the "tops" of all home crafts projects. Make a violin—a replica of a famous "Strad"—the original of which sold for \$80,000.00. Joe Reid who has made hundreds of fine violins makes the job so easy—so inexpensive—in his new book "You Can Make a Stradivarius Violin." You don't need any tools. Reid shows you how to make all the tools you need from old table knives, worn out files, sheet metal, etc. Eight full-size plans, 16x23 inches, folded into the book give you every detail in actual size.

**Violins Bring High Prices**  
Make a violin and you probably will never want to sell it. But good tone modern violins bring terrific prices, yet the materials cost comparatively little. With Reid's plans and step-by-step instructions you can make such a violin for yourself. 15 chapters guide you in selection of wood, fashioning the belly, back, sides, mold, lining, neck, scroll, purfling. Other chapters cover varnishing, finishing, stringing. Others show how to make tools and clamps at little or no cost.

**Order Book Today. Money Back if Not Satisfied.**  
Make your own violin for pleasure or profit. Get book and plans now. Clip this ad and mail with check, money order or cash for only \$3.50 or we will send C.O.D. Money back in 5 days if not satisfied.

**POPULAR MECHANICS PRESS** Dept. 750  
200 E. Ontario St., Chicago

**AUTO RACING TRAILER Coaches**

Four Books Every Fan Needs

Famous for authoritative, detailed information on auto racing, every type of race car, rules, specifications, working drawings, plans, etc. No duplication. Every book different. Money back if not satisfied.

## AUTO RACING • 6th Edition TRAILER COACHES

Championship cars, big cars, midgets, roadsters, Offenhauser dirt track car. Specifications on Indianapolis cars, four-wheel drive details, front drive drawings, etc. Plans for Ford 60 midget, roadster racer. Data on engines, gear boxes, friction and dog clutches, axle ratios, compression ratios, independent suspensions. Indianapolis rules and regulations, etc. More than 100 illustrations. \$2.00.

By Ray F. Kuns. Contains information on the history of trailers, trailer parks and camps; materials, furnishings, trailer chassis, engineering, etc. Construction data on 10, 16 and 22 foot trailers which you can build yourself. 100 illustrations. \$1.50.

## AUTO RACING • 4th Edition

Includes eight working drawings and complete building instructions for standard midget racers, drawings for midget road cars, Miller-Ford V8 front-drive racers are illustrated and described and other big-time data given. Technical pictures give the inside dope on these cars, together with authentic descriptions. 50 pages. 66 illustrations. \$1.00.

## ORDER ON COUPON

**POPULAR MECHANICS PRESS, Dept. 350, 200 E. Ontario St., Chicago**  
Remittance for \$\_\_\_\_\_ enclosed. Send books checked, postpaid.  
 Auto Racing, 6th Edition  Trailer Coaches  
 Auto Racing, 5th Edition  Auto Racing, 4th Edition  
 Send C.O.D., postage extra.

NAME \_\_\_\_\_  
ADDRESS \_\_\_\_\_  
CITY \_\_\_\_\_ ZONE \_\_\_\_\_ STATE \_\_\_\_\_

# Manufacturing Opportunities in Concrete Products Industry

The great building industry is your profitable market for masonry products. Low investment... high returns... wide-open opportunity to establish a lifetime business. The biggest building years in the nation's history are just beginning. New construction, involving billions of dollars, means huge demands for block, drain tile, and other masonry products which YOU can manufacture locally, from local materials with local labor for local consumption. Remember, MASONRY products mesh with today's demands.

Use our modern machines and equipment to insure the finest quality products at pared-to-the-bone manufacturing costs. Sold direct. Backed by 40 years of manufacturing. Write for catalog. Gives prices and full information.

**CONCRETE EQUIPMENT CO.**  
512 Ottawa Ave., Holland, Mich.



## Big Savings on Quality Ball Bearing Wheels

6 x 1.50.....	1.50	10 x 2.00.....	2.45
8 x 1.75.....	1.80	10 x 2.75.....	4.65

Take advantage of these big savings on quality ball bearing wheels. Every wheel has the Bilt-Rite guarantee. 10 Day RETURN PRIVILEGE. WRITE FOR PRICES ON OTHER SIZE WHEELS.

**BILT-RITE WHEEL CO.** Missouri Ave. and Cherry St.  
KANSAS CITY 6, MISSOURI



## "WOVEN-Gards"

BETTER

### Hand Protection at Amazing Low Cost

"Woven-Gards" are hand protectors, mitts, pads and sleeves made out of a wholly new safety material to provide flexibility, comfort, resistance to abrasion and cutting far beyond that of anything used before. They are extremely oil-absorbent for excellent handling of oily, slippery sheets and slabs. The porous weave makes them the best "hot" handlers ever offered. Thousands of enthusiastic users say they have never seen values like "Woven-Gards," best protection at lowest cost. Send now for descriptive folder and prices.

**INDUSTRIAL GLOVES CO.**  
1411 Garfield St., Danville, Ill.  
(In Canada: Safety Supply Co., Toronto)



## New Riding BUZZ MASTER



8 1/2  
H.P.

Now! Clear land easy! Stop walking... ride in comfort. New sulky fits all 3 larger Buzz Masters. Makes cutting brush or mowing pleasant. Easy to handle, attach and take off. Ride to and from your work. Coil spring gives smooth ride even on rough ground. Ottawa Buzz Master clears ground of brush, saplings, undergrowth fast and easy. Adds profitable acres. Big demand working for others in off seasons. Outdates all other land-clearing machines. 7 other models. FREE details. Write today!

**OTTAWA MFG. CO., 1-027 Walnut St., Ottawa, Kansas**

# CHECK CHUCK!

This **"WESTCOTT 75"** The New

THREADED FOR DIRECT ATTACHMENT TO  
1 1/2" — 8 THREAD LATHE SPINDLES — NO  
ADAPTER REQUIRED

Here's a new type quick-acting WESTCOTT Universal Chuck which combines the speed of a lever-operated chuck with the powerful grip of a pinion-operated chuck. Cuts down chucking time when used on a lathe and can be used advantageously on a milling machine dividing head with 1 1/2" — 8 thread spindle. When mounted, it can also be bolted to the table of a drill press, milling machine or bench. PRICE only \$25.75 delivered. Threaded mounting plate \$2.85 extra.

Always demand dependable WESTCOTT CHUCKS, famous since 1872. Independent, universal, threaded 1 1/2" — 8, 1" — 10, 1" — 12, or with adapter recess. Other chucks to 16" diameter.

Write for  
**FREE**  
literature.  
No obligation.



**WESTCOTT CHUCK CO.**  
3600 WALNUT, ONEIDA, NY



## SAVE 2/3 COST

Assemble It Yourself.

We Furnish the Parts.

Build a boat by the Welch system. Complete plans and boat parts ma-

chined ready for assembly. Rowboats to Cruisers. Send 25c for illustrated catalog.

**MIDWEST BOAT CO., Dept. M** MEMONONE FALLS, WISCONSIN



**FEDCO**  
*Saw-Rite*  
Fits any  
1/4" drill

get this

## WONDER-WORKING DRILL SAW

FINEST YET MADE... ZIPS THROUGH  
WOOD, PLASTICS, WALLBOARD, ETC.

You'll never use a hand saw again after you try this light-weight, fast-cutting beauty. Careful design, rugged, precision manufacture and a better blade make this an outstanding buy. Quick-acting, worm-drive, patented clamp gets it on and off your drill in seconds. Combination blade is chrome nickel alloy steel, precision ground, correctly heat treated, balanced and fitted. Cuts grooves, dados, crosscut, rip, hour after hour without sharpening. Depth of cut fully adjustable from 1/8" to 1 1/2", cuts plywood, shelving, wallboard, 2x4's to 2x10's in two cuts, one from each side. Special sighting notch enables you to follow line. Lifetime Oilite bearings, finest quality hardened steel gears, shafts. One or two hand operation with hand-fitting knob. Use coupon to order at once for immediate delivery. Try it for 10 days, full refund if not completely satisfied.

Fedco also makes Saw-Rite Jr. at \$6.95 and Stanzell at \$2.95... ask for FREE literature.

**FEDCO \$9.95**  
*Saw-Rite*  
Attachment

COMPLETE WITH COMBINATION BLADE

**ELECTRO SPECIALTY CO.**

128 Church Street, N. Y. 7, N. Y.

Electro Specialty Co., 128 Church St., N. Y. 7  
Send me \_\_\_\_\_ Saw-Rite #600 Saw Attach-  
ment(s) @ \$9.95; \_\_\_\_\_ Additional blades  
@ \$2.00; \_\_\_\_\_ metal cutting blades @  
\$3.00; \_\_\_\_\_ FREE literature.  
(Write name and address on margin)  
(All prices postpaid except C.O.D.'s)



and CAPEWELL'S Exclusive  
"Statistical Quality Control"  
Brings You a 10% Sawing Bonus

Capewell's exclusive "Statistical Quality Control" raises standards and eliminates sub-standard hack saw blades . . . assures you a bonus of 10% extra cutting.

The printed blade—another Capewell exclusive—carries instructions right on the blade for correct use.

When buying hack saw blades and frames, band saws (in coils or welded), Daffles, ground flat stock, compass and keyhole saws and hammers, always ask for Capewell.



THE CAPEWELL MFG. CO. Dept. 99, Hartford 2, Conn.

### 110V/220V TRANSFORMERS



#0574, NEW. Input 110V/220V AC. Output 18V, 100 amps. Perfect for building your own electric welders, quick battery chargers, etc. Primary leads 26" long. Secondary leads 18". Size 7 $\frac{3}{4}$ x5 $\frac{1}{2}$ x6 in. Mounting brackets. Wt. 40 lb. Original cost \$32.50  
**OUR LOW PRICE . . . \$11.75**

TRANSFORMER, #215, NEW. Input 110V AC. Output 24V, 20 amps. Suitable for running 24V aircraft motors, etc. Mounting brackets. Size 4x4x5 in. Wt. 7 $\frac{1}{2}$  lb.  
**OUR LOW PRICE . . . \$4.65**

TRANSFORMER, #306, NEW. Input 110V AC. Output 12V, 15 amps. Mounting brackets. Size 3x3 $\frac{3}{4}$ x2 $\frac{1}{2}$  in. Wt. 3 lb.  
**OUR LOW PRICE . . . \$3.25**

TRANSFORMER, #1940, NEW. Input 110V AC. Output 11V, 15 amps. Mounting brackets. Size 4x2 $\frac{3}{4}$ x3 in. Wt. 3 lb.  
**OUR LOW PRICE . . . \$2.95**

TRANSFORMER, #506, NEW. Input 110V AC. Output 15V, 35 amps. Mounting brackets. Size 4 $\frac{1}{2}$ x3 $\frac{3}{4}$ x3 in. Wt. 6 $\frac{1}{2}$  lb.  
**OUR LOW PRICE . . . \$3.95**

TRANSFORMER, #2764, NEW. Input 110V AC. Output 17-18-19V, 20 amps. Mounting brackets. Size 4x3 $\frac{1}{4}$ x3 $\frac{1}{4}$  in. Wt. 5 $\frac{1}{2}$  lb.  
**OUR LOW PRICE . . . \$4.65**

TRANSFORMER, #4292, NEW. Input 110V AC. Output 6V and 16V. Amps: 15 at 16V; 5 at 6V. Frame has bolt holes for mounting. Size 3" sq. Wt. 2 $\frac{1}{4}$  lb.  
**OUR LOW PRICE . . . \$3.50**

DC AMMETERS NEW. 0-20 amps. 1 $\frac{3}{4}$ " face. Wt. 4 oz.  
**OUR LOW PRICE . . . 75c**

ORDER FROM THIS AD! All prices F.O.B. St. Louis, Mo. Include postage with cash, bank draft, or money order. MONEY BACK IF NOT SATISFIED!

MAIN SURPLUS & SUPPLY CO., Desk M-9  
11 South 3rd St., St. Louis 2, Mo.

### RHEOSTATS



NEW. Made for heavy duty use with Air Force heated clothing. Ideal for regulating voltage on generators, soldering irons, electric welders, lights, photoflood lamps, etc. Rated 24V, 100 watts, dual female 25 amp, 125V receptacles. Size 7x5 $\frac{1}{4}$ x1 $\frac{3}{4}$  in. Wt. 2 lb.  
**OUR LOW PRICE . . . \$1.95**

OHMITE RHEOSTATS — NEW Type D-1, 50 ohms. Max. amps. 0.75-0.25 Will mount on panels up to 3/16" thick. 1 $\frac{3}{4}$ " dia., depth behind panel, 1 $\frac{3}{8}$ ". No knob furnished. Wt. 5 oz.  
**OUR LOW PRICE . . . 75c**

RHEOSTATS — NEW Hardwick-Hindle. 35 ohms. Will mount on panels 1/4" thick 1-9/16" dia., depth behind panel, 1 $\frac{1}{8}$ ". Wt. 5 oz.  
**OUR LOW PRICE . . . 75c**

RESISTOR #B306063, NEW 125 ohms. 150 watts. Wire wound on porcelain core with vitreous enameled coat. Includes slider and mounting brackets. Size 4 $\frac{3}{4}$ x1 $\frac{1}{2}$ x1 $\frac{1}{4}$  in. Wt. 4 oz.  
**OUR LOW PRICE . . . 35c**

RELAY, #B45A982, NEW Compact, rugged. Potter-Brumfield relays. 24V, 6/8 amps. DC. Single coil, double throw-in, silver contacts. 6 terminals. Size 2 $\frac{1}{4}$ x1 $\frac{1}{4}$ x1 $\frac{5}{8}$ " high. Wt. 6 oz.  
**OUR LOW PRICE . . . 75c**

### SPOT LIGHTS

NEW. Overall length, 8 $\frac{1}{4}$ ". Ideal for windows, store displays, signs, etc. Has ball joint, off-on toggle switch. Heavy brass base. 110V/220V. Less bulb and cord. Wt. 2 $\frac{1}{2}$  lb.  
**SPECIAL . . . \$1.25**



## FURNITURE for YOUR BEDROOM

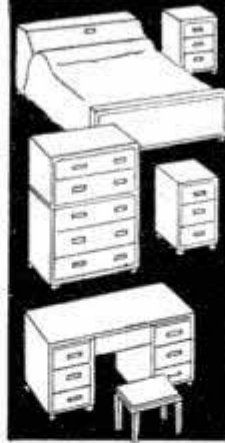

SAVE MONEY, be the envy of your neighbors by making this beautiful bedroom suite yourself! Only a power saw and jointer are needed to turn out this smart suite, featuring bed with storage space, three-piece vanity with cosmetic compartment and makeup mirror, Mr. and Mrs. dresser, and twin night stands with drawers. Letters demanding detailed plans poured in after this furniture was pictured in Popular Mechanics Magazine. Now the 4 plans are ready—easy-to-follow scale drawings—and they're yours for only \$2.00! Send for a complete set today.

POPULAR MECHANICS PRESS  
200 EAST ONTARIO STREET, CHICAGO 11, ILL.



Wherever you drive be SURE at each turn with a HULL AUTOMOBILE COMPASS

A glance tells you the right way to go at every turn. The only automobile compass with 16 years' proof of accurate service despite road jolts and magnetic interferences. At your dealer's or write for circular.

Beaconlite  
Illuminated \$5.95  
Streamline  
standard \$3.95

HULL MFG. CO., P. O. Box 246-D9, Warren, Ohio



\$2.95 EACH

## NOW! FILE YOUR OWN SAWS

Do expert saw filing at home. Precision filing easy without experience. Two simple adjustments. Keeps any hand saw extra sharp and true-cutting. Complete with file. Money back guarantee. Cash with order, prepaid. (COD postage extra.) Order today. \$2.95.

ANOTHER SPEEDCOR TOOL

THE SPEED CORP. PM-9  
512 N.E. 73 Ave., Portland 16, Oregon



## Clark EXPANSIVE BIT

CUTS BETTER • COSTS LESS! Accurate, fast; cuts smooth holes in hard or soft wood Chrome vanadium steel blades, all chrome body No. 250, 1/2"-1 1/2", \$1.69; No. 251, 1/4"-3" \$1.89 GUARANTEED At your dealer or write  
★ ROBERT H. CLARK COMPANY Beverly Hills, Calif.

## STOP FUEL PUMP TROUBLE! BUY MIRACLE AIR LINK

Attention!  
FORDS!  
MERCURYS!  
LINCOLNS!

ON 30 DAY TRIAL!

Sensational AIR LINK Dual Purpose Fuel Pump must end breakdowns, carburetor flooding & vapor lock or YOUR MONEY BACK! Guarantee 2 yrs. or 50,000 mi. No metal parts to wear out—wipes never failer. Install yourself on Ford V8 cars, trucks & Mercurys 1934-50; Lincolns 1934-48 (exc. 60 hp). Price incl. 1mp. push rod. State year, make of car.



ORDER \$9.95 Send cash, check, M.O. PPD or C.O.D.  
MARCO AUTO SUPPLY • 4951 Broadway, Chicago 40, Ill.

## SAVE ALMOST HALF!

### PRECISION MAUSER-TYPE VERNIER CALIPER

Does your work or hobby demand highly accurate measurements? This caliper has the world-famous precision of the former Mauser firm of Germany. Measure to 1/1000 of an inch and 1/20 mm. Use it for outside and length, inside, thread, depth measurements. Over-all length is 8", graduated to 6". Easy-to-use hand-operation with positive-action release. All chrome steel. Get it at almost half-the-price of comparable tools because of new full scale production. Order yours today while our U. S. supply lasts.

Prepaid with your check or money order. Money back guarantee.

ONLY \$14.75 leatherette case.

Dealer Inquiries Invited

GLOGAU & CO., INC.

1900 W. Birchwood, Chicago 26, Ill.

F.O.B. Chicago, C.O.D.



**A MUST FOR EVERY FARM FAMILY!  
 SAVES MONEY FOR HOME OWNERS  
 A PRICELESS GIFT TO SEND TO  
 A FAMILY ON THE FARM!**

**Farm Help That Works  
 Every Day in the  
 Year For  
 Only \$3**

*A Thousand and  
 One Ideas You Can  
 Use on the Farm!*

Popular Mechanics Farm Manual is packed with practical ideas and usable information that can easily be worth hundreds of dollars to every farm family and to home owners everywhere. Here are a few of the things it covers:

**Farm Machinery and Implements**

How to make tractors, scoops, scrapers, cordwood saws, buckrake, power driven elevator, "Farmette" — odd job tractor, hoists, dump trucks, spreaders, seed-grain duster, posthole auger, etc.

**Farm Workshop Equipment and Repairs**

Welding on the farm, soldering, workshop power saws, home built air compressor, small shop forge, workbenches, curing gas engine troubles, hydraulic rams, drive your own wells, etc.

**Poultry and Livestock**

How to build poultry houses, incubators, brooders, at low cost, feeding, stock care hints, hog care gadgets, etc.

**Vegetable Storage — Processing**

All-winter vegetable storage, preparing food for home-freezer storage, how to make your own home freezer, charts, guides.

**Farm Home Improvement**

Fencing, repairing electrical appliances, plumbing, electrical wiring, saving coal, painting, curing leaky basements, hanging wall paper, making garden tools, garages, working with concrete, painting, etc.

**Farm Hints and Kinks**

Forty pages of illustrated practical ideas, short cuts, etc., that will save time, labor and money around every farm and city home.



**POPULAR MECHANICS**

**FARM  
 MANUAL**

**Use This Book to Step up Farm Efficiency—  
 Increase Farm Production—Improve Farm  
 Appearance—Save Time, Labor, Money!**

This is the book that thousands of farmers and home owners have waited for. It is the experience of hundreds of successful operators brought together in one handy, easy-to-read, easy-to-use, working handbook by the editors of Popular Mechanics. It is brimful of short cuts, labor-saving ideas, ingenious apparatus and methods that will simplify the day's work and lighten some of the more tedious chores, make money and save money for you.

**284 FACT  
 PACKED PAGES  
 •  
 HUNDREDS OF  
 ILLUSTRATIONS  
 •  
 FULL SIZE  
 Library Binding**

**HELPS IN THE FIELD — IN THE BARN — IN THE HOME**

Every department of the farm is covered in the Farm Manual. Every member of the family will find in it something that he or she can use to tremendous advantage in farm operation, maintenance and improvement, from the building and care of equipment to painting the farm home and fast freezing fruits and vegetables. It covers all farm buildings, the farmhouse and other homes and is of interest equally to the woman looking for home improvement, beauty and convenience and the man striving for easier and more profitable operation.

**ORDER TODAY — FOR YOURSELF — FOR A GIFT**

Use the coupon below. Mail it today. Book will be sent at once, post-paid if you include payment with your order. If you don't think the Farm Manual is worth even more than you paid for it after five days' use, send it back by mail and your money will be refunded. This may be the best investment you ever made. Rush coupon today.

**MAIL COUPON • Money Back if Not Satisfied**

Popular Mechanics Press, Dept. 49C  
 200 East Ontario St., Chicago 11, Ill.

- Send \_\_\_\_\_ copies of the Farm Manual at once.  
 Remittance (\$3.00 each) enclosed. Send postpaid. Add 15% if outside U.S.A.  
 Send C.O.D. (\$3.00 each) plus delivery charges. U.S.A. only.  
 (If sent as a gift to another, send name and address on separate sheet.)

Name \_\_\_\_\_  
 Address \_\_\_\_\_  
 City \_\_\_\_\_ Zone or Route \_\_\_\_\_ State \_\_\_\_\_

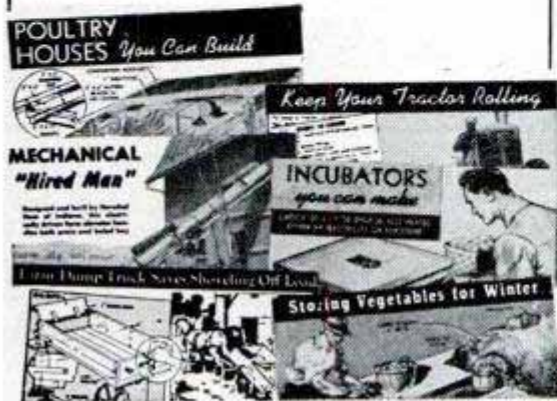

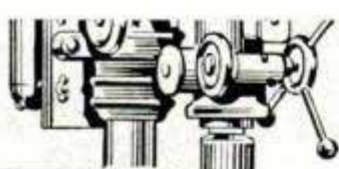

# Handy Flexible SHAFT

With 1/8 Inch Adjustable Chuck

Converts any motor, drill press, electric drill, electric fan (10 inch or larger) into a handy rotary tool.

Attach ROTA-SHAFT in a jiffy. Use for grinding, polishing, sharpening, cleaning, engraving, making tools, carving on metal, plastic, wood, leather, glass. Handles tools from zero to 1/2 inch diameter. 40-inch overall length. Complete with buff and sanding disc ready to use in a drill press chuck. **ORDER TODAY!**

**ONLY \$3.95**



**SEND NO MONEY!** Mail your order. Pay postman only \$3.95 plus postage on delivery. Try 10 days — if not delighted return for money back. For use on motor—35c extra for Special Coupling. Give exact size of motor shaft diameter.

**STRADER PRODUCTS CO., Dept. W-101**  
259 Strader Ave. Cincinnati 26, Ohio



# YOU CAN MAKE THESE WITH POPULAR MECHANICS PLANS AND BLUEPRINTS

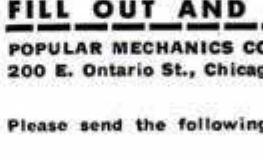
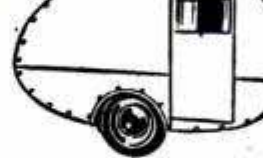
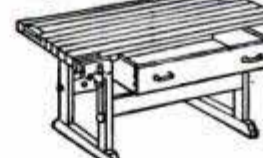

- 501—Colonial Grandfather's Clock .25c
- 507-508—Doll-House, 5-Rooms, Open staircase, fireplace . . . . .50c
- 526—Queen Anne Coffee Table . . . . .25c
- 528—True replica of antique . . . . .25c
- 528-30—Duncan Phyfe Console Table: 30 in. high . . . . .25c
- 529—Lawn Chair: Southern style . . . . .25c
- 593—Three Attractive Corner Shelves: Scroll-sawed . . . . .25c
- 596—Three Hanging Type Shelves: Hold books, china, etc. . . . .25c
- 661—Rocking Horse: Scroll-sawed from plywood . . . . .25c
- 707—12 Ft. Rowboat: Flat-bottom, four seats . . . . .25c
- 795—Two Handsome Cedar Chests .25c
- 811-812—16 Ft. Canoe: Canadian type, cedar planking . . . . .50c
- 813-814—Pop-Outboard Racer: 10 ft. long, stepped bottom . . . . .50c
- 828-835—Sovereign of the Seas: English warship model . . . . . \$2.00
- Sovereign of the Seas: Instruction Book . . . . . \$1.00
- 836—12 In. Bandsaw: Uses plywood, cuts two in. stock . . . . .25c
- 839—Melrose Corner Cabinet: Old Colonial design . . . . .25c
- 846-848—Governor Winthrop Desk: True copy of original . . . . .75c
- 896-897—Three Easily Made Workbenches—Simplified construction .50c
- 906-908—Midget Auto: 58 in. wheelbase, 1/2 to 3/4 h.p. . . . . \$1.00
- 910—Circular Saw Table: Hardwood, 24" x 36", Stationary . . . . .25c
- 917—Outdoor Fireplaces: Several simple but practical . . . . .25c
- 920-922—Lawn and Garden Furniture: Swings, arbors, tree seat . . . . .75c
- 923—Indoor Fireplaces: Standard Sizes . . . . .25c
- 926-927—Venetian Blinds: Three different styles . . . . .50c
- 930—Hooked Rug Frame—Quilting Frame . . . . .25c
- 933—Cape Cod Cupboard: 4 ft. wide, 5 ft. 8 in. high . . . . .25c
- 935—Knee-Hole Desk: 40 in. long, 30 in. high, 31 1/2 in. wide . . . . .25c
- 936—Modern Coffee Table: 24 in. long, 15 in. wide . . . . .25c
- 952—Child's Crib in Maple . . . . .25c
- 958—Colonial Corner Cupboard: 6 ft. 8 in. high . . . . .25c
- 961—Hanging China Cabinet: 38 in. long, 40 in. high . . . . .25c
- 969—Combined Chest and Writing Desk: 35 1/4 in. high . . . . .25c
- 970—Modern Clothes Chest: Built of Plywood . . . . .25c
- 977—Bookcase in Chippendale Style: 47 in. high, 10 in. wide .25c
- 978—Lawn Chair on Wheels: Lightweight, easy to wheel . . . . .25c
- 981—Colonial Wall-Shelf: 30 in. high, 19 in. wide . . . . .25c
- 984—Duncan-Phyfe Drop-Leaf Table: Reproduction of historic piece .25c
- 986-987—Utility Trailers: Built of old auto parts . . . . .50c
- 989-990—Speedy Motor Scooter: Gas engine, 40 to 60 miles on gal. of gas . . . . .50c
- 991—Gun Cabinet: Handy cabinet includes rack for rifles . . . . .25c
- 993—Twin-Deck Beds: 6 ft. 4 in. long, 31 1/2 ft. wide . . . . .25c
- 1106-1112—SEACRAFT—25 FT. CABIN CRUISER: Adaptable as sport fisher, express cruiser, or utility boat. Cruises at 15 knots with marine engine or converted auto engine. Cabin sleeps four. Galley has fresh-water tank, sink, and cook stove. Set of seven large-sized blueprints scaled 1 in. per ft. plus 40-page two-color illustrated booklet, only . . . . . \$10.00
- 1011—Fireplace Fittings: Andirons, log rack, etc. . . . .25c
- 1080-1081—Banta: 12 Ft. Plywood Runabout: Vee-Bottom, 3-passenger . . . . .50c
- 1086—Black Forest Corner Shelf: Scroll-sawed . . . . .25c
- 1089-1090—Home-Constructed Freezing Unit: reaches 30 degree temp. . . . .50c
- 1091-1096—17 ft. trailer, 7 ft. wide. Steel chassis . . . . . \$1.50
- 1102-1105—Midget Trailer: "Tear-drop" body. Sleeping quarters for two . . . . . \$1.00
- 1113-1114—Gold Rush of '47: The A.M.A. Open Class B Record Holder Plane Model . . . . . \$1.00

**BEAUTIFIES**  
natural wood,  
pine paneling

**POLISHES**  
furniture,  
woodwork

NET CONTENTS ONE QUART

SUPERTREATED  
**Pol-mer-ik**  
**LINSEED OIL**  
FOR BETTER PAINTING

ARCHER DANIELS-MIDLAND COMPANY

AND 101 HANDY HOME USES

**IMPROVES**  
paint jobs

**PROTECTS**  
wood and  
metal surfaces

**49¢ 89¢**  
PINT QUART

**101 HANDY HOME USES!**  
Every home, every workshop, needs Pol-mer-ik BOILED Linseed Oil. Free folder tells you how to use it. Write . . .

ARCHER-DANIELS-MIDLAND CO., Minneapolis 2, Minn.

## VENETIAN BLIND KITS

**SAVE AS MUCH AS 50%**

- Assemble your own custom made Venetian Blinds. Complete Kit takes only a few minutes . . . so simple anyone can assemble it.
- **NO EXTRAS TO BUY!** You get beautifully finished aluminum slats, all holes drilled, all hardware, screws, tapes, and cord, tilt, bottom rail, etc. You need only a hammer and screwdriver! Available only by mail from the largest manufacturer of Venetian Blind Kits.

**RUSH COUPON TODAY!**

Flexelite Manufacturing & Supply Co.  
Dept. PM950 — 366 Wilson Ave., Brooklyn 21, N. Y.

Please send literature and Prices.  
 Enclosed find 25c coin for 14 Slat and 14 Tape Samples.  
 Please send dealer information     Salesman Information

Name \_\_\_\_\_  
Address \_\_\_\_\_ City \_\_\_\_\_ State \_\_\_\_\_

### FILL OUT AND MAIL THIS COUPON NOW

**POPULAR MECHANICS CO.**  
200 E. Ontario St., Chicago 11

Please send the following plans \_\_\_\_\_

\_\_\_\_\_ I am enclosing \$ \_\_\_\_\_

Name \_\_\_\_\_

Address \_\_\_\_\_



# LOOK at these Surplus Bargains from ATLAS!

## Continental GAS ENGINE

Brand New, 1 1/2-2 hp 4-cycle with 6 to 1 reduction gear. \$76 value, only.... **\$39.95**



**Famous New "Wasp" ELECTRIC MOTOR**  
Aircooled. Fractional hp AC 110 V. motor with reversible switch. Ideal for Hobbyists. Regularly sold for \$8.95. Special, each **\$4.95**



## MICROMETERS —PRECISION

Made by nationally known manufacturers to give a lifetime of accurate detailed service.

1" Central Tubular, also ideal for tubing..... **\$3.75**  
1" Reed..... **\$5.25**  
2" Central..... **\$5.95**  
5" Central..... **\$7.00**  
6" Central..... **\$7.75**  
Inside Mic. 0-1" McGrath **\$4.95**

Also Millimeter Mikes



## NEW DESK LAMP

Regular \$12.50 value, adjustable. A real buy, **\$5.95** only.....

## PORTABLE COMPRESSOR

1 1/2 hp gasoline-driven, air-cooled Bendix-Westinghouse; 2 air hoses included. Displacement, 4 cubic feet per minute. Wheelbarrow type. Rebuilt, guaranteed.....



**\$99.50**

All Prices FOB, K.C. No COD's. Send chk. or M.O. for immediate shipment.

### ATLAS EQUIPMENT CO.

229 S.W. Blvd., Dept. P.M.9  
KANSAS CITY, MO.



## EASY TO INSTALL LOW-COST TELEPHONE SYSTEMS

Save Time & Steps With ARMY FIELD

## TELEPHONES & WIRE

### Ring and Talk Any Distance Up To 17 Miles!

Hundreds of uses around ranches, industrial projects, anywhere. You can install Field Telephones and have communication in a matter of minutes. They'll save you time and work which means money. Walking or driving short distances to talk is unnecessary. Just string this low-cost, 2-conductor, weatherproof wire, attach to phone terminals and you just ring and talk. Simple as that. You can use from 2 to 8 phones—any number you may require—on the same line for a complete inter-com system. Performance guaranteed to equal present day commercial telephones. Powered by flashlight cells. No maintenance required.

### ACT NOW NEW LOW PRICES ORDER TODAY

W110B 2-CONDUCTOR, TWISTED PAIR, WEATHERPROOF FIELD TELEPHONE WIRE—NEW, unused, excellent condition.

NEW, unused, good serviceable condition.....

PER MILE (wt. 160 lbs.) **\$13.50**

PER MILE **\$10.50**

Write for FREE FOLDER Telephone Specialties

1/2 MILE (wt. 80 lbs.) **\$7.00**

1/2 MILE **\$5.50**

Send check or money order

LORIS SALES P. O. BOX 1896-B9 SACRAMENTO, CALIF.

**E88 FIELD TELEPHONES**  
Factory Reconditioned — New  
Each **\$15.00** Per pair **\$29.50**  
Used, excellent condition  
Each **\$10.00** Per pair **\$19.50**  
All prices FOB Sacramento. No C.O.D. (Calif. residents add 3% for sales tax.) Small orders sent postage collect, heavy orders freight.

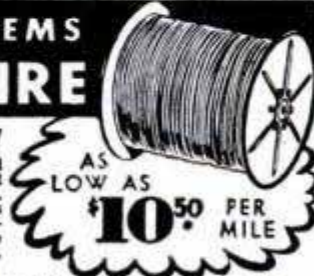

AS LOW AS **\$10.50 PER MILE**

## HEY, DON'T SAW IT... CUT IT!

### IN-A-VISE CUTTERS

are sturdy and long-lasting. Blades are tough, high-grade carbon vanadium **TOOL STEEL**. Replacement Blades available.

Unlike many items, this cutter is made to do the work, not just to sell.

**MONEY-BACK GUARANTEE**

U.S. Pat. No. 2288998

## with the New, Revolutionary IN-A-VISE CUTTER

Saves time, labor and money . . .

Here's a handy new tool that saves valuable shop time! Mechanics everywhere like its quick, practical operation. Replaces many functions of the ordinary hacksaw . . . will cut bolts, rods, bars and high tensile steels up to and including 3/8" dia., fast and clean. Use in any average bench vise. Place cutter in center of vise jaws. Place article to be cut between blades at direct right angle as illustrated at left. Tighten vise jaws.

**ORDER NOW — Postpaid . . . . . \$2.95**  
(No C.O.D.—Calif. Sales Tax, 9c)

**IN-A-VISE CUTTER COMPANY, 215 So. Pacific Avenue, Dept. PM9, Compton 1, Calif.**

## HELPFUL BOOKS

Send post card asking for FREE catalog

Popular Mechanics Press, 200 E. Ontario, Dept. 601, Chicago 11

## Reduce RADIO NOISES

**NEW CLEAR-TONE LINE-NOISE ELIMINATOR**

**Simply Plug** Radio or Appliance cord into Noise Eliminator & plug into wall socket. Enjoy reception FREE from many distracting noises. Send No Money, pay postman \$1 ea. (2 for \$1.75) plus postage or send cash & we'll mail postpaid. Try 5 days, money back if not delighted. Merit Sales, 2256 Orchard St., Dept. J-30, Chicago 14, Ill.

## TAKE 3-DIMENSIONAL PICTURES WITH YOUR OWN 35 MM CAMERA

**STEREO-TACH** **\$17.70**

NOW ONLY (Outfit No. 101, was \$22.50 plus tax) Plus \$2.09 Fed. Tax

and 3-D slide viewer. Make marvelous color or bl. & w. slides. Get Stereo-Tach from your dealer or direct. Money back guarantee.

Dept. PM9, ADVERTISING DISPLAYS, INC., Covington, Ky.

## ATTENTION! CRAFTSMEN! HOBBYISTS!

THE SENSATIONAL NEW **MINISAW**

Now . . . the only miniature circular saw that actually does many things a big saw can do . . . and more! Most amazing practical home utility and light repair tool you ever saw! 3" circular blade cuts wood, soft metal and plastic up to 1" deep and at any angle up to 45°. Easy to attach. Fits Black & Decker and Skilsaw stands. Complete with attachments and tilting saw table.

Only..... **\$10.95**

Complete with saw and sander attachments.... **\$12.95**

Black & Decker—Skilsaw Dealers—Write for amazing offer. SPECIFY MAKE OF STAND WHEN ORDERING

Send check or Money Order to Dept. E

**CLAYTON DIST. & MFG. INC.**  
12548 VENTURA BLVD., NO. HOLLYWOOD, CALIFORNIA

BY APPOINTMENT



TO THE AMERICAN PUBLIC



In some countries products are endorsed by the Crown, and bear the arms of the royal family. That gives them prestige which stimulates sales.

But in democratic America our products are endorsed solely by the approval of the American people, and are identified by brand names and trademarks that have won esteem the hard way.

Here a product must stand on its own feet and fight to survive in the intense rivalry of the market place.

Here there is no easy road to popularity or leadership—no suggestion from government as to what you shall buy or what you shall pay. Under our brand system, which is the very keystone in the structure of our free economy, people can separate the wheat from the chaff and make their purchases solely on the basis of merit and appeal to their per-

sonal tastes and preferences. Our system of brand names and advertising is important to the American way of life for two other basic reasons:

1. It develops broad markets for our goods, which in turn stimulate volume production. As a result, many conveniences that would otherwise be luxuries can be sold at prices almost everyone can afford.
2. Brand competition spurs our manufacturers to greater efforts to please us. And this results in constant product improvement and the birth of many new products to add to our comfort and happiness.

So as you read the advertisements of brand manufacturers in this magazine, remember that your daily purchases of these brands are not only a guarantee of good quality and good values, but also a guarantee of continual progress in better living.

*Brand Names Foundation*

INCORPORATED

A NON-PROFIT EDUCATIONAL FOUNDATION • 119 WEST 57th STREET, NEW YORK 19, N. Y.



# BUILD YOUR OWN TILTING ARBOR SAW!

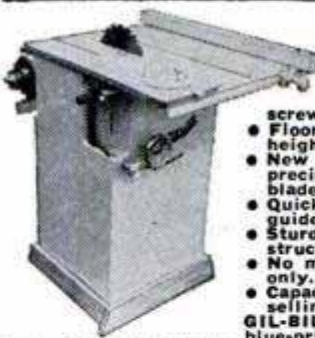

- 27x28 in. table stays level. Blade tilts full 45 degrees.
- 10 in. blade cuts 3 1/4 in. deep, jack-screw depth adjustment.
- Floor model, 34 in. table height.
- New Departure ball bearing arbor, 3/4 in. precision shaft, ready to run, 5/8 in. bore blades.
- Quick positioning, self-aligning rip fence guide.
- Sturdy wood, steel and aluminum construction.
- No machining—build easily with hand tools only.
- Capacity and performance of floor saws selling for \$150.00 and up!

**SAVE \$50 OR MORE**

terms. 11 actual photographs. . . . . \$1.00  
 GIL-BILT Metal Parts Kit, includes Plans, ball-bearing arbor, cast aluminum miter gauge and bar, rip fence guide, machined lock knobs, jackscrew mechanism with 4 1/2 in. handwheel, and all other metal parts including every screw, bolt, nut and washer (less blade) . . . . . \$20.95  
 Same Kit with 10" combination blade . . . . . 24.90  
 Same Kit with 8" combination blade . . . . . 23.90  
 Return Kits in 10 days for refund if not satisfied.

(Prices include postage up to 600 miles)  
 Also available — Plans and Metal Parts Kits for 8" Tilt/Table Saw and 12" Band Saw. Order Plans at \$1.00 each—sent postpaid anywhere in the world, or write for FREE descriptive Catalog.

**GILLIOM POWER TOOLS** P. O. Box 1-PJ, Lambert Field St. Louis 21, Missouri

## SAY YOU SAW IT IN POPULAR MECHANICS

### MAKE BIG MONEY!

Be a floor surfacing contractor and sand both new and old floors. Sanders are easy to operate and better still, you're your own boss. Write for latest "tell-all" booklet entitled "Opportunities in Floor Surfacing", enclosing 25 cents in coin or stamps to cover handling.

## AMERICAN

FLOOR SURFACING MACHINE CO.  
 123 So. St. Clair Street - Toledo 2, Ohio



Ask Your Hardware Store for **FULLER'S Unbreakable Amber Handle SCREW DRIVERS**

America's most popular line of moderately-priced screw drivers! Wide range of sizes. **FULLER TOOL COMPANY, Inc.** 911 Faile St. New York 59  
 World's largest makers of Amber-Handle Tools

### NOW... MAKE MONEY with CELL-U-MOP



Sell Cell-U-Mop... best cellulose sponge (not rubber) mop on market. It's the new, modern way to wash, dust, or wax floors, etc... saves time, work; keeps hands clean, dry; is lightweight, sanitary. Aluminum drain bracket fits on pail. Money-making full or spare-time earning plans. Write today.

**CELL-U-MOP CO.**  
 Dept. PM-9, Freeport, Ill.

## SHARPEN CIRCULAR SAWS LIKE AN EXPERT



**THE SUPER GADGET FOR HOME WORKSHOP**  
 Two simple adjustments. Gets hollow-ground, cross-cut or combination saw blades true and sharp. Fits 6" to 12" blades 1/2" to 13/16" centers. Includes file, complete instructions. \$6.95 postpaid. (C.O.D. postage extra.) Guaranteed money back if not satisfied after 10-day trial. Soon pays for itself. Order today. Free Folder.  
**SURE SHARP MFG. CO., Dept. M-90**  
 P. O. Box 24 Santa Ana, Calif.

\$6.95

## make your own Gems 29.50 F.O.B.

All necessary lapidary equipment is furnished, including a super-charged diamond blade for sawing, and all wheels for grinding, shaping and polishing; also complete instructions. The complete equipment as shown, less motor and belt, for only \$29.50, f.o.b., Burlington, Wisconsin. Write today for information and literature.

**B&I MANUFACTURING CO.**  
 Dept. S Burlington, Wis.



## MILL IT... ON YOUR LATHE!

# PALMGREN

## MILLING ATTACHMENT

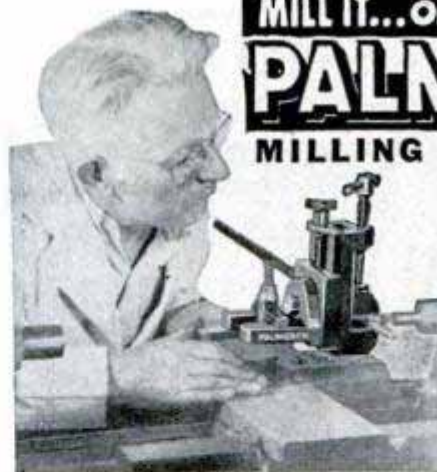

**3 SIZES**  
 No. 250 Illustrated

2 1/2" JAW Only **\$24.75**

**CONVERT LATHE IN 10 SECONDS**

Now you can Mill, Slot, Grind, Groove, Square Shafts, Saw at Angles, Recess and many other important jobs. **SAVE TIME and MONEY!** Why send work out or use costly methods when a **PALMGREN MILLING ATTACHMENT** will solve your problem.

Precision built, it has accurate graduations for rotary angle adjustments, also graduated vertical feed screw. Fits South Bend, Atlas, Craftsman, Logan, Sheldon and all other lathes. Thousands now in use in small and large machine shops, repair shops, railroads, schools, home work shops, etc. **ORDER SIZE NEEDED TODAY!**—it will quickly pay for itself.

### IMMEDIATE DELIVERY

Nos.	Width Jaws	Depth Jaws	Jaws Open	Weight Pounds	Fits Tool Post	Price F.O.B. Factory
150	1 1/2"	1"	1 5/8"	6 1/2	1" Dia.	\$18.75
250	2 1/2"	1-7/16"	2 1/2"	11	1 1/4" Dia.	24.75
400	4"	1 1/2"	4"	25	2" Dia.	39.75

Order From Your Dealer or Jobber; Write for Circular No. 353  
 Mrs. of **PALMGREN PRODUCTS**  
 Since 1915

**CHICAGO TOOL and ENGINEERING CO.**

8365 South Chicago Ave.  
 Chicago 17, Ill.

### JUST A FEW OPERATIONS YOU CAN DO ON YOUR LATHE!

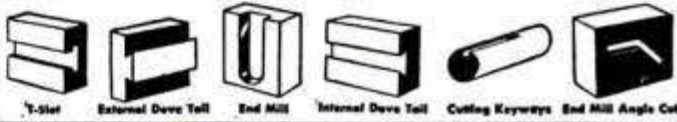

## New! Electric Motors

- New General Electric 1/2 H.P. Induction Type 3450 RPM 110 V-60 cy. 1 Ph. A.C. Motor. Double Shafts 3/8" **\$19.75**
- GEH-5 . . . . . ONLY **\$19.75**
- New Delta 3/4 H.P. Cap/Ind. Ball Brg. 3450 RPM. 110 V. 60 cy. 1 Ph. A.C. Motor (specify rotation desired) #DH-34. **\$29.75**
- New Emerson 1 H.P. Heavy Duty, Repulsion Induction 3450 RPM. 110/220 V-60 cy. 1 Ph. A.C. Motor **\$37.50**
- #EH-1 . . . . . Low Priced at . . . . . only . . . . . **\$37.50**
- New Eicor 1 H.P. Capacitor Induction 1750 RPM 110/220 V-60 cy. 1 Ph. A.C. Motor **\$38.50**
- #EG-17 . . . . . only **\$38.50**
- New "B" Line 2 H.P. Repulsion Induction 1750 RPM 110/220 V-60 cy. 1 Ph. A.C. Motor. #4012, only **\$75.00**
- New 3 Phase Motors 1 H.P. Ass't Makes, 1750 RPM 220 V-60 cy. #A31 . . . . . only **\$37.50**



ALL PRICES ARE FOB. CHICAGO  
 WRITE FOR BARGAIN MOTOR CIRCULAR—SPECIAL MOTORS D.C. & 3 PHASE—ALL SIZES AND SAVE  
**C. MARSHALL SALES, 3546 W. Fullerton Av., Dept. P-9, CHICAGO 47**

**STRIPE WITH PAINT EASY AS USING A PENCIL**

## PAINTERS' STRIPING TOOL

NOW you can do your own expert striping on furniture, bikes, model planes, bulletins, autos, toys, signs, linoleum, wall board . . . make plain walls look like tile! It's easy to paint straight, curved circular, even parallel lines with any color. Handiest paint tool in your workshop! Type "M" Master Painters' Striping Tool complete with tip for 1/16" stripe, \$1.00. Other tools complete with following tips: 1/64", 1/32", 3/64", 5/64", 3/32"/1/8"; \$1.50 ea. Extra tips 75c ea. Entire kit with tool and 7 tips, \$5.00. (C.O.D.'s postage collect.) Dealers write! **WENDELL MFG. CO., 4234 Lincoln Ave., Dept. 39, Chicago 18, Ill.**



**A TOOL... NOT A BRUSH**

**\$1.00 POST PAID**

Dealers Write Today!

# SHORT CUTS to Better Housekeeping



**DON'T BE A SLAVE TO DOMESTIC DRUDGERY!**

**1000 Ways to Save TIME • MONEY • LABOR**

IF YOU HAD THREE LIFETIMES you couldn't amass the practical wisdom packed into the pages of Popular Mechanics' **SHORT CUTS to Better Housekeeping**. Here is the cream of the household lore that has appeared in Popular Mechanics Magazine, PLUS new material prepared especially for this book.

**THE PRICE OF THE BOOK** is saved for you on every page of **SHORT CUTS to Better Housekeeping**. Each of the more than 1000 ideas is designed to save you money, time or useless labor—often all three aims are accomplished!

**NO PHASE OF HOUSEKEEPING** is overlooked—here are sections on Food Preparation, Sewing and Mending, Laundering, Ironing, Removing Spots and Stains, Caring for Clothing, Making Household Accessories Last, Home Formulas You Can Make, Household Repairs, How to Deal With Insect Pests, Caring for Your Pets, Interior Decoration.

**DO YOU KNOW HOW TO:** measure cooking ingredients quickly and accurately? . . . dress poultry without muss or fuss? . . . remove fish scales easily? . . . cut a hot cake? . . . open cans and jars with ease? . . . use spring clothespins in a dozen novel ways? . . . cut your laundry chores in half? . . . polish any metal? . . . thread a needle quickly? . . . baste seams without pins? . . . banish household odors? . . . get rid of ants? . . . make an endless clothesline? . . . refinish floors? . . . repair a broken chair? . . . remove furniture spots and rings? . . . clean ivory? . . . make perfect jelly? . . . keep a new kitten or puppy quiet at night? . . . repair cracked linoleum? . . . smooth a scratched mirror? . . . weatherproof a window? . . . **SHORT CUTS to Better Housekeeping** answers these and hundreds of other questions.

**NO OTHER BOOK** has such a wealth of information, or such positive solutions to household problems. 160 pages, only 60c. Get **SHORT CUTS to Better Housekeeping** at your nearest newsstand or your favorite food market! Or obtain by mail from

**POPULAR MECHANICS PRESS**  
200 East Ontario Street Chicago 11, Ill.

SAY YOU SAW IT IN POPULAR MECHANICS



## PRACTICAL BOOKS ON HOME PLANNING BUILDING • REPAIRS

Plan Now—Build When You Can  
Books Sent C.O.D. Anywhere in U.S.A.

MAIL ORDER TODAY

Select from this list of helpful books. In U. S. books sent postpaid if remittance accompanies order. Outside U. S. include 15% extra for shipping charges.

- How to Plan a House. \$5.00
- Your Home and How to Build It Yourself. \$3.00
- Painting, Decorating. \$1.75
- Carpentry. \$2.50
- Painting, Furniture Finishing and Repairing. Includes floor renewal. \$1.50
- How to Remodel a House Complete, practical. \$5.00
- Building Insulation. \$4.50
- Concrete Handbook Do work for yourself, others. \$2.00
- Blueprint Reading for Building Trades. \$1.50
- Practical Bricklaying. \$2.00
- Primer for Home Builders. \$2.50

## FAMOUS PLAN BOOKS

Books contain floor plans, photos, descriptions of homes.

- AMERICA'S BEST LOW COST HOMES. 125 designs. \$1.00
- DE LUXE SMALL HOMES. 210 designs. \$1.00
- OUR FUTURE HOME. Wide selection of residences, summer homes, garage apartments. \$1.00
- MODERN HOME & GARDENING. 42 popular designs. Improvements, garden short-cuts, etc. \$1.50

Set of Four Books \$3.50

Stair Building \$2.50



**POPULAR MECHANICS PRESS**  
DEPT. 646 • 200 E. ONTARIO STREET, CHICAGO 11

# Bet You Don't Know This About Advertising

by Susan

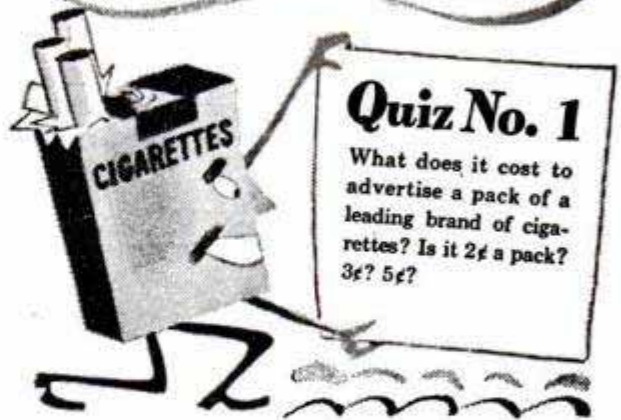

## Quiz No. 1

What does it cost to advertise a pack of a leading brand of cigarettes? Is it 2¢ a pack? 3¢? 5¢?

**Answer:** It costs less than 1/2¢ a pack to advertise the big brands of cigarettes.

That's only half the story. Advertising lowers your cost two ways:

*Cuts the selling costs. And by helping make mass production possible, lowers the production costs, too.*

So advertising saves you many times that 1/2¢ per pack.

## Handy Mail Order List

Little Library of Useful INFORMATION

5 for \$1.00  
12 for \$2.00  
25¢ Each

Here at amazingly low cost is the practical help and information you have always wanted. Articles in previous issues of Popular Mechanics have been classified according to subject and are now available in these handy reprint booklets.

- How to Use Measuring Tools—Micrometers, Calipers, etc.—106.
- Power Driven Saws—74.
- Drill Presses, Grinders, Etc.—79.
- Wood, Metal Turning—Lathes—81.
- Filing Machine, Hacksaw, Cutoff Wheel, Shaper—82.
- Lathe Tools You Can Make—101.
- Workbenches—Tool Cabinets—47.
- Spray Painting—94.
- From Pattern to Casting—91.
- Tool and Saw Sharpening—92.
- Sharpening Drills, Wood Bits—90.
- Successful Wood Turning—32.
- How to Read Blueprint—71.
- Metal Turning Lathe Kinks—99.
- Operating a Metal Lathe—100.
- Heat Treating, Hardening—102.
- Working With Glass—103.
- Servicing Elec. Motors—75.
- Electromagnets & Solenoids—44.
- Transformer Construction—41.
- The Boy Electrician—43.
- Soldering and Brazing—17.
- Arc and Spot Welders—5.
- Electroplating With Nickel, Chromium, Cadmium, Etc.—86.
- Plating Leather, Wood, etc.—87.
- Lower Your Fuel Costs—31.
- Curing Leaky Basements—45.
- Fitting Home Game Room—55.
- Indoor & Outdoor Fireplaces—88.
- Backyard Gardening—39.
- Lawn and Garden Novelties—72.
- Trellises, Pergolas, Fences—76.
- Lawn and Garden Furniture—77.
- Playground Equipment—73.
- How to Use Your Drill Press—125.
- Making Serving Trays—53.
- Knots and Ropework—105.
- Sanders—80.
- House Wiring—89.
- Hanging Wallpaper—38.
- Built-in Fixtures—78.
- Bird Houses—7.
- Magazine Racks—49.
- Clock Cases—50.
- Book Ends—52.
- Small Tables—54.
- Smoking Stands—56.
- Desks—58.
- Book Cases—59.
- Action Toys—66.
- High Flying Kites—67.
- Telescopes—20.
- Metal Craft—28.
- Small Looms—37.
- Gem Cutting—42.
- Photo Enlargers—1.
- Photo Kinks—98.
- Cleaning Formulas—11.
- Taxidermy—9.
- Photo Lighting—119.
- Training Dogs—35.
- Small Furnaces—36.
- Working With Plastics—61.
- Simple Home Improvements—104.
- Ridding Home of Insect Pests—107.
- Children's Room Furniture—51.
- Jigsawed Novelties—57.
- Doll House & Doll Furniture—60.
- 25 Shelves You Can Make—64.
- Novelties Turned on Lathe—62.
- Inlay Pictures—Veneering—63.
- Wood, Soap Carving—65.
- Windmills & Weathervanes—68.
- Lamps from Wood, Metal—69.
- Rustic Furniture—18.
- Wood Finishing—40.
- How to Fix Electrical Appliances—111.
- Painting Your House—117.
- Build Your Own Relays—123.
- Rowboats, Small Dinghy—83.
- Small Sail Boats—84.
- Two Outdoor Runabouts—85.
- Build Own Canoe, Kayak—30.
- Build Class-E Ice Yacht—22.
- Auto Kinks, Shortcuts—10.
- Lawn and Garden Equipment—124.
- Motor-Driven Midget Cars—34.
- Stop Auto Elect. Troubles—95.
- Photo Printers and Dryers—25.
- Photo Darkroom Equipment—96.
- Trick and Table Top Photos—97.
- Home Movie Equipment—118.
- Poultry Houses—108.
- Guns and Decoys—109.
- Re-Silvering Mirrors—70.
- Chemical Experiments—93.
- Log Cabins, Tourist Houses—14.
- Using Basic Tools—120.
- Farm and Garden Tractors—8.
- Building Extra Attic Rooms—23.
- Attractive Basement Rooms—24.

Check Titles Wanted, Clip, Mail with Remittance to  
**POPULAR MECHANICS PRESS, Dept. 635, 200 E. Ontario, Chicago 11**

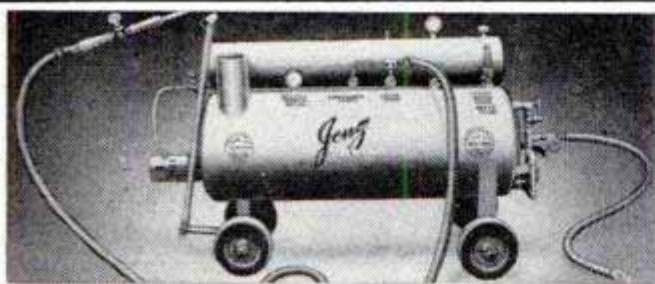

**\$6.00 PER HOUR**

At a cost of 20c with the NEW JENZ SUPER CHIEF STEAM CLEANER. Portable—No moving parts—Cleans anything—Any place—Motors—Chassis—Machinery—Floors—Buildings—Oil Rigs, etc.—Oil fired—Economical—Fully tested and warranted. 75 lbs. steam in ten min.—Model 80. Complete as illustrated..... **\$315.50**

F.O.B., factory

**HI-PURE LABORATORIES, Evansville, Ind.**

**WAR SURPLUS AND OTHER BARGAINS**



**PNEUMATIC RIVETER & CHIPPING HAMMER**

Mfd by Ingersoll-Rand, Chicago Pneumatic and Thor. Pistol grip. Ideal for fender, brake lining, concrete breaking work. Like new. Six rivet sets and bucking bar included, making a complete combination. Wgt. 9 lbs. Each **\$6.95**

**INSIDE MICROMETER 2" to 8"**

Precision made of tool steel. Hardened tips on all six measuring rods. One 1/2" spacer. Chrome finish. Complete with case. **\$6.95**



**MICROMETERS**

Chrome plated, precision engineered and carefully tooled to give long life. All new. 0-1" capacity . . . ea. **\$2.25**. 1-2" cap. **\$3.50**. 2-3" cap. **\$5.50**. 3-4" cap. **\$6.50**.

**HIGH SPEED DRILLS**

All New. Fractional & numbered. Orig. Val. \$15. Nationally known brand. Ast'd. sizes. Set 30. **\$3.50**

**EXTENSION DRILLS**

High Speed Steel, like new. Ass't'd sizes from No. 1/4 to 40. Lengths from 6" to 12". Approximately \$20 value. Set of 12 . . . . . **\$3.75**



**ELECTRIC BELLS**—Vibrating type, high pitch. 115 V., 60 Cycle. Ideal for use indoors or outdoors—on ranches, for schools, plant installations, as signal systems, burglar alarm systems, etc. Nationally known Mfr. ALL NEW in orig. Pkgs. Solid brass clapper & 8 1/2" gong. Wt. 8 lbs. Govt. cost about \$67.50. Close out at . . . **\$7.95** Send check, money order or cash. 25% deposit required on C.O.D. orders. All prices F.O.B. Culver City, Calif. Send 25c for Illustrated Catalog.

**AIRBORNE SALES CO., INC.** DEPT. PM 9-0 CULVER CITY, CALIF.

**AMAZING LOW PRICE!**



**New ELECTRIC MOTOR 1/2 HP WESTINGHOUSE WORKSHOP TOOL MOTOR** **\$19.95** REGULARLY \$29, NOW

BRAND NEW, GUARANTEED Genuine WESTINGHOUSE F.O.B. CHGO. 1/2 HP, Double 3/8" Shafts, 1725 RPM, 115 V. Continuous duty, split-phase type. Best motor bargain ever offered. Rush order today. Send Chk. or M.O. \$19.95 F.O.B. Chicago. SUPERIOR DISTRIBUTORS, 350 W. Ontario St., Chicago 10, Ill.



**HANDY CALCULATOR FOR WOODWORKERS.. ONLY 10c**

Just set dial, quickly solves countless problems. Converts linear to board feet, compares workability of various woods, shows bit sizes, nail specifications. Also tool sharpening tips, etc. 6" diameter heavily varnished cardboard. Send 10c to Greenlee Tool Co. 2109 Columbia Av., Rockford, Ill.

**Build your own JET ENGINE!**



Order these plans today  
1. JET PROPELLED BICYCLE. Assemble your own. Photo and instructions \$1.00.  
2. HOW TO MAKE EXPERIMENTAL JET ENGINES. Seven sheets drawings with information and instructions \$2.95.  
3. BOTH OF ABOVE in one order \$3.75. SEND NO MONEY. Order both at once \$3.75 C.O.D. in USA plus e.o.d. postage. Send check or Money Order and we pay postage. Get other information too. Rush Order.

J. HOUSTON MAUPIN, Dept. 55, Tipp City, Ohio

**at last! a BIG Rugged Sprunger 8" TILT-ARBOR SAW**

Does everything expensive saws do . . . plus these features:

- 8" blade cuts 2 1/2" deep.
- 12"x16" gray iron cast table ground smooth. (Extensions available)
- Double shielded, lubricated for life, ball bearings.
- 5/8" arbor size.
- Motor and blade tilt to full 45°. No belt twist.
- Guaranteed material and workmanship.

See your dealer or write Dept. PM-95



for only **\$38.95** complete (less motor) price subject to change

**ALL METAL**

**SPRUNGER BROS. INC. TOPEKA, IND.**

**HELPFUL BOOKS**

Send post card asking for FREE catalog Popular Mechanics Press, 200 E. Ontario, Dept. 601, Chicago 11

**WAR SURPLUS**

Below are just a few of the many items we have in stock at sensationally low prices:

Pumps	Air Tanks	Fire Pumps	Gas Engines
Grinders	Drop Cords	Saws	Clutches
Air Compressors	Generators	Winches	Motors

Slightly used but reconditioned and fully guaranteed. 2500 Watt. AC, 110 volts, 60 cycle. **\$199.95**

ONLY Same unit NEW **\$295.00**

300 Watt Reg.	\$135	Now \$ 89.50
1,000 Watt . . . . .		\$179.00
1,500 Watt Reg.	\$335	Now \$220
2,500 Watt Reg.	\$700	Now \$295
5,000 Watt Reg.	\$1,665	Now \$575

Comes with 150' No. 6/2 cable; 150' No. 18/2 cable, valued at \$306

7,500 Watt Reg.	\$1,705	Now \$675
10,000 Watt Reg.	\$1,795	Now \$995
25,000 Watt Reg.	\$2,695	Now \$2,100
35,000 Watt . . . . .		\$2,750

All units 10,000 watts and over, 1 or 3 phase 110-220 volts.

Write today for free catalog. Thousands of \$8 saving buys.  
**C & H ELECTRIC Co.**  
434 W. JUNEAU AVE. MILWAUKEE 3, WISCONSIN

**HANDEE** tool of 1001 Uses

- Handicraft Hobbies
- Household Repairs
- Auto Maintenance

**Everyone Needs a Handee!**

Absolutely the finest in hand power tools. Cool running, controlled power for those countless small jobs. A whole toolshop in your hand . . . grinds, drills, engraves, cuts, polishes, saws, routs, sands . . . pays for itself quickly!

HANDEE with 51 accessories, in fitted steel case **\$27.50**

HANDEE with 7 basic accessories **\$19.95**

**MONEY BACK GUARANTEE!** Liberal 10-day free trial offer. Get HANDEE at your dealer's today, or order direct postpaid.



**FREE!** New HANDEE Catalog . . . shows a host of practical applications. Write today!

**CHICAGO WHEEL & MFG. CO.**  
Dept. PM, 1101 West Monroe Street, Chicago 7, Ill.

# \$4.95 JIG SAW

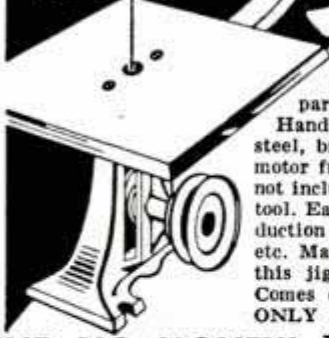

Jig, saber saw, and filing machine. Precision built. Has cast iron base, steel table 8" x 8", hardened working parts. Cuts to center of 20" circle. Handles 1 inch wood stock; cuts sheet steel, brass, plastic, etc. Operates on any motor from 1/8 H.P. and larger. (Motor not included). Not a toy—but a fine power tool. Easy to operate. Can be used for production work, hobby work, model builders, etc. Make money in your spare time with this jig saw turning out things to sell. Comes complete with jig saw blades for **ONLY \$4.95. Order Today!**

**SEND NO MONEY!** Just mail your order. Pay postman \$4.95 plus postage on delivery. Try 10 days—if not delighted, return for money-back.  
**STRADER PRODUCTS** Dept. F302, 259 Strader Ave., Cincinnati 26, Ohio

**MICO MILLI-TOOL**  
 Engraves - Reproduces  
 Metal - Wood - Plastic

**\$79.50**  
 less accessories

Send for  
**FREE BULLETIN**

MICO INSTRUMENT CO., 74 CAMBRIDGE ST., CAMBRIDGE, MASS.

## Say You Saw It in POPULAR MECHANICS

**Amazing New CARBOLOY® "LIVE-SPIRAL" Masonry Drill**

**ROTARY DRILLS TOUGHEST MASONRY CONTINUOUSLY WITHOUT STALLING**

No packing of dust, no jamming. Unique spiral wire lifts dust from hole as it is drilled. Carboloy tip bites through any masonry. Handy Kit C-1/4", 3/8", 1/2" drills in sturdy leather plastic kit, \$5.00 postpaid or C.O.D. Free circular from your dealer or write. "Carboloy" and "Live-Spiral" are trademarks of Carboloy Co., Inc.

**CARBOLOY COMPANY, INC., 11185 E. 8 Mile Blvd., Detroit 32, Mich.**

POSTPAID ANYWHERE IN U.S.A. WE FURNISH ALL MACHINED METAL PARTS, EVERY SCREW, NUT, BOLT, WASHER, AND COMPLETE PLANS FOR THIS...

**BIG 10" POWER SAW**

**\$10.95** FULL REFUND IF LESS GUARD NOT SATISFIED & WOOD IN 10 DAYS

COMPLETE PLANS 10c  
**MARCUS-POLLAK**  
 DEPT. N, ROYERSFORD, PA.

ASSEMBLE IT YOURSELF WITH SIMPLE HOUSEHOLD TOOLS!

Another of 1000s of uses for the genuine

**WISE-GRIP WRENCH**

Holding round-head carriage bolt from turning

Genuine VISE-GRIP, the most sensational hand tool ever built! LOCKS to work with more than Ton-Grip! Turns anything, even in closest quarters. Does difficult jobs quickly—easily. Does jobs no other tool can do. Insist on the Genuine VISE-GRIP with Involute Jaw Curve that holds all shapes. Knurled Jaw Tips that grip to the very tip. Thin Nose, Super Wire-Cutter. With cutter—No. 7W, 7", \$2.25; No. 10W, 10", \$2.50. Without cutter—No. 7C, 7", \$1.85; No. 10C, 10", \$2.25. If not at your dealer's order direct.

**PETERSEN MFG. CO., Dept. P-9, DeWitt, Nebr.**

**SAW SHARPENER**

Table model, gums and sharpens rip saws, combination saws & cut-off saws. Ideal for "Skill-saw" blades. Cap. 4" to 20" diam. Complete with 1/4 h.p. motor & 1 grinding wheel & cord — \$64 f.o.b. Portland. Shipping weight, 63#. **SEND FOR FREE LITERATURE.**

**P. T. HOBBS MACHINERY**  
 8375 N. Interstate, Dept. 57, Portland 17, Ore.

**YOURS AT BIG SAVING!**

Stow 6' flexible shaft with 3-jaw chuck and grinder head, complete as shown. Can also be used direct on motor. Excellent for workshop.

**GENERAL AIRCRAFT SUPPLY CORP.**  
 City Airport, Detroit 5, Mich.

WAS \$24.95  
**NOW... ONLY \$16.95**

CASH WITH ORDER  
 No C.O.D.'s, Please.

**DRAINS CELLARS, WASH TRAYS CIRCULATES OIL**

Pumps 1800 GPH 300 gal. 30' high, use 1/8 to 1/2 HP motor. Will not clog.

**\$6.50**

Postpaid if cash with order. (Add 50c for west of the Mississippi.)  
 Thousands in use since 1936

**LABAWCO PUMPS, BELLE MEAD 7, N. J.**

**ELECTRIC MOTOR BARGAINS!**

1 HP 3450 RPM **\$34.50**  
 1/2 HP 1750 RPM **\$15.75** 3/4 HP 1750 RPM **\$26**  
 1/2 HP 3450 RPM **\$15.75** 3/4 HP 3450 RPM **\$26**

**Every Motor Fully Guaranteed**  
 Heavy Duty, Repulsion Induction or Capacitor Types, 110-220 Volts, 60-cycle, Single phase. Standard Makes (G.E., Wagner, Le-land, Westinghouse, etc.). Rush your order TODAY—large stock of motors—1 & 3 phase. 32-v. direct current bargains. Prices f.o.b. **ROBERTS ELECTRIC CO., 7232 Madison, Forest Park 25, Ill.**

Immediate Delivery

**FURNITURE FOR YOUR BEDROOM**

YOU'LL BE THE ENVY of your neighbors with this beautiful bedroom suite in honey maple, oak or walnut! Here's a bed with storage space... a three-piece vanity with cosmetic compartment and makeup mirror... a Mr. and Mrs. dresser... twin night stands with drawers!

Send for Complete Plans Only **\$2.00**

**YOU MAKE IT YOURSELF!** Only two power tools, a saw and a jointer, are needed to turn out this modern bedroom furniture. No other project of Popular Mechanics Magazine in recent years has captured the fancy of home craftsmen as has this easy-to-build suite. Letters demanding detailed plans poured in after the suite was pictured in Popular Mechanics. And now the plans are ready! They're detailed scaled drawings—a complete set of 4. Send for them today!

**POPULAR MECHANICS PRESS**  
 200 East Ontario Street, Chicago 11, Illinois

I enclose \_\_\_\_\_ for a complete set of plans for making the modern bedroom suite illustrated above.

Name \_\_\_\_\_  
 Address \_\_\_\_\_  
 City \_\_\_\_\_ Zone \_\_\_\_\_ State \_\_\_\_\_

# Where'd you get the orphan, Tom?

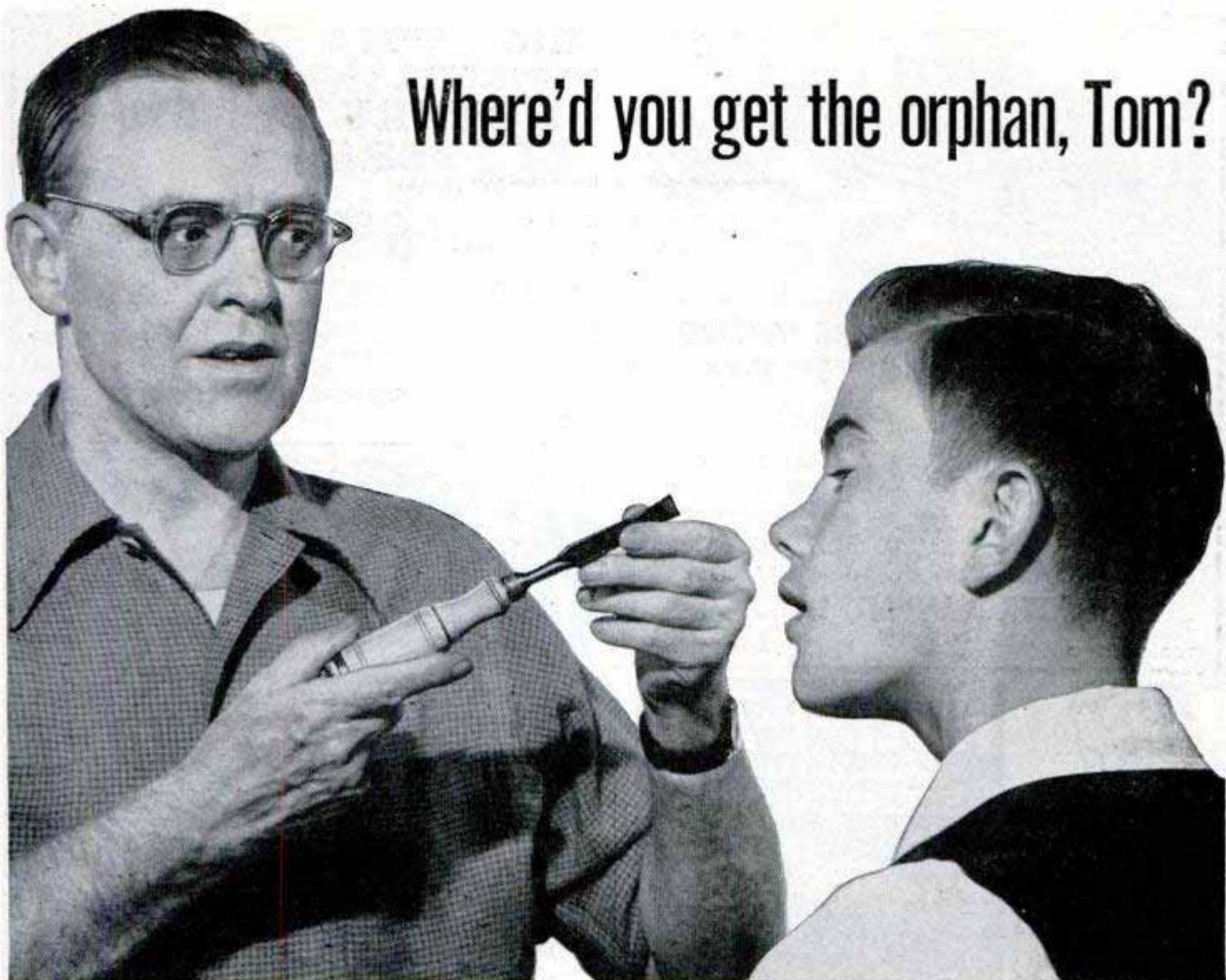

**TOM:** Orphan? What do you mean, Dad?

**DAD:** This chisel. There's no brand name on it.

**TOM:** What of it? Just feel that edge.

**DAD:** That's not much to go by when you're buying a chisel, son. Even a piece of cheese can have a sharp edge, you know.

**TOM:** You mean this chisel's no good?

**DAD:** I mean you can't be *sure* it's good. No brand name, no reputation to back it up. It's one of those bargain counter orphans—and they generally let you down.

**TOM:** Well, it didn't cost much, anyway.

**DAD:** Better get your money back — if you can. And then go over to the hardware store and buy a *good* chisel—one with an advertised brand name you can trust. The hardware man will always steer you right.

*Your HARDWARE DEALER sells QUALITY tools  
and hardware... Buy from HIM*



# POPULAR MECHANICS

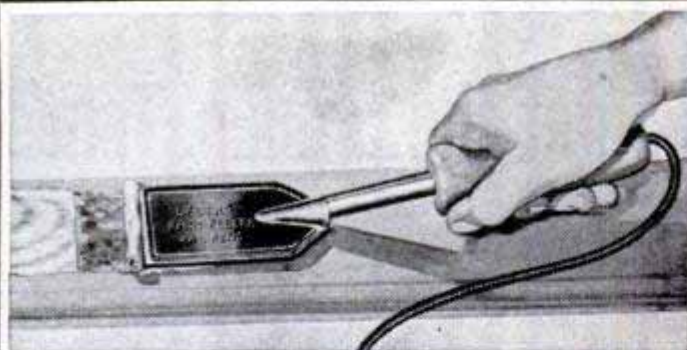

## PEEL PAINT TO BARE WOOD WITH ONE EASY STROKE

NEW ELECTRICAL TOOL removes 1 to 10 or more coats of paint from any wood surface as easy as cutting butter with a hot knife. No scraping, cutting, burning, sanding, or chemicals. The new Lectro Paint Peeler instantly softens paint electrically and peels it off the surface clean to the bare wood with one easy stroke. It's faster than a blow torch—there's no danger of fire—will not scorch or burn delicate wood surfaces. Makes no mess—no smell—it's even fun to use. Removes any paint, enamel quickly and easily. Sturdily constructed to last for years. Sent complete with extra long, quality electrical cord. Simply plug into any A.C. or D.C. outlet—let heat for several minutes and remove paint to the bare wood on exterior or interior painted surfaces, floors, woodwork, cupboards, furniture, antiques, boats, window-sills, screens, doors—a hundred other uses. Price \$4.95 postpaid—nothing else to buy. Full money back guarantee. For immediate shipment—send check, cash or money order to:

**LECTRO WELD, INC.**

Dept. PM9

5700 Detroit Ave.

Cleveland 2, Ohio



## HOLD-E-ZEE

THE ORIGINAL AUTOMATIC GRIP SCREWDRIVERS

FIRST CHOICE OF SKILLED CRAFTSMEN



Models for All Types of Screws

Pol'd.

At Leading Dealers Everywhere

Gripper Recedes into Handle

Upton Bros., Inc. Rochester 14, N. Y.

## STOP CHANGING MOTOR OIL!

End this needless expense forever with

**RECLAIMO** Today's Most Advanced OIL RE-REFINING filter FOR CARS, TRUCKS, TRACTORS & DIESELS

Continuously cleans and RE-REFINES motor oil as you drive (by utilizing motor heat)—keeps oil in high grade lubricating quality at all times!

"RECLAIMO"

- REMOVES SOLIDS (by filtration)
- REMOVES WATER (by distillation)
- PREVENTS Excess Fuel Dilution
- PREVENTS Acid and Sludge Formation
- ADDS Thousands of Miles to Engine Life

**MAINTAINS** Stable Viscosity **ELIMINATES** All Oil Changes

FREE 32-PAGE BOOK "OIL FACTS" (with bona-fide \$1000.00 offer on page 30), gives you the complete "Reclamo" story and details of our extraordinary 90-DAY NO-RISK TRIAL OFFER! Write for your copy TODAY!

**Reclamo Sales Div., Inc.**

4508 S. Logan, Dept. M-1, Lansing, Mich.

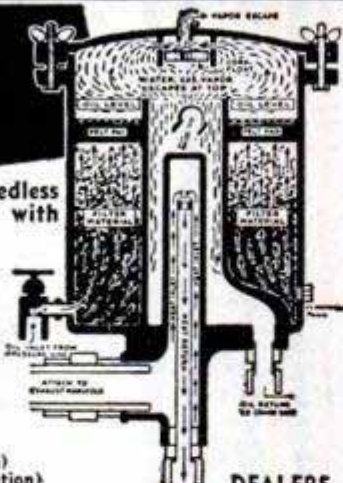

DEALERS WANTED

U.S. BUREAU OF STANDARDS, Bul. 86 States, "Oil does not wear out - mechanically."

MONEY-BACK GUARANTEE

## HIGH SPEED STEEL ROTARY CUTTERS

1/8" Shanks

SET No. 18..... \$6.85 POST PAID



Send check or money order today.

This set of 18 cutters consists of the most popular shapes and sizes used by individuals throughout the country.

Due to the high quality workmanship, these cutters are unsurpassed for performance and efficiency.

Packed in sturdy case as illustrated. Dealer inquiries invited.

**RICO SUPPLY COMPANY**

P. O. Box 828

Dept. C

Saginaw, Mich.

"UP-TO-DATE" COMBINATION

## RABBIT-ROUTER PLANE

ONLY 4.95



USABLE WHERE OTHER PLANES CAN'T REACH

Has BUILT-IN GAUGE, MARKER, SQUARE

Get professional results! Ideal for setting Hinges and Locks perfectly, and for fine intricate grooving, etc. 3/4" wide blade. 4-tools-in-one, only \$4.95 postpaid or COD plus postage.

**ILLINOIS STAMPING & MFG. CO.**

DEPT. P

220 N. JEFFERSON

CHICAGO 6, ILL.

## MAGNETS

OF ALL TYPES—10c UP AMAZINGLY POWERFUL!

4 oz. Alnico Magnet, lifts 10 lbs.

\$1.00. Our Leader, 15 oz. Magnet,

lifts 40 lbs. \$2.50. New alloy—will not

weaken! Useful for lifting valuables from tanks,

lakes, or rivers easily! 7 small magnets \$1.10 with

list of many shop and home uses. Satisfaction guaranteed.

R. EYRICH, 2566 N. 49TH ST., MILWAUKEE 10, WIS.

## TREASURE -- \$10,000

New locator detects metals, valuable minerals and buried treasure. Money-back guarantee of superiority.



Also geiger counters. Govt. reward of \$10,000 for uranium discovery. Write for FREE information.

**THE GOLDAK COMPANY**

1542 W. GLENOAKS BLVD., GLENDALE 1, CALIF.



## SHAPER & SASH CUTTERS

Saw Blades, Mortise Chisels, Boring Tools, Jointer, Planer Moulding Knives, Dovetail Cutters, Countersinks, Dowels, Vises, Arbors, Complete Line of Wood Shop Equipment. New 80 page large catalogue No. 105. Postpaid 25 cents.

**WOODWORKERS TOOL WORKS** Jefferson & Quincy Sts., Chicago 6, Ill.



## TRAILER COACHES

Here's everything you want to know about trailers, with plenty of pictures and plans and instructions for building three different types. Covers also, history of trailers, trailer parks, camps and overnight-stops information, furniture, furnishings, materials and engineering data. If you want to build a trailer, live in a trailer, or just want to know more about trailers, get this book. Only \$1.50 postpaid. Rush order to:

POPULAR MECHANICS PRESS • Dept. 350, 200 E. Ontario St., Chicago

## Build it Yourself!

Complete Trailer Book and Construction Data for 10, 16 and 22 Foot Trailers — Only \$1.50

Partial Contents

Trailer Parks—Living in a Trailer—Towing a Trailer—Floor Plans—Service—Classifications—Balance—Dollies—Jacks—Weight Distribution—Construction—Working Drawings for a Two-Place, Standard Travel and Standard Dwelling Trailers. Size 8 1/2 x 11 1/4 inches.

# "Wellworth" Sensational Offer! Reg. \$60.50 WESTINGHOUSE AIR COMPRESSOR

ONLY  
\$18.50

Model T-1 Brand New — 2 CYLINDER PISTON TYPE. Operates with 1/2 H.P. Motor or equivalent gas engine.

Compressor, pressure tank, air gauge, air chuck, 20-ft. hose, pop valve, copper tubing with 4 brass flared fittings for connecting compressor to tank, 4-way cross and 3 nipples.

COMPLETE OUTFIT, **\$29.45**  
wt. 52 lbs.

EQUIPMENT LESS COMPRESSOR, \$10.95  
COMPRESSOR SEPARATELY, \$18.50

Compressor has 2" bore, 1 1/4" stroke, ball bearing, 3.27 CFM at 600 R.P.M. Capacity up to 6.54 CFM. Size 9"x11 1/8"x6 5/8". Wt. 26 lbs. Ideal for spraying paints, insecticides, etc., inflating tires, operating air tools, and other uses. All new equipment. U.S. government surplus. Replacement parts available. Amazing buy. Don't miss it. 10,000 satisfied users.

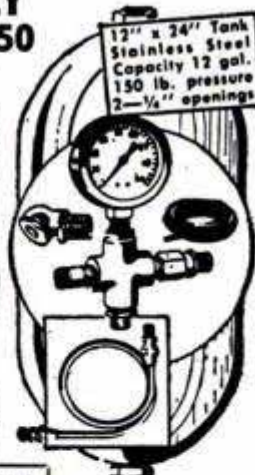
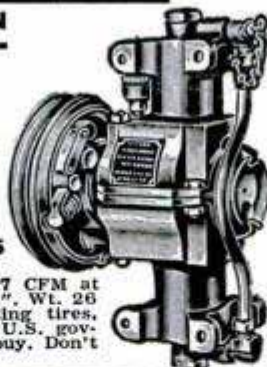

12" x 24" Tank  
Stainless Steel  
Capacity 12 gal.  
150 lb. pressure  
2-1/2" openings

## "WELLWORTH" V-BELT CLUTCH



Takes starting load off engines or motors. When speed is reached, a flip of handle shifts clutch from idling to driving position. Handles "A" belts, 2.35" pitch diameter, 3/8" bore. Ideal for use with lawn mowers, garden tractors, home workshop motors, etc. 3 1/4" long. Safe, easy to mount, sealed bronze bearings, positive action. Shpg. wt. 3 lbs.

**\$7.50**

Same clutch furnished with 3/4" bore.

**\$8.50**

## Save 50% on GAS ENGINES!

### ← Red Seal Continental

Gas engine. 1 1/2 HP with 6 to 1 reduction gear. Operates at 450 R.P.M. List Price \$79.50. Shipping weight 54 lbs. **SPECIAL PRICE..... \$39.50**

Wisconsin Engines—Model A.B. 1.7 to 3 HP. List Price \$90.00. **SPECIAL PRICE..... \$60.00**

Briggs & Stratton—Model AP. List Price \$102.00. **SPECIAL PRICE..... \$59.50**

Model BP 3.5 to 4.5 HP. List Price \$112.00. **SPECIAL PRICE... \$67.50**

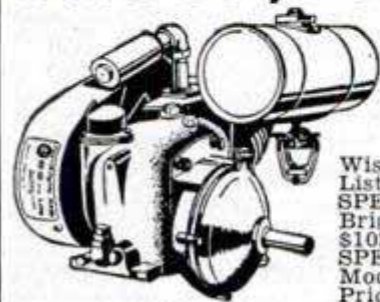

## AUTOMATIC PRESSURE SWITCH... \$5.50



## AIR TANK and ACCESSORIES

Air receiver, stainless steel, 12"x24", 400 lb. test. Ideal for carrying on trucks, autos and wherever compressed air is needed. Equipped with 500 lb. air gauge, tire chuck, 3 ft. high-test air hose, air inflation valve with core for retaining pressure in tank, and fittings. Two 1/4" openings.

Complete outfit with 12"x24" tank, shipp. wt. 20 lbs. . . . **\$6.95** Tank only **\$4.95**

Same outfit with 6"x24" tank, shipp. wt. 10 lbs. . . . **\$4.95** Tank only **\$2.95**

## LIGHT PLANTS! BARGAINS, WAR SURPLUS Send For Free Folder

## WELLWORTH TRADING CO.

1831 S. STATE ST. DEPT. D-9 CHICAGO 16, ILL.

## 140 CFM "WELLWORTH" BLOWER

Single-inlet blower that gives top performance on heating, ventilating, exhausting, cooling, drying and similar applications. 5 1/8"x4" mounting flange with 2 1/2" square discharge, 3 1/2" dia. blower wheel powered by direct-connected 1/15 H.P., 110 V., 60C., A.C. motor with conduit box and 20" leads, 7 1/2" wide less flange by 7 1/2" H. x 6 3/4" D. Suited for hundreds of new and replacement uses. Shpg. wt. 6 lbs. . . . **\$14.20**



## "Wellworth" BLOWER at a Bargain Price

Quiet operating. Double wheel inlet, double width blower. For heating, ventilating, cooling, air washing, exhausting and forced draft. DIMENSIONS: 10" wheel; outlet 1 3/8" x 1 3/8"; inlet 3/4". Height 19". Width 18". Depth 16 1/2". C.F.M., 1/4" S.P., 1800; outlet vel. 1575; motor 1/4 H.P. with overload relay; cord & plug, 110 v. 60 cy. A.C. Ship. wt. 67 lbs. **\$39.50**  
Special price . . .



Prices f.o.b. Chicago. Money back guarantee. Send check or money order today. Prompt shipment.

**NEW CATALOG!** Motor guide, air compressors, blowers, home and factory workshop tools. Also big bargains in luggage. Send 10c for postage.

## HELPFUL BOOKS

Send post card asking for FREE catalog

Popular Mechanics Press, 200 E. Ontario, Dept. 601, Chicago 11

## Say You Saw It in POPULAR MECHANICS

### Build Your Own Motorized Workshop

This Famous Book Shows How to DO IT!

### Easy-to-Make 40 Different Power Machines

Make them yourself—lathes, drill presses, sanding machines, shaper, circular, band and scroll saws and other power tools — from wood, pipe, and discarded parts that cost little or nothing. Get the new edition of "Forty Power Tools You Can Make" even though you have the older edition. This new book has 20 new tools. Make yourself up-to-date, efficient power machines that will save you hundreds of dollars. Send \$1.50 with order and save high C. O. D. charges. Your money back if not satisfied.



POPULAR MECHANICS PRESS, 200 E. Ontario St., Chicago 11, Ill.

## Make Garden Masonry for Spare-Time Profits

Millions of homes can use these Ornamental products — urns, vases, flower boxes, bird baths, lawn seats, flagstones, etc. Easily made of sand and cement. Permanently glazed in a range of smart colors. Distinctive — attractive — quick selling.

## Eye-Appeal Makes for Cash-and-Carry Sales

Selling prices allow 200% to 300% mark-up on basic costs. Only a small investment needed for supply of molds. Easily set up in shed or garage. Write immediately for catalogue OM and price list.

**COLORCRETE INDUSTRIES, INC.**  
710 Ottawa Ave., Holland, Mich.



**WE MADE A FABULOUS BUY... AIRCRAFT GENERATORS AND WE'RE PASSING IT ALONG TO YOU! NOW! YOU CAN BUILD YOUR OWN ARC WELDER FOR ALMOST NOTHING CONSIDERING ITS VALUE**

These Jack & Heintz, finest precision built R.I. Generators, used on B-29's cost the Government approximately \$400.00. Gives from 300 to 400 amps at 27V. Ideal for all welding, light and heavy up to 5/8" thickness. FREE complete instructions for conversion of this Generator to welding unit. **R - 1 NOW ONLY 1795**

**Other AIRCRAFT GENERATORS**  
That can be made into Arc Welders.

P-1	27 Volts	200 Amps	1595	E-5A	12 to 15 Volts	50 Amps	1295
1273-1A	27 Volts	75 Amps	1295	03	27 Volts	100 Amps	2595

**K-21 AERIAL CAMERA**

Equipped with I2.5 E.K. Aero Ektar 7" focal length Coated Lens. 24 Volt D.C. Electrically operated, complete with motor, cables, filter and carrying trunk. Lens alone is worth over \$250.00 and can readily be adapted to 4 x 5 Press type camera. Don't miss this chance to own the "Pride" of professional color photographers. **ARMY RE-ISSUE - CAMERA COMPLETE \$79.00**



VT-1

**VICKERS HYD. TRANSMISSION**



Self contained; 2 H.P. constant torque of all speeds with variable volume reversible, piston pump (controlled by outside lever) supplying piston hydraulic motor. Automatic pressure, dash pot for smooth control. Power output R.P.M. - 0 to 1/3 input R.P.M. in both directions. Input R.P.M. - 1800 continuous 4000 intermittent. Dash pot can be removed for greater R.P.M. Ideal for Lathes, Duplicator setup on Mills, Conveyors, Small Cars, Drives, Gearing, etc. Includes two 4" Spline Shafts for input and power take-off. **2500**  
Cost Government approx. \$400. ....

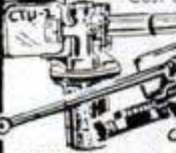

**ELECTRIC ACTUATORS**

These have hundreds of uses for any mechanical device that needs a controlled two-way action, such as raising and lowering or opening and closing doors, windows, gates, shutters, valves, etc.

**CTU-1** Lear No. 400A linear actuator. 24 Volt D.C. motor, 20,000 R.P.M., approximately 1/30 H.P. Drives the actuator through a high reduction gear box, resulting in 4 1/2" stroke in 14 seconds. Compression and tension loads up to 300 lbs. Has adjustable micro switch for limits of travel. Overall length retracted 10". A highly precise instrument. **ONLY 795**

**CTU-2** Foote linear actuator. 24 Volt A.C. or D.C., 6500 R.P.M., 1/6 H.P. Series wound motor, 4 1/2" stroke in 13 1/2 seconds. Compression and tension Loads up to 750 lbs. Adjustable micro switch for limits of travel. Overall length retracted 11". **ONLY 695**

**MOTORS**



**HEAVY DUTY G.E. GEAR HEAD MOTOR - 1 1/2 H.P.**, 24 Volt D.C., 125 Amp reversible motor drives reduction gear box unit 44.5 to 1, resulting in 168 R.P.M. at 5/8" diameter take-off shaft. Motor contains electro magnetic brake.

UNIT COMPLETE **1095**  
GEAR BOX ALONE **795**      MOTOR ALONE **495**

**DUMORE ELECTRIC MOTOR.** Adaptable to rigid or flex drive, 400 R.P.M. at power take-off. Contains 1/25 H.P., 24 Volt, 7 1/2 Amp reversible motor for indicating position. Has limit switches, magnetic brake, resistor to coordinate instrument. Overall dimensions - 8 1/2 x 4 1/2 long. **Only 750**

**LEAR ELECTRIC MOTOR.** 24 Volt - 6 Amps, series wound reversible motor with overload clutch. Motor turns 11,000 R.P.M. Has 11 to 1 gear reduction box turning 1000 R.P.M. at take-off. Adaptable to flex or rigid drive. **795**  
Has limit switch box. Size 10" x 4".



**REMOTE INDICATING SELSYN MOTOR.** Will operate on 115 Volt, 60 Cycle A.C. 2 1/4" diameter, 4" length. Works on simple electrical connection and can be used for any distance. Turn shaft of one unit and the other will follow accurately. Can be used on TV and Ham antennas, lens focus, weather vanes, film footage, and liquid levels, etc. **\$295 PAIR**



**SANSELL MOTOR - 27 Volts, 16 Amps.** 1/5 H.P. reversible, series wound on motor. 3800 R.P.M., shaft 9/32" diameter. 12-spline, 4-1/8" x 2-3/8". **ONLY 395**

**TERMS:** Order from this Ad. All sales final. All Prices F. O. B., Glendale. Pay by M. O. or Check. P. O.'s accepted from D & B. firms. 1/2 deposit with C. O. D.'s

**PALLEY SUPPLY CO**      6321 SAN FERNANDO RD.      Dept. PM 9  
GLENDALE 1, CALIF.

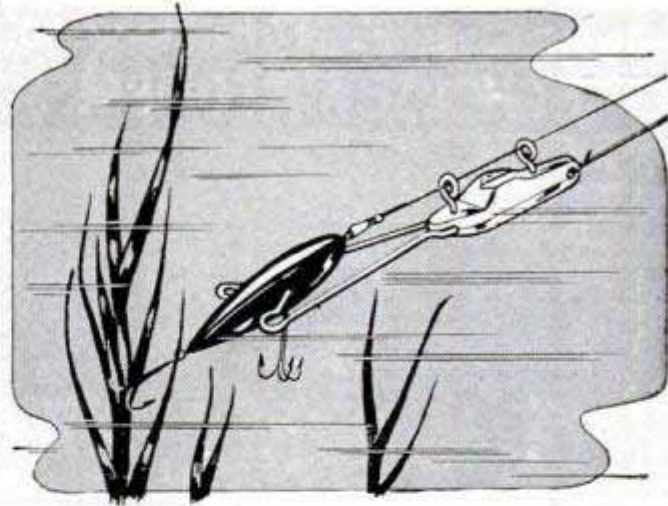

**Fishing-Tackle Retriever**

Fishing lures snagged on the bottom of a lake or river can be recovered with a new tackle retriever. The streamlined retriever is fastened to a long length of stout cord. The angler slips it over the fish line, which he holds taut while the retriever slides down to the snagged lure. Two wire arms form a V-shaped trap which slips over the lure and won't release. Tugging on the cord releases the tackle from the bottom.

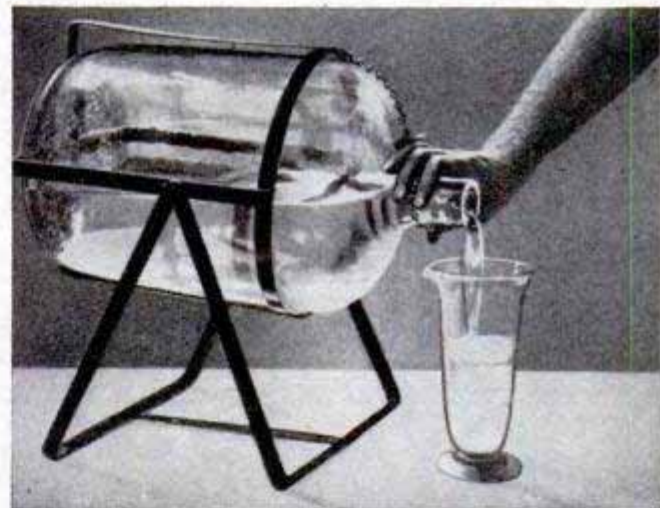

**Bottle Tilter**

Small amounts of liquid can be poured easily from a big, five-gallon jug if it is installed in a new bottle tilter. Designed for laboratory and industrial use, the tilter prevents spilling and splashing dangerous liquids and facilitates measuring small amounts from the big bottle. The bottle slips into a metal framework which is pivoted to a supporting stand. A chain attached to the framework fastens around the neck of the bottle to prevent it from slipping out when it is tilted far forward.

Made directly from coal in a single stage, a new form of carbon that is hard enough to scratch glass has been developed in England.

*Powell Duffryn Carbon Products, Ltd.*



**92 PAGE CATALOG**  
 War Surplus - Tools, Machinery, Raw Materials, Clothing, etc. Illustrated with valuable info., tables, charts & data. Send 25¢ to cover handling & postage.

# SAVE UP TO 85% IN WAR SURPLUS

Order from this Ad. All sales final. All Prices F.O.B. Los Angeles. Pay by M.O. or Check. P.O.'s Accepted from D & B Firms. 1/2 deposit with C.O.D.'s.



**PALLEY FAMOUS MIXES!** Prepared especially for the HOME CRAFTSMAN, HOBBYIST, INVENTOR, GADGETEER or SHOP MECHANIC.

**GADGET MIX** - Rivets, Spacers, Bolts, Screws, Gears, Wheel Bearings, Springs and Clamps. No. 106, 3 lbs. . . . . **1.19**

**BEARING MIX, No. 170A.** Approx. 20 needle, Ball & Roller Bearings, New & Used. Sizes: 1/2" to 4". Some of these cost Gov't \$10 a piece. Never such a value! 5 lbs. ONLY . . . . . **1.59**

**HINGE MIX, No. 170H.** 12 pairs of Strap and butt hinges, Hops, 1" x 1" to 7/8" x 10" in length and 8" strap. 2 lbs. . . . . **1.09**

**ABRASIVE AND GRINDING WHEEL MIX** - 50 pieces including honing stone, pencil rolls, wheels, etc. A sharp value. No. 170AG **99c**

**SPRING MIX, No. 206** - Torsion, Compression & Tension Springs. Ass'd. sizes. A treasure trove for emergencies. Scores of springs. 5 lbs. for ONLY . . . . . **1.69**

**RIVET MIX - 3 POUNDS** - Consisting of sizes from 1/4" long to 3" long in many diameters & alloys. **1.19**

**FILE MIX** - Ten assorted Files, 4" to 12", includes 3 Vixens, half rounds bastards, mills, etc., in seconds and used but in good condition. 1 Vixen alone worth our price for entire mix. F-1 **99c**

**PULLEY MIX, No. PM-1** - You'll want this one around. 10 micarta & metal pulleys ranging from 1" to 5" with ball and one piece bearings. These are aircraft pulleys, the best made with 100's of uses. A WONDERFUL BUY!!! **2.95**

**COUNTERSINK MIX, No. 168.** Wide assortment. Excellent condition. High speed steel. Assortment of ten 100° and 110° with pilot sizes ranging from 3/32" to 3/16" No. CM-1 **2.69**

**SCREW MIX** - 5 lbs. incl. 2 1/2 lbs. wood screws & 2 1/2 lbs. machine screws. All sizes. Save dollars and always have plenty of screws on hand. **1.39**

**NUT MIX NM-1** - 3 lbs. approx. 500 nut. Anchor, Lock, Castle, Hex, Elastic Stop Nuts, etc. You'll always have plenty of Nuts in the shop. NM-1 **1.39**

**SUPER COMBO MIX - No. SC2.** Here's a real bargain. All eleven above mixes for ONLY . . . . . **14.95**

**REAMER MIX - No. 168.** Reamer assortment: Special Taper line Finish Reamers, High Speed Steel. Slightly used but in excellent condition. Ten assorted sizes ranging from .168x.165 & .244x.215 to .425x.385 & .432x.403. One alone worth our selling price of ten. For set of ten Reamers . . . . . **4.49**

**METAL SNIPS** - Hard steel blades. Comp'd action. Expansion spring and locking device. Right and left hand types. **NOW 2.59**

**15' MONKEY WRENCH**  
 Adjustable Jaw - Opens to 4"  
 Drop Forged. Auto Type.  
 Cadmium Plated **89c** Black **79c**

**PIANO HINGE**  
 Overall Width Length Price Ea.  
 1 1/4" (5/8" side) 72" alum. \$1.00  
 2" (1" side) 9" alum. \$1.75  
 3 1/2" (1-3/4") 54" st. steel \$1.69  
**BRASS HINGE** - 1 1/4" (5/8" side). 0.40  
 Any length at . . . . . 29¢ per ft.

**PALLEY SUPPLY CO**  
 DEPT. PM9 GLENDALE 1, CALIF.

## UTILITY BOXES FOR HOME - OFFICE, SHOP, ETC.

**ALUMINUM**  
 "Odds 'n Ends" box for sportsman, shop, or house. Decorative and sturdy. Aluminum construction.  
 13 1/4 x 11 1/2 x 4 . . . . . **2.75**  
 12 1/2 x 10 1/4 x 6 . . . . . **2.69**  
 7 1/2 x 5 x 4 . . . . . **99c**

**TWO HEAT SOLDERING IRON**  
 World's Hottest Iron Value!  
 Two soldering irons in one with button heat control. Push the button - Select 150 or 300 Watt heat for light or heavy work. Complete with tip, bench holder, 5' asbestos cord, 110V AC. A \$15.00 Value For . . . . . **3.95**

**INSTRUMENT MIX**  
 6 DIFFERENT TYPES 6  
 Contains 1 each of the following items:  
 Flight Check-off • Position Indicator  
 Selsyn Fuel Gauge • Air Speed Indicator  
 Fuel/Air Ratio • Oxygen Regulator  
 These instruments contain sensitive meter movements, jewels, bearings, gears & valves.  
**COST THE GOV'T MORE THAN \$500.00**  
**SPECIAL!! ALL 6 FOR ONLY 5.95**

**Sperry Aircraft Directional GYRO COMPASS**  
 Dial is 360° swing calibrated 1/10° (6 min). Panel Mount 4 1/2" square with 3" luminous dial. Can be used in autos, planes, or boats by attaching one tube to intake manifold for required vacuum. Complete with reset caging knob. Gov't. overhauled - ONLY . . . . . **\$449**

**TACHOMETER - Type C-9A.** Operates on direct drive with flexible shaft. Range is 0 to 4500 RPM. Ideal for use on single engine planes or boats, autos, etc. Drives direct from camshaft or at 2-1 reduction from crankshaft. . . . . **44.75**

**FIRE EXTINGUISHER**  
 Kiddie Lux CO2 Type. Built to Gov't spec. Shatter-proof, heavy case. Fully re-charged. With horn.  
 No. 602A - 7 1/2 lb. \$35 Value. **19.25**  
 No. 603 - 10 lb. A. \$65 Value. . . . . **25.75**  
 No. 605-A - 15 lb. New. Break disc Type. A \$75 Value . . . . . **29.75**  
 No. 605-B - 15 lb. Wheel Control Type. . . . . **32.95**  
 No. 605-C - 15 lb. New. Squeeze Grip Type. \$85 Value. . . . . **39.95**  
 Note: Weights listed are capacity extinguisher charge.

**2 TON WINCH**  
 Can be Hand or power operated. Has large capacity steel drum for cable. Powerful gear - reduction drive and manual brake. . . . . **36.50**

**AIR COMPRESSOR**  
 High Pressure  
 General Electric, 2 stage AC - DC. Rated pressure 1000 lbs. per sq. in. with 1/3 H.P. 27 volt, 7 AMP series wound motor with fan for cooling. Thousands now in use for spraying, inflating, laboratory use, etc. Can be adapted to 110 volt A.C. with transformers  
 A tremendous value at approx. 5% of original cost . . . . . **22.50**  
 We also have transformers for above.

**RIBO RIVET GUNS**  
 Pistol & Gooseneck Type  
 Gooseneck **88** Pistol **89.95**

**RAWHIDE Mallet**  
 For working soft metal, or plastics, driving pins, etc. Weight 2 1/2 lbs., metal collar with rolled leather insert head. **1.09**

**UTILITY HAMMER**  
 For use as masonry chisel, stake driver, sledge, etc. Head special forged steel, sharp cutting edge. Handle is select hardwood.  
 1 1/2 lb., 14" handle . . . . . **79c**  
 2 lb., 21" handle . . . . . **99c**

**AUTO PULSE PUMP** - Ideal for fuel pump for auto or boat. 24 Volt D.C. Can be adapted to 6 Volt D.C. 1/8" stand-ard pipe parts . . . . . **5.50**

**WHEELS** For Wagons, Dollies, Handtrucks, Wheelbarrows, etc. 10" dia., with 1/2" center hole. (can be drilled out to take 5/8" axle) Wheel is 1/8" steel with 10 x 1.75 heavy duty, semi-pneumatic cushioned rubber tire. . . . . **\$1.75**

**1/4" CLARK ELECTRIC DRILL.** Heavy duty. Reconditioned, made to rigid Gov't. spec's. 110V A.C., 60 cycle, 1 phase, ball bearing motor, 5,000 R.P.M., 1/4" Jacobs Chuck, 8 ft. cord, plug. **15.95**

**2 SPEED PORTABLE MOTOR-ENERGIZER.** Used as auxiliary power source, to actuate starters or as principal power source. 1001 uses as high speed drill motor, power booster, etc. Has governor, 50 ft. electrical cable. Length 34". Power A.C., 110-115V, 60 Cycle, D.C. **NEW 27.50**  
**AN ELECTRIFYING BUY!**

**ADJUSTABLE TAP WRENCHES**  
 Jaws are made of tool steel, hardened & tempered. Won't break or get out of line.  
 #57 Threadwell Cap. 1/4" to 1 1/8" Length 19" . . . . . **\$2.49**  
 #8 Vermont Cap. 3/4" to 1 5/8" Length 40" . . . . . **\$3.49**  
 #24 Greenfield Cap. 1 3/4" to 4" Length 72" F. . . . . **\$6.49**

**AIRCRAFT CABLE**  
 Rust resistant alloyed steel, extra flexible, preformed - 7 x 19 strand-on reels.  
 1/16" . . . . . 3 1/2¢ 7/32" . . . . . 7 1/2¢  
 5/64" . . . . . 4¢ 1/4" . . . . . 9¢  
 3/32" . . . . . 4 1/2¢ 9/32" . . . . . 10¢  
 1/8" . . . . . 5¢ 5/16" . . . . . 12¢  
 5/32" . . . . . 5 1/2¢ 3/8" . . . . . 13¢  
 3/16" . . . . . 6 1/2¢ 1/2" . . . . . 16¢  
 Stainless Steel Cable  
 1/16" . . . . . 5¢ 1/8" . . . . . 14¢  
 1/4" . . . . . 24¢  
 Aircraft control cable 18 ft. long, 3/16" diam. with turnbuckle ends. . . . . **99c**

**Neoprene Sheet Stack RUBBER**  
 Price per Thickness Approx. Width run yd.  
 #325 .020 1/64" 36" \$1.75  
 #328 .032 1/32" 22" 1.38  
 #330 .064 1/16" 36" 2.39  
 #331 .093 3/32" 36" 3.39  
 #329 .125 1/8" 46" 4.75  
 Note: No. 329 is Laminated rubber sheet with cloth center.  
 No. 332 - Grey Neoprene Rubber Floor Mat. Has raised non-skid Diamond pattern with durable cloth backing. Stock size: 36" x 48" x 1/16" thick **\$1.95 ea.**

## NEW HYDRAULIC CYLINDER SPECIAL

20,000 lb. thrust (push pull) using 1500 PSI line pressure as obtained from our hyd. pumps. Or will produce 40,000 lb. thrust with 3,000 lb. line pressure. CAN ALSO BE OPERATED ON LOW PRESSURE AIR SYSTEMS. 4" Bore, 1 1/2" dia. piston shaft, 18" stroke, length 30 1/2". Equipped with ball bearing loaded clevis type mounting and swivel type high pressure steel pipe bracket for easy use. Ideal for road, farm & shop machinery, presses, etc. Cost Gov't \$390.00 **22.50**

**No. 9-E HYDRAULIC CYLINDER**  
 Double action cylinder. Has a bore of 1-3/8" and shaft of 1". Stroke is 9". Overall length 15 1/2". Built for 1500 lbs. continuous duty, 3000 lbs. intermittent duty. Will lift or push up to 2300 lbs. Can be adapted to hundreds of jobs. **NOW 8.95**

**No. 3 HYDRAULIC CYLINDER**  
 Double action. Bore is 1". Shaft 3/4". Has a stroke of 2 1/2" to 4". Stroke can be adjusted with internal sleeve stops. Overall length is 8 1/2". Will take 1500 lbs. continuous duty, 3000 lbs. intermittent. Will lift or push up to 1100 lbs. **3.75**

**4-WAY VALVE**  
 Poppet Type. Valve shuts off at neutral position. Has 3/8" AC Tube Ports - 9/16 20 thread. Will stand 1,500 P.S.I. **4.75**

**BENDIX HYDRAULIC HAND PUMP**  
 Provides an instantaneous source of tremendous power for almost any heavy work. Double action stroke. Delivers .30 cu. in. per cycle at 3000 PSI. Max. press. 5000 PSI. Built-in Reservoir cap. 2 1/2 qts. 3/8" pipe outlets. Has Pressure Release Valve. 7/8" dia. by 23 3/16" overall ht. Weight 15.2 lbs. A \$40.00 Value for . . . . . **13.95**  
 IN EXCELLENT CONDITION

**Hydraulic PUMPS**  
 Logan Gerator type. For operating hydraulic systems on trucks, tractors, etc. Delivers 8 GPM at 1200 RPM, at 1000 PSI with 5 HP. Can also be used as Hydraulic Fluid Motor. Has 3/8" stand pipe parts, 1/2" splined shaft for pulley or direct attachment. 5 1/2" dia. by 7" long. Used, but condition guaranteed. **ONLY 17.50**

**VARIABLE GEAR BARGAINS**  
 6 to 1 with screw shaft #111 . . . . . **\$4.98**  
 85 to 1 (can be used for radio antennas, etc.) **\$3.95**

**GEAR BOXES** VTG-1 - 90°, bevel gear 1 1/2 to 1 reduction, size 7" x 6". A Lifetime Value. . . . . **\$3.95**  
 VTG-2 - Inline spur gear 16 to 1 reduction, thru 4 gears. Final take-off 4 1/2" dia. 26 tooth. 1/2" Alum. spur gear. . . . . **\$6.49**  
 Both above gear boxes have lever control for engaging & disengaging positive clutch. Dust proof housing. Lubricated bearings. Both can be adapted to Vickers Transmission.

**ELECTRONIC TRANSMISSION GEAR TRAIN**  
 GT-1, approx. 50 Bronze Spur & Pinion Gears - 3/8" to 4" dia., 5 sets of 7 cluster gears, 2 complete worm and worm gear drive sets, 40 N.D. ball bearings, 1/2" to 1 1/2" dia., watch springs, bushings posts, face plates, housings - Micro Switches, 2 miniature controlled clutches, etc. Gears in multiple size & sequence, identical teeth ratio, giving 100's of gear reduction combinations. **\$8.49**  
 Wt. 19 lbs. . . . .

NOTE: 72 page Hydraulic & Tool catalog. Send 25¢ to cover handling and postage.

# NEW 14" South Bend Economy Model DRILL PRESS

**\$69.50**  
f.o.b. factory  
less  
motor and chuck

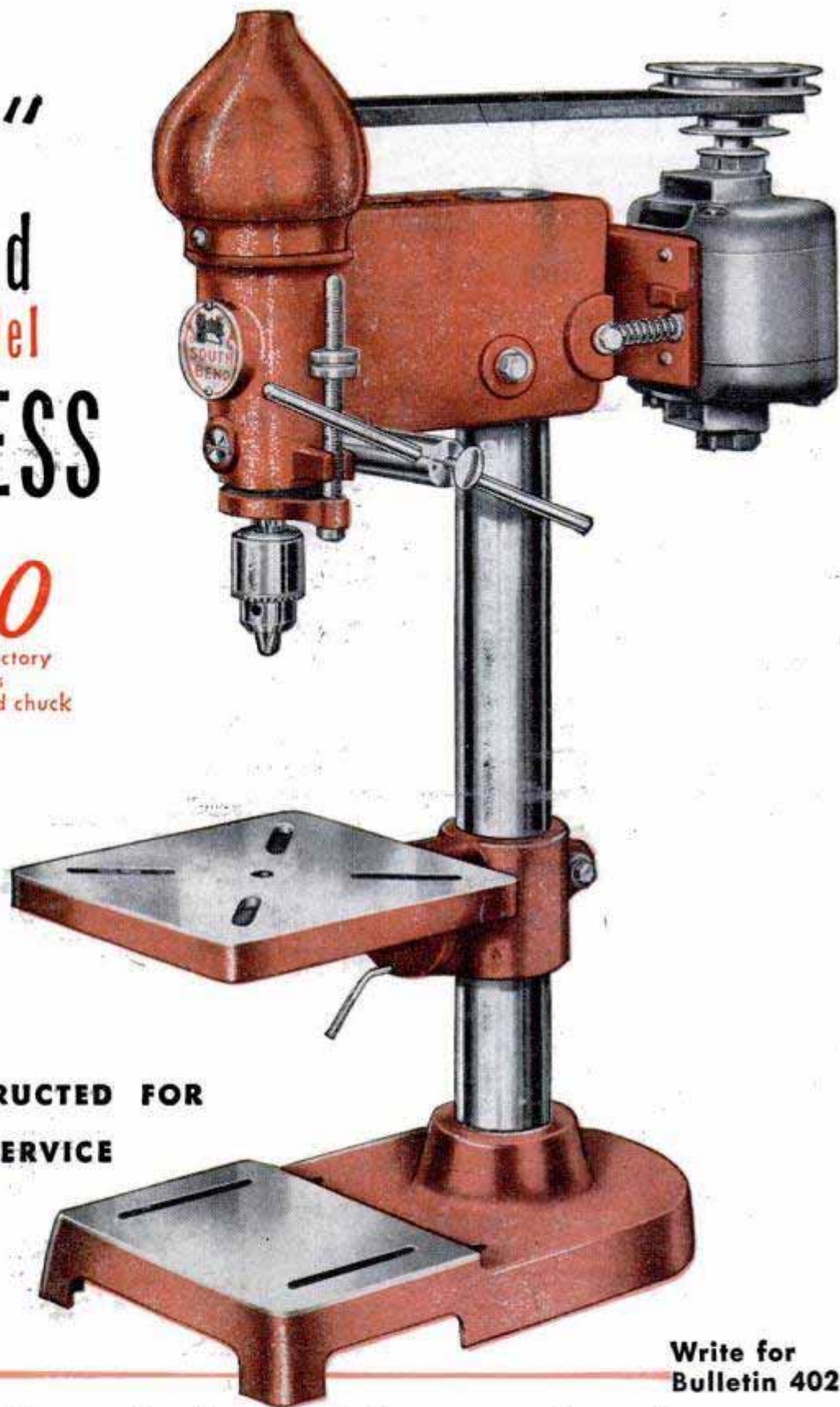

**RUGGEDLY CONSTRUCTED FOR  
MACHINE SHOP SERVICE**

**Features** include automatic belt tension, direct reading depth stop, full tilting table, rigid one-piece head casting, free-floating six-spline spindle, four pre-lubricated precision ball bearings, and adjustable feed tension.

**Specifications:** Drills to center of 14-1/4" circle, maximum drill size 1/2" in steel, spindle run out .005" or less, spindle square to table within .0075" in 5". Net weight of bench model shown, less motor and chuck is 124 lbs.

**Write for  
Bulletin 402**



**SOUTH BEND LATHE**

SOUTH BEND 22, INDIANA  
Building Better Tools Since 1906

Printed by Popular Mechanics Company, Chicago, Ill., U. S. A.

# NOW AT MY RISK!

I want you to read the  
**WARNER SUCCESS PLAN**



It shows you how to...  
**METALIZE BABY SHOES**  
AND OTHER KEEPSAKES

- how you can start in spare time with your home as headquarters.
- how to build—step by step—to big profits and personal independence.

This is the famous Warner Success Plan—the Plan for Personal Success in your own fascinating business that many men, married couples credit with freeing them from the limits of a pay check and from the drudgery of a time clock.

It gives the exact step by step instructions for starting a business in spare time—without risking the job or steady pay. It shows with pictures, photographs, and drawings exactly how to Metalize Baby Shoes and other keepsakes. It shows how to get the orders coming in—how to expand—how to get others working for you—how to be SURE of at least twice your present pay before you give up your job for a life of personal independence.

## 15 Million Prospects

There are 15 MILLION pair of Baby Shoes in the country right now ready to be Metalized. Last year alone, more than THREE MILLION more babies were born.

There's not one of these mothers who doesn't want her baby's first shoes preserved forever. The Business is tremendous... and never ending.

The Warner Success Plan shows you how to turn this exciting opportunity into cash. Shows exactly how to prepare the shoes, how to put on them a coating of genuine gold, silver, or bronze metal by simple Warner Electroplating process. Shows how to get the business coming in, how to start in spare time, how to pyramid profits. Shows you how the whole family can have fun while building for an independent future. My own Shop here in Chicago does a Big Business by the very secrets I will now unfold to you.

## Read The True Facts

Don't say "Yes" now. You must have ALL THE FACTS. Then decide. First, I want you to read the entire Plan—at my risk. After investigating—after discussing it with your family—then and only then do you decide whether to use the plan and make the small investment necessary to start.

## MAKE 12 TIMES YOUR MATERIAL COSTS

Remember, the Warner Process is not a cheap imitation "PAINT" process. It is the genuine METALIZING through real Electroplating. And in spite of being the best, your materials cost so little that your profits are 12 Times your material cost. Then, when mothers order the shoes mounted as book-ends, as pictures, as ash-trays or pen sets, you make the BIG EXTRA PROFITS on the beautiful mounts.

**WARNER-ELECTRIC CO.**  
1512 Jarvis Avenue  
DEPT. 3-P  
Chicago 26, Illinois



**\$5.00**  
**An Hour PROFIT**

Yes, even in spare time it is possible for a man to finish enough work to pay \$5.00 an hour for his time. Think what this can pyramid into when the family helps.

## 3c MAY START A FORTUNE

Today I want you to do only one thing. Send the coupon. Let me give you all the facts. Remember, what I send you does not cost you a cent beyond the postage you put on your letter to me. With an opportunity like this, a man who has a serious interest in his future MUST investigate. MAIL the COUPON TODAY and see for yourself why so many families have called the WARNER SUCCESS PLAN a "godsend".

**DON'T SEND A PENNY  
JUST MAIL THIS COUPON TODAY!**

**Raymond E. Brandell, Mgr., WARNER ELECTRIC CO.**  
1512 Jarvis Ave., Dept. 3-P, Chicago 26, Ill.

As long as it doesn't cost me a cent, I am willing to read the facts, investigate, then give you my decision. Send the facts by next mail. Everything you send now is FREE!

NAME \_\_\_\_\_

ADDRESS \_\_\_\_\_

CITY \_\_\_\_\_ Zone \_\_\_\_\_ STATE \_\_\_\_\_



## WE SUPPLY ALL MATERIALS

You don't have to go "hunting" when Warner is behind you. We supply all materials, all mounts, chemicals, and metals. And you get the low prices made possible by our big quantity purchases and our own manufacture. You send for just what you need and never have any big investment tied up in stock.



**MUSICAL COMEDY STAR** — *Nancy Fabray*: "As I welcome Camel mildness and flavor..."



**BOSTON RED SOX** pitcher, *Mel Parnell*: "I'd walk a mile for a Camel, any time. Great-tasting smoke..."



**RIFLE CHAMPION** *Audrey Bockmann*: "Camels certainly score a hit with my taste. And they're so mild!"



**EZIO PINZA**, former star of "So. Pacific": "I smoke the cigarette that agrees with my throat — Camel!"



**DISC JOCKEY** *Bob Maxwell*: "My voice gets a steady workout. My throat welcomes Camel mildness."



**TELEVISION STAR** *Marguerite Piazza* agrees: "As a singer, I enjoy Camel mildness. Camels taste grand!"



**RADIO SONGSTRESS** *Fran Warren*: "Camels are mild! My 30-Day Test proved they agree with my throat!"



**RALPH BELLAMY**, noted actor: "Throat irritation doesn't go in show business. Camels agree with my throat!"



"I'VE JOINED the millions of smokers who'd walk a mile for a mild Camel!" *Ann O'Rourke*, secretary.



"I'VE SMOKED mild, cool Camels for 20 years. Camel flavor suits me to a 'T.'" *G. Campbell*, sportsman.



**PATRICIA MORISON**, musical comedy star: "Yes, I made my own 30-day Camel mildness test. It was fun."



**TELEPHONE OPERATOR** *Ethel James*: "In my job, cigarette mildness is important. Camels are my smoke!"



**PETER LIND HAYES**, comedian: "I found what mildness means when I made my Camel 30-Day Test!"

# HOW MILD CAN A CIGARETTE BE? Smoke Camels and See!



**Millions Prove Camel Mildness in their "T-Zones"**  
(T for Throat and T for Taste)

**YOU**, as a smoker, know there is one sensible way to test a cigarette. The reliable test is to smoke pack after pack. That's why many smokers have made their own Camel 30-Day Mildness Tests.

And noted throat specialists confirmed Camel mildness in a coast-to-coast test of hundreds of smokers who smoked only Camels for 30 days. Their throats were examined each week — 2,470 examinations. The doctors' findings: — *Not one single case of throat irritation due to smoking Camels!* But make your own 30-Day Test. You'll discover why...

**MORE PEOPLE SMOKE CAMELS THAN ANY OTHER CIGARETTE**

R. J. Reynolds Tobacco Co., Winston-Salem, N. C.

**MEL MILDNESS** with my throat the start!", re-housewife Mrs. Kinney.



"KE a pack of day. Every tastes good! els for me!" *R. ie*, Personnel dir.