

AUGUST 1950

35 CENTS

ANC

POPULAR MECHANICS MAGAZINE



WRITTEN SO YOU CAN UNDERSTAND IT

REG. TRADE MARK, GREAT BRITAIN, No. 410426

OFF.



**"BOWLING" DOWN FORESTS
FOR A SUPER DAM**—Page 90

Get out of the

Danger Zone

The More You Delay—The More You Pay

There's always danger ahead when piston rings wear out—danger of much greater expense unless new rings are installed promptly.

But if you *do* install new rings at the first symptom of wear, you can protect your engine and insure its long and economical life.

Check your own situation on the Danger Zone chart, with the help of your service man. This simple precaution may save you both money and headaches. For the more you delay the more you pay. And if you need new piston rings, get Hastings, the rings designed for replacement service. It's the best money you can spend on your car.

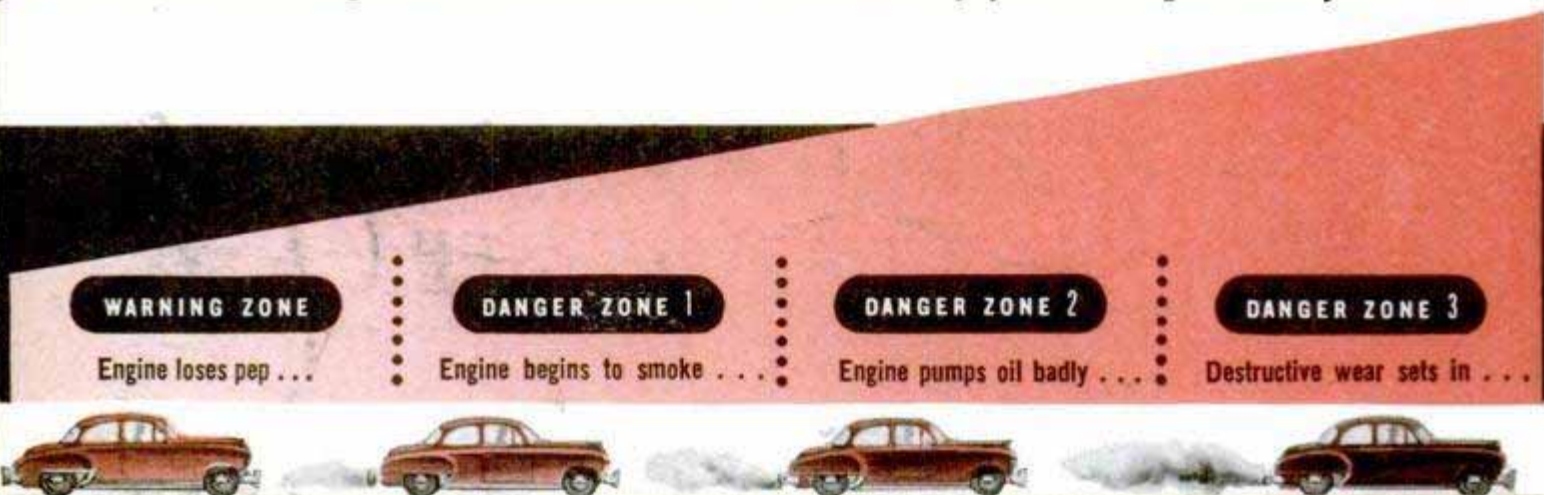

WARNING ZONE

Engine loses pep ...



DANGER ZONE 1

Engine begins to smoke ...



DANGER ZONE 2

Engine pumps oil badly ...



DANGER ZONE 3

Destructive wear sets in ...



Needs a tune-up

Clean, adjust and re-time ignition. Clean fuel supply and carburetor screens. Adjust carburetor. Adjust tappets and fan belt. Check compression and vacuum readings for symptoms of ring wear.

Needs new piston rings and minor engine repairs

- Replace piston rings. Align rods. Adjust rods or replace rod bearings. Reseat and reface valves.
- Tune engine.
- These repairs are comparatively inexpensive and put the engine back in peak condition for thousands of economical miles. Delay puts the engine in Danger Zone 2.

Needs new piston rings and major engine repairs

- Replace piston rings. Replace piston pins. Adjust—probably replace—main bearings. Align rods. Adjust rods or replace rod bearings. Reseat and reface valves. Tune engine.
- These repairs naturally cost more than those needed in Danger Zone 1, but they put the engine back in condition for thousands of additional miles of satisfactory service. Delay leads to costly Danger Zone 3.

Needs new piston rings and complete overhaul

- Repairs cost three or four times as much as in Danger Zone 1.
- Remove engine. Rebore cylinders. Replace pistons, pins, rings. Replace main bearings. Align rods, refit or replace rods, or replace rod bearings. Overhaul valve lifters, rocker arms. Replace timing chains or gears. Reseat, reface valves. Replace guides and springs. Replace camshaft bearings. Clean oil lines. Overhaul oil pump.
- Clean, re-install and tune engine.

TOUGH BUT OH SO GENTLE



HASTINGS

MANUFACTURING COMPANY
HASTINGS, MICHIGAN
HASTINGS LTD., TORONTO

STEEL-VENT PISTON RINGS



TOUGH on Oil-Pumping • GENTLE on Cylinder Walls

Drive anywhere this summer

AND NEVER HAVE A FLAT TIRE!



Fishing haunts back in the woods . . . picnic spots off the main road . . . unexpected puncture-full detours . . . and never worry for a second about having a flat tire!



Run right over razor-sharp glass! The punctures will be sealed as you ride, with Seiberling SEALED-AIR Tubes (completely different from any other tubes in the world!)

NO ONE CAN IMITATE THE WAY THIS TUBE SEALS PUNCTURES!

Exclusive design principle . . . perfected, proved, and patented by Seiberling . . . makes SEALED-AIR Tubes different from all others in the world . . . gives you *more protection* against troublesome flats and dangerous blowouts.

Outlasts set after set of tires. Think of the savings! And you won't have to spend a nickel on tire repairs, either. If you drive a car or truck, mail the coupon below for complete details on this amazing tube . . . and what it can do for you.

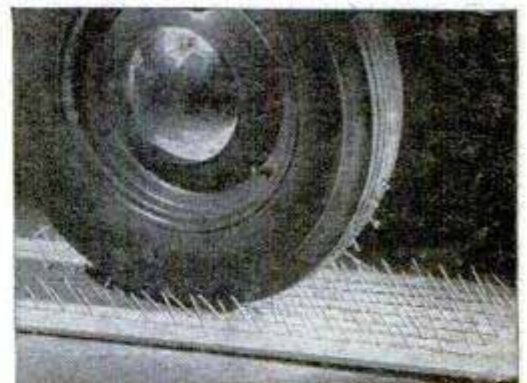

Pick up nails . . . not just one nail, but a dozen or a hundred . . . and what happens? NOTHING, when Seiberling patented SEALED-AIR Tubes are inside your tires.

Mail the Coupon NOW!

SEIBERLING

Sealed-Air TUBES

WITH PATENTED BULKHEADS

FREE

True Story: "10,189 PUNCTURES, AND NOT ONE FLAT." Learn how the only tube built around patented Bulkheading principle can save you money . . . AND TROUBLE. No obligation. Simply mail this coupon now (before YOU have a flat!) to Seiberling Rubber Co., Dept. PM-1, Akron 9, Ohio.

Name _____

Address _____

City _____ State _____

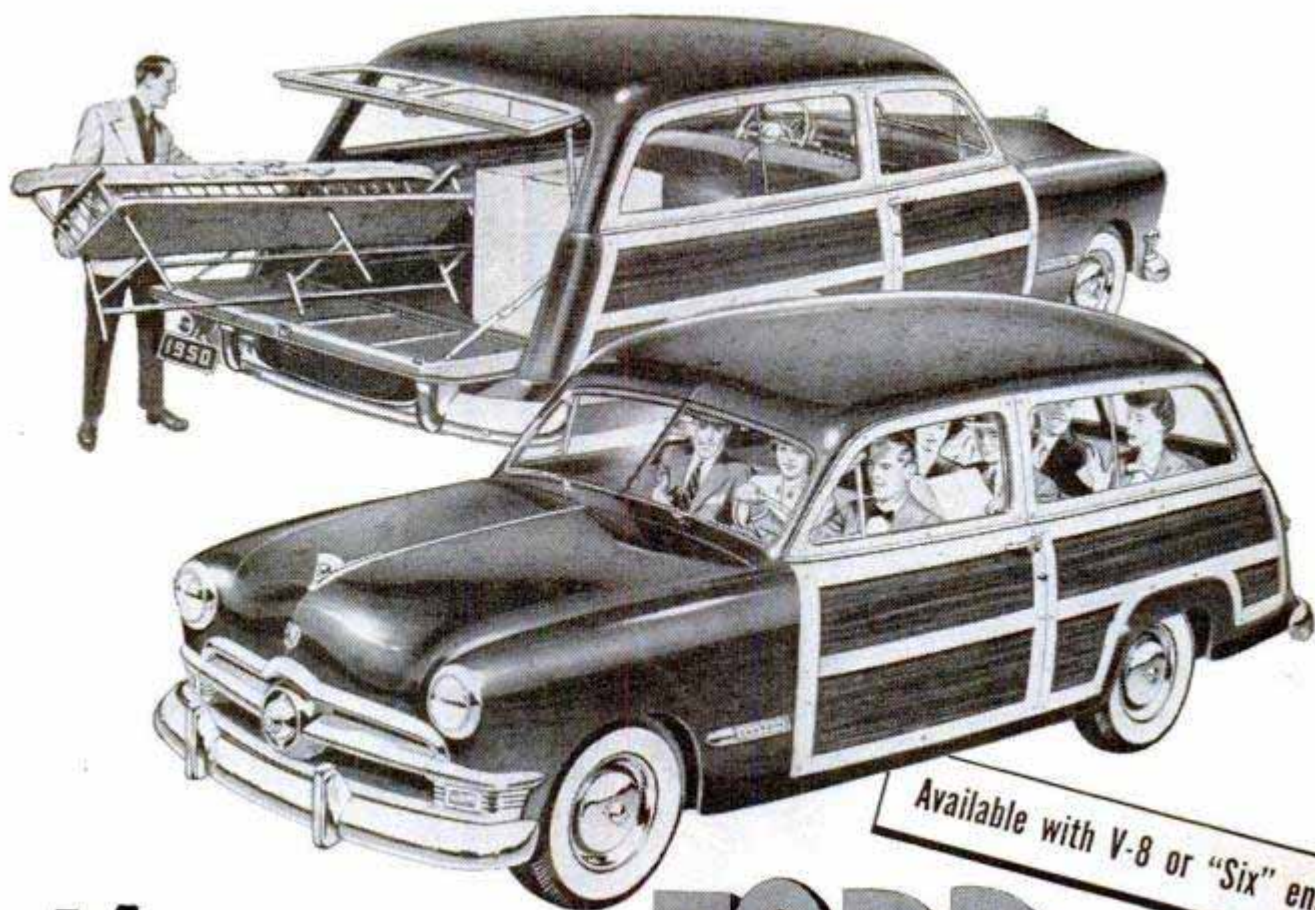

Available with V-8 or "Six" engine

Meet the new FORD "Country Squire" STATION WAGON

The "Double Duty" Dandy of them all!

Carries 8 big people in comfort . . . handles half a ton of freight with ease, thanks to "Stowaway" center seat and "Flat-Deck," one level cargo space.

Just look...



It's got more flat carrying area than any other station wagon in its class. Simply remove rear seat—no tools required.



Lift and reverse center seat cushion with handy tab. Fold the "Stowaway" seat-back forward.

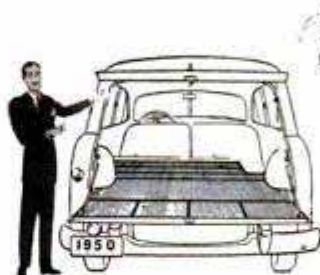

3 Slip insert panel in place and—presto—you have a continuous flat loading deck measuring nearly 9½ feet to end of tailgate . . . 38.8 square feet of "level-loading" area.

Smart station wagon looks with welded all-steel body . . . grained mahogany finished exterior steel panels framed in genuine birch or maple . . . torsion-bar type tailgate hinge . . . flush tailgate . . . non-sag cushion in driver's seat with foam rubber pad . . . two-door design for greater strength, safety . . . two-tone tan vinyl and simulated leather upholstery and interior trim.

White sidewall tires, wheel trim rings, optional at extra cost.

So economical, too—to buy and to own... See your Ford Dealer

Popular Mechanics Magazine

Registered in U. S. Patent Office and Canada

H. H. WINDSOR, Founder

H. H. WINDSOR, JR., Editor and Publisher



this month's cover

NOW THEY'RE mowing forests as easily as a Kansas farmer cuts a field of wheat. Timber, 35 square miles of it, had to be cleared for the walloping Hungry Horse Dam, now under construction. A pair of ingenious contractors attached a cable between two "cats," supported it in the center with a huge steel ball and sent the cats off on separate courses. You can see the smashing result on our cover. On page 90 is the story of this titanic game of jackstraws

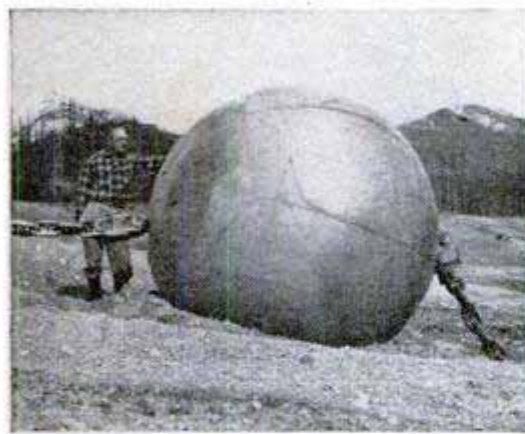

Published monthly by Popular Mechanics Company, 200 E. Ontario St., Chicago 11, Ill. H. H. Windsor, Jr., president; William Harrison Petridge, vice president; D. F. Windsor, vice president and secretary-treasurer; Clover L. Perkins, advertising manager; Alan M. Deyoe, circulation manager. Single copy in the United States and Canada, 35 cents; subscription rates in United States and possessions, Canada, Philippines and countries of the Pan-American Postal Union, 1 year \$3.50; 2 years, \$6.00; 3 years \$8.00. To all other countries add \$1.00 a year over United States prices for overseas postage. If you plan to move, notify us at least 30 days in advance so you will not miss an issue. Give both old and new addresses. Entered as Second Class Matter, September 15, 1903, at the Post Office at Chicago, Illinois, under Act of March 3, 1879. Entered as Second Class Matter at Post Office Dept., Canada. Copyright 1950 by Popular Mechanics Company, Copyright under International Copyright Union. Copyright in France. All rights reserved under Pan-American Copyright Union. Printed in the United States of America.

Volume 94 AUGUST 1950 Number 2

Managing Editor.....Roderick M. Grant
 Assistant Managing Editor.....Wayne Whittaker
 Shop Notes and Crafts Editor.....James R. Ward
 Radio-Television, Electronics Editor.....Frank L. Brittin
 Associate Editor, Aviation.....Aubrey O. Cookman, Jr.
 Associate Editor.....Clifford B. Hicks
 Automotive Editor.....Siler Freeman
 Art Director.....Frank Beatty
 Director, Bureau of Information.....Allan Carpenter

Assistant Editors

Donald R. Brooks Dorothy E. Hoffmann Arthur R. Railton
 H. H. Windsor III

Assistant Editors, Shop Notes and Crafts

W. Clyde Lamme Wayne C. Leckey Frank N. Stephany A. E. Youngquist
 Eastern Editor.....Richard F. Dempewolff
 Empire State Bldg., Room 2906, New York 1, N. Y.

Western Editor.....Thomas E. Stimson, Jr.
 3872 Franklin Ave., Los Angeles 27, Calif.

Representative in Great Britain.....Douglas W. Wedderspoon
 77 Baker St., London W. 1, England

IN THIS ISSUE

Hot-Rod Derby on the Salt Flats - - - - -	65
A Super-Tanker Feeds Oil-Thirsty America - - - - -	72
Home-Owned Big Top - - - - -	81
"Bowling" Down Forests for a Super Dam - - - - -	90
I Read "P.M." Behind the Iron Curtain - - - - -	98
Spinning a Span to Foil the Wind - - - - -	102
The "Big Blow" Takes the Diesel's Challenge - - - - -	108
School for Jet Pilots - - - - -	117
The Shipyard That Grew From a Toolbox - - - - -	128
Deep in the Heart of Ohio - - - - -	134
What's New for Your Home - - - - -	140
Restoring Old Williamsburg's Relics - - - - -	144

For the Craftsman

Your Modern Kitchen—Part I - - - - -	150
Reseating An Antique Chair - - - - -	162
Care and Repair of Bamboo Rods - - - - -	175
Inexpensive Boat Accessories - - - - -	180
Record Cabinet Serves as Hassock - - - - -	186
Build This 6-in. Circular Saw - - - - -	193
Precision Measuring—Part II - - - - -	203
Shopping for Tools - - - - -	208
Radio-Television, Electronics - - - - -	211
Clinic for Homemakers - - - - -	220

Other items, and manufacturers of available products described, are listed on pages 12, 14 and 16

Where'd you get the orphan, Tom?

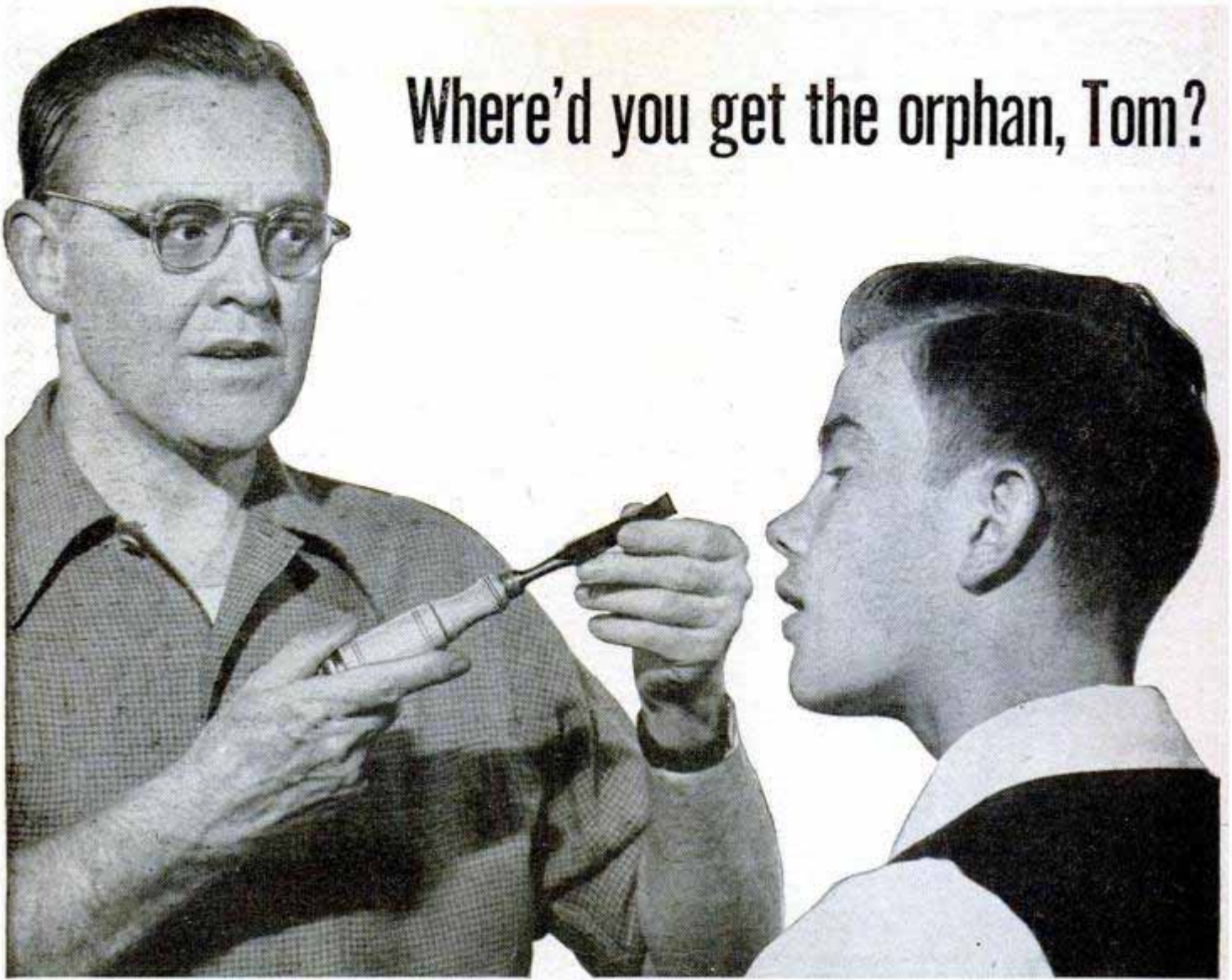

TOM: Orphan? What do you mean, Dad?

DAD: This chisel. There's no brand name on it.

TOM: What of it? Just feel that edge.

DAD: That's not much to go by when you're buying a chisel, son. Even a piece of cheese can have a sharp edge, you know.

TOM: You mean this chisel's no good?

DAD: I mean you can't be *sure* it's good. No brand name, no reputation to back it up. It's one of those bargain counter orphans—and they generally let you down.

TOM: Well, it didn't cost much, anyway.

DAD: Better get your money back — if you can. And then go over to the hardware store and buy a *good* chisel—one with an advertised brand name you can trust. The hardware man will always steer you right.

Your **HARDWARE DEALER** sells **QUALITY** tools
and hardware... Buy from HIM



POPULAR MECHANICS

What's **NEW**
in Batteries?

AUTO-LITE **Sta-ful** BATTERY... *needs water* *only 3 times a year*

IN NORMAL CAR USE

A revolutionary new development, the Auto-Lite "Sta-ful" Battery, protects you against a major cause of battery failure . . . damage to plates due to liquid loss. This new "Sta-ful" Battery Design permits a liquid reservoir with more than 3 times the reserve capacity of ordinary batteries . . . keeps plates fully covered and active months longer in normal car use.

In addition, "Sta-ful" gives you 70% longer average life* than batteries without Sta-ful features. Fibre-glass retaining mats protect every positive plate and keep the power producing material in place for maximum dependability. Get more for your battery dollars—replace with an Auto-Lite "Sta-ful" Battery. See your Dealer today.

AUTO-LITE BATTERY CORPORATION

Toledo 1

Ohio



*Proven by tests conducted according to SAE Life Cycle Standards.

Because of its unique design and construction, the new Auto-Lite "Sta-ful" Battery holds more than 3 times the liquid reserve of ordinary batteries.

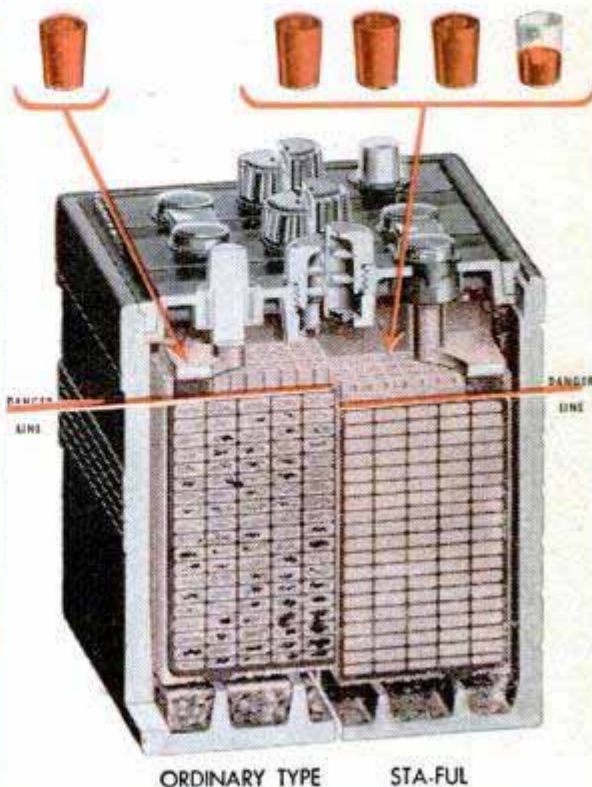

Note how the protective Fibre-glass mat retains the power-producing material in the positive plate while ordinary battery plates shed the active material until it fills the sediment well.

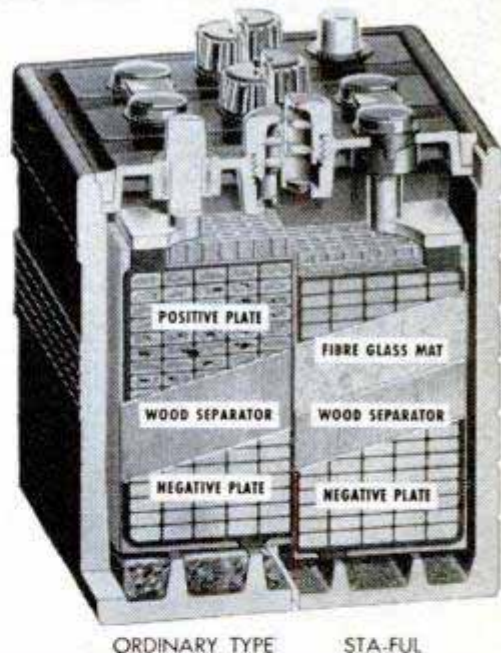

AUTO-LITE

Sta-ful BATTERIES

This One



PYROIL

saves dollars —and makes sense!

Many a driver has complained "It isn't the original cost of the car—it's the upkeep." That's why it makes sense to add Pyroil. Pyroil saves dollars in maintenance and depreciation costs.

When you put Pyroil in your gas tank, you're lengthening the life of your car—because Pyroil improves lubrication—Pyroil protects your motor against costly upkeep due to excessive friction-wear of piston, cylinder walls, bearings, etc. Pyroil contains the special property of making oil cling to metal surfaces, providing a constant film of protective lubrication at all times.

It makes sense to add Pyroil—add more economical miles to your car.

Pyroil for Aircraft Engines

Use Aircraft Pyroil B for lubricating oil, Aircraft Pyroil A for gasoline.

GIVEN! An attractive Pyroil metal savings bank, takes coins up to 50c pieces. **MOTORISTS**, it's yours for the asking—sent postage paid.

Manufactured and Guaranteed by Pyroil Company, 106 Pyroil Bldg., La Crosse, Wisconsin

Canadian Distributors: Central Purchasing Agencies, Ltd., Toronto, Ontario



PYROIL COMPANY

106 Pyroil Bldg., La Crosse, Wisconsin

I want my car to last and run properly. Please tell me more about Pyroil and how it can accomplish this for me.

Name _____

Address _____

City or Town _____ State _____



in this corner.....

THE EDITORS



WE WERE naturally intrigued when we read a newspaper dispatch from Pearl Harbor last May 19 telling of the arrival there of two U. S. Marine Corps flyers who had been released after being prisoners of the Chinese Communists for 18 months. M/Sgt. Elmer Bender told the reporters that "their favorite reading matter during their long imprisonment was *Popular Mechanics Magazine*."

Well, we haven't been prying behind the Iron Curtain lately and we wondered just how *Popular Mechanics* got into their hands in Red China. We looked over our subscription list. It showed some 80,000 subscribers beyond the 48 United States, a lot of them in Australia and England, the Philippines and Hawaii. In China there were a few over 300. How the two captive Americans in China came upon our favorite magazine was a mystery worth looking into, so we asked Tom Stimson, our Western Editor, to talk to Sergeant Bender and Chief Electrician's Mate William C. Smith when they reached California.

The story of Sergeant Bender appears on page 98. Arranging to get it from the Marine sergeant, who had just re-enlisted, was, Tom Stimson wrote us, "a rigorous task, as you will appreciate when I tell you that today I had to take my wife and our four-year-old daughter down to Corona Del Mar, pick up Sergeant Bender and his cute wife and child, wait for Smith to show up, and drive down to the beach for a picnic lunch and watch the two four-year-olds disport in the sand and surf."

Our editors have a very hard life.

* * *

Letter to the Editor

Dear Sir:

Your article "Hall of a Thousand Illusions" in the April issue describes the Radio City Music Hall organ as the "largest in existence." Apparently your writer is misinformed.

The only way to judge the size of an organ is by the number of speaking pipes it contains, not by the elaborateness of its console or the loudness of its voicing. I believe the Music Hall organ was the largest ever built by the Wurlitzer company, however.

There are literally hundreds of organs in churches all over the country with many

(Continued to page 8)

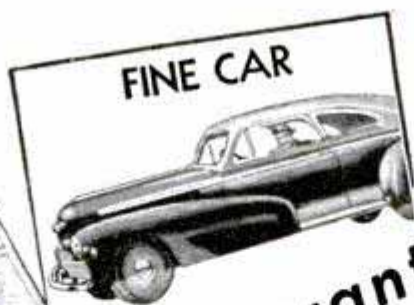

To the man who wants
an **ACCOUNTANT'S**

to enjoy
CAREER



IF you're that man, here's something that will interest you.

Not a magic formula—not a get-rich-quick scheme—but something more substantial, more practical.

Of course, you need something more than just the desire to be an accountant. You've got to pay the price—be willing to study earnestly, thoroughly.

Still, wouldn't it be worth your while to sacrifice some of your leisure in favor of interesting home study—over a comparatively brief period? Always provided that the rewards were good—a salary of \$4,000 to \$10,000?

An accountant's duties are interesting, varied and of real worth to his employers. He has *standing!*

Do you feel that such things aren't for you? Well, don't be too sure. Very possibly they *can* be!

Why not, like so many before you, investigate LaSalle's modern Problem Method of training for an accountancy position?

Just suppose you were permitted to work in a large accounting house under the personal supervision of an expert accountant. Suppose, with his aid, you studied accounting principles and solved problems day by day—easy ones at first—then more difficult ones. If you could do this—and could turn to him for advice as the problems became complex—soon you'd master them all.

That's the training you follow in principle under the LaSalle Problem Method.

You cover accountancy from the basic Principles right up through Accountancy Systems and Income Tax Procedure. Then you add C. P. A. Training and prepare for the C. P. A. examinations.

As you go along, you absorb the principles of Auditing, Cost Accounting, Business Law, Statistical Control, Organization, Management and Finance.

Your progress is as speedy as you care to make it—depending on your own eagerness to learn and the time you spend in study.

Will recognition come? The only answer, as you know, is that success *does* come to the man who is really *trained*. It's possible your employers will notice your improvement in a very few weeks or months. Indeed, many LaSalle graduates have paid for their training—with increased earnings—before they have completed it! For accountants, who are trained in organization and management, are the executives of the future.

Write For This Free Book

For your own good, don't put off investigation of *all* the facts. Write for our free 48-page book, "Accountancy, The Profession That Pays." It'll prove that accountancy offers brilliant futures to those who aren't afraid of serious home study. We'll also include "Ten Years' Promotion in One"—a book which has helped many men. Send us the coupon *now*.

**LASALLE EXTENSION
CHICAGO 5, ILL.**

Over 3200 Certified
Public Accountants among
LaSalle alumni

Other LaSalle Opportunities

- Higher Accountancy
- C.P.A. Coaching
- Bookkeeping
- Law: LL.B. Degree
- Business Management
- Salesmanship
- Traffic Management
- Foremanship
- Industr'l Management
- Stenotypy
(Machine Shorthand)

LASALLE EXTENSION UNIVERSITY

A CORRESPONDENCE INSTITUTION

417 S. Dearborn St. Dept. 864-HR Chicago 5, Ill.

I want to be an accountant. Send me without obligation, "Accountancy, the Profession that Pays"—also "Ten Years' Promotion in One."

Name.....Age.....

Address.....

City, Zone & State.....



NEW LOW PRICE!

Get Giant Tube
Regularly 49¢

NOW ONLY

43¢



**MORE
DOCTORS**

Who Specialize in Care of The Skin

USE MENNEN BRUSHLESS

Than All Other Brands Combined

HELPS MAKE BEARDS UP TO 47% SOFTER!

(Continued from page 6)

more pipes than are in the Music Hall organ. In fact, I have worked on some of them myself.

For your information, the largest organ in the world is in the Convention Hall at Atlantic City, N.J., and contains over 32,000 pipes. A close second is the organ in Wanamaker's store in Philadelphia, which has 30,000 pipes. The Music Hall organ is reported to contain about 3300 pipes.

C. Jason Tilton,
1817 Tennessee St.,
Lawrence, Kans.

Mr. Tilton is right. Wurlitzers tell us the Music Hall organ ranks as the "biggest theater organ in existence."

* * *



Circus Fat Man

Hurry — hur-ry — hurr-ry! See the bearded lady and the fat man! This is Freddie, the circus fat man, carved by Paul Caster of Des Moines, Iowa, whose miniature circus is one of those pictured in our color section starting on page 81. It's the story of a fascinating hobby that requires infinite artistry and time without end.

* * *

Letter to the Editor

Dear Sir:

I beg to call your attention to a new type of electrical heating in Norway . . .

The system . . . consists of two plates of wallboard which are nailed up on the ceiling. The upper plate is a porous one, and below is a hard plate . . . On the inner side of the hard plate the elements are glued up,

(Continued to page 10)

A TRUE I. C. S. STORY taken from an actual letter



I was a World War II pilot ...



A prisoner of war in Germany ...



Back home, I was hired by National ...

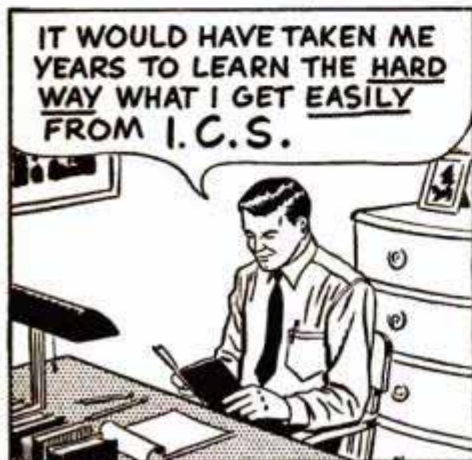

Studied with I. C. S. in my spare time ...



I. C. S. sent reports to my employer ...

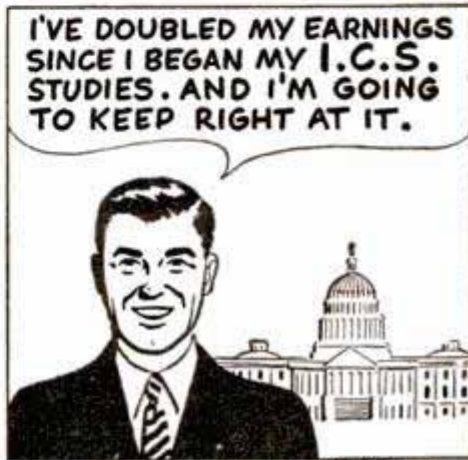

I am now Washington District Manager.

How have you done since the war? Start now to get the training that leads to advancement. Mail coupon *today!*

Parke Wright
PARKE WRIGHT

INTERNATIONAL CORRESPONDENCE SCHOOLS

APPROVED
under the
G.I. BILL

BOX 5681-K, SCRANTON 9, PENNA.

Without cost or obligation, please send me full particulars about the course BEFORE which I have marked X:

- | | | | |
|---|--|--|--|
| <p>Business and Academic Courses</p> <ul style="list-style-type: none"> <input type="checkbox"/> Accounting <input type="checkbox"/> App. Psychology <input type="checkbox"/> Business Administration <input type="checkbox"/> Bus. Correspondence <input type="checkbox"/> Certified Public Accounting <input type="checkbox"/> Commercial <input type="checkbox"/> Commercial Art <input type="checkbox"/> Cost Accounting <input type="checkbox"/> Federal Tax <input type="checkbox"/> First Year College <input type="checkbox"/> Foremanship <input type="checkbox"/> Good English <input type="checkbox"/> Higher Mathematics <input type="checkbox"/> Industrial Supervision <input type="checkbox"/> Motor Traffic <input type="checkbox"/> Retailing <input type="checkbox"/> Salesmanship <input type="checkbox"/> Sign Lettering <input type="checkbox"/> Spanish <input type="checkbox"/> Air Conditioning and Plumbing Courses <input type="checkbox"/> Heating <input type="checkbox"/> Refrigeration | <p>Chemical Courses</p> <ul style="list-style-type: none"> <input type="checkbox"/> Chemical Engineering <input type="checkbox"/> Chemistry, Analytical <input type="checkbox"/> Chemistry, Industrial <input type="checkbox"/> Chemistry, Mfg. Iron & Steel <input type="checkbox"/> Petroleum Refining <input type="checkbox"/> Pulp and Paper Making <input type="checkbox"/> Architecture <input type="checkbox"/> Building Estimating <input type="checkbox"/> Civil Engineering <input type="checkbox"/> Contracting and Building <input type="checkbox"/> Highway Engineering <input type="checkbox"/> Lumber Dealer <input type="checkbox"/> Reading Structural Blueprints <input type="checkbox"/> Sanitary Engineering <input type="checkbox"/> Structural Drafting <input type="checkbox"/> Structural Engineering <input type="checkbox"/> Surveying and Mapping <input type="checkbox"/> Communications Courses <input type="checkbox"/> Electronics <input type="checkbox"/> Prac. FM and Television <input type="checkbox"/> Prac. Telephony <input type="checkbox"/> Radio, General <input type="checkbox"/> Telegraph Engineering | <p>Electrical Courses</p> <ul style="list-style-type: none"> <input type="checkbox"/> Electrical Drafting <input type="checkbox"/> Electrical Engineering <input type="checkbox"/> Electric Light and Power <input type="checkbox"/> Lighting Technician <input type="checkbox"/> Practical Electrician <input type="checkbox"/> Power House Electric <input type="checkbox"/> Ship Electrician <input type="checkbox"/> Internal Combustion Engines Courses <input type="checkbox"/> Auto Technician <input type="checkbox"/> Diesel-Electric <input type="checkbox"/> Diesel Engines <input type="checkbox"/> Aeronautical Engineer's, Jr. <input type="checkbox"/> Aircraft Drafting <input type="checkbox"/> Forging <input type="checkbox"/> Heat Treatment of Metals <input type="checkbox"/> Industrial Engineering <input type="checkbox"/> Industrial Instrumentation <input type="checkbox"/> Industrial Metallurgy <input type="checkbox"/> Machine Shop <input type="checkbox"/> Machine Shop Inspection <input type="checkbox"/> Mechanical Drafting <input type="checkbox"/> Mechanical Engineering | <ul style="list-style-type: none"> <input type="checkbox"/> Mold-Loft Work <input type="checkbox"/> Patternmaking—Wood, Metal <input type="checkbox"/> Reading Shop Blueprints <input type="checkbox"/> Sheet-Metal Drafting <input type="checkbox"/> Sheet-Metal Worker <input type="checkbox"/> Ship Drafting <input type="checkbox"/> Ship Fitting <input type="checkbox"/> Toolmaking <input type="checkbox"/> Welding Engineering <input type="checkbox"/> Welding—Gas and Electric <input type="checkbox"/> Railroad Courses <input type="checkbox"/> Air Brake <input type="checkbox"/> Diesel Locomotive <input type="checkbox"/> Locomotive Engineer <input type="checkbox"/> Locomotive Fireman <input type="checkbox"/> Locomotive Machinist <input type="checkbox"/> Railroad Section Foreman <input type="checkbox"/> Steam and Diesel Loco. Eng. <input type="checkbox"/> Stationary Engineering Courses <input type="checkbox"/> Boilermaking <input type="checkbox"/> Combust. Engrg. <input type="checkbox"/> Marine Engineering <input type="checkbox"/> Power Plant Engr. <input type="checkbox"/> Rayon Weaving <input type="checkbox"/> Textile Courses <input type="checkbox"/> Cotton Manufacturing <input type="checkbox"/> Loom Fixing <input type="checkbox"/> Loom Weaving <input type="checkbox"/> Textile Designing <input type="checkbox"/> Woolen Manufacturing |
|---|--|--|--|

Name _____ Age _____ Home Address _____
 City _____ State _____ Working Hours _____ A.M. to _____ P.M.
 Present Position _____ Employed by _____
 Length of Service _____ Enrollment under G.I. Bill approved for World War II Veterans. Special tuition rates to members of the Armed Forces.
 in World War II _____ Canadian residents send coupon to International Correspondence Schools Canadian, Ltd., Montreal, Canada.

Your Success in Aviation begins at Embry-Riddle

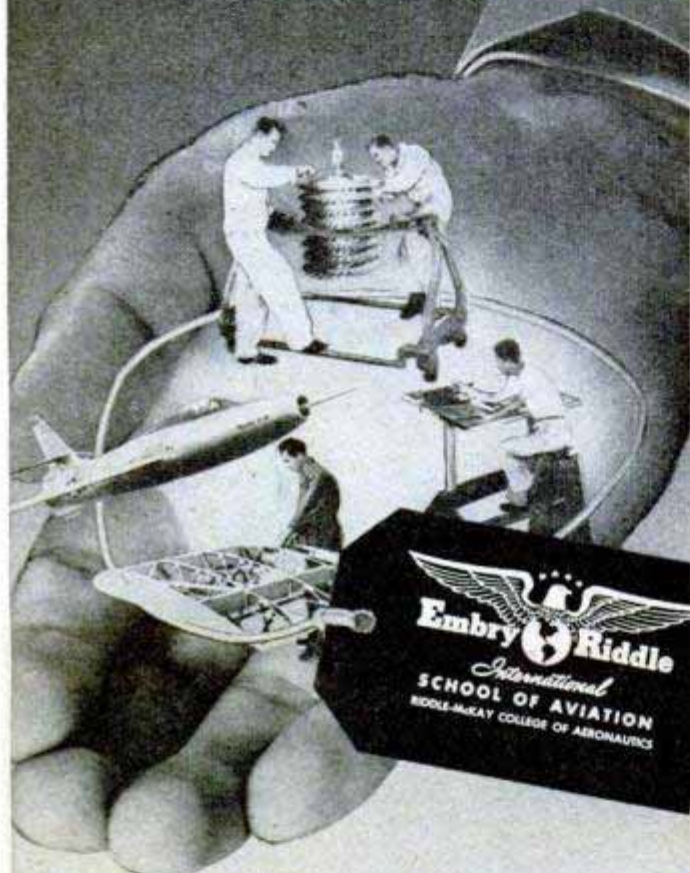

There's a bright future ahead for you in Aviation. In fact, no other career field today can possibly offer you so much opportunity. The aviation industry urgently needs men with skilled minds and hands to build, fly and maintain the giant aircraft of this great new Air Age.

The properly trained man climbs faster and higher in Aviation, just as in any other profession. That's why we say *your aviation success begins at Embry-Riddle*. For Embry-Riddle offers you the matchless advantage of knowledge and experience gained over a quarter-century of specialized aviation training.

In a few short months Embry-Riddle prepares you for engineering, master mechanic, flight or combined pilot and mechanic positions. All courses stress *thorough, practical* study including work on *five* aircraft in Embry-Riddle's airline-size hangars.

Enjoy Florida's unexcelled year-'round climate, its wealth of aviation and recreational facilities. Live, work and play on Embry-Riddle's modern campus -- the most complete aviation school plant in America. Save time, earn good money faster... send coupon *today* for full information.

Dean of Enrollments - Dept. 99
Embry-Riddle School of Aviation
Miami 30, Florida

Please Print

NAME _____

ADDRESS _____

City _____

State _____ Age _____

I am interested in...

- A.&E. Mechanic
- Commercial Pilot
- Engineering
- A.&E. Combined Commercial Pilot
- Flying Mechanic
- Drafting & Design

Check One Veteran Non-Vet

TRAIN IN MIAMI--AIR CAPITAL OF THE WORLD

(Continued from page 8)

and they consist of usual aluminum foils.

In a room, the whole ceiling is covered with these double plates, and all plates are connected in series. When you put on 220 volts . . . the whole ceiling is heated up to say 35 degrees Centigrade . . . The system is regulated either by a thermostat or by a three-pole switch, in connection with a transformer; by this way, the whole ceiling is always heated but at different voltages, thus regulating the heating.

I have installed the system in my home, and believe it or not, but the floors are warm and we feel much more well than with other heating systems.

The system is patented in the U.S.A. and an article in your magazine would perhaps make someone interested in starting a factory.

Perhaps a manufacturer of wallboards would be interested, as the factory of this kind only requires a minimum of machinery but a very great deal of wallboard.

In a house equipped with this electric heating you can see nothing, no fireplaces, no radiator, only a usual painted ceiling. You can place the furniture just where you like it, no dust, no noise and no smell, fireproof and everlasting.

F. W. Gjersoe,
Faberg in Norway.

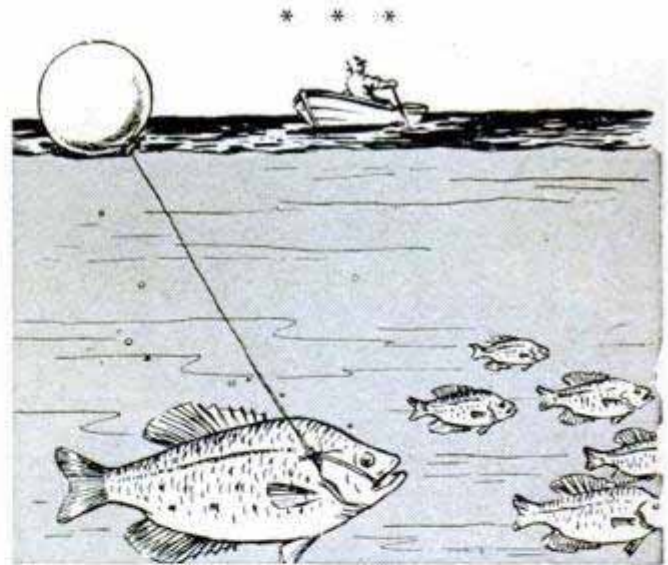

Ever Hunt Fish With Balloons?

Fishermen, here's a tip on how to find schools of crappie. Smiley Burnette, singing comic of western movies, says he fishes for crappie with very light tackle and takes along about 10 feet of string in his pocket, and a few rubber balloons. When he catches the first fish, he fastens the string through its mouth and gill, ties an inflated balloon on the other end of the string, and tosses the fish back. It swims right back to school, and Smiley follows the balloon and starts hauling in crappies on all sides.

WHAT Every AUTO MECHANIC Wants to Know

A motor vehicle is a machine of many parts, each part designed and constructed for its own special function. All good mechanics, like good doctors, should know the working theory and operation of each part and understand what causes trouble and how to remedy it.

LET AUDELS AUTO GUIDE SOLVE YOUR PROBLEMS

Every auto mechanic, helper, serviceman and operator can use AUDELS AUTO GUIDE. The information it gives saves time, money and worry. Highly endorsed by all users. It presents the whole subject of auto mechanics from A to Z in plain language and simple terms.

This Big Practical Book gives full information with working diagrams covering the principles, construction, ignition, service and repair of modern cars, trucks and buses.

A complete Guide of 1800 pages, with over 1500 illustrations showing inside views of the working parts, with instructions for service jobs. Diesel engines, Fluid and Hydra-matic drives fully explained.

IT PAYS TO KNOW HOW TO

How to fit pistons—How to locate engine knocks—How to fit connecting rod bearings—How to service main bearings—How to recondition valves—How to time valves—How to adjust fan belts—How to adjust carburetors & chokes—How to rebuild a clutch—How to service automatic transmissions—How to service brakes—How to adjust steering gear—How to cope with ignition troubles—How to service distributors—How to time ignition—How to "tune up" an engine.

INFORMATION IN A HANDY FORM

73 INTERESTING CHAPTERS—Read this partial list of subjects on which practical information is fully given for quick reference under the headings as shown below. Ready Reference Index.

All Parts of an Automobile—Automotive Physics—The Gas Engine—Gas Engine Principles—Multi-Cylinder Engines—Horse Power—Automobile Engines—Stationary Parts—Moving Parts—Pistons—Piston Rings—Connecting Rods—Crank Shafts—Valves—Valve Gear—Cams and Cam Action—Valve Timing—Cooling Systems—Fuel Feed Systems—Dual Fuel Feed—Mixture—Carburetors—Carburetor Service—Automatic Choke—Super-Chargers—Transmissions—Special Transmissions—Fluid and Hydra-matic Drives—Clutches—Universals and Propeller Shafts

A Ready Reference

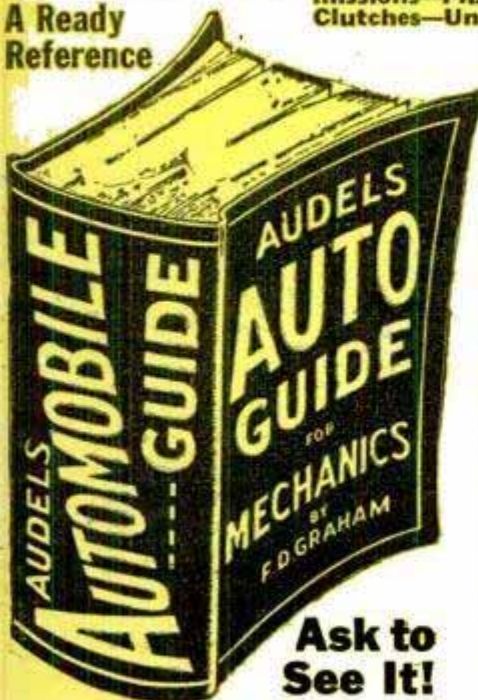

—The Differential—Rear Axles—Rear and Front Suspension—Running Gear—Brakes—Wheel Alignment—Knee Action—Steering Gear—Tires—Lubricants and Lubrication—Automotive Electricity—Ignition Systems—Magneto Ignition—Spark Plugs—Ignition Coils—Distributors—Automatic Spark Control—Ignition Timing—Generators—Starters—Generator and Starter Testing—Lighting Systems—Storage Batteries—Charging and Testing—Diesel Engines and Trouble Shooting.

7 DAYS' FREE TRIAL
TO GET THIS ASSISTANCE FOR YOURSELF SIMPLY FILL IN AND MAIL COUPON TODAY.

\$4 COMPLETE PAY \$1 A MONTH ONLY

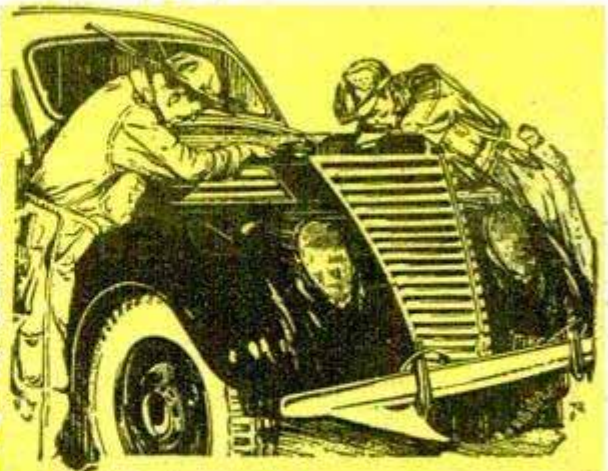

Sent on 7 Days Approval

Step up your own skill with the facts and figures of your trade. Audels Mechanics Guides contain Practical Inside Trade Information in a handy form. Fully illustrated and Easy to Understand. Highly Endorsed. Check the book you want for 7 DAYS FREE EXAMINATION. Send No Money. Nothing to pay postman.

MAIL ORDER

AUDEL, Publishers, 49 W. 23 St., NEW YORK 10, N. Y.

Please send me postpaid for FREE EXAMINATION books marked (X) below. If I decide to keep them I agree to mail \$1 in 7 Days on each book or set ordered and further mail \$1 monthly on each book or set until I have paid price, otherwise I will return them.

- AUTO GUIDE**, 1800 Pages . . . \$4
- DIESEL ENGINE MANUAL, 400 Pages . . . 2
- WELDERS GUIDE, 400 Pages . . . 1
- MACHINISTS Handy Book, 1600 Pages . . . 4
- POWER PLANT ENGINEERS Guide, 1500 Pages . . . 4
- ENGINEERS & FIREMANS EXAMS, 528 Pages . . . 1
- PUMPS, Hydraulics & Air Compressors, 1658 Pgs. . . 4
- MARINE ENGINEERS Handy Book, 1280 Pages . . . 4
- ENGINEERS & Mechanics Guides (8 Book Set) . . . 12
- Answers on Practical ENGINEERING, 254 Pages . . . 1
- ELECTRIC WIRING DIAGRAMS, 210 Pages . . . 1
- ELECTRICIANS EXAMINATIONS, 250 Pages . . . 1
- ELECTRICAL DICTIONARY, 9000 Terms . . . 2
- ELECTRIC MOTOR GUIDE, 1000 Pages . . . 4
- HANDY BOOK OF ELECTRICITY, 1440 Pages . . . 4
- ELECTRICAL POWER CALCULATIONS, 425 Pgs. . . 2
- RADIOMANS GUIDE, 914 Pages . . . 4
- ELECTRONIC DEVICES, 216 Pages . . . 2
- ELECTRIC LIBRARY, 7000 Pages (12 Book Set) . . . 18
- Vols. I, II, III, IV, V, VI, VII, VIII, IX, X, XI, XII \$1.50 Ea.
- OIL BURNER GUIDE, 384 Pages . . . 1
- HOUSE HEATING GUIDE, 1000 Pages . . . 4
- CARPENTERS & Builders Guides (4 Book Set) . . . 6
- PLUMBERS & Steamfitters Guides (4 Book Set) . . . 6
- MASONS & Builders Guides (4 Book Set) . . . 6
- BLUE PRINT READING, 416 Pages . . . 2
- PAINTERS & DECORATORS MANUAL, 450 Pgs. . . 2
- GARDENERS & GROWERS Guides (4 Book Set) . . . 6
- REFRIGERATION & Air Conditioning, 1280 Pgs. . . 4
- SHEET METAL WORKERS Handy Book, 388 Pgs. . . 1
- SHEET METAL PATTERN LAYOUTS, 1100 Pgs. . . 4
- AIRCRAFT WORKER, 240 Pages . . . 1
- MECHANICAL DRAWING GUIDE, 160 Pages . . . 1
- MECHANICAL DRAWING & DESIGN, 480 Pgs. . . 2
- MATHEMATICS & CALCULATIONS, 700 Pgs. . . 2
- MECHANICAL Dictionary, 968 Pages . . . 4
- MILLWRIGHTS & Mechanics Guide, 1200 Pgs. . . 4

Name _____

Address _____

Occupation _____

Employed by _____ 40

AUDEL, Publishers, 49 W. 23 St., New York 10, N. Y.

NOW!

BRIGGS SMOKES 3 WAYS BETTER*



1. Stays lighted longer ... by 19%



2. Cleaner burning ... by 16.4%



3. Less tar ... by 21.6%

So today ...

Put this
in your
pipe

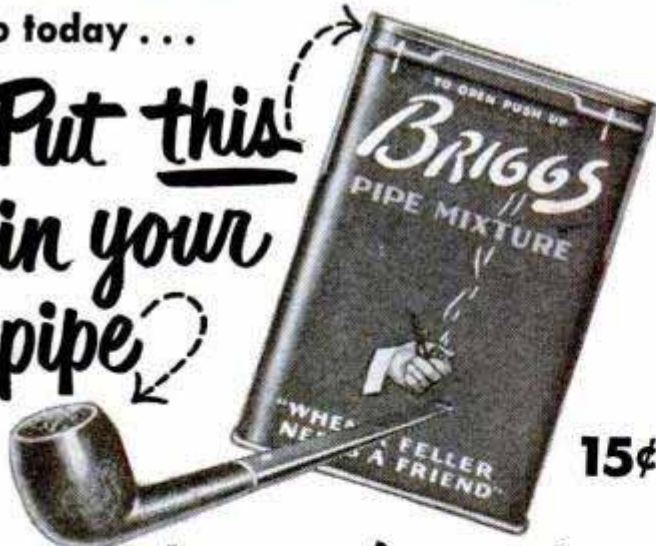

15¢

and smoke it!

*Yes, our new process makes Briggs better by actual test! Better even than the swell-smoking Briggs that proved so fine and friendly in your pipe before. And remember this: when tobacco burns steady, free and clean, that's when you enjoy *all* the goodness of Briggs' fine tobacco, aged and mellowed in oaken casks. Today—try 3-ways-better Briggs!

Also available in Canada

WHERE-TO-BUY-IT INDEX

Source of supply appears after items commercially available

AUTOMOTIVE

Leg rest for drivers (Schetzer Mfg. Co., Goodland, Kans.)	70
Three-cylinder car (IFA [Vereinigung Volkseigener Fahrzeugwerke], Leipzig, Germany)	79
Detroit listening post	85
Rambler station wagon (Nash Motors Div., Nash-Kelvinator Corp., Detroit 23, Mich.)	96
Britain exports ideas in motoring	101
Ground-hugging motor car being made in Sweden	122
Silicone auto polish is immune to heat of sun (Boyle-Midway Div. of American Home Products Corp., 22 E. 40th St., New York City)	122
Hybrid auto is mobile welder	122
Mail buggy	127
Ride in comfort with car headrest (Penn Products, Inc., Tomahawk, Wis.)	127
Supercharger for your car (Italmecanica, Inc., 147 W. 54th St., New York 19)	252
Automatic car-door lock system (Sellwell Industries, Inc., 994-996 Ellicott Square Bldg., Buffalo, N. Y.)	260
Front-wheel gauge (Bear Mfg. Co., Rock Island, Ill.)	262

BOATS

"Dry dock" boathouse has battery-powered hydraulic hoist (Standard Steel Products Mfg. Co., 2836 S. 16th St., Milwaukee 15, Wis.)	97
Flat-bottom sailer skims in the breeze (Webster Yacht Anchorage, 2349 Webster St., Alameda, Calif.)	100
Aluminum racer (Paragon Marine Construction Co., Inc., 1834 Purdy Ave., Miami Beach, Fla.)	113
Trappers in rowboats	124

FARM

Fertility detector uses electricity to test hens' eggs	89
Beet thinner (Great Western Sugar Co., 1530 16th, Denver, Colo.)	112
Rasperry picker has the shakes	113
Soil "waffle iron" reduces erosion (R. H. Sheppard Co., Inc., Hanover, York County, Pa.)	142
Squeezed hay dries faster	260

FISH AND FISHING

Lure holds live lightning bugs (Fire-Lite Mfg. Corp., Gosport, Ind.)	89
Weed guard for fish lures (T-Z Bait Co., South Bend, Ind.)	96
Live-bait lure (Timcor, Inc., 1448 W. 29th St., Cleveland 13, Ohio)	116
Ten-mirror fishing lure (Northwest Silversmiths, 118 N.E. 24th Ave., Portland, Ore.)	116

HOUSE AND HOME

Paper drop cloth (Kennedy Car Liner & Bag Co., Inc., Shelbyville, Ind.)	70
House follows job	71
Bathtub hoist (Blackhawk Mfg. Co., 5325 W. Rogers St., Milwaukee 1, Wis.)	133
Midget darner (Mari Importing Co., 120 Liberty St., New York 6)	133
Back rest hinged to bed headboard (Towsley, Inc., 326 E. Vermont St., Indianapolis 4, Ind.)	140
Fan bracket (Phil Rich Mfg. Co., Inc., 2401 San Jacinto, Houston, Tex.)	140
Lipstick "matches" (Lip-Tip Co., 16 City Square, Boston 29, Mass.)	140
Magnets hold refrigerator door shut (General Electric Co., Bridgeport 2, Conn.)	140
Pants hanger holds six pairs (T. H. Jenkins Co., 2424 N. Sacramento Ave., Chicago 47)	140
Guard rack for coffee maker (Guardex Co., 2850 N. Mississippi Ave., Portland 12, Ore.)	141
Storm window has three separate units (Eagle-Picher Co., Cincinnati 1, Ohio)	141
Sauce pan drains without scalding hands (Kewaskum Utensil Co., Kewaskum, Wis.)	141
Automatic dishwasher requires no drain (Hotpoint, Inc., 5600 W. Taylor St., Chicago 44)	141
Hose rack (Fawcoco Mfg. Div., Falls Stamping & Welding Co., Cuyahoga, Ohio)	141

INDUSTRY

"Waffle iron" roller packs road harder (Gardner Road Mixers, Inc., 416 Orange St., Redlands, Calif.)	79
Chemically treated fabrics resist mildew and rot (Interchemical Corp., Fair Lawn, N. J.)	116
Raising the roof	116
Tires galore under dragline floor	133
As the pipe is bent so the oil will flow	139
Laboratory in a box handles "hot" isotopes	147
Push-button concrete mixer (Arizona Sand & Rock Co., South Seventh, Phoenix, Ariz.)	148
Niagara Falls goes on night shift	240
Lightweight plaster (Great Lakes Carbon Corp., 18 E. 48th St., New York 17)	248
Canned foods retain fresh taste	252
Underground oil reservoirs (Hydrocarbon Storage Co., Kermit, Tex.)	258
Scaffold works like jack (P. Hoitsma Adjustable Scaffold Bracket Co., 261-265 E. 23rd St., Paterson 4, N. J.)	264

LAWN AND GARDEN

Rolling cutter trims lawn edges (Earl L. Chadwick, Box 4080, Portland, Ore.)	95
Charcoal igniter (Robert E. Buxton, 214 Johnson St., Maryville, Calif.)	97
Vertical broiler (Creighton-Calkins Co., Inc., 1951 E. 75th St., Chicago 49)	112
Disabled veteran still mows lawn	147

MODELS, NOVELTIES AND TOYS

Foam-plastic model plane (Kemnitz Corp., Milwaukee, Wis.)	95
Put-together toys from plywood parts	107
Child-size bulldozer works like the real thing (New London Metal Processing Corp., New London, Conn.)	126
Midget motorcycle built to scale	126

(Continued to page 14)



BE A SUCCESS AS A RADIO-TELEVISION TECHNICIAN

TWO FREE BOOKS SHOW HOW MAIL COUPON

America's Fast Growing Industry

HURRY VETERANS

G. I. Bill gives you valuable training benefits. But time is running out. Act now to get N. R. I. training under G. I. Bill. Mail Coupon! Hurry!

Offers You All Three

1. EXTRA MONEY IN SPARE TIME

Many students make \$5, \$10 a week extra fixing neighbors' Radios in spare time. The day you enroll I start sending you SPECIAL BOOKLETS to show you how to do this. Tester you build with parts I send helps you service sets. All equipment is yours to keep.

2. GOOD PAY JOB

Your next step is a good job installing and servicing Radio-Television sets or becoming boss of your own Radio-Television sales and service shop or getting a good job in a Broadcasting Station. Today there are over 81,000,000 home and auto Radios. 2700 Broadcasting Stations are on the air. Aviation and Police Radios, Micro-Wave Relay, Two-Way Radio are all expanding fields making more and better opportunities for servicing and communication technicians and FCC licensed operators.

3. BRIGHT FUTURE

And think of the opportunities in Television! In 1949 almost 3,000,000 Television sets were sold. By 1954 authorities estimate 20,000,000 Television sets will be in use. 100 Television Stations are now operating, with experts predicting 1,000. Now is the time to get in line for success and a bright future in America's fast growing industry. Be a Radio-Television Technician.



I TRAINED THESE MEN

CHIEF ENGINEER, POLICE RADIO
"Soon after finishing the N.R.I. course, worked for servicing shop. Now I am Chief Engineer of two-way PM Police Radio Installations."—S. W. DINWIDDIE, Jacksonville, Illinois.

SHOP SPECIALIZES IN TELEVISION
"An authorized serviceman for 5 large manufacturers and do servicing for 7 dealers. N.R.I. has enabled me to build an enviable reputation in Television."—PAUL MILLER, Maumee, O.

\$10 WEEK IN SPARE TIME
"Before finishing course, I earned as much as \$10 a week in Radio servicing at home in spare time. Recommend N.R.I. to everyone interested in Radio."—S. J. PETRUFF, Miami, Fla.

WORKS FOR TELEVISION DEALERS
"Am tied in with two Television outfits and do warranty work for dealers. Fall back to N.R.I. text books often for installing Television set."—ROBERT DOHMEN, New Prague, Minnesota.

I Will Train You at Home

You Practice Servicing or Communications with

MANY RADIO KITS

Keep your job while training at home. Hundreds I've trained are successful RADIO-TELEVISION TECHNICIANS. Most had no previous experience; many no more than grammar school education. Learn Radio-Television principles from illustrated lessons. Get PRACTICAL EXPERIENCE—build valuable multimeter for conducting tests. You practice servicing Radios or operating transmitters—experiment with circuits common to Radio and Television. You keep all equipment. Many students make \$5, \$10 a week extra fixing

neighbors' Radios in spare time. SPECIAL BOOKLETS start teaching you the day you enroll.

Send Now For 2 Books FREE—Mail Coupon

Act Now! Send for my FREE DOUBLE OFFER. Coupon entitles you to actual lesson on Servicing; shows how you learn Radio-Television at home. You'll also receive my 64-page book, "How to Be a Success in Radio-Television." You'll read what my graduates are doing, earning; see photos of equipment you practice with at home. Send coupon in envelope or paste on postal. J. E. SMITH, President, Dept. OHP, National Radio Institute, Washington 9, D. C. Our 37th Year.

Have Your Own Business

Many N.R.I. trained men start their own Radio-Television sales and service business without capital. Let me show you how you, too, can be your own boss, have a good income from your own shop.

The ABC's of SERVICING

How to Be a Success in RADIO-TELEVISION



You Build This MODERN RADIO

As part of my Servicing Course, you build this complete, powerful Radio Receiver that brings in local and distant stations. N.R.I. gives you ALL the Radio parts... speaker, tubes, chassis, transformer, sockets, loop antenna, etc.

You Build This TRANSMITTER

As part of my Communications Course, I SEND YOU parts to build this low-power broadcasting transmitter. You learn how to put a station "on the air," perform procedures demanded of Broadcast Station operators, make many practical tests.



Good for Both—FREE

MR. J. E. SMITH, President, Dept. OHP
National Radio Institute, Washington 9, D. C.

Mail me Sample Lesson and 64-page Book about How to Win Success in Radio-Television. Both FREE. (No salesman will call. Please write plainly.)

Name..... Age.....

Address.....

City..... Zone..... State.....

Check if Veteran Approved Under G. I. Bill

ARE YOU *NATURALLY* INVENTIVE?

"Cash In" On Your Natural Talent
By Learning **WHAT** To Invent—
2100 Inventions Needed Now!

TURN your talents into CASH! Invent the *simple* things that people need and want!

The Kiddie Kar brought its inventor a cool MILLION dollars. A 70-year old grandmother made \$350,000 on an overall buckle. Others became independently wealthy by "dreaming up" the rubber pencil tip, the ordinary paper clip, the hair-pin, etc. YOU can cash in, too—if you concentrate your talent on the inventions that are really NEEDED!

The EASY Way to Get Started



\$250,000

\$135,000

Don't waste time and brain-work on something nobody wants! Find out **WHAT** to invent. A valuable book by Raymond F. Yates, noted science editor and inventor, lists and describes over 2100 PRACTICAL, money-making ideas that are crying aloud to be invented!

These 2100 ideas are the things *most needed* and *surest* to make money. They are listed under 34 different headings for quick reference: Electrical, Radio, Automotive, Agricultural, Building, Household, Clothing, Toys, Time-Savers, etc.

This book **ALSO** tells how to think inventively; how to PROTECT your ideas; how to develop an invention **STEP-BY-STEP**, etc.



\$100,000

\$1,000,000

SEND NO MONEY FREE 5-DAY EXAMINATION

Would YOU like a slice of the \$280,000,000 that American inventors get *each year* in royalties? Get started *now!* Just mail the coupon and get "2100 Needed Inventions," by Raymond F. Yates, for 5 days' FREE trial. If, even in that short time, you are not convinced this book can help you make money—just return it and owe nothing. Otherwise, send only \$2.50, plus few cents postage, as payment in full.

Any one of the 2100 ideas in this book can bring *somebody* a fortune. Maybe it can be YOU! Mail the coupon and get this book on FREE TRIAL *at once!* **Wilfred Funk, Inc., Dept. T498, 227 East 44th Street, New York 17, N. Y.**

WILFRED FUNK, Inc., Publishers, Dept. T498, 227 East 44 Street, New York 17, N. Y.

Please send me 2100 NEEDED INVENTIONS for FREE EXAMINATION. If I keep the book I will send you \$2.50 plus few cents actual postage. Otherwise I will return it within 5 days, without further obligation.

Name _____

Address _____

City _____ Zone No. _____ State _____
(if any)

Check here if enclosing \$2.50 WITH this coupon, and we will pay all postage charges. Same 5-day return privilege, for full refund, applies. (Canadian Orders—25c extra for carrying charges. Only U. S. currency accepted.)

(Continued from page 12)

Toy pistol puffs smoke (Product Engineering Co., 4739 S.E. 17th Ave., Portland 2, Ore.).....	252
Magnetic model trains grip rails (Lionel Corp., 15 E. 26th St., New York City).....	254
Two-wheel stroller.....	260
Sewing kit on key chain (Novo-Plas Mfg. Co., Inc., 32 Fulton St., New York 7).....	262

PHOTOGRAPHY

Hot or cold, this photo film doesn't care.....	100
Film labels (Strobo Research, 4351 N. 35th St., Milwaukee 16, Wis.).....	112
"Rubber necked" tripod (Odin Mfg. & Equipment Co., Inc., 3006 Touhy Ave., Chicago 45).....	139
Loose-leaf photo album makes its own binding (General Products, 4234 Lincoln Ave., Chicago 18).....	142
Cameras in disguise.....	143
Swinging reflector for flash photos (Nordic Mfg. Co., 1 E. 22nd St., Minneapolis 4, Minn.).....	258

TELEVISION

TV showroom for inventors.....	86
Stereo-television for atom lab.....	88
Television borrows movie "tricks".....	123

MISCELLANEOUS

Treadless home loom (Hand-Skill Looms, Inc., 59 Social St., Woonsocket, R.I.).....	70
Schedule board for baseball games.....	70
Aerial cable car is river ferry.....	79
Kite-balloon-kytoon (Dewey & Almy Chemical Co., Cambridge, Mass.).....	80
Bomber for smallest carriers (Douglas Aircraft Co., Inc., Santa Monica, Calif.).....	89
German iron lung (Heinrich & Bernard Draeger, Luebeck, Germany).....	95
Excessive speed is biggest cause of highway deaths.....	96
Paint-tube caps (Louis Francis, 233 N.E. 20th Terrace, Miami 37, Fla.).....	113
Land alive!.....	114
Plastic "skin" protects paint (No-Skin Paint Cover Co., Mahopac, N. Y.).....	126
Hand-operated gas pump ends pouring spillage (Lucas Screw Products, Inc., 950 Exchange St., Rochester, N. Y.).....	127
It's small but smart, this "suitcase brain" (Northrop Aircraft Co., Northrop Field, Hawthorne, Calif.).....	142
Hot periscope.....	147
High altitude plays tricks on eyes.....	240
Lock-type hooks (Woolworth Stores).....	242
Trailer cooler (International Metal Products Co., 500 S. 15th, Phoenix, Ariz.).....	250
2000-year-old language finally gets an alphabet.....	254
Desk-top air circulator (National Reinforced Plastics Corp., Building 409 Berry Field, Nashville, Tenn.).....	254
Blackout "eye".....	256
Telephone amplifier for hard-of-hearing (Canadian Benaudi Co., Box 1255, 61 Robert St., Ottawa, Can.).....	256
Aureomycin speeds animal growth.....	264

Craftsman and Shop Notes Index

AUTOMOTIVE

Ignition trouble caused by oil vapor in distributor.....	160
Keep your car riding like new.....	198
Check locates leaky head gasket.....	200
Oil pump primed for starting by releasing air pressure.....	210

FARM

Horseshoe at top of hitching post permits securing reins quickly.....	160
Inexpensive grain blower utilizes scrap parts.....	195
Easily seen warning symbols painted on trailer endgate.....	195
Two oil drums welded together form gasoline storage tank.....	196
Spring toggle holds clevis pin.....	196
Burning auto tire kills weeds.....	200
Storage space for ground feeds.....	200
Concrete watering pit built around broken drain tile.....	207
Temporary farrowing house made from bales of straw.....	207
Screened window in door ventilates storage cave.....	210

HOBBIES, NOVELTIES AND TOYS

Candy turtle party favors utilize walnut shells.....	160
For magazines.....	161
Refreshment novelties.....	166
Cut scale lumber on your circular saw.....	169
Cut-down glove protects thumb when whittling.....	174
Inexpensive trays and coasters from cardboard.....	179
Spinning-block pull toy—a children's favorite.....	185
Streamlined bicycle lights form headlights for youngster's auto.....	185

HOUSE AND HOME

Baking soda polishes stainless steel.....	158
Sandpaper aids pressing pleats.....	158
Crayons strengthened with cellulose tape.....	158
Removing drippings from candleholders.....	158
Shield for sharp points of scissors.....	159
Emergency seal for envelope flaps.....	159
Convenient way for hanging wash in bathroom.....	159
Section of hose aids in using steel wool.....	159
Spring keeps cork tight in vacuum bottle.....	159
There's a trick to drying windows.....	160
Insert for pedestal-type ash tray facilitates disposal of waste.....	165
Window awning has bamboo slats to provide better circulation.....	172
Lemon juice cleans marble.....	172
Length of rod locks gas-range controls in off position.....	172
Scraper made from garden hoe removes old plaster.....	174
Chopping board of laminated hardwood fitted with detachable tray for mixing.....	178
Wallpaper moistened for removal by using vacuum-cleaner spray.....	179

(Continued to page 16)



INVENTORS

Learn how to protect your invention. The U. S. Patent Laws provide that any new and useful art, machine, article of manufacture, or composition of matter, or any new and useful improvement thereof, may be patented if the act of invention is involved. Therefore, every inventor with a valuable invention should take advantage of the Patent Laws and proceed for patent protection in order to safeguard his rights.

A patent gives the inventor the exclusive right to prevent others from making, using, or selling the invention claimed in the patent for a period of seventeen years.

The Patent Laws were enacted for the benefit of the inventor to give him protection for the features of his invention which are patentable. These features must be properly and concisely set forth and claimed in a formal application for patent, in order to comply with the requirements of the Patent Laws. For that reason, unless the inventor is familiar with patent matters, he should engage a competent registered patent attorney or agent to represent him. We are registered to practice before the U. S. Patent Office and are prepared to serve you in the handling of your patent matters.

A specially prepared booklet entitled "Patent Guide for the Inventor", containing detailed information with respect to patent protection and procedure, together with a "Record of Invention" form will be promptly forwarded to you without obligation upon request.

CLARENCE A. O'BRIEN & HARVEY JACOBSON

Registered Patent Attorneys

01-H DISTRICT NATIONAL BUILDING

WASHINGTON 5, D. C.



Become an Electrical Engineer

...with these MAJOR advantages

1 Save a valuable year by gaining your B.S. degree in 36 months through the option of year-round study. Specialize by majoring in either *Electronics* or *Electrical Power*.

2 You become an Electronic or Electro Technician within 12 months after enrolling in the Electrical Engineering course. Thus, even if you should leave school before gaining your degree, you have been trained for specific occupations.

3 Obtain an outstanding education—Receive laboratory experience (on modern equipment) *immediately*. This actual experience and an exceptional number of technical specialty courses, plus all essential college studies, prepare you for a career in these dynamic, growing fields.

• Military or practical experience and prior schooling evaluated for advanced credit. Preparatory and refresher courses available.

• 1,555 currently enrolled from 48 states and 23 foreign countries. Over 35,000 alumni. Terms open Oct., Jan., July, April.

MILWAUKEE SCHOOL of ENGINEERING

Technical Institute • College of Electrical Engineering



Write for free 110-page catalog and 44-page pictorial booklet, "Your Career".



MILWAUKEE SCHOOL OF ENGINEERING

Dept. PM-850, 1020 N. Broadway, Milwaukee, Wis.

Without obligation, send me the 110-page catalog and 44-page "Your Career" booklet.

(Check 6 to 36 month courses which interest you)

Electrical Engineering: Power Electronics

Radio-Television Welding Refrigeration

Electricity Air Conditioning Heating

Name..... Age.....

Address.....

City..... Zone..... State.....

Check if World War II Veteran

(Continued from page 14)

LAWN AND GARDEN

Bag hung from circular frame easily filled with leaves.....	165
Birds kept from eating grass seed.....	168
Carryall.....	173
Cone-shaped strawberry patch has sheet-metal trays.....	174
Firm foundation under flagstones keeps them from tilting.....	178
Adjustable brackets extend roller to raise lawn-mower cutter bar.....	184
Preventing lawn-roller rust.....	184

OFFICE, SHOP AND STORE

Handy masking-tape "dispenser" provided by plastic sheet.....	157
Portable garage light utilizes gooseneck desk lamp and brake drum.....	207
Low-cost shop heating system.....	210
Desk slide arm has glass insert to provide handy tracing frame.....	210

OUTDOOR RECREATION

Gun used to ignite campfire.....	165
V-belts serve as boat-dock fender.....	170
Empty talcum-powder can forms picnic salt shaker.....	171
Rubber-ball halves on table legs protect picnic lunch from ants.....	172
Gathering and storing cold-weather fish baits.....	184
Proper storing keeps bait frogs and crayfish lively.....	185

PAINT AND PAINTING

Disposable liner for paint tray saves cleaning time.....	157
Adjacent paint swatches on glass match colors professionally.....	178
Ink bottle in paint sprayer saves cleaning cup.....	184

PHOTOGRAPHY

Board supported by camera tripod forms collapsible utility table.....	188
Wetting-agent dispenser.....	188
Quartz or carbon-arc sun lamps print excellent proofs.....	188
Spare parts carried in match book.....	188
Miniature spot for close-up work utilizes coffeemaker bowl.....	188
Photographer's prop stand.....	189
Paper clip on print tongs hooks over tray edge.....	189
Tape across top of pan head tightens loose camera.....	189
Parallax correction for a 35-mm. camera.....	190
Newspaper flattens curled prints.....	191
Sandpaper on flash-gun speeds cleaning bulb terminals.....	191
Holder for applicator stick.....	191
Basement windows sealed with plywood panels.....	192
Steel ball shims reflector swivel when clamp arm is removed.....	192
Cotton dispenser for darkroom.....	192

TOOLS

Croquet-ball file holder.....	174
Retruing center hole without removing stock from lathe.....	195
Wire grip for speeder handle prevents blistered hands.....	196
Lathe bench.....	197
Grease-gun nozzle kept dirt-free.....	200
Shavings box.....	201
Magnetic holder for small hand tools (Billings & Spencer Co., Hartford 1, Conn.).....	208
Portable pipe-threading unit (Muncie Gear Works, Inc., Muncie, Ind.).....	208
Coupling facilitates changing hand pieces on flexible shafts (Wyzenbeek & Staff, Inc., 848 W. Hubbard St., Chicago).....	208
Spring-loaded center punch (Birk Mfg. Co., Niantic, Conn.).....	208
Shingles and siding cut, notched or punched with three-in-one tool (Tri-States Building Materials Co., Box 1476, Fort Worth, Tex.).....	209
Portable power-feed attachment (DeWalt Inc., Lancaster, Pa.).....	209
Tool cleans copper tubes for soldering (Makay Co., 626 Copley Road, Upper Darby, Pa.).....	209
Magnetic level (Tunxis Mfg. Co., Box 652, Hartford, Conn.).....	209

MISCELLANEOUS

Faucet handle provides key rack.....	165
Built-up corner posts for cabin eliminate notching legs.....	168
Vacuum bottles soldered together permit variety in hot lunch.....	168
Rock-wool insulating batts cut quickly by using dull handsaw.....	168
Bar clamped to sheet metal serves as depth stop.....	168
Flashlight cells taped together form low-voltage battery.....	170
Solar water-heating unit for summer cottage improvised by draping garden hose over roof.....	171
Light bulb suspended in bass drum keeps head dry outdoors.....	171
Plastic cleans sanding disks.....	174
Driving screws in end grain.....	178
Wire solder binds extension cords.....	178
Electric detector locates nonmetallic sewer line.....	179
Pan of water forms level for checking slope.....	184
Interior walls of metal tubes cleaned with abrasive strips.....	196
Rubber skirt tacked to type brush prevents spattered solution.....	200
Vegetable grater shells corn.....	210

Radio-Television, Electronics

Full-color tubes for TV (Radio Corp. of America, 30 Rockefeller Plaza, New York City 20).....	211
Five-tube circus-wagon super for playroom.....	212
Folded exponential horn.....	215
Electronics today (Electron microscope and printed-circuit TV tuner, RCA Victor Corp., Camden, N. J.; magnetic alarm switch, Nu-Way Signal Co., 4152 W. Division St., Chicago 51; hearing aid with "Movable Ear" attachment, Sonotone Corp., Box 200, Saw Mill Road, Elmsford, N. Y.; electronic light alarm, Syracuse Electronics Corp., 619 S. Salina St., Syracuse, N. Y.; TV/FM amplifier, Sonic Industries, 221 W. 17th St., New York City).....	216

IMPORTANT NOTICE—It is the intention of this magazine to provide its readers with information regarding the latest developments in the mechanical arts. We take no responsibility as to whether the disclosures contained in our articles are covered by patents and advise readers to investigate this subject before making, using, or selling any of the products, machines, or processes described in order to avoid possible liability for patent infringements.

INVENTORS

If you believe that you have an invention, you should find out how to protect it. The first step is to have a search made of the prior pertinent U. S. patents. If a report on this search indicates that the invention appears patentable you can apply for a patent, and the specifications and claims should be prepared.

The firm of McMorrow, Berman & Davidson, with offices in Washington, D. C., is qualified to take the necessary steps for you. We can make a preliminary search on your invention, advise you whether we think it can be patented, and prepare your application for patent.

Unless you are fully familiar with the U. S. Patent Laws, we recommend that you engage the services of a Registered Patent Attorney to protect your interests. The patent laws are *your* laws. A patent gives you the right to prevent others from making, using or selling the invention claimed in your patent for a period of 17 years.

Use these patent laws for your protection. Investigate whether your invention can be patented. If you have what you believe to be an invention, we suggest that you have this firm make a search for you.

Send for a copy of our Patent Booklet entitled "How To Protect Your Invention," containing information about patent protection and patent procedure. Along with this we will also send you an "Invention Record" form, for your use in writing down and sketching details of your invention. We will mail them promptly. No obligation. They are yours for the asking.

McMORROW, BERMAN & DAVIDSON

Registered Patent Attorneys

PATENTS • COPYRIGHTS • PATENTS

135-F VICTOR BUILDING, WASHINGTON 1, D. C.

Which of these 2 one time WEAKLINGS PAID only a Few Cents to become an All-Around HE-MAN at Home?

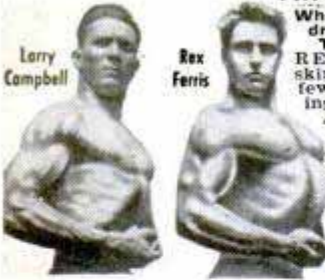

Which One Paid Hundreds of Dollars to Train at My Side? REX FERRIS, was a skinny weakling, paid a few cents to start building into a Champion All Around He Man! LARRY CAMPBELL paid me hundreds of dollars to train at my side years ago. Start to become an All Around He Man at home with these same secrets for only a few cents—like Rex Ferris did!

Amazing get-acquainted offer—YOURS for only

10c

Instead of \$1 For all 5 Courses plus FREE Photo Book!

Be A Winner at Anything YOU Tackle with Progressive Power—SPORTS! JOB! SCHOOL! FRIENDS!

Let's Go, Pal! I'll prove I can make YOU an

"ALL-AROUND" HE-MAN

FAST—OR NO COST! says George F. Jowett World's Greatest Body Builder

Enjoy My "Progressive Power" Strength Secrets! Give Me 10 Easy Minutes a Day—Without Strain!

I'll teach you the "Progressive Power Method" through which I rebuilt myself from a physical wreck the doctors condemned to die at 15, to the holder of more strength records than any other living athlete or teacher! "Progressive Power" has proven its ability to build the strongest, handsomest men in the world. And I stand ready to show you on a money back basis—that no matter how flabby or puny you are I can do the same for you right in your own home. Let me prove I can add inches to your arms, broaden your shoulders, give you a man-sized chest, powerful legs and a Rock-like back—in fact, power pack your whole body so quickly it will amaze you! Yes, I'll jam you with power and confidence to master any situation—to win popularity—and to get ahead on the job! Through my proven secrets I bring to life new power in you inside and out, until YOU are fully satisfied you are the man you want to be.

PROVE IT TO YOURSELF IN ONE NIGHT

Send only 10c for my 5 easy-to-follow, picture-packed courses now in 1 complete volume "How to Become a Muscular He-Man." Try it for one night! Experience the thrilling strength that surges through your muscles. **10 DAY TRIAL!** Think of it—all 5 famous courses in one picture-packed, muscle-building volume only 10c. You must actually FEEL results in ONE WEEK, or your money will be promptly refunded!



"The Jowett System is the greatest in the world!" says R. F. Kelly, Physical Director, Atlantic City

Whom experts call George F. Jowett "Champion of Champions." • World's wrestling and weight lifting champ at 17 and 19. • World's Strongest Arms • 4 times World's Perfect Body—plus other records.

FREE!

PHOTO BOOK Famous Strong Men!

HOW TO MOLD MIGHTY LEGS

HOW TO MOLD A MIGHTY BACK

HOW TO MOLD A MIGHTY CHEST

HOW TO MOLD A MIGHTY ARM

HOW TO MOLD A MIGHTY GRIP

HOW TO MOLD A MIGHTY NECK

How to BECOME A MUSCULAR HE-MAN

with 1100 Complete Courses on Building a Mighty Arm, a Mighty Grip, a Mighty Neck, a Mighty Back

I want thousands of new friends—regardless of cost! Get all 5 (valued at \$5.00 each), Muscle Building Courses, for only 10c. Packed with How-To-Do-It Pictures! Start to build a body you will be proud of.

FREE GIFT COUPON!

Jowett Institute of Physical Culture
230 Fifth Avenue, New York 1, N.Y. DEPT. PM-08

Dear George:—Please send by return mail, prepaid, **FREE** Jowett's Photo Book of Strong Men, plus all 5 Muscle Building Courses. 1. Molding a Mighty Chest. 2. Molding a Mighty Arm. 3. Molding a Mighty Grip. 4. Molding a Mighty Back. 5. Molding Mighty Legs—Now all in One Volume "How to Become a Muscular He-Man." Enclosed find 10c for postage and handling. No C.O.D.'s.

George F. Jowett
Champion of Champions

NAME _____ AGE _____

ADDRESS _____

CITY _____ ZONE & STATE _____

New Advertising Machine



Prints & Illustrates 1¢ Post Cards

FREE Learn how thousands of business men, in every line, are boosting sales in spite of conditions—with 1¢ messages—printed and illustrated in a few minutes on gov't post cards—with amazing new patented **CARDMASTER**. Your "today's" ideas, read by your prospects next morning. Not a toy, but a sturdy advertising machine, built to last for years. Low price, sold direct. Guaranteed for five years. Send name today. **SEND NAME** We'll send **FREE** illustrated book of money-making **IDEAS** for your business and complete, unique advertising plans. **RUSH YOUR NAME TODAY.** **CARDMASTER COMPANY** 1920 SUNNYSIDE, Dept. 138, CHICAGO 40, ILL.

WHY DON'T YOU WRITE?

Writing short stories, articles on business, politics, sports, shop crafts, local and club activities, etc., will enable you to earn extra money. In your own home, on your own time, the New York Copy Desk Method teaches you how to write the way newspaper men learn—by writing. Our unique "Writing Aptitude Test" tells whether you possess the fundamental qualities essential to successful writing. You'll enjoy this test. Write for it, without cost or obligation.

Veterans: This course approved for Veterans' Training.
NEWSPAPER INSTITUTE OF AMERICA
SUITE 5590-M, ONE PARK AVENUE, NEW YORK 16, N. Y.

NEW! MINIATURE DUST MASK

Wear when sanding, grinding, paint spraying, sweeping, dusting, furnace cleaning, etc. Handy as a pair of glasses. Just keep mouth closed and breathe through nose is all you do to operate. Protects against dusts, lint, coal, cement, grain dust. Has 9 sq. in. filter.
Order today.
JERRY BRYANT, Dept. PM, 919 N. Michigan Ave., Chicago 11, ILL.

LEARN AERONAUTICAL ENGINEERING
Aircraft and Engine Mechanics (A & E)

Train at the Flying Wing school—New classes starting soon. Write for illustrated catalog.

Northrop Aeronautical Institute
APPROVED FOR VETERANS DIVISION OF NORTHROP AIRCRAFT, INC.
1527 E. Broadway, Hawthorne, Los Angeles County, California

RUPTURED?

Get Relief This Proven Way

Why try to worry along with trusses that gouge your flesh—press heavily on hips and spine—enlarge opening—fail to hold rupture? You need the Cluthe. No leg-straps or cutting belts. Automatic adjustable pad holds at real opening—follows every body movement with instant increased support in case of strain. Cannot slip whether at work or play. Light. Waterproof. Can be worn in bath. Send for amazing **FREE** book, "Advice To Ruptured," and details of liberal truthful 60-day trial offer. Also endorsements from grateful users in your neighborhood. Write:
CLUTHE SONS, Dept. 31, Bloomfield, New Jersey

LEARN RADIO



INSIDE OUT!

THAT'S the way to become an expert radio service man. Study the theory and principles first. These are vitally important. Then roll up your sleeves and actually work with radios—assembling, experimenting, trouble-shooting, repairing. That way you learn radio from the inside out.

Which explains why I.C.S., in its new Radio Course, concentrates on *equipment*. You get the best. Matched parts for an excellent 5-tube superheterodyne receiver. Your own professional-quality multimeter. A complete signal generator

kit. High-grade servicemen's tools. "Rider's Perpetual Trouble-Shooter's Manual." Plus lesson material and instruction service second to none. Also included is Principles of Television, which is a steppingstone to TV installation and service.

Learn by doing! That's the world-famous I.C.S. method. Thoroughly practical. Completely modern. *Success proved*. The coupon below brings you full details—on radio servicing or on any of the more than 400 I.C.S. Courses. Mark and mail it *today!*

INTERNATIONAL CORRESPONDENCE SCHOOLS



BOX 5682-K, SCRANTON 9, PENNA.

Without cost or obligation, please send me full particulars about the course BEFORE which I have marked X:

RADIO SERVICING

- Air Conditioning and Plumbing Courses
- Air Conditioning
- Heating
- Refrigeration
- Chemical Courses
- Chemical Engineering
- Chemistry, Analytical
- Chemistry, Industrial
- Chemistry, Mfg. Iron & Steel
- Petroleum Refining
- Pulp and Paper Making
- Civil Engineering, Architectural and Mining Courses
- Architecture
- Architectural Drafting
- Bridge and Building Foreman
- Building Estimating
- Civil Engineering
- Coal Mining
- Contracting and Building
- Highway Engineering
- Lumber Dealer
- Reading Structural Blueprints
- Sanitary Engineering
- Structural Drafting

- Structural Engineering
- Surveying and Mapping
- Communications Courses
- Electronics
- Telegraph Engineering
- Practical Telephony
- Radio, General
- Radio Operating
- Television
- Telegraph Engineering
- Electrical Courses
- Electrical Drafting
- Electrical Engineering
- Electric Light and Power
- Lighting Technician
- Practical Electrician
- Internal Combustion Engines Courses
- Auto Technician
- Diesel-Electric
- Diesel Engines
- Gas Engines
- Mechanical Courses
- Aeronautical Engineer's, Jr.
- Aircraft Drafting
- Forging
- Heat Treatment of Metals
- Industrial Engineering
- Industrial Instrumentation

- Industrial Metallurgy
- Machine Shop
- Mechanical Engineering
- Mold-Loft Work
- Patternmaking—Wood, Metal
- Reading Shop Blueprints
- Sheet-Metal Drafting
- Sheet-Metal Worker
- Ship Drafting
- Tool Designing
- Welding Engineering
- Welding—Gas and Electric
- Railroad Courses
- Air Brake
- Diesel Locomotive
- Locomotive Engineer
- Locomotive Fireman
- Locomotive Machinist
- Railroad Section Foreman
- Steam-Diesel Loco. Eng.
- Stationary Eng'r's Courses
- Boiler making
- Combustion Engineering
- Engine Running
- Marine Engineering
- Power Plant Eng'r's

- Mech. Drafting
- Textile Courses
- Cotton Manufacturing
- Loom Fixing
- Textile Designing
- Woolen Manufacturing
- Rayon Weaving
- Business and Academic Courses
- Accounting
- App. Psychology
- Business Administration
- Bus. Correspondence
- Certified Public Accounting
- Commercial
- Cost Accounting
- Federal Tax
- Foremanship
- Good English
- Higher Mathematics
- Industrial Supervision
- Motor Traffic
- Retailing
- Salesmanship
- Sign Lettering
- Spanish
- Traffic Management
- Advertising
- Bookkeeping
- Bus. Law
- Commercial Art
- First Year College
- French
- High School
- Illustration
- Postal Civil Service
- Retail Bus. Management
- Secretarial
- Stenography

Name _____ Age _____ Home Address _____
 City _____ State _____ Working Hours _____ A.M. to _____ P.M.
 Present Position _____ Employed by _____
 Length of Service in World War II _____ Enrollment under G.I. Bill approved for World War II Veterans. Special tuition rates to members of the Armed Forces.
 Canadian residents send coupon to International Correspondence Schools Canadian, Ltd., Montreal, Canada.

INVENTORS

If you consider your invention to be something of importance—if you have invented any new and useful art, machine, manufacture or composition of matter or improvement thereof—you are advised to protect your invention by applying for a U. S. patent.

A patent is a valuable right. It grants you a monopoly—the right to exclude others from making, using or selling your invention as claimed for a term of seventeen years.

The specification and claims of a patent, particularly if the invention be at all complicated, constitute one of the most difficult legal instruments to draw with accuracy. Therefore, unless you are thoroughly familiar with such matters, you are advised to employ a competent registered patent attorney or agent.

This firm is registered to practice before the U. S. Patent Office and is available to assist in the preparation and prosecution of your patent application.

The "Evidence of Invention" form mentioned below is offered as a convenience to you in making your disclosure to us for search purposes.

You should date and sign your disclosure and have it witnessed by two or more persons who are capable of understanding your invention.

Your disclosure should be mailed to us together with a letter authorizing us to conduct a preliminary

search among previously granted U. S. patents for similar types of invention.

We then make this search and prepare a report of the probable patentability of your invention. If such report is favorable, we recommend the further course for you to take.

The "Evidence of Invention" form and booklet are suggested as conveniences to you and us in starting action on your invention.

VICTOR J. EVANS & Co. *Merlin M. Evans*
REGISTERED PATENT ATTORNEY
530-J MERLIN BUILDING, WASHINGTON 6, D. C.

We shall be glad to send you promptly and without obligation, an instructive booklet, "Patent Protection for Inventors", which was prepared to give inventors detailed information and steps to take toward patent protection—also our convenient "Evidence of Invention" form. Use address Victor J. Evans & Co., 530-J Merlin Building, Washington 6, D. C.

PATENTS

COPYRIGHTS

FREE

A NEW HOME INDUSTRY





Let us show you how extremely easy and PROFITABLE it is to make beautiful and useful things out of LIQUID PLASTICS, LIQUID MARBLE, LIQUID IVORY, LIQUID GLASS, CERAMICS, ETC. . . . as easy as pouring water out of a glass! Make novelties, jewelry, gifts, artware, toys, tools, dies, gadgets, ceramics . . . a million useful things! We supply everything—**MATERIALS, INSTRUCTIONS and BUYERS!** Send only 25c for 1. Big catalog of 300 casting materials, molds and accessories, 2. A beautiful CASTING free (to show you what you can do), and 3. Actual **INSTRUCTIONS** on how to cast and start in the **CASTING BUSINESS!** VALUABLE MOLDS given FREE with orders! Send 25c today—this may be the lucky coin that will start the most fascinating and profitable phase of your life.

PLASTICAST COMPANY (DEPT. C)
170 N. Halsted St. (Write to P. O. Box 987
Chicago 6, Ill. nearest address) Palo Alto, Calif.

CANADIAN CUSTOMERS, please order directly from: **CANADIAN INDUSTRIAL PLASTICS, LTD.**, 1056 1/2 Pender West, Vancouver, B.C.

Aptitude Tests for men, women, boys, girls, discover the kind of work or studies best for your success! You get a personal report—a guide for life—more happiness—more prosperity. . . . Write for complete facts. . . .

VOCATIONAL COUNSELORS, 5057 Woodward Avenue, Detroit

Learn PHOTOGRAPHY

There's big money in PHOTOGRAPHY—and an action-packed career for you. Our HOME STUDY COURSE is your spare-time SHORT CUT TO SUCCESS! Or, if you wish—PERSONAL ATTENDANCE TRAINING at our famous New York School is available with subsistence under the G. I. Bill. Our 40th year. Write immediately!

NEW YORK INSTITUTE OF PHOTOGRAPHY

Dept. "49," 10 West 33 Street, New York 1, N.Y.

EASY EXTRA MONEY \$

SELL CHRISTMAS CARDS

to friends, clubs, neighbors, and fellow workers. It's Easy! The country's outstanding line. 6 FREE SAMPLES of name-on cards (low as 50 for \$1.00), stationery, napkins. Box samples on approval. Prompt service.

LIBERTY BELL STUDIOS — Dept. B-2, 1013 Filbert St., Phila. 7, Pa.

Rupture Troubles Ended

Advanced method has healed thousands. No leg straps, no elastic, no plasters. No pressure on hips or spine. Flexo-pad. Entirely different. Endorsed by doctors, mechanics, clerks. Very light. **INEXPENSIVE. GUARANTEED.** Write for information and trial.

SMITH MANUFACTURING COMPANY
EST'D 1893 DEPT. PM PRESTON, ONTARIO

Command Bigger Money!

STUDY LAW

STUDY AT HOME for BUSINESS SUCCESS and LARGER PERSONAL EARNINGS. 40 years expert instruction — over 114,000 students enrolled. LL.B. Degree awarded. All text material furnished. Easy payment plan. Send now for FREE BOOK — "Law and Executive Guidance." It explains the course — how you may enroll and the many ways you can profit from Law Study. Write TODAY to:

AMERICAN EXTENSION SCHOOL OF LAW
Dept. 29-PM, 646 N. Michigan Ave., Chicago 11, Ill.

COYNE HAS STARTED

Thousands of men
ON THE PATH TO *Good Jobs..Security*



You'll find men in every town and city working happily at important good pay jobs in Electricity, Television and Radio. Thousands of these men could tell you that they were trained for these jobs in our great training shops right here in Chicago, the Electronic center of the world.

Just like yourself, these men heard about Coyne practical, down-to-earth shop training method. And they were wise enough to recognize their opportunity when it knocked. This is YOUR opportunity. I urge you not to let it slip by.

B. W. Cooke,
President

TELEVISION - RADIO



TELEVISION-RADIO FIELD WIDE OPEN

Television is growing so rapidly that actual shop training on the latest new equipment is the **only** way to be sure of up-to-date knowledge in the Television-Radio Field. There is no room for the half trained man. Today you have to **know** how.

It's easy to learn at Coyne because you are actually **doing** the job. You work right here in our great shops with a fine group of young men. The instructors are experts in their line with the skill and patience to be **real** teachers. At Coyne you learn thoroughly and you learn rapidly.

ELECTRICITY

NOT "HOME STUDY"

This is no "Home Study" course. You work right in our own big shops—with the latest, most modern equipment. Then in informal class rooms you'll learn the necessary **theory** of the equipment you are actually working with.

ELECTRICAL JOBS PAY WELL

Good pay and plenty of opportunity—that's the way this business is. See the endless possibilities for men with practical training, in power plant work, motors, generators, armature winding, home and factory wiring, appliances, refrigeration, maintenance, etc. That's for **you**.

GI APPROVED MAIL COUPON FOR BIG FREE BOOK

And non-veterans who are short of cash can finance their tuition and pay in easy monthly payments.

Whether you prefer Electricity or Television-Radio this is **your** school. Find out all about it. We will send you a big, fully illustrated book that will answer all your questions about either or both courses. They cost you nothing and nobody is going to call to high pressure you. We only want students whose interest is sincere. Mail this coupon NOW.

B. W. Cooke, Pres.



B. W. Cooke, President
COYNE ELECTRICAL AND TELEVISION-RADIO SCHOOL
500 S. Paulina St., Dept. CO-72H
Chicago, 12, Ill.

Send me the book checked below and details of your training offer. This does not obligate me and no salesman will call.

- TELEVISION-RADIO
 ELECTRICITY

NAME.....

ADDRESS.....

CITY.....STATE.....

COYNE

ELECTRICAL & TELEVISION-RADIO SCHOOL

500 S. Paulina St., Dept. CO-72H, Chicago 12, Ill.



WHAT SECRET POWER DID THIS MAN POSSESS?



BENJAMIN FRANKLIN
(A Rosicrucian)

WHY was this man great? How does anyone—man or woman—achieve greatness? Is it not by mastery of the powers within ourselves?

Know the mysterious world within you! At-tune yourself to the wisdom of the ages! Grasp the inner power of your mind! Learn the secrets of a full and peaceful life!

Benjamin Franklin—like many other learned and great men and women—was a Rosicrucian. The Rosicrucians (NOT a religious organization) first came to America in 1694. Today, headquarters of the Rosicrucians send over seven million pieces of mail annually to all parts of the world. Write for YOUR FREE COPY of "The Mastery of Life"—TODAY. No obligation. No salesmen. A non-profit organization. Address: Scribe T.L.L.

THIS BOOK
FREE!

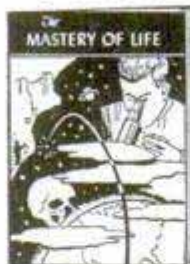

The ROSICRUCIANS

SAN JOSE • (AMORC) • CALIFORNIA

SEND THIS COUPON

Scribe T.L.L.
The ROSICRUCIANS (AMORC)
San Jose, California
Please send me the free book, *The Mastery of Life*, which explains how I may learn to use my faculties and powers of mind.

Name _____

Address _____

City _____

PRINT YOUR OWN POST CARDS

COMPLETE
OUTFIT
only
\$7.50

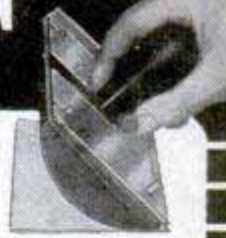

Amazing results in sales, inquiries and contacts . . . saves time and money . . . very easy to use GEM STENCIL DUPLICATOR is ideal for Advertising, Announcements, Notices, Labels, Forms, Price Lists—hundreds of uses for every type of business and organization. Comes complete with all supplies, instructions and 60-page Book of Ideas.

FREE TRIAL OFFER: Try it before you buy it! Write and a GEM OUTFIT will be sent you postpaid. After 10 days, send only \$7.50 or return the GEM, no questions asked. The GEM must sell itself; you be the judge.

BOND EQUIPMENT CO. • Dept. 135
6633 Enright • St. Louis 5, Mo.

SEND NO MONEY • FREE TRIAL OFFER

FREE AMAZING NEW BOOK "HOW TO ANSWER ADS"



Never before have you seen anything like this. Tells you in simple language the correct way to answer ads. Gets you quicker replies—better results, and greater satisfaction. Will save you time and money and it's ABSOLUTELY FREE. No obligation whatever. Every reader of advertising should have this booklet. Send a postcard for your copy NOW. Advertising Department, Popular Mechanics Magazine, Room 600, 204 East Ontario Street, Chicago 11, Ill.



RE-STRING RACKETS AT HOME—EARN MONEY

EASY — PLEASANT — PROFITABLE
FREE Write for 1950 Catalog and Instruction Sheet NOW.

W. A. RICKEL & CO., 803 S. Boulevard, Dept. F-53, Oak Park, Ill.



RAISE HAMSTERS

The new wonder animals from Syria. Often called Toy Bears. Delightful pets. Everyone wants them. Laboratories need thousands. Clean, odorless. Raise anywhere. A profitable and interesting hobby or business. We furnish breeding stock with manual of instructions.

Write today for free illustrated literature.
GULF HAMSTERY, 1536 BASIL, MOBILE, ALA.



BE A LOCKSMITH

Learn from experts at home! Age or handicap no disadvantage. Profitable profession. **FREE** booklet. INSTITUTE OF LOCKSMITHING, Dept. P-9, 55 Park Ave., Rutherford, N. J.

Learn WOOD PRODUCTION ENGINEERING

At Home In Your Spare Time

KLOK TRAINING offers you exceptionally practical and fascinating instruction in the woodworking industry arts—Sketching—Drafting—Rod Making—Time Study—Cost and Production Scheduling in an 81-Lesson Home Study Course or through Resident Training at Grand Rapids. Enables you to attain a top woodworking position or to run your own shop more successfully. Free G. I. instruction. Money back trial offer to non-veterans. Write me—today for **FREE BOOKLET**. State age, veteran or non-veteran, Home Study or Resident Course, occupation.



JOHN H. KLOK, President

KLOK INSTITUTE

Woodworking Industry Training Since 1928
H. Louis St., N.W. Grand Rapids 2, Mich.



GET INTO

DIESEL-AUTO MECHANICS

Master All Phases

JOB LIKE THESE ARE AVAILABLE TO TRAINED MECHANICS. CHOOSE THE FIELD YOU LIKE BEST

Get Complete Training

- Diesel Fuel Injection
- Automotive Motor Tune-up
- Diesel Engine Rebuilding
- General Garage Mechanic
- Agricultural Implements
- Auto Engine Rebuilding
- Auto Elec. Service
- Public Utilities
- Parts Dealers
- Bus & Truck Lines
- Industrial Maintenance
- Contracting & Excavating
- Business of Your Own
- AND MANY other similar openings.

As a National Schools graduate, you are trained for ALL opportunities in the Diesel & Auto Industries

EARN WHILE YOU LEARN

With our practical Master Shop-Method Home Training, you study at home in your spare time. You receive Spare Time Work Lessons, which show you how to earn while you Learn . . . for extra money and experience. You Learn by DOING.

TOOLS AND EQUIPMENT

To make your training complete, we give you selected mechanic's tools and equipment, illustrated below, including all-metal toolbox — as a regular part of your instruction.



Shop-Method Home Training by an Established Resident School Prepares you for Many Good Jobs

Opportunity is everywhere for the trained Diesel-Auto Mechanic. Highways throng with cars, busses, trucks, tractors. Garages and Service Stations are kept busy. Factories, ships, farms, railroads, general industry, are dependent upon engine power. Here's a dynamic, fast-growing field that needs trained men who know ALL phases: installation, operation, maintenance and repair. Now—National Schools offers you a practical, all-embracing Diesel-Auto Mechanic's Course, including all of these advantages:

Complete training, covering—Diesels, High Speed and Heavy Duty; Semi-Diesels, Gasoline and Special Fuel Engines AND Allied Mechanics.

- Basic Lesson Texts
- Diesel Installation
- Operation - Maintenance
- Diesel Chart Manual
- Spare Time Lessons
- Engine Service Manuals
- Engine Repair
- Drive Systems
- Diesel Electric Power
- Thermodynamics

TOOLS AND EQUIPMENT

INVESTIGATE
Secure Full Information

NEW, ILLUSTRATED BOOK & SAMPLE LESSON SHOW HOW WE TRAIN YOU . . . SEND FOR THEM TODAY!

NO COST
NO OBLIGATION

APPROVED FOR VETERANS

Check coupon below

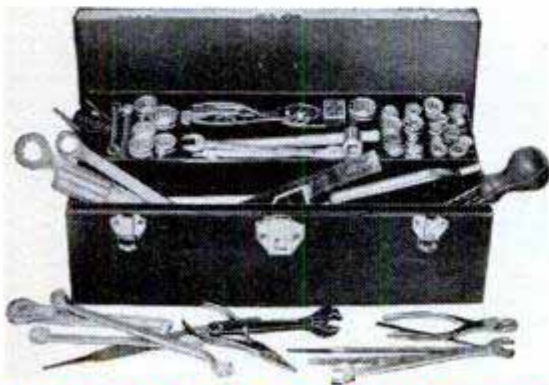

WE GIVE YOU TOOLS OF YOUR TRADE

NATIONAL SCHOOLS

LOS ANGELES 37, CALIF. • EST. 1905



FIND OUT NOW... MAIL COUPON TODAY

NATIONAL SCHOOLS, DEPT. PMD-8
4000 South Figueroa Street
Los Angeles 37, California

(Mail in envelope or paste on penny postcard)

Mail me FREE the book, YOUR FUTURE IN DIESEL-AUTO MECHANICS, together with the Sample Lesson. I understand I may keep and use the information with no obligation.

Name _____ Age _____

Address _____

City _____ Zone _____ State _____

Check here if Veteran of World War II



**What's
your problem...**

NOT SATISFIED with YOUR PAY CHECK?

**Home study training, in spare
time, can
increase your earnings!**

The success of many of today's money-makers started in a coupon similar to the one below, which they checked, signed and mailed to AMERICAN SCHOOL. The information they received opened doors of real opportunity to promotions and bigger pay checks.

Who earns these rewards? It's the ambitious man with know-how and self-confidence which come from training. It's the man who looks far beyond the next pay day and sets his goal, and is willing to devote some of his spare time to acquiring the knowledge that will give him the power to climb the success ladder.

IT COSTS SO LITTLE — PROVIDES SO MUCH

At a cost you can afford and in hours you might otherwise waste you can prepare to climb in the field of work you prefer. American School, an educational institution organized *not for profit*, offers you a wide choice of training opportunities. Give serious thought to the list in the coupon, then check one or more subjects, add your name and address and mail it. You will receive full information, without obligation of any kind. Do it now.

AMERICAN SCHOOL
DEPT. GC-45, DREXEL AT 58th, CHICAGO 37

PRACTICAL, EFFECTIVE HOME - STUDY TRAINING SINCE 1897

Take This First Easy Step

CHECK, CLIP AND MAIL COUPON NOW

AMERICAN SCHOOL, Dept. GC-45, Drexel at 58th, Chicago 37, Ill.
Without obligation, please send me FREE information on training course checked below.

- | | | |
|---|--|--|
| <input type="checkbox"/> Accounting | <input type="checkbox"/> Business Mngmt. | <input type="checkbox"/> Plastics Engr. |
| <input type="checkbox"/> Air Conditioning | <input type="checkbox"/> Contracting | <input type="checkbox"/> Plumbing—Pract. |
| <input type="checkbox"/> Architecture & Building | <input type="checkbox"/> Diesel Engr. | <input type="checkbox"/> Private Secretary |
| <input type="checkbox"/> Automotive | <input type="checkbox"/> Drafting & Design | <input type="checkbox"/> Radio Operating & Servicing |
| <input type="checkbox"/> Engineering | <input type="checkbox"/> Electrical Engr. | <input type="checkbox"/> Railway Training |
| <input type="checkbox"/> Aviation—Practical | <input type="checkbox"/> Electricity—Pract. | <input type="checkbox"/> Refrigeration |
| <input type="checkbox"/> Aviation Drafting & Design | <input type="checkbox"/> Electronics—Indus. | <input type="checkbox"/> Sheet Metal |
| <input type="checkbox"/> Better Forem'nship | <input type="checkbox"/> High School | <input type="checkbox"/> Pattern Drafting |
| <input type="checkbox"/> Bookkeeping | <input type="checkbox"/> Machine Shop Operations | <input type="checkbox"/> Shop Management |
| | <input type="checkbox"/> Mechanical Engr. | <input type="checkbox"/> Tool Making |

Name _____ Occupation _____
Address _____ Age _____
City & Zone _____ State _____

**Earn \$18 an Evening
Up To Without Selling**



No Wonder John C. West, Cleveland, made over \$200.00 a week his first three weeks in Spare Time. Get Sworn Proof of many other exceptional profit records.

It's EASY! Just show housewives how to END FOREVER the nasty, messy job of defrosting refrigerators. Profits come rolling in.

Amazing Patented Device! Just plug it in—show what it does—housewives won't let you take it out. Make up to \$6.50 on each call!

FREE PROFIT PLAN

Just send card with name and address for GUARANTEED Starting Offer and SURE PROFIT PLAN. Cash in on our National Advertising to 29,000,000 prospects. RUSH—reserve your Territory.

D-FROST-O-MATIC

6 North Michigan, Dept. PM-8, Chicago, Ill.



MAKE MONEY!
RAISE CHIN-CHIN
CHINCHILLA RABBITS
Pedigreed! Valuable Breeders!
PROFITABLE! EASY! PLEASANT!
Free Illustrated Booklet—WRITE TODAY!
ROCK HILL RAÑCH **SELLERSVILLE 36, PA.**

SELL MADE-TO MEASURE **CLOTHES**
Popular Prices • Good Profits



Earn good money selling Homeland made-to-measure clothes for men or ladies—at low prices made possible by selling direct from maker to wearer. Satisfaction guaranteed. Full time or part time. Be in business for yourself; make good profits. We supply complete outfit at no cost to you. Apply NOW for new Fall line. Homeland Tailors, Inc., Dept. E, Baltimore 3, Md.

Learn CARTOONING

HAVE FUN! MAKE MONEY! Cash in on your sense of humor at HOME—BY MAIL. No experience needed to start. Write today for FREE TRIAL LESSON and full particulars.

Moon Gag Cartoon School, Dept. E, Fall Creek, Wis.



REAL ESTATE

BE A BROKER

PAYS BIG! SEND FOR FREE, BIG, ILLUSTRATED CATALOG NOW! No obligation. Graduates report making substantial incomes. Start and run your own business quickly. Men, women of all ages, learn easily. Course covers Sales, Property Management, Appraising, Loans, Mortgages, and related subjects. **STUDY AT HOME** or in our classrooms in big cities. Diploma awarded. G.I. approved. Nationally known.

WEAVER SCHOOL OF REAL ESTATE (Est. 1936)
15 E. Pershing Road Dept. PM Kansas City, Mo.



LEARN WATCH REPAIRING at home or at our G. I. Approved resident school. Individual instruction by competent instructors. WRITE TODAY FOR FREE INFORMATION. JOHN VAN PUFFELEN, Director
AMERICAN INSTITUTE OF SPECIALIZED WATCH REPAIR
1012-14 Franklin St. S.E. — Grand Rapids 8, Michigan

GREAT PROFITS
MAKE YOUR OWN RUBBER MOLDS

X.L. RUBBER MOLDS

will realize your great profits quickly!
WRITE FOR NEW FREE CATALOG

YOU can EASILY learn to cast thousands of perfect plaques, book ends, figurines, ash trays, etc. IT'S EASY, FUN, PROFITABLE! X.L. Rubber, Pts. \$2.00; Qts. \$3.50; Gallons \$8.95; Models and enough rubber for 3 molds \$1.30 postpaid.



SEND FOR FREE FACTS

PLASTIC ARTS STUDIO Address Dept. 2
3403 S. Madison St. Muncie, Ind.

Now IN YOUR OWN HOME Learn

TELEVISION RADIO

the Amazingly Effective

D.T.I. WAY

—with the aid of **BOTH HOME EQUIPMENT and HOME MOVIES**

What will mailing the coupon below *do for YOU?* Just this! You'll find out about one of today's most remarkable... practical ways to prepare to get into America's amazing billion dollar opportunity field of TELEVISION-RADIO-ELECTRONICS. You'll see how to get into fascinating work that pays well... that offers one of America's most promising futures... that enables you to start your own business almost "on a shoe string," if you prefer this to a job opportunity.

And above all, you'll get some **GOOD NEWS** especially welcomed by men anxious to earn **REAL MONEY** in this thrilling field. For you'll see that **NOW** you can get the kind of practical, laboratory-type training so desirable for making real progress in Television-Radio-Electronics... and **WITHOUT LEAVING HOME.**

You'll see that DeForest's Training, Inc. sends everything needed to set up your own **HOME LABORATORY.** You get and keep the same type of basic electronic equipment used in our modern Chicago Training Laboratories. You get home training that includes the knowledge and experience gained from training thousands of students first hand in Chicago. And to top it all, you use DTI's amazingly effective and exclusive home training aid—**INSTRUCTIVE MOVIES.** But why not get the complete story? Mail coupon today for information-packed literature.

MODERN LABORATORIES

If you prefer, get all your preparation in our new Chicago Training Laboratories—one of the finest of its kind. Ample instructors, modern equipment. Write for details!

NO PREVIOUS EXPERIENCE NEEDED
NOW...get EVERYTHING YOU NEED
for real Laboratory-Type training
AT HOME

Above:
Work over
300
fascinating
experiments
with this
equipment

You
KEEP
all test
equipment

1. Build over 300 fascinating experiments from 16 **BIG SHIPMENTS** of Electronic-Radio parts which you **KEEP.**

2. Build valuable commercial-type test equipment—as shown to the left—which you **KEEP.** This includes a quality **OSCILLOSCOPE**—a must for Television work.

3. Use a 16 mm. movie projector and new series of Hollywood produced instructive movies—a wonderful aid to help you grasp important fundamentals faster...easier...better.

4. Enjoy well-illustrated, easy-to-read lessons with handy **FOLD-OUT** diagrams.

5. Get an honest-to-goodness **EMPLOYMENT SERVICE** to help you get a good job after graduating—or assistance in starting your **OWN SALES AND SERVICE BUSINESS.** Mail coupon today for the complete details.



Build and Keep this 16-INCH TV RECEIVER—OPTIONAL after completing regular training.



New "black" RECTANGULAR TUBE

Get **BOTH** of these colorful, information-packed folders **FREE**



SEE FOR YOURSELF
Mail
Coupon
Today

DeFOREST'S TRAINING, INC. Dept. PM-G8
2533 N. Ashland Avenue, Chicago 14, Ill

Without cost or obligation, I would like valuable, information-packed folders showing how I may get started toward a good job or my own business in Television-Radio-Electronics.

Name _____ Age _____
Street _____ Apt. _____
City _____ Zone _____ State _____

DeFOREST'S TRAINING, INC.
Chicago 14, Illinois
A DeVry Institution

EARN MORE IN DRAFTING



More Opportunities for Employment and Promotion

"Here I am at work making good money as a draftsman. I'm glad I sent the coupon to Chicago Tech for that Free Trial Lesson and found out how easy it is to learn Drafting in spare time at home. Today I feel secure in my job because the draftsman's work comes first on any new project. And, in addition, draftsman can't be replaced with machines. What's more, I feel I'm slated for promotion and more pay, because I see so many draftsmen advancing to high-pay jobs."

LEARN IN SPARE TIME—AT HOME!
(or at the College in Chicago)

A few hours of pleasant home study every week—that's all. No interference with your present job. All the tools you need; drawing outfit included. With Chicago Tech's help, you train yourself step by step. This tested method—developed over 46 years of C.T.C. progress—prepares men quickly for good positions in industry.



FREE INFORMATION—SEND COUPON
To prove to you how easy it is to learn Drafting at home by the Chicago Tech method, we will send you this **FREE TRIAL LESSON**. No charge for this lesson, now or later. Fill out and mail coupon, or send post card today.

CHICAGO TECHNICAL COLLEGE

K-213 Tech Bldg., 2000 S. Michigan Ave., Chicago 16, Illinois
Mail me **FREE** Lesson with information about big opportunities in **DRAFTING**.

Name _____ Age _____

Address _____

City _____ Zone _____ State _____

BIG PAY JOBS for men who qualify in DIESEL



ASSURE YOUR FUTURE. Steady, high-pay jobs await men qualified in Diesel, Tractor, and Heavy Equipment. Are you qualified for job and advancement opportunities in this fast-growing field? You can qualify!

COMPLETE DIESEL COURSE NOW AVAILABLE. If you are ambitious and want to get ahead in this big money field, you'll want to know about the complete Diesel home training course now offered by Interstate Training Service. Covers all phases of operation, repair, service. Easy to master in spare time. No interference with present job. Up-to-the-minute. Regularly revised to cover new developments. We invite comparison of material offered. Free placement advisory service.

YOU OWE IT TO YOURSELF to investigate Interstate Training Service Diesel Training. Thousands agree it has helped them to better jobs... better pay. It can do the same for you!

WRITE FOR FREE INFORMATION TODAY

INTERSTATE TRAINING SERVICE, Portland 13, Ore.
Please see that I receive **FREE** 24-page book, "Getting Ahead in Diesel." K-B

NAME _____ AGE _____
ADDRESS _____
CITY _____ ZONE _____ STATE _____



Be an INVESTIGATOR

JAMES S. BOLAN, FORMER NEW YORK CITY POLICE COMMISSIONER offers **MEN & WOMEN** an opportunity for a Professional Career in Modern Investigation & Criminology by comprehensive Home Study Course. Free placement service assists graduates to obtain jobs. **APPROVED FOR VETERANS.** Licensed by State of New York. Write for Booklet P

THE BOLAN ACADEMY, INC.
EMPIRE STATE BLDG., NEW YORK 1, N. Y.

CARPENTRY BRICKLAYING

APPROVED FOR VETERAN TRAINING • **FREE CATALOG**

PENNSYLVANIA INSTITUTE SCHOOL OF TRADES
30th & MARKET STS. PHILA. 4, PENNA.

LEARN TO WRITE a Good Hand!

FOR BUSINESS AND SOCIAL SUCCESS!
Easy to improve your handwriting at home quickly with my new instruction books just off the press. Master all the secrets of better penmanship. Simple and easy, fully illustrated, highly endorsed. Begin today. Write for: New Free Book, "How to Become a Good Penman," or check books wanted, \$1.00 each, Business Writing Artistic Writing Card Writing Engraving Alphabets Birth and Design Flourishing Complete Set \$4.50 Enclose 10c for your name beautifully written and special penpoint for shaded writing. S. A. Ziller, President, **TAMBLYN SCHOOL OF PENMANSHIP**, 441 Ridge Bldg. In Business Over 52 Years Kansas City, Mo., U.S.A.

LAW FREE BOOK THE LAW TRAINED MAN

Your **FREE** copy of "The Law-Trained Man" shows how to gain prestige and greater earnings through Blackstone home law study. All instruction material furnished including 18-volume Law Library written by 65 well-known law authorities. Lawyers, judges among our graduates. LL.B. degree. Low cost; easy terms. Write today.
BLACKSTONE COLLEGE OF LAW 225 N. Michigan Ave. Dept. 50C, Chicago 1, Ill.

A Correspondence Institution Founded in 1890

Learn TELEVISION-ELECTRONICS RADIO

2 Big Books FREE Train at Home—Get Big Kits of Radio Parts! Prepare now in spare time. Practical instruction. Approved for Veterans. Write for details and 2 Radio Books—**ALL FREE!** Rush name today!
SPRAYBERRY ACADEMY OF RADIO Dept. 10-M 111 No. Canal Chicago 6, Illinois



LABORATORY TECHNICIAN

BE A LABORATORY SPECIALIST! complete course. Big demand from hospitals, doctors, clinics. We teach all branches of medical laboratory work, including **Medical and Dental X-Ray**.

Approved by American College of Medical Technologists
Co-educational Free Placement Bureau
Free Catalog

Accredited for "veteran" training
CHICAGO COLLEGE OF LABORATORY TECHNIQUE
Dept. P.M., 431 S. Wabash Ave. Chicago 5, Illinois

Always write your name and full address clearly when answering advertisements

WATCHMAKING

★ Watch Repairing ★ Jewelry Engraving ★ Jewelry Repairing

Combination men earn top pay. Learn in school fully accredited by Horological Institute of America in Washington, D. C. and United Horological Association of America. Approved for veterans. Receive tools, tuition and subsistence while learning.

Established 1935. Write for **FREE** booklet



The Baronian School, Inc.

2116 WALNUT ST. (DEPT. C) PHILA. 3, PA.



7 DAY FREE TRIAL
Return and Pay Nothing if Not Completely Satisfied



NOW! You can easily
Fix ANY Car
in less time-- and do a better job too!

Used by U. S. Army and Navy

Here's the Quick, Easy Way to Repair ANY CAR BUILT SINCE 1935. Step-by-Step Instructions by Factory Experts, Over 2100 "How-to-do-it" Pictures, Over 200 "Quick Check" Tables Make it "Easy as Pie" For Even a Beginner To Do A First-Rate Job.

"MoToR's Manual paid for itself on the first 2 jobs, and saved me valuable time by eliminating guesswork." — W. SCHROP, Ohio

NO auto repair job is tough when you've got MoToR's brand-new AUTO REPAIR MANUAL. Shows how to save work on those "ornery" jobs. Helps you make MORE MONEY by doing more jobs in less time. Try this amazing book FREE for 7 days.

"Instructions so clear have no trouble learning anything about any car. Now working as mechanic in big plant." — SAM ORDONEZ, Cal.

Want to fix anything from carburetor to rear end, Jeep to Cadillac, shabby '35 to shiny '50? Here's the quick, easy, right way—the way factory experts advise. Just look up make, model, and job in quick index—and go to it. Clear, ILLUSTRATED instructions lead you step by step through whole job.

"Have become foreman of my garage—thanks to help of your Manual." — ELMER HENSLER, Wisc.

150 official factory shop manuals for you — spotted all the vital repair information you need — dove-tailed it all together into ONE handy, easy-to-understand book.

EVERYTHING YOU'LL NEED TO KNOW

MoToR's Manual takes nothing for granted. Starts at the very beginning; tells how to identify all 741 car models. More than 2100 easy-to-follow Photos, Drawings, Diagrams guide you step-by-step right thru each operation. Almost 750 big pages crammed with Factory Specifications and Adjustment Tables, Tune-up Charts, Tables of Measurement and Clearances, Overhauling and Replacement facts, Automatic Transmissions, New GM Rochester Carburetor, and much MORE!



ABOVE: Showing operation of Buick Dyna-Flow—and, BELOW: How to adjust Ford Clutch. Every moving part is covered in simple words and BIG, CLEAR Pictures.

NO OTHER MANUAL LIKE IT!

The engineer-editors of MoToR Magazine collected and "broke down" over

COVERS ANY CAR BUILT SINCE 1935!

- | | | |
|-----------|-----------|--------------|
| Auburn | Ford | Mercury |
| Austin | Frazier | Nash |
| Bantam | Graham | Oldsmobile |
| Buick | Hudson | Packard |
| Cadillac | Hupmobile | Pierce Arrow |
| Chevrolet | Kaiser | Plymouth |
| Chrysler | Lafayette | Pontiac |
| Cord | La Salle | Reo |
| Crosley | Lincoln | Studebaker |
| De Soto | Lincoln | Terraplane |
| Dodge | Zephyr | Willis |

Same FREE Offer on NEW MoToR's TRUCK & TRACTOR REPAIR MANUAL

New Edition covers EVERY job on EVERY popular make gasoline truck and farm tractor made from 1936 thru 1949! Over 1400 pictures, 961 pages, 300,000 facts. All types Gasoline Engines, Fuel Systems, Governors, Lubrication, Ignition, Starters, Generators, Clutches, Axles, Brakes and more! For FREE 7-DAY TRIAL, check box in coupon.



Try Book FREE 7 Days

SEND NO MONEY! Just mail coupon! When the postman brings book, pay him nothing. First, make it show you what it's got! Unless you agree this is the greatest time-saver and work-saver you've ever seen—return book in 7 days and pay nothing. Mail coupon today!

Address: MoToR Book Dept., Desk 1J, 250 West 55th St., New York 19, N. Y.



Published by MoToR, The Leading Automotive Business Magazine.

MAIL COUPON NOW FOR 7-DAY FREE TRIAL

MoToR BOOK DEPARTMENT
Desk 1J, 250 West 55th Street, New York 19, N. Y.

Rush to me at once: (Check box opposite book you want)

MoToR's New AUTO REPAIR MANUAL. If O.K. I will remit \$1 in 7 days, (plus 35c delivery charge), then \$2 monthly for 2 months, and a final payment of 96c a month later. Otherwise I will return book postpaid in 7 days. (Foreign price, remit \$8 cash with order.)

MoToR's New TRUCK and TRACTOR REPAIR MANUAL. (Described at left.) If O.K. I will remit \$2 in 7 days, and \$2 monthly for 3 months, plus 35c delivery charge with final payment. Otherwise I will return book promptly. (Foreign price, remit \$10 cash with order.)

Print Name.....Age.....

Address.....

City & Zone No.....State.....

SAVE 35c delivery charge by enclosing WITH COUPON check or money order for full payment of \$5.95 for Auto Manual (or \$8.00 for Truck Manual). Same return-refund privilege applies.

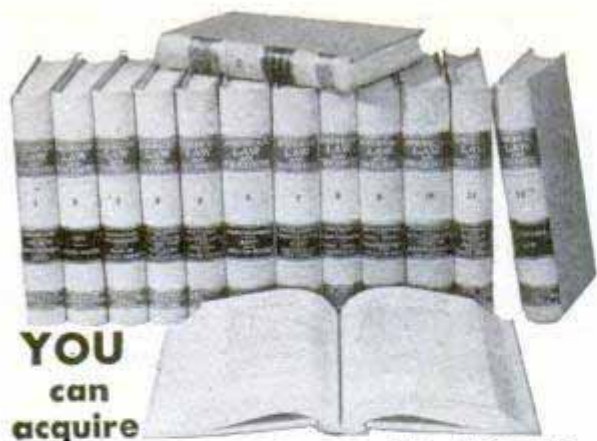

**YOU
can
acquire**

LAW NIGHTS AT HOME! L. L. B. DEGREE

LaSalle's famous Law Library—used as reference in many Law libraries and Law offices—has enabled thousands to master Law surprisingly fast, in spare hours at home, for business and professional advancement.

These 14 remarkable volumes, compiled by leading professors and lawyers, cover the whole basic field of Law in condensed, orderly, simplified manner.

You advance rapidly with this great library, plus special lectures furnished. We guide you step-by-step with personalized Problem Method of instruction . . . you learn by doing—handling legal problems—not by memorizing rules.

Send for two FREE 48-page booklets, "Law Training for Leadership," and "Evidence," answering questions about Law and its value to you, and telling how LaSalle Law graduates are winning rapid advancement in business and public life. Mail coupon below. No obligation.

LA SALLE EXTENSION UNIVERSITY A Correspondence Institution

417 S. Dearborn St., Dept. 864-L, Chicago 5, Ill.

Send me your two FREE booklets described above; without obligation.

Name.....Age.....

Street.....

City, Zone & State.....

ENGINEERING DEGREE IN 27 MONTHS

Big Demand for Graduates

Aeronautical, Chemical, Civil, Electrical, Mechanical and Radio Engineering (including Television)

Hundreds of young men are earning engineering degrees in this recognized institution each year—continuous operation. New terms start quarterly. Many students earn a major part of their college expenses in this large industrial center.

Low tuition. Competent instruction. Thorough, intense, practical program. Modern laboratory facilities including new physics lab. and modernized wind tunnel. Individualized instruction emphasized.

Approved for Veterans. Engineering preparatory courses. Students from 48 states and 21 foreign countries. Enter September, December, March or June. Send coupon for free catalog and full information. Enroll now.

— SEND COUPON TODAY —

INDIANA TECHNICAL COLLEGE

580 E. Washington Boulevard
Fort Wayne 2, Indiana

Please send me free information on B.S. Engineering Degree in 27 months as checked.

Aeronautical, Chemical, Civil, Electrical,
 Mechanical, Radio-Television.

Name.....

Address.....

LEARN AT HOME TO MOUNT BIRDS



Animals, Heads, Fishes, Pets; to TAN. Be a Taxidermist. Profit and FUN.

Hunters, save your valuable TROPHIES. Mount ducks, squirrels, everything. Learn to TAN for leather and furs. Wonderful HOBBY Have a HOME MUSEUM.—BIG PROFITS mounting for others. INVESTIGATE NOW.

FREE BOOK With 100 fine game pictures. NOW absolutely FREE. Write TODAY.

Send Postal TODAY for FREE BOOK. State AGE. N. W. SCHOOL OF TAXIDERMISTRY, Dept. 2508, Omaha, Nebr.



NATION'S
LARGEST
EXCLUSIVE
ELECTRICAL
SCHOOL

"LEARN-BY-DOING"

ELECTRICITY

PRACTICAL TRAINING
NOT "HOME STUDY"

Get actual experience in great shops of M.T.I. Learn all phases Practical Electricity; Housewiring, Motors, Const., Maintenance, etc. Living arrangements, Part-time jobs, etc. Pay after graduate plan.

A post card brings the story.
MICHIGAN TECHNICAL INSTITUTE, Dept. PM-8
2281 W. Fort St., Detroit 16, Michigan

LEARN WATCH REPAIRING



AT HOME. By our modern and original system of instruction you can learn every part of the WATCH REPAIRING TRADE AT HOME. Prepare yourself for a well-paying position or start in business after completing our course of instruction. Good watch repairers are in demand and generally earn very good salaries. For particulars apply to the WISCONSIN SCHOOL OF WATCH REPAIRING 759 North Milwaukee St., Milwaukee 2, Wis.

Learn PHOTOGRAPHY at Home

Splendid opportunities. Prepare in spare time. Practical basic training. Long-established school. Send for free book, "Opportunities in Photography." No obligation.

American School of Photography, 1315 S. Michigan Ave., Dept. 313C, Chicago 5, Ill.

LEARN MEAT CUTTING At Home—In Spare Time



Get into the vital meat industry. Concise, practical Home Training based on 25 years' proven instruction methods used at National's famous resident school. Prepares you for bigger pay as Meat Cutter, Supervisor, market manager or more money in your own store. Go as rapidly as your spare time permits. Diploma. Start NOW to turn your spare hours into money. Send for FREE bulletin today. No obligation.

NATIONAL SCHOOL OF MEAT CUTTING, INC., Div. U-119, Toledo 4, Ohio

"YOU ARE UNDER ARREST!"



Help Bring Crooks to Justice Through Scientific CRIME DETECTION!

We have taught thousands this exciting, profitable, pleasant profession. Let us teach you in your own home. Learn Fingerprinting, Firearms Identification, Police Photography, Secret Service Methods thoroughly, quickly, at small cost. Over 800 of all American Bureaus of Identification employ I. A. S. students or graduates. We can prepare you for this fascinating work, during spare time. Write today, stating age, for "Blue Book of Crime."

INSTITUTE OF APPLIED SCIENCE, 1920 Sunnyside Ave., Dept. 135-C Chicago 40, Ill.

SHINE WITHOUT 'POLISH'

New Invention! • Sells Like Wild



Replaces messy pastes, liquids. Simply glide over shoes—and PRESTO!—you have a lustrous, long-lasting shine. No mess. No fuss. No soiled hands. Clean. Handy. WORKS LIKE MAGIC! For Men's, Women's and Children's Shoes. Low priced. Lightning seller!

SAMPLES FOR AGENTS Sample offer sent immediately to all who send name at once. A penny postal will do. SEND NO MONEY—just your name. KRISTEE CO., 672 Bar Street, AKRON, OHIO

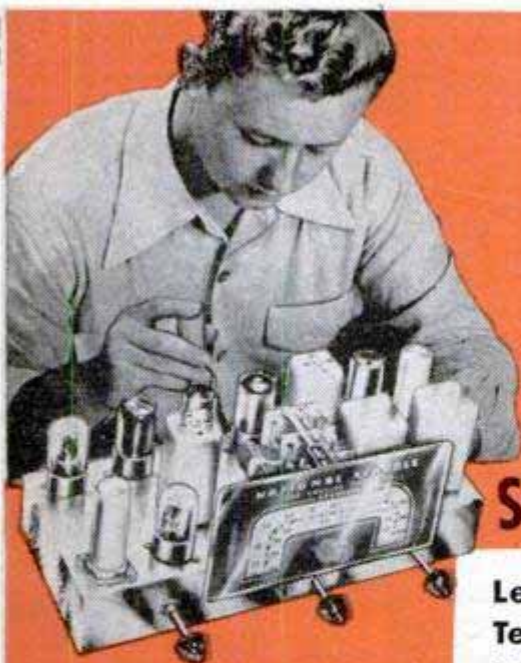

Learn RADIO

TELEVISION, ELECTRONICS

by

SHOP METHOD HOME TRAINING

Let **NATIONAL SCHOOLS**, of Los Angeles, a practical Technical Resident Trade School for almost 50 years, train you for today's unlimited opportunities.

You receive all parts, including tubes, for building this fine, modern Superheterodyne Receiver. This and other valuable standard equipment becomes your property.

these two **FREE** books will tell you how



**WE BRING
NATIONAL
SCHOOLS TO YOU!**

GOOD JOBS AWAIT THE TRAINED RADIO TECHNICIAN

You are needed in the great modern Radio, Television and Electronics industry! Trained technicians are in constant and growing demand at excellent pay—in Broadcasting, Communications, Television, Radar, Research Laboratories, Home Radio Service, etc. National Schools Master Shop Method Home Study Course, with newly added lessons and equipment, can train you in your spare time, *right in your own home*, for these exciting opportunities. Our method has been proved by the remarkable success of National Schools-trained men all over the world.

You Learn by Building Equipment with Standard Radio Parts We Send You

Your National Schools Course includes not only basic theory, but *practical training as well—you learn by doing*. We send you complete standard equipment of professional quality for building various experimental and test units. You advance step by step until you are able to build the modern superheterodyne receiver shown above, which is yours to keep and enjoy. You perform more than 100 experiments—build many types of circuits, signal generator, low power radio transmitter, audio oscillator, and other units. The Free Books shown above tell you more about it—send for them today!



NOW! NEW PROFESSIONAL MULTITESTER INCLUDED



This versatile testing instrument is portable and complete with test leads. Simple to operate, accurate and dependable. You will be able to quickly locate trouble and adjust the most delicate circuits. You can use the Multitester at home or on service calls. It is designed to measure AC and DC volts, current resistance and decibels. You will be proud to own and use this valuable professional instrument.

Lessons and Instruction Material Are Up-to-date, Practical, Interesting

National Schools Master Shop Method Home Training gives you basic and advanced instruction in all phases of Radio, Television and Electronics. Each lesson is made easy to understand by numerous illustrations and diagrams. All instruction material has been developed and tested in our own shops and laboratories, under the supervision of our own engineers and instructors. A free sample lesson is yours upon request—use the coupon below.

TELEVISION TRAINING A complete series of up-to-the-minute Television lessons is an integral part of your course, covering all phases of Television repairing, servicing and construction.

Here are just a few of the interesting facts you learn with the **FREE SAMPLE LESSON**

1. How radio receivers operate.
2. How the antenna circuit is constructed.
3. Converting signal currents into sound.
4. How the R-F transformer handles the signal.
5. How the tuning circuit functions.
6. The Radio "bands."

**APPROVED
FOR
VETERANS**
Check coupon below.

NATIONAL SCHOOLS

LOS ANGELES 37, CALIFORNIA EST. 1905



MAIL OPPORTUNITY COUPON FOR QUICK ACTION

National Schools, Dept. PM-8
4000 South Figueroa Street
Los Angeles 37, California

(Mail in envelope or
paste on penny postcard.)

Mail me **FREE** the book "Your Future in Radio-Television" and the sample lesson of your course. I understand no salesman will call on me.

NAME _____ AGE _____

ADDRESS _____

CITY _____ ZONE _____ STATE _____

Check here if veteran of World War II

GET THE DETAILS - SEND THE COUPON →



YOU CAN LEARN TO BE AN ARTIST

ENJOY THIS FASCINATING HOBBY — TRAIN FOR A PROFITABLE CAREER

Your future is in your own hands. Prepare yourself now in COMMERCIAL ART, DESIGNING, and CARTOONING—all in ONE up-to-date home study course. Trained artists are capable of earning \$65, \$80 and more a week. No previous art experience necessary — we teach you step-by-step, our method is simple and practical. For 36 years WSA graduates have been "making good"—WHY NOT YOU? Enjoy an art job in Advertising, Television, Publishing, etc. **FREE BOOK**, "Art for Pleasure and Profit" fully describes course, service and commercial opportunities. **TWO ART OUTFITS** included with training. **LOW COST—ONLY \$5 MONTHLY** (VETERANS! Course G.I. approved)



FREE BOOK gives details!

Washington School of Art, Studio 128W
1115—15th St., N.W., Washington 5, D. C.
Please send me full information and your Free Book, "Art for Pleasure and Profit." (please print)

Name _____ AGE _____
Street _____
City _____ Zone _____ State _____



9 BIG BUILDING BOOKS



12th EDITION FOR
EXAMINATION
SEND NO MONEY

Learn to draw plans, estimate, be a live-wire builder, do remodeling, contracting. These 9 practical, profusely illustrated books cover subjects that will help you to get more work and make more money. Masonry, concrete forms, carpentry, steel square, roof framing, construction, plumbing, heating, painting, decorating and many other subjects. More than 4000 pages — 2750 illustrations.

BETTER JOBS — BETTER PAY UP-TO-DATE EDITION

A nationwide building boom is in full swing and trained men are needed. Big opportunities are always for MEN WHO KNOW HOW. These books supply quick, easily understood training and handy, permanent reference information that helps solve building problems.

These books are the most up-to-date and complete we have ever published on these many subjects.

Coupon Brings Nine Big Books for Examination

AMERICAN TECHNICAL SOCIETY—Publishers since 1898
Dept. GC19 Drexel at 58th Street Chicago 37, Ill.

You may ship me the Up-to-Date edition of your nine big books, "Building, Estimating and Contracting," without any obligation to buy. I will pay the delivery charges only, and if fully satisfied in ten days, I will send you \$3.00, and after that only \$4.00 a month, until the total price of only \$34.80 is paid. I am not obligated in any way unless I keep the books.

Name _____

Address _____

City _____ State _____

Please attach a letter stating your age, occupation, employer's name and address, and name and address of at least one business man as a reference. Men in service, also please give home address.



Not a toy! A perfectly balanced small arm for sport and small game! Special introductory offer: "Powr-Pak" Pistol Sling, 50 "Tru-Flite" 23 gr. pellets, extra sling, 10 "Red Dot" targets, postpaid, \$2.25 cash, check or money order. No COD's! Money back guarantee. Order yours today from Baron Industries, Box 3578P, Cleveland 18, Ohio. Order extra supply 23 gr. "Tru-Flite" Pistol Sling pellets with your Powr-Pak. 250 for \$1.00.

MONEY for MEN ALL DATA FREE

THE PLASTEX Industry needs manufacturers on small scale and for big production of Lamp and Clock Stands, Art Goods and Novelties in Plastex and Marble imitation. Experience unnecessary, 1/2c material makes regular 10c store sellers. Rubber moulds furnished for speed production. Small investment brings good returns. Big chain store orders now being placed. Ambitious men have chance for real prosperity. Our Free booklet will interest and benefit you.

PLASTEX INDUSTRIES, Dept. A
3400 Third Ave. New York 56, N. Y.

STAMMERER?

New booklet, "Stammering, and How to Stop It," sent free to any stammerer upon request. Write today. BENJAMIN N. BOGUE, Dept. 504, Circle Tower, Indianapolis 4, Ind.



HOMESITES \$300 LOW TERMS

In California's loveliest Garden Spot, on scenic shores of beautiful Morro Bay. Enjoy future independence with excellent soil, soft water, wonderful fishing, hunting, boating, bathing, etc. Grow fruits, vegetables, poultry. Perfect temperate climate. Congenial community. Finest investment. Free literature.

RICHARD S. OTTO

DEPT. M SAN LUIS OBISPO, CALIFORNIA

Send \$1 for QUICKEE SPECIAL! CLEANS HANDS — WITHOUT WATER!

In just 17 seconds, QUICKEE removes stubborn paint, grease, grime, tar, glue, printers' ink, etc.—without water. Dab on QUICKEE, wipe off on rag and your hands are clean enough to sit down to dinner. Not gritty. Soft as cold cream. Contains Lanolin. Send \$1 for all 3—tube to keep in car, 13 oz. can for home and trial sample. Use sample. If not delighted, return unopened tube and can for full refund.

TUDOR CHEMICAL SPECIALTIES, INC. 229 W. 179 STREET
NEW YORK 53, N. Y.

Always write your name and full address clearly when answering advertisements

FALSE TEETH

That Loosen Need Not Embarrass

Many wearers of false teeth have suffered real embarrassment because their plate dropped, slipped or wobbled at just the wrong time. Do not live in fear of this happening to you. Just sprinkle a little FAS-TEETH, the alkaline (non-acid) powder, on your plates. Holds false teeth more firmly, so they feel more comfortable. Does not sour. Checks "plate odor" (denture breath). Get FASTEETH at any drug store

R·T·S - ORIGINATORS OF PRACTICAL HOME TRAINING

IN TELEVISION RADIO AND ELECTRONICS

YOU BUILD THIS 23-TUBE TELEVISION RECEIVER



YOU KEEP ALL EQUIPMENT - it's Yours!

...GIVES YOU 11 BIG TELEVISION & RADIO KITS AT NO EXTRA COST!



YOU BUILD THIS 6-TUBE SUPER HETERODYNE RADIO AND SHORT WAVE CONVERTER

Let RTS show you how to MAKE GOOD MONEY in Radio and Television. Learn NOW while Television is in its infancy. Be ready for the BIG BOOM in America's fastest growing Industry. You will work and learn with REAL TELEVISION and RADIO EQUIPMENT—RIGHT AT HOME! Study in spare time. You can EARN EXTRA MONEY while learning, like many RTS students.

Located in the heart of the Radio-Television capital of America—RTS has trained thousands during the past 28 years. RTS was FIRST to make practical TELEVISION training possible at home.

Opportunities are wide open! More than 3 and a half million TV receivers now in use! More than 60 million radios in the country! Daily the demand for TRAINED MEN INCREASES... EVERYWHERE!

Prepare NOW for these better jobs at GOOD PAY! INVESTIGATE! If you want a career in Radio-Television DON'T ACT WITHOUT GETTING THE FACTS FROM THE LEADER—RTS—ORIGINATORS OF PRACTICAL TELEVISION HOME TRAINING! Send coupon for Actual Lesson and BIG ILLUSTRATED BOOK — both sent to you FREE!

FOLLOW THE LEADER • GET THE FACTS

RADIO-TELEVISION TRAINING SCHOOL, DEPT. PM-8
5100 South Vermont Avenue, Los Angeles 37, Calif., U.S.A.

Send FREE Illustrated Book showing how I can make good in TELEVISION and Radio through training under the guidance of expert RTS Technicians. No obligation. (No Salesmen will call).

Both Free! SEND FOR LESSON AND BIG ILLUSTRATED BOOK

NAME _____ AGE _____

ST. & NO. _____

CITY _____ ZONE _____ STATE _____

RADIO-TELEVISION TRAINING SCHOOL
5100 S. Vermont Ave., Los Angeles 37, Calif., U.S.A.
ESTABLISHED 1922 — 28 YEARS AGO

**"TOOK IN \$217
FIRST 10 DAYS"**

**Some Make More,
Some Less... We Help
You to Start Your
Own All-Year
Business, Make
Big Money!**

With our easily operated, highly efficient wall washer, Chas. Stelle took in \$217 gross in first ten days. E. L. Goss took in more than \$10,000 in one year. E. C. Taber wrote, "I made \$400 gross in two weeks." And no wonder — this machine washes walls 6 times faster and better than by hand.

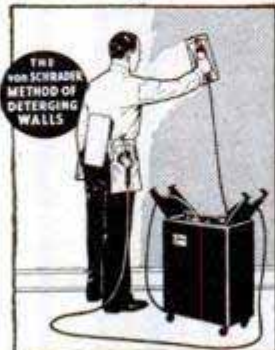

Your Money-Making Opportunity

We want more men to go into this profitable business for themselves and enjoy independence. There are customers everywhere—homes, offices, schools, churches, hotels, stores, etc. What you take in is mostly profit, for material costs are low. And there's no need to rent a shop or office. Operate your business from your home.

Lose no time. Get all facts without obligation. **WRITE FOR FREE INFORMATION.** Ask for Wall Washer Details at once.

VON SCHRADER MFG. CO., 866 PL, RACINE, WIS.

**Learn this
Profitable
Profession**

**IN 90 DAYS
AT HOME**

**Money-Making Career Open
to Men and Women, 18 to 50**

Hundreds of men and women between 18 and 50 make \$10 to \$20 in a single day giving scientific Swedish Massage and Hydro-Therapy treatments. There is big demand from doctors, hospitals, sanatoriums and clubs. Graduates earn large full time incomes from these or in private practice in their own offices. Others make good money from home treatments given in spare time. Learn this interesting, money-making profession in your own home, through our home study course. Same instructors as in our nationally known resident school. You can win independence and prepare for future security by qualifying for your Diploma. Course can be completed in 3 to 4 months. Many earn while they learn. Begin your training at once.



Anatomy Charts & Booklet FREE

Enroll now and we will include, at no extra cost, many needed supplies. Fit yourself to help meet growing demand for Scientific Swedish Massage. Send the coupon at once for complete details. Anatomy Charts and 32-Page Illustrated Booklet, FREE, postpaid.

THE COLLEGE OF SWEDISH MASSAGE
Dept. 064K, 41 E. Pearson, Chicago 11, Illinois
Please send me FREE and postpaid, Anatomy Charts, 32-page Booklet and complete details on Home Training.

Name _____ Age _____
Address _____
City _____ State _____



**Free Fall
Catalog**

Ready August 3

Fully illustrated, 96 pages showing Hunting Footwear Clothing, and fifty-two other leather and canvas specialties of our own manufacture for campers and hunters.

L. L. Bean, Inc.
133 Main St.
Freeport, Maine

BRAND NEW



**30 DAY FREE TRIAL
7x50 Prism
BINOCULARS**

Finest Precision Optics
Buy Direct from Importer
Money Back Guarantee

Many other models
AS LOW AS \$6.00*
(*plus Fed. Tax)

FREE Illustrated Catalog & Book,
"How To Select Binoculars"
Dealers: Write for discounts.

BUSHNELL Importers

45 E. Green St., Dept. M-8
Pasadena 1, California

**Learn ELECTRIC APPLIANCE
REPAIR AND SERVICE**

FREE! PLAN FOR YOUR SUCCESS

BIG PROFITS — BIG DEMAND for qualified men in field of Home Freezers, Washing Machines, Dishwashers, House wiring, Auto electricity, etc. Learn at home — start your own business. NO PREVIOUS EXPERIENCE NEEDED. Special tools & equipment furnished. Earn while learning. Write for YOUR FREE SUCCESS PLAN — ACT NOW!

PACIFIC TRAINING SCHOOL Dept. P-508
7217 South Broadway • Los Angeles 3, California

**FREE
BOOK**

**FREE
Bargain
Book**

Packed with hundreds of sensational bargains—new and used—in still and movie photo equipment and accessories. Write for your free copy today to

Central Camera Co.

Dept. 8-H, 230 S. Wabash, Chicago 4, Ill.

Photographic Headquarters Since 1899

RUPTURE



RELIEF...OR YOUR MONEY BACK

A simple... sturdy truss support built nature's way by old surgical appliance manufacturer. You risk nothing... relief or your money back. Send now for free booklet.

WEB TRUSS CO. Dept. M-8 Hagerstown, Md.



**BOYS!
Make Your OWN RADIO!**

Learn Interesting Details

Fun, interest and education in making your own simple, tubeless, batteryless crystal radio. Send 25c for a genuine Melomite crystal with complete illustrated instructions for making your own set. Compete with others for long distance reception. Crystal sent postpaid with instructions and our own publication "The Magic Crystal" which is full of news, diagrams, questions and answers of interest. Send 25c TODAY.

You may start a successful career in RADIO. Send 25c

ALLEN RADIO, Dept. 140, Clinton, Mo.

Draw me!



COPY THIS GIRL

\$1275.00 in Prizes

**5 PRIZES! 5 Complete \$255 Art Courses,
including Drawing Outfits!**

**Here's your big chance, if you want to
become a commercial artist, designer,
or illustrator! An easy-to-try way to
win FREE art training!**

Amateurs Only! Our students not eligible.
Make copy of girl 5 ins. high. Pencil or pen
only. Omit the lettering. All drawings must be
received by Sept. 30, 1950. None returned.
Winners notified.

Latest Winner List! Free course winners in
previous contest—from list just released: Miss
M. Bowen, Carleton College, Northfield, Minn.;
C. Leduc, 4074 Marlowe, Montreal, Canada;
Dr. O. Schwarz, 41-05 Parsons, Flushing, N. Y.;
G. Bastin, Jr., Rt. 1, Cave City, Ky.; Miss
R. Villarreal, 717 San Enrique, Laredo, Tex.

Art Instruction, Inc.

MINNEAPOLIS • NEW YORK
CHICAGO • LOS ANGELES

MEMBER NATIONAL HOME STUDY COUNCIL

**Whether you win or not we send you our
comments on your work, if your draw-
ing shows promise! Trained illustrators
and artists now making big money.
Find out now if YOU have profitable
talent. You've nothing to lose—*every-
thing to gain.* Mail your drawing today.**

ART INSTRUCTION, INC., Dept. 8130

500 S. 4th St., Minneapolis 15, Minn.

• Please enter my attached drawing in your
September drawing contest. (PLEASE PRINT)

Name _____ Age _____

Address _____ Phone _____

City _____ Zone _____ County _____

State _____ Occupation _____

Learn A Trade NOW! PRACTICAL SHOP TRAINING!

In Our Chicago Shops

- | | |
|---|--|
| <input type="checkbox"/> AUTO MECHANICS | <input type="checkbox"/> WELDING—ARC and GAS |
| <input type="checkbox"/> DIESEL MECHANICS | <input type="checkbox"/> MACHINIST |
| <input type="checkbox"/> REFRIGERATION | <input type="checkbox"/> PIANO TUNING |
| <input type="checkbox"/> BODY-FENDER | |

Above Approved For G. I.'s and Civilians
One of America's Leading Practical Schools
7 Floors of Fully Equipped Shops
Over 50,000 Successful Graduates
Expert Individual Instruction
Learn by Doing—Low Living Expense
Established 1902—Day and Evening Classes

Also the following Home Study Courses

- | | | |
|----------------------------------|--|---------------------------------|
| <input type="checkbox"/> PLASTIC | <input type="checkbox"/> REFRIGERATION | <input type="checkbox"/> DIESEL |
|----------------------------------|--|---------------------------------|

—CALL IN PERSON OR MAIL THIS AD TO—

GREER SHOP TRAINING

(Desk 10) 460 South State St., Chicago 5, Ill.

Please send without obligation free information regarding trade checked above. (Specify whether you are a Veteran or Civilian)

Name _____ Age _____
Address _____
City _____ State _____

3 TRADES IN 1 CAREER

Secures Your Future



WATCHMAKING • JEWELRY- ENGRAVING • STONE SETTING •

Each trade can be a full-time job; together they assure numerous high paying opportunities, or a business of your own. Profit by the *Nationally Recognized Training Methods* of the *Kansas City School of Watchmaking*.

ENROLLMENTS NOW AVAILABLE

Clip and Mail this Coupon Today

KANSAS CITY SCHOOL OF WATCHMAKING
1218 Admiral Blvd.
Kansas City 6, Missouri

Please send me, without obligation, complete information on training in the above courses.

Name _____
Street _____
City _____ State _____
 Check if Veteran G. I. Approved

LET ME PROVE
I CAN MAKE
YOU A NEW MAN

Just tell me where you want handsome, powerful muscles. Are you fat and flabby? Or skinny and gawky? Are you short-winded, peppy? Then write for my 48-page FREE BOOK, about "Dynamic Tension", and learn how, in only 15 minutes a day, I can make you a healthy, confident, powerful HE-MAN.

CHARLES ATLAS,
115 E. 23rd St.,
Dept. 88, New York,
N. Y.



WANT FAST PROMOTIONS?

Employers prefer *high school graduates* for managerial jobs. You can complete the C.T.I. guided study course in *months*. It equals resident work. Approved H.S. texts supplied. Credit for work elsewhere. College prep. Handsome diploma. *Easy terms*. Get set for success!—Write for valuable free booklet today!

COMPLETE
HIGH SCHOOL
AT HOME

COMMERCIAL TRADES INSTITUTE

1400 Greenleaf Dept. H2-8 Chicago 26

BECOME A BETTER PAID MAN BY BEING A WELL TRAINED MAN

Learn a profitable trade—the Eastern Technical School way. Enroll now for an eight month course in Radio or Refrigeration. New classes beginning every April—August—December. Veterans — Nonveterans. Write for free catalogue. Graduates successfully placed from Coast to Coast.

EASTERN TECHNICAL SCHOOLS
888 PURCHASE STREET NEW BEDFORD, MASSACHUSETTS

RADIO ENGINEERING. Broadcasting, Television, FM, Servicing, Electronics, Aviation, Marine & Police Radio taught thoroughly. Engineering course equivalent to 3 years' college radio work. Approved Veteran Training. Catalog free.
VALPARAISO TECHNICAL INSTITUTE, Dept. D, Valparaiso, Ind.

How to Make Money with Simple Cartoons

A book everyone who likes to draw should have. It is free; no obligation. Simply address **FREE BOOK**
CARTOONISTS' EXCHANGE
Dept. 98D Pleasant Hill, Ohio

HOLLYWOOD MUFFLER THE TONE YOU LOVE TO HEAR

MORE SPEED—POWER—MILEAGE
are yours with a Hollywood Muffler . . . plus a tone you'll love to hear! Not a gutted muffler. Easy to install.

**IMPROVED DESIGN
PRECISION MADE
ELECTRIC WELDED!**
Outlasts ordinary mufflers 3 to 1
Ford, Chevrolet, Plymouth \$6.00
All other cars \$8.00
Duals, Ford & Merc. \$24.50. 3" Chrome Barker Tip. \$3.25. Order direct. Send check or M.O. and save postage.
Dealers Write **WILKINSON MUFFLER CO. 811 WILT STREET FT. WAYNE, IND.**



NEARLY A MILLION PEOPLE

have taken up music this easy way

SEE HOW SIMPLE IT IS!

"My country 'tis of thee,
Sweet Land of Liberty"

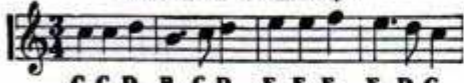

C C D B C D E E F E D C



First note on the music above is "C." Follow dotted line to keyboard and locate "C" on the piano. Find other notes the same way. As you strike them you'll be playing the melody of "America."

You, too, can play sooner than you ever dreamed possible!

YES, nearly a million delighted people have taken up music this quick, "easy as A-B-C way." Some are now on the radio, some on the stage, and thousands of others are getting more fun out of life with their music. Isn't this convincing proof of the success of the famous U. S. School methods? Many pupils didn't know one note of music. Yet in a short time they learned to play their favorite instrument. What countless others have done, YOU can do!

It's fun, too. Right from the start you learn real tunes by note. Simple melodies to begin with, then more advanced pieces. Soon you should be playing your favorite numbers—popular or classical.



FREE BOOKLET EXPLAINS ALL

Best of all it costs only a few cents a day to learn music this no-teacher way, everything included. So if you want to learn music fast . . . if you want to be a "hit" at every party . . . if you want to get more invitations than ever before . . . don't fail to send for our fascinating FREE 36-Page Booklet and Print and Picture Sample. These tell you how you can learn music quickly, easily, at home and at low cost. Remember, no salesmen will call on you or phone. Mail coupon today to U. S. School of Music, 78 Brunswick Bldg., New York 10, N. Y.



LAWRENCE WELK, Popular Band Leader, says, "I strongly urge anyone who wants to learn music quickly and reasonably to take a U. S. School Course."

FREE PRINT AND PICTURE SAMPLE

U. S. School of Music,

78 Brunswick Bldg., N. Y. 10, N. Y.

Please send me Free Booklet and Print and Picture Sample. I would like to play (Name Instrument)

Instrument _____ Have you instrument? _____

Name _____

Address _____

SAVE 2c — STICK COUPON ON PENNY POSTCARD

BLISS Electrical Training

Intensive 32 weeks' residence course in fundamentals of industrial electrical engineering, including radio and electronics. Extensive laboratory, shop work, drafting. Prepares for electrical technician and engineering aides

in communications, power, manufacturing, business machines, sales, service. G.I. approved. 57th year. Enter November 6. Catalog. 7638 TAKOMA AVENUE, WASHINGTON 12, D. C.

LEARN MEAT CUTTING AT NATIONAL

Pay After Graduation



The steady dependable trade of Meat Cutting taught easily in 8 short weeks. YOU LEARN BY DOING under actual meat market conditions in big modern school at Toledo.

For beginners or men with experience. Get a profitable store of your own. Remember, PEOPLE MUST EAT! Big pay jobs. Free employment help. Thousands of successful graduates.

Buying, cutting, percentage, pricing, advertising, selling, etc. A complete retail meat education. National School established over 25 years. Get National training NOW. Pay your tuition in easy weekly payments

after you graduate. G. I. approved. Send coupon for FREE 52 page school catalog — TODAY.

National School of Meat Cutting, Inc., Dept. 50H, Toledo 4, Ohio

Send me your FREE school catalog on National Training at Toledo in Meat Cutting, Meat Merchandising and Self Service Meats. No obligation. No salesman will call.

Name _____

Address _____

City _____ State _____

() Check here if Veteran of World War II

HIGHEST ROYALTIES and CASH

FOR YOUR INVENTIONS

(Patented and Patent Pending Only)

Write for **FREE** booklet without obligation

UNIVERSAL MARKETING CO.

354 S. SPRING ST. (Suite M)

LOS ANGELES 13, CALIF.

BE A NOTARY PUBLIC

Old legal-supply house, 22 cities, guides you to quick official appointment, equips you fully. Pay after appointment (2 payments \$12.50 each). Lifetime public office, income. You notarize legal papers, using only your signature and official seal, receive your fees. Easy. Details free.

STATIONERS EXCHANGE

HELOTES 10, TEXAS

INVENTORS

Whether an invention is patentable can be substantially determined by a search of the U. S. Patent records. Without obligation, write for information explaining the steps you should take to secure a patent.

JOHN N. RANDOLPH

Registered Patent Attorney

201 Columbian Building, Washington 1, D. C.

INVENTORS

IF YOU WISH TO PROTECT YOUR INVENTION, You should take steps to protect it by a U. S. Patent. Write me for "RECORD OF INVENTION" form.

CARL MILLER

REGISTERED PATENT ATTORNEY

WOOLWORTH BLDG., 35th FLOOR, 80A
NEW YORK CITY

INVENTORS

Before you make any effort to market your invention, you should take the first steps toward proceeding for patent protection.

The usual first step is to have a search of the U. S. patent records conducted, so that I can report to you on the question of patentability.

I shall be pleased to furnish you with information relative to patent procedure, upon request from you, and this will be without any obligation on your part.

PATRICK D. BEAVERS

(Formerly RANDOLPH & BEAVERS)

Registered Patent Attorney

934 Columbian Building Washington 1, D. C.

INVENTING

-FOR PROFIT! If you have an inventive turn of mind, write for free 28-page booklet explaining how the Institute of American Inventors is helping inventors pre-test the profit possibilities of proposed devices to fill today's unprecedented demand for useful new inventions.

INSTITUTE of AMERICAN INVENTORS

Dept. 4, 631-E St. N.W., Washington 4, D. C.



PATENTS
C. A. SNOW & CO.
REGISTERED PATENT ATTORNEYS
WRITE FOR INFORMATION TO
428 SNOW BUILDING, WASHINGTON 1, D. C.

PATENTS "Proof of Invention"
Folder mailed without obligation.
E. E. VROOMAN, Registered Patent Atty.
505 McKim Building, Washington 5, D. C.

PATENTS PATENT LAWYER
GUSTAVE MILLER ASSOCIATE EXAMINER
U. S. PATENT OFFICE 1922-1929
Registered Patent Attorney and Advisor
U. S. NAVY DEPT. 1930-1947
80-PM WARNER BLDG. WASHINGTON 4, D. C.
Send for PATENT INFORMATION book and "INVENTOR'S RECORD" without obligation



IS \$10.00 A DAY WORTH A ONE CENT STAMP ?

NO EXPERIENCE NEEDED

Let me show you how YOU can make as high as \$10 a day, without previous experience, by showing Merit Christmas & Everyday Cards, Stationery & Napkins to your friends, neighbors, relatives and others. We print your customers' names at no extra cost. No risk or investment. Drop me a penny postcard TODAY and I'll send you complete Selling Plan and samples on approval by return mail.

MERIT GREETING CARD CO.

370 PLANE ST.

Dept. 46

NEWARK, N. J.

Say You Saw It in
POPULAR MECHANICS

Learn **BAKING** At Home

Baking is one of America's high industries in wages. Nearly depression-proof. Thorough basic home course lays sound foundation. If you have aptitude, write for **FREE BOOKLET**, "Opportunities in Commercial Baking." National Baking School, 1315 Mich. Ave., Dept. 135C, Chicago 5



SPEED AND POWER Handbook

50 CHAPTER LIBRARY EDITION
Tens of thousands have been sold!
Build Fast Stock Cars! California Roadsters! 160 MPH Rods! Covers Crosleys to Cadillacs—all makes—Authentic—Direct from California!



Photos Drawings 128 ENAMELED PAGES

SAVE MANY DOLLARS
Build your own Dual Manifolds! Superchargers! Hot Cams! Water Injectors! Hi-Compression Heads! Mileage Devices! Get up to ten more miles per gallon! Get racing speed, lightning acceleration, dynamic power increases from any make passenger automobile! Get construction drawings! Tuning techniques! Speed tricks! Economy secrets! Ingenious formulas! Covers "Racing Frames"—"Reciprocating Masses"—"Jet Engines"—"Wheel Geometry"—"Dynamometers"—"Dual Pipes, Gears, Fuels, Porting, Relieving, Lowering! Balancing"—50 breathtaking chapters!
Includes "CALIFORNIA AUTOMOBILE CUSTOMIZING"—Diagrams! Photographs in Color! Newest Ideas! Restyling all makes! Including 1950 Racing Equipment Catalogue. Also, "Economy Manual" and "Injection Information." 300 illustrations. Five items, complete—\$1.98 postpaid. Racing Equipment Catalogue without book—50c.

NEWHOUSE AUTOMOTIVE INDUSTRIES
5805 EAST BEVERLY BLVD. DEPT. B4
LOS ANGELES 22, CALIF.



SHORTHAND in 6 Weeks at Home

Famous Speedwriting system. No signs; no symbols; no machines; uses ABC's. Easy to learn; easy to write and transcribe. Low cost, 100,000 taught by mail. For business and Civil Service. Also typing. 27th year. Write for free booklet to:

Speedwriting

Dept. 1508-A, 55 W. 42 St., New York 18

BINOCULAR BARGAINS

Write For Our Special Low Prices Before Buying
ENTERPRISE DISTRIBUTING CO.
Temple Bar Bldg. (Established 1922) Cincinnati, Ohio

MAKE MONEY RAISE Pedigreed RABBITS FOR US!

Grinstead's Famous ANGORAS, GIANT CHINCHILLAS and NEW ZEALANDS (World's Most Profitable Rabbits) We buy ALL you raise—ALL the time! Write today for FREE INSTRUCTIONS, Illustrated Literature, and Prices.
GRINSTEAD FARMS, Dept. 70, Edwardsville, Ill.

Be an AUTO MACHINIST

Draw Top Pay—No Job Worries
Be a high-paid auto machinist! Specialize—make more money New FREE booklet tells how to prepare for good jobs as an auto machinist or auto mechanic. G. I. Approved School of Auto Mechanics.
FREE: Write for your FREE booklet today

AMERICAN TRADE SCHOOLS
2417D McGee Street Kansas City, Mo.



WHAT IS YOUR IDEA OF A GOOD JOB?

Do you want independence . . . good pay . . . a chance to become one of your town's most respected citizens? Would you like to know that your skill is your security as long as you live? These are a few of the advantages of Watchmaking, the mechanical profession that has been called "depression-proof" by unbiased national authorities.
Don't wait for "breaks" that never come, learn the facts now about real opportunities ahead for our skilled graduates. Our 32-page catalog will tell you all about outstanding G.I.-approved courses in master watchmaking, chronograph watch repair and jewelry engraving. Write today!

Western Pennsylvania Horological Institute, Inc.
Desk A-43, 706 Smithfield St., Pittsburgh 19, Pa.

FREE 10-DAY TRIAL

HOUSE CARPENTRY and Joinery

DO IT YOURSELF AND SAVE MONEY!

Every step of carpentry in and around a house is clearly explained and illustrated in this big, useful book. Shows you how to build forms for foundations, footings, walls, steps, walks—How to build sills, girder supporting posts and girders—How to figure loads for house framing—How to lay out, cut and erect floor joists—How to lay flooring—How to frame outside and inside walls, allowing for openings—How to check the plumb of studs—How to brace and sheathe up outside walls—How to erect ceiling joists—How to frame around a chimney and stair well—How to lay out rafters for a gable roof, dormer roof, porch roof—How to sheathe the gable ends and rafters—How to build cornices—How to lay shingles—How to build porches and bays—How to apply siding—How to frame up inside walls—How to construct stairs—How to place trim around windows and doors—How to fit and hang sash—How to hang doors—How to make closets, shelving and built-in equipment—How to lay finished wood flooring, linoleum flooring—How to hang a set of garage doors—How to insulate.

OVER 600 ILLUSTRATIONS SHOW YOU JUST WHAT TO DO AND HOW TO DO IT
If you have a hammer, saw and plane, just follow the step-by-step directions and do any house carpentry job from foundation forms to interior trim. Here, in one remarkable volume, is the practical know-how that saves you time and money on house carpentry jobs of every description.
"I built my entire 5-room house myself with no other instruction except your book."—James Sidwell, Twin Falls, Idaho.

USE IT FOR TEN DAYS FREE
Don't send us a penny. Just mail coupon and get "HOUSE CARPENTRY" for 10 days FREE trial. If not delighted, send book back to us and owe nothing. If you keep it, entire cost is only \$3.98, plus few cents postage. Mail coupon below for your free trial copy.

MAIL THIS COUPON

Simmons-Boardman Publishing Corp. PM-850
30 Church Street, New York 7, N. Y.

Send me for 10 DAYS' FREE TRIAL, "House Carpentry and Joinery." I will either return it in 10 days and owe nothing, or send only \$3.98 (plus shipping charges) in full payment.

Name _____
Address _____
City _____ State _____

SAVE! Send \$3.98 with this coupon and we pay postage. Same return and refund privilege.

Photography

for 

PLEASURE or PROFIT

Learn at home. Spare time. Practical basic training. Long-established school. Many have earned while learning. Send coupon below for free booklet, "Opportunities in Modern Photography" and full particulars.

AMERICAN SCHOOL OF PHOTOGRAPHY
1315 Michigan Avenue Dept. 135C Chicago 5, Illinois
Send booklet, "Opportunities in Modern Photography," full particulars and requirements. No salesman will call.

Name _____ Age _____
Address _____
City _____ Zone _____ State _____



Look! No Oars! No Motor! New PROPELOAR

• twice as fast . . . twice as easy as rowing

Propeloar is noiseless, practically effortless! Forward . . . backward . . . set your own pace. Both hands free for rod, gun, or what have you? Lightweight aluminum. Fold for easy carrying, attach to almost any boat in one minute — no tools. Boatloads of fun for vacation. Only \$49.95 to buy . . . no cost to operate!

Send for free folder TODAY

PRODUCTION ENGINEERING COMPANY

946 Dwight Way • Berkeley, California

WHAM-O SPORTSMAN*

HITS LIKE A .22 RIFLE—
KILLS RABBITS, SQUIRRELS.
Powerful, silent, accurate.
For hunting, target,
routing pests.

Dealers
Write



HUNTING SLINGSHOT

Heavy ash hardwood stock.
40 steel balls, extra rubber straps.
GUARANTEED. Send \$1.00 today to

Wham-O Mfg. Co., Box 82, South Pasadena, Calif.
* The professional model of Nat'l Slingshot Assn.

SAY YOU SAW IT IN POPULAR MECHANICS

HOW MUCH CASH DO YOU NEED?

ARTISTIC Christmas Cards
Make BIG MONEY in your spare time with sensational 21-Card \$1 Christmas Assortments! Amazing values sell fast! You make up to 100% CASH PROFIT! Gift Wraps, Metallics, Everyday, Personal Stationery, other fast-selling money-makers.

NO EXPERIENCE NEEDED!

Folks sell themselves when they see **EMBOSSSED Name-Imprinted Christmas Cards at 50¢ for \$1 and up.** You earn tremendous profits! *Extra Cash Bonus!* Send for 21-Card Assortments on approval and **FREE Imprint Samples NOW!**

ARTISTIC CARD CO., INC.

958 WAY ST., ELMIRA, N.Y.

Rush 21-Card Assortments on approval plus **FREE Imprint Samples.**

NAME _____

ADDRESS _____

CITY _____ Zone _____ STATE _____

**MAIL
NOW!**



200
ILLUSTRATIONS

SPEED & MILEAGE MANUAL

Easily Get Super Speed, Acceleration, Mileage—
Top Racing Performance From Any Automobile!

Famous New Book shows simplified Setup-up Methods—Speed Tuning—Economy Secrets—Customizing Plans!—Latest Track Proven Methods for all cars! Tells how to build your own **SPEED EQUIPMENT!** **FAST SPORT CARS!** "CALIFORNIA HOT RODS"! 200 H.P. ROAD & TRACK **CONVERSIONS!** Complete Instructions on building inexpensive Superchargers! Dual Manifolds! "Water Injectors"! High Compression Heads! Twin Mufflers! Economizers! All about—Fast Engines, Gas Saving, Retuning, "Cam Secrets," Multiple Carburetion, Fuels, Porting, Ration, Frames, "Offys"! **BRAND NEW METHODS, Plans, Formulas, "Racing Tricks"—STOCK CAR SPEED SECRETS!** Reveals 100 Ways to save gas! Shows latest "HOLLYWOOD CUSTOM STYLING!" Streamlining! Sport Changes! Lowering! Speed Conversions! Including—California Roadster Plans! Racer Diagrams! Working Drawings! Performance Charts! Graphs! Beautiful Photographs! Etc.!

Large manual (plus) "California Equipment Catalog" and Hot Rod Handbook.

**ALMQUIST AUTOMOTIVE
ENGINEERING**
Milford 22P, Pa.

ALL \$1.98
THREE—1 P.Pd.



Bar Bells

Buy Direct From Factory **\$8.95**
Write for free booklet
and price list

INDEPENDENT IRON WORKS

2416 East 23rd Street, Dept. B
Los Angeles 11, Calif.

6 POWER BINOCULAR



Pocket Size—weighs
only 4 oz.! Field of
370 ft. at 1000 yds.

Precision constructed PRISM Binocular, NOT a Field Glass. Lightweight metal, Black & Chrome Finish, Carries United Seal of Quality, COATED! Achromatic lens, Leather case, straps. UNCONDITIONAL MONEY BACK GUARANTEE. Pay postman plus postage. Cash orders ppd., Add tax, United Binocular Co., Dept. ARF-1708, 7941 S. Halsted, Chicago 20. (Dealers Wanted).

STRENGTHEN Your VOICE!

YES—you can now build yourself a powerful speaking and singing voice with this amazing new scientifically sound tested method. Self-training . . . no music or piano required. Results GUARANTEED. Just send your name for the sensational details. FREE chart of your vocal mechanism included! Please state your age.

PERFECT VOICE INSTITUTE, Studio H-2, 1141 S. Wabash Ave., Chicago 5, Ill.

PEARL FINISHING OFFERS YOU BIG MONEY RIGHT AT HOME

FREE Facts show how to earn up to \$25 to \$50 per day AT HOME. Be First! Gleaming Pearl Finish for **BABY SHOES** in Pink, Blue, Ivory—plus hundreds of items of leather, plaster, metal, etc.

WRITE TODAY!

PEARL-KOTE CO., 2111 W. Manchester, Los Angeles 47, Dept. PM-8

FOAM RUBBER

FOR HOBBYISTS, CRAFTSMEN, EXPERIMENTERS



LOWEST PRICES—SAVE 50%

16 x 16 x 1 1/2" . . . ea. \$1.25

16 x 22 x 1 1/2" . . . ea. 1.55

18 x 24 x 2" . . . ea. 2.00

24 x 24 x 2" . . . ea. 2.75

AUTO SEAT TOPPER PADS

Place on seat cushion and cover with your seat cover.

24" x 60" x 1 1/2" ea. \$5.00

24" x 60" x 2" . . . ea. \$7.50

Use for furniture cushion fillers, mattresses, mattress pads, cushions. Foam Rubber is available in any size or thickness. Send For Free Price List. Immediate delivery. No C.O.D.'s. ADD 10% FOR POSTAGE & HANDLING TO ABOVE PRICES

RIOR RUBBER COMPANY, Dept. P-8

50 E. Cermak Road

Chicago 16, Ill.

SAVE with SAFETY the THORESEN way! THORESEN'S IRONCLAD GUARANTEE PROTECTS YOU



SHOCK Resist Swiss 6.97 no extras!
Military style! Drop it! Bang it! Guaranteed 2 years against all breakages because of exclusive SWISS INSULATOR invention. Luminous hands and numerals. Unbreakable crystal. Sweep second. Heavily chromed. Thin, smart! Not jeweled but guaranteed accurate. Long, satisfying service. No extras for tax—full price—6.97
Special! 17 JEWEL DELUXE MODEL. 5 year GUARANTEE (Featured in ESQUIRE). Wonderful precision. Shock and WATER resistant too. An outstanding value at our low, tax-free price of 17.65

Thoresen's 17 Jewel FULL AUTOMATIC 29.88 no extras!
De-Luxe model—fully automatic! Set it, then forget it! It winds itself as you wear it. Patented Incabloc. Anti-Magnetic. Sweep second. Luminous dial. WATER & SHOCK resistant. All stainless steel back case. 17 jewels. Near-miracle accuracy. Thin! Handsome! 5 YEAR GUARANTEE. Formerly \$75.00. Thoresen's direct-to-you price, only—29.88—no extras. Rush! Supply limited!



Genuine ZIRCONS! MEN'S INITIAL RING

Something SPECIAL for men! Your initial in raised Gold Color Effect, set in a Vermillion-Red stone. Flanked by 2 GENUINE ZIRCONS imported from far-away Siam. Now yours for only \$4.97, yet it looks like \$650.00 or more! Remember . . . these are NOT imitations but 100% GENUINE ZIRCONS that sparkle with a 1000 rays of light! Color and cut like precious diamonds. Real, honest value!

Any item sent on APPROVAL!

Send only sale price shown—no extras—for quick, insured delivery, or order C.O.D. plus postage. Complete satisfaction GUARANTEED or money back pronto!

THORESEN Direct Sales Dept. 6H-200

FREE 10 DAY TRIAL

Price promptly refunded if not thrilled within 10 days after receiving. Not a penny's charge for "handling," postage, parts or repairs on watches! THORESEN makes lifetime friendly References: Bank of Athens, New York, or any bank in America. Send only amount shown — no extras. C.O.D.'s sent plus postage.

THREE SYNCHRO DIAL Precision Made Swiss Chronograph

Outstanding value sleek handsome 3 dial chronograph. Amazing accuracy. Ideal for hobbyists, mechanics, scientists, doctors, sportsmen, students, aviators, etc. 20 SUPER FEATURES—3 Synchro Dials, 30 minute register. 1/5 second calibration, rugged shock-resist case, sweep second, luminous dial. Built-in tachometer and telemeter measures speed and distance of planes, autos, horses, photos, etc. without stopping movement. 3 year guarantee. Formerly \$39.95. Now at slashed price of \$14.95. No extras.



14.95
no extras!

131 West 33rd St., NEW YORK 1, N. Y.

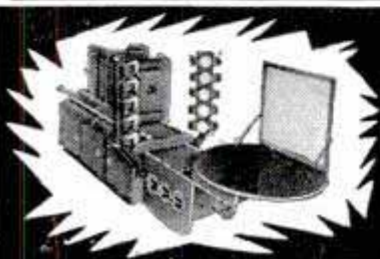

BE A PHOTO-ENGRAVER

We furnish complete equipment and supplies. Learn at home or in our modern, friendly APPROVED school in MISSOURI. Get into this big demand, high profit, high wage field. You can start your own profitable, full time or part time PHOTO-ENGRAVING business right in your own home.

Be independent, be your own boss or pave the way to a high pay job with experience gained in your own shop.

TASOPÉ TRAINING and TASOPÉ EQUIPMENT has enjoyed world wide recognition since 1931. Write for descriptive literature today. No obligation.

THE AURORA SCHOOL OF PHOTO-ENGRAVING, DEPT. 9PM., TASOPÉ BLDG., AURORA, MO.

Want to Get Ahead in Business?
Get A BUSINESS EDUCATION!

THRU Hills TO SUCCESS

Regardless of whether your aim is to specialize or generalize in your business education, this nationally known and approved school will gladly counsel with you. We offer you nation wide recognition and placement service as secretary, stenographer, accountant or salesman. Hill's offer both Resident & Home Study Courses. Write **FREE** Dept. PMO today for Big 32 page SUCCESS BOOK

Hills BUSINESS UNIVERSITY AND EXTENSION SCHOOL
619 W. MAIN ST. OKLAHOMA CITY 2, OKLAHOMA

RAILWAY MAIL CLERK, GOVERNMENT CLERK, MAIL CARRIER, POSTOFFICE CLERK

U.S. GOVERNMENT JOBS

SHOE REPAIR OFFERS BIG INCOME

LEARN IN 12 WEEKS TIME

You can own your own shop or earn big income as skilled shoe repairman. Growing demand everywhere at top wages for men who know how. We teach you quickly by actually working on shoes and modern machines. School open to all from 18 to 60 years of age. FREE BIG 20 PAGE BOOK explains everything. Send for your copy today. Established 1927.

MODERN SHOE REBUILDING SCHOOL
Chicago and Los Angeles only Approved for Vets Dept. PM
2937 Belmont Ave., Chicago, Ill. 361-12th St., Oakland, Calif.
806 So. Figueroa St., Los Angeles 14, Calif.

JOBBER'S PLASTIC-SHINE

DISTRIBUTORS: LIQUID PLASTIC CAR POLISH IN GROWING DEMAND EVERYWHERE

- SALES GALORE
- RE-ORDERS POURING IN
- HUGE PROFITS
- NATIONALLY ADVERTISED
- EXCLUSIVE TERRITORIES OPEN

SEND FOR DETAILS!
PLASTIC-SHINE LABS., INC.
7516 N. W. 7th AVE., MIAMI, FLA.

START AS HIGH AS \$3,450 YEAR

Many Early Examinations Expected. Prepare NOW! Veterans Get Special Preference! 40 Page Civil Service Book FREE Mail Coupon Today SURE

Franklin Institute
Dept. G-83,
Rochester 4, N. Y.
(Not Government Controlled)

Gentlemen: Rush to me, FREE of charge, list of U. S. government big pay jobs. Send FREE 40-page book describing salaries, vacations, hours, work, etc. Tell me how to qualify for one of these jobs.

COUPON

Name _____
Street _____
City _____ Vet? _____

SAY YOU SAW IT IN POPULAR MECHANICS

How to **IMPORT!** For Profit and Pleasure



ONCE-IN-A-LIFETIME OPPORTUNITY

World Trade boom offers new, big money opportunities for men and women! Learn how to import at low foreign prices for buyers in your locality at high U. S. prices.

BUY-SELL, WORLD-WIDE WITHOUT CAPITAL

Big profits possible, no investment in goods, operating world-wide business from your own home by mail order, spare or full time. (See examples of recent prices in other countries, at left). Also big savings on clothes, tools, gems, antiques, watches, cameras, china, silk, toys, etc., for your own use. Get FREE list of over 1000 low priced imported products from Europe, the Orient and other parts of the world. It makes no difference where you live. World Trade can be carried on in or near small towns or large cities—anywhere. Travel opportunities. Practical, low-cost World Trade Course teaches you quickly at home in spare time.

WORLD TRADE GROUP HELPS YOU START

Membership in International Traders Guild included with course. Helps you get samples and prices and go after big profits NOW Importing and Exporting. No previous special experience or schooling required. World Trade Certificate awarded. There is no obligation when you send for FREE details and list of Imports. (No salesman will call on you.) Write today. Airmail reaches us overnight.



The Mellinger Co., Exporters-Importers
1418 DJ Westwood Blvd., Los Angeles 24, Calif.

Now **CHEAP OIL BURNER** FOR HEATING AND COOKING STOVES • FURNACES

HEAT YOUR HOME, COOK YOUR MEALS
WITH CHEAP FURNACE OIL



NO MORE SHOVELING COAL OR ASHES. Sensational Fuelizer Starter Vaporizing System turns Cheap No. 1 Furnace Oil, also Range, Heater, Tractor Distillate, Kerosene and like oils into oil heat—one of the quickest, hottest fires known. **LIFETIME GUARANTEE. \$1.00 Bonus Offer for Testing.**

We will let you try it in your own stove or furnace for one month. Get yours for introducing. Big profits QUICK. Be first. Send in your name today for details and cash in on the tremendous demand for this Amazing Invention.

NORTHWEST MFG. CO., 730-K, Mitchell, S. Dak.



BECOME A **JET ENGINE** EXPERT

BE READY
Start NOW

Aviation's NEWEST OPPORTUNITY — Study with LIVE JETS at CAL-AERO only — AERONAUTICAL ENGINEERING & MASTER AVIATION MECHANIC training since 1929 — Approved for VETERANS. WRITE TODAY for Special Information.

PMS

NAME _____ AGE _____

ADDRESS _____

CITY _____ ZONE _____ STATE _____

CAL-AERO TECHNICAL INSTITUTE
GRAND CENTRAL AIR TERMINAL • GLENDALE 1, CALIFORNIA

NEW TRIPLE WINDOW CONVERTIBLE TOP



\$125.00 Value!
Comes Complete
Nothing Else
to Buy. **\$49.95**

TRIPLE VISION REAR WINDOW FOLDS DOWN WITH TOP!

Rear window plus corner windows made of Crystal Clear Flexible Plastic—Blind Spots reduced to minimum for greater safety. Convertible owners can drive with top up—enjoy more vision than most closed cars. Top is of durable 3 ply waterproof material with rubber for longer wear & lasting beauty. Rear curtain has Zippers.

For Buick, Cadillac, Chevrolet, Chrysler, DeSoto, Dodge, Ford & Mercury, Olds., Plymouth, Pontiac, 1941-50. Packard & Studebaker, 1946-50.

Be sure to Specify Make, Year & Model, Black or Tan Material.

Send 25% Cash With All Orders, Balance C.O.D.

JUST OUT! Get the largest Auto Accessory & Parts Catalog in the world. Over fifteen thousand items, including Hollywood Accessories, Hi-Speed Equipment, Rebuilt Engines, all parts & accessories for all cars & trucks. We have that Hard-to-Get-Part! Completely illustrated. Jam packed with bargains. Send 25c.

J. C. WHITNEY & CO.

1917GT ARCHER AVE.

CHICAGO 16, ILL.



47 WAYS TO MAKE MONEY

HELPS YOU GET AHEAD BY SHOWING YOU HOW

REVEALED IN FIRST ISSUE EVERY ISSUE OF "HERE'S HOW" packed jam full of plans, schemes, ideas, that show sure-fire ways to make money—in the home or outside—in full time or spare time. No other magazine like "HERE'S HOW". Stories, articles are practical, factual, inspirational. Any one page in any one issue may well point the way to financial independence and security. Tells how to start a business of your own—with or without capital—and how to make home crafts pay big profits. A single idea in "HERE'S HOW" may be worth \$1,000 to you! Don't miss first issue—just off the press. Send 25c for sample copy. How Publishing Co., 1512 Jarvis Avenue, Dept. H-28, Chicago 26, Ill.

BE FIRST

in your locality to cash in on 47 ways to make money, in the first issue of "HERE'S HOW" Only 25c. Hurry!

Learn **CARPENTRY** **BRICK LAYING**

Get into the billion dollar building trades. Learn now while opportunities are greatest. Train in our completely equipped shops under expert instructors. G.I. Approved. Enroll now. Limited classes. Write for FREE Catalog.

MIDWEST SCHOOL OF BUILDING TRADES, Dept. PM-8

411 N. Center St.

Bloomington, Ill.

LEARN **UPHOLSTERING**

A money-making business or side-line. Practical home training teaches you quickly, easily. Low cost, easy terms. You get professional upholsterer's tools. Write or send penny postcard

today for FREE ILLUSTRATED BOOKLET.

WEST COAST UNIVERSITY Extension Dept. PM 80
1601 S. WESTERN AVE. LOS ANGELES 6, CALIF.

Become a Doctor of **PSYCHOLOGY**

Win the degree of Ps.D. Teach the secret of contentment, happiness. Solve mental worries. Experience the revelation of truth. Chartered college. Individual help. Write for FREE book. COLLEGE OF UNIVERSAL TRUTH, 5153-B North Clark St., Chicago.

Be an **INVESTIGATOR**



RECOGNIZED & APPROVED SCHOOL OF INVESTIGATION

--Extension Training Division--

Learn a profitable and interesting profession while earning at home in your spare time. Free Placement Service assists graduates to obtain good positions. State your age. Write For Free Booklet P

NATIONAL DETECTIVE ACADEMY

239 SOUTH OXFORD AVENUE
LOS ANGELES 4, CALIFORNIA

★ Save those bearings! ★ Cut repair bills!
 ★ Increase machine life!

BLACK GOLD

PRESSURE PROOF OIL



Worth Its Weight In Gold For Lubricating All Metal-On-Metal Parts

NOTHING better for electric motors, bearings, machinery, guns, and 1001 other uses. It penetrates, will not wash off, is heat proof, contains no acid, inhibits corrosion, stays fluid below zero. 2-oz. bottle only \$1.00 postpaid. Double your money back if you are not completely satisfied.

BLACK GOLD PRODUCTS CO.
 2344 COTTAGE GROVE AVE., CHICAGO 16, ILL.

TRI-STATE COLLEGE

FOUNDED 1884

Time tested, world famous accelerated B.S. Degree courses in Civil, Elect., Mech., Chem., Aero., and Radio and Telev. Engineering; Bus. Adm. and Acct. May be completed in 27 months. Also 36 weeks courses in Surveying, Drafting. For ambitious, earnest students. Preparatory Dept. for those who lack required high school work. G.I. approved. Visit campus, see well equipped labs. Low cost. Personalized instruction. World-wide student body. Grads. successful. Enrollment limited to 1600. Enter Sept., Jan., March., June. Write for Catalog.



**B. S.
 DEGREE IN
 27 MONTHS**
 •
**World Wide
 Enrollment**

TRI-STATE COLLEGE
 480 College Avenue Angola, Indiana

Yes, More Brilliant Than a Diamond!



Amazing New Discovery

Write today for the full story of the latest miracle of science, discovered in the laboratories of one of the world's largest corporations. The story of the beautiful Kenya Gem that so closely resembles a diamond that only an expert can tell the difference.

More Fire! More Brilliance!

Yes, this marvelous gem has more brilliance, more fire, and a more dazzling display of color than the finest diamond of equal size. And yet you can now own an unmounted Kenya Gem for only \$24 (1 carat) to \$96 (4 carats); also men's or ladies' beautiful gold rings for as little as \$45. If you wish, you can buy on EASY PAYMENT TERMS.

The Cinderella of Modern Science

Kenya Gems are the sensational discovery you read about in Sat. Eve. Post, Jewelers' magazine and N. Y. Times, "the only thing on earth more brilliant than a diamond." It is a true gem, crystallized by science instead of nature and perfectly cut by expert cutters.

Send Coupon or Write today for FREE illustrated literature.

KENYA GEM CORPORATION, Dept. 288
 Philadelphia 44, Pa.

Mail This FREE COUPON Today!

Kenya Gem Corporation, Dept. 288, Philadelphia 44, Pa.
 Please send me, without obligation, the FREE illustrated descriptive literature telling all about Kenya Gems.

Name

Address

City State

MAKE MONEY with Bostonian SHIRTS

TAKE orders for old, reliable line finest quality dress and sport shirts. All styles... fabrics... colors... sizes. Sensational LOW PRICES. No experience needed. FREE Samples of actual fabrics and big Style Kit waiting for you! Send no money, but rush name NOW! **BOSTONIAN MFG. CO.**
 89 Bickford St., Dept. H-40, Boston 30, Mass.



Say You Saw It in Popular Mechanics

Watchmakers MAKE MONEY!

Large earnings, professional dignity and a steady, secure future can be yours as a Master Watchmaker! You can choose a fine job or go into business for yourself.

The nationally-known Sweazey System teaches you in the shortest allowable time . . . at home or in our modern, fully-accredited resident school.

SEND FOR FREE PAMPHLET and Information NOW!

Since 1908, Chicago School of Watchmaking graduates have been in constant demand. Big opportunities for trained workers. Resident courses in watch repairing, gem setting, and engraving. Home Study Course in Master Watchmaking.

CHICAGO SCHOOL OF WATCHMAKING, 1608 Milwaukee Avenue
 Chicago 47, Illinois, Dept. 180

Please send copy of "Civilization's Debt to the Watchmaker" and information on courses without cost or obligation.

I am interested in
 Resident School Veteran
 Home Study Non-Veteran

NAME _____
 ADDRESS _____
 CITY _____ ZONE _____ STATE _____



NOW EASY TO START A Big Business ON A SMALL INVESTMENT



WARNER SUCCESS PLAN

Gives exact instructions showing you

- How to start in spare time
- How to use home as headquarters
- How to bring in the business
- How to do real METALIZING in genuine GOLD, SILVER, or BRONZE, by the easy Warner Method
- How to start without risking your job
- How to pyramid your profits
- How to be sure of steady, big income.

Don't turn this page until you've given serious thought to your future. In the uncertain years ahead, the men who own their businesses are the ones who will be happiest. A small start now easily can lead you to complete independence, freedom from time clocks, freedom from fear of lay-offs, freedom from the limits of a pay check.

Now, while you can do it without risk—now is the time to investigate the exceptional opportunity offered you by the Warner Success Plan. Looking into the market, checking up on the possibilities for big sales and big profits will not cost you anything. Isn't this the time to lay the foundation for a future of complete independence—a life of happiness—a steady, dependable income?

METALIZING BABY SHOES AND OTHER KEEPSAKES

offers an exciting new opportunity to men or couples who want personal independence

If you'd like the feeling of being boss instead of being bossed—the Baby Shoe business is made to order for you. Just think of the appeal. A mother's love for her child—her desire to preserve forever the tiny shoes in which her baby took its first toddling steps. No wonder orders come easy and fast. No wonder profits are big. Then think of the Future. Fifteen Million babies in the last five years—three million last year—millions more next year. As long as babies are born, this business will prosper—in good times or bad. Think of the fun. Every job is different, interesting. And when you deliver a job and collect the money, you get a tremendous glow of satisfaction out of the mother's happy exclamations over your work. There's not another business I know of that offers you such big rewards in cash, in security, in a future, in independence that can be started on such a shoestring. You'll be glad you saw this ad—IF YOU SEND THE FREE COUPON.



READ THE ENTIRE PLAN

7 DAYS AT MY RISK

DON'T SEND A PENNY NOW — Just Send Your Name

This is one of the most fascinating businesses you can imagine. There are 15 MILLION pair of baby shoes waiting right now to be METALIZED. The opportunities are unlimited. The future is very big. And it's a business in which the whole family can have fun helping. A perfect business for man and wife to start—or for two partners. And I want you to read the whole Plan at my risk. Don't spend a cent unless you go ahead.

I want every serious minded man to let me show what I've done in our own shops here in Chicago—reveal the exact facts about the profits to be made and the way to make them. I don't want you to spend a cent for supplies until you've studied the facts, talked them over with the family, and satisfied yourself that this is the ONE BIG OPPORTUNITY FOR YOU. That's why I allow you to read all trade secrets contained in the Warner Success Plan at My Risk. If you don't go ahead, you don't pay a cent.



ALL FACTS FREE! MAIL!

Raymond E. Brandell, Mgr., Warner Electric Co.,
1512 Jarvis Ave., Dept. 3-0, Chicago 26, Ill.

As long as it doesn't cost me a cent, I am willing to read the facts, investigate, then give you my decision. Send the facts by next mail. No cost to me now or at any other time.

NAME _____

ADDRESS _____

CITY _____ Zone _____ STATE _____



\$5.00 AN HOUR

Yes, it's possible for one man to turn out enough work to make \$5.00 an hour for his time. Think of how that pyramids when a partner or the whole family works.

Old Established Firm Backs You Up

The Warner Electric Company just celebrated its 26th year of success. You get a *Real Start* when you "join up with Warner"—you get real *Guidance to Success*.

Warner Electric Co., Dept. 3-0
1512 Jarvis Ave., CHICAGO 26, ILL.

WE SUPPLY EVERYTHING

You don't have to go "hunting" when Warner is behind you. We supply all materials, all mounts, chemicals, and metals. And you get the low prices made possible by our big quantity purchases and our own manufacture. You send for just what you need—and never have any big investment tied up in stock.

**WORLD'S
BEST
WANT AD
MEDIUM**

CLASSIFIED Advertisements



Advertisements in this section 75 cents per word, each insertion, minimum 10 words, payable in advance
To be inserted under proper classification, copy must be in our office the 22nd of the
second month preceding date of issue

F. W. Johnson, Manager, Classified Advertising
Popular Mechanics Magazine, 200 East Ontario Street, Chicago 11, Illinois

YOU'LL PROFIT

By reading and answering the classified
ads in this section. Hundreds of oppor-
tunities for you to make and save money

AUTOMOBILES, MIDGET CARS

"SPEED & POWER" Handbook — 128 enameled pages! Covers all makes of cars! Covers "jet propulsion," "racing frames," "wheel geometry," "dynamometers," "reciprocating masses," "gear ratios," "dual pipes," "fuel formulas," porting, balancing, lowering, relieving, 60 breathtaking chapters. Authentic. By automotive engineers. Shows exactly how to build your own dual manifolds. Superchargers. Hot cams. Water injectors. Hi-compression heads. Mileage devices! Save many dollars! Get up to ten more miles per gallon—racing speed, lightning acceleration, dynamic power increases from any make passenger automobile! Covers building fast stock cars. California roadsters. 160 m.p.h. rods! Construction drawings! Tuning techniques! Speed tricks! Economy secrets! Ingenious formulas! Library edition—Includes, "California automobile customizing," color photographs. (Newest ideas). Conversions. (Re-styling all makes). Including "1950 Speed Equipment Catalogue". Plus "Economy Handbook", and "Injection Information". 300 illustrations. Five items, complete, \$1.98 postpaid. Newhouse Automotive Industries, 5805-B2 East Beverly, Los Angeles 22. (See page 37).

CALIFORNIA Custom accessory headquarters. Buy direct from original designers and save. Chrome dash panels, solid hood sides, grille panels, speed equipment, dual pipes, push button door conversions, chrome motor accessories, fender skirts. 34 page illustrated catalog 25c. Eastern Auto, 3319A South Grand, Los Angeles 7, Calif.

MODERN Motor Car Magazine. Facts, figures, photographs on all cars—new, old, American, foreign. Styling, racing, club and historical features. Sample copy 25c; \$3.00 yearly. Crestline Publications, Box 581-A, Holliston, Mass.

"WATER Injection". Also speed, power, economy methods. Free illustrated information. Neher Industries, La Verne, California.

SPEED-Equipment—Lowest prices. Send 25c for illustrated manual and catalog. Speedomotive, Box 182N, Covina, Calif.

SAVE Gasoline, oil, tires, brakes—New illustrated economy manual. Get more power, speed, better automobile performance. Introduces 17 new economy products—super sparkplugs, water-oil injector, rocket booster, mileage meter, etc. Special 50c. National Automotive Research Corporation, Venice 28, California.

RACING Equipment from California. Speed-Dress-up accessories for every make passenger automobile—Racing ignitions, carburetors, flywheels, camshafts, water injectors, mufflers, crash helmets. Thousands of items in stock! Dual manifolds (for Willys Jeeps to Oldsmobile Rockets). Finned hi-compression heads, covering 155 different makes and models. "1950 Illustrated Equipment Catalogue" plus, "Driving Economy" 25c. (Dealers, request wholesale catalogue). Newhouse Automotive Industries, 5805-B7 East Beverly, Los Angeles 22.

NEW Book just out, "Special Racing Cars and Hot Rods of the World." 160 photographs, charts, drawings. Complete mechanical information cars of all nations. Supercharging, engines, suspension, transmissions. A "must" for every race car enthusiast. Postpaid, \$1.50. Clymer, Dept. 8-A, 1268 So. Alvarado, Los Angeles 6.

FREE Trial—Latest Ford "Speed and Power" manual! Sent on approval, this 128 page book of cutaway construction drawings, photos and understandable technical data. Includes information on installing V-8 motor in Model A chassis, hydraulic brakes for any Ford roadster, and fast car information. How to rework V-8, Mercury, Ford 6, Zephyr, Model A engines for speed. If you don't agree this is the finest hot rod manual you've ever seen—just send it back within 10 days. Send no money, pay postman nothing, try before you buy. If satisfied send \$2.00 to California Bill, 4611-B-8 York, Los Angeles 41.

NEW Clymer books—German Racing Cars and Drivers, prewar, postwar, \$2.00—Chevrolet Owner's Handbook gives service data all Chevrolet cars 1929 to 1950 including Powerglide, \$1.50—Catalog all new 1950 American automobiles, photographs, technical descriptions, specifications, automatic transmission information, \$2.00—Grand Canyon Economy Test complete book results and technical information, \$1.50—Outboard Motor Complete Service Manual, \$3.50—Motorcycle Road Racing world famous riders, motorcycles, \$2.00. All postpaid. Clymer, Dept. 8A, 1268 So. Alvarado, Los Angeles 6, Calif.

"SPEED & Mileage" Manual—"Complete new 60th edition, world famous power book, endorsed by champions!" Full speed, power, economy, increasing information for all passenger cars. Covers speed equipment, construction, speedtuning, race car building, California hot rod plans, custom restyling, sports car conversions, etc. Easily get super speed, mileage, acceleration—top racing performance from any car! Shows inexpensive ways to build speed equipment, superchargers, dual manifolds, high compression heads, twin mufflers, racing cams, water injectors, economizers. Save 75%! Complete instructions with working diagrams on engine rebuilding, souping up, restyling, customizing, gas saving, racing tricks, fuels, cam secrets, balancing, porting, jet formulas, ratios, frames, "offys"! Learn 100 ways to save gas! Reveals stock car speed secrets! California speed shop methods! Custom styling information! Streamlining! Lowering! Sport changes! Hollywood roadster plans! 200 h.p. conversions—Fords, Chevys, Plys., etc. Large photographs, performance charts, blueprints, 200 illustrations. Guaranteed finest, most authoritative speed book. (Worth \$10.00.) "Big Manual" plus Speed Equipment catalog, plus "Hot Rod Handbook"—all three only \$1.98. Almquist Engineering, Milford 21P, Pennsylvania. (See display ad page 38.)

FREE Trial 10 days. Latest Chevrolet "Speed-Power" Manual sent on approval! Ninety pages of accurate information tells how to increase speed, power and economy of 1937 through 1950 Chevrolets. Learn how to install late engines in pre-1937 chassis. Full data on cams, high compression, multiple carburetion, supercharging, ignition, etc. Proves that your Chevrolet can have superior power and speed. Send no money, pay postman nothing. Try before you buy! If you don't agree this is the finest Chevrolet manual you've ever seen—just send it back within 10 days. If satisfied, send \$2.00 to California Bill, 4611 B-8 York, Los Angeles 41.

NEW Book just out, "The Sports Car Engine." Complete information speed tuning, design, maintenance all sports cars. Postpaid, \$1.50. Clymer, Dept. 8-A, 1268 So. Alvarado, Los Angeles 6, Calif.

SAVE Gasoline! Sensational Game Need-

"HOLLYWOOD" Mufflers, racing cams, dual manifolds, hi-compression heads, speed equipment—"Buy direct from manufacturer and save!" "Big 1950 Racing Equipment Catalog-Handbook" 25c. (Sample color catalog 10c.) Dealers wanted. Almquist Engineering, Milford 29P, Penna.

NEW Automobile history scrapbook; just published; over 250 ads and illustrations of antique and vintage automobiles. Some you've never heard of. \$1.50. Wiglesworth-Chasteen, Inc., 7134P Alhambra, Mission, Kansas.

SEE Our ad under motorcycles for midget car bargains. Midget Motors Directory, Athens, Ohio.

WANT Better gas mileage? Your car can attain it. Stamp brings details. Stan Stanton, Liberty, N. Y.

"SPEED Equipment" bargains—California mufflers \$4.50, V-8 duals \$15.90, chrome carburetor stacks 98c, dual manifolds \$9.95, chrome echo cans \$1.55, racing camshafts \$29.95 exchange, water injector \$12.95, hi-compression heads \$19.75. All popular brands. Big illustrated catalog 25c. Dealers wanted. Almquist Engineering & Mfg., Milford 13P, Pennsylvania.

MOTOR Trend Magazine—Custom, foreign, domestic, sports cars. Road testing, racing, auto shows, etc. Sample copy 25c. Full year \$3.00. Motor Trend, 1015 S. La Cienega, Los Angeles 35, Calif., Dept. PM.

HOT Rod—The only monthly magazine about building roadsters, streamliners, etc. Sample copy 25c. \$3.00 yearly. Hot Rod, 1015 So. La Cienega, Los Angeles 35, Calif. Dept. PM.

CHEVROLET Owners—Don't "Watch the Fords go by." Your Chevy can beat the Fords. Stamp brings particulars. Hi-Torque Speed Shop, Liberty, N. Y.

AUTOMOBILE Racing, sixth edition, 100 illustrations. Drawings, building instructions Ford-60 midget, California roadster, Offenhauser racer. World's record 158.5 m.p.h. car. \$2.00 postpaid; \$2.40 c.o.d. Popular Mechanics Press, 200 E. Ontario St., Chicago 11, Ill.

NEW Sensational seat cover. Mono, 6545 Santa Monica Blvd., Hollywood, California.

SILENCE Overhead-valves, attachments unnecessary. \$2.00. Derderian, Box 542, Sandston, Virginia.

SMITHYS Mufflers for all automobiles. Free list. Buck's Auto Parts, Box 1296H, Merced, California.

AUTOMOBILE Racing book, fifth edition, well-illustrated. Building bodies, frames, engines, Ford conversions. Plans. Roadsters—Indianapolis cars. \$1.00 postpaid. Popular Mechanics Press, 200 E. Ontario St., Chicago 11, Ill.

FROM Speedway to roadway! Track-proved hi-speed heads and manifolds now available for your passenger car! No special tools needed! Increase horsepower 25%! Astounding getaway! Free illustrated catalog. Speedsport, 6215P Diversey, Chicago 39.

AUTO SUPPLIES AND EQUIPMENT

NEW And used guaranteed parts for civilian and army cars and trucks. Largest stock in America. Mail orders. Pioneer Auto Wrecking Co., 734 W. 13th Ave., Denver, Colorado.

CENTER Turn-Lite, steers with front wheels. Custom designed. Guaranteed. For all '49-'50 Fords, '50 Studebakers. \$15.95 postpaid. Agents wanted. Lobe-Lite Mfg. Co., 1803 Kenilworth, Berwyn, Ill.

AUTOISTS: Our unique little Visor Clip holds pencil, map, etc., conveniently accessible. Mail your address and 40c for a good deal to R.E.K. Manufacturing, 8530 Woodward, Detroit 2, Mich.

NEW "Economy and power" methods. Free. Neher Industries, La Verne, Calif.

WELDING Brings bigger profits to automotive shops. Easy to use Hobart Welders. Easy Terms. Catalog free. Hobart Welders, Box M-805, Troy, Ohio.

MOTORISTS Save gasoline by Vacuumating overrich mixtures. Fits all cars. For free particulars write Vacuumatic, Dept. 1636, Wauwatosa, Wis.

LACHAPELLES Motor and motor fuel treatment (patented) stops ping, gives more miles per gallon, more miles per motor. It puts bearings on the pistons. 100,000 miles treatment \$3.00 postpaid or c.o.d. Ferns Products, 8120 Walnut Dr., Los Angeles 1, Calif. (Data sheet on request.)

HUBODOMETERS For trucks and trailers. Tachometers and speedometers. Speedometer & Clock Co., 2727 S. Michigan Ave., Chicago 16, Ill. Established 1927.

WHEEL Alignment recorder. Drive over. \$16.98. Guaranteed. Particulars free. Salesmen wanted. Align-A-Matic, Box 94B, West Orange, N. J.

JUST Out! Get the largest auto accessory and parts catalog in the world. Over fifteen thousand items, including Hollywood accessories, hi-speed equipment, rebuilt engines; all parts and accessories for all cars and trucks. New, used and rebuilt! We have that hard-to-get-part! Completely illustrated, jam-packed with bargains. Send 25c. J. C. Whitney & Co., 1919 Archer Ave., Chicago 16, Ill.

SAVE Gasoline! Sensational Game Needs. Free trial. See page 242.

REBUILD Starters, generators, regulators, batteries. Introductory manual \$1.00. Modern Technical Manuals, Box 4704, Kansas City, Mo.

MOTORISTS—Looking for real comfort? New seat cushion supports your back, eliminates driver's fatigue. Write for free booklet. Back Comfort Co., Pueblo, Colorado.

BUICK Parts—Enjoy new-car pep and power in your old Buick. Same day service from world's largest stock of new (not rebuilt) Buick parts and engines. Ship anywhere. Dime brings catalog. Write today. Robertson Buick Co., 1001 S. Wabash Ave., Chicago 5, Ill.

NEW Government surplus. Low voltage circuit tester in steel box cost \$202. Our price \$27.50. Will test batteries, starters, generators, voltage regulators, grounds, short circuits. Wilt Electrical Company, 7829 S. Racine Ave., Chicago 20, Ill.

DRIVE Safely—Side-window wiper \$1.00 postpaid. Park Sales, P.O. Box 73, Forest Park, Illinois.

UNCONDITIONALLY Guaranteed auto thief alarms. Novak Manufacturing Company, 3131 West 13th, Gary 1, Indiana.

CHEVROLET Parts. Scarce motor, body, sheet metal parts. Grossman Chevrolet, Minneapolis, Minnesota.

AUTO And truck parts. New and used. Lowest prices. Complete stock. Prompt replies. Babbitt Auto Parts, 2833 Chicago Ave., Chicago 22, Ill.

BRUSH Plating outfits connect to a battery. No tanks or shop required. Free particulars. Gunmetal Co., Avenue J, Decatur, Illinois.

AUTO TRAILERS

MODERN Trailer coach. Designing, building, traveling. Bookstores everywhere. Postpaid \$4.00. Craftsman Books, Box 1153, Milwaukee 1, Wis.

TRAILER Coaches. Save money. Buying? Building? Sound engineering construction, chassis, bodies, furnishings. Travel, dwelling, trailer plans. \$1.50 postpaid. Popular Mechanics Press, 200 E. Ontario St., Chicago 11, Ill.

BUILD Your own trailer! Save money! Have every feature you want! Plans for house, sport, camp and utility trailers. Catalog describing 9 models 10c. 15c in Canada and overseas. Jim Dandy, Box 125-A, Wausau, Wisconsin.

MOTORCYCLES, BICYCLES, MOTORSCOOTERS AND SUPPLIES

CLOSE Out specials, new, used and rebuilt motorcycle engines, transmissions, generators, carburetors, tires, tubes, etc. List 10c. Triangle, 2157 Harrison, Chicago, Illinois.

1947 SALISBURY Motorscooter \$20 (needs engine repairs); James motorcycle \$25; Motorscoot \$15; Servicycle \$30; midjet car kits \$25; Wards engine \$4, other gasoline engines as low as \$2. Send 25c (35c for first class mailing) for latest directory number thirty-six, just out, listing these and hundreds of others bargains in midjet cars, motorscooters, motors, homebuilders parts, plans, etc. (Mailorder only.) Midjet Motors Directory, Athens, Ohio.

MOTORCYCLE Parts and accessories, new, used, Indian and Harley. Complete stock. Fast service. Catalog free! Motorcycle Service Co., Crawfordsville, Indiana.

MOTORCYCLISTS—Parts and accessories, new and used, all models Harley Davidson, Indian, Henderson. Catalog 25c. Triangle, 2157 Harrison, Chicago, Illinois.

CYCLE—Monthly motorcycle enthusiasts' magazine. Road tests, technical data, foreign and domestic. Many illustrations. Sample copy 25c. One year—\$3.00. Cycle, 1015 So. La Cienega Blvd., Los Angeles 35, California, Dept. PM.

KNEEACTION Moto-Scot \$10; motorbike (front and rear brakes) \$5; Whizzer motorbike with clutch and all attachments \$25; Indian motorcycle \$30; good midjet car \$35; tire-wheel combination \$2.50. Rush 25c (35c for first class mail) for new catalog #945 listing sensational bargains in motors, motorscooters, motorcycles, Servicycles, midjet cars, etc. Associated, Box 1764-CS, Toledo, Ohio.

SPECIAL—1946 Whizzer in Schwinn bicycle \$20. Also Cushman motorscooter (good tires and lights) \$15; Shaw bicycle motor \$15; midjet car \$15. Rush 25c (35c for first class mail) for new summer catalog #17 listing many other amazing post-war bargains in wheels, engines, motorscooters, midjet cars, monocyces, motorettes, etc. Gail, 538 Erie, Toledo, Ohio.

MOTORCYCLE Magazine—Worldwide coverage. Yearly subscription \$1.00. Sample 15c. Motorcycle News, 5424-A Sawyer, Chicago 25.

BICYCLES—New Raleigh 3-speed English, world wide reputation for quality; best value today. Free catalogue. McHugh Brothers, 1876 Central Avenue, Yonkers, New York.

HARLEY-Davidson parts, accessories, repair manuals on all models. 24 hour service. Authorized factory dealer. Philadelphia Harley-Davidson Company, 857 North Broad Street, Philadelphia 23, Penna.

RECONDITIONED Motorcycles and motors. Chromium accessories. Complete stock Indian parts. Expert rebuilding. Fast service. Indian Motorcycle Sales, Kansas City 1, Mo.

HARLEY-Davidsons—Used, guaranteed. Genuine Harley-Davidson parts, accessories, obsolete model parts, expert service. Send 25c for motorcycle and accessory bulletins. \$2.25 for 45" Army Motorcycle Manual. Knuth's, 2491 Fondulac, Milwaukee, Wis.

TIRES And industrial wheels, suitable for scooters, wheelbarrows, farm equipment, etc. All sizes. Bicycles and accessories. Send dime for list. Cycle Transport Company, 1241 So. Michigan Ave., Chicago 5, Illinois.

AVIATION

LIGHTPLANE Gliders, motors, circulars illustrated 20c. Craftsman Books, Box 1153, Milwaukee 1, Wis.

PROPELLERS. Plans, supplies, for ice sleds, snow sleighs, air boats. Literature 20c. Banks-Maxwell, Box 3301E, Ft. Worth.

PROPELLERS—For sleds, airdrive boats. Literature. Standard Aircraft, Box 387, Ft. Worth, Texas.

BATTERIES, GENERATORS

EDISON Nickel batteries, 37 to 600 ampere. Also kits with Edison plates: make your own. Interesting literature. Hawley Smith Co., Croton Falls 1, New York.

ELECTRICAL SUPPLIES

WATTHOUR Meters. Reconditioned. Ideal for cabins. \$2.95. Truman Price, Raymond, Washington.

MAGNET Wire, insulation, transformer lamination. Morton Electrical Service, Madison, Wisconsin.

BE Independent, be secure, have your own profitable business—earn \$10 and more a day making beautiful, fast-selling lamps at home. No equipment needed. Illustrated course teaches you quickly. Course, parts catalog, wholesale price list—only \$2. Gearon Co., Dept. 200-B8, 27 S. Desplaines, Chicago 6, Ill.

FREE Catalog—Motors, generators, welders from aircraft generators, water softeners, automobile airconditioning, uranium locators, many other electrical bargains. LeJay Company, Minneapolis, Minn.

LAMPS—Build own originals, parts wholesale, any amounts. Catalogue 10c. Brown Lamp Co., Box 501, Wellston, St. Louis 12, Mo.

ELECTRIC Pencil: Engraves all metals \$1.25. Beyer Mfg., 10511-H Springfield, Chicago 43.

FANS—Parts, kits, assemblies. Free bargain list. Engineering Sales, Box 458, Hopewell 2, N. J.

LAMPS—Building, wiring made easy by charts and directions in 56 page illustrated lamp parts catalog. 25c. Gyro Lamps, 5402P Clark, Chicago 40.

32 VOLT Appliances—World's largest line. Catalog free. Haines Corporation, Dept. N, Minneapolis, Minn.

WELDING, SOLDERING, PLATING

WELDING Is profitable business with Hobart "Build Your Own" portable generator. Low cost. Write for free booklet. Hobart Welders, Box M-802, Troy, Ohio.

COMPLETE Electroplating equipment for baby shoes \$69.95. Includes rectifier, tank, anodes, chemicals. Free price list. Easco, Sandybank, Media, Penna.

ACETYLENE Welding outfits, brand new \$45.00, used 25 arc welder \$46.00. Eagle Welding, Dept. PM, 5085 Broadway, Chicago 40, Ill.

WELDERS: 1/16" Metal \$3.95, 1/8" \$6.45. Essay Manufacturing, Quincy 69, Mass.

THERMASOL Magic solder outfit. Solders without iron, flux, cleaning. Suitable 1001 jobs. Anyone can use. \$1.00 complete, postpaid. Keystone, Box 4770, Johannesburg, South Africa.

RADIATOR Repairing, cleaning, recoring. How to equip small shop at low cost. Supply sources, trade secrets, instructions. Now only \$3.50 postpaid. Radiator Service, McBain, Mich.

A.C. Arc welders, 4 sizes, lowest prices. Holgeron's Service, Canton, Kans.

BUILD Your own 100 ampere electroplating rectifier at a low cost. Starkweather, Ottawa, Kans.

RADIATOR Repairing books, supplies, equipment, gasoline torch. Write, Curfman Co., Maryville, Mo.

BUY Direct from factory. Welding and cutting equipment. All makes of equipment repaired. Established 1913. Box 331, Hamilton, Ohio.

ELECTROPLATING Salts and rectifiers. Mirror resilvering and chipped glass nameplate supplies. John Sprinkle, V55, Marion, Indiana.

MACHINERY, TOOLS, SUPPLIES

DIVIDING Head, rotary tables, etc. For Atlas millers. Free machine tool accessories catalog. Montgomery, 53 Park Place, New York City 7, N. Y.

WINCHES—Government surplus, complete with 300 ft. 3/8" galvanized cable. New, original boxes, \$150 value. Excellent for marine, rigging, trucking, etc. 1200-3600 lb. capacity. Limited time only, \$49.50 for winch and cable (less than cost of cable alone). Approximately 200 lb. shipping weight. Freight collect, no c.o.d.'s. Bachman Wholesale Company, 27 Herman Street, Rochester 5, N. Y.

RADIAL Arm saws, surplus, 2 h.p., single phase, new, regular \$410. Special \$229.00. Iowa Machinery, Des Moines, Ia.

CONCRETE Block machines. Standard sizes. \$39.50. Average 400 daily. Free catalog. Concrete Machine Company, 5129 South Compton, St. Louis 11, Mo.

POWER Tools. Big savings when you build your own with Lewis castings. 23 wood and metalworking tools with blueprints. Most can be completed with lathe and drillpress. Commercial quality. Ideal for home shops, schools, small manufacturing. Catalog 10c. Lewis Machine Tool Co., 3217 Union Pacific Ave., Dept. M, Los Angeles.

CHUCKS, Independent, universal; threaded 1 1/2"-8, 1"-8, 1"-10, 1"-12, or with adapter recess. Other chucks to 16" diameter. Write for quotation and free literature. No obligation. Westcott Chuck Co., 3600 Walnut, Oxnard, N. Y.

BOATS, OUTBOARD MOTORS

KNOCK-DOWN Boat kits. Outboards, inboards, sails, hydroplanes. Easy to assemble. Minimum cost. Catalog with specifications, prices, 25c. Brooks Boat Company, Carrollton, PM, Michigan.

AUTO Conversions and parts—Marine manifolds for all engines. V8—\$40 pair; Model A \$32; Willys \$30; 6 cyl. Chevrolet, Pontiac, \$50; 6 cyl. Buick, Lycoming, \$65; 8 cyl. Pierce, Packard, \$80; downdraft models add \$5. Your transmission converted to marine gear, most makes \$40, a few \$50; propellers 14"—\$13.50, 16"—\$16.75; shafts, struts, couplings, etc. Everything you need for your boat. Buy direct from the factory and keep the dealers profit for yourself. Money back guarantee. Conversion Parts Co., 278 Adams St., Boston 22, Mass.

BUILD A better boat than you can buy for the money, with Ozarka's exclusive laminated-rib construction and carefully pre-formed and pre-fitted parts. Save to 55% on all popular types from simple car-top models to one-design knockabout sailboats, priced from \$39.50 to \$329.00. Shipped complete, ready for easy assembly. Send 25 cents for literature, refunded on first purchase. Ozarka, Inc., 680 Borden Lane, Woodstock, Illinois.

TWENTY Plywood boat plans \$1.00. Catalog boat building plans 10c. The Rudder, 15 Murray Street, New York 7.

SEND For free bargain list of used, rebuilt, and demonstrator boats, boat trailers, outboard motors, inboard marine engines, marine hardware and equipment. Garland Frasher Marine Sales, 540D 31st Street, Huntington, W. Va.

220 PAGE Marine hardware catalog, beautifully illustrated for \$1.00. Money refunded with first order plus 10% discount. Marine Products, 7 Longfellow St., Baldwin L. I., N. Y.

ILLUSTRATED Book, outboard boat construction, regular price \$1.50. August special 75c postpaid. Boat patterns, kits, thirty designs, descriptive literature 25c. Germain Boat Company, W. Saginaw, Michigan.

FORD And Jeep marine conversion kits. Request catalog. Arthur Gershel, Dept. 0, 51 Chambers St., New York 7, N. Y.

P38 TWIN Tank boat, free picture, plan \$1.00. Twin Tank, Box 89, Merced, Calif.

SAVE 2/3 Cost. Assemble your own boat. Complete plans and boat parts machined ready for assembly. No experience necessary. Rowboats to cruisers. Illustrated catalog 25c. Midwest Boat Company, Menomonee Falls, Wisconsin.

STEERING Wheels, windshield brackets, from \$6.95. Modern fittings, water skis at lowest prices. Complete pre-cut plywood boats. Bargains galore. Folder 10c. Marine, Box 681, Mendota, Minnesota.

REBUILT Outboard motors at bargain prices! Late model Johnsons, Evinrudes, Mercury, etc. A 3c stamp brings list—new and used. Parts for all makes, including chain store brands. Write for prices, giving description of parts needed. Money back guarantee. When in Boston visit the largest outboard motor plant in the world. Outboard Motor Mart, Inc., 309B Atlantic Ave., Boston, Massachusetts.

OUTBOARD Motor bargains—\$35.00 up. Send for free list! Save big money! Used parts for most makes and models. Crandall-Hicks, 911 Commonwealth, Boston, Mass.

CONVERT Fords and Jeep to 100% marine engines with Osco's world famous Convo-Kits. Deluxe catalogue 25c (coin). Oscomotors, 3627B Lawrence, Philadelphia 40, Penna.

P38 BELLY Tanks, steel, \$9.95. Free picture. Bucks Auto Wrecking, Box 89, Merced, Calif.

NEW, Used, rebuilt marine motors. Marine conversions, fittings. Free catalog. Stokes Marine Supply, Dept. 24, Coldwater, Michigan.

MARINE Conversions for Ford and Jeep engines. Catalog 10c. Lehman Manufacturing Company, Department D, Newark 2, New Jersey.

FULL Size, cut to shape boat patterns, blueprints, 7 1/2-38 feet. Illustrated "Build a Boat" catalog, 25c (coin). "How to Build Boats" book, \$1.00. PolyWog houseboat plans \$10. Marine catalog \$1.00. Marine Specialty Mfg. Co., 3107 Detroit Ave., Cleveland 13, Ohio.

ENGINES, MOTORS, DYNAMOS

BARGAIN 11 Inch ventilating or exhaust fan with 1/15 h.p. 110 v. a.c. motor \$4.85. Motor only \$3.85. Kaynine Konvoy, Box

MOTOR Winders, free bulletins, winding and testing equipment. Motor Industries, Quincy, Illinois.

MOTORS—1 Horse \$35; 3/4 \$24; 1/2 \$15. Twin cylinder compressors \$17.50. Fans 32 volt \$3.75. Butler, 1885 Milwaukee, Chicago 47.

WINDING Data, listing 225 motors, single and three phase, \$1.00. Motor Data Co., Box 7631, Kansas City 3, Mo.

ATHLETIC EQUIPMENT, BODY BUILDING COURSES

BARBELLS—Finest quality, \$7.98 up. Free catalog. Lurie Barbell Co., 1729-M8 Rockaway Parkway, Brooklyn, New York.

BE One to three inches taller. A new scientific method for permanent height increase has now been developed. Free information. Natural Methods, Box 453, Briggs Station, Los Angeles.

FREE Illustrated catalogue—Books, magazines, photos, equipment, barbells, courses. Dr. Frank Thompson, Dept. 10, 919 Fourth, Manhattan, Kansas. World's Leading Dealer.

DEADLY Judo—Fiercest fighting technique. Trick knockouts. (Over 200 illustrated pictures.) Expert instructions; three volumes. Complete \$2.25. Variety House, Box 46-B Wall Station, New York 5.

BARBELLS, Exercise equipment. Courses. Free booklet. Good Barbell Co., Reading, Penna.

PHYSICAL Perfection. 12 courses \$2.00. Fully guaranteed (news and pictures 10c). Sid's System, PM16, Southgate, California.

SPORTING GOODS, GUNS, FISHING TACKLE, ARCHERY, TRAPPING

BAMBOO—Bundle of 100 imported poles, 12 foot length, for fishermen, trappers, etc. \$10.00 f.o.b. New Orleans. Dart Export Corporation, 515 South Peters St., New Orleans 12, La.

TENTS. All types and sizes, vast selection, camping equipment; war surplus. Lowest prices. Free catalogue. Morsan, 10-19 R 50th Avenue, Long Island City 1, N. Y.

LEARN Gunsmithing! Details, copy "Guns and Gunsmithing," 25c. Gunsmith's Supply, Palatine 2, Illinois.

SEND 10c For list 150 used guns. Frayseth's, Willmar, Minn.

FIREARMS, Ammunition; foreign-American. List 25c. Frank Farish, Vicksburg, Miss.

WOW. Fishing sensation—Pure rubber baits and lures. Natural colors. Amazingly lifelike. One dozen assorted types, crawdad, frog, ladybug, etc. Only \$2.95 postpaid. Sample flyrod lure 25 cents. Bob James, Wysor Building, Muncie, Indiana.

190 PROFUSELY Illustrated pages antique and modern pistols, swords, daggers, armor, etc. 50c. Robert Abels, A860 Lexington Ave., New York 21.

SNOOPERSCOPE Book \$1.50. Infrared catalogue 10c. Precise, 942 Kings Highway, Brooklyn 23, New York.

ENJOY Fishing as never before! Amazing new Kel-O-Bob automatic fishing float measures water automatically. You can cast with it, reel fish all the way. No knots to clog your reel. Satisfaction guaranteed. Order today, one for 60c, two for \$1.00. Keller Laboratories, Oneida, N. Y.

SPORTSMEN—Drive to distant hunting, fishing without backache, fatigue. New seat cushion guarantees relief. Postcard brings complete details. Back Comfort Co., Pueblo, Colorado.

HUNTING Arrows for small game and roving. 19 for \$3.00 postpaid. Shafts fitted with steel points and processed ready to assemble with patented vanes. No tools required. Performance guaranteed. Send for further details. Nu-Fletcher, 46 No. Manchester Street, Brockton, Mass.

SHOTGUNS, rifles, revolvers, 500 modern, obsolete. Also cartridges. Each list 10c coin. Ed Howe, 62 Main, Coopers Mills, Maine.

RIFLE Stocks: Laminated and regular. Blanks, semi-finished, finished. Enfield, Springfield, Mauser, etc. Literature. Banks-Maxwell, Box 3301E, Ft. Worth.

FISHERMEN—Make your own sinkers with our molds. Free illustrated booklet. Reading Instrument Co., Box 78, Reading, Penna.

5000 BARGAINS. Firearms, binoculars, war relics. Catalog 40c. Smith Firearms,

TAXIDERMISTRY

MODERN Taxidermist Magazine, Greenfield Center 2, N. Y. Devoted entirely to taxidermy, photos, articles, methods. Trial year's subscription, \$1.00.

BINOCULARS, TELESCOPES, MICROSCOPES, MAGNIFIERS

ILLUSTRATED Catalog and book, "How to Select Binoculars," only 10c. Bushnell Importers, 43-8M East Green, Pasadena 1, California.

SIX Power coated prism binoculars \$16.45 (plus 20% tax). Free trial, general price list, particulars. Prentiss Importers, Mercury Bldg., West Los Angeles, Calif.

ASTRONOMICAL Telescopes, binoculars, microscopes, bought, sold, repaired. Books. Lists 10c. Rasmussen-Reece, Amsterdam, N. Y.

SAVE 50% On new binoculars! Free catalog. Free book, "How to Select Binoculars." Write today! Bushnell Importers, 43-8M East Green, Pasadena 1, California.

TELESCOPES, 30 Power, extends 36" precision lenses. Satisfaction guaranteed or money refunded. \$2.95 postpaid. Criterion, Dept. PMC 5, 438 Asylum, Hartford 3, Conn.

BINOCULARS, Telescopes, watches, guns. Buy, sell, trade. Schweer's, Donnellson, Iowa.

WAR Surplus bargains, binoculars, telescopes, sextants, millions of lenses, prisms, reticles, eyepieces, objectives, etc. Mail 10c for big "Catalog CH." Send \$1.00 for stock CH; 10-piece lens kit and big instruction booklet. Edmund Salvage Co., Barrington, N. J.

GIANT Astronomical telescope with 6 ft. tripod \$15.00, f.o.b. factory. 100 power. (10,000 area magnification). Clear vision, full power guaranteed. Ready for use. Suffolk Science Service, Dept. BT, Riverhead, N. Y.

REFLECTING Telescopes, 60X, completely assembled \$25.00. Guaranteed observatory clearness. Free information. Skyscope, 475 Fifth Avenue, New York 17.

TELESCOPES, Binoculars, microscopes, big bargain catalog free. Brownscope Company, 24 West 45th Street, New York.

POWERFUL Astronomical telescopes easily made. Perfect lenses and instructions; 100X \$3.00; 100X and 200X \$4.00; 100X, 200X and 400X \$6.00. Full power, clear vision guaranteed. Instructions alone 10c. Suffolk Science Service, Riverhead, N. Y.

PETS—DOGS, BIRDS, RABBITS, HAMSTERS, ETC.

SPORTSMEN: 200 Pointers, setters, straight cooners, combination hunters, rabbit and fox hounds. Reasonable. List free. Ramsey Creek Kennels, Ramsey, Illinois.

BEAUTIFUL Pure white pedigreed police puppies. Ansonia Kennels, Mose, N. Dak.

RAISE Guinea pigs. Money making business. Booklet free. Taylor, B426A, Hapeville, Georgia.

\$50 WEEKLY Raising Angora or New Zealand rabbits. Particulars free. White's Rabbitry, Newark 38, Ohio.

HAMSTERS—Best breeding stock available, \$3.00 pair. Buy from us and save high advertising costs. Write for free information. Lakeview Hamster Colony, Newfield, N. J.

HAMSTERS—Moneymaking fast breeding virgin stock. Equipment. Dixie Hamstery, 502-C Trinity Lane, Nashville 7, Tennessee.

SEE Gulf Hamstery ad on page 22. Shows picture of Hamster.

NEW Profits from hamsters! Easily raised. Small space. Odorless. Rapid breeders. Sell laboratories, people, pet shops. Pair \$3.00. Trio (1M-2F) \$5.00. Literature free. American Hamstery, 3826-C Lemmon Avenue, Dallas, Texas.

A Practical beginning to successful rabbit raising. 48 page illustrated booklet. Dime. American Rabbit Breeders Association. 36 AR & CBA Bldg., Pittsburgh, Penna.

\$300 MONTHLY Raising Angoras for our market. Particulars free. Wilson, Stanton 17, Calif.

MINK Raising information free. Complete. Lake Superior Mink Farm, Superior, E.E. Wisconsin.

GRINSTEAD'S Famous Angoras! Giant Chinchillas! World's most profitable rabbits. Finest pedigree, heavy-producing, prize-winners. Literature free. Grinsteads, Edwardsville, Illinois.

INCREASE Your income by raising domestic rabbits. Small space needed. Ready market for delicious meat, fur and wool. Largest magazine in the industry tells you how. \$1.50 per year. Sample 15 cents. No stamps. Small Stock Magazine, Lamoni 20, Iowa.

PLANTS, SEEDS, NURSERY AND GARDEN SUPPLIES

PALMS Grown from seeds make potted trees of tropical beauty. For seeds write Ruco, Box 2082, Los Angeles 54, Calif.

FARMS, FARM LANDS, REAL ESTATE

FREE List, farms, ranches, central Arkansas, fertile soil, good markets. Owen Farm Agency, Conway, Ark.

NEW Free fall catalog, farm bargains, many equipped, illustrated, many states! United Farm Agency, 1408-PM Consumers Bldg., 220 South State St., Chicago 4, Ill.

\$5.00 MONTHLY Buys 40 acres. Near town. Price \$200. Free list. Box 425-P, Carthage, Mo.

WEST'S New Digest of farms and country real estate—free! Values galore—Maine to Florida. West's, CK-5, Pittsburgh 17, Penna.

FLORIDA. Beautiful homesites in new Lake County development, \$245 at \$10 monthly. Near Ocala National Forest, many pretty lakes, streams, pavement. World's best bass fishing, wonderful hunting. Folder free. Howard Vernor, DeLand, Florida.

GOOD Farms—Ranches. Washington, Minnesota, Montana, Idaho, Oregon, North Dakota. Dependable crops, favorable climate. Write for literature, lists describing typical farm opportunities. Specify which state. J. W. Haw, 119 Northern Pacific Ry., St. Paul 1, Minn.

HOMESITES \$300—Convenient payments. California's finest garden section. On Morro Bay's scenic shores. Wonderful fishing, hunting, boating, bathing. Fertile soil, softest water, temperate climate, congenial community. Free literature. Richard Otto, Department M, San Luis Obispo, California.

STROUT'S Golden anniversary farm catalog. Over 2800 outstanding bargains. Coast-to-coast, 32 states. Mailed free. Strout Realty, 7 So. Dearborn St., Chicago 3, Ill.

FARM Manual shows you how to make extra profits from your farm. 284 pages of farming lore, \$3.00. Popular Mechanics Press, 200 E. Ontario, Chicago 11, Ill.

POULTRY, FARM SUPPLIES

INCREASE Your poultry income—Thorough knowledge means greater success. Our interesting, practical, home study course has trained thousands during past 29 years. Don't delay, write today for free booklet describing courses, methods, opportunities. National Poultry Institute, Dept. 50-C, Adams Center, New York.

KNOW How to raise poultry for profit. Read Poultry Industry. Every issue packed with helpful hints and practical suggestions. Latest articles on breeding, feeding and management. Subscribe now. 1 year 65c. 2 years one dollar, foreign subscriptions \$1.00 a year. Poultry Industry, Dept. P.M., 376 Boylston St., Boston 16, Mass.

PROFITABLE OCCUPATIONS

HAVE Fun! Make money! "Working With Leather"—64-page booklet tells how. Send 25c for copy. Free catalog and valuable information included. Wilder-Craft, 1039 Crosby, Chicago 10.

OUTDOOR Work for extra income. Information free. Morris, 328-A Parkway NE, Atlanta 5, Georgia.

EASY To learn profitable arc welding in short time at low cost. V-A contract. Catalog free. Hobart Trade School, Box M-803, Troy, Ohio.

MAKE Money with your hobbies. Our illustrated catalog is a buying guide for leathers, plastics, metals, all hobbycraft materials, tools, kits; a volume of ideas and instructions. Send 10c. Sto-Rex Crafts, Dept. M-8, 141 9th St., San Francisco, Calif.

TURN Your spare time into cash. Make quick-selling, highly profitable lamps—every home a prospect. No experience or special tools required. New 1950 56-page illustrated catalog shows shades, shade frames, figurines and bases, oil lamp converters, boring compounds, and dozens of similar items. Also all kinds of sockets, cords, pipes, harps, finials, bases, and hundreds of other parts—everything you need. Special 8-page section shows 6 beautiful lamps in kit form ready to assemble. You buy wholesale, sell at retail—make big profits. Hundreds doing it. You can, too. Send 25c today for catalog and wholesale price list. Refundable first order. Gearon Co., Dept. 500-B8, 27 S. Desplaines, Chicago 6, Ill.

JIGSAW Owners attention! Start earning money at home cutting out wooden novelties and souvenirs. Write H. Cook, Dept. A, 4407 S. Normal Ave., Chicago 9, Ill.

FREE Book "How to Make Money With Home Workshop" describes amazing methods used by hundreds of successful craftsmen. Tells what to make, how to sell workshop output spare time. Write at once for details. Remember it's free! Craftsman, 115-A8 Worth St., New York City.

FOREIGN Employment. Construction men, building trades, mechanics, helpers, office men. Good workers interested in foreign development projects. Pipe lines, dams, power plants, roadways, shipping, oil refineries, etc. Transportation and quarters furnished; high wages. Listings of firms actively working on projects in Arabia, Persian Gulf, Africa, Alaska, Canada, South America, Europe, etc. Send \$1.00 for foreign construction compendium and application forms. Foreign Service Bureau, Dept. PM-8 (Employment), P.O. Box 295, Metuchen, N. J.

MUSHROOMS Crown boxes, barrels. Instructions 50c. Spawn \$1.00. Manureless process. \$2.00. Gordons, 553 William, Winnipeg, Manitoba.

FULLFASHION Nylons \$1.00 doz., socks 95c doz., combs 20c doz., rayon panties \$3.50 doz., men's underwear \$3.50 doz., chenille spreads \$2.50, quilt tops. 39c. Sample razor blades, complete stock list. 25c. Sibert Company, Chattanooga 4, Tenn.

RAISE Pheasants on the \$100 week plan. Little capital and space can make you independent. Free details. Great Central Game Management System, Columbus, Kansas.

WANTED—Purchasing agents. No money or experience required. Write Dept. C, Purchasing Manager, 2719 Lawrence, Chicago, Ill.

MAKE Flexible molds! Cast plaques, bookends, figurines! Free sample! H. Tooker, 630-M Chestnut, Hamilton, Ohio.

LIFETIME Income as notary public. Appointment assistance. Stationers, Helotes 50, Texas.

RAISE Fishworms. Easy, profitable. Send 25c in coin for complete instructions. Huffman Worm Ranch, Rives Junction 2, Mich.

\$250 WEEK Reported! Free illustrated book "505 Odd, Successful Businesses." Work home! Expect something odd! Pacific-E, Oceanside, California.

INTERESTED In Latin America and foreign employment? \$1.00 brings 1950 copyrighted "Foreign Service Directory," world wide listings in construction; oil; mining; aviation; steamships; manufacturers; transportation; exporters, importers. Hot list firms hiring. How-when-where to apply. Application form free. Global Reports, P.O. Box 883-P, Hollywood 28, Calif.

BE The Popular Mechanics representative in your neighborhood and earn big profits in your spare time. Write Popular Mechanics Magazine, Room 408M, 200 E. Ontario St., Chicago, Ill.

\$46 FROM Square foot plywood; jigsaw necessary. Write, Woodarts, P-38, Bridgewater, Mass.

OWN And operate mirror shop! Supplies for resilvering mirrors, making chipped glass nameplates and electroplating. John Sprinkle, V50, Marion, Indiana.

\$40.00 WEEKLY Made growing mushrooms, fresh, dried. Dominion patent 331583. Free spawn. North American, 169P Yonge, Toronto, Canada.

ALASKA—Last great American frontier. \$1.00 brings 1950 copyrighted directory and government map free. Big construction projects; fishing; mining; aviation; hunting-fishing-game rules; fur-farming; lumber; live stock; agriculture. Homestead land and highway information. Listing firms hiring. Application form. Alaska Opportunity, P.O. Box 883-P, Hollywood 28, Calif.

BOOKS, PERIODICALS, PICTURES POSTCARDS

BRIGHTEN The corner where you are by reading The Light of the World \$3.95; In Tune With the Infinite \$2.50; Mr. Jones, Meet the Master, \$2.50. Order today. You'll help brighten Satia's Corner, 425 Division, Lake Charles, La.

INTERESTED In railroads? Read "European Railways" every month. Send \$1.50 for year's subscription. Robert Spark, 48 Cedar Road, Sutton, Surrey, England.

AMAZING New magazine. No other magazine in the world like new "Here's How." Every page devoted to schemes, plans, ideas for making money at home or outside, full or spare time. Tells how to start own business, how to sell personal service, how to make homecraft pay big profits, how to quickly win financial independence. Every story and article practical, stimulating, inspirational. Get copy of first issue of "Here's How" just off press for only 25c. One idea in this amazing new magazine may be worth \$1,000 to you. Be first in your locality to read "Here's How." Rush name and 25c today to Raymond Brandell, Publisher, 1512 Jarvis Avenue, Dept. CL-2, Chicago 26, Illinois.

NAME The book—We'll get it! Chicago Book Mart-PBM, 3725 Southport, Chicago 13, Illinois.

KODACHROMES—Slides of Mexico on approval. Douglas Whiteside, Yosemite, California.

ATTRACTIVE Typical South America postcards \$1. Rosello, Casilla, 2354, Buenos Aires (Argentina).

THE World in color. Sensational 35mm slides, 10 for \$1.00. C.O.D. or send \$1.00 for sample set. Money back guarantee. Free list. Evan J. Anton Productions, Dept. B, 20 East 42 Street, New York 17, N. Y.

CANARY Booklet and 3 bird magazines—\$1.00. American Canary Magazine, 3449-51 N. Western Ave., Chicago 18, Illinois.

HOW-To-do-it books on every subject. Written in Popular Mechanics' famous easy-to-understand style and profusely illustrated. Subjects include workshop planning and practices, projects, hobbies, household repairs, motoring, outdoor sports, photography, home building and many others. Also booklets on specific topics. Write for free illustrated catalogue. Popular Mechanics Press, 200 E. Ontario, Chicago 11, Ill.

BOOKHUNTERS! All subjects. Send wants! Jaher Book Service, 620-P East 178 Street, New York 57.

BOOKFINDERS! (Scarce, out-of-print, unusual books). Quickly supplied. Send wants. Clifton, Box 1377-PM, Beverly Hills, Calif.

NATIONAL Geographic Magazines 1888-1949. Any issue, Box 327-PM, Periodical Service, Swarthmore, Penna.

MAGIC TRICKS, PUZZLES, JOKER NOVELTIES

LEARN Ventriloquism. Make money. Have fun. Big opportunity! Radio, television, stage appearances. Free information. Write, stating your age. Dummy catalogue 25c. Maher, Box 36-M80 Kensington Station, Detroit 24, Michigan.

FREE! Hot pepper gum, 24 other tricks, with illustrated catalogue 25c (refunded first order). Fink Co., (B-1618), Philadelphia 5.

JOIN Our New Magic Club. Send 10c for illustrated catalogue and free particulars. Magic & Fun Mart, 53-A Prince St., New York.

SEND 10c For new catalogue of card, cigarette, pocket, coin, comedy, handkerchief, parlor and stage tricks. Magic Factory, Minneapolis 2, Minn.

PROFESSIONAL Catalog, 124 pages, 25c. Williams, 900 Plymouth, Ellwood City, Penna.

FREE Monthly mailings informing you of latest magical inventions. Aim Magic Company, 143 Verona Ave., Newark 4, N. J.

AMAZING Trick—Defies gravity, holding 100 times its weight. Complete trick \$1.00. Elenel Co., 722 Adams, Owosso, Michigan.

BE A magician. Large professional magic catalog of latest tricks, 35c. Ireland, C-109 North Dearborn, Chicago 2.

500 TRICKS. Douglas famous catalog 27 now only 10c. Unequaled service to magicians for 30 years. Send 10c today. Douglas Magicland, Dept. 1, Dallas, Texas.

MAGIC Tricks, puzzles, books, cards, punch boards. Catalog 10c. Specialty, Box 871, St. Louis 1, Mo.

512-PAGE Catalogue of 2500 tricks, pocket, parlor, stage. World's finest magic. Send \$1.50 for catalogue (refunded first \$6.00 order). Kanter's, M-1311 Walnut, Philadelphia 7.

200 ELECTRIC Stunts, 110 volts, \$1. Kutting Sons, Los Altos, Calif.

16 CARD Tricks and catalog 25c. Sterling Magic, Royal Oak, Mich.

WORLD'S Largest professional magic shop. Keeps you in touch with latest tricks. To receive mailings, send 50c for new catalog. Holden's, M220 West 42nd St., New York.

VENTRILOQUISM Taught. 3c stamp bring particulars. Smith, 801 Bigelow, Peoria 5, Ill.

COINS, TOKENS, CURRENCY

100 COPPER And silver foreign coins sent in trade for any amount of old gold sent us. B. Lowe, Holland Bldg., St. Louis 1, Mo.

OLD Money wanted. Do you know that coin collectors pay up to \$100.00 for certain U. S. cents? And high premiums for all rare coins? We buy all kinds. Send 4c for large coin folder. May mean much profit to you. Numismatic Co., Dept. 20, Fort Worth, Texas.

COINS Wanted, will pay up to \$2000 for certain coins, send 25c for catalogue. Burton's, 111 So. Third, Columbus, Ohio.

FREE Lists. Bargain lots. Nelson's Coinery, Box 346, Rye, N. Y.

GIANT Bargain catalogue 15c, buying lists 5c. Bebe's, 1180 East 63rd, Chicago 37, Illinois.

OLD Coins at 75c each. 1804 1/2c, 1820 10c, 1831 25c, 1877 50c. All with clear dates. Gold coins bought at top prices. Hollinbeck, R.U.L. Bldg., Des Moines, Iowa.

ANCIENT Roman coins 2000 yrs. old—2 small, \$1.00; 1 large, \$1.00; 10 diff., \$4.00; 33 diff. foreign, \$1.00; 100 diff. foreign, \$3.00. Chelsea, 26 W. 18, New York City 11.

WORLD'S Greatest coin paper and two wooden nickels 10c, or six different wooden nickels 25c. Lawrence Brothers, Anamosa, Iowa.

25 COINS And bills, 25c. Oddehon, Box 482, St. Louis, Mo.

FREE! Foreign coin, banknote and coin collectors illustrated catalog to approval service applicants. Send 3c postage. Tatham Coinco, Springfield 30, Mass.

GET Profit and pleasure in collecting old coins. Send 10c for 56 page illustrated coin catalog. You'll be delighted with it. Send for it now. B. Max Mehl, 370 Mehl Bldg., Fort Worth, Texas. Largest rare coin establishment in U. S. Established 50 years.

16 PAGE Coin bargain list and Mexican 10 peso bill, all for dime. Coin Shop, 31 North Clark, Chicago 2, Illinois.

COMMEMORATIVE \$1/2. Oregon, Texas, Kentucky, Cleveland, Long Island, \$2.00 each. Illustrated catalogue 25c. Norman Shultz, Salt Lake 9, Utah.

STAMP COLLECTING

GIANT, Midget, triangle, diamond, other odd stamps. Free with tiptop approvals. Niagara Stamps, Niagara-on-the-Lake 11, Canada.

307 ALL Different 15c. Beautiful collection of commemoratives, triangles, high values, bicolored stamps, etc., only 15c. Garcelon, Box 400, Calais, Maine.

300 FOREIGN Stamps plus 50 all different United States plus watermark detector and perforation gauge. Everything 10c to approval applicants. Jerry Whitehead, 315M South Fifth Avenue, Canton, Illinois.

FREE—Famous Americans set, Flag set, National Parks set, and Presidential set to \$5.00. A total of 90 stamps free to customers for our unsurpassed U.S. and foreign selections. Send 3c for 15 of the above stamps and full particulars. Triboro Stamp Co., 145 Nassau St., Dept. 108, New York.

UNITED States bargain! It sounds unbelievable, but nevertheless it's true: "50 different United States stamps, face value as high as \$5.00 for only 10c" to approval applicants, but only one per person. Please state whether approvals shall consist of only U. S. or foreign also. Globus Stamp Company, 268 Fourth Ave., New York 10, N. Y., Dept. 219.

FLAG Stamp free with your request for U. S. approvals. Wenigman, 1933 Patterson, Chicago 13.

PROFUSELY Illustrated 76 page! U. S. catalogue, 25c deposit. Miller Stamp, Malden 48, Massachusetts.

LOOK—Gift of United States commemorative sets. Free premiums with each order. Approval applicants send 5c. Locust Stamp Co., Box 390T, Peekskill, New York.

SAN Marino collection free—25 different, old and new issues, airmails, commemoratives, high values. Absolutely free with approvals. Viking, 130-27 Clinton St., Brooklyn, N. Y.

FREE! Book identifying stamps, plus valuable information. Approvals. J. Moumblow, 740 Hegney, Bronx 56, New York.

FINE Approvals. Fast, personal service. What countries do you prefer? I'll send their stamps. Skinner, 438 Locust, Long Beach 12, Calif.

ZANZIBAR, Pitcairn Islands, Turks, Caicos, Gilbert, Ellice, Solomon, Leeward, Gambia, Tanganyika and others. Complete collection free. Send 5c for postage. Gray Stamp Company, Dept. PM, Toronto 5, Canada.

FREE! Canadian sets, royal visit. George VI, George V, coronation, jubilee, others to approval applicants. Ensign, Box 118-M, South Orange, N. J.

WHOLESALE Lists to dealers. 3c postage. Grossman, 100 West 42nd, New York 18.

SMALL Collection U.S. stamps \$1.00. Law, Box 725, Lynn, Mass.

NEW Zealand collections of 100 different fine used, \$1. Lovell's, Taupiri, New Zealand.

COMPLETE Mint sets on approval. Hammel, Box 865-A, Waterbury 20, Conn.

100 DIFFERENT British Colonies 15c. Rahmer, Box 123P, Rome, N. Y.

50 DIFF. China 5c. Worldwide approvals sent. Holmes, 628 Connally Drive, East Point, Ga.

UNBEATABLE Penny approvals, U.S. and foreign. Sparta, Box 426, Dansville, New York.

500 MIXED Stamps and surprise packet for 10c with approvals. Fahsing, Dept. PM, Atascadero, California.

RUSSIA 25 Different 3c. Approvals. Wilcox, Box 271, Bremerton, Wash.

WORLDWIDE Stamps. All different. 200, 25c; 500, 50c; 1000, \$1.00; 2000, \$2.50; 5000, \$12.50. Beacon Sales, Northboro, Mass.

1/2-1c APPROVALS! Bargains galore! Cole, 43-A Rnewalt, Buffalo 21, N. Y.

LIBERIAN Triangulars, 10c with approvals. Vargo Stamps, 6044 South Fairfield, Chicago 29, Illinois.

100 DIFFERENT Worldwide, 5c. Approvals. Stearns, 26970-B Princeton, Inkster, Michigan.

FREE "Stamp Finder." Tells instantly country to which any stamp belongs. 32 pages profusely illustrated. Garcelon, Calais 17, Maine.

BIG U.S. illustrated catalogue free. Stone, Box 52, Dorchester 24, Mass.

FREE Sample newsy, informative stamp weekly. Southern Philatelist, Box 1948, Miami 35, Florida.

500 DIFFERENT, Only 25c with priced-right approvals. Niagara Stamps, Niagara-on-the-Lake 30, Canada.

SOUVENIR Sheet free. Request unusual approvals. Knight, Box 3770, Portland 8, Oregon.

QUEENSLAND! Macau! Wurttemberg! Free! Approvals. Box 326A, Passaic, N. J.

STAMP Magazine! Copy free! "Stamp Post." South Catalina, Pasadena, Calif.

1/2-1c UP Approvals. Pagewood, 1355 N. Dearborn, Chicago 10, Ill.

EXCHANGE Stamps universe. Particulars free. "Exchangers," Bry 126, Seine, France.

500 STAMPS For only 10c! This mammoth value includes airmails, pictorials; stamps from strange countries, cataloging up to 25c each! Also approvals. Mystic Stamp Company, Camden 80, New York.

FREE—Complete China "Great Wall" airmail set. Approvals. Sanders, 6126-K Carpenter, North Hollywood, Calif.

FREE! 25 Different Switzerland, with swell approvals. Kardell, 209 Bower, Santa Fe, New Mexico.

GIGANTIC! Wonderful! Penny approvals! Sensational bargains cataloging to \$1.00. Commemoratives; pictorials; airmails. Free! Premiums! Price lists! "Perforation-O-Gauge!" Waynesco, Box 7008, Long Beach, California.

GERMANY! Mint Hitlerheads (12) free. Approvals. Will Deems, Ravenswood, W. Va.

500 JAPAN Stamps 10c. Kenmore, Arlington 74-J4, Mass.

LIECHTENSTEIN UPU 10c to approval applicants. Edwin Bowditch, Bloomfield, Conn.

FREE! 50 Different Japanese stamps! Approvals. Star Stamps, 225 Willard, Jamestown, New York.

AMAZING Offer! 500 United States stamps—including commemoratives, airmails, high values to \$5.00. Only 10c to approval applicants! Illustrated bargain lists free. Mystic Stamp Co., Dept. 80, Camden, New York.

BARGAINS! 2,000 Foreign stamps \$1.00, 5,000 \$2.00, 2,000 U. S. \$1.00, 5,000 \$2.00. Postal Sales Company, Department 4123, Washington 13, D. C.

GRUESOME Murder set! 3c, approvals. Eisenmac, 719A—11th Street N.W., Washington, D. C.

DEALER Wholesale list. Packets, triangles, etc. Hammond Stamps, Auburn-dale 66, Massachusetts.

FREE—Cuba Roosevelt issue and illustrated catalog. Littleton Stamps, Littleton 12, N. H.

300 DIFFERENT Foreign stamps 15c approval applicants. McKinney, Elsie, Mich.

50 DIFFERENT U. S. 10c. No approvals. Seidenberg, Box 944, Appleton, Wis.

10,000 DIFFERENT 1c Each! Gordon Davison, Box 1019S, Manchester, N. H.

50 DIFF. Portuguese colonials! 25c. Northeast, Box 6618, Kansas City, Mo.

SCARCE Atomic bomb airmail and 100 all different war-issues, airmails, etc. 10c to approval applicants! Star Stamp Company, Jamestown, New York.

FREE Philatelic supply list. Penny approvals on request. Reed, Box 980, Chicago 90, Illinois.

100 EXOTIC Japan—All different, 10c. Kenmore, Arlington, 74-K7, Mass.

GENUINE "Goya nude" set (catalogs 55c) 15c. Approvals. Royal Stamp Company, Tamaqua, Penna.

110 DIFFERENT Hitlers, Roosevelt, Liberia, Haiti, etc. 10c. Buckey, 208 Ludlow Bldg., Dayton 2, Ohio.

STAMPS Wanted. Collections, duplicates, surplus stock, mint and used. Trade for printing; buy outright if bargain. What have you, what's wanted. Vanroy Shirk, Lebanon, Penna.

FREE Collection—Over 100 different stamps of the world—commemoratives, she-wolf, camels, giraffes, ships, rare Austria race horse, others all to approval buyers; also Scott International Albums, stamp catalogs. Bell Stamp Service, Dept. S-2, Box 190, Bell, California.

ILLUSTRATED Stamp magazine, 26 weeks 25c. Stamp Journal, Kalamazoo, Michigan.

PENNY Approvals that satisfy. Neil Gronberg, Box 5441-P, Philadelphia 43, Penna.

FREE! Beginner's packet! With lists! Stampmart, Box 2071, Hartford 1, Conn.

U.S. Illustrated price list free. DeLisle, 154 S. 2nd St., San Jose, Calif.

"HOW To recognize rare stamps." Book profusely illustrated. Only 10c! Kenmore, Arlington 74-H8, Mass.

OLD Scarce U. S. seconds on approval. Slightly defective. Bargain prices. Hernefield, Clintonhill Station, Newark 8, N. J.

200 DIFFERENT Including Roosevelt triangle, 5c to approval applicants. M. Avalon—Stamp Company, Springfield, Mass.

750 FRANCE And colonies stamps 10c. Littleton Stamp Co., Littleton 25, N. H.

ARMENIA, Ten bicolored stamps, value 75c free to approval buyers. Apex Stamps, Box 2188, Miami 13, Florida.

FREE. Scott's International album, valuable colorful collection, hinges, other big premiums. Full particulars with approvals. Raymax, 123-Z William St., New York 7.

TOPS! Our book "How To Collect Stamps." Send for your free copy today! Littleton Stamp Co., Littleton 37, N. H.

200 BRITISH Empire stamps plus valuable publications only 3c. Kenmore Stamps, Arlington 74-B17, Mass.

FREE—Illustrated catalog! Kenmore Stamps, Arlington 74-C7, Mass.

MAGNIFIER, Big stamp magazine; first U. S. commemorative; plus unused \$5000 Foreign Legion, diamond, giant, and other worthwhile stamps. Everything free to approval buyers. Capital Stamp Company, Little Rock 2, Arkansas.

WORLD—500 Diff. 50c. 1000-\$1.00, 75 Canada 25c. Approvals, lists. Victoria Stamp Company, London 4, Canada.

FREE! Powerful magnifying glass—To approval applicants; also big bargain lists. Jamestown Stamp Co., Dept. 207, Jamestown, New York.

200 DIFFERENT Stamps 10c with approvals. 500 mixed United States 25c. Carlton's, Tujunga, Calif.

DEALERS—Wholesale list. Postage 3c. Frank, 5031 Queensberry, Baltimore 15, Md.

U. S. Price list. Send postage. State Stamp Service, 1225 Park Building, Pittsburgh 22, Penna.

WOW! \$10.00 Worth of fun 10c! What a treasure hunt! Big package 500 foreign stamps, including airmails, pictorials and others from the world over; stamps worth up to 25c each. This offer sent for 10c to approval applicants only. Jamestown Stamp Co., Dept. 22, Jamestown, New York.

WORLD'S Largest stamp (7½x14 inches). A real curiosity! Retail for 50c, only 3c to approval applicants. Tatham Stamp Co., Springfield 30, Mass.

FREE! 100 Worldwide different stamps to approval buyers. Big U.S. and illustrated bargain lists sent with approvals. Bookman, Maplewood, N. J.

ANTIQUES, RELICS, INDIAN GOODS, CURIOS

8 ANCIENT Indian arrowheads \$1.00, tomahawk \$1.00, 4 fine bird arrows \$1.00, list free. Lear's, Glenwood, Arkansas.

1 GENUINE Obsidian Indian arrowhead from northern California \$1.00. No two the same. Frank Estes, 2334 Court St., Redding, Calif.

PRECIOUS STONES, MINERALS

35 COLORFUL Western mineral specimens, identified, carded, boxed, \$3.00 postpaid. H & B Minerals, 714B Francis, Houston 6, Texas.

GEMCUTTING, Silvercraft authority. Illustrated magazine tells how. Cut rocks, make jewelry. 150 ads every issue illustrating lapidary equipment, offering gems for collectors, cutters. Postal brings literature. Lapidary Journal, Box 1228J, Hollywood 28, Calif.

LOST Mines—Buried treasures, southwest, 367 page book, \$2.10. 15 genuine Indian arrowheads, \$2.00. Old Civil War percussion musket, \$15.00. Assortment Texas moss agate, petrified wood, rainbow rock, etc. \$1.00 and \$2.00. All postpaid except musket. Catalogs: Old guns, Indian relics, minerals, old books, Texas current books, 10c each. Old Fort Davis, Fort Davis, Tex.

DIAMONDS For industry. 2 carats weight \$10. No duty. Brilliant halfcarat \$100. Duty 10%. Airmail. Joachim Goldstein, Diamondclub, Antwerp.

AGATES, Cutting machines, mountings. Free list. North West Gems, Box 305, Tacoma 1, Wash.

MINERAL—Treasure locators — Geiger counters. Can be purchased on monthly payment plan. Free literature. Fisher Research Lab., Inc., Palo Alto, Calif.

GEMSTONES, Mineral specimens. Every variety. Lowest prices. Postcard brings free booklet. Plummer's, 2183C Bacon, San Diego 7, California.

METAL Detectors. The very latest circuit. Send 25c for literature. Hedden Metal Detectors, 3329 Liberty Ave., Pittsburgh 1, Penna.

HOBBIES AND COLLECTIONS

50 DIFFERENT Army embroidered patches \$1. Other bargains. Insignia Mart, 703A Broadway, New York 3, N. Y.

INVENTING Can be an interesting and profitable hobby. Write for complete particulars. Institute of American Inventors, Dept. 40-E 631-E St. N.W., Washington 4, D. C.

CAMERAS, PHOTO SUPPLIES

35MM. Owners. Develop, reverse slides yourself in one hour. Thrilling, easy! Black or color. Sample free. Write: Lake Camera Exchange, Drawer 842D, Gary, Indiana.

PHOTOMURALS. Your negatives or ours. Catalogue 25c. Photomammoth Murals, 12048 Vanowen St., North Hollywood, Calif.

GLOW Label equipment decals make panchromatic film loading, developing in total darkness easy! Luminous titles, triangles, dots, etc. help locate equipment. Non-fogging, permanent. Complete dark-room set \$1.00 each. Dime brings literature and sample. Dealers: write on letterhead. Tekni-Labels Company, 732-PM S. Victory, Burbank, California.

CLIPIT—Don't use rubber bands for storage, get film clips for movie film reels. Clips edge of reel and holds film through perforations. Simple to attach and detach. Send 25c for six. Madison Products Co., Toledo 2, Ohio.

BUY Photographic supplies wholesale. Free catalog. Expert camera repairing. Capital Photo Supplies, 2428 Guadalupe, Dept. 2, Austin, Texas.

PARIS In scintillating color. 10 breathtaking 35mm slides \$1.00. Free catalog. Pacemaker Photo, Dept. P21, P.O. Box 809, Chicago 90, Illinois.

PHOTOCOPY Anything—Papers, books. No darkroom. 8½"x11" complete \$6.95. Fotoflek, 3751 St. John's Terrace, Cincinnati 36, Ohio.

KODACHROME Slides. 35mm 2x2. Stereo—realist art originals. Stereo—realist world scenes. Lists. Pan-Atlantic Color-slides, Box 182B, New York 31, N. Y.

FREE Photographic bargain book packed with hundreds of sensational values in still and movie cameras, lenses and latest accessories. Super savings for you in new and used equipment. Liberal trade-in allowances, too, on your equipment. Write now for your free copy to Central Camera Company, Dept. 9E, 230 S. Wabash Ave., Chicago 4. (Photographic headquarters since 1899.)

BASS Says: Bargaingram 257 ready and waiting for you. The book which tells all. The finest in new and used camera equipment, a veritable encyclopedia. Write, phone or call the sign of the old "Horse Trader." 39th year of satisfaction or your money back dealing. Bass buys, sells and trades. Bass Camera Company, Dept. AG, 179 W. Madison St., Chicago 2.

PHOTO FINISHING

GRAPHIC For quality! 8 exposure roll printed regular size, 25c. Oversize 35c. 12, 55c; 16, 65c. Reprints 4c. 35mm 36 exposure fine grained, enlarged 3¼"x4½", \$1.25, 20 \$1.00. Fast service. Satisfaction guaranteed. Price list, mailers on request. Graphic Photo Service, Dept. M, 8 Saint John Street, Plains, Pennsylvania.

AUTOMATIC Photo-electric finishing. 8-25c; 12-40c; 16-55c. Oversize, add 10c. Mississippi Finishing, 2212 East 12th, Davenport 4, Iowa.

ROLL Developed and 8 oversized prints in handsome album folder 35c; 12 exposure 50c; 16 exposure 65c. Techni-Foto, Lorain, Ohio.

ROLL Developed, 16 prints 25c. Reprints 2c. Dick's Photo, Louisville 12, Ky.

NEGATIVES Enlarged 4x5, beautifully colored, 50c. Mr. Frazier, 305 84th St., Brooklyn, New York.

GREAT NEWS! New low price on our famous jumbo oversize finishing. New Chicago plant with latest, exclusively-improved equipment produces new high-quality work. 8-exp. roll deluxe finish only 30c. 12-exp. 45c. 16-exp. 55c. 36-exp. \$1.25. Oversize reprints 4c. Send us your next order, magnificent results will delight you. Century Photo Service, Box 5208, Chicago 80, Ill.

16 **CONTACT** Prints from 8 exposure roll 35c. Reprints 3c; 40, \$1.00. Double size prints in album book—8 exposure roll 30c; 12, 45c; 16, 60c. Reprints 4c; 30, \$1.00. Apex Photo Service, Box 197, Bronx 51, New York.

DOUBLE Size prints. 8 exposure roll 30c; 12, 45c; 16, 55c. Same day service. Send for free mailers. Emerson Photo, Box P, Emerson, N. J.

YOUR 8 Exposure roll developed and 8 sparkling Photopak fan fold prints in album 25c. 12 exposures 40c. Mail-A-Film Service, Box 90 GPO, New York City.

AUTOMATIC Photo-electric finishing. 8-25c; 12-40c; 16-55c. Oversize, add 10c. Mississippi Finishing, 2212 East 12th, Davenport 4, Iowa.

UNBEATABLE For quality and price. You will be surprised and pleased with the beautiful results from our celebrated jumbo oversize finishing. New low prices, same as contact. 8-exp. roll superfine finish only 30c. 12-exp. 45c. 16-exp. 55c. 36-exp. \$1.25. Oversize reprints 4c each. Send us your order, you will be delighted. Free mailers. Mailbag Film Service, Box 5440A, Chicago 80, Ill.

FREE Price list on quality developing, printing, enlarging. Write for it today. Bryan's Photo Shop, Dept. M, Panama City, Florida.

SAVE Money on developing and printing. Send this ad and 15c with any 6 or 8 exposure roll or 25c with any 12 or 16 exposure roll. Initial order only, one roll. Economy Photo Service, Box 1251-C, Saginaw, Michigan.

OIL Coloring photographs can be a fascinating hobby or profitable sideline for those with artistic talent. Learn at home. Easy simplified method. Send for free booklet. National Photo Coloring School, 1315 Michigan, Dept. 343B, Chicago 5, Ill.

BEAUTIFUL Enlargement from each picture on roll 30c. Cut Rate Photos, Dept. B-4, Janesville, Wisconsin.

AMERICA'S Finest 35 m.m. fine grain developing. 20 big 3½" x 5 enlargements, \$1.50; 36, \$2.00. Established 1926. Photo-shop, Linton 3, Ind.

8 **BEAUTIFUL** Double size pictures and roll developed 30c. 8 hour service. Free mailers. Pacific Photo Service, Box 666, San Francisco, Calif.

GIANT Size prints. 8 exposure roll 35c. 12—50c, 16—65c. Cain's, Box 4872 Florence Branch, Los Angeles, Calif.

8 **HOUR** Service. Your 8 exposure roll printed jumbo or regular size 30c; 12 exposures 35c; 16 exposures 50c; 20 exposures 75c; 36 exposures \$1.00. Reprints 3c. Fine grain developing. Send for mailers. Quality Photo Service, Box 468A, San Francisco 1, Calif.

Two Beautiful prints from each picture on roll 30c. Twenty-nine years of satisfied customers. Quick service. Lens Photos, Dept. J-4, Janesville, Wisconsin.

MOEN'S New equipment, better prints quick as a flash. 8 exposure rolls developed and printed contact size 30c, reprints 3c each; 8 supersize genuine Moentone prints 35c. Mailers free. Moen Photo Service since 1898, 41 Moen Bldg., LaCrosse, Wis.

FREE 5 x 7 Enlargement with each roll developed and printed. 6 or 8 picture roll 35c. 12 or 16 picture roll 55c. Send coin with roll. No c.o.d. If you fail to get pictures on your roll of film, we will mail a new roll to you at no additional cost. Overnight service. Mailers sent free on request. Deluxe Film Service, Box 1268, Shreveport, Louisiana.

2 **BEAUTIFUL** Hi-Gloss prints each good negative and enlarging coupon with each 8 exposure roll developed 28c. Free mailers. Owlphoto Co., Weatherford, Oklahoma.

PHOTO Handbook tells you how to take, develop and print your own pictures, build your own enlarger, etc. For the amateur and professional photographer. 160 pages, \$2.00. Popular Mechanics Press, 200-PF East Ontario, Chicago 11, Illinois.

MOTION PICTURES AND SOUND EQUIPMENT

NEW \$17.50 16MM. sound musicals, cartoons, \$9.95, \$8.95. New \$9.75 sound cartoons, \$5.95. Big bargain list free. Blackhawk Films, Dept. PME, Davenport, Iowa.

SOUND Recording tape—Leading manufacturer's surplus. Sold on money-back guarantee f.o.b. Opelika. 600' paper base 65c (plastic \$1.00). 1200' paper base \$1.00 (plastic \$1.50). Talking Tape Distributors, 506 North 3rd Street, Opelika, Alabama.

ADD "Spice" to home projection shows with old-time Nickelodeon slides. 2x2. Kodachrome. Write for free list. Nickelodeon Co., New Fliedner Bldg., Portland 5, Oregon.

1000' 16MM. Silent-sound film \$7.50. International, 2120 Strauss, Brooklyn 12, N. Y.

FREE MOVIES. Thousands of subjects. Interesting. Entertaining. Fascinating. Latest directory—only 50c. National Cine Society, 126 Lexington Avenue, New York 16, N. Y.

FREE List 16mm s.o.f. Belmont Films, 76 Forest Way, Clifton, N. J.

WILD Game films. 8mm., 16mm. natural color, black-white. Taken in natural habitats by famed Eberhart organization. Send for free list. Wild Life Films, Dept. 8-PM, 6063 Sunset Blvd., Hollywood, Calif.

16MM **Hobbyists**—Send 10c stamps for illustrated list of well known manufacturer's slight seconds of sprockets, rollers, shafts, etc. Post Office Box 902, Mission, Kansas.

SUNSHINE And health films available in 8mm and 16mm. Write for free catalog. Tel-A-Film Co., Dept. PM, 935 Cincinnati St., Dayton, Ohio.

BETTER 8MM. and 16mm. movie camera film. Free equipment catalog. Better Films, 742 New Lots, Brooklyn 7, N. Y.

NOVELTY Film, 16mm. Sound and silent. Free list. Sherman, Box 11463, Briggs Station, Los Angeles 48, Calif.

"THE World's Greatest Passion Play." 8mm., 16mm. and 35mm. Specify silent or sound. Rent or purchase. Hemenway Film Co., 33-F Melrose St., Boston 16, Mass.

SNOW White movie screen paint. Free literature. 126½ West Main, Danville, Illinois.

RENT 16MM. sound films, 50c reel. Rogers Films, Box 26, East Atlanta, Ga.

8-16MM. Silent-sound films. Complete rental library. All latest subjects. Free catalogue, (sample film 10c). Garden Film, 317 West 50th, New York 19.

BASS Says: 39 years of leadership guarantees satisfaction. Finest cine equipment, 8mm., 16mm., and 35mm., silent and sound. Write the old "Horse Trader." Satisfaction or your money back always! Bass Camera Company, Dept. A, 179 W. Madison St., Chicago 2.

MAGAZINES, 16MM., new! Empty, 50c. Loaded fresh film, \$1.25! Processing service. 10% discount six lot! Catalog, Eso-S, 47th Holly, Kansas City 2, Missouri.

UNUSUAL 8 And 16mm. films, used by many art students. Write for free catalogue. Send 25c for sample strip. Friart, 140-A-Liberty Street, New York 6.

GUARANTEED Fresh anti-halo outdoor movie film! Weston 16! Daylight loading! Processing free! Three spools double 8 mm. \$4.50! Six single 8 mm. for Univex. \$4.60! Postpaid! Catalog, Eso-S, 47th Holly, Kansas City 2, Missouri.

RENT 16MM. sound films, 50c reel. Large selection; free catalog. Film Service, 128 Chestnut St., Roselle Park, N. J.

MUSIC AND MUSICAL INSTRUMENTS

YOU Can play the piano by ear—in one week by the quickest, easiest, short cut system in the world. Gives all tricks and pointers for playing correct bass with left hand, the main secret in playing by ear. Write Hoover Specialties, RD 2, Chambersburg, Penna.

WRITE Songs. Big money and reputation. Write for information. J. Gordon Pub. Co., 4700 South California Avenue, Chicago.

NEW Interesting recording deal. Details. Turner, P.O. Box 2201-M, Bridgeport 8, Conn.

YOUR Voice! made loud, clear, powerful with my diaphragm exerciser. Write, Inventor "Oz." 34a—Box 665, St. Louis, Mo.

POEMS Wanted for musical setting. Send poems for free examination. Five Star Music Masters, 630 Beacon Bldg., Boston, Mass.

PROFESSIONAL Songwriting services. May we help you? Associated, Box 95-A, Times Square Station, New York City 18.

RECORDS Guaranteed new. Hillbilly, popular, spirituals, 4 for \$1.00. Free record with first order. Free catalog. Mailorc, Dept. 96, 570 N. Gay St., Baltimore 2, Md.

WANTED! Poems for musical settings. Write Songwriters' Service, Clifton, N. J.

POEMS Wanted. Percentage basis collaborations. Terry Tune Master, 709½ PM North Broadway, Oklahoma City 2.

POEMS Considered for musical setting. Send poem for free examination and useful rhyming dictionary. Richard Brothers, 24 Woods Building, Chicago.

SONGWRITERS! Outstanding, ethical offer. Hibbler, C-5, 2157 N. Avers, Chicago 47.

SONGWRITERS! Send poems, songs. Music Service, 243 West 72nd St., PM, New York 23.

1950 ACCORDIONS — Wholesale. Free catalog. American Accordion Center, 5329 Belmont, Chicago.

POEMS Wanted to be set to music. Free examination. Send poems. McNeil, Master of Music, 510-PM S. Alexandria, Los Angeles, California.

MUSIC Arranged, songs printed. Frank Wildt, Music Publisher, Lancaster, Penna.

RADIO AND TELEVISION

FREE—Send for latest radio catalog and bargain bulletin. Has thousands of top values in television, radio, electronic supplies. Concord Radio Corp., Dept. LH-50, 901 W. Jackson, Chicago 7, Ill.

15 TESTED One-tube circuits 25c, including "Radiobuilder," catalog. Laboratories, 578-C. San Carlos, California.

BUILD Crystal set, crystal and clear instructions 25c. Hubbard, Baker, Oregon.

AMAZING Distance reception on one tube radio. Pictorial plans 25c. Arthur Alena, Wall Street Station, Box 271, New York 5.

TELEVISION And radio engineering taught practically, also electrical engineering, armature winding, electrical drafting. Day and evening classes. Special correspondence courses. G. I. approved. Canadian School of Electricity, 282 Ontario W., Montreal.

MAKE Simple, tubeless, batteryless, distance-getting crystal radios. Crystal and illustrated instructions 25c postpaid. Allen, 427-P, Clinton, Mo.

BUSINESS OPPORTUNITIES

DYNAMIC Sales kit sells for you. Photo-Kolor postcards. Sensational, new, full-color photo postcards; for manufacturers of toys, radios, autos, lamps, rugs, resorts, hotels, etc. Amazing low cost sells 9 out of 10. Terrific demand, earnings! Send 50c (refundable) for dynamic sample sales kit. Details free! Moss Photo Service, Dept. 200, 155 W. 46 St., New York City 19.

MAKE Products yourself. No machinery needed. Work at home. Build big business. One and two ingredient formulas. Over 50 fast sellers. Just package and label. Complete set only \$1.00. Nelko Chemical Service, 3462-F Merchandise Mart Sta., Chicago 54, Ill.

LEARN Sewing machine repairing at home. Earn \$125.00 week spare time. Plus, new machines, motors, etc. wholesale. Free particulars. Taylor Service Co., Hamilton, Ohio.

MAKE Money spare or full time casting metal toys and novelties. Big wholesale and chain store demand for autos, soldiers, ashtrays, banks, etc. keep manufacturers busy. Production moulds furnished for up to 100 and more castings per hour. No experience or special place necessary. "Cash-in" on holiday orders now being placed. Write for information and illustrations of patterns needed. Metal Cast Products Co., Dept. A, 1696 Boston Road, New York 60, N. Y.

OWN A printing business. Good profit printing cards, stationery, etc. in spare time. Easy rules furnished. Have home shop. Send dime for complete printer's supply book and samples. Kelsey, Inc., Z-24, Meriden, Conn.

SELL By mail from home. Start small, spare time. Be independent. Booklet, "How to Build Your Own Mail Order Business", sent postpaid for 25c. Walter Bevil Publications, 3408 Avenue G, Fort Worth 5, Tex.

PUBLISH Interesting ready-made 64-page magazine under your name. Many benefits. Low starting capital—Big spare-time profits. No experience necessary. 25c brings sample copy and 16-page booklet giving complete money-making details. Write Aloha Company, 1438-M Brownlee, Corpus Christi, Texas.

MAGAZINES—Trade and class. Help you get ahead. Latest copies. Nearly 1200 covering every business, trade, profession, sport, hobby or other interest available through our easy-to-get acquainted service. Particulars and pricelist free. Commercial Engraving Publishing Co., 34C North Ritter, Indianapolis 19, Indiana.

HOW And where to obtain capital. Small and large loans. Free particulars. Star Service, Wapakoneta, Ohio.

BOOKKEEPERS Earn \$100.00 week up-erating your "bookkeeping service." Simplified plan. Information free. Bookkeeping Service, Box 664-M, Springfield, Missouri.

SOMETHING New — Preserving baby hand and foot prints with life like relief as beautiful wall plaques. Complete course, equipment and material offered. Details. Steepleton, 3136 Walnut Street, Huntington Park 2, California.

FABULOUS Earnings—Fascinating pastime. Growing genuine, living miniature (Ming) trees. New sensational business or hobby. Astounding information free. Dwarf Trees, Box 355, Briggs Station, Los Angeles 48, Calif.

ANNOUNCING Home study course in commercial baking. Practical basic training. Good field for those with aptitude. Nearly depression proof. Send for free booklet, "Opportunities in the Baking Industry." National Baking School, 1315 Michigan Ave., Dept. 343C, Chicago 5, Ill.

ACHIEVE Business and financial success in your own collection-credit agency business. Home or office. Quickly learned. Free folder. Write Cole & Associates, Syracuse 2, N. Y.

START Your own business on credit. Always your own boss. 1554 dealers, sold \$5,000 to \$26,500 in 1948; their average \$6,742. We supply stocks, equipment on credit. 200 home necessities. Sales experience not needed to start. Wonderful opportunity to own pleasant, profitable business backed by world-wide industry. Write Rawleigh Co., Dept. H-U-PPM, Freeport, Ill.

LEARN Piano tuning, repairing — at home in 30 days. Unlimited income. Phonograph recordings, tools and instructions furnished. Write Capitol City Tuning School, Department C-834, 129 East Michigan, Lansing 16, Michigan.

BIG Money! Spare or full time in your home. No selling! Spray new miracle finishes, plush and suede, on signs, radios, automobiles, figurines, lamps, toys, etc. Our business is booming. Help us fill huge demand. New easy Flok-Kraft methods. Material costs few pennies. You get dollars. Free samples, complete powerful money-making plan free. Write now! Coast, 1002L S. Los Angeles St., Los Angeles 15, Calif.

"WATERLESS (Lanolin) Hand Cleaner." (Oil base.) Make, sell. No machinery. Build profitable business. Complete formula \$1.00. Ideal Service, Park Ridge 1, Ill.

LEARN Typing, bookkeeping, business plans, mail order schemes. Formulae, postal data, miscellaneous tables. Reliable old book. Send stamp. Lackey, 1128 Delaware, Detroit 2, Michigan.

FREE! Complete details. Operate profitable mail order business. Everything supplied. Successful "beginner's" plan. Lynn, 5710-M Bankfield, Culver City, California.

NEW Profitable home business repairing zippers. Thousands of customers waiting. No experience required. We furnish everything. Write Texas Specialty Company, 204-B Texas, Texarkana, Texas.

IMPORT-Export! Men, women. Learn from established world trader. Your own profitable world-wide business by mail order from home without capital; or travel abroad. Experience unnecessary. Free details. Mellinger, C-1, Los Angeles 24.

MIRROR Resilvering. Wonderful home business. Complete formula 25c. Magic two-way mirrors. You can see out—no one can look in. Formula 50c. How to make coppered mirrors, vases, glasses. Formula \$1.00. All three \$1.50. Nelko Chemical Service, Box 3462, Chicago 54, Ill.

WEST And northwest Canada. Tourist attractions, oil, mining, farming, trapping, hunting. Alaska highway. Land of opportunities. Booklets, maps. Any information. \$1.00. Box 354, Edmonton, Alberta, Canada.

MAKE Perfumes—Profitable mail order business. Information free. "International", 6347 Parnell-PM-8, Chicago 21, Ill.

SEND One dollar and I'll show you how to receive dozens of dollars daily by mail. Christian, 727-D West Main, Ashland, Ohio.

25 PROFITABLE Page-size mechanical drawings, waste can projects, 50c. Inquiries welcomed. Dowel Krafters, Route 2, Box 210-A, Hampton, Virginia.

OPERATE Profitable mailorder business. Particulars free. George Lenhoff, Lincoln 8, Nebraska.

AMIDON Fittings for pipe scaffolds. Amidon Engineering Co., Elyria 4, Ohio.

HOME Electroplating units \$8.95. Includes tank, rectifier. Free details. Reed Engineering, 620 So. Inglewood, Inglewood, Calif.

MAKE Tough, durable plastic—1c pound. Makes attractive floors, walls, built-ins, roofs. Build good home, \$150.00 room. Bays Laboratory, Oklahoma City 9.

EXPORT-Import offers trained men unlimited big paying job opportunities, own business, independence, etc. Free facts book. Write International Trades, 246-P, Fifth Ave., New York City 1.

EARN Money by mail with my plan. Free details. Satterfield, Box 345-C, Mansfield, Ark.

MAKE Perfumes. Men, women. Write Carey Laboratories, 1914 Chouteau, PM8, St. Louis 3, Missouri.

PROFITABLE Mail selling propositions free! Wehner, Box 142-A8, Roxbury 19, Mass.

I MAKE Big money in the mail-order business. You can do the same at home with copyrighted system. Write me and I'll tell you how. F. Little, R.D. #1, Glenshaw, Penna.

START Mailorder business. Complete plan. Satisfaction or refund. Valuable sample 25c. Hughes, 4327 Dalton, Los Angeles 62.

BRONZED Baby shoe mountings, equipment and supplies. Buy wholesale from world's oldest and largest manufacturers of all metal mountings. Sales Dept., Hollywood Bronze Supply, 6141 S. Wentworth Ave., Chicago 21, Illinois or 1766-70 North Vermont Avenue, Hollywood 27, Calif.

WITH An Acme filer, 40 hand saws can be sharpened per day. At \$1.00 per saw, that could be \$40.00 in your pocket. Send for free literature. Max Mfg. Co., 138 Stockton Ave., San Jose 11, California, makers of the famous Acme sharpeners for circular saws.

FIX Typewriters, full or part time. In-expensive copyrighted home study course quickly trains you for high earnings. Factory methods cover all phases with drawings and illustrations. No curiosity seekers. Typewriter Repair, 8915 Corbet, Tarentum, Pennsylvania.

BE Successful in your own business. Avoid costly errors. Bulletin listing over 300 supply sources for best informative material \$1.00. Research Unlimited, Box 1284, Milwaukee, Wis.

START Well-paying home mailorder business. Amazing opportunities. Literature free. Rowland Plain, 1 Laurel Ave., PM-83, Binghamton 44, New York.

BIG Profits, new idea in garden and lawn ornaments. Information free. Practical Products, Box 51, Scottdale, Ga.

SAWDUST. Turn it into cash. Six methods. Instructions 25c. Charles Co., 12-AWS, Norwood, Ohio.

WANTED. Men to operate profitable electroplating and mirror shops at home, part time or full time. We furnish electroplating equipment and training. Write Tyco Metals, Box 12008V, Houston 17, Tex.

WHERE To buy 500,000 articles wholesale. Details free. Krueger, 3418M Wolcott, Chicago 13.

LEARN Gun repairing at home. Profitable. Modern Gun Repair School, Box 717, Dubuque, Iowa.

SELL Delicious snowballs. 400% profits. Ice shaver and flavors for 500, \$2.00. Supplies list free. Snowball Company, 9534P Lemturner, Jacksonville 8, Florida.

BETTER Jobs in electroplating! Free details. Joseph Kushner Electroplating School, Stroudsburg 774, Pennsylvania.

FASCINATING Machineless process offers \$200.00 weekly, renewing carpets, upholstery, scientifically. Puraclean, 17 V, East 42nd, New York 17.

LEARN The profitable and fascinating art of electroplating baby shoes at our expense! Write for details to manufacturers of world's largest assortment of plating mounts, equipment and supplies. Dept. W1, Hollywood Bronze Supply, 6141 So. Wentworth Ave., Chicago 21, Illinois or 1766-70 North Vermont Ave., Hollywood 27, Calif.

900% SELLING "Silver detarnishing plates," 508-PM8 NY. Street, Aurora, Ill.

SPIN Angora wool into yarn. Interesting work. House of Angora, PM5, Springfield, Illinois.

HOW You can have income for life. Churches, bazaars, son or daughter. We supply you. Nothing to buy. Soliciting business. Write. Mrs. Harry Walters, Mediapolis, Iowa.

SENSATIONAL Nylons guaranteed against runs. Nationally advertised. Not sold in stores. No experience or money needed. Also lingerie, robes, men's hosiery. Outfit, sample, etc. free. Wonderful opportunity earn big money spare or full time. See our full page advertisement on page 57. Kendex Corp., Babylon 146, New York.

EASY To make expensive perfume with low cost "essential concentrate base." Fast, tremendous profits. Write post card. H. May, Box 4473-P, Coral Gables 34, Fla.

MAKE Classy glass ornaments, new, nothing like them, cost 1/2 cent, large profits, huge market, dandy hobby. Samples, diagrams, instructions \$1.00. Hobby, 243 S. Lexington, St. Paul 5, Minn.

START Own business in spare time from home. Fifty formulas—one dollar. Star, Box 21, Brooklyn 14.

FREE Details. "The Magic Formula for Mailorder Success." Mailord Company, 204-C8 East 81, New York 28, N. Y.

OPERATE Profitable mail order business. Write Macs' Service, 214B S. Broadway, Greensburg, Ind.

MAKE—Sell sensational new product. 300% profit. No machinery, just add water. Everything supplied. National, Box 88-F, Boston 22, Mass.

HOME Business making statuettes, plaques, artificial marble, rubber molds. Silvering mirrors. Formulas. Folder free. Creative, 236-L, Winnetka, Illinois.

\$35 WEEKLY! Home! Two hours daily! Free! Walsh, 894 Main St., Buffalo 2, N. Y.

START Home manufacturing business making cleaning compounds, soaps, insecticides, cosmetics, polishes, food flavors. No machinery. Literature free. Kemix, Park Ridge, Ill.

SEND For "1001 Ways to Make Money," 25c (refundable). 1001 Opportunities Club, 1495 Westchester Ave., New York 59.

LIQUID Rubber. Make flexible molds. Free sample. Chaney, 1130 E. 16th St., Jacksonville 6, Fla.

EARN At home casting novelties. Free instructions using latex molds. Major Chemical Company, 164 Portland Street, Cambridge 39, Mass.

EARN Money at home with your typewriter! Spare time! Details free. Edwards, Publisher, 3915-PM, 12th, Des Moines 13, Iowa.

COLOR Concrete with chemicals. Marble-glaze cement benches, pottery, garden ornaments. Home-shop. 10c brings sample, pictures. Hollywood Cementcraft, 8527-R Wonderland, Hollywood 46, Calif.

MEN—Women. Everybody likes candy. Learn to make professionally. Our 40th year. Ragsdale Candies, D5, East Orange, New Jersey.

BUY It wholesale! Manufacturers, distributors offer 850,000 items. Literature free. Olsen, 1231-A East Third St., Duluth 5, Minn.

UNPAINTED Figurines. Beautiful models. Write for new wholesale price list. Oman, 642J Broadway, St. Paul 1, Minn.

RESURFACE Butchers' chopping blocks with easy, fast working, portable electric machine. Unique service in wide demand with little competition. Large steady profits from full or part time work. Hill Machine Company, Box 677B, Rockford, Ill.

THOUSANDS Articles wholesale. "Supply Source Directory" 10c. Ideal Service, Park Ridge 30, Illinois.

MEN Make big money in moving picture business. We furnish sound projector and films. Small weekly rates. Experience unnecessary. Southern Visual Films, Dept. P.M., 686 Shrine Bldg., Memphis, Tenn.

SPECIAL Rubber for making molds. Literature and sample free. Universal, Box 1076-A, Peoria, Ill.

COPUBLISH Leading m.o. paper. Latest copy Mail Sale Advertiser, details, dime. Vanroy Shirk, Lebanon, Penna.

MADE \$24,500 Using money making plans from Schemer Magazine, world's oldest mailorder publication. Box 775M, Alliance, Ohio. Year \$2.00. Sample 20c.

WRITE For free booklet and catalog telling how to earn substantial profits in your spare time by forwarding new and renewal subscriptions to all magazines for your friends and neighbors. Oldest U. S. agency. Established 1869. Moore-Cottrell, North Cohocton, New York.

MAKE Flexible molds! Cast plaques, bookends, figurines! Free sample! H. Tooker, 630-R Chestnut, Hamilton, Ohio.

USE Your home as magazine subscription station. Represent all magazines. Liberal commissions. No experience—no capital needed. Catalog, full details free. Write McGregor Magazine Agency, Dept. 500B, Mount Morris, Ill.

BE Appointed state notary public now! Details. Stationers, Helotes 50, Texas.

COMMERCIAL Deep frying course. Mock chicken legs, potatoes. New and proven methods. Learn about this money-making field. \$2.50 p.p. Concession, Toledo 13, Ohio.

MAKE Rubber stamps, metalize baby shoes, repair dolls, silver mirrors, make beautiful figurines. Catalogue of "30 ideas" free! Universal, Box 1076-A, Peoria, Ill.

LAMPS—Earn money building and repairing in your home. Easy-to-understand wiring charts and detailed instructions in illustrated catalog showing all parts. Send 25c. Gyro Lamps, 5404 P Clark, Chicago 40.

GOOD News! Save time and money on your business correspondence. Write for details. Tepco, New Providence 2, New Jersey.

NATURAL Molding Latex. Extra thick. Free sample. W. Wooley, 115-A Donald,

MAKE Upholstery cleaner at home. No experience. Gallon sells \$1.69—costs 10c. Quart size, full details 25c. Kohne, 506 West 45th, Chicago.

PROFITABLE Business making and building with easy-laying interlocking building blocks. Rex Products, Dept. 10, Piqua, Ohio.

POPCORN Poppers, peanut roasters, copper candy, caramelcorn kettles. Northside Co., Indianola, Iowa.

\$250 WEEK Reported! Free illustrated book "505 Odd Successful Businesses." Work home! Expect something odd! Pacific-E, Oceanside, California.

PEARL Finishing—New, amazing; huge profits. Start making big money first day. Free facts show easy way to \$25 to \$50 per day at home. No experience needed. No course of instruction to buy. Be first, scoop the market. Write Pearl-Kote, Dept. R, 2111 West Manchester, Los Angeles 47, Calif.

200 NEW Money making plans, tips, ideas for increasing your income. Folio free. Reynard Pub., Smithfield 3, Ohio.

A FACTORY in your home, garage! Mfg. and sales rights, mechanics' waterless hand cleaner, glass cleaner, and amazing "Lazybones" auto cleaner-polish, \$500-\$800 monthly. No special equipment necessary. All formulas free. Western Aircraft Mfg., Dept. D, Los Angeles 6, Calif.

YOUR Own profitable home business. Preserve live flowers to last forever. New simple discovery. Enormous demand all year 'round. Tremendous profits! Light fascinating work. Send \$2.00 for working equipment, instructions, and valuable sales plans. Satisfaction guaranteed or money promptly refunded. Alfred Hermansen, 210 Fifth Ave., Suite 1102A, New York 10, N. Y.

YOUR Home as headquarters make a product to clean dirty mechanic hands in 30 to 50 seconds without water. Big profit. Postcard gets free folder. Harbin, Box 4624, Atlanta 2, Ga.

\$25 WEEKLY Working two hours daily. No canvassing. No manufacturing. Lycke, Box 2471-A, Cleveland 12, Ohio.

POPCORN And potato chip equipment. Long Eakins Company, 5060 High, Springfield 99, Ohio.

WANTED Unused U. S. postage stamps, small discount. Advance Stamp Co., 24 East 23rd St., New York.

CO-PUBLISH And advertise in The Central Mail Advertiser. Sample copy 10c. Low rates. Large circulation. Bagby Printing Co., Georgetown, Ohio.

EARTHWORM Breeding. Valuable bulletins on successful methods mailed free. Earthmaster Publications, Dept. 14, Sun Valley, Calif.

LIQUID Marble—Colorful, glossy! Molded, brushed, sprayed! Cast novelties, statuary, colored tiles. Flexible molds. Composition floors. Particulars free. Marbleizing Service, Edwardsville, Illinois.

EXTRA Money. No selling; operate vendors. Amazing profits, details free. Silver King, Suite B, 622 Diversey, Chicago 14.

UNPAINTED Bookends, plaques, statuettes, figurines. List. Haverty Products, 1219 8th Ave., Altoona, Penna.

RESILVER Mirrors at home. Formula 25c. Ideal Service, Park Ridge 8, Illinois.

HOW To set up and run a mirror shop! Resilver mirrors. Make chipped glass nameplates. Electroplating salts and rectifiers. John Sprinkle, V60, Marion, Indiana.

CASH For your idea, 280 manufacturers need inventions, patented or unpatented. List free. Invention Bureau, 208M Clinton, Oak Park, Illinois.

MAKE Money making new greaseless doughnuts at home on electric machine. Wholesale to grocers, drug stores, cafes, hamburger shops. Send for free recipes and plans. M. Ray Company, 3605 South 15 Ave., Minneapolis 7, Minnesota.

RECAST Old batteries into new. Latest achievements. Battery Laboratories, Minneapolis.

READ "Advance"—The voice of mail order. Offers money-making opportunities, sources of supply, personal guidance, etc. Issued monthly. Sample copy 25c. Yearly subscription \$2.00. Advance Publishing Company, 313 East 21st Street, Suite 450, New York 10, N. Y.

START Mailorder bookshop—Everything furnished. 25c brings booklet, samples, exciting ideas. General Publications, Ossining, N. Y.

OPERATE Profitable mail order business. Write Walter Service, 4159-A East

A BUSINESS In your own home! Our chemicals, plus free water and cheap "grocery store" materials can bring you over \$500 monthly earnings. Plans and formulas free. Chemica Division, 1269 S. Norton, Los Angeles 6.

MAILING Postcards selling repeat merchandise is profitable. Everything supplied. Details free. Gordon Publishers, Box 23, Pawtucket, R. I.

137 WAYS To make money, in home or office, business of your own. Full particulars free. Elite Co., 220 Grand St., New York 13.

BRUSH Plating outfits connect to a battery. No tanks necessary. Good paying business at home plating autoparts, bathroom fixtures, bicycles, reflectors, silvering mirrors. No shop or experience required. Outfits furnished. Free booklet. Gunmetal Co., Ave. H, Decatur, Ill.

COLORGLAZED Concrete pottery made without molds. Patented method. Cemetery products, novelties, tiles. Basement leak-sealing. Money-making projects. Booklet, details free. Men only. National Potteries Company, Grand Rapids, Minnesota.

MONEYMAKING OPPORTUNITIES

BOOKKEEPERS Boost income operating simplified bookkeeping service. Kern, 4942 Vineland Ave., No. Hollywood, California.

6 DIFFERENT Moneymaking mail-order magazines, \$1.00. Wilbur Erickson, Englishtown, New Jersey.

SELL "Fortune's Favorite Mailorder Plan." Details free. Ad-man Dankmeyer, 2831A Guilford, Baltimore 18, Maryland.

MAKE Money. Plans for making improved block handsander. Low mfg. cost. Profitable sideline. Send \$1. Rm. 103, 5617 Hollywood Blvd., Hollywood, Calif.

BUY Wholesale—Million articles. Supply source directory, dime. Free samples, hundreds of advertised items. Supply Source Directory 25c. Nelko, Box 3462, Chicago 54, Ill.

BARGAINS In moneymaking arc welding. Electric or gas engine, a.c. or d.c., portable or stationary. Write needs. Hobart Welders, Box M-804, Troy, Ohio.

CHURCHES, Ladies' clubs receive \$130.00, 12 tables. You sell advertisements for tables. Unique Gift Club Plan, Pine Hill, New Jersey.

\$15 HOURLY Spare-time, without investment! Aichner, 267-H1 Maple, New Wilmington, Penna.

EARTHWORMS—150 Hybrid Breeders, eggs, culture \$1.60 postpaid—Guaranteed—William Barnard, 2121 Vanderbilt Lane, Redondo Beach, Calif.

INDEPENDENT Income! Make leather belts, billfolds, purses. Big catalog and genuine steerhide keyholder, 10c. Tandy Leather, Box 397E, Tulsa, Okla.

EARN Money at home! Thousands do! "Home Worker Magazine" tells how. Sample, 25c. Sizemore, Box 7, 4917 Kostner, Chicago 30, Ill.

BIG Orders await you as novelty manufacturer. National organization offers opportunity manufacturing fast selling designs by ornamental casting. Big profits. Plastercraft, 359 3rd St., San Bernardino, California.

CONCRETE Birdbath, frogs, lawn ornaments, metal molds, gardenware. 404 Stilz, Louisville 6, Ky.

EARN Money evenings, copying and duplicating comic cartoons for advertisers. Adservice, Argyle 1, Wisconsin.

RUN Low cost ads—Mail postcards offering books, merchandise. Big profits. Everything supplied. Write: National, Box 88-H, Boston 22, Mass.

"MAIL Order Naturals"—Your guide to rich profits in mail selling. Interesting details free. E. Lay, 3819 Kenmore, Chicago 13.

BIG Money in saw filing by new method. Information free. Zapart, 586 Manhattan Avenue, Brooklyn 22, N. Y.

IF You have ever had an idea for anything that can be manufactured at all, this is your opportunity. Write today. Free details rushed! Inventions Unlimited, 1509 No. Cooper, Colorado Springs, Colo.

EARN Money by mail, like I do! Free details. House of Friendship, Bowen Court, Douglas, Mass.

DISTRIBUTE Sensational songwriter booklet, "Commercial Music." Ideal home mail-order business, publication, details, discounts, \$1.00. Popular, Box 927, Atlanta, Georgia.

QUICK Profits taking magazine subscriptions, handling greeting cards. Cassell Publishers Service, Westfield, N. J.

BUY Nylons direct from mill. Make good profits on fast selling nylons. Quick delivery on any quantity. Write for confidential wholesale price list. Joy Hosiery Mills, Delaware 13, New Jersey.

MAKE And sell a proven item welcomed by smokers like I do. Details free. Thos. W. Mogck Laboratories, 40 Wood St., Camden 2, N. J.

WESTERN Advertiser offers many worthwhile moneymaking opportunities. Sample copy free. H. Edlund, 557 Kensington, Los Angeles 26, Calif.

LEARN Professional candy making profitable home business. Details 10c. Pate, Kissimmee, Florida.

RAISE Your business value, standing, as state notary public. Information. Stationers, Helotes 50, Texas.

\$250 WEEK Reported! Free illustrated book "505 Odd Successful Businesses." Work home! Expect something odd! Pacific-E, Oceanside, California.

EASY Ways to earn extra income are described in Money-Making Hobbies. 132 projects you can make at home and sell anywhere. 160 pages, \$1.98. Popular Mechanics Press, 200-MH East Ontario, Chicago 11, Ill.

DOLLARFUL Ideas for you every month in advance—"Voice of Mail Order." Leads the field in exclusive supply sources. Plans for mail order operation; new products, etc. Details free. Advance Publishing Company, Suite 350, 313 East 21st Street, New York 10.

PUBLISH Your own magazine. Handsome 52 page format, well edited, illustrated. Cost low as \$1.00 month. Brings you prestige, profits. 25c brings sample, details. National, Ord, Nebr.

READ Progressive Mailtrade, the magazine that tells how to make money by mail. Dime brings sample and special offer. Progressive Mailtrade, Box 357, Sheboygan, Wisconsin.

FORMULAS, PLANS, ETC.

YOUR Formula manufactured and packed for you as specified. Information free. Priform Co., 3806 Norfolk Ave., Baltimore 16, Maryland.

WATERLESS Hand cleaner. (No ammonia.) Easily made. Good profit. 2 dependable formulas \$1.00. Nelko Chemical Service, Box 3462, Chicago 54, Ill.

10,000 FORMULAS And trade secrets. Free literature. Stillman, 555 Kingston Ave., Brooklyn 3, N. Y.

TESTED Formulas. Interesting descriptive booklet free. Pont, Box 635-PM, Terre Haute, Indiana.

FREE Formulas for making 3 types of waterless hand cleaner. Also glass cleaner and amazing "lazybones" auto cleaner-polish. Organic Chemicals, 1269 S. Norton Ave., Los Angeles 6.

MAKE—Sell cleaners, soaps, polishes, flavors, cosmetics. No machinery. Formula literature free. Kemico, Park Ridge 16, Illinois.

FORMULAS For nearly everything. Catalog free. Write Creative, Winnetka, Ill.

REAL Manufacturing formulas. Lists free. Cummings, Chemist, Gordon Ave., Syracuse 4, N. Y.

PLASTICS

COMPLETE Line internally carved gifts and jewelry. Free catalogue. Pilot Plastics Co., 67C1 Fulton St., New York City 7.

NEW Liquid plastic. Clear, colors. Cast without heat. Embed flowers, insects, coins. Saw, drill, carve. Send 25c for exciting new home project manual showing how to get started. Castolite, Dept. J-101, Woodstock, Illinois.

PLASTIC Sheets. (Air Force Surplus) 19" x 23". Many uses. 3 for \$2.00. Sterling, 511 N. Ashland, Chicago 22, Ill.

LUCITE, Plexiglas, acetate, 85 different colors, thicknesses. Immediate shipment from stock. Rod, tube, casting plastic. Wholesale, retail. Catalog, instructions, bargain lists, 10c. Gem-O'-Lite, Box 686S, North Hollywood, Calif.

PLASTIC: Sheets, cut pieces, and scrap in clear and colors. Rod, tubing, acetate, dies, jewelry findings. Send \$1.00 for 4 pound scrap assortment and fabricating manual. Regal Plastic Supply, 720 Main, Kansas City, Missouri.

LUCITE, Plexiglas. Any size sheets, masked. Square foot (12 x 12) cost, 1/16", 96c; 1/8", \$1.25; 3/16", \$1.52; 1/4", \$1.80. Colors add 10%. Include 10% postage. Almac Plastics, 230 Fifth Ave., New York 1, N. Y.

INTERNAL Carved roses, orchids, swans, goldfish, butterflies, etc. Jewelry and gifts. Crystal Floral Novelty Co., Bound Brook, New Jersey.

EARN Money with plastics. New book, "Money-Making Hobbies," shows you how. 160 pages, \$1.98. Popular Mechanics Press, 200 E. Ontario, Chicago 11, Ill.

PLASTIC, Sheets, rods, tubes, etc. Free list. Plastic Supply Co., 2901 N. Grand Blvd., St. Louis 7, Mo.

CHEMISTRY

COMBINATION Offer—Chemical balance, litmus paper, spoon, catalog of chemicals, apparatus, kits, \$1.00. Catalog only, 25c. Rex Laboratories, 2849-A Birchwood, Chicago 45, Illinois.

SNOOPERSCOPE Book \$1.50. Infrared catalogue 10c. Precise, 942 Kings Highway, Brooklyn 23, New York.

NEW Catalogue of laboratory chemicals and apparatus 10c. Luther Laboratories, New Britain, Connecticut.

OH Boy! New book of science. Experiments, formulas, secret processes, together with catalogue of laboratory supplies, only 25c. National Scientific Company, 2204 W. North Avenue, Chicago 47, Ill.

NEW Idea chemical and apparatus outfits for home experimenting. Photo-scales, microscopes, chemicals, biological and laboratory supplies in small quantities. Catalog 15c. Established 1931. John H. Winn, 124A West 23rd Street, New York, N. Y.

ILLUSTRATED Catalog: Chemistry, mineralogy, biology. 10c. Tracey Laboratories, Evanston, Illinois.

CHEMICALS And apparatus for industrial, analytical, and private laboratories. Catalog 15c. Dept. M-50, Biological Supply Co., 1176 Mt. Hope Ave., Rochester, 20, N. Y.

AGENTS WANTED

AT Last! Something new and sensational in Christmas cards. Show gorgeous satins, velours and metallics never before offered. Gets easy orders fast! Pays up to 100% cash profit. Free samples of 30 Christmas cards with name, 50 for \$1.00 up. 80 assortments. Personalized book matches and stationery, gift items. 2 assortments on approval. Write Puro Co., 2801 Locust, Dept. 040-K, St. Louis, Mo.

SELL Dress fabrics to friends, neighbors. Stylish, beautiful materials. Year round profits. No experience needed. Free details. National, 640 Broadway, Dept. M, New York 12.

JUST Out! New thrilling sensation in Christmas cards. Make big money! Show lustre foils, satins, brilliants. Amazing values bring easy orders! Christmas cards with name 50 for \$1 up. Also imprinted book matches, stationery, many gifts. Get 30 free samples with name; two \$1 boxes on approval. Joy Greetings, 507 N. Cardinal, Dept. B-60, St. Louis 3, Mo.

"PERSONALIZED" Mints! Exclusive, new sensation now being sold to hotels, restaurants, taverns, etc. Steady repeats! 100% profits! Exclusive territory. Rush name for free samples and details. Forman Associates, Dept. P, 361 West Superior, Chicago 10.

MAKE Money easy. \$5.00 for selling only ten 21 Christmas card boxes. Also metallic and plastic cards, personalized cards and stationery, note paper and wrappings. Send for samples. Howard P. Ellis, Dept. PM, Pitman, N. J.

HOUSE Paint—Sell users and stores. Private label. Steady work. Big pay. Certified Products, Louisville, Ky.

MEXICAN Feather pictures. Unusual novelty \$1.00 (stamps) brings \$2.00 worth samples, details. Refunded if unsatisfied. Aztec Art-P, Apartado 762, Mexico City.

\$50.00 EASILY Made in spare time. Sell sensational new name-imprinted Christmas cards. 50 sell for only 1.00. Not obtainable elsewhere. Big profit. Write for free samples. Kit on approval. Regal Greetings, Hazel Park 48, Michigan.

300% PROFIT Selling guaranteed household product. Friendly Products Co., Dept. P850, Box 665, Youngstown 1, Ohio.

SELL Restaurant cardboard signs. Jacmor Signs, 336 Henry Street, New York City.

AMAZING 1950 Personalized 50 for \$1. Christmas cards, everyday cards, stationery, napkins, dolls. Other wonderful values. Samples on approval. Plateless, 392 Broadway, N. Y.

MAKE Money for yourself or organization. Sell big value Christmas. Everyday assortments, wrappings, stationery, girls, deluxe personals to friends, others. 100 items. Amazing profit. No experience necessary. Special offers. Extra cash bonus plan. Write today for samples on approval and exciting details. Hedenkamp, 361 Broadway, Dept. PM-8, New York.

AMAZING Offer—\$40 is yours for selling only 50 boxes Christmas cards. And this can be done in a single day. Free samples. Other leading boxes on approval. Many surprise items. No experience needed. Free samples personalized Christmas cards, stationery, napkins. Write today. It costs nothing to try. Cheerful Card Co., 1547 White Plains, N.Y.

BIG Bargains for big profits. Over 100 sensational values. Men's used suits \$2, pants 35c, topcoats \$1.25, overcoats \$2, shoes 20c. Experience unnecessary. Free wholesale catalog. Superior, 1250-A Jefferson, Chicago.

SELL New 39c novelty. Sell 4 out of 5 prospects. Dept. 2, National Sales & Service, Greenville, Penna.

IMAGINE—Extra cash for you! Sell friends amazing value metallic, felt applique, comic, 50 for \$1.00 Christmas cards. Exclusive gift wraps. All-occasion assortments, scented stationery, animated books, gifts. Profits to 100%. Special offers. Bonus. Write today for free samples name imprinted Christmas cards, napkins, stationery, feature assortments on approval and free catalog. Elmira Greeting Card Co., C-2209 Elmira, N.Y.

MAKE Dollar sales over phone: keep half. No investment if reference OK. Sample, sales talk \$1. Martin Products, Arabi, La.

\$50 CASH! Sell America's leading 21 card Christmas assortments. Samples on approval. New, sensational money-making gift items. Free samples 50 and 25 for \$1.00 personal Christmas cards. Write Lorain Art Studios, Dept. 67, Vermilion, Ohio.

BUY Thousands of nationally advertised products direct from manufacturers and distributors. Write for "Buy Direct and Save." Service Publishing, 1420-A Investment Bldg., Pittsburgh 22, Penna.

RAISE Money for yourself, your club or church. Sell friends metallic Christmas cards, wrappings, children's books, gifts, novelties. Big profits. Bonus. Request feature samples on approval, free samples name imprinted Christmas cards, stationery, napkins, free catalog and free selling guide. New England Art Publishers, North Abington 255, Mass.

ABSOLUTELY Free! Big package actual sample fabrics and style presentation of dresses, lingerie, hosiery, etc. Take orders. Commissions big. Send no money. Melville Co., Dept. 5623, Cincinnati 3, Ohio.

EARN \$3 Hour spare time—Sell Sunshine's beautiful, exclusive Christmas cards. 21 nationally famous French folders, \$1.00; 24 evergreen cards, 24 lined envelopes \$1.00; 50 imprints \$1.25. Many more. Samples on approval. Write for Sunshine's complete sales kit, free imprint folders. Sunshine Art Studios, Dept. PM-8, 115 Fulton Street, New York 8, N.Y.

\$1 STARTS You in business. Sell fine \$1 ties. \$1.50 and up values only \$7.20 dozen, you make \$4.80. Send only \$1 for 2 sample ties. Catalog free. Philip's Neckwear, Dept. K-44, 20 West 22nd Street, New York 10.

SELL Swiss wristwatches 14K goldplated case-bandunit; rhinestone dial. Sensational! \$15 retailer. Send for information and sample \$6 c.o.d. Money back guarantee. Dunhall Imports, 101PM Cedar St., New York City.

CALL On friends with sensational Christmas cards in handy assortments. Sell for \$1.00. Profit up to 50c. Also popular-priced personal Christmas cards, everyday assortments, stationery, gift items. Samples on approval. Wallace Brown, Dept. M-4, New York 10, N.Y.

SAVE—Make money. Buy merchandise wholesale. Free details. Orysen's, 1147 Sun-kist, Waukesha, Wisconsin.

LOOK Here! Wanted—Men to start in business on credit. Sell some 200 farm-home products. Thousands our dealers now make quick sales, big profits. For particulars write Rawleigh's, Dept. H-192-PPM, Freeport, Ill.

FREE Samples, and amazing plan giving you gorgeous dress without penny cost. Rush name today with dress size. Harford, Dept. C-235, Cincinnati 25, Ohio.

BRAND New! Amazingly different and smart Christmas cards bring you big money! Take easy orders for sensational new Christmas cards. Pays up to 100% cash profit. Christmas cards with name 50 for \$1, up Big line. Personal stationery and book matches. Get sample assortments on approval. Imprints free. Write today. North Star, 31 Glenwood, Dept. K-18, Minneapolis, Minn.

CASH In on tremendous demand for new low priced burglar alarm for cars, homes and farm building. Nothing like it! Everybody wants one. 286% profit. Unique sample offer. Northwest Electric Co., Dept. H-10, Pukwana, S. Dak.

NYLON Uniforms. Immediate delivery, immediate profits. Sell to doctors, dentists, nurses, waitresses, beauticians, housewives. Free sales kit. Superior Fabrics, Dept. P8, 3936 Market, Philadelphia 4, Penna.

NEED Extra dollars? Even beginners make profits to 100% selling new "Christmas Pearls", metallics, hankie assortments. Big line novelties, kiddies' books, wrappings. Bonus. Free sample portfolios name imprinted Christmas cards, stationery—50 for \$1.00, up. Feature boxes on approval. Write Pilgrim Greetings, 111 Summer, Dept. AN-5, Boston, Mass.

ANYONE Can sell Hoover DuPont Nylon Uniforms for beauty shops, waitresses, doctors, nurses, others. In white and colors. Exclusive styles. Top quality. Low priced. Exceptional income. Real future. Equipment free. Write fully. Hoover, Dept. G-100, New York 11, N.Y.

SHINE Shoes without "polish." New invention. Lightning seller. Shoes gleam like mirror. Samples sent on trial. Kristee, 152, Akron, Ohio.

\$50 YOURS. Sell only 100 boxes beautiful Xmas cards; also 50 and 25 for \$1 imprinted; others: novelties, metallics; stationery, write now for approval samples, cost nothing to try. Pen-n-Brush, PM-8, 139 Duane St., New York City 13.

MAGIC Cleaner—Laundry soap deal. Hotter than a firecracker. Big profits. Sample free. Bestco, 4642 No. Central, Chicago.

SPARE Time, \$50 up weekly selling top line personalized Xmas cards, stationery, etc. Samples free. Box ass'ts on approval. Victory Studios, Mt. Vernon, N.Y.

DON'T Be discouraged. Let us help you make money! No investment. Free selling outfit! Automatic selling methods. Be your own boss. Sell comfort shoes direct from factory. Write today! Consolidated Shoe System, Dept. CS-53, Chippewa Falls, Wis.

SELL The famous "Sunshine Line" greeting cards. New de luxe 21 card assortment with, or without, Scripture texts; fast selling religious plastics; brand-new gift wrap; Christmas notes; specialty items such as Christmas bell; holiday high lights; swing along; children's assortments; etc. Write for samples. Triumphant Art Publishers, Dept. G9, Anderson, Indiana or San Jose 6, Calif.

GET 'Em while they're hot. Newest products, surplus goods, mfgs. sellouts. Brand new red-hot money makers. Tremendous profits. Rush 25c for latest monthly issue Buyers' Bulletin listing lowest wholesale sources. It will amaze you. National, 2014 Broadway, Dept. PM-1, Indianapolis 2, Ind.

FREE Literature—Thousands wholesale supply sources. Money-making business ideas. Wilkin Company, Hillsboro 4, Ohio.

FISHERMAN'S "Water-Depth Measuring-Gauge," 508-PM8 N.Y. Street, Aurora, Illinois.

CASH Waiting for you! Collect big advance commissions selling exclusive cork-cushioned shoes. Free outfit and selling guide. Concordian Shoes, G-3 West Concord, Mass.

SELL Plastic cement. 1001 household, automobile repair uses. Metalite, 77 Jewett, Buffalo 14, N.Y.

NEW Bathroom deodorizer. Hangs on wall. Banishes odors bathroom, kitchen. Lightning seller. Samples sent on trial. Kristee, 152, Akron, Ohio.

NYLONS Direct from mill. Samples free. Guaranteed against runs. No experience or money needed. Also 14K gold chains from factory. Earn big money spare or full time. Become manager, appoint agents. We pay you 40c for every \$1 your agents earn. Ergim Co., 992 Columbus Ave., New York.

FREE Catalog, fast sellers, novelties, blades, balloons, etc. Lowest prices. Hansen Sales, 2851 Madison, Chicago 12.

FAST Profits—No investment. Send for big, free catalog. Plastic aprons, tablecloths, etc 150 sure-fire items. We guarantee sales. Write the Halliday Company, Dept. M-6, 15-19 Pennington, Passaic, N. J.

QUICK Money—Sensational Christmas cards, plastics, metallics, stationery, napkins. 50 cards with name \$1. Approval sample. Torres, 373 A-Fulton St., Brooklyn 1, N. Y.

FORGE Ahead financially! Start profitable business—mail, locally! Amazing invention! Free sample offer! Consolidated Equipment, 781 Guardian Bldg., Cleveland 14, Ohio.

MEXICAN Feather pictures. Sell on sight; 200% profit! Free details. Sample 10c stamps. Sylvia-PE, Apartado 9036, Mexico City.

SENSATIONAL Nylons guaranteed against runs. Nationally advertised. Not sold in stores. No experience or money needed. Also lingerie, robes, men's hosiery outfit, sample, etc free. Wonderful opportunity earn big money spare or full time. See our full page advertisement on page 57. Kendex Corp., Babylon 146, New York.

AGENTS. Clinch sales easy. \$100.000 secrets. Free information. Viking Sales Company, Box 1481, New Haven, Conn.

COSTS 4c. Sells fast for \$1. Information free. Pacific Sales, Box 1458-A, Wenatchee, Wash.

\$85 WEEKLY Selling 4 pair shoes daily direct. Free outfit. Samples. No investment. Experience unnecessary. Advance commissions, bonus. Paragon Shoes, 739 Columbus, Boston, Mass.

CASH In on amazing profits. Sell hammer-screwdriver combinations to homes, hardware stores, service stations, etc. Also many other items. Samples furnished. Brocker Manufacturing Company, York 3, Penna.

HOME Power units. Delivered. Approval basis. Sales kit free. Modern-AG, Excelsior Springs, Mo.

REPEAT Sellers. Big demand. Profitable. Parker Drug Co., Hoboken 8, N. J.

SOLDAX Liquid repair builds you steady repeat business. Sell any type store, gas stations, garages. Contact—Soldax Company, Hoosick Falls, New York.

DISTRICT Agency. Power mowers—\$59.50 up, 5 models. Appointment dealers. Write fully. Rotacut, R-2018, Excelsior Springs, Mo.

FREE Samples. Big profits showing amazing Glow-in-the-Dark specialties. House numbers, pictures, plastic novelties, ashtrays, keyholders, religious and nursery objects, etc. Madison Plastics, 303 Fourth Ave., New York 10, N. Y.

CHRISTMAS Card agents. Sell America's only \$1.00 Gift wrap assortment containing 30 full size sheets; giant plastic pencil containing personalized pencils; Santa stocking with name; Rudolph, the red nosed reindeer assortment. Over 100 Christmas card box assortments and surprise items. Write today for five free portfolios of personalized Christmas cards. Elmcraft, Dept. 13, 5930 S. Western, Chicago 36.

1950 XMAS Card catalog ready! Earn more money as a wholesale jobber! Large selection of dollar box assortments, imprints, religious, personalized Christmas cards! Three dollar sample boxes \$1, postpaid! Write for free holiday bulletin. Elfko, 438 North Welis, Chicago 10.

FREE Outfit, write today! Sell embroidered advertising uniforms and work clothes, initial buckles, belts, badges, 2000 emblems. Hook-Fast Co., Box 480PM, Roanoke, Virginia.

BE Renewal headquarters for all magazines. Handle everything at home. Big profits. No experience—no capital needed. Free catalog tells how. Write McGregor Magazine Agency, Dept. 500A, Mount Morris, Ill.

DRAW Side income under notary public appointment. Stationers, Helotes 50, Tex.

WRITE for free booklet and catalog telling how to earn substantial profits in your spare time by forwarding new and renewal subscriptions to all magazines for your friends and neighbors. Oldest U. S. agency. Established 1869. Moore-Cottrell, North Cohocton, New York.

DRESSES, 18c; Coats \$1.00, blouses 35c. Free catalog. Crown, 164-P Monroe Street, New York.

SELL Balloons! Combs! Novelties! Excellent sideline. Carleton House, Texas City, Texas.

NEWEST Money making sensation. Sell personal initialed belts, buckles, cap and breast badges, tie holders, etc. Choice 2000 emblems. Write special outfit offer today. Hook-Fast, Box 1425PM, Providence, R. I.

JEWELRY Factory desires salesmen, distributors, jobbers. Pickcraft, 19 Bank Street, Attleboro, Mass.

SELL Big money-maker to men and women. Easy handwork makes fast-selling useful articles. Sunmade Company, Brockton 64, Mass.

GOLD Laquered window sign letters. Large sizes penny each. New foils. Absolutely beautiful. Free samples. Atlas, 544 W. 79th, Chicago 20.

AGENTS: Stamping names on key protectors. Sample 25c. Stamping outfits, checks, social security and name plates. Hart Mfg. Co., 303 Degraw St., Brooklyn, N. Y.

EXCELLENT Sideline for printing and advertising salesmen. Decalcomania name plates in small quantities. Great demand. Also, make money with our line of automobile initials and sign letters. Free samples. "Ralco" XL-Roxbury, Boston 19, Mass.

PHOTO-Salesmen-agents. Sell beautiful hand-colored plastic enlargements. Collect deposit, we deliver. Profitable sideline. Send card, for free sample kit. Novel Portrait Co., 3343 North Ave., Chicago, Ill.

AGENTS—300% Profit selling genuine gold window letters; stores and offices. Free samples. Metallic Letter Co., 438-B North Clark, Chicago.

HIGH-GRADE SALESMEN

SALESMEN—Sideline. Earn \$3,000 next 5 months selling calendars, advertising specialties. Buyers everywhere. Big commissions advanced. Samples free. Continental Calendar, 542-A South Dearborn, Chicago.

SALESMEN. Earn \$50.00 weekly, selling only three pairs shoes daily. Commission and bonus. Wide variety for men, women, children. No investment. Experience unnecessary. Free catalog. Tanners Shoes, 665 Boston, Mass.

PRINTING Salesmen — Red hot items. Colorful plastic business cards and advertising specialties. Samples free. Rolway Plastics, 151 Foundry, Wakefield, Mass.

NEW Jobs open in selling! Send name, address for five free issues of Opportunity Magazine's money-making guide, listing hundreds of companies who'll pay you well, full or part-time. No experience needed. Opportunity, 28 E. Jackson, Dept. 17, Chicago 4, Ill.

ADVERTISING Book matches—Cash in on big demand; sell union label matches. Cuts for all businesses and political parties. Free powerhouse selling kit, low prices, protection guaranteed on repeat orders. Cash commissions. Superior Match Co., Dept. M-850, 7530 Greenwood, Chicago.

CALENDARS — New, unique, colorful shaped for individualized use of garages, gas stations, real estate, grocery, insurance, others. Free kit. Apex, 822 Market St., Camden 2, N. J.

SENSATIONAL Nylons guaranteed against runs. Nationally advertised. Not sold in stores. No experience or money needed. Also lingerie, robes, men's hosiery. Outfit, sample, etc. free. Wonderful opportunity earn big money spare or full time. See our full page advertisement on page 57. Kendex Corp., Babylon 146, New York.

WANTED: Man who needs to earn at least \$75 weekly. Must be willing to work eight hours a day. National organization. Permanent. Write Red Comet, Inc., Department 697, Littleton, Colorado.

EXCEPTIONAL Earnings selling famous Bostonian shirts. Spare time, full time, sideline. Sales kit, actual fabrics, free. Bostonian, 89 Bickford, Dept. A-10, Boston 30, Mass.

WRITE 3 Words—Collect \$7.65 on 10-second demonstration to merchants. Write on glass with amazing magic crayon—Presto! 5 color advertising message takes fire, glows like brilliant neon. Three sales daily bring \$22.95 profit. Rush postcard for details. Complete sales kit, free! Max-lume Co., 125 W. Hubbard, Dept. CL-8, Chicago 10, Ill.

BIG Money taking orders. Shirts, ties, Sox, pants, jackets, sweaters, shoes, uniforms, etc. Sales equipment free. Experience unnecessary. Nimrod, 4922-AN Lincoln, Chicago.

EDUCATIONAL AND INSTRUCTION

IT'S Fun learning a language by Linguaphone. At home, in leisure time, quickly, easily, correctly master Spanish, French, Italian—any one of 29 languages through proved Linguaphone conversational method. Send for free book. Linguaphone Institute, 83-M Radio City, New York City.

REVOLUTIONARY Conception of public bookkeeping! \$5.00 hourly. Simple instructions. Full, spare time. Systems, shortcuts, obtaining clients. Auditax, 10775-M Tabor, Los Angeles 34.

GET Photographic mind with Super-memory. Write Thor Books, M-8, Box 1210, Chicago.

IT'S Later than you think! G.I. training will soon be over. Inquire about training for job opportunities to make your future secure. Don't risk losing your veteran's entitlement. Factual information free. Write Box A4393, W.P.H.I., Chamber of Commerce Building, Pittsburgh 19, Penna.

FREE Bible correspondence courses — Adult, junior, offered by world-wide radio Bible broadcasters. Write: Voice of Prophecy, Box 55, Los Angeles 53, California.

YOU For president of your own credit-collection agency. Many who answered our ads now have their names on office doors. Franklin Credit, Roanoke 7, Va.

BE A real estate broker through home study or classroom instruction. Write for free book. Approved for veterans. Weaver School of Real Estate, 15 E. Pershing Rd., Box CP-8, Kansas City 8, Missouri.

SEE Our collection-credit business ad under Business Opportunities. Cole & Associates, Syracuse, N. Y.

LEATHER Carving. Fascinating, highly-paid art; age-old secrets now taught for first time in home study course. For hobby, profession or profitable business, write: Baird School of Leather Carving, Box 1367-M, Dept. 18, Manitou Springs, Colo.

"HOW To Break and Train Horses"—A book every farmer and horseman should have. It is free; no obligation. Simply address Beery School of Horsemanship, Dept. 1108, Pleasant Hill, Ohio.

MAKE Up to \$35-\$45 week as a trained practical nurse! Learn quickly at home. Booklet free. Chicago School of Nursing, Dept. M-8, Chicago.

GRADUATE Watchmakers! Reach an untapped source of profitable new business in chronograph watch repair. Easy step-by-step Essembl-O-Graf method taught in GI-approved 22 week resident course or by low-cost home study plan. Be the first in your community to display the handsome Certified Chronograph Technician's diploma. Complete information on request. Western Pennsylvania Horological Institute, Desk A-93, 706 Smithfield Street, Pittsburgh, Penna.

FAMOUS Singers; Secrets! Information! Free! Studio, 14356B Jersey, Norwalk, California.

AMAZE Your friends: Produce oil paintings at home. \$5 brings complete ten lesson course. Prickett Studios, Box 49, San Diego 12, California.

READ With speed! New amazing method. Save hundreds of hours yearly. Free home test. No obligation. Rush postcard. Brownson, 9111 S. Hoyne, Chicago 20.

USED Correspondence courses and educational books bought, sold, rented. Catalog free. Educational Exchange, Summer-ville, Ga.

DRAFTING, Design, mathematics, building estimating, surveying, engineer's license preparation. Veterans accepted. Mondell Institute, 230 West 41st, New York.

NATIONAL Detective Academy. See our advertisement on page 40.

GUNSMITHING—Learn for profit, pleasure! Practical residence course, day or eve, G.I. approved. Limited enrollment. Facts free! Pennsylvania Gunsmith School, 423 Federal, Pittsburgh.

CIVIL Service jobs. Study course and service helps you pass exam. Write Box 363, Oak Park, Illinois.

DENTAL Technician's manual. Authentic, direct information. Write for free illustrations. Grant Laboratory, 219 W. 7th St., Los Angeles 14, Calif.

LEARN Building design, or design your own home or cabin. Write Tech-Talk Design, 19375 Charleston, Detroit 3, Mich.

STUDY To be a doctor of psychology or metaphysics. Obtain Ps.D., Ms.D., D.D. or Ph.D. degree. Chartered by state. Write for free book telling how. The Neotarian Fellowship, Dwight Building, Kansas City 6, Missouri.

USED Correspondence courses and books sold and rented. Money back guarantee. Catalog free. (Courses bought.) Lee Mountain, Pisgah, Alabama.

HOME Study course, drugless therapy. Free literature. Institute of Drugless Therapy, Tama, Iowa.

INVESTIGATOR Training. Phillips Secret Service System, 1917-B North Ken-neth, Chicago 39.

BOOKKEEPERS! Increase your earnings! Operate your own simplified "dollar-a-week" bookkeeping and tax service. Full or spare time. Details free. No obligation. Ellis, Box 200, Cedar Grove, N. C.

PIANO Tuning pays. Learn this profitable profession at home. Our Tonometer and mechanical aids make learning easy. No knowledge music necessary. Diploma granted. Largest and oldest school—52nd year. G.I. approved. Write for booklet. Niles Bryant School, 78 Bryant Bldg., Washington 16, D. C.

SECRET Investigation. Experience unnecessary. Investigators particulars free. George Wagner, M 125 West 86th, New York.

MEDICAL Laboratory Technicians in great demand. We train you in your own home. Catalogue free. Imperial Technical Institute, Box 973-J, Austin, Texas.

PLAYS, STORIES, MANUSCRIPTS

MAKE Extra money rewriting ideas in newspapers, magazines, books. May bring up to \$5 per hour, spare time. Experience unnecessary. Write for free details and how to get free Writer's Market Guide! Comfort Writer's Service, Dept. 8-L, 200 S. 7th, St. Louis, Mo.

I WANT New writers to cash checks of \$1 to \$100 offered daily. The easiest way to write for pay. No previous experience necessary. Free details. Saunders M. Cummings, 468-11 Independence Bldg., Colorado Springs, Colo.

INFORMATION

WHERE To buy most anything. We furnish supply sources. Single item, 25c. 5 for \$1.00. Service Bureau, Box 5053, Chicago 80, Ill.

BUSINESS SERVICE

WHERE To buy it information, almost anything. Write, listing items. Kelly, 9544-D Whitcomb, Detroit 27, Michigan.

SPECIAL SERVICES

LETTERS Remailed 25c each. Ideal, 1301—60th St. S., St. Petersburg, Florida.

NEW York letters remailed 25c each (coin). Errands accomplished confidentially. Lorenzo, 510 West 135 St., New York 31, N. Y.

MECHANICS, Inventors. Let successful consulting metallurgist solve your metal selection, heat treating and metal working problems. Heat treating information any type steel \$1.00. G. W. Pirk, 138 Thomas St., Utica, N. Y.

CHICAGO Mail address. Business or personal. Faultless, P-3439 Michigan, Chicago 16.

NEW York or Brooklyn postmark. Letters remailed 25c. Mrs. Frazier, 305 84th St., Brooklyn, New York.

PHOTOGRAPHIC Missions accomplished. New York City. Confidential. Negative, print \$5.00. Anthony Todaro, Box #1096 G.P.O., New York 1, N. Y.

CARTOONING, COMMERCIAL ART, SHOWCARD WRITING, SIGN PAINTING

COMPLETE Course in cartooning. Simplified, easily followed instructions. Costs less than 8 cents a lesson. No money risk offer. Circulars, details free. Write Progressive Enterprises, 237 Bridge Street, Struthers, Ohio.

MASTER Cartoon course—Monthly, 50c. Free details. 1437 N. Highland, Los Angeles.

TALENT Test, information. Give age. Art, Box 8066, Dallas 8, Texas.

CARTOON Your way to success! Internationally known instructor, Raye Burns, will personally teach you to create salable, original cartoons at home. Course of 26 lessons only \$2.85. Send remittance with order or write for free details and addresses of successful students. Raye Burns School, Box 3583-M, Cleveland 18, Ohio.

LEARN Cartooning quickly! New method covering seventy subjects teaches you, from the first stroke of your pencil, to originate and sell your finished work. This fine, big course only \$1.95. Catalog on other courses free. National Artists, Box 4248-H, Dallas 8, Texas.

"How To Make Money With Simple Cartoons"—A book everyone who likes to draw should have. It is free; no obligation. Simply address Cartoonists' Exchange, Dept. 98-C, Pleasant Hill, Ohio.

9 ALPHABET 3 Numeral pattern sets and catalog, \$1.00. Sign Letter Distributors, P.O. Box 101, Mineola, N. Y.

AIRBRUSH Art. Photo retouching. Free catalog, N.Y. School of Airbrush Art, 117-C E. 60 St., New York, N. Y.

SIGN Painting taught at home. Test lesson free. Ben Kerns, Box 812-T, Greenville, S. C.

CHALK Talks. Laugh producing program, \$1.00. Catalog 10c. Balda The Cartoonist, Oshkosh, Wisconsin.

ADVERTISING AGENCIES, LETTER WRITERS, FOR ADVERTISERS

TRADEMARKS Designed complete with cut, \$10.00. Rough sketch, \$1.00. Catalog free. Burke, 3208 McKinney, Dallas.

CLASSIFIED Mailing lists. Details on request. Service Sales, Box 188, Detroit Lakes, Minn.

SALES Producing advertising! Copy, art, printing. Gard, 1007 So. Grand, Los Angeles.

FREE Consultation—Friendly service any size budget. Send for Advertisers Handbook. Monroe Advertising Agency, Box 1002, Chicago 90.

ADVERTISE: 24 Words, 40 newspapers \$3.50. Lists free. Advertising Bureau, 10511-C Springfield, Chicago 43.

MAILING Lists: \$5.00-1000 up. Write Dixie Service, King, N. C.

ADVERTISERS! Reach nearly 18,000,000 readers. 25 Sunday national newspapers, 18 words, \$51.50. "Terrific pullers." 20 popular newspapers, \$10.00. "Free booklet." Special—One inch display 2,-821,198 circulation, \$48.30. Newmark's Advertising Agency, (Established 1893), 217-7th Ave., New York 11.

24 WORDS In 50 weeklies, \$4.96. J. Darnell, 730 Hays, Jackson, Tennessee.

ADS Placed in out of town newspapers and magazines. Low rates. Catalogue free. Ideas that pay. Baker Advertising Agency, Successors Ankrum Agency, 189 W. Madison, Chicago 2.

TYPEWRITERS, DUPLICATORS, OFFICE DEVICES

TYPEWRITERS \$17.50; new portables \$59.50; adders \$12.50, addressers \$9.95, duplicators, \$9.95. Typewriters, 118N Spruce, Wichita, Kansas.

REVOLUTIONARY Portable addresser. No plates. New! Sensational! Only \$9.95 complete! Fully guaranteed. Pru-A-Ex, Kingsport, Tennessee.

PRINTOMATIC Selffeeding post card printing duplicator \$13.50. Envelope addressing machines \$24.50. Pittsburgh Typewriter Company, 336-R Fourth Avenue, Pittsburgh 22, Penna.

RECONDITIONED Typewriters, printing devices. Write Dixie Service, King, N. C.

RUBBER STAMPS AND OFFICE SUPPLIES

LINE 20c; 2-35c; 3-50c. Stamp Works, Auburn, Nebraska.

3 LINES 50c; Pad 35c; signature \$2. Stamp-Right, Wauwatosa, Wis.

DELUXE Cushioned, indexed, knob handle; 3 lines 50c, 4-60c. Pads 40c, Ink 45c. Free literature. Warner Stationery, Havre de Grace, Maryland.

PRINTING, MULTIGRAPHING, MIMEOGRAPHING GUMMED LABELS

125 LETTERHEADS (8 1/2 x 11 Hammermill) \$1.00 postpaid. Envelopes, business cards, same. Race Printers, Hudson, New York.

SMALL Lots printing low prices. Estimates, list free. Vaprint, 283M Newman, Harrisonburg, Va.

QUALITY Printing! Free price list. Nationwide Printing Company, 2337 Bath Avenue, Brooklyn 14, N. Y.

AMERICA'S Best business card values! "Cuts" printed to illustrate any service. \$3.95 per 1000, post paid. Samples, U.S.A. only. Midtown specialty, Dept. PM8, Box 1254, Detroit 31, Michigan.

5000 HANDBILLS 6"x9" Postpaid \$14.95. Journal Printing Co., Newark, Ark.

1000 6 3/4 ENVELOPES Printed and mailed post paid \$4.75. Letterheads \$4.65. Check or money order. Prompt service. Globe Press, P.O. Box 188, West Haven, Conn.

BUSINESS—Personal printing. Your requirements? Daugh, Box 219, Cambridge 39, Mass.

MIMEOGRAPHING — Bulletins, forms, artwork, anything. Salem Print, 3131 Salem, Dayton 6, Ohio.

MIMEOGRAPHING — Letters, pricelists, formulas, instructions. Also commercial artwork. Lowest prices. Dave's Letter Shop, 275 Clisby, Macon, Ga.

MULTIPAGE Varytyping, printing, multigraphing; cost-paving arrangements. U-Tel-M, 252 8th S.E., Washington, D. C.

1000 3x6 Circulars printed, \$1.95. Farley Printery, Box 15, Everts, Ky.

1000 BUSINESS Cards \$2.50 prepaid. Samples free. Reliable Print Shop, 905 East Jefferson, Louisville 6, Ky.

100 8 1/2x11 HAMMERMILL Letterheads and 100 envelopes \$1.85. Herbert Hudson, Centredale, R.I.

FINE Printing, offset, letterpress. We specialize in booklets, folders, publications, office forms. Send copy for estimate. Quality Printing Company, Richmond 20, Virginia.

QUALITY Printing. We specialize in publications, newspapers, tabloids. Send copy for estimate. Bagby Printing Co., Georgetown, Ohio.

SEND 10c Now, for our 48 page 1950 price list—refunded first order. McCall Press, 1326 South 27th, Omaha, Nebraska.

500 3/4x2 1/4 FOUR Line gummed stickers 35c; red border 50c. Moritz Printery, Saginaw, Mich.

MIMEOGRAPHING—Letters, pricelists, formulas, instructions. Lowest prices. Lem's Letter Shop, 5710 Stanton, Detroit 8.

PRINTING OUTFITS AND SUPPLIES

PRINT Your own cards, stationery, circulars, advertising. Save money. Simple rules. Print for others, nice profit. Raised printing like engraving too. Have home shop. Details free. Kelsey Presses, L-11, Meriden, Conn.

PRESSES, Supplies, paper. Catalog 10c. Printers Supply, 211, Springfield, Missouri.

PRESSES, Type, cabinets, supplies. List for stamp. Lincoln Press Company, 220-M Hartwell, Fall River, Mass.

CASH For type, other metal or exchanged for leads, rule, slugs. Anderson's, 4341-PM Meade, Chicago.

MAKE Your own rubber printing cuts. Self-molding process. Plexirubber, Argyle 1, Wisconsin.

PRINTING Presses, type, supplies. Lists 3c. Turnbaugh Service, Loysville, Penna.

PATENT ATTORNEYS

INVENTORS—If you consider your invention to be something of importance, take steps to protect it with a United States Patent which gives you the right to exclude others from making, using and selling your invention as claimed. "Patent Protection for Inventors" outlines steps to take to secure patent protection. Mailed promptly without obligation. Victor J. Evans & Co., Merlin M. Evans, Registered Patent Attorney, 531-J Merlin Building, Washington 6, D. C.

INVENTORS—If you believe that you have an invention, you should find out how to protect it. The firm of McMorrow, Berman & Davidson is qualified to take the necessary steps for you. Send for copy of our patent booklet "How to Protect Your Invention" and "Invention Record" form. No obligation. McMorrow, Berman & Davidson, Registered Patent Attorneys, 1348 Victor Building, Washington 1, D. C.

LUCKE & Lucke, 12 East 41 Street, New York. Patents, designs. Registered United States Patent Office.

REGISTERED Patent attorney offers services. Sanders, 6430 Evans, Chicago 37, Ill.

HERMAN Lewis Gordon, registered patent attorney. Patent investigations and opinions. Warner Building, Washington, D. C.

CANADA—Ramsay Company Registered, 273 Bank Street, Ottawa, Canada.

INVENTORS: Learn how to protect your invention. Unless the inventor is familiar with patent matters, he should engage a competent registered patent attorney or agent to represent him. We are registered to practise before the U.S. Patent Office and prepared to serve you in handling your patent matters. "Patent Guide for the Inventor" containing detailed information concerning patent protection and procedure with "Record of Invention" form will be forwarded to you upon request—without obligation. Clarence A. O'Brien & Harvey Jacobson, Registered Patent Attorneys, 01B-G District National Building, Washington, D. C.

PETER Fries, Jr., Registered Patent Attorney. Patents, novelty searches, designs, copyrights. 110 East 42nd Street, New York City.

PATENTS—Irving L. McCathran, 315 McLachlen Bldg., Washington 1, D. C. Registered Patent Attorney.

PATENTS. "Proof of Invention" folder mailed without obligation. E. E. Vrooman, Registered Patent Attorney, 507 McKim Building, Washington 5, D. C.

INVENTORS: When you are satisfied that you have invented something of value write me, without obligation, for information as to what steps you should take to secure a patent. Write Patrick D. Beavers (Formerly Randolph & Beavers) Registered Patent Atty., 935 Columbian Bldg., Washington 1, D. C.

C. A. SNOW & Co.—M-427, Snow Building, Washington 1, D. C. Registered Patent Attorneys. Write for information.

"INVENTOR'S Guide" free on request. Frank Ledermann, Registered Patent Attorney, 154 Nassau St., New York 7, N. Y.

INVENTORS: Write for free brochure "Evidence of Invention." Labiner, World Building, New York 7.

INVENTORS: Without obligation, write for information explaining the steps you should take to secure a patent. John N. Randolph, Registered Patent Attorney, 203 Columbian Bldg., Washington 1, D. C.

PATENT Practice before U. S. Patent Office. Validity and infringement investigations and opinions. Booklet and form "Evidence of Conception" forwarded upon request. Lancaster, Allwine & Rommel, Registered Patent Attorneys, Suite 411, 815-15th Street, N.W., Washington 5, D. C.

INVENTORS. For "Record of Invention" form, contact Carl Miller, Registered Patent Attorney, Woolworth Building, New York.

FOR INVENTORS

INVENTORS—Honest marketing assistance and services, patented, patent pending inventions. Write for our free booklet without obligation. Market Contacting & Data Service, 11106-A3 Longwood, Chicago 43.

INVENTORS—If you believe that you have an invention, you should find out how to protect it. The firm of McMorrow, Berman & Davidson is qualified to take the necessary steps for you. Send for copy of our patent booklet "How to Protect Your Invention" and "Invention Record" form. No obligation. McMorrow, Berman & Davidson, Registered Patent Attorneys, 1347 Victor Building, Washington 1, D. C.

INVENTORS—This firm is registered to practice before the United States Patent Office and is available to assist you in the preparation and prosecution of your patent application. "Patent Protection for Inventors" booklet containing detailed information and steps to take toward patent protection will be sent upon request. No obligation. Victor J. Evans & Co., 532-J Merlin Building, Washington 6, D. C.

CO-OPERATIVE Development, manufacturing, sales. American Inventors' Association, Durango, Colorado.

PATENT Searches (same reliable service as conducted for patent attorneys) \$5.00. 48 hour service. Patent copies included. Protection forms free. Write Raymond L. Smith, Patent Searcher, 410 Bond Building, Washington 5, D. C.

PATENT Searches \$5.00. Reports airmailed within 48 hours. Invention protection forms free. Write Miss Ann Hastings, Patent Searcher, P.O. Box 176, Washington 4, D. C.

PATENT Searches by former patent office examiners \$5.00. Protection forms free. Write Patent Examiners, 734 15th Street, N. W., Washington 5, D. C.

SUCCESS Guaranteed. Inventors with patented and patent pending inventions for sale or lease, request our free book. No obligation. Dept. 1-F, Universal Marketing Co., 354 South Spring St., Los Angeles 13, Calif.

INVENTORS! Save hundreds of dollars in patent fees, brokers commissions and promoters rake-offs. Amazing self-teaching invention-drawing and patent-preparing kit shows how you can make magnificent 3-dimensional "pictorial models" of your ideas—fast. No instruments needed, just use pencil. Improve and perfect your ideas with this almost automatic kit designed by a prominent patent attorney-inventor. Write your own patent specifications. Skill absolutely unnecessary. Price \$1.75. Also 70-page guidebook "How to Win Sales and Make Better Inventions" describing how to protect and promote your invention before you patent it; how to give it that streamlined look that spells sales-leadership, coin snappy, money making trademarks and slogans. Get this door-opener to inventive success, and learn all about the 39 brand-new ways in which I.F.I. gives power to modern men of ideas. Price \$2.00. Or both together with three exclusive, I.F.I. secret self-registering records of invention (85c if purchased alone), and other valuable literature, complete, for only \$3.75, and we'll airmail your money back if you don't say the package is worth many times the price. Order now, from Inventors-for-Industry Inc., Desk PM8, Suite 501, 1947 Broadway, New York 23, N. Y.

INVENTORS: Learn how to protect your invention. Unless the inventor is familiar with patent matters, he should engage a competent registered patent attorney or agent to represent him. We are registered to practise before the U.S. Patent Office and prepared to serve you in handling your patent matters. "Patent Guide for the Inventor" containing detailed information concerning patent protection and procedure with "Record of Invention" form will be forwarded to you upon request—without obligation. Clarence A. O'Brien & Harvey Jacobson, Registered Patent Attorneys, 01A-G District National Building, Washington, D. C.

COMPREHENSIVE Inventors services by patent research organization: Patent searches, including patent copies, patent drawings, invention marketing, protection forms free. Industrial Patent Reports, Box 1081, Massachusetts and North Capitol, Washington 13, D. C.

I.F.I. Creative co-operation includes: Superscope patent searches; commercial prospects analysis; pre-patent priority protection; invention-improving; finding backers; invention-styling for sales-leadership, plus the promoting, marketing, and selling of inventions for maximum cash and royalties. Write today for free information. Inventors-for-Industry Inc., P.M. 7, Suite 501, 1947 Broadway, New York 23.

INVENTORS: If you have an invention for sale, patented or unpatented, write Institute of American Inventors, Dept. 40A, 631-E St. N.W., Washington 4, D. C.

INVENTIONS Wanted. Prominent manufacturers and national distributors look to us for new products. You can also benefit by having us assist you with your invention from the idea stage through to the developed product, fully protected. Ask for Booklet "M." Elo Development Co., Chatham Phenix Bldg., Long Island City 1, New York.

PATENT Owner Representative. Years of experience. Can I help you? Charles A. Scott 773PM Garson Avenue, Rochester 9, N. Y.

INVENTORS: Without obligation, write for information explaining the steps you should take to secure a patent on your invention. John N. Randolph, Registered Patent Attorney, 202 Columbian Bldg., Washington 1, D. C.

CASH For your idea. 280 manufacturers need inventions, patented or unpatented. List free. Invention Bureau, 208M Clinton, Oak Park, Illinois.

"INVENTOR'S Guide" free on request. Frank Ledermann, Registered Patent Attorney, 154 Nassau St., New York 7, N. Y.

INVENTORS. For "Record of Invention" form, contact Carl Miller, Registered Patent Attorney, Woolworth Building, New York.

INVENTORS: The usual first step is to have a search of the U. S. Patents conducted, so I can report on patentability. Write, without obligation, Patrick D. Beavers (Formerly Randolph & Beavers), Registered Patent Att., 936 Columbian Bldg., Washington 1, D. C.

INVENTIONS WANTED

INVENTORS Marketing assistance. Circular free. Stanley Hull, 7829-K Euclid, Cleveland 3, Ohio.

INVENTIONS Promoted. Patented or unpatented. Write Adam Fisher Company, 61 Enright, St. Louis, Mo.

INVENTORS: Nationally-known manufacturer seeks new patented products suitable for manufacture by high production methods. Write P.O. Box #7312, Chicago.

INVENTORS—What have you, patented, patent pending to offer manufacturers? Our booklet free without obligation. Market Contacting & Data Service, 11106-A2 Longwood, Chicago 43.

AUTOMOTIVE Items patented or pending wanted on royalty basis. Deal direct. We manufacture and distribute in the automotive field. Dept. PM, Furman Co. Inc., 41 E. 28th Street, New York 16, N. Y.

THE U. S. patent system does not compel inventors into rash "patent (s)pending." The intent of the patent law is to give you the chance of making a pre-patent test of the worth of your ideas. And high-character priority protection for this purpose can be obtained through: Inventors-for-Industry Inc., Dept. P.M.7, Suite 501, 1947 Broadway, New York 23. Write today for free information.

INVENTORS: Hundreds of manufacturers have requested our assistance in locating marketable new products. Complete information free. Institute of American Inventors, Dept. 40-D, 631-E St. N.W., Washington 4, D. C.

HIGHEST Royalties—Cash. Patented and patent pending inventions only. Request our free book. No obligation. Dept. 1-W, Universal Marketing Co., 354 South Spring St., Los Angeles 13, Calif.

CASH For your idea. 280 manufacturers need inventions, patented or unpatented. List free. Invention Bureau, 208M Clinton, Oak Park, Illinois.

INVENTIONS Wanted. Patented or pending only. Inventors' Exchange-B, Hartford 1, Conn.

PATENTS FOR SALE

INVENTORS: Test the commercial value of your patented or unpatented inventions, quickly and inexpensively. Write for free information. Institute of American Inventors, Dept. 40-B, 631-E St. N.W., Washington 4, D. C.

MANUFACTURING

METAL Stampings. Tools, dies and fixtures. Send drawings or sample for estimate. Sterling Manufacturing Company, Davison, Michigan.

MODELS — Small lot manufacturing. Metals, plastics, etc. Milburn, Burlington, Kentucky.

MODELS, MODEL SUPPLIES

KING of hobbies—Bottled models. Boat kit A—\$1.00. No c.o.d.s. Particulars, Frogge, 28 Park, Massena, N. Y.

POWER Models. Unusual steam, gasoline and traction engines. Metals, tools, accessories. New catalog 50c. Chas. Cole, Ventura, Calif.

STEAM Engines, boilers, castings. Catalog 25c. Anton Bohaboy, 2297 Price, Rahway 7, N. J.

BUILD Historic ship models, complete kits 39c to \$9.00. Catalog 10c. Ideal Models, 19 W. 18th, New York 11, N. Y.

MINIATURE Engines, castings and drawings. Catalog world's largest selection 25c. Miniature Engine Laboratories, 200-A Cement Ave., Sandusky, Ohio.

SHIP And yacht model fittings; blueprints. Send 25c for illustrated catalog No. 25—listing hundreds of items. A. J. Fisher, 1002-1 Etowah Ave., Royal Oak, Mich.

STEAM Locomotives, 1½", ¾", ½", ¼" scales. Castings, parts, rail, steam fittings! Thorough drawings with instructions. Catalog 35c. Little Engines, Lomita, Calif.

LIONEL Trains catalog 10c. 36 pages illustrated. Hobby Shop, 72 West Washington, Chicago 2, Illinois.

SHIP Models and yacht supplies complete. Large 64 page catalogue 30c. Bill Wild's, 510 East 11 St., New York City 9.

HOME CRAFTSMEN

MAKE Leather belts, billfolds, purses. Big catalog and genuine steerhide keyholder, 10c. Tandy Leather, Box 397C, Tulsa, Okla.

FOAM Rubber, sponge rubber for cushions, pads. Send for free sample, prices. Do-Mor, Inc., 1123-4th Ave., Rockford, Illinois.

LEATHERCRAFT Tools, accessories, bargains! Francis Byrd, 3406 Montrose Ave., Richmond, Va.

ALUMINUM, Copper and designs for making trays. Metal Supply Inc., Rochester 20, N. Y.

LEATHERCRAFT. Everything needed by beginners, advanced hobbyists and professional leatherworkers. Largest stock of supplies in U.S. Moderate-priced tooling leathers, top quality calfskins, tools, supplies, kits. Send 10c for big catalog. J. C. Larson Co., 820 S. Tripp, Dept. 175, Chicago 24.

16 NEW Lawn chairs, 22 picnic tables, benches, trellises, etc. All 38 plans with necessary full size patterns, \$1.00. Mastercraft 83M, 7041 Olcott, Chicago 31, Ill.

STAINLESS Steel sheets, 30 to 32 gauge, 15" x 36", postpaid only \$2.50 each. Send check or m.o. to L. J. Michies, Fremont, Ohio.

CRAFT Catalog free. "Artcraft's Little Giant." 6500 items covering several crafts. "Tops in our field." Artcraft Leather, Dept. PM, 271 12th St., Oakland 7, Calif.

FREE Shellcraft catalog. Enjoy this fascinating and profitable hobby. New lower prices on supplies. Schillings Shellcraft, R. #3, Box 96B, Sarasota, Florida.

GARDEN Figures, lawn chairs, novelties, furniture, toys, etc. 68 popular plans, with full size patterns, \$1.00. Mastercraft 81M, 7041 Olcott, Chicago 31, Illinois.

JIGSAW Owners attention! Start earning money at home cutting out wooden novelties and souvenirs. Write H. Cook, 4407 S. Normal Ave., Chicago 9, Ill.

CRAFT Catalog. A helpful buying guide for leathers, plastics, metals, all hobby-craft materials, tools, kits: a volume of ideas and instructions. Illustrated! Send 10c. Sto-Rex Crafts, Dept. M-8, 141 9th St., San Francisco, Calif.

89 FULL Size Jig saw patterns of beautiful shelves, ornaments, toys, novelties. Plus "How, Where to Sell." Only \$1.00. Mastercraft 84M, 7041 Olcott, Chicago 31, Illinois.

SHELLCRAFT Jewelry supplies. Beautiful oil dyed shells; instructions; catalog free. The Shell Mart, P.O. Box 78—Sta. A, St. Petersburg 2, Florida.

WHOLESALE Shellcraft Book 15c. Large shellcraft kit \$1.69 postpaid. Shell-Art Novelty, Dept. PM, 5th and Moore, Philadelphia 48, Penna.

LEATHERCRAFT, Copper tooling, textile painting. Make spare time, profitable time. Free illustrated catalog shows everything you need. Kit Kraft, 7377 Melrose, Hollywood 46, California.

LEATHERCRAFT Supplies, leather, tools, lacing. Catalogue 10c. Mail orders. Crown Leather Co., 22 Spruce Street, New York 7.

LEATHER, Tools, lacings, supplies. Free catalog. National Handicraft, 199 William St., New York 7.

LEATHERCRAFTERS: Belt kits, projects, leather, supplies. Free catalog. Art Leather, 411 Joseph Ave., Rochester 5, N. Y.

SEA Shells, cut shells, oil colored shells at lowest prices. Free illustrated catalogue showing many new jewelry designs with instructions. Southern Shellcraft Supply, Clearwater, Florida.

OZARK Wood samples. Eleven useful identified varieties. Prepaid \$1.25, check or cash to Davis Lumber, Cabool, Mo.

SHELLS, Plastics, findings. Low prices. Catalog 5c. Frances Jones, Box 251, Sarasota, Fla.

NEW 96 Page leather and craft catalog. 1000's of items. Send 10c. Russo Handicraft Supplies, Dept. 4D, 245 South Spring, Los Angeles, California.

8 BEAUTIFUL Full-size whatnot patterns 25c. Joannes, P.O. Box 141-M, Omaha 7, Nebr.

80 FULL Sized patterns. Lawn ornaments, toys, novelties \$1.00. Modern Woodcraft, Saginaw, Mich.

\$46 FROM Square foot plywood. Jigsaw necessary. Write, Woodarts, C-38, Bridgewater, Mass.

KNOCKDOWN Cedar chests. Lumber and veneers. Free price list. Giles & Kendall Company, Huntsville, Ala.

JEWELRY Findings, rhinestones, pearls, sequins, cameos. J & M Novelties, Box 464P, Griffith, Ind.

MAKE IT YOURSELF

BUILD Your own "tractor." Plans. Walking riding. Free information. Ellsworth Tractor Co., D-1, Camptonville, California.

SAVE 50%-75% Building automatic electric water heater or Zeolite water softener. Particulars free. 226 Carson Products, 2505 Benjamin, Minneapolis 18, Minn.

SAFETY "Lawn mower." Brush cutter. Small timber saw. Free plans. Eltraco, 11 Valdrive, Camptonville, California.

MAKE Your own adjustable drawing board. Size three feet by four feet. Save fifty percent. Write for description. C. Van E. Hopper, 122 South Bluefields Avenue, Lakeland, Florida.

FREE Handbook, build sawmills, block machines, freezers, tractors, scooters, 250 shop, farm, home machines. Nichols Co., Dept. C-1001, Purvis, Miss.

GRANDFATHER Clock easily built. Big savings. See ad on page 255.

LATEST Model quilt chest. Each removed or replaced without deranging others. Plans \$1, refundable. Description free. Jennings, 5319c Beeman, Dallas, Texas.

AIR Conditioner. Save \$300.00. Build your own from junked refrigerator. Send 50c for instruction booklet. J. Schmidt, 4809 N. Seeley Ave., Chicago 25, Ill.

STREAMLINED, Built-in kitchen cabinets to fit any kitchen. Illustrated manual describes designing and construction. All for \$1.00. Thombert Company, Newton 10, Iowa.

MAKE Your own battery charger for a few cents. Complete illustrated instructions only \$1.00. Vaughan, Box 341, Columbia, S. C.

\$600. BUILDS Cozy 4 rooms and bath. Concrete block, stuccoed. Instructions and blueprint \$1.00. Farrow, G-83, Box 645, Columbus 16, Ohio.

OVER 300 Plans and blueprints in Popular Mechanic's big 32 page Plan Catalog. Furniture, boats, trailers, tools, toys, gun rack, home freezer, many more. Send 3c stamp for copy. Popular Mechanics Press, 200 East Ontario Street, Chicago 11, Ill.

SOLAR Water heater systems efficient any locality. Standard materials, low cost. Free facts. Solar Water Company, Box 175, Coral Gables, Florida.

GARDEN Tractor. Make it yourself. Used car parts. See page 255.

"CONCRETE Block Homes," 32 page booklet on how to build. \$1.00. H. C. Lightfoot, Civil Engineer, Richboro 1, Penna.

PLANS AND BLUEPRINTS

CONCRETE Block machine plans \$2.00. 178 other home, farm devices. Built from junkyard materials. Handbook 25c. (Refundable). Free literature. Kimo, Box 307-PM, New York 19.

SURVEYING INSTRUMENTS

GUARANTEED Factory rebuilt transits and levels, sale or rent, with purchase option. We will repair, trade or buy old instruments. Write for list M-06. Warren-Knight Co. (Manufacturers of Surveying Instruments), 136 North 12th St., Philadelphia 7, Penna.

WATCHES, OLD GOLD, JEWELRY

MAKE Big money buying old gold, broken jewelry, watches, dental gold, spectacles, mutilated coins, etc. Free shipping containers on request for your customers. Try it and see for yourself. Lowe's, Dept. POM, Holland Bldg., St. Louis 1, Mo.

WATCHMAKERS' Tools, materials, sold-bought. Catalogue! Bengal Company, Culver City, California.

WATCHES Cleaned, repaired. Only \$4.00. Year guarantee. National Watch Repair, Box 2414A, Cleveland 12, Ohio.

HIGHEST Cash paid for old, broken jewelry, gold teeth, watches, silverware, diamonds, spectacles, platinum. Free information. Satisfaction guaranteed. Government licensed. Rose Smelting Company, 29-A East Madison, Chicago.

GOLD Plated jewelry supplies—Rhinstones, pearls. Illustrated catalog 10c. Barry's, 47-A Branford Place, Newark 2, N. J.

TOBACCO, SMOKERS' SUPPLIES

HAVANA Tobacco, hand-rolled cigars. Send postcard for low factory prices. Havana Club Cigars, Box 69-P, Key West, Florida.

OF INTEREST TO WOMEN

EXCELLENT Profits. Make fast-selling chenille Christmas poinsettias, corsages, Santas, monkey trees, dolls. Literature free. Velva, Dept. M, Bohemia, N. Y.

SEW—Our ready-cut line. Fast, easy. Illustrated folders 10c. Liebig Industries, Beaver Dam 5, Wisconsin.

300 HOUSEHOLD Hints—Amazing book of kinks, recipes, moneysaving ideas on cleaning, repairing, etc. 25c. Nelco, Box 3462-H Merchandise Mart Sta., Chicago 54.

1000 WAYS To save time, money, labor. Amazing new book "Short-Cuts to Better Housekeeping." 160 pages packed with ideas every housewife will appreciate. Well illustrated. Only 60c postpaid. Popular Mechanics Press, Dept. SC, 200 E. Ontario St., Chicago 11, Illinois.

FOR SALE—MISCELLANEOUS

SAVE Money on army and navy surplus. Write today for new 40-page illustrated catalog. Tenuusa Sales Co., Dept. Y, 1451 Market, Chattanooga, Tenn.

UNIDENTIFIED Bell—Christian bell, bronze, about 1 ton, 4' high and 4' wide at bottom. Religious figures and Latin inscription on side. Gschaar, No. 5 Nihon—Odori, Nakaku, P.O. Box 261, Yokohama Post Office, Yokohama, Japan.

DRESSES 18c; Coats \$1.00; blouses 35c. Free catalog. Crown, 164-PA Monroe Street, New York.

WANTED—MISCELLANEOUS

WANTED: Saw filing machines. Box 194, Park Ridge, N. J.

WANTED Number 10 deluxe erector; weighs 150 lbs. Builds 500 models, 2500 engineering parts. 312-page How to Make "em" Book. 72-page Locomotive book. George Heidema, 188 E. 27th Street, Holland, Michigan.

WANTED—Scrap mercury (quicksilver), tantalum, bismuth, tungsten. Metallurgical Products Co., Established 1909, 35th and Moore Sts., Phila. 45, Penna.

PERSONAL

MEXICAN Legal matters reliably handled. Box 263, El Paso, Texas.

TORONTO—Niagara Falls letters re-mailed 25c. Photographic postcards 15c. Dave's Service, 115 Oxford St., Toronto 2, Canada.

"HOW Can I find out?" You can! Information discreetly developed. Any matter, person, problem, anywhere. Worldwide. Officially licensed, bonded service. Established 1922. Reasonable. Confidential. William Herman, 170 Broadway, New York.

MISCELLANEOUS

BUY Wholesale and save! Plumbing, heating, roofing, building supplies; tools, paints, etc. Rush 25c for price lists, catalogs, samples, other details. Dept. E, "Handy Man-Wholesale Buying Plan," 1009 E. Cheltenham Avenue, Philadelphia 24, Penna.

INCREDIBLE! Unprecedented! Become a mental superman overnight! Floor everybody! No studying! "Memoprop" does all your thinking! It's uncanny! Revolutionary! Write: Bljou, Box 1727-M2, Hollywood 28, California.

ADDRESSES, Better class women mail shoppers. 1000. \$1. Deitrich Nursery, Box 5020, Miami, Fla.

VALUABLE Big mails, four months, 25c. Fresh weekly names, mailorder buyers, opportunity seekers, etc., 1,000. \$3.00. Trial 300. \$1.00. Wright Publications, Memphis 8, Tenn.

SHORTEST Process for "board feet" known. Handy card 25c. 6 for \$1. Luther Sorrels, Clarksville, Texas.

BRONZE Name plates: Adds distinction to your residence, office, boat, summer cottage. Free catalog. Nelson Co., Dept. 15, St. Paul 2, Minn.

"OPPORTUNITIES Galore" — Interesting profitable mailing, 10c. Valles, Box 242-BH, Brooklyn 1, New York.

MAIL Trade Magazine, opportunities mail, name listed, 10c. Everett, 243 54th, East Paterson, N. J.

"INTERESTING Mails"—Details. 25c! Bentz, Pine Hill's House, (B/72), Chatawa, Mississippi.

CARTOONS, The kinds you'll like. Samples 25c. Verret, Raceland, Louisiana.

PANNING Gold — Beginners booklet 36 pages; catalogue, supplies, mining books, maps "where to go." 25c. Old Prospector, B-440, Dutch Flat, Calif.

ELECTRIC Paint remover from wood, plaster surfaces, curved or irregular. Safe, flameless. Precision built of chromeplated and stainless steels. Absolutely guaranteed. \$12.95. Your dealer or B & L Tool Company, 51 Rue St. Blaiseville, Conn.

"WATERLESS (Lanolin) Hand Cleaner." (Oil base.) Make, sell. No machinery. Build profitable business. Complete formula \$1.00. Ideal Service, Park Ridge 3, Ill.

SENSATIONAL New line of Geiger counters for uranium detection. All types, all prices. No finer selection. Also mineral rights and new gold, silver and mineral detectors. Complete information free. Delectron Co., 5631 Cahuenga, Dept. B-8, North Hollywood, California.

"PLASTIC Collar ribs," fit slotted collars in dress shirts. Trim easily to length. Year's supply (4 doz.) ppd., only \$1.00. Kol'r Neet, 3719 Wilshire, Los Angeles 5.

PROSPECTING Equipment. Lowest prices; Geiger counters from \$35.50. Metal detectors from \$75. Ultraviolet lamps from \$12.50. Western Radiation Laboratory, 1107 West 24th Street, Los Angeles 7, Calif.

CUT Taxes. Keep auto-truck expenses at rock bottom. \$1.00. W. W. Winterfield Co., St. Paul 2, Minn.

READ With speed! New amazing method. Save hundreds of hours yearly. Free home test. No obligation. Rush postcard. C. Brownson, 9111 S. Hoyne, Chicago 20.

IF You want to earn \$200 month, inventing toys, games, gadgets, write—Hendrickson, Argyle 1-A, Wisconsin.

NEON House numbers, any color \$14.95 complete. LuxArt, Box 15597, Los Angeles 8, Calif.

HAIRCUT As You Like It. New booklet tells how. 25c. Mastrolia, 5½ Jane, New York City, 14.

SEEK Fabulous riches in buried treasures! Explore abandoned mines, hills, deserts, streams for natural gold, silver, other precious metals. Details free! Pathfinder Company, Dept. 8PM, 1726 Beverly Drive, Pasadena 7, Calif.

TATTOOING Outfits, supplies. Illustrated list free. Zeiss, 728 Leslie, Rockford, Illinois.

"LIQUID Lead." Bond practically any metal, including aluminum. Works cold. Makes lead molds. Hundreds other uses. Amazing product that is needed in every home and shop. Trial kit \$1.00 postpaid. Anti-oxidizing soldering flux for aluminum and other difficult soldering, such as cracked blocks and castings, tinning welds, etc. Two ounces \$1.00 postpaid. Both for \$1.85 postpaid. Critcher Specialty, 731-A W. Euclid, Detroit 2, Mich.

GEIGER Counter model C-18, fits coat pocket. 2 pounds weight, ultra sensitive, dependable, immediate shipment, only \$35.00. Fisher Research Lab., Inc., Palo Alto, Calif.

"RECEIVE Mail." Moneymaking offers, opportunities, catalogs, Name listed 10c. Ideal Service, Park Ridge 10, Ill.

SPRAY Gun—New, 2-3 cubic ft. pressure type, clamp on qt. alum, cup and 2 nozzles. \$6.50 plus postage. (Retail for \$11). Money back guarantee. Balko, 2303 Devon Ave., Chicago 45, Ill.

SAVE Money on paint brushes. Buy direct. Post card brings descriptions and prices. Kenmore Brushes, P.O. Box 53, Kenmore 17, N. Y.

TRAVEL Free throughout world in post-war Merchant Marine. Vacation or exciting career. Salaries high. Men. Women. 1950 guide tells how. Only \$3. American Seamans Guide, 545 Fifth Avenue, New York City.

GENUINE Buckskin coin purse and illustrated buckskin catalogue both for only 15c. Berman Buckskin Co., 227 N. 1st, Minneapolis, Minn.

TREASURE, Mineral locators. Goldak now offers treasure locators for \$75.00. Geiger counters reduced to \$95.00. Write the Goldak Co., 1541 West Glenoaks Blvd., Glendale 1, Calif.

FREE—Amazing new book, "How to Answer Ads." Never before have you seen anything like this. Tells you in simple language the correct way to answer ads. Gets you quicker replies—better results, and greater satisfaction. Will save you time and money and it's absolutely free. No obligation whatever. Every reader of advertising should have this booklet. Send a postcard for your copy now. F. W. Johnson, (Room 600), 200 East Ontario Street, Chicago 11, Ill.

TREASURE—Mineral locators — Geiger counters M-scope type for arctic-tropic use. Unsurpassed in efficiency. Factory guarantee. Lowest prices. Can be purchased on monthly payment plan. Free literature. Fisher Research Lab., Inc., Palo Alto, Calif.

SQUARE Dance instructions, 40 dances. \$1.00. Wesley Rader, 1922 Grant, Denver, Colorado.

TATTOOING Machines, outfits. Free catalogue. Jensen, 120 West 83rd Street, Los Angeles 3.

Earn Big Money

WRITING ORDERS

AMAZING NYLONS

Guaranteed Against
RUNS AND SNAGS
Regardless of Cause!

The world's ONLY complete, nationally advertised nylon hosiery line actually guaranteed against runs, snags or excessive wear, REGARDLESS OF CAUSE! It's amazing, but true! No matter what the cause—hard use or deliberate abuse—Kendex nylons are replaced FREE if they run, snag or become unfit for wear within entire guarantee period! Every weight from sheerest 15-denier to heavy 70 denier—all gauges up to luxury 60 gauge—all sizes, lengths, popular shades, fancy heels, black seams—full fashioned and seamless. Nothing is missing to make sure every woman is pleased. In spite of the amazing guarantee, retail postage prepaid prices start at \$1.08 the pair for sheerest 15 denier 51 gauge. Should free replacement be necessary, actual cost becomes 54¢ a pair! How could any woman possibly resist saving money and solving her hosiery problems? NOT SOLD IN STORES. Men and women wanted NOW, spare or full time, to write orders and earn big money. You can get orders even if you never sold a thing in your life!

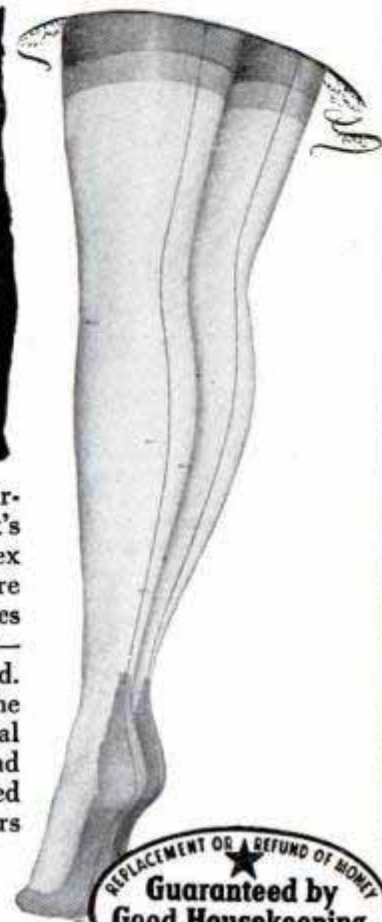

MEN'S HOSE GUARANTEED 1 YEAR

Kendex gives you FOUR complete lines, including sensational men's hosiery line actually guaranteed for ONE YEAR! Any pair not giving satisfactory wear within 12 months is replaced FREE without question. All styles, patterns, colors, yarns (including nylon) at lowest prices that mean steady income for you 52 weeks a year.

LINGERIE HOUSECOATS — ROBES

Full line of lingerie, housecoats and robes. Woven and knitted fabrics—rayon, cotton and NYLON. Nothing is lacking. Unbelievable prices that defy competition and make women eager to order. Imagine a beautiful all NYLON slip, with NYLON lace, at \$2.95 or a lace trimmed rayon satin slip at \$1.58! Kendex values sell themselves.

NATIONALLY ADVERTISED

Kendex has advertised in Life, Look, Collier's, McCall's, Saturday Evening Post, Ladies' Home Journal, Good Housekeeping, etc. Carries the Good Housekeeping Guarantee Seal. Thousands of orders shipped daily. Yearly volume in millions. A dependable responsible national organization.

FREE NYLON STOCKING AND MONEY-MAKING OUTFITS

Man or woman — young or old, YOU can easily earn steady income, spare or full time. No money or experience needed. We supply EVERYTHING free and set you up in business at OUR expense. Nothing to buy or deliver. Write orders, we deliver and collect. Big advance pay plus huge cash bonus that increases your earnings up to 40%! Your name and address on postcard will bring you sample nylon stocking; samples of lingerie, hose, robe materials; self-selling sales books with FULL COLOR illustrations; 36-page sales manual showing you easy steps to success; color cards, free "door openers" worth \$1 each but which you give away free; special plan to have others sell for you, etc., etc. You can start making money the minute you receive the complete FREE outfits!

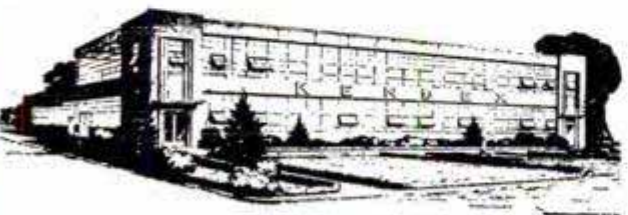

YOUR COST ONE CENT!

SEND NO MONEY. Pay nothing now or later No obligation. Not even a promise to return outfits. Simply write your name and address on a penny postcard and mail to us. We'll immediately rush you everything you need FREE and postage prepaid. WRITE TODAY!

KENDEX CORPORATION • BABYLON 146, N. Y.

AMAZING COMFORT - NO SPECIAL FITTING
RUPTURE-EASER

For MEN, WOMEN and CHILDREN

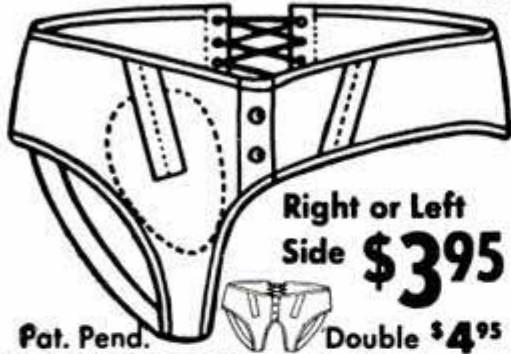

Right or Left Side **\$3.95**

Pat. Pend. Double **\$4.95**

A strong, form fitting washable support. Back lacing adjustable. Snaps up in front. Adjustable leg strap. Soft, flat groin pad. No steel or leather bands. Unexcelled for comfort. Also used as after operation support. Mail orders give measure around the lowest part of the abdomen. Specify right or left side or double. We Prepay Postage Except on C.O.D.'s.

Over 100,000 Satisfied Users!

10 Day Trial Offer

Money-back guarantee if you don't get blessed relief.

Delay may be serious - ORDER TODAY!

PIPER BRACE CO.

308 East 12th Street Dept. PM-85 Kansas City 6, Mo.

BE AN INVESTIGATOR

WORK HOME or TRAVEL. Experience unnecessary.

CRIMINOLOGY Particulars FREE. Write to **GEO. M. P. WAGNER**, 125 W. 86th St., N. Y.

operate your own business

TEACH DRIVING

DUAL BRAKES For any make car. Easily installed in two minutes. No drilling of holes - no screws - no damage to car. Patented.

EXTENSION PEDALS For short people - easily installed. Eliminates difficulty in reaching clutch, brake and gas pedals.

ART OF DRIVING BOOKLET Indispensable instruction guide for students. Answers 90 safe driving questions. By Richard A. Law. **\$1.00**

Write today for FREE literature.

LAW SAFE DRIVING METHOD 40-05A MAIN ST. FLUSHING, N. Y.

5 YEAR WRITTEN GUARANTEE BULOVA 15 & 17 JEWEL MOVEMENT

Originally Sold up to **\$59.50**

ONLY \$16.95
Plus \$1.70 Tax

- Also
- **BENRUS**
- **GRUEN**
- **WALTHAM** or
- **ELGIN**
- WATCHES**



Choice **\$16.95**

Genuine Bulova, Benrus, Gruen, Waltham, Elgin and other famous wrist watches in latest style Yellow Gold Cases.

You get these unredeemed 5-year guaranteed lifetime quality **FAMOUS MAKE WATCHES** now at truly enormous savings because we bought out **SURPLUS STOCKS** of leading New York and Maryland Jewelers. Order now while they last. State make preferred. Order men's or ladies'.

TRIAL OFFER! WEAR AT OUR RISK! Money back in 5 days if not delighted! **SEND ONLY \$1** down payment with order. Pay balance to postman on arrival plus postage. Or we pay postage if you enclose \$16.95, plus \$1.70 tax.

FREE! HANDSOME EXPANSION BAND INCLUDED WITH PREPAID ORDERS. Order now!

MARYLAND DISTRIBUTORS
Dept. 106, 501 E. Baltimore St., Baltimore 2, Md.

Free Folder: America's best Watch and Diamond Ring Values. Practically Wholesale Prices to User Direct

15 or 17 Jewel Wrist Watches
Water-resist. Shock-protected with Swiss Precision Movement
Originally \$30
OUR PRICE NOW \$9.95
Plus \$1 Tax

SEND ONLY 10c for **BIG CATALOG**
of WAR SURPLUS
OPTICAL BARGAINS

Build Your Own RIFLESCOPE, BINOCULARS, TELESCOPES, ETC.
We Furnish Optics and Instructions

- **LENSES, PRISMS & RETICLES**
- **EYEPIECES and OBJECTIVES**

Send \$1.00 for Stock #2-H 10-Piece Lens Kit and Big Instruction Booklet.

We Have Numerous Types of Assembled Optical Instruments Including BINOCULARS and RIFLESCOPES.
CHECK OUR BARGAINS . . . Mail 10c for CATALOG H

EDMUND SALVAGE COMPANY
BARRINGTON, NEW JERSEY

WHEELS - WHEELS

5" Disc Wheel 5/8" Tire 5/16" or 3/8" sleeve	30c ea.
6" Disc Wheel 5/8" Tire 5/16" or 3/8" sleeve	35c ea.
7" Disc Wheel 3/4" Tire 3/8" sleeve	45c ea.
8" Disc Wheel 1 1/8" Tire 1/2" sleeve	70c ea.
7" Disc Wheel 1" Tire 1/2" ball bearing	80c ea.
8" Disc Wheel 1 1/8" Tire 1/2" ball bearing	\$1.00 ea.
8" Disc Wheel 2" semi-pneum. T. 1/2" B.B.	\$1.35 ea.
10" Disc Wheel 1.75 semi-pneum. T. 1/2" B.B.	\$1.50 ea.
12" Disc Wheel 1.75 semi-pneum. T. 1/2" B.B.	\$1.85 ea.

Above wheel prices include hub cap
Plus postage, 20% - C.O.D.'s accepted

UNITED WHEEL STAMPING CO., PM-8
2756 W. 115th STREET CHICAGO 43, ILLINOIS

IDEA PROTECTOR

No Patents - - No Attorneys

New, absolutely fool-proof method of establishing date of ideas or inventions through copyrighted process. All simple details handled by you. Send \$1.00 for complete idea protector, including instructions. Satisfaction guaranteed or money refunded.

IDEA PROTECTOR CO.

4226 N. FIGUEROA LOS ANGELES 65, CALIF.

PLEASURE! - PROFIT!

Learn Watch-Clock Repairing at Home, Our Easy Way. Write for Free Information.

MODERN TECHNICAL SUPPLY CO.
Dept. 8PM, 55 WEST 42nd STREET, NEW YORK 18, N. Y.

MEN A Blue Print For YOUR SUCCESS!

Here is your opportunity for Success An amazing new finishing system that will start you in your own profitable business. No experience necessary - up to \$10 an hour easy Spare or full time in your own home or garage Start small - grow big fast We will guide you every step of the way This is BIG - don't miss your chance Send name now for FREE SAMPLE of my complete, easy profit plan for your success **COAST INDUSTRIES**

Dept. 28, 1004 S. Los Angeles St., Los Angeles 15, Calif



FREE BOOKLET & SAMPLE

SAY YOU SAW IT IN POPULAR MECHANICS

ROCKET PERFORMANCE

"Vapojet" is designed on the accepted water injection principle so successfully used on wartime aircraft to increase speed, power and efficiency. "Vapojet" captures water vapors from the radiator and oil vapors from the crankcase, combines them with the fuel, and converts this normally lost power into productive energy and superior performance. Users claim faster pickup, smoother running and extra mileage. "Vapojet" fits most cars and tractors . . . especially effective with high compression engines. Easy installation, takes minutes. **30 DAY MONEY BACK GUARANTEE!**

"Vapojet" on any car designed to reduce carbon "ping" . . . engine wear . . . **AND GIVES** automatic adjustment of fuel-air ratio at any altitude. **ORDER TODAY only**



U.S. Patent 2,188,175

\$9.95

post paid. Check or money order. \$1 deposit on C. O. D. Listcar, year, no.cylinders.

AGENTS WANTED
Distributors **B & G AIR SERVICE, INC.**
Dept. PMA 13610 S. Central Los Angeles 2, Calif.

BUILD THIS HOUSE Yourself



The Famous Popular Mechanics House

The picture below is from an actual photograph of the Build-It-Yourself House with breezeway and garage, as built by Jack Brownson, 23-year-old veteran, in Aurora, Illinois.

Designed by Popular Mechanics and Famous Architects. Every Detail Simplified and Explained. No Previous Experience Needed!

Can you use everyday tools as well as the average Popular Mechanics reader? Then you, too, can easily build this modern house in any of its five designs, doing every part of the job yourself. The new Popular Mechanics Book, "Your Home—How to Build It Yourself" will show you how.

Space for Living and Family Growth

This beautiful, modern house is 1½ stories, with basement, living room, kitchen, dining nook, two bedrooms, bath, plenty of closets and space for two additional bedrooms on second floor. The house itself is 35' 9"x28' 11"; breezeway 20' 10"x8'; garage 20' 10"x12'.

The House That Has Everything

Designed for easy construction and the most living space for the least cost, the Build-It-Yourself House is also most attractive and suitable for any community and most income groups. The basic plan is adaptable to four other exterior designs.

Get Book and Plans Now—Build When You Can

You may never have thought about actually building a house yourself, but now that building restrictions have been lifted, it is easier than you think. So order book and plans today. Even if you engage a contractor to build for you, you will need the plans. And you certainly will want the book which can easily save you hundreds of dollars, whether you build this or any other house.

Mail Coupon for New Book and Plans!

Build It Yourself or Have It Built —Save Hundreds of Dollars!

PLANS YOU CAN READ AND FOLLOW

Plans consist of ten working-size blueprints—floor plans, elevations, construction notes, framing, joints, lumber and mill list, specifications, plumbing and wiring diagrams. Every measurement is marked—every detail made clear as ABC. Book has 100 pages—three-fifths are photographs and drawings. Some sections in colors, showing just how your house will look when finished.

BIG BOOK
8½x11 inches

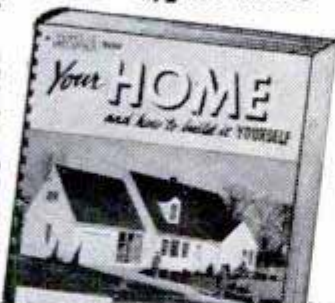

MAIL COUPON FOR BOOK AND PLANS

POPULAR MECHANICS PRESS

200 E. Ontario St., Chicago 11

I enclose \$_____ Send me the items checked at once.

- Your Home and How to Build It Yourself.....\$ 3.00
- Complete set of plans for Popular Mechanics Home.. 12.50
- Book and plans at reduced price..... 14.00
- Duplicate sets of plans..... 5.00

Name _____

Address _____

City _____ Zone _____ State _____

How to Write Short Stories, Mysteries, Articles



Keith Monroe

For Part-Time or Full-Time Income,

Learn at Home. Free Lesson Shows How

HAVE you ever had an urge to write? Have you or your friends had interesting experiences or ideas about social people, places, hobbies, sports, business or social activities, that might make interesting stories or articles for general magazines, trade and technical journals, fraternal publications, etc.?

Editors agree: the demand for new writers is greater than ever, and you don't have to be a genius to make money. Many Palmer beginners earn while learning, receiving small but welcome checks for material that may be turned out quickly once you acquire the technique. And now it's easier to learn than you may imagine, through Palmer's unique method of training—for not just one field of writing, but for all: Fiction, Article, Radio. Endorsed by famous authors—including Rupert Hughes, Gertrude Atherton, Katharine Newlin Burt, A. E. Van Vogt, and by hundreds of successful graduates.

Now Sells to Big Magazines

"Since studying the Palmer course, I've been able to sell to The Post, Life, American, Esquire, Reader's Digest, and other top magazines. It's the finest course anywhere."—Keith Monroe, Santa Monica, Calif.

You get practical writing assignments to do at home, saving time, effort and money. Your work is individually handled by professional writers.

FREE sample lesson and free book, "The Art of Writing Salable Stories" shows how you may earn extra income or make writing a full-time career. Be independent—work where, when, how you please. Send today! Palmer Institute of Authorship, Since 1917, Desk T-80, 1680 N. Sycamore, Hollywood 28, Calif.

APPROVED FOR VETERANS

FREE LESSON Palmer Institute of Authorship, Desk T-80

1680 N. Sycamore Hollywood 28, Calif.

Please send me free sample lesson and illustrated book explaining how your home-study training helps new writers get started. This is confidential. No salesman will call.

Mr. _____
Mrs. _____
Miss _____

Address _____

City _____ Zone _____ State _____

Please print clearly. Veterans: Check here

FREE TV



CATALOG & SAMPLE LESSON

RADIO TELEVISION TRAINING ASSOCIATION

Dept. 248
972 BROAD ST.
NEWARK 1, N. J.

Rush me your FREE Catalog "How to Make Money in Television," in spare time, AT HOME, while learning; details FREE round trip to N. Y. C.; together with FREE Sample Lesson. I am under no obligation.

Name.....Age.....

Address.....

High School at Home

Many Finish in 2 Years

No classes. No time wasted going to and from school. Progress as fast as your time and abilities permit. Standard H. S. texts supplied. Thousands enroll each year in this 52-year-old school. Send for FREE descriptive booklet.

AMERICAN SCHOOL, Dept. HC45
Drexel at 58th St., Chicago 37, Ill.

Without obligation, please send FREE descriptive booklet.

Name _____

Address _____



HERE'S A NEW AND VITAL BUSINESS!

LEARN ELECTRICAL EQUIPMENT SERVICING

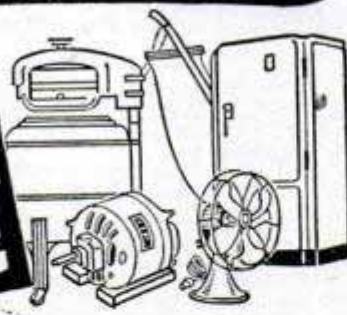

OFFERS BIG MONEY—INDEPENDENCE

Learn in spare time at home. **NEW Shop Method Training System.** Work as many hours as you wish—the Electrical Equipment Technician is his own boss. It is not unusual for a technician to charge on the basis of \$5.00 to \$6.00 an hour! Command big wages!

NO PREVIOUS EXPERIENCE NEEDED

We furnish everything! Tool kits, training kits, including the famous Christy trouble-detecting **ELECTRONIC KIT.** Plus illustrated instructions written in simple, easy-to-understand language, chock full of photographs and drawings. Shows you how to repair factory and household electrical units. Power machinery, refrigerators, washing machines, vacuum cleaners, irons, etc. Gives you a working knowledge of electricity, house wiring, motor winding, welding, nickel plating, etc. Shows how to build power tools you need, how to solicit business and what to charge. Many report paying for their entire course, tools, etc. on earnings made at home while learning!

FREE BOOK SENT TO YOU

Send your name for **FREE** booklet on Electrical Equipment Servicing and instructions for paying us later from your **EARNINGS WHILE LEARNING!**

CHRISTY TRADES SCHOOL

DEPT. D-8403 4432 N. KEDZIE AVE., CHICAGO 25, ILL.

Learn How **AUTOMATIC TRANSMISSIONS** Work

Hydra-Matic Dynaflo
 Ultramatic Powerglide
 Gyro-Matic Simplimatic
 and Others

The NEW BIG PAY Auto Field



Engineering Boiled Down Into Ham and Eggs Language for you

by *Jed Purvis*, Technical Editor, Motor Service Magazine, Member Society of Automotive Engineers.

The Only Book of its Kind and a Must for Every Man Who Works on Modern Cars

Auto mechanics, service station men, auto salesmen, students—even car owners—you need this timely book. You can't understand all about all of the new transmission systems without a copy of **AUTOMATIC TRANSMISSIONS SIMPLIFIED** handy. It covers in complete detail, every automatic transmission system, including those listed above, plus Tip-Toe Shift, Drive Master, Vacumatic, Torque Converters, Overdrives, Hydraulic Servos, Vacuum Boosters and others. It tells how they work—how they are constructed—what goes wrong—how to locate troubles and service all types.

Simplified Instruction — Over 200 Pictures, Diagrams, Etc.

Automatic Transmissions Simplified is complete, practical, easy to read and understand. It is all new and up-to-the-minute material prepared especially for this book by one of America's most authoritative automotive writers. No rehash of old stuff. It's the last

word in usable, practical information.

No Mathematical Formulas No Engineering Terms

If you can read this ad you can read and understand and make profitable use of the material in this book. The text is free from technical and engineering terms. Photos, charts, drawings, diagrams, some in color, make it as easy to understand as a road map.

Money Back Guarantee

Clip this ad and mail with your name and address with only \$4.00, check, currency or M.O., or pay postman on delivery. Your money back in 5 days if you are not satisfied.

Goodheart-Willcox Co., Dept. 135, 1321 S. Michigan Ave., Chicago

"SEA CRAFT" BLUEPRINTS READY NOW!

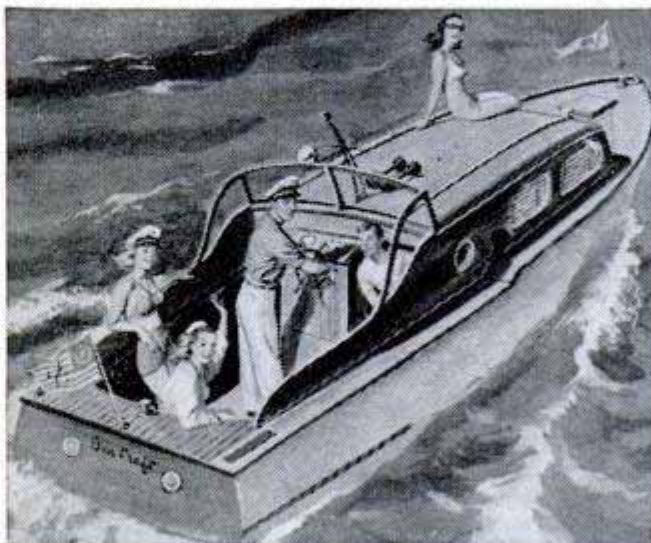

Build this luxurious cabin cruiser yourself and save money. What a beauty it is! A 25-foot boat readily adaptable as a sport fisher, express cruiser, or utility boat. Cruises effortlessly at 15 knots with a marine engine or converted auto motor. Its spacious cabin sleeps four and has a galley complete with fresh-water tank, sink, and cook stove. Has open cockpit large enough for fishing, lounging, etc.

During war the Coast Guard used "Sea Craft" for ship-to-shore travel. Order today your complete set of seven large-size blueprints scaled 1 inch to the foot. These, plus a 40-page two-color illustrated booklet giving step-by-step instructions, only \$10.00.

POPULAR MECHANICS PRESS

200 EAST ONTARIO ST. CHICAGO 11, ILL.

Bet You Don't Know This About Advertising
by Susan



Quiz No. 1

What does it cost to advertise a pack of a leading brand of cigarettes? Is it 2¢ a pack? 3¢? 5¢?

Answer: It costs less than 1/2¢ a pack to advertise the big brands of cigarettes. That's only half the story. Advertising lowers your cost two ways:

Cuts the selling costs. And by helping make mass production possible, lowers the production costs, too.

So advertising saves you many times that 1/2¢ per pack.

WATCHMAKING

Be a Watchmaker — Be Independent
Get practical training in Chicago's first accredited watchmaking school.

Day and Evening Classes—Approved for Veterans
Write today for free information

CHICAGO INSTITUTE OF WATCHMAKING
7 SO. PULASKI ROAD Dept. PM-8 CHICAGO, ILLINOIS



You can improve your Writing and become an Expert Penman at home in spare moments by my Simplified Method and increase your ability and prestige and your chances for business and social advancement. **FREE BOOK, "How to Become an Expert Penman"**—Shows photographs, specimens of penmanship and testimonials of others who have improved their writing and ability and become expert penmen and penwomen at home my Easy Way. No obligation. Don't Delay—Write Today! Send 10c for Shading Penpoint and your name with flourished bird elegantly written on a card.

T. M. TEVIS, BOX 25K, CHILLICOTHE, MO.

MAKE MONEY IN LANDSCAPING

Thorough training by Internationally known Landscape Architect to start your own business, improve your home or advance in this well paid field. Many Opportunities. Approved for Veterans. Send for FREE BOOK.



NATIONAL LANDSCAPE INSTITUTE
Dept. P-8, 310 So. Robertson Los Angeles 48, Calif.

LOCKSMITHING & Key Making

PRACTICAL UP-TO-DATE COURSE—ONLY \$3.95
Easy-to-learn modern information for self-instruction. How to work on locks, de-code, make master-keys, repair, install, service, etc. For every handyman, home owner, carpenter, mechanic, service station operator, fix-it shop, hardware dealer, gunsmith. 53 plain illustrated lessons. **FULL PRICE ONLY \$3.95. SEND NO MONEY.** Just pay postman plus C.O.D. postage. Or send \$3.95 with order, we'll ship postpaid. Satisfaction guaranteed or refund.
NELSON-HALL CO., 1139 S. Wabash Ave., Dept. H-2, Chicago 5, Ill.

FAMOUS DAN LURIE
BARBELLS
\$7.98 SATISFACTION GUARANTEED OR YOUR MONEY BACK!
Proven \$15 bodybuilding course FREE with every purchase. YOUR MONEY BACK if not delighted with results after 6 weeks.
Send for FREE CATALOG
DAN LURIE BARBELL CO.
1701 M-8 PITKIN AVENUE, Dept. 159-H
BROOKLYN 12, N. Y.

Happy Highways Ahead!
With Popular Mechanics new **MOTORIST'S HANDBOOK**. 160 pages of authoritative advice to keep your car rolling smartly—longer. Brakes, body, spark plugs, battery, starter—every automotive part is covered in this up-to-the-minute manual of year 'round driving pleasure.
Your news dealer has the 60c paper edition. Order the clothbound \$2.00 volume from
POPULAR MECHANICS PRESS
200 E. ONTARIO ST. CHICAGO 11

OWN a Business
Clean and Mothproof rugs and upholstery "in the home." Patented equipment. No shop needed. Duraclean dealer's gross profits up to \$20 a day on EACH serviceman. These Nationally Advertised services create repeat customers. Easy to learn. Quickly established. Easy terms. Send today for FREE Booklet—Full details.
DURACLEAN CO., 0-168 DURACLEAN BLDG. DEERFIELD, ILL.

Thrilling Work COLORING PHOTOS
Fascinating vocation learned at home by those with aptitude. Thrilling pastime. National method brings out life-like colors. Free booklet.
NATIONAL PHOTO COLORING SCHOOL
1315 S. Michigan, Dept. 135C, Chicago 5

MINIATURE "OLD TIMERS" AUTO SET MERCER 1911 Model \$3.95 Raceabout

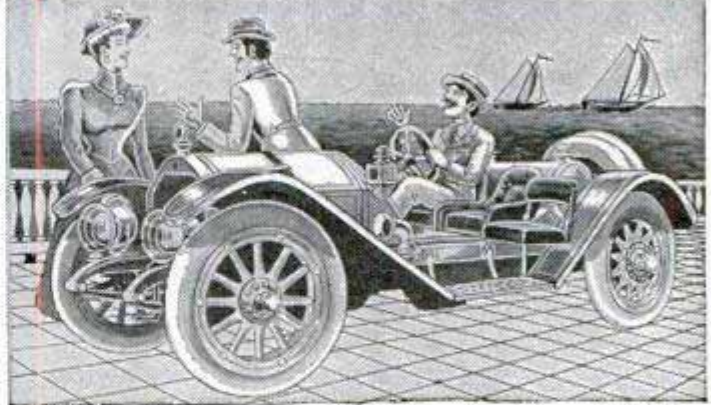

Here's that famous sports car that had grandpa all agog in 1911! The MERCER Raceabout featured an extra side seat—now banned. It's one of the great cars of an era that produced the Stutz—one that you will want to build and treasure forever! Comes complete with easy to follow instructions, plastic wheels, head lamps, cowl lamps, radiator, horn and steering wheel. Length 9 1/4"—only \$3.95.

1911 Maxwell ..\$2.50	1910 Model "T"
1903 Model "A"	Ford
Ford	1903 Rambler ..\$2.50
1904 Olds	1909 Model "T"
1909 Stanley	Ford
Steamer ..\$2.95	1900 Packard...\$2.50
1911 Buick\$2.50	1903 Cadillac ..\$2.50
1914 Stutz	1910 International
Bearcat...\$3.95	Harvester \$2.95

SEE them at your hobby, toy, or department store, or write to us
Add 25c for postage and handling; no C.O.D.'s, please.

Hudson Miniatures' "OLD TIMERS"
SCRANTON HOBBY CENTER, Dept. 14, Scranton 10, Pa.

STILL LOOKING FOR THE RIGHT SPOT?
Train for Success thru C.T.I.

- AUTO MECHANICS
- BODY-FENDER REPAIR
- DIESEL MECHANICS
- ELECTRICITY
- REFRIGERATION
- RADIO-TELEVISION
- MECHANICAL DRAFTING
- BUILDING CONSTRUCTION
- FACTORY MANAGEMENT
- HIGH SCHOOL

Want a better job or quick promotions? C.T.I. trains you at home in spare time, or in our big resident school. Mail coupon for valuable booklet on your opportunities.

COMMERCIAL TRADES INST.
1400 Greenleaf, Dept. E2-8
Chicago 26 Veteran Non-Vet.
Name _____ Age _____
Address _____
City & State _____
Course _____

Would YOU Like to Make \$1,000 A MONTH?

That's what Stanley Hyman is making selling the amazing new **PRESTO Fire Extinguisher!**

OVER 11,000 people died in fires last year. An eager public has been waiting for a practical new kind of fire extinguisher. Now it's here! Tiny "Presto" is about the size of a flashlight. Does the job of bulky extinguishers that cost 4 times as much and are 8 times as heavy. Ends fires fast as 2 seconds. Fits in palm of hand. Never corrodes. *Guaranteed for 20 years!* Sells for only \$3.98!



Stanley Hyman



Science's New Midget Miracle "PRESTO"

You can make good money showing this new discovery to owners of homes, cars, boats, farms, etc. Stanley Hyman reports making over \$1000 a month. H. J. Kerr, \$20 a day. William Wydallis, \$15.20 an hour.

What's the secret of "Presto's" amazing power? It's a new wonder chemical developed during the war, found to be 1.5 to 6 times as effective as chemical contents of other extinguishers on an equal-weight basis. Makes possible, for the first time, an extinguisher that is small, light, and amazingly effective.

Help supply the demand for this important new discovery. Write for FREE Sales Kit. No obligation; no capital required. But don't put it off. Every day you hesitate may cost you \$10, \$15, or even \$50 you could be making.

Send postcard or letter to: **MERLITE INDUSTRIES, Inc., Dept. 58, 201 East 16th Street, New York 3, N. Y.** (If you want a regular Presto to use as a demonstrator too, send \$2.50. Money back if you wish. FREE re-fill for your Demonstrator.)

SUCCESS AND SECURITY THROUGH TECHNICAL TRAINING

Increase your earning power. Send today for our free 150 page handbook "ENGINEERING OPPORTUNITIES" giving details of over 90 homestudy courses in all branches of Civil, Mining, Structural, Mechanical, Plastics, Electrical, Radio, Aeronautical Engineering and other fields.

Without obligation, write Canadian Institute of Science & Technology Ltd., 505 Century Building, 412-5th Street, N.W., Washington 1, D.C. Canadian inquiries — 263 Adelaide St. W., Toronto, Ont. Special discount for Servicemen.

MAIL THIS COUPON TODAY!



Name.....
Address.....
Age.....

Be A MASTER PLUMBER

Earn \$15 To \$50 A Day

DON'T ENVY THE PLUMBER — BE ONE

Every skilled workman will tell you that Plumbers have the best of it. WINTER and SUMMER the Plumber is busy at top wages. No skilled Plumber is ever out of a job—compare his opportunities with any trade, plus the opportunities of having your own shop. We teach you Plumbing with TOOLS (not books) under Licensed Master PLUMBERS in one of the finest equipped schools in America. We make you a Plumber, every branch is taught thoroughly—Lead Work—Blueprint for plan reading—all other tricks.

LEARN IN 30 WEEKS WITHOUT PREVIOUS EXPERIENCE

If you like to work with tools you owe it to yourself to investigate. No need to ever work as an apprentice. Get free bulletin. Write now! G.I. APPROVED. Our 24th year.

UNIVERSAL PLUMBING SCHOOL
877 HOLMES STREET KANSAS CITY, MO.



LEARN Commercial DEEP SEA DIVING

High paying and fascinating profession. 20 week course. World famous school. Latest equipment. Specialized training in all underwater work. Approved for Veterans. Write for FREE Booklet.

SPARLING DIVING SCHOOL
Dept. PM-8
1148 WILMINGTON BLVD., WILMINGTON, CALIF.

Say You Saw It in
POPULAR MECHANICS

STUDY AT HOME

WITH AN EDUCATIONAL INSTITUTION

Courses in ARTS AND SCIENCES: Philosophy; Education; Letters; Public Health; Medical Jurisprudence; Psychology; Sociology; Physics; Chemistry; Geology; Pol. Science; Theology; Law; Business and Commerce; Accounting; Mathematics; Statistics; Agriculture. **Courses in ENGINEERING:** Electrical, Civil, Mechanical, Drafting, Architectural, Automotive, Steam, Diesel, Aeronautical, Radio, Structural, Mining, Industrial, Petroleum, Marine, Refrigeration, Air Conditioning, Chemical. Send for free catalog.

McKinley-Roosevelt Incorporated, 4610-K3, Sheridan Rd., Chicago 40, Illinois



Boy! What a Picture!

And boy, what a book is Popular Mechanics new PHOTO HANDBOOK. Gives you the big three of superior photography:

1. The secret of taking better shots.
2. The technique of clearer developing.
3. The way to build better photo equipment.

Be an expert! Have fun! Save money!
Paper covered edition on all newsstands... 60c
Order colorfully bound library volume from
POPULAR MECHANICS PRESS... \$2.00
200 E. ONTARIO ST. CHICAGO 11



TRAILER COACHES

Here's everything you want to know about trailers, with plenty of pictures and plans and instructions for building three different types. Covers also, history of trailers, trailer parks, camps and overnight-stops information, furniture, furnishings, materials and engineering data. If you want to build a trailer, live in a trailer, or just want to know more about trailers, get this book. Only \$1.50 postpaid. Rush order to:

POPULAR MECHANICS PRESS • Dept. 350, 200 E. Ontario St., Chicago

Build it Yourself!

Complete Trailer Book and Construction Data for 10, 16 and 22 Foot Trailers — Only \$1.50

Partial Contents

Trailer Parks—Living in a Trailer—Towing a Trailer—Floor Plans—Service—Classifications—Balance—Dollies—Jacks—Weight Distribution—Construction—Working Drawings for a Two-Place, Standard Travel and Standard Dwelling Trailers. Size 8 1/2 x 11 1/4 inches.

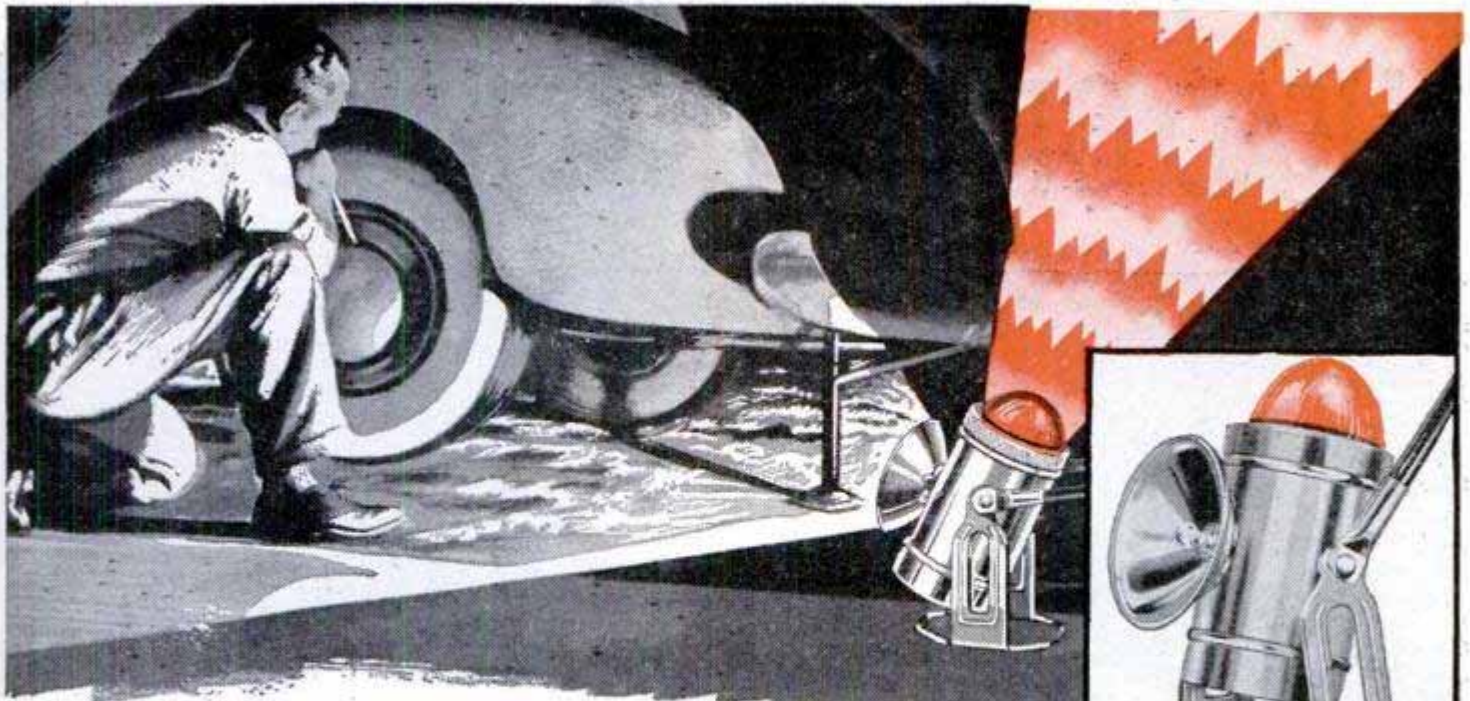

Sensational New...
"BLINKER" HANDILITE

AUTOMATIC FLASHER LANTERN

CONSUMER DEMAND RUNNING WILD ON SPECTACULAR ONE SECOND DEMONSTRATION—A "GOLDMINE" FOR SALESMEN AND DISTRIBUTORS

So new only a handful of salesmen have it—yet such crazy things are happening it is unbelievable. Graham, a spare-time salesman, ordered six. He unpacked them at work and the other employees were so thrilled by HANDILITE that all six were sold in his own office. In 10 minutes he made \$14.70 and had to order 12 more. Dunlop walked into a large office building with the red flasher "on." Within a half hour, he had sold 5 to building employees before even hitting the offices. He sold twelve—all he had—within the hour! But it is no wonder people buy HANDILITE as soon as they see how it works—what it does!

Now at last roadside accidents can be averted when car owners are forced to park their cars at night for tire changes or emergency repairs. For the first time, a vivid F-L-A-S-H-I-N-G RED signal light has been incorporated in a portable, battery-powered electric lantern. The amazing one-second "Wordless Demonstration" makes sales as fast as you turn the switch. Irresistible appeal is already sweeping thousands of Salesmen and Distributors to new money-making successes.

THOUSANDS WANT IT

FORTY MILLION MOTORISTS need and want HANDILITE. TRUCK and FLEET OWNERS, VACATIONISTS, SPORTSMEN, HOMEOWNERS and FARMERS want it as perfect emergency light. A perfect warning light—also unequalled as a general purpose lantern—as boat light, for hunting, camping. A thousand uses—in garage, basement, attic—for nighttime trips to farm buildings, as tractor or farm wagon light—for summer homes and summer resorts.

LONG NEEDED INVENTION

Make no mistake. HANDILITE is no novelty invention by a hopeful unknown. It is produced by the same manufacturer whose products are already standard with the mighty railroads of the country.

Selling HANDILITE is not like selling anything you have ever sold before. Here is a dazzling, convincing new product that literally sells itself. Walk in anywhere. Flip the switch—immediately your prospect sees the vivid red signal light flash its warning—visible a mile away. A second turn—on comes the white light casting a brilliant beam for 1,000 feet, while the red light continues to blink. A third turn—and

the red light goes off, leaving only the white lantern beam. A fourth turn—all lights are off. WITHOUT SAYING A WORD, YOU HAVE THE MOST COMPELLING SALES TALK you've ever given!

MAKE AMAZING EARNINGS SELLING DIRECT & TO STORES

Write at once for complete facts. Learn how you can sell direct at Big Profits—Then, after cleaning up in a territory, sell stores big quantities for resale under a proven plan that moves HANDILITE fast. The first man to open up is going to clean up. So get the facts, quick. Already territories are going fast. Write, wire, or airmail the coupon—but do it this minute. Every minute is precious.

HANDILITE CO. Dept. 48
 Sturgeon Bay, Wis.

The Handilite Co., Dept. 48
 Sturgeon Bay, Wisconsin
 I want to get in on HANDILITE.
 Rush facts and sample offer at once.

Name.....
 Address.....
 City..... State.....

HEAD OF THE LIST... he's got P.A.*

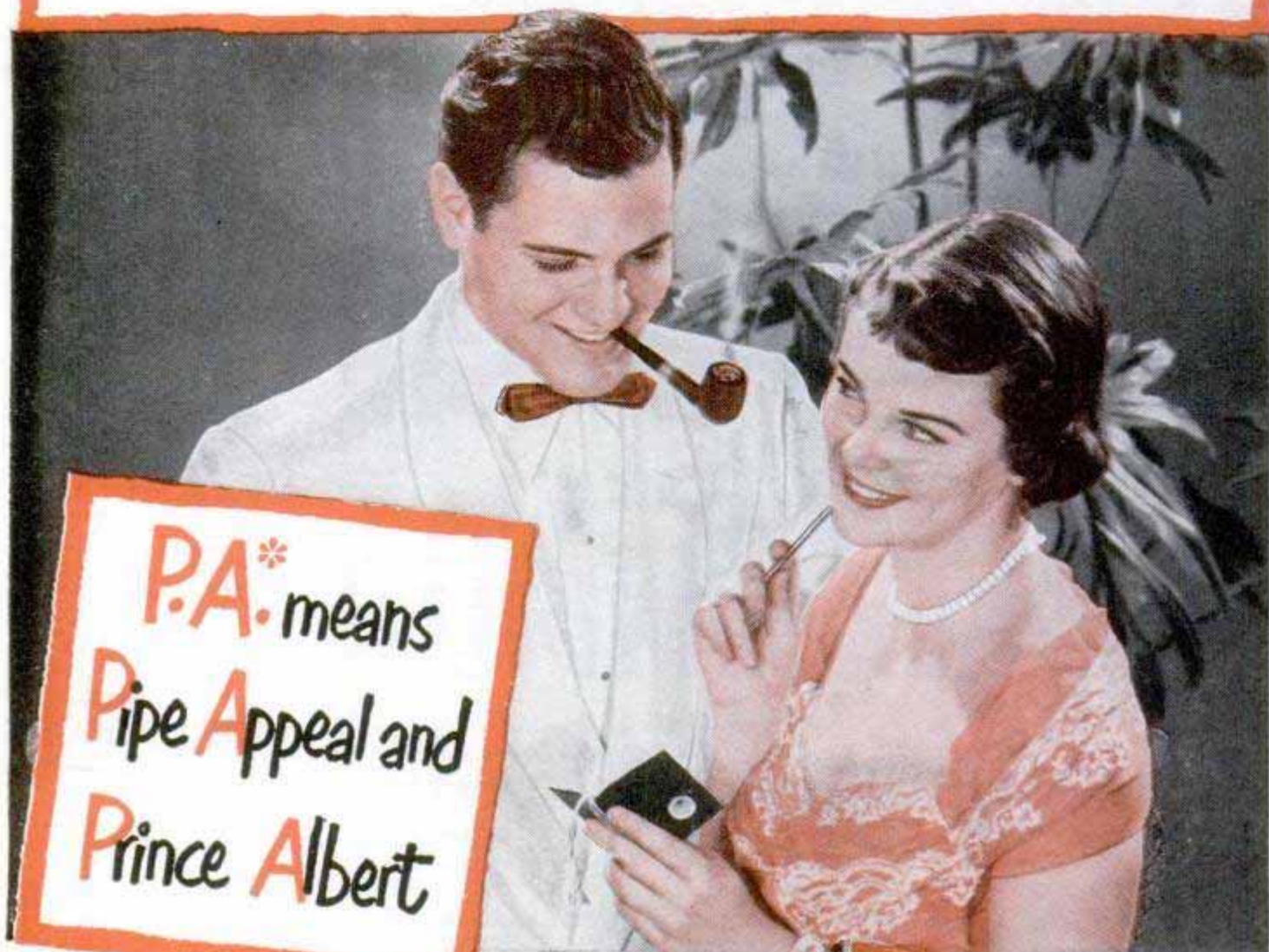

R. J. Reynolds Tobacco Co.,
Winston-Salem, N. C.

● You just know she has him at the head of *her* list. He's got Pipe Appeal! And you can guess he's got mild, rich-tasting Prince Albert in *his* pipe! Crimp cut P. A. is America's largest-selling smoking tobacco! Get P. A.! Prince Albert's choice tobacco is specially treated to insure against tongue bite.



P.A.'S CRIMP CUT
MAKES IT EASY TO ROLL
A FINE CIGARETTE!

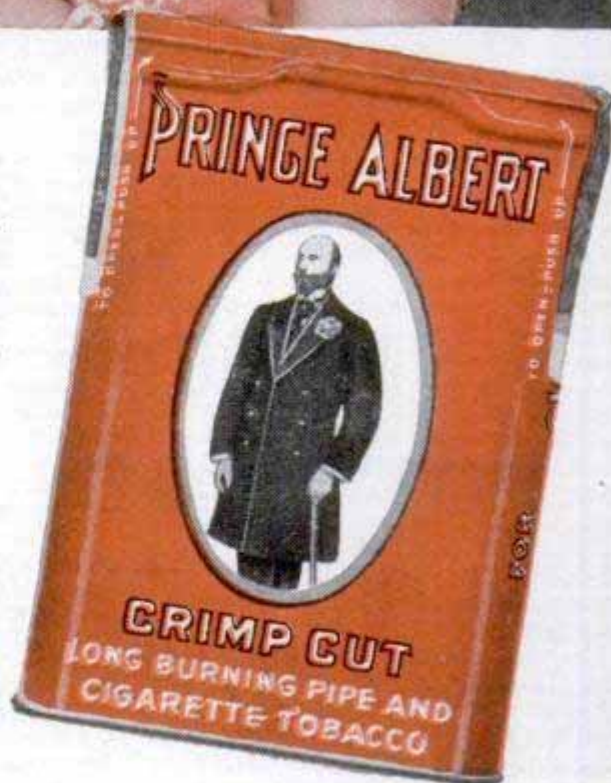

THE NATIONAL JOY SMOKE!

POPULAR AUGUST 1950 MECHANICS

WRITTEN SO YOU CAN UNDERSTAND IT
VOL. 94 NO. 2



More than a dozen drivers await their turn for a snarling dash down the salt flats in a race against a stop watch

Hot-Rod Derby on the Salt Flats

By Ewart Thomas

ON THE Bonneville Salt Flats in Utah late this month you'll be able to see the oddest collection of fast automobiles ever assembled.

Some will be "competition coupes" with cabs which appear to be squashed flat, one or two may be "twin tank" jobs that resemble a wartime P-38 with the driver

in one compartment and the engine in the other. Some will be flat streamliners not much more than knee high.

Each represents its builder's ideas on how to design the world's fastest car, in its class, with the funds available.

One of the cars is nicknamed the Ant-eater because it has a snout projecting

Roadster with a belly-tank nose has three ram tubes for packing air into the carburetors of its rear engine



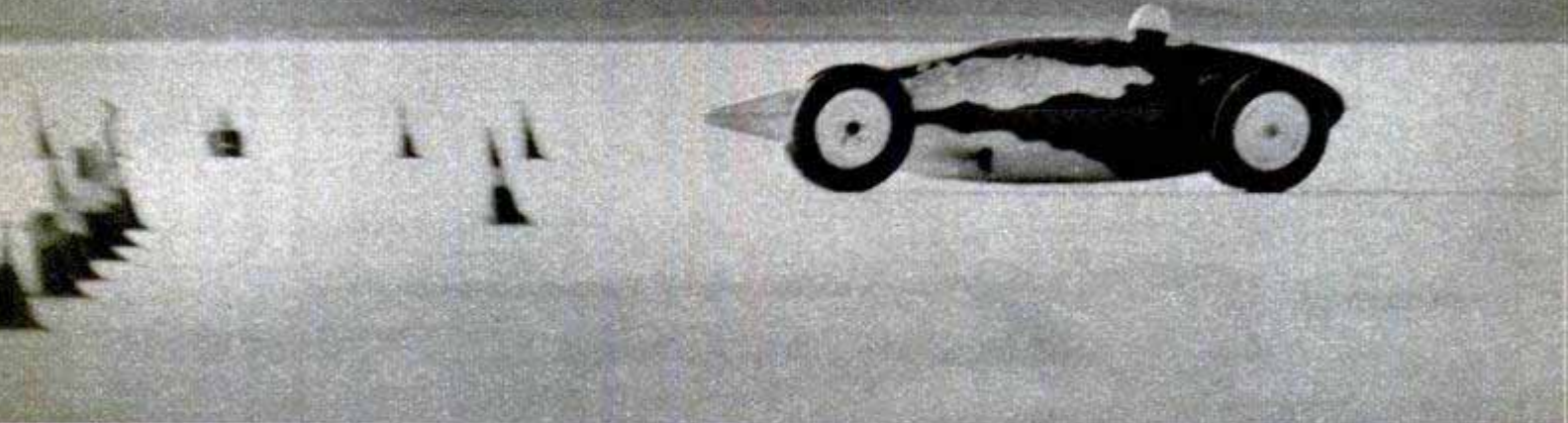

Photo courtesy Hot Rod Magazine

Another belly-tank hot rod streaks through the time trap at Bonneville. Two runs are made and the times averaged for official record

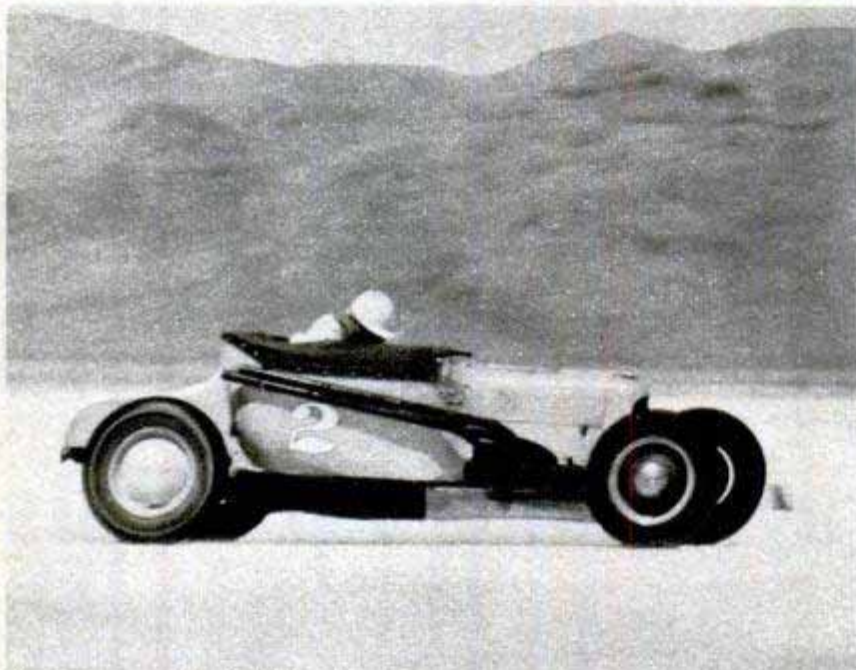

Photo courtesy Hot Rod Magazine

Stripped-down competition roadster has two radiators but no cooling fan. A fan cuts down horsepower. Below, the Anteater's belly-tank nose provides room for driver and controls. Engine is in the rear



in front. The driver sits over the front axle in the long snout because the conventional body is entirely filled with engine and supercharger. Another is a twin-engine "odd rod" with the driver in the middle and an engine over each axle.

Some of the cars sport Model-T bodies and appear to have been built 30 years ago but even these cars, beneath their hoods, have snarling, hopped-up engines.

All of the cars are classed as hot rods because they are home-built creations, but the hot rods have grown up. Amateur automobile testing has become a recognized sport and most of the rods are pure racing machines of advanced mechanical design.

The occasion for the meet is the second annual running of the Bonneville National Speed Trials and the dates are August 21 to 27. The place is the table-flat expanse of hard salt on which John Cobb set his automotive world record for the flying mile at 403 miles per hour.

Cobb's record won't be threatened, of course, for he had 2400 horsepower under the hood, and few of the home-built cars can develop more than 225 or 250 horsepower. The present hot-rod record of 193 miles per hour (or 189.78 miles per hour average for two runs in opposite directions) was set at the salt

flats last summer by a streamliner with a Mercury engine which had been souped up to produce 225 horsepower.

Alex Xydias and Dean Batchelor of Burbank, Calif., who own the car, hadn't expected that their Special would go that fast, and they first used tires that were guaranteed for speeds of no more than 175 miles per hour. Both front tires lost their treads at about 190 miles per hour and the bodywork was slightly damaged. The car was brought to a safe stop and later, using Indianapolis-type tires, set its present record. Two professional race cars that were clocked at the same meet last year made top speeds of only 136 and 144 miles per hour.

This year Xydias and several other owners of streamliners are hoping to do 200 miles per hour or better. A typical car that is being put together especially for Bonneville is a rear-engine streamliner from Pasadena, owned by Marvin Lee, that was clocked at 151 miles per hour, both ways, on the salt last year. This summer a new body was designed for it, and the Chevrolet-six engine that last year developed 243 horsepower at 4400 revolutions per minute has been additionally reworked to turn up 5000 revolutions per minute. Straight alcohol is used as fuel, metered through a high-pressure injection system.

Lee's new and narrower body was designed with the help of an aerodynamicist friend who took special pains to obtain a minimum frontal area. To avoid building wheel housings that might be larger than necessary, for instance, wheels and tires were whirled in a special test rig at 2800 revolutions per minute, roughly equal to 230 miles per hour, to learn the amount of centrifugal growth that occurs at that speed. Measurements showed that the tires expand $1\frac{7}{16}$ inches in diameter at that speed and the dimensions of the wheel covers

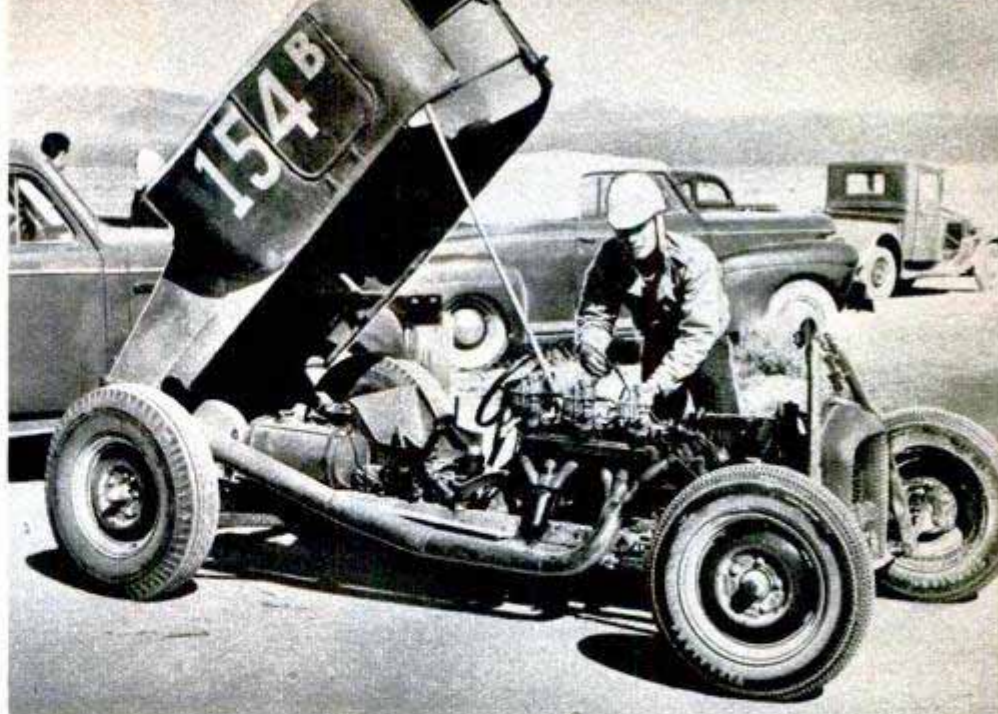

Owner of this roadster swings the entire body back on hinges to get at oversize engine for a tune-up before start of the time trial

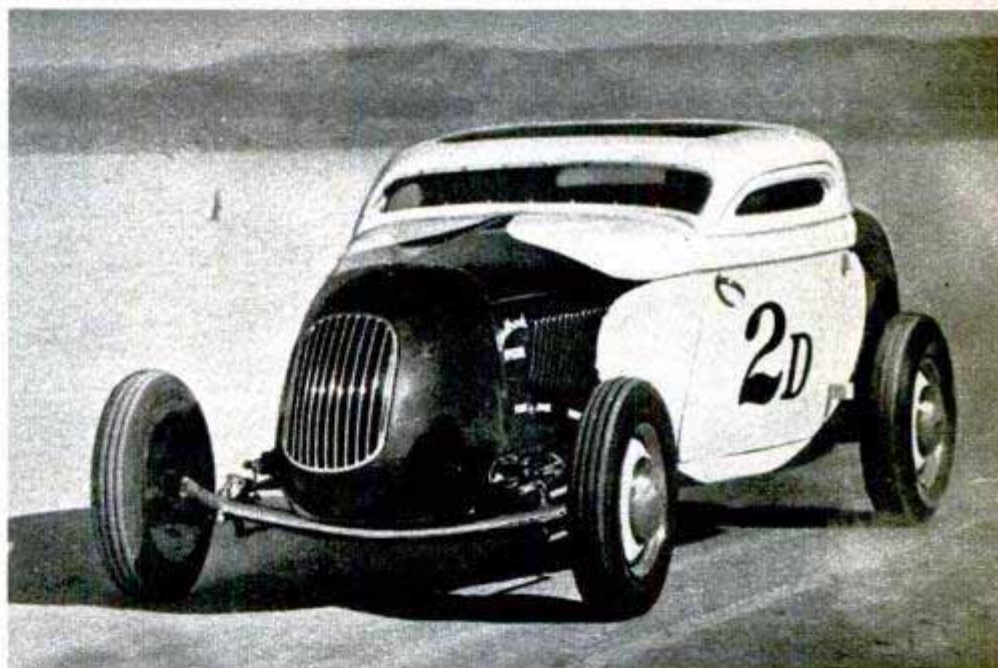

Chopped-down coupe has only a slit of Plexiglas for a windshield. Mercury engine gives it a top speed of 142 miles an hour. Below, hot-rod's supercharger, partly homemade, is mounted atop the engine

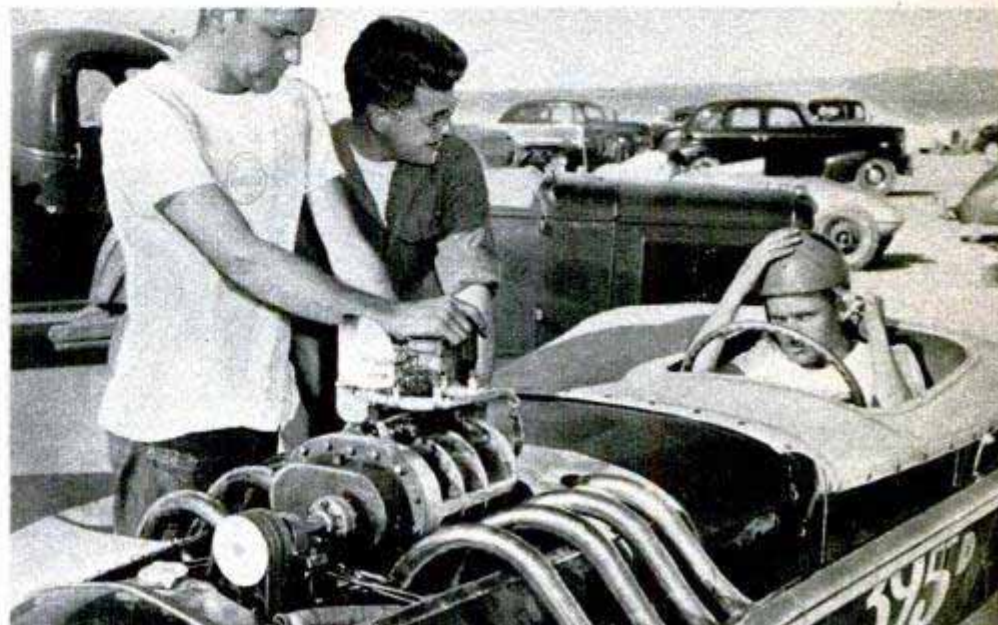

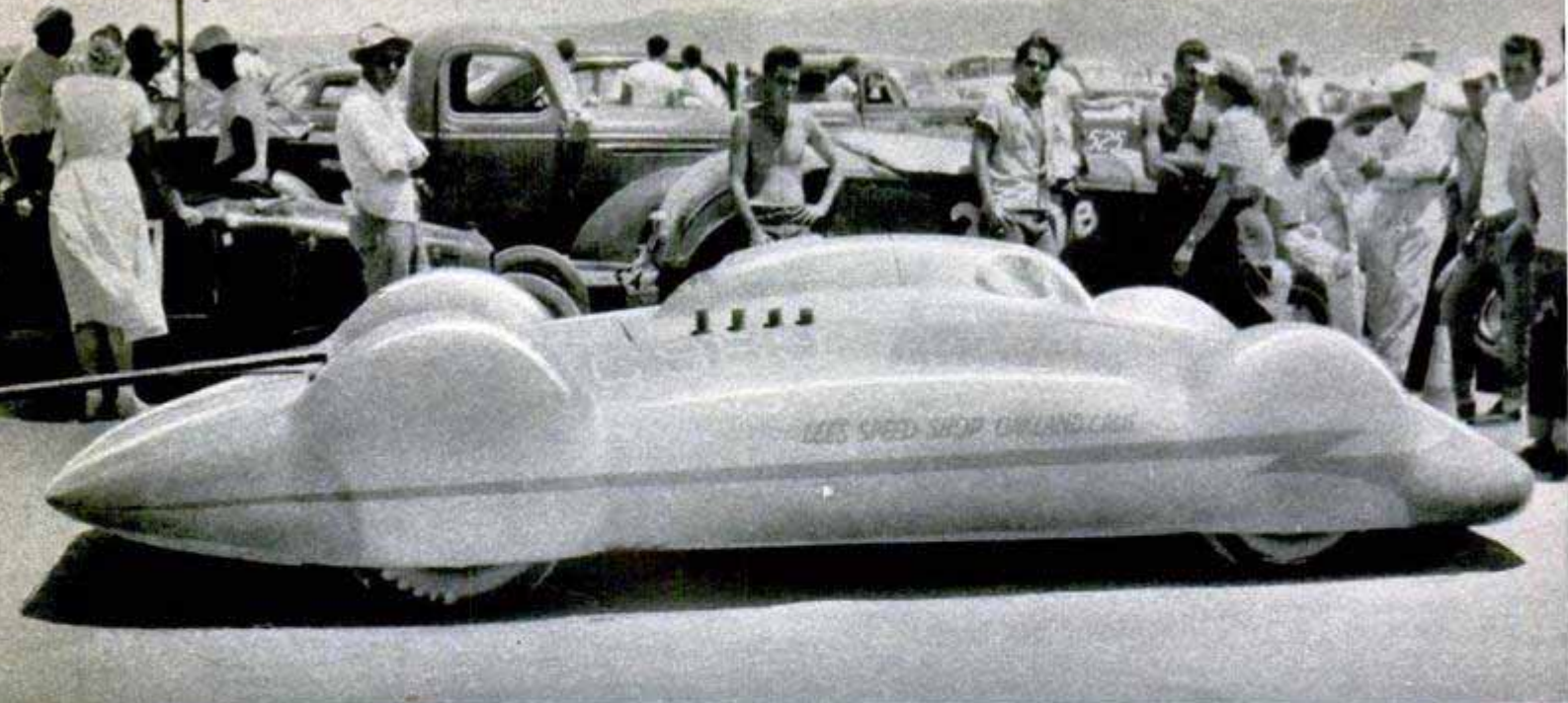

were accordingly laid out to allow for that growth.

Hot rods fall into two broad groups—the street jobs or highway cars that are used for ordinary transportation as well as time trials, and the special racers that are used only for time trials and that are towed or trucked to the scene. Cars in the latter group usually have no starting mechanisms and must be pushed. In these cars the nose is completely cowled to reduce wind resistance. An oversize water tank replaces the radiator and no cooling fan is used. The engines don't overheat because the cars are driven no more than five miles at a time.

The street jobs, too, usually dispense with the fan to reduce horsepower wastage and many of them use two radiators, one behind the other, to insure proper engine cooling in traffic. Many of the cars have quick-change rear ends or gearboxes so that a gear combination can be installed to fit a tire size that is being tested or for driving against a heavy wind.

Engines are completely reworked and the changes may include special ignition, special intake manifold with up to one carburetor per cylinder or a fuel-injection system, high-compression heads, enlarged cylinders to take oversize pistons, "stroked" crankshafts to permit the use of longer connecting rods, and superchargers. In southern California, center of the hot-rod sport, a number of speed shops cater to hot-rod owners, providing them with special equipment that adds to an engine's power.

Special fuels and carburetion often add many miles to a car's top speed; even the mixing of about 10 percent of water to the gasoline has been found a help. The trick here is to pour the water and gas into cans, shake the fuel vigorously, dump it into the tank and take off at once, before the two liquids have a chance to separate. More

† Squatty streamliner is powered by a V-8 engine mounted in the rear. Note the push-rod behind car. Many hot rods have no starters and must be pushed

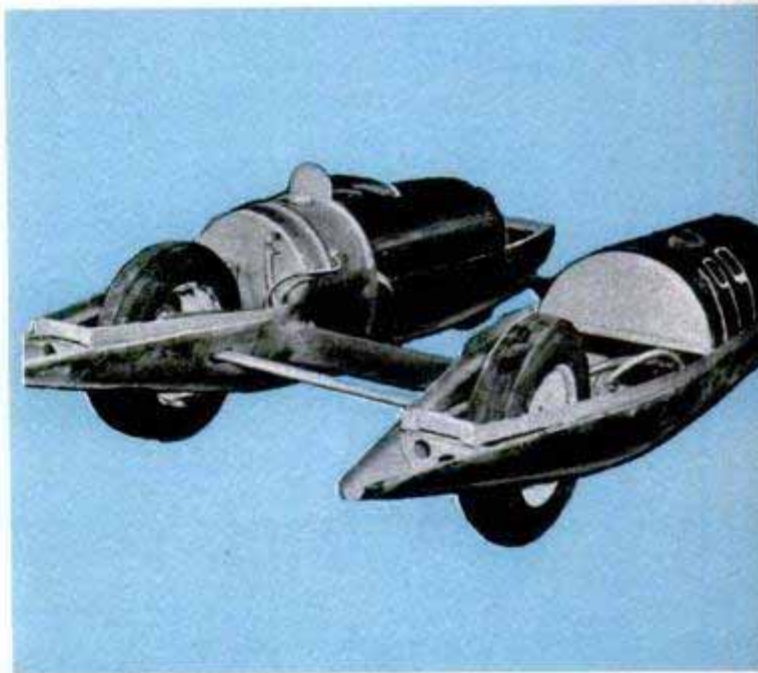

commonly used is methanol or wood alcohol. Fuel lines of up to 1/2-inch inside diameter are used with alcohol, as are special jets in the carburetors. Instead of supercharging their carburetors, some enthusiasts use "ram tubes" to pack more air into the intakes. The tubes may project up like the pipes of an organ or they may protrude out in front of the car.

One of the rules on the California dry lakes where many time trials are held is that in trying for a two-way record a car must make its second run in the opposite direction within 15 minutes of its first run. This allows enough time for the driver and a couple of helpers to change the tires all around. It is the custom to use the largest size tires that the owner has when running with the wind and to change to one or

(Continued to page 238)

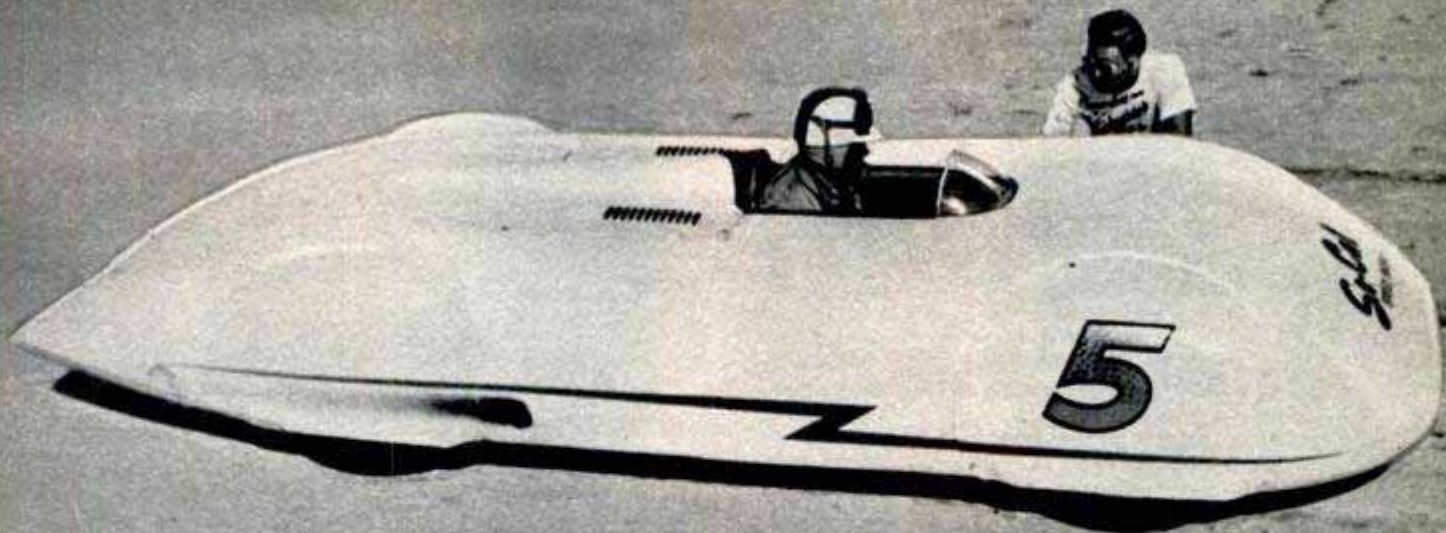
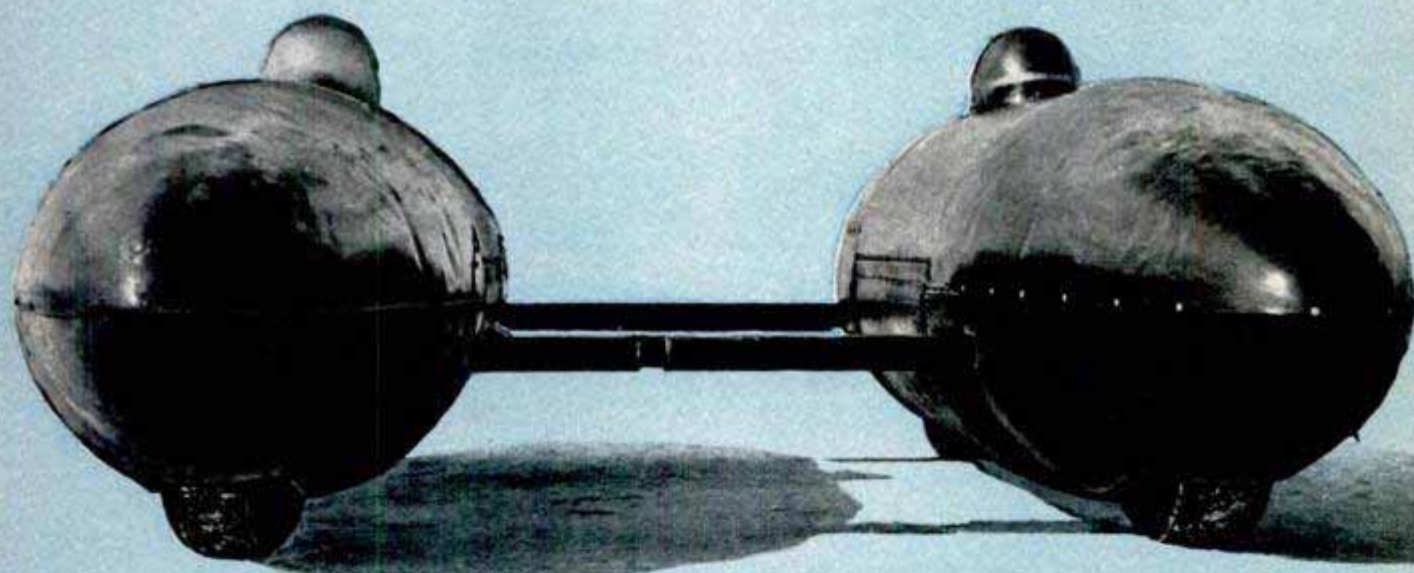

Photo courtesy Hot Rod Magazine

↓ Driver sits in one belly tank and the engine is in the other, in novel streamliner. On opposite page, same car partly disassembled for work on springs

↑ Present record holder is a flat streamliner that hurtled across the salt flats at 193 miles an hour. The car is powered with reworked Mercury V-8 engine



Driver, about to try for a new record for the flying mile, straps himself in the cockpit and mechanics replace the hood

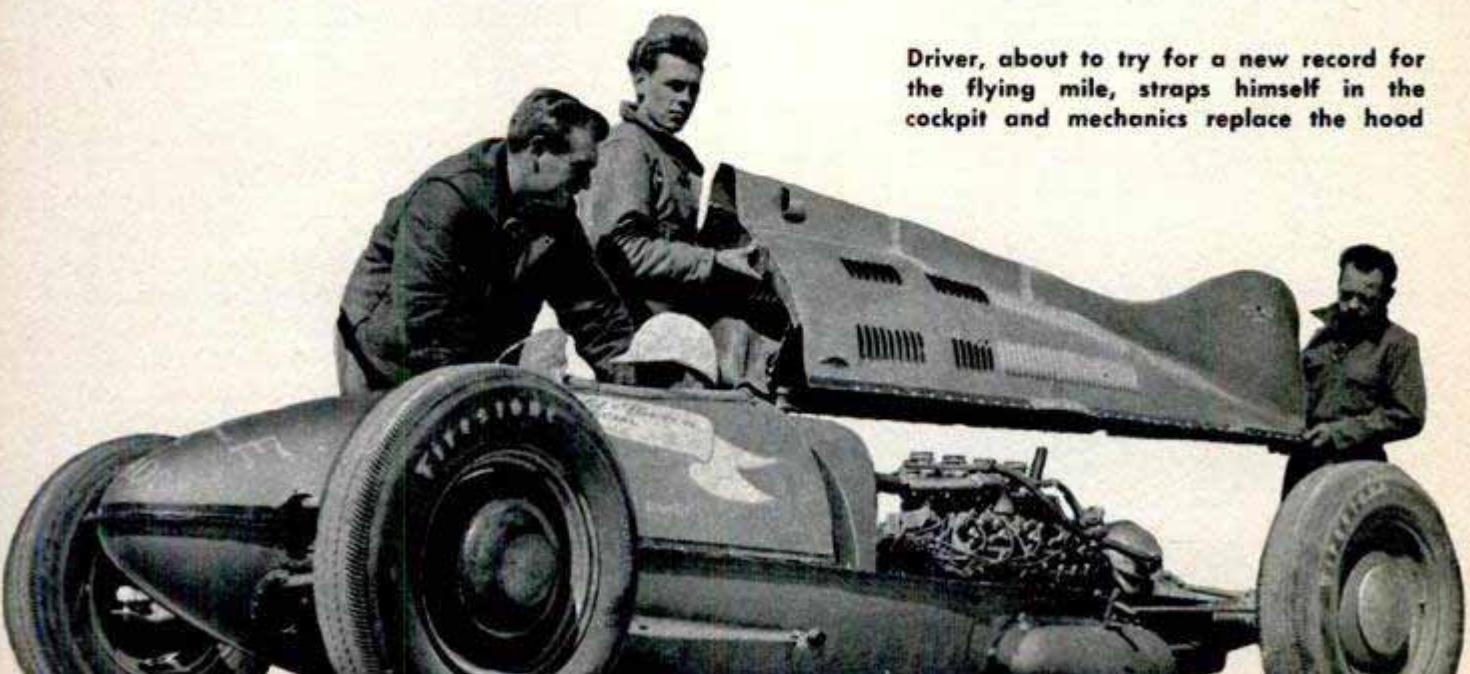



Senator-Inventor

To plot the complicated schedule of eight baseball teams in the Western League, Senator Edwin C. Johnson of Colorado invented a schedule board. It looks like a cross between a giant cribbage board and a piano keyboard. The senator, who is also president of the baseball league, uses the peg-studded board to read the current 154-game schedule at a glance.

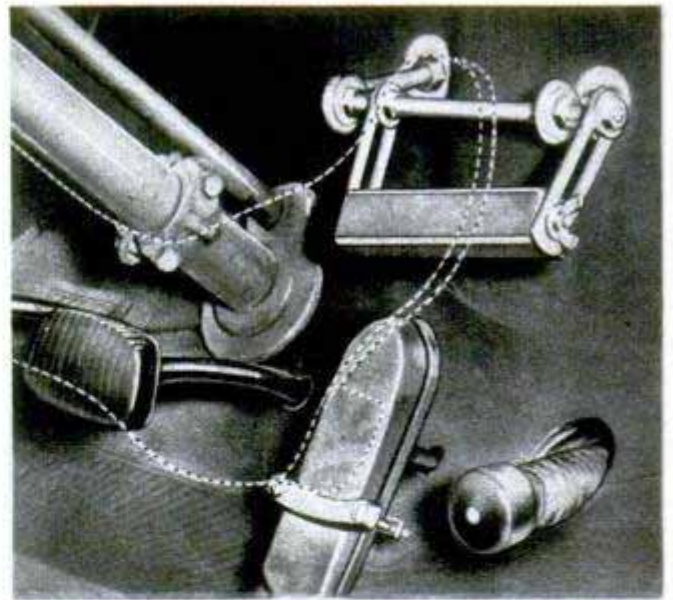

Leg Rest for Drivers

Motorists get relief from the physical strains of long-distance driving with an adjustable rubber rest bar that fits just above the accelerator pedal. It provides a comfortable and secure resting place for the fore part of the foot, while the heel presses down on the accelerator. Alternating use of it with the usual ball-of-the-foot-on-the-pedal method avoids the fixed position that causes leg cramps and fatigue when driving for long periods.

Paper Drop Cloth

Made of heavy pliable paper, an inexpensive drop cloth covers floors and furniture during home decoration. The paper covering, measuring almost 9 by 12 feet, enables homeowners to protect their furnishings without buying expensive drop cloths. It may be reused many times and will serve as a picnic or beach blanket or garage-floor covering during car repairs.

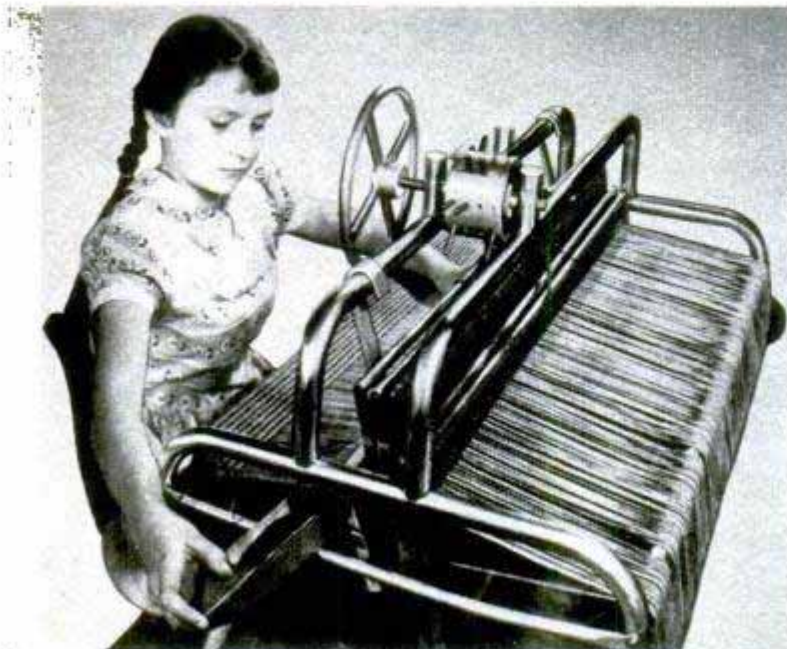

Treadleless Home Loom

One handwheel on a new home loom replaces the eight treadles formerly required, thereby making weaving a hand operation entirely. The loom is designed primarily for those who wish to make weaving a part-time, money-making hobby. A yard of 38-inch material an hour can be woven on the loom, which handles silk, cotton, linen, worsted or wool. The frame of the loom is made of aluminum-alloy tubing and the entire machine weighs only 35 pounds.

☞ Falling at Potter, Neb., on July 6, 1928, the largest recorded hailstone weighed 1½ pounds.



All aboard! Loaded on a giant trailer, the Mitchell family residence is ready to follow the job anywhere

House Follows Job

WHEN James G. Mitchell, traveling engineer for a construction firm, is ordered to a new job, he doesn't worry about a house for his family of five—he takes it with him! And the house is no crowded trailer. It's a comfortable five-room home complete with shrubbery and a trim fence for the yard.

Mrs. Mitchell designed the portable house after convincing her husband that a family of five is a little too big for trailer life. The home is built on heavy oak skids and is 33 feet long and 12 feet wide. It weighs about 30,000 pounds and is strong enough to withstand frequent trips aboard a huge trailer. Whenever they move, the Mitchells rent a piece of ground, preferably near a school for the children. The trailer pulls up, unloads the house and in an hour the plumbing and electricity are hooked up. Then the family settles down to get acquainted with the new neighbors.

Below, who would guess that this neat house was "on the road" a few days ago? Shrubby and fence travel with the building. Right, Mitchell and daughter sit down with the paper. A spinet piano is to the left



A winch pulls the 30,000-pound house onto the bed of the trailer. Under the floor are thick oak skids



WE SENT AN EDITOR TO VENEZUELA ON ONE OF THE BIG OIL FERRIES TO LEARN HOW...

A Super-Tanker Feeds Oil-Thirsty America

By Richard F. Dempewolf

FROM HUGE tank-farm drums, sitting atop the coastal peaks like squat pill-boxes against the Venezuelan sky, thick crude oil slid by gravity through the 20-inch pipes snaking down the hillsides. In the mountain-bound harbor of Puerto La Cruz, it gushed into the cavernous belly of the super-tanker SS Amtank, monster oil ferry carrying million-dollar cargoes to the States from the Sinclair Refining Company's Venezuelan fields.

All night long the Amtank had been taking on crude through the three 10-inch

rubber hoses attached to her deck manifold. The black boa-constrictor-like tubes surged and hummed in their rope slings under the pressure of 17,000 barrels per hour of the black gold racing through them.

When the ship started loading at midnight, her gangplank was almost vertical. Now, loaded close to capacity, she had gained a little weight — 23,000 tons — and her fat hull settled 20 feet in the bay. Her decks were flush with the dock and the gangway was a horizontal plank. On the flying bridge, Capt. Harold H. Mathis stood

Riding low in the water with 9,000,000 gallons of oil in her belly, the Amtank prepares to leave Puerto La Cruz



ready to cast off. Another half hour and the ship would be on her 4½-day, 1800-mile trip back to the States with enough oil to keep 1000 American homes warm all winter, run 7000 cars for a year and have enough low grade left over to run the Queen Mary for a week.

Today, ships running oil across the seas are a far cry from the old barques that first lugged it in leaky wooden barrels and periodically exploded at sea from fumes ignited by galley embers or sparks struck on brightwork. The modern tanker was born in 1885 when a German shipowner, sick of losing his barrel-toting tubs, bought an old U. S. Civil War ship, stripped out her hull and fitted her up with 72 steel tanks capable of holding 700,000 gallons.

Super-tankers coming off the ways in 1950 range up to 630 feet in length and carry cargoes of 10,000,000 gallons. From Middle Eastern Saudi Arabian oil fields and the north coast of South Africa, great fleets of them ply back and forth to U. S. ports, hauling oil cheaper than it would cost to buy it domestically and pipe it to markets in other parts of the country.

The Amtank was among the first of these postwar mammoths. Trimmed for action and oil, her wheelhouse is long and narrow to cut wind resistance. An unsupported flying bridge juts from each side of it like a pair of wings to give the skipper his over-side view for docking. Virtually no superstructure obstructs the sweep of wind

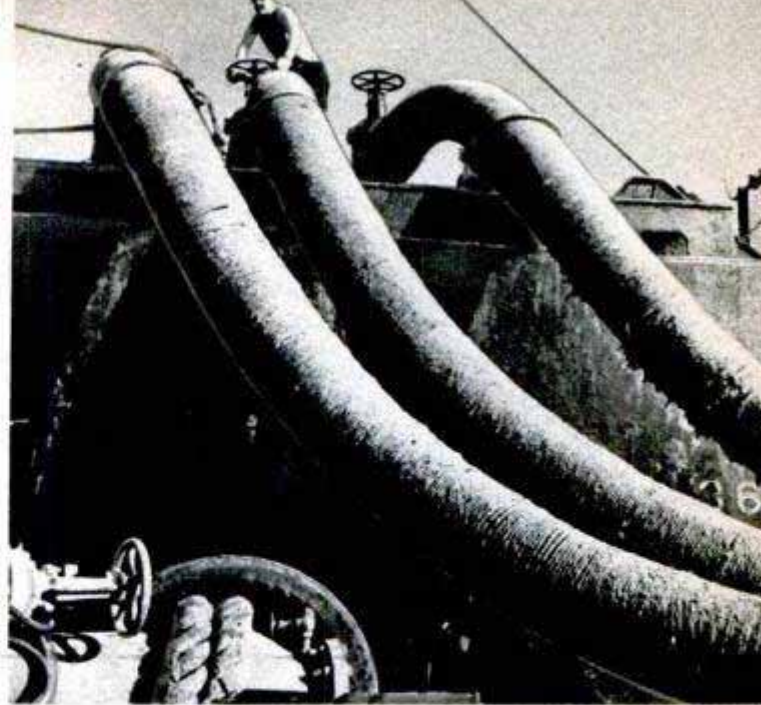

Huge hoses pipe oil from the wells to the tanker

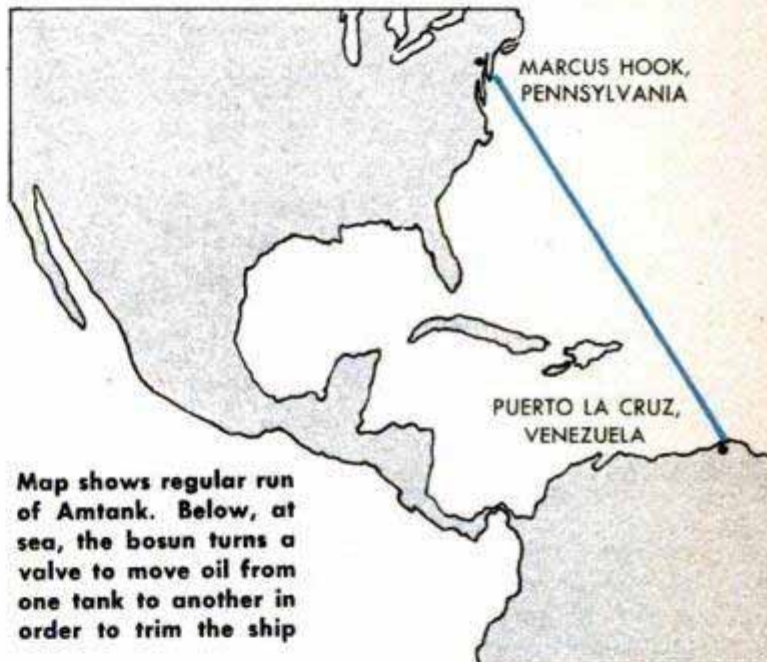

Map shows regular run of Amtank. Below, at sea, the bosun turns a valve to move oil from one tank to another in order to trim the ship

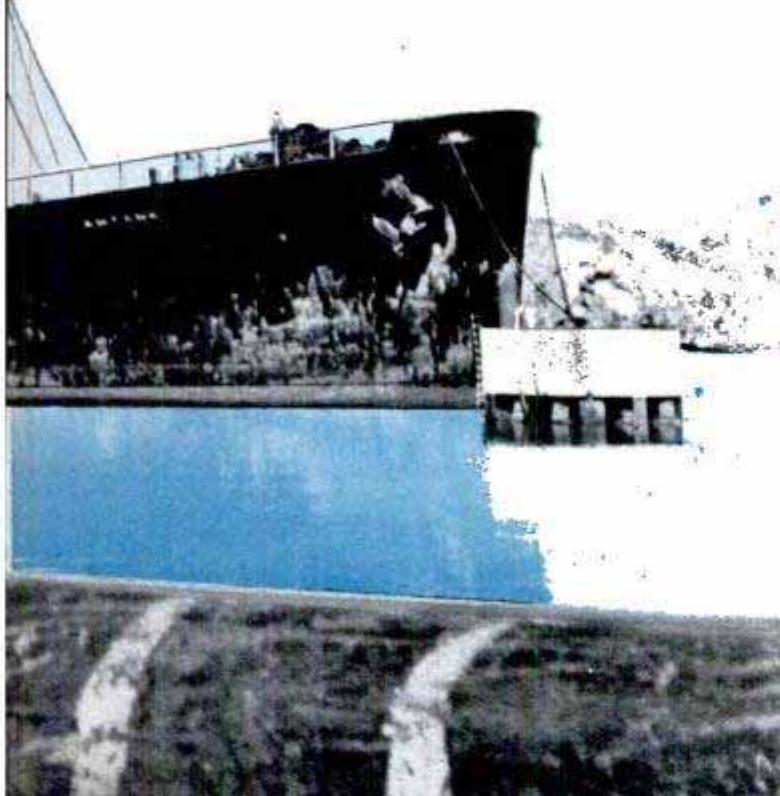

across her flat decks except low nubbins of oil hatches, breather pipes and brightly colored valve wheels. She measures 556 feet long and 80 feet abeam, and while she weighs only about 7000 tons empty, she'll tote four times her weight in cargo—about 200,000 barrels, or 9,000,000 gallons. A mighty 15,000-horsepower, 21-jet geared steam-turbine engine sends her along at a sound 17 knots. She's done better than 20 with a tail wind and a shove from the Gulf Stream.

Like any tanker, she is not just a big hollow bathtub with a deck on top. Her hull is neatly sliced into nine welded-steel sections which give her structural support and keep her temperamental cargo from sloshing around. Each section is divided in thirds by two fore and aft bulkheads. If you could lift off her top decks, she'd look like an overgrown egg box. On the tank bottom rests a network of pipes, valves and suction heads, all feeding from the pump room, aft. By maneuvering the valves, which are activated by long-stemmed wheels on the decks, any combination of tank sections can be connected together by pipe lines, disconnected or blocked off for loading or unloading.

It takes a total of 43 officers and men to handle the Amtank, plus a sharp skipper who knows what he's doing. The biggest headache, however, is nursed by the chief mate. Cargo is his baby, and he can start worrying the minute it comes aboard. It's messy, explosive, heavy and it moves fast. It can break up a ship if not loaded properly. When handling a single cargo like crude, some mates simply open all valves and let the oil swish through the entire

Scraping decks is daily but potentially dangerous job. Pneumatic, nonsparking metal brushes are used



ship until it's almost full. Then everyone races around like mad shutting down valves. Not on the Amtank.

When the big hoses are hooked on at Puerto La Cruz, inspectors stroll casually from hatch to hatch, measuring ullage (the air space between the top of the oil and the top of the tank) with a long rule. Others drop a tape to the tank bottom. The tape has a white paste on it which turns gray when touched by salt water. Thus, the amount of salt water or "thieftage" in the tank bottoms is accurately determined. Meanwhile, valvemen walk around the deck swinging wheels. All but the center tanks are blocked off. These fill first. Then oil surges into the outboard sections, or "wings." This way the ship stays on an even keel. Chief Mate Bob Warrick usually leaves wing tanks 6, amidships, empty to eliminate strain and sag in the center of the ship when she's under way. Last of all, wing tanks 8 and 4 are filled to trim the ship fore and aft, so her bow rides a little higher for easier and faster cruising. Harbor depth permitting, a three-foot drag is desirable.

It's no job for amateurs to swing the big wheels that open and shut valves 40 feet deep in black oil as a tank comes full, and flow must be switched to other tanks. This is "topping off"—a tense moment in cargo loading, since those tanks are filling at a rate of 12,000 gallons a minute! The valveman starts "squeezing down" as the oil comes near deck level. If the mate forgets to watch his ullage for a few seconds, or misses his guess, he'll get a spill. Two hundred gallons of oil per second will geyser 20 feet in the air from the ullage plugs.

Before cleaning a tank, a crewman drops a hose from a gasometer inside and checks air for deadly fumes





Photo from forepeak shows the "flying bridges" which give Amtank's skipper an unobstructed view of dock

This is more spectacular than healthy. Mates in charge who let it happen, automatically quit on the spot. It happened unavoidably once on another ship to Clarence Stewart, the Amtank's second mate, when a valve stem wrung off in a valve-man's hands as he started to shut down. "Never saw such a mess in my life," he recalls. "In a couple of seconds, the deck was ankle deep in oil and we were skittering around like drunken skaters. Worst of all, we couldn't swab down until we left port. Pollution laws."

The boys tell about one spill-happy mate who was so disgusted he just left the geyser running, walked off the ship and was never seen again. Neither was a lot of oil.

Weapon? Yes, against corrosion. Rotating pressure nozzle spews water through tanks to peel off rust



In emergency, when there's no time to clear tanks of gas, crewmen wear fresh-air masks for repair work

Under way, things calm down. The 30,000 tons of ship and oil plow along like a semi-submarine, two thirds underwater. There's only about eight feet of freeboard on a loaded tanker. Her nose digs into waves which sweep over her decks like surf on a beach. Foc'sle, wheelhouse and after house jut like islands from the sea.

Officers eat aft, and must dash across the open trunk deck for 75 yards to get chow. In a heavy sea, with decks rolling 35 degrees, it's as easy as walking sideways across a ski slide. To keep from losing crews to the big briny, the Amtank boys have rigged a life line—a long steel cable running head-high between bridge and after house. From it dangle rope handles,

From wheelhouse to after house is 75 yards of rough weather. Cable helps crew negotiate the tilted deck



shaped like upside-down subway hand straps. In heavy weather, a hungry officer grabs a handle and runs like a jack rabbit. If he times his dash between waves, he may not get wet.

If the chief mate has done a good job of loading, cargo presents no problems at sea. But plenty of unpleasant things might happen. Captain Mathis, gazing at the scud out over the plunging bow of his ship, can recite a string of probable hazards that would stand your hair on end.

"You can plow into a minor collision in a fog and blow everything to Kingdom Come," he says. "Or you can break her apart by keeping full speed in heavy weather."

"If oil is loaded cold and the ship runs into hot weather," he points out, "the stuff will expand like yeast. If the mate forgot to leave enough ullage, he'll have oil spurt-ing from every plug and cranny in the decks."

During the war, a lot of tankers plowed the ocean with the hallmark of green crews plastered all over them—masts and deck-houses smeared to their pinnacles with stains, where expanding gasoline or oil had burst from hatches and sprayed every-thing. "How those guys lived so long is a mystery," marvels Mathis.

There are plenty of things for a good tanker skipper to watch at sea. Cargo must be shifted from tank to tank continually on the trip. The big boilers use 100 tons of water and fuel a day from the after

tanks. This does things to the trim. Left alone, the ship would arrive in port 24 to 30 inches higher in the rear and down in the bow, than when she started on a four-day voyage. Inches count when you're running from salt ocean to a fresh-water harbor channel, where a ship like the Am-tank sinks an extra eight or nine inches due to buoyancy change. "There are skip-pers," says Mathis, "who don't move 10 tons of their cargo from tank 1 to tank 8 each day. That's all it takes to raise the bow and sink the stern one inch. One man ran an off-time skip into fresh water and missed his harbor channel course by a few yards. He hit a sandbar at 17 knots and sheared off half the bottom."

If the weather gets rough, so does the skipper's job. That 17,000-ton, million-dol-lar cargo can pack an awful wallop slam-ming against steel bulkheads. "It costs \$2000 a day to run this ship," says Mathis, "whether she's moving or not. It's tough to figure when it's smarter to stand still at that cost or keep moving and maybe bust up a \$5,000,000 ship."

Mathis can tell by the "feel," he says. "Her bow digs in, she slows down like a sled hitting a snowdrift and you can feel the torque along her big keelson. If you don't slow down, you can bust her in two—which one eager skipper did do."

To illustrate this, Mathis tells about rid-ing in a North Atlantic convoy during the war. Sixteen tankers rolled and pitched through a four-day storm, while the leader

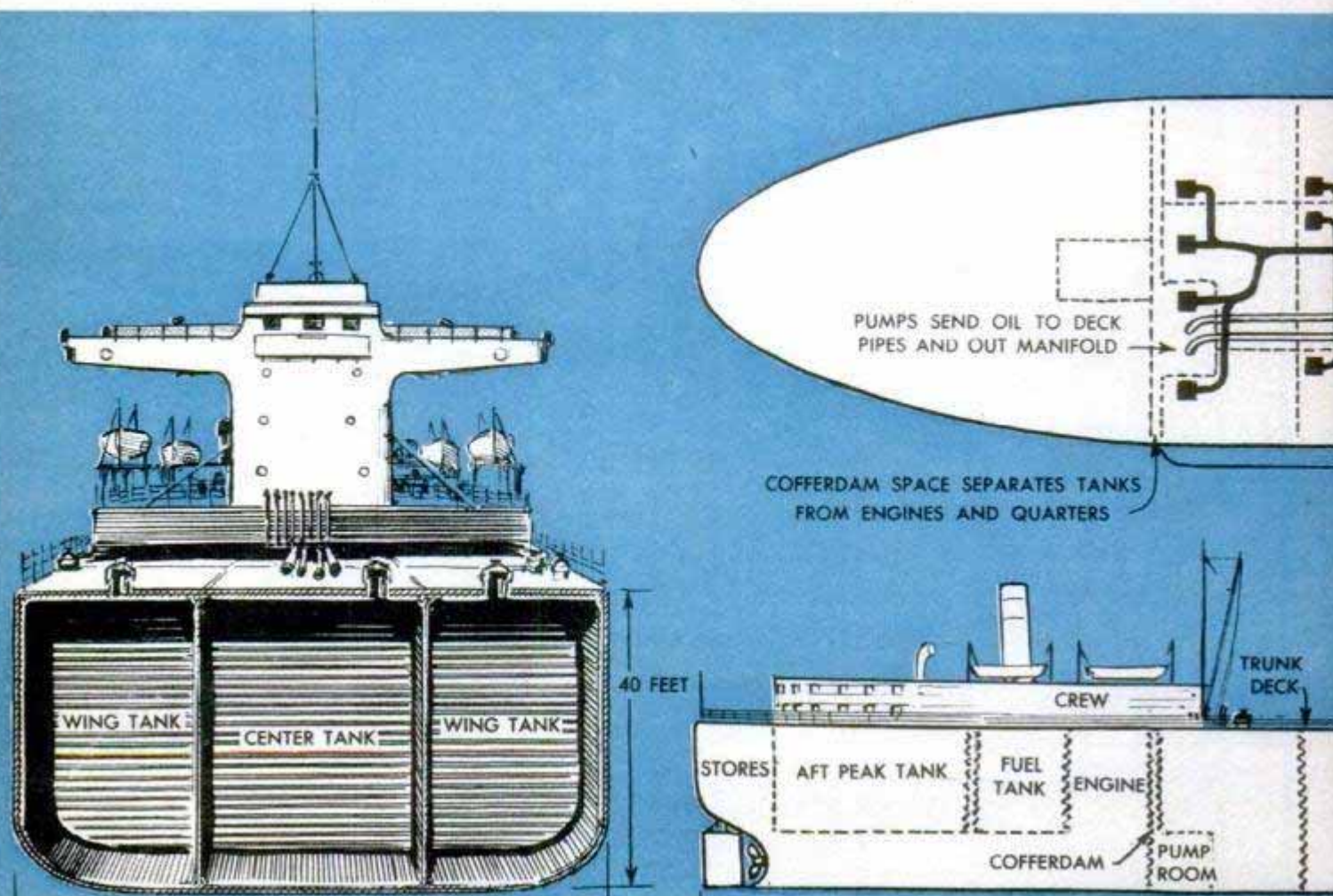



During his trip to Venezuela our roving and slightly green editor rode out the worst storm the Amtank ever encountered, a hurricane off Hatteras that sent the seas crashing over the tanker's deck every few seconds. The Amtank, loaded, has only eight feet of freeboard. During a storm, sloshing oil could pound ship to pieces

Cutaways of Amtank show how bulkheads divide the tanker's hull lengthwise and crosswise into individual tanks. Ingenious piping system permits the shifting of cargo from one tank to another to keep the ship in trim

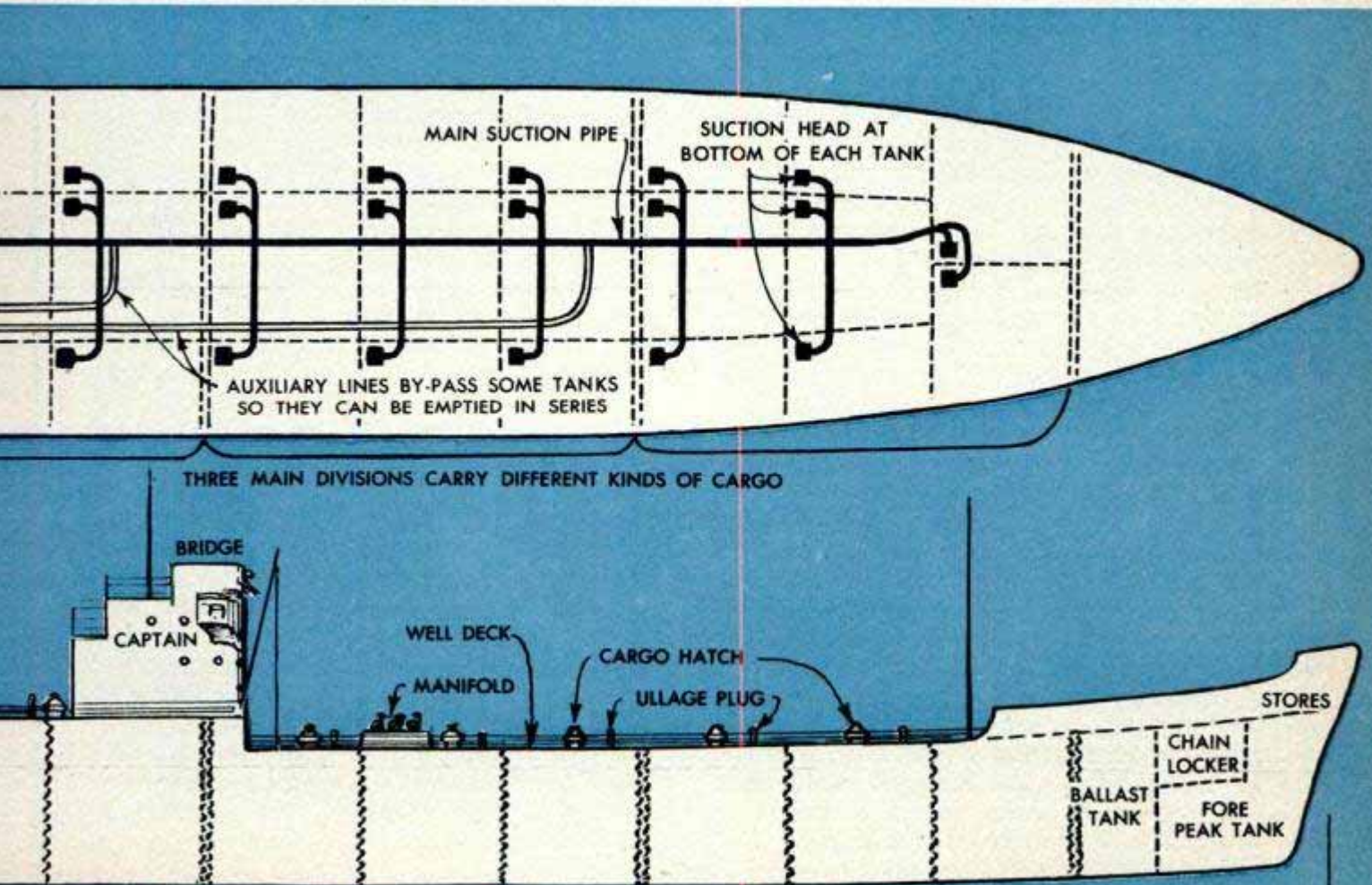

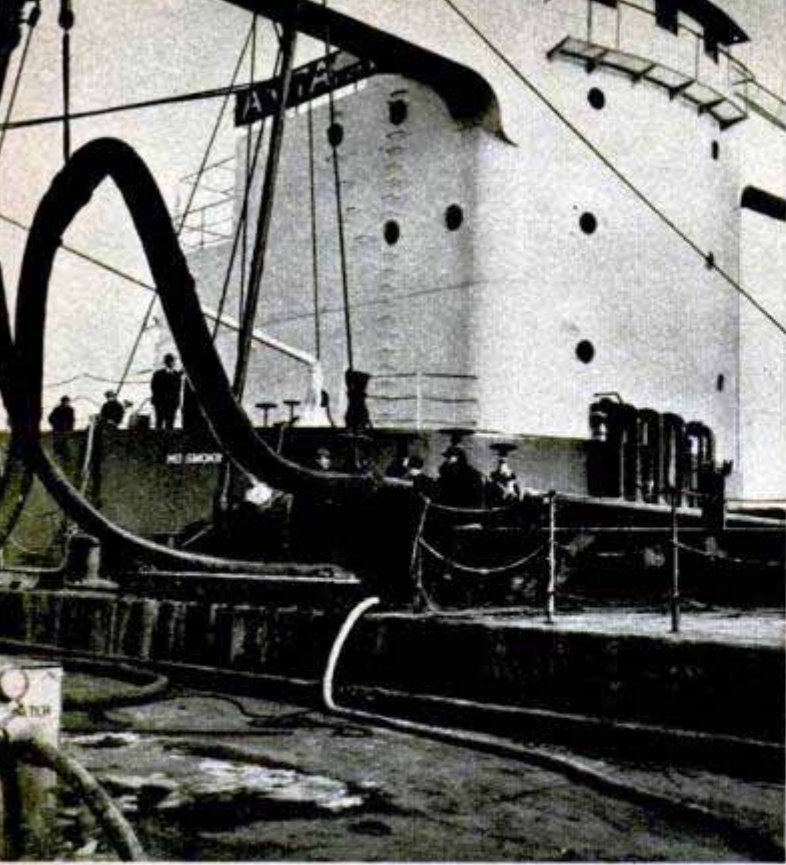

At Marcus Hook, Pa., crude oil roars out of Amtank's belly through huge pipes at 3000 gallons per minute

kept top speed. "You could hear half-inch-steel tank bulkheads fracture and rip in those ships as the cargo slammed, beat, twisted and tore them loose from welded corners, then the jarring thud as partitions broke loose and fell to the bottom." Mathis brought his ship about, slowed to two knots and came in whole. All 15 others were badly damaged.

When different grades of cargo are being carried by a tanker and bulkheads break, the oil must be re-refined. Owners don't like that. But worst is the loss of stability in the ship. The oil is free to slosh around. If you ever tried carrying a big tippy dish-pan full of sloshing water, you know what happens. In a rough sea, a loaded, badly damaged tanker can capsize.

Once at Marcus Hook, Pa., her home port, the Amtank makes short shrift of her oil. Again inspectors with their rules and tapes measure the ullage and thieftage. Hoses are coupled to the manifold. Forty feet below decks in his pump room, the pumpman starts his big centrifugals whirling at 1750 revolutions per minute. Oil gushes out at 3000 gallons per minute. Again tanks are blocked and emptied in series to keep the ship on an even keel. Since the suction heads are one inch off the tank bottoms, some oil is left. The after tanks are emptied last so that, toward the end, the empty bow of the big ship tips clear out of the water until she resembles a rowboat with a fat fisherman sitting in the stern. Dregs from the forward tanks seep aft through open sluice valves and the last of the oil is sucked from the ship by two

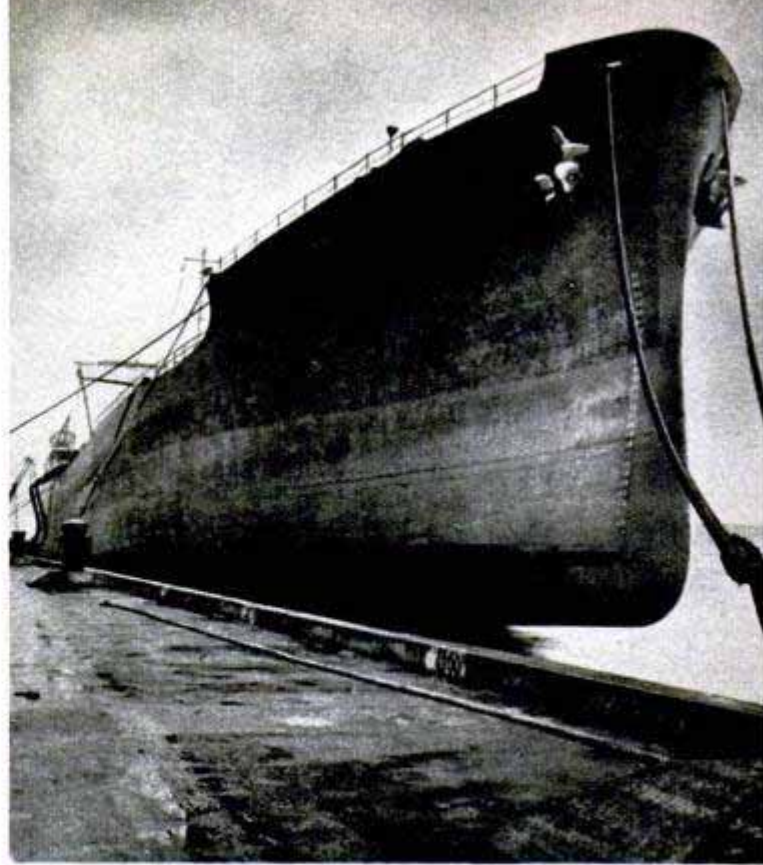

After 9,000,000 gallons of oil have been unloaded, Amtank is so buoyant her nose sticks out of the water

reciprocating "stripping" pumps, which won't lose suction like the centrifugals if a little air comes through the lines.

Once dry, the ship is off for another load, taking on sea-water ballast in some of her tanks as she goes so she'll ride solidly and not kite all over the ocean.

On the empty return, the crew immediately charges into its never-ending fight with rust. Scale and corrosion (from sour crude), must be stripped from tank sides and the bottoms cleaned of sludge, salt water, sand, scale and carbon. This can be dangerous, since empty tanks generate poisonous explosive gases. The special hatch-cover wheels are spun open, the gas hisses and roars like a subway train around the edges of the big steel lids.

Sometimes a $\frac{3}{4}$ -inch steel steam hose hooked to a big blower is stuck into the tank. Steam is blown in, gas out. The Amtank is equipped with a built-in gas ejector, too—a Venturi affair hitched to the tank pipe system. Engine-room steam, forced through the Venturi, sucks gas from any tank with open valves. But the system uses too much fresh water—a precious commodity—so it's seldom used. Instead, the boys use the Butterworth Machine, an overgrown version of a self-swirling garden-hose nozzle, hitched to the end of a two-inch rubber tube. The double-barreled nozzle, geared to rotate in two planes at once, is dropped into an open cargo hatch. Four hundred gallons of water per minute, heated to 180 degrees, are pumped through it at 190 pounds pressure. The big nozzle

(Continued to page 230)

Three-Cylinder Car

German motorists attending the Leipzig Spring Fair looked enviously at a sleek convertible that will be manufactured principally for export. Built for economical operation, the car has an unusual three-cylinder engine rated at 28 horsepower. It will sell abroad at an estimated price of \$1200. Called an IFA, the car is produced by a state-owned trust that includes the former DKW and Horch auto factories.

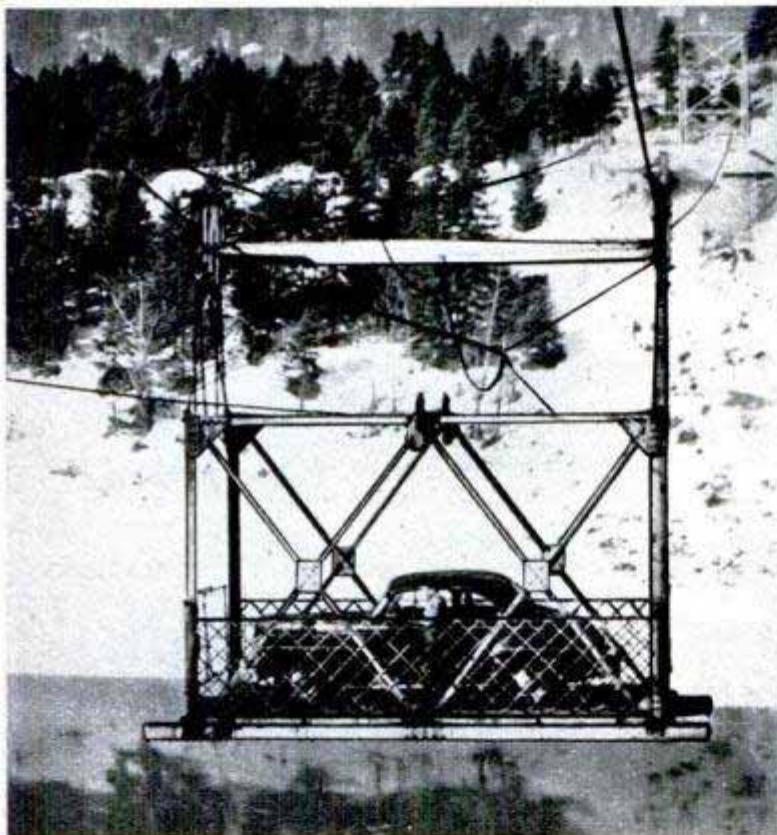

Aerial Cable Car Is River Ferry

When you cross the Fraser River in eastern British Columbia, Can., you go by aerial ferry, swinging across the 1000-foot-wide chasm in a metal basket. The ferry, which accommodates a truck, car, team of horses or 40 passengers, is supported by a pair of cables, each a shade under two inches in diameter. A donkey engine on one bank pulls the towing cable. Two men operate the ferry, the purser who rides the basket and collects the fares and the engineer who operates the engine on signals from the purser. Normally, the basket rides about 80 feet above the river, but in the spring of 1949 the river rose to within two feet of the floor of the car, forcing interruption of the ferry service for nine days because of high-floating debris.

"Waffle Iron" Roller Packs Road Harder

Individual steel pads that leave a waffle design are used instead of the conventional smooth wheel on a new road roller. It gives twice the compression by reducing the bearing surface. A smooth rear wheel wipes out the waffles by packing down the untouched sections left by the front roller.

Department of Agriculture officials figure that the 12,000,000 gallons of frozen concentrated orange juice marketed in just one season would form a "golden glacier" sixty feet wide, five feet deep and a mile long.

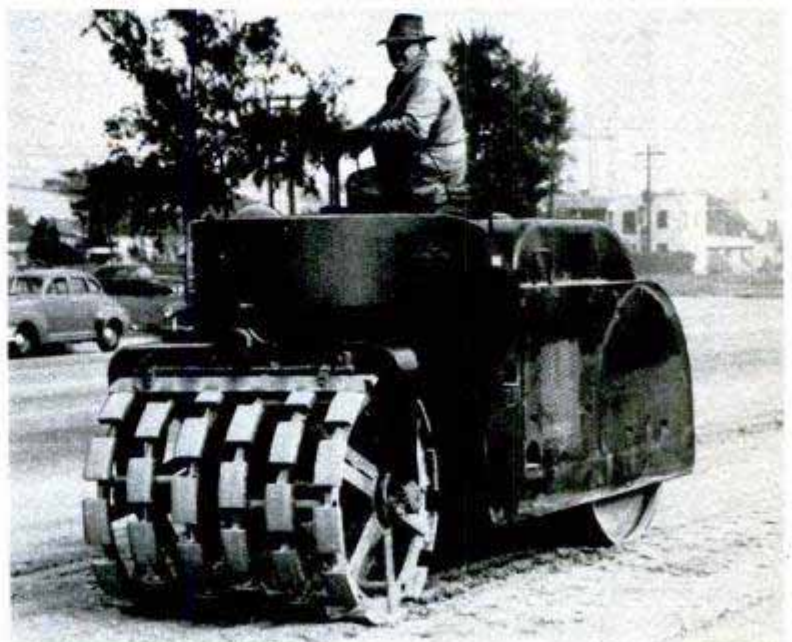



Kytoons support radio antennas high in the air. The Red Cross is testing it for disaster communications



Live in a TV fringe area? A Kytoon will raise your antenna (the cross on underside) for good reception

KITE + BALLOON = KYTOON

ON CALM DAYS, kite enthusiast Domina Jalbert felt frustrated. Although he had kites of all types, he simply couldn't make one fly when there wasn't any breeze.

This frustration led to the Kytoon, a hybrid sky rider that combines the best features of the kite with the best of the balloon. Even the name, Kytoon, is a combination of kite and balloon. By adding the kite's ability to "climb" the wind to a lighter-than-air, helium-filled balloon, Jalbert produced a "sky hook" that flies vir-

tually motionless above its mooring. Unlike a kite, it won't nose dive, being lighter than air. Yet it won't drift downwind like a captive balloon because its fins make it rise into the wind.

Its extreme stability makes it an ideal way to elevate radio or TV antennas. It supports advertising signs over business districts and carnivals. So stable is it that it can be used as a sighting target on large-scale surveys or to carry cameras aloft for low-level aerial photographs.

First flight of the original Kytoon in 1943. The war made helium unavailable, so it was inflated with air

Kytoons were packed in rubber life rafts to elevate the radio antennas of wartime flyers downed at sea

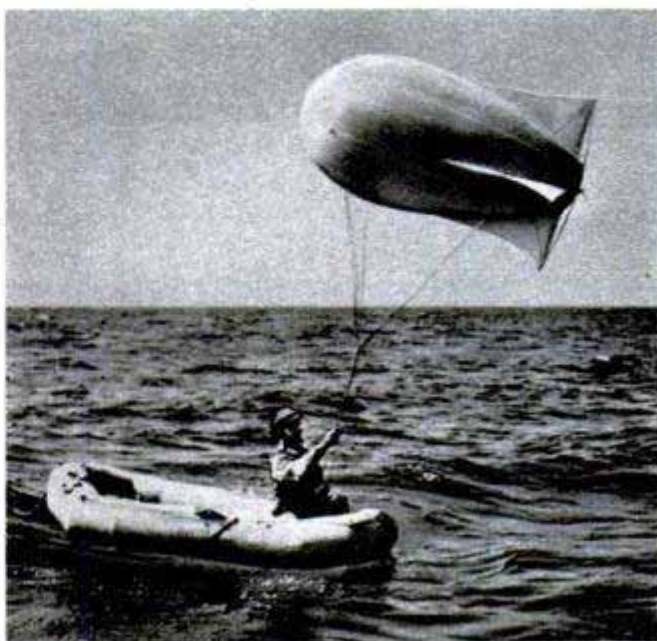
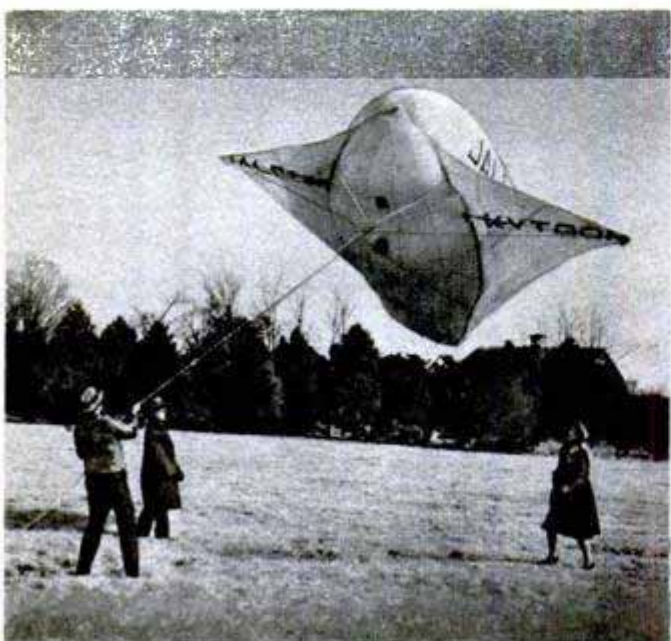



See...
 William Donahue
 46 Leoville
 Torrington, Conn.

Harold Davis photo

The love and care that hobbyists lavish on their miniature world is a source of continual amazement. Take now the case of the

HOME-OWNED BIG TOP

By Hank and Vera Bradshaw

WANT TO OWN a circus? Then get busy and start building one of your own. Right now, there are at least 500 miniatures under construction—and completed ones are rare. That's the report from the Circus Model Builders and Owners Association. The association's unusual admittance rules require that each member

have under construction a miniature circus, or that he own one. Many of these are authentic reproductions of circuses no longer in existence.

Basements and garages are the workshops for this remarkable hobby; unused attics sometime serve as the necessary "winter quarters" for the little circus folk.

*Wanda
 2422 Kenway Drive
 Des Moines 10, Iowa.*





A. Aubrey Bodine photo

Sixty vehicles have been unloaded and the "biggest show on earth" is about to begin. An uncle-nephew team in Baltimore built this big top with all its paraphernalia, scaled to perfection at $\frac{1}{4}$ inch to the foot

Membership in the Circus Model Builders and Owners Association spreads across the United States, up into Canada and even boasts brethren in Surrey, England. It's a unique organization composed of men and women who not only love and admire the big top but seek to preserve in miniature its spangles and breath-taking thrills.

Some members have become so enveloped in their hobby that it has been transformed into a full-time bread-and-butter earner; but most are using it as an exciting, spare-time adventure. Hours are spent carving, painting, stitching and designing—working toward the enviable day when there'll be a "circus to show." There is a relentless search for appropriate materials,

experimenting, a hunt for seldom-made items and patient work to make the unobtainables—minute galvanized water buckets, table settings and Lilliputian folding chairs. Some plans are so extensive it will be 10 or 15 years before the creator will realize his dream. Actually, a lifetime is involved.

This construction of miniature circuses is not a hit-and-miss affair; there is no guesswork. Replicas of the big top from the barking deer to the mess wagon are true copies, exquisitely carved. A passion for accuracy and exacting duplication sends members searching through newspapers, old records and pictures; to interviews with old-timers of the sawdust trail,

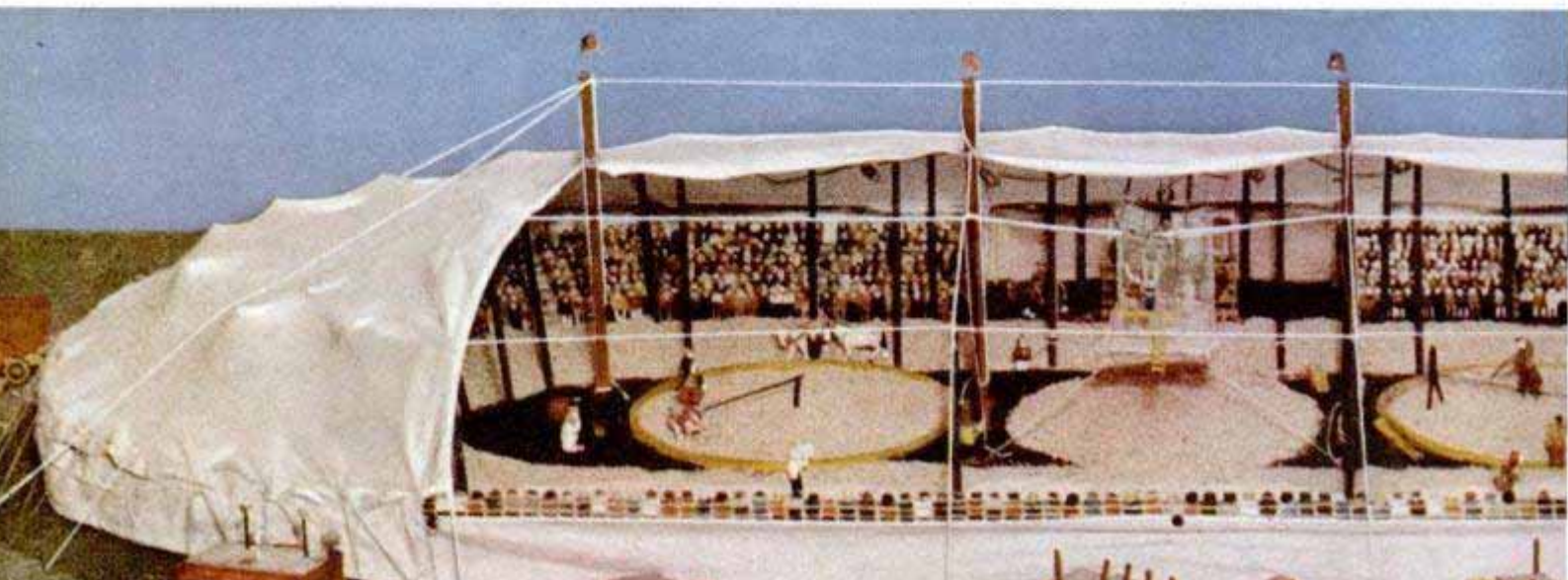



Milwaukee Journal photo

Complete to a jeweled dome is this wagon for the ibex, one of 350 vehicles fashioned by Joe Taggart

magicians, aerialists and explorers of the jungle; as well as out to attend every circus that comes their way. The result is that they are producing almost priceless miniatures, ranging in scale from 1/8 inch to three inches to the foot.

Among exhibitors, J. Harold Dunn of Wichita, Kans., is probably one of the best known. He has spent 18 years building a tiny show that is constantly in demand.

These fascinating, colorful little big tops are real spectacles, and organization members are often called upon to display them in business establishments. Maxine and Harry Chalfant, Colorado Springs, Colo.,

Hur-ry! Hur-ry! Hur-ry! The big show is just starting! In Ed Hollis' circus all the performers actually move—powered by a motor from a record player

Harold Davis photo



Milwaukee Journal photo

Another Taggart wagon holds ferocious Bengal tigers. The craftsman spends about a month on each vehicle



John R. Robinson

Paul Caster works out details of a model. Gilded on in foreground is one of the most valuable in the collection. Below, refreshment stand even has cash register

Milwaukee Journal photo





Milwaukee Journal photo

Joe Taggart touches up a spectacular wagon. Each 16-spoke, iron-rimmed wheel has more than 100 parts

set up their $\frac{3}{4}$ -inch Parago circus in a local shoe store. The layout centered their banner line (advertising for side show), fronted by three ticket boxes and two stages. Two savage head-hunters occupied one stage while the second held the leopard-girl, mermaid and half-girl. Ticket sellers were in the boxes and a barker was on one stage hawking the side shows.

Inside the animal cages were two hyenas, a mother kangaroo with a baby in her pouch, a tigress and two cubs, two polar bears and cubs, and five lions. There also

were zebras, llamas, camels, ostriches and monkeys. The show's bull elephant "Snyder" was in harness dragging poles, and the smaller elephant "Babe" was chained to her stake.

Five clowns added to the scene—one had a trained pig, another gallantly rode in a hippo cart with a duck.

Ed Hollis of Salem, Ind., found business a little slow one day and started carving a circus. He is now three fourths finished with a Hagenbeck-Wallace model. The "Five Graces" bandwagon is complete with

band and 10 horses. His figures are distinctive in that each expresses some action—a man holds a bottle of pop, a child eats a hot dog. Circus hands sleep in the shade of a baggage wagon, but the blacksmith is shoeing a horse. Hollis is now carving the Clyde Beatty animal act.

The association takes pride in stimulating interest in the circus, but its greatest service is providing its members with authentic diagrams, information and pictures from which to work—even going so far as to supply

(Continued to page 224)

Side show being built by Paul Caster will be 13 feet long. Already completed are Freddie, the fat man, a magician's act and a knife-throwing act

John R. Robinson photo





Milwaukee Journal photo

Joe Taggart touches up a spectacular wagon. Each 16-spoke, iron-rimmed wheel has more than 100 parts

set up their 3/4-inch Parago circus in a local shoe store. The layout centered their banner line (advertising for side show), fronted by three ticket boxes and two stages. Two savage head-hunters occupied one stage while the second held the leopard-girl, mermaid and half-girl. Ticket sellers were in the boxes and a barker was on one stage hawking the side shows.

Inside the animal cages were two hyenas, a mother kangaroo with a baby in her pouch, a tigress and two cubs, two polar bears and cubs, and five lions. There also

were zebras, llamas, camels, ostriches and monkeys. The show's bull elephant "Snyder" was in harness dragging poles, and the smaller elephant "Babe" was chained to her stake.

Five clowns added to the scene—one had a trained pig, another gallantly rode in a hippo cart with a duck.

Ed Hollis of Salem, Ind., found business a little slow one day and started carving a circus. He is now three fourths finished with a Hagenbeck-Wallace model. The "Five Graces" bandwagon is complete with

band and 10 horses. His figures are distinctive in that each expresses some action—a man holds a bottle of pop, a child eats a hot dog. Circus hands sleep in the shade of a baggage wagon, but the blacksmith is shoeing a horse. Hollis is now carving the Clyde Beatty animal act.

The association takes pride in stimulating interest in the circus, but its greatest service is providing its members with authentic diagrams, information and pictures from which to work—even going so far as to supply

(Continued to page 224)

Side show being built by Paul Caster will be 13 feet long. Already completed are Freddie, the fat man, a magician's act and a knife-throwing act

John R. Robinson photo





Milwaukee Journal photo

Complete to a jeweled dome is this wagon for the ibex, one of 350 vehicles fashioned by Joe Taggart

magicians, aerialists and explorers of the jungle; as well as out to attend every circus that comes their way. The result is that they are producing almost priceless miniatures, ranging in scale from 1/8 inch to three inches to the foot.

Among exhibitors, J. Harold Dunn of Wichita, Kans., is probably one of the best known. He has spent 18 years building a tiny show that is constantly in demand.

These fascinating, colorful little big tops are real spectacles, and organization members are often called upon to display them in business establishments. Maxine and Harry Chalfant, Colorado Springs, Colo.,

Hur-ry! Hur-ry! Hur-ry! The big show is just starting! In Ed Hollis' circus all the performers actually move—powered by a motor from a record player

Harold Davis photo



Milwaukee Journal photo

Another Taggart wagon holds ferocious Bengal tigers. The craftsman spends about a month on each vehicle

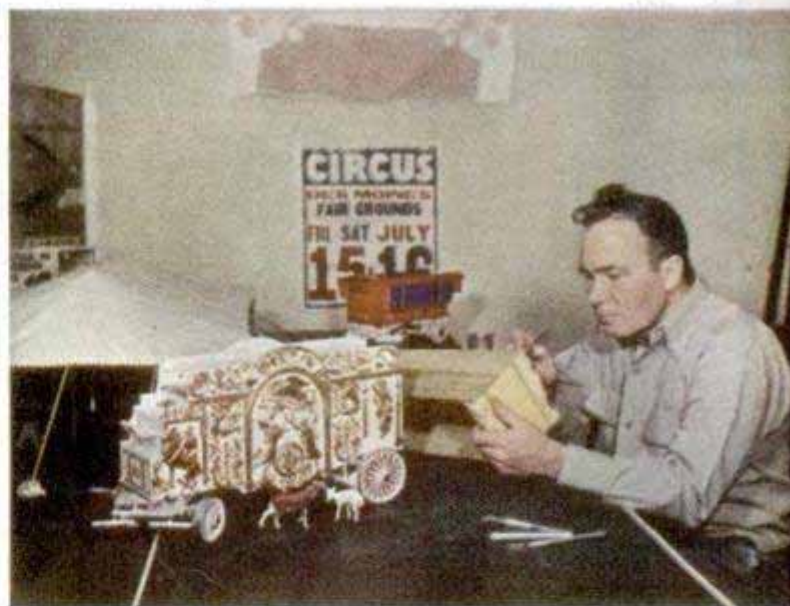

John R. Robinson photo

Paul Caster works out details of a model. Gilded wagon in foreground is one of the most valuable in existence. Below, refreshment stand even has cash register

Milwaukee Journal photo



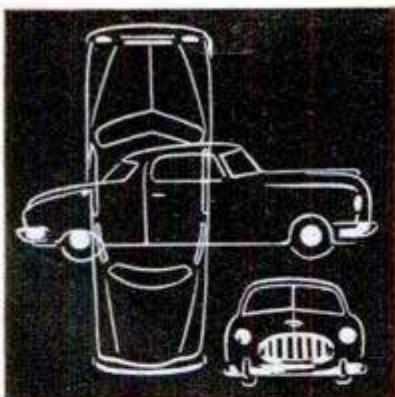

Detroit Listening Post

By Siler Freeman

BUICK will introduce the first tinted-glass windshield in the industry this fall. Charlie Chayne, chief engineer, has been working on the device for some time, not so much in the development of the green-shaded windshield, as to get the state vehicle administrators in the various jurisdictions to accept it.

Sixteen states have okayed the windshield, which will do away with the sunshades and the interior sun shields. The states include Michigan, Ohio, Indiana and Illinois. New York is still one of the hold-outs against tinted glass.

The new windshield glass, in which the tinting is impregnated during manufacture, will be made exclusively for Buick by Libbey-Owens-Ford in Toledo. The tinting is graduated from top to bottom and is very easy on the eyes when driving into the sun, whether it is high or low.

Chayne has been experimenting for more than a year with the tinted windshield on his own cars with good results. Buick has made studies of the effects of the glass on driver fatigue and reports astounding results. The tinted windshield will eventually find its way into all General Motors cars, when more states approve its use.

Chrysler is not only planning the new V-8 high-compression engine but is now testing a new six of the overhead-valve type. The new engine is reported to have shown more than 150 horsepower in its early tests.

The company is calling on some of its aviation-engine technique from war days in the finishing of the combustion chambers. Instead of being rough, they are polished up. It will be some time before the testing is completed on the new engine and Chrysler decides what to do with it. As it takes about 18 months to bring out a completely new engine, it looks like the six will be for 1952 production, at least.

The so-called hard-top convertible (which does not convert) is here to stay. Buick's experience, which is typical, insures this styling continuance for next year.

Buick is currently delivering about 45 percent of its total production in its Riviera model, which comes both in two-door and

four-door sedans. Most of the demand is for the coupe but because of a great backlog of ordering, the four-door Riviera is finding its way into many customers' hands.

Hydra-Matic transmissions, the first of the fully automatic devices in the field, are far from being made obsolescent by the newer torque converters. In fact, Hydra-Matic has spread far beyond General Motors, which pioneered and developed it.

Hudson will be the newest addition to its list of outside customers. It probably will be unable to supply the independent until late in the fall or perhaps when Hudson decides to introduce its 1951 models.

Already, beside Oldsmobile, Pontiac and Cadillac, Hydra-Matic is being sold to Lincoln, Kaiser-Frazer and Nash. Rumor has it that Cadillac will blossom out with its own transmission, which will leave capacity to supply the outsiders who have contracted with GM for the device, rather than go into an expensive tooling program.

Meanwhile, Ford is pushing its own transmission plant in the Cleveland area. That, with the new engine plant, is going to run the company into many millions for its post-postwar expansion and decentralization program.

Packard spent \$7,000,000 to build its Ultramatic. Other independents may be better fixed financially than Packard but none wants to follow its trail blazing.

Ford officials are a trifle discouraged by the slowness of Borg-Warner in getting into production on its new drive. Borg-Warner, however, has run into tooling troubles.

While Ford envisioned first deliveries by midsummer with Mercury getting a few into customer's hands first, it looks like fall now before Borg starts shipping.

Chevrolet has ironed out its production and technical difficulties on its Powerglide and is in full production in the Cleveland plant. It is turning out 1000 of the automatic transmissions a day and, by September, will double the output. Ed Kelley, chief engineer of Chevrolet, has his staff working on advances which will not only step up its efficiency but add to its economy features.



Stenographer, truck driver and businessman—all kinds of people—show Simon and TV audience their "pet ideas"

TV SHOWROOM FOR INVENTORS

WHEN Ernie Simon, pioneer Chicago TV announcer, was telecasting an interview program one evening, a man pulled out an invention and demonstrated it. Simon was entranced, and it occurred to him that almost everyone from housewife to businessman has a "pet idea" he'll "do something about someday." An offer to show inventions on the program brought an

avalanche of useful and weird contrivances. The inventions have made the telecast one of the most popular interview programs. Many inventors receive a mailbox full of orders following their appearance. A manufacturer once called while the program was on the air and offered to buy the invention that had been shown by an enterprising housewife, spot cash.

Inventor brought a knock-down screen frame. Assemble it, tack on screen, take it apart for winter storage

Another shows off swinging record rack which exhibits the titles on both sides of individual records

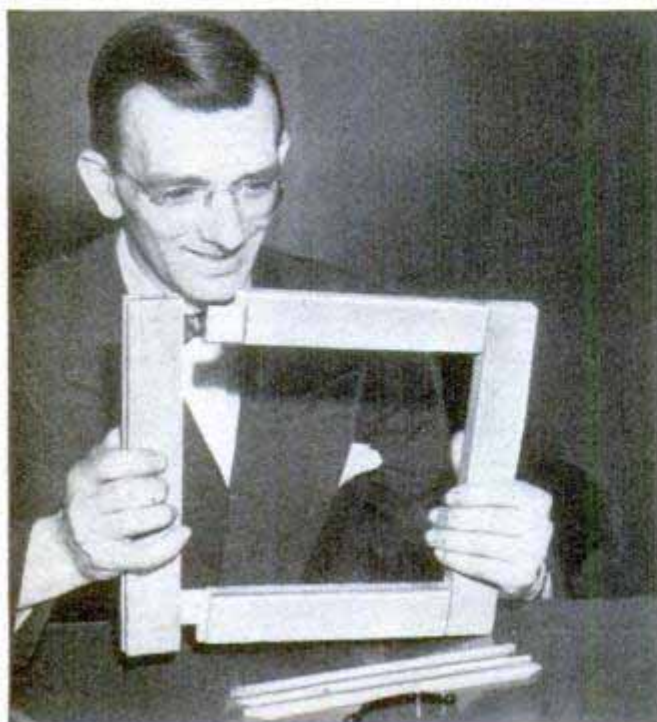

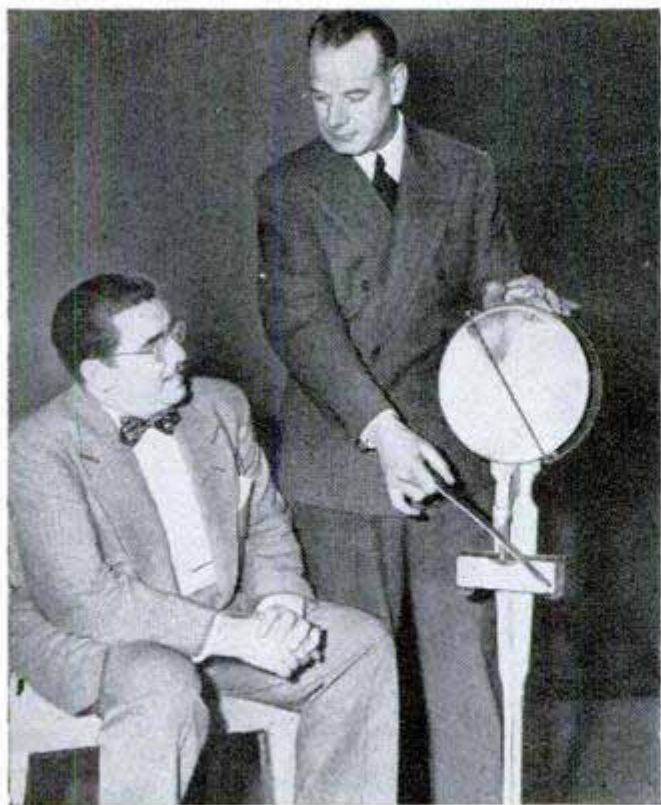

Anybody want to buy a one-man band? Surprisingly, 15 people did after inventor showed it on television

Upper, right, saw blade is claimed to outlast conventional types 100 to 1 because teeth have carbide tips

Right, program director looks over a recorder. When electric eye is tripped, it plays advertising message

Below, right, glass-topped table holds real or artificial flowers, spectacularly lighted from below

Clever housewife popped up with screwdriver with one spring which holds head while screw is started

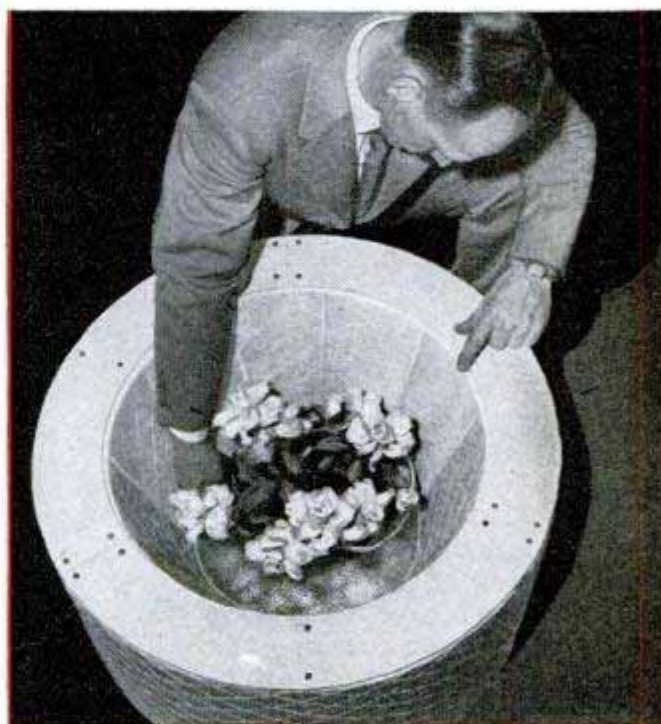
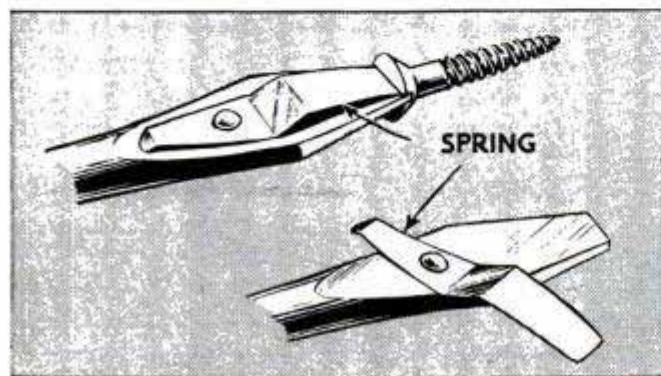
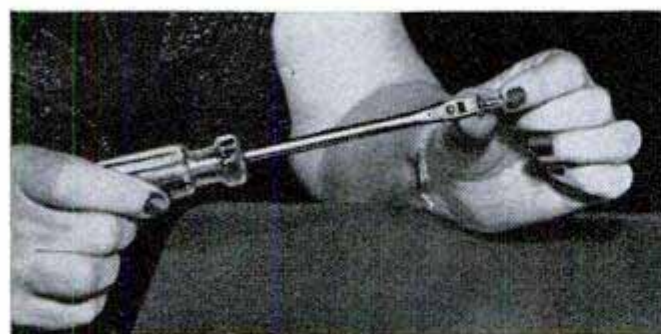



With three-dimensional television, an atomic-laboratory engineer can see to manipulate radioactive materials behind lead-shielded walls. Above, operator views double picture on screen through prismatic glasses and sees a single-depth picture. Below, left, stereo-television camera, remotely controlled "arm" in the center and operator of new-type remote-control board in background. Below, right, close-up of controls

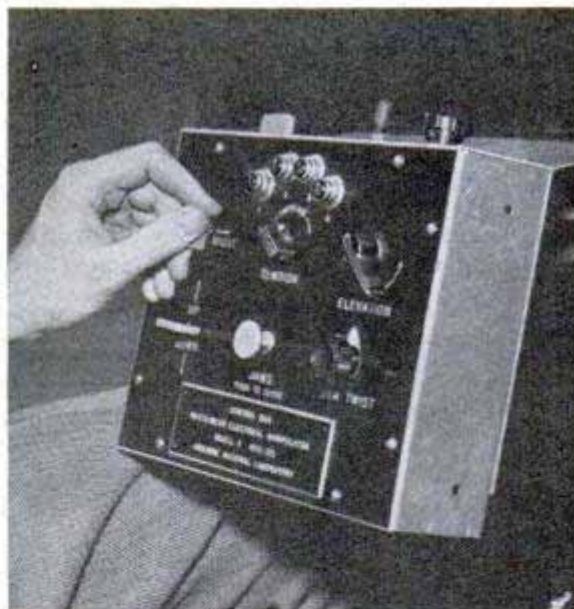
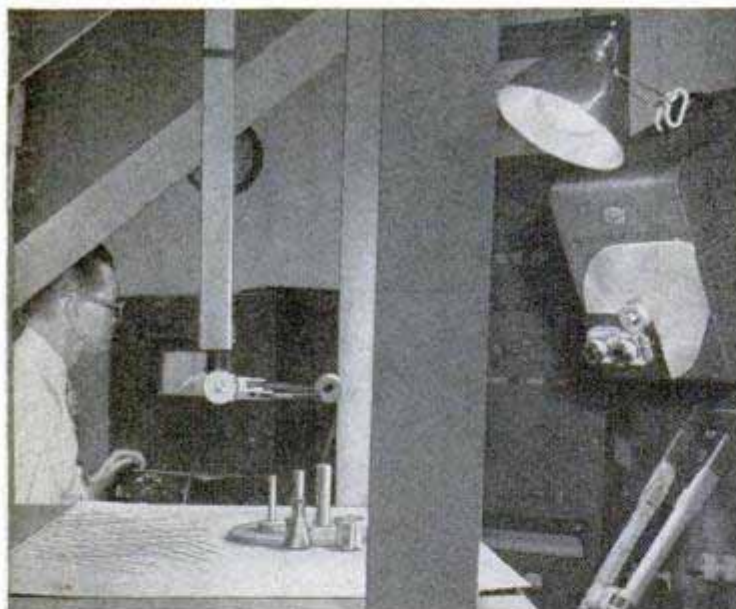

STEREO-TELEVISION FOR ATOM LAB

Television in three dimensions has been developed by engineers at the Argonne National Laboratory near Chicago. Used along with electronic remote-control devices, it enables atomic scientists to conduct experiments at a safe distance from deadly radioactive materials. When operating a mechanical hand, three-dimensional views are almost essential in grasping beakers and performing infinite precision

tasks behind the lead shields. Dr. H. L. Hull, director of Argonne's remote-control engineering division, has devised two types of stereo-television. Both use the double-lens camera. One receiver presents two nearly identical pictures on the television screen which must be viewed through prismatic glasses to get one three-dimension picture. The other projector superimposes one image on top of the other and looks out of focus until viewed through polarized spectacles.

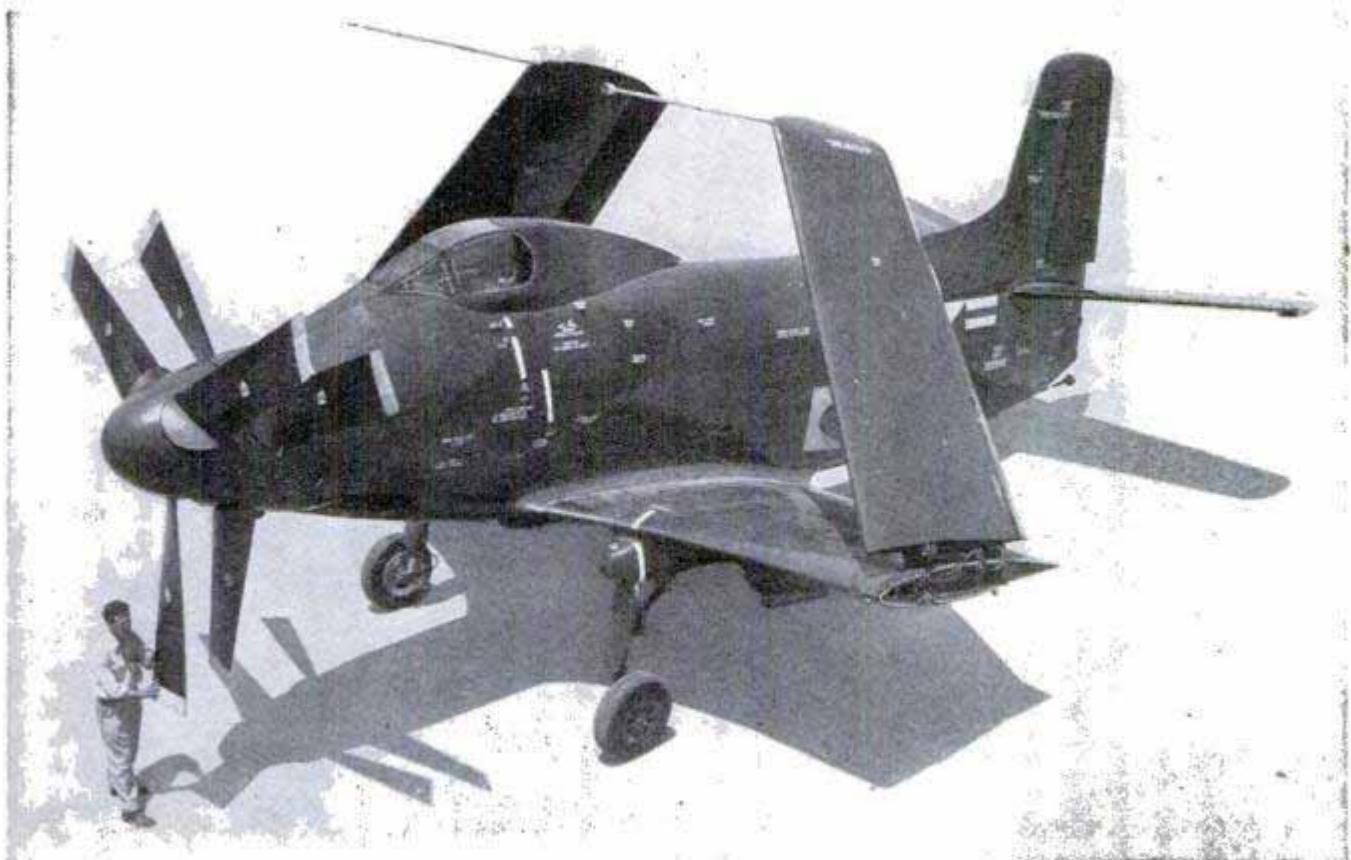

Douglas Aircraft Co. photo

Bomber for Smallest Carriers

Built to operate from the smallest carriers, the Navy's new Skyshark turboprop bomber will fly over 500 miles an hour. It is equipped with a T-40 Allison twin turbo-

prop engine of 5500 horsepower, driving two contrarotating propellers. It will carry a greater pay load than any jet fighter or bomber known for the same expenditure of fuel. Once airborne, the plane can increase its range by flying on either turbine.

Fertility Detector Uses Electricity to Test Hens' Eggs

Electronics may soon tell poultry farmers which eggs are fertile, thus eliminating the present trial-and-error method of incubation. All that is needed, according to Karl Norris of the Department of Agriculture, is an instrument to measure minute differ-

ences in response to electric current. Fertile eggs respond differently from nonfertile eggs. Modern electronics may soon produce a practical device for measuring the few millionths-volt difference that shows fertility, Norris says.

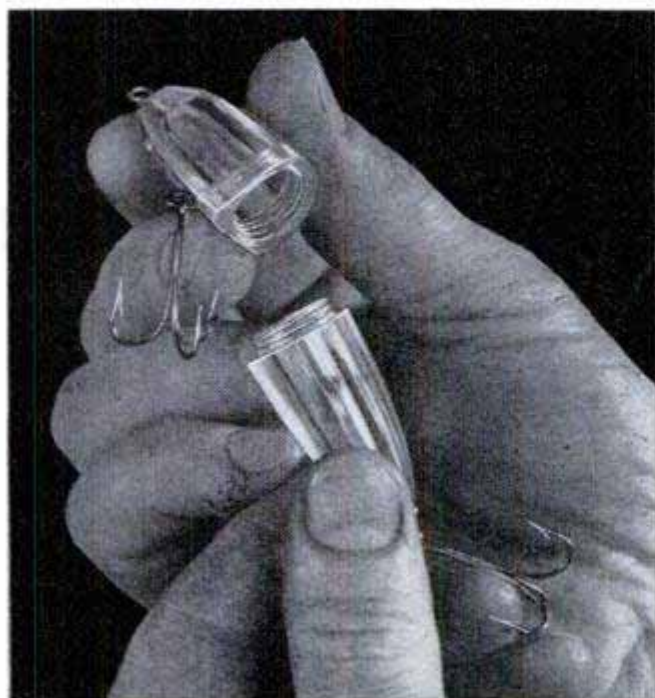

Lure Holds Live Lightning Bugs

One night an Indiana fisherman was having trouble persuading the fish to strike even though they were leaping out of the stream to snap at lightning bugs. The following night the angler returned with a small glass bottle to which he had wired some hooks. He put a half-dozen lightning bugs in the bottle and used it as a lure with good results. Now the idea has grown into a new transparent-plastic lure which can be unscrewed and lightning bugs inserted for night fishing. The lure can be used where fishing with artificial light is prohibited, according to the manufacturer.

Rated the world's most compressible substance at very high pressures is the rare metal, cesium, which is reduced to only three eighths of its original volume by a force of 34,000 pounds per square inch.



Big steel ball holds line off ground during mowing operation to avoid stumps of large trees logged out

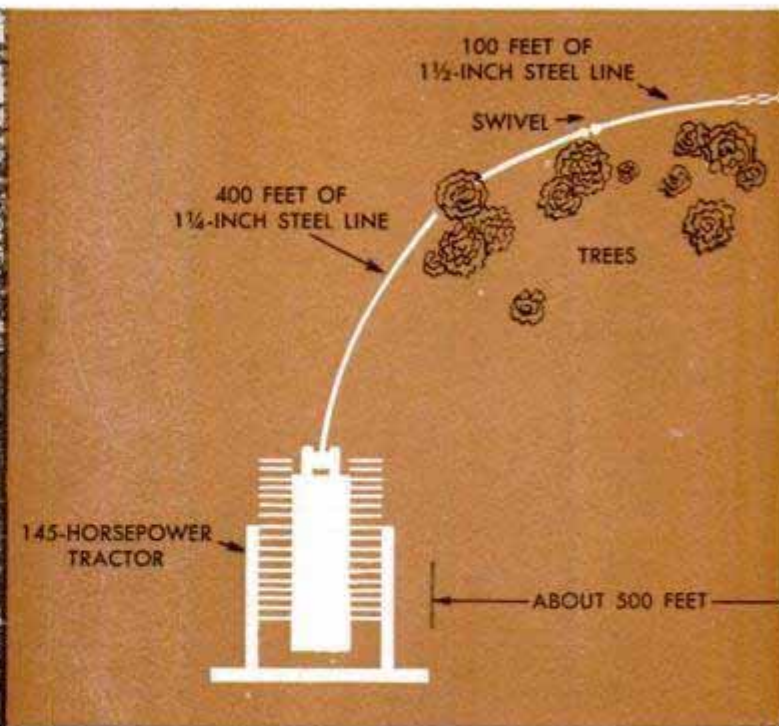

“Bowling” Down

MOW DOWN a forest like it was a field of wheat? Not even the legendary Paul Bunyan could do that.

But wait—up in northern Montana a couple of ingenious engineer-contractors have built mowing machines that slash through timber just the way a threshing machine moves through a grain field. Trees 100 and 150 feet tall topple over like straws. Between breakfast and lunch two men and their equipment can mow down as much as 100 acres of virgin forest. Then the clanking, roaring “stacking cats” move in

Trees fall like tenpins as tractors pull the steel line through the forest. The steel ball is behind trees

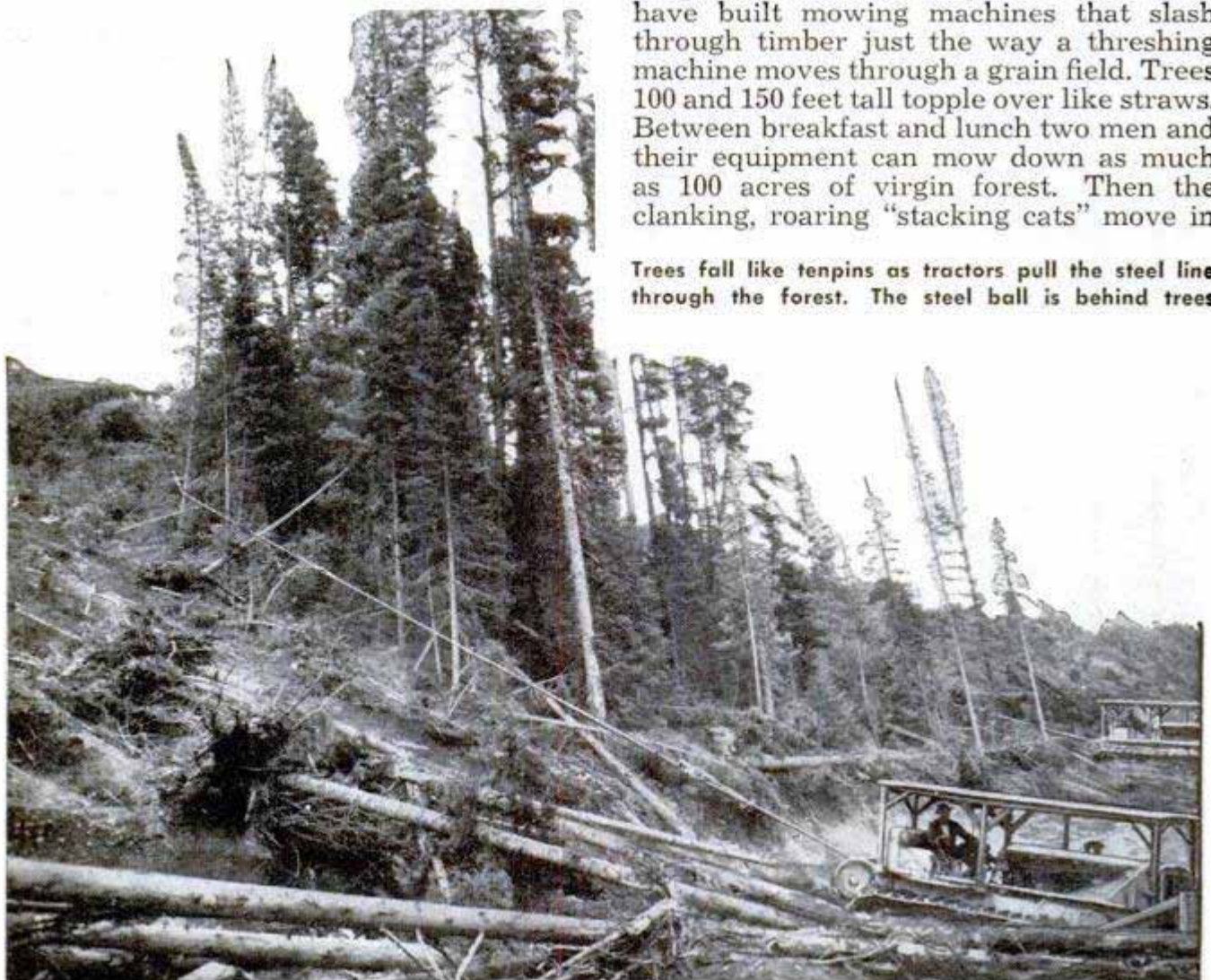

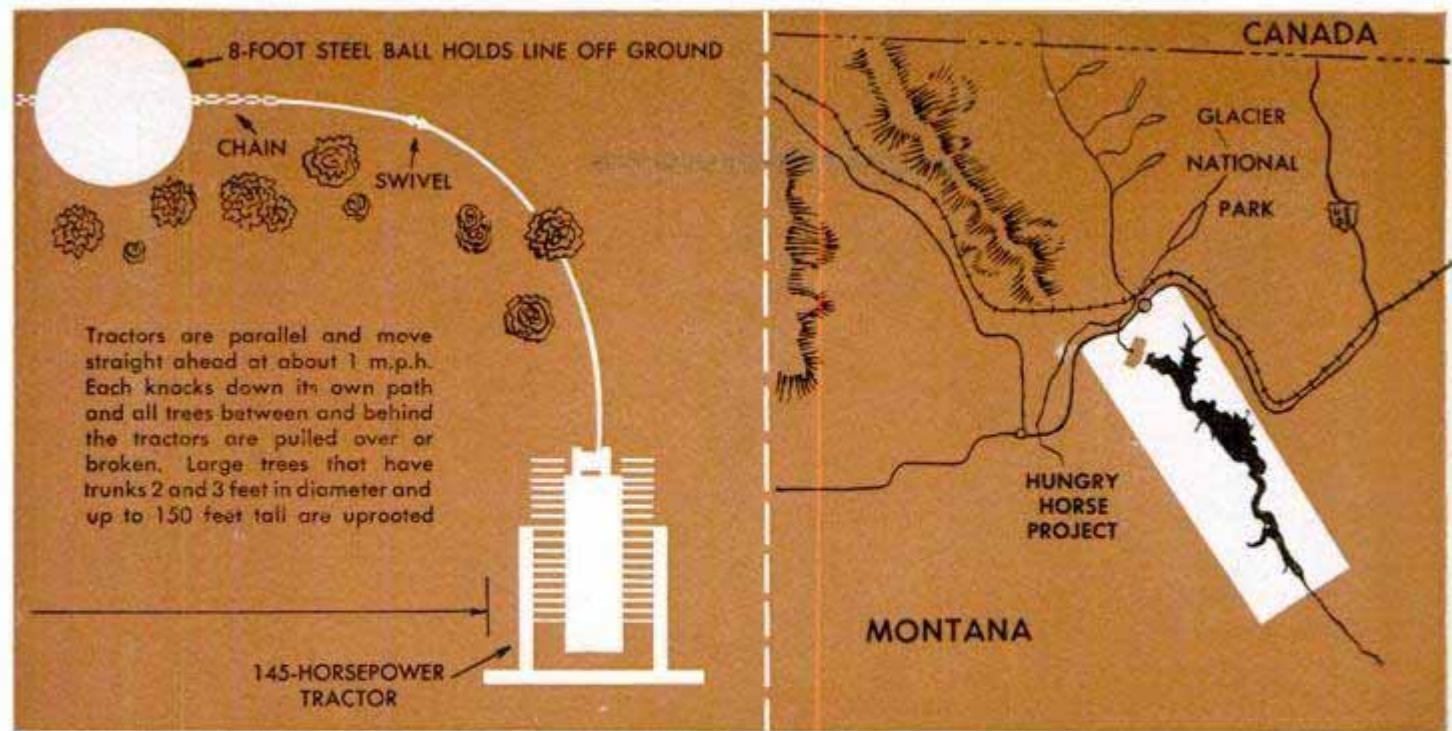

Forests for a Super Dam

and rake the fallen trees into windrows.

These Gargantuan operations are taking place in the reservoir area back of Hungry Horse Dam which, when completed in 1953, will be the fourth largest concrete dam in the world. The reservoir site is 34 miles long and up to 3½ miles wide, some 35 square miles in all. Before the clearing operations began it was covered with a thick forest of pine, fir, larch and spruce.

The area contained 80,000,000 board feet of merchantable timber and the first task was to log these trees, saw them up and haul the lumber out. This left hardly a dent in the thick forest.

Every tree that remains, almost every

twig, must be removed and the ground scraped clean before the site can be used as a reservoir. Otherwise trunks and limbs would be floated by the rising water and would drift down and clog the debris booms and the trash racks that will guard the intakes of the 285,000-kilowatt powerhouse.

When the Bureau of Reclamation asked for bids for removing the first portions of the 25,000 acres of forest, smart engineers from as far away as Louisiana and California tried to figure out the cheapest way of clearing the trees.

Twin rig for clearing away fallen trees is made of two tractors that push a 21-foot rake with 13 teeth

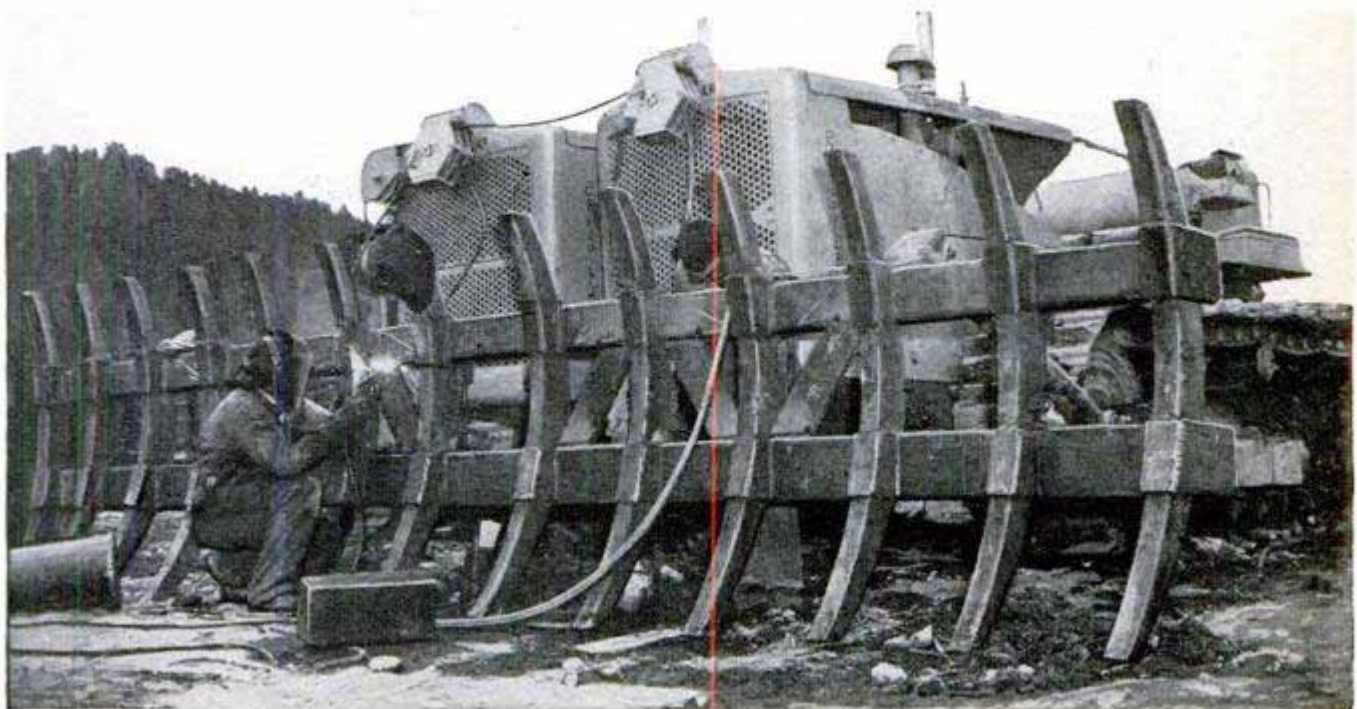



Drillers wearing life lines knock down broken bits of surface rock on wall of canyon to which one side of dam will be anchored. Below, general view of the site shows the river, earth cofferdam and beginning of concrete foundation

Chopping down the trees one by one would take too long and be too costly. Burning the forest as it stood would be dangerous to the surrounding timber and would leave a litter of charred debris. Pushing the trees over with track-type tractors would be simpler, for a powerful diesel can walk right through brush and trees and knock down everything as it goes.

Pondering over these ideas last year, S. L. Wixson and John H. Trisdale of Redding, Calif., wondered if a steel line rigged between two tractors could knock down trees as effectively as does a tractor's bulldozer blade. The two clearing contractors knew that a pair of tractors working in unison can exert a terrific pull. The idea might work and so they tried it out.

They placed two tractors about 100 feet apart and connected them with a steel line 200 feet long. Then the tractor team headed into the forest on parallel courses. Each tractor bladed down the trees in front of it, slack was taken up on the line and the tractors moved ahead. Then the forest began tumbling down! Every tree between the tractors was caught by the steel line and pulled over. Some of the trunks were snapped off short, larger ones were levered

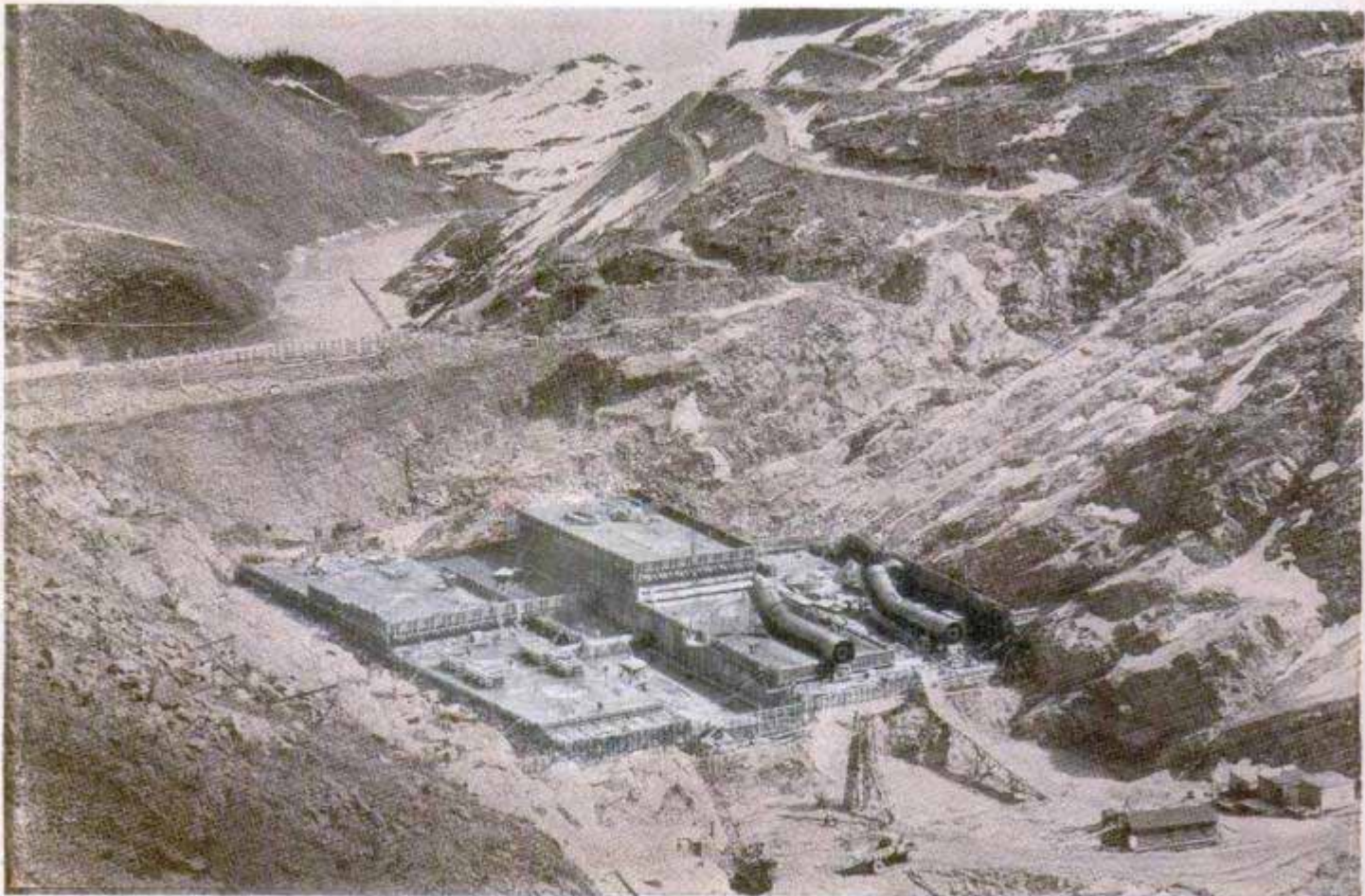

bodily out of the ground, and only the light brush bent under the line and swayed back into place. The two tractors had more than enough power for the job.

Last winter the men worked out a refinement to the original idea. They needed something to hold the wire a minimum of four feet off the ground so the wire could avoid being hung up on the stumps that remained from the recent lumbering operation. Scattered through the forest, these obstacles could slow down the whole job.

The contractors designed a hollow steel ball, eight feet in diameter and weighing 4½ tons, and attached it by means of swivels to the middle of the line, halfway between the two tractors. The ball rolls along over the ground and serves its purpose perfectly. It does better than anticipated, in fact, for it not only carries the line over the stumps but holds the line high enough to provide extreme leverage against a tree. The shallow root system is forced up out of the ground and a big tree simply tips over. Too, the weight of the ball prevents the line from riding too high when a stand of immature and willowy trees is being knocked down.

Last year Wixson and Trisdale jointly cleared 7210 acres of forest. This year they



Swivel connected in steel line on each side of the big ball allows it to roll and prevents twisting of the stout lines

are operating as separate contractors and, with the new equipment, each is clearing approximately as much acreage as both together were able to handle last year.

Trisdale estimates that two tractors with a ball and line can do as much work as a dozen "cats" equipped only with blades. Too, he says, it's a safer operation because the tractor operators are always far in advance of the timber that is crashing down behind them.

This is an artist's conception of how the 2115-foot-long Hungry Horse Dam will look when finished in 1953



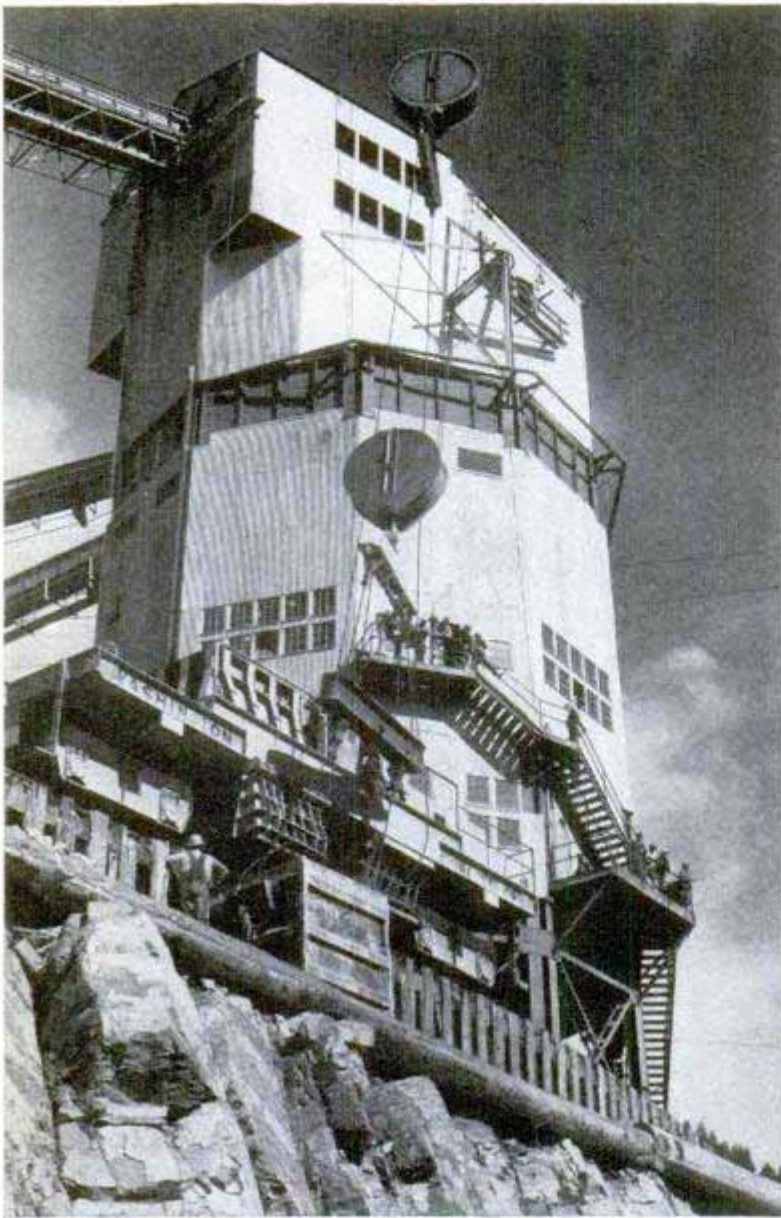

Concrete-mixing plant built on canyon wall has a capacity of 400 cubic yards per hour and is operating 24 hours a day. The boss of the plant (below) has controls for making 12 different types of mix required for various parts of the structure

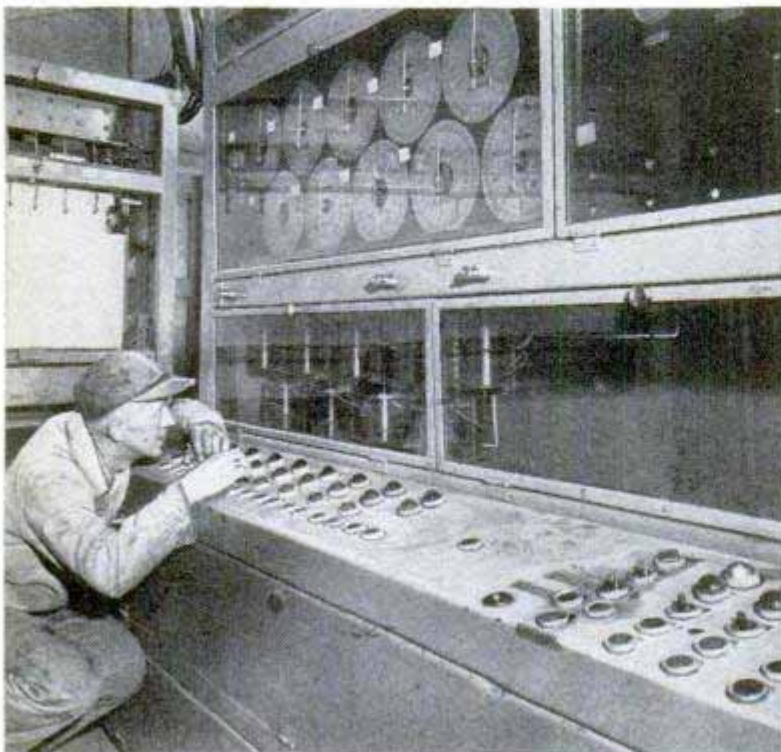

A typical forest mowing machine consists of two HD-19 Allis-Chalmers tractors, each of 145 horsepower and each with 400 feet of $1\frac{1}{4}$ -inch cable on its winch. The end of each cable or line is connected to one of the huge swivels and from the swivel 100 feet of $1\frac{1}{2}$ -inch line leads to the giant ball. Thus, as much as 1000 feet of line is available for the big loop behind the cats, with the ball at the center of the loop.

Ordinarily, the two tractors now work about 500 feet apart. Each one beats down its own path through the forest and the loop meanwhile pulls down everything between them. If the trees are too big and thick for this operation, each tractor can anchor itself behind a convenient tree or stump and then winch in on its end of the line. This multiplies the pull and makes it possible to yank down trees that may be two or three feet in diameter. When all the line is winched in, the operators slack off and move their rigs ahead, then make another pull.

After two "cat skimmers" have worked together for a couple of days they learn to understand each other perfectly. If the line behind one rig gets hung up on a stump, the operator can increase his winch speed to pull the ball over on his side. This rides the line up higher so that it clears the stump. His companion may be far out of sight in the forest but he can tell from the pull what the operator wants and he slacks off his end of the line to allow the ball to travel.

The mowing machines leave behind them a jumble of trunks, limbs and roots that appear almost impossible to clean up. That's where the stacking cats come in. These are D-8 Caterpillar tractors equipped with 14-foot blades and with nine pronged teeth under the blade. Working in teams of two or three units side by side, sometimes in teams of five, the cats drop their blades and move into the tangled timber.

Trunks slowly turn over, sometimes upending themselves, and gradually the mass of trees is pushed and jockeyed into huge piles 30 or 40 feet tall. All small trees and brush are swept away in

(Continued to page 246)

Foam-Plastic Model Plane Flies Like the Real Thing

Youthful flying enthusiasts can put together a solid, scale-model airplane in a few hours and make a successful flight the first time they wind up the propeller. Sold as a kit, the flying model is precut of a plastic-foam material that is three times lighter than balsa. The assembled plane weighs slightly more than one ounce. All parts are cut so that perfect balance is automatic, eliminating the tricky job of balancing a conventional flying model. The plastic is strong enough to take hard landings and the wings flex like a spring to withstand damage. The rubber-band motor fits inside a hole in the fuselage.



German Iron Lung

Even though a new German iron lung is opened for examination and treatment of the patient, there is no interruption in breathing because his head is enclosed in a plastic hood where oxygen is forced into the lungs. This eliminates the need for giving treatments through small ports in the chamber wall. The lung is driven by a hydraulic motor and respiration frequency can be adjusted from 6 to 30 breaths a minute. Demonstrated in Frankfurt, Germany, the lung sells for about \$2000.

Rolling Cutter Trims Lawn Edges

Grass which grows out across the edges of sidewalks and flower beds is trimmed neatly and easily with a new no-stoop garden tool. Rolling its rubber-tired wheel along the lawn or sidewalk causes the circular cutting blade to rotate against two stationary blades, trimming the grass. The edger cuts when rolled in either direction and can be held at any desired angle to trim the grass around buildings, stepping stones, fences and trees.

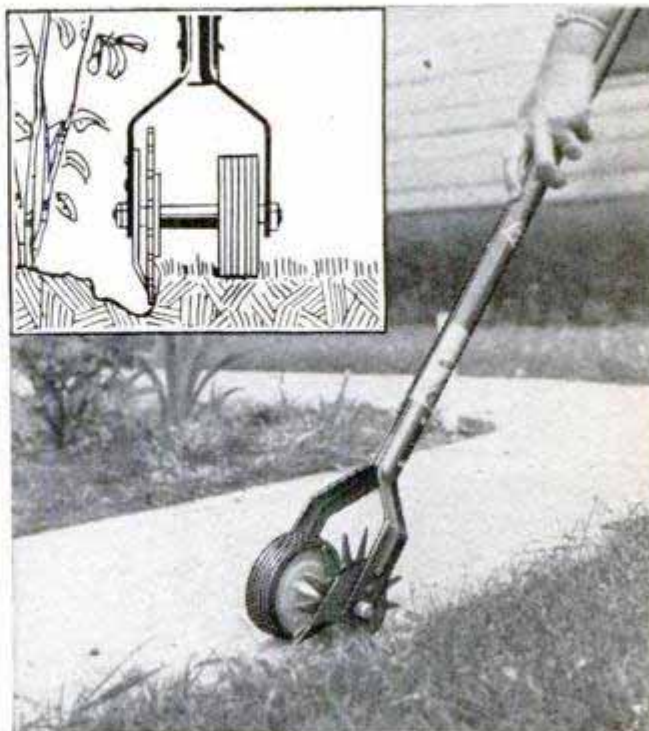

Popular Mechanics provides two sources of further information concerning articles published in each issue: the WHERE-TO-BUY-IT INDEX, which starts on page 12, and the WHERE-TO-FIND-IT LIST, available to readers without charge. For your copy of the WHERE-TO-FIND-IT LIST, just send a postcard to Bureau of Information, Popular Mechanics, 200 East Ontario Street, Chicago 11, Ill.

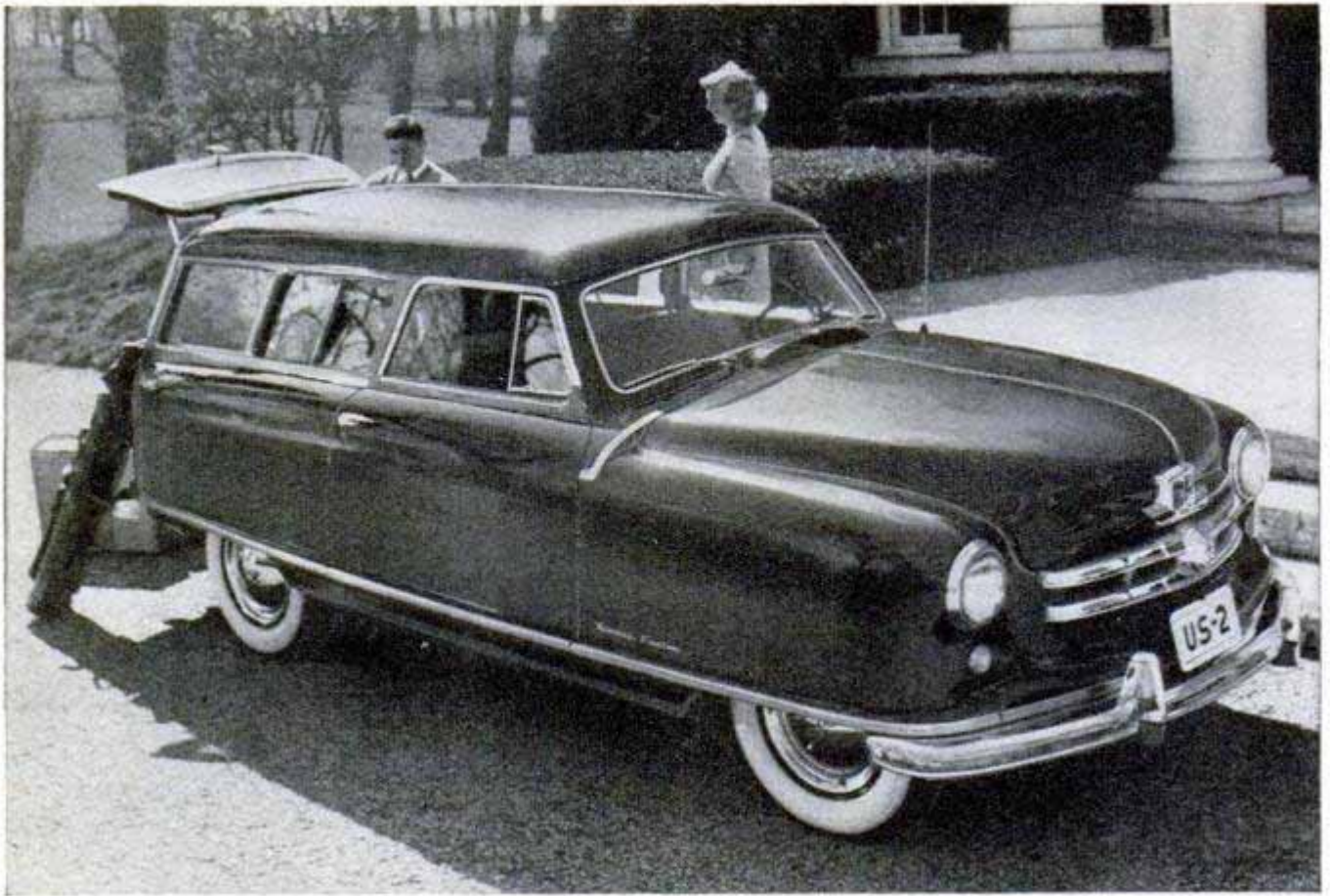

Rambler Station Wagon

Five passengers and a big pile of luggage or sports equipment are accommodated with ease in the Nash Rambler custom station wagon. The two-door, all-steel car has interior space of 8 feet 11 inches and with the back seat shoved forward cargo space measures 6 feet 5 inches. The station wagon is mechanically the same as the con-

vertible model and is powered by an 82-horsepower 6-cylinder L-head engine. It has a wheelbase of 100 inches, over-all length of 176 inches and height (empty) of 62 inches. Seat-cushion upholstery is easily unhooked for dry cleaning. The factory delivered price of the car (\$1808) includes radio, air-conditioning system, directional signals, foam cushions, wheel disks, courtesy lights and electric clock.

Excessive Speed Is Biggest Cause of Highway Deaths

Excessive speeding by motorists was a greater factor in traffic casualties in 1949 than in any previous year, according to a survey made by The Travelers Insurance Companies. Accidents due to speeding resulted in 10,100 deaths and 398,700 injuries. There were 890 fewer deaths among pedestrians in 1949 than in 1948, but 180 more

persons were killed while jaywalking between intersections than during the previous year. For the first time since the war, the percentage of 18 to 24-year-old drivers involved in accidents took a downward turn. However, youthful drivers are still involved in many more accidents than their number warrants, the report states.

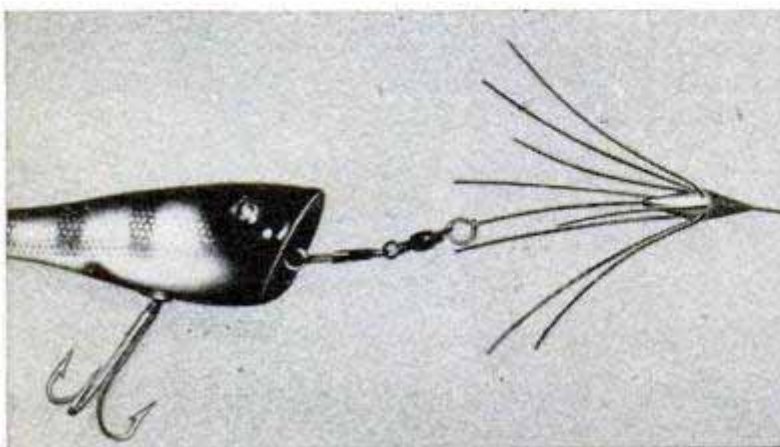

Weed Guard for Fish Lures

Underwater weeds are brushed aside by a new guard, attached in front of any fishing lure to prevent snagging the hooks. Made of bronze, the guard has several swept-back prongs which spread the weeds to make a hole through which the lure can pass. The guard is permanently installed on its own leader and can be slipped forward on the leader to permit easy removal of fish.

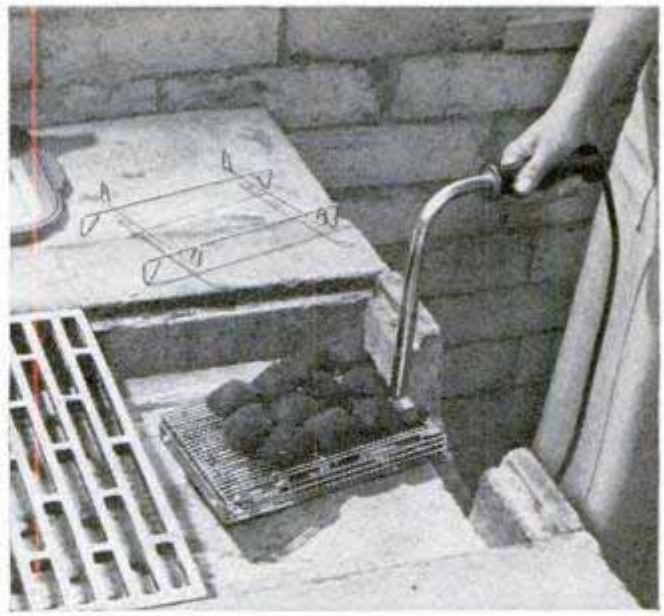
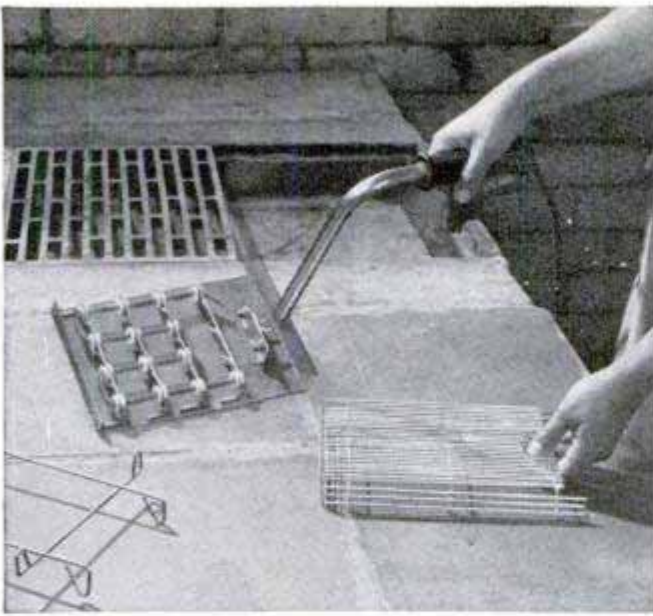

Above, easily taken apart for cleaning, the igniter is sturdily made. Above, right, to start a fire, you spread charcoal on the igniter and plug in the cord. In 15 minutes the fuel is ready to burn. Right, the igniter makes a convenient hot plate during the meal

Charcoal Igniter

Trying to get the charcoal burning is often such a chore that it takes most of the fun out of outdoor barbecues, but a new electric igniter solves the problem. The igniter, which consists of an electric heating element in a chrome-plated frame, preheats the charcoal or briquettes, assuring a good fire in just a few minutes. A stand is furnished with the igniter so it can be used as a hot plate to keep coffee and other food warm while the meal is being prepared on the fireplace grill.



"Dry Dock" Boathouse Has Battery-Powered Hydraulic Hoist

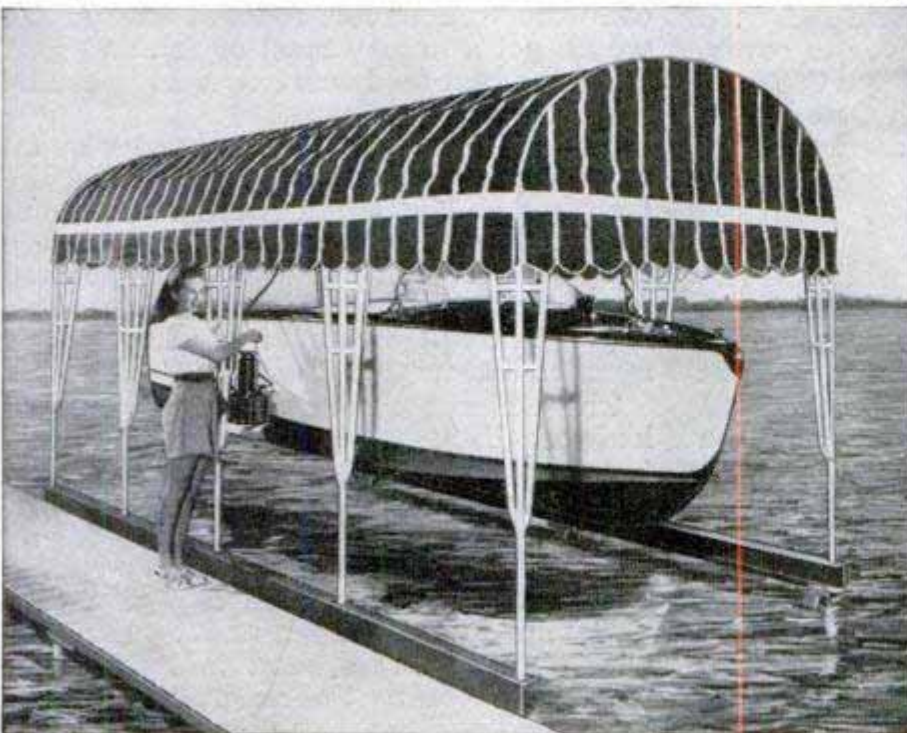

Your boat is hoisted out of the water, safe from dock damage due to wind and waves, in less than a minute by a battery-operated lift built into a canvas-topped boathouse. All you have to do is drive into the shelter, hook cables to the bow and stern and push a lever. The 6-volt battery, actuating a hydraulic pump, does the rest. There is very little battery drain, one charge lasting all season. The boathouse, fabricated in easily handled sections, can be put up by one man in a day. When taken down, the pieces pack compactly.



I Read "P.M." Behind the Iron Curtain

By

M/Sgt. Elmer Bender, U.S.M.C.

Popular Mechanics, issue of August 1947, brings back memories to Sergeant Bender, for it was this issue which turned up in a Chinese Communist village to give two American prisoners hours of reading enjoyment

A COPY of *Popular Mechanics Magazine* that turned up miraculously in a remote mud village—that was a high spot in our 18 months of captivity by the Chinese Communists. How the magazine got into that part of China I have no idea but it was an old and welcome friend. We read it and reread it from cover to cover.

Chief Electrician's Mate William C. Smith and I were taken prisoner on October 19, 1948, when the light liaison plane I was flying ran out of gas and we had to land on an ocean beach. Ascribe that to a technical malfunction. The gas indicator showed that the tank was almost full even while the engine was turning over for the last time.

We sat down only 15 miles north of our home station, the Marine Air Base at Tsingtao on the Shantung peninsula, and we were surrounded at once. That same day we were hustled inland and turned over to a guard unit of the Chinese Communist army. We were held by that unit during our whole captivity while it slowly moved from one village to another.

We weren't treated badly. The Reds kept us under 24-hour guard and in each village we were confined to one hut much of the time, though often we were allowed to

wander around the village when accompanied by a sentry. They gave us adequate quilted clothing and we ate as well, or rather as poorly, as everyone else.

Our standard diet was dark bread. Now and then when word of another victory over the Nationalists reached the village we all got a luxury meal of fish and rice. Even the best food was extremely poor by American standards.

Our chief troubles were worries about what was going to happen to us, and the fact that we had nothing to do. We didn't know if the United States was even aware that we had been captured. We received no news at all, month after month, and we began to think that everyone except our families had forgotten us.

The Chinese smoke a rough, uncured leaf tobacco and Smitty had been allowed to keep his pocket knife. We used up one week carving pipes for ourselves. We got hold of a block of reddish-brown wood and from it Smitty shaped a pipe with a curved stem and I carved myself a pipe with a flat stem, in two pieces and ornamented with a round brass band that originally may have been part of an electric fixture. It's a good pipe and I still have it.

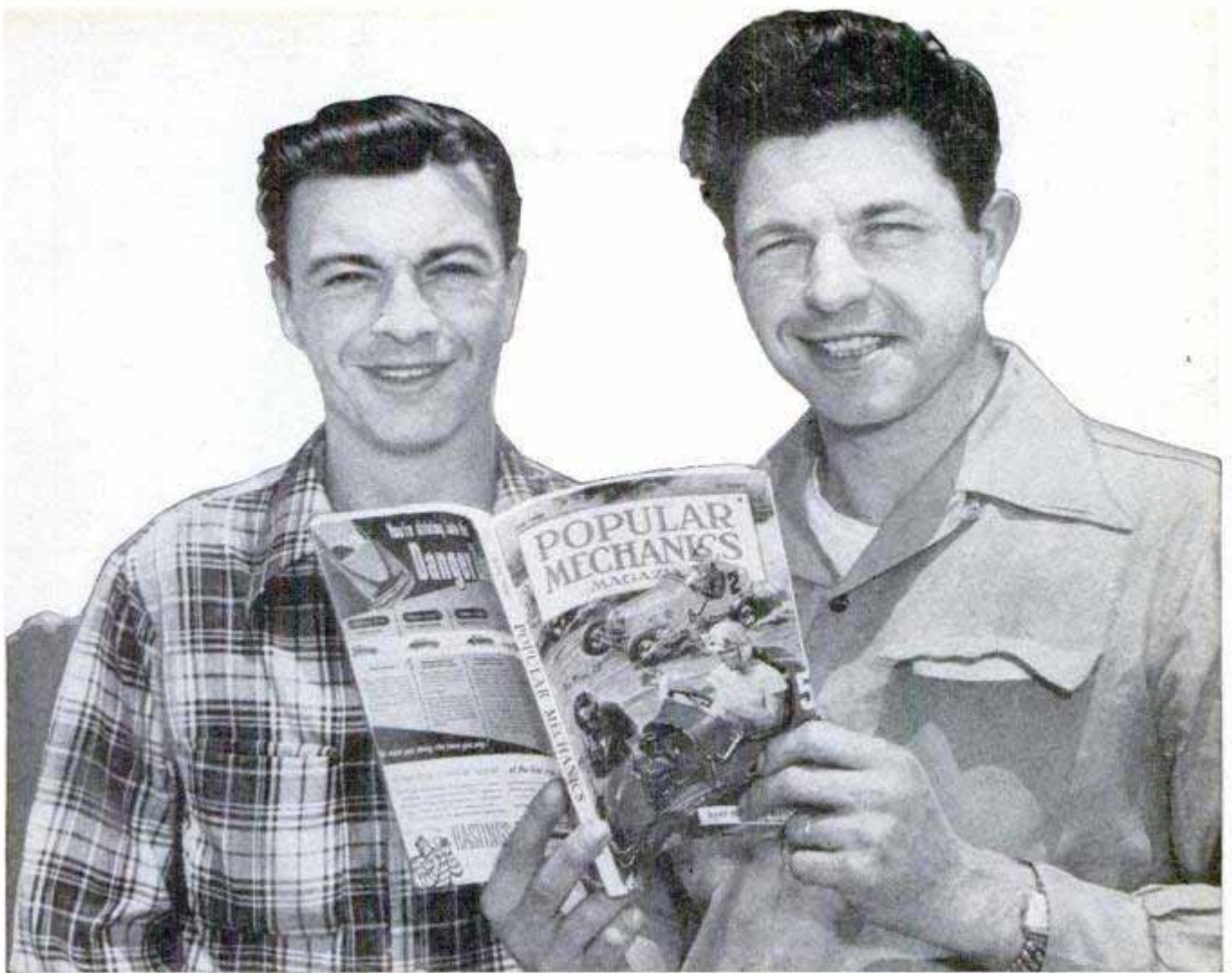

Back on duty in California, Bender and his fellow prisoner, William C. Smith, look at the June 1950 issue

We learned to speak a little Chinese and we spent a lot of time talking with Lieutenant Ho, one of the guard commanders who spoke fluent English. We became pretty good friends. Ho did his best to convert us to the Communist cause but we had one argument that he couldn't beat. If the American system is so poor, we asked him, why is the average American the envy of the rest of the world? For myself I'd hate to trade life in America for existence in a primitive Chinese village.

Now and then in one of the villages a couple of old magazines printed in English would be located and brought to us. We'd spend a day looking them over. Mostly they were English editions of Chinese magazines that probably had been printed in Shanghai. Then one day Lieutenant Ho came into our hut with a smile on his face and a copy of *Popular Mechanics* in his hands. He'd found it somewhere and he knew we'd like to read it. He'd enjoyed it himself, he said.

It was the August 1947 issue, less than two years old, and we got a lot of enjoyable hours out of it. An article on the fine points of how to use a soldering iron interested me, as did a short description of the B-36 bomber. Smitty enjoyed the camera ar-

ticles and the one on the sub-zero military testing laboratory in Florida. In the Seabees he had done some winterization work on electrical equipment. We both learned something from an article on weight-lifting, a kind of exercise we hadn't tried before. From then on we practiced lifts with a stone grain grinder that the villagers used. It weighed possibly 50 pounds.

The Chinese, incidentally, are great weight-lifters. Vehicles of any kind are scarce, so if something has to be moved it goes up on a man's back or at the ends of a pole that is slung across his shoulders. I saw one man staggering along with a good 500 pounds on his back.

Three months ago Smitty and I were beginning to think that we'd have to spend the rest of our lives in China. Nothing was happening and our guards acted as if they had taken on a lifetime job. Then, suddenly in May, we were taken down to the coast and released. The Navy flew us home.

I don't think that captors ordinarily ask favors of their prisoners, yet Lieutenant Ho had one request that he made just as we were departing. It would be a big favor, he said, if we could find a way after we got back to the United States to forward him some more copies of *Popular Mechanics*!



Flat-Bottom Sailer Skims in the Breeze

Yachtsmen on California's lakes are bragging about a slender, flat-bottom sailboat that is so light on the water it skims along in the slightest breeze. It has a 350-pound cast-iron keel and carries 115 square feet of sail. Flotation tanks, fore and aft, make it safe even in rough water. With an over-all length of 20 feet and a beam of 4 feet, it is essentially a one-man craft. The flat bottom and narrow beam make it easy to haul on a trailer. The craft, called the Zephyr, is available in kit form or can be bought assembled and ready to sail.

Light as a feather on the water, the Zephyr will sail in a whisper of wind, above. It's becoming a favorite on California lakes. Below, flat-bottomed, the boat is easily hauled by trailer. It has a cast-iron keel

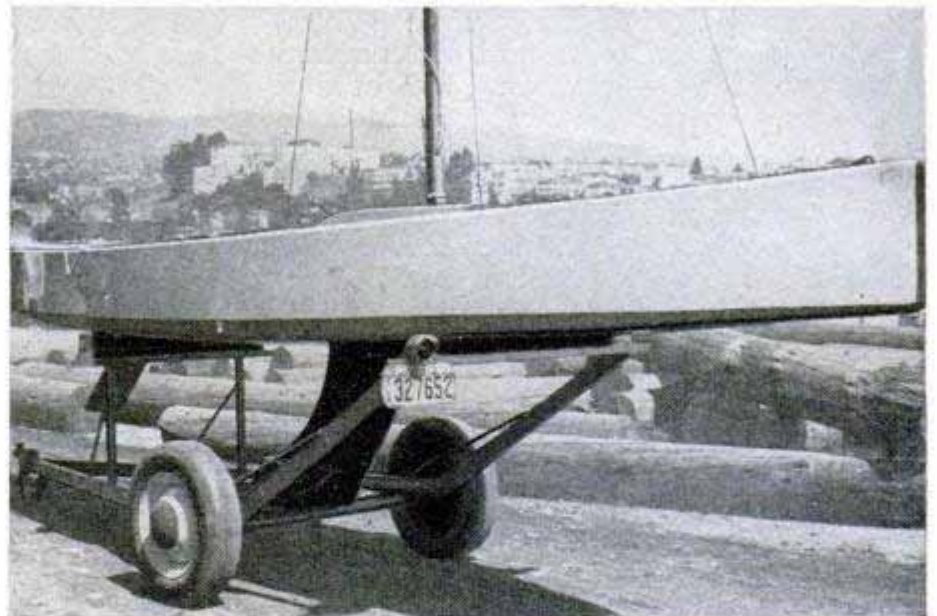

Hot or Cold Weather, This Photo Film Doesn't Care

Working perfectly in temperatures ranging from 65 below zero to 140 above, a new photographic film has been developed by Armour Research scientists for the Army Signal Corps. Ordinary film is extremely fragile at 40 below zero and cannot be used in many cameras. The film base used is the

cellulose derivative, n-propyl cellulose acetate. It was tested in a simulated camera apparatus which rolled the film back and forth over a series of sprockets. For the subzero tests, the entire apparatus was packed in a box with Dry Ice which lowered the temperature to 65 below.

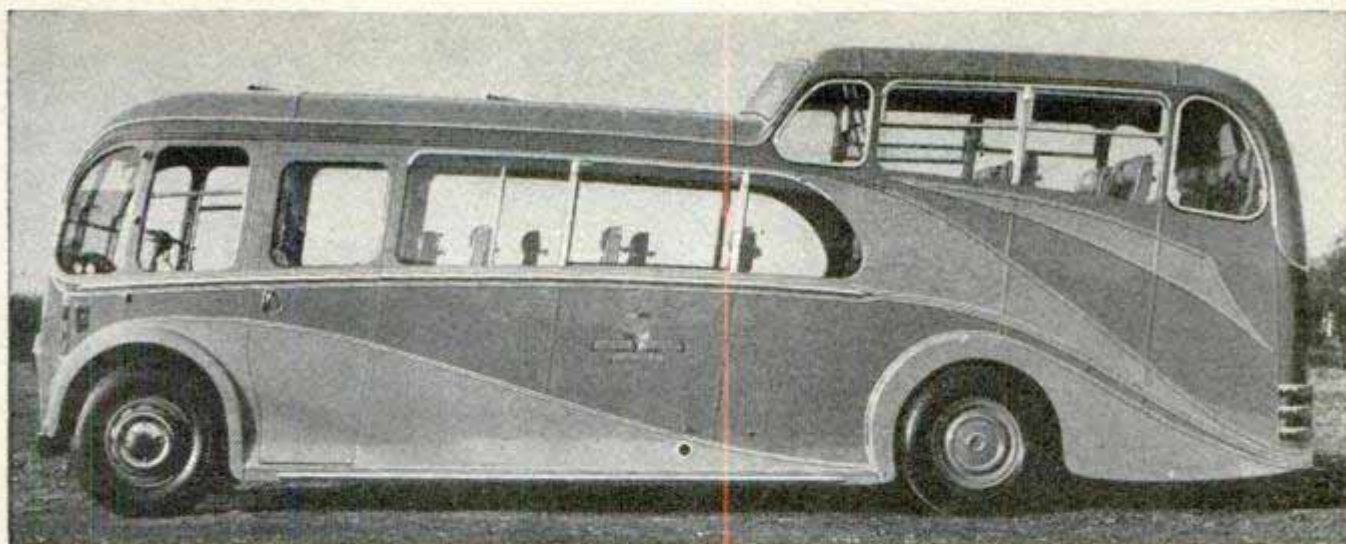

Britain Exports IDEAS IN MOTORING

British auto engineers, seeking foreign buyers, have come up with some novel ideas in cars and busses. Above is a piggyback bus which gives passengers on the upper deck a complete view of the countryside. Luxurious interior furnishings cater to the passenger. Britain hopes to export the twin-deck bus

Right, the Silverstone is a sports car with racing-car lines. An extra-wide chassis keeps the car stable even at high speeds. Racing models of this car have won many victories in Europe. Note the exposed front-wheel suspension system and headlights

Below, the luxurious Aston Martin sports sedan has a long, curved hood. Its seats are covered with white leather. A four-cylinder engine powers the car. The Aston Martin, originally a racing car, has held European records for many years. This passenger model retains much of the racer's speed

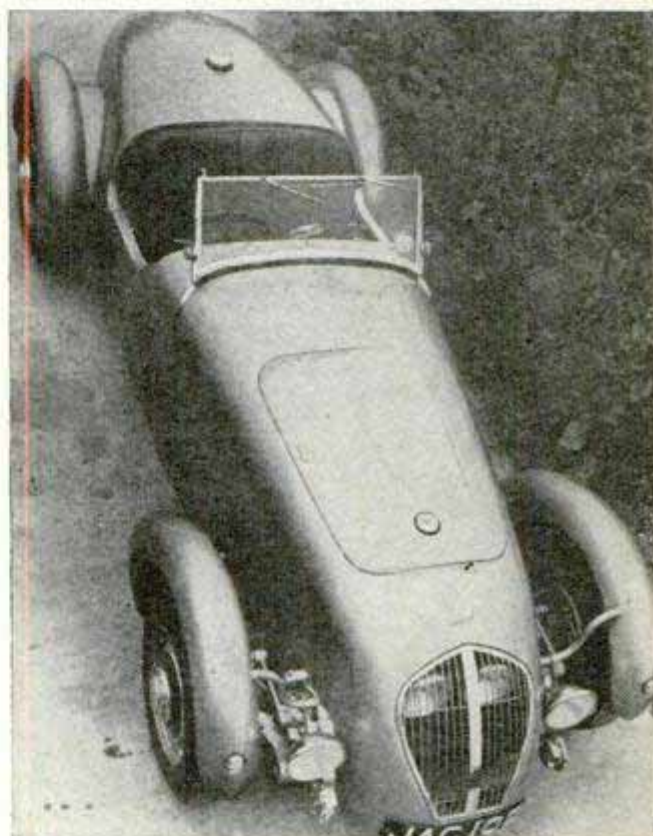

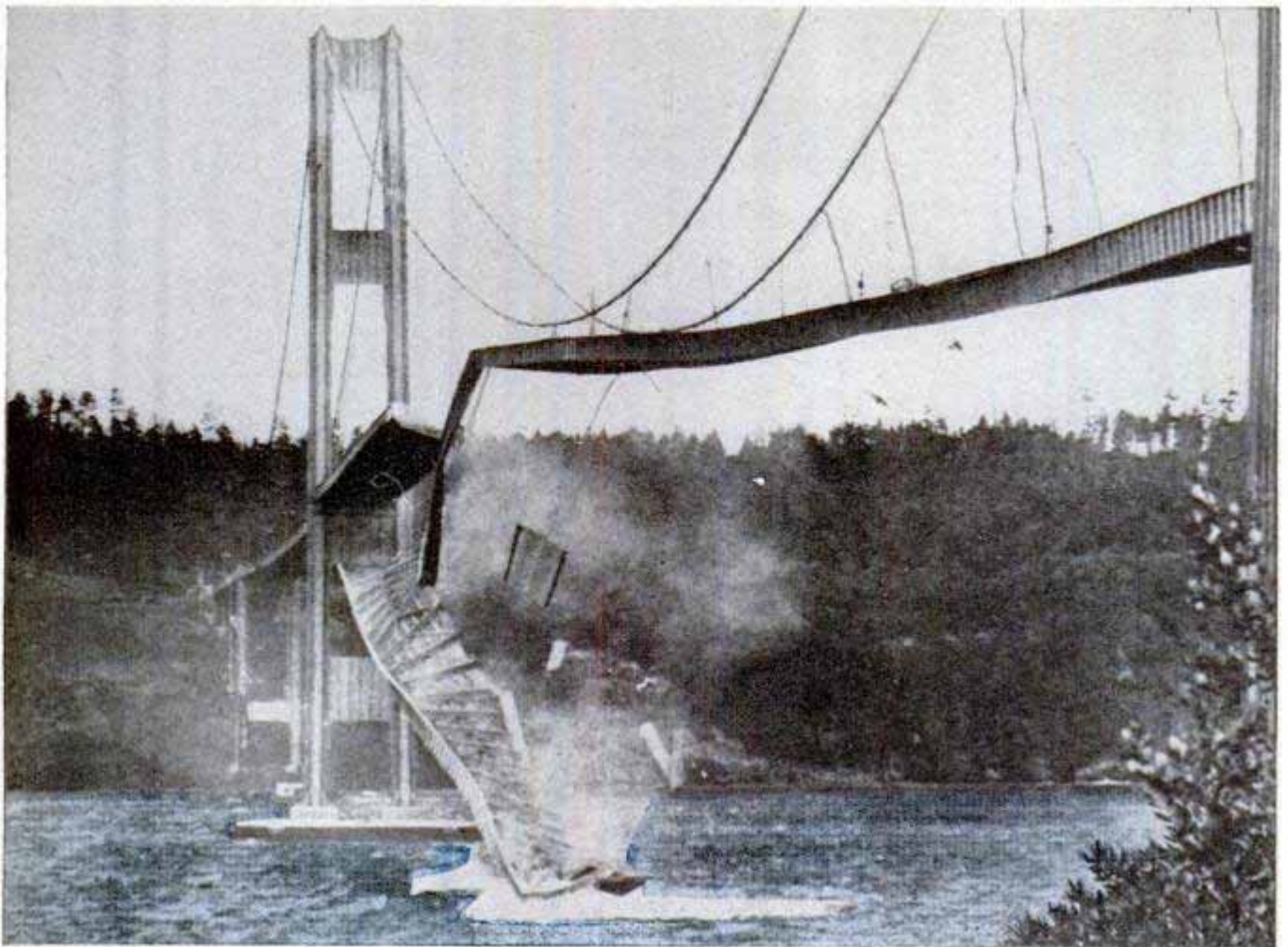

Copyright, Bashford-Thompson

This picture of the old Narrows bridge collapsing under a 47-m.p.h. wind haunted designers of the new span

Spinning a Span To Foil the Wind

By Paul O. Anderson

IT TAKES a lot of wire to build a bridge. Out in Tacoma, Wash., where engineers are building the third longest suspension span in the world across the treacherous Narrows, the John A. Roebling's Sons Co. has "spun" 104,667,656 feet of No. 6 wire in two 20 $\frac{1}{8}$ -inch-diameter cables that support the bridge roadway. These cables are being wrapped with an additional 4,832,000 feet of wire to protect them from the elements. The job is one of the final ones before the bridge is opened in September.

The 5979-foot structure replaces one that was destroyed by a windstorm in November 1940. Its 2800-foot central span is exceeded only by the 4200-foot Golden Gate span in San Francisco and the 3600-foot central span of the George Washington bridge in New York City.

Early in 1949 steelworkers started erect-

ing the 507-foot main towers, using the old concrete piers with slight modifications. The towers were completed by mid-July and turned over to the Roebling's Sons Co. for cable spinning. But before the main cables could be spun it was necessary to string catwalks from shore to shore.

This work had to be carefully balanced, since the two tall towers are not embedded in the concrete piers, but stand on 3-inch-thick steel baseplates. The catwalks closely followed the planned curvature of the main cables so workmen could conveniently adjust wires as each cable was spun.

The hundred million-odd feet of wire used in the cables figures to 20,738 miles, or a long way from here to there if stretched out in a single line. The wire is slightly smaller than a lead pencil. Each cable contains 8702 individual wires made up into 19



strands. These do not contain 458 wires each, as you might think. The Roebling's Sons Co. has learned it is best to lay 460 wires in each strand except those at the top and bottom. Engineers say the cable compacts to a more perfect circle if this is done.

Spinning the cable takes plenty of man power and machinery, but the fundamental operation is not too difficult to understand.

After the catwalks were strung, master wires were stretched across—one for each cable—and carefully surveyed. This was done at night to minimize errors introduced by heat waves. A theodolite was set up in the east tower leg directly below one of the guide wires and was sighted on a marker on the corresponding leg of the west tower. This horizontal line of sight was established 240 feet above the water, or just below the lowest point of the main cable sag at mid-span.

After dark surveyors took their stations. One stood at mid-span and lowered a target in the line of sight while another at the theodolite took readings to determine the actual height of the guide

Nearing completion, new Narrows bridge, Tacoma, Wash., will withstand a gale of 120-m.p.h. Below, initial step before the spinning started was to survey master wire to serve as guide

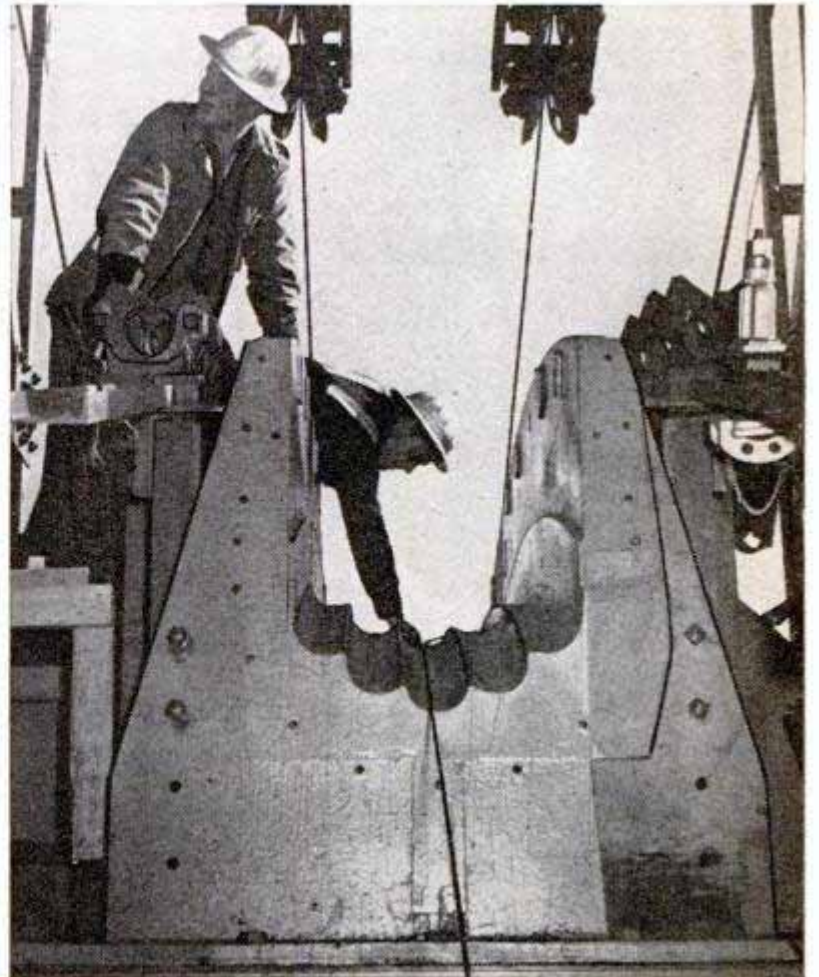

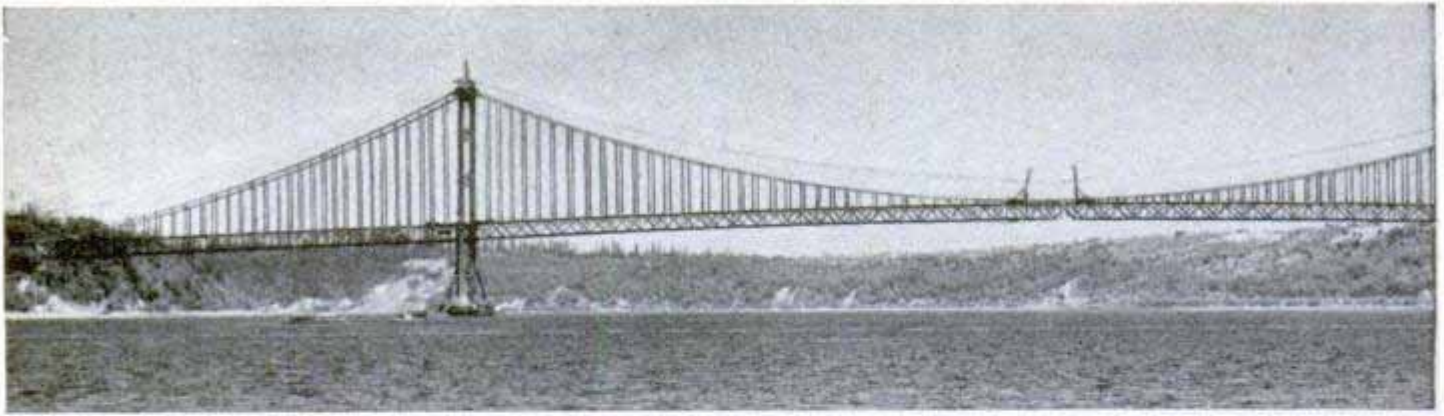

Third longest suspension span in world, Narrows bridge has 2800-foot central span and 507-foot towers

wire. Engineers at the spinning control station on the east anchorage then compared the readings with proper values as determined through earlier calculations.

The difference of the actual reading, corrected for temperature, and the proper value next was multiplied by a coefficient to determine how much to let out or take in on the wire. With the job calling for perfect coordination, communications were all important. Walkie-talkie radios and an elaborate telephone system were used at the various stations. The operation was repeated for the other guide wire.

Prior to this, spinning machinery had

been set up on the east anchorage. An endless tramway running rope operated from an electric motor at this point, across the top of the towers, down the other side and returning. On each side of the running rope was a spinning carriage: A triangular frame with two 4-foot diameter, freely rotating sheaves. The electric motor pulled this running rope in either direction. As one spinning carriage was hauled across the Narrows, the other was returning. Other parts of the spinning gear were a hydraulic unreeling machine, a counterweight tower and various guide sheaves.

Reels of wire were placed on the unreel-

During construction catwalks of open mesh were assembled in sections and slid down the supporting ropes

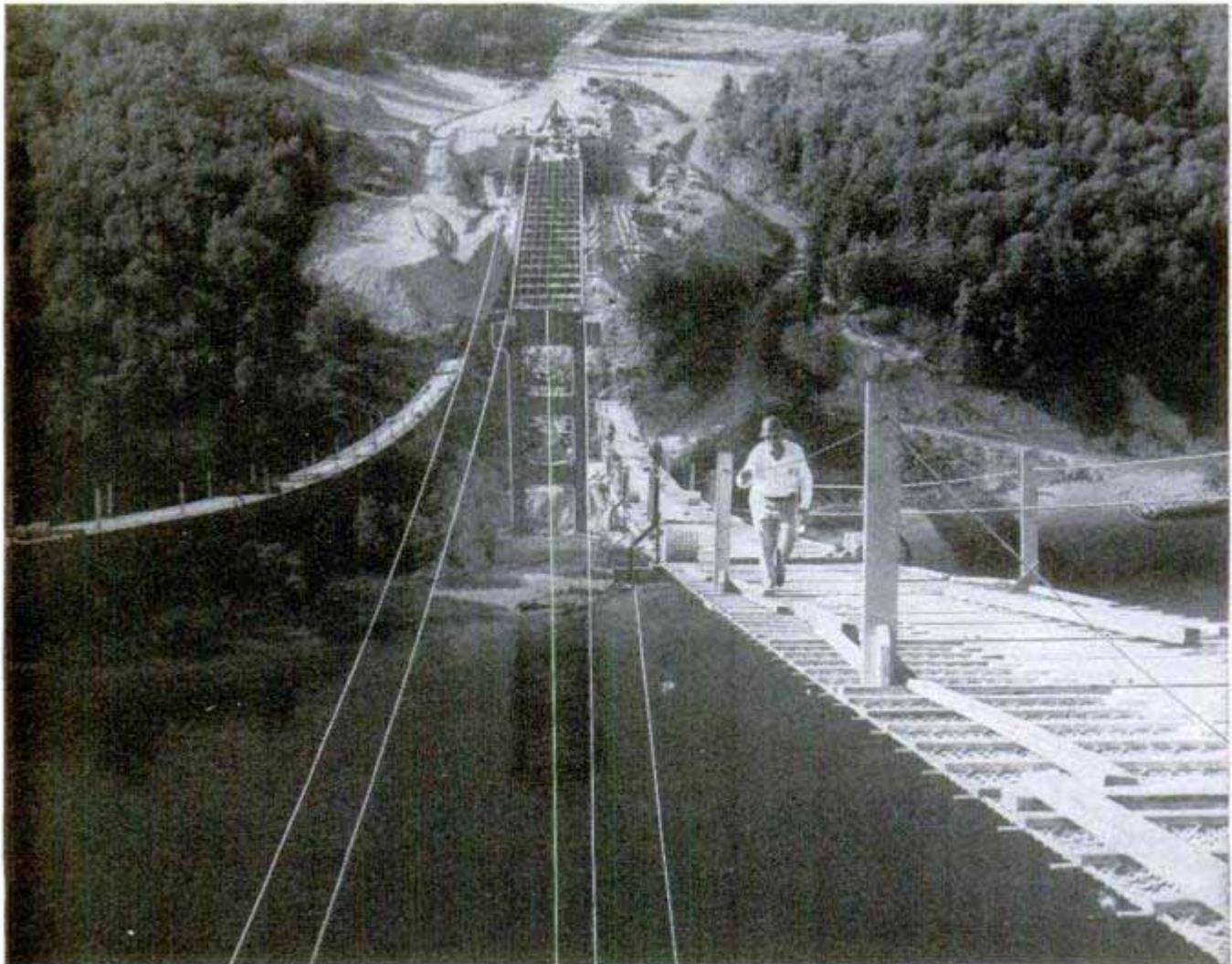

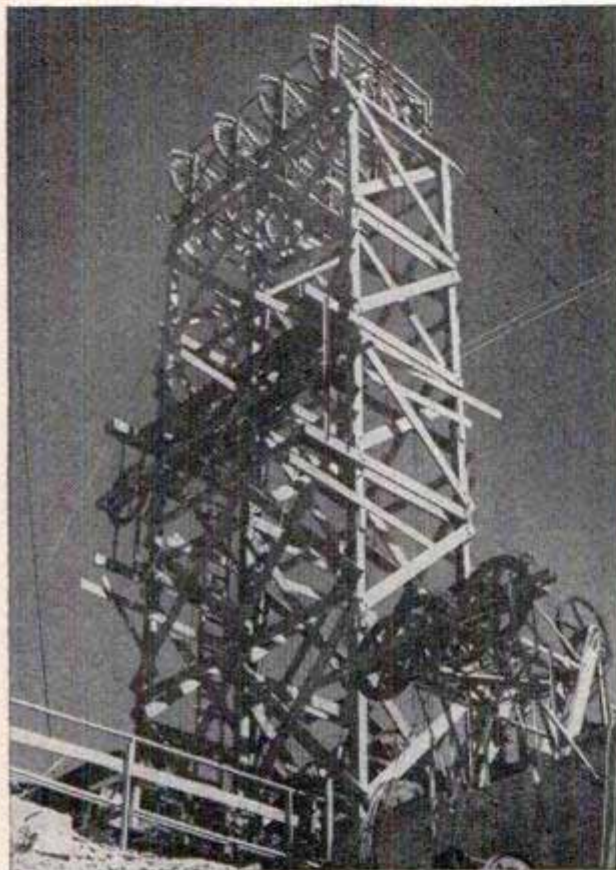
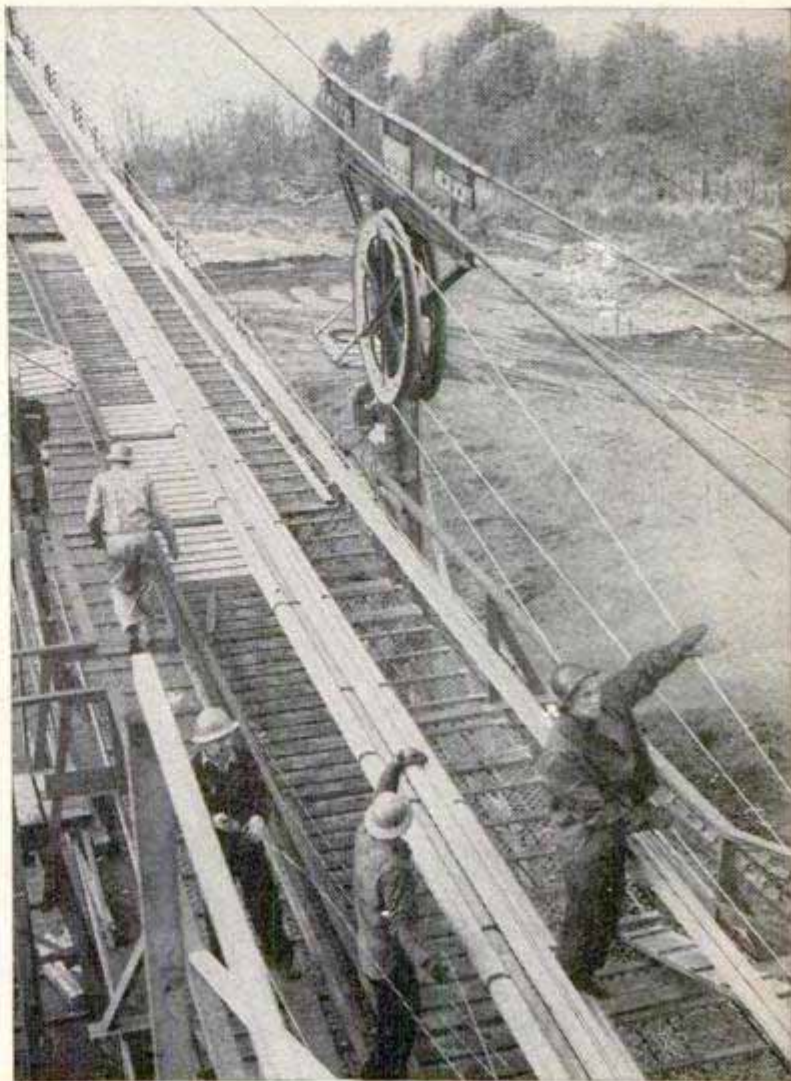

Photos and diagram below show the operation used in spinning over 100,000,000 feet of wire in bridge cables. Above, workmen in spinning pit put new wires on spinning carriage and send it on its way. The system of sheaves and guides used for spinning is complicated. A counterweight tower (left) keeps the wire at an even tension and shows the unreeling motor operator if his motor is synchronized with running rope motor

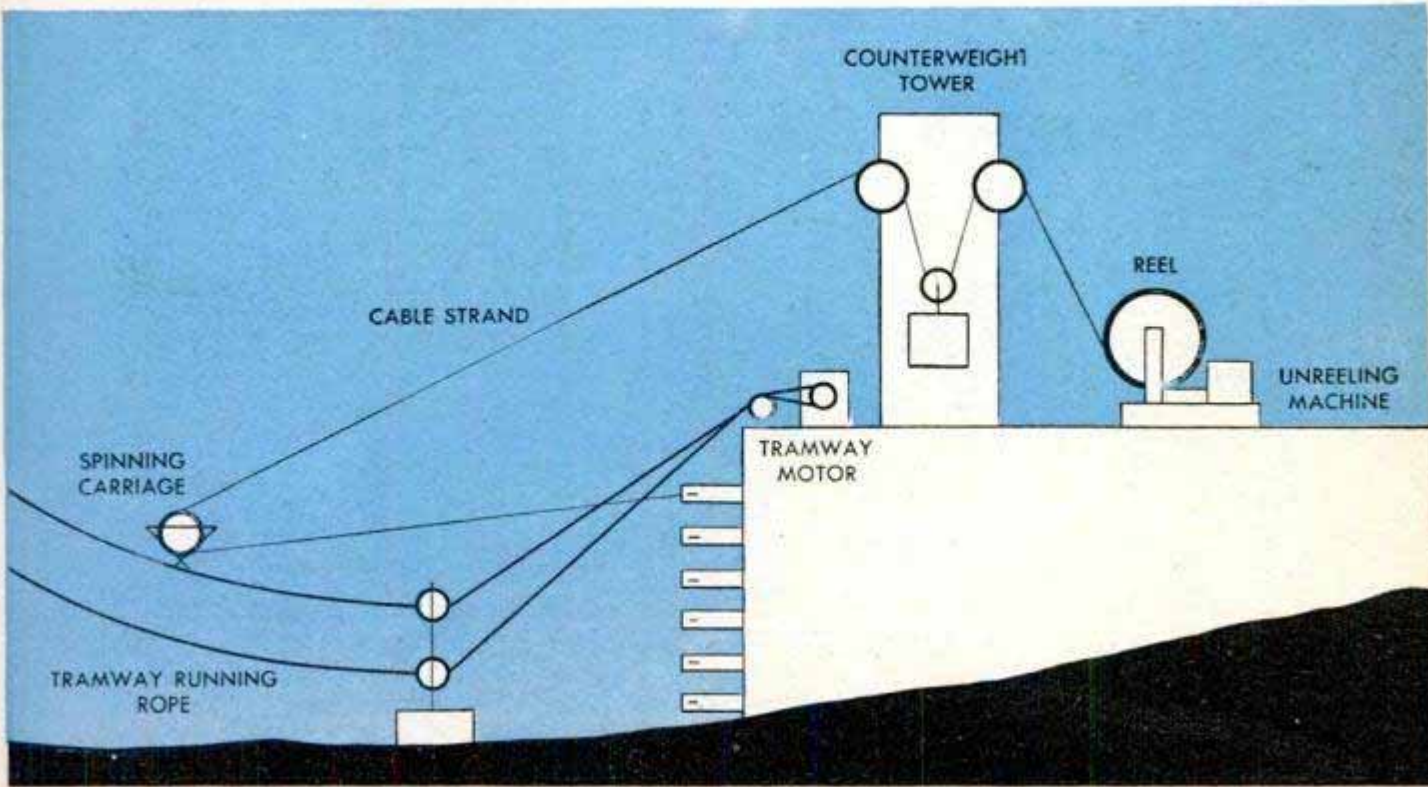

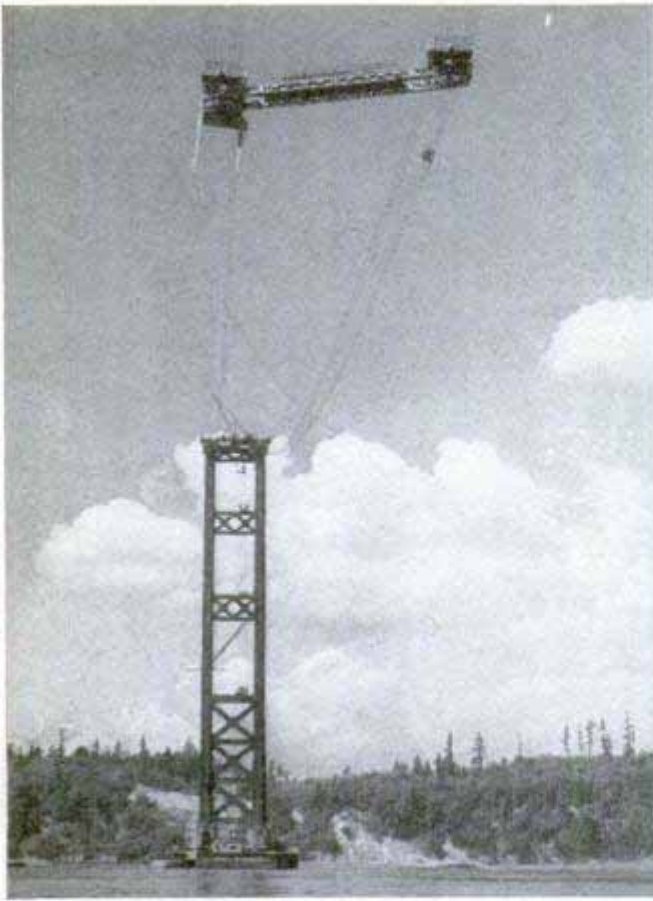

After the towers were completed workmen threw heavy wire rope across to support the catwalks. Below, a traveling derrick eases one of the deck girders into position near mid-span as an inspector watches

ing machines, run through the counterweight tower, around the spinning carriage wheel and secured to an eye bar embedded in the huge concrete anchor block.

The tramway motor was started, carrying the spinning carriage on its way. The unreeling machines operated in synchronism with the tramway motor. When there was a difference in speed of the two, an operator saw the counterweight rising or falling. A slight adjustment of the hydraulic motor kept the wire unreeling evenly.

The tramway running rope traveled at 700 feet a minute, paying out 1400 feet of line a minute. As the spinning carriage approached the far side, a selsyn indicator warned the operator to stop. In the meantime an empty carriage arrived at the east anchorage and workmen slipped on loops of the stiff wire in a matter of seconds. A reversal of the running rope sent the carriage on its way.

Two strands were spun at once, taking about 44 hours for the job. The operation went on day and night, in rain and snow. The first two weeks of spinning saw only one strand completed, but before two months had passed, erection manager Robert Cole was grinning at the records made.

"You know," he said, "it's only possible

(Continued to page 244)

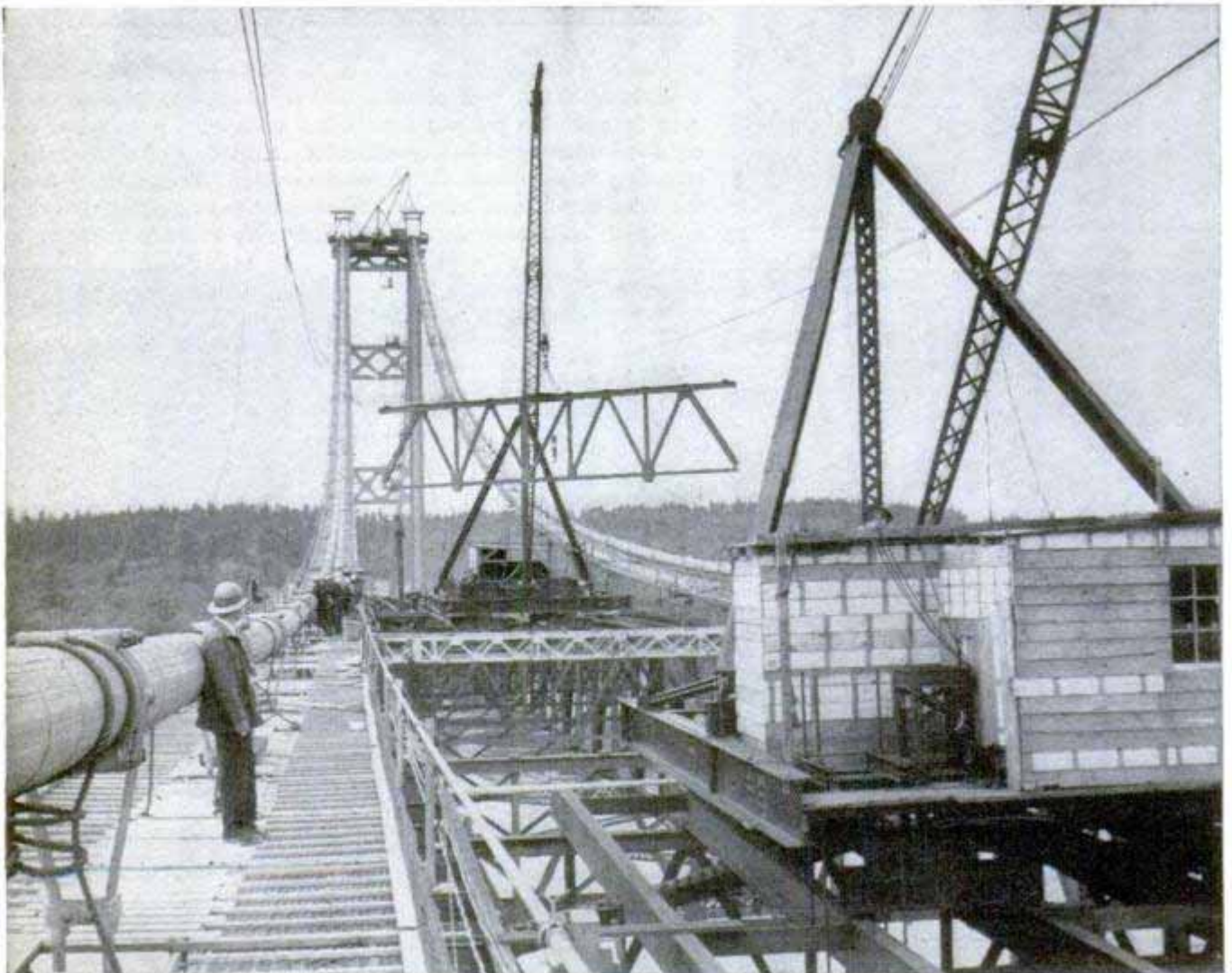



This young craftsman assembled his own blackboard and stool while the girl built herself a wheeled horse

Put-Together Toys From Plywood Parts

YOUNG roughnecks equipped with a new building set made of precut plywood parts can build their own large-scale toys, play with them and then knock them apart. The parts, consisting of wheels, dowels and odd-shaped pieces, fit together in ingenious ways to build several toys, satisfying both the creative and destructive urges of the youngster. There are no screws or bolts.

Pegs serve as fasteners for the set. The youngster can make his own blackboard which can be converted into an easel, take it apart and make a desk, rocking horse or rolling cart. Other possibilities are a table, stool, bench, airplane, house, car and rocking chair. The set is available in three sizes consisting of 6 to 21 flat pieces. Sixteen toys can be made with the largest set.

Left, designer Anne Tyng, who developed the make-it-and-break-it toy, poses behind one of her kits. Right, the child-built car may not be streamlined, but it will roll and that will thrill any creative youngster



The "BIG BLOW" Takes the Diesel's Challenge

THERE was almost a full mile of boxcars behind the X-50, running as an extra out of Los Angeles for Salt Lake City, when the big locomotive crept through San Bernardino and started up Cajon Pass grade.

Engineers sometimes blew their boilers out on the Cajon hill when steam was king. It's the longest, toughest grade on the Union Pacific system. These days the standard power for a heavy freight is three diesel units at the head end of the train plus a diesel pusher behind.

Yet the X-50, the locomotive that looks like a diesel and sounds like a jet plane, was tackling the hill by itself with a single pusher at the rear of the train. The engine's high whine and its steady exhaust roar grew a little louder when it encountered the grade; aside from that the engineer could hardly tell that he was operating a new kind of engine that runs on wind and that may cause a revolution in railroading.

Sometimes called the "Big Blow," the X-50's power plant is a gas turbine similar to a jet-aircraft's engine. A jet airplane gets its propulsion from the thrust produced by hot, pressurized gases leaving the exhaust at high velocity. But in the locomotive the turbine itself makes use of the energy. The turbine shaft is connected through reduction gears to generators and the generators provide the electric power for the traction motors that turn the axles. There is no jet effect.

Built by the General Electric and the American Locomotive Company to test the

possibilities of gas-turbine power plants for railroad use, the locomotive has been in heavy-duty freight service on Union Pacific's western divisions for much of the past year.

In essence the road was asked to regard the locomotive as equal in power to three diesel units and to use it accordingly. During the tests the X-50 has accumulated several thousand hours of main-line operation in temperatures as high as 110 degrees and at altitudes ranging from slightly above sea level to as high as 8000 feet with remarkably few difficulties. There have been a few minor breakdowns of auxiliary equipment, but failures of the main power plant have been negligible.

The initial testing period ends this summer and to date the turbine has amply confirmed its design calculations. It is in fact more efficient today than when it first went to work because several modifications suggested by operating experience have been made. One or more General Electric technicians ride the locomotive in addition to its regular crew, and an extra caboose is attached right behind the locomotive to carry the specialists and test equipment.

The X-50 is 83 feet 7½ inches long and weighs 250 tons. It develops 4500 horsepower for traction purposes and has a continuous tractive effort of 77,800 pounds at 18 miles per hour. It is geared for 69 miles per hour top speed. The power plant itself is amazingly simple and weighs six pounds per horsepower, about half the weight per

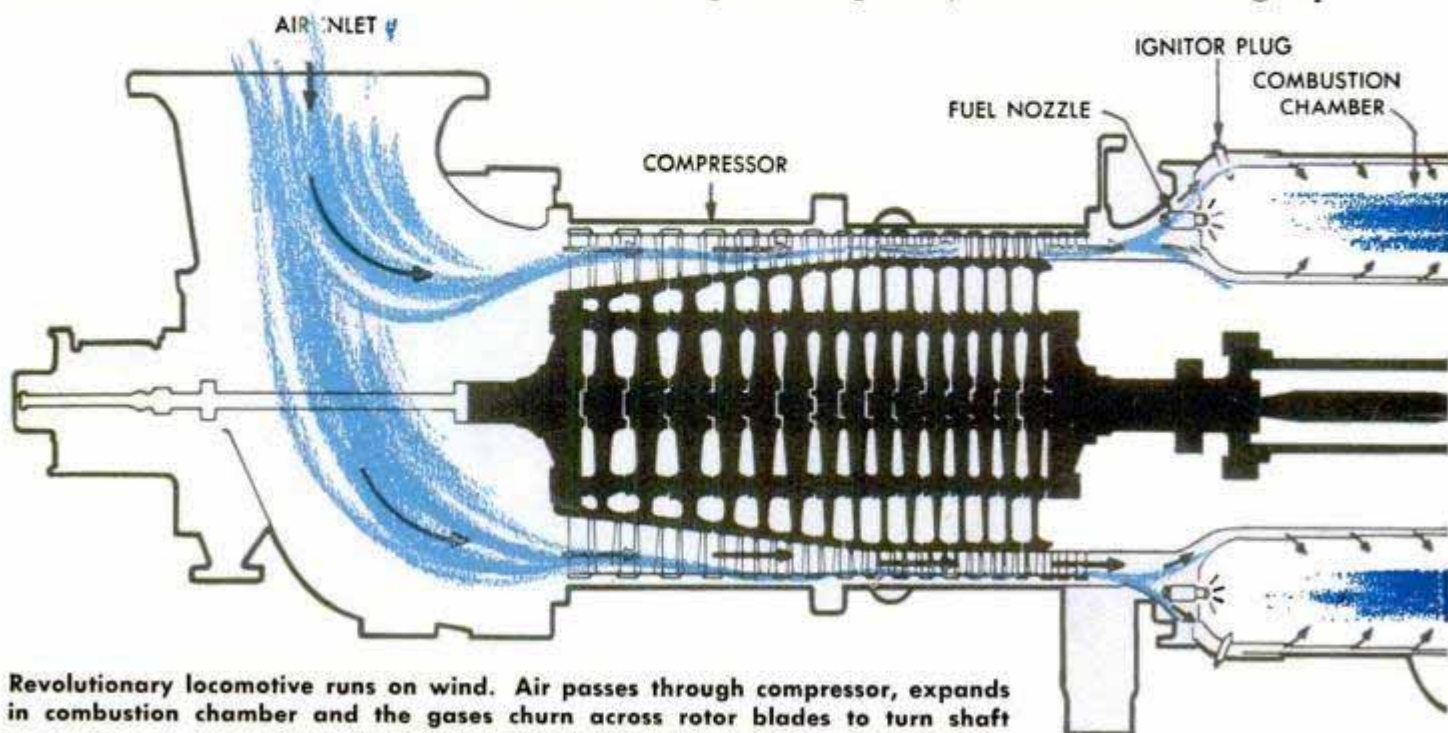

Revolutionary locomotive runs on wind. Air passes through compressor, expands in combustion chamber and the gases churn across rotor blades to turn shaft

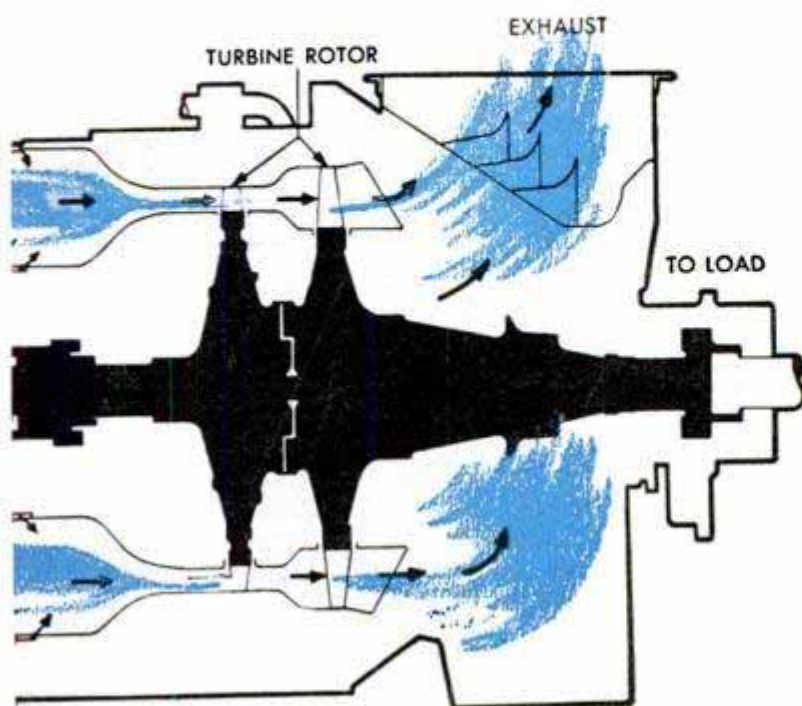

horsepower of a locomotive-type diesel engine. The gas turbine-electric locomotive develops 53 horsepower per foot of length as compared to 30 horsepower for a diesel-electric.

The turbine draws in 70,000 cubic feet of air per minute and compresses it to six times normal atmospheric pressure in a 15-stage axial-flow compressor. Burning fuel heats the air to about 1400 degrees in six combustion chambers. The hot compressed gases then expand through a two-stage turbine and are discharged upward through the locomotive roof. The exhaust velocity is 150 miles per hour and the volume of gas that is discharged amounts to 150,000 cubic feet per minute.

Two thirds of the power generated by the turbine are used to drive its compressor and one third is left for useful work. The total useful power is about

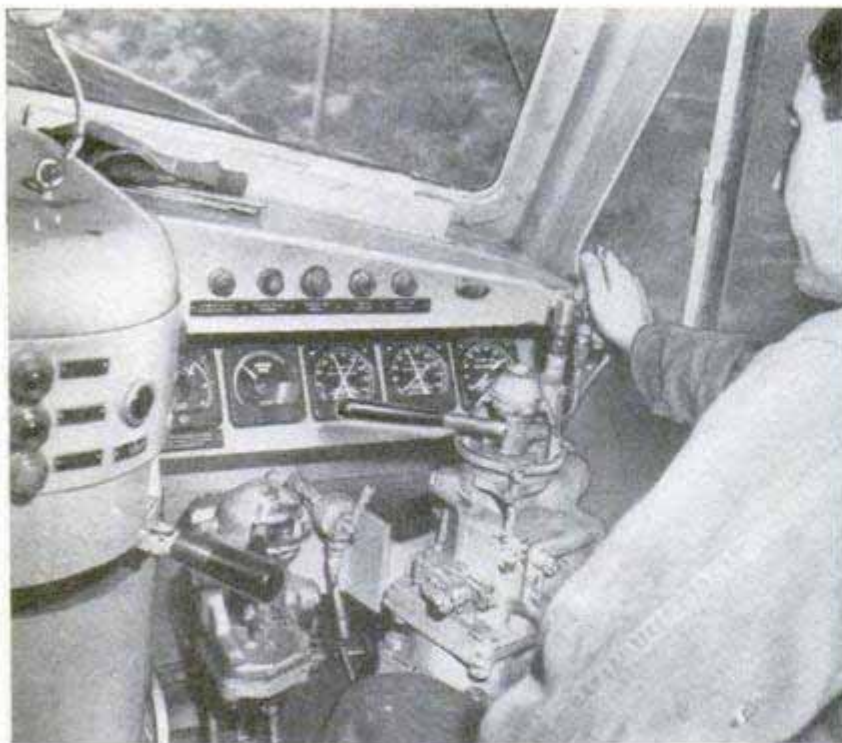

Cab controls are simple and in many cases automatic. Above, right, wind in engine room is strong enough to steal a man's hat and hold it against the air filter

4800 horsepower, of which 300 horsepower is used to operate the auxiliaries.

The power plant was designed to operate for 15,000 hours between overhauls, about three times the working period of a diesel, and has only one major moving part. Vibration and mechanical stresses are low because of its lack of reciprocating parts. Such elements as combustion chambers can be easily replaced.

From the standpoint of fuel consumption the gas turbine is less efficient than a diesel and consumes one third as much fuel when idling as when under a full load. It idles at 5000 revolutions per minute and develops full power at 6700 revolutions per minute. On the other hand, except during the starting operation, the turbine uses just about the cheapest fuel available. It burns grade 6 or Bunker C oil, a tarlike refinery residual fuel produced in the process of refining crude oil. This substance is heated by steam coils, filtered and then additionally heated to 210 degrees. At this temperature it is liquid enough to be handled like diesel fuel and is injected into the combustion chambers in an atomized state. The locomotive carries 6600 gallons of Bunker C in tanks in its frame structure, a supply that is sufficient for 12 hours of operation at full load.

Active research is being carried on by some agencies in the development of a successful means of using powdered coal for fuel in gas turbines.

The power plant is only 19 feet long and occupies only a portion of the locomotive's engine room. The balance of the space is

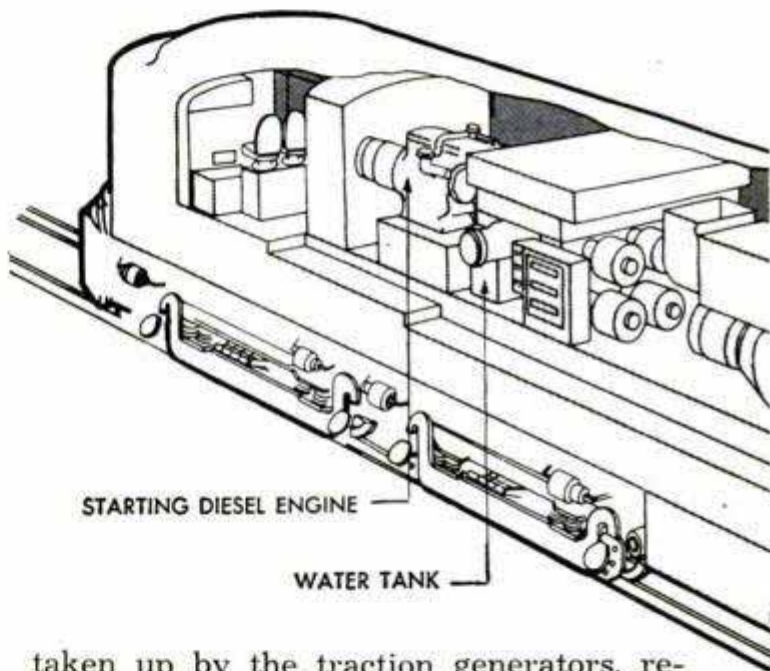

taken up by the traction generators, reduction gears, a small and compact steam boiler for heating the Bunker C oil, the electric-control equipment, lube-oil cooler and a 250-horsepower diesel engine. The diesel is used for starting the main power plant and for hostler service inside a yard when the turbine is shut down.

The X-50 can be warmed up, inspected and made ready to go in about 20 minutes. The starting operation consists of first starting the diesel auxiliary and then using the diesel to crank the power plant up to idling speed. To do this the diesel drives a generator which supplies power to one of the main locomotive generators that, for this operation, acts as a motor, turning the turbine shaft. During its acceleration period, the power plant burns diesel fuel and the change-over to Bunker C is made as

(Continued to page 236)



X-50 with its phenomenal power can pull almost a mile of cars up toughest grade on the Union Pacific system

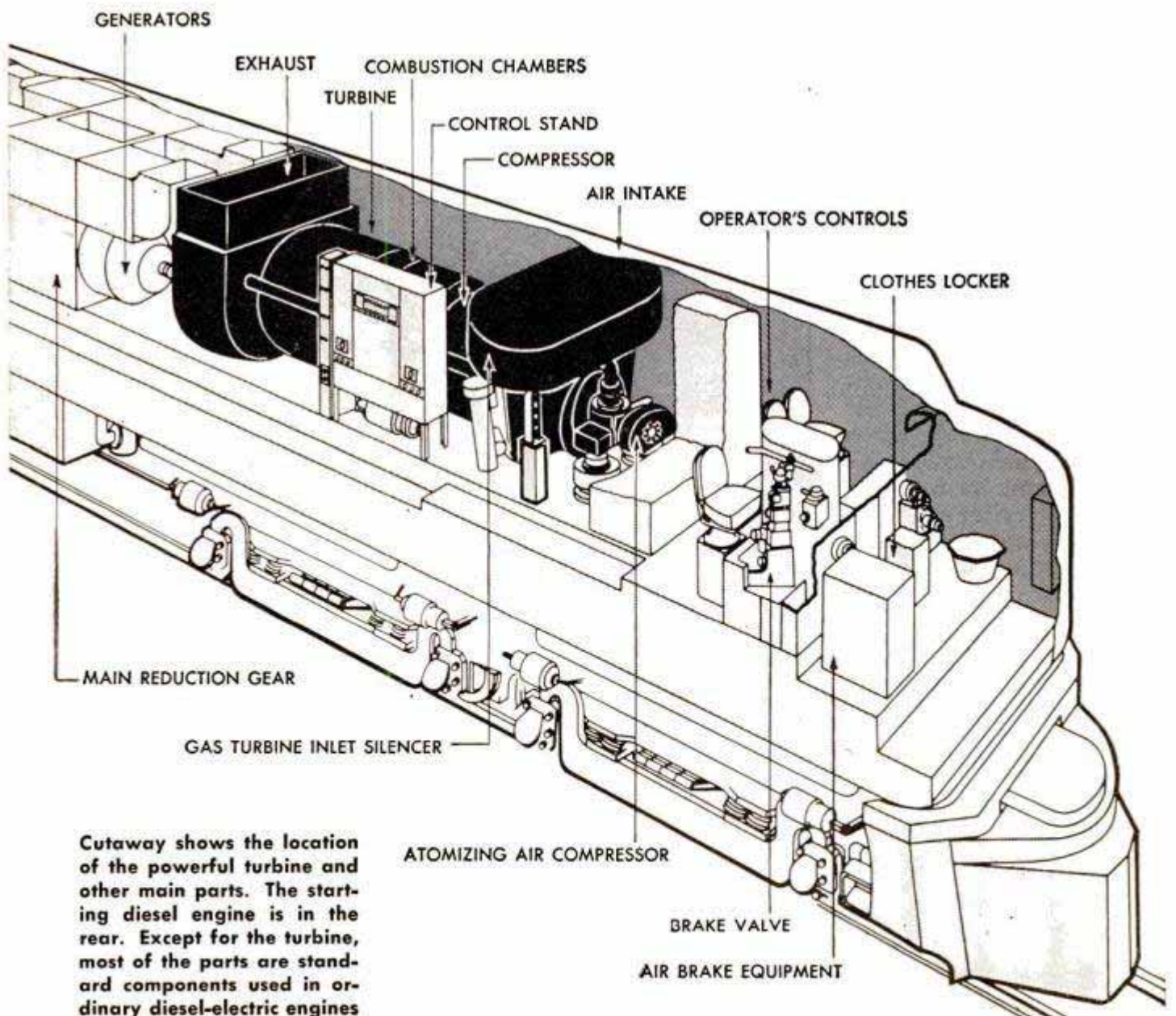

Cutaway shows the location of the powerful turbine and other main parts. The starting diesel engine is in the rear. Except for the turbine, most of the parts are standard components used in ordinary diesel-electric engines



Vertical Broiler

You can broil steaks vertically alongside the fire in a new charcoal grill, thereby preventing fat from dripping down into the fire and causing sudden flare-ups. A narrow V-shaped pocket holds the charcoal. The meat is clamped in wire holders and suspended along the two sides as close to the charcoal as the chef desires. This leaves the top of the grill free to boil coffee or fry potatoes for the outdoor meal. The grill can be carried by the handle like a bucket or can be disassembled and packed flat in a carton.

Beet Thinner

Four rows of beets are thinned simultaneously by a new tractor-drawn machine which systematically rips out part of the vegetables in order to give the remainder more room to grow. As the machine is pulled down the field, its four cutting units whirl at right angles to the rows. Each cutting unit has eight knives which dig under the surface of the soil to cut out part of the beets, thus thinning each row. The machine can be used on beets of varying sizes and can be operated in any soil moisture condition in which a tractor can operate. It is estimated that the

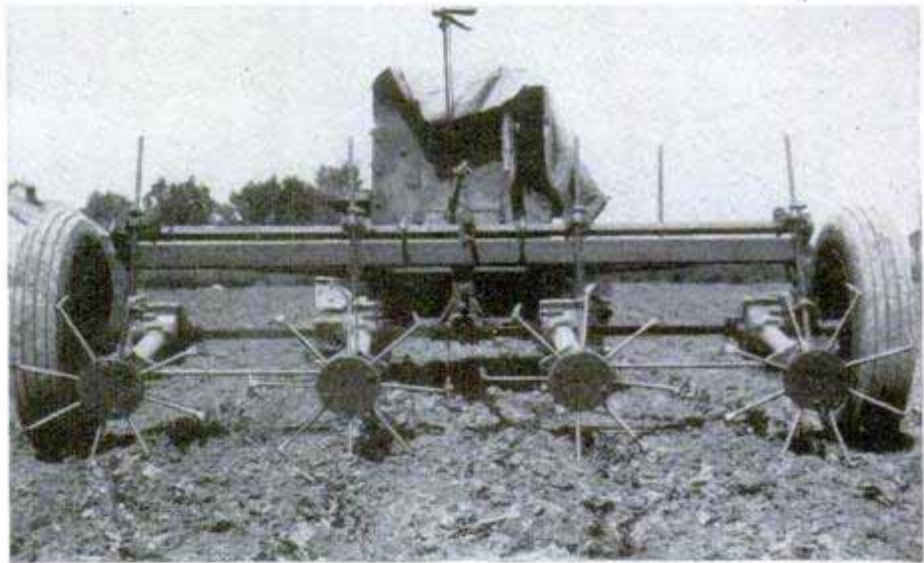

machine reduces thinning labor from one third to one half that required by conventional methods.

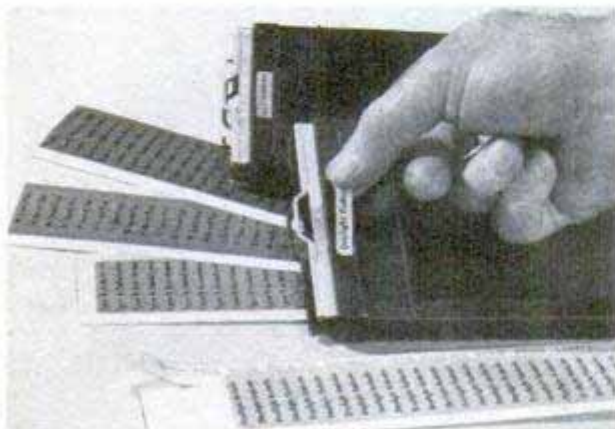

Film Labels

Photographers can see at a glance what kind of film is in each holder when they use adhesive-backed labels for identification. The labels come in five different colors, one for each of the basic film types. In addition, the trade names of the popular films are printed on the labels. Made of durable waterproof cloth, the identification labels are self-sticking and can be transferred from one holder to another easily.

Wings whose position can be altered in flight make it possible for the new Martin jet light bomber to use short air strips.

Aluminum Racer

Maintenance is just about zero on an aluminum-alloy racing runabout that is rustproof, leakproof and unaffected by sun or weather. The 13-foot boat has an exceptionally sharp turning radius and weighs only 800 pounds, including the inboard engine. It will pull several water skiers, can be used for racing or it will idle down enough for trolling. With the standard engine, the boat skims along at 32 miles an hour and this speed can be increased considerably for racing by "souping up" the engine. The craft is available



in kit form, which includes a completely fabricated hull, a 60-horsepower marine engine and hardware. If the buyer prefers, he can buy it completely assembled.

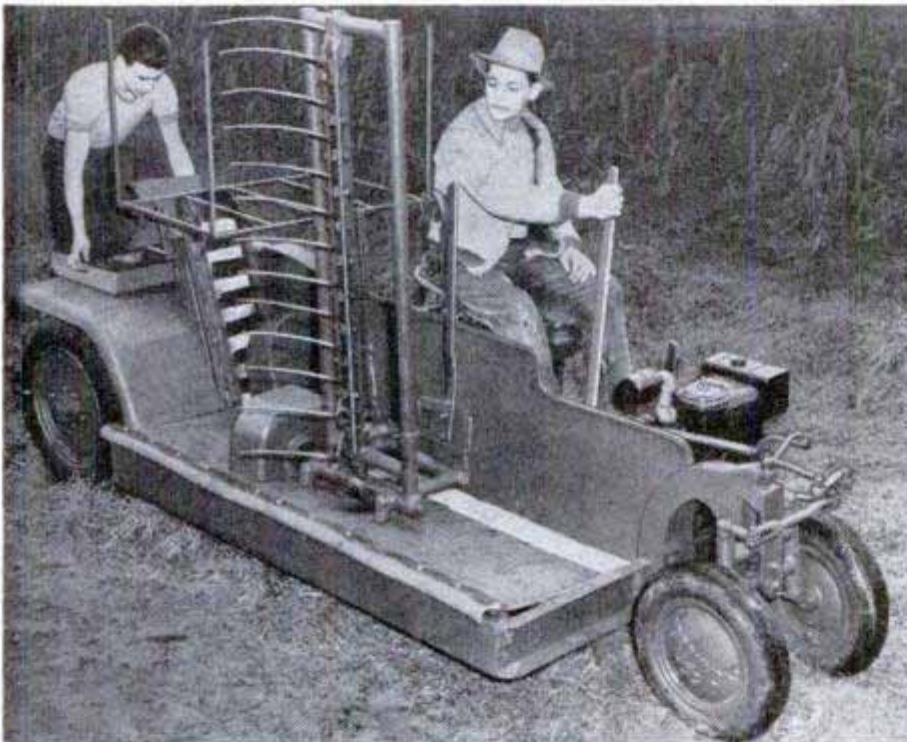

Raspberry Picker Has the Shakes

Harvesting five acres of raspberries in a day, a mechanical picker shakes the ripe berries loose and collects them as it rolls along between the rows. Built by a Washington berry farmer, the picker has two 1½-horsepower engines, one to move the machine forward, the other to operate a vertical shaker arm that has a series of horizontal fingers. The ripe fruit falls to a flat bed beneath the shaker arm and rolls on a conveyor belt that transports it to the rear.

Paint-Tube Caps

Artists save paint and, at the same time, keep their sketch boxes orderly with a set of molded lead caps that serve as a reservoir for the paints. Screwed on to the tube in place of the original cap, the lead caps permit the artist to work directly from the reservoir, making wasteful blobs on the palette unnecessary. The paint will not harden in the reservoirs during short periods. If the paints are to be stored for a long time, a layer of oil is put over them and the lead



lips folded down. The square sides of the reservoirs hold the tubes in place when the box is carried.

There are right and wrong ways of falling. Take these tips from a man who taught the Navy how to tumble safely and . . .

LAND ALIVE!

TWO MEN are trapped by smoke and flames on the fourth floor of a burning building. Leaping from the window is their only possible escape.

One man, even though death is certain in the fire, is afraid to jump. His friend slugs him on the jaw and throws him out of the window and he lands flat on his back. The braver man then leaps out and lands on his feet.

Which of the two men will survive?

It will be the coward who lives, though badly injured, while the man who landed on his feet will be speared through his vital organs by his own thigh bones.

Countless cases of men falling from great heights were analyzed by the Navy and it was found that by far the best chance of survival occurred when the victim landed flat on his back.

Falling from a lesser height, on the other hand, the least injury will be suffered when the victim, for instance a man falling from the roof of a two-story building, takes the initial shock on his feet but distributes the force of his fall by letting his body roll.

When you trip, moving at slow speed, extending arms is easiest way to break the fall before landing flat

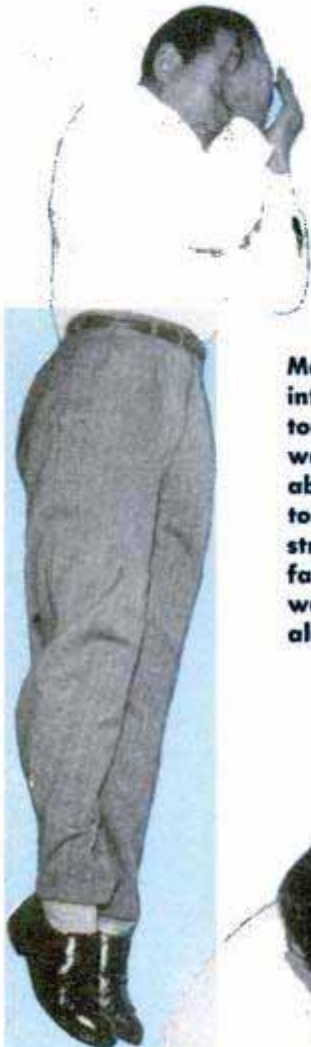

Men have dropped into the sea from astounding heights this way—and lived to tell about it. By keeping toes pointed, body straight during the fall, jumper cuts the water's surface with almost no resistance



In tumbling from a fast-moving auto or train, the log roll, above, is the best method of avoiding serious injury. Arms are held close to the body, with the hands shielding the face during the roll



By Eugene M. Hanson

Photos by the Author

The Navy considered the problem of how to fall safely so important that a special training film was made during the war to teach such know-how. The man who demonstrated the various techniques for falling safely was a former professional tumbler, Bruce Connor, who is now a physiotherapist in Los Angeles and spends a good part of his time teaching paralyzed war veterans how to walk on crutches, and in case of accident how to fall off the crutches without being hurt.

Connor says many lives would be saved and countless injuries avoided if every school child were taught, as part of the physical-education curriculum, how to take a fall properly.

He sums up the findings with two bits of advice:

"First, always try to roll your body in the direction you are falling; second, always try to land as flat as possible."

This applies to ordinary falls, those which can happen to anyone at any time, just as much as to the more spectacular accidents, Connor makes it clear.

He who slips on ice, a rug on a smooth floor or a roller skate usually falls backward, and the point most susceptible to serious injury is the end of the spine. If

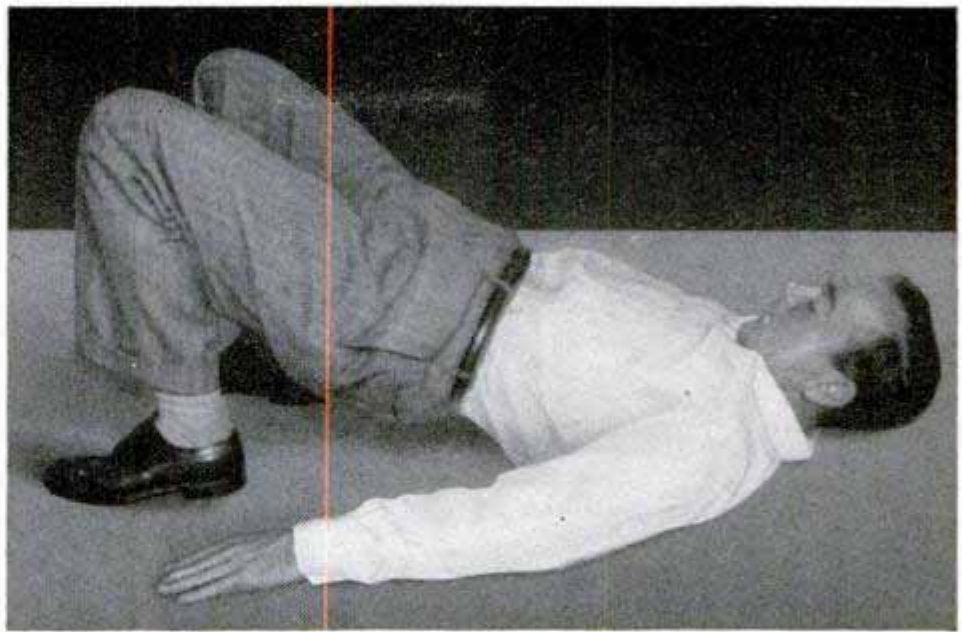

When you slip, this is the safest way to land. The feet, arms and shoulders, rather than the vulnerable base of the spine, will absorb most of the shock

you remember to try to land flat, you will arch your back and thus keep from landing on the vulnerable tailbone.

In falling forward, on the other hand, the exact technique depends on how fast you are moving. If you trip at ordinary walking speed, you can ordinarily save yourself by catching your weight on your hands in the push-up position. If you are carrying something, drop it. Don't try to catch your weight on one arm. You're likely to break it.

If you fall when running, try to go into a football roll. Twist sideways and land with a rolling motion, hip, side and shoulder taking the first shock, and with knees bent,

(Continued to page 242)

Somersaulting forward, left, is the best way to break a headlong fall. A running fall should be taken by going into a football roll, right. Hip and shoulder take the impact, and you can roll right back to your feet

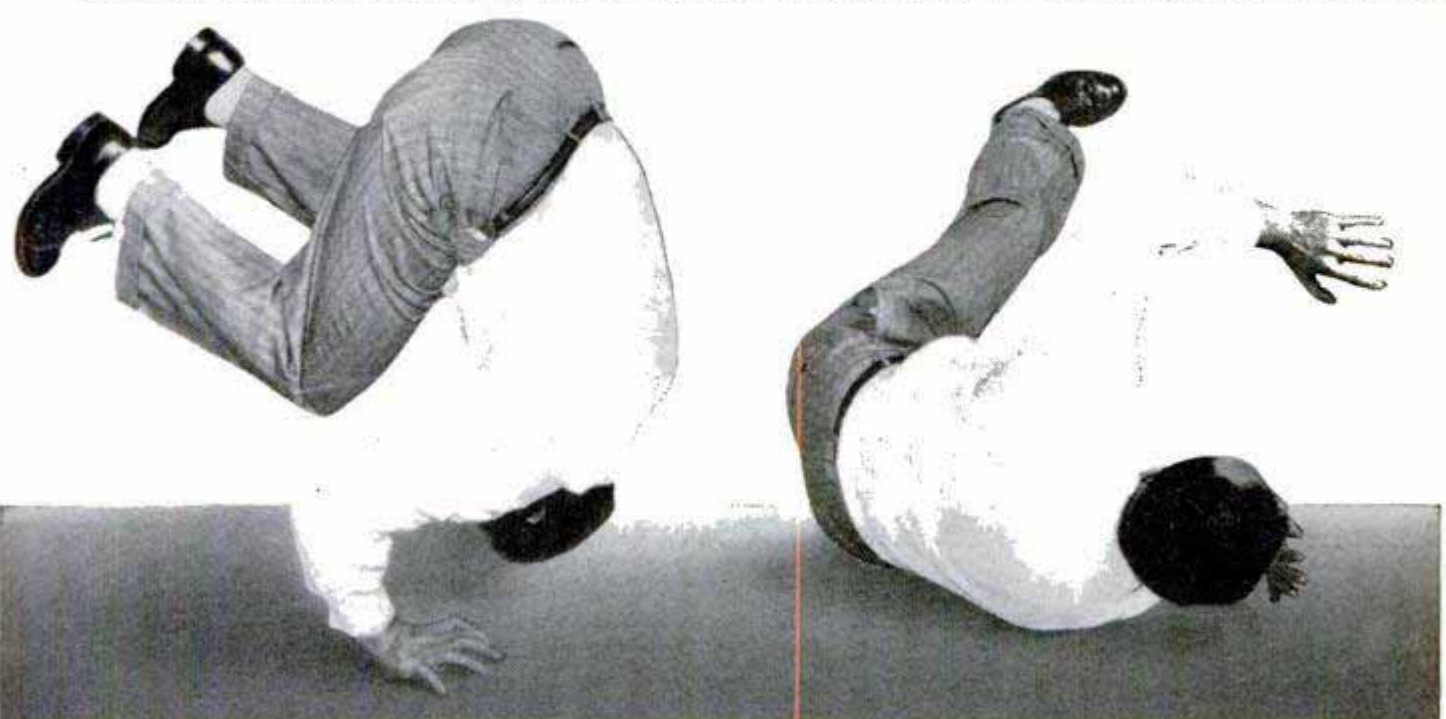

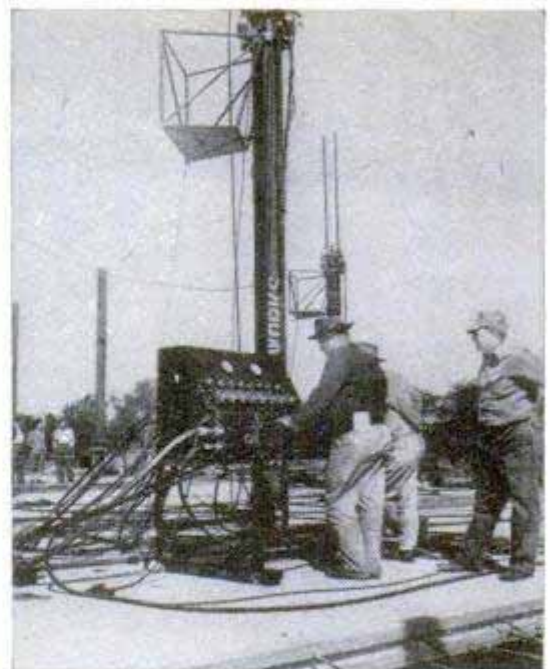
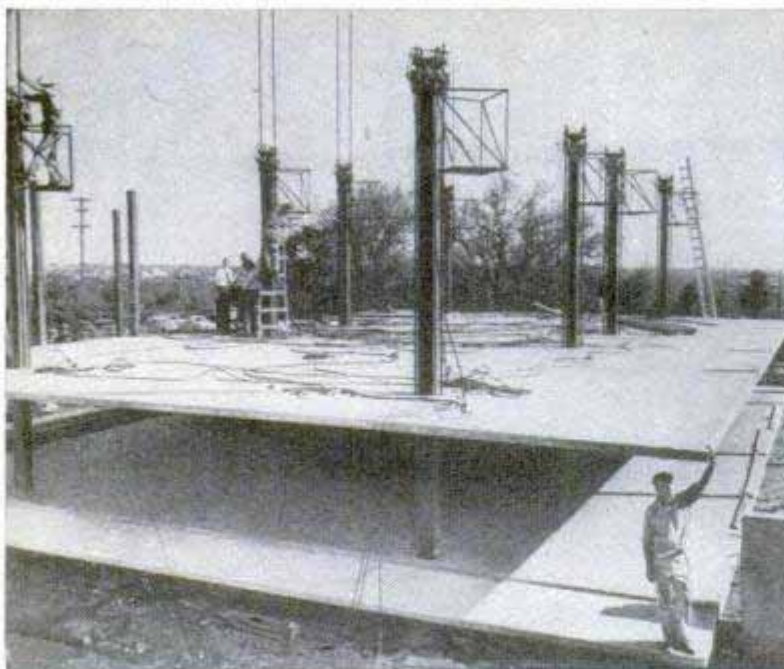

Raising the Roof

Engineers who erected a new building for Trinity University at San Antonio, Tex., literally raised the roof. They simply poured the big concrete roof on the ground

in 46 by 73-foot sections, then raised the slabs into position with eight hydraulic jacks. One of the sections weighed 168 tons. A central control panel was used to regulate the movement of the jacks as the big slabs were eased into position.

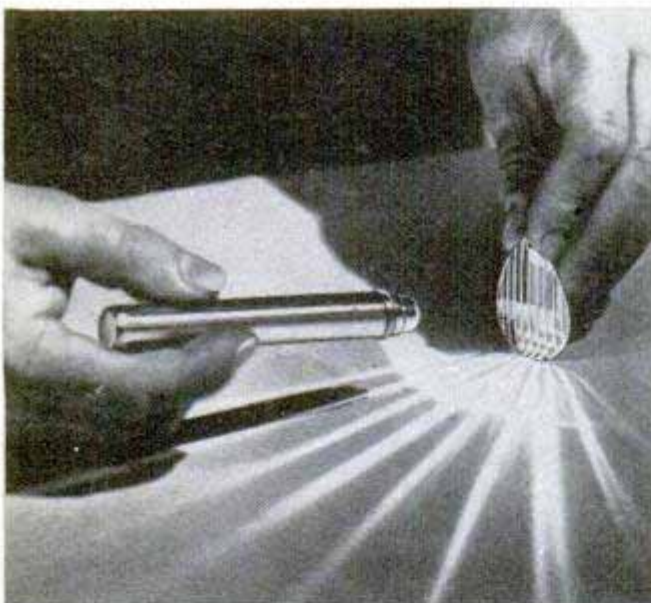

Ten-Mirror Fishing Lure

Ten tiny mirrors on a new angling lure reflect the sunlight to catch the attention of the fish. The highly polished mirror surfaces are cut into both the concave and convex sides of the lure. They reflect both infrared and ultraviolet light, which some scientists believe are the wavelengths seen by fish.

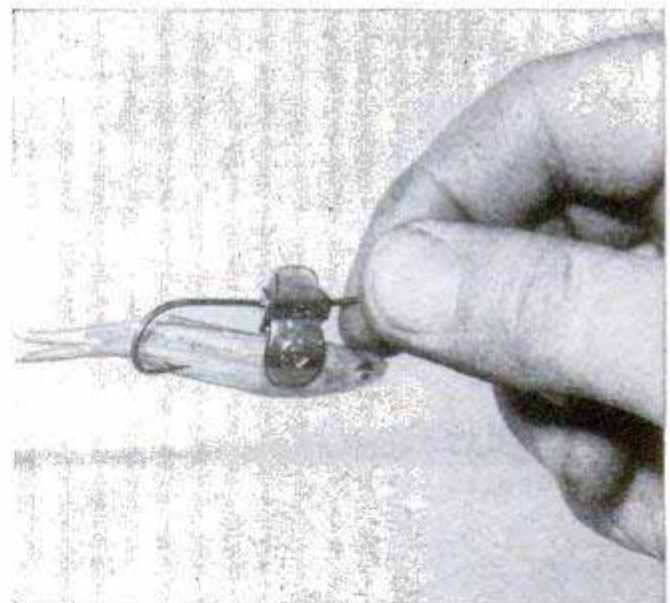

Live-Bait Lure

Live bait is kept alive and allowed to move naturally with a new lure clamp. Gentle spring pressure and serrations on the holding pads prevent escape without injury to such bait as minnows, crabs and frogs. As many as 15 to 21 casts can be made with the same live bait. The lure is made in three hook sizes.

Chemically Treated Fabrics Resist Mildew and Rot

Fabrics treated with a new chemical become highly resistant to mildew and rot. The treatment promises to gain back, for many fabrics, the fields that have been lost to the plastics, such as shower curtains

and sunshades. Rot and mildew largely result from the growth of fungi and bacteria on textile fibers. The new chemical is poisonous to these organisms, but does not affect higher forms of animal life.



U. S. Air Force photo

Jets fly basic "finger" combat formation, with four planes arranged like the finger tips of the right hand

YOU ARE RED LEADER and the three other pilots in your formation are right behind you, holding together in a tight group at 600 miles per hour.

In the cockpit of the F-86 Sabre you make another routine instrument check. Tail-pipe temperature: 600 degrees Centigrade. Percent of power: 95. Fuel: one third remains. Everything is satisfactory and you glance again at the aircraft altitude indicator. It's steady at 43,000 feet.

You have been at altitude for more than half an hour and are beginning to feel it. You've got a touch of the aerial bends in spite of your oxygen and in spite of the pressurized cockpit that puts you more than a mile below your actual altitude. Your knees and elbows have begun to

ache, you are tired and your feet are freezing cold.

The cockpit is heated, but the heater doesn't entirely compensate for the outside temperature of minus 45 degrees Centigrade. Everything in the cockpit is icy cold and you are wearing gloves.

Your eyes seem to be affected by the altitude, too. There's nothing in the vast sky to focus on and if you were staring at infinity you might fail to see an aircraft only three or four miles away. Fortunately, radar can find your targets and guide you to them.

The clock tells you that the point of no return is approaching and that it's time to go home. Pressing the transmitter button, you get ready to talk. "Red Leader to

By **Thomas E. Stimson, Jr.**

Masked pilot peers from pressurized cockpit. Jets perform best at very high altitude, about nine miles up

SCHOOL FOR JET PILOTS

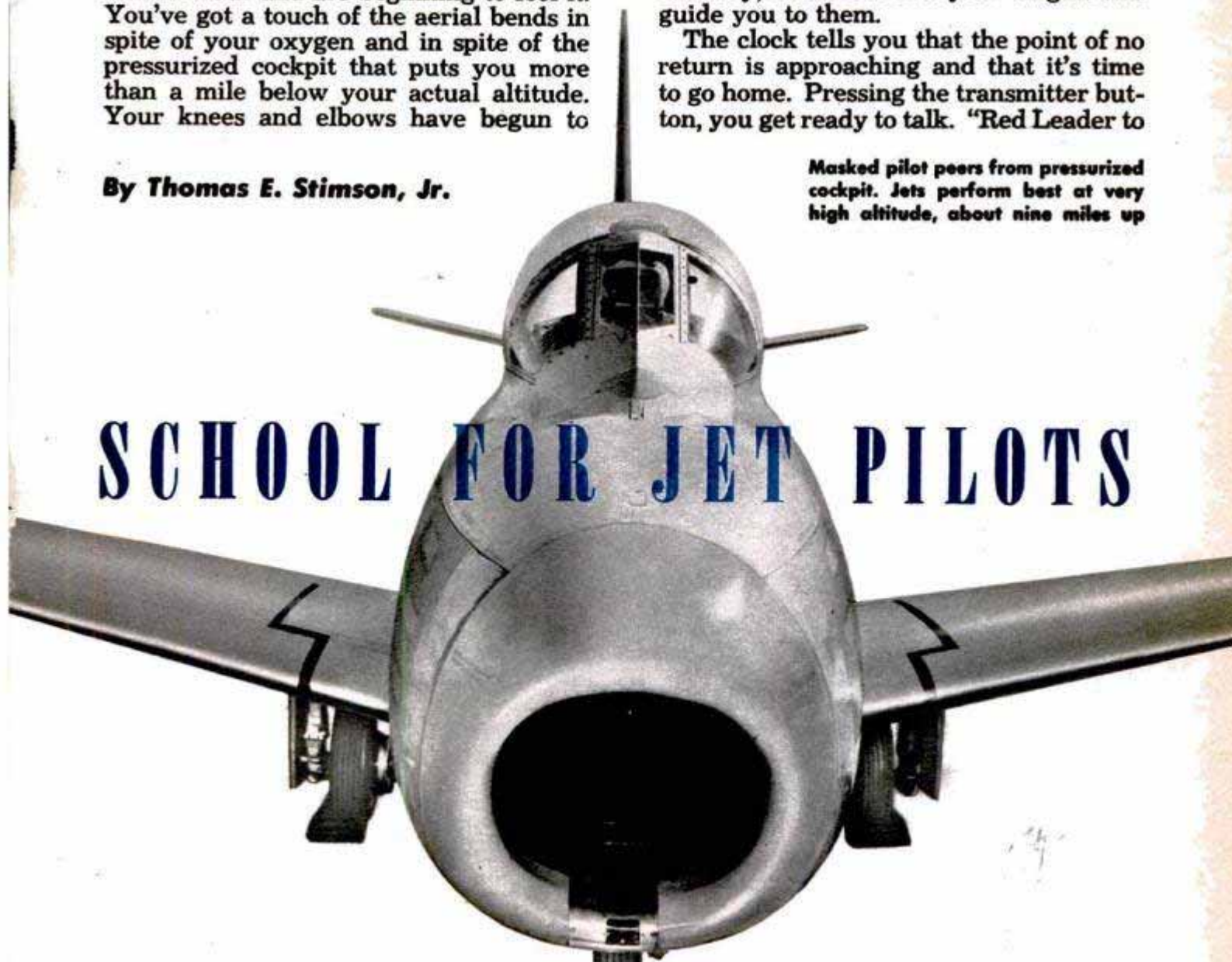

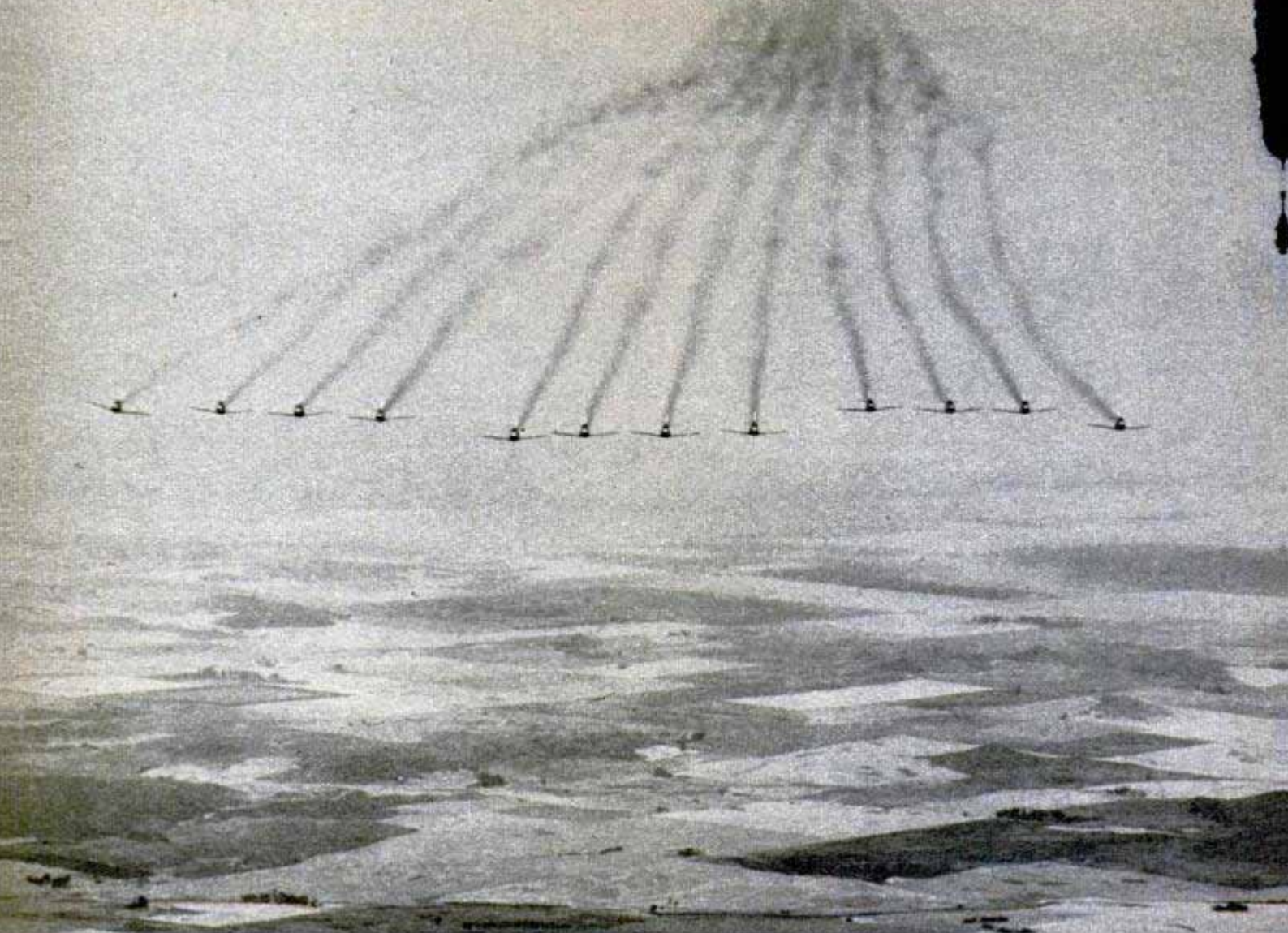

Sabres swooping down on a low target. Smoke trails indicate engines are operating near their full power

Red Flight," you say, and pause. Talking is a real effort and you are forcing your voice up from your chest. "We are starting back to the base now. Making a 180 right."

You make your turn as smoothly as you can, because in the thin air it's easy to overcontrol. And you turn in a wide sweep, careful not to exceed three Gs of pull. In a tighter turn at this altitude, the plane might simply shudder along in a high-speed stall.

Sturdy shoulder straps hold pilot safely in place during high-speed air buffeting and high-G turns



It doesn't take long to get down to 30,000 feet. From here on in the jet is a delight to fly. The cockpit is so quiet that you could hear the thump of your machine guns if you fired them. The plane is as stable as an airliner, even though you are pushing 650 miles per hour, and it handles so smoothly that you can fly tight formations that would seem foolhardy in propellered aircraft.

The elevator and aileron controls are operated through hydraulic boosters and with this help the stick doesn't tighten up exorbitantly even when transsonic speeds are reached.

Relaxing in the cockpit on a straight course, you have to remind yourself that with just a little pressure on the controls you can make a six-G turn. You won't black out, with your antigravity suit, but your oxygen mask will try to pull loose from your face and your goggles are apt to slide down on your nose. Your head sags onto your chest in six-G maneuvers and your arms and legs grow as heavy as lead.

The swept-wing F-86 is the newest, hottest fighter plane in military service. It has been clocked, combat loaded at 670.981 miles per hour. Ceiling hasn't been announced but the plane is designed to intercept jet bombers that reputedly are flying

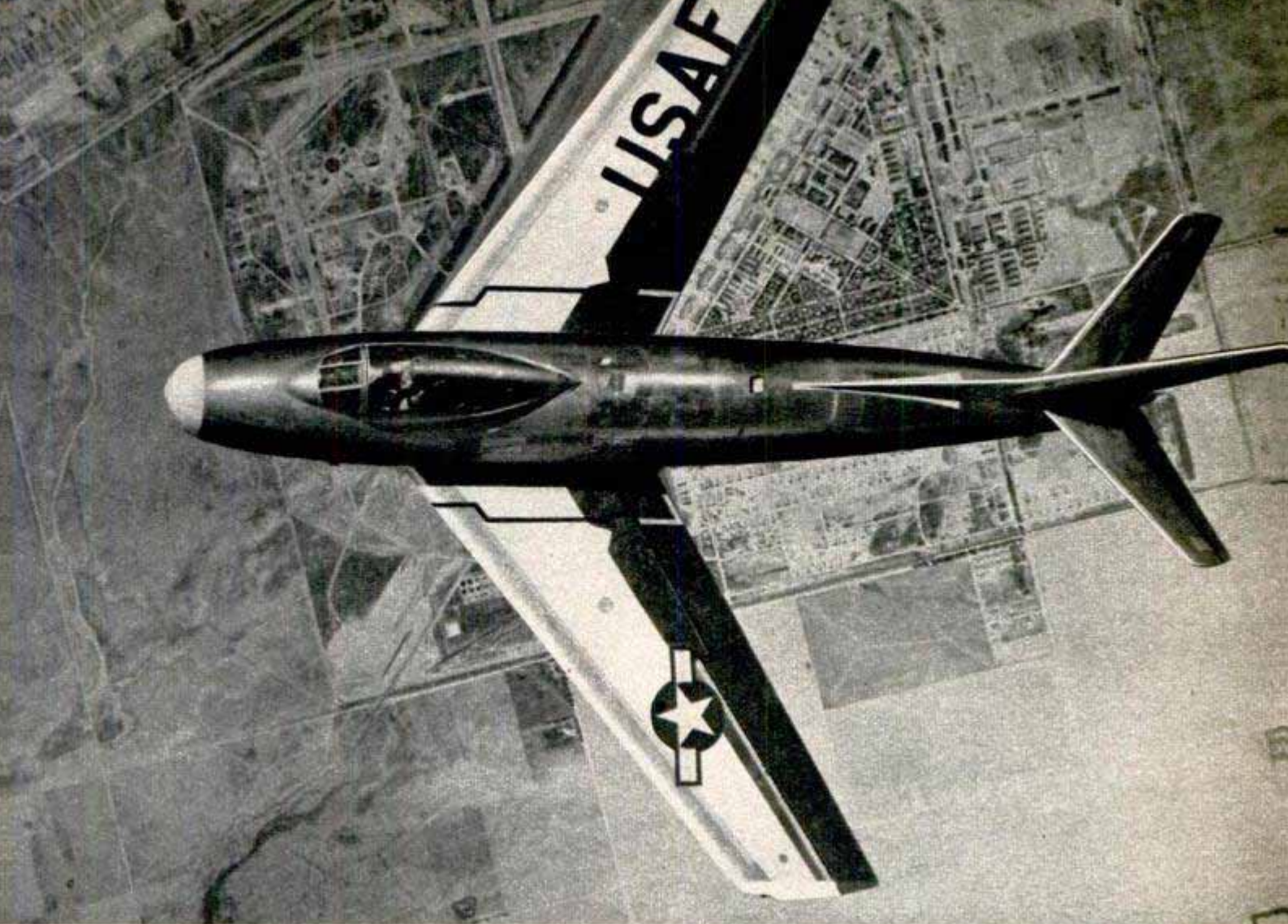

nearly nine miles or more above sea level. Brand new techniques and maneuvers are being invented to make fullest use of the plane's superior qualities.

The first Sabres that came off the line at North American went direct to March Air Force Base in California, where the famous First Fighter Group was given the job of developing the tactics that would make best use of the plane's speed and climbing ability. The 27th (Falcon), the 71st (Winged Mailed Fist), and the 94th (Hat in the Ring) squadrons of the group had their beginnings in the first World War, with Nieuports and Spads. The group has done the service testing of the F-80, the P-43, the P-38 and other well-known fighting aircraft.

Today the First Fighter pilots are flying their newest jets in the formations that were so successful in the last war. The basic combat "finger" formation of four aircraft still works extremely well. In this formation the planes are arranged like the finger tips of the right hand, with the leader in front, one wingman behind and to the left, and with the third and fourth planes trailing to the right. In simulated combat, the planes spread out but still maintain their relative positions. In spite of their extreme high speed, the new aircraft operate as teams and probably always will.

Overhead view of an F-86, emphasizing the 35-degree sweepback of its wings. Below, pilot's hands held up while machine guns are being loaded assures ground crew that guns will not be accidentally discharged



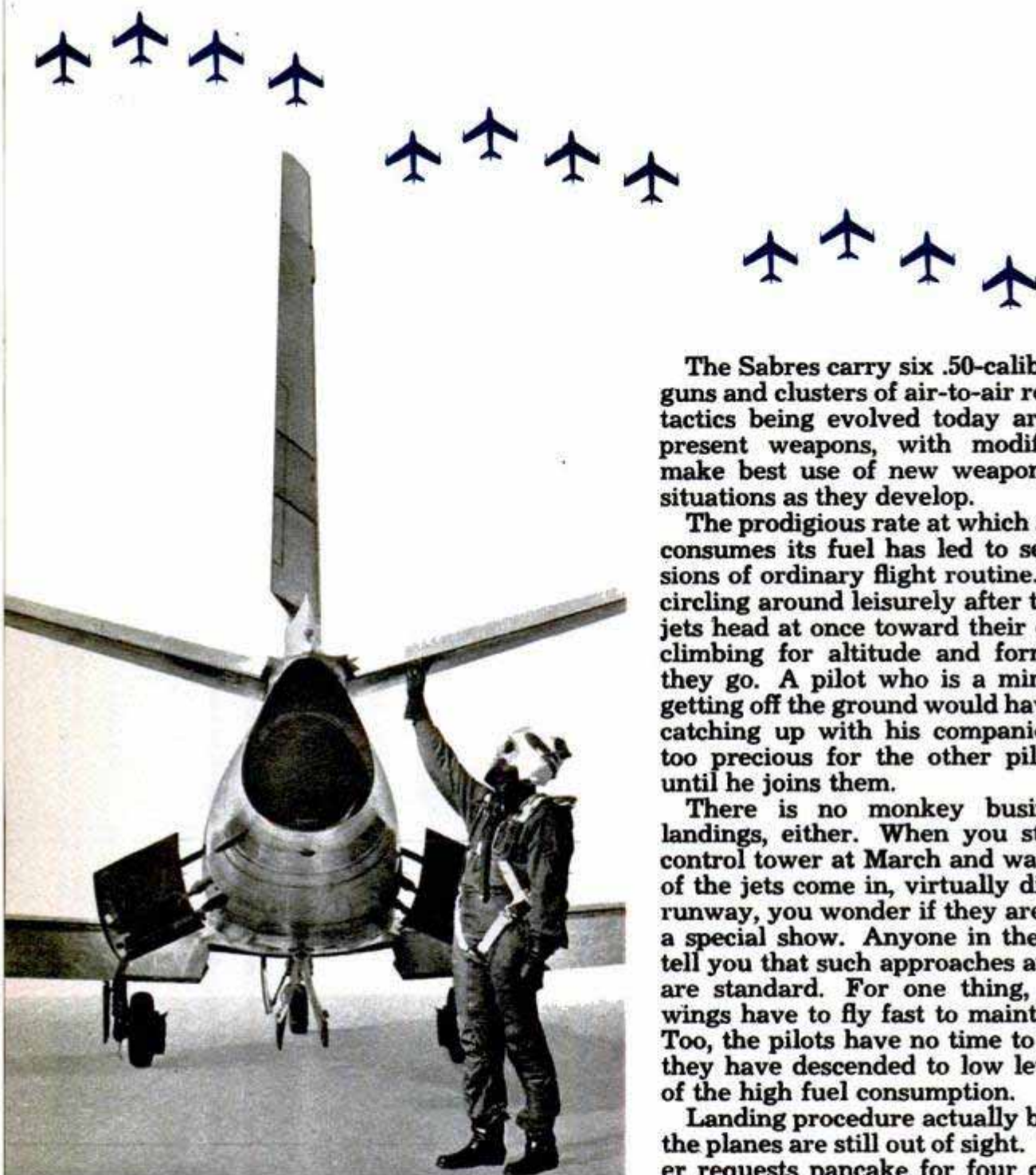

Each pilot personally checks plane before take-off. Flyer above is testing elevators and below he looks over the hydraulic cylinder that extends fuselage dive brakes that help slow plane down for landings

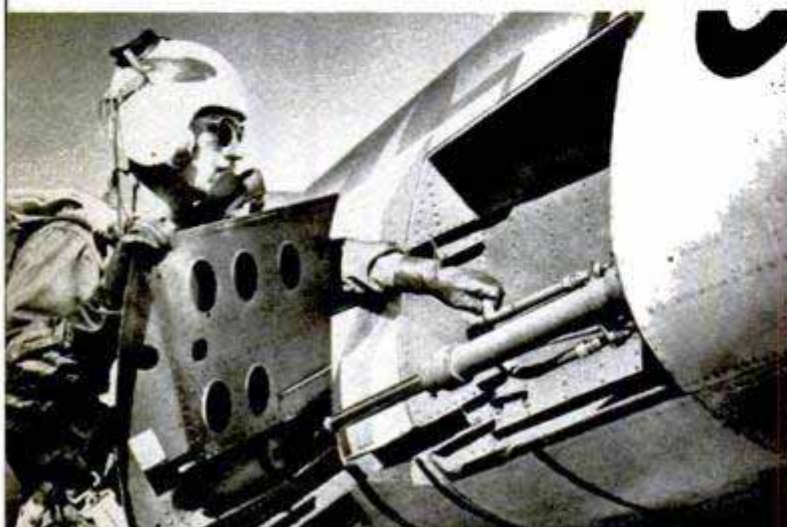

The Sabres carry six .50-caliber machine guns and clusters of air-to-air rockets. The tactics being evolved today are based on present weapons, with modifications to make best use of new weapons and new situations as they develop.

The prodigious rate at which a jet engine consumes its fuel has led to several revisions of ordinary flight routine. Instead of circling around leisurely after take-off, the jets head at once toward their destination, climbing for altitude and forming up as they go. A pilot who is a minute late in getting off the ground would have difficulty catching up with his companions; fuel is too precious for the other pilots to wait until he joins them.

There is no monkey business about landings, either. When you stand in the control tower at March and watch a group of the jets come in, virtually diving at the runway, you wonder if they are putting on a special show. Anyone in the tower will tell you that such approaches and landings are standard. For one thing, the swept-wings have to fly fast to maintain control. Too, the pilots have no time to waste once they have descended to low level because of the high fuel consumption.

Landing procedure actually begins while the planes are still out of sight. "Red Leader requests pancake for four chickens" is the way a leader may ask permission to land. The tower replies, telling the leader what runway to use, the altimeter setting at the field and the condition of the wind.

Now the planes are only five miles away and beginning their deceleration process. Over the radio the leader gives the command, "Speed brakes out, NOW!" At "Now!" each pilot pushes the button that extends his fuselage flaps. Simultaneously and almost instantaneously the four aircraft slow from an original 600 to 300 miles per hour. The pilots' heads are thrown forward abruptly by the fast braking.

On the base leg, still high above the field, each pilot chops his power, drops his landing flaps, and extends his wheels. Slots in the leading edge of the wing automatically extend themselves to provide better control

at slow speed. One at a time the pilots make diving turns that line them up with the runway and then drop onto it. On the ground the nose is held up so that the wing creates a drag, helping to slow the plane. Not until the speed is down to 90 or 100 miles per hour does the pilot drop the nose wheel on the ground and begin to apply the brakes.

The aircraft land in a staggered formation in good weather, trailing each other at 1500-foot intervals. In poor visibility they are talked down by Ground Control Approach operators.

The jets can operate at low and medium altitudes. Now that they have speed brakes that allow them to fly at reduced speed they are a match for slower aircraft that previously could outmaneuver them. The jets actually are at their best at high altitude where they get more miles per gallon of fuel and where piston-engine aircraft are at a disadvantage.

About half of America's present jet pilots are ex-combat flyers who stayed with the Air Force after the war. They made the transition to jets without much extra training and immediately were "sold" on the new planes.

Augmenting these experienced pilots are the younger men graduating from the training bases. The first postwar students got instruction in a series of successively faster aircraft before they were allowed to try out the jets; now it has been found that some of these steps

(Continued to page 226)

Link Aviation, Inc., photo
Ground trainer for jet flyers, with all controls, instruments and reactions of a high-speed plane. While pilot sits under the hood, instructor at console to the rear creates emergency situations for him to work out



Odd double mask for blind-flying training. Inner shield's amber filter allows normal vision. When outer blue filter shade (raised here) is lowered over inner shield the pilot cannot see. To fly on instruments alone, he pulls outer shield down to where cockpit windows are obscured

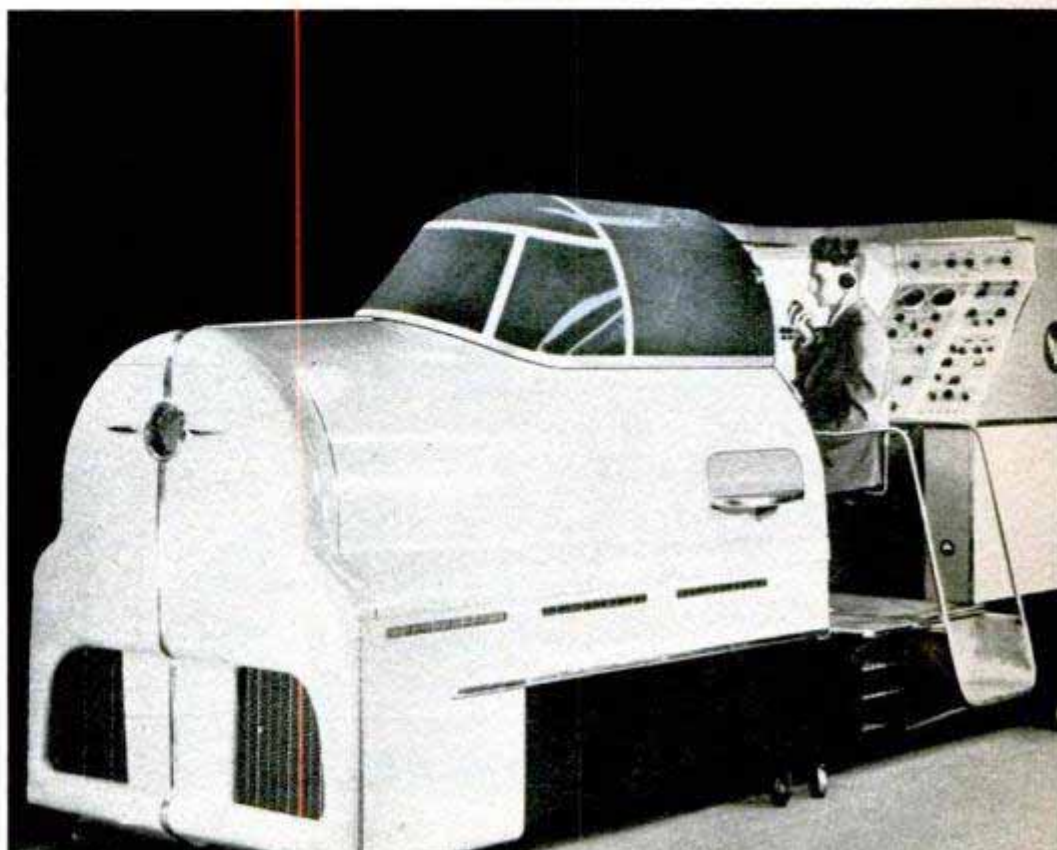

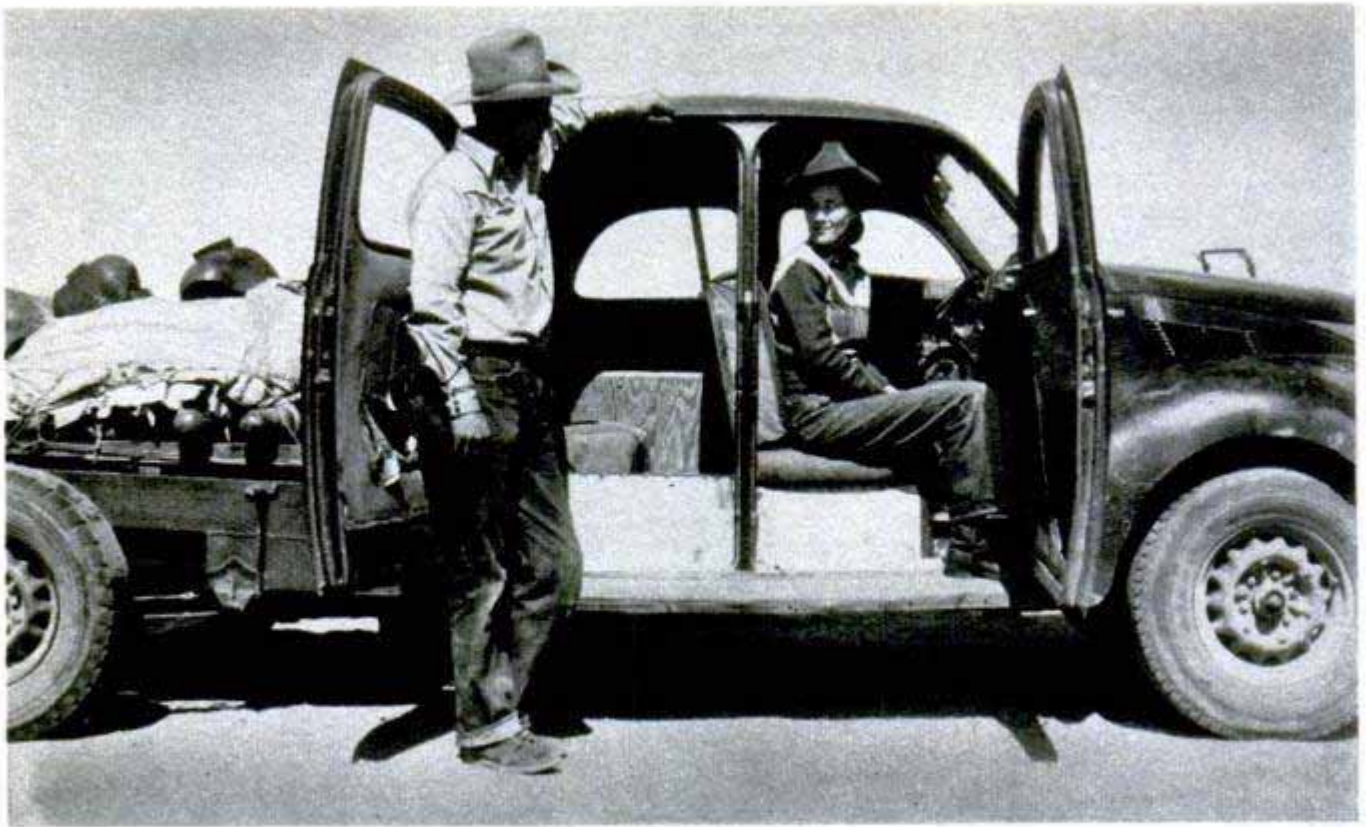

Hybrid Auto Is Mobile Welder

There's a little of everything and a lot of ingenuity in a hybrid automobile that started life as a Lincoln Zephyr and has become an efficient mobile welding outfit. Built by Manuel Farmer of Lancaster, Calif., the car contains assorted parts from a Chevrolet, Dodge, Pontiac, Oldsmobile, GMC, plus, of course, the original Zephyr. The Chevrolet engine is located in a box

behind the front seat and it powers the vehicle and also a 200-ampere generator mounted under the hood where the original motor was located. The radiator is now just three inches in front of the fire wall and cool air is drawn back to the engine through two pipes under the front seat. The chassis was lengthened to allow space for extra gas cylinders. Farmer uses the hybrid machine as he travels in the desert doing on-the-spot welding for ranchers.

Silicone Automobile Polish Is Immune to Heat of Sun

Silicones — the synthetic substances which protected military equipment during the war—are stirred into the formula for a new car polish. The chemicals are water repellent and are not affected by high tem-

peratures. They produce a glass-hard surface that prevents moisture and heat from penetrating paint and chrome surfaces. One application of the polish lasts six months, according to the manufacturer.



Ground-Hugging Motor Car Being Made in Sweden

Cruising the streets of Stockholm is a new Swedish car, built so low it seems to glide along the ground. The little car seats two and is designed to sell for about \$386. When the plant is in full operation, about 50 of the cars will be turned out each week.

Information not listed on articles in the index, starting on page 12, frequently is listed in the WHERE-TO-FIND-IT LIST, available without charge from Bureau of Information, Popular Mechanics Magazine, 200 E. Ontario St., Chicago 11



Television Borrows Movie "Tricks"

"Teleparencies" depicting such widely different scenes as a Paris street or an Arizona desert are being used as sets in television studios. They consist of a translucent screen as large as 12 by 18 feet on which a photograph of the desired locale is projected, blending in with stage properties in the foreground. Above, insert at upper right-hand corner shows how the live actors in the foreground blended in with the projected studio set on an actual TV screen

For a poolroom scene, below, left, the actor is realistically "shooting" ball projected on screen. Below, right, a composite television scene, including actors, "props" and projected background. Adapted from motion-picture practices, the television technique requires pictures that are made in special perspective

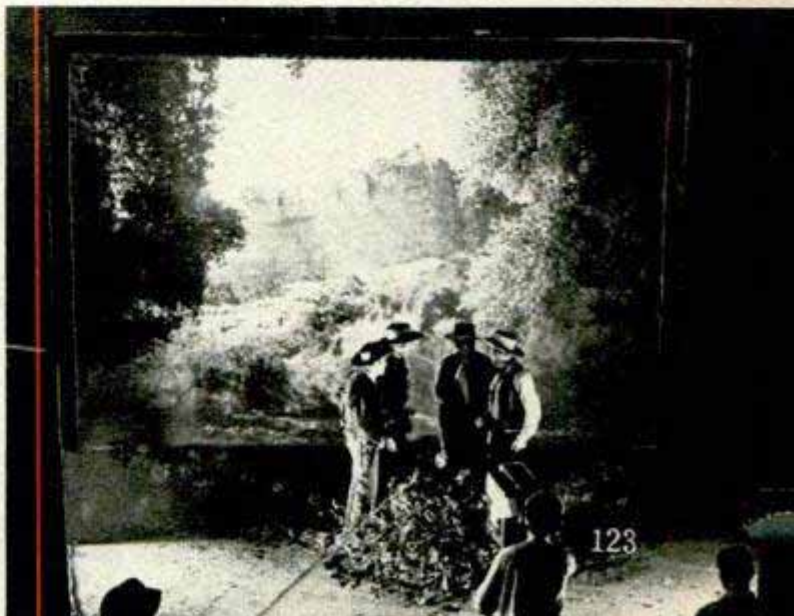
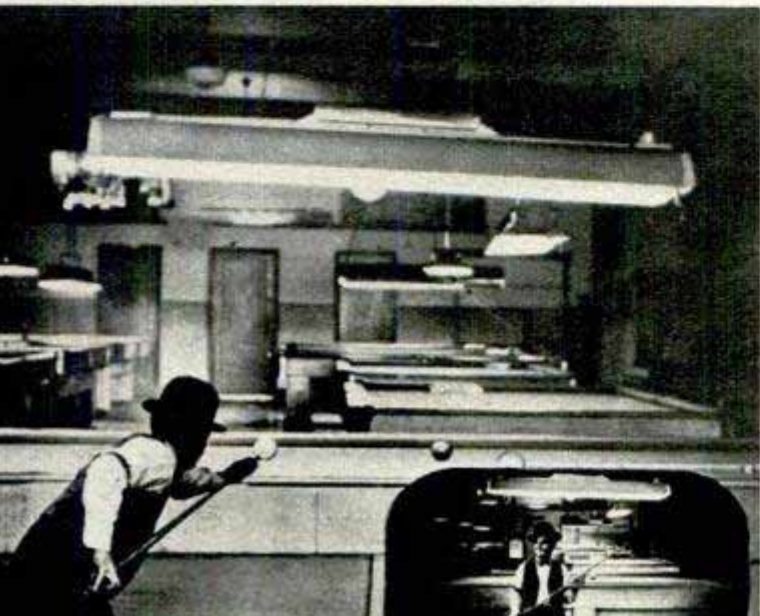



The sea is calm here, but there are days, lots of them, when closing the mouth of the trap is a battle with the waves. Note the pulleys on the larger dory. Below, sketch of the underwater trap

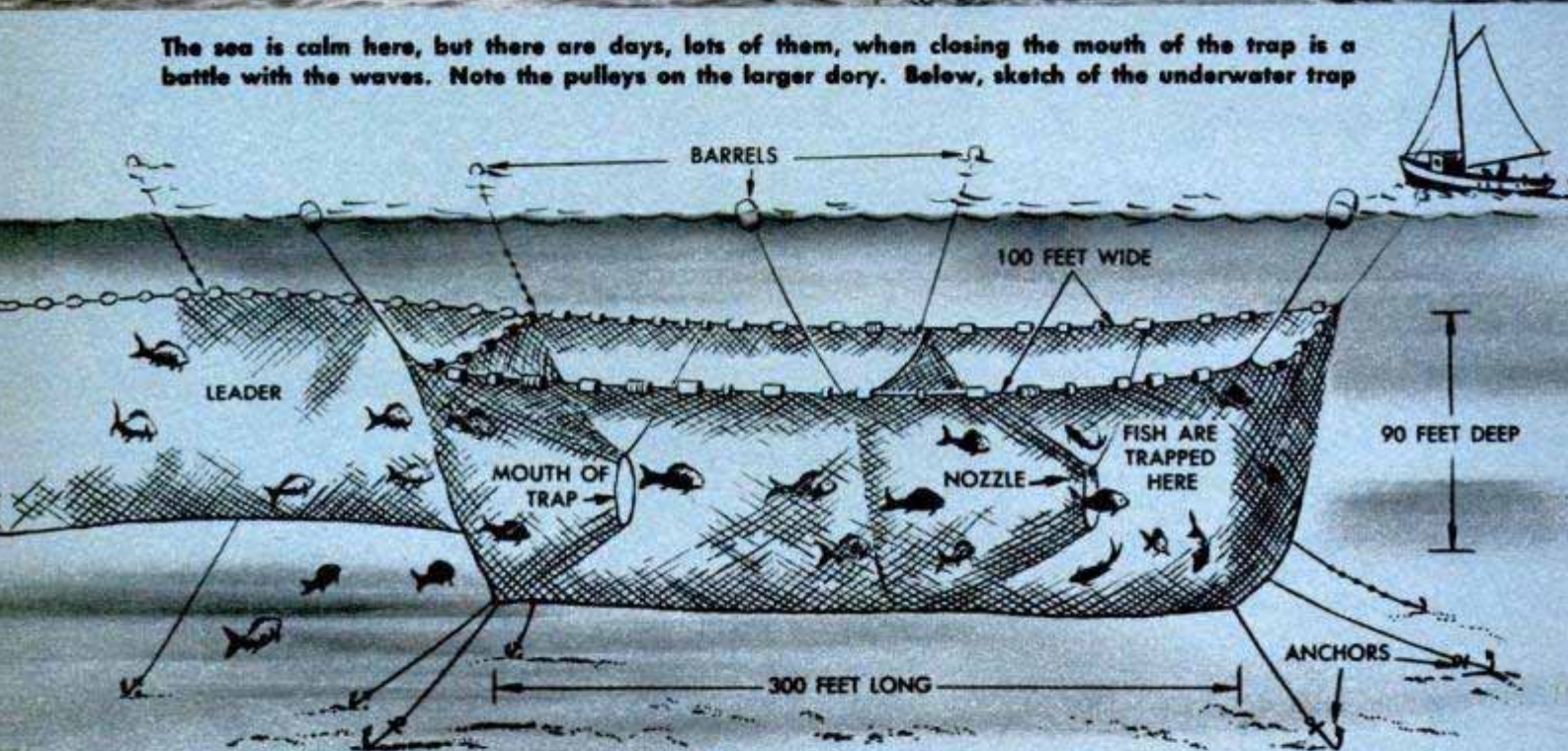

Below, in the early morning light, a fishing boat, towing its dories, heads out to tend the nets



TRAPPERS IN ROWBOATS

ROMANCE and fishing villages go together. Anybody who has ever heard the putt-putt-putt of the squat fishing boats as they slip out of the harbor in the quiet before the dawn or as they return in the sunset heavily laden with the day's catch will agree. The small-boat fisherman, and there are thousands of them along our coast lines, still does battle with the elements much as his ancestors have done for centuries. It is still man against the unpredictable sea.

Out of Newport, R. I., more than 100 fishermen haul in 75,000 pounds of fish weekly, nine months out of the year, with giant net traps. Like a mammoth underwater rattrap, the net is anchored a mile or so offshore. Fish by the hundreds swim in through funnel-shaped openings to be entrapped. Early each morning, the fishing boats, trailing several dories, go out to the nets. Rugged fishermen, bronzed by the sun and wind, take to the dories to pull the heavily laden nets to the surface with a heave-ho.

As the trap nears the surface, the dories work closer and closer together until the fish can be scooped into the "mother" boat with a winch-operated basket net. Today's catch aboard, the crew resets the trap for tomorrow's catch. On the trip back to the unloading docks, the fishermen are kept busy sorting the catch, which is mostly scup.

For nine months each year, these fishermen tend their nets seven days a week. During the three mid-winter months, they stay ashore, mending their nets, working on their boats and swapping yarns.



It's a long, tough pull to haul in a trap with its load of fish, especially when you're standing in a dory. Below, the fishermen transfer the fish from the trap to the power boat. Most of the fish here are scup. Also caught are bass, mackerel and flounder

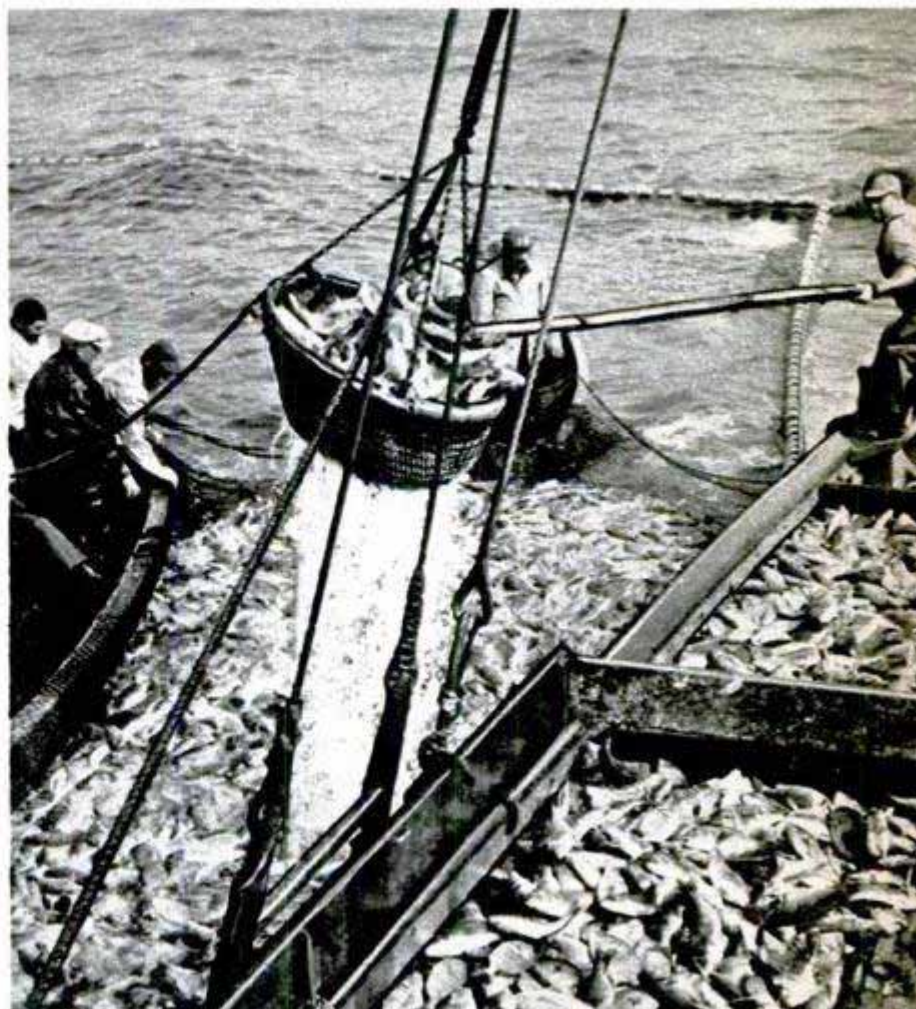



Midget Motorcycle Built to Scale

Built to scale, a half-size motorcycle is the pride and joy of Yoji Ono, a Hawaiian, who spent almost a year on the project. Patterned after a standard Harley-Davidson cycle, the machine uses wheelbarrow wheels and a small concrete-mixer engine. Fenders, gasoline tank, handle bars, seat and most other parts were hand made by Ono. He travels more than 50 miles on a gallon of gasoline and the cycle has a top speed of over 55 miles an hour.



Plastic "Skin" Protects Paint

By covering the surface of the paint with a plastic sheet, you can prevent the formation of the thick skin that usually forms when you put a partially filled can away after use. The plastic is placed directly on the paint, sealing out the air. In effect, the plastic does exactly what the paint itself would do if left uncovered. It can be wiped off and reused any number of times and comes in sizes to fit both gallon and quart-size paint cans.

Child-Size Bulldozer Looks and Works Like the Real Thing

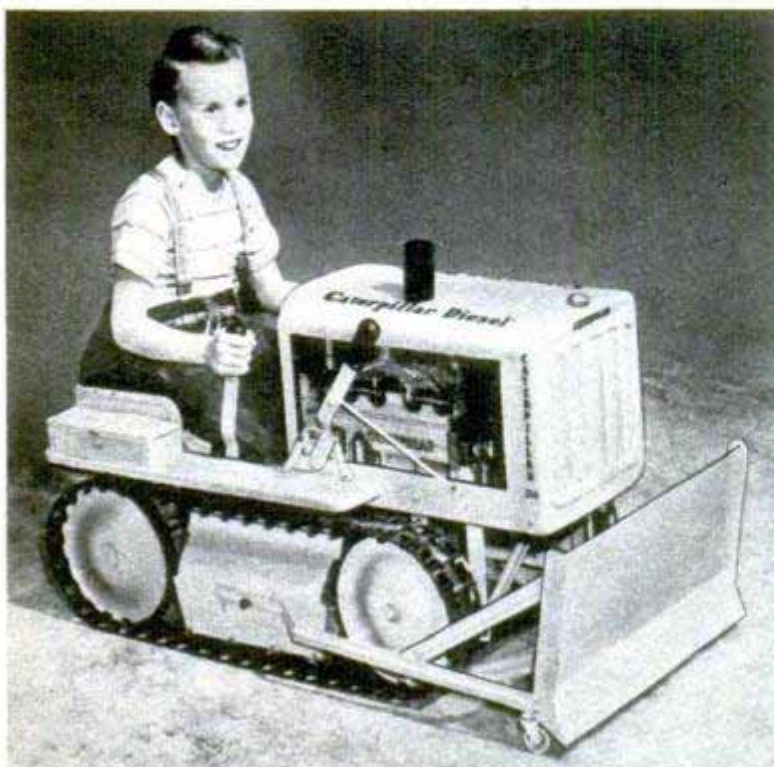

Scaled down to child-size, a pedal-operated bulldozer is a realistic model of a Caterpillar diesel tractor, complete with everything except the engine noise. The endless track rolls over four rubber-tired wheels and the tractor is steered by clutch levers just like the real thing. When one of the steering levers is pulled, the track on that side is raised, allowing the other track to swing the toy around. Another lever raises and lowers the blade. Energetic youngsters will use it to clear snow off sidewalks this winter.

☐ If you'd like to take a long trip, travel one megaparsec, which is over 19 quintillion (19,000,000,000,000,000,000) miles and is the unit used by astronomers to describe the distances of remote galaxies.



Refueling an outboard is a messy operation if the water is rough, but by using this small pump you won't spill a drop. Right, it's handy for pumping gas from your automobile, too



Gas Pump Ends Pouring Spillage

Transferring gasoline from a large container to a smaller one, a dangerous operation when done by the pour method, is made safe by a hand pump that eliminates spillage and explosive fumes. The pump, which handles six quarts a minute, has interchangeable caps that screw on any standard fuel can. It also pumps gasoline

from your car into the gas tank of power mowers, outboard motors and camp stoves, eliminating the need for keeping a separate gasoline supply around the house or summer cottage. Refueling outboard motors while out on the lake is done safely from a seated position when the pump is screwed into the fuel storage can.

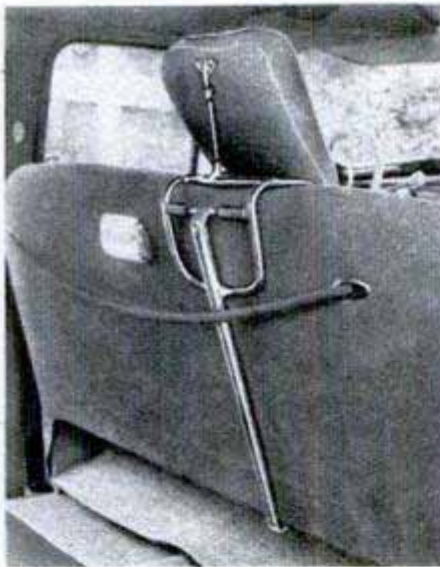

Ride in Comfort With Car Headrest

With the addition of a comfortably padded headrest, the front seat of your car becomes as comfortable as an easy chair. The metal frame slips over the back of the seat and can be adjusted to any desired height. It enables the passenger to sleep comfortably on long trips and makes those long waits while your wife shops more enjoyable.

Mail Buggy

Plowing through the mud roads near Bartleso, Ill., is a weird vehicle that combines the traits of a tractor and a car. It was built for a rural mail carrier whose route carried him over wheel-deep mud roads in river-bottom land. Mounted on a Ford model-A truck chassis are four tractor wheels to give the vehicle additional road clearance and power in low speeds.

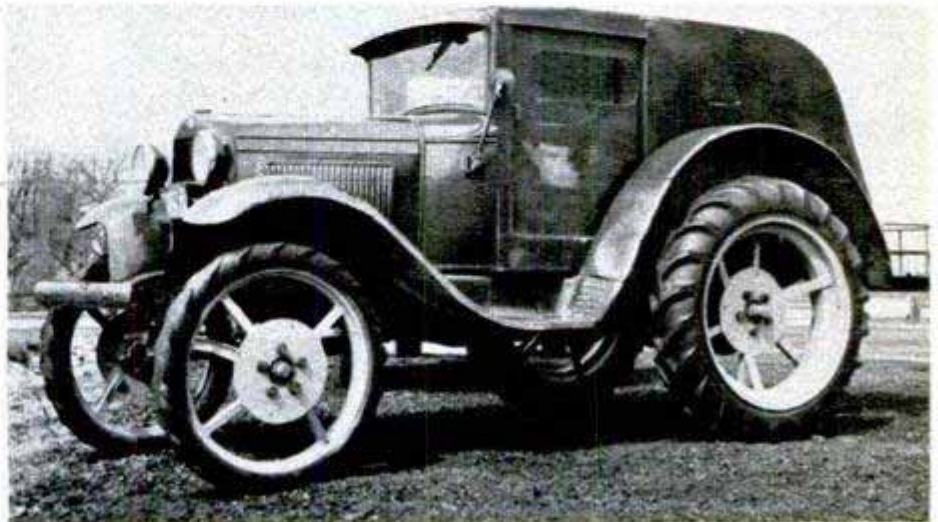

the SHIPYARD that grew from a TOOLBOX

well with 21 years of experience and behold—one shipyard.

“My shipyard actually started in my old tool chest,” he says, “and I still have some of my first tools in my box here at the plant today. One of the originals is an old iron smoothing plane.”

Before he acquired his first real boat at the age of 10, Derecktor concentrated on building models. He built some dandies—schooners (two or more masted vessels with the mainmast aft instead of forward such as is found in the yawl or ketch) and some de luxe models of old-fashioned square riggers with two or three masts. He would work for months striving for perfection in a model. When it was finished he would take the model to the shore and let it go. This amazed his chums and Bob never bothered to explain that a man with a real feeling for ships knows that they have to be free.

The summer Derecktor was 10 he heard about a sailboat that had been sunk and practically abandoned off the shore at Rye,

You could go 'round the world in this Mackinac sloop which Derecktor says is his most interesting design

By Wayne Whittaker

A LONG the old Boston Post Road where it swings out close to the shore on Long Island Sound at Mamaroneck, N.Y., stands a new shipyard that has the old-time shipbuilders talking all the way from the tip of Maine to Sandy Hook. Although this shipyard is only three years old, down its ways are sliding modern masterpieces in the form of sleek sailing yachts that make many a veteran craftsman catch his breath.

The man to whom the old salts are paying tribute is 28-year-old Robert E. Derecktor, who looks more like a husky blond sailor than a shipbuilder.

“Bob knows as much about boats as any man on the coast,” said one admirer, “and he’s hep on combining old-time hand craftsmanship with modern methods. He even makes most of his own tools. Where he ever learned so much at his age is a mystery. He sure didn’t pick it up at Swarthmore College or driving a torpedo boat for the Navy.”

“It ain’t no mystery to me,” said another old-timer as he tested a pinch of snuff. “I’ve seen that boy 200 miles out at sea when he was 11 years old in a sailboat he had rebuilt from an old wreck.”

Here’s Derecktor’s own recipe for starting a shipyard: Take a few old tools such as a chisel, a brace, a hammer, a smoothing plane and add to these a seven-year-old boy with a “fever” for boats. Mix these

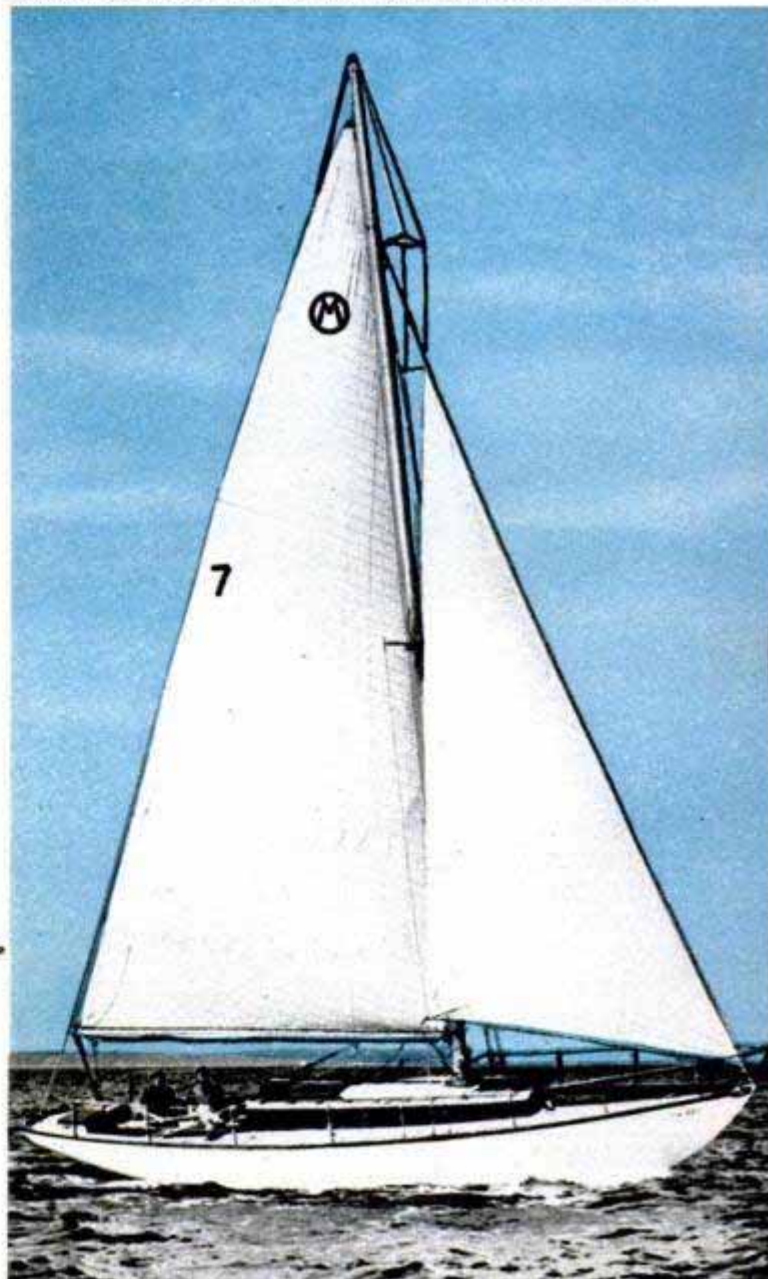



Once a seven-year-old boy with a toolbox and a "fever" for boats, Derecktor now builds his sleek yachts here

a few miles from White Plains where his family was living. It was a 15-foot sloop with jib and mains'l. The rudder was off, the deck was rotten and the mast badly broken. Bob found the owner who said he would be glad to sell it for a small sum. His father, a nonseagoing attorney, was not enthused at the idea but finally weakened.

"I tell you I was in a sweat," Derecktor recalls. "Two of my friends helped me get that boat home. One of the fellows was about my age and the other 18. We fixed up a carting rig out of an old Buick chassis and finally got the wreck into our back yard. I worked all winter on that boat and by spring it was seaworthy. We launched it by running a cradle down into the water off the beach and christened it Spray."

Two years later Bob sold the Spray for \$150. He needed the money to help buy materials to build a 26-foot sailboat he was designing himself. First, he had offered the design to his manual-training teacher and suggested it as a class project. The teacher told him he was too young and to go back to building his little models.

All that winter Bob worked in the family basement on the vital and preliminary loft work which is the first step in building a boat.

"I had never seen a boat built and had to depend on books and magazines for my information," he said. "First, I painted the basement floor white (you can imagine

how I startled the family) and then laid down the lines from my plans for making the templates."

Determined young Bob bought mahogany planking (he says Philippine mahogany was cheap in those days), oak for the frame and fir for the decks. He even built a hollow mast for his boat. Today, all the masts on the Derecktor boats are of hollow construction. These masts are stronger and lighter weight than others, he says. However, his first mast was made of pine and today he uses only Sitka spruce from the

Blueprint in hand, the youthful shipbuilder checks over the details of a sailer now under construction

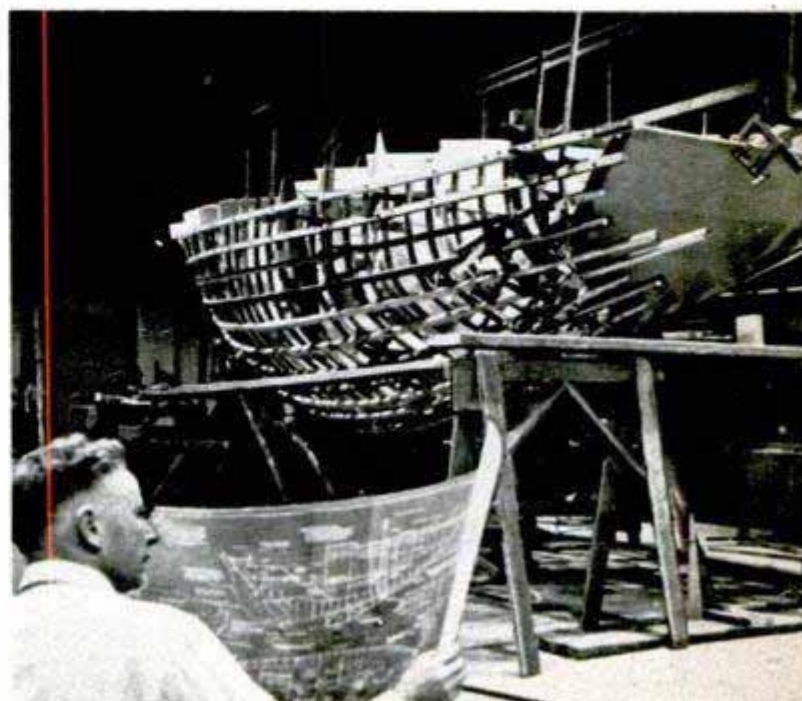

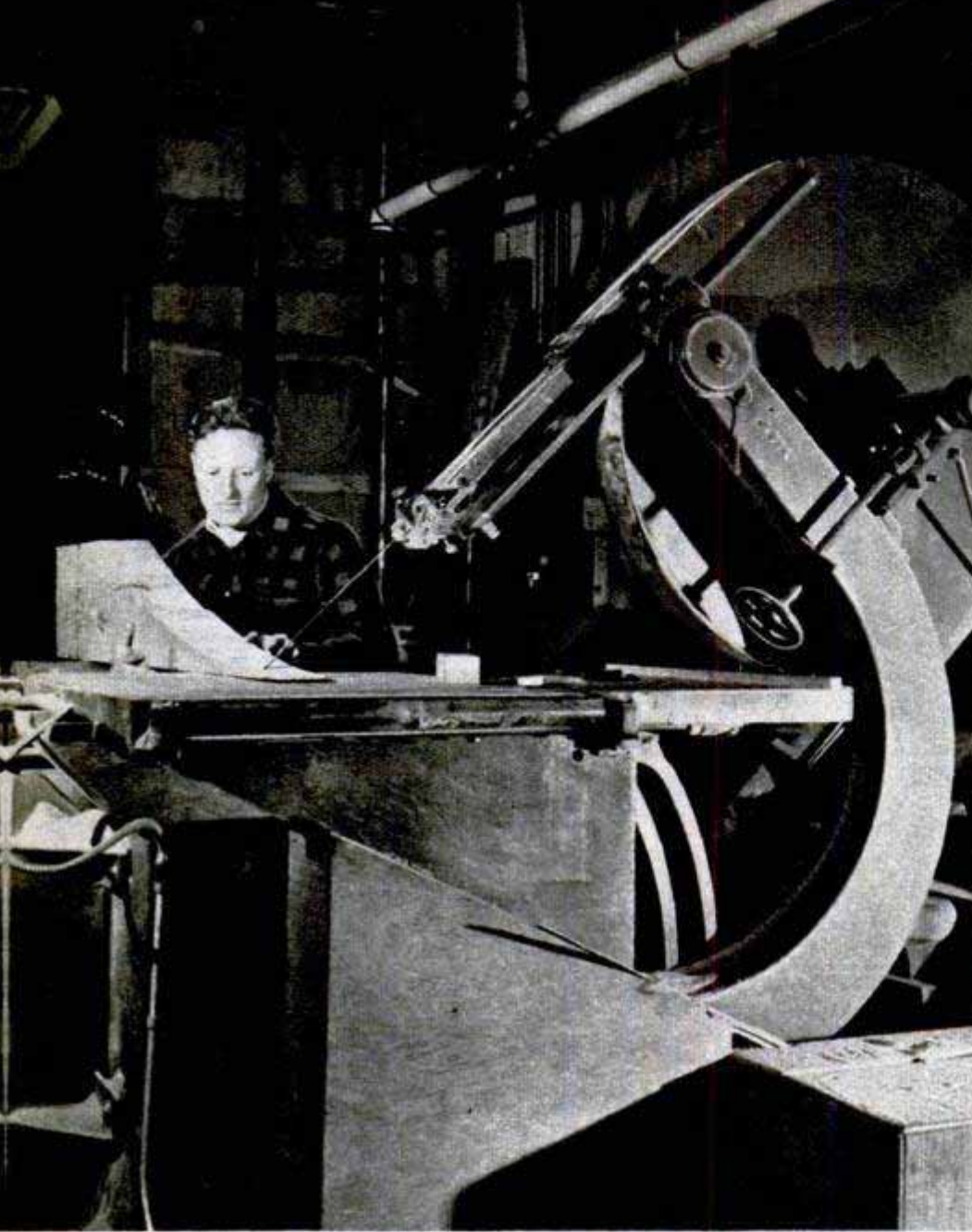

Aleutian Islands for mast material.

When spring came the templates were all made, materials were at hand and Bob started construction of the boat in the back yard on a floor he had made.

He laughed. "I didn't make the old mistake of building that 26-footer in the basement. Instead I built a shop around the boat as I went along. When I got through I had a building 12 feet wide, 10 feet high and 30 feet long. I guess by this time the family realized they had a shipbuilder on their hands. I can't say they were enthused—just resigned."

The Spindrifft, as he named the boat of his first design, was finally launched from the public beach at Rye when Derecktor was 15. The boat had three bunks and was designed for long trips. The designer and builder says he did not sleep a wink the night before the launching—but he really didn't need to worry. The sturdy Spindrifft is still operating off the New England coast. Derecktor

This ship bevel bandsaw would never have fit in young Derecktor's toolbox!

Below, a shipbuilder uses a smoothing plane. On the bench is a jack plane with its mouthpiece of ebony

Derecktor adx, held by workman, has a handle which permits better control than commercial type on deck

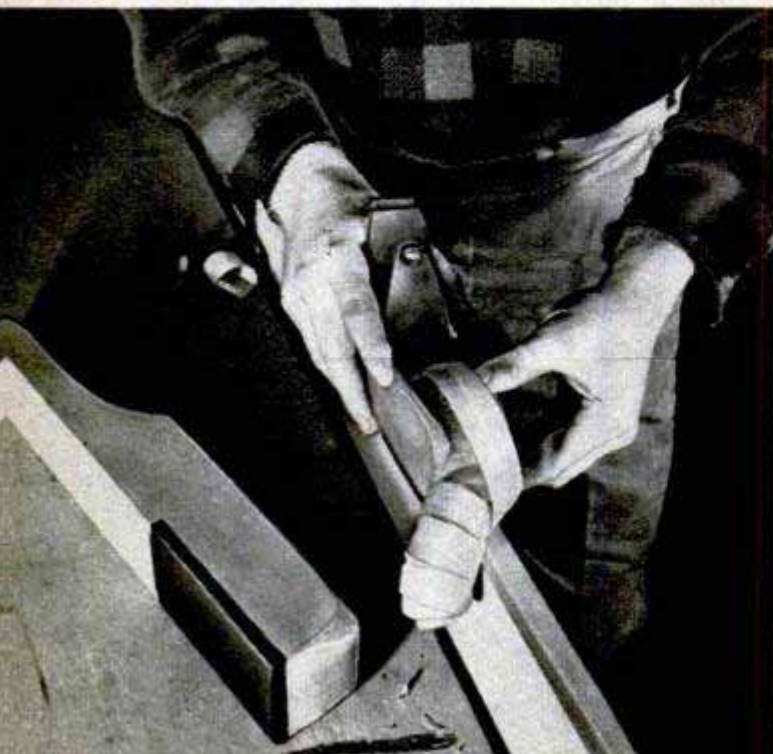

inspected it only recently and found it shipshape—including the original hollow mast which he had made with wedges and improvised oak frames because he didn't have enough clamps.

The mast still bears a scar or two of one of Derecktor's most harrowing experiences off the coast of Maine. He and another boy had sailed out of Cape Small at the mouth of the Kennebec River headed for Nova Scotia. Some sparks from the stovepipe set the sail on fire. It went up like a Roman candle and almost set the mast on fire. The boys worked like fury with wet mops and finally extinguished the blaze. They managed to limp back to shore, repaired the mast and got a new mains'l. Another time out in the Spindrift, Bob was caught in a storm 100 miles at sea out of Nantucket. Buffeted by 25-foot waves, the young sailor had to heave to for 36 hours. He kept just a little sail up and kept the Spindrift headed at an angle to the wind. As usual he returned home safely.

Experiences at sea and working summers in shipyards helped build up Derecktor's knowledge of how a ship should be built. He learned that in finishing hulls there is no substitute for a trained eye and sensitive hand using wooden planes and hand sanding. The old-timers taught him about wood. Today, he can recognize a dozen kinds of mahogany at a glance. He selects his mahogany today—not by the load—by the piece. His favorite wood for trim is Honduras or Guatemalan mahogany. However, he says, African or Philippine mahogany is best for hulls because of the long lengths available and the great strength of the wood due to its interlocking grain.

Compare these two drawknives. The one in use is the Derecktor tool, designed to provide greater control

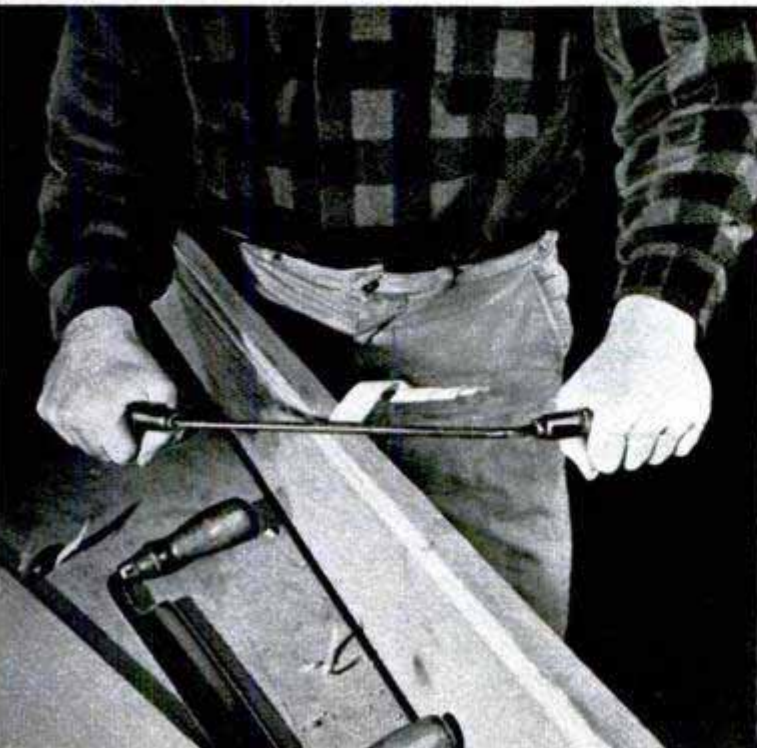

Honduras mahogany works easily and resists contracting and swelling from the water. He uses oak for frames and backbones and most structural members. The planking is usually either Virginia or Port Orford (Ore.) cedar in the small boats and for the heavy ones he uses yellow pine or mahogany. For the de luxe yachts or any craft designed for use in tropical waters, Derecktor uses teak for planking. The teredo worm does not attack teak.

When it comes to tools, he prefers rock maple for making planes and some of the bottom pieces are made of ebony. Derecktor has a huge ebony log in his plant that he found in a friend's basement over in Riverside. A seagoing ancestor found the log a hundred years ago along the coast of Africa and brought it home as a curio.

Specially made tools, redesigned and built by Derecktor, include bevel squares, boring bars, scrapers, gouges and chisels, planes, slices and adzes for heavier work, various types of hammers and both wood and metal mallets. Derecktor says commercial bevel squares are too large and improperly designed for measuring internal angles between small members. His assortment of special planes consists of smoothing planes, jack and joiner planes, molding and spar planes, as well as "scrub" planes for cleaning a big rough piece of wood. There are special low-angle planes for working cross-grain and riven-grain woods and high-angle tools for smoothing and joining soft and uniform-grain woods. The handles are carefully positioned so that the pressure is exerted behind the blade and downward.

One special mallet for calking is "alive"

Calking mallet, shown in use, rings to tell worker when the cotton is being put in with correct force



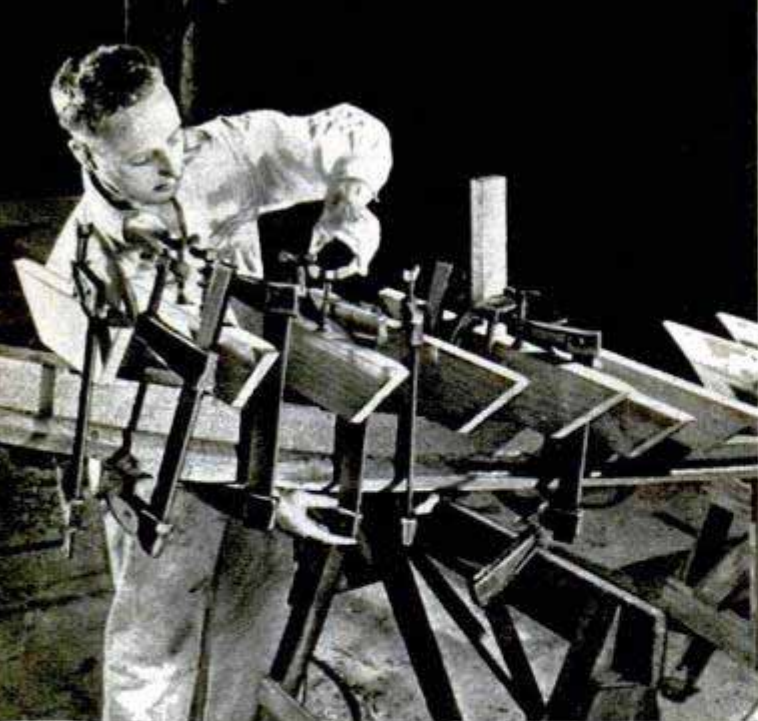

Shipbuilder at the Derecktor yard is clamping down the timbers on a backbone preparatory to drilling

and gives off a certain ring when calking is put in with just the right amount of force. Derecktor says that when calking is put in with a wheel one cannot tell when the cotton is hard enough.

Derecktor considers the adz an important and neglected tool—neglected in both use and design.

"The shape and size of the blade and handle, the angle between the blade and handle and the curvature of the head in both directions are subtle and important," he says. "The handle must be so shaped that the hand is leading the cutting edge rather than pushing it. Also, the bevel of the cutting edge must be such that the adz will neither bite too deeply (when the angle is too acute) nor must it be so blunt that the adz will bounce back."

Of the big machines in his plant the ship bevel bandsaw is the most versatile. It permits pieces to be cut with changing bevels and at the same time following a curved line. Another important machine is the

Here are a few of the hand tools used by the expert boatbuilder. They include adzes, slices and planes



spindle shaper with a 12-inch head which enables the operator to shape large timbers up to 12 inches thick.

Derecktor prefers to train his own men and now has 16 employees. Just as the old-timers along the coast taught him, he teaches them about tools and woods and hand craftsmanship. Recently, he added a sideline to his yacht building—the production of solid-mahogany furniture of original and modern design.

Derecktor personally follows every operation. In the loft he makes sure that each boat is laid down precisely according to his design. The finished templates include bevels, rabbets and fastening locations—every bolt and screw must be carefully designated. After the various structural members are cut out, the backbone is set up level and plumb and the molds erected in positions indicated in the loft layout. The molds are permanently braced and "ribbons" strung around at close intervals following the plank lines. These ribbons and molds are temporary and used to bend the oak frames to the proper curvature. Before working with the frames, they are softened in a steam box. Then come the planking, deck beams, the deck itself, joiner work, bulkheads, engine beds, tank foundations and finally the engine itself.

Derecktor thinks the most interesting boat he has turned out so far is a 40-foot Mackinac cruising and open-racing sloop. It is powered with a 40-horsepower Universal engine and will sleep four to six persons. This sloop could easily make a round-the-world cruise.

Derecktor's advice to anyone buying a boat—either new or used—is to make sure that it will fill your needs as to sleeping space, speed and performance. Its ability in rough water is a vital factor. The boat should be made of good materials and well fastened. For example, a good boat should be put together with bronze, copper or Monel fastenings of the proper type, diameter and spacing. The wood should be properly seasoned and if you are buying a new boat examine it for sap runs.

"Also, it is a good idea to find out if the boat was designed by a reputable man and built by a reputable builder. Remember that narrow planking usually indicates a boat that will hold its shape. It's a good idea to examine the seams for solid calking. Make sure they are tight inside.

"Still better advice," Derecktor adds, "is to take a friend along who knows something about boats." He paused. "And another thing. Be mighty careful about giving toolboxes to small boys who have a fever for boats. First thing you know they may have a shipyard and no time to go sailing!"

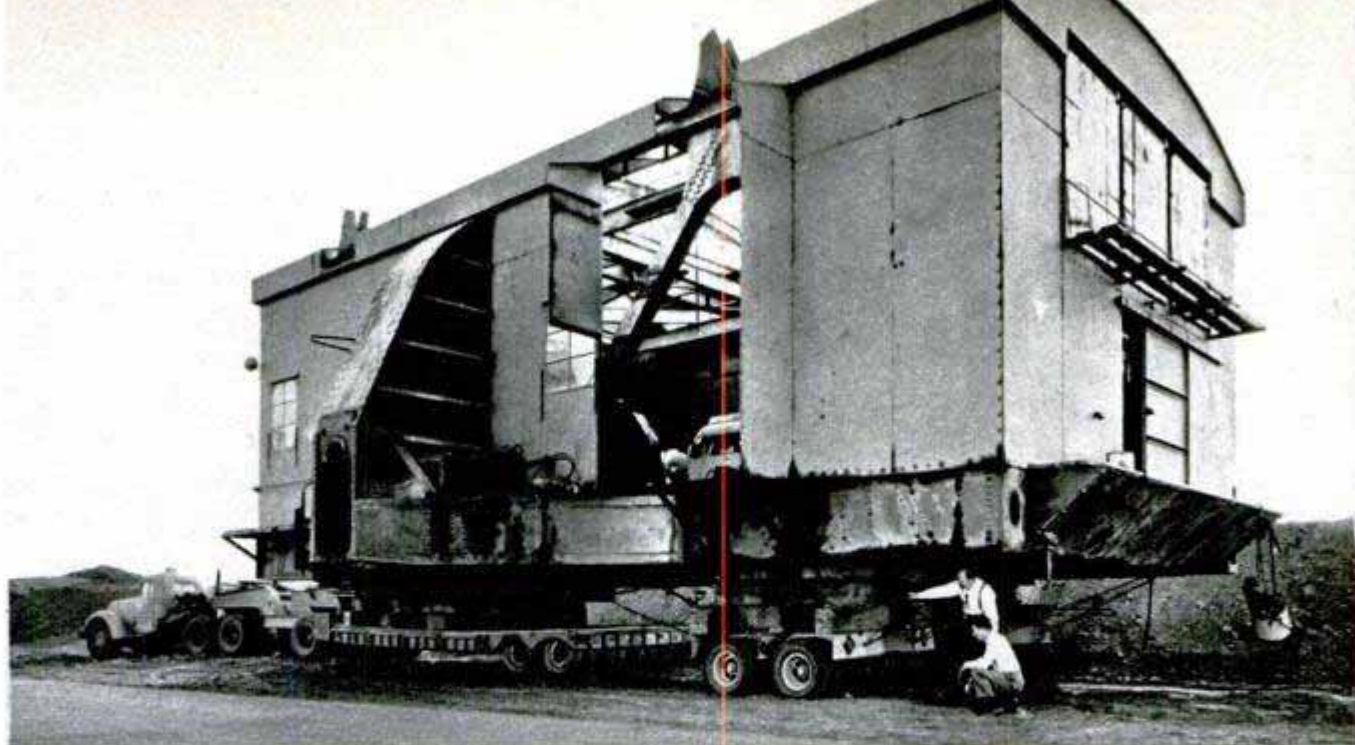

B. F. Goodrich Co. photo

Tires Galore Under Huge Dragline Floor

Enough tires to last a motorist a lifetime were used recently to move a 220-ton section of a huge dragline over 60 miles of unpaved roads, including 30 miles built especially for the job. The problem was to transport a 610-ton dragline from Tracy to Los Banos, Calif. The huge machine was

divided into sections, the biggest chunk too large to travel the improved highways. It was mounted on 66 tires distributed beneath a truck trailer and two special dollies. When all was ready, the big section was hauled down the road, each tire under the heaviest part supporting 8333 pounds.

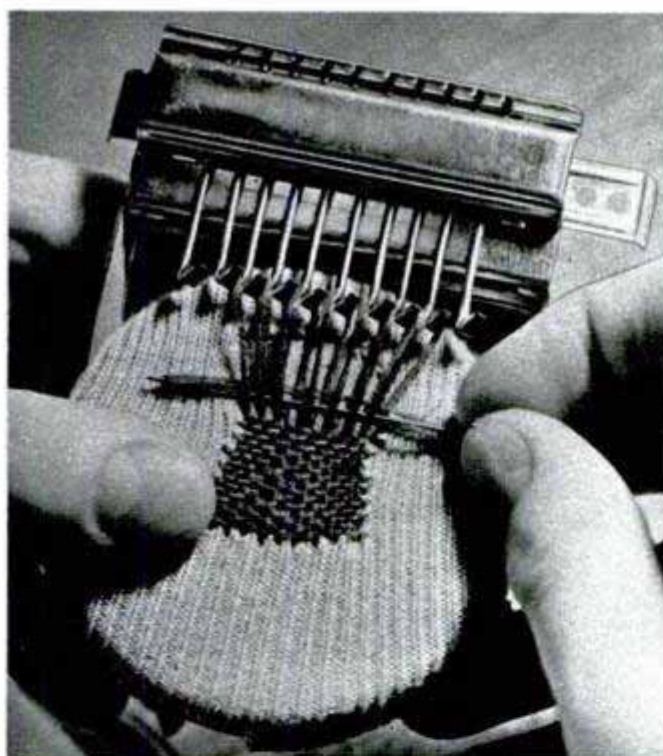

Midget Darner

With a tiny, English-made darner, housewives can do a professional weaving job to repair worn clothing. Actually the darner is a miniature loom with a mechanism which alternately raises and lowers the threads to produce an interwoven effect. The small loom repairs holes in silk, wool and linen.

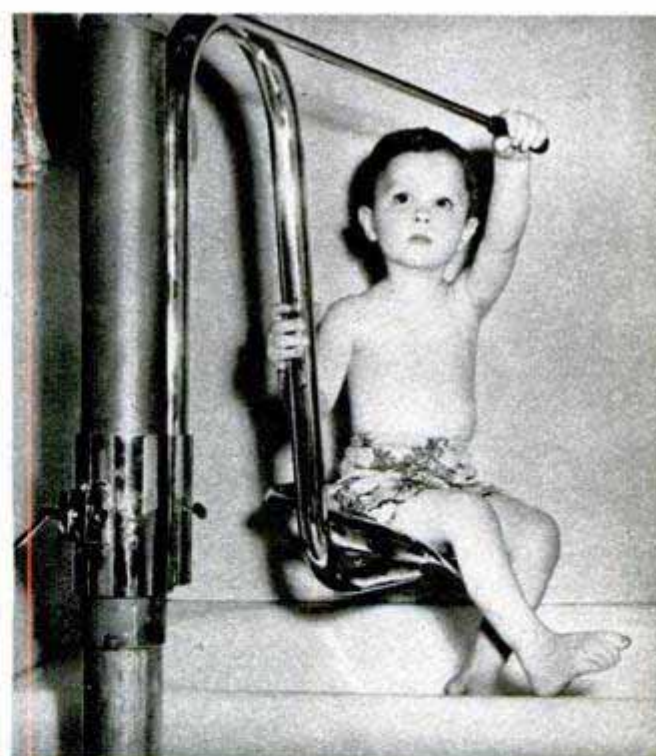

Bathtub Hoist

Peter Wagner of Chicago once took a nasty spill while climbing into his bathtub. The result is his bath hoist, which lifts Wagner, youngsters, invalids or anyone else over the edge of the tub and lowers them gently into the water. The hoist, which is operated by the bather, works like an auto jack.

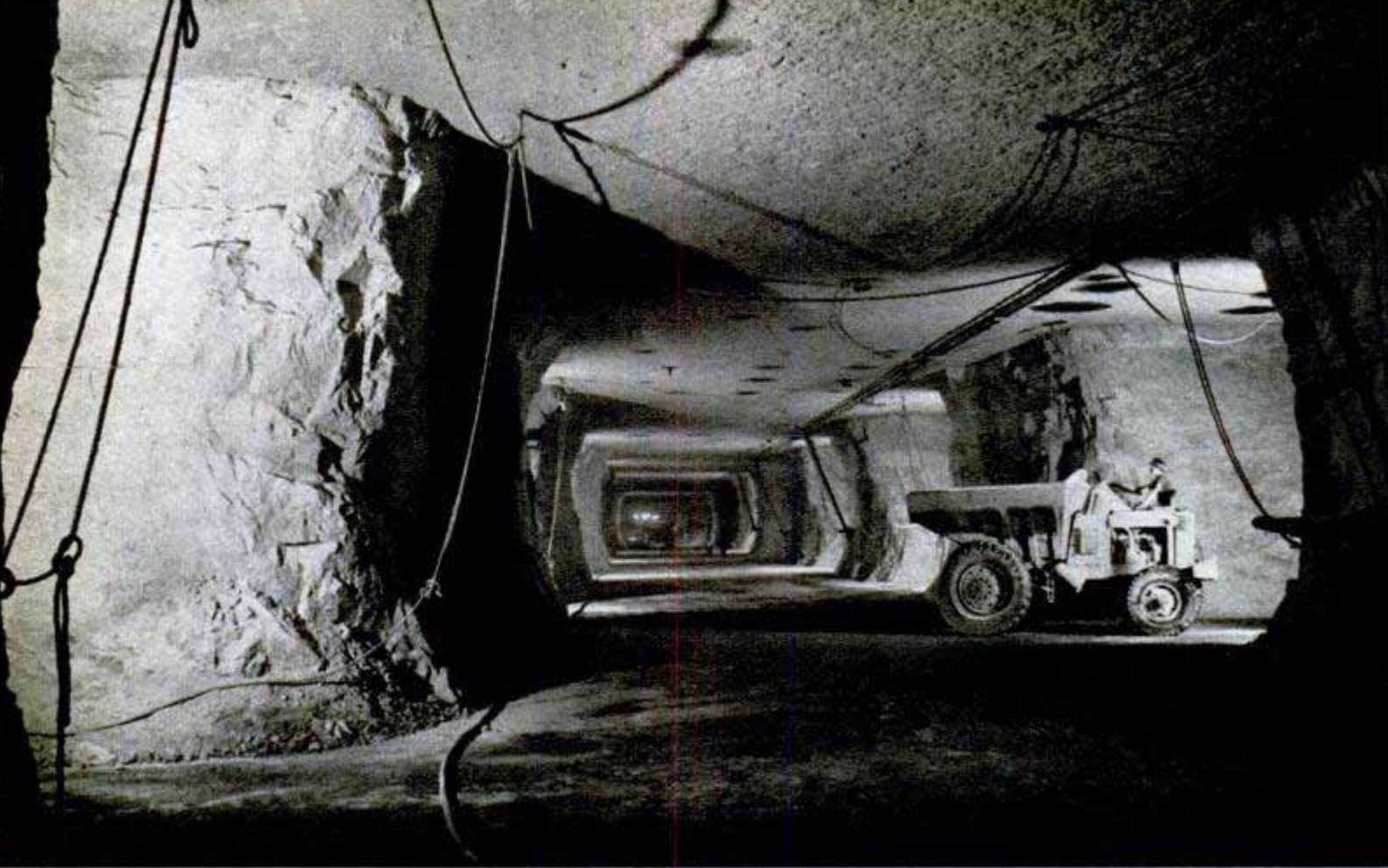

Pittsburgh Plate Glass Co. photos

Traveling through all the rooms of the subterranean limestone "city" would require a 12-mile walk

Deep in the Heart of Ohio—

half a mile deep, in fact, they're mining limestone in a vast underground city where diesel trucks and giant shovels roam through labyrinths of rock

By Walter E. Burton

IT TAKES four minutes on one of the world's longest elevator runs to span some 300,000,000 years to the Devonian Age.

After stepping from the elevator into a strange new world, you may look around for a Tyrannosaurus or other prehistoric reptile; but, instead, you will see an occasional scurrying dump-truck dieselsensis (diesel-engine dump truck) and other modern monsters, some of which create great noise. For you are nearly a half mile below the surface of Ohio, inside a 345-foot-thick deposit of Columbus limestone, where valuable industrial raw material is being dug in what is considered the world's deepest limestone mining operation.

About the time of the first World War, the Columbia Chemical Division of the



Pittsburgh Plate Glass Company began to think about a limestone source near home. "Home" was Barberton, Ohio, where their big plant produces soda ash, chlorine, carbon dioxide and various other heavy chemicals essential to thousands of industrial plants.

Chief raw materials required are salt and limestone. Salt from deposits deep in the earth beneath the plant and near-by areas is brought to the surface through salt wells. The limestone came via Great Lakes boats to Lake Erie ports, thence to Barberton.

To get to the salt under Barberton, it was necessary to drill through considerable limestone; so the chemical makers knew that they were practically sitting on an inexhaustible supply. But it is nearly a half mile down, and to dig that far costs money. The problem therefore boiled down to one of cost and convenience of local deep-lime mining, compared with cost and inconvenience of hauling the stone long distances.

The company decided in 1940 to establish a mine that would give it access to the deep lime under the area, selecting a site about two miles from the plant. It took drilling and mining crews, aided by 100,000 pounds of dynamite, 400 days to sink twin shafts 550 feet apart, each measuring 7 by 16 feet, to the limestone. One shaft turned out to be 2258 feet deep, the other, 2323 feet. Because they extend through numerous layers of sandstone and shale, both are framed with steel and lined with concrete.

To sink the shafts and hollow out the beginning of an underground "city," rugged men of Finnish extraction, long experienced in digging iron ore and copper in the deep mines of Michigan and Tennessee, were brought to Barberton. More than 30,000 tons of rock had to be brought up the shafts to make room for such necessary

Conveyor belts above Barberton mine carry stone to screening plant and storage bin. Headframe above the half-mile-deep service shaft is shown at right

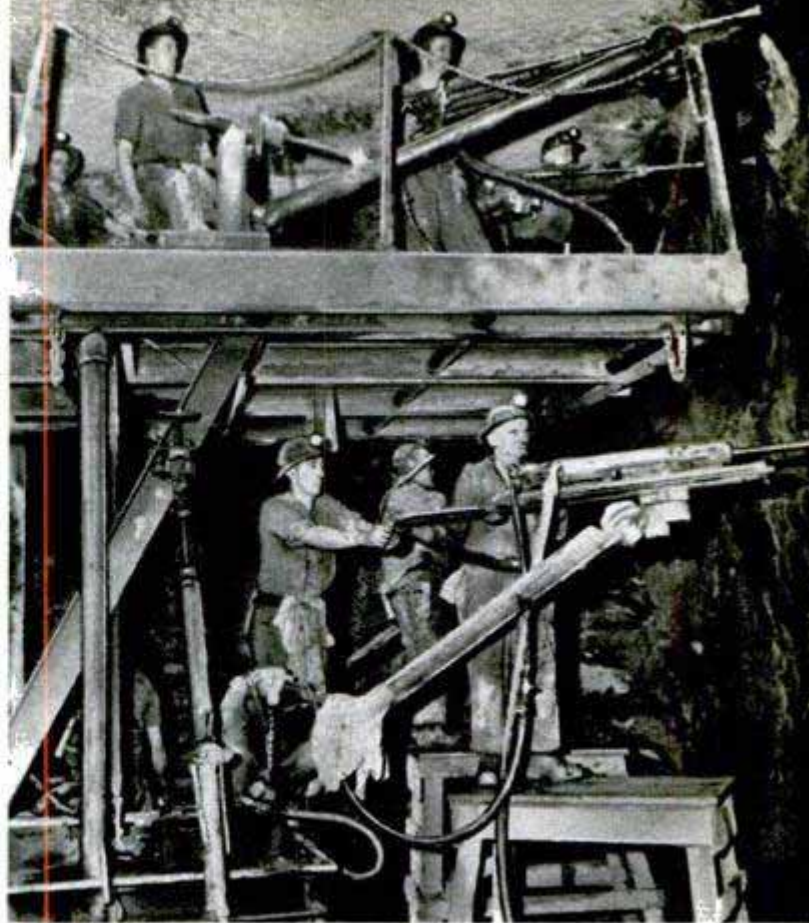

Working from a mobile rig, drillers make holes sufficiently deep so that dynamite charge will shatter a 50-foot depth of solid limestone. From a section of mine wall 32 feet wide and 28 feet deep, some 800 tons of rock will be shaken loose by the explosions

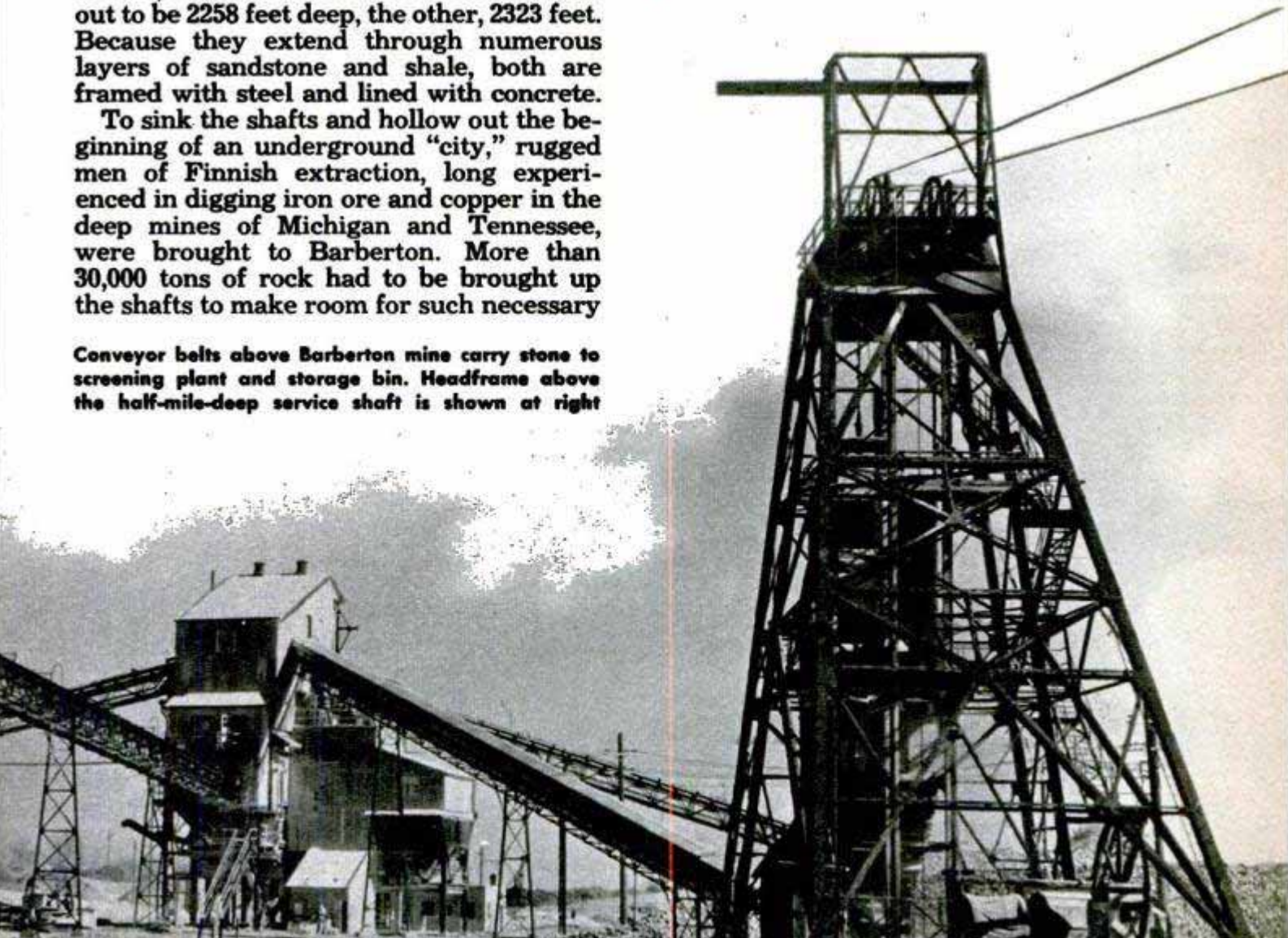



All the huge electric shovels used to load the limestone had to be carried below in pieces, then reassembled by mechanics

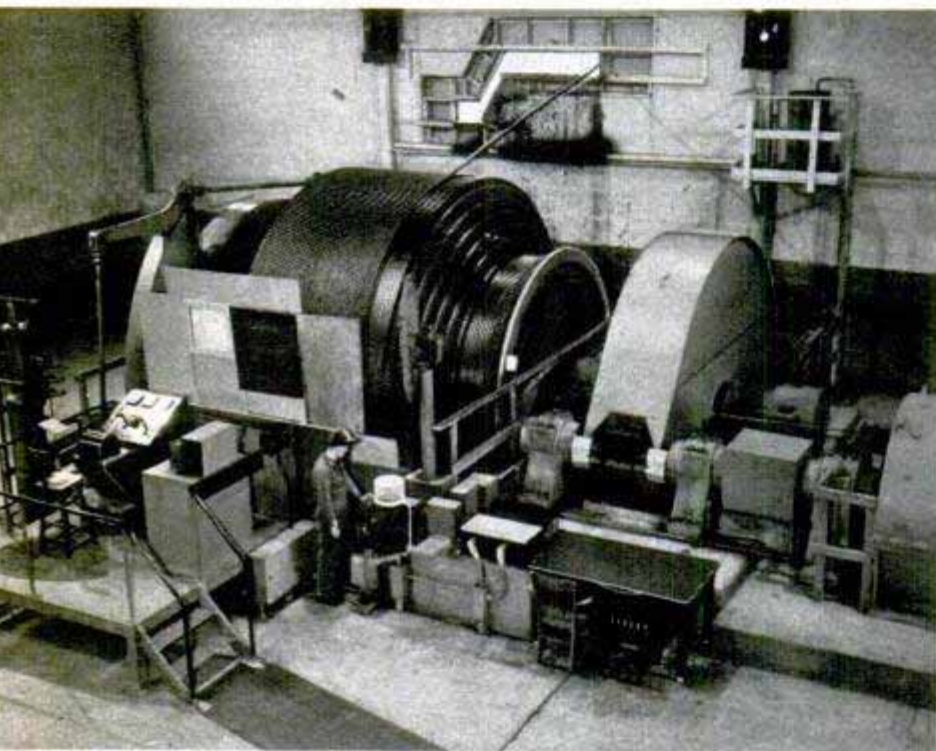

To the cable on this hoist are attached the two skip buckets that each carry up 10 tons of rock at a time to the surface. Below, the two mechanical arms on this Joy loader gather rock and place it on a moving belt that takes it to dump trucks



mining equipment as a rock-crushing unit capable of reducing three-ton chunks to six-inch size, belt conveyors, transformer stations, maintenance and repair shop, welding department, employees' dining room, and one of the world's largest and deepest-buried septic tanks. By 1943 the 550 feet between the two shaft bottoms had been spanned by this network of underground chambers.

Into one of the shafts was built a conventional-looking service elevator or hoist, which transports men and supplies in a nonstop run at 10 miles per hour over a vertical distance almost twice the height of the Empire State Building. Each minute, 100,000 cubic feet of conditioned air for ventilating the underground workings is forced down this shaft; and to enter or leave the elevator house on the surface it is necessary to pass through an air lock. In the other shaft is a pair of rock-carrying skips — six-ton bucketlike affairs each carrying 10 tons of limestone to the surface at a trip, one skip going up while the other (empty) goes down. In two minutes a skip is loaded and whisked to the surface at a speed of 23 miles per hour, and unloaded before it stops.

The service hoist is handled by an elevator man whose run is four minutes and nearly a half mile between floors. The car is about six by eight feet and approximately the height of the average passenger elevator; yet on it and the production skips, all of the massive mine machinery was lowered into the underground chambers. Much of the equipment had to be specially designed so it could be lowered a piece at a time and then put back together by mechanics. To reduce time wasted by hauling damaged parts to the surface for repairs, a complete maintenance shop was established underground. In addition, there are roving repair crews which can rebuild a jumbo rock-drilling outfit or a loading machine on the spot.

The mine began to grow outward through the limestone strata, using a two-entry room-and-pillar method of mining. First, parallel entries were blasted through the rock; then rooms extended side-wise from them. Approximately half of the stone is left in place to

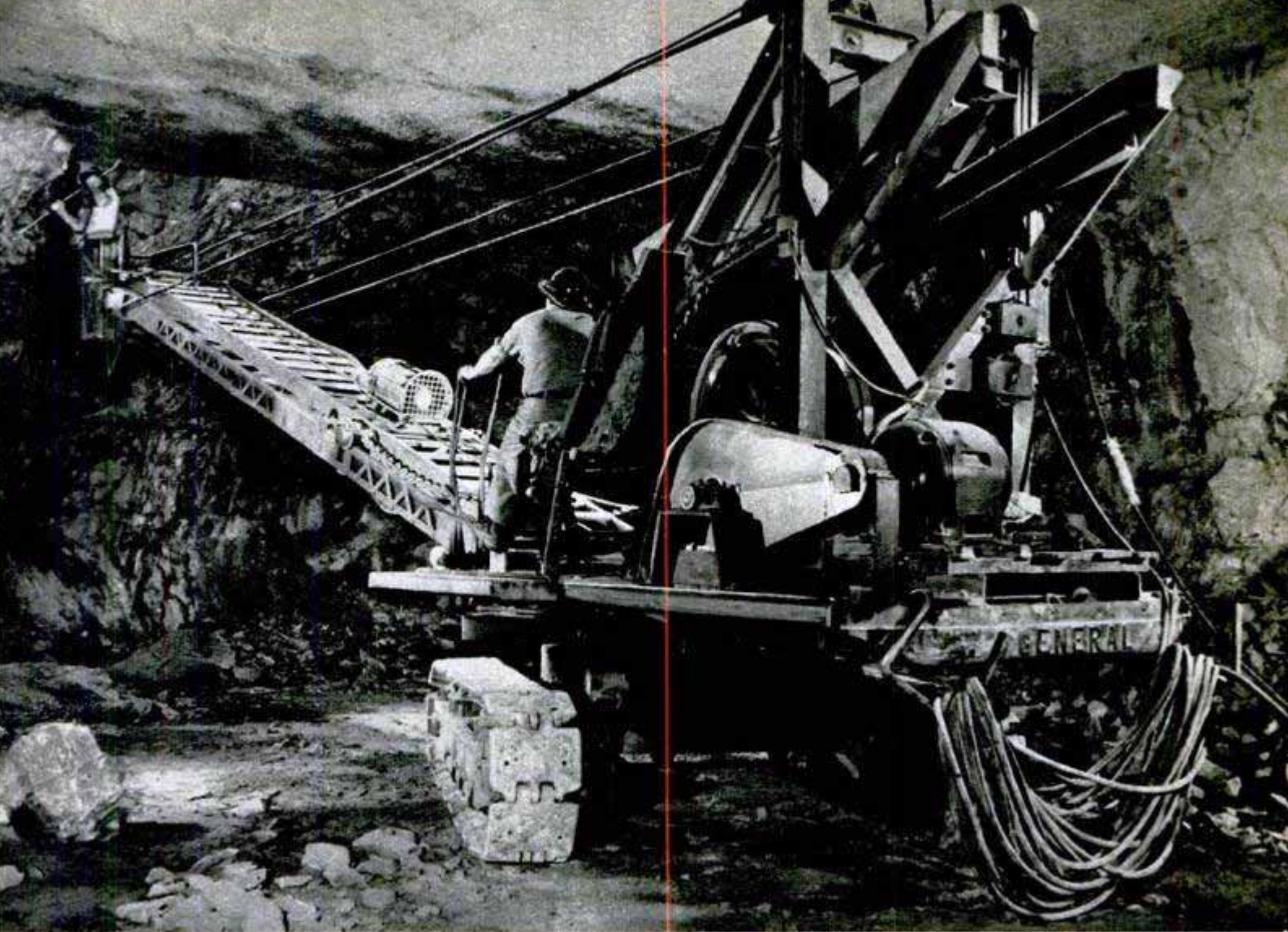

After the blasting is over, scaling crews with crowbars remove dangerous loose rock from walls and ceilings

act as pillars for supporting the mine roof. Each room measures about 32 feet wide, 600 feet long and is generally 28 feet high. Eventually, stone will be blasted from ceilings to increase their height to 46 feet. A complete trip through all the rooms and entries would be about 12 miles long. Such a journey is not difficult, either on foot or in one of the dump trucks or other vehicles, for the floor of the mine is as smooth as the average city street. Calcium chloride and waste oil from engines is spread on the roadways to keep down the dust.

Suppose we select a sample chunk of limestone, follow it, and see what it has to go through to become a part of some useful chemical, a bit of aggregate to strengthen a highway or a building, or a quantity of fertilizer to help a farmer raise better crops.

To go back to the very beginning would require a trip of something like 300,000,000 years, for that is the time that has elapsed since the Columbus limestone was laid down, geologists estimate. Our bit of this lime deposit may have been formed from primitive marine shells which settled to the bottom of the body of water that covered the area. With billions of other lime particles, and intermixed with smaller quantities of magnesium, silicon and other

materials, these particles in time became an integral part of a huge sheet of limestone. This sheet is made up of numerous laminations or strata, some harder than others, and each separated from the others—a fact useful in mining operations.

Eventually, glacial action and other geological influences covered the lime bed with shale, sandstone and other materials to a depth of nearly a half mile. There our chunk of stone slept undisturbed for millions of years.

The piece of dense, gray rock eventually found itself a part of the 28 by 32-foot working face of the mine. Like a battery of machine gunners, the drilling crew moves in. Their pneumatic drills, mounted on a mobile rig, are adjustable so that any part of the rock face can be drilled. A pattern of holes has been worked out for the Barberton mine, one designed to cause the rock to break into pieces that are the best size for subsequent handling and processing. Drillers are taught this pattern by projecting a slide image of it on the rock face, and marking the hole positions with daubs of red paint.

The holes are grouped closely, usually a foot or two apart, at the center, and arranged so the initial charge of dynamite



Placing dynamite in hole drilled in rock face. It is set off remotely after last man leaves the mine

will blow out a central plug. To help guide the breaking of the rock, a few of the holes are not filled with explosive. Farther out from the center, holes are positioned so that subsequent explosive charges will dislodge the rock progressively outward from the central cavity.

The rock drills are jointed tubular sections of steel, tipped with either a conventional hardened-steel bit or with one having tungsten-carbide cutting inserts. A steel bit will penetrate about nine feet of rock before requiring sharpening. A bit tipped with carbide, which ranks close to the diamond in hardness, may go 200 feet before becoming too dull. Water is forced through the drills while they are biting into the rock. The $2\frac{1}{8}$ -inch holes for explosives may go to a depth of nearly 50 feet.

After the drilling crew has completed the hole pattern, the blasting crew takes over. The charges are rammed into the drilled holes, as much as a ton of explosive being used a night. Electric blasting caps are arranged so that the central holes will fire first, followed successively by holes farther and farther from the center. When our sample chunk of rock comes tumbling down from its resting place, it is accompanied by some 800 tons of other pieces—representing the breaking-up of a block measuring, roughly, 28 by 32 by 50 feet.

No one knows exactly what happens when a blast is set off, because there is no one in the mine then. Not until the last man has left is the dynamite set off, by remote electrical control. Blasting takes place just before midnight. By the time

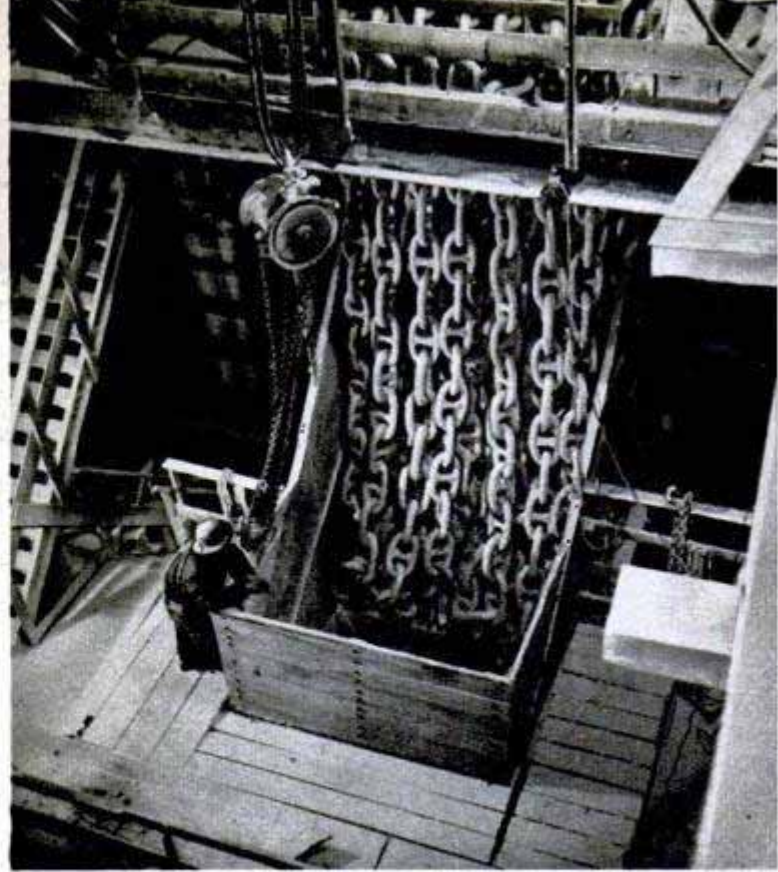

Massive, slow-moving chains of Ross feeder prevent hunks of rock from plunging headlong into feed bin

the morning shift has gone to work, all dust and fumes from the blasts have been removed by the mine's ventilating system. Our sample piece is now lost in a huge pile of broken stone.

Before it can be disturbed, the scalers must do their stuff. Using crowbars and working singly or in pairs from a "man bucket" attached to a boom extending from a Caterpillar-tread tractor, they examine every inch of the walls and ceiling of the recently blasted area. They pry loose any dangling piece of rock that might fall on workmen during later loading operations. Because of the stratified nature of the limestone deposit, the ceiling is positioned at a seam, and is as smooth as the ceiling in many a living room.

When the scalers have finished, an electric shovel, specially designed to operate in the restricted rooms of the mine, moves in. Or instead of a shovel, a Joy loader, with mechanical arms, scoops up the loose stone like an excited gambler raking in the chips. Then the stone is loaded into stubby diesel-operated dump trucks. Diesel engines are used in all mobile machinery because the fumes from them are practically free of carbon-monoxide gas. The mine's ventilating system removes exhaust gases.

A truck bearing our sample piece of limestone starts its speedy trip from the working face back to the center of the mine. It is prevented from tangling with other trucks by traffic signals exactly like those used at city-street intersections. The final signal is triggered by a photoelectric cell.

(Continued to page 218)



Jaws on Tractor Bend Pipe Line

Pipe lines that carry oil for the Sinclair Oil Co., over the mountains from Venezuela fields to the coast are bent to match the hilly terrain by a powerful device mounted on the pipe-laying tractors. At the base of the tractor crane is a jaw which grabs the pipe and tugs it against the girders of the crane. Power is supplied by the tractor engine. Short, powerful tugs make a series of tiny crimps to bend the pipe.

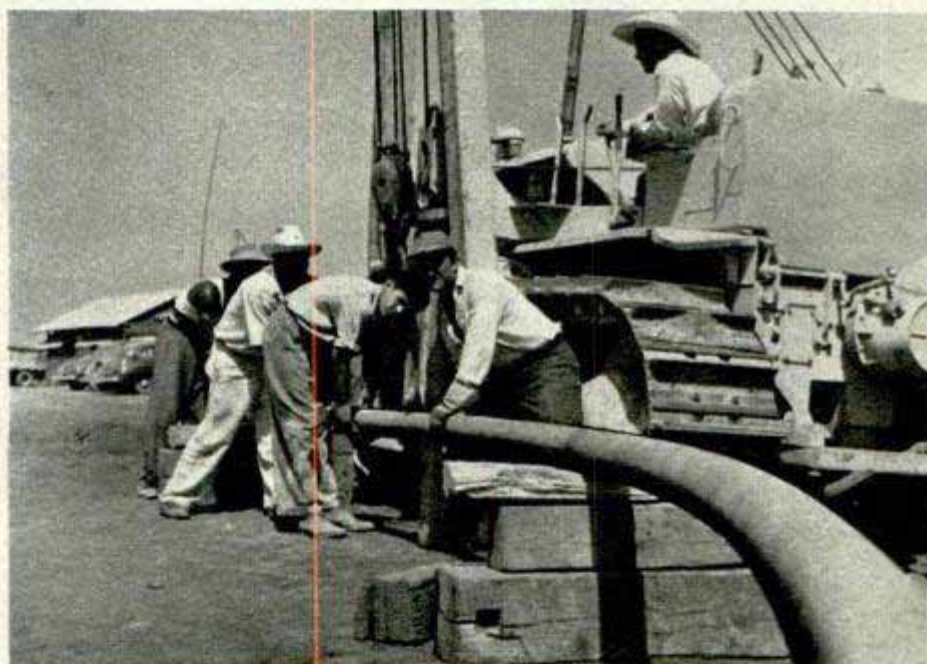

"Rubber Necked" Tripod

Photographers using a new "rubber necked" tripod can set their cameras at any angle regardless of the position of the legs. A flexible connector between each leg and the tripod head is the secret of the universal action. The legs of the tripod are not fixed and can even be opened out in spread-eagle fashion for close-to-the-ground shots. The head swivels 360 degrees independent of the flexing action. There is no need for lock screws as the head remains firmly in any position once it has been set.

☐ Nearly half of the fish landed at U. S. ports is used in fish meal—to feed hogs and poultry—and in fish oil for industrial purposes, according to the U. S. Fish and Wildlife Service.

WHAT'S NEW *For Your Home*

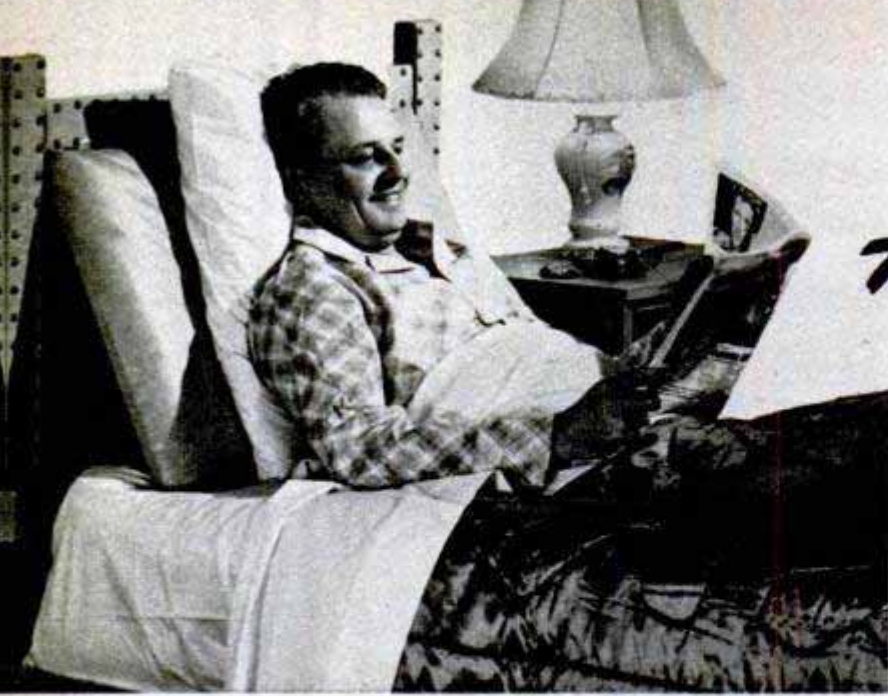

READERS-IN-BED can read for hours without back or neck kinks by reclining on a back rest that's hinged to the headboard. Sliding up and down like a window sash, it adjusts to any tilt. Between uses, it swings back into the headboard.



FAN BRACKET lets you aim the breeze where you like, even down into a tray of ice to cool the air. Its wide legs increase stability.

LIPSTICK "matches," at right, won't burn, but they will make milady sparkle. A tiny mirror inside the flap makes her retouching precise.

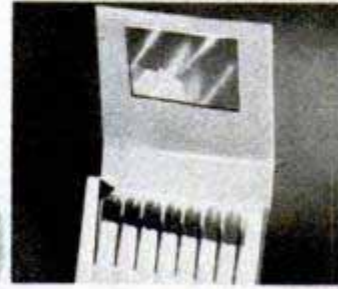

MAGNETS in door of a refrigerator, below, hold it shut without a latch. Foot pedal opens it. Handy ice-cube tray releases one at a time.



PANTS HANGER, right, relieves crowded closets, prevents wrinkles. It holds six pairs on the horizontal rods and it swings down for ready access, up for storage.

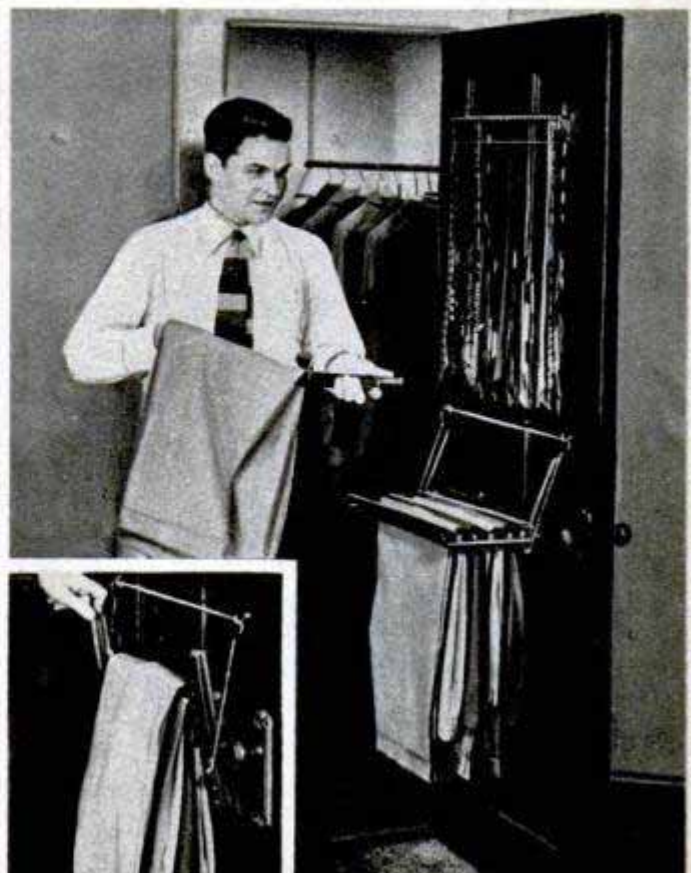

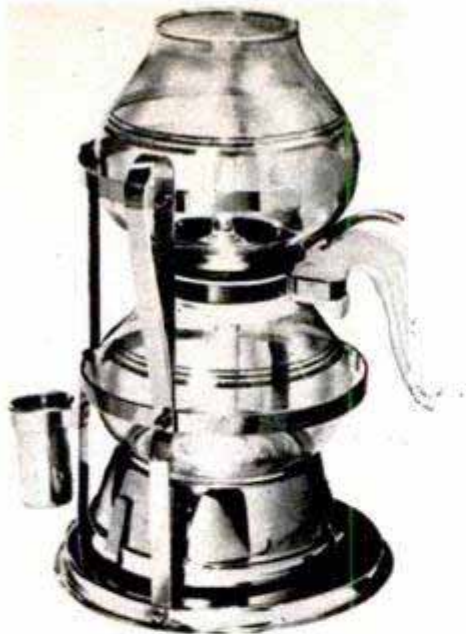

↑ **GUARD RACK** lets you carry any glass coffee maker and its stove with one hand. It protects glass bowls from breakage, too

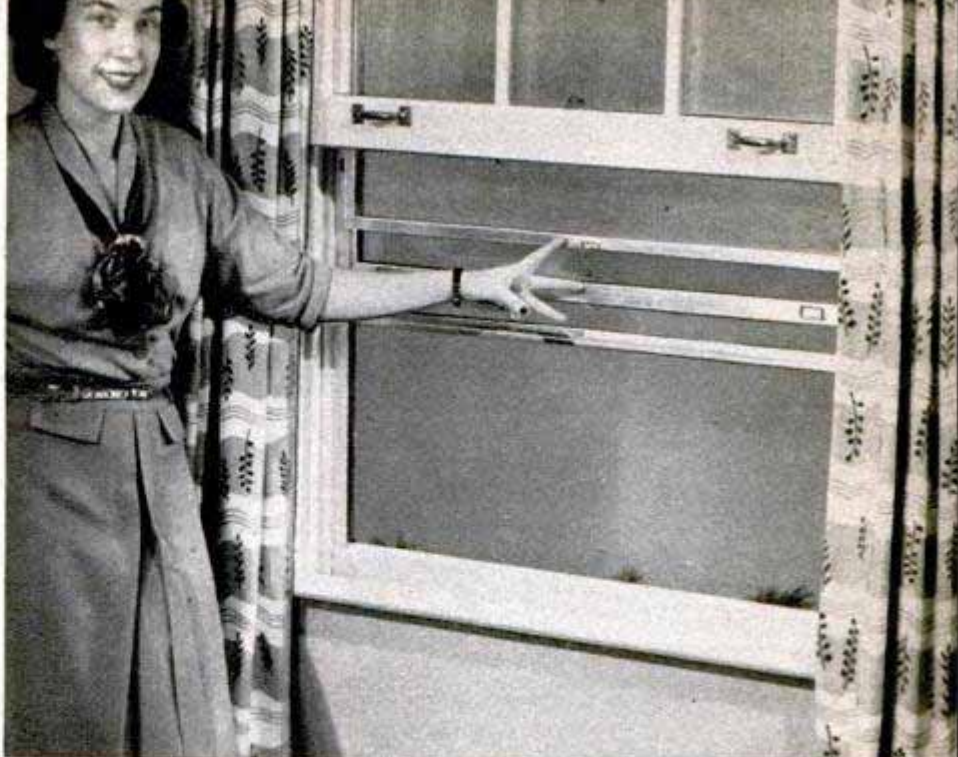

STORM WINDOW, above right, has three separate units, two glass and one screen. Each moves independently in its track

SAUCE PAN, right, has holes in lid and pan rim so water can be drained without scalding hands. Lid locks in place



AUTOMATIC DISHWASHER, below right, requires no drain installation. It pumps the waste water directly into the sink

↓ **HOSE RACK** keeps hose coiled neatly for storage and holds the nozzle at any angle when you are spraying the lawn

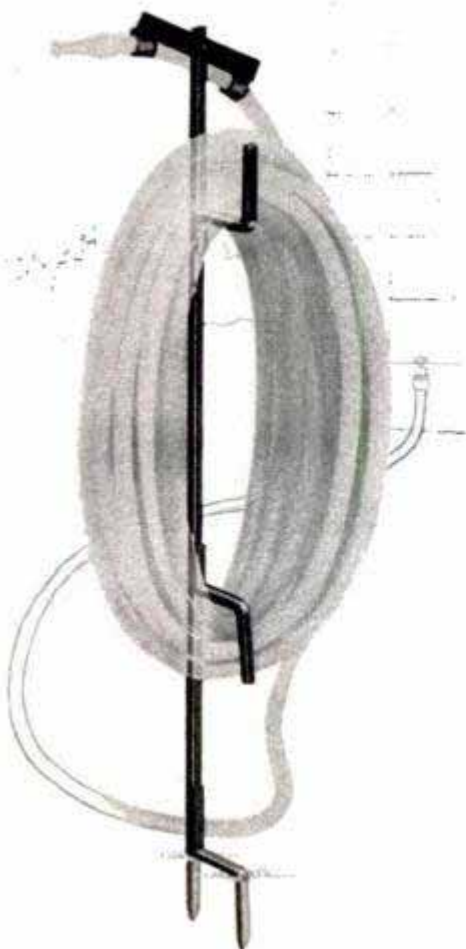

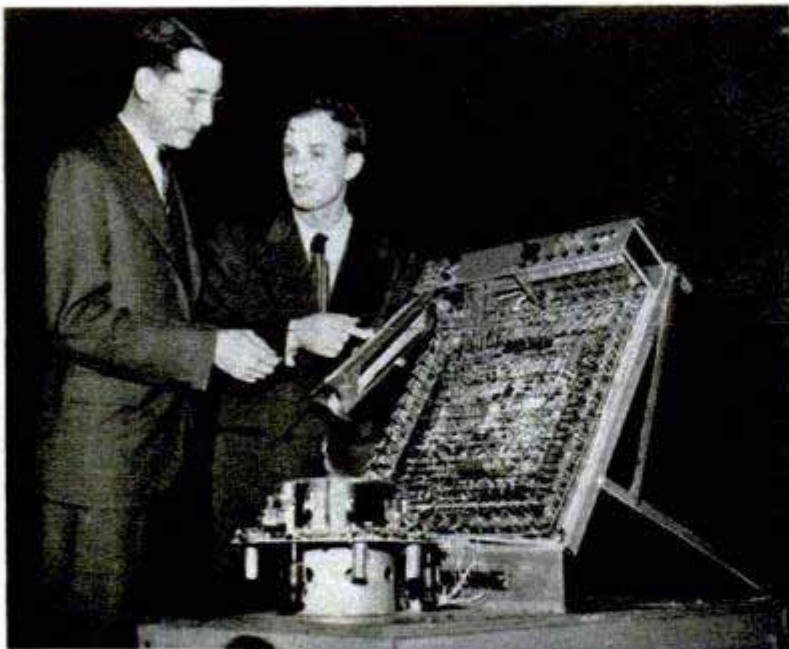

It's Small But Smart, This "Suitcase Brain"

Not much larger than a suitcase, a new electronic "brain" can handle most of the intricate problems solved by the huge automatic computers, some of them almost the size of a basketball court. The small computer, called the Maddida for its initials (magnetic drum digital differential analyzer) was designed by 31-year-old Floyd G. Steele. It is only two feet wide, four feet long and three feet high, and weighs 750 pounds. When a difficult problem is fed into the Maddida it comes up with an answer accurate to within one part in a million.

Soil "Waffle Iron" Reduces Erosion

Pockmarking the soil with thousands of indentations that look like the grid of a waffle, a soil-preparation tool pulverizes the soil, tamps it around seeds and reduces erosion. The wheels of the implement, which are cut away at four evenly spaced intervals, leave tiny retaining walls over the surface of the field. Rain water collects inside these retaining walls, preventing wash-off. The implement has an over-all width of 10½ feet.

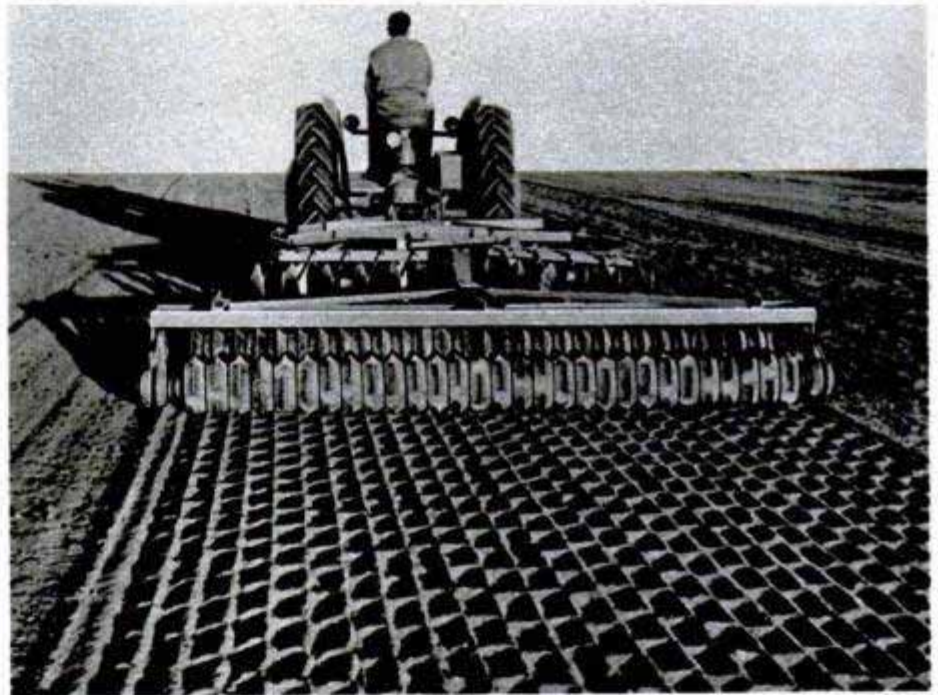

Loose-Leaf Photo Album Makes Its Own Binding

There's no limit to the number of pages you can add to a loose-leaf photographic album because each page becomes part of the binding. The pages are transparent plastic pockets, the open sides of which interlock to form a hinge. A metal pin is threaded through the hingelike edges of the pockets, locking them together securely. No matter how many pages are added, the album always opens flat.

Sources of available products described in this issue are listed in the WHERE-TO-BUY-IT INDEX. Sources of further information on other articles are included in the WHERE-TO-FIND-IT LIST, available to readers without charge. For your copy of the list, just write Bureau of Information, Popular Mechanics, 200 E. Ontario St., Chicago 11



1

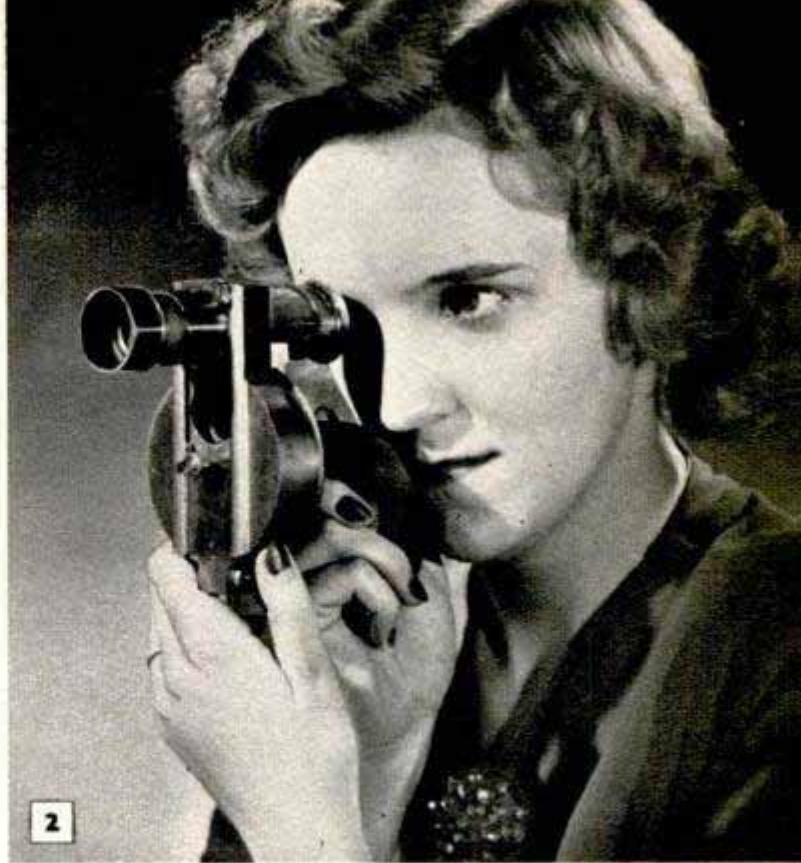

2

CAMERAS IN DISGUISE

Climaxing the mystery yarn of 50 years ago was the instant the intrepid spy or detective clicked his concealed camera, capturing the evidence. Cameras were bulkier then, but designers disguised them ingeniously. These cameras are displayed at the George Eastman House in Rochester, N. Y. Opera glasses and pistols are sure-fire giveaways for spies, yet that didn't deter the designers. Those in Photo 1 are cameras in disguise. That harmless-looking man surveying land near the Army base was really a spy and his theodolite, like the one in Photo 2, was a camera! The dapper detective was never without his cane because it had a camera in its handle, Photo 3. Back in 1890, the ascot tie, Photo 4, was the mark of a gentleman, but this one had a built-in camera, its lens forming the stickpin. Cruder but just as efficient is the circular camera that shoots through a buttonhole, Photo 5

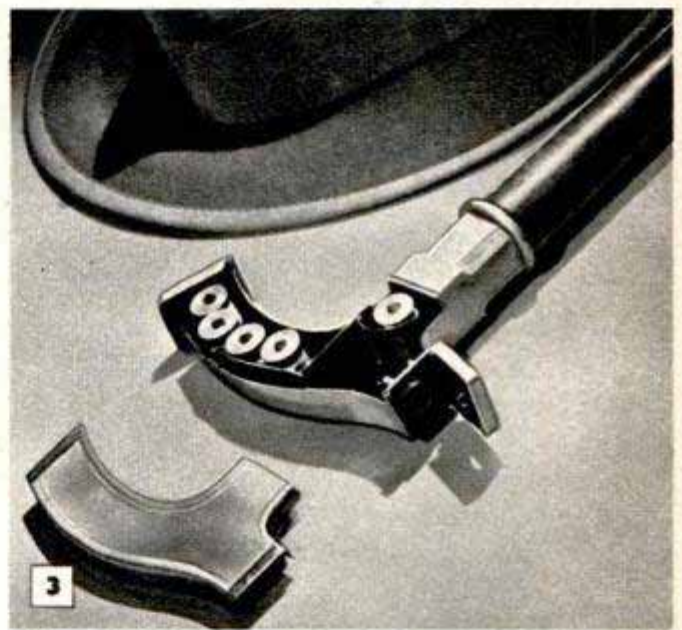

3



4

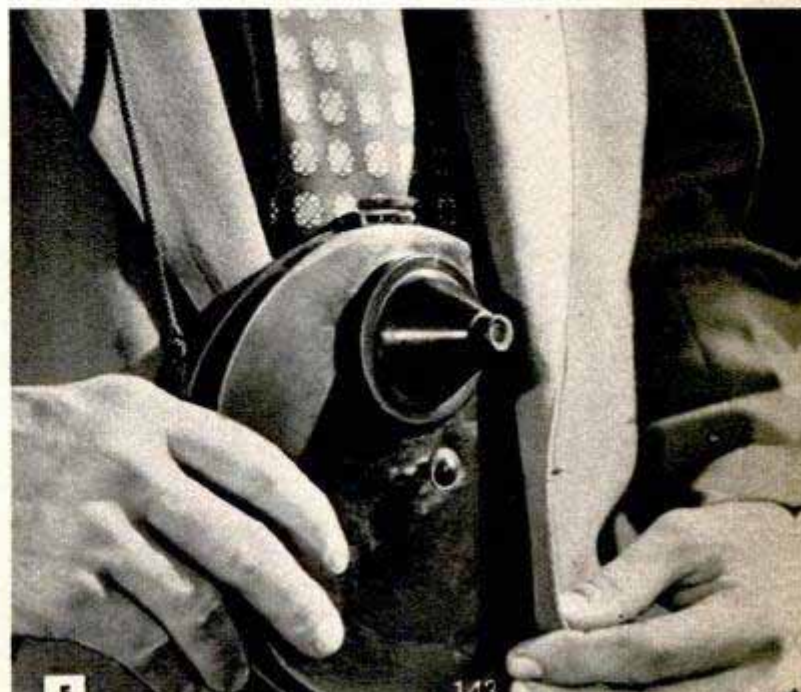

5

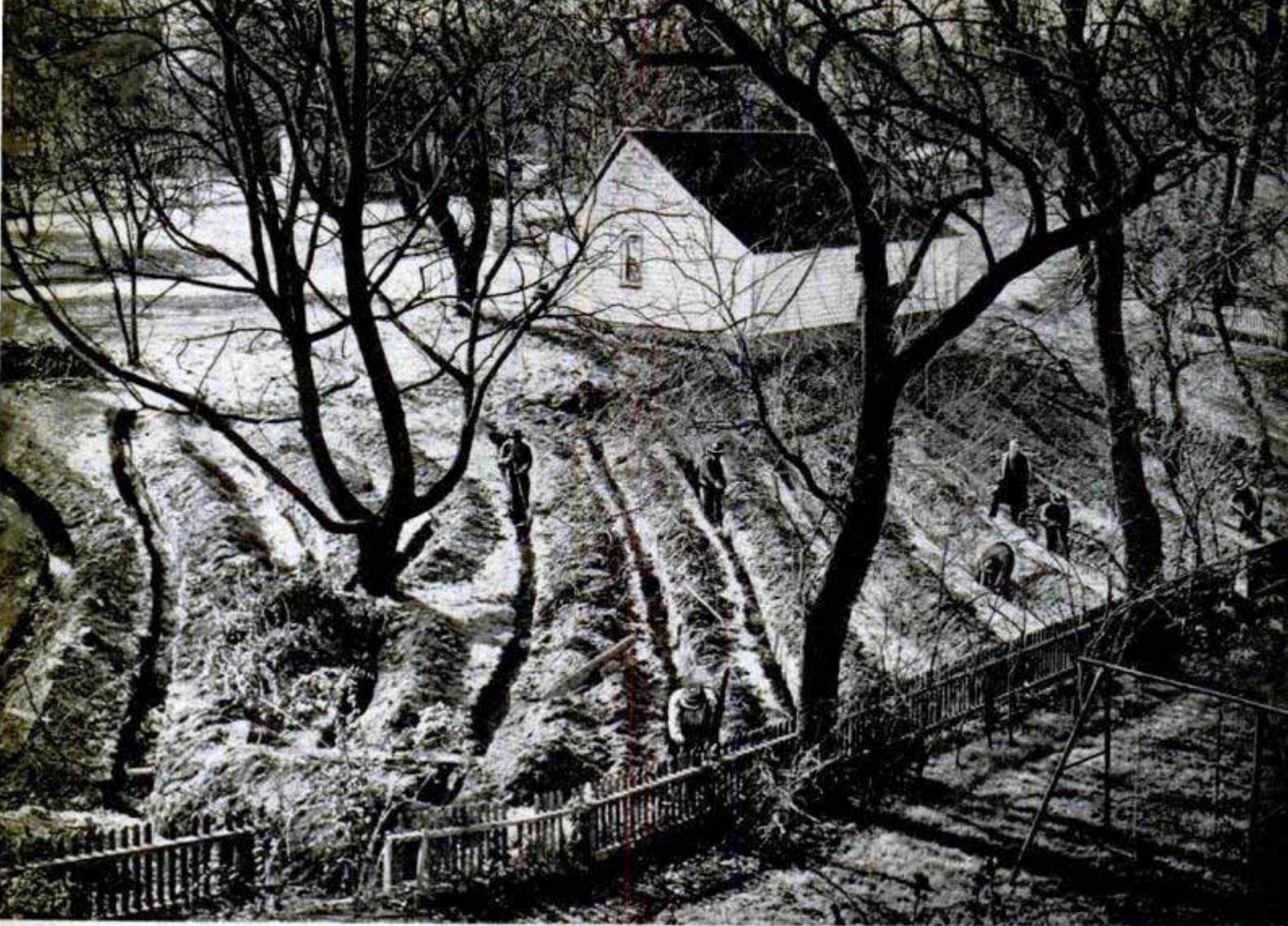

Careful digging, such as shown here, uncovers colonial relics that are restoring yesterday to Williamsburg

Restoring Old Williamsburg's Relics

Modern archaeologists have perfected some ingenious tricks to keep those priceless bits of pewter, copper and iron, dug from the earth of colonial Virginia's capital, from crumbling into dust

THERE'S more to restoring an old city than just digging up its relics. The laborious and time-consuming excavation work would be utterly wasted if it were not followed by a "metal embalming" process, without which an iron hinge or lock, buried since the 18th century, would crumble into dust in a museum cabinet within 10 years.

At Williamsburg, Va., the famed village that is being reconstructed as it was 250 years ago, scientists have developed a remarkable iron-preserving process. Here's how M. W. Thomas, Jr., Director of the Archaeological Museum at Williamsburg and one of the experts who perfected the process, describes it:

Very rusty iron of the type found in the

Williamsburg excavations is more like a sponge than a metal when it is removed from the earth. This is a result of the action of soil acids and other agents. The first step in preserving a piece of such iron is to clean it by hand to remove outside rust and dirt. Often a toothbrush is used on delicate parts. Next, the iron is placed in a container along with fragments of metallic zinc and a solution of sodium hydroxide (caustic soda and an ingredient of lye). This stew is boiled for 4 to 14 hours, while complicated chemical actions take place. Essentially, the combination of metals and an alkaline solution forms an electrolytic cell so that electrolysis plays a part in the cleaning. Hydrogen bubbles form on the iron and help to pry off particles of rust.

The hydrogen reduces some of the rust while the alkali dissolves more of it. The metallic iron is not affected by going through this treatment.

Next, a series of boiling and rinsing operations in water, plus the addition of some acid, clears the iron of the alkali and other chemicals. The piece is then dried. A slight coating of oxide is retained so that the iron will look its age instead of possessing a bright metallic luster. After thorough drying in an oven, the specimen is immersed in smoking-hot paraffin for 12 to 20 minutes and then is removed and cooled. The wax seals all pores against the further admission of rust-causing agents and gives the iron a pleasant sheen. The wax provides practically no resistance to wear, but is ideal for museum pieces that seldom are handled. When a wax-treated specimen becomes dirty, it is only necessary to dip it again in hot paraffin to clean it.

Thomas, a chemist by profession, is charged with assembling, study, classification and preservation of all artifacts left by the early inhabitants of Williamsburg. It may be significant that, of the 40 tons or so of such relics in his laboratory when this was written, 40 percent were fragments of wine bottles! Bottle glass made in the 18th century and buried in the earth ever since is corroded to a depth of $\frac{1}{16}$ inch or more. In some cases, there are holes "rusted" all the way through the glass. Flint glasses and other kinds harder than bottle glass show less corrosion. Fragments of very beautiful goblets having air-twist, cotton-twist and teardrop designs in their stems were unearthed. Modern replicas of such goblets are now being manufactured and sold.

Lying on a table in Thomas' office was

Reproductions of air-twist and baluster-stem glassware patterned after fragments recovered at Williamsburg



Director Thomas of Williamsburg Museum, right, examines foundations near which these bottles were found

a shallow tray containing some moldy looking chunks of metal. These were pieces of lead type found at the foundation of a print shop operated around 1736 by William Parks. This type, of the design made famous by William Caslon in the 18th century, is being cleaned and a press is to be constructed for using it. Type and other lead articles discovered in the restoration area are cleaned by alternate treatment with nitric and hydrochloric acids and sodium hydroxide.

One material that has just about stumped



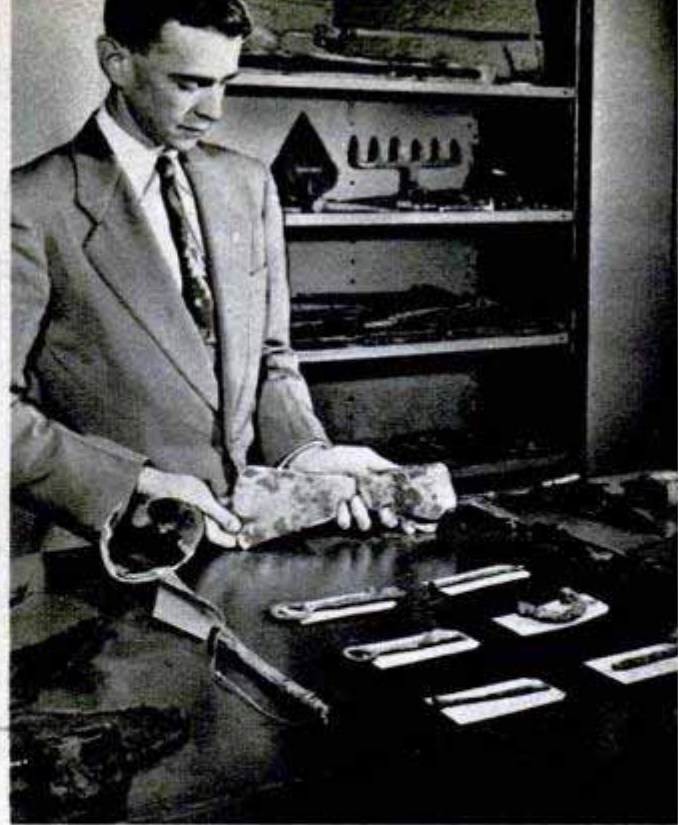

Left, wearing colonial garb, this workman fashions metal articles by methods used more than two centuries ago. Right, Director Thomas holds an 18th-century axhead which has been preserved by "metal embalming" process

the Williamsburg Archaeological Laboratory is pewter. This alloy of lead and tin was used widely in colonial times. Dishes, mugs, candlesticks and other items made of it are subject to a disease in which the tin of the alloy undergoes a change of form without experiencing a chemical change. There is no known way of stopping this disease once it starts and its progress cannot be reversed without melting the pewter. Any antique piece of pewter, Thomas explains, may develop a spot of the tin disease at any time and this spot may spread through the piece and eventually destroy it. Keeping the pewter surface clean and well polished seems to be a way of preventing or delaying the malady.

Usually, copper articles are corroded the least of all Williamsburg artifacts and in most cases require only a good scrubbing with water. If copper and brass are found to have an attractive greenish patina, no attempt is made to clean the metal other than simple washing. When the patina is unattractive, it is removed with brass polish, restoring the metal to its original lustrous condition. Visitors to the restored Virginia town see considerable brass, both old and new, and often marvel at the beautiful polish. Lacquer or other coating materials are not used to preserve such polish. Thomas says that any coating applied to retard tarnishing suppresses some of the beautiful sheen and some may eventually deteriorate and attack the brass.

Wood preservation is another of the archaeologist's problems. Most of the original wood rotted long ago, but occasionally a piece worth preserving is found. If ter-

mites have attacked it, they cease to be a threat as soon as the wood is placed on a museum shelf or otherwise stored where the insects cannot have access to ground moisture. But powder-post beetles are a bigger problem. These industrious bugs, which were named for their ability to reduce wood to a powder, continue to work in a piece of wood no matter where it is stored, unless they are killed by chemical treatment or other process.

Some fragments of wood discovered in old buildings have provided clues to the kinds and colors of paints used in the colonial town. When a painted board is found, architects and laboratory workers remove the paint layer by layer until the first coat is uncovered. Such painted boards sometimes are found under stairways and in other parts of 18th-century buildings that survived to the present. Old records describing shipments of pigments from England have helped in analyzing the paints and in formulating finishes that duplicate the originals.

Thomas also is concerned with the never-ending search for ancient muskets, pistols and other arms for the restored powder magazine, governor's palace and other buildings. Many of these now on display are true 18th-century pieces. Others are more recent, but are used because of the lack of older ones. Some of the guns used by original Williamsburg inhabitants never can be replaced, simply because no specimens have survived to this day.

Williamsburg gets most of its guns from dealers in antique firearms, from museums

(Continued to page 234)



Laboratory In a Box Handles "Hot" Isotopes

"On the outside looking in" is an accurate description of the way scientists work with certain low-energy radioactive isotopes in miniature laboratories. Only the gloved hands of the technician protrude into the plywood box, which is coated with Vinylite resin-base paint. A large window permits full visibility. Air pressure within the box is kept slightly below atmospheric pressure and exhaust air is filtered to remove contaminated material. These boxes are the low-cost solution to the handling of low-energy radio isotopes and provide virtually complete contamination control.

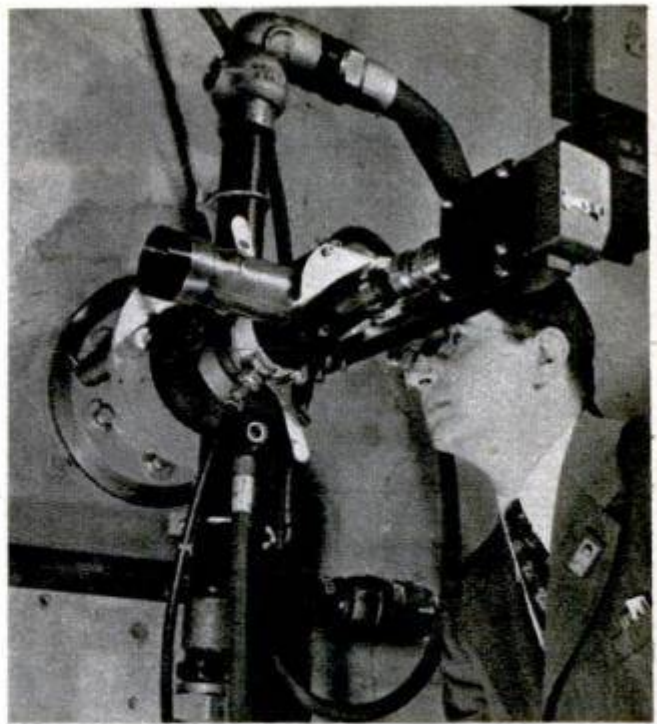

Hot Periscope

Engineers at General Electric can look directly up into the exhaust stack of a jet engine pouring out 2500-degree gases without noticing the heat. The explanation is a 12-foot periscope, steel jacketed and cooled by 45 gallons of water a minute, which extends into the test chamber through a wall. A quartz window, washed by a powerful stream of cold air, peers up into the business end of the engine. On the viewers' end of the periscope, through which engineers study the pattern of burning gases, are a 16-mm. motion-picture camera, an eyepiece for an observer and a screen several persons may watch.

Disabled Veteran Still Mows Lawn

Drawn by a power mower, F. J. Baker, Jr., of Dunedin, Fla., a disabled veteran of World War II, mows his lawn from a wheelchair. The chair is attached to the mower by a piece of steel shaped like a slingshot which Baker had designed by the Rebco Company, Clearwater, Fla.

☞ Grass that stays green the year around where there is little or no frost, a Bermuda type known as U-3, is one of the developments in an experimental turf culture program at the University of California at Los Angeles.





Operator selects a disk to match the kind of concrete ordered and places it on a turntable. Disk makes electrical contacts to release material and water into mixers in the proper ratio. Above, right, diagram shows the multilevel mixing tower

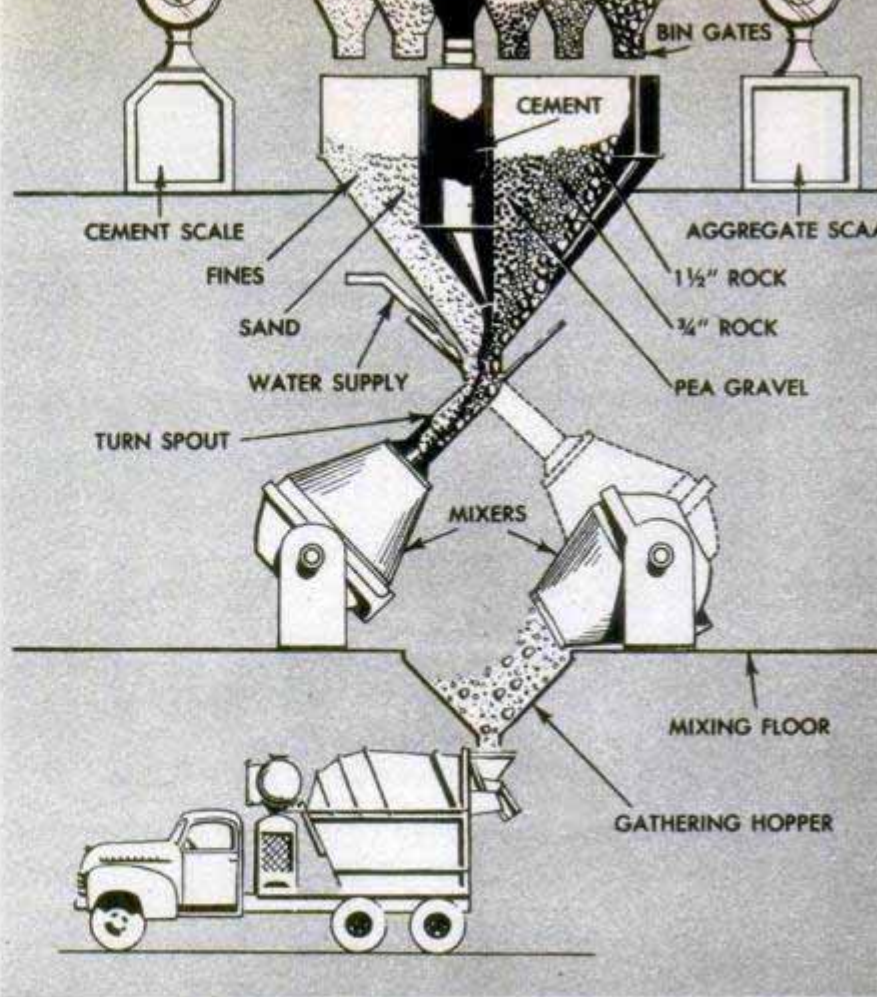

Conveyor belt dips under road to bring materials from stock piles on other side. Four levels of tower from top down contain storage bins, control room, mixers and loading station

Push-Button CONCRETE MIXER

THREE men can prepare over a thousand yards of concrete a day in a towering push-button mixer near Phoenix, Ariz. The big tower has six bins which are filled by conveyor belt from stock piles of material. Orders for concrete are sent to the control room by pneumatic tube. Depending upon the order, the operator selects a disk and places it on a turntable. As the disk revolves, buttons make electrical contact to release material into the mixers. Three minutes after a driver sends up his order, the concrete is dumped into his truck.

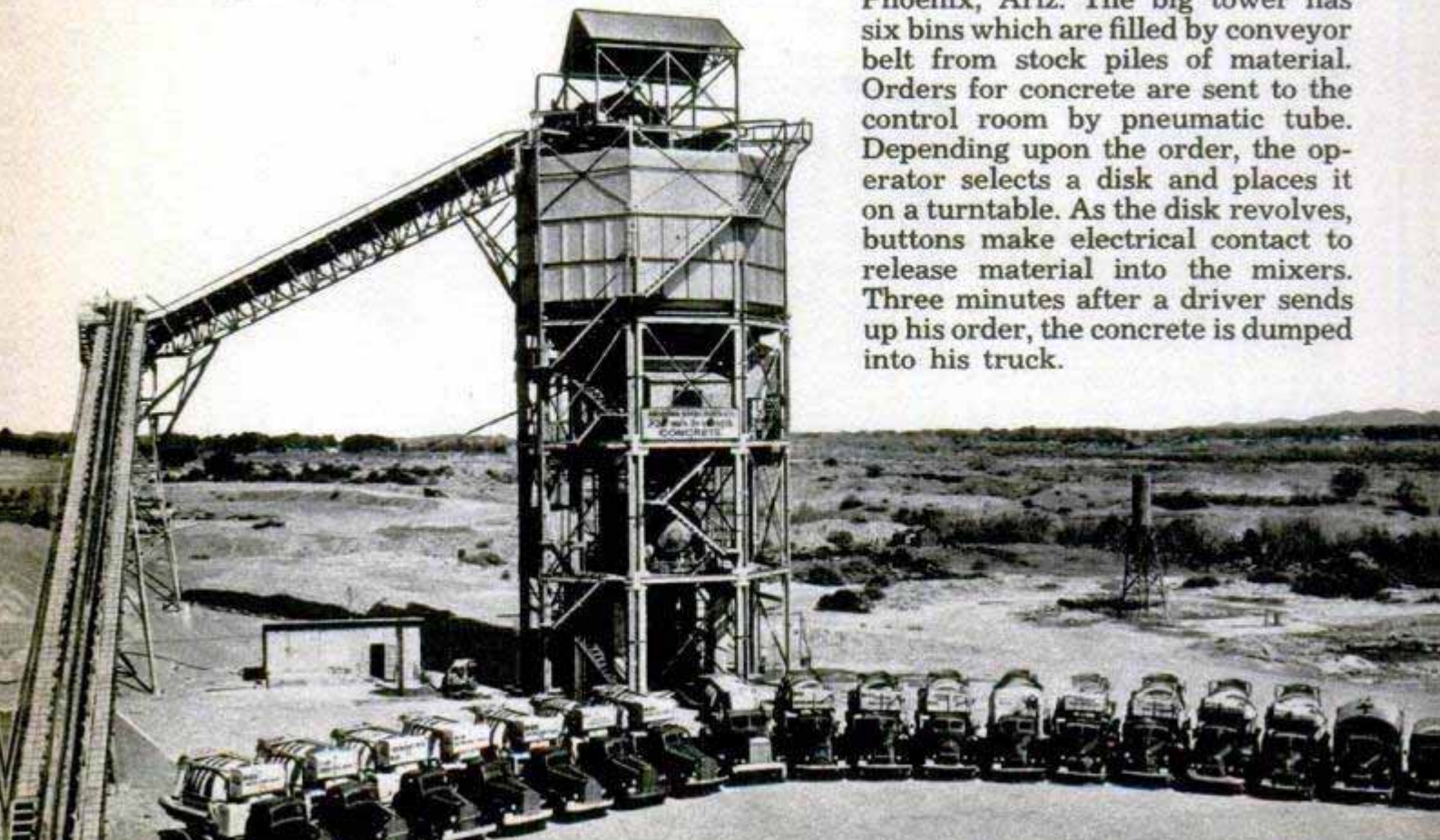

the

POPULAR
MECHANICS

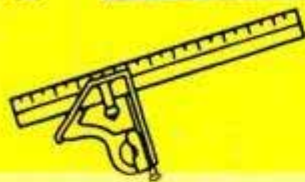

CRAFTSMAN





Photo courtesy Harry E. Turk

Cabinets need not be entirely painted. Doors and drawer fronts can be finished natural to give pleasing contrast. Note the smart "drop ceiling" cornice between cabinets



St. Charles Mfg. Co. photo

The corner plant shelf over the sink, above, and the writing desk, below, are two window "built ins" that add a touch of distinction to the modern functional kitchen
General Electric Co. photo

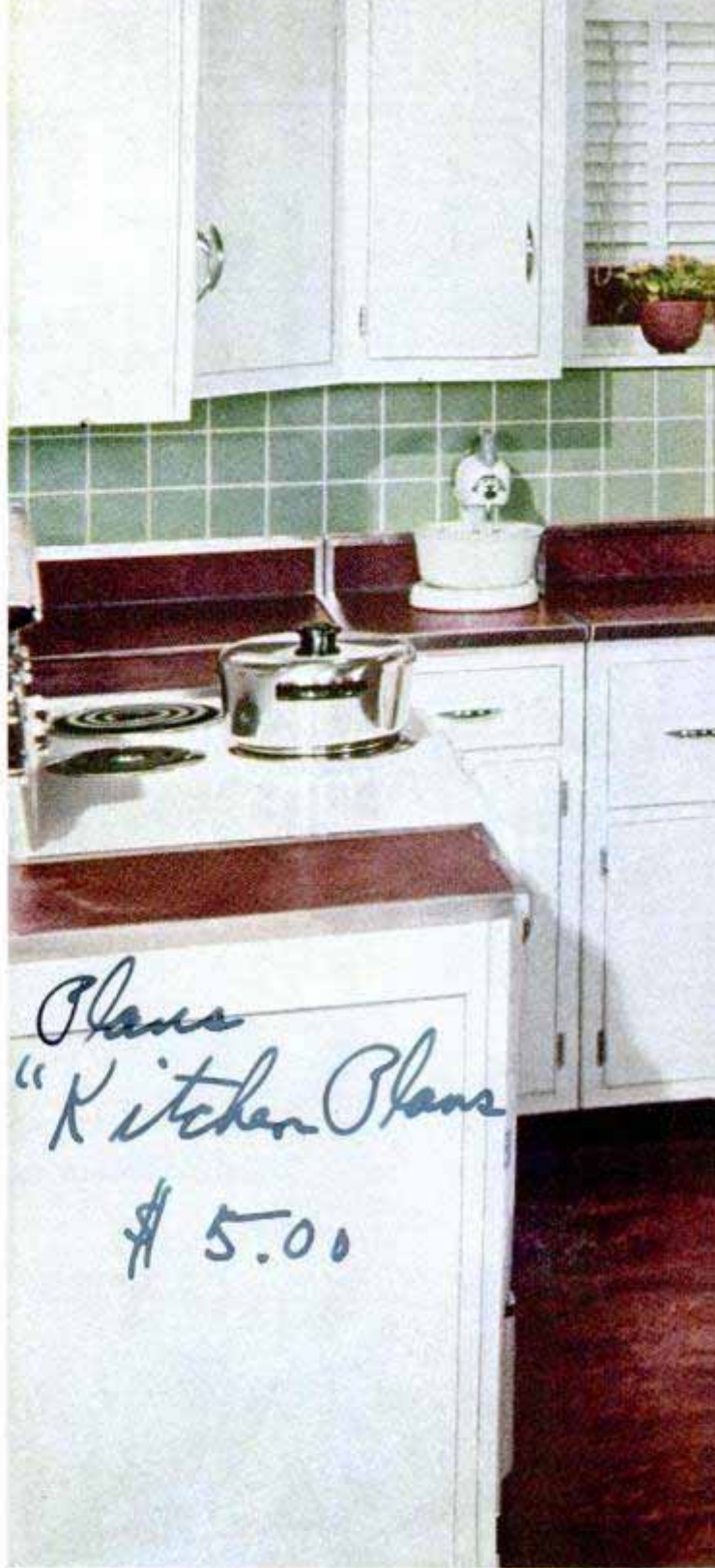

Masonite Corp. photo

Your MODERN KITCHEN

By E. R. HAAN

PART I — ESSENTIALS OF PLANNING

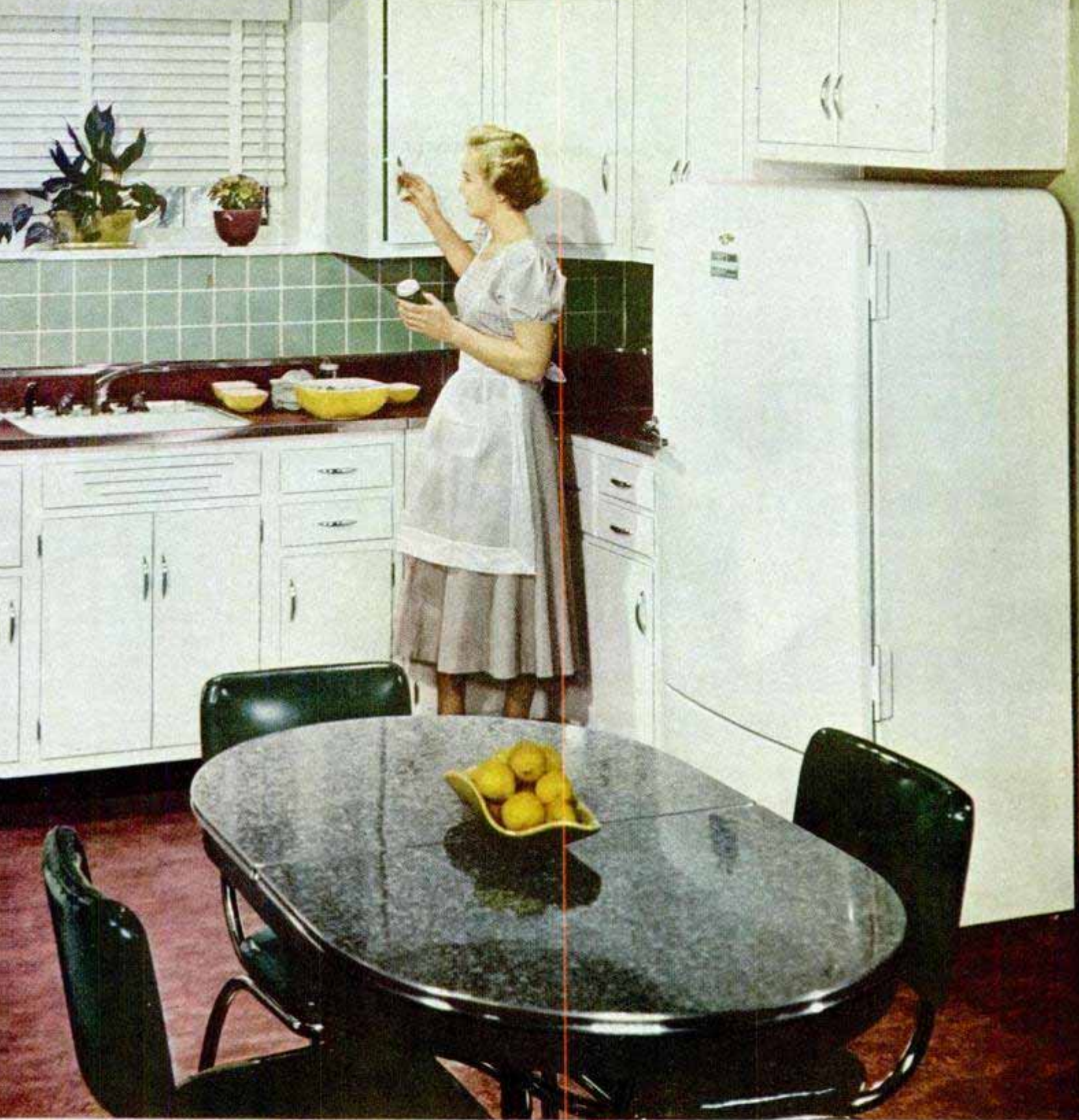

THAT MODERN KITCHEN you have dreamed about is well within a modest budget if you are willing to do most of the work yourself, even the planning. You can build the cabinets, or purchase and install them at a considerable saving. In either case, the arrangement should be well planned to save steps as well as to get a pleasing appearance. Every hour of planning will be time well spent. In fact, many homeowners, after they have the arrangement worked out to their satisfaction, make up a small scale model of their proposed kitchen. A model helps you to visualize the full-size kitchen and often shows up oversights in planning that were not apparent in sketches and plan drawings.

1

4 BASIC ARRANGEMENTS

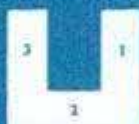

U-SHAPED

Dead-end, U-shaped kitchens generally are the most efficient type of layout. They save many steps between sink, range and refrigerator.



L-SHAPED

This kitchen plan is next best, but household traffic may interfere with work areas in narrow rooms. This should be avoided wherever possible.

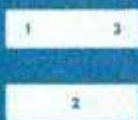

CORRIDOR TYPE

Small rooms with a door at each end may require this arrangement. Often, distances between the three units are less than in L-shaped kitchen.



SINGLE-WALL TYPE

Extra work may be required for work areas.



Four basic arrangements: Today's kitchens are based on the four basic arrangements shown in Fig. 1. You can approximate one of these arrangements even if the fundamental design of your present kitchen cannot be altered. Keep in mind that in every kitchen there are three centers of activity, which are storage, preparation and cleaning, and cooking and serving. All of these centers include vital appliances and cabinets placed in a production-line sequence so that kitchen operations can proceed orderly from storage to the dining table. The line starts at the service door where food is delivered and ends at the nearest point to where it is served. A, B and C of Fig. 11 indicate the paths of back-and-forth walking. It is important that these be as short as possible over the usual minimum of 4 ft. to save steps, especially distance B between sink and range, where most walking is done.

By studying the typical kitchen layouts in Fig. 2, you'll find one that is most adaptable to the shape of your present kitchen. The new arrangement

ENDLESS APPLICATIONS

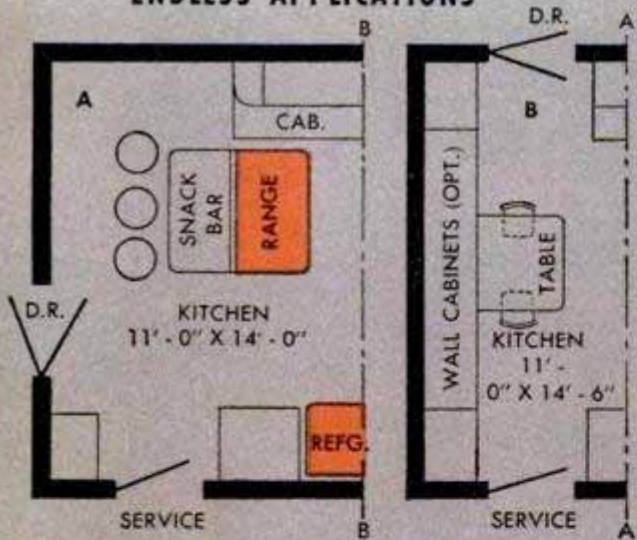

Unless you wish a complete remodeling job, changing over to any one of these basic layouts depends largely upon the present location of the sink and doors, as well as the size and shape of the room. Plans C, D and E are most efficient when the refrigerator is equipped with a left-hand door

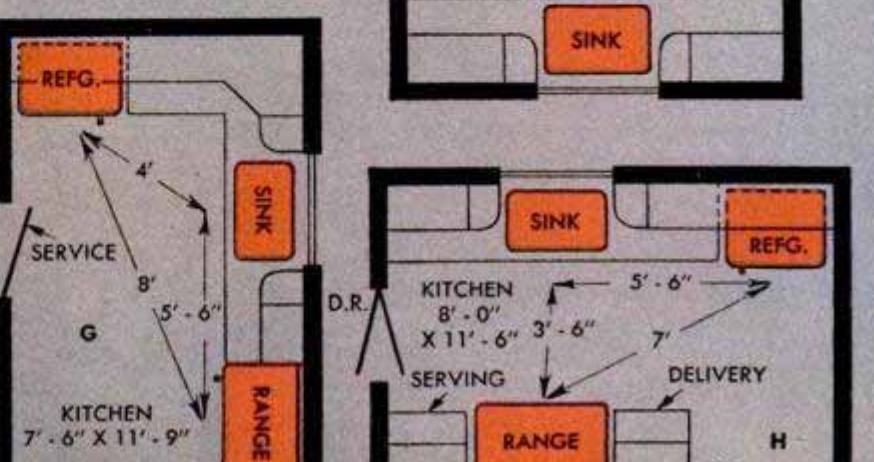
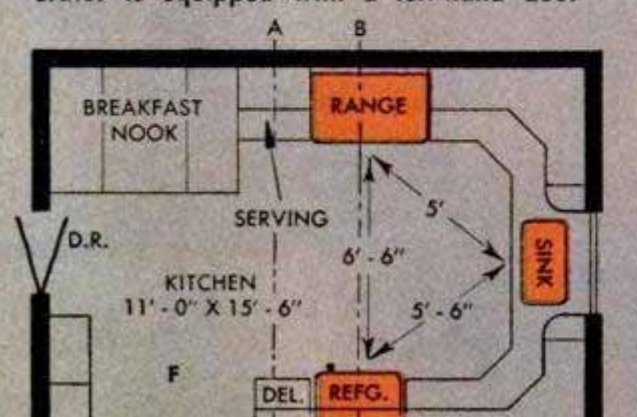
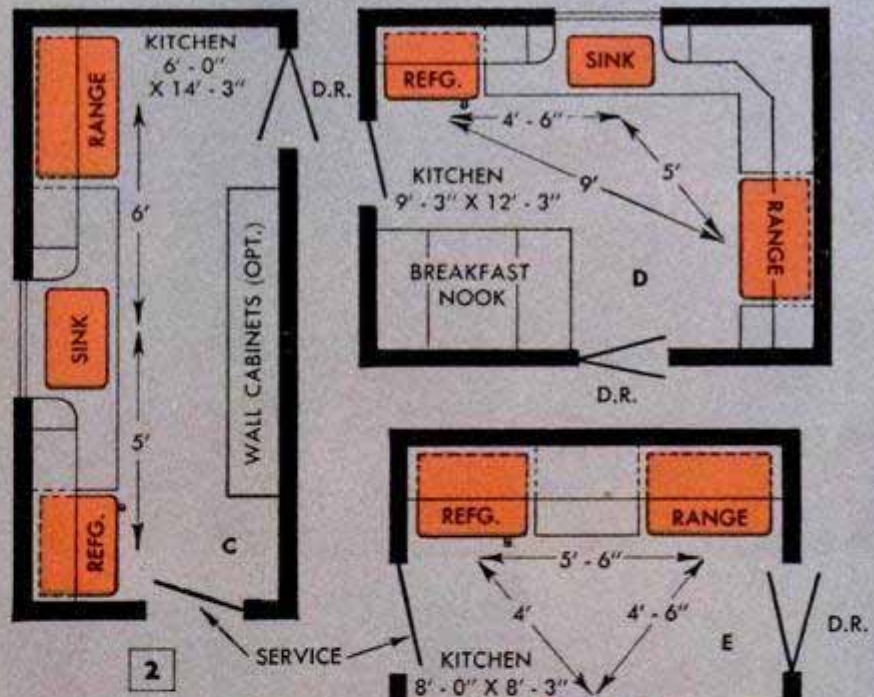

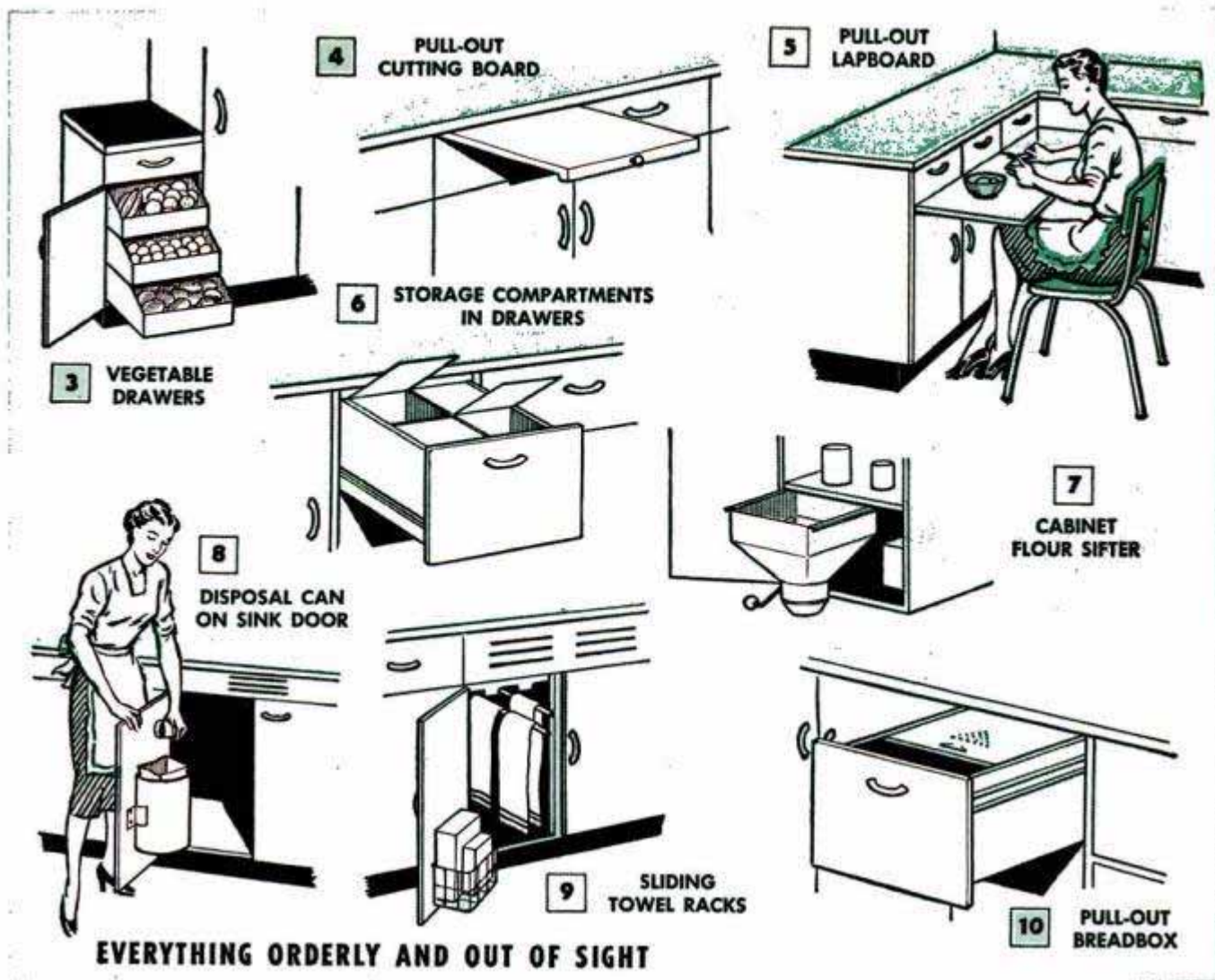

will depend largely on the location of the sink as extensive plumbing changes are expensive, although pipes can be shifted about 8 in. in either direction at small cost. A dead-end, U-shape kitchen generally is the most efficient. See Plan F of Fig. 2. Two alternate arrangements of one end are shown at A and B. If the room is less than 11 ft. wide, the two wall cabinets on the same wall as the window are eliminated and the width of base cabinets along this wall is reduced. Then the plan will fit an 8 or 9-ft. kitchen width but the alternate arrangements at A and B may not be possible. If your kitchen is 4 or 5 ft. shorter than the plan shown at F, the breakfast space may have to be sacrificed.

Storage center: Counter space of at least 18 x 24 in. should be provided next to the refrigerator on the side where the door opens. This is for deliveries as well as for food to be removed from or returned to the refrigerator. Cabinet storage space should be within arm's reach of this counter. If you have a home freezer cabinet, it should be placed next to the refrigerator if space permits. For vegetables and fruits, a near-by base cabinet should contain a tier of easy-sliding, ventilated drawers, Fig. 3. Flour, sugar, etc., can be kept in a

drawer having metal containers as in Fig. 6. Or, you may prefer to keep flour in a sifter that slides into a wall cabinet as in Fig. 7. Some cereals and condiments may be kept in wall cabinets most convenient to points where food is prepared. Always keep in mind that supplies should be stored close at hand where they are first used.

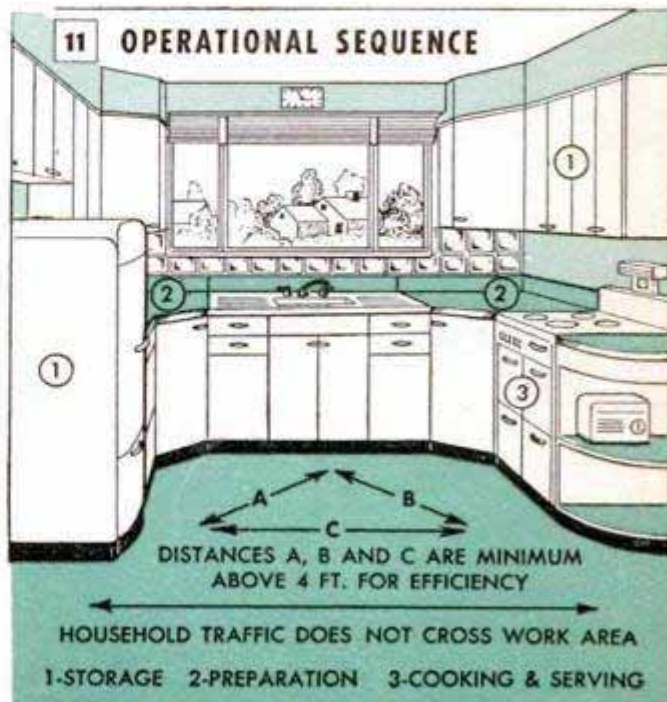



Preparation and cleaning center: This includes counter space of not less than 24x36 in. at one or both ends of the sink. For cutting, you can install a slide-out hardwood leaf, Fig. 4, or a slide-out lapboard, 26 to 28 in. above the floor, for working in a seated position as in Fig. 5. Processing equipment is stored in drawers or on shelves of base cabinets along the preparation counter. Counter space where dishes are stacked for washing should not be less than 24 x 36 in. This may be the same counter used for food preparation. It will be on your right when facing the sink if you wash dishes, from stacking to storing, in a right-to-left sequence. Then the cabinets where dishes are stored should be at your left, so they can be dried and put into the cupboard. Cutlery goes into partitioned drawers nearby, and cooking utensils preferably on easy-sliding shelves or drawers in base cabinets. Dishwashing equipment is stored under the sink and this space may include one or more sliding towel racks as in Fig. 9. Convenient disposal cans may be fitted on the sink-cabinet doors as in Fig. 8—one provided with a waxed-paper bag to catch refuse, and the other for empty cans, jars and bottles. If you go beyond the manual dishwashing stage, you'll install an electric dishwasher and perhaps also a motorized disposal unit.

Cooking center: The cooking range should be located conveniently near the dining-room door, breakfast nook or both. A counter not smaller than 24 x 24 in. should be placed next to the range to facilitate transferring cooked food to serving dishes. Base cabinets near the range can hold some of the heavy cooking utensils. Bread and bakery goods are kept near the range in a special metal-lined drawer

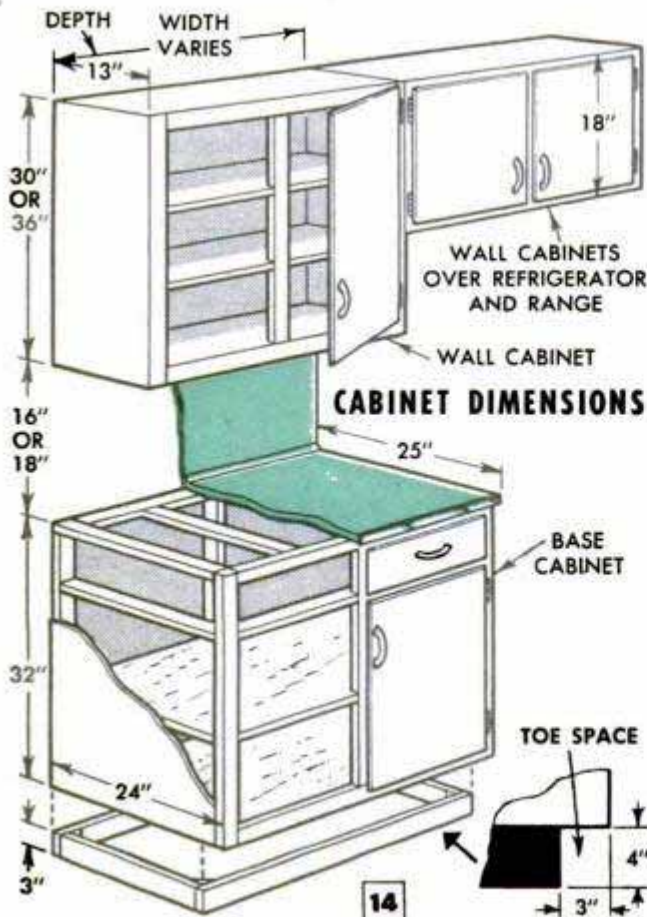

15 SIZES AVAILABLE IN READY-MADE WOOD AND STEEL CABINETS (dimensions in inches)			
TYPE CABINET	WIDTHS	HEIGHT	DEPTH
Wall	15, 18, 21 24, 27, 30 36, 42	18, 30, 36	12, 13
Base	15, 18, 21 24, 27, 30 36, 42, 48	36	24 to 24¾
Counter			25 to 27
Corner wall units	24 and 26 on each wall	30, 36	13
Corner base units	29 and 36 on each wall	36	24 to 24¾
Sink units	18, 21, 24, 30 36, 42, 48, 54 60, 66, 72, 84	36	24 to 24¾
Utility	18, 21	84	13, 18, 21, 24, 24¾

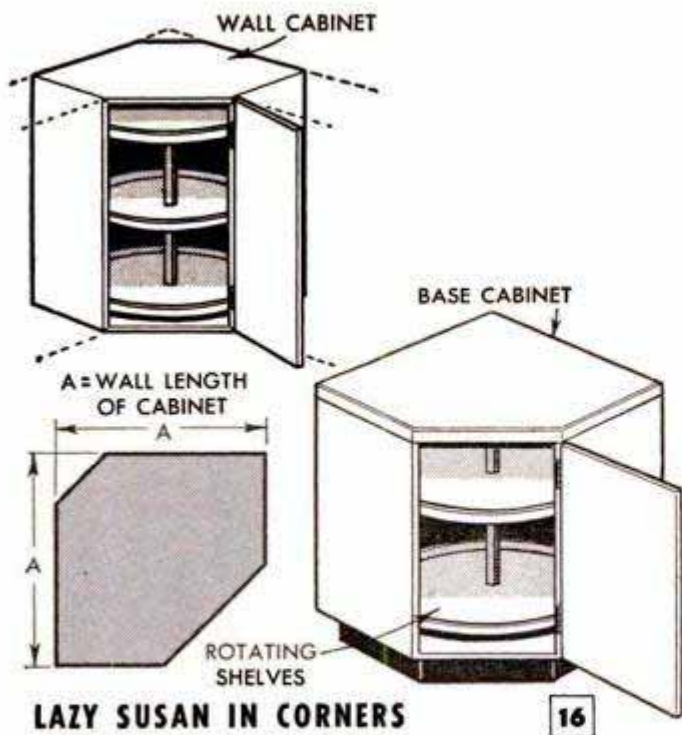

LAZY SUSAN IN CORNERS

16



17

similar to the one in the drawing in Fig. 10.

Planning center is optional: If space permits, you can have a planning center. A drop-leaf table 30 in. high and a stool or chair that slides under it are provided as in Fig. 12. An open wall shelf holds a small radio and cookbooks so that the table can be pulled out into the room and used for other purposes. A shallow drawer keeps pads, pencils and bills out of sight.

Figuring storage space: When planning a new kitchen, first determine the storage and counter space needed. This varies with the size of the house and the family (see Fig. 13). Compare your figures with the measurements of base and wall cabinets given in Figs. 14 and 15 so that you can work out cabinet and counter dimensions to suit. Ready-made wooden and steel cabinets are available in the sizes given in Fig. 15. If the kitchen is larger than needed, only part of it may be required, leaving space for a breakfast nook or snack bar as suggested in Fig. 2, plans A, B, D and F.

Corner space can be utilized to best advantage by using corner cabinets, available in both wall and base types. These have doors at a 45-deg. angle to the walls as in Fig. 18. Some types are available with rotating shelves, as in Fig. 16, which further increases their convenience. A utility cabinet for brooms, dust mops and vacuum cleaner, and a cabinet for clothes and rubbers, can be included in your kitchen plans. Also include a built-in ironing board if the kitchen is to be used for ironing.

Planning with scale models: An excellent method of crystallizing a plan is to draw the floor space of your present kitchen to scale, say $\frac{1}{2}$ in. to 1 ft., including the exact position of the sink, doors and windows

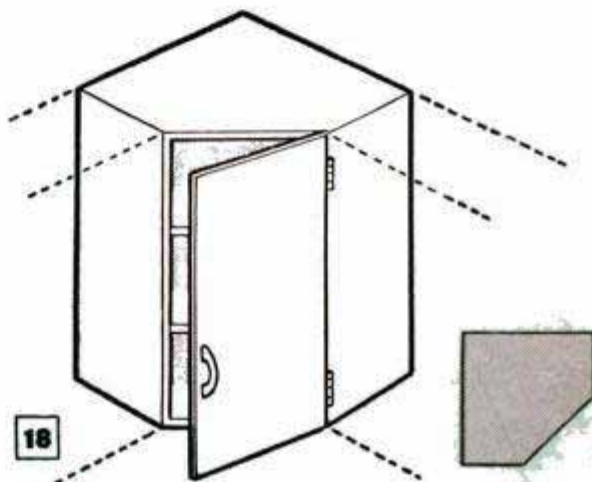

18

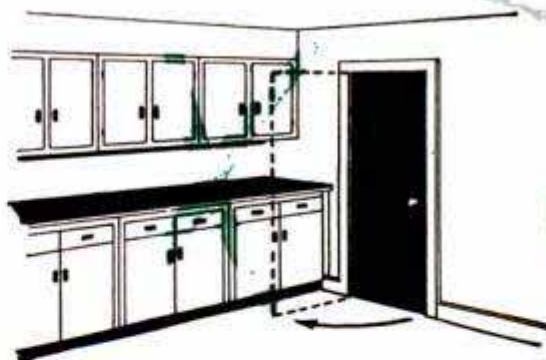

19

DOOR SWINGS AGAINST CABINET

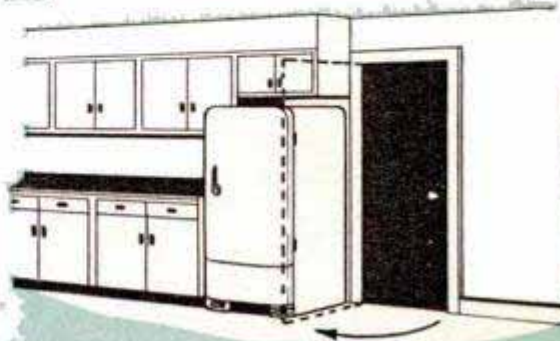

20

DOOR SWINGS AGAINST SIDE OF REFRIGERATOR

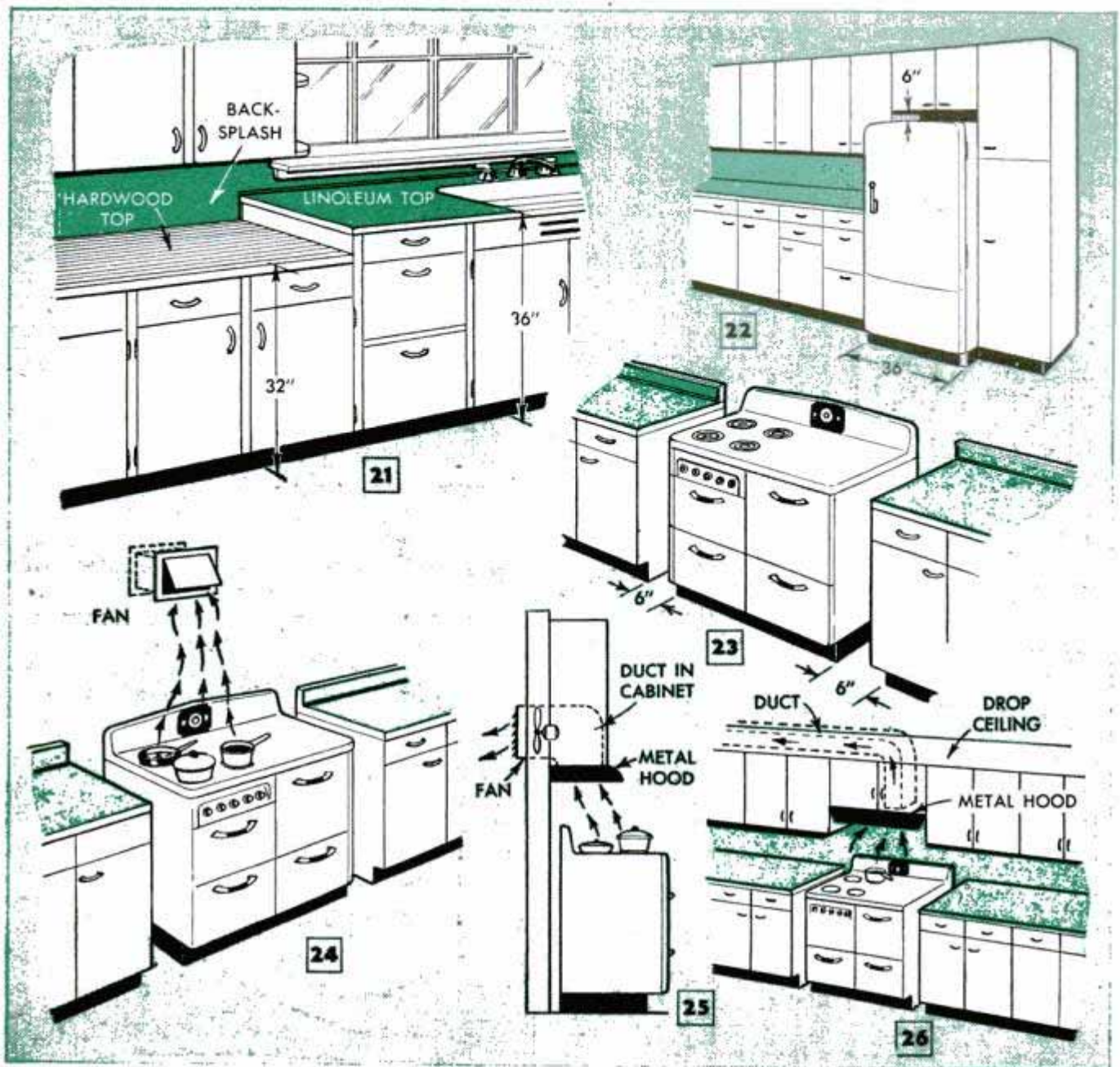

Then cut out, also to scale, cardboard strips representing the range and refrigerator, and two strips representing the total length of the wall and base cabinets required. After positioning the range and refrigerator at the right locations, cut up the cabinet strips to fit between and adjacent to them. Work clearance between counters and appliances facing each other should not be less than 4 ft.

Windows and doors: Sometimes, for best results, it may be advisable to have a carpenter change the location of a window or door—or just the direction the door swings. Windows in frame houses are easier and less expensive to change than those in brick houses. For adequate illumination, the window area of a kitchen should not be less than 20 percent of the floor area. One counter at least, preferably the preparation and cleaning counter, should be well lighted from a window. Most women prefer to have a sink at a window but this is not essential in a well-planned, efficient kitchen. Win-

dows never should be “boxed in” by wall cabinets. A much better appearance results when cabinets are spaced about 9 in. from the window edges and rounded shelves are installed as shown in Fig. 17.

Changing the position of a door entails considerable mess. A door should not swing into a work area or interfere with the use of cabinets and appliances as in Fig. 19. Nor should a door swing against an open wall which should be used for a necessary cabinet. A door may swing against the end of a cabinet or appliance as in Fig. 20. Two doors are preferred to three, especially in small kitchens. If possible, they should be located so that household traffic will not cross kitchen work areas, as indicated by the arrow in Fig. 11 and also in the floor plans A, B and F in Fig. 2.

Cabinet heights, clearances, spacing: Base cabinets should have toe space 4 in. high and 3 in. deep to facilitate working at counters without leaning. Standard height of base cabinets is 36 in. although

the food-preparation counter, or part of it, may be lower to suit the user. A 32-in. height here suits the average woman. Glued-up hardwood tops are available as shown in Fig. 21. There should be a clearance of 15 to 18 in. between counters and wall cabinets.

Wall space over sinks and counters should be protected with a backsplash, Fig. 21, not less than 4 in. high and preferably extending from the counter to the wall cabinets. When planning cabinets, a space 36 in. wide generally is allowed for a refrigerator, with a 6-in. clearance above it, Fig. 22. Most kitchen ranges are of the 36 or 39-in. size. Normally, a 42-in. space is allowed to accommodate them but if the range is set between cabinets, or a cabinet and a wall, this allowance is not enough to permit cleaning the sides of the range. A 6-in. space at each end as shown in Fig. 23 is better. A 30-in. wall cabinet may be set over an electric range with the usual 18-in. clearance. Gas ranges, however, require at least a 30-in. clearance because of their greater fire hazard. This still permits the use of 18-in. wall cabinets over them, if necessary, but none at all is preferable.

Kitchen ventilation: An exhaust fan gives a complete change of air in a few minutes to eliminate cooking odors, excess heat and humidity. Air exhausted by the fan is automatically replaced by fresh air drawn in through an open window, or air coming from other rooms. Often an exhaust fan is located over a service door. However, if the range is against an outside wall, a better place for the fan is directly above the range as in Fig. 24. Two other arrangements are shown in Figs. 25 and 26.

Lighting fixtures: It's advisable to have a center ceiling light for general illumination of 10 foot-candles. A control switch should be located at each important entrance. Sink, range and breakfast table can be illuminated from the ceiling with flush-type fixtures which are easy to keep clean. Intensity of light at these spots should be 40 foot-candles. For work areas under wall cabinets, illumination can be provided by tubular lamps, either the fluorescent or filament type. These are installed on the underside of the wall cabinets so that the lamps will be out of the line of vision. Counter lamps may be controlled individually or all by one wall switch. It's much better to have too many electrical outlets than too few, and at least two should be provided on each wall. Locate several along the counters, using multiple outlet strips. Others should be provided at the range, refrigerator, exhaust fan, radio, toaster and ironing board. A sunken outlet also may be installed for an electric clock.

(To be continued)

Handy Masking-Tape "Dispenser" Provided by Plastic Sheet



For the artist-hobbyist as well as professional artists and photographers who use a considerable amount of masking tape to mount their work, selecting tabs of tape from a sheet-plastic dispenser is both convenient and economical. Completely cover the sheet on both sides with strips of tape laid edge to edge. Then, using a T-square and stencil knife, cut the tape into tabs of the desired size. The soft plastic will not dull the stencil knife as would glass, and with the tape stored in this manner it does not lose any of its adhesive quality.

Paul H. Will, Chicago.

Disposable Liner for Paint Tray Saves Cleaning Time

When using a roller and shallow tray to apply paint to the interior walls of my house, I found that a considerable amount of time ordinarily spent in cleaning

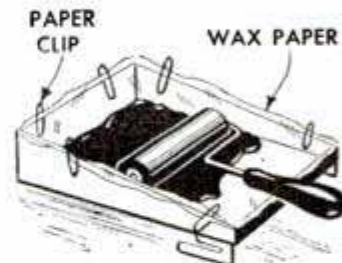

the tray could be saved by fitting the paint tray with a wax-paper or cellophane liner. The liner is cut and folded to cover the bottom and sides of the tray completely and is held in place with paper clips pressed over the edge of the tray. When the job is finished or a new color is to be applied, only a few minutes are required to remove the liner, discard it and replace it with a clean one.—Ted J. Kubit, Detroit, Mich.



FOR A SPARKLING FINISH on a toaster or other stainless-steel appliance, polish with baking soda. Sprinkle the soda on a clean, soft cloth and rub over the surface. Follow by rubbing with a second clean cloth to make the surface glisten like new



NEXT TIME YOU PRESS A PLEATED SKIRT try placing a sheet of coarse sandpaper under the pleats to hold them in place. This will save pinning the pleats together. It also results in a neater job, as there will be no indentations in the fabric caused by the pins

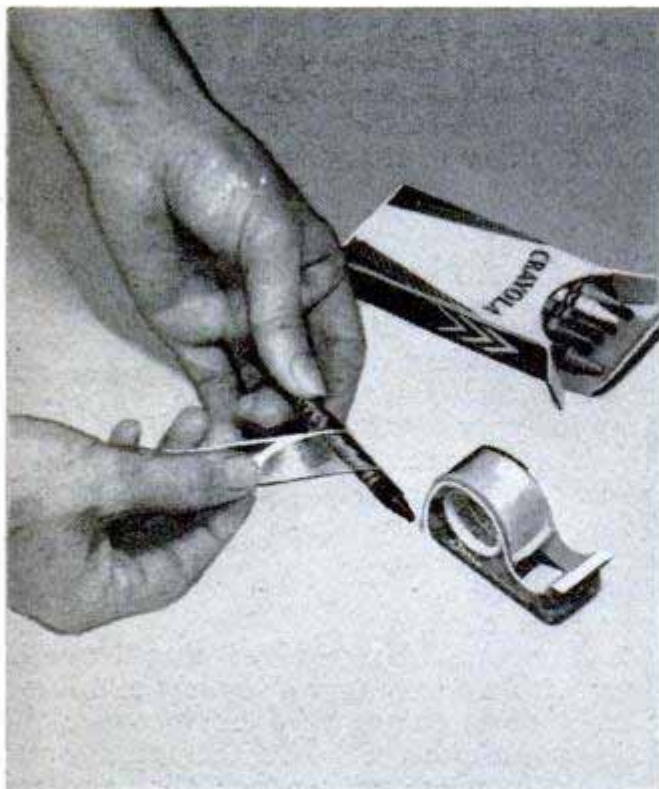

WRAPPING CRAYONS WITH CELLULOSE TAPE reinforces them to withstand the pressure when the youngsters really bear down to get the color on thick. The tape is wrapped spirally around the crayon and peeled off as necessary to expose more of the tip



DON'T MAR THE HIGH POLISH of wooden candle-holders by trying to scrape off the drippings. Instead, set the holder in the refrigerator until the wax becomes hard and brittle, after which drippings can be picked off without scratching the finish

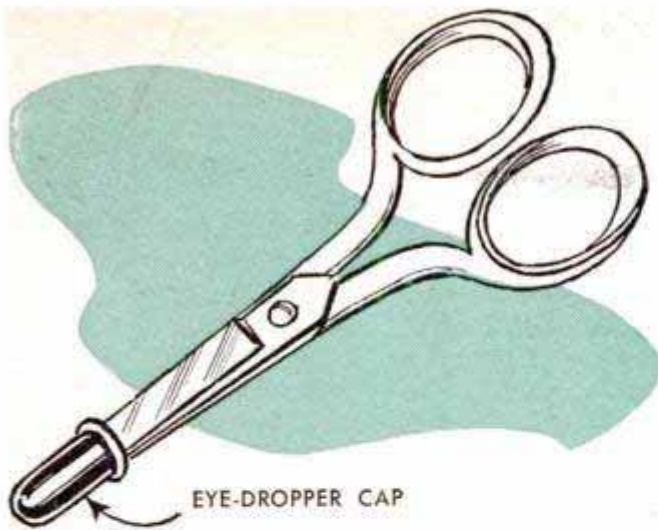

EYE-DROPPER CAP

TO SHIELD SHARP POINTS OF SCISSORS which are carried in a handbag or knitting bag, press an eye-dropper cap over the points. This will hold the blades of the scissors closed as well as prevent the points from tearing fabric or injuring fingers

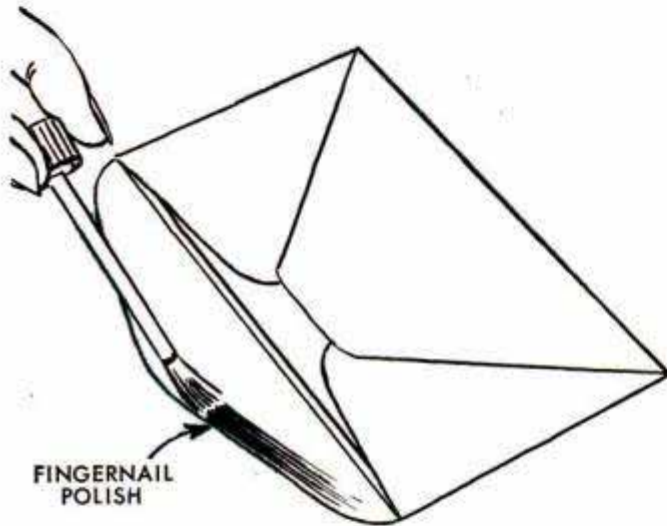

FINGERNAIL POLISH

ENVELOPE FLAPS THAT WON'T STICK are particularly irritating if the envelope has already been addressed and stamped. When this happens, you can seal the envelope by applying a thin coat of fingernail polish over the mucilage and pressing the flap closed

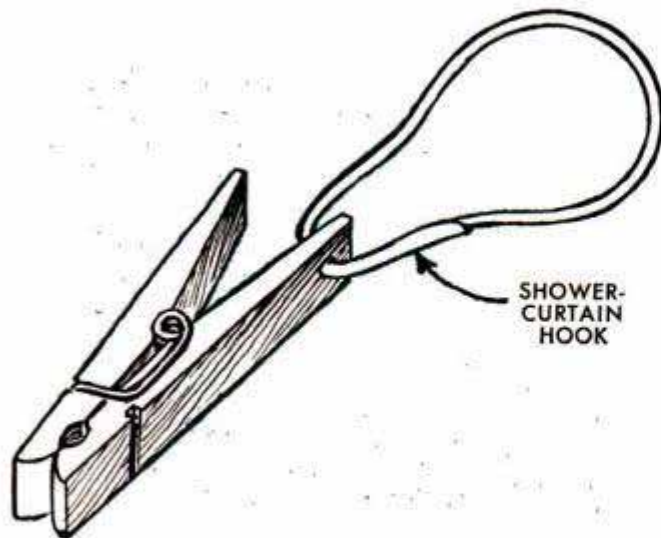

SHOWER-CURTAIN HOOK

NIGHTLY WASHINGS OF HOSE AND UNDERTHINGS will not clutter up the bathroom if they are dried by hanging from a towel rack or shower-curtain rod. Use spring-type clothespins suspended from shower-curtain hooks, drilling the pins to slip over the hooks

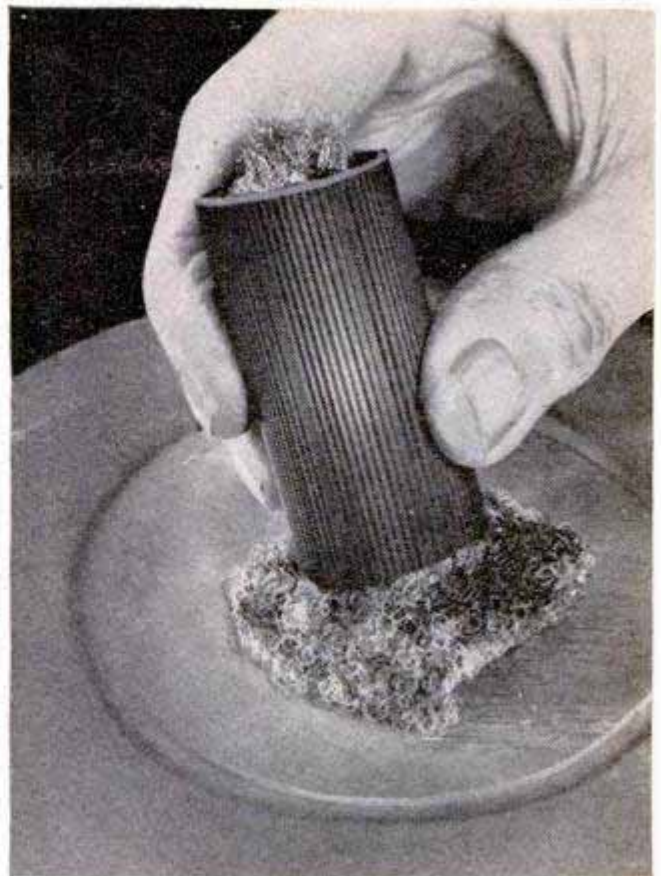

STEEL WOOL IS EXCELLENT FOR SCOURING pots and pans except that it is hard on the fingers. To protect the hands when using steel wool, stuff a wad of the wool into a short section of garden hose and feed the wool through from the top as required

A VACUUM-BOTTLE CORK SOMETIMES WORKS LOOSE because of pressure within the bottle. An easy way to avoid this is to fit the cork with a compression spring which presses against the cover. Turn the end of the spring into the top of the cork like a corkscrew



Horseshoe at Top of Hitching Post Permits Securing Reins Quickly



Nailing a horseshoe to a heavy post, so that it forms an eye at the top end, provides a hitching post to which the reins can be secured in a jiffy. There's no need to tie and untie the reins. Instead, just pass the reins through the opening formed by the horseshoe and then bring the end back, dropping it over the edges of the horseshoe as pictured in the drawing. To release the reins, just lift the loop from around the horseshoe and pull the reins loose.

G. E. Hendrickson, Argyle, Wis.

There's a Trick to Drying Windows

When drying windows after washing, it is a good idea to dry the outside of each pane with vertical strokes and the inside with horizontal strokes or vice versa. Then, you can tell at a glance whether any remaining streaks are on the inside or outside of the windowpane.

Mrs. Mathilda Zweiberth, St. Louis, Mo.

Ignition Trouble Caused by Oil Vapor in Distributor

A worn distributor shaft will permit a small quantity of crankcase vapor to pass into the distributor where it will cause arcing and rapid burning of the points. Any time that ignition trouble is suspected and examination of the parts fails to turn up any of the more common causes, look for a black, sooty deposit on the breaker plate just below the points as indicated by the pencil point in the photo. The next thing is to make sure that the breather cap on the oil-filler tube is not clogged or damaged in any way that would restrict passage of air. If the breather cap is clear and in good condition, then the trouble probably is due to a badly worn distributor shaft. The only permanent repair is replacement of the defective shaft or worn bushings.

Ed Packer, Chicago.

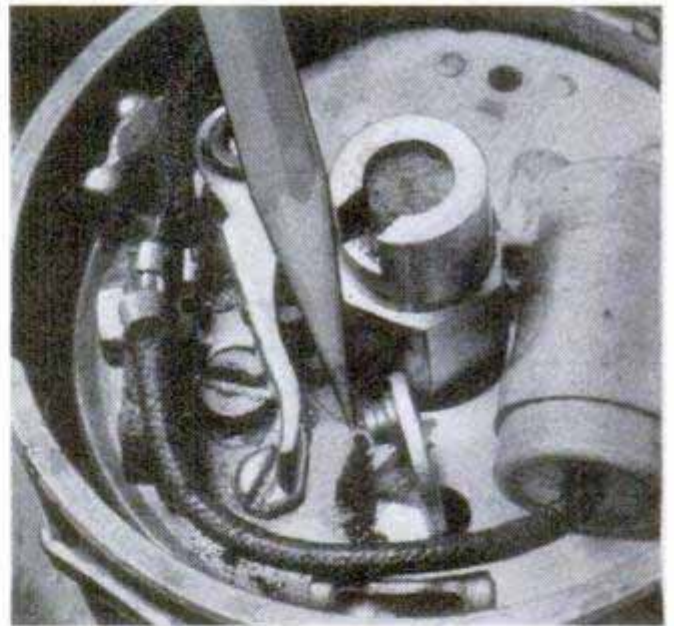

Candy Turtle Party Favors Utilize Walnut Shells

For something unusual in the way of favors for a children's party, make these candy turtles from gumdrops, raisins and

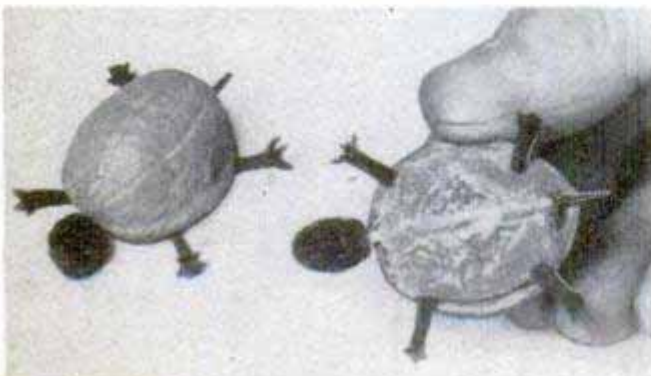

walnut shells. Press a gumdrop into half of a walnut shell and then stick a toothpick through the exposed portion of the gumdrop along the length of the shell. Allow the point of the toothpick to project slightly so it looks like a tail and impale a raisin on the blunt end of the toothpick to serve as a head. Then press four cloves into the gumdrop to simulate the feet. A number of the turtles can be made up in just a few minutes.—William Swallow, Brooklyn, N. Y.

☞ Marigold bouquets can be deodorized by dissolving a teaspoonful of sugar in the water before arranging in the vase.

FOR MAGAZINES

By Benj. Nielsen

IF UNUSUAL APPEARANCE in magazine racks appeals to you and you like a project that tests your craftsmanship, tackle this two-section walnut rack with its distinctive loop facing. Each sidepiece is made in three parts which are grooved with a special cutter shaped from flat steel as in the lower right-hand detail. The ends of a piece of $\frac{1}{4}$ -in. steel, $1\frac{3}{4}$ in. wide, are twisted at right angles to the shank and then ground to form a center point with a radius on each side. The center of the shank is drilled for mounting on the circular-saw arbor and the tool is held by hand for facing the center disk of each sidepiece in the lathe. After the disk has been grooved, a section is carefully cut out for the second grooved part, while the third part is cut to suit the radius of the disk. The three parts are assembled with dowels and glue. Turned feet are doweled and glued to a bottom board, and the sidepieces and a centerpiece are attached with screws and glue.

Below, note long $\frac{1}{4}$ -in. dowel used to join horizontal section to cutout portion of center disk

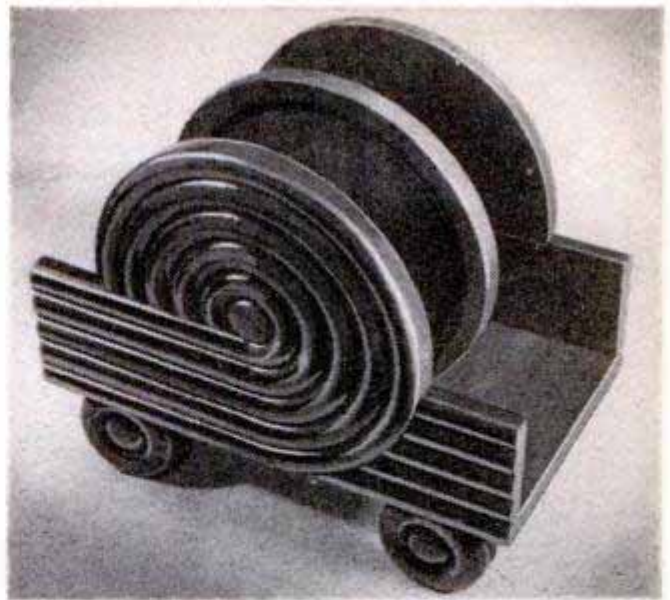

Parts are coated with shellac and, after assembly, are rubbed down and given a coat or two of varnish

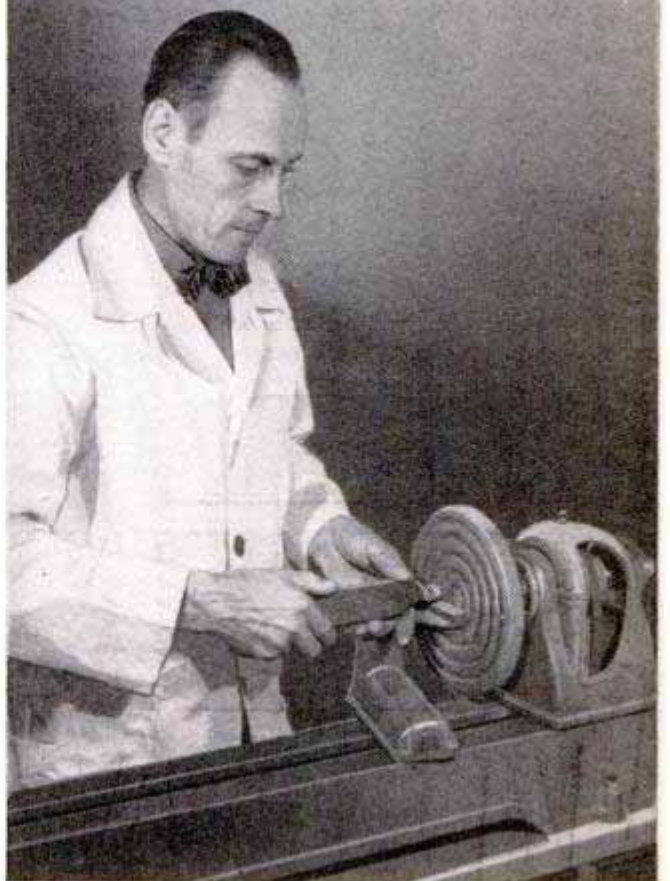
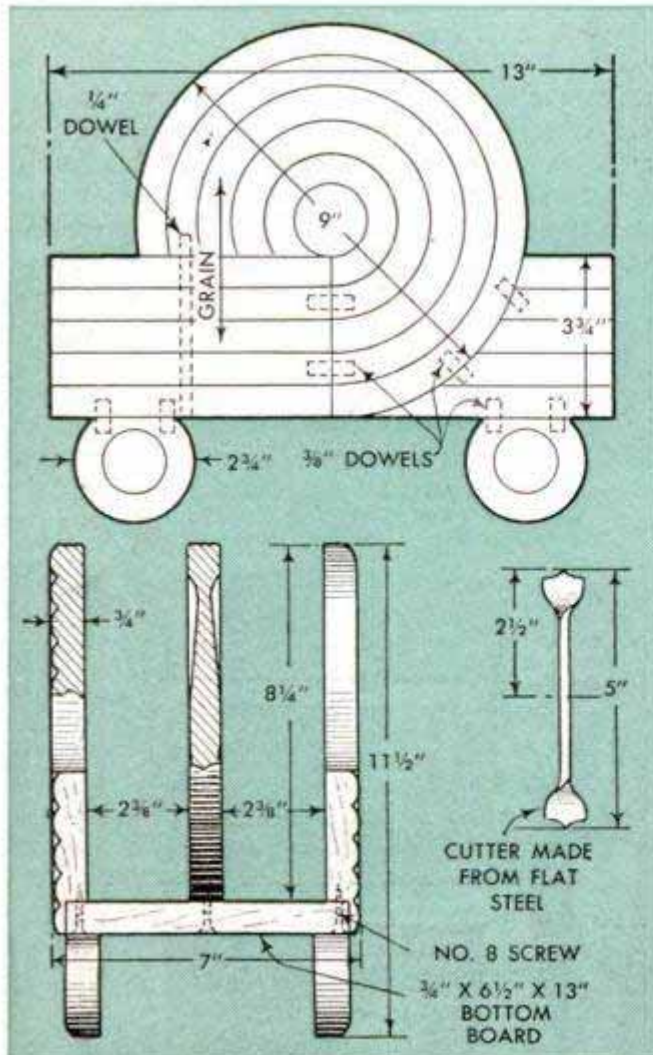
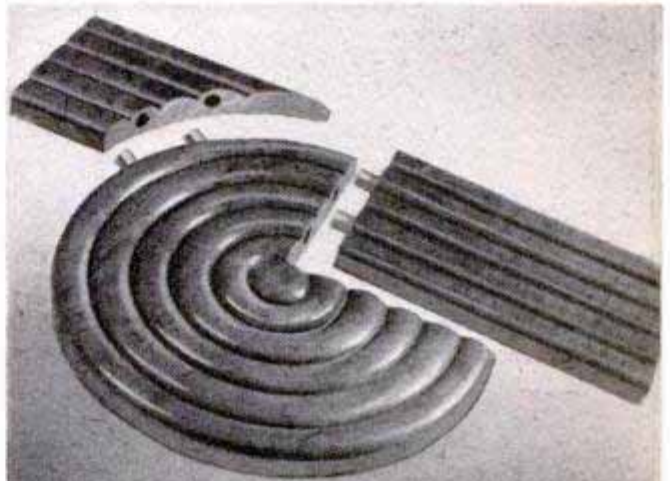

RESEATING AN

That fine old chair relegated to the attic for want of a seat can be brought back into the good graces of your home by weaving a new seat of genuine rush

By L. M. A. Roy

RUSH SEATS, characteristic of ladder-back, Hitchcock and other fine old period chairs, are not difficult to weave, and if you have stored away a cherished piece, planning to have it resealed, bring it out of retirement and do the job yourself. A ruler, shears and a hardwood hook are all the tools you'll need.

The average-size chair seat takes about 1½ lbs. of cattail rush, which can be purchased from a dealer in chair-seating materials, or you can gather and dry the rushes yourself. These are cut around the middle of August or early September, at which time they are fully grown

and have passed the green and tender stage. It is important to cut them before they become hard and woody. When cut, separate the leaves and spread them out to dry. Drying requires about a week and it is important to have the rushes thoroughly dry as mildew may occur and make them unfit for use. Next, place the rushes in water and let them soak overnight to make the leaves soft and pliable. Then, before using, run the rushes through an ordinary clothes wringer to remove the excess water and air. During this process the leaves will make a crackling sound, indicating they are just right for twisting.

The beginning step in weaving is perhaps the most important one of the whole job and the steps illustrated in the diagrams should be studied beforehand to acquaint you with the weaving pattern. As most

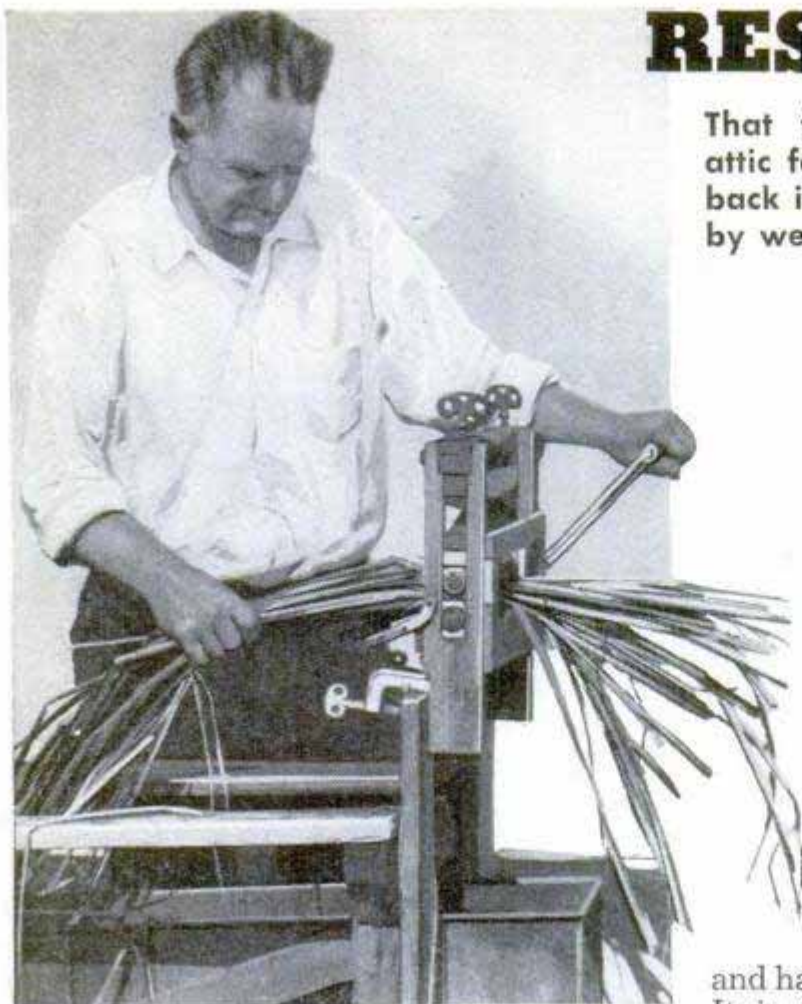

Virgin rush is made soft and pliable by soaking in water overnight and then wringing out before using

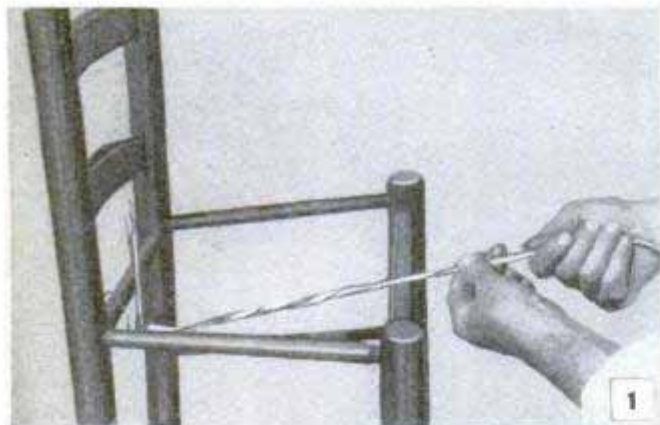

Starting strand is twisted and brought forward to the front rung where it is wrapped as shown below

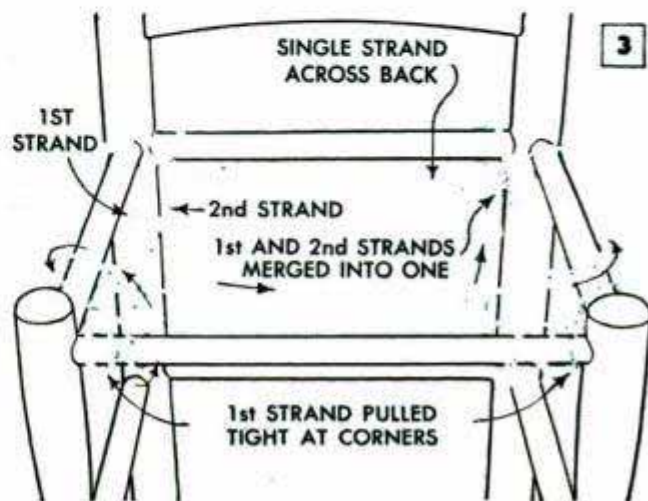
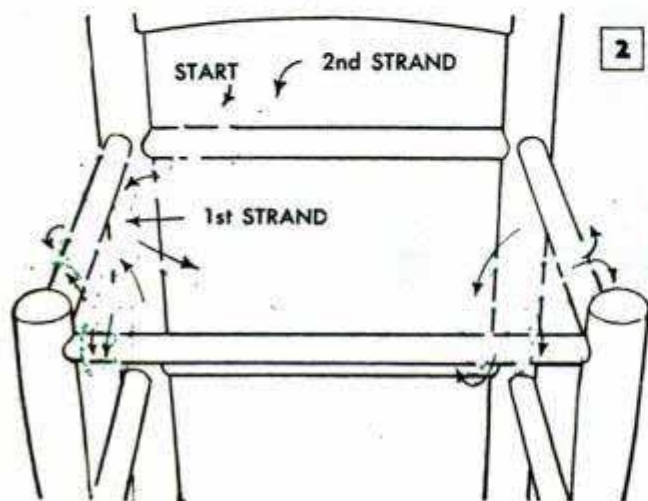

ANTIQUE CHAIR

chair seats are wider at the front than at the back, the weaving is started in the following manner: With the chair facing you, select two rushes, one tip and one butt length. The tip is the top growth and the butt is the stalk of the rush. Twist the middle section of the two strands and loop them over the back rung of the seat frame, temporarily fastening one half of the length to the chair back. Fig. 1 shows half of the strand being twisted and brought forward. This method is used to permit twisting the rush tightly. When necessary to splice in a new rush to the strands being worked, insert it between the others, using either the tip or butt to keep the strand of uniform diameter. Hitchcock chairs are generally reseatd with fine strands about $\frac{1}{8}$ in. in diameter, others with $\frac{3}{16}$ -in. strands. The working end of the strand is kept twisted tightly and brought over the front rung at

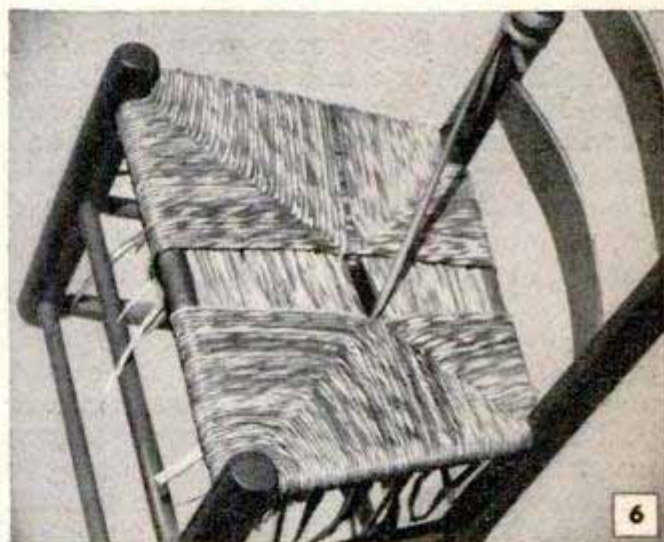
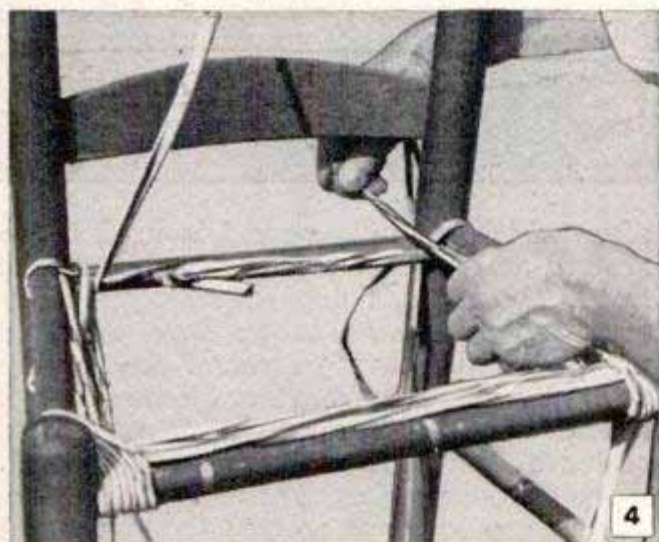
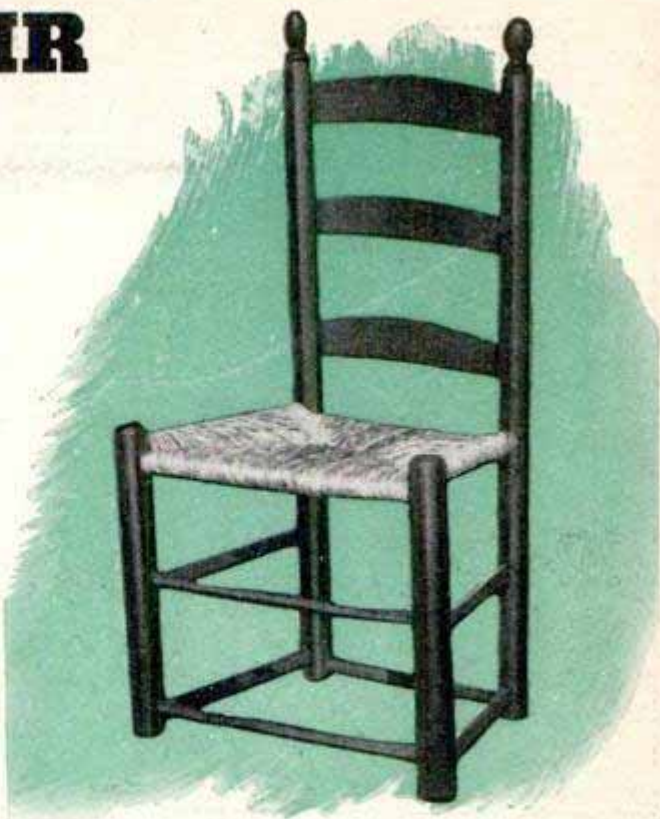

Above, the seat is built up "square" by adding to the sides and front twice as fast as the back. Below, when the distances along the back and front rungs are equal, a single strand is used to fill in the center

Above, here the side areas are nearly filled and when this point is reached, the rest of the seat is completed by weaving from front to back. Below, this view shows front and back areas almost completed

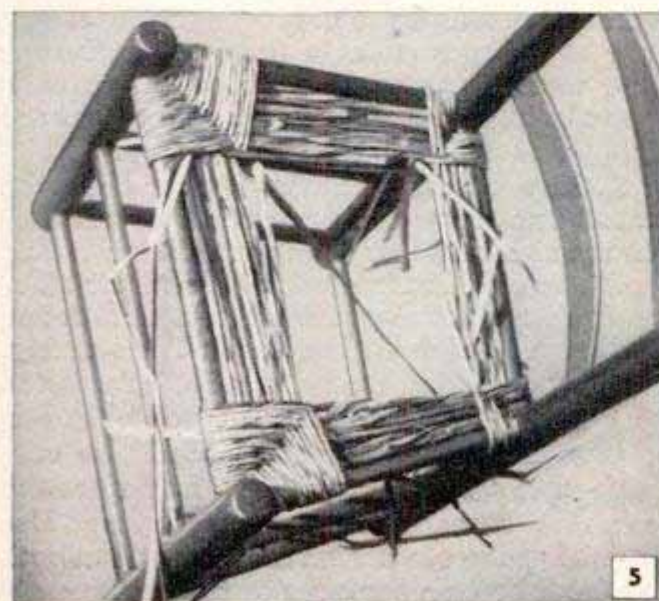

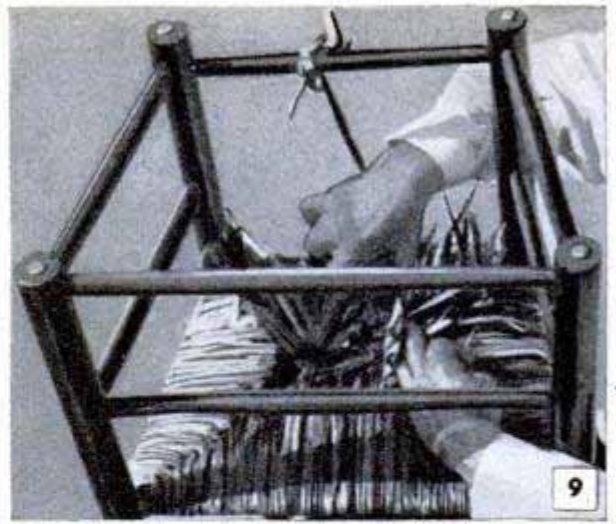

Above, after the weaving is completed, protruding strands on the bottom are snipped off close and the seat is varnished top and bottom

Left, when the side rungs are higher than the front one, rush is stuffed between the layers of the weave with a chisel-like wooden tool

the left post, then down around and up through the frame and over the left side rung. Repeat the same wrapping step twice as indicated by the arrows in Fig. 2 and then continue the twisted strand across to the opposite side rung. Here it is wrapped around the rung, up through the frame, around the front rung twice, as before, and finally strung to the rear post where it is tied. Now, going back to the starting point, proceed with the other half of the strand and weave it around the left rear corner post as in Fig. 3 and then follow the same procedure as before, ending where you left off with the first half of the twisted strands. At this point the two halves are merged and continued as one strand, passing it over and around the rear rung, up through the frame, around the side rung and then back across to the starting point at the rear, left-hand post. In bringing the strand forward again, it is first divided into two halves as before and then one is brought to the front and wrapped around the rungs at the corner exactly as was done with the starting strand, except that the second and subsequent strands are wrapped around the rungs only once. At the right rear post, the strands are merged into one strand, Fig. 4, which is passed around the rungs and brought across the back to the starting point. Thus, each complete time around you add one strand across the back, two along the sides and two across the front. The reason for this is to build out the slanting sides of the seat twice as fast at the front rung as at the back. This step is repeated until the center opening in the seat takes on a square shape, Fig. 5,

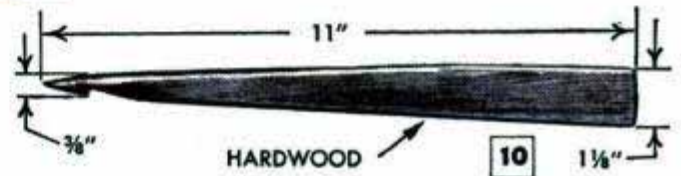

after which a single strand is used to go around and around the opening until it is filled. The sides, being shorter, generally close up first and when this point is reached, the weaving strands are merely run back and forth from front to back rungs in the form of a figure eight, passing them under at the center opening in the seat. Keep the strands pushed closely together as they are wrapped around the rungs and keep the top strands under slight tension and twisted tightly. As the center opening in the seat gradually closes up, Fig. 6, a wooden hook, such as the one shown in Fig. 10, will be found helpful in pulling the strands through the narrow opening. Fig. 7 shows the seat nearly finished, and after the weaving is completed, the loose ends protruding from the bottom of the seat are snipped off close as in Fig. 9.

Chairs with side rungs higher than the front rungs should have stuffing inserted in the side and front sections. This is added from the top surface when filling the sides and from underneath in stuffing the front. The rear section is not stuffed. The stuffing, which consists of scraps of rush, is forced in place with a flat wooden-shaped chisel as shown in Fig. 8. The seat should be varnished as soon as completed and before the rush has a chance to loosen in drying. Use a good grade of varnish and apply it to both top and bottom surfaces of the seat.

Bag Hung From Circular Frame Easily Filled With Leaves

There's nothing to filling a gunny sack with yard rakings if the bag is held open by means of this circular rack. The top of the sack is impaled on six hooks evenly spaced around the rack and, when filled, the sack is simply unhooked from the rack and carried away. Drapery hooks or short pieces of pointed rod are welded or brazed to the top ring of the rack to form the hooks. Three splayed legs, consisting of 3-ft. lengths of rod welded to the ring, hold the rack steady while the sack is being filled. The ring is a 16 or 17-in.-dia. circle bent from flat iron, rod or conduit. The unit is lightweight so that it is easy to set up wherever needed in the yard.

H. E. Chapman, Tulsa, Okla.

Faucet Handle Provides Key Rack

Key rings and chains are always at hand if they are kept on this novel key rack improvised from an old faucet handle. To make the key rack, press a short length of hardwood dowel into the handle and fasten with a setscrew. If the handle is not fitted with a setscrew, simply drive a slightly oversize dowel into the hole. Then fasten the other end of the dowel to the

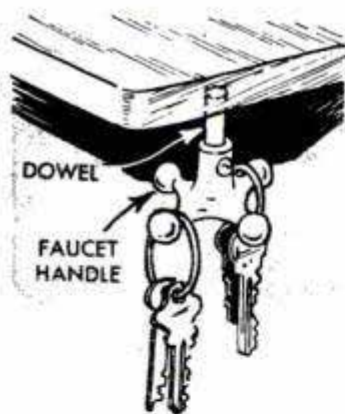

underside of a convenient shelf by using a wood screw driven through the shelf from above or by pressing the dowel in a hole drilled in the underside of the shelf and gluing it in place.—Frank Shore, New York City.

Gun Used to Ignite Campfire

When you start to build that all-important campfire and find that the supply of matches has been depleted, you can use a shotgun or rifle to start the fire. Remove the shot or bullet from the cartridge, tap out a little of the powder and rub it into a small piece of cloth which has been torn from a handkerchief or shirttail. Then wad the cloth, insert it in the shell and place the shell in the chamber of the gun. Gather a pile of dry grass or leaves and some small dry splinters. Step back a few feet and fire the gun into the pile of grass. The shot will ignite the powder in the cloth and will require only a little blowing and fanning to start a small blaze that is sufficient to ignite the dry splinters.

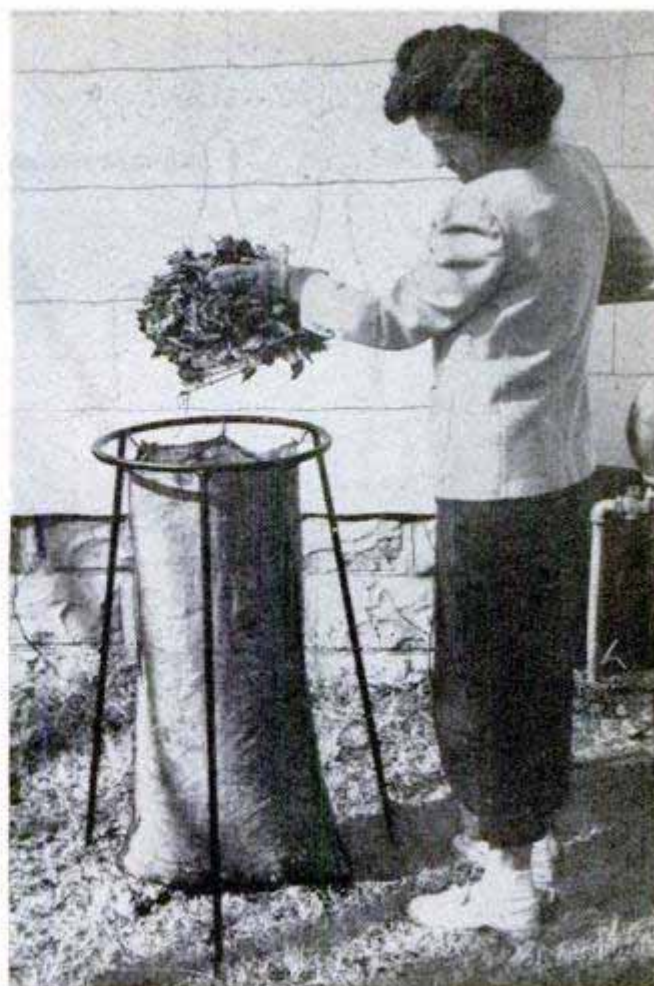

Insert for Pedestal-Type Ash Tray Facilitates Disposal of Waste

Food and other waste matter which ordinarily makes a pedestal-type ash tray difficult to clean is disposed of easily if it is caught by an ordinary tin can set below the removable top of the tray. Two aligning holes are punched in opposite sides of the can near the open end, and stove bolts fastened in the holes support the can on the top edge of the pedestal. If desired, a length of rod passed through the holes may be used instead of the bolts. The rod, of course, must be slightly longer than the diameter of the tin can and threaded at both ends so that nuts may be used to lock it in place. The funnel-shaped top of the ash tray will guide all the waste into the can, and the latter may be removed quickly for a thorough washing.

T. C. Jensen, Galesville, Wis.

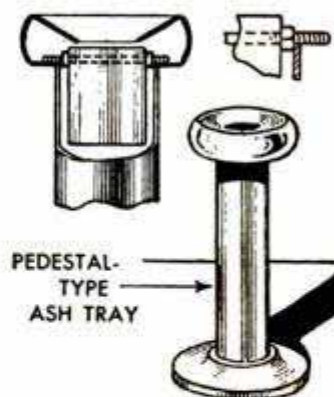

Porcelain enameled coffee pots can be kept fresh by boiling them once a week in a solution of baking soda and water.

Beverage Stand

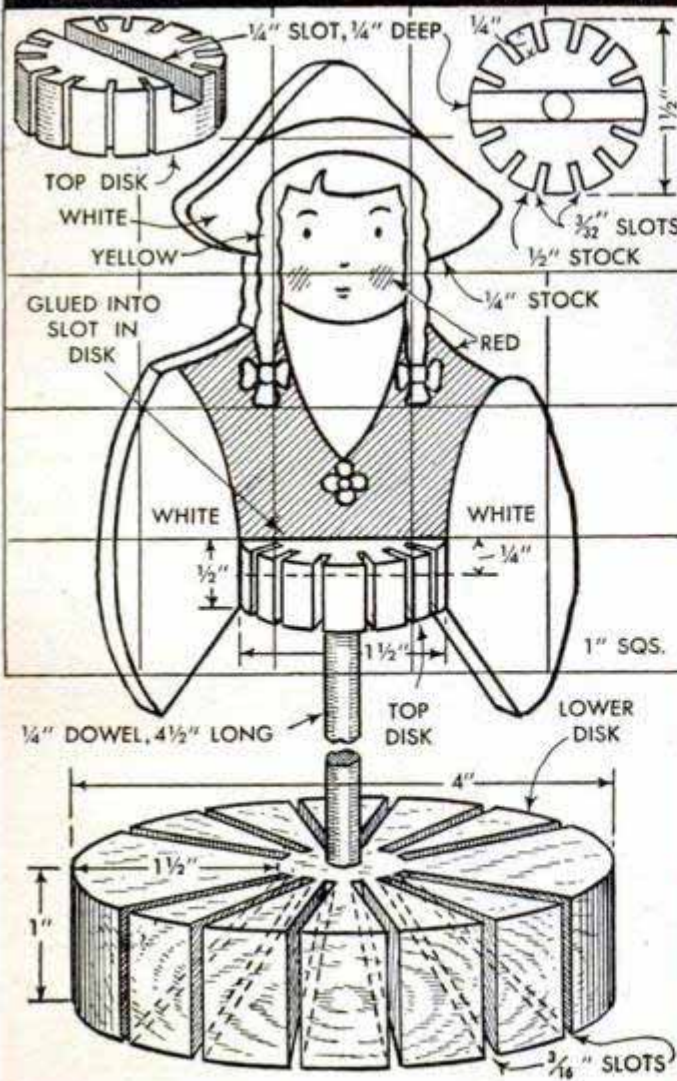
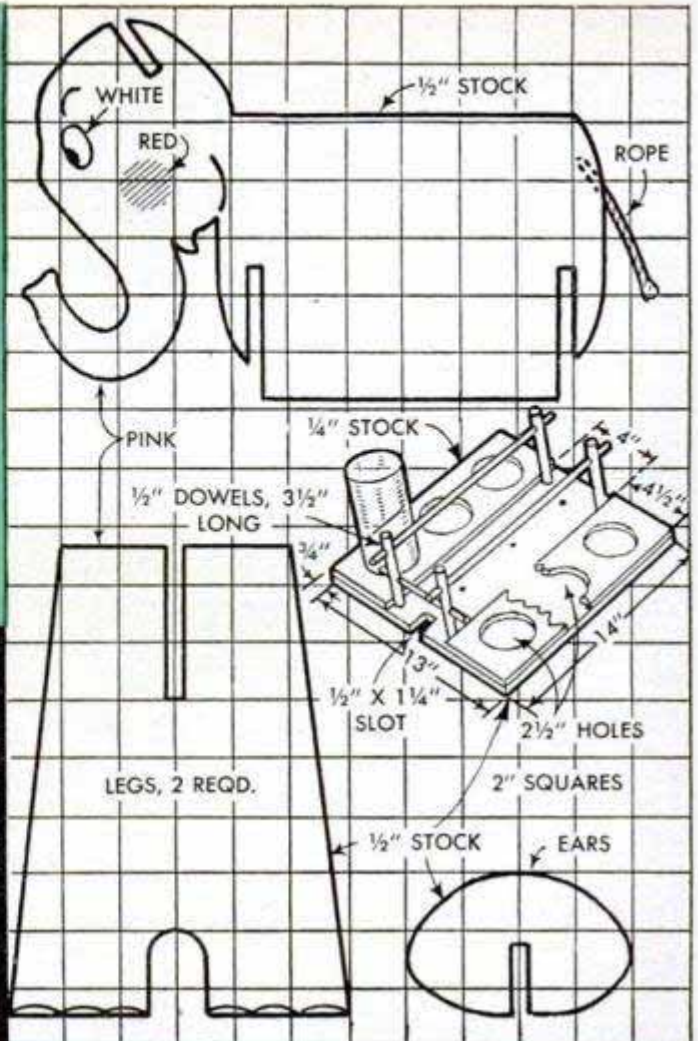
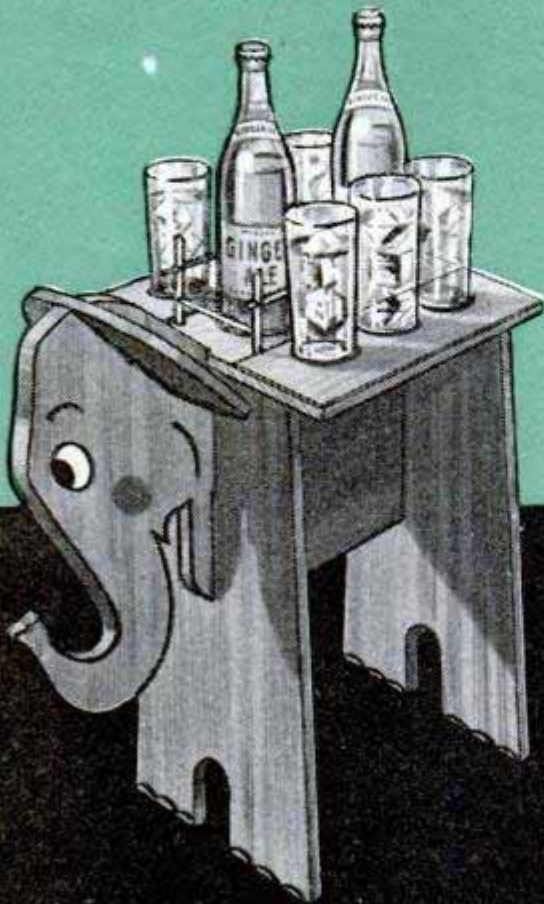

Napkin Holder



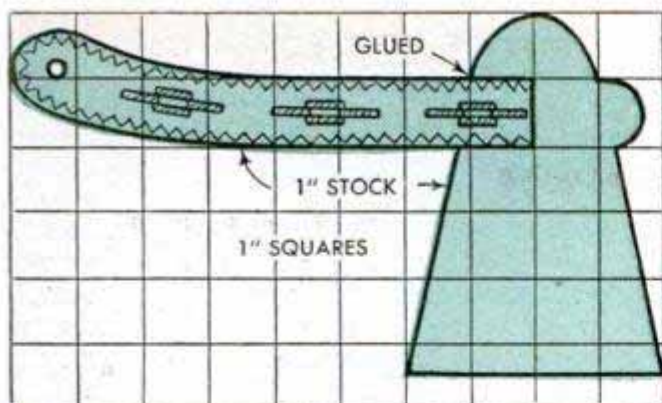

Tomahawk for Crushing Ice Cubes

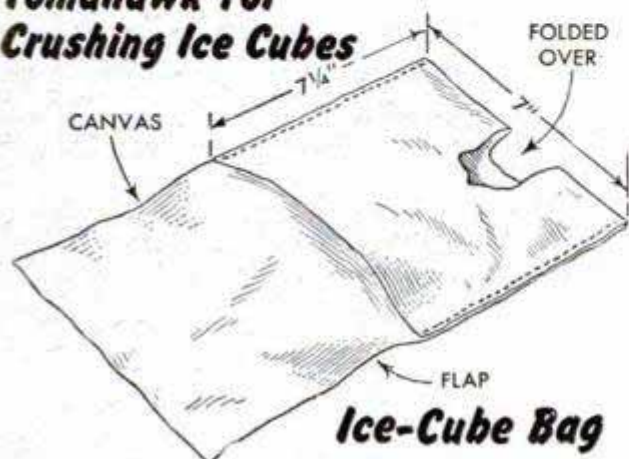

REFRESHMENT NOVELTIES

By Roberta L. Fairall

ADD A TOUCH of easy informality to your entertaining by providing these colorful accessories to aid in serving the refreshments. With a jigsaw or small bandsaw you can complete any one of them in an evening and have them ready for decorating in gay, informal colors.

Tomahawk for crushing ice: This novel one-piece accessory is suitable for use either in the kitchen or rumpus-room. Outline it on a piece of hardwood, such as maple, and bandsaw the stock to the pattern lines. Drill a small hole near the end of the handle for hanging on a hook. Then enamel in bright red and paint an Indian design on the handle in black. Make a chopping bag of heavy canvas, with a full-length flap, for holding the ice cubes. The over-all size given is about right for holding a half-dozen cubes.

Beverage Stand: This unusual stand will get a big hand at any informal party. When assembled, the pygmy elephant stands chair-seat height and holds bottled refreshments and six tall tumblers on his back. The body, legs and ears are bandsawed from 1/2-in. plywood and the parts are notched as shown in the pattern details so that they fit together snugly without the

use of nails, screws or glue. Sand the exposed edges and round them slightly. Then apply an undercoater and two coats of pink enamel. When the enamel is thoroughly dry, paint the eyes in black and white, add the red spots and the eyebrow and profile lines in black, and also outline the toes in black. The back of the elephant, which is a tray, is made from 1/2-in. plywood, notched on one edge as indicated and fitted with a bottle rack made from 1/4 and 1/2-in. dowels. Recesses for the tumblers are made by cutting round holes in two pieces of thin stock and then gluing these to the base on each side of the bottle rack. Finish to match the other parts.

Napkin holder: One-dozen paper napkins folded into narrow triangles form the skirt of the doll figure, which is bandsawed or jigsawed from 1/4-in. plywood to the shape and dimensions given in the squared detail. Two slotted wooden disks form the holder. The upper one is grooved to fit snugly onto the lower edge of the figure. Both disks are slotted by running spaced saw cuts in from the edge and each disk is center-drilled for a 1/4-in. dowel. All parts are assembled with glue. Enamel the figure with the colors suggested in the detail.

Rock-Wool Insulating Batts Cut Quickly by Using Dull Handsaw



When insulating his house with rock-wool batts, one man found that they could be cut to size easily by using a dull handsaw to work through the fibers. To hold the batts for cutting, he nailed two boards to wooden cleats so that the boards were spaced about an inch apart, and then he supported the boards on sawhorses as shown in the illustration.

Vacuum Bottles Soldered Together Permit Variety in Hot Lunch

Vacuum bottles soldered end to end provide one worker with two hot food preparations to go with his sandwiches at lunch

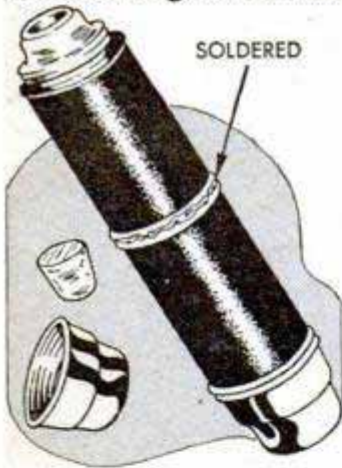

time. Using two small bottles of the pint or $\frac{1}{2}$ -pint size, solder their metal bottoms together and file the joint smooth. Finally, paint the joint with enamel to match the finish of the bottles. — Arthur Trauffer, Council Bluffs, Iowa.

Built-Up Corner Posts for Cabin Eliminate Notching Logs

To save notching logs when building cabin walls, one carpenter uses a boxing of vertical boards to support the corners. Two boards are nailed together at right angles and guide strips are nailed along the inside corner. The logs are simply set against the boards and guide strips and spikes are driven through the boards into the ends of the logs. Boards nailed over the corners complete the boxing.

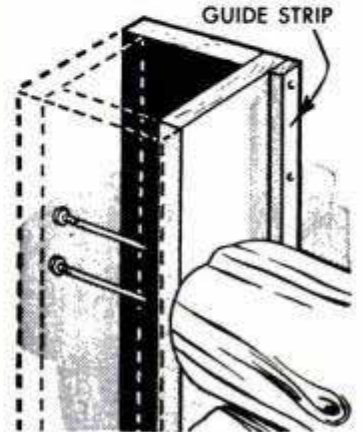

Albert H. Blackmon, Neeses, S. C.

Birds Kept From Eating Grass Seed

If you sow your lawn only to have the birds eat the grass seed, color the seed with bluing before spreading it. Soak the seeds in a solution of bluing and water until they are well colored, and then scatter the seed. The birds will not eat the seed and the coloring does not affect the fertility.

Bar Clamped to Sheet Metal Serves as Depth Stop

Craft projects in sheet metal sometimes require that a series of cuts having an identical depth be made along the edge of the work. This can be done quickly by using a metal bar to serve as a depth stop for the tin snips. The bar, which should be as long or longer than the work, is clamped to the sheet metal. Locate the bar parallel with the edge to be cut and fasten it in place with C-clamps. Then open the jaws of the snips as wide as possible, press them against the edge of the sheet and cut the metal. The upper jaw of the snips will strike the metal bar and be prevented from cutting any deeper. If the same procedure is used with all the cuts, their depth will be identical. The distance of the bar from the edge of the sheet will determine the depth of the

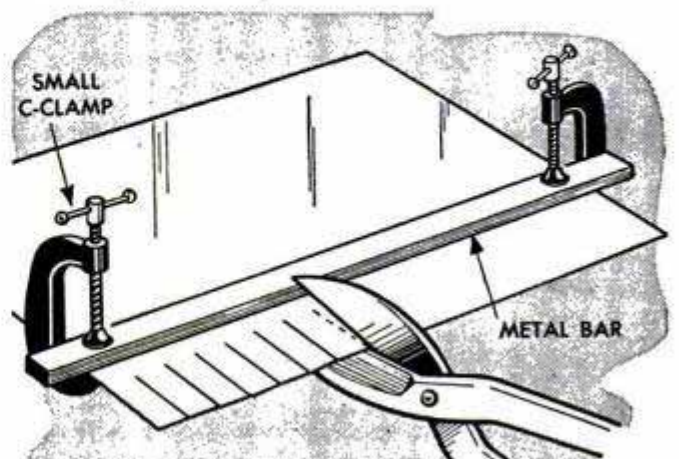

cut. However, the distance must not be greater than the length of the snip jaws.

Herbert E. Fey, New Braunfels, Tex.

CUT SCALE LUMBER on your circular saw

IF YOUR HOBBY is modeling homes and you have the problem of getting the scale lumber needed, why not make it yourself? By using regular power tools, it's possible to produce exact scale lumber on a production basis. In fact, this type of production offers an ideal means of making your workshop pay. By contacting other home modelers you may be able to work up scale lumber and parts to their specifications. Framing lumber, siding, certain types of millwork and complete roof panels can be made on a circular saw. It's easy to make framing lumber almost any size, Figs. 2 and 3, but siding and roof panels take more time. First, determine the sectional scale size of the material and check the width of the saw cut. Then, lay out the end of the stock from which the scale sizes are to be cut, Fig. 3, marking parallel lines to indicate the width of each cut. Make the ripping cuts as in Figs. 1 and 3, noting that the first series of cuts does not go clear through the stock. Turn the piece to the adjacent working face and run the second series of cuts. Here the blade is set to cut clear through as in Fig. 3. In this second series each pass of the stock over the blade produces four to six pieces of the same sectional size. Using this method, it's possible to produce a number of scale-size 2 x 4s, 2 x 6s or 2 x 10s from a single piece of stock.

Large models will require scale-sized



1

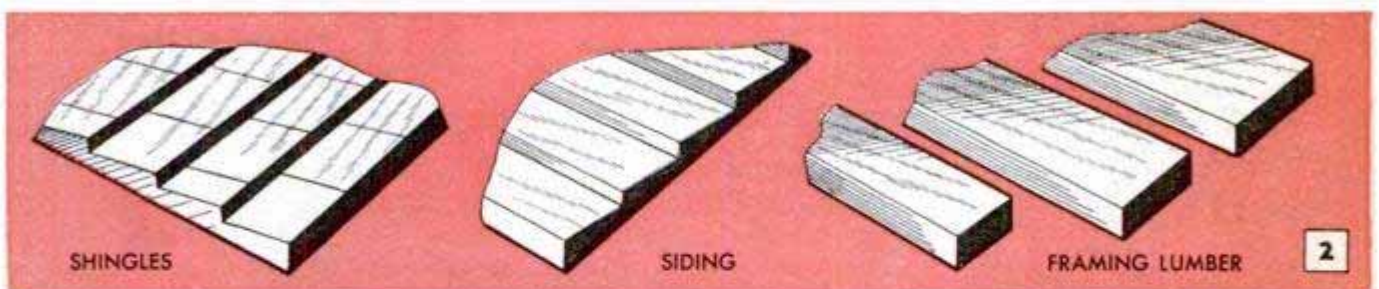

2

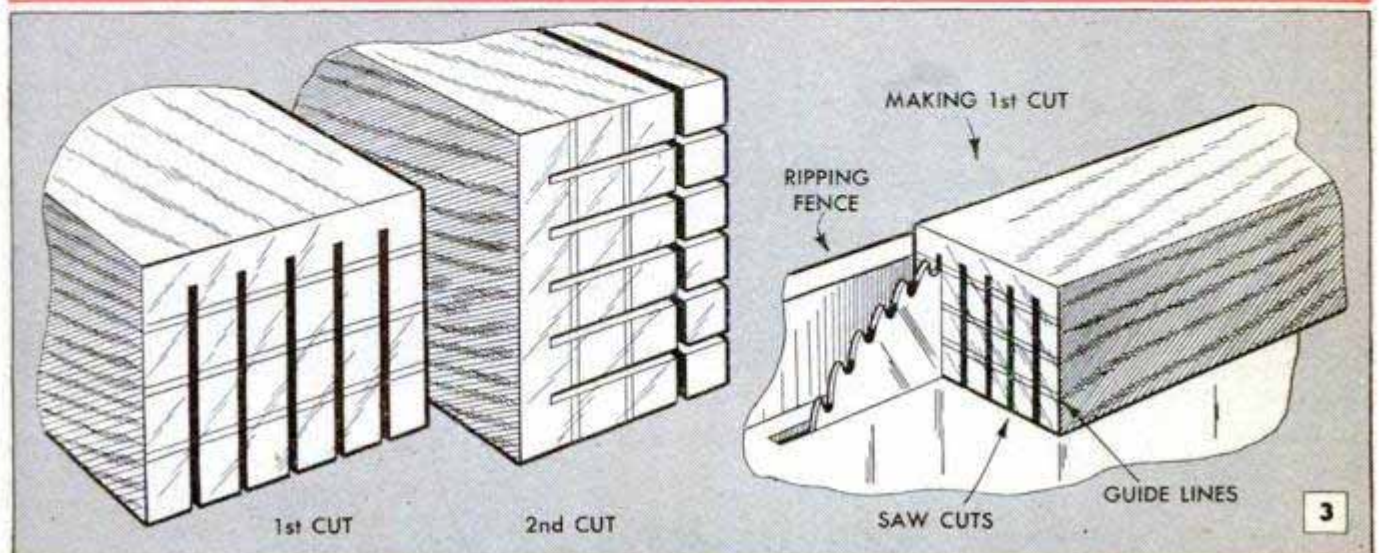

3

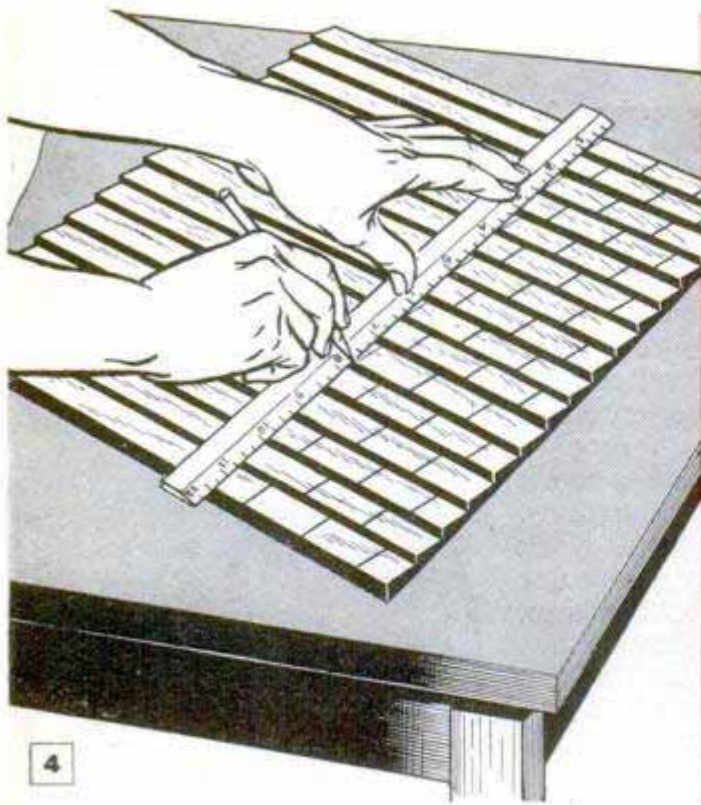

drop siding in individual boards. These can be made as in Fig. 5, details A and B. Tilt the saw table, or the arbor, to about 5 deg., adjust the ripping fence and make the first cut as at A. Then turn the piece end for end lengthwise without turning it over sideways. Again adjust the ripping fence for a beveled board of the proper thickness at the top edge and run the second cut as in detail B. This cut gives you the first beveled board. By simply repeating the process any number of boards can be produced to a uniform size. Simulated siding and roofing shingles are produced easily on panels, either of plywood or of solid stock glued

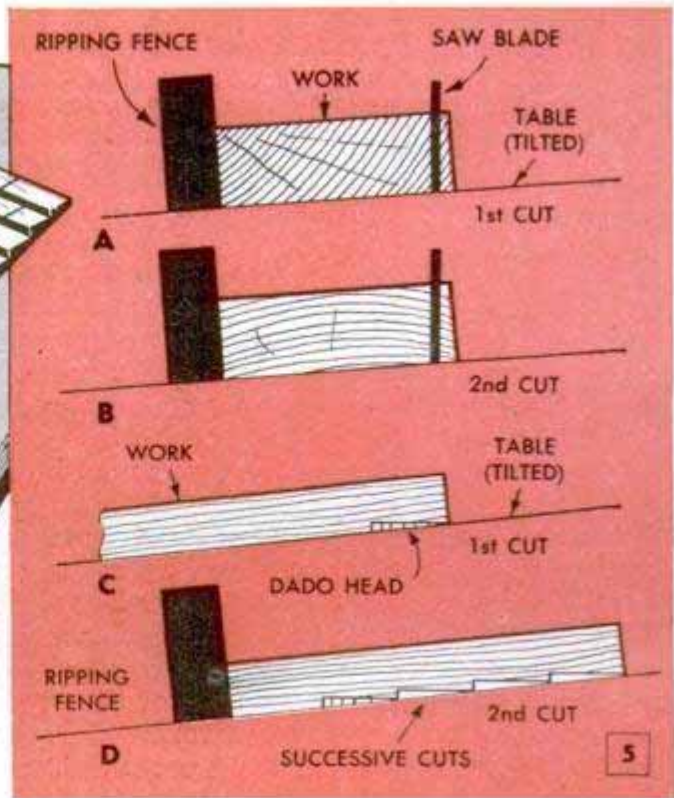

together edge to edge. The cuts are made with a dado head as in details C and D, Fig. 5, still keeping the table tilted. Here the cuts are made from one edge only; the piece is not turned. Each dado cut represents one strip of siding, which requires that the dado head be assembled to cut the correct width. The trick, of course, is in setting the dado to the right height and moving the ripping fence an equal distance each time. Shingles are simulated by scoring the panels with a sharp scribe as in Fig. 4. The effect will be more realistic if the scoring is made so that the shingles appear to be laid in random widths.

Flashlight Cells Taped Together Form Low-Voltage Battery

On occasion, it is necessary to connect two or more flashlight cells in series for running a toy motor or setting up an elec-

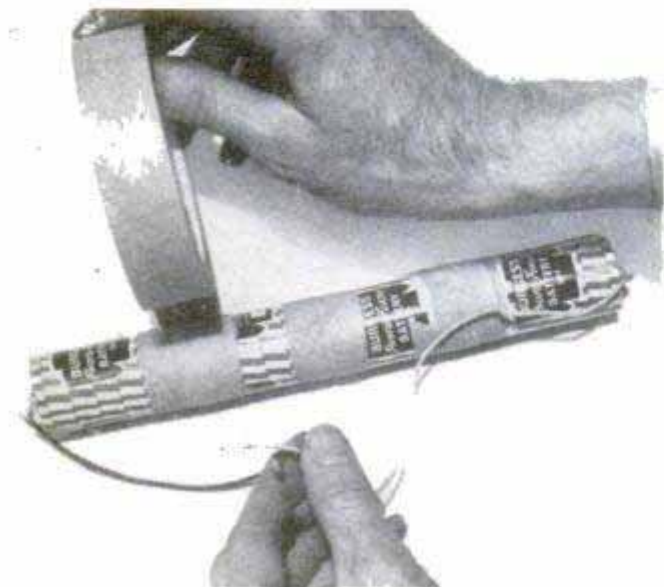

trical experiment. The simplest way to do this is to place the cells end to end, hold them tightly together and wrap a few turns of masking tape around each joint. After wrapping, twist the cells slightly to assure a good connection. The leads are soldered to the end of the battery.

V-Belts Serve as Boat-Dock Fender

Several used V-belts cut into 10-in. strips and nailed vertically to the edge of a dock, provide an inexpensive fender for approaching or moored boats. The belts are nailed at approximately the same height as the rub rails of the boats likely to pull up at the dock. Use finishing nails so that their heads can be driven into the rubber.

Karl N. Greife, Pittsfield, Ill.

☞ If you don't have a small garden trowel, a shoehorn will do the trick.

If you've been putting up with uncomfortably cold showers at your summer cottage simply because installing a water heater does not seem worth the trouble or the expense, here's a way you can have hot water at the cost of 100 ft. of garden hose with no fuel or power bills to pay. However, running water and an outside faucet must be available. Connect one end of the hose to the faucet, drape the hose in loops over the ridge of the cottage roof and run the other end of the hose to an outdoor shower stall. That's all there is to it—you let the sun take care of heating the water in the hose. Be sure to use black hose as it will absorb heat readily, and locate the loops so that they are exposed to bright sunlight for the maximum amount of time each day. On sunny days, there will be sufficient hot water for two or three showers in succession, and the water will again become warm in about

Solar Water-Heating Unit for Summer Cottage Improvised by Draping Garden Hose Over Roof

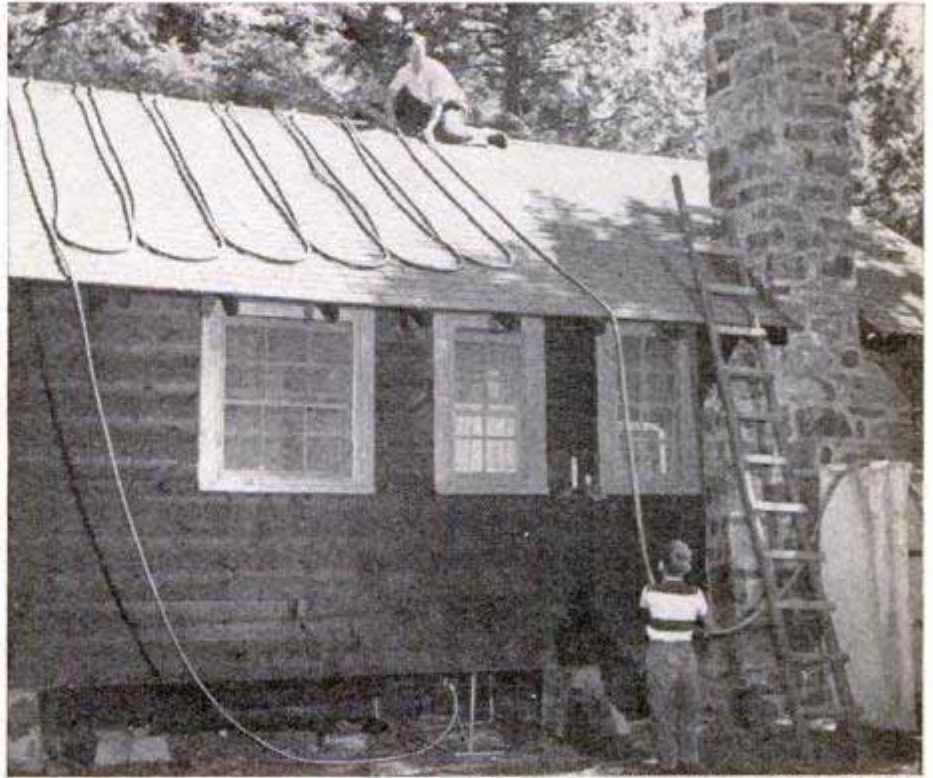

Photo courtesy United States Rubber Company

a half hour. On cloudy days, of course, the water will be lukewarm or cold. The hose should give four or five seasons of service before replacement is necessary.

Lawrence McCracken, Rye, N. Y.

Empty Talcum-Powder Can Forms Picnic Salt Shaker

Ideal for picnics or camping trips, a spillproof salt shaker can be improvised from an empty talcum-powder can. Pry off the top and then wash both the can and the top with hot water. Dry thoroughly, fill the

can with salt and replace the top. Screw the cap tightly over the perforated mouth of the can or, if the cap is the type which remains on the can, simply turn it closed.

Fred Cornelius, El Paso, Tex.

Light Bulb Suspended in Bass Drum Keeps Head Dry Outdoors

Dance-band drummers who play many of their shows outdoors will find it profitable to install a 60-watt light bulb inside

their bass drums. The heat from the bulb keeps the drumheads dry and also helps prevent warpage of the drum shell. To install the bulb, remove one of the drumheads and pass the extension cord through the air opening. When the drum is set up, the air opening should be at the top of the drum so the light bulb will hang at the center of the drum. The extension cord can be wrapped around one of the tension rods to keep it from pulling the light socket against the shell. Lengths of string or cord tied to the light socket and then to lugs inside the drum will keep the light from swinging against the heads when the drum is in use. Of course, colored bulbs can be used if subdued light is desired.

Clifford D. Coover, Minneapolis, Minn.

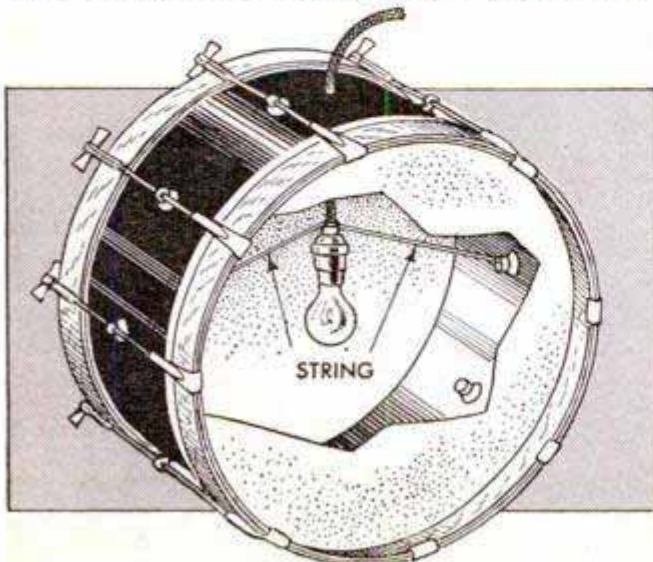

☞ The flame of a candle or match will quickly loosen tight paint-jar caps.

Window Awning Has Bamboo Slats to Provide Better Circulation



Lengths of bamboo nailed to a wooden frame provide a window awning that not only allows sufficient air circulation to prevent the forming of a hot-air pocket under the awning, but also permits more light to filter through than the conventional fabric covering. In addition to these advantages, the bamboo awning is inexpensive and especially attractive on a summer cottage where an informal effect is desired. Nail a wooden frame to the outside window casing so that the bamboo is supported at a 45-deg. angle. Then paint the frame and allow it to dry before covering with the bamboo. To prevent splitting of the bamboo slats, nail holes should be drilled through them before fastening to the frame.

Hi Sibley, Nuevo, Calif.

Rubber-Ball Halves on Table Legs Protect Picnic Lunch From Ants

Keeping ants away from the picnic lunch is always a problem, especially on outings during the hot summer months. One effective way to protect the food is to set it on top of a card table, the legs of which have been fitted with guards made from rubber-ball halves. Just cut two hollow rubber balls in half so that you have a dish-shaped section for each of the four table legs. Then cut out a square from the bottom of each rubber dish, making the cutout slightly smaller than the cross section of the leg. To install the guards, press the dishes over the table legs, and partially fill each dish with powdered ant poison.

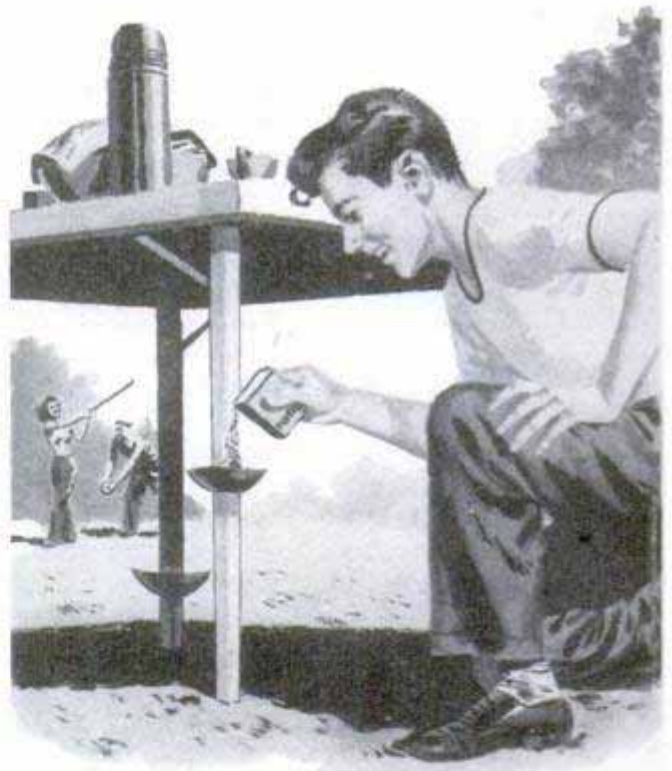

Lemon Juice Cleans Marble

If washing with soap and water does not remove stains from marble table tops and mantels, try rubbing the spots with lemon juice, using a wad of cotton. Rinse the surface thoroughly with clean water to prevent any possible damage to the marble.

Length of Rod Locks Gas-Range Controls in Off Position

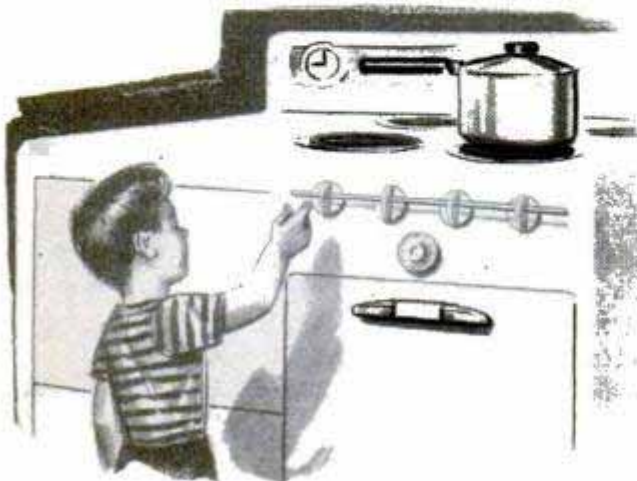

Inquisitive children can be prevented from turning on the burners of kitchen ranges which have circular-type burner controls, if the control knobs are locked in the off position with a length of small-diameter rod. Aligning holes are drilled through the upper portions of the knobs and the rod is simply passed through the holes. If the position of the oven control does not permit locking all the burner controls with a single rod, a shorter length of rod can be used on each side of the oven control. A section of rod cut from an old refrigerator shelf will provide a lock that does not detract from the appearance of the range.

CARRYALL

By Evan Wright

IDEAL for wheeling a basket of wet laundry, garden rubbish, feed, fruit or other heavy loads, this handy two-wheel utility cart can be put to many uses around both the home and farm. It features a pivoted basket holder which is self-leveling to prevent spilling even over the roughest ground, and the low-slung design of the cart makes the heaviest load easy to wheel.

Although the diameter of the flat-iron basket holder is average for the standard wooden basket, it's a good idea to check the size of any metal basket before making the holder. Make the frame and the wheel brackets first, using regular $\frac{3}{4}$ -in. rigid-type conduit and welding at all joints indicated. Drill the wheel brackets for the $\frac{1}{2}$ -in. axle. The lower left-hand detail shows how the basket holder is pivoted on stove bolts which pass through holes drilled in the frame and the rim of the holder. First, the bolt is inserted through the hole in the holder, then a nut is run down the length of the threads and the bolts are inserted in the holes drilled in the frame of the cart. Place a lock washer over the end of each bolt and turn on a nut. Then adjust the holder for free movement by loosening the inner nut and tightening the outer one as required.

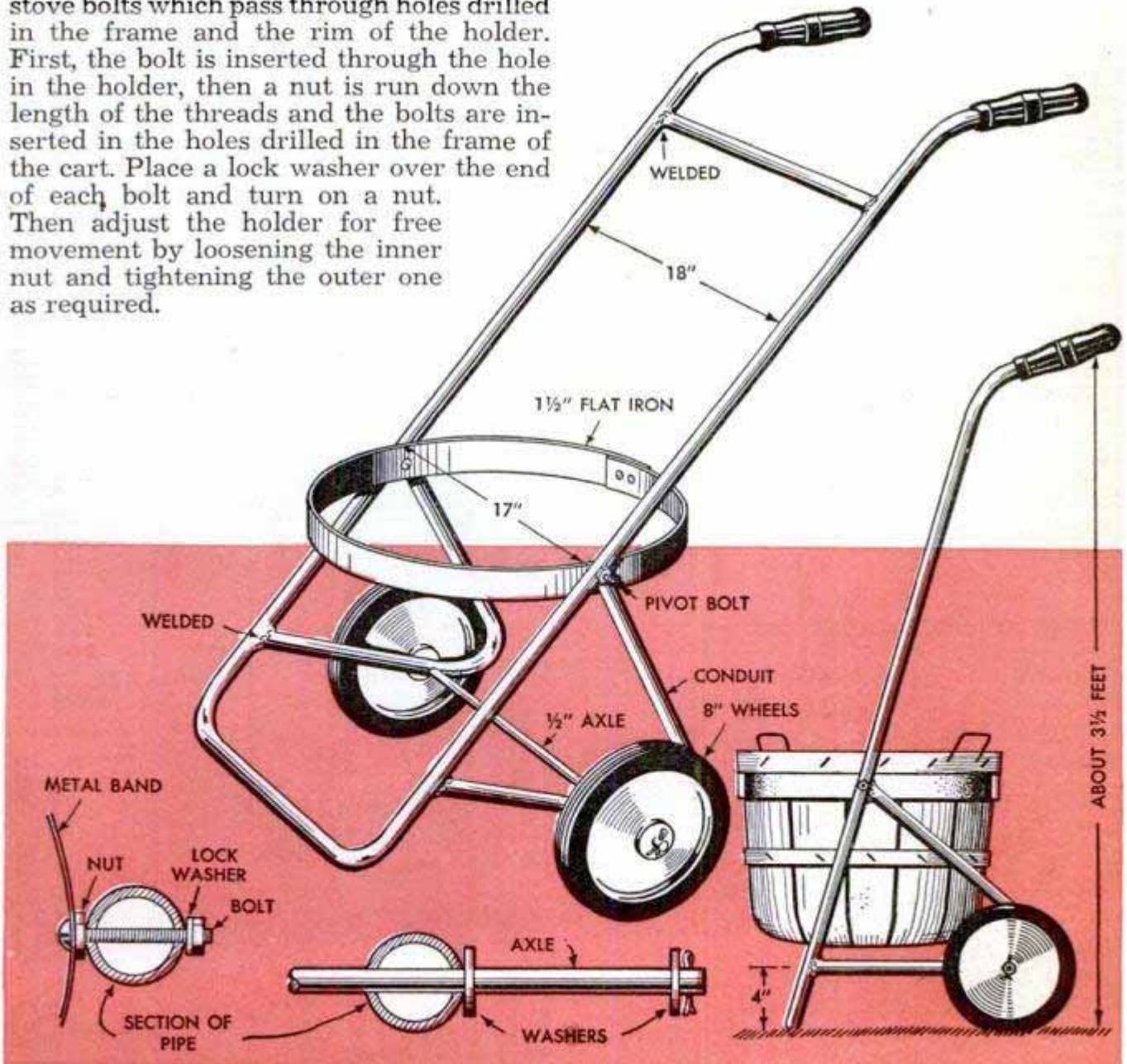

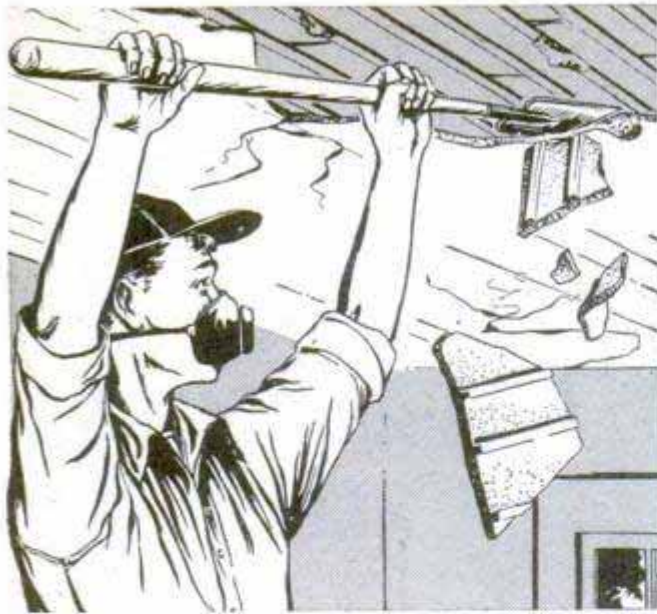

Scraper Made From Garden Hoe Removes Old Plaster

One homeowner who likes to do his own remodeling found that an altered garden hoe was just the thing for removing old plaster down to the lath. He simply heated the curved shank of the hoe and straightened it to bring the cutting edge of the blade in line with the handle. This novel tool is especially effective on a ceiling, as it is easily forced under the edge of the plaster and the long handle permits working from a step-ladder at some distance from dust and falling fragments.

Cut-Down Glove Protects Thumb When Whittling With Jackknife

Especially handy for those who are just beginning to take up whittling as a hobby, an old leather glove can be used to shield the thumb from knife cuts and bruises. The fingers are cut from the glove, leaving only the thumb and enough of the wrist to hold the glove in place. — W. B. Eagan, Louisville, Ky.

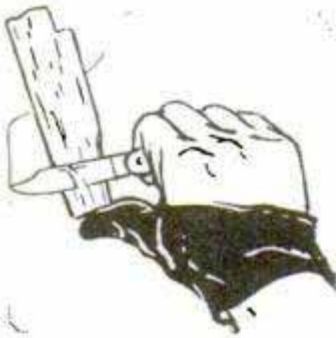

Croquet-Ball File Holder

Excellent holders for files, punches and nail sets can be made by mounting half of a discarded croquet ball on a wooden block. After sawing the ball in half, drill a number of holes in the rounded surface of one of the halves to take the tangs or tips of the tools. Then fasten the flat side of the drilled holder to the base block by using glue and a flat-headed screw which is driven flush with the underside of the base.

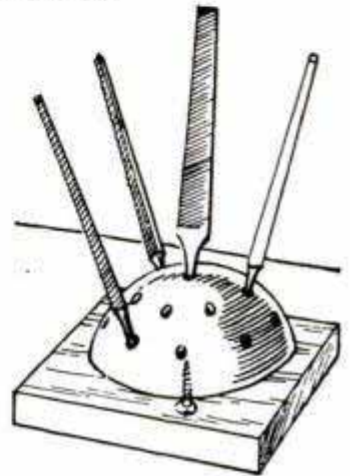

Cone-Shaped Strawberry Patch Has Sheet-Metal Trays

Distinctive in appearance as well as a practical spacesaver, this cone-shaped strawberry patch holds a large number of plants in an extremely small area. The largest, or bottom, tray is only 36 in. in diameter and the entire bed is approximately 5 ft. high, thus allowing you to pick the berries without kneeling. Each cylindrical tray is made of galvanized sheet metal with the bottom perforated to permit drainage. The trays are supported by angle-iron brackets welded to a center post of 3-in. pipe which is embedded in concrete. The exposed portions of the bed are painted as desired.—Grover Brinkman, Okawville, Ill.



Plastic Cleans Sanding Disks

To increase the efficiency of my sanding disks, I clean them by holding a scrap of plastic against the abrasive disk while the disk is turning. Unless the disk is completely clogged, this does a quick cleaning job.—J. Jachimowicz, Washington, D. C.

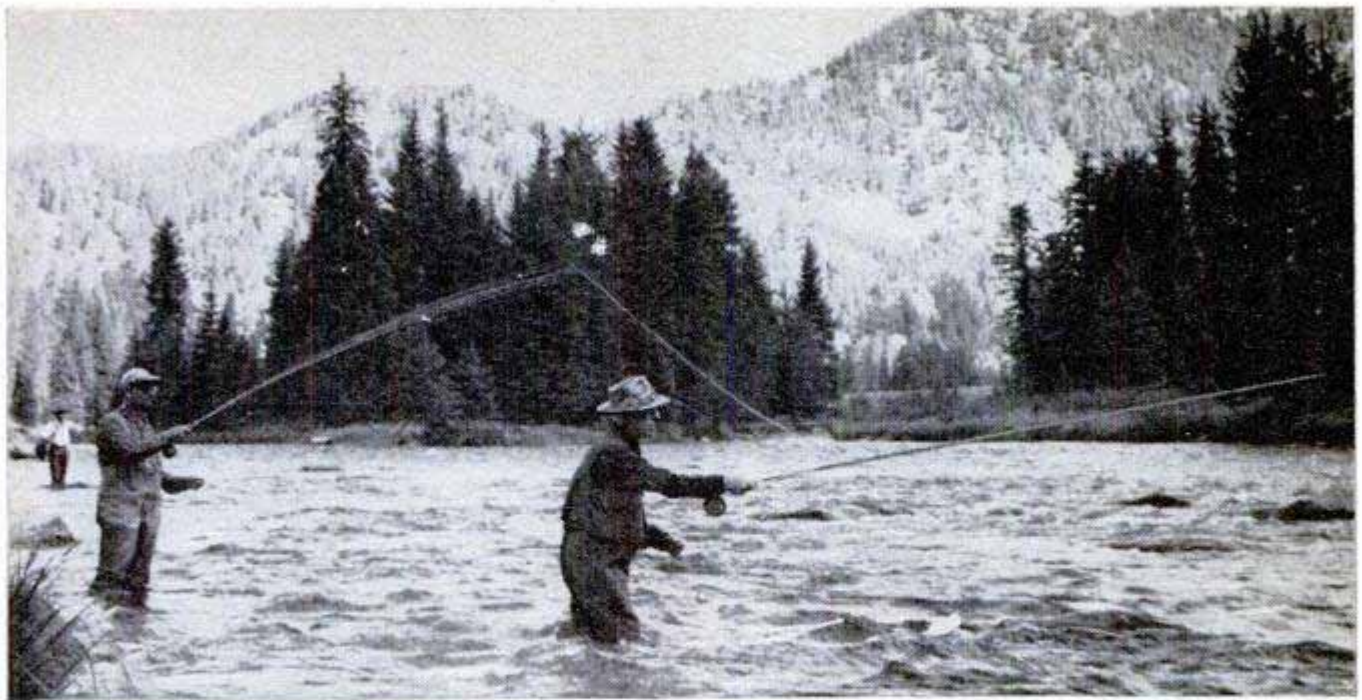

Care and Repair of BAMBOO RODS

By Claude M. Kreider

YOU WON'T have to tell about the big one that got away if you take time to recondition your bamboo fishing rod before going on that first all-important trip of the season. A careful fisherman assembles and checks his rod between trips and goes over it in every detail, from reel seat to top, at least twice a year. A sticking ferrule, for example, will immediately attract his closest inspection, as will a loose one. Either fault affects the life and spring of a good rod. Whipping the rod lightly will turn up a loose ferrule but one that is just slightly slack can be discovered only by bending the individual rod sections. Next on the inspection schedule are the line guides, the rod top, the cork grip and reel seat, after which comes the silk windings, one by one, and then the condition of the finish. Worn agate or metal guides may tear a line to shreds long before you can play a big one into the landing net, and a fighting trout gets a real break if you strike him hard with a loose rod top. Whipping white water with a worn reel seat or a worn grip that may suddenly loosen and twist in your hand is just asking for trouble which usually happens right at the critical moment.

Rod refitting: A complete refitting job on a worn rod is time well spent. The first step is to make a chart to show the spacing of the guides and windings on each section of the rod as in Fig. 2. Slit the windings with a razor blade and remove them and

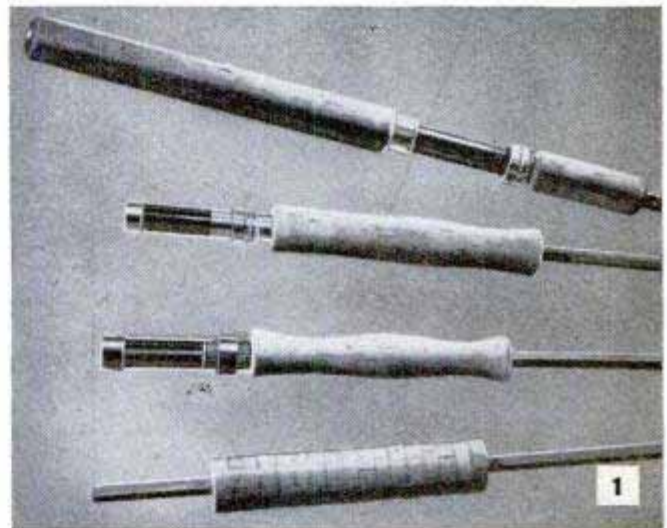

Above, the three lower types of grips are supplied for fly rods. The upper one is a two-handed grip usually used in surf casting. Below, before removing wrappings make a chart showing their locations

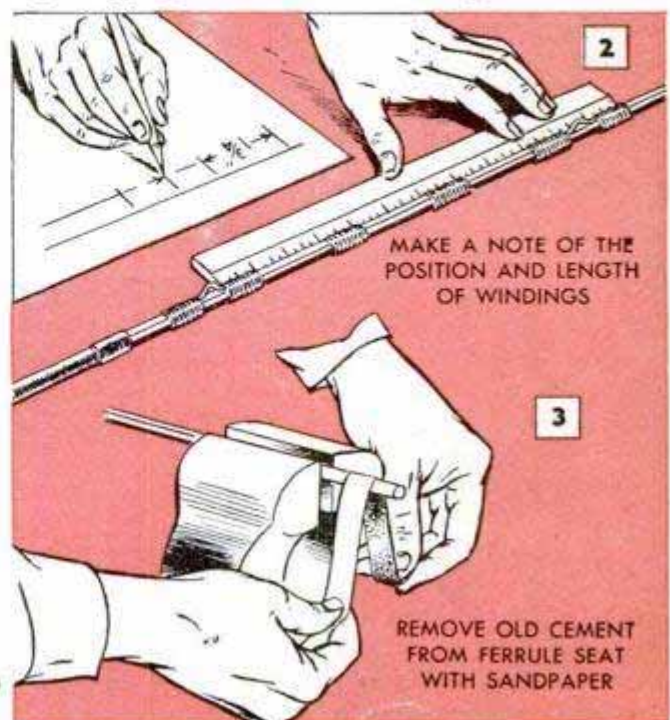

2
MAKE A NOTE OF THE POSITION AND LENGTH OF WINDINGS

3
REMOVE OLD CEMENT FROM FERRULE SEAT WITH SANDPAPER

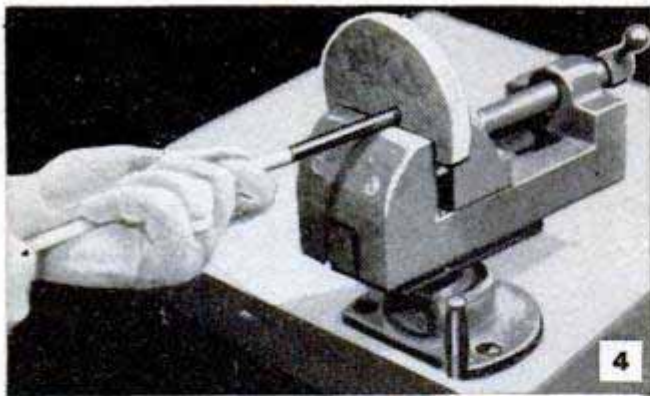

After applying cement, press the ferrules in place on the seats against a wooden block held in a vise

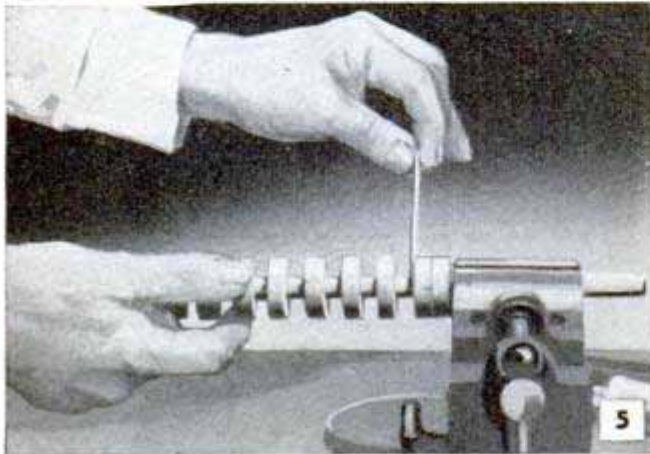

When renewing the rod grip, spread cement on both meeting surfaces of disks before forcing together

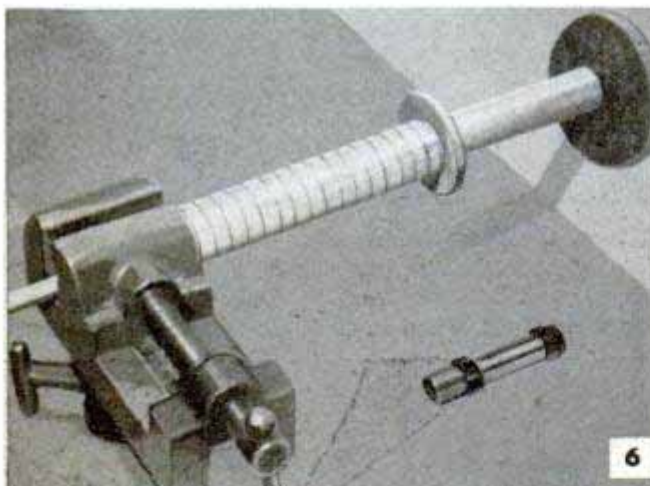

Above, the cork disks are forced together tightly on the filler stick. Below, the grip is rough-shaped with a wood rasp or a coarse, half-round file

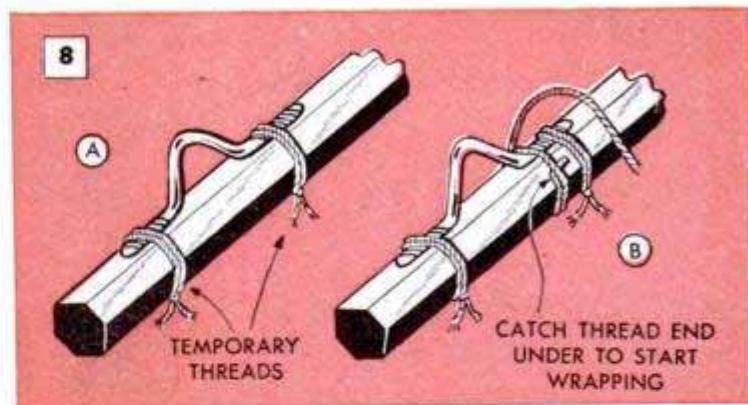
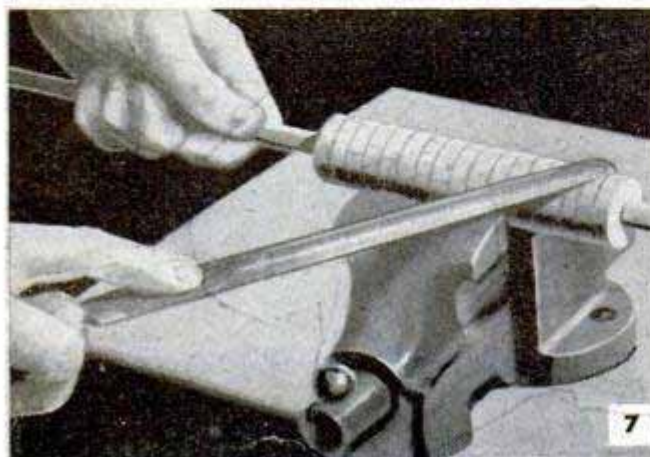

also remove the rod top, or top guide, by applying heat to soften the cement. Scrape off all the old varnish—old varnish which has lost its elasticity can slow up the action of a good rod—and smooth the flat surfaces with fine sandpaper or No. 00 steel wool. Now's the time to reset that loose ferrule. On some rods the ferrules are pinned and cemented and often, after removing the pin, the sleeve will slip off when pulled and twisted lightly. If it resists a light pull, apply heat from a candle or alcohol burner and remove with pliers. Remove the old cement from the ferrule seat with a strip of sandpaper as in Fig. 3. Check the ferrule for fit, then recement it in place, using the special stick cement supplied for this purpose. Usually it is necessary to heat the ferrule slightly and press it quickly in place. If the ferrule has been damaged in any way, especially if it is of the double-shouldered welt type or the shouldered-and-banded type with closed ends, it may be necessary to renew both male and female parts. Reseat after cementing, using the method shown in Fig. 4.

Repairing reel seats and grips: If a close examination of the reel seat and grip shows that renewal of the parts is necessary, heat the seat moderately to soften the cement, and then pull it from the rod. Cut off the old cork grip with a sharp knife, sand off the cement and smooth the filler piece, or stick. One-piece cork grips, Fig. 1, are available as renewal parts for most rods, but many fishermen prefer to build up and shape the grip from cork disks as in Figs. 1, 5, 6 and 7. Apply glue, or stick cement, between the disks as in Fig. 5, force them tightly together as in Fig. 6 and, after the cement sets, rough-shape the grip as in Fig. 7. Finish the grip to the shape desired with fine sandpaper, Fig. 9. Then attach the reel seat. New cement over the projecting end of the filler stick usually will reset an old seat securely. A new one is generally installed in the same manner but it may be necessary to reduce the size of the filler slightly by sandpapering. After applying cement liberally, press the seat tightly into place as in Fig. 10.

INSERT END OF
THREAD IN
LOOP

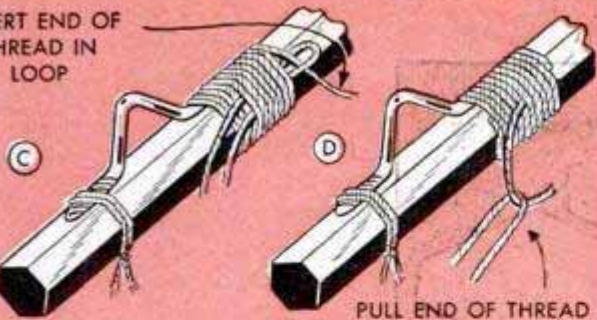

PULL END OF THREAD
UNDER WRAPPING

Mounting guides: Many fishermen prefer steel snake guides for fly rods. On bait rods, the ring-type guide generally is considered best. Tops or tip tops for both bait and fly rods should be chrome plated and on fly rods the stripping guide should be of the ring type and chrome plated. Fig. 8, details A to D inclusive, shows the procedure in binding, or rewinding, guides to the rod. Refer to your chart for the exact position of the guide and then proceed as pictured. Some fishermen apply a thin coat of rod varnish over the area to be wrapped, then proceed with the wrapping before the varnish sets. The simplest way to apply the wrapping is to hold the rod under the left arm and rotate it with the left thumb and forefinger. The right hand guides the thread and maintains the correct tension. No. 00 silk is the size most commonly used, but many fishermen prefer a heavier thread for wrapping guides. It also is regular practice to rewrap the ends of the ferrules where the metal meets the bamboo. As a rule, the wrapping is started a few turns below the ferrule ends and is carried up to the edge of the metal. Ferrules that have serrated ends should be wrapped up to the shoulder or bead.

Repairing a fracture: Occasionally the separate strips of bamboo will open under severe strains and in some cases may splinter. Generally, such fractures can be repaired. Carefully pry open the parts at the joints and insert toothpicks in the openings as in Fig. 11. Then brush waterproof glue into the openings, pull out the toothpicks, press the parts tightly into place and bind with strong cord wound on the glued portion in a crisscross pattern as in Fig. 12. When dry, remove the wrapping and sand smooth on all the flat faces.

Finishing: It's regular practice to re-finish an old rod with three coats of special rod varnish. Wipe the rod sections to remove all dust and lint. Thin the first coat with a small quantity of pure turpentine and in applying the varnish flow it on with as little brushing as possible. Hang the sections vertically to dry. Smooth the sections between coats with fine steel wool.

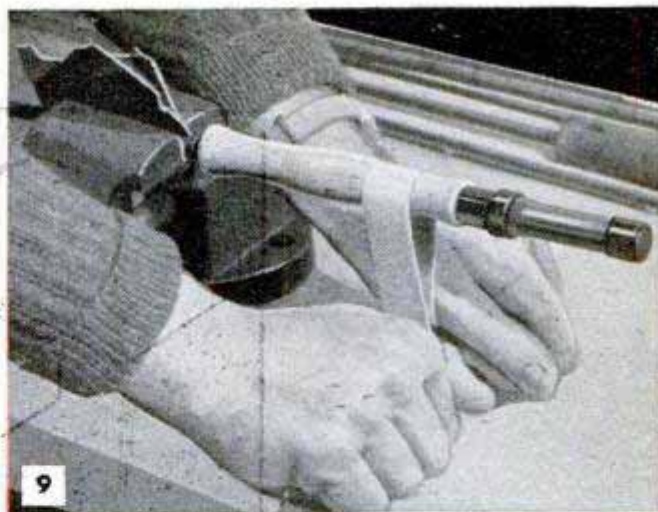

9 Finish the cork grip by sanding smooth. Pad vise jaws with rubber or leather to avoid damage to rod

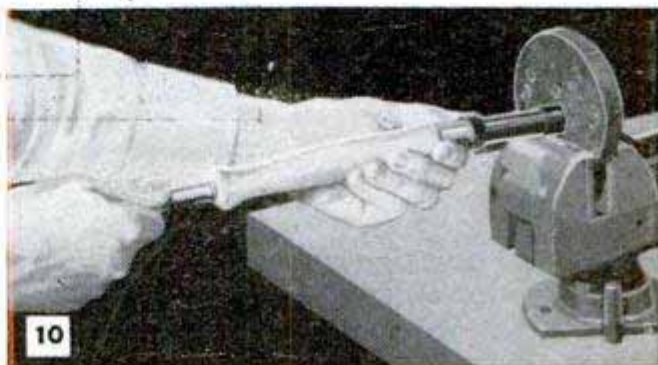

10 After cementing, force the reel seat in place by pressing it against a wooden block held in the vise

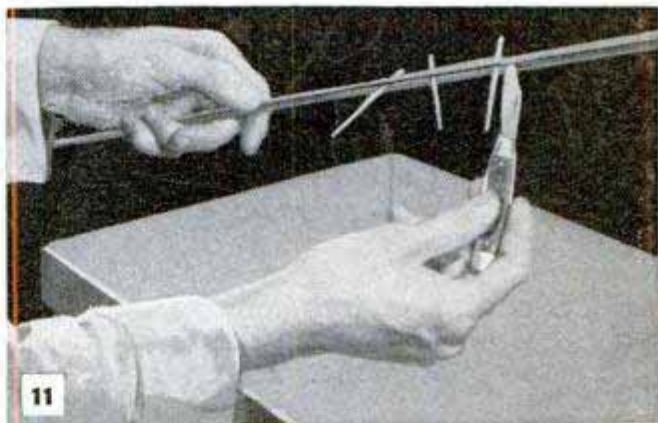

11 Above, repair a fracture by prying members apart and inserting toothpicks. Below, apply glue, press parts together and wrap tightly with cord till dry

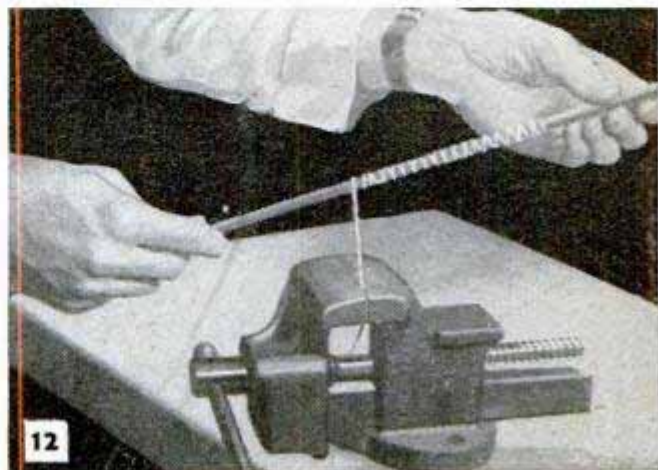

Chopping Board of Laminated Hardwood Fitted With Detachable Tray for Mixing

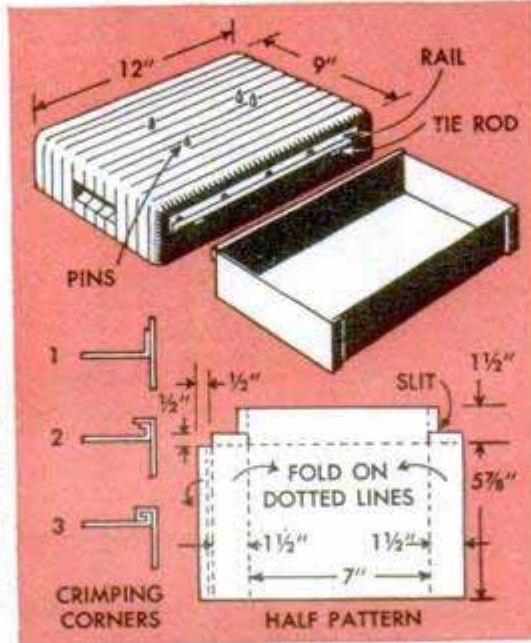

Combining a detachable mixing tray with a sturdy chopping block of laminated hardwood results in one of the handiest of kitchen utensils. Four removable pins of brass or aluminum anchor meat to the block for easy carving. The hardwood strips can be laminated by gluing them together or fastening with two tie rods. The mixing tray is cut from sheet aluminum according to the half pattern and the corners are crimped in three steps as shown. The tray hooks over a sheet-metal rail screwed to the edge of the chopping block. — Roland Cueva, Heyburn, Ohio.

Adjacent Paint Swatches on Glass Match Colors Professionally

The next time you run out of paint before finishing a job and must mix a new batch to match a given color, try comparing the color with a method often used by professional painters. Smear the color to be matched on a piece of glass and next to this place a swatch of the shade being mixed. Then turn the glass over to view the two colors. If there is the slightest difference in

shade you will notice a definite line between the two smears. Continue to mix the color until no line is visible. — Jeff Sterns, New Bedford, Mass.

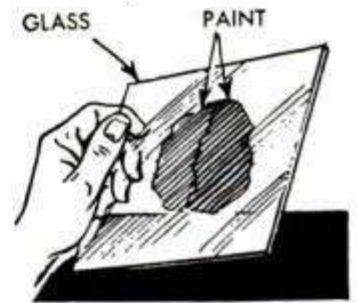

Firm Foundation Under Flagstones Keeps Them From Tilting

When laying a flagstone walk, remember that it is important to have a firm foundation under each stone to keep it from tilting or rocking under foot. To do this, cut the outline of the stone in the lawn, making it about an inch deeper than the thickness of the stone. Then fill the hole

with sand or mud until the top of the stone rests flush with the sod. Add another 1/2 in. of sand or mud and tamp the sand or, if you use mud, press the stone into the hole to the desired level. Allow the stone to set for 24 hours before walking on it.

Robert C. Kendall, Oak Park, Ill.

Driving Screws in End Grain

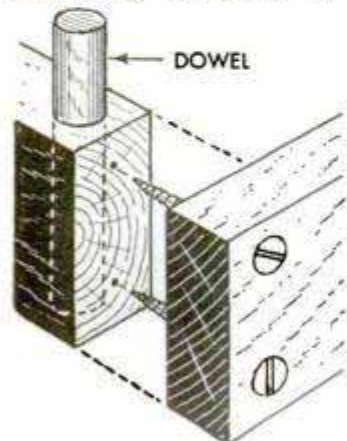

Wood screws driven into end grain will not pull loose if they are driven into a length of dowel. Before driving the screws, drill a hole parallel to the end of the piece and in such a position that the screws will enter it when completely driven.

Then press the dowel into the hole. In this way the screws will actually be driven into surface grain instead of end grain.

Wire Solder Binds Extension Cords

Extension cords of portable tools and electric appliances which must be wrapped and unwrapped frequently for storage can be bound in a neat bundle with a short length of wire solder. A turn or two of solder will keep the cord from unwinding, and the solder can be removed in a jiffy without untying or untwisting when the cord is to be plugged into a receptacle.

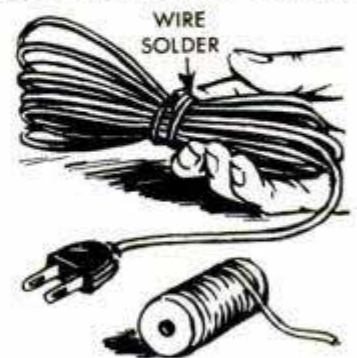

Louis Hockman, Sherman Oaks, Calif.

100 W. P.

Inexpensive Trays and Coasters From Cardboard

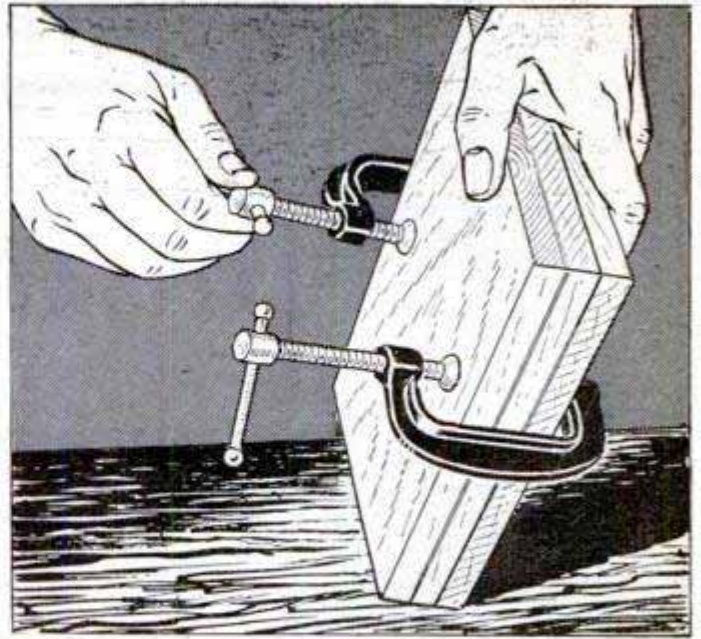
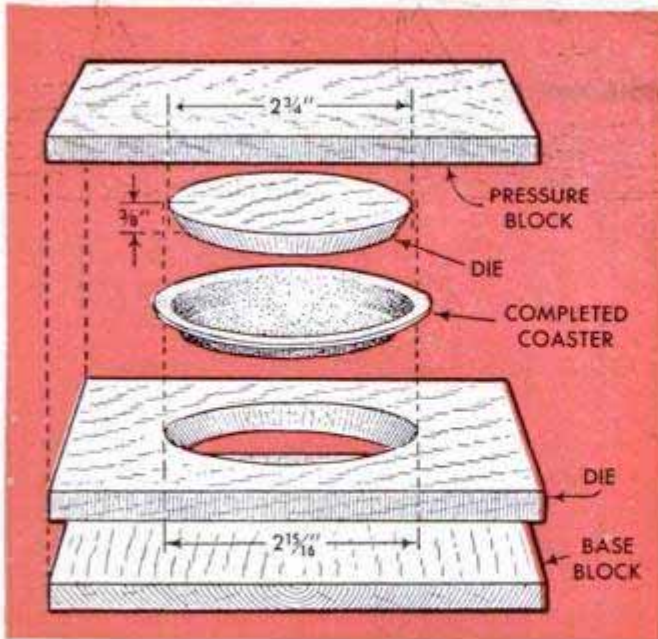

Ideal for the little girl's party, or even the teenage hostess who wants something different and personal, these die-cast coasters and trays of cardboard can be made in many shapes and decorated in any color or combination of colors, including spatter and mottled finishes, as well as finishes in which colorful bronzing powders are used. The trays are so inexpensive to make that any youngster can do it, although dad may have to jigsaw the dies to shape. Use 1/2-in. stock for the coaster dies and 3/4-in. stock for the trays. Cut the cardboard blanks 1/2 in. oversize and to the shape of the die. Then soak them in water until pliable and form. Clamp the dies together and leave them until the cardboard is dry, after which it is ready for finishing. If the trays or coasters become soiled, just make some new ones



Electric Detector Locates Nonmetallic Sewer Line

Before starting excavation for a new building which is to be adjacent to an older one on your property, it will be necessary

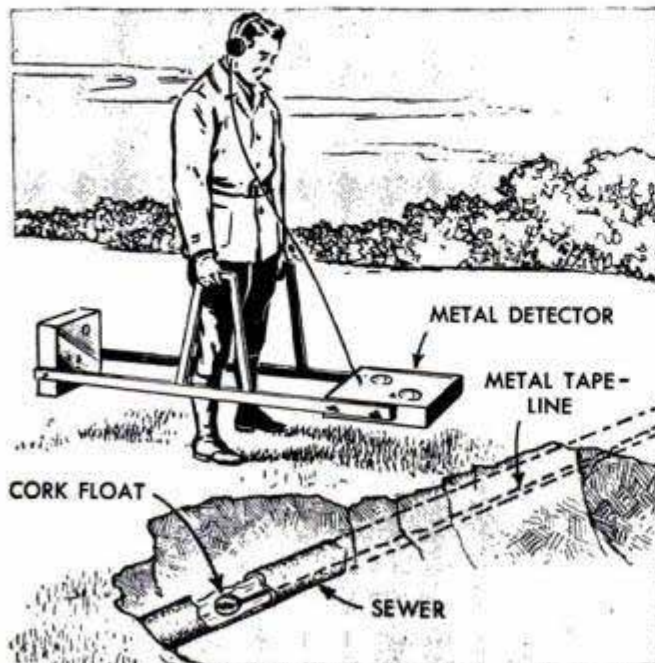

to locate the course of the sewer lines running from the present house. Even though the sewer pipe is of nonmetallic tile, an electric metal detector can be used to locate the position of the sewer accurately. To do this, just run a metal tapeline or auger into the sewer so that the detector will pick up the course of the tape. If there is sufficient water in the sewer, the end of the tapeline can be floated to facilitate moving it through the pipe. This is done merely by tying a cork float to the end of the tape.

Edgar Barnhart, Whittier, Calif.

Wallpaper Moistened for Removal By Using Vacuum-Cleaner Spray

Next time you are redecorating and have to soak the wallpaper in order to remove it, try using the spray equipment which is supplied with the vacuum cleaner. To do a quick job of loosening the paper, make sure that the spray-gun container is kept filled with warm water.



INEXPENSIVE BOAT

By George Brook Taylor



MOORING-CHAIN BUOY



SOLAR-SWITCH ANCHOR LIGHT



BOAT-HOOK BRACKETS



FENDER CLEATS

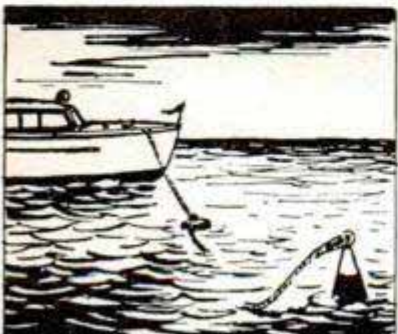

PENNANT PICKUP BUOY

EXPERIENCED power boatmen who regularly work their boats offshore for hire or for pleasure keep at hand certain accessories that save time, comply with boating regulations and are always available to serve both normal and emergency uses. Most of these are made easily by the owners themselves at a considerable saving in initial cost.

Mooring buoy: If chain is used on the mooring anchor, a mooring buoy is needed to support the end of the chain at water level. The buoy pictured at the left and detailed in Fig. 2 is made from stock sizes of cork, brass studs with nuts for both ends, two square pieces of marine plywood, canvas (about 12 oz.) and a flanged tube of copper or galvanized iron having an inside diameter which will permit the chain to run freely. Any boatman can make the buoy by following the assembly details given in Fig. 2.

Solar switch for anchor light: When it is necessary to moor a boat outside designated anchorage areas it is essential to show a riding light after sundown. The light detailed in Fig. 1 is controlled automatically by solar heat acting on a 3-in. thermostat of the double-wafer type which is hooked up to the 6-volt storage battery. The thermostat-and-contact assembly serves as one side of the electrical circuit of the switch, the other side being the bridge and one of the binding-post assemblies to which one of the lead wires is attached, as will be seen from the detail in Fig. 1.

In use, solar heat—sunlight—expands the thermostat which breaks contact between the washer-nut unit and the bridge, thus turning off the light. Contraction of the ther-

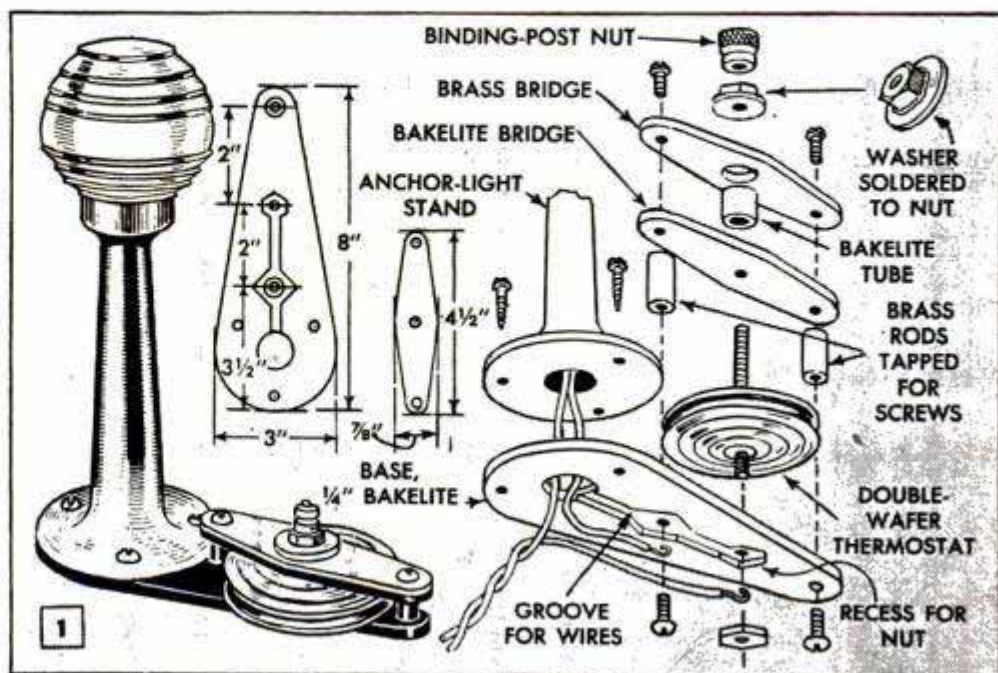

ACCESSORIES

mostat when the sun sets or is covered by dark clouds, reverses the action and closes the circuit, thus turning on the light. Current drain is reduced to the minimum by using a 6-volt radio-dial bulb in a miniature screw-base adapter, which fits the anchor-light socket. The regular anchor-light stand and the thermostat are mounted on a Bakelite base as detailed in Fig. 1. The binding post on the top of the thermostat is made up as shown in the pull-apart view, using a piece of spring bronze for a washer contact, and the bridge is supported on two brass spacers, tapped at both ends. Bakelite parts are used where insulation is required. Note that the Bakelite base is recessed on the bottom to house the wiring and the nut which holds the thermostat assembly. With this arrangement it is easy to unscrew the thermostat from the base should it be necessary to replace it. On cabin cruisers, the light unit is placed on top of the cabin where it is not likely to be damaged. Seal the joint with calking compound. When mounted on deck it may be necessary to provide a glass cover to protect the switch. However, it should be remembered that the cover will tend to slow the action of the thermostat by retaining solar heat. During the winter months in the northern latitudes this delayed timing would probably prove satisfactory but in or near the tropics faster action of the switch is desirable. Painting the thermostat black also would tend to have the same effect as the glass cover. In hooking the switch to the battery just cut one side of the power line and connect in series at the switch as shown in the detail in Fig. 1. When the switch is in continuous operation, clean the contact points at regular intervals.

Boat-hook bracket: An indispensable piece of loose equipment aboard a large cruiser is a boat hook, but owing to its length it can pose a storage problem on the smaller boats. To be of any practical use on a cruiser the hook and handle should be at least 10 ft. long and the place for such a piece of equipment usually is on top of the deckhouse as in the photo above Fig. 3. Located in this position the hook is always at hand when you need it and when not in

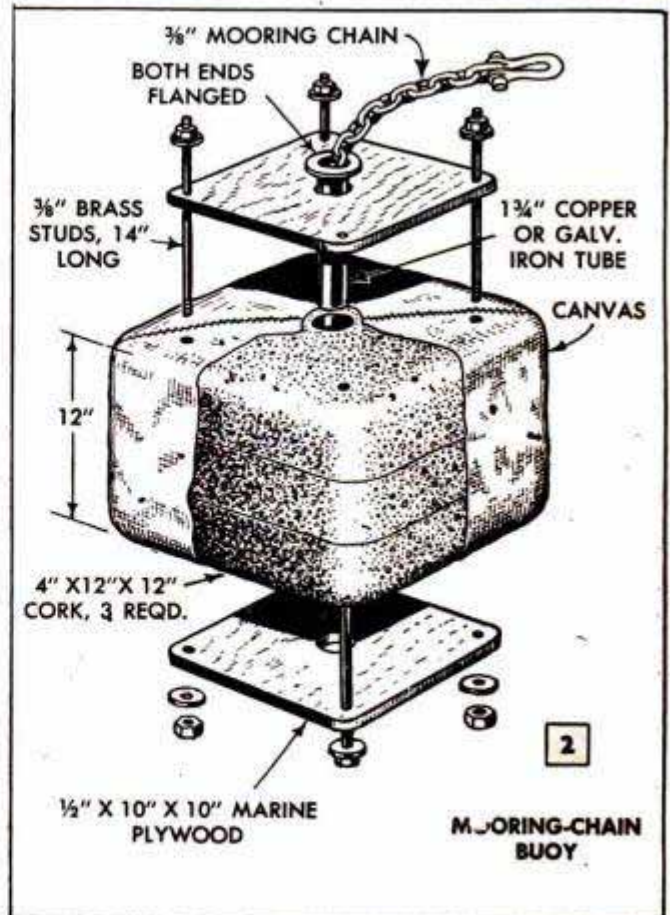

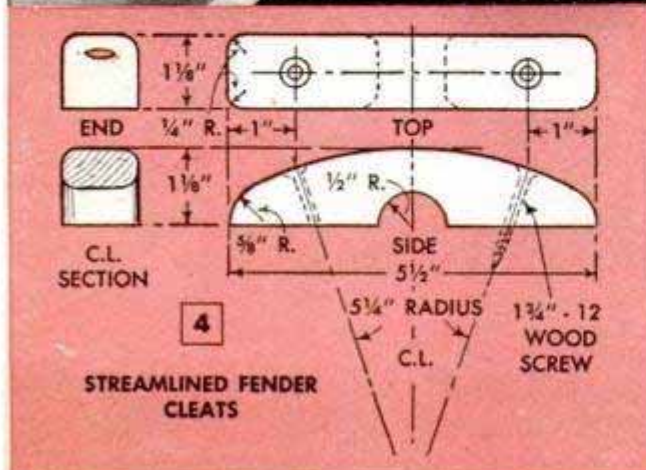
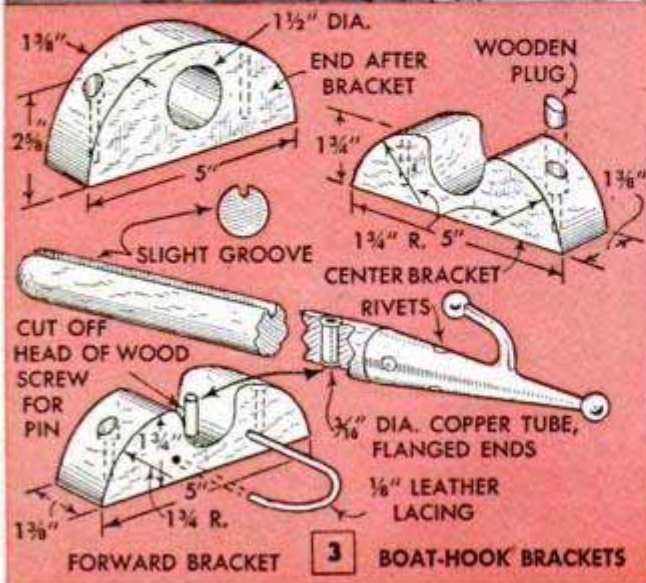

use it is held firmly in place on a special bracket which prevents it from being knocked down or blown overboard. One feature of the boat-hook bracket detailed in Fig. 3 is unique: The handle is drilled transversely about $1\frac{1}{2}$ in. above the hook ferrule to take a $\frac{3}{16}$ -in.-i.d. copper tube with flanged or flared ends. The tube fits over a pin in the center of the front bracket member as indicated. The pin is formed by turning a brass wood screw into the bracket and then cutting off the head as suggested. Bandsaw the three members of the bracket from selected mahogany to match the boat woodwork and smooth with fine sandpaper. Center-bore the rear member to take the handle of the hook, then drill and counter-bore all three members for screws and wooden plugs. Attach the bracket members to the top of the deckhouse on the center line with brass wood screws. Drive plugs cut from matching wood into the counterbores and file and sand flush. Finish the wood with at least two coats of spar varnish. To lash the boat hook in place, insert the end of the handle in the hole in the rear bracket member and slide it back until the copper tube in the handle near the hook will drop over the pin in the front member. Then tie in place with the leather lacing provided. The lacing holds the hook securely in place, and the pin engaging the sleeve in the handle prevents it from sliding either forward or backward.

Safety fender cleats: Any boatman who has ever "stubbed" a toe on a metal fender cleat while wearing canvas deck shoes can appreciate the streamlined safety cleats pictured and detailed in Fig. 4. One boatman who experienced a painful injury in such a manner designed these cleats to support the fenders along the narrow side decks of his cabin cruiser. They are made from selected white oak and can be finished in the natural color with spar varnish or painted in whatever color suits the boatman's fancy. Note that each one is bandsawed to a $5\frac{1}{4}$ -in. radius across the top and to a $\frac{5}{8}$ -in. radius at each end. This leaves a center height of only $1\frac{1}{8}$ in. As detailed, the cleats should be made in pairs from a block $2\frac{1}{4}$ in. wide and $5\frac{1}{2}$ in. long. Mark intersecting center lines from the edges of the block and bore a 1-in. hole at the intersection. Then bandsaw the radii on both edges and rip the block in half on the long center line. Round the top edges and also the inner edges of the half-round opening. Attach the finished cleats to the deck with flat-headed brass screws. In rigging a fender on this type of cleat, most boatmen would use a continuous loop through the eye of the fender and the half-round opening in the cleat and tie with a square or reef knot.

Pennant pickup buoy: This buoy is similar in construction to the mooring buoy already described. Its purpose is to carry the end of the Manila pennant when you leave the permanent mooring buoy. When you return to the mooring, the pennant buoy is picked up with the boat hook, thus bringing the eye of the pennant to hand with the minimum of effort. As in the detail, Fig. 5, the buoy is built up from cork to a 6 x 6-in. sectional size and a length of 12 in. and is covered with canvas. Holes are drilled through the built-up cork block near the ends to take $\frac{5}{8}$ -in. hardwood dowels which are cut flush with the surface of the cork. After the canvas covering has been cut to size and sewed in place, wet it to shrink the fabric tightly over the block. Then attach a heavy canvas strap with brass screws and washers, the screws passing through holes punched in the strap and into the ends of the dowels on both sides of the cork block. The free ends of the strap are fitted with a bronze ring and snap as shown. At the opposite end of the buoy block the strap is left slack to form a loop which can be caught with the boat hook. To stiffen the loop so that it will stand clear of the buoy block, apply two or more coats of outdoor enamel or airplane wing dope to the strap. Paint the buoy block with orange or ivory-colored outdoor enamel and letter the boat number and name on both sides in black. Either of the body colors (some boatmen will prefer orange) shows up clearly on dark water in daylight and also at night when picking up the buoy with a searchlight. The enamel will take better if the canvas is first filled with a coating of white lead. Be sure the latter is thoroughly dry before applying enamel.

Improvised deck scupper: Here's another inboard accessory worked out by a boatman from a sink strainer and it's as neat and efficient as any of the conventional brightwork. In fair weather, deck scuppers seem the least essential of any of the deck fittings but when the wind makes up and sends spray spinning off the wave crests you'll be glad you installed them. Primarily, of course, they're installed for the purpose of draining away water used when washing down the deck on larger cabin boats. The installation shown in partial section in Fig. 6 is made in a plywood deck covered with linoleum. For a neat job simply bore a hole through the deck and scarf the edge of the linoleum around the hole so that the flange of the strainer fits flush when the locknut is tightened from underneath. Use the entire sink-strainer fitting as shown in the inset detail. Attach a hose to the lower end of the fitting with a clamp and lead it down to a bronze through-hull fitting of the type having a tailpiece.

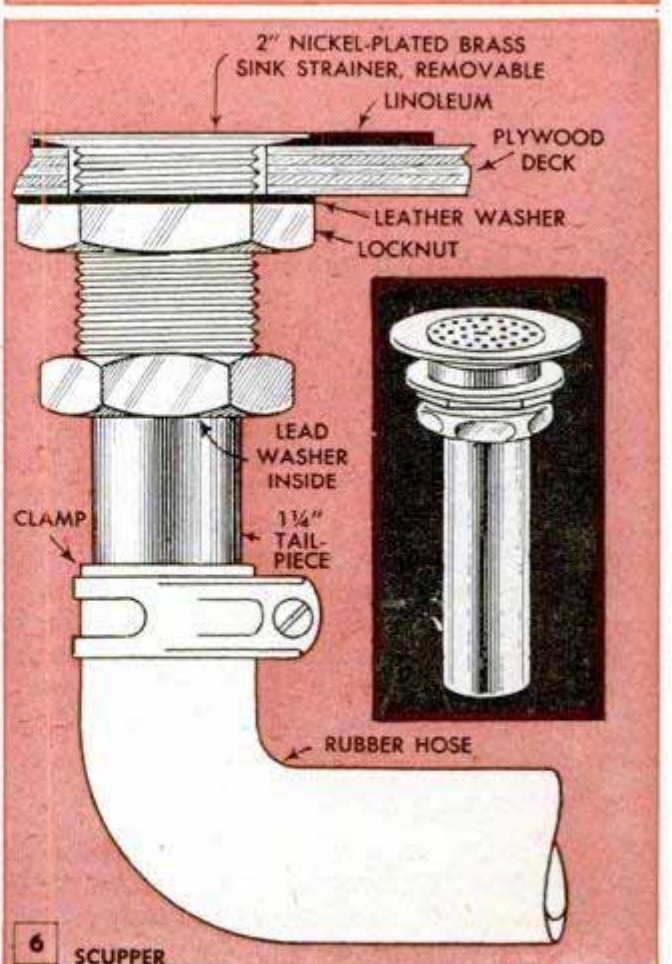
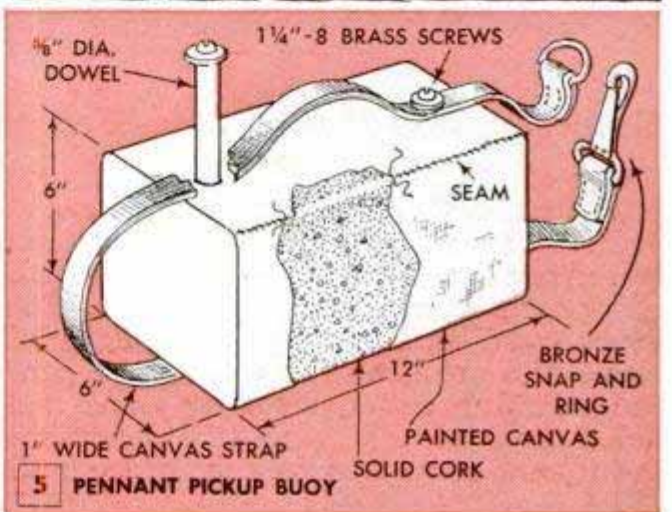

Adjustable Brackets Extend Roller to Raise Lawn-Mower Cutter Bar

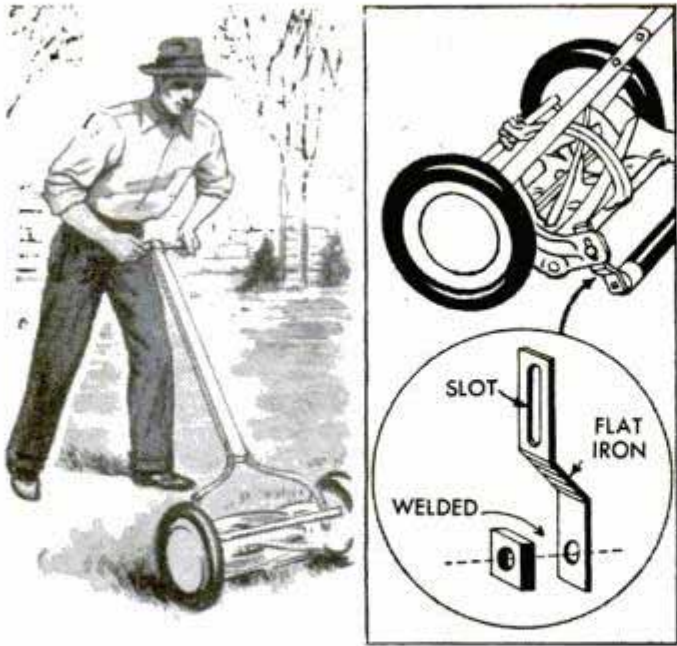

To assure that growth of a lawn continues throughout the dry, hot days of summer and also to prevent the soil from cracking and drying out, it is sometimes desirable to keep grass trimmed to a length of $2\frac{1}{2}$ or 3 in. during the late summer months. On mowers not equipped to permit adjustment of the cutter bar to the required height, this can be done by fitting the roller mounting brackets with flat-iron extensions. After slotting and drilling two pieces of flat iron as shown in the detail, ream the threads out of a small nut and weld it over the hole to serve as a bushing for the roller shaft. The offset in the bracket extensions is bent to suit the length of the roller. Bolting the slotted portions of the extensions to the original roller brackets permits varying the adjustment.

Gathering and Storing Cold-Weather Fish Baits

One of the best pan-fish baits for early fall is the small ear worm found in sweet corn. The worms should be gathered and stored in a deep box or barrel together with a few cornstalks with the ears left on. The grubs found in horseweed and goldenrod stems also are good fall and winter pan-fish bait. Just cut off the stems above and below the swelled portions (the worms are inside) and store them in a dry place until

you need the grubs. Angle worms should be dug in late summer and stored where they will not freeze. Keep the worms in a wooden box packed with alternate layers of damp moss and well-rotted leaf mold. Do not keep the worms too damp. Many species of minnows can be kept in a fairly deep pond or in a galvanized water tank where fresh water is pumped in daily. Feed them a little raw oatmeal or small worms.

Pan of Water Forms Level For Checking Slope

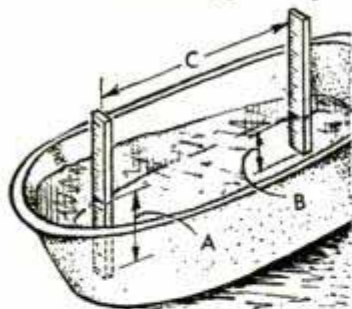

Finding it necessary to determine the degree of slope when pouring a new driveway and not having a level to do the job, I checked the slope by using two rulers and a pan of

water. I filled the pan about three-quarters full of water and set it in the driveway excavation, first being sure that the surface underneath the pan was uniform. Next I held two rulers on end in the water so that the distance C was exactly 1 ft. The depth of water in inches at B was subtracted from the depth at A, giving the slope per foot.

Leonti Thompson, New York City.

Preventing Lawn-Roller Rust

If your lawn roller is the type which is filled with water, it can be kept from rusting on the inner surfaces by adding a rust inhibitor to the water.

Ink Bottle in Paint Sprayer Saves Cleaning Cup

Time wasted and paint lost in cleaning a quart-size sprayer cup after painting small objects can be saved if an inner container such as an ink bottle or baby-food jar is used to hold the paint. Partially fill the ink bottle with



enamel of the desired color and set it inside the cup of the sprayer. After painting the articles, clean the spray gun by replacing the ink bottle with a second bottle filled with gasoline. In this way, the regular container is kept clean and ready for use on a larger job. If you buy the paint in $\frac{1}{4}$ -pint cans, the can of paint usually may be placed right inside the sprayer cup.

☐ Furniture hardware can be cleaned by scouring it thoroughly with borax and water, and then polishing with a soft cloth.

Spinning-Block Pull Toy—a Children's Favorite

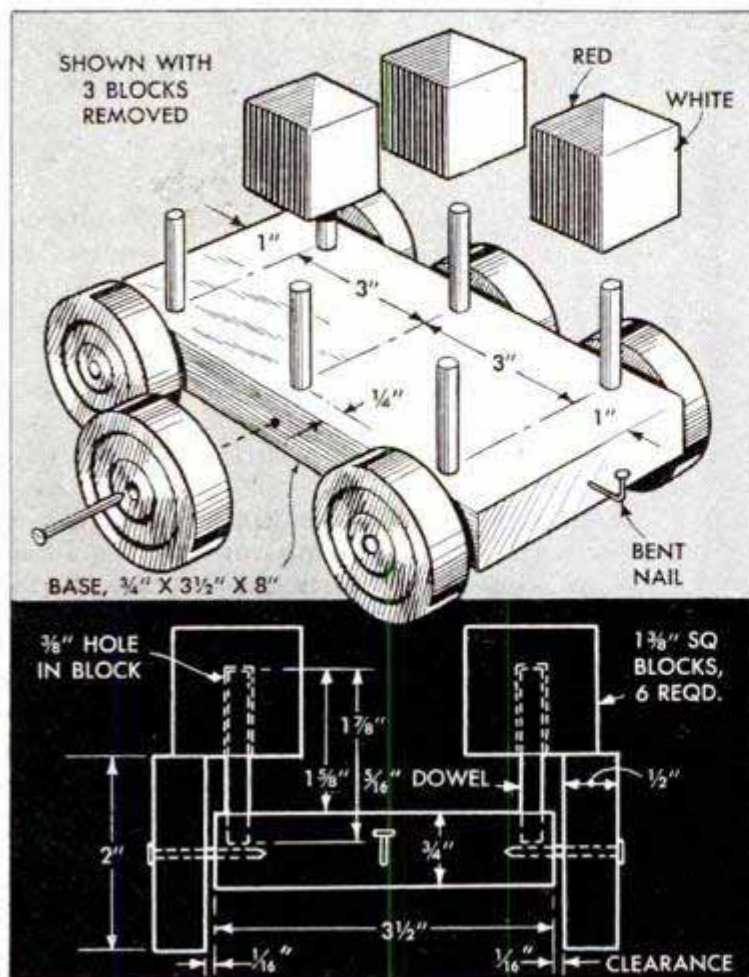

That toddler of yours doesn't need to be convinced that daddy's wonderful, but if you want to give him a real thrill, spend an hour or two some evening and make him one of these exciting pull toys. Six colorful blocks which fit loosely over dowels ride on the top edges of the wheels and spin as the wheels turn. The faster the toy is

pulled, the faster the blocks spin. The base of the toy is a block of wood drilled for the dowels, the wheels are turned and nails provide axles. After the parts are cut out and enameled, they should be allowed to dry overnight. However, once the parts are dry they can be assembled in five minutes.
I. M. Fenn, Chicago.

Proper Storing Keeps Bait Frogs and Crayfish Lively

Crayfish and frogs will be in lively condition when used for bait if they are kept in a clean, dampened gunny sack. Place some leaves and small branches in the sack and tie the top shut to keep the bait inside. The

branches will hold the sides of the sack apart. The sack should be moistened with cold water as necessary to keep it wet, and it should be stored in a cool, dark place.
R. A. Jenkins, Los Angeles, Calif.

Streamlined Bicycle Lights Form Headlights for Youngster's Auto

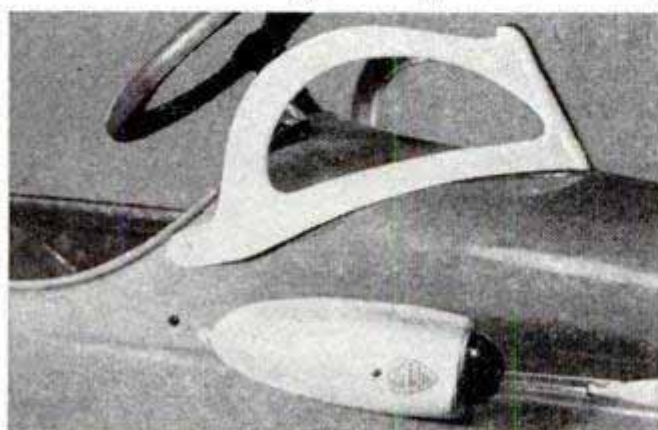

Mounting small bicycle lights on the sides of a child's automobile will provide neat headlights which not only add to the appearance of the car but make it more realistic for the young driver. A light may be mounted on either side of the cowl or front grille, or a bicycle horn may be substituted for one of the lights.

☞ To remove shellac from fabric, saturate the spot with grain or denatured alcohol. Then apply wet fuller's earth over it and, when dry, brush off.

RECORD CABINET

serves as hassock

By Elma Waltner



Set in front of phonograph, above, cabinet provides comfortable seat for changing records. Below, furniture glides raise cabinet to facilitate opening door

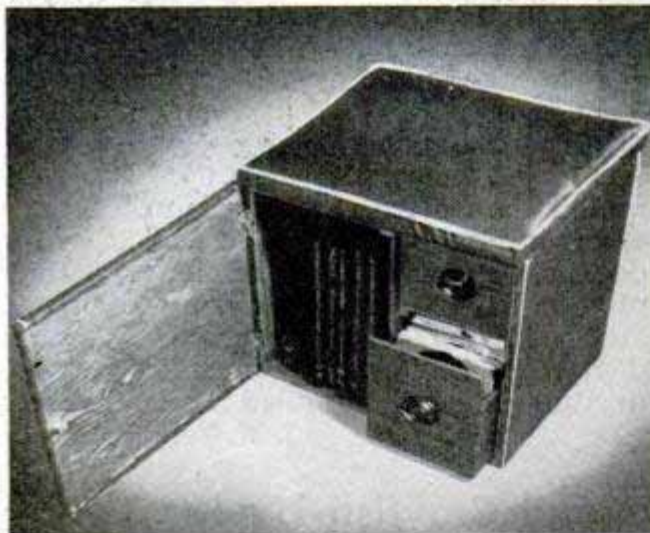

Panel joints are glued and fastened in place with countersunk screws, below. Pilot holes drilled in end grain will prevent possible splitting of panel

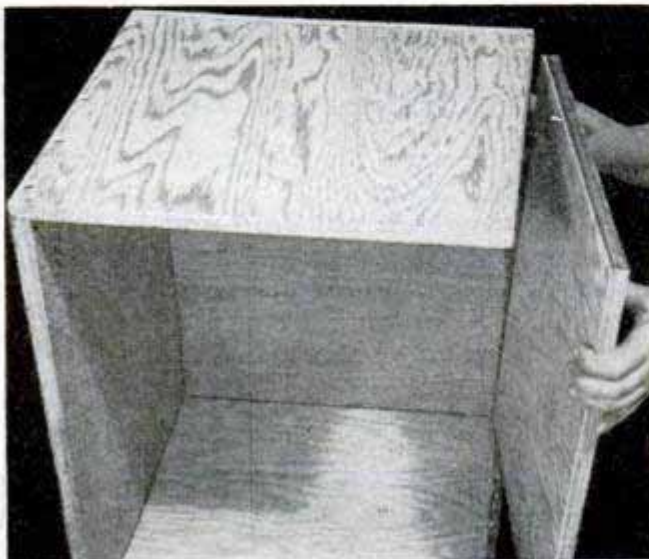

AFTER A few years, a phonograph-record collection invariably overflows all available storage space which, in many cases, poses the problem of adding a record cabinet to a room already crowded with furniture. If this is the situation in your home, here is a combination hassock-record cabinet that not only will take care of the overflow of records but will double as a comfortable seat. The cabinet is partitioned into three sections, one for storing 10 or 12-in. record albums and two drawers for filing 7-in. records and miscellaneous items.

The sides, bottom and top of the cabinet are of $\frac{5}{8}$ -in. plywood and countersunk screws and glue are used to fasten all the joints. A recess must be routed or cut into the front edge of the right-hand side panel to permit mounting a friction catch for the cabinet door. A plywood partition then is set up between the top and bottom panels and a plywood shelf for the upper drawer is nailed to cleats attached to the side panel and partition. The shelf cleats are cut $\frac{1}{2}$ in. shorter than the shelf itself so the face of the lower drawer will fit flush with that of the top drawer.

The cabinet door is simply a $\frac{5}{8}$ -in. plywood panel that is hinged with invisible hinges. If the latter are not available, ordinary butt hinges can be used with satisfactory results. However, these also should be set in mortises so that the hinge leaves are flush with the wood surfaces.

Plastic or imitation leather is used to up-

Photo below shows router bit being used to cut mortise in cabinet door. Matching mortises in door and edge of side panel receive invisible-hinge plates

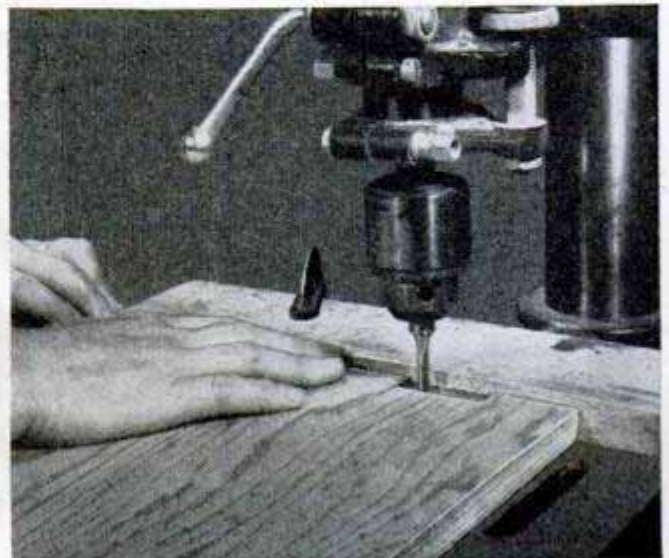

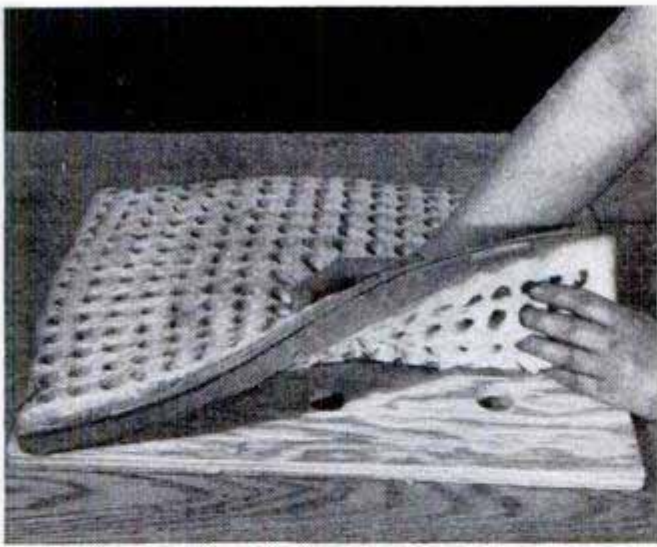

A plywood base slightly larger than over-all dimensions of cabinet top is fitted with foam-rubber pad to provide seat cushion. Note ventholes in plywood

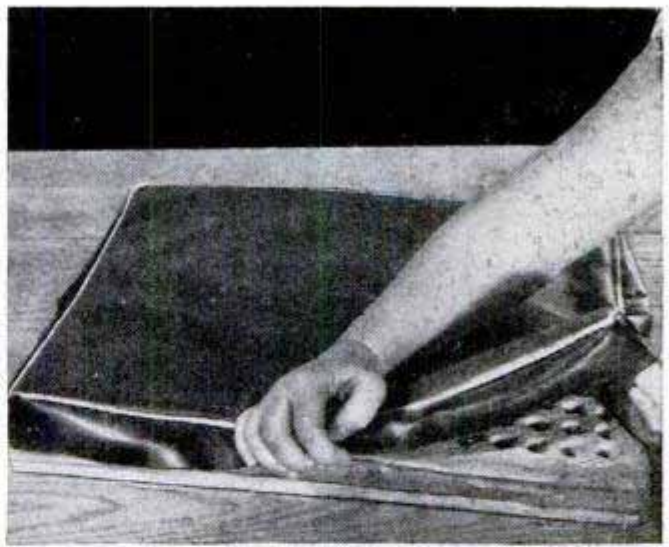

Cover for seat cushion is sewed together and placed over pad, above. Upholstery is brought around sides of cabinet and tacked to the top and bottom, below

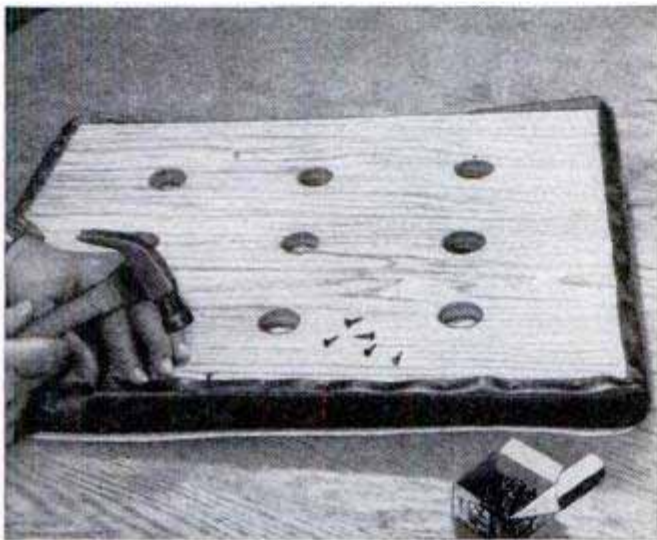

Seat-cushion cover is tacked to underside of plywood base and, after assembly, cushion is mounted on cabinet with countersunk screws driven from underside

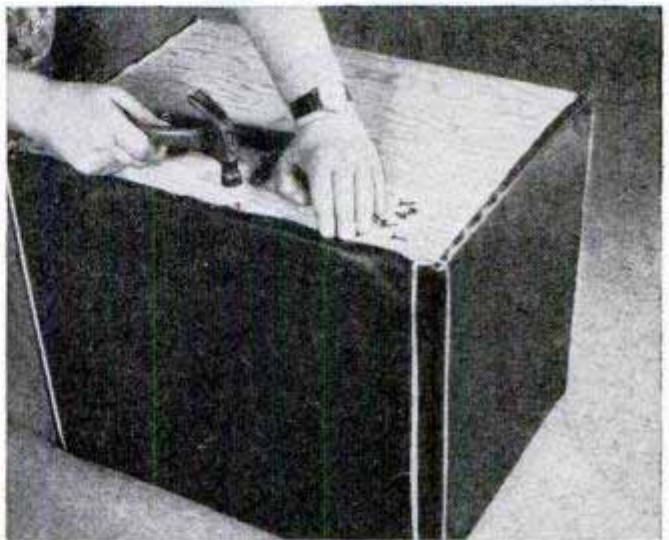

holster the cabinet, which is trimmed with a decorative welt seam of a contrasting color. The welt is sewed between the upholstery panels and corner strips when covering the sides, and between the top panel and boxing, or edge strips, when covering the cushion. The latter consists of a plywood base, a foam-rubber pad and the upholstery, which is brought around the edges of the base and tacked to the underside. A neater job of upholstering can be done around the door opening and on the door itself if the exposed edges of the material are glued to the wood between the tacks.

The drawers are made as in the detail, the drawer bottom being nailed in rabbets cut along the lower edges of the sides, front and back. Dimensions of both drawers are the same except that the face of the bottom one is made high enough to reach the lower edge of the top drawer. Furniture glides attached to the corners of the cabinet, raise it off the floor sufficiently to permit opening the door without binding.

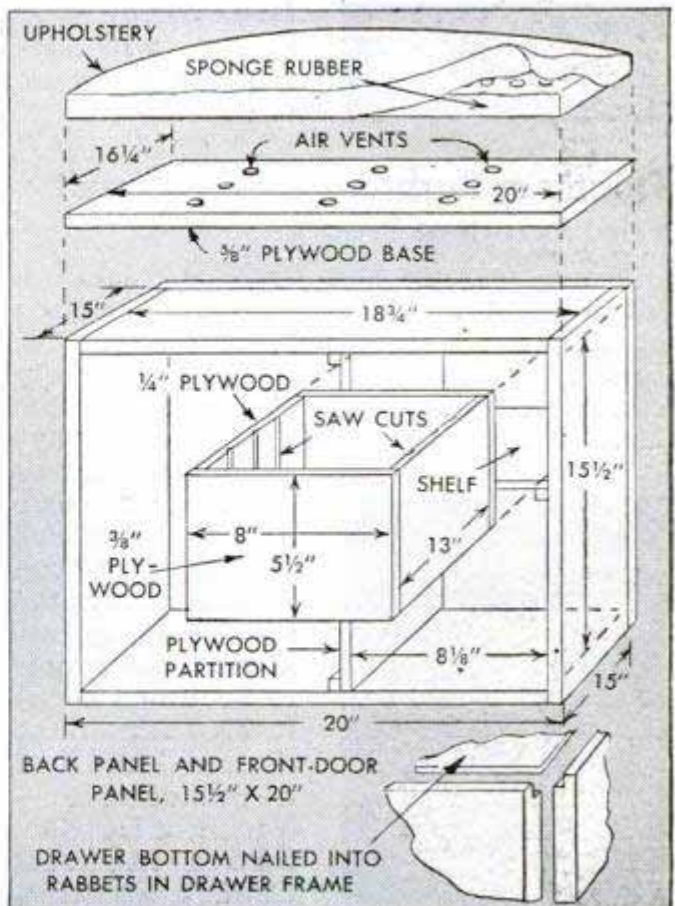

Board Supported by Camera Tripod Forms Collapsible Utility Table

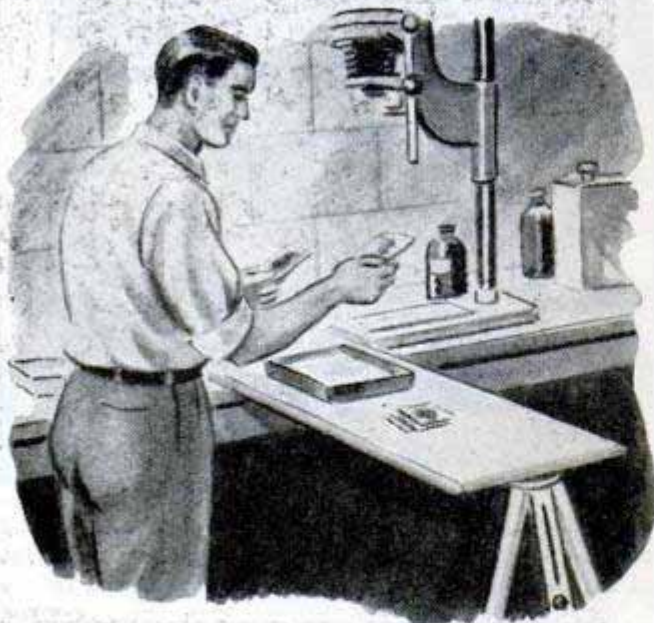

If, on occasion, you need extra work space in the darkroom, it can be attained quickly by improvising a utility table from a board and a camera tripod. Mount a standard tripod bushing in the underside of the board or simply drill a hole in the board to receive the tripod screw. Then support one end of the board on a table or bench top and use the tripod to provide a support for the other end, turning the tripod screw into the bushing or pressing it into the hole in the board. The board can be stored in an out-of-the-way place when not in use to keep it handy for emergencies.

Edward L. Fisher, Milwaukee, Wis.

Wetting-Agent Dispenser

Some photographers who add a wetting agent to their developer find that a hand-lotion dispenser of the type pictured is more convenient to use than a bottle and medicine dropper. After cleaning the lotion bottle and dispenser thoroughly, fill the bottle with a solution consisting of



$\frac{1}{2}$ oz. of concentrated wetting agent to 10 oz. of water. With the wetting agent diluted in this way, each depression of the dispenser plunger will adequately treat 8 oz. of developer.

Quartz or Carbon-Arc Sun Lamps Print Excellent Proofs

When making sunproofs at night on print-out studio proof paper, use a quartz or carbon-arc sun lamp to do the job. Proofs from negatives of ordinary density can be made in a few minutes, and the sun lamp is actually more desirable than day-



light, as it allows positive timing control. Unlike daylight, the sun lamp is always the same intensity, allowing the proofs to be timed accurately to attain the desired shade or depth of tone.—Virginia Hanson, Santa Monica, Calif.

Spare Parts Carried in Match Book

Small spare parts for a camera can be carried in the pocket with little danger of loss if they are attached to the inside of an empty match book.



Tightly fasten each part to the book cover with a strip of cellulose tape and, if desired, write any pertinent information regarding the parts on the inside of the cover or on a label glued to the outside.

John J. Rea, Urbana, Ill.

Miniature Spot for Close-Up Work Utilizes Coffeemaker Bowl

Wired to a photoflood reflector, the top bowl of a vacuum-type coffeemaker provides a miniature spot for extreme close-up work or microphotography. The metal bowl, mounted over the front of the reflector as shown in the photo, will throw a brilliant pin point of light at close range. Be careful when using the unit to prevent overheating, and handle the bowl cautiously after use to avoid burns.

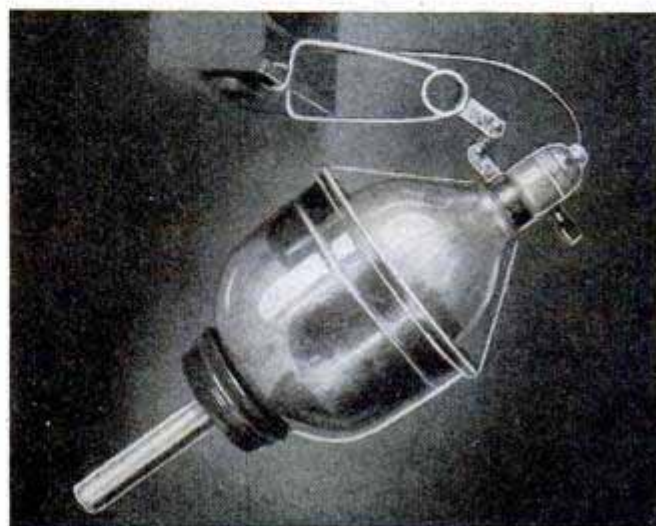

PHOTOGRAPHER'S PROP STAND

Photographing insects, plant specimens, etc., requires a special prop stand for close-up work, especially if magnification of the object is necessary. This stand supports a reading glass beneath the camera lens as in the upper photo at the right. It also doubles as a magnifier for spotting prints, as in the lower right-hand photo, or viewing negatives when making a critical analysis of detail. The design of the stand provides a universal adjustment of the glass, which can be locked firmly in any position by means of a screw eye and wing nut. The angle positions indicated are optional. All parts except the metal arm should be of hardwood smoothly sanded and shellacked.

E. Peter Smith, Los Angeles, Calif.

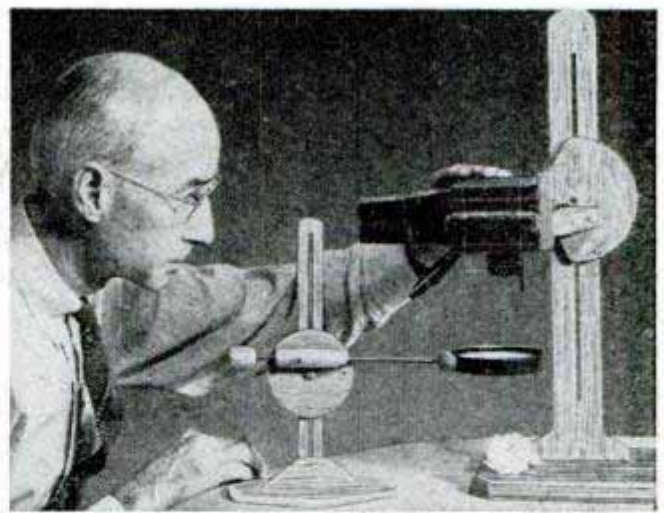

A universal adjustment of the stand simplifies the placement of magnifier when photographing extremely small objects where critical focusing is necessary

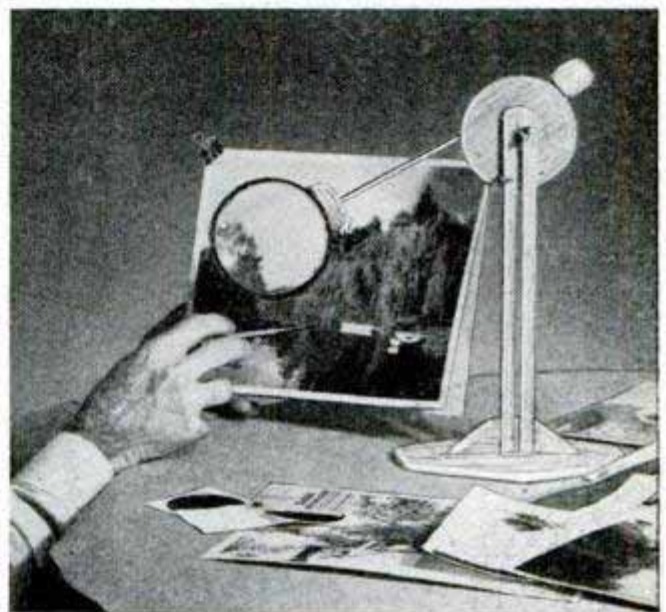

Simply readjusting the glass gives you a magnifying viewer for spotting prints or examining fine detail in choice negatives. Unit also can be made to serve as a magnifier for bench assembly of small parts

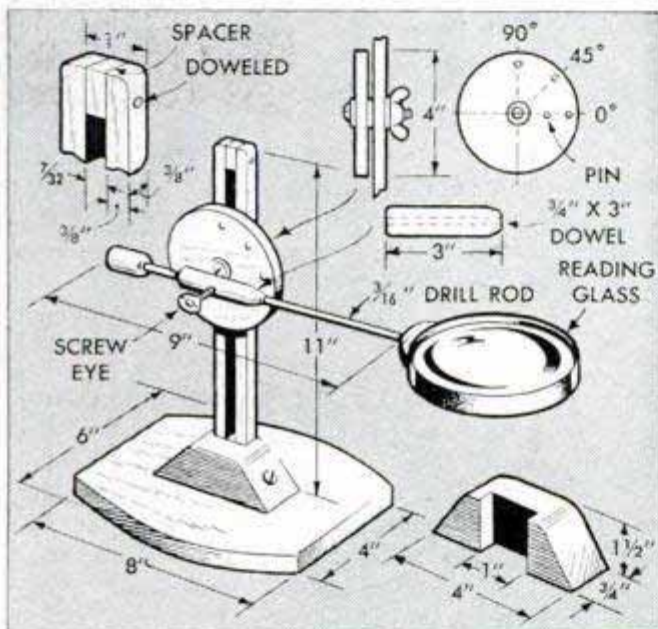

Paper Clip on Print Tongs Hooks Over Tray Edge

To keep wooden print tongs from sliding into the developer when resting them on the edge of the tray, fasten a wire paper clip over one of the legs of the tongs, thus providing a stop which catches on the edge of the tray. If the arm of the tongs is too wide to permit slipping the inner loop of the paper clip over it, open the clip and bend the wire around the arm. Bend the wire so that it projects a slight distance from both edges of the arm.

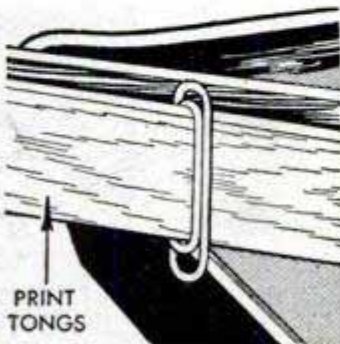

Tape Across Top of Pan Head Tightens Loose Camera

If the screw in the top of a pan head does not hold the camera securely enough to keep it from slipping when the head is turned quickly, cover the pan-head surface with black photo tape. The thickness of the tape together with its nonslip surface will keep the camera from turning after the screw has been tightened. Note that the screw projects through the tape and that the latter is trimmed around the edges to suit the shape of the pan-head top.

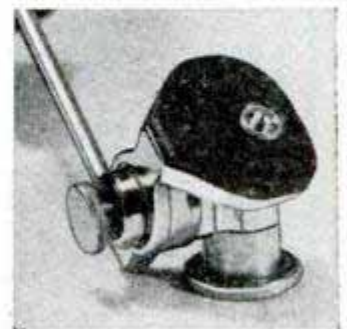

PARALLAX CORRECTION for a

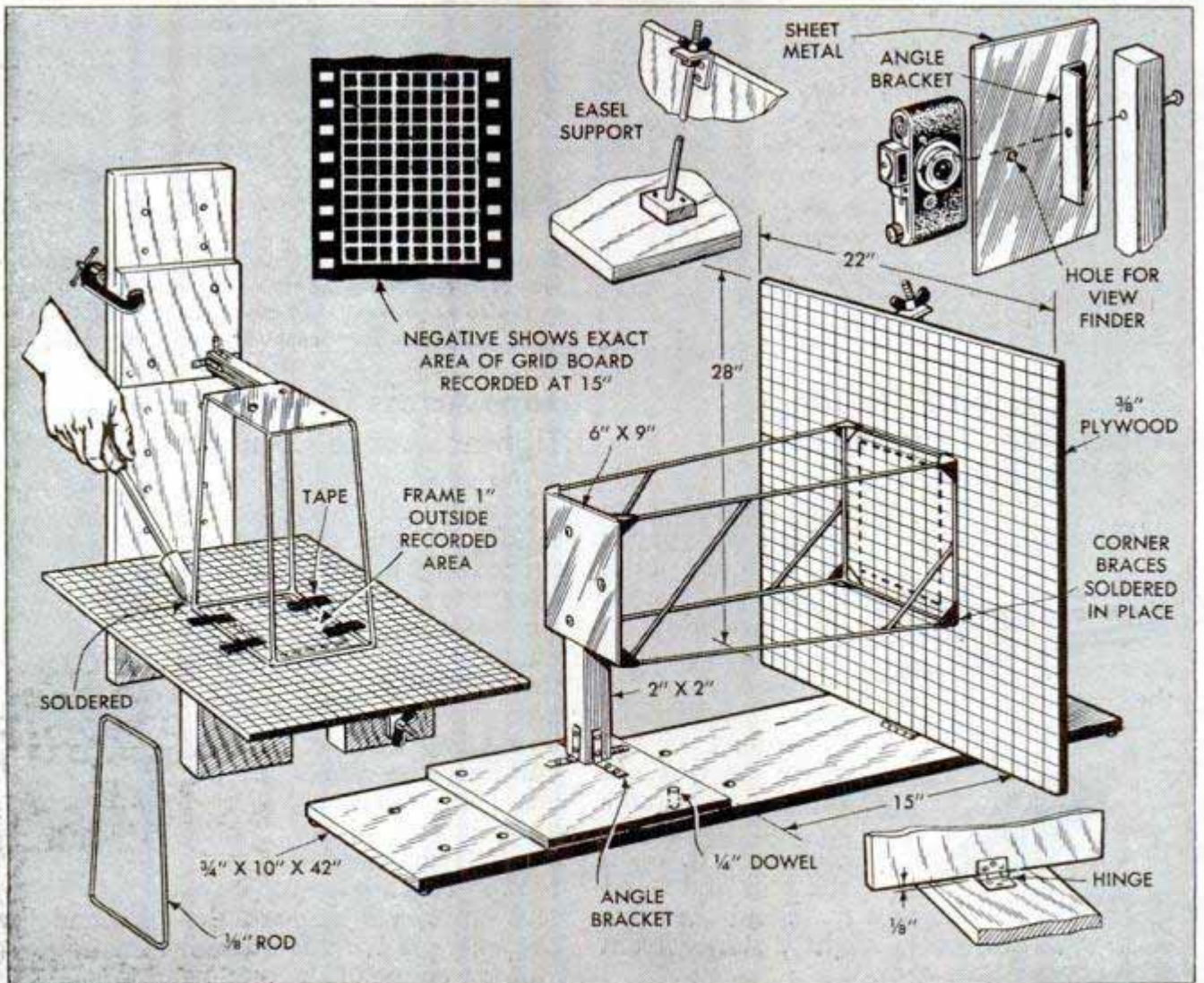
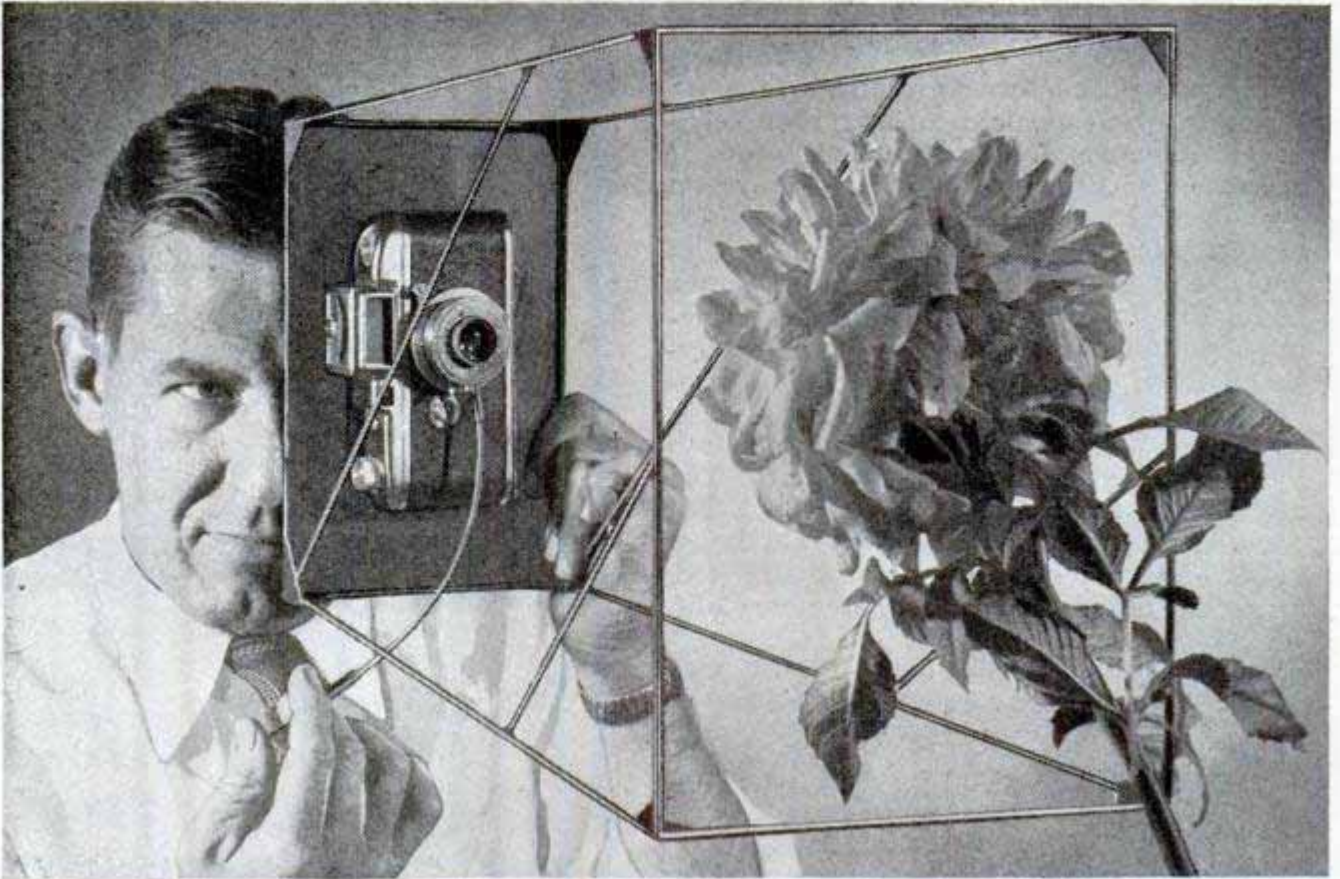

35-mm. camera

By Paul Will

IN EXTREME close-up work where it is desired to make color transparencies of a single flower or other object with a 35-mm. camera, there is always the problem of parallax. At such close range the lens coverage and that of the view finder do not coincide. Thus, when the subject appears to be framed perfectly, it actually isn't and may even be partly out of the picture. To correct this, I made the simple device shown at the left which automatically centers the subject and brings it into sharp focus without adjusting the camera.

The wire frame forms a depth stop, and to shoot an object on the ground, I merely stand the device vertically over the subject and shoot. Likewise, in shooting a specimen or copy mounted on a wall, the device is simply held against the wall. The same is true in shooting a flower, and it's all done without an auxiliary close-up lens.

To determine the length of the wire framework, a wooden carrier is made according to the detail at the left. The dimensions given are not critical, and the 15-in. dimension is the distance I found necessary for my particular camera. The camera is mounted on a sheet-metal plate by means of a piece of angle iron. Note that a small peephole is made in the plate in line with the view finder. The camera and plate are supported by a post fastened to a movable base which is located at one end of a 3½-ft. board and an easel is provided at the opposite end to determine the area covered by the lens. This easel also can be used for copy work and may be hinged to fold flat. Rule the easel in 1-in. squares in ink and also rule heavy reference lines intersecting at the center of the board. Now, noting on the camera scale the closest distance the lens can be located from the easel, clamp or bolt the movable base to the carrier. If, for example, the scale reads 1¼, locate the lens 15 in. from the easel. With this done, take a test shot and make a print. Count the number of squares on the print and the same number on the easel, keeping the count in the same relation to the center lines both vertically and horizontally. Mark this area with a dotted line. It defines the exact area covered by the lens. Now, leaving the camera undisturbed, stand the set-up on end and assemble the framework in the manner shown, painting all parts with flat-black lacquer. Note that the open end of the frame is made 1 in. larger over-all than the recorded or dotted area so that the frame will not register on the film.

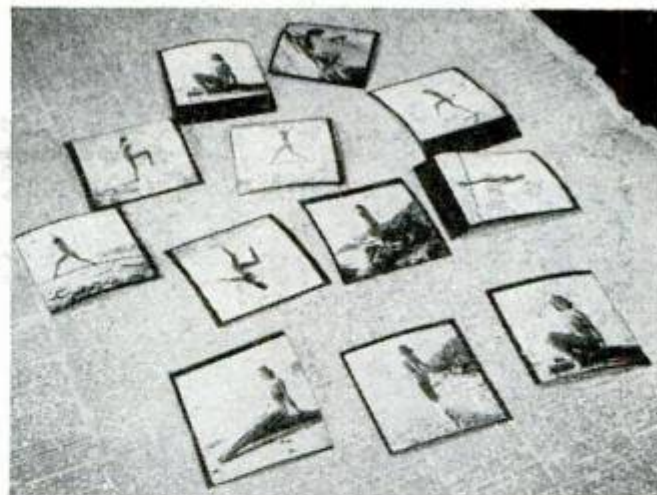

Newspaper Flattens Curled Prints

When heat is used to dry glossy prints on ferrotype tins, the prints have a tendency to curl. While they are still warm from the drier, the prints can be flattened quickly by placing them face up on several thicknesses of newspaper which have been sprinkled with water. The prints will absorb enough moisture from the newspaper to relieve the excessive dryness which causes the curl.

Sandpaper on Flash-Gun Adapter Speeds Cleaning Bulb Terminals



To assure good contact, many photographers moisten the base terminal of each flash bulb before inserting it in the socket. A faster and, more important, a much safer way to assure firing is to rub the terminal across a strip of sandpaper or emery cloth

which has been cemented to the flash-gun adapter or to a convenient spot on the camera case.—H. Leeper, Canton, Ohio.

Holder for Applicator Stick

Cotton and an applicator stick are always handy if they are kept right with the retouching medium. To provide a holder for these items, tape the top section of a lipstick container to the side of the bottle.



Basement Windows Sealed With Plywood Panels

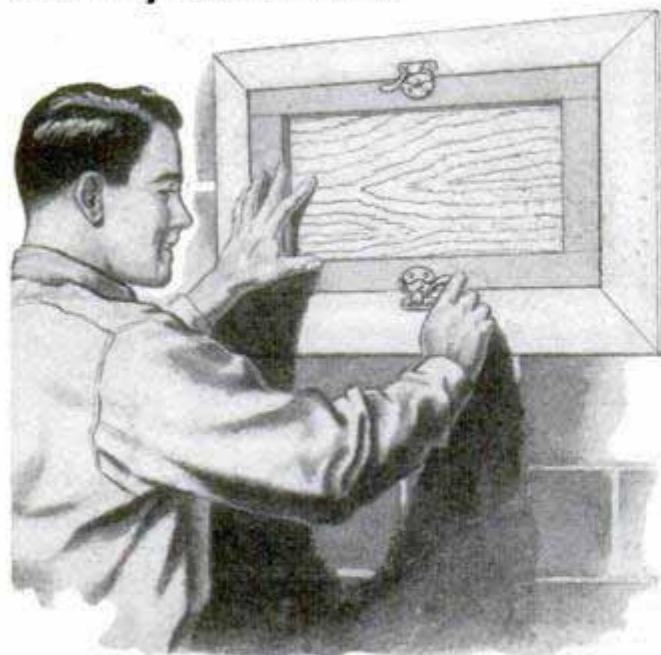

Keeping light from entering through the windows of an improvised darkroom often entails enough trouble to dampen the enthusiasm of many an amateur photographer. One way to seal the windows of a basement laundry room or a utility room in a jiffy is to make lightproof panels which fit snugly between the edges of the window casings. Sheets of plywood, hardboard or cardboard are used for the panels. These are cut to size and framed with strips of wood. Then felt weather stripping or strips of cloth folded three or four times are tacked around the edges of the panels to form a light seal, and ordinary sash locks are used to clamp the panels in place.

Hugh Lineback, Stillwater, Okla.

Steel Ball Shims Reflector Swivel When Clamp Arm Is Removed

If a clamp-on photoflood reflector is mounted permanently on a stand, it is desirable to remove the clamp arm so that it does not interfere when adjusting the reflector.

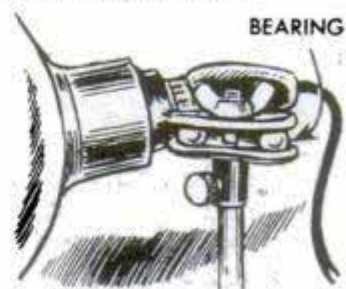

As the swivel ball is part of the clamp arm, it is necessary to substitute another metal ball which will serve as a spacer to hold the joint plates parallel. A ball from a bearing or a steel "marble" of the right size will shim the swivel fixture, allowing the reflector to be easily adjusted and holding it in position.

Cotton Dispenser for Darkroom

Instead of bothering to open the package of absorbent cotton and tear a wad of it from the roll as needed, one photographer saves time by rolling wads of cotton into balls and storing them in a cardboard candy or shoe box.

The balls are of a size found to be most convenient for swabbing film, cleaning ferrotype plates and filtering solutions.

Stored in the candy box, the cotton is available for quick selection and, if kept covered, is protected from dust and lint.



Books That Will Save You Hundreds of Dollars

Popular Mechanics CONCRETE-BLOCK HOUSE FOR \$3650 is the answer to the problem of every family that feels the present high cost of housing makes owning a home an impossibility in the immediate future. Build a house yourself and you can save over 50 percent of its cost. Any average handy man need not hesitate about tackling the job. Sure, it takes time and work, but there is nothing difficult about it because the editors of *Popular Mechanics* have taken all the mystery out of home building in a book which they prepared as the house was being built. They followed construction in detail and prepared the book to take you through construction step by step. The editors not only tell you how to build the house, but they show you how by diagrams and photos. The text, photos and diagrams are keyed by figure numbers so that you can't go wrong. This

five-room home is dampproofed and insulated. You can still start this summer and get the structure enclosed before bad weather sets in. Just send \$2.00 for the book. A set of blueprints is available for \$12.00, or you can get both the book and blueprints for \$12.50.

Popular Mechanics VETERINARY GUIDE FOR FARMERS will pay for itself in a few weeks no matter whether you own many animals or only a single pet. It will not make you a graduate veterinarian, but will enable you to diagnose and treat many common animal ailments. It costs less than one professional call of a veterinarian, and may be the means of saving the life of an expensive animal or prized pet in an emergency. The book is written in easy-to-understand terms and is divided into various sections covering different animals. The book sells for \$3.50.

All books are available from *Popular Mechanics* Book Dept., 200 E. Ontario St., Chicago 11, Ill.



Shop Notes



#174

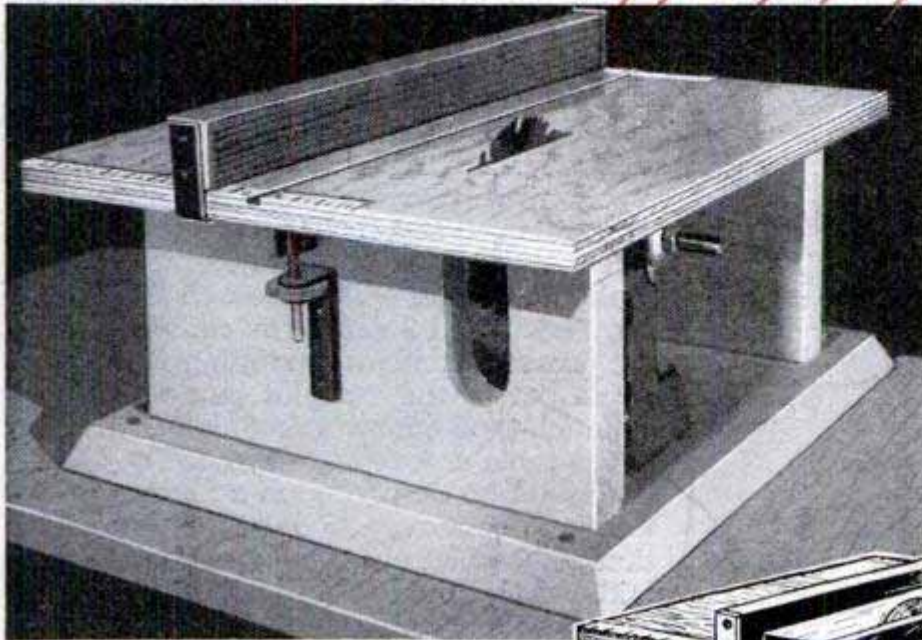

Build This 6-in. CIRCULAR SAW

By Dick Hutchinson

HOME CRAFTSMEN, hobbyists and others who have only occasional need for a small circular saw can easily build a serviceable one from a few pieces of hardwood, assorted bolts, flat iron and a polishing head of the type having a straight spindle fitted with two machined collars. A light polishing head of this type makes a suitable arbor for a 6-in. saw blade. The top, or saw table, Fig. 1, is made from $\frac{3}{4}$ -in. hardwood plywood, such as oak or birch. Have your lumber dealer cut the piece to size, run the $\frac{3}{16} \times \frac{7}{8}$ -in. groove and also cut the saw slot in the position indicated in the detail. The slot should be $\frac{1}{4}$ in. wide. Some polishing heads have larger pulleys than others, making it necessary to dado or recess the underside of the top as indicated by the dotted lines in Fig. 1 to provide clearance for the pulley and belt. If required, this cut can be made at the time the groove is cut. Cutting the belt slot in the table support, Fig. 5, is easy; just bore a $2\frac{1}{8}$ -in. hole with an expansive bit and make two saw cuts inward from one edge of the piece to remove the waste. Then reinforce the opening with two blocks attached to the back face with screws. Fasten

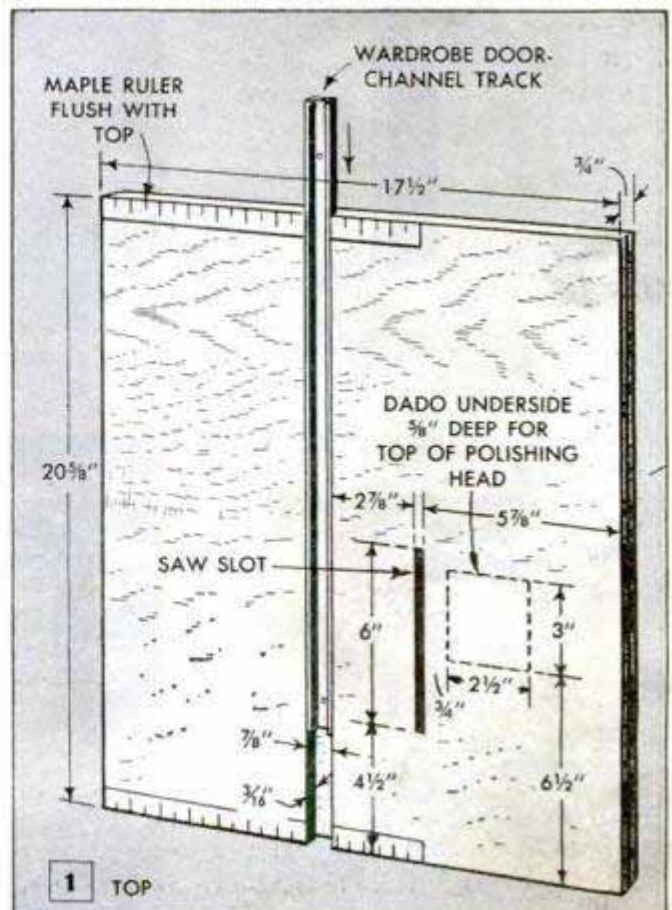

1 TOP

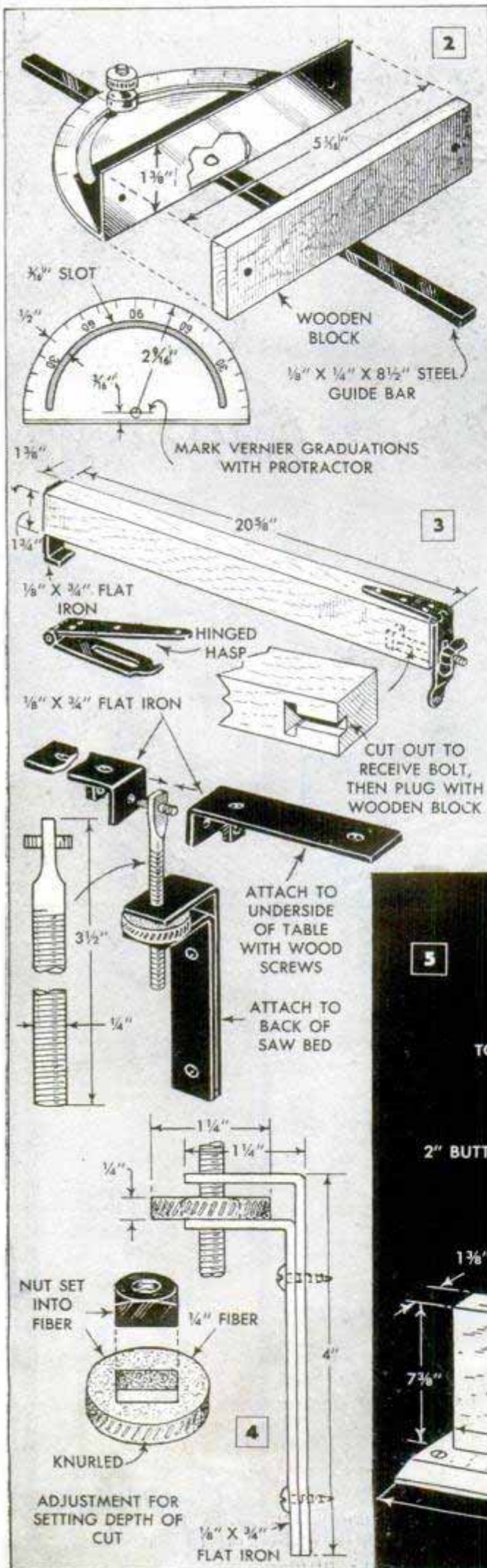

this support to a base of $\frac{3}{4}$ -in. plywood with screws driven through the plywood from the underside. Then cut another support of the same size and attach it near the opposite end of the base. Locate the polishing head on the base and fasten it in place with screws or bolts. Now, place the saw blade on the polishing head, and bring the top into position with the blade projecting through the slot. Shift the top until the blade is centered in the slot. Then mark the location of the hinges.

Parts which make up the elevating screw mechanism are detailed in Fig. 4 and shown in position in Fig. 5. This type of elevating screw gives a positive adjustment of the table height and will not loosen after being set. Figs. 2 and 3 detail the construction of the crosscut guide and ripping fence. The guide bar of the crosscut guide runs in a channel-type door track which is inserted in the table groove as in Fig. 1. The swinging metal guide pivots on a rivet, permitting it to be moved 45 deg. in either direction. The semicircular slot must be carefully laid out and filed to a uniform width. Details of the ripping fence will be clearly seen from Fig. 3. Fig. 1 shows scales made from hardwood rulers and set into the front and back edges of the table as an aid to accurate setting of the ripping fence. However, these are not essential as it is quite easy to set the ripping fence accurately with a rule. Finish the table with two coats of shellac and rub with steel wool.

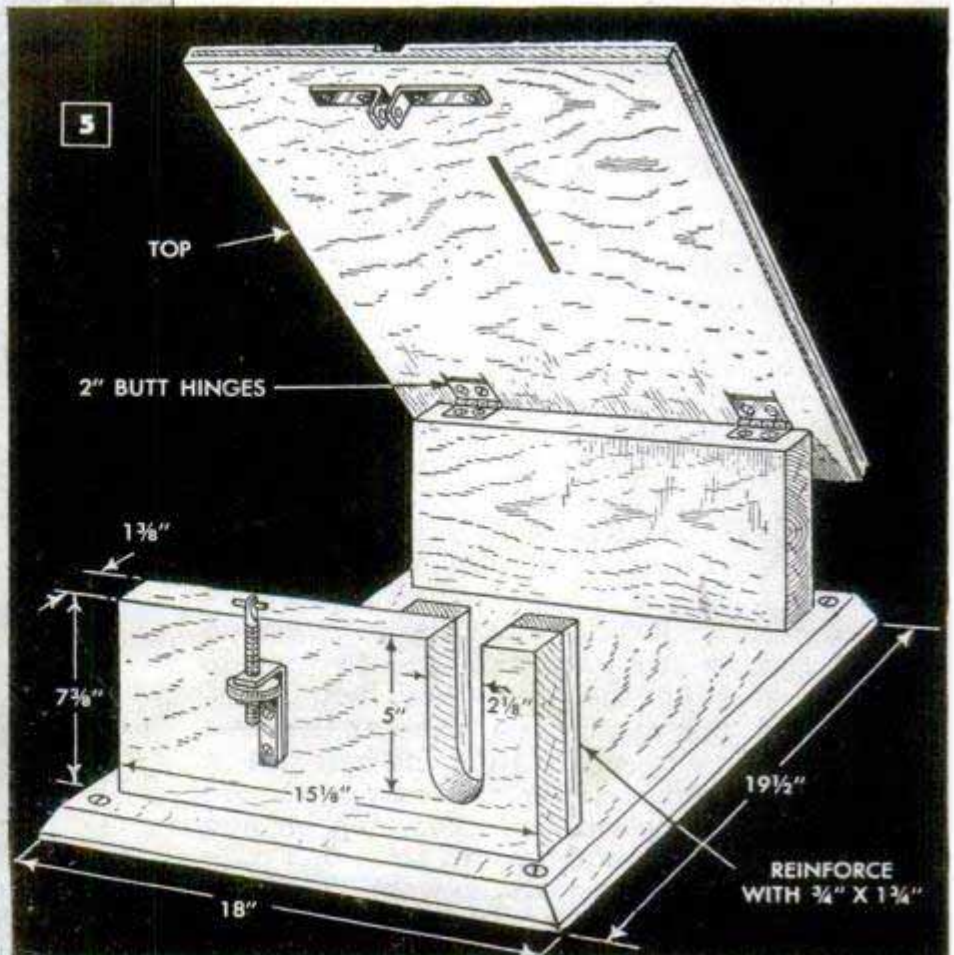

Inexpensive Grain Blower Utilizes Scrap Parts

Operated by a 6-hp. motor or by a belt drive from a tractor, this home-made grain blower is just the thing for elevating grain into farm bins to be ground for feed during the winter season. Built inexpensively from scrap parts, the blower will handle as much as 10 bushels of small grain per minute. The blower shell is $\frac{1}{8}$ -in. sheet metal bent to a circular shape and held between two sheet-metal sides with 8-in. carriage bolts. The hopper is also of sheet metal fastened to an angle-iron frame, and a sliding door regulates the amount of grain being fed into the blower. The blower drive assembly consists of the front hub, bearing

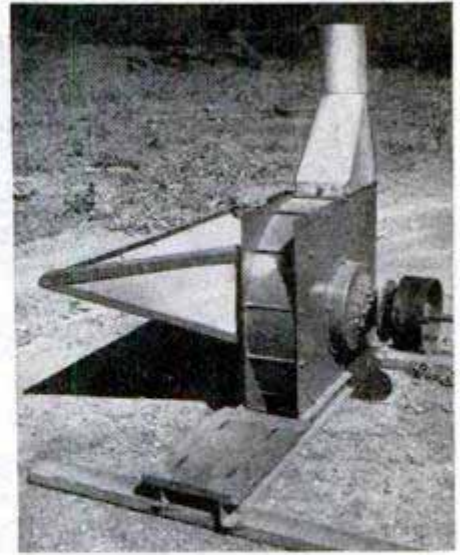
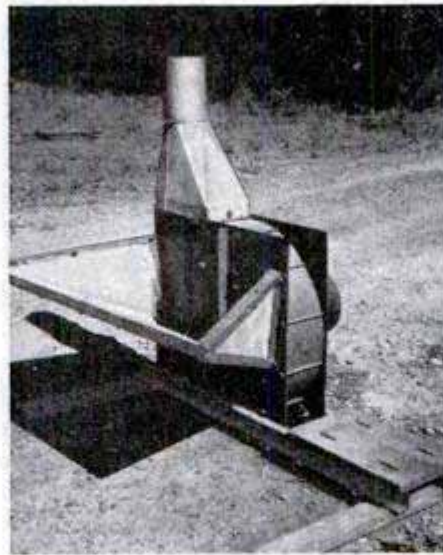

and axle of a 1936 truck. Four fan blades of $\frac{1}{8}$ -in. sheet metal are welded to a section of arbor bolt, or square axle, from a disk harrow. Then the arbor is mounted on the truck axle to complete the assembly.

Retruing Center Hole Without Removing Stock From Lathe

When turning heavy stock between centers, machinists sometimes experience trouble caused by enlargement of the center hole at the tailstock end of the work. This happens quite frequently when a number of heavy cuts must be taken on the same piece. Ordinarily, it is necessary to remove the stock from the lathe in order to true the center hole, but this can be avoided by using a center-truing bit made as in the detail. Use a short piece of hex stock of a suitable sectional size and turn, center-drill and grind as indicated. Then temper the bit to hold a cutting edge. To use the bit, block up the stock to hold it in position, then run the tailstock center back

until the bit can be placed in the center hole of the work. Run the tailstock quill in until the tail center enters the center hole in the bit. Seat the tailstock center fairly tight and turn the bit with a wrench. Usually one turn of the bit will clean and true the center hole accurately.

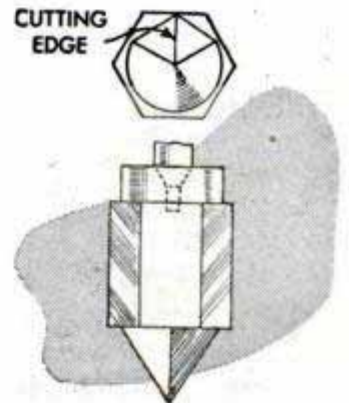

A. E. Kerswell, San Bernardino, Calif.

Easily Seen Warning Symbols Painted on Trailer Endgate

A tractor trailer is difficult to see on the highway at dusk or in a rainstorm unless it is painted in colors having high visibility

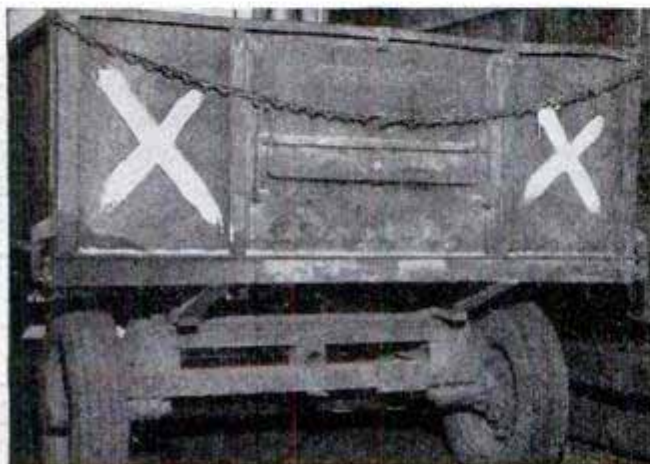

properties or is otherwise clearly marked with a warning symbol which is visible at a distance. Ordinary red reflectors are often insufficient warning to approaching motorists. Some farmers who regularly use tractor trailers on the highway paint large "X" symbols on the trailer endgate, using a bright-yellow or orange paint. The symbols should be as large as possible so that they are readily seen under poor light conditions during the day or evening. Always use two symbols, one near each side of the wide endgate so that the full width of the trailer is clearly indicated.

Loose piston rings and worn pistons or cylinders are indicated by oily conditions of the spark plugs.

Two Oil Drums Welded Together Form Gasoline Storage Tank



Welding together two 55-gal. oil drums to form a single drum of 110-gal. capacity provides a handy gasoline storage tank for the farm. Drums having one damaged end can be used, as one end of each drum must be cut off before welding them together. After welding, paint the outside of the tank with aluminum paint to reflect heat, mount it on a wooden stand and fit one end with a spigot. Before welding, be sure to steam-clean the inside of each drum thoroughly to prevent the possibility of an explosion resulting from the ignition of oil fumes.

L. H. Houck, Jefferson City, Mo.

Spring Toggle Holds Clevis Pin

Any farmer who has ever had the clevis pin work out of the clevis when hauling a loaded tractor trailer on the highway or in rolling fields, will appreciate the safety features of this clevis-pin lock. A short

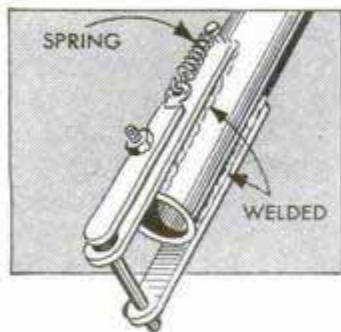

bolt welded to the top clevis bar serves as a pivot for the spring-loaded toggle. The latter is simply a short length of flat iron drilled near one end to fit over the bolt loosely. A metal ring, or eye, is welded to the

rear end of the toggle and a hook-shaped lug is welded to the drawbar back of the clevis, as shown. One end of a coil spring is hooked into the eye and the other end is hooked over the lug. Moving the toggle sideways in either direction releases the clevis pin.

Interior Walls of Metal Tubes Cleaned With Abrasive Strips

Here's a way to mirror-polish the inside walls of metal tubes. Shoulder a length of $\frac{1}{4}$ -in. drill rod $\frac{1}{8} \times \frac{1}{4}$ in. at one end and thread the

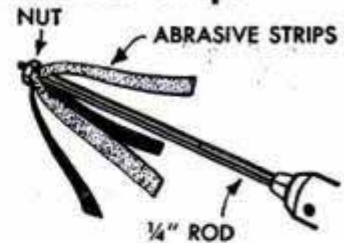

projection. Then cut two 1 x 12-in. strips from abrasive cloth, punch a hole through each strip at the center and slip the two strips over the shouldered projection at the end of the rod. Run down a $\frac{1}{8}$ -in. nut to hold the strips in place. Then tighten the free end of the rod in a hand-drill chuck as shown. Hold the tubing in a vise, insert the tool in one end of the tube and rotate the hand drill rapidly, moving it simultaneously back and forth. On long lengths of tubing, work from both ends.

Leroy J. Hebert, Lexington, Mass.

Wire Grip for Speeder Handle Prevents Blistered Hands

As the speeder handle for my set of socket wrenches had no rotating handgrip on the crank, I found that prolonged use of the wrench was hard on my hands. To facilitate using the wrench, I fashioned a suitable handgrip by wrapping 9-ga. wire around the crank. The starting end of the wire is clamped tightly to the crank with a pair of vise-type pliers and the wrench handle is turned to wind the wire. The ends of the coil can be squared by cutting off the ends of the wire diagonally, and they can be soldered in place if desired. However, the 9-ga. wire is stiff enough to hold its shape without soldering. In order to clamp the

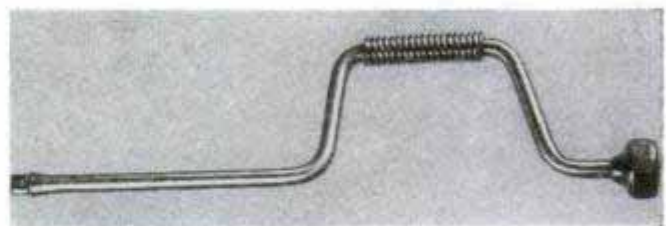

end of the speeder handle in a vise to facilitate winding the wire, I sandwiched the handle between two pieces of board before tightening the vise jaws. These were drilled previously to form a matching half-round groove in each piece which keeps the handle from tilting but still permits it to be rotated while wrapping the wire.

Charles S. White, Vernon, Tex.

ⓘ Keeping tire valve caps in place is important. They help prevent air leakage and keep dirt out of the valve core.

LATHE BENCH

By H. F. Sheldon

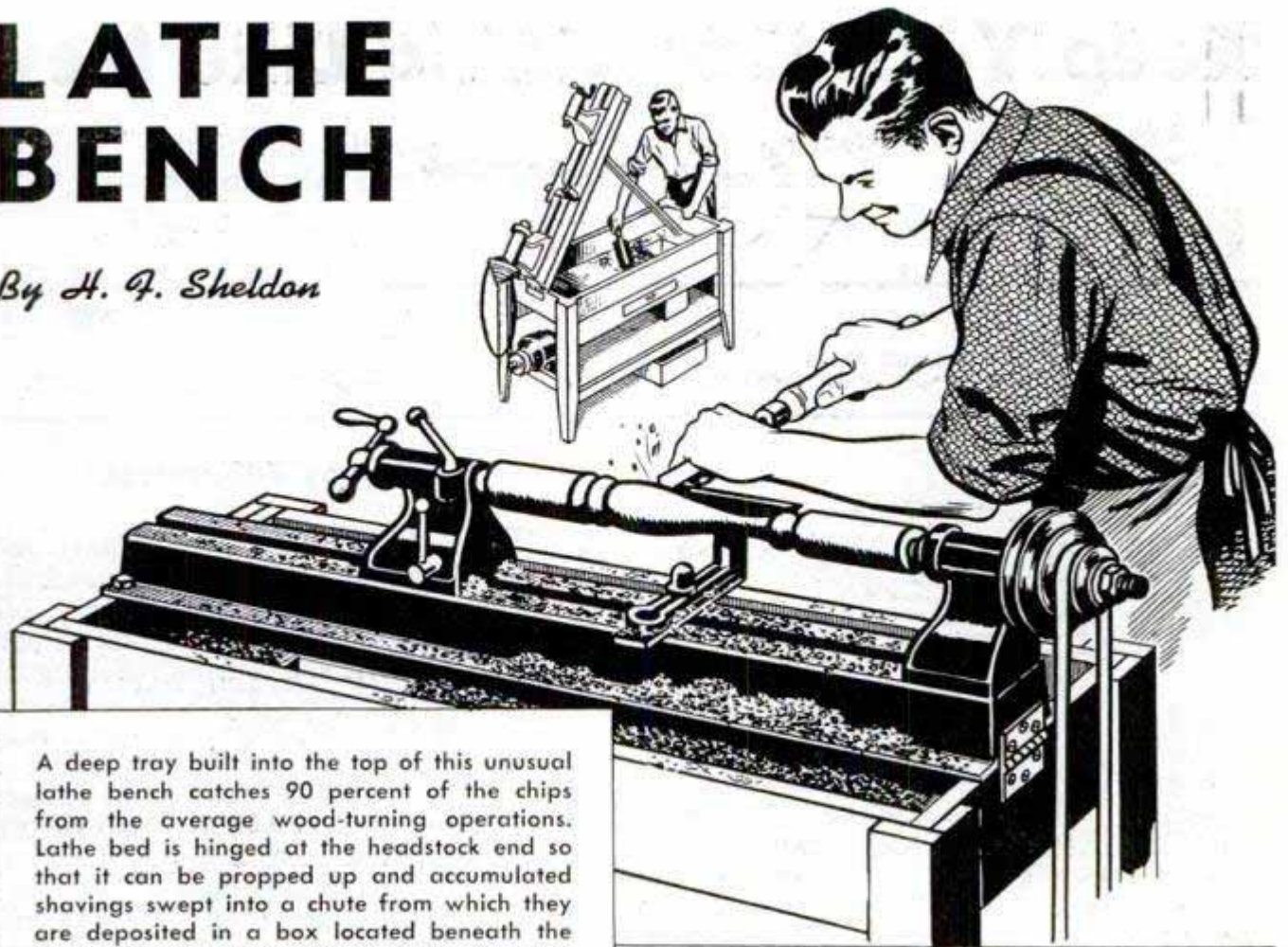

A deep tray built into the top of this unusual lathe bench catches 90 percent of the chips from the average wood-turning operations. Lathe bed is hinged at the headstock end so that it can be propped up and accumulated shavings swept into a chute from which they are deposited in a box located beneath the bench. There also is a drawer for lathe tools and the lower shelf provides a solid base for the motor. Actual dimensions of the bench are, of course, determined by the size of your lathe

6" X 6" CHUTE FOR SHAVINGS

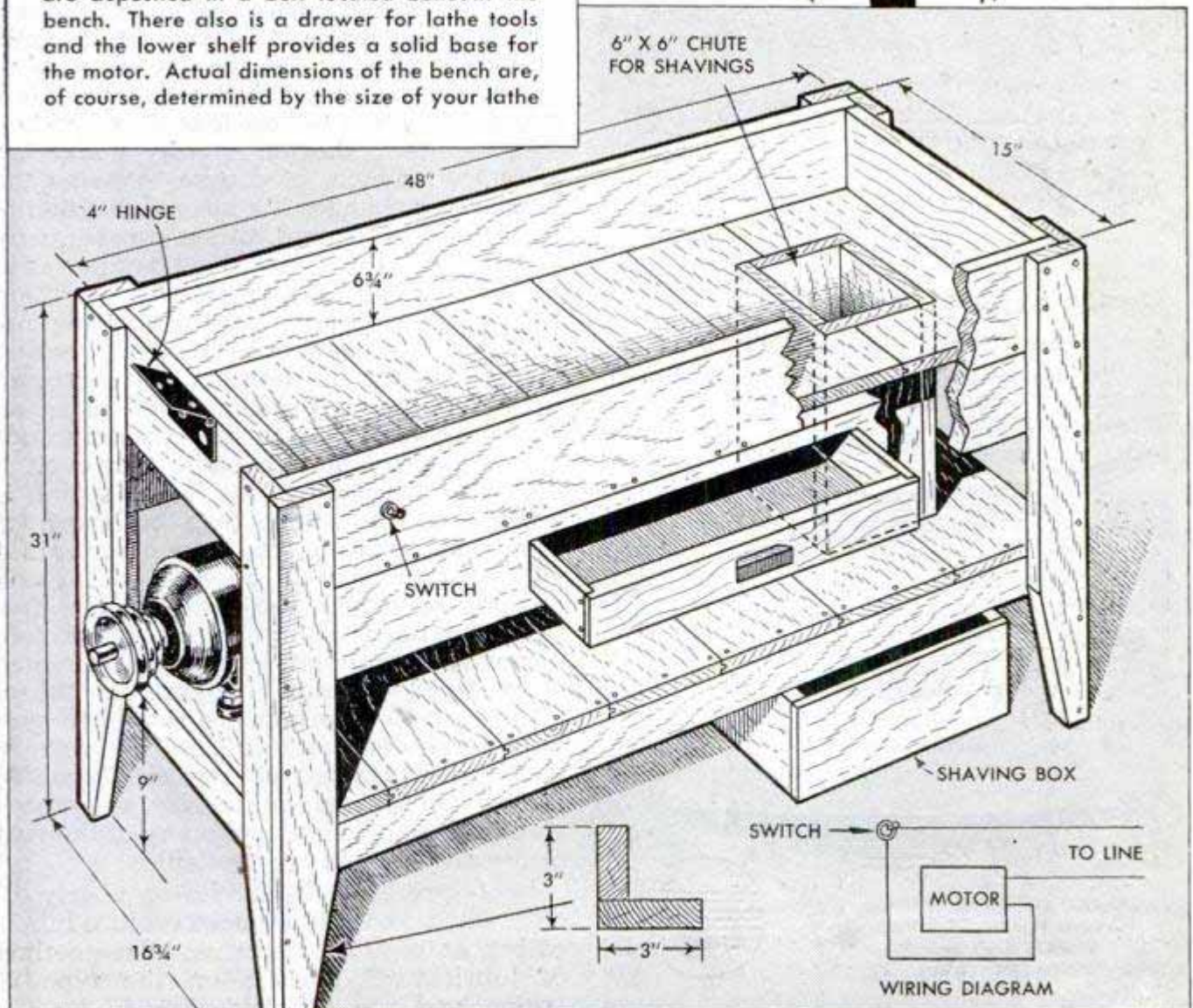

Keep Your Car Riding Like New

Straight-line steering and smooth riding qualities built into your car are retained by regular servicing of springs

CAR CHASSIS AND BODY

WHEELS AND AXLES

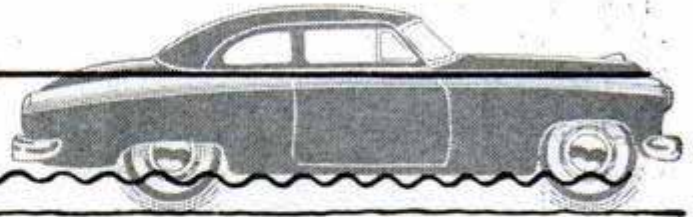

By Murray Fahnstock

WHEN YOU hit a hole in the pavement or a bump in a side road the shock absorbers snub out rebound of the car axle but the springs take the real punishment by preventing the shock from reaching the car frame and body. Even when you're cruising on a smooth highway, the springs soften the ride by constantly flexing to equalize irregularities in the road surface. Lack of lubrication can cause rapid wear in leaf springs, and rust and metal fatigue combine to cause a slow loss of "life" in a coil-spring suspension of the type shown in Fig. 1. Under normal load conditions, spring suspensions of this type are designed to operate with the A-bars, or control arms, in approximately a level position. After years of service the springs may weaken and, in effect, shorten slightly under the body load which, of course, remains the same. This changes the normal position of the control arms and, in some cases, may even change the front-wheel camber as in the lower detail in Fig. 1. This condition can cause a serious loss in steering response and it also results in rapid wear on the tires. Often the defect can be corrected by shimming the springs with spacing washers which fit into the retaining cups at the top and bottom ends. However, if body sag is excessive, or if one spring is lower than the other, then both springs should be replaced. On some older cars it will be necessary to check steering and possibly to realign the front wheels after shimming or installing springs. On certain newer cars, coil springs may be shimmed or replaced without changing the wheel alignment. Coil springs are simply torsion bars, upper detail in Fig. 2, and any surface flaws caused by rust will weaken them. To protect coil springs against rust, keep them well painted or coated with any of the rust preventives which are available.

Leaf springs and shackles on nearly all older-model cars and trucks require lubricating at regular intervals. The method of lubricating depends on the type of spring and the provisions made by the

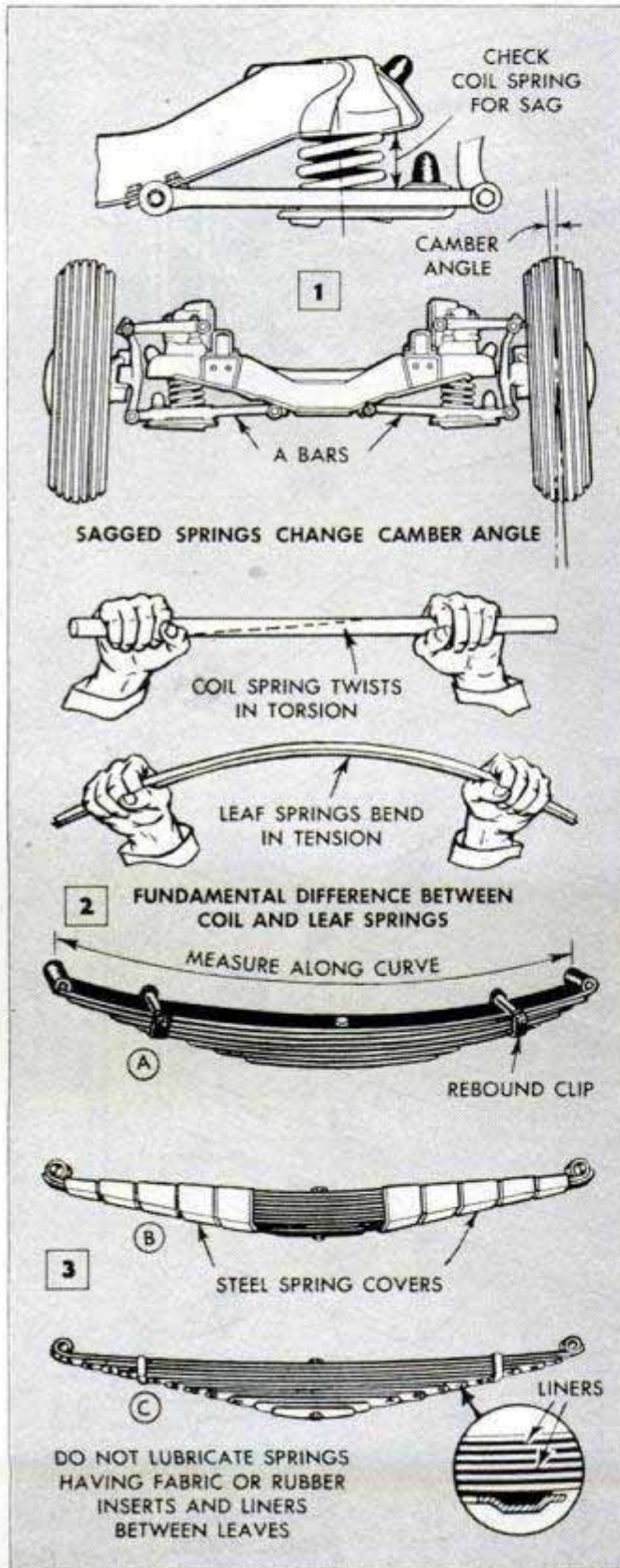

manufacturer for applying lubricant. All leaf springs bend under tension as in the lower detail in Fig. 2 and on nearly all cars more than 10 years old the springs are of the type shown at A in Fig. 3, the ends of the spring leaves being cut square or diamond pointed as in Fig. 7. Some, however, were made with round, tapered ends on all the leaves except the top leaf, Fig. 7. On later-model cars, and on some light trucks, the leaf springs either are fitted with steel covers as at B in Fig. 3, or are of the nonlubricated type detailed at C. On the older-type springs, Fig. 3,A, it may be necessary to loosen the rebound clips and pry the leaves apart in order to apply lubricant between the leaves. Whenever such springs are lubricated always make the checks detailed in Figs. 4, 5 and 6. If measurement from the top of the spring to the lower side of the frame varies more than $\frac{3}{4}$ in., check the low spring carefully for a broken leaf or excessively worn shackle bolts. Renew faulty parts, as otherwise lubrication of the spring may increase leaf deflection and result in breakage of adjacent leaves. If possible, use the lubricant specified by the manufacturer of the car. Otherwise use chassis grease to which a small quantity of powdered graphite has been added, or use penetrating oil.

Lubrication of covered springs is easily done, without removing the metal cover, by the use of the special spring-lubricating fitting detailed in Fig. 8. On some of the late-model cars the need for lubrication of the leaf springs has been eliminated by the use of waxed fabric liners between the adjacent leaves, detail C in Fig. 3. On others, rubber "buttons" are placed under the tips of the spring leaves. The only service required on springs of this type is replacement of worn liners or buttons. This is done by jacking up the car body to take the weight off the springs. Then the leaves are pried apart with a screwdriver or a special spring spreading tool, and the worn liners or buttons are removed from the depressions in the leaf tips and replaced. On some liners, only the worn ends are renewed. This is done by wedging the leaves apart and cutting off the worn portion of the liner with a hacksaw blade. Replace with new end sections of liner fabric. When the rebound clips are removed for any reason, be especially careful when replacing them to see that they fit with the correct clearance, Figs. 5, 6 and 9. This clearance is important as it allows the main leaf to twist when the car or truck is driven diagonally across a low culvert or onto a ramp.

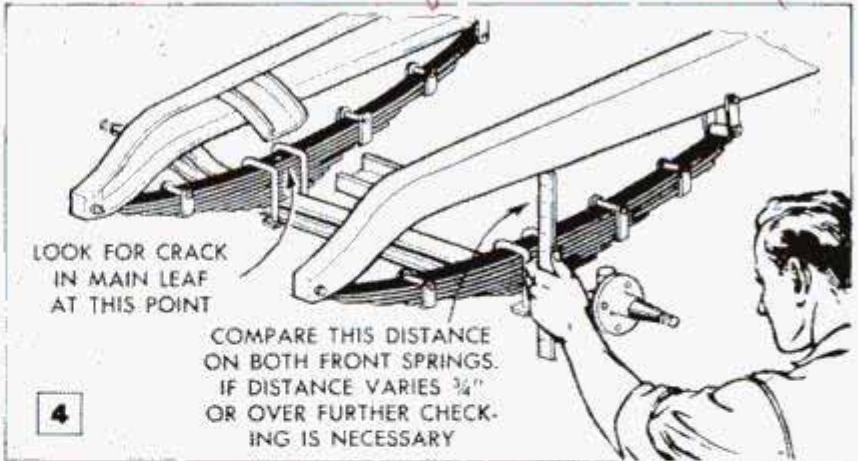

4

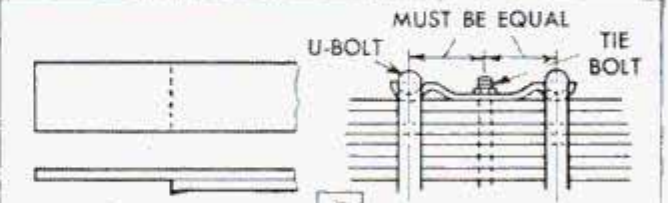

5

TIE BOLT POSITIONS SPRING IN PROPER PLACE

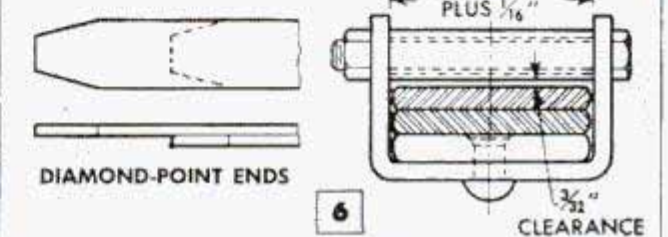

6

CLEARANCE CORRECT CLIP CLEARANCE FOR FREE SPRING ACTION

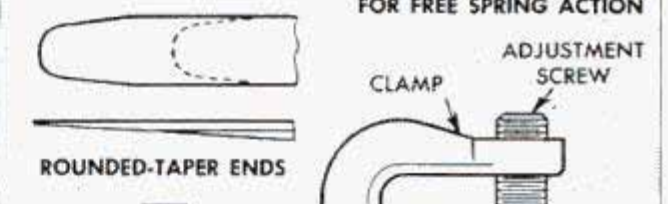

7

SPECIFY TYPE OF LEAF ENDS WHEN PURCHASING NEW LEAVES

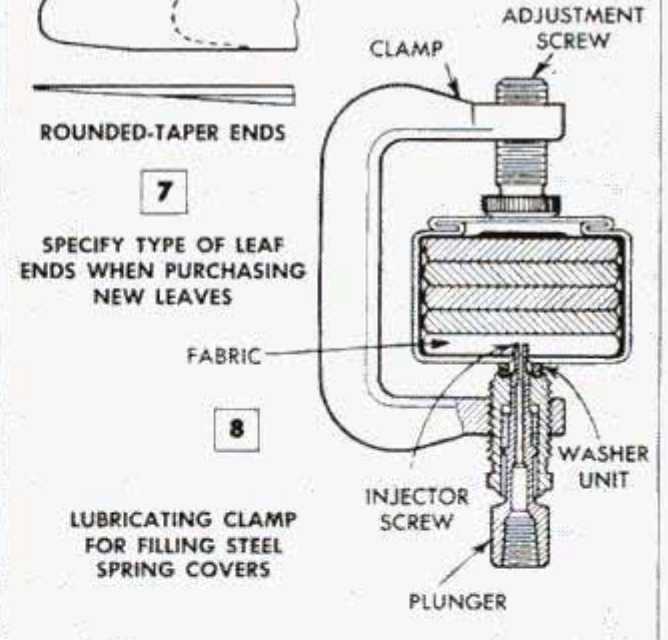

8

LUBRICATING CLAMP FOR FILLING STEEL SPRING COVERS

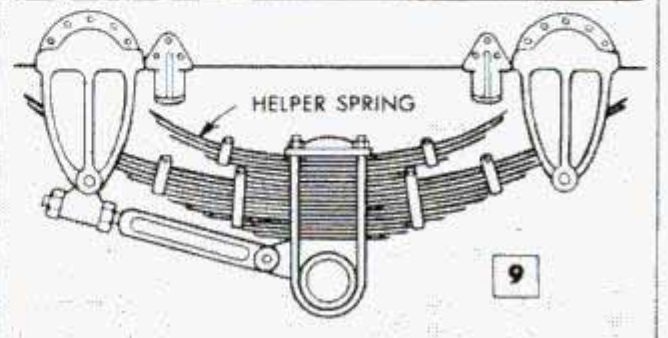

9

TRUCK-TYPE HELPER SPRING

Burning Auto Tire Kills Weeds



One farmer found that burning a discarded auto tire made a fire hot enough to kill brush and patches of weeds. A length of wire tied to the tire permits pulling it over the ground without getting too close to the flames. To ignite the tire, stuff it with old rags and paper and pour some kerosene over them so that they will burn long enough to ignite the rubber. Using a tire in this way also provides a quick method of starting a backfire to bring a spreading brush fire under control.

A. M. Wettach, Mt. Pleasant, Iowa.

Grease-Gun Nozzle Kept Dirt-Free

To keep the nozzle of a hand-type grease gun free from foreign matter, just slip an empty 12-ga. shotgun shell over the end of the nozzle. The shell fits snugly and is easy to remove from the nozzle.

Benj. Nielsen, Aurora, Neb.

Rubber Skirt Tacked to Type Brush Prevents Spattered Solution

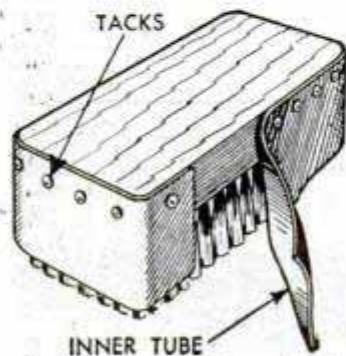

When cleaning type forms with gasoline or caustic solutions there is a danger of spattering near-by equipment and damaging or soiling it. To remove this danger, fit the brush with a skirt cut from inner-tube

or sheet rubber. Just tack the skirt to the wooden handle so its lower edge does not quite reach the ends of the bristles.

Check Locates Leaky Head Gasket

This quick check will spot a leaky head gasket every time. First braze a tire valve into the base, or shell, of a spark plug, being careful to produce an airtight braze with no pinhole openings.

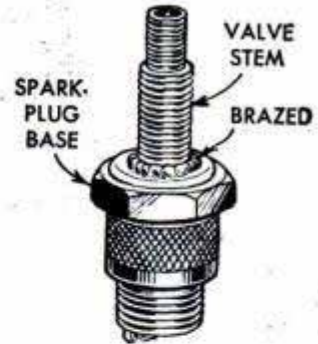

Starting with the No. 1 piston, remove the spark plug and screw in the improvised air valve. Then turn the engine over until the piston is at the top dead center with both valves closed. Place the transmission in gear and, if necessary, block the rear wheels so that the car cannot roll. Apply air from the tire-inflating line to the test valve. If there is a leak in the head gasket, bubbles will immediately appear in the radiator tank. This procedure will turn up head-gasket leaks which cannot be detected by other methods. Auto mechanics will need three test valves made in this way, one each in the 10, 14 and 18-mm. sizes. — Henry G. Lutter, Libertyville, Ill.

Storage Space for Ground Feeds Included in Stock-Tank Shelter

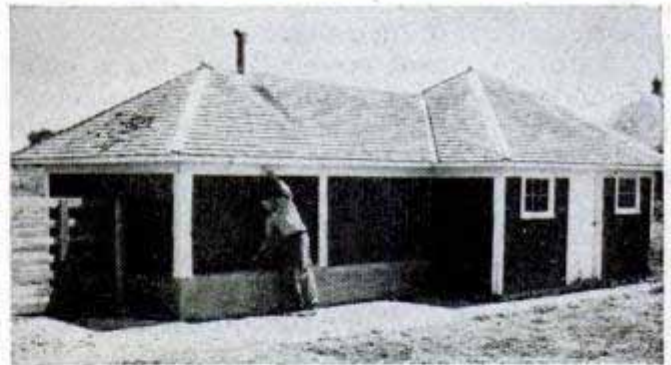

Located on the fence line between farm feed lots, this neat structure provides dry storage for ground feeds and year-round shelter for a large concrete watering tank. The tank shelter is fitted with hinged doors which are kept closed during the night when the temperature is below freezing, thus making it unnecessary to operate a tank heater except during the most severe winter weather. The feed-storage section of the building is of conventional construction with a concrete floor. The sides of the water tank serve as sills for heavy posts and plates which support the roof structure of the tank shelter.

Ⓛ Don't forget to apply just a touch of oil to the distributor cam each time the car is lubricated.

SHAVINGS BOX

By Paul A. Waugh

DISPOSAL of light, fluffy shavings from a jointer is aided by this neat shavings box. As pictured at the right, it works just like a tilting flour bin and is easily removed from the jointer stand for emptying, thus keeping the shop clean and reducing the fire hazard to the minimum. The back, bottom and sides are made from plywood and the front from solid stock. Note that the upper ends of both sides are cut part way across the width on a $10\frac{3}{4}$ -in. radius, the curved cuts ending in $\frac{1}{4} \times \frac{1}{2}$ -in. notches. The back sides of the notches form stops. The front piece is rabbeted on both sides and the lower corners are notched as shown. In assembling, the joints are fastened with glue and small nails or screws. After assembly, a cleat is nailed and glued to the bottom as in the underside view, below, and two small blocks are glued to the bottom in the position indicated. The box is supported by a $\frac{5}{16}$ -in. metal rod as in the lower right-hand photo. To place the box in position in the stand, slide it inward on top of the supporting rod. Then tilt it outward until the stops strike the vertical sides of the top piece of the stand. Then raise the box slightly so that the blocks on the bottom will slip over the rod. To remove the box simply tilt it outward until the stops engage the stand. Then raise it slightly and pull outward at the bottom.

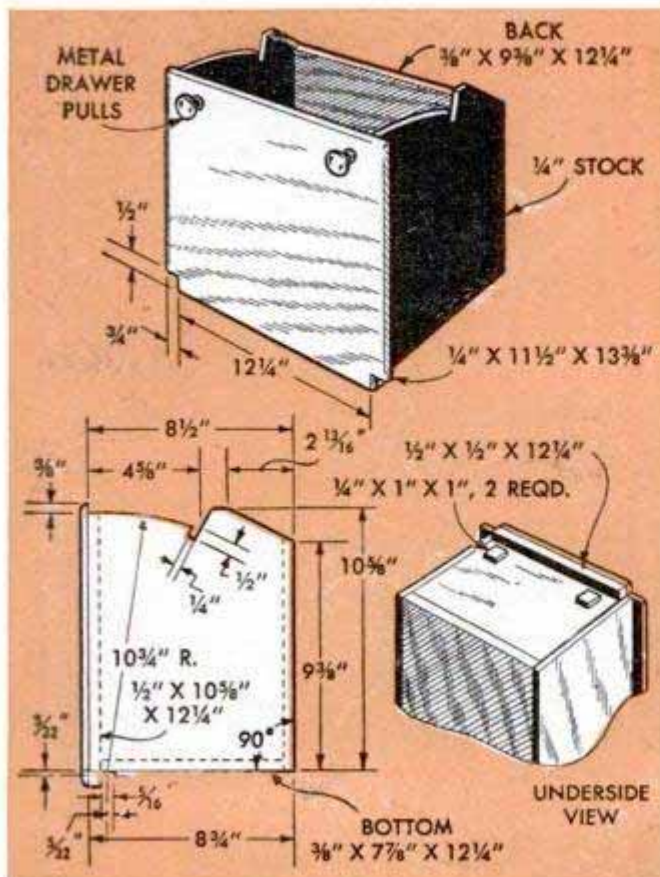
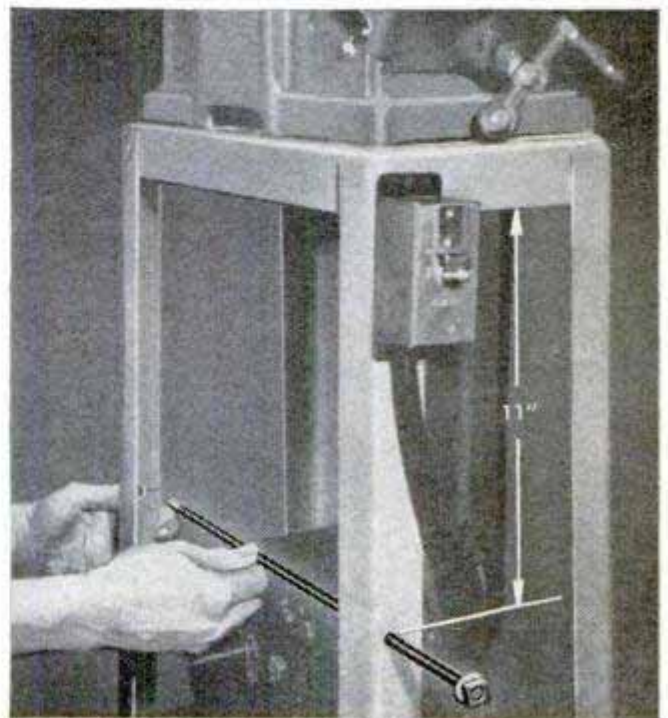
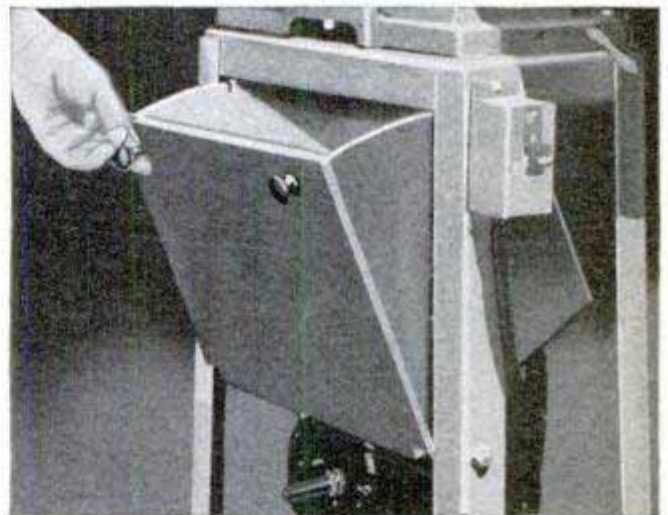
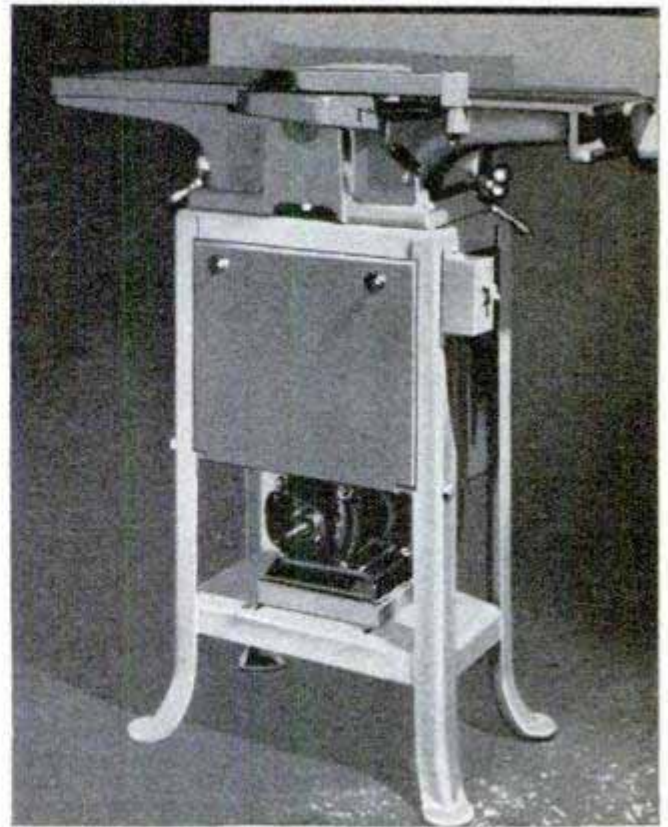

PRECISION With "Mikes"

Part II

By *W. Clyde Lamme*

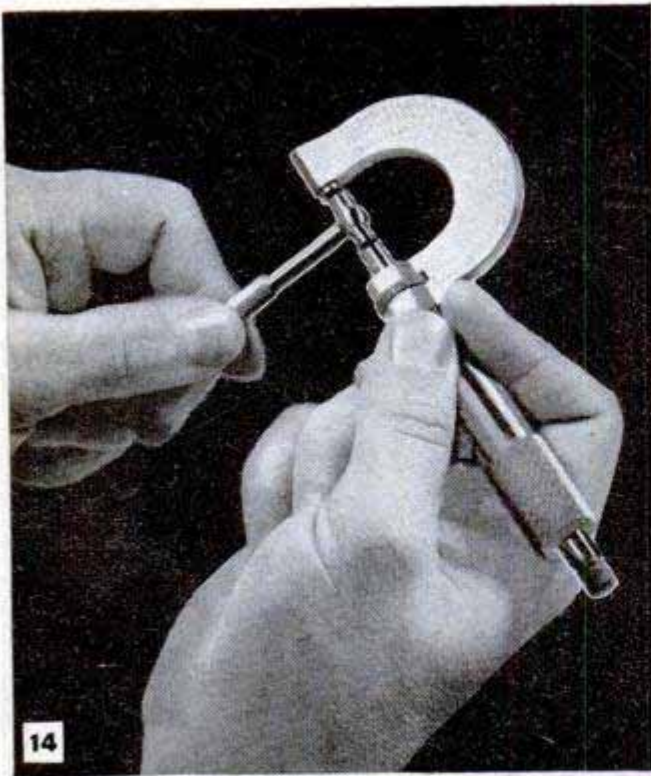

IN ORDER to use precision measuring instruments efficiently it is necessary to keep in mind that there never is a perfect measurement. There are always tolerances and limits. Generally speaking, the term tolerance refers to the allowable error, while limit, or limits, refers to the specification of the large and small dimensions. As an example, a hole is to be bored 1 in. in diameter. If the work is of such a nature that the diameter must be held within fairly close limits, large and small dimensions will

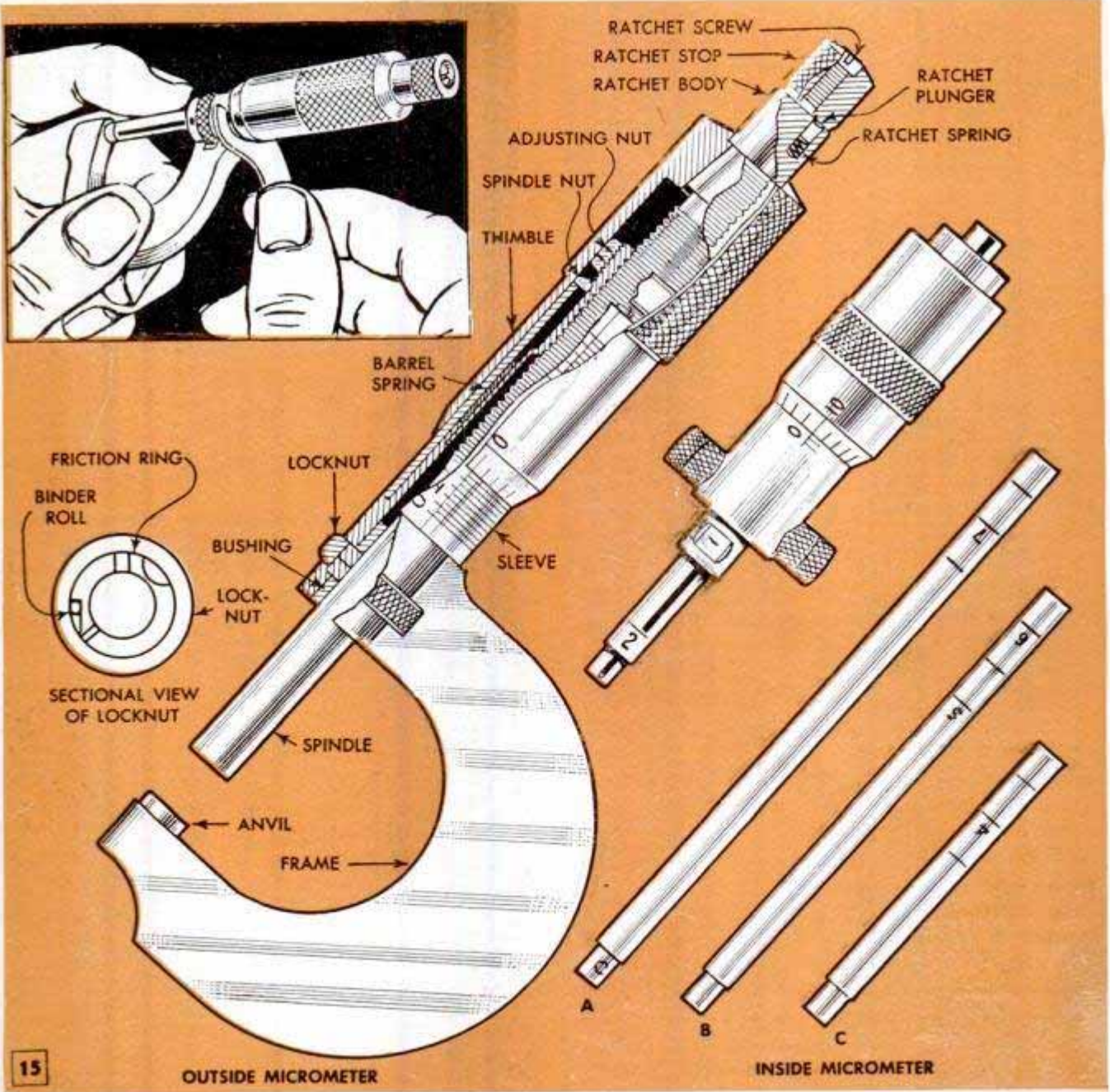
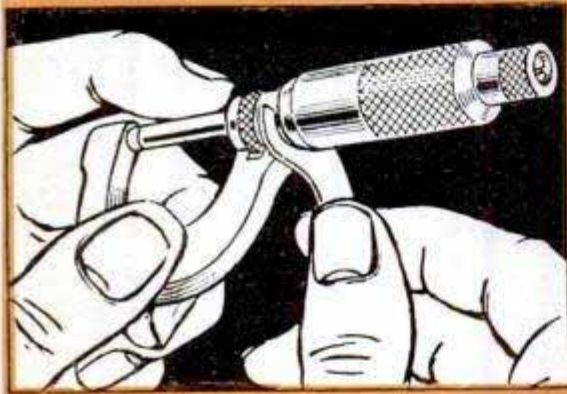

15

OUTSIDE MICROMETER

INSIDE MICROMETER

MEASURING and Trammels

be specified as plus and minus, that is, the hole can be bored slightly over 1 in. or slightly under and still meet the requirements. But the measurements of the finished work cannot exceed the limits specified as otherwise the job will not serve its purpose.

As pointed out in Part I last month, the important thing is the ability to make measurements of consistent accuracy and to follow through with the production of work which checks within the specified limits with an equal consistency. Specified limits define the necessary degree of accuracy. For ordinary machine work in production shops, dimensions nearly always are specified in thousandths and in some cases in "tenths," or ten thousandths, of an inch. Production shops usually work within thousandths while limits specified in ten thousandths are used by manufacturers of highly specialized products. Ten thousandths are used also in toolrooms and die shops and in experimental laboratories where mock-ups and scale models are made for reference or testing purposes and where, for various reasons, work must be produced within very close limits.

A graduation line on the average rule is several thousandths of an inch in width thus making fine measurements impracticable. The double contact of the ordinary caliper makes consistently accurate measurements within close limits dependent to a considerable extent upon the skill and experience of the individual. Although very accurate work still is done with these simple measuring tools, shops that must work to close limits, with a consistent accuracy not attainable with ordinary rules and calipers, require more precise measuring instruments, such as the micrometer caliper.

The micrometer caliper, or "mike," as it is commonly called, is simply a slide caliper with a fixed contact, or anvil, and a movable contact, or spindle, actuated by a precision screw adjustment provided with graduations which can be read in thousandths of an inch. The common types of outside and inside mikes shown in Fig. 15 have many uses in the shop and are made in a wide range of sizes. Inside mikes are supplied with extensions, A, B and C in Fig. 15, to increase their capacity. Many other types are available for special purposes. Reading an ordinary mike in thousandths is quite simple to do. The screw, Fig. 15, is accurately made with a pitch of

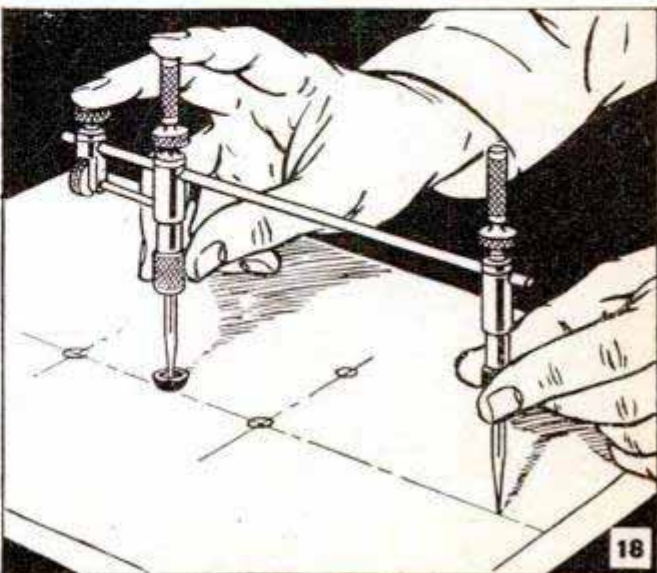
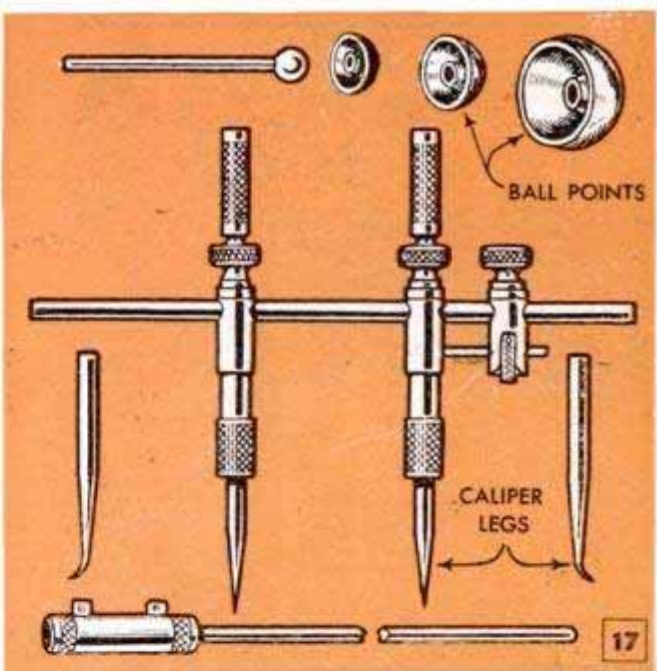
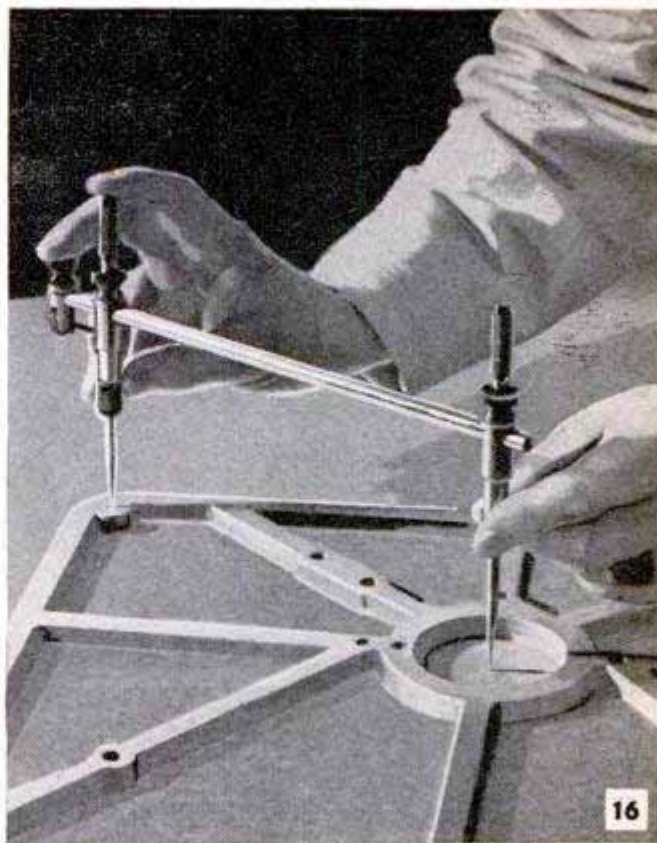

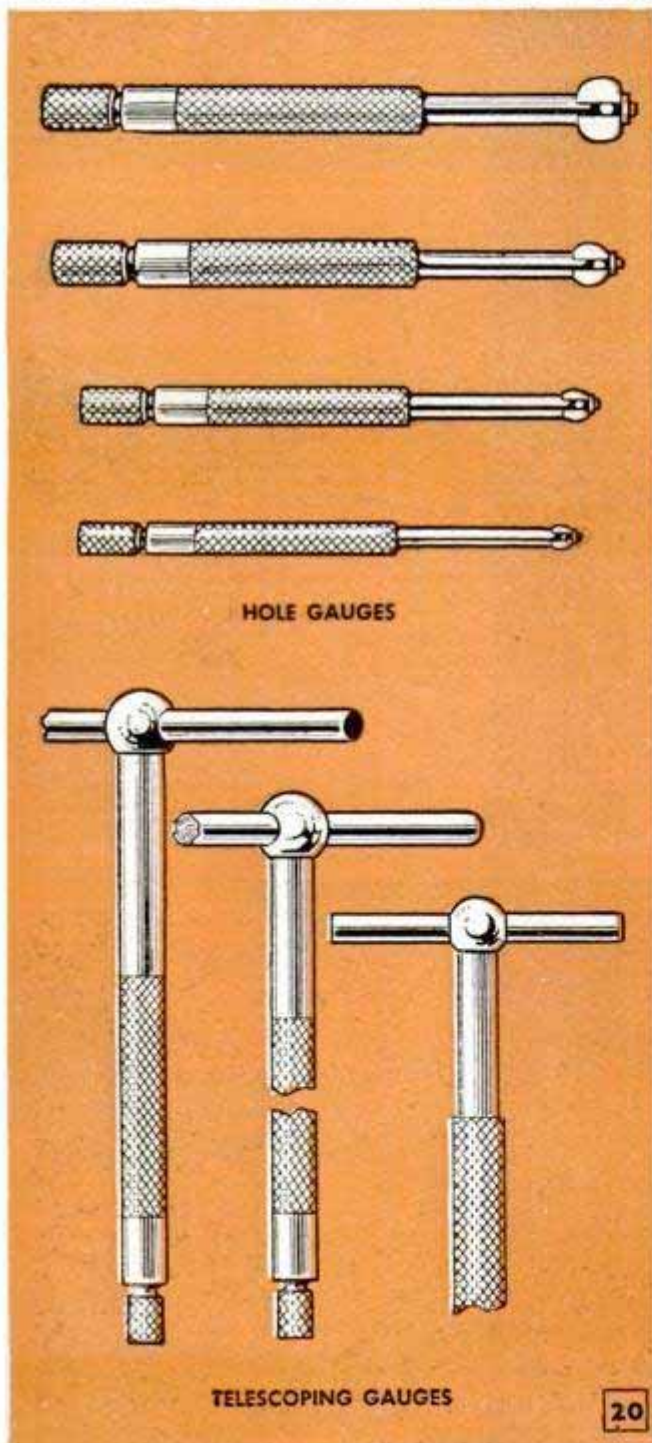
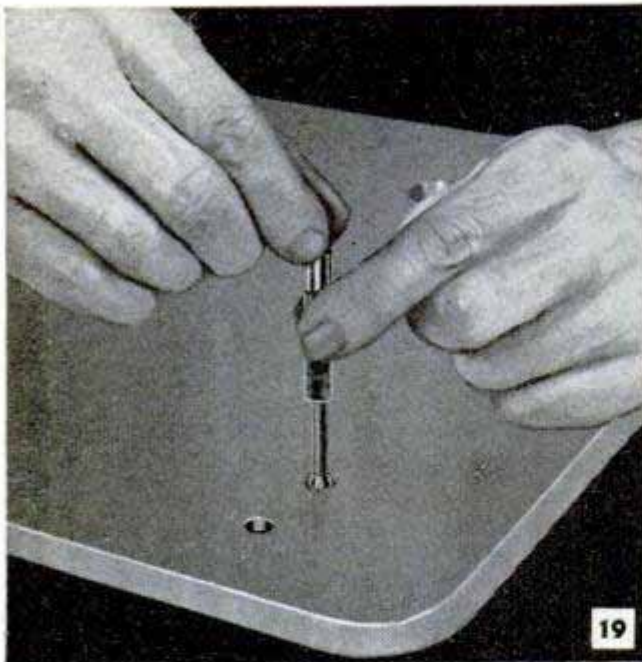

40 threads to the inch and advances one fortieth (.025) of an inch with each complete turn. On a mike of 1-in. capacity, Fig. 14, the sleeve is graduated longitudinally with 40 lines to the inch. Every fourth line is longer and is numbered 1, 2, 3 and so on, to indicate divisions in tenths of an inch. The beveled end of the thimble, Fig. 15, is graduated into 25 divisions numbered from 0 to 25. As one turn of the thimble, from 0 to 0, advances or retracts the spindle one fortieth (.025) of an inch, rotation of the thimble from 0 to the first graduation will move the spindle one twenty-fifth of one fortieth, or one twenty-fifth of twenty-five thousandths, which is .001 in.

On certain types of mikes, such as the micrometer depth gauge, the sleeve usually is numbered from 10 to 0 and it should be kept in mind that in this case, the total reading will be a value less than the lowest graduation visible on the sleeve. The inside mike is shown in use in Fig. 22. Ordinary outside mikes are available with a ratchet stop built into the end of the thimble, as in Fig. 15, or into the thimble itself. This feature is helpful when a number of measurements must be made quickly and accurately or when the same instrument is used by more than one person. The ratchet stop reduces the possibility of error to the minimum as it is so designed that it will slip and thus prevent the spindle from turning after a given amount of pressure is applied when taking the measurement. Nearly all mikes are provided with an adjustment to compensate for wear in the threads. This adjustment is made with a spanner wrench as in the inset, Fig. 15.

When it is necessary to scribe, lay out, or transfer dimensions of greater lengths than can be spanned with dividers, machinists often use a trammel, Fig. 17. The instrument consists of a polished bar, or beam, on which the points are adjustable by means of special clamps, or carriers. One

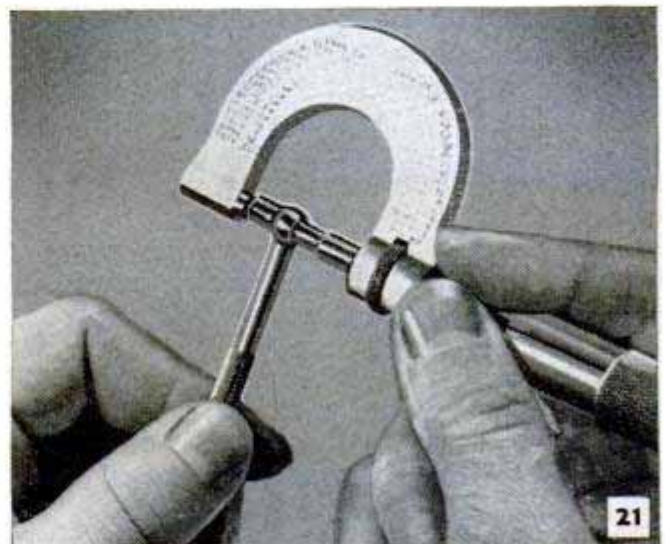

clamp is provided with a slow-motion screw to permit fine adjustments. Various types of points, or legs, are furnished to adapt the unit for scribing, Fig. 16, measuring from holes, Fig. 18, and for measuring distances across or inside which are too great for ordinary calipers or mikes. For the latter use, the trammel is fitted with caliper legs, Fig. 17. Trammel beams and couplings are available for increasing the span of the trammel to 36 in. or more.

Telescoping gauges, Fig. 20, are often used when it is necessary to obtain precise measurements of internal diameters, Fig. 26. The head of the telescoping gauge is made with one fixed and one telescoping member, and in ordinary use the head is telescoped by pressing on the ends of the members as in Fig. 24. When the distance across the head is slightly less than the diameter of the work to be measured, the head is locked by turning the knurled screw at the end of the handle. The gauge is inserted in the work and the head is released by slacking the screw. The telescoping head then expands across the opening, the spring tension keeping it in contact with the walls until the binding screw is tightened to hold the adjustment. Then the distance across the head is miked, as in Fig. 21, to determine the precise diameter of the hole. Before taking a measurement with a telescoping gauge, be sure there are no metal chips or other small particles on the contacts. When taking internal measurements with the telescoping gauge it should be held with the handle in line with the axis of the opening and the handle should be rocked slightly to make sure the contacts are seated firmly against the walls. Small-hole gauges, Figs. 19 and 20, serve much the same purpose as the telescoping gauges for measuring holes ranging from $\frac{1}{8}$ to $\frac{1}{2}$ in. in diameter. Hole gauges are made with a split ball at the contact end which is expanded by means of a tapered sleeve, Fig. 20. The sleeve is actuated by

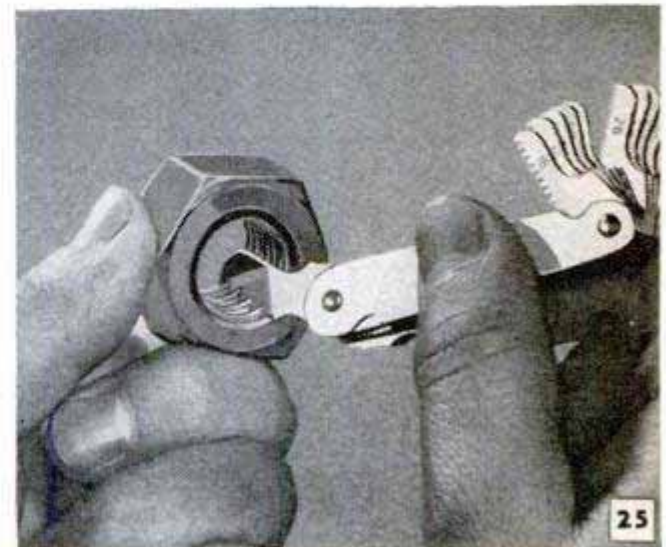
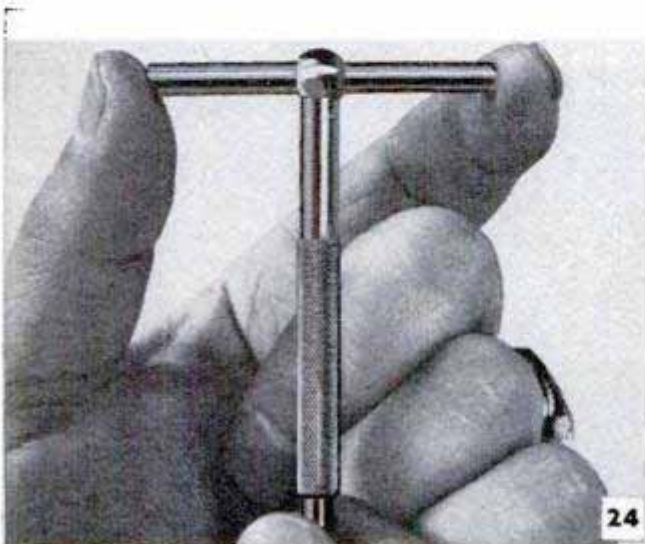
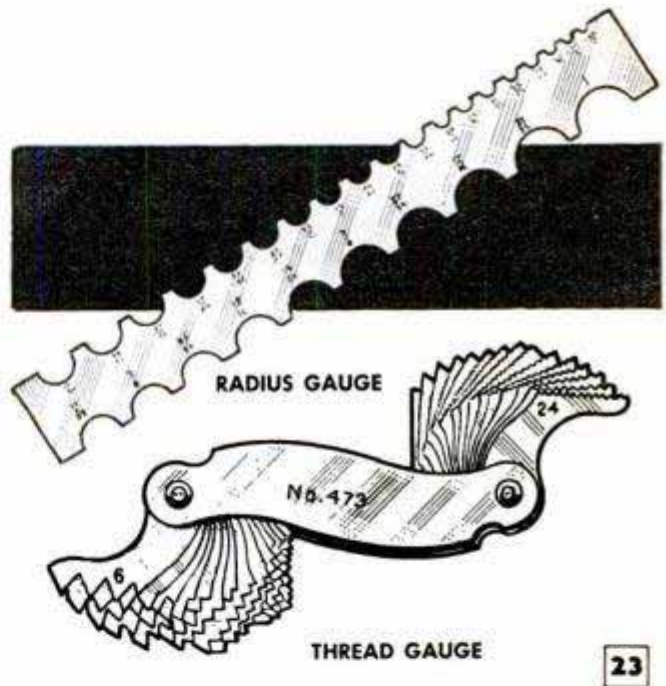
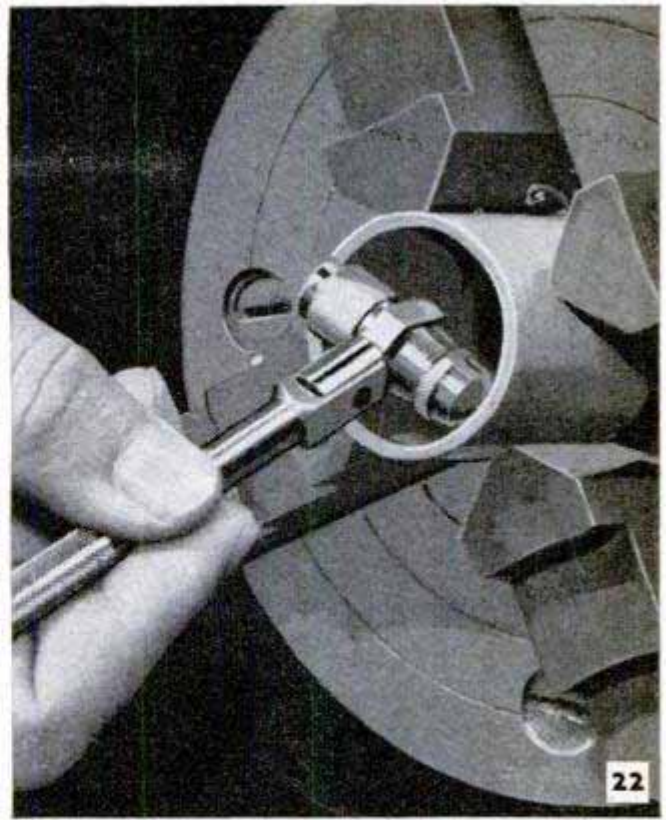

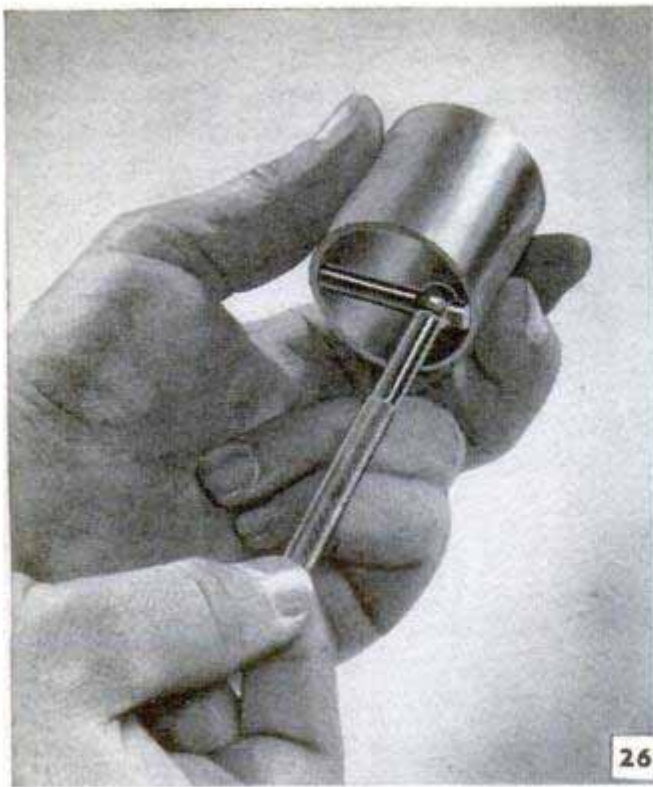

26

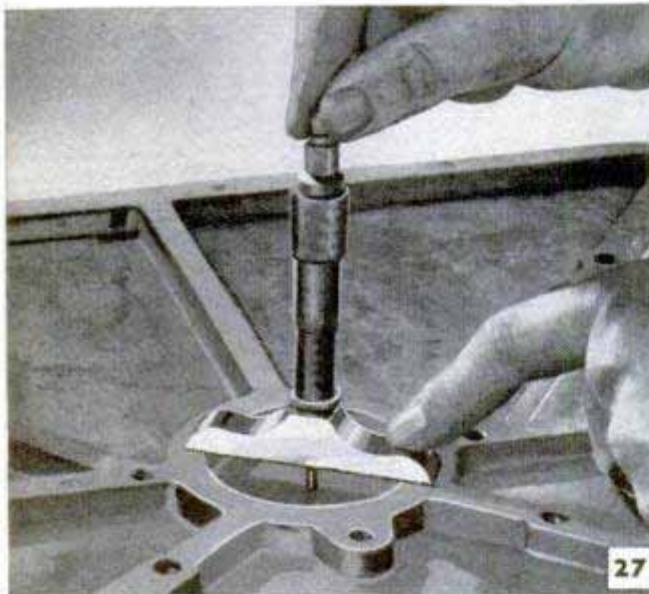

27

turning the knurled tip of the handle. This advances or retracts the sleeve, thus changing the diameter of the split ball. The gauge is used as in Fig. 19, the ball end being placed on the hole and the knurled tip turned until the ball will slide into the hole. Then the knurled tip is turned in the opposite direction until the ball contacts the sides of the hole firmly, but not so tightly that it cannot be withdrawn easily. The trick in taking consistently accurate measurements with the hole gauges, and also with the telescoping gauges, is in judging the degree of frictional contact between the measuring instrument and the work. Another thing to be careful about when taking measurements with hole gauges, telescoping gauges and inside micrometer calipers is to be sure that the contacts are in full engagement with the walls of the work. All such instruments have rounded contacts

and, therefore, it is necessary that they be pushed into the opening far enough to assure that the contacts touch the walls at the highest point of the radius. Before taking a measurement with any of these units, clean the work thoroughly to remove chips and grime which might cause inaccuracies of several thousandths of an inch.

Two other gauges widely used in the shops are the radius, or ball, gauge and the thread gauge, Fig. 23. The former is especially made for diesinker's use but it also is used in some shops for making a quick check of the diameters of rod stock. As will be seen from the detail, the gauge is simply a length of polished steel with 180-deg. radii milled into each edge. Sizes are stamped on the body of the gauge and generally range from $\frac{1}{8}$ to 1 in. in 32nds. Similar types of gauges are made for measuring wire, drills and screws. Likewise, the thread gauge, Fig. 23, is one variation of many similar types of gauges made for checking fillets and angles. Although commonly called a thread gauge, it is perhaps more properly referred to as a screw-pitch gauge. It consists of a number of thin leaves of polished steel pivoted in each end of a short frame. When not in use all the separate leaves fold inside the frame to prevent damage. On one edge of each leaf there are teeth corresponding to standard thread sections. When the pitch of a thread is not known, the leaves of similar size are opened and placed successively over the thread until one is found which meshes with that particular thread. The pitch of the thread is then read from the stamping on that individual leaf. The free end of each leaf is made narrow so that it can be inserted in a nut as in Fig. 25.

The depth mike, Fig. 27, or micrometer depth gauge, is simply an ordinary depth gauge fitted with a micrometer head instead of a graduated bar, or spindle. It is especially designed for accurate measurement of holes, grooves, recesses, projections and offsets in work of an irregular shape. The base is ground flat and the sides are finished perpendicular to the bottom so that the unit can be placed either on top of a finished surface or against a machined shoulder to obtain accurate readings. The micrometer head usually is furnished with a ratchet stop, and extra rods, or plungers, can be obtained in various lengths up to 6 in. or more for measurement of deep holes. Also the bases are furnished in different widths, or spans, up to 6 in. The rods are available in the round or flat type with flat ends, or $\frac{1}{2}$ ends turned and lapped convex. These features extend the instrument's usefulness to include a greater variety of work.

[Certain technical information courtesy L. S. Starrett Co.]

(To be continued)

Portable Garage Light Utilizes Gooseneck Desk Lamp and Brake Drum

If you do much work on the car in your home garage or if you have an auto-repair shop and need an extra light, you'll find this special floor lamp a big help in concentrating the light just where you want it. The lamp base consists of a discarded brake drum with a $\frac{3}{4}$ -in. pipe flange welded to the outside face of the drum and directly over one of the bolt holes. A length of $\frac{3}{4}$ -in. pipe is screwed into the flange to form the lamp column. Then a $\frac{3}{8}$ -in. hole is drilled through the top of a pipe cap and the cap is screwed onto the top end of the column. If an old gooseneck desk lamp is available, it can be used for the upper portion of the shop lamp. However, this part of the lamp can be improvised from an 18-in. length of flexible metal tubing. Solder a $\frac{1}{8}$ -in. brass pipe nipple into one end of the tubing and solder the other end of the tubing to the pipe cap. Pull a length of ordinary lamp cord through the tubing and the column and lead one end out through

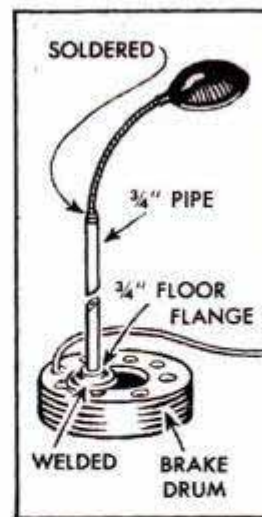

one of the holes in the brake drum. Screw a switch-type lamp socket onto the brass nipple and add a reflector of the type designed to screw onto the socket. Complete the lamp by attaching a cord and plug.

Concrete Watering Pit Built Around Broken Drain Tile

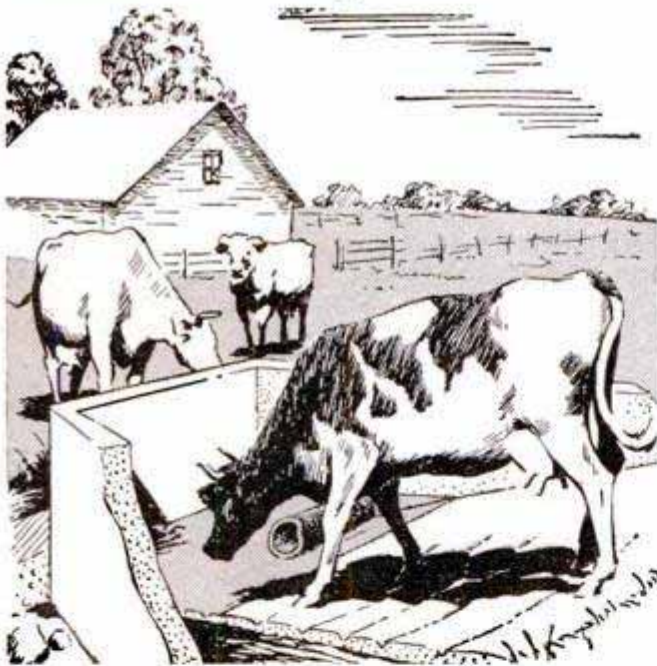

A continuous supply of cool, clear water for stock can be had by breaking through a drain tile and building a concrete watering pit around it. If possible, this should be done near a fence so that the watering pit does not interfere with plowing the field. A long ramp on one side of the pit permits the cattle to reach the water at the bottom, and this should be located so that surface water will not contaminate the drinking water. The pit can be dug out and the walls poured in wooden forms, or trenches can be dug for the walls and the earth used as a form, the center portion of the pit being dug out after the walls have hardened. Note that parallel ridges in the ramp provide a better foothold for the cattle. These can be made by pressing strips of wood into the freshly poured concrete and removing the strips after the concrete sets.

Temporary Farrowing House Made From Bales of Straw

Farmers and hog raisers, faced with the necessity of providing temporary or emergency shelter for brood sows at farrowing time, often use bales of straw or discolored hay for this purpose. The ends and back of the house are formed by two tiers of bales held in place by steel fence posts driven into the ground on each side. A 2 x 6-in. plank laid across the ends supports the bales which are laid side by side on top of the plank to form the roof.



☐ An old soft-bristled toothbrush comes in handy for cleaning and oiling firearms.



SHOPPING

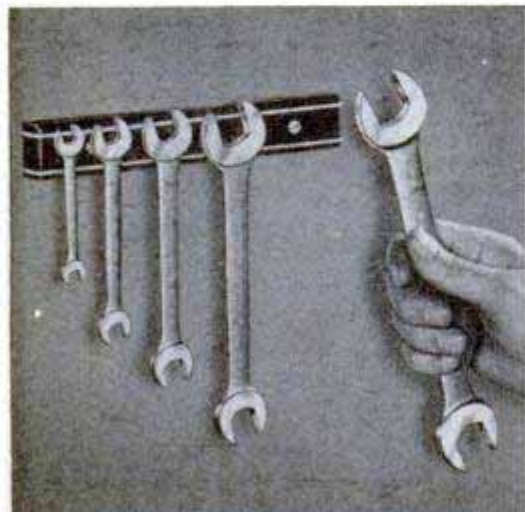

WITH NEW MAGNETIC HOLDER, shown above, small hand tools, such as end wrenches, are held securely and in plain view without hooks or hangers of any kind. Screw holes already drilled permit attaching the holder to the wall above the workbench. The holder, fitted with strong magnets of the permanent type, is supplied with a wrench set designed to meet the needs of the home workshop or small garage. According to the manufacturer, powerful magnets hold magnetism indefinitely

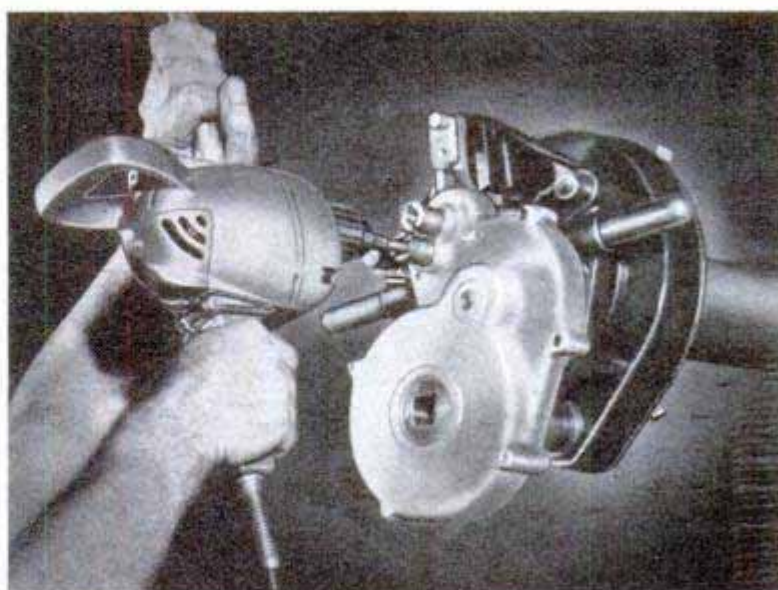

A PORTABLE PIPE-THREADING UNIT that can be driven by any $\frac{1}{2}$ -in. heavy-duty electric drill is pictured above. It is designed to take any standard pipe die. In use, the selected die is started on the end of the pipe and the unit is attached to it. Power from the electric drill is applied through a 20-to-1 gear-reduction drive. After threading, the drive spindle, which is held in the drill chuck, is inserted in a reverse socket and the die is backed off

HAND PIECES ON FLEXIBLE SHAFTS, below, left, can be changed quickly when this new snap-on-and-off coupling is used. It allows the operator to change from one tool to another without having to unscrew the hand piece from the shaft. A new-type locking sleeve on both the straight and angle spindles permits the hand piece to swivel freely, but prevents it from becoming accidentally disconnected and thereby endangering the operator

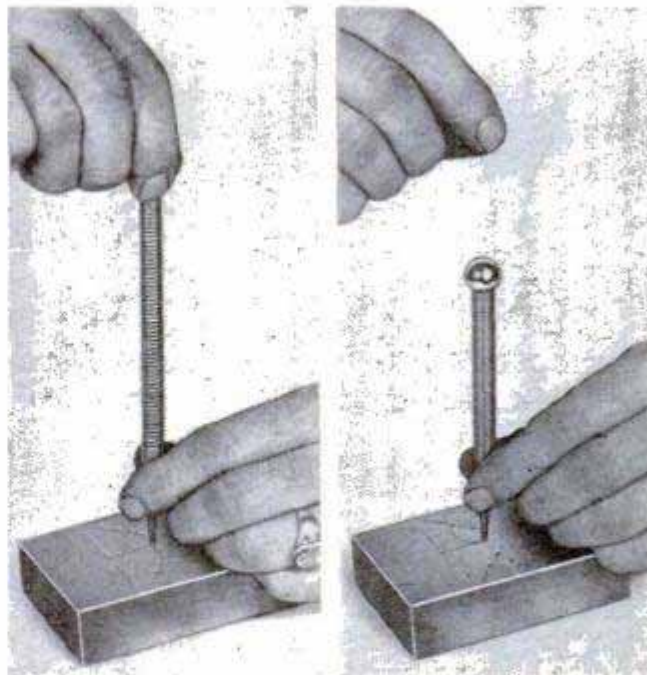
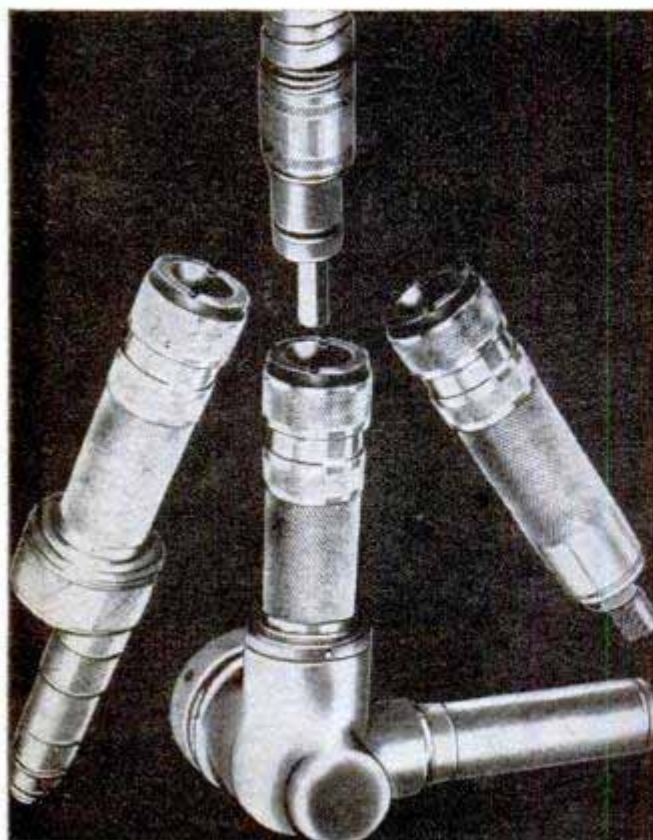

ACCURATE CENTER PUNCHING is easy when you use this spring-loaded center punch. Simply scribe lines to locate the holes, place the point of the punch on the intersections, then pull the spring-loaded head upward and release it in the manner pictured above

FOR TOOLS

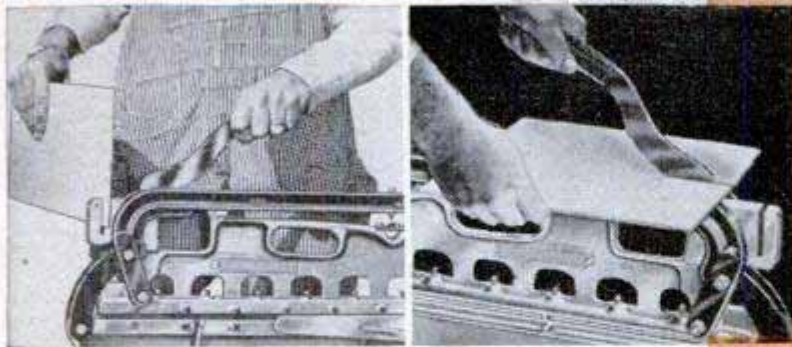

ASBESTOS SHINGLES AND SIDING are easily cut, notched or punched with this hand-operated three-in-one tool. It's a complete self-contained unit designed for use right on the job. Using a cutting blade that works something like a metal shear, the operator can trim shingles or siding to any angle or length. In the views above, left, the operator is punching holes for nails and, at right, a notch is being cut



PORTABLE POWER-FEED ATTACHMENT, right, simplifies and speeds up tedious, time-consuming job of "walking" long stock through a radial saw. When properly set up it will power-feed stock for straight and bevel ripping, molding, shaping, grooving and rabbeting. The unit is so designed that material being fed to the saw automatically is held tightly against the ripping fence to assure maximum accuracy. The power drive is fitted with both infeed and outfeed rollers having speed adjustments permitting a feed range from 10 to 120 feet per minute. The unit is portable and motor-driven, and can be easily attached to the machine

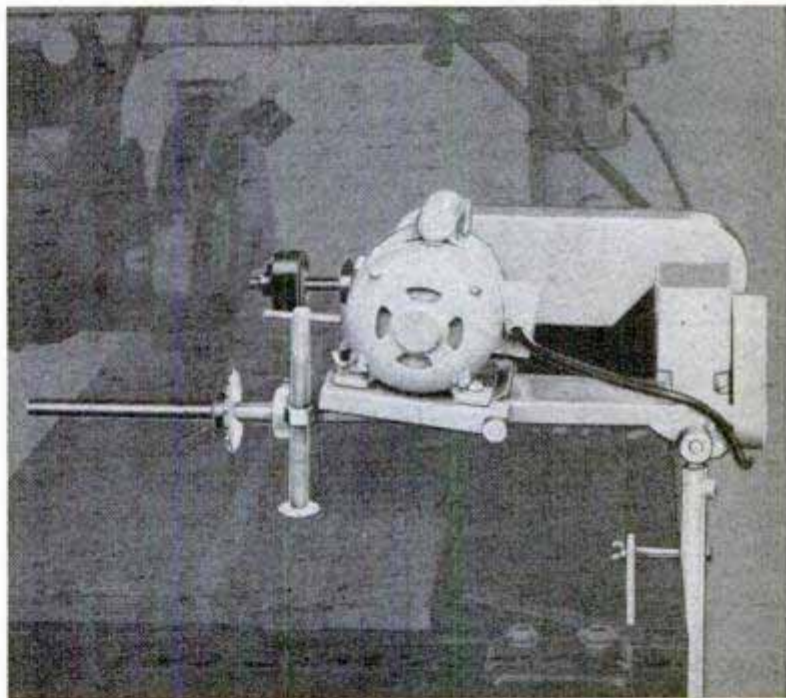

CLEANING COPPER TUBES preparatory to soldering them end to end is done in a jiffy with this new tool. It consists of four holders, each fitted with special-type circular wire brushes, the inside diameters of which range from $\frac{3}{8}$ to 1 in. Each brush is slightly smaller than the outside diameter of tubing it is intended to fit. To clean the end of the tube, simply insert it into the proper opening and turn it several revolutions, then twist it slightly as it is withdrawn. It comes out clean and bright for soldering

A MAGNETIC LEVEL that sticks tightly to pipe or machines takes the place of that "extra arm" so often needed by plumbers and electricians when plumbing vertical lines of pipe or conduit. The reason this level sticks to metal is that it's fitted with two powerful permanent magnets. The level has a wooden body and is short, about 10 in. long, which makes it handy to store in an ordinary carryall tool kit. Ends of wooden frame are tapered, torpedo-type, and there are three glasses in standard positions. Picture at right shows how easy it is to plumb pipe. Note that hands are left free for holding the pipe in place



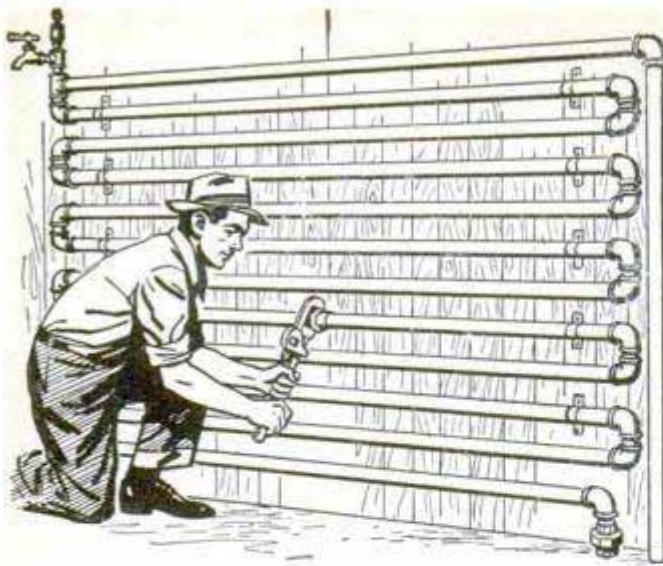

Low-Cost Shop Heating System

When it is necessary to have heat in the farm workshop, basement or small garage, you can install an efficient hot-water system by using ordinary pipe fittings and a coal-burning water heater. The heater, preferably one of the larger sizes, can be placed in any convenient location in the building. The radiators, or coils, are assembled from pipe and fittings as pictured. Provide an expansion tank located at some point higher than the highest radiator. All horizontal pipes must be carefully leveled when installed, as otherwise the system may become air-locked.

Charles L. Stratton, Hollis, N.H.

Desk Slide Arm Has Glass Insert To Provide Handy Tracing Frame

If a desk in the home or office is equipped with a slide arm, a convenient tracing frame can be had by fitting the arm with a sheet of plate glass.

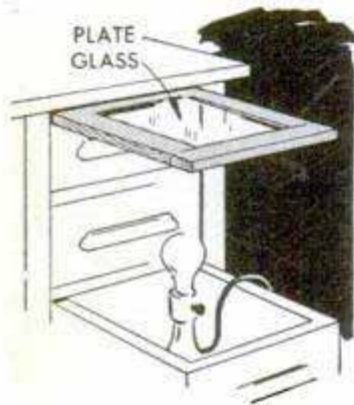

Cut out the center portion of the arm and nail cleats to the four inside edges of the opening. The cleats should form a rabbet to hold the plate glass flush with the top surface of the arm. To use the tracing frame, just pull out

the slide arm and the bottom desk drawer. Then, set a lamp in the drawer directly under the tracing frame.

W. H. McClay, Pasadena, Calif.

Oil Pump Primed for Starting By Releasing Air Pressure

Very often auto mechanics experience trouble in starting an oil pump after dropping the oil pan or flushing the crankcase.

This usually is due to air-lock in the oil passages. One mechanic found that he could vent entrapped air from the oil lines by partly unscrewing the compression nut on the line leading to the dash gauge. After slacking off the nut, the oil line is loosened slightly in the seat to

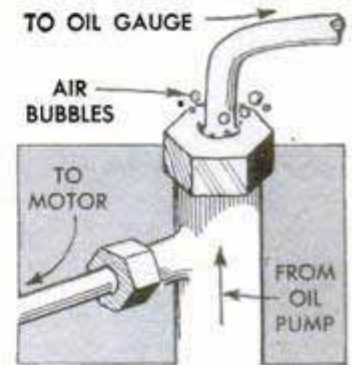

allow the air to escape. As soon as the air pressure is vented, the pump will prime itself and resume operation.

P. R. Wilson, Brooklin, Ont., Can.

Screened Window in Door Ventilates Storage Cave



An opening cut in the door of a farm storage cave provides ventilation for the cave during the summer months and helps to reduce danger from the deadly toxic gases known as blackdamp. Screen wire is tacked over the opening and, during wet weather, a tarpaulin can be thrown over the door. For the winter months, tar paper or a glass substitute fastened over the opening will protect the cave from extreme cold.

Vegetable Grater Shells Corn

Shelling popcorn or ears of corn for chicken feed is done quickly by rubbing each ear back and forth across an ordinary vegetable grater. This is much faster as well as considerably easier on the fingers than shelling the corn by hand.

Blanche Campbell, Phoenix, Ariz.

FULL-COLOR TUBES FOR TV

TWO TRULY remarkable new color-television tubes recently demonstrated by RCA are claimed to provide the key to all-electronic fully compatible color television for the home. Two color TV receivers were used in the demonstrations as the new tubes are of different types. One employs a single electron gun to "paint" the pictures. The other uses three electron guns each of which has an electron beam geared magnetically to actuate each of the three primary colors—red, green and blue—on the face of the tube and blend them true to the original scene being telecast, as illustrated in the simplified sketch, Fig. 1.

Television in natural colors has been possible for some time. The reason that it was not authorized for commercial broadcasting was due to the fact that none of the nine proposed systems met the Federal Communications Commission's compatibility requirements that were necessary to prevent obsolescence of equipment and several millions of television receivers now in the homes. The compatibility requirement states that the system used to produce TV color pictures must operate in harmony with existing black-and-white television to receive the color TV programs on present TV sets in black and white. Receiver circuit principles of both types of the tricolor Kinescope tubes are detailed in block diagrams, Figs. 2 and 3. These include the conventional black-and-white TV chassis.

The face of each color tube is coated on the inside with dots of color phosphors arranged in triangular groups of three—one red, one green and one blue as indicated in Fig. 1. There are 117,000 dots of each color, making a total of 351,000. Behind the tube face there is a metal masking screen containing 117,000 holes approximately the same size as the dots of color phosphor. The holes are so placed that they overlap equally each red, green and blue dot of a triangular group. The angle of the electron beam determines the color. The amount of light in color given off by each dot varies in exact accordance with the information supplied from the picture signals taken from the air. This action occurs so rapidly that the light from the activated color dots blends into the natural colors of the original scene.

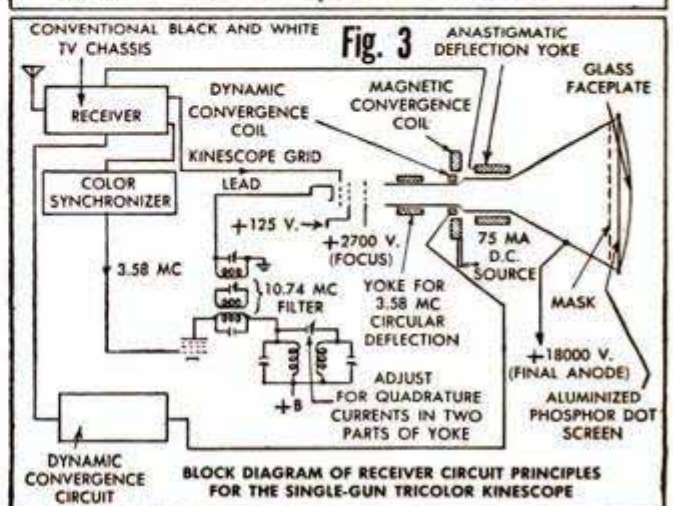
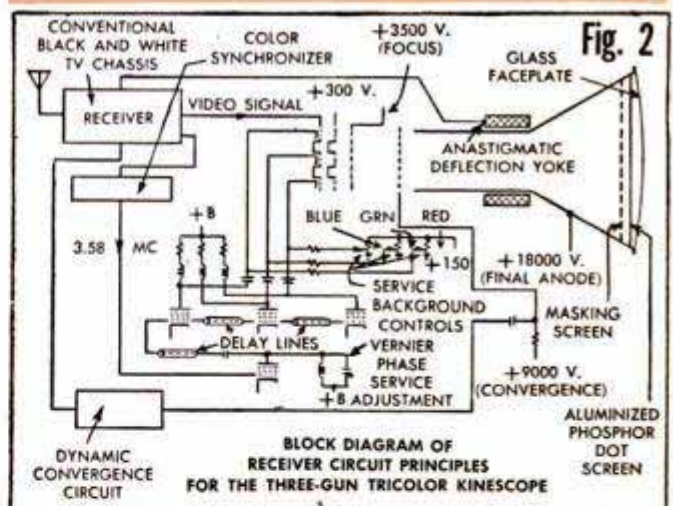
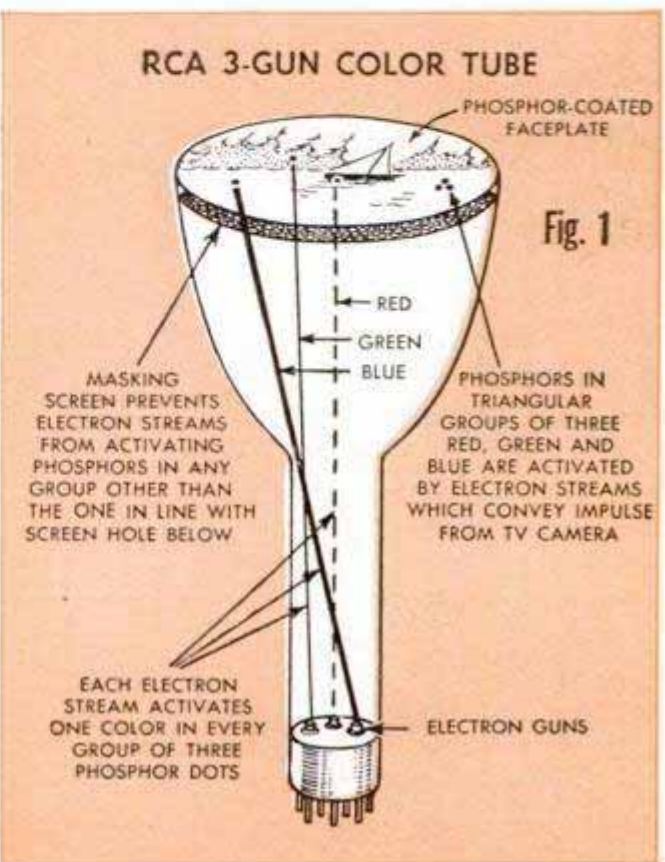

FIVE-TUBE CIRCUS-WAGON



Front view of completed set showing suggested decorations in a contrasting color. The receiver panel and end panels are painted with white enamel

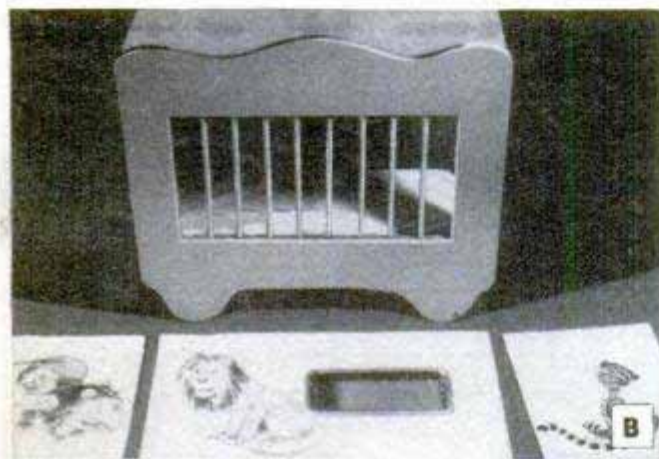

Cabinet and panels ready for final assembly. Animal decals carry out the circus-wagon effect. These are applied after the white enamel is thoroughly dry

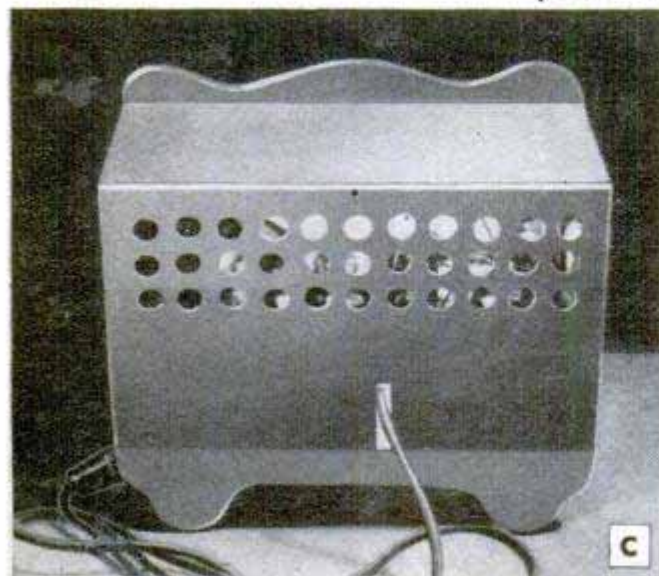

Rear view showing holes drilled in back cover to provide necessary ventilation and the cutout for the 110-volt power-line cord which is clamped to chassis

THIS FIVE-TUBE radio in its attractive circus-wagon cabinet will provide joy and decoration for the child's room. It will fit into practically any modern playroom decorative scheme, and it gives dad or big brother an ideal workbench project.

Conventional in design, the set is not difficult to build. All parts are standard and easily available from radio parts houses. The coils are the reliable Meissner type, and the loop antenna is a standard broadcast-band replacement type. The one used in the model is an Allied No. 55-506. It may be mounted in the top of the cabinet as indicated in photo E, but a better method would be to mount it on the inside of the cardboard, or fiber, rear cover of the cabinet. The loudspeaker is a 3½-in. PM type with a 4-ohm voice coil. The output transformer is mounted directly on the speaker. The slide-rule tuning dial is the well-known "Croname" No. 231.

Drill the chassis base as detailed in Fig. 1; the large holes are made with a 5/8-in. Greenlee socket punch. Instructions for mounting the slide-rule tuner come with the tuning dial specified. The holes necessary for mounting the dial on the chassis are detailed in Fig. 4. The locations of the various parts on the base are clearly shown in photo D; the underside view of the base appears in photo F.

Mount the two-gang variable tuning condenser on ¼-in. steel-tubing spacers so that the variable condenser frame is ¼ in. above the chassis. This extra space is necessary to permit proper placement of the drum for the slide-rule tuning dial. A complete schematic circuit diagram is given in Fig. 2. Wire the filament circuit first, and make sure that the tube sockets are placed in the positions indicated by the socket key locations in Fig. 1. Leave the wires for the speaker and loop antenna long enough to

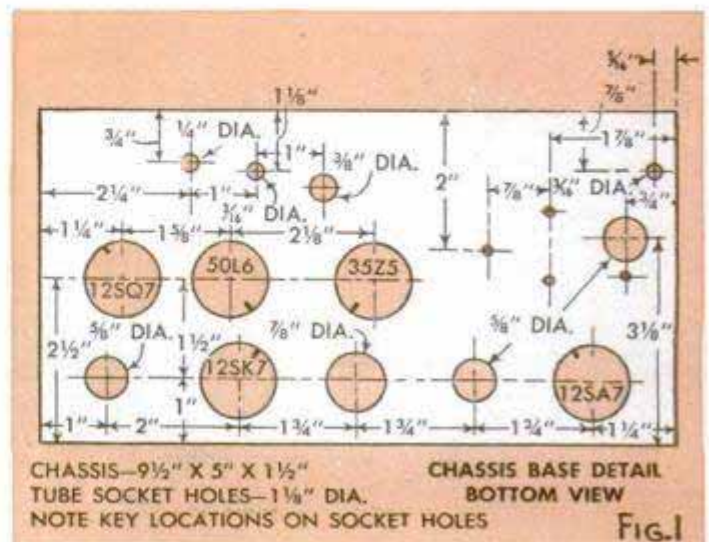

SUPER FOR PLAYROOM . . .

permit their removal from the cabinet for checking and alignment.

When installing the chassis base in the wooden cabinet, cover the heads of the mounting screws under the cabinet so as to avoid any possibility of shock. The simple cabinet construction is detailed in Fig. 3. The top and bottom of the front and right-side openings are drilled with a $\frac{3}{16}$ -in. drill to a depth of about $\frac{1}{2}$ in., and are spaced 1 in. apart. This provides for $\frac{3}{16}$ -in. birch dowel bars $5\frac{1}{2}$ in. long. Eight are at the front, and two at the right end. The receiver panel is $\frac{1}{4} \times 6\frac{1}{2} \times 11\frac{1}{16}$ -in. plywood. The cutout for the dial is $1\frac{7}{8} \times 4\frac{1}{2}$ in. The decorative front, with the curved top and bottom, is made of $\frac{3}{8}$ -in. pine. The end panels are made from $\frac{1}{16} \times 5 \times 6\frac{1}{2}$ -in. fiberboard. A number of $\frac{1}{8}$ -in. holes are drilled in the left end panel for the speaker grille. The panels are painted with white enamel, and the cabinet and bars with red enamel, after which animal decals are applied as desired. Alignment of the set is quite simple if a strong signal can be tuned in at each end of the broadcast band. Try to tune in

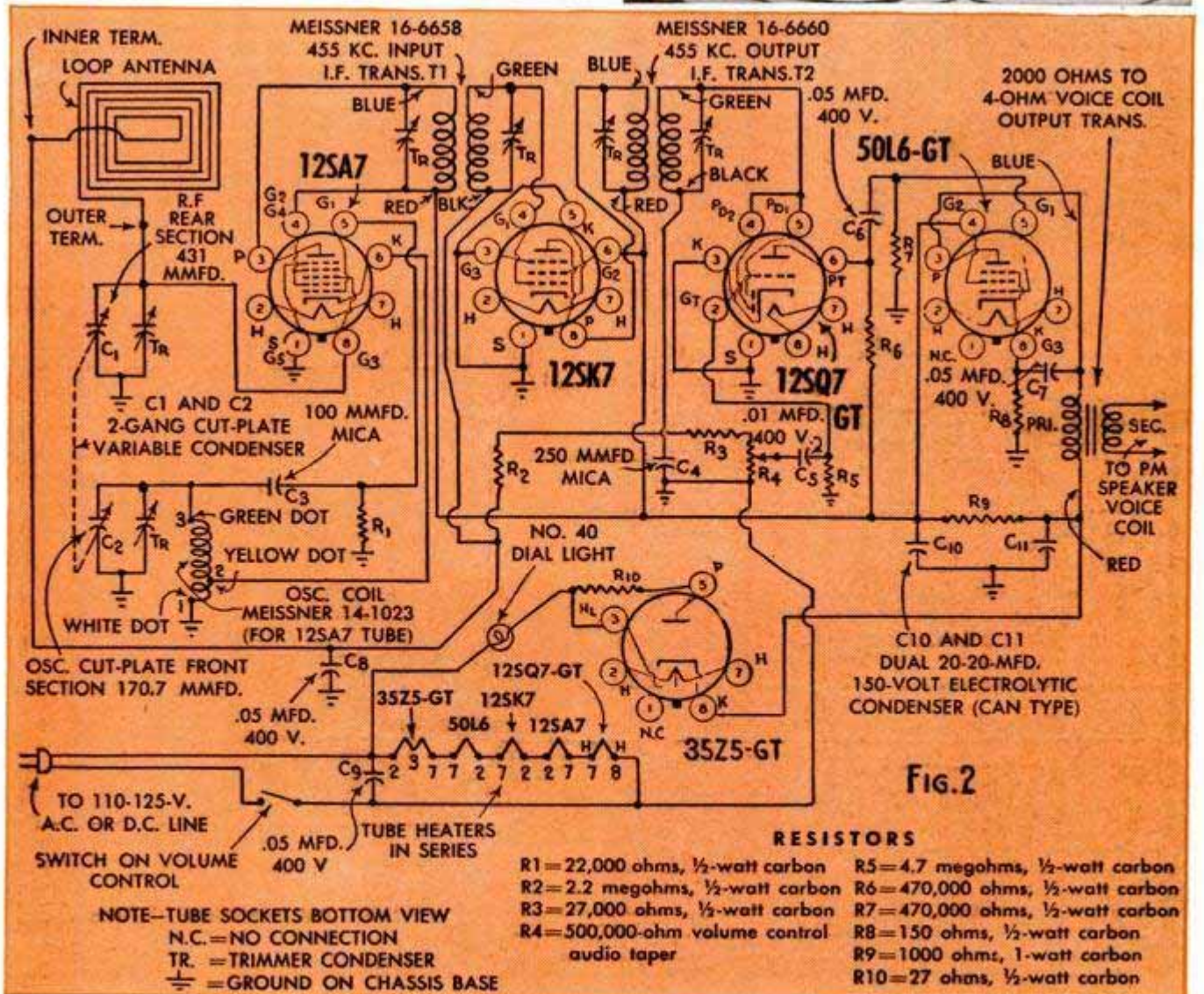
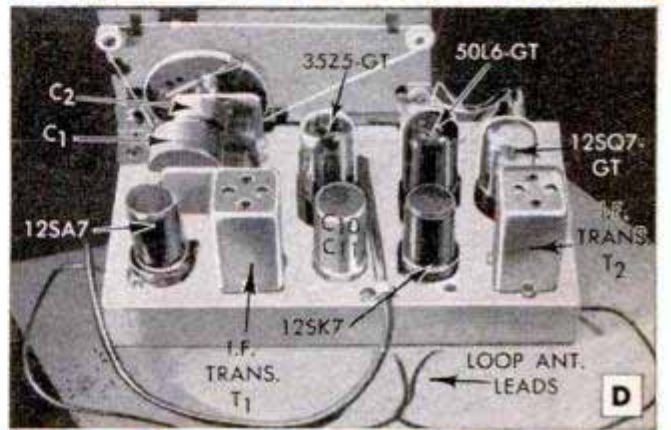

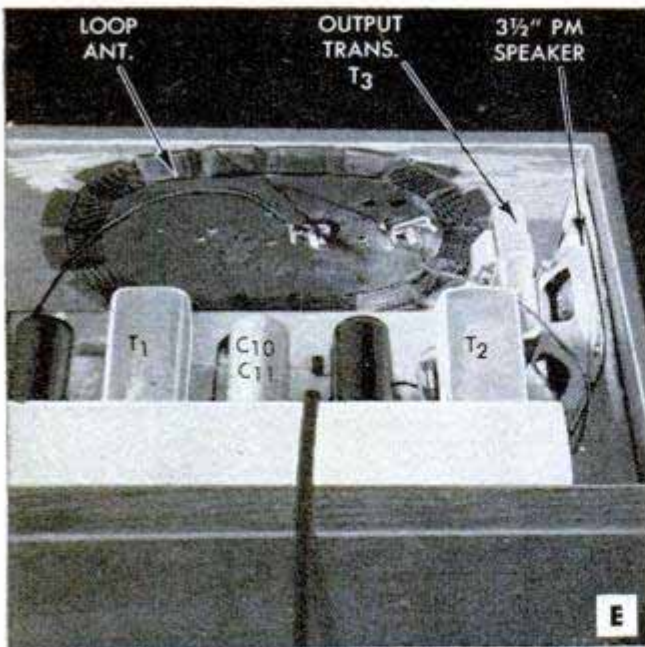

a station at about 670 kc. or one that comes in with the variable tuning condenser nearly closed. The i.f. transformers are peaked at the factory and require very little adjusting. With the set still tuned to this station, adjust the trimmer on C2 (the oscillator cut-plate front section) to bring in the station at the proper dial reading. Now tune in a station at about 1400 kc. and adjust the trimmer on C1 (the r.f. rear section of the tuning condenser) until the station is received with maximum volume. Should you have any difficulty in aligning the set, most radio shops will do it for you with a signal generator and an output meter. Detailed student material list R-392 is available from Popular Mechanics Radio and Electronics department upon receipt of ordinary letter postage.

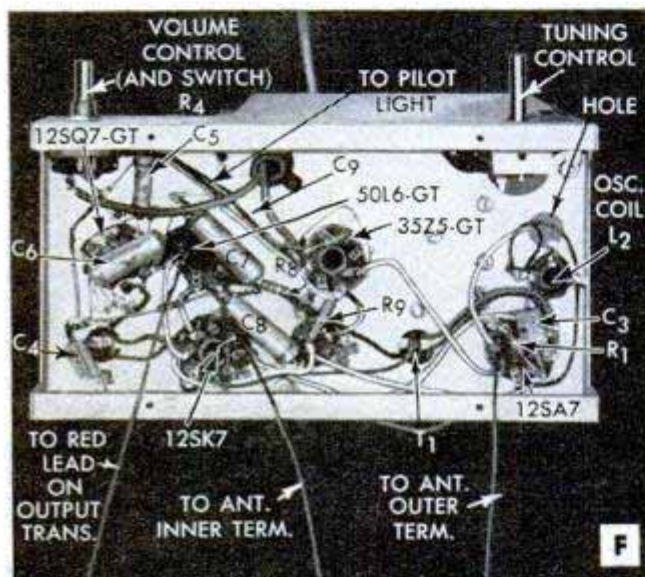

NEW RADIO-TV HANDBOOK IS ANNOUNCED

Popular Mechanics Press announces publication of "Radio-TV and Electronics Handbook" on September 15. The author, Frank L. Brittin, W9DCX, is Radio-Television, Electronics Editor of *Popular Mechanics Magazine* and a Senior Member of the Institute of Radio Engineers.

The book is a nontechnical guide for the student, experimenter and every owner of a radio or TV set. Providing practical how-to-do-it information with photographs, sketches and simple diagrams, the book helps you eliminate unnecessary service calls, aids you in the installation of TV antennas and tells you how to build inexpensive student sets, amplifiers, photocell relays, record players, test sets and other electronic devices. It covers the installation of remote speakers and interroom phones and the building of code-practice sets and amateur transmitters. Glossaries of commonly used radio parts, television terms and schematic symbols are included. "Radio-TV and Electronics Handbook" may be purchased from your bookstore or Popular Mechanics Press, price \$2.50.

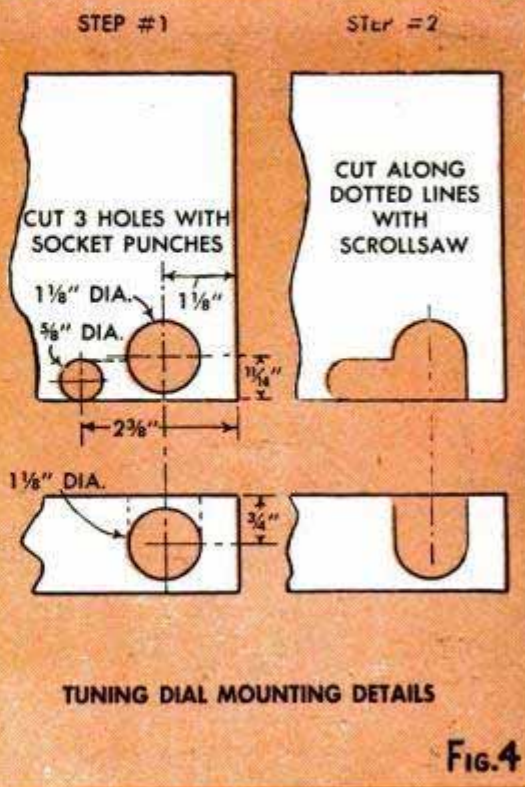
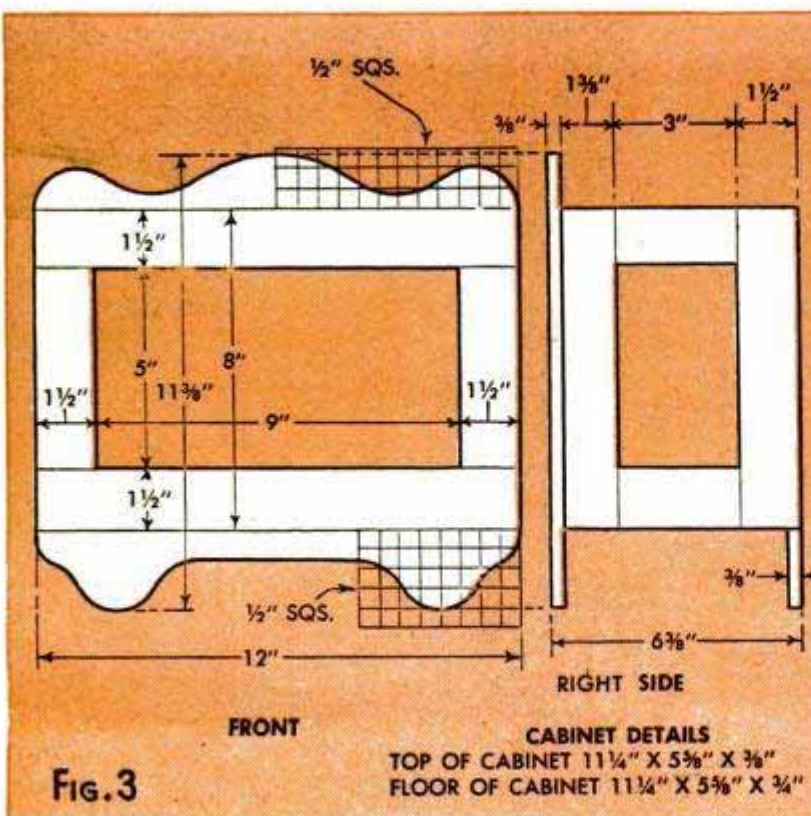

Folded Exponential Horn

By Dr. R. C. Hitchcock

THE FIDELITY and volume of an exponential horn is much higher than for practically any other speaker enclosure or baffle. If you have heard one you probably want one for yourself. An exponential horn permits a small speaker cone to get a "grip" on a large volume of air. It doubles its area at certain successive distances along the horn. This horn is 10 ft. long.

Starting with an 8-in. speaker, the small cone radiates treble notes from the top grille. But the bass notes travel in and out three times in two parallel paths, finally emerging with excellent fidelity from the "mouth" of the horn, which is 13 by 33 in. The preliminary model, photo A, was made of clear plastic. Smoke blown through the model traces the direction of the horn. All construction details are given in Figs. 1 and 2. Photos B, C and D show front and rear views of the completed horn. Half-inch birch plywood is used for the large horizontal partitions, and $\frac{3}{4}$ -in. balsa or pine for smaller sections. All joints should be made airtight with airplane cement.

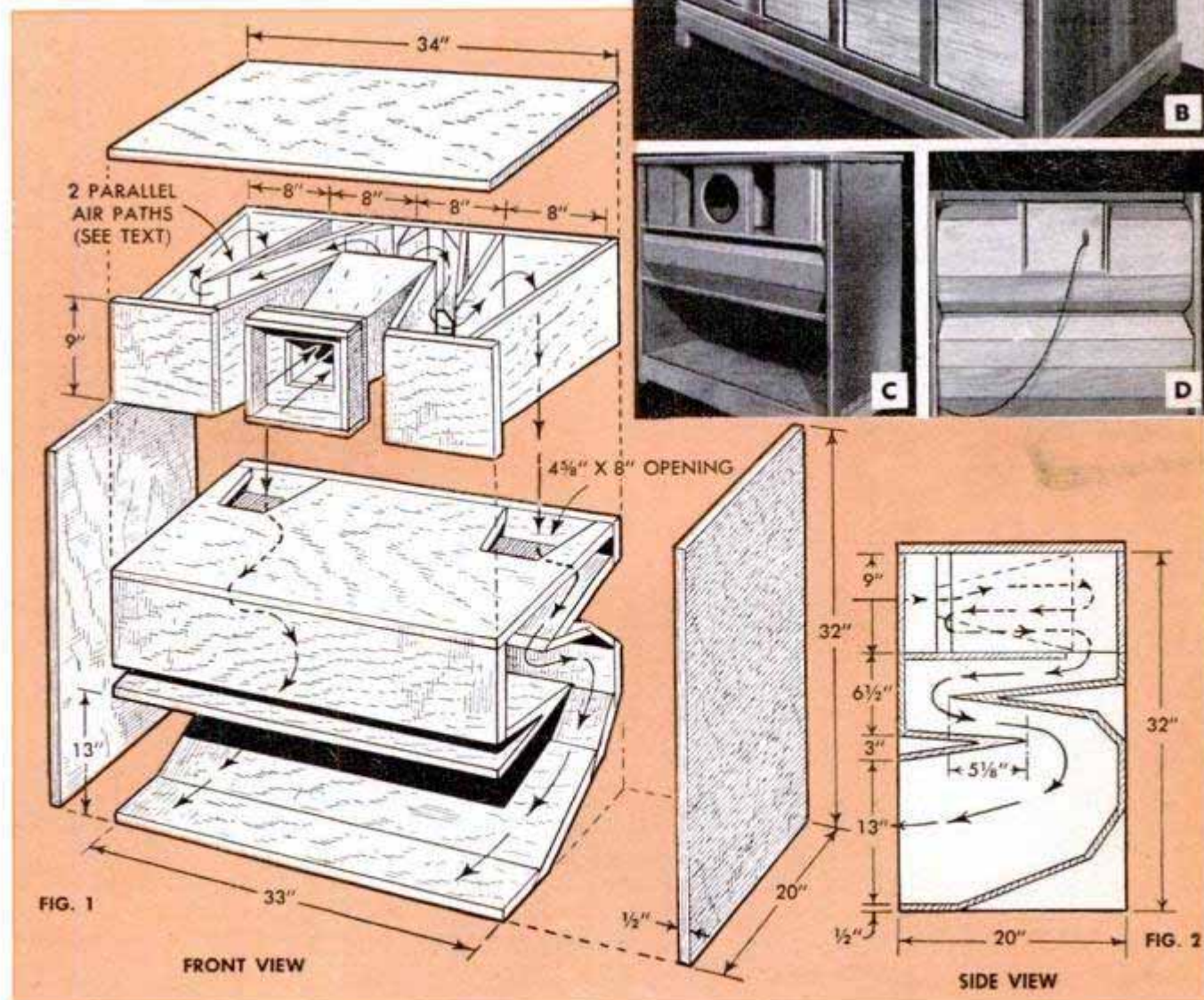
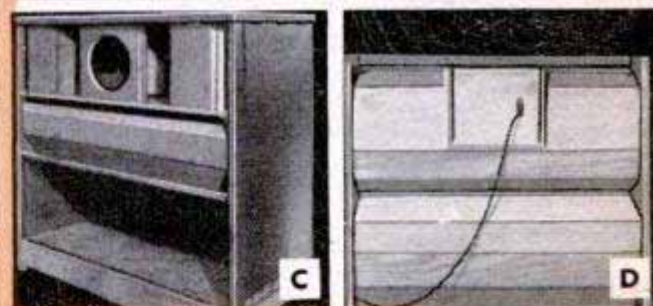
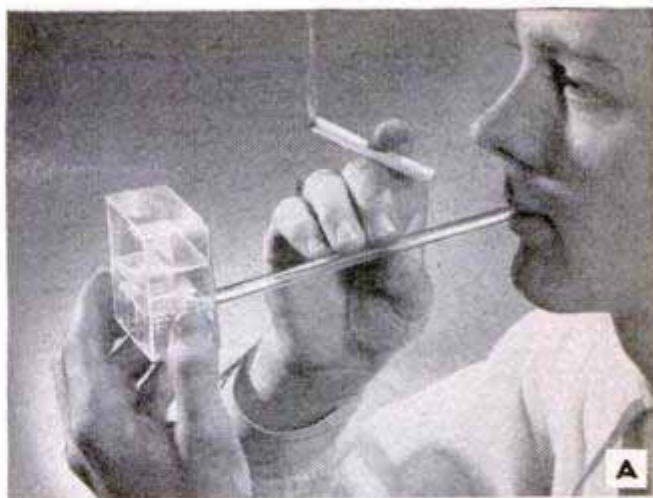

ELECTRONICS TODAY



A

A—Simplified table-model RCA permanent-magnet type electron microscope provides useful magnifications up to 50,000 diameters by photographic enlargement, with direct magnification in the instrument ranging up to 6000 diameters. "Little Giant" electron microscope opens new windows on the unknown. One third the price of the large universal model, it is hailed as a means of broadening the applications of electron microscopy in medicine and in industry



B

B—Amplifier designed to provide high-gain preselection for any television or FM receiver. This "Super Sonic" TV/FM preselector is also claimed to reject unwanted off-carrier signals and extraneous noises



C

C—Not a radio—this cabinet houses an electronic light alarm. An extension wire connects to any lamp in other rooms. Turned on, the device picks up sound, changes it to electrical energy and causes the light bulb to flash. Mothers use it as an electronic nurse; the deaf to translate doorbell sound

D—Hearing aid features "Movable Ear" detached microphone. It is easily covered by a necktie, as illustrated in photo, or women can wear it under a brooch



D

E—Television industry's first printed-circuit TV-tuner unit, recently announced by RCA tube department, eliminates mechanical winding of separate coils

F—Magnetic switch, set in gravel, dirt or cement garage driveways, becomes energized when a car passes over it, sounding a bell or chime. It warns persons in the home of approaching car, permitting them to turn on light; it also triggers garage-door openers

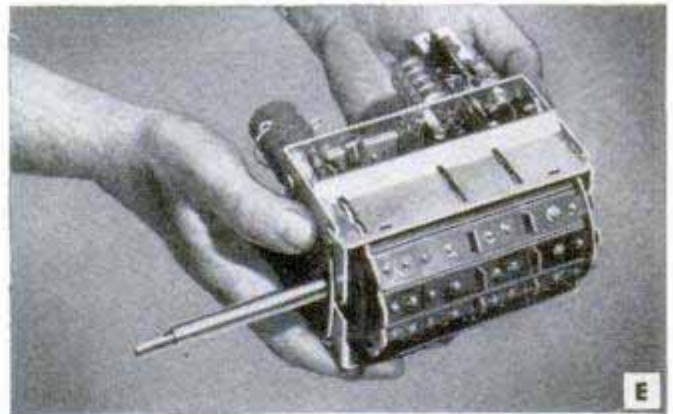

E



F

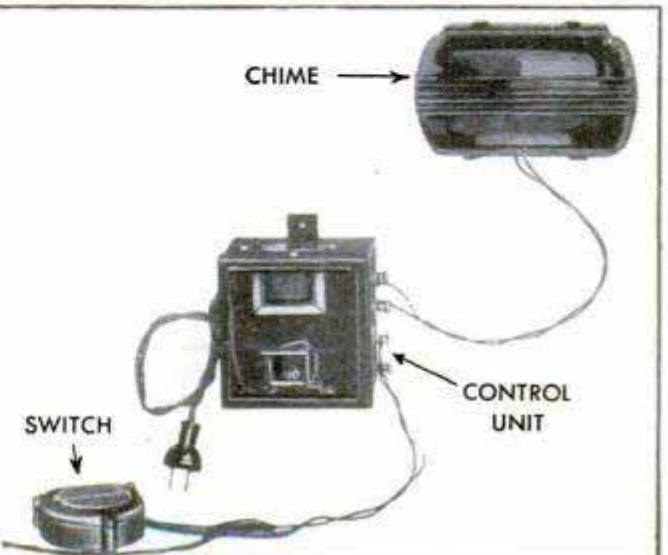

Better pictures come easier with **KODAK** equipment

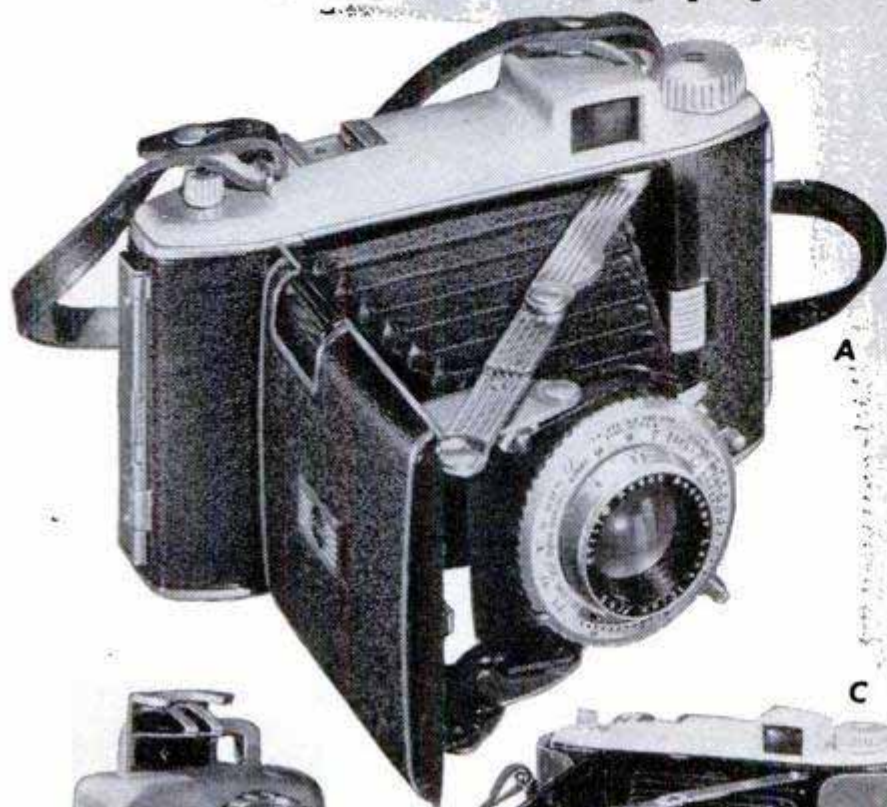

A. Kodak Tourist "800" Camera—World's fastest between-the-lens shutter—the action-freezing Synchro-Rapid 800. Fast $f/4.5$ Lumenized lens; built-in exposure guide; new-type shutter release. Takes full-color pictures as well as black-and-white. Flash shots, too. Negatives, $2\frac{1}{4} \times 3\frac{1}{4}$. Perfect companion for a holiday or hunting trip . . . for any picture-taking occasion. \$95. Other *de luxe* models—with $f/4.5$ lens, 1/200 shutter, \$71; with $f/6.3$ lens, 1/100 shutter, \$47.50.

B. Kodak Auto-Release — Snaps your picture for you about 10 seconds after setting, so you can "get in the act." Fits any camera with a cable release socket. Double spring insures shutter tripping. \$4.25.

C. De luxe Field Case — "Tourist" looks better, carries better, handles better...and it's safer in this handsome leather case. Reinforced with steel frame. Opening in back shows exposure guide and window. Front flap removable. \$10.50.

D. Kodak Tourist Adapter Kit —Use it with your "Tourist" $f/4.5$ or $f/6.3$ and get pictures in 4 sizes! Accessory back and masks let you make miniature color slides, 28×40 mm.; half 620, $1\frac{5}{8} \times 2\frac{1}{4}$; square 620, $2\frac{1}{4} \times 2\frac{1}{4}$; or full 620, $2\frac{1}{4} \times 3\frac{1}{4}$. \$14.50.

E. Kodak Metal Cable Release—Take shot after shot without jarring camera. Excellent for "T" and "B" exposures. Non-stretching braided metal won't kink. 7-inch size, \$99. 12-inch size, \$1.17.

F. Kodapod—Slips in a pocket —gives rock-steady support when it's needed. Toothed jaws take a bulldog grip on tree, fence, or any wooden object. Other end threads into camera tripod socket. Ball-and-socket joint locks in any desired position. \$3.50.

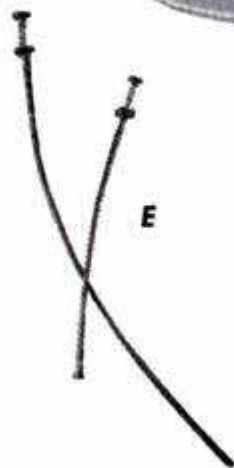
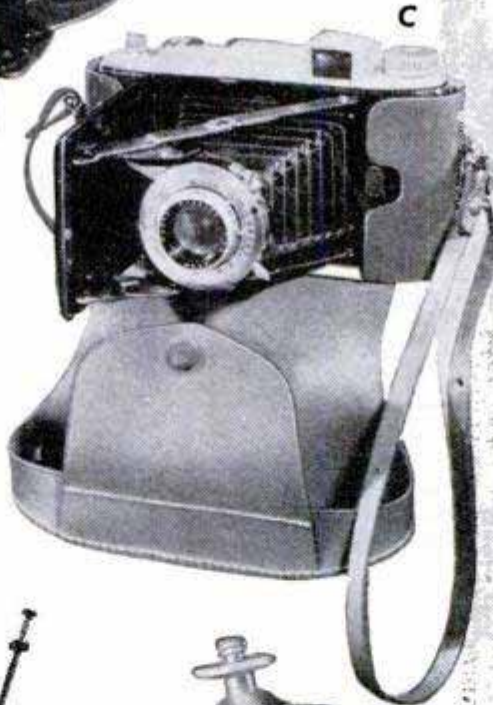

EASTMAN KODAK COMPANY
Rochester 4, N.Y.

Prices include
Federal Tax
where applicable

Kodak
TRADE-MARK



Care and Feeding of Engines

BY S. P. CORP

GOOD CRANKCASE VENTILATION

Good crankcase ventilation at all engine speeds from idling to full speed is a "must" for good engine lubrication. This is important because the "blow-by" gases which get into the crankcase have a high acidic combination which attacks lubricating oil and forms sludge. The only way this formation can be prevented is by sufficient ventilation to carry the blow-by gases away before they attack the lubricating oil.

Although almost every engine manufacturer uses some kind of crankcase ventilation system, frequently an additional ventilation system is needed. There are several on the market, one of which is illustrated here. It is a controlled blower type.

This system forces clean air through crankcase and out vent tube at all times when ignition is on, regardless of engine speed.

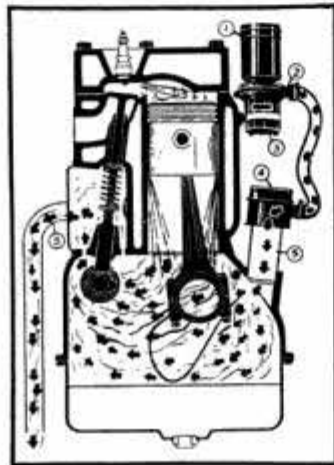

WHY SO MANY ENGINE NUMBERS?

Some engines have extra numbers and letters stamped on the block. This usually indicates a deviation from standard size when machining bores, crankshafts, journals and pins.

Always check for parts deviation from standard. To put standard rings in an oversize bore means trouble. Each engine manufacturer has his own coding system. If you don't know it, find out before re-ringing.



USE BEST RINGS—IT PAYS

Overhauling is like house painting. So much of the job is labor—so little of it part-cost. The only wise way is to use the best rings—Sealed Power Piston Rings. No other ring equals the oil-control benefits of the Sealed Power MD-50 Steel Oil Ring—the only ring with the Full-Flow Spring. It controls oil even in badly tapered and out-of-round bores. It gives you double the drainage with half the drag. Ask your dealer for a Sealed Power ring set specifically engineered to do the best possible job in your engine. Write Sealed Power Corporation, Dept. G-8, Muskegon, Mich., for the free booklet, "7 Ways to Save Oil."

Deep in the Heart of Ohio

(Continued from page 138)

It controls movements of trucks into and out of the corridor leading to the crusher bin. When a truck enters the corridor, it cuts a light beam and the signal flashes "stop" in the direction of other approaching trucks.

Arriving at the crusher, the truck dumps its load into the big, funnel-like bin. When the truck leaves the corridor, the traffic signal automatically indicates clear; or if one-way traffic is maintained past the crusher, and the truck leaves by a different corridor, the truck driver operates the signal by hand after his load has been dropped.

Our representative piece of limestone is now in for a rugged time. Sliding from the bin, its movement being regulated by lengths of massive steel chain, it finally goes through the crusher, where it loses any excess weight and size it may have had. Then it is carried on rubber conveyor belts to a vibrating screen. If small enough, it passes through one of the screen holes and is transported to a 400-ton-capacity storage bin. If it measures more than 6½ inches in diameter and won't go through the screen, it is sidetracked to another conveyor belt and carried back to the crusher feed bin for another trip through.

In the storage bin, our chunk of rock gets only a brief rest. It soon finds itself sliding, along with numerous other pieces, into a 250-cubic-foot measuring pocket. There are two such pockets, each feeding one of the skip buckets which travel practically continuously up and down the production shaft. One of the skips comes to a halt at the bottom of its shaft, the other skip being at that instant at the top of the shaft.

A man on the platform above the loading chute touches a control, and 10 tons of limestone, containing our sample piece, pours into the skip. Precisely two minutes later and somewhat better than 2300 feet higher, our limestone chunk sees its first daylight in 300,000,000 years.

Its fate from then on may take any of several turns, but first it travels on a rubber conveyor belt to the screening mill. If it measures 1 to 6½ inches in diameter, it is loaded on an electric train and hauled to the Columbia Chemical plant. There it is taken apart chemically and its various portions made into such products as washing soda, carbon-dioxide gas and pigments for rubber. If smaller than one inch, the piece may become agricultural lime, which is in great demand in this part of Ohio. Or it may find itself eventually in an asphalt road or a concrete building foundation.

(Continued to page 224)

Once Again Dependable

CHAMPIONS

Win In Indianapolis "500" Mile Race



BE A CHAMPION DRIVER . . . Follow The Experts in Their Choice of Spark Plugs



Once again the checkered flag brought a Champion-equipped car into the winner's circle in the 1950 Indianapolis Speedway Classic, for the 19th time. 7 out of the first 10 cars used dependable Champions.



Johnny Parsons, winner, and 1949 AAA Champion, set a new record with an average speed of 124.002 miles per hour for the 345 miles of the race—cut short by rain. Johnny always uses Champions.



If you tested spark plugs as exhaustively as the race driver, you would know that Champions insure the utmost in performance and dependability. The majority of these experts use Champions.

CHAMPION SPARK PLUG COMPANY, TOLEDO 1, OHIO

Listen to the CHAMPION ROLL CALL . . . Harry Wismer's fast sportscast every Friday night, over the ABC network

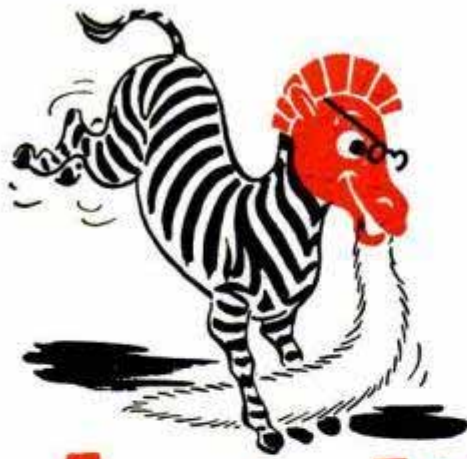

For Longer Life Portable Radio Batteries



BURGESS BATTERIES have longer life because Chrome Protection curbs internal action when your radio is idle. Be sure you have **BURGESS** Portable Radio Batteries and you'll have full power for more hours of static-free listening pleasure!

BURGESS ENGINEERING assures long, dependable battery service.

BURGESS GUARANTEE, backed by the foremost name in radio batteries, means complete satisfaction.

BURGESS *Portable Radio*
BATTERIES
BURGESS BATTERY COMPANY
FREEPORT, ILLINOIS

Clinic



for Homemakers

As a service to our readers in solving the hundreds of problems pertaining to a home—inside or out—the editors of *Popular Mechanics* invite you to present your problems to The Clinic Editor for help and advice. Address your questions to The Clinic Editor, *Popular Mechanics Magazine*, 200 East Ontario Street, Chicago 11, Ill.



Locating Studs

Q—How does one locate the studs in a plastered wall when it is necessary to drive screws into them to support a large wall cabinet? Due to the weight of the cabinet it is necessary to reach the studs with screws. Isn't there some method of locating the studs accurately without drilling trial holes? *F.M., Utica, N.Y.*

A—Studs usually can be located quite easily simply by tapping the plaster lightly with a hammer. The method is well-known among builders. Move the hammer slowly to the right or left, tapping the surface of the plaster continuously. You will detect a progressive change in the tone, or reverberation, produced by the individual taps as the hammer nears a spot directly over a stud. The taps produce a hollow sound over the space between the studs but when the plaster is tapped directly over a stud the tone is much sharper and of a more metallic quality.

Cleaning Asbestos Siding

Q—The walls of my two-story home are covered with asbestos siding, which seems to be rather badly weather-stained, especially below the windows. Is it practical to wash this siding and if so, how do I do the job and what cleaning preparation should be used? Or, should the siding be painted?—*E.R., Carbondale, Ill.*

A—Manufacturers of asbestos siding supply a special cleaner for this type of siding. Inquire of your local building-materials dealer. He can supply you with the cleaning compound direct, or, if he does not have it in stock, he can obtain it for you. Complete directions for its use will be included with this product. Of course, you can use other common cleaning solutions, probably with fair success, provided the siding is not too badly stained with embedded grime. Carbon tetrachloride can be used to remove the stains under the windows. *Caution:* Carbon tetrachloride should be handled with care. Avoid inhaling the fumes, as they are toxic. Some instructions for cleaning asbestos siding will direct you to begin at the bottom of the wall and work upward to the cornice. As a rule this is considered a good practice, although in some cases it may be best to work from the top

(Continued to page 222)

Your car...

...can be seriously damaged by a leaky radiator. Don't take chances—take care! Use Warner Liquid Solder...it's non-metallic, deposits tiny fibers to repair leaks anywhere in the cooling system. Fast, sure and easy to use—just shake...pour...and fret no more.

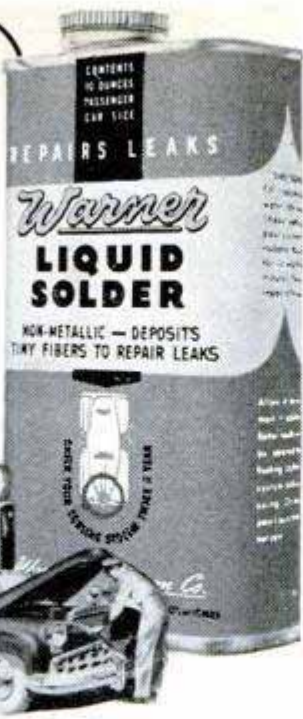

Warner
A FAMOUS NAME
IN AUTOMOBILE HISTORY

In Two Sizes, at Service Stations, Accessories Stores, Car Dealers, Auto Repair Shops

BeMaCo Dependable
AUTOMATIC SAW SET

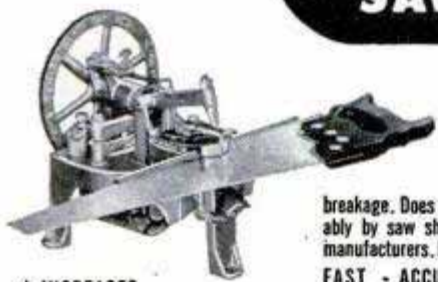

Sets 400 teeth per minute on hand or band saws 4 to 16 point. Hammer and anvil action sets teeth accurately and uniformly...No tooth breakage. Does a perfect job. Used profitably by saw shops everywhere and saw manufacturers. Every machine guaranteed!

★ INCREASES PROFITS
BEAVER MFG. CO.
802M S. 1515 AVE. • INGLEWOOD, CALIF.

BOAT BLUEPRINTS & FULL SIZE PATTERNS

and specifications. Designed by Naval Architect. Cruisers, runabouts, sloops, outboards, sailing canoe, etc. Low prices. Send 25c (coin) for illustrated catalog. SPECIAL: Send \$1.00 for "HOW TO BUILD BOATS" book, postpaid. Poly Wog Houseboat Plans, \$10. Marine Catalog \$1. Cleveland Boat Blueprint Co., Dept. 666, Cleveland 13, Ohio

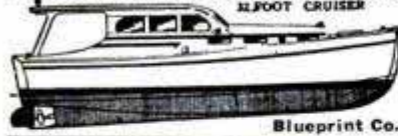

SAY YOU SAW IT IN POPULAR MECHANICS

Easy and Cheap to Operate

SHAW "DU-ALL" and "PEPPY PAL" TRACTORS

These rugged walking or riding tractors are ideal for farm, truck garden, orchard, poultry farm. Operate on a few cents an hour. A child can handle them.

DO DOZENS OF JOBS Both riding and walking tractors quickly and easily plow, cultivate, harrow, disk, bulldoze, spray, haul, grind, saw wood, etc.

LOW FACTORY PRICES Buy direct or through your dealer. Year's guarantee!

RIDING TRACTORS 4 models from 5 to 12½ H.P., 58 in. wheelbase, 36 to 52 in. wide, 24 in. plant clearance. Hand or electric starter. Walking Tractors 1½ to 5 H.P.

FREE Illustrated folders giving complete details and price lists—write today!

SHAW MFG. CO.
4508 FRONT ST., GALESBURG, KANS.
668G NORTH 4TH ST., COLUMBUS, O.



Used and Endorsed by
LEADING OUTDOORSMEN
Everywhere!

Coleman
GOLDEN ANNIVERSARY
FOLDING CAMP STOVE

*Other Models Priced as low as \$9.95 in U.S.A.



"I have good food in a hurry with my Coleman," says **ANDY DEVINE**, popular outdoorsman, movie star and owner of Sportsmen's Tavern, Big Bear Lake, California.



"My Coleman means more fun and less work outdoors," says **COREY FORD**, well-known outdoor writer and author of recent collection of dog stories, "A Man of His Own".



"I always get quick, dependable service from my Coleman," says **TED TRUEBLOOD**, nationally known writer on hunting and fishing and author of "The Angler's Handbook".

New streamlined stove cooks like a city gas range. Instant lighting. Folds up and carries like a suitcase. Safe. See your Coleman dealer.

MORE HOURS OF FUN
Coleman Floodlight LANTERN



Floodlights 100-ft. area. 20 times as bright as wick-type lanterns. Instant lighting. Storm-proof. Safe. Can't spill fuel. Priced as low as \$9.95 in U.S.A.
The Coleman Company, Inc., Wichita 1, Kansas

The Coleman Company, Inc., Dept. 223-PM, Wichita 1, Kans. Please send me FREE booklet about Coleman Camp Stoves and Coleman Lanterns.

NAME.....
ADDRESS.....
CITY..... STATE.....



Ideas* * out of * this World

... yours with these
Wizards with Wood

Ideas for bonding wood! Ideas for finishing effects! Want 'em? Then send postcard for leaflets on Firzite, Satinlac, Weldwood Glue — used by professionals and offered by United States Plywood Corporation. . . .

Strongest Wood Glue Ever Made



To make things or fix things, use **Weldwood Glue** for all wood-to-wood bonds. Makes joints stronger than the wood itself. Mixes easily with water. Stain-free, rot-proof . . . highly water-resistant! 15¢, 35¢, 65¢, 95¢ and larger sizes.

WELDWOOD
PLASTIC RESIN GLUE

A MUST for Finishing Fir Plywood



Tame that wild grain with **FIRZITE**. It tight-seals the pores . . . virtually prevents grain rise or checking . . . readies the surface satin-smooth for paint, stain or enamel. (For blond, pickled, wiped or tinted effects use White Firzite).

FIRZITE

Newer than Shellac or Varnish



For "natural wood" finishes on furniture or woodwork, there's nothing like **Satinlac**. Brings out the natural grain and color beauty of any plywood or solid wood. Avoids that "built-up" look, and will never turn yellow or darken with age. "Water-white", easy to brush or spray, dries ready for next coat in 2 or 3 hours.

SATINLAC

Ask for Weldwood Glue, Firzite and Satinlac at hardware, paint or lumber dealers.

Send post card for interesting glue and finishing leaflets.

UNITED STATES PLYWOOD CORPORATION
Dept. 88, 55 West 44th St., - New York 18, N.Y.

(Continued from page 220)

of the wall down. Ordinarily we do not recommend painting either asbestos siding or shingles, although it can be done. We would suggest that you try renewing the siding with the special cleaner before attempting the application of paint.



Painting Brick

Q—I have a new house with walls of common brick. The walls seem to absorb considerable moisture during driving rainstorms and I've wondered if it might not be wise to paint them. It seems to me that this would form a coating which would prevent absorption of moisture. Wouldn't this be a good idea?

J.J., Dallas, Tex.

A—The mere fact that the bricks absorb moisture is not ordinarily considered sufficient reason for painting them. If the walls are of sound construction with tight mortar joints, it is not likely that moisture from ordinary rains is finding its way to the inner surface of the bricks in any appreciable quantity even though the wall is of single-course thickness, as in brick-veneer construction. Unless you wish to change the color of the wall, we would suggest that you consider application of a masonry sealer. This material seals and waterproofs the surface and dries transparent, that is, it does not change the color or texture of the wall. The sealer is applied with a brush and ordinarily only one coat is required. On the other hand, if you wish to change the color and, to some extent, the texture of the wall, then an application of oil-base paint or a masonry paint is the thing. Apply either of the products in accordance with the manufacturer's instructions for application to masonry walls.

Rolling Lawn

Q—What is the best time to roll a lawn? I've been told that rolling in early fall, rather than in early spring, is recommended for best results, as spring rolling packs the soil and causes it to dry out and crack open, thus damaging the sod. Is this information correct?

J.S., Des Moines, Iowa.



A—The time to roll a lawn is determined by its general condition and not so much by season or custom. Among the more variable factors which govern to some extent are: age of the sod, condition and type of the soil, relative mildness or severity of the preceding winter, moisture content of the soil at the time of rolling and the thickness, or density, of the turf. Ordinarily, old, established lawns do not require rolling from season to season. Many landscape gardeners do not recommend rolling older lawns at any time, especially if the general condition of the turf is good. Where leveling is required on such lawns, top dressings of black soil or peat moss are more often used. Rolling alone cannot be depended upon to level a lawn. The only practical purpose served by rolling the lawn in early spring is to press down individual plants that have been heaved by frost action during the warmer weather of late winter when there is alternate freezing and thawing. Even then, rolling should be light to avoid packing the soil unduly. Rolling is permissible when a lawn has been spot-seeded or when the soil over comparatively large areas has been reworked and reseeded. Rolling the new seeding levels the high spots, firms the loosened soil and presses the seed into contact with the top soil without covering it too deeply. Many homeowners roll lawns in the early fall. This can be considered a good practice on soils which are loose and loamy and do not tend to pack under the weight of the roller.

DREMEL'S STRAIGHT-LINE ACTION GUARANTEES SCRATCH-FREE SURFACES

Here's fast cutting, finish sanding at its best. Dremel introduces a new electric sander, sturdily built to withstand hours of continuous use. It is light in weight... will not tire operator. Its straight-line (non-rotary) action leaves no scratches, no rotary marks—just satin-smooth surfaces ready for any type finish. Here, for the first time, is an electric sander built for years of faithful service—all at the remarkably low price of only \$24.50.

A POWERFUL, FAST CUTTING TOOL FOR CRAFTSMEN, HOME and INDUSTRIAL USERS

Craftsmen find this new Dremel model has the extra stroke and power needed for heavier woodworking projects such as cabinet-making, boat building and refinishing, garden furniture, etc. Home-owners say it's just the tool for preparing surfaces for painting and varnishing—for refinishing walls, woodwork, furniture, dry wall joints, siding and other surfaces. The Model 2000 also does a professional job of polishing waxed surfaces—eliminating all the back-breaking labor on cars, furniture, floors, stairways, etc. Industrial users likewise find this new Dremel Sander a faithful performer in furniture, cabinet, building and body shop operations.

RUGGED DESIGN and PERFORMANCE FEATURES

- Only two moving parts—requires no oiling.
- Reciprocal (straight-line—non-rotary) action leaves no marks... cannot burn surface.
- 21 square in. sanding surface speeds production... 14,400 cutting strokes per min.
- Cam-type holder permits changing paper in seconds.
- Die-cast aluminum housing with moulded Bakelite cover... Light weight, only 5 pounds... Over-all size 3 1/2" wide x 4 1/2" high x 7" long.
- 8 ft. Underwriter's Approved cord... operates on 110-120 v. A.C.

ONLY
\$24.50
WITH STEEL
CARRYING CASE
AND COMPLETE
ACCESSORIES

14,400
Sanding
Strokes
per Minute

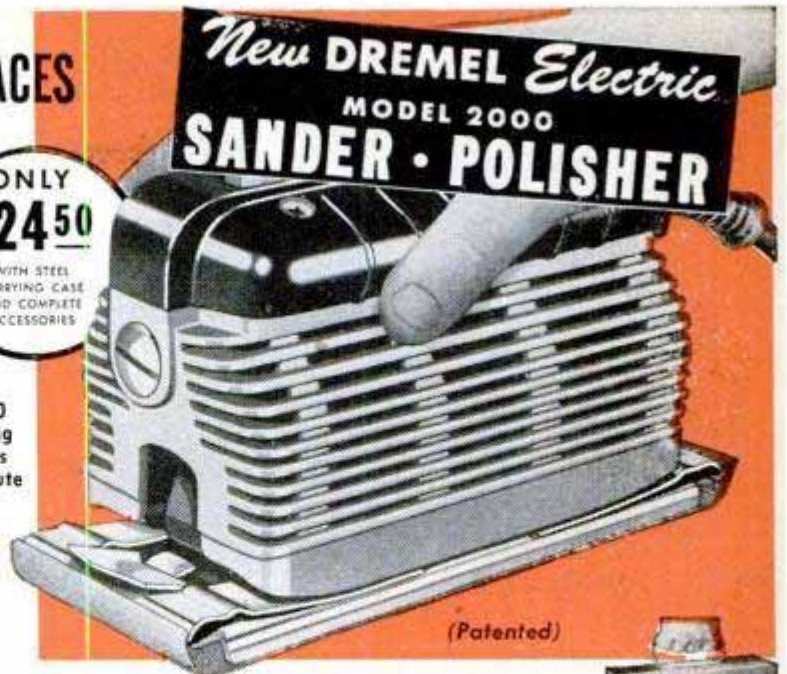

PRICE INCLUDES STURDY CARRYING CASE

Perfect portability of Sander, cord, abrasives, and polishing pads is provided in this sturdy, 3-shelf metal storage case. Price also includes 25 assorted sheets abrasive paper and a high-grade sheepskin polishing pad.



DREMEL Model "A" SANDER-POLISHER

Over 200,000 Now In Use!

A lighter-capacity Sander that takes all the work out of home or hobby projects. Popular with women for polishing furniture, etc. Same design and construction features as larger model. Furnished in attractive cardboard box. If your dealer can't supply, order direct from factory.



\$14.85

DREMEL Electric COPING SAW

CUTS SCROLLS LIKE MAGIC—SANDS AS IT SAWS



FREE
PROJECT
PLANS

SAFE! AS A HANDSAW

For home, hobby, repair work—no other tool pleases so much for so little cost. Works in any direction—delivers 7,200 strokes per minute smoothly, effortlessly. Saws through 3/4" medium-hard wood at a foot-a-minute speed. Touch-of-the-trigger, foolproof action. Only 2 moving parts, never needs oiling. Uses 110-120 v. A.C.

... for 6 useful
projects packed
with each saw

KINKADE GARDEN TRACTOR

and Power Lawnmower

A Practical Power Plow and Cultivator for Suburbanites, Gardeners, Florists, Estates, Fruit, Nursery & Poultrymen.

Easy Terms - Write Today
American Farm Machine Co.
1058 33rd Ave. S. E. Minneapolis, Minn.



Catalog
Free

MOTO-TOOL — THE POCKET-SIZE MACHINE SHOP



Don't confuse Moto-Tools and Accessories with so-called "bargain offers". Compare Dremel feature for feature with competitive tools. If our products are not superior in every way, we don't want you to buy.

Portable
DRILL
PRESS

Only
\$9.95

(Less
Moto-Tool)



MOTO-TOOL KIT NO. 2
With 23 Accessories
(High Speed Steel Cutters, Grinding Wheels, Polishers) — \$23.50
MOTO-TOOL NO. 2
(only) with one emery wheel point — \$16.50

Moto-Tool is the most versatile tool you can own—grinds, routs, drills, carves, engraves, polishes, etc. Look at these features: Approx. 27,000 R.P.M. • Dynamically balanced armature eliminates vibration. Oilless (oil-sealed) bearings • Dust-filtered air-cooling system • Weighs 13 oz. • Uses 110-120 v. AC • Used in plants of General Electric, Ford, Remington Arms, Nash-Kelvinator, etc.

WHERE TO BUY DREMEL TOOLS



Dremel Tools are sold everywhere. If your dealer cannot supply you, send remittance in full and we will ship postpaid. Or send only \$2, and pay postman balance plus postage and fee. Money back if not delighted after 5 days' trial.

DREMEL MFG. CO., Dept. 110-H, Racine, Wis.

PISTON TYPE COMPRESSOR



EASY PROFIT IN PAINT SPRAYING

Paints walls, ceilings, screens, furniture and machinery faster, better. All complete as shown less motor. Carry anywhere. Fully guaranteed. Could be used with 1/4 H.P. motor or less. Price \$35.00 less motor F.O.B. Chicago. \$5.00 deposit balance C.O.D. or see your dealer. With motor \$55.00.

IDEAL AUTOMATIC PUMP CO., Dept. P.M.8
801 W. Washington Blvd. Chicago 7, Ill.

M-SCOPE TREASURE-MINERAL LOCATORS

WRITE FOR FREE, ILLUSTRATED 16-PAGE BOOKLET

M-Scope Treasure-Mineral Locators, Geiger Counters, New Low Prices, unsurpassed in efficiency. Full factory guarantee. Immediate shipment.

YOU CAN PURCHASE THESE INSTRUMENTS ON A MONTHLY PAYMENT PLAN

URANIUM

FISHER RESEARCH LAB., INC., PALO ALTO, CALIF.

GOLD



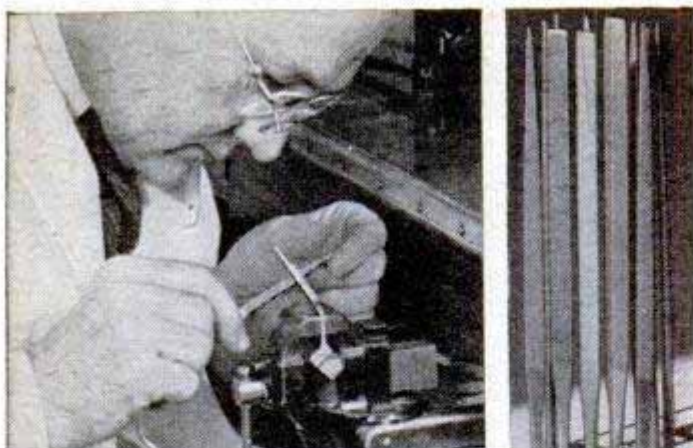

SWISS PATTERN FILES of the BETTER KIND

for every type of precision filing



WHEN fits and tolerances resolve themselves into denominators of thousandths, the files used on the work must be right for precise filing. Nicholson X.F. (Extra Fine) Swiss Pattern Files are widely regarded as the finest you can buy. They cover practically every need of the tool, die, pattern, model, watch, clock, jewelry and fine-instrument maker.* Their accuracy and general high quality are outstanding in these primary essentials:

SPECIFIED HIGH CARBON STEEL that is carefully inspected for proper grain size, and maximum hardenability and uniform performance.

UNIFORM TOOTH STRUCTURE—assured by most modern file-making machinery.

SOUND TEETH TIPS capable of high hardening—the result of cutting only after file blank has been ground and drawfiled to remove every trace of surface decarburization.

UNIFORM HARDNESS AND STRAIGHTNESS to aid long life and accurate filing.

**Illustrated above is the famous Nicholson kit of twelve assorted X.F. Swiss Pattern Round Handle Needle Files—pride of the hobbyist and precision craftsman. Plastic box, with bottom stand, is in beautiful orange-and-blue design. At good hardware stores everywhere.*

FREE BOOK, "FILE PHILOSOPHY"—48 interesting illustrated pages on kinds, use and care of files. Write to—



NICHOLSON FILE CO.
22 Acorn St., Providence 1, R.I.
(In Canada, Port Hope, Ont.)



NICHOLSON FILES

FOR EVERY PURPOSE

Whatever its ultimate fate, our pet piece of limestone, dug from a sleep that far outranks Rip Van Winkle's, has had its rebirth in one of the world's most fascinating mines; and in its new life it is contributing its tiny bit toward a civilization that will go to almost any length to procure and utilize such a commonplace material as stone.

The Barberton mine can produce limestone at the rate of 300 tons an hour indefinitely. It probably will not go much deeper than it is, for the stone in the lower portions of the deposit is not quite as suitable for chemical uses as that now being taken from the upper layers. The mine, which now extends over about 70 acres, will continue to expand in working area as rock between the entries and existing rooms is worked out.

Visitors like to speculate about the fate of the mine if it should become obsolete as a source of limestone. It would make an excellent underground factory, some think. It is intriguing to imagine it as a place of refuge in case the neighborhood should become the target of a bombing attack—until someone asks how ventilation and elevator service could be assured.

Home-Owned Big Top

(Continued from page 84)

dimensions and a diagram for a shifting crate for seals.

Members conduct an exchange of ideas and a barter system of their own through the association's official bulletin "The Little Circus Wagon." Ads such as this appear: "Wanted: Is there any member who would have a picture of Ringling Bros.' cook-house ranges with the smokestacks sticking out the sides of the tent being held with iron supports? Would like to get one or borrow one." This member was stuck on a detail which might seem slight to the average onlooker, but was of great significance to the builder.

Some members have become more adept at certain phases than others. Young Dyer Reynolds of Pawtucket, R. I., is known for his miniature clowns—true studies of such famous funnymen as Felix Adler, Lew Jacobs and Paul Jerome. Clowns, members will tell you, often change costume but never their make-up. Reynolds is also known for his lifelike clay animals.

Paul Caster of Des Moines, Iowa, was offered \$600 for his Columbia bandwagon before its completion. Scaled at one inch to the foot, it glows with intricate gold carving. The tiny wheel brake up front actually works. He's well under way with his

(Continued to page 226)



MOTORCYCLING— World's Greatest Sport!

Ride a
HARLEY-DAVIDSON
HYDRA-GLIDE

THE lure of motorcycling is like nothing else in this world! Once it's in your blood... brother, you'll never be the same again! From then on, nothing can ever equal the fascination of cruising down a scenic country road with a Harley-Davidson purring quietly under you... the he-man thrill of soaring up a steep hill like a climbing jet... the breathless feeling of levelling off for the straight-aways... the sense of power and freedom you get whenever you settle back in the saddle and "give 'er the gun!" In no other sport are friends so loyal, gals so glamorous. Nowhere is fun so easy to find as at exciting race meets, hillclimbs, gypsy tours and other club events. A Harley-Davidson is your ticket to endless good times, to happy, healthful outdoor enjoyment. You can own one on easy terms. So why not get started now? See your dealer today.



HARLEY-DAVIDSON MOTOR CO., Dept. P, Milwaukee 1, Wisconsin

Send me FREE copy of ENTHUSIAST Magazine filled with motorcycle action pictures and stories.

Name.....

Address.....

City..... State.....

DEALERS: Valuable franchises are now available for the full line of famous Big Twins and the 125 Models. This is your opportunity to line up with the greatest name in motorcycles. Write or wire for complete information today.

You'll always
be proud to say

"Mine's a
Winchester"

... and no wonder! For the name *Winchester* on your 22 is a name which is reverently echoed in every corner of the earth from the cold north country to the steaming jungles of the tropics.

The Model 61 shown at left is a sportsman's dream come true. A light, finely-balanced, slide-action repeater that is well adapted for moving targets, running small game . . . all types of 22 shooting. Genuine American walnut stock . . . proof-steel barrel. Holds 14 Long Rifle, 16 Long, or 20 Short 22 caliber cartridges interchangeably. Also furnished in 22 W. R. F. only. See it at your dealer's.



FREE! Folder giving full details of all Winchester 22 caliber sporting and target rifles. Address: Dept. 342-C, Winchester Repeating Arms Co., Division of Olin Industries, Inc., New Haven 4, Conn.



The World Famous Model 61
WINCHESTER
TRADE-MARK
SPORTING RIFLE

side show—Freddie, the fat man, a knife-throwing act, and a magician with his lady stooze are completed.

When a circus arrives in town, local association members meet it at dawn with their cameras, notebooks and tape measures—and possibly request to check or photograph some phase for a fellow member hundreds of miles away. These avid fans want to know exactly how the circus unloads, which wagon arrives on the lot first, how it sets up and what new animals and acts have been added. The camera is used to record paraphernalia for future reference, and out comes the tape measure to get dimensions of the equipment so the miniature scale will be perfect.

The association is not without its crusades. It wants the circus to remain the colorful extravaganza of long ago. Members are upset over the discarding of sunburst wheels from the wagons (wooden wheels painted in a sunburst of color) and the substitution of dull rubber wheels, which delight city officials.

The year 1918 ended the elaborate, heavy, circus parades. The association wants them back, but they carry no false hopes. Many reasons have been given for their discontinuance: traffic, expensive licenses and the damaging of city streets.

But such thoughts don't bother the miniature circus owners when they bring their shows to town. The circuses unload just as their big brothers, the wagons enter the lot in proper order, the tents go up and the side-show acts take their places. Quickly, then, the ticket seller enters his booth—the hawker raises his megaphone to his lips—and, behold, "The Greatest Show on Earth" is again open to the public.

School for Jet Pilots

(Continued from page 121)

are unnecessary. Student pilots go direct to two-place F-80 trainers almost as soon as they have learned how to fly. The transition from slow to fast aircraft and from piston engines to jets is helped by new ground training devices, including a brand new jet type of synthetic trainer.

All the controls, instruments and reactions of a fast aircraft are included in the new training machine and the operations are precisely as they would be in actual flight. Rates of roll, climb and acceleration are faithfully duplicated and the controls are loaded so that pressures vary with the air speed.

The student who sits under the hood in the new device is under the control of a check pilot, or instructor, who sits at an

(Continued to page 228)

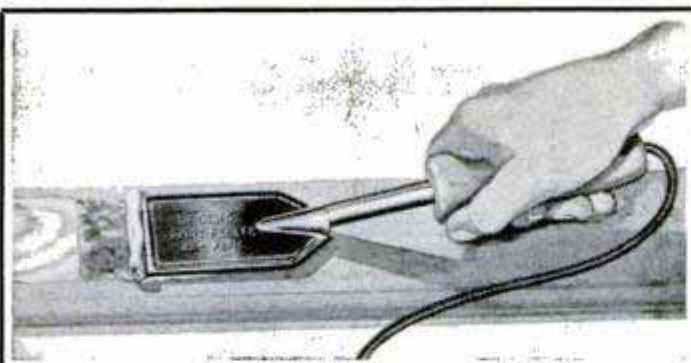

PEEL PAINT TO BARE WOOD WITH ONE EASY STROKE

NEW ELECTRICAL TOOL removes 1 to 10 or more coats of paint from any wood surface as easy as cutting butter with a hot knife. No scraping, cutting, burning, sanding, or chemicals. The new Lectro Paint Peeler instantly softens paint electrically and peels it off the surface clean to the bare wood with one easy stroke. It's faster than a blow torch—there's no danger of fire—will not scorch or burn delicate wood surfaces. Makes no mess—no smell—it's even fun to use. Removes any paint, enamel quickly and easily. Sturdily constructed to last for years. Sent complete with extra long, quality electrical cord. Simply plug into any A.C. or D.C. outlet—let heat for several minutes and remove paint to the bare wood on exterior or interior painted surfaces, floors, woodwork, cupboards, furniture, antiques, boats, window-sills, screens, doors—a hundred other uses. Price \$4.95 postpaid—nothing else to buy. Full money back guarantee. For immediate shipment—send check, cash or money order to:

LECTRO WELD, INC.

Dept. PM8

5700 Detroit Ave.

Cleveland 2, Ohio

Save Time!!! Save Money!!! SEND FOR THIS BIG, NEW Woodworkers Catalog No. 17

ONLY **15c** New low prices...great selection of fine domestic and imported woods...bargains in hard to get supplies--144 pages of items and ideas for woodworkers. Quick delivery on mahogany, walnut, maple, cherry, poplar, oak, red cedar, and others properly seasoned, kiln dried. Send 15c for your copy--TODAY. Dept. A-8



RAFTSMAN WOOD SERVICE CO.

2729 S. MARY STREET-CHICAGO 8, ILLINOIS

WHIZZER 3 H. P. MOTOR

America's finest bike motor

Make your bike a lively, powerful motor bike with big, new Whizzer 3 h. p. bike motor. 4-cycle, 138 c.c. 5 to 40 m. p. h. Up to 100 miles per gallon. See your Whizzer dealer or write WHIZZER MOTOR CO., 310 S. Sanford St., Pontiac, Mich.



A TOOL... NOT A BRUSH

\$1.00 POST PAID

NOW! PAINT STRIPING MADE EASY!

PAINTERS' STRIPING TOOL

Easy to use as a pencil! Draws parallel lines, straights, curves, circles with paint, enamel, lacquer, etc. Do your own striping on autos, furniture, toys, bikes, model planes, signs, linoleum... make wall board look like tile. Painters - craftsmen, order today! Type "M" Master Painters' Striping Tool complete with tip for 1/16" stripe, \$1.00. Other tools complete with following tips: 1/64", 1/32", 3/64", 5/64", 3/32", 1/8"; \$1.50 each. Extra tips 75c ea. Entire kit with tool and 7 tips—\$5.00. (COD's postage collect.)

DEALERS WRITE TODAY!
WENDELL MFG. CO.
4234-B Lincoln Ave., Chicago 18, Illinois

Halt Engine Overheating



Before You Get Burned!

Add **BARDAHL**
to Your Crankcase Oil

STOP dangerous heat that runs up repair bills! Simply add one quart of BARDAHL to regular oil.

Before you drive 10 miles, you'll see the difference. Temperature goes down—compression goes up. Motor runs better, sounds better than ever before.

BARDAHL penetrates metal pores, clings to friction surfaces. It's the perfect way to loosen up tight engines on new cars or overhauled cars.

Ask the best mechanic in town about BARDAHL. He's been using it for years!

BARDAHL OIL

Reduces Friction to a Fraction

BARDAHL OIL COMPANY
Seattle • St. Louis



LAWNMOWER SHARPENER OPERATORS

Increase your output...
Year 'round business!

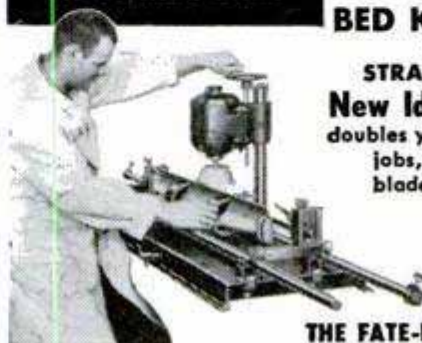

NEW BED KNIFE GRINDER

sharpens all STRAIGHT EDGE TOOLS
New Ideal Bench Grinder
doubles your output of sharpening jobs, speedily grinds straight blade knives. Sharpens all kinds of straight edge tools and ice skates. Write for FREE, fact-filled folder.

THE FATE-ROOT-HEATH COMPANY
Dept. D-3, Plymouth, Ohio

NEW!

Klean-Strip Remover Peels Off Paint



Throw away messy, dangerous solvents! Klean-Strip, the new-type remover, needs no

after-wash, will neither burn nor explode. Just apply with brush, or spray gun . . . then slide off the loose film. That's all there is to it!

Klean-Strip actually breaks the bond between wood or metal and the finish you want to remove. Peels off any paint, enamel, varnish, synthetic or lacquer. Works fast, leaves the surface clean, smooth and dry, ready for a perfect refinish job.

The next time you buy paint, get a can of Klean-Strip, too! Available at better paint, hardware, and department stores everywhere.

W. M. BARR & CO.
2354 S. Lauderdale
Memphis, Tenn.



Clean · No-Wash
Non-Inflammable



"SAVE IT AND
FIX IT"

MENDS

DISHES, FURNITURE, LUGGAGE

It's transparent, water-proof, flexible and durable. Get a tube today.



DUCO CEMENT

REG. U. S. PAT. OFF.

outside console and plagues the student with many of the emergency situations that are apt to occur in real flight. By pressing buttons the instructor can introduce the effects of rough air, wing and pitot icing, fuel pump or hydraulic-system failure, or can stir up a thunderstorm, complete with lightning flashes.

During a training period a student may find that he has a burned out tail pipe, his engine is disabled, he is headed for the runway with his wheels up and is too slow for a bail-out. He can still land safely. By turning one master switch, the "angelic switch," the instructor wipes out all the student errors and simulated mechanical failures and the student makes a fresh start.

A radar sight now being tested automatically solves all fire-control problems for machine guns, rocket firing and dive bombing, either in daylight or dark. It can be switched to manual control for targets that do not reflect a radar beam. With the sight, designated the A-1C and made by Sperry, the pilot centers his target inside a circular pattern of light, then presses a button that fires the guns or rockets and releases the bombs at the proper time.

Navigation must be exact because the margin of reserve fuel is extremely small. A detailed flight plan has to be worked out ahead of time then adhered to precisely. In a slow aircraft, with plenty of reserve fuel, a pilot can hold on one leg of a radio range in poor visibility and work out his approach problem; in a jet he can't fool around. He must hit the range on the nose and go through the approach and landing procedure on the first time around. Fuel is too critical for too many tries.

Pilots age more rapidly than do other military personnel and the suspicion is that jet pilots grow old faster than do those who fly slower aircraft. The question is, what can the jet pilots do to husband their energy? Do they need more frequent vacations, is rest or exercise best, should they have hot and cold showers, massages or what?

To find out, the Air Force has the University of Southern California making special tests of 100 men in its fatigue laboratory. For six weeks the men are taking special exercises, for six weeks they take no exercise at all, for six-week periods they receive various conditioning treatments. They regularly undergo complete physical and mental check-ups, including tests of their ability to withstand severe accelerations while riding on a human centrifuge.

Aircraft are overhauled and maintained at regular intervals. Now the Air Force is going to find out what is necessary to keep its pilots in the best possible condition, too.



Get more value for less money! Make Your Choice an Empire Level

No. 151 Aluminum Level. Extremely accurate with adjustable-interchangeable vials. Has 2 levels, 2 plumbs, and a choice of 2 45° vials or 2 additional plumbs. Beautifully finished, easy to work with. A tool you can be proud to own.

18" ... \$6.40 24" ... \$6.80 28" ... \$7.80

Order EMPIRE Levels from your local dealer, or write for complete information.

EMPIRE TOOLS MFG. COMPANY
Dept. PM 10930 W. Potter Rd., Milwaukee 13, Wis.

OTTAWA Buzz Master

7 MODELS—\$99.00 up

Greatest offer made in our 46 years of manufacturing. A model to fit your needs and your pocketbook. Free details.

OTTAWA MFG. CO., 2-027 Brush St., Ottawa, Kans.

No Other Like It!

ONAN Portable ELECTRIC PLANTS

FOR CABINS, TRAILERS, CONTRACTORS, BOATS

Light weight, compact, air-cooled, engine-driven. Furnish regular city-type A.C. electricity for lights, appliances, radios, etc. Can be carried by hand. Fits trunk of car. Plug-in receptacles on plant. Larger models for farms, homes, businesses beyond highlines. Catalog shows over hundred models. 350 to 75,000 watts.

GASOLINE OR DIESEL POWERED
Prices begin at \$169.50

WRITE FOR CATALOG

D. W. ONAN & SONS INC.
5836 Royalston Ave., Minneapolis 5, Minn.

GRAVELY 5-HP TRACTOR

DOES 19 LAWN, GARDEN and FIELD JOBS—

QUICK and EASY!

Sickle Mower attachment cuts tall grass, weeds, head-high, thumb-thick brush! . . . Ideal for jobs around small farms, suburban homes.

ONE TRACTOR DOES 19 JOBS!

- * ALL GEAR DRIVE
- * POWER REVERSE
- * A QUALITY TRACTOR

"Power vs. Drudgery" tells how to put POWER to work! Write today!

FREE

GRAVELY MOTOR PLOW & CULTIVATOR CO.
BOX 863 DUNBAR, W. VA.

FIELD-TESTED FOR 28 YEARS

How SHOPSMITH "change-ability" saves you \$300

SHOPSMITH is a single, compact unit that converts quickly (less than a minute) into an 8-inch circular saw, 12-inch disc sander, 33-inch wood lathe, vertical and horizontal drill press. With extra attachments, it is also a jigsaw, jointer, shaper, drum sander, mortiser, grinder and buffer. Yet SHOPSMITH costs just \$199.50 with motor, \$169.50 without.

IMPORTANT SAVINGS! The very fact that you can change SHOPSMITH from tool to tool saves you upwards of \$300. Saves you space, too—56 square feet of it!

HERE'S HOW: SHOPSMITH does away with costly duplication. Single-purpose tools have many parts in common—arbors, bearings, castings, tables, motors, etc.—parts that account for 50-75% of the cost of each tool. SHOPSMITH combines these parts into one flexible unit, does it so successfully that you actually get greater accuracy, more capacity, extra quality.

EACH PART PRECISION MADE! SHOPSMITH can afford to put top quality into every part because each part is used for all major operations. Stress-proof steel spindle has induction hardened tip, four grease-sealed ball bearings. Quill and ways are centerless-ground to watchmakers' tolerances. Heavy-duty, fine-grain castings are simultaneously bored to assure perfect alignment of all parts.

SEE SHOPSMITH! At any Montgomery Ward, leading department or hardware store. See for yourself why it's America's largest selling power tool.

FREE 16-page illustrated booklet brings you complete details and specifications. Simply mail coupon below.



SHOPSMITH, Dept. 129-B,
at factory nearest you
12819 Coit Rd.,
Cleveland 8, Ohio, OR
417 Montgomery St.,
San Francisco, Calif.

Please send me a free copy of the SHOPSMITH booklet.

Name _____
Address _____
City _____
Zone _____ State _____



of Aluminum, Brass, Copper, Stainless Steel

*Easily! Quickly!
at Low Cost!* For beginners and experienced craftsmen—here's a complete supply of quality metals pre-cut to the size you want . . . and at lowest metal warehouse prices!

ALUMINUM and COPPER CIRCLES. RECTANGULAR SHEETS of Aluminum, Brass, Copper and Stainless Steel. Easy to work, ready to be formed into trays, coasters and hundreds of useful items and gifts.

BRACELET BLANKS of Aluminum, Brass, Copper and Stainless Steel. Perfect for jewelry, ornaments . . . simple to work into attractive handicraft.

FREE BOOKLETS! "Making Aluminum Trays and Coasters", and "Copper Metalcraft" give complete directions for making beautiful metalcraft items easily and quickly. Send for your Free Copy Today!



METAL GOODS CORPORATION

628 Rosedale Ave., St. Louis 12, Mo.

A book every hobby crafter should have



May we send it to you? Send 10¢ for mailing cost.

It's the new 28-page X-acto Catalog, handsomely illustrated, giving sizes, prices, contents of entire X-acto line.

**KNIVES & TOOLS
KNIFE & TOOL SETS
LEATHERCRAFT TOOLS
PLEXON ARTCRAFT STRIP
METALCRAFT KITS
WOODCARVING KIT
TRIX and ELEKTRIX
Model Engineering System**

Points the way to a lifetime of fun with hobbies. Send for it today.

x-acto Reg. U. S. Pat. Off.
HOBBY KNIVES and TOOLS

X-acto Crescent Prod. Co., Inc. 440 4th Ave., N. Y.

A Super-Tanker Feeds Oil-Thirsty America

(Continued from page 78)

squirts its stream in all directions with such force that oil, wax, rust and scale are torn from the tank sides in a few minutes, and gas is forced out. The tank is then tested for fumes with a gasometer, which samples the vapor and indicates its explosiveness.

When the indicator says the tanks are gas-free, men climb in. Buckets, hung from special Amtank cranes, are lowered to them, filled with junk from the tank bottom, hauled up and dumped overboard.

Occasionally, men must go into gassy tanks to make emergency repairs on jammed valves. Looking like a man from Mars, the repairman descends wearing a fresh-air mask. On deck, another crewman pumps fresh air to him through a long hose. Nobody cares for this job, since the mask is uncomfortable in the hot tanks.

The Amtank's second mate took a chance one day and went down without the mask to free a stuck valve. He was on the bottom only a couple of minutes. On the way back up the ladder he felt sleepy. At the top, he collapsed and fell over the rim of the hatch. "If I'd gone the other way," he recalls with a shudder, "I'd have dropped 40 feet to the hard steel bottom."

The explosive gas on any tanker is a constant concern. Smoking is strictly forbidden anywhere except in the after house and bridge. Fire rules are rigid, and for that reason tankers have fewer fires than other ships despite the hazard.

Crews must continually scrape the steel decks for painting, but the tools they use—wire brushes, whirling metal star scrapers, mechanical chisels and hammers—are made of nonferrous metals and are driven pneumatically instead of electrically so there will be no sparks. The Amtank boys, incidentally, have a unique way of painting. They smear it on the broad decks with mops instead of brushes, using a petroleum-base paint. "We can do a whole deck in half a day," Mathis boasts.

Despite precautions, freak accidents do happen occasionally. Between tank 9 and the pump room on the Amtank is a cofferdam space. Due to unusual stresses, a steel cofferdam plate fractured and cargo leaked into the space. Somehow gases seeped into the after officers' washroom, and an engineer going in to attend his morning ablutions lit a prebreakfast cigarette. Kabloom! The explosion blew out bulkheads and hatches, overturned chairs and tables and started fires in the messroom. Luckily the fire was quickly doused. The engineer

(Continued to page 232)

BASEMENT OR CLOSET DAMP?

NEW! IMPROVED!
SOLVAY
AIR-DRYETTE JR.

with
SOLVAY CALCIUM CHLORIDE

absorbs moisture—the cause of rust, warping, mildew in workshops, darkrooms, closets, playrooms, storage rooms, vaults. Built to last for years. Big capacity. Works fast, absorbs up to 3½ qts. per day. Compact, inexpensive, clean, safe, odorless. Thousands in use. Write for booklet and name of your nearest dealer.



Dept. 89-8, SOLVAY SALES DIVISION
Allied Chemical & Dye Corporation
40 Rector Street, New York 6, N. Y.

Pioneers

Leaders

AIR RIFLES

BENJAMIN

AIR PISTOLS

SHOOT WITH SAFETY

BE SAFE—SHOOT WITH COMPRESSED AIR—ALWAYS READY No Cartridges or Tanks to Replace or Recharge. If you want the most **PRACTICAL GUN** to use anywhere—inside or outdoors—get a **SAFE—CLEAN—ECONOMICAL BENJAMIN** with Adjustable Power and Amazing Accuracy. Send for Free Folder of Latest Models Today. **BENJAMIN AIR RIFLE CO., 890 MARION ST., ST. LOUIS 4, MO.**

HOW to Make Your Own RUBBER MOLDS

Here's a quicker, easier way to make exact reproductions of an object in any quantity. No heat curing required; no shrinking of materials. Objects of clay, plasticine, wood, metal, glass or stone-like ashtrays, bookends, medals, souvenirs, plaques, sculpture can be copied exactly right at home! Perfect for reproducing Dresden figurines. No previous experience needed. No special tools required. Our new Brochure 328 gives exact, step-by-step instructions anyone can follow. Send 10c for it to **SCULPTURE HOUSE, 304 West 42 Street, New York 18, N. Y.**



FREE AMAZING NEW BOOK "HOW TO ANSWER ADS"



Never before have you seen anything like this. Tells you in simple language the correct way to answer ads. Gets you quicker replies—better results, and greater satisfaction. Will save you time and money and it's **ABSOLUTELY FREE**. No obligation whatever. Every reader of advertising should have this booklet. Send a postcard for your copy **NOW**. Advertising Department, Popular Mechanics Magazine, Room 602, 204 East Ontario Street, Chicago 11, Ill.

MODERN LAWN MOWER SHARPENER

FOR LAWN MOWER SHOPS
FIX-IT SHOPS

GOLF COURSES • PARKS
101 OTHER JOBS

Sharpens All Reel Type Mowers • Hand, Power or Gang • 10 to 20 Minutes • No Dismantling • No Extra Attachments Needed.

All reel type mowers, from 5-inch edgers to 36-inch power mowers, are quickly sharpened to extreme ends of both left and right twist blades.

ORDER NOW
Immediate Delivery

Handle, wheels, roller and motor remain in place when sharpening is in process. Bed knife is sharpened in same brackets. Grinding head rides on five ball bearing races. Easy to operate. Also sharpens chisels, joiner knives, planer blades. Big profit maker. Own your own business. Send Today for **FREE Illustrated Bulletin No. 10-C**

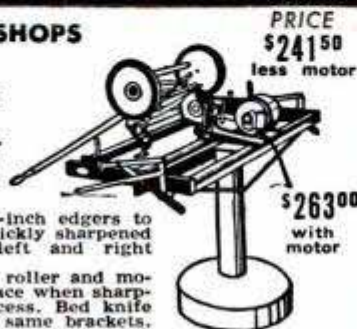

PRICE
\$241.50
less motor

\$263.00
with motor

MODERN MFG. CO. 160 N. FAIR OAKS AVE
PASADENA 1, CALIFORNIA

How to give QUICK REST to tired eyes

MAKE THIS SIMPLE TEST TODAY



EYES OVERWORKED? Put two drops of gentle, safe Murine in each eye. Then feel that refreshing, soothing sensation that comes instantly. You get—



QUICK RELIEF from the discomfort of tired eyes. Murine's seven important ingredients are scientifically blended to cleanse and refresh overworked, tired eyes. Use Murine morning and night and whenever your eyes tell you to.

MURINE
FOR YOUR EYES



CRAFTSMAN

REG. U.S. PAT. OFF.

HAND and POWER TOOLS

Famous for fine quality... precision performance... lower price! Buy them **NOW**... at Sears convenient Retail Stores... located in principal cities throughout the United States.

SEARS, ROEBUCK and CO.

BEAUTIFIES natural wood, pine paneling

POLISHES furniture, woodwork

IMPROVES paint jobs

PROTECTS wood and metal surfaces

49¢ PINT
89¢ QUART

101 HANDY HOME USES!
Every home, every workshop, needs Pol-mer-ik BOILED Linseed Oil. Free folder tells you how to use it. Write...

ARCHER-DANIELS-MIDLAND CO., Minneapolis 2, Minn.



HERE'S the quick easy way to build your own handy workshop. A place where you can keep your tools and do repairs without interruption. Pick a corner of your cellar, or perhaps the garage. Nail up big sturdy panels of Gold Bond Gypsum Wallboard to a rough lumber framework or over the old material. Lightweight, fireproof panels of Gold Bond Gypsum Wallboard saw like lumber, won't warp, swell or contract. Decorate with Gold Bond Sunflex, the low cost wall paint that dries in one hour.

Available at your local Gold Bond lumber and building materials dealer!

**NATIONAL GYPSUM COMPANY
BUFFALO 2, NEW YORK**



For Loose Castor Guides

Remove the guide, fill the hole with a putty-like mixture of Smooth-On No. 1 Iron Cement and drive the guide back in. It will stay in place, because Smooth-On, in hardening, expands slightly and takes hold tight. Use Smooth-On for tightening other loose parts and also for stopping leaks in boilers, furnaces, piping, radiators, etc. Buy Smooth-On No. 1 in 1 3/4 oz., 7 oz., 1 lb., 20 or 100 lb. size at your hardware store. If they haven't it, write us.

FREE Repair Handbook

Shows how to save time and money, making many household repairs. 40 pages. 170 pictures. Clear directions. Send today.

SMOOTH-ON MFG. CO., Dept. 37H
570 Communipaw Ave., Jersey City 4, N.J.

SO-313

Do it with
SMOOTH-ON
THE IRON CEMENT OF 1000 USES



escaped with everything but his hair and eyebrows—a badge of distinction which he could add to the mark of every tanker man: barked shins from slamming into cargo hatches.

The most hazardous place on a tanker is deep in the pump room, where a little gas always seeps from the glands. "Can't be helped," says Mathis. "On one tanker they tried tightening the glands, and the pump friction made them so hot the oil in the pipes went up and blew off the whole after end of the ship."

So serious is pump-room gas that on the Amtank no one goes down unless someone above is watching through the grating. Over in England during the war, a pumpman on a Mathis ship went down to oil his centrifugals and passed out. The watcher went down to rescue him and he passed out. So did a third would-be rescuer. The U. S. Army, wearing masks, finally had to come aboard and rescue all three.

Lighting a cigarette in the pump room is pure suicide, and only one man ever tried it on one of Mathis' ships. He was an assistant pumpman and drunk. The pumpman saw him just as he was about to light the match on pump-room floorplates. It was never lit. The pumpman's wrench connected with his skull. At the trial, the pumpman was cleared immediately.

Since that time, no crewman feeling jubilant from a night ashore has ever come aboard a Mathis ship.

"These gases are too tricky to fool with," says the Amtank's skipper. "I've watched St. Elmo's fire play across open hatches, and I've seen lightning strike right into the tanks and nothing happened. On the other hand, not long ago off Virginia a tanker exploded for no apparent reason at all. Her whole forepeak went flying into space."

Along with all other precautions on the empty trip to the tropics, the Amtank stages deadly serious fire drills. Every man wears a life jacket, or else. Hoses are broken out and checked, lifeboats swung from the davits. So far the lifeboats have never really had to hit water.

As she headed north, hull down, on her 111th trip from Sinclair's southern oil fields last March, the Amtank's distinctive unsupported flying bridge, looking like some airborne flying monster, was all you could see. She could boast a record average haul of 5,000,000 barrels of cargo a year. And up in the dusk-dimmed wheelhouse the self-satisfaction was evident in the contented cluck, cluck, cluck of the automatic Gyro Pilot as it quietly nudged her plunging bow back on course whenever a big wave shoved it off.

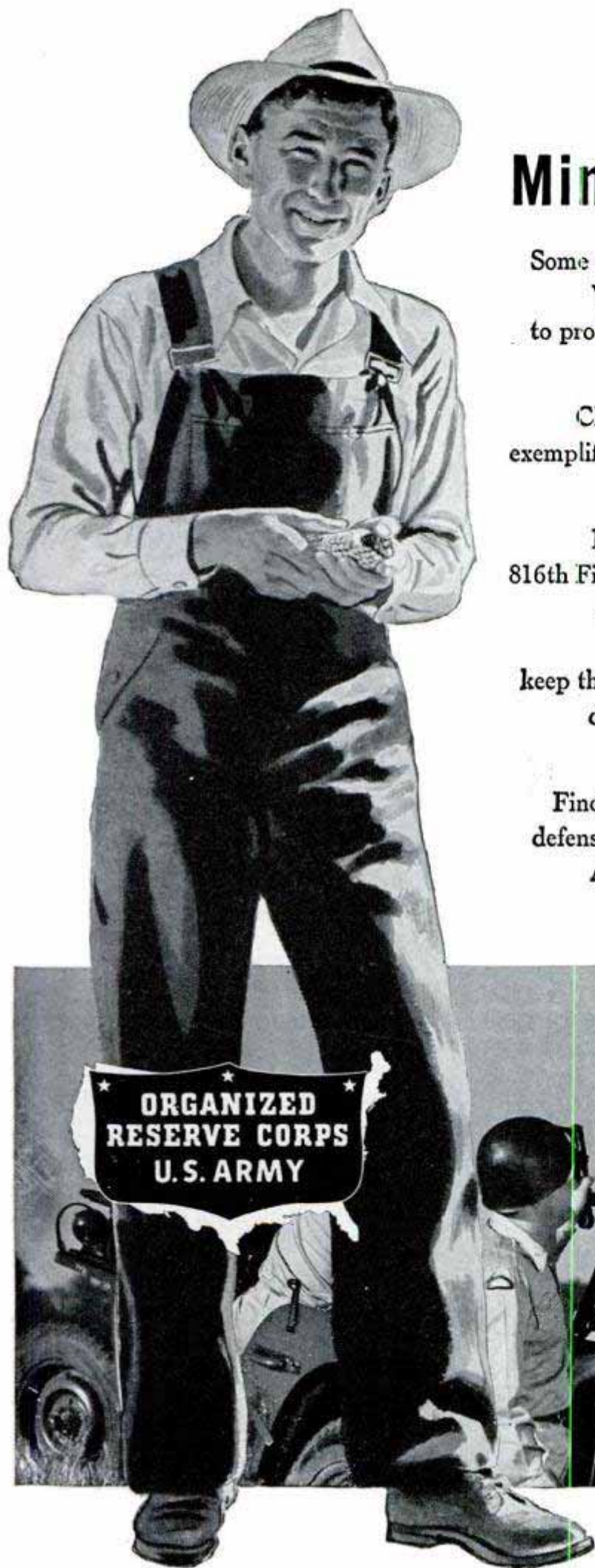

Minute Man... 1950

Some things have changed since 1776, but not this.

We here in America still need "Minute Men" to protect our liberties—just as much as we needed "Minute Men" to win them.

Charles H. Boyd, farmer, veteran and student, exemplifies our modern version of those men who stood and fought at Lexington and Concord.

He is the 1st Sgt. of Headquarters Company, 816th Field Artillery Bn., an Organized Reserve Corps unit, located in Columbia, Missouri. He, and thousands of Army Reservists like him, keep themselves and their units trained and ready to defend our country and our freedom by being active in the Organized Reserve Corps.

Find out more about this vital component of our defense establishment by visiting your nearest U. S. Army and U. S. Air Force Recruiting Station or your nearest ORC Unit Instructor.



SERGEANT FIRST CLASS BOYD USING FIELD TELEPHONE DURING SUMMER CAMP MANEUVERS

**Takes HARD WORK
out of HOME JOBS!**



**EASY FOR
WOMEN
TO USE —
Weights only
3½ lbs.!**

**SAVES TIME
and EFFORT
HUNDREDS
OF WAYS!**

**HOME-UTILITY
5" SANDER-POLISHER**

\$29.95

complete with sanding discs, lambswool polisher,
¼" Jacobs drill chuck, cans of wax and auto polish!

The Home-Utility 5" Sander-Polisher is a versatile appliance that's perfect for your home! You'll use it for polishing and waxing cars, floors, furniture, wood-work; sanding to remove paint and varnish or to prepare surfaces for finishing; drilling for cabinet work or repairs. With additional low-cost accessories, it will also grind, sharpen, clean, buff, burnish! Extra-powerful motor for high-speed work operates on any light circuit, drives wood augers to ½" diam. in hardwood as well as twist drills to ¼" diam. in steel. See it, try it at your hardware, electrical or implement dealer's! THE BLACK & DECKER MFG. Co., Dept. H8M, Towson 4, Maryland.

HOME-UTILITY Division, BLACK & DECKER Mfg. Co.
World's largest builders of quality electric tools!

**ELECTRIC
HOME-UTILITY
TOOLS**

¼" DRILLS • ½" DRILLS • DRILL KITS
LECTRO-SAWS • BENCH GRINDERS

HYDRAULIC Power Transmission
WITH Infinitely VARIABLE SPEEDS, Clutch and INSTANT REVERSE—OUTPUT TORQUE ADJUSTMENT UP TO 180 inch POUNDS

This positive displacement Hydraulic Torque Converter is the ideal fluid drive with thousands of uses . . . Output Speeds Infinite . . . 0 to 550 R.P.M. . . . in either direction . . . Change Speeds WHILE RUNNING . . . Control and Transmit your power this SMOOTH Oil-Way . . . Will handle ¼ H.P. to 1½ H.P. Motor. Industrial or Home & Farm Use . . . Cost government \$300. High Quality Precision Workmanship. Buy this unit to get the most for your money. Case measures 7½" long 7" high 6½" wide. Input & Output Shafts 5/8" dia. Beautiful Red Crackle Finish Case.

FINGER TIP CONTROL

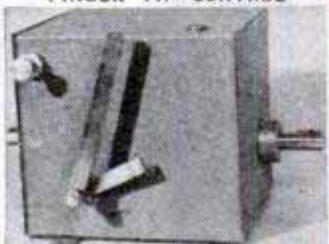

Shipping Wght. 25 pounds

Only **\$54.50**

If C.O.D. is requested a 10% Deposit must accompany order and we ship F.O.B. Chicago.

1½"-8 thread lathe
Chuck Adapter, \$3 extra

Prepaid in U.S.A.
2 quarts oil
included FREE

DIRZIUS MACHINE SHOP "E" 1423-25 So. 52nd Ave., Cicero 50, Ill.

Restoring Old Williamsburg's Relics

(Continued from page 146)

and occasionally from a private collector. Thomas tries to obtain specimens requiring little or no reconditioning. One of his happiest moments was when he unpacked a shipment of 18th-century muskets sent over by an English dealer and found them to be as perfect as the day they were made. "The owners of those guns certainly knew how to take care of them," he says.

Bones and bone objects found at the restored Virginia town are preserved by careful cleaning and, when necessary, reinforcing with shellac or other binder. However, when bone and iron are found in combination, as a bone-handled knife, the problem is difficult because the treatment that preserves the iron will damage or destroy the bone.

Chemist-archaeologist Thomas seems to have an endless job at Williamsburg. In the restoration of a building (an activity that still goes on), his part of the project starts almost before the historical research has been completed. He watches carefully all excavating activities carried on by archaeologist James Knight and takes to his laboratory any articles that might provide information helpful in making the new building and its furnishings duplicates of the originals. In the restoration work, one objective is to re-create residences, shops and other buildings that existed in the original Williamsburg. This is not easy, for a lot of information can become lost over two centuries and more. So, every fact that is unearthed, no matter how small, may be of great value.

Thomas is asked many questions. One of them is: "Why is concrete used for building steps and some floors and walks?" The answer is that concrete is not used for these items of the restoration, but that they are made of Portland stone from England, the same kind of material originally used. This stone looks very much like concrete, and is the material from which portland cement got its name. Incidentally, Portland stone, being relatively soft, is not proving highly resistant to the wear of thousands of visitors' feet that pass over it each year.

If you visit Williamsburg to see how our colonial predecessors lived, remember that there is a lot more in the restored town than casually meets the eye. One of the behind-the-scenes activities is the archaeological research which is responsible for the authenticity of the buildings, furnishings and other things that combine to make the one-time capital of colonial America live again.

"SURE, ALL MUFFLERS LOOK ALIKE...

BUT WHAT A DIFFERENCE
WHEN YOU GET A GENUINE
FORD MUFFLER!"



"THEY'RE BEST FOR FORDS," MY MECHANIC TOLD ME, "AND THEY'RE THE LOWEST PRICED QUALITY MUFFLERS WITH ALL THESE FEATURES..."



"FORD MUFFLERS ARE DOUBLE-WRAPPED...THEY ACTUALLY HAVE TWO SKINS, FOR EXTRA SILENCE AND LONGER LIFE."



"THIS FREE-FLOW DESIGN GIVES YOU BETTER GAS MILEAGE. AND SAFETY-SEAMS AT BOTH ENDS ELIMINATE GAS SEEPAGE."



"IN SHORT, THEY'RE MADE RIGHT TO FIT RIGHT AND LAST LONGER IN FORDS."
"MISTER," I SAID, "YOU'VE CERTAINLY CONVINCED ME."

"AND I'VE LEARNED IT'S THE SAME
WITH ALL GENUINE FORD PARTS. THEY'RE
BUILT TO SAVE ME TIME, MONEY, AND
THEY MEAN REAL
SATISFACTION"



AVAILABLE WHEREVER YOU SEE
THIS SIGN AT ALL FORD DEALERS AND
SELECTED INDEPENDENT GARAGES

**KEEP YOUR FORD
ALL FORD !**





AMAZING...worn Connecting Rod Bearings Fouled this Piston!

Yes, from down at crankshaft level came the piston-fouling performance-stealing trouble. Connecting rod bearings normally meter oil flow for proper internal engine lubrication. When worn they lose control of oil flow. Excess oil is thrown into cylinder assemblies, reaches combustion chambers and cokes up piston heads, piston rings, spark plugs and valves, stealing power, performance and pick-up. Correct the trouble where it starts—let new piston rings do their own job—replace with Federal-Mogul Oil-Control Bearings to restore power, pep and economy!

FEDERAL-MOGUL SERVICE
(Division of Federal-Mogul Corporation)
DETROIT 13, MICHIGAN



Control Oil Pumping
where it starts...replace with
FEDERAL-MOGUL
OIL CONTROL BEARINGS

The "Big Blow" Takes the Diesel's Challenge

(Continued from page 110)

soon as full speed is reached. The diesel generator is disconnected as soon as idling speed is reached.

The locomotive has a different noise from an ordinary diesel. The high-pitched whistle and the exhaust blast that are characteristic of gas turbines can be heard but they are like the noise from a jet aircraft that is some distance away. An exhaust deflector was installed and has helped reduce the sound. Inside the engine compartment, however, it is a different story. There it is impossible to shout loudly enough to be heard even a few inches away. The operating cabs at each end of the locomotive are insulated and quiet.

Surprisingly, the inside of the engine compartment is always cool, even on a hot day. This is because there is a steady wind blowing through the compartment at all times. The overhead filtered intake of the turbine draws its huge quantities of air from the engine compartment and the compartment in turn sucks its air supply from the outside through 86 large filter panels contained in the side walls. There is always a draft in the engine room.

With the exception of its power plant the X-50 is composed mostly of standard diesel-electric locomotive components. It uses standard two-axle swivel trucks, standard generators and traction motors, the usual G.E. amplidyne excitation control system, and dynamic braking in addition to locomotive and train air-brake systems.

The engineer's station is similar to that on a diesel-electric locomotive and the engineer has his throttle pedestal at his left and the air-brake valve controls in front of him. An instrument panel contains a speedometer, an ammeter that shows motoring and braking amperages, a notching guide that indicates how fast the engineer may apply power by means of the throttle, and air-pressure gauges. Above these dials is a row of lights that indicate such conditions as turbine top speed, maximum dynamic braking and wheel slip.

The engineer's throttle handle controls the power plant in much the same manner as the accelerator pedal on an automobile, thus providing a means of securing any desired output, from minimum to maximum power. A power-plant regulator automatically controls the fuel supply to the turbine to maintain any desired speed and also limits the amount of fuel to prevent excessive temperatures in the turbine. In

(Continued to page 238)

★
**TOOL
 OF MANY
 USES!**

**NEW
 CRESCENT
 N° 282 Pincer**

6" - \$1.35 8" - \$1.55 10" - \$1.90

NEW IN PERFORMANCE. New in quality. While known as a Carpenter's Pincer, No. 282 is a very versatile tool for any amateur or professional mechanic. Cutting edges are keen and leverage is ample for easy cutting. In addition to the uses illustrated opposite, No. 282 has a screwdriver point on one handle. Traditional Crescent quality. Polished jaws, parkerized handles. Three sizes . . . 6, 8 and 10 inch. Sold by Hardware Dealers and Industrial Distributors.

CRESCENT TOOL COMPANY
 Jamestown, N. Y.

CRESCENT TOOLS

*Sign of the Artisan
 Symbol of Excellence*

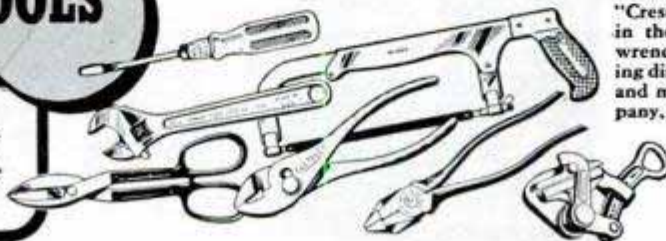

CUTS CLOSE TO FLAT SURFACES

CUTS WIRE NAILS, ETC.

PULLS NAILS

PULLS TACKS

"Crescent" is our trade-mark, registered in the United States and abroad, for wrenches and other tools. Sold by leading distributors and retailers everywhere and made only by Crescent Tool Company, Jamestown, N. Y.

FREE ALLIED'S RADIO & TV CATALOG SUPPLEMENT

LATEST RADIO & TV RELEASES HUNDREDS OF GREAT VALUES

Send for ALLIED's latest Supplement! Packed with new TV releases, home radios, recorders, High-Fidelity Music and P. A. Systems, test instruments, new electronic developments—plus hundreds of big values. Get the latest—get more for your money—get your FREE ALLIED Supplement now. Write for it today!



HELPFUL RADIO BOOKS!

Dictionary of Electronic Terms. All-new reference guide has definitions of over 2500 terms used in television, radio, electronics and nucleonics. Invaluable for engineers, students, experimenters. Has useful data appendix. Published and made available by ALLIED at minimum cost. No. 37-756. Only **25c**

- | | |
|--|---|
| Radio Formulas & Data.....No. 37-752... 10c | All 6 Books
No. 37-799
Only \$1.00 |
| Simplified Radio Servicing.....No. 37-755... 10c | |
| Radio Builders' Handbook.....No. 37-750... 15c | |
| Radio Circuit Handbook.....No. 37-753... 25c | |
| Radio Data Handbook.....No. 37-754... 25c | |

FREE CATALOG

Order from ALLIED RADIO
833 W. Jackson Blvd. • Dept. 5-H-0 • Chicago 7

ALLIED RADIO

See your ALLIED Catalog for Everything in Radio & TV

"I'll take the WHITE one every time!"



WYTEFACE Steel Tapes, with their jet black markings on a white background, are easier to read in any light. They are rust-resisting, hard to kink and easy to clean.

Protected by U. S. Patent 2,089,209

WYTEFACE

TRADE MARK

STEEL TAPES

KEUFFEL & ESSER CO.

normal operation there's no occasion for anyone to enter the engine compartment.

The X-50 has an operating cab at each end. It was designed for double-end operation although present conditions make this unnecessary. There are seats for three crew members in each cab and the cabs are equipped with heaters, defrosters and windshield wipers.

You can't get a railroad official or a power-plant expert to commit himself on the future of the gas-turbine electric locomotive yet. He'll tell you that the unit is being tested and that no final conclusions can be drawn without many more months of testing. Usually, though, there's a twinkle in the speaker's eye while he's talking. There isn't much doubt that he's already convinced that the gas-turbine electric has great possibilities.

Hot-Rod Derby on the Salt Flats

(Continued from page 68)

two sizes smaller to pull against the wind on the return. Every little bit helps, the drivers figure, and in some cases heavy cardboard and yards of masking tape are used to fill hollows in a body, to smooth its contours and increase its streamlining.

Classes of cars that will run at Bonneville are: roadsters equipped with stock bodies, radiators and shells, and with clutch and full transmission; modified roadsters; lakesters that may have specially built bodies not exceeding 36 inches maximum width; competition coupes, and streamliners with special bodies of any dimensions.

These classes are subdivided according to engine displacement into five engine groups ranging from less than 91 cubic inches to 350 cubic inches and over. Engines must be of American manufacture and of the internal-combustion reciprocating type.

All drivers must wear approved safety belts and goggles and cars must be equipped with fire extinguishers. No windshields of glass are permitted but glass head lamps need not be removed if they are suitably taped. Cars that are not designed to start under their own power must be equipped with a rear push-plate or bumper for push starting. There are various other equipment and safety rules and all cars that compete at Bonneville are subject to inspection.

The Bonneville time trials will be conducted by the Southern California Timing Association in cooperation with the Salt Lake City Chamber of Commerce. The trials are open to all fast cars that can meet

(Continued to page 240)

GROBAN'S BRAND NEW WAR SURPLUS SPECIALS! UNCONDITIONALLY GUARANTEED

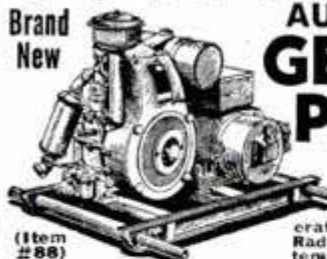

AUXILIARY ELECTRIC GENERATING PLANT

FOR GENERAL UTILITY AND EMERGENCY USE
2500 WATTS • 115 VOLTS
60 CYCLES A.C.

Plenty of current to operate your: Oil Burner, Sump Pump, Refrigerator, Home Freezer, Power Saw, Lights, Radio and Television, Home Water System Pumps.
Complete integrated heavy duty electric power plant. Signal Corps Model PE-75, driven by Briggs & Stratton, one cylinder 6 1/2 H.P. Model ZZ, 4-cycle engine with killer button, oil bath air cleaner, governor, muffler, starting rope, and radio interference filter. The self-excited Leland or Westinghouse generator is rated 2500 Watts, 115 Volts, 60 Cycle A.C. single phase, belt driven, with guard and duplex receptacle.
When generator is not in use, you can use the engine separately to power other equipment.
Mounted on adjustable steel skids, notched for carrying poles. Net wt. 310 lbs. Shpg. wt. 440 lbs. Dimen. 36"x19 1/2"x24". 12 month guarantee. \$726.00 value.

295.00
F.O.B. Chicago

NEW STATIONARY OR PORTABLE D.C. ARC WELDER

250 AMPS. MODEL 252
FOR ANY WELDING JOB, LIGHT OR HEAVY



Stop Costly Repair Bills,
Weld It Yourself and Save
Only One or Two Jobs Will Pay for Entire Welder

Designed for many years of trouble-free service. Handles anything from light gauge sheet metal to 1/2" plate. This precision-engineered Direct Current ELECTRIC ARC WELDER is offered at but a fraction of its original value. It can be mounted permanently or easily transported for portable use. Does the job instantly, where and when you need it.
The War Surplus generators for these Arc Welders were built by General Electric, Westinghouse, and Delco-Remy at a cost of over \$300.00. They are light in weight; have oversized lifetime grease-sealed ball bearings; air-cooled commutator; dial type rheostat for easy pinpoint control; high-low range switch; reactor coil for even arc; handles 1/16" to 1/4" rods. Run welder at 2500 R.P.M. from drive pulley or power take-off of tractor, a 7 1/2 H.P. electric motor or a 10 H.P. gas engine. Use two V-belts, or flat belt (on pulley). Continuous welding rating—200 amps.; intermittent rating—250 amps.; 0-30 volts. Now AT A FRACTION OF ITS VALUE. Price includes double V or flat belt pulley and instruction book. Ship. wt. 107 lbs. F.O.B. Chicago

99.50

ACCESSORY KIT including welding helmet, electrode holder, two 10 ft. cables with clamp and 5 lbs. of assorted welding rods. (ITEM #66) **10.50**
REMEMBER, SATISFACTION IS GUARANTEED

Excellent Hydraulic VALUES!

HYDRAULIC CONTROL VALVES

ITEM #24. Four-way control valve with built-in relief valve, for use with one double action hydraulic cylinder, may be used with 1500 P.S.I. hydraulic system to open and close hydraulic cylinders. Ship. wt. 8 lbs. A \$38.00 value postpaid **7.95**
ITEM #26. Four-way control valve for use with two hydraulic double-action cylinders. Each cylinder may be operated independently of the other or in conjunction with the other. Oil may be locked in any of the cylinders to hold the piston at any required position. Ship. wt. 6 lbs. A \$60 value. postpaid **10.95**



VICKERS HYDRAULIC TRANSMISSION

MODEL AA16801A
Ideal for lathe drive, miniature cars, power machinery, gearing, etc. Rated 2 HP maximum input at 3750 RPM. Output speed continuously variable from 0 to 1/3 of input speed in either direction. Self contained reservoir. All controls external. Even power at all speeds. Complete with two 1/2" shafts with flat for pulley attachment. Ship. wt. 20 lbs. Gov't acquisition cost \$325.00. A tremendous value at **25.00**
F.O.B. Chicago (ITEM #85)

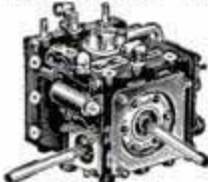

Hydraulic Cylinders—Air or Oil

Large supply of new labor-saving, economical hydraulic equipment in many types and sizes. Use these positive, highly efficient, smooth pressure hydraulics on presses, arbors, lifts, loaders, power control, positioning, brakes, plastic dies, auto frame alignment, etc., etc.
ITEM #4—All steel double action hydraulic cylinder, 1 1/2" bore, 2 3/8" stroke. Clevis mounting. Will lift 1000 lbs. with 1000 P.S.I. line pressure. Perfect for positioning and feeding movements. Shpg. wt. 4 lbs. F.O.B. Chicago. **4.95**
ITEM #33C—Double action hydraulic cylinder, 1 1/2" bore, 4 1/2" stroke. Clevis mountings at both ends. Uses 1/4" pipe fittings. Postpaid **8.95**
ITEM #32—Double action, 1 1/2" bore, 9" stroke, will lift 1760 lbs. with 1000 P.S.I. line pressure. Wt. 4 lbs. A \$45.00 value. Postpaid **10.95**
ITEM #41—Double action hydraulic cylinder, 2" bore, 6" stroke, clevis mounting at base end of shaft. Overall length closed 12 1/2". Has 3/4" stainless steel shaft, uses 1/4" tubing fittings. Will lift up to 3100 lbs. with 1000 P.S.I. line pressure. Weight 7 lbs. Postpaid **12.50**
ITEM #16—Double acting cylinder, 1 1/2" bore, 27" stroke. Will lift 1760 lbs. with 1000 P.S.I. line pressure. Wt. 8 lbs. A \$55.00 hydraulic cylinder value for only Postpaid **12.95**
ITEM #15—Double acting cylinder, 3" bore, 8 1/2" stroke. All steel hydraulic cylinder, will lift up to 7000 lbs. with 1000 P.S.I. line pressure. Wt. 12 lbs. A \$78.00 value, Postpaid **19.50**
ITEM #31—Double acting cylinder, 3 1/2" bore, 11" stroke. Will lift 9600 lbs. with 1000 P.S.I. line pressure. Wt. 15 lbs. A \$92.00 value. Postpaid **22.50**
ITEM #40—Double action, 3 1/2" bore, 20" stroke. Rated lift capacity 9600 lbs. with 1000 P.S.I. line pressure. Clevis mounting, aluminum alloy barrel with 1 1/2" stainless steel shaft and piston. Wt. 20 lbs. A \$125.00 Value. F.O.B. Chicago **25.00**
ITEM #42—Double action hydraulic cylinder, 4" bore, 18" stroke. Rated lift capacity with 1000 P.S.I. line pressure is 12,560 lbs. Ship. wt. 30 lbs. AN EXCELLENT VALUE FOR **32.50**
F.O.B. Chicago
HI-PRESSURE FITTINGS for cylinders and valves available at 35c ea. for 3/4" size and 50c ea. for 1/2" size.



LOGAN HEAVY DUTY HYDRAULIC PUMP

For operating hydraulic cylinders and hydraulic motors on tractors, bulldozers, construction machinery, lift trucks, industrial applications, etc. Delivers 10 GPM at 1200 RPM at 1000 P.S.I. using 5 HP. Has 3/4" inlet, 1/2" outlet, 3/4" shaft with flat and keyway for direct or pulley drive. Has flange with 4 bolt holes for convenient mounting. Ship. wt. 22 lbs. Overall dimen.: 7" L x 5 1/2" H x 5 1/2" W. A \$105.00 value. FOR ONLY **22.50**
F.O.B. Chicago (ITEM #29)



DIRECT CURRENT GENERATORS

For welders, plating, truck and marine use, D.C. appliances, lights, etc. Aircraft quality—lifetime grease sealed ball bearings. Heavy duty.
ITEM #89—Type M-2, rated 50 Amps.—24 Volts. Mfd. by Leeco-Neville Co. Shpg. wt. 32 lbs. Gov't. Acq. Cost \$176.00. F.O.B. Chicago **16.50**
NOW ONLY
ITEM #90—Type P-1, rated 200 Amps.—28 Volts, 2500 RPM. Mfd. by General Electric, Ford, Delco-Remy and Westinghouse. Gov't. Acq. Cost \$300.00. Shpg. wt. 54 lbs. F.O.B. Chicago. **22.50**
ITEM #91—Type R-1, rated 300 Amps.—30 Volts. Mfd. by Jack & Heintz. Gov't. Acq. Cost \$380.00. Shpg. wt. 70 lbs. F.O.B. Chicago. **35.00**
Each individually packed in wooden box.

EMERGENCY ELECTRICITY!

750 WATT • 115 VOLT • 60 CYCLE A.C. LIGHT PLANT

USE FOR: Home lighting, trailers, tourist cabins, hunting lodges, fire truck lighting, emergency standby units. Plenty of power for home freezer, oil burners, incubator, radio or light GENERATOR: Manufactured by Ecor, rated 750 Watts, 115 Volts A.C., 60 cycles at 1800 R.P.M. Complete with volt meter regulator, \$249.00 value. (ITEM #86) These generators built to exacting Signal Corps specifications, are the answer to your lighting needs.
GASOLINE ENGINE: Briggs & Stratton, Model AP, 2 1/4 H.P., 1800 R.P.M. Completely radio shielded, full accessories including air cleaner, muffler, starting rope, killer button, remote control wire. Shpg. wt. 165 lbs. Complete unit, \$249.00 Value. NOW ONLY F.O.B. Chicago



GENERATOR ONLY (Item #67) Same as described above. Shpg. wt. 60 lbs. F.O.B. Chicago. **59.50**

UTILITY ROTARY VANE PUMP

Perfect For Water, Oil or Insecticides
Sprays DDT, 2-4D, sulphur compounds, etc. Pressure to 150 lbs., 15 gals. per min. at 1200 RPM using 2 HP. As vacuum pump for milking machines, lab use, etc., delivers 26" vacuum, 4.5 cu. ft. per min. at 1500 RPM using 3/4 HP. Rotate either direction, 1/2" pipe thread ports, 1/2" standard shaft, 4 ball bearings. Easy to mount—Ready to run. Shpg. wt. 13 lbs. (ITEM #51) F.O.B. Chicago **16.50**



PUROLATOR OIL FILTER

PERMANENT TYPE
The perfect oil filter to keep your motor oil or hydraulic fluid clean at all times. Protect your pump or engine with this unit. Just turn the handle and the element is clean. Standard 3/8" inlet and outlet ports to accommodate 12 gallons per minute. Shipping wt. 4 lbs. A \$13.00 value. (ITEM #70) postpaid **4.95**



FREE: 44 PAGE CATALOG— Full of unsurpassed War Surplus "buys" including generators, pumps, welders, double action hydraulic cylinders, control valves, tanks, hose, fittings and data on hydraulic applications. Write today.

ORDER DIRECT FROM AD — SEND PAYMENT OR PURCHASE ORDER, TODAY — SATISFACTION GUARANTEED

GROBAN SUPPLY CO. 1507 SOUTH MICHIGAN AVE. Chicago 5, Ill. Dept. PM-8

LOWEST PRICED

3 HORSE POWER

GARDEN TRACTOR

Full Year
Guarantee



LARGE
FULL
SIZE

It's True!

ONLY

\$144.50

F.O.B. Factory

IT IS POWERFUL!! Breaks Sod 6" Deep with 7" Turnplow. Attachments • Cultivator • 7" Plow • Disc Harrow • 30" Cutter Bar • Snow Plow and Many Others.

YOUR MONEY BACK if not 100% satisfied and you do not agree the **DEPENDABLE** tractor is equal or better in quality, power, performance and appearance than any 3 H.P. tractor on the market regardless of price. Weighs approx. 300#, Timken bearings, all precision gears in oil, 6:00 x 12 Super-Traction tires, 3 H.P. Clinton engine, Finger-tip balance so child can operate. Color—Tractor red trimmed in yellow.

SAVE UP TO \$100.00 on tractor alone.

ISN'T THIS WORTH A ONE CENT INVESTIGATION? Then send order now or drop postcard for **FREE** literature. Orders filled in turn received, so hurry!! No obligation for literature.

STRINGER MFG. CO.

Box 14-A, Lafontaine, Kansas

the required safety rules. There is no limit to the number of changes that a participant may make to his car or engine nor is there a limit to the number of times that he may run the course. As soon as he finishes one run he may drive back to the starting end and get in line once more. Each run will be timed.

The course is a straightaway and is five miles long to allow plenty of room for accelerating to top speed and for slowing down again. Photoelectric timing devices that are accurate to one thousandth of a second will clock the cars over a ¼-mile distance and a one-mile distance laid out along the middle of the course. The ¼-mile trap will be used for timing all cars until the latter part of the afternoon of each day, after which the day's fastest car in each class will have a chance to make a run both ways over the one-mile distance for an official record.

It's hard to say how many cars will be tested this year but a guess is that some 200 cars from all parts of the United States will participate. Spectators may approach within ⅛ mile of the course during the trials. Bonneville is six miles from the small town of Wendover on the Nevada border where meals and some hotel accommodations are available. Many of the spectators and participants will camp out on the salt during the week.

Niagara Falls Goes on Night Shift To Generate Power

Niagara Falls now is working 'round the clock—during the day it puts on its centuries-old show for honeymooners but at night it generates electrical power. Niagara consists of twin cataracts. Of the estimated 200,000 cubic feet of water which normally passes over these two falls each second, 100,000 cubic feet will be reserved for the daytime tourists' show during the spring and summer months. At nights and in the off-season for tourists, all but 50,000 cubic feet will be diverted above the falls for hydroelectric use.

High Altitude Plays Tricks on Eyes

Persons living at high altitudes are likely to become wall-eyed. Strangely, the opposite also is true, for many high-altitude residents are cross-eyed. Dr. Jorge Valdeavellano of Lima, Peru, has discovered that 60 percent of all Peruvians who have lived for more than six months at an altitude of at least 10,000 feet have a wall-eyed condition and can't make their eyes converge on a near object. Another 12 percent have crossed eyes which turn inward too much.



GANGWAY! I'M DOING 50!

Large, easy-to-read dial gives speeds up to 50 mph on amazing new

Air-Flight
BICYCLE SPEEDOMETER

for bicycles, scooters, tricycles, motor scooters, etc. Uses same principle as aircraft air-speed indicators.

39¢

At dealers, or send 39c plus 6c for postage.

INSTRUMENT DIVISION
KNICKERBOCKER PLASTIC CO., INC.
4101 San Fernando Road • Glendale 4, California

YOU WON'T GET ANYWHERE UNLESS YOU START

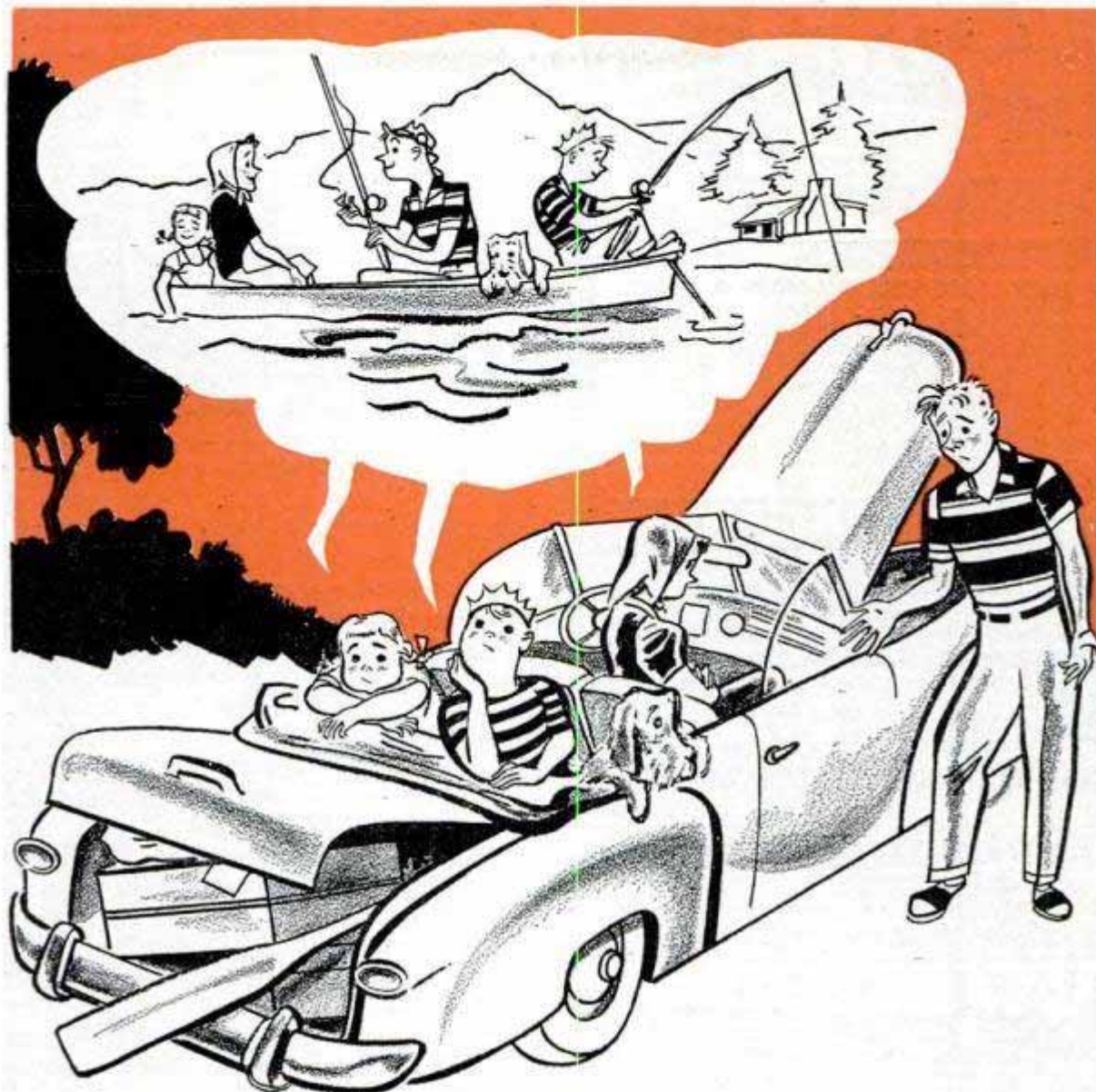

WHEN IT'S AN *Exide* ...YOU START

Up at dawn, all set for that long-planned vacation trip . . . and the car won't start.

Don't let this happen to you. Buy starting assurance . . . buy an Exide.

Remember, a single starting failure can be far more costly than the little extra you pay for a trustworthy Exide Battery.

Depend on the Exide Dealer for good products, good service.

1888:::DEPENDABLE BATTERIES FOR 62 YEARS...1950 "Exide" Reg. Trade-mark U. S. Pat. Off.

THE ELECTRIC STORAGE BATTERY COMPANY, Philadelphia 32

Exide Batteries of Canada, Limited, Toronto



New AUTOMOTIVE DISCOVERY

TRY IT FREE IN YOUR CAR!

THE OBJECTIVE IS
TO GIVE YOUR CAR
✓ MORE MILEAGE
✓ FASTER PICK-UP
✓ EASIER STARTING
✓ BETTER IDLING

FITS ALL CARS



THE AMAZING NEW GANE "air-flow" NEEDLE

INSTALL IT
YOURSELF in a
FEW MINUTES

ABOUT ONE-HALF MILLION NOW IN USE!

Up to 25% MORE MILEAGE, EASIER STARTING, FASTER PICK-UP and SMOOTHER IDLING—many users report with this SENSATIONAL NEW automotive product. NOW, test it in your car AT OUR EXPENSE. Then, after 10 days, check mileage and engine performance. If satisfied, send only \$1.50 per needle (8 cyl. cars take 2). If not entirely satisfied, just return it—FAIR ENOUGH? Authorities differ in opinions on merits of Ganes and some users report no improvement so TRY BEFORE YOU BUY... And that's not all.

BOOK SENT FREE!

When you accept this Gane Needle Free Trial offer. Yours to keep even if you decide NOT to buy the GANE Needle after you've tried it. Tells how to save gasoline, oil, tires, brakes... how to get more power, speed and better engine performance.

SEND NO MONEY • PAY POSTMAN NOTHING
There are no strings attached to this UNBELIEVABLE OFFER. Just send name, address, year and make of car and name of carburetor.

NATIONAL AUTOMOTIVE RESEARCH CORP.
DEPT. J-8 VENICE, CALIFORNIA



OWN A Printing Business

Cards, Tickets, Stationery, etc. Good profit in spare time. PRINT YOUR OWN greeting cards, movie titles, church work, etc. Save money. Easy rules supplied. Raised printing like engraving too. Have home shop. Sold direct from factory only. Pays for itself in short time. Write for free catalog of outfits, and all details. KELSEY PRESSES, 0-37, MERIDEN, CONNECTICUT

EVERY ELECTRIC DRILL A PORTABLE SAW



9.95

Can Be Used With One Hand!
Any 1/4" or 3/8" Drill a Powerful Saw
in ONE MINUTE

"ARCO-SAW" is a rugged tool with right angle gear drive (no clumsy, dangerous, direct drive with drill sideways). Works like a high priced Portable Saw.

CUTS 1-5/16", or 2 x 4 by turning over ONLY ARCO GIVES YOU ALL THESE FEATURES: Safety-yoke assures rigid connection and absolute safety—Big handle affords firm grip for two-hand operation—Precision one-piece gear box—Self-lubricating lifetime bearings—Wide shoe-plate for straight, square cuts—Lowest priced, quality Replacement Blades.

"HYCARBON" Crosscut Blade \$1.60
"HYCARBON" Combination Blade \$1.60
90-day Factory Guarantee

NOW! EVERY "ARCO-SAW" AN ANGLE SANDER & POLISHER

Your "ARCO-SAW" becomes a powerful right angle sander & polisher in just a few minutes. Ideal for removing paint from cars & walls, simonizing cars, polishing linoleum & furniture. Swivel action between drill chuck & gear box permits new freedom of use at any angle on every surface, or when necessary safety-yoke can be used to hold unit rigid. No need to buy an expensive special angle gear drive. New ARCO "SAND-N-POLISH" Attachment consists of flexible molded rubber head, sanding disc, lambswool polisher, bottom plate, hexagon adaptor, & also 1/2" adaptor for use in drill chuck.

\$1.95



ORDER TODAY at your dealer or send us check or M.O. (Postpaid). C.O.D.'s—Postage extra.

UNCONDITIONAL 10-DAY
MONEY-BACK GUARANTEE

DEALERS—Write for
nearest jobber.

ARROW METAL PRODUCTS CO.

DEPT. PM-8, 140 WEST BROADWAY, NEW YORK 13, N. Y.

Land Alive!

(Continued from page 115)

arms close to the body. If you do this properly, you'll roll right to your feet again in one smooth motion.

Falling at high speed, as from a running horse, an automobile or train, your best bet is the log roll. Keep the body straight for this, with legs stiff, chin against the chest, elbows over the stomach and hands over the face. The roll must be a perfectly sideways spin, with no end-over-end action that would thump the head against the ground. Pulling in the elbows will help to make the roll less bumpy.

When falling headlong, as when tripping on a stairway or off some elevation, the forward roll is called for. The hands touch first in this roll, and take some of the shock. The chin is tucked against the chest and the shoulders take the main shock as the body rolls forward.

Like all other rules, those on how to fall have their exceptions. If you should slip and fall on a steep mountain slope, you might do well to spread out arms and legs to prevent rolling with the fall, because in this case the rolling might be hard to stop—the exception to the rule about rolling in the direction of the fall.

The other rule—try to land as flat as possible—has its exception when the victim is falling from a great height into deep water. In this case, try to land feet first, with toes pointed, elbows hugging the stomach and hands over the face.

As for his advice against the wrong way to fall—don't ever put out one arm or one leg to break a fall—he couldn't think of a single exception.

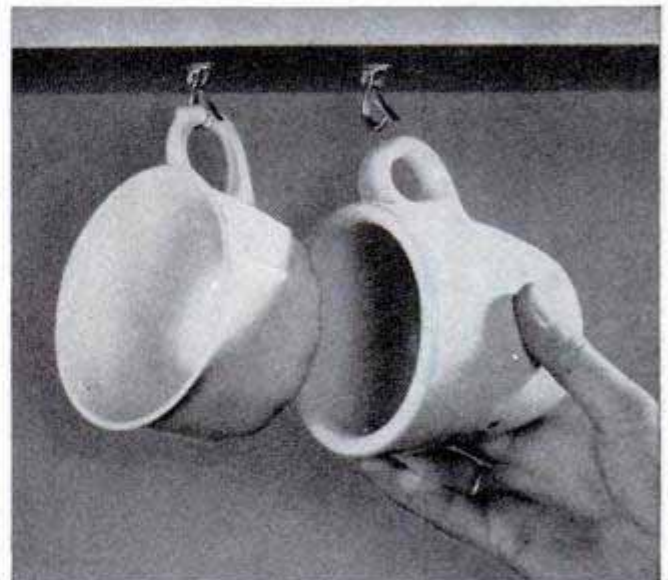

LOCK-TYPE HOOKS prevent cups stored in trailers and aboard ship from being dislodged by sharp bumps and rolling. A spring latch covers the hook opening

Snap-on ARMATURE RECONDITIONING TOOL

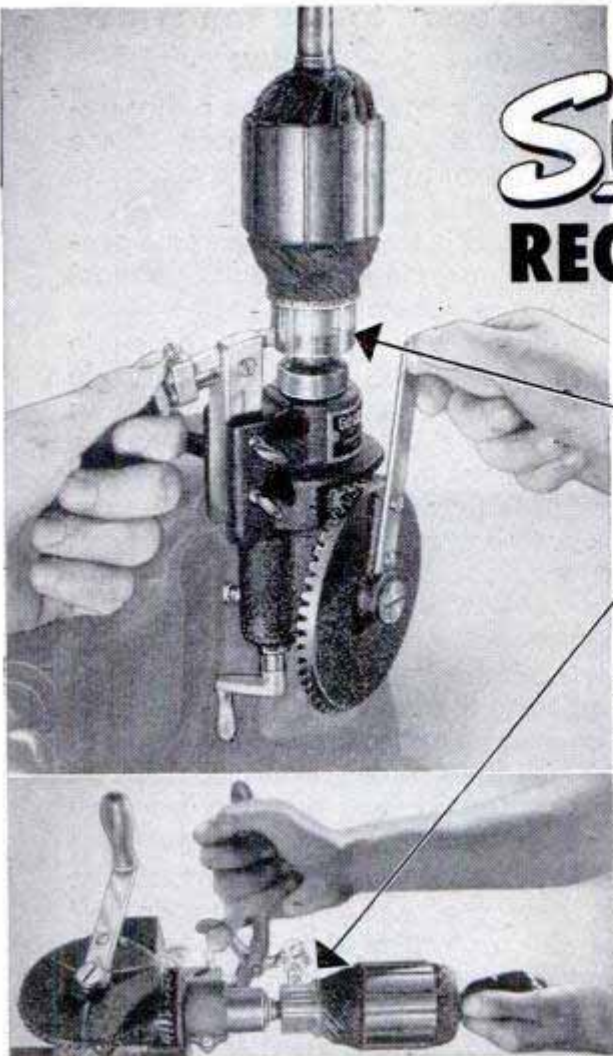

does both

- 1 turns down armature
- 2 undercuts the mica

*Trade-mark of Snap-on Tools Corp.

Armatures reconditioned faster than on an expensive lathe — and the work is tops! Just clamp this tool in a vise and you're ready to go. Cuts controlled to the finest shaving. Pays for itself quickly—simple to operate. Handles everything that comes to the automotive garage.

SNAP-ON TOOLS CORP.,
8062-H 28th Ave.,
Kenosha, Wis.

ENCLOSED Money Order
 Check Company Purchase Order for \$34.75 for Armature Tool. (For vacuum cleaner, fan, sewing machine and other small motors order Small Collet and Bushing ADAPTER SET, \$10.50 extra). Add local sales tax.



NAME.....
ADDRESS.....
CITY.....STATE.....

ARC WELDING PAYS \$300. to \$500. MONTHLY



A.C. shop welder

Knock out first class welding jobs in a hurry with this full capacity unit. Take on big jobs or small. New transformer reactor type with 500 different current settings. Silent, Easy to use. Costs very little to operate.

LOW MONTHLY PAYMENTS to help you get started now. "pay out of extra profits." Ask for details.

A.C. field welder

Cash in on big profits. Go to the profitable outside jobs with this new gas engine driven, two-in-one unit. Make arc welded repairs or flip a switch and operate A-C lights, tools, motors. Meet emergencies caused by power failure.

FREE CATALOG will be sent on request with no obligation whatsoever.

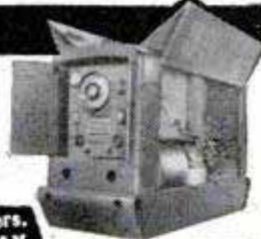

Also D-C Welders. — WRITE TODAY.

HOBART BROTHERS COMPANY, BOX M-801, TROY, OHIO.

BRUSH PLATING OUTFITS

• for re-plating articles in the home and shop. No tanks necessary. Free particulars. •
GUNMETAL CO., AVE. M, DECATUR, ILLINOIS

90 PATTERNS \$1

LAWN ORNAMENTS-NOVELTIES



FULL SIZE patterns up to 20" high of Dutch Boy & Girl, Dwarf, Penguin, Fishing Boy, Animals, Birds, Novelties and many other popular items. Easy to make and sell. Just trace, cut out and paint. Send \$1.00 today for the LAWN ORNAMENT PACKET containing all 90 patterns.

MASTERCRAFT PLANS, Dept. 82M
7041 Olcott Ave. Chicago 31, Illinois

Say You Saw It in Popular Mechanics

WRITE FOR FREE Building Instructions

BUILD YOUR OWN POWER LAWN MOWER

WHY PAY MORE FOR FACTORY BUILT MOWERS?

Now anyone can save time and effort mowing field or lawn by building their own whirl type Power Mower. Build it in a short time with parts and instructions we furnish. Requires no special tools.

Write Today for Free Building Instructions
T & H MFG. CO., INC.
Dept. MPB-8, 811 E. 31st St.
Kansas City, Mo.

The Rite-Way Mower Attachment



DRIVING RELIEF! New LEFT-FOOT ACCELERATOR

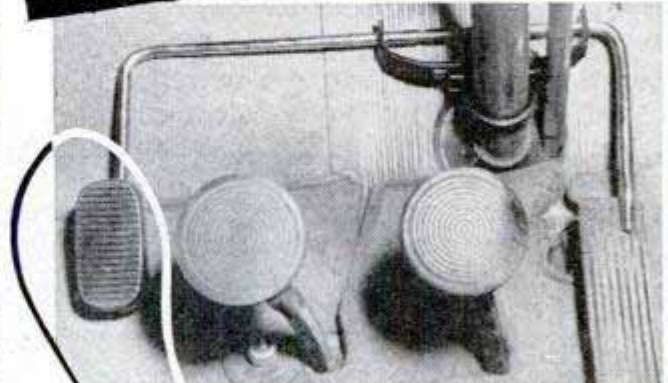

Dealer inquiries invited.

Long drives are short with "Lefty"! Eliminate leg, back, and foot fatigue and enjoy greater driving comfort... feed gas with left foot when desired with "Lefty," the new left-foot accelerator. One trip will convince you. Cars, \$4.85; trucks, \$6.75; plus 3% California sales tax. Specify year and make.

C & B Co., P.O. Box 506, Yuba City, California

Local Colorcretors Can Earn High Incomes

COLORCRETE is today's biggest business opportunity in the building field. High returns from a low investment. Easy, fascinating work. Large waiting market because Colorcrete is applied over all kinds of old and new masonry surfaces — exterior and interior.

Beautifies and Protects All Types of Buildings



Pneumatic pressure sprays plastic-like Colorcrete to give enduring beauty and water-resistant values. Range of 30 gleaming colors; many textures. Easy to wash. Smartly modern. Write or wire today for Opportunity Portfolio, which gives complete story.

COLORCRETE INDUSTRIES, INC.
570 Ottawa Ave., Holland, Mich.

NOW DADO ANY WIDTH

WITH DA-DALL!

Pat. Pend. U.S.A. & For.

A simple turn of a screw adjusts your saw to any desired Dado cut! DA-DALL cannot slip, is self-tightening, self-adjusting, of all-steel construction. Does a clean, true job!

ONLY \$4.95

DA-DALL cuts hard or soft wood, plywood, without chipping! No blades or complicated dials. All arbor sizes

RULE-WAGNER CO.

Box 694, Dept. D-4
Walnut Creek, Calif.

Dealers, Jobbers Write for Information

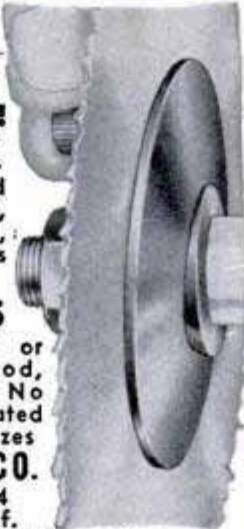

As the Cars Go

By ROD RODRIGUEZ

Auto Editor

SHOULD YOU PLAN to polish your car, investigate Autobrite®, a new silicone process distributed by Boyle-Midway Inc., Division of the American Home Products Corp. It's on sale at hardware, variety, grocery, drug, auto accessory and department stores. Autobrite gives a car a super shine which will last six months or more and takes only minutes to do it.

It protects against oxidation, rust and corrosion. It gives a glass-hard surface that keeps moisture and heat from penetrating paint and chrome surfaces, and is resistant to blistering sun, rains, ice, dust, fumes and even corrosive sea air.

* * *

Reprinted from editions of Sunday, April 30, 1950
by permission of New York Mirror

Spinning a Span to Foil the Wind

(Continued from page 106)

for the carriage to make 24 trips a day operating at full speed, but darned if the graveyard shift didn't turn in 25 trips the other day!"

Cole explained it was a bookkeeping record, since the previous shift had almost completed a trip before it went off.

After spinning was completed, the cable strands were compacted to a perfect circle with a hydraulic press. Cable bands then were attached and suspension cables were dropped at 30-foot intervals on the horizontal. The final operation of winding the cable tightly with a protective wire could not be done until after the roadbed was in because the cable was stretched by the additional weight.

The Bethlehem Pacific Coast Steel Corp., which built the towers, also built the roadway. The steel frames for the roadway of the first bridge were prefabricated on barges, then towed into position beneath the bridge cables and hoisted into place.

The new bridge is much heavier than the old one, however, and engineers do not trust the 10-knot tides that race through the Narrows. For this reason, the roadbed was built directly from each tower.

The first 60 feet was cantilevered out from each side. At the end of these cantilevered sections traveling derricks placed the next section, piece by piece. As each section was completed, the derricks moved out to erect the next section. A railroad along the completed deck transported the steel beams.

It was necessary for engineers to maintain a nicely balanced construction so undue stresses would not be placed on the main cables and towers. To aid in determining the construction schedule, the University of Washington Engineering School built an erection model of the bridge, scaled with one foot equaling 100. However, weights used to load the model were scaled so one pound represented 92,475.

As construction of the roadway proceeded, engineers at the bridge telephoned their next day's schedule to the university. Corresponding weights were hung from the proper suspender cables and workers peering through a Filar microscope focused on the model's "main cable" could determine the deflection. When bending exceeded accepted tolerances, the actual erection schedule was altered.

In a number of ways this bridge differs from any other ever constructed by man. Its design is the result of years of study to minimize the effect of wind on suspension

(Continued to page 246)



"ONE-STOP SHOPPING" for ALL electric drill accessories!



If it's new, if it's good, BERTRAM has it — ORDER TODAY!

Throw away that "weak sister"—
here's a **PORTABLE POWERHOUSE!**



NEW
BULL "200"
1/4" ELECTRIC DRILL
only **\$14.95**

WE GUARANTEE YOUR MONEY BACK if it isn't more powerful than any 1/4" electric drill at any price!

You'll never "stall out" with the new Bull "200" electric drill: it runs at 1500 rpm under heaviest hand pressure! Designed to be used with all the time-saving accessories on this page. New specially wound, universal AC-DC motor! New spindle lock and keyless chuck for easier, faster, one-hand tightening! Here, for the first time, is a man-sized drill for man-sized jobs — at an unheard-of **\$14.95** price!



AUTOMATIC SCREWDRIVER

for any elec. drill, drill press, or flexible shaft. When ordering, specify standard or Phillips head. **\$4.95**



BULL HACK SAW

Cuts through wood, plastic, nails, sheet metal, plaster. Gets into "tight spots" with power — ideal for floor or wall repair. Small, light, sturdy, with all working parts of hardened steel. Roller bearings. **\$16.95**



NEW PORTABLE BELT SANDER

Fits any 1/4" electric drill. Does every job from roughing to finishing. Handles like a plane. Complete with 3 pressure pads and 2 sanding belts. **\$19.95**



MOST ECONOMICAL DRUM SANDER

on the market!
A portable 2" drum sander for elec. drill or drill press. No need to buy costly sanding sleeves — **CUT YOUR OWN STRIPS OUT OF ORDINARY SAND-PAPER!** **\$2.50**

Polish, Sand 'n Save with the BULL BUFFER



Polish and sand the easy, right-angle way. Exclusive gear reduction; exclusive swivel action. More than 100,000 now in use. Complete with sheepskin bonnet, rubber pad, 2 sanding discs. **\$9.95**

BULL BUFFER ACCESSORIES

1/2" JACOBS HEX KEY CHUCK converts Bull Buffer into angle-head drill attachment for drilling at right angles in wood or steel from 1/16" to 1/2". **\$5.00.**

2 1/2" CUP WIRE BRUSH. Easily attached to Bull Buffer head. Removes paint, rust, scale, etc. in a jiffy. **\$1.75.**

ADAPTER B SET. For high-speed sanding. Doubles drill speed by running Bull Buffer backward. **\$2.00.**

RUBBER PADS. Oil resistant, finest quality. Specify 3", 4" or 5" diameter. **\$1.85 ea.**

SHEEPSKIN BONNET. 5 3/4" top-quality bark tan bonnet for buffing. **\$1.25.**

WOOL PAD. 5 1/4" diameter, half-inch pile wool pad with rubberized back. For cleaning—won't mat down. **\$1.35.**

SANDPAPER DISCS. 5" Garnet discs for wood (0000-000-00-0-1-2 1/2-3). 10c ea. #4 open grit, each 15c.



HIGH SPEED JITTER SANDER

for those perfect flawless finishes on wood or metal. Ideal for furniture refinishing, fender repairing, etc. Easy one-hand operation **\$9.95**



4-IN-1 HOLE SAW!

Cuts 1", 1 1/2", 2", 2 1/2" holes in any 3/4" stock — wood, plastic or metal. Fits any 1/4" drill or drill press. Complete, with arbor and 4 saw blades. **\$4.95**

\$9.95



NEW BULL HEDGE TRIMMER

For use with any 1/4" elec. drill. Shuttle action of 9" hardened high carbon steel blade clips any hedge evenly... cleanly... quickly! Also ideal for trimming grass around walls, house, etc. No vibration. Blade can be turned to any angle.

All Bull Tools are Guaranteed

NEW BULL SAW

\$9.95

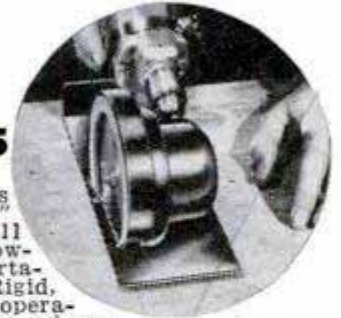

Converts any 1/4" elec. drill into a powerful, portable saw. Rigid, one-hand operation. One-piece safety guard; visual guide. Depth of cut: 1 1/2". Complete with high carbon steel combination saw blade. **\$9.95**



BULL MANDREL KIT

includes mandrel, 2 1/2" grindstone, 3" wire brush, 4" cloth buffing wheel, only **\$2.19**



BULL MORTISING KIT

Complete kit for mortising and routing on-the-job with elec. drill or drill press. Includes Bull Mortising Adapter and 1/4", 3/8" and 1/2" chisels with corresponding bits. **\$23.90**

Bull Mortising Adapter only, \$6.95

Fits any 1/4" elec. drill and any standard shank chisel.

SEPARATE BIT & CHISEL PRICES ON REQUEST

NEW MASONRY DRILL

For use with any 1/4" elec. drill. New design helps you drill faster... easier... cleaner... deeper! Unique wire spiral lifts dust right up out of hole. Tough-alloy-steel shank; tip of cemented carbide.

SPECIFICATIONS & PRICES

Nominal Diameter	Shank Diameter	Overall Length	Price Each
3/16	5/32	3"	\$1.40
1/4	3/16	4"	1.40
5/16	1/4	4"	1.50
3/8	*5/16 or 1/4	4"	1.60
7/16	*3/8 or 1/4	6"	1.85
1/2	*3/8 or 1/4	6"	2.05

*When ordering, specify standard or 1/4" shank diameter. Prices of larger bits on request.

DRILL BIT SETS

FOR WOOD OR STEEL — High-speed drill set with 13 mechanics length drills, sizes 1/16" to 1/4", by 64ths. Easy to carry in tool box. Complete with handy Huot Metal Index, **\$5.60.**

FOR WOOD ONLY — Ideal sets for tool boxes, elec. drill kits, etc.

SET W-4 includes 4 bits, 5/16" to 1/2", by 16ths. **\$3.20**

SET W-5 includes 5 bits, 1/4" to 1/2" by 16ths. **\$3.55**

GREENLEE SOLID CENTER WOOD AUGER BIT SET — Finest quality wood bits available for straight or angular drilling in hard or soft woods. Set includes 1/4", 5/16", 3/8", 7/16" and 1/2" diameter bits. **\$3.95.**

BERTRAM ENGINEERING & SUPPLY CO.
3121 MAIN STREET
Dealers—Write today for new 1950 catalog
KANSAS CITY, MO.

Look! \$70 Buys ALL This!

**10-Day
FREE
TRIAL**

Cash or
Easy Time
Pay Plan

**EMRICK
All
PURPOSE
SPECIAL**

\$70 price includes every item shown here except the bench lumber.

**DOES SAME WORK
AS \$200 WORTH
OF SINGLE UNITS**



EMRICK 5-in-1 MACHINE Complete with 1/3 H.P. Motor, Drive Pulley, V-belt, 7" Saw Blade, 5 Wood Drills, 6 Best Quality Lathe Turning Tools, 2 Steel Bench Legs, Buffering Wheel, 6 Abrasive Discs and Distic.

**5
Complete
POWER
TOOLS
for
TURNING
DRILLING
SAWING
SANDING
GRINDING**

115 pounds of REAL machinery. Biggest Bargain in power tool history! \$11.39 below our factory-to-you price. You can do practically any type of wood-working—handle big jobs—make home repairs—operate money-making business. Emrick saves you both jobber and dealer profits. Order NOW — or write for FREE literature. EMRICK, Inc. 1543 Clinton, Kalamazoo, Mich.

KING MIDGET Home Assembled Auto

WORLD'S LOWEST PRICED CAR!

Drive for as low as 50c per week. Precision built parts direct from factory with beautiful all steel body. Get the facts on this amazing small auto—send 25c for detailed circular with large picture, 3 view drawings and price of all parts, or send \$1 (refunded first order) for this plus actual assembly book with 42 photos, drawings; blueprints of snow, ice conversions. Ideal for micro-midget racing — Get this information.



**MIDGET MOTORS MFG. CO.
ATHENS 1, OHIO**



NEW
**CHIEF
CAR-WASH MITT**
NO SCRATCHING

Give Your Own Professional Wash in Less Than 10 Minutes
You've never seen finer help for surface cleaning.

BIG SOFT FLUFFY MITT
No Metal In Head To Scratch

Inner lining feature keeps hand dry—directs water on car. No slopping, no splashing, no pails, no rags. Simply hose surface to loosen dirt. Attach Chief Mitt to hose. Use just enough water to carry away dirt. Chief Mitt rinses as it cleans. No metal, wood or rubber to scratch, streak or smear. Its big, soft, fine "moppy" yarn covers the car in a jiffy. The hose is flexible plastic—allows free motion of hand when washing surfaces. Use dry as dusting mitt. Get your Chief Mitt today—direct from manufacturer at special factory price of only \$2.25 postpaid. Send check or money order (No C.O.D. please). Money back if not satisfied. Address Chief Mitt Co., 4608 N. Ravenswood Avenue, Chicago 40, Illinois.

SPECIAL OFFER

only \$2.25

Post Paid



spans. The original bridge was destroyed by a 47-mile-an-hour wind. Prior to its failure it weaved up and down in light winds, making motorists seasick.

During the war engineers spent more than three years developing a design based on aerodynamic principles. A model was built and tested in a wind tunnel at the University of Washington, and the new design is stable in winds of 120 miles an hour.

To achieve this, the new bridge has a number of interesting features. The eight-foot solid roadbed girder of the old bridge has been replaced with a 33-foot-deep girder of open construction. The bridge has been widened in relation to its length from 39 to 60 feet.

The four-lane highway has three-foot ribbons of steel grille between each lane and sidewalk so air pressure on either side of the deck will be dissipated.

The bridge also has huge shock absorbers at critical points to take up any motion that might develop. In other respects it is a far heavier bridge. For instance, 23,000 tons of structural steel and wire will go into it, compared to 12,000 tons in the old bridge.

When the bridge is opened to traffic next month, the engineers vow that motorists will be able to travel across without taking a seasick remedy along.

"Bowling" Down Forests For a Super Dam

(Continued from page 94)

the same operation and the ground is left bare. The stacked timber dries out for a few weeks and then is burned.

An operation like this requires big equipment and the contractors have it, yet neither thinks that the ultimate in equipment has been designed so far. Trisdale, for instance, recently put two D-8s side by side and welded them together into one unit, then fastened a 21-foot blade with 13 teeth across the front. One man operates this "D-16." With 270 horsepower behind the blade there is virtually nothing that this powerful rake can't move. It does the work of three separate units.

During the time that the reservoir-clearing operation is progressing the dam itself is growing higher and higher. Hungry Horse Dam is located on the south fork of the Flathead River in northern Montana, a few miles south of Glacier National Park. The river originates on the west slope of the continental divide and flows eventually into the Clark Fork, a branch of the Columbia River.

The dam's odd name comes from Hungry

(Continued to page 248)

GARAGEMEN, SERVICE STATION OPERATORS, CAR OWNERS!

SAVE UP TO 50% ON THESE NATIONALLY-KNOWN AUTOMOTIVE SERVICE ITEMS



\$39.

For better than 30 years, the KRW Direct-to-User Policy has SAVED MILLIONS for THOUSANDS of Garage and Service Station Operators and Car Dealers. KRW manufactures hundreds of specialized tools and equipment which have been factory-approved by Ford and other car manufacturers. KRW Tools are used the world over. See our rating in Dun & Bradstreet. It's tops.

KRW SIX AMPERE SLOW CHARGER

Handles 1 to 12 3-Cell Batteries or Equivalent. Complete ready to use.

This heavy-duty battery charger is ideal for safe charging of all types of car, truck and aircraft batteries. It incorporates all the latest design and construction features. Comes complete with bulb, wiring and connectors, ready to plug in and operate. Case is 11" x 13" x 6". Operation is simple and fool-proof. Plug and Jack arrangement, like a telephone switch-board. You merely plug in to the jack corresponding to number of batteries on the line. Thousands now in use. Operates on 110 Volt, 60 Cycle.

KRW FASTCHARGER

FULLY AUTOMATIC. OPERATES ON 110 VOLTS A.C.

Simplest and most efficient on the market. Only one knob to turn, one dial to watch. New electric timer is foolproof in operation... it automatically discharges, fast charges, slow charges and shuts off. Customer can be shown exact condition of battery on the easily understood full-color dial. You can do this under proper load without danger of buckling plates. Use it also for "cycling" batteries that are badly sulphated. Equipped with 8" fan and heavy-duty motor. Lowest priced dependable unit on market. Money back if not satisfied after 30 days.

\$130.



KRW GARAGE JACK

3 TON CAPACITY



Lowest Price only **\$90.**

This outstanding Jack value meets every requirement of strength, fast lifting, quick spotting and dependability. Lifting capacity 3-tons. Weight 195 lbs. Length overall including handle 88". Length of chassis 53". Floor to top of rest pad 4" minimum. Raises to 24" maximum. Equipped with Self-cleaning Release Valve, Tamper Proof Safety Valve, Crowned, Roller Bearing Front Wheels and Ball Bearing Swivel Rear Wheels. Finger-tip Control Button.

TERMS: Cash with order. If C.O.D., 25% must accompany order. Concerns with established credit sold on open account. All PRICES F. O. B. Factory. (Subject to change without notice.)

SOLD WITH 30-DAY MONEY-BACK GUARANTEE

KRW AIR COMPRESSORS. TWO STAGE

Highest Quality. 4 Models—9.75 to 38.3 cu. ft. Displacement.

Why pay \$200 to \$300 Premium. For 35 years, KRW has passed these savings on to users. Every feature which can contribute to maximum efficiency and long life has been "built in". Cylinders are nickel-chrome alloy iron. Crankshafts drop-forged with integral counterweights. Timken Roller Bearings. Lynette Connecting Rods. Semi-steel Pistons with 3 compression and one oil ring. Constant level oiling system. Plate-type Valves. Automatic Air Breather. Combination Filter and Air Cleaner. Pressure Unloader for Easy Starting. Pressure Control Switch and Thermal Relay protects motor against overloading and undervoltage. 200 lbs. pressure ASME Tanks. **PRICES FOLLOW:**
 2 H.P. 9.75 c.f.m., 80 gal. tank **\$375.00** 7½ H.P. 28.4 c.f.m., 80 gal. tank **\$654.00**
 5 H.P. 20 c.f.m., 80 gal. tank **\$440.00** 10 H.P. 38.3 c.f.m., 80 gal. tank **\$685.00**

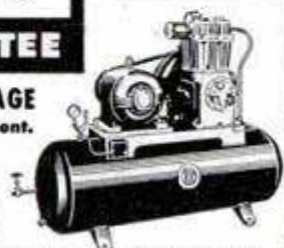

WRITE FOR LITERATURE WITH DETAILED SPECIFICATIONS

SATISFACTION OR MONEY BACK GUARANTEE All Tools or Equipment

described in this advertisement are sold subject to your trial for 30-days after receipt. If you are then not thoroughly satisfied, return the goods to us and your money will be immediately REFUNDED.

SERVICE AVAILABLE IN ALL PRINCIPAL CITIES

K·R·WILSON 213 MAIN ST. BUFFALO 3, N.Y.
 WORLD'S LARGEST MANUFACTURER OF GARAGE TOOLS AND EQUIPMENT

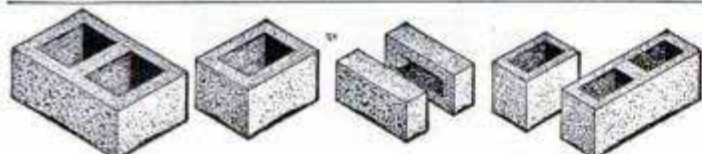

Make Concrete Blocks and Bricks

New superior method makes square, true, easy-to-lay units which will pass any building code. Small investment, high production, big profits. One \$30.00 machine will make four 5"x8"x12" blocks per minute—1000 per day. Pays for itself in a few days. Sell blocks or save 2/3 building cost by making and laying your own.

POST CARD BRINGS FREE FOLDER

Economy Manufacturing Company
 Dept. P Stone Mountain, Georgia

Attention Leathercrafters

LOOK WEST, to the home of Leather Carving and Stamping. More than 100 LEATHERCRAFT KITS in finest Tooling and Carving Leathers. Best assortment of tools and accessories in U.S.A. Other handcraft materials also.

SEND 10c FOR 96-PAGE ILLUSTRATED CATALOG.

GRIFFIN CRAFT SUPPLIES (since 1924)

5626-A Telegraph Avenue Oakland 9, California

MOTOR OIL Should NOT Be Changed!

Learn WHY! Send for FREE 32-page booklet. Mention year and make of your car, truck or tractor. RECLAIMO MFG. CO., Inc., 5083 Elston, Dept. 36, Chicago 30, Ill.

★ Fell a tree like this in less than a minute with a McCULLOCH



New One-man POWER SAW

Finest gasoline-powered chain saw for all tree work, wood cutting, land clearing, etc. Use it to fell, buck, or rip. For trees up to 3-foot diameter. Weighs only 25 lb., develops full 3 hp. Starts instantly. Cuts in any position—take it anywhere. Send for free data.



\$295.00
 f.o.b. Los Angeles

Endorsed by professional loggers everywhere

NATION-WIDE SALES and SERVICE **McCULLOCH** **McCULLOCH MOTORS CORP.**
 6101-E West Century Boulevard
 Los Angeles 45, California
SEND FOR FREE LITERATURE

NEW PACKAGED BOATS



17 models, 8'-16"; Tredonic racers, cruisers; Outboard, inboard, skiffs. Assembled frames: Tri-Keel construction; Tredonic bottom; spray rails; easy to build!
SEND 25c FOR CATALOG!
 Catalog and booklet "Plywood Boats", \$1.00

BOAT PATTERNS-BLUE PRINTS

1950 Catalog—100 designs by naval architects. Racing classes, cruisers, inboard, outboard, sail. 6 to 35 ft. Plywood—Steel—Plank. Construction plans, full-size patterns. **SEND 35c FOR CATALOG** or \$1.00 for catalog and booklet on "Boat Building."

MARINE MART—DEPT. 24—BUFFALO 7, N. Y.

INSTALL YOUR OWN LOW-COST TELEPHONE SYSTEMS

SAVE TIME & STEPS

WITH ARMY FIELD TELEPHONES & WIRE

AS LOW AS **\$10.50** PER MILE

Hundreds of uses for quick, dependable communication around home, ranch, industry. Performance guaranteed to equal present-day commercial telephones. You can use from 2 to 8 phones — any number you require — on the same line for a complete in-cord system. Simple to install. Just string this low-cost, weatherproof wire and attach to phone terminals. Powered by flashlight cells. No maintenance required.

Ring and talk any distance up to 17 miles!

EES FIELD TELEPHONES

Factory Reconditioned — each **\$15.00** per pair **\$29.50**
New

W110B ARMY FIELD WIRE

Just purchased 10,000 miles! New low prices!



Used extensively by Ranchers, Telephone Companies, on Construction Projects, etc., for extended communication systems.

NEW, unused, excellent condition—
per Mile (wt. 160 lbs.)..... **\$13.50**
1/2 Mile (wt. 80 lbs.) **\$7.00.** 600-ft. Reels **\$3.00**

NEW, unused, good, serviceable condition—per Mile..... \$10.50
1/2 Mile..... **\$5.50**

NEW W130 LIGHTWEIGHT ASSAULT WIRE

1/2 mile reels (2600 ft. illus.) wt. 16 lbs..... **\$9.95**
3/4 mile reels, wt. 9 lbs..... **\$4.95**

All prices FOB Sacramento. No COD. (Calif. residents add 3% for sales tax.) Small orders sent postage collect, heavy orders freight.

Write for FREE FOLDER—Many More Items!

Send Check or Money Order **LORIS SALES, P.O. Box 1896-B8, Sacramento, Calif.**

MAKE BIG MONEY

Sharpening Lawn Mowers...

SPARE OR FULL TIME

PROOF "I have had my Universal Grinder only 2 months. Live 1 1/2 miles from town. Yet have already made net profit of \$227." G. Spurlock, Arkansas. "One customer sends another. 40c newspaper ad produced nearly \$500 worth of business." C. E. Hardy, Missouri. "Not one dissatisfied customer! Means I get their business again." J. E. Barker, New Jersey. "A real machine. Works fine on power mowers, too." J. H. Fisher, Pennsylvania.



ONLY ON THE UNIVERSAL LAWN MOWER GRINDER

... can the inside face and edge of the stationary blade, as well as the reel blades, be ground to proper clearance **ALL IN ONE SET-UP**, without removing any blade from either hand or power mower. **Send Today for Free Details.**
ROGERS MFG. CO. Dept. M-80 LINDSEY, OHIO

RUBBER HOSE SALE



Brand new genuine Neoprene Hose—outlasts ordinary rubber 3 to 1. Reinforced with super tough cotton cord plies. Flexible, easy to handle. Easy F'lo brass couplings with standard pipe threads for quick connections, included. **Pump water for irrigation, stock, tanks, home, barn, fire fighting, etc. Pump Gas or Fuel Oil. Save more than 60%.**

(Inside Diam.) **1 1/4 in. 1 3/4 in. 1 1/2 in.**
Length **25 ft. 40 ft. 30 ft.**
Price **\$8.75 13.75 13.75**

If specified we will send special hose for gas or oil at same prices.

HYDRAULIC HOSE

High pressure, heavy duty, complete with swivel fittings. Pipe thread connections. Any length desired. Minimum order \$2.00. **INSIDE DIAMETER**
1/4"—40c per ft., 3/8"—50c per ft., 1/2"—70c per ft., 5/8"—90c per ft.



EXTENSION CORD 40 ft. heavy duty, made of specially insulated No. 14 2-conductor wire. So tough that you can drive over it and yet amazingly flexible and easy to handle. Resists oil, grease or water. Extend electricity up to 400 ft. without voltage drop. Use indoors or out. Complete with heavy rubber plug and outlet. Wt. 2 1/2 lbs. Usually \$4.50—Special 40 ft. **\$1.95.** Comb: 2-40 ft. and 1-20 ft. (total 100 ft.) **\$4.75.**

All prices f.o.b. Chicago area. Satisfaction guaranteed. Send ck. or M.O. **MASTER MECHANIC CO., Dept. 28, BURLINGTON, WIS.**

Horse Creek that flows into the Flathead and the creek was named in token of two freight horses, Tex and Jerry, that wandered away from their sleigh back in the winter of 1900. For a month the two horses struggled through snowdrifts in search of food and they were in a starved condition when accidentally found. Fed up on oats, the hungry horses gained back enough strength to be led back to camp.

The dam is to be of the arch-gravity type and the structure will depend both on its own weight and the support of its abutments to hold back the water in its reservoir. When complete, the dam will be 2115 feet long at the crest, 564 feet high and will contain about 2,900,000 cubic yards of concrete. It will be the third tallest concrete dam in the world and its bulk will be exceeded only by Grand Coulee, Shasta and Hoover Dams.

Twelve contracting firms that banded together under the name of General-Shea-Morrison Company are building the dam and powerhouse at a cost of \$43,431,000. Construction techniques in general follow the practices that were developed for building America's other huge dams. An 1180-foot diversion tunnel that was blasted through one wall of the canyon is now used to carry the river around the dam site. When the dam is completed, this tunnel will be sealed with a concrete plug and water will begin to back up in the reservoir. When the reservoir is full it will contain 3 1/2 billion acre-feet of water and its maximum depth will be 500 feet. Instead of cascading down the face of the dam in an open spillway, excess water will flow into an open "glory hole" type of spillway and will fall the height of a 47-story building on its way to the outlet portal. The odd spillway is being built back of the dam as part of the general contract.

The dam is to be a key project in the Bureau of Reclamation's program for taking full advantage of the water resources of the whole Columbia River drainage area. It will help control floods, will assist in balancing the downstream irrigation program and will contribute its share of electric power to the area.

Lightweight Plaster Takes Load Off Walls

One tenth as heavy as sand, a new material processed from volcanic glass found in the Southwest may serve as a substitute in plaster and concrete. It saves about four tons in plastering a normal five-room house. Both plaster and concrete made with the new aggregate have superior insulating properties.

TUNE UP Your Car Engine with HI-REV NOW!

WORLD'S FASTEST PENETRATING OIL!

Marvel HI-REV is a GUM SOLVENT . . . its use will permit sluggish engines to regain their high standard of performance. It frees sticky valves and improves compression. Add one pint to gasoline tank for jet cleaning. One pint in radiator cleans rust from water jacket and radiator core.

HI-REV SUPREME AS TAR & ROAD OIL REMOVER

Excels any known product in freeing rusty nuts and bolts. Lightning fast on pipe joints and oil well fittings. Of great value in boat yards and around salt water . . . loosens rusty threaded connections easily. Will not produce rust or corrosion of any kind. Simple to apply in a stream from pint can by reversing cap spout. Made by the makers of famous

Marvel Mystery Oil. Emerol Manufacturing Co., Inc., 244 W. 69th St., New York 23, N. Y.

**WRITE
NOW!**



EMEROL CHASSIS OIL

A waterproof Lubricant for all chassis work. Clings, penetrates and protects against rust, despite hard rains. Will not affect car finish in any way.



AIR CONDITION *Any CAR*

PLANS SHOW YOU HOW . . . \$1.00 • HOT OUTSIDE . . . COLD INSIDE

Enjoy pleasure driving in cool comfort in scorching outside temperatures, with real mechanical refrigeration. (Not a dry ice or window unit.) Easily installed by anyone handy with tools. No experience necessary. Powered direct from your engine. Completely automatic. PATENT FEATURE controls temperature from idle to 100 mph. Build and install it yourself! Keeps your automobile comfortable. Tractor Cab cool. Truck cooled for hauling perishables. Send \$1 for your set of PLANS now. Do it today!

LEJAY MFG. CO., 547 LeJay Bldg., Minneapolis 8, Minn.

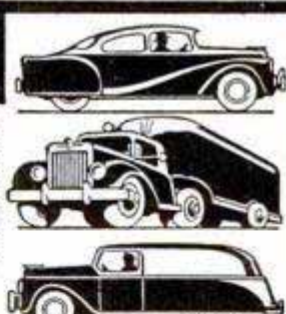

MANUFACTURE BUILDING BLOCKS

Easy to start your own profitable business. General high speed, low cost Concrete Vibrator Block Machine produces 1000 blocks in 8-hour day. All sizes and shapes. Complete details FREE. Mail \$1 for wonderful book, "How to Build Your Own Concrete Block Home."

Only
\$199



GENERAL ENGINES CO.
307 HUNTER ST., Dept. P11 GLOUCESTER, N. J.

POWER MOWERS & KITS

LOW FACTORY PRICES
DIRECT TO YOU

**FREE
PLANS**

On America's finest Lawn Mowers and Easy-to-Assemble Kits and Parts. TRIANGLE Mowers are quality-built and powered high for easy cutting and long wear.



SAVE MONEY 3 WAYS

1. Buy complete assembled mowers in 3 or 4 wheel models, 18" and 20" sizes.
2. You assemble complete mower from our precision built Kits and Parts.
3. Build your own from our FREE PLANS using Triangle Kits, Parts, Engines, Wheels, Etc.

WRITE TODAY for full facts, Free Plans, Parts List, and LOW, Factory Prices.

TRIANGLE MFG. CO.
Dept. M-G, Box 185
Fort Scott, Kansas



Easy To Build

U-MAK-IT BOAT KITS

ROWBOATS

OUTBOARDS

INBOARDS &
CRUISERS



SEND 25c (coin)
NEW CATALOG
ORDER YOURS TODAY

U-MAK-IT PRODUCTS 703P-WHITTIER ST.
New York 59, N. Y.

Last Year's Profit \$3,000!

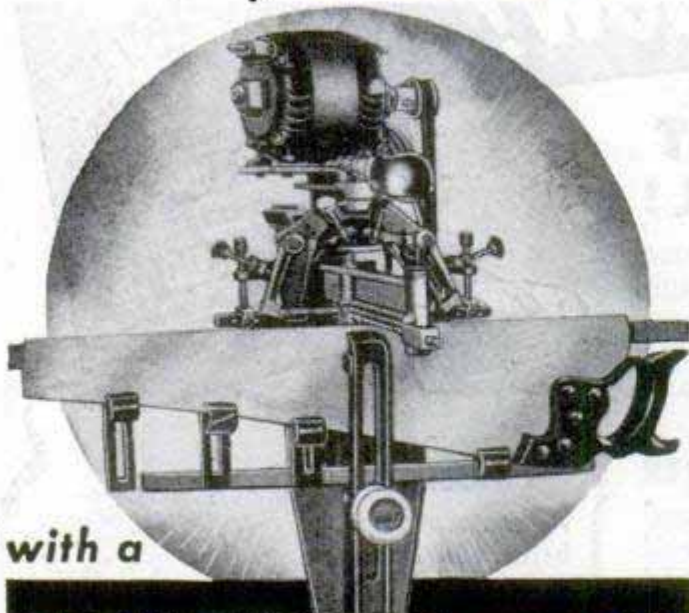

with a

FOLEY *automatic* SAW FILER

"Last year's profit amounted to \$3000. Not so bad for a one-man outfit"—from Charles C. Hough. James B. Williams wrote us—"I made \$765 last year filing saws, and it sure comes in handy. I do this work in my spare time." Men in communities of all sizes make up to \$2 or \$3 an hour with the Foley Saw Filer working full time or part time. That extra money comes in mighty handy in these days of high prices.

It's no trick to take care of the saw filing for your neighborhood hardware or lumber dealer—plus looking after the saws for farmers, townspeople, manual training departments and factories. The Foley files all hand saws, also band and cross-cut circular saws. It's a cash business, no canvassing, no eyestrain and no experience needed.

FREE BOOK

Shows How to Start

"INDEPENDENCE AFTER 40" shows just how you can start at home in your spare time—work in your basement or garage. It's an immediate cash business that can develop into a full-time repair shop. Send coupon today — no salesman will call.



Send For **FREE BOOK**

FOLEY MFG. CO., 816-O Foley Bldg.
Minneapolis 18, Minn.

Send me free book "INDEPENDENCE AFTER 40."

Name _____

Address _____

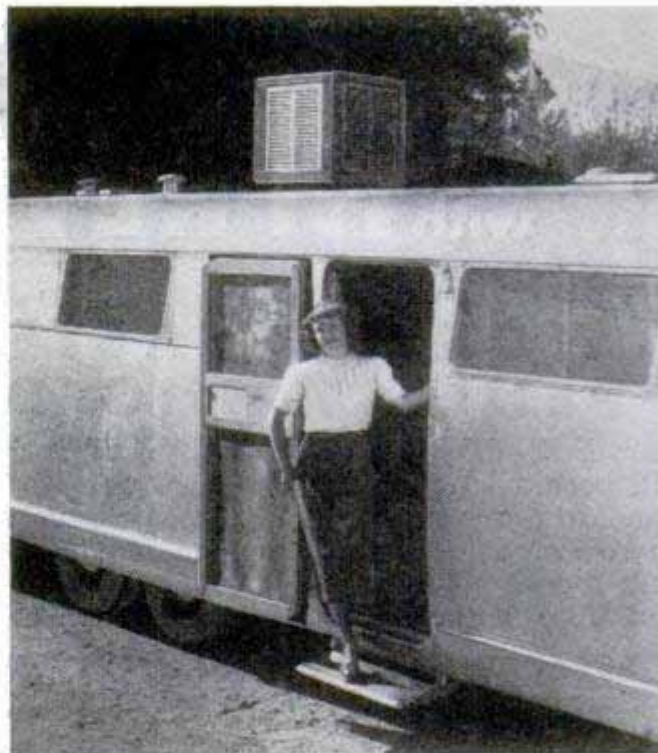

Above, it's cool inside, thanks to the boxlike unit on the trailer roof. Below, the air is drawn through four water-moistened pads and cooled by evaporation

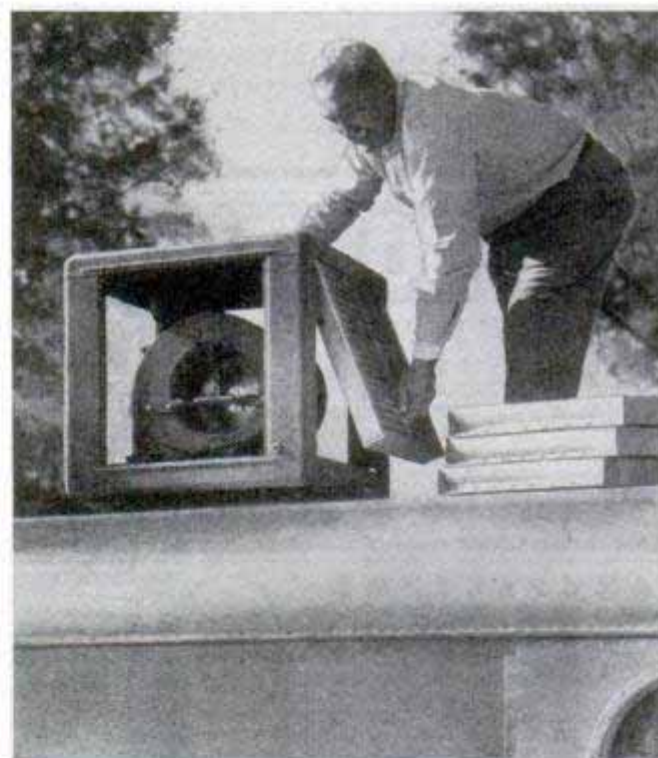

Trailer Cooler

Trailers are kept cool by a compact unit that mounts directly over the roof-ventilator opening without bolts or screws. The air is cooled and filtered as it is drawn through four water-moistened pads that form the sides of the cooler unit. A circulating pump returns the excess water from the reservoir in the base to the top of the wood-fiber pads. Air is circulated by either a fan or high-speed blower. The fan model is fitted with a two-speed switch control.

Build This 5-Room Concrete Block House Yourself - Complete for less than \$3650

Popular Mechanics Home of the Year

Has All These Features

- ★ Five Finished Rooms plus Bath and Three Closets
- ★ Concrete Block Walls—Poured Concrete Floors—Vapor-Sealed Walls Stuccoed Outside—Fully Plastered Inside
- ★ Complete Heating and Plumbing Equipment and Electric Wiring
- ★ Modern Cabinet Kitchen
- ★ Insulated Ceiling

Build-It-Yourself Book and Set of Building Plans, Only \$12.50

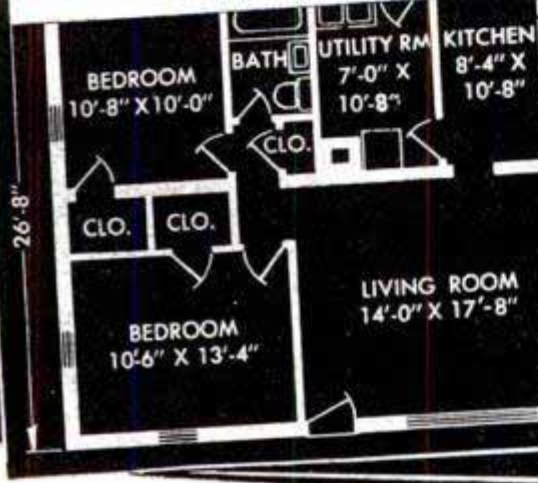

Beat the High Cost of Home Owning! No Experience Needed! Follow Book and Plans! Save Thousands of Dollars!

If you can mix a batch of concrete following simple instructions, and saw a board straight you can build this new Popular Mechanics concrete block house yourself. Yes Sir! In a few months of spare time you can laugh at the housing shortage and save several thousand dollars while acquiring a home you will be proud to own.

Like Popular Mechanics' famous Build-It-Yourself frame house introduced in 1947, a new BUILD-IT-YOURSELF BOOK for this five room Concrete Block House is now ready, along with a full size set of building blueprint plans. The book covers every construction detail and the plans are so simplified, so easy to follow, that you need have no experience to do a fine workman-like job. On the other hand, if you want to hire a contractor or an ordinary builder, have him follow these plans and still enjoy a tremendous saving. Read further about this fine permanent type house. See how easy you can build it and own it yourself. Order book and plans on coupon below.

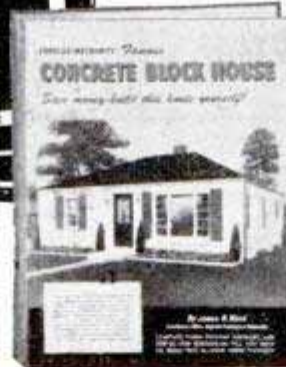

Start Planning Now!

It's Easier Than You Think to Own Your Home

IDEAL FOR FAMILY OF FOUR

Popular Mechanics Build-It-Yourself Concrete Block House is 26'-8" deep by 32'-8" wide. It has 675 square feet of comfortable living space—living room, two bed rooms, cabinet kitchen, utility room, bath and three closets. Built in a Chicago suburb, a relatively high price region, in a high price year, its total cost was less than \$3650.00 including all material, heating, plumbing and electrical equipment and outside labor for installing the equipment and plastering all rooms. In many localities it can be built for even less and additional savings can be made by using less expensive bath and kitchen equipment.

LONG LIFE MATERIALS — EASY UPKEEP

Construction is concrete throughout—poured concrete floors and concrete block walls—both vapor sealed for insulation—construction that requires no special skill. Walls are furred-out and plastered inside, stuccoed outside. Ceiling is insulated. Only a very minimum of carpentry is required—

simple shingled hip roof, door frames and trim, which almost anyone can do. Interior doors are new flush type. Hot air heating plant may be gas, oil or coal-fired. Hot air ducts terminate in ceiling, cold air ducts are tile laid under the floor.

EASY TO BUILD — EASY TO OWN

Every part of the construction is simplified and thoroughly explained in the BUILD-IT-YOURSELF Book, from the turning of the first shovel full of earth to the last flick of the paint brush. It is written in plain, understandable terms and packed with pictures and diagrams that make every construction detail simple as ABC. The book also tells how to make your own concrete blocks, how to select and buy a lot and how to build a house of bricks. Book and set of ten working blueprint plans are all you need to get started and enjoy the thrills of home owning, doing the job yourself and saving money too. Book, \$2.00. Set of plans, \$12.00. See coupon for special money-saving offer when both are ordered together.

USE THIS COUPON TO GET BUILD-IT-YOURSELF BOOK AND PLANS

Popular Mechanics Press, Dept. 600
200 East Ontario Street, Chicago 11

Send postpaid, the items checked. Remittance for \$_____ enclosed.

- Build-It-Yourself Concrete Block House Book \$ 2.00
- Set of 10 Builders Blueprint Plans 12.00
- Book and Plans ordered together (Save \$1.50) 12.50
- Extra sets of plans—each 5.00

Name _____

Address _____

City _____ Zone _____ State _____

*Start Saving
Right Now!*

WITH AN
Atlas

8"
TILT/ARBOR
SAW

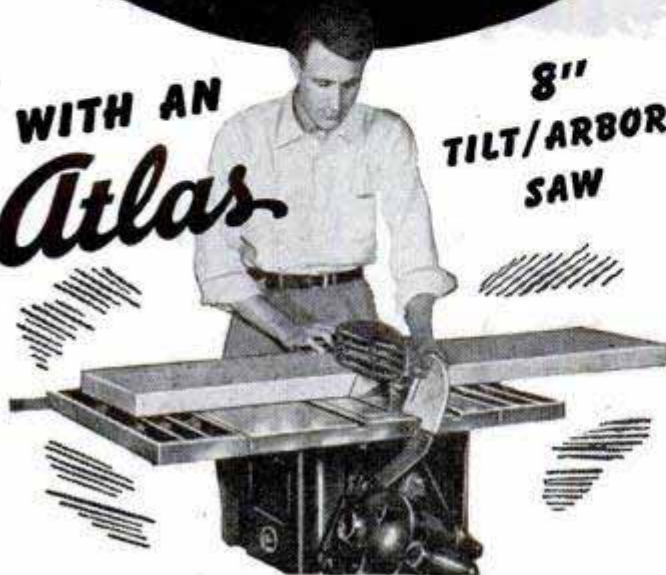

**Make home repairs . . . build
useful furniture, cabinets,
cupboards, garages, tool houses**

The day you put this Atlas saw to work in your shop or on the job you can start saving money. It helps you gain hours of time on every project. Saves tedious hand-sawing. Makes your shop hours really productive.

The Atlas will handle your big work, too. Its 22" x 18" precision-ground table has 10 $\frac{3}{8}$ " ahead of blade—table 22" x 35 $\frac{1}{2}$ " with low-cost extensions. Blade cuts 2 $\frac{3}{8}$ " deep—tilts 45°. Full length, quick-positioning rip fence. Vernier control for accuracy. Ball bearings for smooth dependability. See it at your Atlas dealers today, or send coupon.



FREE Catalog—Write

Please send your catalog on the 8" Tilt/Arbor Saw and other Atlas tools.

Name _____

Address _____

City, State _____

ATLAS PRESS CO.

843 N. Pitcher Street,
Kalamazoo, Michigan



**MATCHED PRECISION TOOLS FOR
WOODWORKING AND METALWORKING**

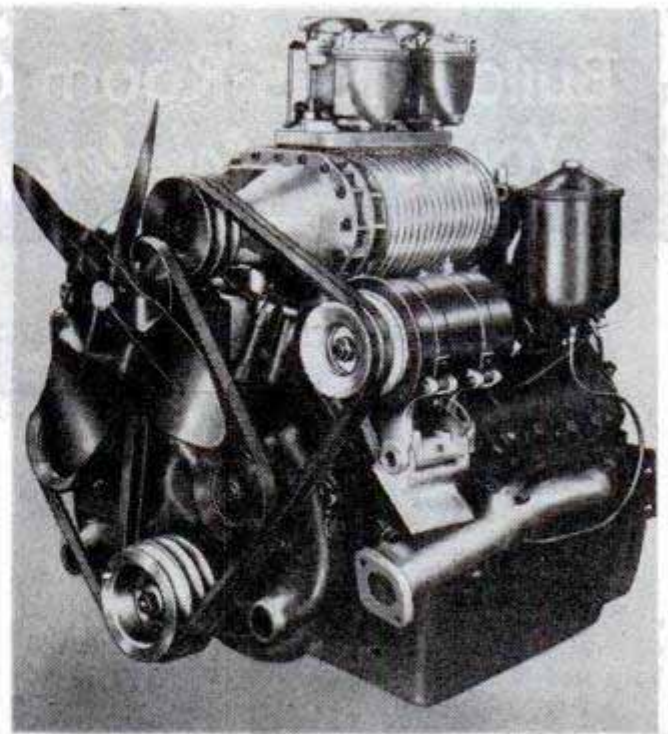

Supercharger for Your Car

You can increase the horsepower of your automobile engine between 35 and 45 percent by installing a low-pressure supercharger that is driven by the fan belt. The supercharger kits, made by an Italian race-car manufacturer, are available for several American cars as well as for European cars, such as the Austin and MG. No engine modifications are necessary. It is especially valuable when driving in mountainous areas. The kits are available for the Ford, Mercury and Crosley.

Toy Pistol Puffs Smoke

Every time a "small fry" cowboy fires a new toy revolver it ejects a realistic puff of "smoke." A tiny bellows in the gun forces out a miniature cloud of harmless powder when the trigger is pulled. The gun fires 5000 puffs of smoke on its initial load, and additional powder is available.

Canned Foods Retain Fresh Taste

Tomorrow's canned foods will taste as fresh as food right from your garden, thanks to tiny amounts of a gray-green powder called subtilin. Minute amounts of the drug have preserved foods for nine months without spoilage in tests conducted by the Department of Agriculture. The foods taste fresher because the subtilin makes unnecessary the flavor-draining, high-temperature canning methods used today. Heat is used, but for a much shorter time and at a much lower temperature. The subtilin and low heat combine to destroy the food-spoiling organism.

SALE

HOLLYWOOD TYPE MUFFLERS

for all cars

**Warehouse Close-Out
Saves Middleman's Profit**

This is no gutted muffler. Saves gas, increases power and speed. C.O.D.s accepted. State make and year of car.

\$3.95

EACH

Postage prepaid in
U.S.A. if cash sent
with order

MUFFLER OUTLET, Box 741, Fort Wayne, Indiana



LOOK at these *Surplus Bargains* from **ATLAS!**

**Make Your Own
POWER LAWN MOWER
Cutter Assembly**

Complete with 18" blade and double ball bearing drive, only



\$11.95



**OSTER
ELECTRIC
MOTOR**

1/40 hp, 60 cycle, 110 v. capacitor type, induction. 1725 Rpm. Special

\$4.95

BENCH LEGS

Steel, Arc welded. Provide support for platforms, wood top tables, steel benches. Heavy Duty:



	Wide	High	Each
Used	29" x 28 1/2"		\$2.39
Used	31 1/2" x 40"		\$3.75
New	32 1/2" x 27 1/2"		\$3.95

BRACES: 5 ft., \$1.25; 6 ft., \$1.50; 8 ft., \$1.75

**Warner
Scarab
GAS
ENGINE**

New, 1 1/2-2 hp. 4 cycle.

A special, now



\$39.50



**WORK
TABLE
LAMP**

Over 37 1/2" wgt. 1 lb. Has 4 flexible joints. 110 volt. Less plug and bulb. Real Surplus Bar. Real gain. Only **\$3.45**

Same as above. 25" long. has 3 flexible joints. Less plug and bulb. Only **\$2.95**

All Prices FOB, K. C. No COD's, Send Chk. or M.O. for immediate shipment

ATLAS EQUIPMENT CO.

229 S.W. Blvd., Dept. PM8
Kansas City, Mo.

HANDIEST TOOL YOU EVER OWNED!



**WONDERFUL NEW
TRIPLE BIT SCREW DRIVER**

We know you're tired of hunting for the right screw driver when you need it! We have the answer: 3 different bits in 1 screw driver . . . two more always ready in the handle!

CLICK—Unlock bit. CLICK—Push bit into hole in handle. CLICK—next bit springs and locks into place! 1/4" bit, 5/32" bit, No. 2 Phillips bit—all in 1 compact tool. High carbon steel and insulated plastic handle. 200-lb. torque tested, unconditionally guaranteed against breakage and twisting. Double your money back guarantee!

**BAUGH PRODUCTS COMPANY
GASTONIA, NORTH CAROLINA**



Order direct! Use this coupon

BAUGH PRODUCTS CO.
BOX 3A GASTONIA, N. C.
Please rush my TRIPLE BIT SCREW DRIVER. If I'm not delighted with it, I understand you are guaranteeing double my money back.

NAME _____

STREET _____

CITY _____ STATE _____

—\$1.50 enclosed (shipped postpaid)

—Ship C.O.D. (pay small postage cost)

\$1.50
COMPLETE

Adjustable wrenches in 6", 8", 10" and 12" sizes



OUR FINEST MECHANICS TOOLS

Now Priced for Every Pocketbook

McKaig-Hatch Superior Design In Polished-Chrome, Forged Tools

Exact design in these tools does faster, better work on every job. Every tool is forged of finest alloy steel, heat treated and carefully finished in gleaming polished chromium. Now you can own tools that mechanics have preferred for years—at prices you'd expect to pay for ordinary tools.

- Every tool fully guaranteed for material and workmanship.
- Thinner design—increased strength.
- High tensile strength and hardness.

There is no substitute for a McKaig-Hatch Tool

SEE YOUR TOOL DEALER

Dealers and Jobbers
Write for New Literature

Open end 5 and 6 wrench sets 3/4" to 1"

Combination 5 & 6 wrench sets 3/4" to 3/4"

12 pt. Box End 5 & 6 wrench sets 3/4" to 1"

Slip Joint Pliers 5" to 10" sizes

5 styles of Claw Hammers

Pipe Wrenches 10", 14" and 18" sizes

McKAIG-HATCH INC.
125 Skillen Street • Buffalo 7, New York

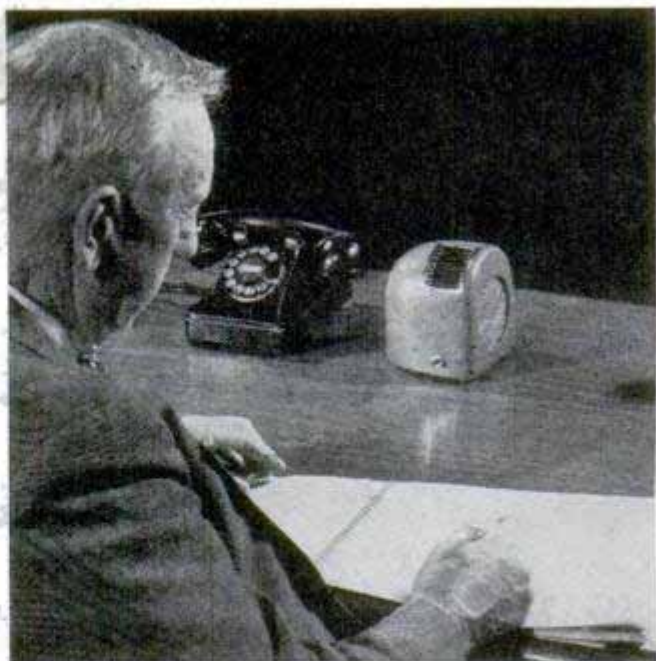

Desk-Top Air Circulator

Designed for desk-top use, a new air circulator is smaller than a telephone, yet does the work of a 10-inch fan. The circulator creates a gentle flow of air instead of a blast which disturbs papers on the desk. The cabinet and motor are mounted on rubber. Two finishes are available—black and mahogany. The circulator consumes less power than a 40-watt bulb.



Saf-Way Ladder Bracket

A practical device for supporting a ladder on an easier and safer working position. It can be used for changing storm windows, screens, painting your home, etc. Fits on any ladder and can be used on side of building—off of roof—on corners.

See story in June issue of Popular Mechanics Page 135

WRITE FOR FREE CIRCULAR

HANDI EQUIPMENT CO.
908-10th Street Racine, Wis.

2000-Year-Old Language Finally Gets an Alphabet

After more than 2000 years as the spoken language of the Indians of Peru, the language, Quechua, has been given an official alphabet. Never written or spelled out before, the tongue was the official language of the Incas over 2000 years ago. Recently, various authors have tried to put the language into writing, but each writer used his own system of symbols. Now, writers and language experts have devised an official alphabet and the Indians are busy learning the "ABCs" of Quechua for the first time in history.

Magnetic Model Trains Grip Rails

Model railroaders now are using magnetized locomotives which grip the rails, giving the engines greater drawbar pull and grade-climbing ability. The magnetic force is provided by permanently magnetized wheel axles or by powerful bar magnets placed close to the wheels. Ordinary model locomotives have difficulty in negotiating grades and pulling heavy loads because their wheels start slipping. A new magnetized locomotive can pull a five-car train up a five-degree slope from a dead start.



Mufflers—All Ford, Chev., Ply... \$4.45

All Buick, Pont., Olds., Chrys., Dodge, Hudson, K.F., Pack., etc... \$5.45

V-8 and Merc. Duals (32-50 incl.) \$15.95

SPORTONE
(Reg. U. S. Pat. Off.)
MUFFLERS

DURABILITY
Olds V-8 Duals \$35

A SANDEE Sportone will outlast two ordinary mufflers and give More Power! More Speed! More Mileage!—plus a tone quality unsurpassed.

Please ship (item): _____ Price _____
Car and Year _____ Name _____
Address _____

Beautiful SANDEE Fender Skirts \$9.95

DEALERS WANTED

SANDEE MUFFLER CO. 5643 Corryne Pl. Culver City, Calif.



Sensational Auto Spot Light



Marvelous utility light when case is open!

Throws beam 300 ft.

A powerful light that takes small current consumption . . . about half that of your parking lights. Plugs into cigar lighter socket. Throws beam 300 ft. to find distant objects, read road signs, house numbers. Provides bright light for changing tires, for outings, picnics. Can serve as emergency driving light.

Small (4 1/4" x 1 1/2"), attractive, red translucent case, with 16 ft. of quality, rubber covered wire. Buy TODAY from your dealer or mail \$3 for immediate prepaid shipment.

The STA-TITE MFG. CO. 816 Delaware St., KANSAS CITY 6, MO.



for POWER, LIGHTS, WELDING Pays BIG Profits!

Do your own welding, run motors, lights, and tools. Ready on a moment's notice. Be independent of electric power lines on big profitable outside repair jobs and emergency lighting requirements. Brings in extra money-making jobs. Send now for details on how easy you can use this new low cost 2 in 1 unit, no obligation.

PAYS FOR ITSELF TERMS AS LOW AS \$18 MONTHLY

"BUILD YOUR OWN" combination arc welder and power unit using this AC-AC Generator. Complete, ready for hook-up to your own gasoline engine, tractor or truck. Makes a BIG saving in first cost. Also available in DC of different sizes. Write today.

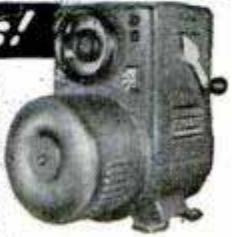

HOBART BROTHERS COMPANY, BOX M-80, TROY, OHIO • Write for Free Catalog

Another of thousands of uses for **WISE-GRIP WRENCH**

LOCKS With Ton-Grip

LOCKS to work with more than Ton-Grip! Does jobs no other tool can do. Involute Jaw Curve holds all shapes. Knurled Jaw Tips hold to the very tip. Has Thin Nose, Super Wire-Cutter. With cutter—No. 7, 7", \$2.25, No. 10W, 10", \$2.50; Without cutter—No. 7C, 7", \$1.85, No. 10C, 10", \$2.25. If not at your dealer, order direct. **PETERSEN MFG. CO., Dept. P-8, DeWitt, Nebr.**

2 CIRCULAR SAWS ON 2 MANDRELS— ALL AT ONE LOW PRICE **\$1.50**

1" diameter saws on 1/8" Mandrels. For cutting wood, plastic, or soft metals. Order at once! Send Check or Money Order for this big bargain.

Send Check or M. O.

SCHUPACK SUPPLY CO., 7331 Cottage Grove, Dept. M-8, Chicago 19, Ill.

ILLUSTRATED BARGAIN CATALOG 10c

Post Paid in U.S.A.

Always write your name and full address clearly when answering advertisements

YOU BUILD IT GARDEN TRACTOR

From used Ford parts. Plans \$1.00. Free info. **PAUL'S TRACTOR CO., 1301 W. Arrow, Fontana, Cal.**

SOUTH BEND

LATHES DRILL PRESS SHAPER

9" to 16-24" Lathes 14" Drill Presses 7" Bench Shaper

Write for literature — indicate machine.

SOUTH BEND LATHE, SOUTH BEND, IND.

BUILD FINE GRANDFATHER CLOCK NOW

The simple sensible Red-I-Kut way as thousands have—**SAVE HALF. SHOP TESTED PLANS "SPIRIT OF THE CENTURY"** Narrow waist 83" tall or stately straight side **"SPIRIT OF AMERICA."** **EASY-TO-FOLLOW photopack PLANS** tell all — plus **BROCHURE** of heavy brass weight Westminster, tube chime, movements, gorgeous dials, 3/4" solid mahogany case kits. Send \$1.00 today—Both Plans \$1.50 NOW. **KUEMPEL CHIME CLOCK CO., #8 Kuempel Bldg., Minneapolis 16, Minn.**

\$ RETOOTHING SAWS PAYS BIG \$

EARN \$15.00 HOURLY . . . as automatic rethooter cuts new 4 pt. to 16 pt. rip or cross-cut teeth on hand saws in 50 seconds. Requires less space, less time and less effort . . . while doing a perfect job. Gives a lifetime of service and has a 1 year guarantee. Free folder on request.

WRITE FOR VALUABLE BOOK Automatic Retooter

Send 25c in coin for Burr's Blue Book of saw shop charges and other valuable information.

SAW SHOP CHARGES COAST TO COAST

BURR MFG. CO., Dept. 8, 8933 Venice Blvd., Los Angeles 34, Calif.

NEW Saginaw BALL-BEARING BUMPER JACK

- SAFEST, STURDIEST BUMPER JACK EVER BUILT!
- PRESSED-STEEL TUBULAR SHAFT—RIGIDLY ATTACHED BASE.
- SAME PRINCIPLE OPERATES AIRPLANE WING FLAPS.
- HANDLE CAN'T SPIN WHILE CAR IS IN AIR—FOLDS OUT OF WAY FOR STORING.
- FITS EVERY BUMPER.

ROLLING BALLS REDUCE FRICTION —A CHILD CAN OPERATE IT.

AVAILABLE NOW THROUGH YOUR UNITED MOTORS DEALER OR USE THIS COUPON

United Motors Service, Dept. S-31 General Motors Bldg., Detroit 2, Mich. Send me information about the new Saginaw jack, and where I can buy it.

A BIG BOOK BUY!

For Every Home Craftsman

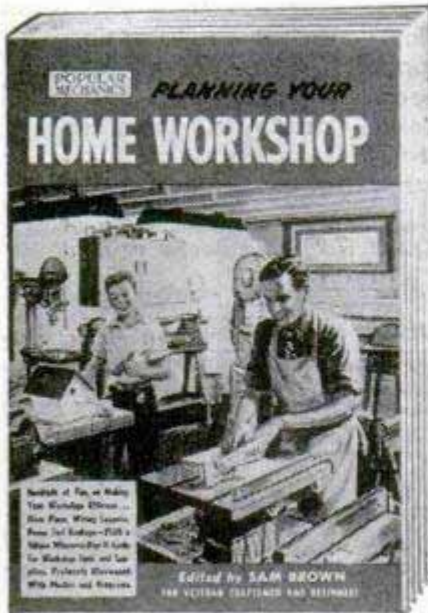

- FLOOR PLANS
- POWER TOOLS
- HAND TOOLS
- MOTOR HINTS
- SHOP LIGHTS
- WORK BENCHES
- TOOL CABINETS

PLANNING YOUR HOME WORKSHOP

Edited by SAM BROWN

Only Sam Brown and Popular Mechanics could give you such a book as "Planning Your Home Workshop," for these are magic names in the world of craftsmanship. Brown is a recognized authority and author of many articles and books on home workshops, advisor to power tool manufacturers and a man who has worked with every type of power tool, with all kinds of materials, and has a world-wide reputation for excellence in fine craftsmanship.

Planning Your Home Workshop is a "must" for the beginner and the experienced home shop worker, for no other book gives such complete information on shop layout and maintenance.

Your Shop — Layout — Equipment and Practical Shop Maintenance

This book shows how to set up a shop on a limited budget, how to avoid costly mistakes by buying the right tools, where to get the tools you need and want, what size and type to select, the basic "big-six" power tools, what hand tools to buy, floor plans and layouts to suit available space and facilities, the best use of electric motors, shop furniture you can build, hobbies for the home workshop, a selection of projects, and many other subjects. It contains 128 pages with more than 250 photos and 100 detailed scale drawings, many in colored line.

POPULAR MECHANICS PRESS 200 EAST ONTARIO STREET
CHICAGO 11, ILLINOIS

Gentlemen: I enclose \$2.50. Please send me my copy of *Planning Your Home Workshop* in sturdy cloth binding.

(Name) _____

(Address) _____

(City) _____ (Zone) _____ (State) _____



Telephone Amplifier For Hard-of-Hearing

Small enough to be carried around in the pocket or handbag, a battery-operated amplifier enables the hard-of-hearing to hear telephone conversations easily. No connections are necessary. The amplifier unit is simply placed under the telephone. A special earphone is used with the device. Another amplifier is designed for use with standard hearing aids, eliminating the need for the earphone.

Blackout "Eye"

Searching for persons or objects in total darkness poses no problems for soldiers wearing sniperscopes. Clamped to a helmet, the equipment combines an infrared light source and an electronic telescope. Its energy comes from a power pack and battery which can be carried in a knapsack on the operator's back. *see letter*



BUILD YOUR OWN TILTING ARBOR SAW!



- 27x28 in. table stays level. Blade tilts full 45 degrees.
- 10 in. blade cuts 3/4 in. deep, jack-screw depth adjustment.
- Floor model, 34 in. table height.
- New Departure ball bearing arbor, 3/4 in. precision shaft, ready to run, 5/8 in. bore blades.
- Quick positioning, self-aligning rip fence guide.
- Sturdy wood, steel and aluminum construction.
- No machining—build easily with hand tools only.
- Capacity and performance of floor saws selling for \$150.00 and up!

SAVE \$50 OR MORE

Plans, 11 actual photographs... \$1.00
 GIL-BILT Metal Parts Kit, includes Plans, ball-bearing arbor, cast aluminum miter gauge and bar, rip fence guide, machined lock knobs, jackscrew mechanism with 4 1/2 in. handwheel, and all other metal parts including every screw, bolt, nut and washer (less blade)... \$20.95
 Same Kit with 10" combination blade... 24.90
 Same Kit with 8" combination blade... 23.90
 Return Kits in 10 days for refund if not satisfied.

(Prices include postage up to 600 miles)
 Also available—Plans and Metal Parts Kits for 8" Tilt/Table Saw and 12" Band Saw. Order Plans at \$1.00 each—sent postpaid anywhere in the world, or write for FREE descriptive Catalog.

GILLIOM POWER TOOLS P. O. Box 1-PH, Lambert Field St. Louis 21, Missouri

COMPARE THESE SURPLUS Closeouts!

Lowest-Ever Closeout Price! PORTABLE WESTINGHOUSE AIR COMPRESSORS

2 Cylinder Piston Type
 Reg. \$60.50
 Model T-1 Complete

1850
 FOB PGH

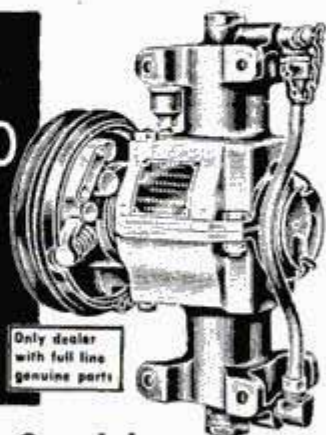

Only dealer with full line genuine parts

Brand New Surplus Special at amazingly low price. Westinghouse, 2" bore, 1 1/2" stroke, 6.54 CFM volume, with forged crankshaft, automatic throw-out clutch for safe remote operation. Suggested pressure, 75 PSI. Mounts on truck, car engine—or operate with 1/2 HP motor. For farm, home, industry, painters, air tools. Instructions, spare parts kit included. Send check or money order. Weight 28 lbs.

PRESSURE TANK ASSEMBLY

AIR RECEIVER, stainless steel, 12 1/2" x 24", 400 lb. test, 12 gal. capacity, 2-3/4" openings, COMPLETE INCLUDING Air Gauge, 25 ft. High Pressure Hose complete with fittings and chuck, Tire Check, Relief Valve, 4-way Cross and flared Fittings and Copper Tubing for connecting compressor to tank. Shipping weight 25 pounds.

COMPLETE
10.95

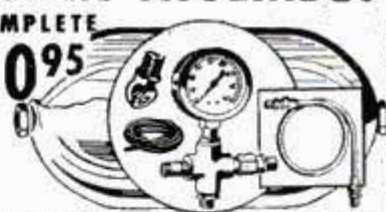

Cutler-Hammer **PRESSURE SWITCH... \$6.50**
 AUTOMATIC

3 ply AIR HOSE, 3/8" I. D. in 12' lengths, **\$1.80**

All prices FOB Pittsburgh, Pa. Send check or MO
NATIONAL EQUIPMENT CO.
 929 FIFTH AVE., DEPT. 5 — PGH. 22, PA.

SAY YOU SAW IT IN POPULAR MECHANICS

PARTS FOR MILITARY TRUCKS

At Big Savings New FREE Catalog For Jeep, Dodge, Chevrolet, G.M.C., Studebaker

Brand New JEEP TOP and CURTAINS Fits all Military Jeeps. Also adaptable to Civilian Jeep... **\$49.50**
 Brand HYDRAULIC JACKS Walker, 3 ton. Complete, limited supply. ea... **\$9.95**

American AUTO PARTS CO. INC.
 1830 LOCUST — DEPT. PM
 KANSAS CITY, MISSOURI

WELD BRAZE, SOLDER, and CUT

ONLY \$9.95 F.O.B. complete! EASILY... QUICKLY!

No experience needed. Follow simple instructions, weld on iron, steel, bronze, brass, aluminum, and other metals. Plugs into any properly wired 110 volt A.C. or D.C. line. Make or save time and money doing repair work for yourself and others. Repair men, farmers, tinsmiths, home and auto owners, hobbyists, etc., say FOUR-WAY pays for itself over and over. Order today or send for Free details.

FOUR-WAY WELDER COMPANY, Dept. F2-HA
 2326 So. Michigan Ave. • Chicago 16, Illinois



CAPE COD CHAIRS TRELLISES • ARBORS DUTCH WINDMILLS

Chairs style B-C-A PLANS 50c Ea., all 3 only \$1.00. 12 different trellis designs PLAN of all 12 only 50c. Authentic 40" high Dutch Windmill Detailed PLAN only 75c. Unique 40" high Light-house having copper lantern, ideal for garden or on lake shore of summer home. Large detailed PLAN 75c.

SPECIAL ALL PLANS ABOVE \$3.00 VALUE ONLY \$2.50
 SEND 10c for catalogue of many fine projects.
CRAFTSMAN'S MODEL CO. DELAFIELD, WISCONSIN

DON'T RISK YOUR LIFE—on tires of inferior quality. We handle perfect, dependable tires—only one grade: the best!



10% OFF ON TWO OR MORE TIRES
NOT VULCANIZED NOT RECAPPED
 BUT GUARANTEED PERFECT USED TIRES—NO SECTIONAL OR SPOT REPAIRS OF ANY KIND
 Tread deepened for longer wear, added protection. Drive with confidence—equip your car with triple inspected SAFETYRE. Every SAFETYRE carries a liberal 2 YEAR GUARANTEE—every passenger tire, an additional 30-day absolute replacement clause. You can't buy better used tires if your life's at stake—and it is!

2 Year Guarantee — Best Grade Only — Free Tube With Each Tire
 600-16 5.50 700-16 7.40 750-16 10.45 Whitewalls \$1.00 extra (when we have them)
 600-16(6) 6.50 650-15 5.65 550-16 5.50
 650-16 6.25 700-15 5.75 550-17 6.95

REMEMBER—EVERY TIRE PERFECT, EVERY TIRE A GENUINE VALUE
 LO-PRESSURE TIRES FOR THAT SOFTER RIDE
 670-16 5.95 670-15 5.75 760-15 7.35 Whitewalls \$1.00 extra.
 760-16 7.95 710-15 6.96 820-15 7.95

TRUCK TIRE VALUES
 Truck Owners—Get more loads per tire, more miles per tire dollar. Tires to suit your needs at prices to suit your pocketbook.
 600-20 10.95 750-20 12.45 825-20 19.95 1100-20 26.95
 650-20 11.95 32x6(8) 11.95 900-20 16.50 1000-22 18.95
 700-20 11.95 32x6(10) 14.95 1000-20 21.50 1100-22 24.50
 Top quality military tires... 750-20... 15.95

DON'T FORGET: 10% OFF IF YOU ORDER TWO OR MORE TIRES
The SAFETYRE CO. MAIL ORDERS PROMPTLY FILLED. Send check or money order with this ad.
 920 W. CARY ST., RICHMOND, VA.

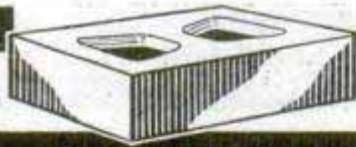
BRIKCRETE

Local Manufacturing of this Modern Masonry Has High Earning Power

Several hundred territories are being opened up for local Brikcrete manufacture by men of vision and aggressiveness. Brikcrete ties in with today's huge building program. Makes possible better construction at lower cost. Truly better than brick; actually cheaper than lumber. Combines strength, safety, insulation value, colorful beauty that fits today's styling.

Brikcrete is made in locally owned plants, using local materials and local labor. That's why high quality and low price still permit a 100% to 150% mark-up. We supply complete equipment; easy terms if required. Generous co-operation. Exclusive manufacturing privileges in protected territory. Write for information.



Brikcrete Associates, Inc.
4679 Division Ave. S
Grand Rapids 8, Mich.

Go anywhere
in a hurry,
at amazing
LOW COST

Up to 75 miles to the gallon! Plus the smoothest kind of riding comfort—soft coil springs, big balloon tires, easy-riding seat. And real safety — brilliant lights, powerful brakes. Easy to handle — quick pick-up, slips through traffic, parks anywhere. Choice of models.

See your Cushman dealer for demonstration. Or send card for Free Folder.

CUSHMAN MOTOR WORKS
Dept. M-8, Lincoln, Nebr.



"YANKEE" VISES

*bold work through every step
without a misstep*

Any job locked in a "Yankee" Vise, is correctly positioned for every operation . . . hand or machine. Lifts on and off swivel base at bench. Machined accurately . . . top, bottom, sides and front end . . . V-grooved block for rounds. Four sizes, with and without swivel base . . . 1½", 2", 2¾" and 4" jaw widths. At your dealer's.



Write for
"Yankee"
Tool Book

NORTH BROS. MFG. CO.
217 W. Lehigh Ave., Phil. 33, Pa.

YANKEE TOOLS NOW A PART OF
STANLEY
THE TOOL BOX OF THE WORLD

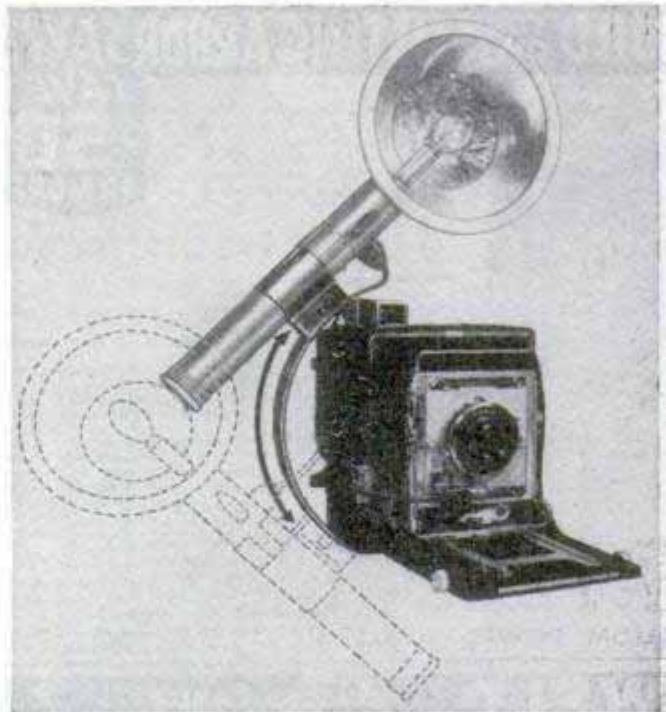

Swinging Reflector For Flash Photos

Flash bulbs can be fired from directly above the camera lens to eliminate unwanted side shadows when a curved flash-gun mount is used. The mount is a steel track that attaches to the side of a press camera, allowing the photographer to swing his flash gun in a 90-degree arc. For horizontal shots, the reflector is swung upward and locked directly over the camera lens. For vertical shots, it is swung downward to the other end of the track.

Underground Oil Reservoirs

With some assistance from engineers, Mother Earth is solving a storage problem that has long vexed the oil industry. Vast man-made underground caverns are replacing steel tanks as reservoirs for butane and propane. Both are fire hazards and have to be stored under pressure to be kept in liquid form. After ordinary drilling equipment opens a vertical shaft to the desired strata, the reservoir is formed by washing out or dissolving the earth structure around the shaft. A dissolving liquid, water or an acid, is shot down the shaft through a rotating pipe with a flexible rubber hose at its lower end until the required space is washed out. Drilling mud forced down under pressure seals off the walls of the underground chamber and prevents pollution of the stored liquids.

☐ With 77 percent of their area covered by forests, the New England states have a larger proportion of woodlands than any other region in the United States.

NEW! ILLUSTRATED AUTOMOBILE ECONOMY MANUAL

Sent to you **FREE!** Tells You How To **SAVE BRAKES! SAVE GAS! SAVE OIL!** & reduce upkeep on your car

Tells you how to get more **POWER, SPEED, MILEAGE, PICK-UP & BETTER PERFORMANCE** from your car. Written so you can understand it and follow its simple instructions. Also tells how to get new automotive products that are designed and engineered to **CUT** automobile driving costs, including mileage meters, radial cathode spark plugs, rocket boosters, water-alcohol injectors, exhaust superdischargers etc. Send only 25c to cover handling and mailing. Supply is limited, so order now. Send name, address to:

NATIONAL AUTOMOTIVE RESEARCH CORPORATION Dept. J-8B
350 W. Washington Blvd., Venice, Calif.

Economy in Driving **ALSO INTRODUCES 25 NEW ECONOMY PRODUCTS**

BIG MONEY FOR YOU

Selling Mechanical Trades

It saws all Metals, Bolts, Asbestos, Rivets, Wood, Fibre, Pipe and Tubing. Invest only \$9 in demonstrating sample. You can make over \$50 daily. Write for details.

E. H. STACKHOUSE
219 N. 63rd St.
Dept. PM 5-50
PHILA., PA.

Find HIDDEN TREASURES

GEIGER COUNTERS for Uranium Detection. (see at left). **TREASURE DETECTORS** for gold, silver, etc. Lightweight, ultra sensitive. None finer at ANY PRICE. Information FREE.

Detection Co. Dept. 8-B
5631 Cahuenga, No. Hollywood, Calif.

SAVE MONEY

Build this 18 ft. House Trailer yourself \$286.00. Blueprints, Building instructions and 1950 parts catalog 50c. Don't Delay. Write Today

NATIONAL TRAILER EQUIPMENT COMPANY
Dept. PM-8, 1007 N. WATER STREET, MILWAUKEE, WISCONSIN

YOU CAN BUILD A PICNIC TABLE LIKE THIS



With our **PRE-FABRICATED MODERN STYLED 1 1/4" BENT PIPE FRAME**

Assemble your Picnic Table in a few minutes with our kit containing all metal parts, hardware and plans. Makes Table 7 ft. long. Seats 8 people, will not upset. Prime coated, easily moved about, dismantles for winter storage.

Send for descriptive folder **F. O. B. Niles, O. Wt. 80 lbs. In Ohio \$14.95**
Add 3% Sales Tax. Sorry No C. O. D.'s
DAUM & OFFUTT, Dept. M, P. O. BOX 203, NILES, OHIO

SAY YOU SAW IT IN POPULAR MECHANICS

★ ★ ★ ★ ★ ★ ★ ★ ★ ★

OUR 296th ADVERTISEMENT REAL DIESEL ENGINE!

\$2.95

• Ideal for planes, boats, midget cars
• Actually runs at 7500 RPM, produces 1 1/7 HP
• Height a full 3 1/2 inches; weight 3 ounces

You can't beat this price!
• Comes to you completely assembled, ready for operation

MAYBE WE'RE CRAZY, giving away a precision diesel engine, complete with cylinder and piston, carburetor, crankshaft, connecting rod, etc. for **ONLY \$2.95**. But we're selling thousands of **DEEZILS** all over the world, and that keeps our production costs down. **DEEZIL** is streamlined, compact, rugged. Starts quickly, easy to install, runs for years! Fast delivery if you **ORDER DEEZIL TODAY!**

Send **\$2.95 plus 25c postage**

GOTHAM HOBBY CORP., Dept. P, 107 E. 126th St., New York 35, N. Y.

★ ★ ★ ★ ★ ★ ★ ★ ★ ★

MAYRATH

5 HP TRACTOR



ONLY **\$295**
MOWER \$87.50

2 to 20 Miles Per Hour

- ROSS STEERING GEAR
- THROTTLING GOVERNOR
- 3 SPEEDS FORWARD - 1 REVERSE
- IMPROVED CLUTCH
- 5:00x16 TIRES
- ALL ATTACHMENTS AVAILABLE

WRITE FOR CIRCULAR

MAYRATH, INC.
DODGE CITY, KANSAS

FURNITURE FOR YOUR BEDROOM

YOU'LL BE THE ENVY of your neighbors with this beautiful bedroom suite in honey maple, oak or walnut! Here's a bed with storage space... a three-piece vanity with cosmetic compartment and makeup mirror... a Mr. and Mrs. dresser... twin night stands with drawers!

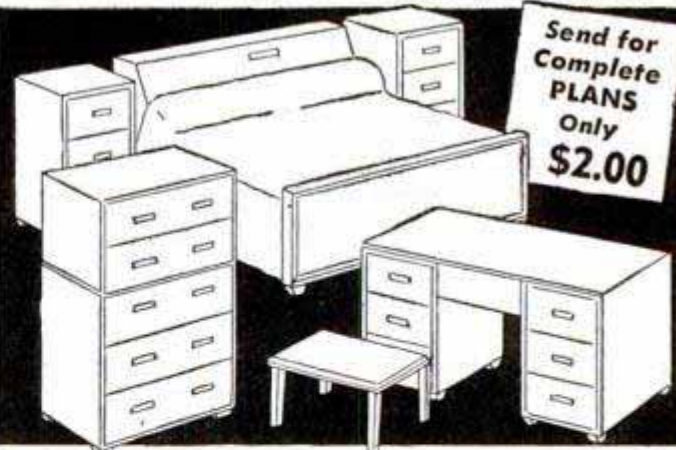

Send for Complete Plans Only **\$2.00**

YOU MAKE IT YOURSELF! Only two power tools, a saw and a jointer, are needed to turn out this modern bedroom furniture. No other project of Popular Mechanics Magazine in recent years has captured the fancy of home craftsmen as has this easy-to-build suite. Letters demanding detailed plans poured in after the suite was pictured in Popular Mechanics. And now the plans are ready! They're detailed scaled drawings—a complete set of 4. Send for them today!

POPULAR MECHANICS PRESS
200 East Ontario Street, Chicago 11, Illinois

I enclose _____ for a complete set of plans for making the modern bedroom suite illustrated above.

Name _____

Address _____

City _____ Zone _____ State _____

SHOPMASTER POWER TOOLS

Only
\$39.95

Each
Complete,
less motor

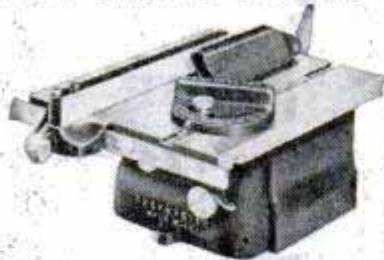

Now you can get Shopmaster quality in power tools specially designed for the smaller home workshop, operating on a limited budget. Efficiently designed, they contain features found only on the highest priced tools.

Write for catalog on complete line of Shopmaster Tools.



SHOPMASTER, INC.

1214 Third St. S.

Minneapolis 15, Minn.

\$300.00 FOR ONLY \$9.95

SOMETHING GOOD FOR THE HOBBYIST

BRAND NEW CONTINUOUS DUTY
PRECISION INVERTER UNIT

INPUT 25-28.5 Volts D.C. OUTPUT 80 Volts-500 VA
800 Cycles

1001 Uses for this Fine Inverter that sells for \$300.00. Can be converted to suit your own needs or used for the many Electrical Parts it contains. This Unit has Electrical Parts galore, including: Filter, Condenser, Resistor, Voltage Regulator, Rectifier, Field Assemblies, Fuses, Starter Relay, Coils, and a Maintenance Handbook. Shipping weight 60 lbs.

Prices F.O.B. Chicago. Include approx. postage on orders paid for in advance. C.O.D. orders enclose 25% balance sent C.O.D. WRITE FOR FREE ILLUSTRATED CIRCULAR.

U. A. S. Corp. Dept. PM8, 5637 W. 63rd Pl.
Chicago, Illinois

HANDEE

Tool of 1001 Uses

The original tool of this type and today's finest. Choice of mechanics, repairmen and craftsmen for 18 years. Handee is the best tool investment you can make.

IT RUNS COOL — Smooth, controlled power when you want it, as you like it. Non-fatiguing because it is perfectly balanced and has 7-bar armature rather than only 3. Speed 25,000 r.p.m. Wt. 12 oz.

Handee with 7 accessories \$19.95
Handee with 51 accessories in steel case.... \$27.50

At your dealer's or order today postpaid on money-back guarantee. Write for catalog. Chicago Wheel & Mfg. Co., Dept. PM., 1101 Monroe St., Chicago 7, Ill.



A Whole
Toolshop
in 1 hand

GRINDS, DRILLS
ENGRAVES, CUTS
POLISHES, SAWS
ROUTS, SANDS



Two-Wheel Stroller

Two small wheels, a tubular-metal frame and a harness-type seat are all it takes to make a baby stroller developed in Germany. It can be taken almost anywhere because it occupies little space. The child sits in the seat and hangs onto the rectangular frame.

Automatic Car-Door Lock System

Children can't open a door while the car is moving if the doors are protected by an ignition-controlled lock system. Whenever the ignition switch is turned on, the doors lock automatically. A switch on the dashboard allows the driver to unlock the doors whenever he wishes. Should the car overturn, a mercury switch releases the locks.

Squeezed Hay Dries Faster

Farmers can put freshly cut hay in the barn on the same day it is mowed when the hay is crushed during the mowing operation. Tests carried out by engineers of Canada's Experimental Farms Service show that crushed hay, cut at 8:30 in the morning, is ready for storage by evening. A special farm implement was designed to pick up the new-mown hay, crush it between two power-driven steel rollers and strew it back on the ground to dry. No significant change in feeding value of the hay was detected.

Low cost complete Dynamic MULTI-METALCRAFT-WORKSHOP 12 tools in 1!

Over 50,000 Satisfied users! Here's the biggest shop value offered. Now you can make or repair 1001 useful auto & home appliances, farm and shop equipment. Fabricate anything of iron, steel, brass, bronze and other metals. Can pay for itself on first job or project. No experience needed. Complete instructions furnished. Works on any properly wired 110 Volt 50/60 cycle A.C. line. **Everything Included. Complete, ready-to-use.** You get Power Unit, Electric Torch, Etching & Soldering Tool, Headshield, Electrode Holder, Welding ground and power cables, Ground clamp, Simplified instruction manual, Metal fabricating rods, Flux, Etc.

Gift
Accessories
Worth \$8.30
Included
For
Prompt
Action
At No
Extra Cost

FREE

Complete Illustrated Descriptive Literature. Write Today for Details on Money-Back Guarantee. 10 Day Trial Offer!

DYNAMIC WELDER CO.
15 E. 23rd St.

Dept. D2-HA6
Chicago 16, Ill.

SOLDERING METAL CUTTING ARC WELDING TOOL MARKING

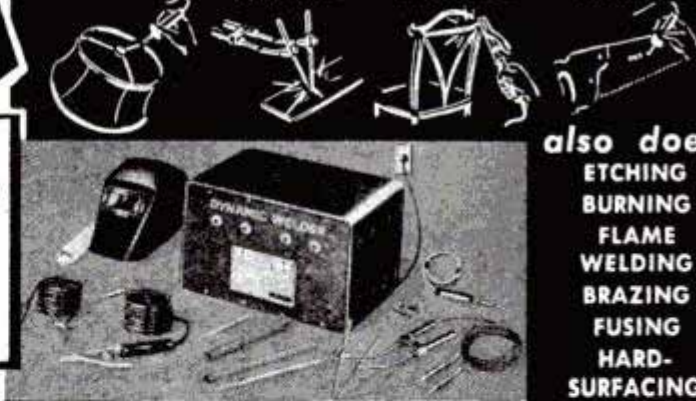

also does
ETCHING
BURNING
FLAME
WELDING
BRAZING
FUSING
HARD-
SURFACING
SWEATING &
PREHEATING

GAR WOOD JR. presents—

— BOAT DESIGNS — DETAILED CONSTRUCTION PLANS

Famous "GAR WOOD" Designs Simplified in construction for the Home Builder
INBOARDS — OUTBOARDS — CRUISERS — RACERS
SEND 25c FOR ILLUSTRATED BROCHURE AND BOOKLET "HOW TO CHOOSE AND BUILD YOUR BOAT"
Many Ideas for Easy, Successful Home Boat Building
GAR WOOD JR., Box 4373, Miami Beach 41, Fla.

SPECIAL OFFER to Hobbyists

ONLY
4⁹⁵

Hard Angle Jobs Set-up in 5 Seconds

Save TIME! MONEY! Drill, mill, grind, etc., round, square, irregular pieces at any angle—Quickly—Easily—Accurately with PALMGREN "HOBB-E" ANGLE VISE
Accurately machined and graduated. 1 1/2" Jaws, 1-Plain, 1-Grooved. Order NOW! Only \$4.95. Write for "HOBB-E-TOOL" Circular.



CHICAGO TOOL & ENGINEERING CO.

8365 SOUTH CHICAGO AVE.

CHICAGO 17, ILL.

S AGENTS 300% Profit SIGN LETTERS

For Store Fronts and Office Windows. Anyone can put them on. Free samples. Liberal Offer to General Agents.
METALLIC LETTER CO., 430 N. Clark, Chicago 10



EXTRA LOUD
TWANGERS
GENUINE MUSIC WIRE
EXTRA HEAVY



Protects Car Fenders—Doors—White Sidewalls!
Deluxe Quality! Sensational Value!

Send \$1.00 (postpaid)

Address: Lumidor Co., Los Angeles 58, Calif.

\$1.00
PR.
BOXED

Say You Saw It in
POPULAR MECHANICS

NEW! SPECIAL TYPE Eklind EMERGENCY BRAKE SIGNAL-LITE



- Red plastic shield as-cutcheon. ● Warns driver when emergency brake is on.
- Fits all cars including '50 models.

\$2.50 postpaid

Install this handy signal-lite that glows red when ignition key is turned on, with emergency brake set. The red cap also removes for handy map reading light.

Complete instructions for easy installation with each lite.

If your dealer cannot supply you, order direct (No C.O.D.'s)

EKLIND TOOL & MFG. CO. 2623 N. Western
Chicago 47, Ill.

New! Electric Motors



New Westinghouse 1/2 H.P. Induction Type 3450 RPM 110 V-60 cy. 1 Ph. A.C. Motor, Double Shafts 5/8" **ONLY \$21.75**
"WVH-5" **ONLY \$29.75**
New Delta 3/4 H.P. Cap/Ind. Ball Brg. 3450 RPM. 110 V. 60 cy. 1 Ph. A.C. Motor (specify rotation desired) "DH-34" **\$29.75**
New Emerson 1 H.P. Heavy Duty, Repulsion Induction 3450 RPM. 110/220 V-60 cy. 1 Ph. A.C. Motor **\$37.50**
"EH-1" Low Priced at... only **\$38.50**
New Ecor 1 H.P. Capacitor Induction 1750 RPM 110/220 V-60 cy. 1 Ph. A.C. Motor **\$75.00**
"EG-17" only **\$37.50**
New "B"-Line 2 H.P. Repulsion Induction 1750 RPM 110/220 V-60 cy. 1 Ph. A.C. Motor "4012" only **\$75.00**
New 3 Phase Motors 1 H.P. Ass't Makes, 1750 RPM 220 V-60 cy. "A31" only **\$37.50**

ALL PRICES ARE FOB. CHICAGO

KEEP COOL THIS SUMMER . . . BEAT THE HEAT

Fan Blade and Motor Combination. 1/4 H.P. Induction Motor, 110 V.-A.C. 1725 RPM. Overload Protection **\$7.50** Fob. Chgo.
Only **\$3.50** Fob. Chgo.
18-inch Torrington Zephyr-Aire 3300 CFM Fan Blade, Only **\$10.00** Fob. Chgo.
or Combination together **\$10.00** Fob. Chgo.
(Both). Only **\$10.00** Fob. Chgo.

WRITE FOR BARGAIN WINDOW FAN, ATTIC FAN and ELECTRIC FAN MOTOR CIRCULAR and SAVE MONEY • All Sizes C. MARSHALL SALES, 3546 W. Fullerton Av., Dept. P-8, CHICAGO 47

GOVT. COST
~~\$24.25~~



NOW
\$19.75

CHRONOMETRIC TACHOMETER

U. S. NAVY SURPLUS—ACCURACY—PRECISION—GUARANTEED

For PRECISION timing of all rotating mechanisms. Incomparable GUARANTEED ACCURACY of 1/10 of 1%. An RPM counter and surface speed indicator combined with chronometric operation which AUTOMATICALLY computes period of test in EXACTLY 6 SECONDS. No stop watch or personal equation necessary. UNSURPASSED for cameras, projectors, gen-

erators, motors, sanders, turbines, saws, shafts, looms, fans, lathes, etc. Packed in plush-lined, simulated leather case. UNCONDITIONALLY GUARANTEED subject to your inspection and approval. Manufactured by JAEGER and TOTCO, leaders in field of exacting measuring devices. Only \$19.75 Shipped postpaid in U.S.A. on cash orders.



NEW ASTROGRAPHS

Brand new Astrographs, complete with plywood compartment case, 14 1/2" x 11" x 10". Ideal for tool kit, camera or utility case. Leather handle, metal corners. Instrument adaptable for titler, contact printer and many useful gadgets. Gov't cost \$300. **\$2.95**
While they last.

For 7 rolls astrograph film, add \$1.50

Order these surplus bargains today. We pay postage on cash tachometer orders. Add postage to other items. 20% dep. on C.O.D.'s

A-10 Bubble SEXTANT

Never before at this price! Complete with hardwood case. Gov't cost. **\$7.95**
\$300. Now..... **\$7.95**

Kohlsman ALTIMETER



Ideal for Auto or Airplane. Used but GUARANTEED accurate. Don't wait. Order NOW! Original gov't cost, \$168. Each **\$10.95**

Semlers' ASSOCIATED SURPLUS Dept. PM-80 5720 WILSHIRE BLVD., LOS ANGELES 36, CALIF.

NEW BAND SAW CUTS METAL, FIBER, PLASTIC FASTER, MORE ACCURATELY AND AT LOWER COST!



NOW every shop can have the advantages of band sawing. Wells new Model 49A is a rugged, horizontal cut-off saw that will do a man sized job. Welded steel frame and tubular base along with

many design features proved in Wells' widely used larger machines make it portable and easy and economical to operate. Automatic shut off at end of cut. Capacity—rectangular, 3½" x 6¾"; rounds, 3½" diameter. Shipped ready to operate complete with heavy-duty 1/6 H.P. Motor.

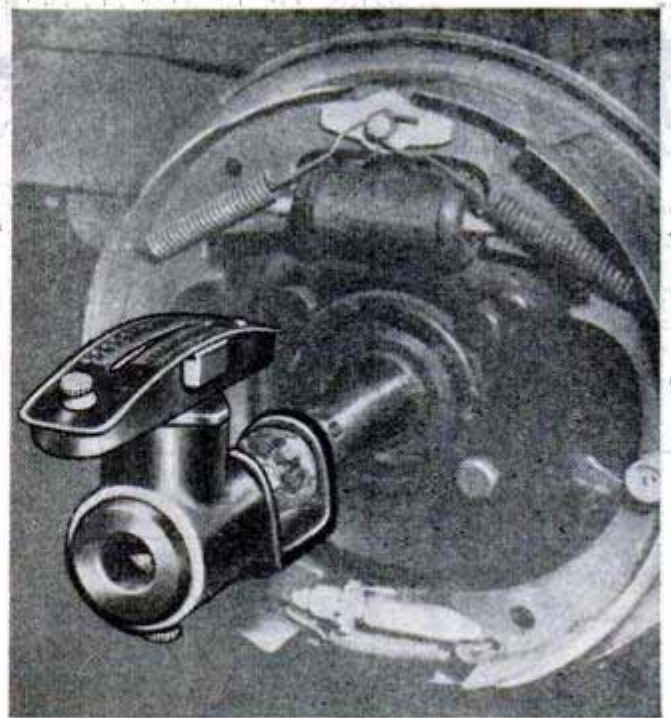

Front-Wheel Gauge

Front-wheel corrections are made quickly and accurately with a precision gauge that checks caster, camber and king-pin angle from the end of the spindle or steering knuckle. It can be used with the front wheels on or off the car. Because it remains in position during adjustments, the gauge provides a continuous check while the work is in progress.

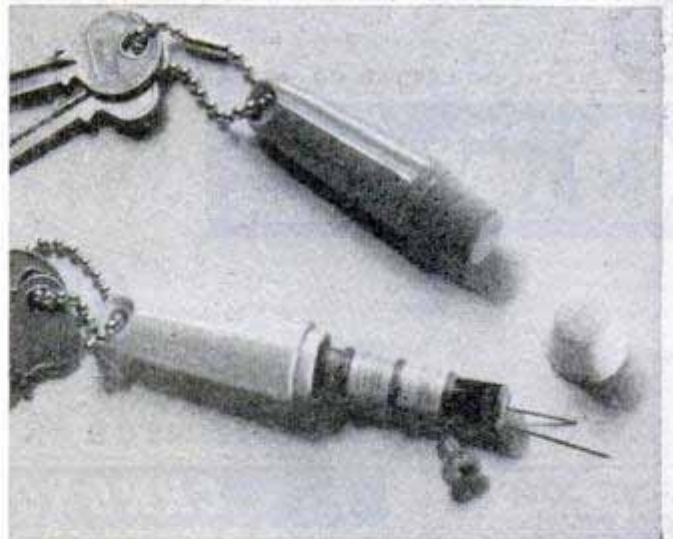

Sewing Kit on Key Chain

Wherever you go, you'll be able to make minor sewing repairs if you carry your keys on a chain that has a complete sewing kit tucked inside its plastic charm. The cap for the cigar-shaped charm is a thimble and inside is a spool unit with four reels for thread. The hollow center of the spool unit provides storage space for the needle supply. Made entirely of plastic, the kit is durable and light in weight.

WELLS MANUFACTURING CORP.
95 Mechanic Road • Three Rivers, Michigan

CHRONOGRAPH WRIST WATCH

\$7.90

Plus Tax

Lifetime Guarantee



(EXCLUSIVE OF PARTS)

3 DIALS—5 HANDS—2 BUTTONS
Multi-purpose watch that measures distance, speed, time, moving objects. Used as Stop Watch or Timepiece. Has Sweep-Second Hand for full 60 Second count. Second Dial records up to 45 minutes. Third Dial then records up to 6 hours. Seconds—Minutes—Hours, all recorded automatically.

INDEPENDENT MOVEMENTS

The movement of this fine Swiss Made watch continues to run when sweep hands are stopped. For sportsmen, professional men and women—time-keeper works when other hands and dials are

stopped—separate movements permit dual use at same time.

RUGGED CONSTRUCTION

Precision workmanship and shock resistant features are added to enhance the value of this watch. Sold elsewhere for as high as \$17.00. Our low introductory price is only \$7.90 plus 10% tax. (Total \$8.69). Send check or money order and we prepay postage. Or sent C.O.D. plus charges. LIMITED STOCK!

MARDO SALES CO., 480 Lexington Ave., Dept. 1714, N.Y. 17, N.Y.

WAR SURPLUS AND OTHER BARGAINS



PNEUMATIC RIVETER & CHIPPING HAMMER

Mfd by Ingersoll-Rand, Chicago Pneumatic and Thor. Pistol grip. Ideal for fender, brake lining, concrete breaking work. Like new. Six rivet sets and bucking bar included, making a complete combination. Wgt. 9 lbs Each **\$6.95**

INSIDE MICROMETER 2" to 8"

Precision made of tool steel. Hardened tips on all six measuring rods. One ½" spacer. Chrome finish. Complete with case. **\$6.95**

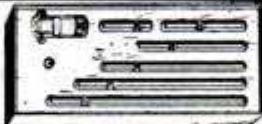

MICROMETERS



Chrome plated, precision engineered and carefully tooled to give long life. All new. 0-1" capacity . . . ea. **\$2.25**. 1-2" cap. **\$3.50**. 2-3" cap. **\$5.50**. 3-4" cap. **\$6.50**.

HIGH SPEED DRILLS

All New. Fractional & numbered. Orig. Val. \$15. Nationally known brand. Astd. sizes. Set 30. **\$3.50**

EXTENSION DRILLS

High Speed Steel, like new. Asst'd sizes from No. ¼ to 40. Lengths from 6" to 12". Approximately \$20 value. Set of 12 **\$3.75**

Send check, money order or cash. 25% deposit required on C O D orders. All prices F O B. Culver City, Calif. Send 25c for Illustrated Catalog.

AIRBORNE SALES CO., INC. DEPT. P.M. 8-0
CULVER CITY, CALIF.

HIGH POWER TELESCOPE

60 POWER - ALUMINUM TUBES - OPENS TO 33"

Variable Power Eyepiece Adjustable to 15X, 30X and 60X. Made in U.S.A.

\$4.50



5 Sections. 4 Ground & Polished Lenses. Also used as 50X Microscope. Ready to use. only \$4.50 POSTPAID. **BROWSCOPE CO.** Dept. 8M, 24 W. 45th St. NEW YORK 19, N. Y.

Use Your Foot to Blow Your Horn with "ADD-A-HORN"

Foot operated horn control, connects to your present horn—Frees both hands for steering—Eliminates hand fumbling while passing or in emergencies, and increases driving safety and pleasure for the family. Quickly and easily installed. COMPLETE INSTRUCTIONS INCLUDED WITH YOUR "ADD-A-HORN" ATTACHMENT. SHIPPED PREPAID ANYWHERE IN THE U.S.A. ONLY. **\$1.00**

"ADD-A-HORN" DIVISION
MECH-TRONICS CORPORATION
2425 N. HALSTED STREET CHICAGO 14, ILLINOIS

WAR BARGAINS
Over 200 terrific
SURPLUS ALSO FACTORY VALUES!
SEND FOR FREE CATALOG
SIoux FALLS SURPLUS STORE
SIoux FALLS, S. DAK.

TREASURE -- \$10,000

New locator detects metals, valuable minerals and buried treasure. Money-back guarantee of superiority.



Also geiger counters. Govt. reward of \$10,000 for uranium discovery. Write for FREE information.

THE GOLDAK COMPANY
1542 W. GLENOAKS BLVD., GLENDALE 1, CALIF.

NEW SAW EASY HANDLING BIG POWER



New American Portable Electric Saw saves time, labor and money in production work. Not a hobby tool. One hand operation. Cuts any angle. 8" blade. Write... give occupation.

AMERICAN

FLOOR SURFACING MACHINE COMPANY
535 So. St. Clair St. Toledo 3, Ohio

TAKE 3-DIMENSIONAL PICTURES WITH YOUR OWN 35 MM CAMERA

NOW ONLY (Outfit No. 101, was \$22.50 plus tax)
STEREO-TACH \$17.70
Plus \$2.09 Fed. Tax

and 3-D slide viewer. Make marvelous color or bl. & w. slides. Get Stereo-Tach from your dealer or direct. Money back guarantee. Dept. PMS, ADVERTISING DISPLAYS, INC., Covington, Ky.



WONDER-PASTE Paint Remover

The modern, easy way to strip paint, varnish, enamel, etc. At paint and hardware stores.

WILSON-IMPERIAL CO., 119 Chestnut St., Newark 5, N. J.

Build your own JET ENGINE!



Order these plans today

1. JET PROPELLED BICYCLE. Assemble your own. Photo and instructions \$1.00.
2. HOW TO MAKE EXPERIMENTAL JET ENGINES. Seven sheets drawings with information and instructions \$2.95.
3. BOTH OF ABOVE in one order \$3.75. SEND NO MONEY. Order both at once \$3.75 C.O.D. in USA plus c.o.d. postage. Send check or Money Order and we pay postage. Get other information too. Rush Order.

J. HOUSTON MAUPIN, Dept. 55, Tipp City, Ohio

CROSLLEY Announces ROLL-DOWN WINDOWS IN NEW SUPER LINE



See the new SUPER line of Crosley cars with deluxe features—Super Station Wagon, Super Sedan Deluxe, and Super Convertible have roll-down windows, new chrome trim, fold-up rear seat, with finer construction, custom details and tailoring, full interior finish. Equally important improvements on the Super Sports model, which includes the features of the famous Crosley Hotshot.



Also see improved Crosley trucks—Pick-up and Panel Delivery. Resident salesmen wanted! Write for details.

FREE! Latest 1950 CROSLLEY CATALOG. Write Crosley Motors, Inc., 2530-HU Spring Grove Ave., Cincinnati 14, Ohio

CROSLLEY
a FINE car

"You see them everywhere"

POWER MOWERS

Only \$69.50 DEALER PRICE

Powerful—Streamlined

Complete with Maytag, Power Products or Briggs-Stratton Engine—18" rotary tool-steel, fully guarded blades—cast aluminum body. Cuts grass and weeds, wet or dry—does all trimming—chops grass into fine mulch, eliminating raking. Send check with order, or specify C.O.D.

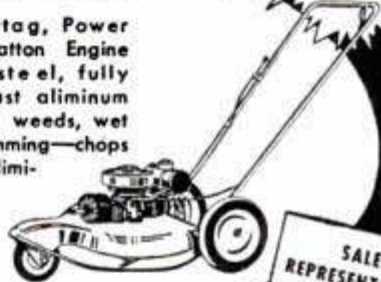

Write for free information

SALES REPRESENTATIVES WANTED

HARTMAN Corp.

1122 SO. KIRKWOOD RD. ST. LOUIS 22, MO.

SAY YOU SAW IT IN POPULAR MECHANICS

Only \$3.49 NOW! For Your Car!

Complete with 8 Foot Cord **LUMINATOR ALL-PURPOSE SPOTLIGHT**

PLUGS INTO CIGARETTE LIGHTER 90,000 BEAM CANDLE POWER!



USE INSIDE OR OUTSIDE CAR

THE IDEAL LIGHT FOR

... locating House Numbers, reading Street Signs, Road Markers. Fog—to follow Curbs. Emergency Warning. Trouble Light, tire repair—motor repair. Back up Light, Map Reading Light, Beach Parties, Picnics, Boats—for Landing, Mooring, Navigating.

LIGHT WHEN and WHERE YOU WANT IT!

A powerful, bright-as-day beam of light right in your hand! Just plug LUMINATOR Portable Spotlight into cigarette lighter socket in your car—and presto!—brilliant portable light for any and every need! Compact... fits in glove compartment. Has genuine G. E. 6 to 8 volt Sealed Beam unit—100 hour life, same as headlights. Handsome polished aluminum. Bakelite handle. Order yours today.

SEND NO MONEY! Mail order. Pay postman only \$3.49, plus few cents postage and C. O. D. on delivery. Or send \$3.49 and we pay postage. Money back in 15 days if not delighted. Act now. **LUMINATOR, Inc., 120 N. Peoria St., Dept. H-10, CHICAGO 80, ILLINOIS**

ELECTRIC SIREN

6 volt. Complete with push button... **\$10.95**

"HOT ROCKET" Illuminated Ornament

Chrome Plated Terrific Value at **\$6.50**

Five Red luminous Plastic fins whirl, looking like jet propulsion in action. 9 inches long, has internal lights. Metal parts are gleaming chrome. Fits all cars.

Illuminated Chrome Plated DELUXE FENDER FINS

Get that Cadillac Look! For 1949-50 Chev., Ford, Pontiac, 1950 Plym., Dodge, Chrysler, DeSoto. R6d reflector lens. Contoured to fit rear fenders perfectly. **PAIR \$9.95**

HOLLYWOOD MUFFLERS

FOR ALL CARS

Gives that Motorboat Tone. Universal type to fit all cars, ca... **\$4.45**

NEW CONVERTIBLE TOPS & REBUILT MOTORS for all Cars. Write for Prices.

Send 25% Cash With Orders, Balance C.O.D.

JUST OUT! Get the largest Auto Accessory & Parts Catalog in the world. Over fifteen thousand items, including Hollywood Accessories, Hi-Speed Equipment, Rebuilt Engines, all parts & accessories for all cars & trucks. We have that Hard-to-Get-Part! Completely illustrated. Jam packed with bargains. Send 25c.

J. C. WHITNEY & CO.

1917GA ARCHER AVE.

CHICAGO 16, ILL.

Sensational

WORLD WAR II SOUVENIR

The Official British Commando Issue
"FAIRBAIRN" FIGHTING KNIFE



BRAND NEW **\$2.95**

postpaid, complete with official sheath

ORDER TODAY!

We have now placed the entire available supply on sale.

Here is another import scoop by R. H. Vazquez & Co. The "Fairbairn" is the actual knife used by British Commandos in hand-to-hand fighting. Made of high quality steel. Blade length 7". Overall length 12". Genuine leather sheath with metal tip, as issued.

Absolutely the most beautiful knife of World War II, a rare and unusual bargain. Knives are brand new with blued finish. Send check or money order. \$2.95 each postpaid. Dealer inquiries invited.

R. H. VAZQUEZ & CO.

DEPT. 8-PM, 972 E. COLORADO BLVD., PASADENA 1, CALIF.

SURPLUS MACHINE SHOP TOOLS

SET 1c 12 Different Size High Speed Morse Taper Shank Drills up to 9/16" with No. 1 and 2 taper. \$40.00 value. Priced at only **\$4.95**

SET 2c 10 Different Size High Speed Morse Taper Shank Drills from 1/2" to 1 1/4". \$90.00 value. Priced at only **\$8.95**

SET 3c 10 Different Size High Speed Morse Taper Shank Drills from 1" to 2" with No. 3, 4 and 5 taper. \$180.00 value. Priced at only **\$39.95**

SET 4c 10 Different Size High Speed Morse Taper Shank Reamers up to 1 1/8". \$50.00 value. Priced at only **\$4.98**

SET 5c 8 Different Size Hand Reamers up to 3/8". Brand New. Priced at only **\$3.75**

SET 6c 8 Different Size High Speed Hand Taps up to 3/8". \$15.00 value. New and slightly used surplus. Priced at only **\$2.00**

All merchandise is sold with a money back guarantee of satisfaction and is shipped postpaid.

T & T TOOL, 101 W. Archer, TULSA, OKLA.

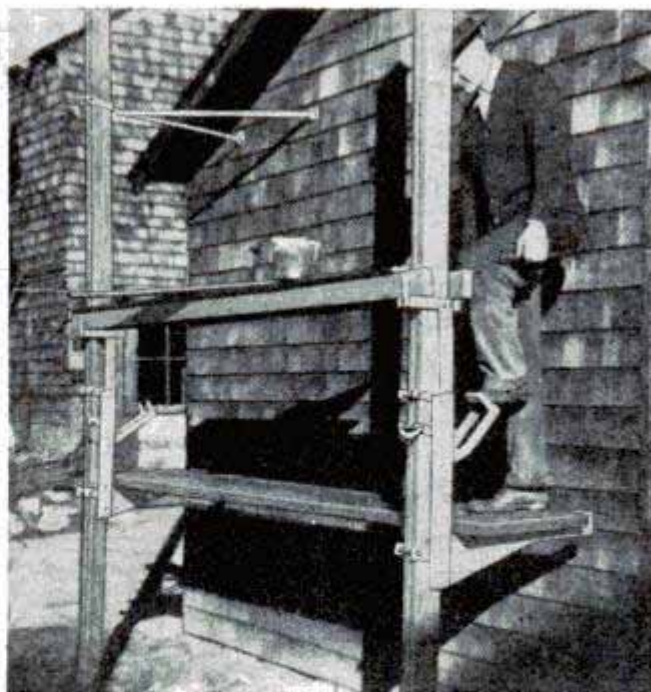
**Scaffold Works Like a Jack**

Workmen using adjustable scaffold brackets can raise the platform to any desired level simply by jacking it up with two foot levers. Safety locks keep the platform secure at any position. It can't slip even under a one-ton load. The scaffold is attached to the building by a pair of horizontal braces at the top of the uprights. There is no other connection with the building, the platform being supported away from the wall. The double guard rail can be used as a workbench simply by nailing a wide plank to it.

Aureomycin Speeds Animal Growth

Aureomycin, the wonder drug so effective against pneumonia, whooping cough and other diseases, speeds the growth of animals up to 50 percent. Drs. E. L. R. Stokstad and T. H. Jukes of Lederle Laboratories recently discovered that the drug is a powerful growth accelerator. Extremely small amounts of the drug, mixed with animal feeds, have produced startling jumps in the weight of pigs, turkeys and chickens. Although aureomycin is expensive in pure form, the scientists discovered that it was just as effective in an unpurified state, and that only .0004 of an ounce added to a pound of feed rapidly added flesh to test animals. Use of the drug with animal feed may decrease meat production costs. Why aureomycin accelerates growth is not yet known, but the scientists suspect that it attacks germs within the body which rob the animal of valuable vitamins. It has been suggested that the drug may stimulate the growth of undernourished and undersized children.

Send 10c Today for Your Copy of New, Mammoth 1951 Catalog of Nearly 8,000 Novelties---Nearly 600 Pages

Collier's, Coronet, New Yorker, Tide Magazine Write About This Amazing "World's Most Unusual" Catalog

More interesting than carnival, world's fair & science exhibit rolled into one. Odd hard-to-get novelties, gifts, funnery from all over world. More fun than reading best selling book. Costs us nearly \$1.00 a copy. You send only 10c for this big 800 page catalog—nothing more to pay or buy. Partial contents:

Accordions	Acres	Alarms	Alibans	Aligators	Alps	Animals, Live	Archery	Artist Supplies	Ash Trays	Astronomy	Atomic Science	Auto Items	Awards	Awls
Admirals	Admirals	Admirals	Admirals	Admirals	Admirals	Admirals	Admirals	Admirals	Admirals	Admirals	Admirals	Admirals	Admirals	Admirals
Admirals	Admirals	Admirals	Admirals	Admirals	Admirals	Admirals	Admirals	Admirals	Admirals	Admirals	Admirals	Admirals	Admirals	Admirals



SEND 10c TODAY WITH YOUR NAME AND COMPLETE ADDRESS—NO LETTER NECESSARY
 Big 800 page catalog of over 7000 novelties, 3500 pictures, 6-color cover, 1/2-inch thick. Send 10c at once—no obligation. (Postage stamps accepted.)
 Rush 10c with name & address today let
JOHNSON SMITH & COMPANY, DEPT. 265, DETROIT 7, MICHIGAN

NEWEST CAR MOP!

—Gives faster and easier wash job. Simply attach nozzle to garden hose—then swab surface with mop head. Extra long (4 ft. 2 in.) RUBBER-COVERED HANDLE will not scratch. No stepladders! No ruined clothes or dispositions! Handle guaranteed. Mop replaceable at small cost. Order today!

Only \$5.00
 Postpaid

BOYSE MFG. CO. 5157 SO. MOODY AVE. CHICAGO 38, ILLINOIS

Rotary drill any masonry CARBOLOY

faster - easier - cleaner - deeper
NO STALLING

Most revolutionary carbide masonry drill ever designed! Unique spiral wire lifts out dust as hole is drilled. Carboloy tip goes through any masonry. Kit C-1/4", 3/8", 1/2" drills in sturdy leather plastic kit, \$5.05, postpaid or C.O.D. Ask your dealer for free circular or write. "Carboloy" and "Live-Spiral" are trademarks of Carboloy Co. Inc.

CARBOLOY COMPANY, INC. 11185 E. 8 Mile Street, Detroit 32, Mich.

HANDY CALCULATOR FOR WOODWORKERS.. ONLY 10c

Just set dial, quickly solves countless problems. Converts linear to board feet, compares workability of various woods, shows bit sizes, nail specifications. Also tool sharpening tips, etc. 6" diameter heavily varnished cardboard. Send 10c to Greenlee Tool Co. 2108 Columbia Av., Rockford, Ill.

New MICROSCOPE 40X - FITS POCKET

Try 5 Days. Full Refund if Not Satisfied

Enlarges area 1600 times. 4 precision lenses. Instant focus. No adjustments. Beautifully satin finished aluminum body. 5" long. An excellent inspection instrument. Perfect wide field. Limited supply. Order direct today.

20X—\$2.98

DU MAURIER CO., Dept. 208, Elmira, N.Y.

STARRETT "Tools and Rules" BOOK

Describes and illustrates the precision methods skilled mechanics use. Only one dime. Write Dept. AP.

THE L. S. STARRETT CO., Athol, Mass., U. S. A.

SAVE 1/3 ON NEW POWERBIKE!

PRESTO — your bike's a speedy POWERBIKE when you install new POWERBIKE unit. Amazing new DIRECT FROM FACTORY PLAN now offers you speedy low cost transportation for only \$18.23 down. Send stamp for FREE PICTURE CATALOG.

SAGINAW PRODUCTS CORP. 108 River St., Saginaw, Mich.

NEW SELF-DRIVE B-M POWER MOWER!

For Modern Lawn Care

Why waste energy pushing a Power Mower when a new self-propelled B-M Mower can be had at our low factory cost? Available in 20" or 22" sizes with 2 or 3 h.p. Clinton engines. Send for our FREE literature showing four models in three sizes including the new direct blade drive with vertical shaft motor. Prompt shipment.

LOW FACTORY PRICE
FULLY GUARANTEED

Write For FREE Literature

MODEL PD1

B-M MOWER CO., Box 66-PM, Blue Mound, Kansas

40 NEW EDITION Power Tools YOU CAN MAKE

40 Power Tools

You Can Make at Little or No Cost

TURN WOOD, SCRAP AND WASTE INTO PRACTICAL POWER SHOP TOOLS

Don't limit your workshop fun to use of hand tools. Get the new edition of "Forty Power Tools You Can Make" with many new tools, and make your own power machines. Step up your fun and production. Do a better job with power tools. Make them yourself from wood and old discarded materials at small cost.

This book gives every detail in plain language you can understand and follow. Hundreds of pictures and plans show every step to follow. Mail coupon with \$.50 today. Even though you have the old edition get this new book with 20 new tools. Money back if not satisfied.

Some of the 40 Tools You Can Make

Table Saw with Tilting Arbor	Wood Lathe
Saw Sander Unit	Power Hacksaw
Drill Press from pipe fittings	Double Duty Sander
Bending Brake	Jig Saws
Thickness Planer	Band Saws
	40 Different Tools in All

POPULAR MECHANICS PRESS, Dept. 4000 200 E. Ontario St., Chicago 11

Send the new edition of "Forty Power Tools You Can Make."
 Remittance for \$1.50 enclosed.

Name _____
 Address _____
 City _____ Zone _____ State _____

LEARN TO BE A



DIAMOND CUTTER

... AND EARN BIG PAY!

ENROLL NOW FOR 58 WEEK COURSE
AT THE ONLY SCHOOL IN AMERICA
TRAINING MEN IN THIS PROFESSION

You can become an expert in this exclusive highly paid profession . . . in only 14½ months! It is a fascinating, highly-skilled field offering lifetime security, high income to qualified people. And there's always a demand for your services.

At STEWART GEM & DIAMOND CUTTING INSTITUTE you learn by doing . . . under the trained eye of craftsmen with 15 to 20 years experience. You get 5 full hours of personal instruction daily in this intensive course. Also night classes for students who must earn money while studying.

Course prepares you for several lucrative fields: Diamond Cutter, Gem Cutter, Stone Buyer, Jewelry Sales, Jewelry Wholesaler and Importer, Jewelry Grader, Jewelry Appraiser.

We are limited to only 415 students. So don't delay . . . WRITE now . . . TODAY . . . for full details. Approved for G.I.'s.

SEND FOR FREE LITERATURE TODAY
STEWART GEM & DIAMOND CUTTING
INSTITUTE

565 MAIN AVE. • PASSAIC, NEW JERSEY



HIGHEST QUALITY TOOLS

For the Homeshop Worker who wants and can afford the best. All DUMORE handgrinders, flexible-shaft tools, duplicating machines, attachments, and accessories are guaranteed to satisfy you or your money back. Write for free illustrated catalog!

The DUMORE COMPANY
Dept. H-51 Racine, Wis.

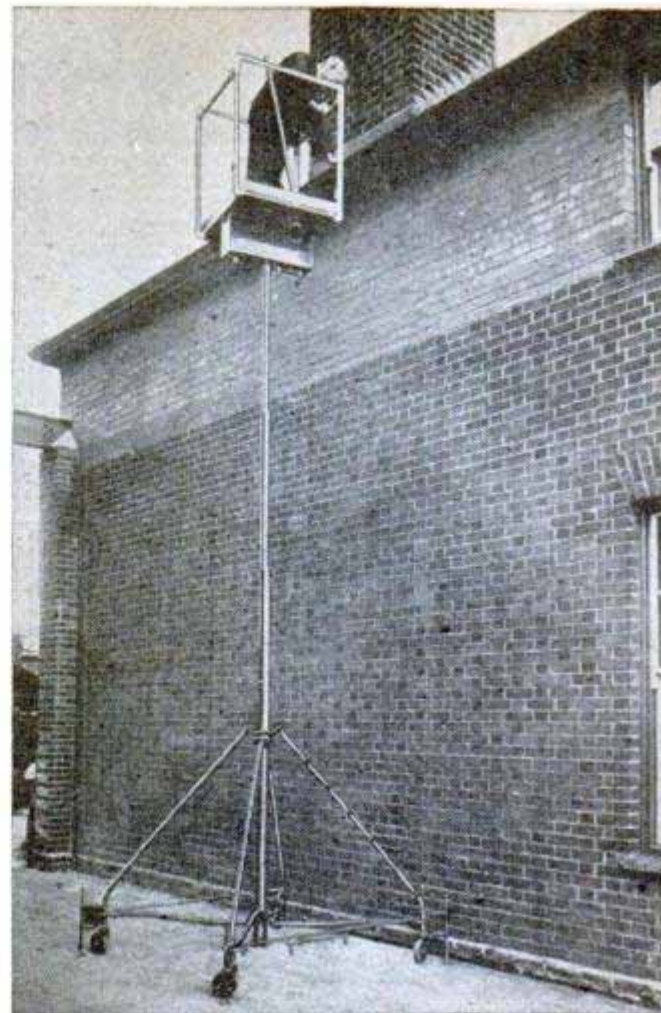

Mechanical "Beanstalk"

Work at a height of 22 feet is easily reached by a mobile hydraulic platform. The user operates a manual hydraulic pump that boosts the tubular-steel platform to its maximum altitude in two minutes. It is lowered by pulling a pressure release. Four screw jacks lift the equipment off its rubber-tired casters and hold it in position during use. The complete unit can be folded to permit passage through a doorway six feet six inches high and less than 2½ feet wide.

Radioactivity Detector

Going the famed Geiger counter one better, an extremely sensitive radioactivity detector not only shows the presence of a radioactive material, but also identifies the material. Called a gamma-ray spectrometer, it has already uncovered previously unknown deposits of uranium in northern Saskatchewan. It uses a crystal of sodium iodide activated by a tiny amount of a radioactive iodine salt. The use of tiny electronic parts, such as those in hearing aids, keeps the weight of the device down to eight pounds. With it, substantial deposits of uranium ore have been detected at distances of several hundred feet.



Handy Flexible SHAFT

Converts any motor, drill press, electric drill, electric fan (10 inch or larger) into a handy rotary tool

Attach ROTA-SHAFT in a jiffy. Use for grinding, polishing, sharpening, cleaning, engraving, making tools, carving on metal, plastic, wood, glass. Convenient handpiece for easy handling . . . with ½ inch Adjustable Chuck. 40-inch overall length. Complete with buff and sanding disc ready to use in a drill press chuck. Order today!

SEND NO MONEY! Mail your order. Pay postman only \$3.95 plus postage on delivery. Try 10 days—if not delighted, return for money-back. For use on motor, add 35c for Special Coupling and give exact size of motor shaft diameter.

STRADER PRODUCTS CO.

DEPT. U-101
259 Strader Ave. Cincinnati 26, Ohio

ONLY
\$3.95

OLD FAN MOTOR



VACUUM CLEANER MOTOR



... speaking of the really hot days in
JUNE, JULY and AUGUST, my home workshop
seems the coolest part of the house



When the temperature is in the 90's, there's nothing like leisure moments spent in a home workshop to take one's mind off the heat—a relaxing hobby is the "key" to hot weather comfort.

Try it, this year—you need not be an expert. As to what to make—there are many interesting and useful projects in the CRAFTSMAN section of every issue of POPULAR MECHANICS.

No home is complete without the constructive economies offered to the whole family by the ownership of tools. The latest, and best available tools are regularly advertised in POPULAR MECHANICS—you can shop for your needs right in the pages of this issue!

Power tools are particularly suitable to hot weather home workshop activity . . . a lathe,

band or bench saw, etc., require practically no physical effort to operate, yet completely occupy hand, eye and—most important—mind.

However, a word to the wise: If you install a workshop, complete with power tools, now—there will be less broiling on the beach, less idle sitting, sweltering, this summer. It will prove difficult to lure you from what seems the coolest place in the house—*your* home workshop!

Jim Ward
CRAFTSMAN EDITOR

P.S. I would be pleased to hear from you as to your experiences with summertime home workshop activity—why not write! Simply mark the envelope: Room 512.

JIM

POPULAR MECHANICS, read by 3,528,000
home workshop fans, **SUMMER** and **WINTER**

200 EAST ONTARIO STREET, CHICAGO 11, ILLINOIS

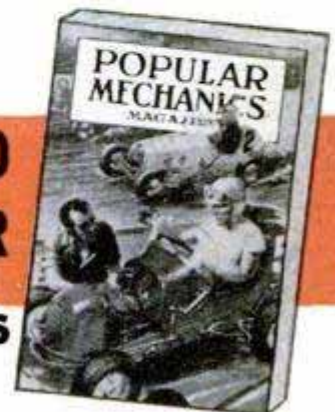

PLYMOUTH SAVE MONEY!

Owners



Learn How to Make Your Car Run Better . . . Last Longer . . . and Save Hundreds of Dollars!

Get this book, written especially for you, without one penny of risk and get more out of your car. Mail coupon for **MANUAL FOR PLYMOUTH OWNERS** today. When the book comes, skip through the pages and see how your investment in one of America's most popular automobiles can be even a better investment than you thought. If you don't agree, send the book back and you'll get your money back.

A Popular Mechanics Book Written Just for You

Not a re-hash of service manuals. A complete new Popular Mechanics book written for the Plymouth owner by an outstanding automotive authority with the full cooperation of Plymouth engineers and service directors. It will save you money on repairs and service; make your Plymouth last longer; give you safe, economical and trouble-free motoring. And this is true whether you take your Plymouth to a regular service station or service it at home.

Prevents Trouble. Cuts Down on Repair Bills

Nothing like this manual anywhere. It covers all phases of operation, service and maintenance. It has entire chapters on the individual parts of your Plymouth—battery, ignition, starter, generator, regulator, lighting, fuel system, engine, lubrication, gasoline qualities, cooling systems, transmission, differential, rear axle, brakes, wheel alignment, tire care, body maintenance, trouble shooting on the road, etc. It covers your Plymouth, new and older models, step by step—bumper to bumper—showing you how parts operate; what can go wrong; how repairs and adjustments should be made and how to avoid all types of troubles.

Money Back if Not Satisfied

Mail the coupon today. Send only \$3.50 or you can pay postman. Money back guarantee protects you.

Official, Authoritative, Practical Information

Written by C. E. Packer, formerly service school instructor and auto show lecturer for automobile manufacturers, Member Society of Automotive Engineers, Editor of Automobile Digest, contributor to leading magazines, author of some of the biggest selling books on Automotive subjects. Prepared with the full authority and active cooperation of the Plymouth Division of the Chrysler Corporation.

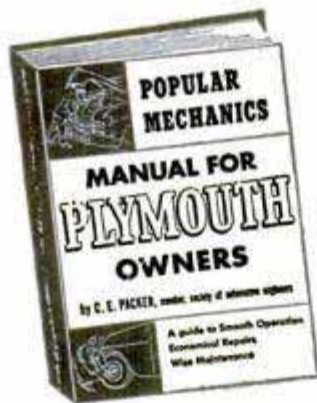

288 Pages. Hundreds of How-To-Do-It Illustrations and Diagrams

The entire book follows Popular Mechanics famous easy-to-read and easy-to-understand style. While primarily intended for the Plymouth owner, to help him get more out of his car at lower cost, it can be worth its weight in gold to the auto mechanic and service station operator who works, not only on Plymouths, but on all other makes as well, to which the information in the book can be easily applied.

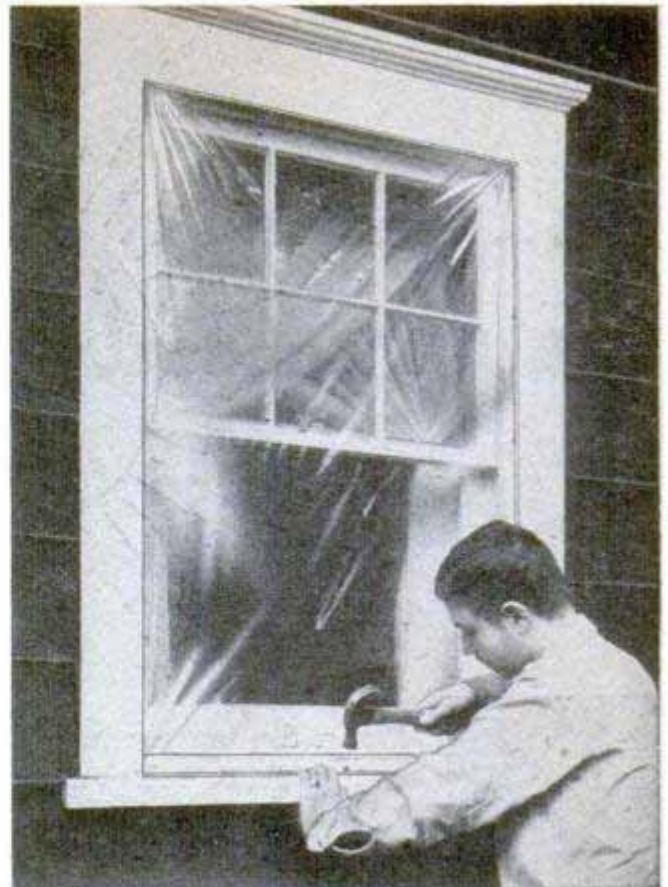

Plastic Storm Windows

Storm windows made of transparent plastic can be installed by the homeowner with a minimum of time and expense. They are sold in a kit which includes a large sheet of plastic, eight framing strips and nails for tacking the material in place. The plastic can be nailed to the front or, for a neater job, to the inside edges of the window casing. By attaching a sheet of it to a screen door, you can quickly convert it into an effective storm door.

Scrap-Iron Concrete

Atomic radiation, a hazard near atomic installations, is stopped more effectively by a mixture of cement, scrap iron and limonite, an iron ore, than by regular concrete mixes. Two scientists at Princeton University have discovered that a three-foot wall of iron and limonite concrete is 280 times as effective as ordinary concrete in stopping neutrons. It also is 20 times as effective against gamma radiation.

Giant-Size Patent

One of the longest patents ever issued in this country consists of 136 sheets of drawings and 188 columns of printed specifications describing a telephone-bill computer. Invented by three Bell Telephone engineers, the computer translates a series of punched holes into a monthly bill.

Order on this Handy Coupon

**POPULAR MECHANICS PRESS, Dept. A
200 E. Ontario St., Chicago 11, Ill.**

Send Manual for Plymouth Owners at once. If not satisfactory I will return it within 5 days and you will refund full purchase price.

Remittance for \$3.50 enclosed. Send C.O.D.

Name _____

Address _____

City _____ State _____

DECORATIVE CHROME STRIPS



For your car, boat, furniture, etc. Highly polished chrome finished strips with clinched edges for flush mounting to any surface. The 3 pound kit provides approx. 15 pieces in lengths from 6 inches to 3 feet and average 3/4 inches wide. Wgt. 4 lbs. No. R224. 3 lb. Assort. only... **\$2.00**

MEDICAL STERILIZER



Consists of alcohol burner and sterilizing tray in hinged metal case 1 1/2 x 1 1/2 x 2 1/2 inches. Burner may be used separately. Bright nickel finish. All brand new. **A125-Ea. 98c**

CLINOMETER



SHOWS DEGREE OF INCLINE
The pendulum acts as a plumb bob. It swings back and forth over a calibrated scale that shows you the degree of incline. Use on ships to show amount of roll—may be used for any purpose where it is desired to determine the degree of incline. Plastic body 1 1/2 x 7 inches. Brass pendulum in black finish. Shipping weight 3 lbs. Stock No. 393. Each only... **\$3.95**



FISHERMAN'S FLY AND BAIT MAKING KIT
Everything you need for making tempting lures and baits. 2 lbs. No. 437. Per Kit... **\$5.00**

WIRE CUTTER

Heavy duty compound leverage. Cuts up to 1/4 inch wire. Upper jaw acts as feeder to cutting edges. Insulated handles. Ideal for farm fence work and shop use. Shp. wgt. 2 lbs. Stock No. 392—Each... **\$1.95**



U.S. WAR SURPLUS AND HUNDREDS OF OTHER BARGAINS



TRAILER UNDER-CARRIAGE

Build your own trailer for boat, camping gear or delivery service. Fitted with 26x2.125 U.S. Royal Tires. Motorcycle type wheels. Solid steel axle, leaf type springs and body mounting brackets. All brand new! Hitch not included. Folds to fit trunk of car. Shipped express collect only. No. 199. **\$18.95**

7 LB. EXPERIMENTERS PARTS ASSORT. KIT



Valuable radio and electronic parts by weight—resistors, trimmers, condensers, capacitors, etc., plus stamped out metal chassis. Shipped in chassis form with parts ready to assemble as needed. Real bargain. Surprise package. No. 130R—7 lbs. **\$1.79**

MESS HALL BENCHES



For picnics, social gatherings, clubs, lodges, etc. Used but perfect. Hardwood top 9 x 72 inches, seats 4 or 5 people. Folding type angle iron legs with metal brace and lock. Best and cheapest seating you ever bought for this money. Weight each 25 lbs. Stock No. 440. Each... **\$2.95**



MCCLELLAN SADDLE

Brand new! Top grade cowhide. 12 inch seat. Hair girth. Has straps for blanket roll and knapsack. Gun boot and sabre loops. Shipping weight 15 lbs. Stock No. A145. Each **\$16.95**

HAND MICROPHONE



Top quality hand microphone with control button in handle. Highly sensitive. Has rubber covered cord and tel. plug. Fine for use on home recorders, public address systems, etc. Slightly used—perfect. Shp. wgt. 2 lbs. Stock No. 170. Each... **\$1.95**



SILVERED OPTICAL PRISMS

Solid glass, with 2 silvered facet precision ground and polished. 1 1/2 inch long base 2 1/2 in. wide, sides 1 1/2 inches. Free from scratches, abrasions and imperfections. Use in any type optical system—photograph, telescopes, etc. Weight each 3/4 lb. A \$2.00 value. Stock No. 556. Each... **\$2.00** Four for **\$5.00**

CAMERA TRIPOD

Purchased from Gov't. Slightly damaged, easily repaired. For cameras up to 6x10 inches. Folds to 32 inches, extends to 58 inches. Needs adapter to mount camera. Wgt. 5 lbs. Stock No. 190, Ea. **\$4.95**

SATCHEL POUCH

Heavy canvas pouch. Ideal for tooling lunches, shopping books, etc. Has 11 1/2 inch pocket. Brand new, guaranteed perfect. Has a oversize flap with single strap fastener. A113—EACH **\$1.69**

G. I. PISTOL BELTS



Of heavy canvas webbing. Adjustable. Selected all around. Used but perfect. Wgt. 2 lbs. No. 131, Each... **98c**



RADIO HEAD-PHONES

Extremely sensitive with 4000 ohms resistance. Brand new and fully guaranteed. With moisture-proof cord and phone plug. A splendid value for the radio serviceman and experimenter. A106—PAIR... **\$2.95**

BAYONET BLADE

Fine forged steel. Ground but not polished. May be made into a throwing or hunting knife or spear. Blade 6 1/2 inches, 1 3/8 inches overall. Will take and hold a fine edge. Shp. wt. 1 lb. No. 564-R—Each... **49c**

BELT AND SHOULDER HOLSTER

Of heavy cowhide. U.S. Gov't. issue. Slightly used but perfect. Specially made when ordering. No. 900—BELT No. 901—SHL'DR. **\$1.95**

ARMY SLIDE RULE



An accurately calibrated slide rule with two extra slides—for quick computation of range for artillery fire. Measures 18 x 3 inches. Provides for wind direction, deflection, trajectory, etc. Shipping weight 2 lbs. No. 544. Each only... **\$2.50**

ALL PURPOSE LIFE PRESERVER BELTS



Brand New! Guaranteed water tight. Use them at the beach on the shore or in the water. Tie together for rafts. Use as canoe stabilizer. Belt consists of two air chambers. Inflate automatically with sparklet cartridges or manually with attached hose. A real bargain at this price. No. 1261. Each... **\$1.00**

HI-PRESSURE TANK WITH OXYGEN GAUGE

A high pressure shatter-proof tank 23x5 1/2 inches complete with demand oxygen mixer gauge. Tank capacity 280 cubic inch rated at 500 pounds square inch pressure. Cost the Government many times this low price. Shp. wgt. 7 lbs. Stock No. 389. Each... **\$4.95**

OXYGEN TANK

Loaded with aviators' breathing oxygen at 1800 lbs. pressure. Tank 13 1/2 x 5 1/2 with rounded ends, brass fittings. Ship express only. Wgt. 13 lbs. No. 390, Each **\$3.50**

Type A2 LEATHER JACKET

The leather coat buy of the year! Brand New Army Air Force Type A2 with full length zipper, shoulder straps, knitted waist band and wrists and full cut-in lining with fur collar—lightest wearing. Order by chest size. Shp. wt. 5 lbs. No. 201—Each **\$19.95**

ELECTRIC MOTOR

Small but powerful. Shaded pole type, designed for fan application. 1 1/2 V. 60 cycle. Has 1/2 inch shaft, one inch long. Operates at 3150 RPM under no load, 2000 RPM under 2.33 oz. inches load. Full load current .6 amp. Mounting bracket included. Ideal for use on toys, window displays, etc. Shp. wgt. 1 1/2 lb. No. 555—Ea. only **\$1.95**



VEEDER COUNTING MACHINE

Counts to 999 and repeats—reset any time. Use for all counting operations. Has 1/8 inch shaft 1/2 inches long. Top measures 1 1/4 x 2 1/2 inches. Shp. wgt. 1 lb. Stock No. 436, Each... **\$1.95**

ORDER DIRECT FROM THIS AD

Values galore! Hundreds of hard-to-find items for home, shop and outdoors. Make remittances by money-order, bank draft or personal check. Send 25% deposit on C.O.D. orders. No C.O.D.'s on orders for less than \$5.00. Include sufficient postage on parcel-post orders—any overage will be promptly refunded. All quotations F.O.B. Chicago. Used items and materials are guaranteed serviceable and as described. Your money back if not more than satisfied.

NEW CATALOG Now Ready—Send 10c To Cover Postage and Mailing

STARK'S

Dept. PM-8
509 S. STATE ST.
CHICAGO 5, ILL.

BRAND NEW B-4 FLIGHT BAGS

A sensational buy—brand new, 1950 models, made to Air Force specifications of rugged, plastic impregnated green fabric—self-proof—waterproof—rip-proof. Bag including pockets measures 24 x 18 x 6 inches. All around zipper opens bag to 3 suit wardrobe hangers included. Big outside pockets with full length zippers. But take years of service. Use it for travel, vacationing, hunting or whatever. It's the way of a lifetime at this special sale price. Shp. wt. 11 lbs. **\$25.00**



Stock No. 438
EACH ONLY **\$25.00**

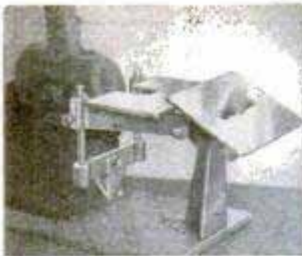

ATTENTION!
CRAFTSMEN!
HOBBYISTS!
 THE SENSATIONAL NEW
MINISAW

Now . . . the only miniature circular saw that actually does many things a big saw can do . . . and more! Most amazing practical home utility and light repair tool you ever saw! 3" circular blade cuts wood, soft metal and plastic up to 1" deep and at any angle up to 45°. Easy to attach. Fits Black & Decker and Skilsaw stands. Complete with attachments and tilting saw table.

\$10.95

Only . . . Complete with saw and sander attachments . . . **\$12.95**

Black & Decker—Skilsaw Dealers—Write for amazing offer. SPECIFY MAKE OF STAND WHEN ORDERING. Send check or Money Order to Dept. E

CLAYTON DIST. & MFG. INC.
 12548 VENTURA BLVD., NO. HOLLYWOOD, CALIFORNIA

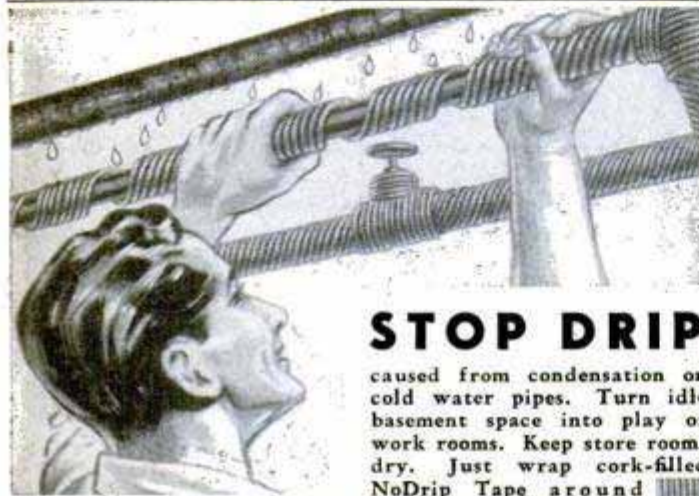

STOP DRIP

caused from condensation on cold water pipes. Turn idle basement space into play or work rooms. Keep store rooms dry. Just wrap cork-filled



NoDrip Tape around pipes and joints. Do it yourself. Clean and easy to apply. Roll covers about 10 feet of 1/2" pipe, \$1.69. Higher west of Rockies and Canada. Get at Hardware, Department Stores, or sent postpaid. Write for free circular. J. W. Mortell Co., 522 Burch St., Kankakee, Ill.



SAY YOU SAW IT IN POPULAR MECHANICS

REMEMBER IT'S DANGEROUS to pay less if you want safe balanced matched tires. Hundreds of thousands of folks in U. S. have sent their money in advance, assured by satisfied friends, that we will never break faith.

GOOD YEAR **Firestone**

GOODRICH, UNITED STATES, GENERAL, FISK, KELLY & OTHERS. Our policy is to select your tires so carefully, as if our very future depended on the service given by that particular tire.

FREE TUBE WITH EVERY TIRE | ORIGINAL GOOD TREAD | NO RECAPS
 JUST SLIGHTLY WORN | NO RETREADS

★★★ Grade. 16 Months Golden Rule Guarantee Bond

600-16 \$4.19	700-15 \$4.50	850-20 \$7.90	32x6(8) \$8.60
650-16 4.65	670-15 4.75	700-20 8.50	32x6(10) 10.75
700-16 5.20	710-15 5.20	750-20 8.60	900-20 13.40
650-15 4.40	550-17 4.65	825-20 14.25	1000-20 14.20

DELUXE GRADE. 26 MONTHS GOLDEN RULE GUARANTEE BOND

THIS GRADE MADE THE BLATT NAME "WORLD FAMOUS". TAKE \$2 OFF THE PRICE OF EACH DELUXE GRADE TIRE, IF YOU DO NOT WISH THE TUBE.

600-16 \$7.35	650-15 \$7.75	MATCHED BALANCED TRUCK TIRES
600-16(6) 7.95	670-15 7.75	600-20 \$10.95
650-16 7.95	700-15 7.95	900-20 \$16.75
700-16 7.95	710-15 7.75	1000-20 17.50
750-16 8.75	760-15 8.35	32x6(8) 12.50
550-16 7.25	820-15 8.00	32x6(10) 13.75
550-17 7.75	475-19 7.45	750-20 13.50
525-18 7.35	550-19 7.95	825-20 17.50
		750-15 11.95

MILITARY Rugged Guar. 45,000 Miles
 ★★★★★ Guar. 30 Mos. (Supers 14 Mos.)

600-16 SUPER \$5.45	750-16 SUPER \$9.75	900-16 SUPER \$7.44
★★★★ 6.45	★★★★ 10.95	★★★★ 9.65
RUGGED 7.45	RUGGED 12.22	RUGGED 10.75



BLATT GIRARD & LANCASTER AVES. SUPPER \$8
 DEPT. PM, PHILA., PENNA. RUGGED \$14
 Send ck. or money order and this ad for rush shipment. We won't ship a tire we wouldn't use ourselves. The name to trust in rubber.

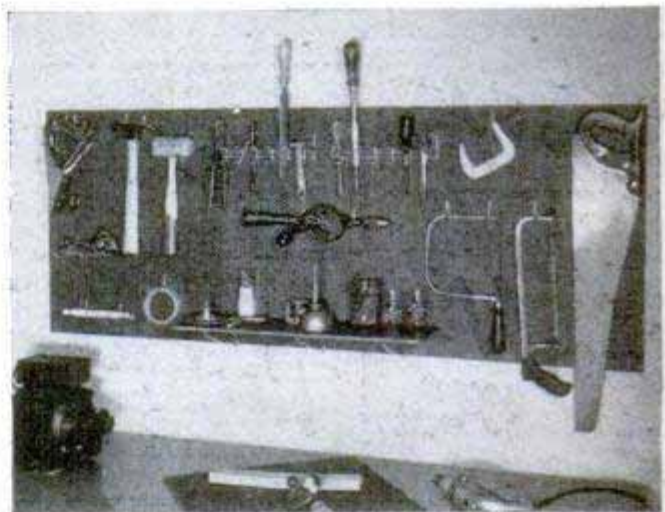
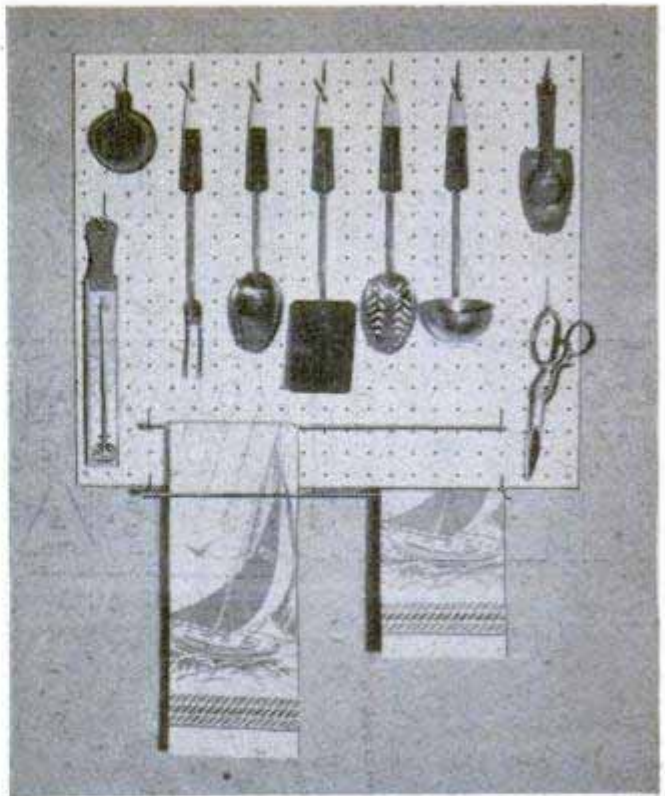

Pegboard

Hooks can be inserted anywhere in a new pegboard to provide a mounting surface for kitchen utensils, tools or clothing. The 20 by 23-inch panel, made of hardboard, is drilled with more than 450 holes. Special hooks and bars can be inserted in any of the holes to make the desired storage pattern. Kits are available for kitchen, workshop or closet use, each containing hardware.

Breathing Water

From experiments with a pressure chamber they devised, two University of Illinois medical professors believe that by breathing water diluted with oxygen man may be able to work safely at any depth to which fish may go. It may help prevent fatal convulsions in deep-sea divers and during future travel in the biosphere.

Make Use of
**POPULAR
MECHANICS
BOOKS**

STREAMLINED HELP



**BETTER JOBS
HOBBIES
AND PASTIMES
HOME AND FARM
WORKSHOPS
HOME REPAIRS-
IMPROVEMENTS**

THE INEXPENSIVE PRACTICAL BOOKS WITH A MILLION READERS!

Want help on your job—extra knowledge that brings extra pay? Want to save money on home repairs? Want practical information to better enjoy hobbies and home and farm workshop projects? Then get a Popular Mechanics Book. These easy-to-use books, written in plain, everyday how-to-do-it English, and extravagant with pictures, plans, diagrams, etc., will give you the practical help you need. Full library size, cloth bound book unless otherwise described. Rush order on coupon today. Money back if not satisfied.



FORTY POWER TOOLS YOU CAN MAKE

Have your own powered workshop at low cost. Tells how to make forty different machines such as lathes, drill press, jig saw, band saw, circular saw, sanders, from pipe fittings, old auto parts, wood, etc. New 1948 edition. \$1.50

POPULAR MECHANICS PHOTO HANDBOOK

An entirely new and different book from our popular Photo Guide. It's a complete guide to better pictures and darkroom technique, and features dozens of handy gadgets you can make yourself. \$2.00

BUILD A BOAT FOR PLEASURE OR PROFIT

How to build 17 low-cost boats at home—power, sail or row boat. Prepared especially for the home builder with limited tools, no experience and little money to spend. Plans, diagrams and illustrations. \$2.00

WHAT TO MAKE FOR CHILDREN

A Popular Mechanics book for Dad, Mother and the whole family. Shows how to make toys, dolls, doll houses, slides, see-saws, rocking horses, furniture. 175 projects to make from discarded or inexpensive materials. \$2.00

THE GARDEN BOOK

How to build your own trellises, fences, lawn furniture, outdoor fireplace, attractive ornaments and other things for your yard and garden. Beautify your grounds—enjoy attractive equipment—at low cost. \$1.50

OUTDOOR SPORTS MANUAL

220 helpful articles and hints for fishermen, hunters, campers, trappers, archers and boatmen. If you love the outdoors, double your enjoyment with the help of this new book. Contains 334 illustrations. \$2.00

WHAT TO MAKE. 11 Volumes



The famous annual craftsman's guide. Shows what to make and how to make hundreds of things in spare time for fun or profit. Novelties, gifts, toys, games, furniture, etc. Cloth bound and filled with instructive pictures. Single volumes, each \$1.75. Save money on 11 volume set, complete, only \$16.50.

POPULAR MECHANICS SHOP NOTES

New 1950 volume. Latest in series of practical and helpful year books for every man who uses tools. Contains 240 pages and 750 illustrations. This book will make money for you and make your job easier. Soil-proof paper cover. \$1.00

POPULAR MECHANICS MOTORIST'S HANDBOOK

For every man who drives a car and wants to do his own servicing and simple repairs. A money-maker for the professional auto repairman. Hundreds of ideas, helps, and kinks you can use every day. \$2.00.

CONCRETE HANDBOOK

How to do all types of concrete work and make ornamental things of cement—walks, driveways, foundations, steps, vases, benches, etc. Ideal book for home owner, handyman and construction men. \$2.00

WELDING, BRAZING AND SOLDERING

How to construct welding equipment and use it effectively—small arc welder, spot welder, arc torch. Best approved methods, tricks and kinks to use in soldering, brazing, heat treating iron and steel. \$1.75



YOUR HOME and HOW TO BUILD IT YOURSELF

Step by step instruction by which anyone with ordinary knowledge of use of hand tools can build a five-room house complete. Every detail is shown in pictures with amazing clarity. Will save hundreds of dollars building any house. Spiral bound. \$3.00. Complete set regular builders plans \$12.50. Book and plans \$14.00.

FARM MANUAL

Hundreds of articles on making farm implements and equipment, maintaining the home, farm workshop, live stock and poultry, many farm hints and kinks. A book for every member of every farm family. 284 pages. Hundreds of illustrations. \$3.00



THE BOY MECHANIC

One of the most popular and best known Popular Mechanics publications. Describes hundreds of things for boys to do and make. Develops natural talents and industry. Crammed with how-to-do-it illustrations. The perfect gift for every boy. \$2.00

PAINTING, FURNITURE FINISHING AND REPAIRING

A book for craftsmen, home owners, shop workers and furniture repairmen and finishers. Covers repairs and finishing, restoring antiques, spray and brush painting of all kinds. An all 'round book for everyone. \$1.50

USE THIS HANDY COUPON • Mail Today

POPULAR MECHANICS PRESS, Dept. 128, 200 E. Ontario St., Chicago 11

Send Popular Mechanics books checked. I will pay postman, plus charges (U.S.A. only). Remittance enclosed—send fully prepaid. I will return books in five days for return of money if not satisfactory. Outside U.S.A. please add 15% for postage and wrapping.

Forty Power Tools . . . \$1.50	What to Make (Children) . . . \$ 2.00	Boy Mechanic \$ 2.00
Painting, Finishing, etc. 1.50	Garden Book 1.50	Concrete Handbook . . . 2.00
Motorist's Handbook . . 2.00	What to Make (1 Vol.) 1.75	Welding, Brazing 1.75
Photo Handbook 2.00	11 Volumes 16.50	Your Home 3.00
Build a Boat 2.00	Shop Notes 1.00	Book with Plans . . . 14.00
Sports Manual 2.00		Farm Manual 3.00

Name _____

Address _____

City _____ State _____

Check for
**FREE
Catalog**



2 DRILLS IN 1

This attachment gives you two drills in one. It converts any 1/4 inch electric drill to 1/2 inch capacity. Reduction gears reduce the drill speed 5 to 1, the average speed of a 1/2 inch drill, and thereby increases the power. Absolutely indispensable for all shop work and home craftsmen. Satisfaction guaranteed. Order yours now.

Send check or Money Order with order. Jobbers write for special information.

\$11.95 post paid

G. M. CO. MANUFACTURING, INC.
1308 43rd AVE. LONG ISLAND CITY 1, NEW YORK

1/3 Usual Price



7x50 BINOCULARS
With COATED LENSES and PRISMS

Precision Optics **\$30***
BRAND NEW

Highest optical performance. Over twice the light transmitting power of any 8x40, 10x50, 7x35 or 6x30, three times that of any 8x30, and eight times that of any 6x15 binocular. Fully corrected, needle sharp achromatic optics with wide angle of view. Lifetime aluminum alloy construction, leather covered.

OUTPERFORMS BINOCULARS COSTING OVER \$100.
DeLuxe Leather Case and Straps \$4.50*

*20% Fed. Tax — Money Back Guarantee — We Pay Postage

BROWSCOPE CO. Dept. 8M, 24 W. 45th St. NEW YORK 19, N.Y.



DIVE FOR EXTRA DOLLARS!

Commercial & Sports Divers, Diving Clubs, Boat Owners & Anchorages, Sea Scout Ships, Marine Research Groups, Others. We have the largest, most complete stock of surplus diving equipment in U.S. — ALL TESTED — EXCELLENT CONDITION.

Send for FREE illustrated catalog, price list, decompression tables & job possibilities.

DIVERS' SUPPLY, Dept. PM-80
1136 WILMINGTON BLVD., WILMINGTON, CALIF.

CARBURETOR TOO RICH MAKES MOTORIST TOO POOR



Car owners who are wasting money and not getting proper gas mileage due to over-rich mixtures will be pleased to learn how to save gasoline by VACU-MATING over-rich mixtures. VACU-MATIC fits all cars, trucks and tractors. It is automatic and operates on the supercharge principle. Easily installed in a few minutes.

SALESMEN WANTED! Big Profits! Send name, address on penny postcard for free particulars and how to get yours for introducing.

VACU-MATIC CO., 7617-1634 W. State St., WAUWATOSA, WIS.



Boat Owners!

TIRED OF PUMPING?

"Little Squirt" Bilge Pump is always on duty. No electricity—entirely automatic. Operates by natural rocking of boat.

PRICE \$22.50 COMPLETE

COLUMBIAN BRONZE CORPORATION
Freeport, L. I., New York

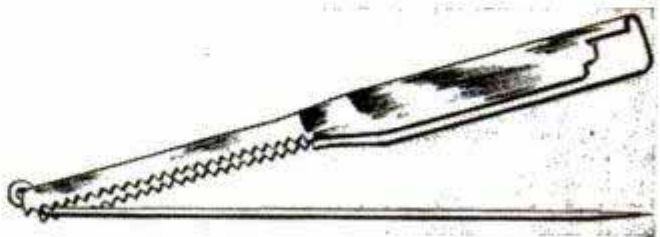
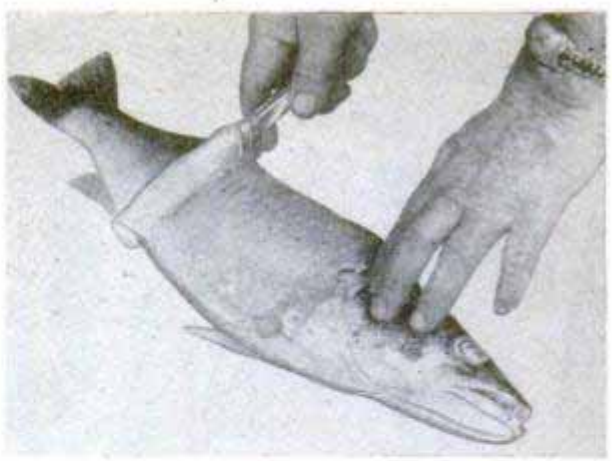

Pocket Tool Scales or Skins Fish

With a new pocket tool, a fisherman can either scale or skin his catch. A point on the tool is slipped under the fish's skin, then doubled back and fastened like a safety pin. When the tool is turned the skin rolls off around it. A serrated edge on the tool can be used to scale the fish if desired.

Pollen Stored in Freezer

Last-year's apple pollen, stored like a frozen vegetable in a home freezer, was used to "father" California apples this spring. Specialists of the U. S. Department of Agriculture conducted the experiment after tests convinced them that long-term storage of frozen apple pollen may be possible. Apple-tree pollen, unlike many other pollens, loses its power to germinate when dried and kept in ordinary cold storage. Storage by freezing, if proved successful this year, will be of great value to apple growers, permitting them to cross late-season apples with varieties which bloom early in the spring.

All-Synthetic Tires

Tires now can be made entirely of synthetic rubber. The all-synthetic tire is made possible through the development of a new type of rubber which builds up very little heat. In the past, synthetic rubber has proved satisfactory for treads and inner tubes, but because it built up heat it was not considered suitable for the tire carcass. The latest synthetic, made through a new process, has approximately the same heat build-up as natural rubber.



SYNGRO
ELECTRIC
**SANDER-POLISHER
and MASSAGER!**
Exclusive Double Arc Motion.
14,400 strokes a minute!
Just guide it. Comparison
it best. With 10 sandpapers,
2 polish pads, cord, plug, \$14.50 at deal-
ers or postpaid from
SYNGRO Corp., Dept. D-80, OXFORD, MICHIGAN

READY!

**SHARPEN CIRCULAR SAWS
LIKE AN EXPERT**

THE SUPER GADGET FOR HOME WORKSHOP
Two simple adjustments. Gets hollow-ground,
cross-cut or combination saw blades true and
sharp. Fits 6" to 12" blades 1/2" to 13/16"
centers. Includes file, complete instructions.
\$6.95 postpaid. (C.O.D. postage extra.) Guar-
anteed—Money back if not satisfied after 10-
day trial. Soon pays for itself. Order today.
Free Folder.
**SURE SHARP MFG. CO., Dept. M-80
P. O. Box 24 Santa Ana, Calif.**

\$6.95

NONE BETTER! SUPER DRILL GRINDER

Sharpens round shank drills from
3/32" to 1/2" in diameter, up to 6"
long. Grinds old drills like new in 4
different point angles, using hand or
power grinding wheels. Money-back
guarantee.

Price only \$2.95
At Dealers or Postpaid
**CRANDALL MFG. CO. 1512 W. Slauson, Dept.
FA-50, Los Angeles 44, Calif.**

make your own Gems 29.50 F.O.B.

All necessary lapidary equipment is furnished,
including a super-charged diamond blade for sawing, and
all wheels for grinding, shaping and polishing; also com-
plete instructions. The complete equipment as shown,
less motor and belt, for only \$29.50.
f.o.b., Burlington, Wisconsin. Write
today for information and literature.

B&I MANUFACTURING CO. Dept. S Burlington, Wis.

COMPLETE FLEXIBLE SHAFT MACHINE only \$16.95

With Pencil-Size Handpiece for
"Finger-Tip" Control

Performs countless tasks quickly, easily! Use
FOREDOMS on wood, metal, glass, plastics, etc.
Provides easy accessibility, unobstructed view.
Grinds, polishes, drills, mills, engraves, sharp-
ens, slots, sands, carves, etc., etc. Complete
\$16.95. No. 50 Accessory Set \$1.50 additional.
Order today. **FREE CATALOG 1132-E.**

FOREDOM ELECTRIC CO., Dept. 1132-E, 27 Park Pl., N. Y. 7

POSTPAID ANYWHERE IN U.S.A.

WE FURNISH ALL MACHINED METAL PARTS, EVERY SCREW,
NUT, BOLT, WASHER, AND COMPLETE PLANS FOR THIS

BIG 10" POWER SAW \$10.95 FULL REFUND IF
LESS GUARD NOT SATISFIED
& WOOD IN 10 DAYS

COMPLETE PLANS 10c
MARCUS-POLLAK
DEPT. N, ROYERSFORD, PA.

ASSEMBLE IT YOURSELF WITH SIMPLE HOUSEHOLD TOOLS!

Clark EXPANSIVE BIT

CUTS BETTER • COSTS LESS! Accurate, fast; cuts
smooth holes in hard or soft wood. Chrome vanadium
steel blades, all chrome body No. 250, 1/2"-1 1/4", \$1.69; No.
251, 3/4"-3" \$1.89 GUARANTEED At your dealer or write
★ **ROBERT H. CLARK COMPANY Beverly Hills, Calif.**

STOP

**PUT HYDRAULIC BRAKES ON YOUR
MODEL A-B OR V-8 FORD!**

Install them yourself with Ansen's complete conversion kit.
All parts and instructions furnished. Price—with exchange on
backer plates and shoes... \$65.00 (F.O.B. Los Angeles, Calif.)
1950 "Insert-type" catalog available. Includes Speed Tuning
Info., Hot Rod and Midget Racing Histories, etc. 35c.

WRITE **ANSEN AUTOMOTIVE ENGINEERING INC.**
3801-PM WEST JEFFERSON • LOS ANGELES 16, CALIFORNIA

**STOP!
LOOK OUT!**

**PROTECT
YOUR
FAMILY**



from intruders with amazing new Dorascope, the device that lets you see who's at your door, without being seen yourself. Unique lens arrangement gives head-to-waist view of caller even when inches from door. Dorascope telescopes to fit any standard door thickness; 3-minute installation. Order white or brown. **\$1.95** postpaid. Money back guarantee.

DEPT. 200, Dorascope, Inc., 15937 Grand River, Detroit 27, Mich.

BUILD AN ARC WELDER FROM OLD GENERATOR

For Light or Heavy Work. 75-200
amps. No previous experience
needed. Complete **PLANS** and
Valuable Catalog 35c.
LEJAY MANUFACTURING CO.
1347 LeJay Bldg., Minneapolis 8, Minn.

SAVE OVER 50%

**ON THESE BRAND NEW
WAR SURPLUS POWER UNITS**

Buy Now and Save!
50 to 75% savings. Don't miss
these sensational buys.

2500 WATT, AC, 115 Volt, 60 Cycle, Single Phase, ENGINE Briggs & Stratton, air cooled, 6 1/2 H.P. GENERATOR: Westinghouse or Le-land, belt drive with guard and Duplex receptacle mounted. NET WEIGHT 310. Gross Shipping Weight 441. Shipping size 36"x19"x26". Included is \$30.00 worth of spare parts and tools. GUARANTEED. WAS FORMERLY PRICED AT APPROX. \$700.00. NOW PRICED FOR YOU AT ONLY \$295.00 NEW.

Recon- ditioned **\$199.95** Generator only. **\$145.00** NEW

5 KW. 120 Volts, 60 Cycle, AC, ENGINE Hercules 4 cycle, Gasoline. GENERATOR: Mfr'd. by Hobart Bros. Unit includes remote control and power cable on reels valued at \$89.00, exhaust pipe, power cable plug, remote control stop-start switch, automatic volt regulator, continuous duty 6.3 KVA at 80% power factor, frequency meter, radio and television filtered. Unit is completely automatic and cannot be damaged by lack of care. Net weight 770 lbs. Shipping weight 1070 lbs. 44" long, 22 1/4" wide, 30" high, 220 volt output can be supplied on all units at a small additional cost. FORMERLY PRICED AT \$1600.00. Guaranteed. NOW PRICED FOR YOU AT ONLY **\$495.00** anted

SALE SPECIALS SPECIAL OFFER TO ANYONE PUR- CHASING EITHER OF THE ABOVE UNITS.

Ball bearing wheels and axle to make unit... **SALE \$10.00**
portable, \$30.00 value.
Transformer to make it 110-220, ... **SALE \$20.00**
\$60.00 value.
50' #12 wire with connectors, ... **SALE \$4.00**
\$28.00 value.
100' #15 wire with connectors, ... **SALE \$5.00**
\$32.00 value.

WRITE FOR FREE CATALOG listing thousands of Surplus bargains.
C & H ELECTRIC CO.
434 W. JUNEAU AVE. MILWAUKEE 3, WISCONSIN

PAY RAISING—EXTRA MONEY BOOKS

Use these books to prepare for a better job—bigger pay—to start a profitable spare time or full time business of your own, improve your home, or start a hobby. Popular Mechanics specializes in supplying outstanding self-help books on many subjects. Send for our FREE catalog.

- Outdoor Sports Manual**
Hunters, Fishermen, Trappers, Campers, Archers, Boatmen, here is your book! . . . \$2.00
- Shop Notes Library**
5 Vols. — 1950, 49, 48, 47, 44 (No Dup. Mat.) . . . \$3.48
- Shop Notes—1950** . . . \$1.00
- Painting, Furniture Finishing and Repairing** . . . \$1.50
- Rewinding and Servicing Electric Motors (No. 75)** . . . \$2.50
- Photo Handbook**
An entirely new and different book from our Popular Photo Guide. It's a complete guide to better pictures and dark-room technique, and features dozens of handy gadgets you can make yourself. . . . \$2.00
- Motor's Truck Repair Manual**
Mechanics, Truck Specialists, Service Stations, Fleet Owners! Here is your book! Covers every job on every truck made since 1936 — 1400 pictures, 652 Pages . . . \$8.00
- Garden Book**
Build own trellises, lawn furniture, fireplaces, ornaments, etc. . . . \$1.50
- Diving, Cutting and Welding in Underwater Salvage Operations.** Only book of its kind . . . \$2.00
- Picture Framing**
Modern methods for making and painting picture frames. Fully illustrated. . . . \$2.75
- Television Servicing** — The basic book for the practical radio man. Covers circuits, instruments and trouble shooting. Price . . . \$4.00
- Bee Keeping for Profit and Pleasure.** Bees pay big profit. \$2.00
- 210 Deluxe Small Homes** \$1.00
- Into the Freezer and Out**
A complete handbook on the home freezing of foods \$2.50
- Concrete Handbook**
New book on using concrete around home, garden, farm . . . \$2.00
- Leather Art** by Baird
Leathercraft is a wonderful hobby whether for pleasure or for pay. Get this beautifully illustrated, clearly detailed book at once. Tells you each step and furnishes actual designs . . . \$3.00
- Welding, Brazing and Soldering**
How to build own equipment and how to use it effectively . . . \$1.75
- Modern Refrigeration**
Electric, Gas. Be service expert . . . \$5.00
- Dyke's Auto Ency.** (includes Diesels, airplane engines). New 20th Ed. World's greatest book for mechanics. . . . \$7.50
- Household Mechanics**
The "fix-it" book to end all "fix-it" books. Covers electric appliances, painting, carpentry, etc. . . . \$2.98
- Oil Burner Handbook** . . . \$2.50
- Build Your Own Boat**
Describes 17 popular boats—rowboats, sailboats, plywood outboard, etc. 192 pgs. \$2.00
- House Wiring (No. 89)** . . . \$2.50
- Turn Scrap Into Money**
Convert old auto generators into motors, welders, etc. . . . \$1.00
- Popular Mechanics Farm Manual**
Packed with practical ideas and usable information that can easily be worth hundreds of dollars to every farm family and to homeowners everywhere. Send for free descriptive folder giving complete contents! . . . \$3.00
- Woodworking for Every-body** . . . \$2.75
- Sheet Metal Work** . . . \$3.00

- Tool and Saw Sharpening (No. 92)** . . . \$2.50
- Forging Practice** . . . \$1.50
- Action Toys (No. 66)**
Plans for 21 easy-to-make toys . . . \$2.50
- Foundry Work** . . . \$2.25
- Pattern Making**
Wood, metal . . . \$2.25
- Forty Power Tools**
Build own saw, drill, lathe, sander, etc., from scraps—save money . . . \$1.50
- Carpentry** . . . \$2.50
- The Young Craftsman**
Over 450 things boys can make . . . \$2.00
- Five Acres and Independence**
How to make money on small farm . . . \$2.50
- Your Home and How to Build It Yourself.** Step-by-step construction of the famous POPULAR MECHANICS house. Wonderfully illustrated. \$3.00
- Drake's Householders Cyclopedic**
This is the time to save money on those necessary home repair jobs—Repairing, Remodeling, Carpentry, Painting, Decorating, Plumbing, Heating, Electric Wiring and Appliance Repairs, Furniture Repairs — This new book covers them all . . . \$5.00
- Motorist's Handbook**
Popular Mechanics scores again. A 160 page guide to automotive happiness . . . \$2.00
- Modern Fruit Production.** Best book on the subject. Everything you need to know about the orchard. Price . . . \$5.00
- What to Make for Children**
Junior tough on toys? Build him playthings that will last. . . . \$2.00
- LeJay Manual of Homemade Electric Equipment.** How to construct 50 items that are scarce and valuable . . . \$1.50
- How to Estimate for the Building Trades:** Material and labor costs for masonry, plumbing, electricity, carpentry, heating, hardware, painting, etc. 629 pages . . . \$5.50
- Rabbits for Food and Fur** \$2.50
- Tool Making** . . . \$4.00
- Tool Design** . . . \$4.50
- Plumbing Installation & Repair** . . . \$2.00
- Ropp's Calculator**
Figuring made easy . . . 75c
- Slide Rule Simplified** . . . \$2.75
- Drake's Refrigeration Service Manual** . . . \$2.00
- Primer for Home Builders**
All the information you need to know in building a house . . . \$2.50
- How to Read Aircraft Blueprints** . . . \$4.40
- America's Best Low Cost Homes**
125 popular practical designs . . . \$1.00
- Toys You Can Make of Wood** . . . \$2.50
- A.B.C. of Poultry Raising** \$2.50
- Ice Cream for Small Plants**
Some technical formulas for ice cream, ices and frozen desserts on a commercial scale . . . \$2.50
- Furniture Joinery** . . . \$2.00
- Essentials of Upholstery** . . . \$3.25
- Radio Physics Course**
A thorough training in radio fundamentals . . . \$5.00
- Lessons in Ornamental Penmanship.** You can easily learn to write beautifully. Delight and amaze your friends with the skill you can acquire by using this book—Only . . . \$1.50

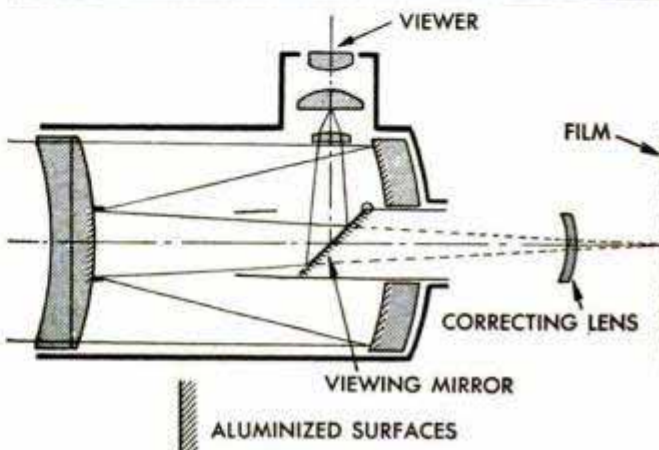
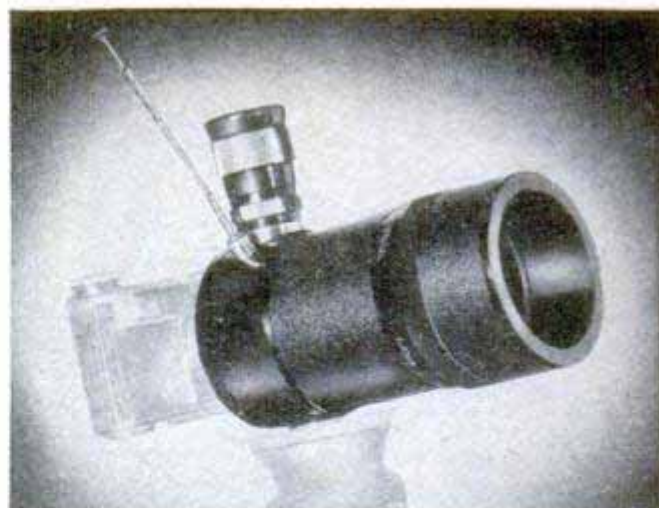

Compact Telephoto Lens "Folds" Light Rays

By "folding" the focal length of an 18-inch telephoto lens three times, a new optical system reduces size and weight to a minimum. Invented by a Dutch physicist, the optical system reflects the light rays with two mirrors, one concave, the other convex, and then passes the beam through a correcting lens. A reflex viewing system is built into the lens so the photographer can see a magnified image of exactly what the film will record. The reflex viewing mirror flips out of the way when the exposure is made. Because of its compactness, the lens, which is available in this country, makes possible hand-held telephoto shots.

Absolute Filter

Dust-free hospitals and laboratories may be possible with a new filter that traps radioactive dusts. The filtering medium is a soft, feltlike paper, containing submicroscopic asbestos fibers which direct the air through such tortuous channels that all the particles become entangled in the fibers. Where present methods of air cleaning will pass 1000 to 3000 particles of the 20,000 present in a cubic inch of ordinary atmosphere, the new filter will leave an average of only a single particle.

MAIL THIS COUPON TODAY

Check the books you want, write your name and address below, and mail this advertisement with money order or check. Outside U. S. A. include 15% additional for shipping charges.

Books selected will be mailed promptly on our "money back if you're not entirely satisfied" guarantee.

Name _____

Address _____

City _____ State _____

Mail to **POPULAR MECHANICS PRESS**
DEPT. 700 — 200 EAST ONTARIO ST., CHICAGO 11, ILL.

FOR BIG MEN ONLY!

SIZES 10 to 16 WIDTHS AAA to EEE

We SPECIALIZE in large sizes only—sizes 10 to 16; widths AAA to EEE. Loafers, Wing Tips, Moccasins, Dress Oxfords, High and Low Work Shoes, House Slippers, Rubbers, Overshoes, Sox. Extra quality at popular prices. Satisfaction guaranteed. Sold by mail only. Write for FREE Catalog.

SEND FOR FREE CATALOG

KING-SIZE, Inc., 978, Brockton, Mass.

WANT \$10,000?

Earn the government Super Sensitive P. R. I. Uranium with a **GEIGER COUNTER** Find gold, silver, and other valuable ores with a P. R. I. Treasure Locator. World's finest instruments. FREE catalog.



Write today.

PRECISION RADIATION INSTRUMENTS, Inc. Dealer Inquiries Invited
5478PM Wilshire Blvd., Los Angeles 36, Cal.

END GENERATOR REGULATOR AND BATTERY TROUBLE!!



REPLACE YOUR CAR VOLTAGE REGULATOR WITH AMAZING WATTAGE EMERGENCY DRIVE REGULATOR BATTERY CHARGING RATE - LOWER FOR SUMMER TO INCREASE OR DOUBLE THE LIFE OF YOUR BATTERY, GENERATOR AND IGNITION - TO KEEP BATTERY AT TOP CAPACITY AND GIVE YOUR CAR THAT TOP NEW CAR PERFORMANCE. - STATE TRUNK AND HOOD OF CAR AND SEND FOR FREE CATALOG AND HOW YOU COULD ENJOY TRAVELING WITHOUT RETURNING TO CLEVELAND 8, OHIO P.O. BOX 2162-Z

SCIENTIFIC ELECTRIC CO. CLEVELAND 8, OHIO

FREE SAMPLES! GLOW IN THE DARK!



BIG PROFITS showing amazing Luminous Specialties—house numbers, pictures, plastic novelties, religious and nursery objects, ash trays, key-holders, etc. Large manufacturer. Enormous demand. Sell on sight, WRITE AT ONCE for FREE samples. Madison Mills, 303 4th Ave., Dept. M-4, New York 10, N.Y.

New Champion ALL METAL Home Electric SPRAY GUN \$9.95 COMPLETE CHAMPION IMPLEMENT CORP., Dept. 2708 45 W. 45th Street, New York 19, N. Y.

DRAINS CELLARS, WASH TRAYS CIRCULATES OIL Pumps 1800 GPH 300 gal. 30' high, use 1/8 to 1/2 HP motor. Will not clog. \$6.50 Postpaid if cash with order. (Add 50c for west of the Mississippi.) Thousands in use since 1936 LABAWCO PUMPS, BELLE MEAD 7, N. J.

GIGANTIC SURPLUS SALE

110-VOLT, AC POWER PLANTS AND HUNDREDS OTHER ITEMS
• Brand new top quality 110-volt, 60-cycle, 2500-watt portable Power Plant. Complete in original crate with full kit of tools and spare parts. (Only 139 units available.)
• Ideal plant for farmers, sportsmen, contractors, etc. Plant will run motors up to 2 h.p. Fully guaranteed to satisfy.
• Order from ad or send today for complete sales catalog. Other "buys" include air compressors, paint spray units, motors, binoculars, electric drills, etc.



Govt. Cost over \$600
\$279.50
Prepaid

BURDEN SALES COMPANY 810 "O" ST. LINCOLN, NEBR.

MILLER ROTARY

1/2" SPEED ROPE-SAW DRILL-BIT
IT SAWS & CUTS REAMS

DRILL PRESS SAW-CUTTING
ELECTRICIAN'S HANDY CUTTER

SAWS, CUTS, REAMS... sheet metal, angle iron, pipe, wood, plastic, Transite, etc. Amazing high-speed combination bit and saw fits any 1/4" or 1/2" electric drill or slow drill press; takes place of up to \$50 in tools. Drills own starting hole to quickly cut, saw or ream opening. Easy to operate. Ideal for carpenters, auto mechanics, electricians, plumbers, hobby workers, many others. Abrasive resistant high speed steel. No breaking. Will withstand severe continuous use. Resharpens at no charge. 1/4" diameter, overall length 3 1/2", cutting section 2" long with flutes ground from solid.

SEND CASH, CHECK OR M.O.
ORDER NOW \$3.95 Postpaid MoneyBack Guarantee

International Twist Drill Corp.
624 Wyandotte, Room 636, Kansas City 6, Missouri

ARC WELDING

FOR PROFIT OR PLEASURE

60 LBS. OF READY MADE PARTS Only \$24.95

BUILD YOUR OWN HEAVY DUTY WELDER SAVE Buy Only NECESSARY PARTS

All necessary parts Ready-Made and easy to assemble. You can do all around welding on steel, cast iron and other metals after only a few hours practice. Illustrated instruction manual included. Sold on 30-Day Money-Back Guarantee!

FREE: Write today for fully illustrated Pamphlet P-8

ATOMIC ARC WELDER CO. 1037 So. 19th St. OMAHA, NEBR.

Gives 100% penetration. Welds are stronger than original metal. Operates on 110 or 220 AC.

SAY YOU SAW IT IN POPULAR MECHANICS

FULLY GUARANTEED TIRES COST LESS!

Nationally famous FIRESTONE, GOODRICH, U.S. ROYAL, GOODYEAR, and other makes. Every tire selected and inspected for your safety.

SALE	Military New Tread Guaranteed 24 mos.		New Tread Tires Guaranteed 24 Months						
	600x16	7.48	600x16(6)	7.95	550x17	6.95	670x15	7.55	
SALE	600x16(6)	8.98	650x16	7.95	650x15	7.55	710x15	8.55	
	750x20	19.98	650x16(6)	9.45	700x15	8.55	760x15	9.55	
SALE	Good Tires. Guaranteed 12 Months. Tube Free with These Tires		PENN'S LARGEST STOCK						
	600x16	3.58	700x16	4.98	32x6(8)	8.98	825x20	11.48	
SALE	650x16	3.78	750x16	6.88	32x6(10)	10.88	900x20	11.78	
	650x15	3.68	650x20	7.58	750x20(8)	8.18	1000x20	12.78	
SALE	700x15	3.88	700x20(R)	8.98	750x20(10)	9.98	1100x20	13.78	
	AAA Premium Grade. Guar. 18 Months. Tube Free with These Tires.								
SALE	600x16	5.18	750x16	7.58	650x20	9.88	825x20	15.68	
	650x16	5.38	600x16(6)	6.48	700x20	10.88	900x20	14.98	
SALE	650x15	5.28	700x15(6)	6.98	32x6(8)	10.48	1000x20	16.48	
	700x15	5.48	700x17(6)	8.88	32x6(10)	12.48	1100x20	17.58	
SALE	700x16	6.18	750x17	10.88	750x20(8)	10.68	1100x22	18.78	
	820x15	6.98	600x20	9.18	750x20(10)	12.88	1400x20	25.98	
SALE	MILITARY SPECIAL		AA GUARANTEED 12 MONTHS						
	900x16	8.58	1000x20	14.98	750x20	8.68	1100x20	16.98	
SALE	900x20	13.98	1000x22	14.98	AAA Guar. 24 Mos.	900x16	10.98	750x20	12.68
	NEW TRACTOR-IMPLEMENT-INDUSTRIAL-SOLID and AIRPLANE TIRES and TUBES—Write for Low Prices								

Largest stock of used tires in the East. Thousands of satisfied customers. Write for sizes not listed.
MONEY ORDER OR CHECK WITH ORDER.

PYRAMID TIRE CO. 1333-35 North 5th St. Dept. M, Phila. 22, Pa.

YOU CAN MAKE THESE WITH POPULAR MECHANICS PLANS AND BLUEPRINTS



- 501—Colonial Grandfather's Clock. 25c
- 507-508—Doll-House, 5-Rooms, Open staircase, fireplace. 50c
- 526—Queen Anne Coffee Table: True replica of antique. 25c
- 528—Duncan Phyfe Console Table: 30 in. high. 25c
- 529—Lawn Chair: Southern style. 25c
- 593—Three Attractive Corner Shelves: Scroll-sawed. 25c
- 596—Three Hanging Type Shelves: Hold books, china, etc. 25c
- 661—Rocking Horse: Scroll-sawed from plywood. 25c
- 707—12 Ft. Rowboat: Flat-bottom, four seats. 25c
- 795—Two Handsome Cedar Chests. 25c
- 811-812—16 Ft. Canoe: Canadian type, cedar planking. 50c
- 813-814—Pops Outboard Racers: 10 ft. long, stepped bottom. 50c
- 828-835—Sovereign of the Seas: English warship model. \$2.00
- Sovereign of the Seas: Instruction Book. \$1.00
- 836—12 in. Bandsaw: Uses plywood, cuts two in. stock. 25c
- 839—Melrose Corner Cabinet: Old Colonial design. 25c
- 846-848—Governor Winthrop Desk: True copy of original. 75c
- 896-897—Three Easily Made Workbenches—Simplified construction. 50c
- 906-909—Midget Auto: 58 in. wheelbase, 1/2 to 3/4 h.p. \$1.00
- 910—Circular Saw Table: Hardwood, 24" x 36", Stationary. 25c
- 917—Outdoor Fireplaces: Several simple but practical. 25c
- 920-922—Lawn and Garden Furniture: Swings, arbors, tree seat. 75c
- 923—Indoor Fireplaces: Standard Sizes. 25c
- 926-927—Venetian Blinds: Three different styles. 50c
- 930—Hooked Rug Frame—Quilting Frame. 25c
- 933—Cape Cod Cupboard: 4 ft. wide, 5 ft. 8 in. high. 25c
- 935—Knee-Hole Desk: 40 in. long, 30 in. high, 31 1/2 in. wide. 25c
- 936—Modern Coffee Table: 24 in. long, 15 in. wide. 25c
- 952—Child's Crib in Maple. 25c
- 958—Colonial Corner Cupboard: 6 ft. 8 in. high. 25c
- 961—Hanging China Cabinet: 38 in. long, 40 in. high. 25c
- 969—Combined Chest and Writing Desk: 35 1/4 in. high. 25c
- 970—Modern Clothes Chest: Built of Plywood. 25c
- 977—Bookcase in Chippendale Style: 47 in. high, 10 in. wide. 25c
- 978—Lawn Chair on Wheels: Lightweight, easy to wheel. 25c
- 981—Colonial Wall-Shelf: 30 in. high, 19 in. wide. 25c
- 984—Duncan-Phyfe Drop-Leaf Table: Reproduction of historic piece. 25c
- 986-987—Utility Trailers: Built of old auto parts. 50c
- 989-990—Speedy Motor Scooter: Gas engine, 40 to 60 miles on gal. of gas. 50c
- 991—Gun Cabinet: Handy cabinet includes rack for rifles. 25c
- 993—Twin-Deck Beds: 6 ft. 4 in. long, 31 1/2 ft. wide. 25c
- 1106-1112—SEACRAFT—25 FT. CABIN CRUISER: Adaptable as sport fisher, express cruiser, or utility boat. Cruises at 15 knots with marine engine of converted auto engine. Cabin sleeps four. Galley has fresh-water tank, sink, and cook stove. Set of seven large-sized blueprints scaled 1 in. per ft. plus 40-page two-color illustrated booklet, only. \$10.00
- 1011—Fireplace Fittings: Andirons, log rack, etc. 25c
- 1080-1081—Banta: 12 Ft. Ply-wood Runabout: Vee-Bottom, 3-passenger. 50c
- 1086—Black Forest Corner Shelf: Scroll-sawed. 25c
- 1089-1090—Home-Constructed Freezing Unit: reaches 30 degree temp. 50c
- 1091-1096—17 ft. trailer, 7 ft. wide. Steel chassis. \$1.50
- 1102-1105—Midget Trailer: "Tear-drop" body. Sleeping quarters for two. \$1.00
- 1113-1114—Gold Rush of '47: The A.M.A. Open Class B Record Holder Plane Model. \$1.00

FILL OUT AND MAIL THIS COUPON NOW

POPULAR MECHANICS CO.
200 E. Ontario St., Chicago 11

Please send the following plans _____

I am enclosing \$ _____

Name _____

Address _____

NEW BATHROOM DEODORIZER

Secret chemical invention automatically banishes unpleasant odors in bathroom, kitchen, anywhere. Gives off refreshing fragrance. Just hang on wall. No liquids, sprays, or wicks. Needs no attention. *Beautifully designed!*

SAMPLES for AGENTS Sample offer sent immediately to all who send name at once. Hurry—postcard will do. **SEND NO MONEY—just your name.**

KRISTEE CO., 673 Bar St., Akron, Ohio

BUILD YOUR OWN FAN

One-piece cast aluminum propellers for cooling and ventilating.

Size	Polished	Unpolished	Bore				
Inches 2 Blade 3 Blade 2 Blade 3 Blade			Inches				
15	\$3.00	\$4.00	\$2.50	3.00	1 1/2	5/8	3/4
18	3.75	4.50	3.00	3.50	1 1/2	5/8	3/4
20	4.00	5.00	3.25	4.00	1 1/2	5/8	3/4
24	4.50	5.50	4.00	4.50	1 1/2	5/8	3/4

Let us give you our prices on your aluminum castings.

Write for pamphlet on larger fan blades, wire guards, fan bases, shutters, pillow blocks, exhaust fan frames, etc. Shipped prepaid if money accompanies order. Dealers write for discount.

KLOPPENBERG ALUMINUM FDY., Dept. PM80, Davenport, Iowa

WAR SURPLUS BARGAIN!

OXYGEN BREATHING SET

Save up to 90%, now \$7.45

Consists of AAF lightweight D2 tank (6"x24") tank, regulator, 0-500# gauge, face mask w/short hose. Unused, net weight under 7 1/2. Only \$7.45. Filled w/oxygen, \$2.00 extra. (Filled sent Express only). Refiller hose, orifice valve (necessary for refilling), \$2.00 Extension hose (6 ft.), mask to tank, \$2.00. Canvas carrying bag for set, 50c. No C.O.D.

AERO PARTS SUPPLY, 8102 Lockheed, PM-6, Houston, Texas

MARCOT KEY MACHINE

Immediate Delivery

MARCOT No. 8 KEY MACHINE, mounted on Cabinet, less motor \$ 95.00
Auto Code Book and Depth Keys. 12.50
100 Dz. Popular Key Blanks. 60.00

Set — Key File, Follow-Through Rods, Lock Picks, Bit Key Gauge, Thimble, Pins, Springs. 10.50
"Locksmith Trade Books" 6.75

How to Open Locks without Keys or Picks; Secret of Locksmithing; How to Make Keys by the Impression Method; Master Key Systems.

TOTAL COST. \$184.75

A. J. MARCOTTE CO., 1200 N. Kedzie Ave., Dept. PM, Chicago 51, Ill.

RETAIL PRICE \$125.00

FACTORY TO YOU \$59.95

SUPERSHOP includes precision-built 8" tilting table saw, vertical and horizontal drill press, 30" lathe, sander, grinder. 100% BALL BEARING. Write for FREE catalog, full details, trial plan.

POWER TOOLS, INC. 114 YATES AVENUE BELLOIT, WIS.

GERSTNER Tool Chests

Gerstner chests are reasonable in price, and offer the utmost in value. Free catalog for machinists and toolmakers.

GERSTNER TOOL CHESTS
450 COLUMBIA ST. DAYTON 7, OHIO

ELECTRIC MOTOR BARGAINS!

1 HP 3450 RPM \$34.50
1/2 HP 1750 RPM \$15 3/4
1/2 HP 3450 RPM \$15 3/4

3/4 HP 1750 RPM \$26
3/4 HP 3450 RPM \$26

Every Motor Fully Guaranteed

Heavy Duty, Repulsion Induction or Capacitor Types, 110-220 Volts, 60-cycle, Single phase. Standard Makes (G.E., Wagner, Leonard, Westinghouse, etc.), Rush your order TODAY—large stock of motors—1 & 3 phase. 32-v. direct current bargains. Prices f.o.b. **ROBERTS ELECTRIC CO., 7322 Madison, Forest Park 22, Ill.**

Enough plans, projects, and ideas for A WHOLE YEAR OF WOODWORKING FUN!

— in the popular hobbyist's magazine **THE DELTAGRAM®**

Send in your subscription! Mail check or money order.

POWER TOOL DIVISION
ROCKWELL MANUFACTURING CO.
802H E. Vienna Ave., Milwaukee 1, Wis.

6 big issues \$1

Save
50% to 75%

LIGHT PLANTS

Brand NEW!
WAR
SURPLUS

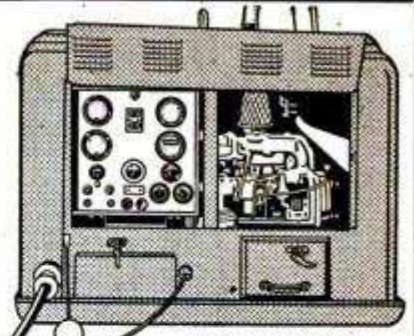
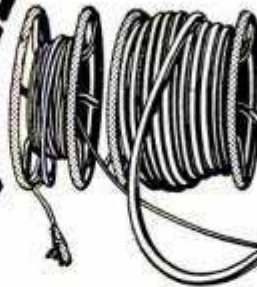
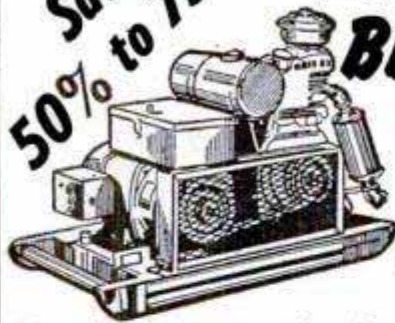

**SIGNAL CORPS
POWER UNIT PE 197**

Model P.E. 197 — LIGHT PLANT

Generator mfrd. by Hobart Bros. 5000 Watts—5 KW. Continuous duty 6.3 K.V.A. at 80% power factor. 110-120 volt—60 cycles A.C. 52 amps. Single phase—remote control stop and start switch. Frequency meter, radio & television filtered. 150 ft. automatic remote control cable on reel; 150 ft. No. 6 heavy duty cable on reel. Power cable plug, flexible exhaust tubing, Delco heavy duty battery. Time clock, complete panel board, automatic volt regulator. Hercules gasoline engine (14 h.p. at 1800 r.p.m.) with radiator. 25% built-in overload. Steel canopy housing—ventilated side panels. Spare parts, tools and instructions included with unit.

Size of unit—46" long, 24" wide, 32" high. Net weight, 875 lbs. Shipp. wt. 1200 lbs. Regular price was \$1600.00. Cables with reels alone were valued at \$400. Now—while our supply lasts—**complete equipment**.....

\$475.00

Sensational money saving buy of war surplus light plants. Indispensable as auxiliary electric generating plant to operate your radio, television, deep freeze and all other electric home utilities and appliances: pumps, power saws, water systems, lights, etc. A valuable addition for farms, homes and shops. Ideal "Stand-By" Unit.

LELAND LIGHT PLANT

110-120 volts, single phase 2500 watt. A.C. 60 cycle with 25% reserve power. ENGINE: Briggs & Stratton. Model ZZ. Air Cooled. 6½ H.P. LELAND GENERATOR. "V" Belt drive with guard, and Duplex Receptacle Plug-in. NET WT. 310 lbs. Shipping Wt. 440 lbs. Brand New! Complete with spare replacement parts, tools, instructions. Fully Guaranteed.

Mfrs. List Price \$700.00
Our Special Bargain Price
Only

\$295.00

"Wellworth" Sensational Offer! Reg. \$60.50 ONLY WESTINGHOUSE AIR COMPRESSOR \$21.50

Model T-1 Brand New — 2 CYLINDER PISTON TYPE. Operates with ½ H.P. Motor or equivalent gas engine.

Compressor, pressure tank, air gauge, air chuck, 20-ft. hose, pop valve, copper tubing with 4 brass flared fittings for connecting compressor to tank, 4-way cross and 3 nipples.

COMPLETE OUTFIT,
wt. 52 lbs.

\$32.50

EQUIPMENT LESS COMPRESSOR, \$2.95 COMPRESSOR SEPARATELY, \$21.50

Compressor has 2" bore, 1½" stroke, ball bearing, 3.27 CFM at 600 R.P.M. Capacity up to 6.54 CFM. Size 9"x11½"x6½". Wt. 26 lbs. Ideal for spraying paints, insecticides, etc., inflating tires, operating air tools and other uses. All new equipment. U.S. government surplus. Replacement parts available. Amazing buy. Don't miss it.

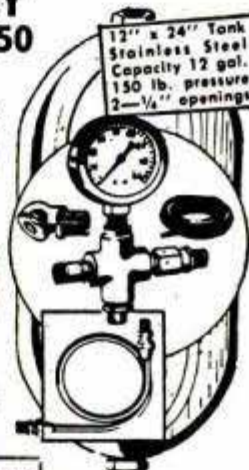
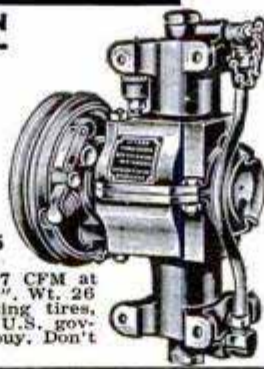

"WELLWORTH" V-BELT CLUTCH



Takes starting load off engines or motors. When speed is reached, a flip of handle shifts clutch from idling to driving position. Handles "A" belts, 2.35" pitch diameter, 5/8" bore. Ideal for use with lawn mowers, garden tractors, home workshop motors, etc. 3¼" long. Safe, easy to mount, sealed bronze bearings, positive action. Shpg. wt. 3 lbs.

\$7.50

Same clutch furnished with ¾" bore.

\$8.50

AIR TANK and ACCESSORIES

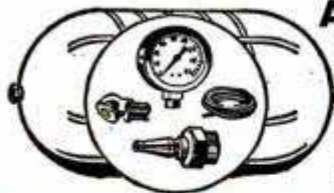

Air receiver, stainless steel, 12"x24". 400 lb. test. Ideal for carrying on trucks, autos and wherever compressed air is needed. Equipped with 500 lb. air gauge, tire chuck, 3 ft. high-test air hose, air inflation valve with core for retaining pressure in tank, and fittings. Two ¼" openings.

Complete outfit with 12"x24" tank, shipp. wt. 20 lbs. **\$6.95**

Tank only **\$4.95**

Same outfit with 6"x24" tank, shipp. wt. 10 lbs. **\$4.95**

Tank only **\$2.95**

Prices f.o.b. Chicago. Money back guarantee. Send check or money order today. Prompt shipment.

68 PAGE BOOKLET! Motor guide, air compressors, blowers, home and factory workshop tools. Also big bargains in luggage. Send 10c for postage.

WELLWORTH TRADING CO. 1831 S. STATE ST., DEPT. D-8, CHICAGO 16, ILL.

SHEET METAL BRAKES

Forms angles, flanges and Pittsburgh locks. 26 gauge steel, heavier aluminum. Cam locking. Portable, can be bolted to bench, or clamped to edge of truck. All steel, reinforced. Shipped Exp. Coll. 30" size. Wt. 42 lbs., \$26.50. 36", Wt. 52 lbs. \$31.00. 48", \$45.00. Floor mountings, portable, 29" high, \$7.00. 12" BRAKE. Fits in vise to form difficult compound bends, up to 20 gauge steel. Not illustrated. **\$12.50 PP.**

18" CURVE FORMER, Capacity 16 gauge steel. **\$10.00**

SHEET METAL PLIERS, 2½" wide, \$2.00; 5" \$2.50. Immediate delivery. Order direct, cash or C.O.D. or send for folder.

WISE BRAKE MFG. CO., P-1116 So. 27th St., Omaha 5, Nebr.

YOUR CAR'S GAS GAUGE IS NO GOOD TO YOU UNLESS...

... unless you care whether or not you are running out of fuel. Neither is a HULL AUTOMOBILE COMPASS of value to you, unless you care which way you are going. See Hull Compasses at your dealer's, or write for circular.

Beaconlite Illuminated **\$5.95** Streamline standard **\$3.95**

HULL MFG. COMPANY, P.O. Box 246-D8, Warren, Ohio



ASSEMBLE YOUR OWN MOWER

\$69.60
F.O.B. WICHITA

SAVE 40%

INCLUDES NEW CLINTON 1.8-2 HP VERTICAL ENGINE AND ALL PARTS

CAST ALUMINUM BASE

This is a modernized streamlined and nicely finished product. Two-tone baked enamel. Full 20" cut, hardened steel, one-piece cutting blade with safety clutch. Ball bearing, large size rubber-tired wheels.

CUTS TALL GRASS

will mow to carpet smoothness tall coarse grass, cuts close to fence.

Price Complete **\$69.60** Satisfaction Guaranteed
Cash With Order or Money Refunded

NEFF EQUIPMENT CO.
400 PETROLEUM BLDG., WICHITA, KAN.



Bet You Don't Know This About Advertising

by Susan



Quiz No. 2

How much does it cost per dozen to advertise the well-known brands of oranges? Is it 2¢? 3¢? 5¢ a dozen?

Answer: It costs less than 1/2¢ a dozen to advertise the big-name brands of oranges.

That's only half the story. Advertising lowers your cost two ways:

Cuts the selling costs. And by helping make mass production possible, lowers the production costs, too.

So advertising saves you many times that 1/2¢ per dozen.

LAWN ORNAMENT-NOVELTY PATTERNS

28 Lawn Ornament Patterns, 25c. Other patterns; 15-20" high; Dutch Girl, Dutch Boy, Pirate, Bull Terrier, Mexican Girl, Mexican Boy, Dwarf, Penguin, Flower Girl, 10c each. 25 Novelty Patterns, 30c. All 62 Full Size Patterns, \$1.00 Postpaid. Strother Pattern Service, Dept. BV-8, Box 128, Belington, W. Va.

BUILD YOUR OWN TRAILER



LINCO Level-Load AXLE

\$34.50

Includes axle hubs & bearings. 1-ton capacity. Shipping weight 105 lbs. Prices f.o.b.

One-piece solid forging steel SAE 1040. Heavy springs coiled around axle cushions shock. Distributes load evenly. No swaying. Safety through even load and low center of gravity. Guaranteed. Write for details of our complete line of axles.

E. B. MORITZ FOUNDRY,
628 E. Wash., Santa Ana, Calif.

Build Your Own Motorized Workshop

This Famous Book Shows How to DO IT!



NEW EDITION



Easy-to-Make 40 Different Power Machines

Make them yourself—lathes, drill presses, sanding machines, shaper, circular, band and scroll saws and other power tools—from wood, pipe, and discarded parts that cost little or nothing. Get the new edition of "Forty Power Tools You Can Make" even though you have the older edition. This new book has 20 new tools. Make yourself up-to-date, efficient power machines that will save you hundreds of dollars. Send \$1.50 with order and save high C. O. D. charges. Your money back if not satisfied.

POPULAR MECHANICS PRESS, 200 E. Ontario St., Chicago 11, Ill.

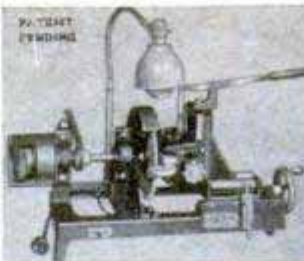

Start a NEW BUSINESS!

or Add to your present Repair Business

SHARPEN DULL PIPE WRENCHES

PIPE TAPS & DIES
"GUM" CIRCULAR SAWS

Write for Information

J. C. MOORE INDUSTRIES
BOX M 276 FREDONIA, PA.

DO MORE PLANING JOBS WITH LOW-COST BELSAW \$195.



AMAZING 12 1/4-IN. PLANER Does All Ordinary Planing Mill Jobs. Provides attachments for Jointing, Rabbeting, Tongue, Groove, Matching. 12 1/4 x 6-in. capacity. 3-knife solid round all-steel cutterhead. Power feeds at 24 feet per minute, 42 cuts per inch. Provides for full line of accessory attachments—Grind and Joint knives in THE CUTTERHEAD WITHOUT REMOVING.

BELSAW MACHINERY CO

81014 Field Bldg., 315 Westport Rd., Kansas City 2, Mo.

FREE BOOK



UP TO 25% MORE MILEAGE ON CARS, TRUCKS & TRACTORS

QUICKER PICK-UP . . . BETTER MILEAGE WITH ECONOMICAL NEW VAPORIZER

Drivers claim up to 25% savings with new water vaporizer operating on fighter plane principle. Eliminates carbon and "pinging". Get faster pick-up, better performance. NOW, for first time, fully automatic unit available at LOW COST! For cars, trucks & tractors. Won't harm engine. Water vapor improves efficiency. Easily installed. Give make, year, no. cylinders of car. ONLY \$5.95 Postpaid. Send Money Order.

AUTOMATIC VAPORIZER MFG. CO.

Box 7033, Station G Los Angeles 37, California

Say You Saw It in POPULAR MECHANICS

MACHINE SHOP EQUIPMENT



The No. 49 edition of the famous Center Tool Co. Catalog is now ready! Every workshop owner should have a copy. 240 pages full of illustrations, descriptions, and prices of the latest tools made by best known manufacturers in U. S. You pay the cost of printing—50c. We refund your 50c with your first order of \$10.00 or more. Prompt delivery on most tools. Send check or money order today!

CENTER TOOL CO.

153 Centre Street, Dept. C, New York 13

NEW! FAN

SIX FEET HIGH
18" BLADES
DISPLACES OVER 3500 CU. FT. AIR

One of the quietest fans ever made—it's constructed to give a lifetime of trouble-free service. G.E. 1/4 H.P. 110 volt 60 cycle 1750 R.P.M. motor. Guard fully encloses blades. 16" base. This new fan is used the year 'round wherever heat and ventilation are a problem. It's completely guaranteed and priced far below any comparable fan. Order today for immediate delivery. C.O.D. If cash with order, we pay postage. **MONEY BACK GUARANTEE**

LOKOMONA COMPANY
P. O. Box 86 — Royal Oak 1, Michigan

ONLY \$39.50

MAGNETS

OF ALL TYPES—10c UP
AMAZINGLY POWERFUL!

4 oz. Alnico Magnet, lifts 10 lbs.
\$1.00. Our Leader, 15 oz. Magnet,
lifts 40 lbs. \$2.50. New alloy—will not
weaken! Useful for lifting valuables from tanks,
lakes, or rivers easily! 7 small magnets \$1.10 with
list of many shop and home uses. Satisfaction guaranteed.

R. EYRICH, 2566 N. 49TH ST., MILWAUKEE 10, WIS.

HELPFUL BOOKS

Send post card asking for FREE catalog

Popular Mechanics Press, 200 E. Ontario, Dept. 601, Chicago 11



1950 Shop Notes Now Ready!

Popular Mechanics SHOP NOTES is always sought after and this year it is better than ever. 240 interest-packed pages for electrician, carpenter, mechanic, painter, auto-worker, welder, farmer, plumber and home craftsman. The 1950 issue contains data on drilling, fenders, batteries, clamps, milling, gauge block, making arc welder, making bandsaw, belt sander, etc. Hundreds of articles—Hundreds of ideas. See your newsdealer or order direct from

POPULAR MECHANICS PRESS — \$1.00
200 East Ontario Street * Chicago 11, Illinois

SAVE UP TO 85%

IN WAR SURPLUS from "GADGETEERS" HEAVEN

92 PAGE CATALOG - War Surplus - tools, machinery, raw materials, clothing, etc. Illustrated with valuable info., tables, charts & data. Send 25¢ to cover handling and postage.

NEW NAVY WADING SUIT

Here's one that will make surf fishing a pleasure. Made of rubberized canvas with vulcanized seams, it keeps you absolutely dry. Has built in rubber gloves and 1/2 length rubber boots. Air tight Buoyancy pockets inside keep you balanced in deep water. Has 100% waterproof liner. Guaranteed condition. **6.95**

AAF CASE

Genuine top grade leather. Multi-compartment. Lock and Straps. Ideal for Artists, Students, Salesmen, etc. Used, good condition. **7.95**

AIR CORPS BRIEF CASE

This is a genuine piece of AAF equipment. Made of best grade Brown Leather in a handsome Pebble finish with a light canvas liner. Has two full length map or paper compartments and three smaller pockets. An ideal case for students, salesmen, artists, etc. Full heavy duty zipper closure. 12" x 16". Shpg. Wt. 3 lbs. ONLY **2.95**

Loose Leaf BINDER

3 metal post. Cylindrical locking heavy duty 3/16" fabricated hinged cover. End identification window. Ideal for price books, salesmen catalogues, photo albums, students, publications, Reference books, etc. Will hold 500 sheets, 8" x 11". **59c ea**

U.S. NAVY INSULATED OFFICER FOOD CONTAINER

Why bother cooking on that triad? This lightweight plastic Thermal Food Container holds enough hot, fresh food for 8 people. Has 2-5 qt. removable Pyrex Baking Dishes for meat, veg. or liquids, 1-9 qt. Plastic container for ice, etc. Each section individual - Case of sturdy plastic with carrying handle. **10.95**

PLEXI DOME

Overall length 21" - Width at widest point 11" - at base 4". 6" deep. For Fish & Flower Bowls - Cab Roof - Lights. **1.89**

GOOSENECK LAMP

Consists of 24 volt control box with dimmer switch, 18" flexible extension & frosted glass shade. Can be used on 110 volt current. **2.49**

NAVIGATORS LAMP

A handy light for desk, work bench, chart table, engine room, etc. Can be used on 6-12-24-110 V by changing bulb. 3 ft. shaft has 4 joints to adjust position. ONLY **\$2.95**

NAVY Sealed Beam LAMP

U.S. Navy Portable Pistol Grip light. Has sealed beam and aiming sight. Ideal for search, spot or Emergency light on auto, boat, farm etc. **2.25**
24 Volt, 4" lens **2.25**
24 Volt, 5" lens & carry case **3.25**
Set of 3 filters, Red, Grn, Amber (specify type lamp) **99¢**

Sleeping Bag



MUMMY BAG

Has outer cover of forest green, water repellent balloon cloth. Filled with 15% Duck Down and 85% Chicken Feathers. 1/2 length zipper. Size 34" x 84". **12.95**

KAPOK BAG

-Here's real warmth and comfort. Has special water-repellent, olive green, heavy duty cover. Filled with 4 lbs. of 100% imported Kapok. Stays soft - will not mat down, 3/4 length zipper. Head flap makes dust cover when rolled. Full length mattress pocket. Size 34" x 77". **13.50**



16 mm MOVIE CAMERA

Has semi-telephoto 1 3/8" (35mm) lens with yellow filter - 3 shutter speeds: for normal (16 frames) semi-slow motion (32 frames) and slow motion (64 frames per second). Uses any standard Eastman film magazine or Type 'G' AAF magazine. Takes Black & White or Full Color pictures. Operates on 24V (dry cell batteries) & requires slight conversion for hand use. Diagram furnished. Cost Gov't \$235.00. NOW **\$24.50**
CONVERTED GUN CAMERA - Fully reconditioned with start switch on front. Choice of finishes - Grey, Black, Blue. **\$33.95**

U.S. AIR CORP RUBBER BOATS



Reconditioned and ready . . . with carrying case. Safe, Lightweight, Easy to Pack and Carry. An Ideal boat for fishing or fun. Also available: filling adaptors for air refills at any gas station. **1.29 ea**

1 MAN with PADDLES **14.95** 4 & 5 MAN **29.95**
Oars **2.95** PR Pump **2.95** ea 7 MAN **42.50**

"MAE WEST" Pneumatic LIFE JACKET

Another necessary item for your summer or fall vacation. These AAF rubber boats have been fully reconditioned and are ready for immediate use. Comes complete with carrying case. Safe and lightweight. For Fishing or Fun. **2.49**



Aviators (AN-6530) Windproof & Dustproof **GENUINE GOGGLES**
Rubber or chamois covered frame. Clear or Green GROUND LENSES are inter-changeable. Adjustable nose bar. Ideal for flying, motor cycling, etc. **1.69**

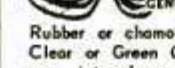

GO-1 GOGGLE KIT
NEW! U.S. Navy - Has soft sponge rubber frame, 4 Polaroid lenses 2 green, 1 red, 1 clear. Perfect for racing, cycling, etc. **89¢**

Genuine ARMY AIR FORCES SUNGLASSES

HERE'S THE REAL McCoy!
ARMY AIR FORCE - 6 base. Precision Polished & Ground Glass-Free caliber lenses. Leather case to be attached to belt. Gold plated adjustable frame. Pearlloid swivel bar and pads. \$17.50 Peilley value for ONLY **3.95**

CAMPING SPECIALS

EISENHOWER JACKETS - Famous for Smart and Rugged wear. Re-issues in excellent condition. **5.95**
ARMY PUP TENTS - 2 Man. Used. Perfect. **5.95**
MESS TRAY - Stainless Steel. **79¢**
HUNTING KNIFE - 6" Blade. With Leather Sheath. **1.69**
BOLO KNIFE - 10" Parkerized blade, with case. **1.19**



NEW WATCH
Has Shock Absorbing jewel movement. Sweep Second Hand, luminous dial, stainless steel case. Guaranteed for 1 year. **6.95**



RADIO HEADSET
Low Impedance. Ideal for amateur radio, crystal sets, or professional use. Adjustable ear phones. Used and in excellent condition. **1.59**



MICROPHONE
Telephone type - Highly Sensitive with excellent, clear tone. This was the Signal Corps favorite. An ideal instrument for the radio "ham" and professional recording studio, broadcasting, home recording, public address, etc. A Sensational Buy! Complete with cord and plug. **2.29**



CLAMP-ON ANYWHERE LAMP With adjustable ball and socket swivel head, long rubber covered cord and wall plug. The All Purpose Lamp. Wonderful for Indoor Photography, Floodlights, Baby Spot or Large Spot, Personal Bed Reading, Workbench, Garage, etc. Lamp Alone **99c**
Highly Polished 9" diameter Parabolic Reflector or 5" diameter Spot Reflector at Only **85c ea.**

DIVING EQUIPMENT

DIVING MASK

Soft rubber mask fits over eyes. Has heavy duty glass eyepiece. Adj. head-band. **1.59** Miss 5" **1.69** M. 5 1/2" **2.95**

SWIM FLIPPERS

Top quality rubber. Has pebble tread bottom. Adj. heel strap. Reinforced for strength. Vented for air & drainage. Ideal for diving and swimming. **5.95** pair

FISHING SPEAR

Corrosion resistant. Ideal for spear fishing. 11' long with barbed end. Dia. of socket 1 1/2". **3.95**

DIVER'S UNIT

Complete with air supply tank, regulator & base. For dives to 25 ft. depth. Holds air supply for approx. 15 min. per dive. **6.95**

G-1 AIR STORAGE TANK

A days supply for diving unit. 12 1/2" x 24". 500 lbs. pressure. **4.75** . . .

AIR HOSE

Used to top G-1 storage tank. To refill DV-1 Diving Unit. **1.59**

AIR CORPS HELMET

Fine grade leather. Chamois lined with chin cup on strap. Intermediate weight. Ideal for summer wear. NEW ONLY **1.59**

16 POCKET VEST

Sturdy, Yet Light Wt. Satin Lined with Tie Straps, 14 Outside Pockets, Plus Knife, gun, or Tool, Leather Holder, 2 large 11" x 8" Pockets Inside. Wonderful Hunting, Fishing, or Mechanic. A Steel **\$2.49**

FOAM RUBBER

Molded & pre-shaped. Can be cut to fit your Chair seat, Boat, Auto, Truck or Trailer Seats. Ideal for all Sports Events.
25" x 65" x 1 1/2" . . . **\$7.45**
25" x 60" x 1 1/2" . . . **\$6.45**
18 1/2" x 20 1/2" x 4 1/2" . . . **\$5.65**
4 1/2" x 18" x 22" . . . **\$5.65**
4" x 20" x 22" x 23" . . . **\$4.95**
4 1/2" x 15" x 16" . . . **\$4.95**

LEATHERETTE

to cover Chairs, Patio Furniture Nooks, Auto Seats, etc. 10 colors at a BARGAIN PRICE.
PRICE (per yard.)
36" Grey, Brown, Black **\$1.19**
36" Lt. Green, Dark Green, Blue . . . **1.65**
54" Red, Grey, Lt. Blue, Ivory, Yellow . . . **1.89**

Name Brand PEASTIC LEATHERETTE

Waterproof, Heat Resistant plastic covering. In Yellow - Chinese Red, Green, Grey, Charhouse, Brown, Yacht Blue, 54" Width. ONLY **1.95** yd.

TANK

Dural with welded seams, 2" filler with cap, two standard pipe parts for hookup. Visible liquid level gauge on side. Ideal for Gas, Oil, Water, or "spare" on auto, tractor, truck or boat. Sturdy, light. Capacity 6 gal. **4.95**

NEW TANK

For Gas, Oil, Water, etc. Seamless, welded tank made of aluminum with filter Screen and Pack. Has stick level gauge. 19 gal. capacity. **6.95**

PALLEY SUPPLY CO

6321 SAN FERNANDO RD. Dept. PMB GLENDALE 1, CALIF.

LARGEST FIRM OF ITS TYPE IN THE WORLD

NOW READY! A Sensational New Line Of 1951 MIDWEST TELEVISION

CONSOLES and COMPLETE
CHASSIS Featuring
The New MAMMOTH
19 1/2-Inch
BLACK PICTURE TUBE
At Low Factory Prices

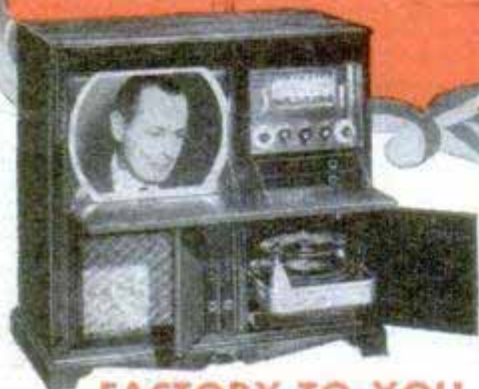

FACTORY-TO-YOU

Never before have you seen such tremendously BIG, clear pictures, such luxurious cabinets, such sensationally low Factory Prices as Midwest offers in its 31st Anniversary Line of 19 1/2" and 16 1/2" TV Consoles, TV-Radio-Phono combinations, and complete TV Chassis. Features include: Mammoth 19 1/2-Inch Picture Tubes (225 sq. in. image); 16 1/2-Inch Picture Tubes (151 sq. in. image); Video-Sonic Tuner; big 12" Panasonic Speaker; Simplified One-Knob Tuning; Synchronized Sound and Picture, and many other outstanding features.

FACTORY AUTHORIZED SERVICE AVAILABLE IN TELEVISION AREAS

\$44.95 Will Put This Luxurious
**NEW 1951 MIDWEST VIDEO
GRAND 19 1/2" TELEVISION**
Console with AM-FM Radio and New 3-Speed Automatic
Intermix Phonograph In Your Own Home On 30 DAYS TRIAL.
You Must Be Satisfied or YOUR MONEY BACK

MIDWEST Offers A Complete Line Of 19 1/2-Inch and 16 1/2-Inch TELEVISION Models



MIDWEST "CONSTELLATION" TELEVISION CONSOLE with GIANT 16 1/2-Inch PICTURE

Another sensational Midwest Television value! A powerful BIG-PICTURE receiver in a strikingly beautiful Console Cabinet, provides 151 square inches of bright, clear, steady picture.

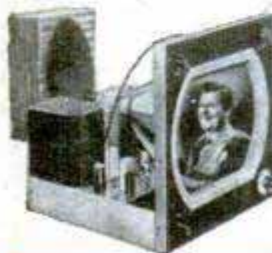

COMPLETE 16 1/2-Inch TELEVISION CHASSIS

Ready for custom installation in your own cabinet. Just plug in, hear and view.

"CONSTELLATION" 19 1/2-Inch Picture Tube TELEVISION CONSOLE

The most sensational buy on the market today. Only \$29.99 will put this mammoth 225 square-inch picture TV Console in your home on 30 Days Trial.



"VIDEO GRAND" TELEVISION-RADIO- PHONOGRAPH with GIANT 16 1/2-Inch Picture Tube

A magnificent combination offering 151 square-inch picture, AM-FM Radio and 3-Speed Automatic Intermix Phonograph.

Complete 19 1/2-Inch TELEVISION CHASSIS

Ready For Custom Installation In Your Own Cabinet. Just plug in, hear and view.

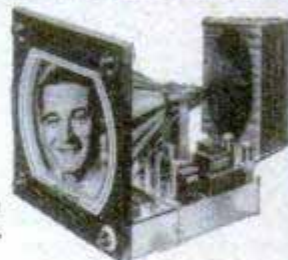

...and TELEVISION Adapter CONSOLES and CHASSIS for Use with MIDWEST RADIOS

These units operate only in conjunction with the Television Audio Switch-Over of the 1948, 1949, 1950, and 1951 model Midwest Radios.

Get MORE For Your RADIO and TELEVISION DOLLAR... BUY DIRECT From

... Also Powerful New World-Ranging 5-Band

1951 MIDWEST Series 16 RADIOS

In Beautiful Consoles
and Complete Chassis
FACTORY-TO-YOU



**EASY
TERMS**



**30 DAYS
TRIAL**

Again, as for the past 31 years, Midwest brings you the absolute tops in radio engineering and performance in its new 1951 Radio Line featuring the magnificent SYMPHONY GRAND Radio-Phonograph Combination with the powerful 5 Wave Band Series 16 AM-FM Radio Chassis and the 3-Speed Automatic Intermix Phonograph that plays all makes of records.

Read What These Satisfied MIDWEST Owners Say:

"My Midwest Television Tops Them All"



Chicago, Ill.—I have given my new Midwest Video-Grand Television-Radio Combination a thorough test and it has come through with flying colors. From the rich looking cabinet, the excellent AM and FM radio reception, to the perfect television picture. My Midwest tops them all. We are proud to own a Midwest Television.

Eric A. Kroehner
2123 N. St. Louis Ave.

"Better Than Sets Costing Twice As Much"

St. Albans, N.Y.—Our friends criticized us for ordering a Midwest Television by mail but when they saw our Video Grand they gasped in amazement at its perfection of tone and fine clear pictures. They tell us now that our Midwest is better than sets costing twice as much.

Frederick J. Willis
114-17—211 St.

"Amazed At The Precision Picture Control"



Santa Ana, Calif.—I wish to take this opportunity to heartily recommend the Midwest "Constellation" Television receiver which I purchased from you. My friends who see my Midwest Television are amazed at the precision picture control it provides. They are even more surprised at the price, which they usually guess is double the amount I paid.

L. C. Bullock
822 Cypress St.

"Midwest Is The Most In Radio For The Least Price"

Springfield, Mass.—To your potential customer I say this: Ask the man who owns one—and I'll answer for every Midwest Radio owner that Midwest is the most in radio for the least price.

Roy J. Harrington
104 Shattuck St.

"The Most Wonderful Tone You Could Ask For"

Detroit, Mich.—I am very well satisfied with my Midwest Symphony Grand Radio-Phonograph that I purchased from your factory more than a year ago. It has the most wonderful tone you could ask for and all my friends envy me for having such a wonderful set.

Donald Pfeiffer
6219 Baldwin Ave.

"Brings In London, England, Easily"

Hot Springs, Ark.—I received my new Midwest Series 16 Radio and I am certainly well pleased with it. It brings in London, England, easily as well as Canadian and other faraway stations. I have other different makes but my Midwest is the best of all. Thanks for making such good radios.

W. M. Swoyer
Crystal Route 270

\$24⁰⁰

Will Put This Beautiful
1951 SYMPHONY GRAND
Radio-Phonograph In Your Own Home
On 30 DAYS TRIAL

\$10⁹⁵
DOWN

**MIDWEST
SERIES 16
5 WAVE
BAND
RADIO CHASSIS**



—the same as is used in the SYMPHONY GRAND Combination, is also available for custom installation in your own cabinet. Low Factory Price... 30 Days Trial.

• WRITE IN NAME AND ADDRESS (PLEASE PRINT) ON COUPON OR 1c POSTCARD •

MIDWEST RADIO & TELEVISION CORP.
Dept. 25A, 909 BROADWAY • CINCINNATI 2, OHIO

Please send me your new FREE 1951 Catalog.

NAME _____
ADDRESS _____
CITY _____ ZONE _____ STATE _____

SEND COUPON TODAY
For This NEW 1951
4 COLOR

Free MIDWEST
RADIO & TELEVISION
CATALOG



MIDWEST RADIO & TELEVISION CORP.
DEPT. 25A, 909 BROADWAY, CINCINNATI 2, OHIO

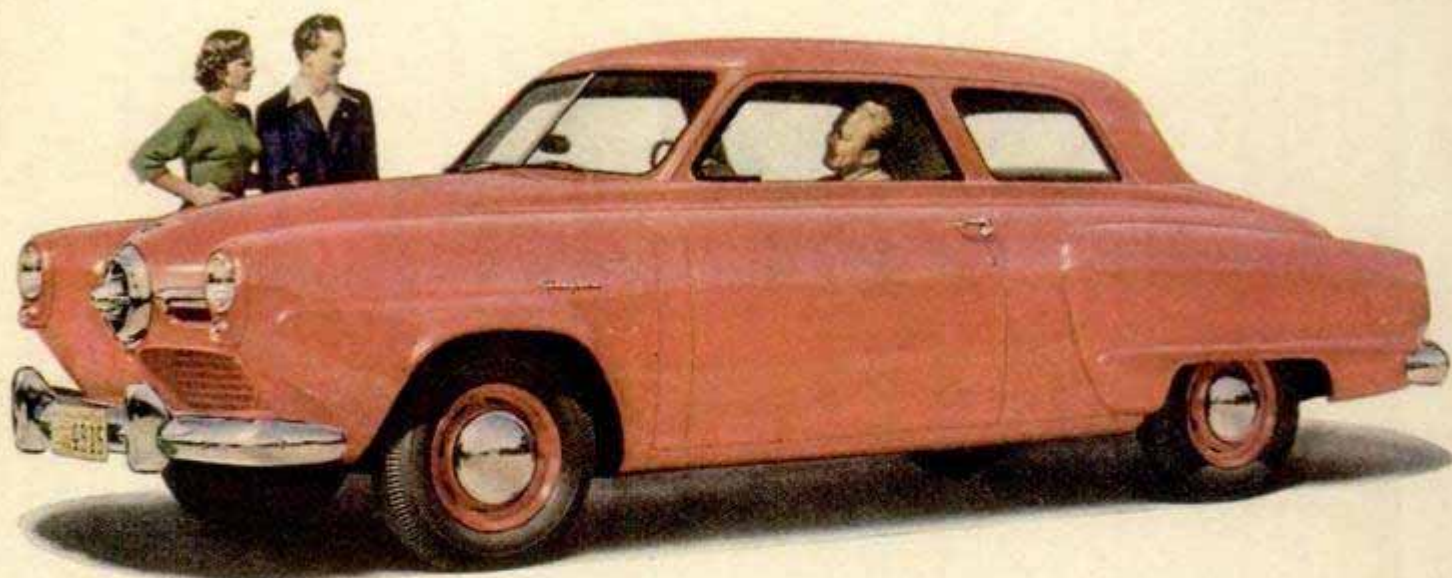

Smart buyers of lowest price cars say...

**NOW 4 TO SEE
INSTEAD OF 3**

**The Studebaker Champion
is one of the 4 lowest price
largest selling cars
in America!**

\$1487⁵⁰

Studebaker
Champion
Custom 6-pass.
2-door sedan
as shown

This is the South Bend
delivered price and includes
Federal Tax

It does not include
transportation from
South Bend, or state and
local taxes, if any

Prices subject to change
without notice