



POPULAR MECHANICS

MAGAZINE

WRITTEN SO YOU CAN



See Page 73

MAKE YOUR OWN BEACH EQUIPMENT

Featured in the Craftsman Section—page 166

BE A CHAMPION DRIVER

LEARN THE "SIGN LANGUAGE" OF THE HIGHWAY!

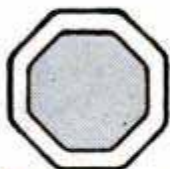

1. The meaning of a highway sign is generally indicated by its shape. The octagonal sign means STOP.



2. A round sign indicates a RAILROAD CROSSING and warns you to approach it with caution.



3. A diamond shaped sign tells you to SLOW DOWN—indicating a dangerous curve, hill, or similar hazard.

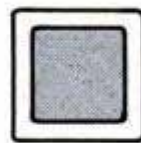

4. A square sign normally indicates SCHOOL ZONE or other areas involving hazards to pedestrians.

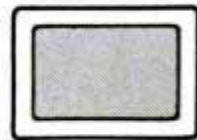

5. A rectangular sign gives TRAFFIC DIRECTIONS—Keep To Right, No Left Turn, No Parking, etc.

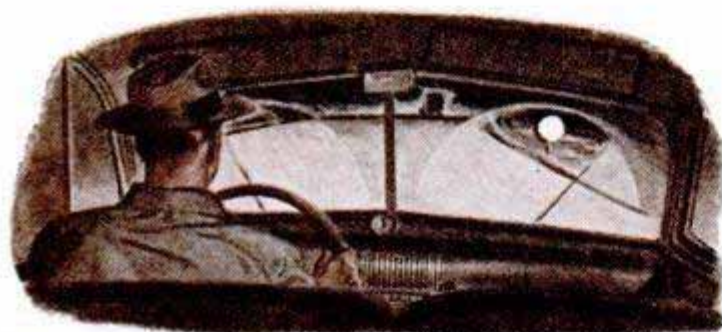

On a dark, rainy night like this, the shape of the sign ahead tells this driver that a railroad crossing lies ahead. It alerts him in time and warns him to **approach it with caution.**



Because children are inclined to be heedless, drivers should be particularly watchful for signs indicating school zones. Caution and courtesy distinguish **the Champion driver.**

A Champion driver is attentive to little things that pay big dividends in the pleasure, security, economy and dependability that you derive from your car. Spark plugs contribute largely to these dividends. Check them at regular intervals and replace them every 10,000 miles. They quickly pay for themselves. The great majority of champion drivers prefer and use Champions—the spark plugs champions use.

... BE A CHAMPION DRIVER—IT PAYS!

FOLLOW THE EXPERTS—

Demand



"I used the same identical set of Champion Spark Plugs in winning four major speedboat events last year, including the international Harmsworth race."

—R. Stanley Dollar



CHAMPION SPARK PLUG COMPANY, TOLEDO 1, OHIO

Listen to the CHAMPION ROLL CALL... Harry Wismer's fast sportscast every Friday night, over the ABC network

How RIVETLESS LININGS

Improve Braking, Cut Costs

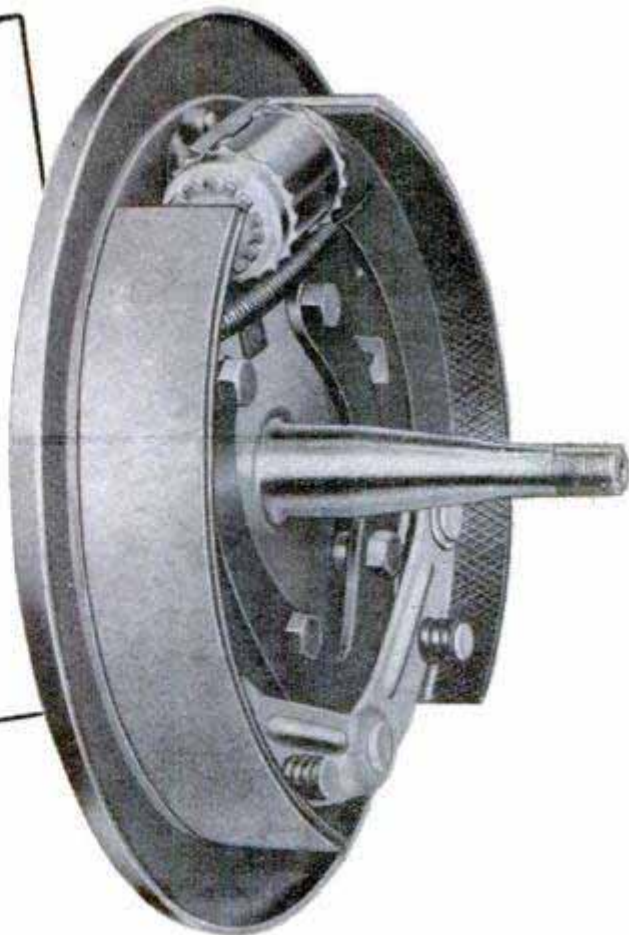

CHEVROLET'S Perma-Bond Dobl-Life brake linings, adopted a year ago, have proved their superiority in actual service on more than 1,000,000 passenger cars. They not only improve the braking, but also save money for the car owners.

Because the brake lining is bonded to the shoe, there are no rivets . . . and that means that rivet squeals

There are no rivet holes through the lining to collect damaging grit . . . and no rivets to prevent using practically the full thickness of the lining.

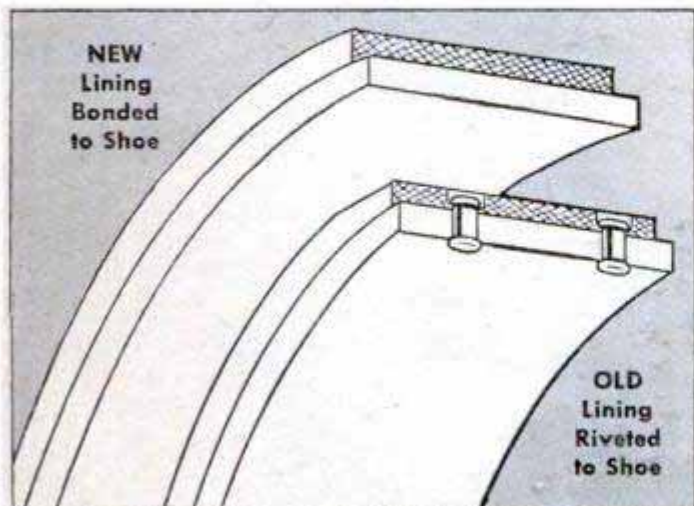

and rivet-scored drums are things of the past. Brakes formerly had to be relined as soon as the linings wore down to the rivets; now, with bonded linings, virtually the entire thickness of the linings can be used.

Bonded linings cut motoring costs two ways. They eliminate the expense of repairing rivet-scored drums . . . and they last about twice as long as the riveted linings. Perma-Bond rivetless brake linings are only one of the many quality features that make Chevrolet **FIRST . . . and Finest . . .** at Lowest Cost!

Your Chevrolet dealer invites you to see the new 1950 models at his showroom.



CHEVROLET MOTOR DIVISION, General Motors Corporation, DETROIT 2, MICHIGAN

This One



JUNE 1950

Look What I'm Learning

—AND EARNING, TOO,
IN A U. S. ARMY
SPECIALIST SCHOOL



Choose Your Own Course to Train for a Career with a Future

Look over these Army Specialist Training courses with your own future in mind. Under the new U. S. Army Career Plan you can discover your best abilities, earn while you learn, and prepare yourself for a satisfying career in a field you are suited for. Opportunity for advancement, earnings you can bank, a secure and congenial way of life—all can be yours in today's Army. Get details at your nearest Recruiting Station.

HERE ARE SOME OF THE COURSES AVAILABLE:

AUTOMOTIVE MAINTENANCE
MEDICAL EQUIPMENT
REPAIRMAN

LOCOMOTIVE REPAIRMAN
CONSTRUCTION EQUIPMENT
MECHANIC

OFFICE MACHINE SERVICE MAN
MARINE ENGINE MECHANIC
ELECTRICIAN

WATER SUPPLY TECHNICIAN
TIRE REBUILDER

CONSTRUCTION MACHINE
OPERATOR

TELEPHONE AND TELEGRAPH
INSTALLER REPAIRMAN

TELETYPE REPAIRMAN

SURGICAL TECHNICIAN

MAP REPRODUCTION

WATCH REPAIRMAN

FIRE CONTROL INSTRUMENT
REPAIRMAN

LEADERSHIP COURSE

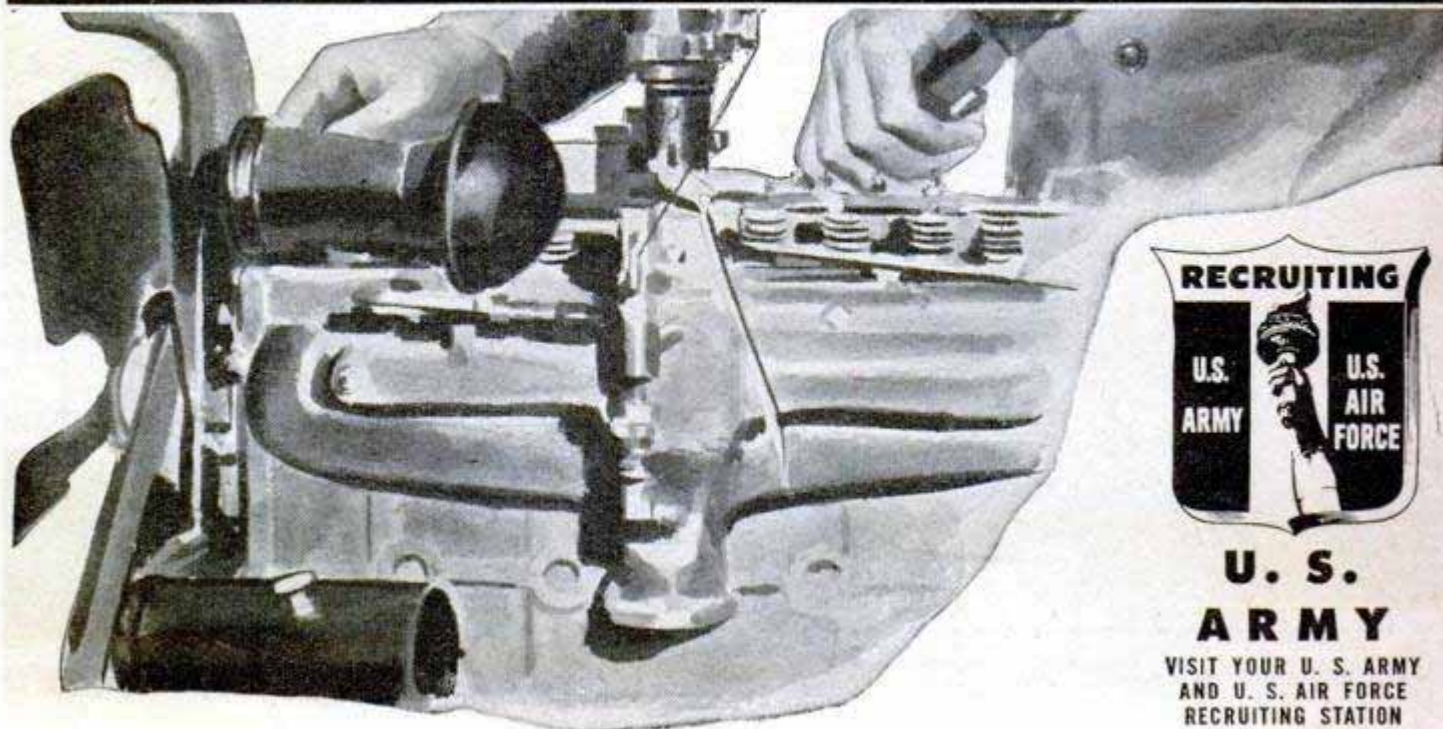

**U. S.
ARMY**

VISIT YOUR U. S. ARMY
AND U. S. AIR FORCE
RECRUITING STATION

Popular Mechanics Magazine

Registered in U. S. Patent Office and Canada

H. H. WINDSOR, Founder

H. H. WINDSOR, JR., Editor and Publisher

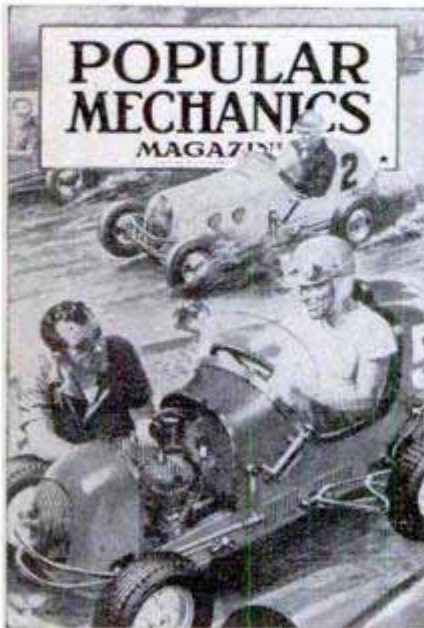

this month's cover

EVER WATCH a frightened beetle skitter around a pile of dirt? That's the way the new T.Q. midget racers behave to give screaming spectators a new dirt-track thrill. T.Q. stands for three quarter, which is about the size of the little beetles in comparison to the standard midget racer. They're just a bit larger than Junior's sidewalk auto, which, as a matter of fact, inspired this newest racing craze. Don't sell these half-pints short, though—some of them tear along the straightaway at 100 miles an hour. There's only a handful of T.Q.s in existence, so here's a perfect opportunity for the mechanic or racing fan to get a reserved seat on a new bandwagon. Don't take up the hobby if you're slightly overweight though—it's said that even the smallest driver must grease himself in order to squeeze behind the wheel. For more information on the rip-roaring midgets turn to the opening story, page 73

Published monthly by Popular Mechanics Company, 200 E. Ontario St., Chicago 11, Ill. H. H. Windsor, Jr., president; William Harrison Petridge, vice president; D. F. Windsor, vice president and secretary-treasurer; Clover L. Perkins, advertising manager; Alan M. Deyoe, circulation manager. Single copy in the United States and Canada, 35 cents; subscription rates in United States and possessions, Canada, Philippines and countries of the Pan-American Postal Union, 1 year \$3.50; 2 years, \$6.00; 3 years \$8.00. To all other countries add \$1.00 a year over United States prices for overseas postage. If you plan to move, notify us at least 30 days in advance so you will not miss an issue. Give both old and new addresses. Entered as Second Class Matter, September 15, 1903, at the Post Office at Chicago, Illinois, under Act of March 3, 1879. Entered as Second Class Matter at Post Office Dept., Canada. Copyright 1950 by Popular Mechanics Company, Copyright under International Copyright Union, Copyright in France. All rights reserved under Pan-American Copyright Union. Printed in the United States of America.

Volume 93 JUNE 1950 Number 6

Managing Editor.....Roderick M. Grant
 Assistant Managing Editor.....Wayne Whittaker
 Shop Notes and Crafts Editor.....James R. Ward
 Radio-Television, Electronics Editor.....Frank L. Brittin
 Associate Editor, Aviation.....Aubrey O. Cookman, Jr.
 Associate Editor.....Clifford B. Hicks
 Automotive Editor.....Siler Freeman
 Art Director.....Frank Beatty
 Director, Bureau of Information.....Allan Carpenter

Assistant Editors

Donald R. Brooks Dorothy E. Hoffmann Arthur R. Railton
 H. H. Windsor III

Assistant Editors, Shop Notes and Crafts

W. Clyde Lammey Wayne C. Lecky Frank N. Stephany A. E. Youngquist
 Eastern Editor.....Richard F. Dempewolf
 Empire State Bldg., Room 2906, New York 1, N. Y.

Western Editor.....Thomas E. Stimson, Jr.
 3872 Franklin Ave., Los Angeles 27, Calif.

Representative in Great Britain.....Douglas W. Wedderspoon
 77 Baker St., London W. 1, England

IN THIS ISSUE

Popcorn Bowl Racers	- - - - -	73
College in the Tall Timber	- - - - -	84
Navajos Hunt Big Game—Uranium	- - - - -	89
Send Me a Five-Room House	- - - - -	100
They Jump for Other Men's Lives	- - - - -	110
Workshops for GI Joe	- - - - -	121
Prairie Oil Boom	- - - - -	125
What's New for Your Home	- - - - -	132
High-Speed Splinter	- - - - -	136
Spray Bomb and A-Bomb—Cousins Under the Shell	- - - - -	146
Bring on Your Inventions	- - - - -	158

For the Craftsman

Beachward Ho!	- - - - -	166
Stop Those Water Leaks!	- - - - -	183
Make Your Boat Safe	- - - - -	189
Basement Golf	- - - - -	194
Titles That Spark Interest	- - - - -	200
Use the Right Abrasive—Part III	- - - - -	205
Sawing Metal on Your Bandsaw	- - - - -	211
Motor Tune-Up—Part II	- - - - -	217
Radio-Television, Electronics	- - - - -	221
Clinic for Homemakers	- - - - -	232

Other items, and manufacturers of available products described, are listed on pages 10, 12 and 14

**"That hammer?
You're kidding!"**



It's a fact, Bill. I've been using this same hammer for 29 years. It helped to build the house you were born in.

Well, I don't know how you do it. I hardly ever *use* a hammer, and yet I've broken two of them in the last year or so.

That so? What kind of hammers were they? What brand, I mean.

Gosh, I don't know. Guess they didn't *have* any brand names. But they were good bargains.

That's where the trouble is, Bill. Look . . . see the name on this hammer? Whenever you see that brand name, you

know it's a good hammer. Stick to the well-known, advertised brands when you buy tools, and in the long run you'll save a lot of money.

That makes sense, Fred. I'll remember it.

And do your buying at the hardware store, where they don't try to sell you anything but quality tools. That way you'll always get your money's worth.



POPULAR MECHANICS

Take a "GYPSY VACATION" with a

HARLEY-DAVIDSON *HYDRA-GLIDE*

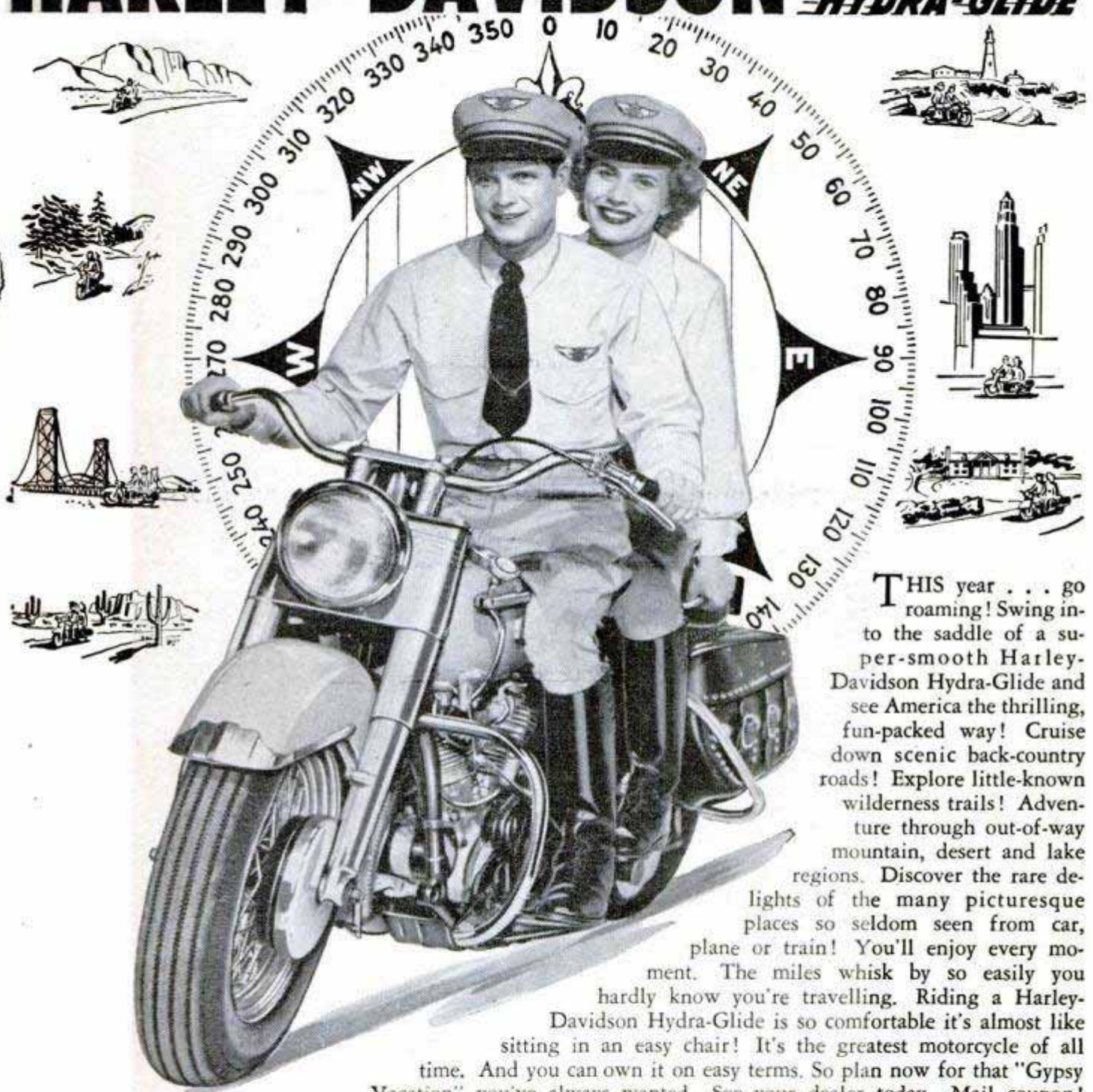

THIS year . . . go roaming! Swing into the saddle of a super-smooth Harley-Davidson Hydra-Glide and see America the thrilling, fun-packed way! Cruise down scenic back-country roads! Explore little-known wilderness trails! Adventure through out-of-way mountain, desert and lake regions. Discover the rare delights of the many picturesque places so seldom seen from car, plane or train! You'll enjoy every moment. The miles whisk by so easily you hardly know you're travelling. Riding a Harley-Davidson Hydra-Glide is so comfortable it's almost like sitting in an easy chair! It's the greatest motorcycle of all time. And you can own it on easy terms. So plan now for that "Gypsy Vacation" you've always wanted. See your dealer today. Mail coupon!

HARLEY-DAVIDSON MOTOR CO., Dept. P, Milwaukee 1, Wisconsin
 Send FREE copy of ENTHUSIAST Magazine filled with motorcycle action pictures and stories.

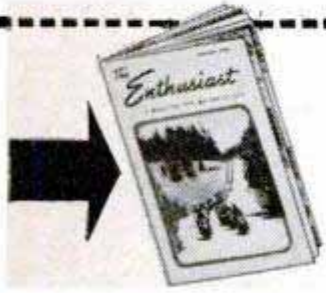

Name.....
 Address.....
 City..... State.....

DEALERS: Valuable franchises are now available for the full line of famous Big Twins and the 125 Models. This is your opportunity to line up with the greatest name in motorcycles. Write or wire for complete information today.

Big Wheel

IN ANY LEAGUE!

IN baseball, as in every other sport, the star performer, the big wheel, is the fellow with *constant control*.

In bicycling, the "big wheel" is the one that has a New Departure Safety Brake, the lightest, strongest, most powerful brake ever built. The brake that gives you *constant control* at all times. It brings any bike to a ...

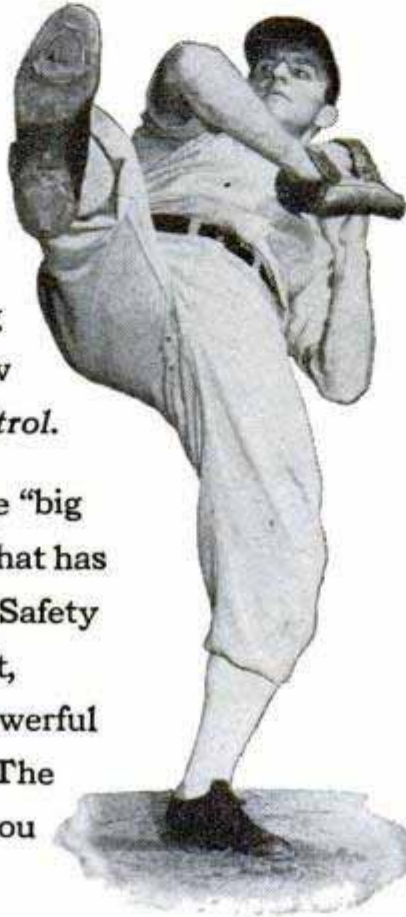

1884



Be sure your new bike has a

New Departure

SAFETY BRAKE 
a product of

New Departure • Division of General Motors • Bristol, Connecticut

in this corner..... **THE EDITORS**



A NEW NAME appears on our masthead this month. Siler Freeman, automotive editor of the Detroit Times, has been appointed automotive editor of *Popular Mechanics Magazine* to bring you first-hand, authoritative reports from America's "Motor City." He will continue to serve the Times while covering the automobile industry news for us.



A veteran newspaperman, Mr. Freeman is 48 years old and lives in Detroit with his wife and four children. Born in New York City, he spent his early school years in Schenectady and began working on newspapers after graduating from high school in 1918. After serving with the Navy in World War I, he attended the University of Illinois and was graduated in 1923 from Syracuse University. He was successively reporter, sports editor and assistant city editor of the Schenectady Union-Star, copyreader and assistant city editor to Albany newspapers and drama critic of the Worcester, Mass., Gazette. Then he became news editor and assistant managing editor of the Toledo News-Bee, and went to Detroit in 1928 as a sports writer for the News. He studied law and received his law degree from Wayne University in 1931. He joined the Detroit Times staff in 1934 and in 1941 was made automotive and aviation editor. Since 1944 Mr. Freeman has been president of the Off-the-Record Club, composed of automotive and aviation writers.

* * *

We Mixed Our "W" States

"Your March issue, page 102," writes D. H. Caryl, Science Desk Librarian at the University of Washington Library in Seattle, "contains a misstatement that indicates to us Westerners that your staff might be contaminated by Wisconsin propagandists. The article 'Sea-Going Eggbeaters' gives credit to F. A. Kirsten of the University of Wisconsin. Sir, the gentleman in question is Prof. F. K. Kirsten of

(Continued to page 8)

5 reasons why ACCOUNTANCY

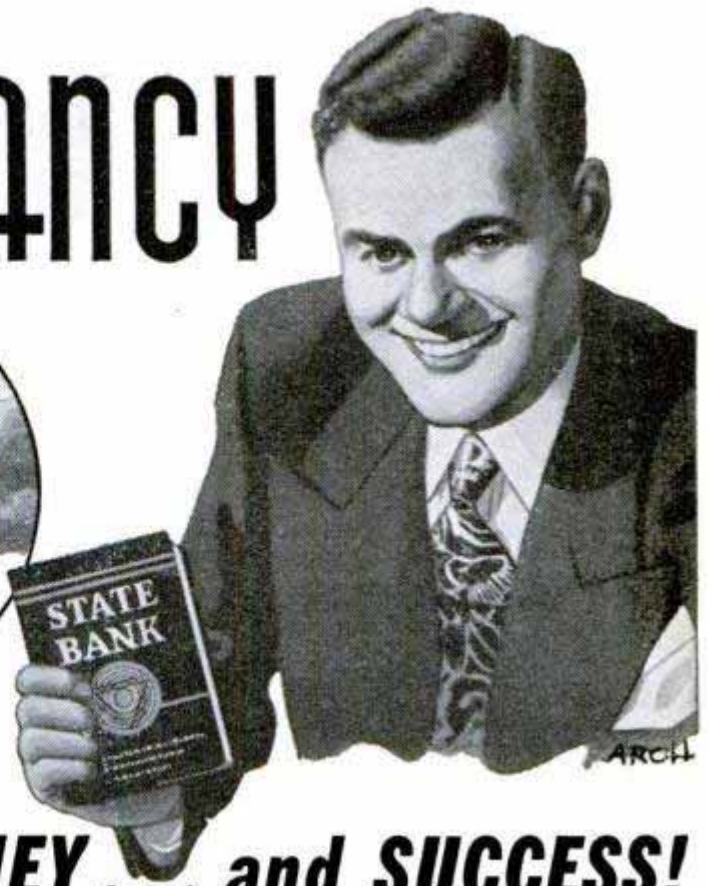
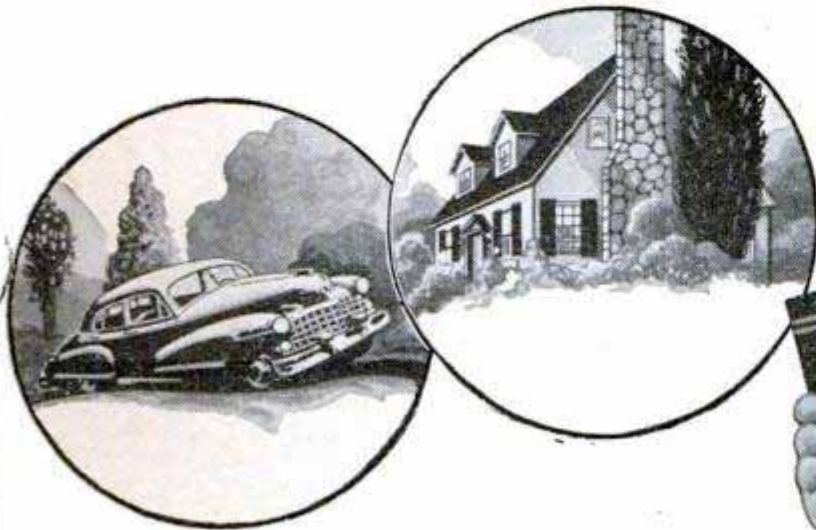

offers you MORE MONEY . . . and SUCCESS!

REASON #1. If you were an expert accountant right now, chances are you would find yourself among the highest-paid of all professional men and women. Even back in "depression years," surveys showed that accountants earned more on the average than men in other major professions.

REASON #2. The demand for accountants is great—everywhere. All businesses must have trained accountants to cope with ever-growing requirements. It's a profession offering wide opportunity—always—to the man who knows.

REASON #3. You can fit into any business, anywhere in the country—because accounting principles are universal. Think what this means in terms of security and independence!

REASON #4. Accountancy is open to all. Any man or woman of good intelligence, who enjoys figure work and is willing to follow LaSalle's systematic "problem method" plan, can rapidly qualify for a highly profitable, enjoyable

lifetime career . . . and he doesn't have to finish his training before beginning to "cash in."

REASON #5. Without losing a day from your present work, you can prepare in spare hours at home, at low cost, under LaSalle's step-by-step "Problem Method" of "learning by doing." This famous plan accounts for LaSalle's remarkable record of having trained nearly 10 per cent of all Certified Public Accountants in the U. S. . . . and of having put many thousands of others into high-paying careers.

Send today for LaSalle's interesting booklets, "Accountancy, the Profession That Pays," and "Success Reports." Learn about the five great fields of opportunity . . . and LaSalle's time-tested plan for helping men and women to rapid advancement, higher income, greater prestige and professional standing. The coupon below will bring these fact-filled booklets to you—without cost or obligation. Mail the coupon NOW.

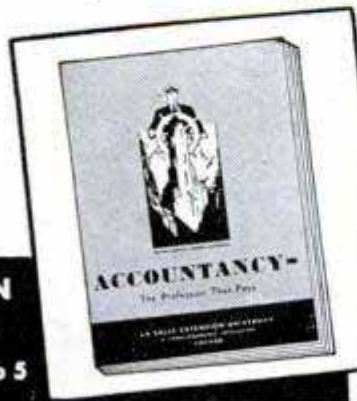

LaSalle Extension University A Correspondence Institution

Dept. 664-H, 417 S. Dearborn St., Chicago 5, Ill.

Please send me, free of all cost or obligation, your 48-page illustrated book "Accountancy, the Profession That Pays," and the booklet "Success Reports"—send also "Ten Years' Promotion in One"—a book which has helped many men.

Name Age
Address
City, Zone, State

**LASALLE EXTENSION
UNIVERSITY**
417 S. Dearborn St., Chicago 5

RECIPE for smoother driving

a few ounces of PYROIL in your gas tank... 1 pint of PYROIL in your crankcase...

Smoother driving and longer life for your car are as close as your nearest gas station. When you ask your service man to add Pyroll, he's sure to say, "Yes, Sir!" with added respect for you as a motor-wise driver. For he knows Pyroll will give you *improved lubrication* service. Pyroll improves lubrication, because it wraps a fine protective film of oil around piston and cylinder rings. Pyroll cleans your motor and keeps it clean... Pyroll keeps your motor completely lubricated at all times. Your gas station attendant knows the Pyroll recipe. Just ask him to add Pyroll... add miles to your car.

Pyroll for Aircraft Engines

Use Aircraft Pyroll B for lubricating oil, Aircraft Pyroll A for gasoline.

GIVEN! An attractive Pyroll metal savings bank, takes coins up to 50c pieces. **MOTORISTS, it's yours for the asking—sent postage paid.**

Manufactured and Guaranteed by Pyroll Company, 104 Pyroll Bldg., La Crosse, Wisconsin

Canadian Distributors: Central Purchasing Agencies, Ltd., Toronto, Ontario.



PYROIL COMPANY

104 Pyroll Bldg., La Crosse, Wisconsin

I want my car to last and run properly. Please tell me more about Pyroll and how it can accomplish this for me.

Name _____

Address _____

City or Town _____ State _____



(Continued from page 6)

the UNIVERSITY OF WASHINGTON. To a loyal Washingtonian this is almost defamation of character, however we will forgive you this time."

We're sorry. The staff will turn its face to a corner for five minutes.

* * *

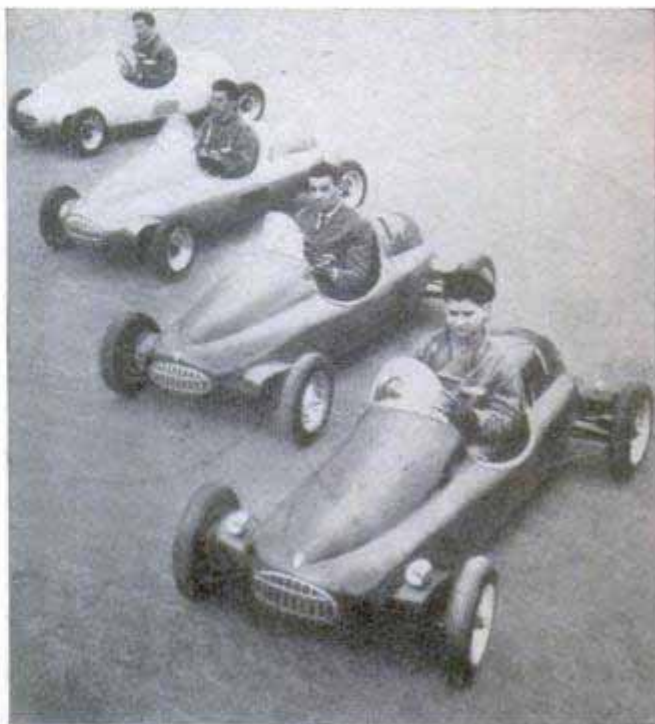

Half-Pints of Speed

This month's cover and the story beginning on page 73 tell of America's newest breed of racing cars, so small they roll on scooter wheels. Here is the Italian version of the midget racer. Lined up in the yards of the Innocenti Works at Milan, these are described by the photographer as "the smallest racing cars in the world."

* * *

Letter to the Editor

Dear Sir:

Would deeply appreciate your publishing a request for back copies of *Popular Mechanics* or other magazines pertaining to hobbies. We here at Yokota Air Force Base, Japan, feel we have the finest setup for hobbies of any field or camp in Japan.

Our shops include a full model-train layout, a miniature race track for cars, a field for flying hand-controlled planes, as well as workshops for building these models. We also have clubs for camera, radio, leather, plastic and woodcraft hobbyists.

S/Sgt. Henry A. Luke, 15234202,
512th Recon. Sqd. (VLR) Wea,
APO 328, c/o P.M.,
San Francisco, Calif.

(Continued to page 18)

A tale of two Texans



J. R. TODD of Crane, Texas, has this to say about his I. C. S. Course in Certified Public Accounting:

“ My I. C. S. training is really paying off. Already, I'm netting \$120 a month profit on my investment—with more to come. Dividends like these are convincing proof of the value of I. C. S. training. ”



H. A. HOWELL of Big Spring, Texas, completed the I. C. S. Course in Architectural Drawing, is currently enrolled in the Complete Architectural Course. He writes:

“ I got my present job on the strength of my I. C. S. training. As a result, I'm \$100 a month richer. You can see why I'm so sold on I. C. S. ”

Few investments pay you as well as the time and money you spend preparing yourself for advancement. I. C. S. records offer convincing proof of this fact. Each year, I. C. S. receives more than 1500 letters from students reporting salary increases and promotions.

What they are doing, you can do. And now's the time to start. Your first step: marking and mailing the coupon. It brings you a wealth of information about the career that interests you.

INTERNATIONAL CORRESPONDENCE SCHOOLS

APPROVED
under the
G. I. BILL

BOX 5677-K, SCRANTON 9, PENNA.

Without cost or obligation, please send me full particulars about the course BEFORE which I have marked X:

- | | | | |
|---|--|---|--|
| <p>Business and Academic Courses</p> <ul style="list-style-type: none"> <input type="checkbox"/> Accounting <input type="checkbox"/> App. Psychology <input type="checkbox"/> Business Administration <input type="checkbox"/> Bus. Correspondence <input type="checkbox"/> Certified Public Accounting <input type="checkbox"/> Commercial <input type="checkbox"/> Commercial Art <input type="checkbox"/> Cost Accounting <input type="checkbox"/> Federal Tax <input type="checkbox"/> First Year College <input type="checkbox"/> Foremanship <input type="checkbox"/> Good English <input type="checkbox"/> Higher Mathematics <input type="checkbox"/> Industrial Supervision <input type="checkbox"/> Motor Traffic <input type="checkbox"/> Retailing <input type="checkbox"/> Salesmanship <input type="checkbox"/> Sign Lettering <input type="checkbox"/> Spanish <input type="checkbox"/> Air Conditioning and Plumbing Courses <input type="checkbox"/> Heating <input type="checkbox"/> Refrigeration | <p>Chemical Courses</p> <ul style="list-style-type: none"> <input type="checkbox"/> Chemical Engineering <input type="checkbox"/> Chemistry, Analytical <input type="checkbox"/> Chemistry, Industrial <input type="checkbox"/> Chemistry, Mig. Iron & Steel <input type="checkbox"/> Petroleum Refining <input type="checkbox"/> Pulp and Paper Making <input type="checkbox"/> Civil Engineering, Architectural and Mining Courses <input type="checkbox"/> Architecture <input type="checkbox"/> Building Estimating <input type="checkbox"/> Civil Engineering <input type="checkbox"/> Contracting and Building <input type="checkbox"/> Highway Engineering <input type="checkbox"/> Lumber Dealer <input type="checkbox"/> Reading Structural Blueprints <input type="checkbox"/> Sanitary Engineering <input type="checkbox"/> Structural Drafting <input type="checkbox"/> Structural Engineering <input type="checkbox"/> Surveying and Mapping <input type="checkbox"/> Communications Courses <input type="checkbox"/> Electronics <input type="checkbox"/> Prac. FM and Television <input type="checkbox"/> Radio, General <input type="checkbox"/> Telegraph Engineering | <p>Electrical Courses</p> <ul style="list-style-type: none"> <input type="checkbox"/> Electrical Drafting <input type="checkbox"/> Electrical Engineering <input type="checkbox"/> Electric Light and Power <input type="checkbox"/> Lighting Technician <input type="checkbox"/> Practical Electrician <input type="checkbox"/> Power House Electric <input type="checkbox"/> Ship Electrician <input type="checkbox"/> Internal Combustion Engines Courses <input type="checkbox"/> Auto Technician <input type="checkbox"/> Diesel-Electric <input type="checkbox"/> Diesel Engines <input type="checkbox"/> Mechanical Courses <input type="checkbox"/> Aeronautical Engineer's, Jr. <input type="checkbox"/> Aircraft Drafting <input type="checkbox"/> Forging <input type="checkbox"/> Heat Treatment of Metals <input type="checkbox"/> Industrial Engineering <input type="checkbox"/> Industrial Instrumentation <input type="checkbox"/> Industrial Metallurgy <input type="checkbox"/> Machine Shop <input type="checkbox"/> Machine Shop Inspection <input type="checkbox"/> Mechanical Drafting <input type="checkbox"/> Mechanical Engineering | <p>Mold-Loft Work</p> <ul style="list-style-type: none"> <input type="checkbox"/> Patternmaking—Wood, Metal <input type="checkbox"/> Reading Shop Blueprints <input type="checkbox"/> Sheet-Metal Drafting <input type="checkbox"/> Sheet-Metal Worker <input type="checkbox"/> Ship Drafting <input type="checkbox"/> Ship Fitting <input type="checkbox"/> Tool Designing <input type="checkbox"/> Toolmaking <input type="checkbox"/> Welding Engineering <input type="checkbox"/> Welding—Gas and Electric <input type="checkbox"/> Railroad Courses <input type="checkbox"/> Air Brake <input type="checkbox"/> Diesel Locomotive <input type="checkbox"/> Locomotive Engineer <input type="checkbox"/> Locomotive Fireman <input type="checkbox"/> Locomotive Machinist <input type="checkbox"/> Railroad Section Foreman <input type="checkbox"/> Steam and Diesel Loco. Eng. <input type="checkbox"/> Stationary Engineering Courses <input type="checkbox"/> Boilermaking <input type="checkbox"/> Combust. Engrg. <input type="checkbox"/> Engine Running <input type="checkbox"/> Marine Engineering <input type="checkbox"/> Power Plant Engr. <input type="checkbox"/> Steam Engineer <input type="checkbox"/> Textile Courses <input type="checkbox"/> Cotton Manufacturing <input type="checkbox"/> Loom Fixing <input type="checkbox"/> Rayon Weaving <input type="checkbox"/> Textile Designing <input type="checkbox"/> Woolen Manufacturing |
|---|--|---|--|

Name _____ Age _____ Home Address _____

City _____ State _____ Working Hours _____ A.M. to _____ P.M.

Present Position _____ Employed by _____

Length of Service in World War II _____ Enrollment under G.I. Bill approved for World War II Veterans. Special tuition rates to members of the Armed Forces. Canadian residents send coupon to International Correspondence Schools Canadian, Ltd., Montreal, Canada.

WHERE-TO-BUY-IT INDEX

Source of supply appears after items commercially available

Your Success in Aviation begins at Embry-Riddle

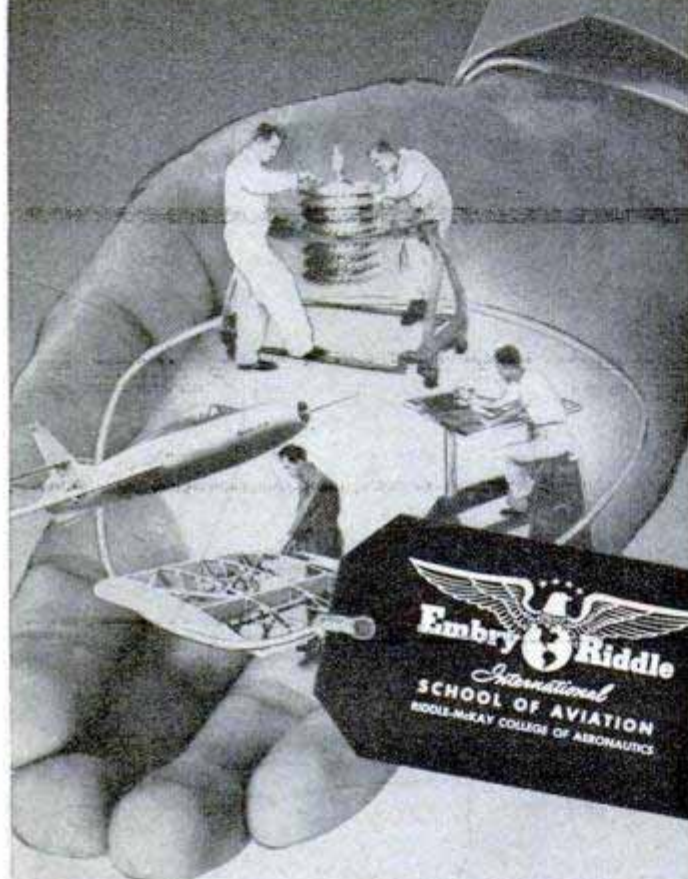

There's a bright future ahead for you in Aviation. In fact, no other career field today can possibly offer you so much opportunity. The aviation industry urgently needs men with skilled minds and hands to build, fly and maintain the giant aircraft of this great new Air Age.

The properly trained man climbs faster and higher in Aviation, just as in any other profession. That's why we say *your aviation success begins at Embry-Riddle*. For Embry-Riddle offers you the matchless advantage of knowledge and experience gained over a quarter-century of specialized aviation training.

In a few short months Embry-Riddle prepares you for engineering, master mechanic, flight or combined pilot and mechanic positions. All courses stress *thorough, practical* study including work on *live* aircraft in Embry-Riddle's airline-size hangars.

Enjoy Florida's unexcelled year-round climate, its wealth of aviation and recreational facilities. Live, work and play on Embry-Riddle's modern campus - the most complete aviation school plant in America. Save time, earn good money faster...send coupon *today* for full information.

Dean of Enrollments - Dept. 99
Embry-Riddle School of Aviation
Miami 30, Florida

Please Print

NAME _____

ADDRESS _____

City _____

State _____ Age _____

I am interested in...

- A.&E. Mechanic
- Commercial Pilot
- Engineering
- A.&E. Combined Commercial Pilot
- Flying Mechanic
- Drafting & Design

Check One Veteran Non-Vet

TRAIN IN MIAMI--AIR CAPITAL OF THE WORLD

AUTOMOTIVE

Arc welder charges battery (Lincoln Electric Co., Cleveland 1, Ohio)	78
Three-color stop light signals driver's action (Harrell Products, 771 N. Van Buren St., Milwaukee 2, Wis.)	82
Motor car at home on rails or roads (Fairmont Railway Motors, Inc., Fairmont, Minn.)	99
Battery's life expectancy increased by chemical (Pioneers, Inc., 2411 Grove St., Oakland 12, Calif.)	105
Boy won't need dad's car now	105
Plastic shades on headlights cut down glare (Macolite Corp., 1019 W. 7th St., Box 846, Little Rock, Ark.)	109
Key ejector (Del Hagens of Westchester, Dept. 11, Larchmont, N. Y.)	119
Invalid car (AC Cars Ltd., Thames Ditton, Surrey, England)	135
Vitamin pills for your car	135
Mail-order judge collects traffic fines (International Business Machines Corp., World Headquarters Bldg., 590 Madison Ave., New York City 22)	153
Low-cost homemade car	160
Lighted-cigarette dispenser (Hammacher Schlemmer, 145 E. 57th St., New York City 22)	258

AVIATION

Canadian all-weather fighter (A. V. Roe, Canada Ltd., Toronto, Canada)	78
Smallest airplane	141
1950 Bellanca (Bellanca Aircraft Corp., New Castle, Del.)	141
"Rescue knife" for crash victims	145
Robot test pilot	151
Periscopic hood	156
Ridding fast planes of their "barnacles"	157
Model air-freight terminal	160

BOATS

A cabin for your boat	106
Chemical spray dissolves and washes away paint (Nelrem Corp., 39 Broadway, New York City)	120
Have fun in a boat, but don't drown	154

FARM

Turbojet orchard heater (Edward West, Jr., Marquardt Aircraft Co., Van Nuys, Calif.)	82
Rotary shield on tractor cultivator protects plants (Industrial Machine & Tool Co., 126 Clark St., Des Moines, Iowa)	124
Trailer "sows" chicken feed (Ventreas Poultry Breeding Farm, Marysville, Calif.)	131
Boy builds push-button farm	145
Music for bossie	153

HOUSE AND HOME

Ash tray gives off incense (W. Nelson, IMPCO, Box 996, Houston 1, Tex.)	83
Prefabricated floor forms (Westbilt, Inc., 93 Tiffany Blvd., Newark 4, N. J.)	98
Air drier (Solvay Sales Div., 40 Rector St., New York City 6)	132
Electric spit (Admiral Corp., 3800 W. Courtland, Chicago)	132
Renewable sprayer (Re-All Corp., 2005 Wayside, Houston, Tex.)	132
Greasing brush (Miles-Kimball Co., Oshkosh, Wis.)	132
Hose connector (The Okola Co., 555 Gateway Bank Bldg., Minneapolis 1, Minn.)	133
Electric timer (Miller-Harris Instrument Co., Milwaukee 3, Wis.)	133
Coffee dispenser replaces can lid (Serva Matic Corp., 560 W. Fulton St., Chicago 6)	133
Pail gripper (Die-Co Company, 706 N. Division St., Peekskill, N. Y.)	133
Garbage container (American-Standard, Pittsburgh, Pa.)	133
Tackless carpeting (Roy M. Roberts, Roberts Co., 1536 N. Indiana Ave., Los Angeles, Calif.)	152

INDUSTRY

Platinum "cat" makes engine purr	88
Egg sorter	95
Central control panel for intercom system (Campbell-Norquist & Company, 77 N.E. Holladay, Portland 12, Ore.)	99
"Jackknife" oil derrick rolls to work (Lee C. Moore Corp., City National Bank Bldg., Houston, Tex.)	116
Elevator truck (Lull Mfg. Co., 3612 E. 44th St., Minneapolis 6, Minn.)	131
Food laboratories seek frozen milk with natural flavor	131
Factory without walls	161
Enough bread for an army	162
Petroleum reserves at new peak	254

LAWN AND GARDEN

Broiler's case serves as table (Home Supply Mfg. Co., 228 N. Old Manor, Wichita, Kans.)	79
Remote-control lawn sprinkler (Chicago Roller Skate Co., 4414 W. Lake St., Chicago 24)	115
Portable sprinkler has five outlets (Howard Sales Co., 1650 Belmont Ave., New Hyde Park, N. Y.)	118
Wheelless power mower (Whirler Glide Mower Co., Monteverde, Fla.)	124

MODELS

Heap-big wooden Indian	80
Whittling barber	142
Ship models in plastic	144
Tin-can railroad	156

(Continued to page 12)

WHAT Every AUTO MECHANIC Wants to Know

A motor vehicle is a machine of many parts, each part designed and constructed for its own special function. All good mechanics, like good doctors, should know the working theory and operation of each part and understand what causes trouble and how to remedy it.

LET AUDELS AUTO GUIDE SOLVE YOUR PROBLEMS

Every auto mechanic, helper, serviceman and operator can use AUDELS AUTO GUIDE. The information it gives saves time, money and worry. Highly endorsed by all users. It presents the whole subject of auto mechanics from A to Z in plain language and simple terms.

This Big Practical Book gives full information with working diagrams covering the principles, construction, ignition, service and repair of modern cars, trucks and buses.

A complete Guide of 1800 pages, with over 1500 illustrations showing inside views of the working parts, with instructions for service jobs. Diesel engines, Fluid and Hydra-matic drives fully explained.

IT PAYS TO KNOW HOW TO

How to fit pistons—How to locate engine knocks—How to fit connecting rod bearings—How to service main bearings—How to recondition valves—How to time valves—How to adjust fan belts—How to adjust carburetors & chokes—How to rebuild a clutch—How to service automatic transmissions—How to service brakes—How to adjust steering gear—How to cope with ignition troubles—How to service distributors—How to time ignition—How to "tune up" an engine.

INFORMATION IN A HANDY FORM

73 INTERESTING CHAPTERS—Read this partial list of subjects on which practical information is fully given for quick reference under the headings as shown below. Ready Reference Index.

All Parts of an Automobile—Automotive Physics—The Gas Engine—Gas Engine Principles—Multi-Cylinder Engines—Horse Power—Automobile Engines—Stationary Parts—Moving Parts—Pistons—Piston Rings—Connecting Rods—Crank Shafts—Valves—Valve Gear—Cams and Cam Action—Valve Timing—Cooling Systems—Fuel Feed Systems—Dual Fuel Feed—Mixture—Carburetors—Carburetor Service—Automatic Choke—Super—Chargers—Transmissions—Special Transmissions—Fluid and Hydra-matic Drives—Clutches—Universals and Propeller Shafts

A Ready Reference

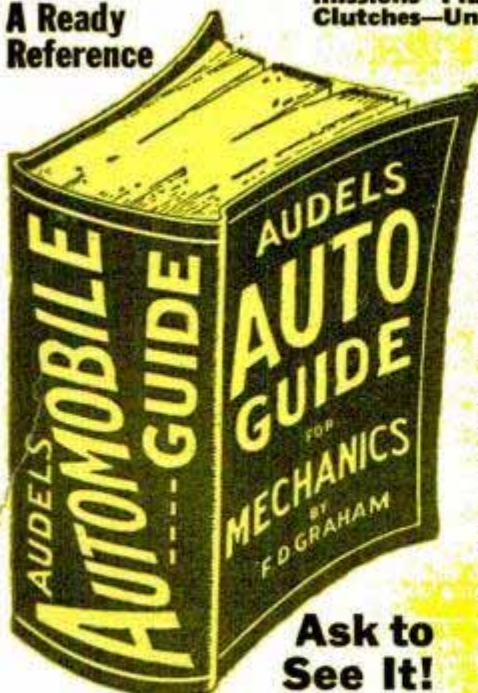

—The Differential—Rear Axles—Rear and Front Suspension—Running Gear—Brakes—Wheel Alignment—Knee Action—Steering Gear—Tires—Lubricants and Lubrication—Automotive Electricity—Ignition Systems—Magneto Ignition—Spark Plugs—Ignition Coils—Distributors—Automatic Spark Control—Ignition Timing—Generators—Starters—Generator and Starter Testing—Lighting Systems—Storage Batteries—Charging and Testing—Diesel Engines and Trouble Shooting.

7 DAYS' FREE TRIAL
TO GET THIS ASSISTANCE FOR YOURSELF SIMPLY FILL IN AND MAIL COUPON TODAY.

\$4 COMPLETE PAY \$1 A MONTH ONLY

Ask to See It!



Sent on 7 Days Approval

Step up your own skill with the facts and figures of your trade. Audels Mechanics Guides contain Practical Inside Trade Information in a handy form. Fully illustrated and Easy to Understand. Highly Endorsed. Check the book you want for **7 DAYS FREE EXAMINATION**. Send No Money. Nothing to pay postman.

CUT HERE MAIL ORDER

AUDEL, Publishers, 49 W. 23 St., NEW YORK 10, N. Y.

Please send me postpaid for FREE EXAMINATION books marked (x) below. If I decide to keep them I agree to mail \$1 in 7 Days on each book or set ordered and further mail \$1 monthly on each book or set until I have paid price, otherwise I will return them.

- AUTO GUIDE**, 1800 Pages . . . \$4
- DIESEL ENGINE MANUAL, 400 Pages . . . 2
- WELDERS GUIDE, 400 Pages . . . 1
- MACHINISTS Handy Book, 1600 Pages . . . 4
- POWER PLANT ENGINEERS Guide, 1500 Pages. 4
- ENGINEERS & FIREMANS EXAMS, 528 Pages. 1
- PUMPS, Hydraulics & Air Compressors, 1658 Pgs. 4
- MARINE ENGINEERS Handy Book, 1280 Pages 4
- ENGINEERS & Mechanics Guides (8 Book Set). 12
- Answers on Practical ENGINEERING, 254 Pages 1
- ELECTRIC WIRING DIAGRAMS, 210 Pages . . . 1
- ELECTRICIANS EXAMINATIONS, 250 Pages. 1
- ELECTRICAL DICTIONARY, 9000 Terms . . . 2
- ELECTRIC MOTOR GUIDE, 1000 Pages . . . 4
- HANDY BOOK OF ELECTRICITY, 1440 Pages 4
- ELECTRICAL POWER CALCULATIONS, 425 Pgs. 2
- RADIOMANS GUIDE, 914 Pages . . . 4
- ELECTRONIC DEVICES, 216 Pages . . . 2
- ELECTRIC LIBRARY, 7000 Pages (12 Book Set). 18
- Vols. I, II, III, IV, V, VI, VII, VIII, IX, X, XI, XII \$1.50 Ea.
- OIL BURNER GUIDE, 384 Pages . . . 1
- HOUSE HEATING GUIDE, 1000 Pages . . . 4
- CARPENTERS & Builders Guides (4 Book Set). 6
- PLUMBERS & Steamfitters Guides (4 Book Set). 6
- MASONS & Builders Guides (4 Book Set) . . . 6
- BLUE PRINT READING, 416 Pages . . . 2
- PAINTERS & DECORATORS MANUAL, 450 Pgs. 2
- GARDENERS & GROWERS Guides (4 Book Set). 6
- REFRIGERATION & Air Conditioning, 1280 Pgs. 4
- SHEET METAL WORKERS Handy Book, 388 Pgs. 1
- SHEET METAL PATTERN LAYOUTS, 1100 Pgs. 4
- AIRCRAFT WORKER, 240 Pages . . . 1
- MECHANICAL DRAWING GUIDE, 160 Pages. 1
- MECHANICAL DRAWING & DESIGN, 480 Pgs. 2
- MATHEMATICS & CALCULATIONS, 700 Pgs. . . 2
- MECHANICAL Dictionary, 968 Pages . . . 4
- MILLWRIGHTS & Mechanics Guide, 1200 Pgs. 4

Name _____
Address _____
Occupation _____
Employed by _____

AUDEL, Publishers, 49 W. 23 St., New York 10, N. Y.

NOW!

BRIGGS SMOKES 3 WAYS BETTER*



1. Stays lighted longer ... by 19%



2. Cleaner burning ... by 16.4%



3. Less tar ... by 21.6%

So today ...

Put this
in your
pipe

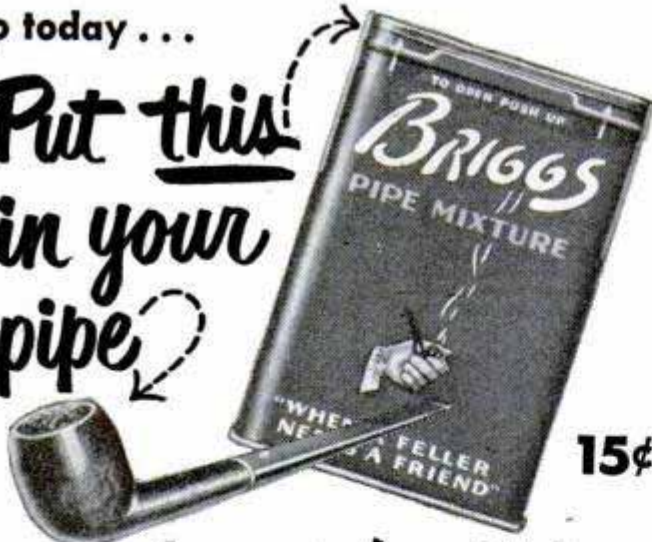

and smoke it!

*Yes, our new process makes Briggs better by actual test! Better even than the swell-smoking Briggs that proved so fine and friendly in your pipe before. And remember this: when tobacco burns steady, free and clean, that's when you enjoy *all* the goodness of Briggs' fine tobacco, aged and mellowed in oaken casks. Today—try 3-ways-better Briggs!

Also available in Canada

(Continued from page 10) OUTDOOR RECREATION

Golf-bag divider separates 14 clubs (CluBBoy, Inc., 750 Equitable Building, Denver, Colo.)	95
Electronic umpire judges balls and strikes	115
Floater lures bait and fish (Nelson & Neiman, Box 36, H.P., Des Moines 13, Iowa)	119
Plastic water wheel (Bilnor Corp., 53-06 Grand Ave., Maspeth, Long Island, N. Y.)	120

PHOTOGRAPHY

Prince's weapon is a camera gun	78
On-the-scene movie titler (Zusser Mfg. Co., 6702 Sheridan Road, Chicago 26)	79
Single-lens camera uses reflex principle (Ercona Camera Corp., 527 5th Ave., New York City)	83
Glass "doughnut" in lens ends fuzzy photographs	94
Photo-mounting kit (Terry Tim Studios, 425 Main St., Cincinnati, Ohio)	108
Daylight screen uses three mirrors to enlarge image (Wolcott, Kinnard, Kinnard Co., 325 W. Vine St., Milwaukee 12, Wis.)	118
Photo tone matcher assures good prints (Arpin Products, Inc., 422 Alden St., Alden, N. J.)	156

TOOLS

Paint thickness gauge (Krouse Testing Machine Co., 573 E. 11th Ave., Columbus 3, Ohio)	79
Power scythe (Hoffco, Inc., Richmond, Ind.)	108
Ladder platform (San Francisco Scaffolding Co., 2350 Jerrold Ave., San Francisco 24, Calif.)	109
Dust "elevator" speeds drilling (Carboloy Company, Inc., Box 237, Roosevelt Park Station, Detroit 32, Mich.)	119
Ladder bracket (Handi Equipment Co., 908 10th St., Racine, Wis.)	135
Electronic torch too hot to measure (General Electric Co., Schenectady 5, N. Y.)	141
Thread-measuring gauge (O-Vee Spring Gauge Co., 2514 W. Vernon Ave., Los Angeles 8, Calif.)	151

MISCELLANEOUS

Pasteurized vegetables	14
Ash tray from beer cans	82
Atom-smasher analyzes smog	83
Detroit listening post	93
Suitcase on wheels (Dale Fifth Avenue, 719 5th Avenue at 56th St., New York City 22)	95
"Little America" in Japan	96
Stamp examiner (Alwil Products Co., 1631 N. Natchez Ave., Chicago 35)	108
Plumber's tree	119
Metallic element shrinks when heated	130
War against hail	130
Blowing distortion out of Palomar's eye	134
World's wettest spot gets special gauge	144
Ash tray fits cigarette (R. J. Turner, Box 211, Montebello, Calif.)	145
Ticket "detective" (Theatre Control Corp., 319 Orleans St., Detroit 7, Mich.)	151
Projector aids hymn singing	152
Fluorescent tubes now have guide bumps (Westinghouse Electric Corp., Lamp Division, Bloomfield, N. J.)	152
Hair drier is noiseless (Ammann Sanders Mfg. Co., 307 E. 2nd St., Tulsa, Okla.)	152
Taxicab SOS	153
Covered-wagon ferry restored in Wyoming	164

Craftsman and Shop Notes Index

FARM

Carpenter's apron holds jars to facilitate berry-picking	176
Unloading gate in trailer box is lever-controlled	209
Design of concrete stock tank resists damage from ice	209
Furrower spaces potato rows for tractor cultivation	209
Auto valve holds loose pump rod	209
Easily made baby-chick creep	210
Outdoor milk-pail rack permits drying containers in sun	210
Drums filled with water provide weights for land roller	216

HOUSE AND HOME

Wooden pull-out bar on wardrobe aids handling garments	172
Safety shutoff for gas range is out of child's reach	172
Clay holds phonograph needles	172
Open top sash to cool room	173
Setting hair at home	174
Clothespins weight nylons on clothesline	174
Storing crochet hooks	174
Flower cuttings kept moist	174
Curling iron forms reel for ball of yarn	174
Hinges held in place for drilling screw holes	175
Improvised rest for paste brush	175
Locking window screens	175
Storage rack for children's toys	175
Trick to prevent spilling drawer contents	175
Lemons softened in cold water	176
Salt polishes tarnished silverware	180
Built-in wastebasket	181
Slanted partitions in spice drawer hold cans for easy selection	187
Drop of wax on candle wick permits lighting quickly	188

IMPORTANT NOTICE—It is the intention of this magazine to provide its readers with information regarding the latest developments in the mechanical arts. We take no responsibility as to whether the disclosures contained in our articles are covered by patents and advise readers to investigate this subject before making, using, or selling any of the products, machines, or processes described in order to avoid possible liability for patent infringements.

(Continued to page 14)

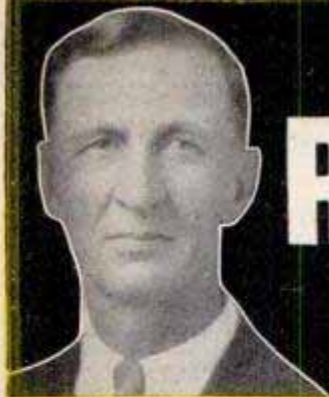

BE A SUCCESS AS A RADIO-TELEVISION TECHNICIAN

TWO FREE BOOKS SHOW HOW MAIL COUPON

America's Fastest Growing Industry

I TRAINED THESE MEN AT HOME



"Today I am considered an expert Radio-Television Technician. Have four employees. Business has doubled."—PAUL MILLER, Toledo, Ohio.

"Am Broadcast Engineer for Station KROP. Fundamentals of Radio learned in N. R. I. invaluable."—JERRY COLLETT, Brawley, California.



"For the past five years, I have been averaging \$15 and up a week repairing Radios in my spare time."—STANLEY GENTON, Cincinnati, Ohio.

"Since I finished your course, have been busy repairing Radios, installing Television. It's the coming business."—V. MARCHE-SANI, Philadelphia, Pa.



"After finishing course, opened my own repair shop. Can't praise your training too high."—ERNEST T. SLATE, Corsicana, Texas.

Offers You...

1. EXTRA MONEY IN SPARE TIME

As part of my servicing course, I send you SPECIAL BOOKLETS starting the day you enroll that show how you can make \$5, \$10 or more a week EXTRA fixing neighbors' Radios in spare time while learning. Tester you build with parts I send helps.

2. GOOD PAY JOB

Your next step is a good job installing and servicing Radio-Television sets, or becoming boss of your own Radio-Television Sales and Service Shop, or getting a good job in a Broadcasting Station. In 1945, there were 943 Radio Stations. Today, about 2,700 are on the air! Result—thousands of qualified men stepped into good jobs. Then add developments in FM, Two-Way Radio, Police, Aviation, Marine, Micro-wave Relay Radio. Think what this means! New jobs, more jobs, good pay for qualified men.

3. BRIGHT FUTURE

And think of the opportunities in Television. Only 19 Stations were on the air in 1947. Today, more than fifty. And the experts say there will be over 1,000 within three years. Manufacturers are producing over 100,000 Television sets a month. Be a successful Radio-Television Operator or Technician. . . get in line for success and a bright future in America's fastest growing industry!

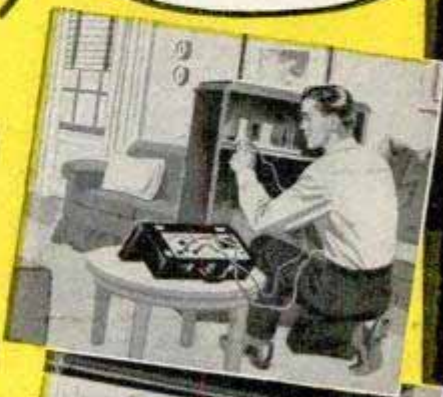

I Will Train You at Home You Practice Servicing or Communications with MANY KITS

I've trained hundreds of men with no previous experience to be successful TECHNICIANS. I will train you, too. Or now you can enroll for my NEW practical course in Radio-Television Communications. Train for your FCC operator's or technician's license. You learn Radio-Television theory from clear, illustrated lessons in my tested home study courses.

As part of both my Servicing and Communications course, I send you MANY KITS of modern equipment that "bring to life" theory you learn.

You Build This MODERN RADIO

As part of my Servicing course, I send you speaker, tubes, chassis, loop antenna, transformer. EVERYTHING you need to build this modern Radio. Use it to conduct many valuable tests and practice servicing. It's yours to keep.

You Build This TRANSMITTER

As part of my New Communications course, I send parts to build this low-power broadcasting Transmitter that shows how to put a station "on the air." Perform procedures demanded of Broadcast Station operators, conduct many tests, experiments. It's yours to keep.



Building circuits, conducting experiments with them, introducing and repairing defects, gives you valuable, practical experience. (Some of the equipment you get is shown below.) Everything I send is yours to keep.

Mail Coupon for Books FREE

Coupon entitles you to ACTUAL LESSON on Radio Servicing with many pictures and diagrams plus my 64-page book, "HOW TO BE A SUCCESS IN RADIO-TELEVISION" . . . both FREE. See what my graduates are doing and earning. Send coupon today. J. E. SMITH, President, Dept. OFP, National Radio Institute, Pioneer Home Study Radio School, Washington 9, D. C.

VETERANS

GET THIS TRAINING UNDER G. I. BILL. MAIL COUPON NOW.

Good for Both—FREE

MR. J. E. SMITH, President, Dept. OFP National Radio Institute, Washington 9, D. C.

Mail me Sample Lesson and 64-page Book about How to Win Success in Radio-Television—both FREE. (No salesman will call. Please write plainly.)

Name..... Age.....
 Address.....
 City..... Zone..... State.....
 Check if Veteran Approved Under G. I. Bill



LAWN AND GARDEN

Border blocks for your garden.....178
 Leaking hose nozzle repaired with faucet packing.....180
 Flower box serves as hothouse.....182
 Ready-made trellis crosspieces provided by wooden coat hangers.....192
 Plumb bob for terrace walls aids in keeping uniform slant.....192

NOVELTIES

Novel swinging tie rack is made from dowels.....173
 Monogram craftwork initials hammered from wire solder.....182
 Wagon wheels form novel trellis.....187

OUTDOOR RECREATION

Cans form liner for inexpensive picnic icebox.....177
 Eight concrete building blocks provide knockdown charcoal grill.....177
 Special baits for catching common fish when ordinary lures fail.....179
 Film container holds fishhooks.....187
 Replacing outboard-motor shield speeded by wing nuts.....188
 Bilge pump.....193
 Floating landing-net frame utilizes tennis racket.....210

PHOTOGRAPHY

Hand reflects enlarger light when changing lens setting.....199
 Keeping track of exposed film by inverting holders.....199
 Label attached to camera indicates film type.....199
 Copying prints through water produces better negatives.....199
 Paper toweling forms blotter roll for drying small prints.....199
 Trimming film before developing to fit cut-film hangers.....204
 Handy switch controls floor lamp when showing color slides.....204
 Music box mounted on camera holds attention of children.....204

TOOLS

Special-shaped modeling tools easily formed from plastic.....176
 Emery dust laps oilstone to renew cutting surface.....180
 Garden hose shields saw teeth.....182
 Golf ball provides plumb bob.....188
 Gauge speeds setting lathe tool when facing bored work.....216

MISCELLANEOUS

Magnifying glass supported by plastic cylinder.....172
 Pencil eraser forms bottle cork.....172
 Plastic egg tray forms palette for mixing water colors.....173
 Sunken vase for cemetery flowers cannot be tipped by wind.....176
 Slats for ladder-back chairs are bent on special wooden form.....180
 Pipe tenon makes rigid repair for broken chair back.....182
 Bushing centers toggle bolt.....188
 Rosin removes water-base paint.....188
 Inner lid for putty can keeps contents fresh.....188
 Lag screws draw up joints between stiles and rails of paneled door.....192
 Wire solder anchors wood screw.....192
 Two-piece sidewalk forms are bent readily.....210
 Stand for small display sign improvised from paper clips.....210
 "Floating" reinforcing rods.....216
 Fuse clip holds pencil on board.....216

Radio-Television, Electronics

Make your own printed circuits (Microcircuits Co., New Buffalo, Mich.).....221
 Portable knockabout super built in a lunch box.....222
 TV and electronics today (Pen-size hearing aid and voltmeter for testing hearing-aid batteries, Telex, Inc., Minneapolis 1, Minn.; TV receiver has giant-size screen, General Precision Equipment Corp., 90 Gold St., New York City; sound-fountain speaker, Bell Sound Systems, Inc., 555 Marion Rd., Columbus 7, Ohio; miniature tubes, Mullard Ltd., Shaftsbury Ave., London, England; multiplier probe for TV voltmeter, Insuline Corp. of America, 3602 35th Ave., Long Island City, N. Y.).....224

Pasteurized Vegetables

Fruits and vegetables now are pasteurized like milk to kill all disease germs they may have picked up from contaminated soil. Occupation troops in Japan are the first to try the pasteurized vegetables. Research workers at Rutgers University worked out the technique for the Army Quartermaster Corps. In the past the Army has forbidden consumption of produce grown in some foreign areas because it was contaminated with typhoid, dysentery and other disease germs. Now tomatoes, lettuce, spinach and carrots can be heat-treated at 240 degrees F., killing the germs but leaving intact the quality of the fresh foods.

Become an Electrical Engineer

B. S. Degree in 36 Months

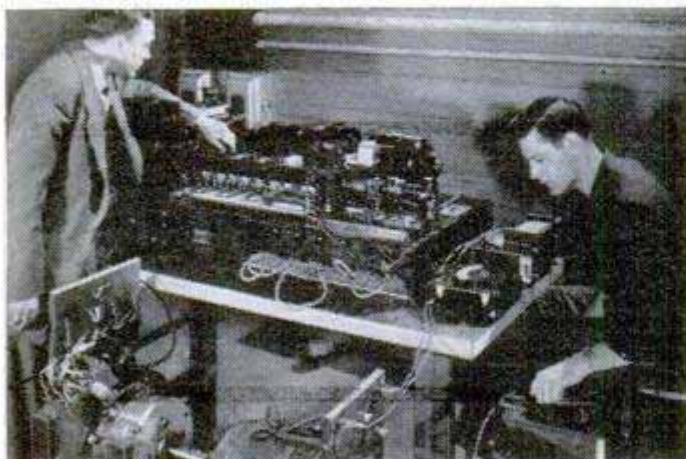

MAJOR in POWER or ELECTRONICS

Important advantages are yours at this nonprofit Technical Institute and College. A valuable year is saved by gaining your B.S. degree in 36 months of continuous study. You get both practical, specialized training in well-equipped laboratories—and a solid education in Electrical Engineering and related arts.

In 12 months, the world-famous concentric system equips you for specific occupations and brings the valued Electro Technician or Electronics Technician Certificate which is credited toward your B.S. degree.

Military, Academic or Practical Training is evaluated for advanced credit. Preparatory courses are also available.



Faculty of 85 specialists. 1555 currently enrolled from 48 states and 23 foreign countries. Over 35,000 alumni. Terms open July, Oct., Jan., April.

MILWAUKEE SCHOOL of ENGINEERING

Technical Institute • College of Electrical Engineering

Write for free 110-page catalog and 48-page pictorial booklet, "Your Career".



Milwaukee School of Engineering
 Dept. PM-650
 1020 N. Broadway, Milwaukee, Wis.

Without obligation, send me the 110-page catalog and 48-page "Your Career" booklet.

(Check 6 to 36 month courses which interest you)

- Electrical Engineering: Power Electronics
 Radio-Television Electricity Welding
 Air Conditioning Heating Refrigeration

NAME _____ AGE _____

ADDRESS _____

CITY _____ ZONE _____ STATE _____

Check if World War II Veteran

INVENTORS

Learn how to protect your invention. The U. S. Patent Laws provide that any new and useful art, machine, article of manufacture, or composition of matter, or any new and useful improvement thereof, may be patented if the act of invention is involved. Therefore, every inventor with a valuable invention should take advantage of the Patent Laws and proceed for patent protection in order to safeguard his rights.

A patent gives the inventor the exclusive right to prevent others from making, using, or selling the invention claimed in the patent for a period of seventeen years.

The Patent Laws were enacted for the benefit of the inventor to give him protection for the features of his invention which are patentable. These features must be properly and concisely set forth and claimed in a formal application for patent, in order to comply with the requirements of the Patent Laws. For that reason, unless the inventor is familiar with patent matters, he should engage a competent registered patent attorney or agent to represent him. We are registered to practice before the U. S. Patent Office and are prepared to serve you in the handling of your patent matters.

A specially prepared booklet entitled "Patent Guide for the Inventor", containing detailed information with respect to patent protection and procedure, together with a "Record of Invention" form will be promptly forwarded to you without obligation upon request.

CLARENCE A. O'BRIEN & HARVEY JACOBSON

Registered Patent Attorneys

OI-F DISTRICT NATIONAL BUILDING

WASHINGTON 5, D. C.

Make Use of
**POPULAR
MECHANICS
BOOKS**

STREAMLINED HELP



**BETTER JOBS
HOBBIES
AND PASTIMES
HOME AND FARM
WORK SHOPS
HOME REPAIRS-
IMPROVEMENTS**

THE INEXPENSIVE PRACTICAL BOOKS WITH A MILLION READERS!

Want help on your job—extra knowledge that brings extra pay? Want to save money on home repairs? Want practical information to better enjoy hobbies and home and farm workshop projects? Then get a Popular Mechanics Book. These easy-to-use books, written in plain, everyday how-to-do-it English, and extravagant with pictures, plans, diagrams, etc., will give you the practical help you need. Full library size, cloth bound book unless otherwise described. Rush order on coupon today. Money back if not satisfied.



FORTY POWER TOOLS YOU CAN MAKE

Have your own powered workshop at low cost. Tells how to make forty different machines such as lathes, drill press, jig saw, band saw, circular saw, sanders, from pipe fittings, old auto parts, wood, etc. New 1948 edition. \$1.50

POPULAR MECHANICS PHOTO HANDBOOK

An entirely new and different book from our popular Photo Guide. It's a complete guide to better pictures and darkroom technique, and features dozens of handy gadgets you can make yourself. \$2.00

BUILD A BOAT FOR PLEASURE OR PROFIT

How to build 17 low-cost boats at home—power, sail or row boat. Prepared especially for the home builder with limited tools, no experience and little money to spend. Plans, diagrams and illustrations. \$2.00

WHAT TO MAKE FOR CHILDREN

A Popular Mechanics book for Dad, Mother and the whole family. Shows how to make toys, dolls, doll houses, slides, see-saws, rocking horses, furniture. 175 projects to make from discarded or inexpensive materials. \$2.00

THE GARDEN BOOK

How to build your own trellises, fences, lawn furniture, outdoor fireplace, attractive ornaments and other things for your yard and garden. Beautify your grounds—enjoy attractive equipment—at low cost. \$1.50

OUTDOOR SPORTS MANUAL

220 helpful articles and hints for fishermen, hunters, campers, trappers, archers and boatmen. If you love the outdoors, double your enjoyment with the help of this new book. Contains 334 illustrations. \$2.00

WHAT TO MAKE. 11 Volumes



The famous annual craftsman's guide. Shows what to make and how to make hundreds of things in spare time for fun or profit. Novelties, gifts, toys, games, furniture, etc. Cloth bound and filled with instructive pictures. Single volumes, each \$1.75. Save money on 11 volume set, complete, only \$16.50.

POPULAR MECHANICS SHOP NOTES

New 1950 volume. Latest in series of practical and helpful year books for every man who uses tools. Contains 240 pages and 750 illustrations. This book will make money for you and make your job easier. Soil-proof paper cover. \$1.00

POPULAR MECHANICS MOTORIST'S HANDBOOK

For every man who drives a car and wants to do his own servicing and simple repairs. A money-maker for the professional auto repairman. Hundreds of ideas, helps, and kinks you can use every day. \$2.00.

CONCRETE HANDBOOK

How to do all types of concrete work and make ornamental things of cement—walks, driveways, foundations, steps, vases, benches, etc. Ideal book for home owner, handyman and construction men. \$2.00

WELDING, BRAZING AND SOLDERING

How to construct welding equipment and use it effectively—small arc welder, spot welder, arc torch. Best approved methods, tricks and kinks to use in soldering, brazing, heat treating iron and steel. \$1.75



YOUR HOME and HOW TO BUILD IT YOURSELF

Step by step instruction by which anyone with ordinary knowledge of use of hand tools can build a five-room house complete. Every detail is shown in pictures with amazing clarity. Will save hundreds of dollars building any house. Spiral bound. \$3.00. Complete set regular builders plans \$12.50. Book and plans \$14.00.

FARM MANUAL

Hundreds of articles on making farm implements and equipment, maintaining the home, farm workshop, live stock and poultry, many farm hints and kinks. A book for every member of every farm family. 284 pages. Hundreds of illustrations. \$3.00



THE BOY MECHANIC

One of the most popular and best known Popular Mechanics publications. Describes hundreds of things for boys to do and make. Develops natural talents and industry. Crammed with how-to-do-it illustrations. The perfect gift for every boy. \$2.00

PAINTING, FURNITURE FINISHING AND REPAIRING

A book for craftsmen, home owners, shop workers and furniture repairmen and finishers. Covers repairs and finishing, restoring antiques, spray and brush painting of all kinds. An all 'round book for everyone. \$1.50

USE THIS HANDY COUPON • Mail Today

POPULAR MECHANICS PRESS, Dept. 128, 200 E. Ontario St., Chicago 11

Send Popular Mechanics books checked. I will pay postman, plus charges (U.S.A. only). Remittance enclosed—send fully prepaid, I will return books in five days for return of money if not satisfactory. Outside U.S.A. please add 15% for postage and wrapping.

Forty Power Tools . . . \$1.50	What to Make (Children) . . . \$ 2.00	Boy Mechanic \$ 2.00
Painting, Finishing, etc. . 1.50	Garden Book 1.50	Concrete Handbook 2.00
Motorist's Handbook . . . 2.00	What to Make (1 Vol.) . 1.75	Welding, Brazing 1.75
Photo Handbook 2.00	11 Volumes 16.50	Your Home 3.00
Build a Boat 2.00	Shop Notes 1.00	Book with Plans 14.00
Sports Manual 2.00		Farm Manual 3.00

Name _____

Address _____

City _____ State _____

Check
for
FREE
Cata-
log

INVENTORS

If you believe that you have an invention, you should find out how to protect it. The first step is to have a search made of the prior pertinent U. S. patents. If a report on this search indicates that the invention appears patentable you can apply for a patent, and the specifications and claims should be prepared.

The firm of McMorrow, Berman & Davidson, with offices in Washington, D. C., is qualified to take the necessary steps for you. We can make a preliminary search on your invention, advise you whether we think it can be patented, and prepare your application for patent.

Unless you are fully familiar with the U. S. Patent Laws, we recommend that you engage the services of a Registered Patent Attorney to protect your interests. The patent laws are *your* laws. A patent gives you the right to prevent others from making, using or selling the invention claimed in your patent for a period of 17 years.

Use these patent laws for your protection. Investigate whether your invention can be patented. If you have what you believe to be an invention, we suggest that you have this firm make a search for you.

Send for a copy of our Patent Booklet entitled "How To Protect Your Invention," containing information about patent protection and patent procedure. Along with this we will also send you an "Invention Record" form, for your use in writing down and sketching details of your invention. We will mail them promptly. No obligation. They are yours for the asking.

McMORROW, BERMAN & DAVIDSON

Registered Patent Attorneys

PATENTS • COPYRIGHTS • PATENTS

135-D VICTOR BUILDING, WASHINGTON 1, D. C.

Which of these 2 one time WEAKLINGS PAID only a Few Cents to become an All-Around HE-MAN at Home?



Which One Paid Hundreds of Dollars to Train at My Side? REX FERRIS, was a skinny weakling, paid a few cents to start building into a Champion All Around He Man. LARRY CAMPBELL paid me hundreds of dollars to train at my side years ago. Start to become an All Around He Man at home with these same secrets—like Rex Ferris did!

Amazing get-acquainted offer—YOURS for only 10c Instead of \$1 For all 5 Courses plus FREE Photo Book!

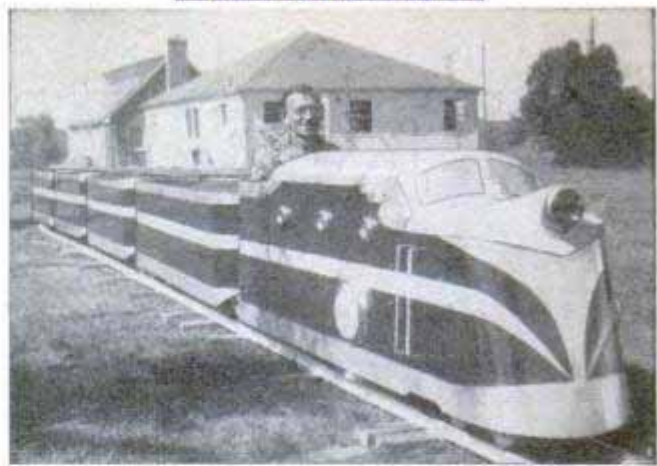

Neighborhood Streamliner

Father-and-son combination, Leon H. Shay and Leon R. Shay of Freeport, Ill., the elder a Popular Mechanics reader "for more than 25 years," built this streamliner with a six-horsepower engine to carry the neighborhood youngsters, as many as 32 at a time, around a 300-foot loop track. It can travel from one to 45 miles an hour and is usually piloted by Shay's two granddaughters, aged 4 and 7. "We are hoping to take care of all the kids around here this summer," writes Mr. Shay.

This Is Tough on Flies

The garbage trucks have gone out of business in Jasper, Ind., and the garbage can is an outlaw. The entire town of 6800 has abolished garbage collection and electric garbage disposers are being installed in the sinks of Jasper householders. All food wastes will be shredded and washed away to the new municipal sewage-treatment plant. The city authorities hope that by eliminating garbage cans, the fly and rodent nuisance will be minimized and Jasper will be a healthier place to live.

Plug-in the Salt Shaker

Puerto Rican humidity must clog the salt shakers. An inventor at Guaynabo, P. R., has obtained a U. S. patent on a salt shaker with a built-in electric heater.

INDEX TO POPULAR MECHANICS NOW AVAILABLE To make it easier for readers to locate articles quickly, a complete printed index for the first six months of this year has been prepared. To reserve a copy of the index for yourself, your library or workshop, send your request with 10 cents to cover handling and mailing costs to Bureau of Information, 200 E. Ontario St., Chicago 11, Ill.

Be A Winner at Anything YOU Tackle with Progressive Power—SPORTS! JOB! SCHOOL! FRIENDS!

Let's Go, Pal! I'll prove I can make YOU an ALL-AROUND HE-MAN FAST—OR NO COST! says George F. Jowett World's Greatest Body Builder



George F. Jowett Whom experts call "Champion of Champions," World's wrestling and weight lifting champ at 17 and 19. World's Strongest Arms 4 times World's Perfect Body—plus other records.

Enjoy My "Progressive Power" Strength Secrets! Give Me 10 Easy Minutes a Day—Without Strain!

I'll teach you the "Progressive Power Method" through which I rebuilt myself from a physical wreck the doctors condemned to die at 15, to the holder of more strength records than any other living athlete or teacher! "Progressive Power" has proven its ability to build the strongest, handsomest men in the world. And I stand ready to show you on a money back basis—that no matter how flabby or puny you are I can do the same for you right in your own home. Let me prove I can add inches to your arms, broaden your shoulders, give you a man-sized chest, powerful legs and a Rock-like back—in fact, power pack your whole body so quickly it will amaze you! Yes, I'll jam you with power and confidence to master any situation—to win popularity—and to get ahead on the job! Through my proven secrets I bring to life new power in you inside and out, until YOU are fully satisfied you are the man you want to be.

PROVE IT TO YOURSELF IN ONE NIGHT

Send only 10c for my 5 easy-to-follow, picture-packed courses now in 1 complete volume "How to Become a Muscular He-Man." Try it for one night! Experience the thrilling strength that surges through your muscles. 10 DAY TRIAL! Think of it—all 5 famous courses in one picture-packed, muscle-building volume only 10c. You must actually FEEL results in ONE WEEK, or your money will be promptly refunded!

Advertisement for "How to Become a Muscular He-Man" featuring a stack of books and a coupon. The books include: "How to Mold a Mighty Chest", "How to Mold a Mighty Back", "How to Mold a Mighty Arm", "How to Mold a Mighty Grip", "How to Mold a Mighty Leg", "How to Mold a Mighty Neck", "How to Mold a Mighty Waist". The coupon offers a free photo book of famous strong men.

FREE GIFT COUPON! Jowett Institute of Physical Culture DEPT. PM-06 230 Fifth Avenue, New York 1, N.Y. Dear George:—Please send by return mail, pre-paid, FREE Jowett's Photo Book of Strong Men, plus all 5 Muscle Building Courses. 1. Molding a Mighty Chest. 2. Molding a Mighty Arm. 3. Molding a Mighty Grip. 4. Molding a Mighty Back. 5. Molding a Mighty Leg—Now all in One Volume "How to Become a Muscular He-Man." Enclosed find 10c for postage and handling. No C.O.D.'S. NAME _____ AGE _____ ADDRESS _____ CITY _____ ZONE & STATE _____

How to pass a genius

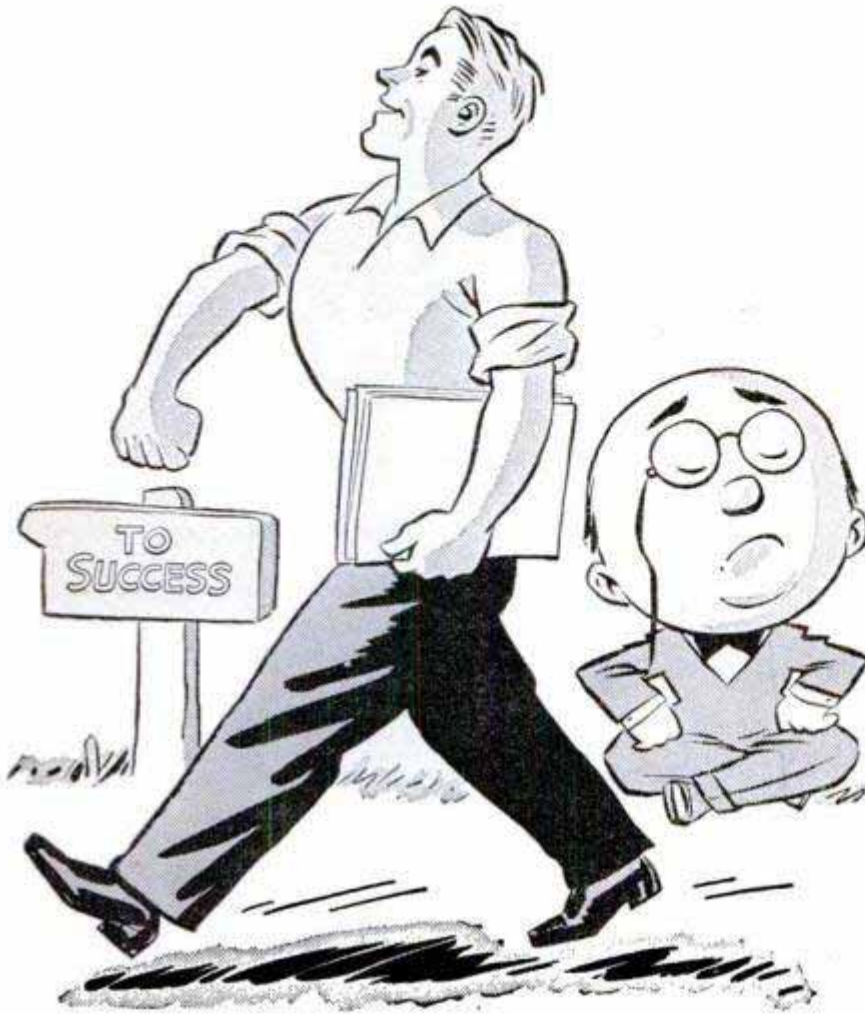

All of us can't be geniuses. But any ordinarily talented mortal can be a success—and that's more than some geniuses are.

Now, as in Æsop's time, the race doesn't always go to the one who potentially is the swiftest. The *trained* man has no trouble in passing the genius who hasn't improved his talents.

In good times and bad times, in every technical and business field, the *trained* man is worth a dozen untrained ones, no matter how gifted.

The International Correspondence Schools can't make you into a genius. For more than 58 years, however, I. C. S. has been helping its students to become *trained, successful leaders*—and it can do the same for you.

Mark your special interest on the coupon. Don't be like the unsuccessful genius who wastes his life in dreaming of what he intends to do. *Act now!*

INTERNATIONAL CORRESPONDENCE SCHOOLS

APPROVED
under the
G. I. BILL

BOX 5678-K, SCRANTON 9, PENNA.

Without cost or obligation, please send me full particulars about the course BEFORE which I have marked X:

- | | | | |
|--|--|--|--|
| <p>Air Conditioning and Plumbing Courses</p> <p><input type="checkbox"/> Air Conditioning
<input type="checkbox"/> Heating
<input type="checkbox"/> Refrigeration</p> <p><input type="checkbox"/> Plumbing
<input type="checkbox"/> Steam Fitting</p> <p>Chemical Courses</p> <p><input type="checkbox"/> Chemical Engineering
<input type="checkbox"/> Chemistry, Analytical
<input type="checkbox"/> Chemistry, Industrial
<input type="checkbox"/> Chemistry, Mfg. Iron & Steel
<input type="checkbox"/> Petroleum Refining
<input type="checkbox"/> Plastics
<input type="checkbox"/> Pulp and Paper Making</p> <p>Civil Engineering, Architectural and Mining Courses</p> <p><input type="checkbox"/> Architecture
<input type="checkbox"/> Architectural Drafting
<input type="checkbox"/> Bridge and Building Foreman
<input type="checkbox"/> Building Estimating
<input type="checkbox"/> Civil Engineering
<input type="checkbox"/> Coal Mining
<input type="checkbox"/> Contracting and Building
<input type="checkbox"/> Highway Engineering
<input type="checkbox"/> Lumber Dealer
<input type="checkbox"/> Reading Structural Blueprints
<input type="checkbox"/> Sanitary Engineering
<input type="checkbox"/> Structural Drafting</p> | <p><input type="checkbox"/> Structural Engineering
<input type="checkbox"/> Surveying and Mapping</p> <p>Communications Courses</p> <p><input type="checkbox"/> Electronics
<input type="checkbox"/> Practical Telephony
<input type="checkbox"/> Radio, General
<input type="checkbox"/> Radio Operating
<input type="checkbox"/> Radio Servicing
<input type="checkbox"/> Television
<input type="checkbox"/> Telegraph Engineering</p> <p>Electrical Courses</p> <p><input type="checkbox"/> Electrical Drafting
<input type="checkbox"/> Electrical Engineering
<input type="checkbox"/> Electric Light and Power
<input type="checkbox"/> Lighting Technician
<input type="checkbox"/> Practical Electrician</p> <p>Internal Combustion Engines Courses</p> <p><input type="checkbox"/> Auto Technician
<input type="checkbox"/> Diesel-Electric
<input type="checkbox"/> Diesel Engines
<input type="checkbox"/> Gas Engines
<input type="checkbox"/> Aviation</p> <p>Mechanical Courses</p> <p><input type="checkbox"/> Aeronautical Engineer's, Jr.
<input type="checkbox"/> Aircraft Drafting
<input type="checkbox"/> Flight Engineer
<input type="checkbox"/> Forging
<input type="checkbox"/> Foundry Work
<input type="checkbox"/> Heat Treatment of Metals
<input type="checkbox"/> Industrial Engineering
<input type="checkbox"/> Industrial Instrumentation</p> | <p><input type="checkbox"/> Industrial Metallurgy
<input type="checkbox"/> Machine Shop
<input type="checkbox"/> Mech. Drafting
<input type="checkbox"/> Mechanical Engineering
<input type="checkbox"/> Mold-Loft Work
<input type="checkbox"/> Patternmaking—Wood, Metal
<input type="checkbox"/> Reading Shop Blueprints
<input type="checkbox"/> Sheet-Metal Drafting
<input type="checkbox"/> Sheet-Metal Worker
<input type="checkbox"/> Ship Drafting
<input type="checkbox"/> Ship Fitting
<input type="checkbox"/> Tool Designing
<input type="checkbox"/> Toolmaking
<input type="checkbox"/> Welding Engineering
<input type="checkbox"/> Welding—Gas and Electric</p> <p>Railroad Courses</p> <p><input type="checkbox"/> Air Brake
<input type="checkbox"/> Car Inspector
<input type="checkbox"/> Diesel Locomotive
<input type="checkbox"/> Locomotive Engineer
<input type="checkbox"/> Locomotive Fireman
<input type="checkbox"/> Locomotive Machinist
<input type="checkbox"/> Railroad Section Foreman
<input type="checkbox"/> Steam-Diesel Loco. Eng.</p> <p>Stationary Eng'r's Courses</p> <p><input type="checkbox"/> Boilermaking
<input type="checkbox"/> Combustion Engineering
<input type="checkbox"/> Engine Running
<input type="checkbox"/> Marine Engineering
<input type="checkbox"/> Power Plant Eng'r's
<input type="checkbox"/> Steam Engr.</p> | <p>Textile Courses</p> <p><input type="checkbox"/> Cotton Manufacturing
<input type="checkbox"/> Loom Fixing
<input type="checkbox"/> Textile Designing
<input type="checkbox"/> Rayon Weaving
<input type="checkbox"/> Woolen Manufacturing</p> <p>Business and Academic Courses</p> <p><input type="checkbox"/> Accounting
<input type="checkbox"/> App. Psychology
<input type="checkbox"/> Business Administration
<input type="checkbox"/> Bus. Correspondence
<input type="checkbox"/> Certified Public Accounting
<input type="checkbox"/> Commercial
<input type="checkbox"/> Commercial Art
<input type="checkbox"/> Cost Accounting
<input type="checkbox"/> Federal Tax
<input type="checkbox"/> Foremanship
<input type="checkbox"/> Good English
<input type="checkbox"/> Higher Mathematics
<input type="checkbox"/> Industrial Supervision
<input type="checkbox"/> Motor Traffic
<input type="checkbox"/> Retailing
<input type="checkbox"/> Salesmanship
<input type="checkbox"/> Sign Lettering
<input type="checkbox"/> Spanish
<input type="checkbox"/> Advertising
<input type="checkbox"/> Bookkeeping
<input type="checkbox"/> Bus. Law
<input type="checkbox"/> Bus. Management
<input type="checkbox"/> Commercial
<input type="checkbox"/> First Year College
<input type="checkbox"/> French
<input type="checkbox"/> High School
<input type="checkbox"/> Illustration
<input type="checkbox"/> Postal Civil Service
<input type="checkbox"/> Retail Bus. Management
<input type="checkbox"/> Secretarial
<input type="checkbox"/> Stenography
<input type="checkbox"/> Traffic Management</p> |
|--|--|--|--|

Name _____ Age _____ Home Address _____

City _____ State _____ Working Hours _____ A.M. to _____ P.M.

Present Position _____ Employed by _____

Length of Service in World War II _____ Enrollment under G.I. Bill approved for World War II Veterans. Special tuition rates to members of the Armed Forces. Canadian residents send coupon to International Correspondence Schools Canadian, Ltd., Montreal, Canada.

INVENTORS

If you consider your invention to be something of importance — if you have invented any new and useful art, machine, manufacture or composition of matter or improvement thereof — you are advised to protect your invention by applying for a U. S. patent.

This firm is registered to practice before the U. S. Patent Office and is available to assist in the preparation and prosecution of your patent application.

The "Evidence of Invention" form mentioned below is offered as a convenience to you in making your disclosure to us for search purposes.

You should date and sign your disclosure and have it witnessed by two or more persons who are capable of understanding your invention.

Your disclosure should be mailed to us together with a letter authorizing us to conduct a preliminary search among previously granted U. S. patents for similar types of invention.

We then make this search and prepare a report of the probable patentability of your invention. If such report is favorable, we recommend the further course for you to take.

The "Evidence of Invention" form and booklet are suggested as conveniences to you and us in starting action on your invention.

VICTOR J. EVANS & Co. *Merlin M. Evans*
REGISTERED PATENT ATTORNEY

530-G MERLIN BUILDING, WASHINGTON 6, D. C.
PATENTS COPYRIGHTS

We shall be glad to send you promptly and without obligation, an instructive booklet, "Patent Protection for Inventors", which was prepared to give inventors detailed information and steps to take toward patent protection—also our convenient "Evidence of Invention" form. Use address Victor J. Evans & Co., 530-G Merlin Building, Washington 6, D. C.

PRINT YOUR OWN POST CARDS

COMPLETE OUTFIT
only
\$7.50



Amazing results in sales, inquiries and contacts . . . saves time and money . . . very easy to use GEM STENCIL DUPLICATOR is ideal for Advertising, Announcements, Notices, Labels, Forms, Price Lists—hundreds of uses for every type of business and organization. Comes complete with all supplies, instructions and 60-page Book of Ideas.

FREE TRIAL OFFER: Try it before you buy it! Write and a GEM OUTFIT will be sent you postpaid. After 10 days, send only \$7.50 or return the GEM, no questions asked. The GEM must sell itself; you be the judge.

BOND EQUIPMENT CO. • Dept. 135
6633 Enright • St. Louis 5, Mo.

SEND NO MONEY • FREE TRIAL OFFER

"How to Make Money with Simple Cartoons"



A book everyone who likes to draw should have. It is free; no obligation. Simply address

FREE BOOK

CARTOONISTS' EXCHANGE
Dept. 96-D Pleasant Hill, Ohio

Become a Doctor of PSYCHOLOGY

Win the degree of Ps.D. Teach the secret of contentment, happiness. Solve mental worries. Experience the revelation of truth. Chartered college. Individual help. Write for FREE book. **COLLEGE OF UNIVERSAL TRUTH, 5153-B North Clark St., Chicago.**



LABORATORY TECHNICIAN

BE A LABORATORY SPECIALIST; complete course. Big demand from hospitals, doctors, clinics. We teach all branches of medical laboratory work, including Medical and Dental X-Ray.

Approved by American College of Medical Technologists
Co-educational Free Placement Bureau
Free Catalog

Accredited for "veteran" training

CHICAGO COLLEGE OF LABORATORY TECHNIQUE
Dept. P.M., 431 S. Wabash Ave. Chicago 5, Illinois



MAKE MONEY!

RAISE CHIN-CHIN CHINCHILLA RABBITS
Pedigreed! Valuable Breeders!
PROFITABLE! EASY! PLEASANT!
Free Illustrated Booklet—WRITE TODAY!
ROCK HILL RANCH SELLERSVILLE 36, PA.

Command Bigger Money!

STUDY LAW

STUDY AT HOME for BUSINESS SUCCESS and LARGER PERSONAL EARNINGS. 40 years expert instruction — over 114,000 students enrolled. LL.B. Degree awarded. All text material furnished. Easy payment plan. Send now for FREE BOOK — "Law and Executive Guidance." It explains the course — how you may enroll and the many ways you can profit from Law Study. Write TODAY to:

AMERICAN EXTENSION SCHOOL OF LAW
Dept. 27-PM, 646 N. Michigan Ave., Chicago 11, Ill.

THESE MEN ARE GETTING PRACTICAL TRAINING

IN **ELECTRICITY**



On Real:

**A.C. and D.C. MOTORS
GENERATORS
SWITCHBOARDS
CONTROLLERS
WIRING JOBS
APPLIANCES
ELECTRONIC UNITS**

(Shown at left—Instructor demonstrating latest type of Test Unit for checking the efficiency of a Motor.)

AND **RADIO-TELEVISION**

On Real:

**TELEVISION SETS
RADIO RECEIVERS
F.M. (Frequency Modulation)
RECORD CHANGERS
AUTO RADIOS
AIRPLANE RADIOS
PUBLIC ADDRESS Systems**

(Right—Instructor explaining operation of 20-inch Cathode Ray tube used in Dumont Television Set.)



Just Like YOU Can Get in the Great SHOPS of COYNE

Prepare NOW for a real future the quick, practical way. Come to the Great Shops of COYNE in Chicago. Largest and best equipped school of its kind—now celebrating our 51st Anniversary. GI approved. Finance plan for non-veterans. **Mail coupon.**

NOT "HOME-STUDY" COURSES! At Coyne you learn on real, full-size equipment. Trained instructors show you how, then you do typical jobs yourself. We don't teach by mail.

CLIP COUPON NOW for big new illustrated Coyne book on either **ELECTRICITY** or **RADIO-TELEVISION** or both. No obligation; no salesman will call. Get the facts now!

**B. W. COOKE, Pres.
ELECTRICAL & RADIO-
TELEVISION SCHOOL**

500 S. Paulina St., Dept. AO-72H
Chicago 12, Ill.

COYNE



**Mail Coupon for
FREE BOOKS!**



B. W. COOKE, President
COYNE ELECTRICAL &
RADIO-TELEVISION SCHOOL
500 S. Paulina St., Chicago 12, Ill. Dept. AO-72H

Send FREE, the book checked below, and details of your training offer. This does not obligate me and no salesman will call.

ELECTRICITY RADIO-TELEVISION

NAME

ADDRESS

CITY.....STATE.....



ADCOX TRAINS YOUR HANDS TO MAKE GOOD MONEY QUICK!

AT AUTO BODY and FENDER WORK



L. L. ADCOX, President

Streets and highways of America are jammed with high speed automobiles. Smash-ups occur every minute of the day and night... and the damages must be repaired BY MEN WHO KNOW HOW to make smashed, dented and scratched Bodies and Fenders look like new again!

ADCOX SCHOOL, backed by 41 years of Trade School experience, plus modern facilities and expert instructors, can fit you for a job or business of your own in 10 to 12 weeks of training!



Wrecked Pontiac (at left) looked good as new after an Adcox student completed the job.

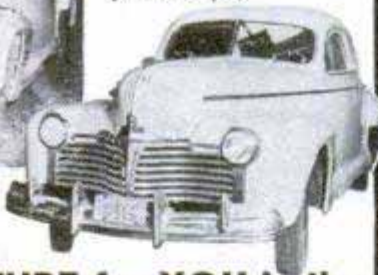

You work on ACTUAL wrecks in Adcox big Body and Fender repair shop!

There's a FUTURE for YOU in the Pacific Northwest!

It's a fine place to live and enjoy life — a great place to raise your family. Population and business opportunities are growing. Body and Fender men and Diesel Engine Trouble Shooters do well here!

ADCOX SCHOOL CATALOG FREE

APPROVED FOR VETERANS

L. L. ADCOX, President
ADCOX SCHOOL
237 N. E. Broadway, Portland 12, Oregon
Without obligation, send FREE Catalog No. 2.

Name _____
Address _____
Town _____ State _____
If World War II Veteran, Check Here



OWN YOUR OWN ELECTRIC APPLIANCE REPAIR BUSINESS!

Waffle Iron, Grill, Oven, Sewing Machine, Refrigerator, Washers, Dryers, Heaters, Vacuum Cleaners, Fans, Stoves, Ranges, Dishwashers, Freezers, Air Conditioners, Radios, Televisions, and more.

New shop method home training system gives you electrical "know how". You learn at home building, testing, repairing. Earn right from the start. Electronic testing kit, heating element kit, illustrated lessons supplied on a "Pay as You Earn" plan.

FREE Illustrated book on Electrical Appliance Repairing. Send card today.

CHRISTY TRADES SCHOOL
4432 N. Kedzie Ave., Dept. D-8203,
Chicago 25, Ill.

LEARN AERONAUTICAL ENGINEERING
Aircraft and Engine Mechanics (A & E)

Train at the Flying Wing school—New classes starting soon. Write for illustrated catalog.

Northrop Aeronautical Institute
APPROVED FOR VETERANS DIVISION OF NORTHROP AIRCRAFT, INC.
1527 E. Broadway, Hawthorne, Los Angeles County, California

Learn TELEVISION-ELECTRONICS RADIO

2 Big Books **FREE** Train at Home—Get Big Kits of Radio Parts! Prepare now in spare time. Practical instruction. Approved for Veterans. Write for details and 2 Radio Books—**ALL FREE!** Rush name today!

SPRAYBERRY ACADEMY OF RADIO
Dept. 10-K 111 No. Canal Chicago 6, Illinois

GREAT PROFITS MAKE YOUR OWN RUBBER MOLDS

X.L. RUBBER MOLDS will realize you great profits quickly! **WRITE FOR NEW FREE CATALOG**

YOU can EASILY learn to cast thousands of perfect plaques, book ends, figurines, ash trays, etc. **IT'S EASY, FUN, PROFITABLE!**
X.L. Rubber, Pts. \$2.00; Qts. \$3.50; Gallons \$8.95; Models and enough rubber for 3 molds \$1.30 postpaid.

PLASTIC ARTS STUDIO Address Dept. 2 3403 S. Madison St. Muncie, Ind.



SAVE 1/3 ON NEW POWERBIKE!

PRESTO — your bike's a speedy **POWERBIKE** when you install new **POWERBIKE** unit. Amazing new **DIRECT FROM FACTORY PLAN** now offers you speedy low cost transportation for only \$18.23 down. Send stamp for **FREE PICTURE CATALOG**.

SAGINAW PRODUCTS CORP.
108 River St., Saginaw, Mich.



STAMMERER? New booklet, "Stammering, and How to Stop It," sent free to any stammerer upon request. Write today. **BENJAMIN N. BOGUE**, Dept. 504, Circle Tower, Indianapolis 4, Ind.



Be an INVESTIGATOR

JAMES S. BOLAN, FORMER NEW YORK CITY POLICE COMMISSIONER offers **MEN & WOMEN** an opportunity for a Professional Career in Modern Investigation & Criminology by comprehensive Home Study Course. Free placement service assists graduates to obtain jobs. **APPROVED FOR VETERANS**. Licensed by State of New York. Write for Booklet P

THE BOLAN ACADEMY, INC.
EMPIRE STATE BLDG., NEW YORK 1, N. Y.

GET INTO

DIESEL-AUTO MECHANICS

Master All Phases

JOBS LIKE THESE ARE AVAILABLE TO TRAINED MECHANICS. CHOOSE THE FIELD YOU LIKE BEST

Get Complete Training

- Diesel Fuel Injection
- Automotive Motor Tune-up
- Diesel Engine Rebuilding
- General Garage Mechanic
- Agricultural Implements
- Auto Engine Rebuilding
- Auto Elec. Service
- Public Utilities
- Parts Dealers
- Bus & Truck Lines
- Industrial Maintenance
- Contracting & Excavating
- Business of Your Own
- AND MANY other similar openings.

As a National Schools graduate, you are trained for ALL opportunities in the Diesel & Auto Industries

EARN WHILE YOU LEARN

With our practical Master Shop-Method Home Training, you study at home in your spare time. You receive Spare Time Work Lessons, which show you how to earn while you Learn . . . for extra money and experience. You Learn by DOING.

TOOLS AND EQUIPMENT

To make your training complete, we give you selected mechanic's tools and equipment, illustrated below, including all-metal toolbox—as a regular part of your instruction.

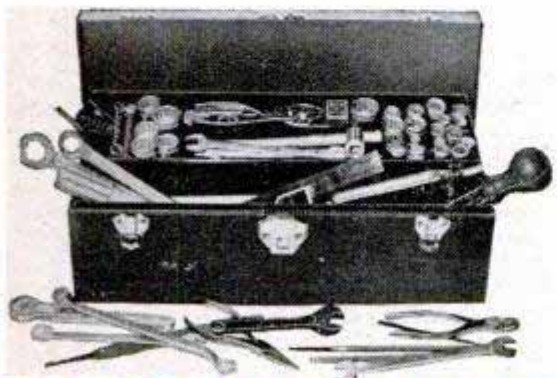

WE GIVE YOU TOOLS OF YOUR TRADE



Shop-Method Home Training by an Established Resident School Prepares you for Many Good Jobs

Opportunity is everywhere for the trained Diesel-Auto Mechanic. Highways throng with cars, busses, trucks, tractors. Garages and Service Stations are kept busy. Factories, ships, farms, railroads, general industry, are dependent upon engine power. Here's a dynamic, fast-growing field that needs trained men who know ALL phases: installation, operation, maintenance and repair. Now—National Schools offers you a practical, all-embracing Diesel-Auto Mechanic's Course, including all of these advantages:

Complete training, covering—Diesels, High Speed and Heavy Duty; Semi-Diesels, Gasoline and Special Fuel Engines AND Allied Mechanics.

- Basic Lesson Texts
- Diesel Installation
- Operation - Maintenance
- Diesel Chart Manual
- Spare Time Lessons
- Engine Service Manuals
- Engine Repair
- Drive Systems
- Diesel Electric Power
- Thermodynamics

TOOLS AND EQUIPMENT

INVESTIGATE
Secure Full Information

NEW, ILLUSTRATED BOOK & SAMPLE LESSON SHOW HOW WE TRAIN YOU . . . SEND FOR THEM TODAY!



NATIONAL SCHOOLS
LOS ANGELES 37, CALIF. • EST. 1905



FIND OUT NOW...MAIL COUPON TODAY

NATIONAL SCHOOLS, DEPT. PMD-6 (Mail in envelope or paste on penny postcard)
4000 South Figueroa Street
Los Angeles 37, California
Mail me FREE the book, YOUR FUTURE IN DIESEL-AUTO MECHANICS, together with the Sample Lesson. I understand I may keep and use the information with no obligation.

Name _____ Age _____

Address _____

City _____ Zone _____ State _____

Check here if Veteran of World War II



THOUGHTS HAVE WINGS

You Can Influence Others With Your Thinking

TRY IT SOME TIME. Concentrate intently upon another person seated in a room with you, without his noticing it. Observe him gradually become restless and finally turn and look in your direction. Simple—yet it is a *positive demonstration* that thought generates a mental energy which can be projected from your mind to the consciousness of another. Do you realize how much of your success and happiness in life depend upon your influencing others? Is it not important to you to have others understand your point of view—to be receptive to your proposals?

How many times have you wished there were some way you could impress another favorably—*get across to him or her your ideas?* That thoughts can be transmitted, received, and understood by others is *now* scientifically demonstrable.

This FREE Book Points the Way

The tales of miraculous accomplishments of mind by the ancients are now known to be fact—not fable. The method whereby these things can be **INTENTIONALLY**, not accidentally, accomplished has been a secret long cherished by the Rosicrucians—one of the schools of ancient wisdom existing throughout the world. Write for the free copy of the fascinating sealed book, **"THE MASTERY OF LIFE,"** which explains how you may receive this unique wisdom and benefit by its application. Address: Scribe S. W. Y.

The ROSICRUCIANS

San Jose, (AMORC) California

USE THIS COUPON

Scribe S. W. Y.
The Rosicrucians
San Jose, California

I am sincerely interested in an intelligent method of attaining a mastership of life. Send me without obligation, your FREE Book which explains how I may receive and use your age-old method.

Name.....
Address.....
City.....

I Can Make You A New Man

Let Me Prove It In Only
15 Minutes a Day!

LET me PROVE that "Dynamic Tension" can give you a gloriously healthy body—powerful muscles, smashing strength, tireless energy! Many of those I have helped were run-down, nervous, lethargic. They got rid of their "bay windows"—and now feel new vigor flowing through their systems. They feel that they added years to their lives.

Send postcard for my FREE 48-page book, "Everlasting Health and Strength." No obligation. Address:

**CHARLES ATLAS, Dept. 86,
115 East 23rd St., New York 10, N.Y.**



**CHARLES
ATLAS**

BE A NOTARY PUBLIC

Old legal-supply house, 22 cities, guides you to quick official appointment, equips you fully Pay after appointment (2 payments \$12.50 each). Lifetime public office, income. You notarize legal papers, using only your signature and official seal, receive your fees. Easy. Details free. **STATIONERS EXCHANGE HELOTES 10, TEXAS**

Now Many Wear

FALSE TEETH

With More Comfort

FASTEETH, a pleasant **alkaline** (non-acid) powder, holds false teeth more firmly. To eat and talk in more comfort, just sprinkle a little **FASTEETH** on your plates. No gummy, gooey, pasty taste or feeling. Checks "plate odor" (denture breath). Get **FASTEETH** at any drug store.

Learn CARTOONING

HAVE FUN! MAKE MONEY! Cash in on your sense of humor at HOME—BY MAIL. No experience needed to start. Write today for FREE TRIAL LESSON and full particulars.

Moon Gag Cartoon School, Dept. E, Fall Creek, Wis.



**NATION'S
LARGEST
EXCLUSIVE
ELECTRICAL
SCHOOL**

"LEARN-BY-DOING"

ELECTRICITY

**PRACTICAL TRAINING
NOT "HOME STUDY"**

Get actual experience in great shops of M.T.I. Learn all phases Practical Electricity; Housewiring, Motors, Const., Maintenance, etc. Living arrangements, Part-time jobs, etc. Pay after graduate plan.

A post card brings the story.

**MICHIGAN TECHNICAL INSTITUTE, Dept. PM-6
2281 W. Fort St., Detroit 16, Michigan**

JUNIOR MIMEOGRAPH

PRINTS

Post Cards

Labels

Tags

Price Lists

QUICK

Easy to use, inexpensive in operation, this modern machine guaranteed 5 years. Thousands in use. Write for complete information.

DUPLICARD

P. O. Box 13087

Dept. 12

Houston 19, Texas



only
\$16.50
complete
with supplies

TELEVISION



RADIO and ELECTRONICS OFFER YOU

REAL MONEY and REAL JOB OPPORTUNITIES!

OPTIONAL FEATURE



BUILD AND KEEP FULL-VIEW 16-INCH RECTANGULAR "BLACK" PICTURE TUBE TELEVISION RECEIVER

PREPARE AT HOME . . . Become a TELEVISION · RADIO · ELECTRONICS TECHNICIAN! *No Previous Experience Necessary*

Here is everything you need to prepare you at home for FASCINATING WORK, GOOD MONEY and a THRILLING FUTURE in one of America's most promising fields. This includes the opportunity to build and keep the top-quality 16 inch rectangular picture tube television receiver shown above or a 10 or 12½ inch ROUND picture tube set . . . if you choose. No matter which tube you select, you will get bright, sharp, steady pictures. This is an optional feature—available at slight additional cost when you complete your training described below. Get the complete facts. See how D.T.I.'s wonderfully practical method meets industry's needs. No previous experience needed. Mail coupon today!

16 Big Shipments of Parts — Plus Lessons

Work over 300 electronic experiments and projects from 16 big shipments of parts. This includes building and keeping all test equipment and radio set shown at left side of page. Modern easy-to-read lessons with handy fold-out diagrams simplifies your entire training.

You Also Use Home Movies

D.T.I., alone, includes the modern, visual training aid MOVIES to help you learn faster, easier at home. See electrons on the march and other fascinating "hidden action" — a remarkable home training advantage that speeds your progress.

EMPLOYMENT SERVICE

When you complete your training, our effective Employment Service helps you get started toward a real future in Television-Radio-Electronics.

Modern Laboratories

If you prefer, you can get ALL your preparation in our new, Chicago training laboratories . . . one of the finest of its kind. Ample instructors . . . modern equipment. Write for details!

6 Tube Radio Receiver.

LEARN-BY-READING



LEARN-BY-SEEING

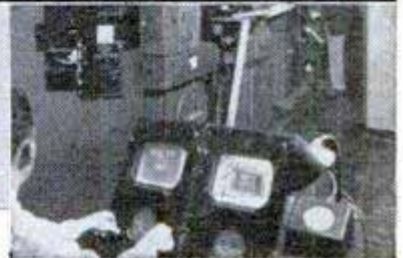

LEARN-BY-DOING

MAIL THIS COUPON TODAY!

DeFOREST'S TRAINING, INC. Dept. PM-G-6
2533 N. Ashland Ave.,
Chicago 14, Illinois

If under 16, check here for special information.

Without obligation, give me complete facts showing how I may make my start in Television-Radio-Electronics.

Name..... Age.....

Street..... Apt.....

City..... Zone..... State.....

DeForest's Training, Inc.

CHICAGO 14, ILLINOIS
A DeVry Institution

9 BIG BUILDING BOOKS

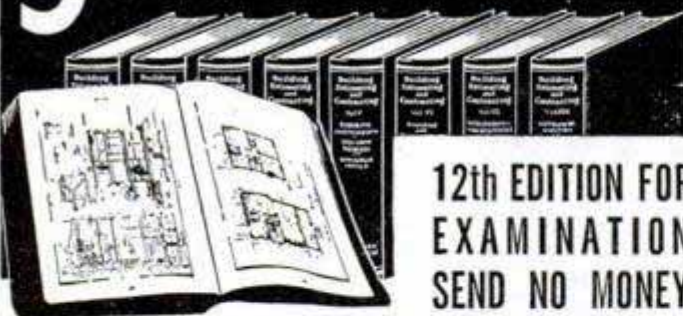

12th EDITION FOR EXAMINATION SEND NO MONEY

Learn to draw plans, estimate, be a live-wire builder, do remodeling, contracting. These 9 practical, profusely illustrated books cover subjects that will help you to get more work and make more money. Masonry, concrete forms, carpentry, steel square, roof framing, construction, plumbing, heating, painting, decorating and many other subjects. More than 4000 pages — 2750 illustrations.

BETTER JOBS — BETTER PAY UP-TO-DATE EDITION

A nationwide building boom is in full swing and trained men are needed. Big opportunities are always for MEN WHO KNOW HOW. These books supply quick, easily understood training and handy, permanent reference information that helps solve building problems.

These books are the most up-to-date and complete we have ever published on these many subjects.

Coupon Brings Nine Big Books for Examination

AMERICAN TECHNICAL SOCIETY—Publishers since 1898
Dept. GA19 Drexel at 58th Street Chicago 37, Ill.

You may ship me the Up-to-Date edition of your nine big books, "Building, Estimating and Contracting," without any obligation to buy. I will pay the delivery charges only, and if fully satisfied in ten days, I will send you \$2.00, and after that only \$3.00 a month, until the total price of only \$34.80 is paid. I am not obligated in any way unless I keep the books.

Name _____

Address _____

City _____ State _____

Please attach a letter stating your age, occupation, employer's name and address, and name and address of at least one business man as a reference. Men in service, also please give home address.

Learn this Profitable Profession



IN 90 DAYS AT HOME

Money-Making Career Open to Men and Women, 18 to 50

Hundreds of men and women between 18 and 50 make \$10 to \$20 in a single day giving scientific Swedish Massage and Hydro-Therapy treatments. There is big demand from doctors, hospitals, sanatoriums and clubs. Graduates earn large full time incomes from these or in private practice in their own offices. Others make good money from home treatments given in spare time. Learn this interesting, money-making profession in your own home, through our home study course. Same instructors as in our nationally known resident school. You can win independence and prepare for future security by qualifying for your Diploma. Course can be completed in 3 to 4 months. Many earn while they learn. Begin your training at once.



Anatomy Charts & Booklet FREE

Enroll now and we will include, at no extra cost, many needed supplies. Fit yourself to help meet growing demand for Scientific Swedish Massage. Send the coupon at once for complete details. Anatomy Charts and 32-Page Illustrated Booklet, FREE, postpaid.

THE COLLEGE OF SWEDISH MASSAGE
Dept. 064G, 41 E. Pearson, Chicago 11, Illinois
Please send me FREE and postpaid, Anatomy Charts, 32-page Booklet and complete details on Home Training.

Name _____ Age _____

Address _____

City _____ State _____

FREE

A NEW HOME INDUSTRY



Let us show you how extremely easy and PROFITABLE it is to make beautiful and useful things out of LIQUID PLASTICS, LIQUID MARBLE, LIQUID IVORY, LIQUID GLASS, CERAMICS, ETC. . . . as easy as pouring water out of a glass! Make novelties, jewelry, gifts, artware, toys, tools, dies, gadgets, ceramics . . . a million useful things! We supply everything—MATERIALS, INSTRUCTIONS and BUYERS! Send only 25c for 1. Big catalog of 300 casting materials, molds and accessories. 2. A beautiful CASTING free (to show you what you can do), and 3. Actual INSTRUCTIONS on how to cast and start in the CASTING BUSINESS! VALUABLE MOLDS given FREE with orders! Send 25c today—this may be the lucky coin that will start the most fascinating and profitable phase of your life.

PLASTICAST COMPANY (DEPT. C)

170 N. Halsted St. (Write to P. O. Box 987
Chicago 6, Ill. nearest address) Palo Alto, Calif.
CANADIAN CUSTOMERS, please order directly from: CANADIAN INDUSTRIAL PLASTICS, LTD., 1056 1/2 Pender West, Vancouver, B.C.

LEARN AT HOME TO MOUNT BIRDS



Animals, Heads, Fishes, Pets; to TAN. Be a Taxidermist. Profit and FUN.

Hunters, save your valuable TROPHIES. Mount ducks, squirrels, everything. Learn to TAN for leather and furs. Wonderful HOBBY Have a HOME MUSEUM. BIG PROFITS mounting for others. INVESTIGATE NOW.

FREE BOOK With 100 fine game pictures. NOW absolutely FREE. Write TODAY.

Send Postal TODAY for FREE BOOK. State AGE. N. W. SCHOOL OF TAXIDERMY, Dept. 2506, Omaha, Nebr.



REAL ESTATE BE A BROKER

PAYS BIG! SEND FOR FREE, BIG, ILLUSTRATED CATALOG NOW! No obligation. Graduates report making substantial incomes. Start and run your own business quickly. Men, women of all ages, learn easily. Course covers Sales, Property Management, Appraising, Loans, Mortgages, and related subjects. **STUDY AT HOME** or in our classrooms in big cities. Diploma awarded. G.I. approved. Nationally known.

WEAVER SCHOOL OF REAL ESTATE (Est. 1936)
15 E. Pershing Road Dept. PM. Kansas City, Mo.

FREE BOOK TELLS HOW

Learn ACCOUNTING BOOKKEEPING

This nationally renowned school has demand for graduates in good salary positions thru Nationwide recognition and placement service. Write Department PMM today for Big 32 **FREE** page Success Book to be sent to you

Hills BUSINESS UNIVERSITY AND EXTENSION SCHOOL
619 W. MAIN ST. OKLAHOMA CITY 2, OKLAHOMA

RUPTURED?

Get Relief This Proven Way

Why try to worry along with trusses that gouge your flesh—press heavily on hips and spine—enlarge opening—fail to hold rupture? You need the Cluthe. No leg-straps or cutting belts. Automatic adjustable pad holds at real opening—follows every body movement with instant increased support in case of strain. Cannot slip whether at work or play. Light. Waterproof. Can be worn in bath. Send for amazing FREE book, "Advice To Ruptured," and details of liberal truthful 60-day trial offer. Also endorsements from grateful users in your neighborhood. Write:

CLUTHE SONS, Dept. 31, Bloomfield, New Jersey

TRI-STATE COLLEGE

FOUNDED 1884

Time tested, world famous accelerated B.S. Degree courses in Civil, Elect., Mech., Chem., Aero., and Radio and Telev. Engineering; Bus. Adm. and Acct. May be completed in 27 months. Also 36 weeks courses in Surveying, Drafting. For ambitious, earnest students. Preparatory Dept. for those who lack required high school work. G.I. approved. Visit campus, see well equipped labs. Low cost. Personalized instruction. World-wide student body. Grads. successful. Enrollment limited to 1600. Enter Sept., Jan., March., June. Write for Catalog.



**B. S.
DEGREE IN
27 MONTHS**
•
**World Wide
Enrollment**

460 College Avenue

Angola, Indiana



Free Book

RAISE HAMSTERS

The new wonder animals from Syria. Often called Toy Bears. Delightful pets. Everyone wants them. Laboratories need thousands. Clean, odorless. Raise anywhere. A profitable and interesting hobby or business. We furnish breeding stock with manual of instructions.

Write today for free illustrated literature.
GULF HAMSTERY, 1536 BASIL, MOBILE, ALA.



OWN a Business

Clean and mothproof rugs and upholstery "in the home." Patented equipment. No shop needed. Duraclean dealer's gross profits up to \$20 a day on EACH serviceman. These Nationally Advertised services create repeat customers. Easy to learn. Quickly established. Easy terms. Send today for FREE Booklet—Full details.

DURACLEAN CO., 0-166 DURACLEAN BLDG. DEERFIELD, ILL.

BE AN INVESTIGATOR

WORK HOME or TRAVEL. Experience unnecessary.
INVESTIGATOR Particulars FREE. Write to GEO. M. P. WAGNER, 125 W. 86th St., N. Y.

Say You Saw It in Popular Mechanics

IS YOUR JOB DEPRESSION PROOF?

Can you lose employment because of depression, business failure or old age? Learn watchmaking, the mechanical profession called "depression-proof for trained men" by impartial national authorities. Old age brings increased respect rather than insecurity. Study veteran-training approved courses in watch and clock repair, jewelry engraving, chronograph repair at the world's largest, best-equipped watchmaking school. Certified by the Horological Institute of America, Washington, D. C.

SEND FOR FREE 116-PAGE INFORMATION PACKET

**WESTERN PENNSYLVANIA
HOROLOGICAL INSTITUTE**
WORLD'S LARGEST WATCHMAKING SCHOOL



Desk 40, Chamber of Commerce Bldg., Pittsburgh, Pa.



NOW ANY AUTO REPAIR JOB CAN BE A "Push-Over" for You!

IN LESS TIME — WITH LESS WORK — AND MORE PROFITS!

Used by U. S. Army and Navy



NOW, tackle anything from carburetor to rear end on ANY car built from 1935 thru 1950! Fix it quick, easy, right the FIRST time! Just look up make, model, and job in quick index of MoToR's brand-new 1950 Edition AUTO REPAIR MANUAL. Clear, illustrated instructions—you just can't go wrong! 7-DAY FREE TRIAL!

Earn More Money! Win Prestige!

Boiled down in one BIG handy 750-page book—the complete "dope" from 150 Official Factory Manuals. 200,000 service, repair, tune-up facts, 35,000 essential dimensions!

Covers 741 car models. Includes all new automatic transmissions, GM Rochester carburetors, 2100 cut-away photos, diagrams, charts show what the clear text tells. Used by Army, Navy, Tech Schools, thousands of auto-repairmen. Makes every operation so easy, you'll tackle jobs you wouldn't think of doing before. You'll win added prestige, more money!

SEND NO MONEY

Mail coupon—without money! When book arrives—make it show you what it's got! Unless you agree it's the greatest time and work saver you've ever seen—return it in 7 days, pay nothing. Mail coupon NOW! MoToR Book Department, Desk 1G, 250 West 55th Street, New York 19, N. Y.

COVERS ANY CAR BUILT SINCE 1935!

- | | |
|-----------|------------|
| Auburn | Kaiser |
| Austin | Lafayette |
| Bantam | La Salle |
| Buick | Lincoln |
| Cadillac | Mercury |
| Chevrolet | Nash |
| Chrysler | Oldsmobile |
| Cord | Packard |
| Crosley | Pierce |
| De Soto | Arrow |
| Dodge | Plymouth |
| Ford | Pontiac |
| Frazer | Reo |
| Graham | Studebaker |
| Hudson | Terraplane |
| Hupmobile | Willys |

Same FREE Offer On MoToR's Truck and Tractor Manual

BRAND-NEW! Covers EVERY job on EVERY popular make gasoline truck, tractor made from 1936 thru 1949. FREE 7-Day Trial. Check proper box in coupon.



MAIL COUPON NOW FOR 7-DAY FREE TRIAL

MoToR BOOK DEPT.

Desk 1G, 250 W. 55th St., New York 19, N. Y.

Rush to me at once (check box opposite book you want):

MoToR's New **AUTO REPAIR MANUAL**. If O.K., I will remit \$1 in 7 days (plus 35c delivery charges), \$2 monthly for 2 months and a final payment of 95c one month after that. Otherwise I will return the book postpaid in 7 days. (Foreign price, remit \$8 cash with order.)

MoToR's New **TRUCK & TRACTOR REPAIR MANUAL**. If O.K., I will remit \$2 in 7 days, and \$2 monthly for 3 months, plus 35c delivery charges with final payment. Otherwise I will return book postpaid in 7 days. (Foreign price, remit \$10 cash with order.)

Print Name.....Age

Address

CityState

Check box and save 35c delivery charge by enclosing WITH coupon entire payment of \$5.95 for Auto Repair Manual (or \$8 for Truck and Tractor Repair Manual.) Same 7-day return-refund privilege applies.



**Put your future
in your own hands**

BE AN ARTIST

**Here's the Amazing
Way We Teach You
Step-by-Step to Draw
At Home in Spare Time**

Draw for money. You will enjoy W. S. A. training and can progress rapidly. **COMMERCIAL ART, DESIGNING, CARTOONING**—all in one complete, modern home study course. No previous art experience necessary. We start you from the beginning. Good art jobs available in advertising, television, newspaper and magazine publishing, department stores, art studios, etc. You can become your own boss. For 36 YEARS our graduates have been "making good"—**WHY NOT YOU?**



**Trained Artists Are Capable of Earning
\$65-\$80 and MORE a WEEK**

Write for **FREE BOOK**, "Art for Pleasure & Profit"—tells about our course, instruction service, material furnished, what our graduates say, and commercial opportunities for you. **TWO ART OUTFITS** and other features included with training. **Low cost—only \$5 monthly.**

VETERANS! Course G.I. Approved

FREE BOOK gives details!

WASHINGTON SCHOOL OF ART, STUDIO 126W

1115—15th St., N.W., Washington 5, D.C.

Please send me full information and your Free Book, "Art for Pleasure and Profit." (Please print name, etc.)

Name _____ AGE _____

Street _____

City _____ Zone _____ State _____

High School at Home

Many Finish in 2 Years

No classes. No time wasted going to and from school. Progress as fast as your time and abilities permit. Standard H. S. texts supplied. Thousands enroll each year in this 52-year-old school. Send for **FREE** descriptive booklet.

AMERICAN SCHOOL, Dept. HA45

Drexel at 58th St., Chicago 37, Ill.

Without obligation, please send **FREE** descriptive booklet.

Name _____

Address _____

WATCHMAKING

★ Watch Repairing ★ Jewelry Engraving ★ Jewelry Repairing

Combination men earn top pay. Learn in school fully accredited by Horological Institute of America in Washington, D. C. and United Horological Association of America. Approved for veterans. Receive tools, tuition and subsistence while learning.

Established 1935. Write for **FREE** booklet



The Baronian School, Inc.

2116 WALNUT ST. (DEPT. C) PHILA. 3, PA.

*Utilities
Engineering
Institute*

Founded 1927

**Diesel • Auto Body & Fender
REFRIGERATION • AIR CONDITIONING**

Practical training in these big pay trades covers overhauling, troubleshooting, installation, maintenance techniques. Proved, easy-to-follow method prepares you at home in spare time, follows with actual shop practice. Also G.I. approved resident courses.

Full information **FREE!** Write today
2525 Sheffield Ave., Dept. C-6, Chicago 14, Ill.

HOW TO MAKE MONEY!



RAISE HIGHLY PROFITABLE Angora Rabbits backyard easy way. Multiply fast. No experience required. Wool brings **TOP PRICE.** Plenty markets. Write **TODAY** for **FREE** INFORMATION, PRICES & **WHERE** to **SELL.**

WHITE'S RABBITRY
NEWARK 10, OHIO

RADIO ENGINEERING, Broadcasting, Television, FM, Servicing, Electronics, Aviation, Marine & Police Radio taught thoroughly.

Engineering course equivalent to 3 years' college radio work. Approved Veteran Training. Catalog free.
VALPARAISO TECHNICAL INSTITUTE, Dept. D, Valparaiso, Ind.

**NEW! LOW COST!
RESPIRATOR**

Wear when sanding, grinding, paint spraying, sweeping, dusting, furnace cleaning, etc. Handy as a pair of glasses. Just keep mouth closed and breathe through nose is all you do to operate. Protects against nuisance dusts, lint, coal, cement, grain dust, hay fever pollen. Has 9 sq. in. filter. For **EYE** protection against paint spray, dusts, gases, fumes, smoke, order our **Fog-Proof Rubber GOGGLES \$1.65 p.p.** (All prices postpaid in U.S.A.)

JERRY BRYANT, Dept. PM
919 N. Michigan Ave. Chicago 11, Ill.



Order Today \$1.00
POST PAID

**LEARN MEAT CUTTING
At Home—In Spare Time**



Get into the vital meat industry. Concise, practical Home Training based on 25 years proven instruction methods used at National's famous resident school. Prepares you for bigger pay as Meat Cutter, Supervisor, market manager or more money in your own store. Go as rapidly as your spare time permits. Diploma. Start **NOW** to turn your spare hours into money. Send for **FREE** bulletin today. No obligation.

NATIONAL SCHOOL OF MEAT CUTTING, INC., Div. U-117, Toledo 4, Ohio

Be an AUTO MACHINIST

Draw Top Pay—No Job Worries

Be a high-paid auto machinist! Specialize—make more money. New **FREE** booklet tells how to prepare for good jobs as an auto machinist or auto mechanic. G. I. Approved School of Auto Mechanics.

FREE: Write for your **FREE** booklet today

AMERICAN TRADE SCHOOLS
2417B McGee Street Kansas City, Mo.



SAY YOU SAW IT IN POPULAR MECHANICS

Learn BAKING At Home

Baking is one of America's high industries in wages. Nearly depression-proof. Thorough basic home course lays sound foundation. If you have aptitude, write for **FREE BOOKLET**, "Opportunities in Commercial Baking."

National Baking School, 1315 Mich. Ave., Dept. 135A, Chicago 5





Get
Into

TELEVISION, RADIO ELECTRONICS

Master ALL Phases

Get Complete Training. You Receive and Keep All Tubes, Equipment, Parts and Lessons. No Extra Charges.

**GOOD PAY
and Unlimited Opportunities
in JOBS LIKE THESE:**

Business of Your Own
Radio Manufacturing, Sales, Service
Broadcasting Telecasting
Television Manufacturing,
Sales, Service
Laboratories: Installation, Maintenance of Electronic Equipment, Electrolysis, Call Systems
Garages: Auto Radio Sales, Service
Sound Systems and Telephone Companies; Oil Well and Drilling Companies; Engineering Firms
Theatre Sound Systems Police Radio
And scores of other good jobs in many related fields

**YOU CONDUCT MANY
EXPERIMENTS LIKE THESE!**

Checking action of condensers
Experiments with AF and RF amplifiers.
Experiments with resonance
Producing beat frequencies
Calibrating oscillators
Experiments with diode, grid-bias, grid-leak and infinite impedance detectors
Practical experience in receiver troubleshooting
Application of visual tester in checking parts and circuits
Experiments with audio oscillators
Advanced trouble-shooting
... and many, many others

Complete Training by Practical Resident Trade School, Est. 1905

The same highly trained faculty, instruction materials and methods used here in our large, modern resident school, are adapted to your training in your own home. Shop Method Home Training has been proved by hundreds of successful graduates.

Both Resident and Home Study Courses Offered

**YOU
LEARN BY
DOING**

You receive special laboratory experiment lessons to show you how to build with your own hands various experimental units such as those shown at left, and how to conduct many tests.



**YOU RECEIVE THIS
PROFESSIONAL MULTITESTER
YOU BUILD ALL THESE AND
MANY OTHER UNITS WITH
PARTS WE SEND YOU!**

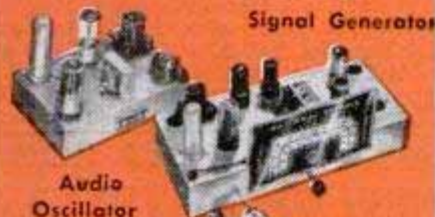

Signal Generator

Audio Oscillator

T.R.F. Receiver

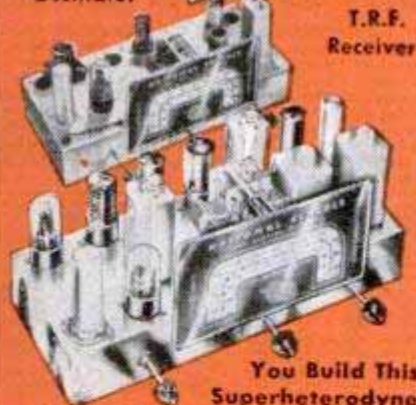

You Build This Superheterodyne



You Receive a Special Series of Modern Lessons in TELEVISION, all a part of your course: you master all phases.

You will find all lessons easy to understand because they are illustrated throughout with clear diagrams and step-by-step examples that you work out yourself. Every piece of the equipment and complete lesson material we send you is yours to keep and enjoy, including the multitester, experimental equipment, all parts of the Superheterodyne, tube manual, radio dictionary, and complete, modern Television texts. All parts are standard equipment.

**Shop Method Home Training . . .
Earn While You Learn**

With our practical resident Shop Method Home Training, you study in your spare time. You receive Spare Time Work Lessons, which show you how to earn while you learn. Service neighbors' radios and TV receivers, appliances, etc., for extra money and experience. Many National students pay all or part of their training with spare time earnings!

DON'T DELAY! The Radio-Television Industry needs trained men NOW!

**APPROVED
FOR
VETERANS!**
Check coupon below!

For quick action, mail coupon today and we'll rush you full information.

Free!

NEW, ILLUSTRATED OPPORTUNITY BOOK AND SAMPLE LESSON SHOW YOU HOW WE TRAIN YOU . . . SEND FOR THEM TODAY! NO COST. NO OBLIGATION.



NATIONAL SCHOOLS

LOS ANGELES 37, CALIF. • EST. 1905

FIND OUT NOW . . . MAIL COUPON TODAY

National Schools, Dept. PM-6
4000 South Figueroa Street
Los Angeles 37, California

Send me your FREE book "Your Future in Radio" and the sample lesson of your course. I understand no salesman will call on me.

NAME..... AGE.....

ADDRESS.....

CITY.....ZONE.....STATE.....

Check here if Veteran of World War II

Mail in envelope or paste on penny postal.

EARN MORE IN DRAFTING



More Opportunities for Employment and Promotion

"Here I am at work making good money as a draftsman. I'm glad I sent the coupon to Chicago Tech for that Free Trial Lesson and found out how easy it is to learn Drafting in spare time at home. Today I feel secure in my job because the draftsman's work comes first on any new project. And, in addition, draftsmen can't be replaced with machines. What's more, I feel I'm slated for promotion and more pay, because I see so many draftsmen advancing to high-pay jobs."

LEARN IN SPARE TIME—AT HOME! (or at the College in Chicago)

A few hours of pleasant home study every week—that's all. No interference with your present job. All the tools you need; drawing outfit included. With Chicago Tech's help, you train yourself step by step. This tested method—developed over 46 years of C.T.C. progress—prepares men quickly for good positions in industry.



FREE INFORMATION—SEND COUPON

To prove to you how easy it is to learn Drafting at home by the Chicago Tech method, we will send you this FREE TRIAL LESSON. No charge for this lesson, now or later. Fill out and mail coupon, or send post card today.

CHICAGO TECHNICAL COLLEGE

G-213 Tech Bldg., 2000 S. Michigan Ave., Chicago 16, Illinois

Mail me FREE Lesson with information about big opportunities in DRAFTING.

Name _____ Age _____
Address _____
City _____ Zone _____ State _____

BIG PAY JOBS for men who qualify in DIESEL



ASSURE YOUR FUTURE. Steady, high-pay jobs await men qualified in Diesel, Tractor, and Heavy Equipment. Are you qualified for job and advancement opportunities in this fast-growing field? You can qualify!

COMPLETE DIESEL COURSE NOW AVAILABLE. If you are ambitious and want to get ahead in this big money field, you'll want to know about the complete Diesel home training course now offered by Interstate Training Service. Covers all phases of operation, repair, service. Easy to master in spare time. No interference with present job. Up-to-the-minute. Regularly revised to cover new developments. We invite comparison of material offered. Free placement advisory service.



YOU OWE IT TO YOURSELF to investigate Interstate Training Service Diesel Training. Thousands agree it has helped them to better jobs... better pay. It can do the same for you!

WRITE FOR FREE INFORMATION TODAY

INTERSTATE TRAINING SERVICE, Portland 13, Ore.
Please see that I receive FREE 24-page book, "Getting Ahead in Diesel." (K-6)

NAME _____ AGE _____
ADDRESS _____
CITY _____ ZONE _____ STATE _____

ACTUAL PHOTO

6 POWER PRISM BINOCULARS

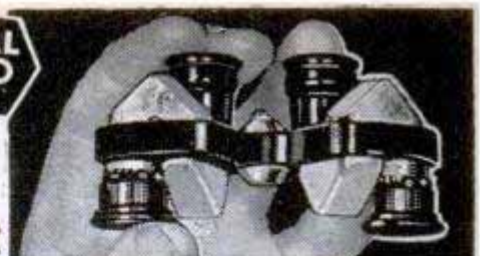

VEST POCKET IN SIZE!

COATED! Dynamic in power and range. At 1000 yards has sharp, clear field of 370 feet! Military type. Achromatic lens! Moisture-proofed... Dust-proofed! All metal construction. Individual eye focusing. Adjustable for all eye widths! A compact, durable, all purpose prism binocular. NOT a field glass. Coated! Quality binoculars that bear the United seal on their frame. Because they are made to rigid UNITED specifications. America's leading binocular house—selling by mail since 1937. Economy priced at fraction of what similar glasses sell at retail! Complete with leather case and straps only \$19.50. Add Federal tax. Cash orders sent postpaid. On C.O.D.'s include \$2 deposit. **Guaranteed.** Try 20 days at our risk. United Binocular Co., 7941 S. Halsted, Dept. ARF-1608, Chicago 20.

LEARN TO WRITE a Good Hand!

FOR BUSINESS AND SOCIAL SUCCESS!
Easy to improve your handwriting at home quickly with my new instruction books just off the press. Master all the secrets of better penmanship. Simple and easy, fully illustrated, highly endorsed. Begin today. Write for: New Free Book, "How to Become a Good Penman," or check books wanted, \$1.00 each. Business Writing Artistic Writing Card Writing Engraving Alphabets Bird and Design Flourishing Complete Set \$4.50 Enclose 10c for your name beautifully written and special penpoint for shaded writing.
S. A. Ziller, President, TAMBLYN SCHOOL OF PENMANSHIP
441 Ridge Bldg. In Business Over 52 Years Kansas City, Mo., U.S.A.

SAY YOU SAW IT IN POPULAR MECHANICS

Get The Book That Tells About INVENTIONS WANTED

Lists hundreds of interests as authorized by leading U. S. companies themselves. Book names men to contact, how to submit ideas. Send \$2.50 today for 1950 issue of **GREEN LEAF GUIDE** (National Reference Book.)

FIELD PUBLICATIONS

Box 752

Dept. M

Port Washington, N. Y.

FREE AMAZING NEW BOOK "HOW TO ANSWER ADS"



Never before have you seen anything like this. Tells you in simple language the correct way to answer ads. Gets you quicker replies—better results, and greater satisfaction. Will save you time and money and it's **ABSOLUTELY FREE**. No obligation whatever. Every reader of advertising should have this booklet. Send a postcard for your copy NOW. Advertising Department, Popular Mechanics Magazine, 200 East Ontario Street, Chicago 11, Ill.

CARPENTRY BRICKLAYING

APPROVED FOR VETERAN TRAINING • FREE CATALOG

PENNSYLVANIA INSTITUTE SCHOOL OF TRADES
30th & MARKET STS. PHILA. 4, PENNA.

500 Pages, 7000 Novelties

Send 10c for mammoth, amazing catalog of 7000 novelties. 1-inch thick, roto picture section, 6-color cover. Carnival, circus, world's fair & science exhibit rolled into one! Includes live animals & pets, scientific supplies, hobbies, funmakers, planes & boats, looms, magic tricks, joke articles, unusual seeds, gadget timesavers, cameras, optical goods, projectors, movies, lucky jewelry, religious novelties, telegraph sets, disguises, musical instruments, stamps, coins, puzzles, fortune tellers, radios, experimental sets, auto & bike accessories, Western wear, telescopes, magnifiers, compasses, banks, smokers' gadgets, artists' supplies, printing sets, engines, motors, shockers, knives, billfolds, fireworks, guns, rifles, sports, money makers, swimming helps, 1000 fascinating books, games, locks, live chameleons, rings, exercisers, curious plants, etc., etc. (DeLuxe Hard Bound Library Edition 25c Postpaid.) Regular paper covered edition 10c. (Stamps accepted.) Sent Air Mail, \$1.00. **JOHNSON SMITH & COMPANY, Dept. 232, DETROIT 7, MICHIGAN**

10c

**YOU BUILD THIS
23-TUBE
TELEVISION
RECEIVER**

NOW!

FOR THE FIRST TIME YOU CAN GET
Real Practical HOME TRAINING In

TELEVISION

RADIO AND ELECTRONICS



**YOU WORK AND LEARN
WITH REAL TELEVISION
AND RADIO EQUIPMENT**

RADIO-TELEVISION TRAINING SCHOOL'S Master Technicians guide you. Located in the very heart of America's Television, Broadcasting, Radio and Sound Industries, RTS is right "on-the-spot" where new technical improvements are first introduced; is in the best possible position to bring students ACTUAL METHODS and practices developed by the RADIO-TELEVISION industry, leading to real money making opportunities. The 11 BIG KITS RTS GIVES YOU enable you to do many practical jobs, build the equipment illustrated; perform more than 100 other fascinating, valuable experiments. These jobs you do give you ACTUAL SHOP experience so vitally necessary to your future success. Thus RTS methods assure you BALANCED TRAINING—Theory PLUS Real Experience.

to earn WELCOME EXTRA CASH, even BEFORE FINISHING YOUR TRAINING! In fact, when friends and neighbors know you are studying Radio-Television you may—like many RTS students—actually get MORE REPAIR WORK THAN YOU CAN HANDLE.

**27 YEAR
SUCCESS RECORD**

Backed by over a quarter-century of experience in home training, RTS (formerly Radio Training Association of America) offers practical "Learn-by-doing" methods, assuring you quick step-by-step progress. Begin preparing for your future in Radio-Television now while the time is ripe. If you are at all mechanically inclined—and have a grammar school education, RTS can teach you how to MAKE GOOD in Radio-Television.

GET THE FACTS

Send for FREE BOOK which tells you all about the RTS "time-tested" home-training plan, developed by technicians in the heart of the Radio-Television field. Fill out the coupon now—TODAY! and your FREE BOOK entitled "How To Make Good in Radio-Television" will go out to you AT ONCE. No Obligation. No salesman will call. ACT NOW!

**OPPORTUNITIES NOW
WIDE OPEN FOR
Properly Trained Men**

Latest reports estimate 400 MILLION new television and radio sets will be built in the next 10 years . . . more than 72 million dollars is being spent RIGHT NOW just for radio repairs ALONE! When you are thoroughly trained by RTS Experts—who have their fingers on the pulse of the Radio-Television industry—a field of unlimited opportunities will open up for you in Your Own Radio-Television Sales & Service Business, F.M., Equipment Manufacturing, Communications and allied fields.

**EARN EXTRA MONEY
while learning at HOME**

Under the RTS amazingly easy, practical home-training plan there is no need for you to quit your present job. You study in SPARE TIME ONLY! RTS Experts show you how

RTS LEADS THE WAY

WE GIVE YOU

**11 BIG
TELEVISION
AND RADIO KITS
AT NO EXTRA COST**

**YOU BUILD THIS
6-TUBE STANDARD
SUPER HETERODYNE
RADIO SET with
SHORT WAVE
CONVERTER**

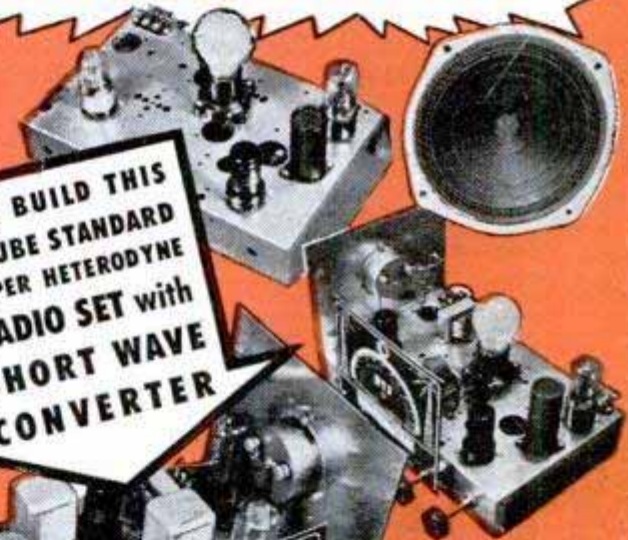

**YOU
KEEP ALL
EQUIPMENT
—it's Yours!**

**★
SEND
FOR THIS
30-PAGE
FREE
BOOK
★**

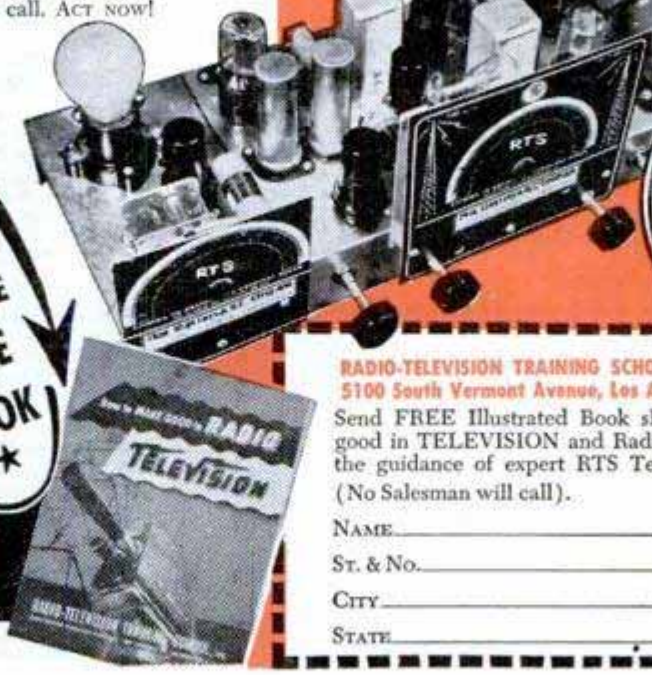

RADIO-TELEVISION TRAINING SCHOOL
5100 SO. VERMONT AVE., LOS ANGELES 37, CALIF., U.S.A.
ESTABLISHED 1922 — 27 YEARS AGO

RADIO-TELEVISION TRAINING SCHOOL, DEPT. PM-6
5100 South Vermont Avenue, Los Angeles 37, Calif., U.S.A.

Send FREE Illustrated Book showing how I can make good in TELEVISION and Radio through training under the guidance of expert RTS Technicians. No obligation. (No Salesman will call).

NAME _____ AGE _____
St. & No. _____
CITY _____ ZONE _____
STATE _____



YOU
can
acquire

LAW NIGHTS AT HOME! L L.B. DEGREE

LaSalle's famous Law Library—used as reference in many Law libraries and Law offices—has enabled thousands to master Law surprisingly fast, in spare hours at home, for business and professional advancement.

These 14 remarkable volumes, compiled by leading professors and lawyers, cover the whole basic field of Law in condensed, orderly, simplified manner.

You advance rapidly with this great library, plus special lectures furnished. We guide you step-by-step with personalized Problem Method of instruction . . . you learn by doing—handling legal problems—not by memorizing rules.

Send for two FREE 48-page booklets, "Law Training for Leadership," and "Evidence," answering questions about Law and its value to you, and telling how LaSalle Law graduates are winning rapid advancement in business and public life. Mail coupon below. No obligation.

LA SALLE EXTENSION UNIVERSITY A Correspondence Institution

417 S. Dearborn St., Dept. 664-L, Chicago 5, Ill.

Send me your two FREE booklets described above, without obligation.

Name _____ Age _____

Street _____

City, Zone & State _____

SEND FOR Inventors' IDEA Guide

ONLY \$1.00 POSTPAID
INVENTORS MAKE BIG
MONEY!! HERE ARE OVER
1,000 PRACTICAL IDEAS
FOR NEEDED INVENTIONS.



INVENTORS' IDEA GUIDE

1410 Raymond Ave.
St. Paul 8, Minnesota

Enclosed find \$1.00 for your new bulletin to help inventors.

Name _____

Address _____

If not entirely satisfied I may return bulletin within 5 days for refund.



NEW! Trash Disposal Unit Burns Refuse Safely

• A new type outdoor dispose-all unit safely and quickly burns garbage and trash in any weather. All refuse, damp, green or dry is fully consumed. Scientific draft design completely eliminates fire hazard of flying ash, sparks, burning, blowing bits of paper. Intense combustion removes neighbor-annoying nuisance of flying scraps, smoke, smell.

Sturdily built to last for years. Nothing to get out of order. Needs no watching. Will not blow over. Will not destroy grass or shrubs. Ends refuse hauling and fire hazards to quickly pay for itself. Measures 23" square at base by 40" high. Weighs 23 lbs. Over 2 bu. capacity. Recommended by Bureau of Fire Prevention. Full price \$9.95—nothing else to buy. Sent F.O.B. Cleveland. Money back guarantee. Send check, cash, or money order to:

ALSTO COMPANY, Engineers Bldg., Dept. PM-6, Cleveland, Ohio

New Advertising Machine Prints Post Cards

FREE LEARN HOW thousands of business men, in every line, boost sales in spite of conditions—with ads printed on postcards by amazing new patented **CARDMASTER** advertising machine. Low price, sold direct. Guaranteed 5 years. **SEND NAME** for **FREE** illustrated book, new money-making ideas and complete, unique advertising plans. **Cardmaster Co., 1920 Sunnyside, Dept. 136, Chicago 40, Ill.**



LEARN WATCH REPAIRING



AT HOME. By our modern and original system of instruction you can learn every part of the **WATCH REPAIRING TRADE AT HOME.** Prepare yourself for a well-paying position or start in business after completing our course of instruction. Good watch repairers are in demand and generally earn very good salaries. For particulars apply to the **WISCONSIN SCHOOL OF WATCH REPAIRING** 759 North Milwaukee St., Milwaukee 2, Wis.

Rupture Troubles Ended

Advanced method has healed thousands. No leg straps, no elastic, no plasters. No pressure on hips or spine. Flexo-pad. Entirely different. Endorsed by doctors, mechanics, clerks. Very light. **INEXPENSIVE. GUARANTEED.** Write for information and trial.

SMITH MANUFACTURING COMPANY
EST'D 1893 DEPT. PM PRESTON, ONTARIO



RE-STRING RACKETS AT HOME—EARN MONEY

EASY — PLEASANT — PROFITABLE
FREE Write for 1949 Catalog and Instruction Sheet NOW.

W. A. BICKEL & CO., 803 S. Boulevard, Dept. F-53, Oak Park, Ill.

Career Training in a Minimum of Time RADIO—ELECTRONICS TELEVISION ENGINEERING

GRADUATES of CREI residence school are preferred by industry because of their *training and ability.* CREI prepares the young man for a good job in industry in a minimum of time. 23 years practical experience. CREI offers an outstanding faculty, modern laboratories, shops and equipment. New students accepted twice monthly and each may advance as rapidly as he is capable. Basic course with one specialized course requires an average of 20 months to complete.
Approved for Veterans' Training.

• Write for Details and Free Booklet

**CAPITOL RADIO
ENGINEERING INSTITUTE**
Dept. 176B, 16th & Park Rd. N.W.
Washington 10, D.C.



LEARN HOW TO MAKE REAL MONEY IN

TELEVISION

RADIO & ELECTRONICS

AT NO EXTRA COST!
YOU GET A ROUND TRIP TO
NEW YORK CITY
FROM ANYWHERE IN THE U. S. OR CANADA

After you have completed the home study section of your course, your transportation to *New York City*—both ways—from any point in the United States or Canada will be paid by RTTA. At our affiliated training shops in New York City you'll get 2 *solid weeks*—50 hours of intensive laboratory work—on the most modern and scientific equipment. You'll live in New York City, the heart of the television industry, where the headquarters of the National Broadcasting Company,

American Broadcasting Company, Columbia Broadcasting System, Mutual Broadcasting System and many large television and radio companies are located.

FREE EMPLOYMENT HELP

Upon completing your laboratory resident course, you will *personally be recommended* for a position by our placement director, who will help you get started toward a money-making future in television, radio and electronics.

RTTA FURNISHES EVERYTHING—TUBES, BATTERIES, and LARGE TV PICTURE TUBE

IN DOUBLE QUICK TIME
EARN BIG PAY,
OWN YOUR OWN BUSINESS

NOW—you can qualify for a money-making career, through RTTA's sensational plan. In addition to becoming a **CERTIFIED TELEVISION TECHNICIAN**, you build yourself a complete large screen television set of the finest commercial quality, for your own use. You get 15 **BIG KITS** to enable you to get practical experience, build the equipment illustrated, including a radiotelegraph and radiotelephone transmitter, and many other testing units.

No matter where you live, no matter what you do, RTTA's effective methods can help you toward a **FAT PAY CHECK** or **YOUR OWN BUSINESS**. *Previous experience is unnecessary.*

ALL EQUIPMENT FURNISHED

The kits you will receive contain all the necessary **TUBES** and **BATTERIES** . . . a complete set of tubes for your **TELEVISION RECEIVER** including the **PICTURE TUBE**. In addition, you'll receive everything needed to build a complete TV set, and many more testing units.

EARN WHILE YOU LEARN

You will learn how to *earn money* in your spare time, without interfering with the work you are now doing. From the very beginning,

the **RADIO TELEVISION TRAINING ASSOCIATION's** plan is a practical **MONEY-MAKING COURSE**. We will show you how to cash in on your new knowledge, even while you are learning. *Act now* by clipping the coupon to find out how you can become a **CERTIFIED TELEVISION TECHNICIAN** and *earn extra money*.

WE PREPARE YOU FOR YOUR FCC LICENSE

RTTA prepares you to qualify for your FCC license. *Pay is higher* for the FCC license holder because only a comparative few of the thousands of men in radio-television today hold FCC tickets.

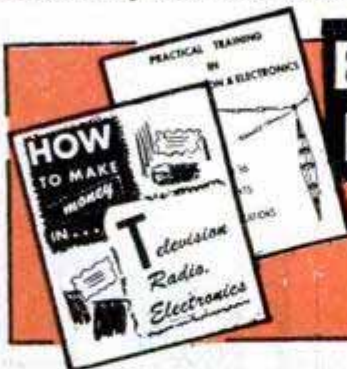

Yours absolutely **FREE**—an actual **SAMPLE LESSON**! Send for it today! You'll receive also our **FREE** catalog "How to Make Money in Television," telling how you can train for a money making job. *Mail Coupon Now!*

RADIO TELEVISION TRAINING ASSOCIATION
972 BROAD STREET NEWARK 1, NEW JERSEY

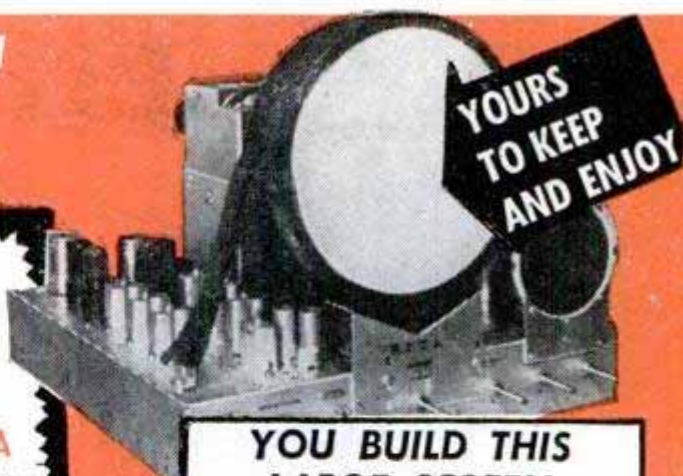

YOURS TO KEEP AND ENJOY

YOU BUILD THIS LARGE SCREEN TELEVISION RECEIVER

YOUR CHOICE OF 10, 12½ OR 16 INCH PICTURE TELEVISION TUBE

CAN BE CONVERTED FOR COLOR TELEVISION

STUDY AT HOME IN YOUR SPARE TIME



R. F. SIGNAL GENERATOR

YOU GET 15 BIG TELEVISION-RADIO KITS AT NO EXTRA COST. YOU BUILD THESE ILLUSTRATED UNITS



AUDIO OSCILLATOR

YOU KEEP ALL EQUIPMENT



MULTITESTER

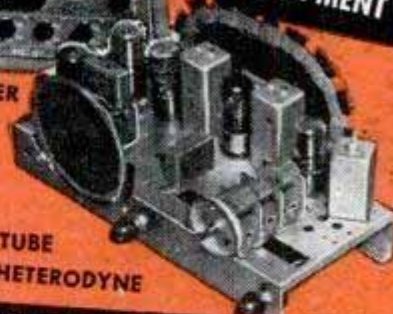

6 TUBE SUPER-HETERODYNE

FREE SAMPLE LESSON COUPON

RADIO-TELEVISION TRAINING ASSOCIATION, DEPT. 146
972 Broad Street, Newark 1, N. J.

Rush me the **FREE** Sample Lesson of your practical Home Television Course—**together with your FREE** Catalog "How to Make Money in Television" in **SPARE TIME** while learning. No obligations! I understand no salesman will call. **(PLEASE PRINT.)**

NAME _____ AGE _____
ADDRESS _____
CITY _____ ZONE _____ STATE _____

DRAW ME!



COPY THIS GIRL AND TRY FOR

\$1275 IN PRIZES!

5 PRIZES IN THIS JULY CONTEST! 5 Complete \$255 Art Courses, including Drawing Outfits!

Here's your big chance, if you want to become a commercial artist, designer, or illustrator! An easy-to-try way to win FREE art training!

Whether you win or not our instructors send you their comments on your work, if your drawing shows promise! Trained illustrators and artists now making big money. Find out if YOU have profitable art talent. Mail your drawing today!

Amateurs Only! Our students not eligible. Make copy of girl 5 ins. high. Pencil or pen only. Omit the lettering. All drawings must be received by July 31, 1950. None returned. Winners notified.

Latest Winner List! Free course winners in previous contest—from list just released:
C. Weber, Rt. 1, Osmond, Neb.; Miss C. Rodina, Rt. 1, Jackson, Minn.; G. Johnson, 325 Sand Alley, McKeesport, Penna.; Miss A. McLaughlin, 317 W. 45th, N. Y. City; Miss H. Meisner, 308 Hobart, Trenton, N. J.

Art Instruction, Inc.

MINNEAPOLIS • NEW YORK
CHICAGO • LOS ANGELES

MEMBER NATIONAL HOME STUDY COUNCIL

ART INSTRUCTION, INC. DEPT. 6130
500 S. 4th St., Minneapolis 15, Minn.

Please enter my attached drawing in your July drawing contest.

(PLEASE PRINT)

Name _____ Age _____

Address _____ Phone _____

City _____ Zone _____ County _____

State _____ Occupation _____

SOLVE REAL CRIMES!



Yes, YOU may be the one to lead the thrilling chase.

There IS satisfaction in bringing a crook to justice through SCIENTIFIC CRIME DETECTION. The thrill of solving the mystery may be yours.

We can teach you Finger Printing and Criminal Investigation; teach you quickly and easily in your own homes.

HUNDREDS OF IDENTIFICATION BUREAUS employ men trained by I.A.S. You too, may work for these Crime Detection Bureaus. Let us show you how we can prepare you for this exciting, well-paid profession in your spare time. Write today . . . NOW. No salesman will call. (Be sure to state your age.)

INSTITUTE OF APPLIED SCIENCE

(A Correspondence School Since 1916)

Dept. 135A, 1920 Sunnyside Ave., Chicago, 40, Ill.

Be A
FINGER
PRINT
Expert

FREE!

Send for thrilling "BLUE BOOK OF CRIME" which tells how Criminal Investigators work.

START YOUR OWN MONEY-MAKING BUSINESS

Clean rugs on customers' floors with highly efficient electric machine which is making BIG MONEY for others and giving them independence. Special skill or experience not required. No shop necessary. Write today for complete FREE information. Address:

VON SCHRADER MFG. CO., 610 PL., RACINE, WIS.

LAW FREE BOOK



Your FREE copy of "The Law-Trained Man" shows how to gain prestige and greater earnings through Blackstone's home law study. All instruction material furnished including 18-volume Law Library written by 65 well-known law authorities. Lawyers, Judges among our graduates. LL.B. degree. Low cost; easy terms. Write today.

BLACKSTONE COLLEGE OF LAW Dept. 50A, Chicago 1, Ill.

A Correspondence Institution Founded in 1890

Aptitude Tests for men, women, boys, girls, discover the kind of work or studies best for your success! You get a personal report—a guide for life—more happiness—more prosperity. Write for complete facts.

VOCATIONAL COUNSELORS, 5057 Woodward Avenue, Detroit



BE A LOCKSMITH

Learn from experts at home! Age or handicap no disadvantage. Profitable profession. FREE booklet.

INSTITUTE OF LOCKSMITHING, Dept. P-7
55 Park Ave., Rutherford, N. J.

it's fun to earn

RAISING HAMSTERS

Cash in on the growing demand for SYRIAN GOLDEN HAMSTERS recently introduced into the U. S. Ideal pets . . . big laboratory demand. Hardy, clean, odorless. Easily and profitably raised anywhere.

AKOPIAN HAMSTERY

the largest in the West

7358 H VARNA AVE. • NORTH HOLLYWOOD, CALIF.



write for
FREE booklet

Learn WATCH REPAIRING

Earn while AT HOME you learn

This fascinating and profitable trade can be learned in YOUR SPARE TIME at HOME through our thorough and complete Home Study Course, especially designed and written for HOME STUDY

OR
AT OUR G.I. APPROVED RESIDENT SCHOOL

WRITE FOR FREE INFORMATION

JOHN VANPUFFELN, Director

American Institute of
Specialized Watch Repair

Individual instruction given by competent instructors in an atmosphere conducive to good learning.

Department 1012-14 Franklin Street, S.E.
P. M. 101 GRAND RAPIDS-7, MICH.

BUILDERS

TRADE GUIDES



4 Vols. \$6

AUDELS CARPENTERS AND BUILDERS GUIDES—4 VOLS. \$6

Inside Information for Carpenters, Builders, Joiners, Building Mechanics—all Wood-workers. 1600 pages; 3700 diagrams; flexible; pocket size. Short-cut instructions, new methods, ideas, solutions, plans, systems—money saving suggestions. An easy progressive course for the apprentice. A practical daily helper and Quick Reference for the master worker. A Helping Hand to Easier and Better Work and Better Pay. To get this aid for yourself, simply fill in and mail the FREE COUPON below.

INSIDE TRADE INFORMATION ON:

How to use steel square; How to file and set saws; How to build furniture; How to use mitre box; How to use chalk line; How to use rules; How to make joints; Carpenters' arithmetic; Mensuration problems; Estimating

strength of timbers; How to set girders and sills; How to frame houses and roofs; How to estimate costs; How to build houses, barns, garages, bungalows, etc.; How to read and draw plans; Drawing up specifications; How

to excavate; How to use settings 12, 13 and 17 on the steel square; How to build hoists and scaffolds—skylights; How to build stairs; How to put on interior trim; How to hang doors; How to lath—lay floors; How to paint.

"Audels Guides worth four times their price—handy too as I carry them in pocket for reference." W. J. Bates, Knoxville, Pa.



4 Vols. \$6

AUDELS PLUMBERS AND STEAMFITTERS GUIDES—4 VOLS. \$6

A new edition—just out! A practical, illustrated, Reference Library and Study-Course for Master Plumbers, Journeymen and Apprentice Steamfitters, Gas Fitters and Helpers, Sheet Metal Workers, Draughtsmen, Master Builders, Engineers and all Building Trade Students. 1670 pages; 3642 diagrams; flexible; pocket size. Guides explain all the principles, advances and short cuts of the Plumbing and Heating trade. Contains instructions on how to figure and estimate jobs. Use FREE COUPON below to examine, without obligation, this valuable work.

INSIDE TRADE INFORMATION ON:

Air Conditioning. Soldering, tinning. Joint wiping, bending, beating. Pipe—iron—steel, threading. Mathematics, tables, physics. Materials—iron, steel, copper, brass, lead, tin, antimony. Sheet metal—galvanized—plate. Sanita-

tion, syphonage, tanks. Drainage, sewage, purification. Fixtures—bath—kitchen. Pipe fittings, soil pipe, tools. Laying out work. Roughing. Screwed fittings, flanges, joints. Pipe bending, examples. Elbows. Heating, ven-

tilation, refrigeration. Water supply, mains, wells, tanks. Gas-fittings. Underwriters. Sheet metal work, problems, methods, Brazing, heating, lead burning. Welding, various welds, methods. Blacksmithing, forges, tools.

"Audels Guides are practical, easy to understand, reliable. Cover the field in plain language." W. F. Arminger, Annapolis, Md.

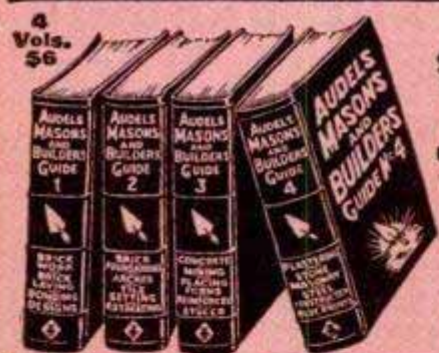

4 Vols. \$6

AUDELS MASONS AND BUILDERS GUIDES—4 VOLS. \$6

A complete, illustrated trade reference library, for Bricklayers, Cement Workers, Plasterers, Tile Setters and Stone Masons, including a practical outline of Steel Construction. 1100 pages; 2067 diagrams; flexible; pocket size. A practical Trade Assistant explaining modern methods of masonry construction. Easy to understand and apply. A reliable and authentic reference work and study-course for Master Journeyman and Young Mechanic. Use FREE COUPON below and find out for yourself, without obligation, whether this set will benefit you.

INSIDE TRADE INFORMATION ON:

Bricklaying, tools, materials; Brick designs, patterns, bonds; Setting frames and foundations; Mortars, scaffolds, estimating; Mortars and mortar mixing; Tile setting, mosaic, hollow tile; Straight edge test, trow-

eling; How to figure brick work; Safe loads, piers, chimneys; Boiler settings, anchors, fire stops; Labor tables; Concrete, forms; How to figure concrete work; Stucco—on old and new buildings; Plastering—wood lath—metal;

Plasterers agreement; Plastering on various surfaces; Stone masonry; Cutting, finishing, estimating stone; Derricks, rigging; Steel construction; Fire proof; How to read blue prints.

"Audels Masons Guides are the best books on the subject. Have laid brick 12 years and am a better judge." H. A. Sonnett, Corliss, Pa.



PRACTICAL ELECTRICITY—1 VOL. \$4

Audels Handy Book of Practical Electricity is a simplified Ready Reference and Study Course in one pocket size volume—for Engineers, Professional Electricians and Students. 1040 pages; 2600 diagrams; flexible bound. A reliable authority and handy helper for every electrical worker. Contains important and valuable wiring diagrams, calculations, machine sketches, helps on maintenance and repair. Use this FREE COUPON today and find out, without obligation, how this handy book will help you in your daily work.

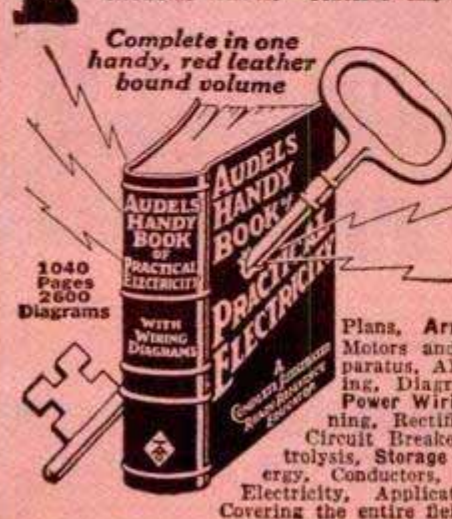

INSIDE TRADE INFORMATION ON:

Electro-Therapeutics, X-Rays, Shocks, Welding, Brazing, Radio Hook-ups, Motion Pictures, Telephone, Telegraph, Cranes, Bells, Elevators, Pumps, Tools, Ship Drive, Railways, Vehicles, Automobile Electric Systems, Ignition, Generation, Lighting, Plant Management, Power Plans, Armature Winding, Repairing, A. C. Motors and Apparatus, D. C. Motors and Apparatus, Alternator Construction, Dynamos, Wiring, Diagrams, Sign Flashers, Cable Splicing, Power Wiring, Outside Wiring, Switches, Lighting, Rectifiers, Converters, Transformers, Fuses, Circuit Breakers, Rheostats, Electro Plating, Electrolysis, Storage Batteries, Magnetism, Electrical Energy, Conductors, Insulators, Static, Dynamic, Radio Electricity, Applications, Ready Reference and Index Covering the entire field of Modern Electricity.

Learn More and You Will Earn More!

Know your job and you'll never be without one. The skilled man is always in demand. Knowledge is power. Learn your trade thoroughly by easy reading. This coupon is your opportunity for advancement and better pay. You risk nothing in sending for Audels Guides for free examination. Send it NOW!

FREE EXAMINATION COUPON

THEO. AUDEL & CO.
49 W. 23 ST. NEW YORK CITY

Please mail me for free examination the books marked (x) below. If I find them satisfactory, I agree to mail \$1 in 7 days, on each set ordered, and to further mail \$1 monthly on each set until I have paid the purchase price.

4 CARPENTERS GUIDES \$6 4 PLUMBERS GUIDES \$6

4 MASONS GUIDES \$6 1 ELECTRICIANS HANDY BOOK \$4

NAME.....

ADDRESS.....

OCCUPATION.....

EMPLOYED BY..... PM-27

INVENTORS

Before you make any effort to market your invention, you should take the first steps toward proceeding for patent protection.

The usual first step is to have a search of the U. S. patent records conducted, so that I can report to you on the question of patentability.

I shall be pleased to furnish you with information relative to patent procedure upon request from you, and this will be without any obligation on your part.

PATRICK D. BEAVERS

(Formerly RANDOLPH & BEAVERS)
Registered Patent Attorney

934 Columbian Building Washington 1, D. C.

INVENTORS

Whether an invention is patentable can be substantially determined by a search of the U. S. Patent records. Without obligation, write for information explaining the steps you should take to secure a patent.

JOHN N. RANDOLPH

Registered Patent Attorney

201 Columbian Building, Washington 1, D. C.

PATENTS PATENT LAWYER

COPYRIGHTS

GUSTAVE MILLER

Registered Patent Attorney

60-PM WARNER BLDG.
WASHINGTON 4, D. C.

ASSOCIATE EXAMINER

U. S. PATENT OFFICE 1922-1929

Patent Attorney and Advisor

U. S. NAVY DEPT. 1930-1947

Send for
PATENT INFORMATION book
and "INVENTOR'S RECORD"
without obligation

INVENTING

-FOR PROFIT! If you have an inventive turn of mind, write for free 28-page booklet explaining how the Institute of American Inventors is helping inventors pre-test the profit possibilities of proposed devices to fill today's unprecedented demand for useful new inventions.

INSTITUTE of AMERICAN INVENTORS
Dept. 4, 631-E St., N.W., Washington 4, D. C.

INVENTORS

Protect your Invention by a U.S. Patent

Write me for free record of Invention Form

SHERMAN LEVY

620 Victor Building

724 Ninth Street

Washington 1, D. C.

RAZOR BLADE BARGAIN

Buy your double-edge razor blades retail at wholesale prices. Made of fine surgical steel and precision ground. **GUARANTEED**—complete satisfaction or your money refunded. Order yours today—introductory offer 100 blades for only \$1.00.

MYLOMO AGENCY, P. O. Box 59, Bronx 53 N. Y.

WHY DON'T YOU WRITE?

Writing short stories, articles on business, politics, sports, shop crafts, local and club activities, etc., will enable you to earn extra money. In your own home, on your own time, the New York Copy Desk Method teaches you how to write the way newspaper men learn—by writing. Our unique "Writing Aptitude Test" tells whether you possess the fundamental qualities essential to successful writing. You'll enjoy this test. Write for it, without cost or obligation.

Veterans: This course approved for Veterans' Training.

NEWSPAPER INSTITUTE OF AMERICA
SUITE 5590-H, ONE PARK AVENUE, NEW YORK 16, N. Y.

Say You Saw It in
POPULAR MECHANICS

HIGHEST ROYALTIES and CASH

FOR YOUR INVENTIONS

(Patented and Patent Pending Only)

Write for **FREE** booklet without obligation

UNIVERSAL MARKETING CO.

354 S. SPRING ST. (Suite M)

LOS ANGELES 13, CALIF.



PATENTS
AND TRADE MARKS
C. A. SNOW & CO.
REGISTERED PATENT ATTORNEYS
WRITE FOR INFORMATION TO
428 SNOW BUILDING, WASHINGTON 1, D. C.

GEORGE B. OUJEVOLK

Patent Attorney

Canadian Patent Agent

Philippines Trademark Attorney

92 LIBERTY STREET NEW YORK 6, N. Y.

INVENTORS

IF YOU WISH TO PROTECT YOUR INVENTION, You should take steps to protect it by a U. S. Patent. Write me for "RECORD OF INVENTION" form.

CARL MILLER

REGISTERED PATENT ATTORNEY

WOOLWORTH BLDG., 35th FLOOR, 60A
NEW YORK CITY



WOULDN'T TAKE \$1000 FOR COURSE
 "The lessons are so simple that anyone can understand them. I have learned to play by note in a little more than a month. I wouldn't take a thousand dollars for my course."
 *S. E. A., Kansas City, Mo.



PLAYS ON RADIO
 "I can't keep from telling you that I have a good position playing from KTHS, Hot Springs, Ark., every morning."
 *J. S., Okla.



PLAYS AT DANCES
 "The Piano course I'm taking is the 3rd course with your school. Previously I took Saxophone and Clarinet. Since then I've played a lot of dance jobs."
 *E. A., Lake View, Iowa

THOUSANDS NOW PLAY who never thought they could!

You, too, can play any instrument by
 this **EASY A-B-C METHOD**

YOU think it's difficult to learn music? That's what thousands of others have thought! Just like you, they longed to play some instrument. But they denied themselves the pleasure—because they thought it took months and years of tedious study to learn. And then they made an amazing discovery! They learned about a wonderful way to learn music at home—without a private teacher—without tedious study—and in a surprisingly short time. They wrote to the U. S. School of Music about this remarkable short cut method. A free print and picture sample actually showed them how easy it was to learn.

The result? Over 850,000 people have studied music at home this simple, A-B-C way. They have found the key to good times, popularity and profit.

And that's what you can do right now. Simply mail the coupon. Get the proof that you, too, can learn to play your favorite instrument—quickly, easily, in spare time at home. Just read the fascinating illustrated booklet—examine the print and picture sample. Tear out

the coupon now, before you turn the page. Instruments supplied when needed, cash or credit. U. S. School of Music, 76 Brunswick Bldg., New York 10, N. Y. 52nd year. (Established 1898.)

**Actual names on request. Pictures by professional models.*

FREE! Print and Picture Sample

U. S. School of Music, 76 Brunswick Bldg., New York 10, N. Y.

I am interested in music study, particularly in the instrument indicated below. Please send me your free booklet, "How to Learn Music at Home" and your Print and Picture Sample. (Do you have instrument?)

<input type="checkbox"/> Piano	<input type="checkbox"/> Piano Accordion	<input type="checkbox"/> Reed Organ	<input type="checkbox"/> Clarinet
<input type="checkbox"/> Guitar	<input type="checkbox"/> Saxophone	<input type="checkbox"/> Tenor Banjo	<input type="checkbox"/> Trombone
<input type="checkbox"/> Violin	<input type="checkbox"/> Trumpet, Cornet	<input type="checkbox"/> Ukulele	<input type="checkbox"/> Other Instrument

Name _____ (PLEASE PRINT)

Street _____

City _____ State _____

Check here if under 16 years of age.

SAVE 2c—Stick coupon on penny postcard

WHICH OF THESE *Opportunities* INTERESTS *You* MOST?

● Today, choose the job you want—and prepare for it. Or if you are already engaged in the work you like best, start training now for quicker promotion. Acquire the knowledge that will help you to get ahead faster, make more money and have greater security.

American School, founded in 1897 as an educational institution *not for profit*, can help you to reach your goal just as it has helped others during the past fifty-three years. Check the coupon at right, add your name and address and mail it at once. The school will send you details on its training plan and outline of study prepared by specialists. There is no charge, no obligation, so send the coupon immediately.

CHECK, CLIP AND MAIL COUPON NOW

AMERICAN SCHOOL, Dept. GA45, Drexel at 58th, Chicago 37, Ill.

Without obligation, Please send FREE and postpaid, bulletin and details of the Subjects checked:

- | | | |
|--|---|--|
| <input type="checkbox"/> PLASTICS ENG'R | <input type="checkbox"/> Accounting | <input type="checkbox"/> Drafting and Design for Men and Women |
| <input type="checkbox"/> Refrigeration | <input type="checkbox"/> Electrical Engr. | <input type="checkbox"/> Radio |
| <input type="checkbox"/> Architecture and Building | <input type="checkbox"/> Electricity-Pract. | <input type="checkbox"/> High School |
| <input type="checkbox"/> Contracting | <input type="checkbox"/> Electronics, Industrial | <input type="checkbox"/> Air Conditioning |
| <input type="checkbox"/> Practical Plumbing | <input type="checkbox"/> Bookkeeping | <input type="checkbox"/> Mechanical Eng. |
| <input type="checkbox"/> Automotive Engr. | <input type="checkbox"/> Private Secretary | <input type="checkbox"/> Shop Management |
| <input type="checkbox"/> Aviation Drafting | <input type="checkbox"/> Diesel Engineering | <input type="checkbox"/> Tool Making |
| <input type="checkbox"/> Aviation | <input type="checkbox"/> Sheet Metal Pattern Drafting | <input type="checkbox"/> Better Foremanship |
| <input type="checkbox"/> Business Management | <input type="checkbox"/> Railway Training | <input type="checkbox"/> Machine Shop Operations |

Name _____ Occupation _____

Address _____ Age _____

City _____ State _____

AMERICAN SCHOOL

Dept. GA45, Drexel at 58th Street, Chicago 37

PAY RAISING—EXTRA MONEY BOOKS

Use these books to prepare for a better job—bigger pay—to start a profitable spare time or full time business of your own, improve your home, or start a hobby. Popular Mechanics specializes in supplying outstanding self-help books on many subjects. Send for our FREE catalog.

- Outdoor Sports Manual**
Hunters, Trappers, Campers, Archers, Boatmen. Here is your book!\$2.00
- Shop Notes Library**
5 Vols. — 1950, 49, 48, 47, 44 (No Dup. Mat.).....\$3.48
- Shop Notes—1950**.....\$1.00
- Painting, Furniture Finishing and Repairing**.....\$1.50
- Rewinding and Servicing Electric Motors (No. 75)**.....25c
- Photo Handbook**
An entirely new and different book from our Popular Photo Guide. It's a complete guide to better pictures and dark-room technique, and features dozens of handy gadgets you can make yourself.....\$2.00
- Motor's Truck Repair Manual**
Mechanics, Truck Specialists, Service Stations, Fleet Owners! Here is your book! Covers every job on every truck made since 1936 — 1400 pictures, 952 Pages.....\$6.00
- Garden Book**
Build own trellises, lawn furniture, fireplaces, ornaments, etc.\$1.50
- Diving, Cutting and Welding in Underwater Salvage Operations.** Only book of its kind.....\$2.00
- Picture Framing**
Modern methods for making and painting picture frames. Fully illustrated.....\$2.75
- Television Servicing**—The basic book for the practical radio man. Covers circuits, instruments and trouble shooting. Price.....\$4.00
- Bee Keeping for Profit and Pleasure.** Bees pay big profit. \$2.00
- 210 Deluxe Small Homes \$1.00**
- Into the Freezer and Out**
A complete handbook on the home freezing of foods \$2.50
- Concrete Handbook**
New book on using concrete around home, garden, farm.....\$2.00
- Leather Art by Baird**
Leathercraft is a wonderful hobby whether for pleasure or for pay. Get this beautifully illustrated, clearly detailed book at once. Tells you each step and furnishes actual designs.....\$3.00
- Welding, Brazing and Soldering**
How to build own equipment and how to use it effectively.....\$1.75
- Modern Refrigeration**
Electric, Gas. Be service expert.....\$5.00
- Dyke's Auto Ency.** (includes Diesels, airplane engines). New 20th Ed. World's greatest book for mechanics.....\$7.50
- Household Mechanics**
The "fix-it" book to end all "fix-it" books. Covers electric appliances, painting, carpentry, etc.....\$2.98
- Oil Burner Handbook**.....\$2.50
- Build Your Own Boat**
Describes 17 popular boats—rowboats, sailboats, plywood outboard, etc. 192 pgs. \$2.00
- House Wiring (No. 89)**.....25c
- Turn Scrap Into Money**
Convert old auto generators into motors, welders, etc.\$1.00
- Popular Mechanics Farm Manual**
Packed with practical ideas and usable information that can easily be worth hundreds of dollars to every farm family and to homeowners everywhere. Send for free descriptive folder giving complete contents!.....\$3.00
- Woodworking for Every-body**.....\$2.75
- Sheet Metal Work**.....\$3.00

- Tool and Saw Sharpening (No. 92)**.....25c
- Forging Practice**.....\$1.50
- Action Toys (No. 66)**
Plans for 21 easy-to-make toys.....25c
- Foundry Work**.....\$2.25
- Pattern Making**
Wood, metal.....\$2.25
- Forty Power Tools**
Build own saw drill, lathe, sander, etc., from scraps—save money.....\$1.50
- Carpentry**.....\$2.50
- The Young Craftsman**
Over 450 things boys can make.....\$2.00
- Five Acres and Independence**
How to make money on small farm.....\$2.50
- Your Home and How to Build It Yourself.** Step-by-step construction of the famous POPULAR MECHANICS house. Wonderfully illustrated. \$3.00
- Drake's Householders Cyclopaedia**
This is the time to save money on those necessary home repair jobs—Repairing, Remodeling, Carpentry, Painting, Decorating, Plumbing, Heating, Electric Wiring and Appliance Repairs, Furniture Repairs—This new book covers them all.....\$5.00
- Motorist's Handbook**
Popular Mechanics scores again. A 160 page guide to automotive happiness.....\$2.00
- Modern Fruit Production.** Best book on the subject. Everything you need to know about the orchard. Price.....\$5.00
- What to Make for Children**
Junior tough on toys? Build him playthings that will last.\$2.00
- LeJay Manual of Homemade Electric Equipment.** How to construct 50 items that are scarce and valuable.....\$1.50
- How to Estimate for the Building Trades:** Material and labor costs for masonry, plumbing, electricity, carpentry, heating, hardware, painting, etc. 629 pages.....\$5.50
- Rabbits for Food and Fur** \$2.50
- Tool Making**.....\$4.00
- Tool Design**.....\$4.50
- Plumbing Installation & Repair**.....\$2.00
- Ropp's Calculator**
Figuring made easy.....75c
- Slide Rule Simplified**.....\$2.75
- Drake's Refrigeration Service Manual**.....\$2.00
- Primer for Home Builders**
All the information you need to know in building a house.....\$2.50
- How to Read Aircraft Blueprints**.....\$4.40
- America's Best Low Cost Homes**
125 popular practical designs.....\$1.00
- Toys You Can Make of Wood**.....\$2.50
- A.B.C. of Poultry Raising** \$2.50
- Ice Cream for Small Plants**
Some technical formulas for ice cream, ices and frozen desserts on a commercial scale.....\$2.50
- Furniture Joinery**.....\$2.00
- Essentials of Upholstery**.....\$3.25
- Radio Physics Course**
A thorough training in radio fundamentals.....\$5.00
- Lessons in Ornamental Penmanship.** You can easily learn to write beautifully. Delight and amaze your friends with the skill you can acquire by using this book—Only.....\$1.50



NOW YOU CAN SHAVE IN YOUR CAR!

Car Shaver Motor—Use your electric shaver in your car! Dynamotor will supply 110-120 Volt DC approx. 15 Watts from 6 Volt DC auto battery and will operate most types of AC-DC Shavers. Also has many other uses, such as operating small 3 way portable radios in car, etc. Used by Gov't. to supply voltage to radio equipment. Shipping Weight: 7 lbs. **\$2.00**

ORDER NO. PM-6250.....

Send Full Remittance with Order • Postage C.O.D.

FAIR RADIO SALES
132 SOUTH MAIN ST. LIMA, OHIO

Imported **CHRONOGRAPH** multi purpose **WRIST WATCH \$5.90** 2 PUSH BUTTONS

Plus 59c Fed. Tax WITH INSTRUCTIONS

GIVEN—washable, ventilated plastic band "Wonder" Watch. Used to time autos, airplanes, horse races, athletic events.

• Tachometer • Telemeter • Hands & Nos. Glow in Dark • Unbreakable Crystal • Large Red Sweep Hand • Tells Time • Measures Speed & Distance • Stop Watch • Precision Made

Send money order for \$6.49. For C.O.D.'s enclose \$1.00 with order for Fed. Tax, postage, handling.

1 YR. WRITTEN GUARANTEE

THE JEWELBOX, Dept. SP-1674 Broadway, N.Y. 19, N.Y.

Learn PHOTOGRAPHY

There's big money in PHOTOGRAPHY—and an action-packed career for you. Our HOME STUDY COURSE is your spare-time SHORT CUT TO SUCCESS! Or, if you wish—PERSONAL ATTENDANCE TRAINING at our famous New York School is available with subsistence under the G. I. Bill. Our 40th year. Write immediately!

NEW YORK INSTITUTE OF PHOTOGRAPHY
Dept. "49," 10 West 33 Street, New York 1, N.Y.

SHOE REPAIR OFFERS BIG INCOME
LEARN IN 12 WEEKS TIME

You can own your own shop or earn big income as skilled shoe repairman. Growing demand everywhere at top wages for men who know how. We teach you quickly by actually working on shoes and modern machines. School open to all from 18 to 60 years of age. FREE BIG 20 PAGE BOOK explains everything. Send for your copy today. Established 1927.

MODERN SHOE REBUILDING SCHOOL
Chicago and Los Angeles only Approved for Vets Dept. PM
2937 Belmont Ave., Chicago, Ill. 361-12th St., Oakland, Calif.
806 So. Figueroa St., Los Angeles 14, Calif.

STRENGTHEN Your VOICE!

YES—you can now build yourself a powerful speaking and singing voice with this amazing new scientifically sound tested method. Self-training... no music or piano required. Results GUARANTEED. Just send your name for the sensational details. FREE chart of your vocal mechanism included! Please state your age.

PERFECT VOICE INSTITUTE, Studio F-2, 1141 S. Wabash Ave., Chicago 5, Ill.

Learn WOOD PRODUCTION ENGINEERING
At Home In Your Spare Time

KLOK TRAINING offers you exceptionally practical and fascinating instruction in the woodworking industry arts—Sketching—Drafting—Rod Making—Time Study—Cost and Production Scheduling in an 81-Lesson Home Study Course or through Resident Training at Grand Rapids. Enables you to attain a top woodworking position or to run your own shop more successfully. Free G. I. instruction. Money back trial offer to non-veterans. Write me—today for FREE BOOKLET. State age, veteran or non-veteran, Home Study or Resident Course, occupation.

From THE ONLY SCHOOL OF IT'S KIND

FREE Booklet

JOHN H. KLOK, President

KLOK INSTITUTE
Woodworking Industry Training Since 1928
F. Louis St., N.W. Grand Rapids 2, Mich.



MAIL THIS COUPON TODAY

Check the books you want, write your name and address below, and mail this advertisement with money order or check. Outside U. S. A. include 15% additional for shipping charges.

Books selected will be mailed promptly on our "money back if you're not entirely satisfied" guarantee.

Name _____
Address _____
City _____ State _____

Mail to **POPULAR MECHANICS PRESS**
DEPT. 700 — 200 EAST ONTARIO ST., CHICAGO 11, ILL.

A Tested Business That You Can Start At Home

... Operate as a spare-time, extra-money activity,
... or build into a full time, permanent business
leading to personal independence.

By Raymond E. Brandell

NOTE: Mr. Brandell's long experience in helping thousands of men and women start their own businesses establishes him as an authority and a safe guide. His latest recommendation, we think, is the most interesting of the many businesses he has sponsored. W.E.C.

THIS latest assignment of mine proved to be not only one of the most fascinating jobs I ever undertook, but one of the toughest.

"Find a business," I was told, "that fits this description: It must be new enough so that not many are in it. It must be one that can be operated in a small space—by either a man or woman—in spare time. The work must be interesting, and preferably the kind that will give the worker artistic or creative satisfaction. It must be a business that anyone can *learn* without weeks or months of study. It must be one that can be started without a big investment in special equipment, materials, or supplies, and it must still pay a good rate of profit for every hour invested!"

I wrote down the points as they were given to me, ran my fingers through my hair, went back to my own office and stared at the wall for fully an hour. Sometimes staring at a blank space helps me think—brings pictures to my mind.

But, as I soon concluded, this job was not going to be accomplished by thinking, alone. When I finished the assignment—when I had found the business that fitted every one of the requirements, I had spent eleven months in market studies, personal investigation of hundreds of different kinds of home businesses, sales checks, even research on such seemingly unrelated subjects as chemistry and electronics. And I had spent close to twenty thousand dollars of the company's money.

But the business that came out of my efforts has proved to be worth every hour and every dollar of its cost—for, already, it has been tested and proved successful by a number of men and women. In actual practice, it has proved to be the perfect starting point for those who wish to break away from payrolls, time clocks, and the uncertainty of "jobs." It has enabled many men and a number of women to start a business in spare time (without risking

present jobs or income) and later expand it into a full time activity.

The product of the business is one that is familiar to everyone. But the method by which the product is produced probably is an art you've never heard of. I was first started on the investigation of this particular business by a story that I read in the American Magazine. It told about a couple in Ohio, man and wife, who had done a volume of business in excess of a million dollars in one year. Their profit must have been enormous, because the cost of materials that went into each product was only 43c—while the product sold for \$6.00. And it could be produced with not more than an hour of labor time. They had started with no experience and with an investment so small that anyone could get the money together.

Right from the beginning it had the earmarks of the business I was looking for. And everything I unearthed about it confirmed my early impression.

When I tell you what they made and sold, your first thought probably will be "Old Stuff." But wait. Give it a second thought, because while the product is old and well established, the number of people who know how to make it are very few, indeed. And the annual sale runs into millions, because the product is one that is wanted and cherished by every mother. It's a product that is purchased because of love and sentiment—and it's products like this that are called "depression proof." In poor times, people often skimp on necessities to have the things that warm the heart—and that is one of the outstanding characteristics I discovered in Metalized Baby Shoes.

You've seen them. You've seen the real ones, and you've seen the imitation ones—those that were coated with genuine metal, in gold, silver or bronze; and those poor imitations that were merely painted with bronze paint. The genuine

metalized shoes are made by a process called Electroplating. Electroplating of metal objects is quite common. But to electroplate a non-metallic object requires special knowledge. And that's the process I want to tell you about.

All the results of my investigation have been put into a large printed plan. It is illustrated with more than a hundred drawings, pictures, and photographs. It is called the Warner Success Plan—because it is a completely charted path to success in the Baby Shoe business. It tells all the secrets of electroplating non-metallic objects. It tells how to prepare the shoe, how to assemble the few pieces of equipment needed, how to put a coating of genuine gold, silver, or copper on a shoe or any other non-metallic keepsake. It tells how to get the orders coming in, how to finish the work, how to start in spare time and then—when you are ready—expand into a full time business.

I'd like to lend you this plan—give you an opportunity to read every word of it—learn every secret it holds—so you can then make your own investigation of this business and make your decision on the basis of facts instead of guesswork. If you decide to go into it, you can buy a copy of the Warner Success Plan to keep as your guide. But make that decision later.

Right now, all you need to do is send your name on a penny postcard to the Warner Electric Company, 1512 Jarvis Ave., Dept. 3-H, Chicago 26, Illinois. They are the publishers of the plan and they will arrange to send a copy for your inspection without any money risk on your part.

I'm mighty happy about my part in finding and writing up this business because it has proved to be a wonderful starting point for so many people. I'm sure you'll find it worth every minute you spend in reading it. Send your name, today, so you won't forget it.



AUTO BOOKS ON APPROVAL



SEND NO MONEY. Just mail the coupon for a complete set of 4 Big, Thick Auto Books, 20th Edition. Over 2700 Pages! Whether you are a mechanic or helper, expert or apprentice, auto owner or driver, take immediate advantage of this FREE EXAMINATION OFFER.

MAKE GOOD MONEY NOW HOLD A PERMANENT JOB

America wants its automobiles kept in good repair. Men with "know how" are in demand, at big pay. These books will help you get and hold an important job, or give you a chance to go into business for yourself now or later. Any man who half tries to improve himself can learn auto servicing and repairing by this quick reference method. Use the JIFFY INDEX to find easily understood answer to any auto problem. These wonder books prepared by eleven of America's great automobile engineers. Many hundreds of valuable illustrations. Send the coupon TODAY.

A year's consulting privileges with our engineers now given with these books without extra charge.

Publishers Since 1898

CAN YOU FIX IT?

These wonder books tell step by step HOW to make difficult repairs and adjustments, how to keep a car at maximum efficiency, including latest improvements in car design and operation. Engine troubles and how to correct them well covered.

4 BIG, THICK VOLUMES

Over 2700 pages, 2000 illustrations, wiring diagrams, etc. Beautiful modernistic, washable cloth binding.

AMERICAN TECHNICAL SOCIETY, Dept. AA19

Drexel Ave. at 58th St., Chicago 37, Ill.

I would like to examine your 4-Volume Set of Auto Books. I will pay the delivery charges only, but if I choose I may return them express collect. If after 10 days' use I prefer to keep them, I will send you \$2 and pay the balance at the rate of only \$3 a month until \$24.80 has been paid. Include consulting service as offered above.

Name _____

Address _____

City _____ State _____

Please attach letter stating age, occupation, employer's name and address and name and address of at least one business man as reference. Men in service, also please give home address.

Learn A Trade NOW! PRACTICAL SHOP TRAINING!

In Our Chicago Shops

- | | |
|---|--|
| <input type="checkbox"/> AUTO MECHANICS | <input type="checkbox"/> WELDING—ARC and GAS |
| <input type="checkbox"/> DIESEL MECHANICS | <input type="checkbox"/> MACHINIST |
| <input type="checkbox"/> REFRIGERATION | <input type="checkbox"/> PIANO TUNING |
| <input type="checkbox"/> BODY-FENDER | |

Above Approved For G. I.'s and Civilians

One of America's Leading Practical Schools
7 Floors of Fully Equipped Shops
Over 48,000 Successful Graduates
Expert Individual Instruction
Learn by Doing—Low Living Expense
Established 1902—Day and Evening Classes

Also the following Home Study Courses

- | | | |
|----------------------------------|--|---------------------------------|
| <input type="checkbox"/> PLASTIC | <input type="checkbox"/> REFRIGERATION | <input type="checkbox"/> DIESEL |
|----------------------------------|--|---------------------------------|

— CALL IN PERSON OR MAIL THIS AD TO —

GREER SHOP TRAINING

(Desk 10) 460 South State St., Chicago 5, Ill.

Please send without obligation free information regarding trade checked above. (Specify whether you are a Veteran or Civilian)

Name _____ Age _____

Address _____

City _____ State _____

K-R-O KILLS RATS

• K-R-O BIS-KITS are ready-made, easy to use; containing *fortified red squill*, they're safer around livestock, pets, and poultry. K-R-O POWDER is 100% *fortified red squill*; economical to use in badly infested areas when mixed with natural baits. BIS-KITS, 35c and \$1.00; POWDER, 75c at drug, seed, and feed stores. Money-back guarantee. *The K-R-O Company, Springfield, Ohio.*

SHORTHAND IN

Famous Speedwriting system. No signs; no symbols; no machines. Uses ABC's. Easy to learn, write, transcribe. Low cost. 100,000 taught by mail. Also typing. 27th Yr. Write for free booklet to:



6
WEEKS
AT HOME

HOMESITES \$300 LOW TERMS

In California's loveliest Garden Spot, on scenic shores of beautiful Morro Bay. Enjoy future independence with excellent soil, soft water, wonderful fishing, hunting, boating, bathing, etc. Grow fruits, vegetables, poultry. Perfect temperate climate. Congenial community. Finest investment. Free literature.

RICHARD S. OTTO

DEPT. M SAN LUIS OBISPO, CALIFORNIA

BARBELLS

Save Money — Buy the finest barbell equipment direct from our foundry — No other company can match our low price or value! Send to-day for our FREE Barbell Catalog

BUR BARBELL CO.
Lyndhurst 18, New Jersey

95 lb. SET \$10.80
Extra plates 10c lb.

FOAM RUBBER

FOR HOBBYISTS, CRAFTSMEN, EXPERIMENTERS



LOWEST PRICES—SAVE 50%	AUTO SEAT TOPPER PADS
16 x 16 x 1 1/2" . . . ea. \$1.25	Place on seat cushion and cover with your seat cover.
16 x 22 x 1 1/2" . . . ea. 1.55	
18 x 24 x 2" ea. 2.00	24" x 60" x 1 1/2" ea. \$5.00
24 x 24 x 2" ea. 2.75	24" x 60" x 2" . . . ea. \$7.50

Use for furniture cushion fillers, mattresses, mattress pads, cushions. Foam Rubber is available in any size or thickness. Send For Free Price List. Immediate delivery. No C.O.D.'s. ADD 10% FOR POSTAGE & HANDLING TO ABOVE PRICES

RIOR RUBBER COMPANY, Dept. P-6
50 E. Cermak Road Chicago 16, Ill.

LEARN MEAT CUTTING AT NATIONAL

Pay After Graduation



The steady dependable trade of Meat Cutting taught easily in 8 short weeks. You LEARN BY DOING under actual meat market conditions in big modern school at Toledo.

For beginners or men with experience. Get a profitable store of your own. Remember, PEOPLE MUST EAT! Big pay jobs. Free employment help. Thousands of successful graduates.

Buying, cutting, percentage, pricing, advertising, selling, etc. A complete retail meat education. National School established over 25 years. Get National training NOW. Pay your tuition in easy weekly payments

after you graduate. G. I. approved. Send coupon for FREE 52 page school catalog — TODAY.

National School of Meat Cutting, Inc., Dept. 50-F, Toledo 4, Ohio

Send me your FREE school catalog on National Training at Toledo in Meat Cutting, Meat Merchandising and Self Service Meats. No obligation. No salesman will call.

Name _____
 Address _____
 City _____ State _____
 Check here if Veteran of World War II

BE A PHOTO-ENGRAVER

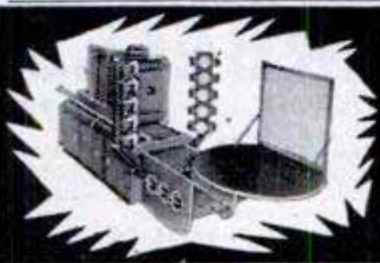

We furnish complete equipment and supplies. Learn at home or in our modern, friendly APPROVED school in MISSOURI. Get into this big demand, high profit, high wage field. You can start your own profitable, full time or part time PHOTO-ENGRAVING business right in your own home.

Be independent, be your own boss or pave the way to a high pay job with experience gained in your own shop.

TASOPÉ TRAINING and TASOPÉ EQUIPMENT has enjoyed world wide recognition since 1931. Write for descriptive literature today. No obligation.

THE AURORA SCHOOL OF PHOTO-ENGRAVING, DEPT. 9PM., TASOPÉ BLDG., AURORA, MO.

LEARN MOVIE THEATRE MANAGEMENT

The Motion Picture Theatre Business offers big opportunities for trained men. Get into a fascinating field with a promising future. Train at home in spare time. Free Catalog. Established 20 years.

THEATRE SCHOOL, 370 Washington St., Elmira, New York

LOCKSMITHING & Key Making

PRACTICAL UP-TO-DATE COURSE—ONLY \$3.95

Easy-to-learn modern information for self-instruction. How to work on locks, de-code, make master-keys, repair, install, service, etc. For every handyman, home owner, carpenter, mechanic, service station operator, fix-it shop, hardware dealer, gunsmith. 53 plain illustrated lessons. **FULL PRICE ONLY \$3.95. SEND NO MONEY.** Just pay postman plus C.O.D. postage. Or send \$3.95 with order, we'll ship postpaid. Satisfaction guaranteed or refund.

NELSON-HALL CO., 1139 S. Wabash Ave., Dept. F-2, Chicago 5, Ill.

BECOME A JET ENGINE EXPERT

BE READY Start NOW

Aviation's NEWEST OPPORTUNITY — Study with LIVE JETS at CAL-AERO only — AERONAUTICAL ENGINEERING & MASTER AVIATION MECHANIC training since 1929 — Approved for VETERANS. WRITE TODAY for Special Information.

NAME _____ AGE _____
 ADDRESS _____
 CITY _____ ZONE _____ STATE _____

CAL-AERO TECHNICAL INSTITUTE
 GRAND CENTRAL AIR TERMINAL • GLENDALE 1, CALIFORNIA

TRAVEL FOR "UNCLE SAM"!

AS HIGH AS \$3,450 FIRST YEAR

RAILWAY POSTAL CLERKS

Veterans Get Special Preference



Many other Government Jobs. City and Rural Carriers— Postoffice Clerks— Meat Inspectors— Accountants— Stenographers— Typists— etc. Prepare now for next Examinations.

FRANKLIN INSTITUTE,
 Dept. E-84, Rochester 4, N. Y.
 (Not Government Controlled)

Sirs: Rush to me, without charge, copy of 40-page book, "How to Get a U. S. Government Job," list of positions, and full particulars telling how to qualify for them.

Name _____
 Street _____
 City _____ Vet? _____

EASY WAY TO EARN BIG PAY

LEARN A TRADE

Train at Home or in C.T.I. Shops

Good jobs are waiting for trained men! You can qualify within months—either by training at home in spare time, or in our Chicago shops. The fields listed at right offer big opportunities for advancement. Or, you can prepare to open a shop of your own—and gain independence!

It costs nothing to get the facts. Mail coupon below for valuable FREE booklet!

C. T. I. OFFERS BETTER TRAINING IN:

- AUTO MECHANICS
- BODY-FENDER REPAIR
- DIESEL MECHANICS
- ELECTRICITY
- REFRIGERATION
- RADIO - TELEVISION
- MECHANICAL DRAFTING
- BUILDING CONSTRUCTION
- FACTORY MANAGEMENT

COMMERCIAL TRADES INSTITUTE

1400 Greenleaf Ave., Dept. E2-6
Chicago 26, Ill.

Veteran
 Non-Vet

Send valuable FREE information on opportunities in industry, and how I can train for them.

Name..... Age.....
Address.....
City..... State.....
Course interested in.....

Coronado "pose-breefs"

THE NEW BODY-MOLD TRUNKS FOR IDEAL BODY DISPLAY. WORN BY LEADING BODY BUILDERS OF THE WORLD!

Here's the perfect brief trunks for body building, lifting, swimming, physique photography and contests. Designed by champions... worn by leading body builders of the world. No bind, no boxed or chopped off appearance. Body-mold fit for tall or short men in sizes 26 to 38. Complete freedom... complete coverage. Satisfaction guaranteed. Send check or money order today. Postpaid.

8 colors: white, black, light blue, royal blue, red, gold, aqua or chartreuse.

1. Elasticized Nylon, the very finest . . . 7⁹⁵
2. Elasticized Nylon and Acetate . . . 5⁹⁵
3. Elasticized Satin Acetate 4⁹⁵
4. Workout trunks Assorted colors . . . 3⁹⁵

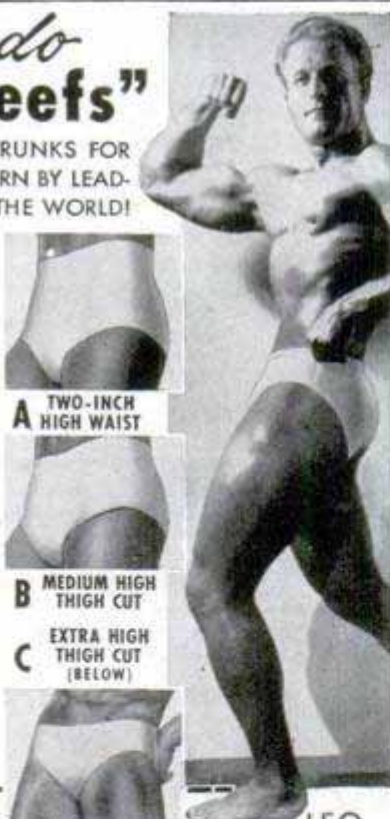

A TWO-INCH HIGH WAIST
B MEDIUM HIGH THIGH CUT
C EXTRA HIGH THIGH CUT (BELOW)

Coronado Surf Shop,
627 8th Avenue, San Diego 1, California

Please send me, postpaid, Pose-Breefs as follows: (Circle)
Style **A B C** Fabric No. **1 2 3 4**

Color: 1st choice _____ 2nd choice _____ Size _____

Name _____
Address _____
City _____ State _____

Please send your illustrated brochure

LEO STERN
Mr. California '46 shown above in his "pose-breefs"

SEND ONLY 10c for

BIG CATALOG of WAR SURPLUS OPTICAL BARGAINS

Build Your Own RIFLESCOPE, BINOCULARS, TELESCOPES, ETC.
We Furnish Optics and Instructions

- LENSES, PRISMS & RETICLES
- EYEPIECES and OBJECTIVES

Send \$1.00 for Stock #2-H 10-Piece Lens Kit and Big Instruction Booklet.

We Have Numerous Types of Assembled Optical Instruments Including BINOCULARS and RIFLESCOPES. CHECK OUR BARGAINS . . . Mail 10c for CATALOG H

EDMUND SALVAGE COMPANY
BARRINGTON, NEW JERSEY

TEACH DRIVING

Full Time or Part Time

Dual controls for your car, easily and quickly installed. Very economical. How to teach driving and operate a profitable business. Special controls and testing devices for schools or groups. Write for information. No obligation.

NATIONAL DRIVING SCHOOL

P. O. BOX 1381 WILMINGTON, DELAWARE



BARBELLS

FINEST QUALITY \$8.98 up
FREE CATALOG

Send today for big new 4 color fully illustrated free catalog of BARBELLS, Dumbbells and Health equipment. Free—world famous \$15.00 Dan Lurie Barbell and Dumbbell training courses with every purchase.

DAN LURIE BARBELL CO.
DEPT. 159, 1729-M6, ROCKAWAY PARKWAY
BROOKLYN 12, N. Y.

STUDY AT HOME

WITH AN EDUCATIONAL INSTITUTION

Courses in **ENGINEERING**: Electrical, Civil, Mechanical, Drafting, Architectural, Automotive, Steam, Diesel, Aeronautical, Radio, Structural, Mining, Industrial, Petroleum, Marine, Refrigeration, Air Conditioning, Chemical.

Courses in **ARTS AND SCIENCES**: Philosophy; Education; Letters; Public Health; Medical Jurisprudence; Psychology; Sociology; Physics; Chemistry; Geology; Pol. Science; Theology; Law; Business and Commerce; Accounting; Mathematics; Statistics, Agriculture.

McKinley-Roosevelt Incorporated, 4610-K3, Sheridan Rd., Chicago 40, Illinois

Learn PHOTOGRAPHY at Home

Splendid opportunities. Prepare in spare time. Practical basic training. Long-established school. Send for free book, "Opportunities in Photography." No obligation.

American School of Photography, 1315 S. Michigan Ave., Dept. 135A, Chicago 5, Ill.

Say You Saw It in Popular Mechanics



LEARN TO SERVICE AND REPAIR ELECTRIC APPLIANCES

Get a Good Job—Run Your Own Business

Be the man who knows how to service and make quick repairs on washing machines, vacuum cleaners, heaters, toasters, stokers and household motors and gadgets of all kinds. Get into this pleasant, easy and good pay work. Get the sensational new book—Electric Appliance Repair and Servicing.

An investment of only \$3.00 will positively get you started in this vital field in a good-pay job or help you build up a profitable business of your own. Run it from your home. No starting capital needed. No experience in electricity required. The book explains how to diagnose and locate trouble and how to fix it. 302 Pages. 188 how-to-do-it illustrations.



MONEY BACK IF NOT SATISFIED

Clip this ad and mail with only \$3.00, currency, check or M. O. or we will send C.O.D. Use the book for 5 days. See how easily you can make it pay for itself hundreds of times over. Then if you are not fully satisfied—send it back and we will refund your money quick. Rush order today. Get started at once.

DRAKE & CO., Dept. 1-A, 117 Green Bay Road, Wilmette, Ill.

COOK OUTDOORS

on the Fyro-Grill

—Build the Fireplace

Yourself—around the Fyro-Grill Steel Form!



\$21.95

Enjoy serving family and guests with meals cooked outdoors. Use the Fyro-Grill as the form and build your outdoor fireplace around it, as simple or elaborate as you wish. Has removable steak grill, adjustable grate, draft control.

Send for FREE Folder showing 10 beautiful outdoor fireplace designs that you can build.



PRICE FIREPLACE HEATER & TANK CORP.

162 W. AUSTIN ST., BUFFALO, N. Y.

SPEED AND POWER Handbook

50 CHAPTER LIBRARY EDITION

Tens of thousands have been sold! Build Fast Stock Cars! California Roadsters! 160 MPH Rods! Covers Crosleys to Cadillacs—all makes. Breathtaking Methods. Authentic — Direct from California!

SAVE MANY DOLLARS

Build your own Dual Manifolds! Superchargers! Hot Cams! Water Injectors! Hi-Compression Heads! Mileage Devices! Get up to ten more miles per gallon! Get racing speed, lightning acceleration, dynamic power increases from any make passenger automobile! Get construction drawings! Tuning techniques! Speed tricks! Economy secrets! Ingenious formulas! Covers "Racing Frames"—"Reciprocating Masses"—"Jet Engines"—"Braking Characteristics"—"Dynamometers"—"Dual Pipes, Gears, Fuels, Manifolds, Porting, Relieving, Lowering! Balancing.

Includes "CALIFORNIA AUTOMOBILE CUSTOMIZING"—Drawings! Diagrams! 50 Photographs in Color, Newest Ideas! Conversions! Carson Tops! Restyling all makes! Streamlining! Chopping! Channeling! Including 1950 Racing Equipment Catalogue! Complete—\$1.98 Postpaid. Racing Equipment Catalogue without book—50c.

NEWHOUSE AUTOMOTIVE INDUSTRIES
5805 EAST BEVERLY BLVD. DEPT. B4
LOS ANGELES 22, CALIF.



Photos
Drawings

ANGORAS FOR QUICK MONEY

Angoras cheaply and easily raised. Thousands needed for breeders in new industry furnishing wool for textile mills. Free illustrated booklet shows sales opportunities, success stories, etc. Write—

WILSONS, Stanton 17, California

Yes, More Brilliant Than a Diamond!

Amazing New Discovery

Write today for the full story of the latest miracle of science, discovered in the laboratories of one of the world's largest corporations. The story of the beautiful Kenya Gem that so closely resembles a diamond that only an expert can tell the difference.



More Fire! More Brilliance!

Yes, this marvelous gem has more brilliance, more fire, and a more dazzling display of color than the finest diamond of equal size. And yet you can now own an unmounted Kenya Gem for only \$24 (1 carat) to \$96 (4 carats); also men's or ladies' beautiful gold rings for as little as \$45. If you wish, you can buy on EASY PAYMENT TERMS.

The Cinderella of Modern Science

Kenya Gems are the sensational discovery you read about in Sat. Eve. Post, Jewelers' magazine and N. Y. Times, "the only thing on earth more brilliant than a diamond." It is a true gem, crystallized by science instead of nature and perfectly cut by expert cutters.

Send Coupon or Write today for FREE illustrated literature.

KENYA GEM CORPORATION, Dept. 286
Philadelphia 44, Pa.

Copyright 1950 Kenya Gem Corp.

Mail This FREE COUPON Today!

Kenya Gem Corporation (Dept. 286) Philadelphia 44, Pa.

Please send me, without obligation, the FREE illustrated descriptive literature telling all about Kenya Gems, the new discovery more brilliant than a diamond.

Name

Address

City State

WHAM-O SPORTSMAN*

HITS LIKE A .22 RIFLE—KILLS RABBITS, SQUIRRELS. Powerful, silent, accurate. For hunting, target, routing pests.

At dealers or send direct.

HUNTING SLINGSHOT

Heavy ash hardwood stock. 40 steel balls, extra rubber straps. GUARANTEED. Send \$1.00 today to

Wham-O Mfg. Co., Box 82, South Pasadena, Calif.

* The professional model of Nat'l Slingshot Assn.



New Lightning Seller! 47 Million Prospects! Up to \$4.97 PROFIT on Every Order!

An invention like the new "Magic Defroster" comes along only once or twice in a man's entire lifetime. GRAB IT QUICK! Everybody in the United States who owns an electric refrigerator is a prospect for the "MAGIC DEFROSTER" because it ends FOREVER the need of manual defrosting. Just plug in any outlet and the refrigerator defrosts AUTOMATICALLY overnight. Saves electric current... saves time, work, and money. And the "MAGIC DEFROSTER" is NATIONALLY ADVERTISED — outsells all similar devices.

FREE! "MAGIC" SALES PLAN

NOTHING ELSE LIKE IT. Boosts cash earnings to new all-time high. Sent FREE with complete money-making facts about the "MAGIC DEFROSTER" — fastest seller to hit Direct Selling Field in years. Salesmen, Crew Managers, Distributors are flabbergasted by Sales. Rush your name on a penny postcard today. Everything is FREE.

MAXILUME COMPANY, 125 West Hubbard Street, Dept. D-86, Chicago 10, Illinois

AMAZING
"Magic
Defroster"
RETAILS FOR
Only \$9⁹⁵



"Net Profit \$75⁵⁶ THE VERY FIRST DAY!"

That's what R. E. Meade
made selling the amazing new
PRESTO Fire Extinguisher!

OVER 11,000 people died in fires last year. An eager public has been waiting for a practical new kind of fire extinguisher. Now it's here! Tiny "Presto" is about the size of a flashlight. Does the job of bulky extinguishers that cost 4 times as much and are 8 times as heavy. Ends fires fast as 2 seconds. Fits in palm of hand. Never corrodes. Guaranteed for 20 years! Sells for only \$3.98!

You can make good money showing this new discovery to owners of homes, cars, boats, farms, etc. Of course, not everybody makes as much as R. E. Meade did the very first day. But Stanley Hyman reports making over \$1000 a month. H. J. Kerr, \$20 a day. William Wydallis, \$15.20 an hour.



Science's
New Midget
Miracle
"PRESTO"

What's the secret of "Presto's" amazing power? It's a new wonder chemical developed during the war, found to be 1.5 to 6 times as effective as chemical contents of other extinguishers on an equal weight basis. Makes possible, for the first time, an extinguisher that is small, light, and amazingly effective.

Help supply the demand for this important new discovery. Write for FREE Sales Kit. No obligation; no capital required. But don't put it off. Every day you hesitate may cost you \$10, \$15, or even \$50 you could be making.

Send postcard or letter to:

**MERLITE INDUSTRIES, Inc., Dept. 56,
201 East 16th Street, New York 3, N. Y.**
(If you want demonstration sample too, send \$2.50. Money back if you wish. FREE re-fills for your Demonstrator.)



R. E. MEADE

SAY YOU SAW IT IN POPULAR MECHANICS

LEARN TO BE A DIAMOND CUTTER ... AND EARN BIG PAY!

ENROLL NOW FOR 58 WEEK COURSE
AT THE ONLY SCHOOL IN AMERICA
TRAINING MEN IN THIS PROFESSION

You can become an expert in this exclusive highly paid profession . . . in only 14½ months! It is a fascinating, highly-skilled field offering lifetime security, high income to qualified people. And there's always a demand for your services.

At STEWART GEM & DIAMOND CUTTING INSTITUTE you learn by doing . . . under the trained eye of craftsmen with 15 to 20 years experience. You get 5 full hours of personal instruction daily in this intensive course. Also night classes for students who must earn money while studying.

Course prepares you for several lucrative fields: Diamond Cutter, Gem Cutter, Stone Buyer, Jewelry Sales, Jewelry Wholesaler and Importer, Jewelry Grader, Jewelry Appraiser.

We are limited to only 415 students. So don't delay . . . WRITE now . . . TODAY . . . for full details. Approved for G.I.'s.

SEND FOR FREE LITERATURE TODAY
**STEWART GEM & DIAMOND CUTTING
INSTITUTE**

565 MAIN AVE. • PASSAIC, NEW JERSEY

YOU CAN MAKE THESE WITH POPULAR MECHANICS PLANS AND BLUEPRINTS



- 501—Colonial Grandfather's Clock. 25c
- 507-508—Doll-House, 5-Rooms, Open staircase, fireplace. . . . 50c
- 526—Queen Anne Coffee Table: True replica of antique. . . . 25c
- 528—Duncan Phyfe Console Table: 30 in. high. . . . 25c
- 529—Lawn Chair: Southern style. 25c
- 593—Three Attractive Corner Shelves: Scroll-sawed. . . . 25c
- 596—Three Hanging Type Shelves: Hold books, china, etc. . . . 25c
- 661—Rocking Horse: Scroll-sawed from plywood. . . . 25c
- 707—12 Ft. Rowboat: Flat-bottom, four seats. . . . 25c
- 795—Two Handsome Cedar Chests. 25c
- 811-812—16 Ft. Canoe: Canadian type, cedar planking. . . . 50c
- 813-814—Pops Outboard Racer: 10 ft. long, stepped bottom. . . . 50c
- 828-835—Sovereign of the Seas: English warship model. . . . \$2.00
- Sovereign of the Seas: Instruction Book. . . . \$1.00
- 836—12 in. Bandsaw: Uses plywood, cuts two in. stock. . . . 25c
- 839—Melrose Corner Cabinet: Old Colonial design. . . . 25c
- 846-848—Governor Winthrop Desk: True copy of original. . . . 75c
- 896-897—Three Easily Made Workbenches—Simplified construction. 50c
- 906-909—Midget Auto: 58 in. wheelbase, 1/2 to 3/4 h.p. . . . \$1.00
- 910—Circular Saw Table: Hardwood, 24" x 36", Stationary. . . . 25c
- 917—Outdoor Fireplaces: Several simple but practical. . . . 25c
- 920-922—Lawn and Garden Furniture: Swings, arbors, tree seat. . . . 75c
- 923—Indoor Fireplaces: Standard Sizes. . . . 25c
- 926-927—Venetian Blinds: Three different styles. . . . 50c
- 930—Hooked Rug Frame—Quilting Frame. . . . 25c
- 933—Cape Cod Cupboard: 4 ft. wide, 5 ft. 8 in. high. . . . 25c
- 935—Knee-Hole Desk: 40 in. long, 30 in. high, 31½ in. wide. . . . 25c
- 936—Modern Coffee Table: 24 in. long, 15 in. wide. . . . 25c
- 952—Child's Crib in Maple. . . . 25c
- 958—Colonial Corner Cupboard: 6 ft. 8 in. high. . . . 25c
- 961—Hanging China Cabinet: 38 in. long, 40 in. high. . . . 25c
- 969—Combined Chest and Writing Desk: 35¼ in. high. . . . 25c
- 970—Modern Clothes Chest: Built of Plywood. . . . 25c
- 977—Bookcase in Chippendale Style: 47 in. high, 10 in. wide. 25c
- 978—Lawn Chair on Wheels: Lightweight, easy to wheel. . . . 25c
- 981—Colonial Wall-Shelf: 30 in. high, 19 in. wide. . . . 25c
- 984—Duncan-Phyfe Drop-Leaf Table: Reproduction of historic piece. 25c
- 986-987—Utility Trailers: Built of old auto parts. . . . 50c
- 989-990—Speedy Motor Scooter: Gas engine, 40 to 60 miles on gal. of gas. . . . 50c
- 991—Gun Cabinet: Handy cabinet includes rack for rifles. . . . 25c
- 993—Twin-Deck Beds: 6 ft. x in. long, 31½ ft. wide. . . . 25c
- 1106-1112—SEACRAFT — 25 FT. CABIN CRUISER: Adaptable as sport fisher, express cruiser, or utility boat. Cruises at 15 knots with marine engine or converted auto engine. Cabin sleeps four. Galley has fresh-water tank, sink, and cook stove. Set of seven large-sized blueprints scaled 1 in. per ft. plus 40-page two-color illustrated booklet, only. . . . \$10.00
- 1011—Fireplace Fittings: Andirons, log rack, etc. . . . 25c
- 1080-1081—Banta: 12 Ft. Plywood Runabout: Vee-Bottom, 3-passenger. . . . 50c
- 1086—Black Forest Corner Shelf: Scroll-sawed. . . . 25c
- 1089-1090—Home-Constructed Freezing Unit: reaches 30 degree temp. . . . 50c
- 1091-1096—17 ft. trailer, 7 ft. wide. Steel chassis. . . . \$1.50
- 1102-1105—Midget Trailer: "Teardrop" body. Sleeping quarters for two. . . . \$1.00
- 1113-1114—Gold Rush of '47: The A.M.A. Open Class B Record Holder Plane Model. . . . \$1.00

FILL OUT AND MAIL THIS COUPON NOW

POPULAR MECHANICS CO.
200 E. Ontario St., Chicago 11

Please send the following plans _____

I am enclosing \$ _____

Name _____

Address _____

POPULAR MECHANICS

PORTABLE
PLASTIC
INFLATABLE

WADING POOLS



- a. Small Fry Size—30"x30"x6".....\$3.95
- b. Junior Size 38"x38"x6".....\$4.95
- c. Senior Size—44"x44"x9".....\$7.95

The old swimming hole was never like this! With these inflatable pools you can be sure of fresh, clean water, right from your tap and have your own swimming pool on your front lawn. Safe, sanitary, no crowds, no danger. Solves your hot-weather problems. Deflates to handbag size. Comes in 3 sizes. (see above) Send no money! C.O.D. you pay postage. Remit with order, we pay postage.

NOVELTY MART, 59 E. 8th St., N.Y. 3, N.Y., Dept. M97

Learn CARPENTRY BRICK LAYING

Get into the billion dollar building trades. Learn now while opportunities are greatest. Train in our completely equipped shops under expert instructors. G.I. Approved. Enroll now. Limited classes. Write for FREE Catalog.

MIDWEST SCHOOL OF BUILDING TRADES, Dept. PM-6
411 N. Center St. Bloomington, Ill.

BAR STOOL COVERS

made from burn resistant, plastic coated, artleather. Sewed with contrasting cord and elastic snap bottom to insure good fit. Colors: red, blue, green, cream. Up to 12" dia., 8" depth. Send \$1.25 each postpaid. State color, diameter and depth. No COD's. Samples on request.

HANSON'S UPHOL., 666 Vernon Ave., Glencoe, Ill.

Say You Saw It in
POPULAR MECHANICS



200
ILLUSTRATIONS

SPEED & MILEAGE MANUAL

Easily Get Super Speed, Acceleration, Mileage—
Top Racing Performance From Any Automobile!

Famous New Book shows simplified Soup-up Methods—Speed Tuning—Economy Secrets—"Customizing Plans"—Latest Track Proven Methods for all cars! Tells how to build your own SPEED EQUIPMENT! FAST SPORT CARS! "CALIFORNIA HOT RODS"! 200 H.P. ROAD & TRACK CONVERSIONS! Complete Instructions on building inexpensive Superchargers! Dual Manifolds! "Water Injectors"! High Compression Heads! Twin Mufflers! Economizers! All about—Fast Engines, Gas Saving, Retarding, "Cam Secrets," Multiple Carburetion, Fuels, Porting, Ratios, Frames, "Offys"! BRAND NEW METHODS, Plans, Formulas, "Racing Tricks"—STOCK CAR SPEED SECRETS! Reveals 100 Ways to save gas! Shows latest "HOLLYWOOD CUSTOM STYLING"! Streamlining! Sport Changes! Lowering! Speed Conversions! Including—California Roadster Plans! Racer Diagrams! Working Drawings! Performance Charts! Graphs! Beautiful Photographs! Etc.!

Large manual (plus) "California Equipment Catalog" and Hot Rod Handbook.

ALMQUIST AUTOMOTIVE ENGINEERING
Milford 62P, Pa.

ALL \$1.98
THREE—1 P.Pd.

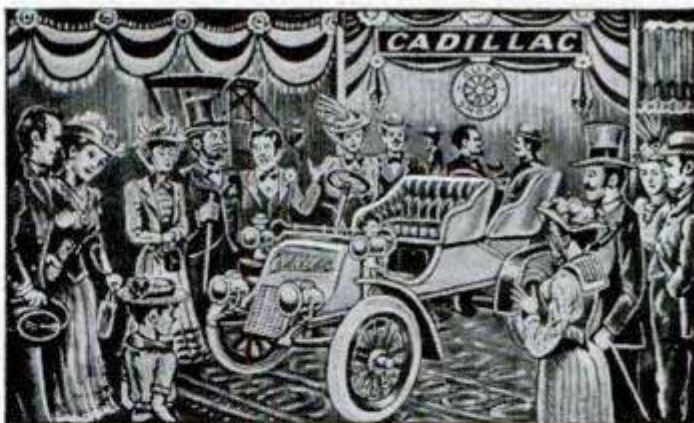

First Showing of a Proud Car

Yours! A 1903 CADILLAC

EASY-TO-MAKE Miniature Model — \$2.50

A little gem you'll treasure and show with pride! Authentic 3/4" scale model OLD TIMER Auto Sets include complete instructions, plastic wheels, head lamps, cowl lamps, radiators, horns, bulbs, steering wheel, radiator caps. Wood and special process board are die-cut; dowel parts cut to length. 9 other famous models! Start today!

FREE!
Write for
Your Copy of
Our 4-Color
FOLDER!

1911 Maxwell \$2.50	1910 Model "T"
1903 Model "A"	Ford ... \$2.50
Ford ... \$2.50	1903 Rambler \$2.50
1904 Olds ... \$1.95	1909 Model "T"
1909 Stanley	Ford ... \$2.95
Steamer \$2.95	1900 Packard \$2.50
1911 Buick "Bug" — \$2.50	

SEE them at your local hobby or department store, or write to us direct. Add 25c for postage and handling; no C. O. D.'s, please.

Hudson Miniatures' "OLD TIMERS"
SCRANTON HOBBY CENTER, Dept. 14, Scranton 10, Pa.

GET THIS HANDY TOOL and build hundreds of useful gadgets

MAKES WELDING AT HOME EASY
Also brazes, cuts, solders, even charges batteries.
Fixes garden tools—toys—fenders—pipes.

NEW Low Priced LINCOLN ARC WELDER

- Plugs into 110 volt light socket.
- Easy to weld, cut, braze or solder.
- Approved by Underwriters Laboratories.
- Built by The Lincoln Electric Company, world leader in arc welding.



PRICE ONLY

\$48.00

Lincwelder 60 and accessories

Fill out order and mail to

The Lincoln Electric Co., Dept. 192, Cleveland 1, O.

Ship me the "Lincwelder 60" with accessories \$48.00

Enclosed is check money order

Send me free bulletin on the new "Lincwelder 60"

Name _____

Address _____

City _____ State _____ 201

BAR BELLS



BUY DIRECT FROM FACTORY

FREE CATALOG
on Paramount Bar Bells and our Proven System. Write Today!! Save up to 30%.

\$8.95 up

INDEPENDENT IRON WORKS
2416 East 23rd Street, Dept. B6 Los Angeles 11, Calif.

REMEMBER it's DANGEROUS to pay less if you want safe, balanced matched tires. **WE REPEAT**—Consider your family's safety, not just PRICE. You see our adv. every month. Positively not recaps. We serve ambulances, fire trucks, school buses, trucks and cars. "Out-of-Town folks" buy now and take 10% discount. Your car is only as **SAFE** as your tires.

GOOD YEAR **Firestone**
Goodrich **U. S. ROYAL**

& others. Original good tread. Slightly worn. Extra fine track. Our policy is to select your tires as carefully as if our very future depended on the service given by that particular tire.

FREE Tube with each tire

26 MONTHS GOLDEN RULE GUARANTEE BOND
These are genuine "Many Purpose" "AAA" Tires. Read that top line again! You'll save MORE than \$

600-16	\$5.55	650-16	\$5.95	700-15	\$5.85	475-19	\$5.95
600-16(6)	6.50	700-17	9.99	650-15	5.75	525-18	5.95
700-16	6.85	750-16	7.95	550-17	6.75	550-16	5.55

America's great Lo-Price Value 12 Months Guar. Limited Supply

600-16	\$3.45	650-16	\$3.65	700-16	\$5.40	650-15	\$3.85
		700-15	3.75	750-16	5.95	550-17	5.75

LO-PRICE TRUCK TIRES 12 MONTHS GUARANTEE

32x6(8)	\$8.65	750-20(10)	\$9.25	1100-20	\$13.20	650-20	\$7.75
32x6(10)	10.75	825-20	11.10	700-20	9.10	900-20	11.15
						1000-20	12.65

SUPERCUSHION TIRES (24 lb. air) to fit your present wheels
670-15(650-15) \$6.25 | 760-15(700-15) \$7.45 | 670-16(600-16) \$6.66
710-15(650-15) 6.85 | 820-15(700-15) 6.25 | 760-16(650-16) 7.50

WE ARE TRUCK-TIRE EXPERTS
Matched Tires. Truck-owners the world over depend on us to keep their trucks rolling ON TIME. TRUCKERS—Paying these few cents more will mean thousands of extra miles to you.

6-8-10-12-14-16 ply "Many Purpose" "AAAA" Grade

GOLDEN RULE 26 MONTHS REPLACEMENT GUARANTEED BOND

600-20	\$9.95	32x6 (8)	\$10.95	900-20	\$16.66	1000-22	\$16.66
650-20	9.95	32x6 (10)	13.95	1000-20	17.77	1100-22	17.77
700-20	10.95	750-20(10)	13.95	1100-20	18.88	1100-24	18.88
750-20	10.95	825-20	17.77	750-15	11.45	700-17	13.33

MILITARY "AAAA" Guar. 30 mos. (Supers 14 mos.)

750-16	900-16	750-20
Super \$9.75	Super \$8.60	Super \$8.48
"AAAA" 12.22	"AAA" 10.90	"AAAA" 13.00

Military Rugged 600-16 \$7 750-20 \$16

BLATT GIRARD & LANCASTER AVES., Dept. PM
BLATT BLDG., PHILADELPHIA 31, PA.
Send ck. or money order and this ad for rush shipment. We won't ship a tire we wouldn't use ourselves. Instant shipment down South, Far West and the world over.

FACTORY-TO-YOU

MIDWEST

RADIO and TELEVISION

at NEW LOW FACTORY PRICES



Available in Consoles and Complete Chassis

LONG EASY TERMS
30 DAYS TRIAL
Right In Your Own Home

Send for **FREE** 32-Page 4 Color CATALOG

MIDWEST RADIO & TELEVISION CORP.
Dept. X25B, 909 Broadway, Cincinnati 2, Ohio

NAME _____
ADDRESS _____
CITY _____ ZONE _____ STATE _____

Got an Idea? An Inventive Mind? ...
Want to Cash In on It? ...

THEN GET
CLOTH BINDING
\$2.50

MONEY from IDEAS

MONEY FROM IDEAS by Myron P. Laughlin, is a down to earth, informative and useful book for every man with an active, inventive mind, who believes he has ideas that can be patented. Get this book to determine what inventions are needed for today's market, and how to go about inventing them; how to get a patent, protect it, sell it and make money out of it. 144 pages, well illustrated, indexed, and contains an appendix of patent forms, most valuable for the sale, assignment or licensing of patents.

Vital, Informative and Practical Help!
Inventions and How They Are Patented—What Inventions Can Do For You—The Growth of an Idea—Let Others Experience Guide You—An Invention, How It Was Developed—An Invention, How It Was Protected—An Invention, How It Paid Its Way in the World—How to Make Money From Inventions—Invention is a Business—Specialization—Sources of Information, A Where-to-Find-It Index—Records of Progress—Development Work—Starting a Business—Selling Patent Rights—Selecting a Patent Attorney—Patent Forms—Form of Assignment and Royalty Agreement—Form of License—Helpful Books.

POPULAR MECHANICS PRESS
200 E. ONTARIO ST.
CHICAGO 11, ILL.



Say You Saw It in Popular Mechanics

"SEA CRAFT"

BLUEPRINTS READY NOW!

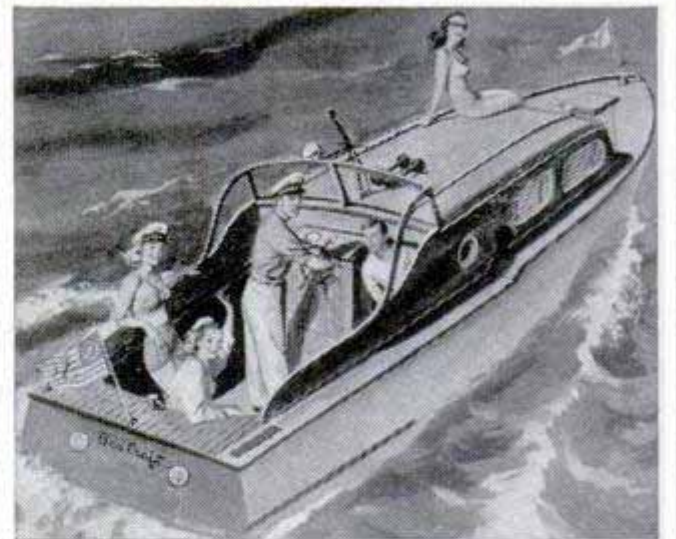

Build this luxurious cabin cruiser yourself and save money. What a beauty it is! A 25-foot boat readily adaptable as a sport fisher, express cruiser, or utility boat. Cruises effortlessly at 15 knots with a marine engine or converted auto motor. Its spacious cabin sleeps four and has a galley complete with fresh-water tank, sink, and cook stove. Has open cockpit large enough for fishing, lounging, etc. During war the Coast Guard used "Sea Craft" for ship-to-shore travel. Order today your complete set of seven large-size blueprints scaled 1 inch to the foot. These, plus a 40-page two-color illustrated booklet giving step-by-step instructions, only \$10.00.

POPULAR MECHANICS PRESS
200 EAST ONTARIO ST. CHICAGO 11, ILL.

Make Your Own LOW COST POWER TOOLS

Use Wood, Scrap, Discarded Materials—Make Practical, Proven Machines

Order today the new "Forty Power Tools You Can Make." Even though you have the older edition, get this new book with twenty brand new tools — 40 in all. Make your own motorized lathe, drill press, sander, shaper, circular, band, scroll and jig saws from old auto and other discarded parts. Make forty different tools following simple instructions, diagrams and photos and have an efficient, up-to-date shop. Save money, time and hard work and do a better job with low-cost power tools. Sent post-paid for only \$1.50 with order. Avoid high C. O. D. charges.



POPULAR MECHANICS PRESS
200 E. ONTARIO ST., CHICAGO 11, ILLINOIS



Boy! What a Picture!

And boy, what a book is Popular Mechanics new PHOTO HANDBOOK. Gives you the big three of superior photography:

1. The secret of taking better shots.
2. The technique of clearer developing.
3. The way to build better photo equipment.

Be an expert! Have fun! Save money!
Paper covered edition on all newsstands. . . . 60c
Order colorfully bound library volume from
POPULAR MECHANICS PRESS. . . . \$2.00
200 E. ONTARIO ST. CHICAGO 11

WATCHMAKING

Be a Watchmaker — Be Independent

Get practical training in Chicago's first accredited watchmaking school.

Day and Evening Classes—Approved for Veterans
Write today for free information

CHICAGO INSTITUTE OF WATCHMAKING
7 SO. PULASKI ROAD Dept. PM-6 CHICAGO, ILLINOIS

Say You Saw It in
POPULAR MECHANICS

Learn ELECTRIC APPLIANCE REPAIR AND SERVICE

FREE! PLAN FOR YOUR SUCCESS

BIG PROFITS — BIG DEMAND for qualified men in field of Home Freezers, Washing Machines, Dishwashers, House wiring, Auto electricity, etc. Learn at home — start your own business. NO PREVIOUS EXPERIENCE NEEDED. Special tools & equipment furnished. Earn while learning. Write for YOUR FREE SUCCESS PLAN — ACT NOW!

PACIFIC TRAINING SCHOOL Dept. P-506
7217 South Broadway • Los Angeles 3, California

FREE BOOK



NEW

IMPROVED...AMERICANIZED

JUDO

TWO BIG BOOKS FULLY ILLUSTRATED
1220 SHOW-HOW PHOTOS. 71 LESSONS
MANY NEW HOLDS

Protect yourself and others. Size and strength mean nothing. Knowledge and skill enable you to master any situation even against biggest bullies or armed thugs. Written and illustrated by one of the world's great Judo experts. Volume 1, basic and advanced holds, Volume 2, very advanced. . . each volume \$1.50.

BOTH BOOKS \$2.50 POSTPAID
OR C.O.D. PLUS POSTAGE
5-day Money Back Offer. ACT NOW!

DEPT. PM-6

IMPROVED JUDO, INC. P.O. Box 7355, Sta. L, Los Angeles, Calif.

Big Combination Offer!
SAVE...

SAVE 2/3 Build Own **ATTIC OR WINDOW FAN**

ASSEMBLE IT YOURSELF

COOL YOUR 5 ROOM HOUSE FOR \$27.00

FRONT ALL METAL

ASSEMBLY

ASSEMBLY AND FRONT

SIZE	PRICE	SIZE	PRICE
20"	\$23.00	30"	\$33.00
24"	27.00	36"	38.70
26"	28.50	42"	40.45
28"	31.50	48"	47.45

It's easy. Anyone can make. THE ASSEMBLY takes the guess work from your completed fan. THE ASSEMBLY comes complete with instructions, fan catalogue, blade, belt, pulleys, fan front and all parts with the exception of the motor and box. The only work necessary is to put 4 boards around the front for your window or attic, mount your motor with four bolts, and you have a sturdy, efficient fan at these sensationally low prices. Thousands sold. Order Model M-2 of size fan wanted. Send check or money order plus \$2.00 for express and packing charges, or send \$5.00 deposit and fan will be sent you C.O.D.

TROUSDALE MFG. CO., 266 Madison, Memphis, Tenn.

SALESMEN!

WRITE
THREE
WORDS
COLLECT
\$7.65

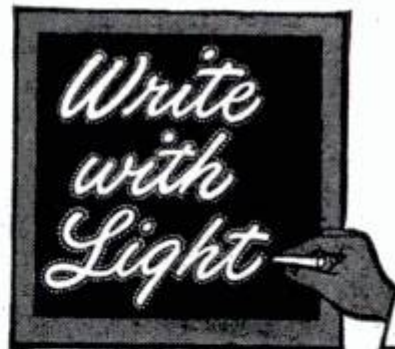

SENSATIONAL NEW ADVERTISING SIGN

YES, MAKE \$7.65 on 10-second demonstration to merchants. Write on glass with amazing magic crayon and presto—a 5-color advertising message takes fire and glows like a brilliant neon sign! Three sales a day and \$22.95 profit is for "lazy" men. Workers can double to triple that amount. FREE SALES KIT. Don't wait. Rush your name and address on a penny postcard for full details and complete sales kit—ALL FREE.

MAXILUME CO., 125 W. Hubbard
DEPT. L-86 CHICAGO 10, ILLINOIS

Serving You Well in America's Large *Citizen* Army

Meet Bruno Tomchesson of Bryan, Texas—expert cabinet-maker, family man, active in his community's affairs.

Typical of the thousands upon thousands enrolling in the Organized Reserve Corps, Bruno looks upon this good-citizenship opportunity in terms of *service*. He is active in Bryan's American Legion Post 159. He promotes his Legion's fine Youth's Baseball Organization.

And twice a month he trains as Motor Sergeant with Headquarters Battery, 352nd Armored Field Artillery Battalion.

A pleasant way to maintain old friendships! Rewarding, too—for under the *new* Reserve Program, Bruno draws full pay of his grade for each training assembly, builds retirement credits, equips himself for further advancement.

Bruno Tomchesson, civilian and soldier, indeed serves you well, as do Army Reservists everywhere, manning 9,000 units.

Learn more about the Organized Reserve Corps—a small part of your defense budget, a big part of your defense strength. Inquire at your nearby U. S. Army and U. S. Air Force Recruiting Station or for full particulars write directly to Executive for Reserve and ROTC Affairs, Dept. of the Army, Washington 25, D. C.



★
★
★
**ORGANIZED
RESERVE CORPS
U. S. ARMY**



**WORLD'S
BEST
WANT AD
MEDIUM**

CLASSIFIED Advertisements



Advertisements in this section 75 cents per word, each insertion, minimum 10 words, payable in advance
To be inserted under proper classification, copy must be in our office the 22nd of the
second month preceding date of issue

F. W. Johnson, Manager, Classified Advertising
Popular Mechanics Magazine, 200 East Ontario Street, Chicago 11, Illinois

1060 CLASSIFIED ADVERTISEMENTS 1060 OPPORTUNITIES FOR YOU

AUTOMOBILES, MIDGET CARS

CALIFORNIA Custom accessory head-quarters. Buy direct from original designers and save. Chrome dash panels, solid hood sides, grille panels, speed equipment, dual pipes, push button door conversions, chrome motor accessories, fender skirts. 34 page illustrated catalog 25c. Eastern Auto, 3319A South Grand, Los Angeles 7, Calif.

SPEED And custom equipment at rock bottom prices. Hollywood power-tone mufflers, dual pipes, large chrome echo cans, high compression heads, dual manifolds, cams, Mallory coils, gears, convertible tops. Save big money. Send 25c for literature and deduct it from your first order. Jack Hubbard, 9440 Mackenzie Road, St. Louis 23, Mo., Dept. PM5

DIRECT From California. Dual manifolds for Willys Jeeps to Oldsmobile Rockets. Finned heads, three carburetor manifolds, over 150 different makes and models. Speed and dress-up equipment for passenger automobiles. Magneto ignitions, aluminum flywheels, racing camshafts, water injectors, crash helmets, exhaust headers. New 1950 illustrated speed catalogue, 25c. (Dealers, request wholesale catalogue). Newhouse Automotive Industries, 5805-B7 East Beverly, Los Angeles 22.

SPECIAL British car issues. Auto Car 35c, Motor 35c, London Times 35c, Motor Cycle 25c, and from Switzerland Illustrated Automobile Review catalog 1950 \$1.75. Send for subscription price list of automobile publications of Europe. The International News Company, 131 Varick Street, New York, N.Y.

HOT Rod—The only monthly magazine about building roadsters, streamliners, etc. Sample copy 25c. \$3.00 yearly. Hot Rod, 1015 So. La Cienega, Los Angeles 48, Calif. Dept. PM.

DASHBOARD Controlled garage door operator. "Build Yourself" pamphlet \$1.00, refundable. Kaytor Laboratories, Lynwood, California.

MOTOR Trend Magazine—Custom, foreign, domestic, sports cars. Road testing, racing, auto shows, etc. Sample copy 25c. Full year \$3.00. Motor Trend, 1015 S. La Cienega, Los Angeles 48, Calif., Dept. PM.

AIRCOOLED Oil filter, other items. Free folder. Stonewall Company, 2005-M Cedar, Alhambra, California.

SPEED & Mileage Manual—New jumbo edition! 200 illustrations, drawings, charts, photographs! Guaranteed finest, most authoritative book! Easy, inexpensive ways to build speed equipment! California hot rods! Beautiful custom cars! 200 h.p. road, track conversions! Superchargers! Dual manifolds! Racing heads! Twin mufflers! Water injectors, economizers! Get super speed, mileage, acceleration, top racing performance from any car! Complete instructions with working diagrams on fast engines, speed tuning, restyling, customizing, gas saving, racing tricks, cams, fuels, balancing, porting, ratios, frames, "Offys!" Learn 100 ways to save gas! Reveals stock car speed secrets! California speed shop methods! Custom styling information! Streamlining! Lowering! Sport changes! Hollywood roadster plans! Speed conversions! (Covers all cars.) Large manual plus equipment catalog plus hot rod handbook—all three only \$1.98. Alquist Engineering, Milford 61P, Pennsylvania.

SPECIAL Offer hot rod camshaft re-grinding. One day service. \$23.50 exchange. Auto Electric Service, Box 54, Anderson, Indiana.

JUST Published! Clymer's No. 6 Motor Scrapbook. Latest and best. Heretofore unlisted antique cars, motorcycles. \$2.00—History Motorized Vehicles, data on early gasoline, steam, electric cars, steam engines and motorcycles. \$2.00. Clymer, Dept. 6A, 1268 S. Alvarado, Los Angeles 6, Calif.

NEW Book! German racing cars and drivers. Includes 300 Leica photographs, complete history all pre and post-war German cars, Auto-Union, Mercedes-Benz, Veritas, BMW information all famous European Grand Prix races. History Caracciola, Lang, Stuck, Rosemeyer, other great drivers and famous tracks. \$2.00 postpaid. Clymer, Dept. 6A, 1268 S. Alvarado, Los Angeles 6, Calif.

"SPEED Equipment" bargains—California mufflers \$4.50, V-8 duals \$15.90, chrome carburetor stacks 98c, dual manifolds \$9.95, chrome echo cans \$1.55, racing camshafts \$29.95 exchange, water injector \$12.95, hi-compression heads \$19.75. All popular brands. Big illustrated catalog 25c. Dealers wanted. Alquist Engineering & Mfg., Milford 63P, Pennsylvania.

NEW Grand Canyon Economy Test Book. 31 American cars competed. Full technical details, rules, all information including gasoline saving article by winner. See how your favorite car performed in world's most important test. 145 photographs, charts, drawings, travelogue, historical Grand Canyon and Boulder Dam information. \$1.50. Outboard Motor Service Manual. All makes, \$3.50—Ford Owner's Handbook all Ford data 1932 to 1950, \$1.50. Model "A" Ford Manual \$1.00—1950 British Car catalog \$2.00—U. S. Car Catalog \$2.00 postpaid. Clymer, Dept. 6A, 1268 S. Alvarado, Los Angeles 6, Calif.

BIG New catalog! Over 500 racing, hot rod, speed equipment, auto parts and Hollywood accessories! Pictures! Speed tips! Customizing! Mileage information! Lowest prices! Illustrated catalog 25c. Alquist Engineering, Milford 65P, Penna.

MODERN Motor Car Magazine—Covers all cars, new, old, American, foreign—all activities. Shows, racing, clubs. Sample copy 25c; \$3.00 yearly. Crestline Publications, Box 581, Holliston, Mass., Dept. M6.

CHEVROLET Owners Handbook. Just out! Complete service data A to Z all Chevrolet models 1930 to 1950 inclusive. \$1.50 postpaid. Clymer, Dept. 6A, 1268 S. Alvarado, Los Angeles 6, Calif.

"HOLLYWOOD" Deeptone mufflers. "Straight-thru" design increases efficiency, speed, acceleration, mileage! Singles, all cars \$4.85. Finest V-8 duals \$15.90. Satisfaction guaranteed. Speed equipment catalog 25c. Alquist Engineering, Milford (64P), Pennsylvania.

FORD Owners and mechanics, we supply several simple replacement parts making Ford and Mercury Brakes free floating, super powerful with soft pedal; eliminating squeal, chatter and groan—\$4.25-\$6.90. All models, 1928-1948. Easily installed by yourself. Write for details. Super Brake-Floater Company, 4022 West Lake Street, Chicago 24, Illinois.

CHEVROLET Owners—Don't "Watch the Fords go by." Your Chevy can beat the Fords. Stamp brings particulars. Hi-Torque Speed Shop, Liberty, N. Y.

SAVE Gasoline! Sensational Gane needles. Free trial. See page 261.

WANT Better gas mileage? Your car can attain it. Stamp brings details. Stan Stanton, Liberty, N. Y.

YOUR Car burn oil? Poor compression? Slow starting? Excessive cylinder wear? Holt's Piston Seal restores compression! Cuts oil consumption! Checks piston slap! Lasts 10,000 miles! This amazing British product now available, forms self-expanding pliable lubricating seal around pistons. Compensates for wear! Cannot harm finest engine. Easily installed; full directions enclosed. \$3.98 tube for 6 or 8 cylinders up to 240 cubic inches. Details on request. Treglow Company, Department F, 200 West 7th Street, Plainfield, N. J.

AUTOMOBILE Nuts—New national all-hobby automobile club mobilizing forces for amateur mechanics, collectors and talk-auto enthusiasts—now offers books, data books, glossy photos, literature—old and new cars, engineering manuals, special publications. Contact other auto fanatics. Write to get your name on free mailing list. Auto Maniacs, Inc., Stockbridge, Mich.

NEW Book exposes 36 tricks used to defraud car buyers. Tells how to buy low, sell high. \$1 postpaid. Yakima Automotive Specialties, Box 672, Yakima, Washington.

SAVE Gasoline, oil, tires, brakes—New illustrated economy manual. Get more power, speed, better automobile performance. Introduces 17 new economy products—super sparkplugs, water-oil injector, rocket booster, mileage meter, etc. Special 50c National Automotive Research Corporation, Venice 26, California.

OIL Cooler: Water cooled engines. Better lubrication, longer life. Complete \$15.00. Free illustrated folder. Dept. PM, Gilbert Brass Foundry Company, St. Louis 15, Mo.

SPEED—Equipment—Lowest prices. Send 10c for catalog and handbook. Speedomotive, Box 182M, Covina, California.

SILENCE Overhead-valves, attachments unnecessary. \$2.00. Derderian, Box 542, Sandston, Virginia.

TEACH Driving—Dual controls furnished. See page 42.

SPEED & Power Handbook—Tens of thousands have been sold! 50 chapter library edition! Diagrams! Breath-taking methods, authentic, direct from California. Covers Crosleys to Cadillacs, all makes. Build your own dual manifolds. Superchargers. Hot cams. Water injectors. Hi-compression heads. Mileage devices. Save many dollars! Get racing speed, lightning acceleration, dynamic power increases from any make passenger automobile! Build fast stock cars. California roadsters. 160 m.p.h. rods! Get construction drawings! Tuning techniques! Speed tricks! Economy secrets! Ingenious formulas! Covers Racing Frames, Reciprocating Masses, Jet Engines, Braking Characteristics, Dynamometers. Also dual pipes, gears, fuels, porting, relieving, lowering, balancing! Includes 1950 speed equipment catalogues! Also California Automobile Customizing, colored photographs. Drawings. Newest ideas. Conversions. Carson tops. Re-styling all makes. Streamlining. Chopping. Channeling. Complete \$1.98 postpaid. Newhouse Automotive Industries, 5805-B2 East Beverly, Los Angeles 22. (See page 43 and 68. Display Advertisement.)

SMITHYS Mufflers for all automobiles. Free list. Buck's Auto Parts, Box 1296H, Merced, California.

SEE Our ad under motorscooters for midget car bargains. Midget Motors Directory, Athens, Ohio.

"WATER Injection." Also speed power, economy methods! Free descriptive, illustrated, information. Neher Industries, La Verne, California.

JUST Out! Get the largest auto accessory and parts catalog in the world. Over fifteen thousand items, including Hollywood accessories, hi-speed equipment, rebuilt engines; all parts and accessories for all cars and trucks. New, used and rebuilt! We have that hard-to-get-part! Completely illustrated, jam-packed with bargains. Send 25c. J. C. Whitney & Co., 1919 Archer Ave., Chicago 16, Ill.

INTERESTED In automobiles? Write for free sample copy. Franson's Weekly Motor News, Box 254, Eugene, Oregon.

FROM Speedway to roadway! Track-proved hi-speed heads and manifolds now available for your passenger car! No special tools needed! Increase horsepower 25%! Astounding getaway! Free illustrated catalog. Speedsport, 6215P Diversey, Chicago 39.

AUTOMOBILE Racing book, fifth edition, well-illustrated. Building bodies, frames, engines, Ford conversions. Plans. Roadsters. Indianapolis cars. \$1.00 postpaid. Popular Mechanics Press, 200 E. Ontario St., Chicago 11, Ill.

RACING Car equipment for all cars, engines, racing heads, manifolds, carburetors, mufflers, etc. Speed instructions and literature \$1.00—refunded first order. Lee Motorcraft Co., 1412-D Great Northern Bldg., Chicago 4, Ill.

AUTOMOBILE Racing, sixth edition. 100 illustrations. Drawings, building instructions Ford-60 midget, California roadster, Offenhausser racer. World's record 158.5 m.p.h. car. \$2.00 postpaid; \$2.40 c.o.d. Popular Mechanics Press, 200 E. Ontario St., Chicago 11, Ill.

NEW Sensational seat cover. Mono. 6545 Santa Monica Blvd., Hollywood, California.

WE Sell direct to customer, speed parts manufactured by us. Fords, Studebaker Champion, Chevrolet and Willys, complete engines for race cars and boats. \$1.00 for illustrated literature and price sheet. R. & R. Mfg. Co., Robert M. Roof, Box 546, Anderson, Indiana.

AUTO SUPPLIES AND EQUIPMENT

SENSATIONAL Illuminated ornament. Lights at night. Universal mounting. \$2.00 postpaid. Heco, 840 West 31st, Chicago 8.

IMPORTED Chamois. English full oil tanned. 24x36, \$4.50; 18x19, \$2.35 postpaid. Guaranteed. Ken Lowe, 8301 State Line, Kansas City 5, Mo.

RAYFLEX Paste wax. Cleans, waxes. One operation. \$1.00. Rathgeber Laboratories, New Haven, Conn.

WHEEL Alignment recorder. Drive over. Guaranteed. \$16.98 prepaid. Align-A-Matic, Box 94, West Orange, N. J.

WELDING Bodies, frames, fenders. Pays with Hobart arc welders. Easy terms. Free catalog. Box 279-M-602, Troy, Ohio.

INITIALS For your car. Samples 6 for 50c. Agents make 600%. Stillwell, Empress Building, Decatur 64, Illinois.

1950 SUPERIGNITIONER: Starting-pep-mileage \$4.50. EG Mfg., Elmsford, N.Y.

LACHAPELLES Treatment (patented) it puts bearings on the pistons, through the gas tank, for extra speed, power, economy. 100,000 miles treatment \$3.00 postpaid. Ferns Products, 8120 Walnut Dr., Los Angeles 1, Calif. (Data sheet on request.)

REDUCE Operating costs, foot cramp, driving tension. Simple gadget underhood indicates speed when gas pedal becomes foot rest. Accelerator functions normally. Does not limit speed or maneuverability. Satisfaction guaranteed. Write R. Harper, 745 E. Woodruff, Hazel Park, Mich.

MOTORISTS Save gasoline by Vacuumating overrich mixtures. Fits all cars. For free particulars write Vacuumatic, Dept. 1613, Wauwatosa, Wis.

SAVE Gasoline! Sensational Gane Needles. Free trial. See page 261.

INITIALS For your car. 6 for 50c. Stillwell, Empress Building, Decatur 64, Ill.

JEEP Parts for military and civilian Jeeps. Fast, efficient service. Phone and wire orders given immediate attention. Retail Supply Co., Box 906, Dept. 1B, Steubenville, Ohio, Phone 4-0854.

"**BURN** Water in your car!" Free illustrated information. Write, Neher Industries, La Verne, Calif.

UNCONDITIONALLY Guaranteed auto thief alarms. Novak Manufacturing Company, 3131 West 13th, Gary 1, Indiana.

JUST Out! Get the largest auto accessory and parts catalog in the world. Over fifteen thousand items, including Hollywood accessories, hi-speed equipment, rebuilt engines; all parts and accessories for all cars and trucks. New, used and rebuilt! We have that hard-to-get-part! Completely illustrated, jam-packed with bargains. Send 25c. J. C. Whitney & Co., 1919 Archer Ave., Chicago 16, Ill.

BUICK Parts—Enjoy new-car pep and power in your old Buick. Same day service from world's largest stock of new (not rebuilt) Buick parts and engines. Ship anywhere. Dime brings catalog. Write today. Robertson Buick Co., 1001 S. Washburn Ave., Chicago 5, Ill.

CHEVROLET Parts. Scarce motor, body, sheet metal parts. Grossman Chevrolet, Minneapolis, Minnesota.

AUTO And truck parts. New and used. Lowest prices. Complete stock. Prompt replies. Babbitt Auto Parts, 2833 Chicago Ave., Chicago 22, Ill.

BRUSH Plating outfits connect to a battery. No tanks or shop required. Free particulars. Gunmetal Co., Avenue J, Decatur, Illinois.

GOVERNMENT Surplus. Low voltage circuit tester in steel box. Cost \$202.00. Our price \$27.50. Will test batteries, starters, generators, voltage regulators, grounds, short circuits. Wilt Electrical Company, 7829 S. Racine Ave., Chicago 20, Ill.

AUTO TRAILERS

SAVE Money—Build your own trailers, carts, freight trucks, wagons, etc., using our axle. Costs less than parts from your local junk yard. Not surplus material. 2,000 pound capacity. \$8.95. Stainless steel trailer hitch balls—Strong, will not rust or tarnish. Dress up your rear bumper for \$4.50. Free literature. Dealer inquiries invited. Axle Manufacturing Company, Box 1605, Beaumont, Texas.

UTILITY, Camping trailer plans, 25c. Gray, 4517 East 12th Street, Oakland 1, California.

FINDLEY Trailer Primer; 16,000 words of advice on trailers, dollies, hitches, mountain driving, etc., written after trailering 50,000 miles. \$1.00. The Findleys, P.O. Box 907-B, Ft. Myers, Florida.

BUILD Your own trailer for boats, general utility. New axle and wheel assemblies, with Timken bearings. \$25.00 without tires or tubes. Write Standard Equipment Co., Dept. PM550, Cedar Rapids, Iowa.

BUILD Your own trailer! Save money! Have every feature you want! Plans for house, sport, camp and utility trailers. Catalog describing 9 models 10c. 15c in Canada and overseas. Jim Dandy, Box 125-A, Wausau, Wisconsin.

TRAILER Coaches. Save money. Buying? Building? Sound engineering construction, chassis, bodies, furnishings. Travel, dwelling, trailer plans. \$1.50 postpaid. Popular Mechanics Press, 200 E. Ontario St., Chicago 11, Ill.

MOTORCYCLES, BICYCLES, MOTORSCOOTERS AND SUPPLIES

CYCLE—Monthly motorcycle enthusiasts' magazine. Road tests, technical data, foreign and domestic. Many illustrations. Sample copy 25c. One year—\$3.00. Cycle, 1015 So. La Cienega Blvd., Los Angeles 48, California, Dept. PM.

KNEEACTION Moto-Scoot \$10; motorbike (front and rear brakes) \$5; Whizzer motorbike with clutch and all attachments \$25; Indian motorcycle \$30; good midget car \$35; tire-wheel combination \$2.50. Rush 25c (35c for first class mail) for new catalog #945 listing sensational bargains in motors, motorscooters, motorcycles, Servicycles, midget cars, etc. Associated, Box 1764-CS, Toledo, Ohio.

MOTORCYCLE Road Racing. New book complete history all years British Isle of Man, world's greatest road race. \$2.00 postpaid. Clymer, Dept. 6A, 1268 So. Alvarado, Los Angeles 6, Calif.

EXCLUSIVE Agencies and dealerships open. Most incredible lightweight motorcycle in world. Sells in \$250 price range. Hydramatic-type drive, internal expanding brakes, rubber mounted 3-HP 4-cycle engine, up to 110 miles to gallon gas, many other exclusive features. Full protection on repeat orders. Small investment required. Write for literature. Foreign country inquiries welcomed. Pony Cycle Division, Box P6M, 1124 National Bank Building, Detroit 26, Michigan.

SPECIAL—1946 Whizzer in Schwinn bicycle \$20. Also Cushman motorscooter (good tires and lights) \$15; Shaw bicycle motor \$15; midget car \$15. Rush 25c (35c for first class mail) for new summer catalog #17 listing many other amazing post-war bargains in wheels, engines, motorscooters, midget cars, monocycles, motorettes, etc. Gail, 538 Erie, Toledo, Ohio.

REBUILT Tested 1½ to 3 h.p. engines for motorbikes, motorscooters, small autos, farms, shops, etc. \$9.00 to \$30.00. Send \$1.00 for forty page catalogue, manual and parts book so you can order properly for immediate delivery. Cauffier Motor Industries, Dept. 122, Temperance, Michigan.

1949 MICROMIDGET Racer \$85; home-made midget \$20, new Regal motorscooters, \$37.50 less engines; 3 to 5 h.p. gasoline engine \$5; Smith motorwheel \$8. Four balloon tires \$3. Plenty new midget cars, motorscooters, homebuilders parts, plans, transmissions, clutches, engines, sprockets, etc., at factory prices. Mail order only. Send 25c for new illustrated catalogue Number 35, just out, listing these and hundreds of other bargains, new and used. (35c by first class mail). Midget Motors Directory, Athens, Ohio.

INDIAN And Harley, new and used parts catalog. 15c. Cylinder reboring, motor rebuilding, batteries, accessories. Everything for the motorcycle. Bootz, 1700 East University, Des Moines 16, Iowa.

MOTORCYCLE Magazine—Worldwide coverage. Yearly subscription \$1.00. Sample 15c. Motorcycle News, 5424-A Sawyer, Chicago 25.

BICYCLES—New Raleigh 3-speed English, world wide reputation for quality; best value today. Free catalogue. McHugh Brothers, 1876 Central Avenue, Yonkers, New York.

HARLEY-Davidson parts, accessories, repair manuals on all models. 24 hour service. Authorized factory dealer. Philadelphia Harley-Davidson Company, 857 North Broad Street, Philadelphia 23, Penna.

WORLD'S First jet turbine bicycle engine. Fits any bike. Smooth, economical, \$150.00. Dealers wanted. Literature 25c. Jet Engine Co., St. Augustine, Fla.

RECONDITIONED Motorcycles and motors. Chromium accessories. Complete stock Indian parts. Expert rebuilding. Fast service. Indian Motorcycle Sales, Kansas City 1, Mo.

HARLEY-Davidsons—Used, guaranteed. Genuine Harley-Davidson parts, accessories, obsolete model parts, expert service. Send 25c for motorcycle and accessory bulletins. \$2.25 for 45" Army Motorcycle Manual. Knuth's, 2491 Fondulac, Milwaukee, Wis.

TIRES And industrial wheels, suitable for scooters, wheelbarrows, farm equipment, etc. All sizes. Bicycles and accessories. Send dime for list. Cycle Transport Company, 1241 So. Michigan Ave., Chicago 5, Illinois.

AVIATION

PARACHUTE, Mansize, white silk w/ harness, etc. 65 yards. Surplus. \$12.95 f.o.b. No c.o.d. Aero Parts Supply, 8102 Lockheed, Houston, Texas.

PROPELLERS, Plans, supplies, for ice sleds, snow sleighs, air boats. Literature 20c. Banks-Maxwell, Box 3301E, Ft. Worth.

PROPELLERS—For sleds, airdrive boats. Literature. Standard Aircraft, Box 387, Ft. Worth, Texas.

BATTERIES, GENERATORS

GENUINE Edison batteries, fifteen year life. Unconditionally guaranteed. Free literature. See-Jay Company, 3522 Webster Avenue, New York 66, N. Y.

EDISON Nickel batteries. 37 to 600 ampere. Also kits with Edison plates: make your own. Interesting literature. Hawley Smith Co., Croton Falls 1, New York.

ELECTRICAL SUPPLIES

BE Independent, be secure, have your own profitable business—earn \$10 and more a day making beautiful, fast-selling lamps at home. No equipment needed. Illustrated course teaches you quickly. Course, parts catalog, wholesale price list—only \$2. Gearon Co., Dept. 200-B6, 27 S. Desplains, Chicago 6, Ill.

ELECTRIC Appliances, fans, motors, supplies, tools. Catalogue 10c. 1500 items. Arcor Sales, 3463 Itaska, St. Louis 11, Mo.

FREE Catalog—Motors, generators, welders from aircraft generators, water softeners, automobile airconditioning, uranium locators, many other electrical bargains. LeJay Company, Minneapolis, Minn.

USED High voltage insulators. Free list. Box 455, Davenport, Iowa.

50 FT. Heavy duty extension cord with bulb guard \$2.98 postpaid. Tom Sheehan, 1154 Van Buren St., Chicago 7, Ill.

FANS, Parts, kits, G.E. motor bargains, precision balanced blades, bearings, pulleys, etc. Free literature. Rich Fan Manufacturing Co., 2401 San Jacinto, Houston, Texas.

LAMPS—Build own originals, parts wholesale, any amounts. Catalogue 10c. Brown Lamp Co., Box 501, Wellston, St. Louis 12, Mo.

ELECTRIC Motors, free bargain list. Plenge, 9 Stuyvesant Oval, New York 9, N. Y.

OUTDOOR Post lanterns, wholesale prices from \$4.98. Free catalog. Roe Sales, Box 611, Grand Rapids, Mich.

ELECTRIC Pencil—Engraves all metals. \$2.95. Reb Industries, Elmhurst, Illinois.

FANS — Parts, kits, assemblies. Free bargain list. Engineering Sales, Box 458, Hopewell 2, N. J.

LAMPS—Building, wiring made easy by charts and directions in 56 page illustrated lamp parts catalog. 25c. Gyro Lamps, 5402P Clark, Chicago 40.

MAGNET Wire, insulation, transformer lamination. Morton Electrical Service, Maywood 8, Illinois.

TRAFFIC Appliance parts, wholesale catalog-handbook, \$1.00 (refunded, first order). C-US Supply, 2512-I Prevost, Ft. Worth 7, Texas.

ELECTRIC Pencil; Engraves all metals \$1.25. Beyer Mfg., 10511-H Springfield, Chicago 43.

32 VOLT Appliances—World's largest line. Catalog free. Haines Corporation, Dept. N, Minneapolis, Minn.

WELDING, SOLDERING, PLATING

METALGRIP, New general utility solder, solves many problems in metal fabrication and repair. Trial jar 50c. Free literature. James Rowan, 234 W. Schiller St., Chicago 10, Ill.

ACETYLENE Welding outfits, brand new \$45.00 (2 heavy regulators, torch, 3 tips, hose, lighter); arc welders. Eagle Welding, Dept. PM, 5085 Broadway, Chicago 40, Ill.

WELDING Builds paying business with Hobart "build-your-own" portable. Free catalog. Box 279-M-604, Troy, Ohio.

110V. PORTABLE Transformer welders, \$29.50. "Morris," 1850A State, Schenectady 4, N. Y.

WELDERS: 1/16" Metal \$3.95, 1/8" \$6.45. Essay Manufacturing, Quincy 69, Mass.

MAKE Your own aluminum solder, fluxes, special solders. Formulas 50c each, 3 for \$1.00. W. Wolfe, Woodcrest Rd., Downers Grove, Ill.

A.C. Welders, power mowers. Bargains galore. Holgeron's Service, Canton, Kans.

LOW Heat tap and dial adjustment rheostat, on mounting panel for P-1, P-2, etc. Welding generators \$13.50 p.p. Haddican Mfg. Co., Satanta, Kansas.

NEW Electrolytic tank chrome plating unit. Guaranteed, \$8.00. Manteno Mfg., Manteno, Ill. F247.

BUILD Your own 100 ampere electroplating rectifier at a low cost. Starkweather, Ottawa, Kans.

RADIATOR Repairing books, supplies, equipment, gasoline torch. Write, Curfman Co., Maryville, Mo.

BUY Direct from factory. Welding and cutting equipment. All makes of equipment repaired. Established 1913. Box 331, Hamilton, Ohio.

ELECTROPLATING Salts and rectifiers. Mirror resilvering and chipped glass nameplate supplies. John Sprinkle, V55, Marion, Indiana.

MACHINERY, TOOLS, SUPPLIES

15" x 6' LATHE \$150, 20" upright drill \$140. Small Universal miller \$160. Larger one \$410. 14" shaper \$240. 24" x 12' lathe \$860. Large Universal miller and motor in base \$840. 4 ft. radial drill \$460. Power hack saws \$80-\$125. Good machines, low prices, money back guarantee. Conversion Parts Co., 278 Adams St., Boston 22, Mass.

HARDWARE, Tools, drills, taps, dies, electric motors, pumps, belts, pulleys, brass, steel, drill rod. Free catalog. Terek, 6304 Patterson, Chicago 34.

CONCRETE Block machines, Standard sizes. \$39.50. Average 400 daily. Free catalog. Concrete Machine Company, 5129 South Compton, St. Louis 11, Mo.

NEW Revolverly saw filing tool. Zapart, 586 Manhattan Ave., Brooklyn 23, N. Y.

POWER Tools. Big savings when you build your own with Lewis castings, 23 wood and metalworking tools with blueprints. Most can be completed with lathe and drillpress. Commercial quality. Ideal for home shops, schools, small manufacturing. Catalog 10c. Lewis Machine Tool Co., 3217 Union Pacific Ave., Dept. M, Los Angeles.

INDICATORS—For lathe work. New, surplus. Inside, outside, reads .0015"—\$1.95. Postpaid. Surplus catalog free. Jacktools, 2011-F Yale, St. Louis 17, Mo.

BALL Bearings 1/4 list price. Free list. Burgess, Box 168, Ferguson, Mo.

NEW Deco air compressors, 1/2 h.p. \$55. E & D Co., 353 W. 59 St., New York City.

DRILL Grinder for twist drills, \$2.95. See ad on page 268.

CHUCKS, Independent, universal; threaded 1 1/2"-8, 1"-8, 1"-10, 1"-12, or with adapter recess. Other chucks to 16" diameter. Write for quotation and free literature. No obligation. Westcott Chuck Co., 3600 Walnut, Oneida, N. Y.

BOATS, OUTBOARD MOTORS

SAVE On boat supplies—Large stock rebuilt outboard motors. Free list. Assemble your own 8 ft. cartop. Only \$35.00 f.o.b. Chicago. Write us your needs. Buy direct and save. Masters & Son, 212 W. Chicago Avenue, Chicago.

GET Our big 224 page low-price 1950 marine hardware and boat equipment catalog! Send \$1.00 for packing and mailing—refunded with first order. Garland Frasher Marine Sales, 540-E 31st Street, Huntington, West Virginia.

BUY Our conversion parts to change your auto engine into a high-grade marine engine. Marine manifolds, transmissions changed to high speed reverse, Marine bronze pumps, propellers, shafts, couplings, stuffing boxes, struts, rudders, etc. Heads for marine engines. Buy direct from the factory and keep the dealers profit for yourself. Money back guarantee. Conversion Parts Co., 278 Adams St., Boston 22, Mass.

BUILD Your own—Three point racing hydroplanes, others. Informative literature 25c. Champion Boats, P.O. Box 7132-D, Long Beach 7, California.

KAYAK Blueprints, deluxe models—Catalogue 10c. Viking Canoes, Merrick, N. Y.

BUILD A better boat than you can buy for the money! Save 33-55%. Exclusive laminated ribbed construction, prefabricated for easy assembly. All popular types from simple car-top models to mahogany-decked runabouts, one-design knockabout sailboat, priced from \$39.50 to \$329.00. Send 25 cents for literature, to be returned on first purchase. Ozarka, Boats, 660 Borden Lane, Woodstock, Illinois.

OUTBOARD Motor bargains—\$35.00 up. Send for free list! Save big money! Used parts for most makes and models. Crandall-Hicks, 911 Commonwealth, Boston, Mass.

REBUILT Outboard motors at bargain prices! Late model Johnsons, Evinrudes, Mercury, etc. A 3c stamp brings list—new and used. Parts for all makes, including chain store brands. Write for prices, giving description of parts needed. Money back guarantee. When in Boston visit the largest outboard motor plant in the world. Outboard Motor Mart, Inc., 309B Atlantic Ave., Boston, Massachusetts.

CONVERT Fords and Jeep to 100% marine engines with Osco's world famous Convo-Kits. Deluxe catalogue 25c (coin). Oscomotors, 3627B Lawrence, Philadelphia 40, Penna.

TWENTY Plywood boat plans \$1.00. Catalog of boat building plans 10c. The Rudder, 15 Murray Street, New York 7.

P38 BELLY Tanks, steel, \$9.95. Free picture. Bucks Auto Wrecking, Box 89, Merced, Calif.

BOAT Builders! Boat owners! The world's most complete marine catalogs covering hardware, windshields, steerers, propellers, fittings, engine conversions, plywood, boat lumber, marine paint and finishing materials. Send 25c. Special offer: All marine catalogs plus valuable booklet on boat building and 250-page boatsman's guide, send \$1.00. Marine Mart, Buffalo 7-B, Buffalo, N. Y.

KNOCK-DOWN Boat kits, Outboards, inboards, sails, hydroplanes. Easy to assemble. Minimum cost. Catalog with specifications, prices, 25c. Brooks Boat Company, Carrollton, PM, Michigan.

WOOD Hulls can be permanently waterproofed with our Fiberglass-Plastic treatment. Eliminates leaking, caulking, splitting, painting. Easily applied, complete instructions. Cost only \$4.75 square yard hull or deck. Save time and maintenance costs. Enjoy a dry boat this summer. Industrial Plastics, 3807 Harrison, Oakland, California.

FULL Size, cut to shape boat patterns, blueprints, 7 1/2-38 feet. Illustrated "Build a Boat" catalog, 25c (coin). "How to Build Boats" book, \$1.00. PolyWog houseboat plans \$10. Marine catalog \$1.00. Marine Specialty Mfg. Co., 3107 Detroit Ave., Cleveland 13, Ohio.

SAVE 2/3 Cost. Build your own boat with our ready cut parts by the Welch system. No experience necessary. Rowboats to cruisers. Illustrated catalog 25c. Midwest Boat Company, Menomonee Falls, Wisconsin.

NEW, Used, rebuilt marine motors. Marine conversions, fittings. Free catalog. Stokes Marine Supply, Dept. 24, Coldwater, Michigan.

MARINE Conversions for Ford and Jeep engines. Catalog 10c. Lehman Manufacturing Company, Department D, Newark 2, New Jersey.

ENGINES, MOTORS, DYNAMOS

WELDER Bargains. A.C. or d.c., engine or electric drive, portable or stationary. Write needs to Box 279-M-605, Troy, Ohio.

GENERATORS 750 Watt, 110 volt, alternating current, \$38.50. Welding generator 150 ampere \$35.00. Other bargains. Butler, 1885 Milwaukee, Chicago 47.

MOTOR Winders, free bulletins, winder and tester equipment. Motor Industries, Quincy, Illinois.

WINDING Data, listing 225 motors, single and three phase, \$1.00. Motor Data Co., Box 7631, Kansas City 3, Mo.

ATHLETIC EQUIPMENT, BODY BUILDING COURSES

ACROBATS! Strength, Health. Free information. Write! Knoff, A650, Pewaukee, Wisconsin.

PHYSICAL Perfection. 12 courses \$2.00. Fully guaranteed (news and pictures 10c). Sid's System, PM16, Southgate, California.

FREE Illustrated catalogue—Books, magazines, photos, equipment, barbells, courses. Dr. Frank Thompson, Dept. 10, 919 Fourth, Manhattan, Kansas. World's Leading Dealer.

DEADLY Judo—Fiercest fighting technique. Trick knockouts. (Over 200 illustrated pictures.) Expert instructions; three volumes. Complete \$2.25. Variety House, Box 46-B Wall Station, New York 5.

BARBELLS, Exercise equipment. Courses. Free booklet. Good Barbell Co., Reading, Penna.

SPORTING GOODS, GUNS, FISHING TACKLE, ARCHERY, TRAPPING

POCKET Alarm watch! Nickel case, radium dial, \$12.75 value, \$6.95. Bacon Brothers, 177 Milk, Boston 9, Mass.

"COMMERCIAL Fishing, or Fishing for Profit." Copy sent free. Laurence Barcus-M2, Terre Haute, Indiana.

IMITATE Birds! World's only larky sings pure notes, warbles, trills, chirps, blinks eyes, wiggles tongue. Precision waterless mechanism. \$1.00. Bacon Brothers, 177 Milk, Boston 9, Mass.

SHOTGUNS, Rifles, revolvers, 500 modern, obsolete. Also cartridges. Each list 10c coin. Ed Howe, 62 Main, Coopers Mills, Maine.

RIFLE Stocks: Laminated and regular. Blanks, semi-finished, finished. Enfield, Springfield, Mauser, etc. Literature. Banks-Maxwell, Box 3301E, Ft. Worth.

TENNIS Rackets restrung. Free details. Harold Lehman, EMC, Harrisonburg, Virginia.

MOLDS, (For fisherman's sinkers, squids, jigs and lures.) Handled and hinged. Quality fishing tackle. Free catalogue. E. L. Sweet & Son., Tonawanda, New York.

FISHERMAN—Lead sinkers. High quality, low cost, guaranteed. Free information. Wechsel, 5858 Deane, Toledo 13, Ohio.

OUT-Of-pawn. Shotguns, rifles, pistols. No list. Write wants. Enclose stamp. Virginia Pawnbrokers, Danville, Virginia.

SEND 10c For list 100 used guns. Frayseth's, Willmar, Minn.

FISHERMEN—Make your own sinkers with our molds. Free illustrated booklet. Reading Instrument Co., Box 78, Reading, Penna.

FREE Guidebook, "Top Tips For Fishermen." Send now for this fascinating, new, free, Richardson 32-page booklet containing 357 fishing tips, compiled by the expert fishermen who make Richardson rods—the fishing rods that are tagged with the "Sign of the Fish!" For your copy, sent without cost or obligation, print your name and address on a penny post card and mail to Richardson Rod & Reel Co., 3166 N. Sawyer Ave., Chicago 18, Ill.

AMMUNITION, Foreign-American; firearms. List 25c. Frank Farish, Vicksburg, Miss.

190 PROFUSELY illustrated pages antique and modern pistol, sword, etc. values. 50c. Robert Abels, A860 Lexington Ave., New York 21.

5000 BARGAINS, Firearms, binoculars, war relics. Catalog 40c. Smith Firearms, Runnemed, New Jersey.

BINOCULARS, TELESCOPES, MICROSCOPES, MAGNIFIERS

BINOCULARS, maps, globes, clocks, books. Free catalogs. BeLanger's, 51-K Talcott, Rockville, Conn.

ILLUSTRATED Catalog and book, "How to Select Binoculars," only 10c. Bushnell Importers, 43-6M East Green, Pasadena 1, California.

"FREE" Catalogue! Thousand war surplus optical bargains. Lenses, prisms, telescopes, binoculars, etc. Send \$1.00 for 10 lens hobbyist set and project booklet. H. Jaegers, 93-08 95th Avenue, Ozone Park 16, New York.

BINOCULARS—Guaranteed repairs, prompt service, estimates. Tele-Optics, 5514 Lawrence, Chicago 30, Illinois.

WAR Surplus bargains, binoculars, telescopes, sextants, millions of lenses, prisms, reticles, eyepieces, objectives, etc. Mail 10c for big "catalog CH." Send \$1.00 for Stock CH—10-piece lens kit and big instruction booklet. Edmund Salvage Co., Barrington, N. J.

ASTRONOMICAL Telescopes, binoculars, microscopes; bought, sold, repaired. Books. Lists 10c. Rasmussen-Reece, Amsterdam, N. Y.

GIANT Astronomical telescope with 6 ft. tripod \$15.00, f.o.b. factory, 100 power, (10,000 area magnification). Clear vision, full power guaranteed. Ready for use. Suffolk Science Service, Dept. BT, Riverhead, N. Y.

BINOCULARS, Telescopes, watches, guns. Buy, sell, trade. Schweer's, Donnellson, Iowa.

REFLECTING Telescopes. 60X, completely assembled \$25.00. Guaranteed observatory clearness. Free information. Skyscope, 475 Fifth Avenue, New York 17.

TELESCOPES, Binoculars, microscopes, big bargain catalog free. Brownscope Company, 24 West 45th Street, New York.

POWERFUL Astronomical telescopes easily made. Perfect lenses and instructions; 100X \$3.00; 100X and 200X \$4.00; 100X, 200X and 400X \$6.00. Full power, clear vision guaranteed. Instructions alone 10c. Suffolk Science Service, Riverhead, N. Y.

PETS—DOGS, BIRDS, RABBITS, HAMSTERS, ETC.

ST. BERNARD Pups! Beauties! Details, also numerous delightful pictures free. Manitow Kennels, Watrous, Sask., Canada.

MAGILL'S Hamsters. Wonderful pets! Clean, easy to raise anywhere. Splendid profit opportunities. We furnish finest breeding stock, supplies, everything needed. Write for free illustrated literature. Magill's Hamstery, Drawer 430-B, Springfield, Missouri.

RAISE Golden hamsters—Start a profitable hobby today. Free literature and special offer. Blackhawk Hamstery, 636-M Jackson Street, Ft. Atkinson, Wisconsin.

RAISE Guinea pigs. Good profitable home business. Booklet free. Taylor, B426A, Hapeville, Georgia.

SEE Gulf Hamstery ad on page 27. Shows picture of Hamster.

MAKE Big money! Raise Chinchilla rabbits. Cash markets supplied for your production. Write today! Rockhill Ranch, Sellersville 15, Penna.

"LAZY-Daisy Fishbowl siphon-evacuator." Cleans, fills hollow-handled fishbowls. No tub needed. 50 cents. No stamps. P. O. Box 3395, Alcott Station, Denver 12, Colorado.

HAMSTERS \$1.50 Up. Marketing booklet given with order. Literature free! Wisconsin Hamstery, Pewaukee, Wisconsin.

HAMSTERS, "Beginners outfit." One pair hamsters, 80 page book folio of 5 market plans. A \$5.00 value for only \$3.50 f.o.b. Waterford. Literature on request. Pat's Hamster Farm, Waterford 3, N. J.

BEAUTIFUL Pure white pedigreed police puppies. Ansonia Kennels, Mose, N. Dak.

RAISE Highly profitable Angora rabbits. Plenty cash markets. Details free. White's Rabbitry, Newark, Ohio.

RABBITS: New Zealand whites. Ringland Rabbitry, 1726—30th, Des Moines 10M, Iowa.

GOLDEN Hamsters: Selected breeders and pet stock at reasonable prices. For your free information write: The E. K. Farm, Route 1, Box 56A, Arlington Heights, Illinois.

ANGORA Shearing tables, wool spinners, breeding stock. House of Angora, PM2, Springfield, Illinois.

RAISE Pheasants on the \$100 week plan. Little capital and space can make you independent. Free details. Great Central Game Management System, Columbus, Kansas.

\$3000 YEARLY Raising Angora rabbits. Markets furnished for your output. Particulars free. Kise's Enterprises, St. Paul 8, Minn.

CAPONIZE Chemically, no surgery, tenderizes, flavorizes four to eight weeks all age roosters. Free simple instructions. Golden Valley Hatchery, Dept. 14, Parkville, Missouri.

HAMSTERS: No finer breeder or pet stock at any price. \$2.50 pair, \$3.75 trio. Free folio. Valley Hamstery, 734 North Milam, San Benito, Texas.

\$300 MONTHLY Raising Angoras for our market. Particulars free. Wilson, Stanton 17, Calif.

RAISE Rabbits. Four pound fryers in eight weeks. Ready market for meat, fur, wool. Illustrated book, describing leading breeds, housing, breeding, feeding, marketing. By America's largest rabbit association. 10c. American Association, 12 AR& CBA Building, Pittsburgh 17, Penna.

MINK Raising information free. Complete. Lake Superior Mink Farm, Superior, E1, Wisconsin.

GRINSTEAD'S Famous Angoras! Giant Chinchillas! World's most profitable rabbits. Finest pedigree, heavy-producing, prize-winners. Literature free. Grinsteads, Edwardsville, Illinois.

INCREASE Your income by raising domestic rabbits. Small space needed. Ready market for delicious meat, fur and wool. Largest magazine in the industry tells you how. \$1.50 per year. Sample 15 cents. No stamps. Small Stock Magazine, Lamoni 20, Iowa.

PLANTS, SEEDS, NURSERY AND GARDEN SUPPLIES

RAISE Your own trees and shrubs from seed for shade, windbreak, erosion control, etc. Write for free planting guide and price list. Woodlot Seed Co., Norway 4, Michigan.

REMOVE Any tree stump for as low as \$1.00. New sensational compound—No blasting, chopping or digging. 4 oz. \$1.00 (enough for stump up to 36" in diameter); 8 oz. \$1.50; 1 lb. \$2.75; 5 lbs. \$12.50. Order today. Get rid of ugly stumps the easy way. Send no money. Pay postman or send cash with order and save c.o.d. charges. Money back if not satisfied. H. D. Campbell Co., Rochelle 7, Illinois.

FARMS, FARM LANDS, REAL ESTATE

IF You want to buy or sell motor or trailer courts, ranches, farms, bowling alleys, homes, income property coast to coast, contact Parkway Realtors, Silver City, New Mexico.

VIRGIN Ozark land, 40 acres, \$200. Terms. Write Armstrong, Shook, Mo.

BIG Free summer catalog, farm bargains, many equipped, illustrated, several states! United Farm Agency, 1408-PM Consumers Bldg., 220 South State St., Chicago 4, Ill.

WEST'S New Digest of farms and country real estate—free! Values galore—Maine to Florida. West's, CK-5, Pittsburgh 17, Penna.

15,000,000 ACRES Government and state farm, timber and grazing lands in California, Oregon, and Washington. 50c acre up, minimum. 10c (coin) brings circulars. Pacific Lands, Post Office Box 2350-PM, Hollywood 28, Calif.

FLORIDA. Beautiful homesites in new Lake County development, \$245 at \$10 monthly. Near Ocala National Forest, many pretty lakes, streams, pavement. World's best bass fishing, wonderful hunting. Folder free. Howard Vernor, DeLand, Florida.

GOOD Farms—Ranches. Washington, Minnesota, Montana, Idaho, Oregon, North Dakota. Dependable crops, favorable climate. Write for literature, lists describing typical farm opportunities. Specify which state. J. W. Haw, 119 Northern Pacific Ry., St. Paul 1, Minn.

HOMESITES \$300—Convenient payments. California's finest garden section. On Morro Bay's scenic shores. Wonderful fishing, hunting, boating, bathing. Fertile soil, softest water, temperate climate, congenial community. Free literature. Richard Otto, Department M, San Luis Obispo, California.

\$5.00 MONTHLY Buys 40 acres near town; price \$200. Free list. Box 425-P, Carthage, Mo.

STROUT'S Golden anniversary farm catalog. Over 2800 outstanding bargains. Coast-to-coast, 32 states. Mailed free. Strout Realty, 7 So. Dearborn St., Chicago 3, Ill.

GOVERNMENT Lands \$2.00 acre up. Information all states twenty-five cents. National Tax Service, 901-A Majestic Bldg., Detroit.

FARM Manual shows you how to make extra profits from your farm. 284 pages of farming lore, \$3.00. Popular Mechanics Press, 200 E. Ontario, Chicago 11, Ill.

FARMS, Ranches, lodges, resorts. Big selection. Milwaukee Road territory, Washington, Idaho, Montana, Dakotas, Minnesota, Iowa, Missouri, Michigan, Wisconsin, Illinois, Indiana. Free colorful descriptive folders, price lists. L. H. Robbins, 738J Union Station, Chicago 6, Ill.

POULTRY, FARM SUPPLIES

EARN \$4 To \$12 hourly. Chick sexing, turkey sexing, culling and caponizing. G.I. approved. Pilch's School, Box SSC-10, Thompsonville, Connecticut.

OUTDOOR Toilets, cesspools, septic tanks cleaned, deodorized with amazing new product. Just mix dry powder with water; pour into toilet. Safe, no poisons. Save digging and pumping costs. Postcard brings free details. Burson Laboratories, Dept. Z-43, 955 Willard Ct., Chicago 22, Ill.

INCREASE Your poultry income—Thorough knowledge means greater success. Our interesting, practical, home study course has trained thousands during past 29 years. Don't delay, write today for free booklet describing courses, methods, opportunities. National Poultry Institute, Dept. 50-C, Adams Center, New York.

KNOW How to raise poultry for profit. Read Poultry Industry. Every issue packed with helpful hints and practical suggestions. Latest articles on breeding, feeding and management. Subscribe now. 1 year 65c. 2 years one dollar, foreign subscriptions \$1.00 a year. Poultry Industry, Dept. P.M., 376 Boylston St., Boston 16, Mass.

PROFITABLE OCCUPATIONS

TURN Your spare time into cash. Make quick-selling, highly profitable lamps—every home a prospect. No experience or special tools required. New 1950 56-page illustrated catalog shows shades, shade frames, figurines and bases, oil lamp converters, boring compounds, and dozens of similar items. Also all kinds of sockets, cords, pipes, harps, finials, bases, and hundreds of other parts—everything you need. Special 8-page section shows 6 beautiful lamps in kit form ready to assemble. You buy wholesale, sell at retail—make big profits. Hundreds doing it. You can, too. Send 25c today for catalog and wholesale price list. Refundable first order. Gearon Co., Dept. 500-B6, 27 S. Desplaines, Chicago 6, Ill.

NEED A good job? Want a better one? Show employers professionally written list of your qualifications. Written by college-trained personnel man who has hired hundreds of employees. 100 action-getting copies. Money back guarantee. Send list of your experience and \$4.98 to Louis McCann, 436 March, Shillington, Penna.

10,000 NYLONS, Rays, 8c pair, up; Chenille goods, underwear, uniforms, wholesale. Free razor blades. Complete stock list 25c. Sibert Company, Chattanooga 4, Tennessee.

MUSHROOMS Grown, boxes, Barrels. Instructions 50c. Spawn \$1.00. Manureless process. \$2.00. Gordons, 553 William, Winnipeg, Manitoba.

FREE Book "How to Make Money With Home Workshop" describes amazing methods used by hundreds of successful craftsmen. Tells what to make, how to sell workshop output spare time. Write at once for details. Remember it's free! Craftsman, 115-A6 Worth St., New York City.

FOREIGN Employment. Construction men, building trades, mechanics, helpers, office men. Good workers interested in foreign development projects. Pipe lines, dams, power plants, roadways, shipping, oil refineries, etc. Transportation and quarters furnished; high wages. Listings of firms actively working on projects in Arabia, Persian Gulf, Africa, Alaska, Canada, South America, Europe, etc. Send \$1.00 for foreign construction compendium and application forms. Foreign Service Bureau, Dept. PM6 (Employment), P.O. Box 295, Metuchen, N. J.

LIVE Frogs, fish, plants booklet 10c. Vol Brashears, Berryville, Ark.

MAKE Flexible molds! Cast plaques, bookends, figurines! Free sample! H. Tooker, 630-M Chestnut, Hamilton, Ohio.

LIFETIME Income as notary public. Appointment assistance. Stationers, Helotes 50, Texas.

ALASKA! Jobs! Better salaries! \$1.00 brings booklet, with map, written by Alaskan traveler, listing companies hiring, plus opportunities in construction, fishing, farming, lumbering, fur farming, government positions, homestead lands. Alaskan Opportunities, Dept. PM, 7512 18th N.E., Seattle 5, Wash.

BIG Money—Learn watch-clock repairing at home. Inquire Modern Technical Supply, 55-PM West 42nd Street, New York 18.

ALASKA—Last great American frontier. \$1.00 brings 1950 copyrighted directory and government map free. Big construction projects; fishing; mining; aviation; hunting-fishing-game rules; fur-farming; lumber; live stock; agriculture. Homestead land and highway information. Listing firms hiring. Application form. Alaska Opportunist, P.O. Box 883-P, Hollywood 28, Calif.

RAISE Fishworms. Easy, profitable. Send 25c in coin for complete instructions. Huffman Worm Ranch, Rives Junction 2, Mich.

\$250 WEEK Reported! Free illustrated book "505 Odd, Successful Businesses." Work home! Expect something odd! Pacific-E, Oceanside, California.

INTERESTED In Latin America and foreign employment? \$1.00 brings 1950 copyrighted "Foreign Service Directory," world wide listings in construction; oil; mining; aviation; steamships; manufacturers; transportation; exporters, importers. Hot list firms hiring. How-when-where to apply. Application form free. Global Reports, P.O. Box 883-P, Hollywood 28, Calif.

MAKE Money at home—Casting fast-selling plastex novelties and metallizing baby shoes. Tremendous possibilities—full, spare time. No experience needed. Full instructions given. Write: Leonard Moëse, 161-A Madison Ave., New York 16, N. Y.

LEARN Reweaving! Free details. Frank Harris, 2502 St. Thomas, New Orleans, La.

BE The Popular Mechanics representative in your neighborhood and earn big profits in your spare time. Write Popular Mechanics Magazine, Room 408M, 200 E. Ontario St., Chicago, Ill.

\$46 FROM Square foot plywood; jigsaw necessary. Write, Woodarts, P-38, Bridgewater, Mass.

OWN And operate mirror shop! Supplies for resilvering mirrors, making chipped glass nameplates and electroplating. John Sprinkle, V50, Marion, Indiana.

\$40.00 WEEKLY Made growing mushrooms, fresh, dried. Dominion patent 331583. Free spawn. North American, 169P Yonge, Toronto, Canada.

GAMES, TOYS, NOVELTIES

WILL Manufacture, distribute nationwide your novelty, toy game, gadget, ornament, etc. Satisfaction guaranteed. Chetco Products, Ltd., Wellsville, Penna.

BOOKS, PICTURES, POSTCARDS

CANARY Booklet and 3 bird magazines—\$1.00. American Canary Magazine, 2839 PM North Halsted, Chicago 14, Illinois.

OLD Phonograph records. Collecting and selling old records is not only fun but is highly profitable and it's easy. Our 1950 edition Accredited Handbook of Record Values gives actual values to \$800; tells how to buy, sell and grade old records. Lists thousands by hundreds of artists. Most complete record value handbook printed. Used by collectors, dealers and libraries throughout the country. Contains the information you need. Send \$2.00 today for your copy. C. Carr Company, Dept. R4, Beverly, New Jersey.

MACHINISTS Compact reference book. Useful. Send \$1.00. G. A. Knudsen, 523 48 St., Brooklyn 20, N. Y.

SALEM, Fascinating witchcraft city. Free catalogues. MacSwiggan, Arbella, Salem, Mass.

NEW Quiz book game; automatically scores, answers; interesting, educational. Send 25c. Quiz-Master Publishing, 72 Orange Street, Brooklyn 2, N. Y.

ENCYCLOPEDIAS, Used, catalog available. Rare books located. Literary Mart, 8 East 33rd, New York 16.

SUBSCRIPTIONS To all periodicals. Free folder. CMA, 26 Grace Terrace, Pittsfield, Massachusetts.

DON'T Be left behind! Amazing offer to learn engineering drawing and blue-print reading at home using this new simplified manual. Pay postman only \$1.89 plus postage. Write today to Box 7301, Pittsburgh 13, Penna.

HOW-To-do-it books on every subject. Written in Popular Mechanics' famous easy-to-understand style and profusely illustrated. Subjects include workshop planning and practices, projects, hobbies, household repairs, motoring, outdoor sports, photography, home building and many others. Also booklets on specific topics. Write for free illustrated catalogue. Popular Mechanics Press, 200 E. Ontario, Chicago 11, Ill.

BOOKHUNTERS! All subjects. Send wants! Jaher Book Service, 620-P East 178 Street, New York 57.

BOOKFINDERS! (Scarce, out-of-print, unusual books). Quickly supplied. Send wants. Clifton, Box 1377-PM, Beverly Hills, Calif.

NATIONAL Geographic Magazines 1888-1949. Any issue, Box 327-PM, Periodical Service, Swarthmore, Penna.

MAGIC TRICKS, PUZZLES, JOKER NOVELTIES

FREE! Illustrated catalogue of world's greatest magic tricks, joker's novelties, etc. 2c and up! To cover cost send 25c (refund first order). Fink Specialty Co., (B-1618), 9th and Market, Philadelphia 5.

VENTRILOQUIST Dummies. Catalogue 25c. Be a ventriloquist. Free literature. State age. Maher, Box 36-M65, Kensington Station, Detroit 24, Michigan.

MAGIC Monthly. Year 25c. Sample and 1949 catalogue free. Eagle Magic, Minneapolis 2, Minn.

500 TRICKS, Douglas famous catalog 27 now only 10c. Unequaled service to magicians for 30 years. Send 10c today. Douglas Magician, Dept. 1, Dallas, Texas.

ENCYCLOPEDIA Explaining hundreds of tricks. 10c. (Catalogue free!) Aim Magic Company, 143 Verona Avenue, Newark 4, New Jersey.

STARTLING New trick only 25c. Magic Mart, 2009 Noble St., Pittsburgh 15, Penna.

5 BIG Books, 275 pages. Over 1,000 tricks. Only \$1.49. Billy Simmons, Route 1, Box 295, Vidor, Texas.

GAGS, Acts, scripts! Catalog, 10c. Kleinman, 5146-B Strohm, North Hollywood, Calif.

SAMPLE And price lists 25c. Fast sellers. Pace, 956 Hamilton, St. Louis, Mo.

MYSTIFYING Ace disappears from between two cards instantly. Complete trick easy to do free if 25c is sent for big catalog 500 Amazing Magic Tricks. The Magician, 2463-P Kensington Ave., Philadelphia 25, Penna.

SEND 10c For latest trick catalog, circulators and joker's tricks. Sore finger joke 50c. Fly pin 15c. Joy buzzer 50c. Laramie Sales, 4800 So. Laramie Ave., Chicago, Ill.

AMAZING! Put large cucumber inside small necked bottle. Instructions 50c. Bill Kobert, Doniphan, Missouri.

500-PAGE Catalogue of 2500 tricks, pocket, parlor, stage. World's finest magic. Send \$1.50 for catalogue (refund first \$6.00 order). Kanter's, M-1311 Walnut, Philadelphia 7.

200 ELECTRIC Stunts, 110 volts, \$1. Kutting Sons, Los Altos, Calif.

16 CARD Tricks and catalog 25c. Sterling Magic, Royal Oak, Mich.

MAGIC Tricks, puzzles, books, cards, punch boards. Catalog 10c. Speciality, Box 671, St. Louis 1, Mo.

WORLD'S Largest professional magic shop, keeps you in touch with latest tricks. To receive mailings, send 50c for new catalog. Holden's, M220 West 42nd St., New York.

BE A magician. Large professional magic catalog of latest tricks. 35c. Ireland, C-109 North Dearborn, Chicago 2.

PROFESSIONAL Catalog. 124 pages, 25c. Williams, 900 Plymouth, Ellwood City, Penna.

VENTRILOQUISM Taught. 3c stamp bring particulars. Smith, 801 Bigelow, Peoria 5, Ill.

COINS, TOKENS, CURRENCY

OLD Money wanted. Will pay \$100.00 for 1894 dime, S. mint. \$50.00 for 1913 Liberty head nickel (not buffalo). Big premiums paid for all rare coins. Send 4c for large coin folder. May mean much profit to you. Numismatic Co., Dept. 20, Fort Worth, Tex.

HUGE 16 Page bargain list 10c. Four Whitman folders \$1.00. Ray's, 109 Mathilda, Sunnyvale, Calif.

100 COINS And bills \$1.00. Oddehon, Box 482, St. Louis, Mo.

FOREIGN Bills, 10 different 15c; foreign coins, 10 different 25c. Lists. O. Arnold, Macon, Mo.

BARGAINS! Rare collection contains United States large cent over 90 years old, flying eagle cent, white Indian cent, 1881 cent, 1909V.D.B. cent, 1912-D cent, 2c piece, 3c silver, 3c nickel, half dime, shield nickel, 1913 nickel, nickel without word cents, Liberty seated dime, Liberty seated quarter, old paper money, Civil War cent, Confederate money, foreign coin, foreign bill, and our complete buying-selling catalogue, everything \$3.00. Catalogue alone 25c. 20 different dates Indian cents \$1.00, 15 different dates large cents \$3.00, 8 different dates 2c or 3c pieces \$2.00, 1864-L cent \$2.00. Worthy Coin Corporation, 294 Washington, (D-216), Boston, Mass.

SEND 10c For two wooden nickels and world's best coin paper. Lawrence Bros., Anamosa, Iowa.

OLD Coins at 3 for \$1. 1818 1c; 1866 2c; 1852 3c silver; 1853 5c silver; 1853 10c. All with clear dates. Gold coins bought at top prices. Hollinbeck, R.U.L. Bldg., Des Moines, Iowa.

43 MIXED Indian cents \$1.00. 33 diff. foreign coins \$1.00. Chelsea, 26 West 18th St., New York City 11.

FREE! Foreign coin, banknote and coin collectors illustrated catalog to approval service applicants. Send 3c postage. Tatham Coinco, Springfield 30, Mass.

GET Profit and pleasure in collecting old coins. Send 10c for 56 page illustrated coin catalog. You'll be delighted with it. Send for it now. B. Max Mehl, 370 Mehl Bldg., Fort Worth, Texas. Largest rare coin establishment in U. S. Established 50 years.

16 PAGE Coin bargain list and Mexican 10 peso bill, all for dime. Coin Shop, 31 North Clark, Chicago 2, Illinois.

COINS Wanted, will pay up to \$2000 for certain coins, send 25c for catalogue. Burton's, 111 So. Third, Columbus, Ohio.

COMMEMORATIVE \$1/2. Oregon, Texas, Kentucky, Cleveland, Long Island, \$2.00 each. Illustrated catalogue 25c. Norman Shultz, Salt Lake 9, Utah.

STAMP COLLECTING

FREE! Ifini set cataloging 75c, Congo leopard, Falklands map stamp, plus others cataloging over \$1, with approvals. F. Moublow, 740 Hegney, Bronx 56, N. Y.

FREE! Canadian sets, royal visit, George VI, George V, coronation, jubilee, others to approval applicants. Ensign, Box 118-M, South Orange, N. J.

BELIEVE It or not: 25 different British, West Indies stamps are yours for the asking. Beautiful pictorials, 19th and 20th century, including free monthly magazine. Send only 5c for postage. Empire Stamp Company, Dept. PM, Toronto 5, Canada.

WOW! \$10.00 Worth of fun! What a treasure hunt! Big package 500 foreign stamps, including airmails, pictorials and others from the world over; stamps worth up to 25c each. This offer sent for 10c to approval applicants only. Jamestown Stamp Co., Dept. 22, Jamestown, New York.

FREE U. S. price list, postage 3c. Mark Hanna, 335 5th Ave., Pittsburgh 22, Penna.

WORLD'S Largest stamp (7 1/2 x 14 inches). A real curiosity! Retail for 50c, only 3c to approval applicants. Tatham Stamp Co., Springfield 30, Mass.

FREE! 100 Worldwide different stamps to approval buyers. Big U.S. and illustrated bargain lists sent with approvals. Bookman, Maplewood, N. J.

ANTIQUES, RELICS, INDIAN GOODS, CURIOS

8 ANCIENT Indian arrowheads \$1.00, tomahawk \$1.00. List free. Lear's, Glenwood, Arkansas.

PRECIOUS STONES, MINERALS

CUT And polish gems for pleasure or profit. Jade, agate and moss agate, mix, 4 oz. \$2.00 postpaid. Instructions included with order only. Rocky Mt. Mineral Co., Box 1003, Casper, Wyo.

"ULTRA Violet" mineral detector. Kit including tube, instructions \$1.75. Ultraco, 1472-R Broadway, New York 19.

"LOST Mines and Buried Treasures of Southwest." Nearly 100 accurate accounts, 367 pages. "Coronado's Children," by Dobie, \$2.10 postpaid. Southwest book catalog 10c. Old Fort Davis, Fort Davis, Texas.

AGATES, Cutting machines, mountings. Free list. North West Gems, Box 305, Tacoma 1, Wash.

MINERAL-Treasure locators — Geiger counters. Can be purchased on monthly payment plan. Free literature. Fisher Research Lab., Inc., Palo Alto, Calif.

GEMSTONES, Mineral specimens. Every variety. Lowest prices. Postcard brings free booklet. Plummer's, 2183C Bacon, San Diego 7, California.

METAL Detectors. The very latest circuit. Send 25c for literature. Hedden Metal Detectors, 3329 Liberty Ave., Pittsburgh 1, Penna.

HOBBIES AND COLLECTIONS

GLASS Top cases, 6" x 8" x 3", partitioned drawer, suitable for hobbyists' supplies, etc. Send \$1.00 for 4. School Book & Supply Co., South Milwaukee, Wis.

50 DIFFERENT Army embroidered patches \$1. Other bargains. Insignia Mart, 703A Broadway, New York 3, N. Y.

VARIETY Unpainted plaster ornaments. Free literature. Box 341, Oswego, Kansas.

POSTCARDS, Unused, western (30) and one antique postmarked card (over 40 yrs.), \$1.00 postpaid. Old Fort Davis, Fort Davis, Texas.

GENUINE Swiss imported files, 5 1/2 inches. One dozen assortment in case \$4.95. Shore, Box 54, New York 57.

INVENTING Can be an interesting and profitable hobby. Write for complete particulars. Institute of American Inventors, Dept. 40-E 631-E St. N.W., Washington 4, D. C.

UNUSED Matchbook covers—100 different \$1.00. Catalog 25c. Charles Edelman, 1311C East 84, Cleveland 3, Ohio.

CAMERAS, PHOTO SUPPLIES

BUILD Your own camera. Ansco "Craftsman" home construction kit. Complete instructions. Only \$3.50. Money back guarantee. Send today. P D Q Services, Dept. M-6, 12224 W. Pico, Los Angeles 64, Calif.

CLIPIT — Don't use rubber bands for storage, get film clips for movie film reels. Clips edge of reel and holds film through perforations. Simple to attach and detach. Send 25c for six. Madison Products Co., Toledo 2, Ohio.

KODACHROMES On approval. Name any Western National Park. We'll send selection. Douglas Whiteside, Yosemite National Park, California.

BUY Photographic supplies wholesale. Free catalog. Expert camera repairing. Capitol Photo Supplies, 2428 Guadalupe, Dept. 2, Austin, Texas.

35MM. Owners. Develop yourself, slides in one hour. Black or color. Sample free. Lake Camera Exchange, Drawer 842C, Gary, Indiana.

SNOOPERSCOPE Tube. Permits night-time vision. Tube and complete instructions, \$14.95. Limited quantities. Infrared filters 15c. Detailed snooperscope book \$1.50. Precise, 942 Kings Highway, Brooklyn 23, New York.

AERIAL Camera, AAF, K-21, new Graflex, motor driven or manual, 24-volt or 110 volt with transformer. Original packing. Hundreds of uses, photographically or for parts alone. Complete except for lens and filter. Lowest price in country; extra-special, for limited time, \$24.50 with transformer, which can be used to operate surplus aeronautical motors and assemblies. No c.o.d. Check or money order with order. Amazing Bachman's, Dept. PM, 27 Herman Street, Rochester 5, N. Y.

WILL You risk 25c for mammoth 1950 photographic catalog? Deductible from first \$2.50 order. Bloom's Camera Center, 1657-PM Main, Springfield, Mass.

SENSATIONAL Contact printer \$68.50 plus tax. De Photo, 648 Helen, Detroit 7, Michigan.

FREE Photographic bargain book packed with hundreds of sensational values in still and movie cameras, lenses and latest accessories. Super savings for you in new and used equipment. Liberal trade-in allowances, too, on your equipment. Write now for your free copy to Central Camera Company, Dept. 9E, 230 S. Wabash Ave., Chicago 4. (Photographic headquarters since 1899.)

PHOTOMURALS, Giant transparencies, photos on canvas. Your negatives, photos, or ours. We satisfy nation's leading photographers. 1950 catalogue, 25c refunded on orders. Photomammoth Murals, 12048 Vanowen St., North Hollywood, Calif.

PHOTOCOPY Anything, papers, books. No darkroom, 8 1/2" x 11" complete, \$6.95. Fotoflek, 4801 Yarmouth, Cincinnati 29, Ohio.

BASS Says: Bargaingram 257 ready and waiting for you. The book which tells all. The finest in new and used camera equipment, a veritable encyclopedia. Write, phone or call the sign of the old "Horse Trader," 39th year of satisfaction or your money back dealing. Bass buys, sells and trades. Bass Camera Company, Dept. AG, 179 W. Madison St., Chicago 2.

PHOTO FINISHING

SUPERB Custom enlargements on beautiful Indiatone or opal paper. Your photographs deserve the finest service. Costs no more. 5x7, 30c; 8x10, 50c; 11x14, \$1.00. Pacemaker Photo Service, Dept. 3, P.O. Box 809, Chicago 90, Illinois.

8 BEAUTIFUL Double size pictures and roll developed 30c. 8 hour service. Free mailers. Pacific Photo Service, Box 666, San Francisco, Calif.

ALWAYS 10 Reprints 25c. 50—\$1.00. 8 enlarged prints from roll or negative 30c. 16—50c. Dick's Photo, Louisville 12, Ky.

PROTECT Photos. Plastic enclosed. Wallet size 25c. Sealview, Wayne, Penna.

ENLARGEMENTS — 8x10 25c. 5x7 15c. Developing 25c. Box C3368, Columbus 11, Ohio.

FREE 35MM. Kodak bobbin to file your negatives. Write Universal, Box 124B, Station P, Brooklyn 12, N. Y.

FILMS Developed—8 prints, one 5x7 enlargement 25c. Hitone, Box 2446A, Cleveland 12, Ohio.

GIANT Size prints, 8 exposure roll 35c. 12—50c, 16—65c. Cain's, Box 4872 Florence Branch, Los Angeles, Calif.

AMAZING Introduction offer. Film developed; 8 enlarged glossy prints 20c. 12 exposures, 30c; 16, 40c; 36, 90c. Money back guarantee. Immediate delivery. Mail-A-Way Photo, Box 375, Fitchburg 40, Massachusetts.

16 DECKLEDGE Velox prints from any 8 exposure roll film developed 30c. 10c package of 100 mounting corners free. W. Skrudland, Lake Geneva, Wis.

NEW Negative and two 5x7 enlargements from your photo, \$1.00. Free list. Photo-Lab, 1204 Sutter, San Francisco 9, Calif.

8 HOUR Service. Your 8 exposure roll printed jumbo or regular size 30c; 12 exposures 35c; 16 exposures 50c; 20 exposures 75c; 36 exposures \$1.00. Reprints 3c. Fine grain developing. Send for mailers. Quality Photo Service, Box 468A, San Francisco 1, Calif.

SAVE Money on developing and printing. Send this ad and 15c with any 6 or 8 exposure roll or 25c with any 12 or 16 exposure roll. (Trial offer). 24 hour service. Economy Photo Service, Box 1251-C, Saginaw, Michigan.

8 EXPOSURE Roll 25c. Reprints 3c. Life Studios, Onalaska, Wisconsin.

TWO Beautiful prints from each picture on roll 30c. Twenty-nine years of satisfied customers. Quick service. Lens Photos, Dept. J-4, Janesville, Wisconsin.

16 CONTACT Prints from 8 exposure roll 35c. Reprints 3c each; 40—\$1.00. Double size prints in album book, 8-exposure roll 35c; 12—50c; 16—65c. Reprints 4c each. Apex Photo Service, Box 197, Bronx 51, N. Y.

TRIAL Roll developed. Eight prints, Enlargement coupon 25c. Hollytints, P-1350, Hollywood 28, California.

MOEN'S New equipment, better prints quick as a flash. 8 exposure rolls developed and printed contact size 30c, reprints 3c each; 8 super size genuine Moentone prints 35c. Mailers free. Moen Photo Service since 1898, 41 Moen Bldg., LaCrosse, Wis.

PRIVATE Laboratory. Amateur art. Black-white and color. 35mm. specialists. GK Laboratories, Box 127, Catskill, N. Y.

THE Photo Mill. Immediate service! No delay! Eight exposure roll developed and printed for thirty cents, plus valuable coupon for eight reprints, four jumbos or two 5x7 enlargements for a slight additional charge. Film developed and eight jumbo prints 35c. Thousands of satisfied customers send us their work year after year. The Photo Mill, Dept. K, 1511 Hennepin, Minneapolis, Minnesota.

STAMP Size photos. Sheet of 100 gummed perforated stamp photos from any size picture or negative \$1.25 original returned. Bay Photo Service, Box 210, Oakland 12, Calif.

FREE Price list on quality developing, printing, enlarging. Write for it today. Bryan's Photo Shop, Dept. M, Panama City, Florida.

AUTOMATIC Photo-electric finishing. 8-25c; 12-40c; 16-55c. Oversize, add 10c. Mississippi Finishing, 2212 East 12th, Davenport 4, Iowa.

35MM Rolls developed. Enlarged 3 1/2 x 5 prints, 36 exposures \$1.00, 20 exposures 65c. 8 exposure rolls developed, printed oversize 30c. 12 exposures 45c, 16 exposures 55c. MacDonald's Photos, Box 30-J, Wheaton, Illinois.

FREE 5 x 7 Enlargement with each roll developed and printed. 6 or 8 picture roll 35c. 12 or 16 picture roll 55c. Send coin with roll. No c.o.d. If you fail to get pictures on your roll of film, we will mail a new roll to you at no additional cost. Overnight service. Mailers sent free on request. Deluxe Film Service, Box 1268, Shreveport, Louisiana.

2 BEAUTIFUL Hi-Gloss prints each good negative and enlarging coupon with each 8 exposure roll developed 28c. Free mailers. Owlphoto Co., Weatherford, Oklahoma.

MOTION PICTURES AND SOUND EQUIPMENT

BIGGEST 16MM. sound film bargain. Twelve used 100' musical films, \$9.95 plus postage. Others \$13.95, \$15.95 per dozen. Big list free. Blackhawk Films, Dept. PMC, Davenport, Iowa.

"THE World's Greatest Passion Play." 8mm., 16mm. and 35mm. Specify silent or sound. Rent or purchase. Hemenway Film Co., 33-F Melrose St., Boston 16, Mass.

LOWER Cost movies! Big selections. Lists 10c. Turke Films, Hinsdale 1, Ill.

SNOW White movie screen paint. Free literature. 126 1/2 West Main, Danville, Illinois.

ASSORTMENT 200 Feet 50c 16mm. professional film cuttings. Pictures, sound tracks, television, color. Film Associates, Dayton 9, Ohio.

LET'S Swap sound features. What's yours? Swap Shop, Hazleton, Penna.

HOT Out of the camera. 1950 productions just completed. \$2.50 8mm., \$6.00 silent 16mm., \$7.50 16mm. sound, 40 all new numbers. Free list. Modiano Films, 10663 Burbank Blvd., North Hollywood, Calif., Dept. K.

FREE! Movies loaned free (5000). \$1.00 for listings only charge. Educational Films, 133 Murray St., Elizabeth 2, N. J.

RENT 16MM. sound films, 50c reel. Rogers Films, Box 26, East Atlanta, Ga.

WILD Game films. 8mm., 16mm. natural color, black-white. Taken in natural habitats by famed Eberhart organization. Send for free list. Wild Life Films, Dept. 6-PM, 6063 Sunset Blvd., Hollywood, Calif.

NEW 1950 Movie title catalogue. Kodachrome samples. 25c. Elite, Box 526-M, Minneapolis.

SAVE 50%—On movies. Free circulars. Fromaders, Box 637-A, Davenport, Iowa.

MAGAZINES, 16MM., new! Empty, 50c. Loaded fresh film, \$1.25! Processing service. 10% discount six lot! Catalog. Eso-S, 47th Holly, Kansas City 2, Missouri.

UNUSUAL 8 And 16mm. films, used by many art students. Write for free catalogue. Send 25c for sample strip. Friart, 140-A-Liberty Street, New York 6.

2 NEW Autry home movies! "Indian Uprising," "Loaded Guns." \$1,000,000 cast! Send \$1 for sample reel and catalog. (State projector size.) 200' reel, 8mm, \$4.25. 100' reel 16mm. \$2.75. 400' reel sound \$17.50. Other sizes available. Your dealer or Hollywood Films, 6060-K Sunset Blvd., Hollywood 28, Calif.

16MM. Sound features \$25.00. Shorts \$5.00. Bedner, 5300 So. Talman, Chicago.

GUARANTEED Fresh anti-halo outdoor movie film! Weston 16! Daylight loading! Processing free! Three spools double 8 mm. \$4.50! Six single 8 mm. for Univex, \$4.60! Postpaid! Catalog. Eso-S, 47th Holly, Kansas City 2, Missouri.

RENT 16MM. sound films, 50c reel. Large selection; free catalog. Film Service, 128 Chestnut St., Roselle Park, N. J.

FREE Movies. Thousands of subjects. Interesting. Entertaining. Fascinating. New directory—only 50c. International Cine Society, 126 Lexington Ave., Dept. M, New York 16, N. Y.

8-16MM. Silent-sound films. Complete rental library. All latest subjects. Free catalogue. (sample film 10c). Garden Film, 317 West 50th, New York 19.

MOTION Picture technique at home. Big money. Special registration for veterans. Free catalog. Motion Picture Institute, Birmingham 4, Mich.

BASS Says: 39 years of leadership guarantees satisfaction. Finest cine equipment, 8mm., 16mm., and 35mm., silent and sound. Write the old "Horse Trader." Satisfaction or your money back always! Bass Camera Company, Dept. A, 179 W. Madison St., Chicago 2.

LEARN Movie projection, management. Free catalog. Theatre Institute, Elmira, N. Y.

MUSIC AND MUSICAL INSTRUMENTS

YOU Can play the piano by ear—in one week by the quickest, easiest short cut system in the world. Gives all tricks and pointers for playing correct bass with left hand, the main secret in playing by ear. Write Hoover Specialties, RD 2, Chambersburg, Penna.

SONGWRITERS—Honest, outstanding music writing offer. Len-Tex Studios, Leonard, Texas.

SONG—Poems set to music. Send your poems for our proposition and useful Rhyming Dictionary. Richard Brothers, 24 Woods Building, Chicago.

"PROFESSIONAL Songwriting services." May we help you? Wyler, Box 95-A, New York City 18.

POEMS wanted for musical setting. Send poems for free examination. Five Star Music Masters, 630 Beacon Bldg., Boston, Mass.

SONGS Wanted. Guaranteed publication recordings marketed. Both share 50-50 expenses and profits. Free information. Gregory, 1695 Broadway, New York.

PLAY Piano! Easy, complete self-instruction. Beginners quickly play chords, popular music, classics. Two books; Beginners—advanced, your choice, only \$1 each. Check or money order only. Moreau Studios, Dept. A-1, 139 Mathewson St., Providence 3, R. I.

POPULARITY, Always—Learn at home to play guitar tunes in one week. Free guitar with course. Write immediately for free information D'Alaro Guitar Institute, Dept. 1P, 545 Fifth Avenue, New York 17, New York.

SONGWRITERS! Outstanding, ethical offer. Hibbler, C-5, 2157 N. Avers, Chicago 47.

POEMS Wanted. Percentage basis collaborations. Terry Tune Master, 709½ PM North Broadway, Oklahoma City 2.

SONGWRITERS! Send poems, songs. Music Service, 243 West 72nd St., PM, New York 23.

1950 ACCORDIONS—Wholesale. Free catalog. American Accordion Center, 5329 Belmont, Chicago.

POEMS Wanted. Set to music. Free examination. Send poems. McNeil, Master of Music, 510-PM S. Alexandria, Los Angeles, California.

MUSIC Arranged, songs printed. Frank Wildt, Music Publisher, Lancaster, Penna.

WRITE Songs. Big money and reputation. Write for information. J. Gordon Pub. Co., 201 N. Hoyne Ave., Chicago.

RADIO AND TELEVISION

FIX Any radio. Amazing new instrument locates radio troubles double quick. Simple instructions show you how. Thousands now in use. Free. Write today for 32-page illustrated technical manual. "The Inside Story." Feiler Engineering Co., Dept. 6PM5, 1601 S. Federal St., Chicago 16, Ill.

NAVADIUM Long distance crystal set \$1.00. 100 unmounted crystals \$25.00. Hearing aids, telephones, phonographs. Navadium Foreign Service, Milbank, S. D.

WESTERN Electric fixed crystal detector 99c. Scarce. Radio City Labs, 30-3 Church Street, New York 7.

POLICE Receiver, complete circuit, excellent design, simple to construct. For home office or auto. \$1.00. ETC Electronic & Television Co., 850 Broadway, Denver, Colorado.

BUILD Television set using surplus 5BP4—schematic, plus free RCA, Dumont schematics, 25c. Melpro Company, P.O. Box 40-M, Brooklyn 20, N. Y.

15 TESTED One-tube circuits 25c, including "Radiobuilder" catalog. Laboratories, 578-C, San Carlos, California.

TELEVISION And radio engineering taught practically, also electrical engineering, armature winding, electrical drafting. Day and evening classes. Special correspondence courses. G. I. approved. Canadian School of Electricity, 282 Ontario W., Montreal.

FREE—Send for latest radio catalog and bargain bulletin. Has thousands of top values in television, radio, electronic supplies. Concord Radio Corp., Dept. LF-50, 901 W. Jackson, Chicago 7, Ill.

WANT To be a television director, actor, announcer? Send for free pamphlets. Hollywood Radio Publishers, 6411 Hollywood Blvd., Hollywood 28, California.

MAKE Simple, tubeless, batteryless, distance-getting crystal radios. Crystal and illustrated instructions 25c postpaid. Allen, 427-P, Clinton, Mo.

SEND For our bargain bulletins on radio and electronic components. Never undersold. Buyers Syndicate, 30 E. Taylor St., Springfield 3, Mass.

BUSINESS OPPORTUNITIES

RESURFACE Butchers' chopping blocks with easy, fast working, portable electric machine. Unique service in wide demand with little competition. Large steady profits from full or part time work. Hill Machine Company, Box 677B, Rockford, Ill.

MAKE Money this easy way at home. Make your own costume jewelry. Pleasant, interesting. No experience needed. We supply settings and sparkling rhinestones at wholesale prices. Steady profits. Write for details. Sparkle Mart, Dept. B, 475 Fifth Ave., New York.

MAGAZINES—Trade and class. Help you get ahead. Latest copies. Nearly 1200 covering every business, trade, profession, sport, hobby or other interest available through our easy-to-get-acquainted service. Particulars and price-list free. Commercial Engraving Publishing Co., 34C North Ritter, Indianapolis 19, Indiana.

EARN \$100/\$250 Weekly, installing, maintaining fluorescent lighting. Proven business opportunity. Free facts. "Fluorescent" 712-A State Tower Bldg., Syracuse, N. Y.

LEARN The profitable and fascinating art of electroplating baby shoes at our expense! Write for details to manufacturers of world's largest assortment of plating mounts, equipment and supplies. Dept. W1, Hollywood Bronze Supply, 1766-70 North Vermont Ave., Hollywood 27, Calif.

IF You want to cash in on mail order and have sufficient capital, write of your plans. 23 years experience. Mathews, Lafayette Building, Philadelphia 6, Penna.

MIRROR Resilvering. Wonderful home business. Complete formula 25c. Nelko Chemical Service, Box 3462, Chicago 54, Ill.

"WATERLESS (Lanolin) Hand Cleaner." (Oil base.) Make, sell. No machinery. Build profitable business. Complete formula \$1.00. Ideal Service, Park Ridge 1, Ill.

MAIL Selling opportunities galore! Free! Wehner, Box 142-A6, Roxbury 19, Mass.

BETTER Jobs in electroplating. Free details. Joseph Kushner Electroplating School, Stroudsburg 772, Pennsylvania.

MAKE "4-In-1" closet door panthangers at home for 15c. Retail \$1.00. Plans and instructions \$10.00. Guy Perry, Wheaton, Ill.

WEEK'S Pay for one day's work per week possible. Backyard or basement enterprise. Write for plan. House of Angora, PM3, Springfield, Ill.

FREE Facts about "selling by mail," Allen Shaw, Hialeah, Florida.

THOUSANDS Articles wholesale. "Supply Source Directory" 10c. Ideal Service, Park Ridge 30, Illinois.

MAKE Fancy ornamental dolls for profit. No sewing. Details free. Lakeshore Supply, 534-E Surf St., Chicago 14, Ill.

EFFECTIVE, Order-producing mail order ads, letters, circulars. O'Malley Advertising, 309 Rittenhouse N.W., Washington 11, D. C.

MAKE Money at home—Mailing literature, handling orders. Pleasant, profitable. Everything furnished! Literature free. Smith, Box 2592-P, Hines, Illinois.

METALLIZING Baby shoes is a profitable business. Details. Schwiager, Columbia 1, Wis.

LEARN Profitable screen process printing. Details free. Joseph Bolger, 148 Concord, River Edge, New Jersey.

OPERATE Profitable mail order business. Custom Service, 5063 Pico, Los Angeles 35.

START A collection agency. Profitable, dignified. Details free. D'Yarmett, 245 Church, Newark, Ohio.

MAKE—Sell, sensational new product. It's needed. 300% profit! Just add water. Everything furnished. National, Box 88-P, Dorchester 22, Mass.

MEN—Women. "Everybody likes candy." Learn to make professionally. Details free. (Our 40th year.) Ragsdale Candies, D5, East Orange, New Jersey.

COLOR Concrete with chemicals. Marble-glaze cement benches, pottery, garden ornaments. Home-shop. Dime brings sample, pictures. Hollywood Cementcraft, 8527-R Wonderland, Hollywood 46, Calif.

\$35 WEEKLY. Home, sparetime work. No investment. Guaranteed satisfaction. 25c. John P. Walsh, 894 Main St., Buffalo 2, N. Y.

EARN Money by mail with my plan. Free details. Satterfield, Box 345-C, Mansfield, Ark.

EARN Money cleaning automobile upholstery. Lambert, 5531 Plover, St. Louis 20, Mo.

BUSINESS Information Center, Chesterland, Ohio, will locate sources of any manufactured product you need. \$1.00 brings you 10 sources, guaranteed satisfaction.

HOW And where to obtain capital. Small and large loans. Free particulars. Star Service, Wapakoneta, Ohio.

"HOW To start a successful mail order business." The guide to sound, profitable mail merchandising, 25c. Manhattan House, P.O. Box 50, New York 28, N. Y.

LEARN Piano tuning, repairing—at home in 30 days. Unlimited income. Phonograph recordings, tools and instructions furnished. Write Capitol City Tuning Co., Department C-634, 129 East Michigan, Lansing 16, Michigan.

BIG Money! Spare or full time in your home. No selling! Spray new miracle finishes, plush and suede, on signs, radios, automobiles, figurines, lamps, tovs, etc. Our business is booming. Help us fill huge demand. New easy Flok-Kraft methods. Material costs few pennies. You get dollars. Free samples, complete powerful money-making plan free. Write now! Coast, 1002H S. Los Angeles St., Los Angeles 15, Calif.

BE Independent—Operate America's lowest price penny vending machine. Big profits. Immediate shipments. Write for bulletin and prices. Fielding Mfg. Co., Desk 60, Jackson, Mich.

FISHWORMS. How raise, sell, hundreds, millions. Surface without digging. Instructions 50c. Charles Co., 12-AWQ, Norwood, Ohio.

START Your own business on credit. Always your own boss. 1554 dealers, sold \$5,000 to \$26,500 in 1948; their average \$6,742. We supply stocks, equipment on credit. 200 home necessities. Sales experience not needed to start. Wonderful opportunity to own pleasant, profitable business backed by world-wide industry. Write Rawleigh Co., Dept. F-U-PPM, Freeport, Ill.

BRONZED Baby shoe mountings, equipment and supplies. Buy wholesale from world's oldest and largest manufacturers of all metal mountings. Sales Dept., Hollywood Bronze Supply, 1766-70 North Vermont Avenue, Hollywood 27, Calif.

MEN Make big money in moving picture business. We furnish sound projector and films. Small weekly rates. Experience unnecessary. Southern Visual Films, Dept. P.M., 686 Shrine Bldg., Memphis, Tenn.

SPECIAL Rubber for making molds. Literature and sample free. Universal, Box 1076-A, Peoria, Ill.

FREE! Complete details. Operate profitable mail order business. Sensational successful small "beginner's" plan. Lynn, 5710-M Bankfield, Culver City, California.

UNUSUAL Mail order plan. Highly profitable. There's nothing else like it! Details free. Jim Anderson, 727 Carney Blvd., Marinette, Wisconsin.

MAKE Perfumes—Profitable mailorder business. Information free. "International," 6347 Parnell-PM-6, Chicago 21, Illinois.

WANT A business of your own? Make \$20 to \$30 a week extra money at home! Thousands do! Interesting service cleaning upholstery and rugs—and mothproofing. Big demand. No selling. "Free illustrated folder tells how." Americlean Company, Inc., Dept. G-28, 211 North 7th Street, St. Louis, Missouri.

SAWDUST. Turn it into cash. Six methods. Instructions 25c. Charles Co., 12-AWP, Norwood, Ohio.

YOU Can actually see the metal flow on with a Tyco electro-plater! Electroplate metals, mirrors, glass, wood, leather, plastics! No tanks or expensive equipment. Start your own profitable mirror and plating business at home! Outfits furnished! Write for free booklet. Tyco Metals, Box 12008M, Houston 17, Texas.

BABY Shoe mountings. Bookends, frames, etc. St. Albans Plating and Casting, 135-17 135 Ave., So. Ozone 20, N. Y.

COPUBLISH Leading m.o. paper. Latest copy Mail Sale Advertiser, details, dime. Vanroy Shirk, Lebanon, Penna.

MAKE Tough, durable plastic—1c pound. Makes attractive floors, walls, built-ins, roofs. Build good home, \$150.00 room. Bays Laboratory, Oklahoma City 9.

SCRAP Wood, sawdust, shavings, logs. How to get free and turn to cash. Over 150 ways. 25c. Lee Books, Box 502, Chicago 90.

MADE \$24,500 Using money making plans from Schemer Magazine, world's oldest mailorder publication. Box 775M, Alliance, Ohio. Year \$2.00. Sample 20c.

SCAFFOLDS—Safe, adjustable. Standard pipe held with Amidon fittings. Opportunity for representatives, dealers, jobbers, distributors. Amidon Engineering Company, Elyria 4, Ohio.

OWN Your mailorder business, envelopes, bags. Big profits. Omaha Envelope, 4721-B California, Omaha 3, Nebr.

PLATING Equipment and rectifiers. Unique opportunity to start own business or cultivate hobby. Surprisingly small investment. Plate or replat baby shoes, jewelry, etc. Write for free information. Box 125, New York 51, N. Y.

YOUR Own business for \$125. Write for picture and complete information about profitable vending business. Logan Distributing Co., 2320 Milwaukee Ave., Dept. P, Chicago 47, Ill.

FREE Illustrated instructions casting novelties. Genuine latex for molds. Major Chemical Co., 164 Portland Street, Cambridge 39, Mass.

MANUFACTURE Easy way, add water our concentrates, make flavors, lotions, perfumes, shampoos, cleaners, polishes, 125 products, labels your name, bottles. Qualgo, E-20030 Russell, Detroit 3.

MOLDING Latex. 70% solids. Natural gum rubber. Detailed instructions furnished with order. \$3.00 per qt., \$8.50 per gal. I.o.b. The Perma-Flex Mold Co., 1919 E. Livingston Ave., Columbus 9, Ohio. Terms cash, check or money order. No c.o.d.'s.

FREE Details! "The Magic Formula for Mailorder Success." Mailord Company, 204-C6 East 81, New York 28, N. Y.

AWNINGS, Aluminum, finest, colors, patented, kits, dealers and assemblers represent us. Sundrella Mfg. Co., 5202 N. 22nd Ave., Phoenix, Ariz.

FIX Typewriters, full or part time. Inexpensive copyrighted home study course quickly trains you for high earnings. Factory methods cover all phases with drawings and illustrations. No curiosity seekers. Typewriter Repair 6915 Corbet, Tarentum, Pennsylvania.

LIFE-TIME Manufacturing business. Extremely profitable homework. Formula lists free. Thermolab, Peoria 4, Ill.

MOLDING Rubber, sample $\frac{1}{2}$ pt. \$1.00; \$2.95 qt.; \$7.95 gal. postpaid. Molds made to order. Plastercraft Supply Co., 3051 St. Clair Ave., Cleveland 14, Ohio.

MASONIC Book ends, manufacture by ornamental casting at home. Easily learned, splendid profits, large market. Small investment. Plastercraft, 395 9th St., San Francisco.

MAKE Extra spare time money! Enter "fair" contests! Sample copy "Fair Monthly" and information, 25c. Hobby Novy Sales Service, Post Office Box 247, Kenton, 16, Ohio.

MAKE Money—Co-publish progressive magazine. 16 page booklet gives detail instructions. Dime brings booklet and magazine. Write today to Mailtrade, Box 357, Sheboygan, Wisconsin.

MONEYMAKING Ideas, opportunities galore. Particulars free. Peterson, Rix Lodge, North Platte, Nebraska.

BABY Shoes—Brushplate your own, gold, silver, copper; a few cents each. Sample quarter pint, brush, instructions \$1.00. Metal-Cote, 1321-N Belmont, Chicago.

WRITE For free booklet and catalog telling how to earn substantial profits in your spare time by forwarding new and renewal subscriptions to all magazines for your friends and neighbors. Oldest U. S. agency. Established 1869. Moore-Cottrell, North Cohocton, New York.

MEN-Women!—Make big money spare or full time at home. Flock and pearl finishing offers you opportunity of a lifetime. Write today for free sample and free catalog. Bing Products, 88-PM6 Broad, Boston 10, Massachusetts.

START Well-paying home mailorder business. Amazing opportunities. Literature free. Rowland Plain, 1 Laurel Ave., Binghamton 44, New York.

SENSATIONAL Nylons guaranteed against runs. Nationally advertised. Not sold in stores. No experience or money needed. Also lingerie, robes, men's hosiery. Outfit, sample, etc. free. Wonderful opportunity earn big money spare or full time. See our full page advertisement on page 65. Kendex Co., Babylon 846, New York.

ELECTRICALLY Inclined. Average \$50 weekly working few hours daily. No canvassing. Sensational (illustrated details) free. 6c stamps appreciated. Manhattan, Box 6, New York 35, New York, Dept. M.

START Home manufacturing business making cleaning compounds, soaps, insecticides, cosmetics, polishes, food flavors. No machinery. Literature free. Kemix, Park Ridge, Ill.

LIQUID Rubber, make flexible molds. Free sample. Chaney, 1130 E. 16th St., Jacksonville 6, Fla.

MAKE Flexible molds! Cast plaques, bookends, figurines! Free sample! H. Tooker, 630-R Chestnut, Hamilton, Ohio.

LEARN Export-import! Represent manufacturers. Conduct barter-exchange without capital. Trade bulletins—world directories supplied. Book free. International Trade, 246-P, Fifth Ave., New York 1.

BE Appointed state notary public now! Details. Stationers, Helotes 50, Texas.

USE Your home as magazine subscription station. Represent all magazines. Liberal commissions. No experience—no capital needed. Catalog, full details free. Write McGregor Magazine Agency, Dept. 500B, Mount Morris, Ill.

BUY Wholesale—Million articles. Supply source directory, dime. Nelko, Box 3462, Chicago 54, Ill.

MAKE Perfume. Men, women. Write Carey Laboratories, 1914 Chouteau PM5, St. Louis 3, Missouri.

MANUFACTURE Food flavors, cosmetics, polishes, etc., in basement work shop. Easy, no machinery needed. Formula catalog free. Monde, Pulaski, Wisconsin.

SELL By mail from home. Start small, grow big. Booklet "How to Build Your Own Mail Order Business" tells how. Only 25c with other "pointers" sent free. Walter Bevil Publications, 3408 Avenue G, Fort Worth 5, Texas.

DOLLARS Three ways with "Kitty-Kat" readi-cut baby shoes. Complete local and mail order plans. Write No-Co-Ro, Oakland 6-K, California.

EARN Money at home with your typewriter! Spare time! Details free. Edwards, Publisher, 3915-P, 12th, Des Moines 13, Iowa.

COMMERCIAL Deep frying course. Mock chicken legs, potatoes. New and proven methods. Learn about this money-making field. \$2.50 p.p. Concession, Toledo 13, Ohio.

MAKE Rubber stamps, metalize baby shoes, repair dolls, silver mirrors, make beautiful figurines. Catalogue of "30 ideas" free! Universal, Box 1076-A, Peoria, Ill.

NEW Profitable home business repairing zippers. Thousands of customers waiting. No experience required. We furnish everything. Write Texas Specialty Company, 204-B Texas, Texarkana, Texas.

155 HOLLYWOOD. California money-making opportunities. Details free. Lincoln Publications, Box 1211, Hollywood 28.

LAMPS—Earn money building and repairing in your home. Easy-to-understand wiring charts and detailed instructions in illustrated catalog showing all parts. Send 25c. Gyro Lamps, 5404 P Clark, Chicago 40.

GOOD News! Save time and money on your business correspondence. Write for details. Tepeco, New Providence 2, New Jersey.

SEWING Machine home setup. Our trained repair, sales and service men make big money first day. New machine motors, etc. furnished. Write Taylor Service Co., Hamilton, Ohio.

BUY It wholesale. Manufacturers, distributors offer 800,000 items. Literature free. Olsen, 1231-A East Third St., Duluth 5, Minn.

MAKE Upholstery cleaner at home. No experience. Gallon sells \$1.69—costs 10c. Quart size, full details 25c. Kohne, 506 West 45th, Chicago.

MONEY Making opportunities, free details. Acheson, Box 23, Boston 17, Mass.

PROFITABLE Business making and building with easy-laying interlocking building blocks. Rex Products, Dept. 10, Piqua, Ohio.

NATURAL Molding Latex. Extra thick. Free sample. W. Wooley, 115-A Donald, Peoria, Ill.

MAKE Your fortune with food specialties. Others have. People have to eat. Enter \$1,000,000,000 industry with no experience, small capital. Gaynor, 4406 Cottage, St. Louis 13, Missouri.

WHOLESALE Baby shoe electroplating. Best work, lowest prices. Warren, 9608 Laurel, Los Angeles 2.

POPCORN Poppers, peanut roasters, copper candy, carameltcorn kettles. Northside Co., Indianola, Iowa.

\$250 WEEK Reported! Free illustrated book "505 Odd Successful Businesses." Work home! Expect something odd! Pacific-E, Oceanside, California.

PEARL Finishing—New, amazing; huge profits. Start making big money first day. Free facts show easy way to \$25 to \$50 per day at home. No experience needed. No course of instruction to buy. Be first, scoop the market. Write Pearl-Kote, Dept. R, 2111 West Manchester, Los Angeles 47, Calif.

200 NEW Money making plans, tips, ideas for increasing your income. Folio free. Reynard Pub., Smithfield 3, Ohio.

A FACTORY In your home, garage! Mfg. and sales rights, mechanics' waterless hand cleaner, glass cleaner, and amazing "Lazybones" auto cleaner-polish. \$500-\$800 monthly. No special equipment necessary. All formulas free. Western Aircraft Mfg., Dept. D, Los Angeles 6, Calif.

YOUR Own profitable home business. Preserve live flowers to last forever. New simple discovery. Enormous demand all year 'round. Tremendous profits! Light fascinating work. Send \$2.00 for working equipment, instructions, and valuable sales plans. Satisfaction guaranteed or money promptly refunded. Alfred Hermansen, 210 Fifth Ave., Suite 1102A, New York 10, N. Y.

YOUR Home as headquarters make a product to clean dirty mechanic hands in 30 to 50 seconds without water. Big profit. Postcard gets free folder. Harbin, Box 4624, Atlanta 2, Ga.

\$25 WEEKLY Working two hours daily. No canvassing. No manufacturing. Lycke, Box 2471-A, Cleveland 12, Ohio.

HOME Business making statuettes, plaques, artificial marble, rubber molds. Metallizing baby shoes. Silvering mirrors. Formulas. Folder free. Creative, 236-L, Winnetka, Illinois.

CO-PUBLISH And advertise in the Central Mail Advertiser. Sample copy 10c. Low rates. Large circulation. Bagby Printing Co., Georgetown, Ohio.

EARTHWORM Breeding. Valuable bulletins on successful methods mailed free. Earthmaster Publications, Dept. 14, Sun Valley, Calif.

MAKE Money spare or full time, casting metal toys and novelties. Big wholesale and chain store demand for cast metal autos, soldiers, ashtrays, banks, etc. keeps manufacturers busy. Production moulds furnished for up to 100 and more castings per hour. No experience or special place necessary. Write for full information and illustrations of patterns needed. Metal Cast Products Co., Dept. A, 1696 Boston Road, New York 60, N. Y.

POPCORN And potato chip equipment. Long Eakins Company, 5060 High, Springfield 99, Ohio.

QUICK Money! "Repairing car batteries!" At home! Easy too! Batteryman, Grand Junction, Colorado.

DRESDEN Craft figurine molds and many others, natural liquid rubber, statuary plasters, flock finishes, etc. Illustrated catalog and "Plastercraft" manual free. Blue Rapids Supply, Blue Rapids, Kansas.

WANTED Unused U. S. postage stamps, small discount. Advance Stamp Co., 24 East 23rd St., New York.

LIQUID Marble—Colorful, glossy! Molded, brushed, sprayed! Cast novelties, statuary, colored tiles. Flexible molds. Composition floors. Particulars free. Marbleizing Service, Edwardsville, Illinois.

EXTRA Money. No selling; operate vendors. Amazing profits, details free. Silver King, Suite B, 622 Diversey, Chicago 14.

UNPAINTED Bookends, plaques, statuettes, figurines. List. Haverly Products, 1219 8th Ave., Altoona, Penna.

RESILVER Mirrors at home. Formula 25c. Ideal Service, Park Ridge 8, Illinois.

HOW To set up and run a mirror shop! Resilver mirrors. Make chipped glass nameplates. Electroplating salts and rectifiers. John Sprinkle, V60, Marion, Indiana.

CASH For your idea, 280 manufacturers need inventions, patented or unpatented. List free. Invention Bureau, 208M Clinton, Oak Park, Illinois.

MAKE Money making new greaseless doughnuts at home on electric machine. Wholesale to grocers, drug stores, cafes, hamburger shops. Send for free recipes and plans. M. Ray Company, 3605 South 15 Ave., Minneapolis 7, Minnesota.

RECAST Old batteries into new. Latest achievements. Battery Laboratories, Minneapolis.

FREE! Illuminating folder "A Business Gold Mine." Real dividends for your spare time in lucrative business. No personal selling. Kabel, 1413 W. Tioga St., Philadelphia 40, Penna.

WHERE To buy 500,000 articles wholesale. Details free. Krueger, 3418A Wolcott, Chicago 13.

READ "Advance"—The voice of mail order. Offers money-making opportunities, sources of supply, personal guidance, etc. Issued monthly. Sample copy 25c. Yearly subscription \$2.00. Advance Publishing Company, 313 East 21st Street, Suite 450, New York 10, N. Y.

A BUSINESS In your own home! Our chemicals, plus free water and cheap "grocery store" materials can bring you over \$500 monthly earnings. Plans and formulas free. Chemica Division, 1269 S. Norton, Los Angeles 6.

START Mailorder bookshop—Everything furnished. 25c brings booklet, samples, exciting ideas. General Publications, Ossining, N. Y.

OPERATE Profitable mail order business. Write Walter Service, 4159-A East 112th, Cleveland 5, Ohio.

MAILING Postcards selling repeat merchandise is profitable. Everything supplied. Details free. Gordan Publishers, Box 23, Pawtucket, R. I.

137 WAYS To make money, in home or office, business of your own. Full particulars free. Elite Co., 220 Grand St., New York 13.

BRUSH Plating outfits connect to a battery. No tanks necessary. Good paying business at home plating autoparts, bathroom fixtures, bicycles, reflectors, silvering mirrors. No shop or experience required. Outfits furnished. Free booklet. Gunmetal Co., Ave. H, Decatur, Ill.

COLORGLAZED Concrete pottery made without molds. Patented method. Cemetery products, novelties, tiles. Basement leak-sealing. Money-making projects. Booklet, details free. Men only National Potteries Company, Grand Rapids, Minnesota.

MONEYMAKING OPPORTUNITIES

BECOME A mail order specialist. Write J. M. Stenger, 500-20th St., Rock Island, Ill.

START Your own profitable, specialized, mail order business! Interesting "how" details, free. I. J. Associates, 310 Garfield Avenue, Plainfield, N. J.

ENJOY Extra earnings the hobby way! Write today. Ertel's Mail Services, 1519 17th Southeast, Washington 20, D. C.

WESTERN Advertiser offers many worthwhile moneymaking opportunities. Sample copy free. H. Edlund, 557 Kensington, Los Angeles 26, Calif.

MAIL Dealers reference directory \$1.00. Dealers wanted. Sell by mailing circulars. Free information. Clancy, 1799-S Cedar, New York 53, N. Y.

UNPAINTED Figurines. Free list. Progress Company, 4033-P Chowen, Minneapolis 10, Minn.

AUTOMOBILE Salesmen wanted! Train now. Sales manual, tips, trade secrets, \$1, postpaid. Jandor, 613 Voris, Peoria 3, Ill.

QUICK Profits taking magazine subscriptions, handling greeting cards. Cassell Publishers Service, Westfield, N. J.

EARN Money evenings, copying and duplicating comic cartoons for advertisers. Adservice, Argyle 1, Wisconsin.

SCRAP Wood turned into cash. Proven method, plans 50c. E. Bunnell, Tarpon Springs, Fla.

CO-PUBLISH National magazine. Big profits, prestige, security. Free booklet tells how. Aloha Company, 1438 Brownlee, Corpus Christi, Texas.

CHURCHES, Organizations \$130 and 12 card tables. You sell advertisements for table tops. Unique Gift Club Plan, Pine Hill, New Jersey.

FIND A job anywhere. Particulars, send 35c coin. Statistics, Box 1169, Washington 13, D. C.

BOOKKEEPERS Earn \$100.00 week operating your "bookkeeping service." Simplified plan. Information free. Bookkeeping Service, Box 664-M, Springfield, Missouri.

SELL Your ideas for greeting cards. Big demand. Not a school. Write for details. Art Service, Box 483, New Orleans 1, La.

"NO-RISK" Advertising! Sell your products by radio; pay for orders received! 50c. Simon, 59-E Park Avenue, New York City 16.

MONEYMAKERS: Pay 7c, collect \$1.53. 75c brings \$125. All 35c coin. Skeptical? Postal, Teycer, Chemist, 1287½, Chicago 90.

SNOWBALLS And ices. Make them yourself. Tremendous profits. Ice shaver with four flavors and instructions, enough for 500 snowballs, \$2.00 plus 4 pounds postage. Free folder. Snowball Company, 9534C Lemturner, Jacksonville 8, Florida.

CONCRETE Birdbath—Metal molds. High daily production equipment. Gardenware, 404 Stiltz, Louisville 6, Ky.

MAKE Money reporting. My book tells you how. Details free. Phil Lance, 5092 C Street, Philadelphia, Penna.

SIXTY Billion dollars lost gold! Your opportunity to gain wealth. Mail name and address on penny postcard to Frank Miller, 221 Harcourt Street, Long Beach 5, California.

REPAIR And build batteries. Illustrated manual \$1.00. Battery Instruction Supply Bureau, Oakland 10, Calif.

CASH Incomes from inventive ideas. "Ideas to Profits" tells how. Free information. Arthur Cunningham, Box 1132, Chicago 90, Ill.

PERSONALIZED Perfumes are spreading like wildfire! Easy, dignified work (no experience needed) brings immediate profits, astonishing repeat business! Complete details free. Komar Company, LaPorte 12, Indiana.

LEARN Professional candy making profitable home business. Details 10c. Pate, Kissimmee, Florida.

A 25c Mail order plan that brings quarters galore. Send a quarter for our 6-formula sure winner plan complete. Observer Office, Montague, Michigan.

BUY Nylon direct from mill. Write for jobbers prices. Joy Hosiery Mills, Delaware 13, New Jersey.

SILVER Plating, new way. Big profits. Fairchild Company, Mt. Vernon, Ohio.

MAIL Order opportunities galore. Sanchez, Box 66-F, Chelsea Station, New York 11.

RAISE Your business value, standing, as state notary public. Information. Stationers, Helotes 50, Texas.

DOLLARS In personalized baby record books. Sell by mail. Use same literature we do. No-Co-Ro, Oakland 8, Calif.

METALLIZE Baby shoes. Amazing profitable business. Complete formula, working instructions, supply sources, 50c. Nelko Chemical Service, Box 3462, Chicago 54, Ill.

PUBLISH Your own magazine—As little as \$1 a month. Make profits, gain prestige. Details free. With sample magazine 25c. Rinehart, 235 Baltimore St., Hanover 2, Penna.

\$3,000 YEAR Can be yours! Sell by mail. I'll show you how. Free details. Ralph H. Swafford, Box 212, Rossville, Georgia.

\$250 WEEK Reported! Free illustrated book "505 Odd Successful Businesses." Work home! Expect something odd! Pacific-E, Oceanide, California.

BIG Profits yours! Sell "different," unique items by mail; otherwise. Real pullers! Sales aids furnished. Details, beneficial literature free! Parker Specialties, Sauk City, Wisconsin.

RAISE Ginseng. Roots bring fortunes. How to grow, where to sell. Write Fezler Seed Co., Patchogue, N. Y.

EARN Money by mail, like I do! Free details. House of Friendship, Bowen Court, Douglas, Mass.

EASY Ways to earn extra income are described in Money-Making Hobbies. 132 projects you can make at home and sell anywhere. 160 pages, \$1.98. Popular Mechanics Press, 200-MH East Ontario, Chicago 11, Ill.

DOLLARFUL Ideas for you every month in advance—"Voice of Mail Order." Leads the field in exclusive supply sources. Plans for mail order operation; new products, etc. Details free. Advance Publishing Company, Suite 350, 313 East 21st Street, New York 10.

PUBLISH Your own magazine. Handsome 52 page format, well edited, illustrated. Cost low as \$1.00 month. Brings you prestige, profits. 25c brings sample, details. National, Ord, Nebr.

EARN Money at home! Thousands do! "Home Worker Magazine" tells how. Sample, 25c. Sizemore, Box 7, 4917 Kostner, Chicago 30, Ill.

READ Progressive Mailtrade, the magazine that tells how to make money by mail. Dime brings sample and special offer. Progressive Mailtrade, Box 357, Sheboygan, Wisconsin.

FORMULAS, PLANS, ETC.

FORMULAS—Special offer. Literature free. Moon, 604 Broadway, Fulton, N. Y.

FORMULAS As low as ten cents each. Box 148, Benton Harbor, Michigan.

SOAP Formula. Easy to make. Cleans everything that requires cleaning. For the washer. It's magic. \$1.00. K-C Products, Box 516, Columbus 16, Ohio.

ANY Formula \$1 or money back. O. S. McCollum, 383 Miller, Vaux Hall, N. J.

WATERLESS Hand cleaner. (No ammonia.) Easily made. Good profit. 2 dependable formulas \$1.00. Nelko Chemical Service, Box 3462, Chicago 54, Ill.

10,000 FORMULAS And trade secrets. Free literature. Stillman, 555 Kingston Ave., Brooklyn 3, N. Y.

FREE Formulas for making 3 types of waterless hand cleaner. Also glass cleaner and amazing "lazybones" auto cleaner-polish. Organic Chemicals, 1269 S. Norton Ave., Los Angeles 6.

MAKE—Sell cleaners, soaps, polishes, flavors, cosmetics. No machinery. Formula literature free. Kemico, Park Ridge 16, Illinois.

FORMULAS For nearly everything. Catalog free. Write Creative, Winnetka, Ill.

TESTED Formulas. Interesting descriptive booklet free. Pont, Box 635-PM, Terre Haute, Indiana.

REAL Manufacturing formulas. Lists free. Cummings, Chemist, Gordon Ave., Syracuse 4, N. Y.

PLASTICS

PLEXIGLAS, Lucite, metallic coated acetate, plastic foam, jewelry findings, accessories, over 2000 items. 25c which brings price lists, catalog, other valuable literature refunded on first order. Plastic Parts, 1157-S Kingshighway, St. Louis, Mo.

COMPLETE Line internally carved gifts and jewelry. Free catalogue. Pilot Plastics Co., 67C1 Fulton St., New York City 7.

NEW Liquid plastic. Clear colors. Cast without heat. Embed flowers, insects, coins. Saw, drill, carve. Send 35c for exciting new home project manual showing how to get started. Castolite, Dept. G101, Woodstock, Illinois.

AMAZING Liquid plastic kit \$3.25. Embed photographs, keepsakes, coins. Makes solid objects, clear, colors. Beautiful results in half hour. Easily tooled. Inexpensive hobby. Send 15 cents for catalogue. Kristalon Plastics, Dept. Z-60, Box 29, Wilmette, Illinois.

INTERNAL Carving, fabricating, hobby-supplies and materials. Lowest prices. Best quality. Write for free price lists. Caraday Sales, 160 E. 34 St., New York 16.

PLASTIC: Sheets, cut pieces, and scrap in clear and colors. Rod, tubing, acetate, dies, jewelry findings. Send \$1.00 for 4 pound scrap assortment and fabricating manual. Regal Plastic Supply, 720 Main, Kansas City, Missouri.

INTERNAL Carved roses, orchids, swans, goldfish, butterflies, etc. Jewelry and gifts. Crystal Floral Novelty Co., Bound Brook, New Jersey.

EARN Money with plastics. New book, "Money-Making Hobbies," shows you how. 160 pages, \$1.98. Popular Mechanics Press, 200 E. Ontario, Chicago 11, Ill.

LUCITE, Plexiglas. Any size sheets, masked. Square foot (12 x 12) cost, 1/16", 96c; 1/8", \$1.25; 3/16", \$1.52; 1/4", \$1.80. Colors add 10%. Include 10% postage. Almac Plastics, 230 Fifth Ave., New York 1, N. Y.

PLASTIC, Sheets, rods, tubes, etc. Free list. Plastic Supply Co., 2901 N. Grand Blvd., St. Louis 7, Mo.

WHOLESALE Plastics supply catalog. 10c. Lucite, clear, colored. Metallic acetate, 15 colors. Thick lucite cutoffs, polished blanks for carving. Metal findings, tools, ideas, bargains galore. Quantity prices on casting plastic. Gem-O'-Lite, Box 686S, North Hollywood, Calif.

CHEMISTRY

NEW Idea chemical and apparatus outfits for home experimenting. Photo-scales, microscopes, chemicals, biological and laboratory supplies in small quantities. Catalog 15c. Established 1931. John H. Winn, 124A West 23rd Street, New York, N. Y.

ILLUSTRATED Catalog: Chemistry, mineralogy, biology. 10c. Tracey Laboratories, Evanston, Illinois.

CHEMICALS And apparatus for industrial, analytical, and private laboratories. Catalog 15c. Dept. M-50. Biological Supply Co., 1176 Mt. Hope Ave., Rochester, 20, N. Y.

HELP WANTED

SELL Automatic fire alarms now. Low cost, big profits. Needed every home, store, farm. Write Harmony Brass Co., Plano 3, Illinois.

AGENTS WANTED

DISTRIBUTORS, Agents make 300% profit selling new product. Big demand everywhere. Fully guaranteed and bonded. Friendly Products Co., Box 665, Youngstown 1, Ohio.

FOUND! Over 100 ways to make extra money and friends. Sell Metallic Christmas cards, wrappings, children's books, gifts. Big profits. Bonus. Request feature samples on approval, free samples name imprinted Christmas cards, stationery, napkins, free catalog and free selling guide. New England Art Publishers, North Abington 251, Mass.

MAKE Money fast! Sell Christmas and everyday cards to friends, neighbors, clubs, others. Amazing profits. Over 100 sell on sight items including 5 leading 21 card \$1 assortments, religious, 50 for \$1, metallics, comics, stationery, children's books, ladies' rain sandals, deluxe personals. Bargain offers. Extra cash bonus plan. Write today for samples on approval. Hedenkamp, 361 Broadway, Dept. PM-6, New York.

HOUSE Paint—Sell users and stores. Private label. Steady work. Big pay. Certified Products, Louisville, Ky.

FAST Profits—No investment. Send for big, free catalog. Plastic aprons, tablecloths, etc. 150 sure-fire items. We guarantee sales. Write the Halliday Company, Dept. M-4, 347 Broadway, Passaic, N. J.

NAME Plates sell fast. Mirror lettered. 100% profit. Demonstrating samples free. Barkers, 949 Greenwood, Zanesville, Ohio.

POWER Mowers—\$59.50. Gas-electric. Delivered. Guaranteed sales. Modern-AE, North Kansas City, Mo.

EASY Profits selling "300 Household Hints." Lightning 25c seller. Sample 10c. King, 55-P Oleander, West Springfield, Mass.

BUY Thousands of nationally advertised products direct from manufacturers and distributors. Write for "buy direct and save." Service Publishing, 1420-A Investment Bldg., Pittsburgh 22, Penna.

SELL Ultra-blue stock signs to stores. 1000 slogans, comedy, general, religious. "7x11" cost 6c, sells 35c. Make money. 15 samples \$1.00 postpaid. Lowy, 812 Broadway, Dept. 544, New York City 3.

MAKE Money easy. \$5.00 for selling only ten \$1.00 boxes of everyday cards. Also radiant black plastic, metallic and other cards, note paper and wrappings. Send for samples. Howard P. Ellis, Dept. PM-6, Pitman, N. J.

RELIGIOUS Plaques, great profit, in spare time. 75 religious subjects, various sizes, easy to sell, and carry, new. For information, write Joseph Bella, 6703 10th Ave., Brooklyn 19, N. Y.

NYLON Uniforms. Immediate delivery, immediate profits. Sell to doctors, dentists, nurses, waitresses, beauticians, housewives. Free sales kit. Superior Fabrics, Dept. P6, 3936 Market, Philadelphia 4, Penna.

LOOK Here! Wanted—Men to start in business on credit. Sell some 200 farm-home products. Thousands our dealers now make quick sales, big profits. For particulars write Rawleigh's, Dept. F-192-PPM, Freeport, Ill.

CASH In on tremendous demand for new low priced burglar alarm for cars, homes and farm building. Nothing like it. Everybody wants one. 286% profit. Unique sample offer. Northwest Electric Co., Dept. F-10, Pukwana, S. Dak.

FACTORY Representatives. Power mowers—\$59.50. Appoint agents-dealers. Exclusive deal. Rotacut, R-2006, Excelsior Springs, Mo.

BIG Profits—Fast selling personalized jewelry. Free literature. Delite Corp., 238-M Neptune Ave., Brooklyn, N. Y.

FREE Samples, and amazing plan giving you gorgeous dress without penny cost. Rush name today with dress size. Harford, Dept. B-735, Cincinnati 25, Ohio.

300% PROFIT, Steady reorders, lifetime income. 50 samples \$3.00, brings \$12.50. Details, sample 25c. Nichols Company, Dept. 103, Purvis, Miss.

WHEEL Alignment recorder. Drive over. \$16.98. Salesmen wanted. Align-A-Matic, Box 94, West Orange, N. J.

EXCLUSIVE Agency—Toilet flush balls. Sell every hardware and plumber. Big profits year round. Taylor Reversible Ball, 2651 Gilbert, Cincinnati, Ohio.

LIFETIME Business at home. 500% profit. Package and distribute "Dainty-Fluff" constant repeater. Particulars free. E. M. Simmons Co., Fremont 20, Ohio.

NO More tying shoelaces. Sells in quantities. Rosenstein, 1514 North Eighth, Philadelphia 22, Penna.

QUICK Profits selling beautiful personalized napkins. Selling kit free. Snowcraft, 81-A Theron, Johnson City, N. Y.

AMAZING Metallic birthday cards, stationery, napkins. Samples on approval. Plateless, 392 Broadway, New York 13.

CARBON Papers, ribbons, pencils. Big profits. Rothblat, 9½ Thayer Street, New York 34.

FREE Outfit, write today! Sell embroidered advertising uniforms and work clothes, initial buckles, belts, badges, 2000 emblems. Hook-Fast Co., Box 480PM, Roanoke, Virginia.

AGENTS Wanted: Costume jewelry. 57 different styles of \$1.00 to \$7.50. Retailers send 75c for details including actual sample set. Anthony Umberto, P.O. Box 107, New York 12, New York.

QUALITY Plastics at new low prices! Proven hits in tablecloths, aprons, garment bags, utility covers. Free catalogue M16. Acclaim Products, 49 West 24th Street, New York 10, N. Y.

MEXICAN Feather pictures. Big profits; no investment! Free details; sample 10c stamps. Silvia-PC, Apartado 9036, Mexico City.

NEWEST Money making sensation. Sell personal initialed belts, buckles, cap and breast badges, tie holders, etc. Choice 2000 emblems. Write special outfit offer today. Hook-Fast, Box 1425PM, Providence, R. I.

AMAZING Offer—\$40 is yours for selling only 50 boxes Christmas cards. And this can be done in a single day. Free samples. Other leading boxes on approval. Many surprise items. No experience needed. Free samples personalized Christmas cards, stationery, napkins. Write today. It costs nothing to try. Cheerful Card Co., 1415 White Plains, N. Y.

WANTED Agents—Dealers! Silfens Poultry Killer pierces or decapitates. Thousands now in use. A sensational Weedrake for home gardens included free when you enclose \$1.00 both items. Send postpaid anywhere in U. S. Handy Specialties Distributors, Box 354, Elmhurst, Illinois.

CHRONOGRAPH Wrist watches. New low, wholesale price \$48.00 dozen. Sells for \$8.00. Sample \$5.00. Guaranteed. Box 587, New York 17, N. Y.

WRITE for free booklet and catalog telling how to earn substantial profits in your spare time by forwarding new and renewal subscriptions to all magazines for your friends and neighbors. Oldest U. S. agency. Established 1869. Moore-Cottrell, North Cohocton, New York.

SENSATIONAL Nylons guaranteed against runs. Nationally advertised. Not sold in stores. No experience or money needed. Also lingerie, robes, men's hosiery. Outfit, sample, etc. free. Wonderful opportunity earn big money spare or full time. See our full page advertisement on page 65. Kendex Co., Babylon 846, New York.

MEXICAN Feather pictures, unusual novelty. \$1.00 (stamps) brings \$2.00 worth samples. Refund if unsatisfied. Aztec Art, Apartado 762, Mexico City.

BE Renewal headquarters for all magazines. Handle everything at home. Big profits. No experience—no capital needed. Free catalog tells how. Write McGregor Magazine Agency, Dept. 500A, Mount Morris, Ill.

DRAW Side income under notary public appointment. Stationers, Helotes 50, Tex.

SENSATIONAL \$1.00 Household specialty! Repeats constantly! 233% profit! Sample 10c! Levine's, 15-X Boulevard Station, New York 59, N. Y.

NEW Atomic plumber cleans clogged sinks—Toilets with ease. Handiest tool made. Needed in every home, store, factory. Sells fast at \$1.25. Cost 50c. Zimpro, 4642 No. Central Ave., Chicago.

INFORMATION—Money-making plans and wholesale supply sources will increase your income! Write, Reynard Service, Smithfield 4, Ohio.

PROFITS To 100%. Show lovely greeting cards, plastics, metallics, personalized stationery, napkins, coasters, novelties. Approval sample. Torres, 373A Fulton St., Brooklyn 1, N. Y.

DRESSES, 18c; Coats \$1.00, blouses 35c. Free catalog. Crown, 164-P Monroe Street, New York.

FREE Literature—Thousands wholesale supply sources. Moneymaking business ideas. Wilkin Company, Hillsboro 4, Ohio.

SELL Balloons! Combs! Novelties! Excellent sideline. Carleton House, Texas City, Texas.

FREE Samples. Big profits showing amazing glow-in-the-dark specialties. House numbers, pictures, plastic novelties, ashtrays, keyholders, religious and nursery objects, etc. Madison Plastics, 303 Fourth Ave., New York 10, N. Y.

JEWELRY Factory desires salesmen, distributors, jobbers. Pickcraft, 19 Bank Street, Attleboro, Mass.

AGENTS: Stamping names on key protectors. Sample 25c. Stamping outfits, checks, social security and name plates. Hart Mfg. Co., 303 Degraw St., Brooklyn, N. Y.

SELL Big money-maker to men and women. Easy handwork makes fast-selling useful articles. Sunmade Company, Brockton 64, Mass.

GOLD Lacquered window sign letters. Large sizes penny each. New foils. Absolutely beautiful. Free samples. Atlas, 544 W. 79th, Chicago 20.

EXCELLENT Sideline for printing and advertising salesmen. Decalcomania name plates in small quantities. Great demand. Also, make money with our line of automobile initials and sign letters. Free samples. "Ralco" XL-Roxbury, Boston 19, Mass.

PHOTO-Salesmen-agents. Sell beautiful hand-colored plastic enlargements. Collect deposit, we deliver. Profitable sideline. Send card, for free sample kit. Novel Portrait Co., 3343 North Ave., Chicago, Ill.

AGENTS—300% Profit selling genuine gold window letters; stores and offices. Free samples. Metallic Letter Co., 438-B North Clark, Chicago.

HIGH-GRADE SALESMEN

SALESMEN, Full or part time. It's new. Sells on sight. Big repeats. Prefer men calling on lumber, hardware, builders supply, motor courts, department stores. Your commission 10%. Beautiful low price screen door grille. Fits any door, easy to install. Thousands sold in Florida by Sears and other outlets. Big season ahead. Sample grille, sales data, etc. \$5. Returnable. Special deal to big distributors. Ross Engineering Co., P.O. Box 2250, Daytona Beach, Fla., Dept. 3.

LONG Needed invention. Established company. Need full or part time men. Every home, store, factory a prospect. Low price, long profits. Free sample outfit. Write Red Comet, Inc., Dept. 644, Littleton, Colorado.

IT'S New! It sells! "The Little Helper" for service stations. One dollar brings sample. Money back guarantee. McLaren Products, P.O. Box 1021, Riverside, Calif.

ADVERTISING Book matches—Cash on big demand; sell union label matches. Cuts for all businesses and political parties. Free powerhouse selling kit, low prices, protection guaranteed on repeat orders. Cash commissions. Superior Match Co., Dept. M-650, 7530 Greenwood, Chicago.

SALESMEN—Make \$2500 next 7 weeks. New sensational deal every merchant wants. Beautiful sales kit free. States Trading, 330-B So. Wells, Chicago.

SALESMEN—Absolutely make \$50 a day. New sensational utility item for every food, beverage outlet, etc. Big profits. Johnson-Hill, 53-PP West Jackson, Chicago.

OVER \$500 Weekly for several weeks for Ruffo and Maurice. \$250 weekly common, selling patented 31 to 1 power tool. Prospects everywhere. 2-min. demonstration. Palscoel Co., Ltd., Massena P4, N.Y.

MAN! This is hot! Make \$6.35 on every sale! Make over \$30.00 a day! We have new adding machines in original cartons, you can sell for only \$12.95! Yes only \$12.95, and you'll make 49%! They're executive model portables, precision built, fully guaranteed. Send for life-size color photo and full details. Write today to Lightning Adding Machine Co., Inc., Dept. ZD-15, 543 So. Spring St., Los Angeles 13, California.

SALES Organizers—Just out! Greatest sport story of the year. "My 66 Years in Big Leagues" by Connie Mack. 50,000,000 prospects. Sensational seller. Red-hot deal. Write quick! Universal House, 1014-BL Arch, Philadelphia.

SELL Custom made and stock decals. Up to 50% commissions. Free sales kit. Radiant Co., 56 West Washington, Chicago, Ill.

SENSATIONAL Nyions guaranteed against runs. Nationally advertised. Not sold in stores. No experience or money needed. Also lingerie, robes, men's hosiery. Outfit, sample, etc. free. Wonderful opportunity earn big money spare or full time. See our full page advertisement on page 65. Kendex Co., Babylon 846, N. Y.

WRITE 3 Words—Collect \$7.65 on 10-second demonstration to merchants. Write on glass with amazing magic crayon—Presto! 5 color advertising message takes fire, glows like brilliant neon. Three sales daily bring \$22.95 profit. Rush postcard for details. Complete sales kit, free! Maxilume Co., 125 W. Hubbard, Dept. CL-8, Chicago, Ill.

IF You sell, you need Opportunity Magazine—the "salesman's bible," packed with down-to-earth ideas that boost your earnings; filled with hundreds of announcements of new, fast selling items and lines. Send your name and tell us what you're selling now for free copy of latest issue. No obligation. Opportunity, 28 E. Jackson, Dept. 32, Chicago 4, Ill.

BIG Money taking orders. Shirts, ties, socks, pants, jackets, sweaters, shoes, uniforms, etc. Sales equipment free. Experience unnecessary. Nimrod, 4922-AN Lincoln, Chicago.

EDUCATIONAL AND INSTRUCTION

GOOD Jobs and a sound substantial future await in hotel and institutional field. Men and women, all ages, needed for well-paid positions that offer color, excitement, ever-new and fascinating duties. Record-breaking travel means even greater opportunities for trained men and women in hotels, clubs and institutions. Lewis School receiving calls for managers, assistant managers, stewards, hostesses, purchasing agents and 50 other types of important positions! From coast to coast there are important positions that offer splendid opportunities for advancement in a business where you are not dropped because you are over 40. Previous experience proved unnecessary! No need to leave your job to qualify. A good grade school education, plus Lewis Training qualifies you at home, in spare time. Our National Placement Bureau helps to place you—and our amazing Certified Job Plan—actually certifies you will "make good" when placed. Write today for free book! Veterans: Course approved for veteran's training. Lewis Hotel Training School, Room SH-368, Washington 7, D.C. (First and only School of its kind—now in its 34th year.)

LEATHER Carving. Fascinating, highly-paid art; age-old secrets now taught for first time in home study course. For hobby, profession or profitable business, write: Baird School of Leather Carving, Box 1367-M, Manitou Springs, Colo.

PRACTICAL Trigonometry by mail. From actual engineering experience. No textbooks. Individual attention. Details free. Erpenstein, 74 Idora, San Francisco 16.

"HOW To Break and Train Horses"—A book every farmer and horseman should have. It is free; no obligation. Simply address Beery School of Horsemanship, Dept. 1106, Pleasant Hill, Ohio.

MAKE Up to \$35-\$45 week as a trained practical nurse! Learn quickly at home. Booklet free. Chicago School of Nursing, Dept. M-6, Chicago.

BE A real estate broker through home study or classroom instruction. Write for free book. Approved for veterans. Weaver School of Real Estate, 15 E. Pershing Rd., Box CP-6, Kansas City 8, Missouri.

LEARN The collection agency business. Highly profitable. Easily mastered. Free folder. Cole Associates, Syracuse 2, N. Y.

NON-Resident courses: High school, college. Triplespeed selfstudy shorthand. Capital City College, Washington 5, D. C.

OPERATE Collection agency. Pays big. Easily learned by mail. Free bulletin. Franklin Credit School, Roanoke 7, Virginia.

VETERANS! Get government railway mail position. Regulars start \$2750 yearly. Promotions around \$3800. "How to Qualify" mailed free. Ozment Instructions, 107, St. Louis, Mo.

FREE—Bookkeeping lesson, full particulars. Buchalter, 112 West 42, New York 18.

VOICE! Secrets! Free! Information! Studio, 14356B Jersey Ave., Norwalk, Calif.

USED Correspondence courses and educational books bought, sold, rented, catalog free. Educational Exchange, Summer-ville, Ga.

WELDING Training pays. Operating under V.A. contract. Free catalog. Box 279-M-603, Troy, Ohio.

3800 LATEST Used correspondence courses. Catalog 50c. EG, Elmsford, N. Y.

MIND Asleep? Try "Thinking-Alpha-bet." Write Frank Tibolt, 17M, Philadelphia 20.

READ With speed! New amazing method. Save hundreds of hours yearly. Free home test. No obligation. Send postcard. Brownson, 9111 Hoyne, Chicago 20.

PHOTOGRAPHIC Mind with Super-memory. Write Thor Books, M-6, Box 1210, Chicago.

REVOLUTIONARY Conception of public bookkeeping! \$5.00 hourly. Simple instructions. Full, spare time. Systems, shortcuts, obtaining clients. Auditax, 10775-A Tabor, Los Angeles 34.

DRAFTING, Design, mathematics, building estimating, surveying, engineer's license preparation. Veterans accepted. Mondell Institute, 230 West 41st, New York.

U. S. Government jobs! Start high as \$66.34 week. Qualify now for secure positions. Men—women. Many openings expected soon. Experience usually unnecessary. Free 40-page book shows jobs, salaries, sample tests. Write: Franklin Institute, Dept. F-24, Rochester, N. Y.

PRINTING Course. Thorough, complete. Send stamp for details. Director Courses, Box 941, Meriden 3, Conn.

DENTAL Technician's Manual. Written and illustrated so you can understand. Grant Laboratory, 219 W. 7th St., Los Angeles 14, Calif.

USED Correspondence courses and books sold and rented. Money back guarantee. Catalog free. (Courses bought.) Lee Mountain, Pisgah, Alabama.

LINGUAPHONE Makes languages easy. At home learn to speak Spanish, Portuguese, Italian, French, German, Russian, by quick, easy Linguaphone Conversational Method. Save time, work, money. Send for free book. Linguaphone Institute, 83 Radio City Bldg., New York 20, N. Y.

STUDY To be a doctor of psychology or metaphysics. Obtain Ps.D., Ms.D., D.D. or Ph.D. degree. Chartered by state. Write for free book telling how. The Neotarian Fellowship, Dwight Building, Kansas City 6, Missouri.

HOME Study course, drugless therapy. Free literature. Institute of Drugless Therapy, Tama, Iowa.

INVESTIGATOR Training. Phillips Secret Service System, 1917-B North Kenneth, Chicago 39.

BOOKKEEPERS! Increase your earnings! Operate your own simplified "dollar-a-week" bookkeeping and tax service. Full or spare time. Details free. No obligation. Ellis, Box 200, Cedar Grove, N. C.

USED Correspondence courses. Bought, Sold, Rented. Free literature. Baker, 5509-B Winthrop, Chicago 40.

PIANO Tuning pays. Learn this profitable profession at home. Our Tonometer and mechanical aids make learning easy. No knowledge music necessary. Diploma granted. Largest and oldest school—52nd year. G.I. approved. Write for booklet. Niles Bryant School, 78 Bryant Bldg., Washington 16, D. C.

SECRET Investigation. Experience unnecessary. Investigators particulars free. George Wagner, M 125 West 86th, New York.

MEDICAL Laboratory Technicians in great demand. We train you in your own home. Catalogue free. Imperial Technical Institute, Box 973-J, Austin, Texas.

PLAYS, STORIES, MANUSCRIPTS

MAKE Extra money rewriting ideas in newspapers, magazines, books. Receive checks for \$3 to \$100, offered daily. No previous experience necessary. Write for free details and how to get free Writer's Market Guide! Comfort Writer's Service, Dept. 4-L, 200 S. 7th St., St. Louis, Mo.

FREE—My talk "Column Writing That Pays." Ben Arid, 1141A-7th St., Hermosa Beach, Calif.

I WANT New writers to cash checks of \$1 to \$100 offered daily. The easiest way to write for pay. No previous experience necessary. Free details. Saunders M. Cummings, 468-11 Independence Bldg., Colorado Springs, Colo.

INFORMATION

JOB Opportunities. All sections, U.S.A. vacancies many trades, professions. New plants, construction. Housing information. Free particulars. Business Services, Baldwinville, N. Y.

WHERE To buy most anything. We furnish supply sources. Single item, 25c. 5 for \$1.00. Service Bureau, Box 5053, Chicago 80, Ill.

BUSINESS SERVICE

INCORPORATE Your business. Delaware laws. Free details. Tax Research Bureau, Inc., Box 710, Wilmington, Del.

MIAMI Postmark! Letters 25c each. McDowell, 504 Pacific Bldg., Miami 32, Fla.

SAN Francisco postmark! Letters re-mailed 25c each (coin). M. Minson, 1820 Fulton, San Francisco, Calif.

PUERTO Rico—Letters, cards re-mailed 25c (coin). Order scenic cards 5c each. James Paige, 7 Elena Street, Santurce, Puerto Rico.

MAIL—Telephone service. Dunkirk 2-1334. John Payne, 2215 W. 6, Los Angeles, Calif.

WHERE To buy it information about anything. Write, listing items. Kelly, 9544-D Whitcomb, Detroit 27, Michigan.

CHICAGO Address for your mail. Business or personal. Information free. Schultz House, 3116 Seminary, Chicago 13.

SPECIAL SERVICES

MIAMI—Letters remailed 25c each; \$3.00 month. Scenic stationery available. Weina Studio, 2236 N.E. 2nd Ave., Miami 37, Fla.

KEY West postmark. Letters remailed 25c (no stamps). \$3.00 monthly. J. Saunders, 1606 Flagler Ave., Key West, Fla.

PHOTOGRAPHIC Missions accomplished. New York City. Confidential. Negative, print \$5.00. Anthony Todaro, Box #1096 G.P.O., New York 1, N. Y.

DETROIT. Letters remailed 25c each. Baron Letter Service, 1785 Seward, Detroit 6, Mich.

RADIO Electronic engineering consultant. Advice about circuits, inventions, industrial applications. Mail consultation \$10. W. Hollis Caldwell, S.M., 835 Westview St., Philadelphia 19, Penna.

CARTOONING, COMMERCIAL ART, SHOWCARD WRITING, SIGN PAINTING

INCREASE Your earnings! Learn showcard writing quickly! New, easy method teaches everything you should know to learn how to make and sell attractive showcards. Complete course only \$1.00. Catalog free. National Artists, Box 4248-H, Dallas 8, Texas.

CARTOON Your way to success! Internationally known instructor, Raye Burns, will personally teach you to create salable, original cartoons at home. Course of 26 lessons only \$2.85. Send remittance with order or write for free details and addresses of successful students. Raye Burns School, Box 3583-M, Cleveland 18, Ohio.

"HOW To Make Money With Simple Cartoons"—A book everyone who likes to draw should have. It is free; no obligation. Simply address Cartoonists' Exchange, Dept. 96-C, Pleasant Hill, Ohio.

FAMOUS \$75 Lockwood art course now only \$6 postpaid. Other smashing art bargains. Catalog 10c. Art Book Shop, Arnold 8-F, Missouri.

LEARN Professional lettering. Amazing mechanical process. Complete home-study manual illustrating 75 alphabets, 250 designs \$1.00. Major-Art System, 3510-P Palmer, Chicago 47.

AIRBRUSH Art. Photo retouching. Free catalog. N.Y. School of Airbrush Art, 117-C E. 60 St., New York, N. Y.

AMATEUR Cartoonists, artists. Earn while learning. Proven plans. Postal brings details. Jay Borosky, 1571 Fulton, San Francisco, Calif.

SIGNWRITING Simplified—Twelve alphabets, ten numerals, catalogue, \$1. Demonstrators, 639-P Paulina, Chicago 12.

TALENT Test, information. Give age. Art. Box 8066, Dallas 8, Texas.

SIGN Painting taught at home. Test lesson free. Ben Kerns, Box 812-T, Greenville, S. C.

CHALK Talks. Laugh producing program, \$1.00. Catalog 10c. Balda The Cartoonist, Oshkosh, Wisconsin.

ADVERTISING AGENCIES, LETTER WRITERS, FOR ADVERTISERS

GENERAL Stores—Names and addresses on gum paper \$3.50 per thousand. Sales-manager, 812-S 38th, Louisville, Ky.

MAILING List. 500 names \$3.00. Turn-bow, Box 136, Hazel, Ky.

1000 MAIL Order buyers \$4.00. Grabowski, Box 664, Hoboken, N. J.

ADVERTISE: 24 Words, 40 newspapers \$3.50. Lists free. Advertising Bureau, 10511-C Springfield, Chicago 43.

MAILING Lists: \$5.00-1000 up. Write Dixie Service, King, N. C.

ADVERTISERS! Reach nearly 18,000,000 readers. 25 Sunday national key newspapers, 18 words, \$51.50. "Terrific pullers." 20 popular newspapers, \$10.00. "Free booklet." Special—One inch display 2.-821,198 circulation, \$48.30. Newmark's Advertising Agency. (Established 1893), 217-7th Ave., New York 11.

AVOID Costly advertising mistakes. Get enlightening Ad-Guide and Ratebook leading newspapers, magazines, mailing lists, 10c. Chicago Advertising Agency, (Established 1900), Chicago 4.

24 Words In 50 weeklies, \$4.96. J. Darrell, 730 Hays, Jackson, Tennessee.

ADS Placed in out of town newspapers and magazines. Low rates. Catalogue free. Ideas that pay. Baker Advertising Agency, Successors Ankrum Agency, 189 W. Madison, Chicago 2.

TYPEWRITERS, DUPLICATORS, OFFICE DEVICES

LOY'S Abacus, low-cost fast adding calculator for home or office. \$3.50, \$6.50. Free details. Loy's, Dept. PM, 1317 R.I. Ave., N.E., Washington 18, D. C.

TYPEWRITERS \$17.50, Duplicators \$9.95, adders \$12.50, portables \$59.60. "Typewriter," 118 Spruce, Wichita, Kansas.

AMAZING! New! Portable addresser converts into stamp. Only \$9.95 complete; western price \$10.95. Literature, Pagan Island Products, Camdenton, Missouri.

PRINTOMATIC Selffeeding post card printing duplicator \$13.50. Envelope addressing machines \$24.50. Pittsburgh Typewriter Company, 336-R Fourth Avenue, Pittsburgh 22, Penna.

RECONDITIONED Typewriters, printing devices. Write Dixie Service, King, N. C.

RUBBER STAMPS AND OFFICE SUPPLIES

RUBBER Stamps. Copyrighted literature free. Lee-Vall Press, 1208-B Edgemont Street, Indianapolis 23, Indiana.

MIMEOGRAPH Paper, 68c ream, samples. Brookman, 56-A West 44th, New York 10.

PRINTING, MULTIGRAPHING, MIMEOGRAPHING GUMMED LABELS

1000 BUSINESS Cards or statements \$3.50. Samples. Mail Press, 2234 Charles-ton, Toledo 13, Ohio.

BUSINESS Stationery. Samples, prices free. Howprint, 721-23 Eunice, Webster Groves 19, Missouri.

BUSINESS Cards, finest vellum, maximum 5 lines, 1000, \$3.00 postpaid. William Jones, Box 343, Mineola, N. Y.

500 8½x11 EMBOSSED Letterheads \$3.95. Universal Printing, 203 Avon Avenue, Newark 8, New Jersey.

1000 BUSINESS Cards embossed \$3.50 postpaid in U. S. Samples free. Herschel N. Johnson, Box 85, Jacksonville 1, Fla.

STATIONERY Special—100 sheets plus 50 envelopes, printed with name, address, \$1. Free memento: Linotype slug with your name. Hilton's Printery, 137 Front, Worcester, Mass.

500 LETTERHEADS Or envelopes \$2.95 postpaid. Odum Supply, Box 9345, Tampa, Florida.

SEND \$1.00—Receive 100 gummed, modern shipping labels, (2½ x 4), printed name, address (value \$2.00). Pen-a-Kard, 886F Eighth Avenue, New York 19.

1000 ATTRACTIVELY Embossed business cards \$3.00. Samples. Avery, 112-J Elizabeth, Wichita 12, Kansas.

PRINT-Style mimeographing. Free samples. Jordan Letter Shop, 3846 Monteith, Detroit 8, Michigan.

1000 BUSINESS Cards \$1.85 postpaid. Agent's discount. Woodprint, Washington, Michigan.

MIMEOGRAPHING—Reasonable. Any copy. Mallers Service, Box 606-A, Chicago 90, Ill.

MIMEOGRAPHING, Vari-typing. Free price list. L. Brush, 3303 Paseo, Kansas City 3, Missouri.

100 8½x11 HAMMERMILL Letterheads and 100 envelopes \$1.85. Herbert Hudson, Centredale, R. I.

MIMEOGRAPHING, Addressing, samples, price list. Merlen Terwilliger, 303 Chestnut Street, East Bound Brook, N. J.

1000 BUSINESS Cards \$2.50 prepaid. Samples free. Reliable Print Shop, 905 East Jefferson, Louisville 6, Ky.

BUSINESS Or personal monogram stationery. Send copy for estimate. Nif-T-Pak, Box 455, Toledo 1, Ohio.

QUALITY Printing. We specialize in publications, newspapers, tabloids. Send copy for estimate. Bagby Printing Co., Georgetown, Ohio.

SEND 10c Now, for our 48 page 1950 price list—refunded first order. McCall Press, 1326 South 27th, Omaha, Nebraska.

500 ¾x2¼ FOUR Line gummed stickers 35c; red border 50c. Moritz Printery, Saginaw, Mich.

MIMEOGRAPHING—Letters, price lists, formulas, instructions. Lowest prices. Lem's Letter Shop, 5710 Stanton, Detroit 8.

PRINTING OUTFITS AND SUPPLIES

PRINTING Presses, type, supplies. Send stamp for details or dime for complete illustrated printer's supply book and samples. Kelsey Corp., J-11, Meriden, Conn.

MAKE Your own rubber printing cuts. Self-molding process. Plexirubber, Argyle 1, Wisconsin.

PRINTING Presses (hand-new) \$7.50. Keena, 1312-A Jefferson, Grand Rapids, Michigan.

PRESSES, Type, cabinets, supplies. List for stamp. Lincoln Press Company, 220-K Hartwell, Fall River, Mass.

PRESSES, Supplies, paper. Catalog 10c. Printers Supply, 211, Springfield, Missouri.

PRINTING Presses, type, supplies. Lists 3c. Turnbaugh Service, Loysville, Penna.

PATENT ATTORNEYS

INVENTORS—If you believe you have an invention, you should find out how to protect it. The firm of McMorro, Berman & Davidson with offices in Washington, D. C., is qualified to take the necessary steps for you. Send for copy of our patent booklet "How to Protect Your Invention." We will also send you an "Invention Record" form. No obligation. They are yours for the asking. McMorro, Berman & Davidson, Registered Patent Attorneys, 1343 Victor Building, Washington 1, D. C.

HERMAN Lewis Gordon, registered patent attorney. Patent investigations and opinions. Warner Building, Washington, D. C.

INVENTORS—If you consider your invention to be something of importance, take steps to protect it with a United States Patent which gives you the right to exclude others from making, using and selling your invention as claimed. "Patent Protection for Inventors" outlines steps to take to secure patent protection. Mailed promptly without obligation. Victor J. Evans & Co., Merlin M. Evans, Registered Patent Attorney, 531-G Meriin Building, Washington 6, D. C.

PETER Fries, Jr., Registered Patent Attorney. Patents, novelty searches, designs, copyrights. 110 East 42nd Street, New York City.

INVENTORS: Learn how to protect your invention. Unless the inventor is familiar with patent matters, he should engage a competent registered patent attorney or agent to represent him. We are registered to practise before the U.S. Patent Office and prepared to serve you in handling your patent matters. "Patent Guide for the Inventor" containing detailed information concerning patent protection and procedure with "Record of Invention" form will be forwarded to you upon request—without obligation. Clarence A. O'Brien & Harvey Jacobson, Registered Patent Attorneys, 01B-D District National Building, Washington, D. C.

REGISTERED Patent attorney offers services. Sanders, 6430 Evans, Chicago 37, Ill.

PATENTS—Irving L. McCathran, 315 McLachlen Bldg., Washington 1, D. C. Registered Patent Attorney.

PATENTS. "Proof of Invention" folder mailed without obligation. E. E. Vrooman, Registered Patent Attorney, 507 McKim Building, Washington 5, D. C.

CANADA—Ramsay Company Registered, 273 Bank Street, Ottawa, Canada.

INVENTORS: When you are satisfied that you have invented something of value write me, without obligation, for information as to what steps you should take to secure a patent. Write Patrick D. Beavers (Formerly Randolph & Beavers) Registered Patent Atty., 935 Columbian Bldg., Washington 1, D. C.

C. A. SNOW & Co.—M-427, Snow Building, Washington 1, D. C. Registered Patent Attorneys. Write for information.

"INVENTOR'S Guide" free on request. Frank Ledermann, Registered Patent Attorney, 154 Nassau St., New York 7, N. Y.

INVENTORS: Without obligation, write for information explaining the steps you should take to secure a patent. John N. Randolph, Registered Patent Attorney, 203 Columbian Bldg., Washington 1, D. C.

INVENTORS: Write for free brochure "Evidence of Invention." Labiner, World Building, New York 7.

PATENT PRACTICE before U. S. Patent Office. Validity and infringement investigations and opinions. Booklet and form "Evidence of Conception" forwarded upon request. Lancaster, Allwine & Rommel, Registered Patent Attorneys, Suite 411, 815-15th Street, N.W., Washington 5, D. C.

INVENTORS. For "Record of Invention" form, contact Carl Miller, Registered Patent Attorney, Woolworth Building, New York.

FOR INVENTORS

INVENTORS—This firm is registered to practice before the United States Patent Office and is available to assist you in the preparation and prosecution of your patent application. "Patent Protection for Inventors" booklet containing detailed information and steps to take toward patent protection will be sent upon request. No obligation. Victor J. Evans & Co., 532-G Merlin Building, Washington 6, D. C.

INVENTORS—If you believe you have an invention, you should find out how to protect it. The firm of McMorrow, Berman & Davidson with offices in Washington, D. C., is qualified to take the necessary steps for you. Send for copy of our patent booklet "How to Protect Your Invention." We will also send you an "Invention Record" form. No obligation. They are yours for the asking. McMorrow, Berman & Davidson, Registered Patent Attorneys, 1344 Victor Building, Washington 1, D. C.

I.F.I. Creative co-operation includes: Superscope patent searches; commercial prospects analysis; pre-patent priority protection; invention-improving; finding backers; invention-styling for sales-leadership, plus the promoting, marketing, and selling of inventions for maximum cash and royalties. Write today for free information. Inventors-for-Industry Inc., P.M.6, Suite 501, 1947 Broadway, New York 23.

INVENTORS: If you have an invention for sale, patented or unpatented, write Institute of American Inventors, Dept. 40A, 631-E St. N.W., Washington 4, D. C.

PATENT Searches \$5.00, includes patent copies. Same reliable search as conducted for patent attorneys. Free protection forms, 48 hour service. Patent Service Institute, 945-A Pennsylvania Avenue, Washington 4, D. C.

CO-OPERATIVE Development, manufacturing, sales. American Inventors' Association, Durango, Colorado.

HOW To handle ideas. Free booklet. Grayland, 5312D Grace, Chicago 41.

\$1000 IN Cash for inventors. Third Annual Inventors Congress and Industrial Exhibit, June 30-July 1. Sponsored by Pueblo, Colorado, Chamber of Commerce. Write Milt Andrus, Manager, for details today.

PATENT Searches \$5.00. Reports airmailed within 48 hours. Invention protection forms free. Write Miss Ann Hastings, Patent Searcher, P.O. Box 176, Washington 4, D. C.

INVENTORS—Protect your invention by a U. S. patent. Write me for free record of invention form. Sherman Levy, 620 Victor Building, 724-9th Street, Washington 1, D. C.

PATENT Searches (same reliable service as conducted for patent attorneys) \$5.00. 48 hour service. Patent copies included. Protection forms free. Write Raymond L. Smith, Patent Searcher, 410 Bond Building, Washington 5, D. C.

PATENT Searches with patent copies \$5.00. 48 hour service. We serve the patent attorney, the general attorney and the inventor direct. We employ graduate engineers who have served at least 15 years as Patent Office Examiners. Protection forms free. Write Patent Engineering Service, 500 Walker Building, Washington 5, D. C.

TRADEMARKS Designed complete with cut, \$10.00. Rough sketch, \$1.00. Catalog free. Burke, 3208 McKinney, Dallas.

BE Smart: Have a complete sales analysis made, to determine marketability before expensive patenting. Sales Institute, 330 Commercial Exchange Bldg., Los Angeles, Calif.

CHIEF Engineer and successful inventor for large manufacturing concern offers advice on marketing your ideas. Paas, 13 Dogwood Road, West Orange, N. J.

INVENTORS Having patented, patent pending development to offer manufacturers. Booklet, information free. Market Contacting & Data Service, 11106-A3 Longwood, Chicago 43.

FREE Patent pending inventions with patented and patent pending inventions for sale or lease, request our free book. No obligation. Dept. 1-F, Universal Marketing Co., 354 South Spring St., Los Angeles 13, Calif.

INVENTORS: Learn how to protect your invention. Unless the inventor is familiar with patent matters, he should engage a competent registered patent attorney or agent to represent him. We are registered to practise before the U.S. Patent Office and prepared to serve you in handling your patent matters. "Patent Guide for the Inventor" containing detailed information concerning patent protection and procedure with "Record of Invention" form will be forwarded to you upon request—without obligation. Clarence A. O'Brien & Harvey Jacobson, Registered Patent Attorneys, 91A-D District National Building, Washington, D. C.

COMPLETE Services for inventors. Patent searches including analysis, patent copies. Inventions, patents marketed. Protection forms free. Industrial Patent Reports, Box 1081, Massachusetts Avenue and North Capitol, Washington 13, D. C.

INVENTIONS Wanted. Prominent manufacturers and national distributors look to us for new products. You can also benefit by having us assist you with your invention from the idea stage through to the developed product, fully protected. Ask for Booklet "M." Elo Development Co., Chatham Phenix Bldg., Long Island City 1, New York.

PATENT Owner Representative. Years of experience. Can I help you? Charles A. Scott 773PM Garson Avenue, Rochester 9, N. Y.

INVENTORS: Without obligation, write for information explaining the steps you should take to secure a patent on your invention. John N. Randolph, Registered Patent Attorney, 202 Columbian Bldg., Washington 1, D. C.

CASH For your idea. 280 manufacturers need inventions, patented or unpatented. List free. Invention Bureau, 208M Clinton, Oak Park, Illinois.

"INVENTOR'S Guide" free on request. Frank Ledermann, Registered Patent Attorney, 154 Nassau St., New York 7, N. Y.

INVENTORS. For "Record of Invention" form, contact Carl Miller, Registered Patent Attorney, Woolworth Building, New York.

INVENTORS: The usual first step is to have a search of the U. S. Patents conducted, so I can report on patentability. Write, without obligation, Patrick D. Beavers (Formerly Randolph & Beavers), Registered Patent Atty., 936 Columbian Bldg., Washington 1, D. C.

INVENTIONS WANTED

THE U. S. patent system does not compel inventors into rash "patent (s)pending." The intent of the patent law is to give you the chance of making a pre-patent test of the worth of your ideas. And high-character priority protection for this purpose can be obtained through: Inventors-for-Industry Inc., Dept. P.M.6, Suite 501, 1947 Broadway, New York 23. Write today for free information.

INVENTORS: Hundreds of manufacturers have requested our assistance in locating marketable new products. Complete information free. Institute of American Inventors, Dept. 40-D, 631-E St. N.W., Washington 4, D. C.

GADGETEER "Natural" wants sponsor, partner, or agent. M. J. Hoyka, 1010 8th, West Des Moines, Ia.

INVENTORS Marketing assistance. Circular free. Stanley Hull, 7829-K Euclid, Cleveland 3, Ohio.

HIGHEST Royalties—Cash. Patented and patent pending inventions only. Request our free book. No obligation. Dept. 1-W, Universal Marketing Co., 354 South Spring St., Los Angeles 13, Calif.

INVENTIONS Promoted. Patented or unpatented. Write Adam Fisher Company, 61 Enright, St. Louis, Mo.

CASH For your idea. 280 manufacturers need inventions, patented or unpatented. List free. Invention Bureau, 208M Clinton, Oak Park, Illinois.

INVENTIONS Wanted. Patented or pending only. Inventors' Exchange-B, Hartford 1, Conn.

PATENTS FOR SALE

PATENTED Quick change battery cable terminal clamp. Turn of knob to right applies. To left lifts off. Seals out corrosion. Lead product. Walter St. George, 704-6 Ave., S.E., Rochester, Minn.

POPULAR Plastic article for men, patent pending, cash or royalty basis. Stephen Signore, 545 Grand Ave., New Haven, Conn.

INVENTORS: Test the commercial value of your patented or unpatented inventions, quickly and inexpensively. Write for free information. Institute of American Inventors, Dept. 40-B, 631-E St. N.W., Washington 4, D. C.

FOR Sale pending: kicking man toy. Serial No. 283306. L. M. Yaggy, Roth Road, Box 11, Waterloo, Iowa.

MANUFACTURING

METAL Stampings. Tools, dies and fixtures. Send drawings or sample for free estimate. Sterling Manufacturing Company, Davison, Michigan.

NAMEPLATES—Etched metal, any size. Samples, quotations free. Jacktools, 2011-G Yale, St. Louis 17, Mo.

MODELS—Small lot manufacturing. Metals, plastics, etc. Milburn, Burlington, Kentucky.

MODELS, MODEL SUPPLIES

BUILD Historic ship models, complete kits 39c to \$9.00. Catalog 10c. Ideal Models, 19 W. 18th, New York 11, N. Y.

USE Nostickum powder. Clean and easy to use. Silver solder can't stick, clamps, etc. Ounce \$1.00, directions, prepaid. Guaranteed. Powell, 1912, Ruiz, Houston, Texas.

BALL Bearing Fafnir 33K5 3/16" hole 1 1/2" o.d. 25c; stainless steel shaft 3/16" x 1 1/2" 15c; steel universal joint 3/16" hole 3/8" o.d. 1 1/8" long 90c; 50 assorted small gears \$3.95. Reliance Merchandizing Company, 2219 Arch, Philadelphia 3, Penna.

BUILD Model homes for fun or profit! It's so easy with low cost architectural model materials. With these professional materials it's simple to build all kinds of miniature homes, factories, farm buildings, doll houses—of your own design. White plastic doors, door frames, windows, shutters, and window boxes and plywood panels of brick, siding, and shingles are perfect for constructing 1/4", 1/2", and 3/4" scale models. Architectural model materials make model building easy, save hours of time, and are low in cost. For fun or profit send 25c for details and samples. Architectural Model Materials, Inc., Dept. 3-A6, 4339 Diversey Ave., Chicago 39, Ill.

MINIATURE Engines, castings and drawings. Catalog world's largest selection 25c. Miniature Engine Laboratories, 200-A Cement Ave., Sandusky, Ohio.

SHIP And yacht model fittings; blueprints. Send 25c for illustrated catalog No. 25—listing hundreds of items. A. J. Fisher, 1002-1 Etowah Ave., Royal Oak, Mich.

STEAM Locomotives, 1 1/2", 3/4", 1/2", 1/4" scales. Castings, parts, rail, steam fittings! Thorough drawings with instructions. Catalog 35c. Little Engines, Lomita, Calif.

LIONEL Trains catalog 10c. 36 pages illustrated. Hobby Shop, 72 West Washington, Chicago 2, Illinois.

SHIP Models and yacht supplies complete. Large 64 page catalogue 30c. Bill Wild's, 510 East 11 St., New York City 9.

HOME CRAFTSMEN

89 JIG Saw patterns of beautiful shelves, ornaments, novelties, toys. All full size. Plus "how and where to sell." Only \$1.00. Mastercraft 64M, 7041 Olcott, Chicago 31, Illinois.

MING Trees. Complete kit with beautiful pottery container, \$3.25. Large kit, 4 1/2" Chinese figurine, 14" Manzanita, moss, etc. \$5.50. Instructions and sketches, suggested markets, alone, 50c. Price list materials free. Also wholesale. Ming-Craft, Loomis, Calif.

CANDLESTICKS, Solid bronze, rough castings only, finish them yourself. Circular. Major Foundry Service, Box 401, Quincy 69, Mass.

TOYS, Novelties, furniture, garden figures, lawn chairs, etc. 68 popular plans, with full size patterns, \$1.00. Mastercraft 61M, 7041 Olcott, Chicago 31, Illinois.

MAHOGANY, Pine, hardwoods—Save up to 50%. John Tidaback, 506 Buchanan St., Hillside, N. J.

CHAIR Cane, genuine. Samples dime. Instruction book 25c. Fogarty's Craftshop, Troy, N. Y.

LEATHERCRAFT Lacing. New bargains! Byrd, 3406 Montrose Ave., Richmond, Va.

90 ALL New, full size lawn ornament and novelty patterns, up to 20" high. Only \$1.00. Mastercraft 62M, 7041 Olcott, Chicago 31, Illinois.

MAKE MONEY—Sew Read-Cut baby shoes and aprons at home. Fast, easy. Help supply the demand. Liebig Industries, Beaver Dam 5, Wisconsin.

LEATHER, Retail, mail orders, catalog, tools, lacing, supplies. National Handicraft Co., 199 William Street, New York City 7.

GLAMOROUS Jewel like plastic birds. Sell them to your friends for millinery and blouses. Kit of six birds complete with instructions prepaid \$1.00. Catalogue 25c. National, 5835 Magazine, New Orleans 15, La.

"YOU Can actually see the metal flow on" with a Tyco electro-plater! Electroplate metals, mirrors, glass, wood, leather, plastics! No tanks or expensive equipment. Outfits furnished! Write for free booklet. Tyco Metals, Box 12008H, Houston 17, Tex.

JIGSAW Owners attention! Start earning money at home cutting out wooden novelties and souvenirs. Write H. Cook, 4407 S. Normal Ave., Chicago 9, Ill.

16 NEW Lawn chairs, 22 picnic tables, benches, trellises, etc. All 38 plans, with necessary full size patterns. \$1.00. Mastercraft 63M, 7041 Olcott, Chicago 31, Ill.

INDEPENDENT Income! Make tooled leather belts, billfolds, purses for gifts or sale. Big illustrated catalog of materials, tools, instructions. Send 10c. Genuine steerhide keyholder free with catalog. Tandy Leather, Box 397A, Tulsa, Okla.

MACHINISTS, Mechanics, hobbyists. Why guess what drill to use? When using a tap, be sure. Keep handy tap and drill wall chart before you. 50c. Flip Novelty Co., 79 Woodruff Ave., Brooklyn 26, N. Y.

LAWN-Ornament patterns, 13 for \$1. Lawn-furniture 6 for \$1. Catalog free. Dept. M, Mosbro Patterns, 44 Victor, Mimico, Ontario.

SEA Shells, cut shells, oil colored shells at lowest prices. Free illustrated catalogue showing many new jewelry designs with instructions. Southern Shellcraft Supply, Clearwater, Florida.

LEATHERCRAFTERS: Belt kits, projects, leather, supplies. Free catalog. Art Leather, 411 Joseph Ave., Rochester 5, N. Y.

OZARK Wood samples. Eleven useful identified varieties. Prepaid \$1.25, check or cash to Davis Lumber, Cabool, Mo.

SHELLS, Plastics, findings. Low prices. Catalog 5c. Frances Jones, Box 251, Sarasota, Fla.

NEW 96 Page leather and craft catalog. 1000's of items. Send 10c. Russo Handicraft Supplies, Dept. 4D, 245 South Spring, Los Angeles, California.

CRAFT Catalog free. "Artcraft's Little Giant," 6500 items covering several crafts. "Tops in our field." Artcraft Leather, Dept. PM, 271 12th St., Oakland 7, Calif.

LAWN Ornaments. Ready cut patterns, full size, 20 assorted \$1.00 postpaid. Lincoln Craft Studio, Farmington, Conn.

8 **BEAUTIFUL** Full-size whatnot patterns 25c. Joanness, P.O. Box 141-M, Omaha 7, Nebr.

80 **FULL** Sized patterns. Lawn ornaments, toys, novelties \$1.00. Modern Woodcraft, Saginaw, Mich.

LEATHERCRAFT, Copper tooling, textile painting. Materials, tools, supplies. Free illustrated catalog. Kit Kraft, 7377 Melrose, Los Angeles 46, California.

546 **FROM** Square foot plywood. Jigsaw necessary. Write, Woodarts, C-38, Bridgewater, Mass.

KNOCKDOWN Cedar chests. Lumber and veneers. Free price list. Giles & Kendall Company, Huntsville, Ala.

PROFIT With Larson Leathercraft. Belts, purses, 100 other ideas. Largest supply in U. S. Catalog 10c. Larson, Dept. C, 824 S. Tripp, Chicago 24.

JEWELRY Findings, rhinestones, pearls, sequins, cameos, J & M Novelties, Box 464P, Griffith, Ind.

MAKE IT YOURSELF

SAVE 50%—Automatic electric water heater for home, cottage, farm. Particulars free. 225 Carson Products, 2505 Benjamin, Minneapolis 18, Minn.

FREE Handbook, build sawmills, block machines, freezers, tractors, scooters, 250 shop, farm, home machines. Nichols Co., Dept. C-801, Purvis, Miss.

BUILD Your own "lawn mower." Plans, Kits. Completed. Write Eltraco, D-11, Camptonville, California.

BUILD Your own "tractor." Plans, instructions, Walking, riding. "Lawn mower." Plans, Kits. Free information. Eltraco, D-1, Camptonville, California.

MAKE Strong attractive aluminum and wood seesaw for children's fun, inside home or outdoors. Complete construction kit including all parts and instructions, 12 feet formed aluminum tubing, 6 feet wood, rubber handles, steel fastenings, and finishing paper. We prepay delivery anywhere in United States. Send only \$3.98. Grosser, 2854 Fairfield Ave., Bridgeport, Connecticut.

HARD Water? Softener-iron filter easily built. Big savings! Complete plans \$1.00. Details free. Wisconsin Water Systems, Pewaukee, Wisconsin.

BUILD Your own picnic table, work bench using electrically welded steel legs. So simple, just apply lumber and it's complete. Literature free. East Moline Metal Products, Department S2, East Moline, Ill.

BLAST Furnace, cast 6 lb., profitable hobby, plans and foundry practice \$1.00. Inquire, Blast Furnace, Box 8195, New Orleans, La.

GRANDFATHER Clock easily built. Big savings. See ad on page 251.

SAVE 50-75% Building your Zeolite home water softener. Particulars free. Carson Products, Room 203, 2505 Benjamin, Minneapolis 18, Minn.

\$600. **BUILDS** Cozy 4 rooms and bath. Concrete block, stuccoed. Instructions and blueprint \$1.00. Farrow, G-83, Box 645, Columbus 16, Ohio.

BUILD Your own concrete blockmaker. Easy. Inexpensive. Motor or hand. Make block per minute. Write, C. Lee, Mountain View, Okla.

OVER 300 Plans and blueprints in Popular Mechanic's big 32 page Plan Catalog. Furniture, boats, trailers, tools, toys, gun rack, home freezer, many more. Send 3c stamp for copy. Popular Mechanics Press, 200 East Ontario Street, Chicago 11, Ill.

SOLAR Water heater systems efficient any locality. Standard materials, low cost. Free facts. Solar Water Company, Box 175, Coral Gables, Florida.

"CONCRETE Block Homes." 32 page booklet on how to build. \$1.00. H. C. Lightfoot, Civil Engineer, Richboro 1, Penna.

SURVEYING INSTRUMENTS

GUARANTEED Factory rebuilt transits and levels, sale or rent, with purchase option. We will repair, trade or buy old instruments. Write for list M-06. Warren-Knight Co. (Manufacturers of Surveying Instruments), 136 North 12th St., Philadelphia 7, Penna.

WATCHES, OLD GOLD, JEWELRY

WATCHES Cleaned, repaired. Only \$4.00. Year guarantee. National Watch Repair, Box 2414J, Cleveland 12, Ohio.

WATCHMAKER Hobbyist. Parts supplied, free parts list and information. Write Vanson Repair Service, Box 402, Muskegon, Michigan.

HIGHEST Prices paid for old gold, silver, platinum, diamonds, watches, gold teeth, spectacles. Cash immediately. Goods returned if offer unsatisfactory. Government licensed. United Smelting Works. (The Old Reliable), 39-B South State, Chicago.

WATCHMAKERS' Tools, materials, sold-bought. Catalogue! Bengal Company, Culver City, California.

HIGHEST Cash paid for old, broken jewelry, gold teeth, watches, silverware, diamonds, spectacles, platinum. Free information. Satisfaction guaranteed. Government licensed. Rose Smelting Company, 29-A East Madison, Chicago.

CASH For old gold, silver and diamonds. Garrett Lobdell, Northville, N. Y.

GOLD Plated jewelry supplies—Rhinestones, pearls. Illustrated catalog 10c. Barry's, 47-A Branford Place, Newark 2, N. J.

TOBACCO, SMOKERS' SUPPLIES

FREE Literature. Pipes, pipemakers' supplies, carnauba wax. Carvapipe, 2829-B Dixie, Hamilton, Ohio.

CIGARETTE Smokers get wise! Save over half. Parker-15, Hoboken, New Jersey.

FOR THE HOME

INSTALL Gas heat in your present furnace for less than \$140 complete. Domestic heating system. Furnished assembled. Easy installation. Generates own operating current—no connections to house wiring. Includes burner unit, ash door plate, thermostat, limit control. Write Thermex Engineering Co., 400 N. Oakley Blvd., Chicago 12, Ill.

CUCKOO Clocks imported, 10" high, calling every 15 minutes, \$7.95 postpaid. Nessalc, 4 East 41 St., New York 17, N. Y.

7000 **HOUSEHOLD** Necessities wholesale. Catalog details: 25c. Aichner, 267-F1 Maple, New Wilmington, Penna.

OF INTEREST TO WOMEN

300 **HOUSEHOLD** Hints—Amazing book of kinks, recipes, moneysaving ideas on cleaning, repairing, etc. 25c. Nelco, Box 3462, Merchandise Mart Sta., Chicago 90.

EARN Money at home. Assemble perfumery novelties for stores and giftshops. Stamp for particulars or send dollar bill (returnable) for samples and application agreement. Delight M. Company, 4042 Kimball, Chicago 18, Illinois.

OUTDOOR Toilets, cesspools, septic tanks cleaned, deodorized with amazing new product. Just mix dry powder with water; pour into toilet. Safe, no poisons. Save digging and pumping costs. Postcard brings free details. Burson Laboratories, Dept. Y-42, 955 Willard Ct., Chicago 22, Ill.

1000 **WAYS** To save time, money, labor. Amazing new book "Short-Cuts to Better Housekeeping." 160 pages packed with ideas every housewife will appreciate. Well illustrated. Only 60c postpaid. Popular Mechanics Press, Dept. SC, 200 E. Ontario St., Chicago 11, Illinois.

FOR SALE—MISCELLANEOUS

U. S. Army garrison type shoes, all sizes \$4.95 postpaid; satisfaction guaranteed. N. Y. Shoe Co., 2079 Second Ave., New York 29.

FREE Catalog! Save money. Surplus clothing bargains. N. Y. Clothing Co., New York 29.

SAVE Money on army and navy surplus. Write today for new 40-page illustrated catalog. Tenuasa Sales Co., Dept. Y, 1451 Market, Chattanooga, Tenn.

DRESSES 18c; Coats \$1.00; blouses 35c. Free catalog. Crown, 164-PA Monroe Street, New York.

WAR Surplus, aircraft items. Shop equipment, machinery and a million other items. Send 10c for 64 page catalog. Atlas Equipment, 229 Southwest Blvd., Kansas City 8, Mo.

WANTED—MISCELLANEOUS

CIGARETTE Lighters of unusual mechanism and design wanted by collector. Particularly interested European types brought back by GI's. Also antique and freak models. Write description and price wanted. Box PM 1813, Equity, 221 W. 41 St., New York 18.

WANTED Number 10 deluxe erector; weighs 150 lbs. Builds 500 models, 2500 engineering parts. 312-page How to Make "em" Book, 72-page Locomotive book. George Heidema, 188 E. 27th Street, Holland, Michigan.

WANTED, Revolvers, .38 caliber, good condition. Ship express prepaid, receive \$8.00 topbreaks, \$13.00 sidebreaks. Fidelior Co., 728 Joshuagreen Building, Seattle, Wash.

WANTED—Scrap mercury (quicksilver), tantalum, bismuth, tungsten. Metallurgical Products Co., Established 1909, 35th and Moore Sts., Phila. 45, Penna.

PERSONAL

"ROAD Map of Success" helps you choose vocation best for you. Shows path to quicker success. Only 50c. Golden Rule Mail Order House, 1312 East 47th, Chicago 15.

STAMPED Airmail letters re-airmailed from anywhere in U. S., Alaska, Hawaii, Puerto Rico, Virgin Islands, Canton Island, Canal Zone, Guam. Three for \$1.00. Holt, Box 217, Sausalito, Calif.

VALUABLE Big mails, four months, 25c. Wright Publications, 2270-J Hubbard, Memphis 8, Tenn.

MEXICAN Mailing service. Your letters remailed, received 20c. Mystify friends. Photographic postcards 10c. Tillotson. Apartado 1405, Guadalajara, Jalisco, Mex.

BORROW By mail. Loans \$50 to \$300 to employed men and women. Easy, quick. Completely confidential. No endorsers. Repay in convenient monthly payments. Details free in plain envelope. Give occupation. State Finance Co., 210 State Finance Bldg., Dept. G-14, Des Moines 8, Iowa.

GLOBAL Viewcard selection; worldwide remailing service. Free particulars. Travel-post, Box 201 Westend Station, Colorado Springs, Colorado.

FOOL Friends, pretend visiting nation's capital. Three Washington postcards 25c. You address and return; we remail from Washington 10c each. Barbers, Box 403, Berwyn, Maryland.

"WHAT Do you want to know?" Questions answered by our research service on any subject—scientific, business, literary, religious, etc. Quick action. Reasonable rates. State your questions for quotation. Confidential. Fax Research, 30 W. Washington, Chicago 2, Ill.

LETTERS Remailed 25c from Washington, D.C. or Silver Springs, Md. C. J. Deal, 12312 Selfridge Road, Silver Springs, Md.

FLORIDA Postmark. Letters remailed 25c each. For business address write: Strange, P.O. Box 109, Orlando, Fla.

MEXICAN Law. General Practice Attorney, 1203 Arizona Street, El Paso, Tex.

"HOW Can I find out?" You can! Information discreetly developed. Any matter, person, problem, anywhere. Worldwide. Officially licensed, bonded service. Established 1922. Reasonable. Confidential. William Herman, 170 Broadway, New York.

PENMANSHIP Corrector! Improves your penmanship in 3 hours. Proof free. Ozment 9, St. Louis, Mo.

MISCELLANEOUS

READ With speed! New amazing method. Save hundreds of hours yearly. Free home test. No obligation. Send postcard. Brownson, 9111 S. Hoyne, Chicago 20.

"RECEIVE Mail." Moneymaking offers, opportunities, catalogs. Name listed 10c. Ideal Service, Park Ridge 10, Ill.

70 BIBLE Lessons, 25c. Bulletin, Box 87, Cathedral Station, New York 25.

INFORMATION. Any subject. The Roxbys, 747 S. New Hampshire, Los Angeles 5.

SPRAY Gun—New, 2-3 cubic ft. pressure type, clamp on qt. alum. cup and 2 nozzles. \$6.50 plus postage. (Retail for \$11). Money back guarantee. Balko, 2303 Devon Ave., Chicago 45, Ill.

SEEK Uranium, gold, buried treasure! Recover lost outboard motors, tackle, guns. Latest low cost super-sensitive equipment. Free literature. Glen Scientific, Box 151-B, Glen Ellyn, Illinois.

ADD "Spice" to home projection shows with old-time Nickelodeon slides. 2x2. Kodachrome. Write for free list. Nickelodeon Co., New Fledner Bldg., Portland 5, Oregon.

SENSATIONAL New line of Geiger counters for uranium detection. All types, all prices. No finer selection. Also mineralights and new gold, silver and mineral detectors. Complete information free. Detector Co., 5637 Cahuenga, Dept. B-6, North Hollywood, California.

PANNING Gold.—Beginners booklet 36 pages; catalogue, supplies, mining books, maps "where to go." 25c. Old Prospector, B-308, Dutch Flat, Calif.

WET Soil? Amazing, simple method draining it by tremendously waterdrinking useful crop. City or farm. Information \$1.00. Pasner Co., 33593 Plymouth, Plymouth, Mich.

SPANISH Dance picture, instructions \$1.50. All sent c.o.d. Navaro Studio, Box 94, Huron, S. Dak.

"WHY You Should Collect Fossils." Copy sent free. Laurence Barcus-M1, Terre Haute, Indiana.

EARN Up to \$200 month, inventing toys, games, gadgets. Write, Hendrickson, Argyle 1-A, Wisconsin.

PRESERVE Live flowers to last for years without cost. Complete instructions only 25c. Wm. Wingfield, Pinewood, Minnesota.

FLYTRAP. Non-electrical, catches 600-000 flies monthly. For particulars, Villard Mfg. Co., 200 Turpin, Rochester, N. Y.

HEARING Aid batteries, all aids. Free list. Box M51, York, Pennsylvania.

LAWNMOWER Sharpener. Precision built. \$95.00 less motor. Not a lapping machine. Write Lutts, Box 211-PM, Ontario, Calif.

SHOP, Draftsman's, or artist's utility cabinet. Complete plans, \$1.00. W. Marks, Wrightsville, Penna.

FALSE Plate wearers—New plate for old in 24 hours! Low as only \$18.50! Enjoy comfortable, attractive false teeth. Made of lustrous Dupont beauty-pink plastic. Amazing savings. Rush name for free details. West Dental Laboratory, Dept. B, 127 N. Dearborn, Chicago 2, Ill.

REFRIGERATOR Rubber door seals. Rues Trading, 6013E 13th, Brooklyn 19, N. Y.

"THE Pencil with a brain"—Remarkable "automatic roller rule" pencil, made of handsome black Forticel with gold numbers. Useful in business, specialized work, homes, schoolwork, etc. Rolling head over any shaped surface records inches on "Inch-O-Meter" and fractions on head. Handy calculator. Length 6". \$1.59 postpaid. Sunshine novelty catalog free. Sunshine Sales, Dept. PR3, Loudonville, Ohio.

OUTDOOR Toilets, cesspools, septic tanks cleaned, deodorized with amazing new product. Just mix dry powder with water; pour into toilet. Safe, no poisons. Save digging and pumping costs. Postcard brings free details. Burson Laboratories, Dept. P-44, 955 Willard Ct., Chicago 22, Ill.

400 YEAR Calendar. From 1651 to 2050. Exact dates. Send 25c or stamps. M. Jacoby, 606 Stone Avenue, Brooklyn 12, N. Y.

SIGNMAKERS—Wood letters, any style. Catalogue, stamp. Demonstrators, 639P S. Paulina, Chicago 12.

OVER 200 Valance designs for window valances, shadowboxes, etc. Portfolio \$1.00. Boruta, 217 E. State, Trenton, N. J.

"JITTERBUGGING Is Easy." and fun! Big complete course, 100 illustrations; guaranteed. \$2.00. Peters Company, 328 Adams St. N.E., Washington 2, D. C.

INTERESTING Mails—Three months listing 25c. Hughes, 4327 Dalton Ave., Los Angeles 62, Calif.

SAVE—Make money. Buy everything wholesale. Free details. Orysen's, 1147 Sun-kist, Waukesha, Wisconsin.

INCREDIBLE! Unprecedented! Become a mental superman overnight! Floor everybody! No studying! 'Memoprop' does all the thinking for you! It's uncanny! Revolutionary! Send \$1.00. Bijou, Box 1727, Pom., Hollywood 28, California.

SHIRT Mending. Shirt collar turned, 39c each, 3 for \$1.10, plus postage. Mrs. Augusta Jach, Antioch, Ill. Send m.o. or check.

VERMONT Maple syrup and sugar, 100% pure, new crop. List. H. Marshall, Poultney, Vt.

"WATERLESS (Lanolin) Hand Cleaner." (Oil base.) Make, sell. No machinery. Build profitable business. Complete formula \$1.00. Ideal Service, Park Ridge 3, Ill.

SAVE Money on paint brushes. Buy direct. Post card brings descriptions and prices. Kenmore Brushes, P.O. Box 53, Kenmore 17, N. Y.

TRAVEL Free throughout world in post-war Merchant Marine. Vacation or exciting career. Salaries high. Men. Women. 1950 guide tells how. Only \$3. American Seamens Guide, 545 Fifth Avenue, New York City.

GENUINE Buckskin coin purse and illustrated buckskin catalogue both for only 15c. Berman Buckskin Co., 227 N. 1st, Minneapolis, Minn.

TREASURE. Mineral locators. Goldak now offers treasure locators for \$75.00. Geiger counters reduced to \$95.00. Write the Goldak Co., 1541 West Glenoaks Blvd., Glendale 1, Calif.

FREE—Amazing new book, "How to Answer Ads." Never before have you seen anything like this. Tells you in simple language the correct way to answer ads. Gets you quicker replies—better results, and greater satisfaction. Will save you time and money and it's absolutely free. No obligation whatever. Every reader of advertising should have this booklet. Send a postcard for your copy now. F. W. Johnson, (Room 600), 200 East Ontario Street, Chicago 11, Ill.

URANIUM Prospecting equipment. New, improved Geiger counters, \$48.50 to \$125. Scintilliscopes \$5.95. Mineralights from \$12.50. Complete with accessories and radioactive specimens. Prepaid. Improved metal detectors for gold and silver, from \$128.50. Western Radiation Laboratory, 1107 West 24th Street, Los Angeles 7, Calif.

TREASURE—Mineral locators — Geiger counters M-scope type for arctic-tropic use. Unsurpassed in efficiency. Factory guarantee. Lowest prices. Can be purchased on monthly payment plan. Free literature. Fisher Research Lab., Inc., Palo Alto, Calif.

SQUARE Dance instructions. 40 dances, \$1.00. Wesley Rader, 1922 Grant, Denver, Colorado.

TATTOOING Outfits, supplies. Illustrated list free. Zels, 728 Lesley, Rockford, Illinois.

TATTOOING Machines, outfits. Free catalogue. Jensen, 120 West 83rd Street, Los Angeles 3.

REACH Spanish-speaking mail-order buyers. Great new market for your merchandise. Your classified ad in the Spanish Edition of Popular Mechanics will bring you some nice business from this new field. Rate only 25c per word. Circulation 100,000 copies. Mail a trial ad right now. Popular Mechanics Magazine (Spanish Dept.), 200 E. Ontario Street, Chicago 11, Ill.

BECOME A BETTER PAID MAN BY BEING A WELL TRAINED MAN

Learn a profitable trade—the Eastern Technical School way. Enroll now for an eight month course in Radio or Refrigeration. New classes beginning every April—August—December. Veterans — Nonveterans. Write for free catalogue. Graduates successfully placed from Coast to Coast.

EASTERN TECHNICAL SCHOOLS
888 PURCHASE STREET NEW BEDFORD, MASSACHUSETTS

Study By Mail

PHOTOGRAPHY

Do you need additional income? Would it interest you as a career or hobby? Step by step method teaches correct procedure. Profusely illustrated course. Short cuts. Cost cuts. Negatives and prints analyzed during training. Low cost—easy terms.

Send for Free Booklet
FOTO-TECNICA — Box 1468J — Santa Barbara, Calif.

NEON SIGN SCHOOL

Learn Neon. Interesting, clean work, BIG PAY—\$1.50 to \$2.00 an hour to start. 12½ week Job-Practice Course gives you training in Glass Blowing, Neon Tube Bending, Color Gassing, other branches. FREE FOLDER explains. Write today.

ACME NEON INSTITUTE (Write Nearest Office)
330 S. PAULINA ST., Dept. G-3 418½ W. Olympic Blvd., Dept. G-3
CHICAGO 12, ILL. LOS ANGELES 15, CALIF.
G. I. Approved Write for G.I. Information

LEARN IN 12½ WEEKS

YOU CAN'T LOSE!

HAVE A PROFIT MAKING BUSINESS OF YOUR OWN

NATIONALLY ADVERTISED PRODUCTS

NO EXPERIENCE NECESSARY

NO MONEY TO INVEST

FREE SAMPLE OUTFITS

FULL OR PART TIME

A LIFETIME FUTURE

Man or woman—young or old, YOU can earn a steady income in full or spare time as an independent Kendex dealer. Amazing and almost "impossible" earnings can become a reality for you. Herbert Armstrong of Tenn. earned \$202 in 9 days. C. O. Watkins of Oregon sent 92 orders in one day. You have the same opportunity to duplicate these exceptional earnings. Over one million dollars will be earned in 1950 by Kendex dealers—why not let us establish you in your own business and get a share of these wonderful earnings?

KENDEX NYLONS REPLACED FREE . . .

if they run or snag within guarantee period up to three months! Impossible? It's true! No matter what the cause—hard use or deliberate abuse—whether it is fault of the hose or the wearer—Kendex nylons are replaced FREE if they run, snag or become unfit for wear within the guarantee period. How could any woman resist a positive guarantee of satisfaction when she can obtain it without paying any more than other standard advertised brands? Kendex nylons are NOT sold in stores, so you have no competition. Complete line includes everything from heavy 70 denier service weight to gossamer luxurious ultra sheer 15 denier 60 gauge. Proportioned sizes and lengths. Latest colors plus white.

LINGERIE - ROBES - HOUSECOATS - MEN'S HOSE

In addition to the sensational Kendex nylons, you will have a complete line of glamorous lingerie, beautiful robes and housecoats plus a complete line of Kenteraft mens' hosiery guaranteed for one full year. Any pair or pairs of men's hose that does not give satisfactory wear within one year of purchase will be replaced FREE!

NATIONALLY ADVERTISED

Kendex will spend over \$350,000.00 in 1950 to tell millions of readers of the advantages in buying from you. Almost every issue of Good Housekeeping, Saturday Evening Post, McCall's, Women's Home Companion and Ladies' Home Journal carry our advertising in addition to many others. Kendex has advertised in Life, Look, Collier's, etc. Awarded Good Housekeeping Seal. Thousands of orders are shipped daily from coast to coast.

EVERYTHING GIVEN FREE

Risk nothing! Mail coupon and we will send you, free and prepaid, complete money-making outfits including sample nylon stocking, samples of lingerie, robes, housecoats and men's hose fabrics and everything you need to immediately start making money. Complete outfits become your property even if you don't send any business. Simply write orders, we deliver and collect. Advance cash plus huge bonus. No money or experience needed. Mailing the coupon is all you need to start on the road to a 52-weeks-of-the-year high paying business of your own. You have everything to gain and nothing to lose.

FREE NYLON STOCKING

KENDEX CORP., BABYLON, 846, N.Y.



FOUR MONEY-MAKING LINES

- WOMEN'S NYLON HOSIERY
- GLAMOROUS LINGERIE
- HOUSECOATS - ROBES
- MEN'S HOSIERY

MAIL TODAY

NOTHING TO PAY

NO OBLIGATION

KENDEX CORP. BABYLON 846, N.Y.

Date _____ 1950

Send me, free and prepaid, everything I need to make money as a Kendex dealer, including sample stocking etc. There is nothing for me to pay now or later and I am under no obligation in accepting your money-making outfits.

Name _____

Address _____

City _____ State _____

LOWEST Motorized PAINT PRICED SPRAYER

\$16⁹⁵
COMPLETE

Nothing Else To Buy

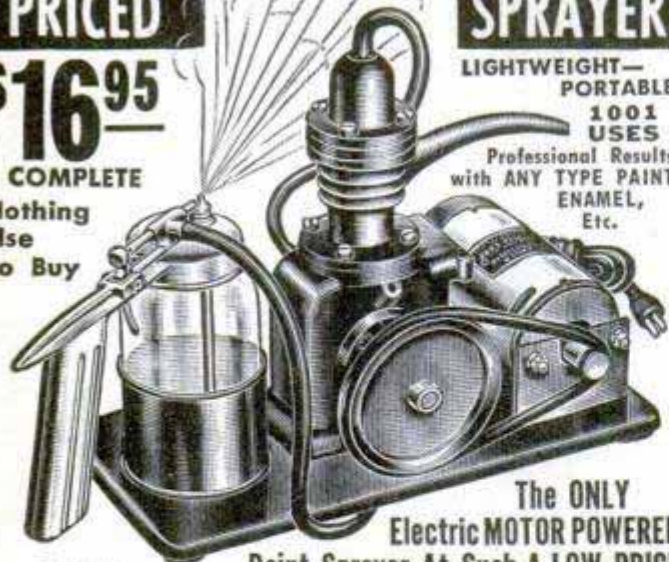

LIGHTWEIGHT—PORTABLE
1001 USES
Professional Results with ANY TYPE PAINT ENAMEL, Etc.

The ONLY Electric MOTOR POWERED Paint Sprayer At Such A LOW PRICE GUARANTEED FOR 1 FULL YEAR!

Just Pull The Trigger and SPRAY

This sensational, new, Portable Electric Sprayer will save you many hours and dollars on screens, furniture, auto touch-ups, and thousands of paint and spray jobs for the home, farm and office. Entire outfit is a compact, lightweight unit. Sprays with any type paint, lacquer, enamel, etc., either oil or water base. Applies a smooth, uniform finish. Sprayer stays clean, won't clog or drip because of special plating inside gun. Ten foot hose permits free, easy use of sprayer for any job. Compressor is piston-type, best there is. Delivers 20 lbs. pressure. AC-DC motor is fan-cooled. SEND NO MONEY! JUST MAIL THIS AD then pay postman on arrival only \$16.95 plus small delivery charge. Keep Sprayer for 10 days at our risk. If not delighted return for full purchase price refund.

STEVEN RICKY, Dep't. D, 1227 Loyola Ave., Chicago 26, Illinois

A BIG BOOK BUY!

For Every Home Craftsman

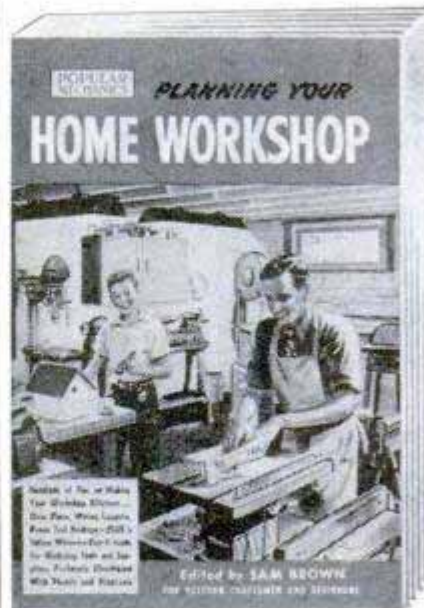

- FLOOR PLANS
- POWER TOOLS
- HAND TOOLS
- MOTOR HINTS
- SHOP LIGHTS
- WORK BENCHES
- TOOL CABINETS

PLANNING YOUR HOME WORKSHOP

Edited by SAM BROWN

Only Sam Brown and Popular Mechanics could give you such a book as "Planning Your Home Workshop," for these are magic names in the world of craftsmanship. Brown is a recognized authority and author of many articles and books on home workshops, advisor to power tool manufacturers and a man who has worked with every type of power tool, with all kinds of materials, and has a world-wide reputation for excellence in fine craftsmanship.

Planning Your Home Workshop is a "must" for the beginner and the experienced home shop worker, for no other book gives such complete information on shop layout and maintenance.

Your Shop — Layout — Equipment and Practical Shop Maintenance

This book shows how to set up a shop on a limited budget, how to avoid costly mistakes by buying the right tools, where to get the tools you need and want, what size and type to select, the basic "big-six" power tools, what hand tools to buy, floor plans and layouts to suit available space and facilities, the best use of electric motors, shop furniture you can build, hobbies for the home workshop, a selection of projects, and many other subjects. It contains 128 pages with more than 250 photos and 100 detailed scale drawings, many in colored line.

POPULAR MECHANICS PRESS 200 EAST ONTARIO STREET CHICAGO 11, ILLINOIS

Gentlemen: I enclose \$2.50. Please send me my copy of *Planning Your Home Workshop* in sturdy cloth binding.

(Name) _____
 (Address) _____
 (City) _____ (Zone) _____ (State) _____

Learn IMPORT For Profit and Pleasure



New, big opportunities for men and women! Learn how you can import at low foreign prices for buyers in your locality at high U. S. prices.

BUY—SELL, WORLD-WIDE WITHOUT CAPITAL

Big profits possible without investing in goods, doing world-wide business from your own home by mail, no matter where you live. (See examples of recent prices in other countries, at left). Also big savings on clothes, tools, gems, antiques, watches, cameras, china, silk, toys, etc., for your own use. Imported products needed in every locality. It makes no difference where you live. You can carry on World Trade in or near small towns or large cities — anywhere. Travel opportunities. Practical, low-cost World Trade Course teaches you quickly at home in spare time.

EXCLUSIVE PRODUCTS FROM ABROAD

Full year's membership in International Traders Guild included with course. Helps you to get samples and prices and go after big profits now Importing and Exporting. No previous special experience or schooling required. World Trade Certificate awarded. There is no obligation when you send for our free illustrated book. (No salesman will call on you.) Write today. Airmail reaches us overnight. The Mellinger Co., Exporters-Importers,

1418-CQ Westwood Blvd., Los Angeles 24, Calif.

THORESEN NATIONALWIDE SALE

BUY DIRECT AND SAVE



Thoresen's De-Luxe **14.98**
17 JEWEL PRECISION tax paid

Masterpiece of superb styling and workmanship! Streamlined 14 Karat Rolled Gold Plate case, stainless steel back. Gilt numerals, curved dome crystal. Genuine Lever 17 JEWEL Precision movement of amazing accuracy. 5 YEAR free service guarantee! Recent list price \$59.50. REDUCED for quick sales! Tax paid price—14.98—no extras!



WATER & SHOCK **8.80**
Resist Case—G. I. Style! tax paid

Military style! Drop it! Bang it! We guarantee it 3 years against any and all breakages—because of exclusive Swiss INSULATOR invention. 7 jewels. Luminous hands & numerals. Unbreakable crystal. Sweep-second. Heavy Chromed. Thin, smart! Marvelous accuracy. Long satisfying service. Tax paid, only 8.80
 15 JEWEL Model tax paid—no extras 14.33
 17 JEWEL Model (5 year guarantee!), tax paid 17.65

Fulcra-Matic Stop **7.97**
CHRONOGRAPH tax paid

Genuine Fulcra-Matic Stop Chronograph & Wrist Watch combined, gives accurate, long satisfying service. Times Races, autos, planes, Sports, etc. 10 WONDER FEATURES: Tachometer, Telemeter & Stop Watch. Luminous Dial, Unbreakable Crystal, Sweep-second hand, Stainless steel expansion band. Best of all—Fulcra-Matic finger tip control! Instructions given. 3 year guarantee. Tax paid, only—7.97.



Thoresen's 17 Jewel **29.88**
FULL AUTOMATIC tax paid

De-Luxe model—fully automatic! Set it, then forget it! It winds itself as you wear it. Patented Incabloc. Anti-Magnetic. Sweep second. Luminous dial. WATER & SHOCK resistant. All stainless steel back case. 17 jewels. Near-miracle accuracy. Thin! Handsome! 5 YEAR GUARANTEE. Formerly \$75.00. Thoresen's direct-to-you price, only—29.88—no extras for tax. Rush! Supply limited!



2.97
Initial Men's Ring
 Extra special! Genuine sterling silver with gold plate sides. Your own initial in raised gold effect flanked by 2 pseudo ZIRCONS of sparkling brilliance. Tax paid—2.97

1.98
"WEIRD" SKULL
 Ruby color eyes flash "weirdly" in semi-darkness! Perfect miniature of skull & bones. Rich 14 Karat Gold Plated. It's the attention-getting ring. Our tax paid price — 1.98

3.55
"Big 5" Men's Ring
 Wins distinction! Extra heavy simulation of a Solid Gold 5 Diamond Ring. Made to endure. Rich \$500.00 appearance. Imported stones of amazing brilliancy! Tax paid—3.55

FREE
10 DAY TRIAL

Price promptly refunded if not thrilled within 10 days after receiving. ALL prices tax paid—NO EXTRAS! Not a penny's charge for "handling," postage, parts or repairs on watches! THORESEN makes lifetime friends! References: Bank of Athens, New York, or any bank in America.

3 SYNCHRO DIAL
Precision-made SWISS
CHRONOGRAPH

Outstanding value! Sleek, handsome, 3 Dial CHRONOGRAPH. Amazing accuracy! Ideal for hobbyists, mechanics, scientists, doctors, sportsmen, students, aviators, etc. 20 SUPER FEATURES: 3 Synchro Dials! 30 min. register! 1/5th second calibration! Rugged shock-resist case, sweep second, luminous dial. Built-in tachometer & telemeter. Measures speed & distance planes, autos, horses, photos, etc. without stopping movement! 3 Year Guarantee. Formerly 39.95. Now at slashed price of 14.95, tax paid. No extras.



SEND NO MONEY — Pay price Shown, plus postage (no extras for tax) on delivery
 THORESEN Direct Sales Dept. 6F-200 131 West 33rd St., NEW YORK 1, N. Y.

BELTON SCHOOL of TOOL DESIGN

SPECIALIZED INDIVIDUAL TRAINING

Machinists, Tool and Die Makers, Mechanical Draftsmen and men with Mechanical Ability can improve their skill by training at Belton, the famous school that SPECIALIZES in teaching Tool and Die Designing and Mechanical Engineering Drafting. Reasonable Rates. Successful graduates, many making top money, prove success of the Belton Personal Assistance Plan. Individual Instruction. Progress as fast as your ability permits. Send for FREE fact folder. BELTON SCHOOL, Dept. G-1, 2457 W. North Ave., Chicago 47, Ill.

BLISS Electrical Training

ELECTRICAL SCHOOL

Intensive 32 weeks' residence course in fundamentals of industrial electrical engineering, including radio and electronics. Extensive laboratory, shop work, drafting. Prepares for electrical technician and engineering aides in communications, power, manufacturing, business machines, sales, service. G.I. approved. 57th year. Enter September 5. Catalog. 7634 TAKOMA AVENUE, WASHINGTON 12, D. C.

TRAVEL—for 'UNCLE SAM'

ARE YOU JOB-SATISFIED?
GET A U. S. GOVERNMENT JOB
Many Positions to Be Filled

Railway Mail Clerks — Postoffice Clerks — Mail Carriers — Stenographers — Typists, Statistical Clerks — Liquor Inspector, etc. 40-page Civil Service Book—FREE.

MEN — WOMEN
Veterans Get Preference

Mail Coupon immediately — today sure. Although not government controlled this can be your first step toward a secure Civil Service career.

As high as \$3,450.00
FIRST YEAR

COUPON
FRANKLIN INST., Dept. E-83, Rochester 4, N. Y.
 Gentlemen: Rush to me, without charge, 40-page book with list of U. S. Government big paid positions. Advise me also regarding salaries, hours, work, vacations, etc. Tell me how to qualify for a position.

Name _____
 Address _____ Vet? _____

CAR WASH—3c!

With Amazing New

"WIZARD"

Car Washer

**SALESMEN! \$30 a Day
On Only 15 Orders!**

Connect "WIZARD" Car Washer to hose and turn on water. Water flows over Cleaning Detergent and Water Softener Tablet in hose coupling. Detergent saturated water flows through 3-ft. aluminum handle and then through millions of tiny pores in Foam Rubber Pad to create thick, foamy suds that remove every trace of dirt, grease, grime and road-tim like magic in 1/3 the usual time. No sloshing. No splashing. A professional washing job in record time without getting your shoes or clothes wet!



No Soap
No Pail
No Sponge
No Chamois
No Rinsing

Car
Shines
Like New
in 1/3
Usual Time

\$495
Retail

FREE! Rush Name for Demonstration Offer

Don't send a penny—just your name on a penny postcard for complete information and big illustrated circular. Tells all about "WIZARD" Car Washer and how salesmen are chalking up phenomenal earnings with this new lightning seller.

GET SAMPLE. For quickest possible action, send only \$2 for Sample Demonstrator that retails for \$4.95. This Special \$2 price is for first Demonstrator only. No more available at this introductory price. If you don't want Demonstrator, send name only. But hurry. Be first in your locality with the biggest money-maker of the year.

MILLER MFG. CO., 812 N. Wells St., Dept. 56, Chicago 10, Ill.



SPRAY-O-NAMEL

Quality Enamel

Sprays right from the can!
No brush! No mess!
No mixing!

Perfect for painting furniture, radiators, automobiles, small objects and many other uses. Dries within one hour. Available, 12 oz. cans, in the following colors:

\$1.59 aluminum, gold and clear
\$1.89 white, black, red, yellow, light blue, sky blue, orchid, chartreuse, green, grey, pink and ivory

Send M. O. or check to

THE VALLI SHOP, 677 N. Michigan Ave., Chicago 11, Ill.

★ Save those bearings! ★ Cut repair bills!
★ Increase machine life!

BLACK GOLD

PRESSURE PROOF OIL

Worth Its Weight In Gold For Lubricating All Metal-On-Metal Parts

NOTHING better for electric motors, bearings, machinery, guns, and 1001 other uses. It penetrates, will not wash off, is heat proof, contains no acid, inhibits corrosion, stays fluid below zero. 2-oz. bottle only \$1.00 postpaid. Double your money back if you are not completely satisfied.



BLACK GOLD PRODUCTS CO.

2344 COTTAGE GROVE AVE., CHICAGO 16, ILL.

Earn \$18 an Evening Up To Without Selling



No Wonder John C. West, Cleveland, made over \$200.00 a week his first three weeks in Spare Time. Get Sworn Proof of many other exceptional profit records.

It's EASY! Just show housewives how to END FOREVER the nasty, messy job of defrosting refrigerators. Profits come rolling in.

Amazing Patented Device! Just plug it in—show what it does—housewives won't let you take it out. Make up to \$6.50 on each call!

FREE PROFIT PLAN

Just send card with name and address for GUARANTEED Starting Offer and SURE PROFIT PLAN. Cash in on our National Advertising to 29,000,000 prospects. RUSH—reserve your Territory.

D-FROST-O-MATIC

6 North Michigan, Dept. PM-6, Chicago, Ill.



MAKE MONEY IN LANDSCAPING

Thorough training by Internationally known Landscape Architect to start your own business, improve your home or advance in this well paid field. Many Opportunities. Approved for Veterans. Send for FREE BOOK.

NATIONAL LANDSCAPE INSTITUTE
Dept. P-6, 310 So. Robertson Los Angeles 48, Calif.



MEN A Blue Print For YOUR SUCCESS!

Here is your opportunity for Success An amazing new finishing system that will start you in your own profitable business. No experience necessary—up to \$10 an hour easy Spare or full time in your own home or garage Start small—grow big fast We will guide you every step of the way This is BIG—don't miss your chance Send name now for FREE SAMPLE of my complete, easy profit plan for your success

COAST INDUSTRIES

Dept. 26, 1004 S. Los Angeles St., Los Angeles 15, Calif



FREE BOOKLET & SAMPLE

EASY TO LEARN CODE

Learn or increase speed with an Instructograph—the Radio-Telegraph Code Teacher that takes the place of an operator-instructor and enables anyone to master code without further assistance. Available tapes from beginners alphabet to typical messages on all subjects. Speed range 5 to 40 WPM. Always ready—no QRM. Thousands have "acquired the code" with the Instructograph System. Write today for convenient rental and purchase plans.

INSTRUCTOGRAPH COMPANY

4701-V Sheridan Road, Chicago 40, Illinois



BURN WATER IN YOUR CAR

WATER-INJECTION is now available for Cars and Trucks with the World Famous

OCTA-GANE WATER INJECTING CARBURETOR

MADE OF BRONZE
THOUSANDS IN USE!

Only \$24.95 DELIVERED complete with STAINLESS STEEL Water Supply Tank.

Send for FREE descriptive, illustrated LITERATURE

DEALER INQUIRIES INVITED

NEW 1950 SPEED EQUIPMENT CATALOGUE, 25c

High Performance for ALL MAKES of cars

NEWHOUSE AUTOMOTIVE INDUSTRIES

5805 EAST BEVERLY BLVD. DEPT. 64
LOS ANGELES 22, CALIF.



BE YOUR OWN BOSS - AND KEEP THE PROFITS

with amazing, beautiful new PEARL finish



Marvelous new finish can be applied permanently to any surface, giving a lovely, lustrous PEARL coating in beautiful colors to thousands of objects. YOU can start right in your own home WITHOUT ANY EXPERIENCE turning out these lovely PROFITABLE things and make a BIG INCOME—up to \$5.00 per hour to start. The market for PEARL-KOTE finishes is TREMENDOUS—in the field of baby shoe covering alone there are 5 million new customers every year. Don't regulate your life to the other fellow's whim... BE YOUR OWN BOSS. Grasp this OPPORTUNITY of a lifetime TODAY. Get all the FREE details right now... SEND TODAY. Find out for yourself what PEARL-KOTE can do for YOU. SEND NO MONEY—a postcard or letter will bring you the FREE FACTS—BUT do it NOW!



I SEND YOU EVERYTHING FOR A FREE 7 DAY EXAMINATION PERIOD - I TAKE ALL THE RISK!!

PEARL-KOTE CO. DEPT. PM6-2111 W. MANCHESTER • LOS ANGELES 47, CALIF.

Be A MASTER PLUMBER

Earn \$15 To \$50 A Day

DON'T ENVY THE PLUMBER — BE ONE

Every skilled workman will tell you that Plumbers have the best of it, WINTER and SUMMER the Plumber is busy at top wages. No skilled Plumber is ever out of a job—compare his opportunities with any trade, plus the opportunities of having your own shop. We teach you Plumbing with TOOLS (not books) under Licensed Master PLUMBERS in one of the finest equipped schools in America. We make you a Plumber, every branch is taught thoroughly—Lead Work—Blueprint for plan reading—all other tricks.

LEARN IN 30 WEEKS WITHOUT PREVIOUS EXPERIENCE

If you like to work with tools you owe it to yourself to investigate. No need to ever work as an apprentice. Get free bulletin. Write now! G.I. APPROVED. Our 24th year.

UNIVERSAL PLUMBING SCHOOL

877 HOLMES STREET KANSAS CITY, MO.



Learn to Write at Home in Spare Time

YOU, easily, can become an Expert Penman in Plain & Ornamental Writing, etc., at home in spare moments QUICKLY by my SIMPLIFIED METHOD, for your PLEASURE and BENEFIT. Write for my FREE BOOK, "How to Become an Expert Penman," which tells about My Method. How it made others Experts at home in spare moments. If you enclose 10c, I'll write your name with flourished bird on card and include Shading Penpoint.



Box 25K, CHILLICOTHE, MO.

Be a TIME STUDY Engineer

... One of the best paid and most interesting jobs in any manufacturing plant, and the stepping-stone to executive positions. You can learn time study at home during spare time in 10 weeks or less. Low cost. Easy terms. Write today and ask for free folder P-1.

CHICAGO INSTITUTE OF TIME STUDY

1260 N. Dearborn St. Chicago 10, Ill.

4 BIG OPPORTUNITY FIELDS

TAKE YOUR CHOICE THROUGH HOME TRAINING

UPHOLSTERING A Money-Making Vocation or a Business of Your Own. Practical. Easy to learn and do. You get materials to make and upholster a fine Ottoman. Professional tools available.

DIESEL Famous Hemphill system that has trained hundreds of successful Diesel operators and mechanics. Many Diesel opportunities the world over. Kit of tools included with lessons.

PLASTICS One of the world's fastest growing industries. Learn fabricating, laminating, molding. Practical type training includes 7 kits with materials and detailed instructions. Many successful graduates.

AIRCRAFT Famous Aero Tech course. Successful graduates since 1940—many holding important jobs in Aviation. Recent government contracts mean many new opportunities. Prepare now.

MAIL COUPON TODAY. Get detailed illustrated books describing field of your choice.

WEST COAST UNIVERSITY, EXTENSION DEPT. PM-60
1601 S. Western Ave., Los Angeles 6, Calif.

Please send me free information about your home training in course I have checked.

Upholstering
Plastics

Diesel Mechanics
Aircraft

Name _____

Street _____

City _____ State _____

Say You Saw It in Popular Mechanics

Earn Dollars in WATCH REPAIRING



EXPERIENCED WATCHMAKERS EARN \$2500-\$5000 A YEAR AND UP. Learn the "Swezey Way" from 42-year old school. Send today for FREE SAMPLE of Home Study watchmaking course.

G.I. approved resident courses also available. Write now. CHICAGO SCHOOL OF WATCHMAKING Dept. 160 1608 N. Milwaukee Avenue, Chicago 47, Illinois

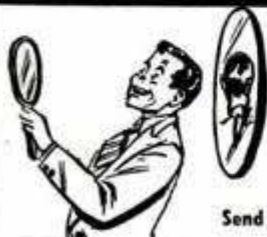

DANGER SIGNAL! 1 MAN IN 10 WILL SAVE HIS HAIR TODAY

NOW— is the time for all SMART MEN to use COMI! Don't let excessive falling hair or receding hairline MAR YOUR HAPPINESS. ELIMINATE the Danger of drying scalp and falling hair today!

Let COMI'S "magic" help wake up your sluggish scalp. SEE and FEEL the difference for yourself. COMI'S special ingredients enables you to have attractive, well-groomed, HEALTHY HAIR. COMI refreshes and invigorates your scalp immediately. Economical. 1 Bottle approx. 3 Mos. treatment. Simple-to-follow instructions. MONEY BACK GUARANTEE.

Send Cash or M.O. TO: COMI PRODUCTS, Dept. 222, 5864 HOLLYWOOD BLVD. HOLLYWOOD 28, CALIF.

\$3.50

COMPLETE (Fed. Tax & Postage included)

Write your hair or scalp problems to Comi. Personalized reply sent FREE, by Originator.

World's Leading AUTO BOOK

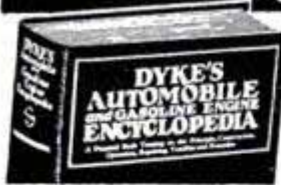

The Indispensable Book for Auto Repairmen - Beginners - Car and Truck Owners.

The new 22nd edition of Dyke's is a complete course of instruction in automotive mechanics with special emphasis on trouble shooting, testing, adjusting and re-

pairing. Easy to use. Easy to understand. New edition with 100 new and revised pages includes wiring diagrams and test data on Ford Six, Ford V-8, Chevrolet, Plymouth and 36 pages of 1949 specifications. Covers new vacuum spark control, ignition distributor spark control, Ford Venturi-Vacuum distributor, Buick Dynaflo, with maintenance, and operating manuals for electrical parts and engine repair. World's biggest book value. Over 1500 pages. 4600 illustrations. Only \$7.50.

Learn AUTO BODY-FENDER REPAIR



Specialize in this Big Pay Field! Start Now to EARN MORE!

This practical book will put you right into the most profitable business in the auto field. Shows you how to get a good job or start a business of your own with little or no capital. Easy to use and understand. Covers use of tools and equipment, gives approved methods, describes materials and shows you how to actually do a professional job, operate a shop, etc. The very latest and most complete information ever published. Only \$3.50.

stand. Covers use of tools and equipment, gives approved methods, describes materials and shows you how to actually do a professional job, operate a shop, etc. The very latest and most complete information ever published. Only \$3.50.

Learn REFRIGERATION



Earn Top Pay or Start Own Business. Sealed Units and Home Freezers Now Included in this Famous Book.

Refrigerator owners are paying big money for competent service and repairs. Get your share of the big wages and profits in this ever-growing field.

Ambitious refrigerator service men with experience will find this newest edition of Modern Gas and Electric Refrigeration is just what they need to specialize in servicing Sealed Units and Home Freezers. Beginners will find it the best means of getting started on pleasant, profitable career. Non-technical. Covers theory, practical application of refrigeration in all branches. Diagrams in eight colors. 928 pages. 408 illus. Only \$5.00.

Clip this ad and mail with check, money order, or currency carefully wrapped or we will send COD. Money back if not satisfied.

GOODHEART-WILLCOX CO. Dept. 128, 1321 S. Michigan Ave., Chicago 5

SAY YOU SAW IT IN POPULAR MECHANICS

ENGINEERING DEGREE IN 27 MONTHS

Big Demand for Graduates

Aeronautical, Chemical, Civil, Electrical, Mechanical and Radio Engineering (including Television)

Hundreds of young men are earning engineering degrees in this recognized institution each year—continuous operation. New terms start quarterly. Many students earn a major part of their college expenses in this large industrial center.

Low tuition. Competent instruction. Thorough intense practical program. Modern laboratory facilities including new physics lab. and modernized wind tunnel. Individualized instruction emphasized.

Approved for Veterans. Engineering preparatory courses. Students from 48 states and 21 foreign countries. Enter June, September, December or March. Send coupon for free catalog and full information. Enroll now.

SEND COUPON TODAY

INDIANA TECHNICAL COLLEGE

560 E. Washington Boulevard
Fort Wayne 2, Indiana

Please send me free information on B.S. Engineering Degree in 27 months as checked.

- Aeronautical, Chemical, Civil, Electrical,
 Mechanical, Radio-Television.

Name _____

Address _____



INCREASE YOUR BUSINESS and SOCIAL PRESTIGE

Yes—you too can write like this and improve your business ability and chances for advancement. Just a few minutes a day is all it takes to become an expert penman using C. P. Zaner's **Ornamental Penmanship**—96 pages of instructions, diagrams and illustrations that show how to improve your writing. Send in for your copy of **Ornamental Penmanship** today and begin improving your writing and increasing your business and social prestige. Quantity limited. \$1.50.

POPULAR MECHANICS PRESS, 200 E. Ontario St., Chicago 11, Ill.

FURNITURE for YOUR BEDROOM

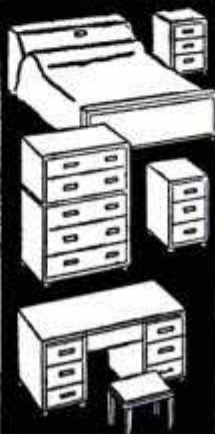

SAVE MONEY, be the envy of your neighbors by making this beautiful bedroom suite yourself! Only a power saw and jointer are needed to turn out this smart suite, featuring bed with storage space, three-piece vanity with cosmetic compartment and makeup mirror, Mr. and Mrs. dresser, and twin night stands with drawers. Letters demanding detailed plans poured in after this furniture was pictured in Popular Mechanics Magazine. Now the 4 plans are ready—easy-to-follow scale drawings—and they're yours for only \$2.00! Send for a complete set today.

POPULAR MECHANICS PRESS
200 EAST ONTARIO STREET, CHICAGO 11, ILL.

Bet You Don't Know This About Advertising

by Susan



Quiz No. 2

How much does it cost per dozen to advertise the well-known brands of oranges? Is it 2¢? 3¢? 5¢ a dozen?

Answer: It costs less than 1/2¢ a dozen to advertise the big-name brands of oranges.

That's only half the story. Advertising lowers your cost two ways:

Cuts the selling costs. And by helping make mass production possible, lowers the production costs, too.

So advertising saves you many times that 1/2¢ per dozen.

"THEY KEEP YOUR FORD ALL FORD"



I WONDER HOW MANY FORD OWNERS KNOW WHAT I LEARNED TODAY.

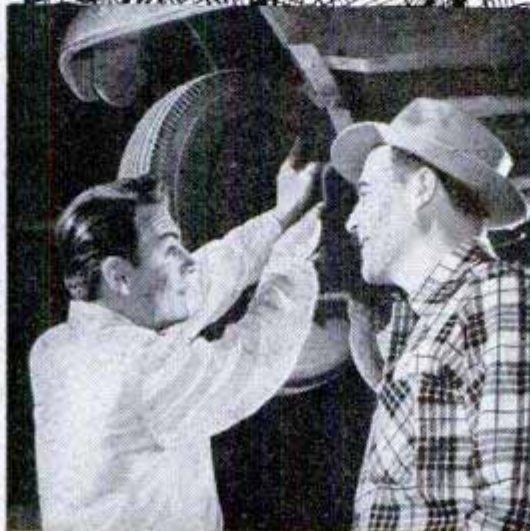

I WAS TALKING TO MY MECHANIC ABOUT THE FINE CARE HE'S BEEN GIVING MY FORD AND DISCOVERED A BIG REASON WHY.



HE TOLD ME HE ALWAYS USES GENUINE FORD PARTS BECAUSE THEY'RE EXACT DUPLICATES OF THE PARTS IN MY CAR.



"THEY'RE MADE RIGHT TO FIT RIGHT TO LAST LONGER," HE TOLD ME. "THEY KEEP YOUR FORD ALL FORD."



"IF ALL FORD OWNERS KNEW HOW MUCH TIME, MONEY AND SATISFACTION THEY GAIN — THEN THEY'D ALWAYS SPECIFY GENUINE FORD PARTS!"

AVAILABLE WHEREVER YOU SEE THIS SIGN AT ALL FORD DEALERS — AND SELECTED INDEPENDENT GARAGES

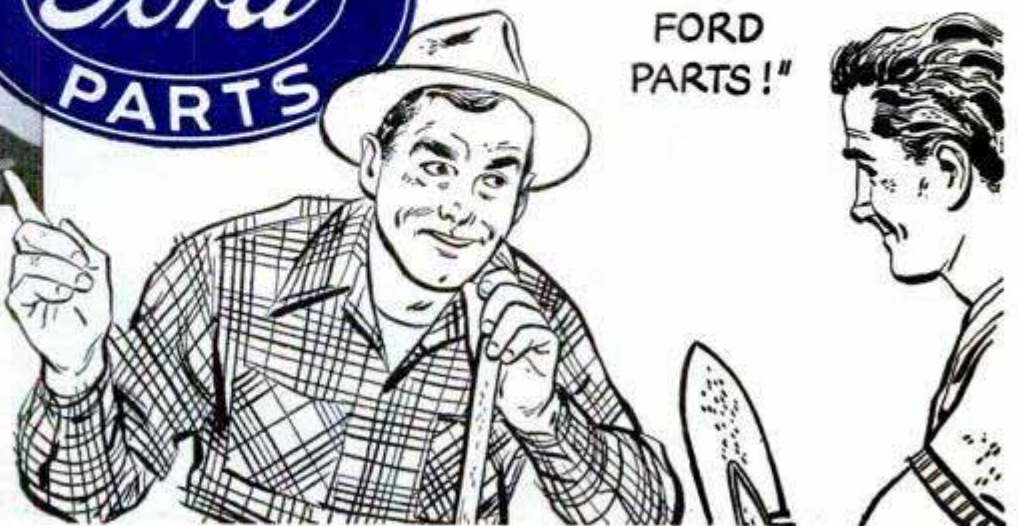

He's riding high
—he has P.A.*

P.A.*

means

Pipe **A**ppeal
and **P**rince **A**lbert

• Yes! He's riding high! He has Pipe Appeal which attracts admiring glances. And he has real smoking pleasure with mild, rich-tasting Prince Albert—America's largest-selling smoking tobacco.

Try P.A.! The choice, crimp cut tobacco used in P.A. is specially treated to insure against tongue bite.

R. J. Reynolds Tob. Co., Winston-Salem, N. C.

IT'S A CINCH, TOO,
TO ROLL FIRM,
NEAT CIGARETTES
WITH CRIMP CUT
PRINCE ALBERT!

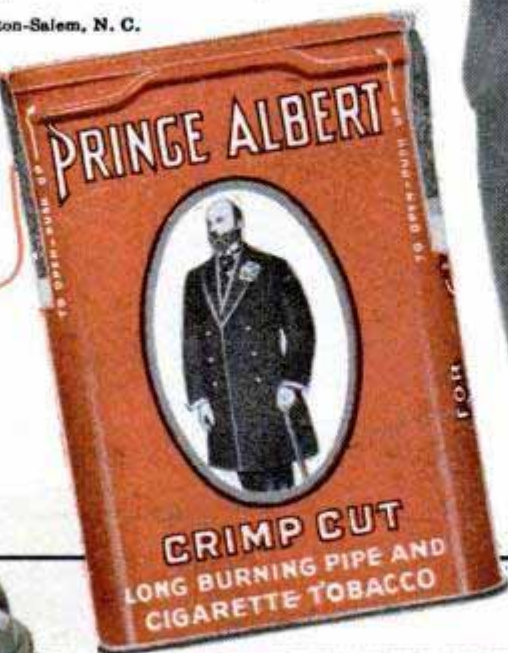

The National Joy Smoke

Sharing a road track not much bigger than a baseball infield is a new class of racing autos with scooter wheels and motorcycle engines—half pint packages of speed!

POPULAR MECHANICS

JUNE 1950

WRITTEN SO YOU CAN UNDERSTAND IT
VOL. 93

NO. 6

*T. Q. Midget
Racing Assoc., Inc.
14543 Longworth
Ave
Norwalk,
Cal.*

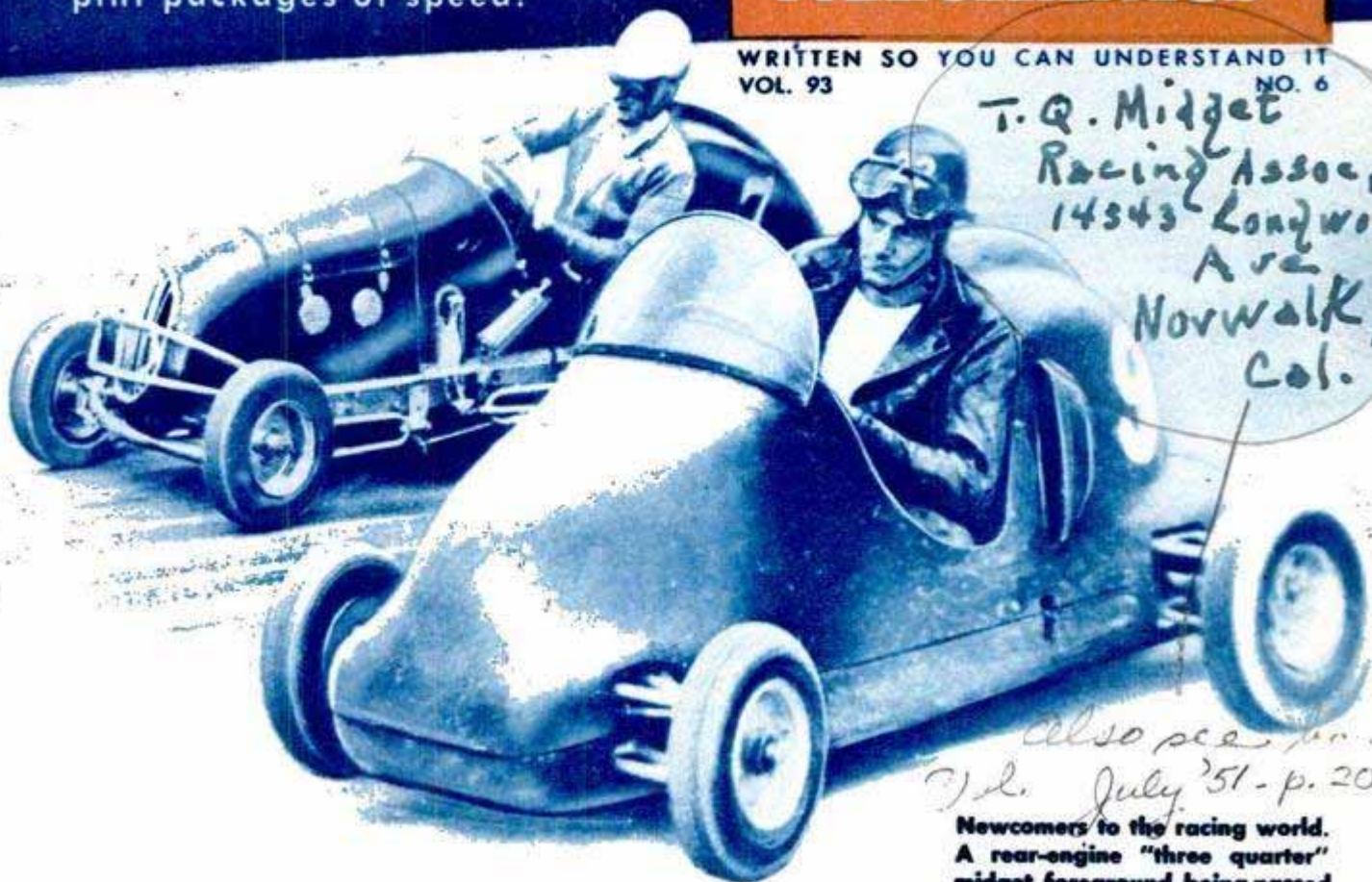

*Also see...
July '51 - p. 201*

Newcomers to the racing world. A rear-engine "three quarter" midget, foreground, being passed on a turn by front-engine job

POPCORN BOWL RACERS

*Midget headquarters
in Chicago.*

MEEET THE newest thing in auto racing—the "three quarter" midget.

These gleaming half-pint creations use motor-scooter wheels and tires. Their frames and rear ends are adapted from Austin and Crosley parts. Most of them are powered with one-cylinder motorcycle engines.

They are so small that the drivers almost need to grease themselves to slide in behind the wheel. Yet some of the bantam-weight speedsters can do a good 100 miles per hour on a straight course.

Three-quarter midgets as a racing class are just getting started on a few Midwest and southern California tracks. No more than a few dozen cars have been built but interest in the design is spreading like wildfire.

With their motors winding up in high-pitched snarls, half a dozen of the little racing machines give spectators

By

Thomas E. Stimson, Jr.

No job for fat men! Drivers almost need grease to slide behind wheel of tiny racers

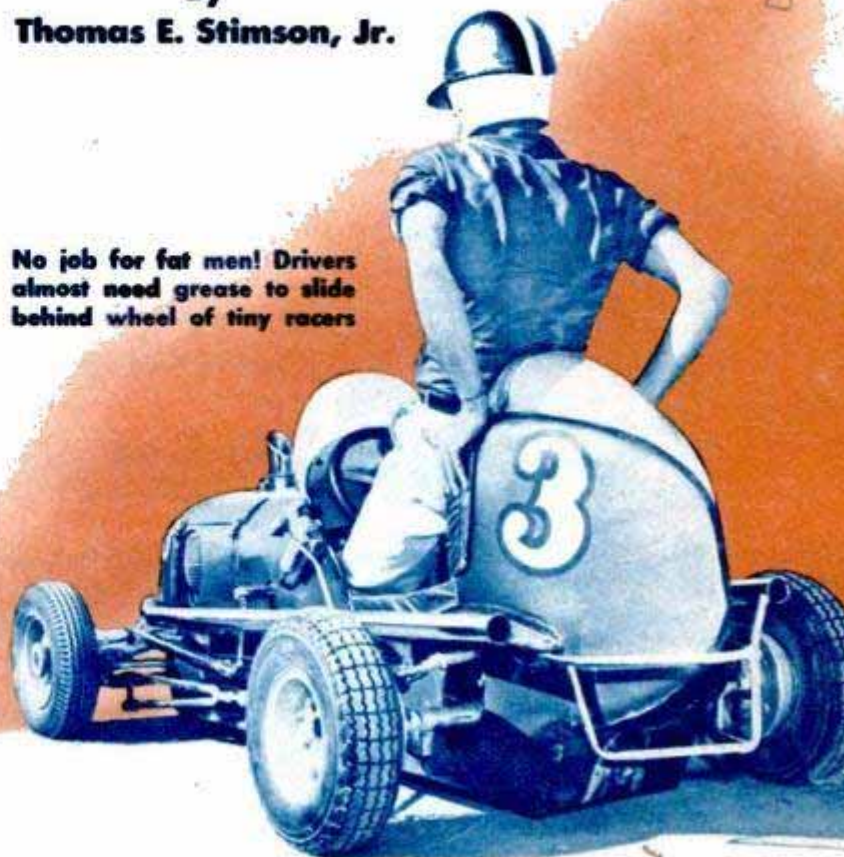

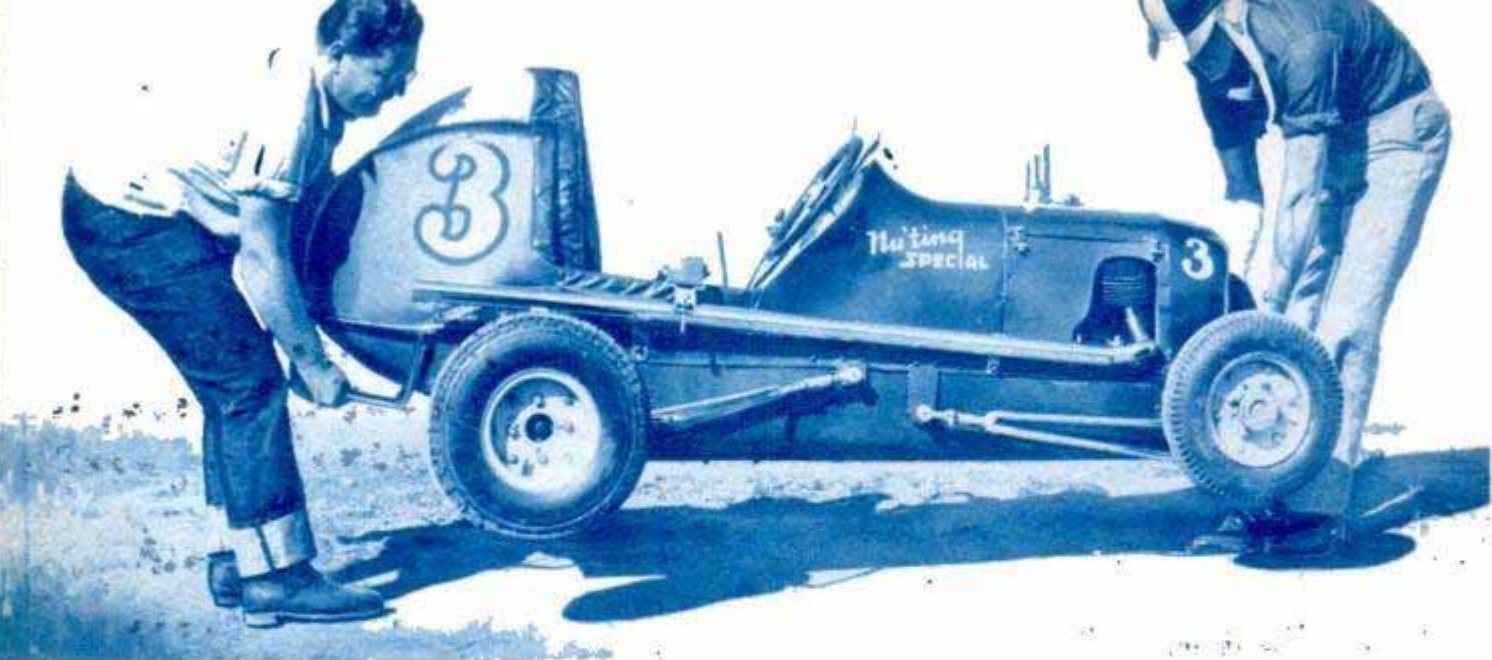

Jacks aren't needed to raise either or both ends of new speedsters. Some cars weigh as little as 350 pounds

a combination of thrills and excitement. They behave much like bigger cars and they provide the action of a motorcycle race on a short track. The three-quarter midgets run on oval or D-shaped tracks that are from $\frac{1}{8}$ to $\frac{1}{6}$ mile long. Their name comes from the fact that they are roughly three quarters the size of a standard midget, though frequently they weigh less than half as much.

All the cars are built in small garages or back yards and probably they always will be, for that's the reason why the T.Q. midget was born.

Many of the three-quarter enthusiasts have wanted to get into big-car racing or into midgets but they haven't been able to afford the cost. Even a midget racer can add up to \$3000 by the time it is tuned to go. Some of the half pints, on the other hand, have been built for \$350, plus the owner's labor. One driver invested \$600 in his car and the trailer on which it is hauled to the track. The most expensive one built to date cost less than \$1500.

To prevent the building of costly motors, powerful enough to run rings around the competition, the ruling association has decreed that every race is a claiming race and that any offer of \$2000 for a car must be accepted by its owner. In the three-quarter midget class, the back-yard builder is king.

That doesn't mean that junk parts can be used or that the cars are tied together with baling wire. Safety rules and inspections, pride of ownership and the normal desire to produce a winning car all insure good sturdy workmanship.

The midgets had their beginning back in 1932, according to one widely accepted version, when Al Williams of Fresno, Calif., built an electric sidewalk car for his child.

Other fathers in the neighborhood built similar scooters for their children, mostly with tiny gasoline engines as power plants. Week ends, the fathers took over the cars and held impromptu races. Some of the owners souped up their engines and eventually the cars grew up into what became the standard midget class.

Many of the original group served in the war and when they got out of uniform they found that the midgets were becoming too expensive for a casual hobby. They returned to the original sidewalk cars. Small power plants were replaced by motorcycle engines, chain drives gave way to drive shafts, and the present T.Q. midget began to shape up.

Today, the rules of the Three Quarter Midget Racing Association specify that the wheelbase must be between 54 and 60 inches, tread from 32 to 40 inches, wheels from 6 to 9 inches in diameter, weight from 350 to 650 pounds, and engine from 30.50 to 45 cubic inches, depending on type. All competition cars must have certain safety equipment that includes firewall, positive neutral, flex-type steering wheel, and a tail that extends beyond the rear wheels. Much of the rest of the design and its construction is left to the ingenuity of the different builders.

To learn what ideas are being tried out, let's examine a few of the present cars. Cecil Buck, deputy sheriff of Norwalk, Calif., put his car together in about five months, working from two to four hours a day and using standard mechanic's tools, plus a welding outfit. Machine work was farmed out.

The frame channels of Buck's three-quarter midget came from an Austin. So did the springs. Front axle and rear end were cut down from the same small car.

Wheels and tires are from two models of motor scooters. Steering is a reworked Franklin steering assembly that moves the front wheels hard over with a quarter turn of the steering wheel.

The engine is a 45-cubic-inch Scout motorcycle engine, with a carburetor from a six-cylinder automobile engine. Two gallons of methanol fuel are carried in a four-gallon tank and a hand air pump is used to force the fuel to the engine. Battery ignition is used and the racer is started by being pushed by a truck. A standard midget gearbox is used with an "in and out" shift stick in place of a clutch.

Buck built the body by cutting down stock shapes from stock automobiles. The front grille comes from a pick-up truck, the tail was welded together from parts of late-model fenders and is capped by a streamlined headrest that once was the fairing behind a Cadillac headlight. The side panels and hood were shaped from metal sheets. The car weighs 425 pounds.

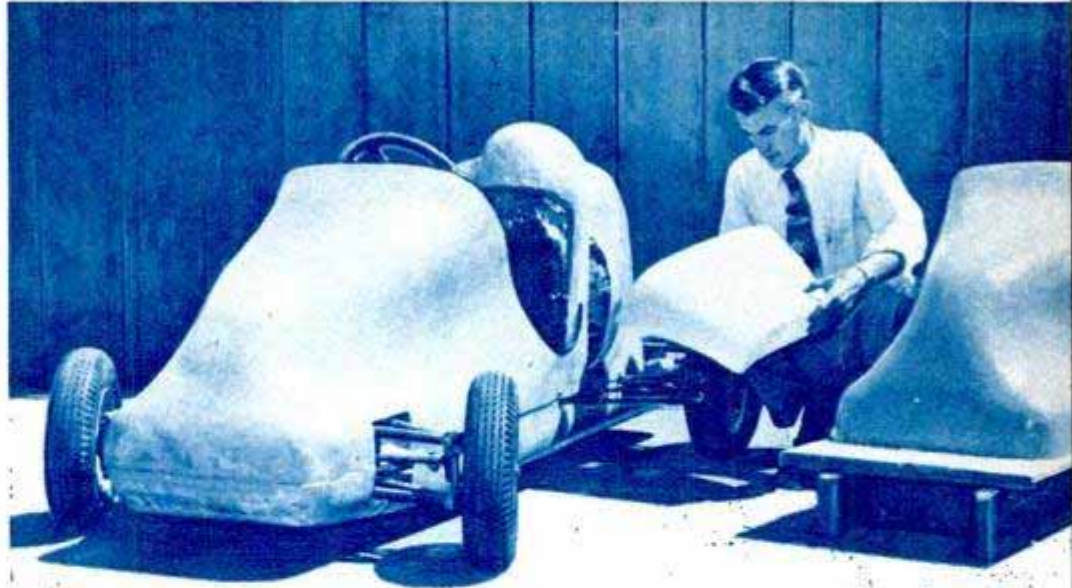

Homemade laminated plastic body. At right is mold over which laminates were fitted. Body was sun-cured, without an oven or pressure equipment

Among the lightest jobs built so far are a pair of rear-engine cars with plastic bodies. They were designed and built by Bob Feuerhelm of Pasadena. Each weighs 350 pounds, has a welded tubular-steel frame and is powered by a 30.50-cubic-inch motorcycle engine that develops 42 horsepower. The engine is in the rear, driver's seat in the center and fuel is carried in front.

Rear-engine midget, with a spring system on each wheel that absorbs four-inch bumps without raising car

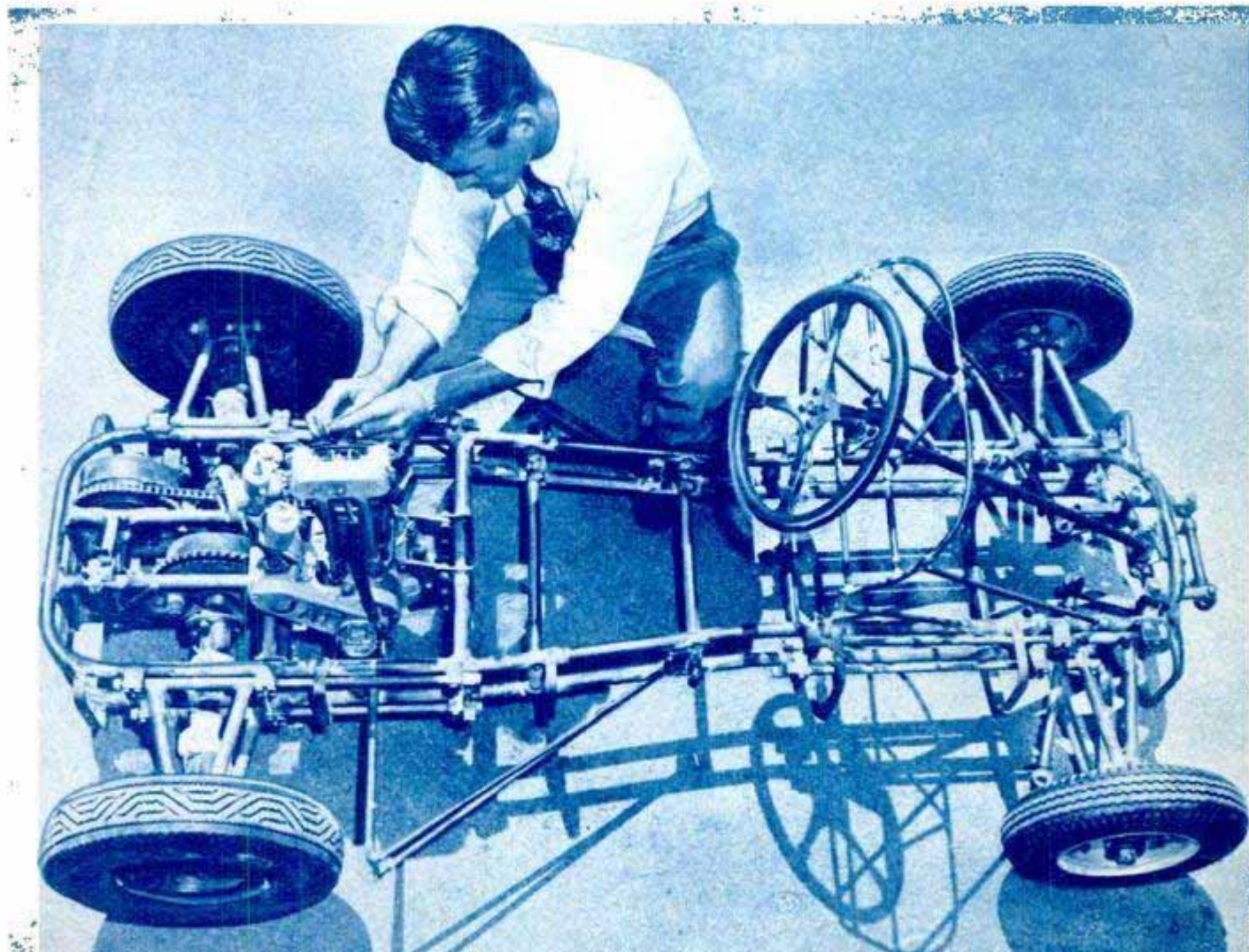

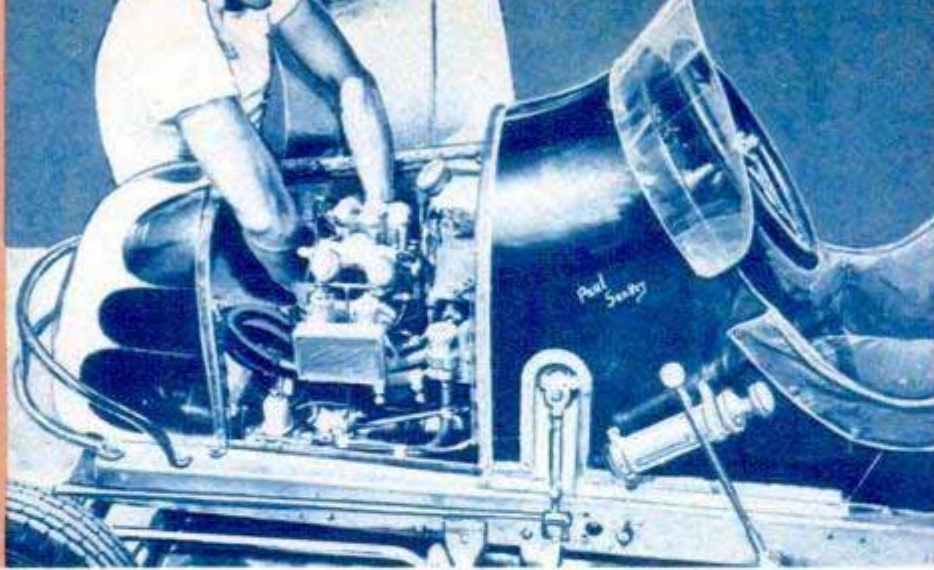

With a motorcycle engine, a cut-down stock-car body and motor-scooter wheels, this car built by a Redondo Beach, Calif., man can circle a 1/5-mile track in about 15 seconds

A motorcycle clutch is installed and is used to help bring the car out of a spin, and a motorcycle brake-drum assembly serves for positively locking both rear wheels. A unique torsion-bar springing system on each wheel permits the wheels to take four-inch bumps without raising the car and without spreading the wheels from the vertical.

Each rear axle has two universal joints. The front spindles were cut down from old Model-T parts and the cars have a new design of direct-type steering, with a 1-to-1 steering ratio.

To reduce the cost of the bodies, Feuerhelm shaped wooden molds to the desired contours and made his own laminated-plastic body parts, using the sun-cure method that requires no oven or pressure equipment. The plastic shapes, including the long pan under the car, are bolted to the frame. Fuel tanks also are of laminated plastic, the expectation being that this material will be unaffected by the vibrations that often start leaks in metal tanks.

Other owners put bodies together by

buying old castoff race-car bodies and cutting them down to size. Instead of a motorcycle engine, one owner is reported to be using a surplus opposed-piston gasoline engine that was once used to open the bomb-bay doors of a bomber. Still another cut a four-cylinder Crosley engine in half and is using only two of the cylinders, with a special cam. The compression ratio was raised to 17 to 1.

Small outboard motors also are being used. Instead of motor-scooter wheels, some owners are using bomber tail wheels, removing the center strip of the wheel to narrow the tread.

Harley Camomile, a Redondo Beach, Calif., enthusiast, has a 530-pound job powered with a 30.50 Triumph, equipped with dual carburetion and an electrically operated fuel pump. The car has hydraulic brakes on the rear wheels, a cut-down Kurtis front axle, a cut-down midget quick-change rear end, reworked Franklin steering, leaf springs, motor-scooter wheels and a cut-down midget body.

These examples all suggest that the sky

Started by a push from a larger car, this midget is just gaining speed and temporarily burning a heavy mixture of methanol



High tail and headrest provide some measure of safety for the driver in case of a roll-over



is the limit as far as new ideas are concerned. No two of the half-pint racers are exactly alike. No one yet knows what is needed to produce a consistent winner. The most powerful engines will deliver the most speed in the stretches, the lightest cars will have less trouble in the turns.

Much of the racing was on an amateur basis in the past, with the drivers competing for the fun of it and with spectators invited free. Now, with experience behind them, virtually all drivers are racing for purses and spectators are charged admission fees from which the purses are taken. If the three-quarter midgets prove to be as popular as their enthusiasts expect, area circuits will be established with one track in each of seven towns. If there is money in it, owners will enter their cars every night of the week.

Winter racing on indoor tracks in auditoriums, bomber hangars and skating rinks, the enthusiasts believe, will make the three-quarter midgets as popular during winter months as the larger race cars are during the summer months. And they offer added thrills for the sportsman who likes to watch exciting speedway duels "close up."

JUNE 1950

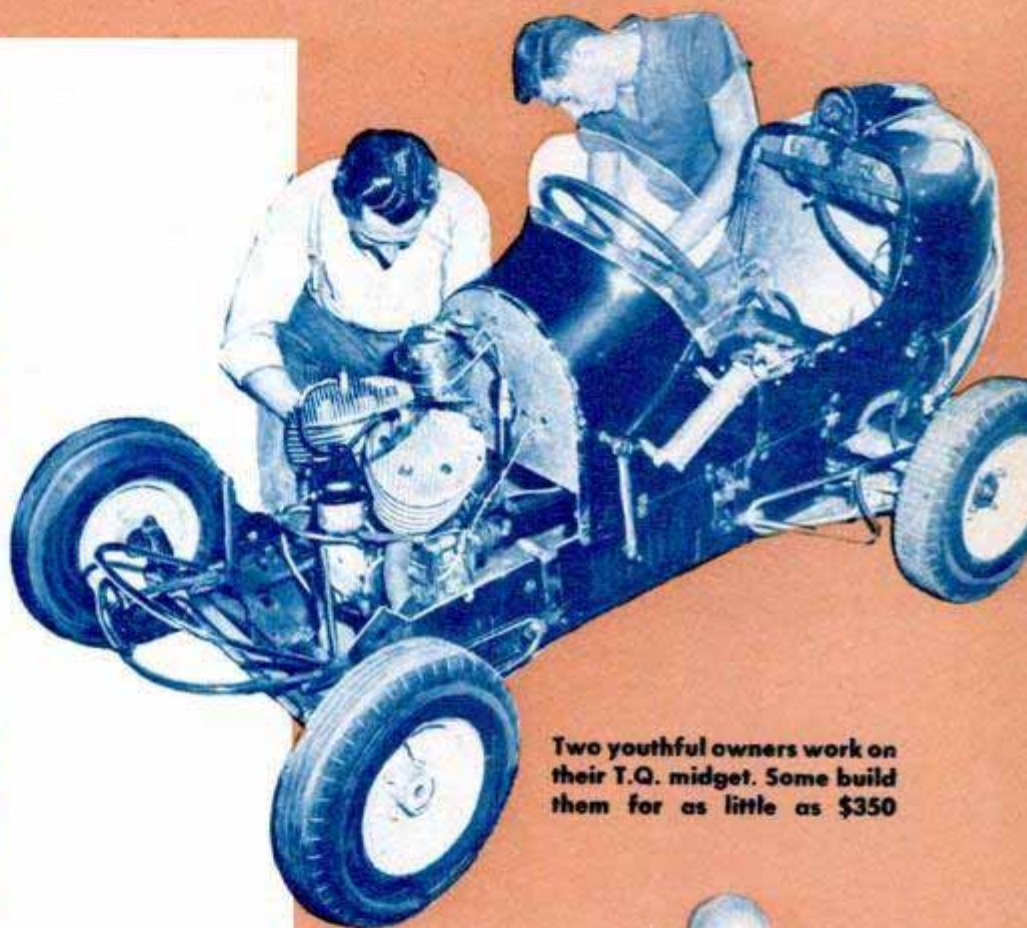

Two youthful owners work on their T.Q. midget. Some build them for as little as \$350

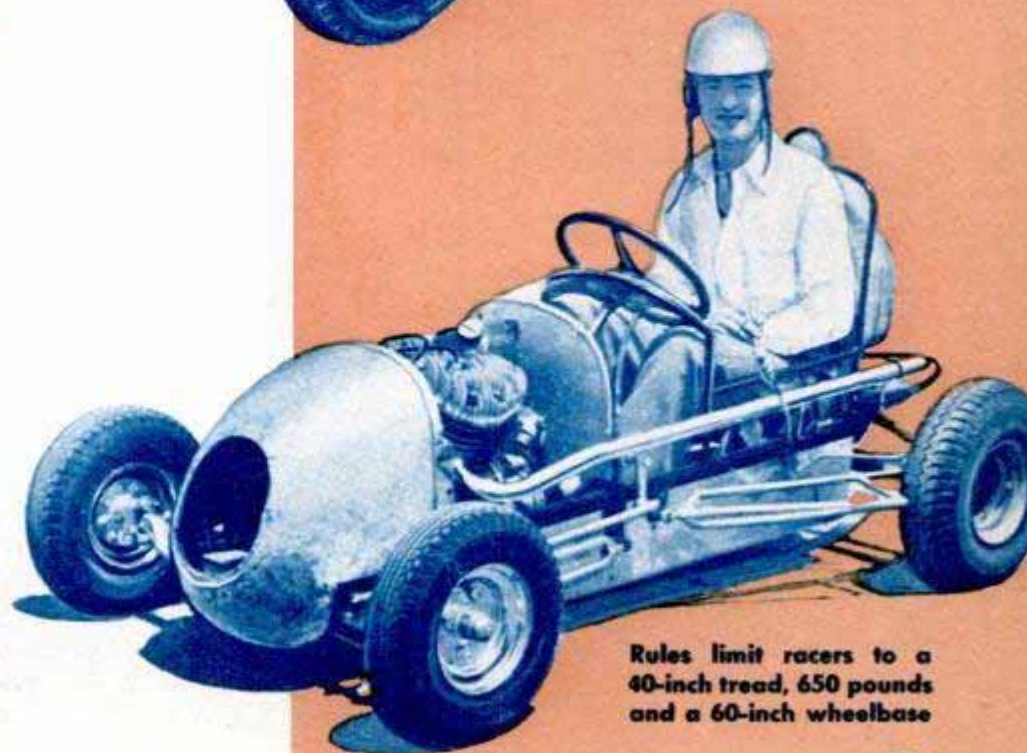

Rules limit racers to a 40-inch tread, 650 pounds and a 60-inch wheelbase

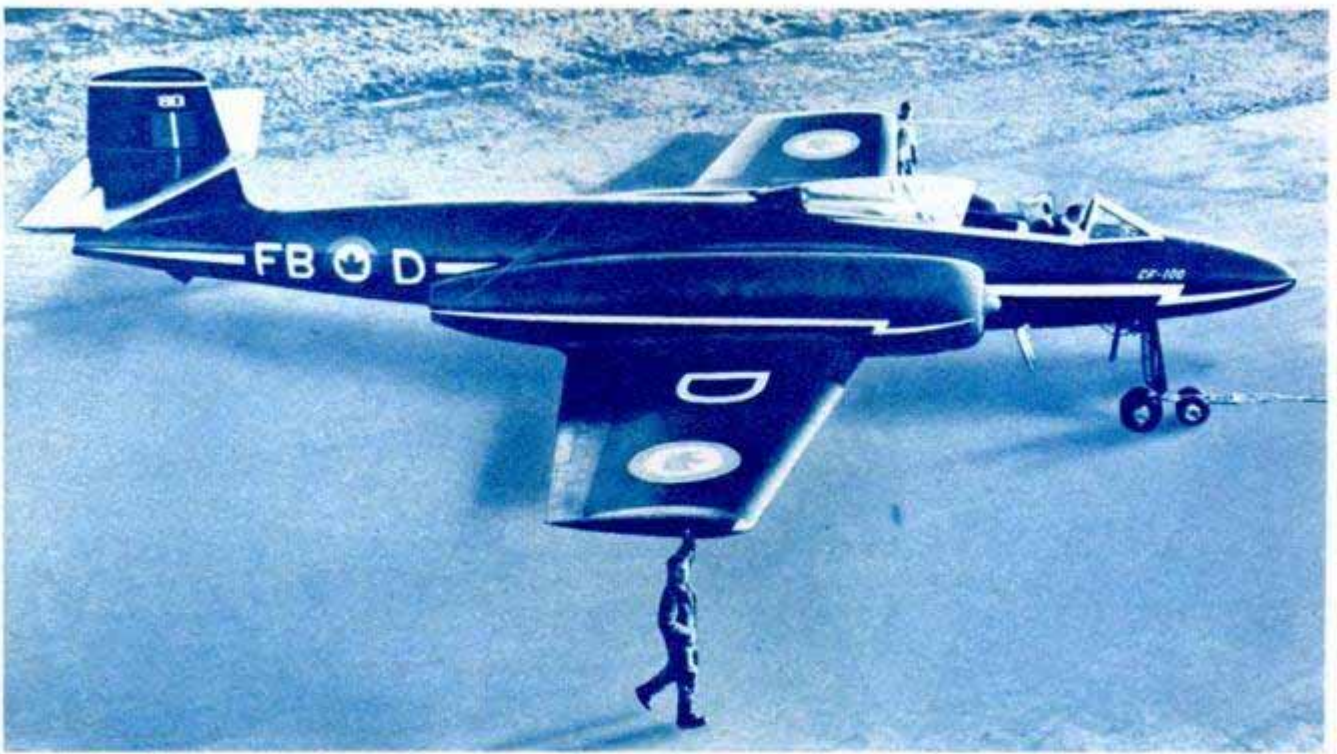

Canadian All-Weather Fighter

Designed specifically to fill Canada's defensive needs for a long-range, all-weather fighter, the new Avro CF-100 is expected to have a speed well over 600 miles an hour.

Fitted with a tricycle undercarriage, the plane is powered by two jet engines and is approximately 52 feet in length and wingspan. The craft carries a pilot and a second crewman to operate extensive radar and navigation equipment from the rear seat.



Prince's Weapon Is a Camera-Gun

When Prince Hanwant Singh, young maharajah of Jodhpur in India, goes hunting pictures, he is armed with a specially designed camera-gun that assures steady aiming. Designed to take various telescopic lenses, the rifle-butted camera brings distant subjects up close. The telescopic sight permits exact aiming on subjects a half mile away.

Arc Welder Charges Battery

Automobile batteries are charged quickly with a rectifier that plugs into a low-cost home arc welder, providing the owner with a double-duty tool. The arc welder, designed to operate on a standard house circuit, is used in small garages, service stations and home workshops for welding, soldering, brazing, cutting and heating metals. With the adapter, the owner can use the welder to restore a dead battery to operating condition overnight.

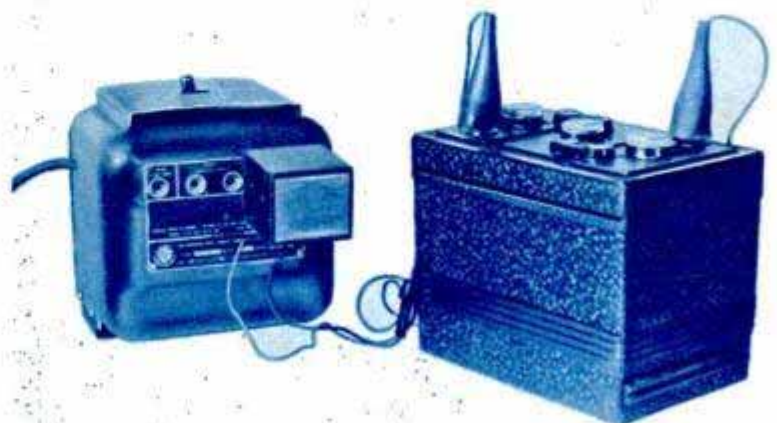

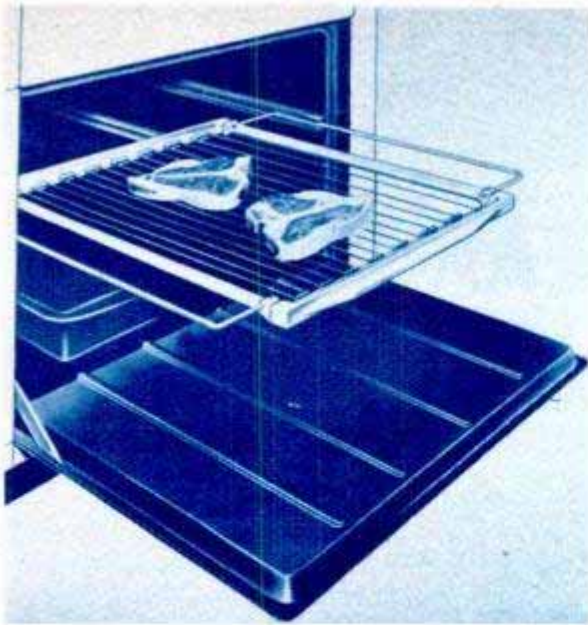

Broiler's Case Serves As Table

When a new charcoal broiler is set up for an outdoor feast, the carrying case doubles as a serving or preparing table. After the meal, the broiler is disassembled and packed into the case to form a unit weigh-

ing only 25 pounds. The rack for the broiler is made of stainless-steel wire, which can be cleaned by simply wiping it with a cloth or paper towel. When used separately, the rack can be adjusted easily to fit the oven in a kitchen stove for broiling meat and other foods.



On-The-Scene Movie Titler

Movie photographers can label their shots as they make them with a pocket-size accessory that slips over the lens like an elongated sunshade. A frosted-glass "slate," on which you jot down identification data, slips into a holder at one end of the titler. There is a lens in the titler, enabling the camera to photograph the title in sharp focus with its lens set at infinity. No additional light is necessary, the light used to illuminate the scene being sufficient. The penciled titles wipe off the glass easily so it is possible to use the small "slate" over and over again.



Paint Thickness Gauge

By the use of magnetic force, a precision gauge measures the thickness of coatings such as paint, enamel and platings on metal. A spring inside the gauge barrel applies an upward pressure on a permanent magnet, a pressure that can be varied by turning the micrometer thimble. When the spring tension is just strong enough to pull the magnet away from the surface, the operator takes a reading on the micrometer scale. This reading, when compared with one taken on uncoated metal of the same quality, provides an accurate measure of the coating thickness.



Dead trees like this one make fine wooden Indians because the wood is thoroughly dry. Below, Suzanne Silvercruys, the noted sculptress, inspects one of Robertson's masterpieces while still in the rough



HEAP BIG WOODEN INDIAN

BACK IN 1919, a four-year-old boy, whopper-jawed with a stick of peppermint candy, sauntered down Main Street in Boise, Idaho. Boy met Indian. Indian looked fierce. Boy yelled for father.

When the father rapped on the Indian's stomach to prove the redman was only so much wood, the boy wailed:

"But he's ugly. He scared me."

Because of this boyhood memory, Thayne Robertson, now 34 and busy sculpturing new wooden Indians, believes he knows why an art—as American as plug tobacco—faded from the national scene. More important, he also believes he knows how it can be brought back.

Any reader who is 35 or more can no doubt remember seeing a wooden Indian. There were once unnumbered thousands of them scattered throughout the United States. No self-respecting cigar store was considered ready for business until a gaudily colored Indian had been rolled out front. Today it is a long jaunt between towns with a wooden Indian.

Several years ago a tobacco company conducted a survey, and found 607 wooden Indians still on active duty in the United States. There are probably only about half that number now. Add a few hundred more tree-stump Indians in museums and private collections, and you have the last of the wooden ones rounded up. What caused the vanishing? Robertson thinks it was because they were too ugly.

He became interested in life-size wooden Indians a couple of years ago, and now carves them along with artistic pipes in his Boise shop.

Robertson has spent many hours studying Indians on their Idaho reservations. He draws detailed sketches of body and facial characteristics, then faithfully reproduces them with chisel on wood. It's good business, too. A new, life-size, wooden Indian brings from \$1000 to \$1500, and the market is booming. Robertson now has enough orders to keep him busy for the next two years. He isn't worried about competition

in the Indian-sculpturing field because it's an art that takes a lot of learning, and is a hard one. Most important is finding the right tree. It must be dead—for about a quarter century. But it must have no decay. Just dry as a desert-rat's throat. The actual sculpturing takes about four months.

Working from a pen-and-ink sketch, Robertson first blocks out the log in major body parts with an ax. Then comes the chisel. As the Indian begins to take definite form, finer carving tools are used. The wrong chipping can ruin many weeks of hard work.

To stay sleek and healthy, a wooden Indian must be well-oiled at all times. So Robertson has revived an old trick of the ancient wood carvers. He bores a hole down through the top of the head and into the trunk as far as possible. The hole is then filled with linseed oil.

Painting of the wooden Indians — four coats — is not done by Robertson himself. He leaves that specialized task to Bill Runyan of Burley, Idaho, himself a carver who comes from a long line of French wood artists. Rightly painted and oiled, the wooden Indian will outlast any live one.

Wooden Indian carving is generally considered an American art, but it really started in England, says Robertson. At the start of the 17th century, wooden Indians were a common sight in London. Only the British artisans were a little mixed up on the shade of American Indians. They made them as dark as Negroes, and for 200 years the figures were generally referred to as "black boys."

They were used to adorn apothecary shops.

(Continued to page 230)

JUNE 1950

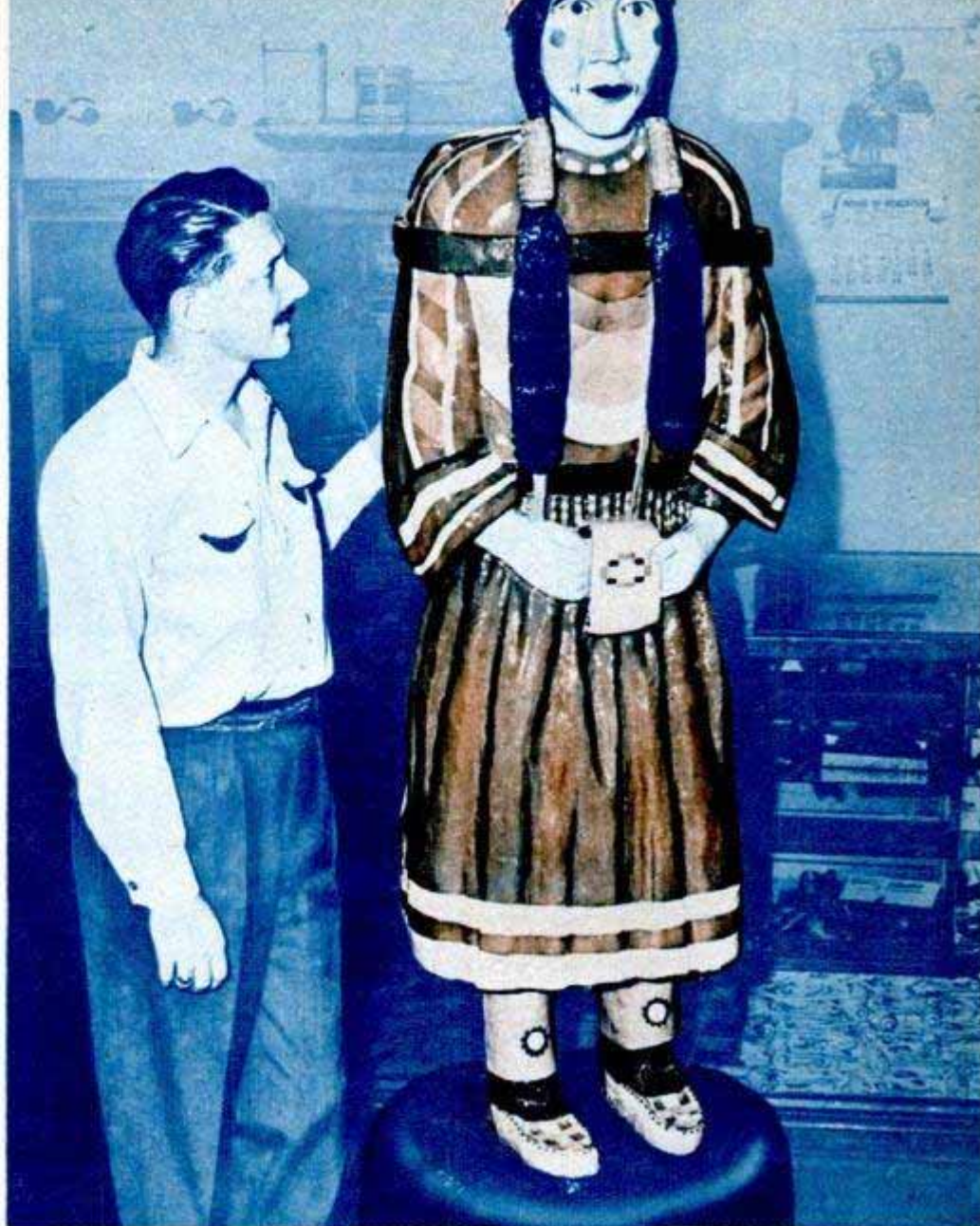

Robertson poses beside Sacajawea, squaw heroine of the Northwest, who is authentic from moccasins to a papoose on her back. The same figure is shown below before paint was applied. Robertson contends that wooden Indians went out of style because the old-fashioned ones were too ugly

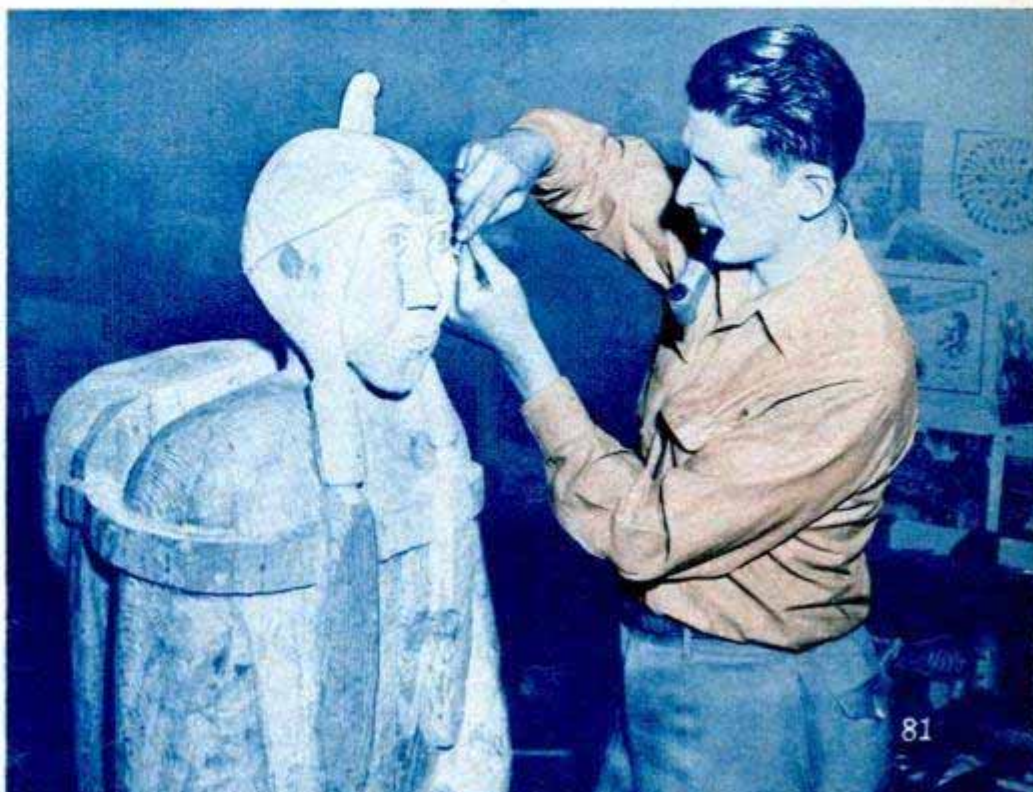

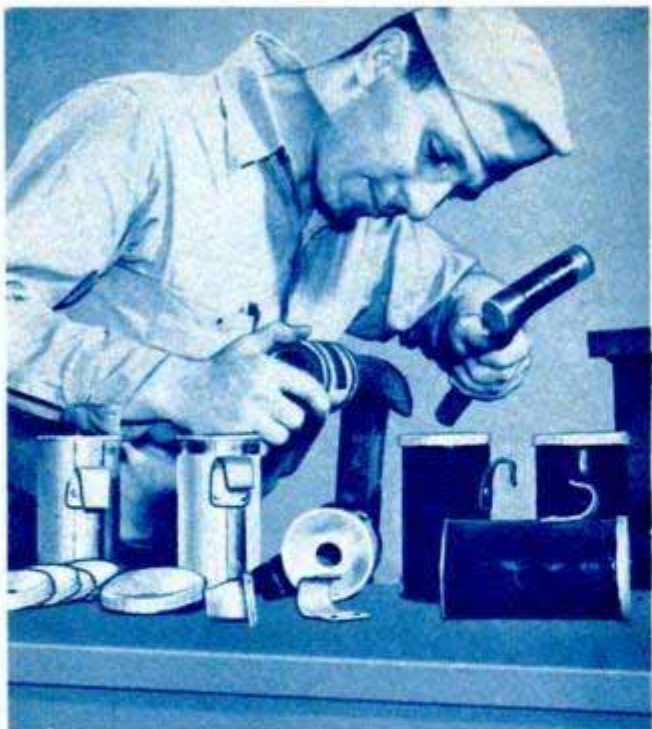

U. S. Air Force photo

Ash Trays From Beer Cans

When he discovered that his squadron's cargo-passenger plane had been stripped of ash trays by souvenir-hunting travelers, Chief Dan Baffari of the Navy went to work with a hammer on several beer cans. He came up with a big stack of attractive ash trays that cost only a few cents apiece. The trays have metal hooks which clamp over the ribs of the passenger compartment, holding them conveniently and securely in place. The tops have flared cigarette rests and the trays are painted with shiny fire-resistant paint.

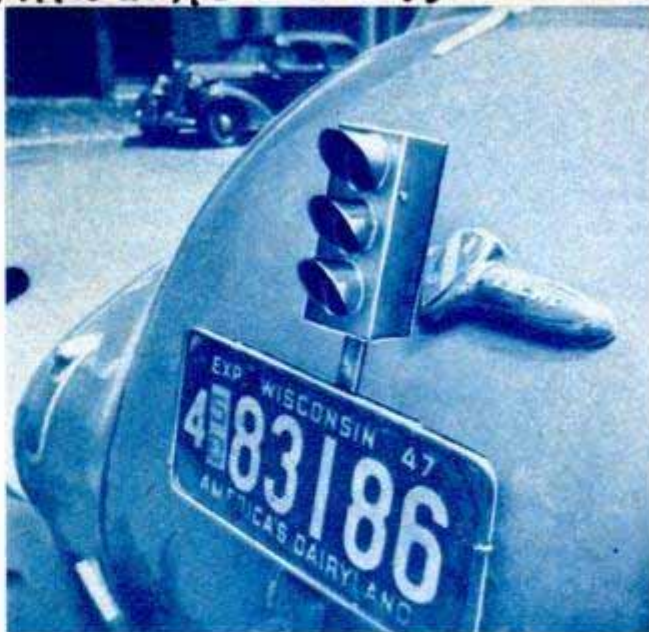

Three-Color Stop Light Signals Driver's Action

Motorists following a car equipped with a three-color stop light know exactly what the driver ahead is doing. When the car is moving forward normally, the green light is on. As the driver applies the brakes, an amber light operates, warning the following driver that the car is slowing down. When the car slows down below 10 miles an hour, these two lights go off and a bright-red light appears. As soon as the car accelerates again, the green light goes back on. The lights work automatically and are housed in a box that looks like a standard traffic light. Only two wires are required for installation.



Turbojet Heater

Hot air blasts out of a new turbojet engine to warm orchards during frosty weather. One of the units will heat 10 acres, according to the inventor, and replaces 500 smudge pots. The turbojet burns about \$2 worth of diesel fuel per hour, whereas fuel oil for the smudge pots costs about \$35. Within three seconds, the unit develops heat to 1000 degrees, but the hot air is mixed with the cold to make it safe for the operator to stand within three feet of the jet's exhaust. The unit weighs 600 pounds.

Popular Mechanics provides two sources of further information concerning articles published in each issue: the WHERE-TO-BUY-IT INDEX, starting on page 10, and the WHERE-TO-FIND-IT LIST, available from Bureau of Information, 200 East Ontario Street, Chicago 11



Single-Lens Camera Uses Reflex Principle

Composing, focusing and picture-taking are all accomplished through one lens of a new miniature camera that uses the single-lens reflex principle. Without increasing the convenient size of the miniature, the new design enables the photographer to focus with a brilliant, full-size image on a ground glass while holding the camera at eye level. A reflecting mirror throws the image on the ground-glass screen and it is "bent" and enlarged by a complex prism and lens system to give a greatly enlarged, upright image. Another innovation is a built-in flash synchronizer for the focal-plane shutter with the contact located inside the tripod socket for quick attachment of the flash gun. The combination lens eliminates all parallax problems whether standard, wide-angle or telephoto lenses are used.

Incense Wafts From Ash Tray When Cigarette Is Placed Inside

Cigarette smoke becomes incense inside a novel ash tray. The tray is shaped like a barbecue pit with a chimney which gives off the smoke. A tube inside the chimney contains a wick which soaks up any household deodorant or a special fluid which smells like incense. When the cigarette is placed on the grill, the smoke passes the wick and then spirals up through the chimney to emerge either odorless or with the odor of incense. A removable tray beneath the grill catches the ashes, and two compartments hold cigarettes and matches.

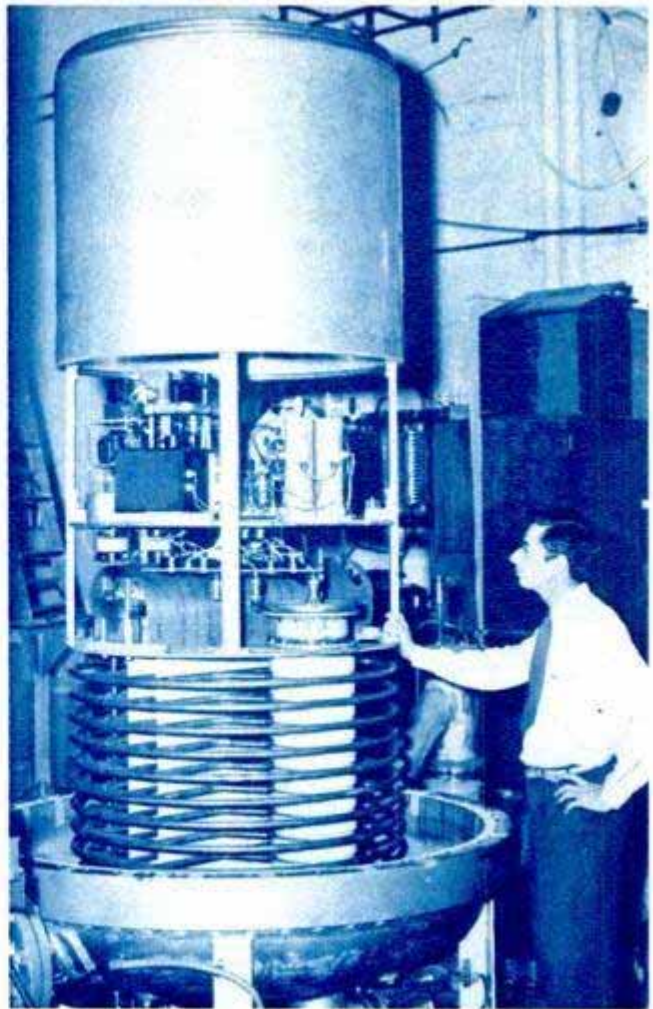

Atom-Smasher Analyzes Smog

As little as a billionth of an ounce of matter can be analyzed by an atom-smashing technique used to study Los Angeles smog. Developed by Stanford Research Institute scientists, the technique uses a half-million-volt electrostatic generator. By bombarding samples of smog, the physicists can detect and analyze layers of material only one molecule in thickness for the elements it contains. Targets of the material are bombarded by a stream of ions, which are scattered and then analyzed by an ion detector. Various elements present in the samples are then readily detected.





In a classroom built by Nature, a student and a professor sit on a stump "desk" and straighten out a point in the day's lesson

College in

By Rafe Gibbs

THERE is a certain type of young man whose elbows get crowded in the ordinary college classroom. He is the student who likes a ceiling of cumulus clouds, walls of pines, desks of fallen logs and blackboards of granite on a mountainside. He'd feel right at home at the University of Idaho forestry summer camp.

Couched on the east shore of Payette

Lakes near McCall, Idaho, the camp is as uncollegiate as caked boots, but the students enrolled in the School of Forestry are enthusiastic. They attend the camp between their sophomore and junior years, and after eight weeks there they've definitely decided whether or not they want to carve careers in the woods.

"The camp seems to separate the men from the boys," commented Prof. Everett Ellis, director, "and it's always gratifying to find that most of the students are men."

Checking one cold morning on a crew that was running a road survey through a swamp, Ellis found a student holding a tape as he stood in water up to his shoulders.

"He was whistling," said Ellis, "but his teeth were chattering."

It was the same swamp through which



Using forestry instruments, two students figure the height of trees in a stand of timber

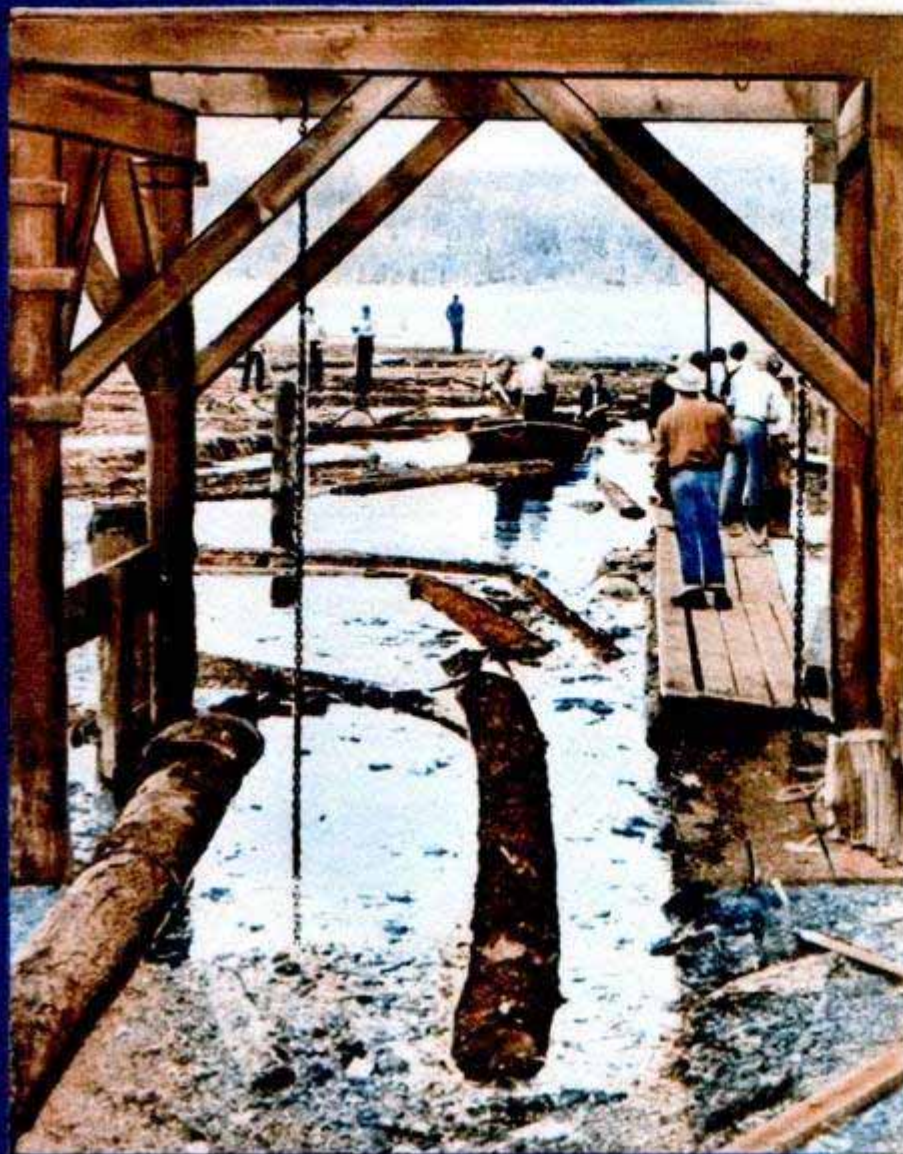

Agile collegians tread floating logs in estimating the number of board feet in a millpond

the Tall Timber

actors portraying Rogers' Rangers waded in the filming of "Northwest Passage." Only difference was that the thespians drew big salaries for the assignment. For the students, getting wet is just part of the course.

Field work is not called off unless it is raining so hard students can't take notes.

"Okinawa was never like this," commented one student.

On the millpond of the Brown Tie and Lumber Company in McCall, the students walk logs, and there are always a few "flunkers" who lose their precarious footing and go spinning into the water. An old-time millworker, watching the students, spat reflectively in the pond and snorted, "Darned if I don't think them kids like getting wet."

They do. After class in the evening, some

too big and too hot to handle."

Besides learning fire-fighting technique, the students get some instructions in detecting causes. When the camp ended last summer, Professor Ellis was still chiding the students about a slip-up in the early part of the camp session.

Fire was started in some brush for instructional purposes, and the student fire-fighters came dashing up fast enough to put it out. But their investigations for cause bore no fruit.

Finally, Professor Ellis, who had been puffing a big black cigar all over camp that morning, roared:

"Where's my cigar?"

A prodding of ashes soon supplied the answer.

Probably the most embarrassed students,

of the students—the better swimmers—try riding the white water of the Payette River in rubber life rafts. So far, two have made it without getting dunked. As they reached calm water, they leaped overboard.

From water, the students sometimes turn to fire. Under a cooperative agreement with the U. S. Forest Service and the Southern Idaho Timber Protective Association, the students form emergency crews to be called out—on a paid basis—when fire comes to the forest. Fire-fighting technique is about the first instruction given the students at the opening of camp, and for the rest of the summer they stand ready to use their knowledge. It is a rare summer, too, in which they are not called out.

The students observe first-hand the use of today's parachute jumpers in fighting fires, as the Forest Service's smoke-jumper school is just up the road.

"The point we emphasize to our future foresters," said Prof. Merrill E. Deters, "is getting to a fire early—before it gets



You can't hold a group of college students down. After a bout with the accordion they'll chop the wood for the next morning's fire

however, were the ones the preceding summer who followed their eyes instead of their forester's instruments. Building a campfire out in the woods, which was in theory a forest fire, Professor Ellis supplied the students with azimuth and distance to the fire. Then crews were sent out at intervals of 15 minutes to find the fire by use of compass and pacing count. Most of the crews made it in about 45 minutes, but one crew took more than three hours.

"What held you up?" Ellis wanted to know, and got some grins.

"Well, you see, it was this way," ex-

plained a spokesman. "We had no more than started out when we spotted smoke. We just forgot about the directions and followed the smoke. Only it wasn't from your fire . . ."

Here the speaker paused to wince. "It came from a Girl Scout camp."

This explanation was a rarity, for foresters—even students—seldom admit getting lost in the woods. Most popular alibi: "I fell in a creek, and had to dry my clothes."

Then there is the story of Prof. Ernest Wohletz, who for many years directed the camp and is noted for his punctuality. He showed up late for a critique, and explained:

"I was checking a cruising crew when I came to a patch of huckleberries. In the center, feeding his face, was an oversize black bear. Now, I had no intention of disturbing the bear's dinner, but he thought I did. He started my way and I began to detour. Every time I heard a noise in the brush I detoured more. I've been detouring, as a matter of fact, all morning."

The students get well acquainted with a variety of wildlife during the eight weeks of the camp. On week ends, many take off into Idaho's famed Primitive Area. There they catch glimpses of mule and white-tail deer, elk and mountain goats. The fishing-minded seek out streams, and Monday breakfasts usually include fresh trout.

Scholars of the tall timber absorb a lesson in modern milling as a big saw rips the logs into lumber

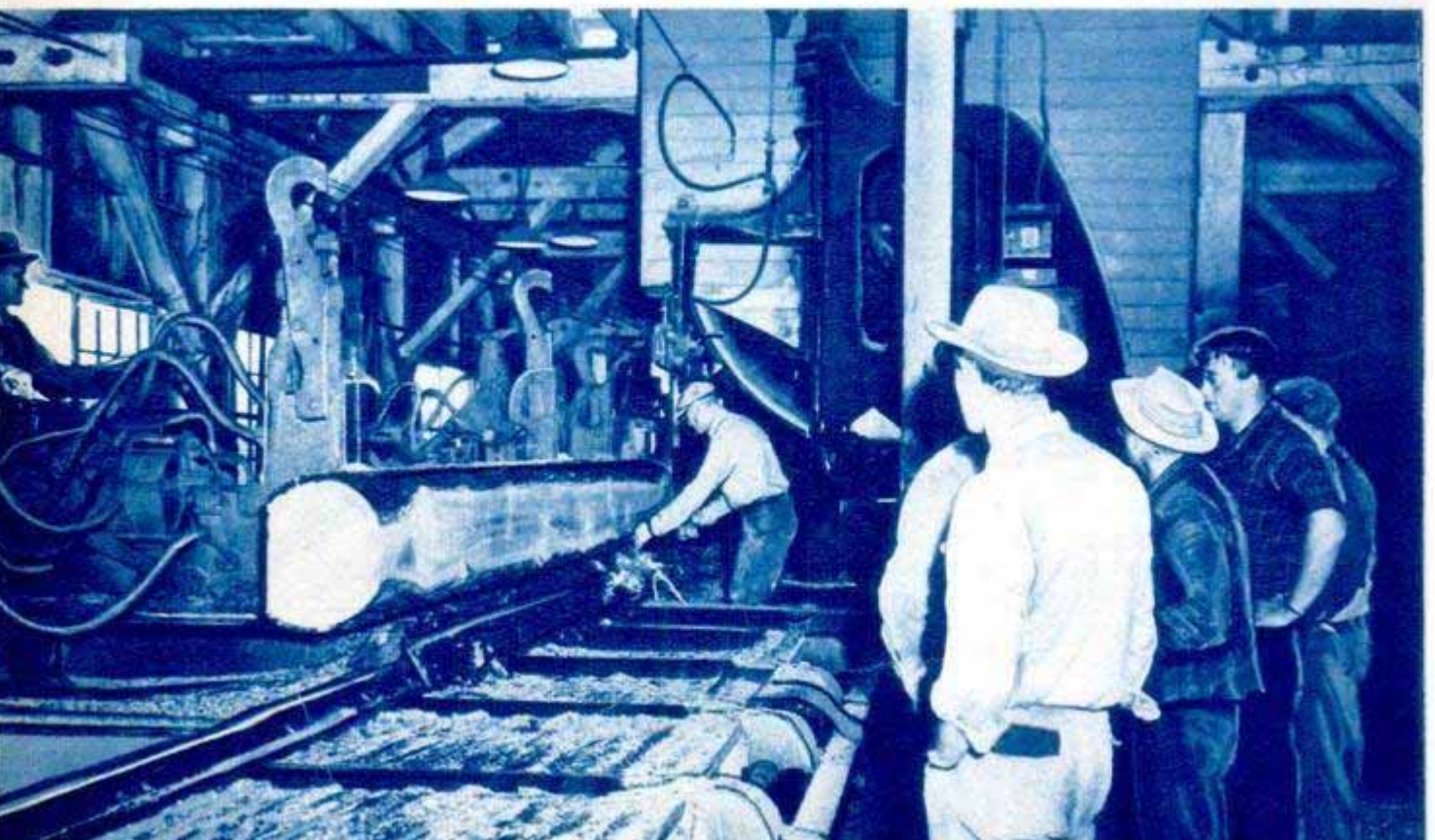

Don't get the idea, however, that the camp is a vacation spot. Some students vacation — before the camp opens. And you can't blame them.

Nature endowed the shores of Payette Lakes with an abundance of towering evergreens, and the camp site was personally selected by Dean D. S. Jeffers of the University of Idaho School of Forestry. The students live in tents. In the center of the camp is a log lodge that blends with the beauty of its surroundings.

"Professor Wohletz hand-picked every log in it—except one," says Dean Jeffers. "That's the log which is cracked."

But the camp is mostly a setting for work. The students hit the wood floors of their tents at 6:40 a.m. Breakfast is at 7. Field work and lecture classes begin at 8 and sometimes do not end until 9 p.m. Then come study hours. Along toward midnight—just before bedtime—the students go out and chop the next day's supply of firewood.

Even in midsummer, mornings are nippy at the 5000-foot elevation, and a fire is as welcome as a letter from home. In fact, the cold is one reason why many students avoid shaving during the eight weeks of camp.

During the day the students ramble the mountain slopes.

(Continued to page 246)

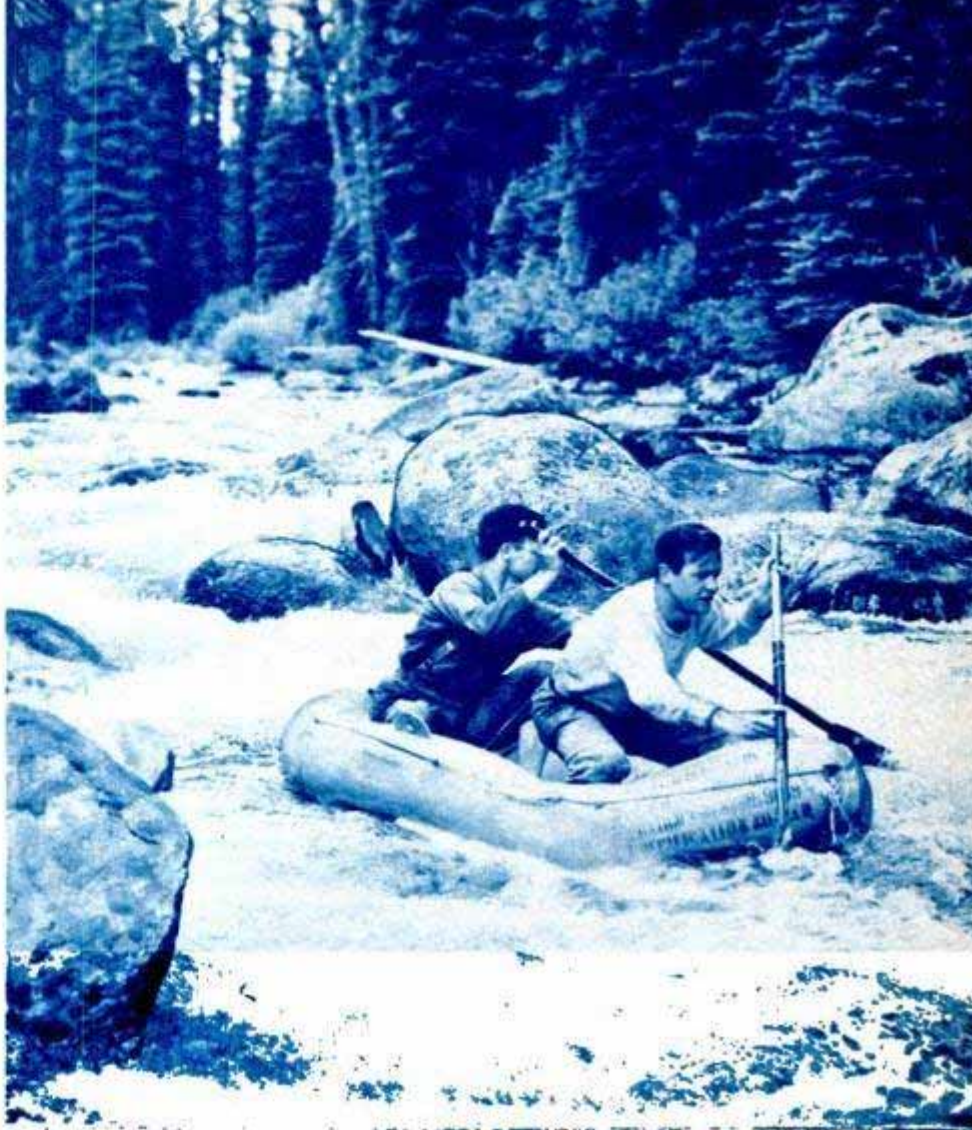

Favorite extracurricular activity is shooting the white rapids of the river in a rubber raft. Only two students have ever completed a trip down the treacherous channel without overturning

Over she goes! Students are dunked in the foaming water when their craft strikes one of many boulders. Left, embryo forester learns to use a "Baltimore cruising stick" to measure a stand of timber

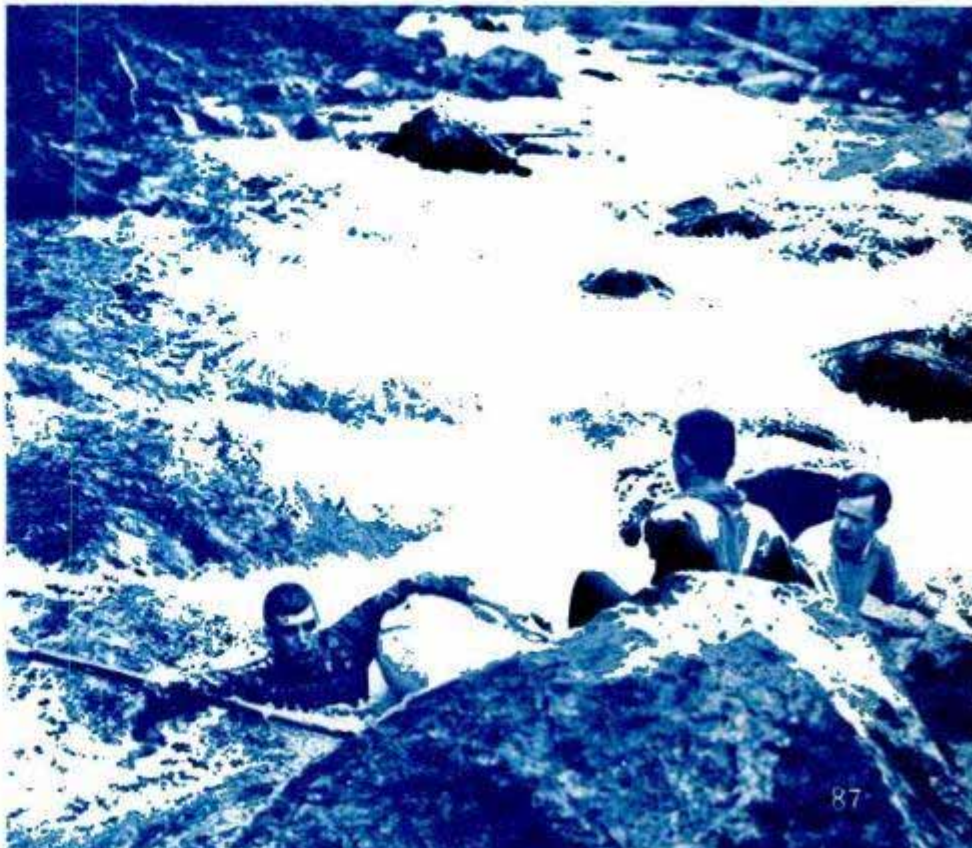

PLATINUM "CAT" MAKES ENGINE PURR

TO MOST of us, platinum is a scarce, precious metal seen only in the company of diamonds and emeralds on display in jewelry-store windows. But, despite its \$70-an-ounce price tag, the rare metal works for a living, making quarter-a-gallon no-knock gasoline for your car!

Mixed with other ingredients, the platinum becomes a catalyst for reforming low-octane straight-run gasoline into a high-quality motor fuel. This reformed gasoline has an octane rating so high it won't knock in any engine under any conditions, according to the Universal Oil Products Company of Chicago, developers of the process.

Motor fuel produced with this platinum "cat" is a mixture of isoparaffins (for antiknock at cruising speeds) and aromatics (for antiknock at power take-offs), similar to the gasoline used in fighter planes during the war. By adding small quantities of tetraethyl lead to this product, called Platformate, refiners can convert gasoline of too poor quality for automobile use into a fuel with octane ratings as high as 98—too high for today's engines! These high-octane fuels will enable the refiner to

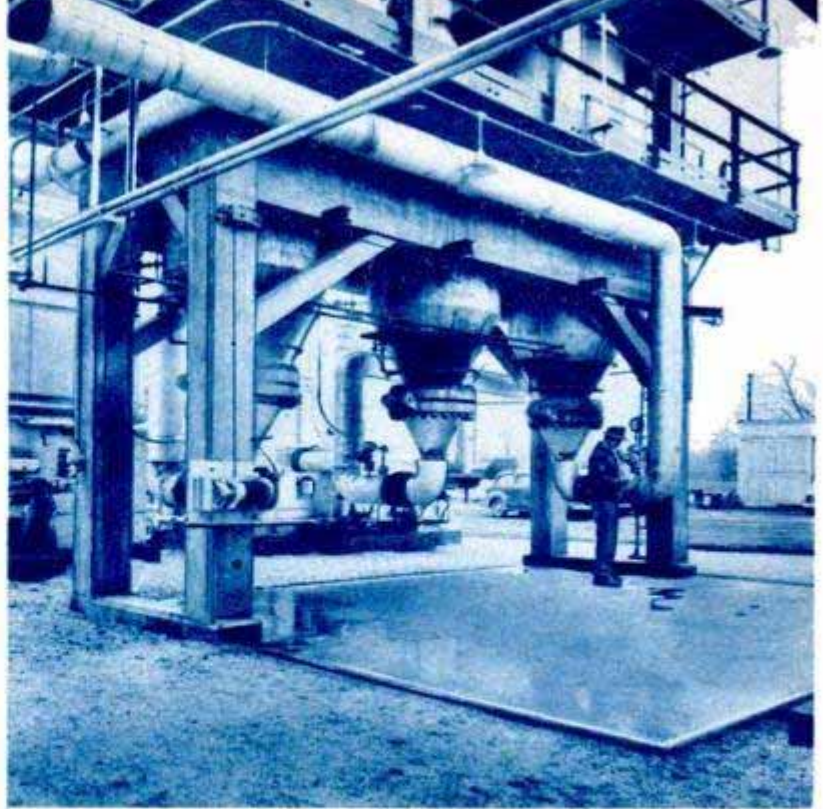

These three vertical tanks with the conical ends are the reactors inside which tiny pellets of a platinum "cat" reform the gasoline

provide gasoline for the high-compression engines of tomorrow.

The catalyst is made into tiny pellets, scarcely larger than a pinhead. These pellets are poured into huge reactors and gasoline vapors forced through them in a continuous process. Tests show that the catalyst doesn't wear out. Even if it does, it can be renewed with no loss of platinum, an important fact because of the high cost of the precious metal.

Diagram of process that changes straight-run gasoline into the high-octane fuel, Platformate (lower right)

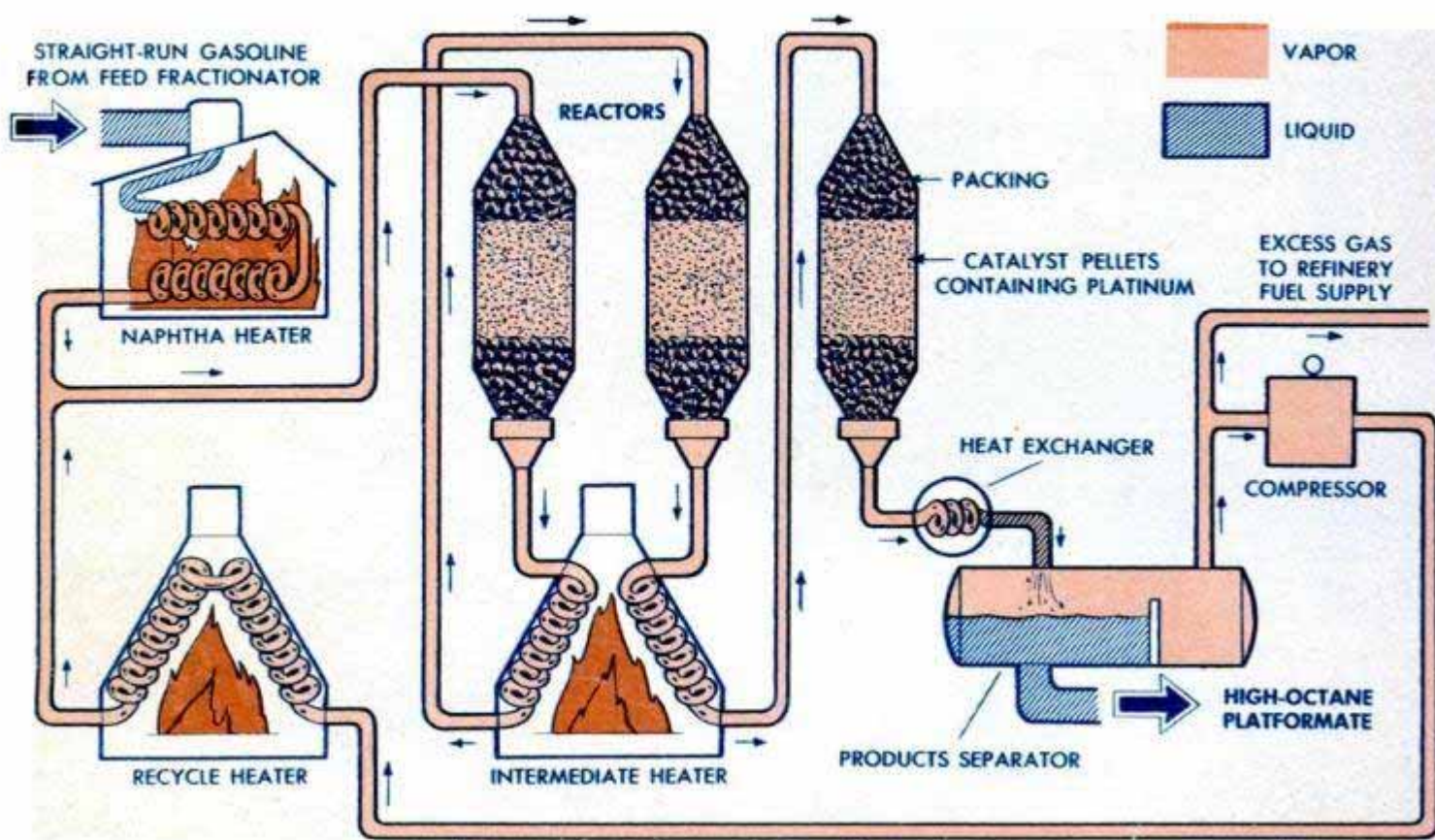



Trader Goulding shows Navajo prospector how a Geiger counter reveals radioactivity in piece of uranium ore
Photos by Thomas E. Stimson, Jr.

The Navajos Hunt Big Game...

Uranium

By Harry Goulding
Indian Trader

NOT LONG AGO two of my Navajo friends rode up to the trading post and told me of a distant canyon where they had noticed some rocks that were crusted with a bright-yellow substance and some nodules of blood-red crystals.

That is exciting news and I'm going to explore the canyon. In this country a canary-yellow mineral that occurs with the red crystals of vanadium is almost certain to be a uranium ore. Possibly by the time you read this the United States will have one more mine that is producing the raw material for atomic energy.

If the stuff that the Indians described proves to be radioactive, it will be the seventh uranium deposit that I have helped to locate. Several I found myself, early in the war, after the government sent out a plea for new deposits of vanadium. The vanadium was needed, to be sure, but no one told us until after Hiroshima that the

Indian miner inspects a chunk of low-grade uranium ore taken from a new mine in Monument Valley

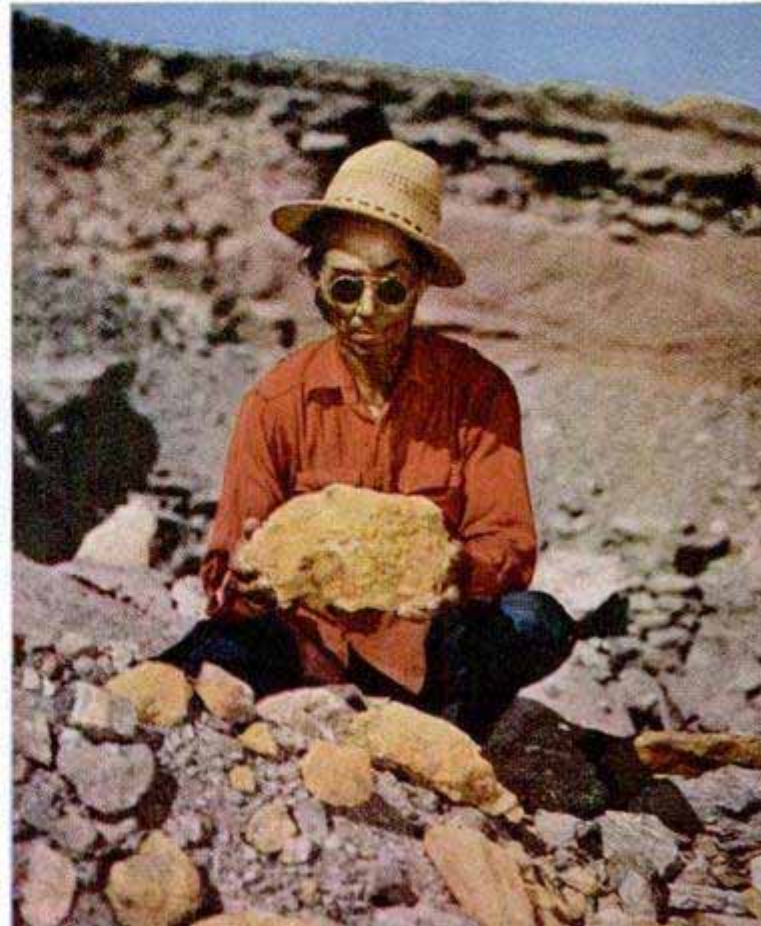

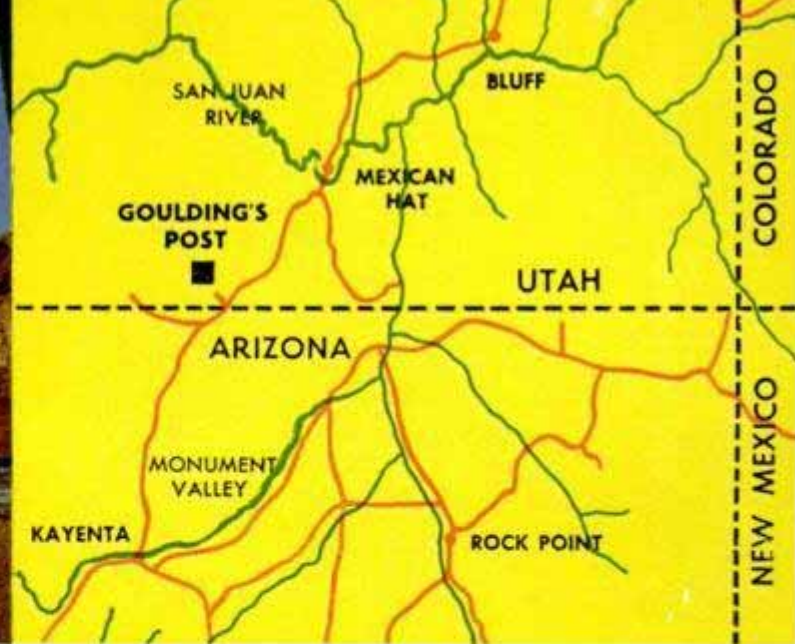
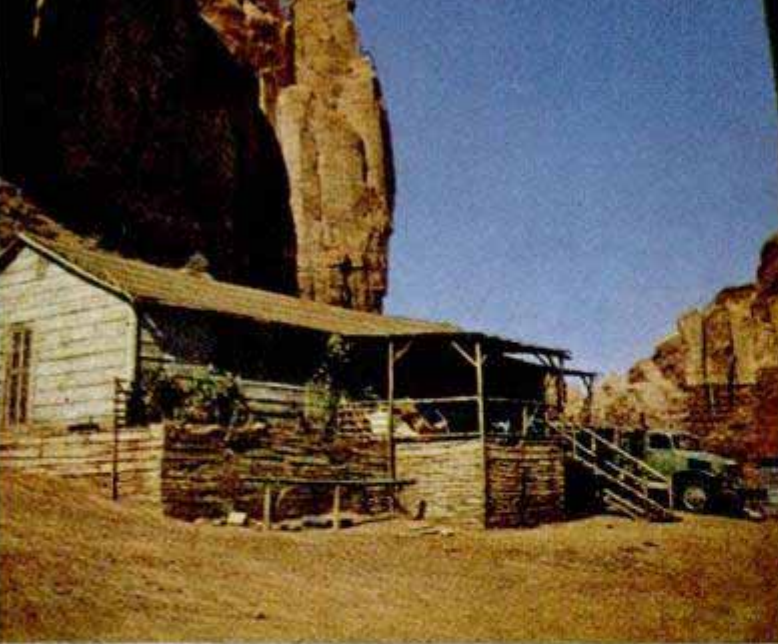

Goulding's rustic trading post is overshadowed by towering cliff in Monument Valley. Map shows San Juan River and its network of dry-bed tributaries; the red lines indicate dirt roads and trails in the region

associated uranium was the real reason why vanadium was being sought.

Radioactivity, in fact, led us direct to one uranium-vanadium deposit. A photographer whom I was guiding through the area happened to pick up an oddly colored rock and, since his pockets were full, he placed it in his film case. Later, he wrote me that all his film had spoiled and he wondered if the rock could be radioactive. An assay showed that it was, and we went back to the spot where he'd found it and opened up a new vein.

One of the richest uranium mines in the country was discovered by a 19-year-old Indian boy, Luke Yazzie, who noticed an

outcrop of yellow ore while grazing sheep on the east side of Monument Valley. He and I drove over in my beefed-up desert car and prospected it, and found plenty of uranium. Work started on it at once and Navajos were employed as miners. Fifty of them are still working at the mine.

During the war the patriotic Indian miners wanted to wake up before dawn every morning so that they could work as many hours as possible. None of them had an alarm clock and one of the Navajo truck drivers volunteered to buy one on his next trip to town. No alarm clocks were available. The Indian used his head and brought back a rooster instead. Every morning at

Indian miners load low-grade uranium ore into truck in valley mine. It is trucked to railroad miles away





Goulding talks to Indian women who have driven 15 miles to trade homemade rugs for cloth at his post. They camp out overnight and return home next day. Right, many Navajo sheep have couple of extra horns

about four o'clock the rooster started to crow. The noise woke up the miners just as efficiently as any alarm clock.

I operate an Indian trading post in Monument Valley in southern Utah, on the Navajo Indian Reservation. My only white neighbor is 20 miles away and the nearest paved road is 100 miles from my post. The region is the most remote, least known and most starkly beautiful portion of the United States. It is an arid, barren desert, so unpopulated that the nearest post office is in another state. I get my mail at Kayenta, Ariz.

Parts of the area are still unmapped and thousands of square miles of it never have been surveyed. I've lived there for 27 years.

Eons ago Monument Valley was a high, flat tableland. Erosion gradually cut numerous box canyons into the tableland, exposing the underlying red sandstone. Eventually, the canyon walls were worn back until here and there they broke into the next canyon. Left behind were scores of pinnacles, buttes and small mesas, some as high as 1500 feet and all with sheer, vertical sides. These towering buttes give the valley its name and are the scenic attraction of the region.

A thousand years or so ago, with a wetter climate, the valley and the whole area were populated by the cliff-dwellers, an agricultural people who lived in rock houses that they built in depressions on the

Totem Pole pinnacle in distance towers 1000 feet from base and is as high as the Eiffel Tower





Trading-post operator takes time out to watch squaw weave a rug on crude loom; his "taxi" waits by post

faces of cliffs. When the climate dried out the cliff dwellers disappeared.

Today, the whole section is an Indian reservation on which thousands of Navajos live. They are a quiet, honorable people with many admirable characteristics. Other tribes have received much government help but the Navajos have been left vir-

tually to shift for themselves. About 400 of them live in Monument Valley and in its immediate vicinity and they make a poor living by grazing sheep and goats on the sparse vegetation.

The nearest school is almost 50 miles away and it is 100 miles to the nearest

(Continued to page 236)

Movie studio built the realistic fort which the Navajos now own and let other studios use—for a fee

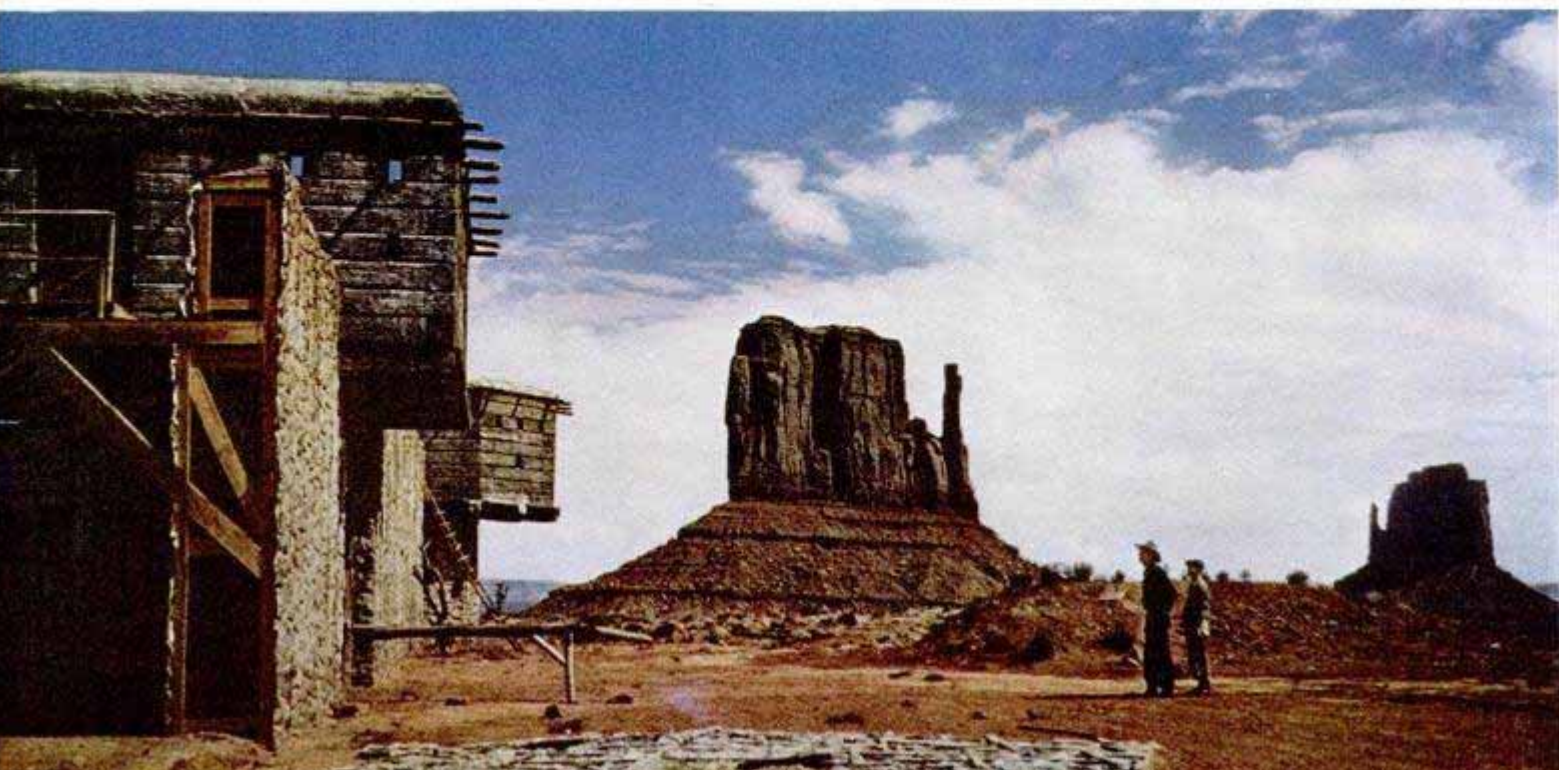

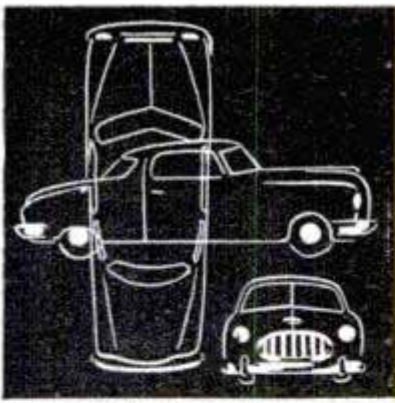

Detroit Listening Post

By Siler Freeman

THE AUTO INDUSTRY may wait another year to hold its first postwar national show. A combined industry show has not been held since 1940.

Because of the interest shown in the General Motors exhibits the past two years and the drawing power of the Chicago show, which was a dealer affair rather than an industry-sponsored exhibit, it was at first believed the manufacturers would get together for their 1951 models.

But the same thing that has prevented previous national shows is again balking efforts to put one on next fall—the raggedy scheduling of new-car announcements. Before the war, most new models were in dealers' showrooms by October. Since resumption of production, however, each company has brought out models when they could be fitted into individual plans.

Last year, for instance, Packard brought out its new line early in summer. The rest strung out until well past the first of the year with the 1950 models. Those which had been introduced in the spring and mid-summer would have looked slightly ancient in a national show.

General Motors, the leading producer and bellwether of the industry, was to have led the rest back to a more even introduction date. Originally, at least one division was to have had new models in September and the rest would have come in with their '51s by Thanksgiving.

All this is changed again. Most of the GM divisions will run through the year on the same cars they are making now.

Chrysler's planning is now all awry because of the long strike. It is doubtful if its divisions can plan on new models before the first of the year and perhaps later.

Ford, which came out in November last year, will probably shoot at this date again. It is rushing its new plants to take advantage of their capacities to aid them in the new models. The Cleveland plant is to furnish the new six-cylinder engine.

Of the independents, Nash and Kaiser-Frazer are first on the scene with 1951 models. K-F's light car will be in its deal-

ers' showrooms in July. Packard is readying new models in August and Hudson will be an early fall arrival.

The industry's lively interest in new transmissions and engines hasn't lessened but continues to grow. Cadillac is reported working on a new one which is rumored to be superior to the other three now being used in General Motors—Hydra-Matic, Dynaflo and Powerglide. The latter, incidentally, is being soft-pedaled by Chevrolet because of technical difficulties in the Cleveland plant where it is made. The few seen on the streets are principally in the hands of Chevrolet executives.

Cadillac's device is said to be a single-phase torque converter which locks into mechanical high. It has been tested under all conditions and pleases the high standards of that division's skilled engineering staff as well as its former chief engineer, John F. Gordon, who is now the general manager of Cadillac.

The Ford Cincinnati plant is being tooled fast for the new transmission which is expected to appear soon on Ford cars. This is the Borg-Warner development which also follows the lock-in principle, considered by automobile engineers a must if slippage is to be conquered in the automatic transmission.

Kaiser-Frazer is starting to get some of the Hydra-Matics it has contracted for from General Motors. Like the rest of the industry, it is experimenting with its own version but doesn't have the money to tool up for such a device.

On the engine front, Ford is about ready to start tooling for its new V-8 engine. This will follow its six-cylinder job or perhaps even overlap it. Both are highly thought of at the Rouge plant.

Chrysler's work on its new V-8 engine has been sharply set back by the strike. The program, however, is all set up for the 1951 models in the big jobs.

Buick also has a new engine under wraps. Although officials in Flint are uncommunicative about it, the new power plant will be of the V-8 variety and high compression.

It all sums up to high-gear competition for the customer's dollar next year.



Left, foreground is fuzzy in this photo. Right, the same camera took this shot, but the Garutso balance was added to the lens and the whole scene is sharp



GLASS "DOUGHNUT" IN LENS ENDS FUZZY PHOTOGRAPHS

THAT OLD bogieman of photographers, sharp focus, has been dealt a body blow by a newly developed ring-shaped lens that increases depth of focus up to 500 per cent. Like a doughnut, the lens is round with a hole in the center and it is called an optical balance.

Used in addition to the regular lens system, the glass "doughnut" is placed between the front and rear elements. It enables the photographer to take pictures that are sharp from 24 inches in front of the camera to infinity, even with the lens aperture fairly wide open. The optical balance does not absorb any appreciable amount of light, thus does not affect exposure time. In addition, it corrects much of the spherical aberration of the conventional lens, providing greater contrast and good definition through the entire field at wide-open apertures.

Invented by Steven Garutso, the optical balance was first used on movie cameras in Hollywood, where Garutso, a former Russian camera manufacturer, has been living for 10 years. He spent 25 years developing the basic formula.

Movies made with the Garutso lens provide an illusion of three dimensions because the amazing depth of focus gives a picture that is similar to what the eye would see. Several motion pictures have been made with the optical balance and production of the device has been limited thus far to installations in professional motion-picture and television cameras. Production of the elements for other movie cameras and still cameras is expected to begin shortly.

A future development may be an auxiliary attachment that can be slipped over the lens like a filter, eliminating expensive installation costs and bringing the device down to a price that the average amateur can afford.

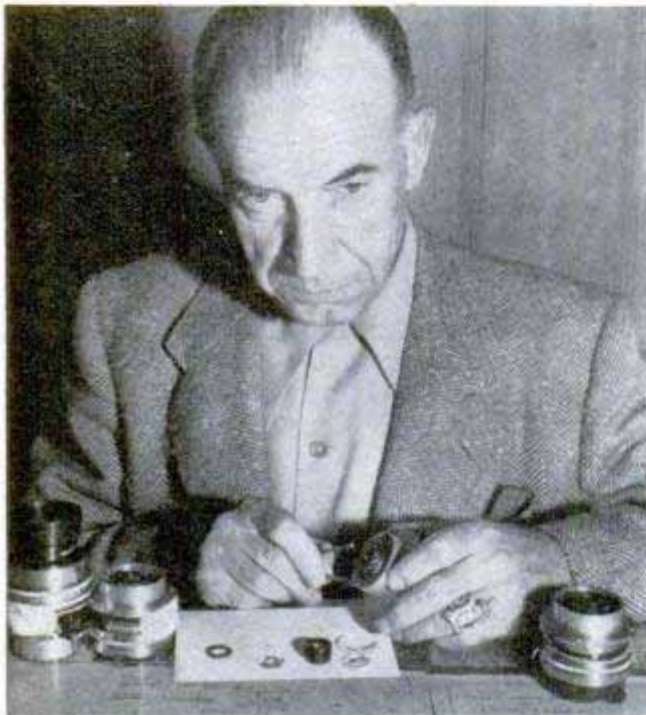

Steven Garutso, the inventor of the optical balance, adds the glass "doughnut" to a motion-picture lens

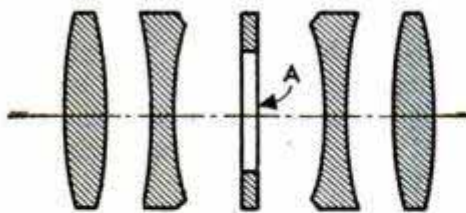

Above, the balance, A, is placed between front and rear lens elements. Below, a close-up of the balance

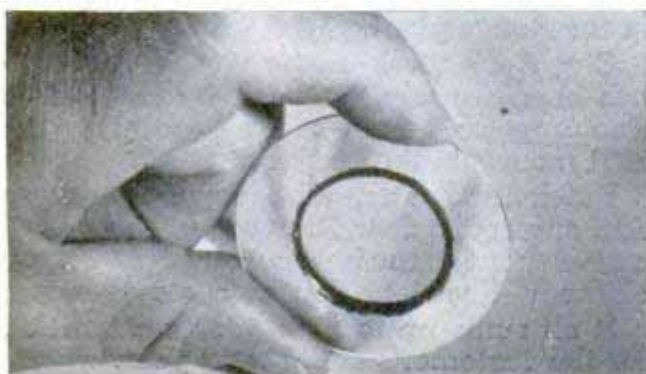

Golf-Bag Divider Separates 14 Clubs

Golfers can select clubs easier with the aid of a device that provides oval-type bags with 14 separate compartments. Weighing approximately one pound, the plastic divider, which fits inside the top of any bag with free space at least 7½ inches long and 4 inches wide, is held in position by screws. Each compartment can be labeled for a specific club. In addition to protecting the shafts and handles of the clubs from scuffing against each other, an empty slot in the device signals the loss of a club to the user.

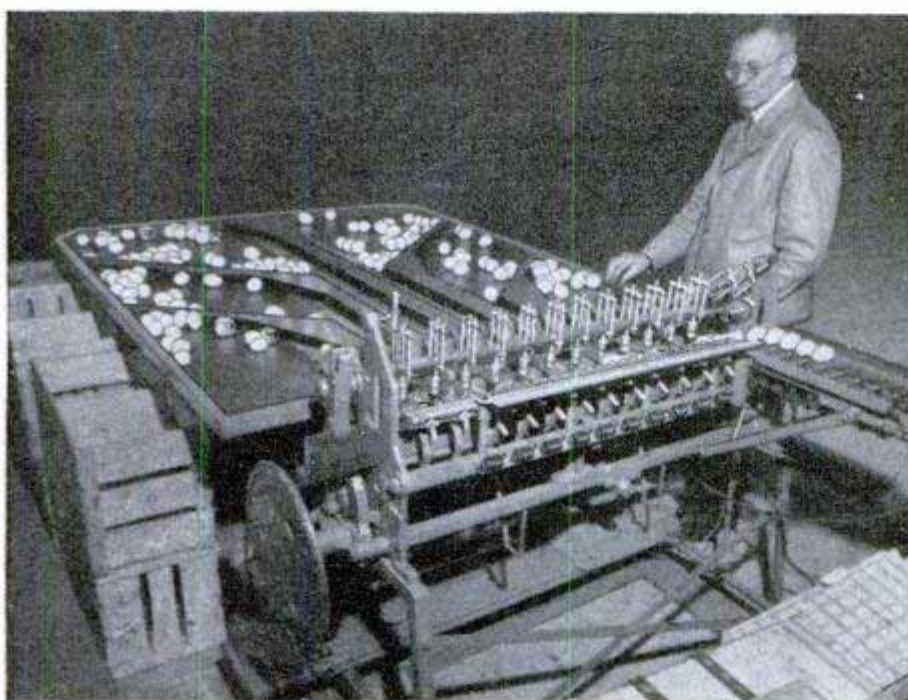

Egg Sorter

As many as 6000 eggs an hour are handled by a German machine that does four operations at once without breaking the thinnest shells. Shown at an agricultural fair in Frankfurt on Main, the machine checks, weighs, stamps and counts eggs which are fed into it by a conveyor belt. The number of eggs of each grade is counted automatically during the operation.

Ⓢ Elevators in buildings in the United States travel 500 million up-and-down miles each year.

Suitcase on Wheels

You can be your own "redcap" if you use a suitcase roller that straps to any type of luggage. Two rollers, mounted on metal brackets, support the weight of the suitcase and you simply pull it along behind you by a convenient handle. The brackets adjust to fit the width of the luggage.

Popular Mechanics provides two sources of further information concerning articles published in each issue: the WHERE-TO-BUY-IT INDEX, starting on page 10, and the WHERE-TO-FIND-IT LIST, which is available to readers without charge from Bureau of Information, Popular Mechanics Magazine, 200 East Ontario Street, Chicago 11, Illinois





Junketing congressmen would feel at home with the Japanese model of our Capitol. Right, Empire State Building

“LITTLE AMERICA”

Most impressive part of the fair is this version of New York City's skyline, shown here under construction

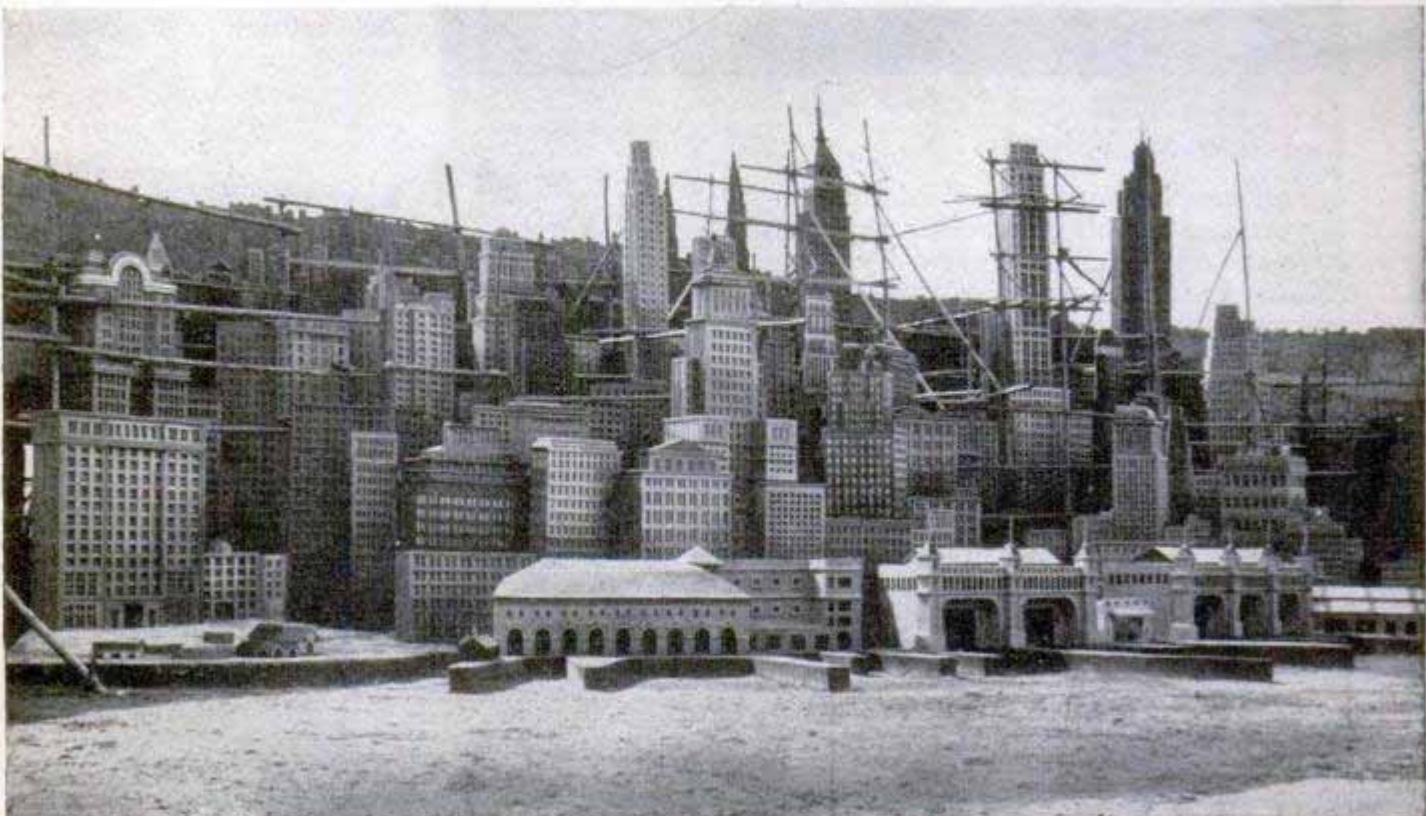



Above, an American GI in Japan looks at a copy of a Lincoln statue. Right, even in the Orient, balloons and fairs go together. That is the White House

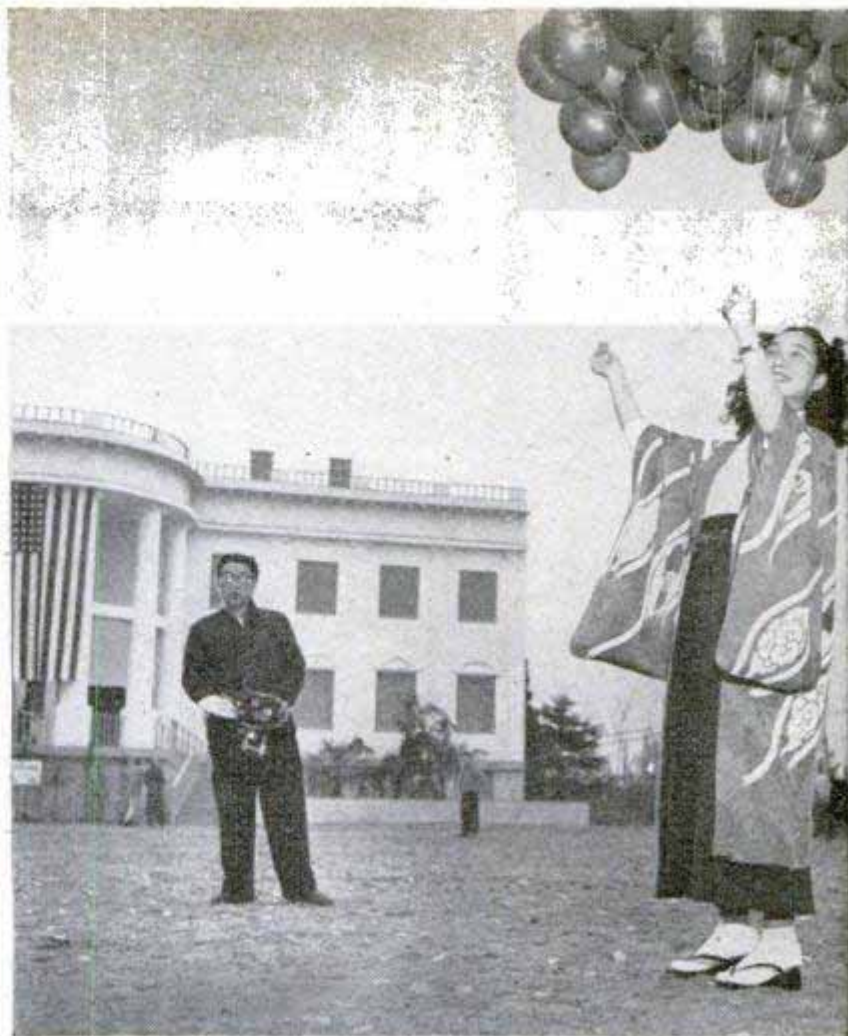

IN JAPAN

JAPANESE get a capsule-size view of the U.S.A. at the America Fair, sponsored by newspapers in Nishinomiya. Covering 75 acres, the fair includes models of famed American buildings as well as such natural phenomena as Grand Canyon, in miniature, of course. New York City's skyline is represented by a detailed scale model as are many of Washington's impressive buildings. On the lighter side are exhibits of bingo games and slot machines! Even the famous sculptures on Mount Rushmore have been skillfully reproduced, with a strange Oriental look.

There's an Oriental look to this reproduction of the Mount Rushmore Memorial

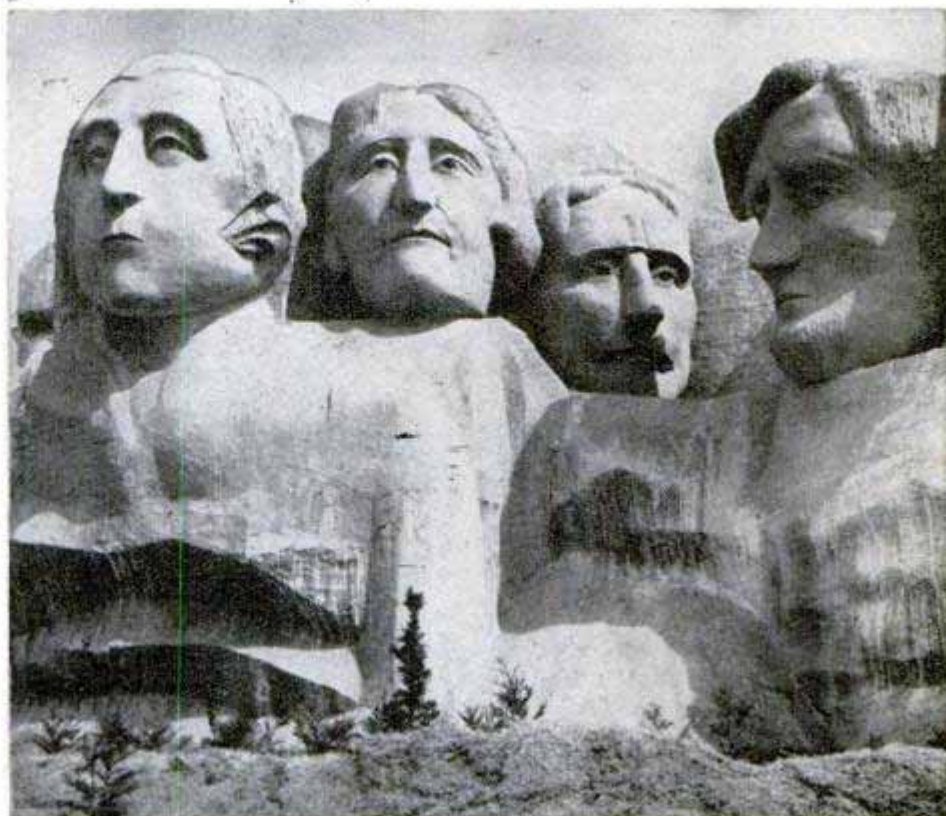

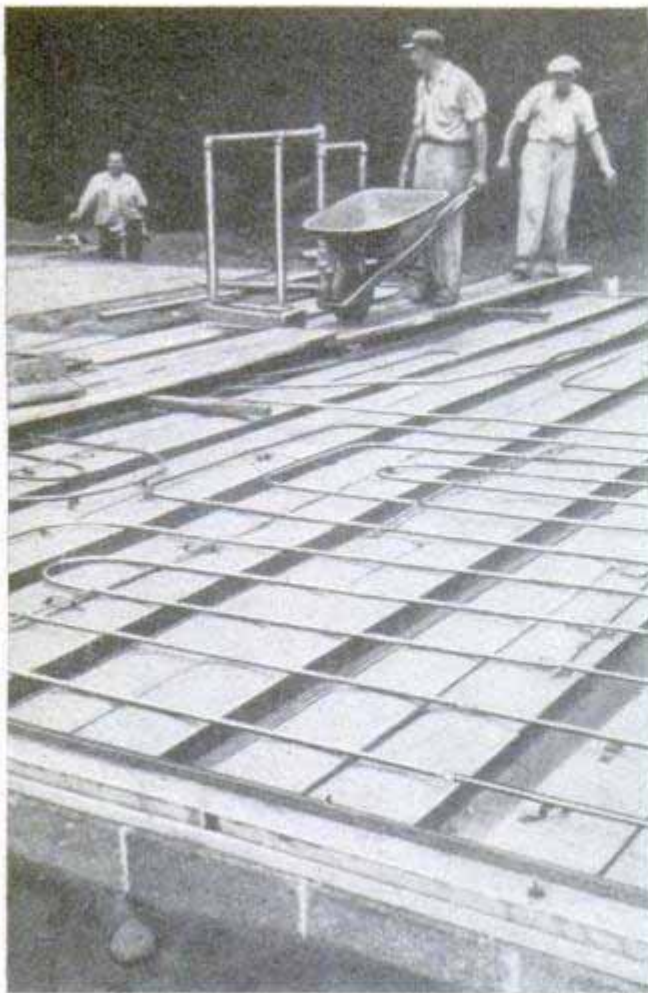

Some installations call for radiant-heating coils. Pipes are placed atop "chairs" fastened to the forms

Below, floor poured on the forms has dead-air insulating space under 75 percent of its area. Bottom, form is given strength by a "bridge" inserted through opening. The form holds up to six inches of concrete

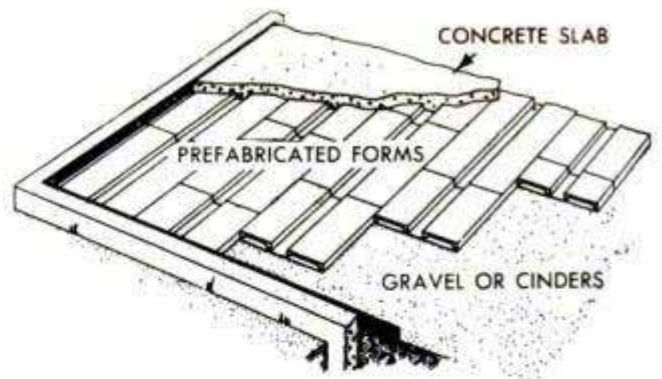

Forms are quickly erected and installed over a large area. Slab is poured and forms are left in place

Prefabricated Floor Forms

Prefabricated forms for concrete floors now are shipped collapsed, and erected on the site. They form a floor that is cast on the ground surface, yet has an insulating dead-air space under 75 percent of the floor area, thus giving a basementless building the advantages of an insulating space. Made of water-repellent material, the forms can be placed quickly and altered for pipes and other construction details with a pocket knife. Radiant-heating coils, which are to be built into the floor, are placed on small metal "chairs" so they will be buried in the one-pour concrete at the correct depth. The forms will support wet concrete loads from the normal four-inch thickness for home construction to six inches, reinforced, for commercial buildings. They are shipped collapsed in bundles which make 100 square feet of assembled form.

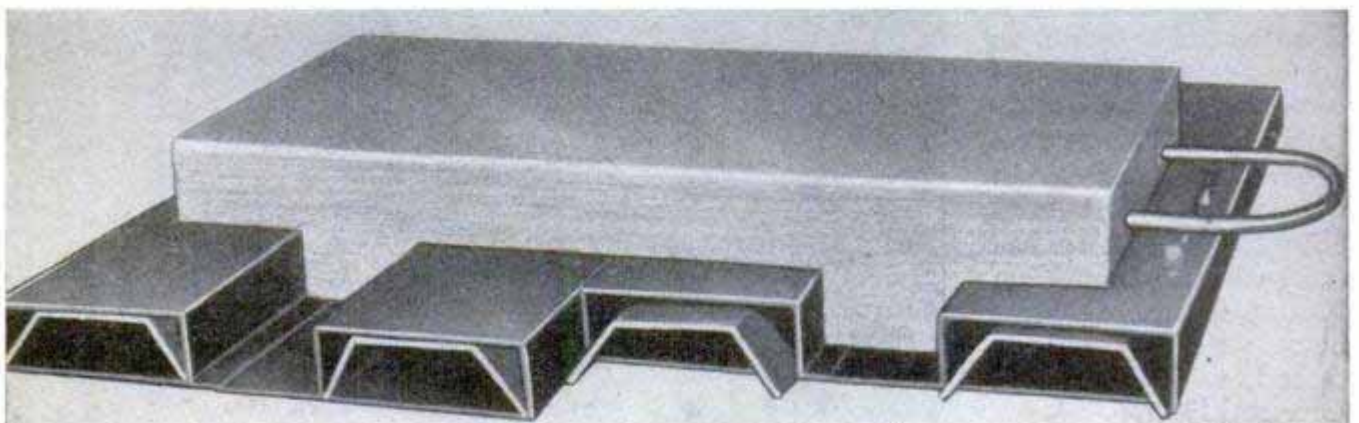
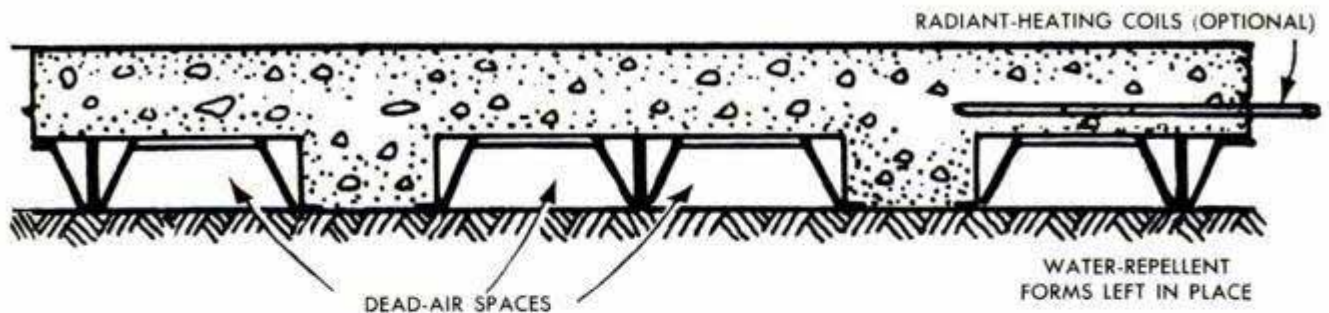

Motor Car at Home On Rails or Roads

Railroad track 29 or Highway 30, it makes no difference to a motor car that rolls along either on its pneumatic tires. Hydraulically raised and lowered, four guide wheels keep the car on the rails, while the standard rubber tires carry the weight for better traction and riding quality. In case of emergency, such as a flat tire, the guide wheels are strong enough to support the load. The truck can leave the rails at any place along the track because of a powerful four-wheel drive that can climb over rails. When the truck is being operated on the rails, the front wheels are locked in a straight-forward position and the steering wheel is not used.

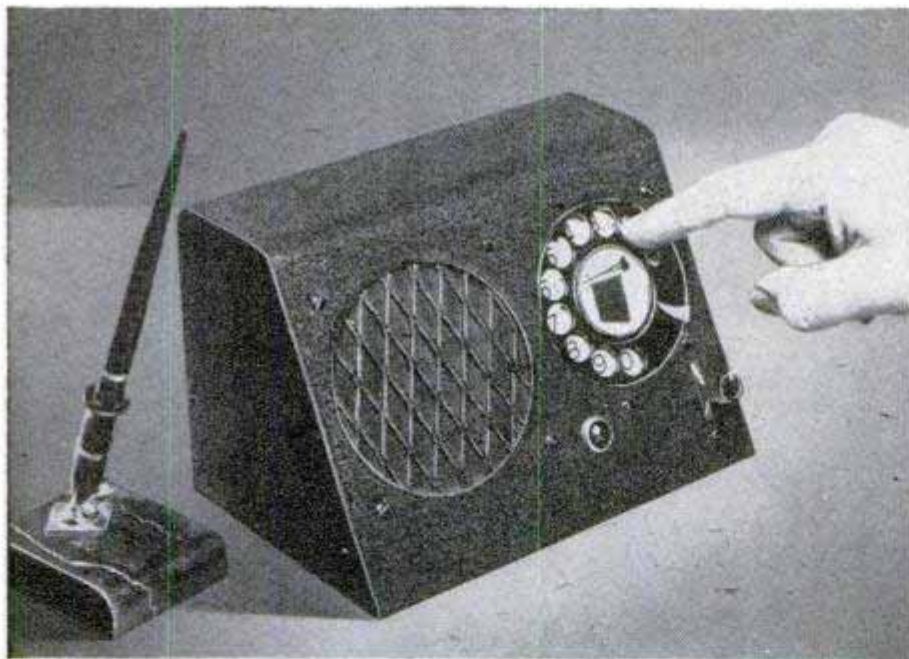

Central Control Panel For Intercom System

Automatically controlled by a central panel to which each speaker set or station is connected, a new intercommunication system offers many advantages. The system uses no radio tubes in the speaker sets and a.c. outlets are not required for the individual stations. Since each station reaches all others on the system only through the central panel, stations may be moved or new ones added without rewiring other stations on the system. In addition, the intercom can be controlled by an automatic time clock which cuts the power in and out of the entire system at predetermined hours, thus eliminating any possibility of leaving a part of the system powered during nonworking hours. Another feature is two-way conversation with privacy between stations.

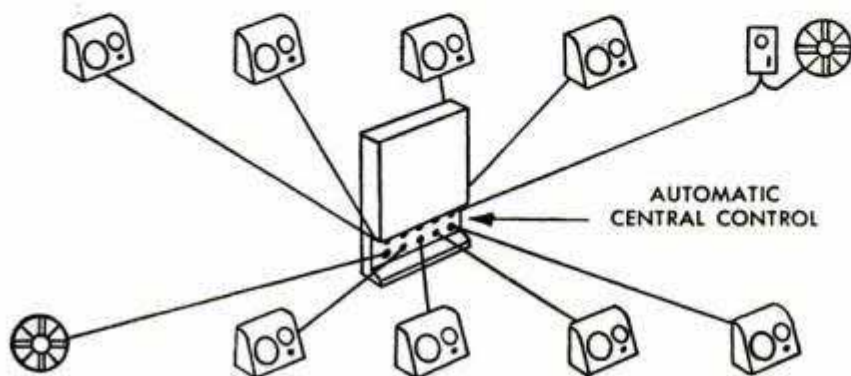

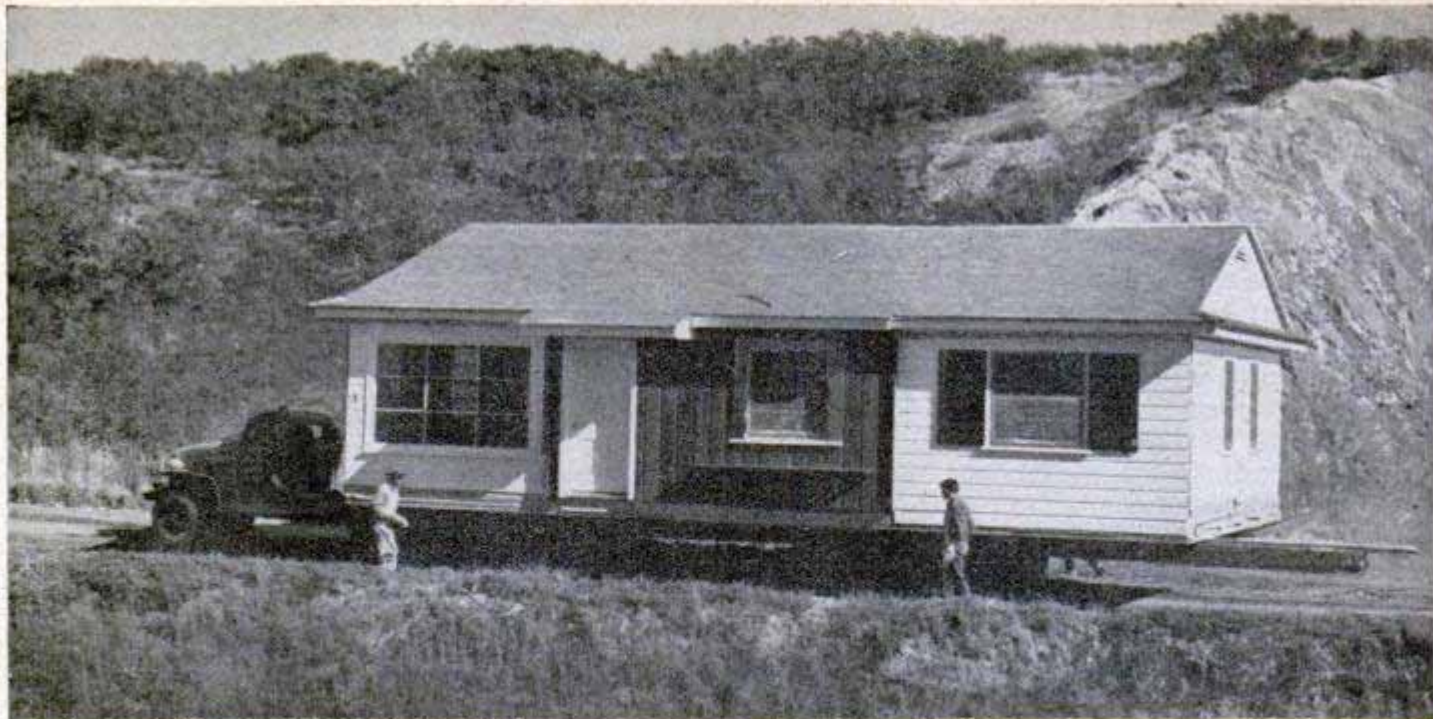

In a few hours the owner can move in! One of smaller factory-built homes rolls down the road toward its site

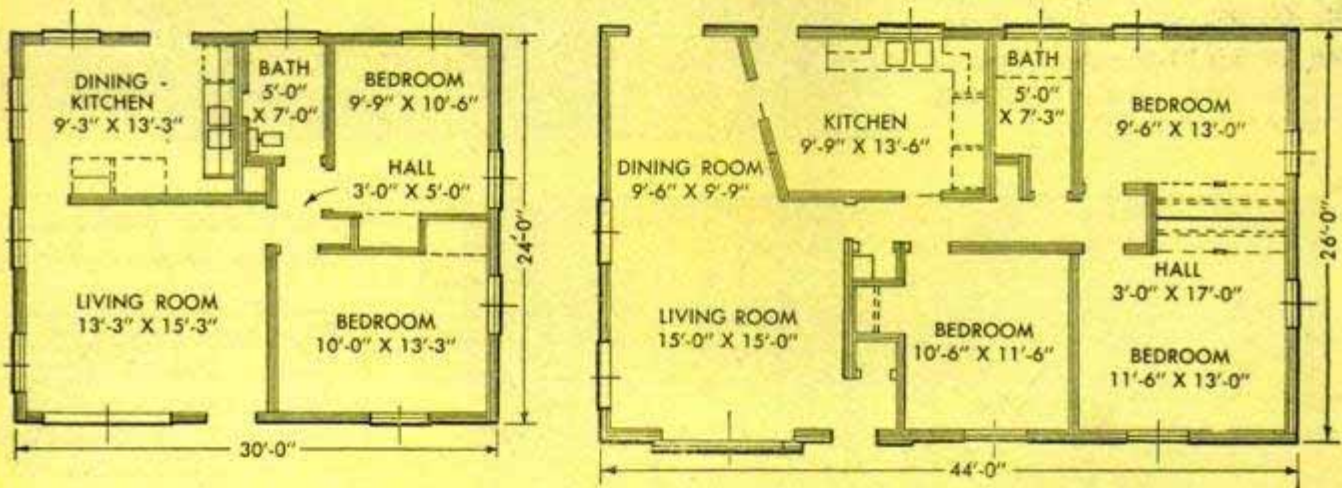

Resting on rollers, 13 homes move toward completion at once. Above, two of five plans offered in San Diego



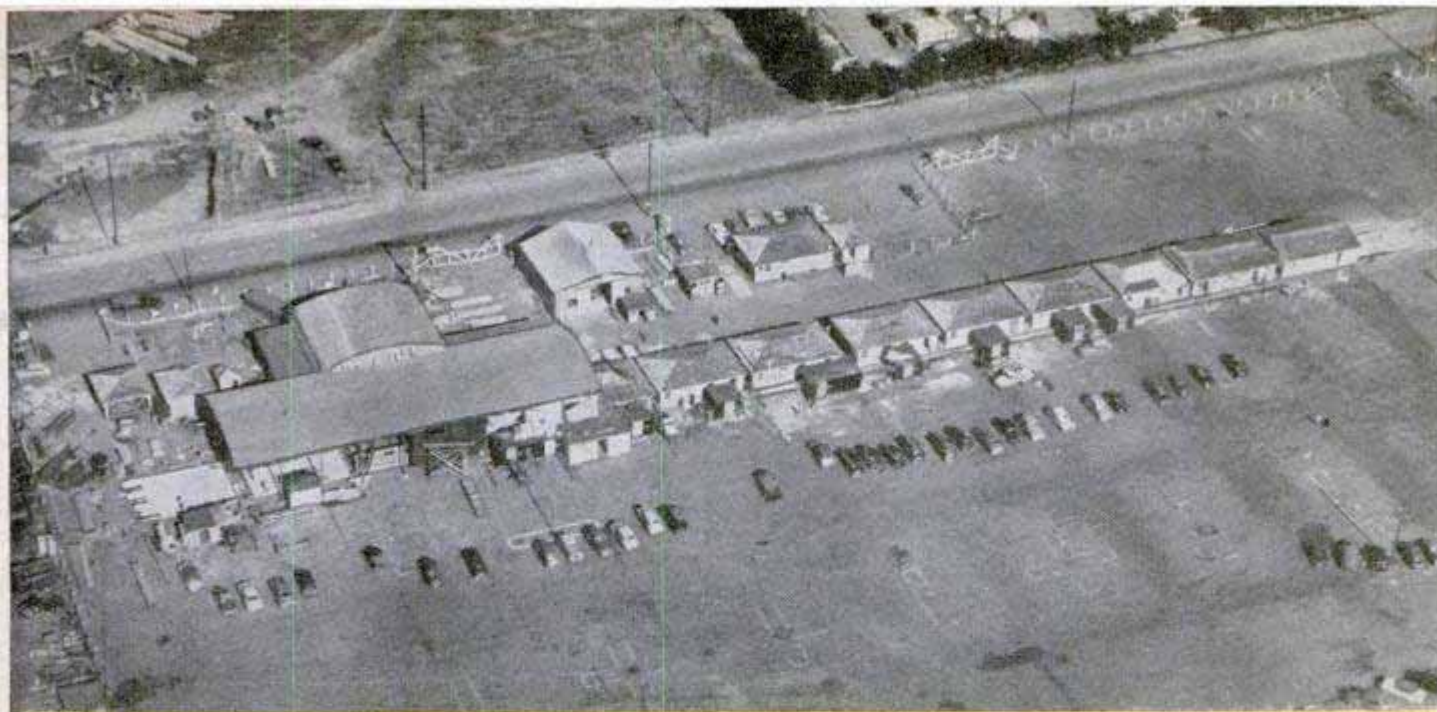

Aerial view of factory shows flooring laid down at left, a completed house rolling off line at right

Send Me a Five-Room House

IN A SCORE of American cities you can phone the local house factory and arrange for the delivery of a brand new home with no more fuss than it takes to buy a new car.

You have your choice of up to seven floor plans and can select your own color schemes. Your house will be built on an assembly line in 13 days and then towed to your site. You can move in the same day the house is delivered if water, gas, electrical and sewage connections are made promptly.

Your new residence will be a full-size house built of standard materials by expert workmen. It will be styled to the area in which you live, tastefully decorated, equipped with quality fixtures and hardware. It will cost about 10 percent less than the price of erecting the same house piece by piece at the site.

The only hitch is that right now the factories are snowed under with orders and you may have to wait several months before your house can be built. Hundreds of other buyers have their purchase orders already on file.

A couple of years ago, a Bakersfield, Calif., contractor named Hugh Curran agreed to build a house that was to be moved as soon as it was finished. The owner would select a site for it in the meantime. During the next few weeks the owner bought a lot, the foundation was poured, and as soon as the house was fin-

ished it was hauled to the site on ordinary house-moving equipment. At the site it was carefully lowered onto the foundation, fastened down and hooked to the public utility lines. Not a window was broken, not a crack was opened up during the moving.

That gave Curran an idea and he designed a long assembly line. At one end the floor joists and flooring of a house would be assembled. This base then would be moved on rollers to stations at which the walls would go up, the shingle roof nailed on and other work performed until a finished house emerged at the other end of the line. Because the house would move during construction, he called it Mobilhome.

A pilot plant was built in Bakersfield and houses began to roll off the line at the rate of one a day. Since then factories have been built in Chicago, Phoenix, Ariz., Gary, Ind., Amarillo, Tex., Reno, Nev., San Diego, Los Angeles and several other California cities. Several more will be built within a few months throughout the Middle West and along the Atlantic seaboard. Some 2000 houses have been produced to date.

A house is delivered free within a 10-mile radius of a factory; beyond that a nominal charge for the extra mileage is made. The biggest tow bill to date amounted to \$600, the price of moving a house a distance of 250 miles. The owner was elated with the deal because the total price was still \$1000 under local estimates.

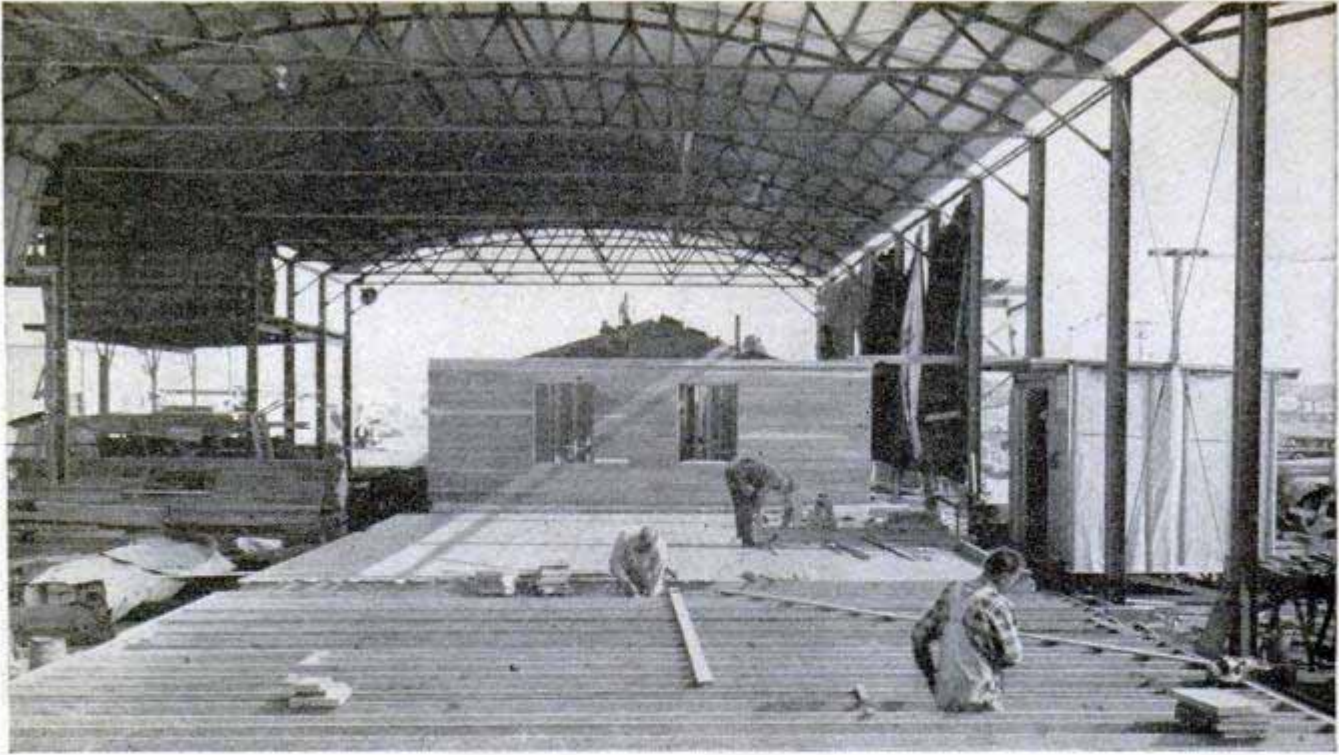

Joists are laid and tied together with bridging members to start new house. Beyond, flooring is nailed down

Typical of the factories is the one at San Diego where the assembly line is 585 feet long. The San Diego plant offers five basic houses that range from 720 to 1144 square feet of floor area in size, priced from \$5750 to \$8650 delivered and hooked up, ready for occupancy. Each house is built to conform to the building code of the area to which it will be moved.

The assembly line rests on a pair of sturdy rails 24 feet apart. To the top of each rail a row of rollers is attached. Steel runners are laid on the rollers and the floor joists are laid directly on the runners. Con-

struction starts at one end of the assembly line by raising into place a pair of hinged jig boards that are slotted to receive the joists of the particular design that is to be built. The 2 by 12 joists are laid down and fastened together with bridging members, then a veneer subfloor is nailed to the joists.

Next the jig boards are swung out of the way and a cable that leads to a winch at the far end of the assembly line is attached to the floor unit. The winch is powered by a geared-down, three-horsepower motor, which pulls the floor unit along the line to the next station. All the partly finished

Preassembled wall is raised into position and fastened to the floor

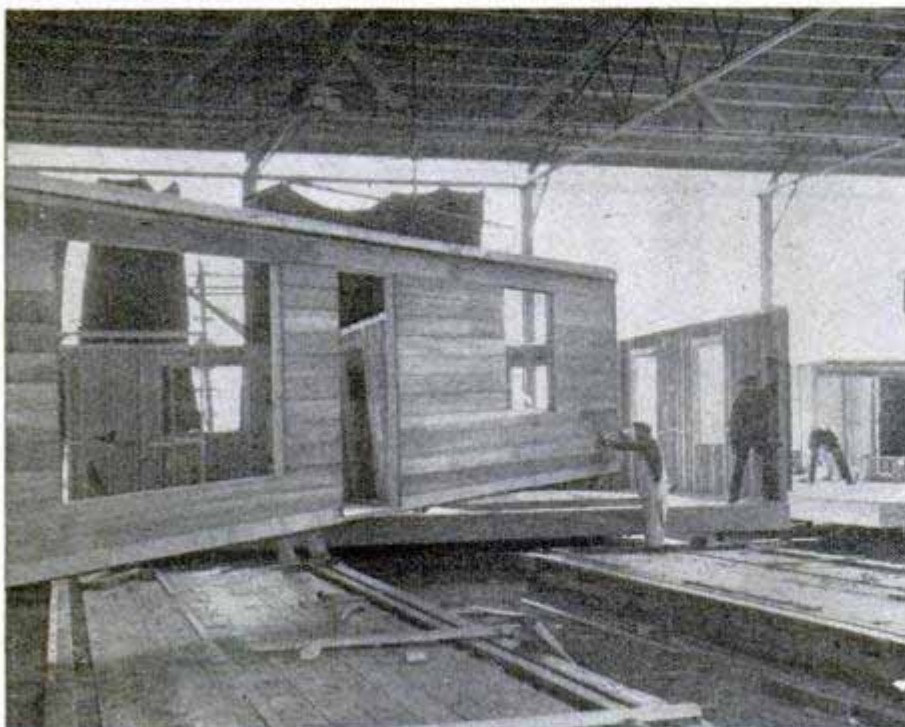

houses in front of the new floor unit are pushed one station down the line when the floor unit moves. The cable is then detached, ready to be hooked up to a new floor unit when that one is finished.

At station two the floor unit receives its select oak floor and a protective layer of thick paper. At station three, under a roof, the exterior walls and interior partitions are lifted into place by overhead cranes. These units had been preassembled in an adjacent working area during the time the floor was being laid. At this station, too, the ceiling joists are installed and the rough wiring and plumbing is started.

There are 13 stations on the line with 13 houses under construction at all times. Each house moves ahead one station each day. Walking along the line, you can see bathroom fixtures and a hot-air furnace being installed in one house, kitchen and bathroom cabinets that were built in an adjacent mill going into another house and the tilework and linoleum being completed in a third. Tomorrow the same crews will be doing the same work in the new houses that have moved to their stations.

Factory-built houses use the so-called "dry wall" construction materials that include lumber and the various prepared wallboards and panels. Plaster and stucco are ruled out because they require extra days or weeks for drying. Instead, walls and ceilings are surfaced with panels of composition materials, the joints of which are taped and sanded to an even appearance. The tops of the ceiling panels contain a layer of aluminum foil.

After final inspection and clean-up at the end of the line, each house is rolled over a shallow pit and is raised on screw jacks to allow the dollies of the moving equipment to be pushed underneath. Then the house is lowered onto the dollies and is towed away. The houses average 10 tons in weight and are up to 26 feet wide on the narrowest dimension, this being the maximum width that can be moved over San Diego city streets without extra permits. Garage units are built and trucked separately to their sites.

San Diego's Mobilhome factory employs from 65 to 70 expert carpenters, painters, plumbers and other artisans. The men work regularly at the plant instead of jumping from job to job, and their work is laid out so that it can be done easily and correctly. The consequence is that construction goes along much more efficiently than in the field. Officials of the FHA and other financing institutions are



Wooden shingles are nailed in place by an experienced workman, who does the same job on every house as it rolls down the line. Below, metal straps, installed diagonally, keep the interior walls rigid

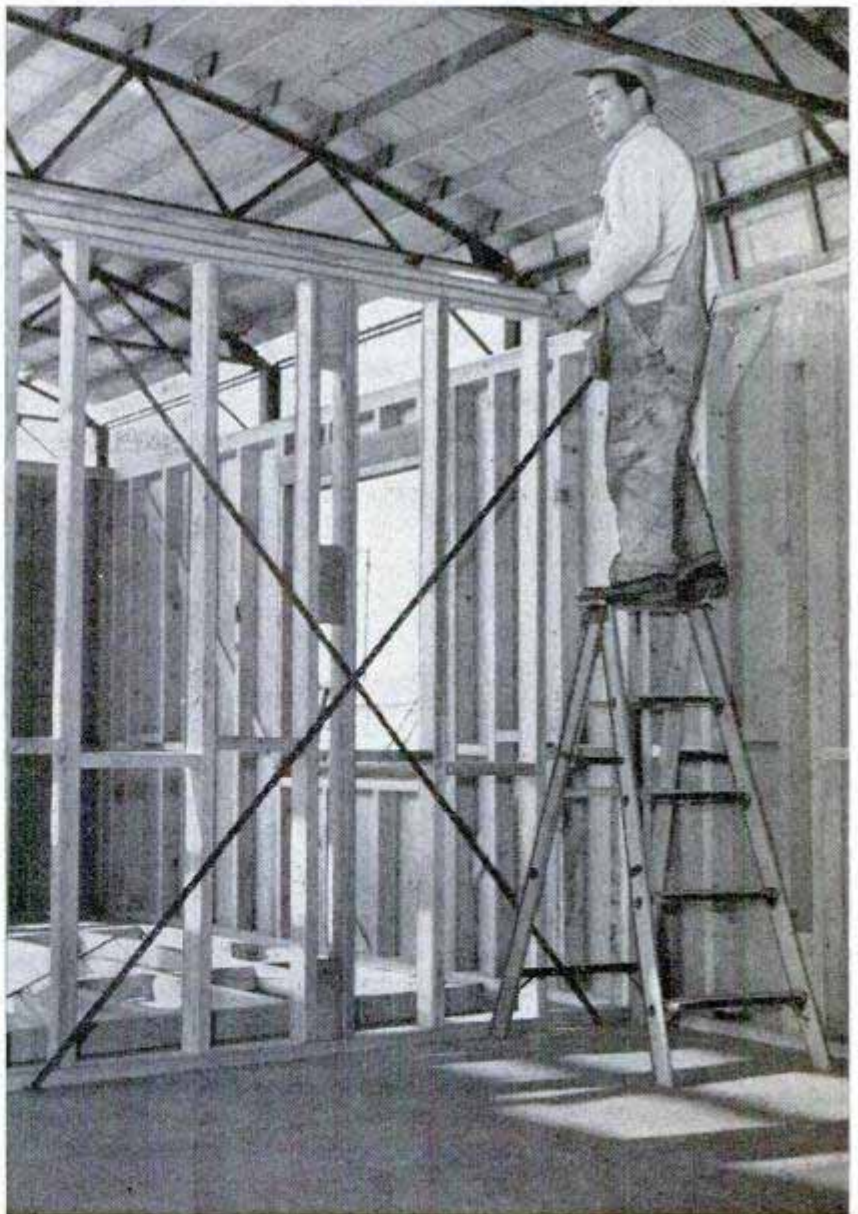



Near the end of the line the house receives three coats of paint. The purchaser chooses the colors

delighted with the quality of the houses.

As long as the present demand for new homes exists, the factories will find it easy to sell stock houses, but what about the future? The factories will continue to be as busy as ever, in the opinion of Ken Glazebrook, president of the San Diego organization. The present factories are the beginning of a real revolution in-house construction, he thinks.

Any house of almost any dimensions and of most standard materials can be custom-built in a factory better and cheaper than at its site, Glazebrook declares. One large house that contains three bedrooms, three baths, a den and the usual living quarters is to be built at the San Diego factory this year. The residence will have 3000 square

Finished home, still on rollers, moves over a pit so the house-moving equipment can be installed



Among the new fixtures built into the homes are windows that can be removed from frames for cleaning

feet of living space, much more than the average house. The scheme is to build it in three separate units, none more than 26 feet wide on one dimension, and then assemble these completed units at the site. The same technique can be used for two-story houses and small office buildings.

If you want stucco on your exterior walls, this material will be applied after the house has been moved. If you want a fireplace, it will be erected in the vacant spot left for it, after the house has been trucked to its site. In the future, Glazebrook says, you'll be able to draw up your own plans and specifications for the kind of house that you want and take them to the nearest house factory for a bid. When you do, you'll be surprised at the low price you get.

During final inspection even the drawers are tested. Then off goes the house to the home-buyer's site



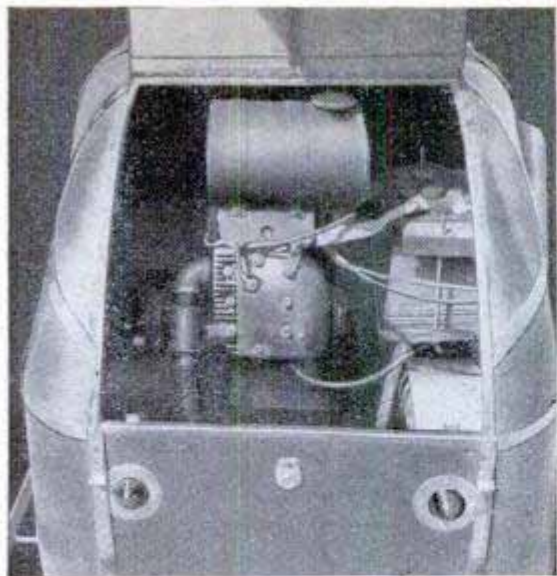

When his 13-year-old son wanted a car instead of a bicycle, an Arizona hobbyist built this neat model, top right, at a cost of \$350. Top left, the engine is in the rear. Above, it cruises along at 40 miles an hour

Boy Won't Need Dad's Car Now!

Thirteen-year-old Jimmy Richardson of Tucson, Ariz., is the envy of all his friends with a midget auto built by his father. What's more, he rides all week on 56 cents worth of gas—the cost for one tankful. The car is made of 20-gauge steel trimmed in stainless steel for a snappy appearance. It stands 2½ feet high, is five feet long and has a ground clearance of only five inches. Built on a frame of bed rail with knee action in front and regular coil springs in the rear, the entire machine weighs about 300 pounds. Its power plant is a six-horsepower, 42-pound Salsbury engine, air-cooled through funnel-shaped vents on

both sides. The car uses an automatic clutch that requires no shifting, is chain-driven with the motor in the rear and stops with mechanical brakes working on the drum-friction principle. On 15-inch wheels it uses 3.50 by 6 tires in front and for better traction 4.50 by 6 tires in back. Jimmy's father, Paul Richardson, reports that the midget has excellent pickup for the size of the engine which is geared five to one. In an early test the car was clocked at 55 miles an hour with a 225-pound man behind the wheel. It was slowed down to a top speed of about 40 miles an hour. Richardson built the midget car in his spare time over a five-week period at a cost of about \$350 for materials.

Storage-Battery's Life Expectancy Increased by Chemical

Storage batteries last longer and recharge more quickly when treated with a chemical compound that successfully combats "sulphation," according to the manufacturer. Added to the electrolyte of lead-acid batteries, the preparation has increased the life of new batteries under severe oper-

ating conditions as much as five times. It contains sodium sulphate and magnesium sulphate which convert the hardened "sulphate" on the plates into a soft, active material. For best results, the chemical should be added to new batteries, but it also works in mechanically sound old batteries.



With the forward roof folded back in good fishing weather, the cabin gives the boat a neat, snug appearance

A CABIN FOR YOUR BOAT

Easily made parts weigh less than 50 pounds, can be stored flat

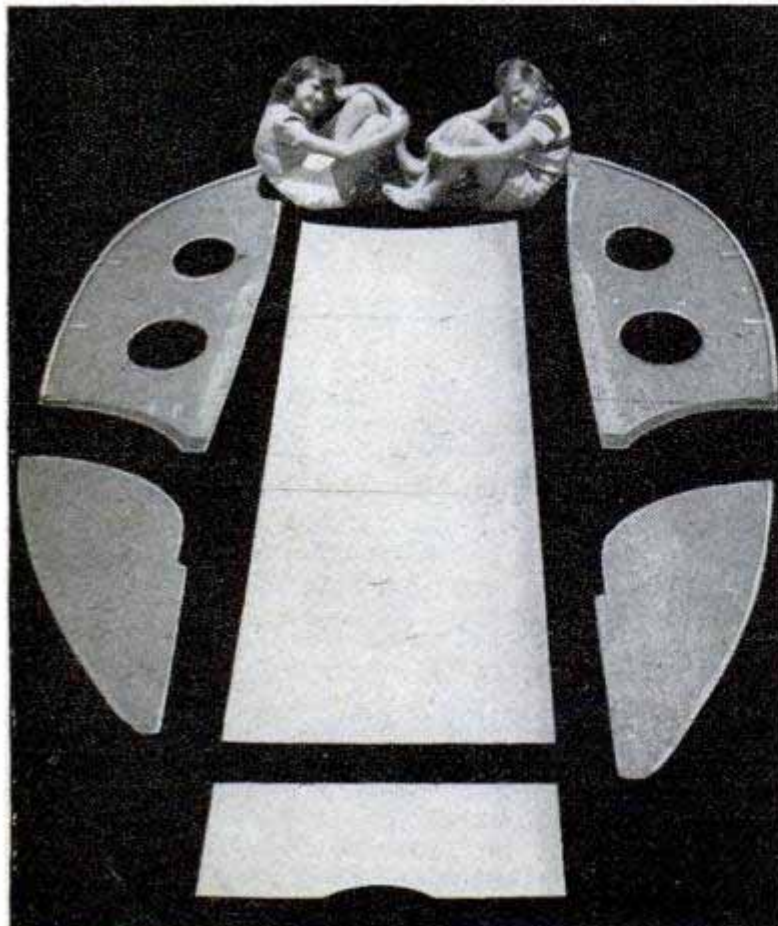

EVERY small-boat owner who has felt the stinging lash of the rain as he plows across a lake has wished for a snug cabin for his open craft. John Gartner of Long Beach, Calif., decided to do something about it, and came up with no flapping canvas, but a genuine weatherproof cabin. Because of the simple construction, he's sure any other boat owner can adapt the idea to his own craft.

The cabin, made of plywood, folds flat for storage, weighs less than 50 pounds and requires less than five minutes' time and a few bolts to assemble. The only essential element on the boat is some kind of coaming on which the cabin can be mounted. The sides and roof of the cabin are made of $\frac{1}{8}$ -inch waterproof plywood, cleated and braced with $\frac{3}{4}$ -inch-square strips of spruce or oak and some pieces of $\frac{1}{4}$ -inch plywood.

Gartner first clamped a piece of plywood to one side of the coaming from the windshield as far back as he wanted the semipermanent housing. The piece was high

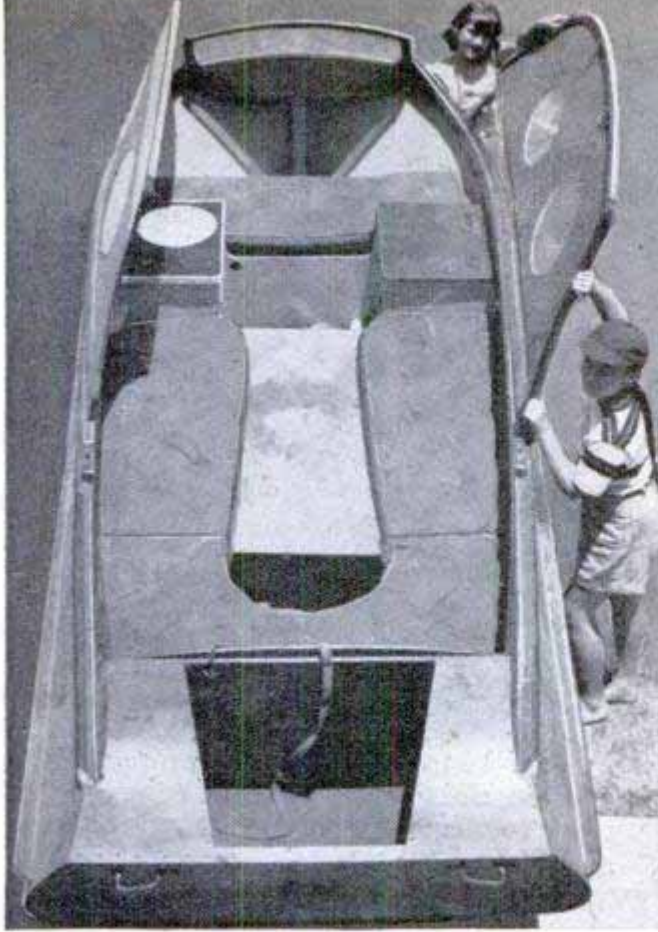

enough to allow comfortable sitting space in at least one seat position. He marked off the roof arch, then clamped another piece of plywood to the aft section and faired down the roof line to the stern. These two pieces of plywood were connected by making joints of $\frac{1}{4}$ -inch plywood strips fastened to each side of the forward section and extending beyond the edge about one inch, thus making a pocket in which the aft section fits snugly.

The top edges of the sections were braced inside with strips of $\frac{3}{4}$ -inch stock bent to the roof curve, and the lower edges reinforced on the outside with strips of plywood three inches wide. Gartner then made duplicate parts for the opposite side of the boat and bolted all four sections to the coaming with $\frac{3}{8}$ -inch brass wing bolts.

He made the top in three sections. The middle section was braced with crosspieces at intervals, and angle irons were screwed to the braces to serve as wing-bolt fastenings on the sides. Then he cut the other two top pieces to size and fastened the three pieces together with piano hinges. An extra section of roofing was needed for the stern of Gartner's particular boat. When on the highway, he lashes down the forward roof with straps. He can get to the storage space inside the boat simply by loosening the hold-down straps.

The windows or portholes, inserted wherever he desired, are made of $\frac{1}{8}$ -inch plastic set in mastic and bolted.

Above, left, side pieces are wing-bolted to the boat's coaming. Top, wing bolts, inserted through angle irons, also hold the roof's center section to the sides. Above, forward roof is strapped down while the boat is on the highway. Loosened straps permit access to the interior. Below, the roof folds down into place on piano hinges to complete the cabin

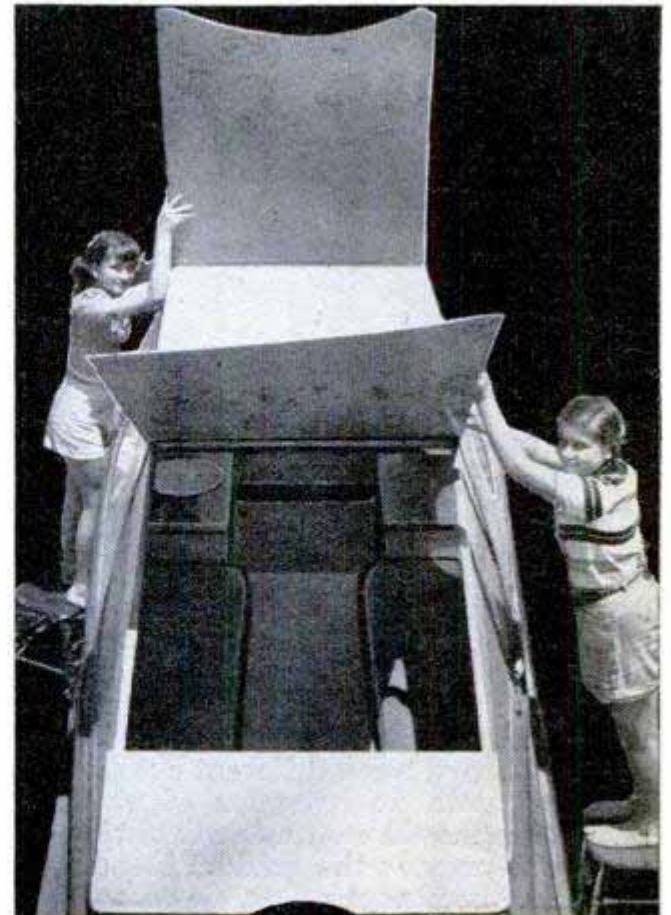



Power Scythe

You don't have to swing a scythe that has an oscillating cutter bar, instead you just guide it along and a lightweight gasoline engine does the work. Ideally suited for trimming around buildings, under fences,



along slopes and rough ground where power mowers can't go, the power scythe weighs only 24 pounds and is carried by a shoulder strap. The cutting blades can be submerged in water for trimming weeds in irrigation ditches or for removing under-water growth around beaches.

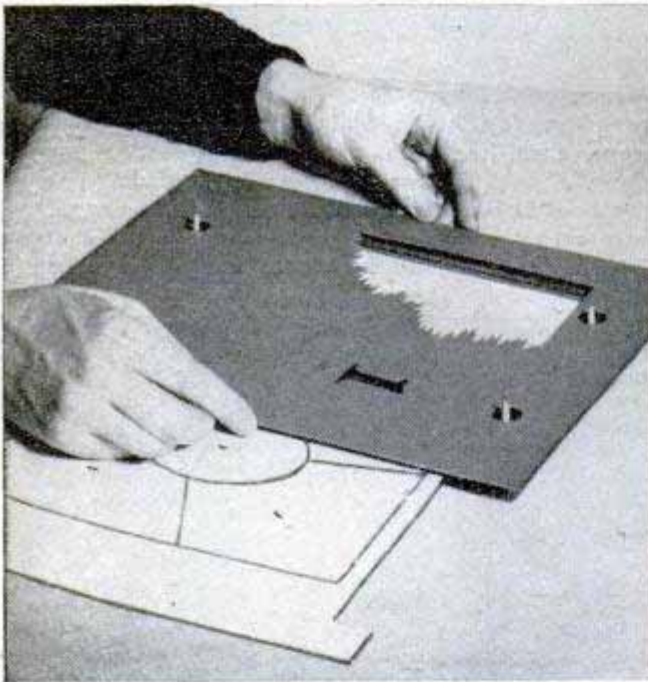

Photomontage Kit

Photographic montages are made from five separate negatives with a masking device that blends them so well there are no separation lines between the pictures. The device, sold in kit form, consists of five masking boards, each numbered for identification, a baseboard with four aligning pegs and a numbered target area on which the individual images are composed. Each masking board has a different cutout area, bordered with an irregular edge. These boards are moved continuously during exposure to provide the gradual blending of adjacent photographs.



Stamp Examiner

All the instruments used by a hobbyist in examining his postage stamps are included in a new gauge. The philatelist first measures the size of the stamp on a scale marked off in inches and millimeters. He then can place the stamp along a rotating gauge, which he turns until the marks exactly match the stamp's perforations. By looking at the number on the indicator he determines the number of perforations, often the only means of distinguishing between a valuable stamp and one worth only a few cents. As a final check, the collector can place the stamp in a tray on the instrument and test it for watermarks with the fluids available for that purpose.



Plastic shades over headlights reduce glare from approaching car, above left, and eliminate that dangerous, "blind" instant when cars pass. The shades are hood shaped, right, and are slotted to direct light rays away from approaching car. To install shades, you remove outer rim, below left, and screw shade in place, right

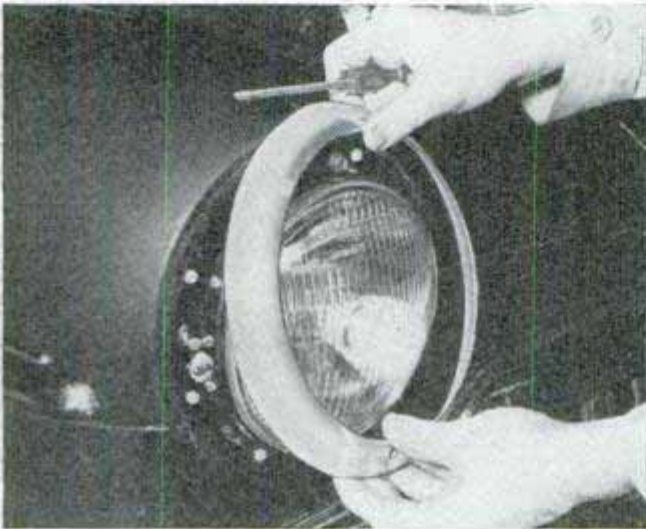

Plastic Shades on Headlights Cut Down Glare

One of the principal causes of automobile accidents at night—headlight glare—is eliminated with a plastic "ray director" that fits over any sealed-beam lamp. The director, or shade, is made up of vertical slots and while it prevents glare it still gives a long driving light, according to the manufacturer. This is accomplished by eliminating certain unnecessary high beams of light and directing the other beams ahead to assure clear vision. A

driver can switch to his bright beam, just before he meets a car without blinding the other driver. This prevents the blind sensation that occurs in the instant of passing. The ray director was invented and patented by Thomas R. Flesher of McAlester, Okla., in 1938, but production was delayed by experiments with various materials and the war. Ray directors are available in smoky, amber or clear plastic and can be installed with ease on a truck or car in a few minutes.

Ladder Platform

Painters and repairmen who stand on ladders for long periods now can work from a platform which hooks over the rungs. The platform, measuring 15 by 20 inches, provides a large standing area. One-inch steel bands hook over the rungs to support the platform, which also can be used as a scaffolding hanger or a rack to hold tools and equipment.

There are 3,300,000 miles of public streets and highways in the United States.

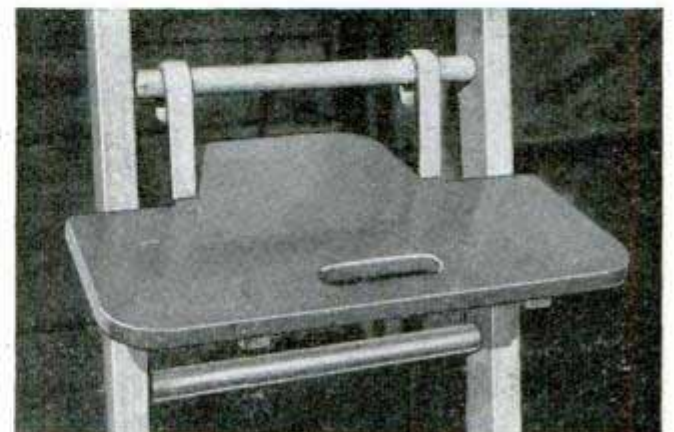

By Ewart Thomas

SOME MEN tame lions for their living. Others shoot Niagara in a barrel. Then there are a few who deliberately dive out of jet planes at 500 miles an hour to find out whether a new-fangled parachute is good enough to lower them safely to the ground.

This group of veteran Navy jumpers forms the hard core of a military project aimed at redesigning the old-time parachute so it still can serve as the escape hatch for the modern pilot, who now whooshes through the air at the speed of sound. The Navy jumper deliberately places himself in an emergency situation, then leaps for his life. Sometimes he dives out of a plane only 200 feet off the ground to find out whether a new style of chute will open quickly enough to save him. A few of the men have bailed out 150 times or more.

In addition to the daredevil jumpers, the Navy's Parachute Experiment Unit at El Centro, Calif.,

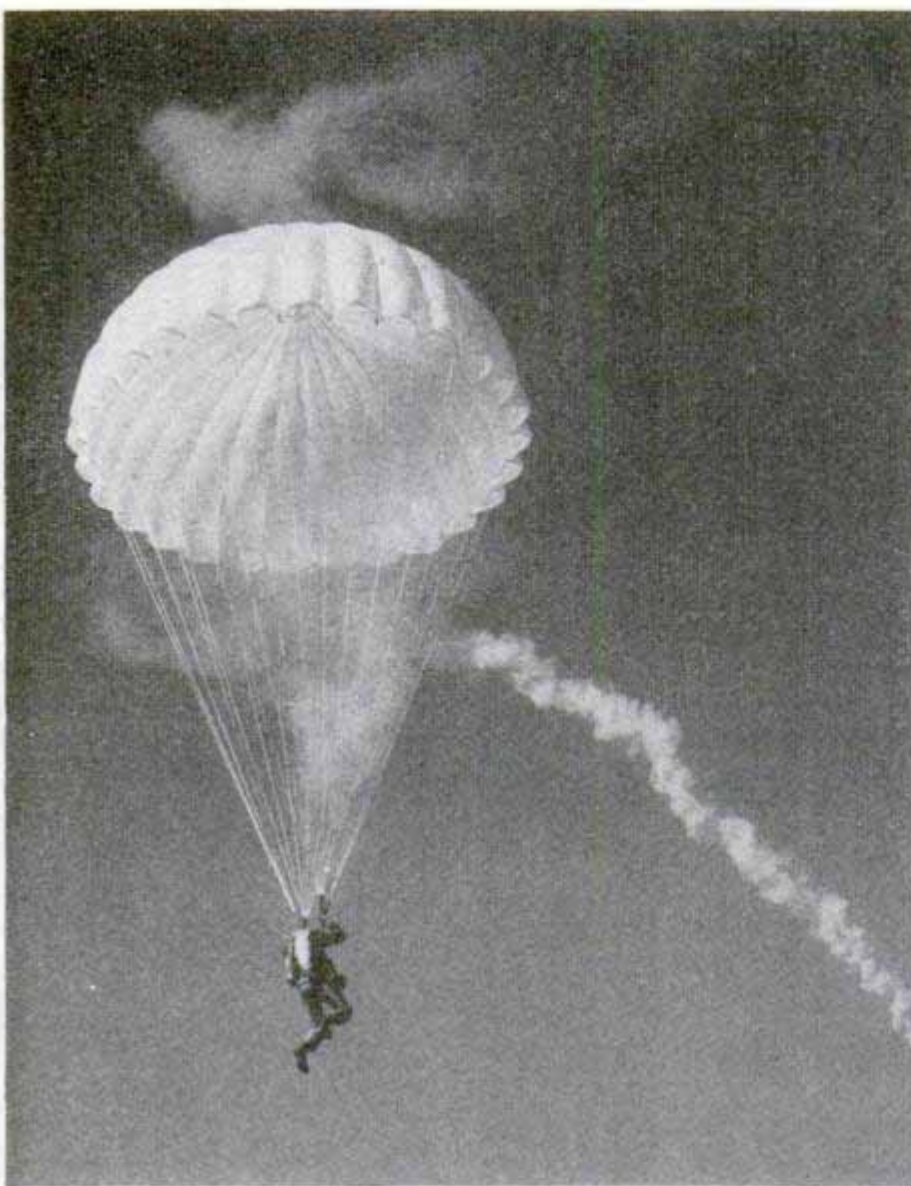

Navy daredevil has just tossed away a smoke candle, which permits ground observation of wind currents. Some of the men have made 150 test jumps

They Jump for Other

Now under development is a supersonic air cannon which will fire shells containing parachutes at 2300 miles an hour. Heated compressed air will hurl chute from nozzle. Radio will transmit behavior of umbrella

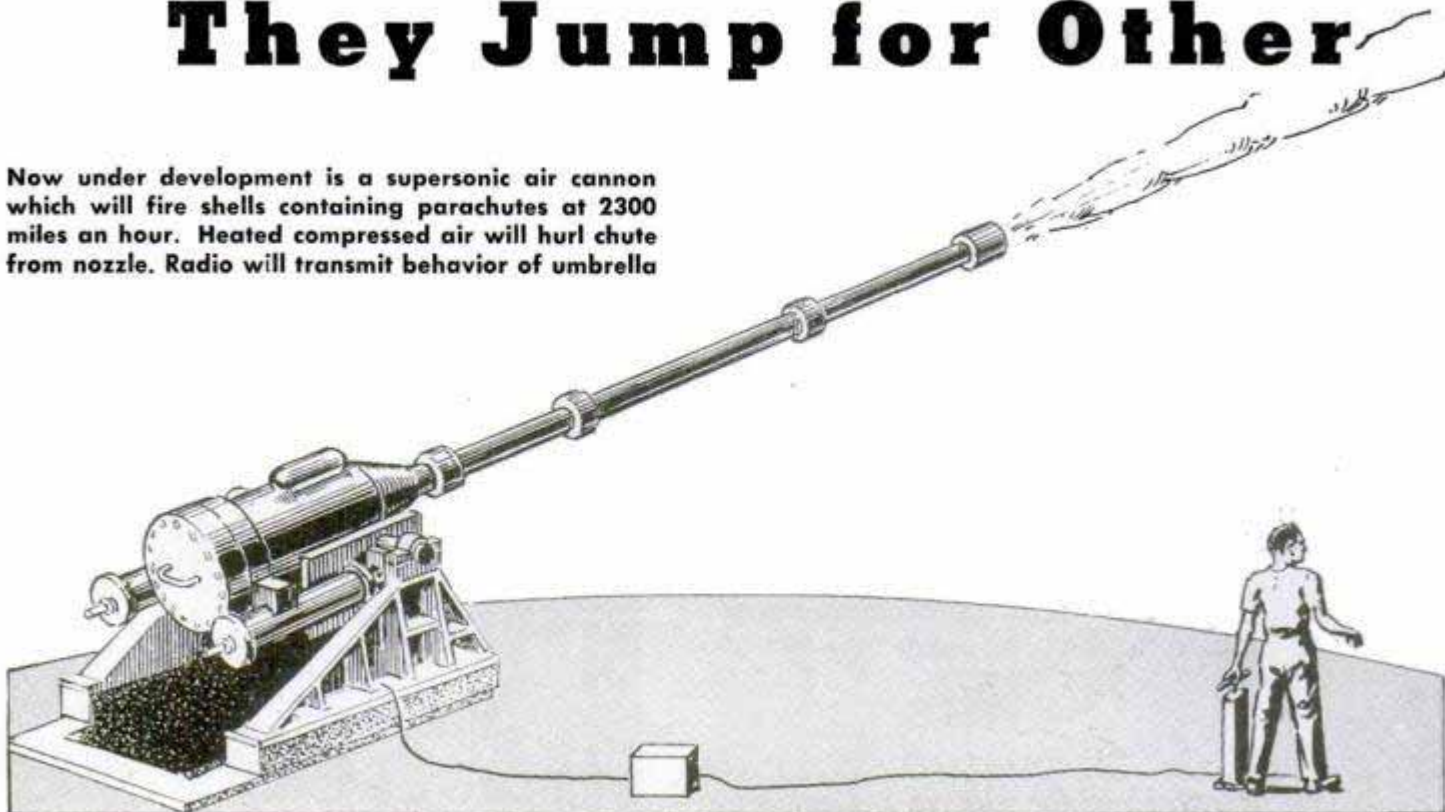

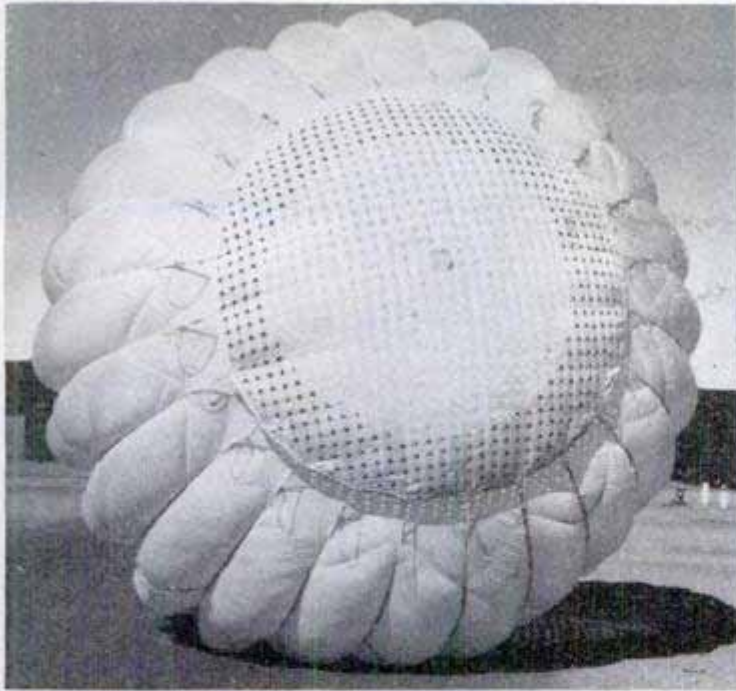

Experimental chute has ribbon relief canopy which raises to spill out air during the opening shock



"Apex" chute has an open center with a smaller canopy above, held in proper position by shroud lines

has robot paratroops to test new umbrella designs, and is building a gigantic slingshot and a supersonic air cannon for fire-testing new chutes.

Tumbled out of speeding aircraft, the robot parachuters report by radio the shocks that are imposed on their steel and rubber torsos. One of the big problems, of course, is to design a chute which will open at high speed without jerking the pilot's life away.

The air cannon will fire a parachute, packed into a hollow-steel projectile, at 2300 miles an hour. The chute will open in flight, and the resulting deceleration of the

Men's Lives

Towed through water at 22 miles an hour, test jumper is about to check a new quick-release mechanism



JUNE 1950

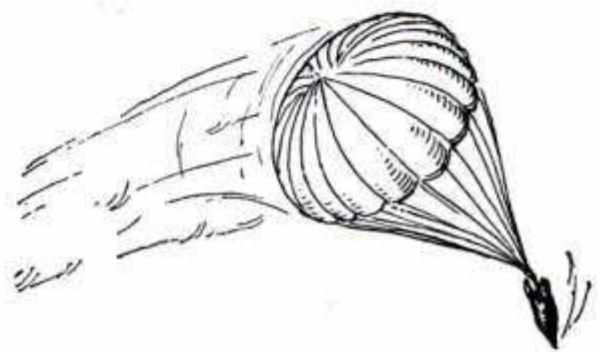

missile will be measured and reported back to the ground by radio.

The slingshot is a long arm atop a 120-foot tower. Dangling from the end of the arm on a 90-foot cable is a nacelle containing a parachute. The arm revolves, gradually building up speed until the nacelle is whirling at 500 miles an hour, when the chute is hurled out to open in free flight.

The research is paying off, too. The principal need of a pilot in trouble is a dependable elevator which will lower him safely to the ground floor. The parachute easily served that purpose in the days of 100-mile-an-hour planes. Now, new types of chutes make it possible for fighter pilots to bail out at 500 miles an hour and live to fly the blue yonder again.

Strange, new types of chutes are emerging from the tests to serve a variety of other uses. Already, 30-foot chutes are used as brakes to help land 60-ton jet bombers, and big drogue chutes lower airborne artillery and vehicles safely to the ground. Nevertheless, parachutes that can carry even greater loads and open safely at even greater speeds will be needed shortly.

A new piece of parachute equipment undergoes months of accelerated testing at

111



Glenn L. Martin Co. photo

Ribbon parachute serves as an extra brake to reduce the landing run of a new high-speed three-jet bomber

El Centro before it is ready for adoption. It may be tested a thousand times by radio automatons and other dummies, then checked by the 10 experienced jumpers in scores of live jumps before it is approved.

Usually, a test jumper carries 35 pounds of equipment including a second chute for emergency use. Occasionally, he is so loaded down with experimental gear that he can't walk. Lifted into the plane by his mates, he's tossed out at the proper altitude.

In most cases, the live jumpers make their own reports of how a new chute func-

tions; in the case of the radio dummies all the needed information including opening shock, strain at different parts of the canopy, oscillation and rate of descent is measured by special instruments. The data is transmitted to the ground via an eight-channel telemetering unit contained in the dummy. The antenna projects upward from the dummy's neck.

Photographers with high-speed movie cameras record the falls of the nonradio dummies and the live jumpers. They work from small aircraft that fly wing-to-wing

Big whirl tower to be built this year will spin chutes on a long cable, then sling them out at high speeds

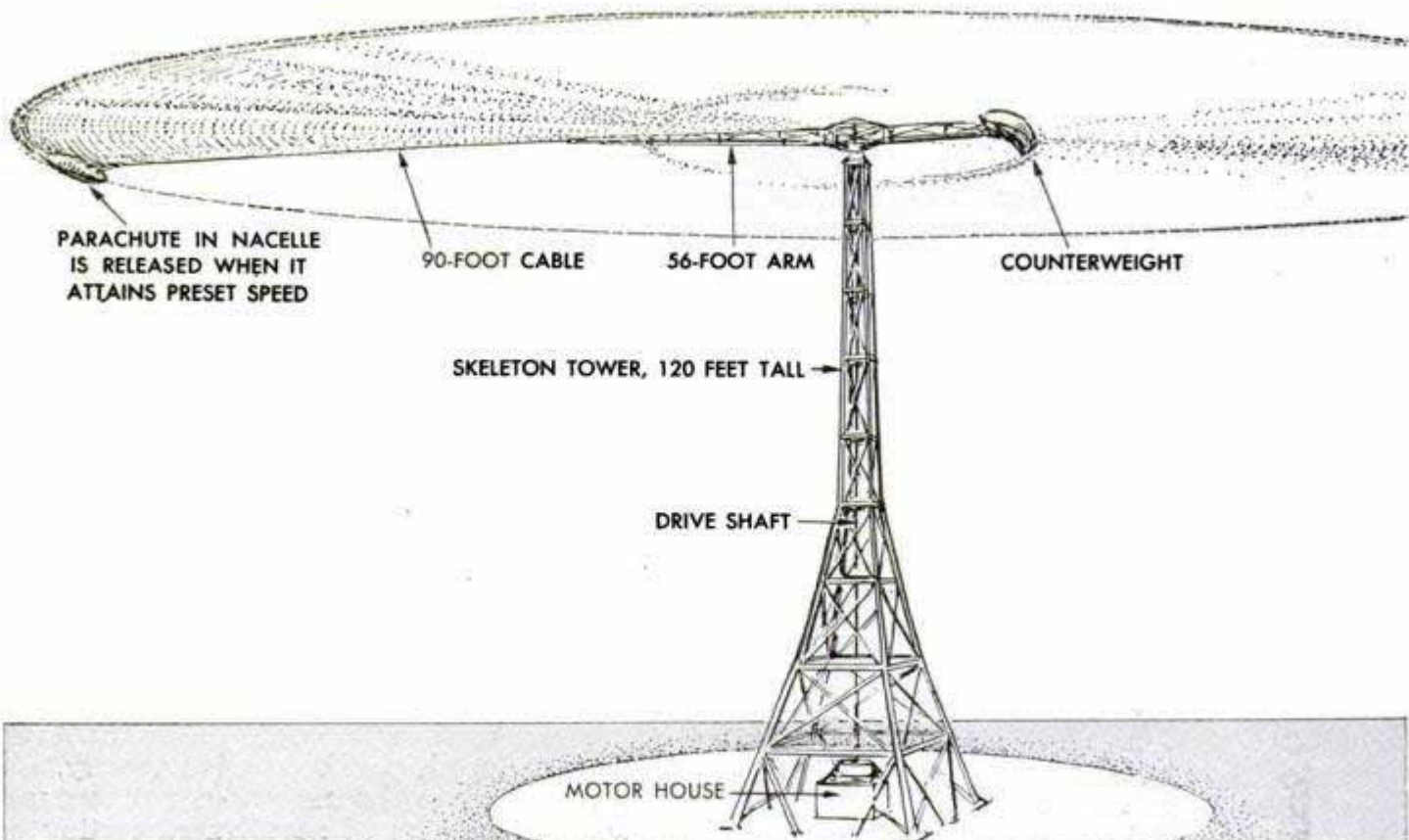

with the parachute plane, or from helicopters that can follow particular jumpers all the way to the ground.

The El Centro experiment unit, directed by Lt. Cmdr. John A. Morrison, has the over-all job of developing and testing all the Navy's aviation life-saving needs. In addition to developing personnel chutes, it tests parachutes designed for such special purposes as lowering pilotless aircraft and prototypes of guided missiles to the ground after their power is expended.

One of the unit's accomplishments is the new chute adopted for use by Navy jet pilots, which may become standard for all Navy needs. The chute reduces or eliminates most objections to earlier designs.

In the first place, the canopy material is lighter and far stronger than the material it replaces. The porous nylon fabric weighs only 1.1 ounces per square yard as against 1.6 ounces per square yard for standard parachute nylon. The new material is cross-ribbed with a concentration of warp and filler threads at approximately $\frac{1}{8}$ -inch intervals, materially reducing the chance of a tear and tending to stop any rip that might occur.

Instead of the usual 24-foot canopy, the new parachute has a 28-foot canopy plus a so-called extended skirt, cut on a camber, that gives the chute a cuplike shape when inflated. The parachute opens more gently, reducing the shock that is imposed on the jumper, and can carry a heavier load more safely to the ground. Extended skirt designs, in fact, are being adopted by all the armed forces.

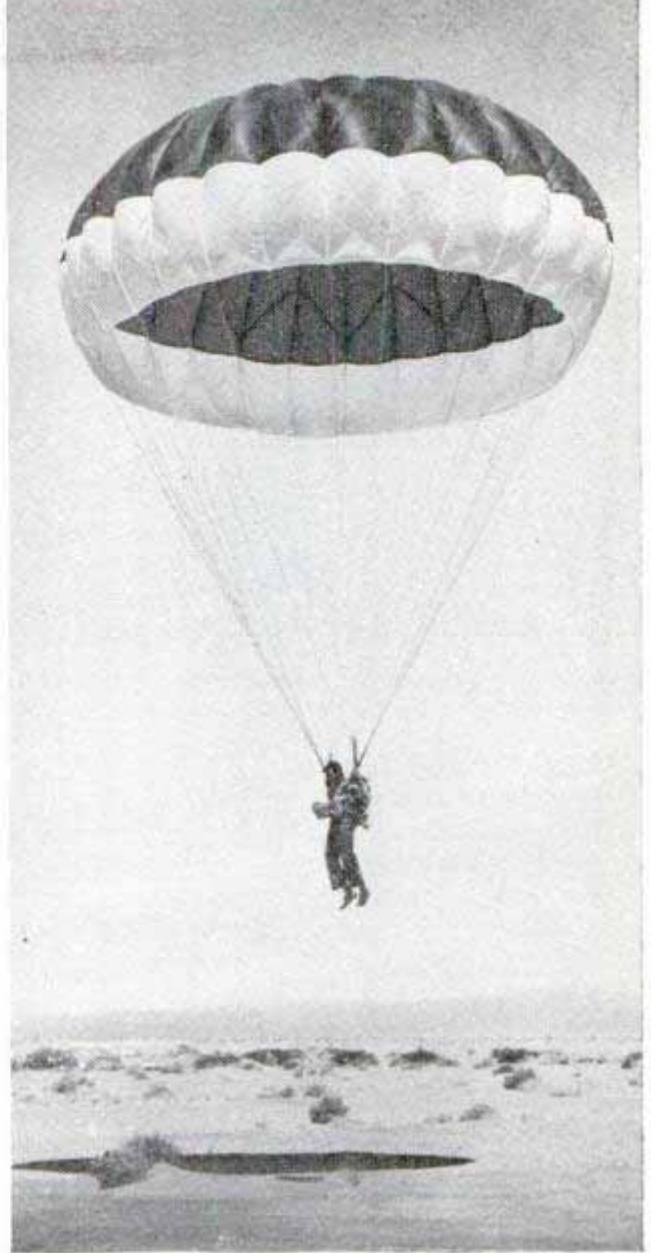

Above, new parachute with extended skirt is becoming standard equipment for Navy jet pilots. It has less opening shock, softer landing, yet packs into same space as old chutes. Below, 105-mm. howitzers spill out of cargo planes to be lowered to ground by parachute

Department of Defense photo





Parachute is strapped on robot jumper for a test leap. Rubber-coated antenna projects from dummy's neck

Minimum opening shock is insured by a new "deployment bag," attached to the pilot chute, which holds the shrouds and canopy. The bag holds the canopy in a tight bundle until the shrouds have been pulled free by the weight of the jumper. Then the canopy itself is released and the deployment bag drifts away with the pilot chute. Simply because it permits the shrouds to stretch out before the canopy is released, the new bag reduces the jar to the jumper by about one ton.

Jumpers who have seen stars in front of

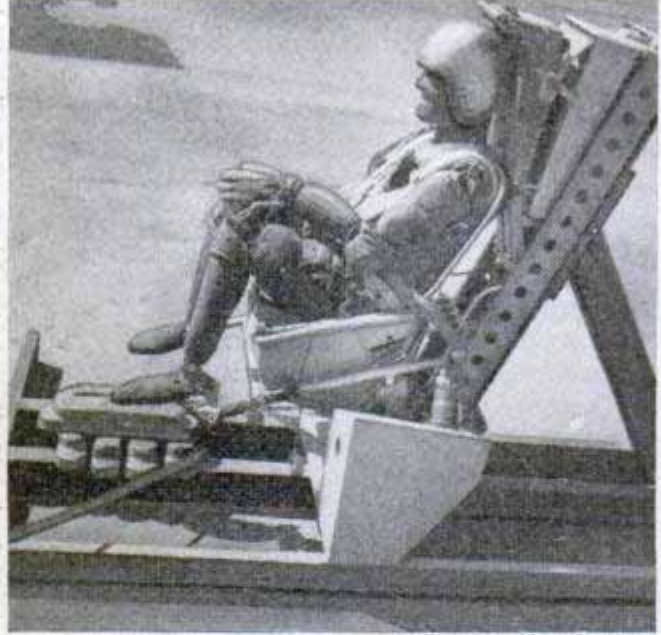

Douglas Aircraft photo

Another robot is used to test ejection seat, which hurls the jet pilot free of his high-speed plane

their eyes when an ordinary chute takes hold at moderate speeds find that they now experience no noticeable shock. And those who have had to maneuver their bodies into position before pulling the rip cord at high speed can now open their chutes at any altitude without excessive shock.

Sometimes jumpers, after landing safely, have been severely injured when they were dragged across rough ground by their inflated chutes. Others have almost been drowned when they landed in the water and were towed by the billowing chute. The new chute has quick-release mechanisms at the shoulders and a jumper can free himself of the parachute as soon as he lands. Another feature of the new chute is that it is made entirely of nylon, including the webbed body harness. The old cotton webbing tended to mildew and had to be replaced at regular intervals for safety.

Ordinary chutes can be opened safely at speeds up to 250 miles per hour and the new chute can withstand openings at 500 miles per hour with safety. At that speed it opens with a boom that can be heard on

(Continued to page 256)



Pilot pulls lever, ejecting the pod. Fins stabilize it in free flight

Gun fires drogue chute out in a deployment bag. Main chute then comes tumbling out the open door

Main chute opens and lowers pod to ground

Latest escape hatch for the pilot is this breakaway cockpit capsule, which is blown from the plane when the pilot pulls a lever. Capsule is pressurized and insulated. Large chute lowers it to the ground

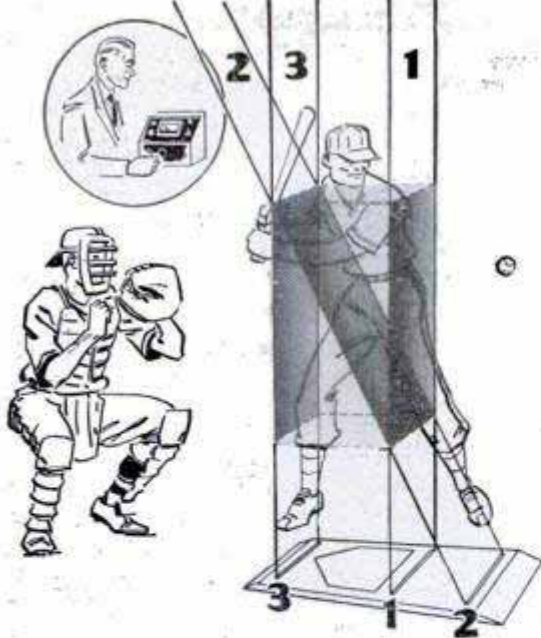

General Electric photo

To register as a strike, a ball must cast shadows, in 1-2-3 sequence, on three electric eyes looking up from 17-inch-wide slots in home plate. Right, Capt. Peewee Reese of Dodgers tests new electronic umpire

Electronic Umpire Judges Balls and Strikes

Players on the Brooklyn Dodgers baseball team have discovered an umpire who is never wrong. The infallible umpire isn't human; it is an electronic unit that flashes a light only when the ball passes through the strike zone—which is 21 inches wide and between the batter's knees and armpits. The Dodgers met "him" at their spring training camp in Florida. The electronic umpire's two main parts are a metal box 4 feet long, 21 inches wide and 1½ inches deep, upon which home plate is located, and a cabinet containing the recording and

strike-indicating equipment. Lenses and mirrors in the ground box enable three electric eyes to "fence in" the strike zone as they look at the sky through three slots in the top of the box. A ball passing through the strike area casts its shadow on the three eyes in a definite sequence, creating impulses which light the strike indicator. The device is intended only for practice and not to replace the umpires in actual games. It can be adjusted to fit the height, and corresponding strike zone, of any player.

Remote-Control Lawn Sprinkler Moves on Wheels

Steps and time are saved by a new lawn sprinkler whose spray range and position are adjusted by pulling or pushing the attached hose. The turning of the corrugated brass wheels on which the sprinkler head is mounted controls the water flow over the area being sprinkled. It can send out a mist-like spray that will cover any radius from 5 to 45 feet.

Doctors in a Danish hospital are carrying experimental pocket-size radios which ring when a particular wavelength is called, signaling the doctor to operate his receiver and find out where he is wanted.

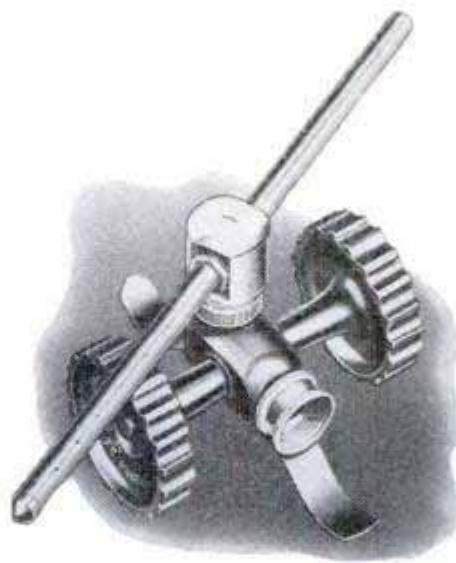

VALUABLE FREE INDEX TO POPULAR MECHANICS NOW AVAILABLE

Your useful free copy of the new six months' index to Popular Mechanics, January through June 1950, will be mailed to you upon receipt of your order and 10 cents to cover handling and mailing. Just address your request for the index to Bureau of Information, Popular Mechanics Magazine, 200 E. Ontario St., Chicago 11

"JACKKNIFE" OIL DERRICK ROLLS TO WORK

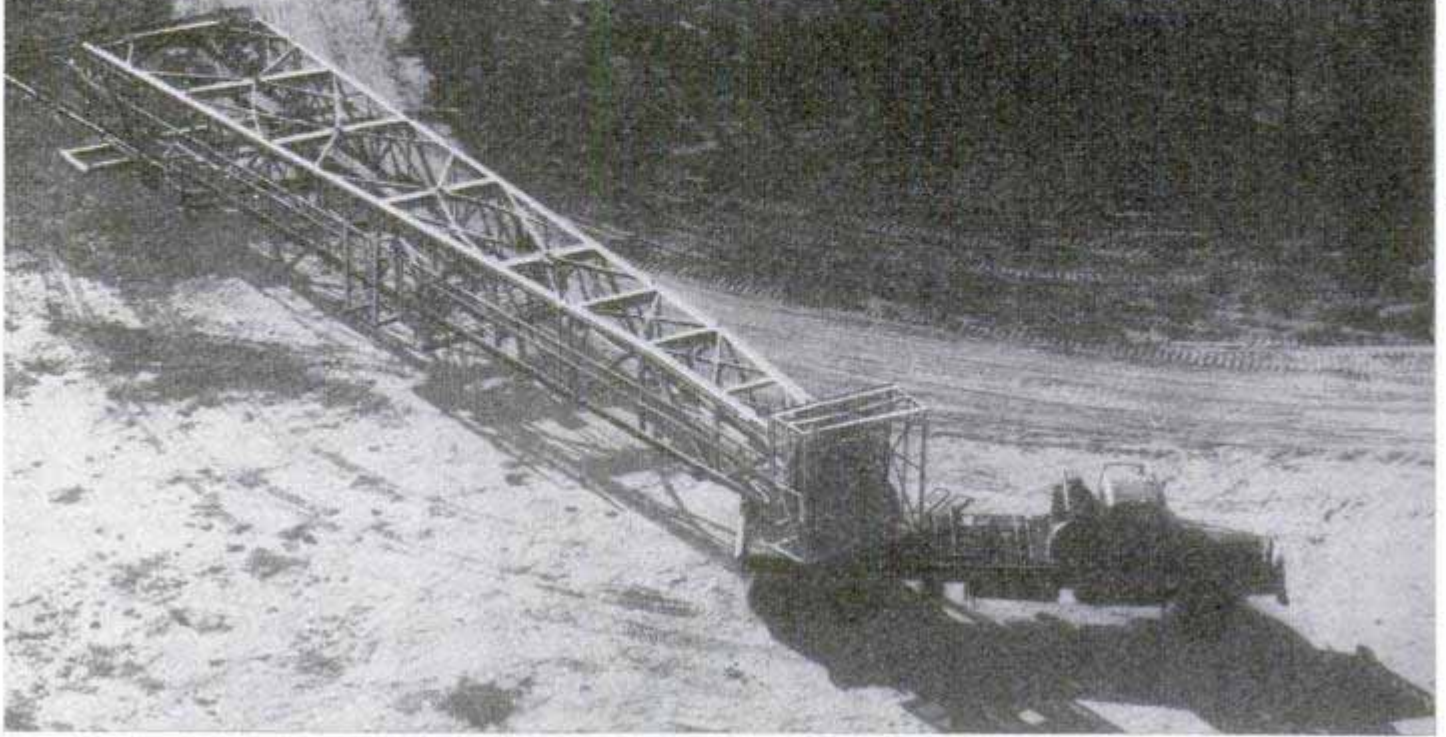

Above, truck swings wide to negotiate a curve in pulling the 136-foot drilling mast to its new location. Below, after pins are slipped out of the legs, the mast is lowered onto a truck and special dolly for the trip

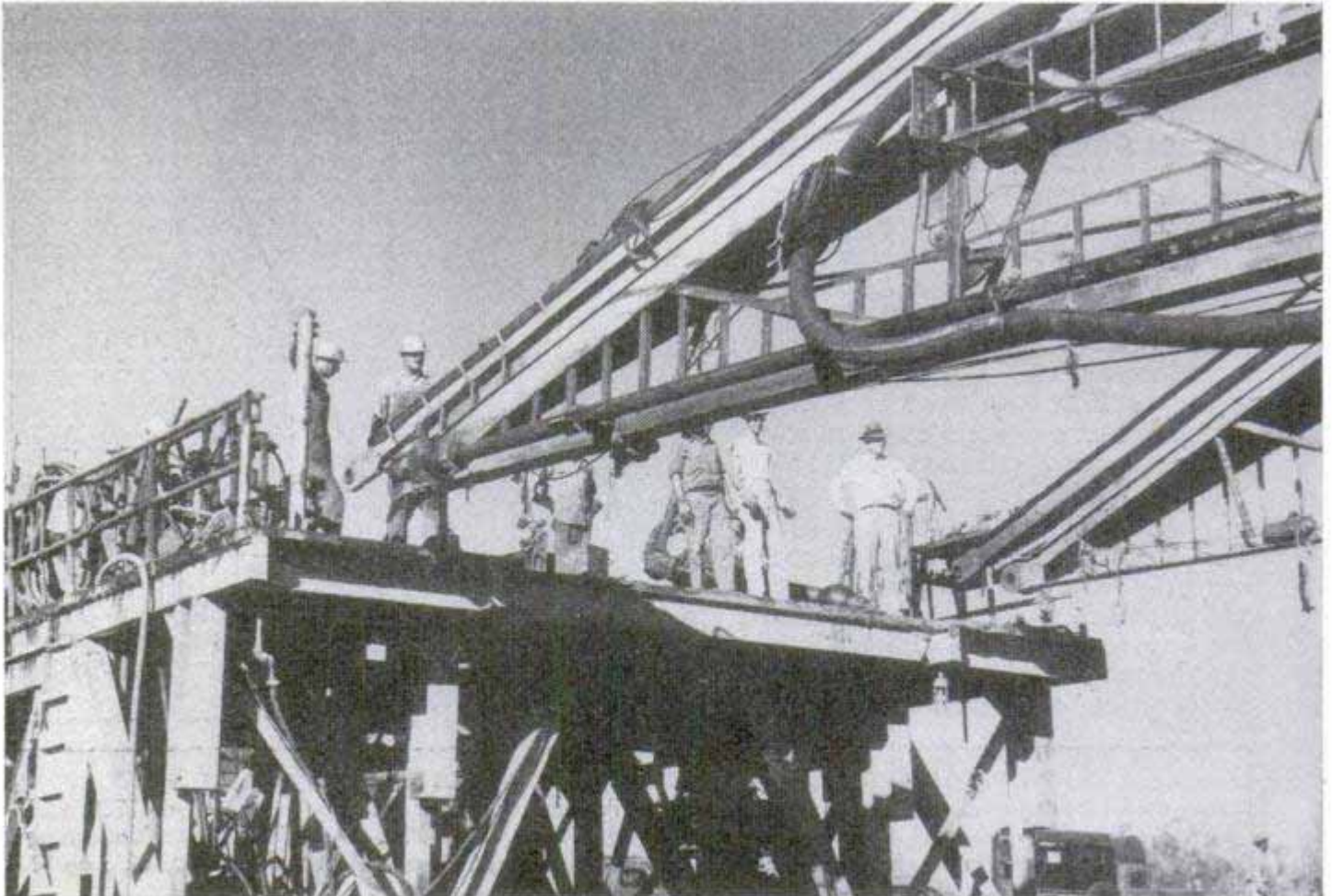

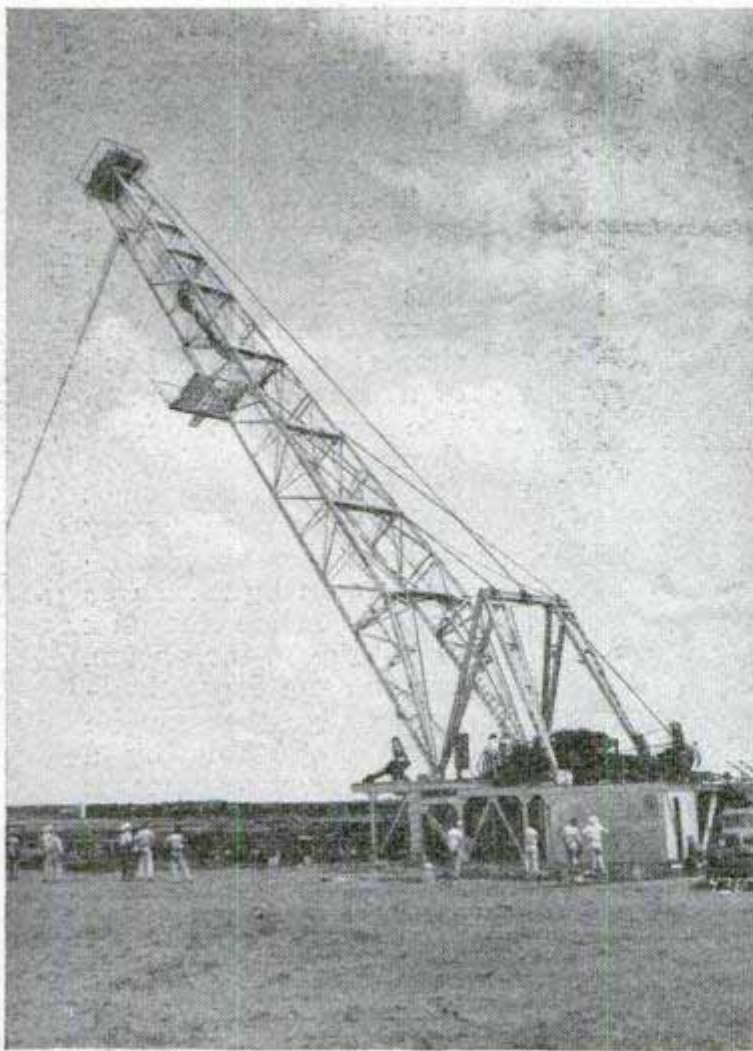

At new location, the mast is raised to position with standard equipment. Right, fastened in place, the rig is ready for another wildcat test

WHEN a new oil derrick has finished its job at one location, it is folded down like a jackknife blade and hauled off to another spot where the next wildcat test is to be made. Conventional rigs must be dismantled, then reassembled with bolts. The jackknife mast is attached to its base by large steel pins. When a move is made, the steel pins are slipped out of their sockets and the mast is swung down to the ground. Then the 136-foot tower is towed on airplane-tired dollies by tandem trucks. The substructure, divided into two 25-ton sections, is moved in the same manner. Three other trucks haul the accessory equipment. A Texas operator moved one of the jackknife rigs 14 times in a 15-mile-long area within seven months.

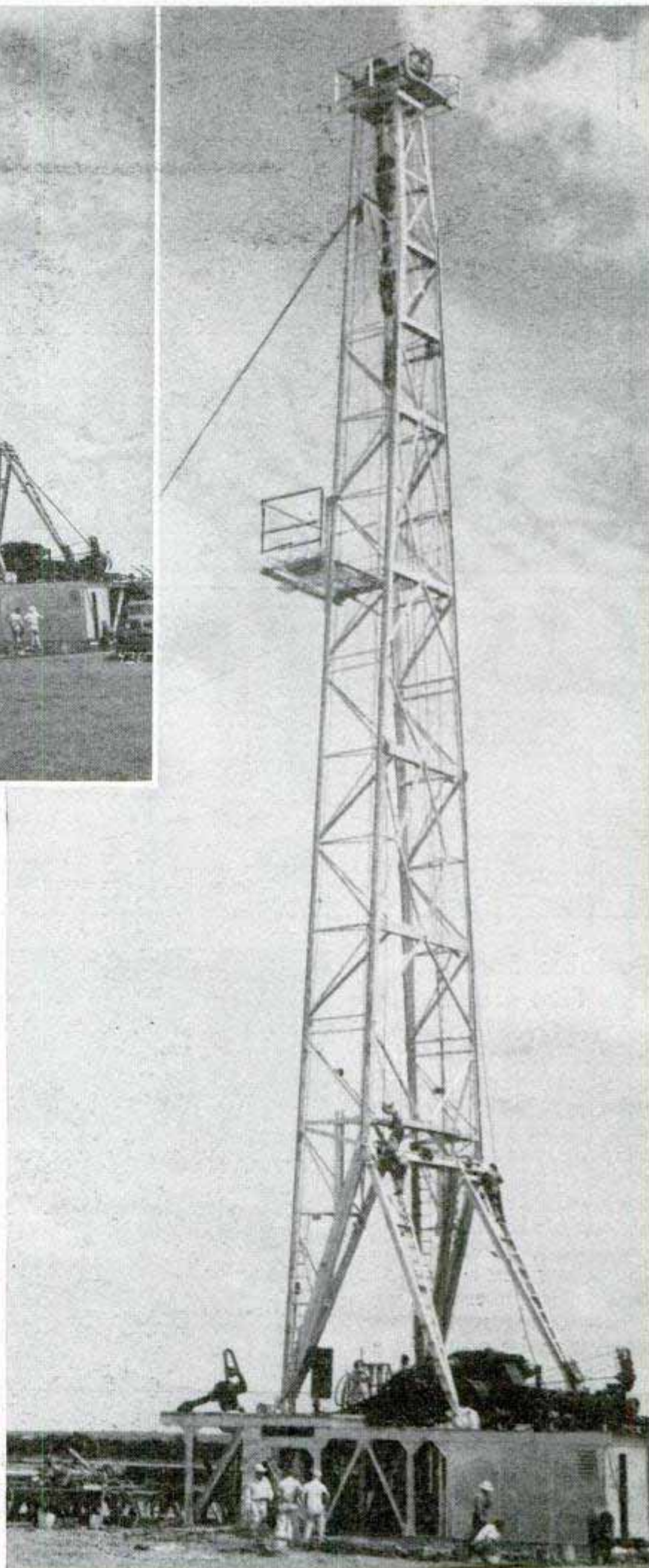

Daylight Screen Uses Three Mirrors To Enlarge Image

Projector operators can sit up front alongside the screen when they use a daylight viewing device that "folds" the light beam three times and shoots it against the back of a translucent screen. The image is projected through an opening on the side of the cabinet and can be seen clearly without dimming ordinary room lights. Three mirrors inside the box "fold" the 34-inch beam, providing a large, brilliant image that can be seen comfortably by a group. The cabinet is only 16 inches high and 12 inches wide. Similar to the "black" screens used in some television sets, the screen provides high contrast without glare. A compartment in the base of the cabinet provides storage space for slides, a small projector and a stand that supports the projector at the proper height.

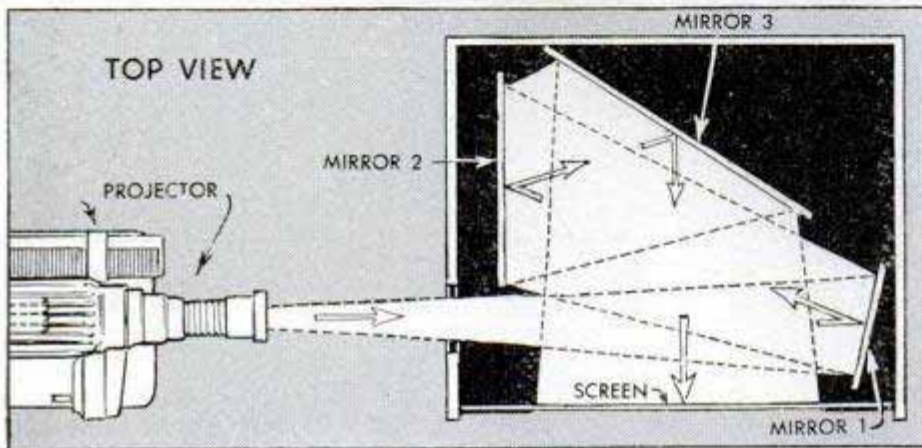

Portable Sprinkler Has Five Outlets

Five brass sprinkler heads spaced along 50 feet of plastic hose may be used to water narrow strips and irregularly shaped areas around trees and shrubs. Skids beneath each of the sprinklers automatically switch into position lengthwise with the hose when the hose is being dragged from a wet area. The range of the spray can be adjusted at the faucet or by turning off some of the outlets.

▮ Brazil's extensive deposits of oil shale can provide enough local fuel for its needs, according to an investigation by the U. S. Bureau of Mines.

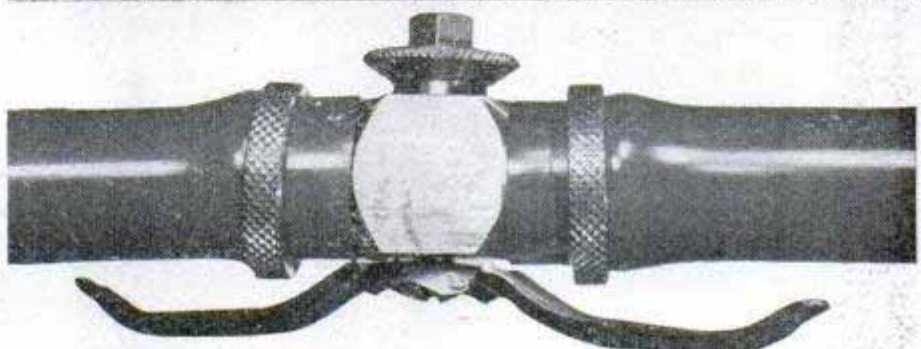

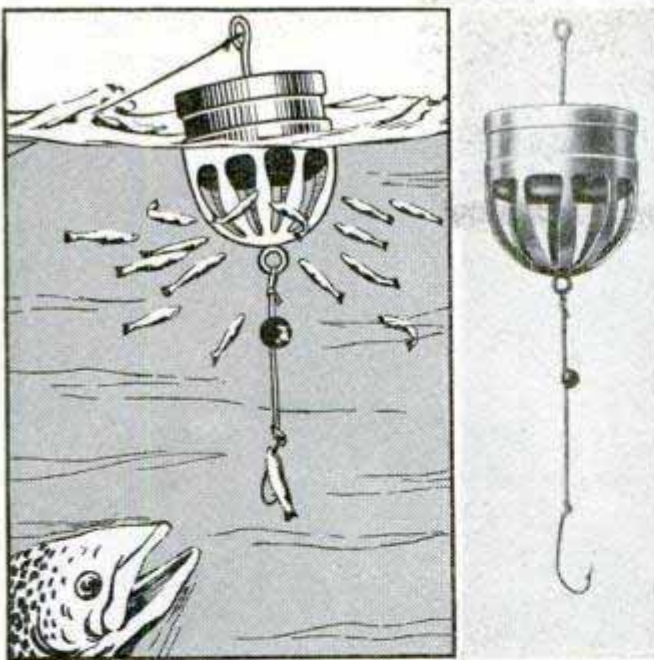

Floater Lures Bait and Fish

Designed for still-fishing, a new floater has a detachable bait container beneath which is attached a leader and hook. Minnows attracted to feed at the floater containing doughball, bread or other bait, in turn attract larger fish to the hook baited with a captive minnow. As the free minnows can swim away, the large fish is left with the captive.

Dust "Elevator" Speeds Drilling

Holes being drilled in masonry are continuously cleaned of dust by a carbide drill with a wire spiral that carries the cuttings up and out of the hole. Because the dust is removed as soon as it is formed, there is no tendency for it to pack in the hole and stall the motor. Drilling is faster because no time is wasted in cleaning the hole and an almost constant rate of penetration is maintained. The drills come in sizes from $\frac{1}{4}$ to 1 inch.

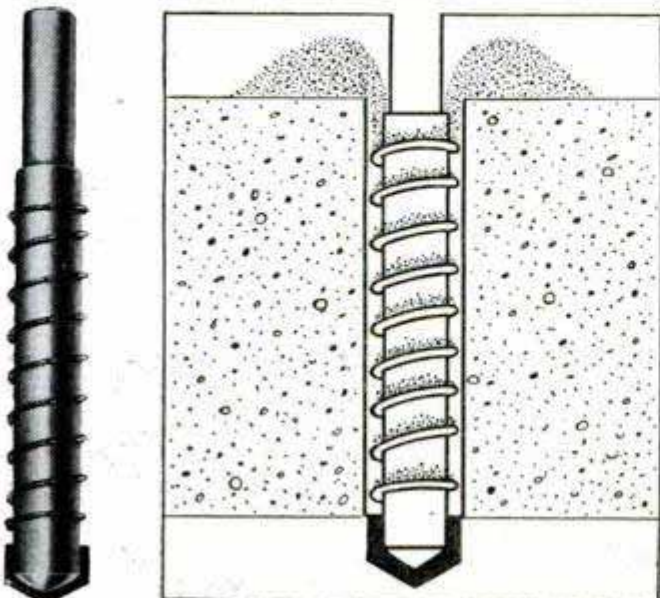

JUNE 1950

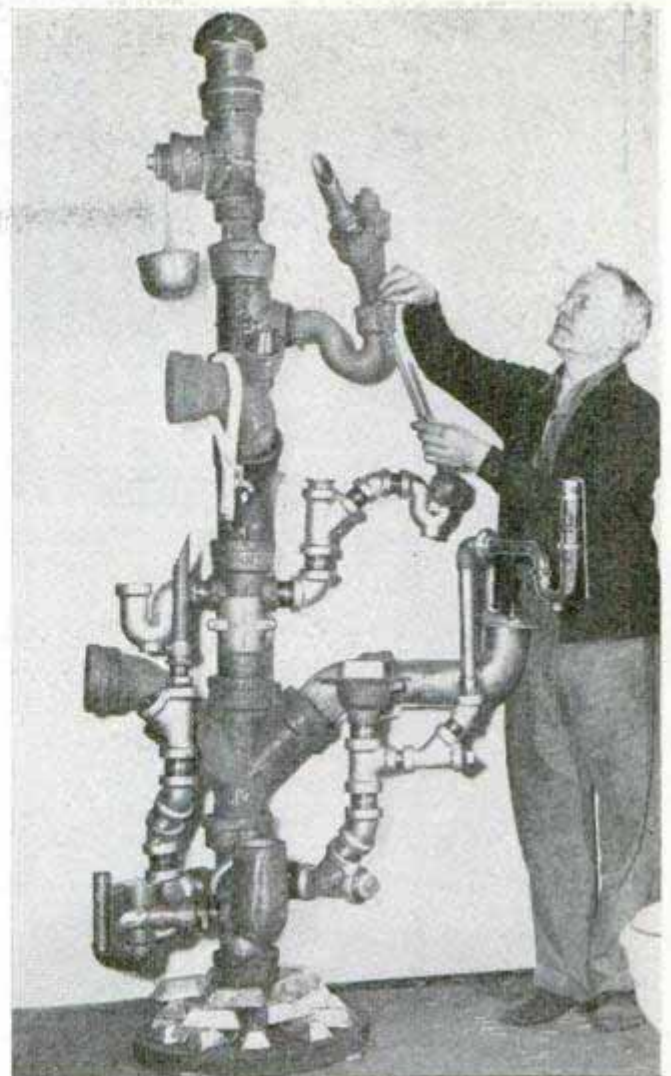

Plumber's Tree

More than 125 joints and fittings form a plumber's tree displayed by a Chester, Pa., firm. All the bends, traps, elbows and other parts comprising it are commonly used soil and water-pipe connections. The joints are packed with oakum.

Key Ejector

Car keys can't be carelessly left in the ignition for a thief when they are installed in a spring-action holder. When the motor is turned off, the key is ejected into the driver's hand, reminding him to pocket it. The ejector also prevents the driver from locking his key inside the car.

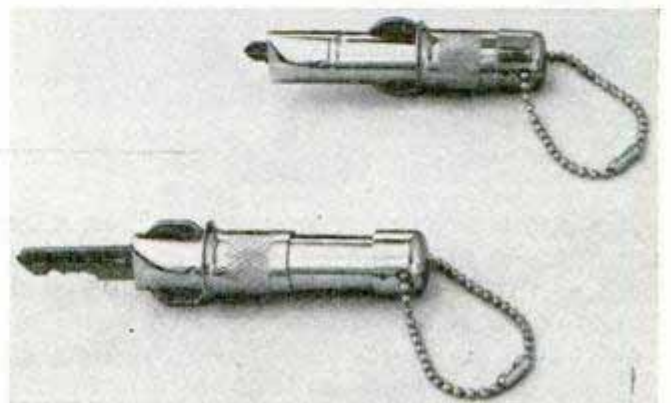

119



Chemical Spray Dissolves and Washes Away Paint

Old paint is washed off almost any surface by a chemical that is applied in a hot-water solution by means of a hose and nozzle. The solution dissolves the paint, one coat at a time, leaving the base surface

ready for immediate refinishing. The chemical is noninflammable, nonacid, odorless and fumeless. It does not harm calking seal, chrome or canvas and is especially valuable for boat owners.



Plastic Water Wheel

Swimmers have a new play item this summer—a huge water wheel which spins on the surface to provide the thrills of a roller coaster. The wheel, made of Vinylite, is six feet in diameter. When inflated, it forms a double ring that has circular open-

ings spaced uniformly between the two rings. It can be made to roll across the surface, used in a competitive “king of the mountain” game or anchored as a float for diving or sun-bathing. The plastic resists abrasion, oil, grease and temperature change. Deflated, the wheel rolls into a small bundle weighing only eight pounds.

WORKSHOPS for G I JOE

By John L. Kent

THIS IS just like home. Now you join the Army and get—a basement workshop!

To make military life as home-like as possible, the Army has even thrown in a fully equipped hobby shop for GIs to use during their off-duty hours.

In fact, home was never like this. It would take a lot of skimping—such as cutting out the movies for a few years—to buy the equipment found in the hobby shops at many of the Army camps today.

The serviceman, as well as the civilian, likes to use his hands, and is proud of whatever skills he may have. A hobby-shop program was set up by the Army's Office of Special Services to provide him with facilities for developing those skills in his off-duty hours. More than 260 hobby shops are already operating at the various forts, camps and stations around the country and at posts overseas.

The shops are an outgrowth of the Army's crafts projects started during World War II. Then, however, much of the equipment was of a portable nature so that it could be moved with the troops. The shops were generally makeshift.

Today, they are equipped with the best woodworking machinery and other tools, and separate rooms and buildings are set aside for them. The typical shop includes a bandsaw, a circular saw, several sanding machines and a number of workbenches. In cabinets along the walls are handsaws,

Making toys and games for youngsters, top, is one of the most popular uses for the Army's hobby shops. A flying model of a Piper Cub, middle, takes shape. Full sets of tools are close at hand. Below, a belt and a leather handbag near completion

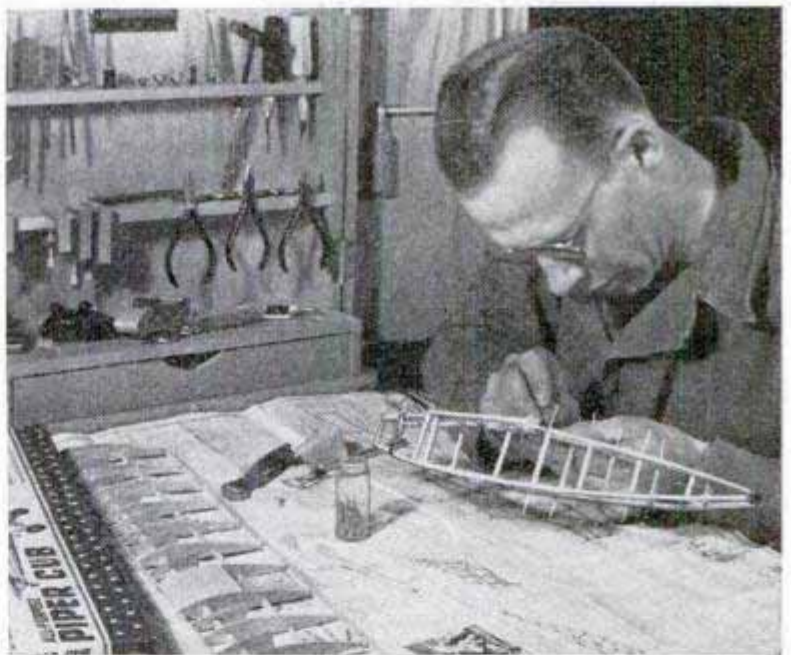

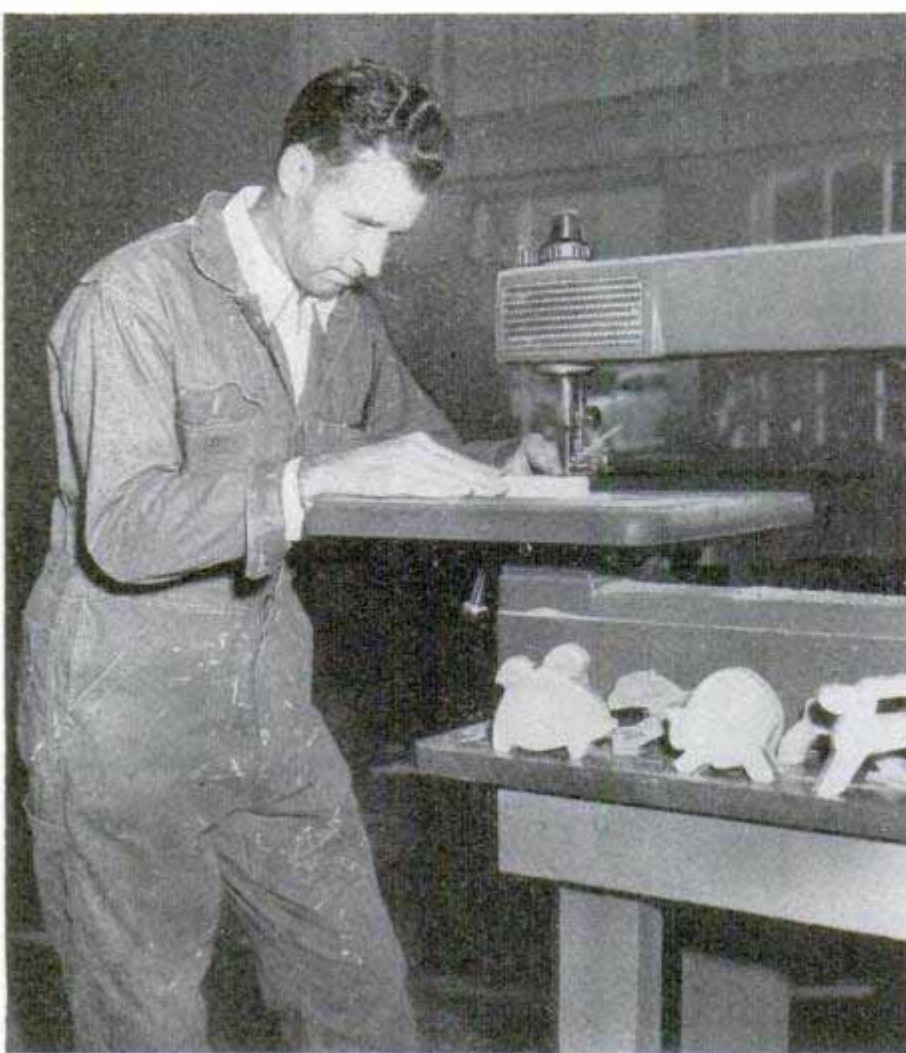

Using a power-operated jigsaw, an officer constructs a Noah's Ark, with a large assortment of animals, as a Christmas surprise for his young son

Winner of second prize in a worldwide crafts contest for servicemen was this China Clipper ship model. Many build tiny stagecoaches and planes

planes, chisels, hammers and other small tools. Some even have metal-working equipment, including power shears and soldering irons, so that budding machinists and radio hams may practice their hobby. Most of the shops also include photographic darkrooms.

Although there is some model-ship building, model airplanes are built at every camp hobby shop. These are usually flying models, powered by miniature gasoline motors. Model cars and stagecoaches are also popular.

The shops are largely financed from "nonappropriated" funds, that is, they are not paid for with the taxpayers' money appropriated by Congress. The money for the equipment and tools comes from profits of the post exchanges, where the soldiers purchase cigarettes, soap and other items.

Supplies such as photographic papers, leather, plastic and wood are sold to the hobbyists at cost.

Running the all-masculine

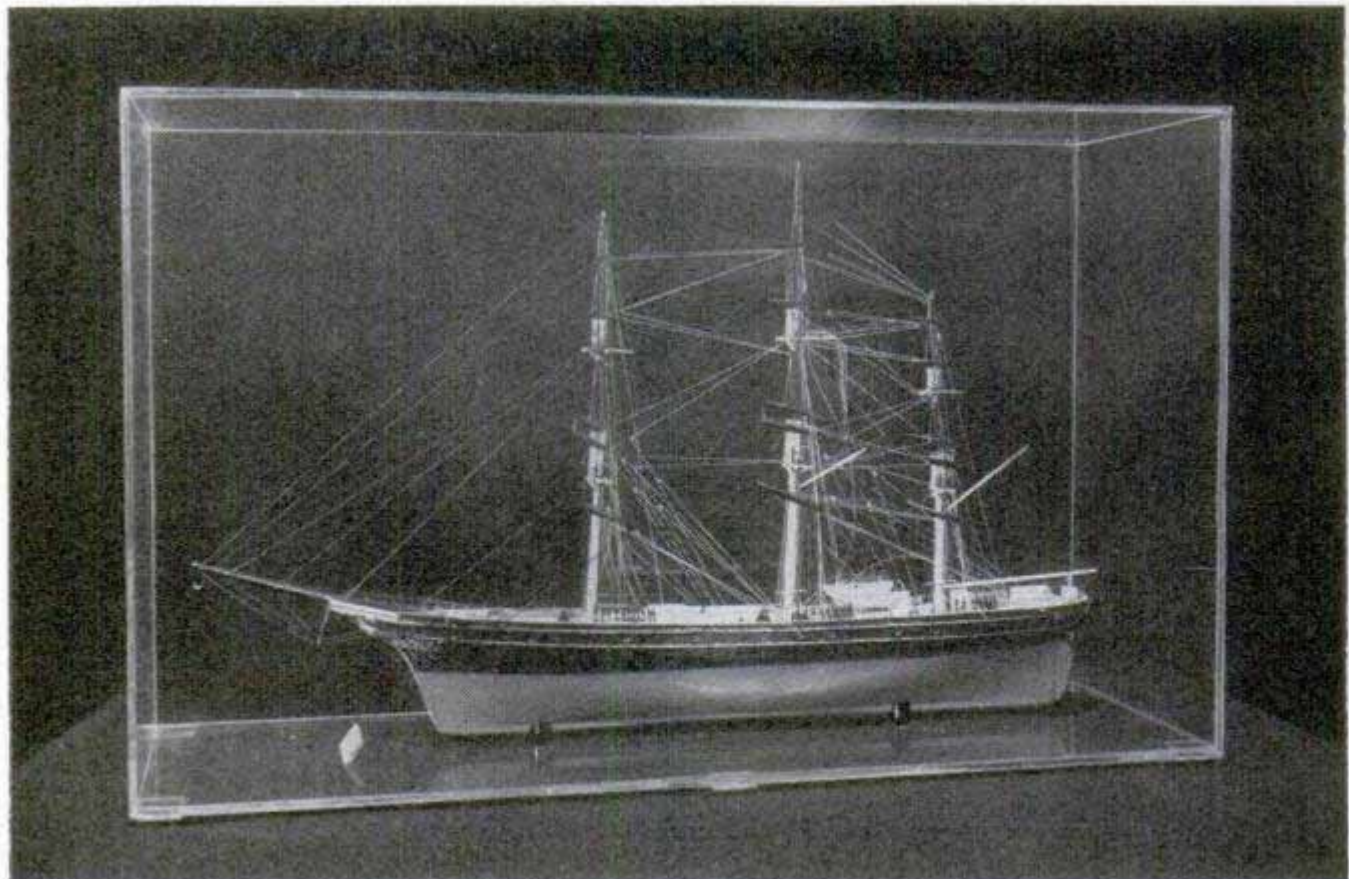

line hobby-shops program is a woman—Dorothy M. Kitterman.

The interest shown in a worldwide crafts contest initiated last year by Miss Kitterman proved that the Army hit upon something that today's soldier appreciates. There were 187 entries from military personnel stationed in the United States and overseas, with first prize going to M/Sgt. Benjamin P. Moody of Fort Sam Houston, Tex. His entry of a hand-tooled leather purse and billfold won him a \$500 U. S. Savings Bond and a complete set of power woodworking equipment. He also got honorable mention for his entry of a leather holster.

Sgt. Robert L. Barnett of Burbank, Calif., won second prize with a China Clipper ship model. Third place went to Pvt. Thomas H. Hannen of Winfield Township, N. J., for his precision square and vise.

Other interesting entries were an intricately carved clock, brooches and pendants carved from deer horn, hand-carved coffee table, chess sets and a miniature Buick convertible.

There's a reason, of course, why the Army is interested in furthering soldiers' hobbies. In dedicating a post hobby shop recently, Maj. Gen. Thomas W. Herren, the Army's Chief of Special Services, explained it.

"In this day of modern warfare," he said, "the Army is becoming increasingly a technician's Army. The soldier of today must be clever with his hands. In the event of an emergency, he must be able to repair a radio transmitter, repair a vehicle or skillfully prepare a map of an area."

The soldier who uses his leisure time in creative recreation has a tangible proof of his ability. There are few satisfactions in life that surpass that of giving a jewel box or lamp he has made to his girl friend or mother. Such personal gifts have a value that money cannot buy.

The Army is also aware that for many men duty assignments do not always provide the chance they need to show their creative ability. As a means of expression, one of the best answers is a personal hobby.

The hobby shops are here to stay.



Two contest judges inspect an intricately hand-carved clock. Another GI fashioned brooches and pendants from deer horn

Master Sergeant Moody, right, receiving first prize from Major General Herren. His hand-tooled handbag is in the foreground





Above, center, with guide cord wrapped around a drum staked in the center of a field, the wheelless mower cuts the grass in a giant circle without attention. Left, the twin model cuts a 36-inch swath. Right, underside view of skid pan and rollers that support the mower and prevent blade from digging up lawn

Below, the operator sits down at his work on this sulky. The mower cuts short and tall grass and works well on rough ground



Wheelless Power Mower

Mowing, rolling and trimming lawns are all one operation with an unusual power mower that glides along on a skid pan, instead of rolling on wheels. A large roller at the rear provides traction and, at the same time, rolls the lawn. A whirling cutter blade mows the grass evenly and, because there are no wheels, it cuts within a fraction of an inch of walls and other obstructions, thus eliminating hand trimming. For mowing large lawns, the machine is tethered by means of a cord wrapped around a drum-type stake. As the machine moves it unwinds the cord, cutting the lawn unattended. In this manner, the center can be cut automatically, leaving only the corners to be mowed by the operator. The mower comes in various sizes and models, which range in width from 18 to 72 inches.

Rotary Shield on Tractor Cultivator Protects Plants

Young plants are protected during cultivation by a rotary shield that attaches to the cultivator and straddles the plants, protecting them from clods and stalks. Cultivation can be done with the tractor in high speed, saving the farmer's time. The slots in the shields allow fine soil to sift in around the base of the shoots to cover grass and weeds. Providing a crop clearance of five inches, the shields work on all types of soils.

University of Wisconsin scientists are trying to breed corn with sterile pollen to eliminate the detasseling operation from hybrid seed-corn production.

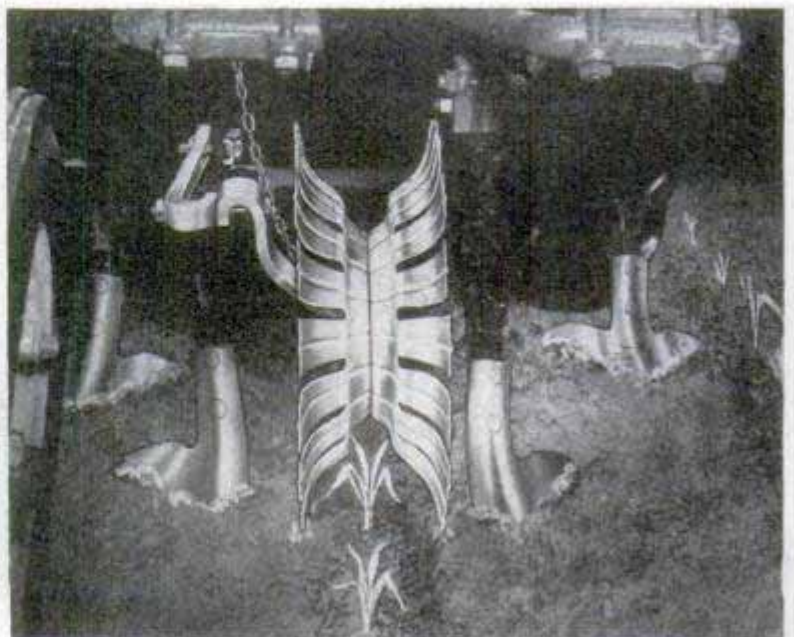



Painting courtesy The Lamp, Standard Oil Company (New Jersey)

Sentinels of Canada's oil boom, these derricks at Leduc field extend for miles over Alberta wheatlands

By Wayne Whittaker

THREE HUNDRED AND FIFTY miles north of Montana's northern border an obliging airplane pilot banks his plane and jerks a thumb in the direction of a sprawling city about the size of Wichita, Kans.

"That's Edmonton," he shouts above the roar of the engines, "the new oil capital. See how the Saskatchewan River divides the town?"

"Yes, but where are the oil derricks?" asks the visitor who has heard fabulous tales of the

PRAIRIE OIL BOOM

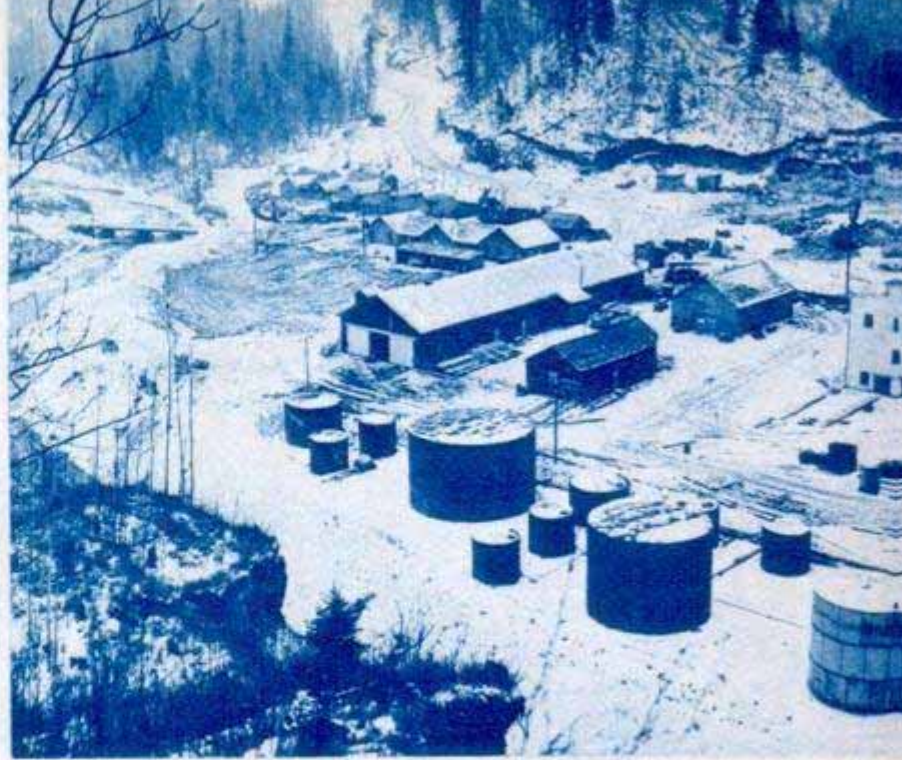

In northern Alberta, at MacMurray, are rich tar sands and recovery plant (right); left, chemist tests sand

province of Alberta's new oil fields and expects to see a forest of derricks.

"They're spread out," answers the Canadian pilot. "Everything in this country is spread out. Before we land I'm going to circle a little to the southwest and you'll see the famous Leduc-Woodbend field."

A few minutes later the visitor looks down on the flat green wheat farms of the Leduc area and the carefully spaced derricks—one about every 40 acres as far as the horizon. There is an orderliness in the spacing of the derricks that is typical of Canada's well-organized and nonhysterical boom that promises to yield at least two billion barrels of oil—possibly five. This is about the biggest thing that has happened to Canada in the country's history.

As the pilot circles back over Edmonton, losing altitude for a landing, he points out the fractionation towers of the oil city's new refinery.

"They moved that refinery down here from Whitehorse piece by piece," he explains. "Carried it down in trucks over the Alaska Road—over a thousand miles."

After landing at the orderly and busy airfield at Edmonton, the visitor boards a taxi for the MacDonald Hotel and along the way looks in vain for evidences of an oil-boom town. There are no get-rich-quick natives in overalls careening around in Rolls Royces, no saloons or brothels in sight along the clean wide streets! Canada's oil-boom capital would make poor meat for the movie cameras.

Whitehorse oil refinery built during war was trucked in pieces 1000 miles over Alaska highway to Edmonton

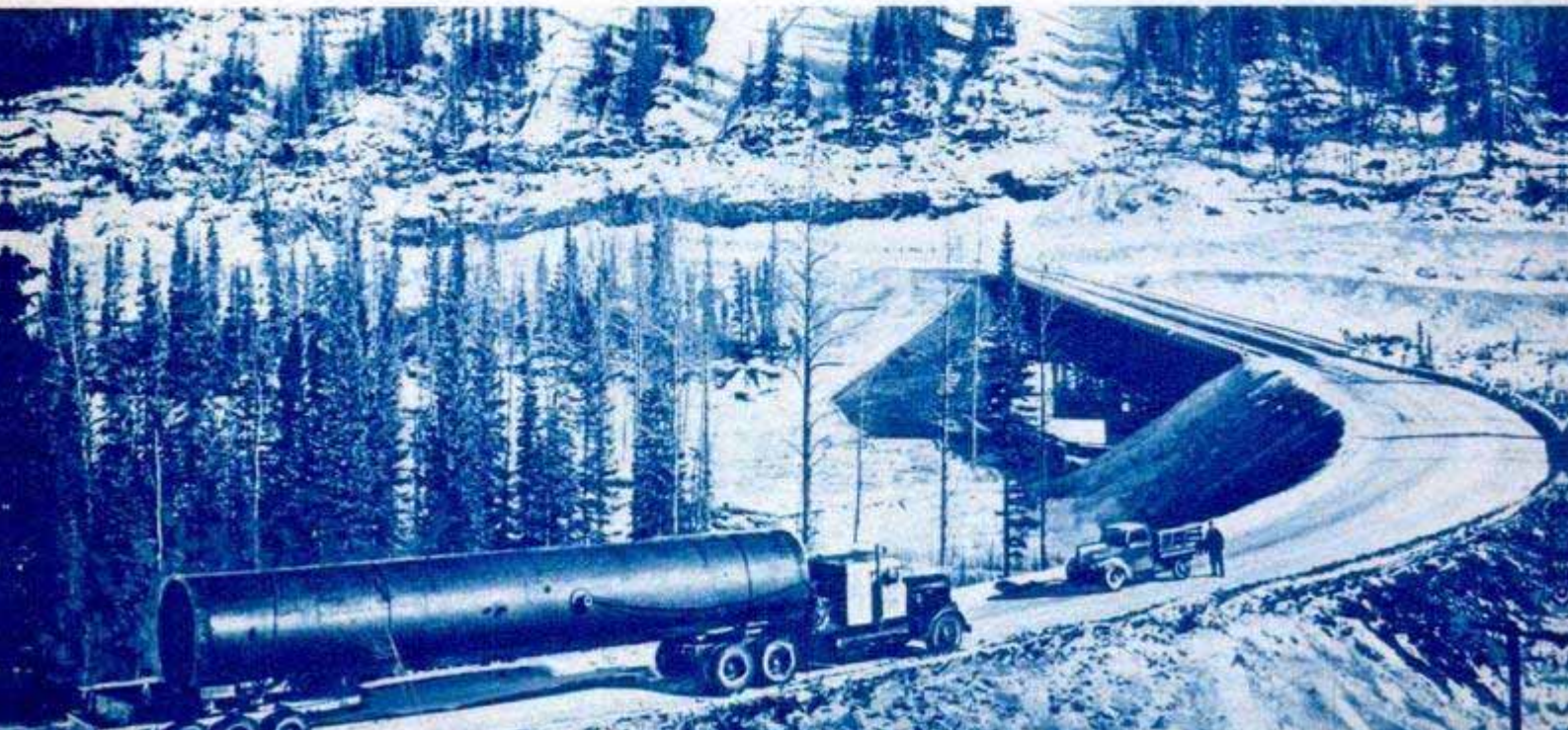

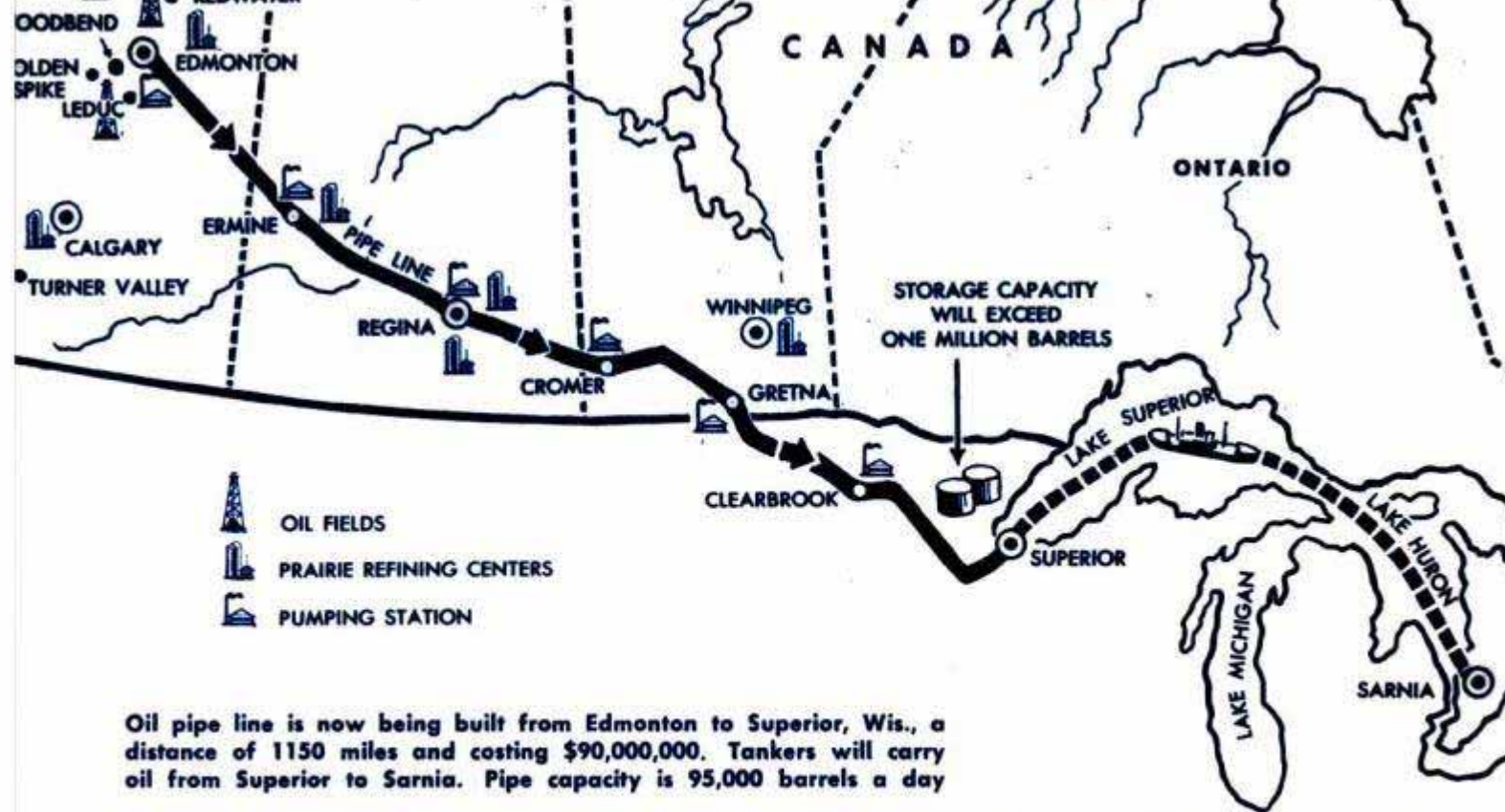

"Don't see any signs of the oil boom," the visitor complains to the taxi driver.

He laughs. "Why should the people get excited? Most of the oil belongs to the government."

Since 1887, the government has reserved mineral rights on any land sold to individuals. The province of Alberta owns the mineral rights under 90 percent of the land (147 million acres) and may someday be rich beyond the dreams of an Indian prince.

For years, oil geologists have known that by all the rule books there should be oil down under the Alberta prairies. Major oil companies, such as Imperial Oil, Ltd., of Canada (an affiliate of the Standard Oil Company of New Jersey) have spent millions on the gamble that there was oil under

those wheat fields, wilderness areas and endless miles of muskeg marsh. Some companies got cold feet after spending a few millions in this high-stake game and bowed out—to their later sorrow. Others, like Imperial, plunged ahead drilling one bone-dry well after another. One single dry well cost a whopping \$1,600,000, but most cost much less. At the height of exploration, companies were spending a million dollars a month for exploring parties alone—seismograph, gravity meter and magnetometer units. Despite all the advances of modern science, the oilmen were learning once again that the only way you can be sure about the presence of oil is to drill, drill, drill. This, Imperial had done over a 25-year period to the tune of 130 dry holes at

Left, gravity meter helps study subsurface structure without taking core. Right, mapping spot for soundings

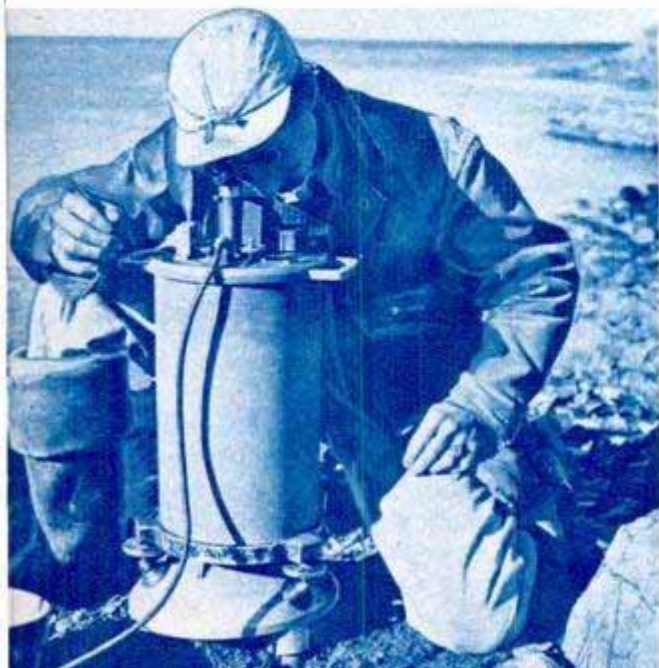



Hard-working crews drilled 5000 feet into the prairie around Leduc to find rich oil storehouse. Below, petroleum engineer checks gauge regulating production to insure maximum recovery

Imperial Oil, Ltd., photo



a cost of more than \$23,000,000. Why didn't they give up? Because the geologists knew the formation of the earth deep under Alberta was the extension of a stratum formed in what is known as the Devonian Age. This rich oil basin, which lies east of the Rocky Mountains, extends from Texas to the Arctic Circle. The Devonian limestone coral-reef formation under Alberta was hiding oil somewhere and lots of it. The trick was to find it by drilling in the right place. When they did—three years ago at Leduc—there was much tossing of hats in the air by relieved geologists.

There was reason for the celebration. A good grade of crude oil gushed forth from the earth at the rate of a thousand barrels a day. Another flowing well was put down and another. One, Atlantic No. 3, gained world fame for the Leduc field by being a bad actor. It went wild for six months during 1948, whooshing up an untold amount of inflammable gas and more than a million barrels of oil. Before it was brought under control, it caught fire and the smoke and flame seemed to extend into the stratosphere.

By this time the rush was on. Today, there are more than 335 wells in the immediate area of Edmonton. This includes the Leduc and adjoining Woodbend fields, the big 1949 strike at Golden Spike just west of Woodbend, and the Redwater field about 30 miles northeast of Edmonton. Some 180 oil companies are now active in Alberta.

The oil boom has been under the thumb of N. E. Tanner, Minister of Mines and Minerals of the province. He handles the oil leases, driving shrewd but fair bargains (according to the oilmen) in the name of the province all based on the premise that the government itself does not want to get actively into the oil business.

The boom has grown to such proportions that neither Edmonton nor the small town of Leduc could handle the influx of oil people—engineers, geologists, field men of every category, drilling crews and their families. Imperial bought a field from a farmer and made it into a town called Devon. This is a crude town with good

plumbing, a fancy restaurant, wide streets and its own newspaper (The Devonian) as well as lots of mud and some portable houses. These portable houses are as compact as a trailer and have sledlike foundations which are handy for moving them along as operations advance. This summer the Devonians are building a \$40,000 swimming pool.

Although most of the farmers around Leduc do not own the mineral rights beneath their land they are prospering by "surface rental" to the oil companies. For the use of a few acres for drilling operations farmers receive \$1200 for the first year and about \$400 a year thereafter.

Since the Whitehorse refinery, originally built for the wartime Norman Wells project in the Far North, has been moved down and set up at Edmonton the western Canadian refineries have a processing volume of about 65,000 barrels a day. The present possible yield of the Alberta wells is 125,000 barrels daily and this is increasing with every new producing well that is drilled. The limit on refining capacity makes prorating of production necessary among the various companies. Canada, long starved for oil, now has the problem of an avalanche of the stuff and a sad lack of properly located refineries. The closest big refinery is at Sarnia, Ont., a long haul from Edmonton. It would take a train of 500 tank cars to haul 100,000 barrels of crude oil out of Edmonton in a day.

The only answer is the pipe line, which is now under construction from Edmonton to Superior, Wis., a distance of 1150 miles. At Superior, tankers will load the oil and carry it via the Great Lakes to Sarnia. This pipe line, stretching across farm lands, woods, swamps and under rivers is costing \$90,000,000. By operating nine crews the Interprovincial Pipeline Company, sponsored by Imperial, hopes to finish the line by the end of the year. The pipe-line route goes from Edmonton, through Regina and Gretna, and then across northern Minnesota to Superior. The line will have three sizes of pipe in various sections, 16, 18 and 20-inch, and it will be able to

(Continued to page 244)

JUNE 1950

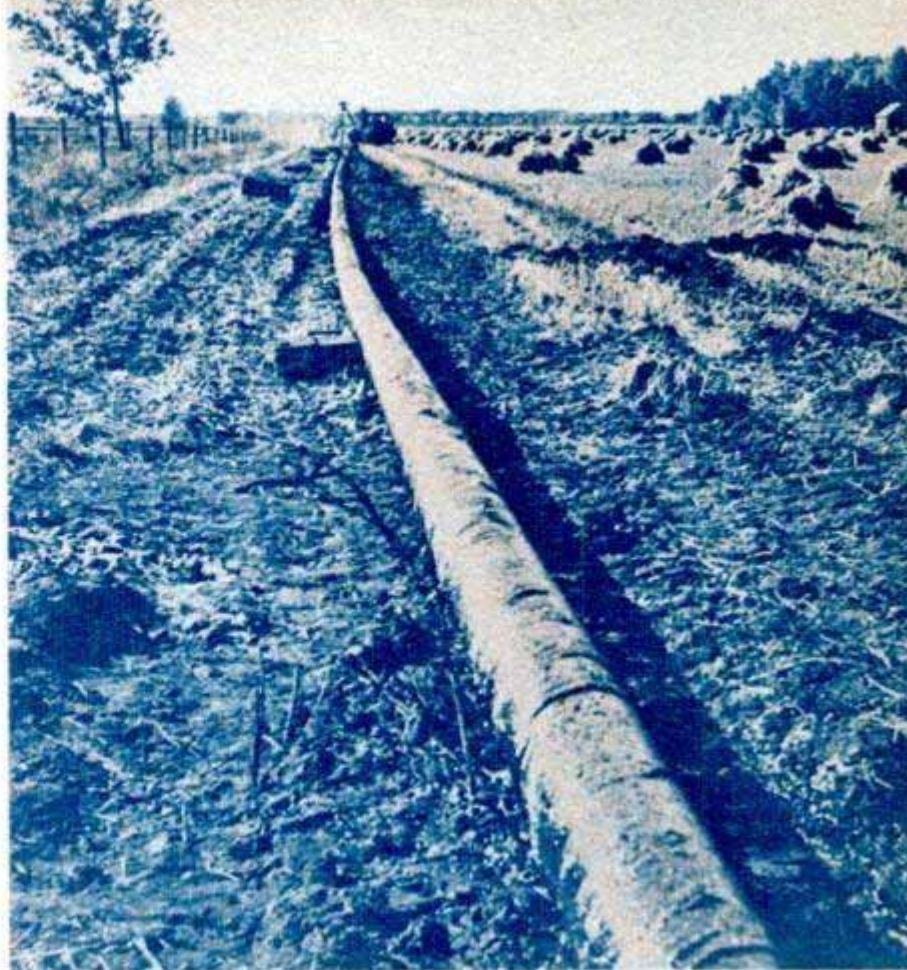

Oil-well artery—pipe line—is being built in three sizes, 16, 18 and 20-inch. Below, burning contaminated oil mixed with mud and chemicals from discovery well at Golden Spike field

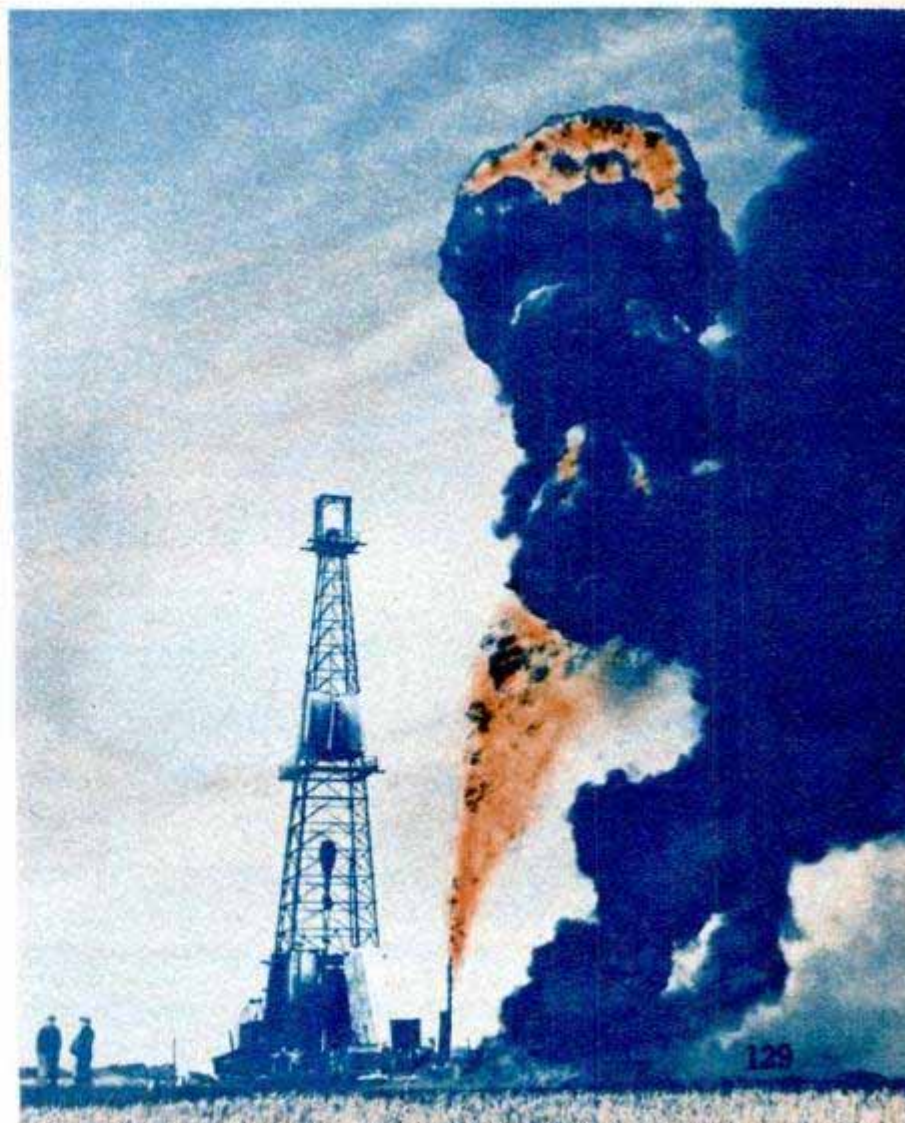



War Against Hail

Vineyard keepers in France and Italy are now engaging in rocket warfare against hailstorms, which cause serious damage to their crops each year. The rockets are fired into the clouds to disperse them before the storm begins. If effective, the rocket technique will save as much as several million dollars for grape growers annually. Networks of antihail rocket zones have been set up in each country with commanders in each zone to direct the "battle" against the damaging storms.

Top, vineyard rocketeers get set to fire. Left, rocket takes off to disperse cloud

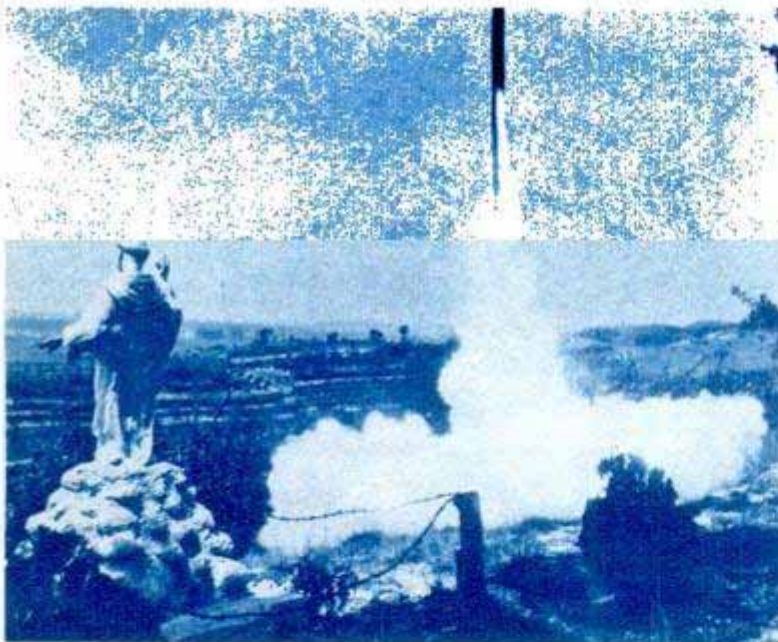

Department of Queer Behavior—Metal Shrinks When Heated

Scientists investigating a rare radioactive metal called polonium have discovered that it has a unique property—it shrinks when it is heated. This is the only metallic element known which grows smaller instead of larger when heat is applied. Polonium was discovered in 1898, but such minute quantities have been available that its

physical properties have never been studied. Larger amounts of the element now are available through the Manhattan Project. Polonium, which has been used in very small quantities to paint figures on luminous watch dials, shoots off alpha rays, thereby decomposing into lead. It has a half-life of 138.3 days.

VALUABLE FREE INDEX TO POPULAR MECHANICS NOW AVAILABLE

Your useful free copy of the new six months' index to Popular Mechanics, January through June 1950, will be mailed to you upon receipt of your order and 10 cents to cover handling and mailing. Just address your request for the index to Bureau of Information, Popular Mechanics Magazine, 200 E. Ontario St., Chicago 11

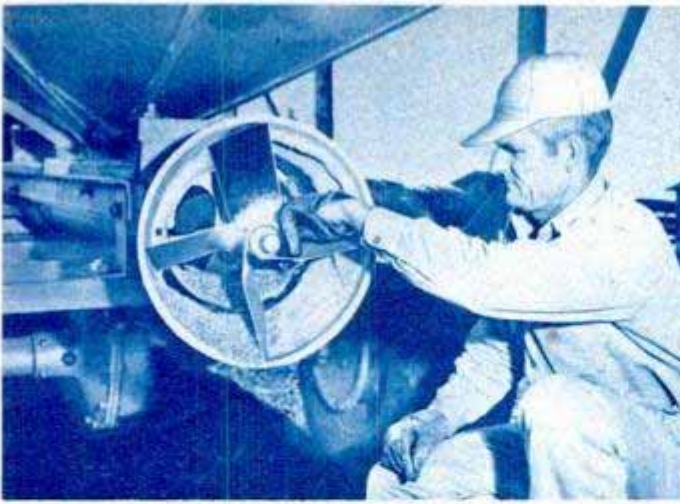

Trailer "Sows" Chicken Feed

Scattering grain for 16,000 pullets by hand required six man-hours of work, so Horace Vantress, manager of a large farm at Marysville, Calif., built a mechanical distributor that does the job in 1½ hours and does it better. The distributor is a two-wheel trailer on which is mounted a hop-

per holding 3000 pounds of grain. An auger, powered by a V-belt, feeds the grain from the base of the hopper to a four-blade whirler at the rear of the trailer. This whirler spreads the grain in a 40-foot swath as the trailer is towed across the feeding area by a Jeep. Vantress has trained a dog to trot in front of the Jeep, chasing the pullets out of its path.

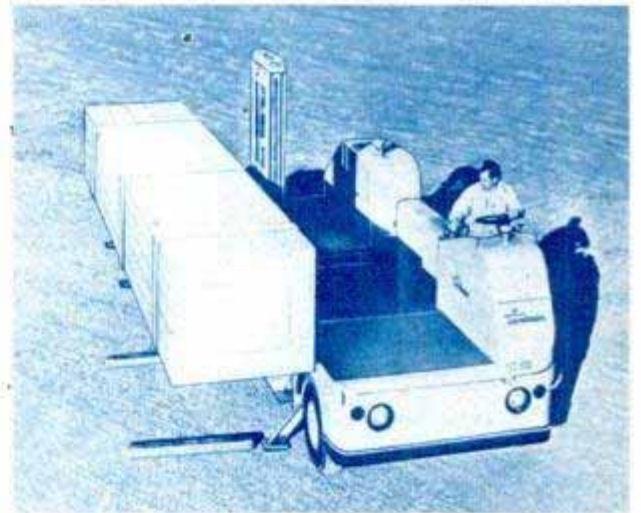
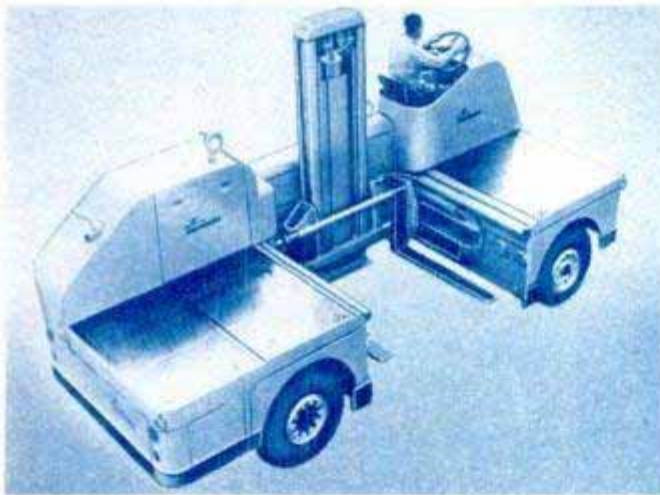

Elevator-Truck

Materials of any type are lifted, then carried any distance from 50 feet to 50 miles by a flat-bed truck with a hydraulic elevator. The middle section of the truck's platform is cut away and replaced by the elevator. The driver and all the controls are carried on the side of the platform. First, the driver wheels the truck up beside the load and lets down a pair of jacks which stabilize the machine so it can lift loads up

to 30,000 pounds. The hydraulic elevator slides out sideways and heavy steel forks pick up the load. Then the forks move up to bring the load aboard and deposit it on the carrying platform. The truck has five speeds forward and one in reverse, and travels along the highway at speeds up to 30 miles an hour. Accessories include a spindle for picking up and laying cable and a pair of cranes for picking up loads in gondolas. The truck is available in 3000, 10,000 and 30,000-pound capacities.

Food Laboratories Seek Frozen Milk With Natural Flavor

Concentrated frozen milk with exactly the same flavor and food content of the real liquid is the latest project of food laboratories. Though the goal hasn't been achieved, frozen-food packers already are looking forward to the time when they can

market frozen milk in cans. To a six-ounce can, the housewife would add 18 ounces of water to make 1½ pints of milk. The packers believe they can market the frozen milk at a lower price than whole milk through savings in transportation costs.

WHAT'S NEW *For Your Home*



AIR DRIER, right, takes the moisture out of that "it's not the heat, it's the humidity" weather, protecting clothes and equipment from damage in damp basements. Holding 15 pounds of calcium chloride, it removes up to 3½ quarts of water a day

ELECTRIC SPIT, below, brings the outdoor barbecue inside. It slips into the oven of a new electric range. An electric motor turns the meat slowly in the heat of the giant broiler



RENEWABLE SPRAYER handles any liquid. Carbon-dioxide cartridge recharges it

GREASING BRUSH has a handle-full of shortening that is brushed on baking pans





HOSE CONNECTOR is held tightly inside the faucet by an expander that works as a knurled screw is turned. It can be used on any faucet and stays tight under pressure



PAIL GRIPPER attaches to any step of a stepladder and grips securely anything from a paint can to a pail of water



ELECTRIC TIMER, built into the base of sun lamp, shuts it off after a preset time

COFFEE DISPENSER meters out a table-spoonful per half turn. It replaces can lid



GARBAGE CONTAINER in center of sink has its own drain so you can rinse all scraps off the dishes directly into it





Above, Dr. Ira S. Bowen, director at Palomar, inspects one of the 12 fans on the telescope. Right, the fans are arranged in a ring on the mirror cell

Blowing Distortion Out of Palomar's Eye

ORDINARY electric fans—a dozen of them—plus an “overcoat” of insulating foil are helping the Big Eye of the Palomar Observatory to see clearer and farther into the vastness of the universe.

Arranged in a circle in the 20-ton metal cell that holds the 200-inch mirror, the fans cut down distortion caused by uneven temperature changes in the glass. A sudden five-degree change in temperature may distort the mirror surface a few hundred-thousandths of an inch while the glass adjusts itself. To the astronomer, even this minute distortion is serious when he is photographing celestial bodies millions of

miles away. The fans reduce this distortion an estimated 50 percent by circulating air over the back of the mirror, causing the giant glass disk to contract or expand evenly. A coating of insulating foil around the rim of the mirror also helps maintain an even temperature over the whole mirror.

Although the Hale telescope at Palomar is already the most perfect large astronomical telescope ever built, astronomers are continuously working toward perfection. Recent repolishing of high spots around the mirror's outer edge and the addition of the fans and insulating foil are part of these continuing efforts.

Two pictures taken by the improved telescope. Left, spiral nebula NGC 628 in the constellation of Pisces. Right, Nova Persei, a star that exploded in 1901 and out of which a gaseous shell has been growing since

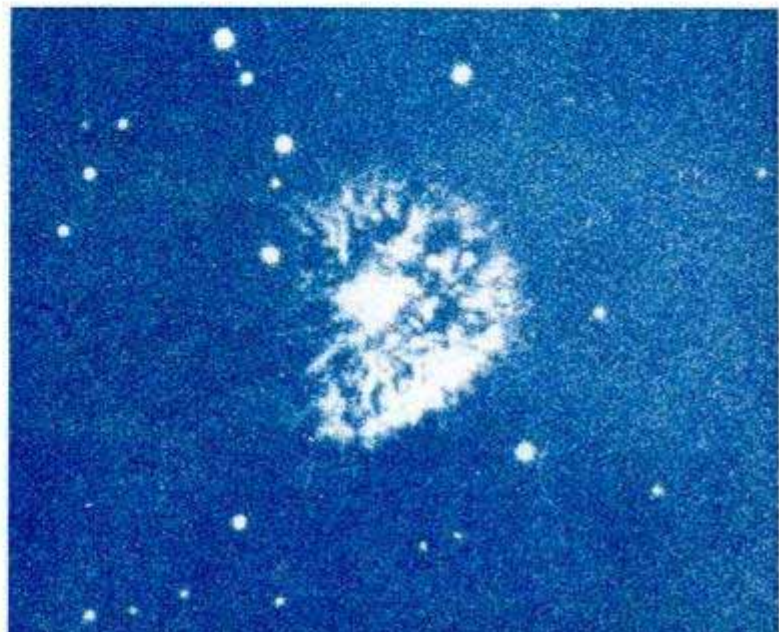
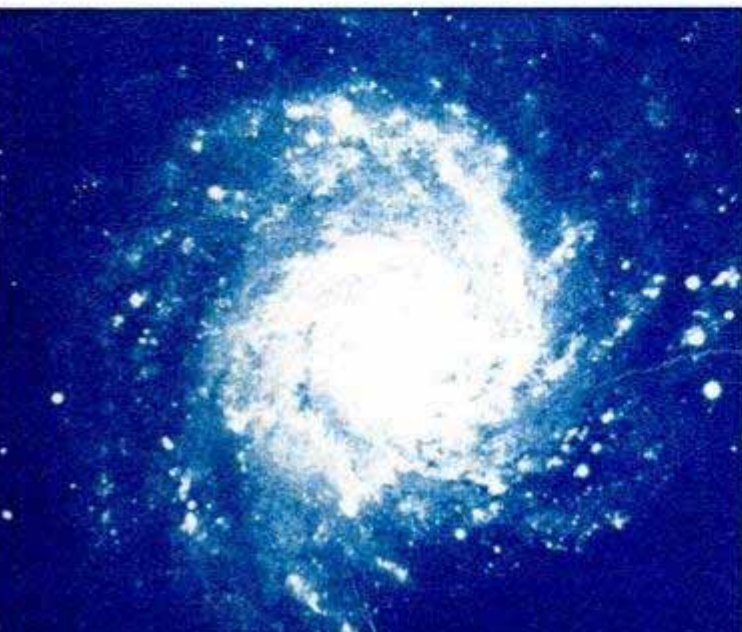

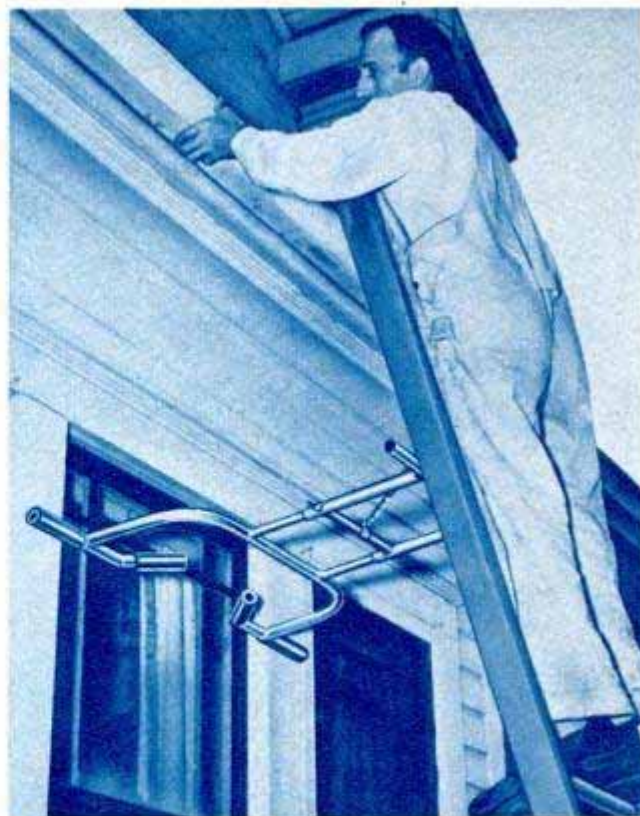
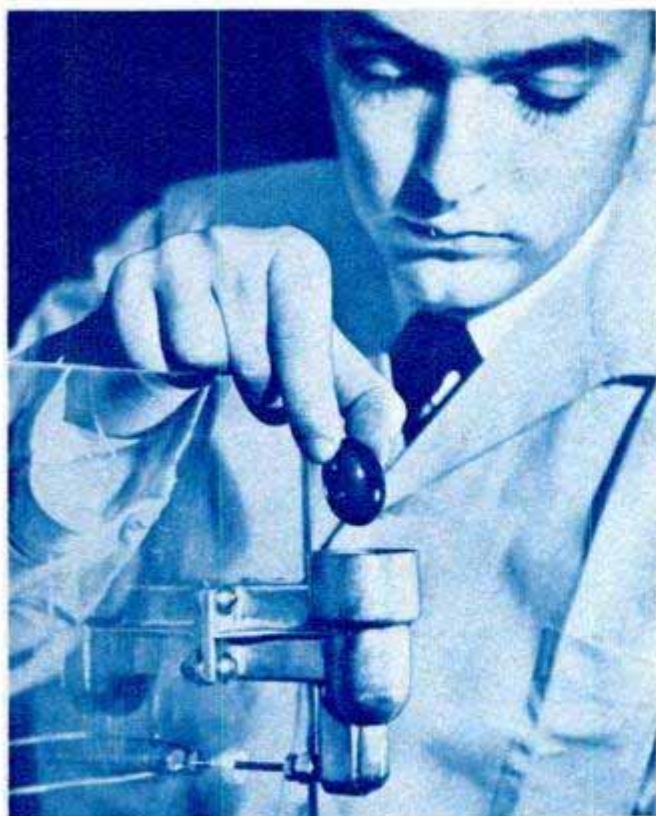

Vitamin Pills for Your Car

Now it's vitamin capsules for your car—"medicine" which warms up an auto engine for quick starts even in the coldest weather. The applicator for the capsules can be installed on the dashboard or steering column. Fluid released from the capsule is atomized and primed into the intake manifold, simultaneously warming the combustion chamber. The result is a pre-warmed engine which, according to laboratory tests, will start in less than 10 seconds even when temperatures drop down to a chilly 40 degrees below zero.

Ladder Bracket

Ladders are made safer and handier by an adjustable bracket which holds the worker away from the side of a building, permitting him to work without leaning. The bracket, which can be clamped to any rung of the ladder, has two rubber feet which hold it securely against the building to eliminate shifting. The feet are far enough apart to span windows of normal size, allowing the ladder to be placed directly in front of the pane. The bracket also will hold the ladder directly on the corner of a building.

Invalid Car

With all controls operated by the hands, a three-wheel British car provides the invalid with a safe, economical means of transportation. Designed especially for the comfort and convenience of wheel-chair users, the car has a double-hinged door that opens wide for easy access. A closed compartment in the rear houses a folding wheel chair. The convertible-type top can be raised or lowered from the seat. There are two brake levers, one on each side of the seat, two clutch controls, one on the gearshift lever, the other on the steering column. The motorcycle-type, twist-grip throttle is mount-



ed on the steering wheel. With three speeds forward and one reverse, the single-seater car goes 70 miles on a gallon and cruises comfortably at 30 miles an hour. Over-all length of the car is nine feet nine inches.

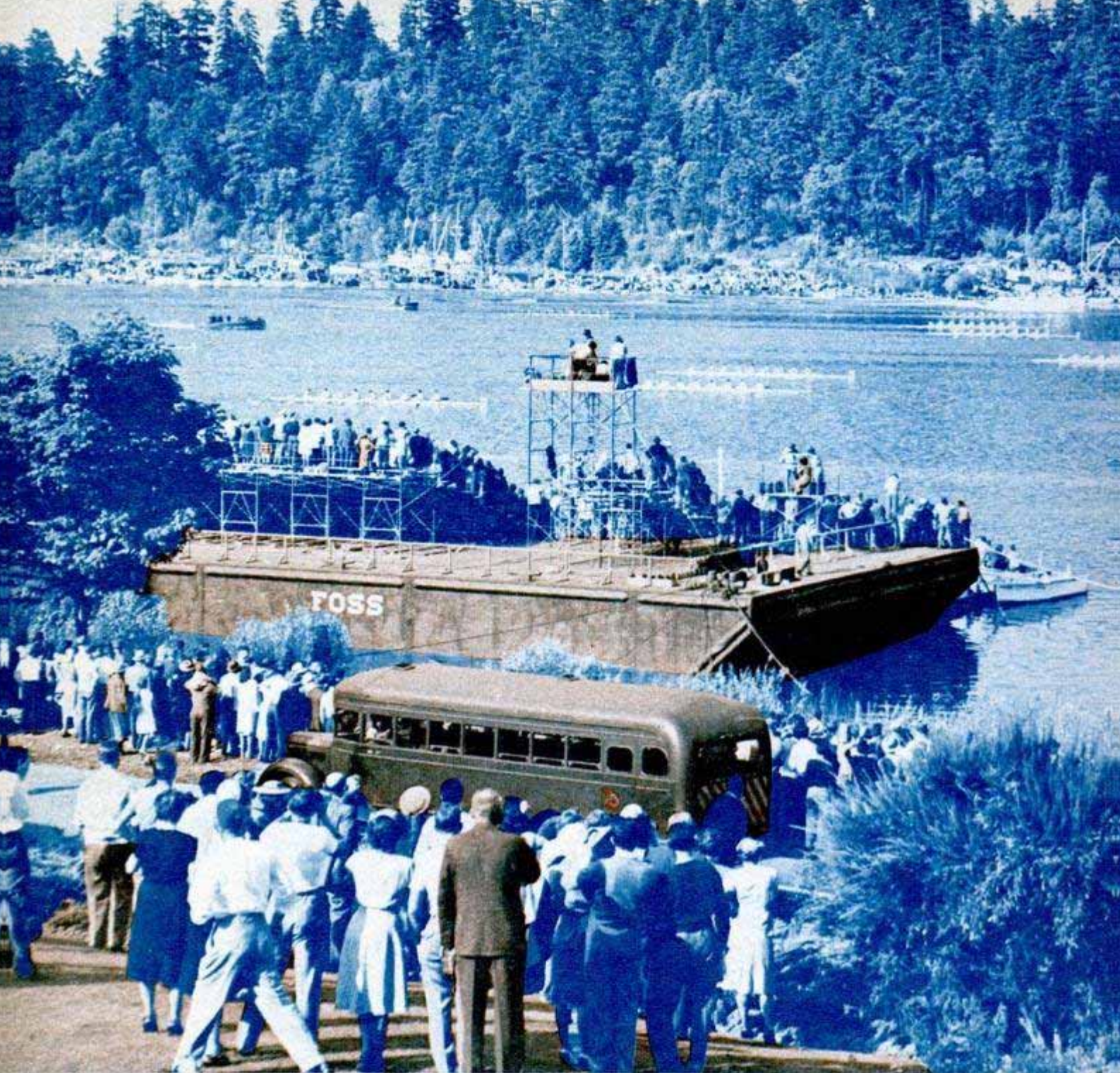

High-Speed Splinter

FROM A DECREPIT old building on the campus of the University of Washington in Seattle come the modern, scientifically designed racing shells that are prized by college and club rowing crews.

The famed Pocock shells are built by George Pocock and his son Stan for some 15 major universities, a number of smaller colleges, and many rowing clubs here and abroad. After an early apprenticeship in England, the elder Pocock has been building shells in Seattle for the last 38 years. Various improvements he has made to the

basic racing shell have increased its speed.

In a splinterlike racing shell, 26 feet long and only a foot wide, an expert oarsman can easily do 12 miles per hour, and for short spurts he can attain speeds of 16 miles per hour and better. The shell weighs only 30 pounds, and has four inches of draft and two inches of freeboard. With his weight almost entirely above the water line, the oarsman has to acquire an acute sense of balance to avoid frequent capsizes.

For greatest leverage, the sculls or oars are secured to tubular-steel outriggers

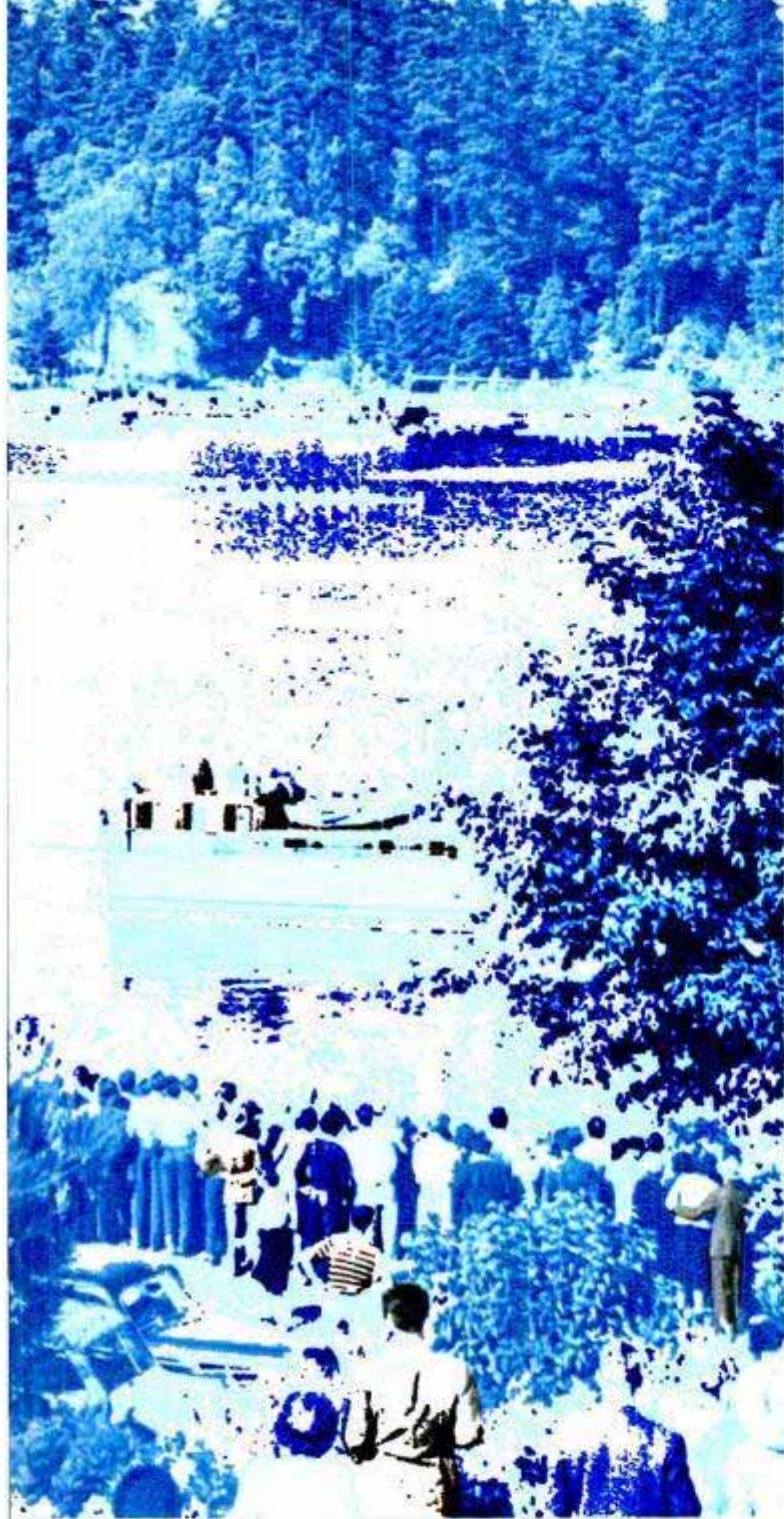

Above, resembling a cluster of water bugs on the surface, eight-man boats from a dozen universities and colleges race on lake adjoining University of Washington campus. Right, checking the lines of a one-man shell. Transparent decking is varnished glass fiber

projecting from the sides of the hull. The oarsman sits on a small wheeled seat that slides on a track on the bottom of the shell, giving him latitude for the longest possible stroke.

Shells are made as singles, doubles, fours, sixes and eights. The big eight-man-and-coxswain shells are the most widely used in competition. An eight-man shell is 61 feet long, two feet wide and weighs 285 pounds, about one quarter of the weight of the crew that it carries. All shells use outriggers and sliding seats and, in the case



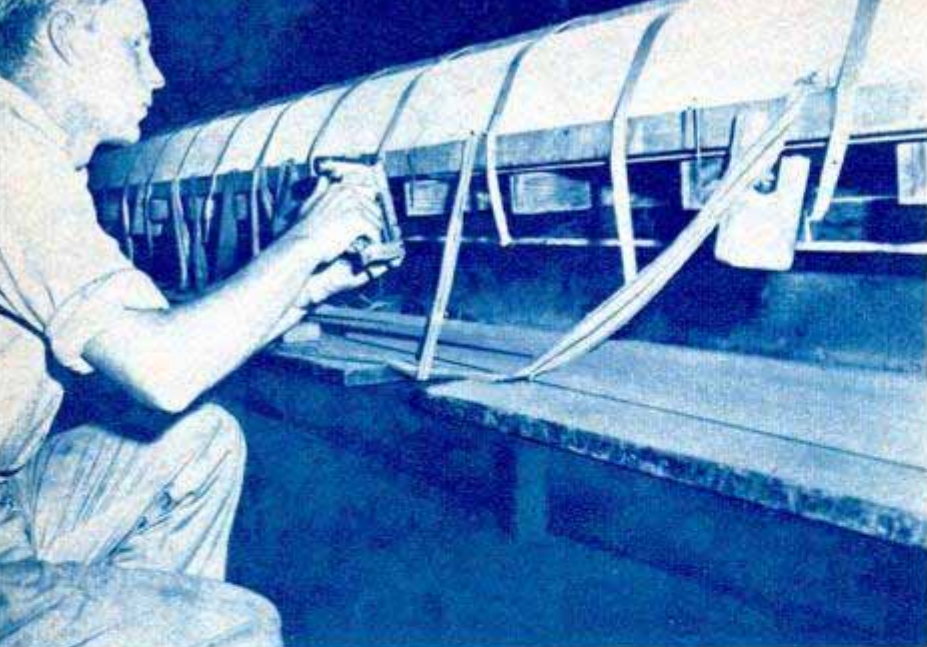

Above, tying down the 1/16-inch-thick plywood skin that will form hull of one-man shell. Steam will mold it into final shape

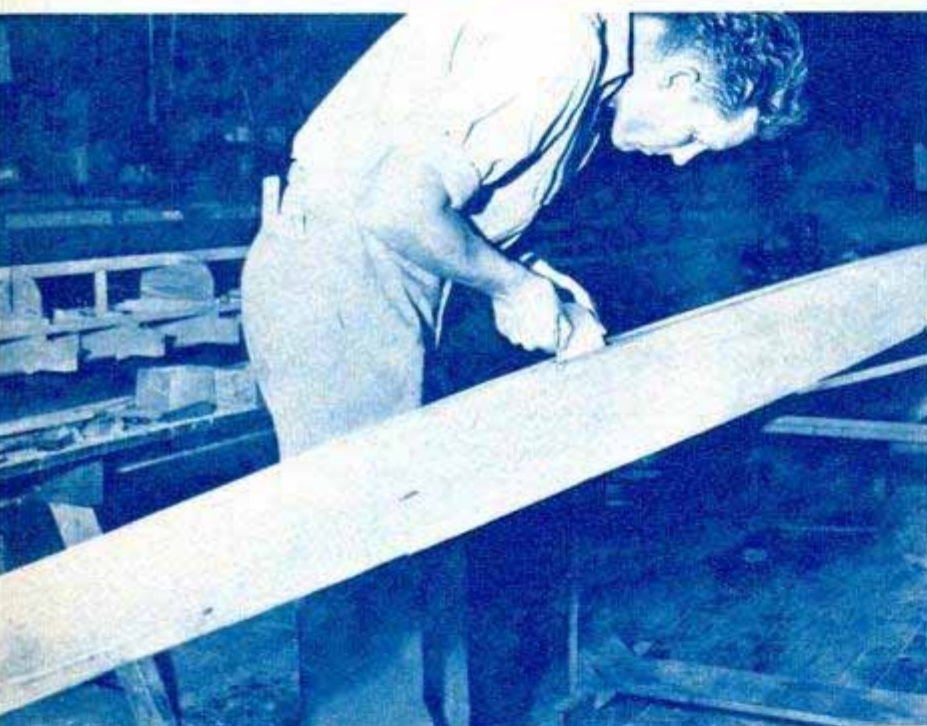

Above, attaching small metal dagger keel to the bottom of a boat. Below, the seats in racing shells rest on rollers that slide back and forth on a track, permitting oarsmen to extend their stroke. The clogs or shoes serve as footrests for the stockinged oarsmen

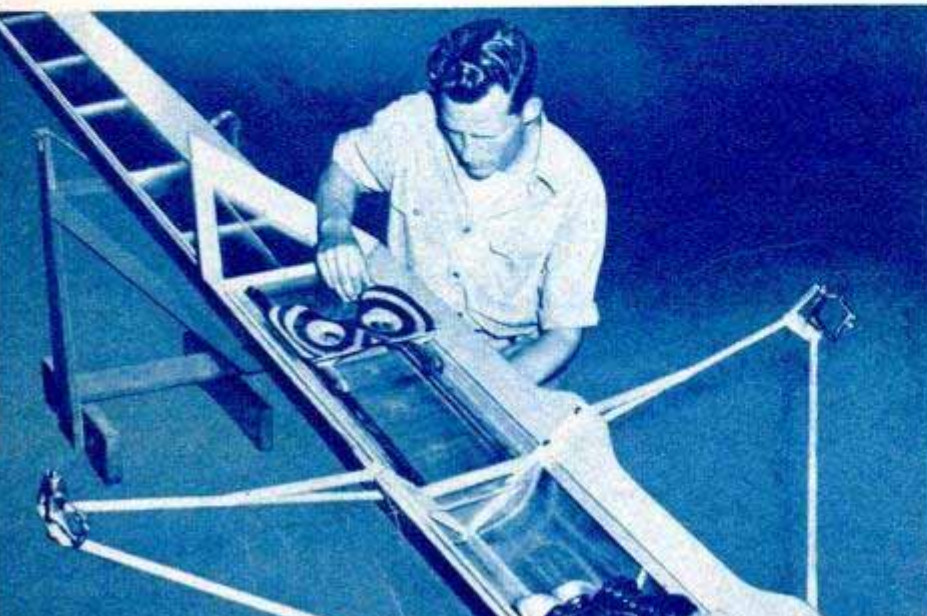

of the larger hulls, each crew member handles only one sweep, the name by which the large oars are known. Crew rowing has its peak at the intercollegiate regatta each June, usually on the Hudson at Poughkeepsie, this year at Marietta, Ohio.

A Pocock shell is a handmade work of art and craftsmanship, fragile but sturdy, light but strong. Even lighter shells could be made but they would not be seaworthy in rough water such as often is encountered at Poughkeepsie. Light as they are, Pocock shells usually are good for 20 years of use. Instead of mass-producing his hulls, Pocock carries each one through from the start and produces no more than a dozen eights and half a dozen singles and fours in an average year.

One Pocock improvement is a new design of outrigger that requires no lower brace attached deep to the hull, which formerly scooped up water and tossed it into the boat. Another is the use of translucent glass-fiber sheeting for the decks, just as strong and somewhat lighter than the veneer that it replaces.

Another improvement is in the elimination of the conventional ribs for singles and other small shells and the ribs in the bow and stern sections of the larger shells. Instead of ribs, simple V-shaped members hold the keel and the gunwales in place. The molded-plywood skin retains its shape without support, at the same time acquiring flexibility that aids in riding through waves and rough water. All shells must be limber enough to work with the water and not pound.

The choice of woods for the different parts of the shell has been a matter of research for years. Each type of wood that goes into the hull is chosen for characteristics that fit it for a specific role. Two-ply red cedar is the ideal skin material and, in the case of a one-man single, is only 1/16 inch thick. An eight-man shell has a skin that is only 5/32 inch thick.

The keel and gunwales are of sugar pine and the deck supports and the few ribs are of ash. All these frame members are



Above, boarding a one-man hull is a ticklish maneuver that usually results in repeated spills for the novice. Interior keel, gunwales and deck members are added (right) to a 26-foot one-man shell. Use of diagonal brace members that do not touch the skin, in place of conventional ribs, permits the skin to flex when slithering through waves and rough water. Below, eight-man craft has a rudder that is steered by the coxswain. Boats are turned upside down in storage

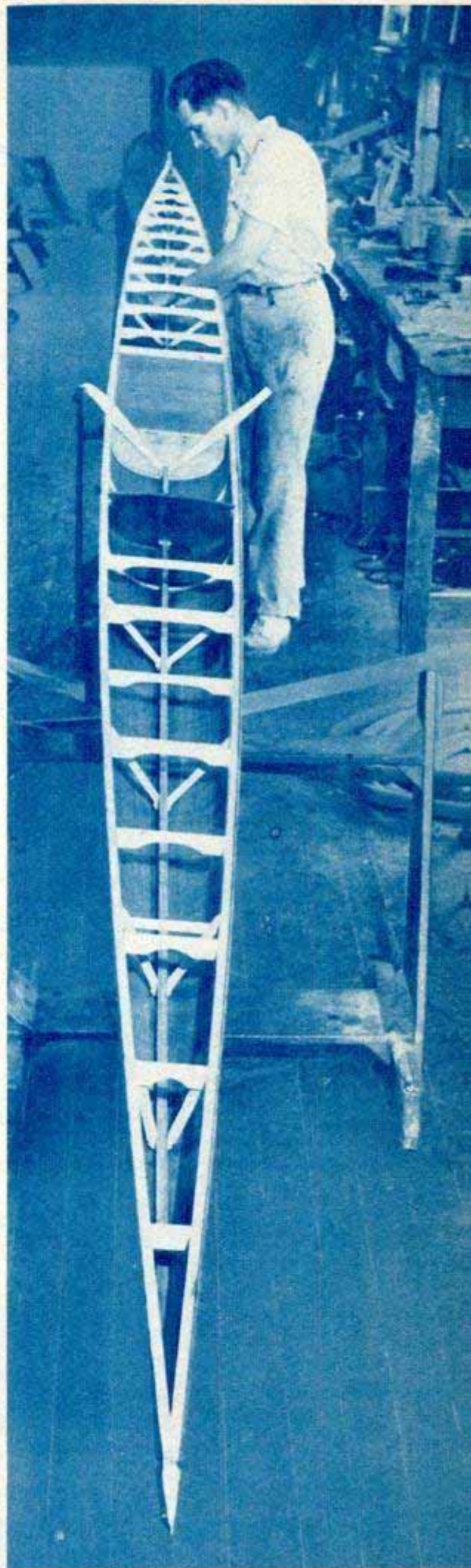
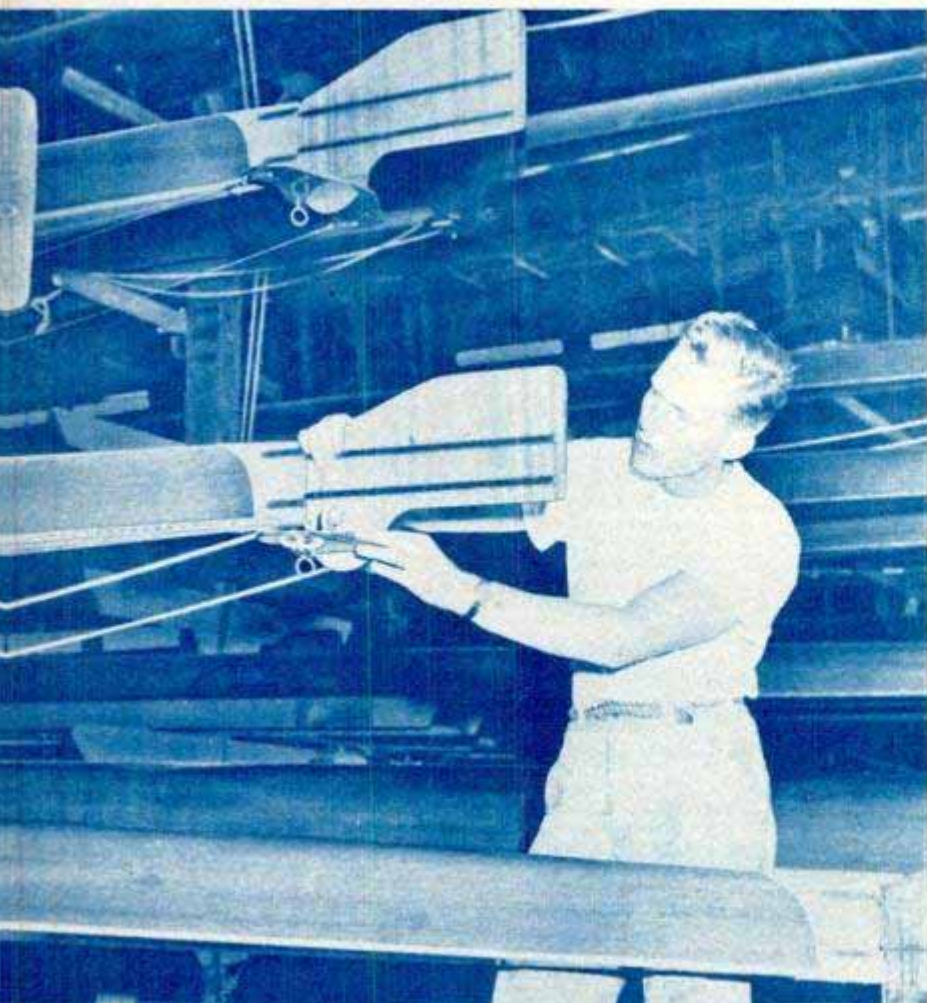

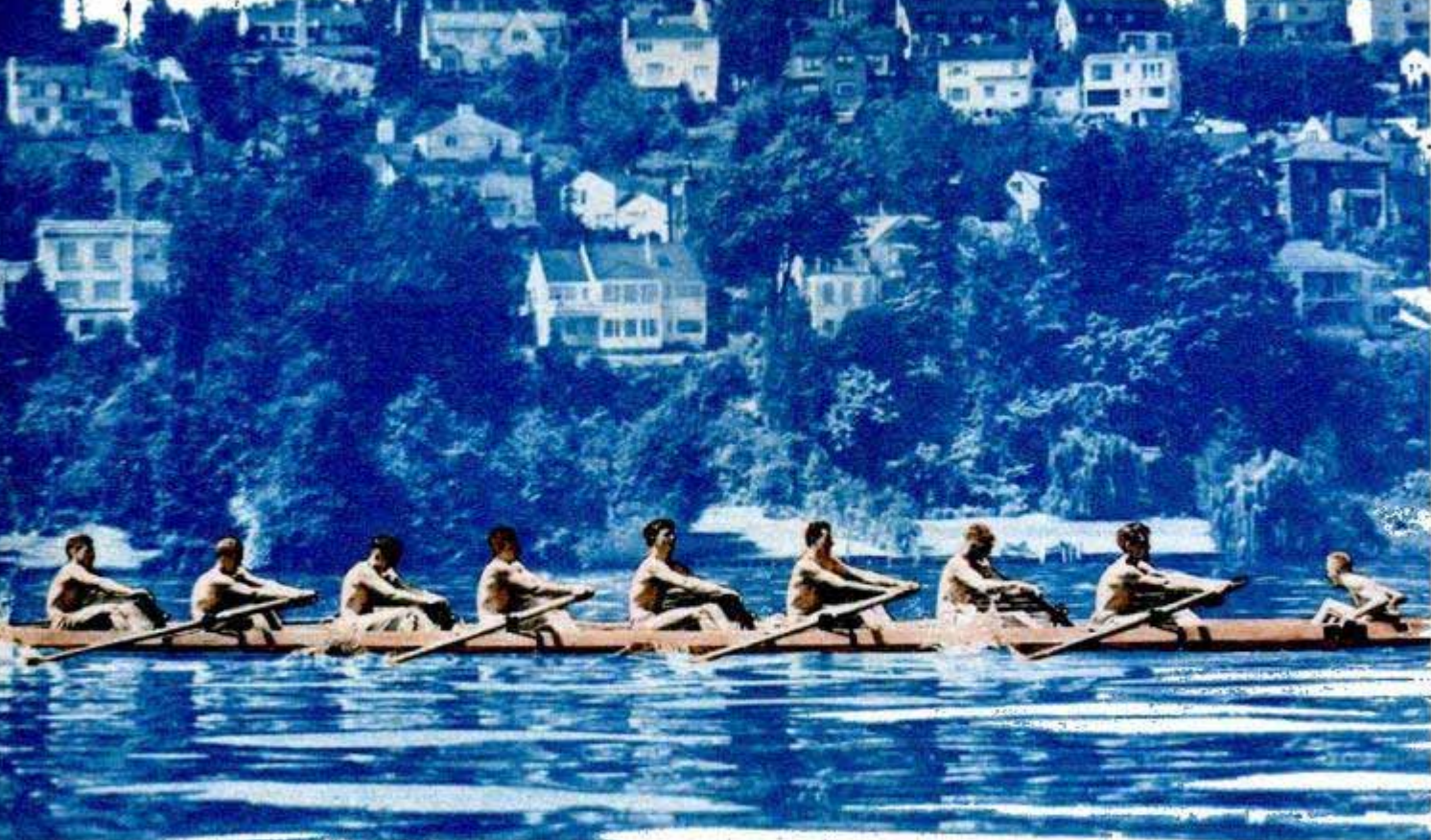

Crew members in a big shell are placed according to weight. The four in the bow should each weigh about 20 pounds less than the four in stern, who weigh up to 185 pounds. The coxswain weighs about 110 pounds

steamed to shape on a mold and are nailed and glued together. The skin, meanwhile, is shaped on a separate steam mold, laid over the frame and then secured to the keel with nails and glue. Glue holds the skin to the gunwales. The decked portions of the hull provide water-tight compartments to keep the shell afloat if it is swamped.

Shells are finished with four coats of hand-rubbed spar varnish. Before a race the hull usually is rubbed down with pumice and linseed oil to provide a smooth, slick surface. Various other treatments, including graphite, have been tried with no noticeable improvement.

One particular spruce, the Rocky Mountain variety, is preferred for sweeps and sculls. Oars made from this wood literally

whip themselves out of the water at the end of the stroke because of their springy action.

A Pocock sweep is 12 feet one inch long and weighs 8½ pounds. The shaft is a hollow tube, reinforced along its back with a glued strip of Australian ironbark to provide compression strength. Without this support the soft-spruce shaft would be crushed. The grip area is of bare wood, roughened to provide traction for the hands. The blades, built up of thin laminates and slightly cupped, are mortised and glued to the shaft. The sculls that are used with the smaller shells are shorter but are made in the same way.

Rowing is one of the oldest competitive

(Continued to page 236)

In the water the hull of a 30-pound shell has approximately four inches of draft and two inches of freeboard



1950 Bellanca Adds Speed and Size

Larger and 30 miles an hour faster than last year's model, the four-place Bellanca has the widest operational leeway in its class. It lands as low as 43 miles an hour and cruises at 180, with a 1400-foot-per-minute rate of climb at its gross weight of 2600 pounds. If a hydraulic line to the landing gear is broken, the gears snap into extended and locked position upon release from the "up" position with a very gentle pull out.



Electronic Torch Too Hot to Measure

Producing a flame that is so hot there is no way to measure its temperature as yet, an electronic torch melts firebrick and tungsten like butter. Tungsten melts at 3370 degrees Centigrade. The flame consists of nitrogen being passed through a high-frequency arc, formed by radio waves at a frequency of one billion cycles per second. A tube, called a magnetron, generates the radio waves, which break up the two-atom nitrogen molecules into individual atoms. When the atoms reunite to form molecules, heat is released. The torch was developed by a General Electric scientist.

Left, scientist watches heat of the electronic torch melt quartz rod like ice cream on a hot summer day

Midget Airplane

Tiny but fast, a midget plane designed and built by Raymond Stits of Battle Creek, Mich., will climb 800 feet a minute and fly 170 miles an hour. With a wingspan of approximately 9 feet and an empty weight of 393 pounds, it is believed to be the smallest airplane in the world. Its maximum carrying capacity is more than 220 pounds.

☐ Old Faithful erupted 1174 times during the 1949 Yellowstone Park season, an average of once every 62.3 minutes.

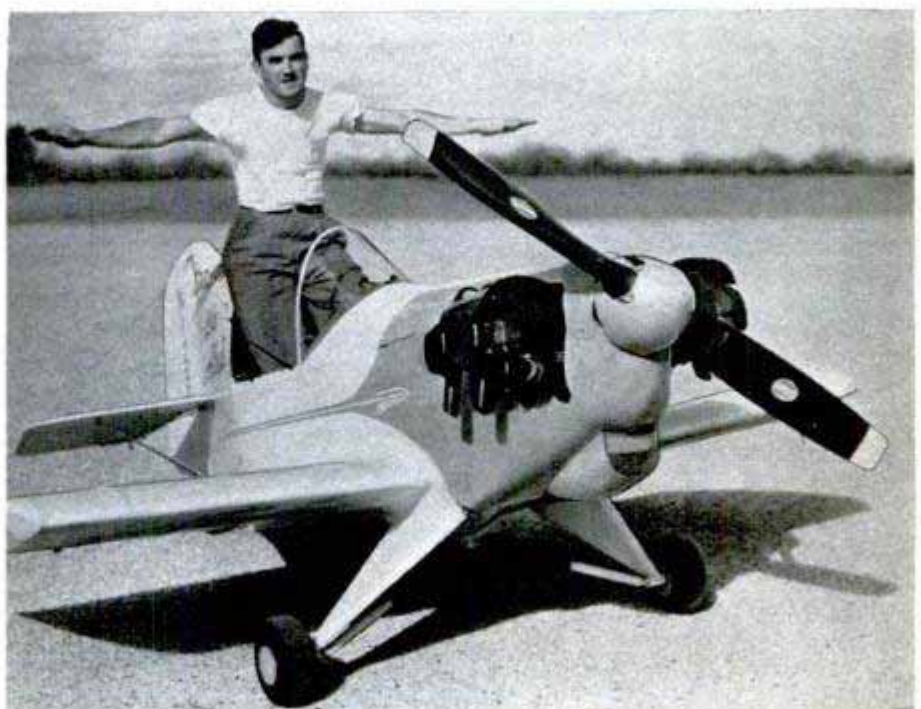

WHITTLING BARBER

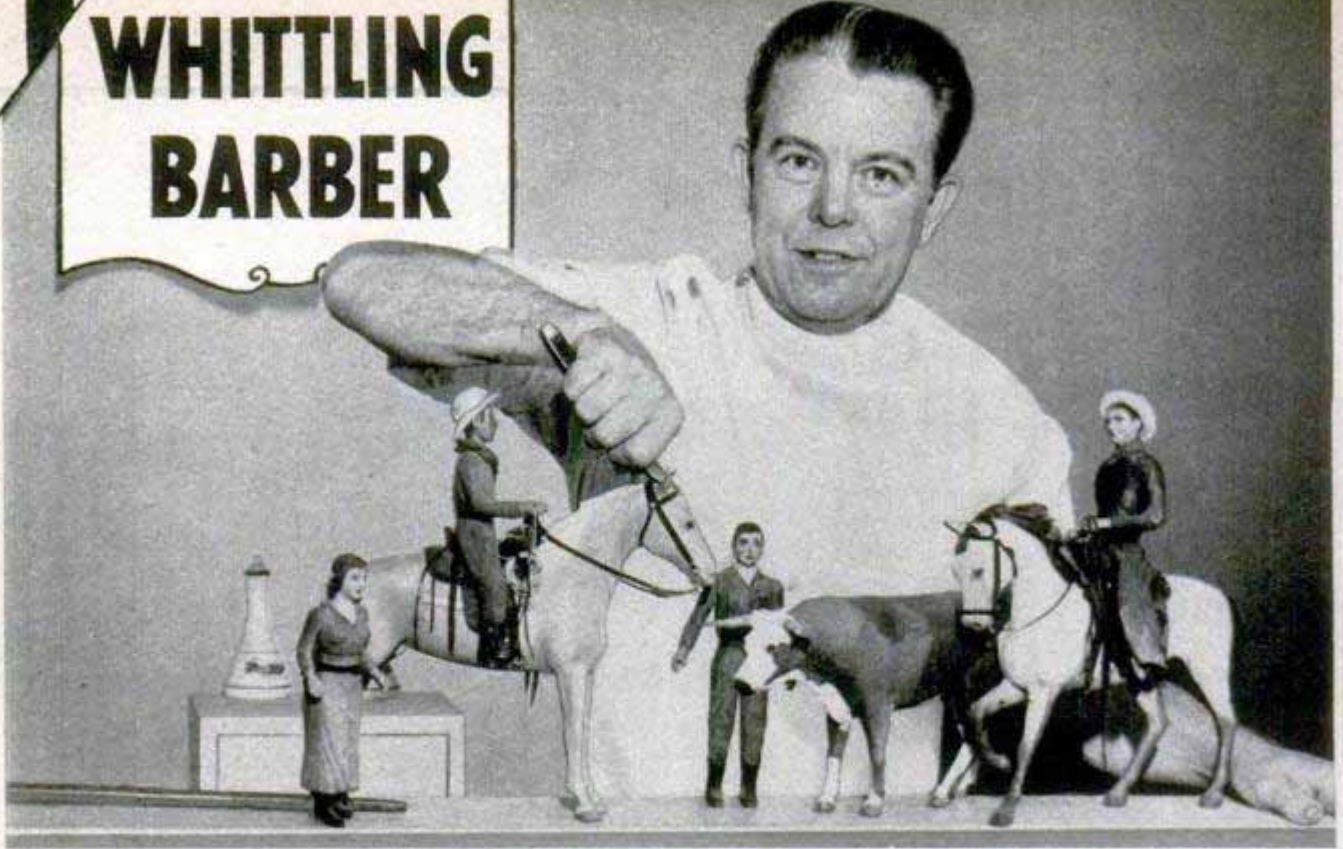

With a 50-cent pocketknife Mercer touches up the ears of a cow pony. Figures are whittled from white pine

CUTTING HAIR is Johnny Mercer's trade, but whenever the last patron leaves his barber shop in North Hollywood, Calif., Johnny heads for the back room where he becomes a cowboy again. Johnny once rode the range in Texas. Now he duplicates the ranch scenes in wood. In

the barber shop you'll find a chaparral glade in a Texas desert, a band of sheep, some red bulls, cows and calves lounging in the shade of scrubby trees, and several horsemen. Johnny whittled each of the figures from white pine, using a 50-cent pocketknife and a few other tools. He

While the old-time rancher stands by, battered hat in hand, his children bring the dusty livestock to the well





In his barber shop Mercer has a stage where he recreates the old West from frontier days in modern times

paints each of them himself, and builds realistic settings which include ranch houses, log cabins and rail fences. He is a good range hand with a needle and thread, too, so he makes all the tiny shirts, chaps and other bits of clothing for his cowboys. To complete his Western scenes, he fashions

saddles and tools, buckets and harnesses. Johnny has exhibited his figures at county and state fairs and handicraft shows. One of his favorite pastimes is teaching young admirers how to whittle. After a few minutes in Johnny's shop, many a young "cowboy" has started whittling his own horse.

He works at a battered bench with a few hand tools. Mercer also fashions clothing and equipment for figures

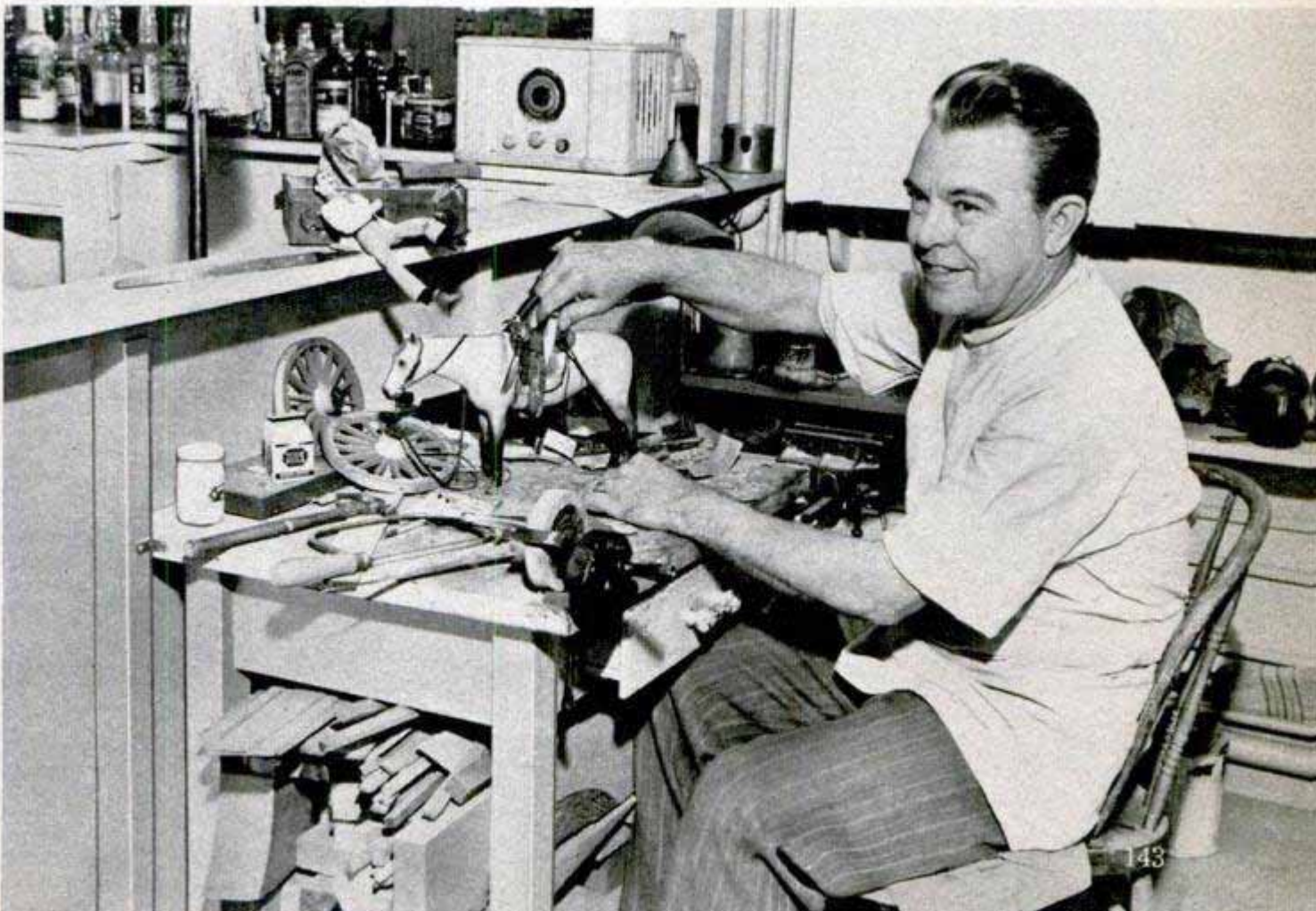



Ship Models in Plastic

Giving a new twist to an old hobby, Ray Workman of Chicago makes ship models out of plastic. Into a Workman model go all types of plastic—liquid material for the hull, sheet and rod plastic for the sails and



masts. In making a hull Workman carves a wooden model and casts it in plaster of paris. Then he melts liquid plastic in a pan on the kitchen stove, dyes it and pours it into the mold. He sandpapers the sheet plastic to give the sails on his models a frosty white appearance.

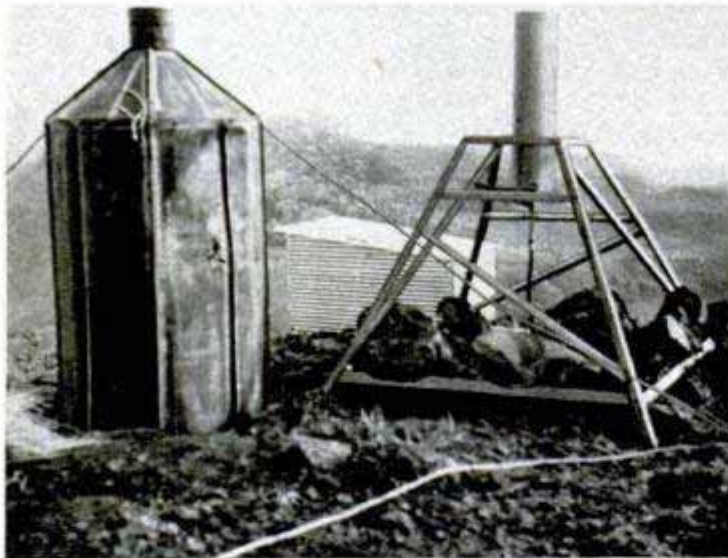

World's Wettest Spot Gets Special Gauge

It's nearly always raining "cats and dogs" atop Mount Waialeale, mile-high peak on the island of Kauai, Territory of Hawaii. So great is the annual rainfall that a specially designed gauge had to be installed to measure it accurately. Previous gauges have been too small for precise measurement. Since 1910, the mountain has been soaked by an estimated average of between 450 and 470 inches each year. In one really wet year, it was estimated that 531 inches fell. The U. S. average is only



Left, the old drumlike rain gauge and the new model. Above, during the frequent downpours, the crew that set up the new gauge took refuge in a mountain cave

29 inches a year. The other leading contender for the world's wettest title is a mountain in India where the average is 426 inches a year. The continuous recording gauge, just installed by the Geological Survey Department, requires reading only once a year and will measure accurately the heaviest downpour. Caught in an upright tube, the rain is piped into a tank in shelter where a stylus records the amount on a roll of waxed paper. A helicopter carried the equipment to the mountaintop.

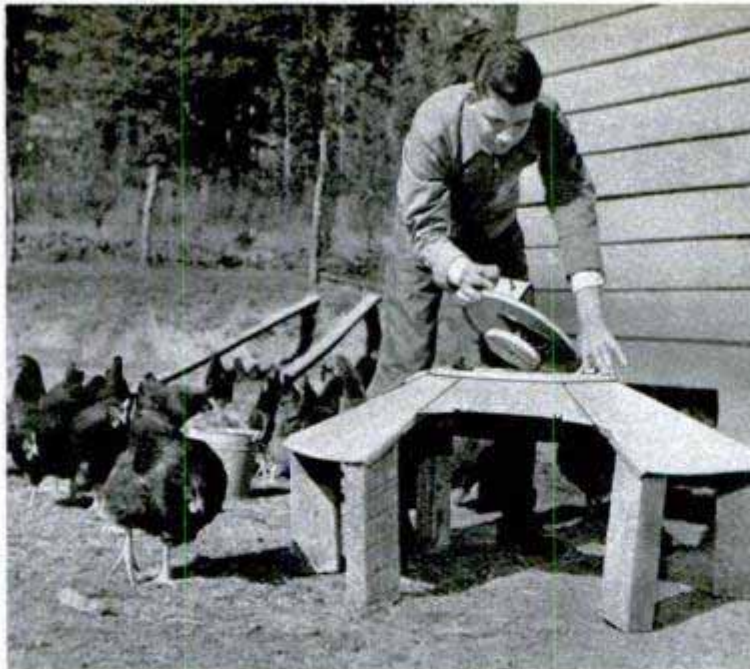

Old hot plate becomes chick brooder in Johnny's hands. Right, another of his machines counts gladiolus bulbs

Boy Builds Push-Button Farm

Around Fayette, Ala., 16-year-old Johnny Clive Williams is known as a wizard at putting electricity to work on the farm. Using such materials as old lard cans, hot plates and discarded vacuum cleaners, the youth has invented ingenious machinery for cutting corners. Johnny's mother raises

gladioli for sale to florists, so Johnny came up with an automatic machine that counts up to 30,000 bulbs a season and dusts each one with DDT. It does a 24-hour job in 3½ hours. The lad, who won a Westinghouse scholarship, also built an electric chick brooder from a hot plate and scraps of metal, rewired the farmhouse, wired the barn and built in fans and lamps.



Ash Tray Fits Cigarette

Smokers can attach a new ash tray directly to their cigarettes. The ash tray is a tube of stainless-steel screen with a hinged cap on one end. The smoker opens the metal cap, pushes the cigarette through the tube, lights it, then pulls it back until the end is in the tube. When he closes the cap the screen catches all the ashes. As the cigarette becomes shorter it is pushed farther into the tube. The cigarette also can be placed upright on the cap without danger of marring any surface.

Rescue "Knife" For Crash Victims

To save survivors trapped in wrecked or burning aircraft, Australian engineers have developed a giant rescue "knife" that cuts through metal fuselages as if they were paper. Eight feet high, with a razor-edge steel spearhead, the knife is mounted on the front of an armored car. In a test at Melbourne, it quickly severed the tail from a surplus bomber.





Du Pont Company photo.

Using Freon, a fluorine product, as the propellant, plastic sprays are being made that protect art work, leather and even garden tools against dust and rust.

SPRAY BOMB and A-BOMB

Below, wood goes up in flame on contact with compound containing 62 percent of available fluorine. Bottom, a few spray bombs already on the market.

Pennsylvania Salt Mfg. photo.

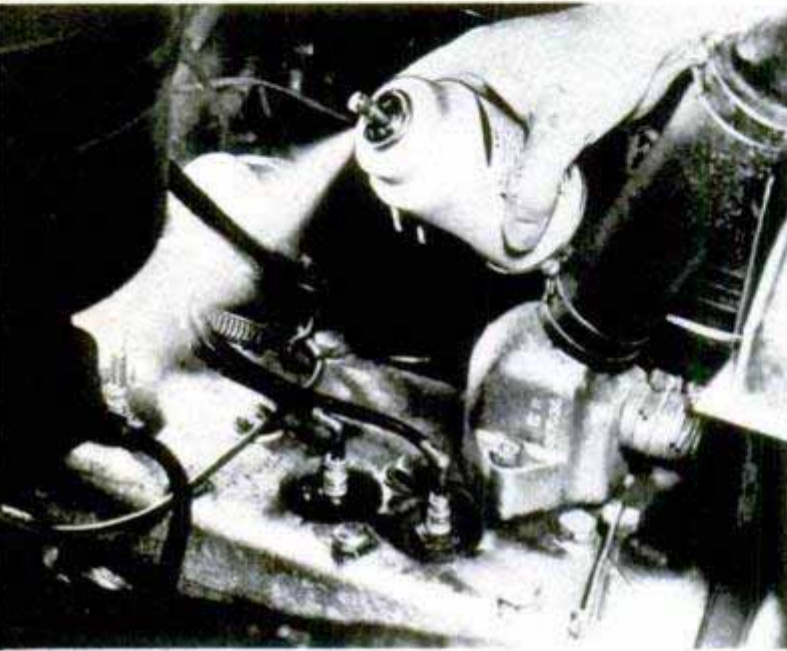

Single spray applications completely moistureproof automobile and other all-weather ignition systems.

High-pressure aerosol bombs help keep trains, planes and other public conveyances free of insect pests.



cousins under the shell

By Leonard Engel

THE OTHER DAY, a paint chemist, threading his way through New York traffic in a brand new sedan, was side-swiped by a passing broken-field driver. The swipe put half a dozen long, ugly scratches in his fender. Having it retouched would normally have cost \$15 or \$20.

But when the chemist reached his lab, he fetched a "spray bomb," a small can containing lacquer and a driving gas to expel

the lacquer in the form of a fine spray. He took aim and pressed a button. In a few minutes, without muss or fuss, the fender's finish was restored to new.

Everyone knows the "bug bomb," the handy canned spray for getting rid of insects. Ready-to-use push-button sprays are already appearing for furniture and kitchen paint and others are coming out for floor and auto wax, furniture polish, rug shampoo and window-cleaning compound. Sprays will spread chemicals to kill kitchen odors, and coat household goods and garden tools with a liquid plastic to protect them from rust and dust. Still other push-button bombs will spray perfume, under-arm deodorant, sun-tan lotion and penicillin.

The approaching canned-spray era in homemaking springs from a remarkable yellowish gas named fluorine. Freon, the driving gas of the bombs, is a fluorine product. Fluorine is nature's supreme terrorist—the most potent corrosive known. It can go through substances as imperishable as stone and incorruptible as stainless steel as easily as a hot spoon through a brick of ice cream. A jet of the pure gas could make flesh burst into flame.

Fluorine was tamed by the scientists who put together the atom bomb. It was needed to produce the atomic explosive uranium 235. Now the puissant vapor is delivering a whopping first installment on the atomic-energy project's promise of a new world.

Beside canned sprays, fluorine has already brought drugs to ward off tooth decay and the dread eye disease, glaucoma; dyes, plastics, lubricating oil and rubber that last indefinitely; safer anesthetics and insecticides. Soon to come are insulation for super-powered electric motors and equipment; heat-resisting fluids for the turbines of atomic power plants, and a fuel hot enough to weld copper or hurl rockets to the moon.

Space ships and welded copper were far from mind when the atomers began looking into fluorine. What they were after was a lever to pry explosive uranium 235 from ordinary uranium—a point on which the whole A-bomb enterprise hung.

The uranium mined at Great Bear Lake—as indeed all the uranium in the earth's crust—is an intimate mixture of two varieties of the metal. Every 100 pounds of natural uranium contains 99.3 pounds of U-238

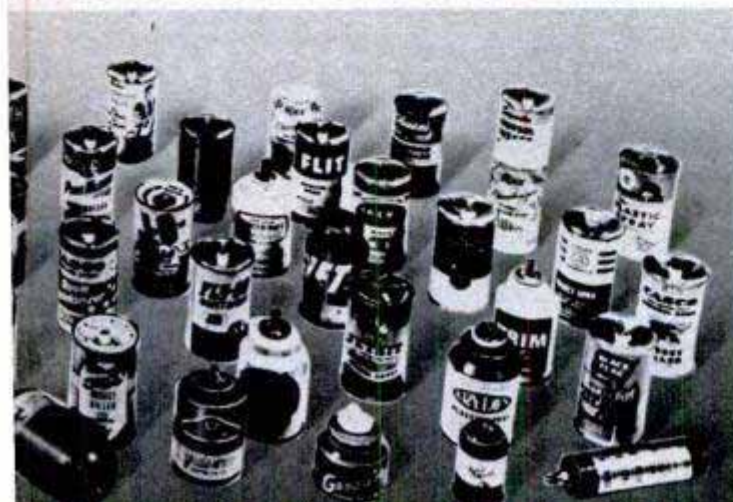
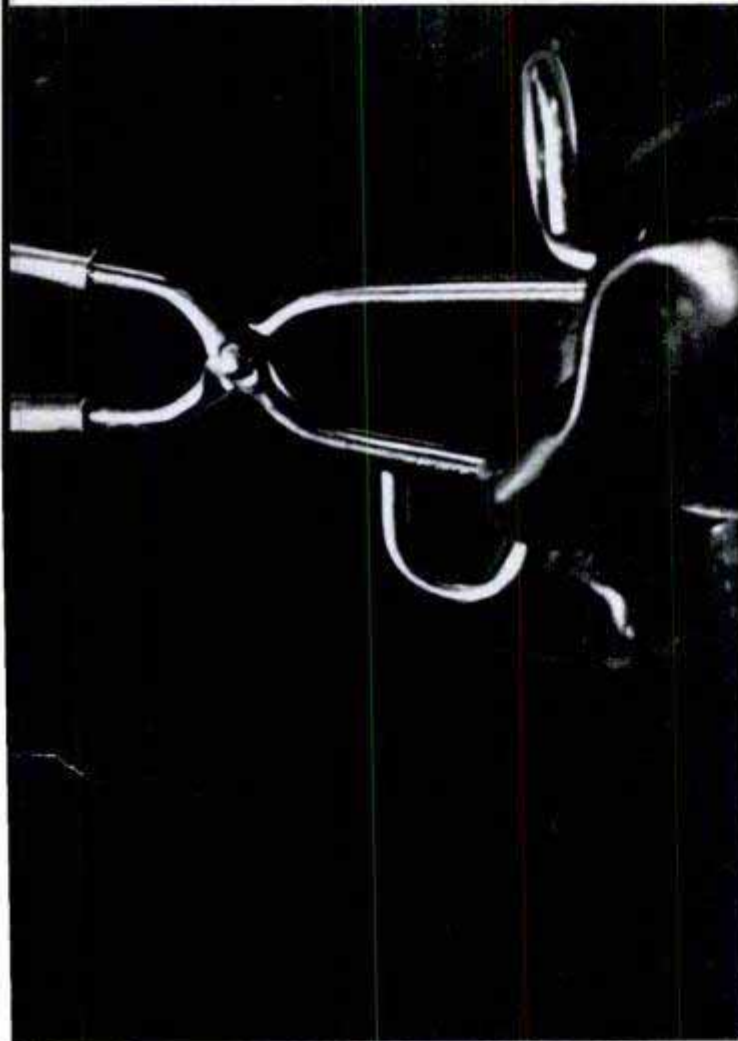

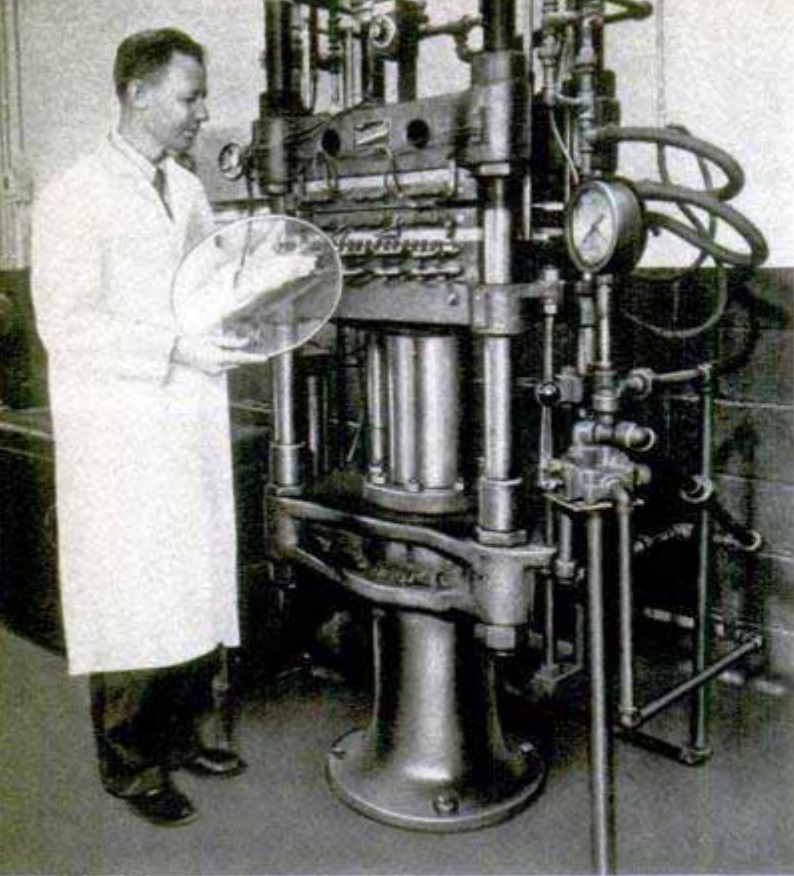

Glasslike, but with toughness of steel, fluorothene plastic lines pipes at uranium separation plants

and .7 pound (a trifle over 11 ounces) of U-235. The two are more alike than identical twins. But only one, the scarcer U-235—and then only when it has been concentrated in pure chunks of a certain size—goes wham.

How to get them apart? Farmers skim cream from milk by whirling milk in a centrifuge; the cream, lighter, floats to the top. U-235 is very slightly lighter than U-238. Perhaps it might be skimmed from natural uranium in somewhat the same way. But uranium would have to be turned into a liquid or, preferably, a gas. The only practical way of accomplishing this was to combine uranium with fluorine to form a gas known as uranium hexafluoride.

Only a handful of laboratories had made fluorine previously, a few whiffs at a time. One of the 92 basic chemical elements, fluorine had lain locked away in rocks of the earth's crust from the dawn of creation to 1886, when a Parisian chemist, Henri Moissan, succeeded in producing a flaskful. What was learned by Moissan, who went on to win fame as the first man to make diamonds synthetically, and others convinced most lab men they wanted nothing to do with the acrid, yellowish gas.

Fluorine attacks practically everything it touches with the utmost fury. Wood and sulphur flare into flame at once. Glass and asbestos disappear in smoke. Even water burns in fluorine, with a bright lavender flame. The gas can also consume steel; overheated steel fluorine-handling equip-

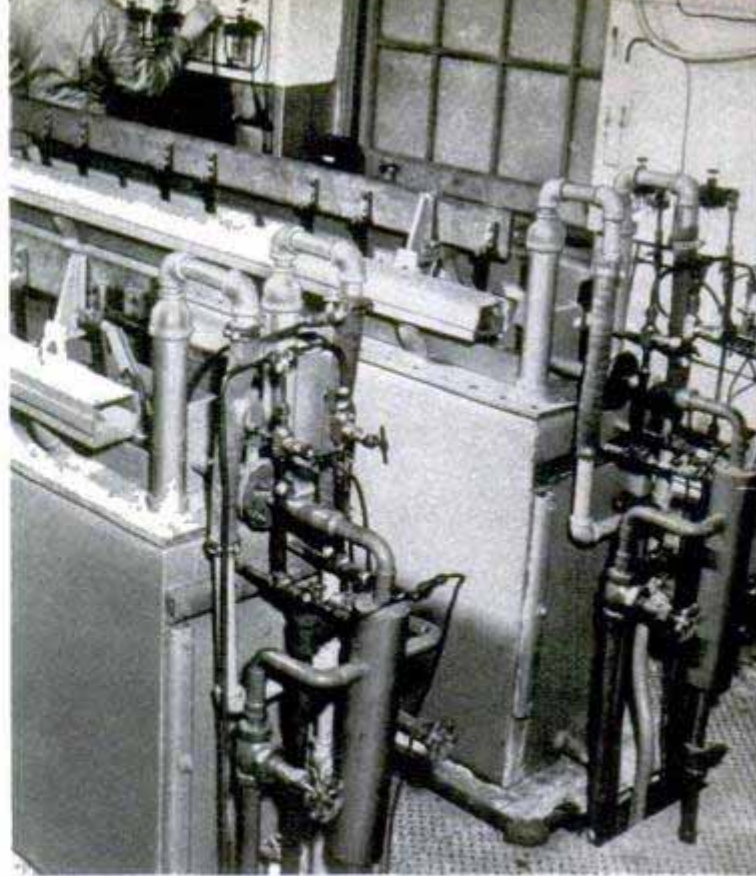

At Penn Salt's Whitmarsh laboratory, fluorine is now being generated in large-scale electrolytic cells

ment may go off like a king-size Fourth of July sparkler. And hydrogen and fluorine make an explosive combination second in potency only to the A-bomb itself.

This was what the atomeers had to produce and handle—not by the ounce, but by the ton. Moreover, the uranium-fluorine compound, uranium hexafluoride, was also something to cause furrowed brows. Samples showed it to be almost as corrosive as the original fluorine.

Operation Fluorine was actually disposed of before anyone was sure that the chain-splitting of atoms—the source of the bomb's power—would work. In 18 months of fevered toil, chemical engineers from three of the companies that took part in the atom project contrived an electric cell for generating pure fluorine in quantity. Meanwhile, a young Cornell University chemistry professor, William T. Miller, Jr., on loan to the secret atomic laboratory at Columbia University, was shrewdly catching the thief with a thief.

Reasoning that something made from fluorine should be immune to further attack by the gas, Doctor Miller devised a remarkable fluorine material, fluorothene, a glasslike plastic with the toughness of mild steel. Fluorothene was exactly what was required for lining the miles of pipe, acres of tanks and tens of thousands of valves and pumps in the giant uranium separation plants. Without Miller's plastic, there would have been no Oak Ridge. Another of his discoveries, a fluorinated oil,

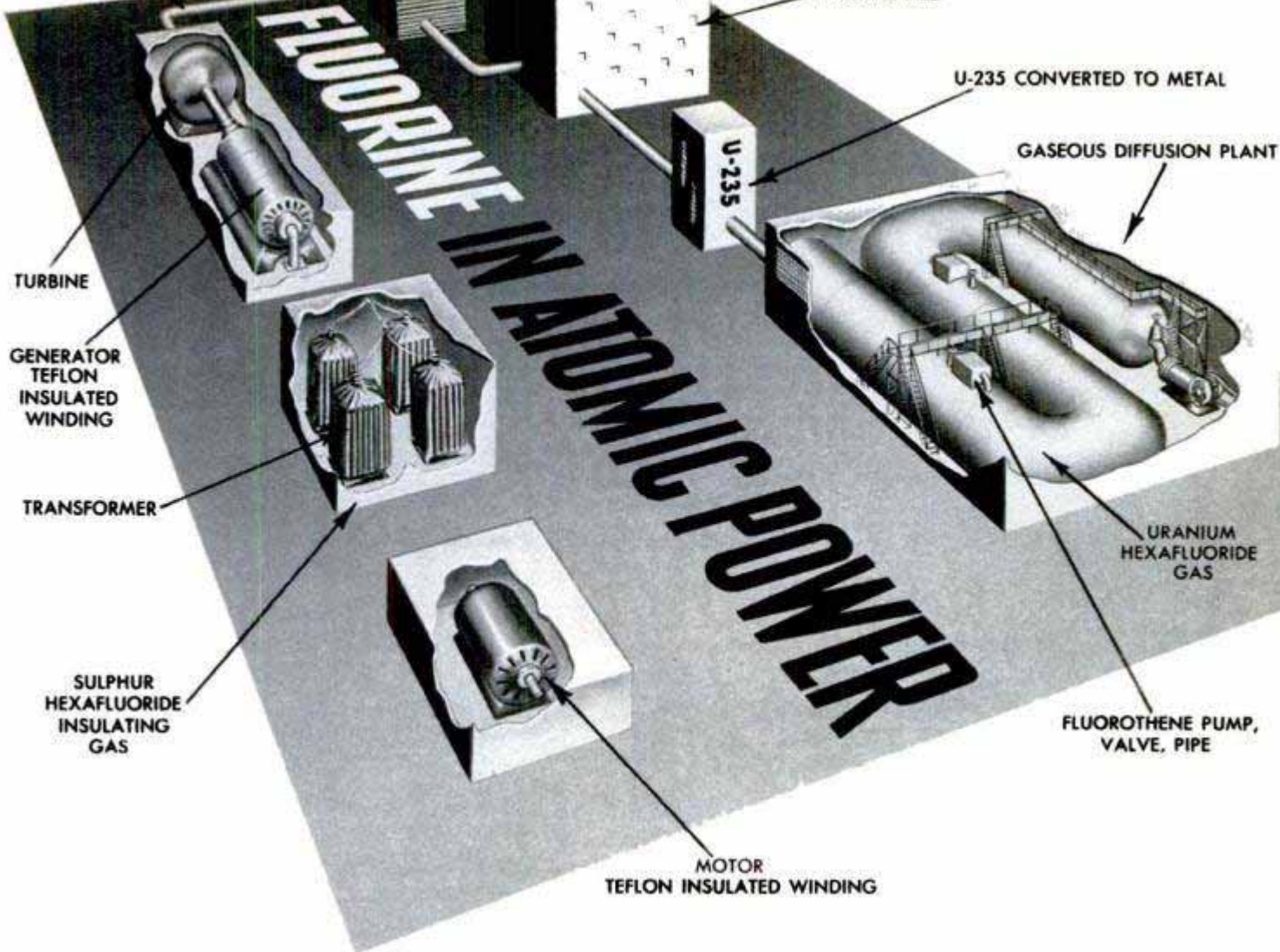

Fluorine products played major roles in developments leading up to the first successful atomic bomb

provided the U-235 plants with a needed fluorineproof lubricant.

You might imagine that nonatoms would still be glad to leave something like fluorine alone. In Miller's discoveries, however, the A-bomb enterprise had served up something guaranteed to whet scientific and industrial appetites. Fluorothene is impervious not only to fluorine, but to virtually all chemical agents. It is already finding a wide place in industry in the handling of corrosive chemicals.

Miller's other development may end the expensive necessity of stopping your car every few hundred miles for a refill of oil. Fluorinated oil is not quite as efficient a lubricant as the petroleum product. Like fluorothene, however, it is proof against a wide variety of disruptive agents, including those that carbonize lubricating oil, and it lasts indefinitely. An improved fluorinated oil sealed into the engine at the factory—in engines of special design—would provide lifetime lubrication for cars.

Fluorothene and fluorinated oil made the pungent gas an irresistible magnet. Literally scores of Canadian and American laboratories are racing to turn up new fluorine products. You can sense what is coming at

the scientific conventions where fluorine is discussed. "Every big company sent a dozen of its best men," says a chemist who attended the fluorine sessions at the last gathering of the American Chemical Society, "but no one but the university people talked. The industry men didn't say a word; they just made notes. They wouldn't even

Handling and packaging of fluorine demands extreme caution. Whitmarsh control chamber has 1/2-inch steel-plate walls and two-inch-thick glass windows

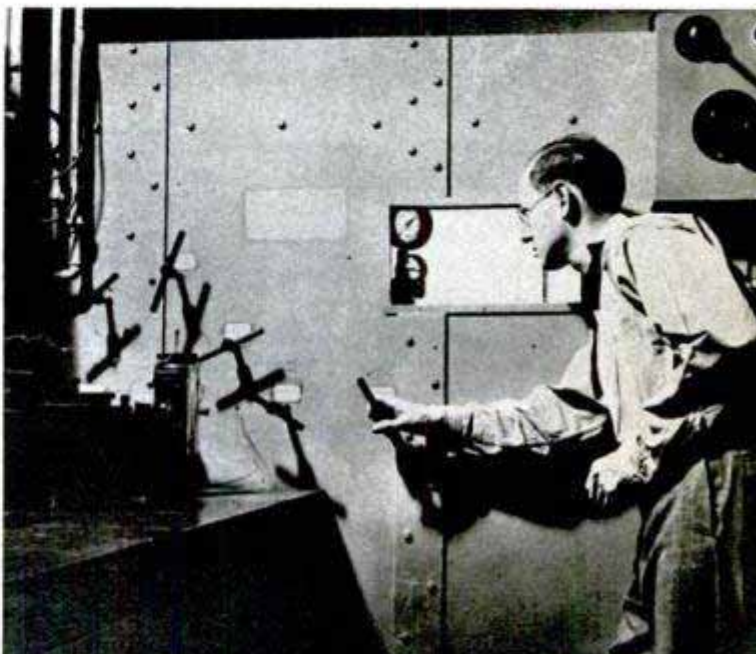

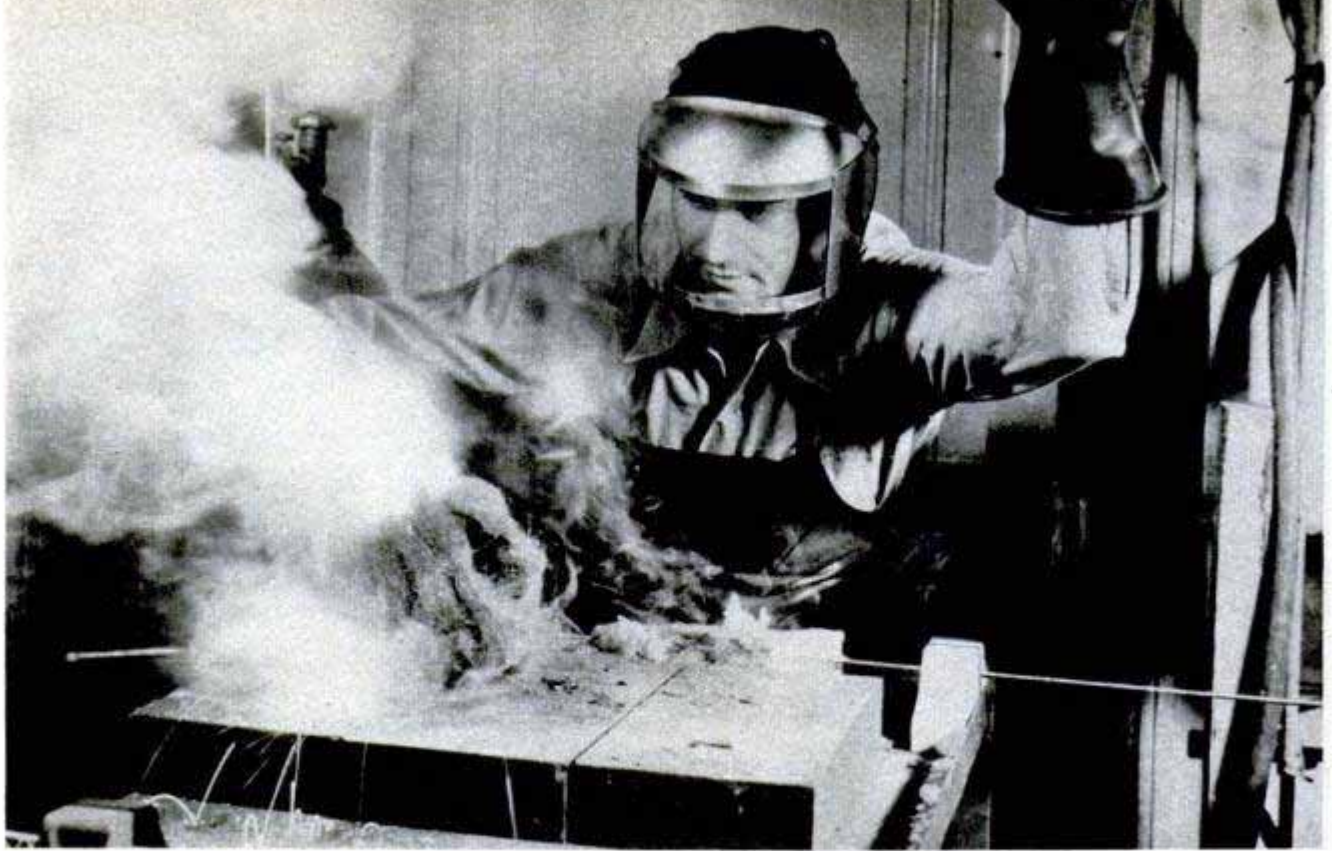

Flaming steel! Steel wool instantly bursts into flame when a small jet of fluorine gas is played upon it

give you the time of day, for fear of giving away a million-dollar fluorine secret."

Paradoxically, what makes fluorine so valuable is the violence that once held researchers off. The tantrums of the yellow gas reflect what chemists call reactivity—readiness to enter into chemical combination. Fluorine unites with other substances more enthusiastically than any other of the chemical elements, and once united, is more tightly joined. Substances containing fluorine are not easily broken up or changed. They withstand, without disintegration or explosion, million-volt bolts of electricity. They can be mixed safely with all sorts of other chemicals, as in the canned sprays. They are little affected by heat, light, oxygen and the other corroding influences that shorten the life of practically everything we use, and make possible goods which, for all practical purposes, won't wear out.

Fluorine's astonishing potentialities are being pursued most intensively at a 100-room mansion, Whitemarsh, in a pleasant Philadelphia suburb. Built 30 years ago for a Philadelphia railroad magnate—and boarded up by his widow when he died—Whitemarsh is the main laboratory of the Pennsylvania Salt Manufacturing Company. This old and respected firm, which marks its hundredth birthday next year, had no hand in the bomb. But it is well acquainted with one of fluorine's less violent cousins, chlorine, the germicidal gas used to purify water; it was the first manufacturer to supply liquid chlorine.

The company was also the main war-

time producer of another fluorine product, hydrofluoric acid, an essential in refining aviation gas. Dr. John F. Gall, its research chief, is probably the foremost American authority on fluorine.

As a starter, the chemists at Whitemarsh have come up with a new fluorine chemical for toughening cement, a rinse to offset "soap yellowing" in laundry and a new insecticide, DFDT, equal to DDT in effectiveness but less dangerous to animals and man. The Whitemarsh chemists have also done valorous service as the foot soldiers of the fluorine campaign, in the hard and unglamorous but vital task of finding better ways of preparing and handling the troublesome genie. One of their accomplishments is a "magic vat," in which electricity is the cook, for generating fluorine. It will take the place of the wartime cell, which worked well but was expensive.

Penn Salt has two of its "magic vats" set up. Except for the fact that they are made of steel, they might be outsize exemplars of the old-fashioned covered bathtub. The fluorine generator strips fluorine from hydrofluoric acid.

The acid, whose corrosive fumes have been employed by glassworkers for 150 years to etch glass, is obtained by chemical treatment of a handsome many-colored crystalline rock, fluor spar, a favorite working material of vasemakers. Powerful currents coursing through the vat decompose carefully purified HF, liberating hydrogen and fluorine, in much the same way as hydrogen and oxygen are liberated from

(Continued to page 248)

Robot Test Pilot

Planes can now get a thorough "flight test" from a calculating machine before they are built. The new apparatus, developed for the Navy by the Massachusetts Institute of Technology, permits design defects to be found and corrected without the cost of actual construction and flight testing. Engineers using it set up an invisible, electrical "model" of any aircraft or guided missile in an advanced stage of design and have an autopilot "fly" the nonexistent, theoretical craft. Questions about the design, fed into the machine by electrical signals, are answered in chart form within seconds.

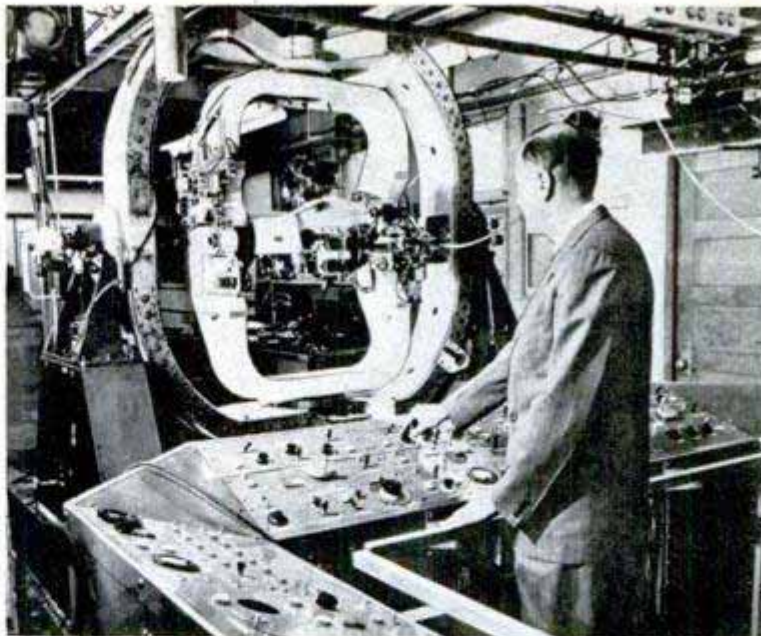

Department of Defense photo.

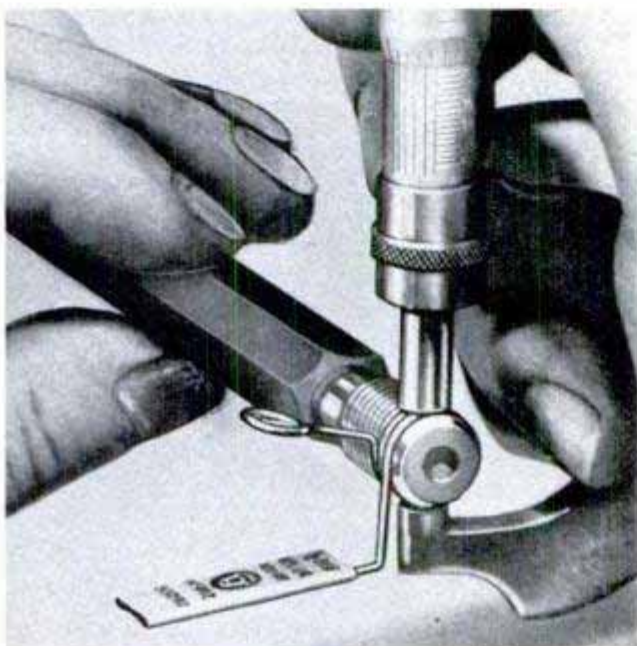

Thread-Measuring Gauge

Coiled to fit inside the screw threads to be measured, a spring-wire gauge enables a machinist to check thread diameters quickly and accurately with a micrometer. Based on the widely used Three-Wire method of measuring diameters, the gauges eliminate the need for holding three separate wires while manipulating a micrometer and also make it unnecessary to refer to complex charts or to make long calculations. All necessary data are marked on a plate attached to the gauge. The operator simply takes a reading and compares it with the limits engraved on the data plate. The coiled gauges, which come in various sizes, open when the projecting ends are squeezed, allowing the gauge to be slipped over the thread quickly.

Ticket "Detective"

Theater tickets are completely processed by a new machine which discourages dishonesty on the part of amusement-house employees. The ticket taker collects the tickets, counts them, cuts them, checks and records the sequence of every ticket, then stacks the stubs into sealed tubes in the order they were collected. Tickets are perforated according to a pattern, and the filled tubes show this pattern at a glance. Any tickets which are missing or not collected in the proper order are spotted immediately, thus preventing employees from palming tickets and re-selling them.

Ticket collector stows stubs in long tubes. Tube at far right shows stubs out of place.

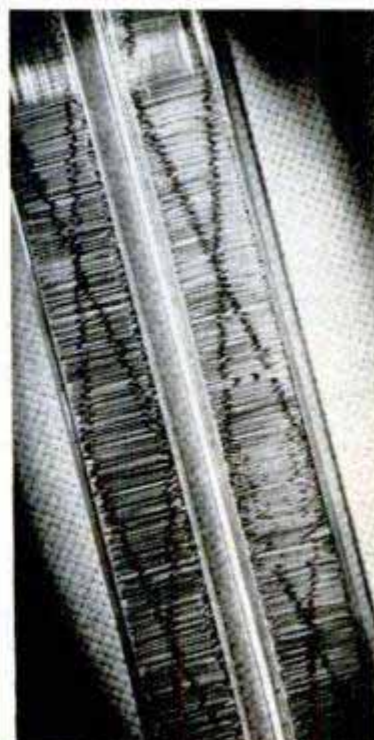



Fluorescent Tubes Now Have Guide Bumps

Tiny bumpers on each side of a fluorescent lamp base enable you to slide the tube into the socket without fumbling. The bumps serve as a guide during insertion and as a visual signal that the tube is in the correct position. Sloping shoulders on the base also make it easier to insert the tube.



Westinghouse photo

Hair Drier Is Noiseless

Soundless in operation, a compact hair drier has a collapsible hood that concentrates the warmth around the head. Electrically operated, the drier requires only 15 to 25 minutes to dry the hair completely. It can be hung on the door or placed on a table. The hood folds into the body of the drier for storage and the entire unit weighs only eight pounds.

Projector Aids Hymn Singing

Singing response at the Belvedere Ward Chapel in Salt Lake City is enthusiastic because of a screen and a motor-controlled slide projector. The projector flashes the words and music on an eight by eight-foot screen in front of the congregation. Well over 100 songs have already been put on slides, and many more will be on the list soon. The projection equipment was installed for \$250, whereas 400 song books would cost several times that amount.

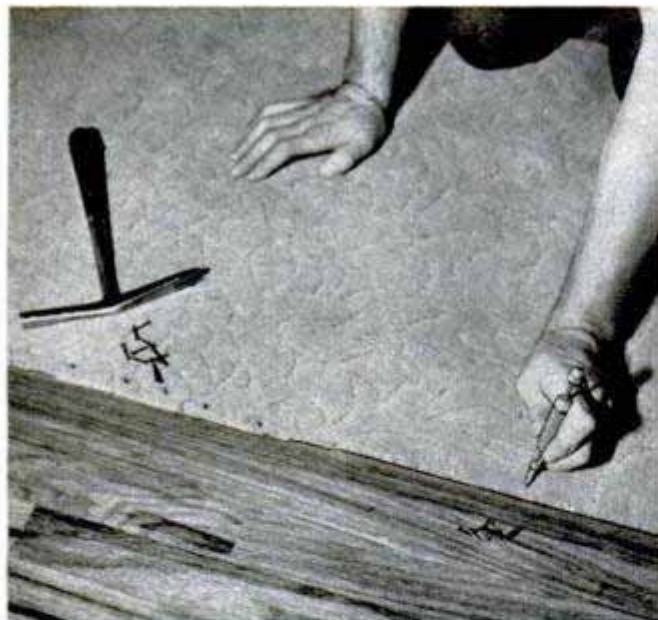

Left, tool sets pins invisibly compared with tack method (far left). Right, pins in plywood strip grip carpet

Tackless Carpeting

Wall-to-wall carpeting is anchored firmly to the floor without unsightly tacks by a pin-studded plywood strip that works on the same principle as a curtain stretcher. The strip, attached to the floor, contains a row of short pins that grip the back of the

carpet from below and cannot be seen from above. Also available is an invisible tacking tool that looks like a nail set. A small carpet pin slips into the barrel of the tool. Lips on the end of the tool open the nap of the rug enough to allow the pin to be driven. When the tool is removed, the nap springs back to cover the head of the pin.

Music for Bossie

Do cows like music well enough to give more milk? Miss Nora Johnston of Thorpe, Surrey, in England, believes they do, and has set out to prove her theory. She travels about a large farm with a portable carillon of her own design, playing a musical accompaniment while the cows are milked. She says figures accumulated over a period of time prove that the milk yield has increased since she started her program of music for Bossie.

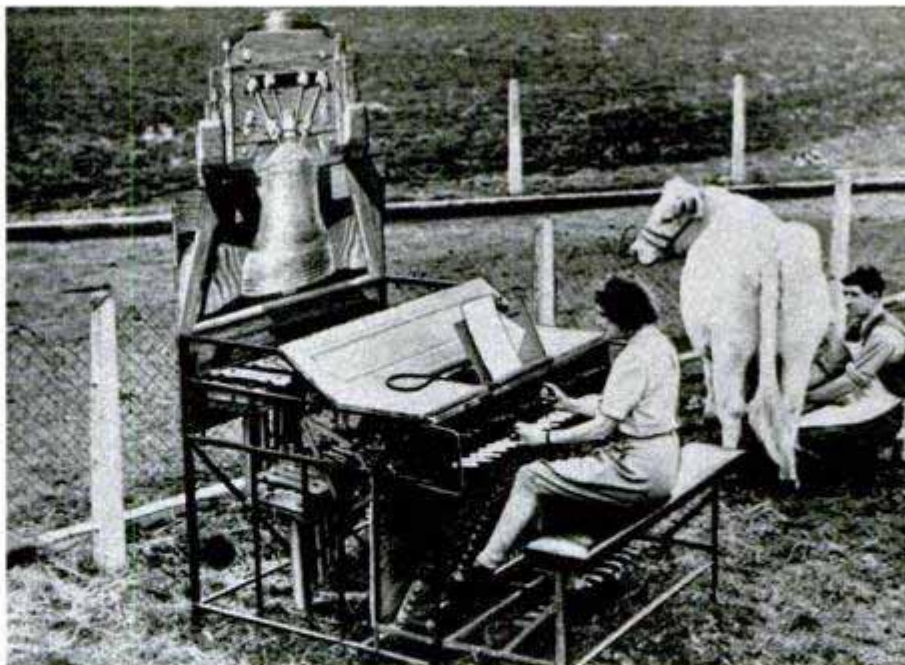

Taxicab SOS

German taxicab drivers, who need assistance in handling troublesome passengers, can send out an SOS by pressing a button that turns on a pair of illuminated signs. Printed on the signs, one being mounted at the front and the other at the rear of the cab, is the word "Hilfe," meaning "Help." The switch can be mounted on the floor or steering wheel if desired. In a test at Munich, five pedestrians saw the sign and immediately called police, who stopped the car after a chase.

Mail-Order Judge Collects Traffic Fines

Parking violators in New York City will mail their fines to a new machine that records each offense and detects all offenses of previous violators. Designed to save the city nearly \$200,000 each year in operating costs, the machine also promises to save New York drivers some 350,000 trips to traffic court during the year.

INDEX TO POPULAR MECHANICS NOW AVAILABLE

Your useful free copy of the new six months' index to Popular Mechanics, January through June 1950, will be mailed to you upon receipt of your order and 10 cents to cover handling and mailing. Address your order to Bureau of Information, Popular Mechanics, 200 E. Ontario St., Chicago 11





Tatum and a Red Cross lifesaving expert demonstrate how not to fish from a boat



Over they go! Standing up in the boat raised the center of gravity. Then the motion of a cast tipped them into the drink

Have Fun in a Boat, But..

SWIMMIN' time again, with a world of fun—and some serious hazards, too. As usual there'll be tipped boats and other horseplay. G. E. Tatum, safety engineer for a public utility, offers common-sense advice on how to have fun and stay alive. In case your boat tips you overboard, Tatum says, rock it to slosh out as much water as possible, then crawl over the stern

Two mermaids, about to be flipped into the river because they stand up to change positions in canoe

and sit on the bottom while you scoop out the rest. In no case should you leave the boat. If the craft capsizes in a fast river, grab it and angle upstream, not down, so the current will help you ashore. In a canoe, keep your weight low, and if you must change places one person should bend low while the other crawls over him. If the canoe overturns, swim to the stern,

That's better. One kneels in the bottom of the craft while the other crawls over her. Both hold side rails





No! Go back to the boat! Most persons in such a predicament swim for shore—the worst thing they can do

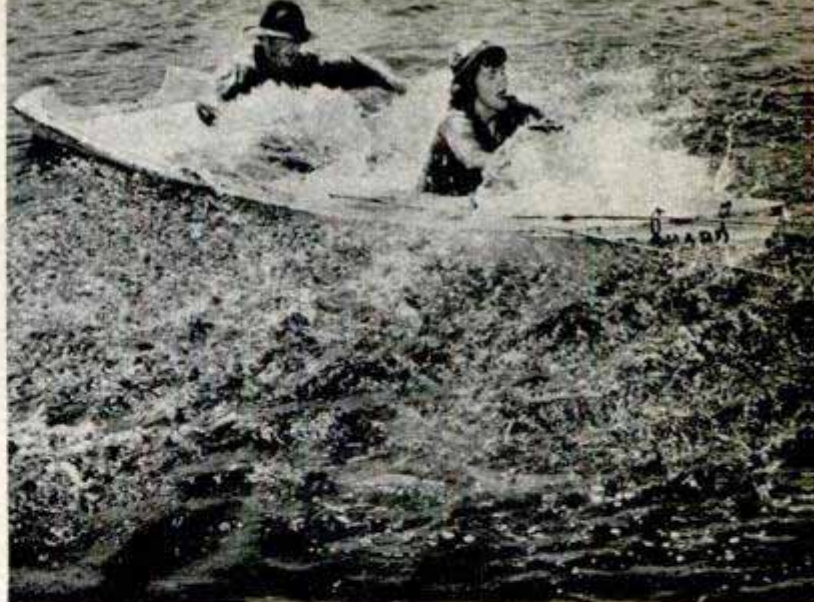

That's right, swim back to the boat. Right it, rock out some water, crawl over stern, splash out the rest

DON'T DROWN

push it down and stand on it under water. The canoe will shoot up and out, dumping part of the water. Then rock it from the side to slosh out the rest, grab both railings and swing yourself in so you land in a sitting position. Safety rules won't spoil your fun, but they may save your life!

Right, don't splash ashore with the current, but against it. Current will push you toward shoreline Tatum shows how to clear a swamped canoe. Grab one side and roll it back and forth. Water splashes out

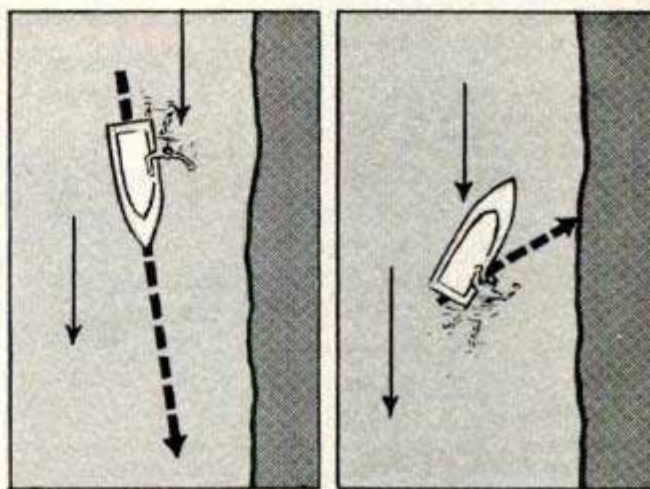

Stuck without a paddle? Lean over the prow and use a breast-stroke motion. You can move fairly fast

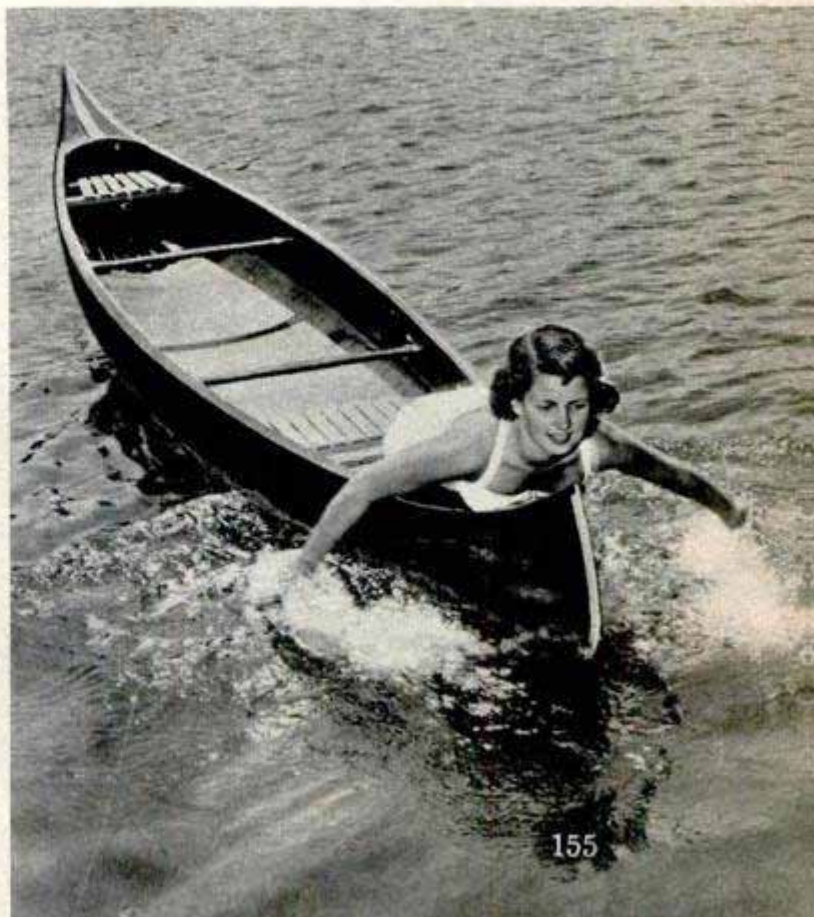



Periscope Hood

Airmen have gone down to the submarine for their latest teaching aid, a periscope that sees down instead of up. It is designed for instrument training, to permit the pilot to see the dials, gauges and knobs before him plainly, but to prevent him from seeing outside the plane. Made of aluminum, the periscope hood weighs less than five pounds and extends out about six inches from the face. The old system required the pilot to add an amber Plexiglas windshield to the plane and to wear tinted glasses in flight. This made it impossible for the pilot to see outside, but allowed him full vision for the instrument panel.

Photo Tone Matcher Assures Good Prints

Photo hobbyists can reduce paper waste with a tone matcher that assures proper development of prints. The matcher consists of four plastic leaves of differing gray tones. The lightest is the tone preferred for flesh tones in portraits and the darkest matches shadow tones. An oval hole in each leaf allows the hobbyist to compare the tones with any portion of the print. The four leaves also serve as agitators during development and the stem is colored to indicate when developer should be discarded.

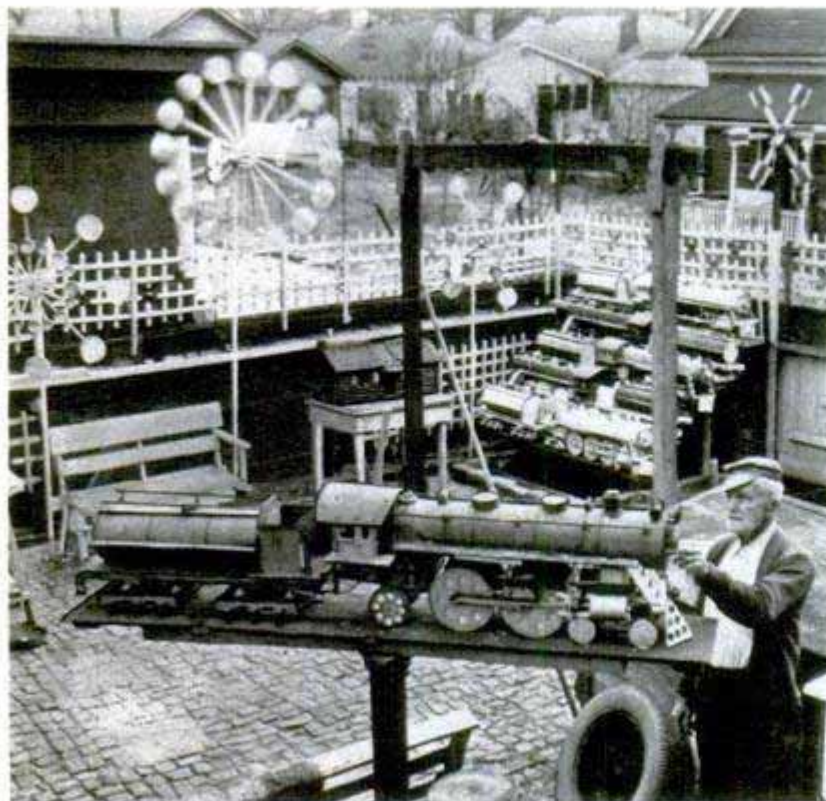
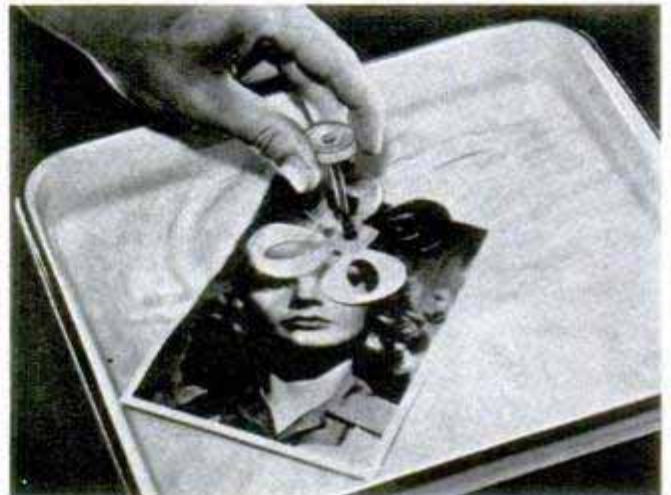

Tin-Can Railroad

When a Georgia railroad man retired, he had to do something "to keep from going crazy" and naturally he turned to trains for his hobby. Using ordinary tin cans as raw material, W. E. Chester, 86-year-old Atlantan, has built himself a realistic collection of locomotives in his back yard. Occasionally, to add variety, he produces weather-vanes and whirligigs, using the always-available tin cans, but most of his time is spent fashioning locomotives of various sizes and types.

¶ Army medical researchers are making mosquitoes radioactive so they can follow the little nuisances with Geiger counters to study their flight and attack habits.

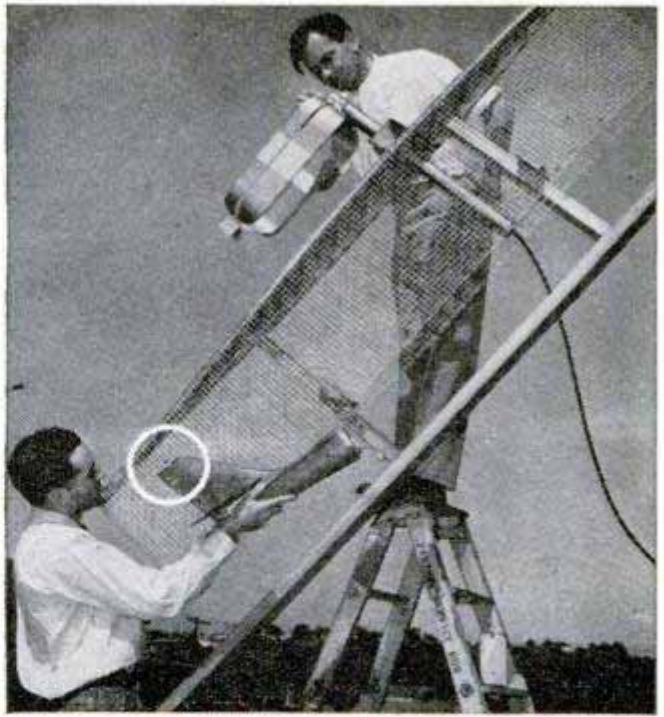
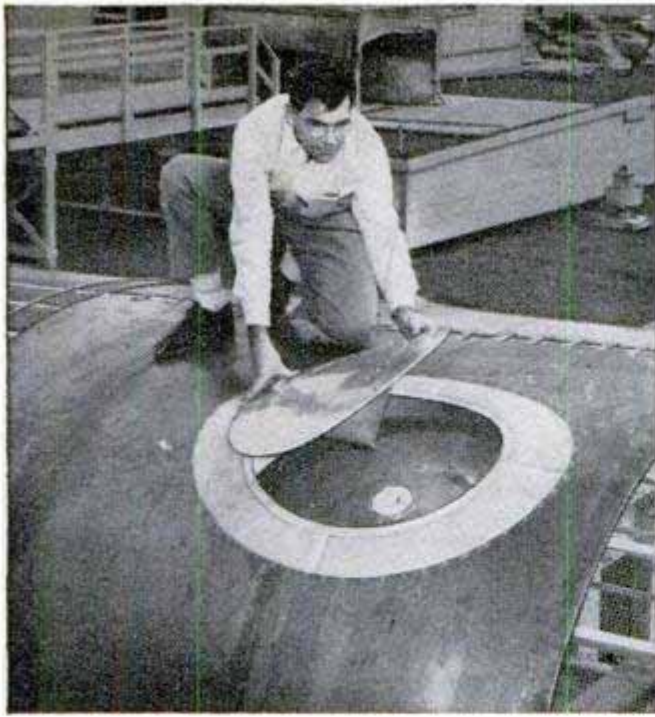

Ridding Fast Planes of Their "Barnacles"

Jet speeds are sweeping radio antennas out of sight. Protruding antennas, long recognized as "built-in headwinds" that slowed the plane, have also been found guilty of creating dangerous shock waves at speeds near sound. To lick the problem, the Boeing Airplane Company has built a special laboratory to learn where they can be put, to work as well or better, without creating drag. The old system required full-size construction, installation, then long hours of flying to test reception. At Boeing, miniature planes and antennas, fastened to a turning arm atop a small tower, "fly" in front of a scaled-down source of radio energy. A cable leads from the tiny antenna to a recorder that accurately graphs the equipment's performance.

Upper left, after tests with 1/25 scale model, engineers went ahead with a flush-mounted antenna on mockup of big jet B-47

Above, comparing scale and full size, tail section and antenna in circle duplicate wire and metal mockup above the ladder

Below, tower on which model planes turn is at left, while radio waves come from "horn" at right. Inset, graph recording of a test

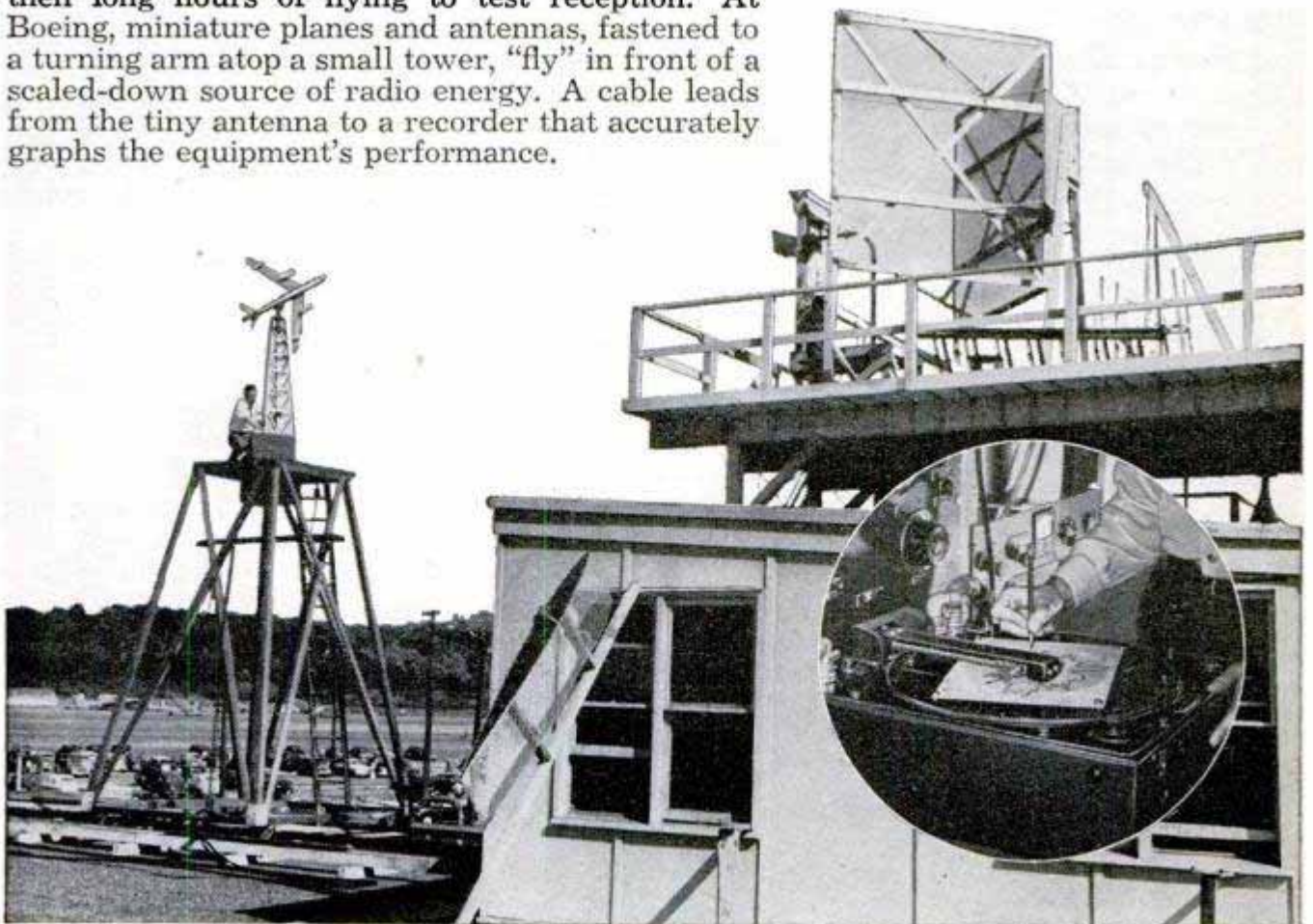



Frank S. Milburn, engineer, (right) confers with man who invented the broom attachment on opposite page

BRING ON YOUR

Frank Milburn is a sort of baby sitter for brain-children. His little shop in Burlington, Ky., hires out as adviser to inventors with ideas—and if they're good, helps put them on the market

STRANGERS who visit the little town of Burlington, Ky., occasionally stop on Main Street and ask a native for directions. Before the visitor can open his mouth the native says:

"S'pose you-all are lookin' for Frank Milburn's place."

The surprised visitor nods.

"Well, you keep on this street until you come to the gravel and then follow the winding road till you pass a red tobacco barn on the left, then at the next bend you'll see a one-story building sitting in a cornfield. That's Frank's place."

Frank's place, as they call the Milburn Manufacturing Company in Burlington, is a mecca for inventors either in person or via the mailbag. Milburn and his associate, Henry W. Jenisch, have learned that the world is chock-full of eager inventors. Milburn says he is convinced

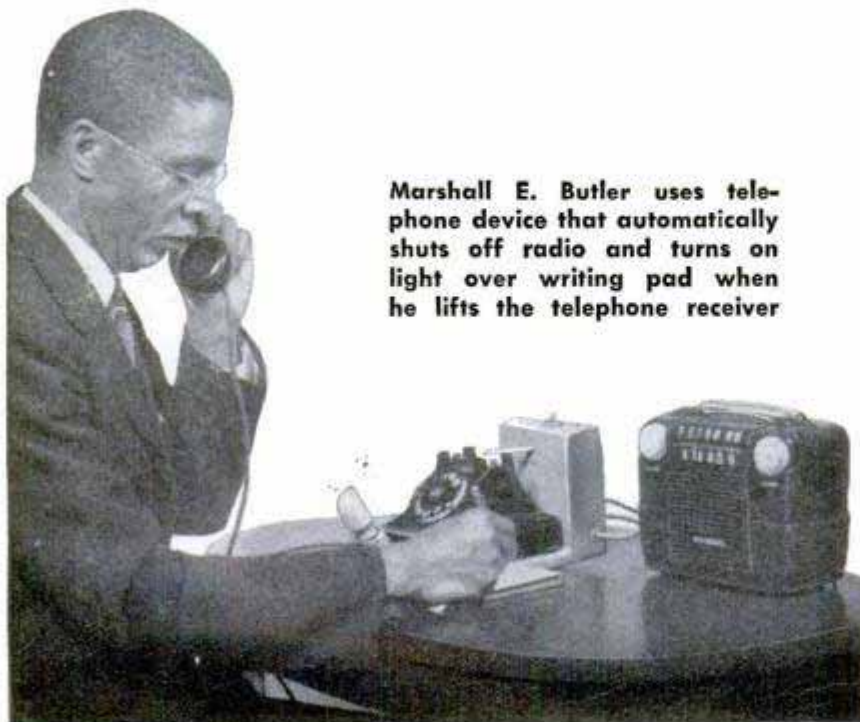

Marshall E. Butler uses telephone device that automatically shuts off radio and turns on light over writing pad when he lifts the telephone receiver

of the old saying that if you scratch the skin of any man deep enough you'll find a potential inventor inside.

Most everybody at some time or other has had an idea for an invention that they would like to turn into a gold mine. But Milburn, who ought to know, says that inventors are not greedy people. They get as big a kick out of hearing their brain-child acclaimed as they do the clink of coins. However, the fact that some \$300,000,000 was paid out in royalties in the U. S. last year doesn't dampen anybody's enthusiasm.

Frank Milburn, a young semiretired engineer, has for a number of years devoted part of his time to acting as a link between inventors and manufacturers. His job is engineering inventions—taking the inventor's rough sketch or crudely made gadget and from this making a production model. In his machine shop, Milburn and his assistants make the dies or molds necessary to produce the items. This, of course, follows careful study of the invention and decisions as to whether it should be made of metal, plastic or some other material.

Milburn charges for his services, but he says he refuses to engineer an elaborate article in which he thinks there is no merit. One man insisted that he produce a die-cast lollipop made of metal with flavoring in the metal alloy! Another insisted that Milburn make a rabbit whistle which is supposed to make a sound like a baby rabbit. The whistle is made of plastic, brass and reed and, over his



Garden-hose attachment on broom is used to clean out a dirty basement. Below, metal joint fastener below stops splitting (top)

INVENTIONS!

better judgment, he made one for the inventor.

But these cases are the exceptions. There are other inventors like M. C. Duncan, a druggist in Russellville, Ky., who for years had had trouble with the various labels that a pharmacist has to use. Many of the labels were so small they would not stay in his typewriter. He came to Milburn with a few sketches and a cardboard model of what he figured would make a good labeling device. It consists of a little stand holding various sizes of labels in the form of rolls. These rolls can be run through a typewriter and torn off in varied sizes. Recently, Duncan added a statement roll to his stand and types out his monthly bills the same way.

Late one afternoon a man from Cincinnati walked into Milburn's office with a paper bag held reverently in both hands. The man dumped its contents on Milburn's desk: two old flashlights and five standard fuses. The inventor explained that he lived in an apartment building where his neighbors were always overloading the fuses which he had to replace. Usually in those cases he could find neither his flashlight nor fuses. His idea was a container for fuses with a flashlight attached. The finished article is now a small pen light fastened to a plastic fuse container.

One of Milburn's favorite inventors is J. A.

(Continued to page 242)

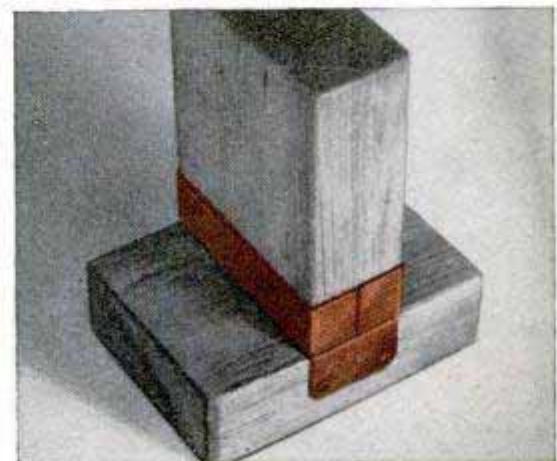
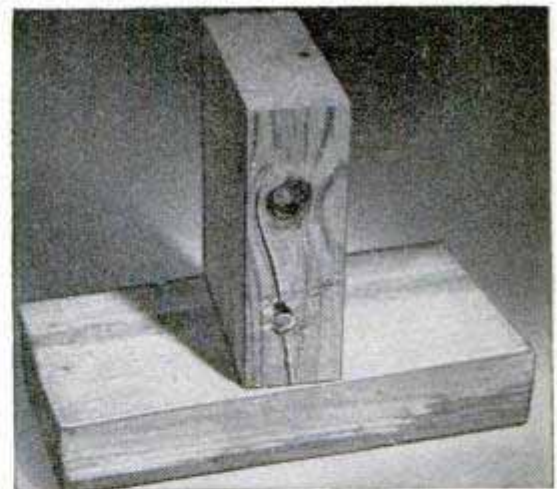

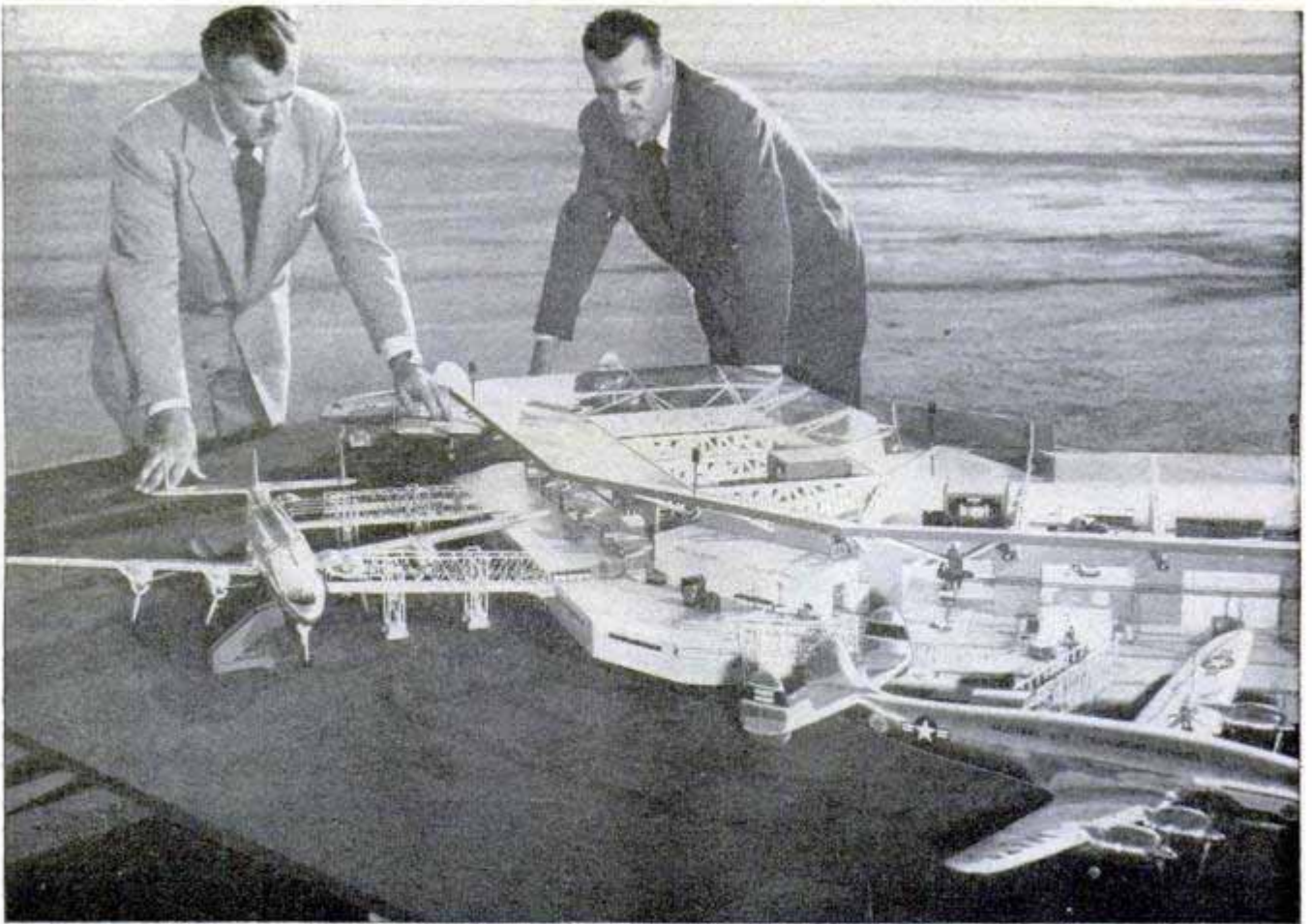

Model Air-Freight Terminal

Air-freight handling is speeded by a new conveyor that tows empty and loaded hand trucks to and from planes over an endless, oval track. The conveyor moves at a speed of three miles an hour. Either the trucks or mechanized loading belts continue into the planes with the freight, using mobile,

extendable platforms. Other features of the air-freight terminal, designed by the Lockheed Aircraft Corporation, are a raised floor to permit level loading and unloading and close-in ramp areas for the largest-type transports. This equipment could handle an estimated 80 tons of cargo hourly, approximately the daily capacity of the largest terminals now existing.

Low-Cost Homemade Car Runs 40 Miles Per Gallon

With the frame and wheels of a 1934 Ford, a 12-horsepower four-cylinder water-cooled engine, a clutch, transmission and

rear end from a junk yard, a former instructor at Dakota Wesleyan University built a unique automobile. The body of the car



was made from scrap lumber, covered with hardboard and held together by two boxes of screws. Headlights, taillights, radiator grille and windshield were obtained at minimum prices. The hood ornament was the container for an airplane's loop antenna and a glass dome for the top is from a refrigerator. The builder, Nelson Beck, devoted six weeks' work and \$76.68 to his project which has begun to repay him by running 40 miles to the gallon at an average speed of 55 miles per hour.

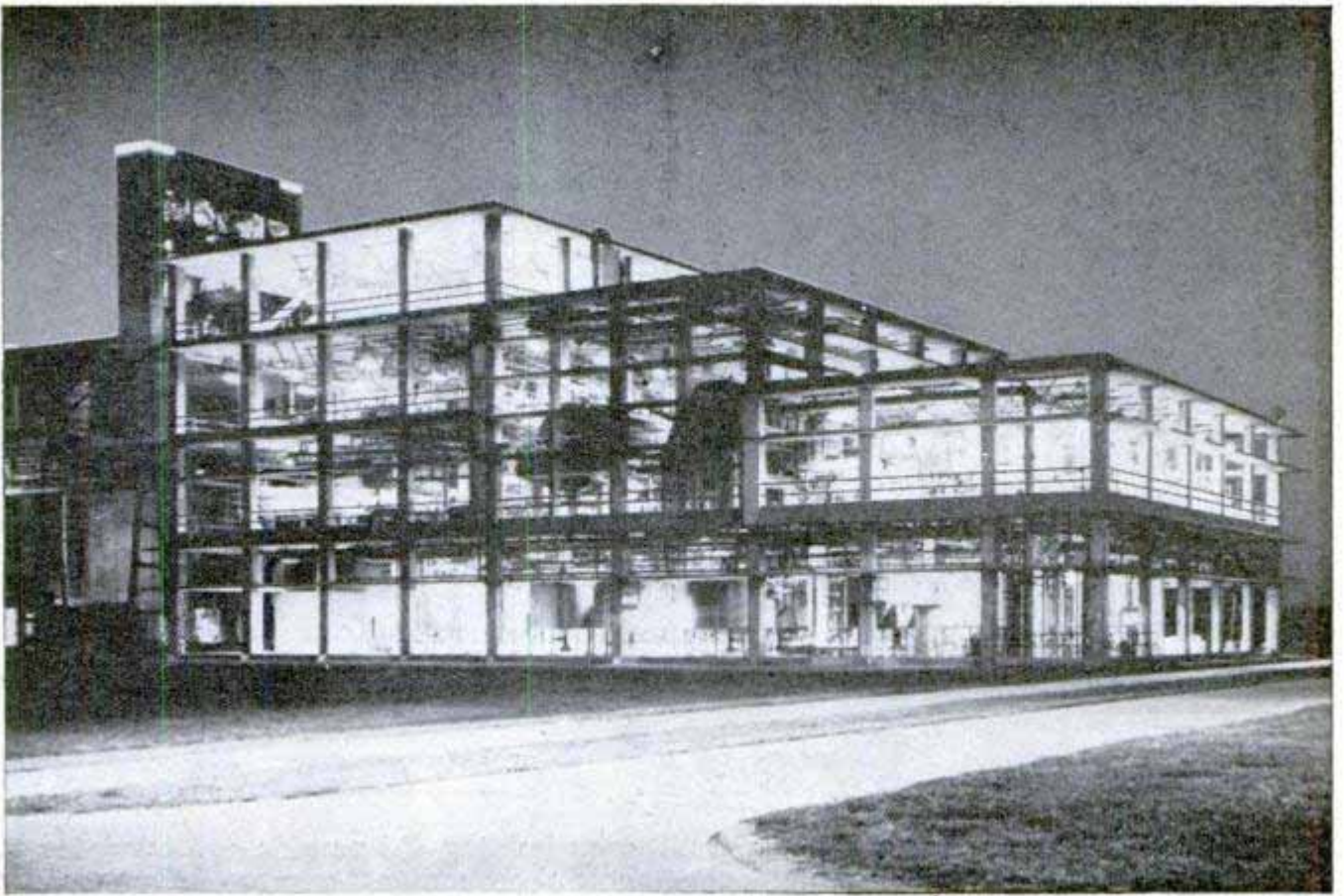

Factory Without Walls

Fresh air wafts through all the buildings of a new factory in Corpus Christi, Tex.—there are no walls to hold back the wind. The factory refines sorghum grains and corn into starch, sugar and cattle feed, a hazardous process because of the danger of grain-dust explosions and poisoning from sulphuric-acid fumes. Designers of the modern factory decided to eliminate all walls, thereby preventing concentrations of dust and fumes inside the buildings. Night photo above shows how the columns bear only the ceilings and floors. Below, left, only stairways and maintenance rooms are enclosed. Right, overhangs hold out sun and rain

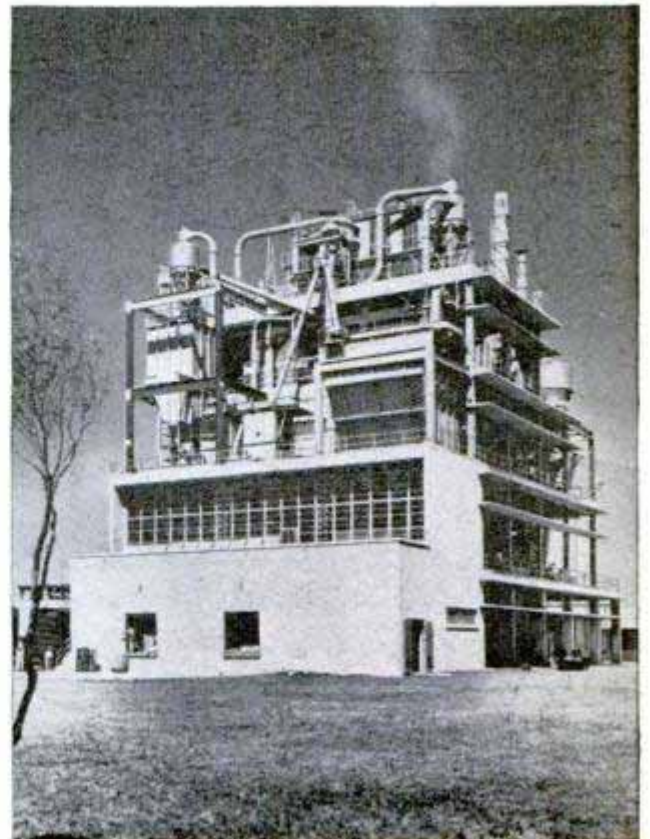

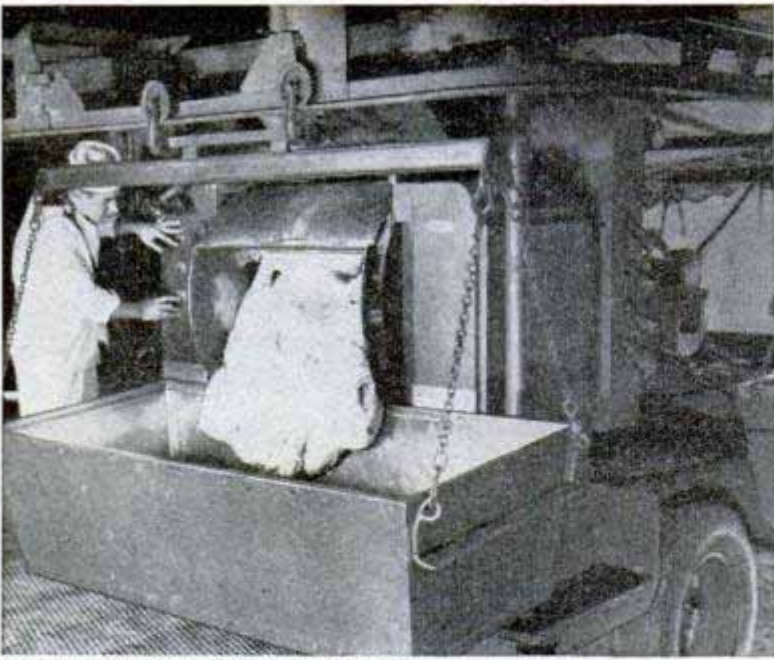

Quartermaster Corps, U. S. Army, photos

Left, mixed dough being poured into 492-pound trough. Right, "punching the dough" during fermentation stage

Enough Bread for an Army

FRESH BREAD daily for 96,000 soldiers, more than double the old equipment's capacity, is turned out by the new mobile bakeries developed by the Army's Quartermaster Corps. Each bakery company, with three mixing and make-up trailers and six oven trailers, can now produce the two-pound loaves at a 20-per-minute rate. The men eat an average of $\frac{1}{2}$ pound apiece daily. The stainless-steel dough troughs,

each holding 492 pounds, are insulated to hold their contents at a fixed temperature during the monorail ride from the mixing bowls. Measuring and molding of the loaves is done mechanically. From the ovens, the loaded pans move over skid-wheel conveyors to storage racks where they are left to cool for two hours. The complete bread-making process takes four hours, including two hours for dough fermentation.

Below, artist's impression of the baking area. Mixing machinery is at the left, baking ovens in the center, storage racks at the right

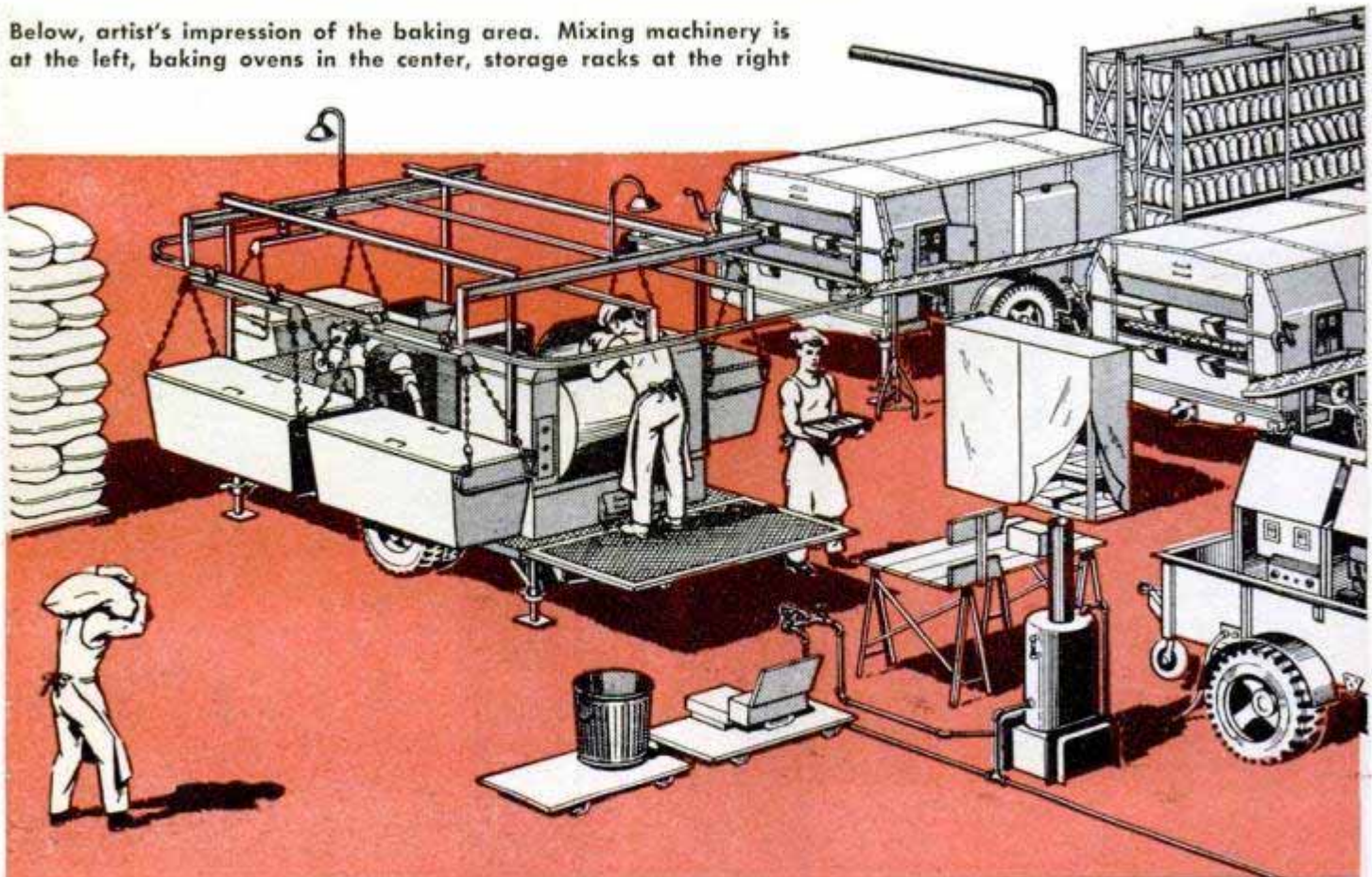



Above, the man standing in the background is feeding dough into the divider, from which two-pound pieces drop onto conveyor belt and move into molder. The two soldiers in the foreground are putting molded loaves into pans, where they will stay for 30 minutes while the dough achieves proper degree of lightness



Above, after the dough has risen to correct consistency, loaves are put into oven to bake for 30 minutes



Above, pans of baked loaves are put on conveyor for transfer to storage racks, where they have to cool for two hours. Below, Army truck and a mixing and make-up trailer ready to roll to new site

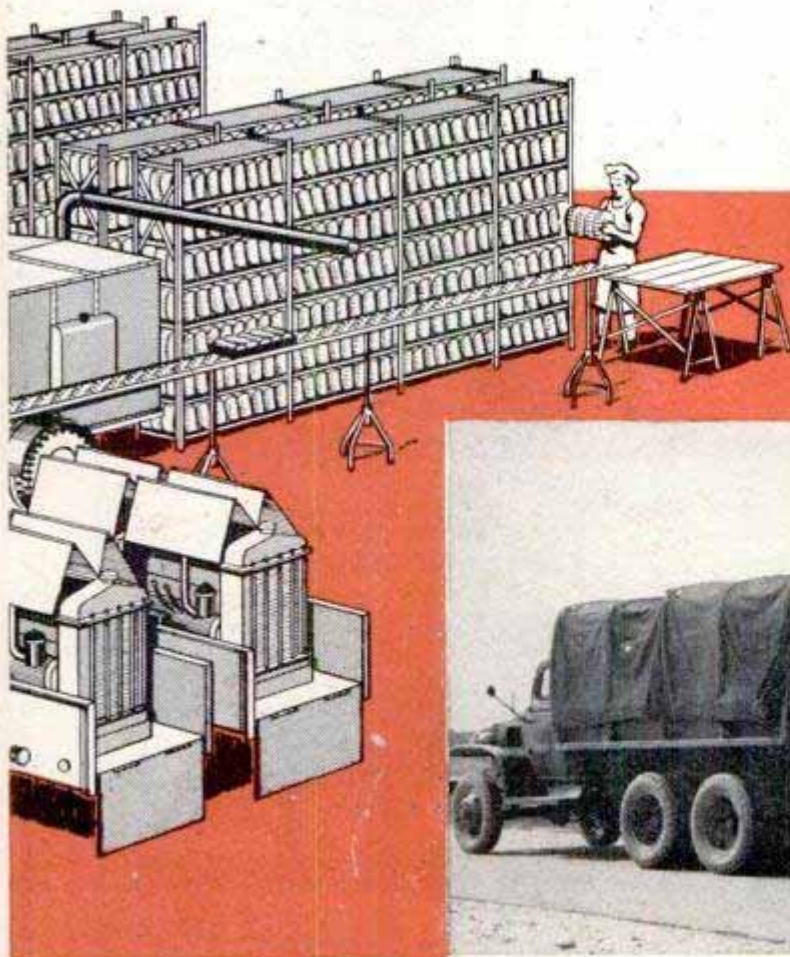

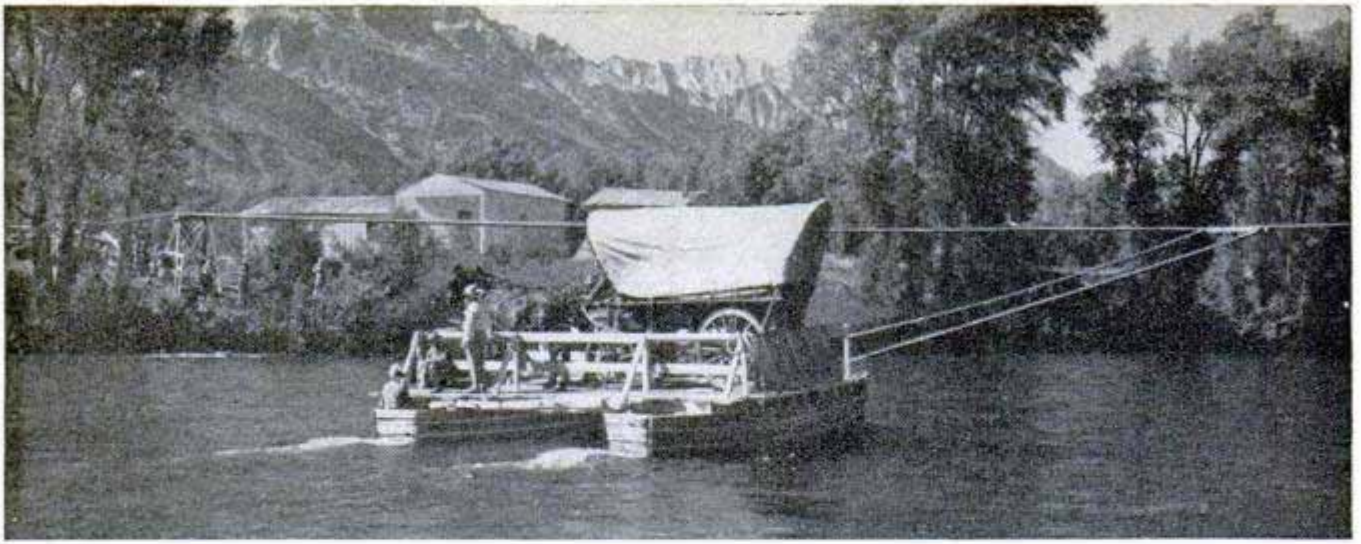

Carrying this old Conestoga wagon and its team of horses, the ferry makes its initial trip across the Snake River after the restoration

COVERED-WAGON FERRY RESTORED IN WYOMING

Increasing traffic in 1927 forced abandonment of Menor's Ferry, for 35 years the only connection between the east and west sides of Jackson Hole, Wyo. Instead, a steel bridge was built near by over the Snake River. After 22 years of inactivity, the ferry has been restored by Rockefeller interests. The replica was achieved by examining old photographs and original remnants of the rotting ferry gear. Now visitors to this ferry at Moose, Wyo., may ride across a real piece of the Old West.

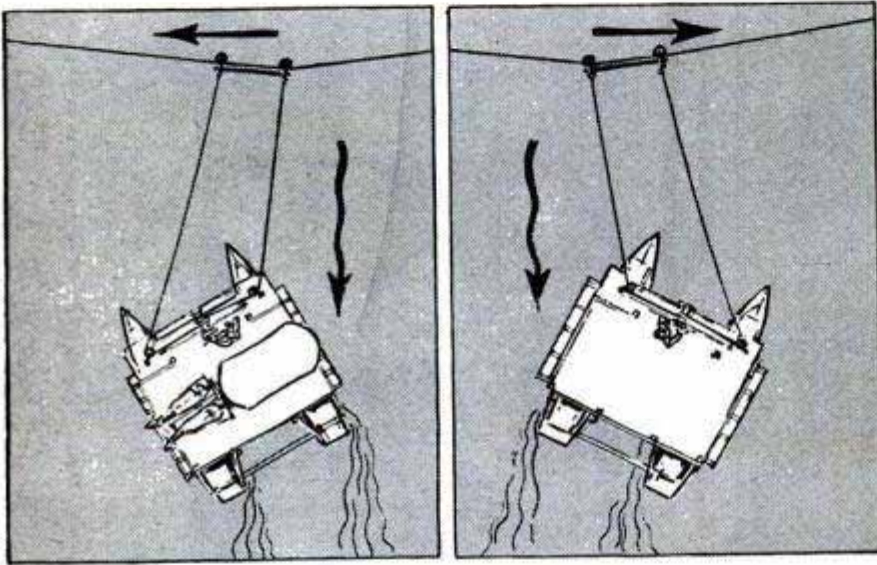

Above, the current is the ferry's "motor." Below, a winch changes the angle of the boat in the current and, thus, its direction of travel

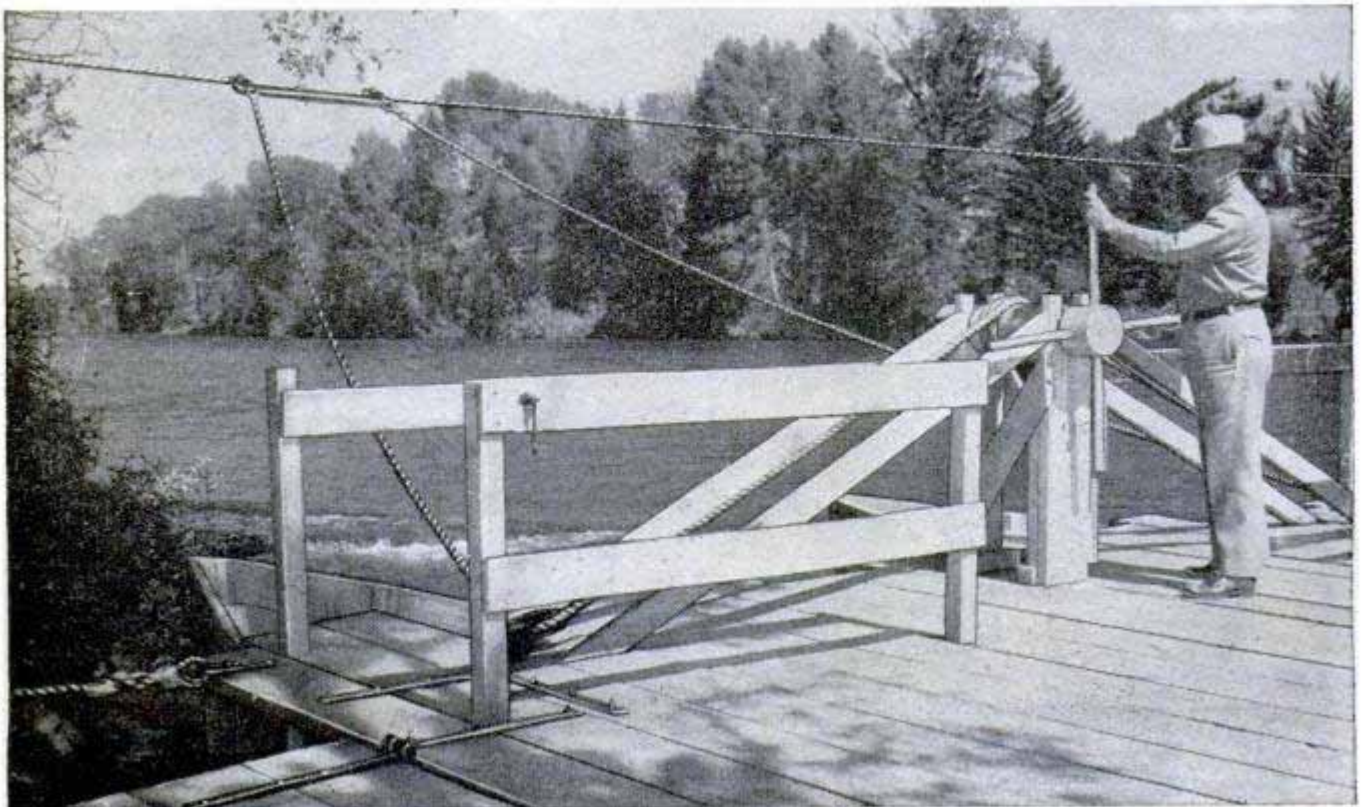

the

POPULAR
MECHANICS

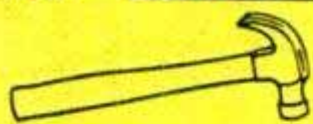

CRAFTSMAN

Featuring

Stop Leaky Plumbing... 183

Fit Out Your Boat... 189

Bandsawing Metal... 211



Kosta
Beach Equipment
See Page 166

Beachward Ho!

By Frank N. Stephany

Spending the summer at a private beach or driving the family to the seashore for a day's outing is twice the fun if you have the right equipment. Whether you enjoy relaxing in the sun or rigorous water sports, here's everything you'll need to have a wonderful time

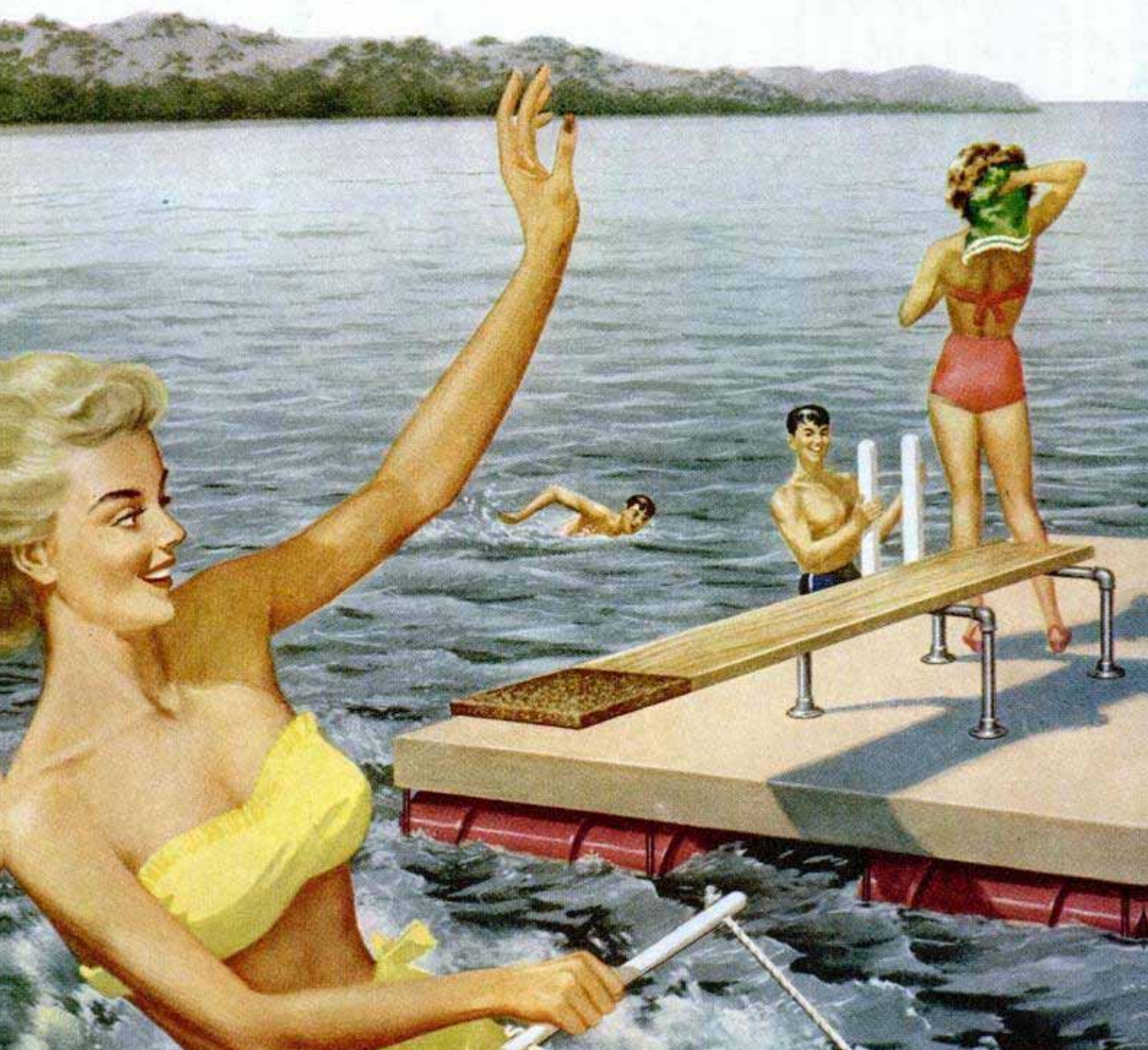

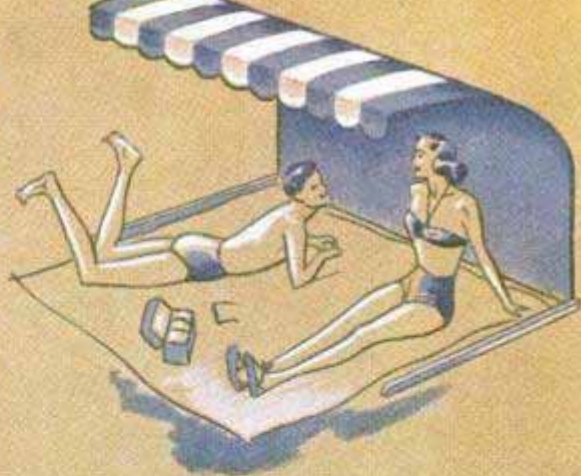

Awning-covered frame provides attractive sunshade



Beach chair folds like a suitcase for easy carrying

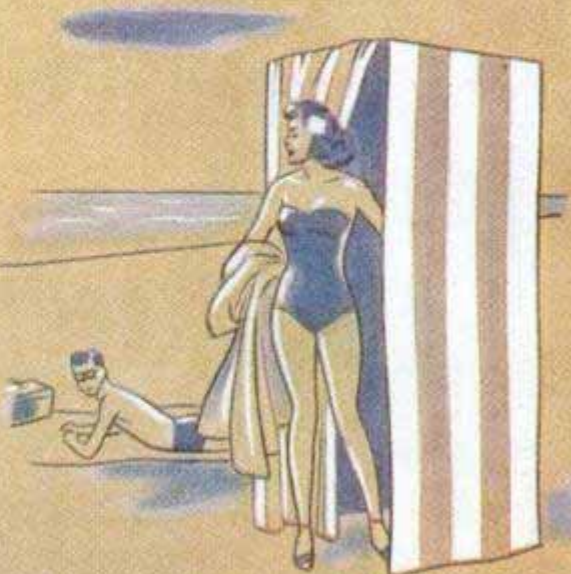

Portable "dressing room" affords complete privacy

Artista

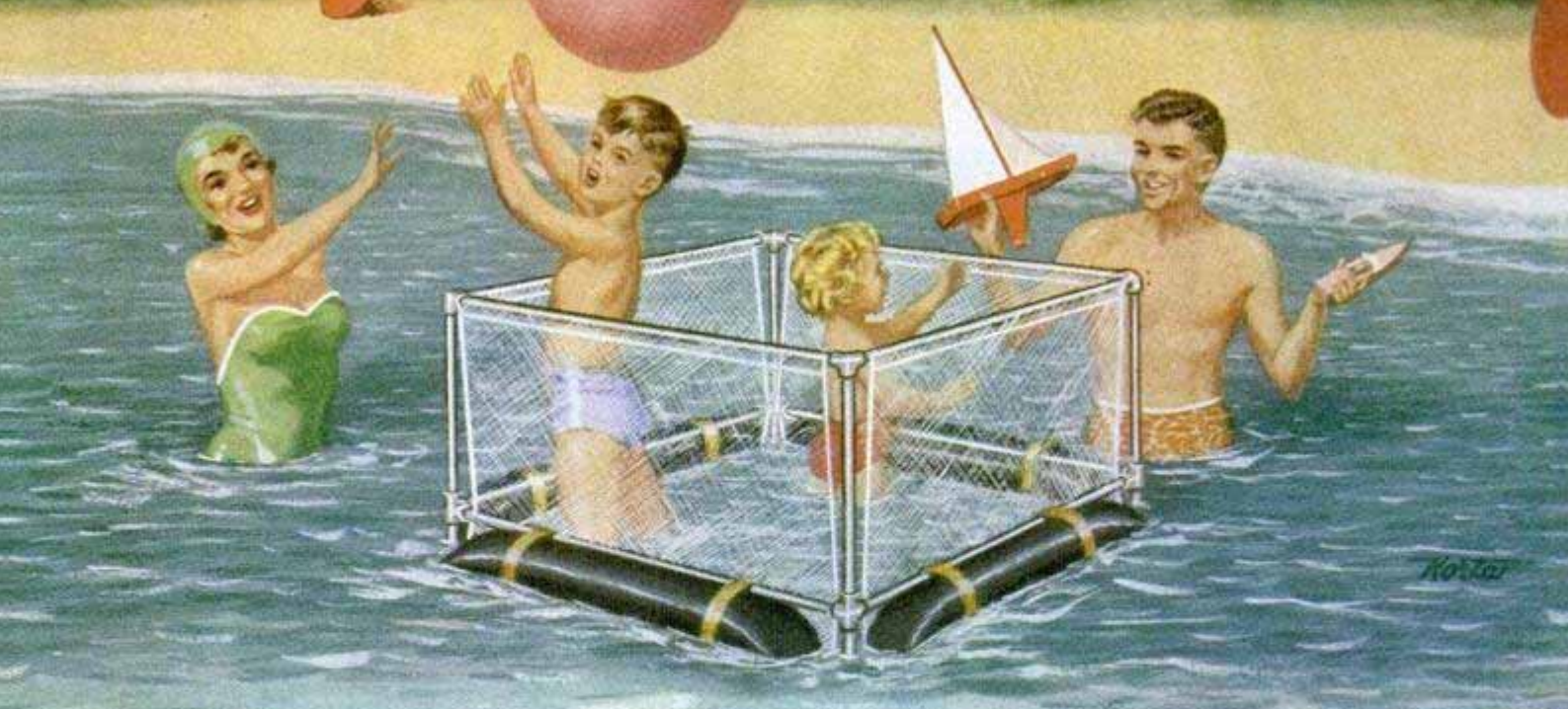

The whole family will enjoy bathing if the youngsters can be towed to deeper water in this floating playpen. Four auto inner tubes prevent tipping

Sturdy aquaplane shown below will bring endless thrills to the more experienced swimmer. Rubber mats at rear provide nonslip footing for rider

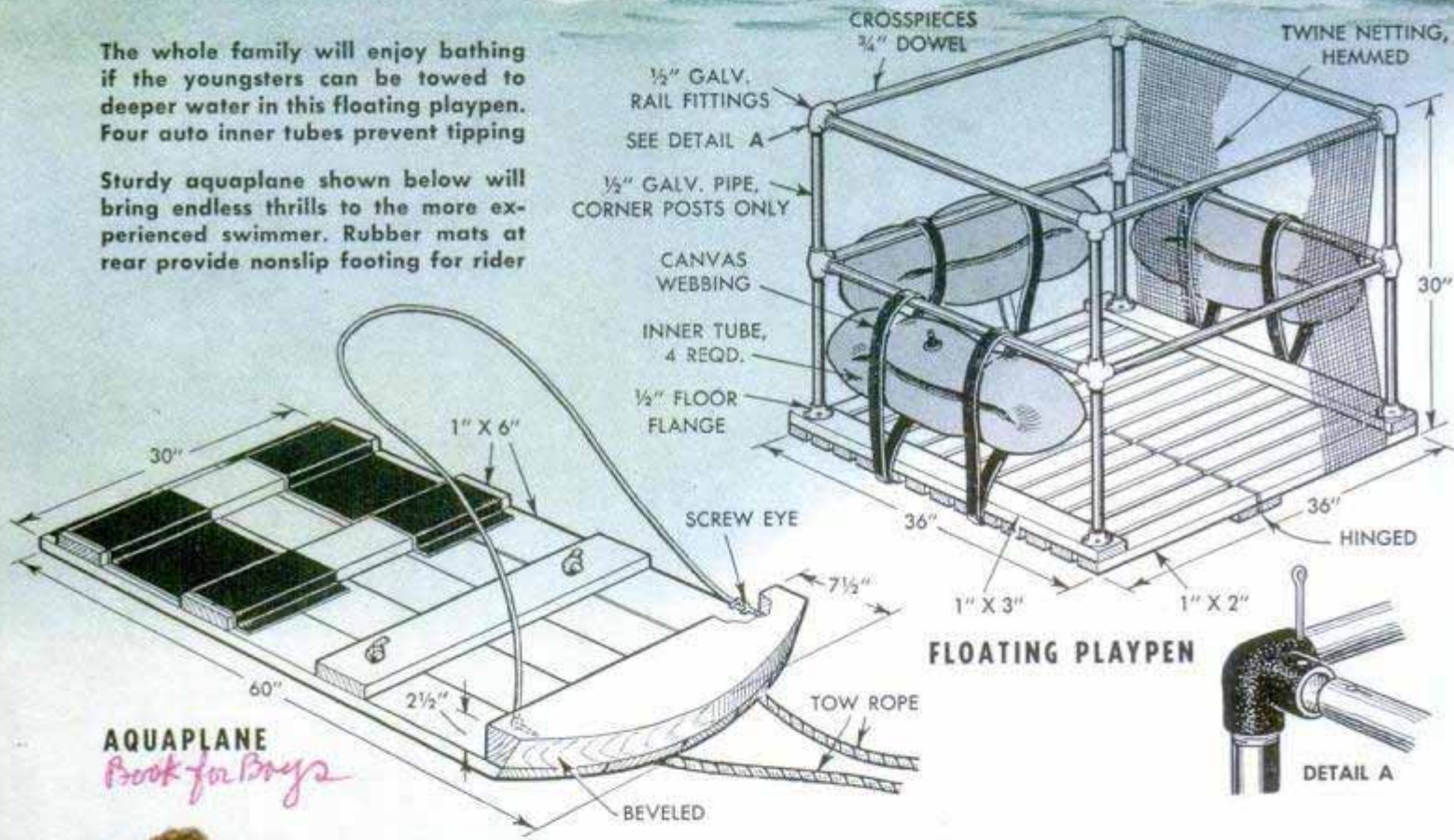

AQUAPLANE
Book for Boys

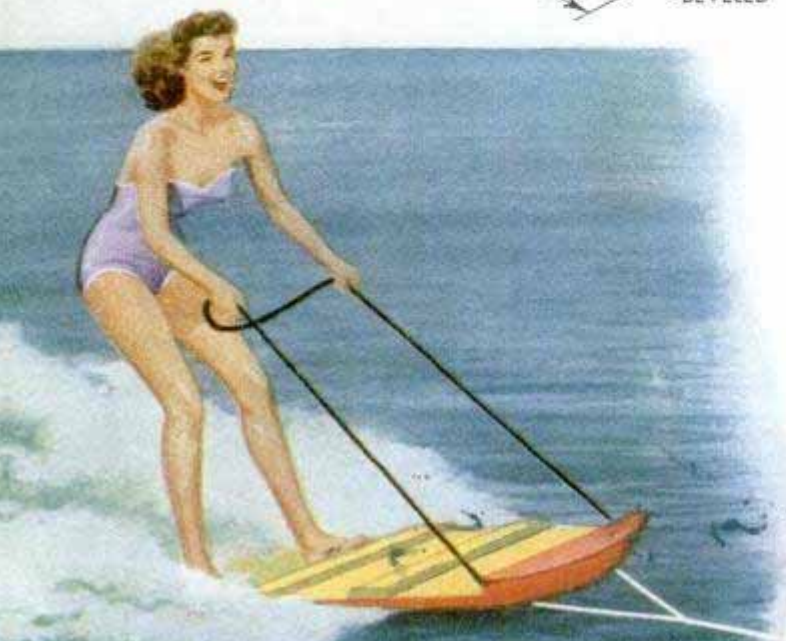

OF THE various beach items described on this and the next three pages, the diving raft, knockdown pier and lounging chair are the only ones which require a considerable amount of work. Most of the remaining articles can be built in a few hours and feature simplicity of construction along with maximum portability. For example, the floating playpen detailed above comes apart merely by removing the pins which hold the rails in place. After the rails are pulled from the netting, the inner tubes deflated and the pipe uprights unscrewed from the floor flanges, the hinged platform can be folded and the entire unit then packed neatly in the trunk of a car.

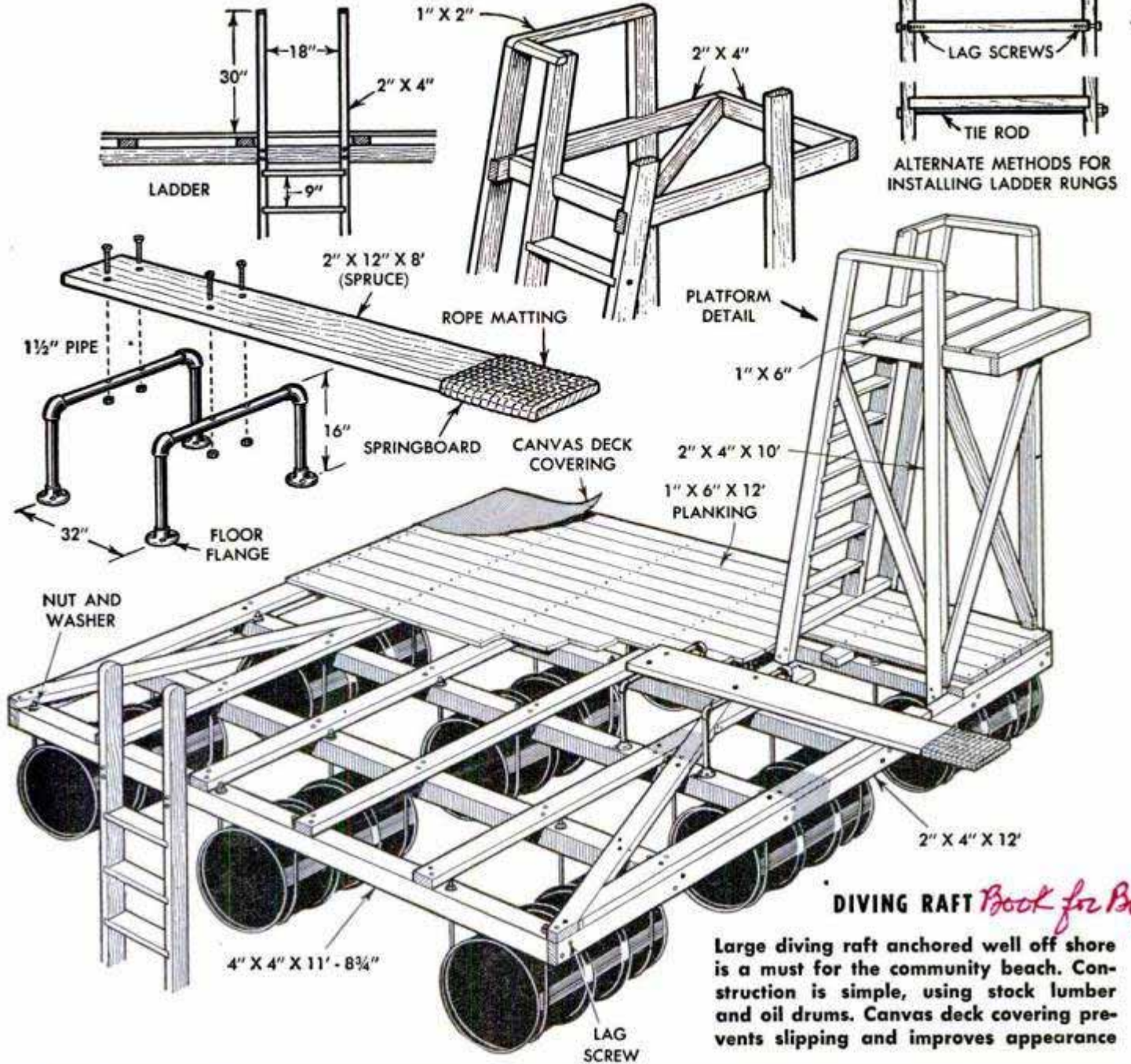

DIVING RAFT *Book for Boys*

Large diving raft anchored well off shore is a must for the community beach. Construction is simple, using stock lumber and oil drums. Canvas deck covering prevents slipping and improves appearance

Removable walk sections and trestles are the feature of this knockdown pier. The individual parts, which can be handled by one man, are stored on land during the winter and quickly set up on permanent underwater posts for summer. Without winter wear, the pier will last longer

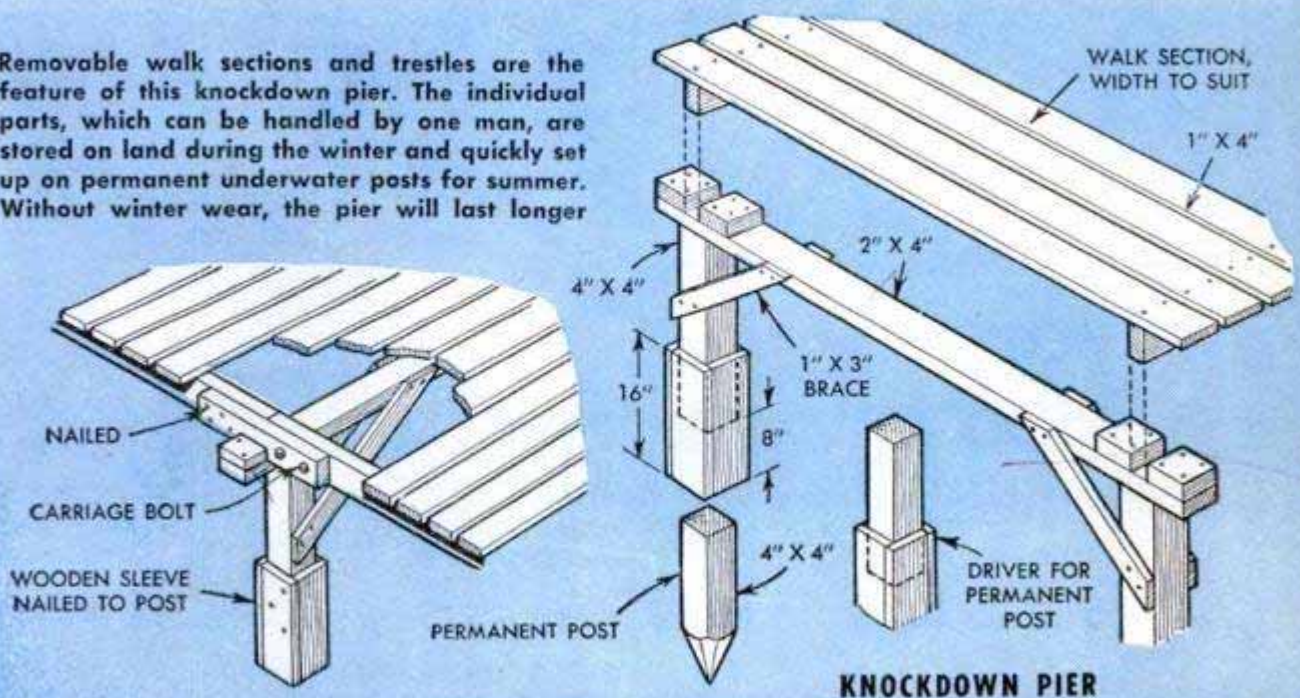

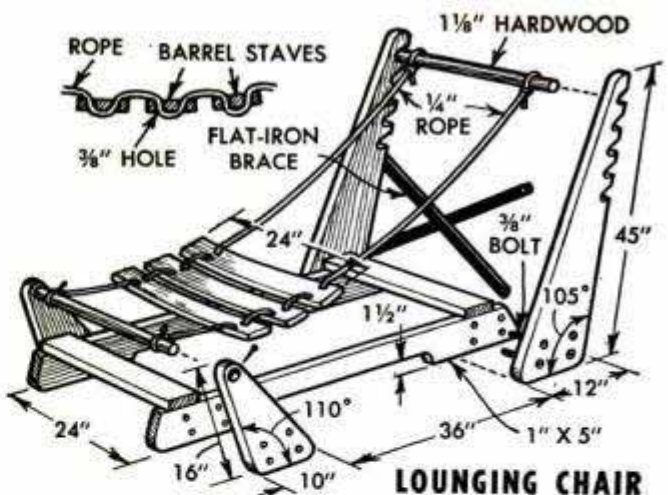

This lounging chair for the private beach is just the thing to help you spend those lazy summer afternoons in solid comfort. It's adjustable to four different positions so you can sit up to read or lie down to relax while basking in the sun

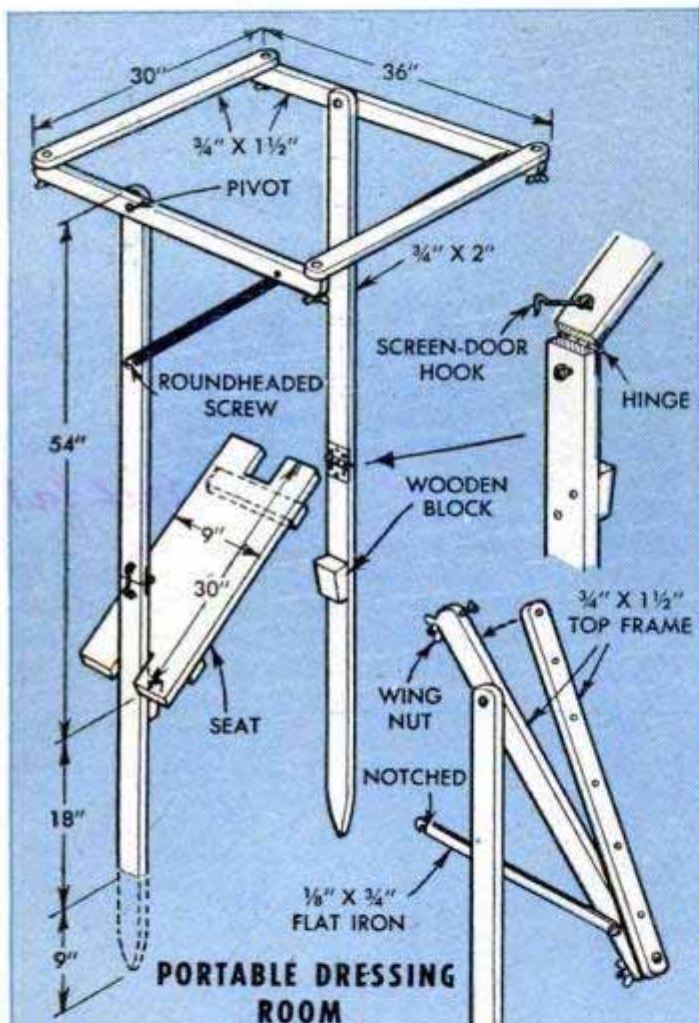

Conveniently carried in the trunk of your car, this portable dressing room is set up on the beach in a few minutes

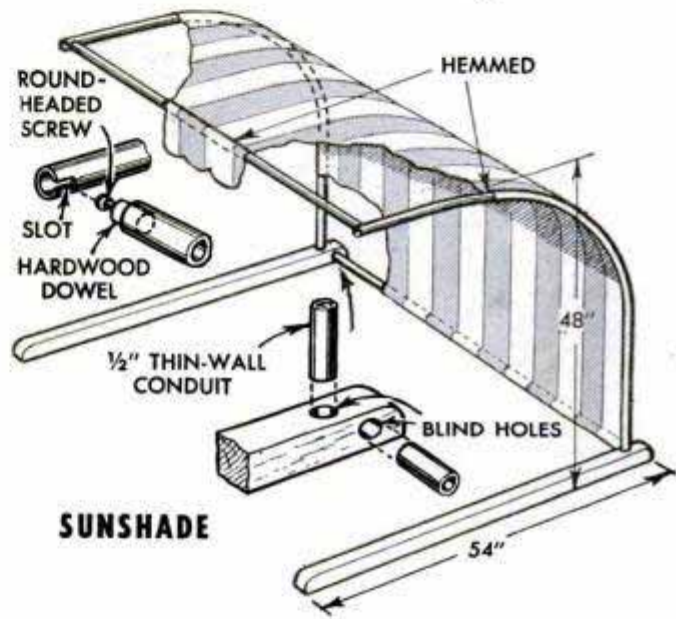

Thin-wall conduit forms the frame for the generously proportioned sunshade shown above. Two lengths of wood support the frame. Below, lazy-back chair with pocket for sundries has handle for carrying. Cushions are used on seat and back

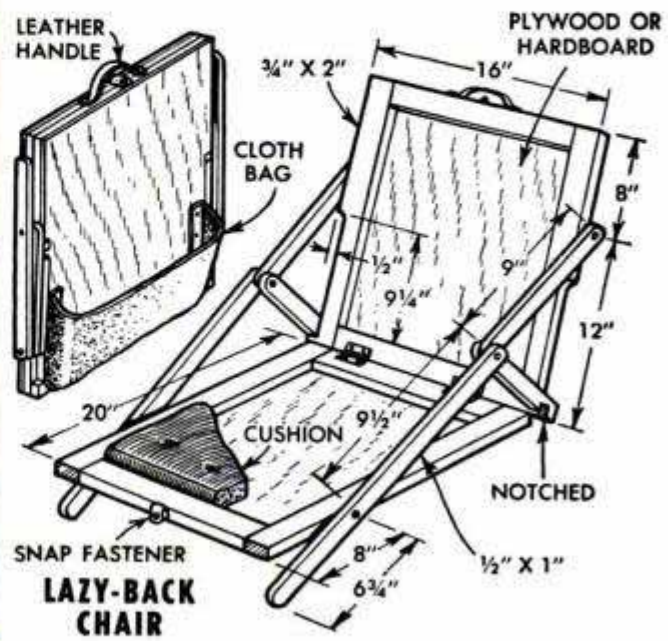

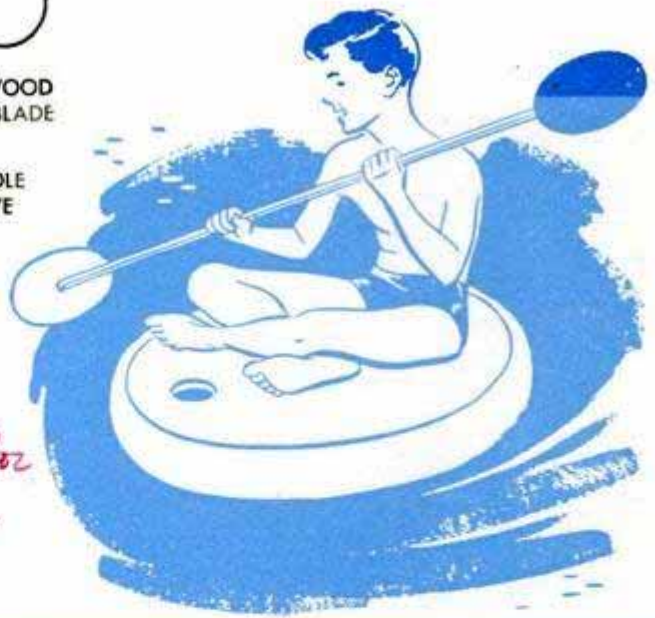
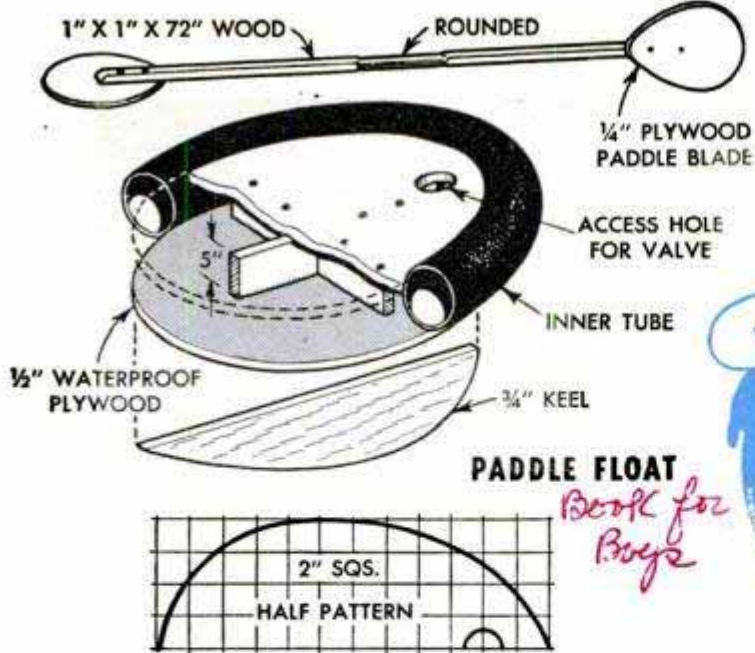

Book for Boys

There's real adventure in the shallow beach water for the young mariner who is master of his own paddle float, above. Drive the stakes for the picnic table, below, place the top over them, and you're all set. For easy handling, the top folds together and the stakes fit in cloth loops

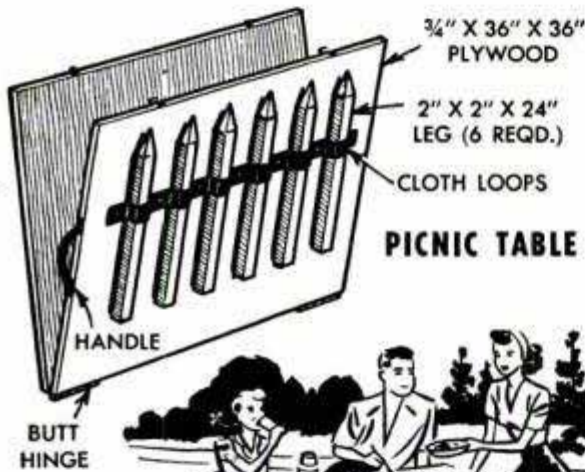

PICNIC TABLE



If the 12 x 12-ft. diving raft, which is floated on tightly sealed oil drums, is too large, the basic construction can be adapted readily to a smaller and less pretentious raft. The cross members are spaced to rest near the edges of the drums and are held tightly in place with hangers of threaded 1/2-in. iron rod. Should extra buoyancy be needed, additional drums are easily installed. Note that the diving platform and spring-board can be located to straddle any pair of the 4 x 4-in. cross members.

The knockdown pier may be built in as many sections of a conveniently handled size as are required to attain the desired length. When assembling the pier, the trestles are slipped over permanent posts set below water level.

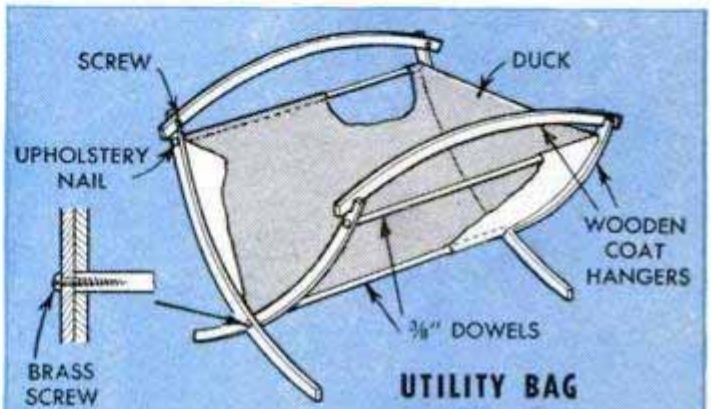

UTILITY BAG

The utility bag shown above is made from wooden coat hangers. The surfboard, below, is simply a pine board with rounded ends. Hardwood cleats glued in grooves on the underside prevent warping

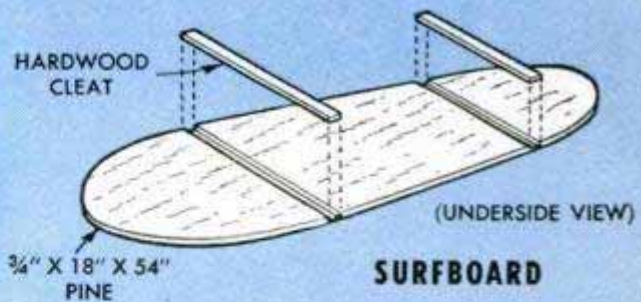

SURFBOARD

Bringing a large canoe across a sandy beach is almost effortless if the boat is lashed to this nail-keg dolly. A reamed floor flange at each end of the keg serves as a bearing for the axle

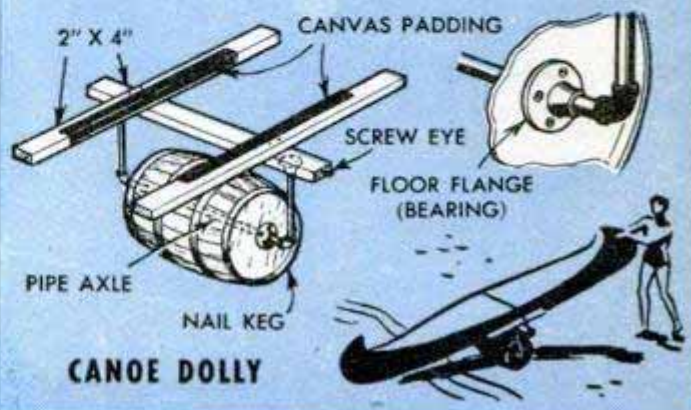

CANOE DOLLY

Wooden Pull-Out Bar on Wardrobe Aids Handling Garments

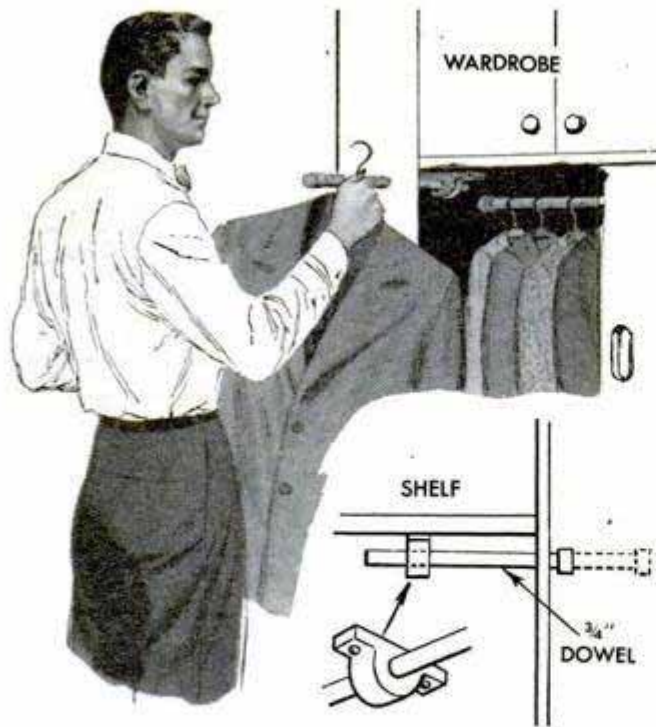

Sorting a number of garments for the dry cleaner or even selecting a particular suit or dress is facilitated by this handy pull-out bar which is installed at one end of a wardrobe. As each garment is removed from the clothes pole, it can be hung from the bar, leaving the hands free to remove another garment, or to close the wardrobe doors. In addition, the bar holds the garments out in the open where it is easy to brush the lint from them. The bar is simply a length of $\frac{3}{4}$ -in. dowel fitted through a hole drilled in the front of the wardrobe and supported by a wooden hanger. A pin driven through the rear end of the dowel prevents its being pulled from the hanger, and a disk, slightly larger than the diameter of the dowel, is screwed to the front end of the bar to keep the coat hangers from slipping off. The bar is stained or painted to match the finish of the wardrobe.—Hi Sibley, Nuevo, Calif.

Magnifying Glass Supported By Plastic Cylinder

Taped around the frame of a magnifying glass, a plastic cylinder steadies the glass at the desired height above the reading matter, thus making it easier to manipulate the glass with one hand while holding the newspaper or magazine in the other. To form the support, cut a sheet of transparent plastic, making it a little longer than the

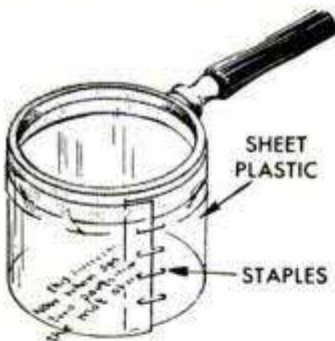

circumference of the lens frame. Then, overlap and staple the ends together to form a cylinder. The width of the plastic should be sufficient to support the glass at the proper height above the type. Then attach the cylinder to the outside of the lens frame with one or more strips of cellulose tape. If the plastic is thin, more than one layer may be required for rigidity.

James Vick, Church Road, Va.

Safety Shutoff for Gas Range Is Out of Child's Reach

When they are allowed to play in a basement where there is a gas range or hot plate, there is always the danger that the children will turn on the jets with disastrous results. To prevent this, equip the gas line with a shutoff which is within easy reach of an adult but well beyond the reach of a small child.—Paul Will, Chicago.

Clay Holds Phonograph Needles

A ball of modeling clay stuck to the underside of a phonograph lid forms a convenient holder for new and used needles. New needles can be inserted in the clay like pins in a pin-cushion while the worn ones may be pressed completely into the clay, thus eliminating any guesswork when selecting a new needle. When a number of used needles have accumulated, the ball of clay is discarded and a fresh one substituted.

Theodore Simonson, Averill Park, N. Y.



Pencil Eraser Forms Bottle Cork

If the cork from a small bottle is lost, a suitable stopper can be had by pressing a detachable pencil eraser into the neck of the bottle. The wedge-shaped top of the eraser provides a fingerhold for removing the stopper.

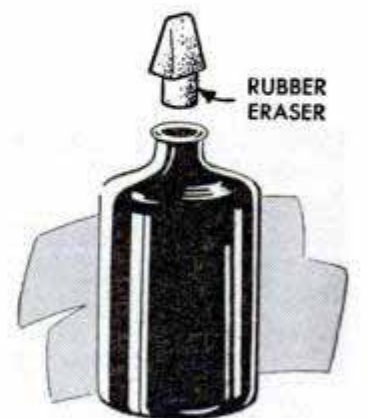

☛ Cayenne pepper sprinkled liberally in the camp food box will give complete protection from ants and mice.

Novel Swinging Tie Rack Is Made From Dowels

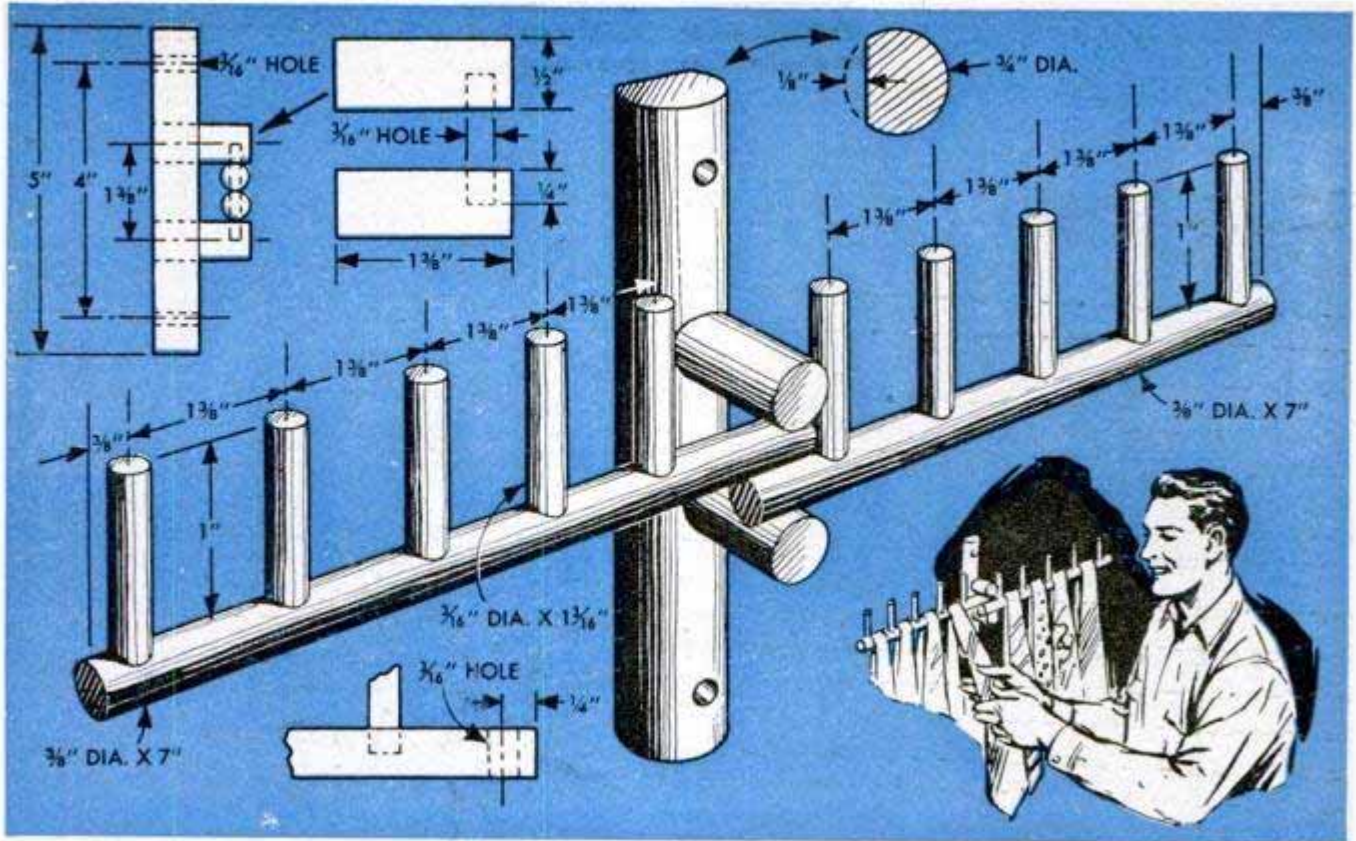

If you like "quickie" projects, here's a wall tie rack that can be made almost entirely on the drill press in a matter of minutes. The whole thing is made of three sizes of standard dowel rod, the armpieces being supported by a V-block when drilling blind holes for the dividers. Locate and drill four holes through the base, two near the ends for screws and two for the 1/2-in. supports for the swinging arms. Cut the arms to length and space and drill holes for the dividers. Cut dividers from 3/16-in.

dowel stock and glue in place on the arms. Drill one end of each arm clear through for a 3/16-in. pivot dowel, also drill 3/16-in. holes halfway through each support piece. Now you're ready to assemble the unit. Place the ends of the arms together so that the 3/16-in. holes line up and force the pivot dowel through until the ends project equally. Then assemble as in the upper left-hand detail. Finish in the desired color and attach to the wall with screws.

I. M. Fenn, Chicago.

Plastic Egg Tray Forms Palette for Mixing Water Colors

A two-part plastic tray of the type used to store eggs in the refrigerator provides an inexpensive palette for mixing water colors. Both the bottom and top of the tray can be used, each affording a dozen individual compartments which will hold more than enough color for ordinary purposes. The tray will rest steadily on a flat surface and is exceptionally easy to keep clean.

Open Top Sash to Cool Room

To cool off a warm room as quickly as possible after a hot summer day, lower the upper window sash several inches in addition to raising the bottom sash. The cool air will enter at the bottom of the window and the hot air in the room will escape readily through the opening at the top. Use a small collapsible screen to keep insects from entering at the top of the window.

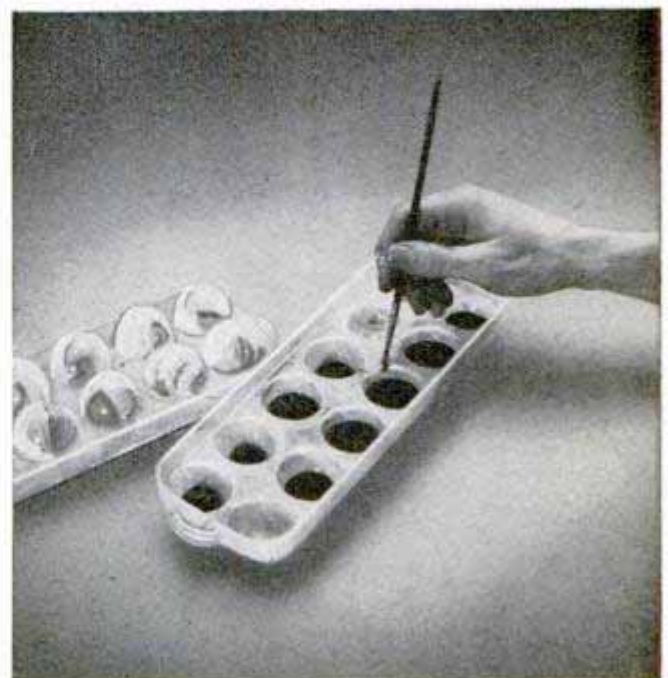

Solving HOME

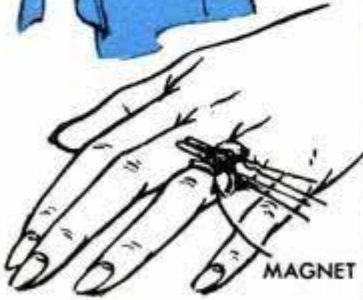

— 1 —
SETTING HAIR AT HOME is facilitated by keeping a supply of hairpins on a small magnet which is fastened to the finger with a rubber band. The pins are immediately available when needed

— 2 —
NEXT TIME YOU HANG NYLONS out to dry, clamp a spring-type clothespin to bottom edge of each stocking. Weighted in this way, the hose are not likely to blow over line and become snagged

— 3 —
STORING CROCHET HOOKS in tall, narrow olive jars makes it easy to find them in sewing box. In addition, this method of storing the hooks will keep them from snagging other sewing items

— 4 —
TO KEEP FLOWER CUTTINGS MOIST when sending them through the mail, impale a grape on end of each stem. The grape will supply sufficient moisture to keep the cutting in good condition

— 5 —
A BALL OF YARN is easier to handle if it is slipped over a curling iron. The latter is clamped to the house dress or apron, forming a reel around which the ball rotates as the yarn is unwound

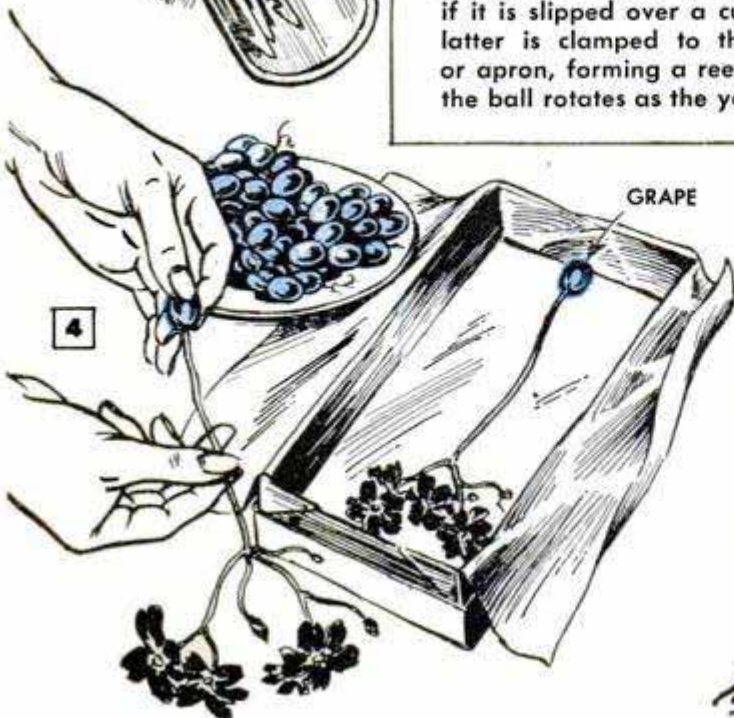
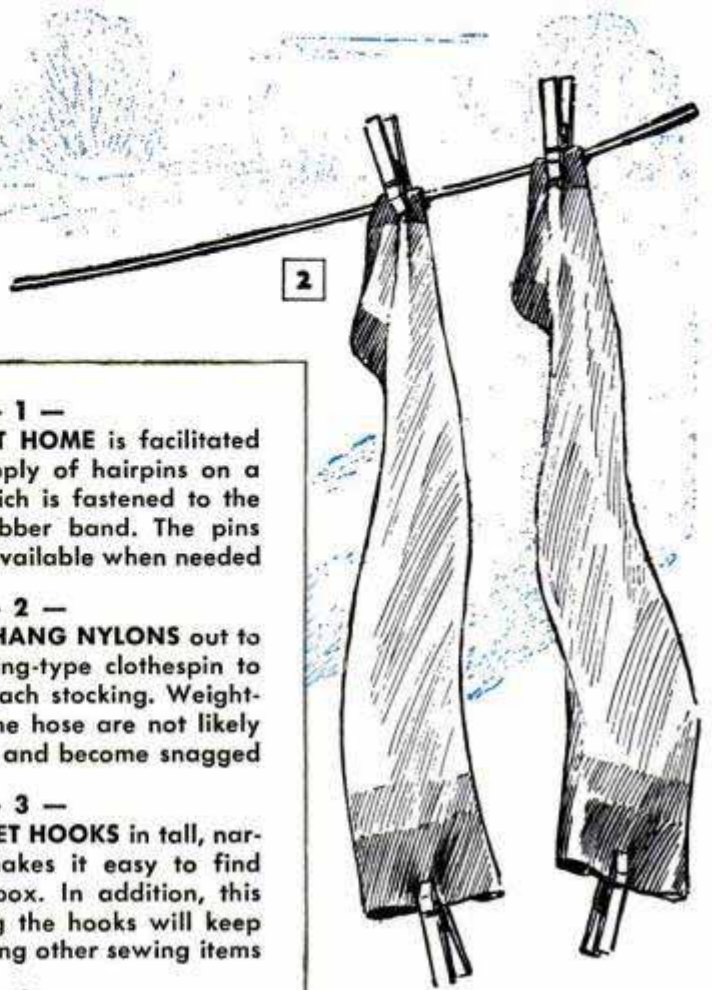

PROBLEMS

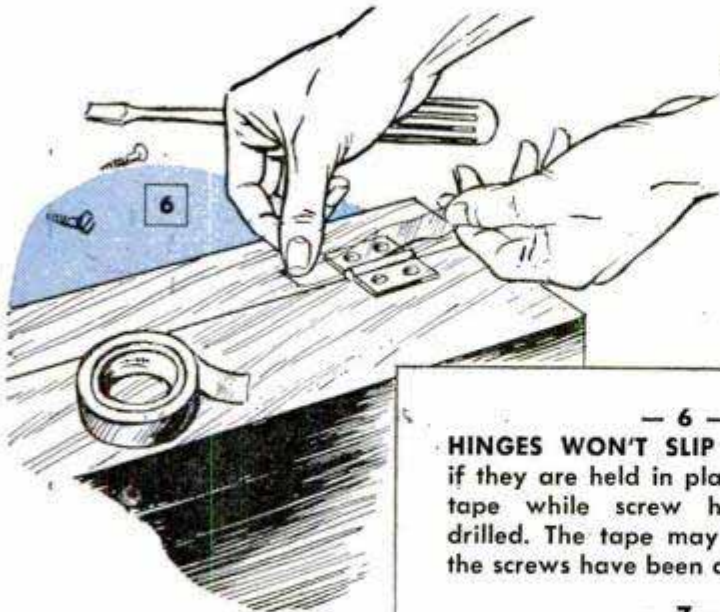

— 6 —
HINGES WON'T SLIP out of position if they are held in place with cellulose tape while screw holes are being drilled. The tape may be left on until the screws have been completely driven

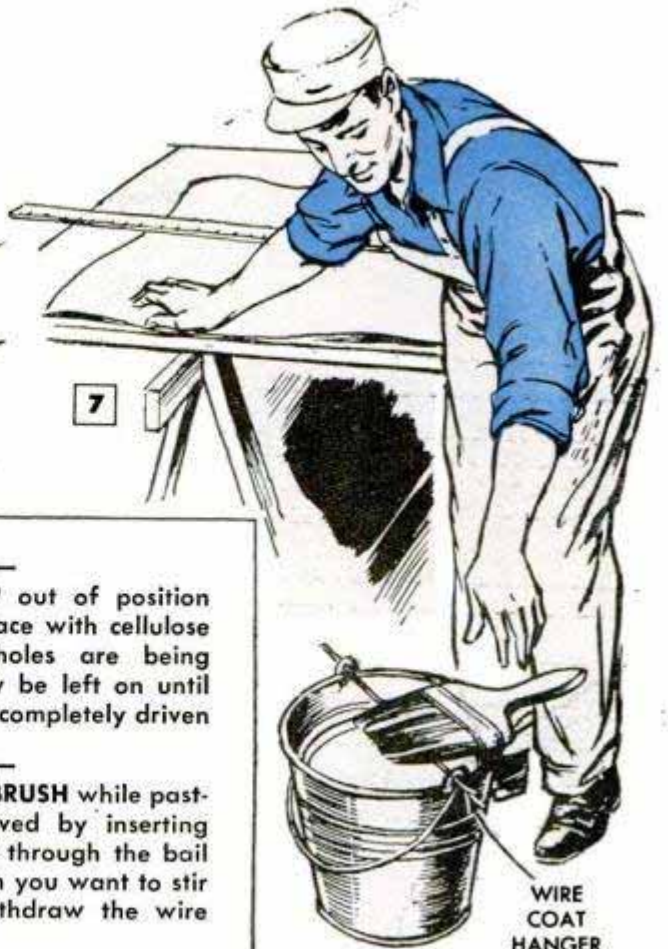

— 7 —
WHERE TO REST THE BRUSH while pasting wallpaper is solved by inserting a length of stiff wire through the bail eyes of the pail. When you want to stir the paste, merely withdraw the wire

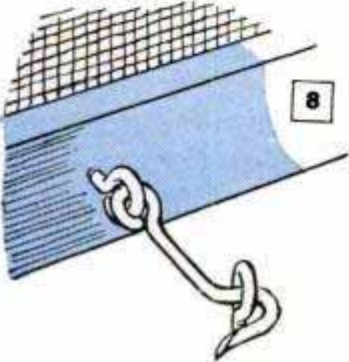

— 8 —
WINDOW SCREENS CAN BE LOCKED in closed position so that it is practically impossible for children to open them. Simply turn the screw eye up over the shank of the hook with a pair of pliers



— 9 —
AN EXCELLENT STORAGE RACK for children's toys is improvised by painting wire vegetable bin to match the room. The toys are clearly visible and it is easy for the children to reach them

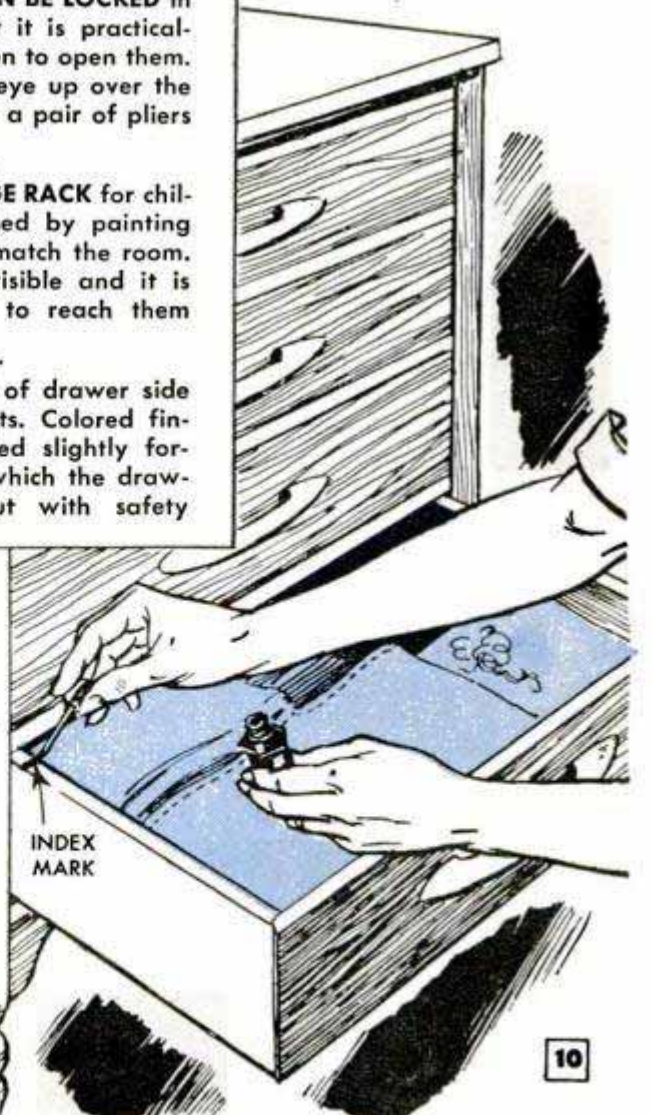

— 10 —
INDEX MARK on edge of drawer side prevents spilled contents. Colored fingernail polish is applied slightly forward of the point to which the drawer can be pulled out with safety

Carpenter's Apron Holds Jars To Facilitate Berrypicking



Having to hold a container while picking berries allows only one hand to be used to lift the bushes and pick the fruit. So that he can do a faster job by using both hands to gather the fruit, one gardener wears a carpenter's apron and inserts a pint fruit jar into each apron pocket. This allows him to pick a quart of berries before emptying the jars into a larger container.

Special-Shaped Modeling Tools Easily Formed From Plastic

Plastics provide an excellent material for making your own special clay-sculpturing tools. The photo to the right shows a number of the various shapes that can be formed to suit practically any requirement. The pattern for each tool is drawn on the protective paper covering on the plastic and cut out with a jigsaw. Shaping the edges and points of the tools is done either by filing with a coarse file or by sanding. If part of the tool is to be bent, the paper covering is removed and the plastic is placed in an oven at 275-300 deg. F. and heated until pliable. Then it is removed and formed by hand to the desired shape. Upon cooling, the plastic regains its original rigidity. In handling the plastic, it is best to wear gloves not only to protect the hands but to avoid finger marks in the soft plastic. If you wish, the tools can be given a high polish by buffing with rouge.

Doris Aller, San Francisco, Calif.

☐ A short candle stub forms an easily removed stopper for a glue bottle. The wax will not adhere to the sides of the bottle as will the cork of an ordinary stopper.

Sunken Vase for Cemetery Flowers Cannot Be Tipped by Wind

This sunken vase for a cemetery lot is not only windproof but it also allows the flowers to enhance the grave for their maximum life without being blown or knocked over. The vase itself is simply a tin can with holes punched about $\frac{1}{4}$

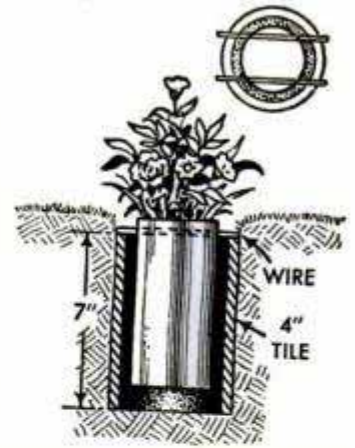

in. from the top edge to take two pieces of stiff wire as indicated in the detail. The vase is placed inside a length of 4-in. tile which has been set in the ground, the wires of the vase resting on the edge of the tile. The latter is set in the ground and the earth packed tightly around it. The hole for the tile should be deep enough so a lawn mower is able to pass over the can without interference.—Ralph Frankart, Tiffin, Ohio.

Lemons Softened in Cold Water

When lemons have been kept for some time and become too hard to permit squeezing out the juice, soak them in a pan of cold water overnight. The water will soften the lemons sufficiently to allow squeezing them without difficulty.

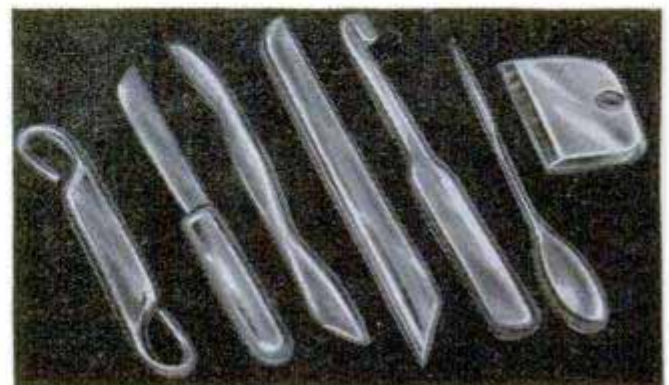
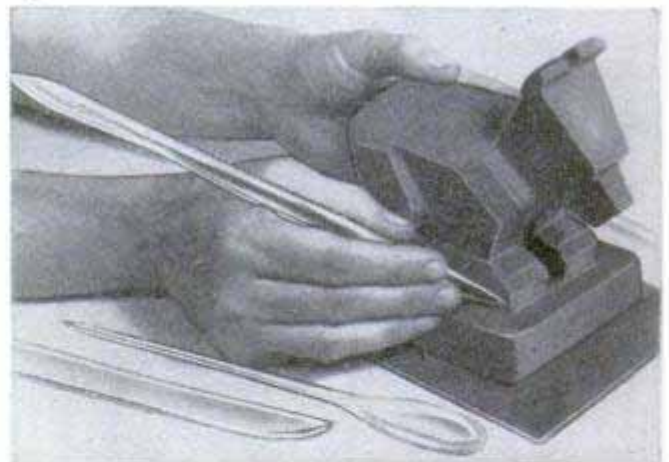

Cans Form Liner for Inexpensive Picnic Icebox

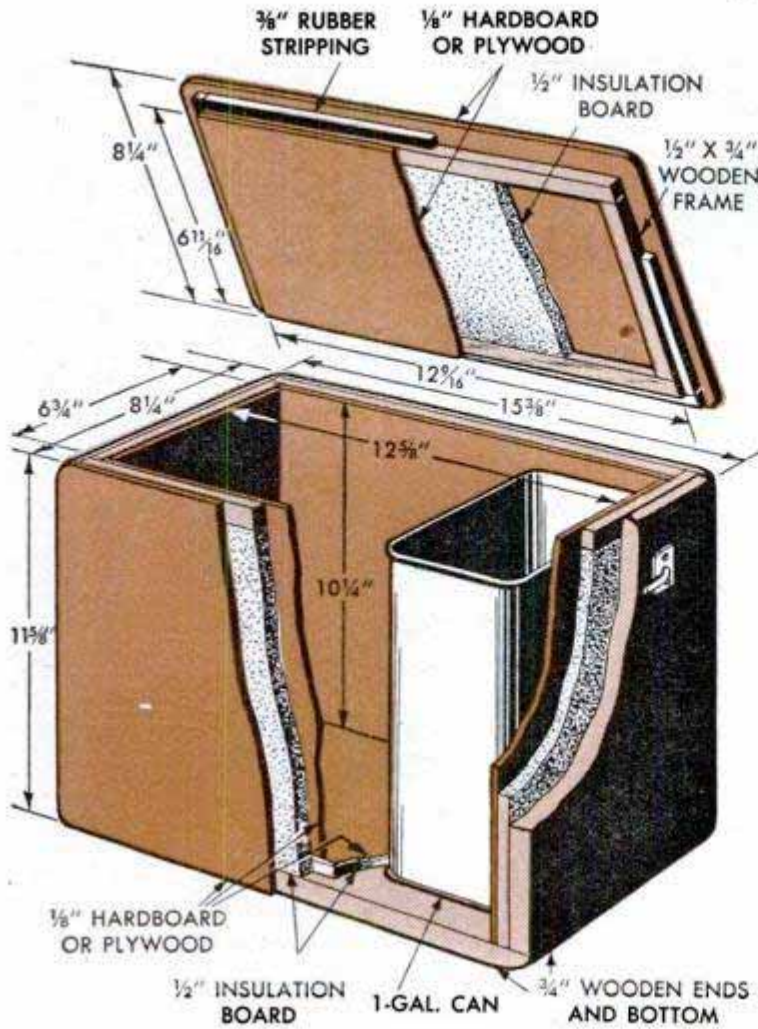

Above, removable open-top cans, one of which contains ice, keep inside of box dry. Below, cover is held securely with a strap and buckle

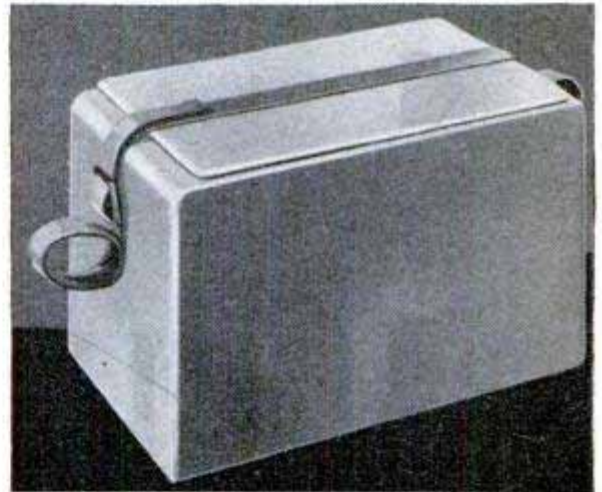

Featuring the use of three standard 1-gal. containers to provide a ready-made metal liner, this neat little icebox is just the thing to keep your picnic beverages cool. Insulated with soft composition board, the box is lined inside and out with tempered hardboard, the ends and bottom being made of wood. Actual dimensions are determined by the size of the cans. Sponge-rubber stripping is used on cover to make tight seal.—Robert Hoppough, Waukegan, Ill.

Eight Concrete Building Blocks Provide Knockdown Charcoal Grill

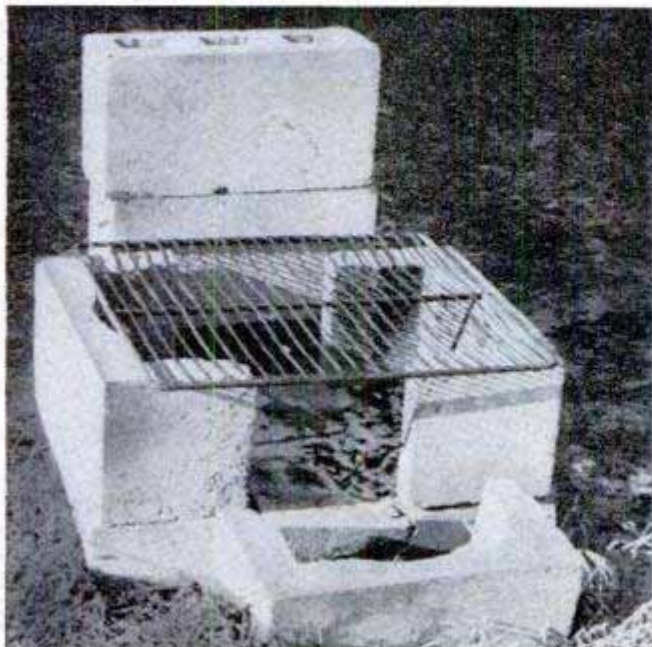

About all the effort required to build this charcoal grill from concrete blocks is the work of stacking them up. That's how simple it is—not even mortar is used. And, being of knockdown construction, the grill can be easily moved from one place to another if desired. The bottom of the pit is formed by laying three blocks together, face up and buried about 4 in. deep. Then one side of three blocks is broken away and two of the blocks are used to form the sides of the pit, with the third one being placed across the back on the ground. The rear block forms an opening for the smoke to enter the flue of the chimney, which is made any desired height by merely setting blocks on top of the rear one. The cored holes in the blocks form a natural flue. A wire oven grate set over the pit provides an excellent broiling shelf.

Border Blocks for Your Garden

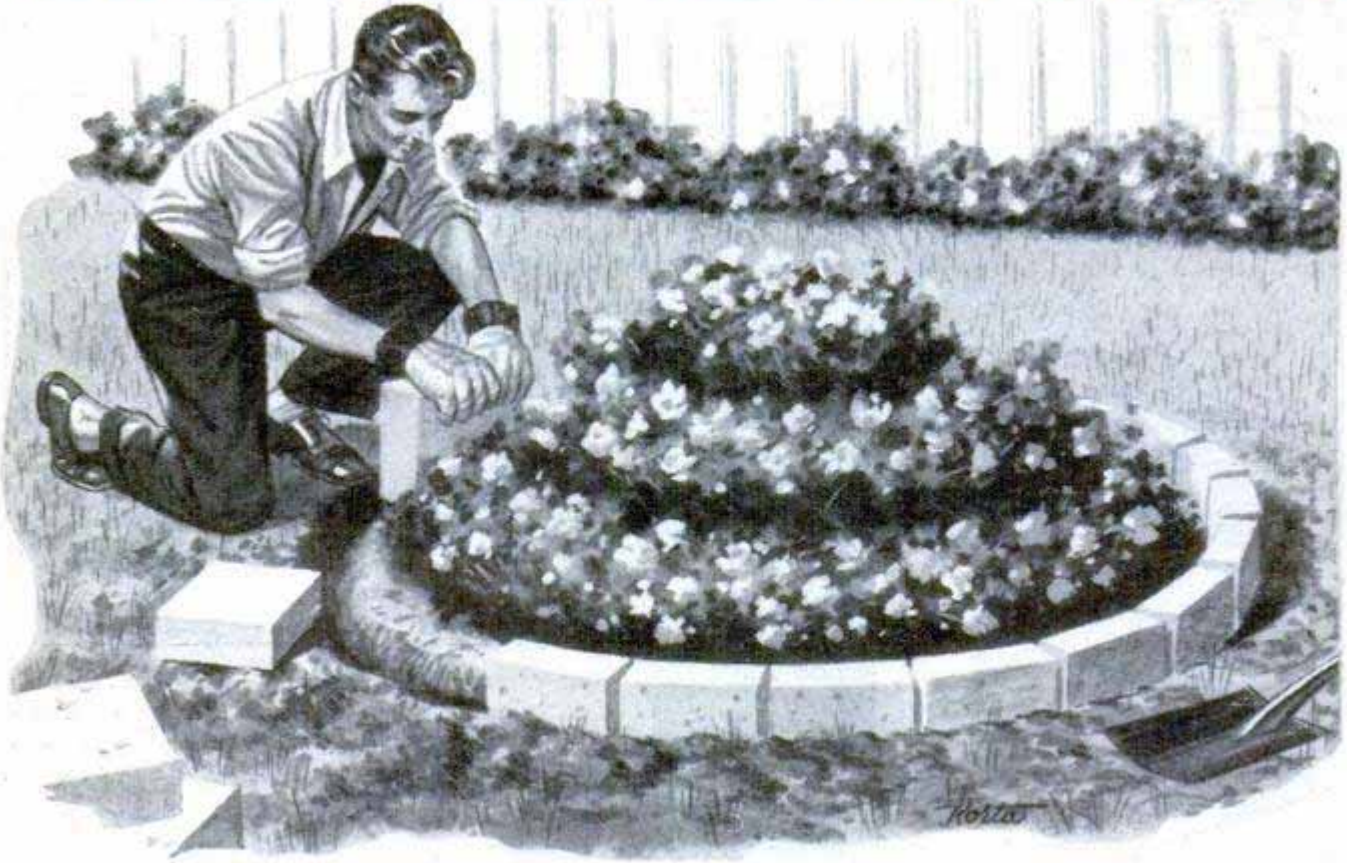

By William O. Davies

CONCRETE blocks can be used to advantage in the garden in many ways, such as, flower-bed edging, walk borders and terrace walls. By pouring the blocks yourself, they are inexpensive and can be made to the size best suited to the intended purpose. The form illustrated permits pouring a dozen identical blocks at a time. However,

the form can be built to make blocks of different sizes. Construction of the form is simple, requiring three stringers of 4 x 4, two 2 x 4s for the endpieces and 14 separator strips of 1 x 4. Notches in the stringers to receive the ends of the separator strips are either cut or formed by cleats nailed to the inside faces of the 4 x 4s as shown in the upper left-hand detail. Notches should be made about $\frac{1}{8}$ in. oversize to allow for

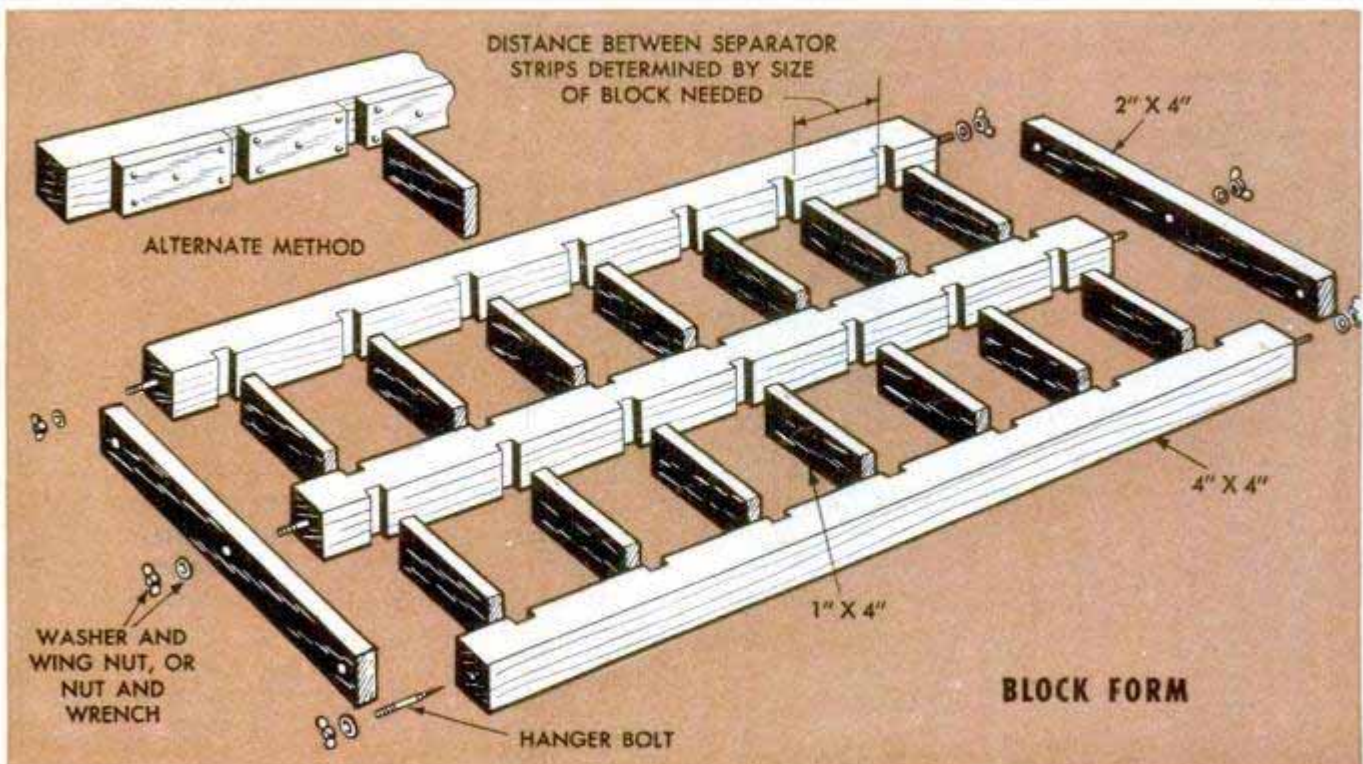

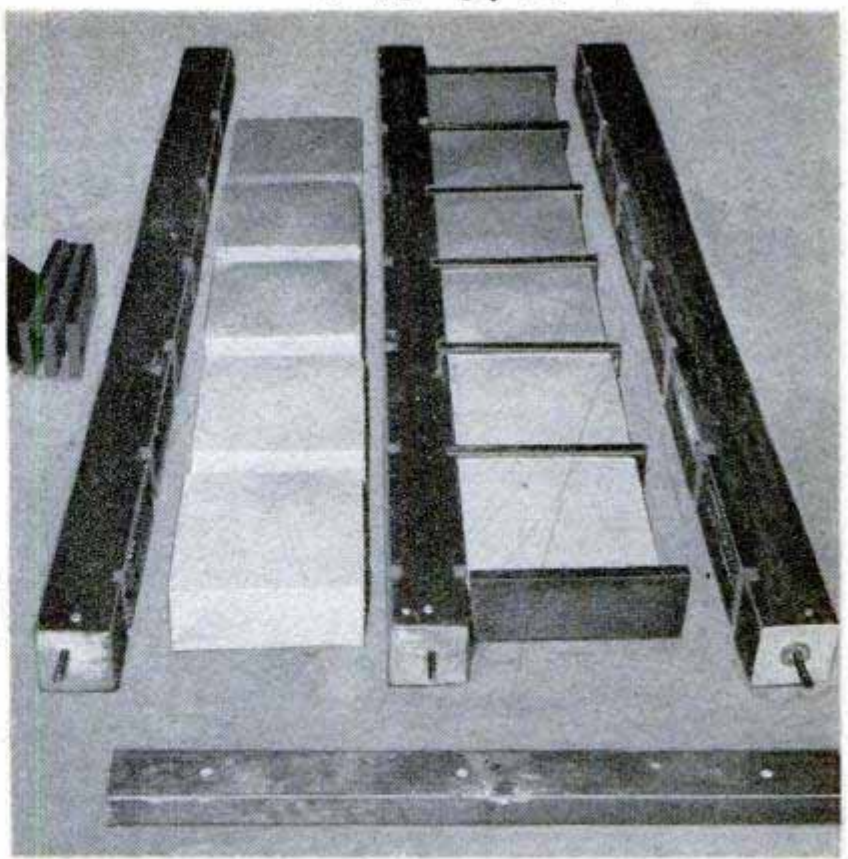
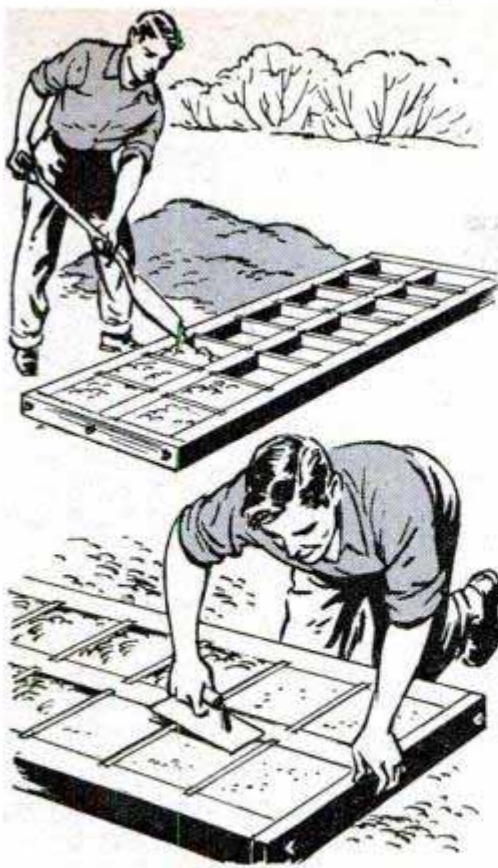

swelling of the separator strips. The end-pieces are drilled to slip over hanger bolts embedded in the ends of the stringers and are fastened with wing nuts. When in place on the hanger bolts, the endpieces should lock the form tightly together.

The form should be assembled on a comparatively smooth, flat surface, such as a concrete garage floor or driveway, so that the underside of the blocks will be even. The base as well as all surfaces of the form which will come in contact with the poured concrete should be coated with oil to prevent sticking. After pouring, the concrete is floated with a straightedge for a rough finish or troweled to a smooth finish. It was found that a mixture of cement, 1 part, sand, 4½ parts and enough water to produce a mix the consistency of mortar gives excellent results. It will set sufficiently under ordinary summer conditions so that the form can be stripped from the blocks

The above photo shows the wooden form partially stripped from the newly cast concrete blocks. Oiling the wood facilitates removing the form. Note that faces of the blocks have been troweled smooth

after 24 hours. The day after the forms have been removed, the blocks should be stacked between layers of boards and allowed to cure for a week before using. After one batch of blocks has been removed from the form, clean the wooden surfaces with a wire brush and recoat with oil before again filling with concrete.

Variety can be had in the blocks by making impressions in the concrete after it has set for several hours, using a star, circle or other simple design to decorate the face of the block. Another interesting treatment is to use old wood for the form and "rake" the surface with a wire brush. In this way, the texture of the grain will stand out in relief on the edges of the concrete blocks.

Special Baits for Catching Common Fish When Ordinary Lures Fail

When ordinary baits don't seem to be tempting the fish, try some of these special baits which have brought excellent results. For bluegills, bream and sunfish, use meal worms or the drone larvae of the honeybee. Yellow perch will bite on an eye taken from a perch which has already been caught. Crappie, calico bass and rock bass like tadpoles, while small-mouth black bass go for small bullheads. Muskellunge and pike usually can be caught with a live meadow mouse when other baits fail. Make a harness for the mouse, using lightweight

wire, and thread two small corks on the wire to keep the mouse afloat. For wall-eyed pike, use a tandem hook with a small spinner ahead of it and bait each hook with a shiner minnow. Most of the fish will be caught on the rear hook. Try small pieces of clam meat for suckers and buffalo. To get action with large-mouth black bass and pickerel, bait a medium-sized green meadow frog on a tandem-type double hook. Kill the frog and skin the hind legs so the skin will trail out behind the frog's feet.—R. A. Jenkins, St. Louis, Mo.

Slats for Ladder-Back Chairs Are Bent on Special Wooden Form

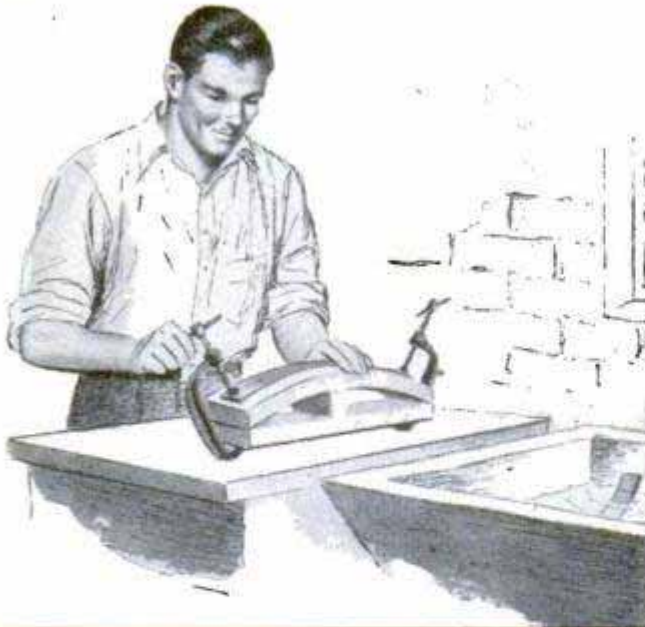

Used by H. E. Schwan of Denver, Colo., to form curved slats for ladder-back chairs, this simple bending form permits the pieces to be steamed while right on the form. The radius of the jig is bandsawed slightly less than the required curve to compensate for spring-back which occurs when the slat is removed from the form. The slats are cut to size and soaked overnight in a tub of water. Then each slat is clamped to the form, being drawn down tightly at each end, and, after this, the slat and form are placed in a hot oven to dry. Steaming takes place during the drying period, causing the slat to assume the approximate curve of the form when the clamps are removed.

David P. Costello, Fort Collins, Colo.

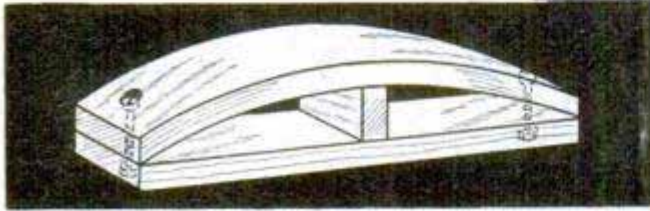

Salt Polishes Tarnished Silverware

To clean tarnished silverware, rinse with water and sprinkle with a liberal amount of table salt. Then rub with a soft cloth or cleansing tissue until the surface takes on a bright polish.

Emery Dust Laps Oilstone To Renew Cutting Surface

A worn oilstone can be resharpened many times before it is necessary to discard it. Simply lap the stone on a steel plate, using coarse emery dust and water as an abrasive. Mix the water and emery dust to a paste consistency and, with the mixture on the plate, rotate the stone both counter-clockwise, as indicated in the drawing, and clockwise. When the stone has been lapped perfectly flat in this manner, the cutting surface will be sharp and completely free from embedded metal particles. If a flat steel plate is not available, a sheet of plate glass which is large enough to permit rotating the stone will serve the purpose.

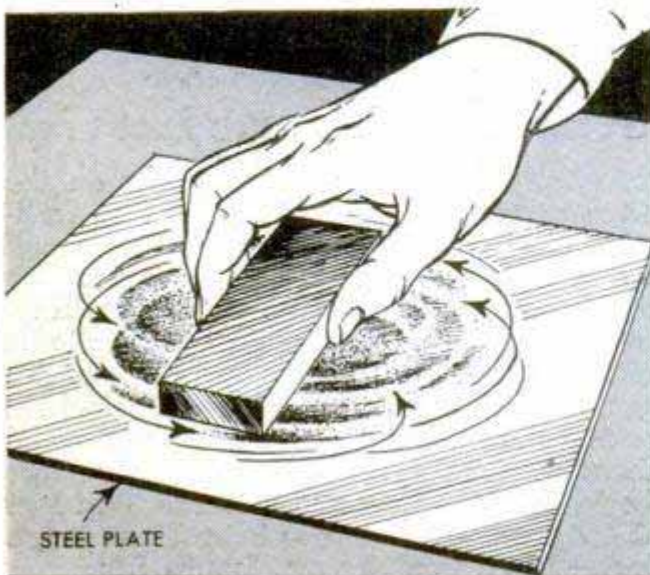

Leaking Hose Nozzle Repaired With Faucet Packing

If the nozzle of your garden hose dribbles continuously even though the washer between the nozzle and the hose connection is in good condition, try tightening the joint between the gland and the nozzle cylinder. If this does not stop the leak, it will be necessary to repack the joint. To do this, unscrew the cylinder from the gland and wind several turns of graphite-string packing between the washer and the gland. It is best to wind the packing as shown in the drawing so that when the gland is screwed to the cylinder, the packing will be evenly distributed throughout the joint.

Charles Kimball, Los Angeles, Calif.

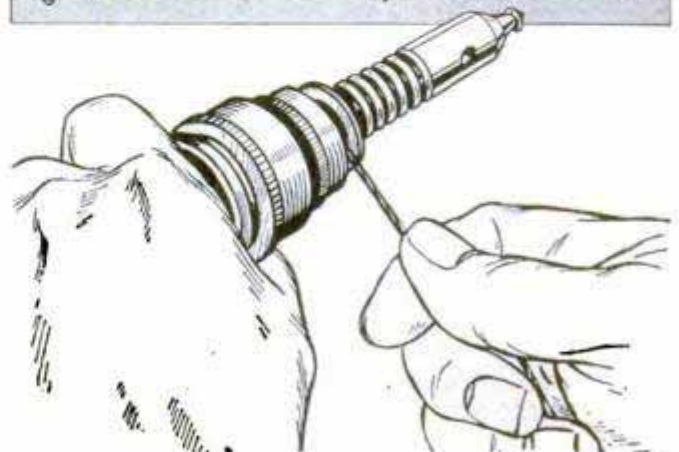
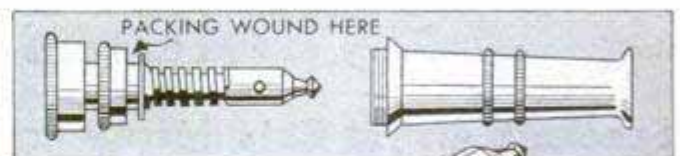

BUILT-IN WASTEBASKET

By E. E. Mason

IF YOU are building a new kitchen-sink cabinet or if the cabinet you already have provides the necessary clearance, you'll find this unusual wastebasket a time and space saver. The sides of the basket are of plywood but the end and bottom pieces are cut from solid stock. After cutting an opening in the sink cabinet, fit the front piece of the basket in the opening, allowing about $\frac{1}{32}$ -in. clearance to prevent binding. Rabbet the edges of the front piece for the plywood sides and join the sides to the front, back and bottom pieces with screws and glue. Provide a swinging stop at the back of the basket as indicated. The basket pivot unit is made up from stock materials as in the lower right-hand detail. In some kitchens the projecting treadle used for tilting the basket will be objectionable. In this case, the treadle can be omitted entirely and a handle provided at the top of the front piece, or the front piece can be made in two parts to form a toe recess for the treadle. When this is done, the pivot unit must be placed farther back.

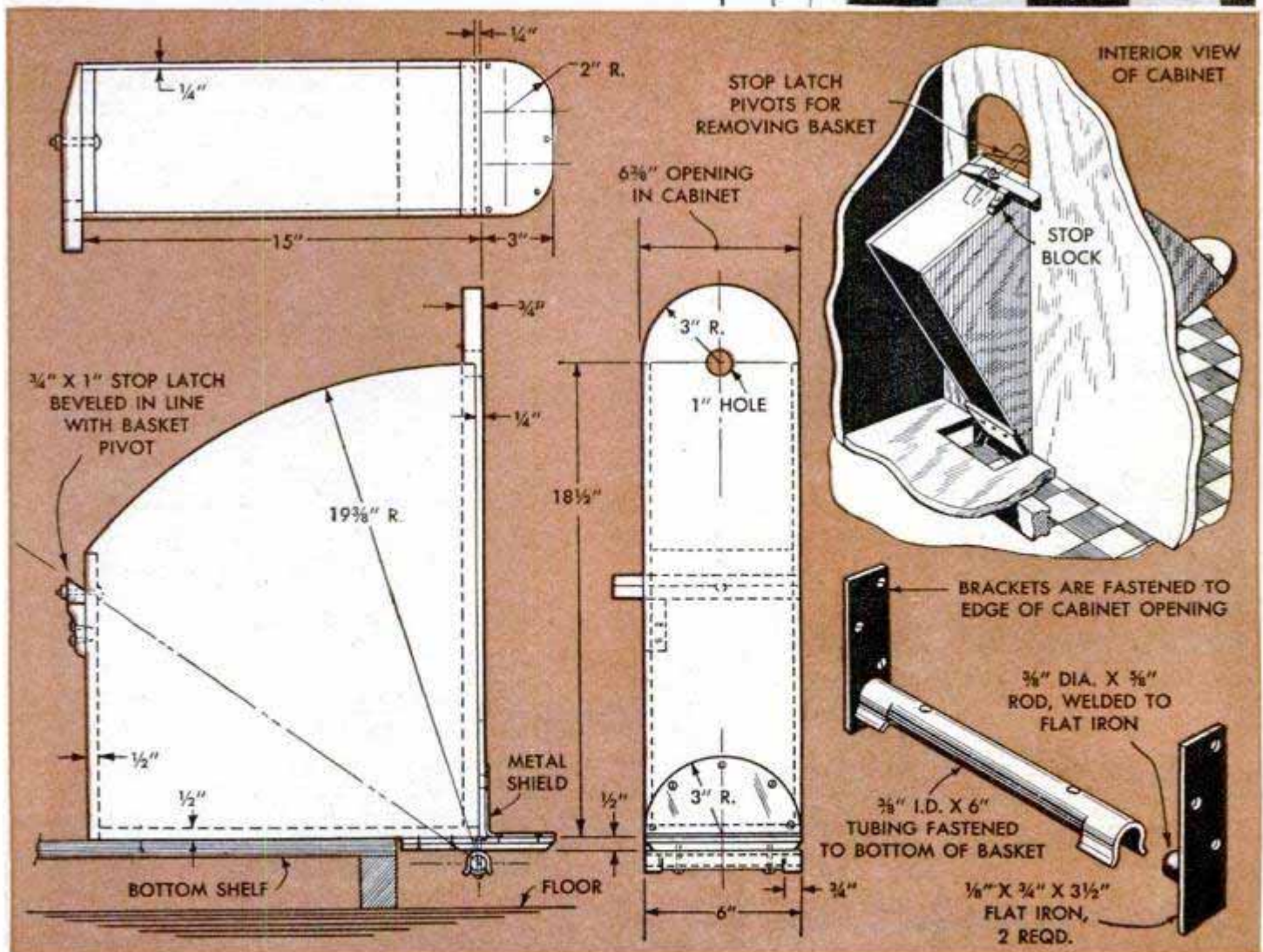

Flower Box Serves as Hothouse



By supporting two panes of glass with slotted wooden blocks, a flower box or a small section of the garden can be converted into a miniature hothouse in a few minutes. This is handy to protect delicate plants from the wind and extreme temperature changes. A triangular piece of wood or sheet metal can be propped at each end of the hothouse to fully enclose the plants, and afford maximum protection.

Pipe Tenon Makes Rigid Repair for Broken Chair Back

Chairs of the type pictured, that have backs which are pegged to the seats, invariably become loose and the backs split off just above the seat. When this happens, here's a way that you can repair the break and make the chair as rigid as when new.

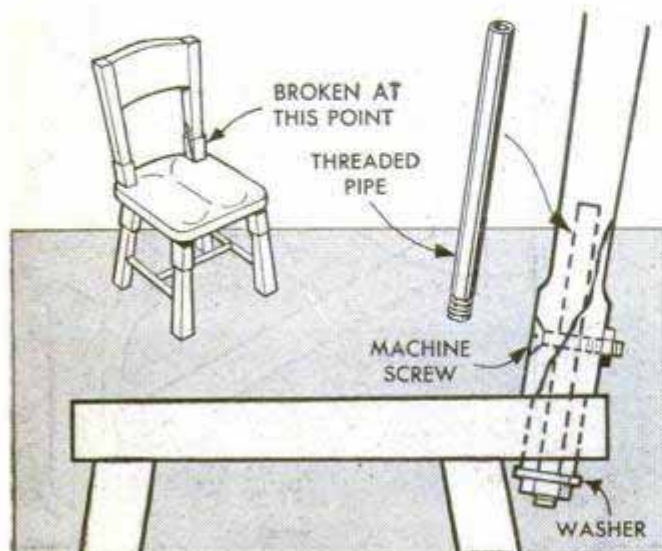

Garden Hose Shields Saw Teeth

When a hand-saw is stored in a toolbox or tray, the saw teeth are likely to be dulled or damaged by contact with other tools. To prevent this, shield the teeth with a section of garden hose. The latter is slit lengthwise so it can be slipped over the teeth, and should be long enough to extend the full length of the saw blade.

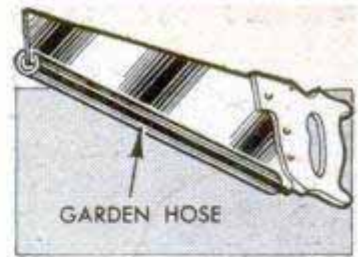

E. W. Moses, Jr., Blacksburg, Va.

Monogram Craftwork Initials Hammered From Wire Solder

Lengths of wire solder bent to shape and hammered flat provide novel monogram initials and numbers for craftwork. Because of the flexibility of the solder, the characters can be fashioned in a variety of interesting designs. After hammering, the solder is sanded or polished to suit and then given a coat of clear lacquer or varnish. When dry, the characters are cemented in place or fastened with small brads.

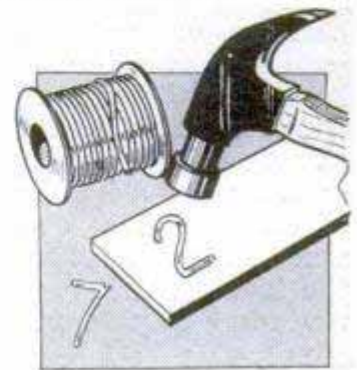

T. P. Ilari, Louisville, Ky.

First, work glue into the split section and clamp securely with a C-clamp or bind it tightly with twine. Then, turn the chair upside down and bore a $\frac{3}{8}$ -in. hole up through the center of the back post for a distance of 4 or 5 in. Cut a length of $\frac{3}{8}$ -in. pipe long enough to extend about 1 in. below the seat, thread the end for a nut and insert the pipe in the hole. Next, pin the pipe in place by drilling a hole crosswise through both the pipe and the post, and add a flat-headed machine screw. Thus, with the pipe locked in the post, the chair back is held firmly to the seat by merely drawing up the nut on the end of the pipe. Note that a wedge-shaped spacer formed from hardwood is used to provide a flat surface for the washer and nut.

☞ To obtain a legible stencil signature, place a square of cellophane wrapper over the stencil and sign the name with a stylus. The cellophane affords a smooth writing surface and eliminates torn stencils.



STOP

WHAT WATER LEAKS CAN COST YOU PER YEAR

SIZE OF LEAK	CU. FT. PER DAY	COST PER YEAR AT \$2.16	RATE PER 100 CU. FT.
..... STEADY DROPS	3		
• 1/4	6	\$4.32	1st 10 M CU. FT. 18¢
• 1/32	23	\$15.12	2nd 40 M CU. FT. 12¢
• 1/16	93	\$60.48	OVER 50 M CU. FT. 9¢
• 1/8	400	\$196.80	

THOSE WATER LEAKS!

By E. R. Haan

DO YOU KNOW how much water can be wasted in the course of a year by a single leaky faucet or flush tank? A slow drip from one of the plumbing fixtures or faucets may cost only a couple of dollars a year, but the price for neglecting a continuous running stream only $\frac{1}{16}$ in. in diameter may run as high as \$60 a year. A study of the chart in Fig. 1 will show why it is important to stop the leaks. Any homeowner can repair most leaky fixtures with only a few household tools and repair parts which are available anywhere.

Repairing compression faucet: When any repair to the plumbing fixtures is to be made, first shut off the water supply. There may be a shutoff valve near the fixture, such as the valve underneath the sink or flush tank, or it may be located in the basement. As a rule, it is best to shut off the main valve at the meter. Almost all faucets in modern homes are of the compression type. There are various styles of the compression faucet such as those having side handles and the two-faucet units having a common spout. Although the exterior characteristics may vary, the principle of operation is the same. The cutaway view of the faucet shown in Fig. 3 is typical. To replace the faucet washer, loosen the cap nut on the faucet. If the nut is hexagon shaped,



2 First step is to unscrew cap nut from faucet

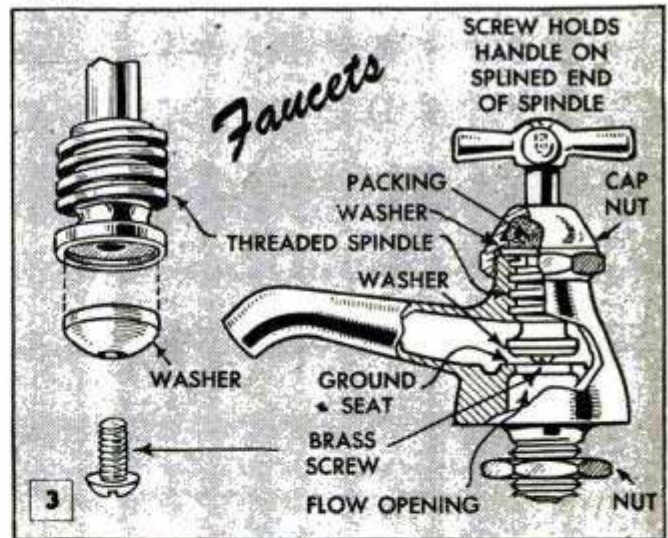

3



4 Lift out the spindle



5 Remove the washer



6 Measure washer size



7 Adjust faucet handle

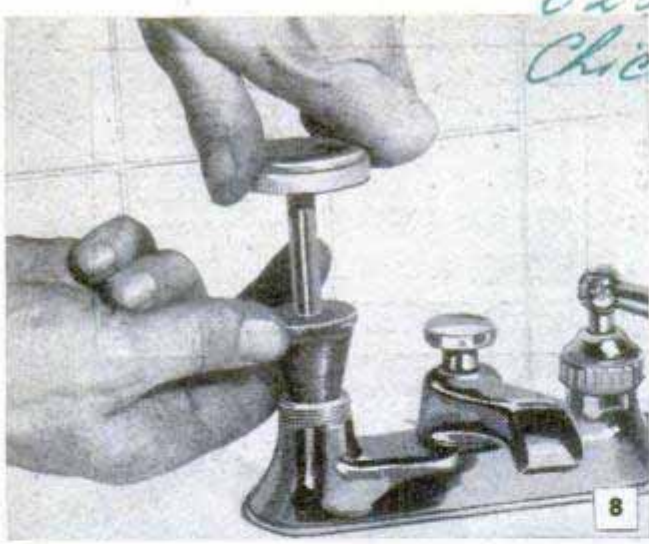

This hand tool quickly refaces faucet seats that are roughened by wear and corrosion. The tool has a tapered thread that screws into the faucet body

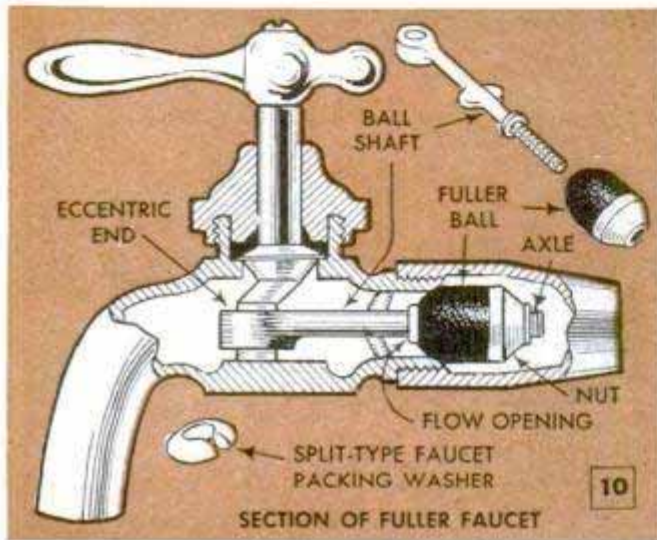

Leaks due to worn or frayed packing can be easily stopped with a packing washer or with a graphite-asbestos wicking especially made for this purpose

use an adjustable wrench, as in Fig. 2. Protect the chrome or nickel finish from being marred by inserting a strip of cardboard between the nut and the wrench jaws. If the cap nut is round and is serrated or knurled, a pipe wrench can be used, the nut being protected from damage by wrapping a cloth around it. After loosening the cap nut, turn the faucet handle in a counterclockwise direction so that the threaded spindle unscrews. Then you can lift out

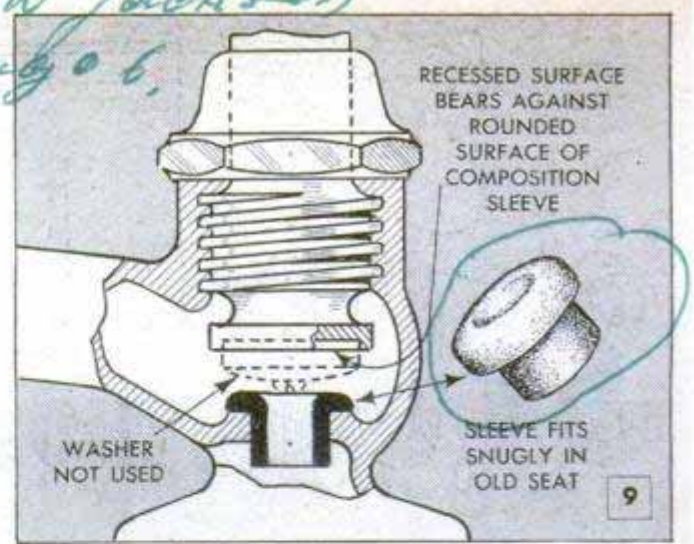

A special composition sleeve slipped into the faucet seat makes old faucets leakproof. Regular washer is not used as the washer seat bears on the sleeve

the spindle assembly as in Fig. 4. It may be necessary also to turn the faucet handle at the same time to provide clearance for the nut. Next, loosen the brass screw that holds the old washer on the end of the spindle, Fig. 5. Sometimes the screw is corroded and so tight that it will not loosen readily. An application of penetrating oil may help. If the screw breaks off, it usually can be removed by drilling a small hole in the remaining threaded portion, pushing the pointed tang of a small file into the hole and then turning the file. If necessary, scrape away all traces of the old washer. To determine the size of a new one, measure the diameter of the recess in which it goes, Fig. 6. It is sometimes necessary to dress the outside edge of a washer with a file to make it fit flat in the recess. With the new washer in place, turn the spindle into the faucet and then screw the cap nut down. When it is desired to shift the position of a faucet handle, the screw holding it is removed as in Fig. 7. Some faucets, however, have handles that cannot be removed from the spindles. For example, there is one in which the spindle works in a sleeve which is lifted out with the spindle. The spindle washer moves upward against the bottom of the sleeve when closing. Replacement of the washer is practically the same, except that a nut holds the washer instead of a screw.

Refacing faucet seat: If the flat surface of the faucet seat against which the washer compresses is rough, it will be impossible to prevent recurring leaks by merely installing new washers. Such roughness is caused by corrosion or by abrasion due to sand and rust particles becoming embedded in the washer. The roughened seat should be refaced by means of the tool shown in Fig. 8. After refacing the seat, see that all bits of metal are flushed away before replacing the faucet spindle. Another method

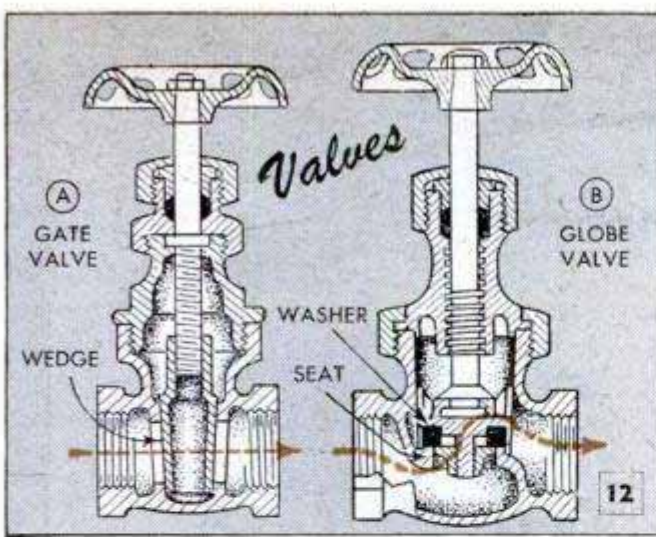

Two types of shutoff valves that are commonly used in water lines to shut off the supply to fixtures. The main shutoff valve usually is placed near meter

of providing a new seat, which eliminates the cost of a refacing tool, is to use a special hard-composition sleeve that is pressed inside the old seat, Fig. 9. The end of the spindle, from which the washer and screw are removed permanently, bears against the top rim of the sleeve when the faucet is closed.

Leaky stem: Leaks sometimes develop between the stem and the cap nut. If tightening of the cap nut does not stop the leak, loosen the nut, slip it up against the handle and replace the packing. You can use stranded graphite-asbestos wicking, which is wrapped around the stem as in Fig. 11. Or, you can use a ready-made packing washer available in either the slit or the solid type. The slit type, Fig. 10, is used on faucets from which the handles cannot be removed.

Repairing Fuller faucets: Although practically obsolete, there are still many Fuller faucets in older homes. On this type of faucet, Fig. 10, the handle can be swung in either direction to open or close the faucet. A horizontal spindle with an acorn-shaped rubber stopper or ball (known as a Fuller ball) at one end is moved back and forth by a crank-shaped vertical spindle to which the handle is attached. The entire faucet must be removed when the ball is adjusted or replaced. The sleeve enclosing the ball cannot be reached with long-nosed pliers. Turning the nut to bring the ball closer to the seat may stop the leak, or a new ball, Fig. 10, may be required. A worn spindle or ball shaft can be replaced at small cost.

Sill cocks and shutoff valves: Sill cocks—outside faucets with threaded spouts to permit attachment of garden hose—are usually of the compression type and have washers just like indoor faucets. Repairs and replacements are made in the same way. Valves installed in water-supply

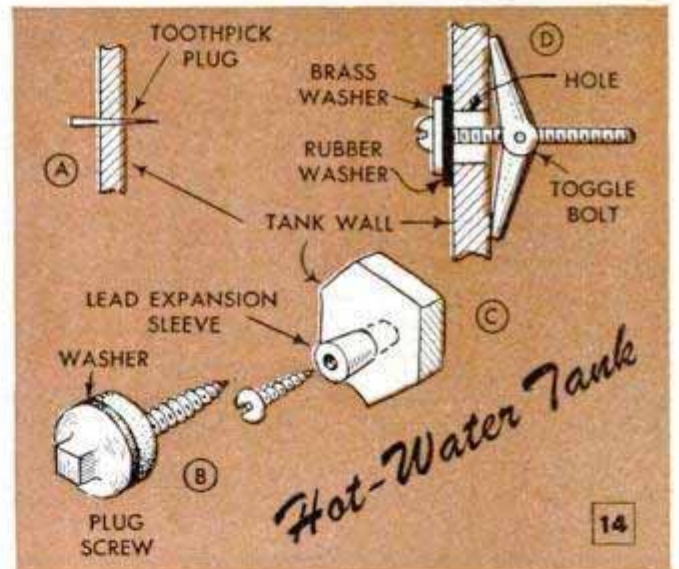

pipes are either of the gate or globe type, Fig. 12. The former, Fig. 12 A, has a sliding wedge to open and close it, while the latter, detail B, is similar to compression-type faucets. As shutoff valves generally remain open those of the globe type are apt to have warped washers and corroded seats from the constant flow of water, particularly hot water. Because of corrosion, they sometimes fail to completely shut off the water supply to permit repairing fixtures. Replacing the washer and perhaps refacing the seat of the valve is then necessary.

Leaky radiator valves: For hot-water and steam radiators, gate or globe valves of special construction are used. Escape of water or steam at the stem is stopped by

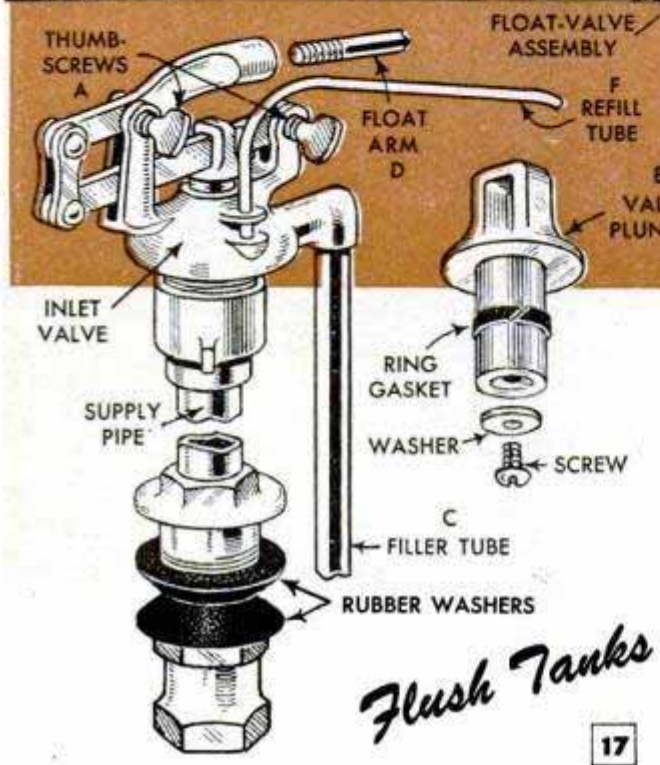
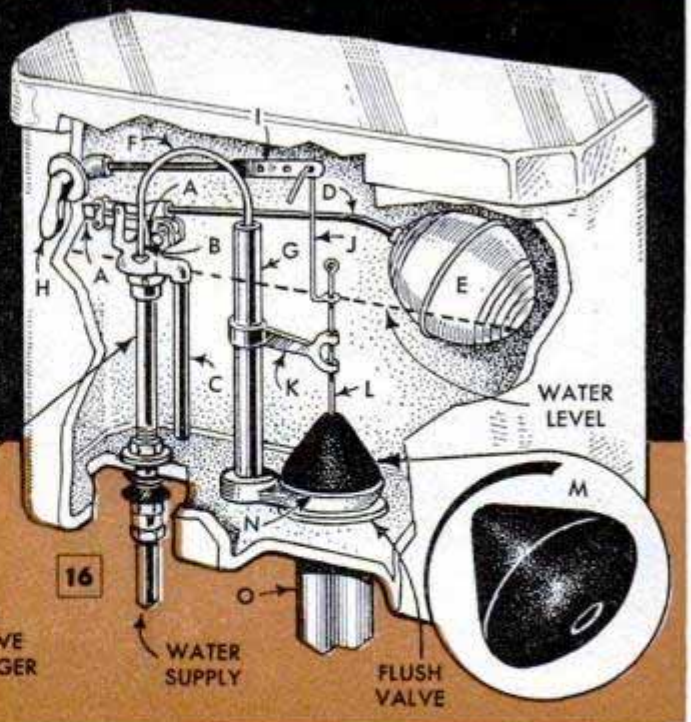
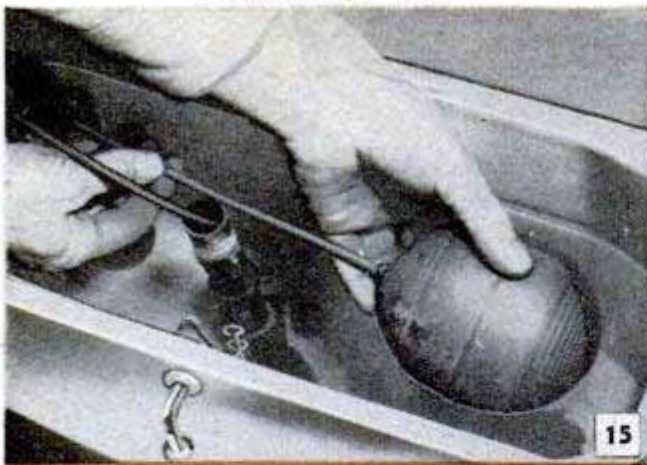

Flush Tanks

tightening the packing nut slightly or by replacing the packing. When repacking is necessary, a hot-water system is drained until the water level is below the radiator; a steam boiler is kept at low heat so that no steam is formed. Then the valve to be repacked is closed, the handle is removed and the packing nut slipped off. Special metallic packing compound for this purpose can be had from plumbing shops, although asbestos wicking, the same as that used in faucets, will do. After removing the old packing, the new is pressed or wound in place tightly.

When a leak occurs at the union which connects to the radiator, and tightening the union does not stop the leak, there may be a little dirt between contacting surfaces. Take the union apart, clean it thoroughly and reassemble. It is best to use a large adjustable wrench for this purpose as in Fig. 13. A pipe wrench not only mars the fitting but may distort it.

Replacing leaky pipe: A temporary repair on a leaky water pipe requires just about as much time and effort as replacing a section of the pipe. First shut off the

Above and at the left: A, pins or thumbscrews to release valve plunger; B, valve plunger; C, filler tube; D, float arm; E, float; F, refill tube; G, overflow pipe; H, trip-lever handle; I, trip lever to release rubber stopper; J and L, stopper wires; K, stopper guide; M, stopper; N, flush-valve seat; O, discharge pipe

water supply, and then cut through the defective portion of pipe with a hacksaw, so that both ends can be unscrewed from the nearest fittings. Get two lengths of pipe of the same diameter as the old pipe and a union to connect them. The total length when connected should be equal to that of the pipe removed. Use pipe-thread compound on the threaded ends of the pipe to form a watertight joint.

Leaky hot-water tank: Leaks in a hot-water tank generally indicate that the tank is old and should be replaced. However, an old tank sometimes can be kept in service until a new one is installed if a temporary repair is made. On insulated tanks the outer jacket and the insulation must be removed first to get at the tank wall. Pin-sized leaks often can be plugged by driving in the ends of round toothpicks, Fig. 14 A. Swelling of the wood keeps these plugs tightly in place. Larger leaks may be stopped by driving in a plug screw as in Fig. 14 B. Another way is to drill or ream the hole to $\frac{1}{4}$ -in. size to admit a tapered lead expansion plug as in detail C. Driving a screw into a small hole through the plug expands it. Still another method is to enlarge the hole enough to permit the insertion of a toggle bolt to hold a brass-and-rubber washer snugly against the outside as shown in detail D.

Water losses from flush tanks: Much more water can be lost through faulty valves of a lavatory flush tank than most

homeowners realize. These tanks have an automatic float valve to admit water into the tank, and a flush valve fitted with a large rubber stopper to discharge the water, Fig. 16. Leakage of water from a flush tank nearly always is accompanied by a slight noise. In checking for a leak, first see if water constantly runs off through the overflow pipe. This indicates either that the float valve is not fully closed or that it leaks when closed. Next, find out whether any water leaks through the flush valve at the bottom of the tank.

To repair either valve, shut off the water supply and flush the water from the tank. If the trouble seems to be at the float valve, unscrew the float and the float rod, Fig. 15. Shake the float to see if it contains water as a result of pinhole leaks caused by corrosion. If so, replace it with a new one. Then release the two removable thumb-screws or pins in the linkage to the valve, detail A in Figs. 16 and 17. This releases the plunger B and permits replacing the washer. If the washer is held by a brass cap, remove the latter carefully to avoid breakage. When the washer is removed, examine the seat of the valve. If this is corroded, replace the entire valve assembly, Fig. 17. These assemblies come in either the long or the short size. To install one, turn off the water and disconnect the supply pipe at the underside of the tank. Then loosen the nut holding the float-valve assembly and lift out the latter. Reverse the procedure when installing a new valve.

When the leakage is traced to the flush valve, first see if the stopper seats properly, Fig. 16 M. The stopper guide K, which is clamped to the overflow pipe G, may not be centered over the valve seat. The wire L, which is screwed to the stopper, should project about an inch through the eye in the wire J, which connects to the trip lever I, or the stopper may not seat properly. If alignment and action of the stopper seem correct, remove the stopper by unscrewing it from the wire and clean the rounded surface. Also dry the valve seat N and clean it with fine emery cloth. If the valve still continues to leak, substitute a new stopper. Generally stoppers require replacement every few years. Occasionally the flush-valve seat is so badly corroded that it allows water to pass when the valve is closed, even after installing a new stopper. This requires replacement of the seat and overflow-pipe assembly, which is one unit.

Film Container Holds Fishhooks

The discarded metal can from a roll of 35-mm. film provides a handy container for carrying extra fishhooks. It fits nicely in the tackle box or in a trouser pocket.



Slanted Partitions in Spice Drawer Hold Cans for Easy Selection

Cans of spices stored in a kitchen-cabinet drawer are easier to select if they are set at an angle so that the labels can be read at a glance. This can be done by fitting the drawer with slanted partitions of plywood or hardboard. For easy removal when cleaning the drawer, the partitions rest on cleats or are set in grooved inserts nailed to the sides of the drawer. To keep the cans from sliding forward and possibly out of sight behind the partition in front of them, tack a strip of wood along the lower edge of each partition.

Wagon Wheels Form Novel Trellis

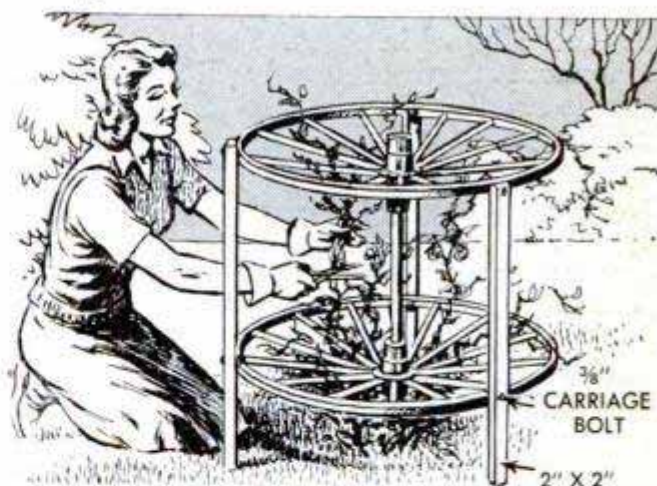

While trying to find a novel way of using a couple of old wagon wheels as ornaments in his yard, one homeowner hit upon the idea of mounting them horizontally, one on top of the other, to form an attractive trellis. He supported the wheels with three 2 x 2-in. stakes spaced evenly around the edges, attaching the wheels to the stakes with $\frac{3}{8}$ -in. carriage bolts. For maximum life, it is best to creosote the portions of the stakes which will be below ground.

Golf Ball Provides Plumb Bob



If you need a plumb bob for a job around the house and do not have one, you can save going to the hardware store by improvising a plumb bob from a golf ball. Just turn a screw eye into the side of the ball to permit attaching the string, and drive a wood screw into the ball directly opposite the screw eye. Try to align the screw eye and screw as closely as possible through the center of the golf ball. Then, cut off the head of the screw and file the shank to a point.

Victor H. Lamoy, Upper Jay, N. Y.

Bushing Centers Toggle Bolt



When toggle bolts are used to attach brackets to plastered walls, the hole made in the wall is necessarily larger than the diameter of the bolt. Thus, it is difficult to draw up the bolt tight enough to hold the shank centered when any weight is exerted on the bracket. To correct this trouble, slip a wooden bushing, the same size as the hole, over the bolt before it is slipped in place. The bushing can be a short length of dowel which is drilled for the shank of the bolt so that the latter is a snug fit in the hole.

Drop of Wax on Candle Wick Permits Lighting Quickly



To insure against embarrassing delays when lighting the candles on a birthday cake or those used for decoration at a party, light an extra candle before the guests arrive and allow a drop of wax to fall on the wick of each candle to be used at the party. In this way, the candles will ignite instantly when the flame of a match is applied to the wicks.

G. E. Hendrickson, Argyle, Wis.

Inner Lid for Putty Can Keeps Contents Fresh

Putty remaining in a partially empty can will stay soft for a longer time if it is protected from the air with a tight-fitting inside cover. Using a rotary-type can opener, cut the end from a tin can and press the metal disk down tightly on top of the putty. The disk should just fit inside the putty can so that it affords the maximum amount of protection from the air. The same idea can be used to preserve wood putty, except that the design of most wood-putty containers does not permit inserting a metal disk that will completely cover the contents. However, a paper disk cut to the same diameter as the inside of the can will serve the purpose.

H. D. Hatch, Wollaston, Mass.

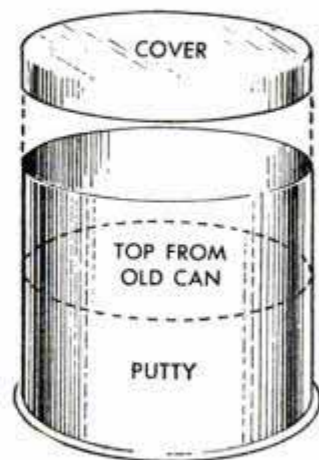

Replacing Outboard-Motor Shield Speeded By Wing Nuts

Removal and replacement of the spark-plug and carburetor spray shield on an outboard motor is speeded by brazing brass wing nuts to the heads of the bolts which hold the shield in place. The bolts can be removed without using a screwdriver and are considerably easier to start in the threads when replacing the shield. However, be sure that the shape of the wing nuts allows the bolt heads to seat properly in the shield.—Clinton R. Hull, Costa Mesa, Calif.

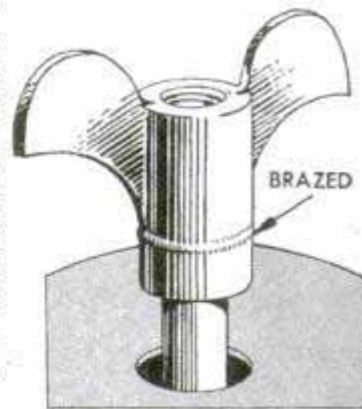

Rosin Removes Water-Base Paint

Water-base paint is removed from walls by rubbing the surface with a cloth which has been immersed in hot water and sprinkled lightly with powdered rosin. A large salt shaker can be used to apply the rosin to the cloth.—A. E. Fenn, Chicago.

Use a 4-in. brush when painting outside walls. It holds considerable paint and is lightweight enough for easy handling.

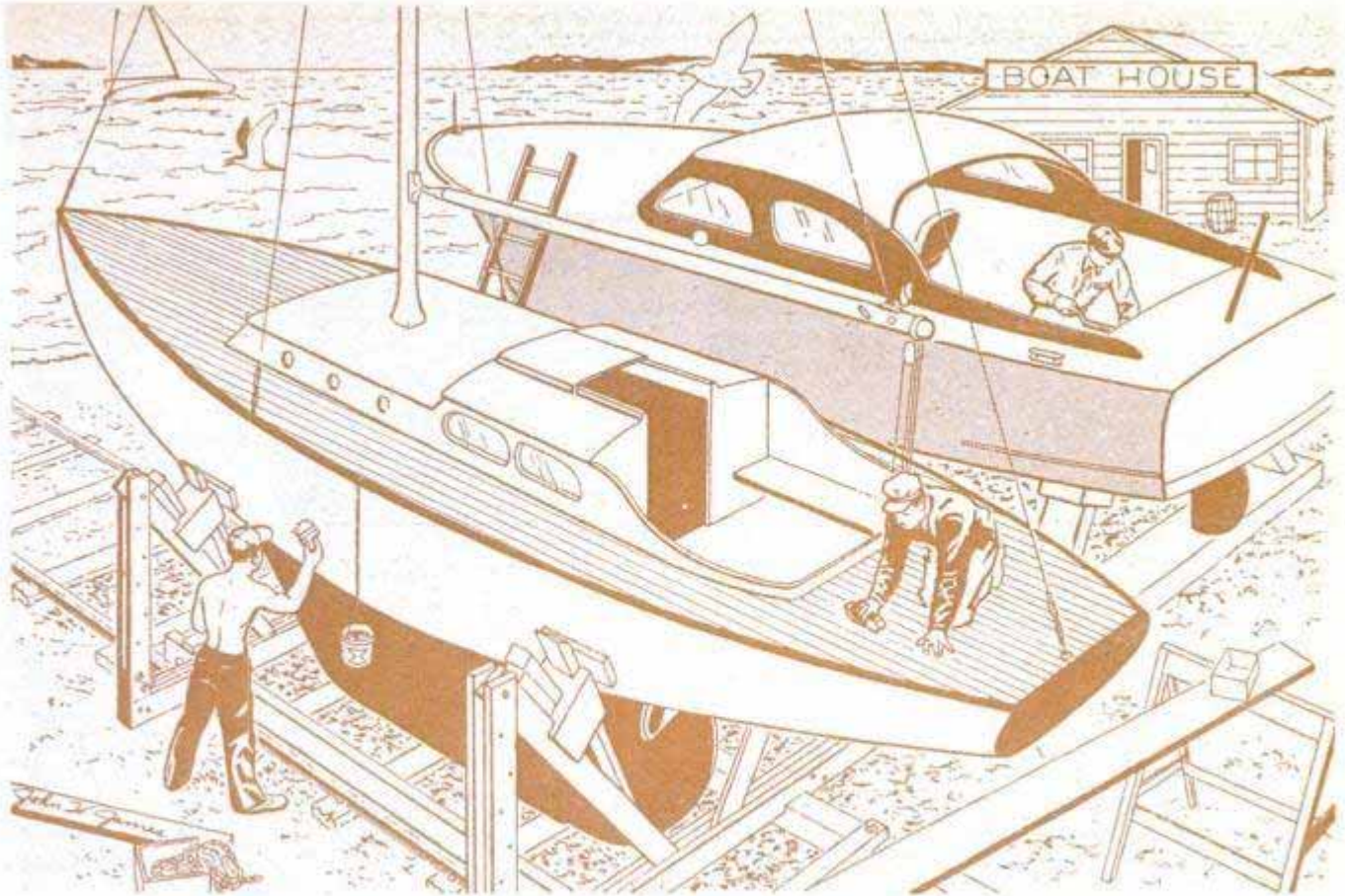

MAKE YOUR BOAT SAFE

By Elon Jessup

BOATMEN say that a boat hull is no better than its fastenings. In this they are referring not only to the condition of the numerous screws, nails, rivets and bolts that hold the parts together, but also to the state of the holding power of each of these fastenings. That's the important thing. In any wooden hull a slow disintegration process is going on constantly, whether the boat is in daily service or laid up in the yard or boathouse for the winter season. Wood shrinks and expands with changes in temperature and moisture content and wet and dry rots attack hidden parts in the bilge. Service conditions vary throughout the season from the severe pounding of a fresh-water chop to the normal working of a wooden hull due simply to strains developed by its forward progress through the water. Any of these conditions sets up stresses in the hull structure which eventually cause flexing of the frame parts and movement of one plank past another in a fore-and-aft direction. This tends to build up shearing stresses on all the fastenings. In power boats with wooden hulls, an in-board motor that vibrates unduly because of improper carburetor adjustment or some other mechanical fault, can cause the same trouble. Thrust from a powerful outboard motor not only will wreck a small-boat

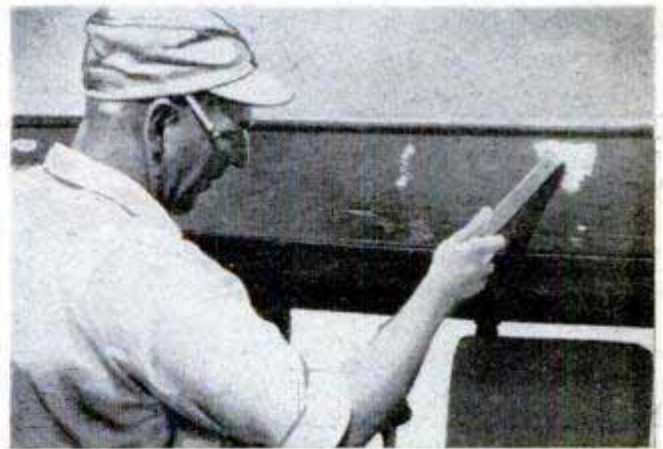

Above, repair damaged planking with any of the special fillers made for marine use. Below, use a flexible wooden strip for scribing to locate the frames



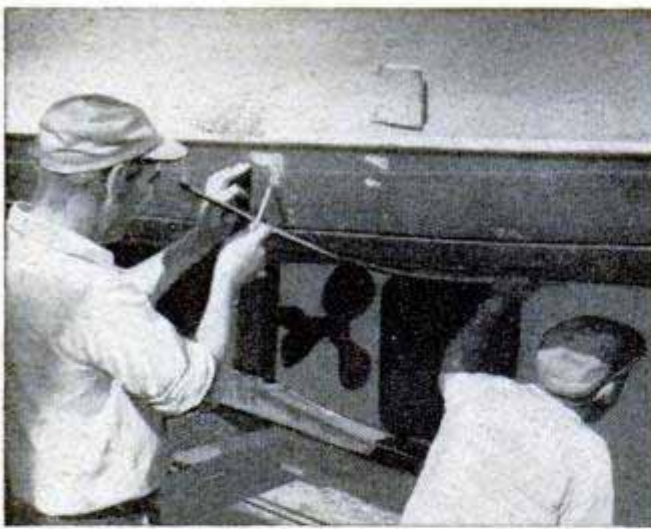

Be sure that the line scribed along the strip is directly over the center of the frame member

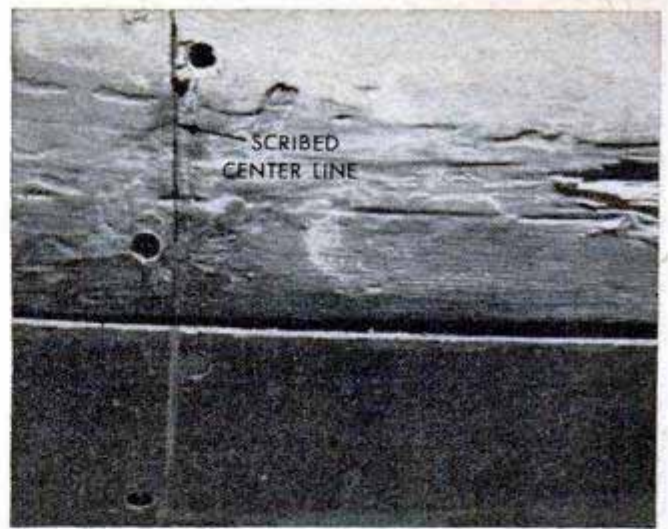

Stagger the new holes for screws alternately on each side of the line scribed on the hull planking

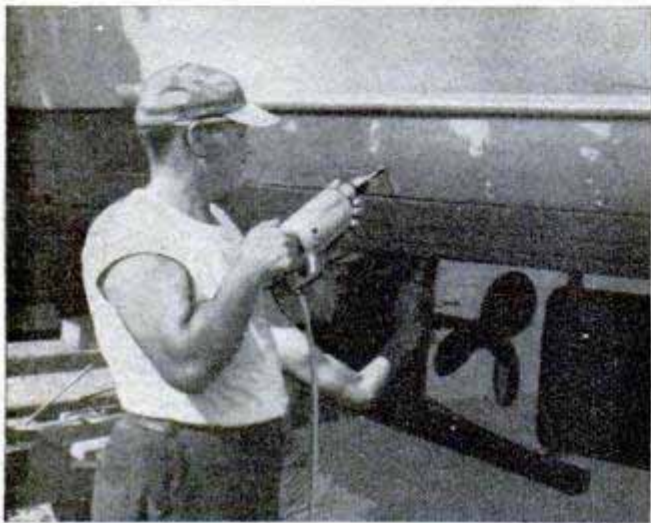

Use an electric drill for drilling the screw holes. Wooden stop on the drill bit assures uniform depth

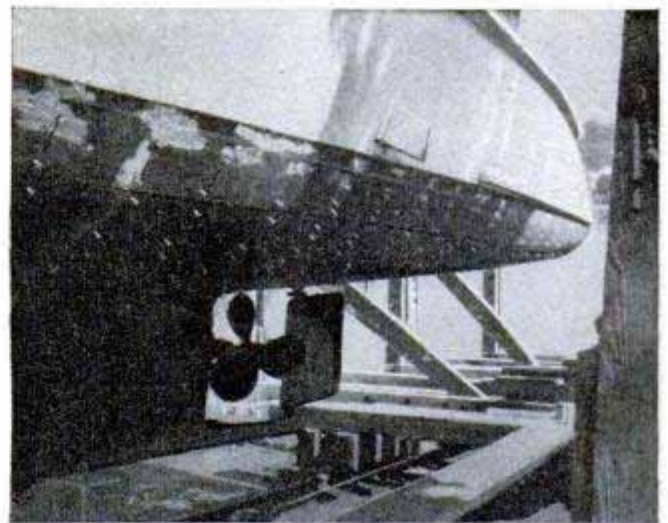

Set small screws lightly in the new holes with a hammer, then drive by hand to a uniform tension

transom in time but also will cause a gradual loosening of the hull fastenings.

Of course, most of the fastenings in the average boat are hidden, but usually there will be indications of loose fastenings long before the safety and usefulness of the boat are seriously impaired. Examine the planking carefully from the keel to a point well up on the freeboard on both the port and starboard sides. If any of the screws holding the planking to the frames or battens are loose, you will see raised edges of the planks at the joints, or seams, as they are often called. A batten, wood lath or a thin strip of wood held with one end at the keel and bent up over the swell of the hull amidships, as in the lower photo on the preceding page, will show up any irregularity of the curve. Use the same batten as in the upper left-hand photo above when scribing lines to indicate the position of a frame member. In older boats, the condition of the frames should be checked at the beginning of each season, especially forward of midships and near the keel on both sides. Soft, spongy wood will not hold fastenings.

If the wood proves to be in good condition, the fastenings are at fault. After years of use, some galvanized fastenings erode to about half their original size. Such a condition develops slowly and grows progressively worse until it reaches the point where something vital lets go. That's why seasonal checks of the hull are so important, especially on older boats.

Just how you proceed to repair natural wear depends on the condition of the hull. In some instances, boatmen find it possible to tighten the original fastenings. This is generally the case where brass, bronze or copper fastenings have been used, as these metals are highly resistant to corrosion. When examination shows that the fastenings must be renewed, it generally is easier to install new fastenings, such as planking screws, without removing the old. To do this, most boatmen score lines on the hull to locate the frames as in the two upper photos above. Then a staggered line of holes is drilled as in the upper right and lower left-hand photos. The staggered line is made to straddle the old line of screws,



Where large screws must be used, set them with a hand screwdriver, then drive home with brace driver



On older boats having large hulls, calking the seams is a job calling for skill and painstaking care

the position of the new holes alternating with the old. This procedure usually is much more practical than removing all the old fastenings. Plug all the new holes with wooden plugs after driving the screws. Repair damaged planking with any of the prepared wood fillers made especially for marine use. When dry, sand the filler flush before painting.

In any fitting-out job, the hull planking should be recalced, especially where the boat has been in use for several seasons without a thorough overhaul. After renewing all necessary fastenings, proceed to calk the hull as in the upper right and lower left-hand photos. After calking, give the hull a thorough sanding in preparation for painting. On old hulls on which the planking is rather rough, some boatmen prefer to rough-sand the hull before calking. Then, a final finish-sanding puts the surface in excellent shape for painting. Before calking a hull, make sure that it will not be necessary to renew any fastenings at the stem or along the keel. Should renewal of any of these fastenings be neces-



Seam cement is forced into calked seams to make a smooth watertight job before sanding and painting



It's regular practice to apply a nonfouling copper bottom paint, especially if boat is used in salt water

sary, be sure to use a new fastening of the same metal as the original. The same is true of the planking screws, especially if the boat is to be used in salt water.

In repainting older boats, large or small, it's the usual practice to apply a copper bottom paint up to the water line and a marine paint of the owner's choice in kind and color from the water line to the sheer. Whether or not a primer is necessary will depend on the condition of the hull and the old paint. Many boatmen consider sanding between coats well worth the extra time consumed as it produces a final finish of top quality and durability. When painting two colors to a line, use painter's masking tape to assure a sharp, clean line between the colors.

Ready-Made Trellis Crosspieces Provided by Wooden Coat Hangers



Half the job of making a small trellis is done before you start if ordinary wooden coat hangers are used for the cross members. Just nail the coat hangers across three uprights of lath or lattice stock, give the trellis two coats of paint and, when dry, embed the ends of the uprights in the ground.

Roland Cueva, Hayburn, Ohio.

Wire Solder Anchors Wood Screw

When a wood screw has worked loose, a quick repair can be made by dropping a short length of wire solder into the hole and then redriving the

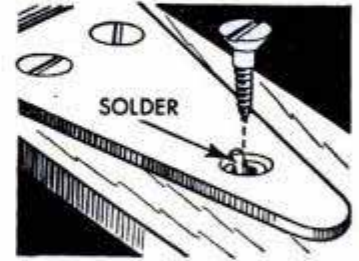

screw. The solder fills the hole so the screw grips tightly. This takes less time than the usual method of filling the hole with a wooden plug and redrilling for the screw.

Plumb Bob for Terrace Walls Aids in Keeping Uniform Slant

By using this easily made plumb bob when building terrace walls, it's a simple matter to keep the angle of slope uniform throughout the length of the construction. You will be surprised at how much neater the finished job will look if you keep an accurate check on the pitch of the wall instead of relying on guesswork. Just build up a frame from scrap lumber, setting the upright at the desired angle to the horizontal members. Drill a hole through the top crosspiece for the plumb line and mark a cross on the upper face of the bottom crosspiece in exact alignment with this hole. Then mount the plumb bob in the frame so that it swings free of the bottom crosspiece. To use, hold the upright against the wall, as shown, and note the position of the plumb bob in relation to the cross mark. When the plumb bob is directly over

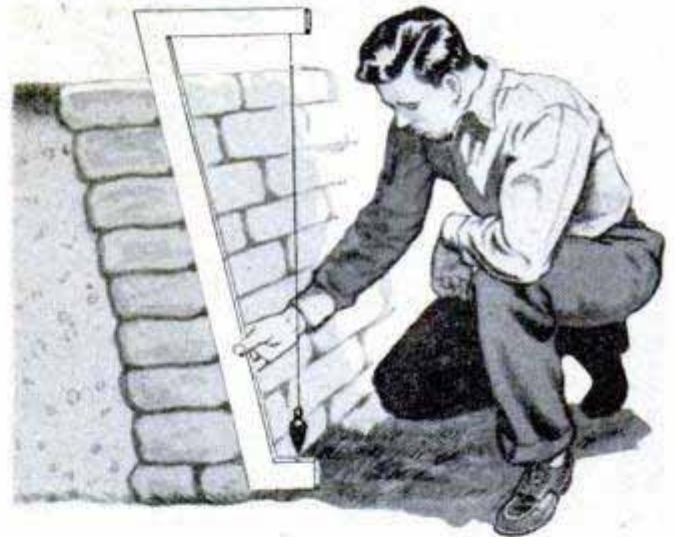

the cross, the wall is at the same angle to the ground as the upright member of the frame.—W. Fehlberg, La Crosse, Wis.

Lag Screws Draw Up Joints Between Stiles and Rails of Paneled Door

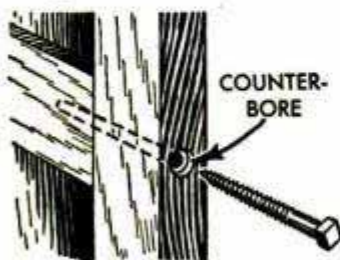

If the joints between the stiles and rails of a paneled door separate as a result of warpage, they can be repaired easily by drawing the two members together

with a lag screw. Frequently, this can be done without removing the door from the hinges. First, a hole is drilled through the stile and into the rail. Then the hole is

counterbored to bring the screwhead slightly below the edge of the door, the counterbore being made large enough to permit driving the lag screw with a socket-head wrench. After the lag screw is in place, the head is covered with wood putty or a hardwood plug which is then finished to match the rest of the door.

☛For maximum operating efficiency, it's important to use a good grade of oil in your car. Inferior oil results in higher gas consumption because of increased friction.

BILGE PUMP

By John M. Avery

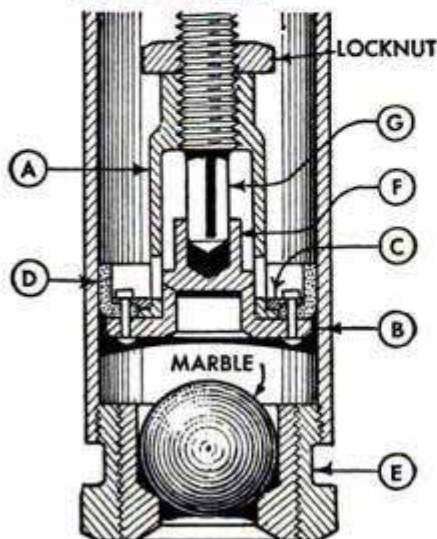
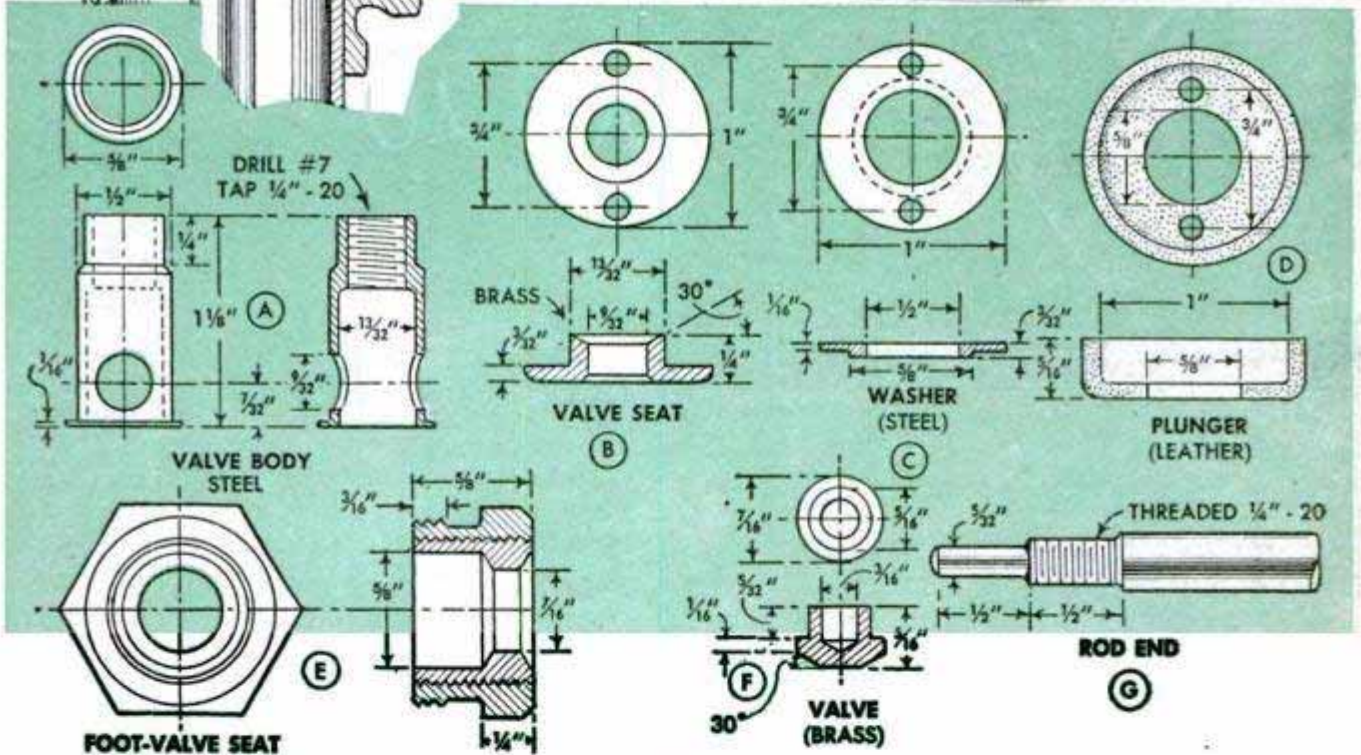
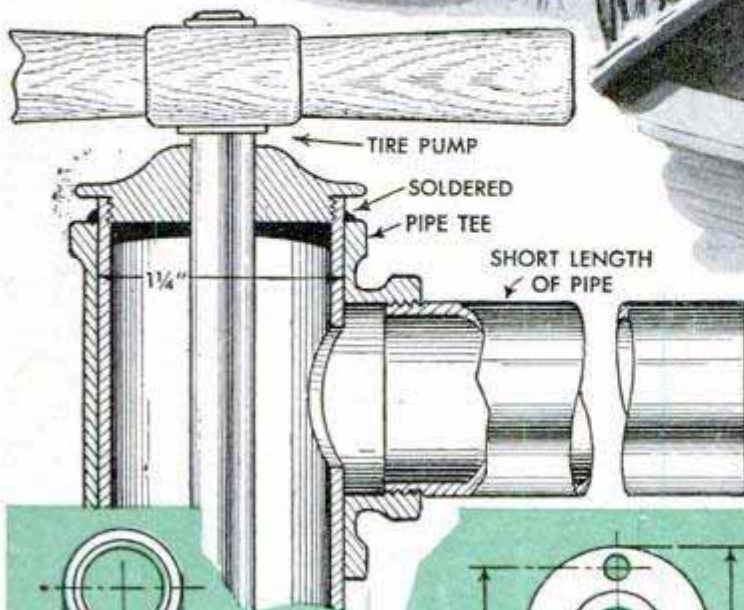
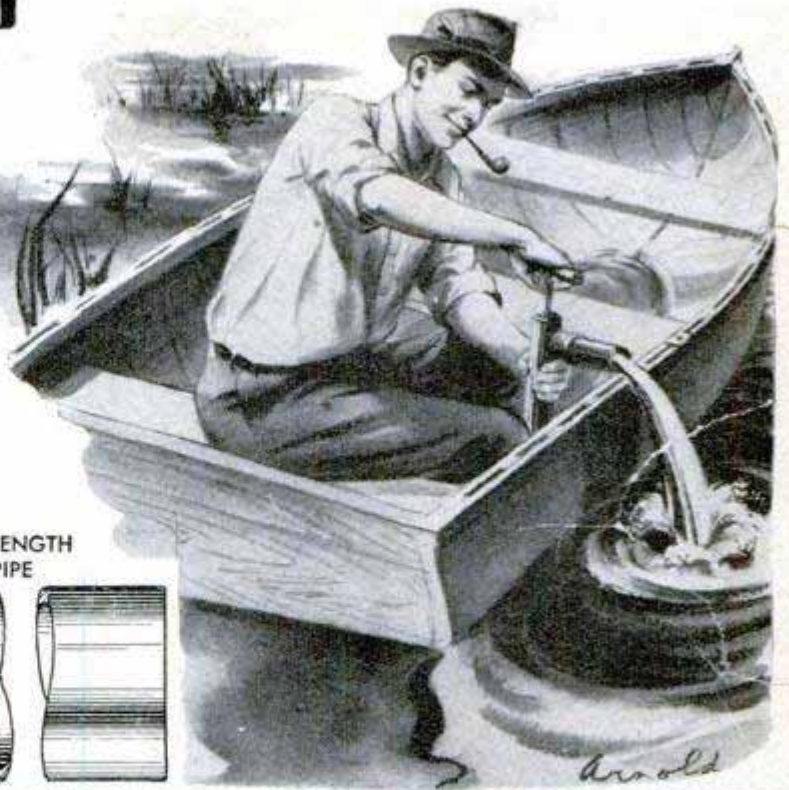

BY FITTING an old tire pump with valves and a discharge spout it can be converted to an efficient bilge pump. The base and hose of the tire pump are removed and the end is threaded internally for a brass pipe bushing which is fitted with a valve seat turned from a smaller bushing. The upper end of the pump is equipped with a pipe tee that is bored out to fit over the end of the barrel and sweat-soldered. A hole is cut through the barrel for the discharge outlet. The body of the valve itself, part A, is made first, as the rest of the component parts are made to fit it. All parts are keyed with the sectional view to show assembly. Note that the small end of the pump rod keeps the valve aligned. A glass marble is used for the foot valve with a cross-wire stop being provided to keep the marble from coming completely out of the valve.

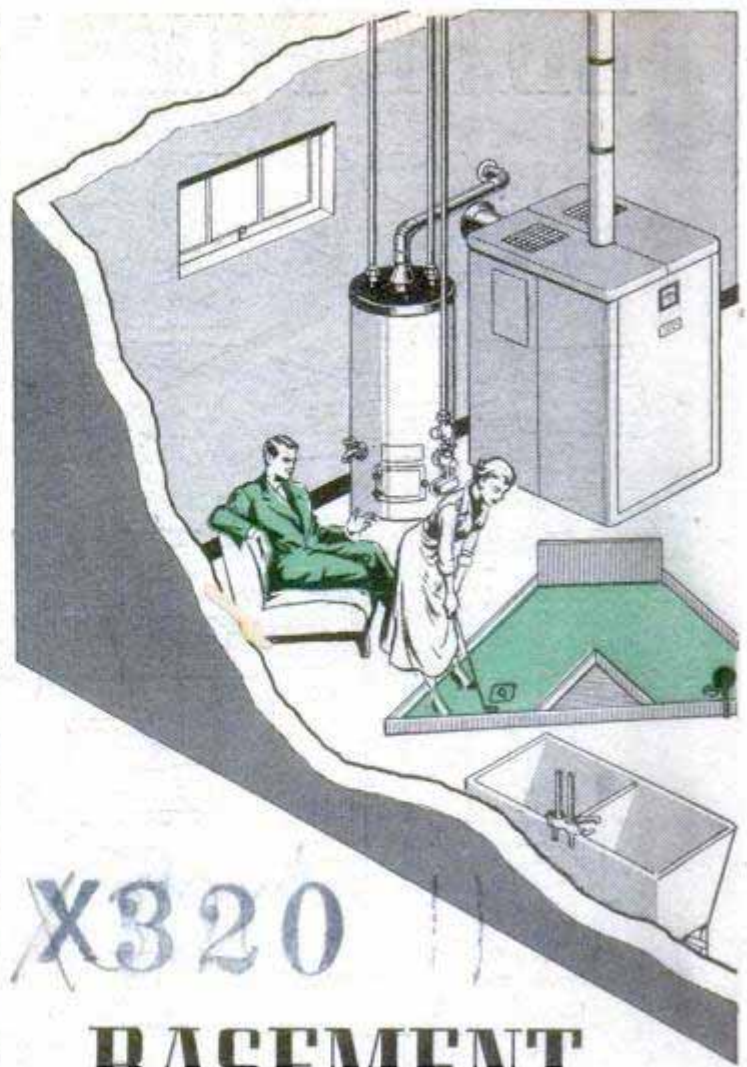

X320

BASEMENT GOLF

By Allan Carpenter

POPULARITY of miniature golf has brought the game right into the basement in the form of a knockdown course that can be picked up and stored away almost as easily as you would a game of croquet. It's an exciting game the whole family can enjoy the year round—from the youngsters on up to the avid golfer who will find it good practice in keeping his putting eye keen. Standard putters and irons are used and scoring is done as in real golf, penalties being counted as strokes. As for space, most basements, especially those with compact heating units, will accommodate the "concentrated" nine-hole course pictured in the illustration above, but, where there's only a minimum of space, a lot of fun can be had from a much smaller course. As each green is complete in itself and lightweight, the course can be quickly set up. Most of the greens are fairly shallow to permit stacking them in little space when not in use. Where yard area

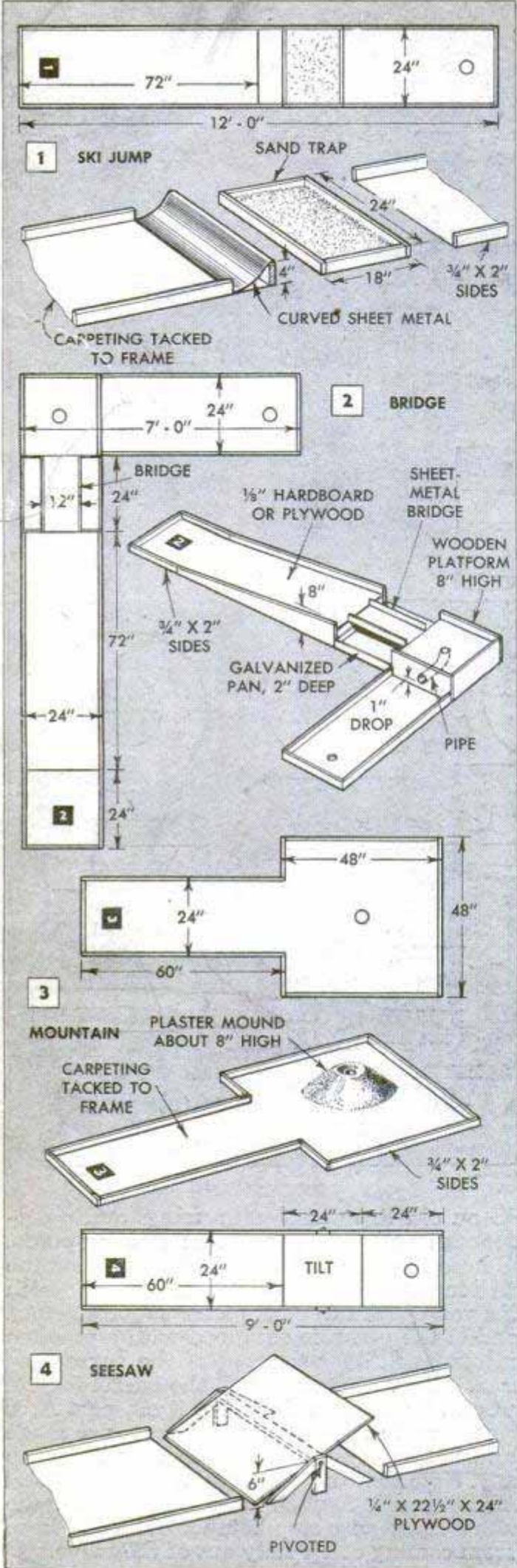

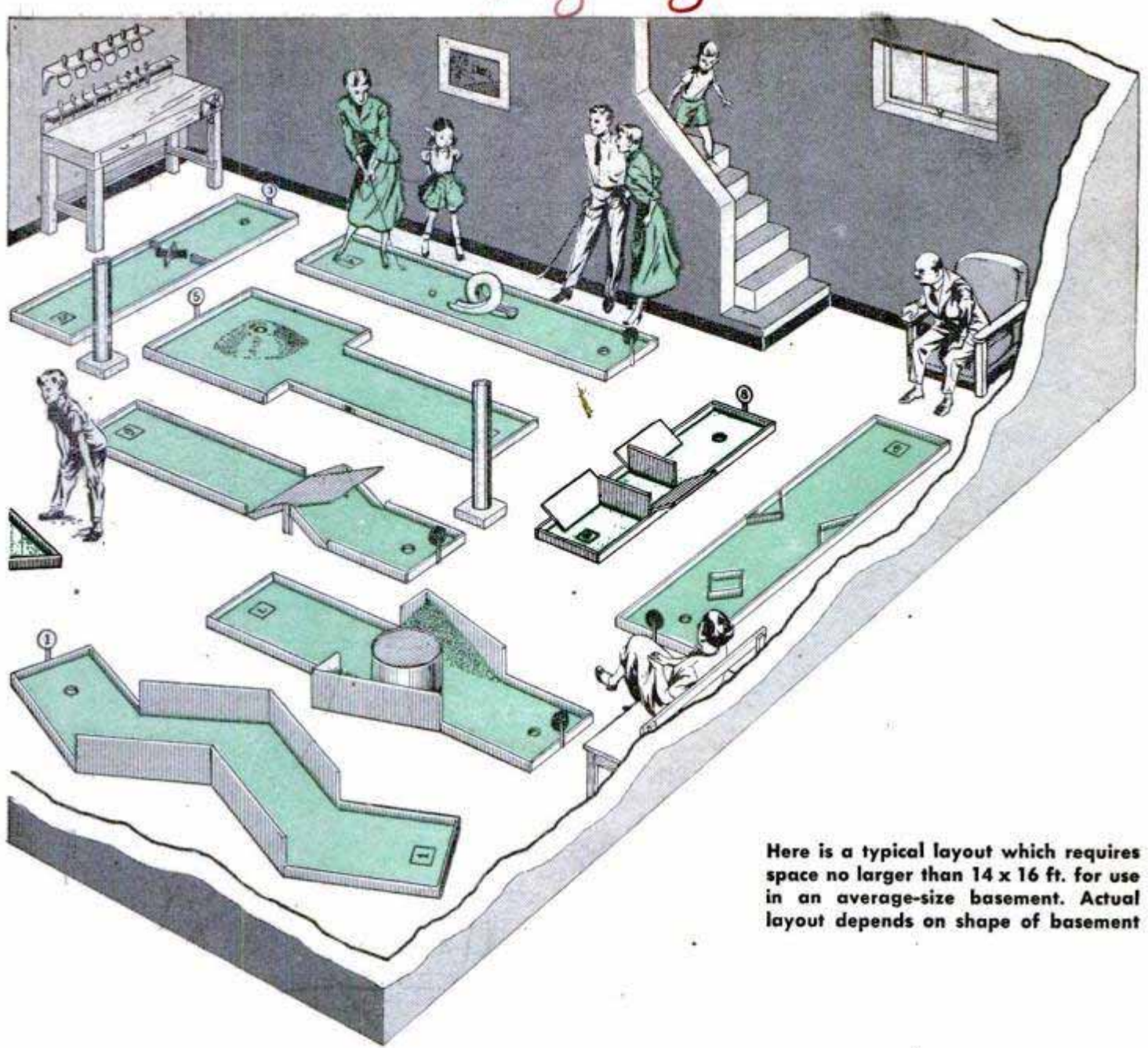

Here is a typical layout which requires space no larger than 14 x 16 ft. for use in an average-size basement. Actual layout depends on shape of basement

is sufficient to permit an outdoor course, a suggested layout for an 18-hole one is given in the plan view on page 197. Construction of nine additional greens is given to supplement the nine shown above.

The various greens detailed can be adapted to almost any size layout. While the ones shown have been purposely kept small, the fairways being only 24 in. wide, they can be made larger, if space permits, and made even more tricky. In laying out your course, remember to place the greens in numerical order, keeping the tee of the following green adjacent to the hole of the preceding green. The last hole, whether it is No. 9 or 18 of the course, should be located so that the player is brought back to the starting point. It is good, too, to place the greens so that the first and last holes are near the basement stairway. In designing your own special greens, don't make a hole-in-one shot impossible. Rather, design and locate the hazard in such a manner that the ball can be banked

into the cup. The plan view for the 18-hole course shows by dotted lines how it is possible to make each hole in only one shot.

Figs. 1 to 18 inclusive detail the construction of all 18 greens. Old carpeting tacked to the edges of the framework is perhaps the best material to use for the turf. The basement floor is much too smooth for accurate control of the ball. Jute padding and coco matting also can be used. For an outdoor course, sawdust is recommended for the playing surface, Fig. 19. This is spread over a dirt fill to produce a layer about 1 in. deep when the sawdust has been dampened and rolled smooth. Commercial courses generally use a concrete base topped with sawdust. If desired, the sawdust can be colored green to look like turf by dyeing it with water-soluble dyes. Shallow can lids are used for cups and Fig. 20 shows how these are set flush with the rug pile in holes cut in the carpet. Adhesive tape applied across the underside keeps the cups from falling out when the greens are

moved. A small square of carpet with a numeral painted in the center is glued to each green to serve as a tee. A can-cover marker attached to the far end of the green identifies each hole.

Green No. 1 features a hazard of curved sheet metal to lift the ball over a sand trap. In green No. 2, an inclined fairway carries the ball over a small bridge. If it misses the bridge, the ball falls into a shallow pan of water, with the player being penalized one stroke for lifting it out. The lower end of the pipe which guides the ball to the cup should be in direct line with the cup to permit a hole-in-one shot. The mountain, green No. 3, has the cup placed in the center of a mound of plaster of paris. The hazard at green No. 4 consists of a plywood panel critically balanced so that the weight of the ball in rolling over it causes the panel to tilt forward toward the cup. In the case of an outdoor course, the hill in green No. 5 can be formed from a mound of dirt, but indoors it is made from sheet metal or linoleum which is bowed and placed across the center of the fairway. An alternate hazard is provided at this hole in the form of a hurdle which is a board set vertically over which the ball must be lifted. For this shot an iron is provided and left at the hole after play is completed. The maze at green No. 6 is formed from strips of $\frac{1}{2}$ x $1\frac{1}{2}$ -in. wood which are tacked in place to the carpeting from the underside.

The obstacle for green No. 7 is made up of short pegs set vertically in front of a sheet-metal bunker. Note that the

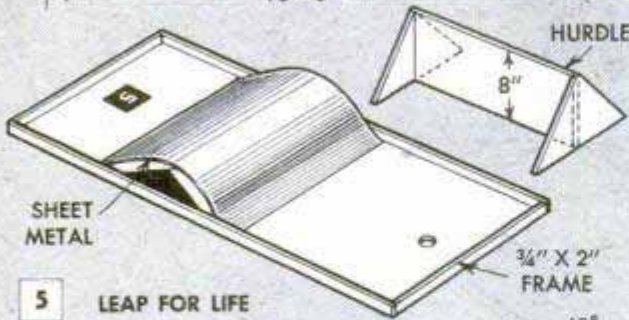
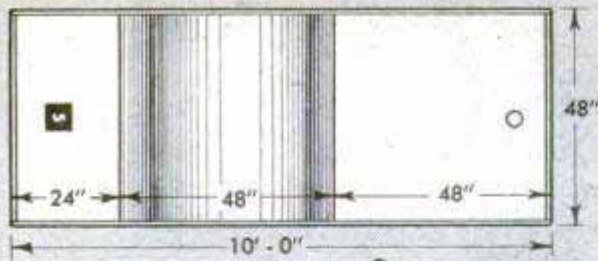

5 LEAP FOR LIFE

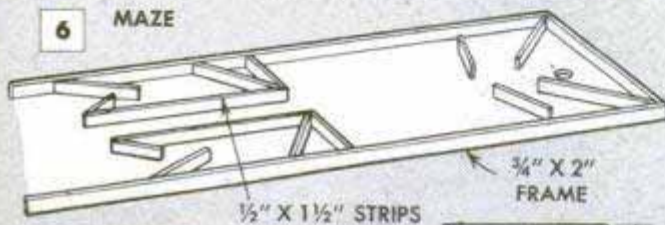
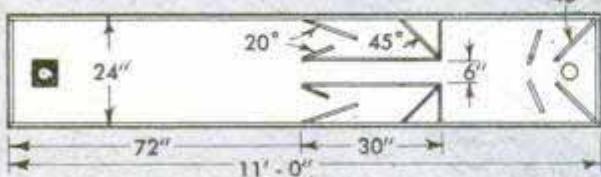

6 MAZE

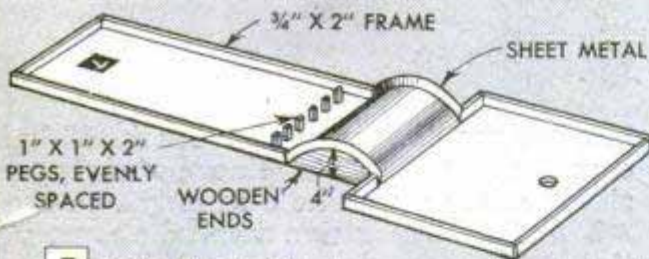
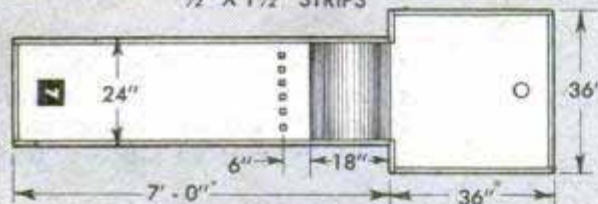

7 OVER THE HUMP

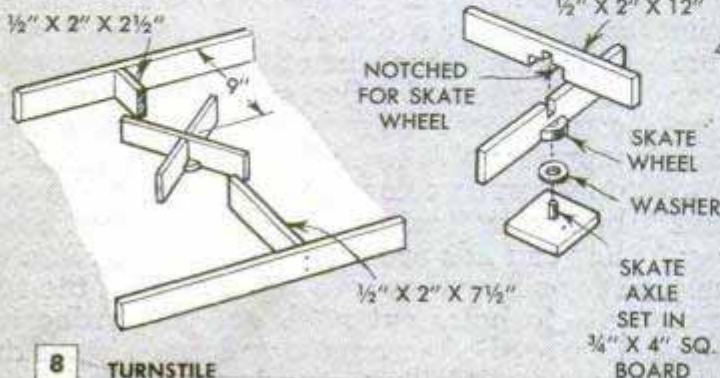
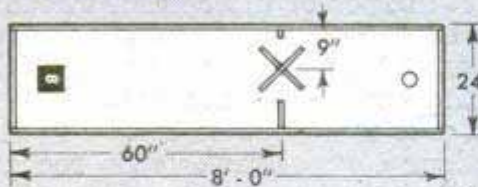

8 TURNSTILE

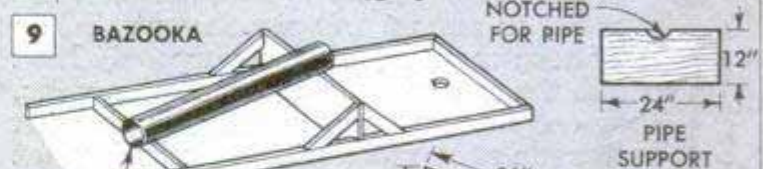
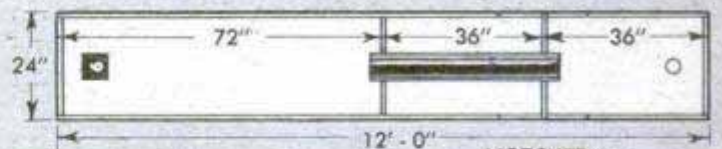

9 BAZOOKA

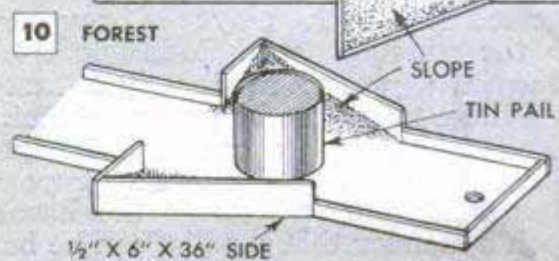
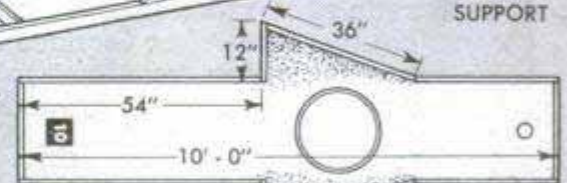

10 FOREST

center space between the pegs must line up with the cup to permit a hole-in-one shot. The pegs can be fastened in position by nailing a wooden strip across the underside of the carpet fairway and then driving screws through the strip and up into the pegs. The strip, cut to fit between the side members, causes a slight hump directly under the pegs. This adds to the difficulty of making a hole-in-one. The pivot point for the turnstile at green No. 8 is placed off center of the fairway so that the blade at the right-hand side is directly in line between the tee and the cup. Be sure that the amount of clearance under the turnstile will not allow the ball to roll under it. The bazooka hazard at green No. 9 consists of a length of stovepipe placed at an angle, the lower end being sunken slightly in the green to permit the ball to enter the pipe easily.

On an outdoor course, green No. 10 is built around a tree if possible, although a barrel or a 5-gal. paint pail will serve the same purpose. The fairway is sloped on each side of the tree to bank the ball. Dirt or concrete can be used to form the bank on an outdoor course, while indoors a piece of

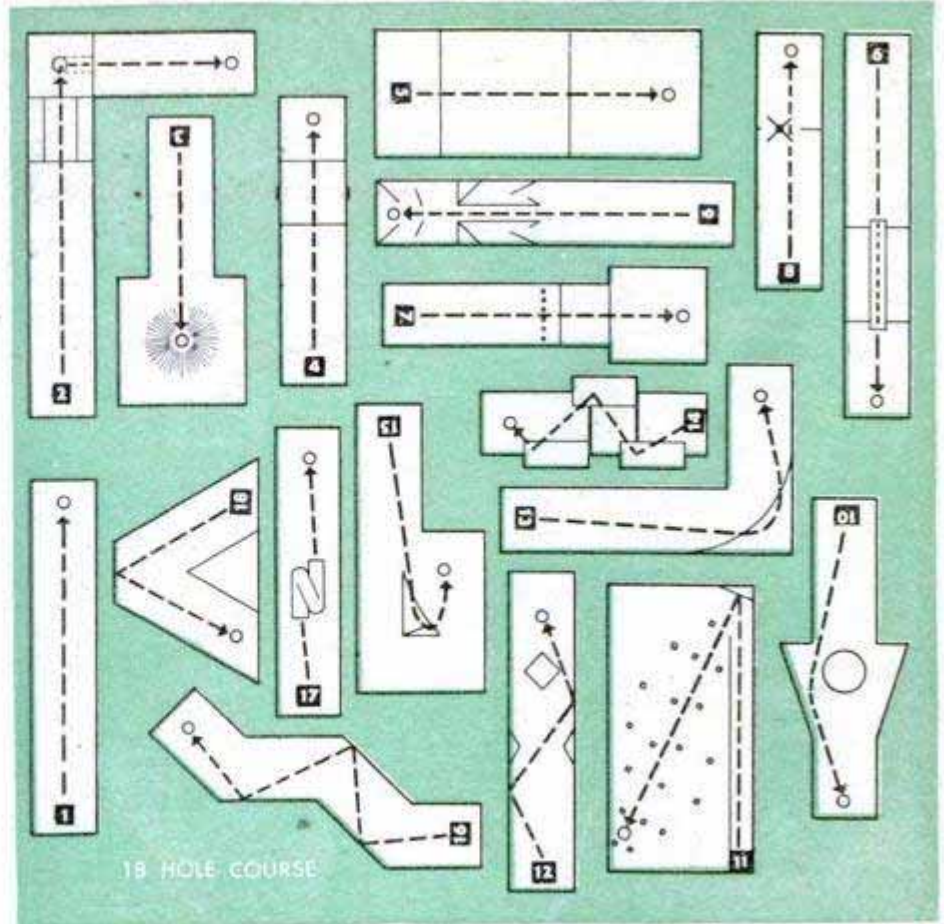

wood and sheet metal are used as shown in detail A, Fig. 13. The pegs at green No. 11 are placed so that a narrow path is kept open between the bank board and the cup. The proper angle to set the bank board so that it directs the ball into the cup is found by experiment. In building this green, the bottom of the framework must be covered with a panel of plywood or hardboard so that the pegs can be attached to it after the carpet is in place. Simple wooden forms

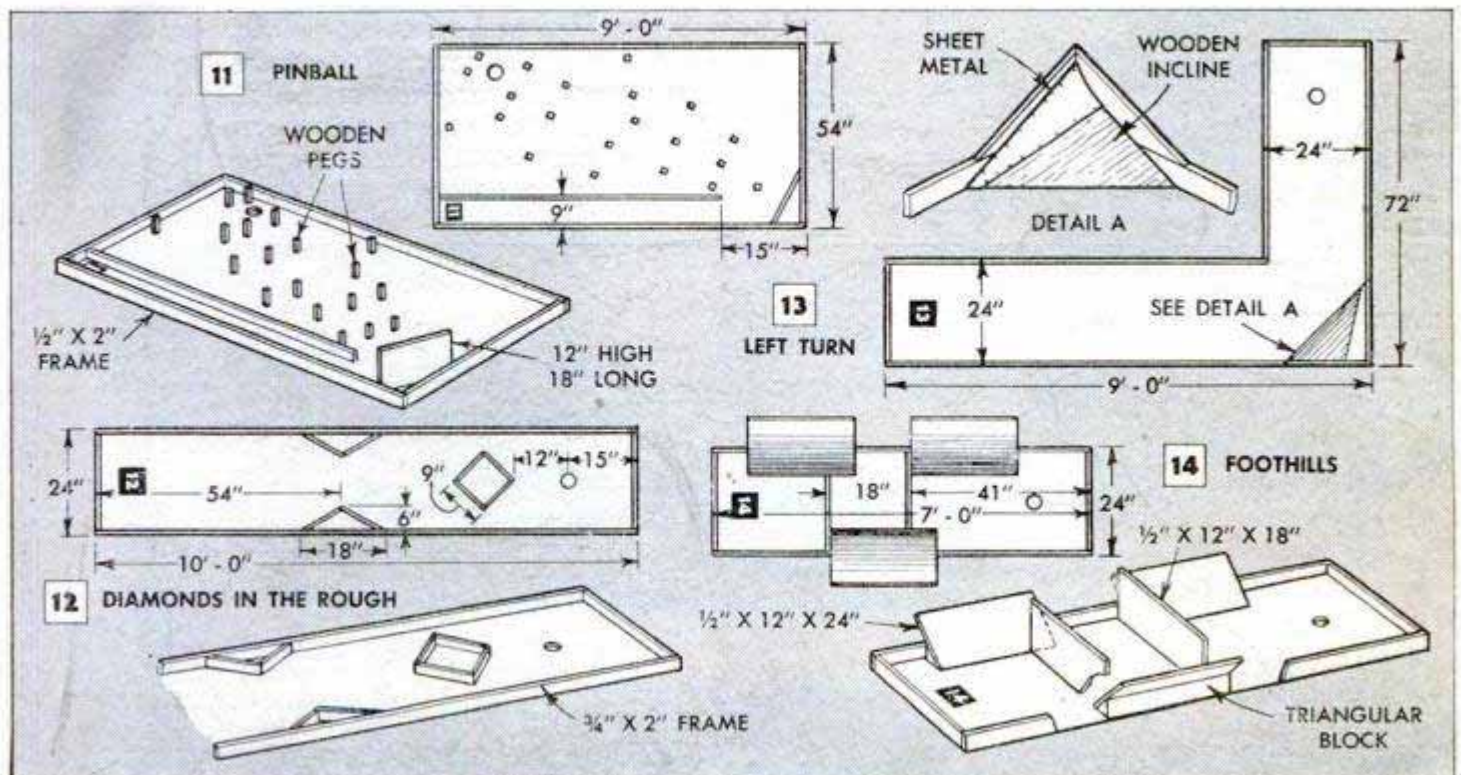

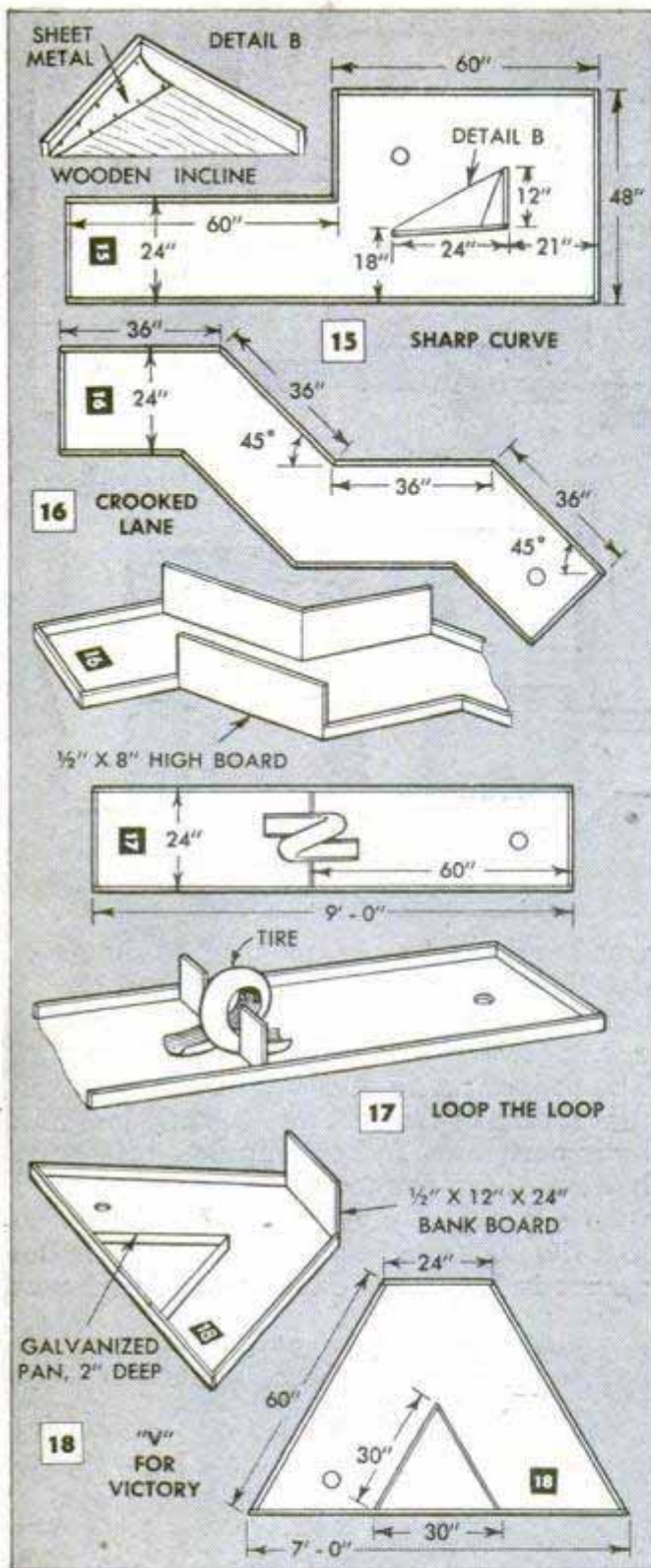

provide the obstacles along the fairway of green No. 12. A bank shot against the right or left-hand side boards is required to make the hole. L-shaped green No. 13 also requires a bank shot to direct the ball to the cup. Here, the player must be careful not to hit the ball too hard as it is easy to overshoot the top of the bank and go out of the green. When this happens the player is penalized one stroke.

Green No. 14 requires a trick shot to make the cup. Three inclined boards, staggered opposite each other, and two vertical obstacles placed across the fairway require rolling the ball up over the inclined pieces to get around the two vertical obstacles. Here, either cleats or a plywood bottom must be fitted to the framework to permit nailing the obstacles in place. Green No. 15 requires another bank shot and accurate aim. The incline, detail B, is formed from sheet metal and plywood and is located the distance indicated from the cup. This can be fastened directly to the carpet. Green No. 16 requires a triple-bank shot to make a hole-in-one. Bank boards are erected along the sides of the fairway at the points indicated.

Sinking a putt on green No. 17 is a lot of fun and requires a good shot to make the ball loop the loop through a section of old auto tire. The ends of the tire are spread apart as shown and screwed in the center of the fairway to a baseboard nailed to the edges of the framework. Wooden baffles are erected at each side of the tire so that the ball must pass through the tire to enter the cup. The fairway of green No. 18 is made V-shaped, with a bank shot being required to sink the putt. A water hazard is installed level with the surface of the fairway so that the ball can roll into it. A triangular shaped pan of sheet metal about 2 in. deep is made to set down into the green. This requires making the frame members wider than actually shown to permit raising the fairway. The bank board is made of a piece of plywood.

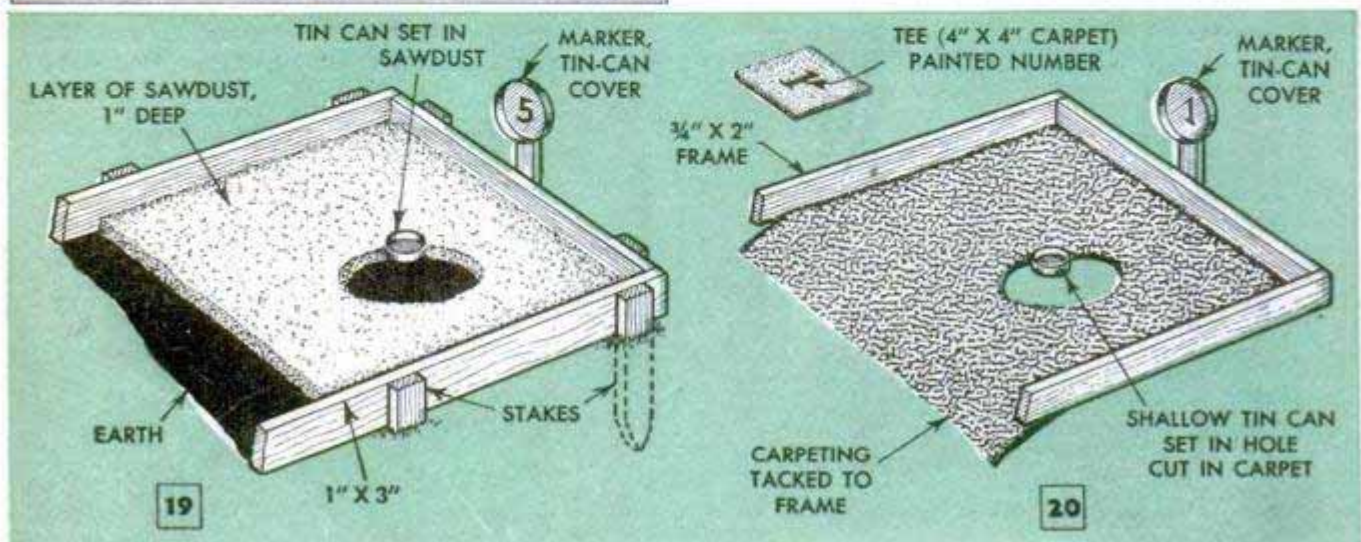

Hand Reflects Enlarger Light When Changing Lens Setting



It isn't necessary to turn on the darkroom lights each time you wish to change or check the diaphragm setting of your enlarger. Instead, turn on the enlarger and cup your hand directly under the lens as shown. This will reflect sufficient light to permit reading the indicator markings.

Keeping Track of Exposed Film By Inverting Holders

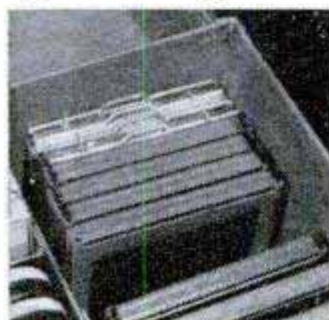

When shooting pictures on location, it's a good idea to save at least one holder of unexposed film for the possibility of a spectacular shot on the way home. To tell at a glance exactly how much unexposed film is left so you can plan the remaining shots, replace each holder upside down in the case after it has been used.

Label Attached to Camera Indicates Film Type

If a 35-mm. camera is usually kept loaded with color film, it is easy to forget whether the film in the camera is daylight or tungsten. To prevent this, cut the band from the film container after the camera has been loaded and attach it to the outside of the camera to serve as a descriptive label.

H. A. Thornhill, Sacramento, Calif.

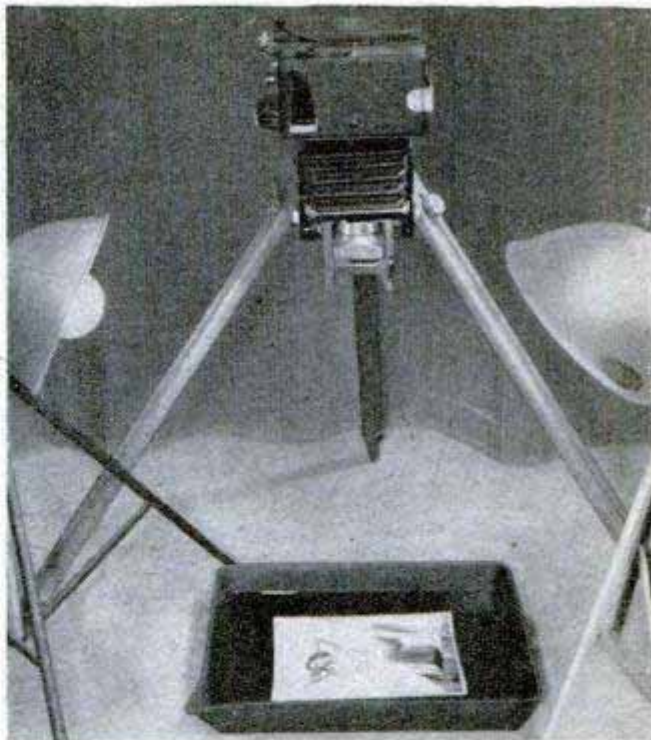
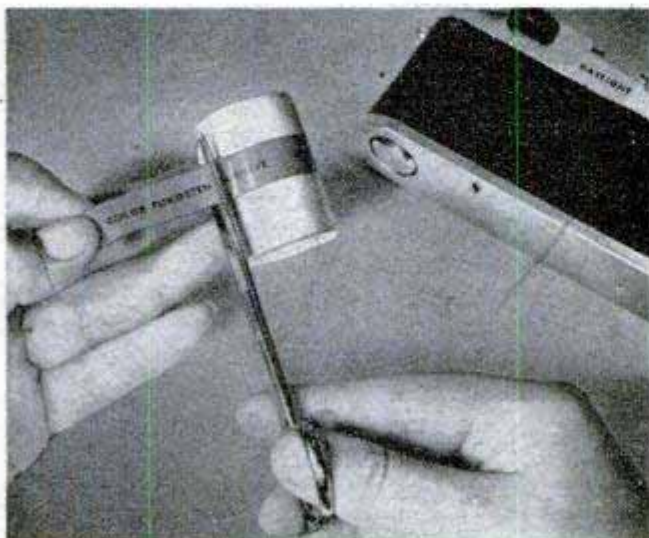

Copying Prints Through Water Produces Better Negatives

One of the best methods to use in copying a photographic print is to shoot it through water. The resulting copy-negative is not only free of surface texture, but the range of tones of a rough-grained paper will be increased. The photo above shows how the exposure is made. The print to be copied is placed in a tray filled with water and the camera is mounted directly over the tray. When the print is thoroughly soaked, it will lie perfectly flat and, if the print that is being copied should have any previous drying marks that tend to disfigure the subject, the water bath will completely eliminate them in the final copy print.

Virginia Hanson, Santa Monica, Calif.

Paper Toweling Forms Blotter Roll For Drying Small Prints

By using a roll of paper toweling and sheets of wax paper, a blotter roll for drying small prints can be improvised in a jiffy. Just unroll a length of the paper towel, cover it with the wax paper and place the prints face down on the wax paper.



Then, roll them into the towel. Dozens of prints can be dried simultaneously in this manner, which takes up little space and produces flat prints.

TITLES THAT SPARK INTEREST

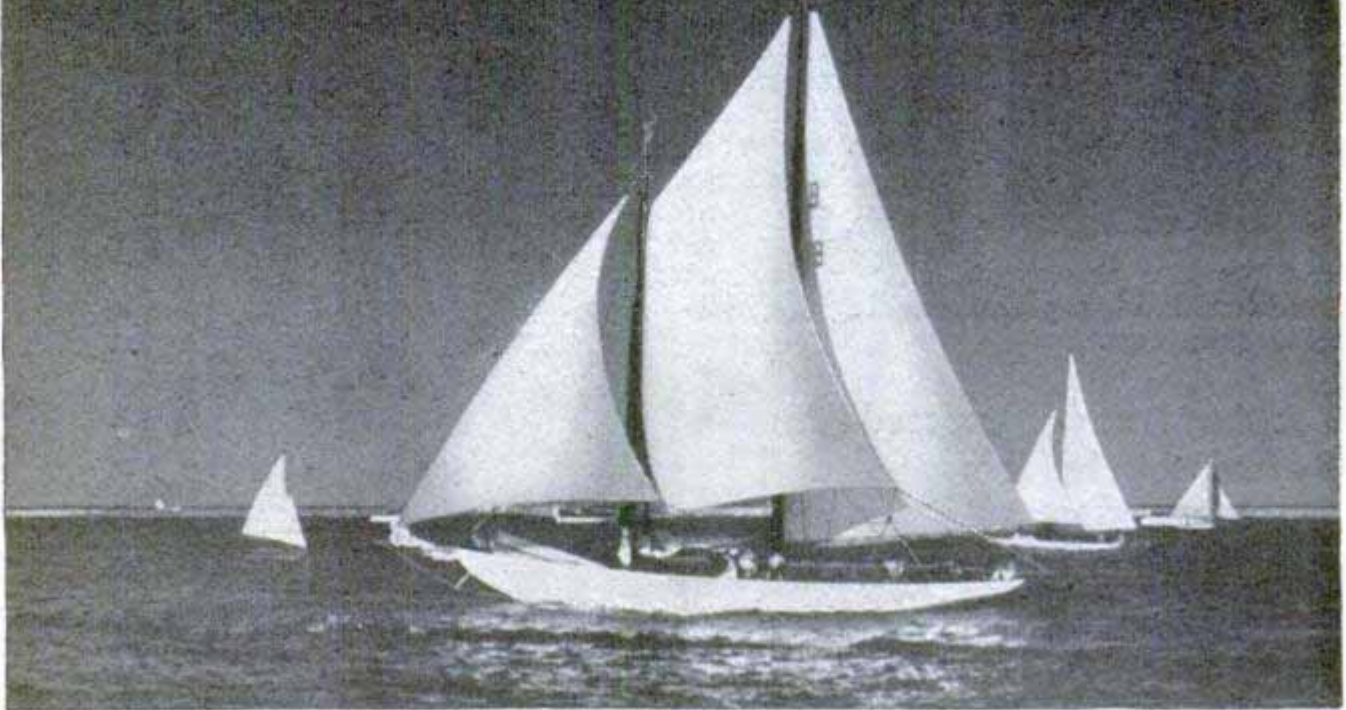

Presenting vacation movies, color slides or albums with catchy, easy-to-read titles gets your evening's entertainment off to a good start

By Alexander Maxwell

THERE'LL be no periods of lagging interest during that first showing of your vacation movies or slides if you plan snappy titles beforehand and carefully run them into the continuity where the action slows a bit or the subject changes. In a general way, the procedures used in making up attractive, unusual and informative titles and subtitles can be applied to any movie continuity as well as albums and color slides on subjects which are entertaining, scientific, industrial or educational. The essential thing is a title cleverly tied in with the picture subject. Ingenuity and imagination used in making up the title sets are what make the sequence interesting and entertaining.

Simple three-dimensional title sets always hold the attention of the audience because of the sense of realism. For some picture subjects, three-dimensional sets will take time to prepare and in any case it's always well to avoid a complex or involved arrangement of the props. The ideal set is assembled in such a way that when photographed and edited into the picture sequence the eye catches both the subject and the title message at a glance. The title set in

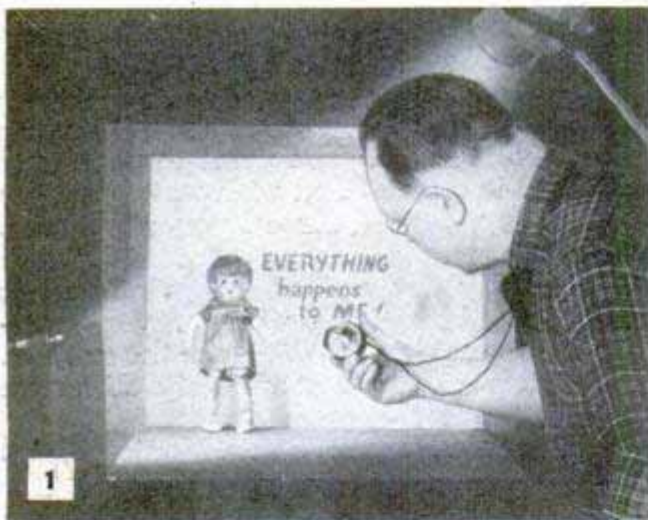

1 Above, checking light intensities with an exposure meter before shooting a three-dimensional title set. Below, photo rendering depends on proper lighting

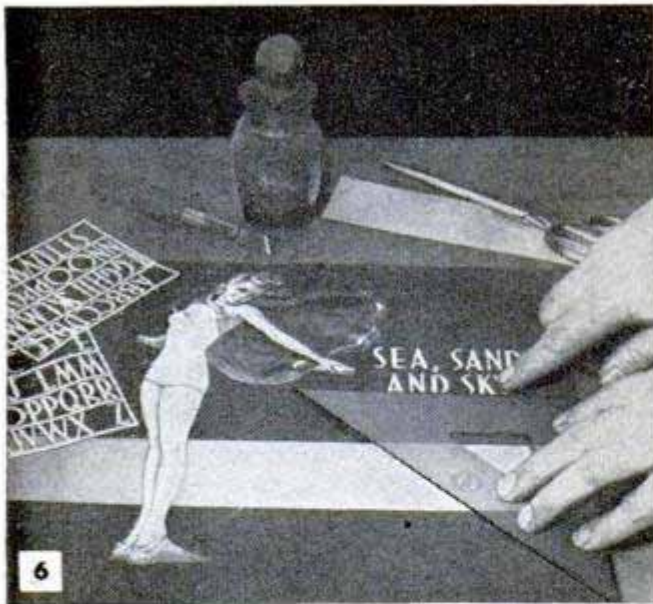



Fig. 1 and the resulting title picture, Fig. 2, is a good example of what to strive for in simple three-dimensional title sets. Dolls like the one shown are effective figure props, as they are so very lifelike when skillfully posed and properly lighted. Remember that in sets like this, lighting does the trick. In the set, Fig. 1, the doll is posed in front of the lettered backdrop in a position to cast a greatly enlarged shadow and the wistful, rather pathetic expression is achieved not only by positioning the arms, legs and body of the figure but by carefully maneuvering the lights to model the face. A spotlight is focused with fairly sharp edges on the lettering and the modeling light is directed from a point slightly below eye level by means of a photoflood reflector having directional flaps. Check the light intensities with an exposure meter before shooting the set, Fig. 1. Another method of making up sets giving a three-dimensional effect is suggested in Figs. 6 and 7. Here, a colored cutout, or clipping, is used as the figure. The cutout is pasted onto a two or three-tone backdrop as in Fig. 6. Lettering is assembled from gummed type characters clipped from monogram alphabets (available from dealers in artist's supplies) and lined up with a draftsman's triangle as shown. The set is then lighted and photographed as in Fig. 1 with the result you see in Fig. 7. Another suggestion, using a metallic-paper backdrop, is shown in Fig. 10. Colored metallic papers in gold, green and red photograph in dazzling brilliance and, in "white," Fig. 10, the metallic-paper backdrop gives a remarkably realistic feeling of a frozen, winter scene through which the schoolgirl (cutout) is happily making her way. Note the three tiny trees placed just below the title to give the shot the effect of depth.

Ordinary photo albums can be made much more interesting if you date picture groups chronologically and add appropriate





Colored pasteups give the three-dimensional effect



Here's the photo rendering of the colored pasteup

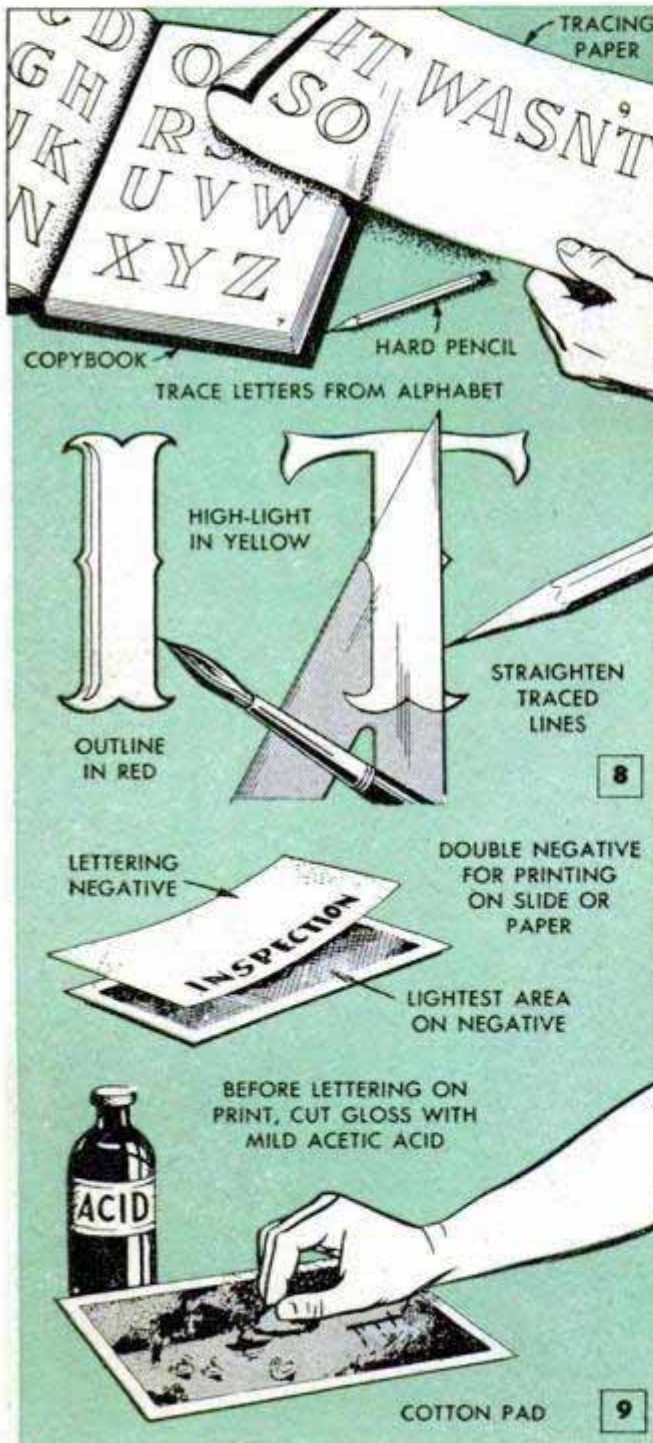

titles as suggested in Fig. 3. These can be simple pasteups, original pen-and-ink sketches if you have artistic ability, or they can be set up in attractive, harmonious colors and color-photographed as already described. The latter procedure is, of course, rather expensive as color prints would have to be made from the transparencies.

During vacation you're always on location, either for movies or still pictures, and Fig. 4 details three ways of making attractive titles either for movies or photo albums. When photographing words scratched in sand or snow, watch the lighting carefully. Of course, you will use natural lighting so form the letters and position the camera in such a way that the light source is slightly above and to the left or right of the line of letters. Otherwise parts of certain letters will not cast a sharp shadow. If you happen to be in "Smoky Canyon" in camp or trailer and there are picture possibilities sufficient to warrant a title, burn the letters into a weathered board and photograph the "set." Welcome signs, highway markers, place names and historical tablets make good title props. Always have them in mind as title possibilities when you're traveling.

In some cases, the titles are more effective if they are lettered directly on the back-drop. This can be done by simply tracing the characters from a copybook or alphabet book of the type used by artists. Trace the required letter outlines on tracing paper as in Fig. 8. Pencil parallel lines on the tracing paper if the letters are to be in precise alignment. After tracing letters for the required number of words, rub the back of the tracing paper with a soft lead pencil, then turn the sheet right side up and register and align it on the backdrop. Tracing the outlines lightly will transfer each letter outline to the backdrop. Next,

straighten and sharpen the transferred letter outlines with a pencil and triangle as in the lower detail, Fig. 8. Finally, fill in the outlines with opaque water colors. One example of this type of work is shown in Fig. 11. In this particular example, each individual letter has been high-lighted, Fig. 8, with a contrasting color.

On posed pictures, it's comparatively easy to make the title by double exposure. The title card, or backdrop, is made up first and shot. Then, without advancing the film, the subject photo is taken. Of course, exposure is a problem, but if you use a card or backdrop with a black matte surface and avoid high lights in the over-all lighting, normal exposure time for the second shot generally produces good results. Making double-exposure slides or movies is more tricky. Some late-model 35-mm. still cameras automatically advance the film when the shutter is wound, a feature precluding the possibility of making double exposures in the regular way. However, by notching the film, Fig. 5, fairly dependable results are obtainable. Shoot the titles first, then rewind and re-register the film for the subject shots. If your movie camera is fitted with a rewind mechanism and a frame counter, Fig. 13, then double-exposed sequences are simple to make. Just note the footage and the starting frame and rewind to that point for the second take. Double-exposure work is not practical with cameras not having the rewind feature, as you cannot rely on a footage counter alone.

To put lettering on a photo or slide already taken, make a negative of the title and place both in the enlarger or printer in exact register. On color slides the black-and-white title negative usually can be sandwiched into the mount without greatly altering color or brilliance. An alternate method is to letter directly on the contact print as in Fig. 9. Before lettering with white ink, cut the gloss on the print with dilute acetic acid as shown. Then rephotograph the altered print.

It is possible to produce a variety of title sets by stenciling both the lettering and the figures onto the backdrop. A variety of letter stencils is available, Fig. 12, and for the backdrop decoration there are geometric designs, home-decoration patterns and natural subjects ranging from fish to flowers. A brilliant stencil job, on a backdrop of contrasting color and photographed in color, makes a worthy part of the show and is exceptionally easy to read where several lines of descriptive type are necessary. Other novel treatments that can be used effectively to add atmosphere to certain subjects are lettering stenciled on rough, grainy wood, burlap, canvas and polished sheet metal.



Metallic-paper backdrops in color give a wide range of unusual title sets. The one above, in "white," carries out the thought of winter very realistically



Above, high-lighted lettering is appropriate when titling historical sequences. Letters are traced and then blocked in with opaque colors. Below, stenciled titles are very effective on novelty backdrops

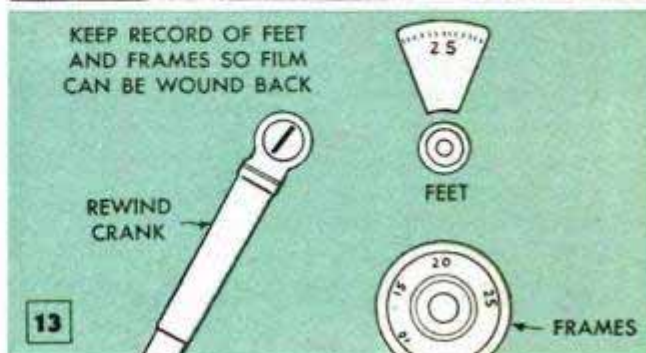

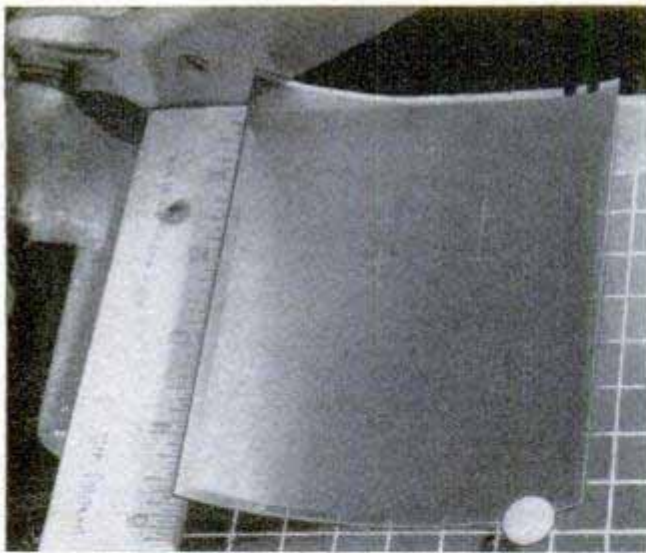

Trimming Film Before Developing To Fit Cut-Film Hangers

Although cut-film hangers are convenient for developing negatives from a film pack, the latter are a little too long to fit in the hangers and must be cut to size. This, of course, must be done in total darkness. To locate the negatives on the trimmer board in the dark, use a sheet of cut film to establish the exact size needed, and press a thumbtack into the board at the edge of the film opposite the blade. Then, when trimming the pack film in the darkness, it is necessary only to push the negative against the thumbtack to be sure that it will be cut to the proper size.

Handy Switch Controls Floor Lamp When Showing Color Slides

Turning a floor lamp on and off as needed when showing color slides is done quickly and conveniently if the lamp is connected to the projector cord. An extension cord for the floor lamp is wired in parallel to the projector cord, as in the wiring diagram, a female plug at the end of the cord receiving the lamp plug. A feed-through switch, which can be held in the projector-operator's hand, permits him to control the floor lamp instantaneously.

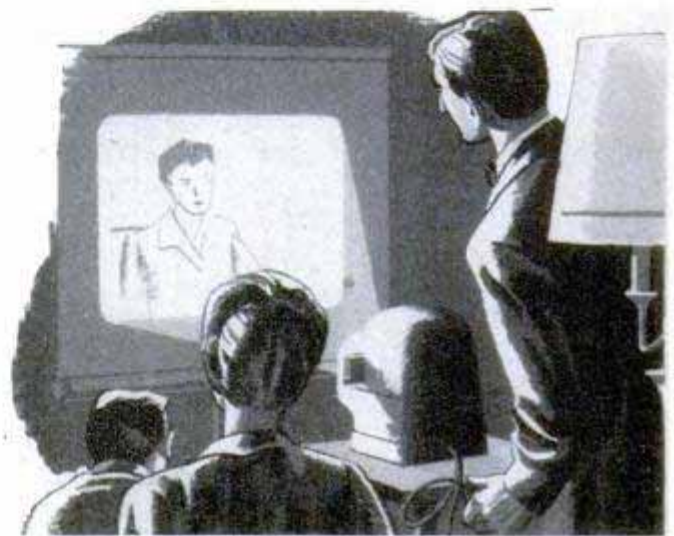

Music Box Mounted on Camera Holds Attention of Children

If a small music box is used to hold the attention of child subjects, it is no problem to get a couple of good pictures before the children become restless. A leather case riveted to the back of a reflex-type camera provides a convenient holder for the music box. On other types of cameras, the box can be mounted on any surface where it will not interfere with operating the camera.

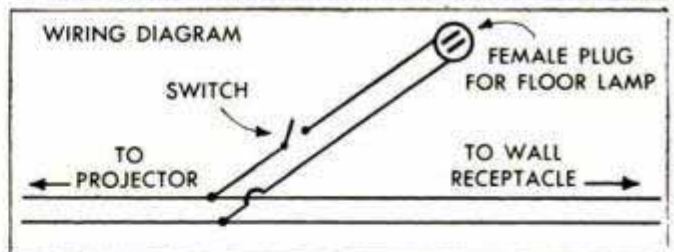

Books That Help You Get Things Done

Every man should have a home workshop. To assist the craftsman, Popular Mechanics had Sam Brown prepare a book called "Planning Your Home Workshop" which is available from our Book Department for \$2.50. In the book you will find shop floor plans, basic tools to start a shop, and the tools to add as you go along, as well as efficient shop arrangement, management, lighting and things to make.

Once your shop is established the Popular Mechanics series called "What to Make" and "Shop Notes" will keep you going indefinitely. There are eleven volumes of "What to

Make," and each one contains hundreds of things to make in your shop. The four issues of "Shop Notes" contain, in addition to things to make, hundreds of helpful ideas for the shop worker, farmer and garage-man.

For the fisherman, Popular Mechanics' "How to Tempt a Fish" is unbeatable. Not only does it contain 128 fact-packed pages, with 20 in brilliant full color, but also instructions for making fishing rods, nets, etc. There are many pages covering fly fishing, bait casting, and fresh and salt-water fishing. Three chapters are written by Joe Godfrey, Jr., world-famous authority on fishing.

What to Make, at \$1.75; Shop Notes, at \$1.00 per copy, and How to Tempt a Fish, at \$2.00 per copy, are available from our Book Department. Send for free complete catalog.

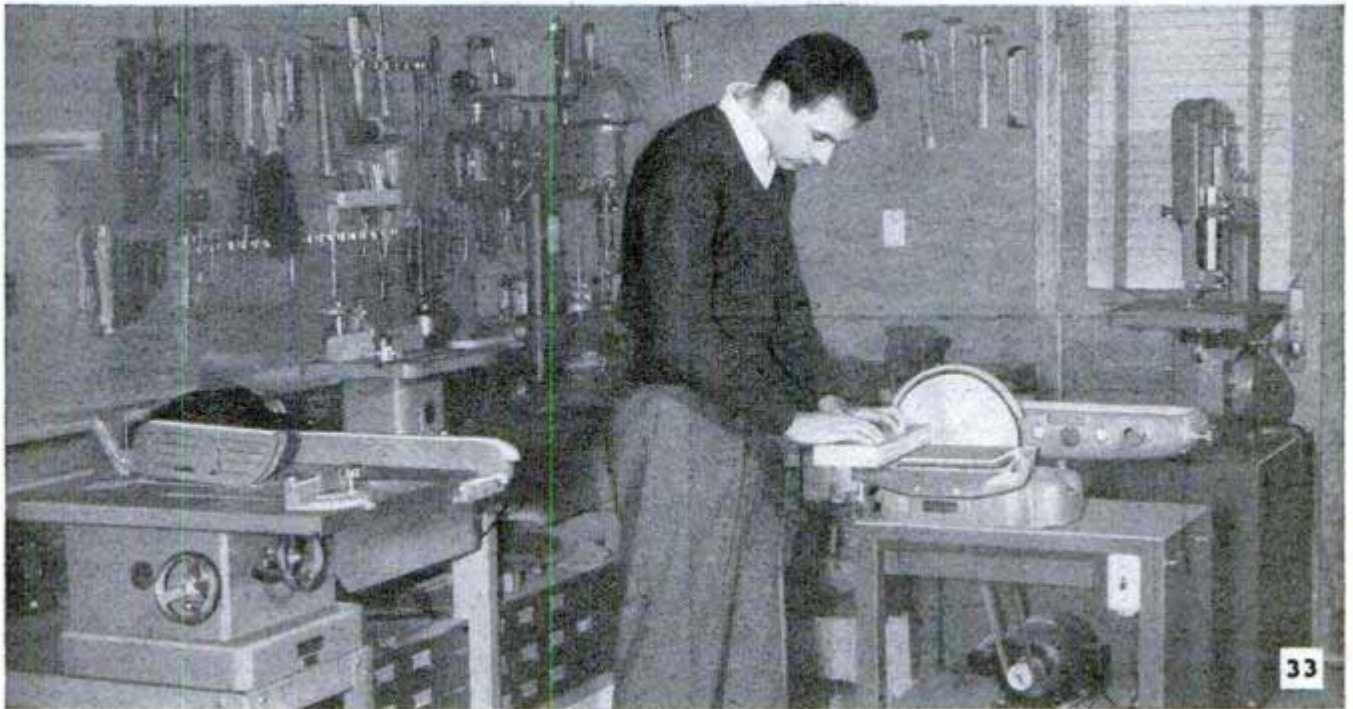

33

Photos and technical service courtesy "3M" Coated Abrasives Division, Minnesota Mining & Mfg. Co., St. Paul, Minn.

Use The Right ABRASIVE Part III

By W. Clyde Lamme

MOST HOME workshops now are equipped with at least one power tool that can be adapted to sanding, either with ready-made attachments or with those you can make yourself. As described in Part II of this story, hand-sanding methods can be relied upon to produce a very fine finish on cabinetwork, both on new projects and on old work. You can do the same thing by machine sanding and do it faster. Also, in its more general application, the power sander is an aid in shaping, squaring and smoothing a variety of small parts made from wood or metal. Small portable and stationary sanding machines are available for use in the home shop. These are of three general types, the disk sander, oscillating sander and belt sander. Disk and belt sanders are made in both the portable and stationary types but the oscillating sander is made only in the portable type. Besides the power-driven sanders, there are a number of attachments and accessories designed for other types of machines to adapt them to sanding operations.

In finishing new or old work by machine sanding, it usually is necessary to use the same abrasive-grit sequence as is used in

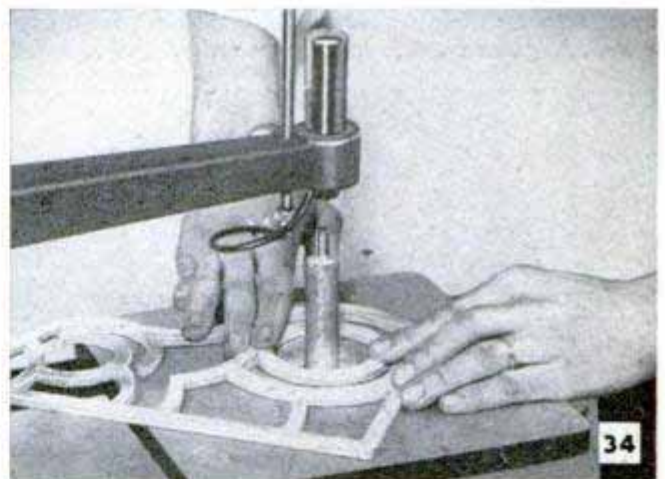

34

Above, this handy sanding attachment is available for small jigsaws. One face is convex and the other flat. Below, the small oscillating sander is just the thing needed to smooth narrow rounded edges



35

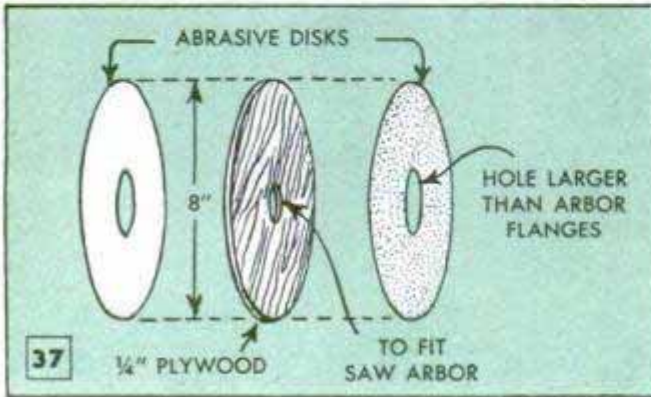
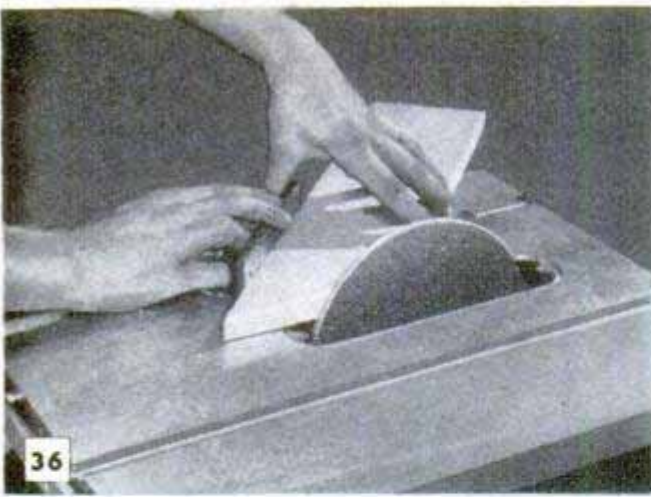

It's easy to make a disk sander for use on your circular saw by gluing abrasive to a disk cut from plywood. Angular work is quickly smoothed and squared

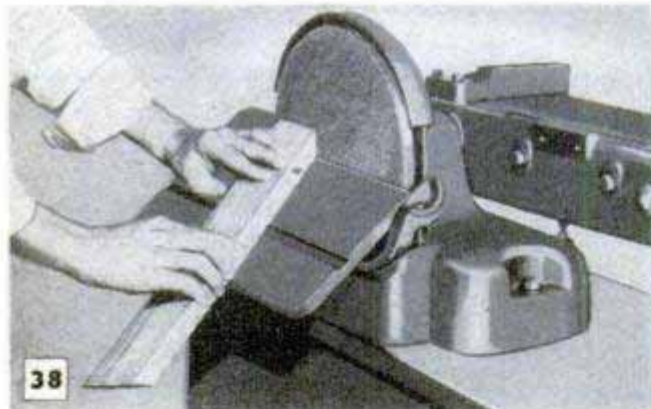

Above, compound angles can be formed on a machine like this. Below, flexible-disk sanding machine is useful for preliminary operations on wood and metal



hand sanding, that is, begin sanding with the coarse grade and progress to the finer grade. However, it should be kept in mind that on the machine, regardless of type, the individual abrasive grains are driven across the surface at much higher speeds than is possible in hand sanding. Owing to the overlap of the cuts made by each individual abrasive grain on the same area of the surface, machine sanding with the coarser abrasives will produce a somewhat smoother surface than the same grade of abrasive when used in hand sanding. Because of this characteristic of the cutting action, it is possible to produce a very smooth surface by first using a coarse abrasive to level and true the work and then following with a fine abrasive. Thus it is possible to produce a creditable job in two passes instead of three or four, as required in handwork.

Fig. 33 pictures a combination disk-belt sander, with the craftsman using the disk on a typical squaring operation on end grain. The rigid sanding disk is especially effective on this particular work, as it will square and smooth end grain ready for finishing in one operation if a medium grade abrasive is used. Fig. 38 shows the same type of combination machine with the disk being used to true a compound miter. Note that the machine table is tilted the required number of degrees. Home craftsmen who do not have this combination machine can utilize the circular saw as in Fig. 36. Simply cut a disk from plywood to 8 in. in diameter for an 8-in. saw and center-drill it to fit the saw arbor, Fig. 37. Then cut two abrasive disks and glue one to each side of the plywood disk. If desired, two different grades of abrasive can be used on the same disk. *Caution:* When operating this disk on the circular saw protect your eyes with goggles. Note in Figs. 33 and 38 that the sanding is done on the "down" side of the disk. Although it is permissible to sand narrow

The flexible disk works close to a raised edge such as that found on recessed panels. Owing to high speed and flexibility of the disk, it cuts very fast

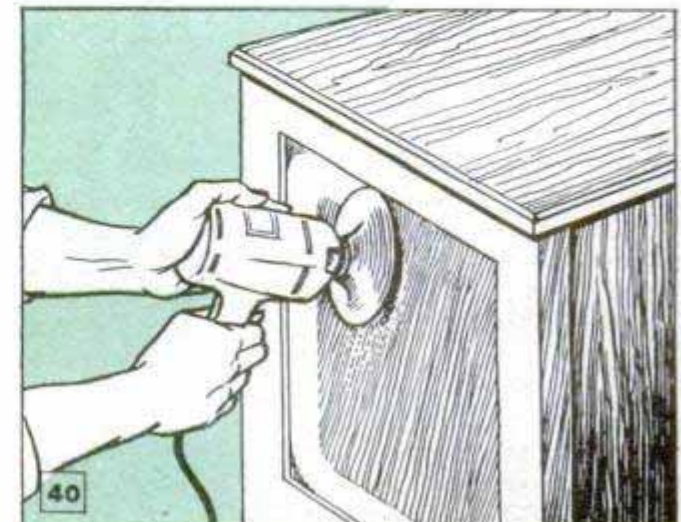

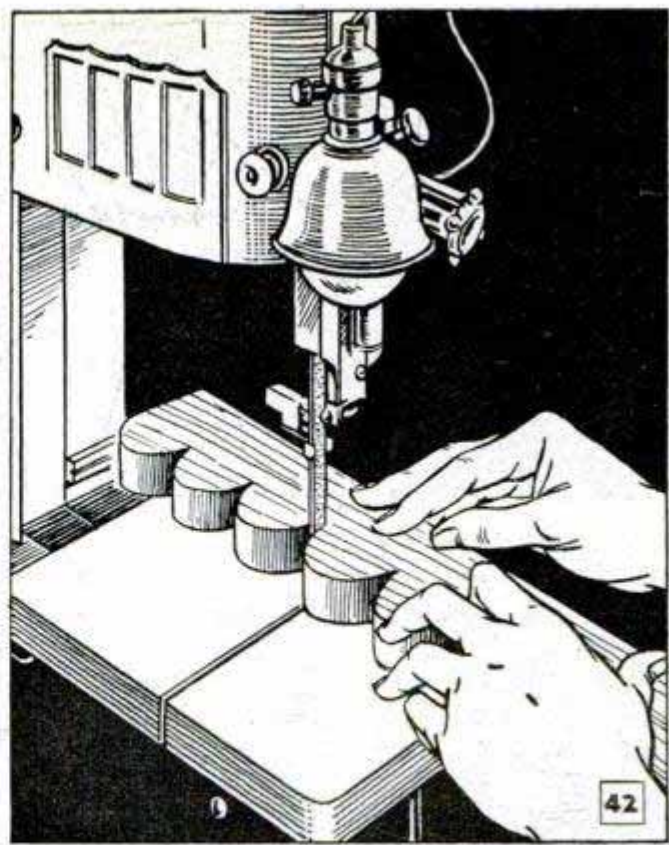
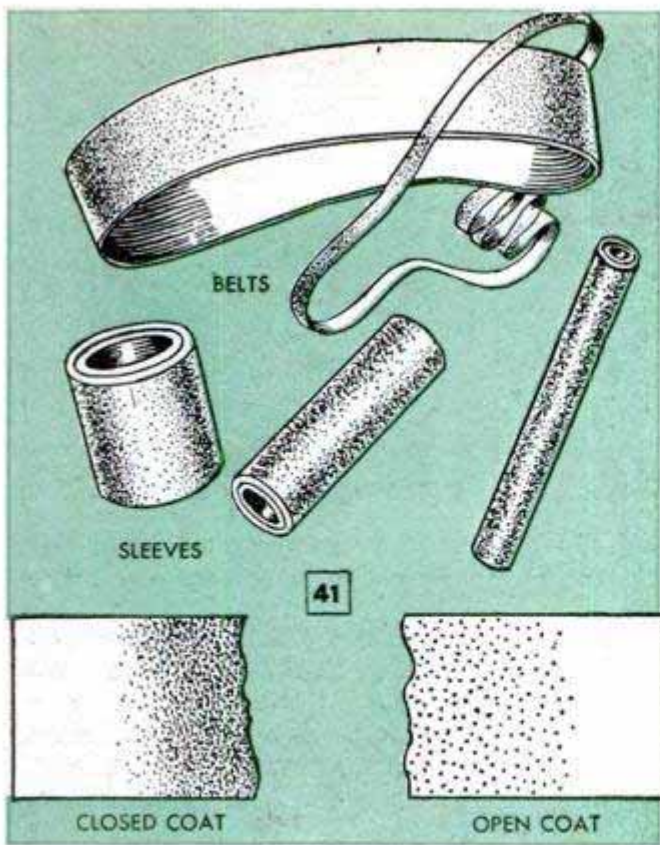

pieces on the "up" side and it also is necessary to use both sides of the disk when sanding end grain on wide work, the surface produced will not be quite as smooth as that sanded only on the side of the disk going down.

One of the handiest accessories for the owner of a jigsaw is the tiny sanding attachment shown in use in Fig. 34. One side is convex and the other is flat so that you can sand concave, convex or flat surfaces with equal facility. Fig. 34 pictures a typical operation on scrolled work. The small size of the drum, less than 1 in. across the flat face, enables the operator to get into corners and small openings such as are found in fine scrolled work. Another handy tool for the craftsman who specializes in

fine cabinetwork and model construction is the small oscillating-type sander pictured in Fig. 35. The sanding pad on this little machine is driven by a vibrating coil housed in the body. The sanding stroke is about $\frac{1}{16}$ in. and the pad is driven at a speed of over 7000 strokes per minute. At this speed, fine abrasive produces a glass-smooth job either on edges, which are difficult to sand, or on flat work. It will work effectively on both metal and wood but is designed only for light work. Other oscillating-type sanders, which operate with the same sanding action but are motor driven, are shown in Figs. 43 and 49. One, Fig. 43, consists of a frame and movable shoe, or pad, and is designed for attachment to a small portable drill. The drill motor drives

This oscillating sander unit is designed to be driven by a $\frac{1}{8}$ -in. portable electric drill. Machine leaves a smooth surface without ripples or long scratches

Small drum sanders are available as accessories in a wide range of sizes for use on shapers and drill presses. When driven at high speeds they sand fast

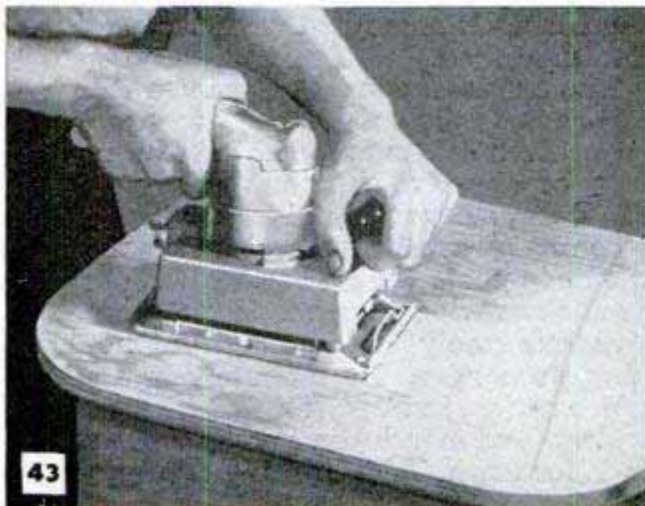

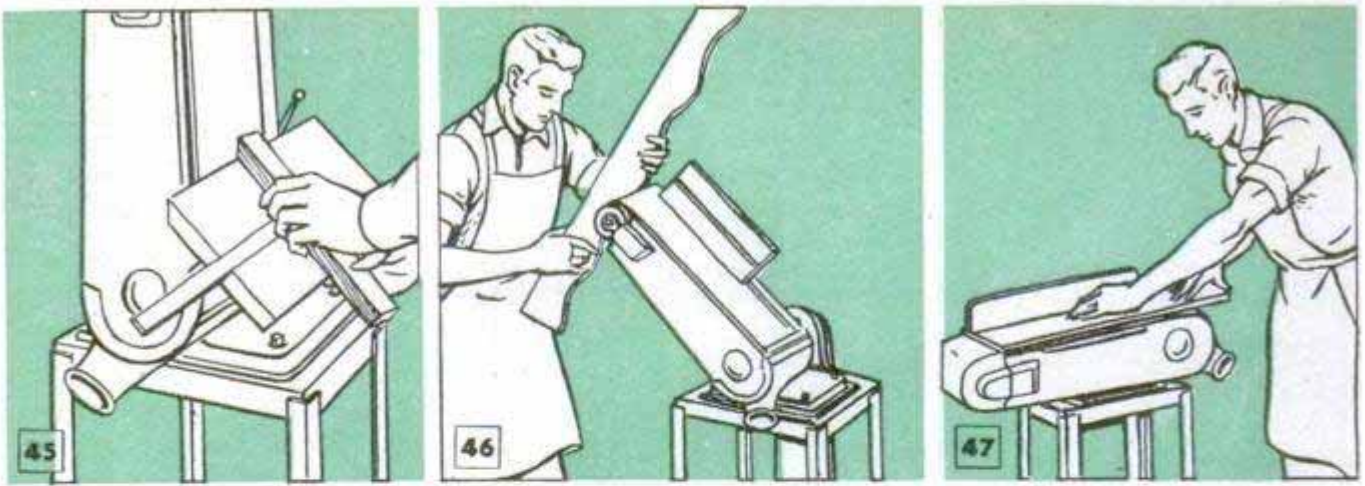

Stationary belt sanders of the type shown in the three views above are versatile machines widely used in small shops. The unit is fitted with a tilting table which is detached when sanding long pieces

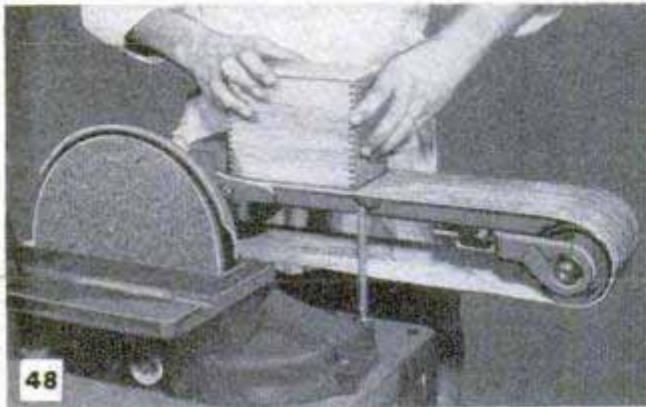

The combination machines are well adapted to finishing operations. The belt is used vertically also

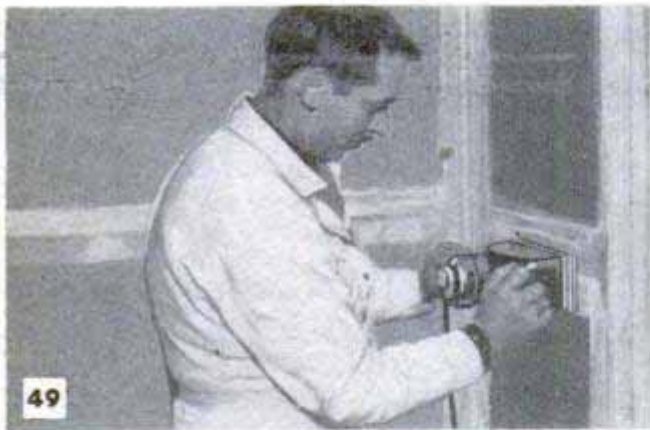

Standard-size oscillating sander has direct drive. Here it is shown being used to smooth taped joints

a special linkage which imparts an oscillating motion to the sanding pad. The other machine, typical of several which are available, has a direct-connected motor which drives a sanding pad of approximately the same size as that on the one just described. In the photo, Fig. 49, the machine is being used by a builder to smooth taped joints on plasterboard walls. Oscillating sanders are especially useful in preparing large surfaces for finishing, as they do a smooth job free from scratches or swirl marks.

Small rotating drum sanders with removable abrasive sleeves are designed for

attachment to various machines such as shapers, and drill presses. Fig. 44 shows one in operation sanding the edge of a piece of fairly heavy stock. The abrasive drum cuts very fast and the stock must be kept moving continuously while in contact with it as, otherwise, marks will be left on the surface. It can be worked on straight flat surfaces or edges and inside any opening having a radius greater than that of the drum. The drums are available in various lengths and diameters and suitable abrasive sleeves, Fig. 41, are readily obtainable.

Portable flexible disk sanders, such as those shown in Figs. 39 and 40, are widely used on a variety of sanding and grinding operations. The flexible disks with short built-in spindles for attachment to flexible shafts and drill chucks, are available as accessory units. Ready-cut abrasive disks are furnished in a variety of sizes for use with these units. In use, the flexible disk sander is tilted slightly so that only one side contacts the surface. It is moved over the surface in a dual motion, back and forth and forward simultaneously. The exception is shown in Fig. 40, where it is necessary to sand close to the edge in a recessed panel. Here the disk is tilted and the sanding progresses in one direction around the edge of the panel. Then the unsanded portion in the center is smoothed with the dual motion described.

The bandsaw sanding attachment in Fig. 42 converts the small bandsaw into a fast, accurate belt sander utilizing the narrow belt, or abrasive "ribbon," shown in Fig. 41. Belts, sleeves and disks for the various machines are quite generally available. On the open-coated type, Fig. 41, the abrasive grains are widely spaced to give the abrasive extremely fast-cutting and nonclogging properties. Belt sanders of the two types shown in Figs. 45 to 48 inclusive are widely used in industry and by home craftsmen for diversified finishing operations.

THE END

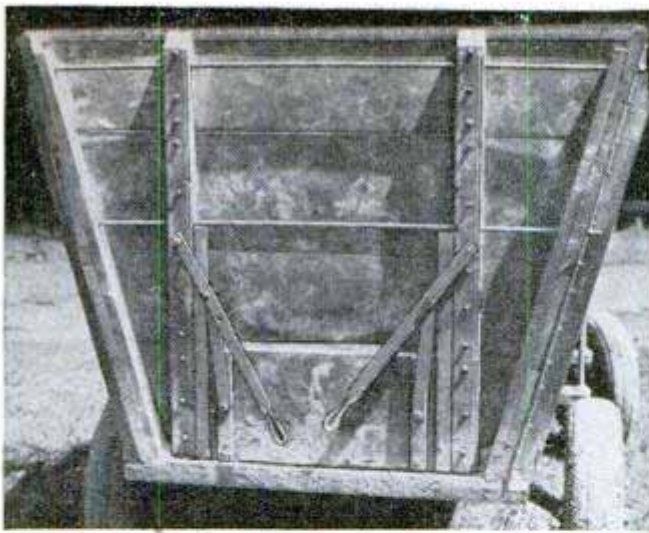

Unloading Gate in Trailer Box Is Lever-Controlled

To simplify the unloading of small grains from a tank-type trailer box at the farm elevator, one farmer fitted a lever-controlled unloading gate over an opening cut in the rear endgate. The arrangement makes it easy to control the flow of small grains into the elevator hopper when unloading from the trailer. The gate is a single piece of selected hardwood, sliding in angle-iron guides which are attached to the endgate cleats. Levers made from flat iron are attached to the ends of the gate by flat-iron links and small bolts. Raising both levers simultaneously lifts the gate. When the gate has been raised to the required height, one lever is held stationary while the other is forced down lightly. This movement wedges the gate in the guides and holds it securely in position until released by a reverse movement of the levers.

W. T. M. Concrete Design of Concrete Stock Tank Resists Damage From Ice

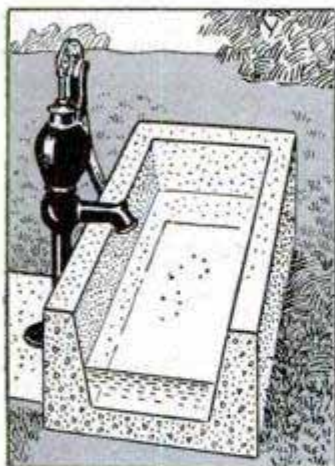

Small concrete stock tanks of conventional design are likely to crack if the water in them freezes solid, especially if the water level is low. One farmer found by experiment that monolithic concrete tanks with sloping inner sides and ends were extremely

resistant to damage, even when the water in them froze solid. All that is necessary in making this type of tank is to construct the form with sloping sides and ends. The slope should be about 5 to 7 deg. If desired, the form can be dug out of firm soil.



Furrower Spaces Potato Rows For Tractor Cultivation

A perennial problem confronting Corn Belt farmers who do not have potato-planting equipment is laying off rows in the small potato patch to equal widths so that, later on in the season, the plants can be cultivated with a mounted tractor cultivator. One farmer solved this problem by removing the beam spacer from an old horse-drawn two-shovel cultivator and cutting off the ends of the shovel beams to shorten them. Then he welded new spacers between the beams to space the shovels to the required center-to-center distance. The original wooden cultivator handles were retained in the new assembly as pictured. In use, a helper guides the furrower and holds it at a uniform depth by means of the handles. For one-man operation, the shovel beams are pivoted so they can be raised and lowered by the tractor hydraulic lift.—L. H. Houck, Jefferson City, Mo.

Auto Valve Holds Loose Pump Rod

A disconnected pump rod is kept from dropping into the well pipe by wedging an old auto valve between the rod and the pipe. The valve is removed easily when the pump is installed.

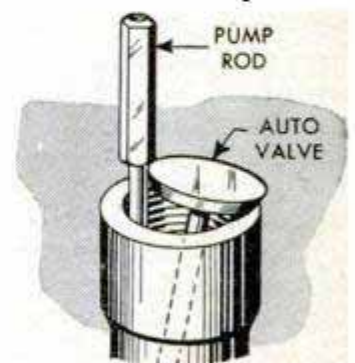

☐ Dry yellow ocher mixed with boiled linseed oil forms a durable putty for patching eaves trough, metal roofs and tanks.

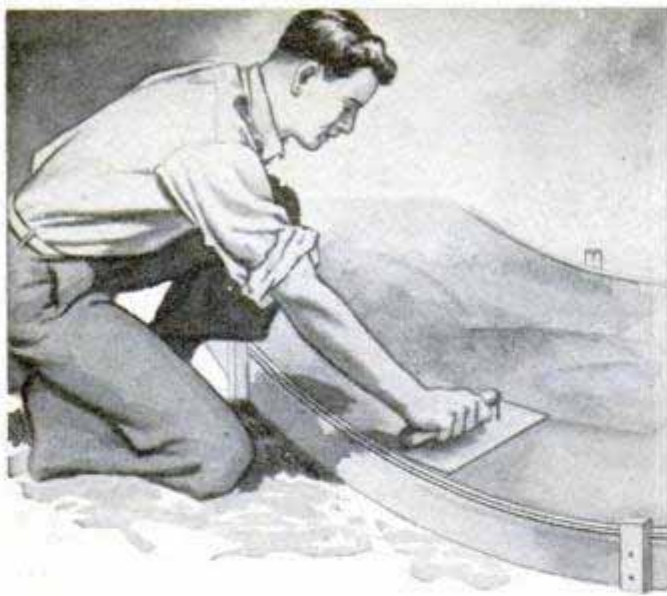

Two-Piece Sidewalk Forms Are Bent Readily

Two thin strips are better than one thick one when staking out forms for a curved walk or driveway. In this way, a smaller radius is possible and a more natural and uniform curve is produced. As shown in the drawing, an inside stake is used to force two 1/4-in.-thick strips into position. Then, when the desired curve is had, the ends of both pieces are nailed to outside stakes and the inside stake is removed. If you wish, short nails can be driven through the pieces here and there throughout the curve to give added rigidity to the form.

W. H. McClay, Pasadena, Calif.

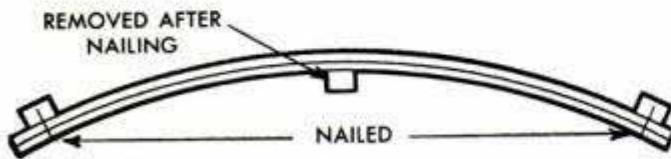

Easily Made Baby-Chick Creep

Baby chicks, penned in small enclosures because of lack of yard space, will develop faster if they are allowed to run at large

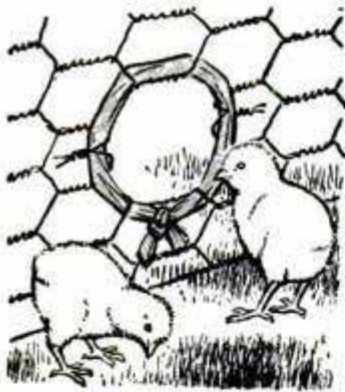

during a part of the day. To permit the chicks to pass in and out of the pen at will, cut one twisted strand of the woven-wire netting, as indicated, and bend the ends back. Then weave a strip of white cloth around the opening. Guided by the white

cloth ring, the chicks quickly learn to find their way in and out of the enclosure through the enlarged hole in the netting.

Stand for Small Display Sign Improvised From Paper Clips

Needing some method of propping a small display sign on top of the cash register in my store, I hit upon the idea of using spring-type paper clips to provide a stand for the sign. I simply bent the arms of the clips outward to form a wide base and snapped the clips to the lower edge of the sign.—Robert L. Gromer, Taft, Calif.

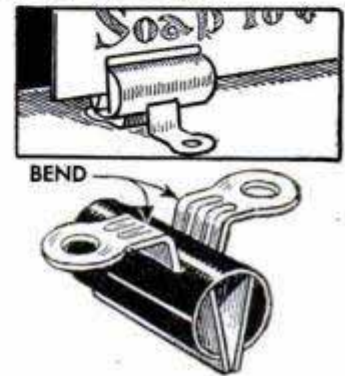

Floating Landing-Net Frame Utilizes Tennis Racket

Using an old tennis racket to provide the frame for a fisherman's landing net results in a sturdy, long-lasting net that will float in case it is dropped into the water. Remove the strings from the racket and simply attach an ordinary landing net to the racket frame.—Harold E. Cripe, Racine, Wis.

Outdoor Milk-Pail Rack Permits Drying Containers in Sun

To promote cleanliness in handling milk and also to save himself time, one dairyman built this outdoor drying rack for milk pails and cream-separator parts which must be regularly washed and dried. The rack is located so that the sun will shine directly into the pails when they are placed in the rack with the open ends up. The legs supporting the rack are of angle iron set into the ground about 18 in. and anchored in concrete. The rack consists of three pieces of light angle iron welded to angle braces and to the legs as shown. The horizontal members are spaced so the pails can be inverted to permit draining.

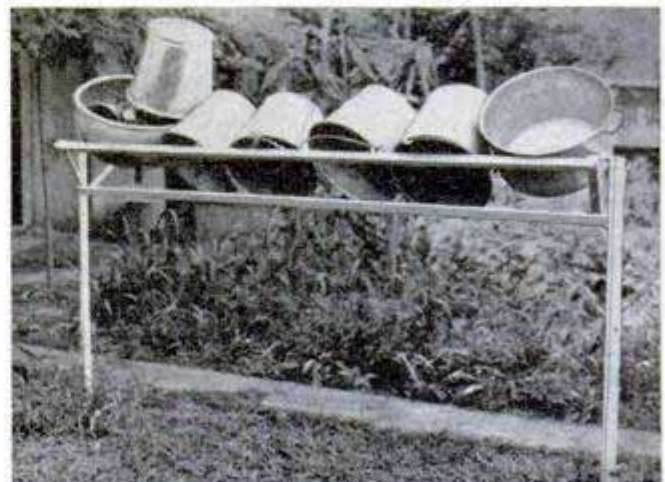

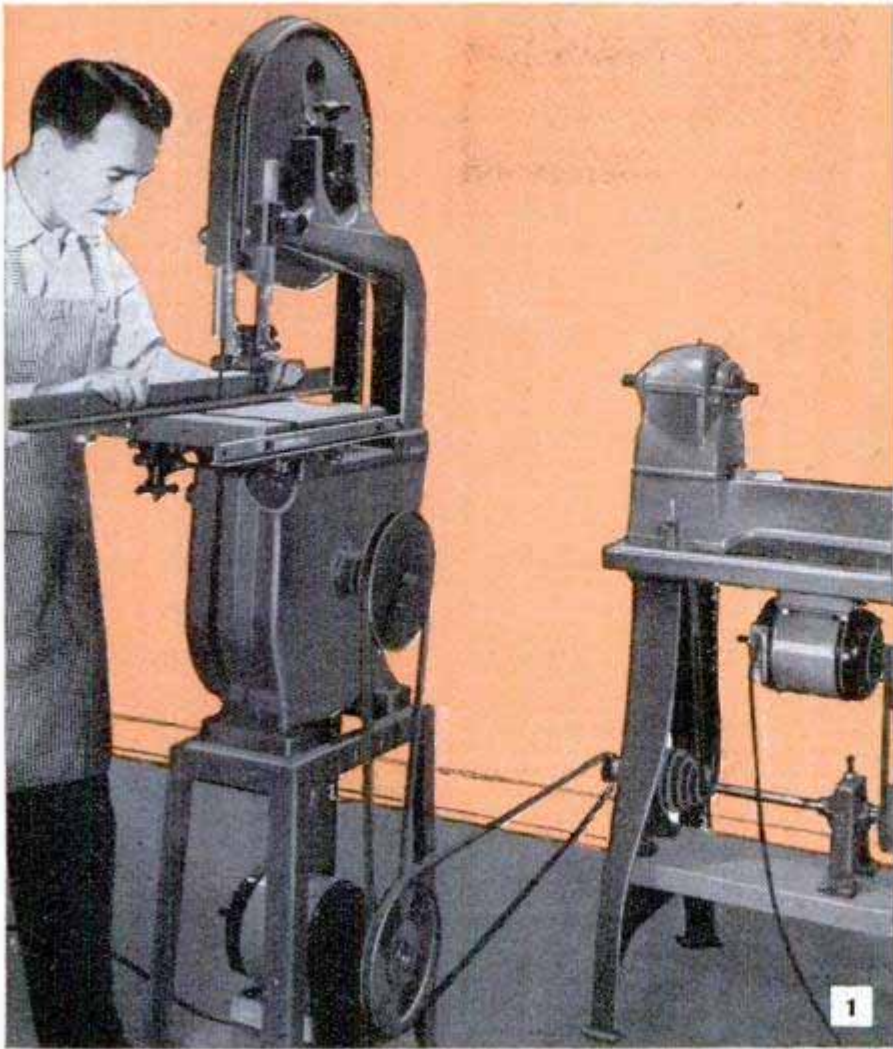

By Sam Brown

WITH METAL-CUTTING blades now available in sizes and gauges suitable for use on small bandsaws, home craftsmen having metal to cut into lengths or shapes can convert these small machines into power-driven band hacksaws. Any wood-cutting bandsaw having band wheels 9 in. or more in diameter can be used for cutting metal. Of course, the smaller machines are suitable only for light work on small pieces of metal. The metal-cutting bandsaw blade makes a square, smooth cut with no ripples or ridges and it does the job in a fraction of the time required in hand hacksawing.

Reducing blade speeds: Average blade speeds for wood-cutting bandsaws range from 2000 to 3000 f.p.m. (feet per minute) although some later-model machines operate with blade speeds up to 4500 f.p.m. In cutting metal, especially when cutting steel and other hard materials, it is necessary to reduce the blade speed to an average of 200 f.p.m. to avoid undue heating and clogging of the blade. Fig. 1 shows one way to do this by utilizing the lathe countershaft for the first reduction. The pulley hookup and the ratio of pulley-sizes is detailed in Fig. 2. The second reduction is made through a 2-in. pulley on the outer end of the lathe countershaft driving an 8½-in. pulley on the bandsaw motor which serves as a second jackshaft. The third reduction, as you can see, is made through a 2¾-in. pulley on the motor shaft driving an 8-in. pulley on the bandsaw. This reduces the band-wheel speed to 52 r.p.m. In this speed-reduction arrangement, the lathe motor is used to drive the setup. Fig. 3 details an alternate hookup giving 57 r.p.m. at the bandsaw pulley. In

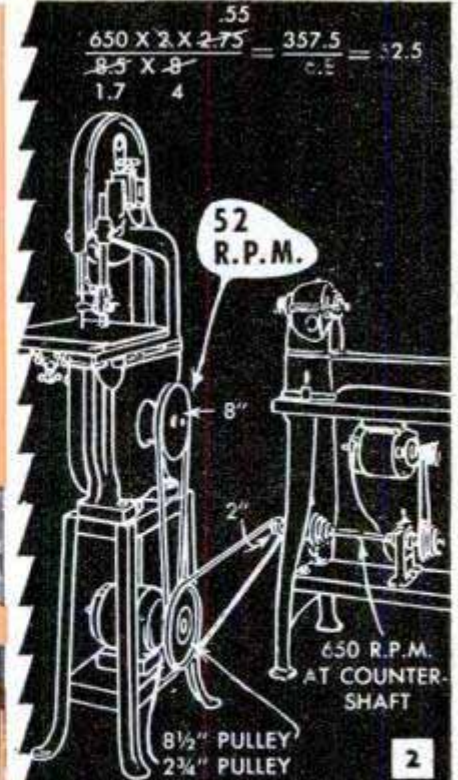

SAWING METAL on Your BAND SAW

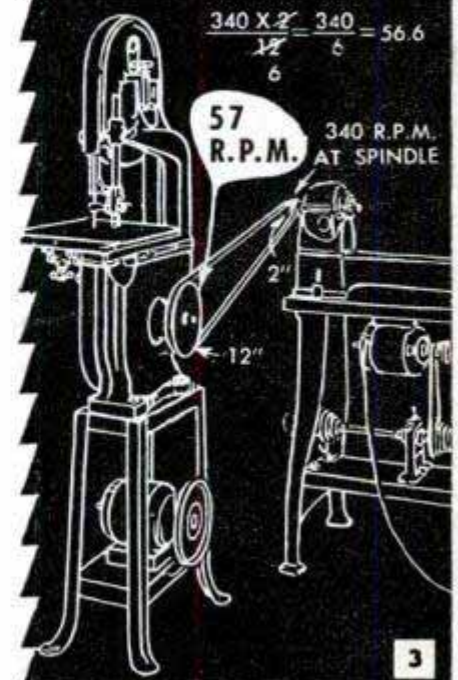

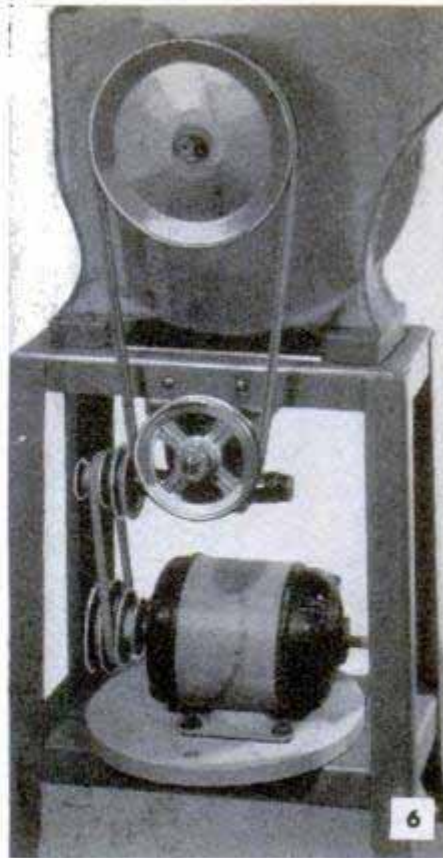
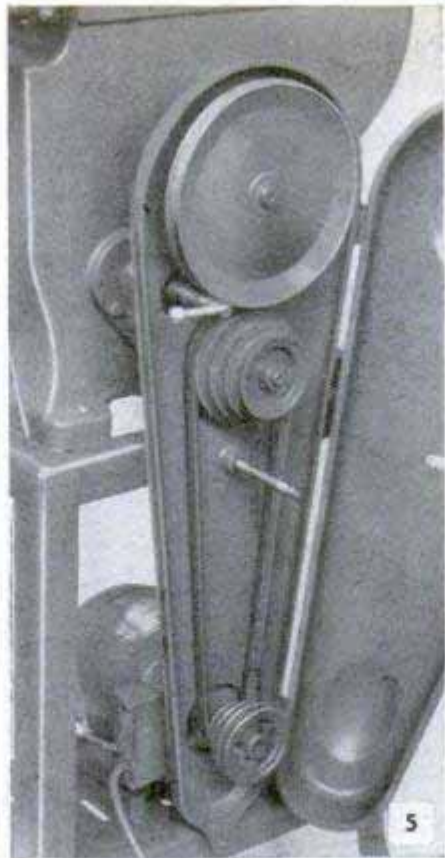
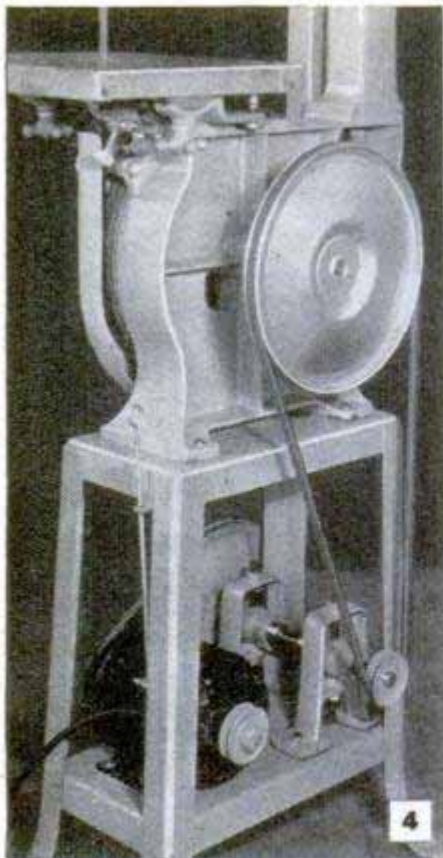

COUNTERSHAFT MAKES A CONVENIENT SETUP. THE USUAL PULLEY ARRANGEMENT IS 2" TO 10" AND 2" TO 12" WHICH GIVES APPROX. 60 R.P.M. (ABOUT 225 F.P.M. WITH 14" BANDSAW)

$$\frac{350}{1750} \times \frac{2 \times 2}{10 \times 12} = \frac{350}{58.3} \text{ R.P.M.}$$

STANDARD TYPE OF METAL-CUTTING BANDSAW, SHOWN ABOVE, USES A BUILT-IN GEARBOX GIVING FOUR SPEEDS OF 125, 175, 250 AND 340 F.P.M. DIRECT DRIVE IS 2200 F.P.M. GEAR-DRIVE BANDSAWS COST SLIGHTLY MORE THAN SIMILAR SINGLE-SPEED MACHINES.

RELATIVELY INEXPENSIVE GEARBOXES CAN BE USED. THE SETUP SHOWN USES 30 TO 1 RIGHT-ANGLE DRIVE, AND WITH FOUR-SPEED CONE PULLEY GIVES SPEEDS OF 70, 110, 150 AND 250 F.P.M. A DIRECT DRIVE FOR WOOD SAWING IS OBTAINED BY TURNING MOTOR WHICH IS BOLTED TO A PIVOTED WOODEN BASE.

either arrangement, you have the advantage of the speed reductions available through the lathe countershaft. Referring to Table II you will see that the 52-r.p.m. speed of the bandsaw pulley, Fig. 2, gives the desired 200-f.p.m. blade speed on 14-in. band wheels. Although not indicated, the installation shown in Fig. 3 should either be bolted to the floor or to a spreader board for best results. This is not necessary with the type of arrangement shown in Fig. 2. Other speed-reducing drives are shown in Figs. 4, 5 and 6. The drive shown in Fig. 5 is the regular speed-reducing unit supplied with a well-known make of metal-cutting bandsaw. Others shown in Figs. 4 and 6 are improvised from standard machine parts.

The metal-cutting blade: Select the blade for the work according to the data given in Table I. This table is merely representative. It does not include the recommendations of all manufacturers of metal-cutting bandsaw blades. Of course, you can do a lot of ordinary work with just one blade, about 18-pitch with a raker set. The main thing to keep in mind in blade selection is the thickness of the work in relation to the number of teeth per inch. There must be at least two teeth in contact with the work

at all times, otherwise you will have trouble with blade breakage. If fast cutting is required, use the coarsest pitch and the widest blade the work will permit. For a smooth finish and slower cutting, use a medium or fine-pitch blade. Use the standard-tooth blade on steel and other hard materials and the buttress, or skip-tooth, blade on soft, nonferrous metals and wood. Note the details at the left of Table I. A good all-around blade combination for home-shop work consists of a $\frac{3}{16}$ or $\frac{1}{4}$ -in., 6-pitch buttress blade for wood and soft metals and an 18-pitch standard-tooth blade of the same width for steel. Where possible, use wood and metal-cutting blades of the same gauge and width.

Cutting tubing and bar stock: One of the principal uses of the bandsaw fitted for cutting metal is cutoff work on metal tubing and also round and square stock. To prevent round stock from turning while being cut, it is necessary to provide some means of holding the stock securely. Suitable clamping arrangements can be improvised easily as in Figs. 10, 11 and 12. The hardwood V-block, Fig. 12, is the easiest to set up and is, in some respects, the best for average work. It is guided by a wood or

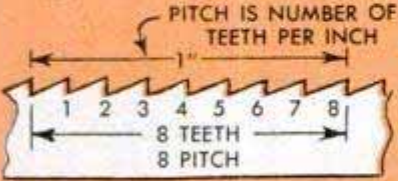
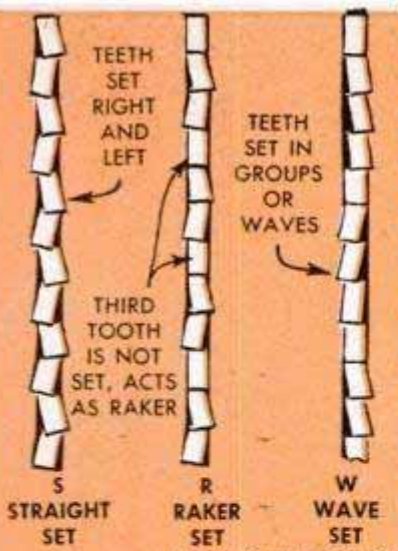

STANDARD TOOTH SHAPE
(USED FOR METAL CUTTING)

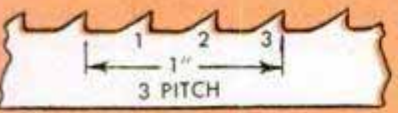

BUTTRESS TOOTH SHAPE
(USED FOR WOOD AND OTHER SOFT MATERIALS)

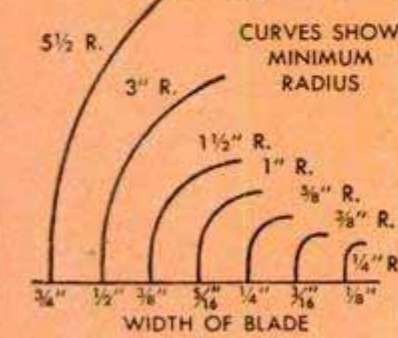
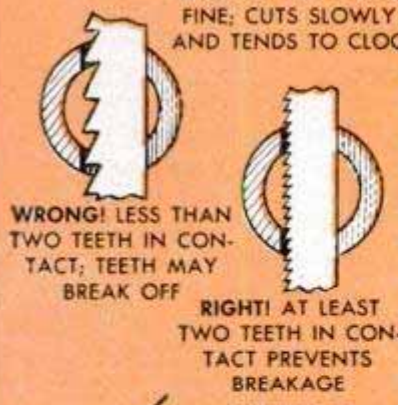
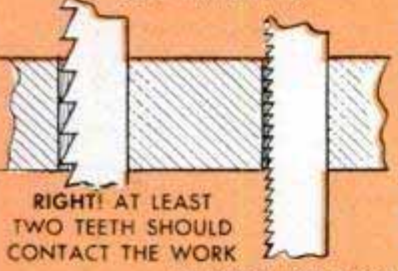

USE THE WIDEST BLADE WHICH WILL MAKE THE CUT

Table I BLADE SELECTOR FOR ALL MATERIALS (1)

MATERIAL	SAW PITCH AND SET (2)				SAW SPEED IN F.P.M. (3)			
	WORK THICKNESS				WORK THICKNESS			
	1/16"	1/4"	1"	3"	1/16"	1/4"	1"	3"
ALUMINUM	18S	10S	8S 4B	6S 4B	2400	2400	2000	1500
ASBESTOS SHEETS	24R	14R	8R	4B	2000	1800	1500	1200
BABBITT OR LEAD	14R	10R	8R 4B	6R 4B	2400	2400	1800	1500
BRAKE LINING	10R	10R	6R	4B	2000	1500	1000	1000
BRASS	18S	14S	10S	8S	2400	2000	1500	1200
BRONZE	18R	14R	10R	8R	500	300	200	140
HARDBOARD	10S	8S	6S 4B	6S 4B	3000	2400	2400	2400
SOFTBOARD	10S	8S	6S 4B	6S 4B	3000	3000	2400	2400
COPPER	18S	14S	10S	8S	1200	800	500	300
CAST IRON	18R	14R	10R	8R	200	160	100	75
MAGNESIUM	14S 8B	10S 6B	10S 4B	8S 4B	3000	2400	2400	2400
PLASTICS	18S	14S	8S	6S 4B	2400	2400	2400	2400
PAPER	10S	10S	8S	6S 4B	1500	1000	1000	1000
HARD RUBBER	24S	18S	8S	6S 4B	3000	2400	2400	2400
SLATE	24R	18R	14R	10R	300	200	160	100
CARBON STEEL	24R	18R	10R	8R	250	200	180	140
MILD STEEL	18R	14R	10R	8R	250	200	180	140
STEEL SHAPES	24R	18R	10R	8R	180	140	120	100
STAINLESS STEEL	24R	18R	10R	8R	100	75	50	50
STEEL TUBING	32W	24W			180	140		
WOOD	14S	10S	8S 6B	6S 4B	3000	3000	3000	2400

(1) ADAPTED FROM TABLES BY DOALL AND OTHERS (3) SPEEDS LISTED ARE NEAR MAXIMUM - LESS SPEED IS SATISFACTORY AND SIMPLY MEANS LOWER CUTTING RATE.
 (2) CAN BE VARIED WIDELY; 18-PITCH, RAKER-SET METAL-CUTTING BLADE IS BEST FOR GENERAL USE.

Table II BANDSAW SPEEDS-F.P.M. TO R.P.M.

WHEEL DIAMETER IN INCHES	FEET PER MINUTE										
	100	120	140	160	180	200	250	300	400	2400	3000
	REVOLUTIONS PER MINUTE										
9	42	51	59	68	76	85	106	127	170	1015	1270
10	38	46	54	61	69	76	95	115	152	920	1150
11	35	42	49	55	62	69	87	104	138	832	1040
12	32	38	45	51	57	64	80	95	128	764	955
13	29	35	41	47	53	59	73	88	118	706	883
14	27	33	38	44	49	54	68	82	108	695	819
15	25	31	36	41	46	51	64	76	102	611	764
16	24	29	33	38	43	48	60	72	96	573	716
18	21	26	30	34	38	42	53	64	84	510	637
20	19	23	27	31	34	38	48	57	76	459	574

EXAMPLE SHOWING USE OF TABLES: 14" BANDSAW CUTTING MILD STEEL 1/2" TO 1" THICK

FROM TABLE I { BLADE SHOULD BE 10R (10 TEETH PER INCH, RAKER SET).
 I { SPEED SHOULD BE 180 F.P.M.

FROM TABLE II { 14" BANDSAW TO RUN AT 180 F.P.M. MUST ROTATE AT 49 R.P.M.
 II

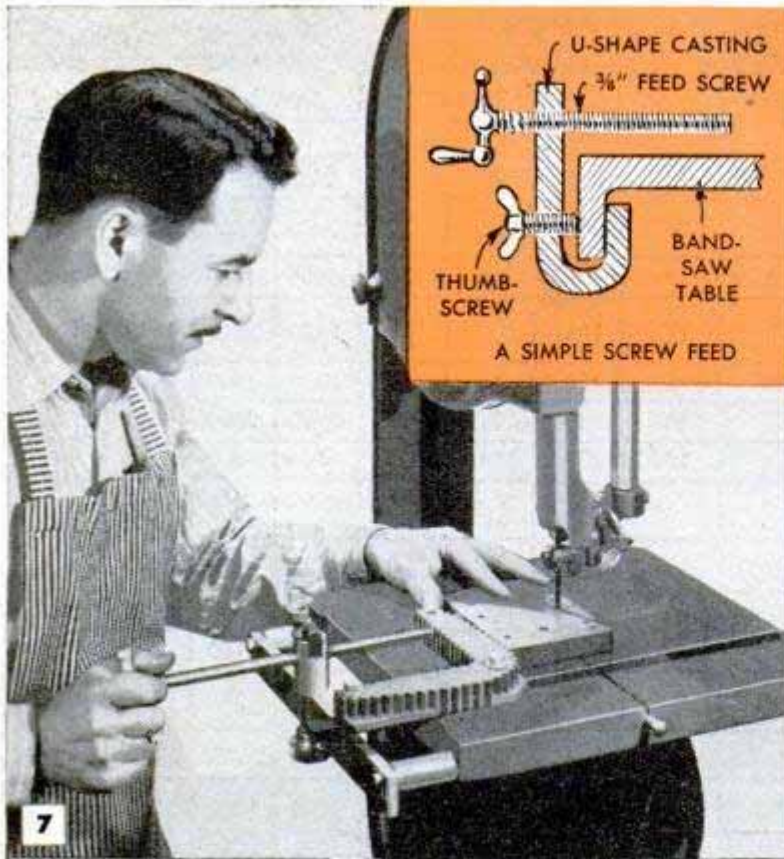

7

A SCREW FEED SAVES EFFORT WHEN SAWING THICK METAL

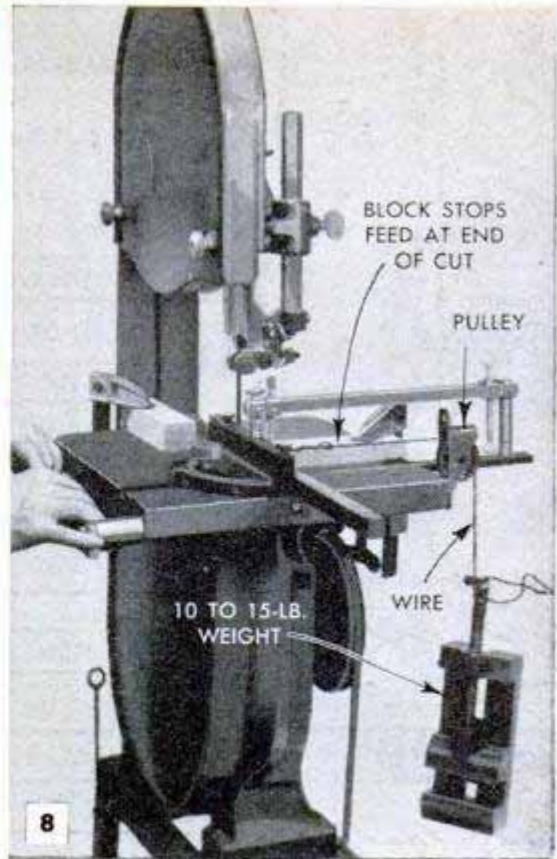

8

WEIGHT PROVIDES STEADY, UNIFORM FEED

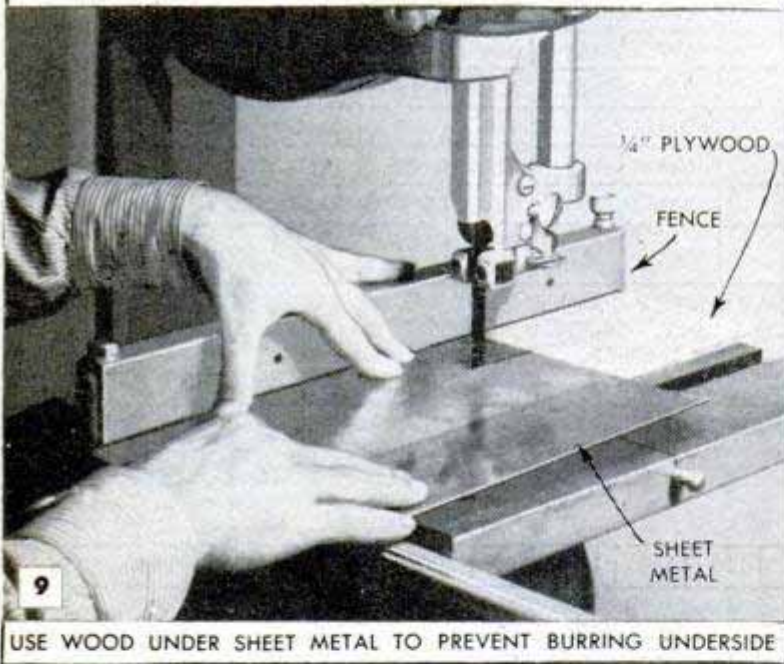

9

USE WOOD UNDER SHEET METAL TO PREVENT BURRING UNDERSIDE

metal bar which fits in the miter-gauge groove milled in the saw table. Another similar device which is quite convenient on small work is pictured in Fig. 10. This also is controlled by a guide bar. On tables not milled for the miter-gauge guide, an ordinary drill-press vise can be used with the guide setup shown in Fig. 11. The vise holds the work and slides against a wooden guide clamped to the machine table. Note that the wooden guide also supports the work to prevent it from tipping under the stress of sawing. Of course, the drill vise must be of the type having both sides milled flat, without any projections.

Mechanical feed: When cutting round

stock, the feed usually is freehand, but this can get pretty tiresome when long cuts must be made in heavy, flat stock. Ready-made mechanical feeding devices are available for most small machines and it also is possible to improvise several that work very well. One type of standard attachment for metal-cutting bandsaws is pictured in use in Fig. 7. The feed is controlled by a hand-actuated screw and the unit can be adjusted to make either straight or curved cuts. The V-shaped jaw, shown bolted to a guide bar in the setup in Fig. 7, also can be used free on small pieces which the "V" will span. In this application, the work is set with its corners in corresponding notches on the edges of the "V" and the feed screw is run up until it bears against the back of the jaw. Turning the screw in forces the work against the blade. By placing the point of the screw successively in adjacent notches as the cut progresses, it is possible to produce cuts of a regular curve. The inset detail in Fig. 7 shows how a similar feeding device may be improvised. A small U-shaped casting is drilled and tapped for a 3/8-in. feed screw and a small thumbscrew as shown. This unit is clamped to the lip at the edge of the machine table. For light work the device serves the purpose very well, but it is not suitable for heavy work where the feeding pressures

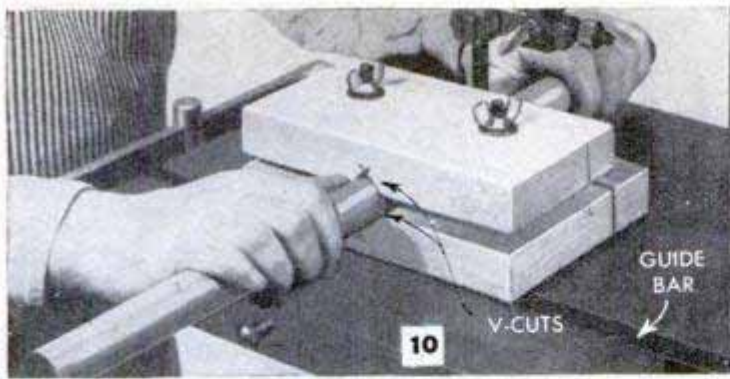

are quite high. Perhaps the best feeding arrangement of all for average use is the weight feed which automatically maintains a uniform tension on the work. On a small bandsaw, it is possible to improvise a satisfactory weight feed as in Fig. 8. A 10-lb. weight provides the correct feeding pressure for cutting steel up to 1 in. thick. Fifteen to 25-lb. weights are about the limit on small bandsaws as heavier weights will cause rapid wear and possibly breakage of the blade guides. As you can see, the setup is simple. A pulley (a window-weight pulley will do) is bolted to a corner of the machine table. A cord or wire is attached to the miter gauge and passed through the pulley to support the weight, which can be anything available that weighs the correct number of pounds. The miter-gauge clamp locks the work in place and stop blocks are clamped to the machine table as indicated. In use, the work is located and clamped in place and the machine is started. No further attention will be necessary until the cut is completed.

Sawing thin stock: Thin sheet metal cut by bandsawing has a tendency to form high burrs on the underside. This can be minimized by placing the work on a piece of plywood as in Fig. 9. On thin sheet metal a fine-pitch blade (24 or 32) with a wave set gives the best results. However, for an occasional job in sheet-metal cutting, you can use a coarser blade by feeding slowly with a very light pressure. As a rule, sheet metal is cut by friction sawing but, of course, this method requires a machine capable of very high wheel speeds. The minimum blade speed required in friction sawing ranges from 3000 f.p.m. upward. Best results will be had with blade speeds ranging between 4000 and 5000 f.p.m. This

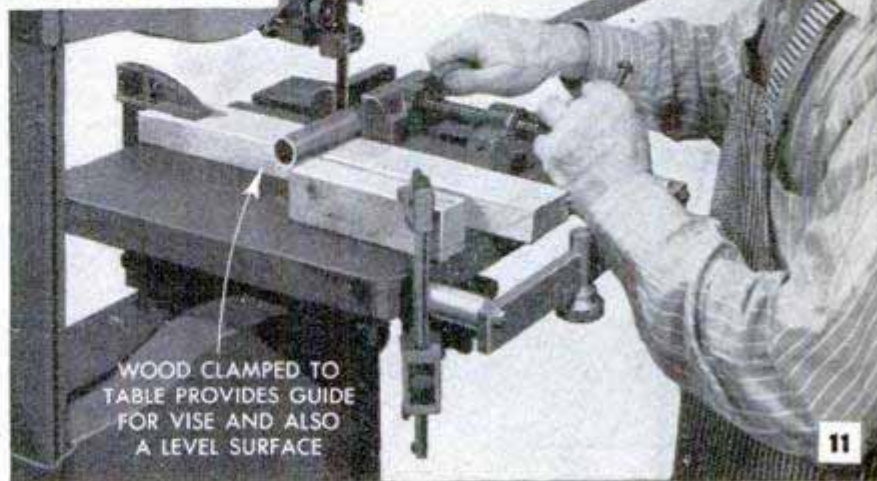

TUBING SHOULD ALWAYS BE SECURELY CLAMPED TO AVOID ROTATION

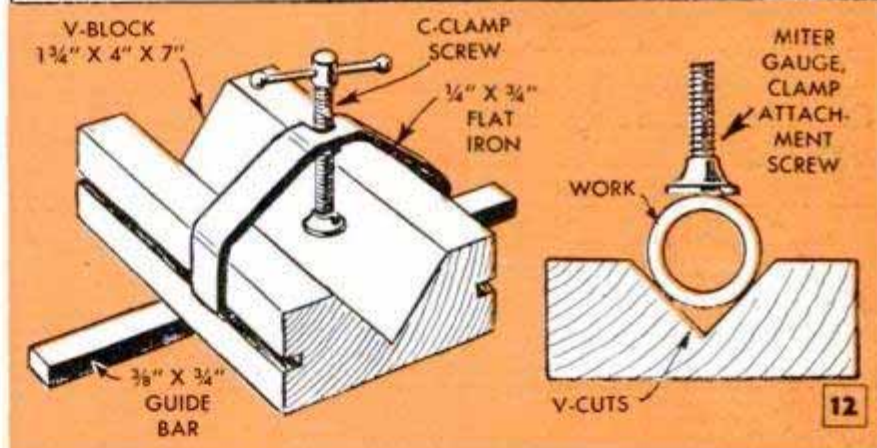

would mean that a 14-in. bandsaw would have to be run at wheel speeds up to 1200 r.p.m. Many small machines are not designed to withstand the required wheel speed with a sufficient margin of safety. For this reason, it is recommended that if friction sawing is done on the small machines the drive be arranged so that blade speeds do not exceed 3000 f.p.m.

General sawing technique: If you are accustomed to operating a bandsaw, you will have no difficulty in cutting metal with the same machine. About the only difference is that in metal cutting the machine operates at a greatly reduced speed and more pressure is required to keep the blade cutting uniformly. Start the cut slowly with light pressure. After the blade is "bedded" in the stock to its full width, the feeding pressure can be gradually increased. It is important to keep the blade cutting uniformly, as otherwise it will tend to heat and clog.

Gauge Speeds Setting Lathe Tool When Facing Bored Work

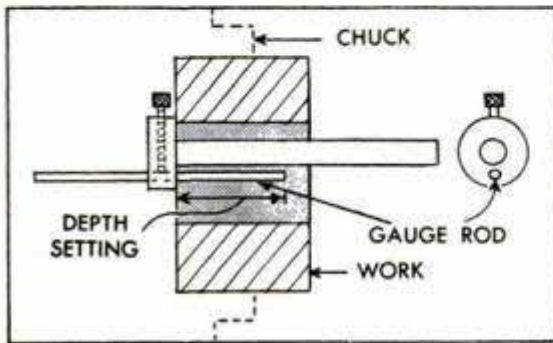
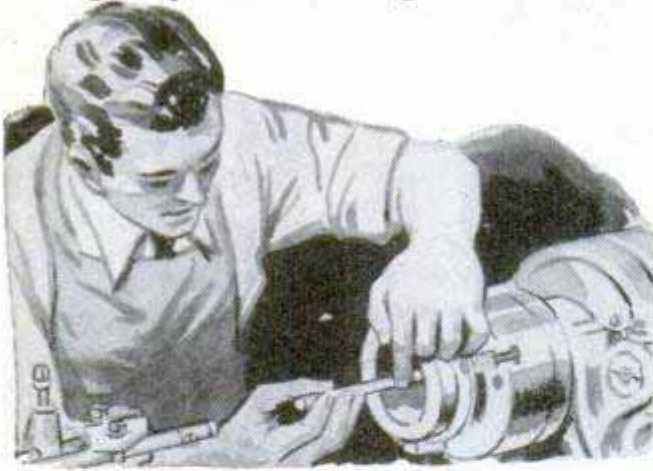

This simple gauge provides a quick, accurate way of setting a lathe tool to make the finish facing cut on bored work. The body of the gauge is a short length of steel shafting having a flange set over one end in a force fit. The flange forms the required shoulder and saves the waste of turning down a suitable part from solid stock. The flange is drilled longitudinally to take a length of drill rod which has been faced at both ends to serve as a gauge rod. The flange also is drilled and tapped transversely to take a knurled setscrew which is tightened on the gauge rod to hold it in place. In use, the rod is set to the required finish depth by measuring from the shoulder with a rule and extending or retracting the rod. After setting the rod to the correct dimension, the knurled setscrew is tightened to hold the rod in place. Now the gauge is inserted in the bore and the shoulder is placed in contact with the back of the work. Then the lathe tool is run up until the cutting edge comes in contact with the end of the gauge rod.

"Floating" Reinforcing Rods

Reinforcing rods for a poured-concrete floor are anchored at the proper depth before the floor is poured by floating them on the heads of nails driven in the sub-flooring. This assures a stronger job than laying the rods directly on the subfloor and also eliminates the messy job of immersing the rods in the wet concrete. The rods are wired to the tops of the nail-heads as shown in the drawing. — Grover Brinkman, Okawville, Ill.

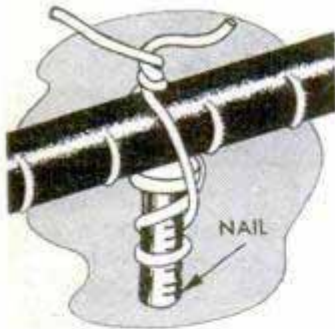

Fuse Clip Holds Pencil on Board

A pencil can be attached to a clip board or slanted drawing board without danger of rolling off, by pressing it in a fuse clip which has been fastened to the board. Use wood screws to attach the base of the clip to the board and, if the clip has metal tabs intended to keep the fuse from slipping, break them off or bend them out of the way. R. W. Kainulainen, Spokane, Wash.

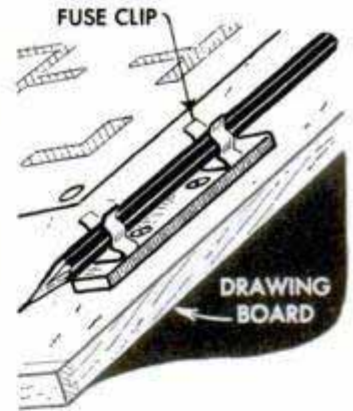

Drums Filled With Water Provide Weights for Land Roller

Under average conditions a large land roller requires variable weights in order to do its best work. Frequently, it is necessary to add weight to the roller before the field is finished, especially on a windy day when topsoil dries fast. Wet areas in fields will require lessening the weight to prevent packing the soil. To save time and avoid the necessity of lifting heavy weights, such as stones or bags filled with sand, some farmers use ordinary 55-gal. steel drums filled with water. These fit into the weight racks of most rollers as pictured and the amount of water in the drums can be varied to add only as much weight as necessary.



Periodic checks of the compression give a good over-all picture of the engine's operating efficiency

By Ed Packer

ALTHOUGH auto servicemen usually rate the fuel system first in seasonal tune-up checks (see Part I of last month), the engine itself also comes in for a thorough going over. To a greater extent than car owners generally realize, the loss of engine smoothness and operating efficiency is due to slowly accumulating deposits of hard carbon, gum and crankcase sludge. Short runs in cold weather, long trips at slow speeds and neglect of oil changes and general servicing of the engine contribute to fouling of the crankcase, upper cylinders, pistons and rings. The carbon and gum deposits not only adhere to these vital parts but circulate throughout the lubricating system and cause rapid wear. Regularly changing the oil-filter cartridge may help, but this precaution alone is not sufficient to correct other causes of engine inefficiency due to bad driving practices.

Lately the use of solvents has become so important in connection with general engine tune-up that many mechanics use these chemicals regularly in tune-up jobs on engines which are rated in good mechanical condition. Solvents for sludge and carbon are used in three ways: added in measured amounts to the fuel, introduced directly into the air inlet to the carburetor and combined with the crankcase oil. It's a general practice, after adding the solvent, to operate the engine for at least 30 minutes at fast idle. Following this desludging, or "limbering," treatment, the crankcase is drained and flushed, the oil-filter cartridge is changed and the crankcase is refilled with new oil.

One of the best quick checks of general engine mechanical condition is made with a compression gauge, Fig. 11. A variation of more than 10 lbs. pressure between cylinders indicates the presence of mechanical faults which need further investigation. The test always should be made with the engine at operating temperature and the throttle and choke in the wide-open position. Two faults commonly turned up by a compression check are bad rings and valves. To determine whether the valves or rings are at fault without removing the cylinder head, unscrew the spark plug and place about a tablespoonful of heavy oil on

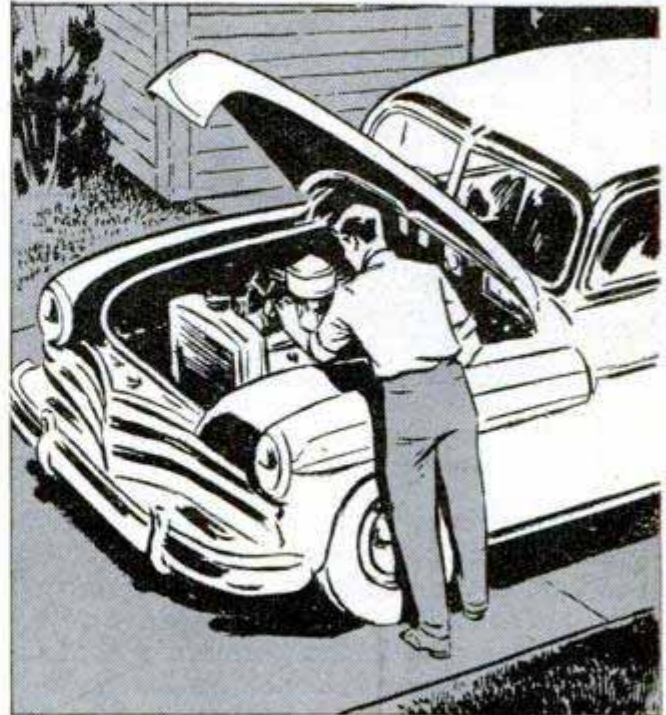

Driving at moderately high speeds for an hour or so will "tune up" an engine that is in good condition

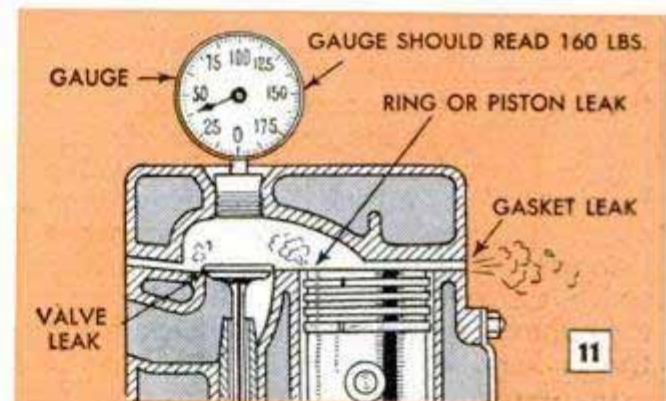

One of the best quick checks of engine condition can be made with a compression gauge

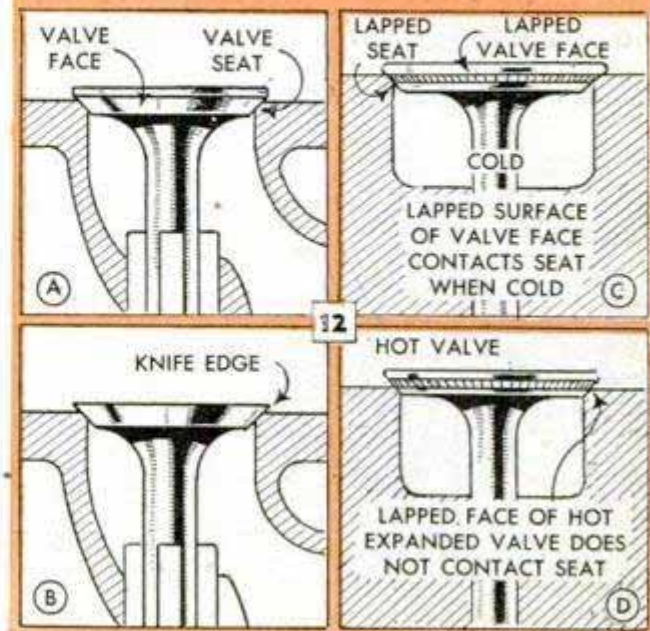

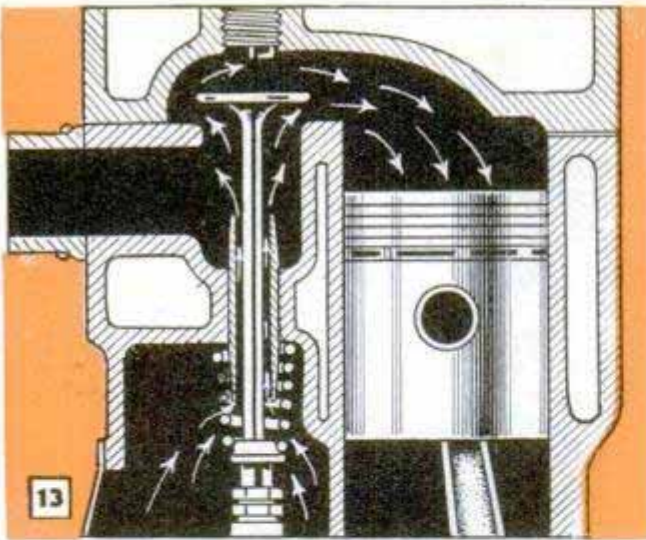

Oil leaks through the intake valves are due to worn guides. Replacement of guides usually is necessary

top of the piston to form a temporary compression seal. Replace the gauge and repeat the test. If the gauge comes up to normal, it is safe to assume that the rings are defective. There also is the possibility that either the piston or cylinder wall is at fault. If no change in the reading results from the second test, then the trouble probably is due to faulty valves. Sometimes a head-gasket leak is the cause of a low reading in one cylinder but this is comparatively rare. If the result of the tests indicates valve trouble, an experienced mechanic will listen carefully at the carburetor air intake and tell you in a moment which valve is leaking in the faulty cylinder. How does he do it? It's simple, when you know what to listen for. A leaking intake valve makes a sharp, distinct hissing sound, but a leak at the exhaust valve cannot be heard because the leakage is into the exhaust manifold.

If the engine has a history of poor performance, then the compression check is likely to be only the start of the job. On older cars, hand grinding and lapping valves and valve seats is a common procedure, but on later-model cars with high-com-

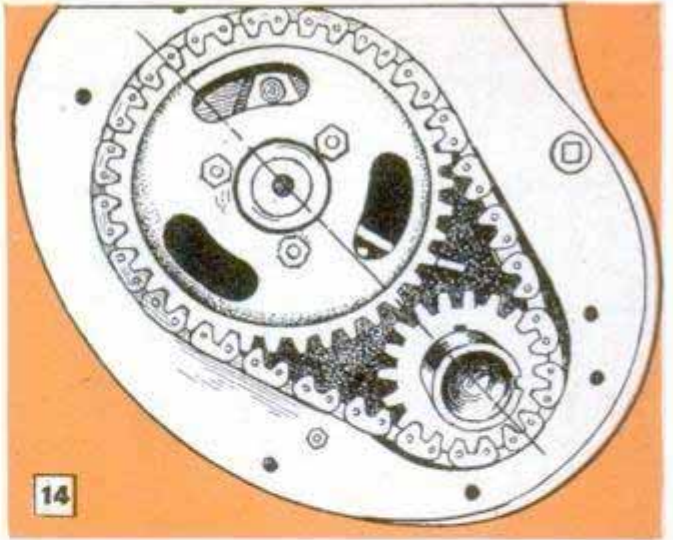

Check the timing chain, or gears, for looseness due to wear. This can cause late timing of the valves

pression engines the valves and valve seats must be reconditioned with special equipment. It is possible, of course, to form a gas-tight joint between the valve and its seat by hand lapping. Of necessity this must be done when the parts are cold, detail C, Fig. 12. When the parts expand as a result of heat, the lapped surfaces no longer make contact, D, Fig. 12. When the valve and seat are ground at the same angle on equipment made for this purpose, the tight-fitting job shown in detail A, Fig. 12, is the result. Never machine or grind old valves to a knife edge as in detail B. When the valve gets hot, the edge may become incandescent and cause what is known as pre-ignition.

Before opening an engine, let it idle for at least 10 minutes, as the high vacuum resulting from idling will tend to draw oil up around loose pistons and worn valve guides. As soon as the cylinder head has been removed, look for oil on the piston heads and on the undersides of the intake valves. If there is oil on the valves, it indicates that oil from the crankcase is being drawn up through the valve chamber and into the cylinder as in Fig. 13. As a rule, this con-

In any new ring job, the cylinder bore should be checked with a dial gauge after the piston has been removed

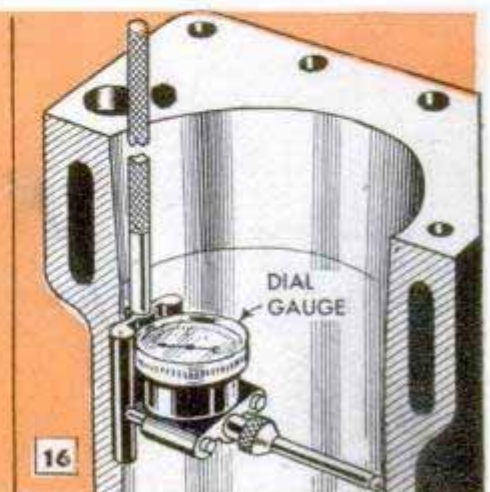
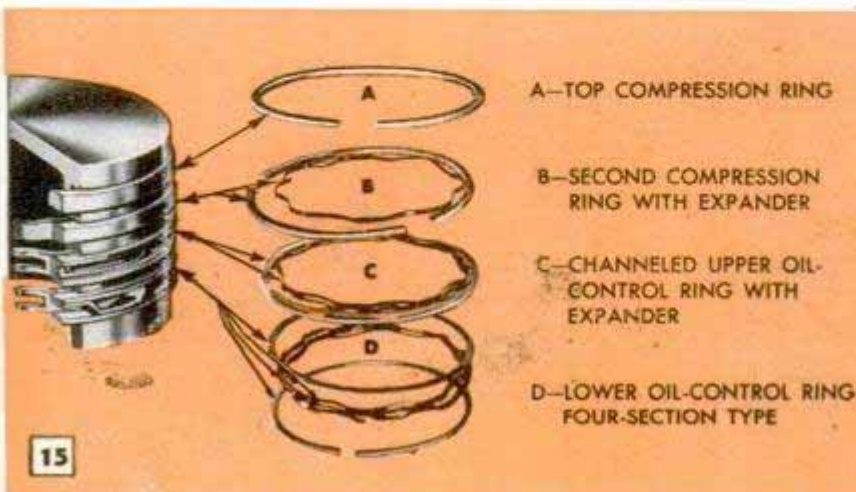

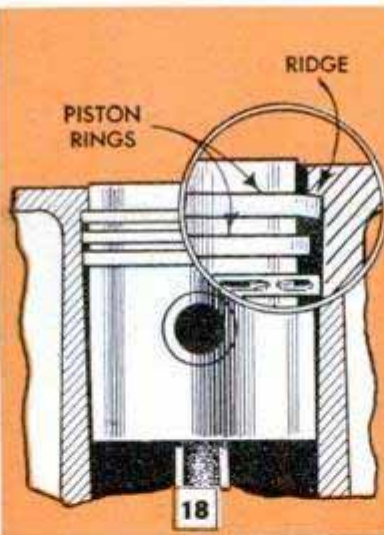
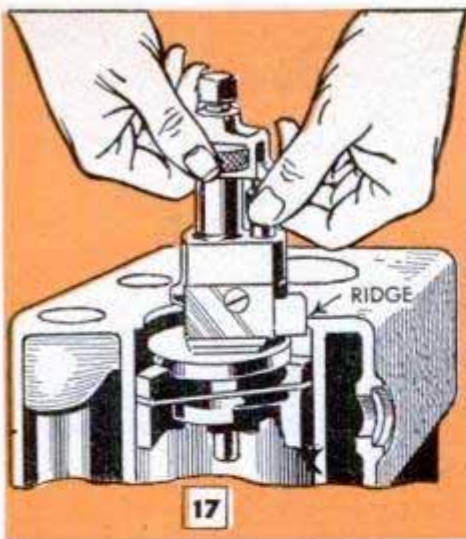

Before removing a piston, cut away the ridge at the top of the cylinder bore with a special reamer

A new ring should roll freely all the way around in the ring groove as, otherwise, the ring may stick

dition calls for replacement either of the valve or the guide, or both. While the engine is open, check the timing chain for looseness resulting from wear. Slack in the chain or wear in the camshaft gears has the effect of late valve timing, Fig. 14. If the intake valves open after the pistons have passed the top dead center, oil will be drawn through loose valve guides into the cylinders. Of course, this condition will be encountered more often in engines of the L-head type.

Before pulling the pistons on any engine which has been subjected to considerable wear, always remove the ridge, or overhang, at the top of the bore with the special reamer shown in Fig. 17. Otherwise, you will have difficulty removing the pistons, Fig. 18. After the pistons have been removed, careful mechanics mike the bores as in Fig. 20, or use a dial gauge as in Fig. 16, and jot down the readings. If these readings show that a rebore job is necessary, it's a general recommendation that the cylinder walls be honed both parallel and round within .0005 in. When installing oversize pistons be sure to follow the manufactur-

er's recommendations for clearance per inch of diameter. This is important and usually the instructions are specific.

When installing piston rings, check each individual ring for up-and-down clearance in its own groove, Figs. 15 and 19. The ring grooves are always cleaned and rigidly inspected to make sure that each ring will roll freely all the way around the groove, Fig. 19. End gap is just as important as the up-and-down clearance. A general recommendation ranges from .006 to .010 in., depending on the type of ring and the diameter of the cylinder bore. In bores larger than 3 in. the recommendations range from .010 to .014 in. In any case, a ring job cannot be considered complete until the connecting-rod bearings have been carefully inspected for looseness. Loose crankpin bearings can completely upset the function of the oil-control rings by throwing an excess of oil on the cylinder walls. Mechanics check bearing clearances with a simple plastic gauge, Fig. 21. This is laid on the bearing cap as in the left-hand detail. The cap is fitted in place, tightened, and then removed. Because of the precise diameter

Plastic gauge makes it easy to check crankpin-bearing clearance. If clearance is too great, oil pumping results

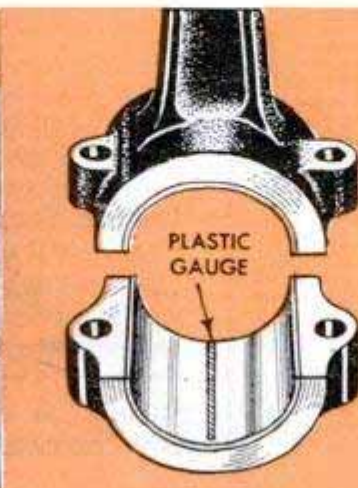
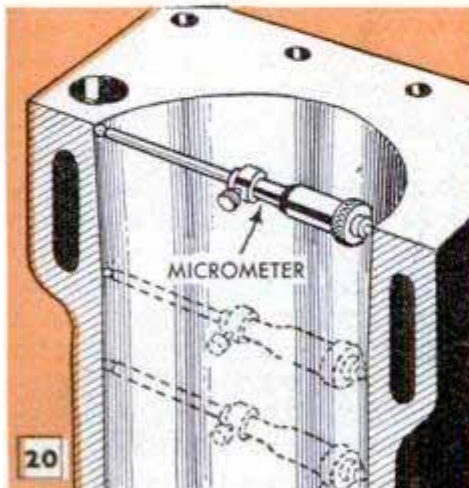

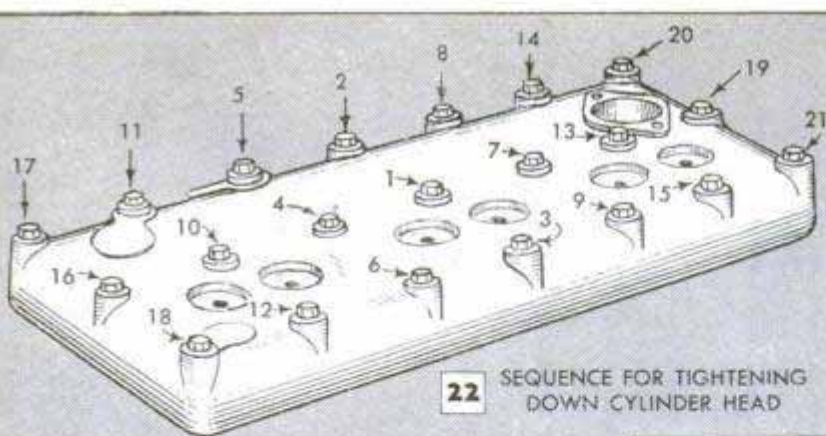

22 SEQUENCE FOR TIGHTENING DOWN CYLINDER HEAD

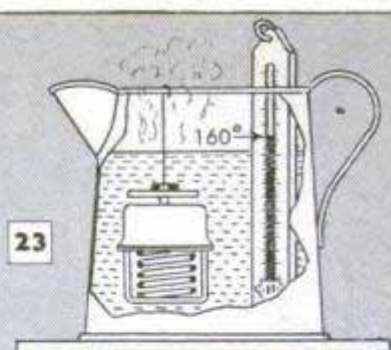

23 SIMPLE SHOP TEST FOR CHECKING THERMOSTAT OPERATING UNIT



BURNT VALVES



SCORED PISTON

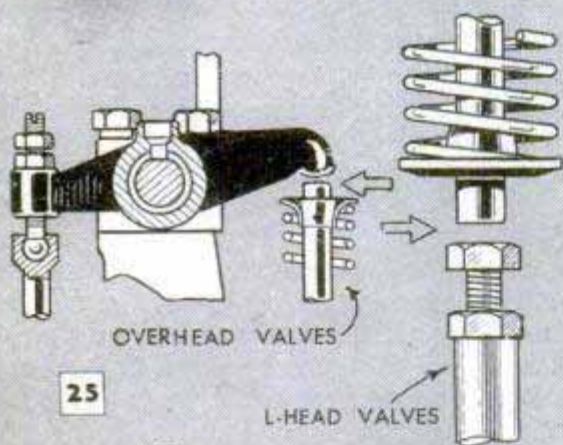

25

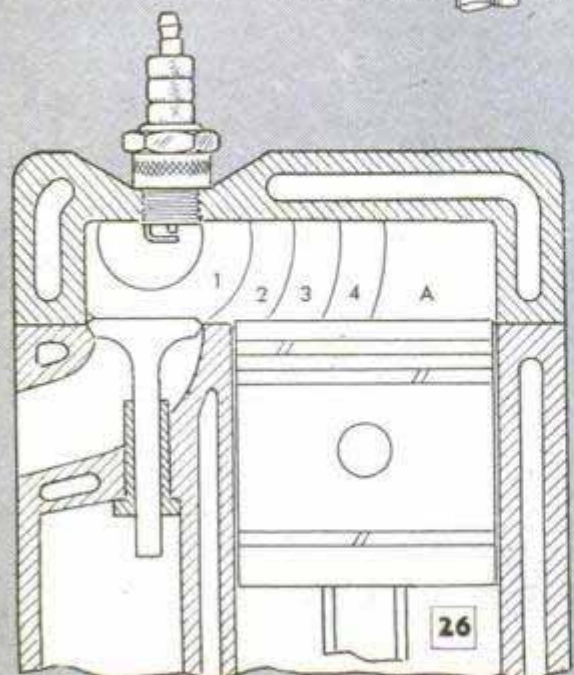

26

of the plastic gauge, the amount it is squeezed, or flattened, can be read in thousandths of an inch of bearing clearance by means of a printed chart which is held against the flattened plastic at the widest point, right-hand detail Fig. 21.

In any major overhaul job where the engine has been opened, always flush out the block and the cylinder head. Sediment may collect and clog water passages causing burned valves and scored pistons, Fig. 24. Check the thermostat, Fig. 23, before replacing it. If the thermostat is functioning properly, it will open in the 160-deg. water bath. A high-temperature thermostat used with permanent antifreeze solutions will begin to open at 175 degrees. Use a new gasket under the cylinder head. The tricky part of reassembling an engine is tightening down the cylinder head. It is of the utmost importance that the tightening sequence be followed precisely as instructed by the manufacturer of the car. The sequence given in Fig. 22 is only general; it will not apply to all makes of cars with L-head engines. However, the sequence in nearly all recommendations begins with the center bolt, No. 1 in Fig. 22, and progresses from the center to the ends of the head. It's best to use a torque wrench and tighten the bolts by stages. Instructions for the final tightening vary, of course, but a common recommendation is to tighten all bolts uniformly to a 50-ft.-lb. tension. After tightening the head, check the valve clearance, as illustrated in Fig. 25.

Detonation, or ping, as it is called, is a secondary ignition, or explosion, that follows normal combustion of the fuel charge. With the piston at top dead center, Fig. 26, or a little below it, ignition takes place progressively through areas 2 to 4 inclusive. Unburned fuel in area A explodes violently as a result of heat and pressure created by the normal ignition. In addition to low-grade fuels, other causes of pinging are a lean mixture, spark too far advanced and an engine running above normal temperature. If an engine gives trouble from pinging, the causes should be corrected.

(To be continued)

MAKE YOUR OWN PRINTED CIRCUITS

NOW YOU CAN experiment with "printed" circuits. A kit containing air-drying conducting and resistance paints is available to the student and experimenter for the construction of miniature radio and electronic circuits. The process consists of determining on paper the size of the painted components and their most compact arrangement, transferring the layout to a suitable base of sheet polystyrene or fiberboard, as shown in photo A, and then drawing the lines and areas of silver or copper paint which act as wires and condensers. Connected areas of carbon and graphite paint serve as resistors.

Photo C shows the "Microcircuits" kit and a small model of a two-tube pocket receiver that appeared in a student construction article in Popular Mechanics Magazine some time ago. The components, such as the variable tuning condenser, audio transformer, batteries and other parts that cannot be painted, are fastened to the case in the conventional manner. The polystyrene base shown in photos C and E is only 1½ by 3½ in. and was fitted into the end of the case enclosing the set. Hearing aids and similar small units can be constructed. A manual of tables comes with the kit so that the user can easily determine the length, width and area of resistors to obtain the proper resistance and wattage values. There are also tables for fixed condensers and inductances. Photo D shows a two-stage amplifier painted on the glass envelope of a twin-triode miniature tube.

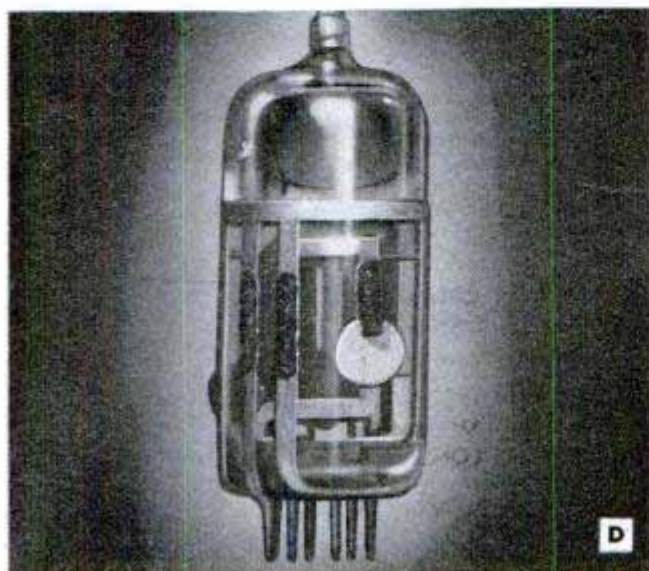
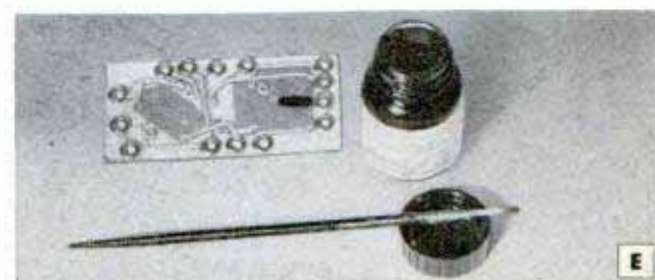
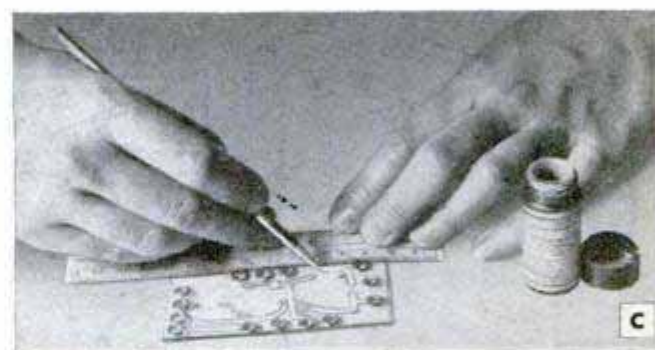
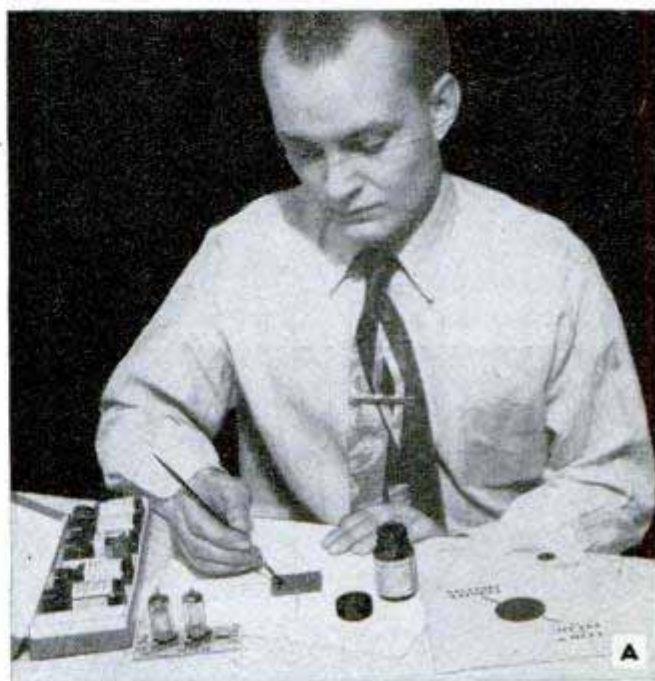

PORTABLE KNOCKABOUT SUPER

By Alex Adler

SPECIALLY designed for vacation days at the beach, camping, boating or other outdoor use, this rugged knockabout four-tube battery-operated portable is small, light in weight, and easy to build from inexpensive standard radio parts. It may also be used on a bicycle with an ordinary 3 to 4-ft. auto antenna. Good reception of local broadcasting stations may be expected with a telescoping rod antenna of this description. In localities remote from broadcasting stations a longer antenna will bring in the distant stations with excellent clarity and volume. The circuit includes automatic volume control.

The sheet-aluminum chassis base detailed in Fig. 1 should be punched and drilled before bending to shape between blocks of wood clamped in a vise. Any metal lunch box of the dimensions given in Fig. 2 may be used. The tuning dial shown in Fig. 1 is full size and may be cut out of the magazine and cemented to the front of the

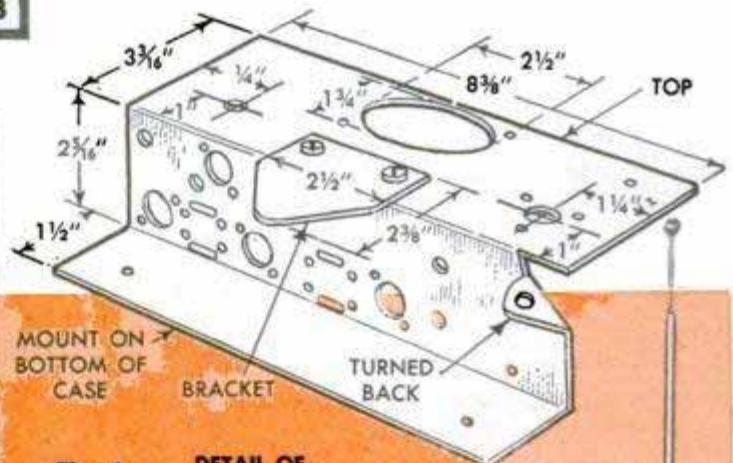
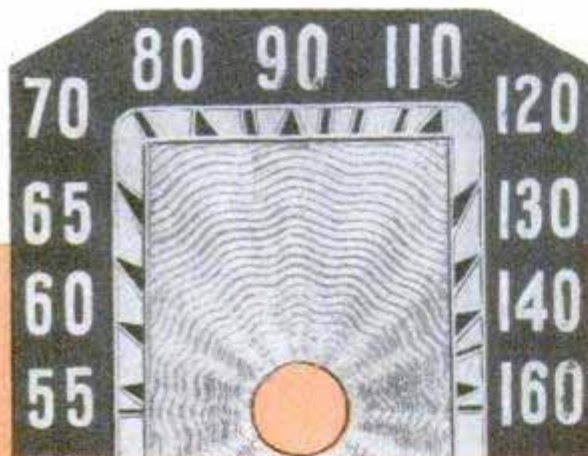
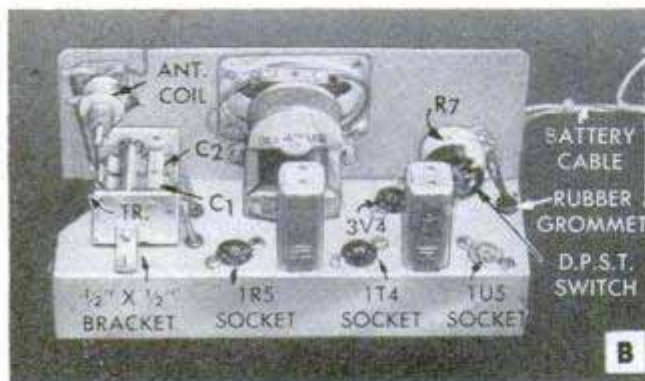
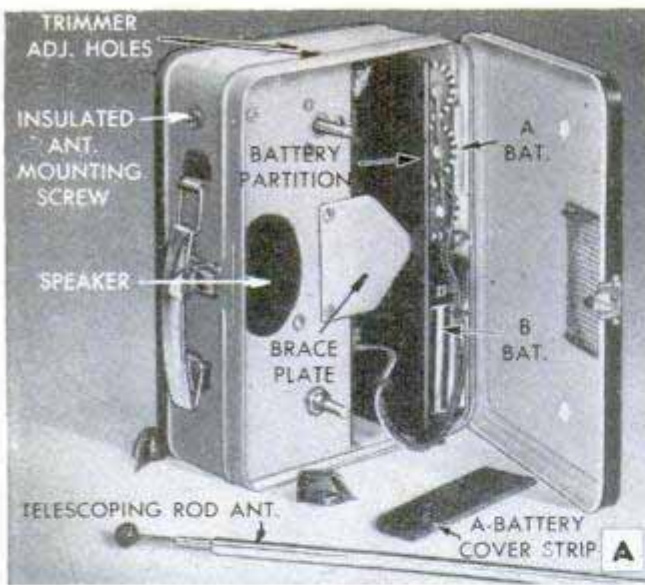

Fig. 1 **DETAIL OF CHASSIS BASE** ALL SOCKET HOLES $\frac{7}{8}$ "

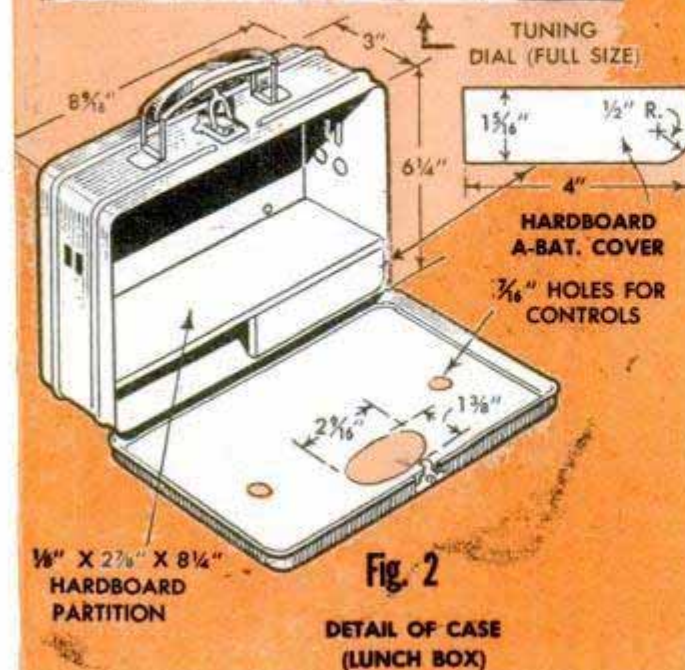

Fig. 2 **DETAIL OF CASE (LUNCH BOX)**

- RESISTORS**
- R1=100,000 ohms, 1/2-watt carbon
 - R2=15,000 ohms, 1/2-watt carbon
 - R3=68,000 ohms, 1/2-watt carbon
 - R4=10 megohms, 1/2-watt carbon
 - R5=4.7 megohms, 1/2-watt carbon
 - R6=1 megohm, 1/2-watt carbon
 - R7=2-megohm volume control midget audio taper (Mallory type MR55)
 - R8=3.3 megohms, 1/2-watt carbon
 - R9=820 ohms, 1/2-watt carbon
 - R10=1 megohm, 1/2-watt carbon



Fig. C

BUILT IN A LUNCH BOX . . .

case as shown in photo C. The speaker grille opening in the front of the case should be backed by a small piece of heavy wire screen. Photos A, B and D show various views of the completed set; photo E is an underside view of the chassis base. When mounting the tube sockets, rotate them to the position that provides the shortest possible circuit connections. The terminals of the i.f. transformers are color coded as indicated in the schematic circuit diagram, Fig. 3.

The 1R5 tube serves two purposes simultaneously. It amplifies the received signal and mixes it with the signal from the oscillator section of the 1R5 to produce the intermediate frequency of 455 kilocycles. The output transformer specified matches the 3V4 to the R.C.A. type 423S1 replacement-type speaker. If any other type of speaker is used it will be necessary to change the output transformer. Select a transformer which has an 8000 or 10,000-ohm primary, and a secondary to match the voice coil of the speaker used. Any midget two-gang cut-plate variable condenser designed for

(Continued to page 226)

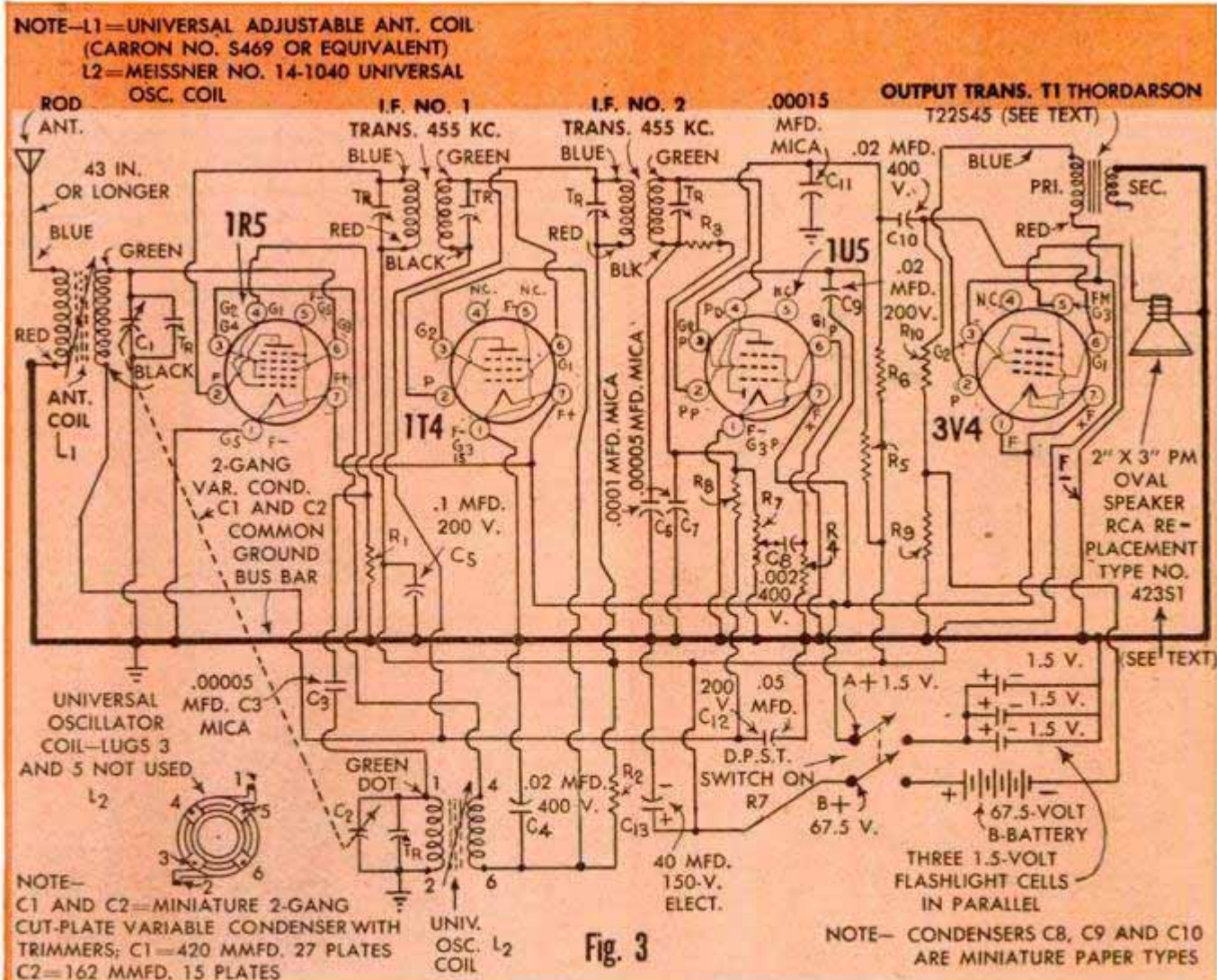
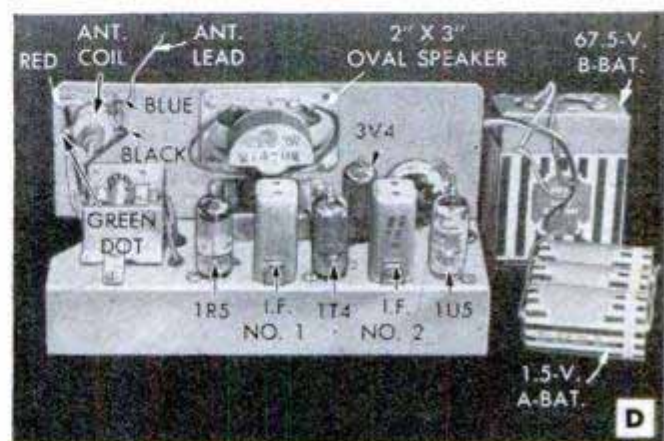

TV and ELECTRONICS TODAY



A—Tube-shaped hearing aid is carried in your pocket like a pen or pencil. It employs ultra-miniature tubes in a printed circuit and the tiny miniature batteries are matched in size resulting in a compact one-piece hearing aid that is only a fraction over five inches long and only $\frac{1}{2}$ inch in diameter

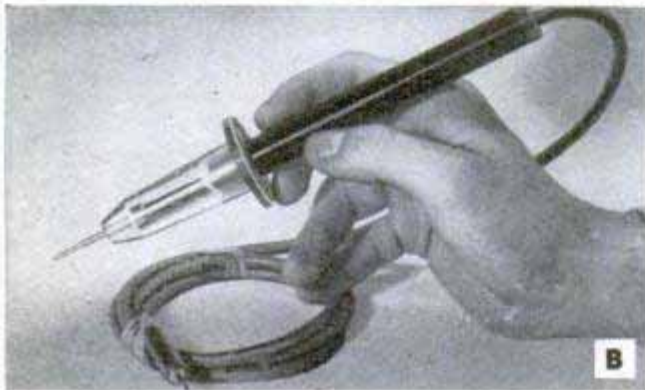

B—Multiplier probe extends the usefulness of existing d.c. voltmeters into the high-voltage television range. The device is ruggedly built with a phenolic barrel and clear Lucite nosepiece providing protection against high TV voltages. In effect it is claimed to add 15,000 volts to scale readings

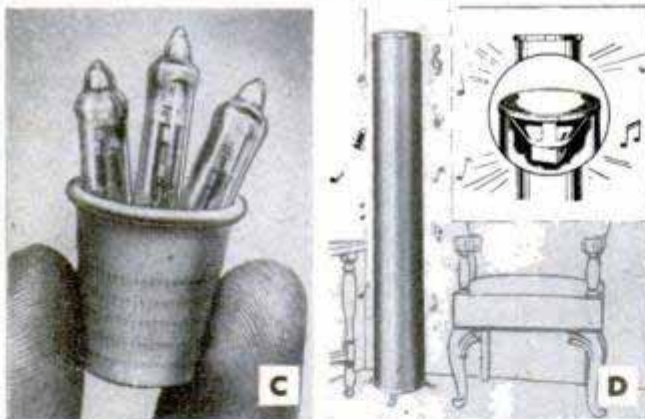

C—Tiny sub-miniature tubes for hearing aids, so small that three of them fit into an ordinary thimble, have been introduced recently by an English manufacturer. They are claimed to increase the life of the A-battery by operating efficiently on a small filament current requiring only 15 milliamperes

D—"Sound Fountain" speaker radiates sound to all parts of the room through a plastic tube. It is claimed to have 30 times the sound-radiating area of a conventional 8-inch loudspeaker. It reproduces sound from any radio or electrical phonograph. The unit can be mounted on the floor, wall or ceiling

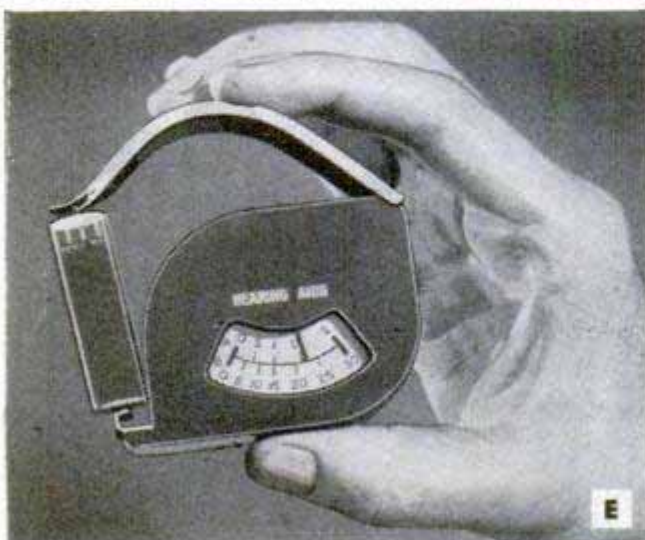

E—Simple voltmeter for testing hearing-aid batteries eliminates dangling cords. Either A or B-batteries may be tested, and there is no danger of connecting the batteries to the wrong terminals. The voltmeter has the same electrical drain as a standard hearing aid and thus insures accurate voltage readings

F—Giant-size TV receiver is designed for use in restaurants, theater lobbies, schools and clubs where a large TV picture of good quality is desired. It provides a 27 x 36-inch picture which is claimed to be equally satisfactory whether seen up close or from 75 feet away. Can be tuned by remote control



"DAD--WE NEED A MONTAMOWER TOO"

"NO MORE LABOR NEIGHBOR"

DOES NOT SHAVE CROWN TRIMS AS IT CUTS

Weight only 8 1/4 lbs



Try it ON YOUR OWN LAWN . . . on approval!

MontaMower is a new, efficient kind of lawn mower that literally "sells itself."

This live, 8 1/4 lb. precision machine first gathers then smoothly and easily cuts a full 16" swath through grass, dandelions, spike grass and tall lawn weeds (including those that ordinarily pop back up to cause you extra work).

AND EVEN MORE IMPORTANT . . . MontaMower does what no conventional mower can do! It cuts right up to walls, fences, trees, under foliage, around close quarter borders - it practically eliminates hand trimming!

MontaMower is sturdy, yet so light that even

women and children can operate it easily and efficiently. Improved metal handle has special device to adjust cutting height. Self sharpening, tool-steel cutting discs.

Unsolicited testimonials from thousands upon thousands of satisfied owners everywhere have convinced us that, in your own hands - on your own lawn, under most conditions, the MontaMower will prove itself far superior to any other type of hand operated mower.

This is why we can sell you this fine low priced mower with a "Written Guarantee" - on a most liberal "Try on your own lawn . . . on approval" basis. Write today for full details on this amazing offer.

MONTA MOWER

MOWS and TRIMS LAWNS in ONE EASY OPERATION

Trims close to buildings, trees and shrubs.

Cuts clean . . . grass, tall lawn weeds and all.



PASTE THIS COUPON ON A PENNY POSTCARD-MAIL TODAY

SOLD DIRECT ONLY NO AGENTS NO DEALERS

MONTAMOWER DISTRIBUTING Co.

Sales and General Offices

P-M 06 KEELER BLDG. • GRAND RAPIDS 2, MICHIGAN

Gentlemen: Without obligation, kindly send me complete descriptive literature, price, guarantee information, and full details of your amazing "Try it on your own lawn" Approval Offer.

NAME _____

ADDRESS _____

CITY _____ ZONE _____ STATE _____



How to Enjoy Your Son's Vacation:

☆ Envy those lazy months of summer vacation your boy's looking forward to? Too bad that you can't trade places.

But there is a way you can share at least part of his fun. That's by making this summer a time to introduce him to your home workshop. Those long summer evenings and week ends, with no school work to take up his time, are ideal for both of you to work together in your shop.

Don't worry about his being too young. There's no better time to teach a boy the rudiments of good craftsmanship. Start him out with easy projects and basic tools, and then let him progress at his own speed.

You'll get a kick out of watching him discover the satisfaction of working with tools. It's, as you know, a fine hobby, excellent training in concentration and control, and the best lure I know for keeping boys off the streets, short of actual constraint. And the things you can give

him a chance to learn this summer will long outlast his vacation.

So look over your workshop now, before his vacation starts. Stock up on the things that you find in short supply. Add the tools you have been meaning to buy — if you wanted them for yourself, you certainly will want your boy to have them.

Get all set for a summer of companionship with your son—a vacation which you'll probably enjoy as much as he.

Jim Ward
CRAFTSMAN EDITOR

P.S. I'd appreciate knowing about your experiences along the above lines—why not write? Simply mark the envelope: Room 511.

JIM

POPULAR MECHANICS, read by 3,528,000 home workshop fans, SUMMER and WINTER

200 EAST ONTARIO STREET, CHICAGO 11, ILLINOIS

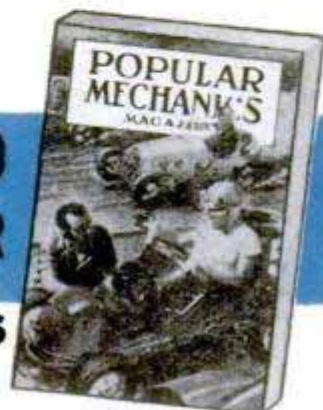



A. Kodak Auto-Release— Lets you get in the picture; snaps it for you about 10 seconds after setting. Fits any camera that has cable release socket. Double spring insures shutter tripping. Grips cable release firmly. \$4.25.

B. Kodak Metal Cable Releases—Take shot after shot without jarring camera. Excellent for time and bulb exposures. Non-stretching braided metal won't kink. 7- and 12-inch, \$9.99 and \$1.17, respectively.

C. Kodak Eye-Level Tripod— "Steady does it" for still or movie camera. Quarter turn locks legs at any height from 2 to 5 feet. \$23.33. And Kodak Turn-Tilt Tripod Head allows effortless panning with multiple-disk, felt-friction clutches. \$15.46.

D. Kodak Service Range Finder—Good-by to guesswork in focusing. Just look through eyepiece, adjust knob until split image becomes single unit. Read scale for focusing distance. Split-field-type finder permits close adjustment even in poor light. With case, \$14.58.

E. Kodak Carrying Cases— Here's smart appearance and protection—the Kodak Snapsack, for Kodak "Tourist" models and many similar folding cameras. \$3.95.

F. Kodak Field Cases— You "wear" your camera 'round your neck for instant use without removal from the case. Illustration shows field case on Kodak Flash Bantam f/4.5 Camera. Prices of field cases start at \$2.50.

See all these—and many other helpful Kodak picture-taking accessories—at your Kodak dealer's

Prices include Federal Tax where applicable

Kodak
LEAD MARK

EASTMAN KODAK COMPANY, ROCHESTER 4, N. Y.



Care and Feeding of Engines

BY S. P. CORP

FACTS ABOUT FAN BELTS

Hot weather. Millions of poor little dead fan belts littering highways. Why? Many were not installed right. Bad belt installation will ruin a lot of water pumps this summer, too. If a fan belt is too tight, the constant pull on the shaft wears out bearings, distorts shaft hole in the pump body, disturbs pump seal, causes leaks.



If belt is too loose, pump won't drive properly, water will not be properly distributed, and engine will overheat. When installing a fan belt, don't use the "crowbar" method (Fig. 1).



Take time to loosen generator bracket bolt. Then adjust fan belt until thumb pressure in center of longest span deflects belt about half an inch, then tighten bolt. Check for slack after running engine a few hours. In all cases, follow manufacturer's specifications.

manufacturer's specifications.

HOW TO SAVE \$300 TO \$500

By changing engine oil at regular intervals and changing the oil filter when it becomes dirty, you can operate your car for 3/10 to 5/10 of a cent less per mile than if you neglect lubrication. That's not much on a per-mile basis, but figured over 100,000 miles of driving, it means a saving of from \$300 to \$500! Oil can do its job only when clean. Change oil regularly. Change the filter when it's dirty. You can't lose! A postal to "Sealed Power, Dept. G-6, Muskegon, Mich.," will bring you a helpful book: "7 Ways to Save Oil."



RINGS THAT RING THE BELL

Sooner or later your engine will need new piston rings. When it's time to re-ring, use the best rings you can get—the rings that ring the bell—Sealed Power Piston Rings. The amazing new Sealed Power MD-50 Steel Oil Ring is the best ring ever made for oil control. It is the only ring with the FULL-FLOW SPRING. It controls oil even in badly tapered and out-of-round cylinders. It gives you double the drainage with half the drag. Your dealer can furnish a Sealed Power ring set specifically engineered to do the best possible job in your engine, whatever the make, model, or cylinder wear condition. Ask him today!

Portable Knockabout Super Built in a Lunch Box

(Continued from page 223)

a 455 to 465-kilocycle intermediate frequency may be used. The oscillator coil specified is a Meissner 14-1040 and this should be used. It comes complete with a terminal chart showing the numbering arrangement indicated in Fig. 3 at the lower left. Any universal-type antenna coil may be used if the builder should have difficulty in obtaining the Carron type S469 specified. Fixed condensers of any standard voltage rating may be used, for example, 200, 400 or 600-volt types.

Wire the filament circuit of the tubes first; use a small soldering iron and make all connections to the tube-socket terminals carefully as the sockets for these miniature-type tubes are quite small and the rosin-core wire solder should be used sparingly in order to avoid shorts. Make all leads as short and direct as possible. Note that all points which are grounded are connected to the common ground bus-bar wire that runs the length of the chassis base. The small circular tube that is in the bottom center of each miniature-tube socket acts as a shield between the socket prongs, and should be connected to the common ground. Connections to the three flashlight A-batteries are made as shown in photo D and in diagram Fig. 3. By connecting them in parallel, the useful life of the batteries is greatly lengthened and the voltage remains at 1.5 volts as specified. The type 3V4 tube is provided with a filament midpoint connection indicated in Fig. 3 as "FM." By using this midpoint connection, the 3-volt tube can be operated on 1.5 volts as shown. Connections to the 67.5-volt portable-type B-battery are made with standard B-battery "button type" snap clips. Terminal 4 on the 1T4 and the 3V4 tubes, and terminal 5 on the 1U5 tube do not connect to any internal portion of the tubes and may be used as convenient tie points when wiring the circuit. Note that all tube sockets shown in Fig. 3 are bottom view.

After the wiring is completed, the batteries connected and the tubes inserted in their sockets, connect a temporary antenna wire, turn on the set and advance the volume control halfway. Then adjust the variable condenser until a station is heard. Next adjust the iron core in the oscillator coil with a small screwdriver until a station around 600 kc. can be received with the variable condenser set at a point 15 or 20 degrees from the fully closed position. Now, without changing the setting of the tuning

(Continued to page 228)

A MILLION DOLLAR SECRET !



There's a million-dollar secret behind the spectacular performance of the new AC Spark Plugs: It's *CORALOX*, AC's patented Insulator.

But there's no secret at all about the easier starting, surer firing and longer life of these new AC's with *CORALOX* Insulator.

Engineers know those facts—hence more new cars and trucks are equipped with AC's than with any other make.

More and more owners, too, are learning about these better AC's—and are buying them for improved service in their cars, trucks and tractors.

AC spent years of scientific research and development work in perfecting *CORALOX*, yet you can have its extra benefits at the price of ordinary spark plugs. Your AC Service Dealer has the new AC's now—to save you time, fuel and money.



AC SPARK PLUGS



AC OIL FILTERS



AC FUEL PUMPS

preferred on millions of vehicles

P A T E N T E D

CORALOX
I N S U L A T O R

AC SPARK PLUG DIVISION • GENERAL MOTORS CORPORATION

NOW! *this* FULL WEIGHT Blade in Handy Dispenser

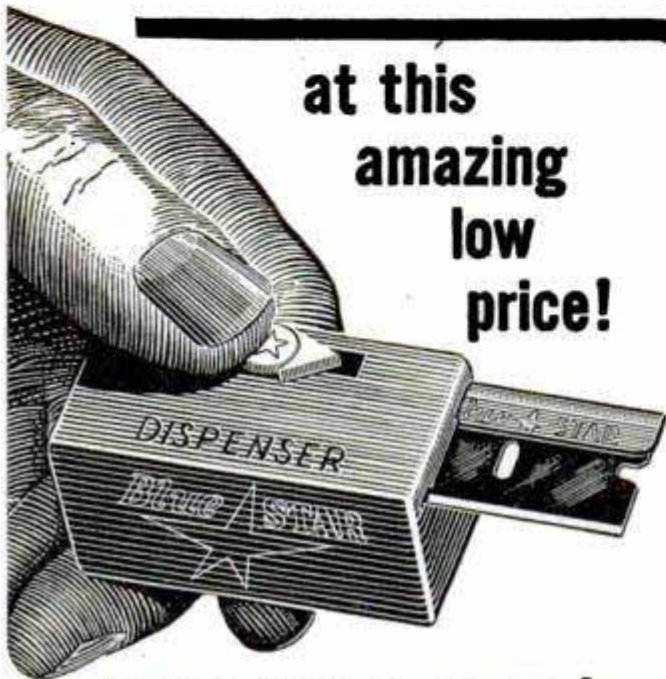

at this
amazing
low
price!

10 BLADES IN DISPENSER **25¢**
REGULAR PACK 3 for 10¢

Try this sturdy, full-weight Blue Star on those tough, hard-to-shave spots. If *any* blue steel blade, at any price, gives you better shaves than Blue Star, we'll give you double your money back.

Blue STAR®

SINGLE EDGE DOUBLE EDGE

PRECISION  PRODUCTS

AMERICAN SAFETY RAZOR CORP. BROOKLYN 1, N. Y.

condenser, adjust the iron core in the antenna coil for maximum volume. Secure the antenna-coil adjusting screw in this position with a drop of cement or by tightening the locknut, if one is provided. The i.f. transformers are factory set and only a slight adjustment will be necessary. Tune the variable condenser to a station at the high-frequency end of the band and then adjust the i.f. transformers very slightly for maximum volume. Never touch these i.f. adjusting screws until the set is operating correctly. Lack of operation at the first test indicates a wiring error, or a defective part. Once the factory setting of the i.f. transformers is lost it is impossible to align the receiver without the use of a signal generator.

The antenna mounting terminal on the top of the case must be insulated from the case. It is made with two fiber washers, a soldering lug, and a 6-32 x 1/2 or 5/8-in. machine screw and a hex nut. A 1/4-in. hole is drilled in the case and the machine screw is inserted from the inside of the case so as to provide an insulated terminal for the antenna lead from the chassis; the threaded stud protruding from the top of the case may be used as a binding post for a wire antenna or the threaded end of a telescoping-type auto antenna. If the rod antenna is not drilled and threaded for the 6-32 screw

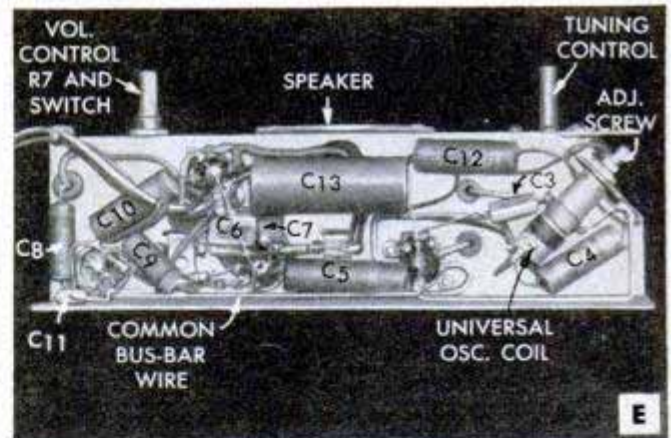

you can have it done at any machine shop. Now place the chassis in the case and determine the proper place to drill the two holes in the side of the case so that the two trimmer condensers on the two-gang variable condenser may be adjusted from the outside with a screwdriver after the case is closed. For final adjustment, tune in a station at the extreme high end of the dial and adjust the trimmer on oscillator section C2 until the station comes in at its correct dial setting; then adjust trimmer on C1 for maximum volume. Detailed student material list R-390 is available from Popular Mechanics Radio and Electronics department upon receipt of ordinary letter postage.

IT'S

EVINRUDE for the features that make FISHING more fun!

● If fishing's your sport, mister... get a *real fishing motor!* Get the great fishing features that mean more fun every run... for years to come! Features such as Evinrude Gearshift... Evinrude Duo-Clutch... Evinrude Fisherman Drive... and scores of other advancements that have made Evinrudes favorites with fishermen for more than forty years!

See your Evinrude dealer. Choose from a complete series of models in the most popular fishing sizes... and for standout performance on fast fishing boats, try the thrilling new Fastwin with Gearshift and Cruis-a-Day Tank... the new Fleetwin with Duo-Clutch and Safti-Grip Propeller Drive. See the two deluxe models for smaller fishing craft—the Sportsman and Sportwin with the famed Fisherman Drive that lets you power through weeds, over rocks and shoals... "wherever there's water to float your boat."

NEW LOW PRICES start at less than \$80.00. Time payments available. If you now have a motor this is the year to trade it in! Ask your dealer for an appraisal. Look for your dealer's name under "Outboard Motors" in your classified phone directory.



New FASTWIN 14 H.P.*

New FLEETWIN 7.5 H.P.*

Free CATALOG

Write today for free full-color catalog of Evinrude's 1950 lines of fishing motors and Hi-Power models for largest outboard boats. Address EVINRUDE MOTORS, 4497 N. 27th Street, Milwaukee 16, Wis.

In Canada: Evinrude Motors, Peterboro, Ontario



GEARSHIFT

New HANDLING EASE

DUO-CLUTCH

NEUTRAL STARTING

New SMOOTHNESS

S-L-O-W TROLLING

CRUIS-A-DAY TANK

FISHERMAN DRIVE

EVINRUDE

FIRST IN OUTBOARDS

41st YEAR

 *O.B.C. certified brake H.P. at 4000 R.P.M.

CASITE AT ONLY 75¢

DOES THIS FOR YOU



CASITE CORRECTS OLD ENGINES

Wake up, clean up, tune up your engine with Casite. Casite's cleansing action quickly removes gum and goo, frees sticky valves and rings, leaves the motor clean and free-running, lets the power zoom through.



CASITE PROTECTS ALL ENGINES

You'll get smoother, safer break-in of any new engine with Casite in the crankcase. In both new and old engines Casite gets oil quickly to wearing parts—cuts repair bills.

CASITE SPEEDS MOTOR OIL 22%

at 100° F. (even more when colder). Even the best lubricating oil must warm up to at least 210° to reach top efficiency. Casite speeds motor oil faster at starting temperatures, assuring lubrication during vital warm-up period. Reduces "start-up wear."

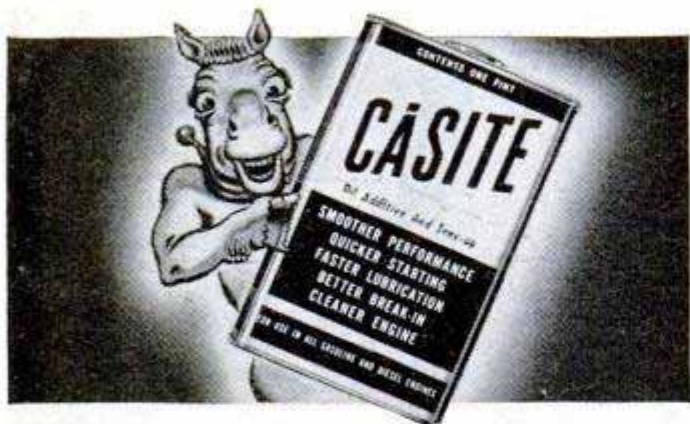

NEW CAR OR OLD CAR, KEEP CASITE IN YOUR CAR
Get it from your garage, service station or car dealer today. Only 75c a pint.

THE CASITE CORPORATION • HASTINGS, MICHIGAN

**Better and Smoother Performance
OR DOUBLE-YOUR-MONEY-BACK**

Heap Big Wooden Indian

(Continued from page 81)

The first wooden Indian is reported to have appeared in America in 1770 in Lancaster, Pa., before the tobacco shop of Christopher Demuth. By 1780, there was a whole tribe of wooden Indians in Baltimore. Then New York tobacconists took up the advertising medium, and the demand for wooden Indians was heavy. They reached their greatest vogue through the nation from 1850 to 1880. Independent artists usually carved them, and sold them directly or through dealers.

When the market dropped out of figure-heads for sailing ships, the men who made these turned naturally to wooden Indians. It was once a common sight to see several logs being swung aboard a ship setting off on a long voyage, and sailors would carve Indians during their idle moments.

Hundreds of wooden Indians were destroyed in the fires which swept Chicago, San Francisco and Baltimore. Woodpeckers, they say, got some. Sidewalk whittlers took care of others. But probably most of them were simply carted off to attic or junk heap for the reason Robertson gives—they just weren't good-looking enough to keep around.

Still, the wooden Indian is dyed-in-the-wool American. Mention of one today—even in termite terms by a wise-cracking radio comedian—stirs in many a man a feeling of distinct nostalgia.

Matter of fact, this nostalgia caused the formation some years ago of a unique organization known as the Society for the Preservation of Wooden Indians. Founder and president is Miller Freeman, widely known Northwest publisher and industrialist, who was aided and abetted by such dignitaries as Governor Sam McKelvie of Nebraska and Representative Frank Horton of Wyoming. There are no dues nor duties, except to seek out wooden Indians and see that they are treated with the proper respect due such mementos of early America. The society also holds national conventions annually at which tomahawk throwing and smoke signalling contests are conducted, members with toupees are scalped, and conversation is in Chinook, a sort of Indian Esperanto. Robertson is the patron saint of the society.

"Things haven't been the same since they hauled in wooden Indians," President Freeman commented recently. "Who knows but what the return of wooden Indians chieftained by Robertson may be a stabilizing influence on men's minds. The Indians may even bring back some of the good old days."

It's Easy to REPAIR ALL ELECTRICAL APPLIANCES and UTILITIES



with the aid of the new model 50
UTILITY TESTER

tests appliances such as • REFRIGERATORS
• RANGES • HEATERS • IRONERS • FANS
• VACUUM CLEANERS • TOASTERS • WASHERS
• WASHING MACHINES • AIR CONDITIONERS
• SHAVERS • SUN LAMPS and MOTORS

ALL MOTORS — single phase, multi-phase, universal, squirrel cage, induction, in fact every type of motor from fractional H.P. to 2 H.P.

- Will measure the actual current consumption of any appliance or utility either A.C. or D.C. and will measure it while the unit is in operation. The reading will be direct in amperes. The appliance or utility may be plugged directly into the front panel receptacle. A special pair of insulated clip-end leads is included for motors, etc.
- Incorporates a sensitive direct-reading resistance range which will accurately measure all resistances commonly used in electrical appliances, motors, etc. This range will enable continuity checks and tests for shorts and opens.
- Will indicate excessive leakage between a motor and a line up to 10 Megohms.
- Will indicate when a three phase motor is running erratically due to a "blown" fuse.
- Will measure the actual voltage and indicate whether the current is A.C. or D.C. and if the frequency is 25 cycles or 60 cycles.
- Will test Thermostats under actual working conditions.
- Is the ideal trouble-shooter as it will instantly locate opens, shorts and grounds.
- Will test all bulbs, radio tube filaments, pilot light lamps, all fuses including cartridge, screw, etc., fluorescent bulbs, etc.
- Will test condensers for both opens and shorts.
- Will accurately check and locate the exact cause of failure in 3 way heat control switches.
- Will check field coils for opens and shorts.
- Will indicate when one side of an appliance or motor connected to the line under test is "grounded."

Shipped on Approval
NO MONEY WITH ORDER NO C. O. D.

TRY BEFORE YOU BUY! Yes, you need send no money with order or pay anything on delivery. Simply fill out this order form and mail it today. Try the Model 50 for 10 days. If completely satisfied, remit \$13.90. If not, return the instrument—no explanation necessary.

The Model 50 Utility Tester comes housed in a round cornered molded bakelite case.

Compact—Measures 3 1/8" x 5 7/8" x 2 1/4"

Complete with all test leads and operating instructions—only

\$13.90

GENERAL ELECTRONIC DISTRIBUTING CO. PM 6
98 PARK PLACE, NEW YORK 7, N. Y.

Please rush one Model 50 Utility Tester. I will either remit \$13.90 after a 10-day trial or return the instrument via Parcel Post.

Name

Address

City State

FREE PREMIUM!!

Check here if you include \$13.90 payment with order. In return for saving due to bookkeeping, we will include a set of 6 assorted key chains with your Model 50. If the Model 50 does not meet with your wholehearted approval after a 10-day trial, return it for full immediate refund of \$13.90 — keep the premium for your trouble.

Screen chores are **LIGHT**



with **LUMITE**
saran screening!

because it's...

*** RUSTPROOF** Guaranteed never to rust, rot or mildew... unaffected by salt air or smoke, rain, snow or industrial fumes! It's the ideal screening for every exterior use.

*** STAINPROOF** Lumite is guaranteed stainproof because it's rustproof. It never needs protective painting. It cleans easily.

*** LASTS AND LASTS** Lumite offers long range economy... costs only 11½ to 12¢ a square foot... when adequately framed gives years of trouble-free screen protection! Sold by hardware, lumber, and building supply dealers.

LUMITE
SARAN SCREENING

*Registered Trade-mark

SEND FOR FREE SAMPLE TODAY

LUMITE DIVISION,
Chicopee Manufacturing Corp. of Ga.
40 Worth Street, New York 13, N. Y.

PM-6

Please send me information and FREE sample of Lumite Screening.

Name.....

Address.....

City.....Zone.....State.....

Clinic



for Homemakers

As a service to our readers in solving the hundreds of problems pertaining to a home—inside or out—the editors of *Popular Mechanics* invite you to present your problems to The Clinic Editor for help and advice. Address your questions to The Clinic Editor, *Popular Mechanics Magazine*, 200 East Ontario Street, Chicago 11, Ill.

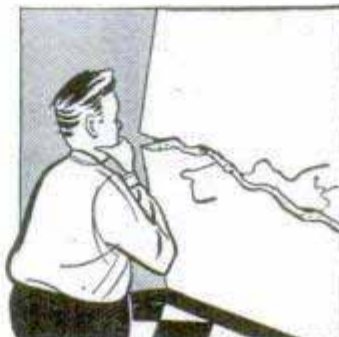

Tipping Wall

Q—My basement walls are of poured concrete and on the north side of the house the wall is cracked lengthwise about 24 to 30 in. above the floor and nearly the full length. It seems to be bulging inward. What is the cause of this?

D.A., Reading, Pa.

A—It is not possible to say definitely what has caused the wall to crack along the length and bulge inward as you describe. If there is poor drainage of the area adjacent to the wall, then the break probably is due to frost action. Also, there is the possibility that the footings are inadequate in sectional size to support the combined weight of the basement and house walls. There are also other causes of this trouble, but they are much less likely than those just outlined. There is no practical way to force the wall back into the vertical position and, of course, ordinary mortar will not hold in the crack. You can brace the wall temporarily to prevent it from tipping farther inward. However, we believe that the only permanent remedy is to take out the old wall and pour new footings and a new wall of adequate sectional strength. Of course, this is a major repair job but we feel sure that in the long run it will pay to have the job done.

Buckling Shingles

Q—My home is less than a year old and already the roof shingles are buckled in places on both sides of the ridge. I did the roofing job myself and I was very careful to follow the instructions. What has caused the shingles to buckle and what can I do about it?

B.S., Chicago.



A—Usually shrinkage of the roof boards causes the shingles to buckle as you describe. Either the roof boards were wet by rain before the shingles were applied, or the lumber already contained too much moisture. In either case, as the boards dry

(Continued to page 234)

Own this **DUNLAP** Drill Kit **NOW!**

OUR OWN TRADE MARK

Drills . . Grinds . . Sharpens . . Sands . . Polishes . . Buffs!



Does hundreds of jobs
Faster! Easier! Better!



**DUNLAP 26-piece
1/4-in. Electric Drill
Kit . . . Complete**

ONLY \$19.50
Cash

**DRILL ONLY
\$13.50**



Drill wood,
metal, etc.

Sanding or
wood working

Polish cars,
furniture, etc.

Stand for
grinding, etc.

NOW . . . a drill kit so fine . . . so handy . . . so low-priced you'll want it the minute you examine it! Precision-built! Powerful enough to drive 1/4-in. bits in steel! 1/4-in. 3-jaw chuck. Triple-reduction gears; aluminum alloy frame. 110-120-volt, 25 to 60 cycle AC-DC motor; 6-ft. cord. Underwriters' Labs. approved! Complete with 10 HIGH SPEED drill bits, 1/16 to 1/4-in.; 4-in. cloth buffing and 3-in. grinding wheels; 4 3/4-in. rubber sanding disc; 5 1/2-in. sheepskin polishing bonnet; 6 assorted sanding discs; disc template; paint mixer; adapter; drill side-handle; drill stand; in 12 3/4 x 6 1/4 x 6-in. steel carrying case.



DUNLAP All-Purpose 1/2-in. Electric Drill

OUR OWN TRADE MARK



Drive twist
drills

Drive wood
augers

Drive cylinder
grinders

Drive hole
saws

NEW! Big, rugged . . . ideal for heavier jobs around farm, garage or maintenance shop! Powerful 110-120-volt, 25 to 60 cycle AC-DC motor drives 1/2-in. bits in steel; 1-in. bits in wood! Finest 1/2-in. capacity Jacobs No. 33B geared key chuck! Triple-reduction gears, motor shaft and chuck spindle of stress-proof alloy steel. Sturdy aluminum alloy frame. Double-pole automatic releasing switch locks for continuous running. 7-ft., 3-wire cord, plug. No-load speed 425 R.P.M. Underwriters' Laboratories, Inc. approved!

**DUNLAP 1/2-in.
Electric Drill**

\$29.95
Cash

\$3.00 Down on
SEARS Easy Terms



See these sensational power tools at your nearest Sears Roebuck Retail Store TODAY!
Sears Easy Terms make it easier to own the tools you need NOW . . . pay while you use them!

CRAFTSMAN and **DUNLAP** Tools by **SEARS, ROEBUCK and CO.**
Famous for fine quality . . . precision performance . . . low price!



SAVE ON REMODELING

IT'S easy and inexpensive to build an extra bedroom, bathroom, game room, photography darkroom or what-have-you with Gold Bond Gypsum Wall-board. Just nail the

sturdy, fireproof panels right to lumber framework or over an old wall or ceiling. Joints can be completely concealed with Gold Bond Perforated Tape Joint System. Decorate with Gold Bond Sunflex—the one hour wall paint. Or, if you prefer papered walls, Gold Bond Gypsum Wall-board takes wallpaper beautifully. It's moisture resistant, won't warp, swell or contract. For further details, write Div. W., Dept. PM-6.

Available at your local Gold Bond lumber and building materials dealer!

NATIONAL GYPSUM COMPANY
BUFFALO 2, NEW YORK

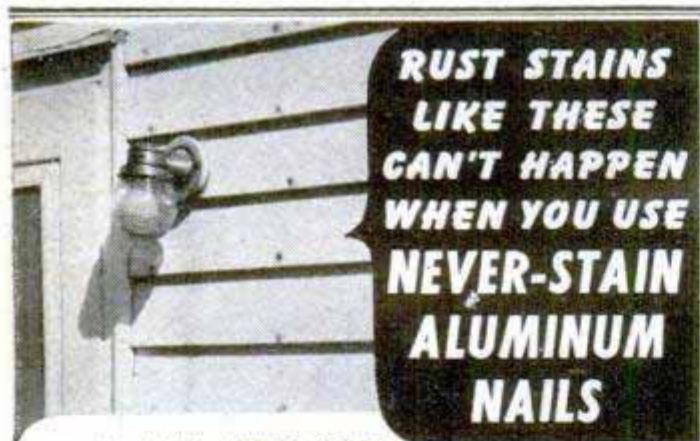

- ★ WILL NEVER STAIN OR STREAK PAINTED SIDING OR COLORFUL ROOFING
- ★ COST LESS TO APPLY—NO PUTTYING OR COUNTER-SINKING NECESSARY
- ★ ALMOST 3 TIMES AS MANY PER LB.

They pay for themselves in the savings they make—and they may save you a \$300 repaint job! Now packaged for the job in different colored boxes, each with quantity, size and type clearly indicated.

THERE IS NO SUBSTITUTE FOR ALUMINUM!

Write for FREE Samples.
Address Dept. PM.

NICHOLS WIRE & ALUMINUM CO.
DAVENPORT, IOWA



(Continued from page 232)

they shrink in sectional size and any course of shingles nailed to one board will buckle as shrinkage of the board lessens the distance between the nails. It also should be noted that buckling can be caused by the swelling of the roof boards due to absorption of excess moisture in the attic. In this case, buckling will occur where the shingle course happens to be nailed to adjacent boards, one of which may be of a high resin content and, therefore, less absorptive than the other. One board swells (expands) and this has the effect of shortening the distance between the nails. Usually buckling caused by swelling of the roof boards will correct itself if excessive moisture is eliminated from the attic by adequate ventilation. Buckling caused by shrinkage of roof boards can be corrected only by carefully removing the nails holding the buckled shingles, flattening the shingles and then renailing. After renailing, the old nail holes should be filled with asphalt roofing cement to prevent leakage.



Insects on Paint

Q—Last summer I painted several houses on contract and on two jobs I had trouble with tiny insects alighting on the fresh paint and sticking fast like flies on fly-paper. I had no trouble with the first coat; it was only during application of the second coat that the insects appeared. Is there any way to prevent this?

G.O., Louisville, Ky.

A—Some painters troubled in this way mix a small quantity of insect repellent with the paint. This is said to be quite helpful. However, we could not recommend the procedure unreservedly as it is possible that certain ingredients of insect repellents would affect the durability of some paints. In most localities, trouble with insects can be avoided without the use of repellents. As a rule, painting on clear, cool days in late spring or early summer after a period of dry weather gives best results as drying conditions are ideal and insects give very little trouble, especially during the morning hours. Under good drying conditions the paint will set insect-free in a short time.

Painting Varnished Woodwork

Q—All the woodwork in my home is varnished in a dark color. Now I would like to paint the woodwork in three rooms to match a new scheme of decorating, but I would like to know beforehand what preparation of the varnished surface is necessary before painting. It seems to me that the paint is likely to peel from the smooth varnished surface. What should I do in the way of preparation?—W.S., Salem, Ore.

A—Assuming that the varnish is in good condition, without checks or large cracks or other surface defects, about all that is necessary is to cut the gloss by going over the surface with steel wool, No. 1 or No. 2 grade. In doing this part of the job, it will pay to be thorough so that no glossy areas are left on the edges or flat surfaces of the woodwork. In the kitchen and bath and on doors and trim where the hands normally touch the surface, wash thoroughly with a mild solution of trisodium phosphate. Then go over these areas with steel wool. Next, apply a prepared undercoater and allow it to dry thoroughly. Follow with one or two coats of gloss or semigloss enamel in the color desired. If you are refinishing woodwork in the kitchen or bathroom, it generally is best to use a gloss enamel. In other rooms, a semigloss enamel is usually more attractive. If you apply two coats of enamel, it's good practice to sand the first coat lightly before applying the finish coat. Another and shorter finishing process is the use of what is known as a spirit enamel for the first coat. Its principal advantage is that there is less danger of peeling or bleeding when it is applied over varnished, dark-stained woodwork.

DREMEL DOES IT AGAIN!

PRESENTING A POWERFUL COMPANION TO THE FAMOUS DREMEL MODEL "A" SANDER

Dremel's new Model 2000 gives you the finest finish sanding money can buy. For polishing too, this new machine is a superb performer. And now it's yours at the remarkably low price of only \$24.50.

RUGGED DESIGN • POWERFUL PERFORMANCE FOR INDUSTRIAL, HOME, and HOBBY USERS

Consider these outstanding features: Die-cast aluminum housing with Bakelite cover; only two moving parts—requires no oiling; straight-line (non-rotary or arc) reciprocal action leaves no marks; 21 sq. in. sanding surface; cam-type holder permits changing paper in seconds; weighs only 5 lbs; over-all size 3 3/8" wide x 4 1/2" high x 7" long; 8 ft. Underwriter's Approved cord; operates on 110-120 V. A.C. Truly an indispensable machine for long and faithful sander-polisher service in industry, home or hobby.

PRICE INCLUDES STURDY CARRYING CASE



Perfect portability of Sander, cord, abrasives, and polishing pads in this sturdy, 3-shelf metal storage case. Price also includes 25 assorted sheets Garnet Paper and a high-grade sheepskin polishing pad.

WHERE TO BUY— If your dealer cannot supply you, order direct from factory using handy coupon. Send full remittance and we ship postpaid. Or send \$2 now and pay postman balance plus postage and fee. Money back if not delighted after 5 day's trial.

DREMEL MFG. CO., Dept. 110-F, Racine, Wisc.

ONLY \$24.50

WITH STEEL CARRYING CASE AND COMPLETE ACCESSORIES

14,400 Sanding Strokes per Minute

New DREMEL Electric MODEL 2000 SANDER • POLISHER



(Patented)



USE THIS ORDER—If Your Dealer Cannot Supply You DREMEL MFG. CO., Dept. 110-F, RACINE, WISCONSIN

- Enclosed find \$_____ (check or money order) in full payment for items checked below.
- Enclosed find \$2. Ship items checked below C.O.D. I'll pay postman balance plus postage and fee.
- Model 2000 Sander \$24.50. Model "A" Sander \$14.85.
- Send FREE Catalog of Dremel Tools

Name _____

Address _____

City _____ Zone _____ State _____

DREMEL Model "A" SANDER-POLISHER

OVER 200,000 NOW IN USE!

A lighter-capacity model that takes all the work out of home or hobby projects. Meets requirements of most users. Same design and construction features as larger model. Furnished in attractive cardboard box. If your dealer can't supply, use coupon to order. \$14.85.



\$14.85

STOP DRINKING

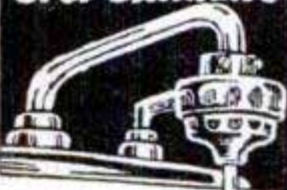

PROTECT YOUR FAMILY'S HEALTH WITH A CRYSTAL FLUID WATER FILTER. ORDER YOURS TODAY . . . ONLY

\$8.50

Postpaid.

DIRTY WATER! ENJOY SPARKLING, CRYSTAL CLEAR WATER with this CRYSTAL WATER FILTER

A better filter. Removes all impurities, microscopic dirt particles and scum from your drinking water. Makes it as sparkling clear as spring water. Easy to attach, does not cut down water flow. Made of cast brass, chrome plated for years of satisfactory service. Filter discs washable and replaceable. Tested, approved, and in universal use. Sold on money-back guarantee.

Attractive sales territories still available.

CRYSTAL WATER FILTER CO.

2231-PM North 17th Street • Milwaukee 5, Wisconsin
DOMESTIC • COMMERCIAL • INDUSTRIAL FILTERS

Have Fun with your own Outdoor Fireplace



Build it Yourself — It's EASY

Everyone loves to cook and eat outdoors. For a fireplace that costs less and works right, just fit masonry to this Model OF-28, 21" high, 26" long, 13 1/2" wide. See your dealer or order direct. Send money order or check. **\$17.95 Complete**

SEND FOR THIS BOOK OF DESIGNS 52 pages of helpful tips on fireplaces and outdoor cookery. . . Send 25c for your copy.



The Majestic Company
366 Erie Street, Huntington, Indiana

BE YOUR OWN BOSS! Make UP TO \$50.00 PER WEEK IN YOUR SPARE TIME

C. E. Hardy of Missouri says, "I am doing a fine business with the Universal Grinder. One Customer sends another. I spent \$40 for a newspaper ad and have done nearly \$500.00 worth of business." G.S. of Ark. says, "I have had my Universal Grinder 2 months and made a net profit of \$227.00."

ONLY ON THE UNIVERSAL LAWN MOWER GRINDER

. . . can the inside face and edge of the stationary blade, as well as the reel blades, be ground to proper clearance

ALL IN ONE SET-UP

WITHOUT REMOVING ANY BLADE FROM THE MOWER

Users who have tried them all acclaim the UNIVERSAL far above any grinder on the market. Write today for full details of our Proved Success Plan. It's Free.



ROGERS MFG. CO., DEPT. M-60, LINDSEY, OHIO

SEND THIS COUPON NOW

ROGERS MFG. CO., Dept. M-60, LINDSEY, OHIO
Please send me full details about the profit possibilities of Lawn Mower Sharpening.

NAME _____

ADDRESS _____

CITY _____ STATE _____

WHY WASTE TIME

with "temporary polishes?"

SIMONIZ GIVES TWICE THE SHINE AND IT LASTS!

Long lasting Simoniz saves time and effort . . . really protects and preserves the finish . . . keeps colors from fading! Your car will stay brighter than new with Simonizing—the Deluxe Beauty Treatment!

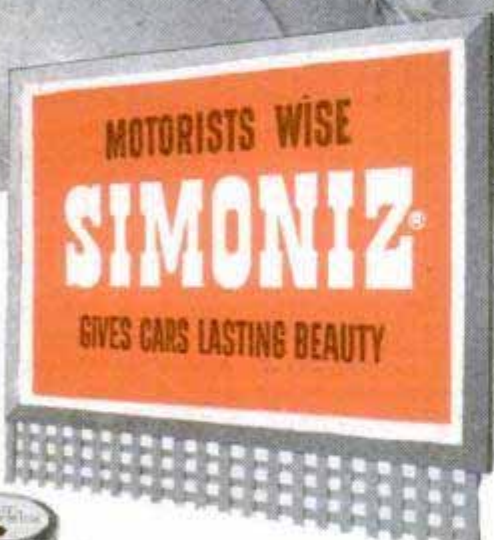
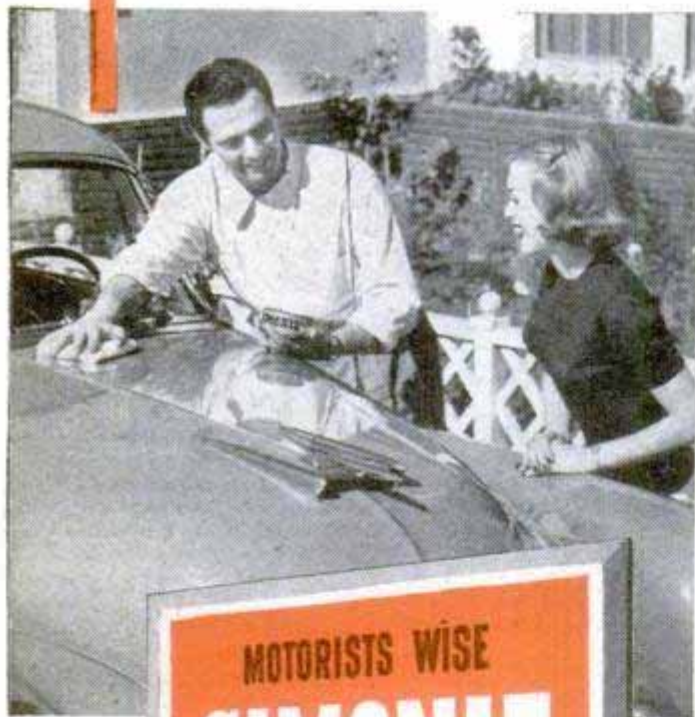

Newer cars need only Simoniz to clean and beautify the finish . . . a single, simple operation. On older cars, first use Simoniz Kleener (Liquid or Paste) to clean the finish. Then Simoniz for lasting beauty.

THE SIMONIZ COMPANY, CHICAGO 16, ILL.

High-Speed Splinter

(Continued from page 140)

sports. Annual dory races were held on the Thames in England as early as 1716 and it was a rough sport even in its early years. Friends of some oarsmen would stand on the bridges that spanned the course and would pour water or drop heavy stones into the boats of competitors. Other "spectators" tried to maneuver large craft in front of struggling dorymen to stir up the water and make the rowing more difficult.

The sport gradually spread to most parts of Europe and across the Atlantic. The first races in America were held on the Hudson around 1750, when crews from various ships raced in whaleboats or in ships' boats. Racing by private clubs and colleges started some 75 years later and the traditional Harvard-Yale boat races began in 1852. Meanwhile, professional oarsmen practiced at training camps, issued challenges and engaged in match races for large purses.

The present fast, lightweight shells began to evolve in the middle-1800s. Outriggers were one of the first improvements, then the English colleges developed the keelless hulls that are in use today. The sliding seat was an American contribution that came in the late '50s. Gradually, the present shells that are built and tuned virtually like violins came into being.

Another American contribution to the sport is the famous Hiram Conibear "comfortable" stroke, now used by virtually all crews, that combines speed with enough relaxation to permit a fast pace all through a long race. Conibear developed his stroke while coach at the University of Washington early in the century.

Pocock hulls and the Conibear stroke, plus continued good coaching, have made Washington the strongest rowing school in the United States. Washington won eight of the last 20 intercollegiate rowing regattas at Poughkeepsie, using the eight-man boats over a four-mile course. And in the 20 regattas Washington placed first, second or third a total of 19 times.

The Navajos Hunt Big Game

(Continued from page 92)

hospital. My trading post is practically the only local link with civilization.

The result is that the Monument Valley Navajos are living just about as they did a century or two ago. Their only houses are crude "hogans" that are built of brush and mud, with perhaps a piece of stovepipe stuck through the roof. Men and women alike still wear their hair long, bound up in

(Continued to page 238)

MONEY BACK
If Not Delighted
in 10 Days
WEAR AT OUR RISK

AMERICA'S BEST WATCH VALUES
PRACTICALLY WHOLESALE DIRECT TO USER

ORDER WITH CONFIDENCE
5 YEAR WRITTEN GUARANTEE

17 JEWEL SELF WINDING
ORIGINALLY \$71.95

Factory Surplus NOW ONLY

One of World's finest. Needs no winding. Winds self as you move. Water and shock resistant. Anti-magnetic. Ace value at former \$71.95 price. Now only \$24.95, plus \$2.59 tax. Order now.

\$24.95



MEN'S OR WOMEN'S **BULOVA**

15 or 17 JEWEL
movement

Originally Sold up to \$59

OUR PRICE ONLY **\$16.95**
Plus \$1.70 Tax

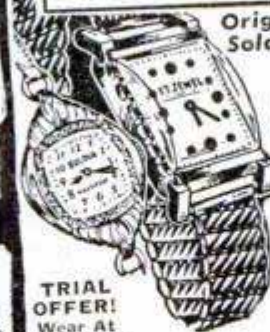

Also

- BENRUS
- GRUEN
- WALTHAM
- or ELGIN WATCHES

TRIAL OFFER!
Wear At Our Risk!

Genuine Bulova, Benrus, Gruen, Waltham, Elgin and other famous wrist watches in latest style Yellow Gold Cases. You get these unredeemed 5-year Guaranteed FAMOUS MAKE WATCHES now at truly enormous savings because we bought out SURPLUS STOCKS of leading New York and Maryland Jewelers. Order now while they last. State make preferred. Order men's or ladies'. Only \$16.95 plus \$1.70 tax. Order now.

17 JEWEL 2 Push BUTTON CHRONOGRAPH
ORIGINALLY \$71.50

Thousands sold at \$71.50 Factory Surplus Now Only

2-push button combination wrist watch, stopwatch, telemeter, tachometer. Incablock shock resistant feature. Sweep second hand. Anti-magnetic. Radium dial. Stainless steel back. Unbreakable crystal. Only \$21.95 plus \$2.20 tax. Order now.

\$21.95



Sturdy WRIST WATCH

- Sweep Second Hand
- LUMINOUS DIALS
- WATER-PROOF PLASTIC BAND

OUR PRICE NOW

Sturdy guaranteed men's watch. Built to keep accurate time. Many formerly sold at double this price and more. Yours now at only \$4.95 plus 50c tax. Order now for self and gifts.

\$4.95



FREE!

Handsome expansion band included free with your order. Write for FREE Watch & Diamond Ring Catalog. Practically wholesale prices to user direct.

ORDER DIRECT FROM THIS AD, FOR SELF AND FOR THRILLING GIFTS. Lowest prices ever, for these guaranteed watches! Order now on famous 5-year written guarantee. Send only \$1 down payment with order. Pay balance to postman on arrival plus postage. Or we pay postage if you enclose full payment plus tax with your order.

MARYLAND DISTRIBUTORS, Dept. 83, 501 E. Baltimore St., Baltimore 2, Md.

AMAZING NEW 1950

NOW 4 BEAUTIFUL COLORS

Powell P-81



10 HP AT 3400 RPMs! Thrill to 50 mph cruising—faster pickup than a car. AUTOMATIC CLUTCH with Powermatic Drive gives sensational performance.

No gears to shift! Safe, smooth Brakes—50 miles per gallon—Length 71"—Height 41"—Weight 196 lbs.

POWELL MANUFACTURING CO. Dept. PM650, Compton, Calif.

DEALER INQUIRIES INVITED

ONLY **\$289.44**
AT COMPTON, CALIF.
INCLUDING EXCISE TAX

WRITE FOR FREE FOLDER AND NEAREST DEALER

Write for **FREE 2 COLOR CATALOG**

YOU CAN HAVE A HOBBY AND A BUSINESS TOO!

with a **HOBBS No. 64 6-IN-1 SAW SHOPETTE**

NOW, at a price you can afford, a rugged, 6-in-1 power machine that works equally well as a Table Rip Saw, Swing Cut-Off Saw, Mitre Saw, Tool Grinder & Polisher, Saw Gummer & Sharpener and also for Dado Grooving. Specifically designed by a company with 40 years experience for home workshops, saw shops, fix-it shops, woodworkers, carpenters, etc. Converts from tool to tool in minutes. Completely portable. Guaranteed. Start your own home workshop or a money making business with a SHOPETTE. Increase your profits if you now own a shop. Power unit & table complete with motor plus 10" rip saw, 10" cut-off saw & emery wheel only \$128 F.O.B.

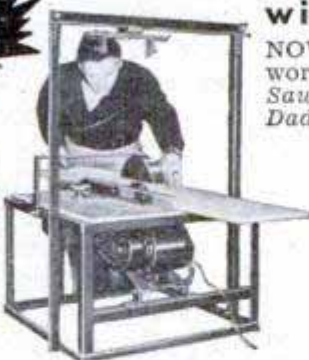

P. T. HOBBS MACHINERY

8375 N. INTERSTATE, DEPT. PM-10, PORTLAND, OREGON

M-SCOPE TREASURE-MINERAL LOCATORS

WRITE FOR FREE, ILLUSTRATED 16-PAGE BOOKLET

M-Scope Treasure-Mineral Locators, Geiger Counters. New Low Prices, unsurpassed in efficiency. Full factory guarantee. Immediate shipment.

YOU CAN PURCHASE THESE INSTRUMENTS ON A MONTHLY PAYMENT PLAN



URANIUM

FISHER RESEARCH LAB., INC., PALO ALTO, CALIF.



GOLD

ALL-STAR FILE TEAM

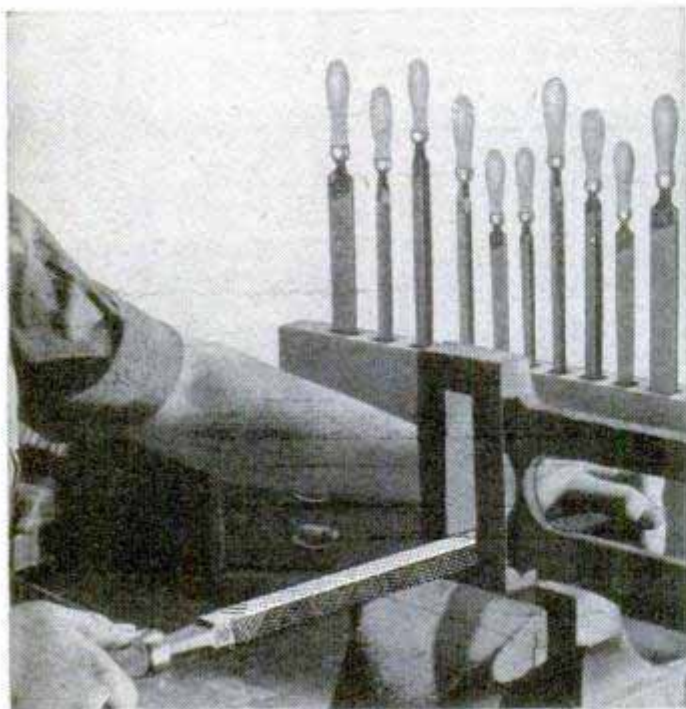

You're ready to tackle almost any filing job with an all-star team of Nicholson or Black Diamond files on the bench.

Each file is a specialist in its own right. Single cut for fine finishing. Double cut for fast stock removal. Special cuts for special purposes. And shapes and sizes to fit every shop need.

Each is made to exacting standards of soundness, hardness and durability.

Keep a good assortment of Nicholson or Black Diamond files "on tap." That way you'll always be sure of having The right file for the job. Available through good hardware dealers everywhere.

FREE - "File Philosophy," a 48-page, illustrated booklet on kinds, care and use of files. *Send for it today!*



NICHOLSON FILE COMPANY
22 Acorn St., Providence 1, R. I.
(In Canada, Port Hope, Ont.)



**NICHOLSON
FILES** FOR EVERY PURPOSE

a knot behind. Because of their natural love for color you find the Indian women always dressed in gaudy clothes no matter whether they are visiting the trading post or are tending sheep out on the desert.

The Navajos still weave their rugs and blankets on crude outdoor looms from balls of dyed yarn. The wool comes from their own flocks. They still grind their corn on a flat rock and they still make their jewelry from silver and turquoise ore.

Living under these primitive conditions, the Indians are a fascinating sight to visitors. Everyone who drives through the country takes snapshots until they run out of film. But there is another side to the picture. No more than three percent of the Indians around Monument Valley speak English, because of the lack of schools.

When one of them is desperately ill and word reaches me in time I try to rush the patient to a hospital. The long, arduous ride over dusty dirt roads and trails doesn't help the patient. Then, if he reaches the hospital alive and eventually recovers, he has to walk back home. There is no other means of transportation.

Their primitive life is not by their own choice. Besides local schools and hospitals, they need irrigation water, brought possibly from the San Juan River. With adequate water they could become industrious farmers, for the soil would support a good agriculture. The only water that's available now comes from a few springs and seeps and provides only enough for drinking and bathing purposes. Indianlike, none of the Navajo families will camp beside a spring. They prefer to camp a mile away, out of sight of the spring, and carry the water they need all the way to camp. This leaves the spring open for use by the coyotes and other wildlife in the vicinity.

Another thing that the Indians need is a paved road, with a bus line. This would allow them to move back and forth, to leave the reservation in search of jobs and to return home when the jobs end.

An Indian trader is more than a simple storekeeper. As a matter of fact, money rarely passes over my counter. Rugs, jewelry and other products are traded in for dungarees, staple foods, tools, saddles and what other necessities the Indians can afford. In turn I sell their products to visitors or through regular channels.

I'm also an interpreter, amateur doctor, general adviser, intermediary on legal matters, lodge operator, prospector and a one-man chamber of commerce.

I operate a modern lodge at my trading post because about 1000 visitors a year drive into the valley and there's no other

(Continued to page 240)

BEAUTIFIES natural wood, pine paneling

POLISHES furniture, woodwork

IMPROVES paint jobs

PROTECTS wood and metal surfaces

49¢ 89¢
PINT QUART

101 HANDY HOME USES!
Every home, every workshop, needs Pol-mer-ik BOILED Linseed Oil. Free folder tells you how to use it. Write . . .

ARCHER-DANIELS-MIDLAND CO., Minneapolis 2, Minn.

NEW!

NYLON

paint brushes

Smoothest painting

Easy to clean

Ideal for nearly all finishes

Durable bristles . . . won't break off

When you ask for a paint brush, ask for a **NYLON . . .**

Nylon paint brushes are made by leading paint brush manufacturers. Sold in paint, hardware and wallpaper stores everywhere, in all popular sizes. Buy a nylon paint brush today!

MAKE YOUR ELECTRIC DRILL A CIRCULAR SAW!

Save time . . .
Save work . . .
Save money

• Right-angle drive with oversize guards is supersafe, perfectly balanced for one-hand use. Attach it to any drill 3/4" and up, in seconds. Full 1 1/2" cut, handles 2" stock by turning over. Machined cutting guide for extra accuracy. Oilite bearings, sealed gears for longer life. Complete with 4" high speed steel saw blade.

\$7.95

Money-Back guarantee only
Dealer inquiries invited
POSTPAID—SEND CHECK OR M.O.
C.O.D.'s ACCEPTED—POSTAGE EXTRA

GLEAM PRODUCTS (Dept. P-6) Whitestone, L.I., N.Y.

STOP DRIP

caused from condensation on cold water pipes. Turn idle basement space into play or work rooms. Keep store rooms dry. Just wrap cork-filled NoDrip Tape around

NoDrip TAPE

pipes and joints. Do it yourself. Clean and easy to apply. Roll covers about 10 feet of 1/2" pipe, \$1.69. Higher west of Rockies and Canada. Get at Hardware, Department Stores, or sent postpaid. Write for free circular. J. W. Mortell Co., 522 Burch St., Kankakee, Ill.

NYLON

PAINT BRUSHES

*for smooth painting
...easy cleanup*



Better Things for Better Living
... through Chemistry

New!
NO WASH!
Non-Inflammable!

**Peels
Off
Paint**

Now you can "strip off" any finish safely, easily, without mess.

Old-fashioned, inflammable solvents work by "dissolving," leaving a sticky, waxy surface that must be carefully washed, or "neutralized." But Klean-Strip penetrates all layers of old paint and actually "breaks" the bond between the bottom layer and the surface to be stripped.

Klean-Strip changes any finish into a wrinkled film that is easily peeled off with brush or putty knife. Leaves surface smooth, clean and dry.

Buy Klean-Strip whenever you buy paint. At better paint, hardware and department stores.

**KLEAN-STRIP
REMOVER**

Product of W. M. BARR & CO.
2350 S. Lauderdale, Memphis, Tenn.

place for them to stay. Incidentally, visitors should never regard the Indians as mere exhibits. They are living their own lives and one should not invade their privacy by photographing them without permission. I tell Indians and visitors alike that a half dollar fee should be paid for the privilege of making pictures.

As a prospector I'm interested in finding mineral deposits that might help the inhabitants. As a white man I can't stake a claim or own a mine on the reservation and there is no reward for making a discovery. Any income or royalties goes direct into tribal funds.

Possibly you never heard of Monument Valley until now but there is a good possibility that you have seen pictures of it. It has served as the background for a number of Western movies. Each year I make a trip to Hollywood to try to get the studios interested in making pictures in the valley. The resulting income is one the biggest financial helps that the Indians have received. The tribe gets a fee for the use of the land and the individual Navajos draw wages for serving as actors. Portions of "Stagecoach," "Darling Clementine," and "She Wore a Yellow Ribbon," among other Western pictures, were filmed in Monument Valley.

It takes a real expedition to make a movie here. Sleeping tents, set materials, lighting plants, water, food and every incidental must be brought in by truck. Actors and crews come in by special busses and aircraft. For the time being we have two-way communication with the rest of the world. Each location group keeps in touch with its home studio by short-wave radio. The motion-picture sets that are erected in the valley are built for permanence and become the property of the tribe. They may be used, for an additional fee, by the next studio that comes in.

The scenic attractions of Monument Valley are so great that eventually, perhaps soon, it will have to be turned into something like a national park. More and more tourists are visting us every year. My hope is that the valley will never be taken away from its inhabitants and turned over to some agency for operation. The valley is the property of the Navajo tribe and if it is to become a public attraction the Indians themselves should be trained in park operation and should be allowed to manage it.

After all, the land was given to them as a reservation because it was considered worthless for any other purpose. No one dreamed, then, that it contained a big percentage of our uranium reserves and that because of this it actually is one of the most valuable areas in the country.



**When Screws Won't Stay
TIGHT, Use SMOOTH-ON**

Apply Smooth-On No. 1 Iron Cement to screw threads and into the screw hole. Insert and tighten up the screw. It will take hold and, when set, will STAY TIGHT, for Smooth-On expands slightly as it hardens, wedging the screw in place. This is only one small use for this general-purpose iron cement. With it you can stop leaks and seal cracks in cast metal parts, tighten loose knobs, casters, tool and utensil handles, make many auto repairs. Buy it in 1 3/4-oz., 7-oz., 1-lb. or larger size at your hardware store. If they haven't Smooth-On, write us.

FREE 40-page Repair Handbook

Many original uses for Smooth-On around the house, on the car, etc. Simple directions. 170 illustrations. Send postcard for YOUR free copy.

SMOOTH-ON MFG. CO., Dept. 37F
570 Communipaw Ave., Jersey City 4, N. J.

Do it with
SMOOTH-ON
THE IRON CEMENT OF 1000 USES



BRIKCRETE

Local Manufacturing of this Modern Masonry Has High Earning Power

Several hundred territories are being opened up for local Brikcrete manufacture by men of vision and aggressiveness. Brikcrete ties in with today's huge building program. Makes possible better construction at lower cost. Truly better than brick; actually cheaper than lumber. Combines strength, safety, insulation value, colorful beauty that fits today's styling.

Brikcrete is made in locally owned plants, using local materials and local labor. That's why high quality and low

price still permit a 100% to 150% mark-up. We supply complete equipment; easy terms if required. Generous co-operation. Exclusive manufacturing privileges in protected territory. Write for information.

Brikcrete Associates, Inc.
4679 Division Ave. S
Grand Rapids 8, Mich.



PAGE GARDEN TRACTORS



WITH
PRECISION
TRANSMISSION



RIDING AND WALKING MODELS

TO DO MORE JOBS AT LESS COST!

New economical '50 line, with extra features! Riding and walking models, 2 to 6 HP. For spring plowing and dozens of other year 'round jobs. Complete gear drive with reverse, no cheap belts or chains. New reduced prices—easy terms—\$188 to \$440 with cultivator and equipment lift. Get benefits of 25 years experience.

WRITE TODAY FOR YOUR FREE CATALOG!



PAGE DAIRY and FARM EQUIPMENT

1904 S. 81st ST.—MILWAUKEE 14, WIS.

BOAT BLUEPRINTS & FULL SIZE PATTERNS

and specifications. Designed by Naval Architect. Cruisers, runabouts, sloops, outboards, sailing

12FOOT CRUISER

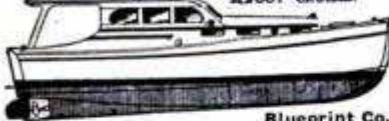

Blueprint Co., Dept. 666, Cleveland 13, Ohio

canoe, etc. Low prices. Send 25c (coin) for illustrated catalog. SPECIAL: Send \$1.00 for "HOW TO BUILD BOATS" book, postpaid. PolyWog Houseboat Plans, \$10. Marine Catalog \$1. Cleveland Boat

ARC WELDING FOR PROFIT OR PLEASURE

60 LBS. OF READY MADE PARTS

Only
\$24.95

BUILD YOUR OWN HEAVY DUTY WELDER

SAVE
Buy Only
NECESSARY
PARTS

All necessary parts Ready-Made and easy to assemble. You can do all around welding on steel, cast iron and other metals after only a few hours practice. Illustrated instruction manual included. Sold on 30-Day Money-Back Guarantee!

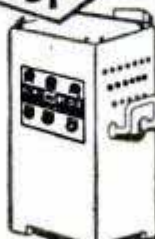

FREE: Write today for fully illustrated Pamphlet P-6

ATOMIC ARC WELDER CO.
1037 So. 19th St. OMAHA, NEBR.

Gives 100% penetration. Welds are stronger than original metal. Operates on 110 or 220 AC.

The Best and Safest For Your Boy

Beginner or expert, you will appreciate the extra quality, accuracy, and safety of a genuine Winchester rifle. The Winchester Model 69 is a young shooter's dream... a full size, lightweight, 5-shot box magazine repeater with the accuracy for which all Winchesters are famous. Shoots 22 Short, Long, Long Rifle cartridges interchangeably.

See this rifle at your dealer's. Operate its precision bolt action, notice the fine walnut stock, the simple dependable safety... all the features you recognize as extra value in this first quality, yet inexpensive, genuine Winchester rifle.



FREE! Folder giving full details of all Winchester 22 caliber sporting and target rifles. Address: Dept. 342-B, Winchester Repeating Arms Co., Division of Olin Industries, Inc., New Haven 4, Conn.

ANOTHER
OLIN
PRODUCT

The World Famous Model 69
WINCHESTER
TRADE-MARK
SPORTING RIFLE

Before you buy any POWER TOOL

get the facts



Free 16-page booklet on SHOPS MITH brings you complete details and specifications. Send coupon below.

YOU HEAR LOTS OF TALK nowadays about multi-purpose power tools. And no wonder! The largest selling power tool in America today is a multi-purpose tool. It's SHOPS MITH!

SHOPS MITH OUTSELLS BECAUSE IT OUTPERFORMS. With SHOPS MITH you can do more jobs, actually do better work, than with any \$500 combination of saws, sanders, lathes and drill presses. Yet SHOPS MITH, *complete with motor*, costs only \$199.50 (without motor, \$169.50).

SHOPS MITH OFFERS YOU: Hairline accuracy. Tremendous capacity. Quality features found only in the most expensive professional-type tools. Important savings in money and space.

YOU GET ALL THESE ADVANTAGES with SHOPS MITH. And while it may take as much as *one minute* to change from one tool to another, you can often save *hours* on any one job.

THAT'S BECAUSE SHOPS MITH IS VERSATILE! You have the proper tool, simplified adjustments and ready-made jigs for difficult or unusual operations, many of which are impossible with single-purpose tools. Yes, you actually save time with SHOPS MITH!

YOU GET THE FACTS—complete, detailed specifications—in an attractive, 16-page, illustrated booklet. It's free! Your nearest Montgomery Ward, leading department or hardware store presents SHOPS MITH for your inspection. Send the coupon today for the facts! Then see SHOPS MITH and *compare!*

SHOPS MITH, Dept. 126-B, at factory nearest you
12819 Coit Rd., Cleveland 8, Ohio, OR
417 Montgomery St., San Francisco, Calif.

Please send me a free copy of the SHOPS MITH booklet. And tell me where I can see SHOPS MITH demonstrated.

Name _____

Address _____

City _____

Zone _____ State _____

Bring on Your Inventions

(Continued from page 159)

Gettlefinger of Cincinnati who has invented a broom attachment he calls the Water-finger. This began when Gettlefinger had to move several times in one year and in each house found a dirty basement to clean. He experimented by tying a hose to the broom and finally made a clamp from a piece of scrap iron and a one-inch section of pipe. Milburn redesigned the attachment from Gettlefinger's crude model and used aluminum casting to hold down the cost of initial tooling. Since then Gettlefinger has set up his own plant to manufacture the device. He has been packaging and selling it in limited quantities.

R. J. Byrum of Grand Forks, N. D., came to Milburn with his idea for a "Dent-L-Aid," a plastic cylinder containing two tubes. One holds a toothbrush and the other a supply of powder. The cylinder seals tightly and can be carried in a woman's purse, glove compartment of a car or pocket in an overnight bag.

Joseph Gastright, a construction engineer of Florence, Ky., recently got annoyed by the poor construction made by erecting joists by toe-nailing them together. He designed a metal joist fastener which was engineered by Milburn and is made from a single metal blank in one forming operation. (See illustration, page 159.)

Marshall E. Butler of Raleigh, N. C., invented something for people who are annoyed by the radio when they are using a telephone. The telephone sits on the device and when the receiver is lifted an automatic switch turns off the radio and at the same time turns on a small light over a writing pad.

Another man designed a plastic cone to protect young plants from frost. A man with arthritis got tired of eating the ground meat prescribed by his doctor. He said it was too dry so he invented a new roller-type meat grinder that turns out a juicier hamburger.

Milburn says working with the small inventors is a lot more fun than engineering for industry. During the war he worked with defense plants, redesigning machinery to boost production.

"Some inventors have to learn the facts of life about production costs," said Milburn. "When they present a manufacturer with their invention and ask \$5,000, \$20,000 or \$100,000 for it plus royalties there is usually no sale. If more inventors would offer manufacturers their brainchildren for 5 percent of the manufacturer's gross—which I think is a fair figure—many more inventions would get into production."

SPRAYING MADE EASY

BECKER *Self-Contained* PRESSURE GUN

Saves Cost of Compressor and Motor

TAKE IT ANYWHERE—the first completely portable spray gun. Needs no compressor, motor, or electrical outlet. Pressure-powered with an inexpensive CO2 cartridge that sprays up to 21 liquid ounces, depending on viscosity. Extra cartridges, 10 for \$1, postpaid, or buy from your local hardware dealer.

PAINTS • VARNISHES • ENAMELS
MOTH-PROOFS • INSECTICIDES

Every home needs a Becker Spray Gun for dozens of jobs in the house, workshop, garden or garage. Complete instructions furnished for effective results. Order yours today for the season ahead.

HOW TO ORDER—If your dealer can't supply, send \$15.95 and we ship postpaid—or \$2 now and pay postman balance plus postage and fee. Money back if not delighted after 5 days' trial.

SULLIVAN-BECKER CO.
Dept. 110-F, Kenosha, Wisc.



ONLY
\$15.95
with 3
cartridges



WORLD'S LOWEST PRICED ADDING MACHINE



Vest Pocket Size
FREE TRIAL
only **\$2.95**
TOTAL COST
SEND NO MONEY

IDEAL FOR BUSINESS AND PERSONAL USE — GUARANTEED ACCURATE. Not a toy. Operates with only a finger flick. Adds, subtracts, multiplies, divides. Counts up to one billion. Pays for itself over and over. Ideal Gift — for Business, Income Tax and School use. MONEY BACK GUARANTEE. Send name and address. Pay postman only \$2.95 plus postage. (Send full cash if outside U.S.) Beautiful rich-looking Leatherette Case included at no extra cost. Money back in 10 days if not delighted. AGENTS WANTED.

CALCULATOR MACHINE CO., (Mfrs.)
Dept. M-1, P. O. Box 248 Glenview, Illinois

BURIED TREASURE. MINERALS AMAZING NEW GOLDAK LOCATORS

SENSATIONAL NEW MODEL!
ONLY 11 pounds weight! One hand operation! Money-Back Guarantee of Superiority. Write for full details.

THE GOLDAK CO.
1542 WEST GLENOAKS BLVD.
GLENDALE, CALIFORNIA

World's largest maker of fine locators.



SAVE OVER \$20

Make your own golf Bagtoter
Sturdy, balanced, easy-rolling, folding Bagtoter is simple to make in a few hours. Easy to get surplus parts. Looks better... is better than expensive jobs. Adaptable to carry outboard motors. A CINCH TO MAKE AND SELL TO GOLFERS... piles up extra dollars for you in spare time. Complete plans, list of materials, instructions only \$1.00 cash or money order. BAGTOTER, Vars Bldg., Buffalo 2, N. Y.



Thompson BEATS the World on BOATS



Safe Boats With Full Length Spray Rails
Keep passengers perfectly dry—even at high speeds. Catalog also shows two new models of "Take-Along" Boats. Two big factories—save you freight.

CATALOG FREE
Write for your copy. State kind of boat in which you are interested.
THOMPSON BROS. BOAT MFG. CO. (151)
213 Ann St. PESHIGO, WIS. Write to (either place) 113 Elm St. CORTLAND, N.Y.

Better Built Lower Prices



Light Boat for Auto

ASK YOUR DEALER

Using too much oil?

SWITCH to PENNZOIL

SOUND YOUR Z

If you suspect you've been using too much oil, find out with your next oil change. Switch to Pennzoil, the 100% Pennsylvania motor oil that lasts longer, grade for grade.

Over 60,000 better dealers recommend Pennzoil at the yellow oval sign. Drive in now and sound your "Z" for the genuine.



Member Penn. Grade Crude Oil Assn., Permit No. 2

TOUGH-FILM PENNZOIL® MOTOR OIL & LUBRICANTS AT BETTER DEALERS... COAST TO COAST

Get the
"HOLE" Story
with
Starrett
ACCURACY



Just a few of the
many Starrett Tools
designed for accurate hole measuring



SATIN CHROME INSIDE MICROMETERS
A Choice of Two Excellent Tools

No. 823 (Tubular Rods)
Rods are centerless ground steel tubes. Micrometer head has $\frac{1}{2}$ " movement with all thousandth lines numbered. Patented handle furnished provides correct reach and balance. Set A, $1\frac{1}{2}$ -8 inches. Set B, $1\frac{1}{2}$ -12 inches.

No. 124 (Solid Rods)
Set includes a micrometer head with $\frac{1}{2}$ " movement, extension rods, spacing gage, handle and spanner wrench. Capacities: Set A (shown) 2-8 inches; Set B, 2-12 inches; Set C, 8-32 inches; Set D, 2-32 inches.

TELESCOPING GAGES
No. 229

For holes from $\frac{1}{2}$ to 6 inches. Ideal for transferring internal measurements to micrometer. Plunger locked or released by knurled screw. Set of five gages.

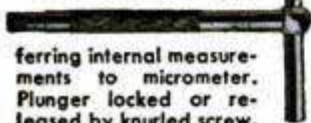

SMALL HOLE GAGES
No. 829

For fast, accurate small hole gaging — supplements No. 229 Telescoping Gages. Four gages in handy red leather case cover a range from $\frac{1}{8}$ to $\frac{1}{2}$ inch. Quick adjustment and sensitive contact make it easy to feel small dimensions accurately and transfer to a micrometer.



No. 830 HOLE GAGES
(Short Type)

Especially adapted for work in close quarters, shallow holes, slots, etc. Note shorter length and special shaped contact. Total capacity, set of five gages in convenient red plastic case, $\frac{1}{8}$ to $\frac{1}{2}$ inch.

SPECIAL OFFER — ONLY 10¢
50-Page "Tools and Rules" Book

"The Tools and Rules for Precision Measuring" tells how to make accuracy a habit, shows the methods skilled mechanics use. 100 pictures plus reference tables. Send only one dime. Address Department AP.



THE L. S. STARRETT CO. • ATHOL, MASS., U. S. A.

TRADE MARK
Starrett
REG. U. S. PAT. OFF.

Since 1880... Standard of Precision

MECHANICS' HAND MEASURING TOOLS AND PRECISION
INSTRUMENTS • DIAL INDICATORS • STEEL TAPES • HACKSAWS
BAND SAWS AND BAND KNIVES • PRECISION GROUND FLAT STOCK

Buy Through Your Distributor

Prairie Oil Boom

(Continued from page 129)

handle 95,000 barrels a day at the start. Later, this can be increased with additional pumps and storage facilities. Storage tanks at Superior will be built to hold 1,500,000 barrels during the winter months when the tankers are frozen in port. The pipe line will be a common carrier—available to all companies operating in Alberta.

Special machines are helping rush work on the pipe line. Specially designed pipe wrappers and coating machines, bending equipment to shape the pipe to the contour of the ground, the biggest ditchers Canada has ever seen, "side-boom cats" (tractors with hoisting booms on their sides) and other steel giants are creeping across the countryside. The big ditchers can trench over a mile a day to a depth of five feet.

When the pipe line and Sarnia refinery are going full blast, a big step forward will be made toward supplying Canada with the 300,000 barrels of oil a day consumed in the country. This oil now comes from the U. S., South America and the Near East. One pipe line from the East Coast to Montreal brings oil from the ocean-going tankers; another pipe line from the Middle West takes oil into Sarnia. It is believed that the Montreal refineries can never be supplied with Alberta oil as cheaply as it can be brought in by tanker and pipe line. However, Canada's annual oil-import bill calling for an expenditure of \$300,000,000 of her limited dollars is expected to be reduced to \$170,000,000. In other words, the Canadians will have \$130,000,000 more each year to spend for things other than oil. This is more than the total cost of the pipe line, which will make the dollar saving possible. Furthermore, if the reserves surpass expectations, the Alberta refineries may pipe oil and natural gas into western U. S.

Although interest is now focused on Edmonton, Canada's oil and gas picture is not limited to that area. Away back in 1914 natural gas was discovered in Turner Valley, southwest of Calgary, Alta., and in 1936 an important oil field was found there which is now down to its last 25,000,000 barrels. Two hundred and forty miles north of Edmonton are the Athabasca Tar Sands which contain the world's greatest oil reserves, estimated as high as 200 billion barrels. At present the cost of processing the sands to obtain oil is too high to compete commercially with other petroleum sources. In the Far North is Norman Wells which was brought into production in wartime at tremendous cost to supply Alaska bases. The operation at Norman Wells is

(Continued to page 246)

GET THIS 1950 CAR ENGINE PROTECTION

the new **MARVEL** **INVERSE OILER**

FOR CONSTANT UPPER CYLINDER LUBRICATION

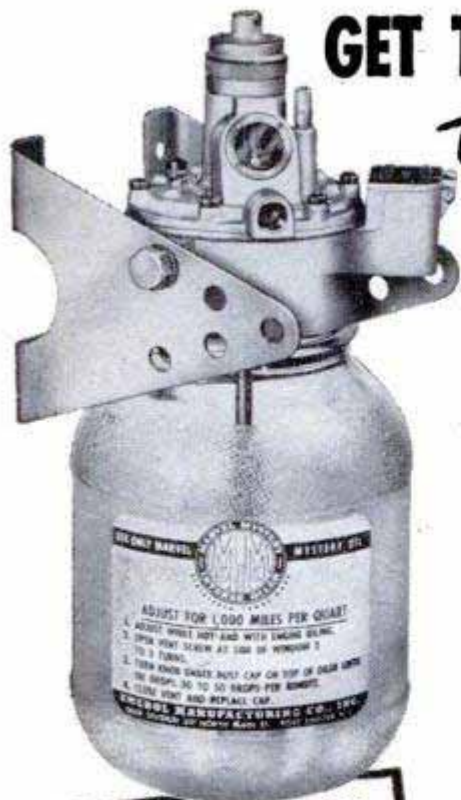

Here's the famous auxiliary lubricating oil system—in a sensational new, low cost, 1 Quart size—that meters MARVEL Mystery Oil to critical upper cylinder engine parts precisely in accordance with the demands of your engine under load. This new, compact OILER, with visible oil supply, functions on the same exclusive MARVEL principle—inversely to manifold vacuum—retarding feed when throttle is closed or at engine idle. You'll keep ring, piston and valve wear down and performance way UP with the MARVEL INVERSE OILER on your car.

MARVEL MYSTERY OIL

Learn about MARVEL Mystery Oil too—the nationally recognized leader among oil improving additives. Added to your regular motor oil, it shields vital parts from excessive frictional wear with its great film strength—produces a slow idle, faster engine pick-up and an even power pull.

**WRITE
FOR THE
FACTS—
NOW!**



**SENSATIONAL NEW
MODEL Q, 1 QUART
VISIBLE RESERVOIR
UNIVERSAL
BRACKET**

Only \$11.20
SIMPLE TO INSTALL

EMEROL MANUFACTURING CO., INC.
242 WEST 69th ST. (Dept. P.M.) NEW YORK 23, N. Y.

FLATFISH!

**WORLD'S
LARGEST SELLING PLUG!**

Noted for its lifelike action. The only lure with offset hooking. That's why it catches 'em for keeps. World's largest selling plug. Made in 26 colors. Underwater, surface and trolling models, \$1.35 each. Musky, \$1.45. Flyrod size, \$1.10.

Send for FREE 48-page booklet, with plug-fishing secrets of famous anglers.



**Free
CATALOG**

HELIN TACKLE CO.
6342 PULFORD, DETROIT 7, MICH.

**YOUR
"DREAM HOUSE"**



ALREADY PLANNED FOR YOU

You will find it in the brand new HOME PLAN BOOK of the Home Building Plan Service.

This new book contains plans never before published. You will find the house of your dreams among the many plans, which include starter homes, small homes, and large homes, in a wide variety of contemporary and traditional designs for both frame construction and block masonry. No C.O.D.'s please.

Complete working blueprints are available for any home illustrated in the Home Building Plan Service books. Send \$1 for each book.

HOME BUILDING PLAN SERVICE
2454-Q NE SANDY, PORTLAND 12, OREGON

Be Your Own Boss



There's a great feeling to being in something for yourself, where all the profits go into your own pocket. American floor sanders make it possible for you to realize this ambition without special schooling or a big investment. Begin small and work up to as large an enterprise as you desire... It all depends on your ambition to get ahead.

Ask for "tell-all" booklet entitled "Opportunities in Floor Surfacing". Use coupon and enclose 25 cents in coin or stamps to cover handling.

**AMERICAN
FLOOR SURFACING MACHINE CO.**

535 So. St. Clair St. • Toledo 3, Ohio
Gentlemen:

Enclosed find 25c in stamps or coin for booklet "Opportunities in Floor Surfacing," telling me how I can start my own floor sanding business.

Name _____
Street _____
City _____ State _____



**NOW YOU CAN BUY
THE ONE AND ONLY
HOWALD PROCESS FIBER GLASS**

Shakespeare WONDEROD



\$15.00
LIST PRICE

Prices
Begin at \$11.25

**TRY ITS AMAZING
1-2-3 ZONE ACTION**

COMPARE
Wonderod at your Sport Store. See what a difference *exclusive* Howald Process Glass Fibers make.

1. The ACTION Zone
With Wonderod's *fast tip action*, you "cast like a bullet" with just a *flick* of your wrist!

2. The POWER Zone
Wonderod has *backbone*—where it's needed—for the power to set the hook.

3. The ACCURACY Zone
Shakespeare's famous *Tru-Aim double offset handle* makes accurate casting as natural and easy as pointing your finger.

BOTH FREE! 1950 Tackle Book and Fishing Calendar—Show best days to fish, best ways to fish, best rods, reels, lines, bait. Casting lessons, fishing tips by U.S. Champion Ben Hardesty. Mail coupon.

Shakespeare

Shakespeare Company, Dept. PM-6
Kalamazoo 2, Michigan

Send me your free 1950 Tackle Book and
Pocket Fishing Calendar.

Name.....

Address.....

HONOR BUILT SINCE 1897



**I GET OVER 75
MILES PER GALLON**

Cushman offers the most practical way to get to work, school or market—do errands—make deliveries! Own, maintain and operate it for $\frac{3}{4}$ c a mile! Cheaper than bus fare or operating an auto. Handles easy, slips through traffic, parks anywhere. Famous Cushman "Husky" engine.

SEE YOUR DEALER. Or rush card for Free Folder and low prices.

Rider Agent Plan Available

CUSHMAN MOTOR WORKS
DEPT. M-6 LINCOLN, NEBR.

Cushman
MOTOR SCOOTER



WRITE
For Folder

now limited to about 900 barrels a day. It is refined there by Imperial and distributed in the Mackenzie River area.

Despite the lack of a western Canadian market and a finished pipe line, oil-exploring parties are moving right along in Canada. Some 60,000,000 acres are under lease in Alberta and about the same amount in Saskatchewan. At the last count there were 102 geophysical crews looking for oil in the region. This is second only to Texas where 143 such parties are at work. The Canadian crews include 81 seismograph, 20 gravity meter and one magnetometer party. Last winter the exploring parties worked through temperatures of 50 degrees below zero. They found that it is an advantage to work the swampy muskeg regions when frozen solid—also, there were no complaints about mosquitoes.

In their quiet manner, the Canadians—farmers, bankers, manufacturers, storekeepers and professional men—highly approve of their oil boom. They wonder what Americans think about it, and the barber on Jasper Avenue in Edmonton philosophizes on the situation.

"The big American oilmen can't kick very hard without kicking themselves because they've likely got a stake in Alberta, too. The military men ought to be happy because our oil reserves are a nice nest egg in case of trouble and if there is any trouble the U. S. and Canada will probably be in it together. And the ordinary guy who drives a car and buys gasoline shouldn't kick, either, because the more oil available the greater chances are that prices might get lower."

Canada's well-controlled oil boom is a quiet but happy affair from every angle.

College in the Tall Timber

(Continued from page 87)

They "cruise" the timber—size up trees and estimate the number of logs they will go; do some multiplying and come up with a good idea of the amount of lumber in a 40-acre stand. They observe grazing conditions, learn which plant species are best for cattle, for sheep, for wild life. They watch logging crews in operation; see the modern bulldozer doing work that would be a credit to Paul Bunyan himself. They visit a mill, estimate board feet of lumber in logs, then follow the logs through the mill to check on their estimates. They do and see, in fact, virtually all the jobs of the man of the woods. And, for the most part, they come away from the camp feeling good because they know their future life will not be spent in a 12 by 12 office.

(Continued to page 248)

HANDEE

Tool of 1001 Uses

The original tool of this type and today's finest. Choice of mechanics, repairmen and craftsmen for 18 years. Handee is the best tool investment you can make.

IT RUNS COOL—Smooth, controlled power when you want it, as you like it. Non-fatiguing because it is perfectly balanced and has 7-bar armature rather than only 3. Speed 25,000 r.p.m. Wt. 12 oz.

Handee with 7 accessories \$19.95
Handee with 51 accessories in steel case...\$24.95

At your dealer's or order today postpaid on money-back guarantee. Write for catalog. Chicago Wheel & Mfg. Co., Dept. PM., 1101 Monroe St., Chicago 7, Ill.



A Whole Toolshop in 1 hand
GRINDS, DRILLS
ENGRAVES, CUTS
POLISHES, SAWS
ROUTS, SANDS

MONEY MEN ALL FREE

THE PLASTEX Industry needs manufacturers on small scale and for big production of Lamp and Clock Stands, Art Goods and Novelties in Plastex and Marble imitation. Experience unnecessary. 1/2c material makes regular 10c store sellers. Rubber moulds furnished for speed production. Small investment brings good returns. Big chain store orders now being placed. Ambitious men have chance for real prosperity. Our Free booklet will interest and benefit you.

PLASTEX INDUSTRIES, Dept. A
3400 Third Ave. New York 56, N. Y.

FREE AMAZING NEW BOOK "HOW TO ANSWER ADS"



Never before have you seen anything like this. Tells you in simple language the correct way to answer ads. Gets you quicker replies—better results, and greater satisfaction. Will save you time and money and it's ABSOLUTELY FREE. No obligation whatever. Every reader of advertising should have this booklet. Send a postcard for your COPY NOW. Advertising Department, Popular Mechanics Magazine, 202 East Ontario Street, Chicago 11, Ill.

POWER HACKSAW \$47.25

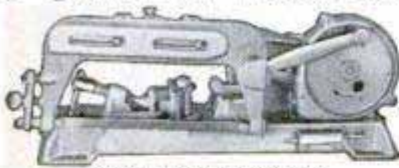

LESS MOTOR
F. O. B. Benton Harbor
● Rugged cast iron construction. Wt. 56 lbs. bronze bearings. Draw cut. Auto. return lift. Auto. shut-off. Vise swivels 45°. Cap. 4"x4".

Send for full details and name of nearest dealer.

EXCEL MACHINE TOOLS Dept. PM-60 BENTON HARBOR, MICHIGAN

OIL FILTER REFILLS...10c

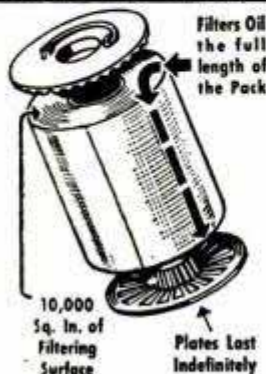

Filters Oil the full length of the Pack

10,000 Sq. In. of Filtering Surface

Plates Last Indefinitely

Here's News! Ordinary toilet paper makes an ideal oil filter. Laboratory tests prove it cleans oil faster and better than popular makes of filter elements. All you need is a simple set of Retlif Adapter Plates... and you can start using toilet paper rolls (costing about 10¢) in your present oil filter. For proof and descriptive literature, send name and address to:

RETLIF CORPORATION, Dept. 31
1239 No. Highland Ave., Los Angeles 38, Calif.
DISTRIBUTOR INQUIRIES INVITED

GET THE WORLD'S GREATEST RADIO & TELEVISION CATALOG!

FREE ALLIED'S 196-PAGE GUIDE TO EVERYTHING IN RADIO & TV AT LOWEST PRICES



Send for the 1950 ALLIED Catalog showing the world's largest stocks of Radio and Television equipment, at lowest money-saving prices! See the latest TV releases, home radios and radio-phonos, Amateur equipment, P. A. Systems and High-Fidelity Sound, tape and wire recorders, test instruments, builders' kits—thousands of parts, tubes, tools, books and diagrams. Get more for your money from the World's Largest Radio & TV Supply House. Get your FREE Catalog today!

HELPFUL RADIO BOOKS!



Dictionary of Electronic Terms. All-new reference guide has definitions of over 2500 terms used in television, radio, electronics and nucleonics. Invaluable for engineers, students, experimenters. Has useful data appendix. Published and made available by ALLIED at minimum cost. No. 37-756. Only...25c

- Radio Formulas & Data.....No. 37-752...10c
 - Simplified Radio Servicing.....No. 37-755...10c
 - Radio Builders' Handbook.....No. 37-750...15c
 - Radio Circuit Handbook.....No. 37-753...25c
 - Radio Data Handbook.....No. 37-754...25c
- All 6 Books No. 37-799 Only \$1.00

ALLIED RADIO

ALLIED RADIO CORP., Dept. 5-F-0
833 W. Jackson Blvd., Chicago 7, Ill.

Rush FREE Catalog
 Send Dictionary No. 37-756
 Send Books checked above } \$.....enclosed
 Send 6 Books No. 37-799 (All book prices postpaid)

Name.....
Address.....
City..... Zone..... State.....

Save Fuel - Be Cool in Summer

**INSULATE YOUR
ATTIC FOR ONLY
\$29.90***



SAVE \$75 to \$100

with **ALFOL**

ALUMINUM FOIL

BUILDING BLANKET

You can insulate your attic, garage, porch or any other room with unfinished walls with ALFOL reflective insulation in an evening, using an ordinary hammer to nail it to studs, beams or rafters.

Alfol's scientific design creates a series of air spaces sealed with pure aluminum foil and forms a perfect moisture barrier. Keeps heat out in summer—in during the cold months.

ALFOL IS COMPACT - LIGHTWEIGHT - EFFICIENT

Each roll of ALFOL aluminum foil reflective insulation weighs only 20 lbs., yet does the work of 250 lbs. of bulk material. ALFOL reflects 95% of all radiant heat—the greatest factor in heat loss. ALFOL is clean and safe to use. No dust, no dirt, no splinters. Used by builders, the U. S. Navy and in the dome of the 200-inch telescope at Mt. Palomar Observatory.

ORDER ALFOL NOW!

ALFOL comes in rolls 250 sq. ft. each, in widths for 12", 16", or 24" centers. You just unroll ALFOL, expand and tack it in place. Price \$14.95 per roll, Postage Prepaid. Two rolls will do the average attic—but measure your requirements to make sure. Check or money order. Sorry, no C.O.D.'s—Money-back guarantee backs ALFOL's claims!

BOOKLET TELLS YOU HOW

With each order, we'll send our illustrated book, explaining the scientific principle of ALFOL reflective insulation and containing full instructions for installing ALFOL. Booklet will be sent without order on receipt of 15 cents in coin.

*This buys 500 sq. feet of ALFOL Type One—enough for the average attic.

REFLECTAL CORPORATION

155 E. 44th STREET

NEW YORK 17, N. Y.

This desire to get out in the woods where a man has to struggle to conjure a mean thought is universal, for the camp's roster has listed men from England, Norway, India, the Philippines, Finland, Paraguay and China. The University of Idaho is primarily an institution for Idahoans, but its school of forestry is an exception. One year it attracted students from 42 other states. A surprising number come from the tree-shy plains of the Midwest, from the five boroughs of New York City where trees are equally scarce.

Life in the woods can be tough at times, but it is surprising how tough the students can get. When flames began sweeping the tree tops of the Bergdoff area one evening, the students were playing softball. Professor Wohletz ran onto the diamond shouting. "We roll."

The bat thudded on home plate, and players and spectators raced for trucks. Three nights later, the students—soot and sweat and dirt-blackened—returned to camp. One of them walked over to the diamond, picked up the bat and thumped it on the plate.

"Hey!" he said. "Who was up?"

Spray Bomb and A-Bomb

(Continued from page 150)

water in the high-school electrolysis experiment. The fluorine is collected in heavy steel tanks.

In action the cell sounds like a miniature thunderstorm. It crackles and rumbles as it starts up, and lets go with a periodic bang, even after it is working smoothly, just to let you know it is still there. The crackling is caused by air seeping into the cell, and the bangs are bubbles of fluorine recombining with hydrogen. But the noise threatens nothing. An ingenious system of automatic vents—one of the many safeguards which have kept lost-time accidents down to zero—dissipates explosions before they can build up.

Penn Salt is selling fluorine produced at Whitmarsh to rival researchers at cost. The motive is not Quaker charity, but speeding the arrival of a spate of fluorine products to guarantee a market for a new fluorine plant. The largest in the world, the plant is now being built in Calvert City, Ky. In any case, Canadian and American laboratories, month by month, are adding to the gas' repertoire. Here are some of the more striking things it is already doing, or foreseen for it by the experts:

Beside priming the production of atomic fuel, fluorine is giving electrical engineers a host of remarkable new materials to work

(Continued to page 250)

Your car...

... can be seriously damaged by a leaky radiator. Don't take chances—take care! Use Warner Liquid Solder... it's non-metallic, deposits tiny fibers to repair leaks anywhere in the cooling system. Fast, sure and easy to use—just shake... pour... and fret no more.

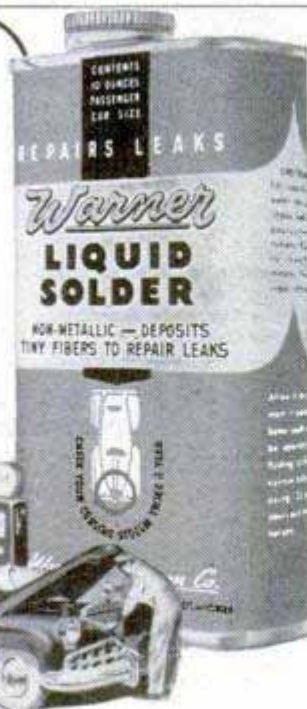

Warner
A FAMOUS NAME
IN AUTOMOBILE HISTORY

In Two Sizes, at Service Stations, Accessories Stores, Car Dealers, Auto Repair Shops

PAINTERS' STRIPING TOOL

A TOOL... NOT A BRUSH

NEW, IMPROVED

Modern—streamlined—fits the hand like a fountain pen! Easy to use as a pencil. Draws parallel lines—straight, curve or circular. Does expert job on autos, furniture, toys, bikes, model planes, signs, bulletins, linoleum, (Makes wall board look like tile.) Every painter and craftsman needs one! Type "M" MASTER Painters' Striping Tool complete with tip for 1/16" stripe, \$1.00. Other tools complete with following tips: 1/64", 1/32", 3/64", 5/64", 3/32", 1/8"; \$1.50 ea. Extra tips 75c ea. Entire kit with tool and 7 tips — \$5.00. (C.O.D.'s postage collect.) Paint dealers, write!

\$1.00 POST PAID

EASY AS USING A PENCIL!



WENDELL MFG. CO.

4234-B Lincoln Ave., Chicago 18, Illinois

POWER MOWERS & KITS

FREE PLANS

LOW FACTORY PRICES DIRECT TO YOU

on America's finest Lawn Mowers and Easy-To-Assemble Kits and Parts. TRIANGLE Mowers are quality-built and powered high for easy cutting and long wear.



- SAVE MONEY 3 WAYS**
1. Buy complete assembled mowers in 3 or 4 wheel models, 18" and 20" sizes.
 2. You assemble complete mower from our precision built Kits and Parts.
 3. Build your own from our FREE PLANS using Triangle Kits, Parts, Engines, Wheels, Etc.

WRITE TODAY for full facts, Free Plans, Parts List, and LOW, Factory Prices.

TRIANGLE MFG. CO.

Dept. M-E, Box 185 Fort Scott, Kansas

MUCH MORE SPEED FOR OUTBOARDS!



of all makes from 7½ to 50 HP on racing runabouts is provided with the famous Michigan "AQUA-JET" propellers. No rebuilding of lower unit is necessary. Each propeller is specifically engineered for the motor on which it is to be used. Other propellers for superior performance for practically every outboard in every application. Write for 1950 catalog, the "Outboarder's Bible," FREE. Michigan Wheel Co., Dept. 1-2 Grand Rapids 3, Michigan.

Tune in the AUTO-LITE Show

"Suspense!"

THURSDAY NIGHTS—CBS

EARN EXTRA DOLLARS

IDEAL LAWNMOWER SHARPENER

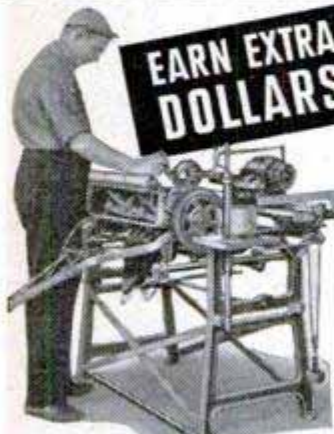

Saves work, saves time, helps you earn extra dollars! Sharpens hand, power mowers without disassembling. Complete shop in one machine — equipped with Bed Knife Grinder and "lapping-in" Reconditioner. Home owners, parks, clubs, cemeteries pay good money for efficient sharpening; get your share!

WRITE NOW FOR FREE CATALOG

THE FATE-ROOT-HEATH CO., Dept. 1-3, Plymouth, Ohio

the SWING'S to GLASS

- ... because glass rods are lighter!
- ... because glass rods are stronger!
- ... because glass rods are faster!
- ... because glass lasts years longer!

...BUT THE BIG SWING IS TO ACTIONGLAS



... because Actionglas adds features like these to the rod that's already perfection in glass...

GlasWeld construction fuses thousands of live glass fibers into a single, solid tip.

MicroTapered for strength where you need it, action where you want it!

Automatic Aligner makes sure handle and guides are always in perfect alignment.

Wedge-Type reel lock keeps constant pressure on reel. There's no danger of slipping.

Formed Corkgrip cushions your grip—makes it non-slip.

Personalized Nameplate engraves your name right on the rod!

Your choice of lengths from 3'7" to 6'1" \$9.95 to \$25.00

\$9.95 TO \$25.00

Actionrod

SOLID GLASS WITH LIVE ACTION

ORCHARD INDUSTRIES, INC.

Detroit, Michigan

THROW AWAY NICOTINE

When the Filter in Medico Pipes or Cigarette Holders turns brown, throw it away with the nicotine, tars, juices and flakes it has trapped. Insert a fresh Filter for cooler, cleaner, dryer, purer smoking!



Real Filters
...not mere hollow tubes!

10
for
10¢

MEDICO V. F. Q. (VERY FINE QUALITY)
Pipes of specially selected imported briar. \$2
Wide variety of shapes. With 10 filters...
Also Frank Medico "Standard"...

America's Outstanding Dollar (\$1) Pipe
Frank Medico Cigarette Holders \$1 & \$2

MEDICO FILTERED SMOKING

Write to S. M. Frank & Co., New York 22, for booklet M

ALL MEDICO PIPES NOW MADE OF
PRE-WAR QUALITY IMPORTED BRIAR

MODERN LAWN MOWER SHARPENER

FOR LAWN MOWER SHOPS
FIX-IT SHOPS

GOLF COURSES • PARKS
101 OTHER JOBS

Sharpens All Reel Type Mowers • Hand, Power or Gang
• 10 to 20 Minutes • No Dismantling • No Extra Attachments Needed.

All reel type mowers, from 5-inch edgers to 36-inch power mowers, are quickly sharpened to extreme ends of both left and right twist blades.

Handle, wheels, roller and motor remain in place when sharpening is in process. Bed knife is sharpened in same brackets. Grinding head rides on five ball bearing races. Easy to operate.

Also sharpens chisels, joiner knives, planer blades. Big profit maker. Own your own business. Send Today for FREE Illustrated Bulletin No. 10-C

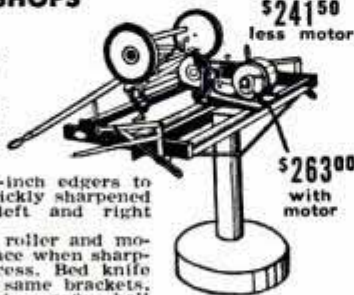

PRICE
\$241.50
less motor

\$263.00
with motor

ORDER
NOW
Immediate
Delivery

MODERN MFG. CO. 160 N. FAIR OAKS AVE.
PASADENA, CALIFORNIA

with. These promise cheaper electricity and better electrical equipment of all kinds, from power plants to household appliances.

A heat-resisting fluid made from fluorine, for instance, is leading to hotter, more efficient turbines. Engineers have been aware for three decades that more energy could be wrung from power-plant fuel—whether coal or the atom—if the turbine "windmill" turning the electric generators were spun by something like mercury vapor instead of steam. Since mercury has a higher boiling point than water, efficient high temperatures would be easier to reach. Experimental mercury turbines have been built to prove the point. Unfortunately, the liquid metal is scarce and expensive, making the mercury turbine an impractical dream. The new fluorine liquid, which has a boiling point near mercury, brings the mercury turbine down to earth.

Another fluorine derivative, a colorless gas made from sulphur and fluorine, is the best insulation yet found for the huge transformers that take juice from power-plant generators and step up its voltage for transmission to home and factory. Thanks to it, smaller transformers will carry bigger loads. Still another fluorine material, Teflon, a waxy substance originated by Du Pont, has a combination of resistance to oil, heat and electricity that makes it near ideal for proofing electric motors against short circuits. Teflon will lead to lighter, more compact and more powerful motors.

A new family of super-durable plastics related to fluorothene is a second prospect offered by the wonder-working gas. Unlike fluorothene, which was designed for industrial use, the newer fluorine plastics will be adapted primarily to everyday articles. They will be less expensive and easier to produce, yet will have fluorothene's virtual immunity to flame, heat and chemicals. They will be useful for all sorts of articles, from protective aprons to baking ware, beyond the reach of present plastics.

Fluorine is also making possible rubber that won't deteriorate with age and is unaffected by oil and acids. About a dozen years ago, Du Pont created the first synthetic rubber, Neoprene, by mixing a small amount of chlorine with an oily liquid obtained originally from natural rubber. Neoprene has now been made with fluorine instead of chlorine. A fluorinated form of "GR-S," the synthetic rubber used in tires, has also been whipped up in researchers' test tubes.

Prof. Herman Mark of the Brooklyn Polytechnic Institute, a top expert on plastics and synthetic rubber, calls the fluorine rubbers the most remarkable materials he

(Continued to page 252)

BASEMENT OR CLOSET DAMP?

NEW! IMPROVED! SOLVAY AIR-DRYETTE JR.

with
SOLVAY CALCIUM CHLORIDE

absorbs moisture—the cause of rust, warping, mildew in workshops, darkrooms, closets, playrooms, storage rooms, vaults. Built to last for years. Big capacity. Works fast, absorbs up to 3½ qts. per day. Compact, inexpensive, clean, safe, odorless. Thousands in use. Write for booklet and name of your nearest dealer.



Dept. 89-6, SOLVAY SALES DIVISION
Allied Chemical & Dye Corporation
40 Rector Street, New York 6, N. Y.

BUILD DUTCH WINDMILLS

Lighthouses, Lawn Figures, Lawn Chairs, Trellises, Etc., Beautify Your Garden

Model B-30 Windmill 24" high.
Wings operate farmer at backsaw. Blueprint...50c
Model B-10 Windmill hexagon style, 40" high overall. A beautiful model. Blueprint...75c
Model H-10 Lighthouse, 40" high. Blueprint...75c
Comfortable, Sturdy Cape Cod Lawn Chair. Blueprint...50c
12 Artistic Trellises. Blueprint all 12 only...50c
Special All Blueprints mentioned above for only \$2.50.

"Over 35,000 Satisfied Customers"
Send 10c for Illustrated Catalog.
CRAFTSMAN'S MODEL CO.
Dept. P-17 DELAFIELD, WIS.



OTTAWA Tiller & Mower

Patented Powerful 2 H-P Red Seal Continental Motor. Attachments for mowing, tilling, power take-off, cultivating and spraying. Lowest prices in history. Two speeds and free wheeling. Thousands in use. Rotary mower only \$89. Made by men with know-how. Now in our 47th year. Free details.

Rotary Mower
OTTAWA MFG. CO., 5-027 Lawn Ave., Ottawa, Kans.

BUILD FINE GRANDFATHER CLOCK NOW
The simple sensible Red-i-Kut way as thousands have—
SAVE HALF. SHOP TESTED PLANS "SPIRIT OF THE CENTURY" Narrow waist 83" tall or stately straight side "SPIRIT OF AMERICA." **EASY-TO-FOLLOW photostack PLANS** tell all — plus **BROCHURE** of heavy brass weight Westminster, tube chime, movements, gorgeous dials, ¾" solid mahogany case kits. Send \$1.00 today—Both Plans \$1.50 NOW.
KUEMPEL CHIME CLOCK CO., 28 Kuempel Bldg., Minneapolis 16, Minn.

Say You Saw It in Popular Mechanics

ONAN Portable ELECTRIC PLANTS

FOR CABINS, TRAILERS,
CONTRACTORS, BOATS

Light weight, compact, air-cooled, engine-driven. Furnish regular city-type A.C. electricity for lights, appliances, radios, etc. Can be carried by hand. Fit trunk of car. Plug-in receptacles on plant. Larger models for farms, homes, businesses beyond highlines. Catalog shows over hundred models. 350 to 75,000 watts.

GASOLINE OR DIESEL POWERED
Prices begin at \$169.50

WRITE FOR CATALOG

D. W. ONAN & SONS INC.

5834 Royalston Ave., Minneapolis 5, Minn.



NEW 5 H.P.*
JOHNSON
MODEL TN

THREE WAYS BETTER!

1. NEW NEUTRAL CLUTCH

Start in neutral. Idle. Flip the lever. Go! It's new — and wonderful!

2. NEW VARI-VOLUME PUMP

Varies the flow of cooling water to the motor's needs — positive cooling at any speed. It's new — and wonderful!

3. NEW SURE-FIRE SHOCK ABSORBER DRIVE

Absorbs the impacts of underwater obstructions. Forget about shearing pins in shallows. It's new — and wonderful!

Drive it and marvel! See your Johnson Dealer. Look under "Outboard Motors" in classified phone book. Time payments.

FREE HANDY CHART

Latest edition. Full details on the 5 great Johnsons for 1950 (2.5 to 22 H.P.*) including the sensational 10 H.P.* Model QD with Gear Shift Control and separate, plug-in Mile-Master Fuel Tank. Write. Sent free.

JOHNSON MOTORS
400 Pershing Road, Waukegan, Illinois
In Canada: Johnson Motors, Peterboro, Canada



JOHNSON SEA-HORSES for DEPENDability



* OBC Certified Brake H. P. at 4000 r. p. m.

FIRST and ONLY

Meter like it in the world!

Range O/Matic

COMBINATION PHOTO METER



Automatic
All-purpose
All-in-one

One instrument that performs all the functions of an automatic:

- 1 RANGE COUPLED FLASH CALCULATOR
- 2 EXPOSURE METER
- 3 RANGE FINDER

FOR ONLY

\$4.95
Incl. fed. tax



UTILITRON

INCORPORATED

30 Church Street, New York, N. Y.

HOW TO SHARPEN YOURSELF

CIRCULAR SAWS

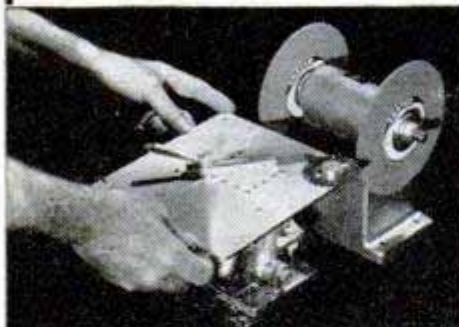

Also Many Carbide Tip Tools And Cutters

This all-purpose, practical circular sharpening fixture is the ultimate in simplicity. Easiest, fastest sharpening method available. Precision built for precision sharpening.

Now, you can keep your saws and tools always sharp for cleaner cuts. Sharpening is a business opportunity, too.

Send check or money order . . . money-back guarantee . . . nothing to lose . . . shipped prepaid with complete operating instructions.

MODEL 135 (Illustrated above) only **\$29.95** for 1½" to 12" diameter saws and cutters.

MODEL 160 only **\$49.50** for 1½" to 16" diameter saws and cutters.

(Tables on above models tilt either side to sharpen angular faces.)

MODEL 280 EX only **\$8.95** for 4" to 8" diameter saws.

MODEL 100 EX only **\$10.95** for 4" to 10" diameter saws.

MODEL 130 EX only **\$17.50** for 2" to 12" diameter saws.

MODEL 550 Swivel Vise graduated to 180° only **\$9.95**.

Grinder stand and grinding wheels not included in price of fixture.

MODEL 300A Dust Proof Ball Bearing Grinding Wheel Stand with 30" "V" Belt **\$15.95** (Illustrated above). Cast Aluminum

Guards only **\$6.50** a pair, 2 Grinding Wheels **\$5.00** extra.

MODEL 600 Saw Swedge only **\$9.95**.

TREYCO PRODUCTS

262 Hartford Ave. Dept. PM-6 Buffalo 23, N. Y.

has ever seen. About the only thing that will wear them out is scraping along a pavement. Nylon and other synthetic textile fibers have likewise been treated experimentally with fluorine, with equally beneficial results.

Still another gift of the new genie is a line of colors that has fashion specialists and textile designers excited. Incorporated in dyes, fluorine brings out pastel tones of a brilliance and delicacy never achieved before. Fluorinated dyes, moreover, are extraordinarily fast to light. Flagmakers are using the first fluorinated dye to achieve livelier, longer-lasting reds for the Union Jack and the Stars and Stripes.

Fluorine is already making a sizable contribution to medicine. The most effective drug dental researchers have turned up for guarding teeth against decay is a gray-green powder, sodium fluoride, which grandma used to spread around the kitchen to kill roaches. It is either added, in minute quantities, to the water supply or painted on children's teeth every six months. Either way, it halves the number of cavities the children would have as adults.

Another medical fluoride, named DFP, saves eyesight in glaucoma, which has been a leading cause of blindness among older people. During the war, researchers at Edgewood Arsenal, the U. S. Army chemical warfare center, prepared DFP as a possible poison gas. Though unsuitable for military purposes, an alert eye specialist noticed that it had an odd effect on the eyes. He shrewdly guessed that it might help reduce the pressure of the watery humor within the eye. If this pressure rises too high—as in glaucoma—delicate internal membranes are crushed and sight is destroyed. DFP keeps the pressure down to safe levels in nine out of ten patients. If they use the drug faithfully, they are assured of vision for the rest of their lives.

Other fluorine preparations are under investigation as anesthetics. Completely non-inflammable, they may end the tragic operating-room explosions that occasionally attend the use of ether. With a larger margin between the clinical and fatal doses, they will elevate surgery to new standards of safety.

When hydrogen combines with fluorine, sufficient energy is set free to generate 6000 Fahrenheit degrees of heat, easily enough to weld jet alloys and copper. Tungsten and boron carbide are also made plastic, opening the way to new methods of fabricating these diamond-hard materials into industrial metal-cutting tools. The hydrogen-fluorine combination, furthermore, packs more power than any known fuel except

(Continued to page 254)

Start Small...Grow Big... with Success Equipment

Your big years are right ahead! You can tie in with the great building industry, yet develop your own business manufacturing concrete block, drain tile, brick, roof tile, etc. We'll start you right in the

Modern Masonry Products

business and help you put it over. We supply complete equipment, built and developed through forty years of dealing with men like you. Helps you build for local market, using local materials and labor. High income potentials. Our line of modern machinery enables you to start small and grow big. Write for new Descriptive Catalog.

CONCRETE EQUIPMENT CO.

512 Ottawa Ave.,
Holland, Mich.

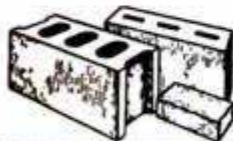

SAVE MONEY

Build this 18 ft. House Trailer yourself \$286.00.

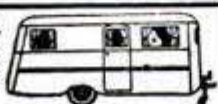

Blueprints, Building instructions and 1950 parts catalog 50c. Don't Delay, Write Today

NATIONAL TRAILER EQUIPMENT COMPANY

Dept. PM-6, 1007 N. WATER STREET, MILWAUKEE, WISCONSIN



\$87.50
LESS
MOTOR

HEAVY DUTY, PRODUCTION SWING SAW

NATIONALLY KNOWN
Just the tool for contractors, lumber yards, shipping rooms, etc. Cross-cuts, miters, rips and dados. Swivels 0° to 90° right or left. 4" depth of cut with 12" blade, 10" blade supplied. Ball bearing arbor lubricated for life. Portable—wt. 115 lbs. Order today! 1/3 cash with order, balance C.O.D. IMMEDIATE DELIVERY!

LEWIS MACHINE TOOL CO., Dept. M, 3217 Union Pacific Ave., Los Angeles 23, Calif.

OTTAWA Buzz Master

7 MODELS—\$99.00 up

Greatest offer made in our 46 years of manufacturing. A model to fit your needs and your pocketbook. Free details.

OTTAWA MFG. CO., 2-027 Brush St., Ottawa, Kans.



No Other Like It!

A "MUST" FOR Motorists!

Indispensable for night driving! Spots light where you need it—360° swivel. 800 ft. beam. Uses 6-volt dry battery. At hdwe., sport, electrical stores.



Delta REDDYLITE
Electric Lantern

ELECTRIC COMPANY
MARION, IND.

\$3.25
less battery

Speedy Power Tool Does 1000 Jobs In a Jiffy!



Removing Paint

Polishing Car



Waxing Furniture

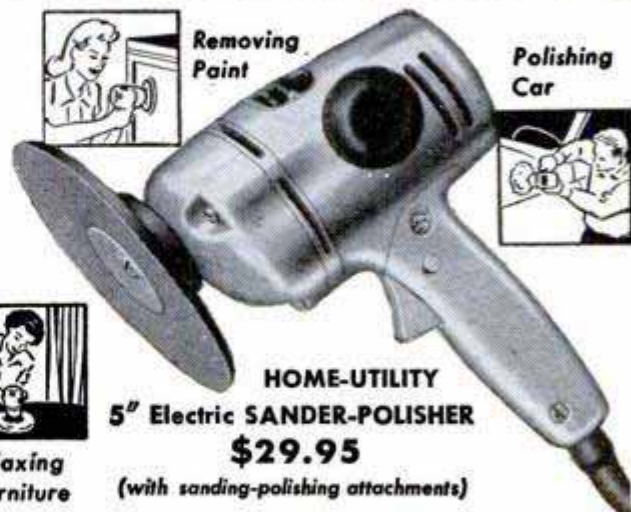

HOME-UTILITY
5" Electric SANDER-POLISHER
\$29.95

(with sanding-polishing attachments)

No Handier Tool for Your Home-Farm Use!

Home-Utility 5" Sander-Polisher takes the hard work out of home jobs—saves you time and effort in hundreds of ways! With the attachments supplied, you can refinish wood; polish cars and silverware, wax furniture, woodwork and linoleum. A 1/4" Jacobs Chuck (only \$3.45) and other low-cost accessories equip it for drilling in metal, wood, plastics; sharpening tools, cutlery, mower blades; removing rust and old paint; grinding, buffing and burnishing!

Easy for women to use, weighs only 3 1/2 lbs. Extra-powerful universal motor runs on any standard light circuit, A.C. or D.C. Quality-built by BLACK & DECKER, world's largest maker of electric tools. See it, try it at your hardware, electrical or implement dealer! THE BLACK & DECKER MFG. CO., Dept. H6M, Towson 4, Md.

Products of The BLACK & DECKER Mfg., Co.

ELECTRIC HOME-UTILITY TOOLS



1/4" Drills



1/2" Drills



6" Saws



Drill Kits



Bench Grinders

SAVE UP TO 25% ON QUALITY BALL-BEARING WHEELS!

Bilt-Rite wheels roll smoothly and easily, are semi-pneumatic, ball-bearing, painted red; guaranteed top quality—and you save up to 25%! Compare Bilt-Rite's quality and price—then get your order in today! Dealer inquiries invited.



BILT-RITE BARGAINS ON BALL-BEARING WHEELS			
(For 1/2-inch Axles)			
6 x 1.00\$1.30	10 x 1.25\$1.95
8 x 1.25 1.65	10 x 1.75 2.15
8 x 1.75 1.80	10 x 2.00 2.45
6 x 1.50			
.....\$1.50			
(For 5/8-inch axle)			
6 x 2.00\$3.95	8 x 2.50\$4.45
10 x 2.75			
.....Only \$4.65!			

Bilt-Rite Guarantee
No better wheels are made regardless of price; 10 day return privilege.

If size you need isn't listed, write for Folio A ORDER TODAY—Send cash, check, or M.O.—Pay postage on arrival.

BILT-RITE WHEEL COMPANY
520 EAST MISSOURI AVE. KANSAS CITY 6, MISSOURI

STOP FAUCET LEAKS PERMANENTLY



with the
SNAP-IN

**HOME FAUCET
REPAIR KIT**

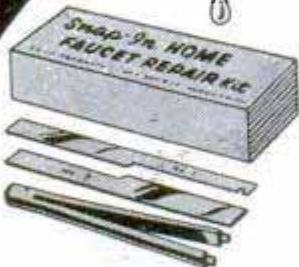

Snap-In
Swivel Washer

It's Simple

for anyone to fix a faucet with the Snap-In Home Faucet Repair Kit and Snap-In Swivel Washers and Monel Metal Seats. Installed in a jiffy! Just snap the patented Snap-In Washer into the end of the faucet stem as shown here! Hold the seat with the Snap-In seat holder and tap into place!



Snap-In Monel
Metal Seat

*Stops Leaks
Permanently!*

Snap-In Swivel Washers last 20 to 30 times longer than ordinary washers. Snap-In Monel Metal

Seats are so highly resistant to water erosion that to our knowledge none has been replaced. Reaming and re-facing unnecessary in most instances. Millions in use. Preferred by leading institutions and industrial firms for over 16 years. Kit, complete with tools, washers and seats only \$2.80

Ask your dealer! If not yet available rush \$2.80 (check or money order) for your kit today! Sent postpaid.

SATISFACTION GUARANTEED

Jobbers' and dealers' inquiries welcomed

SNAP PRODUCTS CORP.

Dept. 5PM, 153 W. Hubbard St., Chicago 10, Ill.

ZONA CRAFTSMAN'S SAW

\$1.50
P.P.



Designed especially for very fine work such as small joints, dovetailing, making perfect fits for inlays, mitre joints, all types of mouldings, including brass and aluminum; ideal for picture frames, etc. Cuts right to the line, no further sanding or finishing needed. Blade is of finest quality high carbon steel, only .015 inch thick. Indispensable to HOME CRAFTSMEN, finish carpenters and cabinet makers. Needs no sharpening due to hardened steel blade.

Precision mitre box for use with ZONA craftsman's saw—accurate floating head (Pat. Pend.) \$1.00 P.P.
SATISFACTION GUARANTEED OR MONEY REFUNDED — DEALER INQUIRIES INVITED

Western Arizona Sales

8841 N. Central Ave., Dept. C. Phoenix, Arizona

U-235 and plutonium. Since the experts are doubtful about atomic fuels as rocket propellants, the new mix will probably drive tomorrow's biggest rockets.

In spite of the fact that their cost has dropped, over 90 percent in some cases, during the past 10 years, fluorine and fluorine products are still comparatively expensive. Many applications are potential rather than actual for that reason.

"What we have to do," explains Doctor Gall, "is whittle away at costs. Fluorine products, however, will never be what I would describe as cheap, because of the large quantities of power and elaborate equipment required for preparing and handling fluorine. Nor do they have to be. Take DFDT, our new insecticide. DFDT is twice as expensive as DDT, but it is more poisonous to insects, so less is needed, and it has important safety advantages as well. DFDT will be a bargain at double the price of DDT per pound. Of course, where the fluorine product does something never possible before, price per pound is even less important."

Doctor Gall's point is underlined by the fluorine industry's phenomenal growth. When the astronomical wartime demand for aviation gas ended, fluorine chemical output fell sharply off. It dropped back nearly to the prewar level, when the industry's wares were limited to a few products like crude hydrofluoric acid for glass etching and Freon, made by an expensive, now obsolete process, for refrigerators.

Now, the fluorine industry has zoomed back to the wartime peak, and growth continues apace. Half a dozen companies beside Penn Salt are building new fluorine facilities: Du Pont in West Virginia, the M. W. Kellogg Company in New Jersey, others elsewhere. The earth's crust contains inexhaustible resources of fluorine, locked away not only in handsome fluor spar, but in plebeian fluo-apatite, the common rock from which comes the farmer's phosphate fertilizer. It is a safe prediction that the inexhaustible ingenuity of the chemist will make the pungent gas one of the stellar performers of this chemical age.

Petroleum Reserves at New Peak

Proved reserves of petroleum and natural gas liquids—established by actual drilling—are at a new all-time peak of over 28 billion barrels. The 1949 total is 1.5 billion barrels over the preceding year's figure. Natural gas liquids include condensates, natural gasoline and liquefied petroleum gases. Proved reserves of natural gas also rose to 180 trillion cubic feet, 6.5 trillion cubic feet over 1948's year-end total.

SHAW CAN MAKE IMMEDIATE DELIVERY



Easy and Cheap to Operate

SAVE TIME, WORK, MONEY!

SHAW DU-ALL

and "PEPPY PAL" TRACTORS

These rugged walking or riding tractors are ideal for farm, truck garden, orchard, poultry farm. Operate on a few cents an hour. A child can handle them.

DO DOZENS OF JOBS Both riding and walking tractors quickly and easily plow, cultivate, harrow, disk, bulldoze, spray, haul, grind, saw wood, etc.

LOW FACTORY PRICES Buy direct or through your dealer. Year's guarantee!

RIDING TRACTORS 4 models from 5 to 12½ H.P., 58 in. wheelbase, 36 to 52 in. wide, 24 in. plant clearance. Hand or electric starter. Walking Tractors 1¼ to 5 H.P.

FREE Illustrated folders giving complete details and price lists—write today!

4506 FRONT ST., GALESBURG, KANS.
668G NORTH 4TH ST., COLUMBUS, O.

PLOW



CULTIVATE



SHAW MFG. CO.

NU-WAY HEAVY DUTY CUTTING UNIT with Timken Roller Bearings

PRICE
\$16.50
WHY PAY MORE



Build your own rotary type lawn or weed cutter. Take the hard work out of weed cutting. Build yourself an up-to-date weed and lawn mower with the Nu-Way heavy duty unit.

Write for Free Circular—We Supply Cutting Unit Complete
TRACTOR-LITE MFG. CO., Spirit Lake, Iowa

Pioneers AIR RIFLES BENJAMIN SHOOT WITH SAFETY Leaders AIR PISTOLS

BE SAFE—SHOOT WITH COMPRESSED AIR—ALWAYS READY No Cartridges or Tanks to Replace or Recharge. If you want the most PRACTICAL GUN to use anywhere—inside or outdoors—get a SAFE—CLEAN—ECONOMICAL BENJAMIN with Adjustable Power and Amazing Accuracy. Send for Free Folder of Latest Models Today. BENJAMIN AIR RIFLE CO., 890 MARION ST., ST. LOUIS 4, MO.

make your own Gems 29.50 F.O.B.

All necessary lapidary equipment is furnished, including a super-charged diamond blade for sawing, and all wheels for grinding, shaping and polishing; also complete instructions. The complete equipment as shown, less motor and belt, for only \$29.50, f.o.b., Burlington, Wisconsin. Write today for information and literature.

B&I MANUFACTURING CO.
Dept. S Burlington, Wis.

NOW DADO ANY WIDTH WITH DA-DALL!
Pat. Pend. U.S.A. & For

A simple turn of a screw adjusts your saw to any desired Dado cut! DA-DALL cannot slip, is self-tightening, self-adjusting, of all-steel construction, does a clean, true job!

ONLY \$4.95

DA-DALL cuts hard or soft wood, plywood, without chipping! No blades or complicated dials. All arbor sizes.

RULE-WAGNER CO.
Box 694, Dept. D-2
Walnut Creek, Calif.
Dealers, Jobbers Write for Information

Break it in RIGHT



So Someday it Won't Break You!

Add **BARDAHL** to Your Crankcase Oil

BABY that new engine with the best lubrication you can buy! Simply add one quart of BARDAHL to regular oil.

Engine tightness disappears, rings and valves remain free, bearings stay cool and comfortable.

BARDAHL penetrates metal pores, cleans out carbon, gives new strength to ordinary oil. Result—engine runs better, breaks in faster, needs fewer repairs.

Ask the best mechanic in town about BARDAHL. He's been using it for years!

BARDAHL OIL

Reduces Friction to a Fraction.

BARDAHL OIL COMPANY
Seattle • St. Louis



KING MIDGET HOME ASSEMBLED AUTO



WORLD'S LOWEST PRICED AUTOMOBILE!

80-90 MI. PER GAL.—45-50 MI. PER HR.
Drive for as low as 50c per week. Precision built parts direct from factory with beautiful all steel body. Get the facts on this amazing small auto—send 25c for detailed circular with large picture, 3 view drawings and price of all parts, or send \$1 (refunded first order) for this plus actual assembly book with 42 photos, drawings; blueprints of snow, ice conversions, information on mini-midget racing, etc.

King Midget is ideal for errands, sports use, to work, short business or pleasure trips, or second-car utility for the whole family. Also tops for mini-midget racing. Room for six footer.

MIDGET MOTORS MFG. CO., ATHENS 1, OHIO

Just off the Press

-and FREE!

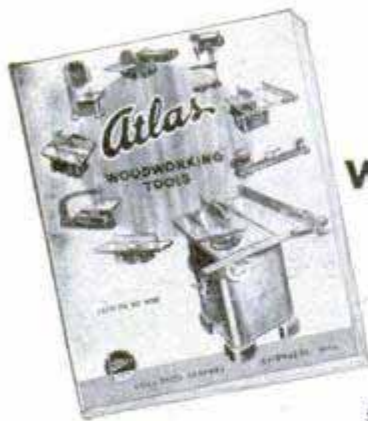

Atlas WOODWORKING CATALOG

Gives you complete information and operating views of these "industrial quality" tools for home shops. Atlas tools can help you this summer on your home building, improving.

SEND A POSTCARD FOR YOUR COPY

ATLAS PRESS COMPANY

643 N. Pitcher St., Kalamazoo, Mich.



**MATCHED PRECISION TOOLS FOR
WOODWORKING AND METALWORKING**



"SAVE IT AND
FIX IT"

FIXES

FURNITURE, DISHES, TOYS
BOOKS AND GLASSWARE

It's transparent, waterproof,
flexible and durable.

Get a tube
today.



DU PONT DUCO CEMENT

REG. U. S. PAT. OFF.

They Jump for Other Men's Lives

(Continued from page 114)

the ground. The chute is strong enough at such speeds, although test jumpers find that their helmets and shoes sometimes are torn from their bodies by the force of the wind when they leave their planes.

One of the goals of the research is a parachute that will open safely at the speed of sound, some 760 miles per hour, and that will have minimum shock when opened at that speed. Something better than the mere deployment bag is needed to reduce the tremendous jerk that would occur. Normal human tolerance for opening shock is about 16 Gs and it is believed the shock could go as high as 30 Gs with safety if proper protection is devised. The answer may be a full parachute suit that will distribute the shock, instead of the present webbed harness.

A speed-of-sound chute won't be needed for some time yet. The present ejection seats of transsonic aircraft adequately slow a man down before his chute opens. And except at minimum altitudes a jumper can deliberately refrain from opening his chute until he slows down to a safe speed or to his terminal velocity. This velocity depends on his weight and altitude, and ranges from 120 to 135 miles per hour. An airman ejected from a craft traveling at the speed of sound would slow down to his terminal velocity in about five seconds.

In seeking better parachutes the El Centro research unit tests all of the new ideas of manufacturers and experiments with a lot of its own ideas. One novel design is the ribbon parachute that consists of cloth strips or ribbons woven into the shape of a canopy. A ribbon chute can withstand a high-speed opening but it is heavy, bulky and descends too rapidly for the jumper's safety. It is ideal as a brake chute for slowing down aircraft, however.

Another experimental design is the pressure-relief type. This consists of an ordinary canopy with its center or crown cut away and then reattached with short, strong elastic cords. Stretched open during a high-speed opening, the crown allows much of the air to spill out around it, reducing the shock. When the chute slows down and air pressure is reduced, the cords pull the crown back into place and the jumper descends at a safe speed.

The pressure-relief canopy works perfectly but there is one fundamental objection to it. In the frigid temperatures of high altitude, its elastic cords would become brittle and snap. Until some desirable material can be found to replace the

(Continued to page 258)



IN A CLASS BY ITSELF...



the '50 FORD

**for Beauty
and Brawn**

YES, Ford is such an admired beauty that once again, for the second straight year, it has been chosen "Fashion Car of the Year" by the Fashion Academy of New York!

But here's a case where beauty is much more than skin-deep. Here's a brawny traveller that's built to take it—with your choice of two great economy engines . . . 100-h.p. V-8 or 95-h.p. Six. What's more . . .

Ford is an all-around economy car—low in first cost . . . low in operating cost . . . low in maintenance cost . . . high in resale value.

Completely integrated chassis design—balanced spring rates . . . correct braking effort distribution . . . low center of gravity . . . easy, positive steering control—gives big car roadability.

"Para-Flex" rear springs have ride-controlling inserts and rubber bushings at shackle and bracket bolts for quiet operation, long life. No lubrication of springs required.

Heavy upper and lower control arms, mounted on an extra large front suspension cross member, hold front wheels in accurate alignment.

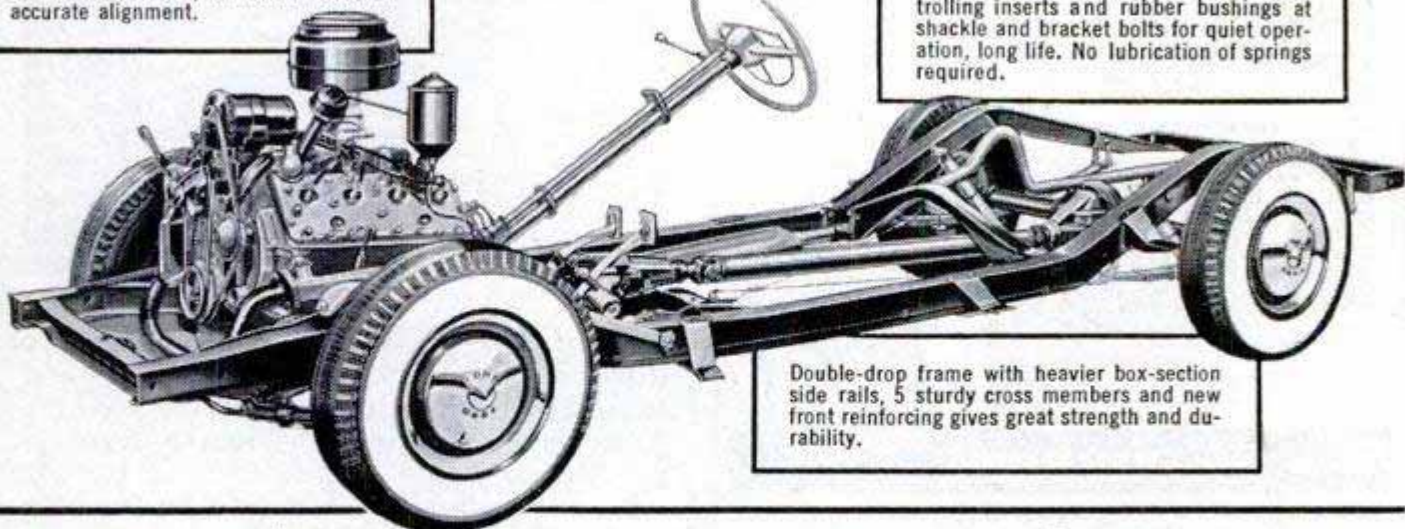

Double-drop frame with heavier box-section side rails, 5 sturdy cross members and new front reinforcing gives great strength and durability.

NOW... "Test Drive" a '50 Ford AT YOUR FORD DEALER'S

FREE PLAN

Tells How to Start
Your Own Business

FILING SAWS



Saws come from 20
and 30 miles

"I rented a two-car garage and have all the work I can do. Some days I start 6:30 in the morning. I get work 20 and 30 miles from my place of business."
—Charles H. Smith.

Buys 3 Foley Filers
in Year and a Half

"Since I started out with my Foley a year ago last June I have progressed so nicely that I now have a fully equipped saw shop with three Foley Filers." — R. W. Persinke.

FOLEY FILED SAWS BRING NEW CUSTOMERS

Here is a steady repeat CASH business you can start in your own basement or garage in your spare time. Every saw you sharpen with the machine accuracy of the Foley Saw Filer is an ad that brings you more customers. S. M. Hollingshead wrote to us: "I am doing very well with my Foley Filer, and I am glad I invested in your machinery. It is very satisfactory and works very well in the small community in which I live."

You can file all hand saws, also band and cross-cut circular saws on the Foley Saw Filer. The adjustments are simple — there is no eyestrain — and you can start right away to turn out perfect cutting saws. "The first saw I sharpened with my Foley Filer came out 100%. I think it is a marvel of perfection." — writes Clarence E. Parsons.

FREE BOOK Shows How to Start

"INDEPENDENCE AFTER 40"

explains how you can get business from hardware stores, home owners, farmers, carpenters, schools, mills, factories, etc. Just think — with a modest investment, no overhead, no stock of goods to carry, you can start right in on a cash business that will help pay the rent, buy groceries, or a new car. Start now — send coupon today. No salesman will call.



Send For **FREE BOOK**

FOLEY MFG. CO., 616-0 Foley Bldg.
Minneapolis 18, Minn.

Send me free book "INDEPENDENCE AFTER 40!"

Name _____

Address _____

cords, the idea has to remain on the shelf. Research likewise is being done on the problem of getting a chute to open in minimum time and distance, a vital necessity to the flyer who finds that he must leave his plane while only a hundred feet or so above ground. One idea that is being explored is to release a charge of compressed air or gas under the canopy as soon as it becomes partly distended. If the compressed air can speed up the opening, it may enable men to jump safely from altitudes that are too low for safe jumps with present equipment.

All the veteran jumpers at El Centro have a word of advice for everyone who wears a parachute and who sometime might have to use it. Devote both hands, they say, to the job of leaving the plane. This applies no matter whether you vault up from the cockpit or leap from a side door. There have been instances in the past when an airman jumped with one hand and pulled his rip cord with the other, the usual result being that the canopy fouls on the tail surfaces and the airman falls to his death.

When both hands are used to leap free of the plane the jumper is safe. It takes only a second, then, to reach the rip cord and pull it, and in that time the jumper has moved entirely away from the plane and has begun to slow down.

Lighted-Cigarette Dispenser

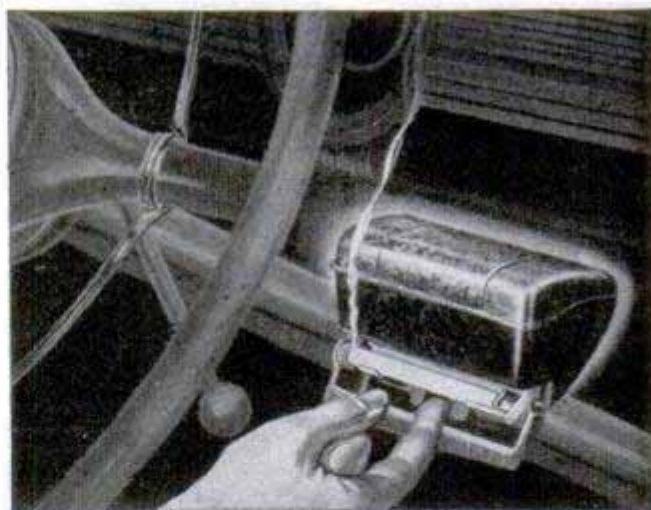

Lighted, ready-to-smoke cigarettes are dispensed by a device that fits all cars and is easily attached to any steering column. It holds 23 cigarettes. When a lever is pressed, a cigarette falls into a trough, where it is held by a spring against the heating filament for three seconds.

☞ Nature doesn't make the flavor of maple syrup, instead it's produced as sap is changed to syrup by browning.

You'll Be **FIRST** with a
MERCURY Hurricane!



KIEKHAEFER

MERCURY

"SUPER 10" Hurricane

Want the outboarding thrill of your life? Put a new MERCURY "Super 10" Hurricane on a good hull, crack the throttle, and you'll get it!

Open 'er up and you'll know why this job is called the "Hurricane." Never before such power and speed, such ease of control . . . yet the fishermen love it for its slow, steady troll . . . it lugs their big boats faster, gives them more time for fishing. Truly the most versatile outboard ever built. See it at your dealer . . . Now!

See the complete MERCURY line for 1950 . . . the outboards with all the features that are really important, *right down the line.*

For the First Time, These New Features in a "10".

NEW "HI-REV" micro-mounted connecting rods of drop forged chrome nickel moly steel, heat treated, hardened, tempered, precision ground and micro-honed to just the right scientific finish.

NEW Improved Porting to permit easier flow of fuel and gases.

NEW Drop Forged Unbreakable Aluminum Clamp and Swivel Brackets, heat treated to the strength of steel.

NEW High RPM Magneto — NEW 8 Reed Valve Cage — Larger Crankcase Opening. Features by the score for the finest outboarding you ever enjoyed!



Full Jeweled Power Ball and Roller Bearings Throughout for easier starts, more performance per horsepower, greater operating efficiency, longer trouble-free life.

Write for
FREE FOLDER

"RIGHT DOWN THE LINE".

KIEKHAEFER CORPORATION
Fond du Lac, Wisconsin, U. S. A.

Features of MERCURY Outboard Motors are protected by issued or pending patents.

THERE'S GOLD in GOOD IDEAS!



Rochester, New York, with its nationally known industries and progressive business community, is constantly seeking new ideas which can be converted into profitable products or enterprises. If you have something worth talking about, — something for which there is a market at a minimum price, —then write for details to:

Division of Public Relations

ROCHESTER DEPARTMENT OF COMMERCE
54 COURT ST. ROCHESTER 14, N. Y.

IN ROCHESTER, GOVERNMENT HELPS BUSINESS

*"I'll take the **WHITE** one every time!"*



WYTEFACE Steel Tapes, with their jet black markings on a white background, are easier to read in any light. They are rust-resisting, hard to kink and easy to clean.

Protected by U. S. Patent 2,089,209

WYTEFACE

TRADE MARK

STEEL TAPES

KEUFFEL & ESSER CO.

HUNDREDS OF ITEMS AND IDEAS FOR THE WOODWORKER

HARD TO FIND LUMBER

A board or carload—Top grade kiln dried Mahogany—Walnut—Wh. Hd. Maple—Cherry—Poplar—Aromatic Red Cedar—Red, White and English Brown Oak—Sapeli—Andiroba—Balsa wood.

BIG NEW No. 17 CATALOG FOR WOODWORKERS.

144 PAGES OF HARD-TO-FIND SUPPLY ITEMS. Full of unequalled bargains and useful information.

NEW LOW PRICES.

OVER 100 NEW ITEMS

Our stocks are gigantic — bigger than ever before. Really **FAST SERVICE** on your orders. Our new catalog includes a "gold mine" of hard-to-find hardware items. Whatever Wood Craftsmen need — **WE HAVE IT.**

The finest craftsman catalog Harold Hunt ever published—32 rare and fancy woods in natural colors — also in color, 43 matched veneer designs, multi-colored bandings, inlays, overlays, scroll patterns, etc. Price 15c, rebated on first order.

CRAFTSMAN WOOD SERVICE CO.

2729 S. Mary St.

Dept. A-6

Chicago 8, Ill.

POWER LAWN MOWERS

SAVE MONEY! TIME! WORK! Buy the Best for the Least

89 UP

Our new direct blade drive VD-1 20-inch cut rotary mower with vertical shaft 4-cycle 1½-2 h.p. Clinton engine is now available. Safety features. Easy adjustments. Order now. Draft or money order. Deposit of \$10 on C.O.D. orders. Other models available including larger self-propelled units. **Write For Free Literature**



Complete FOB Factory
Prompt Shipment
Satisfaction Guaranteed

B-M MOWER CO., Box 66-PM
Blue Mound, Kansas

SOUTH BEND



LATHES
DRILL PRESS
SHAPER

9" to 16-24" Lathes

14" Drill Presses

7" Bench Shaper

Write for literature — indicate machine.

SOUTH BEND LATHE, SOUTH BEND, IND.

TENTS & CAMPING EQUIPMENT



New Tents: 2-man mountain style, nylon \$15.95; canvas \$11.95. 5 x 7 wall \$10.95; 7 x 7 \$12.50. War Surplus, used, reconditioned: Pup tents, single flap \$2.95; double flap \$3.95. 9 x 9 wall \$21.95; 16 x 16 \$32.95. Poles & Stakes included

Check or M.O. Money Back Guarantee Free Tent & Camping Catalog

MOR-SAN-SALES 10-19 E 50th AVENUE
LONG ISLAND CITY 1, N. Y.



ENSHRINE THEIR MEMORIES WITH

U.S. MONUMENTS

Erected. Freight paid.

There is none better. Our free catalog is ready for you. Write today. A-18, U. S. Marble & Granite Co., Oneco, Fla.

BUILD A URANIUM LOCATOR!
(GEIGER COUNTER)

GOVERNMENT NEEDS URANIUM!

Valuable undiscovered deposits may be at your finger tips! Find them with a Geiger Counter. Send \$1.00 for Big How-To-Build Plan . . . Describes easy, inexpensive construction and operation. No technical experience needed. This little locator may show you the way to wealth. Uranium and other needed metals are being discovered daily!

Send \$1.00 Today For Your Big Plan!

LEJAY MANUFACTURING CO.

247 LeJay Bldg., Minneapolis 8, Minnesota





FULLY GUARANTEED TIRES COST LESS!

Nationally famous FIRESTONE, GOODRICH, U.S. ROYAL, GOODYEAR, and other makes. Every tire selected and inspected for your safety.

Military New Tread	New Tread Tires Guaranteed 24 Months			
Guaranteed 24 months	600x16 6.95	550x17 6.95	670x15 7.95	750x16 8.95
600x16	7.98	650x16 7.95	650x15 7.95	710x15 8.95
750x20	19.98	700x16 8.95	700x15 8.95	760x15 9.95

MILITARY ALL PURPOSE TREADS

900x20 13.98	1000x20 14.98	1100x20 16.98	1000x22 14.98
--------------	---------------	---------------	---------------

GOOD USED TIRES. TUBE FREE WITH THESE TIRES

600x16 3.58	700x16 4.98	32x6(8) 8.98	825x20 11.48
650x16 3.78	750x16 6.88	32x6(10) 10.88	900x20 11.78
650x15 3.68	650x20 7.58	750x20(8) 8.18	1000x20 12.78
700x15 3.88	700x20(8) 8.98	750x20(10) 9.98	1100x20 13.78

AAA PREMIUM GRADE TUBE FREE WITH THESE TIRES

600x16 5.18	750x16 7.58	650x20 9.88	825x20 15.68
650x16 5.38	600x16(6) 6.48	700x20 10.88	900x20 14.98
650x15 5.28	650x16(6) 6.98	32x6(8) 10.48	1000x20 16.48
700x15 5.48	700x17 8.88	32x6(10) 12.48	1100x20 17.58
820x15 6.98	750x17 10.88	750x20(8) 10.68	1100x22 18.78
700x16 6.18	600x20 9.18	750x20(10) 12.88	1400x20 22.98

MILITARY SPECIAL 900x16 8.98 750x20 8.98
TRACTOR-IMPLEMENT-INDUSTRIAL-SOLID and AIRPLANE TIRES and TUBES - WRITE FOR LOW PRICES

Largest stock of used tires in the East. Thousands of satisfied customers. Write for sizes not listed.
MONEY ORDER OR CHECK WITH ORDER.

PYRAMID TIRE CO.
 1333-35 North 5th St.
 Dept. M, Phila. 22, Pa.

PENNA'S LARGEST STOCK OF TIRES

The Right Tool for a Right Job
IN YOUR WORKSHOP
EMPIRE LEVELS

Get more value for less money! Make Your Choice an Empire Level

No. 151 Aluminum Level. Extremely accurate with adjustable-interchangeable vials. Has 2 levels, 2 plumbs, and a choice of 2 45° vials or 2 additional plumbs. Beautifully finished, easy to work with. A tool you can be proud to own.

18" ... \$6.40 24" ... \$6.80 28" ... \$7.80

Order EMPIRE Levels from your local dealer, or write for complete information.

EMPIRE LEVEL MFG. COMPANY
 Dept. PM 717 10930 W. Potter Rd., Milwaukee 13, Wis.

STOPS LEAKS PERMANENTLY

Cut your fixture replacement, water and fuel bills with Economy Renewable Seats. Make economical, permanent repairs quickly and easily with the Junior Kit (illus.). Repair bathroom, kitchen and laundry fixtures. Everything you need included in steel box. This is a natural for the "Fixit" shops—get extra income from making permanent repairs on your customers' faucets.

Senior Master Kit also available—repairs faucets and valves up to 1" pipe.
 Write for illustrated circular and prices.

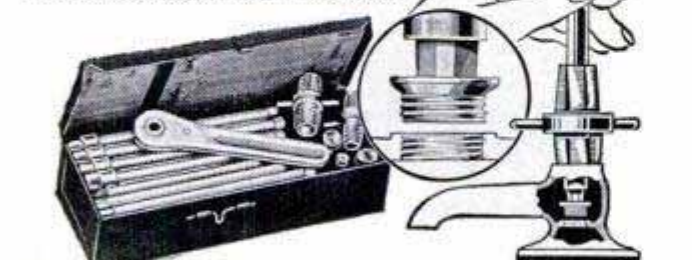

NEW "JIG-A-VISE"

3 tools in one—a Jig . . . a Jack, and a Vise. Ideal for handymen, model makers, home workshops. Use it for holding any piece for drilling, finishing, assembly. Assures accurate work as all surfaces are ground true. Write for complete information and illustrated circular.

ECONOMY VALVE SEAT CO.
 3122 N. California Ave., Chicago 18, Ill.

NEW AUTOMOTIVE DISCOVERY
FREE TRIAL
 IN YOUR CAR!

THE OBJECTIVE IS TO GIVE YOUR CAR

- MORE MILEAGE
- FASTER PICK-UP
- EASIER STARTING
- BETTER IDLING

REPLACES IDLE ADJUSTMENT SCREW IN YOUR CARBURETOR
 MOLLS FOR AIR FLOW

Patent Pending

INSTALL IT YOURSELF in a Few Minutes

THE AMAZING NEW GANE "air-flow" NEEDLE

ABOUT 1/2 MILLION NOW IN USE!

Up to 25% MORE MILEAGE, EASIER STARTING, FASTER PICK-UP and SMOOTHER IDLING are reported by many users of this new SENSATIONAL Automotive Product. (Hundreds of such letters have already been received.) However, they do not show improvement in some cars—Therefore we want you to try them in your car **AT OUR EXPENSE. TRY BEFORE YOU BUY.** Just mail card or coupon below and **TRY THEM FREE** for 10 days. Then check your mileage and engine performance. If satisfied, send only \$1.50 per needle (8 cyl. cars take 2). If not entirely satisfied—just return them and **YOU OWE US NOTHING—FAIR ENOUGH? - TRY BEFORE YOU BUY**

MAIL TODAY
SEND NO MONEY
PAY POSTMAN
NOTHING

NATIONAL AUTOMOTIVE RESEARCH CORP.
 Dept. J-6, Venice, California

RUSH Gane "Air-Flow" Needle for my FREE TRIAL. I SEND NO MONEY—I PAY POSTMAN NOTHING. I will try them for 10 days in my car. Then, if satisfied, I will send only \$1.50 per needle (8 cyl. cars take 2). If NOT SATISFIED, I will return them and I OWE YOU NOTHING.

Name _____

Address _____

City _____ State _____

Make of Car _____ Year _____

No. of Cylinders _____ Make of Carburetor _____

SAY YOU SAW IT IN POPULAR MECHANICS

Stucco Spraying Can Be Your Opportunity

You can build a profitable, lifetime business with Colorcrete. Large waiting market. Work is easy and interesting. Moderate investment; high return. Large waiting market. Full instructions and liberal co-operation.

Sprayed-On Beauty

Colorcrete is modern beauty treatment for masonry surfaces—exterior and interior. Fuses to concrete, stucco, etc. Applied by air pressure. Range of many smart colors. Proven by 20 years of use on all kinds of buildings.

Write or wire for Opportunity Book.

COLORCRETE INDUSTRIES, INC.
 570 Ottawa Ave., Holland, Mich.





For Dad on Father's Day

with these 3 tools you can

grip join
turn squeeze
hold straighten
twist fasten
push tighten
pull loosen
bend cut

anything in and around the house

MagneKit includes

6" Long Chain Nose Pliers
6" Adjustable Wrench
7" Angle Nose Pliers,
PLUS Magnetic Tool Holder,
all for price **\$5.85**
of tools, alone

UTICA MagneKit

with Magnetic Tool Holder

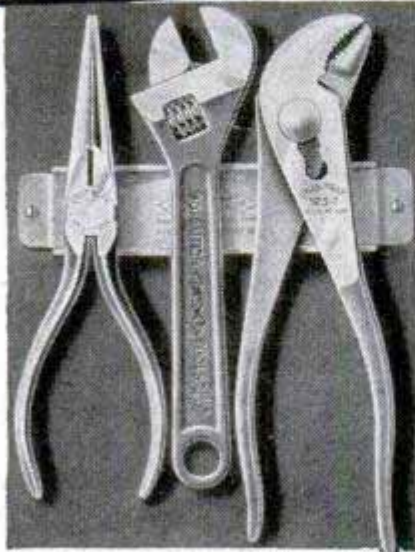

Here's a gift Dad will prize! The 3 basic tools the hobbyist or handyman uses constantly in construction and repair work—PLUS a powerful, permanent Magnetic Holder. "Professional" tools, these, that enable anyone, novice or expert, to do the job easier, quicker, better. Your hardware store has the handy, new MagneKit or can get it for you.

Utica Drop Forge & Tool Corporation • Utica 4, N. Y.

It pays to buy



PISTON TYPE COMPRESSOR



EASY PROFIT IN PAINT SPRAYING

Paints walls, ceilings, screens, furniture and machinery faster, better. All complete as shown less motor. Carry anywhere. Fully guaranteed. Could be used with 1/4 H.P. motor or less. Price **\$35.00** less motor F.O.B. Chicago. \$5.00 deposit balance C.O.D. or see your dealer. With motor \$55.00.

IDEAL AUTOMATIC PUMP CO., Dept. P.M.8
801 W. Washington Blvd. Chicago 7, Ill.

NEW PACKAGED BOATS 1950 KITS



17 New models. Improved design, skiffs, outboards, inboards, sail boats. Tredronic racers, cruisers, 8 to 16 ft., exclusive features. Preassembled frames, Tri-Keel construction, Tredronic bottom, full length spray rails, widest beam, simplified construction, easy to build. World's best boat buy! Send 25c for new 1950 literature, or send \$1.00 for literature, plus booklet "Plywood Boats."

BOAT PATTERNS-BLUE PRINTS

1950 Catalog—over 100 modern designs by famous naval architects. Racing classes, cruisers, inboard, outboard, sail, 6 to 35 ft. Plywood-Steel-Plank. Construction plans, full-size patterns. Send 35c for catalog or \$1.00 for catalog and helpful booklet on "Boat Building."

MARINE MART-DEPT. 24-BUFFALO 7, N. Y.

HYDRAULIC Power Transmission

WITH Infinitely VARIABLE SPEEDS, Clutch and INSTANT REVERSE—OUTPUT TORQUE ADJUSTMENT UP TO 180 inch POUNDS

This positive displacement Hydraulic Torque Converter is the ideal fluid drive with thousands of uses . . . Output Speeds Infinite 0 to 550 R.P.M. . . . in either direction . . . Change Speeds WHILE RUNNING . . . Control and Transmit your power this SMOOTH Oil-Way . . . Will handle 1/4 H.P. to 1 1/2 H.P. Motor. Industrial or Home & Farm Use . . . Cost government \$300. High Quality Precision Workmanship. Buy this unit to get the most for your money. Case measures 7 1/2" long 7" high 6 1/2" wide. Input & Output Shafts 5/8" dia. Beautiful Red Crackle Finish Case.

FINGER TIP CONTROL



Shipping Wght. 25 pounds

Only **\$54.50**

PREPAID

If C.O.D. is requested a 10% deposit must accompany order and we ship F.O.B. Chicago.

1 1/2"-8 thread lathe
Chuck Adapter, \$3 extra

2 quarts oil included FREE

DIRZIUS MACHINE SHOP "C" 1423-25 So. 52nd Ave., Cicero 50, Ill.

DO MORE PLANING JOBS WITH LOW-COST BELSAW \$195.



AMAZING 12 1/2-IN. PLANER Does All Ordinary Planing Mill Jobs. Provides attachments for Jointing, Rabbeting, Tongue, Groove, Matching. 12 1/2 x 6-in. capacity, 3-knife solid round all-steel cutterhead. Power feeds at 24 feet per minute, 42 cuts per inch. Provides for full line of accessory attachments—Grind and Joint knives IN THE CUTTERHEAD WITHOUT REMOVING.

FREE BOOK

BELSAW MACHINERY CO
81013 Field Bldg., 315 Westport Rd., Kansas City 2, Mo.

SEND FOR BOOKLET and LEARN WHY MOTOR OIL SHOULD NOT BE CHANGED!

Mention year and make of your car, truck or tractor. **RECLAIMO MFG. CO., Inc., 5083 N. Euston Ave., Dept. 32, Chicago 30, Ill.**

Attention Leathercrafters

LOOK WEST, to the home of Leather Carving and Stamping. More than 100 LEATHERCRAFT KITS in finest Tooling and Carving Leathers. Best assortment of tools and accessories in U.S.A. Other handcraft materials also.

SEND 10c FOR 96-PAGE ILLUSTRATED CATALOG.

GRIFFIN CRAFT SUPPLIES (since 1924)
5626-A Telegraph Avenue Oakland 9, California

SAVE 3/4 ON ROOFING

BATTLESHIP
ASBESTOS ROOF COATING
Sales Vacancies for Reliable Men
PANTHER
Box 711, Fort Worth 6, Texas



WAR BARGAINS SURPLUS

Over 200 terrific ALSO FACTORY SURPLUS VALUES!
SEND FOR FREE Catalog
SIoux FALLS SURPLUS STORE
SIoux FALLS, S. DAK.

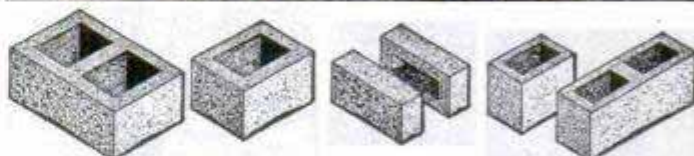

Make Concrete Blocks and Bricks

New superior method makes square, true, easy-to-lay units which will pass any building code. Small investment, high production, big profits. One \$30.00 machine will make four 5"x8"x12" blocks per minute—1000 per day. Pays for itself in a few days. Sell blocks or save 2/3 building cost by making and laying your own.

POST CARD BRINGS FREE FOLDER

Economy Manufacturing Company
Dept. P Stone Mountain, Georgia

SAVE ON THESE BRAND NEW

WAR SURPLUS BARGAINS

UNCONDITIONALLY GUARANTEED

Brand New

AUXILIARY ELECTRIC GENERATING PLANT

**FOR GENERAL UTILITY AND EMERGENCY USE
2500 WATTS · 115 VOLTS · 60 CYCLES A.C.**

Penty of current to operate your: Oil Burner, Sump Pump, Refrigerator, Home Freezer, Power Saw, Lights, Radio and Television, Home Water System Pumps. Complete integrated heavy duty electric power plant, Signal Corps Model PE-75, driven by Briggs & Stratton, one cylinder 6 1/2 H.P. Model ZZ, 4-cycle engine with killer button, oil bath air cleaner, governor, muffler, starting rope, and radio interference filter. The self-excited Leland or Westinghouse generator is rated 2500 Watts, 115 Volts, 60 Cycle A.C. single phase, belt driven, with guard and duplex receptacle.

(Item #88)

When generator is not in use, you can use the engine separately to power other equipment. Mounted on adjustable steel skids, notched for carrying poles. Net wt. 310 lbs. Shpg. wt. 440 lbs. Dimen. 36"x19 1/2"x24". 12 month guarantee. \$726.00 value. NOW

295.00

Aircraft Quality HYDRAULIC CYLINDERS

Large supply of new labor-saving, economical hydraulic equipment in many types and sizes . . . including actuating and double action cylinders, control valves, tanks, pumps, fittings, hose, and data on hydraulic applications. Use these positive, highly efficient, smooth pressure hydraulics on presses, arborers, lifts, brakes, plastic dies, auto frame alignment, etc., etc.

ITEM #4—All steel double action hydraulic cylinder, 1 1/2" bore, 2 1/2" stroke. Clevis mounting. Will lift 1000 lbs. with 1000 P.S.I. line pressure. Perfect for positioning and feeding movements. Shpg. wt. 4 lbs. F.O.B. Chicago. . . . **4.95**

ITEM #33C—Double action hydraulic cylinder, 1 1/2" bore, 4 1/2" stroke. Clevis mountings at both ends. Uses 1/4" pipe fittings. . . . **8.95**

ITEM #32—Double action, 1 1/2" bore, 9" stroke, will lift 1760 lbs. with 1000 P.S.I. line pressure. Wt. 4 lbs. A \$45.00 value. . . . **10.95**

ITEM #41—Double action hydraulic cylinder, 2" bore, 6" stroke, clevis mounting at base and end of shaft. Overall length closed 12 1/2". Has 3/4" stainless steel shaft, uses 1/4" tubing fittings. Will lift up to 3100 lbs. with 1000 P.S.I. line pressure. Weight 7 Lbs. Postpaid. . . . **12.50**

ITEM #16—Double acting cylinder, 1 1/2" bore, 27" stroke. Will lift 1760 lbs. with 1000 P.S.I. line pressure. Wt. 8 lbs. A \$55.00 hydraulic cylinder value for only Postpaid. . . . **12.95**

ITEM #15—Double acting cylinder, 3" bore, 8 1/2" stroke. All steel hydraulic cylinder, will lift up to 7000 lbs. with 1000 P.S.I. line pressure. Wt. 12 lbs. A \$78.00 value. Postpaid. . . . **19.50**

ITEM #31—Double acting cylinder, 3 1/2" bore, 11" stroke. Will lift 9600 lbs. with 1000 P.S.I. line pressure. Wt. 15 lbs. A \$92.00 value. Postpaid. . . . **22.50**

ITEM #6—Double action, 3" bore, 23" stroke, hydraulic cylinder will lift 7070 lbs. with 1000 P.S.I. line pressure. Especially suited for farm and construction machinery. Clevis mounting for easy use. Wt. 22 lbs. A \$154.00 value. F.O.B. Chicago. . . . **27.50**

ITEM #42—Double action hydraulic cylinder, 4" bore, 18" stroke. Rated lift capacity with 1000 P.S.I. line pressure is 12,560 lbs. Ship. wt. 30 lbs. AN EXCELLENT VALUE FOR F.O.B. Chicago. . . . **32.50**

HI-PRESSURE FITTINGS for cylinders and valves available at 35c ea. for 3/8" pipe and 50c ea. for 1/2" pipe.

LOGAN HEAVY DUTY HYDRAULIC PUMP

For operating hydraulic cylinders and hydraulic motors on tractors, bulldozers, construction machinery, lift trucks, industrial applications, etc. Delivers 8 GPM at 1200 RPM at 1000 P.S.I. using 5 HP. Has 1/2" pipe thread ports. Rotate in either direction. Also use as hydraulic motor. 3/4" shaft with flat and keyway for direct or pulley drive. Has flange with 4 bolt holes for convenient mounting. Ship. wt. 22 lbs. Overall dimen.: 7" L x 5 1/2" H x 5 1/2" W. A \$105.00 value. FOR ONLY F.O.B. Chicago



(ITEM #29) **22.50**

Hand Hydraulic PUMPS

Item #11— Postpaid. . . . **8.95**

Item #83—Hand hydraulic pump with built-in transfer valve. Postpaid. . . . **12.95**

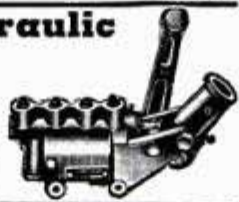

PNEUMATIC AIR DRILLS

Used - Like New

Light, powerful, compact, pistol grip, trigger control. Ideal for shop use or where air pressure is available.

ITEM #80—Ingersoll-Rand. Equipped with 1/4" Jacobs key chuck. Overall dimen.: 6 1/2" long, 5" high, 1 1/2" thick. Wt. 3 lbs. F.O.B. Chicago. . . . **14.95**

ITEM #81—Chicago Pneumatic. Larger Size. Model A, equipped with 1/4" Jacobs key chuck. Overall dimen.: 7 1/2" long, 5" high, 2" thick. Wt. 4 lbs. F.O.B. Chicago. . . . **19.95**



LOGAN HEAVY DUTY HYDRAULIC CONTROL VALVE

Has built-in adjustable relief valve, will operate one double-acting hydraulic cylinder or two cylinders as one or a reversible hydraulic motor. Valve handle latches in neutral position. Made of rugged cast aluminum alloy. Open center unloads the pump in neutral position. Throttling control allows operator to regulate the speed of movement of the hydraulic cylinder or motor. Has removable mounting brackets with 4 bolt holes, 3/8" pipe thread connections. Overall dimen.: 12 1/2" H x 8 1/2" D x 8" W. Ship. wt. 17 lbs. Govt. Acquisition Cost over \$100.00 An Excellent Buy. F.O.B. Chicago

(ITEM #37)

21.95

VICKERS HYDRAULIC TRANSMISSION

MODEL AA16801A

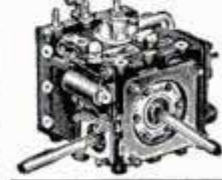

Ideal for lathe drive, miniature cars, power machinery, gearing, etc. Rated 2 HP maximum input at 3750 RPM. Output speed continuously variable from 0 to 1/2 of input speed in either direction. Self contained reservoir. All controls external. Even power at all speeds. Complete with two 1/2" shafts with flat for pulley attachment. Shpg. wt. 20 lbs. Gov't. acquisition cost \$325.00. A tremendous value at (ITEM #85) F.O.B. Chicago

25.00

Vane Type - Manganese Bronze INSECTICIDE PUMP

For spraying DDT, 2-4D, sulphur compounds, arsenic, oil solubles, etc. Pressures up to 200 P.S.I., delivering 5 gallons per minute at 1200 RPM, 8 gals. per min. at 1800 RPM. Will not rust, pit, foul or freeze up. Standard 1" pipe thread ports. Rotation—either direction 9"x6"x7". Shpg. wt. 10 lbs. Gov't acquisition cost \$42.00. . . . NOW Free: Comp. etc. instructions and performance data with each pump. F.O.B. Chicago



(Item #50) **15.00**

A.C. GENERATOR

750 WATTS 115 VOLTS
(Item #67) **60 CYCLES**

Manufactured by Eicor, rated 750 watts at 1800 R.P.M. Complete with voltmeter regulator; 1" shaft, with keyway for direct or belt drive, carried in one bronze and one ball-thrust bearing. These units, built to exacting Signal Corps specifications, are the answer to your lighting needs. Shipping wt. 60 lbs. F.O.B. Chicago



59.50

NEW STATIONARY OR PORTABLE D.C. ARC WELDER

250 AMP. MODEL 252

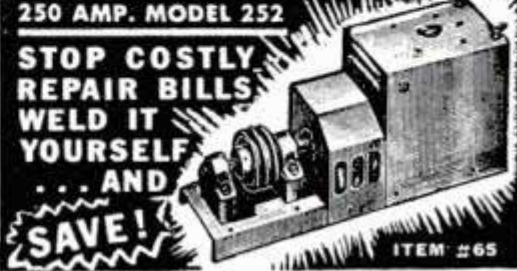

STOP COSTLY REPAIR BILLS WELD IT YOURSELF AND SAVE!

(ITEM #65)

FOR ANY WELDING JOB, LIGHT OR HEAVY

Designed for many years of trouble-free service. Handles anything from light gauge sheet metal to 1/2" plate.

This precision-engineered Direct Current ELECTRIC ARC WELDER is offered at but a fraction of its original value. It can be mounted permanently or easily transported for portable use. Does the job instantly, where and when you need it.

The War Surplus generators for these Arc Welders were built by General Electric, Westinghouse, and Delco-Remy at a cost of over \$300.00. They are light in weight; have oversized lifetime grease-sealed ball bearings; air-cooled commutator; dial type rheostat for easy pinpoint control; high-low range switch; reactor coil for even arc; handles 1/16" to 3/4" rods, Run welder at 2500 R.P.M. from drive pulley or power take-off of tractor, a 7 1/2 H.P. electric motor or a 10 H.P. gas engine. Use two V-belts, or flat belt (on pulley). Continuous welding rating—200 amps.; Intermittent rating—250 amps.; 0-30 volts. Now . . . AT A FRACTION OF ITS VALUE. Price includes double V or flat belt pulley and instruction book. Ship. wt. 107 lbs. Only one or two jobs will pay for entire welder. F.O.B. Chicago

99.50

ACCESSORY KIT including welding helmet, electrode holder, two 10 ft. cables with clamp, and 5 lbs. of assorted welding rods. (ITEM #66) F.O.B. Chicago **10.50**

Remember, Satisfaction is Guaranteed

PURULATOR OIL FILTER PERMANENT TYPE

The perfect oil filter to keep your motor oil or hydraulic fluid clean at all times. Protect your pump or engine. Just turn the handle and the element is clean. Standard 3/8" inlet and outlet ports to accommodate 12 gallons per minute. Shipping wt. 4 lbs. A \$13.00 value. (Item #70) **4.95** postpaid



SELF-PRIMING ELECTRIC PUMP

APPLICATIONS: Oil burners, aquariums, fluid metering, fuel pump, tool post grinder, coolant pump, pressure lubricating pump, general industrial, etc. **MOTOR MFD. BY BLACK & DECKER:** Double ball bearing series wound, continuous duty, 1/30 H.P. electric motor, rated 12,000 R.P.M. Transformer included for use on 110 V AC current. Also applicable for 24-32 V DC. **PUMP MFD. BY WELDON TOOL CO.** with standard 1/4" tubing ports; rated 2 G.P.H.; remove pump and use motor as high speed grinder. **OVERALL DIMENSIONS:** 7 3/4" long x 3 1/4" wide x 3 1/4" high. Approx. wt. 5 lbs. \$51.00 value. (Item #1) postpaid



12.95

ORDER DIRECT FROM AD — SEND PAYMENT OR PURCHASE ORDER, TODAY — SATISFACTION GUARANTEED

GROBAN SUPPLY CO. 1507 SOUTH MICHIGAN AVE. Chicago 5, Ill. Dept. PM-6

WHEN YOU BUY YOUR
POWER LAWNMOWER
OR GARDEN TRACTOR

BE SURE THIS EMBLEM
IS ON THE ENGINE



WORLD'S QUICKEST STARTING,
MOST RELIABLE
SMALL GASOLINE ENGINE



CLINTON MACHINE CO.
CLINTON, MICHIGAN

**CLINTON
ENGINES**



Find **HIDDEN TREASURES**

GEIGER COUNTERS for Uranium Detection. (see at left). **TREASURE DETECTORS** for gold, silver, etc. Lightweight, ultra sensitive. None finer at ANY PRICE. Information FREE.

Detectron Co. Dept. 6-B
5631 Cahuenga, No. Hollywood, Calif.

**IT'S EASY TO CONVERT YOUR
MOWER TO A POWER MOWER
MAKES LAWN MOWING FUN**



Equip your hand mower with a LeJay MidgeTractor. It snaps on in a jiffy. It's ready to go! Backs up and maneuvers amazingly easy. Costs far less than regular power mowers. Unheard of low price—Only \$54.95 complete. Or, \$29.70 less engine... use your own engine (any make 3/4-1 1/2 HP or 3/4 HP electric motor). Free literature. Guaranteed with money back 5-day trial offer. Order your LEJAY MidgeTractor from this ad, do it today. (Sold by mail order only.)

ONLY
\$29.70

If you are a handyman, send 35c for PLAN "Build Your Own MidgeTractor", literature included.

LEJAY MANUFACTURING CO
2947 S. Emerson, Minneapolis 8, Minn.

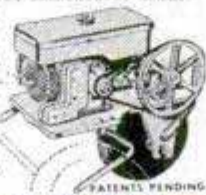

as featured in
Aug. 15 LIFE
pages 52-54

Sailfish
Trade Mark
SPORTABOUT



Now the fast, brilliant "Sailfish" comes knocked down for easy home assembly at a big saving! Safe-T-Plane hull can't sink or swamp. Carries conveniently on car top. Precision pre-cut and pre-formed parts of high quality materials go together quickly. All hardware included. **HULL KIT**, \$69.75. **SAIL KIT**, with centerboard, rudder, spars, rigging and finished sail, \$49.75. **ASSEMBLED BOAT**, factory-finished and complete with sail, \$189. All prices are f.o.b. Waterbury, Conn. Illustrated literature on request.

Mfd. by **ALCORT, INC.**, Waterbury, Conn.

also by California Sailfish Co., Newport Beach, Calif.
Tak-Kraft Mfg. Co., Montreal, Canada

OVER 500 SURPLUS BARGAINS



JUST OFF
THE
PRESS!

NEW! CATALOG

TERRIFIC BARGAINS for Sportsmen — Farm & Home greatest stock of Gov't Surplus for everyday use in America!

SEND 10c FOR YOUR CATALOG TODAY!

FISLER SALES CO. 723 Walnut St.
Kansas City 6, Mo.

**SHARPEN CIRCULAR SAWS
LIKE AN EXPERT**



\$6.95

No experience needed. Two simple adjustments. Gets hollow-ground, cross-cut or combination saw blades true and sharp. Fits 6" to 12" blades with 1/4" to 13/16" centers. Includes file and complete instructions. \$6.95 postpaid. (Check or money order) C.O.D.s postage extra. Guaranteed—Money back if not satisfied after 10 day trial. A money maker for fix-it shops. Soon pays for itself. Order today. Free folder. **SURE SHARP MFG. CO.**, Dept. M-60
P. O. Box 24 Santa Ana, Calif.

TRAILER AXLES



✓ No Swaying
✓ Level Load

One piece solid forging steel SAE 1040

\$39.50

F.O.B.
LOS ANGELES

Includes wheels, hubs and bearings. 2000 lb. capacity

Heavy springs coiled around axle cushion every shock... distributes any load evenly on both springs... assures maximum safety through even load and low center of gravity. Write for details on our complete line of axles.

Satisfaction guaranteed or money refunded!
LINCO AXLE TRAILER CO.

7528 S. BROADWAY
LOS ANGELES 3, CALIF.

HOLLYWOOD MUFFLER
THE TONE YOU LOVE TO HEAR



MORE SPEED—POWER—MILEAGE

are yours with a Hollywood Muffler... plus a tone you'll love to hear! Not a gutted muffler. Easy to install.

Hollywood Muffler:
Trade-mark Reg.
U. S. Pat. Off.

IMPROVED
DESIGN
PRECISION MADE
ELECTRIC WELDED!



Outlasts ordinary mufflers 3 to 1

Ford, Chevrolet, Plymouth \$6.00

All other cars \$8.00

Duals, Ford & Merc. \$24.50. Also Fender Skirts, 10.95. Order direct. Send check or M.O. and save postage.

Dealers
Write

WILKINSON MUFFLER CO. 811 WILT STREET
FT. WAYNE, IND.

DON'T let this happen to your child!

A sudden turn — Sally fell against the door . . . it swung open.

Fortunately Sally will live . . . and later she'll be able to walk again.



For Two Rear Doors—Any Car Back to '37

Send \$12.35 for a postpaid—easy to apply—complete, ready to install set of **MAGICON** electrically-operated, ignition-controlled Auto Door Safety Latches. (\$6.95 for Coupes—right door only.) Replacement guarantee on factory workmanship and material. In Calif. add 3% State Sales Tax. C.O.D. accepted (U.S.A. only) if \$1.00 deposit accompanies order—(F.O.B. Oakland).

MAGICON SALES, INC.
565 - 20th St., Dept. 6—Oakland 12, Calif.

BUILD YOUR OWN FAN



Let us give you our prices on your aluminum castings.

One-piece cast aluminum propellers for cooling and ventilating.

Size	Polished	Unpolished	Bore				
Inches 2 Blade 3 Blade 2 Blade 3 Blade			Inches				
15	\$3.00	\$4.00	\$2.50	\$3.00	1/2	5/8	3/4
18	3.75	4.50	3.00	3.50	1/2	5/8	3/4
20	4.00	5.00	3.25	4.00	1/2	5/8	3/4
24	4.50	5.50	4.00	4.50	1/2	5/8	3/4

Write for pamphlet on larger fan blades, wire guards, fan bases, shutters, pillow blocks, exhaust fan frames, etc. Shipped prepaid if money accompanies order. Dealers write for discount.

KLOPPENBORG ALUMINUM FDY., Dept. PM60, Davenport, Iowa

VISOR PARK-IT



\$1.00
PER PAIR
POSTPAID

A NECESSITY IN EVERY CAR

The Visor PARK-IT* clamps on front or back of any visor—provides a place to put things—holds maps open and folded, sun glasses, letters, women's gloves, pipes, business papers, cigarettes, etc.—all within easy reach. You can install it on your car in a jiffy. The Visor PARK-IT is new—a truly, remarkable accessory. Send \$1.00 for a pair of Visor PARK-ITs mailed postpaid. *T.M. Reg. U.S. Pat. Off., Patents Pending.

PARK-IT CO. • 606 Caxton Building • Cleveland 15, Ohio

OXYGEN BREATHING SET

Originally Cost \$100—Now Only \$7.95!

BRAND NEW SURPLUS. Ready to use. Portable with Automatic "Demand" type valve. The type our Air Force depended on!



A must for airmen, mountaineers, firemen, paint shop workers and others who on occasion need extra oxygen. This popular "demand" type oxygen outfit requires no technical knowledge for use—just breathe into the mask provided and the regulator automatically delivers the oxygen you need as you breathe into the mask! Complete set includes D-2 type shatter-proof steel bottle 6x24 inches; demand type regulator AN-6022-1; 0-500 lb. oxygen gauge and type A-10 demand oxygen mask with hose. Net weight 7 lbs. Shipping weight 10 lbs. Outfit as described above but with empty tank shipped parcel post each \$7.95. With oxygen filled tank (available by express only) \$9.95. Refiller hose, orifice and valve for charging tank with oxygen \$2.00. 6 foot flexible extension hose with fittings \$2.00. **PORTABLE AIR SUPPLY OUTFIT:** Oxygen set minus mask only \$6.95. By adding hose and air chuck (not furnished) you have portable source air for auto tires, garden sprayers, etc. F.O.B. Houston.

SPECIAL DISCOUNT
LOTS OF 6 — 20%
LOTS OF 12 — 25%
LOTS OF 24 — 33 1/3%

SEND CHECK, MONEY ORDER
AERO PARTS SUPPLY CO., Dept. PM-5
8102 LOCKHEED HOUSTON, TEXAS



TIME-SAVING TOOLS
for SHOP and HOME

The Most Versatile Tool a Man Can Own

MOTO-TOOL

Approx. 25,000 RPM

GRINDS, ROUTS, DRILLS, POLISHES, ETC.

Moto-Tools, Kits and Accessories should not be confused with "bargain offers." Compare Dremel Products, feature for feature, with other similar equipment. If ours are not superior in quality, design and performance, we don't want you to buy.

LOOK AT THESE MOTO-TOOL FEATURES

Dynamically balanced armature eliminates vibration • Oilless (oil-sealed) bearings • Patented automatic chuck lock pin • Snap-type sliding switch • Cord protector • Shockproof bakelite housing • Dust-filtered air-cooling system • Weighs 13 oz. • Plugs into any 110-120 V. AC outlet. Backed by over 13 years use in plants of General Electric • Ford • Remington Arms • Nash-Kelvinator • Westinghouse • Douglas Aircraft, etc. . . . plus a money-back Guarantee if not delighted after 5 days' trial.



PRE-WAR PRICES STILL PREVAIL

MOTO-TOOL KIT No. 2, with 23 accessories including high-speed steel cutters and Model 2 Moto-Tool in natural finish hardwood case . . . **\$23.50**

MOTO-TOOL No. 2 with one emery wheel . . . **\$16.50**



Portable DRILL PRESS



This 12" high, precision drill press is ideal for model making, wood carving, routing, etc. Utilizes No. 2 Moto-Tool.

Only **\$9.95** (Less Moto-Tool)

WHERE TO BUY—If your dealer can't supply, send full remittance and we ship postpaid. Or send \$2 and pay postman balance plus postage. Money back if not delighted after 5 days' trial.

DREMEL MFG. CO., Dept. 110-F, RACINE, WIS.

FUN FOR BOYS FROM 8 TO 80

DREMEL Electric COPING SAW

CUTS SCROLLS LIKE MAGIC—SANDS AS IT SAWS



BLADE FACES 4 WAYS

SAFE as a HANDSAW

JUST GUIDE IT!

Only **\$5.85**

FREE PROJECT PLANS

Plans for making six useful, decorative projects packed with each Dremel Electric Coping Saw.

For men who harbor a hobby or do their own repair work . . . for boys who like to make things . . . no other tool will give so much pleasure and satisfaction in the home or workshop for the small amount of money invested as a Dremel Electric Coping Saw. It works in any direction . . . delivers 7,200 strokes per minute . . . so easily, there is no effort . . . so smoothly, work needs no sanding. Saws through 3/4" medium-hard wood at a foot-a-minute speed. Touch-of-the-trigger, foolproof action. Only two moving parts, never needs oiling. Operates on 110-120 v. AC. Thousands and thousands of satisfied users.

WHERE TO BUY—If your dealer can't supply, send full remittance and we ship postpaid. Or send \$2 and pay postman balance plus postage. Money back if not delighted after 5 days' trial.

DREMEL MFG. CO., Dept. 110-F, RACINE, WIS.

JITTERBUG TAKES CONTEST WINNER

Lou Hogue of Novelty, Ohio, who caught this 6-lb. 14-1/2 oz. beauty on a Jitterbug at Chippewa Lake to win the Cleveland Press Bass Contest, says "Day or night I always use a Jitterbug. Its erratic action gets Bass!"



NOISY SURFACE BAIT
3/8 oz.—Sinks slowly at rest
5/8 oz.—Floats



Either Size **\$1.21**

Each
Choice
10
Colors

AT
YOUR
DEALER

NOW!

Also in 3 FIREPLUG® FLUORESCENT FINISHES \$1.45 each.
▶ WRITE FOR FREE FULL-COLOR BAIT CATALOG ◀
FRED ARBOGAST & CO., INC.
1636 WEST NORTH STREET • AKRON 3, OHIO

WE FURNISH ALL MACHINED METAL PARTS, EVERY SCREW,
NUT, BOLT, WASHER, AND COMPLETE PLANS FOR THIS...

BIG 10" POWER SAW

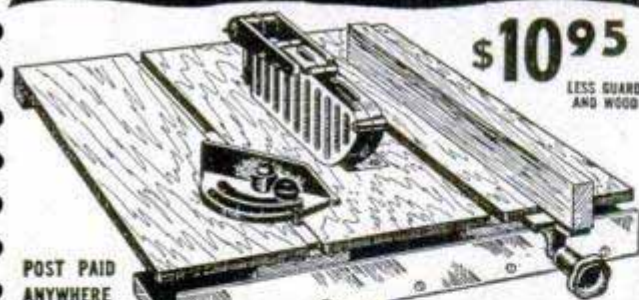

\$10⁹⁵
LESS GUARD
AND WOOD

POST PAID
ANYWHERE
IN U.S.A.

FULL \$10.95
REFUND IF
NOT SATISFIED
WITHIN 10 DAYS

QUALITY
ASSEMBLE IT YOURSELF WITH
SIMPLE HOUSEHOLD TOOLS!

TABLE 24" x 20" • TILTS TO 45°
CUTS 0" TO 3/4" DEEP • TAKES 10" BLADE

COMPLETE PLANS (WITHOUT PARTS) 10c

MARCUS • POLLAK DEPT. 44
ROYERSFORD, PA.

Easy way
to strip
paint...

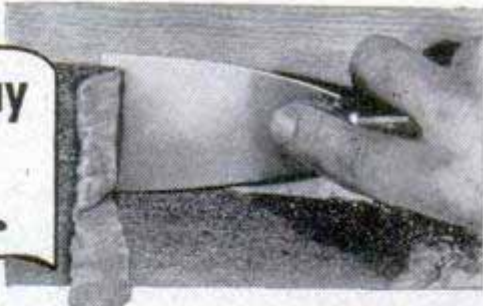

WONDER-PASTE, applied with a paint brush, softens up the toughest paint, varnish, enamel or shellac right down to the surface. Comes off clean at every stroke of your putty knife. Try it. At paint and hardware stores. . . . Write for leaflet on Wonder-Paste and advice on your particular removing problem.

Wilson-Imperial Company, 119 Chestnut Street, Newark 5, N. J.

2 CIRCULAR SAWS
ON 2 MANDRELS—
ALL AT ONE LOW PRICE **\$1.50**
1" diameter saws on 1/4" Mandrels. For cutting wood, plastic, or soft metals. Order at once! Send Check or Money Order for this big bargain.
SCHUPACK SUPPLY CO., 7331 Cottage Grove, Dept. M-6, Chicago 19, Ill.
ILLUSTRATED BARGAIN CATALOG 10c

HANDY CALCULATOR FOR WOODWORKERS.. ONLY 10c
Just set dial, quickly solves countless problems. Converts linear to board feet, compares workability of various woods, shows bit sizes, nail specifications. Also tool sharpening tips, etc. 6" diameter heavily varnished cardboard. Send 10c to Greenlee Tool Co. 2106 Columbia Av., Rockford, Ill.

Only \$498
OTTAWA
Mule Team Tractor
Finest low-cost tractor. Costs too little to do without. Engines burn gasoline or kerosene. Starter and lights available. Other larger Models to choose from. Over 4,000 in world-wide use. Time-proved and tested. At low cost they easily mow, plow, disc, harrow, plant, cultivate, etc. Sold only direct to user. Write for FREE details.
OTTAWA MFG. CO., 2-027 Garden St., Ottawa, Kansas

ELECTRIC MOTOR BARGAINS!
1 HP 3450 RPM **\$34.50**
1/2 HP 1750 RPM **\$15** 3/4 HP 1750 RPM **\$26**
1/2 HP 3450 RPM 3/4 HP 3450 RPM
Every Motor Fully Guaranteed
Heavy Duty. Repulsion Induction or Capacitor Types, 110-220 Volts, 60-cycle, Single-phase. Standard Makes (G.E., Wagner, LeLand, Westinghouse, etc.). Rush your order TODAY—large stock of motors—1 & 3 phase. 32-v. direct current bargains. Prices f.o.b.
ROBERTS ELECTRIC CO., 7232 Madison, Forest Park 15, Ill.

HANDEE-DAPTOR
CONVERT YOUR 1/4" DRILL TO 1/2"
Gives you a \$35.00 tool for only \$2.95.
Adaptor has a 1/4" shank for insertion in your drill. 1/2" chuck takes bits from 1/16" to 1/4" inclusive.
Attractive Dealer Proposition!
DANIELS PRODUCTS COMPANY
2224 N. E. 18th St., Oklahoma City, Okla.

D. C. ARC WELDER
\$300 VALUE — ONLY \$97.50
200 Amperes Continuous Duty. Up to 250 amps. intermittent duty. Easily mounted on your tractor. Welding range from 0-up by dial type control. 1-yr. guarantee with money back 10-day trial period. Write for FREE literature. OR send 35c for PLAN "Build Your Welder from Aircraft Generator" literature included.
LEJAY MFG., 847 LeJay Bldg., Minneapolis 8, Minn.

Get this free SHOPMASTER Power Tool Catalog

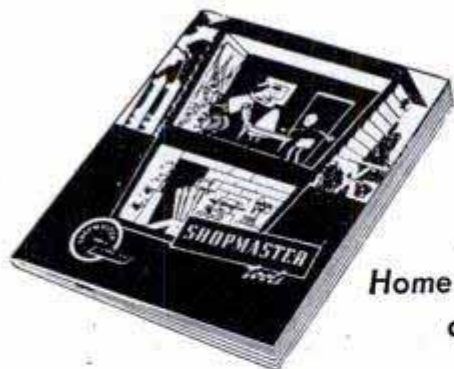

Start your
Home Workshop
at low cost

SHOPMASTER Home Workshop Power Tools are priced to meet every family's purse. Make your spare time relaxing and profitable. Build furniture, repair your home, build toys and playthings for the children.

Start your shop now at little cost. See your SHOPMASTER Dealer. He has full information. Write today for the complete twenty-eight page full color descriptive book.

SHOPMASTER, INC.
1214 Third St. S., Minneapolis 15, Minn.



FREE SAMPLES! GLOW IN THE DARK!

BIG PROFITS showing amazing Luminous Specialties—house numbers, pictures, plastic novelties, religious and nursery objects, ash trays, key-holders, etc. Large manufacturer. Enormous demand. Sell on sight. WRITE AT ONCE for FREE samples. Madison Mills, 303 4th Ave., Dept. K-4, New York 10, N. Y.



MACHINE SHOP EQUIPMENT

The No. 49 edition of the famous Center Tool Co. Catalog is now ready! Every workshop owner should have a copy. 240 pages full of illustrations, descriptions, and prices of the latest tools made by best known manufacturers in U. S. You pay the cost of printing—50c. We refund your 50c with your first order of \$10.00 or more. Prompt delivery on most tools. Send check or money order today!

CENTER TOOL CO.

153 Centre Street, Dept. C, New York 13

BUILD YOUR OWN GEIGER COUNTER!

And SAVE 2/3 of Cost!

NO special knowledge necessary!
You need NO additional parts!

It's EASY to build your own Searchmaster Geiger Counter with this COMPLETE kit. Contains everything you need! Headset, tubes, geiger-counter tube, batteries, plus smart metal case 9 1/2" x 4" x 3 1/2". All parts laboratory tested! Sensitive to both beta and gamma radiation! Fully guaranteed! Illus. instructions show you how to assemble parts quickly.

SPECIAL FREE OFFER!

Radioactive specimen sent FREE with each order. Plus FREE literature, showing you how to locate uranium with your Geiger Counter and win \$10,000! Write for details or order your Searchmaster Geiger Counter Kit now! Postage prepaid with check or money order. C.O.D. orders: send \$5, bal. on arrival.

SCIENCE KITS LTD.

5514-P Hollywood Blvd. • Hollywood 28, Calif.

Superior to many Counters
selling for MORE than \$100!



COMPLETE
KIT
\$29.95



**KIT COMES COMPLETE
Nothing Else to Buy!**

Easy-to-follow Instructions
Come with each Searchmaster Kit

Kit guaranteed
to operate
perfectly when
assembled per
instructions!



*How long's that muck
been in my car?*

Too long, Mister, it's engine-wrecking stuff—and if you want to duck some unpleasant repair bills...you need a new Purolator Refill for your oil filter—quick!

If you've been neglecting to have your oil filter checked, chances are there's horrible muck like this in your car. So when you change your oil this summer, start fresh with a *new filter refill*.

Be sure you get a Purolator Refill. Filters more *completely*, hence saves more substantially on repair bills. Costs only \$1.38 to \$3.00, depending on make of car. Inserted in a few minutes.

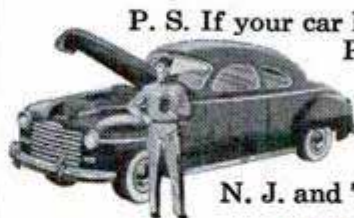

P. S. If your car has no oil filter, a *complete Purolator, both housing and refill*, costs only \$6.50 or a bit more, depending on make of car. Purolator Products, Inc., Rahway, N. J. and Toronto, Ontario, Canada.



*Reg. U. S. Pat. Off.

PARTS FOR MILITARY TRUCKS

4 or 6 Wheel Drive at a SAVINGS—
1/4 ton to 20 ton.



Parts List Available
on Most Makes
Military Trucks and Jeeps
Write stating model
Prices Quoted are Net Wholesale
Brand New — Weatherizing Kits

JEEP TOPS and CURTAINS

Fits all military jeeps, also adaptable to civilian jeeps.
Tops only with back curtain attached.
Waterproof O. D. color.
Our low price, only.....

\$29.50

Side curtains to match with doors
and windows, only.....

\$20.00

Also available—Complete top with back
curtain and side curtains with doors
and 5 windows. Less steel
Bows. Complete set, only.....

\$49.50

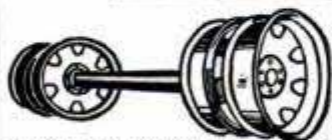

TRAILER AXLE

Heavy duty trailer axle suitable
for many types of trailer
construction. Also excellent for
building of heavy farm trailers
and wagons. It is a 12,000 lb.
capacity square type straight

trailer axle complete with Timken roller bearings, hubs, and
6 hole 750 x 20 Budd Wheels. Without brakes. Axle is 2
inches square and 69 inches between wheel mounting flanges.
Std. width.

With Single Wheels. \$59.50 With Dual Wheels. \$69.50

WINCH CABLE, 1/2", 250 ft. \$30.00

Hundreds of Other Truck & Jeep Parts and Supplies
All prices quoted good 30 days FOB, Kansas City, 25%
Deposit Required on All Orders.

American AUTO PARTS CO. INC.

1830 LOCUST—DEPT. PM
KANSAS CITY, MISSOURI



New POWER KING 8" TILT/ARBOR BALL BEARING SAW



A New Standard of Value from *Atlas*

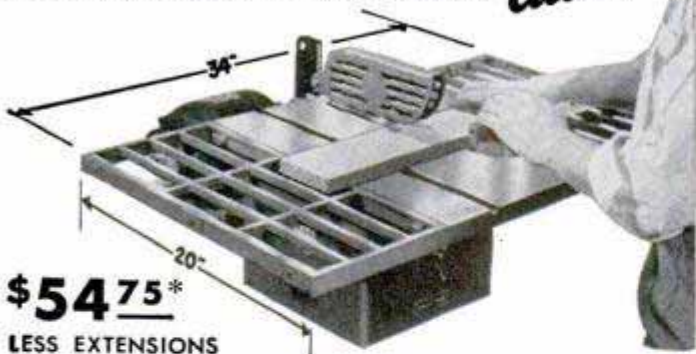

\$54.75*

LESS EXTENSIONS

Has the capacity you need for any type of construction for your home. Cuts 2 5/8" deep. Precision-ground grey-iron table, full-length rip fence, tilt/arb, sealed ball bearings. *Price, F.O.B. Kalamazoo, less motor, extensions, only \$54.75—\$67.75 with two extensions as shown. Send a postcard for new catalog.

ATLAS PRESS COMPANY

635 N. Pitcher St., Kalamazoo, Mich.



CONTINUOUS OR STANDBY POWER

costs you less
per KW now

Big savings in first cost are combined with low fuel and maintenance bills in Witte's new Series AD Dieselectric Plant. Improvements have nearly doubled the power output of this plant . . . have cut the cost-per-KW almost in half.

The new Series AD Dieselectric Plant is rated for continuous 24-hour service at 5.25 KVA-AC (4.2 KW-DC) for tank-cooled models and 5 KVA (4 KW) for radiator-cooled models. Its low cost-per-KW makes it an outstanding source of standby as well as continuous power.

Bulletin 5519 gives complete details on this new Witte Dieselectric Plant. Write for your copy or see your Witte dealer.



WITTE DIESELECTRIC PLANTS AND
DIESEL POWER UNITS

WITTE ENGINE WORKS, KANSAS CITY 3, MO.

Division of Oil Well Supply Company

UNITED STATES STEEL

SHEET METAL BRAKES

Forms angles, flanges, and Pittsburgh locks. Bends 26 gauge steel. Heavier copper and aluminum. Cam locking. Portable, can be clamped to edge of truck. All steel, reinforced.

Wt. 42 lbs. Express collect. . . . \$26.50

36" Size. Wt. 52 lbs. . . . \$31.00

12" BRAKE. Fits in vise to form different compound bends, up to 20 gauge steel. . . . \$12.50 PP.

18" CURVE FORMER, Capacity —16 gauge steel. . . . \$10.00

SHEET METAL PLIERS, 2 1/2" wide. \$2.00; 5", \$3.00

IRON BENDER, Forms hooks, braces, eyelets. Bends 1/4x2, \$10.00

Immediate delivery. Order direct, cash or C.O.D. or send for folder.

WISE BRAKE MFG. CO., P-1116 So. 27th St., Omaha 5, Nebr.

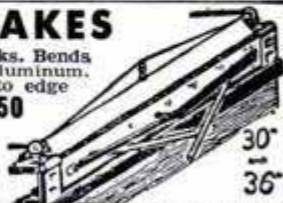

MAGNETS OF ALL TYPES—10c UP

AMAZINGLY POWERFUL!

Box Alnico Magnet, lifts 10 lbs. \$1.00. Our Leader, 15 oz. Magnet, lifts 40 lbs. \$2.50. New alloy—will not

weaken! Useful for lifting valuables from tanks, lakes, or rivers easily! 7 small magnets \$1.10 with list of many shop and home uses. Satisfaction guaranteed.

R. EYRICH, 2566 N. 49TH ST., MILWAUKEE 10, WIS.

NONE BETTER! SUPER DRILL GRINDER



Sharpens round shank drills from 3/32" to 1/2" in diameter, up to 6" long. Grinds old drills like new in 4 different point angles, using hand or power grinding wheels. Money-back guarantee.

Price only \$2.95

At Dealers or Postpaid

CRANDALL MFG. CO. 1512 W. Slauson, Dept. FA-48, Los Angeles 44, Calif.

New! AUTO CLIMB INDICATOR



Amazing safety device. Fits inside any automobile! Know grade percentage climbing or descending. 2" reading dial—handsome plastic & steel case. Money-back guarantee! \$2.95 postpaid. COD postage extra.

MAHAR CO., 502 NORMANDY, SANTA ANA, CALIF.

SUMP PUMPS 2,200 GALLON CAPACITY

1 1/4" outlet — No screen to clog — fool proof

The time tested Lokomona sump pump is absolutely automatic—has a special fool proof trap at the intake—rubber bearing at the bottom. Made of aluminum castings, it's 42" high and carries a 1/4 H.P. 110 V. A.C. heavy duty motor. The pump is designed for continuous dependable service. Any standard motor will fit this pump. Order yours today. COD. If cash with order, we pay postage.

\$36.00 COMPLETE

\$22.00 LESS MOTOR

\$18.00 PUMP ONLY

MONEY BACK GUARANTEE

LOKOMONA PUMP CO., P.O. BOX 86, ROYAL OAK 1, MICH.

Convert Your 1/4" Electric Drill into

Spin-a-Brush

Spin Paint Brushes Clean in 90 Seconds—Anyone Can Do It! Only \$2.35

It's easy to salvage hard paint brushes lying around your basement. Cleans and makes like new. Quickly change from one color to another with same brush—even from black to white! Immediate delivery. Write for literature and name of dealer.

Portable Electric Tools, Inc.

324 West 83rd St., Chicago 20, Ill.

In Canada: 369 Danforth Ave., Toronto 13



ALTIMETER



Modernize your car. Fine desk ornament. Reads up to 20,000 feet. Fluorescent dial glows at night — no connections of any kind required — self contained — Suitable as a laboratory standard instrument — Same as used in airplanes. Brand new — cost gov't many times \$3.50

REMOTE CONTROL THERMOMETER



For automobiles, homes, refrigerators, milk coolers, brooders, orchards, workshops, etc. Temperature bulb at end of 5 or 15 ft. flexible tube (state which). Dial thermometer glows in dark—non electric—very sensitive—-40° to +50° C. and -40° to +125° F. on same dial. Aircraft quality—worth many times \$3.50

MANIFOLD PRESSURE GAUGE



Indicates manifold pressure in your automobile, boat or stationary engine—allows you to operate your engine at maximum operating efficiency and gas economy. Connects to windshield wiper hose or manifold. Complete with connections, hose and instructions. BRAND NEW! \$7.50

Enclose sufficient postage — Excess will be refunded — No COD's

AIRCRAFT COMPONENTS, Inc.

1400 Woodland Avenue Benton Harbor, Michigan

PROBLEM: Pipe union against wall. No space for pipe-wrench. How to turn it?

ANSWER: New Genuine Thin-Nose

WISE-GRIP WRENCH



WISE-GRIP gets into close quarters **LOCKS with Ton-Grip**—makes "impossible" jobs easy! Has 100s of uses about the home, shop, factory. Only the genuine VISE-GRIP has Involute Jaw Curve that holds all shapes, Knurled Jaw Tips that hold to the very tip. Thin Nose, Super Wire-Cutter. With cutter—No. 7W, 7", \$2.25, No. 10W, 10", \$2.50; Without cutter—No. 7C, 7", \$1.85, No. 10C, 10", \$2.25.

If not at your dealers, order direct.

PETERSEN MFG. CO. Dept. P-6 DeWitt, Nebr.

Build your own JET ENGINE!



SEND NO MONEY

Order these plans today

1. JET PROPELLED BICYCLE. Assemble your own. Photo and instructions \$1.00.
2. HOW TO MAKE EXPERIMENTAL JET ENGINES. Seven sheets drawings with information and instructions \$2.95.
3. BOTH OF ABOVE in one order \$3.75. SEND NO MONEY. Order both at once \$3.75 C.O.D. in USA plus c.o.d. postage. Send check or Money Order and we pay postage. Get other information too. Rush Order.

J. HOUSTON MAUPIN, Dept. 55, Tipp City, Ohio

FREE Bargain Book

Packed with hundreds of sensational bargains—new and used—in still and movie photo equipment and accessories. Write for your free copy today to

Central Camera Co.

Dept. 8F, 230 S. Wabash, Chicago 4, Ill.

Photographic Headquarters Since 1899

LOOK! NEW GAS POWER MOWER

• LOW PRICE •

Equipped with — New 4 cycle Briggs-Stratton 9/10th HP engine: Automatic Governor. Full 20-in. 5-blade 5-spider welded reel. Blades electric welded to 5 steel spiders. All Ball Bearing Construction.

Oversize puncture-proof tires. Welded Pressed Steel Frame.

FOR IMMEDIATE DELIVERY—

ARGO-SUMMIT SUPPLY CO., Dept. P-6, 7418 Archer Ave., SUMMIT, ILL.

NEW FEATURES •

- 10% WIDER CUT
- FULL 20 inches
- UNIQUE DESIGN



only **\$78.90**

RUSH ORDER TODAY



BUY DIRECT AND SAVE

Even a Child Can Operate it

in U.S.A. We Pay the Freight Slightly higher west of Rockies

QUESTION:

when does

$$4 \times 1 = 25$$

ANSWER:



when worn
Engine Bearings
cause
Oil Pumping

Strange mathematics? Not when applied to worn main and connecting rod bearings! At installation, the clearance between bearings and shaft "meters" oil for necessary lubrication. Worn to twice the original clearance, bearings pass five times as much oil. And worn to four times the original clearance, *the bearings let 25 times as much oil get through!* Don't blame the piston rings when worn bearings cause oil pumping. Give new rings a chance to do their own job. Check for worn bearings — replace in sets with Genuine Federal-Mogul Oil-Control Bearings. *Ask your mechanic!*

FEDERAL-MOGUL SERVICE
(Division of Federal-Mogul Corporation)
DETROIT 13, MICHIGAN



Control Oil Pumping
where it starts...replace with
FEDERAL-MOGUL
OIL CONTROL BEARINGS

Keep Brushes like New

BEFORE

AFTER

• 5c
• 10c
• 25c

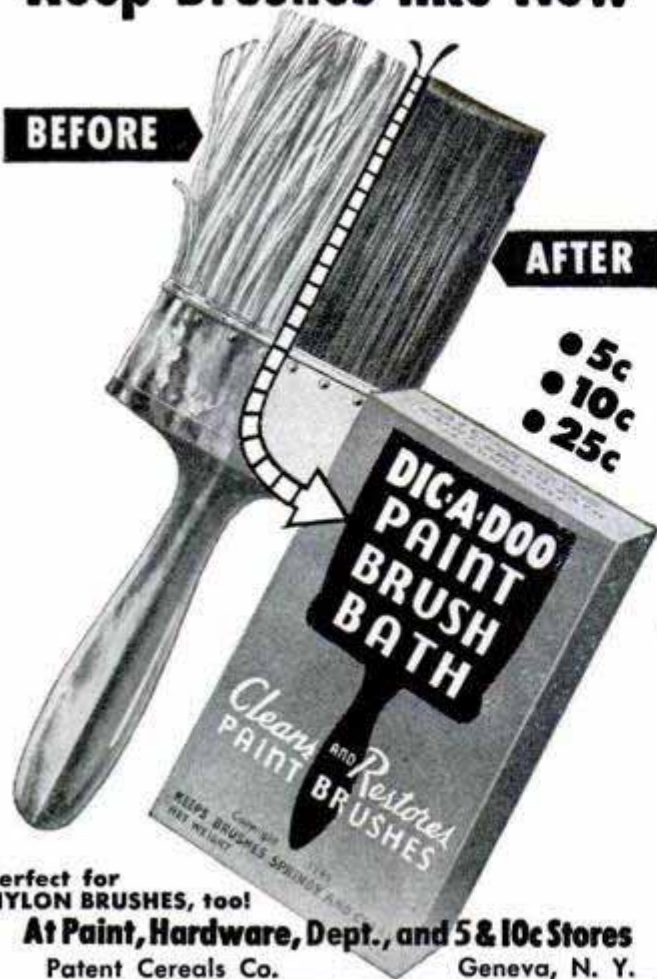

Perfect for
NYLON BRUSHES, too!

At Paint, Hardware, Dept., and 5 & 10c Stores

Patent Cereals Co.

Geneva, N. Y.

The JIFFY metal CABINET

**YOUR ANSWER TO
SMALL ITEMS STORAGE**
at home, office, and shop
(IDEAL GIFT, TOO)

So handy to keep nuts,
bolts, screws, nails,
parts, washers, stamps,
hobbyists' needs, etc.,
at your fingertips.



THIS 32 DRAWER UNIT ONLY \$5.95 POSTPAID

Stop searching, get a 32 or 64 drawer Jiffy to keep those small items that usually get mislaid. Spot welded steel, gray enamel finish, metal drawer guides. Dividers included with aluminum drawers make possible three compartments per drawer. Looks good anywhere. Send check or money order, please—no C. O. D.'s. Prices below. Your money refunded if not satisfied. Dealers write for quantity discount.

SPECIFICATIONS

32 Drawer Unit
6" Deep
12 3/4" Wide
15 1/4" High
64 Drawer Unit
6" Deep
25 1/2" Wide
15 1/4" High
Drawer Size
1 1/4" Deep
2 3/4" Wide
6" Long

WITH ALUMINUM DRAWERS

Dividers and Index Cards Included

One piece rustproof aluminum drawers for heavy service—good for work bench and industry use.

32 drawer - \$8.95

64 drawer - \$15.95

OHIO ORDERS ADD 3% SALES TAX
Marproof Rubber Feet included with all cabinets
POSTAGE PAID

WITH CARDBOARD DRAWERS

Suitable for most home uses. Heavy board kraft covered. Metal drawer pulls.

32 drawer \$5.95

64 drawer \$9.95

3% SALES TAX
POSTAGE PAID

KAYTEE PRODUCTS, Dept. M, Box 588, Canton, O.



**How TIP-TOP
LIQUID SOLDER
Helped Land a
5 lb. Walleye!**

"One day while fishing on a wilderness lake in Minnesota, I accidentally broke my only good spinner. The pike were hitting good so I hurriedly re-set the spinner bracket in Tip-Top Liquid Solder. In a few minutes the spinner was ready to use and I soon caught a 5 lb. Walleye—thanks to Tip-Top."

M. R., Kansas City, Mo.

Tip-Top Liquid Solder is perfect for hundreds of emergency repairs. Forms perfect joint in metals, woods, glass and fabrics. Water and gasoline-proof . . . sticks where others fail. Keep Tip-Top handy at home—in the shop. If your dealer doesn't have Tip-Top, mail us 25c for a tube, along with your dealer's name, today. Tip-Top Products Co.—Omaha, Nebraska.



WHEELS - WHEELS

5" Disc Wheel 5/8" Tire 5/16" or 3/8" Sleeve	30c ea.
6" Disc Wheel 5/8" Tire 5/16" or 3/8" sleeve	35c ea.
7" Disc Wheel 3/4" Tire 3/8" sleeve	45c ea.
8" Disc Wheel 1 1/8" Tire 1/2" sleeve	70c ea.
7" Disc Wheel 1" Tire 1/2" Ball bearing	80c ea.
8" Disc Wheel 1" Tire 1/2" ball bearing	\$1.00 ea.
8" Disc Wheel 2" semi-pneum. T. 1/2" B.B.	\$1.35 ea.
10" Disc Wheel 1.75 semi-pneum. T. 1/2" B.B.	\$1.50 ea.
12" Disc Wheel 1.75 semi-pneum. T. 1/2" B.B.	\$1.85

Above wheel prices include hub cap.
Plus Postage, 20% - C.O.D.'s accepted.

UNITED WHEEL STAMPING CO., PM-6

2756 W. 115th STREET

CHICAGO 43, ILLINOIS

AGENTS 300% Profit SIGN LETTERS

For Store Fronts and Office Windows. Anyone can put them on. Free samples. Liberal Offer to General Agents.

METALLIC LETTER CO., 430 N. Clark, Chicago 10



FOR THE UTMOST
IN MOTORING EASE

Drive By

HULL AUTOMOBILE COMPASS

Beaconlite illuminated Streamline standard
\$5.95 \$3.95

At your dealer's. Write for literature.

HULL MFG. CO., P. O. Box 246-D6, Warren, Ohio



BRUSH PLATING OUTFITS

for re-plating articles in the home and shop. No tanks necessary. Free particulars.

GUNMETAL CO., AVE. M, DECATUR, ILLINOIS

SAY YOU SAW IT IN POPULAR MECHANICS

MILLER ROTARY

HI-SPEED [OPE-SAW] DRILL-BIT

IT SAWS & CUTS DREAMS

DRILL PRESS SAW-CUTTING

SAWS, CUTS, REAMS sheet metal, angle iron, pipe, wood, plastic, Transite, etc. Amazing high speed combination bit and saw fits any 1" or 1/2" electric drill or slow drill press; takes place of up to \$50 in tools. Drills own starting hole to quickly cut, saw or ream opening. Easy to operate. Ideal for carpenters, auto mechanics, electricians, plumbers, hobby workers, many others. Abrasive resistant high speed steel. Will withstand severe continuous use. 1" diameter, overall length 3 1/2", cutting section 2" long with flutes ground from solid.

ELECTRICIAN'S HANDY CUTTER

SEND CASH, CHECK OR M.O.

Order Now

PRICE
\$3.95

International Twist Drill Corp. Room 634
7th & Wyandotte • Kansas City 6, Mo.

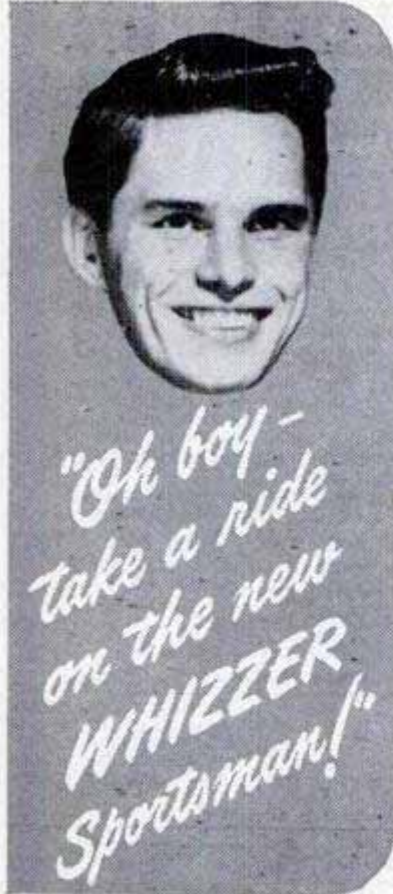

★ Auto-type brakes

★ Kick starter

★ 2-speed automatic transmission

★ Big 3 h.p., 138 c.c., 4-cycle motor

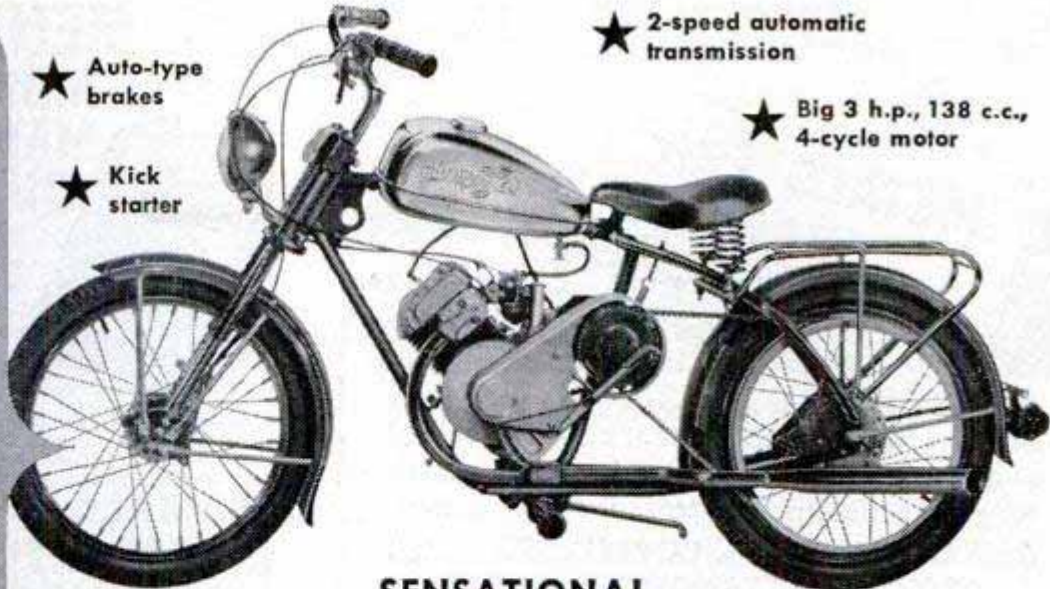

SENSATIONAL NEW MOTORBIKE!

You'll agree it's smooth—in appearance, performance, low-cost operation. This new star of the lightweight motorbikes has a big, comfortable frame; 20" wheels for stability; built-in generator; dual-spring front fork. New, big 3 horsepower air-cooled motor gives you up to 100 miles

a gallon, 5 to 40 miles an hour. For work, for pleasure—for low-cost travel anytime it's the sensational new Whizzer "Sportsman"—ride one and you'll buy **\$239⁵⁰** plus tax FOB Pontiac, Mich. See it at your dealer's!

SEE IT TODAY or write!

WHIZZER MOTOR COMPANY, 306 S. Sanford St., Pontiac, Mich.

ALSO FAMOUS WHIZZER BIKE MOTOR! Motorize your bike with 3 h.p. precision-built Whizzer motor. \$109⁹⁷ FOB Pontiac, Mich.



New Guide STOPS Toilet Leaks

ONLY . . .
\$1⁹⁵
Postpaid

AGENTS WANTED

- Install it yourself in ten minutes
- Stops water waste—pays for itself
- Fits any type of flush tank
- No more jiggling of trip lever

NOW! No more trouble with leaky toilet valves. This amazing new invention is easily installed by *anyone*—by using only two tools—pliers and screw driver. It never sticks—seals correctly every time. The tubular, frictionless guide and non-kinking chain of solid brass are the only working parts. Will not rust or wear out. Satisfaction guaranteed or your money returned. Write today for your "Alert" Flush Valve Guide to:

A·M·G· PRODUCTS CO.
BOX 717B, PITTSBURGH 30, PENNA.

CUT ANY MASONRY MATERIAL WITH CLIPPER MASONRY SAWS!!



CUT WET OR DRY IN SECONDS!



CLIPPER GUARANTEE

"To Provide... Regardless of Hardness... the Fastest Cut... At the Lowest Cost... With the Greatest Ease... Any Time... Any Where!" Ask for details... "How you can try a Clipper on your job."

EXCLUSIVE FEATURES

- PRESSURE EQUALIZER... makes blades last longer. Automatically cushions blade pressure.
- SELECT-A-NOTCH... easily adjust cutting head height from 12" Stone to 1" Quarry Tile.
- DIAL-A-CUT... No Guesswork. Material hardness settings adjust blade pressure—SAVE A BLADE.
- ADJUST-A-CUT... pull knob and free cutting head for "finger-to" head angle setting.
- WET-OR-DRY PUMP... no need to remove belt when cutting dry. Factory Sealed—No maintenance.
- ONE-SPOT OPERATION... operator performs every cut and adjustment from front of saw.

- DRY ABRASIVE BLADES**
Pre-Tested Clipper Superior Blades—over 27 specifications to cut any masonry material.
- WET ABRASIVE BLADES**
Wet (DUSTLESS) Clipper Superior Blades in many specifications suited to specific materials.
- DIAMOND BLADES**
Clipper Diamond Blades for extremely fast & economical cutting of HARD—Vitricous materials.

FREE LITERATURE—MAIL TODAY

CLIPPER MANUFACTURING CO.
2805 WARWICK • KANSAS CITY 8, MO.

MAIL AT ONCE CONTRACTOR
COMPLETE INFORMATION MASON
 HOME OWNER

NAME _____
ADDRESS _____
CITY _____ STATE _____

Clipper 12" to 18" Blade Capacities 9 MODELS, \$195 UP
MANUFACTURING CO.
2805 WARWICK • KANSAS CITY 8, MO.

FACTORY BRANCHES
PHILADELPHIA—ST. LOUIS
CLEVELAND—AUSTIN, TEX.
SAN FRANCISCO—CHICAGO
PITTSBURGH—NEW YORK

CABLE ADDRESS
CLIPPER, K. C., MO.
NATION-WIDE DIRECT FACTORY SERVICE



AT WAREHOUSE-TO-YOU PRICES
 Now ... from **one** convenient and economical source you can get these high quality metals for your needs, pre-cut to your specifications.
ALUMINUM, BRASS, COPPER, STAINLESS STEEL in RECTANGULAR SHEETS
 Easy to work, adaptable to hundreds of uses such as lamp shades, serving trays, wall brackets, etc. Ideal for modern silhouette cut-outs.

CIRCLES of ALUMINUM and COPPER
 Perfect for shaping and forming into useful items, and for perforated design work.

Write for price lists and complete information

FREE BOOKLETS tell how YOU can use these metals—easily and quickly. Write for your free copies today.



METAL GOODS CORPORATION
 628 Rosedale Ave., St. Louis 12, Mo.

NOW!



FILL CRACKS IN A JIFFY

EASY WAY to fill cracks and holes in wood, plaster and other materials. **SAVOGRAN CRACK FILLER** dries hard as stone. **SAVOGRAN WOOD PUTTY** contains real wood—is easily tooled. Both are quick-hardening, non-shrinking—take paint beautifully. Repair furniture, floors, woodwork, tile, knobs—1001 uses! Big 1-lb. can **ONLY 35¢** where you buy paints.

Write for Helpful Free Folder



SAVOGRAN
 DEPT. 35, BOSTON 16, MASS.

CRACK FILLER
WOOD PUTTY



MEN! send for this MONEY-MAKING OUTFIT

MAKE \$15.00 IN A UP TO DAY

Do you want to make more money in full or spare time... as much as \$15.00 in a day? Then write for this **BIG OUTFIT**, sent you **FREE**, containing more than 150 fine quality fabrics, sensational values in made-to-measure suits and overcoats. Take orders from friends, neighbors, fellow-workers. No experience needed. You'll say it's the greatest way to make money you ever saw.

SAMPLE SUITS TO WEAR
Pay No Money! Send No Money!

Our plan makes it easy for you to get your own personal suits and overcoats without paying 1c, in addition to your big cash earnings. This offer is limited. Rush your name and address for big **FREE OUTFIT**—today!

PIONEER TAILORING CO., Dept. F-1116
 Congress & Throop Streets, Chicago 7, Illinois

Aptitude Tests for men, women, boys, girls, discover the kind of work or studies best for your success! You get a personal report—a guide for life—more happiness—more prosperity. Write for complete facts.

VOCATIONAL COUNSELORS, 5059 Woodward Avenue, Detroit

MAKE YOUR OWN POWER TOOLS! ROTATING QUILLS



Steel Housing, Ball Bearing, Up to 10,000 RPM Lubricating

A-51—Pin. Spdle. 5.25 pp. A-52—5/8x4 1/2 Spdle. 6.75 pp.
 A-61—1/2x12 1/2 spindle, hsg., 2x8..... 8.75 pp.
 A-62—3/4x12 1/2 spindle, hsg., 2x8..... 9.25 pp.
 A-63—3/4x12 1/2 spindle, hsg., 2 1/4x8..... 10.00 pp.

A-71—1x17 1/2 spindle, hsg., 2 1/2x11..... 19.75 pp. * 1" Bot. Washer & Collar

FREE Illustrated Circular Enclose check or m.o., Satisfaction Guaranteed!
ASPEGREN PRODS., 1612 (P-3) Webster Ave., New York 57

OWN A Printing Business
 Cards, Tickets, Stationery, etc. Good profit in spare time. **PRINT YOUR OWN** greeting cards, movie titles, church work, etc. Save money. Easy rules supplied. Raised printing like engraving too. Have home shop. Sold direct from factory only. Pays for itself in short time. Write for free catalog of outfits, and all details.
KELSEY PRESSES, 0-37, MERIDEN, CONNECTICUT

SCREWMIX—BEARINGS

Mixed screws & metal screws—30c Lb.	Bore	O.D.	Type	Price
Mixed wood screws—Mixed washers—	3/16"	1/2"	Needle	15c
Mixed cotter pins—30c Lb.	1/4"	5/8"	Needle	15c
Mixed nuts—Mixed aluminum rivets—	1/4"	3/4"	Ball	22c
50c Lb. Mixed steel rivets—20c Lb.	5/16"	1/2"	Needle	15c
BARGAIN OFFER (\$2.40 value) one lb. each of above 7 mixtures— \$1.95	3/8"	7/8"	Ball	35c
POSTAGE Screw Mix, Add 5c per lb.	1/2"	1 1/4"	Ball	40c
POSTAGE Bearings, Add 10c per order, Minimum order \$1.00	5/8"	1 1/4"	Ball	30c
	5/8"	1 3/8"	Ball	40c
	1"	3/4" x 1"	Needle	20c
		1 1/4"	Needle	28c

JAY-CEE SALES CO., 4517 Grand River Ave., Detroit 8, Michigan

SAY YOU SAW IT IN POPULAR MECHANICS

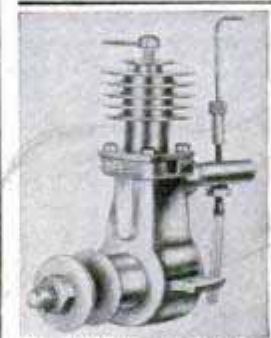

★ ★ ★ ★ ★ ★ ★ ★ ★ ★
OUR 267th ADVERTISEMENT

REAL DIESEL ENGINE!

\$2.95

• Ideal for planes, boats, midget cars
 • Actually runs at 7500 RPM, produces 1/7 HP
 • Precision machined for smooth operation
 • Comes to you completely assembled, ready for operation

MAYBE WE'RE CRAZY, giving away a precision diesel engine, complete with cylinder and piston, carburetor, crankshaft, connecting rod, etc. for **ONLY \$2.95**.

But we're selling thousands of **DEEZILS** all over the world, and that keeps our production costs down. **DEEZIL** is streamlined, compact, rugged. Starts quickly, easy to install, runs for years! Fast delivery if you **ORDER DEEZIL TODAY!**

Send \$2.95 plus 25c postage

GOTHAM HOBBY CORP., Dept. P, 107 E. 126th St., New York 35, N. Y.

CROSLEY the *ONLY* \$1,000 car!



The Crosley isn't a plan on paper or a pilot model. It's a reality — 70,000 have been built. The Crosley is designed not for million-a-year production. It's built for that one family out of a hundred, sophisticated, down-to-earth people who want 35 to 50 miles per gallon and other low upkeep features. It's built for intelligent buyers who want a new, shiny, practical car instead of someone's beat-up secondhand (or fourthhand) car. See—drive the new Crosley Sedan Deluxe. Speedline styling. Rich fabric upholstery. Seats 4, plus luggage. Hundreds of improvements.



FREE! Latest 1950 CROSLEY CATALOG. Write Crosley Motors, Inc., 2530-HS Spring Grove Ave., Cincinnati 14, Ohio.

CROSLEY a FINE car "You see them everywhere!"

LAWN ORNAMENT-NOVELTY PATTERNS
28 Lawn Ornament Patterns, 25c. Other patterns; 15-20" high; Dutch Girl, Dutch Boy, Pirate, Bull Terrier, Mexican Girl, Mexican Boy, Dwarf, Penguin, Flower Girl, 10c each. 25 Novelty Patterns, 30c. All 62 Full Size Patterns, \$1.00 Postpaid. Strother Pattern Service, Dept. BS-8, Box 128, Belington, W. Va.



Be An Invisible Re-Weaver

MAKE BIG MONEY AT HOME

Earn over \$20 daily, full or part time—repair cuts, tears, burns in clothing or any fabric so damage can NOT be seen, BIG demand, big profit, uncrowded field. Complete low-cost home-study course including lifetime equipment. Easy-to-learn, pay-as-you-earn—can mean lifetime income. Write for free details today—now.

FABRICON COMPANY DEPT. M-4
8342 S. Prairie Ave., Chicago 19, Ill.

PAINT YOUR CAR WITH WYPE for \$2.95!

There's no brushing, no masking or spraying. Rivals a professional spray job. Over 500,000 car owners are delighted with the results. See your local dealer, department store or order direct.

WYPE CORPORATION

DEPT. 16-F 2214 DOLMAN ST. ST. LOUIS 4, MO.

Say You Saw It in Popular Mechanics

EVERY ELECTRIC DRILL A PORTABLE SAW

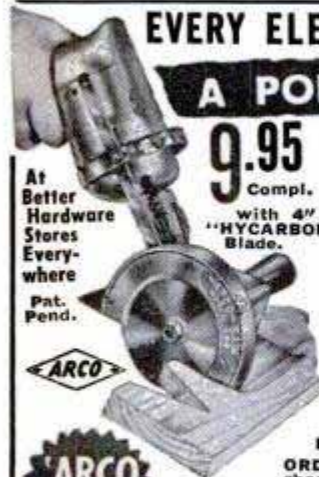

9.95
Compl. with 4" "HYCARBON" Blade.

CONVERTS ANY 3/4" or 1 1/2" DRILL into a Powerful Saw in ONE MINUTE!

Can Be Used With One Hand

"ARCO-SAW" is THE ORIGINAL low priced saw attachment, sold from coast to coast. More "ARCO-SAWS" bought daily than all other makes combined.

HERE'S WHY: "ARCO-SAW" is a rugged, precision-made tool with right angle gear drive. (No clumsy, dangerous direct drive with drill sideways.) Built for years of reliable service — works like a high priced Portable Saw. SAFETY YOKE connects drill and saw, makes it ABSOLUTELY SAFE TO USE! 90-Day Factory Guarantee.

CUTS 1-3/16", or 2x4 by turning over Extra Crosscut Blade, will Rip... \$1.60

ORDER TODAY at your dealer or send us check or M.O. (Postpaid). C.O.D.'s—postage extra.

UNCONDITIONAL 10-DAY MONEY BACK GUARANTEE

DEALERS—Write for nearest jobber.

ARROW METAL PRODUCTS CO.

DEPT. PM-6, 140 WEST BROADWAY, N. Y. 13, N. Y.

NEW DUMORE GRINDER Low Cost—Dual Purpose Combines Lathe & Bench Grinding



\$67.50
Slightly higher west of Rockies

FULL 1/4 HP

.0002" Accuracy . . . Full Shift Stamina

The versatile, new Dumore Utility Grinder converts your 9" - 13" lathe to a precision external grinding machine. Bench or vise mounted, it serves as bench grinder, polisher, wire brusher, or buffer. It's a natural for small machine shops and general shops as well as metal working hobbyists. It gets those occasional special grinding jobs as well as production jobs finished fast and at LOW COST!

Grind It In Your Own Shop—FASTER—CHEAPER

With Utility Grinder garages, repair-shops, fleet operators and maintenance shops can now do fast and low-cost valve grinding, resizing after metalizing, welding clean-up and similar operations requiring precision grinding as well as the every day production jobs. Write for literature to:

The DUMORE COMPANY, Dept. F-74
RACINE, WISCONSIN

Now ALL SHOPS CAN AFFORD PRECISION GRINDING!

AIRCRAFT INVENTION

ROLLS YOUR CAR INTO THE AIR

LIFTS AND LIFTS—

There is no other automobile jack like it. This Saginaw super-jack literally rolls a car into the air. Ball-bearings, rolling between the raceway-shaped threads, reduce effort through increased efficiency—give you remarkable lifting power.

EXTRA SENSIBLE—

There's common sense in buying a Saginaw jack. Added to safety and ease of operation, there is real economy in a jack built to last for years. One good jack is worth more—costs less—than several poor ones.

GET YOURS NOW—

See your nearest United Motors service station.



SAGINAW Recirculating-Ball BUMPER JACK

LASTS AND LASTS—

Tested and proved, this exclusive principle actuated bomb bay doors and wing flaps in thousands of warplanes. The heavy base is permanently attached—can't come loose. The rugged steel construction is built to outlast your car.

EXTRA SAFE—

Won't slip, won't spin, no fluid to leak, no notches to wear. Recirculating balls hold your car where you want it. No kneeling or stretching to prop it under your car. It fits every bumper. Safety like this can mean more than money to you.

UNITED MOTORS SERVICE, DEPT. S-31
General Motors Building, Detroit 2, Michigan
Send me more information about the new Saginaw jack and where I can buy it.

BUILD YOUR OWN TILTING ARBOR SAW!

Exclusive GIL-BILT Build-It-Yourself Features

- No machining—build easily with hand tools only
- No blueprint reading—step-by-step pictorial plans, full scale patterns, actual photographs
- Sturdy wood, aluminum, and steel construction
- Capacity and performance of commercial saws selling for \$60 and up

SAVE
\$50
OR MORE

GIL-BILT 10-INCH TILTING ARBOR SAW



- 27x28 in. table, 13½ in. capacity in front of blade
- 10 in. blade cuts ¾ in. deep, tilts full 45 degrees
- Floor model 34" high, table always stays level
- New Departure ball bearing arbor, ¾" precision shaft turned down for 5/8" bore blades, alum. housing, shipped ready to run
- Jackscrew and 4½ in. dia. handwheel lowers and raises blade
- Cast aluminum miter gauge and self-aligning rip fence guide

GIL-BILT Metal Parts Kit includes Plans, ball bearing arbor, miter gauge and bar, rip fence guide, dado insert, lock knobs, jack screw mechanism and handwheel, and all other metal parts (less blade)..... **\$20.95**
Same Kit with 10" Combination Blade **\$24.90**
Same Kit with 8" Combination Blade **\$23.90**

GIL-BILT 12-INCH BAND SAW



- Cuts to center of 24 inch circle
- Handles stock up to 6 inches thick
- 18x18 inch table tilts 45 degrees
- Lower wheel and drive pulley runs on sealed New Departure Ball Bearings: Upper wheel runs on 5/8" bore Oilite Bronze bearings.
- Upper wheel tension and tilt mechanism of cast aluminum, completely assembled.
- Upper and lower blade guides. Each has ball thrust bearing, self-lub bronze jaws
- Rubber tired wheels. Choice of cast aluminum or make-your-own wood wheels on metal hubs.
- Uses standard 78 inch blades up to 3/8 in. wide.
- Fully enclosed mechanism for utmost safety.

GIL-BILT Metal Parts Kit includes Plans, rubber tires, ¼ inch blade, hubs for wood wheels, ball bearing spindle, tilt mechanism, guides, table tilt segments and all other metal parts..... **\$16.95**

Same Kit with two machined ready-to-install 12" cast aluminum wheels..... **\$20.95**

Return Kits in 10 days for refund if not satisfied.

(Prices include postage within 600 miles. Over 600 add 5%)

Also available—Plans and Parts Kit for 8" Tilt/Table saw. Order Plans at \$1.00 each—sent postpaid anywhere in the world or write for FREE descriptive catalog.

GILLIOM POWER TOOLS P. O. Box 1-PF, Lambert Field St. Louis 21, Missouri

Keep your tools in order, in full view and in easy reach with

NEW! TOOL LOCATOR PRINTS



Get tools out of drawers and boxes where they are hard to find, where they get dull and rusty. Get them up in plain view, in easy reach on TOOL LOCATOR PRINTS.

Two 27" x 42" layouts containing every tool in every size used by average hobbyists; 150 tools all compactly arranged in logical order.

Tack or paste your prints up at the back of the bench or in any convenient spot. Screws or nails driven through the prints hold tools in place.

Each tool easily replaced after use. A glance tells if any tools are missing and which ones.

A set of TOOL LOCATOR PRINTS will save many times its small cost in added convenience, tool protection and time saved.

Set of Two Prints **\$250** Post Paid
Check or Money Order. No COD's please
Alabama residents add 2% sales tax

DEVALL COMPANY

Box 1165, Birmingham, Alabama

Please send me a set of Tool Locator Prints. I enclose \$2.50.

Name _____

Address _____

City _____

State _____

TRIM WHILE YOU WALK

NO SQUEEZING, BENDING OR BLISTERS . . . NO TIRED HANDS OR ARMS



BOLENS Trim-Master

Trims Lawns Easier and Faster

See and try the BOLENS Trim-Master at your nearest hardware, department, or garden implement store. Or write direct for complete details.



BOLENS PRODUCTS DIVISION
Food Machinery and Chemical Corp.
Port Washington, Wisconsin

SWISS CHRONOGRAPH WRIST WATCH



Sweep Second Hand; Precision Workmanship; Rugged Shock-resistant case; Radium hands and numerals; Leather strap. It measures distance, speed of cars, planes, horses and other moving objects. It's a time keeper, stop watch, telemeter, tachometer. ONE YEAR WRITTEN GUARANTEE and full operating instructions enclosed with each watch. SEND NO MONEY. Mail your order today. Pay postman **9.95** plus 10% Federal tax. Total **10.95** plus postage. Or send cash (money order or check) with your order and save postage charge.

DIXIE SUPPLY CO., DANIA 2, FLORIDA

DIVE FLAP ACTUATOR



Used on planes to bend wing flaps and retard its speed. Can be adapted for many uses such as electric hoists, garage doors, etc. Operates on 28 V. D.C. intermittent duty. Easily converted to 110 V. A.C. with step down transformer. Maximum load when jack is extended 1.8 inches. 1950 lbs. Mfd. by Bendix Aviation Corp. Shipping Wght. 18 lbs. Brand New. Original price over \$100. **\$12.95** each, postage paid.

Schematic included. NO C.O.D.

CLARK-REISS CO.

55 WALKER ST. NEW YORK 13, N. Y.

BRAND NEW CAPSTAN WINCHES



NEW LOW PRICE
6000 lb. capacity. Accurately machined gears provide for smooth efficient operation. Suitable for both front or rear mounting. May be used on amphibious jeeps or trucks. All units are brand new and fully guaranteed.

Each **\$17.50**

6 or more **\$15** ea.

BIG, FREE CATALOG WRITE FOR YOUR COPY TODAY

Thousands of other parts and accessories available. SHOP BY MAIL — Order direct from this ad today. TERMS: Net cash with order. Open account to rated firms only. C.O.D. shipments should have 25% deposit with order. All prices are F.O.B. our yards, Chicago, Illinois.

World's Largest Stocks of Jeep Parts

Write for Your Special Requirements—

The King of Jeeps



BERG TRUCK & PARTS CO., INC.
1607 S. Wabash Avenue, Dept. M-6, Chicago 16, Ill.



WHOLESALE GUARANTEED EXCEPTIONALLY GOOD Used Tires Direct to You
 10% discount on 2 or more tires if you send this ad with order
TUBE DELIVERED WITH TIRE AT NO EXTRA COST FOR 15" AND 16" PASSENGER TIRES

Safe — Our tires used on school buses and ambulances
EXCEPTIONALLY GOOD TREAD — NO RECAPS
 GUARANTEED FOR 24 MONTHS

600-16 \$5.49	700-16	\$6.97	525-18	\$6.69	750-20(10)	\$15.98
600-16 (6 ply)	6.49	650-15	5.79	600-20	9.89	825-20	16.98
650-16	5.49	700-15	5.79	650-20	9.98	900-20	17.79
650-16 (6 ply)	6.97	550-17	7.79	750-16	12.50	1000-20	18.99
600-16—6 ply Military—Mud and Snow Tire \$6.37						

ALL GOOD TIRES
 GUARANTEED FOR 12 MONTHS

600-16	\$3.59	550-17	\$5.69	700-20(8)	\$11.79	825-15(14)	\$16.98
650-16	3.89	750-16	8.40	700-20(10)	13.98	825-20	11.19
650-15	3.89	600-20	7.98	750-20(8)	11.79	900-20	11.89
700-15	3.98	650-20	7.99	750-15(10)	12.79	1000-20	12.89

GOLD BOND SPECIAL — 750-20 8 ply MILITARY TIRES
 Will fit 650 x 20 700 x 20 (8 & 10 ply) 34 x 7 (8 & 10 ply)

Special \$10.49	Guaranteed 12 months	
Superior Quality	12.98	Guaranteed 18 months	
Gold Bond Finest	14.98	Guaranteed 24 months	
900 x 16 Special	8.03	900 x 16 extra	11.19

Send check or money order with this ad

GOLD BOND TIRE CO., Dept. PM 24
 512 NORTH 1ST ST., RICHMOND, VA.
 "A gold bond written guarantee with every tire"

CARBURETOR TOO RICH MAKES MOTORIST TOO POOR



Car owners who are wasting money and not getting proper gas mileage due to over-rich mixtures will be pleased to learn how to save gasoline by VACU-MATING over-rich mixtures. VACU-MATIC fits all cars, trucks and tractors. It is automatic and operates on the supercharge principle. Easily installed in a few minutes.

SALESMEN WANTED! Big Profits!
 Send name, address on penny postcard for free particulars and how to get yours for introducing.

VACU-MATIC CO., 7617-1612 W. State St., WAUWATOSA, WIS.

WAR SURPLUS AND OTHER BARGAINS



PNEUMATIC RIVETER & CHIPPING HAMMER

MFD by Ingersoll-Rand, Chicago Pneumatic and Thor. Pistol grip. Ideal for fender, brake lining, concrete breaking work. Like new. Six rivet sets and bucking bar included, making a complete combination. Wgt. 9 lbs. Each \$6.95

INSIDE MICROMETER 2" to 8"

Precision made of tool steel. Hardened tips on all six measuring rods. One 1/2" spacer. Chrome finish. Complete with case. \$6.95



MICROMETERS
 Chrome plated, precision engineered and carefully tooled to give long life. All new. 0-1" capacity . . . ea. \$2.25.
 1-2" cap. \$3.50. 2-3" cap. \$5.50. 3-4" cap. \$6.50.

HYDRAULIC HAND PUMP
 2000 P.S.I.
 For operating hydraulic jacks, presses, hoists, cylinders, etc. Built-in check valve. Alloy aluminum housing. 2 3/4" x 3 1/2" x 8". Ship. wt. 3 1/2 lbs. Value, approx. \$45. Complete with handle. ALL NEW \$6.95

Send check, money order or cash. 25% deposit required on C.O.D. orders. All prices F.O.B. Culver City, Calif. Send 25c for illustrated catalog.

HIGH SPEED DRILLS
 All New. Fractional & numbered. Orig. Val. \$15. Nationally known brand. Ast. sizes. Set 30. \$3.50
EXTENSION DRILLS
 High Speed Steel, like new. Asst'd sizes from No. 1/4 to 40. Lengths from 6" to 12". Approximately \$20 value. Set of 12 \$3.75

AIRBORNE SALES CO., INC. DEPT. PM 60 CULVER CITY, CALIF.

CASH IN ON THE BUILDING BOOM!

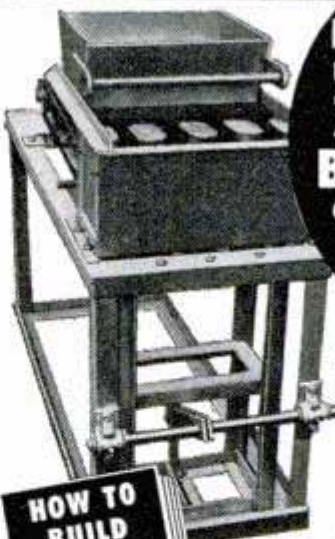

MAKE BUILDING BLOCKS RIGHT IN YOUR OWN BACKYARD AMAZING GENERAL BLOCK MACHINE
 CAPACITY 1000 BLOCKS PER DAY
 \$199 LESS MOTOR
 ONLY 199 F.O.B. PLANT
 SHIPPING WEIGHT 400 lbs.

Cinder and Concrete Blocks in big demand. Sell all you produce, to contractors and builder supply yards, at 15c to 25c each. Easy to start your own profitable business.

GENERAL BLOCK MACHINE can be operated indoors or out, in floor space 9 ft. x 10 ft. All steel construction. Vibrator mounted in sealed ball bearings. Simple to run. Powered by 1/2 H.P. electric motor or 1 H.P. gas engine. Produces up to 1,000 8x8x16 blocks in 8 hour day. Superior 3 core type, meeting all building code requirements. Produces 4x8x16, 8x8x16, 12x8x16 blocks. Material for blocks, cinders, cement, and sand, obtainable anywhere. Full instructions and mixing formulas with each machine. Immediate Delivery. Mail coupon at once for full details, sent free without obligation.

HOW TO BUILD YOUR OWN CONCRETE BLOCK HOME
 Only 1 Prepaid

Wonderful book written and illustrated by our staff of experts.

GENERAL ENGINES CO.
 DEPT. P9 307 HUNTER ST. GLOUCESTER, N. J.

Shows you 8 ways to save money and how to make and lay blocks, laying out building lines, mixing your own concrete, building steps, porches and concrete floors, includes floor plans for 6 beautiful easy to construct concrete block bungalows. Mail coupon at once with \$1.

Name

Address

City..... Zone... State.....

SMALL BALL BEARING

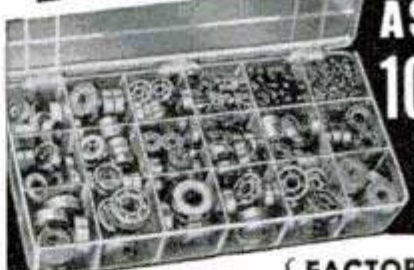

ASSORTMENT 100 POPULAR SIZES & MAKES IN PARTITIONED PLASTIC BOX

NEW - PRECISION FACTORY LIST PRICE ON BEARINGS OVER \$250.00

Bearings are SKF—FAFNIR—MRC—NEW DEPARTURE—NORMA—FEDERAL and others. Sizes from 2mm to 8mm inside diameter, and 4mm to 24mm outside diameter. MECHANICS—TECHNICIANS—HOBBYISTS—just the thing for servicing small machines such as Washing Machines, Vacuum Cleaners, Home Appliances, Cameras, Toys, Instruments, Automotive and equipment of all kinds.

No. MA-1 Assortment of 100 Ball Bearings in Plastic Box complete as shown, postpaid

ONLY \$15.95 ORDER NOW

No. MA-2 Junior Assortment of 50 Ball Bearings in Plastic Box complete, postpaid **ONLY \$7.95**

MEDALLION MFG. CO., 25 E. 25th St., Chicago 16, Ill.

Send me postpaid, Ball Bearing Assortment No. _____ in Plastic Box. I enclose check (or Money Order) for \$ _____.

Name _____

Street _____

City _____ State _____

No. 2728
 1/2" Combination
 Box - Open end wrench



You own the BEST money can buy... when it's P&C

Special analysis steel, hot forged and heat treated.

Box ends hot broached, offset 15° for clearance. Thin walls for close quarters.

Open ends precision milled. Chrome plated, polished ends.

There is a P&C tool for every job. Ask your hardware dealer for P&C punches, pliers, sockets, wrenches and screwdrivers—the BEST tools money can buy.

FREE TOOL BOOKLET gives valuable information for every tool user. Send for your *free copy!*

P&C HAND FORGED TOOL COMPANY
 PORTLAND 22, OREGON

BRAND NEW



30 DAY FREE TRIAL
7x50 Prism BINOCULARS

Finest Precision Optics
 Buy Direct From Importer
 Money Back Guarantee

Many other models AS LOW AS \$6.00* (* plus 20% fed. tax)

FREE Illustrated Catalog & Book, "How To Select Binoculars"

Dealers: Write for discounts.

BUSHNELL Importers 43 E. Green St., Dept. M-6
 Pasadena 1, California

STOP GENERATOR TROUBLE
REGULATOR BATTERY



AMAZING WATTAGE REGULATOR

WITH THE MIRACLE THE AUTO-DRIVING PUBLIC WAITED FOR TO REPLACE THEIR OLD UNRELIABLE VOLTAGE REGULATORS DRIVE WITH OR WITH-OUT YOUR BATTERY GREATEST ADVANCEMENT IN AUTO-IGNITION SINCE THE SELF-STARTER GUARANTEED 100,000 MILES OR ONE YEAR

STATE MAKE AND MODEL OF CAR FOR FREE CATALOG

WRITE TODAY
SCIENTIFIC ELECTRIC CO.
 P.O. BOX 2162-D • STATION H • CLEVELAND 8, OHIO

LIQUID MARBLE COMPOSITION FLOORS FLEXIBLE MOLDS

Mold, Brush, Trowel, Spray It! MOLD novelties, Statuary, Art Goods in Flexible Plastic Molds; 5c material makes \$1 seller. Make Marbleized floors, Tile Walls. Colorful, glossy, amazing! Easily learned; start in garage or basement. Particulars free.

MARBLEIZING SERVICE, Dept. 10-F, Edwardsville, Ill.

TERRIFIC POWER, NO "PUMPING"!
WITH CROSMAN'S NEW CO₂ GUNS



Amazing new "Power without Powder" principle adds new thrills to shooting the Crosman CO₂ Pistol and Rifle with safety indoors or out. See them at your Crosman dealers. Write for free literature.

Crosman Arms Co., Inc., Rochester 7, N.Y.

New 1950 Plastics Supplies Catalog

Just off press. Get details on Plexiglas, Lucite, rods, sheets, tubes, Acetates, cements, dyes, buffs, molding sets, tools, carving kits, everything in plastics. Lowest prices. Price 10c, stamps or coin, with ad for catalog.

Plastics Mfg. & Supply Corp., Dept. PM-6, 4707 Euclid Ave., Cleveland, Ohio

PISTONS



ALUMINUM ALLOY. For Every Make Engine, Any Year, Odd or Foreign! For auto, "hot rod", racing, truck, tractor, motorcycle, scooter, bike, outboard, marine, compressor, industrial. Send sample or specifications.

JUDSON MFG. CO., 1709 Gillingham, Phila. 24, Pa.

SAY YOU SAW IT IN POPULAR MECHANICS

BeMaCo Dependable

AUTOMATIC SAW SET

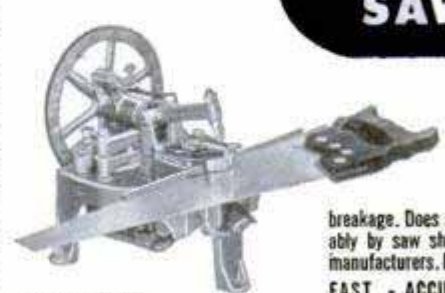

Sets 400 teeth per minute on hand or band saws 4 to 16 point. Hammer and anvil action sets teeth accurately and uniformly... No tooth breakage. Does a perfect job. Used profitably by saw shops everywhere and saw manufacturers. Every machine guaranteed!

FAST - ACCURATE - DEPENDABLE

★ INCREASES PROFITS

BEAVER MFG. CO.
 802L S. ISIS AVE. • INGLEWOOD, CALIF.

NEWEST-GREATEST VALUE!

THIS BIG POWERFUL 1 1/2 H.P. **WHEEL** GENUINE GARDEN-ALL TRACTOR

ONLY \$129.50 TRACTOR F.O.B. LIBERTY, IND.

or \$139.50 F.O.B. SAN FRANCISCO

Garden-All
 LAWN and GARDEN TRACTOR

MODEL "D"



Send NOW for FOLDER!
 Imagine a Garden-All at this low price! It's a sensational value! Quality features throughout! All-steel electrically-welded frame; roller chain final drive; over-riding ratchets for easy turns; bronze bearings; variable tread width—14" to 18"; 4.00 x 12 special implement tires. Versatile! Economical! Low priced attachments:—Disc Harrow, Furrower, Cultivator, Lawn Mower, Sickle Bar, Scraper-Dozer. See the Model "D" before you buy!

GARDEN-ALL TRACTOR, INC.
 Dept. P, 110 W. Union Street, LIBERTY, INDIANA

WELD

BRAZE, SOLDER, CUT quickly... easily

The FOUR-WAY PORTABLE ARC-WELDER

COMPLETE ONLY \$9.95 F.O.B.
10 DAY TRIAL

YOU'LL BE AMAZED by the work you can do on your first job! Plugs into any convenient properly wired 110 volt A.C. or D.C. line. Follow simple directions. Work on iron, steel, bronze, brass, aluminum and other metals. Save money doing own repairs. Make money repairing for others. Thousands of users among maintenance and repair men, farmers, tinsmiths, engineers, home and auto owners, etc. Pays for itself over and over. Order on ten-day trial or send for details.

MAKE OR REPAIR HOME & FARM APPLIANCES FENDERS BICYCLES METAL FURNITURE & 1001 ITEMS

FREE FOUR-WAY WELDER CO., Dept. F2-FA
2326 So. Michigan Avenue • Chicago 16, Illinois
Full Details SEND TODAY

Who Ever Heard of POWER TOOLS

Only \$8.00 Each?

EMRICK WORKSHOP includes Big, Heavy-Duty 30" Lathe, Drill Press, Saw Arbor, Grinder, Sander — in ONE machine, using ONE motor. Equals in performance single units up to \$200.00. Factory price only \$39.95 cash, or on Easy Payments, 10-Day Free Trial. MONEY-BACK Guarantee. Write for FREE literature on new 1950 features and New Low Priced Specials.

NEW LOW PRICES

5-in-1 MACHINE

EMRICK, INC., 1531 Clinton, Kalamazoo, Mich.

MARCOT KEY MACHINE

Immediate Delivery

MARCOT No. 8 KEY MACHINE, mounted on Cabinet, less motor, \$95.00
Auto Code Book and Depth Keys, 12.50
100 Dz. Popular Key Blanks, 60.00
Set — Key File, Follow-Through Rods, Lock Picks, Bit Key Gauge, Thimble, Pins, Springs, 10.50
"Locksmith Trade Books", 6.75
How to Open Locks without Keys or Picks; Secret of Locksmithing; How to Make Keys by the Impression Method; Master Key Systems.
TOTAL COST \$184.75

A. J. MARCOTTE CO., 1200 N. Kedzie Ave., Dept. PM, Chicago 51, Ill.

Gerstner TOOL CHESTS

For the safety of your good tools, use a genuine GERSTNER High Grade chest. Free Catalog for machinists and toolmakers.

GERSTNER TOOL CHESTS
450 COLUMBIA ST. DAYTON 7, OHIO

SAY YOU SAW IT IN POPULAR MECHANICS

QUALITY POWER MOWERS FOR LESS

Make-Ur-Own Rotary POWER MOWER

SHIPPED ASSEMBLED AS SHOWN

Model 50M Just add your elec. motor or gas engine. Concealed 18" blade for safety. 3 cutting heights. Ball bearing wheels.

Model 50GM with 2½ H.P. McCullough gas engine...\$119.50

Model 50GVC with Clinton Vertical 1.8 H.P., 4 cycle.....\$104.50

Model 50E with ½ H.P. electric motor, 75 ft. cord.....\$69.50

← America's Greatest Power Mower Values Fully Guaranteed

Order Model Desired NOW!
F.O.B., K. C. Send check or M.O.

ATLAS EQUIPMENT CO.
229 S.W. Blvd. Dept. M.P.6 Kansas City, Mo.

ATLAS KEEN MOWERS

ONLY \$39.95

You save time, effort, money... get better work



FITS ANY ¼" ELECTRIC DRILL

with the **New 100° Millers Falls BUFFER and SANDER**

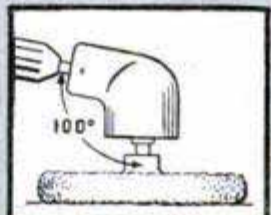

EXCLUSIVE 100° ANGLE DRIVE allows clearance for drill on flat work.

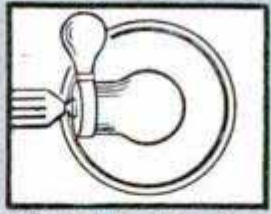

REVERSIBLE SIDE HANDLE gives you steady, firm grip... better control.

In seconds your electric drill becomes an efficient polisher and disc sander. No more blistered hands or aching shoulders! Polishing the car, sanding floors, removing paint, waxing furniture are quicker, easier with this labor-saving new attachment. It's a rugged Millers Falls tool that pays for itself in no time and does real professional work comparable to specialized tools costing many times more. Use it once and you'll never be without it. Get one today at your hardware dealer's.

Ask for the new Millers Falls No. 2120 Buffering and Sanding Attachment. Yours complete with 5" rubber pad, 2 sanding discs and lambswool bonnet for only

\$8.95

MILLERS FALLS TOOLS

SINCE 1868

MILLERS FALLS COMPANY GREENFIELD MASS.

LINOLEUM LAYERS can now scribe those **HARD-TO-GET-TO** places...easily and accurately with the **NEW WILKEE DOUBLE "HINGE" SEAM SCRIBER**

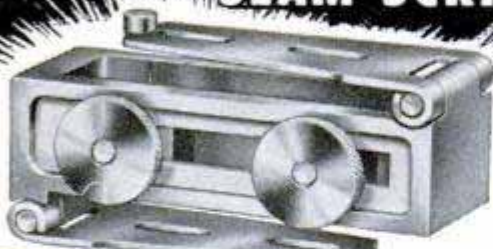

FILE HARD DOUBLE LIFE STEEL HINGES



BRIGHT CHROME FINISH

EASILY and QUICKLY ADJUSTED

Recommended for... Cove Base...Rubber and Tile Top Sinks...Metal Moulding Tops... Splash Walls under Cabinets... Cove Moulding Counter.

FULLY GUARANTEED Money returned without question **DEALER INQUIRIES INVITED**

Shipped postpaid \$4.95

WILKEE MANUFACTURING CO.

Dept. A, 6621 San Fernando Rd., Glendale 1, Calif.

SAY YOU SAW IT IN POPULAR MECHANICS

MEET THE NEW BULL SAW!

Convert your electric drill into a powerful, portable saw for only \$9.95

Your electric drill becomes a portable saw with power to spare when you attach the new Bull Saw! It's sturdy, rigid—yet light enough for one-hand operation. New visual guide lets you see where you're going; new extra wide shoe plate keeps saw blade on the straight-and-narrow. One-piece safety guard of polished aluminum... blade of high-carbon steel... double bearings for long life. Fits rigidly on any 1/4" electric drill. Depth of cut: 1 1/4". Complete, ready to use in drill (When ordering, ask for Model BS-C)

\$9.95



IF YOU ALREADY OWN A BULL BUFFER

you can make your own Bull Saw for only \$7.50! Here's how: order the saw housing (photo 13) and attach it to the anglehead of your Bull Buffer, following the simple directions we send you. That's all—it only takes 30 seconds to change your Bull Buffer into a powerful, portable saw! The housing you need comes complete, only... (When ordering, ask for Model BS-H)

\$7.50



COMPLETE POLISH-SAND-'N-SAW KIT

Includes (photo 2) Bull Buffer*, famous right-angle polisher-sander complete with rubber pad, sheepskin bonnet, 2 sanding discs and (photo 13) Saw Housing that fits on Bull Buffer angle head to give you a powerful Bull Saw. A \$19.90 value, yours for only **\$14.95** (When ordering, ask for Model BS-K)

*Bull Buffer only, with sheepskin bonnet and 2 sanding discs, \$9.95.

At your dealer, or send cash, check or M.O. for prepaid shipment

BERTRAM H. ENGINEERING CO.

3121 MAIN STREET KANSAS CITY, MO.

BUILD YOUR OWN POWER LAWN MOWER

WHY BREAK YOUR BACK MOWING FIELD OR LAWN?

WRITE FOR **FREE** Building Instructions The Rite-Way Mower Attachment Ball Bearing

SAVE MONEY SAVE TIME

Now anyone can save time and effort mowing field or lawn by building their own whirl type power mower. Build according to your own ideas and needs at small cost. Cut close to fences, walks, buildings, etc. Build in short time with parts and instructions we furnish. Save hours of time and back breaking labor.

WRITE TODAY FOR FREE INFORMATION

T & H MFG. CO., Dept. MPB-6
811 E. 31, Kan. City 3, Mo.



IT'S FUN TO BUILD

WANT \$10,000?

Earn the government Super Sensitive P.R.I. bonus. Locate Uranium with a **GEIGER COUNTER**

Find gold, silver, and other valuable ores with a P.R.I. Treasure Locator. World's finest instruments. FREE catalog. Write today.

PRECISION RADIATION INSTRUMENTS, Inc.
5478PM Wilshire Blvd., Los Angeles 36, Cal.

Dealer Inquiries Invited



OIL IMMERSION HEATER

Only \$5.98

Three different heats: 312 watts, 625 watts, 1250 watts, 110 volts, AC or DC. Heating element 11 inches long. Threaded to fit 1 1/4" pipe thread. Easily made into oil heater for your car, truck, tractor or farm equipment. Thousand other uses. Prepaid when remittance accompanies order. You pay postage on C.O.D. order. **S. R. MARKS COMPANY, Inc.**, Montgomery, Alabama. **Only \$5.98**

RETAIL PRICE \$125.00

FACTORY TO YOU \$59.95

SUPERSHOP includes precision-built 8" tilting table saw, vertical and horizontal drill press, 30" lathe, sander, grinder. 100% BALL BEARING. Write for FREE catalog, full details, trial plan.

POWER TOOLS, INC.

112 YATES AVENUE
BELOIT, WIS.



KILRAY AUTO BLIND Keeps Sun Out!

The smart-looking KILRAY keeps cars degrees cooler, protects passengers and upholstery from sun. Installed in a jiffy!

FITS ALL CARS! Polished aluminum brackets and bonderized steel glass give full rear vision; cannot rattle. **\$9.95** postpaid—check or M.O. C.O.D. plus postage. Specify make, year, body style of car.

SANDERS & CO. • 140 PEACHTREE • ATLANTA, GA.

LOOK AT THESE VALUE FEATURES

1 HP. EMERSON REPULSION INDUCTION
3450 R.P.M.
EXTRA HEAVY DUTY NEW MOTORS
3/4 Inch SHAFT
EASILY REVERSED \$37.50 Fob. Chgo.

110/220, 60 Cy 1 Ph.
250% Overload Cap. LATEST DESIGN
Wgt. 63#
SPLASH PROOF



NEW, heavy duty repulsion induction 1 H.P., 3450 RPM, 110/220 V, 60 Cy., 1 Ph., A.C. motor for shapers, planers, circular saws, etc. #EH-1 LOW PRICED at \$37.50 Fob. Chicago.

KEEP COOL THIS SUMMER . . . BEAT THE HEAT

Fan Blade and Motor Combination, 1/4 H.P. Induction Motor, 110 V.-A.C. 1725 RPM. Overload Protection **\$7.50** Fob. Chgo.
Only
16-inch Torrington Zephyr-Aire 2800 CFM **\$3.50** Fob. Chgo.
Fan Blade, Only
or Combination together **\$10.00** Fob. Chgo.
(Both). Only

WRITE FOR BARGAIN WINDOW FAN, ATTIC FAN and ELECTRIC FAN MOTOR CIRCULAR and SAVE MONEY • All Sizes
C. MARSHALL SALES, 3546 W. Fullerton Av., Dept. P-6, CHICAGO 47

GARAGEMEN, SERVICE STATION OPERATORS, CAR OWNERS!

SAVE UP TO 50% ON THESE NATIONALLY-KNOWN AUTOMOTIVE SERVICE ITEMS



\$39.

For better than 30 years, the KRW Direct-to-User Policy has SAVED MILLIONS for THOUSANDS of Garage and Service Station Operators and Car Dealers. KRW manufactures hundreds of specialized tools and equipment which have been factory-approved by Ford and other car manufacturers. KRW Tools are used the world over. See our rating in Dun & Bradstreet. It's tops.

KRW SIX AMPERE SLOW CHARGER

Handles 1 to 12 3-Cell Batteries or Equivalent. Complete ready to use. This heavy-duty battery charger is ideal for safe charging of all types of car, truck and aircraft batteries. It incorporates all the latest design and construction features. Comes complete with bulb, wiring and connectors, ready to plug in and operate. Case is 11" x 13" x 6". Operation is simple and fool-proof. Plug and Jack arrangement, like a telephone switch-board. You merely plug in to the jack corresponding to number of batteries on the line. Thousands now in use. Operates on 110 Volt, 60 Cycle.

\$130.

KRW FASTCHARGER

FULLY AUTOMATIC. OPERATES ON 110 VOLTS A. C.

Simplest and most efficient on the market. Only one knob to turn, one dial to watch. New electric timer is foolproof in operation... it automatically discharges, fast charges, slow charges and shuts off. Customer can be shown exact condition of battery on the easily understood full-color dial. You can do this under proper load without danger of buckling plates. Use it also for "cycling" batteries that are badly sulphated. Equipped with 8" fan and heavy-duty motor. Lowest priced dependable unit on market. Money back if not satisfied after 30 days.



KRW GARAGE JACK

3 TON CAPACITY



Lowest Price only **\$90.**

This outstanding Jack value meets every requirement of strength, fast lifting, quick spotting and dependability. Lifting capacity 3-tons. Weight 195 lbs. Length overall including handle 88". Length of chassis 53". Floor to top of rest pad 4" minimum. Raises to 24" maximum. Equipped with Self-cleaning Release Valve, Tamper Proof Safety Valve, Crowned, Roller Bearing Front Wheels and Ball Bearing Swivel Rear Wheels. Finger-tip Control Button.

SOLD WITH 30-DAY MONEY-BACK GUARANTEE

KRW AIR COMPRESSORS. TWO STAGE

Highest Quality. 4 Models—9.75 to 38.3 cu. ft. Displacement.

Why pay \$200 to \$300 Premium. For 35 years, KRW has passed these savings on to users. Every feature which can contribute to maximum efficiency and long life has been "built in". Cylinders are nickel-chrome alloy iron. Crankshafts drop-forged with integral counterweights. Timken Roller Bearings. Lynite Connecting Rods. Semi-steel Pistons with 3 compression and one oil ring. Constant level oiling system. Plate-type Valves. Automatic Air Breather. Combination Filter and Air Cleaner. Pressure Unloader for Easy Starting. Pressure Control Switch and Thermal Relay protects motor against overloading and undervoltage. 200 lbs. pressure ASME Tanks. PRICES FOLLOW:
2 H.P. 9.75 c.f.m., 80 gal. tank **\$375.00** 7½ H.P. 28.4 c.f.m., 80 gal. tank **\$654.00**
5 H.P. 20 c.f.m., 80 gal. tank **\$440.00** 10 H.P. 38.3 c.f.m., 80 gal. tank **\$685.00**



TERMS: Cash with order, if C.O.D., 25% must accompany order. Concerns with established credit sold on open account. All PRICES F. O. B. Factory. (Subject to change without notice.)

SATISFACTION OR MONEY BACK GUARANTEE All Tools or Equipment

described in this advertisement are sold subject to your trial for 30-days after receipt. If you are then not thoroughly satisfied, return the goods to us and your money will be immediately REFUNDED. SERVICE AVAILABLE IN ALL PRINCIPAL CITIES

K·R·W·I·L·S·O·N 213 MAIN ST. BUFFALO 3, N.Y.
WORLD'S LARGEST MANUFACTURER OF GARAGE TOOLS AND EQUIPMENT

SPECIAL!

Gigantic Mail Sale!

Army POWER PLANTS

2500-Watt, 110-Volt, 60-Cycle

Here's probably your last chance to own one of the Army's finest power plants—at tremendous saving! Genuine PE-75, brand new, in original crate! Cost Gov't. over \$600—yours, while they last, only \$269!

Ideal for contractors, filling stations, cabin camps, carpenters, utilities, businesses in small towns, farmers, ranchers, etc. Use full-time or as emergency plant when regular power lines fail—to operate lights, refrigerator, oil furnace motor, etc. Will stand substantial overload. Voltage output remains practically constant from zero to full load. Filter prevents radio noise. Comes complete, no extra equipment to buy. SPECIFICATIONS: 2500-watt, 110-volt, 60-cycle single-phase generator. Genuine 6.5 h.p. model ZZ Briggs engine. Uses very little fuel. Use for other purposes when not operating plant. This may be last call! ORDER NOW!

BRAND NEW
with original spare parts and tools

Kit contains gaskets, ignition parts, spark plugs, valves, rings, wrenches, wheel puller, pliers, etc.

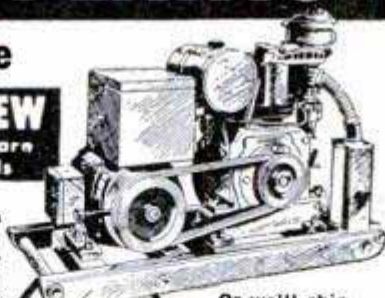

Cost Gov't over \$600

\$269

FOB Lincoln Nebr.

Or we'll ship Frt. Ppd. in USA **\$279**

Limited number used plants excellent condition guar.

\$225

FOB Lincoln, Nebr.

\$235 Ppd. USA

FREE CAT. ADD.

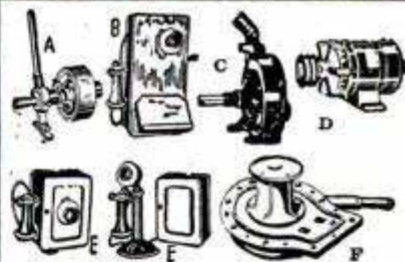

Other Items on Sale!

- A. Utility Clutch, up to 6.5 h.p. **\$13.95**
 - B. Magneto Rural Telephone... **12.40**
 - C. Centrifugal ¾" Pump... **6.50**
 - D. G. E. 300-Amp. Welder Generator... **89.90**
 - E. City Wall or Desk Phone... **4.99**
 - F. Winch, 5000-lb. Cost \$150... **21.95**
- All shipped prepaid

- Other power plant bargains including 750-watt, 3000-watt and 6300-watt sizes. Also generators, alone.
- Dozens electronic, mechanical, power tool bargains.
- Order from ad. Satisfaction guaranteed. Or send card for surplus listings.

BURDEN SALES COMPANY
808 "O" ST. LINCOLN, NEBR.

THE CHOICE OF THOSE WHO WELD FOR PLEASURE AND PROFIT!

DYNAMIC Super Charged ARC-WELDER

OVER 50,000 SATISFIED USERS

DOES WELDING, BRAZING, SOLDERING, CUTTING
It's the finest, precision built heavy duty transformer-welder available for home, farm, or shop use. Does work you'd expect from costlier machines. EASY TO OPERATE. Do expert work; follow simple instructions. Works on iron, steel, brass, bronze, aluminum and other metals. Operates from any properly wired 110 volt 50/60 cycle AC line. Save time, Make money—Build or repair auto, home, farm or shop equipment, etc. for yourself and others in spare or full time. Comes complete Ready-To-Operate. Write today for FREE details on 10 day trial and money back guarantee.

DYNAMIC WELDER CO., Dept. D2-FA4, 15 E. 23rd St., Chicago 16, Ill.

GIFT WORTH \$6.80 INCLUDED



FOR PROMPT ACTION SEND TODAY

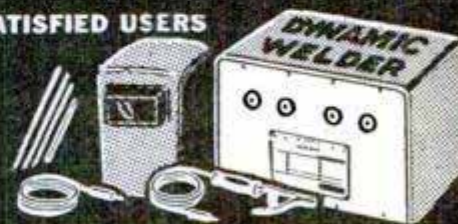

LOWEST PRICED INDUSTRIAL TRANSFORMER TYPE WELDER

THE BIGGEST SURPLUS BARGAINS IN YEARS

ELECTRIC MOTOR 1/2 H.P. 27 V.D.C. R.P.M. 4000 No. 750. For Intermittent or Continuous Duty. 5 1/2" SHAFT. VARIABLE SPEED MOTOR CAN BE ADAPTED TO 110 V. A.C. or R.E.A. line by simple arranging armature brush leads. UNUSED. Instructions incl. **\$5.50**

ELECTRIC MOTOR 1/2 H.P. 24 Volt D.C. R.P.M. 2500. Amp. 22 #HCA24. Gov't. cost **\$3.50**

ELECTRIC MOTOR 1/4 H.P. 28 Volt D.C. R.P.M. 4000 #2832 with simple instructions to convert to 28-32 Volt A.C. Gov't cost \$82.84. Brand New. **\$3.50**

PESCO VACUUM AIR — GENERAL PURPOSE PUMP
Here is a pump for air, fluid, pressure or vacuum. Standard 1/2" pipe thread. Delivers 300 G.P.H. at 2000 R.P.M. Runs forward or reverse. Self aligning shaft. Spine terminal for direct drive, readily replaced with a pulley. Use them for oil burners, MILKING MACHINES, COMPRESSORS, VACUUM PUMP, Weed killer solutions, etc. Engineering report and instructions incl. UNUSED. Originally cost **\$8.50** Postpaid. Now only **\$5.00**



WEAVERS HYDRAULIC HAND PUMP — BRAND NEW. For hydraulic jacks, presses, hoist, etc. For operating hydraulic cylinders, to pump oil or hydraulic fluid under pressure. Has built in check valve, and is capable of delivering 1000 lbs. pressure. Wt. 10 1/2 lbs. A **\$50.00** value. Instructions incl. **\$8.50**

THOMPSON BOOSTER PUMP Built with direct connected motor. Runs on 24 Volt A.C. or D.C. Explosion proof, constructed for pumping gasoline, fuel transfer. Ideal as hot water heating circulator. As coolant pump, fuel booster, oil pump, etc. Discharge connections are 1". Rated 300 G.P.H. Stock #1200. Price only **\$7.50**



STRATOPower CONSTANT DISPLACEMENT HEAVY DUTY PUMP For operating Hydraulic cylinders, hydraulic motors on tractors, bulldozers, construction machinery, lift trucks. For fuel or oil transfer. Industrial Applications, etc. Delivers up to 400 G.P.H. at 3750 R.P.M. Rated 1250 to 1400 P.S.I. 3750 to 4500 R.P.M. HAS BUILT IN RELIEF AT HEAD. Rotation either direction without adjustment. Can be used as hydraulic motor, \$85.00 value. Engineering data & instructions incl. Stock #37. Wt. 8 lbs. Price f.o.b. K.C., Mo., Only **\$12.50**



AIR OR OIL HYDRAULIC CYLINDERS
Here's a double action 1" Bore, 3" Stroke, 3/8" Shaft, Clevis mounting. Overall length 9". Capacity 700 lbs. with 1000 P.S.I. input. Has a capacity of 9800 lbs. with our STRATOPower PUMP 1400 P.S.I. It's perfect for applications such as door openers, positioners, small loaders, control units, etc. A REAL TERRIFIC VALUE. Stock No. 10 Postpaid **\$4.50**

HYDRAULIC CYLINDER SPECIAL Stock No. 12 Gives 12560 lbs. with 1000 P.S.I. input. Capacity 17584 lbs. with our STRATOPower PUMP 1400 P.S.I. or will produce 34168 lbs. with 3000 line pressure. Can also be operated on low pressure system. 4" Bore, 8 3/4" Stroke, 1 1/2" Shaft. Clevis mounting. Gov't cost \$300. "Engineering data & instructions incl." **\$19.50** Wt. approx. 19 lbs. A tremendous Bargain.



HYDRAULIC CYLINDER SWIVEL VALVE For Connecting cylinders required to be movable. Such as Carrying oils, liquids. Loading attachments, plow lifts, etc. Brand New. Stock No. 3915 **\$2.50** Postpaid.

HYDRAULIC CHECK & RELIEF VALVE **\$2.50** Postpaid

VICKERS UNLOADING VALVE Brand New — By passes full amount output of the pump while the cylinder is not in operation. Takes starting load off of electric motor driving the pump. Price. **\$4.95** Postpaid

VICKERS ACCUMULATOR Brand new. Use it for constant pressure both in line and reserve storage or as pressure booster (2000 P.S.I.), ball type 5-1/2" Dia. Stock No. A-650 only **\$5.50**

HYDRAULIC HOSE Length 32", Connection 5/16" swivel flare female. 3000 P.S.I. capacity. **89c** Postpaid (stock #11) only

HYDRAULIC HOSE Length 16", has 1/4" female swivel connector and 1/4" Male connector. Cap. 5000 P.S.I. Stock #12. **89c** Postpaid

Heavy HYDRAULIC CONTROL VALVE #D-8660
Here's your four way hydraulic control valve for use with 2 double action cylinders. Each cylinder may be operated independently of the other or in conjunction with the other. 3/8" pipe thread connections with mounting brackets attached to body of valve. A **\$60.00** value. Brand new. **\$8.95** Postpaid

HYDRAULIC CONTROL VALVE ADEL PRECISION #10086 Brand New
For controlling 2 single action cylinders or one double action cylinder. When pressure is applied to one cylinder the return to the opposite cylinder is opened. Connections are for 3/8" pipe thread. Including operating lever 6" long and has quadrant for locking in either position. A tremendous bargain **\$8.95** Post-only

AMPLIDYNE MOTOR GENERATOR
#5AN31N318A—Use as 24/32 Volt D.C. motor, pulls 1/2 H.P. or 0/60 V. D.C. Generator Belt driven will deliver 30/40 amps. Can be adapted to 110 V. A.C./D.C. 10,000 R.P.M. 1/2 H.P. by simple changes in connections. Unused, instructions incl. (Stock #790). Gov't Cost \$140.00 **\$5.50** Only



CUNO OIL FILTER—BRAND NEW Aircraft type. Filters oil without cartridge replacements. Just turn handle and cartridge is clean. Standard 3/8" inlet and outlet ports. STOP CHANGING OIL. **\$4.95** Postpaid. Instructions incl.



All items guaranteed as represented. Send check or money order. Prices f.o.b. K.C. except when marked postpaid.
GENERAL SALVAGE COMPANY
Dept. 6-17, 2922 E. 27th St., Kansas City, Mo.

FURNITURE FOR YOUR BEDROOM

YOU'LL BE THE ENVY of your neighbors with this beautiful bedroom suite in honey maple, oak or walnut! Here's a bed with storage space... a three-piece vanity with cosmetic compartment and makeup mirror... a Mr. and Mrs. dresser... twin night stands with drawers!



Send for Complete PLANS Only **\$2.00**

YOU MAKE IT YOURSELF! Only two power tools, a saw and a jointer, are needed to turn out this modern bedroom furniture. No other project of Popular Mechanics Magazine in recent years has captured the fancy of home craftsmen as has this easy-to-build suite. Letters demanding detailed plans poured in after the suite was pictured in Popular Mechanics. And now the plans are ready! They're detailed scaled drawings—a complete set of 4. Send for them today!

POPULAR MECHANICS PRESS
200 East Ontario Street, Chicago 11, Illinois

I enclose _____ for a complete set of plans for making the modern bedroom suite illustrated above.

Name _____

Address _____

City _____ Zone _____ State _____

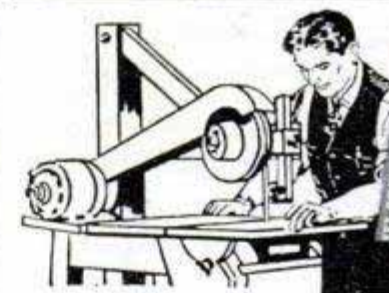

40 NEW EDITION
Power Tools
YOU CAN MAKE

TURN WOOD, SCRAP AND WASTE INTO PRACTICAL POWER SHOP TOOLS

40 Power Tools
You Can Make at Little or No Cost

Don't limit your workshop fun to use of hand tools. Get the new edition of "Forty Power Tools You Can Make" with many new tools, and make your own power machines. Step up your fun and production. Do a better job with power tools. Make them yourself from wood and old discarded materials at small cost.

This book gives every detail in plain language you can understand and follow. Hundreds of pictures and plans show every step to follow. Mail coupon with \$1.50 today. Even though you have the old edition get this new book with 20 new tools. Money back if not satisfied.

- Some of the 40 Tools You Can Make**
- Table Saw with Tilting Arbor
 - Saw Sander Unit
 - Drill Press from pipe fittings
 - Bending Brake
 - Thickness Planer
 - Wood Lathe
 - Power Hack Saw
 - Double Duty Sander
 - Jig Saws
 - Band Saws
 - 40 Different Tools in All

POPULAR MECHANICS PRESS, Dept. 4000
200 E. Ontario St., Chicago 11

Send the new edition of "Forty Power Tools You Can Make."
 Remittance for \$1.50 enclosed.

Name _____

Address _____

City _____ Zone _____ State _____

POWER MOWERS

Only \$69.50
DEALER PRICE

Powerful—Streamlined

Complete with Maytag, Power Products or Briggs-Stratton Engine—18" rotary tool-steel, fully guarded blades—cast aluminum body. Cuts grass and weeds, wet or dry—does all trimming—chops grass into fine mulch, eliminating raking. Send check with order, or specify C.O.D.

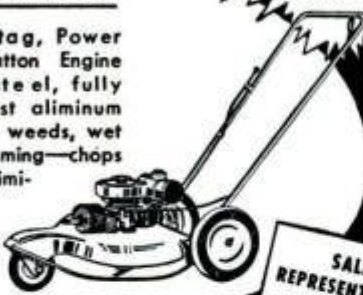

Write for free information

SALES REPRESENTATIVES WANTED

HARTMAN Corp.

1122 SO. KIRKWOOD RD.

ST. LOUIS 22, MO.

OILETTE Lubricator

HANDY

For oiling those hard-to-get-at places
VISIBLE OIL SUPPLY

for SPORTSMEN
MECHANICS - HOBBYISTS



DELIVERS ONE DROP AT A TIME . . .
. . . EXACTLY WHERE YOU WANT IT

Transparent plastic barrel. Accurate push button controls oil. Sturdy construction. For Fishing Reels, Guns, Electric Motors, Model Trains and Airplanes, Typewriters, Clocks, Office Machines, Automotive and Radio Work, and any place that requires fine oiling.

Guaranteed leakproof! Comes filled with a supply of lightweight oil. Easily refilled.

SYMONDS & CO., Dept. (A)

1414 S. Michigan Ave., Chicago 5, Illinois

No C.O.D.s please.

Sent postpaid
Only

\$1.00

12 GAUGE REPEATING SHOTGUN \$19.95



NEW! Only \$4.00 Down!

• Top Quality • Special Purchase

Get the Kessler 3-shot Repeater at the amazing complete price of \$19.95. Bolt Action with thumb safety. Genuine Walnut stock. Red Head Recoil Pad fitted. 12 Gauge. 28" full choke. Weight only 6 3/4 lbs. Money Back Guarantee! Send \$4.00 Time Payment Deposit, or Payment in full to:

KLEIN'S SPORTING GOODS, INC., Dep't M.
227 W. WASHINGTON ST. CHICAGO 6, ILL.
FREE BARGAIN CATALOG & \$1.00 GIFT INCLUDED FOR PROMPT ACTION



Clark EXPANSIVE BIT

CUTS BETTER • COSTS LESS! Accurate, fast; cuts smooth holes in hard or soft wood. Chrome vanadium steel blades, all chrome body. No. 250. 1/2"-1 1/4", \$1.69; No. 251. 3/4"-3", \$1.89. GUARANTEED. At your dealer or write
★ ROBERT H. CLARK COMPANY • Beverly Hills, Calif.

O'PATCHO THE RELIABLE AND INDESTRUCTIBLE CEMENT OF A THOUSAND USES.

NO PRIMING OR ACID WASHING!

For patching, surfacing all types of floors, walls; Tuckpointing; Filling cracks in concrete, wood, masonry, iron; Glazing; Caulking; Sealing furnace doors; Stopping air and water leaks. O'PATCHO will feather-edge and stay put; will bond with concrete, wood, iron, masonry; is an excellent base for all types of paint and finishes; will stand up under severest conditions, save combustion heat. O'PATCHO will work when concrete fails. Write for 10 lb. Can, \$2.95, include 50c excess 300 miles. Money back guarantee.

The Bordeaux Co., 1716 Beverly Glen Pkwy., Chicago 43

PALMGREN

No. 000 ANGLE VISE For MILLING—DRILLING—GRINDING FITTING—FILING

Solve Difficult Angle Jobs

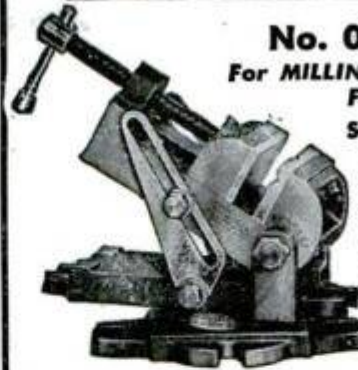

Quick, accurate set-ups at any angle. End make-shift methods—time loss—rejections. Ideal for tool rooms or home workshop. Accurately machined and graduated. Once set it stays locked. Jaws of steel—2 1/2" wide, plain or grooved. PRICE \$12.05 complete with Swivel Base—Vise only \$8.75. Write for other styles and sizes.

DRILL PRESS VISES

For tool room, machine shop, school shop, home shop or repair shop. Accurately machined. Best semi-steel castings. Adjusting screw of hardened steel with fine pitch thread and long bearing. Jaws of steel, grooved or plain. Sizes 1 1/2" — 2 1/2" — 4" Jaws.



No. 6
1 1/2"-GROOVED STEEL
JAW. \$3.30.

No. 83 ROTARY TABLE with . . . DUAL CROSS FEED and ROTARY FEED

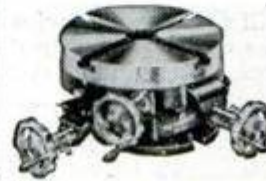

Has 8" Circular Table with full 360° movement and 4" crossfeed travel. Free moving adjusting wheels and dials graduated in degrees. Crossfeed adjusting screws have Acme threads with adjustable dials graduated in thousands. Four slots in base and key slots for bolting to table. No. 83 Rotary 8" Table. . . \$49.50
No. 82 Dual crossfeed—with-out rotary \$39.75

IMMEDIATE DELIVERY Write for Circular No. 12—Order from dealer or direct postpaid if he can't supply.

CHICAGO TOOL AND ENGINEERING CO.

8365 South Chicago Avenue Chicago 17, Illinois
Telephone — Saginaw 1-9675



PEEL PAINT TO BARE WOOD WITH ONE EASY STROKE

NEW ELECTRICAL TOOL removes 1 to 10 or more coats of paint from any wood surface as easy as cutting butter with a hot knife. No scraping, cutting, burning, sanding, or chemicals. The new Lectro Paint Peeler instantly softens paint electrically and peels it off the surface clean to the bare wood with one easy stroke. It's faster than a blow torch—there's no danger of fire—will not scorch or burn delicate wood surfaces. Makes no mess—no smell—it's even fun to use. Removes any paint, enamel quickly and easily. Sturdily constructed to last for years. Sent complete with extra long, quality electrical cord. Simply plug into any A.C. or D.C. outlet—let heat for several minutes and remove paint to the bare wood on exterior or interior painted surfaces, floors, woodwork, cupboards, furniture, antiques, boats, window-sills, screens, doors—a hundred other uses. Price \$4.95 postpaid—nothing else to buy. Full money back guarantee. For immediate shipment—send check, cash or money order to:

LECTRO WELD, INC.

Dept. PM6

3495 West 140th St.

Cleveland 11, Ohio

Earn \$300⁰⁰ to \$500⁰⁰ per month—ARC WELDING!

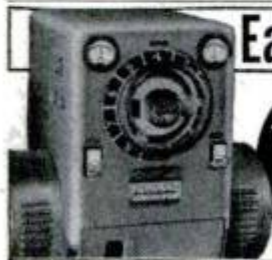

"Pays for itself"
TERMS as low as
\$16.50
monthly

DC welding generator can be powered with any gasoline engine or belt driven from other power source. Same unit as used in Hobart's complete welder with exclusive features and controls for easier, faster, better welding. Helps you start profitable welding business on right basis, with small monthly payments.

It's easy!



to build your own portable welder
With Hobart Generator on used auto engine and chassis, go where welding is needed, make money. Write for info on "Build Your Own" Welders.

HOBART Brothers Co., Box M-601, Troy, Ohio "One of the world's largest builders of arc welders"



Snap-on * MASTER SUPREME 23-PC. SOCKET SET

In this 1/2" sq. drive set, you will find highly engineered design, accurate balance, perfect fit, and a comfortable grip that results in faster, safer, more satisfactory work. Full chrome finish.

\$36⁵⁰ Plus Local Tax

- ★ Patented Palm-Grip handles give a secure grip.
- ★ 32-tooth ratchet action. Double-tooth contact gives added strength.
- ★ Easily removed Welch plugs for servicing friction-grip device.
- ★ Four-way socket grip for faster interchange of various units.
- ★ Hot broached, chip-curved openings give you smooth, strong socket walls.
- ★ Controlled heat-treating for skin-to-core toughness.

SNAP-ON TOOLS CORP., 8062-F 28th Ave., Kenosha, Wis.

Please send me the Master Supreme Socket Set.
I enclose Check, Money Order,
 Company Purchase Order.



Name.....
Address.....
City..... State.....

*Snap-on is the trademark of Snap-on Tools Corporation.

7x50 BINOCULARS
With COATED LENSES and PRISMS
Precision Optics **\$30***
BRAND NEW

Highest optical performance. Over twice the light transmitting power of any 8x40, 10x50, 7x35 or 6x30, three times that of any 8x30, and eight times that of any 6x15 binocular. Fully corrected, needle sharp achromatic optics with wide angle of view. Lifetime aluminum alloy construction, leather covered.

7x50—\$30 illustrated
Ht. 7 in.
Wt. 36 oz.

OUTPERFORMS BINOCULARS COSTING OVER \$100.
*20% Fed. Tax — Money Back Guarantee — We Pay Postage

BROWNSCOPE CO. Dept. 6M, 24 W. 45th St. NEW YORK 19, N.Y.

OUT OF PAWN
GENUINE DIAMONDS

SAVE UP TO 50% AND MORE
Money-Back Guarantee

Approx. 1/2 ct. \$95 Incl. Tax \$200 VALUE

SEND FOR FREE Diamond Catalog

BERMAN'S Illustrated Catalog

Diamonds from estates, banks, unredeemed pledges offered at substantial savings
VALUES FROM \$10 TO \$10,000

All diamonds reset in new mountings.
BERMAN'S DIAMOND LOAN BANK
DEPT. P
BERMAN BLDG., BALTO. 1, MD.
Reference: Your Own Bank or Any Mercantile Agency

E-Z CAR WASHER
Soaps & Washes in One Operation
No Special Soap Required

Easily used—insert teaspoonful of any household soap powder or detergent in built-in soap pouch. 42-inch aluminum handle. Replaceable mop. Washes cars easily without getting yourself wet. Send \$3.50 check or money order. We deliver post paid.

MONEY BACK IF NOT SATISFIED

Simply attach to garden hose.

E-Z CAR WASHER
6 Bond St., (Dept. PM12) New York 12, N.Y.

\$3⁵⁰ POSTPAID

2 DRILLS IN 1

This attachment gives you two drills in one. It converts any 1/4 inch electric drill to 1/2 inch capacity. Reduction gears reduce the drill speed 5 to 1, the average speed of a 1/2 inch drill, and thereby increases the power. Absolutely indispensable for all shop work and home craftsmen. Satisfaction guaranteed. Order yours now.

Send check or Money Order with order. Jobbers write for special information.

\$11.95 post paid

G. M. CO. MANUFACTURING, INC.
1308 43rd AVE. LONG ISLAND CITY 1, NEW YORK

BLOW THEM UP! THEY FLOAT YOU!



FLOAT-EES swim trunks

- Swim with ease—greater safety
- Air on hips balances air in lungs
- Won't tip you upside down*

Pontoons and hose INVISIBLE when worn

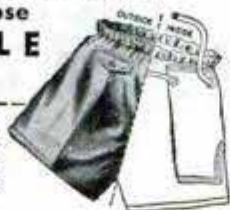

*U. S. Gov't. Army, Navy, Swimming Coaches proved this in Scientific test.

Smartly-styled FLOAT-EES boxer trunks have concealed pockets with plastic pontoons that can be inflated in or out of the water. With FLOAT-EES beginners learn to swim rapidly. Swimmers can relax, swim distances with ease. Blue, tan, maize, maroon.

M Men's Sizes.....30 to 44 at \$6.95 each
A Boys' Sizes.....6 to 16 at \$5.95 each
 Also can be worn by women with their own swim suit bra. State color, size, 2nd choice. Send check. M.O., C.O.D.

ORDER

FLOAT-EES CORP. Dept. M12, 247 West 38th Street, New York 18, N. Y.

RUBBER HOSE SALE



TERRIFIC VALUES!

Brand new genuine Neoprene Hose—outlasts ordinary rubber 3 to 1. Reinforced with super tough cotton cord plies. Flexible, easy to handle. Easy Flo brass couplings with standard pipe threads for quick connections, included.

Pump water for irrigation, stock, tanks, home, barn, fire fighting, etc.

(Inside Diam.) 1 1/4 in. 1 1/2 in. 1 3/4 in.
 Length 25 ft. 40 ft. 30 ft.
 Price \$8.75 13.75 13.75

If specified we will send special hose for gas or oil at same prices. All prices f.o.b. Chicago area. Satisfaction guaranteed. Send check or money order.

AIR HOSE, 1/4" I. Diam. heavy duty double braid suitable for gas stations, spray painting, air-tools, etc. 20 ft. with swivel couplings and tire chuck, Reg. \$6.50 val.—special only \$2.75 f.o.b.

MASTER MECHANIC CO., Dept. 26, BURLINGTON, WIS.

Now CHEAP OIL BURNER FOR HEATING AND COOKING STOVES • FURNACES

HEAT YOUR HOME, COOK YOUR MEALS WITH CHEAP FURNACE OIL

NO MORE SHOVELING COAL OR ASHES. Sensational Fuelizer Starter Vaporizing System turns Cheap No. 1 Furnace Oil, also Range, Heater, Tractor Distillate, Kerosene and like oils into oil heat—one of the quickest, hottest fires known. **LIFETIME GUARANTEE. \$1.00 Bonus Offer for Testing.** We will let you try it in your own stove or furnace for one month. Get yours for introducing. Big profits **QUICK.** Be first. Send in your name today for details and cash in on the tremendous demand for this Amazing Invention.

NORTHWEST MFG. CO., 730-F, Mitchell, S. Dak.

WAR SURPLUS BARGAINS

\$500,000.00 INVENTORY FOR QUICK LIQUIDATION

Surplus items—hundreds of them for home, shop, factory, farm and outdoor use. New items, used items, reconditioned items—all at tremendous savings—all priced for quick sale.

Page After Page of Values

This big catalog shows page after page of amazing money saving values. Send for your copy today. Send 10c to cover postage, mailing, etc. Write today!

SEND TODAY FOR YOUR COPY **10c**

STARK'S Dept. PM6 509 So. STATE STREET CHICAGO 5, ILLINOIS

FATHER'S DAY JUNE 18

KING for a DAY!



For the King!



SYNCRO Electric HONE \$12.50

with STONES THAT MOVE 240 STROKES PER SECOND!

Make Dad glad with this! SYNCRO is the only all-purpose electric hone with 240 strokes a SECOND. Hones sharp home and shop tools, knives—most anything else. Easy. Speedy. Safe. Beautiful chrome finish.

With BUILT-IN MOTOR, 4 stones—\$12.50.



SYNCRO Sander-Polisher-Massager

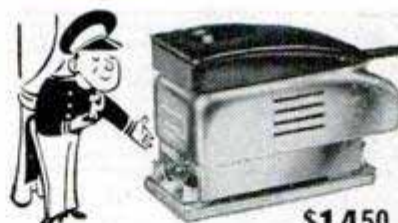

Dad will like this work-saving tool with exclusive Double Arc Motion. For light sanding, polishing, relaxing massaging! Just guide it. Comparison proves it best. Silvery chrome body and black bakelite top. With BUILT-IN MOTOR, 10 sandpapers, lamb's wool, fabric polish pads, \$14.50.

\$14.50

SAFE SYNCRO JIG SAW

For the Royal Family!

Ideal for Dad's workshop—safe for children! THOUSANDS used in schools, hospitals, homes. Saws any length 1/2" wood, thin metal, plastic. Portable. 14,400 safety strokes a minute.

With BUILT-IN MOTOR—\$17.50.



\$17.50

Shows arm adjusted
 ← Arm normal position

THAT'S the Name to Ask For!



SYNCRO ELECTRIC TOOLS

Operate on 60 cycle, 110-120 volt, AC only. At best hardware stores. If none near you send article price, we'll ship POSTPAID promptly.

SYNCRO CORPORATION Dept. D-60, Oxford, Michigan, U.S.A.

SURPLUS

Vickers HYDRAULIC PUMP or MOTOR. Mod. PF2.



This brand new, compact, powerful pump is rated at 1000 PSI, .507 Cu. In. per Rev., 8 G.P.M. at 3750 R.P.M. Delivers up to 6 H.P. Requires 1/3rd to 6 H.P. to drive directly. Change rotation by reversing flow. 5/8" drive spline and 1/2" pipe ports. Wt. 4 lbs. Priced at only **\$8.95** on quantity. Discount

SOLDERING FLUX (Paste) In 1/2 lb. cans manufactured by Kester. For general soldering. Priced at **2 cans for \$1.10**

DRAWER AND CABINET HANDLES

Brand new with solid brass, bright chrome finish body. Black plastic handle. This durable handle will dress up any piece of furniture. Available in two sizes: 2 1/4 x 1" and 1-11/16 x 5/8" body base. These handles are screw mounted, but screws are not included. Minimum order of either size is:

six handles \$1.75 **twelve handles \$3.00**

FURTHER DISCOUNTS ON LARGER QUANTITIES

BRAND NEW REX HIGH SPEED TOOL STEEL BITS

5/16x5/16x2 1/2	1/2x1 1/2x4"	7/8x7/8x5 7/8"
8 Pieces \$1.79	4 Pieces \$1.95	Piece \$1.95
3/8x3/8x3"	3/4x3/4x4 7/8"	Additional discounts on larger quantities.
8 Pieces \$1.95	2 Pieces \$2.49	

SURPLUS CUTTING TOOLS

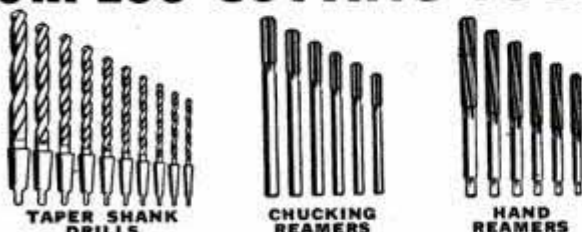

SET 1b	12 Different Size High Speed Morse Taper Shank Drills up to 9/16" with No. 1 and 2 taper. \$40.00 value. Priced at only.....	\$4.95
SET 2b	10 Different Size High Speed Morse Taper Shank Drills from 1/2" to 1 1/4". \$90.00 value. Priced at only.....	\$8.95
SET 3b	15 Different Size Hand Reamers up to 1 1/2" including one small Taper Pin Reamer. ALL BRAND NEW. Priced at only.....	\$6.25
SET 4b	6 Different Size Large Hand Reamers from 1" to 1-9/16". Wt. 23 lbs. approx. Brand new. Priced at only.....	\$19.50
SET 5b	10 Different Size Morse Taper Shank Reamers up to 1". Priced at only.....	\$4.50
SET 6b	10 Different Size High Speed Straight Shank Chucking Reamers up to 1 1/2". Priced at only.....	\$3.95

HIGH SPEED MILLING CUTTERS



SIDE MILLING CUTTERS

Dia.	Width	Arbor Hole	Price Ea.
2	1/8	5/8	\$1.20
2	3/16	5/8	1.25

PLAIN MILLING CUTTERS

	(without side chip clearance)	Slightly used	
-2 1/2	2	1	\$3.95

All merchandise sold with money back guarantee of satisfaction and is shipped PREPAID.

T&T TOOL, 101 West Archer, Tulsa, Oklahoma

— THROW AWAY YOUR BUCKET —

Wash Cars NEW Scientific Way

Storm Sashes, Screens, Etc., Etc.

Without a doubt here is the simplest, quickest and most scientific way to wash any car. Simply insert **SPRA-A-WASH** in the nozzle of the water hose and the combination softens the water, softens the dirt and in a matter of minutes the dirt washes away and without wiping dry; leaves a bright clean finish. You will be amazed at the result. Users are enthusiastic and tell their friends. This opens up a new field for **BIG BUSINESS** and **BIG PROFITS**.

BIG MONEY MAKER

DISTRIBUTORS WANTED
Mail Your Order Today

SPRA-A-WASH, 1043 Chicago Ave., Dept. PM-6, EVANSTON, ILL.

with **Spra-A-Wash**

in a few minutes

No Gadgets to buy

YOU USE WITH YOUR GARDEN HOSE.

We also supply Retainer

Sold on MONEY BACK GUARANTEE



Plenty for 12 Washes

only **\$1.00**

Postpaid in U.S.A.

PRACTICAL BOOKS ON



HOME PLANNING BUILDING REPAIRS

MAIL ORDER TODAY

Plan Now—Build When You Can
Books Sent C.O.D. Anywhere in U.S.A.

Select from this list of helpful books. In U. S. books sent postpaid if remittance accompanies order. Outside U. S. include 15% extra for shipping charges.

How to Plan a House \$5.00
Your Home and How to Build It Yourself \$3.00
Painting, Decorating \$1.75
Carpentry \$2.50
Painting, Furniture Finishing and Repairing
Includes floor renewal \$1.50
How to Remodel a House Complete, practical. \$5.00
Building Insulation \$4.50
Concrete Handbook Do work for yourself, others \$2.00
Blueprint Reading for Building Trades \$1.50
Practical Bricklaying \$2.00
Primer for Home Builders \$2.50

FAMOUS PLAN BOOKS

Books contain floor plans, photos, descriptions of homes.
AMERICA'S BEST LOW COST HOMES, 125 designs \$1.00
DE LUXE SMALL HOMES, 210 designs. \$1.00
OUR FUTURE HOME. Wide selection of residences, summer homes, garage apartments. \$1.00
MODERN HOME & GARDENING, 42 popular designs. Improvements, garden short-cuts, etc. \$50c

Set of Four Books \$3.50

Stair Building \$2.50



POPULAR MECHANICS PRESS

DEPT. 646 • 200 E. ONTARIO STREET, CHICAGO 11

SAY YOU SAW IT IN POPULAR MECHANICS

Handy Mail Order List

Little Library of Useful INFORMATION

5 for \$1.00
12 for \$2.00
25¢ Each

Here at amazingly low cost is the practical help and information you have always wanted. Articles in previous issues of Popular Mechanics have been classified according to subject and are now available in these handy reprint booklets.

How to Use Measuring Tools— Micrometers, Calipers, etc.—106.
Power Driven Saws—74.
Drill Presses, Grinders, Etc.—79.
Wood, Metal Turning—100.
Filing Machine, Hacksaw, Cutoff Wheel, Shaper—82.
Lathe Tools You Can Make—101.
Workbenches—Tool Cabinets—47.
Spray Painting—94.
From Pattern to Casting—91.
Tool and Saw Sharpening—92.
Sharpening Drills, Wood Bits—90.
Successful Wood Turning—32.
How to Read Blueprint—71.
Metal Turning Lathe Kinks—99.
Operating a Metal Lathe—100.
Heat Treating, Hardening—102.
Working With Glass—103.
Servicing Elec. Motors—75.
Electromagnets & Solenoids—44.
Transformer Construction—41.
The Boy Electrician—43.
Soldering and Brazing—17.
Arc and Spot Welders—5.
Electroplating With Nickel, Chromium, Cadmium, Etc.—86.
Plating Leather, Wood, etc.—87.
Lower Your Fuel Costs—31.
During Leaky Basements—45.
Fitting Home Game Room—55.
Indoor & Outdoor Fireplaces—88.
Backyard Gardening—39.
Lawn and Garden Novelties—72.
Trellises, Pergolas, Fences—76.
Lawn and Garden Furniture—77.
Playground Equipment—73.
How to Use Your Drill Press—125.
Making Serving Trays—53.
Knots and Ropework—105.
Sanders—80.
House Wiring—89.
Hanging Wallpaper—38.
Built-in Fixtures—78.
Bird Houses—7.
Magazine Racks—49.
Clock Cases—50.
Book Ends—52.
Small Tables—54.
Smoking Stands—56.
Desks—58.
Book Cases—59.
Action Toys—66.
High Flying Kites—67.
Telescopes—20.
Metal Craft—28.
Small Looms—37.

Working With Plastics—61
Simple Home Improvements—104
Ridding Home of Insect Pests—107
Children's Room Furniture—51.
Jigsawed Novelties—57.
Doll House & Doll Furniture—60.
25 Shelves You Can Make—64.
Novelties Turned on Lathe—62.
Inlay Pictures—Veneering—63.
Wood, Soap Carving—65.
Windmills & Weathervanes—68.
Lamps from Wood, Metal—69.
Rustic Furniture—18.
Wood Finishing—40.
How to Fix Electrical Appliances—111
Painting Your House—117
Build Your Own Relays—123
Rowboats, Small Dinghy—83.
Small Sail Boats—84.
Two Outboard Runabouts—85.
Build Own Canoe, Kayak—30.
Build Class-E Ice Yacht—22.
Auto Kinks. Shortcuts—10.
Lawn and Garden Equipment—124
Motor-Driven Midget Cars—34.
Stop Auto Elect. Troubles—95.
Photo Printers and Dryers—25.
Photo Darkroom Equipment—98.
Trick and Table Top Photos—97.
Home Movie Equipment—118
Poultry Houses—108.
Guns and Decoys—109.
Ro-Silvering Mirrors—70.
Chemical Experiments—93.
Log Cabins, Tourist Houses—14.
Using Basic Tools—120
Farm and Garden Tractors—8.
Building Extra Attic Rooms—23.
Attractive Basement Rooms—24.

Check Titles Wanted, Clip, Mail with Remittance to
POPULAR MECHANICS PRESS, Dept. 635, 200 E. Ontario, Chicago 11

BRAND NEW SURPLUS UP TO 85% DISCOUNT

HEATING & VENTILATING FAN



(Item 10) Easily installed in furnace pipes. Forces even heat to all rooms. Over range, removes kitchen smoke and odors. Powerful continuous duty motor, 110-120 V. A.C. Quiet, super efficient fan moves huge volume of air (400 to 600 c.f.m.) 8" Fan \$5.95, 10" Fan \$6.95.

FRAM OIL FILTER



(Item 12), Model F21. Big 73 cu. in. size. Ample capacity for all cars, trucks, tractors. Universal mounting bracket and standard openings. Fram filters are tops. Easy to install. Wt. 8 lbs. Usually \$7.95—now \$3.75.

ELECTRIC MOTOR



(Item 14) Barber Colman Fan motor; 110 V. A.C.—2800 rpm. Powerful continuous duty. 3/16" dia. shaft, completely wired; perfect for fans, heat boosters, revolving displays, models, polishing, grinding, etc. Easy to mount. Wt. 2 lbs. Usually \$7.50—now \$2.75.

EXTENSION CORD



(Item 16) 40 ft. heavy duty, made of specially insulated No. 14 2-conductor wire. So tough that you can drive over it and yet amazingly flexible and easy to handle. Resists oil, grease or water. Extend electricity up to 400 ft. without voltage drop. Use indoors or out. Complete with heavy rubber plug and outlet. Wt. 2 1/2 lbs. Usually \$4.50—Special 40 ft. \$1.95. Comb: 2-40 ft. and 1-20 ft. (total 100 ft.) \$4.75.



GREASE FITTINGS

(Item 15) Assortment of 50 standard Alemite and Zerk fittings, both straight and angle. Wt. 2 lbs. List price \$8.35—now only \$2.75.

TARPAULINS

(Item 18) 9'x10' complete with ropes and tie-down flaps. Right size for pickup truck. Heaviest qual. 15 oz. green duck for long wear. Water-proofed, treated against mildew. Wt. 30 lbs. Chain stores get \$19—our special \$9.50.



CLIP BOARD

(Item 17) with self-adjusting spring hinge to hold up to 100 sheets of 8 1/2"x11 paper. Constructed of heavy Masonite. Push cover back for instant release. Flip cover shut and notes or drawings are protected. Perfect for engineers, students, truck drivers or artists. Wt. 2 1/2 lbs. Usually \$2.95—Special \$1.00.

ANGLE HEAD

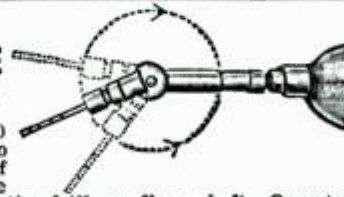

(Item 23) Fits into chuck of any electric or pneumatic drill or flex. shaft. Operates at any angle in a full 360° arc. Makes possible drilling, grinding, carving, routing, etc. in close cramped quarters. Makes impossible jobs easy. Made by Kett Tool Co. Complete with built-in chuck and adj. key. Lists at \$39.95—while they last \$9.95.

PARTS WASHER

(Item 20) Store gas or carbon tet. in 5 gal. safety can. Valve releases just the right amount into washing compartment. Parts are washed and drained on a "dunking" screen—no fishing for parts. Eliminates fire-danger, waste, spillage, evaporation. Wt. 8 lbs. Should sell at \$19.50—Special \$4.95.



OUTBOARD MOTOR COVERS

(Item 19) 36" size, flexible rubberized fabric. Snaps shut. Covers entire motor right on boat. Also used as carrying case. Covers engines on balers, pumps, lawn mowers, etc. Wt. 2 lbs. Usually \$4.95 value—now \$1.75.

5 GAL. FUNNEL

(Item 22) with built-in fine brass strainer. Heavy galv. steel; will last indefinitely. Great time saver. Strain the gas or diesel oil into your engines and end fuel line troubles. Great for handling spray mixes too. Wt. 4 lbs. Reg. price \$4.95—our special \$1.95.



FEED BUNKS

(Item 21) Made of clear 2" oak plank, reinforced at all edges & corners with steel angles. 3'x4'x18" high. Steel handle-rings and oak skids for easy lifting or moving. Cannot be damaged or upset by stock. Wt. 250 lbs. Should last a lifetime. Built very tight. Also makes dandy water trough or put it on wheels and haul with it. Shipped by low cost freight. Cost gov. \$32.50—our Spec. \$5.95 or 2 for \$9.95.



All items brand new surplus. Prices f.o.b. Chicago area. Money back guarantee. Send check or M.O. The A & K EQUIPMENT & SUPPLY CO., Dept. 42, Burlington, Wis.

BOX-TYPE—
STURDY
STEEL

PICNIC TABLE LEGS



Electrically-welded steel legs, ready-drilled. Simply apply your own lumber and it's complete. Send for Free literature!

Complete for one table

\$7.95 Set

East Moline Metal Prod. Co.
East Moline, Illinois

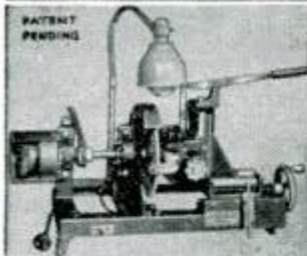

Start a NEW BUSINESS!

or Add to your present Repair Business

SHARPEN DULL PIPE WRENCHES

PIPE TAPS & DIES
"GUM" CIRCULAR SAWS

Write for Information

J. C. MOORE INDUSTRIES
BOX # 276 FREDONIA, PA.

TAKE 3-DIMENSIONAL PICTURES WITH YOUR OWN 35 MM CAMERA

NOW ONLY (Outfit No. 101, was \$22.50 plus tax)
STEREO-TACH \$17.70 Plus \$2.09 Fed. Tax

and 3-D slide viewer. Make marvelous color or bl. & w. slides. Get Stereo-Tach from your dealer or direct. Money back guarantee.



Dept. PM6, ADVERTISING DISPLAYS, INC., Covington, Ky.

DO MORE at LESS COST!



Clutch Driven Bar Tread Tires Attachments for ANY job Fully Guaranteed

4 STYLES OF GARDEN - SMALL FARM TRACTORS Walking or riding models. Dozens of attachments for plowing, sowing, fertilizing, raking, harrowing, wood-sawing, snow-plowing, etc. Uses world-famous Clutch-Driving Action (no belts, no chains).

EASY TERMS—Write today for big, colorful catalog FREE and learn about the new e-a-s-y way to get your RED-E on amazing pays-for-itself Plan! SPECIAL: Discount to User-Agents!

RED-E TRACTOR CO. Richfield, 2, Wis.

BUILD YOUR OWN Belt Driven WINDOW FAN

SAVE \$48 OR MORE

This New... Quick... Easy Way

Sensational New PEDESTAL ASSEMBLY



COOLS 5-ROOM HOME... USING 24" x 40 DEG. PITCH NATIONALLY KNOWN TORRINGTON BLADE... \$19.95

Now it's a cinch to build your own attic or window fan with this sensational new pedestal assembly. Pedestal comes completely assembled with blade and all necessary parts excepting motor and easy-to-make wood cabinet. All you do is house assembly for attic or window using four 1/4" bolts, install motor, and you'll have an efficient, dependable cooling fan. Pedestal can be mounted in various positions. Nothing like it anywhere!

24" ASSEMBLY INCLUDES

Torrington blade, steel shaft, V-belt, pulleys, special aluminum alloy pedestal with precision-fitted Oilite bearings.

CAPACITY 5000 CFM of air at 550 RPM.

FREE Plans

Included with assembly show how to build wood cabinet for attic or window, and various ways to mount motor and assembly.

20 INCH, 2-SPEED \$29.95 WINDOW FAN

Shipped Ready to Plug-In Except for Easy-to-Make Window Panel... Compares with Fans Selling for \$59 or More! Features:

- Torrington blade
- Rubber Mounted Redmond motor
- Heavy gauge wire guard with foot stand
- 2-speed switch (high, low and off)
- 8 ft. rubber cord UL appd.
- Moves 3000 CFM of air
- Rubber grommets, bolts furnished for mounting unit on panel
- Plans included for making panel to fit any window

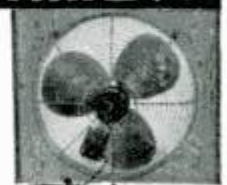

ORDER FROM THIS AD! Send check, cash or M. O. plus \$1.00 for express and handling charges. RETURN IN 10 DAYS FOR FULL REFUND IF NOT SATISFIED! Write for FREE Literature!

ARTRA Aluminum Fdry. & Mfg. Co. 16 E. MADISON, ST. CHARLES, MO.

THOUSANDS BUILD AT 1/2 THE PRICE

20 MODELS U-MAK-IT BOAT KITS



ROWBOATS

8 TO 14 FT.
Special Models
For Fishermen



PRAMS



OUTBOARDS

Fast Round or V Bottoms
12 TO 16 FT. Newest
Assembly Methods



INBOARDS & CABIN CRUISERS

For Fishing, Racing or
Cruising 16 TO 23 FT.



SEND 25c (coin)
ORDER TODAY YOUR
NEW CATALOG

U-MAK-IT PRODUCTS 703P-WHITTIER ST.
New York 59, N. Y.

Beautify Screen Doors



WITH
FITS-ALL
Adjustable Screen Door
GRILLES

- Silver-satin finish
- Will not rust or tarnish
- Strong and sturdy
- Easily installed

PROTECT
THEM,
TOO!



About \$6.95
CHOICE OF 5 STYLES!
Fits all types screen
doors, including
storm doors

MACKLANBURG-DUNCAN CO., OKLAHOMA CITY, OKLAHOMA

WRITE FOR THE NAME OF YOUR LOCAL DEALER



HEED THIS NOTICE! Our Tires Are NOT Re-treads, Re-grooved or New Treads that have been re-capped. Our MATCHED tires give you SAFETY and ECONOMY — the BEST for LESS. You've seen our adv. month after month for years. We serve TRUCKS, BUSES and CARS. OUT-OF-TOWN folks buy now and take off 20% discount. Our EXPERIENCE assures you the BEST BUY in good ORIGINAL TREAD Tires. One Quality — One Price.



Don't Send a Cent

Until you see our tires. Remember you get what we advertise. We ship only good USED original tread tires. A trial of one tire is worth a thousand words and will make you a satisfied customer. We guarantee a special personal selection of tires for you.

BUT IF YOU SEND CHECK OR MONEY ORDER IN FULL WITH THIS AD "NOW" — you may take **20%** discount on every tire. SAVE TIME — SAVE MONEY

TUBE GIVEN WITH EACH PASSENGER TIRE

WRITTEN GUARANTEE — Sent with Every Tire You Buy

These are **** Original Tread Tires — OUR BEST can be used for "Every Purpose" — No Re-caps or Re-grooved
READ THAT TOP NOTICE AGAIN AND SAVE \$ \$ \$

600-16	\$5.55	650-16	\$5.95	700-15	\$5.85	475-19	\$5.95
600-16(6)	6.50	700-17	9.99	650-15	5.75	325-18	5.95
700-16	6.85	750-16	7.95	550-17	6.75	550-16	5.55

SUPERCUSHION TIRES (24 lb. air) to fit your present wheels
670-15(650-15) \$6.25 760-15(700-15) \$7.45 870-16(800-16) \$6.66
710-15(650-15) 6.85 820-15(700-15) 6.25 760-16(650-16) 7.50



WE SPECIALIZE IN TRUCK TIRES ****
Matched Tires Shipped all over USA and Foreign Countries. IMMEDIATE SHIPMENTS Same Day. Depend on STANDARD for SERVICE. Roll along those EXTRA MILES without Delays and SAVE \$ \$ \$

600-20	\$9.95	32x6(8)	\$10.95	900-20\$16.66	1000-22\$16.66
650-20	9.95	32x6(10)	13.95	1000-20 17.77	1100-22 17.77
700-20	10.95	750-20(10)	13.95	1100-20 18.88	1100-24 18.88
750-20	10.95	825-20	17.77	750-15 11.45	700-17 13.33

MILITARY **** GRADE TRUCK TIRES

9.00-16\$12.22 7.50-20\$13.00

Thousands of Tires Shipped to Satisfied Customers Throughout United States and Many Distant Points. Remember Send This Ad with Check or Money Order to Dep't 2.

STANDARD 834 N. Broad St., Philadelphia 30, Pa.



DRAINS CELLARS, WASH TRAYS CIRCULATES OIL

Pumps 1800 GPH 300 gal.
30' high, use 1/8 to 1/2 HP motor. Will not clog. **\$6.50**

Postpaid if cash with order.
(Add 50c for west of the Mississippi.)

Thousands in use since 1936

LABAWCO PUMPS, BELLE MEAD 7, N. J.



Happy Highways Ahead!

With Popular Mechanics new **MOTORIST'S HANDBOOK**. 160 pages of authoritative advice to keep your car rolling smartly—longer. Brakes, body, spark plugs, battery, starter—every automotive part is covered in this up-to-the-minute manual of year 'round driving pleasure.

Your news dealer has the 60c paper edition.
Order the clothbound \$2.00 volume from

POPULAR MECHANICS PRESS
200 E. ONTARIO ST. CHICAGO 11

Say You Saw It in Popular Mechanics

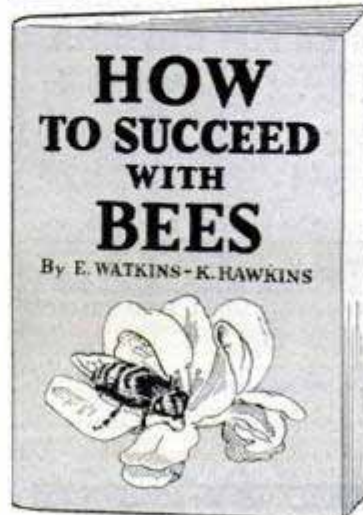

RAISE BEES SELL HONEY MAKE MONEY!

Get How to Succeed with Bees, written by two experts, which tells you all you need to know. Contains 190 tested successful plans to produce big crops of honey. Easy work and little capital required. There is always a ready market for honey and working with bees is fascinating. This 96-page well-illustrated book is only \$1.00 and is absolutely guaranteed to satisfy you or we shall refund your money. Send for your copy today!

POPULAR MECHANICS PRESS
200 E. ONTARIO STREET
CHICAGO 11, ILLINOIS

BUY NOW and SAVE
BRAND NEW!
WAR SURPLUS

LIGHT PLANTS



Don't miss these
sensational buys
50 to 75% SAVINGS

Use for: Farms, cottages, stores, garages, flood-lighting, drilling rigs, refineries, house trailers, fire departments, sound trucks, yachts, tugs, construction, airports, police radios, etc.



Below are TWO of the most **SENSATIONAL** light plant buys in the country:

2500 WATT, AC, 115 Volt, 60 Cycle, Single Phase. ENGINE Briggs & Stratton, air cooled, 6 1/2 H.P. GENERATOR: Westinghouse or Leland, belt drive with guard and Duplex receptacle mounted. NET WEIGHT 310. Gross Shipping Weight 441. Shipping size 36"x19"x26". Complete with spare parts, tools, instructions and fully GUARANTEED. WAS FORMERLY PRICED AT APPROX. \$700.00. **\$295.00** NOW PRICED FOR YOU AT ONLY..... **NEW**

Reconditioned.. **\$225.00**
 Generator only, **NEW \$145.00**

5 KW, 120 Volts, AC, ENGINE; Hercules 4 cycle, Gasoline. GENERATOR; Mfr'd by Hobart Bros. Unit includes remote control cable on reel, power cable on reel, exhaust pipe, power cable plug, remote control stop start switch, automatic volt regulator. Continuous duty 6.3 KVA at 80% power factor, frequency motor, radio and television filtered. Unit is completely automatic and cannot be damaged by lack of care. Net weight 770 lbs. Shipping weight 1070 lbs, 44" long, 22 1/4" wide, 30" high, 220 volt output can be supplied on all units at a small additional cost. FORMERLY PRICED AT \$1600.00. NOW PRICED FOR YOU AT ONLY... **\$475.00** Guaranteed.

750 to 1000 Watt, All Single Phase, 110-220 Volt, AC, NEW \$179.50

VOLTS	WATTS	PRICE
110-220	300	\$ 89.50
110	7500	575.00
110-220	10000	995.00
110	25000	2100.00
110	35000	2750.00
110	60000	5500.00

WAR SURPLUS

Below are just a few of the many items we have in stock at sensationally low prices:

- Pumps
- Grinders
- Air Compressors
- Air Tanks
- Spray Outfits
- Extension Cords
- V Pulleys
- All size light plants
- Generators
- Fire Pumps
- Gear head motors
- Electric hand saws
- Electric chain saws
- Saw Tables
- Winches

A TERRIFIC BUY!
GAS ENGINES
 Briggs & Stratton NEW in original crates, Model AP 1 3/4 to 2 1/2 HP. 3/4" shaft. List Price \$102. Your price **\$59.50**

"MERCURY" CLUTCH
 For motor-scooters, motorbikes, lawn mowers, etc. Can be used with electric motor or any gas engine. "A" belt pulley. List price \$28.00. YOUR price 5/8" bore **\$7.95**, 3/4" bore **\$8.95**.

WRITE TODAY for our free catalog listing thousands of **MONEY SAVING** bargains.

C & H ELECTRIC CO. • 434 W. JUNEAU AVE. • MILWAUKEE 3, WISCONSIN

Say You Saw It in **POPULAR MECHANICS**

★ Fell a tree like this in less than a minute with a McCULLOCH



New One-man POWER SAW

Finest gasoline-powered chain saw for all tree work, wood cutting, land clearing, etc. Use to fell, buck, or rip. For trees up to 3-foot diameter. Weighs only 25 lb., develops full 3 hp. Starts instantly. Cuts in any position — take it anywhere. Send for free data.



\$295.00
 f. o. b. Los Angeles

Endorsed by professional loggers everywhere

NATION-WIDE SALES and SERVICE
McCULLOCH MOTORS CORP.
 6101-E West Century Boulevard
 Los Angeles 45, California
SEND FOR FREE LITERATURE

AUTO RACING TRAILER Coaches
 Four Books Every Fan Needs

Famous for authoritative, detailed information on auto racing, every type of race car, rules, specifications, working drawings, plans, etc. No duplication. Every book different. Money back if not satisfied.

- AUTO RACING • 6th Edition**
 Championship cars, big cars, mid-gets, roadsters, Offenhauser dirt track car. Specifications on Indianapolis cars, four-wheel drive details, front drive drawings, etc. Plans for Ford 60 midget, roadster racer. Data on engines, gear boxes, friction and dog clutches, axle ratios, compression ratios, independent suspensions, Indianapolis rules and regulations, etc. More than 100 illustrations. \$2.00.
- TRAILER COACHES**
 By Ray F. Kuns. Contains information on the history of trailers, trailer parks and camps; materials, furnishings, trailer chassis, engineering, etc. Construction data on 10, 16 and 22 foot trailers which you can build yourself. 100 illustrations. \$1.50.
- AUTO RACING • 4th Edition**
 Includes eight working drawings and complete building instructions for standard midget racers, drawings for midget road cars, Miller-Ford V8 front-drive racers are illustrated and described and other big-time data given. Technical pictures give the inside dope on these cars, together with authentic descriptions. 50 pages, 66 illustrations. \$1.00.
- AUTO RACING • 5th Edition**
 Tells you—Why the Fast Ones are Fast—How to Make Them Fast—How to Build Engines—How to Build Chassis—How to Build Bodies—Who Holds What Records—What the International Formula Is—What Midget Racing Rules Are—How World's Record Cars Are Built—How to Speed Up Ford V8 Cars. \$1.00.

ORDER ON COUPON
 POPULAR MECHANICS PRESS, Dept. 350, 200 E. Ontario St., Chicago

Remittance for \$_____ enclosed. Send books checked, postpaid.
 Auto Racing, 6th Edition Trailer Coaches
 Auto Racing, 5th Edition Auto Racing, 4th Edition
 Send C.O.D., postage extra.

NAME _____
 ADDRESS _____
 CITY _____ ZONE _____ STATE _____

Sensational Invisible Belt Holds Pants Up And Shirt Down!

It does away with suspenders. Old style outside belt not needed. When you remove your coat your shirt tails won't be exposed.

INVISIBELT IS GUARANTEED

to do everything we say it will, or your money back!



- ★ Worn inside pants over the shirt.
- ★ 6 Plastic Uprights snap onto the 6 suspender buttons.
- ★ Holds the shirt down.
- ★ Drapes your trousers perfectly.
- ★ Prevents waistline sag—your pants stay where you put them.
- ★ Relieves pressure on your stomach.
- ★ Gives luxurious waistline comfort.

- ★ Economical — will outwear any leather belt — will outwear two pairs of suspenders.
- ★ Endorsed by Hollywood Screen Stars.

ORDER YOUR INVISIBELT TODAY

Small size for waistlines 28 to 32 in.
Medium, 32 to 36 in. Large, 36 to 40 in.
Extra Large, 40 to 44 in. Every Invisible belt adjustable to 4 waist lengths.

\$2 Post-paid

INVISIBELT

5028 Hollywood Blvd. Dept. F-2
Hollywood 27, California

Send Size Small, Med., Large, Ext. Large
Enclosed is \$2, Cash, Money Order

Name _____

Address _____

City _____ State _____

Say You Saw It in
POPULAR MECHANICS

NEW! Most revolutionary Masonry Drill ever designed



New principle lifts out dust... permits continuous drilling faster, easier, cleaner, deeper

Drills the toughest masonry without a whimper. No packing of dust; no stalling. Amazing spiral wire lifts dust from hole as it is drilled. Ask about handy Kit C-3 drills, sizes 1/4", 3/8", 1/2" in durable leather plastic kit—\$5.05, postpaid, or C.O.D. Free circular. From your dealer, or write

CARBOLOY COMPANY, INC.

11185 E. 8 Mile Ave., Detroit 32, Mich.

"Carboloy" and "Live-Spiral" are trade-marks of Carboloy Company, Inc.

Tipped with Carboloy Cemented Carbide —harder than steel.

Build Your Own Motorized Workshop

This Famous Book Shows How to DO IT!



POPULAR MECHANICS PRESS, 200 E. Ontario St., Chicago 11, Ill.



TRAILER COACHES

Here's everything you want to know about trailers, with plenty of pictures and plans and instructions for building three different types. Covers also, history of trailers, trailer parks, camps and overnight-stops information, furniture, furnishings, materials and engineering data. If you want to build a trailer, live in a trailer, or just want to know more about trailers, get this book. Only \$1.50 postpaid. Rush order to:

POPULAR MECHANICS PRESS • Dept. 350, 200 E. Ontario St., Chicago

POPULAR MECHANICS

Christmas Handbook

144 PAGES
CLOTH
\$2.00

A Wonderful Collection of Ideas, Gifts, Decorations, Toys—You Can Make!

Popular Mechanics new Christmas Handbook is certain to fill a long felt Christmas-time need in thousands of American homes, and to be cherished as a practical, useful gift. There are articles on entertaining and decorations for Christmas-time hostesses—and how-to-do-it instructions for the making of beautiful greeting cards and gifts of all kinds.

Partial Contents

How to Select a Xmas Tree, Exterior and Interior Lighting, Rotating Xmas Trees, How to Make Your Own Greeting Cards, Helpful Hints on Home Decoration, Tips for the Holiday Hostess, How to Make Gifts for All Ages, The Story of Christmas, Christmas in Other Lands, Centerpieces, etc., Gift Wrappings, Christmas Games, How to Make Candles, Xmas-Tree Ornaments.



Order From

POPULAR MECHANICS PRESS
200 East Ontario Street Chicago 11, Illinois

POPULAR MECHANICS

IT'S HERE . . .

IT'S DIFFERENT . . .

IT'S DYNAMITE . . .

DYNATONE

Deep, Mellow Tone MUFFLER

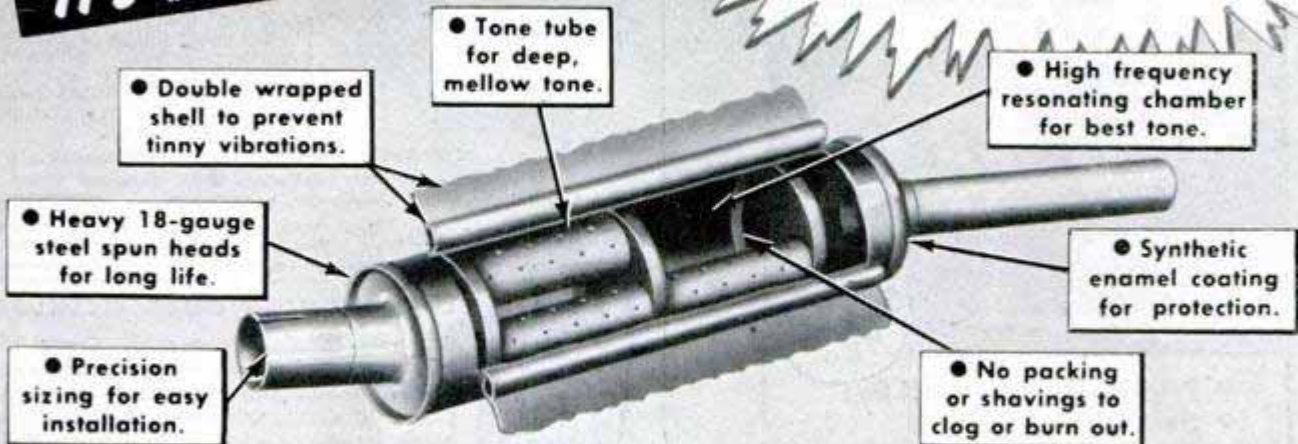

ENGINEERED—Not Packed

YET COSTS LESS THAN MOST HOLLYWOOD MUFFLERS!

The Dynatone has guts! It's the only special muffler engineered for your car. You'll go for its deep, mellow tone—and you'll go for these features, too —

- Lower back pressure
- More power
- More gas mileage
- Longer Life
- No tinny vibrations

Listen to a phonograph recording of the Dynatone at your automotive dealer. Or write us for the name of your nearest dealer.

GOERLICH'S 619 Smith Street • Toledo 1, Ohio

GOVT. COST

~~\$81.25~~



NOW \$19.75

CHRONOMETRIC TACHOMETER

U. S. NAVY SURPLUS—ACCURACY—PRECISION—GUARANTEED

For PRECISION timing of all rotating mechanisms. Incomparable GUARANTEED ACCURACY of 1/10 of 1%. An RPM counter and surface speed indicator combined with chronometric operation which AUTOMATICALLY computes period of test in EXACTLY 6 SECONDS. No stop watch or personal equation necessary. UNSURPASSED for cameras, projectors, gen-

erators, motors, sanders, turbines, saws, shafts, looms, fans, lathes, etc. Packed in plush-lined, simulated leather case. UNCONDITIONALLY GUARANTEED (subject to your inspection and approval. Manufactured by JAEGER and TOTCO, leaders in field of exacting measuring devices. Only \$19.75 Shipped postpaid in U.S.A. on cash orders.



NEW ASTROGRAPHS

Brand new Astrographs, complete with plywood compartment case. 14 1/2" x 11" x 10". Ideal for tool kit, camera or utility case. Leather handle, metal corners. Instrument adaptable for titler, contact printer and many useful gadgets. Gov't cost \$300. **\$2.95** While they last.

For 7 rolls astrograph film, add \$1.50

Order these surplus bargains today. We pay postage on cash tachometer orders. Add postage to other items. 20% dep. on C.O.D.'s

A-10 Bubble SEXTANT

Never before at this price! Complete with hardwood case. Gov't cost \$300. **\$7.95** Now.....

Kohlsman ALTIMETER



Ideal for Auto or Airplane. Used but GUARANTEED accurate. Don't wait. Order NOW! Original gov't cost, \$168. Each **\$10.95**

Semlers' ASSOCIATED SURPLUS Dept. PM-60 5720 WILSHIRE BLVD., LOS ANGELES 36, CALIF.



It Pays to do your own ARC WELDING.

earn \$\$\$ welding for others

"Pays for itself" **Easy TERMS** as low as **\$11 monthly**

It's Simplified

Start doing expert work right away. No guesswork or "experience" needed. Just set controls and make high quality welds. Economical to operate. Save and earn money in hundreds of ways with today's biggest value in transformer A-C Welders.

Shop owners earn \$300 to \$500 or more monthly. Many began in spare time and now have their own business. Possibilities are unlimited if you get started now.

Send for booklet "Hundreds of ways it pays" . . . FREE! Real help in earning more with welding. Write today. Hobart Brothers Company, Box M-60, Troy, Ohio, U.S.A.

Made by HOBART "One of the world's largest builders of arc welders"



Recirculating Pump. Large Supply of water needed for recirculating. Motor: 1/30 H.P., 1550 RPM., 115 V.A.C., 12 3/4" high, 8 3/4 lbs. Fan cooled. **\$19.50**



Make Your Own Fountain. Motor: 110V AC 4-11/16" high, 30 G.P.H., \$9.45 plus \$1.00 for Brass screen and spray nozzle. For Miniature Water Falls and Rock Gardens. Motor: 110V A.C. 90 G.P.H. at no head to 40 G.P.H. at 3' head **\$9.95**



Canal Pump — Bronze and Brass through-out. Motor: 1 1/2 H. P. G.E. 115V A.C., 38" high, 45 lbs., 3400 G.P.H. **\$49.50**



Your Old Bird Bath Comes to Life. Place unit in bird bath and it becomes an adjustable spray fountain. Motor: 110V A.C. **\$19.95** All Sizes Electric Motors In Stock Mfr. of pumps and water display fountains **CANAL ELECTRIC MOTOR, Inc.** Dept. PM6 310 Canal St., N. Y. 13, N. Y.



NEW GUN LIGHTER LOOKS REAL—TRIGGER ACTION



Only
\$4.95

- Precision Made Like Real Gun
- Hard Rubber Handle
- Polished Chrome Finish
- Perfect Pocket Size (3" x 2 1/2")

Here it is! The automatic cigarette lighter that's sweeping the country. Made exactly like real gun... it's sure to fool your friends. When you take it out they will gasp... pull the trigger and you've got a sure light every time. Order yours today! \$4.95 prepaid—we pay postage. C. O. D. you pay postage plus C. O. D. charge. Either way if not completely satisfied, return within 5 days for full refund.

Click Sales Co. 5 No. Wabash Ave.
Chicago 2, Illinois
DEPT. B



Build an AIR COMPRESSOR

Compressor Head 1/2 HP Capacity. Cast iron construction—Piston Type. 2" Bore. 1 3/4" Stroke. 2.5 CFM up to 150 lbs. pressure. Buy Direct. Post Paid Check with Order \$17.50. Money Back Guarantee.

HARRIS MFG. CO.

1710 SO. MICHIGAN AVE. CHICAGO 16, ILL.

SANDEE

Mufflers—All Ford, Chev., Ply....\$4.45

All Buick, Pont., Olds., Chrys.,
Dodge, Hudson, K.F., Pack., etc....\$5.45

V-8 and Merc. Duals
(32-50 incl.)

\$15.95



DEALERS
WANTED

Beautiful
SANDEE
Fender Skirts
\$9.95

A SANDEE Sportone will outlast two ordinary mufflers and give More Power! More Speed! More Mileage!—plus a tone quality unsurpassed.

Please ship (item): _____ Price _____
Car and Year _____ Name _____
Address _____

SANDEE MUFFLER CO. 5643 Corryne Pl. Culver City, Calif.

24-PIECE DRILL KIT \$15.95

A COMPLETE
TOOL SET



Includes Portable Electric Drill, 1/4" chuck, 110-volts; 3" wire scratch brush; 3" cloth buffer; 4 3/4" lamb's wool buffer; 4" rubber backing wheel; 5 coarse, medium and fine sanding discs; steel bench stand; steel paint mixer; 2 3/4" grinding wheel; abrasive grinder; abrasive cutter; 7 high speed drill bits; 2-piece steel arbor with attachments; heavy steel chest.

Orders shipped day received—PRE-PAID. If not completely satisfied, full purchase price refunded. Send check or money order, save C.O.D.

ROBIN-PAIGE CO. Dept. 77B, P. O. Box 608
Richmond 5, Va.

WRITE FOR
FREE
CATALOG



Get largest auto accessory

& parts catalog in world. Over 15,000 items, including Hollywood accessories, hi-speed equipment, rebuilt engines; all parts & accessories for all cars, trucks. New, used, rebuilt! We have that hard-to-get part! Completely illustrated, jam-packed with bargains! Send 25c.

J. C. WHITNEY & CO., 1917 ARCHER AVE., CHICAGO 16

SAY YOU SAW IT IN POPULAR MECHANICS

COMPLETE 8" TILT ARBOR SAW MOVEMENT

TABLE
STAYS
LEVEL



SAVE \$50

FULL BALL BEARING

COMPLETE
MOVEMENT
& PLANS*

\$22.75

F. O. B.
ROYERSFORD, PA.
LESS GARD

PLANS ONLY 25c

\$22.75 REFUND IF NOT SATISFIED IN 10 DAYS

Write **DEPT. B, MARCUS-POLLAK***
ROYERSFORD, PA.

BLADE TILTS TO 50°
MAKE ANY SIZE - FLOOR OR BENCH MODEL

REMOVABLE

Round Stock and Pipe Jaw

FITS ANY STANDARD VISE.
USED AT ALL ANGLES

Size of Stock Governed by Size of Vise

\$1 Postpaid,
Plus Sales Tax

H. A. JOHNSON

3921 LaCresta Ave., Oakland 2, Calif.

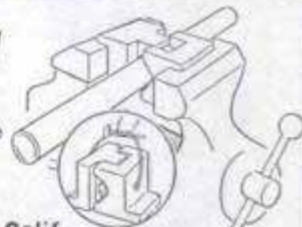

Make Your Own POWER LAWN MOWER

with this DRIVE CUTTER ASSEMBLY

Constructed for those who desire to build their own mower or to replace your old cutter assembly. Complete with 18" blade and double ball bearing drive, only...

\$11.95

Add 50c to cover handling & shipping. No COD's

ATLAS EQUIPMENT CO., Dept. P.M.6
229 SW BLVD. KANSAS CITY, MO.



\$ MAKE MORE MONEY FILING SAWS \$

EARN \$6 AN HOUR WITH THIS
MOTOR DRIVEN BURR SAW FILER

It does a better, faster and easier filing job. No time killing adjustments necessary... the accurate operator controlled file arm will file from both sides. Gives a lifetime of service and has a 1-year guarantee. FREE FOLDER ON REQUEST.

SAW SHOP
CHARGES
Coast to Coast

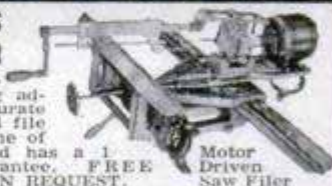

WRITE FOR VALUABLE BOOK

Send 25c in coin for Burr's Blue Book of saw shop charges and other valuable information.

BURR MFG. CO., Dept. 6, 8933 Venice Blvd., Los Angeles 34, Calif.

Your own retail business!

YOU CAN MAKE
\$150-\$200
A WEEK!

no experience
necessary!



PICK YOUR CITY . . . the brand-new "donut-bakery-on-display" is a sensational profit-maker anywhere. Makes all kinds of donuts, practically all automatic. Sets up as a department in a going retail store . . . proven in hundreds of stores across the country. Big percentage of profit.

Training is included. Easy operation. Nationally advertised DOWNY FLAKE brand, is your franchise. New 1950 machinery installed. Starting investment \$2500. Send for details (no obligation).

FREE FOLDER — WRITE TODAY

Doughnut Corporation of America

Box C, 393 Seventh Ave., New York, N. Y.

YOU CAN BUILD A PICNIC TABLE LIKE THIS



With our PRE-FABRICATED MODERN STYLED 1 1/2" BENT PIPE FRAME

Assemble your Picnic Table in a few minutes with our kit containing all metal parts, hardware and plans. Makes Table 7 ft. long. Seats 6 people, will not upset. Prime coated, easily moved about, dismantles for winter storage.

Send for descriptive folder F. O. B. Niles, O. Wt. 80 lbs. In Ohio Add 3% Sales Tax. Sorry No C. O. D.'s **\$14.95**

DAUM & OFFUTT, Dept. M, P. O. BOX 203, NILES, OHIO

Make Money
SELLING
Eshelman
Kulti-Mowers
and DOING
GARDEN
WORK

PLOWS
CULTIVATES
HARROWS
HAULS
SPRAYS
MOWS
CUTS
ROLLS
RAKES

ESHELMAN

\$125
PLUS
TOOLS

1-2-3
H.P.



FOR BETTER
LAWNS
AND GARDENS
also POWER MOWERS
and RIDING TRACTORS
Women can operate it.

Write to Dept. 76
Eshelman Co.
119 Light St., Balto. 2, Md.

ENJOYABLE WOODWORKING PROJECTS!

15 years of THE DELTAGRAM®
reprinted in hard-bound volumes

Clear plans, otherwise out of
print. Buckhorn cloth bindings.
Write for full description.



POWER TOOL DIVISION
ROCKWELL MFG. CO.
802 G E. Vienna Ave., Milwaukee 1, Wis.

All 3
books
\$10
postpaid



HM-85



Always
Fresher
Portable Radio
Batteries

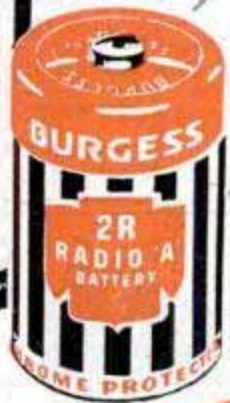

Buy

BURGESS



BURGESS BATTERIES surge to life when you flick on your portable radio. BURGESS power is kept fresh and ready because Chrome Protection curbs internal action in the battery when your radio is idle and allows more complete battery recovery between uses. You get longer listening pleasure.

BURGESS ENGINEERING assures long, dependable battery service.

BURGESS GUARANTEE, backed by the foremost name in radio batteries, means satisfaction.

BURGESS *Portable Radio*
BATTERIES

BURGESS BATTERY COMPANY
FREEPORT, ILLINOIS

BIG PROFITS FOR YOU

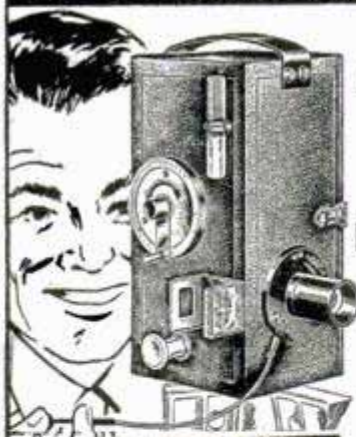

**Making
Finished Photos
in 2 Minutes!
Wonderful
Photo Invention
PDQ
CHAMPION
PHOTOMASTER**

Takes and finishes 30
to 40 photos an hour

**COMPLETE PORTABLE
PHOTO STUDIO**

Size 4 1/2" x 5" x 10"
Weights only 6 lbs.

OVER 700% PROFIT!

Beautiful, everlasting photos — black and white or sepia, size 2 1/2 x 3 1/2 in. Guaranteed not to fade. No dark room needed. Photos are taken DIRECT on "SUPER SPEED" direct positive paper. Loads enough paper for 50 shots in half a minute — in broad daylight.

BE A P.D.Q. PHOTOGRAPHER

No experience required. Simple directions teach you quickly. Work at home or travel. Make expenses plus extra profits. Pictures cost you only 2c. Sell for 15c to 25c. Folks just grab for 'em. They are amazed to see their own photos come to life in broad daylight. Photomaster "shoots" any subject — individuals or groups — buildings and scenes. This new and fascinating business offers unheard-of money-making opportunities everywhere — every day throughout the year. **DETAILS FREE! WRITE**

P D Q CAMERA COMPANY

1161 N. Cleveland Ave., Dept. PM-6, Chicago 10, Ill.

**SENSATIONAL BARRON
SPEED-VISE!**

**AN ALL-PURPOSE
BENCH VISE Only \$195**

• Slickest, handiest, all-metal vise. Screws or bolts to any bench. A work shop 'must' for planing, sawing, drilling, filing, sanding woods, plastics, metals—paper thin to 3" wide, any length. It's permanent, portable for carpenters, pattern and cabinet makers, home craftsmen. Try it on 10 day money back guarantee. Barron Tools convert any Drill Press into a Planer Sander Shaper Jointer Router at 1/10th the cost. Our Free Workshop Guide tells you how!

BARRON TOOL CO., INC.
300 Architects Bldg., Detroit 1, Mich.

**FREE
Power Tool
CATALOG**

\$ Free Course! Big Profits! \$

Flocks & Sandblasts

Dual Purpose Spray Gun! Uses only 25 lbs. Air Pressure

• Thousands of uses in Home, Shop, Industry: Makes Auto Interiors Clean & New, Lines drawers, Marproofs lamp bases, Refinishes any object. All in colorful Flock. Etch & Frost windows, glassware, etc. Removes Paint & Rust from Autos, Tools. Guaranteed! Send \$19.75 or write for free information. Flocking supplies!

BLASTO SPRAY GUN MFG.
Dept. PM-6, 7007 Haas Avenue, Los Angeles 47, Calif.

Only \$19.75 Complete

RUPTURE

RELIEF...OR YOUR MONEY BACK

Simple, easy to wear truss made by old surgical house. You risk nothing. Write for free booklet. Don't delay.

WEB TRUSS CO. Dept. M-6 Hagerstown, Md.

REAL FLYING JET '798

Ready-to-fly out of the box.

Nothing else to buy, nothing to build. Includes finished jet-model plane, installed REAL jet engine, fuel, etc. Fly your own jet-propelled plane, 3 to 5 minute flights at 500 ft. altitudes. Flashes thru the sky like Air Force jet fighters—works on same principles. Order your "Swisher" today. Write for free catalog or

SEND 10c FOR NEW MAMMOTH ILLUSTRATED CATALOG OF THOUSANDS OF HOBBY ITEMS

AMERICA'S HOBBY CENTER, Inc. Dept. B-60, 156 WEST 22 ST., N. Y. 11

Practical Economical Winter Travel

Prepare now for next winter's transportation. SnowCar plans \$2.50. Any part, engines, skis, propellers or complete factory built machines.

CALLAIR, Afton, Wyoming

COMPLETE FLEXIBLE SHAFT MACHINE only \$16.95

WITH PENCIL-SIZE HANDPIECE for "FINGER-TIP" CONTROL. Performs countless tasks quickly, easily! Use FOREDOMS on wood, metal, glass, plastics, etc. Provides easy accessibility, unobstructed view. Grinds, polishes, drills, mills, engraves, sharpens, slots, sands, carves, etc., etc. Complete \$16.95. No. 50 Accessory Set \$1.50 additional. Order today.

FREE CATALOG

FOREDOM ELECTRIC CO., Dept. 1130-E, 27 Park Place, N.Y. 7

WALL MODEL TELEPHONES

DESK MODEL

We can meet any inter-communication telephone requirement. Telephone set, 2 \$17.95 of either model. Complete with batteries, wire, etc. Telephone supplies and parts of every description. 25% deposit with order, balance C.O.D., F.O.B. Brooklyn. **INQUIRIES WELCOMED**

EASTERN TELEPHONE CO. Dept. PM-8, 284 Fourth Ave., Brooklyn 15, N. Y., MAIN 4-1882

Oxygen Breathing Outfit Excellent for miners, firemen and refrigeration men, etc. Complete with two full oxygen tanks and four oxygen generating cartridges. Two hours supply each tank.. **\$29.95**

OXYGEN MASK REGULATOR AND TANK **\$4.95**

LINEAR ACTUATOR UNIT **\$9.95**

50# Push or Pull 2 3/4"

CO2 TIRE INFLATOR **\$3.95**

- 1. MINIATURE MOTOR** 8000 R.P.M.* **\$3.95**
- 2. THERMOSTATIC SWITCH** -50° to +400° **\$3.95**
- 3. Delco Miniature Motor** 120 R.P.M.* **\$4.95**
- 4. CENTRIFUGAL PUMP WITH MOTOR*** **\$12.50**

*All motors 24V AC or DC

WRITE FOR FREE CATALOG

TERMS: Payment with order. Add 10% for P.P. otherwise we ship express collect. No C.O.D.

GADGET SHOP 1215 E. CARTHAGE PL. TULSA, OKLAHOMA

"Wellworth" Sensational Offer! Reg. \$60.50 WESTINGHOUSE AIR COMPRESSOR

Compressor, pressure tank, air gauge, air chuck, 20-ft. hose, pop valve, copper tubing with 4 brass flared fittings for connecting compressor to tank, 4-way cross and 3 nipples. COMPLETE OUTFIT, wt. 52 lbs.

Equipment less Compressor, \$12.50. Compressor separately, \$21.50
Compressor has 2" bore, 1 1/2" stroke, ball bearing, 3.27 CFM at 600 R.P.M. Capacity up to 6.54 CFM. Size 9"x11 1/2"x6 3/4". Wt. 26 lbs. Ideal for spraying paints, insecticides, etc., inflating tires, operating air tools, and other uses. All new equipment. U.S. government surplus. Replacement parts available. Amazing buy. Don't miss it.

Model T-1 Brand New - 2 CYLINDER PISTON TYPE. Operates with 1/2 H.P. Motor or equivalent gas engine.

\$32.50

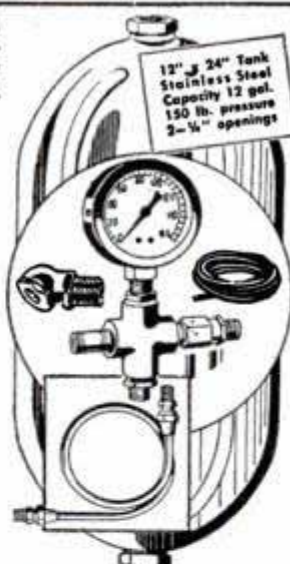
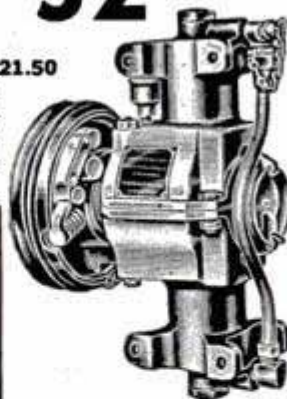

ELECTRIC LIGHT and POWER PLANT

Same as high power line
GASOLINE DRIVEN

Advantageous purchase from U. S. government enables us to offer this great bargain. Ideal for farms, homes, garages, shops, etc. Will operate oil burner, deep freeze units, compressors, saw, pumps, radio and sound systems and general lighting.

SPECIFICATIONS: 115 Volts, single phase 2500 watt, A.C., 60 cycle with 25% reserve power. ENGINE: Briggs & Stratton, Air Cooled, 6 1/2 H.P. I.E. LAND GENERATOR. "V" Belt drive with guard, and Duplex Receptacle plug-in. NET WT. 310 lbs. Shipping Wt. 440 lbs. Brand New! Complete with spare parts, tools, instructions. Fully Guaranteed.

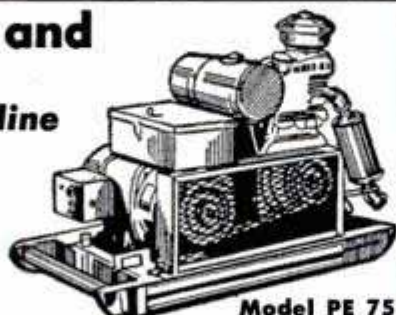

Model PE 75

Mfrs. List Price \$700.00

Only

OUR SPECIAL BARGAIN PRICE

\$295

SEND FOR OUR 68 PAGE BOOK

A handy buyer's guide for home and factory workshop. Unusual bargains in motors, air compressors, electric tools, and many more items. Send 10c for postage and handling.

AIR TOOLS



Used—Like New!
CHICAGO PNEUMATIC RIVETER & CHIPPING HAMMER
CP4X Pistol grip handle. Takes up to 3/16" rivet. Weight 6 lbs. List price \$73.00.
Ideal for work on fenders and auto bodies

SPECIAL PRICE \$8.95
Same as above, \$22.50
brand new



Ingersoll Rand
For Chicago Pneumatic AIR DRILL
Used—like new.
Lever or Pistol type
With 1/4" Jacob Chuck. Wt. 2 lbs. List price \$35.00. Only \$14.95

BLOWER BARGAIN!



Quiet operating. Double wheel inlet, double width blower. For heating, ventilating, cooling, air washing, exhausting and forced draft. DIMENSIONS: 10" wheel; outlet 13 1/4" x 11 3/4"; inlet 8 3/4". Height 19". Width 18". Depth 16 1/2" C.F.M. 1/4" S.P. 1600; outlet vel. 1575; motor 1/4 H.P. with overload relay; cord & plug, 110 v. 60 cy. AC. Ship. wt. 67 lbs. Bargain price . . .

\$39.50



"WELLWORTH" V-BELT CLUTCH

Takes starting load off engines or motors. When speed is reached, a flip of handle shifts clutch from idling to driving position. Handles "A" belts, 2.35" pitch diameter, 5/8" bore. Ideal for use with lawn mowers, garden tractors, home workshop motors, etc. 3 1/4" long. Safe, easy to mount, sealed bronze bearings, positive action.

\$7.50

Automatic PRESSURE SWITCH

For Air or Water

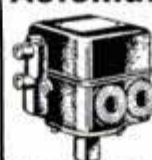

20 to 40 lbs. \$5.50
75 to 100 lbs. 7.50
125 to 150 lbs. with unloader 10.25
1/4" check valve 2.75
1/4" regulator and gauge 5.75

Prices f.o.b. Chicago. Immediate delivery. All items sold on money back guarantee. Send check or money order today.

AIR TANK and ACCESSORIES

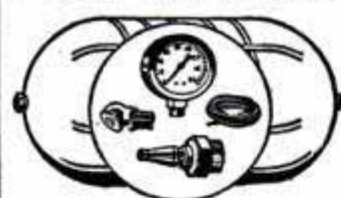

Air receiver, stainless steel, 12 1/2"x24". 400 lb. test. Ideal for carrying on trucks, autos and wherever compressed air is needed. Equipped with 500 lb. air gauge, tire chuck, 3 ft. high-test air hose, air inflation valve with core for retaining pressure in tank, and fittings. Two 1/2" openings. Complete outfit \$7.95
Shipping wt. 20 lbs. Same unit but with 6" x 24" tank \$6.95

WELLWORTH TRADING CO.

1831 S. STATE ST. DEPT. D-6 CHICAGO 16, ILL.

WOOD FASTENERS



Don't split wood—Use "CHEVRONS"—New steel fastener for wood joining (miter joints). Draws wood together eliminating doweling, mortising, nailing. Hammer in—"Presto!"—firm joint. No wobble, distortion. Fastener lends artistic appearance. Can be countersunk, concealed, in hardwood where others fail. For mill workers, artisans, HOME CRAFTSMEN, for repairing screens, doors, sash, frames, cabinets, furniture, moulding. Hurry—Send ONLY 75c for box 100, 3/4" depth, suitable for thickness of wood up to 1 1/4" inch, or \$1.00 for GIANT-Size box NOW! Money back if not delighted.

E. B. PACKARD CO., INC., Dept. PM6, 139 Cedar St., New York 6, N.Y.

HIGH POWER TELESCOPE

60 POWER - ALUMINUM TUBES - OPENS TO 33"
Variable Power Eyepiece Adjustable to 15X, 30X and 60X.

\$4.50

5 Sections. 4 Ground & Polished Lenses. Also used as 50X Microscope. Ready to use, only \$4.50 POSTPAID.
BROWSCOPE CO. Dept. 6M, 24 W. 45th St. NEW YORK 19, N. Y.

HELPFUL BOOKS

Send post card asking for FREE catalog
Popular Mechanics Press, 200 E. Ontario, Dept. 601, Chicago 11

BRONZE FOUNDRY

Schools and Home Workshops

Make your own castings of aluminum, copper, bronze, silver. Foundry sets are available in three sizes including 2400 Deg. F. blast Furnaces. \$22.50; \$29.50; and \$42.00. f.o.b. Kansas City. Free Circular.

KANSAS CITY SPECIALTIES CO. P. O. BOX 6022, DEPT. P-5 KANSAS CITY, MO.

FENDER SKIRTS \$9.95 PER PAIR

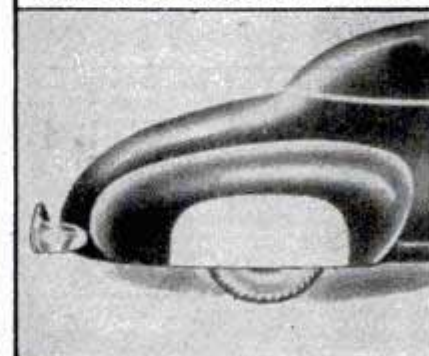

For 95% of all cars. Beautify your car . . . bring out the flowing lines designed in it. Sparkling beauty you'll like. Constructed of heavy gauge body steel, finished in prime. Perfect fit. Prompt delivery.

SANDEE MUFFLER CO.
5643 Carryne Place
Culver City, Calif.
Gentlemen: Please send me one set of Sandee Fender Skirts to fit my
(year and make of car).
 Check or M.O. for \$9.95 enclosed. No C.O.D.s at this low price, please.

DON'T FOOL WITH YOUR EYES
 "The Best is NONE too GOOD!!!"

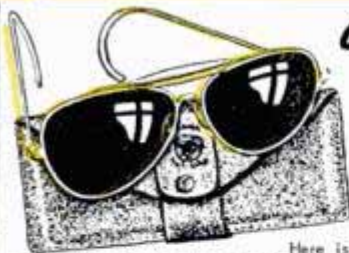

Genuine
 U.S. AIR
 CORPS
**SUN
 GLASSES**

Here is the Real McCoy, 6 Base - finest quality Glare-Free Colibar lenses, optically ground and polished. Has gold plated adjustable frame with Pearlized sweat bar and nose pads. Handsome, genuine leather case is designed to attach to your belt. These fine glasses are made to meet and surpass the most rigid government specifications. Don't miss this amazing value. Protect your eyes from glare. Wear these smartly styled, official Army sun glasses. A \$12.50 Value. **3.95**

SAVE A LIFE! MAYBE YOUR OWN!

**STOP HEADLIGHT
 GLARE with...
 NIGHT DRIVING**

Glasses



Here are the World's finest Night Driving Glasses. With 57 mm yellow amber, 6 Base lenses. These are the finest quality optical glass. Ground and Polished to reduce glare of oncoming headlights. Also made to sharpen "object focus" more clearly at night. A tremendous aid to safe night driving. Has plated frames, Pearlized sweat bar and nose pads and genuine leather case.

ND-1 A \$15.00 Value. **4.29**
 ND-1B CLIP-ON Style. To attach to your glasses. \$12.00 Value **3.95**

IDEAL FOR TELEVISION
 These glasses help sharpen focus, aid in eliminating glare. Discover great T V enjoyment.

Aviators (AN-6530)
 Windproof & Dustproof
GENUINE GOGGLES
 Rubber or chamois covered frame.
 Clear or Green GROUND LENSES are inter-changeable. Adjustable nose bar. Ideal for Flying, motorcycling, etc. **1.69**

GO-1 GOGGLE KIT
 NEW! U.S. Navy - Has soft sponge rubber frame. 4 Polaroid lenses 2 green, 1 red, 1 clear. Perfect for racing, cycling, etc. **89¢**

WATCH BARGAIN

Here's a real Shock Absorbing watch. Has jewel movement, Sweep second hand, luminous dial, chrome case. Guaranteed for one year. Ideal for young and old. **6.95** PLUS 10% TAX

NEW NAVY WATCHES - Just received from Navy Ships Service surplus. Famous 17 jewel Swiss makes. All shock absorbing, anti-magnetic and waterproof. Stainless steel case. **13.95** PLUS 10% FED. TAX

17 JEWEL Chronograph. One of the finest made anywhere. Cased in Switzerland. Sweep second hand, stop and re-set buttons. Measures distance, airspeed, ground-speed, races. Ideal for the sportsman. **21.95** PLUS TAX

U.S. AIR CORPS RUBBER BOATS
 Reconditioned and ready...with carrying case. Safe, Lightweight, Easy to Pack and Carry. An ideal boat for fishing or fun.

2 MAN **24.95** 5 MAN **29.95**
 7 MAN **42.50** OARS **2.95** PUMP **2.95**

"MAE WEST" Pneumatic LIFE JACKET
 A MUST for the Fisherman, or Boat Owner. Why Take a Chance? BE SAFE! Can be inflated by mouth or sparklette bottle charge. **2.49**
 Extra CO₂ Charges 2 for 25¢

DIVING MASK
 Soft rubber mask fits over eyes. Has heavy duty glass eyepiece. Adj. head band. 3 sizes Jr. 4 1/2" **1.59**
 Miss 5" **1.69** Mr. 5 1/2" **2.95**

SWIM FINN
 Pebble tread bottom. Adj. heel strap. Reinforced for strength. Air & drainage vented. For diving & swimming. **5.95**

HIGH PRESSURE OXYGEN BOTTLE
 New, will hold up to 3,000 lbs. with CO₂ use for deep water diving, etc. Equipped with brass valve, 36" hose, dial gauge and canvas bag. **2.29**

FISHING SPEAR - Corrosion resistant. Ideal for Spear Fishing. 11" long with barbed end. 1 in. Dia. socket. **3.94**

PALLEY SUPPLY CO 6321 SAN FERNANDO RD. DEPT. PM-6 GLENDALE 1, CALIF.
CATALOG 92 PAGES-ILLUST. SEND 25¢ TODAY!

COMPARE THESE SURPLUS Closeouts!

Lowest-Ever Closeout Price! **PORTABLE WESTINGHOUSE AIR COMPRESSORS**
 2 Cylinder Piston Type
 Reg. \$60.50 **18.50** FOR PGH
 Model T-1 Complete

Brand New Surplus Special at amazingly low price. Westinghouse, 2" bore, 1 1/2" stroke, 6.54 CFM volume, with forged crankshaft, automatic throw-out clutch for safe remote operation. Suggested pressure, 75 PSI. Mounts on truck, car engine—or operate with 1/2 HP motor. For farm, home, industry, painters, air tools. Instructions, spare parts kit included. Send check or money order. Weight 28 lbs. **AIR HOSE**—to fit, 25-ft. length with fittings & chuck **\$2**

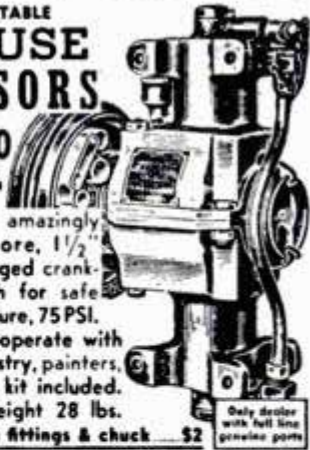

Gov't Surplus Pneumatic Tools

All Guaranteed Like N-E-W AIR GRINDERS

For filing, grinding, sanding, buffing, polishing wire brushes, burrs, etc. complete with Jacobs Collet Chuck



1/4" Collet Chuck 2" Wheel Capacity **\$115.00** List Price ONLY **\$14.85**
 3/8"—1/4" Collet Chuck 3/8"—1 1/2" Wheel Capacity **\$65.00** List Price ONLY **\$8.50**

for any of the following: for any of the following:
 Thor Model 00D Thor Model 10-18 Aro Model 221 Rotor Model 9006 Master Model 20
 Thor Bantam Aro—Turbine Grinder Kipp Model H Kipp Model BB MB Model SS-SR

3 ply AIR HOSE, 3/8" I. D. in 12' lengths, \$1.80

CHICAGO PNEUMATIC Riveters & Chipping Hammers

For chipping, riveting, hammering, peening, auto body work, concrete breaking, etc.
 CP3X—Pistol Grip with air control. 1/2" Bore, 3" Stroke. **\$8.50** Wt., 6 lbs. \$80 list price
 CP4X—1/2" Bore, 4" Stroke **\$10.50**
 CP9X—3/4" Bore, 4" Stroke **\$12.85**

All prices FOB Pittsburgh, Pa. Send check or MO
NATIONAL ARMY STORES
 200 SMITHFIELD ST. DEPT. R—PGH. 22, PA.

AUTOMOBILE RACING—Sixth Edition

Full description with over 100 illustrations of new fast racing creations. Working drawings with step by step building instructions for successful Ford 60 Midget—Model A Roadster—Offenhauser Dirt Track Racer—Miller 158.5 m.p.h. Racer. Details on axles, frames, engines, bodies, etc., etc. Entrance Blank with rules and regulations. A book full of interest for every Auto Racing Fan, Driver, Mechanic and Owner. Money back if not satisfied.
ORDER NOW! \$2.00 POSTPAID; \$2.40 C.O.D.



POPULAR MECHANICS PRESS, 202 E. Ontario St., Chicago 11, Ill.

HEADLIGHT GLARE can at last be SAFELY and effectively blocked with the O. W. Glare Eliminator—the long awaited anti-glare device that DOES NOT block the driver's own view of the road ahead. Operates on an entirely new principle. You simply ignore those passing drivers who fail to dim their lights. Easily installed. No tools. Sold direct mail only, for only \$9.75. Money back guarantee. State make, year. **4413 UNDERWOOD ST. O. W. AUTOMOTIVE DEVICES CO. HYATTSVILLE, MD.**

SAVE UP TO 85% IN WAR SURPLUS from "GADGETEERS" HEAVEN

92 PAGE CATALOG
War Surplus - Tools, Machinery, Raw Materials, Clothing, etc. Illustrated with valuable info., tables, charts & data. Send 25c to cover handling & postage.

TV Antenna KIT

Set up your own antenna of tremendous savings! Kit contains all parts & instructions

Model "A" KIT - Features "V" Cone conical type head with 8ft. x 1 1/2" Hard Aluminum mast. **775**

Model "B" DeLux Kit - Has phenolic head with Dipole separator. Patented receiving elements. 8 ft. aluminum mast, reflector, 60 ft. lead-in wire, 25 ft. guy wire and full instructions... **125**

16 mm MOVIE CAMERA

Has semi-telephoto 1 3/8" (35mm) lens with yellow filter - 3 shutter speeds for normal (16 frames) semi-slow motion (32 frames) and slow motion (64 frames per second). Uses any standard Eastman film magazine or Type "G" AAF magazine. Takes Black & White or Full Color pictures. Operates on 24V (dry cell batteries) & requires slight conversion for hand use. Diagram furnished. Cost Gov't \$235.00. NOW, **\$24.50**

CONVERTED GUN CAMERA - Fully reconditioned with start switch on front. Choice of finishes - Grey, Black, Blue... **\$33.95**

U.S. NAVY OFFICER'S JACKET

Just received! This fine summer weight, grey twill jacket. Hip length. Has four patch pockets. All New. **5.95**

NAVY EISENHOWER JACKET
Same as above but made on Eisenhower style. Has two breast pockets, close fitting button-waist band. An amazing value. **6.95**

TV LEAD-IN WIRE. Best quality, flat rubber covered, double strand wire. 300 Ohm. A PALLEY SPECIAL per ft. **03c**

Sleeping Bags

MUMMY BAG Has outer cover of forest green, water repellent balloon cloth. Filled with 15% Duck Down and 85% Chicken Feathers. 3/4 length zipper. Size 34" x 84". **12.95**

ANTENNA REEL

Just the thing for tuning beam antenna. Powered by 1/8 H.P. 24v G. E. Motor. Removable 6" Reel-limit Switch - Cam Worm gears, Bevel gear. Solenoid engaged... Motor unclogged to gear reduction only when electrical contact made. Operates in either direction. Ideal for auxiliary power take-off, opening and closing doors, etc. **4.52**

KAPOK BAG

Here's real warmth and comfort. Has special water-repellent, olive green, heavy duty cover. Filled with 4 lbs. of 100% imported Kapok. Stays soft - will not mat down, 3/4 length zipper. Head flap makes dust cover when rolled. Full length mattress pocket. Size 34" x 77". **13.50**

NAVY WADING NEW SUIT

Here's one that will make surfishing a pleasure. Made of rubberized canvas with vulcanized seams, it keeps you absolutely dry. Has built in rubber gloves and 1/2 length rubber boots. Air tight Buoyancy pockets inside keep you balanced in deep water. Has 100% waterproof liner. Guaranteed condition. **6.95**

CAMPERS' KIT

14 PIECE

Here is a real cooking must for the camper, winter cabin, home or hotel. Has 14 gleaming aluminum pieces which fit into the largest kettle with frying pan for cover. Consists of 3 kettles, 2 fry pans, coffee pot, 4 plates and 4 cups. Nested size 8" x 9". Wt. 5 1/2 lbs. **10.95**

PARACHUTES (CANOPY)

Ideal for shirts, Lingerie, Blouses, Car Covers, etc. Each canopy is 24 ft. diam. approx. 50 sqyds..

RAYON **9.95** NYLON **14.95**
or SILK

U.S. NAVY INSULATED OFFICER FOOD CONTAINER

Why bother cooking on that trip? This lightweight plastic Thermal Food Container holds enough hot, fresh food for 8 people. Has 2-5 qt. removable Pyrex Baking Dishes for meat, veg. or liquids, 1-5 qt. Plastic container for ice, etc. Each section individual - Case of sturdy plastic with carrying handle. **10.95**

NYLON FISHLINE Special

Strong - Lightweight - 2 ply NYLON FISHING LINE. ROT-PROOF and WATERPROOF... Especially treated for strength and long life. ON SPOOLS.

25 lb. test, 1000 ft. green **\$1.59**
50 lb. test, 400 ft. green... **1.19**
72 lb. test, Braided, Black with Grey, 300 ft. **3.49**
100 lb. test, 300 ft. white **3.79**

NEW TARPS - HEAVY CANVAS

Mildew & Flame Resistant. Cheap Outside Storage. They are Really Moving at These Prices.

5' x 7' **\$3.95** 16' x 32' **\$39.95**
8 1/2' x 10' **\$8.50** 16' x 22' **\$29.95**
Rubberized Linen 7' x 11' NEW **\$5.95**

Only 3 lb. light weight yet waterproof. Ideal for outside car storage.

16 POCKET VEST

Sturdy, Yet Light Wt. Satin Lined with Tie Straps, 14 Outside Pockets, Plus Knife, gun, or Tool, Leather Holder, 2 large 11" x 8" Pockets

Inside, Wonderful Hunting, Fishing, or Mechanic. A Steal **\$2.49**

FOAM RUBBER

Molded & pre-shaped. Can be cut to fit your Chair seat, Boat, Auto, Truck or Trailer Seats. Ideal for all Sports Events.

4 1/2" x 18" x 22" **\$5.65**
4" x 18" x 22" x 23" **\$4.95**
4 1/2" x 15" x 16" **\$4.95**
25" x 62" x 1 1/2" **\$6.45**
25" x 65" x 2" **\$3.45**
25" x 65" x 1 1/2" **\$7.45**

PLEXI DOME

Overall length 21" - Width at widest point 11" - at base 4". 6" deep. For Fish & Flower Bowls - Cab Roof - Lights. **1.89**

AIR CORPS BRIEF CASE

This is a genuine piece of AAF equipment. Made of best grade Brown Leather or in a handsome Pebble finish with a light canvas liner. Has two full length map or paper compartments and three smaller pockets. An ideal case for students, salesmen, artists, etc. Full heavy duty zipper closure. 12" x 16". Shpg. Wt. 3 lbs. ONLY **2.95**

AAF CASE
Genuine top grade leather. Multi-compartment. Lock and Straps. Ideal for Artists, Students, Salesmen etc. Used, good condition. **7.95**

HUNTING KNIFE

6" polished vanadium blade handle, leather grip. In leather sheath

\$5.98 Value for ONLY **1.69**
With Parkerized black Finish **1.49**

LEATHERETTE

to cover Chairs, Patio Furniture Nooks, Auto Seats, etc. 10 colors at a BARGAIN PRICE.

WIDTH	COLORS (per runyd.)	PRICE
36"	Grey, Brown, Black	\$1.19
36"	Li. Green, Dark Green, Blue	1.65
54"	Red, Grey, Lt. Blue, Ivory, Yellow	1.89

PLEXIGLASS & NASCOLITE clear plastic shts.

NASCOLITE - Full sheets app. 1/8" x 37 1/2" x 49 1/2", app. 10 1/2 lbs. each **\$12.50**

NEW PLASTIC RAIN JACKET

A 100% WATERPROOF Jacket that keeps you warm and dry in all rainy weather. Will not crack or rot... has hermetically sealed seams and Nylon stitching. Feather line, full zipper front and 2 roomy pockets. Sizes: Small, Medium, and Large. **NEW 2.95**

BOLO KNIFE

10" x 2" Parkerized blade. 5" Gripp'd Handle. Weight 1 1/2 lbs. ... Ideal for Hunting, Clearing Brush or Trails. With Case **1.19**

PLASTIC LEATHERETTE

Waterproof, Heat Resistant plastic covering. In Yellow - Chinese Red, Green, Grey, Chartreuse, Brown Yacht Blue, 54" Width. ONLY **1.95**

GOOSENECK LAMP

Consists of 24 volt control box with dimmer switch, 18" flexible extension & frosted glass shade. Can be used on 110 volt current. **2.49**

AIR CORPS HELMET

Fine grade leather - Chamois lined with chin cup on straps. Intermediate weight. Ideal for summer wear. **NEW ONLY 1.59**

COMPASSES

No. 152 - MATCHBOX Jewel & Floating dial. **39c**
No. 153 - JEWEL Watch pocket. **1.59**
NEW!!
No. 154 - WRIST STRAP type. **69c**
No. 155 - Navy POCKET CARD TYPE. **89c**

RADIO HEADSET

Low impedance. Ideal for amateur radio, crystal sets, or professional use. Adjustable ear phones. Used and in excellent condition. **1.59**

MS-30U - Two Magnetic Type receivers in watertight brass case. Soft rubber inserts in each receiver to fit into wearers' ear. Pliable steel head band. Ideal for communications, divers, workers in noisy compartments, etc. **NEW 1.59**

NAVIGATORS LAMP

A handy light for desk, work bench, chart table, engine room, etc. Can be used on 6-12-24-110 V by changing bulb. 3 ft. shaft has 4 joints to adjust position... ONLY **\$2.95**

PLASTIC PARALLEL STRAIGHT EDGE

with knobs and rubber pads for non slippage on each section. A must for navigators, mechanics, draftsmen, and engineers... You've never seen 'em at **97c**

MESS TRAY

6 Compartment - Stainless Steel - Rustproof, Wonderful for Outdoor Serving, Barbecue etc. Saves dish washing. Ideal for use in the home, hospital, 'roughing'. 311A - Used but in excellent, Serviceable Condition. **79c**

Loose Leaf BINDER

3 metal post. Cylindrical locking heavy duty 3/16" fabricated hinged cover. End identification window. Ideal for price books, salesmen catalogues, photo albums, students, publications, Reference books, etc. Will hold 500 sheets, 8" x 11" **59c**

NAVY Sealed Beam LAMP

U.S. Navy Portable Pistol Grip light. Has sealed beam and aiming sight. Ideal for search, spot or Emergency light on auto, boat, farm etc. **2.95**

12 Volt light, 4" lens **2.95**
24 Volt, 5" lens & carry case **3.49**
Set of 3 filters, Red, Grn, Amber (specify type lamp) **99c**

New Navigators Magnetic Compass

Type D-12 - Size 7" dia. by 4 1/2" deep. Rubber lined rotating verge range ring... calibrated in 1° from 0-360°

2 parallel grid wires for alignment with N-S line. **\$14.95**

PALLEY SUPPLY CO
6321 SAN FERNANDO RD.
DEPT. PM6 GLENDALE 1, CALIF

CLAMP-ON ANYWHERE LAMP

With adjustable ball and socket swivel head, long rubber covered cord and wall plug.

The All Purpose Lamp. Wonderful for Indoor Photography, Floodlights, Baby Spot or Large Spot, Personal Bed Reading, Workbench, Garage, etc. Lamp Alone **99c**

Highly Polished 9" diameter Parabolic Reflector or 5" diameter Spot Reflector at Only **85c**

TROUBLE LIGHT

With heavy duty reflector guard, all-rubber covered socket with built-in switch and female outlet. **NEW**

With 25 ft. extension cord. **\$2.29**
With 50 ft. extension cord. **\$3.09**

EXTENSION CORD - 18-2 rubber covered. Complete with male & female plugs. 25 ft. 1.49 50 ft. 2.49

LARGEST FIRM OF ITS TYPE IN THE WORLD

Order from this Ad. All sales final. All Prices F. O. B. Glendale. Pay by M.O. or Check. P.O.'s Accepted. From D & B. firms. 1/2 deposit with C.O.D.'s.

**CRAFTSMEN
RECOGNIZE
QUALITY**

by these fine features in a

HACKSAW

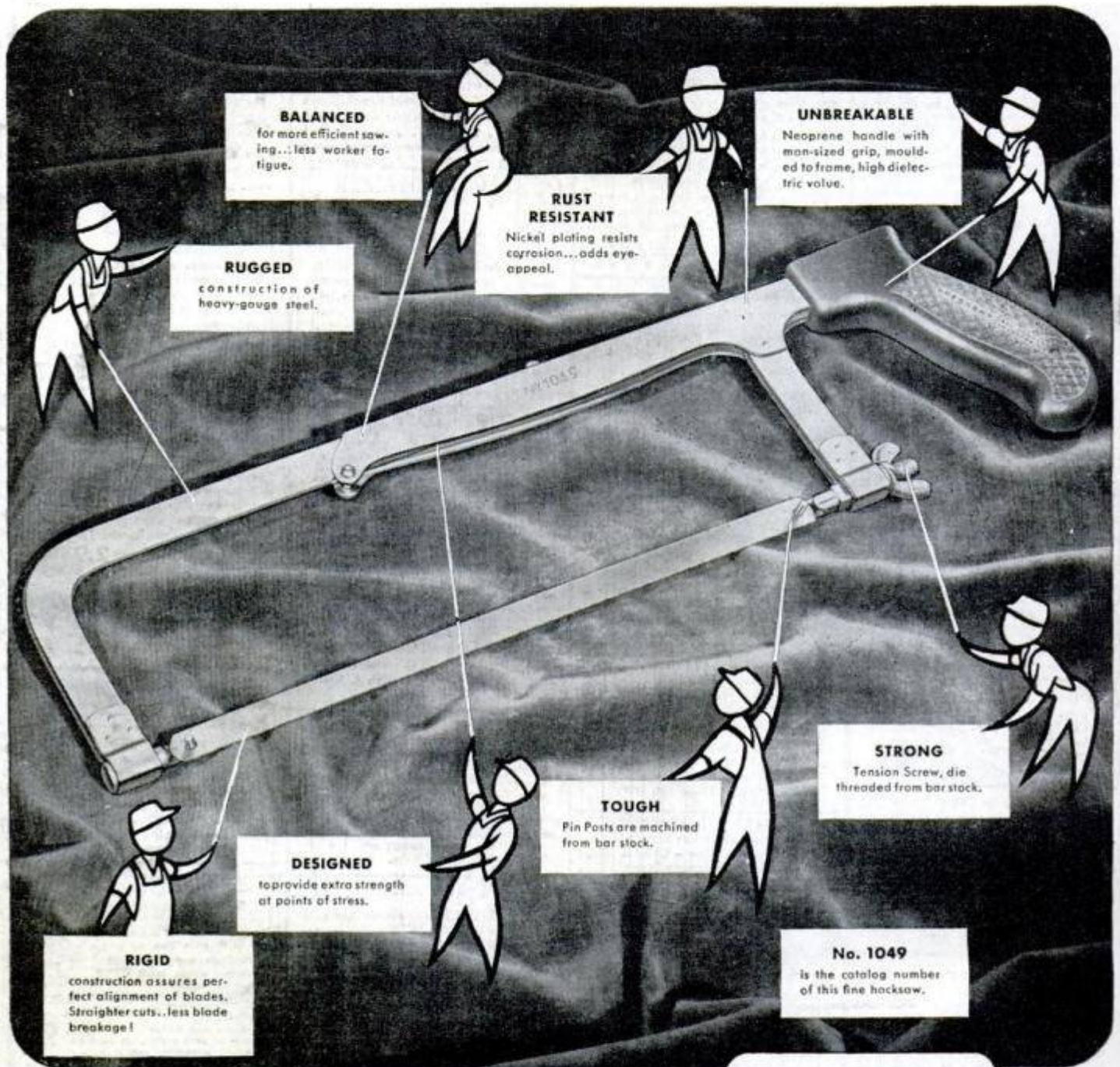

**EVERYBODY
RECOGNIZES
QUALITY**

by this Trade-mark

CRESCENT TOOLS



"Crescent" is our trade-mark, registered in the United States and abroad, for wrenches and other tools. Sold by leading distributors and retailers everywhere and made only by **CRESCENT TOOL COMPANY, JAMESTOWN, NEW YORK**

Printed by Popular Mechanics Company, Chicago, Ill., U. S. A.

Your Dream House for Less Than \$3500!

Looks Like and is a \$25,000 Value.
 All Materials for Basic House Including
 Finished Dormers Cost Less Than
 \$3500. Our Famous "House-that-
 Grows" Plans Show How to Add
 Breezeway and Garage for Nominal
 Cost Later, at Your Convenience.

Note spacious size and cross
 ventilation of rooms. In the
 book floor plans are shown
 with electrical
 wiring, outlets and
 closets.



Build Any One of 8 Beautiful
 Homes Yourself with the aid of
 "Your Dream HOME-
 how to build it for LESS THAN \$3500"

Variety of Designs for Every Taste! For Every Neighborhood!
 Complete Building Plans and Instructions Show You How to

SAVE UP TO 75c ON EVERY DOLLAR!

Every Step Made Easy Even for the Novice!

Thousands are doing it—so can you! With the aid of this easy-to-follow, step-by-step wonder book, you can build YOURSELF the home of your dreams—any one of 8 beautiful homes—even if you're the merest novice! You can own a home far more spacious, beautiful and comfortable than you ever dreamed of—a home that looks like—and IS worth \$25,000—a home you will always be proud of!

**Own a \$10,000 Home for
 Material Costs as Low as \$2500!**

Save up to \$7,500 on a \$10,000 house! And own a home that is stronger, sounder, handsomer than some profit-minded builders might give you! It's common knowledge that, of every \$100 you spend for a commercially built house, only \$25 to \$35 goes for materials. Now this amazing volume shows you how to SAVE that big 75% difference—by building yourself! Complete building plans and simple easy-to-follow instructions offer you a choice of 8 grand spacious homes. Even a Vacation Hideaway for less than \$1500! 1,000 show-how pictures clearly explain EVERY step from selecting the site and starting foundation, to final landscaping. Complete material costs as low as \$1,500! Savings for you ranging from \$4,500 to \$15,000!

FULLY ILLUSTRATED—Complete lists of materials!

For Week's FREE Enjoyment Mail Coupon NOW!

If an ordinary small edition were made, this volume would still be a whale of a bargain at the necessary price of \$12.50. But our huge printing enables us to slash costs more than TWO-THIRDS! . . . bring you this wonder book for the amazingly low cost of only \$3.95! (YOU SAVE \$8.55!) Try it a full week FREE—return it without further obligation if not surprised and delighted, or keep it and pay only \$1 monthly. But act now—even our tremendous printing cannot last long with so many millions of families eagerly awaiting this opportunity! Mail FREE-Trial Coupon today.

© 1950, Wm. H. Wise & Co., Inc., 50 West 47th Street, New York 19, N. Y.



7 Days
 Enjoyment
FREE!



MODERN SUBURBAN!
 Designed by Victor Civkin



CAPE COD COTTAGE!
 Designed by Carl Sigman



COLONIAL HOME!
 Designed by T. Johnson



RANCH HOUSE!
 Designed by C. R. Stork



TUDOR COTTAGE!



Vacation Hideaway!
 by Carl Sigman



Cotswold Cottage!



Prepared by
 Top Building
 Experts and
 Edited by
 Famed
 "Handyman"
 Hubbard Cobb

512 BIG PACKED PAGES! 1,000 CLEAR HOW-TO-DO-IT PICTURES
 Picturized Step-by-Step Instructions from Start to Finish!

- Covers: Selecting Locality & Site
- Complete Material Lists for 8 Houses
- Masonry, Frame Construction
- Clearing Land
- How to Make a Foundation
- How to Build Frame
- How to Insulate Sheathing the Frame
- Building Roof
- How to Set in Windows, Doors
- How to Build Partitions
- How to Install Plumbing
- How to Install Electrical Systems
- How to Install Heating
- Interior Finishing
- How to Apply Siding
- Building Modern Kitchen and Bath
- Painting, Decorating
- How to Build the Garage
- How to Make Built-In Furniture
- Landscaping Your Ground
- How to Finance Without 1c of Cash
- How to Live on Site While Building

Mail This FREE-Trial Coupon Now!

Wm. H. Wise & Co., Inc., 50 West 47th St., New York 19, N. Y.
 Without obligation to me, rush me immediately, for Free Examination, a copy of the big new 512-page book "YOUR DREAM HOME—How to Build It for Less than \$3500"—bound in sturdy rich Novelex. After week's free trial, I will either return book promptly and owe you nothing, or I will keep it and remit only monthly until the amazingly low price of only \$3.95, plus a 1 cent postage, is paid.

SAVE CHARGES ON 3 LB. SHIPMENT!
 —Mail only \$4 with this coupon and we will stand shipping charges. Same return privilege and refund guaranteed.

MR. _____
 MRS. _____
 MISS _____
 (Print plainly in block letters)

ADDRESS _____

CITY _____ ZONE NO. _____ STATE _____

Check here to examine FREE beautiful De Luxe Edition, THUM NOTCHED, in Pinseal-Grained Binding, richly decorated with



Driving into the Danger Zone

WARNING ZONE

Engine loses pep ...

DANGER ZONE 1

Engine begins to smoke ...

DANGER ZONE 2

Engine pumps oil badly ...

DANGER ZONE 3

Destructive wear sets in ...



Needs a tune-up

Clean, adjust and re-time ignition. Clean fuel supply and carburetor screens. Adjust carburetor. Adjust tappets and fan belt. Check compression and vacuum readings for symptoms of ring wear.

Needs new piston rings and minor engine repairs

Replace piston rings. Align rods. Adjust rods or replace rod bearings. Reseat and reface valves.

Tune engine.

These repairs are comparatively inexpensive and put the engine back in peak condition for thousands of economical miles. Delay puts the engine in Danger Zone 2.

Needs new piston rings and major engine repairs

Replace piston rings. Replace piston pins. Adjust—probably replace—main bearings. Align rods. Adjust rods or replace rod bearings. Reseat and reface valves. Tune engine.

These repairs naturally cost more than those needed in Danger Zone 1, but they put the engine back in condition for thousands of additional miles of satisfactory service. Delay leads to costly Danger Zone 3.

Needs new piston rings and complete overhaul

Repairs cost three or four times as much as in Danger Zone 1.

Remove engine. Rebore cylinders. Replace pistons, pins, rings. Replace main bearings. Align rods, refit or replace rods, or replace rod bearings. Overhaul valve lifters, rocker arms. Replace timing chains or gears. Reseat, reface valves. Replace guides and springs. Replace camshaft bearings. Clean oil lines. Overhaul oil pump.

Clean, re-install and tune engine.

The more you delay - the more you pay!

Piston rings should be replaced ... *at the first sign of wear!*

You'll be money ahead if you replace your piston rings when your car first gets into the Danger Zone. But if you delay until the second or third Danger Zone, repairs cost two to four times as much.

In any Danger Zone, ask your motor service man

for Hastings Piston Rings. They *stop* oil-pumping, *check* cylinder wear and *restore* performance.

It's the best money you can spend on your car.

HASTINGS MANUFACTURING COMPANY • HASTINGS, MICH.
Hastings Ltd., Toronto

TOUGH BUT OH SO GENTLE



HASTINGS

STEEL-VENT PISTON RINGS



TOUGH on Oil-Pumping • GENTLE on Cylinder Walls