

MAY 1950

35 CENTS

ANC



# POPULAR MECHANICS

## MAGAZINE

WRITTEN SO YOU CAN UNDERSTAND IT

REG'D. TRADE MARK, GREAT BRITAIN, No. 41042E

REG. U.S. PAT. OFF.



**ROCKET TO THE MOON**

*- No longer a fantastic dream - Page 89*



Studebaker Champion regal de luxe 2-door sedan

## Sleek Studebaker styling saves gasoline for you!

GAS economy is written all over the trim, clean dream lines of this low, long, alluring, excitingly new 1950 Studebaker.

Its very look tells you it's a car with the right build for thrift. You don't see a trace of bulging excess bulk that would squander power.

You see instead a beautifully flight-streamed car—with the sleek, going-somewhere distinction of a jet plane—Studebaker's "next look"!

A Studebaker Champion with overdrive convincingly proved Studebaker gasoline economy

in this year's Mobilgas Grand Canyon Run. The Studebaker Champion averaged 26.551 miles per gallon to beat 30 other cars of 16 makes in straight-out gas mileage.

Stop in now at a Studebaker dealer's and try out a 1950 Studebaker. Its ride is something utterly new—the "miracle ride" of motoring!

## NEW 1950 STUDEBAKER

*Out ahead in style...in thrift...in value!*

White sidewall tires, wheel trim rings and overdrive optional at extra cost



Plenty of "stretch-out" room for relaxed comfort in all the 1950 Studebakers. The low-price Champion two-door sedan pictured above is richly appointed.



Gasoline really delivers mileage in a Studebaker as proved in the Mobilgas Run. Studebaker's automatic overdrive used in that contest is extra cost.



Brakes adjust themselves! Marvelous Studebaker advancement! The swift, sure stopping power of a brand-new car down to the last layer of lining!



This Studebaker father-and-son team is one of many. Their painstaking craftsmanship adds extra value to every Studebaker. Studebaker, South Bend 27, Indiana, U. S. A.

# It's easy to lay a Kentile Floor yourself...and Save Money



- Goes down tile by tile
- Create your own exclusive colorful design
- Ideal for kitchen, bathroom, living room, bedroom, basement playroom—any room
- Lay Kentile in a few sparetime hours—enjoy its beauty for many, many years
- If you don't have the few simple tools required, ask your dealer for the KEN-KIT. (Contains everything needed.)

**IMAGINE!**

As little as **\$22<sup>50</sup>**  
for a 8' x 9' floor.

*Prices vary with size  
of room and the colors  
you choose.*



**YOU CAN  
LAY KENTILE  
IN YOUR SPARE  
TIME AS EASY  
AS 1, 2, 3**

## **FREE! COMPLETE INSTRUCTIONS AND COLOR CHART!**

Send for easy-to-follow self-installation instruction folder and complete color chart showing all Kentile's 25 lovely tile colors. Start planning your floor now! Write to David E. Kennedy, Inc., 62 2nd Avenue, Brooklyn 15, New York.

Easy as can be! Any design—any color combination is a cinch—because Kentile goes down tile by tile. No heavy rolls to lug around. Anyone can lay these 9" x 9" asphalt tiles in place.

Kentile lasts longer, too. It's all pure tile—no felt or other backing. Colors can't wear off because they go right through this remarkably durable flooring.

Because it resists stains and dirt, Kentile is the easiest of floors to clean. Occasional no-rub waxings give a like-new sparkle.

See your Kentile dealer now. Look under FLOORING in your classified phone book for his name and address.

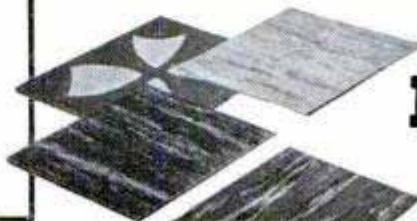

**KENTILE®**

*The Asphalt Tile of  
Enduring Beauty*



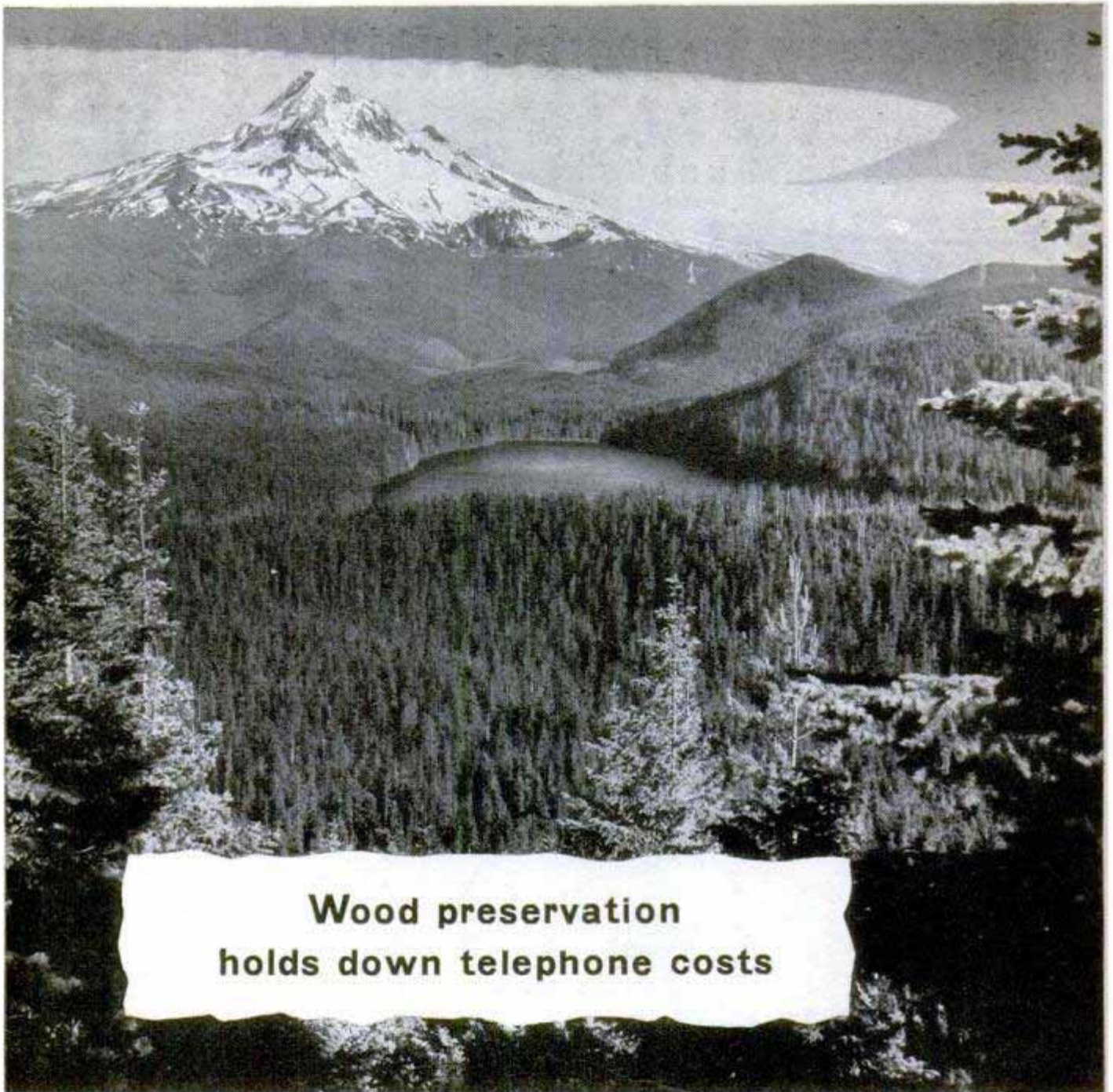

## Wood preservation holds down telephone costs

Poles are a substantial part of the plant that serves your telephone; making them last longer keeps down repairs and renewals that are part of telephone costs. So Bell Laboratories have long been active in the attack on wood-destroying fungi, the worst enemies of telephone poles.

Better, cleaner creosotes and other preservatives have been developed in co-operation with the wood-preserving industry. Research is now being carried out on greensalt — a new, clean, odorless preservative. Even the products of atomic energy research, radioactive isotopes, are used to measure penetration of fluids into wood.

Treated poles last from three to five times as long as untreated poles. This has saved enough timber during the last quarter century to equal

a forest of 25,000,000 trees. More than that, wood preservation permits the use of cheaper, fast-growing timber instead of scarcer varieties.

This and other savings in pole-line costs, such as stronger wires which need fewer poles, are some of the reasons why America's high-quality telephone service can be given at so reasonable a cost. It is one of today's best bargains.

**BELL TELEPHONE  
LABORATORIES**



*Exploring and Inventing, Devising and Perfecting, for Continued Improvements and Economies in Telephone Service.*

# Popular Mechanics Magazine

Registered in U. S. Patent Office and Canada

H. H. WINDSOR, *Founder*

H. H. WINDSOR, JR., *Editor and Publisher*



## *this month's cover*

SOMEHOW Hollywood always manages to sense a trend before it starts. Here we see a cameraman grinding away to record man's first exploration of the moon's craters. The movie will be at your local theater shortly, and without knowing the plot we'll bet that the first man to arch through infinity has one of those pin-up Hollywood gals waiting for him back on earth. Really significant, though, is the fact that the movie is based on scientific data—almost every problem of an interspace rocket has been solved. Dr. Hsue-Shen Tsien of the California Institute of Technology states that engineers could start construction this year of a rocket capable of reaching the moon. We're not rushing to volunteer as crew members, but this business of interplanetary travel no longer is a fantastic dream. To find out how scientists have solved the problems of a space ship, take a look at Tom Stimson's story on page 89

Published monthly by Popular Mechanics Company, 200 E. Ontario St., Chicago 11, Ill. H. H. Windsor, Jr., president; William Harrison Fetridge, vice president; D. P. Windsor, vice president and secretary-treasurer; Clover L. Perkins, advertising manager; Alan M. Deyoe, circulation manager. Single copy in the United States and Canada, 35 cents; subscription rates in United States and possessions, Canada, Philippines and countries of the Pan-American Postal Union, 1 year, \$3.50; 2 years, \$6.00; 3 years \$8.00. To all other countries add \$1.00 a year over United States prices for overseas postage. If you plan to move, notify us at least 30 days in advance so you will not miss an issue. Give both old and new addresses. Entered as Second Class Matter, September 15, 1903, at the Post Office at Chicago, Illinois, under Act of March 3, 1879. Entered as Second Class Matter at Post Office Dept., Canada, Copyright 1950 by Popular Mechanics Company. Copyright under International Copyright Union. Copyright in France. All rights reserved under Pan-American Copyright Union. Printed in the United States of America.

Volume 93    MAY 1950    Number 5

Managing Editor.....Roderick M. Grant  
Assistant Managing Editor.....Wayne Whittaker  
Shop Notes and Crafts Editor.....James R. Ward  
Radio-Television, Electronics Editor.....Frank L. Brittin  
Associate Editor, Aviation.....Aubrey O. Cookman, Jr.  
Associate Editor.....Clifford B. Hicks  
Art Director.....Frank Beatty  
Director, Bureau of Information.....Allan Carpenter

Assistant Editors  
Donald R. Brooks      Dorothy E. Hoffmann      Arthur R. Railton  
                                        H. H. Windsor III

Assistant Editors, Shop Notes and Crafts  
W.Clyde Lammey      Wayne C. Lecky      Frank N. Stephany      A.E. Youngquist  
Eastern Editor.....Richard F. Dempewolf  
Empire State Bldg., Room 2906, New York 1, N. Y.

Western Editor.....Thomas E. Stimson, Jr.  
3872 Franklin Ave., Los Angeles 27, Calif.

Representative in Great Britain.....Douglas W. Wedderspoon  
77 Baker St., London W. 1, England

## **IN THIS ISSUE**

New York Shakes Off Its Bonds - - - -	73
Mystery Men of the TV Screen - - - -	80
Rocket to the Moon - - - - -	89
The Impact of the Hydrogen Bomb - - - -	96
What's New for Your Home - - - - -	106
Strait Jacket for a Super Blowtorch - - - -	110
Flying Disk Aircraft - - - - -	114
The Chain Saw - - - - -	118
Trains in the Trackless Arctic - - - - -	125
This Invisible Plastic, Melamine - - - - -	136
Nine Lives for Oil - - - - -	146
How to Make "Quick Freeze" Camera Shots -	152
Yellowstone's Other "Old Faithful" - - - -	158

## **For the Craftsman**

New Life for Old Furniture - - - - -	166
Hand Puppets Are Easy to Make - - - - -	174
Repainting Interior Walls and Woodwork -	184
Motor Tune-Up—Part I - - - - -	196
Ridding Your Premises of Sparrows - - - -	202
Use the Right Abrasive—Part II - - - - -	212
Portable Hoist for Job Shops - - - - -	218
Radio-Television, Electronics - - - - -	221
Clinic for Homemakers - - - - -	232

*Other items, and manufacturers of available products described, are listed on pages 10, 12 and 14*



# "I Joined the Air Force

## to build a Career"



The new Airman Career Program develops skills for lifetime careers.



Airmen enjoy ample free time for sports and recreation, 30 days annual vacation with pay.



An Airman is a career man, with opportunities for advancement, security and success.

**Where else can you find such opportunities as you're offered in the new Airman Career Program!**

As an Airman you're on your way to a real career. Scientific aptitude tests reveal your strongest abilities. Then you are expertly trained, either on the job or in the world's finest technical schools, for one of the 400 job specialties in the many Airmen career fields—with full pay from the start. You have many opportunities for education, advancement, security, and the good things of life. Inquire about the Airman Career Program at your nearest Recruiting Station.



### U. S. AIR FORCE

Visit Your U. S. Army and U. S. Air Force Recruiting Station

# Cutaway shows you why G-E headlamps do not grow dim:

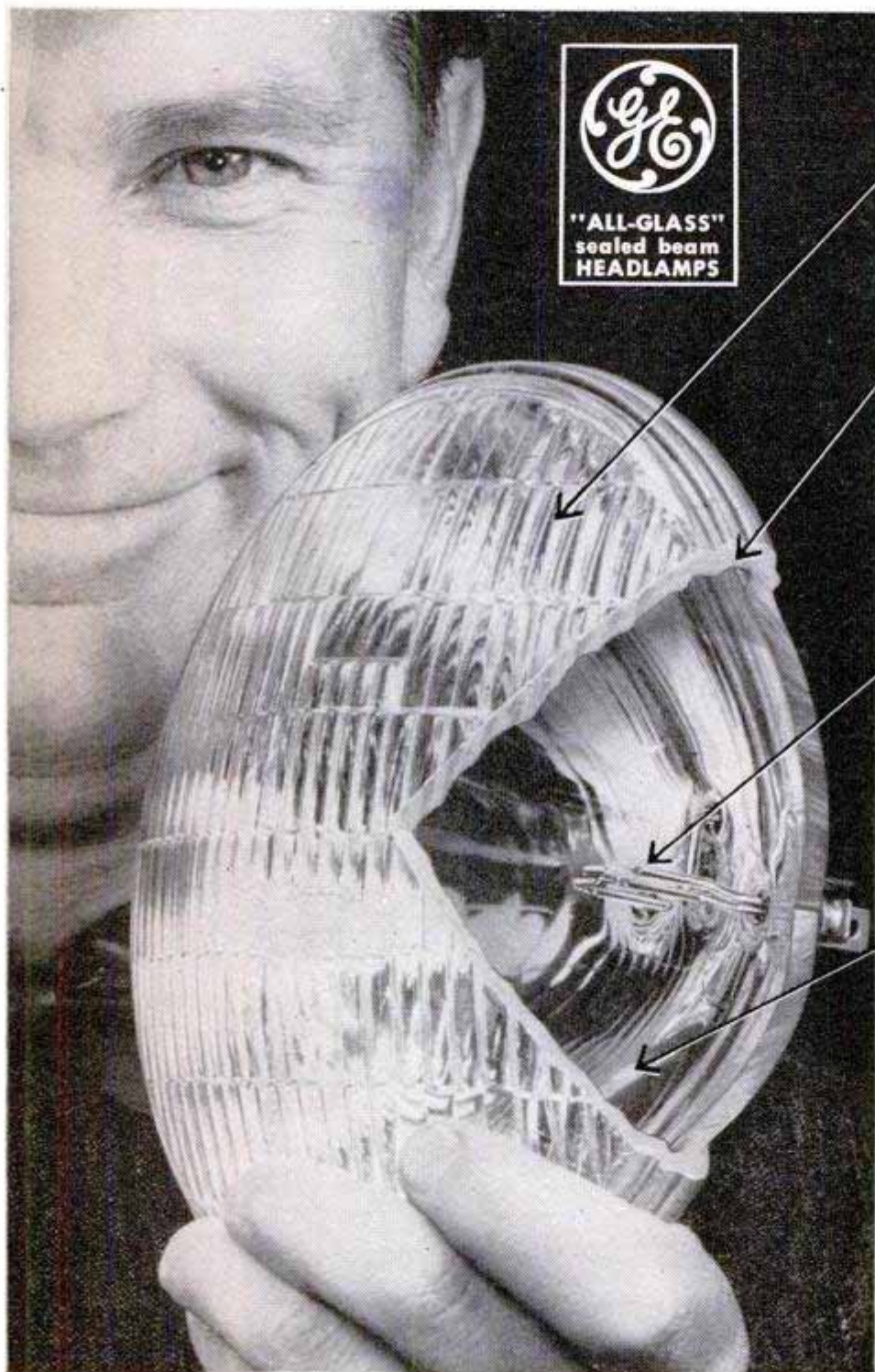

**1** LENS is made of shock-resistant hard glass, precision built to put maximum light on the road.

**2** ONE-PIECE "ALL-GLASS" CONSTRUCTION keeps out all light-dimming dirt and moisture. The average General Electric headlamp gives 99% of original light output even at the end of lamp life.

**3** FILAMENTS are held in vise-like grip — can't shake loose on rough roads. They give 12% more light on the road for driving — 16% more light for passing.

**4** MIRROR-LIKE REFLECTOR stays bright for life; no dirt or moisture can get in to tarnish it.

*NOTE: Have lights checked next time you leave car for service, and insist on G-E!*

You can put your confidence in—

GENERAL  ELECTRIC



Up hill and down dale, out in the open, keeping healthy, having fun, helping Dad, and Mom, too — that's bicycling, *MODERN BICYCLING!*

Today New Departure,  
the powerful safety brake,  
affords constant control.

It brings any bike to a

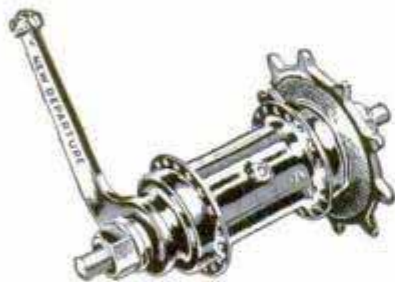

**New Departure**  
SAFETY BRAKE   
a product of

1877

NEW DEPARTURE • DIVISION OF GENERAL MOTORS  
BRISTOL, CONNECTICUT

in this corner.....

## THE EDITORS



I SIMPLY can't remember where I saw that article in *Popular Mechanics*," readers often write us in asking for help in finding some editorial item in a back issue of the magazine.

To make it easier for readers to locate articles quickly, a complete printed index for the first six months of this year is being prepared and will be available on request about the first week of June. To reserve a copy for yourself, your library or workshop, send your request with 10 cents to cover handling and mailing costs to the Bureau of Information, 200 East Ontario Street, Chicago 11, Ill. Copies of the index will be mailed as soon as they come from the presses.

\* \* \*



### Little Mo Is on the Trail

We haven't heard any up-to-the-minute progress reports on "Little Mo" and his companion, Eddie Gallinagh, but about this moment they should be hoofing along those ancient ruts of the Santa Fe Trail that our Associate Editor, Aubrey O. Cookman, Jr., explored in a Jeep with Heath Proctor, airline pilot, last year. Proctor's story appeared in our January issue—his portrait on the cover—under the title "An Airline Pilot Rides the Wagon Trail."

Little Mo, billed as the "smallest Missouri mule in the world," started his trek with

(Continued to page 8)



# Let me send You **FREE PROOF** that you can become an expert **ACCOUNTANT... BOOKKEEPER** **OR C.P.A.**

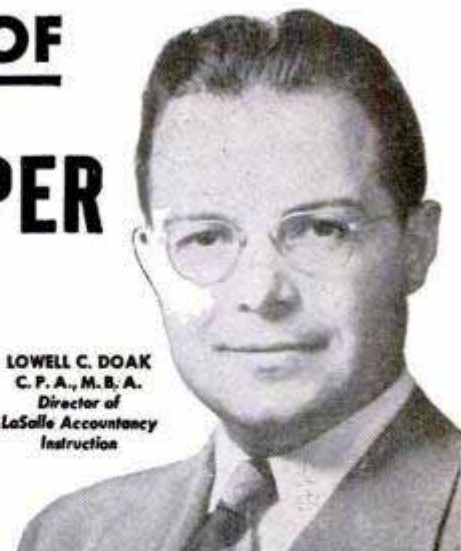

LOWELL C. DOAK  
C. P. A., M. B. A.  
Director of  
LaSalle Accountancy  
Instruction

## FREE SAMPLE LESSON

I offer you this free sample lesson so that you can *prove to yourself* that you CAN master Accountancy—quickly, thoroughly—in spare time at home.

You will see exactly how LaSalle's famous "Problem Method" works . . . how you are led step-by-step through actual accounting work—*learning by doing* and not by study of theory alone. First you tackle easy problems, then more difficult ones—until soon you master them all. And at every step you have the close personal guidance of LaSalle's large staff of C.P.A. instructors.

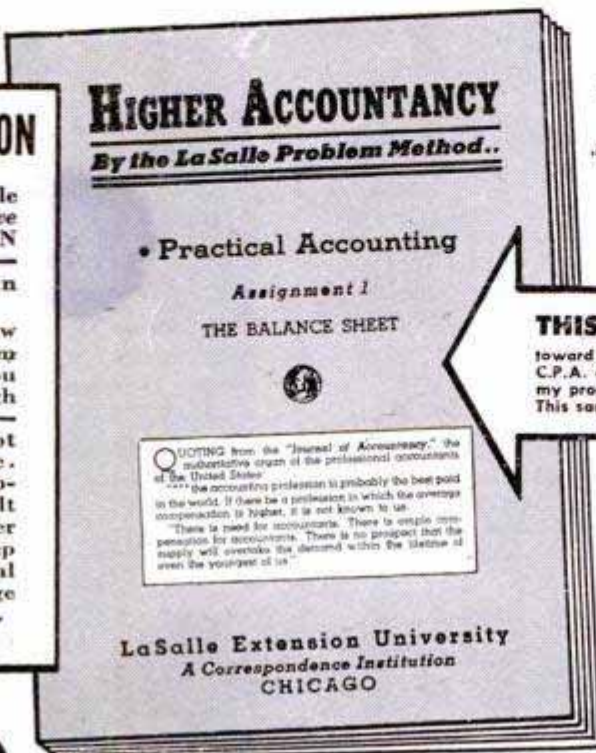

## THIS SAME LESSON STARTED ME

toward a well-paid public accounting career—and my C.P.A. degree. I knew nothing of accounting before—yet my progress was rapid—my earning power climbed fast. This sample lesson will show you why.

**I**f you have been envying the high incomes and good jobs enjoyed by thousands of men and women Accountants today . . . incomes ranging from \$4,000 to \$10,000 and more per year . . . why not launch such a career for yourself?

Do you doubt that you can?

Then let me send you—without cost or obligation—the same Lesson Number One with which LaSalle has started several hundred thousand

men and women toward successful accounting careers. I want you to see for yourself how this remarkable method, originated by LaSalle, makes Accountancy simple, interesting, practical, and certain . . . how it leads you step-by-step to a complete mastery of Accounting—and on up to the coveted degree, of Certified Public Accountant if you so aspire.

It doesn't matter whether you've had previous bookkeeping experience, or whether you don't know a debit from a credit. Whether you wish to qualify as an expert bookkeeper, advanced accountant, cost accountant, auditor, government accountant, income tax specialist, or public accountant . . . you'll find in LaSalle's Problem Method the exact plan to prepare you rapidly and inexpensively—in spare hours at home—without losing a day from your present job.

So right now, today . . . if you are an adult, employed, and earnestly ambitious for rapid advancement in this highest-paying of all professions . . . send your name and address to me on the coupon below. I'll send the free sample lesson—plus our 48-page book outlining today's career opportunities and how you can qualify for them. A coupon like this has started many thousands toward greater success. It can do the same for you. Mail it today!

## Clip Coupon . . . Mail TODAY!

**LaSalle Extension University . . . A Correspondence Institution**  
Dept. 564-H, 417 S. Dearborn Street, Chicago 5, Illinois

YES, MR. DOAK, I want to see how LaSalle's "Problem Method" works . . . how I can qualify for high-pay Accountancy positions. Also, send your 48-page book, "Accountancy, the Profession That Pays" . . . all without cost or obligation.

Name . . . . . Age . . . . .

Street Address . . . . .

City, Zone & State . . . . .

Present Position . . . . .



**Nearly 10%  
of all C.P.A.'s  
in the U.S. have  
been trained by the  
LaSalle Problem  
Method**

## GOOD-PAY JOBS IN 5 BIG FIELDS

If you were an expert accountant right now, chances are you would find yourself among the highest-paid of all professional men and women. Surveys show that accountants earn more than those in other major professions.

There are five big fields of opportunity open to Accountancy-trained men and women . . . opportunities that are wide open and highly inviting, offering maximum income and job security in good times or bad. And under LaSalle's "Problem Method" you can start earning while still learning—either in spare-time or full-time employment . . . or in business for yourself with no capital required.

Get the latest information by sending for our 48-page book, "Accountancy, the Profession That Pays" . . . plus free sample lesson. The coupon at right will bring both to you without cost or obligation. LaSalle Extension, 417 S. Dearborn St., Chicago 5, Ill.

# Springtime is time to add Pyroil

This is fun and fancy-free time for you and your car. To make sure it's trouble-free time, too—give your car the added protection of Pyroil. Pyroil is a "must" for Springtime driving—when the open road invites added miles which add extra wear and tear, extra exposure, extra friction on metal parts.

Pyroil, with its remarkable property of making oil adhere to all metal surfaces, assures constant lubrication. That's why Springtime is time to add Pyroil—add miles of trouble-free driving to your car.

## Pyroil for Aircraft Engines

Use Aircraft Pyroil B for lubricating oil, Aircraft Pyroil A for gasoline.

**GIVEN!** An attractive Pyroil metal savings bank, takes coins up to 50c pieces. **MOTORISTS**, it's yours for the asking—sent postage paid.

Manufactured and Guaranteed by Pyroil Company, 103 Pyroil Bldg., La Crosse, Wisconsin

Canadian Distributors: Central Purchasing Agencies, Ltd., Toronto, Ontario



### PYROIL COMPANY

103 Pyroil Bldg., La Crosse, Wisconsin

I want my car to last and run properly. Please tell me more about Pyroil and how it can accomplish this for me.

Name \_\_\_\_\_

Address \_\_\_\_\_

City or Town \_\_\_\_\_ State \_\_\_\_\_



(Continued from page 6)

Gallinagh, an advertising executive and former stage and screen press agent, from Santa Fe, N. Mex., last New Year's Day and is following the old trail eastward to Kansas City. Arrival is scheduled for that city's 100th birthday, June 3.

The exact specifications for a Missouri mule are not known to us, but we presume Little Mo's claim to the proud title rests on residence. Mo is the son of a Shetland pony mother and a Guatemalan Donkey sire.

\* \* \*

## One Item Seen by Two British Eyes

To the Editor:

With reference to an article on page 146 of your November issue describing an "Electric Housemaid." The statement that it is a wife's custom to clean her husband's shoes is quite inaccurate.

During the last week I have made approximately 50 enquiries without finding one instance to support your statement. I would like to express my appreciation of your excellent magazine.

J. W. Eling-Smith (Major, M.C.),  
Fernleigh, Station Road,  
Borrowash, Derby, England.

To the Editor:

In your November issue you had a small article and photograph of an Electric Housemaid, which polishes shoes and does other wonders. The article gives the impression to any reader that every British housewife has one of these things. I and several thousand people have never even seen one!

It may be that your Mayfair and Park Lane of London folk have such a thing but then they would not come under the "housewife" category. A parallel is that we are led to believe that every American woman owns a refrigerator, washing machine and what have you. Can it be then that each country thinks that the other one is marvellous?

Leslie D. S. Geering,  
37 Bude Road,  
Filton, Bristol, England.

\* \* \*

## Floating Factory

Swedish weeds are succumbing to a chemical weed killer made in a British factory in a Swedish harbor. The factory was aboard a 600-ton ship that anchored at Gothenberg with British chemists aboard. They hired additional Swedish workers, manufactured the required supply of phenoxylene, which attacks weeds but spares grains and grasses, then sailed home again.

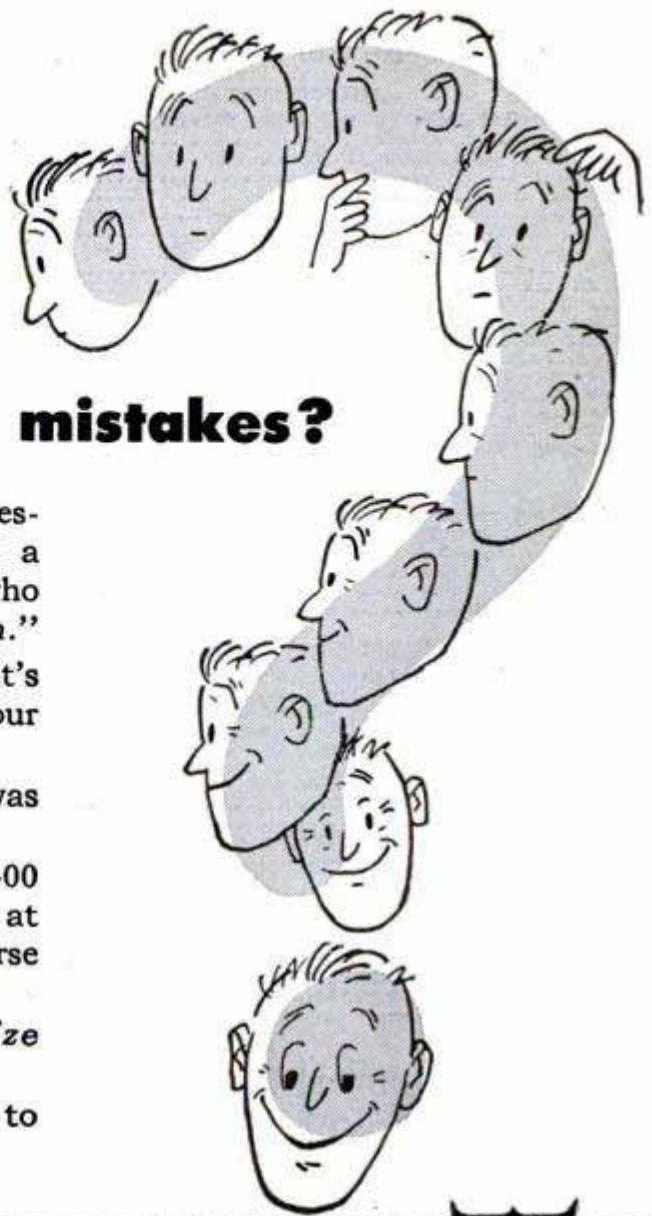

## Can you profit by their mistakes?

"What's your biggest mistake?" That's the question asked of American men and women in a national poll. Almost one out of every three who answered said, "Not getting enough education."

You needn't make that mistake. Not when it's so easy to study with I. C. S. at home in your spare time.

The next biggest mistake, said the men, was "Wrong choice of career."

Study with I. C. S. and you have over 400 courses to choose from. Part of our job here at I. C. S. is making sure that you pick the course that's right for you!

Number Three Mistake? "Failed to seize opportunities."

Be sure to seize your opportunities. Be sure to fill out and mail the coupon below—today!

# INTERNATIONAL CORRESPONDENCE SCHOOLS



BOX 5675-K, SCRANTON 9, PENNA.

Without cost or obligation, please send me full particulars about the course BEFORE which I have marked X:

- |  |  |   |   |
|--|--|---|---|
| <p><b>Business and Academic Courses</b></p> <ul style="list-style-type: none"> <li><input type="checkbox"/> Accounting</li> <li><input type="checkbox"/> App. Psychology</li> <li><input type="checkbox"/> Business Administration</li> <li><input type="checkbox"/> Bus. Correspondence</li> <li><input type="checkbox"/> Certified Public Accounting</li> <li><input type="checkbox"/> Commercial</li> <li><input type="checkbox"/> Commercial Art</li> <li><input type="checkbox"/> Cost Accounting</li> <li><input type="checkbox"/> Federal Tax</li> <li><input type="checkbox"/> First Year College</li> <li><input type="checkbox"/> Foremanship</li> <li><input type="checkbox"/> Good English</li> <li><input type="checkbox"/> Higher Mathematics</li> <li><input type="checkbox"/> Industrial Supervision</li> <li><input type="checkbox"/> Motor Traffic</li> <li><input type="checkbox"/> Retailing</li> <li><input type="checkbox"/> Salesmanship</li> <li><input type="checkbox"/> Sign Lettering</li> <li><input type="checkbox"/> Spanish</li> <li><input type="checkbox"/> Air Conditioning and Plumbing Courses</li> <li><input type="checkbox"/> Air Conditioning</li> <li><input type="checkbox"/> Heating</li> <li><input type="checkbox"/> Refrigeration</li> </ul> | <p><b>Chemical Courses</b></p> <ul style="list-style-type: none"> <li><input type="checkbox"/> Chemical Engineering</li> <li><input type="checkbox"/> Chemistry, Analytical</li> <li><input type="checkbox"/> Chemistry, Industrial</li> <li><input type="checkbox"/> Chemistry, Mfg. Iron &amp; Steel</li> <li><input type="checkbox"/> Petroleum Refining</li> <li><input type="checkbox"/> Pulp and Paper Making</li> <li><input type="checkbox"/> Civil Engineering, Architectural and Mining Courses</li> <li><input type="checkbox"/> Architecture</li> <li><input type="checkbox"/> Building Estimating</li> <li><input type="checkbox"/> Civil Engineering</li> <li><input type="checkbox"/> Contracting and Building</li> <li><input type="checkbox"/> Highway Engineering</li> <li><input type="checkbox"/> Lumber Dealer</li> <li><input type="checkbox"/> Reading Structural Blueprints</li> <li><input type="checkbox"/> Sanitary Engineering</li> <li><input type="checkbox"/> Structural Drafting</li> <li><input type="checkbox"/> Structural Engineering</li> <li><input type="checkbox"/> Surveying and Mapping</li> <li><input type="checkbox"/> Communications Courses</li> <li><input type="checkbox"/> Electronics</li> <li><input type="checkbox"/> Prac. FM and Television</li> <li><input type="checkbox"/> Prac. Telephony</li> <li><input type="checkbox"/> Radio, General</li> <li><input type="checkbox"/> Telegraph Engineering</li> </ul> | <p><b>Electrical Courses</b></p> <ul style="list-style-type: none"> <li><input type="checkbox"/> Electrical Drafting</li> <li><input type="checkbox"/> Electrical Engineering</li> <li><input type="checkbox"/> Electric Light and Power</li> <li><input type="checkbox"/> Lighting Technician</li> <li><input type="checkbox"/> Practical Electrician</li> <li><input type="checkbox"/> Power House Electric</li> <li><input type="checkbox"/> Ship Electrician</li> <li><input type="checkbox"/> Internal Combustion Engines Courses</li> <li><input type="checkbox"/> Auto Technician</li> <li><input type="checkbox"/> Diesel-Electric</li> <li><input type="checkbox"/> Diesel Engines</li> <li><input type="checkbox"/> Mechanical Courses</li> <li><input type="checkbox"/> Aeronautical Engineer's, Jr.</li> <li><input type="checkbox"/> Aircraft Drafting</li> <li><input type="checkbox"/> Forging</li> <li><input type="checkbox"/> Heat Treatment of Metals</li> <li><input type="checkbox"/> Industrial Engineering</li> <li><input type="checkbox"/> Industrial Instrumentation</li> <li><input type="checkbox"/> Industrial Metallurgy</li> <li><input type="checkbox"/> Machine Shop</li> <li><input type="checkbox"/> Machine Shop Inspection</li> <li><input type="checkbox"/> Mechanical Drafting</li> <li><input type="checkbox"/> Mechanical Engineering</li> </ul> | <p><input type="checkbox"/> Mold-Loft Work</p> <p><input type="checkbox"/> Patternmaking—Wood, Metal</p> <p><input type="checkbox"/> Reading Shop Blueprints</p> <p><input type="checkbox"/> Sheet-Metal Drafting</p> <p><input type="checkbox"/> Sheet-Metal Worker</p> <p><input type="checkbox"/> Ship Drafting</p> <p><input type="checkbox"/> Ship Fitting</p> <p><input type="checkbox"/> Tool Designing</p> <p><input type="checkbox"/> Toolmaking</p> <p><input type="checkbox"/> Welding Engineering</p> <p><input type="checkbox"/> Welding—Gas and Electric</p> <p><b>Railroad Courses</b></p> <p><input type="checkbox"/> Air Brake</p> <p><input type="checkbox"/> Diesel Locomotive</p> <p><input type="checkbox"/> Locomotive Engineer</p> <p><input type="checkbox"/> Locomotive Fireman</p> <p><input type="checkbox"/> Locomotive Machinist</p> <p><input type="checkbox"/> Railroad Section Foreman</p> <p><input type="checkbox"/> Steam and Diesel Loco. Eng.</p> <p><b>Stationary Engineering Courses</b></p> <p><input type="checkbox"/> Boilermaking</p> <p><input type="checkbox"/> Combust. Engrg.</p> <p><input type="checkbox"/> Marine Engineering</p> <p><input type="checkbox"/> Power Plant Engr.</p> <p><b>Textile Courses</b></p> <p><input type="checkbox"/> Cotton Manufacturing</p> <p><input type="checkbox"/> Rayon Weaving</p> <p><input type="checkbox"/> Woolen Manufacturing</p> |
|--|--|---|---|

Name \_\_\_\_\_ Age \_\_\_\_\_ Home Address \_\_\_\_\_

City \_\_\_\_\_ State \_\_\_\_\_ Working Hours \_\_\_\_\_ A.M. to \_\_\_\_\_ P.M.

Present Position \_\_\_\_\_ Employed by \_\_\_\_\_

Length of Service in World War II \_\_\_\_\_ Enrollment under G.I. Bill approved for World War II Veterans. Special tuition rates to members of the Armed Forces.

Canadian residents send coupon to International Correspondence Schools Canadian, Ltd., Montreal, Canada.

## WHERE-TO-BUY-IT INDEX

Source of supply appears after items commercially available

### AUTOMOTIVE

Dash-controlled locks for car doors (Magicon Enterprises, 5417 Boyd Ave., Oakland, Calif.)	78
Midget sport car (Neidinger Motors, 7320 Stony Island Ave., Chicago)	88
Nylon tire tube	95
Indianapolis nopefuls (Cummins Engine Co., Columbus, Ind.)	99
Nash Rambler	105
1950 Crosley sports car (Crosley Motors, Inc., 2530 Spring Grove Ave., Cincinnati 14, Ohio)	108
British jet auto (Rover Motor Co., Ltd., Solihull Birmingham & Hay Hall Rd., Tyseley, Birmingham 11, England)	108
Wander wagon (Boyertown Auto Body Works, Inc., Boyertown, Pa.)	117
Spark plug has jet-firing action (Thomas Automotive Products Mfg. Co., 216 Seventh St., Rockford, Ill.)	122
Replaceable grille (Dodge Bros. Corp., 7900 Jos. Campau Ave., Detroit, Mich.)	131
Spark-plug tester (Champion Spark Plug Co., Toledo, Ohio)	134

### BICYCLES AND SCOOTERS

Shaft-driven motor scooter (Consolidated Trading Co., 16 Hudson St., New York City 13)	109
Bike rack (Johnson Mfg. Corp., Albion, Mich.)	123
Rubber straps on bike carrier bind gear of any shape (T. Albers Mfg. Co., 18007 Walnut St., Artesia, Calif.)	131
Bicycle on stilts	141

### FARM AND GARDEN

Power cart converts into garden roller (Waterbury Tool Division, Waterbury 91, Conn.)	79
Springs on trailer simplify loading (Kenneth Dibbern, c/o Mark Stephens Implement Co., Valparaiso, Ind.)	88
Seedlings without setback (Meko Co., 5537 Upton Ave., So. Minneapolis 10, Minn.)	98
Under-tractor mower (Toro Mfg. Corp., 3042 Snelling Ave., Minneapolis, Minn.)	109
Barnyard hay gun	113
Mechanical "gopher" bores channel to retain water (S & S Soil Saver, Waitsburg, Wash.)	155

### FISH AND FISHING

Fish population is tabulated scientifically	78
Individual bait packs (R-Jay Industries, Inc., 234 Portage Trail, Cuyahoga Falls, Ohio)	123
Testing tackle on mermaids	130
Waders with teeth (Wadgrip Mfg., Co., Hudson, N. Y.)	141

### HOBBIES AND MODELS

Model-airplane engine operates on CO <sub>2</sub> (Campus Industries, Inc., 1100 Adams Ave., Philadelphia 24, Pa.)	131
Caricatures in metal	142
Lilliputian fire department	144

### HOUSE AND HOME

Smokeless furnace (Wheeling Furnace Corp., 2nd and Jefferson Sts., Martins Ferry, Ohio)	102
Clamp-on tray for card table (Meredith Inc., 1020 Grey Ave., Evanston, Ill.)	106
Clip rack (S & S Industries, Inc., 598 Grand Concourse, New York City 51)	106
Dish drier (Electro-Mechanical Devices Co., 49 Selden Ave., Detroit 1, Mich.)	106
Gold decal (M. Swift & Sons, Inc., 10 Love Lane, Hartford 1, Conn.)	106
Automatic brake for window sash (Verb Mfg. Co., Inc., Box 550, Coffeyville, Kans.)	106
Drier for dishes or clothes (Thor Corp., Chicago 50)	107
Compact no-line clothesline (W. T. Dailey, 3133 W. Wisconsin Ave., Milwaukee 8, Wis.)	107
Smotherproof pillow protects infants (Mann Safety Pillow Co., Canterbury Suburb, Sydney, Australia)	130
Three-hour playhouse (Lennox Furnace Co., Marshalltown, Iowa)	135
Hollow floor tiles provide radiant heating (Clay Products Assoc., 100 N. La Salle St., Chicago 2)	157

### INDUSTRY

Track shoes for tractors (Electric Steel Foundry, 2141 N.W. 25th Ave., Portland 10, Ore.)	95
Skim milk makes "horsehair" fiber (Arthur D. Little, Inc., Memorial Drive, Cambridge 42, Mass.)	103
Ceiling of light	116
Dry Ice calms "hot headed" well	122
Ultrasonics clean metal	122
Tubing clamp (Unistrut Products Co., 1013 W. Washington Blvd., Chicago 7)	123
Five-million-volt generator	134
"Mighty Mouse"—a baby dozer (Mead Specialties Co., 4114 N. Knox Ave., Chicago 41)	145
Discarded railroad ties turned into paper sacks	155
Pin-ups for coal mines	156
Pilot model of bevatron	163
Generator has liquid brushes	164

### OFFICE, SHOP AND STORE

Miniature addressing machine (Heyer Corp., 1850 S. Kostner Ave., Chicago 23)	123
Electric eraser (Dremel Mfg. Co., 2409 18th St., Racine, Wis.)	124
Transcribed prescriptions	124

(Continued to page 12)

"FOR ME, MR. MURDOCK? JUST FOR TELLING YOU ABOUT MENNEN SKIN BRACER?"

Its He-Man Aroma  
WOWS the Ladies!

- Helps Heal Tiny Razor Nicks!
- Has a Refreshing, "Wake-Up" Tingle!

Large  
5-oz. Bottle  
49¢

Giant  
12-oz. Bottle  
98¢



**NEW  
LOW  
PRICE!**

Giant Tube Regularly ~~49¢~~

**NOW ONLY 43¢**



# WHAT Every AUTO MECHANIC Wants to Know

A motor vehicle is a machine of many parts, each part designed and constructed for its own special function. All good mechanics, like good doctors, should know the working theory and operation of each part and understand what causes trouble and how to remedy it.

## LET AUDELS AUTO GUIDE SOLVE YOUR PROBLEMS

Every auto mechanic, helper, serviceman and operator can use AUDELS AUTO GUIDE. The information it gives saves time, money and worry. Highly endorsed by all users. It presents the whole subject of auto mechanics from A to Z in plain language and simple terms.

This Big Practical Book gives full information with working diagrams covering the principles, construction, ignition, service and repair of modern cars, trucks and buses.

A complete Guide of 1800 pages, with over 1500 illustrations showing inside views of the working parts, with instructions for service jobs. Diesel engines, Fluid and Hydra-matic drives fully explained.

## IT PAYS TO KNOW HOW TO

How to fit pistons—How to locate engine knocks—How to fit connecting rod bearings—How to service main bearings—How to recondition valves—How to time valves—How to adjust fan belts—How to adjust carburetors & chokes—How to rebuild a clutch—How to service automatic transmissions—How to service brakes—How to adjust steering gear—How to cope with ignition troubles—How to service distributors—How to time ignition—How to "tune up" an engine.

## INFORMATION IN A HANDY FORM

73 INTERESTING CHAPTERS—Read this partial list of subjects on which practical information is fully given for quick reference under the headings as shown below. Ready Reference Index.

All Parts of an Automobile—Automotive Physics—The Gas Engine—Gas Engine Principles—Multi-Cylinder Engines—Horse Power—Automobile Engines—Stationary Parts—Moving Parts—Pistons—Piston Rings—Connecting Rods—Crank Shafts—Valves—Valve Gear—Cams and Cam Action—Valve Timing—Cooling Systems—Fuel Feed Systems—Dual Fuel Feed—Mixture—Carburetors—Carburetor Service—Automatic Choke—Super-Chargers—Transmissions—Special Transmissions—Fluid and Hydra-matic Drives—Clutches—Universals and Propeller Shafts

A Ready Reference

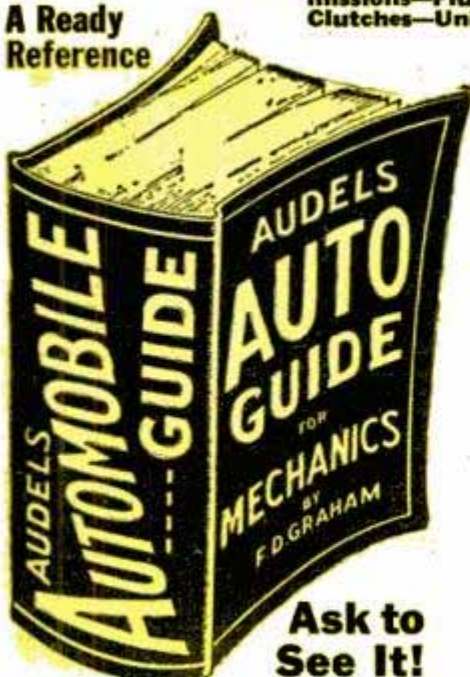

Ask to See It!

—The Differential—Rear Axles—Rear and Front Suspension—Running Gear—Brakes—Wheel Alignment—Knee Action—Steering Gear—Tires—Lubricants and Lubrication—Automotive Electricity—Ignition Systems—Magneto Ignition—Spark Plugs—Ignition Coils—Distributors—Automatic Spark Control—Ignition Timing—Generators—Starters—Generator and Starter Testing—Lighting Systems—Storage Batteries—Charging and Testing—Diesel Engines and Trouble Shooting.

**7 DAYS' FREE TRIAL**  
TO GET THIS ASSISTANCE FOR YOURSELF SIMPLY FILL IN AND MAIL COUPON TODAY.

**\$4 COMPLETE PAY \$1 A MONTH ONLY**



## Sent on 7 Days Approval

Step up your own skill with the facts and figures of your trade. Audels Mechanics Guides contain Practical Inside Trade Information in a handy form. Fully illustrated and Easy to Understand. Highly Endorsed. Check the book you want for 7 DAYS FREE EXAMINATION. Send No Money. Nothing to pay postman.

## ---CUT HERE--- MAIL ORDER

AUDEL, Publishers, 49 W. 23 St., NEW YORK 10, N. Y.

Please send me postpaid for FREE EXAMINATION books marked below. If I decide to keep them I agree to mail \$1 in 7 Days on each book or set ordered and further mail \$1 monthly on each book or set until I have paid price, otherwise I will return them.

- |                          |  |            |
|--------------------------|--|------------|
| <input type="checkbox"/> | <b>AUTO GUIDE</b> , 1800 Pages . . .                             | <b>\$4</b> |
| <input type="checkbox"/> | DIESEL ENGINE MANUAL, 400 Pages . . .                            | 2          |
| <input type="checkbox"/> | WELDERS GUIDE, 400 Pages . . .                                   | 1          |
| <input type="checkbox"/> | MACHINISTS Handy Book, 1600 Pages . . .                          | 4          |
| <input type="checkbox"/> | POWER PLANT ENGINEERS Guide, 1500 Pages . . .                    | 4          |
| <input type="checkbox"/> | ENGINEERS & FIREMANS EXAMS, 528 Pages . . .                      | 1          |
| <input type="checkbox"/> | PUMPS, Hydraulics & Air Compressors, 1658 Pgs. . .               | 4          |
| <input type="checkbox"/> | MARINE ENGINEERS Handy Book, 1280 Pages . . .                    | 4          |
| <input type="checkbox"/> | ENGINEERS & Mechanics Guides (8 Book Set) . . .                  | 12         |
| <input type="checkbox"/> | Answers on Practical ENGINEERING, 254 Pages . . .                | 1          |
| <input type="checkbox"/> | ELECTRIC WIRING DIAGRAMS, 210 Pages . . .                        | 1          |
| <input type="checkbox"/> | ELECTRICIANS EXAMINATIONS, 250 Pages . . .                       | 1          |
| <input type="checkbox"/> | ELECTRICAL DICTIONARY, 9000 Terms . . .                          | 2          |
| <input type="checkbox"/> | ELECTRIC MOTOR GUIDE, 1000 Pages . . .                           | 4          |
| <input type="checkbox"/> | HANDY BOOK OF ELECTRICITY, 1440 Pages . . .                      | 4          |
| <input type="checkbox"/> | ELECTRICAL POWER CALCULATIONS, 425 Pgs. . .                      | 2          |
| <input type="checkbox"/> | RADIOMANS GUIDE, 914 Pages . . .                                 | 4          |
| <input type="checkbox"/> | ELECTRONIC DEVICES, 216 Pages . . .                              | 2          |
| <input type="checkbox"/> | ELECTRIC LIBRARY, 7000 Pages (12 Book Set) . . .                 | 18         |
|                          | Vols. I, II, III, IV, V, VI, VII, VIII, IX, X, XI, XII *1.50 Ea. |            |
| <input type="checkbox"/> | OIL BURNER GUIDE, 384 Pages . . .                                | 1          |
| <input type="checkbox"/> | HOUSE HEATING GUIDE, 1000 Pages . . .                            | 4          |
| <input type="checkbox"/> | CARPENTERS & Builders Guides (4 Book Set) . . .                  | 6          |
| <input type="checkbox"/> | PLUMBERS & Steamfitters Guides (4 Book Set) . . .                | 6          |
| <input type="checkbox"/> | MASONS & Builders Guides (4 Book Set) . . .                      | 6          |
| <input type="checkbox"/> | BLUE PRINT READING, 416 Pages . . .                              | 2          |
| <input type="checkbox"/> | PAINTERS & DECORATORS MANUAL, 450 Pgs. . .                       | 2          |
| <input type="checkbox"/> | GARDENERS & GROWERS Guides (4 Book Set) . . .                    | 6          |
| <input type="checkbox"/> | REFRIGERATION & Air Conditioning, 1280 Pgs. . .                  | 4          |
| <input type="checkbox"/> | SHEET METAL WORKERS Handy Book, 388 Pgs. . .                     | 1          |
| <input type="checkbox"/> | SHEET METAL PATTERN LAYOUTS, 1100 Pgs. . .                       | 4          |
| <input type="checkbox"/> | AIRCRAFT WORKER, 240 Pages . . .                                 | 1          |
| <input type="checkbox"/> | MECHANICAL DRAWING GUIDE, 160 Pages . . .                        | 1          |
| <input type="checkbox"/> | MECHANICAL DRAWING & DESIGN, 480 Pgs. . .                        | 2          |
| <input type="checkbox"/> | MATHEMATICS & CALCULATIONS, 700 Pgs. . .                         | 2          |
| <input type="checkbox"/> | MECHANICAL Dictionary, 968 Pages . . .                           | 4          |
| <input type="checkbox"/> | MILLWRIGHTS & Mechanics Guide, 1200 Pgs. . .                     | 4          |

Name \_\_\_\_\_

Address \_\_\_\_\_

Occupation \_\_\_\_\_

Employed by \_\_\_\_\_

AUDEL, Publishers, 49 W. 23 St., New York 10, N. Y.

# One Step AHEAD!



with  
**EMBRY-RIDDLE**  
Training

## AIRCRAFT & ENGINE MECHANICS

An urgent need exists for properly trained A & E Mechanics throughout commercial aviation. Our C. A. A. approved school with a quarter-century of experience assures you the quickest advancement. Embry-Riddle students learn fast with modern equipment...working on live aircraft in airline-size hangars.

## AERONAUTICAL ENGINEERING

Embry-Riddle's 2-yr. Aeronautical Engineering Course provides training at the technical institute level. Engineers with management responsibility enjoy highest salaries!

## A & E COMBINED \* WITH COMMERCIAL

Airmen with dual pilot-engineering ability are needed by aviation companies and operators. Embry-Riddle combination training offers you the most in your aviation career. \*Not available to veterans, but combined courses may be taken consecutively with proper justification.

## COMMERCIAL PILOT

Embry-Riddle trained pilots benefit from our years of experience with 30,000 students...the best instructors, up-to-date aircraft, superb year-'round flying weather... qualifications unexcelled anywhere. Instrument and instructor's ratings also available.

Never has there been such opportunity for properly trained men in commercial aviation. Put yourself one step ahead of the crowd. Start your career now at Embry-Riddle -- dormitories directly on the airport. For full information fill in the coupon below and mail today!



**Embry Riddle**  
International  
SCHOOL OF AVIATION  
MIAMI 30, FLORIDA

Dean of Enrollments - Dept. 99  
Embry-Riddle School of Aviation  
Miami 30, Florida

Please Print  
NAME \_\_\_\_\_  
ADDRESS \_\_\_\_\_  
City \_\_\_\_\_  
State \_\_\_\_\_ Age \_\_\_\_\_

I am interested in...

A.&E. Mechanic  
 Commercial Pilot  
 Engineering  
 A.&E. Combined with Commercial Pilot \*  
 Flying Mechanic \*  
 Drafting & Design

Check One  Veteran  Non-Veteran

**TRAIN IN MIAMI--AIR CAPITAL OF THE WORLD**

(Continued from page 10)  
**OUTDOOR RECREATION**

Binoculars worn like glasses (Hadco Engineering & Mfg. Co., 2706 W. Belmont Ave., Chicago 18)..... 87  
Golf-ball dredge..... 103  
Mobile "water boy" (Behrens Mfg. Co., Inc., Box 541, Waukesha, Wis.)..... 121

**PHOTOGRAPHY**

Instant-release tripod attachment (A & L Mfg. Co., 1569 S. Crescent Heights Blvd., Los Angeles 35, Calif.)..... 95  
Compact copying camera (F. G. Ludwig, Assoc., Woodbridge, Conn.)..... 116  
Projector throws image on artist's drawing board (J. A. Engel, Inc., 624 Syndicate Bldg., Minneapolis 2, Minn.)..... 144  
Lensmen's lift..... 155

**TOOLS**

Floor-board remover (Decatur Steel Products, Box 28, Decatur, Ind.)..... 79  
Giant "can opener" (Michael A. Schinker Mfg. Co., 6514 S. Western Ave., Chicago 36)..... 98  
Tree hoist (The DoAll Co., Des Plaines, Ill.)..... 103  
Ultrasonic iron solders aluminum (Mullard Electronic Prod., Ltd., Press Dept., Century House, Shaftesbury Ave., London WC 2, England)..... 109  
Mechanic uses head to hold flashlight (Bruno Supply Co., 3021 N. Central Ave., Chicago 34)..... 122  
Rotary grip for tools (Indian Trails Industries, Oshkosh, Wis.)..... 124  
"Frameless" hacksaw (Ziskind Co., Inc., 49 W. 37th St., New York City 18)..... 124  
Quick change motor mount (The Vermont Woodworker Co., Bennington, Vt.)..... 164

**MISCELLANEOUS**

Cigarette won't shed ashes..... 87  
Plastic watch movement (Hamilton Watch Co., Lancaster, Pa.)..... 87  
Army-style umiak..... 88  
Trap lures flies half mile away (Wm. E. Brown, Cutler-Hammer, Inc., 204 Park Ave., Pewaukee, Wis.)..... 95  
X-ray microscope..... 98  
Caltech super greenhouse..... 100  
Underbelly radomes..... 102  
Mechanical "quizzmaster" (Instructional Film Research Program, Pennsylvania State College, State College, Pa.)..... 104  
Rustproof paint sprayed through flame (Edith R. Brill, 433 W. 34th, New York City 1)..... 113  
Rescue techniques for atomic war..... 113  
Hybrid pines save forests..... 121  
"Wing necks" increase capacity of bridge..... 121  
Atomic research establishes dates of ancient civilizations..... 124  
Static alarm guards against explosions during surgery (American Hospital Supply Corp., 2020 Ridge Ave., Evanston, Ill.) 130  
Actinium isolated in quantities (International Rare Metals Refinery, Inc., 630 5th Ave., New York City)..... 131  
Umbrella theater..... 132  
Ball-point pen refueling kit (Squeeze Ink Co., 422 Boyd St., Los Angeles 13, Calif.)..... 134  
Instrument records bird's flight time..... 141  
Automatic diabetes test..... 151  
Protein "factory"..... 151  
Alpine TV station will serve all Switzerland..... 155  
Berkeley cyclotrons do it again--another new element..... 157

## Craftsman and Shop Notes Index

**CAMPING, FISHING AND HUNTING**

Charcoal keeps game fresh..... 172  
Handy container for fishhooks..... 180  
Emergency matches for campers..... 183  
Brick impregnated with kerosene provides weatherproof campfire fuel..... 191  
Waterproof fishing-reel bags..... 200  
Candleholder for campers..... 200

**FARM**

Subsoil irrigator from scrap pipe..... 194  
Quick-acting latches hold barn-lot gates securely..... 195  
Quick-detachable long tongue fitted to tractor trailer..... 210  
Cheesecloth draped over wooden framework keeps food cool through water evaporation..... 211  
Combination creep feeder and sunshade protects calves on open range..... 211  
Straps polish tractor axles..... 217

**HOUSE AND HOME**

Checking refrigerator light switch..... 177  
Inexpensive moth-ball containers..... 178  
Wash-line reel from scrap lumber..... 178  
Temporary shirt rack..... 178  
Washers weight doilies..... 178  
Oil from nut meats hides scratches in furniture..... 179  
Spray bottle freshens potted plants..... 179  
Extra belts stored compactly..... 179  
Removing cork from inside of a bottle..... 179  
Keep bathtub shower spray from splitting..... 179  
Chalk aids in fitting wallboard around outlet boxes..... 179  
Disposal container hung from doorknob..... 179  
Labeling reduces spoilage of left-over food..... 179  
Chart speeds removing stains..... 179

(Continued to page 14)

# You Practice COMMUNICATIONS

I Send You Parts To Build This Equipment



As part of my new Communications Course I send you parts to build your own transmitter. Conduct actual procedure demanded of Broadcast Station Operators, make experiments, learn how to put a transmitter on the air.

**NEW**

# You Practice Radio SERVICING

On This Modern Radio You Build With Parts I Send

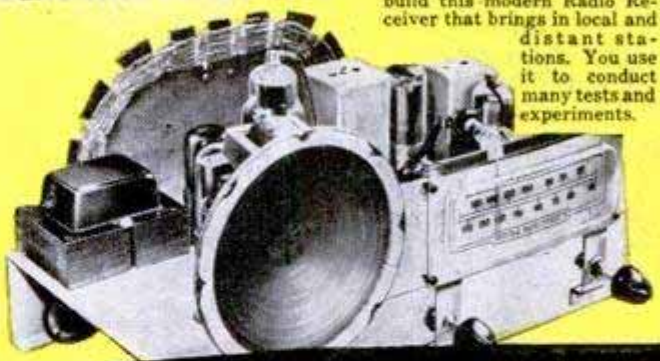

As part of my Servicing Course, I send you the speaker, tubes, chassis, transformer, loop antenna, EVERYTHING you need to build this modern Radio Receiver that brings in local and distant stations. You use it to conduct many tests and experiments.

# BE A RADIO-TELEVISION TECHNICIAN

Learn Servicing or Communications by Practicing in Spare Time with MANY KITS OF PARTS I Send

**YOU BUILD** this tester as part of my Servicing Course. It soon helps you earn \$5, \$10 and more a week EXTRA MONEY fixing neighbors' Radios in spare time while learning.



**YOU BUILD** this Power Pack as part of my new Communications Course. Use it to conduct fascinating experiments with frequency amplifiers, multipliers, buffer stages, etc.

**YOU BUILD** this Superheterodyne Receiver Circuit and conduct Frequency Modulation experiments and many other tests as part of my Servicing Course.



**YOU BUILD** this Signal Generator as part of my Servicing Course for more valuable experience. It provides amplitude-modulated signals for many interesting tests and experiments.



## VETERANS

GET THIS TRAINING UNDER G. I. BILL MAIL COUPON

**YOU BUILD** this Wavemeter as part of my new Communications Course. Use it with Oscillator you also build that furnishes basic power to transmitter and determines transmitter frequency.



J. E. SMITH, Pres. National Radio Institute

Do you want a good-pay job in the fast growing RADIO-TELEVISION Industry? Or do you want to have your own money-making Radio-Television Shop? Here is your opportunity. I've trained hundreds of men to be successful Technicians . . . MEN WITH NO PREVIOUS EXPERIENCE. My tested and proved train-at-home method makes learning easy. You learn Radio-Television principles from my illustrated lessons. You get practical experience building, testing and experimenting with parts I send. All equipment yours to keep.

### Make Extra Money in Spare Time

The day you enroll, I start sending you SPECIAL BOOKLETS that show you how to make \$5, \$10 a week or more EXTRA MONEY fixing neighbors' Radios in spare time while learning. From here, it's a short step to your own shop or a good-pay Radio-Television servicing job. Or be a licensed Radio-Television Operator or Technician. In 1945, there were 943 Radio Stations. Today about 2700 are on the air! RESULT—THOUSANDS OF QUALIFIED MEN STEPPED INTO GOOD JOBS. Another example—only 19 Television stations were on the air in 1947. Today, more than fifty. Within a few months, 150, say the experts—and 1000 within three years. Then add developments in FM, Two Way Radio, Police, Marine, Aviation, Microwave Relay Radio. Think what this means! New jobs, more jobs for qualified men.

### Mail Coupon For Books Free

Act now! Send for my FREE DOUBLE OFFER. Coupon entitles you to actual lesson, "GETTING ACQUAINTED WITH RECEIVER SERVICING." It shows how many pictures and diagrams are used to make learning at home easier, practical. You also get my 64-page book, "HOW TO BE A SUCCESS IN RADIO-TELEVISION." It tells more about YOUR opportunities . . . details of my Course . . . what my graduates are doing and earning . . . how quickly you can be on your way to good pay, success, a bright future. Send coupon in envelope or paste on penny postal. J. E. SMITH, President, Dept. OEP, National Radio Institute, Pioneer Home Study Radio School, Washington 9, D. C.

## I TRAINED THESE MEN AT HOME

"My first job was operator with KDLR, obtained for me by your Graduate Service Dept. Am now Chief Engineer, WQOX." —T. S. Norton, Hamilton, O.

"I received my 2nd Class Radiotelegraph License and worked on ships. Now with Station WEAN as control operator." —R. Arnold, Rumford, R. I.

"Today I am considered an expert Radio - Television Technician. Have 4 employees. Radio repair business has doubled." —P. G. Miller, Toledo, Ohio

"N. R. I. has been my stepping stone from a few hundred dollars a year as a Radio Engineer." —A. B. Michaels, Trenton, Georgia.

"Two months after starting, took a part-time job. Now working full time. Make \$200 a month plus commission on servicing." —L. McNiel, Rockdale, Texas.

"While learning, made \$5, \$10 a week in spare time. Now have spare-time shop at home and earn up to \$25 a week." —Leander Arnold, Pontiac, Michigan.

## Good for Both - FREE

MR. J. E. SMITH, President, Dept. OEP National Radio Institute, Washington 9, D. C.

Mail me Sample Lesson and 64-page Book about How to Win Success in Radio-Television —both FREE. (No Salesman will call. Please write plainly.)

Name..... Age.....

Address.....

City..... Zone..... State.....

Check if Veteran Approved for training under G. I. Bill



MAIL COUPON! FIND OUT ABOUT THIS TESTED WAY TO BETTER PAY

# NOW!

## BRIGGS SMOKES 3 WAYS BETTER\*



1. Stays lighted longer ... by 19%



2. Cleaner burning ::: by 16.4%



3. Less tar ... by 21.6%

So today ...

Put this  
in your  
pipe

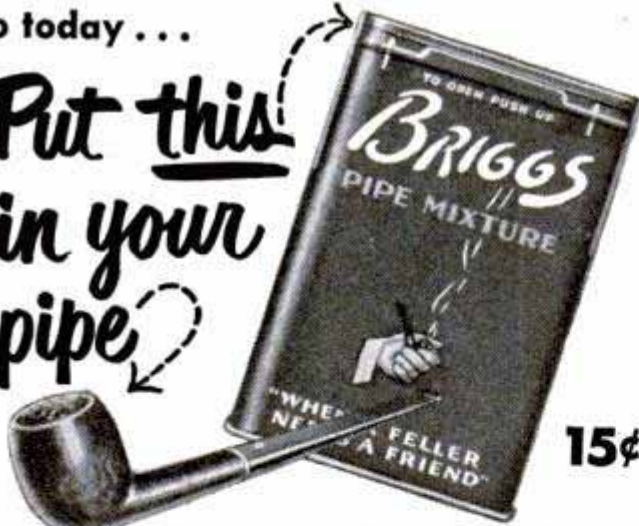

and smoke it!

\*Yes, our new process makes Briggs better by actual test! Better even than the swell-smoking Briggs that proved so fine and friendly in your pipe before. And remember this: when tobacco burns steady, free and clean, that's when you enjoy *all* the goodness of Briggs' fine tobacco, aged and mellowed in oaken casks. Today—try 3-ways-better Briggs!

Also available in Canada

(Continued from page 12)

Oil facilitates removing ice-cube trays.....	179
Cellulose tape restores broken plant stems.....	179
Soft-bristled brush cleans carved furniture.....	179
Cleaning white-head jewelry.....	180
Baby's clothes dried indoors by hanging on playpen.....	194

### LAWN AND GARDEN

Method of coiling garden hose eliminates twisting.....	171
Removable hopper for seeder converts it to yard cart.....	172
Bird cafe.....	173
Poultry wire protects bulbs.....	190
Tips for the home gardener.....	193
Rotary hedge trimmer.....	209

### OUTDOOR RECREATION

Compact bottle warmer made from fruit-juice cans.....	177
Portable stove cooks picnic lunch.....	180
Bar-B-Q chuck wagon.....	181
Cork fishing floats on croquet wickets increase visibility.....	183
Water frozen in milk cartons cools picnic lunch box.....	191
Shells from old auto headlights provide mooring buoy.....	192

### PHOTOGRAPHY

C-clamps exert pressure on plywood panels to form press for flat-drying large prints.....	206
Photo paper and coin tell whether or not safelight causes fogged prints.....	206
Abrasive disk mounted at end of flash-gun case cleans bulb contacts.....	206
Reflector forms portable safelight.....	206
Gun-sight finder for fast-action movies.....	207
Signature printed on greeting card.....	208
Solutions stored in medicine bottles are dispensed with eye droppers.....	208
Sunglasses substitute for filter.....	208
Lighting prints from underside indicates trim line.....	208

### SEWING

Hatpin holds thread for tatting or crocheting.....	178
Empty egg carton stores thread and mending cotton.....	179
Ice-cube tray holds thread spools.....	192

### TOOLS

Grommet cushions drill chuck.....	172
Wooden handle drives screw eyes.....	172
Tenoning jig for small bench saw slides on ripping fence.....	191
Bending "brake" for sheet metal handles large work.....	194
Socket wrench forms nut driver.....	200
Lever and clamp on hand drill permit boring steel beams.....	205
Hardboard paint shield for lathe headstock.....	217
Preventing rust in waterpots.....	217

### TOYS AND NOVELTIES

Novel gate utilizes scrap parts.....	183
Bells sewed to child's play suit form novel buttons.....	192
Seesaw toy is supported by clown cutouts.....	201
Inexpensive wastebaskets decorated attractively by covering with colored leatherette or oilcloth.....	205

### MISCELLANEOUS

Cellulose tape seals screen holes.....	171
Feather forms substitute brush for drawing fine lines.....	171
Dolls stored in plastic hatbox.....	172
Acetone does thorough job of cleaning varnish remover from surface.....	176
Portable box dispenses admission tickets.....	177
Furniture webbing drawn taut with locking pliers.....	180
Lamb's-wool paint roller spun on portable drill for quick cleaning.....	182
Paste brush hung from pail rim by knob fastened to side.....	183
Toothpick prevents spilling fluid when filling cigarette lighter.....	183
Locating center of wood turning.....	192
Nails supported for starting by pressing in clay or putty.....	192
Gooseneck provides pin-up lamp.....	194
Celluloid jackets protect books.....	194
Coiling wire solder makes it more convenient to use.....	195
Twine facilitates hanging picture.....	200
Cardboard box taped to wall catches plaster chips.....	200
Sponge-rubber feet placed under television set absorb traffic vibration.....	201
Centering inner tube in tire casing helps to reduce possibility of blowout.....	204
Container for pipe compound improvised from oilcan.....	210
Straight-line connections dampen pump hammer.....	217

## Radio-Television, Electronics

Electronics today (Electronic narrator and germanium diode crystals, General Electric Co., Electronics Park, Syracuse, N. Y.; TV front-end tuning assembly, Standard Coil Products Co., 2311 N. Pulaski Rd., Chicago 39; wire recorder for dictation, Webster-Chicago Corp., 5610 Bloomingdale Ave., Chicago 39).....	221
Capacity-operated electronic switch.....	222
Home-set service hints.....	224

**IMPORTANT NOTICE**—It is the intention of this magazine to provide its readers with information regarding the latest developments in the mechanical arts. We take no responsibility as to whether the disclosures contained in our articles are covered by patents and advise readers to investigate this subject before making, using, or selling any of the products, machines, or processes described in order to avoid possible liability for patent infringements.



# INVENTORS

Learn how to protect your invention. The U. S. Patent Laws provide that any new and useful art, machine, article of manufacture, or composition of matter, or any new and useful improvement thereof, may be patented if the act of invention is involved. Therefore, every inventor with a valuable invention should take advantage of the Patent Laws and proceed for patent protection in order to safeguard his rights.

A patent gives the inventor the exclusive right to prevent others from making, using, or selling the invention claimed in the patent for a period of seventeen years.

The Patent Laws were enacted for the benefit of the inventor to give him protection for the features of his invention which are patentable. These features must be properly and concisely set forth and claimed in a formal application for patent, in order to comply with the requirements of the Patent Laws. For that reason, unless the inventor is familiar with patent matters, he should engage a competent registered patent attorney or agent to represent him. We are registered to practice before the U. S. Patent Office and are prepared to serve you in the handling of your patent matters.

A specially prepared booklet entitled "Patent Guide for the Inventor", containing detailed information with respect to patent protection and procedure, together with a "Record of Invention" form will be promptly forwarded to you without obligation upon request.

---

**CLARENCE A. O'BRIEN & HARVEY JACOBSON**

*Registered Patent Attorneys*

**01-E DISTRICT NATIONAL BUILDING**

**WASHINGTON 5, D. C.**

**AUTOMOTIVE MECHANICS**

**BODY-FENDER REBUILDING**

**DIESEL MECHANICS**

**BUILDING CONSTRUCTION**

# How to qualify for a **KEY JOB**

It takes more than luck to land a key job. Employers are careful to entrust jobs with responsibility only to *men who have technical skill and knowledge*. They pay well for know-how, and offer security and standing to those who qualify.

Prepare yourself for rapid advancement by training now through famous C.T.I. You can learn a leading trade either at home, in your spare time, or in the big C.T.I. residential school in Chicago. But you must act fast! Opportunities were never greater than they are today. Determine to begin your training soon. *Your first step is to fill out and mail the coupon today.* We'll show you how to convert your "dream job" into a real job.

## **C. T. I. Training unlocks the door to Big Pay and Independence...**

If you want *proof* that C.T.I. training adds plenty of extra dollars to pay-checks, just read these typical comments from a few of our graduates: "I cannot thank you enough for the training I received. *I have had three raises in pay within eight months.*" . . . "Before going to C.T.I., I averaged \$45 to \$50 a week. *Today I average \$75 to \$125 a week.* C.T.I. sure helped my income and brought security!" . . . "If I had not taken a course at C.T.I., *I never would have had a business of my own—or even a job.*" . . . "Even before I completed my C.T.I. home study course, *I was promoted to plant foreman.* Since then I've had three raises."

Yes, it's costing you money to delay training! If you are mechanically inclined—if you are ambitious — if you want to be somebody — *mail this coupon now!*—

**ELECTRICITY & ELECTRONICS**

**REFRIGERATION**

**RADIO & TELEVISION**

**MECHANICAL DRAFTING**

### **FILL OUT - CUT OUT - MAIL TODAY**

Mr. R. C. Anderson, President  
COMMERCIAL TRADES INSTITUTE, Dept. E2-5  
1400 Greenleaf Ave., Chicago 26

Veteran  
 Non-Veteran

Send free illustrated Brochures and other information about the field I have checked below:

- |   |  |
|---|--|
| <input type="checkbox"/> Automotive Mechanics             | <input type="checkbox"/> Electricity & Electronics |
| <input type="checkbox"/> Body & Fender Rebuilding         | <input type="checkbox"/> Radio & Television        |
| <input type="checkbox"/> Diesel Mechanics                 | <input type="checkbox"/> Building Construction     |
| <input type="checkbox"/> Refrigeration & Air Conditioning | <input type="checkbox"/> Mechanical Drafting       |

Name \_\_\_\_\_ Age \_\_\_\_\_

Address \_\_\_\_\_

City \_\_\_\_\_ State \_\_\_\_\_

### **C.T.I. TRAINING IS G.I. APPROVED**

All C.T.I. courses, both residential and home study, are fully approved by the Veterans Administration—which means that eligible veterans will have their tuition paid by the government.



R. C. Anderson  
President

**COMMERCIAL TRADES INSTITUTE, Dept. E2-5**

1400 Greenleaf • Chicago 26



# INVENTORS

If you believe that you have an invention, you should find out how to protect it. The first step is to have a search made of the prior pertinent U. S. patents. If a report on this search indicates that the invention appears patentable you can apply for a patent, and the specifications and claims should be prepared.

The firm of McMorrow, Berman & Davidson, with offices in Washington, D. C., is qualified to take the necessary steps for you. We can make a preliminary search on your invention, advise you whether we think it can be patented, and prepare your application for patent.

Unless you are fully familiar with the U. S. Patent Laws, we recommend that you engage the services of a Registered Patent Attorney to protect your interests. The patent laws are *your* laws. A patent gives you the right to prevent others from making, using or selling the invention claimed in your patent for a period of 17 years.

Use these patent laws for your protection. Investigate whether your invention can be patented. If you have what you believe to be an invention, we suggest that you have this firm make a search for you.

*Send for a copy of our Patent Booklet entitled "How To Protect Your Invention," containing information about patent protection and patent procedure. Along with this we will also send you an "Invention Record" form, for your use in writing down and sketching details of your invention. We will mail them promptly. No obligation. They are yours for the asking.*

**McMORROW, BERMAN & DAVIDSON**

*Registered Patent Attorneys*

**PATENTS • COPYRIGHTS • PATENTS**

**135-C VICTOR BUILDING, WASHINGTON 1, D. C.**

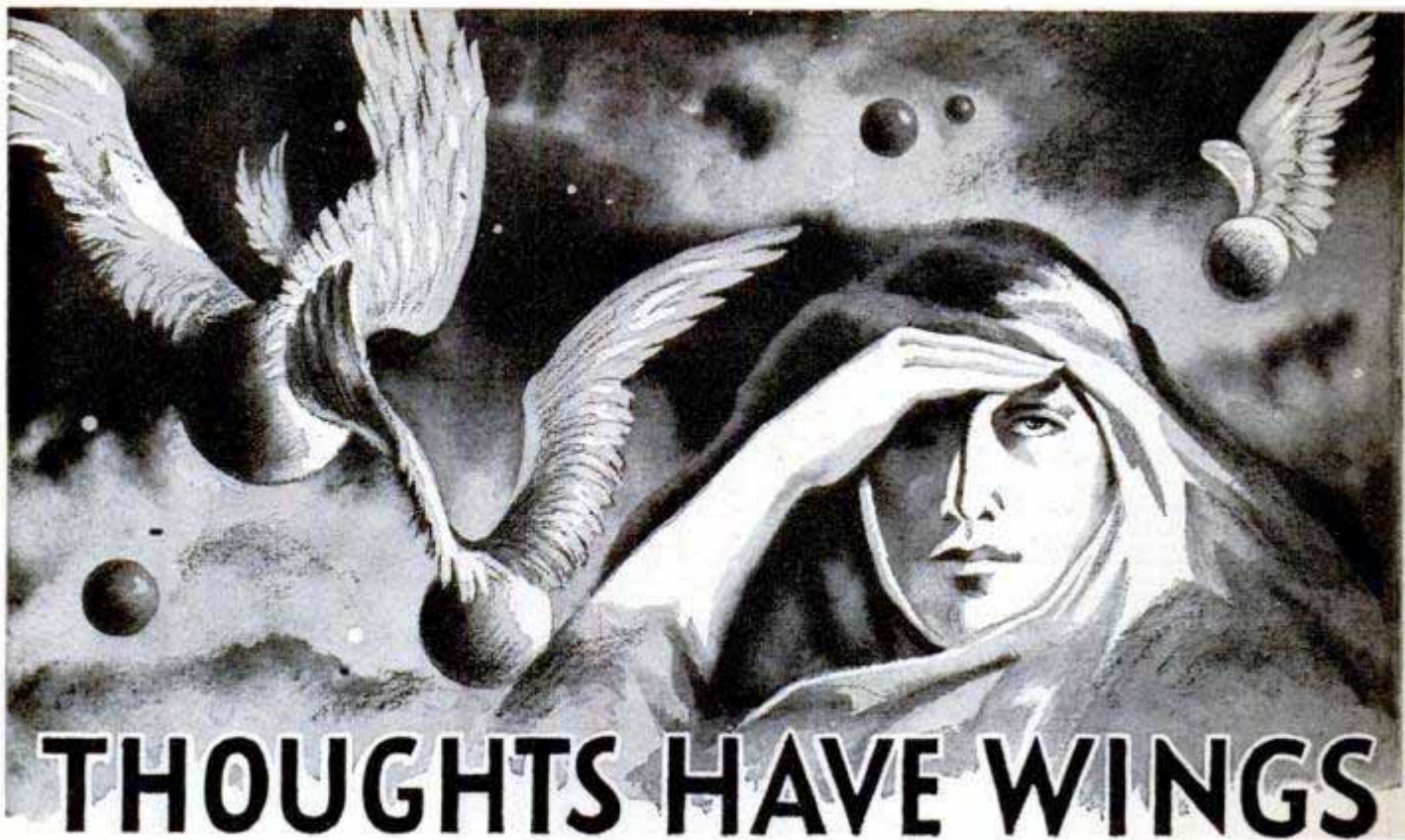

# THOUGHTS HAVE WINGS

*You Can Influence Others*  
**With Your Thinking!**

**TRY IT SOME TIME.** Concentrate intently upon another person seated in a room with you, without his noticing it. Observe him gradually become restless and finally turn and look in your direction. Simple—yet it is a *positive demonstration* that thought generates a mental energy which can be projected from your mind to the consciousness of another. Do you realize how much of your success and happiness in life depend upon your influencing others? Is it not important to you to have others understand your point of view—to be receptive to your proposals?

## Demonstrable Facts

How many times have you wished there were some way you could impress another favorably—*get across to him or her your ideas*? That thoughts can be transmitted, received, and understood by others is now scientifically demonstrable. The tales of miraculous accomplishments of mind by the ancients are now known to be fact—not fable. The method whereby these things can be *intentionally*, not accidentally, accomplished has been a secret long cherished by the Rosicrucians—one of the schools of ancient wisdom existing throughout the world. To thousands everywhere, for centuries, the Rosicrucians have

privately taught this nearly-lost art of the practical use of mind power.

## This Free Book Points Out the Way

The Rosicrucians (not a religious organization) invite you to explore the powers of your mind. Their sensible, simple suggestions have caused intelligent men and women to soar to new heights of accomplishment. *They will show you how to use your natural forces and talents to do things you now think are beyond your ability. Use the coupon below and send for a copy of the fascinating sealed free book, "The Mastery of Life," which explains how you may receive this unique wisdom and benefit by its application to your daily affairs.*

## The ROSICRUCIANS (AMORC)

Scribe R. L. J., The Rosicrucians, AMORC,  
 Rosicrucian Park, San Jose, California.

Kindly send me a free copy of the book, "The Mastery of Life." I am interested in learning how I may receive instructions about the full use of my natural powers.

Name.....

Address.....State.....

# I. C. S. STUDENT JUDGED BEST APPRENTICE IN THE NATION



**Ex-G.I. Took Course in  
Electrical Engineering**

I. C. S. Training proves its worth. Recently, Robert M. Hutchison of Evansville, Ind., was picked as "the best electrical apprentice in the nation." He had studied Electrical Engineering with the International Correspondence Schools.

The award was made by the National Electrical Contractors Association. Hundreds of apprentices from every section of the country figured in the competition.

The same training that brought "Bob" Hutchison national recognition is available

**"Here's why I consider I. C. S. Courses exceptional:**

- 1 I. C. S. texts are easy to understand; explanations are very clear.
- 2 The student determines his own progress; gets a real sense of achievement.
- 3 Textbooks and lesson material make a valuable set of reference books."

**ROBERT M. HUTCHISON**

to you. If you want the security and rewards that come with sound, practical training, mark and mail the coupon *today*. Find out what I. C. S. can do for you.

## INTERNATIONAL CORRESPONDENCE SCHOOLS



BOX 5676-K, SCRANTON 9, PENNA.

Without cost or obligation, please send me full particulars about the course BEFORE which I have marked X:

- |   |   |   |  |
|---|---|---|--|
| <p><b>Air Conditioning and Plumbing Courses</b></p> <input type="checkbox"/> Air Conditioning<br><input type="checkbox"/> Heating<br><input type="checkbox"/> Refrigeration<br><input type="checkbox"/> Plumbing<br><input type="checkbox"/> Steam Fitting <p><b>Chemical Courses</b></p> <input type="checkbox"/> Chemical Engineering<br><input type="checkbox"/> Chemistry, Analytical<br><input type="checkbox"/> Chemistry, Industrial<br><input type="checkbox"/> Chemistry, Mfg. Iron & Steel<br><input type="checkbox"/> Petroleum Refining<br><input type="checkbox"/> Pulp and Paper Making<br><input type="checkbox"/> Plastics <p><b>Civil Engineering, Architectural and Mining Courses</b></p> <input type="checkbox"/> Architecture<br><input type="checkbox"/> Architectural Drafting<br><input type="checkbox"/> Bridge and Building Foreman<br><input type="checkbox"/> Building Estimating<br><input type="checkbox"/> Civil Engineering<br><input type="checkbox"/> Coal Mining<br><input type="checkbox"/> Contracting and Building<br><input type="checkbox"/> Highway Engineering<br><input type="checkbox"/> Lumber Dealer<br><input type="checkbox"/> Reading Structural Blueprints<br><input type="checkbox"/> Sanitary Engineering<br><input type="checkbox"/> Structural Drafting | <p><input type="checkbox"/> Structural Engineering<br/> <input type="checkbox"/> Surveying and Mapping</p> <p><b>Communications Courses</b></p> <input type="checkbox"/> Electronics<br><input type="checkbox"/> Practical Telephony<br><input type="checkbox"/> Radio, General<br><input type="checkbox"/> Radio Servicing<br><input type="checkbox"/> Radio Operating<br><input type="checkbox"/> Radio Engineering<br><input type="checkbox"/> Television<br><input type="checkbox"/> Telegraph Engineering <p><b>Electrical Courses</b></p> <input type="checkbox"/> Electrical Drafting<br><input type="checkbox"/> Electrical Engineering<br><input type="checkbox"/> Electric Light and Power<br><input type="checkbox"/> Lighting Technician<br><input type="checkbox"/> Practical Electrician <p><b>Internal Combustion Engines Courses</b></p> <input type="checkbox"/> Auto Technician<br><input type="checkbox"/> Diesel-Electric<br><input type="checkbox"/> Diesel Engines<br><input type="checkbox"/> Gas Engines<br><input type="checkbox"/> Aviation <p><b>Mechanical Courses</b></p> <input type="checkbox"/> Aeronautical Engineer's, Jr.<br><input type="checkbox"/> Aircraft Drafting<br><input type="checkbox"/> Forging<br><input type="checkbox"/> Heat Treatment of Metals<br><input type="checkbox"/> Industrial Engineering<br><input type="checkbox"/> Industrial Instrumentation | <p><input type="checkbox"/> Industrial Metallurgy<br/> <input type="checkbox"/> Machine Shop<br/> <input type="checkbox"/> Mechanical Engineering<br/> <input type="checkbox"/> Mold-Loft Work<br/> <input type="checkbox"/> Patternmaking--Wood, Metal<br/> <input type="checkbox"/> Reading Shop Blueprints<br/> <input type="checkbox"/> Sheet-Metal Drafting<br/> <input type="checkbox"/> Sheet-Metal Worker<br/> <input type="checkbox"/> Ship Drafting<br/> <input type="checkbox"/> Tool Designing<br/> <input type="checkbox"/> Welding Engineering<br/> <input type="checkbox"/> Welding--Gas and Electric</p> <p><b>Railroad Courses</b></p> <input type="checkbox"/> Air Brake<br><input type="checkbox"/> Diesel Locomotive<br><input type="checkbox"/> Locomotive Engineer<br><input type="checkbox"/> Locomotive Fireman<br><input type="checkbox"/> Locomotive Machinist<br><input type="checkbox"/> Railroad Section Foreman<br><input type="checkbox"/> Steam-Diesel Loco. Eng. <p><b>Stationary Eng'r's Courses</b></p> <input type="checkbox"/> Boilermaking<br><input type="checkbox"/> Combustion Engineering<br><input type="checkbox"/> Engine Running<br><input type="checkbox"/> Marine Engineering<br><input type="checkbox"/> Power Plant Eng'r's | <p><input type="checkbox"/> Mech. Drafting<br/> <input type="checkbox"/> Cotton Manufacturing<br/> <input type="checkbox"/> Loom Fixing<br/> <input type="checkbox"/> Textile Designing<br/> <input type="checkbox"/> Woolen Manufacturing</p> <p><b>Business and Academic Courses</b></p> <input type="checkbox"/> Accounting<br><input type="checkbox"/> App. Psychology<br><input type="checkbox"/> Business Administration<br><input type="checkbox"/> Bus. Correspondence<br><input type="checkbox"/> Certified Public Accounting<br><input type="checkbox"/> Commercial<br><input type="checkbox"/> Cost Accounting<br><input type="checkbox"/> Federal Tax<br><input type="checkbox"/> Foremanship<br><input type="checkbox"/> Good English<br><input type="checkbox"/> Higher Mathematics<br><input type="checkbox"/> Industrial Supervision<br><input type="checkbox"/> Motor Traffic<br><input type="checkbox"/> Retailing<br><input type="checkbox"/> Salesmanship<br><input type="checkbox"/> Sign Lettering<br><input type="checkbox"/> Spanish<br><input type="checkbox"/> Traffic Management <p><input type="checkbox"/> Rayon Weaving<br/> <input type="checkbox"/> Bookkeeping<br/> <input type="checkbox"/> Bus. Law<br/> <input type="checkbox"/> Commercial Art<br/> <input type="checkbox"/> First Year College<br/> <input type="checkbox"/> French<br/> <input type="checkbox"/> High School<br/> <input type="checkbox"/> Illustration<br/> <input type="checkbox"/> Postal Civil Service<br/> <input type="checkbox"/> Retail Bus. Management<br/> <input type="checkbox"/> Secretarial<br/> <input type="checkbox"/> Stenography</p> |
|---|---|---|--|

Name \_\_\_\_\_ Age \_\_\_\_\_ Home Address \_\_\_\_\_

City \_\_\_\_\_ State \_\_\_\_\_ Working Hours \_\_\_\_\_ A.M. to \_\_\_\_\_ P.M.

Present Position \_\_\_\_\_ Employed by \_\_\_\_\_

Length of Service in World War II \_\_\_\_\_ Enrollment under G.I. Bill approved for World War II Veterans. Special tuition rates to members of the Armed Forces. Canadian residents send coupon to International Correspondence Schools Canadian, Ltd., Montreal, Canada.

# INVENTORS

If you consider your invention to be something of importance — if you have invented any new and useful art, machine, manufacture or composition of matter or improvement thereof — you are advised to protect your invention by applying for a U. S. patent.

This firm is registered to practice before the U. S. Patent Office and is available to assist in the preparation and prosecution of your patent application.

The "Evidence of Invention" form mentioned below is offered as a convenience to you in making your disclosure to us for search purposes.

You should date and sign your disclosure and have it witnessed by two or more persons who are capable of understanding your invention.

Your disclosure should be mailed to us together with a letter authorizing us to conduct a preliminary search among previously granted U. S. patents for similar types of invention.

We then make this search and prepare a report of the probable patentability of your invention. If such report is favorable, we recommend the further course for you to take.

The "Evidence of Invention" form and booklet are suggested as conveniences to you and us in starting action on your invention.

**VICTOR J. EVANS & Co.** *Merlin M. Evans*  
REGISTERED PATENT ATTORNEY

530-E MERLIN BUILDING, WASHINGTON 6, D. C.

PATENTS

COPYRIGHTS

We shall be glad to send you promptly and without obligation, an instructive booklet, "Patent Protection for Inventors", which was prepared to give inventors detailed information and steps to take toward patent protection—also our convenient "Evidence of Invention" form. Use address Victor J. Evans & Co., 530-E Merlin Building, Washington 6, D. C.

# Command Bigger Money! STUDY LAW

STUDY AT HOME for BUSINESS SUCCESS and LARGER PERSONAL EARNINGS. 40 years expert instruction — over 114,000 students enrolled. LL.B. Degree awarded. All text material furnished. Easy payment plan. Send now for FREE BOOK — "Law and Executive Guidance." It explains the course — how you may enroll and the many ways you can profit from Law Study. Write TODAY to:

AMERICAN EXTENSION SCHOOL OF LAW  
Dept. 26-PM, 646 N. Michigan Ave., Chicago 11, Ill.

## Be an INVESTIGATOR

JAMES S. BOLAN, FORMER POLICE COMMISSIONER OF NEW YORK CITY offers MEN & WOMEN an attractive opportunity to prepare for a future in *Investigation & Criminology* by comprehensive Home Study Course. Free placement service assists graduates to obtain jobs. APPROVED UNDER G. I. BILL OF RIGHTS. Write for Free Booklet PM.

THE **BOLAN ACADEMY**, INC.  
EMPIRE STATE BLDG., NEW YORK 1, N. Y.

### WHAM-O SPORTSMAN

HITS LIKE A .22 RIFLE — KILLS RABBITS, SQUIRRELS. For Hunting, Target, Routing Pests.

\$1.00 postpaid



### HUNTING SLINGSHOT

Powerful, silent, accurate. Complete with 40 pellets and extra rubber straps. Send \$1.00 today to — Wham-O Mfg. Co., Box 2P, South Pasadena, Calif. PROFESSIONAL MODEL OF THE NAT'L SLINGSHOT ASSN.

At Dealers or Send Direct

HEAVY DUTY STOCK

## NEW! LOW COST! RESPIRATOR

Wear when sanding, grinding, paint spraying, sweeping, dusting, furnace cleaning, etc. Handy as a pair of glasses. Just keep mouth closed and breathe through nose is all you do to operate. Protects against nuisance dusts, lint, coal, cement, grain dust, hay fever pollen. Has 9 sq. in. filter. For EYE protection against paint spray, dusts, gases, fumes, smoke, order our Fog-Proof Rubber GOGGLES \$1.65 p.p. (All prices postpaid in U.S.A.)

JERRY BRYANT, Dept. PM  
919 N. Michigan Ave. Chicago 11, Ill.



## YOU CAN SUCCEED BY KLOK TRAINING

There is no other practical training in the wood industry whereby you can succeed so quickly as through our training. You can study either at home by correspondence or come to Grand Rapids and study with us here. The KLOK Course teaches you *Sketching—Drafting—Rod Making—Time Study—Cost and Production Scheduling*. The training will enable you to run your own shop more successfully or enable you to get a top position in the furniture and woodworking industry. Write NOW for free booklet, "Stepping Stones to Top Positions in the Woodworking Industry." State preference—Home Study or Resident Training—Age, and if you are a Veteran.

AVAILABLE TO VETERANS UNDER G. I. BILL



### KLOK INSTITUTE

Louis St., N. W., Grand Rapids, Michigan

LEARN

# ELECTRICITY

ON REAL EQUIPMENT

IN THE GREAT SHOPS OF **COYNE**



ALSO TRAINING IN  
**RADIO-TELEVISION**

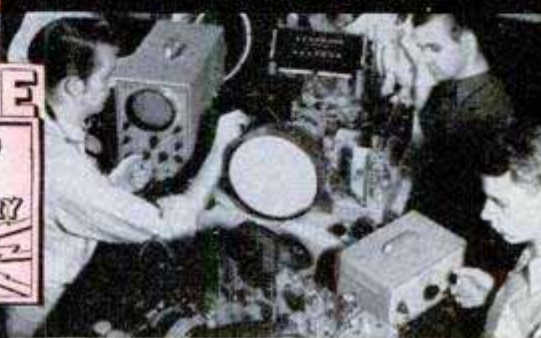

## Get into the OPPORTUNITY FIELD OF ELECTRICITY

For many years Electricity has been a most vital factor in industry. This great field will continue to grow and become more important. Thousands of trained Electrical men will be needed. Why be satisfied with a "no future" job? Prepare for a good job with a real future in Electricity.

### Coyne Trained Men in Good Jobs

Thousands of Coyne trained men in good jobs or in a business of their own in Electricity and Radio-Television, make real money while others putter along. Yes, you can get ready for Good Pay—a Big Future—by training at COYNE here in Chicago. Here you work on real equipment—do actual wiring and trouble-shooting—get the practical-technical training you need.

#### Not "Home-Study"

We do not teach by mail. All training is given in our Great Training Shops in Chicago, plus necessary theory. Expert instructors guide you. No advanced education or previous experience needed.

#### GI Approved — Finance Plan for Non-Vets

COYNE courses are approved under the G.I. Bill. Non-veterans may enroll now, pay most of tuition after graduation. If you need part-time work to help out with living expenses while at Coyne, we'll help you get it.



**1** You are TOLD the how and why of each job.



**2** You're shown how to do typical jobs by trained instructors.



**3** You DO practical job YOURSELF on equipment.

### NEW OPPORTUNITY FIELD

The fast-growing field of Television—the new development in the Radio field offers unlimited opportunities today. Coyne offers a separate course in Radio-Television, Installation, Testing, Trouble-Shooting and Service on Radio, F.M., and Television equipment. Get big free book today.

### Mail Coupon for Big FREE BOOK

Whether you prefer Electricity, or Radio-Television, train on actual equipment, at Coyne. We have a big, fully illustrated book on each course, and we'll send you the one you want, or both, without obligation. Mail coupon—TODAY.

**B. W. Cooke, President  
COYNE ELECTRICAL & RADIO-TELEVISION SCHOOL, 500 S. Paulina St., Chicago 12, Ill. Dept. 50-72H**



**B. W. COOKE, President  
COYNE ELECTRICAL & RADIO-TELEVISION SCHOOL  
500 S. Paulina St., Chicago 12  
Dept. 50-72H**

Send FREE, the book checked below, and details of your training offer. This does not obligate me and no salesman will call.

ELECTRICITY     RADIO-TELEVISION

NAME.....

ADDRESS.....

CITY.....STATE.....

# BE A CLERK all my life? NOT ME!!



Of course you say you won't. But you may be unless you do something about it.

Hoping and wishing won't get you a better job and more money.

You must prepare for that step ahead—be ready to make promotion come.

We have helped thousands of ambitious men and women get ahead in the business world—perhaps we can help you.

At least you should investigate. It may be the turning point in your life to a better job and more money. So send the coupon without delay. Check the field of your choice and we'll send you without obligation the requirements and opportunities in that field—plus "Ten Years' Promotion in One"—a book which has helped many men.

## LASALLE Extension University A Correspondence Institution

417 S. Dearborn St., Dept. 564-R, Chicago 5, Ill.

I want to know whether you can help me get ahead in the field I have checked below. Send free 48-page booklet and full information about your home-study training—plus "Ten Years' Promotion in One."

- |  |  |
|--|--|
| <input type="checkbox"/> Higher Accountancy  | <input type="checkbox"/> Salesmanship          |
| <input type="checkbox"/> C.P.A. Coaching     | <input type="checkbox"/> Traffic Management    |
| <input type="checkbox"/> Bookkeeping         | <input type="checkbox"/> Foremanship           |
| <input type="checkbox"/> Law: LL.B. Degree   | <input type="checkbox"/> Industrial Management |
| <input type="checkbox"/> Business Management | <input type="checkbox"/> Stenotypy             |
|  | (Machine Shorthand)                            |

Name..... Age.....

Address.....

City..... Zone..... State.....

## ENGINEERING DEGREE IN 27 MONTHS

### Big Demand for Graduates

**Aeronautical, Chemical, Civil, Electrical, Mechanical and Radio Engineering (including Television)**

Hundreds of young men are earning engineering degrees in this recognized institution each year—continuous operation. New terms start quarterly. Many students earn a major part of their college expenses in this large industrial center.

Low tuition. Competent instruction. Thorough intense practical program. Modern laboratory facilities including new physics lab. and modernized wind tunnel. Individualized instruction emphasized.

Approved for Veterans. Engineering preparatory courses. Students from 48 states and 21 foreign countries. Enter June, September, December or March. Send coupon for free catalog and full information. Enroll now.

SEND COUPON TODAY

## INDIANA TECHNICAL COLLEGE

550 E. Washington Boulevard  
Fort Wayne 2, Indiana

Please send me free information on B.S. Engineering Degree in 27 months as checked.

- Aeronautical,  Chemical,  Civil,  Electrical,  
 Mechanical,  Radio-Television.

Name.....

Address.....

## PRINT YOUR OWN POST CARDS

COMPLETE  
OUTFIT  
only  
**\$7.50**



Amazing results in sales, inquiries and contacts... saves time and money... very easy to use GEM STENCIL DUPLICATOR is ideal for Advertising, Announcements, Notices, Labels, Forms, Price Lists—hundreds of uses for every type of business and organization. Comes complete with all supplies, instructions and 60-page Book of Ideas.

**FREE TRIAL OFFER:** Try it before you buy it! Write and a GEM OUTFIT will be sent you postpaid. After 10 days, send only \$7.50 or return the GEM, no questions asked. The GEM must sell itself: you be the judge.

**BOND EQUIPMENT CO. • Dept. 135**  
6633 Enright • St. Louis 5, Mo.

SEND NO MONEY • FREE TRIAL OFFER

## WATCHMAKING

★ Watch Repairing ★ Jewelry Engraving ★ Jewelry Repairing

Combination men earn top pay. Learn in school fully accredited by Horological Institute of America in Washington, D. C. and United Horological Association of America. Approved for veterans. Receive tools, tuition and subsistence while learning.

Established 1935. Write for FREE booklet



**The Baronian School, Inc.**

2116 WALNUT ST. (DEPT. C) PHILA. 3, PA.



## Bar Bells

Buy Direct From Factory **\$8.95**  
up

Write for free booklet  
and price list

**INDEPENDENT IRON WORKS**  
2416 East 23rd Street, Dept. B  
Los Angeles 11, Calif.

## REAL ESTATE BE A BROKER

**PAYS BIG! SEND FOR FREE, BIG, ILLUSTRATED CATALOG NOW!** No obligation. Graduates report making substantial incomes. Start and run your own business quickly. Men, women of all ages, learn easily. Course covers Sales, Property Management, Appraising, Loans, Mortgages, and related subjects. **STUDY AT HOME** or in our classrooms in big cities. Diploma awarded. G.I. approved. Nationally known.

**WEAVER SCHOOL OF REAL ESTATE (Est. 1936)**  
15 E. Pershing Road Dept. PM Kansas City, Mo.

FREE  
BOOK  
TELLS  
HOW

## RUPTURED?

Get Relief This Proven Way

Why try to worry along with trusses that gouge your flesh—press heavily on hips and spine—enlarge opening—fail to hold rupture? You need the Cluthe. No leg-straps or cutting belts. Automatic adjustable pad holds at real opening—follows every body movement with instant increased support in case of strain. Cannot slip whether at work or play. Light. Waterproof. Can be worn in bath. Send for amazing FREE book, "Advice To Ruptured," and details of liberal truthful 60-day trial offer. Also endorsements from grateful users in your neighborhood. Write:

**CLUTHE SONS, Dept. 31, Bloomfield, New Jersey**





Get Into

# TELEVISION, RADIO ELECTRONICS

Master ALL Phases

**Get Complete Training. You Receive and Keep All Tubes, Equipment, Parts and Lessons. No Extra Charges.**

**GOOD PAY  
and Unlimited Opportunities  
in JOBS LIKE THESE:**

- Business of Your Own
- Radio Manufacturing, Sales, Service
- Broadcasting Telecasting
- Television Manufacturing, Sales, Service
- Laboratories: Installation, Maintenance of Electronic Equipment, Electrolysis, Call Systems
- Garages: Auto Radio Sales, Service
- Sound Systems and Telephone Companies; Oil Well and Drilling Companies; Engineering Firms
- Theatre Sound Systems Police Radio
- And scores of other good jobs in many related fields

**YOU CONDUCT MANY  
EXPERIMENTS LIKE THESE!**

- Checking action of condensers
- Experiments with AF and RF amplifiers.
- Experiments with resonance
- Producing beat frequencies
- Calibrating oscillators
- Experiments with diode, grid-bias, grid-leak and infinite impedance detectors
- Practical experience in receiver trouble shooting
- Application of visual tester in checking parts and circuits
- Experiments with audio oscillators
- Advanced trouble-shooting
- ... and many, many others

**Complete Training by Practical Resident Trade School, Est. 1905**

The same highly trained faculty, instruction materials and methods used here in our large, modern resident school, are adapted to your training in your own home. Shop Method Home Training has been proved by hundreds of successful graduates.

**Both Resident and Home Study Courses Offered**

**YOU  
LEARN BY  
DOING**

You receive special laboratory experiment lessons to show you how to build with your own hands various experimental units such as those shown at left, and how to conduct many tests.

You will find all lessons easy to understand because they are illustrated throughout with clear diagrams and step-by-step examples that you work out yourself. Every piece of the equipment and complete lesson material we send you is yours to keep and enjoy, including the multimeter, experimental equipment, all parts of the Superheterodyne, tube manual, radio dictionary, and complete, modern Television texts. All parts are standard equipment.

**Shop Method Home Training . . .  
Earn While You Learn**

With our practical resident Shop Method Home Training, you study in your spare time. You receive Spare Time Work Lessons, which show you how to earn while you learn. Service neighbors' radios and TV receivers, appliances, etc., for extra money and experience. Many National students pay all or part of their training with spare time earnings!

**DON'T DELAY! The Radio-Television Industry needs trained men NOW!**

**APPROVED  
FOR  
VETERANS!**  
Check coupon below!

For quick action, mail coupon today and we'll rush you full information.

**Free!**

NEW, ILLUSTRATED OPPORTUNITY BOOK AND SAMPLE LESSON SHOW YOU HOW WE TRAIN YOU . . . SEND FOR THEM TODAY! NO COST. NO OBLIGATION.



**NATIONAL SCHOOLS**  
LOS ANGELES 37, CALIF. • EST. 1905

**FIND OUT NOW . . . MAIL COUPON TODAY**

National Schools, Dept. PM-5  
4000 South Figueroa Street  
Los Angeles 37, California

Send me your FREE book "Your Future in Radio" and the sample lesson of your course. I understand no salesman will call on me.

NAME ..... AGE .....

ADDRESS .....

CITY ..... ZONE ..... STATE .....

Check here if Veteran of World War II

Mail in envelope or paste on penny postal.



YOU RECEIVE THIS PROFESSIONAL MULTITESTER YOU BUILD ALL THESE AND MANY OTHER UNITS WITH PARTS WE SEND YOU!

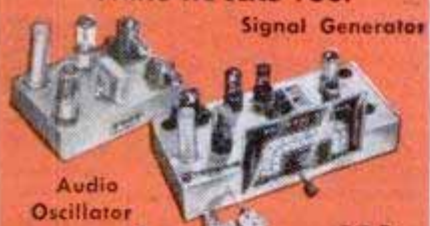

Signal Generator



Audio Oscillator

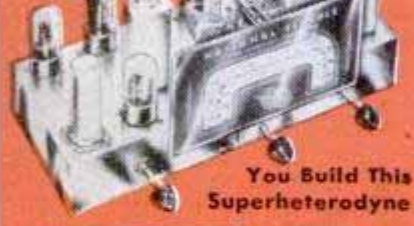

T.R.F. Receiver

You Build This Superheterodyne



You Receive a Special Series of Modern Lessons in TELEVISION, all a part of your course: you master all phases.

**MADE A COOL PROFIT OF  
\$15<sup>26</sup>**

**IN THE VERY FIRST HOUR AND A HALF!**

Here's what JAY NIERENBERG says about "PRESTO", amazing new kind of fire extinguisher: "Had never sold anything like Presto before. Yet in first hour and a half I netted a cool profit of \$15.26." A few days later, he wrote: "Am sold out again—15 more went in the last 3 hours!"



Jay Nierenberg

YOU TOO can make good money showing "Science's New Midget Miracle"—to owners of homes, cars, boats, farms, etc. Tiny "Presto" is about size of flashlight. Yet does job of bulky extinguishers that cost 4 times as much. Has new wonder chemical 1.5 to 6 times as effective as other extinguishing chemicals on an equal weight basis. Ends fire fast as 2 seconds. Fits in palm of hand. Never corrodes. *Guaranteed for 20 years!* Sells for only \$3.98.



Science's New Midget Miracle "PRESTO"

R. E. Meade reports making over \$75 the first day. Stanley Hyman reports making \$1000 a month. H. J. Kerr, \$20 a day. You too can help supply demand. Write for FREE Sales Kit. No obligation; no capital required. Every day you hesitate may cost you \$10, \$15, or even more you could be making. Write at once to:

**MERLITE INDUSTRIES, Inc., Dept. 55,  
201 East 16th St. New York 3, N. Y.**

(If you want demonstration sample too, send \$2.50. Money back if you wish. FREE re-fills for your Demonstrator.)



**AUTO  
BOOKS ON APPROVAL**



**CAN YOU FIX IT?**  
These wonder books tell step by step HOW to make difficult repairs and adjustments, how to keep a car at maximum efficiency, including latest improvements in car design and operation. Engine troubles and how to correct them well covered.

**4 BIG, THICK VOLUMES**  
Over 2700 pages, 2000 illustrations, wiring diagrams, etc. Beautiful modernistic, washable cloth binding.

**SEND NO MONEY.** Just mail the coupon for a complete set of 4 Big, Thick Auto Books. 20th Edition. Over 2700 Pages! Whether you are a mechanic or helper, expert or apprentice, auto owner or driver, take immediate advantage of this FREE EXAMINATION OFFER.

**MAKE GOOD MONEY NOW  
HOLD A PERMANENT JOB**

America wants its automobiles kept in good repair. Men with "know how" are in demand, at big pay. These books will help you get and hold an important job, or give you a chance to go into business for yourself now or later. Any man who half tries to improve himself can learn auto servicing and repairing by this quick reference method. Use the JIFFY INDEX to find easily understood answer to any auto problem. These wonder books prepared by eleven of America's great automobile engineers. Many hundreds of valuable illustrations. Send the coupon TODAY.

**A year's consulting privileges with our engineers now given with these books without extra charge.**  
Publishers Since 1898

**AMERICAN TECHNICAL SOCIETY, Dept. A519**  
Drexel Ave. at 58th St., Chicago 37, Ill.  
I would like to examine your 4-Volume Set of Auto Books. I will pay the delivery charges only, but if I choose I may return them express collect. If after 10 days' use I prefer to keep them, I will send you \$2 and pay the balance at the rate of only \$3 a month until \$24.80 has been paid. Include consulting service as offered above.

Name \_\_\_\_\_  
Address \_\_\_\_\_  
City \_\_\_\_\_ State \_\_\_\_\_  
Please attach letter stating age, occupation, employer's name and address and name and address of at least one business man as reference. Men in service, also please give home address.

**LEARN AT HOME TO MOUNT BIRDS**



**Animals, Heads, Fishes, Pets; to TAN.** Be a Taxidermist. Profit and FUN. Hunters, save your valuable TROPHIES. Mount ducks, squirrels, everything. Learn to TAN for leather and furs. Wonderful HOBBY Have a HOME MUSEUM. BIG PROFITS mounting for others. INVESTIGATE NOW. **FREE BOOK** With 100 fine game pictures. NOW absolutely FREE. Write TODAY. Send Postal TODAY for FREE BOOK. State AGE. N. W. SCHOOL OF TAXIDERMY, Dept. 2505, Omaha, Nebr.



**BIG-MONEY PROFESSION FOR YOU  
EARN IN FULL OR SPARE TIME LEARN AT HOME**



Large incomes in Scientific Swedish Massage, working for doctors, hospitals, sanitariums, clubs or in your own private practice. Hydrotherapy and Electrotherapy included in easy-to-learn course. Prepare for Diploma and Security in this interesting and profitable field. Write for facts and Success Book—FREE.

**THE COLLEGE OF SWEDISH MASSAGE**  
Dept. 064E, 41 E. Pearson, Chicago 11

**HOMESITES \$300 LOW TERMS**

In California's loveliest Garden Spot, on scenic shores of beautiful Morro Bay. Enjoy future independence with excellent soil, soft water, wonderful fishing, hunting, boating, bathing, etc. Grow fruits, vegetables, poultry. Perfect temperate climate. Congenial community. Finest investment. Free literature.

**RICHARD S. OTTO**

DEPT. M SAN LUIS OBISPO, CALIFORNIA



**LABORATORY TECHNICIAN**

**BE A LABORATORY SPECIALIST;** complete course. Big demand from hospitals, doctors, clinics. We teach all branches of medical laboratory work, including Medical and Dental X-Ray. Approved by American College of Medical Technologists. Co-educational. Free Placement Bureau. Free Catalog.

Accredited for "veteran" training  
**CHICAGO COLLEGE OF LABORATORY TECHNIQUE**  
Dept. P.M., 431 S. Wabash Ave. Chicago 5, Illinois



**CARTOONING**

**HAVE FUN! MAKE MONEY!** Cash in on your sense of humor AT HOME—BY MAIL. No experience needed to start. Write today FOR FREE TRIAL LESSON and full particulars. **MOON Gag Cartoon School, Dept. D, Fall Creek, Wis.**

**FREE AMAZING NEW BOOK "HOW TO ANSWER ADS"**



Never before have you seen anything like this. Tells you in simple language the correct way to answer ads. Gets you quicker replies—better results, and greater satisfaction. Will save you time and money and it's ABSOLUTELY FREE. No obligation whatever. Every reader of advertising should have this booklet. Send a postcard for your copy NOW. Advertising Department, Popular Mechanics Magazine, 200 East Ontario Street, Chicago 11, Ill.

**Learn WATCH REPAIRING**

**Earn while AT HOME you Learn!**  
Learn this fascinating and profitable trade in your spare time at home through our Correspondence Department. Each individual student receives individual attention! Post-Graduate course at resident school optional for correspondence students.  
OUR MOTTO: Not how quickly, or but how thoroughly we can train you.

**AT OUR RESIDENT SCHOOL**

APPROVED FOR G. I. TRAINING  
Our school is set up on an individual basis where every student receives individual attention from our competent instructors in a home-like and cheerful atmosphere.  
**Write TODAY FOR FREE INFORMATION:** JOHN VAN PUFFELEN, Director  
**AMERICAN INSTITUTE OF SPECIALIZED WATCH REPAIR**  
1012-1014 Franklin St. S.E., Grand Rapids 6, Mich.

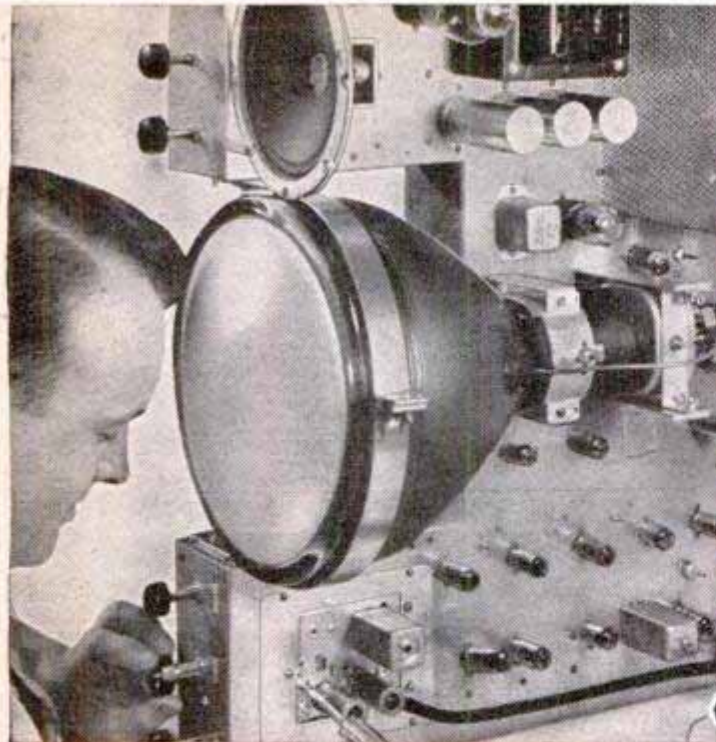

Only D.T.I.  
offers you the  
**"BIG 5"**  
**TELEVISION**  
RADIO-ELECTRONICS  
Laboratory Type  
**HOME TRAINING**

**1** Build and Keep 10, 12½ or 16 inch Picture Tube Quality TELEVISION RECEIVER as you prepare for a Profitable Future

Here is everything you need to prepare you at home for FASCINATING WORK, GOOD MONEY and a THRILLING FUTURE in one of America's most promising fields.

This includes the opportunity to build and keep the top quality Television Receiver shown above—with choice of a 10, 12½ or 16 inch picture tube that gives big, bright, sharp, steady pictures. This is an optional feature—available when you complete your training described below. Get the complete facts. See how D.T.I.'s wonderfully practical "BIG 5" method meets industry's needs: No previous experience needed. Mail coupon today!

**16 Big Shipments of Parts — Plus Lessons**

Work over 300 electronic experiments and projects from 16 big shipments of parts. This includes building and keeping all test equipment and radio set shown at left side of page. Modern easy-to-read lessons with handy fold-out diagrams simplifies your entire training.

**You Also Use Home Movies**

D.T.I., alone, includes the modern, visual training aid . . . MOVIES to help you learn faster, easier at home. See electrons on the march and other fascinating "hidden action"—a remarkable home training advantage that speeds your progress.

**EMPLOYMENT SERVICE**

When you complete your training, our effective Employment Service helps you get started toward a real future in Television-Radio-Electronics.

**Modern Laboratories**

If you prefer, you can get ALL your preparation in our new, Chicago training laboratories . . . one of the finest of its kind. Ample instructors . . . modern equipment. Write for details!

6 Tube  
Radio  
Receiver

**2** You Learn-By-Doing from D.T.I.'s HOME LABORATORY



**3** You Learn-by-Reading from D.T.I.'s MODERN LESSONS



**4** You Learn-by-Seeing from D.T.I.'s HOME MOVIES

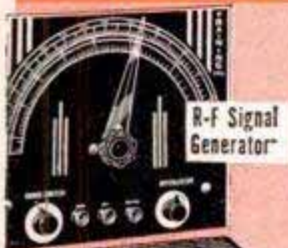

R-F Signal Generator



Multimeter



Oscilloscope



**DeFOREST'S TRAINING, INC.**

Chicago 14, Illinois  
A DeVry Institution

**MAIL THIS COUPON TODAY!**

DeFOREST'S TRAINING, INC. PM-G-5  
2533 North Ashland Avenue,  
Chicago 14, Illinois.

Without obligation, give me complete facts showing how I may make my start in Television-Radio-Electronics.

Name \_\_\_\_\_ Age \_\_\_\_\_  
Street \_\_\_\_\_ Apt. \_\_\_\_\_  
City \_\_\_\_\_ Zone \_\_\_\_\_ State \_\_\_\_\_

# Become an Electrical Engineer

*B. S. Degree in 36 Months*

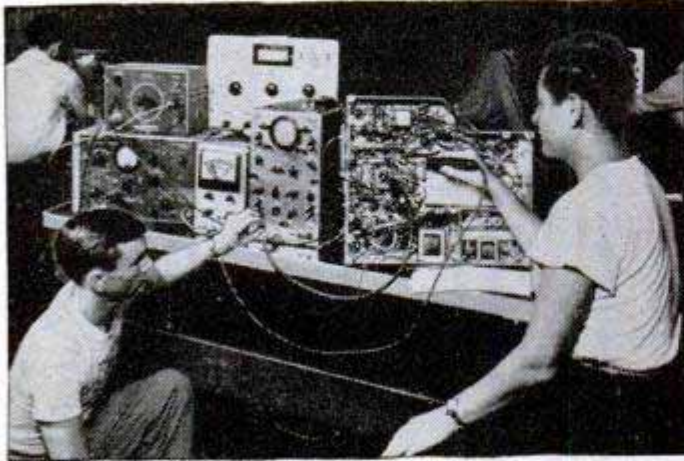

## MAJOR IN ELECTRONICS

Important advantages are yours at this nonprofit Technical Institute and College. A valuable year is saved by gaining your B. S. degree in 36 months of continuous study. You get both practical, specialized training in well-equipped laboratories — and a solid education in Electrical Engineering and related arts.

The **Radio-Television Technician's** certificate can be yours in 18 months. You are then equipped for specific positions in receiver and transmitter testing, servicing, sales and production. This course will be credited toward your B. S. degree in Electrical Engineering.

**Military, Academic or Practical Training** evaluated for advanced credit. Preparatory courses available.



Faculty of 85 specialists. 1555 currently enrolled from 48 states and 23 foreign countries. Over 35,000 alumni. Terms open July, Oct., Jan., April.

## MILWAUKEE SCHOOL of ENGINEERING

Technical Institute • College of Electrical Engineering

Write for free 110-page catalog and 48-page pictorial booklet, "Your Career."



**MILWAUKEE SCHOOL OF ENGINEERING**  
Dept. PM-550  
1020 N. Broadway, Milwaukee, Wis.  
Without obligation, send me the 110-page catalog and 48-page "Your Career" booklet.  
(Check 6 to 36 month courses which interest you)  
Electrical Engineering:  Electronics  Power

Radio-Television  Electricity  Welding  
 Air Conditioning  Heating  Refrigeration

NAME \_\_\_\_\_ AGE \_\_\_\_\_

ADDRESS \_\_\_\_\_

CITY \_\_\_\_\_ ZONE \_\_\_\_\_ STATE \_\_\_\_\_

Check if World War II Veteran

## SPEED AND POWER Handbook

50 CHAPTER LIBRARY EDITION

Build Fast Stock Cars! California Roadsters! 160 MPH Rods! Covers Crosleys to Cadillacs—all makes. Breathtaking Methods. Authentic — Direct from California!

SAVE MANY DOLLARS

Build your own Dual Manifolds! Superchargers! Hot Cams! Water Injectors! Hi-Compression Heads! Mileage Devices! Get up to ten more miles per gallon! Get racing speed, lightning acceleration, dynamic power increases from any make passenger automobile! Get construction drawings! Tuning techniques! Speed tricks! Economy secrets! Ingenious formulas! Covers "Racing Frames"—"Reciprocating Masses"—"Jet Engines"—"Braking Characteristics"—"Dynamometers"—Dual Pipes, Gears, Fuels, Manifolds, Porting, Relieving, Lowering! Balancing, Including 1950 Racing Equipment Catalogues!



SPEED SHOP  
METHODS

Includes "CALIFORNIA AUTOMOBILE CUSTOMIZING"—Drawings! Photographs! Diagrams! Newest Ideas! Conversions! CarsonTops! Restyling all makes! Streamlining! Chopping! Channeling! Complete — \$1.98 Postpaid.  
**NEWHOUSE AUTOMOTIVE INDUSTRIES**  
5805 EAST BEVERLY BLVD. DEPT. 84  
LOS ANGELES 22, CALIF.

## LEARN TO WRITE *a Good Hand!*

**FOR BUSINESS AND SOCIAL SUCCESS!**  
Easy to improve your handwriting at home quickly with my new instruction books just off the press. Master all the secrets of better penmanship. Simple and easy, fully illustrated, highly endorsed. Begin today. Write for:  New Free Book, "How to Become a Good Penman," or check books wanted, \$1.00 each.  Business Writing  Artistic Writing  Card Writing  Engrossing Alphabets  Bird and Design Flourishing  Complete Set \$4.50  Enclose 10¢ for your name beautifully written and special penpoint for shaded writing.  
S. A. Ziller, President, **TAMBLYN SCHOOL OF PENMANSHIP**  
441 Ridge Bldg. In Business Over 52 Years Kansas City, Mo., U.S.A.

## PAINT YOUR CAR WITH WYPE for \$2.95!

There's no brushing, no masking or spraying. Rivals a professional spray job. Over 500,000 car owners are delighted with the results. See your local dealer, department store or order direct.

### WYPE CORPORATION

DEPT. 16-E 2214 DOLMAN ST. ST. LOUIS 4, MO.

## LEARN MEAT CUTTING At Home — In Spare Time

Get into the vital meat industry. Concise, practical Home Training based on 25 years proven instruction methods used at National's famous resident school. Prepares you for bigger pay as Meat Cutter, Supervisor, market manager or more money in your own store. Go as rapidly as your spare time permits. Diploma. Start NOW to turn your spare hours into money. Send for FREE bulletin today. No obligation.

NATIONAL SCHOOL OF MEAT CUTTING, INC., Div. U-116, Toledo 4, Ohio

## AMAZING NEW MAGIC CATALOG

350 pages of mystifying, easy-to-do tricks and illusions. 600 illustrations. Send \$1.00 now for catalog, credited on your first \$5.00 purchase.

### NATIONAL MAGIC CO.

119 S. State St. Dept. M-5 Chicago 3, Ill.

AMERICA'S BOOMING HOBBY — ACT NOW  
RAISE

## TROPICAL FISH

Easily for money or hobby in your own home. One female may have 300 young. For simple, step-by-step information send \$1.00 to  
**TROPICAL FISH, BOX 686, HARTFORD, CONN.**

## it's fun to earn RAISING HAMSTERS

Cash in on the growing demand for SYRIAN GOLDEN HAMSTERS recently introduced into the U. S. Ideal pets . . . big laboratory demand. Hardy, clean, odorless. Easily and profitably raised anywhere.

**AKOPIAN HAMSTERY**  
the largest in the West  
7358 H VARNA AVE. • NORTH HOLLYWOOD, CALIF.

write for  
**FREE booklet**

## SAY YOU SAW IT IN POPULAR MECHANICS

### Learn PHOTOGRAPHY at Home

Splendid opportunities. Prepare in spare time. Practical basic training. Long-established school. Send for free book, "Opportunities in Photography." No obligation.  
**American School of Photography, 1315 S. Michigan Ave., Dept. 1355, Chicago 5, Ill.**

# FREE

## A NEW HOME INDUSTRY



Let us show you how extremely easy and PROFITABLE it is to make beautiful and useful things out of LIQUID PLASTICS, LIQUID MARBLE, LIQUID IVORY, LIQUID GLASS, CERAMICS, ETC. . . . as easy as pouring water out of a glass! Make novelties, jewelry, gifts, artware, toys, tools, dies, gadgets, ceramics . . . a million useful things! We supply everything—MATERIALS, INSTRUCTIONS and BUYERS! Send only 25c for 1. Big catalog of 300 casting materials, molds and accessories. 2. A beautiful CASTING free (to show you what you can do), and 3. Actual INSTRUCTIONS on how to cast and start in the CASTING BUSINESS! VALUABLE MOLDS given FREE with orders! Send 25c today—this may be the lucky coin that will start the most fascinating and profitable phase of your life.

PLASTICAST COMPANY (DEPT. C)  
4637 N. Kedzie Ave. (Write to nearest address) P. O. Box 987  
Chicago 25, Ill. Palo Alto, Calif.  
CANADIAN CUSTOMERS, please order directly from: CANADIAN INDUSTRIAL PLASTICS, LTD., 1056½ Pender West, Vancouver, B.C.

**"LEARN-BY-DOING"**

# ELECTRICITY

**PRACTICAL TRAINING NOT "HOME STUDY"**

**G.I. APPROVED** Get actual experience in great shops of M.T.I. Learn all phases Practical Electricity; Housewiring, Motors, Const., Maintenance, etc. Living arrangements, Part-time jobs, etc. A post card brings the story.

MICHIGAN TECHNICAL INSTITUTE, Dept. PM-5  
2281 W. Fort St., Detroit 16, Michigan

# LEARN WATCH REPAIRING

**AT HOME.** By our modern and original system of instruction you can learn every part of the **WATCH REPAIRING TRADE AT HOME.** Prepare yourself for a well-paying position or start in business after completing our course of instruction. Good watch repairers are in demand and generally earn very good salaries. For particulars apply to the **WISCONSIN SCHOOL OF WATCH REPAIRING** 759 North Milwaukee St., Milwaukee 2, Wis.

# LEARN AERONAUTICAL ENGINEERING

**Aircraft and Engine Mechanics (A & E)**

Train at the Flying Wing school—New classes starting soon. Write for illustrated catalog.

**Northrop Aeronautical Institute**  
APPROVED FOR VETERANS DIVISION OF NORTHROP AIRCRAFT, INC.  
1527 E. Broadway, Hawthorne, Los Angeles County, California

**Career Training in a Minimum of Time**

# RADIO—ELECTRONICS TELEVISION ENGINEERING

GRADUATES of CREI residence school are preferred by industry because of their *training and ability*. CREI prepares the young man for a good job in industry in a minimum of time. 23 years practical experience. CREI offers an outstanding faculty, modern laboratories, shops and equipment. New students accepted twice monthly and each may advance as rapidly as he is capable. Basic course with one specialized course requires an average of 20 months to complete.

Approved for Veterans' Training.

• Write for Details and Free Booklet

**CAPITOL RADIO ENGINEERING INSTITUTE**  
Dept. 175B, 16th & Park Rd. N.W.  
Washington 10, D.C.

**NOW!** BRAND-NEW UP-TO-THE-MINUTE Edition of Famous Manual

# MAKES Any AUTO REPAIR JOB Your "Meat!"

**ENLARGED!** MORE Words! 750 BIG Pages in All!

**REVISED!** MORE Pictures —2100 in All! New Automatic Transmission Data!

**NEW!** Now You Can Repair ALL 1950 MODELS—As Well As Any Car Built Since 1935!

## FREE 7-DAY TRIAL

HERE it is! — the brand-new 1950, revised, enlarged edition of MoToR's AUTO REPAIR MANUAL! Now you can "lick" any job on any car built since 1935 — INCLUDING ALL 1950 MODELS. This famous guide now has 750 big pages. MORE pictures —2100 in all. All about AUTOMATIC TRANSMISSIONS, including Hydramatic, Dynaflo, Powerglide, Ultramatic, Drive-Master, Presto-Matic, etc. New GM Rochester carburetor. Covers 44 NEW car models. 200,000 service and repair facts on 741 models in all.



**Everything You Need To Know** "Breeze through" any job on any car! Step-by-step instructions, and 2100 cut-away photos, drawings, diagrams make every operation easy! Complete "dope" from 150 Official Factory Shop Manuals, boiled down into one handy book!

35,000 dimensions on 741 car models! Whether you want to make a simple carburetor adjustment or completely rebuild a transmission, here's exactly WHAT to do, HOW to do it. Used by U. S. Army, technical schools, thousands of auto service men.

- COVERS ANY CAR BUILT SINCE 1935!**
- |           |            |
|-----------|------------|
| Auburn    | Kaiser     |
| Austin    | Lafayette  |
| Bantam    | La Salle   |
| Buick     | Lincoln    |
| Cadillac  | Mercury    |
| Chevrolet | Nash       |
| Chrysler  | Oldsmobile |
| Cord      | Packard    |
| Crosley   | Pierce     |
| De Soto   | Arrow      |
| Dodge     | Plymouth   |
| Ford      | Pontiac    |
| Frazer    | Reo        |
| Graham    | Studebaker |
| Hudson    | Terraplane |
| Hupmobile | Willys     |

**SEND NO MONEY**

Send no money. Examine this brand-new book—at our risk—for a full week, FREE! Test it right in your own garage or shop. If book doesn't more than pay for itself in 7 days, return it, pay nothing. Mail coupon NOW. MoToR Book Dept., Desk 1E, 250 West 55th St., New York 19, N. Y.

**MAIL COUPON NOW FOR 7-DAY FREE TRIAL**

MoToR Book Dept., Desk 1E,  
250 West 55th Street, New York 19, N. Y.

Rush to me MoToR's AUTO REPAIR MANUAL. If O.K. I will remit \$1 in 7 days (plus 35c delivery charge), then \$2 monthly for 2 months, with a final payment of 95c one month later. Otherwise I will return book postpaid in 7 days. (Foreign price, \$8 cash with order.)

Name.....Age.....  
Please Print Plainly

Address.....

City.....State.....

Check box and SAVE 35c delivery charge by enclosing WITH COUPON entire payment of \$5.95. Same return-refund privilege applies.

# Learn A Trade NOW! PRACTICAL SHOP TRAINING!

## In Our Chicago Shops

- |   |  |
|---|--|
| <input type="checkbox"/> AUTO MECHANICS   | <input type="checkbox"/> WELDING—ARC and GAS |
| <input type="checkbox"/> DIESEL MECHANICS | <input type="checkbox"/> MACHINIST           |
| <input type="checkbox"/> REFRIGERATION    | <input type="checkbox"/> PIANO TUNING        |
| <input type="checkbox"/> BODY-FENDER      |  |

Above Approved For G. I.'s and Civilians  
One of America's Leading Practical Schools  
7 Floors of Fully Equipped Shops  
Over 48,000 Successful Graduates  
Expert Individual Instruction  
Learn by Doing—Low Living Expense  
Established 1902—Day and Evening Classes

## Also the following Home Study Courses

- |                                  |  |                                 |
|----------------------------------|--|---------------------------------|
| <input type="checkbox"/> PLASTIC | <input type="checkbox"/> REFRIGERATION | <input type="checkbox"/> DIESEL |
|----------------------------------|--|---------------------------------|

— CALL IN PERSON OR MAIL THIS AD TO —

## GREER SHOP TRAINING

(Desk 10) 460 South State St., Chicago 5, Ill.

Please send without obligation free information regarding trade checked above. (Specify whether you are a Veteran  or Civilian )

Name \_\_\_\_\_ Age \_\_\_\_\_  
Address \_\_\_\_\_  
City \_\_\_\_\_ State \_\_\_\_\_

## Secure YOUR FUTURE 3 TRADES IN 1 CAREER



### WATCHMAKING • JEWELRY- ENGRAVING • STONE SETTING •

Each trade can be a full-time job; together they assure numerous high paying opportunities, or a business of your own. Profit by the *Nationally Recognized Training Methods* of the *Kansas City School of Watchmaking*.

ENROLLMENTS NOW AVAILABLE

Clip and Mail this Coupon Today

**KANSAS CITY SCHOOL OF WATCHMAKING**  
1218 Admiral Blvd.  
Kansas City 6, Missouri

Please send me, without obligation, complete information on training in the above courses.

Name \_\_\_\_\_  
Street \_\_\_\_\_  
City \_\_\_\_\_ State \_\_\_\_\_  
 Check if Veteran  G. I. Approved

## LET ME PROVE I CAN MAKE YOU A NEW MAN

Just tell me where you want handsome, powerful muscles. Are you fat and flabby? Or skinny and gawky? Are you short-winded, pepless? Then write for my 48-page FREE BOOK, about "Dynamic Tension", and learn how, in only 15 minutes a day, I can make you a healthy, confident, powerful HE-MAN.

CHARLES ATLAS,  
Dept. 85, 115 E.  
23rd St., New York  
10, N. Y.



## BOAT BLUEPRINTS & FULL SIZE PATTERNS

and specifications. Designed by Naval Architect. Cruisers, runabouts, sloops, outboards, sailing canoe, etc. Low prices. Send 25c (coin) for illustrated catalog. SPECIAL: Send \$1.00 for "HOW TO BUILD BOATS" book, postpaid. PolyWog Houseboat Plans, \$10. Marine Catalog \$1. Cleveland Boat Blueprint Co., Dept. 666, Cleveland 13, Ohio

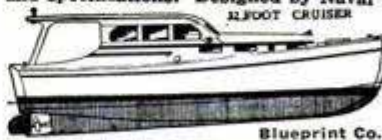

## OWN a Business



Clean and Mothproof rugs and upholstery "in the home." Patented equipment. No shop needed. Duraclean dealer's gross profits up to \$20 a day on EACH serviceman. These Nationally Advertised services create repeat customers. Easy to learn. Quickly established. Easy terms. Send today for FREE Booklet—Full details.

DURACLEAN CO., 0-165 DURACLEAN BLDG.  
DEERFIELD, ILL.

## LEARN MONEY-MAKING CARTOONING

IN SPARE TIME — by Easy Picture Chart Method

Same Simplified Method that has helped train creators of "Terry & Pirates," "Freckles," "Out Our Way," "Winnie Winkle," "Reg'lar Fellers," "Strange As It Seems," "The Neighbors," and many others. Earn while learning. Send 10c for Picture Chart (to test your ability), and full details. (State age.)

THE LANDON SCHOOL, 5005 Cleve. Transit Bldg., Cleveland, O.



## WELDING SHOP TRAINING

G.I. APPROVED—GAS AND ARC  
Classes start on Monday each week. Payment Plan for Non-Vets. Welders needed in practically every industry—train for a field where you have greater assurance of Steady Work, Good Pay. Write for Free Information.

A & S VOCATIONAL WELDING SCHOOL  
1212 E. 63rd Street, Dpt. PM-5, Chicago, Illinois

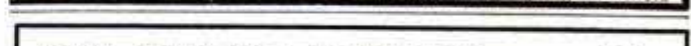

## OIL FILTER REFILLS . . . 10c

Here's News! Ordinary toilet paper makes an ideal oil filter. Laboratory tests prove it cleans oil faster and better than popular makes of filter elements. All you need is a simple set of Retlif Adapter Plates . . . and you can start using toilet paper rolls (costing about 10¢) in your present oil filter. For proof and descriptive literature, send name and address to:

RETLIF CORP., Dept. 15, 1239 No. Highland Ave., Los Angeles 38, Calif.

## KODACHROME SLIDE FILE

Top Quality Specially Priced

Built-in Electric Viewer with 70-inch cord; 1-piece welded spacers; holds 250 ready mounts or 125 glass slides. Heavy gauge steel—hammertone finish; hinged cover with two snap locks and Carrying Handle. A money saving special at our price.

SEND NO MONEY— Just pay \$6.49 plus postage C.O.D. Or, send \$6.49 for postage paid delivery. Satisfaction guaranteed or return in 5 days for refund.

FORJAYS CAMERA SUPPLIES 2114 E. 71st ST., DEPT. D, CHICAGO 49, ILL.



GET INTO

# DIESEL-AUTO

## MECHANICS *Master All Phases*

**JOBS LIKE THESE ARE AVAILABLE TO TRAINED MECHANICS. CHOOSE THE FIELD YOU LIKE BEST**

**Get Complete Training**

- Diesel Fuel Injection
  - Automotive Motor Tune-up
  - Diesel Engine Rebuilding
  - General Garage Mechanic
  - Agricultural Implements
  - Auto Engine Rebuilding
  - Auto Elec. Service
  - Public Utilities
  - Parts Dealers
  - Bus & Truck Lines
  - Industrial Maintenance
  - Contracting & Excavating
  - Business of Your Own
- AND MANY other similar openings.

**As a National Schools graduate, you are trained for ALL opportunities in the Diesel & Auto Industries**

### EARN WHILE YOU LEARN

With our practical Master Shop-Method Home Training, you study at home in your spare time. You receive Spare Time Work Lessons, which show you how to earn while you Learn . . . for extra money and experience. You Learn by DOING.

### TOOLS AND EQUIPMENT

To make your training complete, we give you selected mechanic's tools and equipment, illustrated below, including all-metal toolbox — as a regular part of your instruction.

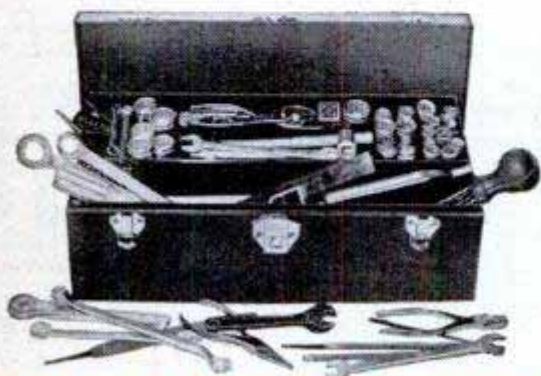

**WE GIVE YOU TOOLS OF YOUR TRADE**



**Shop-Method Home Training by an Established Resident School Prepares you for Many Good Jobs**

Opportunity is everywhere for the trained Diesel-Auto Mechanic. Highways throng with cars, busses, trucks, tractors. Garages and Service Stations are kept busy. Factories, ships, farms, railroads, general industry, are dependent upon engine power. Here's a dynamic, fast-growing field that needs trained men who know ALL phases: installation, operation, maintenance and repair. Now—National Schools offers you a practical, all-embracing Diesel-Auto Mechanic's Course, including all of these advantages:

**Complete training, covering—Diesels, High Speed and Heavy Duty; Semi-Diesels, Gasoline and Special Fuel Engines AND Allied Mechanics.**

- Basic Lesson Texts
- Diesel Installation
- Operation - Maintenance
- Diesel Chart Manual
- Spare Time Lessons
- Engine Service Manuals
- Engine Repair
- Drive Systems
- Diesel Electric Power
- Thermodynamics

### TOOLS AND EQUIPMENT

**INVESTIGATE**  
Secure Full Information

**NEW, ILLUSTRATED BOOK & SAMPLE LESSON SHOW HOW WE TRAIN YOU . . . SEND FOR THEM TODAY!**



**NO COST**  
**NO OBLIGATION**

**APPROVED FOR VETERANS**

Check coupon below

## NATIONAL SCHOOLS

LOS ANGELES 37, CALIF. • EST. 1905



### FIND OUT NOW... MAIL COUPON TODAY

NATIONAL SCHOOLS, DEPT. PMD-5  
4000 South Figueroa Street  
Los Angeles 37, California

(Mail in envelope or paste on penny postcard)

Mail me FREE the book, YOUR FUTURE IN DIESEL-AUTO MECHANICS, together with the Sample Lesson. I understand I may keep and use the information with no obligation.

Name \_\_\_\_\_ Age \_\_\_\_\_

Address \_\_\_\_\_

City \_\_\_\_\_ Zone \_\_\_\_\_ State \_\_\_\_\_

Check here if Veteran of World War II



**YOU  
can  
acquire**

## **LAW NIGHTS AT HOME!** **L. L. B. DEGREE**

LaSalle's famous Law Library—used as reference in many Law libraries and Law offices—has enabled thousands to master Law surprisingly fast, in spare hours at home, for business and professional advancement.

These 14 remarkable volumes, compiled by leading professors and lawyers, cover the whole basic field of Law in condensed, orderly, simplified manner.

You advance rapidly with this great library, plus special lectures furnished. We guide you step-by-step with personalized Problem Method of instruction . . . you learn by doing—handling legal problems—not by memorizing rules.

Send for two FREE 48-page booklets, "Law Training for Leadership," and "Evidence," answering questions about Law and its value to you, and telling how LaSalle Law graduates are winning rapid advancement in business and public life. Mail coupon below. No obligation.

### **LA SALLE EXTENSION UNIVERSITY** *A Correspondence Institution*

417 S. Dearborn St., Dept. 564-L, Chicago 5, Ill.

Send me your two FREE booklets described above, without obligation.

Name.....Age.....

Street.....

City, Zone & State.....

## BIG PAY JOBS

for men who qualify in

# DIESEL

**ASSURE YOUR FUTURE.** Steady, high-pay jobs await men qualified in Diesel, Tractor, and Heavy Equipment. Are you qualified for job and advancement opportunities in this fast-growing field? You can qualify!

**COMPLETE DIESEL COURSE NOW AVAILABLE.** If you are ambitious and want to get ahead in this big money field, you'll want to know about the complete Diesel home training course now offered by Interstate Training Service. Covers all phases of operation, repair, service. Easy to master in spare time. No interference with present job. Up-to-the-minute. Regularly revised to cover new developments. We invite comparison of material offered. Free placement advisory service.



**YOU OWE IT TO YOURSELF** to investigate Interstate Training Service Diesel Training. Thousands agree it has helped them to better jobs... better pay. It can do the same for you!

**WRITE FOR FREE INFORMATION TODAY**

INTERSTATE TRAINING SERVICE, Portland 13, Ore.  
Please see that I receive FREE 24-page book, (K-5)  
"Getting Ahead in Diesel."

NAME.....AGE.....  
ADDRESS.....  
CITY.....ZONE.....STATE.....

# IS YOUR JOB DEPRESSION PROOF?

Can you lose employment because of depression, business failure or old age? Learn watchmaking, the mechanical profession called "depression-proof for trained men" by impartial national authorities. Old age brings increased respect rather than insecurity. Study veteran-training approved courses in watch and clock repair, jewelry engraving, chronograph repair at the world's largest, best-equipped watchmaking school. Certified by the Horological Institute of America, Washington, D. C.

SEND FOR FREE 116-PAGE INFORMATION PACKET

**WESTERN PENNSYLVANIA  
HOROLOGICAL INSTITUTE**  
WORLD'S LARGEST WATCHMAKING SCHOOL



Desk 40, Chamber of Commerce Bldg., Pittsburgh, Pa.

## Be an AUTO MACHINIST

**Draw Top Pay—No Job Worries**

Be a high-paid auto machinist! Specialize—make more money. New FREE booklet tells how to prepare for good jobs as an auto machinist or auto mechanic. G. I. Approved School of Auto Mechanics.

**FREE:** Write for your FREE booklet today.

**AMERICAN TRADE SCHOOLS**  
2417A McGee Street Kansas City, Mo.



## GENUINE AIRLINE BAGGAGE STICKERS

10 ASSORTED (FOREIGN AND DOMESTIC) 30c  
ENELL INC., 8606—37th AVE.  
JACKSON HEIGHTS, NEW YORK, N. Y.

# Rupture Troubles Ended

Advanced method has healed thousands. No leg straps, no elastic, no plasters. No pressure on hips or spine. Flexo-pad. Entirely different. Endorsed by doctors, mechanics, clerks. Very light. **INEXPENSIVE. GUARANTEED.** Write for information and trial.

**SMITH MANUFACTURING COMPANY**  
EST'D 1893 DEPT. PM PRESTON, ONTARIO

## Learn ACCOUNTING BOOKKEEPING

This nationally renowned school has demand for graduates in good salary positions thru National wide recognition and placement service. Write Department PML today for Big 32 **FREE** page Success Book to be sent to you

*Hills* **BUSINESS UNIVERSITY AND  
EXTENSION SCHOOL**  
619 W. MAIN ST. OKLAHOMA CITY 2, OKLAHOMA

**ALL  
PHOTO  
BOOKS**

## PHOTO BOOK CATALOG

Newest catalog lists, illustrates books on all photo subjects by all publishers. Budget payment plan available. Send name on penny post card for your **FREE COPY** today.

**FREE!** **AMERICAN PHOTOGRAPHY**  
607 Guardian Bldg., St. Paul 1, Minn.



# BARBELLS

Finest Quality.....\$7.98 up  
**FREE CATALOG**

Send today for big new 4 color fully illustrated free catalog of BARBELLS, Dumbbells and Health equipment. Free—world famous \$15.00 Dan Lurie Barbell and Dumbbell training courses with every purchase.

**DAN LURIE BARBELL CO.**  
Dept. 159E  
1729 M-5 Rockaway Parkway, Brooklyn 12, N. Y.



**YOU BUILD THIS  
23-TUBE  
TELEVISION  
RECEIVER**

**NOW!**

FOR THE FIRST TIME YOU CAN GET  
Real Practical HOME TRAINING In

# TELEVISION

## RADIO AND ELECTRONICS

**RTS LEADS THE WAY**

WE GIVE YOU

**11 BIG  
TELEVISION  
AND RADIO KITS  
AT NO EXTRA COST**

**YOU WORK AND LEARN  
WITH REAL TELEVISION  
AND RADIO EQUIPMENT**

RADIO-TELEVISION TRAINING SCHOOL'S master Technicians guide you. Located in the very heart of America's Television, Broadcasting, Radio and Sound Industries, RTS is right "on-the-spot" where new technical improvements are first introduced; is in the best possible position to bring students ACTUAL METHODS and practices developed by the RADIO-TELEVISION industry, leading to real money making opportunities. The 11 BIG KITS RTS gives you enable you to do many practical jobs, build the equipment illustrated, perform more than 100 other fascinating, valuable experiments. These jobs you do give you ACTUAL SHOP experience so vitally necessary to your future success. Thus RTS methods assure you BALANCED TRAINING—Theory PLUS Real Experience.

to earn WELCOME EXTRA CASH, even BEFORE FINISHING YOUR TRAINING! In fact, when friends and neighbors know you are studying Radio-Television you may—like many RTS students—actually get MORE REPAIR WORK THAN YOU CAN HANDLE.

**27 YEAR  
SUCCESS RECORD**

Backed by over a quarter-century of experience in home training, RTS (formerly Radio Training Association of America) offers practical "Learn-by-doing" methods, assuring you quick step-by-step progress. Begin preparing for your future in Radio-Television NOW while the time is ripe. If you are at all mechanically inclined—and have a grammar school education, RTS can teach you how to MAKE GOOD in Radio-Television.

**GET THE FACTS**

Send for FREE BOOK which tells you all about the RTS "time-tested" home-training plan, developed by technicians in the heart of the Radio-Television field. Fill out the coupon now—TODAY! and your FREE BOOK entitled "How To Make Good in Radio-Television" will go out to you AT ONCE. No Obligation. No salesman will call. Act now!

**YOU BUILD THIS  
6-TUBE STANDARD  
SUPER HETERODYNE  
RADIO SET with  
SHORT WAVE  
CONVERTER**

**YOU  
KEEP ALL  
EQUIPMENT  
—it's Yours!**

**★  
SEND  
FOR THIS  
30-PAGE  
FREE  
BOOK  
★**

**OPPORTUNITIES NOW  
WIDE OPEN FOR  
Properly Trained Men**

Latest reports estimate 400 MILLION new television and radio sets will be built in the next 10 years . . . more than 72 million dollars is being spent RIGHT NOW just for radio repairs ALONE! When you are thoroughly trained by RTS Experts—who have their fingers on the pulse of the Radio-Television industry—a field of unlimited opportunities will open up for you in Your Own Radio-Television Sales & Service Business, F.M., Equipment Manufacturing, Communications and allied fields.

**EARN EXTRA MONEY  
while learning at HOME**

Under the RTS amazingly easy, practical home-training plan there is no need for you to quit your present job. You study in SPARE TIME ONLY! RTS Experts show you how

**RADIO-TELEVISION TRAINING SCHOOL**  
5100 SO. VERMONT AVE., LOS ANGELES 37, CALIF., U.S.A.  
ESTABLISHED 1922 — 27 YEARS AGO

RADIO-TELEVISION TRAINING SCHOOL, DEPT. PM-5  
5100 South Vermont Avenue, Los Angeles 37, Calif., U.S.A.

Send FREE Illustrated Book showing how I can make good in TELEVISION and Radio through training under the guidance of expert RTS Technicians. No obligation. (No Salesman will call).

NAME \_\_\_\_\_ AGE \_\_\_\_\_  
ST. & No. \_\_\_\_\_  
CITY \_\_\_\_\_ ZONE \_\_\_\_\_  
STATE \_\_\_\_\_

# 9 BIG BUILDING BOOKS

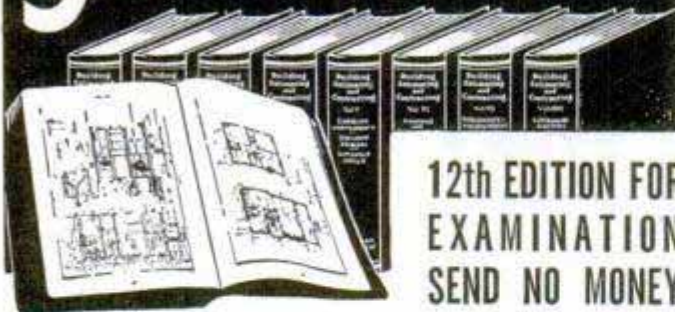

12th EDITION FOR EXAMINATION  
SEND NO MONEY

Learn to draw plans, estimate, be a live-wire builder, do remodeling, contracting. These 9 practical, profusely illustrated books cover subjects that will help you to get more work and make more money. Masonry, concrete forms, carpentry, steel square, roof framing, construction, plumbing, heating, painting, decorating and many other subjects. More than 4000 pages — 2750 illustrations.

## BETTER JOBS — BETTER PAY UP-TO-DATE EDITION

A nationwide building boom is in full swing and trained men are needed. Big opportunities are always for MEN WHO KNOW HOW. These books supply quick, easily understood training and handy, permanent reference information that helps solve building problems.

These books are the most up-to-date and complete we have ever published on these many subjects.

### Coupon Brings Nine Big Books for Examination

AMERICAN TECHNICAL SOCIETY—Publishers since 1898  
Dept. G519 Drexel at 58th Street Chicago 37, Ill.

You may ship me the Up-to-Date edition of your nine big books, "Building, Estimating and Contracting," without any obligation to buy. I will pay the delivery charges only, and if fully satisfied in ten days, I will send you \$2.00, and after that only \$3.00 a month, until the total price of only \$34.80 is paid. I am not obligated in any way unless I keep the books.

Name \_\_\_\_\_  
Address \_\_\_\_\_  
City \_\_\_\_\_ State \_\_\_\_\_

Please attach a letter stating your age, occupation, employer's name and address, and name and address of at least one business man as a reference. Men in service, also please give home address.



## HIGH PAY • SECURITY When You LEARN A TRADE

Get ready for a well-paid, lifetime job or a business of your own in one of these FIVE ESSENTIAL TRADES. Complete training under expert instructors with practical experience prepares you to step into a good paying job with a future and security.

**ELECTRICITY:** Basic electricity, Residential and Industrial Wiring and Appliance Repair.

**PLUMBING:** Every phase — pipe cutting and threading to complete installations, blue print reading.

**AUTOMOTIVE & TRACTOR:** Engine overhaul, Transmissions, Carburetion, Generator-Ignition Systems, Tune Up.

**DRAFTING:** College level training in general Machine and Architectural Drafting

**SHOE REPAIRING:** Complete practical training includes reconditioning and rebuilding.

Approved For Veteran's Training

## NATIONAL TRADE SCHOOL 2610 Grand • Kansas City 8, Mo.

Without obligation to me please send full information on the course checked

.....Automotive and Tractor Technician .. Drafting  
.....Plumbing .....Electricity .....Shoe Repairing

Name.....Age.....

Address.....

City.....State.....

Veteran?.....



## Some make more—some less, with ELECTRIC FURNITURE CLEANER

Here's your chance to start a money-making business of your own. R. O. Donnelly took in \$40 in 7 hours. J. S. Corbit grossed \$279.50 his first month. And so it goes. Homes, hotels, offices, clubs—everywhere that furniture is used is your chance for profits. Auto upholstery, too.

### NO SHOP OR OFFICE NECESSARY

You operate, at low cost, from your home. Supplies cost little. What you take in is mostly profit! If you are ambitious and energetic you should make good money at the start.

**FULL INFORMATION FREE.** Write today. Ask for Furniture Cleaner Booklet. It tells all about this electric machine—how to start a business—and how to succeed. Don't delay.

**VON SCHRADER MFG. CO.**  
536 PL • RACINE, WIS.

Utilities  
Engineering  
Institute  
Founded 1927

## Diesel • Auto Body & Fender REFRIGERATION • AIR CONDITIONING

Practical training in these big pay trades covers overhauling, troubleshooting, installation, maintenance techniques. Proved, easy-to-follow method prepares you at home in spare time, follows with actual shop practice. Also G. I. approved resident courses.

Full information **FREE!** Write today  
2525 Sheffield Ave., Dept. C-5, Chicago 14, Ill.

## HOW TO MAKE MONEY!



RAISE HIGHLY PROFITABLE Angora Rabbits backyard easy way. Multiply fast. No experience required. Wool brings TOP PRICE. Plenty markets. Write **TODAY** for FREE INFORMATION, PRICES & WHERE to SELL.

**WHITE'S RABBITRY**  
NEWARK 10, OHIO

## WRITERS

Conscientious sales service for your short stories, articles, books and plays. Send today for FREE circular "Your Road To Writing Success."

DANIEL S. MEAD LITERARY AGENCY  
Dept. PM5 419 4th Ave., N.Y.C., 16

## TRI-STATE COLLEGE

B. S.  
DEGREE IN  
27 MONTHS

Founded 1884

World-Wide  
Enrollment

Civil, Elect., Mech., Chem., Aero., Radio and Telev., Engineering; Bus. Adm., Acct. Visit Campus, see well equipped labs. Low cost. Prep. courses. Personalized instruction. Grads. successful. Enter June, Sept., Jan., March. Catalog 450 College Ave., Angola, Ind.

Say You Saw It in Popular Mechanics

## Learn BAKING At Home

Baking is one of America's high industries in wages. Nearly depression-proof. Thorough basic home course lays sound foundation. If you have aptitude, write for FREE BOOKLET, "Opportunities in Commercial Baking." National Baking School, 1315 Mich. Ave., Dept. 1355, Chicago 5



LEARN HOW TO MAKE REAL MONEY IN

# TELEVISION

RADIO & ELECTRONICS

**AT NO EXTRA COST!**  
**YOU GET A ROUND TRIP TO**  
**NEW YORK CITY**  
FROM ANYWHERE IN THE U. S. OR CANADA

After you have completed the home study section of your course, your transportation to *New York City*—both ways—from any point in the United States or Canada will be paid by RTTA. At our affiliated training shops in New York City you'll get 2 *solid weeks*—50 hours of intensive laboratory work—on the most modern and scientific equipment.

You'll live in New York City, the heart of the television industry, where the headquarters of the National Broadcasting Company,

American Broadcasting Company, Columbia Broadcasting System, Mutual Broadcasting System and many large television and radio companies are located.

### FREE EMPLOYMENT HELP

Upon completing your laboratory resident course, you will *personally be recommended* for a position by our placement director, who will help you get started toward a money-making future in television, radio and electronics.

**RTTA FURNISHES EVERYTHING—TUBES, BATTERIES, and LARGE TV PICTURE TUBE**

**IN DOUBLE QUICK TIME**  
**EARN BIG PAY,**  
**OWN YOUR OWN BUSINESS**

NOW—you can qualify for a money-making career, through RTTA's sensational plan. In addition to becoming a **CERTIFIED TELEVISION TECHNICIAN**, you build yourself a complete large screen television set of the finest commercial quality, for your own use. You get 15 **BIG KITS** to enable you to get practical experience, build the equipment illustrated, including a radiotelegraph and radiotelephone transmitter, and many other testing units.

No matter where you live, no matter what you do, RTTA's effective methods can help you toward a **FAT PAY CHECK OF YOUR OWN BUSINESS**. Previous experience is unnecessary.

### ALL EQUIPMENT FURNISHED

The kits you will receive contain all the necessary **TUBES** and **BATTERIES** . . . a complete set of tubes for your **TELEVISION RECEIVER** including the **PICTURE TUBE**. In addition, you'll receive everything needed to build a complete TV set, and many more testing units.

### EARN WHILE YOU LEARN

You will learn how to *earn money* in your spare time, without interfering with the work you are now doing. From the very beginning,

the **RADIO TELEVISION TRAINING ASSOCIATION's** plan is a practical **MONEY-MAKING COURSE**. We will show you how to cash in on your new knowledge, even while you are learning. *Act now* by clipping the coupon to find out how you can become a **CERTIFIED TELEVISION TECHNICIAN** and *earn extra money*.

### WE PREPARE YOU FOR YOUR FCC LICENSE

RTTA prepares you to qualify for your FCC license. *Pay is higher* for the FCC license holder because only a comparative few of the thousands of men in radio-television today hold FCC tickets.

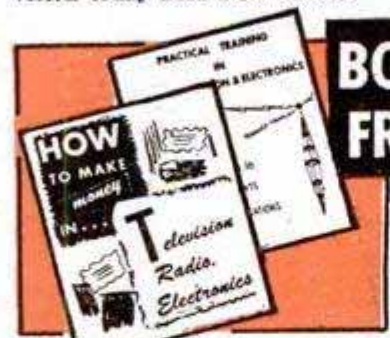

Yours absolutely **FREE**—an actual **SAMPLE LESSON!** Send for it today! You'll receive also our **FREE** catalog "How to Make Money in Television," telling how you can train for a money making job. *Mail Coupon Now!*

**BOTH FREE!**

**RADIO TELEVISION TRAINING ASSOCIATION**  
972 BROAD STREET NEWARK 2, NEW JERSEY

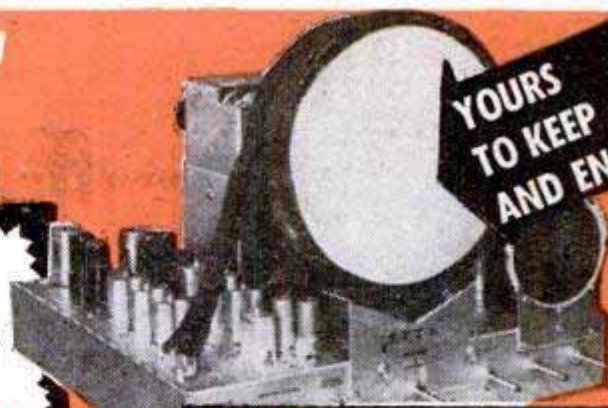

**YOURS TO KEEP AND ENJOY**

**YOU BUILD THIS LARGE SCREEN TELEVISION RECEIVER**

**YOUR CHOICE** OF 10, 12½ OR 16 INCH PICTURE TELEVISION TUBE

**CAN BE CONVERTED FOR COLOR TELEVISION**



**STUDY AT HOME IN YOUR SPARE TIME**

R. F. SIGNAL GENERATOR

**YOU GET 15 BIG TELEVISION-RADIO KITS AT NO EXTRA COST. YOU BUILD THESE ILLUSTRATED UNITS**



AUDIO OSCILLATOR

**YOU KEEP ALL EQUIPMENT**

MULTITESTER

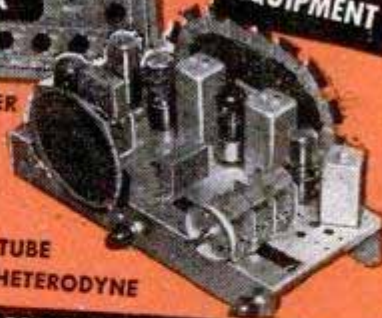

6 TUBE SUPER-HETERODYNE

### FREE SAMPLE LESSON COUPON

RADIO-TELEVISION TRAINING ASSOCIATION, DEPT. 145  
972 Broad Street, Newark 2, N. J.

Rush me the **FREE** Sample Lesson of your practical Home Television Course—together with your **FREE** Catalog "How to Make Money in Television" in **SPARE TIME** while learning. No obligations! I understand no salesman will call. (PLEASE PRINT.)

NAME \_\_\_\_\_ AGE \_\_\_\_\_  
ADDRESS \_\_\_\_\_  
CITY \_\_\_\_\_ ZONE \_\_\_\_\_ STATE \_\_\_\_\_

# get the world's greatest RADIO & TELEVISION CATALOG!

## FREE

### ALLIED'S

196-PAGE GUIDE  
TO EVERYTHING  
IN RADIO & TV AT  
LOWEST PRICES



TELEVISION AND  
HOME RADIOS



SERVICE SUPPLIES  
BUILDERS' SUPPLIES



AMATEUR GEAR



AMPLIFIERS, P.A.  
SYSTEMS, RECORDERS



Everything for Experimenters,  
Builders, Amateurs, Service-  
men, Engineers, Soundmen

Save money on every radio need! Get the 196-page 1950 ALLIED Catalog featuring the world's largest stocks of top-quality equipment, at low, money-saving prices! Latest TV releases, home radios and radio-phonos, Amateur equipment, PA systems and High-Fidelity Sound, recorders, test instruments, builders' kits—plus thousands of parts, tubes, tools, books and diagrams. Get more for your money from the World's Largest Radio Supply House. Send today for your FREE copy of the 1950 ALLIED Radio Buying Guide!

## ALLIED RADIO ★

ALLIED RADIO CORP.  
833 W. Jackson Blvd., Dept. 5-E-O  
Chicago 7, Illinois

Rush FREE 196-Page Catalog

Name .....

Address .....

City.....Zone...State.....

FREE  
CATALOG

## Yes, More Brilliant Than a Diamond!

No Other Gem Like It!  
Amazing New Discovery



Write today for the full story of the latest miracle of science, discovered in the laboratories of one of the world's largest corporations. The story of the Kenya Gem that so closely resembles a diamond that only an expert can tell the difference.

They are more brilliant than the finest diamond of equal size, yet you can now own an unmounted Kenya Gem for only \$24 (1 carat) to \$96 (4 carats); also beautiful rings and earrings for as little as \$45. **Easy Payment Terms.**

Kenya Gems are the marvelous discovery you read about in The Sat. Eve. Post, Jewelers' magazine and N. Y. Times, "the only thing on earth more brilliant than a diamond." Write today for **FREE** illustrated literature.

**KENYA GEM CORPORATION**

Copyright 1950  
Kenya Gem Corp.

Philadelphia 44, Pa. Dept. 285

## STUDY AT HOME

WITH AN EDUCATIONAL INSTITUTION

Courses in **ENGINEERING**: Electrical, Civil, Mechanical, Drafting, Architectural, Automotive, Steam, Diesel, Aeronautical, Radio, Structural, Mining, Industrial, Petroleum, Marine, Refrigeration, Air Conditioning, Chemical.

Courses in **ARTS AND SCIENCES**: Philosophy; Education; Letters; Public Health; Medical Jurisprudence; Psychology; Sociology; Physics; Chemistry; Geology; Pol. Science; Theology; Law; Business and Commerce; Accounting; Mathematics; Statistics, Agriculture.

McKinley-Roosevelt Incorporated, 4610-K3, Sheridan Rd., Chicago 40, Illinois

## STRENGTHEN Your VOICE!

YES—you can now build yourself a powerful speaking and singing voice with this amazing new scientifically sound tested method. Self-training . . . no music or piano required. Results **GUARANTEED**. Just send your name for the sensational details. **FREE** chart of your vocal mechanism included! Please state your age.

**PERFECT VOICE INSTITUTE, Studio E-2, 1141 S. Wabash Ave., Chicago 5, Ill.**



Free  
Book

## RAISE HAMSTERS

The new wonder animals from Syria. Often called Toy Bears. Delightful pets. Everyone wants them! Laboratories need thousands. Clean, odorless. Raise anywhere. A profitable and interesting hobby or business. We furnish breeding stock with manual of instructions.

Write today for free illustrated literature.

**GULF HAMSTERY, 1536 BASIL, MOBILE, ALA.**



## This NEW TYPE ACCORDION

is much easier to play

You can even learn to play it by yourself. For free information write to:

**HUNIBEL ACCORDIONS**  
5154 N. Clark St., Chicago 40, Ill.

## SHOE REPAIR OFFERS BIG INCOME LEARN IN 12 WEEKS TIME

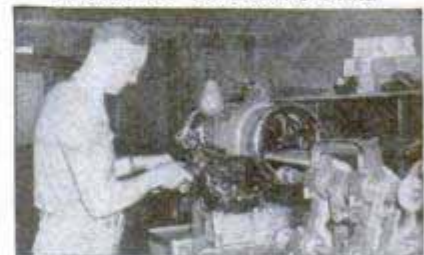

You can own your own shop or earn big income as skilled shoe repairman. Growing demand everywhere at top wages for men who know how. We teach you quickly by actually working on shoes and modern machines. School open to all from 18 to 60 years of age. **FREE BIG 20 PAGE BOOK** explains everything. Send for your copy today. Chicago & Los Angeles schools only approved for Vets.

**MODERN SHOE REBUILDING SCHOOL**  
Established 1927  
2937 Belmont Ave., Chicago, 361-12th St., Oakland, Calif.  
806 So. Figueroa St., Los Angeles 14, Calif.

# BUILDERS

## TRADE GUIDES



### AUDELS CARPENTERS AND BUILDERS GUIDES—4 VOLS. \$6

Inside Information for Carpenters, Builders, Joiners, Building Mechanics—all Woodworkers. 1600 pages; 3700 diagrams; flexible; pocket size. Short-cut instructions, new methods, ideas, solutions, plans, systems—money saving suggestions. An easy progressive course for the apprentice. A practical daily helper and Quick Reference for the master worker. A Helping Hand to Easier and Better Work and Better Pay. To get this aid for yourself, simply fill in and mail the FREE COUPON below.

**INSIDE TRADE INFORMATION ON:**

How to use steel square; How to file and set saws; How to build furniture; How to use mitre box; How to use chalk line; How to use rules; How to make joints; Carpenters' arithmetic; Mensuration problems; Estimating	strength of timbers; How to set girders and sills; How to frame houses and roofs; How to estimate costs; How to build houses, barns, garages, bungalows, etc.; How to read and draw plans; Drawing up specifications; How	to excavate; How to use settings 12, 13 and 17 on the steel square; How to build hoists and scaffolds—skylights; How to build stairs; How to put on interior trim; How to hang doors; How to lath—lay floors; How to paint.
--	---	---

**\*\*Audels Guides worth four times their price—handy too as I carry them in pocket for reference.\*\*** W. J. Bates, Knoxville, Pa.



### AUDELS PLUMBERS AND STEAMFITTERS GUIDES—4 VOLS. \$6

A new edition—just out! A practical, illustrated, Reference Library and Study-Course for Master Plumbers, Journeymen and Apprentice Steamfitters, Gas Fitters and Helpers, Sheet Metal Workers, Draughtsmen, Master Builders, Engineers and all Building Trade Students. 1670 pages; 3642 diagrams; flexible; pocket size. Guides explain all the principles, advances and short cuts of the Plumbing and Heating trade. Contains instructions on how to figure and estimate jobs. Use FREE COUPON below to examine, without obligation, this valuable work.

**INSIDE TRADE INFORMATION ON:**

Air Conditioning. Soldering, tinning. Joint wiping, bending, beating. Pipe—iron—steel, threading. Mathematics, tables, physics. Materials—iron, steel, copper, brass, lead, tin, antimony. Sheet metal—galvanized—plate. Sanita-	tion, syphonage, tanks. Drainage, sewage, purification. Fixtures—bath—kitchen. Pipe fittings, soil pipe, tools. Laying out work. Roughing. Screwed fittings, flanges, joints. Pipe bending, examples. Elbows. Heating, ven-	tilation, refrigeration. Water supply, mains, wells, tanks. Gas-fittings. Underwriters. Sheet metal work, problems, methods. Brazing, heating, lead burning. Welding, various welds, methods. Blacksmithing, forges, tools.
--	---	---

**\*\*Audels Guides are practical, easy to understand, reliable. Cover the field in plain language.\*\*** W. F. Arminger, Annapolis, Md.



### AUDELS MASONS AND BUILDERS GUIDES—4 VOLS. \$6

A complete, illustrated trade reference library, for Bricklayers, Cement Workers, Plasterers, Tile Setters and Stone Masons, including a practical outline of Steel Construction. 1100 pages; 2067 diagrams; flexible; pocket size. A practical Trade Assistant explaining modern methods of masonry construction. Easy to understand and apply. A reliable and authentic reference work and study-course for Master Journeyman and Young Mechanic. Use FREE COUPON below and find out for yourself, without obligation, whether this set will benefit you.

**INSIDE TRADE INFORMATION ON:**

Bricklaying, tools, materials; Brick designs, patterns, bonds; Setting frames and foundations; Mortars, scaffolds, estimating; Mortars and mortar mixing; Tile setting, mosaic, hollow tile; Straight edge test, trow-	eling; How to figure brick work; Safe loads, piers, chimneys; Boiler settings, anchors, fire stops; Labor tables; Concrete, forms; How to figure concrete work; Stucco—on old and new buildings; Plastering—wood lath—metal;	Plasterers agreement; Plastering on various surfaces; Stone masonry; Cutting, finishing, estimating stone; Derricks, rigging; Steel construction; Fire proof; How to read blue prints.
--	--	--

**\*\*Audels Masons Guides are the best books on the subject. Have laid brick 12 years and am a mason judge.\*\*** H. A. Sonnett, Corliss, Pa.

### PRACTICAL ELECTRICITY—1 VOL. \$4

Audels Handy Book of Practical Electricity is a simplified Ready Reference and Study Course in one pocket size volume—for Engineers, Professional Electricians and Students. 1040 pages; 2600 diagrams; flexible bound. A reliable authority and handy helper for every electrical worker. Contains important and valuable wiring diagrams, calculations, machine sketches, helps on maintenance and repair. Use this FREE COUPON today and find out, without obligation, how this handy book will help you in your daily work.



**INSIDE TRADE INFORMATION ON:** Electro-Therapeutics, X-Rays, Shocks, Welding, Brazing, Radio Hook-ups, Motion Pictures, Telephone, Telegraph, Cranes, Bells, Elevators, Pumps, Tools, Ship Drive, Railways, Vehicles, Automobile Electric Systems, Ignition, Generation, Lighting, Plant Management, Power Plans, Armature Winding, Repairing, A. C. Motors and Apparatus, D. C. Motors and Apparatus, Alternator Construction, Dynamos, Wiring, Diagrams, Sign Flashers, Cable Splicing, Power Wiring, Outside Wiring, Switches, Lighting, Rectifiers, Converters, Transformers, Fuses, Circuit Breakers, Rheostats, Electro Plating, Electrolysis, Storage Batteries, Magnetism, Electrical Energy, Conductors, Insulators, Static, Dynamic, Radio Electricity, Applications, Ready Reference and Index Covering the entire field of Modern Electricity.

### Learn More and You Will Earn More!

Know your job and you'll never be without one. The skilled man is always in demand. Knowledge is power. Learn your trade thoroughly by easy reading. This coupon is your opportunity for advancement and better pay. You risk nothing in sending for Audels Guides for free examination. Send it NOW!

**FREE EXAMINATION COUPON**

**THEO. AUDEL & CO.**  
49 W. 23 ST., NEW YORK CITY

Please mail me for free examination the books marked (x) below. If I find them satisfactory, I agree to mail \$1 in 7 days, on each set ordered, and to further mail \$1 monthly on each set until I have paid the purchase price.

4 CARPENTERS GUIDES \$6     4 PLUMBERS GUIDES \$6

4 MASONS GUIDES \$6     1 ELECTRICIANS HANDY BOOK \$4

NAME.....

ADDRESS.....

OCCUPATION.....

EMPLOYED BY..... PM20



# DRAW FOR MONEY!

## BE AN ARTIST

Here's the amazing way we prepare you — step by step — at home in your spare time for a fascinating Art career

It is pleasant and profitable to study Art the W.S.A. way. Trained Artists are capable of earning \$65, \$80 and more a week. **COMMERCIAL ART, DESIGNING, CARTOONING**—all in one complete home study course. Good art positions available in this great field.

Become your own boss. Many earn extra money while learning. No previous art experience necessary. **TWO ART OUTFITS** included with training. Low tuition—only \$5 monthly. See how easily, quickly you can get started. **FREE BOOK**—tells about our modern course, what our graduates say, and commercial opportunities for you.

**VETERANS: COURSE G.I. APPROVED**

### FREE BOOK gives details

**WASHINGTON SCHOOL OF ART**  
Studio 125W, 1115 15 St., N.W.  
Washington 5, D. C.

Please send me full information and Free Book, "Art for Pleasure and Profit." (Please print.)

Name \_\_\_\_\_  
Street \_\_\_\_\_ Age \_\_\_\_\_  
City \_\_\_\_\_ Zone \_\_\_\_\_ State \_\_\_\_\_



## ELECTRICAL TRAINING

Intensive 32 weeks' residence course in fundamentals of industrial electrical engineering, including radio, electronics. Prepares for technician, engineering aides. Approved for veteran training. 57th year. Enter September 5. Catalog.

### BLISS ELECTRICAL SCHOOL

7632 TAKOMA AVENUE  
WASHINGTON 12, D. C.



## SEND FOR Inventors' IDEA Guide

**ONLY \$100 POSTPAID**  
INVENTORS MAKE BIG MONEY!! HERE ARE OVER 1,000 PRACTICAL IDEAS FOR NEEDED INVENTIONS.



**INVENTORS' IDEA GUIDE**

1410 Raymond Ave.  
St. Paul 8, Minnesota

Enclosed find \$1.00 for your new bulletin to help inventors.

Name \_\_\_\_\_

Address \_\_\_\_\_

If not entirely satisfied I may return bulletin within 5 days for refund.

## COOK & SERVE a COMPLETE MEAL Anywhere . . . Anytime in the pocket size SNACKIT'

The complete cooking and serving kit. Only 5" in diameter. Will fit in pocket. Weighs only 11 oz. Large enough to cook and serve a complete meal. Includes Two SNACKIT' pans; famous COOKIT Stove and 12 HEATAB solid fuel tablets. Stove and TWO hour fuel supply fold inside the pans. Perfect for outdoorsmen, tourists, picnickers, bachelors. Ideal gift. Cover keeps out dirt and sand, protects food. Sanitary, easy to clean. Cooks meats, fish, fresh and canned foods, liquids, beans, vegetables, etc. Made of spun aluminum, with cool heatproof Bakelite handles. **SEND NO MONEY!** Pay postman only \$2.95 plus C.O.D. charges. Or send \$2.95 and we pay postage. Money back guarantee. \*trade mark SNACKIT' Co., 18 E. Kinzie St., Chicago 11, Ill.



## How to win an Executive's JOB and PAY

Only one thing stands between you and a top executive's pay—the right kind of ability. You may be skilled in your work, yet if not trained in management you are not likely to be promoted to important executive jobs. Thousands win promotions thru LaSalle's Executive Training—and YOU too can gain tremendous advantage over others by knowing management principles. Write today for FREE 48-page book, "14 Steps to Executive Leadership."

**LASALLE Extension University, 417 So. Dearborn St.**  
A Correspondence Institution Dept. 564-BM, Chicago 5, Ill.

## RADIO ENGINEERING, Broadcasting, Television, FM, Servicing, Electronics, Aviation, Marine & Police Radio taught thoroughly. Engineering course equivalent to 3 years' college radio work. Approved Veteran Training. Catalog free.

**VALPARAISO TECHNICAL INSTITUTE, Dept. D, Valparaiso, Ind.**

## make MONEY CASTING AT HOME

Make your own rubber molds quickly, cheaply with X.L. RUBBER. Cast thousands of perfect figurines, book ends, plaques, ornaments, ash trays, etc. **GREAT PROFITS!**  
Write for NEW Catalog.  
X.L. Rubber, Pts. \$2.00; Qts. \$3.50; Gallons \$8.95; Models and enough rubber for 3 molds \$1.30 postpaid.

Dept. 2, 3403 S. MADISON ST., Muncie Ind.

## LAW FREE BOOK

Your FREE copy of "The Law-Trained Man" shows how to gain prestige and greater earnings through Blackstone home law study. All instruction material furnished including 18-volume Law Library written by 65 well-known law authorities. Lawyers, judges among our graduates. LL.B. degree. Low cost; easy terms. Write today.

**BLACKSTONE COLLEGE OF LAW** 225 N. Michigan Ave.  
Dept. 55, Chicago 1, Ill.

A Correspondence Institution Founded in 1890

## MAKE MONEY! RAISE CHIN-CHIN CHINCHILLA RABBITS

Profitable! Easy! Pleasant! Free illustrated Booklet—WRITE TODAY!  
**ROCK HILL RANCH** SELLERSVILLE 36, PA.

## \$9.00 BIG MONEY FOR YOU FOR DEMONSTRATOR Selling Mechanical Trade

High grade men wanted in open territories. If you can sell modern, world beating accessory tool (The Stackhouse Drill Saw Tool attachment) to garages, auto body shops, sheet metal, carpenters, electricians, and many other mechanical trades, we have money making proposition you can't resist. It saws all Metals, Bolts, Asbestos, Rivets, Wood, Fibre, Pipe and Tubing. Invest only \$9 in demonstrating sample. You can make over \$50 daily. Write for details.



**E. H. STACKHOUSE**  
219 N. 63rd St.  
Dept. PM 5-50  
PHILA., PA.

# WHICH OF THESE *Opportunities* INTERESTS *You* MOST?

● Today, choose the job you want—and prepare for it. Or if you are already engaged in the work you like best, start training *now* for quicker promotion. Acquire the knowledge that will help you to get ahead faster, make more money and have greater security.

American School, founded in 1897 as an educational institution *not for profit*, can help you to reach your goal just as it has helped others during the past fifty-three years. Check the coupon at right, add your name and address and mail it at once. The school will send you details on its training plan and outline of study prepared by specialists. There is no charge, no obligation, so send the coupon immediately.

## CHECK, CLIP AND MAIL COUPON NOW

**AMERICAN SCHOOL, Dept. G545, Drexel at 58th, Chicago 37, Ill.**  
Without obligation, Please send FREE and postpaid, bulletin and details of the Subjects checked:

- |  |   |  |
|--|---|--|
| <input type="checkbox"/> PLASTICS ENGR'G           | <input type="checkbox"/> Accounting                   | <input type="checkbox"/> Drafting and Design for Men and Women |
| <input type="checkbox"/> Refrigeration             | <input type="checkbox"/> Electrical Engr.             | <input type="checkbox"/> Radio                                 |
| <input type="checkbox"/> Architecture and Building | <input type="checkbox"/> Electricity-Pract.           | <input type="checkbox"/> High School                           |
| <input type="checkbox"/> Contracting               | <input type="checkbox"/> Electronics, Industrial      | <input type="checkbox"/> Air Conditioning                      |
| <input type="checkbox"/> Practical Plumbing        | <input type="checkbox"/> Bookkeeping                  | <input type="checkbox"/> Mechanical Eng.                       |
| <input type="checkbox"/> Automotive Engr.          | <input type="checkbox"/> Private Secretary            | <input type="checkbox"/> Shop Management                       |
| <input type="checkbox"/> Aviation Drafting         | <input type="checkbox"/> Diesel Engineering           | <input type="checkbox"/> Tool Making                           |
| <input type="checkbox"/> Aviation                  | <input type="checkbox"/> Sheet Metal Pattern Drafting | <input type="checkbox"/> Better Foremanship                    |
| <input type="checkbox"/> Business Management       | <input type="checkbox"/> Railway Training             | <input type="checkbox"/> Machine Shop Operations               |

Name \_\_\_\_\_ Occupation \_\_\_\_\_

Address \_\_\_\_\_ Age \_\_\_\_\_

City \_\_\_\_\_ State \_\_\_\_\_

## AMERICAN SCHOOL

Dept. G545, Drexel at 58th Street, Chicago 37

## BE A PHOTO-ENGRAVER

We furnish complete equipment and supplies. Learn at home or in our modern, friendly APPROVED school in MISSOURI. Get into this big demand, high profit, high wage field. You can start your own profitable, full time or part time PHOTO-ENGRAVING business right in your own home.

Be independent, be your own boss or pave the way to a high pay job with experience gained in your own shop.

TASOPÉ TRAINING and TASOPÉ EQUIPMENT has enjoyed world wide recognition since 1931. Write for descriptive literature today. No obligation.

THE AURORA SCHOOL OF PHOTO-ENGRAVING, DEPT. 9PM., TASOPÉ BLDG., AURORA, MO.

## LEARN MEAT CUTTING AT NATIONAL Pay After Graduation



The steady dependable trade of Meat Cutting taught easily in 8 short weeks. You LEARN BY DOING under actual meat market conditions in big modern school at Toledo.

For beginners or men with experience. Get a profitable store of your own. Remember, PEOPLE MUST EAT! Big pay jobs. Free employment help. Thousands of successful graduates.

Buying, cutting, percentage, pricing, advertising, selling, etc. A complete retail meat education. National School established over 25 years. Get National training NOW. Pay your tuition in easy weekly payments

after you graduate. G. I. approved. Send coupon for FREE 52 page school catalog — TODAY.

**National School of Meat Cutting, Inc., Dept. 50-E, Toledo 4, Ohio**

Send me your FREE school catalog on National Training at Toledo in Meat Cutting, Meat Merchandising and Self Service Meats. No obligation. No salesman will call.

Name \_\_\_\_\_

Address \_\_\_\_\_

City \_\_\_\_\_ State \_\_\_\_\_

( ) Check here if Veteran of World War II

# INVENTORS

Before you make any effort to market your invention, you should take the first steps toward proceeding for patent protection.

The usual first step is to have a search of the U. S. patent records conducted, so that I can report to you on the question of patentability.

I shall be pleased to furnish you with information relative to patent procedure and also on the matter of trade-mark registration, upon request from you, and this will be without any obligation on your part.

## PATRICK D. BEAVERS

(Formerly RANDOLPH & BEAVERS)  
Registered Patent Attorney

934 Columbian Building Washington 1, D. C.

# INVENTING

**-FOR PROFIT!** If you have an inventive turn of mind, write for free 28-page booklet explaining how the Institute of American Inventors is helping inventors pre-test the profit possibilities of proposed devices to fill today's unprecedented demand for useful new inventions.

**INSTITUTE of AMERICAN INVENTORS**  
Dept. 4, 631-E St., N.W., Washington 4, D. C.

## BE AN INVESTIGATOR

WORK HOME or TRAVEL. Experience unnecessary.

**INVESTIGATOR** Particulars FREE. Write to **GEO. M. P. WAGNER**, 125 W. 86th St., N. Y.

# INVENTORS

IF YOU WISH TO PROTECT YOUR INVENTION, You should take steps to protect it by a U. S. Patent. Write me for "RECORD OF INVENTION" form.

**CARL MILLER**  
REGISTERED PATENT ATTORNEY

WOOLWORTH BLDG., 35th FLOOR, 50A,  
NEW YORK CITY

## New Advertising Machine Prints Post Cards

**FREE** LEARN HOW thousands of business men, in every line, boost sales in spite of conditions—with ads printed on postcards by amazing new patented **CARDMASTER** advertising machine. Low price, sold direct. Guaranteed 5 years. **SEND NAME** for **FREE** illustrated book, new money-making ideas and complete, unique advertising plans. **Cardmaster Co., 1920 Sunnyside, Dept. 135, Chicago 40, Ill.**





# PATENTS

## AND TRADE MARKS

### C. A. SNOW & CO.

REGISTERED PATENT ATTORNEYS

WRITE FOR INFORMATION TO

428 SNOW BUILDING, WASHINGTON 1, D. C.



# INVENTORS

Whether an invention is patentable can be substantially determined by a search of the U.S. Patent records. Without obligation, write for information explaining the steps you should take to secure a patent.

**JOHN N. RANDOLPH**  
Registered Patent Attorney

201 Columbian Building, Washington 1, D. C.

# INVENTORS

Protect your Invention by a U.S. Patent

Write me for free record of Invention Form

**SHERMAN LEVY**

620 Victor Building

724 Ninth Street Washington 1, D. C.

# PATENTS PATENT LAWYER

**GUSTAVE MILLER** **ASSOCIATE EXAMINER**  
U. S. PATENT OFFICE 1922-1929  
Registered Patent Attorney Patent Attorney and Advisor  
U. S. NAVY DEPT. 1930-1947  
50-PM WARNER BLDG. Send for  
WASHINGTON 4, D. C. PATENT INFORMATION book  
and "INVENTOR'S RECORD" without obligation

## GEORGE B. OUJEVOLK

Patent Attorney  
Canadian Patent Agent  
Philippines Trademark Attorney  
509 FIFTH AVENUE NEW YORK 17, N. Y.

SAY YOU SAW IT IN POPULAR MECHANICS

# HIGHEST ROYALTIES and CASH

## FOR YOUR INVENTIONS

(Patented and Patent Pending Only)

Write for **FREE** booklet without obligation

## UNIVERSAL MARKETING CO.

354 S. SPRING ST. (Suite M)

LOS ANGELES 13, CALIF.



**Now CHEAP OIL BURNER**  
FOR HEATING AND COOKING STOVES • FURNACES  
HEAT YOUR HOME, COOK YOUR MEALS  
WITH CHEAP FURNACE OIL



**NO MORE SHOVELING COAL OR ASHES.** Sensational Fuelizer Starter Vaporizing System turns Cheap No. 1 Furnace Oil, also Range, Heater, Tractor Distillate, Kerosene and like oils into oil heat—one of the quickest, hottest fires known. **LIFETIME GUARANTEE. \$1.00 Bonus Offer for Testing.** We will let you try it in your own stove or furnace for one month. Get yours for introducing. Big profits QUICK. Be first. Send in your name today for details and cash in on the tremendous demand for this Amazing Invention.

**NORTHWEST MFG. CO., 730-E, Mitchell, S. Dak.**



**GUNS**  
10 MODELS  
"AUTHENTIC REPLICAS"

**LOOK LIKE REAL GUNS!**

- Reproduced in Actual Size, Design and Balance.
- Made of Solid Cast Aluminum.
- Nothing to Finish.
- Most Models Only \$1.25 Postpaid.

**LYTLE NOVELTY CO.**  
2656 Fashion Ave., Long Beach 10, Calif.

No Canada Orders  
Send 10 cts. in coin for Illustrated FOLDER

**NEW! BIG FIELD**

**FOR PROFIT AND PLEASURE  
COPPER TOOLING & ETCHING**

**EARN BIG MONEY—FULL OR SPARE TIME**



No experience necessary—Start at once. Big MONEY waiting in Copper Art Field. **LEARN QUICKLY. EARN QUICKLY.** Free details. For the **COPPER TOOLIST**, we carry Copper, Sketches and a complete line of lacquers and supplies. Free Price list. **HOLLYWOOD COPPER ART STUDIOS, Box 9338—Post Office Sta. S Los Angeles 5, Cal., Dept. PM-5**

DO IT AT HOME



**BE A LOCKSMITH**

Learn from experts at home! Age or handicap no disadvantage. Profitable profession. **FREE** booklet. **INSTITUTE OF LOCKSMITHING, Dept. P-6, 55 Park Av. Rutherford, N. J.**

**ELECTRICIANS' SCHOOL**

HOUSE AND COMMERCIAL WIRING • MOTOR REPAIR AND REWINDING • ELECTRIC REFRIGERATION

Approved for Veterans Training

**PENNSYLVANIA INSTITUTE SCHOOL OF ELECTRICITY**

42nd and SPRUCE STS. PHILADELPHIA 4, PENNA.

**LEFAX** POCKET SIZE TECHNICAL DATA BOOKS \$1. EACH

Printed on loose leaf, six hole, 6 3/4" x 3 3/4" bond paper, each book contains about 140 pages of technical data, presenting condensed, accurate and essential data for the student, engineer, technical worker and business man.

Architecture	Reinforced Concrete	Surveying
Home Heating	Building Constr.	Mechanical
Illumination	Radio	Drawing
Electrician's Data	Television & FM	Machine Design
Builder's Data	Electricity, AC	Machinists Data
Lumber Data	Electricity, DC	Piping Data
Air Conditioning	AC Motors and	Surveying Tables
General Math.	Generators	Trig-Log Tables
Math. Tables	Transformers,	Metallurgy
Physics	Relays, Meters	Analytic
Chemical Tables	Hydraulics	Chemistry
Metals	Automotive	Highway
General	Engineering	Engineering
Chemistry		

Write for **FREE** catalogs (over 2000 listings). See for yourself how helpful **LEFAX** can be to you. Send \$1 for each book, (or \$5 for any six books listed above) to

**LEFAX DEPT. PM-2 PHILADELPHIA 7, PA.**

**EARN MORE IN DRAFTING**



More Opportunities for Employment and Promotion

"Here I am at work making good money as a draftsman. I'm glad I sent the coupon to Chicago Tech for that Free Trial Lesson and found out how easy it is to learn Drafting in spare time at home. Today I feel secure in my job because the draftsman's work comes first on any new project. And, in addition, draftsman can't be replaced with machines. What's more, I feel I'm slated for promotion and more pay, because I see so many draftsmen advancing to high-pay jobs."

**LEARN IN SPARE TIME—AT HOME!**  
(or at the College in Chicago)

A few hours of pleasant home study every week—that's all. No interference with your present job. All the tools you need; drawing outfit included. With Chicago Tech's help, you train yourself step by step. This tested method—developed over 46 years of C.T.C. progress—prepares men quickly for good positions in industry.



**FREE INFORMATION—SEND COUPON**

To prove to you how easy it is to learn Drafting at home by the Chicago Tech method, we will send you this **FREE TRIAL LESSON**. No charge for this lesson, now or later. Fill out and mail coupon, or send post card today.

**CHICAGO TECHNICAL COLLEGE**

E-213 Tech Bldg., 2000 S. Michigan Ave., Chicago 16, Illinois  
Mail me **FREE** Lesson with information about big opportunities in **DRAFTING**.

Name \_\_\_\_\_ Age \_\_\_\_\_  
Address \_\_\_\_\_  
City \_\_\_\_\_ Zone \_\_\_\_\_ State \_\_\_\_\_

*Learn* **PHOTOGRAPHY**

There's big money in **PHOTOGRAPHY**—and an action-packed career for you. Our **HOME STUDY COURSE** is your spare-time **SHORT CUT TO SUCCESS!** Or, if you wish—**PERSONAL ATTENDANCE TRAINING** at our famous New York School is available with subsistence under the G. I. Bill. Our 40th year. Write immediately!

**NEW YORK INSTITUTE OF PHOTOGRAPHY**  
Dept. "49," 10 West 33 Street, New York 1, N.Y.



**This FREE sample kit can make you a HIGH-PAID MAN in your community**

**LONG NEEDED INVENTION**  
Earn up to \$10,000 per year or more!  
Be your own Boss! No investment!

U. S. Pat. D 153853

You can get started on the road to success with this valuable sample case containing demonstration units and powerful sales literature. Handsome, leather-type finish. Tried and proved, it will make you money.

World-famous automatic fire extinguisher needed by every home, business, and farm. smother's fires without human aid. priced to sell quickly

**ACT NOW!** Be an independent business man! Someone in your community will be appointed soon. **WRITE FOR DETAILS TODAY!**

**RED COMET, INC.** 609 RC Building LITTLETON, COLO.

# Learn ELECTRIC APPLIANCE REPAIR IN YOUR SPARE TIME AT HOME

## START YOUR OWN BUSINESS

**ONE BUSINESS THAT IS NOT EFFECTED by STRIKES, DEPRESSIONS OR POLITICS**

**OWN BUSINESS WITH A POTENTIAL MARKET OF 50,000,000 CUSTOMERS**

New shop-method, home-training system gives you electrical know-how that used to take years to learn. Learn at home by building valuable testing kits, repairing your own and neighbors' appliances. It is not unusual for appliance repairmen to charge on the basis of \$5.00-\$6.00 an hour.

**FREE ILLUSTRATED BOOK**

Shows you how you learn every phase of electrical appliance. How to make money while you learn. Write today for your FREE copy.

**CHRISTY TRADES SCHOOL**  
Dept. D-8103  
4432 North Kedzie Ave., Chicago 25

**ONLY 2 SHINES A YEAR AND SHE GLEAMS LIKE NEW!**

**\$1.00 BRINGS YOU BOTH CANS!**

Yes sir—give your car the glow that rests your elbow! Use LACQUER CLEANER, the amazing pre-wax cleaner, and LACQUERWAX, the famous car finish protector. It's 5 times faster and easier to apply than ordinary paste waxes. One treatment lasts 4 to 6 months.

LACQUERWAX contains no lacquer, but this hard, liquid wax is CLIMATEPROOF! Its brilliant luster shines right thru hot sun and driving rain. You can't wash it off—it won't spot! It brings out and preserves the full beauty of your car's finish. Use the LACQUER CLEANER first to remove dead paste wax and dirt, then LACQUERWAX for the beauty treatment. BOTH 10 oz. cans for ONLY \$1. Mail coupon NOW!

LACQUERWAX CO. (Dept. P.M.-5)  
HARTFORD 3, CONN.

Gentlemen: My dollar bill, check or money order is enclosed for the 2 ten oz. cans—LACQUERWAX & CLEANER.

Name .....

Address .....

City..... Zone..... State.....

**LACQUERWAX**

**JUNIOR MIMEOGRAPH**

- PRINTS
- Post Cards
- Labels
- Tags
- Price Lists

**QUICK**

Easy to use, inexpensive in operation, this modern machine guaranteed 5 years. Thousands in use. Write for complete information.

**DUPLICARD**

P. O. Box 13087

Dept. 11 Houston 19, Texas



only \$16.50 complete with supplies

**FOAM RUBBER**

For Experimenters, Home Craftsmen, Hobbyists

<b>LOWEST PRICES—SAVE 50%</b>	<b>AUTO SEAT TOPPER PADS</b>
16 x 16 x 1 1/2" .ea. \$1.25	Place on seat cushion and cover with your seat cover.
16 x 22 x 1 1/2" .ea. 1.55	24" x 60" x 1 1/2" ea. \$5.00
18 x 24 x 2" .ea. 2.00	24" x 60" x 2" ea. \$7.50
24 x 24 x 2" .ea. 2.75	

Use for furniture cushion fillers, mattresses, mattress pads, cushions. Foam Rubber is available in any size or thickness. Send For Free Price List. Immediate delivery. No C.O.D.'s. ADD 10% FOR POSTAGE & HANDLING TO ABOVE PRICES.

**RIOR RUBBER COMPANY, Dept. P-5**  
50 E. Cermak Road Chicago 16, Ill.

**ARTISTS MAKE MONEY**

Do you like to draw? Send name, address, age and occupation for FREE ART TEST, to find out your ability.

ART INSTRUCTION, Inc.

5130 ART INSTRUCTION BLDG., MINNEAPOLIS 15, MINN.

**MASTER MIND!**



**Learn Short-Cut Mathematics**

Juggle figures, do baffling number tricks. Make people gasp at your marvelous lightning-quick mind. Multiply 4 figures by 4 figures without using old-fashioned multiplication! Big cloth-bound volume; fully illustrated course. Includes worked-out problems, answers, etc. Sensational bargain, only \$1.49, postpaid—or COD plus postage. Satisfaction guaranteed or refund. Order this amazing "Short-Cut Mathematics" today!

**NELSON-HALL CO., 1139 S. Wabash Ave. \$1.49**  
Dept. 2E-2 Chicago 5, Ill. Complete

**MAKE MONEY IN LANDSCAPING**

Thorough training by Internationally known Landscape Architect to start your own business, improve your home or advance in this well paid field. Many Opportunities. Approved for Veterans. Send for FREE BOOK.



**NATIONAL LANDSCAPE INSTITUTE**  
Dept. P-5, 310 So. Robertson Los Angeles 48, Calif.

SAY YOU SAW IT IN POPULAR MECHANICS

**Learn AUTO BODY-FENDER REPAIR**



**Specialize in this Big Pay Field! Start Now to EARN MORE!**

This practical book will put you right into the most profitable business in the auto field. Shows you how to get a good job or start a business of your own with little or no capital. Easy to use and understand. Covers use of tools and equipment, gives approved methods, describes materials and shows you how to actually do a professional job, operate a shop, etc. The very latest and most complete information ever published. Clip this ad and mail with \$3.50 today or we will send COD. Money back if not satisfied.

**GOODHEART-WILLCOX CO., Dept. 127, 1321 S. Michigan Ave., Chicago 5**

# IMAGINE THEIR JOY when they found they could play this easy-as-ABC way!



## LEARNED QUICKLY AT HOME

"I didn't dream I could actually learn to play without a teacher. Now, when I play for people they hardly believe that I learned to play so well in so short a time."  
\*H.C.S., Calif.



## PLAYS AT DANCES

"Your lessons have been most satisfactory. I can play all of the popular songs. I have earned money playing at dances."  
\*E.N.J., New York.



## PLAYS ON RADIO

"I can't keep from telling you that I have a good position playing from K T H S., Hot Springs, Ark., every morning."  
\*J.S., Okla.

## What Instrument Would You Like to Play?

JUST name your instrument and we'll show you how you can learn to play it—quickly, easily, in spare time at home. Mind if you don't know one note of music from another—don't worry about "special talent." And forget all you've ever heard about music being hard to learn.

The truth of the matter is that *thousands now play who never thought they could!* Yes, men and women everywhere have discovered this amazingly easy way to learn music at home. Now they are enjoying the thrilling satisfaction of playing the piano, violin, guitar, saxophone or other favorite instruments. Some of them are playing in orchestras and over the radio; others are teaching music, making money in spare or full time. And thousands are having the time of their lives playing for their own enjoyment and the entertainment of their friends.

**LEARN TO PLAY BY NOTE**  
Piano Guitar  
Violin Saxophone  
Organ Mandolin  
Tenor Banjo  
Hawaiian Guitar  
Piano Accordion  
Or Any Other Instrument

No tedious study and practice, no tiresome exercises. You learn to play *by playing*—start right in with the melody of a simple tune! It takes only a few minutes a day; the cost is trifling. Does it sound too good to be true? Mail the coupon and get the FREE PROOF!

## FREE PRINT AND PICTURE SAMPLE

Fascinating illustrated booklet answers all your questions; free Print and Picture Sample shows how method works. If interested, just mail coupon. U. S. School of Music, 75 Brunswick Bldg., New York 10, N. Y. 52nd Successful Year. \*Actual pupils' names on request. Pictures by professional models.

**U. S. SCHOOL OF MUSIC**  
75 Brunswick Bldg., New York 10, N. Y.

I am interested in music study, particularly in the instrument indicated. Please send me your free illustrated booklet, "How to Learn Music at Home" and the Free Print and Picture Sample.

Name \_\_\_\_\_  
(PLEASE PRINT)

Address \_\_\_\_\_

Instrument \_\_\_\_\_ Have you Instrument? \_\_\_\_\_



## MEN! A Blue Print For YOUR SUCCESS!

Here is your opportunity for Success An amazing new finishing system that will start you in your own profitable business. No experience necessary—up to \$10 an hour easy Spare or full time in your own home or garage Start small—grow big fast. We will guide you every step of the way This is BIG—don't miss your chance. Send name now for FREE SAMPLE and booklet of my complete, easy, profit plan for your success ACT NOW

**AMAZING NEW Miracle Finish**  
MEANS \$\$\$ TO YOU

**FREE! BOOKLET & SAMPLE**

PROFITABLY COVERS, TOYS, RADIOS, LAMP SHADES, AUTO TRUNKS & DASHBOARDS PLUS HUNDREDS OF OTHER ITEMS

Coast Industries Dept. 25 1004 So. Los Angeles St. • Los Angeles 15, Calif.

## OIL FILTER REFILLS . . . 10c

Here's News! Ordinary toilet paper makes an ideal oil filter. Laboratory tests prove it cleans oil faster and better than popular makes of filter elements. All you need is a simple set of Retlif Adapter Plates . . . and you can start using toilet paper rolls (costing about 10¢) in your present oil filter. For proof and descriptive literature, send name and address to:

RETLIF CORP., Dept. 14, 1239 No. Highland Ave., Los Angeles 38, Calif.

## CAR WASH—3c!

With Amazing New "WIZARD" Car Washer

No Soap  
No Pail  
No Sponge  
No Chamois  
No Rinsing

SALESMEN! \$30 a Day On Only 15 Orders!

Car Shines Like New in 1/3 Usual Time \$4.95 Retail

Connect "WIZARD" Car Washer to hose and turn on water. Water flows over Cleaning Detergent and Water Softener Tablet in hose coupling. Detergent saturated water flows through 3-ft. aluminum handle and then through millions of tiny pores in Foam Rubber Pad to create thick, foamy suds that remove every trace of dirt, grease, grime and road-film like magic in 1/3 the usual time. No sloshing. No splashing. A professional washing job in record time without getting your shoes or clothes wet!

**FREE! Rush Name for Demonstration Offer**  
Don't send a penny—just your name on a penny postcard for complete information and big illustrated circular. Tells all about "WIZARD" Car Washer and how salesmen are chalking up phenomenal earnings with this new lightning seller.

**GET SAMPLE.** For quickest possible action, send only \$2 for Sample Demonstrator that retails for \$4.95. This Special \$2 price is for first Demonstrator only. No more available at this Introductory Price. If you don't want Demonstrator, send name only. But hurry. Be first in your locality with the biggest money-maker of the year.

MILLER MFG. CO., 812 N. Wells St., Dept. 55, Chicago 10, Ill.

## How children start women in profitable sparetime HOME BUSINESS

Have you heard about the brand new kind of home business in which there is nothing to buy, nothing to make and nothing to sell? No canvassing, no order taking—no experience or special education—and no tedious study in order to make money. It's exclusively for dignified and responsible women and daily cash profits are limited only by the amount of time you wish to give. After the first few weeks, women in your community will ask to be included in your new service. From a small beginning you can develop as slowly or as rapidly as you wish. Soon your Service becomes as important as the Women's Club or P. T. A.

**Free Folder tells how to start!** The organization sponsoring this new plan is ready to start someone in your community at once. All information is mailed free—but time is precious, so rush name on penny postcard. **HOME SERVICE LEAGUE, 1512 Jarvis Avenue, Dept. 65, Chicago 26, Illinois**

# EARN MORE MONEY IN ELECTRICITY!

with  
**APPLIED PRACTICAL ELECTRICITY**

Coyne's new set helps men get ahead in Electricity. This great Set gives you complete, A to Z know-how. It's all explained in easy-to-follow language, hundreds of charts, examples, pictures. Covers practically all branches of electricity including appliance repairing; AC and DC equipment; electrical refrigeration; industrial electronics and much more. Brings you 10,500 electrical facts; 3,400 subjects; hundreds of wiring diagrams, tables, formulae, shortcut methods. Written and proved in the Coyne shops — backed by 50 years experience in electrical training that has put hundreds of electricians on the road to top earnings. **APPLIED PRACTICAL ELECTRICITY IS THE MOST COMPLETE ELECTRICAL SET IN AMERICA.**

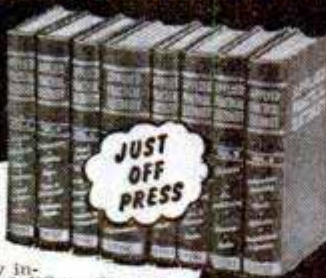

Sent on  
**FREE TRIAL**

## USE SET FREE FOR 7 DAYS!

You have to SEE these books to know how much they'll help you. See them FREE! Just fill out coupon below and mail it in. **SEND NO MONEY.** Examine the set for 7 days **AT OUR RISK!**

## 150 SHOP PRINTS BOOK FREE—FOR PROMPT ACTION



Act promptly and we will include FREE, our valuable new book "150 Shop Prints and How to Read Them". If you return the set at our expense in 7 days, you owe nothing. To keep Set, send either \$23.75 in cash or \$3.00 after 7 days and \$3.00 per month until \$25.50 is paid. Either way, you keep the 150 Shop Prints Book. It's yours FREE! Coupon below is just a request to see APPLIED ELECTRICITY Set and to get FREE Shop Prints Book for doing so. Mail coupon **AT ONCE!**

## FREE TRIAL COUPON—MAIL NOW!

Educational Book Publishing Division  
**COYNE ELECTRICAL & RADIO SCHOOL,**  
500 S. Paulina St., Dept. 50-1, Chicago 12, Ill.  
YES! Send Coyne's new 8 volume Set, "Applied Practical Electricity" to me, postpaid, for 7 days **FREE TRIAL** per your offer. Include, **FREE** of charge, your 150 Shop Prints Book.

Name \_\_\_\_\_ Age \_\_\_\_\_  
Address \_\_\_\_\_  
Town \_\_\_\_\_ Zone \_\_\_\_\_ State \_\_\_\_\_

TRAIN NOW... FOR AN

# AVIATION CAREER

IN SUNNY SOUTHERN CALIFORNIA

**AERONAUTICAL ENGINEERING • MASTER AVIATION MECHANICS**  
**MAXIMUM TRAINING IN MINIMUM TIME**

America's Finest Aeronautical Institute... Est. 1929... 7500 successful graduates... **EARN MORE MONEY...** Approved for Veterans... Board and Room available. **MAIL COUPON TODAY** for full information and catalog, **FREE** and without obligation.

NAME \_\_\_\_\_ AGE \_\_\_\_\_  
ADDRESS \_\_\_\_\_  
CITY \_\_\_\_\_ ZONE \_\_\_\_\_ STATE \_\_\_\_\_

**CAL-AERO TECHNICAL INSTITUTE**  
GRAND CENTRAL AIR TERMINAL • GLENDALE 1, CALIFORNIA

# High School at Home

## Many Finish in 2 Years

No classes. No time wasted going to and from school. Progress as fast as your time and abilities permit. Standard H. S. texts supplied. Thousands enroll each year in this 52-year-old school. Send for **FREE** descriptive booklet.

**AMERICAN SCHOOL, Dept. H545**  
Drexel at 58th St., Chicago 37, Ill.  
Without obligation, please send **FREE** descriptive booklet.  
Name \_\_\_\_\_  
Address \_\_\_\_\_



# NOW YOU CAN SHAVE IN YOUR CAR!

**Car Shaver Motor**— Use your electric shaver in your car! Dynamotor will supply 110-120 Volt DC approx. 15 Watt current from 6 Volt DC auto battery and will operate most types of AC-DC Shavers. Also has many other uses, such as operating small 3 way portable radios in car, etc. Used by Gov't. to supply voltage to radio equipment. **ORDER NO. PM-5250 \$2.00**

Send Remittance with Order • Shipping Charges C.O.D.

## FAIR RADIO SALES

132 SOUTH MAIN ST. LIMA, OHIO

# NEW Time-Saving Wash-Mop for Home-Car Owners "SPONG-IT"



**NO-WIPE FLO-SPONGE**  
SCRUBS, WASHES & RINSES  
CAR IN 10 MINUTES

Clear water flows from supple sponge, leaves surface spotless—no streaking, no chemicals needed. Can't scratch cars, windows, boats, floors, etc. Fits into tight corners. Doubles as superior wet mop. Special, long-life, large DU PONT sponge replaceable at cost under 1¢ per car wash. Send payment with order to save C.O.D. charges. **SATISFACTION GUARANTEED**

Dealer inquiries invited

**SPONG-IT** Manufacturing Co. **\$3.95** Postpaid  
HOLYOKE, COLORADO Dept. PM-1



# Learn to Write at Home in spare time

YOU, easily, can become an **Expert Penman** in Plain & Ornamental Writing, etc. **at home in spare moments QUICKLY** by my **SIMPLIFIED METHOD**, for your **PLEASURE** and **BENEFIT**. Write for my **FREE BOOK**, "How to Become an Expert Penman," which tells about my Method. How it made others **Experts at home in spare moments**. If you enclose 10c, I'll write your name with flourished bird on card and include **Shading Penpoint**.



Box 25K, HILLICOTHE, MO.

# Learn Upholstering

A MONEY-MAKING VOCATION OR A BUSINESS OF YOUR OWN

Practical home training. You get materials to make and upholster a fine Ottoman with your lessons. Professional upholsterer's tools available. Write today for free, illustrated booklet.

**WEST COAST UNIVERSITY, Extension Dept. PM-50**  
1601 S. Western Ave. Los Angeles 6, Calif.

## Say You Saw It in Popular Mechanics

# SURPLUS! 100% BRAND NEW WOOL BATTLESHIP GREY BLANKETS



THOUSANDS SOLD TO SATISFIED CUSTOMERS

Reg. \$6.95 Value

P.P. & Hdlg. For 2—40c For 1—25c

**\$4.45**  
2 for \$8.75

- Each Blanket 100% Wool. According to Gov't. Specifications
- Full Size 64" x 82"
- Extra Full Weight 4 to 4½ lbs. — Each Blanket ½ to ¾ lbs. More Wool
- Each Blanket is Perfect. No Rejects or Shoddy Wool

**WOODLAND** ARMY AND NAVY STORE, BOX 33, 6141 WOODLAND AVE., PHILA. 42, PA.

# ELECTRIFY your SEWING MACHINE



**NEW LOW PRICE!**  
**\$11.50** 1 YR. GUARANTEE

Buy direct from manufacturer and save! Kit comes fully wired, installed in a jiffy. Fits all machines! You get these all-new parts:

- Motor & Bracket
- AC-DC 115v 60c
- Steel pulley & belt
- Multi-speed foot control
- Cord set & block
- Easy instructions

**FREE . . . reg. \$2.95 chrome SEWLITE given with every kit.**  
**10 DAY FREE TRIAL — ORDER NOW!**  
 Send no money, pay COD or send money order and we'll pay postage. Please state whether wheel on your machine turns toward you or away from you. Shipping wt. 6 lbs.

**CONTINENTAL SALES CO.**  
 1046 BEDFORD AVENUE Dept. PM9 BROOKLYN 5, N. Y.

## DO YOUR OWN PLATING AT HOME!

with **ORBAG Sensational Plating Compound** **\$1.00** POSTPAID

This sensational discovery permits you to silverplate your various articles right in your home in leisurely hours. ORBAG is a plating and renovating compound (powder) which you apply by rubbing it with a piece of cloth. It will transmit a silver coating to hundreds of articles—Silverware, Spoons, Forks, Teapots, Trays, Cigarette-lighters, Cases and various home appliances. Harness equipment, Automobile parts, Fishing rods, etc. It silverplates bronze, brass and copper; preserves chrome and nickel. Send \$1.00 to

**ORBAG AGENCY**  
 P. O. BOX 3524 CHICAGO, ILL.

## RE-STRING RACKETS AT HOME — EARN MONEY

EASY — PLEASANT — PROFITABLE  
**FREE** Write for 1949 Catalog and Instruction Sheet NOW.

W. A. BICKEL & CO., 803 S. Boulevard, Dept. F-53, Oak Park, Ill.

## WHEELS — WHEELS

5" Disc Wheel 5/8" Tire 5/16" or 3/8" Sleeve	30c ea.
6" Disc Wheel 5/8" Tire 5/16" or 3/8" sleeve	35c ea.
7" Disc Wheel 3/4" Tire 3/8" sleeve	45c ea.
8" Disc Wheel 1 1/8" Tire 1/2" sleeve	70c ea.
7" Disc Wheel 1 1/8" Tire 1/2" ball bearing	80c ea.
8" Disc Wheel 1 1/2" Tire 1/2" ball bearing	\$1.00 ea.
8" Disc Wheel 1 1/2" semi-pneum. T. 1/2" B.B.	\$1.25 ea.
10" Disc Wheel 1.75 semi-pneum. T. 1 1/2" B.B.	\$1.50 ea.
12" Disc Wheel 1.75 semi-pneum. T. 1 1/2" B.B.	\$1.85 ea.

Above wheel prices include hub cap.  
 Plus Postage, 20% — C.O.D.'s accepted.

**UNITED WHEEL STAMPING CO., PM-5**  
 2756 W. 115th STREET CHICAGO 43, ILLINOIS

## SAY YOU SAW IT IN POPULAR MECHANICS



### Don't Send a Cent

Until you see our tires. "REMEMBER" you get only what we advertise. "Not retreads." "Not regrooved." Not new treads — that have been recapped. WE SHIP ONLY GOOD USED ORIGINAL TREAD TIRES. Send for just one tire and see if this trial will make you a satisfied customer.

**BUT IF YOU SEND CHECK OR MONEY ORDER IN FULL WITH THIS AD "NOW" — you may take 20% discount on every tire. SAVE TIME — SAVE MONEY**

**TUBE GIVEN WITH EACH PASSENGER TIRE**  
**WRITTEN GUARANTEE — Sent with Every Tire You Buy**  
 ONE Quality ONE Price — Why take less? Our Tires used on Buses & Trucks for every purpose — One Trial Will Convince You.

600-16 \$5.35	650-16 \$5.45	700-15 \$5.55	475-19 \$5.95
600-16(6) 6.50	700-17 9.99	650-15 5.45	525-18 5.95
700-16 6.85	750-16 7.95	550-17 6.90	550-16 5.55

**GOOD TREAD — NO RE-CAPS. THESE TIRES WILL CARRY YOU TWICE AS FAR!**

800-20 \$9.95	32x8(8) \$10.70	900-20\$15.55	1000-22 \$17.25
650-20 9.59	32x6(10) 13.33	1000-20 16.65	1100-22 18.45
700-20 10.85	34x7 12.75	1100-20 17.77	1100-24 19.99
750-20 10.50	825-20 15.95	750-15 11.45	700-17 13.00

Thousands of Tires Shipped to Satisfied Customers Throughout United States and Many Distant Points. Send This Ad with Check or Money Order. Dep't. 2.

**STANDARD 834 N. Broad St., Philadelphia 30, Pa.**

# SALESMEN!

**WRITE THREE WORDS COLLECT \$9.95**

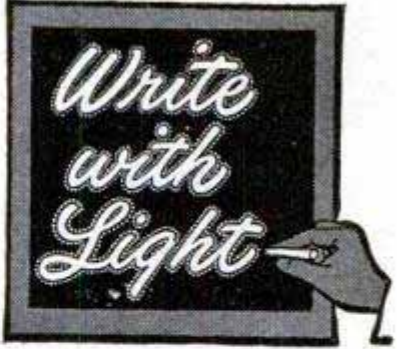

## SENSATIONAL NEW ADVERTISING SIGN

YES, MAKE \$9.95 on 10-second demonstration to merchants. Write on glass with amazing magic crayon and presto—a 5-color advertising message takes fire and glows like a brilliant neon sign! Three sales a day and \$29.85 profit is for "lazy" men. Workers can double to triple that amount. FREE SALES KIT. Don't wait. Rush your name and address on a penny postcard for full details and complete sales kit—ALL FREE.

**MAXILUME CO., 125 W. Hubbard DEPT. L-85 CHICAGO 10, ILLINOIS**



## Start As High As \$3,450 YEAR

**MEN — WOMEN** **FRANKLIN INSTITUTE**  
 (Not Government Controlled)  
 Dept. D-83  
 Rochester 4, N. Y.

Postoffice Clerks-Carriers  
 Railway Postal Clerks  
 Stenographers  
 Accountants  
 Statistical Clerks  
 Typists  
 Liquor Inspectors  
 Many Other 1950 Jobs

Gentlemen: Rush to me, FREE of charge, list of U. S. Government big pay jobs. Send FREE 40-page book describing salaries, vacations, hours, work, etc. Tell me how to qualify for one of these jobs.

**COUPON**

Name \_\_\_\_\_  
 Street \_\_\_\_\_  
 City \_\_\_\_\_ Vet? \_\_\_\_\_

**MAIL COUPON TODAY SURE**

**NEW 22nd EDITION!** 100 NEW AND REVISED PAGES

LEADING AUTO BOOK FOR 33 YEARS

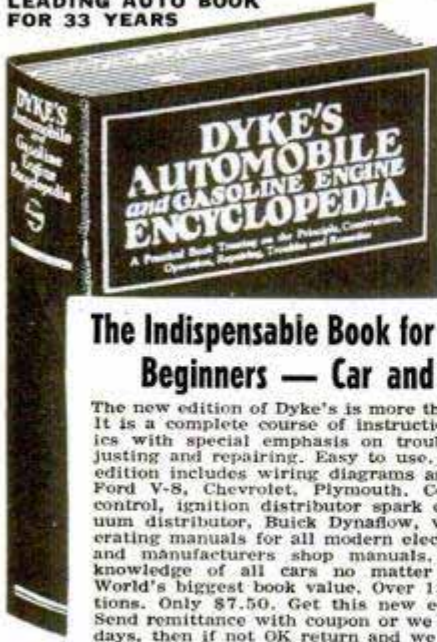

1949 SPECIFICATIONS  
36 Pages of Detailed Information on 1949 Passenger Cars, Trucks, Busses, Tractors, Diesels, Outboards, Power Plants.

Service and Tune-Up Specifications—Fuel and Electrical Systems.

**The Indispensable Book for Auto Repairmen—Beginners — Car and Truck Owners!**

The new edition of Dyke's is more than a book on automobiles. It is a complete course of instruction in automotive mechanics with special emphasis on trouble shooting, testing, adjusting and repairing. Easy to use. Easy to understand. New edition includes wiring diagrams and test data on Ford Six, Ford V-8, Chevrolet, Plymouth. Covers new vacuum spark control, ignition distributor spark control, Ford Venturi-Vacuum distributor, Buick Dynaflow, with maintenance and operating manuals for all modern electrical parts, engine repair and manufacturers shop manuals. Gives a broad practical knowledge of all cars no matter when and where made. World's biggest book value. Over 1500 Pages. 4600 Illustrations. Only \$7.50. Get this new edition for yourself today. Send remittance with coupon or we will send COD. Use for 5 days, then if not OK return and we will refund money.

**MAIL ORDER COUPON**

GOODHEART-WILLCOX CO., Dept. 125  
1321 S. Michigan Avenue, Chicago 5

Send New 22nd Edition Dyke's Automobile and Gasoline Engine Encyclopedia  C.O.D. I will pay postman plus charges. (C.O.D. in U.S. only.)  
 Remittance for \$7.50 enclosed, send postage paid. If not O.K. I will return in 5 days and you will refund purchase price.

Name \_\_\_\_\_  
Address \_\_\_\_\_  
City \_\_\_\_\_ State \_\_\_\_\_

**BE A 'CONSUMER TESTER'**  
Test America's Amazing New Products For Consumers' Testing League



**YOUR CANDID OPINION ABOUT NEW PRODUCTS IS URGENTLY NEEDED BY INDUSTRY TODAY!**

**JUDGE THE USEFULNESS AND PRACTICABILITY OF NEW PRODUCTS PRIOR TO GENERAL SALE — YOU KEEP ALL SAMPLES!**

**WE NEED A FEW HUNDRED ADDITIONAL AVERAGE CONSUMERS—YOU ARE INVITED TO JOIN THIS EXCLUSIVE PANEL!**

Consumers' Testing League is the proving ground of many hundreds of the new, useful, time-saving devices and gadgets used throughout the world in homes and industry. CTL is composed of average American consumers—doctors, lawyers, mechanics, housewives, students, inventors, etc.—all of whom are qualified to give an honest opinion about a new product. CTL tests products of every description, ranging in price from 25c to \$50. As a member your report is valued by industry. You become a judge of the type of new products which industry will produce during the next few years. If you think you are a typical consumer, we invite you to join this panel of consumer testers. Here's what is required of you! CTL will send you four new products during the next four months. You must use them in normal routine living. Then, a written report on each item must be submitted to the CTL, as your frank reaction as: whether you like this item, would recommend it to your friends; what additional uses you may have discovered; or any other comments you feel would be valuable in determining the future of this product. The only expense to you as a member of CTL is \$1 which goes to defray the mailing, handling and administrative expense of sending the four products to you, and tabulating your typical opinions. **YOU KEEP ALL PRODUCTS**—they are yours, with no strings attached. However, you must submit your reports in accordance with the rules, or your membership will not be renewed. Join today, and become an integral part of advancing American industry.

CONSUMERS' TESTING LEAGUE  
6600-P Lexington Ave., Los Angeles 38, Calif.

I would appreciate the privilege of examining America's newest products as a member of Consumers' Testing League. Please enroll me at once. Enclosed is my dollar for which I understand I will receive four products, which I must judge and submit records on promptly. All products remain mine at NO ADDITIONAL COST.

**JOIN NOW!**  
Name \_\_\_\_\_  
Street \_\_\_\_\_  
City \_\_\_\_\_ State \_\_\_\_\_

**AMAZING! NEW! ANYONE CAN DO IT!**

**SUN-FOTO**

With this SUN-FOTO Kit, you can make as many as 150 perfect, permanent prints from your own negatives... on paper, cloth or cards. You can print on neckties, scarves, hankies and greeting cards... in fact, on almost any surface that you can write on.

Makes permanent prints. Will not harm fabric or negative.

**AGENTS WANTED**  
Sent prepaid for \$1.00. Write  
**SUN-FOTO MFG. CO. INC.**  
Hollywood 38, California  
Money Back Guarantee

**\$1.00**

**NAVY PHONES** VOICE POWERED — NO BATTERIES

Mfg. by RCA. Simple hook-up. Splice 2 wires & talk over 1/2 mile. Complete—no extras to buy. Each phone has headset, adjustable transmitter, chest plate, switch (on mike) PLUS 24' of rubber-covered cable. Navy cost \$89 pp. Brand new—never used. For homeowners, farmers, contractors, mines, mills, television set installers, etc. Money-back guarantee. Send check, cash, M.O. \$13.95 pp. for 2 C.O.D.'s pay postage. **\$13.95** complete sets

**GRAND-HAWTHORNE SURPLUS**  
1439 SE Grand, Dept. PM30, Portland, Oregon

**STOP!** Picking towels, etc. off the floor!

HOLD THEM NEATLY, SECURELY, CONVENIENTLY

Only **\$7.00** **FING-O-TIP** TOWEL HOLDER

**One Hand Operation**  
Order today for yourself and as gifts. Sent prepaid if cash with order.

3 for \$2.75 **4 for \$10.00**

Easily mounted on wall or door of kitchen, bathroom, office, or lab. Choice of Red, Yellow, Green, and Blue.

**A. J. GANZ CO., 112-PM No. Hayworth Ave., Hollywood 48, Calif.**

**SNAPPY WRIST WATCH**  
Only \$4.98, not a penny more

You Too, will be proud to wear this classy new wrist watch imported from Switzerland. Made by precision artists that insure a perfect time-piece. Case is chromium plated with a stainless steel back that resists moisture and shocks. Big SWEEP SECOND HAND. LUMINOUS dial that can be seen in the dark. **\$4.98**

**FREE:** At no extra cost we will include a Brand New STAINLESS STEEL STRETCH WATCH BAND and a 1 year guarantee against mechanical defects. Send \$4.98. We Pay Postage.

**MARDO SALES CO., 480 Lexington Ave., Dept. 1709-C, New York 17, N.Y.**

**LEARN MOVIE PROJECTION THEATRE MANAGEMENT**

The Motion Picture Theatre Business offers big opportunities for trained men. Get into a fascinating field with a promising future. Train at home in spare time. Free Catalog. Established 20 years.

**THEATRE SCHOOL, 370 Washington St., Elmira, New York**

**NEW IMPROVED... AMERICANIZED JUDO**

**TWO BIG BOOKS FULLY ILLUSTRATED**  
1220 SHOW-HOW PHOTOS. 71 LESSONS  
MANY NEW HOLDS

Protect yourself and others. Size and strength mean nothing. Knowledge and skill enable you to master any situation even against biggest bullies or armed thugs. Written and illustrated by one of the world's great Judo experts. Volume 1, basic and advanced holds. Volume 2, very advanced... each volume \$1.50.

**BOTH BOOKS \$2.50 POSTPAID**  
OR C.O.D. PLUS POSTAGE  
5-day Money Back Offer. ACT NOW!

DEPT. PM-5  
**IMPROVED JUDO, INC.** P.O. Box 7355, Sta. L, Los Angeles, Calif.

**Big Combination Offer! SAVE...**

Remember it's **Dangerous** to pay less if you want safe, balanced matched tires. **WE REPEAT**—Consider your family's safety, not just **PRICE**. You see our adv. every month. Positively not recaps. We serve ambulances, fire trucks, school buses, trucks and cars.

**GOOD YEAR** **Firestone**  
**Goodrich** **U. S. ROYAL**

& others. Fine Nonskid tread. Slightly worn. Extra fine traction. Our policy is to select your tires as carefully as if our very future depended on the service given by that particular tire.

**FREE Tube with each tire**

26 MONTHS GOLDEN RULE GUARANTEE BOND

These are genuine "Many Purpose" "AAA" Tires. Read that top line again! You'll save MORE than \$

600-16	\$5.55	650-16	\$5.95	700-15	\$5.85	475-19	\$5.95
600-16(6)	6.50	700-17	9.99	650-15	5.75	525-18	5.95
700-16	6.85	750-17	7.95	550-17	6.75	550-18	5.55

America's great Lo-Price Value 12 Months Guar. Limited Supply

600-16	\$3.45	650-16	\$3.65	700-16	\$5.40	650-15	\$3.85
700-15	3.75	750-16	5.95	550-17	5.75	550-17	5.75
32x6(8)	8.65	750-20(10)	9.25	1100-20	13.20	900-20	11.15
32x6(10)	10.75	825-20	11.10	700-20	9.10	1000-20	12.65

**SUPERCUSHION TIRES (24 lb. air) to fit your present wheels**  
710-15(650-15) 6.85 | 760-15(700-15) 7.45 | 820-15(700-15) 6.25

**WE ARE TRUCK-TIRE EXPERTS**  
Matched Tires. Truck-owners the world over, depend on us to keep their trucks rolling ON TIME. TRUCKERS—Paying these few cents more will mean thousands of extra miles to you. 6-8-10-12-14-16 ply

**GOLDEN RULE 26 MONTHS REPLACEMENT GUARANTEED BOND**

600-20	\$9.95	32x6 (8)	\$10.95	900-20	\$16.66	1000-22	\$16.66
650-20	9.95	32x6 (10)	13.95	1000-20	17.77	1100-22	17.77
700-20	10.95	750-20 (10)	13.95	1100-20	18.88	1100-24	18.88
750-20	10.95	825-20	17.77	750-15	11.45	700-17	13.33

**MILITARY "AAAA" Guar. 30 mos. (Supers 14 mos.)**

750-16	900-16	750-20
Super \$9.75	Super \$8.60	Super \$8.48
"AAAA" 12.22	"AAAA" 10.90	"AAAA" 13.00
Military Rugged 600-16 \$7	750-20 \$16	

**BLATT GIRARD & LANCASTER AVES., Dept. PM**  
BLATT BLDG., PHILADELPHIA 31, PA.  
Send ck. or M.O. & this ad. We won't ship a tire WE wouldn't use. Instant shipment down South, Far West and the world over.

**SAVE ON PRINTING**

Letterheads, Forms, Catalogs	2-Color SHIPPING LABELS
1000 — 8 1/2 x 11 — \$3.95	300 — Size 2 1/4 x 4 1/4 — \$1.00
5000 — 8 1/2 x 11 — 3.50/M	1000 — \$2.95; 5000 — \$9.95
10,000 — 8 1/2 x 11 — 2.90/M	Blue and Red Ink. Gummed Stock
Both sides add — 60%	Save Labor, use one-time carbon
2 — Color add — 70%	Snap-Out forms. Get our prices.
16 lb. White Bond. Litho offset	No chg. for Pictures & Drawings.
from copy ready for Camera	Include Postage: Letterheads &
1000 — POST CARDS — \$4.95	Post Cards — 9¢/M, Labels 1¢/M
5000 — 3.10/M	<b>FREE</b> Samples. Prices on all
10,000 — 2.45/M	Printing, Catalogs, Booklets.
2-Colors add 70%. 2 sides — 60%. Layout ready for Camera.	25% cash with CODs.

**JACKSON PRINTING CO., 2011-AD Yale Ave., St. Louis 17, Mo.**

**LEARN EXPORT**

Buy and sell world-wide without capital. Travel abroad if desired. Export men and women in demand. Your own business — profits unlimited. Salaried jobs in many branches of Export-Import. Practical, low cost **WORLD TRADE COURSE** teaches you quickly at home in spare time. No previous special experience or schooling needed. World Trade Certificate awarded. Write today for **FREE BOOKLET**. No obligation. State if veteran. Air-mail reaches us overnight. **THE MELLINGER CO., Exporters-Importers, 1418-CN Westwood, Los Angeles 24, Calif.**

**"ROCKET PERFORMANCE"**

The "Vapojet" water-oil vapor injector is designed on the water injection principle which increased the speed, power and efficiency of our fighter aircraft during the war. Ideal on all cars, especially those with high compression engines. The "Vapojet" draws water vapors from the radiator and oil vapors from the crankcase and combines them with the fuel for superior performance. Many users who write claim faster pick up, smoother running and big mileage increases with regular gas. **30 DAY MONEY BACK GUARANTEE**. Complete kit fits all cars and tractors.



**VAPOJET MFG. CO.** 11424 Biona Dr., Dept. PM-5  
Los Angeles 34, California

**FOR ANY CAR with "Vapojet"**  
Designed To Help Your Car Attain

- More Power
- More Speed
- More Mileage

By Reducing Carbon "Ping" Engine Wear

**ORDER TODAY only \$9.95**

post paid. Send check or money order and save postage. \$1 deposit on C.O.D. List car, year, and no. of cylinders.

**Get into BUSINESS for Yourself!**

**METALIZING BABY SHOES AT HOME IN SPARE TIME**



Get facts about amazing money-making **Warner Success Plan** that shows you every easy step in completely charted path to personal independence—with your home as your headquarters... This proved and tested Plan is working like magic. It's backed by an old, reliable company... And we send it to you on a No-Risk Trial Money Back Guarantee.

**QUICK CASH WAITING**  
Demand for METALIZED Baby Shoes and other keepsakes is growing bigger daily. Our Tested Plan Shows How to Do the Work, How to Bring in the Business, How to Make as much as \$5 an Hour. Spare or full time, big steady profits are waiting for you. Send penny postcard or mail coupon for **FREE** Facts. Act! Time is precious.

**FREE offer of COMPLETE MONEY MAKING PLAN**  
**SEND NO MONEY Just Mail COUPON**

**Ray Brandell, Mgr., Warner Electric Co., 1512 JARVIS AVE., DEPT. 3-E, CHICAGO 26, ILL.**

Please rush complete details about your No-Risk Trial Money Back Plan for Metalizing Baby Shoes. Everything you send is **FREE** and costs me nothing — now or ever.

NAME \_\_\_\_\_

ADDRESS \_\_\_\_\_

CITY \_\_\_\_\_ ZONE \_\_\_\_\_ STATE \_\_\_\_\_

**I HELPED T.E.H. MAKE \$14 A DAY WHILE STILL LEARNING!**

**T. E. H.—West Virginia.** "By the time I finished half your course, I was making \$14.00 per day. I have made enough on the side to more than pay for the course."

**H. T. ARMSTRONG**  
**Learn ELECTRIC APPLIANCE REPAIR & SERVICE**

- WE TEACH:**
- How to Repair
  - Washing Machines
  - Vacuum Cleaners
  - Electric Ranges
  - Lamps, Motors, Irons, etc.,
  - REFRIGERATION and House Wiring
  - At Home In Your Spare Time!

For a man handy with tools, and happiest when working with his hands, **OPPORTUNITY** is Wide Open Today in this great and growing field. Everyone is a customer for the man trained to service electric appliances.

**Open Your Own Shop**  
Our practical HOME COURSE teaches you this business from A to Z—preparing you to take a well-paid job or open your own shop. You can actually start in your basement or garage with the tools we send you... before finishing.



**MAIL THIS COUPON for FREE BOOK**

**H. T. ARMSTRONG**  
**PACIFIC TRAINING SCHOOLS**  
7217 So. Broadway, Dept. P-505, Los Angeles 3, Calif.  
Dear Sirs: Please send me, without obligation, your free booklet and complete details.

Name \_\_\_\_\_

Address \_\_\_\_\_

City \_\_\_\_\_ Zone \_\_\_\_\_ State \_\_\_\_\_

# NOW FOR THE FIRST TIME YOU CAN GET A HOFFMAN MOTORCYCLE

with Super Speed, Dynamic Power Performance and Economical Operation

FROM  
**\$199.95**

Inc. Fed. Tax

Full Year Guarantee



Smooth, Safe Braking Feather-light Steering

See the HOFFMAN at Your Dealer

or Contact the American Distributors

**AMERICAN HOFFMAN CORPORATION**

621 West 54th Street, Dept. K, New York 19, N. Y.

## It's easy to do your own electrical repairs!

(and it costs much less)



Let this clear, simple book show you how to save money, time, trouble

**150 HELPFUL ILLUSTRATIONS.** Be your own repairman. Repair your home electrical appliances correctly and safely. **LEARN IN 10 DAYS OR YOUR MONEY BACK!**

Step-by-step instructions tell and show you how to fix electrical equipment, from flashlights, buzzers, toasters, to the most complicated units . . . How to splice wires, solder, handle fuses and wiring . . . how to repair, and replace cords, plugs, switches, outlets . . . how to install and maintain fluorescent lights, Christmas tree lights, etc. . . . how to repair small motors. **ANYONE CAN LEARN WITH THIS BOOK.** Only normal aptitude required. **Only \$3.00**

## Home Electrical Repairs

By **ALFRED P. MORGAN**, author of *Tools & How To Use Them*

Order from **CROWN PUBLISHERS**, Dept. 41A, 419 4th Ave., N. Y. 16. Save postage by remitting now. Full refund in 10 days if this book does not teach you everything you need to know about home electrical repairs.

## Cure Front End Sag... Get a SMOOTHER RIDE

(PATENT PENDING)

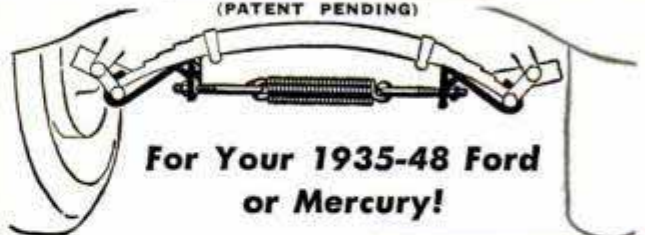

For Your 1935-48 Ford or Mercury!

Ride easier and quieter with a Pickwick "Spring-Booster" on your Ford or Mercury. Install it yourself. Adds pep to tired springs — smooths the ride — equals new springs plus shock absorbers. Send money order or check for your "Spring-Booster" today. Immediate shipment.

**PICKWICK SPRING BOOSTER**  
Reaches weak springs  
FOR ONLY **\$9.97**

Price includes excise tax and shipping charges.

**10 DAY TRIAL**

Money refunded if not satisfied.

DEALER AND JOBBER INQUIRIES SOLICITED

**THE PICKWICK COMPANY**

216 THIRD ST. N. E.

CEDAR RAPIDS, IOWA

**JUST OUT!** Get largest auto accessory



& parts catalog in world. Over 15,000 items, including Hollywood accessories, hi-speed equipment, rebuilt engines; all parts & accessories for all cars, trucks. New, used, rebuilt! We have that hard-to-get part! Completely illustrated, jam-packed with bargains! Send 25c.

**J. C. WHITNEY & CO., 1917 ARCHER AVE., CHICAGO 16**

BEAUTIFIES natural wood, pine paneling

POLISHES furniture, woodwork

IMPROVES paint jobs

PROTECTS wood and metal surfaces

**49¢ 89¢**  
PINT QUART

**101 HANDY HOME USES!**  
Every home, every workshop, needs Pol-mer-ik BOILED Linseed Oil. Free folder tells you how to use it. Write . . .

ARCHER-DANIELS-MIDLAND CO., Minneapolis 2, Minn.



# New CHAMPION All Metal Home Electric SPRAY GUN

Only **10<sup>95</sup>** Complete

**CAST ALUMINUM UNBREAKABLE**

- Precision Built
- Leak Proof
- Light Weight
- Perfection Balanced
- Easy To Handle
- Fully Guaranteed

**Makes Home Painting EASY!**

The Champion is the *only* ALL METAL, unbreakable professional-like electric spray gun on the market at such an amazingly low price! The same engineers who created, built and furnished vital and highly precision instruments for the U. S. Army and Navy now offer this brand new, money-saving, labor-saving, time-saving home sprayer on a free trial basis. Prove for yourself its remarkable features—compare it, feature by feature with *any other* home spray gun you have ever seen. Then decide whether you want to keep it and save its small cost a thousand times over in the many professional-like paint and spray jobs it will quickly and easily do for you in and around the house.

**NOT TO BE CONFUSED WITH DELICATE BREAKABLE PLASTIC!**

All high priced commercial spray guns are made of metal—just like the Champion. That's because it is built to stand long, hard trouble-free usage. Yet its price is so low that no home can now afford to be without a Champion. And it's so easy to use, just fill the jar with the particular paint or liquid you want to use, plug into any household 110 volt. A.C. light socket, press the trigger—and you're spraying. Sturdily engineered to last a life time, yet so simply assembled that it cannot clog or drip and even a child can use and clean it. It paints and sprays faster, smoother and more easily than a brush. Its nozzle is adjustable to suit every job and every taste. Sprays practically every liquid such as Enamel, Lacquer, Varnish, Shellac, Wax, Disinfectants, Light Oils, Insecticides, etc.

PRECISION BUILT BY THE EXPERTS WHO MADE VITAL INSTRUMENTS FOR THE U. S. ARMY & NAVY

WITH 8 Ft. Cord

**FREE! 10 DAY TRIAL**

This iron-clad guarantee is your absolute protection. We know once you try the new Champion home electric spray gun you will not part with it for many times its small cost. Order now—use the CHAMPION ten days and if not satisfied return for refund of full purchase price.

Just PRESS the TRIGGER and You're PAINTING



BIG 25 OZ. Glass Jar

**SAVES ITS COST ON FIRST JOB**

The Champion costs no more than a set of good paint brushes. But its superior finished work cannot be told from the high-costing professional job. No streaks, no runs, no holidays, no leaks, no small crevices overlooked.

The spray is emitted in an even spread by means of a foolproof, completely metal encased electric

vibrator. There is no danger, for no pressure goes into the jar. The gun-like holder and trigger insures complete control over the particular area you wish to spray. It needs no oiling and no special care. You merely clean it after each job and hang it up by means of its special, exclusive hook, until you are ready for your next job.

**FREE IF YOU ACT NOW!**

Here's a priceless volume every home should have. It's "Everybody's Home Fixit Guide." There are 232 pages—21 chapters, complete with pictures. A thousand and one hints on home decorating, furniture, repairs from attic to cellar. All written with words, diagrams and pictures in simple ABC form that shows you how to fix it yourself and save hundreds of dollars in repairs. This useful volume is yours



absolutely free with your order for the CHAMPION all metal home electric spray gun. Order today and get in on this free offer.

**SENT ON APPROVAL**

**HOW TO ORDER**

Just fill in and mail the coupon. When the Champion Electric Spray Gun arrives, simply pay the postman only \$10.95 plus C.O.D. and postage. Use it for 10 full days. Then if you are not satisfied in every way, just return it and your \$10.95 in full will be returned at once. Be sure to mail the coupon now.

**SEND NO MONEY**

CHAMPION IMPLEMENT CORP Dept. 2705 45 West 45th St., New York 19, N. Y.

- Send me one Electric Spray Gun for 10 day free trial.
- I enclose \$10.95 payment in full. YOU PAY POSTAGE.
- Send C.O.D. I will pay postman \$10.95 plus postage. Same money-back guarantee.

Also include the 232 page book "Everybody's Home Fixit Guide." I understand this is mine to keep as a Free Gift.

Name \_\_\_\_\_  
 Address \_\_\_\_\_  
 City \_\_\_\_\_ Zone \_\_\_\_\_ State \_\_\_\_\_

**MONEY BACK GUARANTEE:**  
 If I am not completely satisfied, I will return within 10 days for full refund of purchase price.

**MAIL THIS COUPON TODAY!**

# Meet a Large Citizen Army— *American Style!*



This is Patrolman Stephen N. Warwick of Grand Rapids, Michigan—typical American—war veteran, family man, popular citizen.

As a civilian, Steve has a deep interest in everything that affects Grand Rapids. He especially likes to work with youngsters—in their Youth Center.

As Sergeant Warwick, part-time soldier, he trains twice a month with the 354th Military Police Company, Organized Reserve Corps.

Under the *new* Reserve program, Steve draws full pay of his grade for training assemblies, builds up retirement credits and studies for advancement.

Steve Warwick, civilian and soldier, is typical of many thousands of Army Reservists manning 9,000 units whose part-time service offers you a "*large Citizen Army—American style.*"

The Organized Reserve Corps—a small part of your defense budget—a big part of your defense strength—serves you well.



**WORLD'S  
BEST  
WANT AD  
MEDIUM**

# CLASSIFIED Advertisements



Advertisements in this section 75 cents per word, each insertion, minimum 10 words, payable in advance  
To be inserted under proper classification, copy must be in our office the 22nd of the  
second month preceding date of issue

F. W. Johnson, Manager, Classified Advertising  
Popular Mechanics Magazine, 200 East Ontario Street, Chicago 11, Illinois

## 1118 CLASSIFIED ADVERTISEMENTS 1118 OPPORTUNITIES FOR YOU

### AUTOMOBILES, MIDGET CARS

**SPEED & Power Handbook**—50 chapter library edition! Diagrams! Breathing methods, authentic, direct from California. Covers Crosleys to Cadillacs, all makes. Build your own dual manifolds. Superchargers. Hot cams. Water injectors. Hi-compression heads. Mileage devices. Save many dollars! Get racing speed, lightning acceleration, dynamic power increases from any make passenger automobile! Build fast stock cars. California roadsters. 160 m.p.h. rods! Get construction drawings! Tuning techniques! Speed tricks! Economy secrets! Ingenious formulas! Covers Racing Frames, Reciprocating Masses, Jet Engines, Braking Characteristics, Dynamometers. Also dual pipes, gears, fuels, porting, relieving, lowering, balancing! Includes 1950 speed equipment catalogues! Also California Automobile Customizing—photographs. Drawings. Newest ideas. Conversions. Carston tops. Re-styling all makes. Streamlining. Chopping. Channeling. Complete \$1.98 postpaid. Newhouse Automotive Industries, 5805-B2 East Beverly, Los Angeles 22. (See page 26, Display Advertisement.)

**NEW "Insert type" catalog**—Only 25c! Contains hot rod and midget racing histories, professional speed tuning hints, highway and racing engine specifications; pictures, information, prices on speed, power, custom accessories! We'll send you insert pages containing latest up-to-date changes absolutely free! Ansen Automotive Engineering, 3801-PM W. Jefferson, Los Angeles 16, California.

**OIL Cooler**: Water cooled engines. Better lubrication, longer life. Complete \$15.00. Free illustrated folder. Dept. PM, Gilbert Brass Foundry Company, St. Louis 15, Mo.

**AUTO Bugs!** New book "Auto Facts" gives you "know-how" high-speed methods, tune-up, lubrication data, etc.! Complete "Soup-Up" Manual, only \$1.20. Free information. Hartman, 49-B Lyon, Batavia, N. Y.

**SPEED-Equipment**—Lowest prices. Send 10c for catalog and handbook. Speedomotive, Box 182M, Covina, California.

**VACUUM Gauge testers** with five gauges, hose and case. Ideal for auto mechanics. \$2.90. The Motor Rim Manufacturers Co., 1825 East 24th Street, Cleveland, Ohio.

**YOUR Car burn oil? Poor compression? Slow starting? Excessive cylinder wear? Holt's Piston Seal restores compression! Cuts oil consumption! Checks piston slap! Lasts 10,000 miles! This amazing British product now available, forms self-expanding pliable lubricating seal around pistons. Compensates for wear! Cannot harm finest engine. Easily installed; full directions enclosed. \$3.98 tube for 6 or 8 cylinders up to 240 cubic inches. Details on request. Treglown Company, Department D, 200 West 7th Street, Plainfield, N. J.**

**SILENCE Overhead-valves, attachments unnecessary.** \$2.00. Derderian, Box 542, Sandston, Virginia.

**SPEED Directory**—Official program 1950 hot rod motor sports show. 64 pages cars at show, speed industry directory, timing rules, records, photos. Collectors' item. 50c. Hollywood Associates, 3030 Mountain View, Los Angeles 34, Calif. Dept. SA.

**"WATER Injection."** Also speed, power, economy methods! Free descriptive, illustrated, information. Neher Industries, La Verne, California.

**CALIFORNIA Custom accessory headquarters.** Buy direct from original designers and save. Chrome dash panels, solid hood sides, grille panels, speed equipment, dual pipes, push button door conversions, chrome motor accessories. 34 page illustrated catalog 25c. Eastern Auto, 3319A South Grand, Los Angeles 7, Calif.

**AUTO Owners.** Something new; free details. Digest, 1421 36th, Louisville, Ky.

**SMITHYS Mufflers** for all automobiles. Free list. Buck's Auto Parts, Box 1296H, Merced, California.

**SEE Our ad under motorscooters** for midget car bargains. Midget Motors Directory, Athens, Ohio.

**JUST Out!** Get the largest auto accessory and parts catalog in the world. Over fifteen thousand items, including Hollywood accessories, hi-speed equipment, rebuilt engines; all parts and accessories for all cars and trucks. New, used and rebuilt! We have that hard-to-get-part! Completely illustrated, jam-packed with bargains. Send 25c. J. C. Whitney & Co., 1919 Archer Ave., Chicago 16, Ill.

**BIG New catalog!** Over 500 racing, hot rod, speed equipment, auto parts and Hollywood accessories! Pictures! Speed tips! Customizing! Mileage information! Lowest prices! Illustrated catalog 25c. Almqvist Engineering, Milford 55P, Penna.

**NEW Grand Canyon Economy Test Book.** 31 American cars competed. Full technical details, rules, all information including gasoline saving article by winner. See how your favorite car performed in world's most important test. 145 photographs, charts, drawings, travelogue, historical Grand Canyon and Boulder Dam information. \$1.50—Clymer Motor Scrapbook No. 6. Just out. 200 more antique automobiles, motorcycles illustrated, described. \$2.00—Outboard Motor Service Manual. All makes. \$3.50—Ford Owner's Handbook, all Ford data 1932 to 1950, \$1.50. Model "A" Ford Manual \$1.00—1950 British Car Catalog \$2.00—U. S. Car Catalog \$2.00 postpaid. Clymer, Dept. 5-A, 1268 S. Alvarado, Los Angeles 6, Calif.

**FREE Trial 10 days.** Latest Chevrolet "Speed-Power" Manual sent on approval! Ninety pages of accurate information tells how to increase speed, power and economy of 1937 through 1950 Chevrolets. Learn how to install late engines in pre-1937 chassis. Full data on cams, high compression multiple carburetion, supercharging, ignition, etc. Proves that your Chevrolet can have superior power and speed. Send no money, pay postman nothing. Try before you buy! If you don't agree this is the finest Chevrolet manual you've ever seen—just send it back within 10 days. If satisfied, send \$2.00 to California Bill, 4611 B-5 York, Los Angeles 41.

**"HOLLYWOOD" Deeptone mufflers.** "Straight-thru" design increases efficiency, speed, acceleration, mileage! Singles, all cars \$4.85. Finest V-8 duals \$15.90. Satisfaction guaranteed. Speed equipment catalog 25c. Almqvist Engineering, Milford (54P), Pennsylvania.

**SAVE Gasoline!** Sensational Gane needs. Free trial. See page 69.

**"SPEED Equipment" bargains**—California mufflers \$4.50, V-8 duals \$15.90, chrome carburetor stacks 98c, dual manifolds \$9.95, chrome echo cans \$1.55, racing camshafts \$29.95 exchange, water injector \$12.95, hi-compression heads \$19.75. All popular brands. Big illustrated catalog 25c. Dealers wanted. Almqvist Engineering & Mfg., Milford 53P, Pennsylvania.

**SPEED & Mileage Manual**—New jumbo edition! 200 illustrations, drawings, charts, photographs! Guaranteed finest, most authoritative book! Easy, inexpensive ways to build speed equipment! California hot rods! Beautiful custom cars! 200 n.p. road, track conversions! Superchargers! Dual manifolds! Racing heads! Twin mufflers! Water injectors, economizers! Get super speed, mileage, acceleration, top racing performance from any car! Complete instructions with working diagrams on fast engines, speed tuning, restyling, customizing, gas saving, racing tricks, cams, fuels, balancing, porting, ratios, frames, "Offys"! Learn 100 ways to save gas! Reveals stock car speed secrets! California speed shop methods! Custom styling information! Streamlining! Lowering! Sport changes! Hollywood roadster plans! Speed conversions! (Covers all cars.) Large manual plus equipment catalog plus hot rod handbook—all three only \$1.98. Almqvist Engineering, Milford 51P, Pennsylvania.

**FREE Trial**—Latest Ford "Speed and Power" manual! Sent on approval, this 128 page book of cutaway construction drawings, photos and understandable technical data. Includes information on installing V-8 motor in Model A chassis, hydraulic brakes for any Ford roadster, and fast car information. How to rework V-8, Mercury, Ford 6, Zephyr, Model A engines for speed. If you don't agree this is the finest hot rod manual you've ever seen—just send it back within 10 days. Send no money, pay postman nothing, try before you buy. If satisfied send \$2.00 to California Bill, 4611-B-5 York, Los Angeles 41.

**INTERESTED In automobiles?** Write for free sample copy. Franson's Weekly Motor News, Box 254, Eugene, Oregon.

**DIRECT From California.** Dual manifolds for Willys Jeeps to Oldsmobile Rockets. Finned heads, three carburetor manifolds, over 150 different makes and models. Speed and dress-up equipment for passenger automobiles. Magneto ignitions, aluminum flywheels, racing camshafts, water injectors, crash helmets, exhaust headers. New 1950 illustrated speed catalogue. 25c. (Dealers, request wholesale catalogue). Newhouse Automotive Industries, 5805-B7 East Beverly, Los Angeles 22.

**FROM Speedway to roadway!** Track-proved hi-speed heads and manifolds now available for your passenger car! No special tools needed! Increase horsepower 25%! Astounding getaway! Free illustrated catalog. Speedsport, 6215P Diversey, Chicago 39.

**AUTOMOBILE Racing book,** fifth edition, well-illustrated. Building bodies, frames, engines, Ford conversions. Plans. Roadsters. Indianapolis cars. \$1.00 postpaid. Popular Mechanics Press, 200 E. Ontario St., Chicago 11, Ill.

**RACING Car equipment** for all cars, engines, racing heads, manifolds, carburetors, mufflers, etc. Speed instructions and literature \$1.00—refunded first order. Lee Motorcraft Co., 1412-D Great Northern Bldg., Chicago 4, Ill.

**AUTOMOBILE Racing,** sixth edition. 100 illustrations. Drawings, building instructions Ford-60 midget. California roadster, Offenhauser racer. World's record 158.5 m.p.h. car. \$2.00 postpaid; \$2.40 c.o.d. Popular Mechanics Press, 200 E. Ontario St., Chicago 11, Ill.



























**MIMEOGRAPHING.** Addressing, samples, price list. Merlen Terwilliger, 303 Chestnut Street, East Bound Brook, N. J.

1000 BUSINESS Cards \$2.50 prepaid. Samples free. Reliable Print Shop, 905 East Jefferson, Louisville 6, Ky.

**BUSINESS** Or personal monogram stationery. Send copy for estimate. Nif-T-Pak, Box 455, Toledo 1, Ohio.

**QUALITY** Printing. We specialize in publications, newspapers, tabloids. Send copy for estimate. Bagby Printing Co., Georgetown, Ohio.

SEND 10c Now, for our 48 page 1950 price list—refunded first order. McCall Press, 1326 South 27th, Omaha, Nebraska.

500 3/4x2 1/4 FOUR Line gummed stickers 35c; red border 50c. Moritz Printery, Saginaw, Mich.

**MIMEOGRAPHING**—Letters, pricelists, formulas, instructions. Lowest prices. Lem's Letter Shop, 5710 Stanton, Detroit 8.

## PRINTING OUTFITS AND SUPPLIES

**PRINT** Your own cards, stationery, circulars, advertising. Save money. Simple rules. Print for others, nice profit. Raised printing like engraving too. Have home shop. Details free. Kelsey Presses, L-11, Meriden, Conn.

**PRESSES.** Type, cabinets, supplies. List for stamp. Lincoln Press Company, 220-J Hartwell, Fall River, Mass.

**MAKE** Your own rubber printing cuts. Self molding process. Plexirubber, Argyle 1, Wisconsin.

**PRESSES.** Supplies, paper. Catalog 10c. Printers Supply, 211, Springfield, Missouri.

**PRINTING** Presses, type, supplies. Lists 3c. Turnbaugh Service, Loysville, Penna.

## PATENT ATTORNEYS

**PATENTS**—If you have a valuable invention, you are advised to authorize a preliminary search through appropriate classes of United States patents. This firm is registered to practice before the patent office, and is available to make such search and report to you concerning the probable patentability of your invention. Instructive booklet with "Evidence of Invention" form sent upon request. Victor J. Evans & Co., 531-E Merlin Building, Washington 6, D. C.

**INVENTORS**—If you believe you have an invention, you should find out how to protect it. The firm of McMorrow, Berman & Davidson with offices in Washington, D. C., is qualified to take the necessary steps for you. Send for copy of our patent booklet "How to Protect Your Invention." We will also send you an "Invention Record" form. No obligation. They are yours for the asking. McMorrow, Berman & Davidson, Registered Patent Attorneys, 1341 Victor Building, Washington 1, D. C.

**PETER Fries, Jr.,** Registered Patent Attorney. Patents, novelty searches, copyrights. 110 East 42nd Street, New York City.

**INVENTORS:** Learn how to protect your invention. Unless the inventor is familiar with patent matters, he should engage a competent registered patent attorney or agent to represent him. We are registered to practise before the U.S. Patent Office and prepared to serve you in handling your patent matters. "Patent Guide for the Inventor" containing detailed information concerning patent protection and procedure with "Record of Invention" form will be forwarded to you upon request—without obligation. Clarence A. O'Brien & Harvey Jacobson, Registered Patent Attorneys, 01B-D District National Building, Washington, D. C.

**REGISTERED** Patent attorney offers services. Sanders, 6430 Evans, Chicago 37, Ill.

**PATENT** Information book and inventor's record, free. Gustave Miller, 40-A Warner Building, Washington 4, D. C.

**PATENTS**—Irving L. McCathran, 315 McLachen Bldg., Washington 1, D. C. Registered Patent Attorney.

**PATENTS.** "Proof of Invention" folder mailed without obligation. E. E. Vrooman, Registered Patent Attorney, 507 McKim Building, Washington 5, D. C.

**HERMAN Lewis Gordon,** Registered Patent Attorney. Patent investigations and opinions. Warner Building, Washington, D.C.

**CANADA**—Ramsay Company Registered, 273 Bank Street, Ottawa, Canada.

**INVENTORS:** When you are satisfied that you have invented something of value write me, without obligation, for information as to what steps you should take to secure a patent. Write Patrick D. Beavers (Formerly Randolph & Beavers) Registered Patent Atty., 935 Columbian Bldg., Washington 1, D. C.

**C. A. SNOW & Co.—M-427,** Snow Building, Washington 1, D. C. Registered Patent Attorneys. Write for information.

**"INVENTOR'S Guide"** free on request. Frank Ledermann, Registered Patent Attorney, 154 Nassau St., New York 7, N. Y.

**INVENTORS:** Without obligation, write for information explaining the steps you should take to secure a patent. John N. Randolph, Registered Patent Attorney, 203 Columbian Bldg., Washington 1, D. C.

**INVENTORS:** Write for free brochure "Evidence of Invention." Labiner, World Building, New York 7.

**PATENT** Practice before U. S. Patent Office. Validity and infringement investigations and opinions. Booklet and form "Evidence of Conception" forwarded upon request. Lancaster, Allwine & Rommel, Registered Patent Attorneys, Suite 411, 815-15th Street, N.W., Washington 5, D. C.

**INVENTORS.** For "Record of Invention" form, contact Carl Miller, Registered Patent Attorney, Woolworth Building, New York.

## FOR INVENTORS

**INVENTORS**—If you believe you have an invention, you should find out how to protect it. The firm of McMorrow, Berman & Davidson with offices in Washington, D. C., is qualified to take the necessary steps for you. Send for copy of our patent booklet "How to Protect Your Invention." We will also send you an "Invention Record" form. No obligation. They are yours for the asking. McMorrow, Berman & Davidson, Registered Patent Attorneys, 1342 Victor Building, Washington 1, D. C.

**PATENT** Searches, \$5.00, including patent copies. A more reliable search we conduct for patent attorneys. Free protection forms, 48 hour service. Patent Service Institute, 945-A Pennsylvania Avenue, Washington 4, D. C.

**INVENTORS**—If you consider your invention to be something of importance, take steps to protect it with a United States patent which gives you the right to exclude others from making, using and selling your invention as claimed. "Patent Protection for Inventors" outlines steps to take to secure patent protection. Mailed promptly without obligation. Victor J. Evans & Co., Merlin M. Evans, Registered Patent Attorney, 532-M Merlin Building, Washington 6, D. C.

**INVENTORS:** \$5.00 Analyze your ideas regarding practicability, engineering soundness. Ernst Eger, Consulting Engineer, 410 North Rossmore, Los Angeles 4, Calif.

**PATENT** Searches (same as conducted for patent attorneys) \$5.00. 48 hour service. Patent copies included. Protection forms free. Write Raymond L. Smith, Patent Searcher, 410 Bond Building, Washington 5, D. C.

**WANTED:** Idea man gadget inventor who can create unusual adult or child appeal premium items out of paper, metal or plastic; that are different and inexpensive to produce. Part time or royalty basis. Reliable firm. Please give complete details in letter. Idea Clearing House, 621 N. Dearborn, Chicago, Ill.

**PATENT** Searches \$5.00. Reports airmailed within 48 hours. Invention protection forms free. Write Miss Ann Hastings, Patent Searcher, P.O. Box 176, Washington 4, D. C.

**HOW** To handle ideas. Free booklet. Grayland, 5312C Grace, Chicago 41.

**I.F.I.** Creative co-operation includes: Superscope patent searches; commercial prospects analysis; pre-patent priority protection; invention-improving; finding backers; invention-styling for sales-leadership, plus the promoting, marketing, and selling of inventions for maximum cash and royalties. Write today for free information. Inventors-for-Industry Inc., P.M.5. Suite 501, 1947 Broadway, New York 23.

**"OUTSTANDING** Publication"—"Value plus" say readers. First hundred requesters can examine before paying. Return book or \$2 within 5 days. Write: Directory of Inventor Aids, Drawer 1289V, Clearwater, Florida.

**INVENTORS.** Protect your invention by a U. S. patent. Write me for free record of invention form. Sherman Levy, 620 Victor Building, 724—9th Street, Washington 1, D. C.

**PATENT** Searches \$5.00. 48 hour service. We serve the patent attorney, the general attorney and the inventor direct. We employ only graduate engineers who have served at least 15 years as patent office examiners. Protection forms free. Write Patent Engineering Service, 500 Walker Building, Washington 5, D. C.

**CHIEF** Engineer and successful inventor for large manufacturing concern offers advice on marketing your ideas. Faas, 13 Dogwood Road, West Orange, N. J.

**SCHAULAT** Associates, agents, purchasing and marketing patents, inventions, ideas. P. O. Box 4444, St. Louis 1, Mo.

**SUCCESS** Guaranteed. Inventors with patented and patent pending inventions for sale or lease, request our free book. No obligation. Dept. 1-F, Universal Marketing Co., 354 South Spring St., Los Angeles 13, Calif.

**INVENTORS:** Learn how to protect your invention. Unless the inventor is familiar with patent matters, he should engage a competent registered patent attorney or agent to represent him. We are registered to practise before the U.S. Patent Office and prepared to serve you in handling your patent matters. "Patent Guide for the Inventor" containing detailed information concerning patent protection and procedure with "Record of Invention" form will be forwarded to you upon request—without obligation. Clarence A. O'Brien & Harvey Jacobson, Registered Patent Attorneys, 01A-D District National Building, Washington, D. C.

**INVENTORS** Having patented, patent pending development to offer manufacturers. Booklet, information free. Market Contacting & Data Service, 11106-A3 Longwood, Chicago 43.

**COMPLETE** Services for inventors. Patent searches including analysis, patent copies. Inventions, patents marketed. Protection forms free. Industrial Patent Reports, Box 1081, Massachusetts Avenue and North Capitol, Washington 13, D. C.

**INVENTORS:** If you have an invention for sale, patented or unpatented, write Institute of American Inventors, Dept. 40A, 1926 Eye St. N.W., Washington 6, D. C.

**INVENTIONS** Wanted. Prominent manufacturers and national distributors look to us for new products. You can also benefit by having us assist you with your invention from the idea stage through to the developed product, fully protected. Ask for Booklet "M." Elo Development Co., Chatham Phenix Bldg., Long Island City 1, New York.

**PATENT** Owner Representative. Years of experience. Can I help you? Charles A. Scott 773PM Garson Avenue, Rochester 9, N. Y.

**INVENTORS:** Without obligation, write for information explaining the steps you should take to secure a patent on your invention. John N. Randolph, Registered Patent Attorney, 202 Columbian Bldg., Washington 1, D. C.

**CASH** For your idea. 280 manufacturers need inventions, patented or unpatented. List free. Invention Bureau, 208M Clinton, Oak Park, Illinois.

**"INVENTOR'S Guide"** free on request. Frank Ledermann, Registered Patent Attorney, 154 Nassau St., New York 7, N. Y.

**INVENTORS.** For "Record of Invention" form, contact Carl Miller, Registered Patent Attorney, Woolworth Building, New York.

**INVENTORS:** The usual first step is to have a search of the U. S. Patents conducted, so I can report on patentability. Write, without obligation. Patrick D. Beavers (Formerly Randolph & Beavers), Registered Patent Atty., 936 Columbian Bldg., Washington 1, D. C.

## INVENTIONS WANTED

**NEW** Invention wanted by client. Royalty or purchase arranged after test and free market research. Photographic, household or auto uses preferred. Give full details on use in first letter. Lessing Advertising Company, 914 Walnut Bldg., Des Moines 9, Iowa.

**THE U. S.** patent system does not compel inventors into rash "patent (s) pending." The intent of the patent law is to give you the chance of making a pre-patent test of the worth of your ideas. And high-character priority protection for this purpose can be obtained through: Inventors-for-Industry Inc., Dept. P.M.5, Suite 501, 1947 Broadway, New York 23. Write today for free information.

**INVENTORS** Marketing assistance. Circular free. Stanley Hull, 7829-K Euclid, Cleveland 3, Ohio.









# SALESMEN COINING MONEY

## WITH NEW BABY TABLE

HAS ALL SAFETY FEATURES OF TABLES COSTING UP TO \$35.00!

Until now, good, safe baby tables cost from \$28.50—up! Thousands of mothers who wanted to buy, just couldn't stand the price. Now comes "Baby-Safe" at only \$15.95 COMPLETE so anyone who can afford to buy a high chair can afford a new low seat "BABY-SAFE"!



### Sales Soaring All Over U.S.A.!

No wonder BABY-SAFE sales are booming! No wonder Salesmen are cleaning up. No more price resistance. No more call-backs. No More Lost Sales because of cost. Freeman worked Five hours—made Nine calls—and SOLD FIVE TABLES! Out of 50 calls, Martin sold 18. Mothers buy on sight because the low price of BABY-SAFE puts it within reach of all. Over night, its low price has made "BABY-SAFE" the Big Money-Maker of 1950! In 12 hours Kidd sold 15 tables—made \$75 Cash.

### FREE! Act Quick for FREE Selling Outfit..

Right now, we're ready to put this money-maker into the hands of the kind of salesmen who know how to cash in on a fast seller. Just call on mothers by appointment—demonstrate—collect your cash profits on the spot. Complete Selling Outfit is FREE. Rush name on penny postcard for details, pictures, Sales Kit, order forms, and everything you need to start taking orders at once—even before your Demonstrator arrives.

**BABY-SAFE DIVISION**  
HOME EQUIPMENT MANUFACTURING CO.  
1512 Jarvis Ave., Dept. 95, Chicago 26, Ill.

## Be A MASTER PLUMBER

Earn \$15 To \$50 A Day

DON'T ENVY THE PLUMBER — BE ONE

Every skilled workman will tell you that Plumbers have the best of it. WINTER and SUMMER the Plumber is busy at top wages. No skilled Plumber is ever out of a job—compare his opportunities with any trade, plus the opportunities of having your own shop. We teach you Plumbing with TOOLS (not books) under Licensed Master PLUMBERS in one of the finest equipped schools in America. We make you a Plumber, every branch is taught thoroughly—Lead Work—Blueprint for plan reading—all other tricks.

### LEARN IN 30 WEEKS WITHOUT PREVIOUS EXPERIENCE

If you like to work with tools you owe it to yourself to investigate. No need to ever work as an apprentice. Get free bulletin. Write now! G.I. APPROVED. Our 24th year.

UNIVERSAL PLUMBING SCHOOL

877 HOLMES STREET KANSAS CITY, MO.

## FACTORY-TO-YOU MIDWEST RADIO and TELEVISION

at NEW LOW  
FACTORY PRICES

Available in Consoles and Complete Cassis

LONG EASY TERMS

30 DAYS TRIAL

Right In Your Own Home



Send for FREE 32-Page 4 Color CATALOG

MIDWEST RADIO & TELEVISION CORP.  
Dept. X25A, 909 Broadway, Cincinnati 2, Ohio

NAME \_\_\_\_\_  
ADDRESS \_\_\_\_\_  
CITY \_\_\_\_\_ ZONE \_\_\_\_\_ STATE \_\_\_\_\_

Good Pay — Your Own Business!



## Electric APPLIANCE REPAIR AND SERVICE

This May Be Your Golden Opportunity

Every town—every city neighborhood—needs a specialist on electric appliances. The man who knows how to service and make quick repairs on washing machines, vacuum cleaners, heaters, toasters, stokers and household motors and gadgets of all kinds can make big money right now. Get into this pleasant, easy and good pay work. Get this sensational new book—Electric Appliance Repair and Servicing.

Millions of Appliances

Modern households have three to a dozen electric appliances. You can be one of the well-paid specialists who keep them in working order.

Money Back Guarantee

Clip this ad and mail with only \$3.00, currency, check or M. O. or we will send C.O.D. Use the book for five days. See how easily you can make it pay for itself hundreds of times over. Then if you are not fully satisfied—send it back and we will refund your money quick. Rush order today. Get started at once.

No Experience Needed

An investment of only \$3.00 will positively get you started in this vital field in a good pay job or help you build up a profitable business of your own. Run it from your home—kitchen, garage or basement. No starting capital needed. No experience in electricity required. The book shows all—tells all. Explains how to diagnose and locate trouble and how to fix it. 302 fact-packed pages. 188 how-to-do-it illustrations. This is no come-on—no exaggeration. You can follow the simple instructions and you can make \$2, \$3, even \$5 or more for a few minutes of your time. One job will pay for the cost of the book.

DRAKE & CO., Dept. 15, 117 Green Bay Road, Wilmette, Ill.

## Learn CARPENTRY BRICK LAYING

Get into the billion dollar building trades. Learn now while opportunities are greatest. Train in our completely equipped shops under expert instructors. G.I. Approved. Enroll now. Limited classes. Write for FREE Catalog.

MIDWEST SCHOOL OF BUILDING TRADES, Dept. PM-5  
411 N. Center St. Bloomington, Ill.

## 'How to Make Money with Simple Cartoons'



A book everyone who likes to draw should have. It is free; no obligation. Simply address

FREE BOOK

CARTOONISTS' EXCHANGE  
Dept. 95-D Pleasant Hill, Ohio

## WATCHMAKING

Be a Watchmaker — Be Independent

Get practical training in Chicago's first accredited watchmaking school.

Day and Evening Classes—Approved for Veterans

Write today for free information

CHICAGO INSTITUTE OF WATCHMAKING  
7 SO. PULASKI ROAD Dept. PM-5 CHICAGO, ILLINOIS

## LOCKSMITHING & Key Making



PRACTICAL UP-TO-DATE COURSE—ONLY \$3.95

Easy-to-learn modern information for self-instruction. How to work on locks, de-code, make master-keys, repair, install, service, etc. For every handyman, home owner, carpenter, mechanic, service station operator, fix-it shop, hardware dealer, gunsmith. 53 plain illustrated lessons. FULL PRICE ONLY \$3.95. SEND NO MONEY. Just pay postman plus C.O.D. postage. Or send \$3.95 with order, we'll ship postpaid. Satisfaction guaranteed or refund.

NELSON-HALL CO., 1139 S. Wabash Ave., Dept. E-2, Chicago 5, Ill.

## 'YOU ARE UNDER ARREST!'



Help Bring Crooks to Justice Through Scientific CRIME DETECTION!

We have taught thousands this exciting, profitable, pleasant profession. Let us teach you in your own home. Learn Fingerprinting, Firearms Identification, Police Photography, Secret Service Methods thoroughly, quickly, at small cost. Over 800 of all American Bureaus of Identification employ I. A. S. students or graduates. We can prepare you for this fascinating work, during spare time. Write today, stating age, for "Blue Book of Crime."

INSTITUTE OF APPLIED SCIENCE, 1920 Sunnyside Ave., Dept. 1355, Chicago 40, Ill.

POPULAR MECHANICS

# YOU CAN'T LOSE!

## HAVE A PROFIT MAKING BUSINESS OF YOUR OWN

NATIONALLY ADVERTISED PRODUCTS

NO EXPERIENCE NECESSARY

NO MONEY TO INVEST

FREE SAMPLE OUTFITS

FULL OR PART TIME

### A LIFETIME FUTURE

Man or woman—young or old, YOU can earn a steady income in full or spare time as an independent Kendex dealer. Amazing and almost "impossible" earnings can become a reality for you. Herbert Armstrong of Tenn. earned \$202 in 9 days. C. O. Watkins of Oregon sent 92 orders in one day. You have the same opportunity to duplicate these exceptional earnings. Over one million dollars will be earned in 1950 by Kendex dealers—why not let us establish you in your own business and get a share of these wonderful earnings?

### KENDEX NYLONS REPLACED FREE . . .

if they run or snag within guarantee period up to three months! Impossible? It's true! No matter what the cause—hard use or deliberate abuse—whether it is fault of the hose or the wearer—Kendex nylons are replaced FREE if they run, snag or become unfit for wear within the guarantee period. How could any woman resist a positive guarantee of satisfaction when she can obtain it without paying any more than other standard advertised brands? Kendex nylons are NOT sold in stores, so you have no competition. Complete line includes everything from heavy 70 denier service weight to gossamer luxurious ultra sheer 15 denier 60 gauge. Proportioned sizes and lengths. Latest colors plus white.

### LINGERIE - ROBES - HOUSECOATS - MEN'S HOSE

In addition to the sensational Kendex nylons, you will have a complete line of glamorous lingerie, beautiful robes and housecoats plus a complete line of Kentercraft mens' hosiery guaranteed for one full year. Any pair or pairs of men's hose that does not give satisfactory wear within one year of purchase will be replaced FREE!

### NATIONALLY ADVERTISED

Kendex will spend over \$350,000.00 in 1950 to tell millions of readers of the advantages in buying from you. Almost every issue of Good Housekeeping, Saturday Evening Post, McCall's, Women's Home Companion and Ladies' Home Journal carry our advertising in addition to many others. Kendex has advertised in Life, Look, Collier's, etc. Awarded Good Housekeeping Seal. Thousands of orders are shipped daily from coast to coast.

### EVERYTHING GIVEN FREE

Risk nothing! Mail coupon and we will send you, free and prepaid, complete money-making outfits including sample nylon stocking, samples of lingerie, robes, housecoats and men's hose fabrics and everything you need to immediately start making money. Complete outfits become your property even if you don't send any business. Simply write orders, we deliver and collect. Advance cash plus huge bonus. No money or experience needed. Mailing the coupon is all you need to start on the road to a 52-weeks-of-the-year high paying business of your own. You have everything to gain and nothing to lose.

# FREE NYLON STOCKING

## KENDEX COMPANY, BABYLON, 746, N. Y.



### FOUR MONEY-MAKING LINES

- WOMEN'S NYLON HOSIERY
- GLAMOROUS LINGERIE
- HOUSECOATS - ROBES
- MEN'S HOSIERY

MAIL TODAY

NOTHING TO PAY

NO OBLIGATION

KENDEX COMPANY  
BABYLON 746, N. Y.

Date \_\_\_\_\_ 1950

Send me, free and prepaid, everything I need to make money as a Kendex dealer, including sample stocking etc. There is nothing for me to pay now or later and I am under no obligation in accepting your money-making outfits.

Name \_\_\_\_\_

Address \_\_\_\_\_

City \_\_\_\_\_ State \_\_\_\_\_

# WhiskER®

THE ELECTRIC SHAVER THAT'S  
SOLD BY BARBERS



ONLY  
**\$12.95**  
IN REGULAR  
PACKAGE

**NOW! SMOOTH, CLOSE SHAVES . . . EVEN IN SUMMER!  
WHETHER YOU SHAVE ONCE A DAY—OR, ONCE A WEEK**

Barbers know a good shave when they see one. That's why they recommend and sell WhiskER. WhiskER whisks away any length beard, clean as a whistle, without pulling or stalling. It uses a time-tested hair clipping principle, with an extremely close-shaving blade. Operates quietly on 110 v, 60 cycle AC; no radio interference. The next time you visit your barber or beautician ask to see the WhiskER. If he does not have WhiskER, he can order it for you on a 10 day trial.

**NOW AVAILABLE IN  
DELUXE GIFT CASE**

WhiskER in this attractive, sturdy case makes an ideal gift . . . a useful travel kit. WhiskER and case... **\$14.95**



**ELECTRO TOOL CORPORATION**  
Dept. 520-E, Racine, Wisconsin

**3 Speed Whirl-A-Way  
BUFFER and SANDER**

**KIT \$7.95** Own this fine outfit. Adds many uses to your 1/4" electric drill, both right angle and direct. Precision built. Polished speed-up and reducing gears in hand-grip housing, grease packed. Amazing Value. 3 SPEEDS . . . a right speed for every use. Includes: Sheepskin Bonnet, "Carpet Buffer", 3 types sanding discs, flexible rubber head . . . all equipment and supplies ready to use.

**SEND NO MONEY**

Try "on the job" for 3 days at OUR RISK. Nothing finer for BOATS, CARS, HOME or WORKSHOP. Order today COD (or remit and we pay postage) GUARANTEED to please or full price refunded.

**SAND  
GRIND  
POLISH  
FINISH**

**WALTER WILLIAMS & CO., Dept. PMM**  
2410 N. Lakeview — Chicago 14



## FRY ANYTHING SPATTERY!

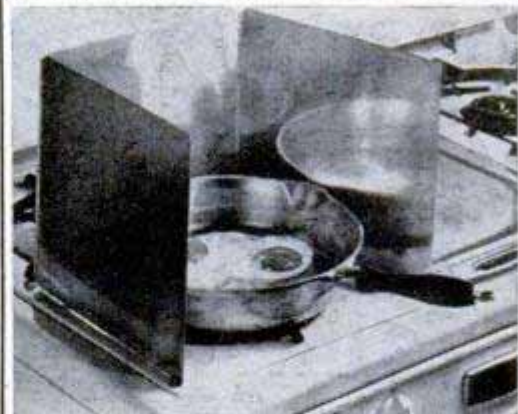

Spatter Shield keeps stove and walls **CLEAN! IT WORKS!** Folds into Cooky Sheet 9 x 10 inches. Use in Trailer, Camping.

**\$1.00**

postpaid  
No C.O.D.'s.  
**ACCEPT NO IMITATIONS UNDER OTHER NAMES!**

Buy the ORIGINAL HIGH GRADE ALUMINUM SPATTER SHIELD, invented and manufactured by

**MRS. LETHA O. W. CORDREY**  
4071 Kansas St. San Diego 4, California

## RUPTURE-EASER

FOR MEN, WOMEN AND CHILDREN

A strong, form fitting, washable support. Back lacing adjustable. Snaps up in front. Adjustable leg strap. Soft, flat groin pad. No steel or leather bands. Unexcelled for comfort. Also used as after-operation support. Give measure around the lowest part of the abdomen. Specify right or left side or double. We pay postage except on COD's. PIPER BRACE CO.

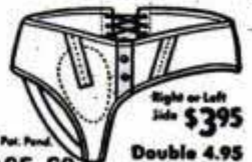

Right or Left Side **\$3.95**  
Double **4.95**

308 East 12th Dept. PM-55 Kansas City 6, Mo.

## Learn TELEVISION-ELECTRONICS

2 Big Books  
**FREE**

Train at Home—Get Big Kits of Radio Parts! Prepare now in spare time. Practical instruction. Approved for Veterans. Write for details and Radio Books—**ALL FREE!** Rush name today! **SPRAYBERRY ACADEMY OF RADIO**  
Dept. 10-J 111 No. Canal Chicago 6, Illinois

**Have Fun! Be a Magician!**  
**CHANGE NICKELS INTO DIMES!**  
Place magic cap over 4 nickels . . . Presto! nickels vanish and 4 dimes appear! Cap may be examined. No skill required! Precision-made device. **ONLY \$1.00 POSTPAID.** Remit money order or cash.  
**AGENTS and DEALERS** → This trick sells like hotcakes! Rush \$6.25 for 1 dozen or \$12 for 2 dozen, postpaid.  
**D. ROBBINS & CO., Dept. D-38, 131 W. 42 ST., NEW YORK 18, N.Y.**

**BURIED TREASURE, MINERALS  
AMAZING NEW GOLDAK LOCATORS**  
**SENSATIONAL NEW MODEL!**  
ONLY 11 pounds weight! One hand operation! Money-Back Guarantee of Superiority. Write for full details.  
**THE GOLDAK CO.** World's largest maker of fine locators.  
1542 WEST GLENOAKS BLVD.  
GLENDALE, CALIFORNIA

## ALTIMETER

Modernize your car. Fine desk ornament. Reads up to 20,000 feet. Fluorescent dial glows at night—no connections of any kind required—self contained—Suitable as a laboratory standard instrument—Same as used in airplanes. Brand new—cost gov't many times . . . **\$3.50**

**REMOTE CONTROL THERMOMETER**  
For automobiles, homes, refrigerators, milk coolers, brooders, orchards, workshops, etc. Temperature bulb at end of 5 or 15 ft. flexible tube (state which). Dial thermometer glows in dark—non electric—very sensitive—-40° to +50° C. and -40° to +125° F. on same dial. Aircraft quality—worth many times . . . **\$3.50**

Enclose sufficient postage—Excess will be refunded—No COD's  
**AIRCRAFT COMPONENTS, Inc.**  
1100 Woodland Avenue Benton Harbor, Michigan

~~Not \$7.50~~

But Only **\$1.00**

For this 3-Pc.  
Pen-Pencil  
Combination

This set was a hand-some bar-gain made to sell by the manufacturer for \$7.50. Now only \$1.00 takes all three — ball point pen, propel... repel... expel pencil, hooded "thin-line" fountain pen with mfr's guarantee.

**IDEAL for Students, Teachers, Professional Users or Anyone Who Writes!**

Your choice of lustrous black, gray or maroon colors with gold colored metal caps handsomely arrayed in a gift box, ready to give, post paid to you for only \$1.00 a set.

**SORRY — LIMIT 3 sets to each customer**

Just send check, money order or currency with your full name and address. No C.O.D.'s. Please write plainly.

**M. M. PEN CO.**

44 EAST LONG ST.

COLUMBUS 15, OHIO



## BARBELLS

Save Money — Buy the finest barbell equipment direct from our foundry — No other company can match our low price or value!

Send to-day for our FREE Barbell Catalog

**BUR BARBELL CO.**

Lyndhurst 17, New Jersey

95 lb.  
SET  
**\$10.80**

Extra plates  
10c lb.

## TAKE 3-DIMENSIONAL PICTURES WITH YOUR OWN 35 MM CAMERA

NOW ONLY **\$17.70**

(Outfit No. 101, was \$22.50 plus tax)

Plus \$2.09 Fed. Tax

and 3-D slide viewer. Make marvelous color or bl. & w. slides. Get Stereo-Tach from your dealer or direct. Money back guarantee.

Dept. PMS, ADVERTISING DISPLAYS, INC., Covington, Ky.



## increased "gas" mileage?



(Patent Pending)

## GANE "Air-Flow" NEEDLES

NEW air-bleed idling jet. Replaces present SOLID IDLING ADJUSTMENT SCREW in your carburetor (8 cyl. cars use 2.) The objective is to lessen the vacuum and thus try to INCREASE YOUR GAS MILEAGE. About 1/2 MILLION NOW IN USE!

Most users who write swear by them and report up to **25% MORE MILEAGE**

and many comment on: **SMOOTHER MOTOR; EASIER STARTING; FASTER PICKUP; BETTER IDLING.** But FRANKLY, some swear at them and curl our hair with "NO improvement"... and fire them back AT OUR EXPENSE — proving Ganes CAN sometimes FAIL. Therefore, we invite YOU to TRY the

### "LITTLE STINKERS"

WITHOUT COST to see what they will do for you. Send NO money. Pay postman NOTHING

### Try Before You Buy — 10 Day Free Trial Offer

Just send us your Name, Address, Make of Your Car, No. of Cyls., and Make of Carburetor by post-card or note. Ganes with literature will be promptly sent you postage paid. ANYONE can install them in ONLY 5 MINUTES.

### USE GANES 10 DAYS

Check for INCREASED "GAS" MILEAGE, which must average 2, OR MORE, EXTRA MILES PER GALLON, or else NEEDLES are NOT worth buying. End of 10 days, send us only \$1.50 per Gane Needle; or you, too, can fire the Little Stinkers back home AT OUR EXPENSE — AND YOU'LL OWE NOTHING — AND WE'LL ASK NO QUESTIONS.

SEND FOR GANES TODAY

National Automotive Research Co.

350 W. Washington Blvd., Dept. J-5, Venice, California

## STAMMERER?

New booklet, "Stammering, and How to Stop It," sent free to any stammerer upon request. Write today. **BENJAMIN N. BOGUE**, Dept. 504, Circle Tower, Indianapolis 4, Ind.



SAY YOU SAW IT IN POPULAR MECHANICS

# Watchmakers MAKE MONEY!

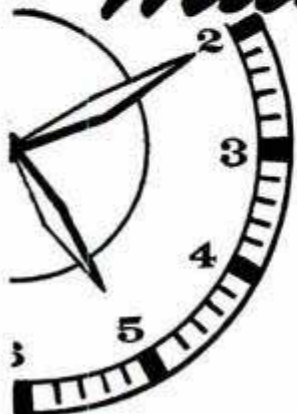

Higher pay and more security in a dignified position that often leads to ownership of a watch repairing and jewelry business, are yours as a Master Watchmaker.

Send for FREE Information now

Since 1908, Chicago School of Watchmaking graduates have been in constant demand. Big opportunities for trained workers. Resident courses in watch repairing, gem setting, and engraving. Home Study Course in Master Watchmaking.

Learn Watchmaking the expert "Sweazey way" — quickly and successfully — in one of America's oldest watchmaking schools. Resident or Home Study.

**CHICAGO SCHOOL OF WATCHMAKING, 1608 Milwaukee Avenue Chicago 47, Illinois. Dept. 150**

Please send information without cost or obligation on:

Resident Courses  I am a Veteran  Non-Veteran  
 Home Study training in Master Watchmaking and FREE ILLUSTRATED SAMPLE of lessons.

Name \_\_\_\_\_

Address \_\_\_\_\_

City \_\_\_\_\_ Zone \_\_\_\_\_ State \_\_\_\_\_

## GARDEN TRACTORS

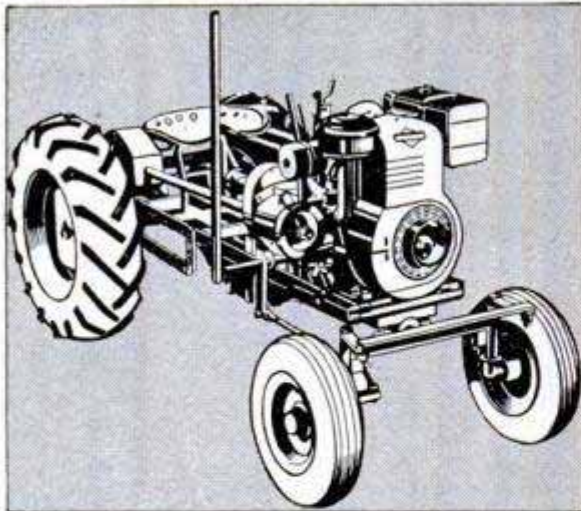

### LOOK--SPEEDEX AGAIN PAVES THE WAY TO LOWER PRICES IN GARDEN TRACTORS

**FOUR--** MODELS 1.9 H. P., 3 H. P., 5 H. P. and our famous 8 H. P. four wheel riding type.

Prices start at only \$119.50 to \$350.00 for the powerful 8 H. P. Rider

**ALL--** Speedex Garden Tractors are built with enclosed gears running in oil, powered with popular-make engines and equipped with the latest type rubber tires.

**JUST--** for the asking we will mail you absolutely FREE a circular illustrating and describing these tractors.

**WHY--** not write today. Please use a penny post card.

**SPEEDEX GARDEN TRACTOR CO.**  
BOX 216-D1 Ravenna, Ohio  
P-1149-34

## SANDEE

Mufflers—All Ford, Chev., Ply....\$4.45

All Buick, Pont., Olds., Chrys.,  
Dodge, Hudson, K.F., Pack., etc....\$5.45

V-8 and Merc. Duals  
(32-49 incl.)  
\$15.95



DURABILITY

DEALERS  
WANTED

Beautiful  
SANDEE  
Fender Skirts  
\$9.95

A SANDEE Sportone will outlast two ordinary mufflers and give More Power! More Speed! More Mileage!—plus a tone quality unsurpassed.

Please ship (item): \_\_\_\_\_ Price \_\_\_\_\_  
Car and Year \_\_\_\_\_ Name \_\_\_\_\_  
Address \_\_\_\_\_

SANDEE MUFFLER CO. 5643 Corryne Pl. Culver City, Calif.

### MARKSMAN AIR PISTOLS \$4.95

Looks and Feels like U.S. Army  
**NEW 45 Auto. Accurate and Powerful. Shoots 177 caliber pellets, darts, and BB's. Generous supply included. Specially Priced... \$4.95**

### GUN LIGHTER

Looks and feels just like a real sturdy Chrome Plated 25 caliber Automatic Pistol. Pull the trigger and it lights automatically. It never fails to light! Large fuel capacity. Genuine Black checkered hard rubber grips. Detachable Table stand included. Made to sell for \$10.00—at Klein's for only \$2.95 postpaid. Size 2 3/4" x 2". Was \$10.00—NOW ONLY **\$2.95**

### \$30.00 SPINNING OUTFIT

Balanced! Complete outfit contains: Airex "Spinner" Bache Brown Reel, Montague 6 1/2 ft. two-piece Split Bamboo Rod, 100 yds. Nylon Spinning Line, 4 Bache Brown Spinning Lures, Instruction Booklet. Worth \$30.00, all for only **\$19.95**.

### ORDER BY MAIL!

Send check or money order or \$2.00 C.O.D. deposit to:  
**Klein's Sporting Goods, Inc.**  
227 W. Washington St.  
Chicago 6  
Note: No Marksman Air Pistols sold to persons under 21. (State your age).

### WASH YOUR CAR IN 10 MINUTES!

WITH FAST, EASY FOUNTAIN BRUSH. TURNS WORK INTO PLEASURE. WASHES AND RINSES IN ONE OPERATION, CARS, TRUCKS, WINDOWS, PORCHES, BOATS, ETC.

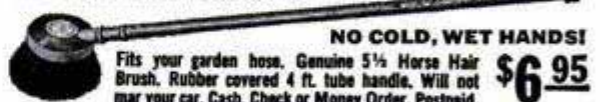

NO COLD, WET HANDS!

Fits your garden hose. Genuine 5 1/2 Horse Hair Brush. Rubber covered 4 ft. tube handle. Will not mar your car. Cash, Check or Money Order. Postpaid. **\$6.95**

PAYS FOR ITSELF—SATISFACTION GUARANTEED

WINSLOW MFG. CO., M - 5, 1428 Balfour, Detroit 30, Mich.

## STOP GENERATOR TROUBLE

WITH THE AMAZING "WATTAGE REGULATOR" IT'S THE MIRACLE THE AUTO-DRIVING PUBLIC WAITED FOR TO REPLACE THEIR OLD UNRELIABLE VOLTAGE REGULATORS TO DRIVE WITH OR WITH-OUT YOUR BATTERY. GREATEST ADVANCEMENT IN AUTO-IGNITION SINCE THE SELF-STARTER GUARANTEED 100,000 MILES OR ONE YEAR. STATE MAKE AND MODEL OF CAR FOR FREE CATALOG. WRITE TODAY

R.O. BOX 2162-D - STATION H - CLEVELAND 8, OHIO

YOU CAN BE AN **HE-MAN** All Around **10c**  
All 5 famous courses by George F. Jowett, world's greatest body builder in 1 complete muscle building volume (valued at \$5 each) now only 10c. Packed with How-to-Do-it pictures. 1. How to Mold a Mighty Arm. 2. Mighty Chest. 3. Mighty Back. 4. Mighty Grip. 5. Mighty Legs. Free strong men photo book. Quick results or money back! Send 10c name, address, age. JOWETT INSTITUTE, Dept. PM-05, 230 Fifth Avenue, New York City

**NEW PHOTO PROCESS**  
enables you to print any photograph on cloth, leather, wood, paper  
Reproduces any snapshot negative on ties, stationery, etc. Permanent. Makes 200 prints. No experience or equipment needed. Simple instructions.  
**BURKE CO.**  
8052 Muskegan Ave.  
Box 2-A5, Chicago 17, Illinois  
ONLY **\$1.98** PREPAID

## ANGORAS FOR QUICK MONEY

Angoras cheaply and easily raised. Thousands needed for breeders in new industry furnishing wool for textile mills. Free illustrated booklet shows sales opportunities, success stories, etc. Write—

WILSONS, Stanton 17, California

### BUY DIRECT FROM DISTRIBUTOR

Gents' 17 JEWEL Automatic (self-winding) WRIST WATCH

Waterproof . . . Shockproof . . . Stainless Steel Back . . . Anti-magnetic . . . Sweep Second Hand . . . Luminous Dial made to retail for \$71.50. Guaranteed for 1 Year . . . satisfaction guaranteed or money refunded within 10 days. SPECIAL \$24.95 plus 10% Fed. tax (\$2.50) . . . Total \$27.45 Ladies Size - Suitable for Nurses - Some features - Some Price . . . Send check or money order to: Dept. PM-5



INTERNATIONAL WATCH COMPANY 8512 So. Vermont Ave. Los Angeles 44, Calif.

## HIGH POWER TELESCOPE

60 POWER - ALUMINUM TUBES - OPENS TO 33"

Variable Power Eyepiece Adjustable to 15X, 30X and 60X.

**\$4.50** Leather Case Included  
5 Sections. 4 Ground & Polished Lenses. Also used as 50X Microscope. Ready to use, only \$4.50 POSTPAID.  
**BROWSCOPE CO.** Dept. 5M, 24 W. 45th St. NEW YORK 19, N. Y.





# HOSPITAL CARE

Anywhere  
In the  
United States



FOR ONLY

3 <sup>1</sup>/<sub>2</sub>¢  
A DAY

## FOR YOU AND YOUR FAMILY

Accident or sickness is bad enough . . . BUT . . . it's worse when you're caught short of cash for Surgeon and hospital bills. NOW, there's no excuse to risk danger, tears and worry. The MUTUAL HOSPITALIZATION PAYMASTER POLICY offers financial assistance to help you meet accident and sickness costs for only a few cents a day, according to the terms of the policy. And the beauty of it all, is that you choose your own surgeon, your own hospital in your own town, or anywhere in the United States. Learn today how this hospitalization is available to every member of your family in good health, from birth to 75 years of age.

### CASH BENEFITS PAID QUICKLY!

In accordance with the terms stipulated in the PAYMASTER POLICY, cash benefits are provided for sickness, surgery, loss of life, limb or sight caused by accidental injury. Indemnity for LOSS OF WAGES is also available in many cases. The cost is so astonishingly low you just can't risk being without this protection. There's no unnecessary delay . . . no red tape when cash benefits are due!

### CLAIMS PAID REGARDLESS OF ANY OTHER PROTECTION PLANS YOU MAY NOW OWN

Even though you may now be insured for accident and sickness, you should have the additional protection that PAYMASTER provides. For PAYMASTER pays regardless of any other coverage you may have for the same disability. You owe it to yourself and your family to find out everything about this new kind of PAYMASTER protection . . . the low cost plan that helps you pay hospital bills in case of illness and accident.



## What You GET!

For accidental death due to ordinary accident, PAYMASTER pays \$1000. For death due to accident while travelling in a common carrier, PAYMASTER pays \$2000. For loss of sight or limbs, PAYMASTER pays from \$500 up to \$1000. PAYMASTER also pays most working people, other than housewives, a benefit of \$25 a week for up to 13 weeks for LOSS OF WAGES while hospitalized for accidental injury . . .

from \$5 up to \$300 for hospital residence up to 30 days for sickness and up to 30 days for accidental injury . . . from \$5 up to \$200 for surgery in any one policy year, and from \$5 up to \$100 for operating room, X-ray, anaesthesia, blood transfusions, oxygen tent, ambulance, etc. In all, PAYMASTER helps pay for almost 100 vital services common in many sickness and accident emergencies.



E. J. BECKER

Mutual Hospitalization Insurance Co.  
Noted pioneer and recognized authority in the field of hospitalization insurance sold exclusively by mail. Creator of the New PAYMASTER POLICY offered only by this company.

## RUSH COUPON FOR FREE DETAILS

Other benefits, such as maternity and full coverage for persons up to the age of 75 are also provided under this versatile policy, at slight additional cost. You'll surely agree there's nothing quite like this outstanding, New PAYMASTER HOSPITALIZATION POLICY which pays you cash benefits regardless of any other insurance held by you covering the same disability. Write today . . . NOW! Let us send you FREE of obligation, all the facts about our PAYMASTER POLICY. You'll also get interesting information and advice that will help you decide. NO AGENT WILL CALL. Send the coupon. We'll send full details FREE by return mail.

MUTUAL HOSPITALIZATION INSURANCE CO., Dept. 105, Wilmington 99, Delaware

MUTUAL HOSPITALIZATION INSURANCE COMPANY  
DEPT. 105, WILMINGTON 99, DELAWARE

Please send me FREE full details concerning New PAYMASTER PLAN. No agent will call.

Name \_\_\_\_\_

Address \_\_\_\_\_

City, Zone, State \_\_\_\_\_

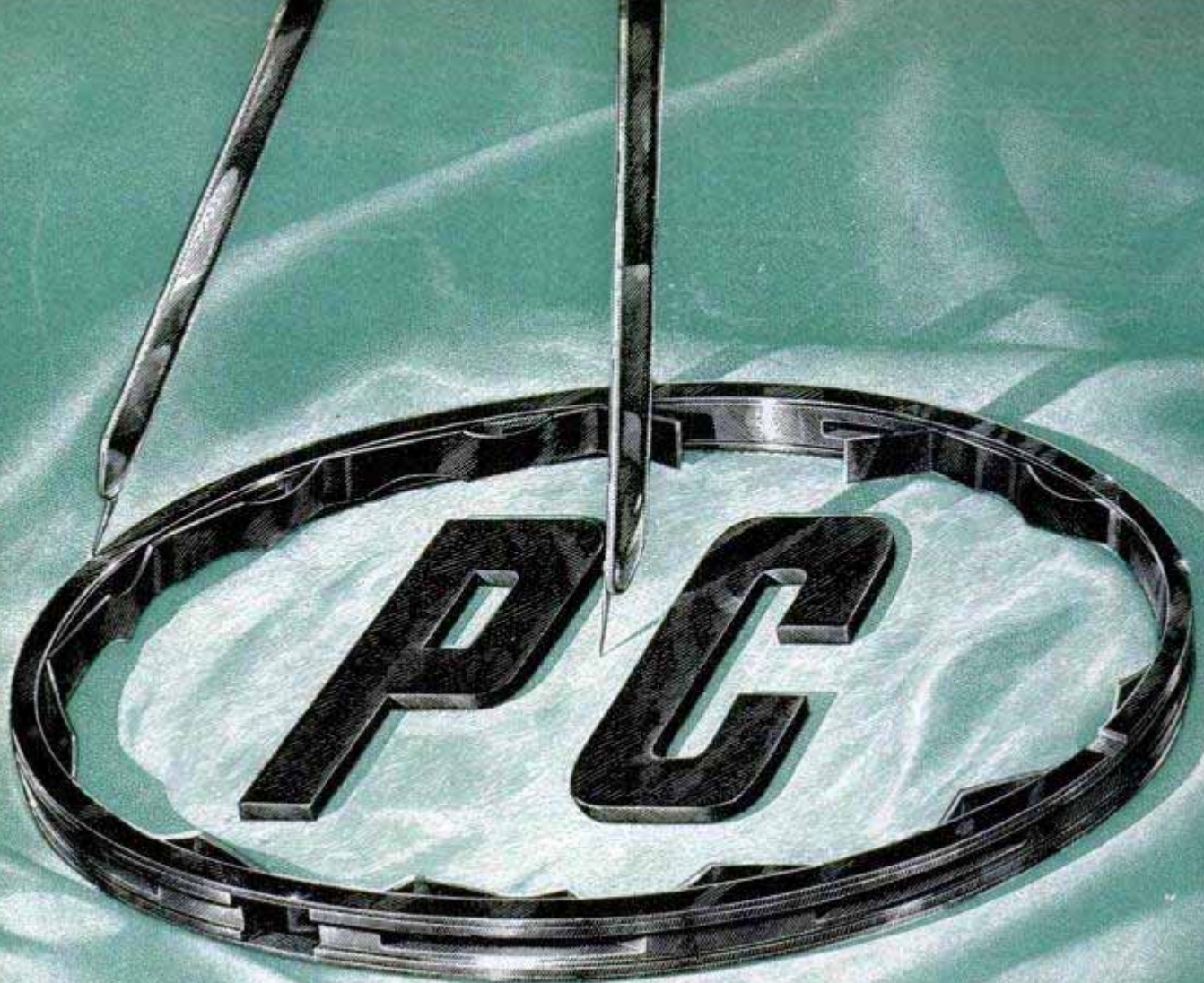

# Perfect Circle

*The Most Honored Name in Piston Rings*

Perfect Circle Piston Rings—*honored* by Doctors of Motors for their dependability . . . by America's foremost automotive engineers for their design . . . by motor-wise car owners for their economy . . . and by racing drivers for their performance. Perfect Circles have proved their superiority in millions of successful installations!



Honored by  
Doctors of Motors



Honored by  
Automotive Engineers



Honored by  
Racing Drivers



Honored by  
Car Owners

Perfect Circle Corporation, Offices: Hagerstown, Indiana, and Toronto, Canada, Plants: Hagerstown, Richmond, New Castle, and Tipton, Indiana, and Toronto, Canada.

*Tune In!*

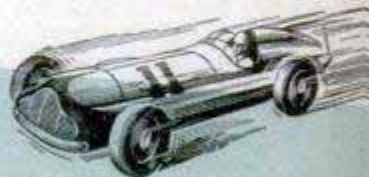

## The Indianapolis 500-Mile Race

Thrilling contest of men and machines—a racing classic which is the sports event of the year!

**TUESDAY, MAY 30**

Over the Entire Mutual Broadcasting System.  
See your local newspaper for time and station.

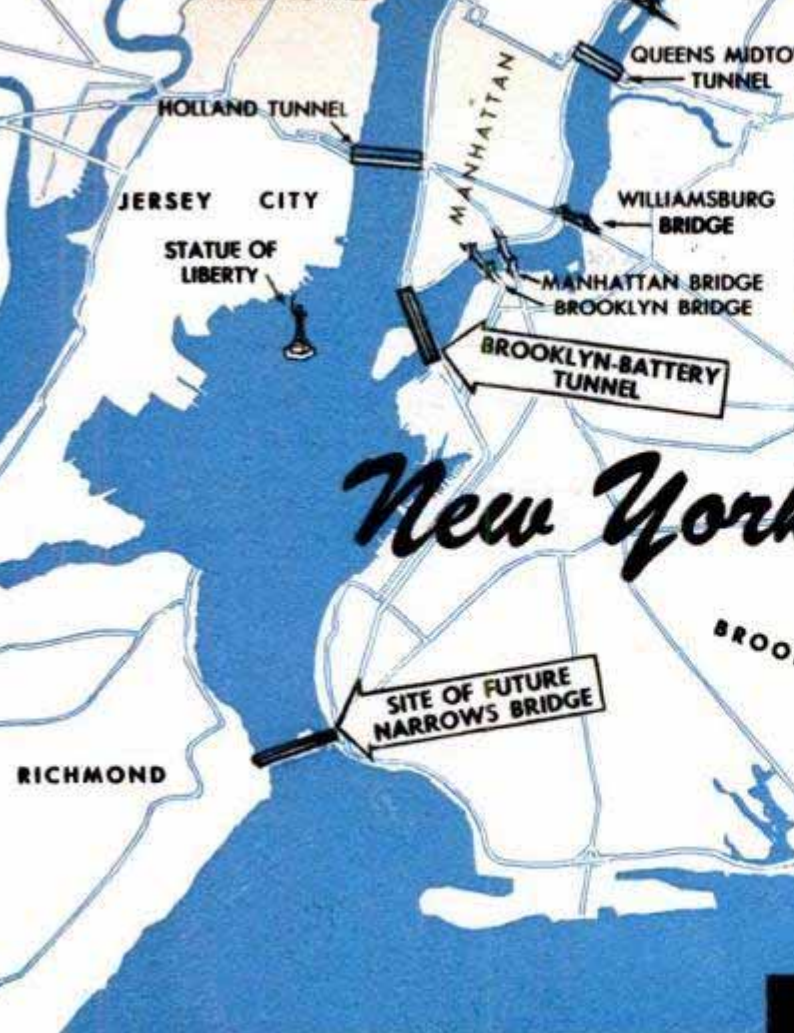

# New York Shakes off its Bonds

Two projects—the sparkling new Brooklyn-Battery Tunnel and the proposed Narrows Bridge—will keep traffic rolling through the commercial capital of the world. Below, bridge's suspension span will be the longest ever built

Triborough Bridge and Tunnel Authority diagram

*By Clifford B. Hicks*

**A**N HISTORIC headache to New York traffic engineers is the network of deepwater rivers and harbors that has nurtured their city. Ships and barges cruise along the same waterways that cut across the motorist's path wherever he turns. New York is made for ships, not wheels.

Now, two mighty projects are on tap to keep the nation's vehicles rolling through the caverns of the city. One is the new tunnel, scheduled to open this month, which dips down beneath the water of the East River to link Manhattan with Brooklyn. The other is the "impossible" bridge, the one that couldn't be built, a tremendous span to cross the Narrows of New York Harbor. Impossible or not, the bridge will be built within 10 years, states an official of the Triborough Bridge and Tunnel Authority, which is directing both projects.

Most daring of the two enterprises is the Narrows bridge, which will arch majestically across the harbor from Brooklyn to Staten Island—the longest single suspension span ever built. For years officials have begged for the bridge, and for years critics have scoffed that it just couldn't be built. The Authority's engineers finally decided it was feasible and petitioned the War Department for approval. To the surprise of some cynics, the War Department gave the project a green light.

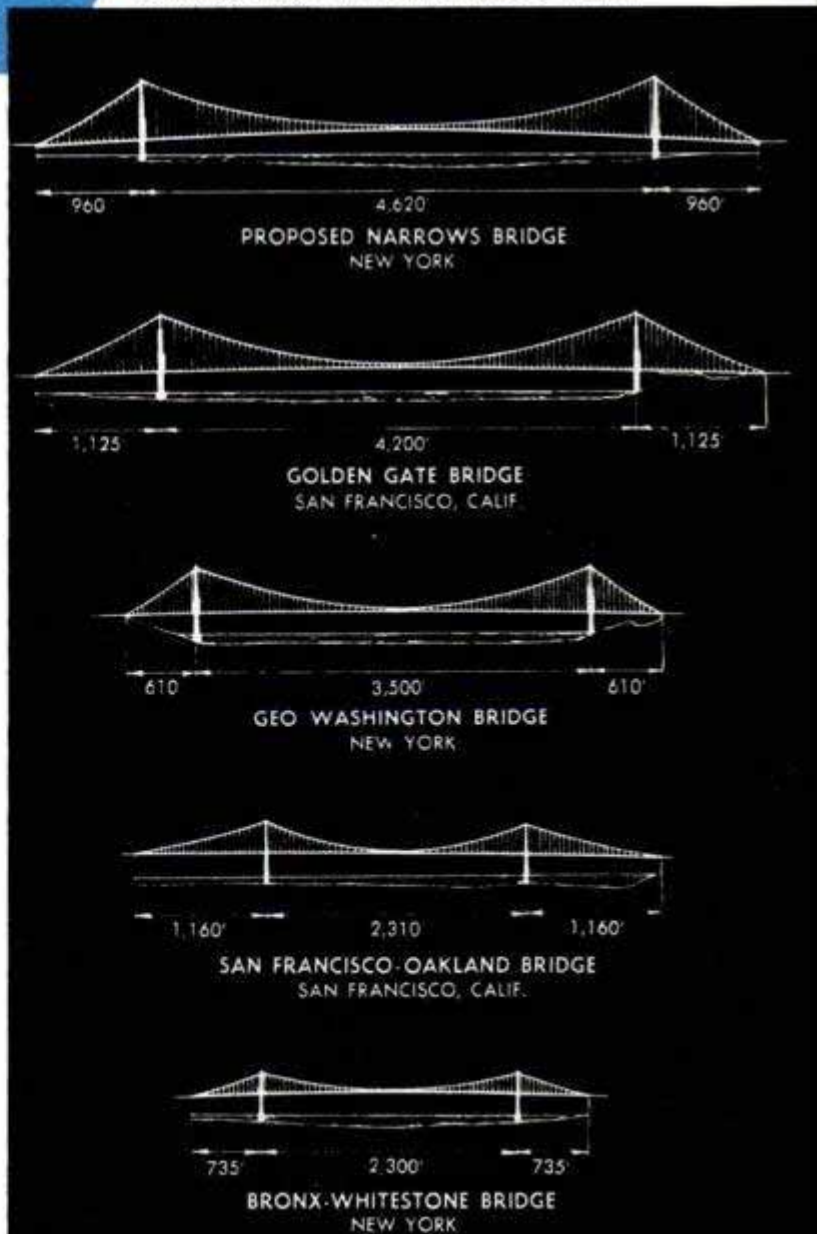

The reason the War Department enters the picture is because the Narrows bridge will straddle the vital shipping channel, the point of entry and departure for wartime as well as peacetime America. Scoffers could imagine the bridge after the first bombing raid—a fallen snarl of steel and cable plugging up the harbor.

But, according to high-rankers in the Authority, it would be virtually impossible to drop the bridge into the channel. Only a direct hit could snap one of the giant twin cables, a spokesman says, and a hit anywhere else on the bridge would not sink it. The Luftwaffe dumped some 1600 bombs on Scotland's Firth of Forth bridge and never did drop it into the water. And, the spokesman points out, even if a horseshoe hit should sink the bridge, experience has shown that modern salvage experts could cut away the knotted debris within 24 hours to pull the plug from the channel.

Rough estimates indicate the price tag on the Narrows bridge will be about \$70,000,000, whereas the Authority would have to spend \$100,000,000 or more in burying a tunnel under the channel. Such a tunnel would carry only four lanes of traffic and the bridge will accommodate six.

Anyone who has motored north or south through New York grasps the need for a crossing of some type at the Narrows. Today, the motorist must swing far west into New Jersey to by-pass the city, or jerk through the metropolitan traffic. Noncity drivers emerge shaken and glassy-eyed from the Manhattan snarl. The bridge will make it possible for you to drive from a point north of New Haven, Conn., smack through the center of eight percent of the nation's population to Perth Amboy, N. J., without seeing a single stop sign or any cross traffic. You'll zip past 13,500,000 people without touching your clutch—if any cars have clutches by the time the span is completed.

For the Authority estimates that at least 10 years will pass before the first car rolls across the majestic arch. It will take years to dig up the necessary capital. About \$20,000,000 must come from some outside source, and right now the Authority is offering prayers and petitions to the federal agencies of its rich Uncle. Then engineers will spend years designing the bridge, and finally the builders will toil for at least three years to

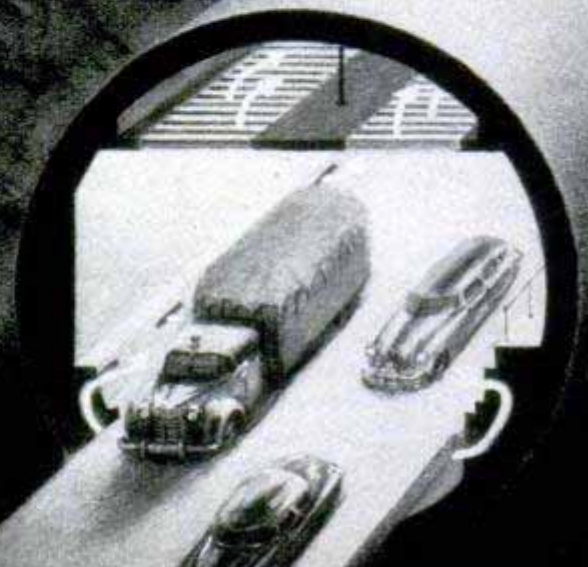

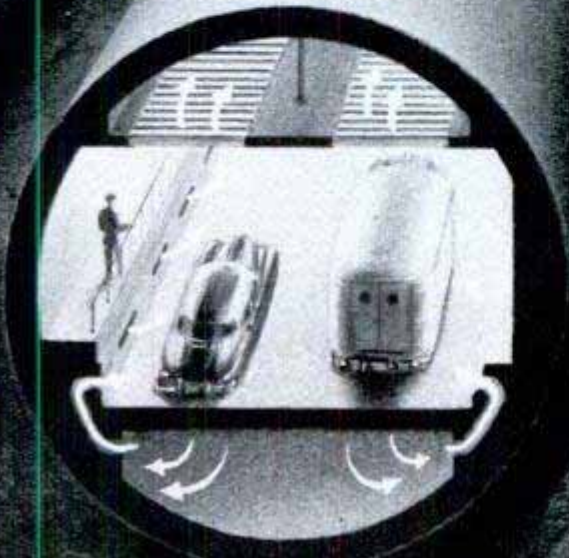
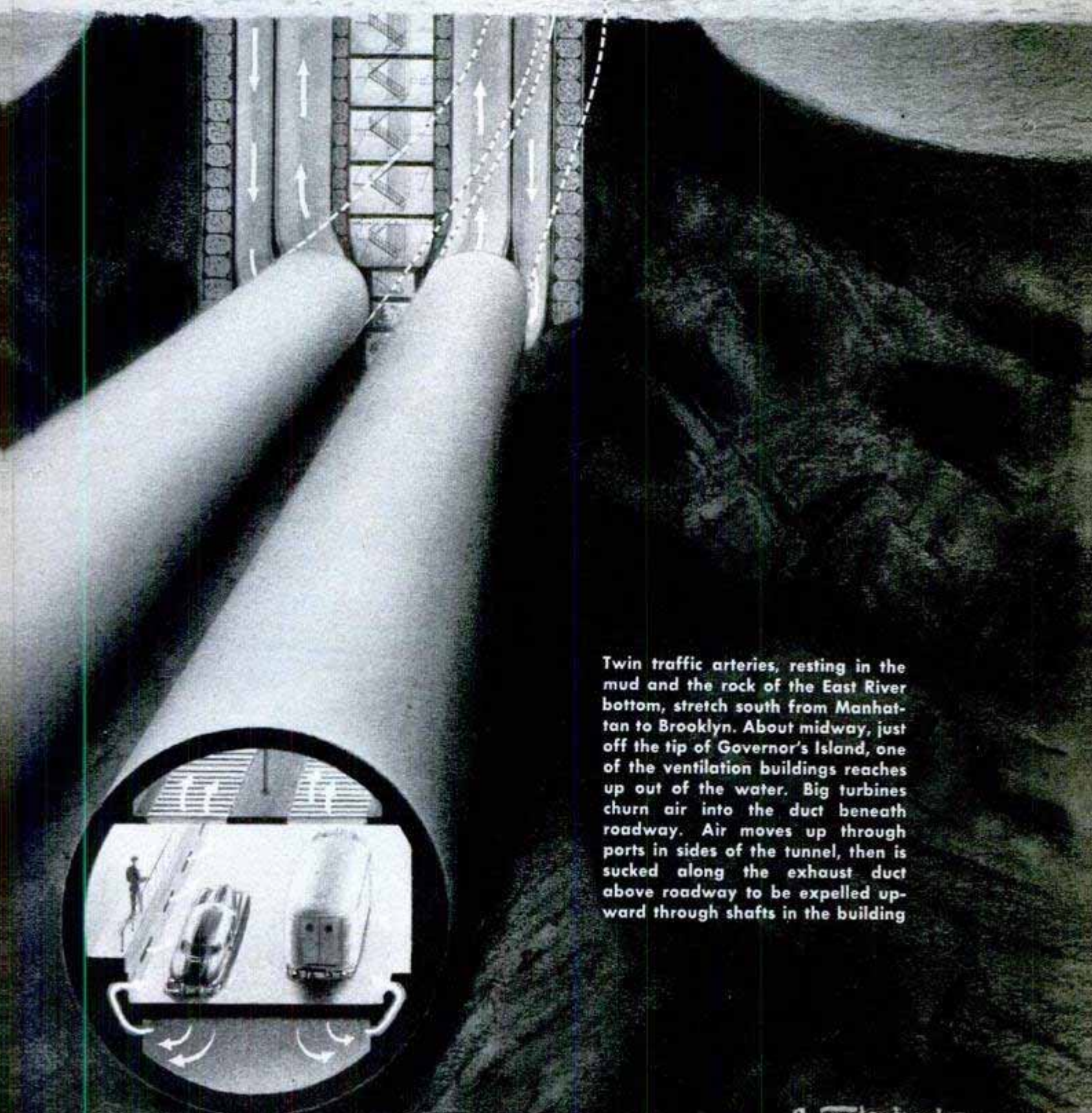
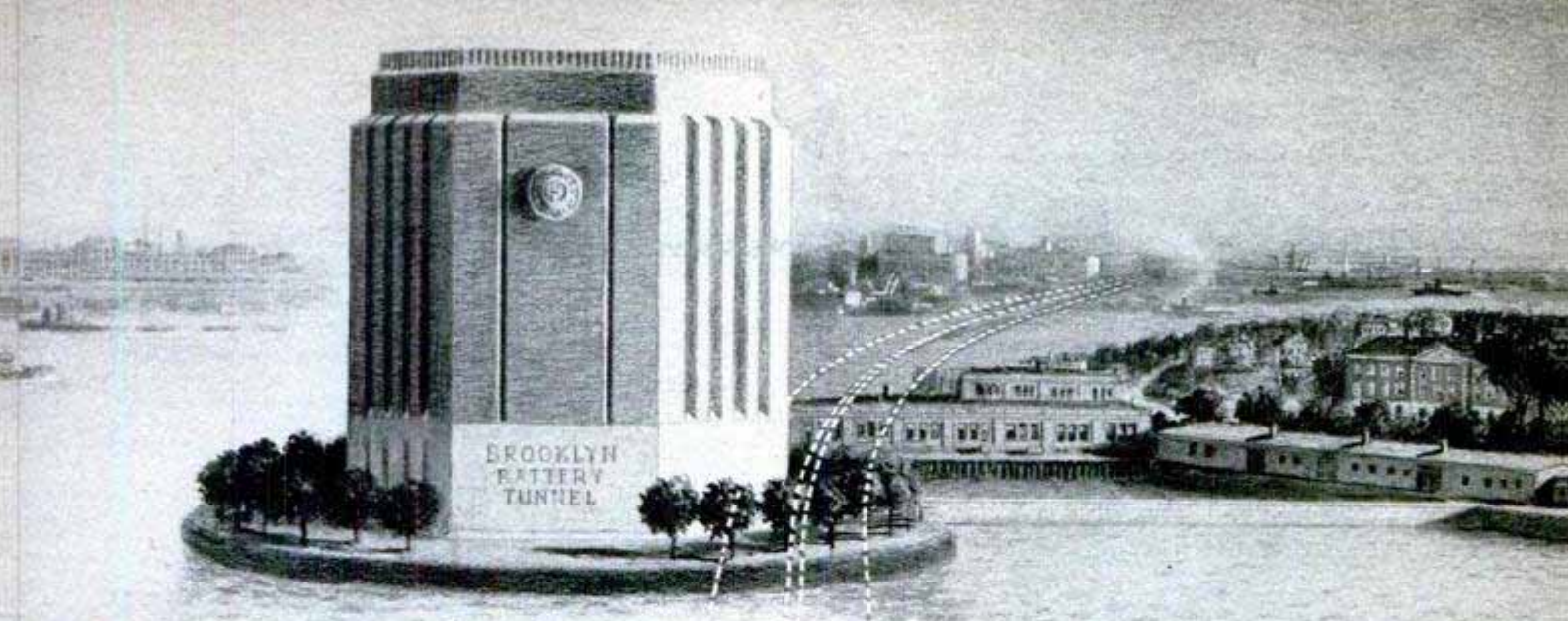

Twin traffic arteries, resting in the mud and the rock of the East River bottom, stretch south from Manhattan to Brooklyn. About midway, just off the tip of Governor's Island, one of the ventilation buildings reaches up out of the water. Big turbines churn air into the duct beneath roadway. Air moves up through ports in sides of the tunnel, then is sucked along the exhaust duct above roadway to be expelled upward through shafts in the building

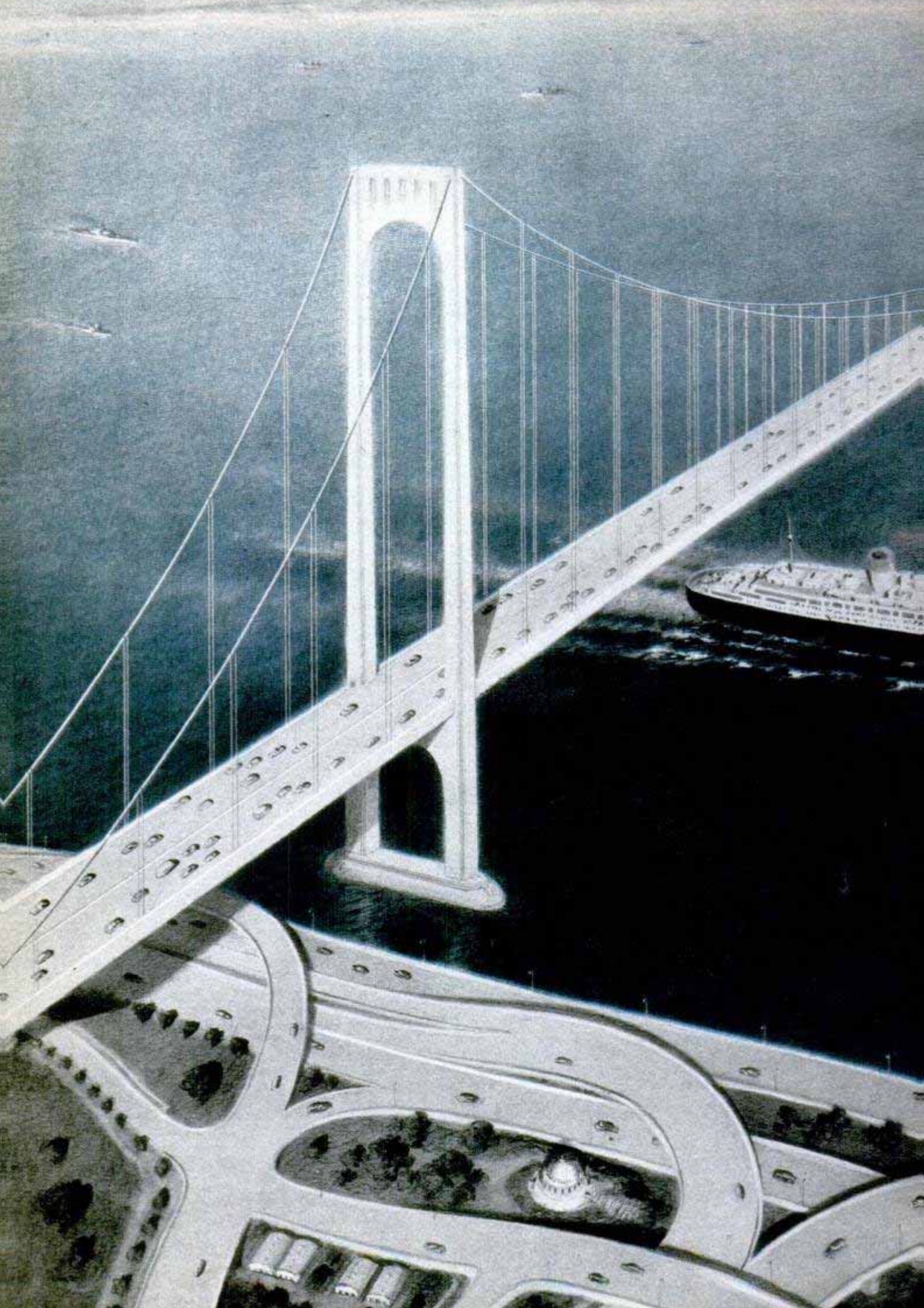

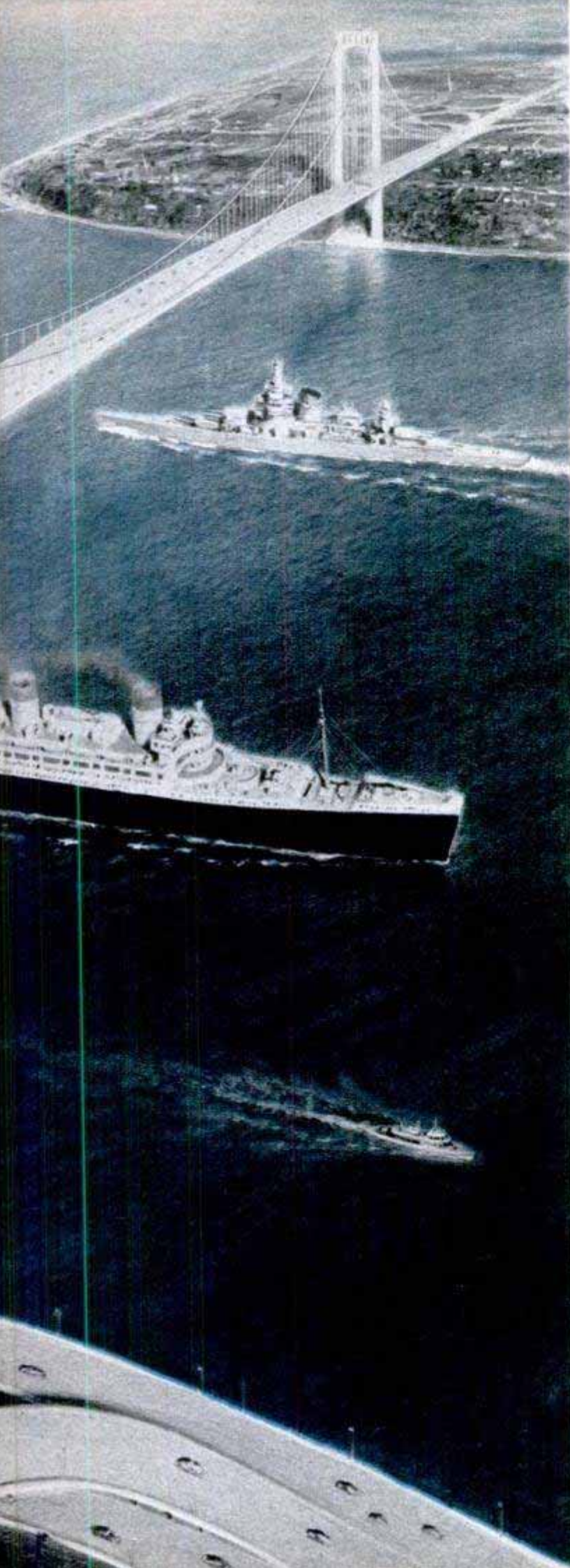

spin the span across the Narrows.

But officials speak fondly of the bridge as though it already were in existence. Glistening twin towers stretch 800 feet into the sky to support the center span, which soars outward to its mighty 4620-foot length. At the center point the road-bed hovers 237 feet above high water, permitting anything afloat or ever conceived to pass beneath.

One of the most exciting engineering problems ever posed is how to suspend such a span on a spider-web of cables. The bridge will feel as solid as a rock but actually will heave from the day of its birth. Engineers say you can't even feel a one-foot wave along a suspension bridge. When you bounce as much as three feet you can sense it but you still aren't in any danger. "Galloping Gertie" was the worst example of a dancing bridge. Tacoma's famous span waggled in rebellion from the first day of operation until four months later when she gave a final gasp which popped her cables and dropped her \$6,400,000 body into the narrows of Puget Sound.

Engineers visualize no such difficulty with the ribbon across the Narrows of New York Harbor. The world's finest engineering minds will be consulted in drawing up the final plans.

Under capacity loads, the bridge could carry 20 million cars a year. That's welcome news to Gotham residents, especially Staten Islanders who still are dependent upon an antiquated ferry system to paddle them over to Manhattan. About 90 percent of the traffic which flows along the through routes of New York is local traffic, so any metropolitan motorist has a direct stake in the span.

He's vitally interested, too, in the Brooklyn-Battery Tunnel—the first link between Manhattan and Brooklyn since the Manhattan Bridge was built in 1909—which will open its portals to him this month. Sand hogs drove it through the rock, muck and silt beneath the East River, a tunnel 9117 feet long between yawning portals, making it the longest vehicular tunnel in America and second only to England's Mersey Tunnel in the world.

Now the motorist will be able to cruise south along either side of slim Manhattan Island to its very

(Continued to page 248)



## Fish Population Is Tabulated Scientifically

Shortly before the last war, someone recalled that lightning, in striking the water, often stunned fish for yards around. Several of the more progressive state game and fish administrations began to experiment with electric shock, and a shocking machine to aid in counting and tagging was devised and made ready for a test. The shocker consisted of a gasoline-driven generator capable of delivering a steady flow of electricity with ample amperage to momentarily stun a fish. If a fish bumped into the electrical field established between the two poles bearing the electrical charge, he'd receive a hotfoot on an international scale and soon be still as death. The state of Colorado has developed the shocking unit to its highest degree, and the fish-and-game officials of



that state have used the instrument with much success in taking a census of their trout streams. A crew of four or five men operate the shocker, which is portable, and since fish remain stunned for three minutes or more, the census takers have ample time to examine them.

## Dash-Controlled Electric Locks for Car Doors

Controlled by a dash button, an electrically operated lock system prevents any car door from being opened as long as the ignition switch is turned on. The locks, one on each door, are instantly released when the control button is pressed. Concealed in the door posts, the locks prevent children from falling out while the car is in motion and also make it impossible for intruders

to enter the car or open a door without the driver's permission. As soon as the engine is turned off, the locks release, allowing normal use of the doors.

☐ Odorless wall paints, using no deodorants or perfumes to mask the scent, are now on the market, making it possible to occupy a room while the paint is still wet.



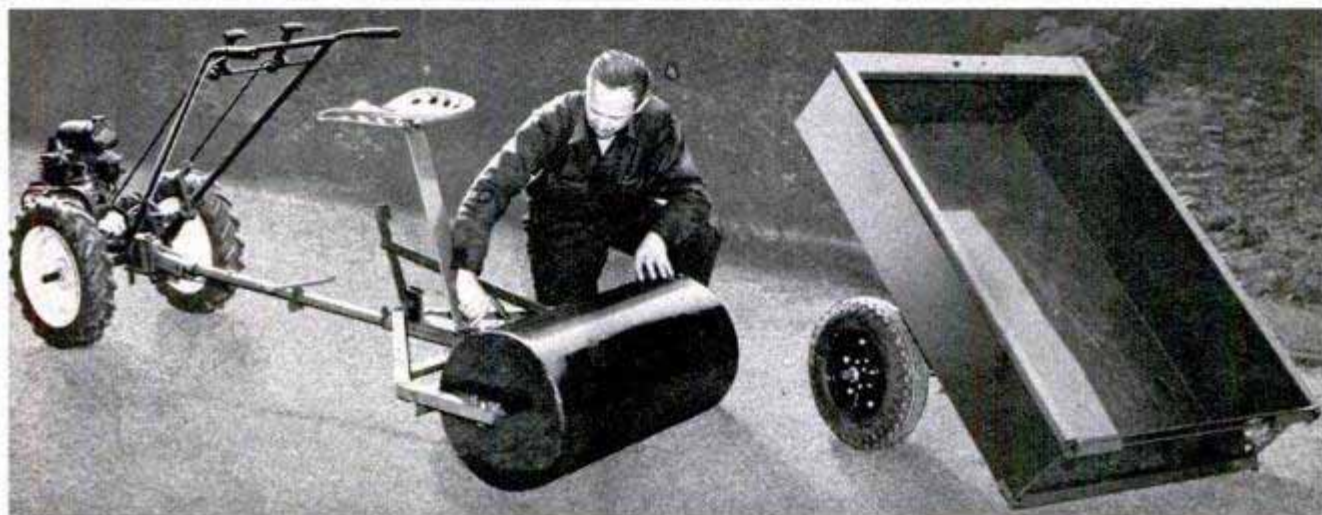

## Power Cart Converts Into Garden Roller

Now combined into one power implement are a garden roller and a large dump cart. The little vehicle has a gasoline engine mounted above and between the two front wheels. The operator sits on a steel seat

just forward of the rear wheels with the forward edge of the steel cart just beneath him. When desired, the cart can be slipped off and the heavy garden roller installed in place of the two rear wheels.

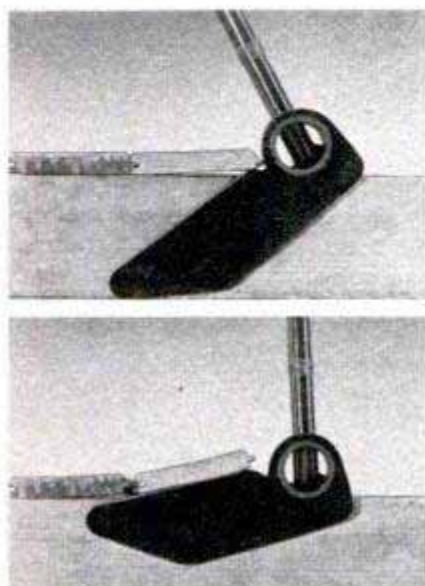

## Floor-Board Remover

Old flooring, siding and sheathing can be removed easily, without damaging the tongue and groove, by a new-type salvage bar. A single motion raises the tongue side of the board and draws it outward, disengaging it from the adjoining board. It can be used astraddle single joists or next to double joists. Weighing 6½ pounds, the lever is 25 inches long, handles boards up to eight inches wide and has no moving parts.

# MYSTERY

By Richard F. Dempewolff

**T**ELEVISION screens, tuned in on a recent CBS spine-tingling "Suspense" show, darkened dramatically. People watching the show on home sets tensed as three video characters boarded an elevator high in a skyscraper. The camera viewed the inside of the car and withdrew as the doors slid closed. Suddenly there was a sharp crack of snapping cable. Fast-receding screams of passengers were heard. The dial atop the door spun as the car plummeted and crashed. An instant later, the audience saw the smoking, shattered wreckage inside the doomed cage. Passengers lay sprawled about. The bumper at the bottom on the shaft jabbed through the battered floor of the car. Metal sides

TV engineers, like the one at the control panel (left) can combine images to bring front views of Toscanini and the choir he's directing to your set simultaneously, a view you will never get in the concert hall. Below, this is CBS' video studio in New York City

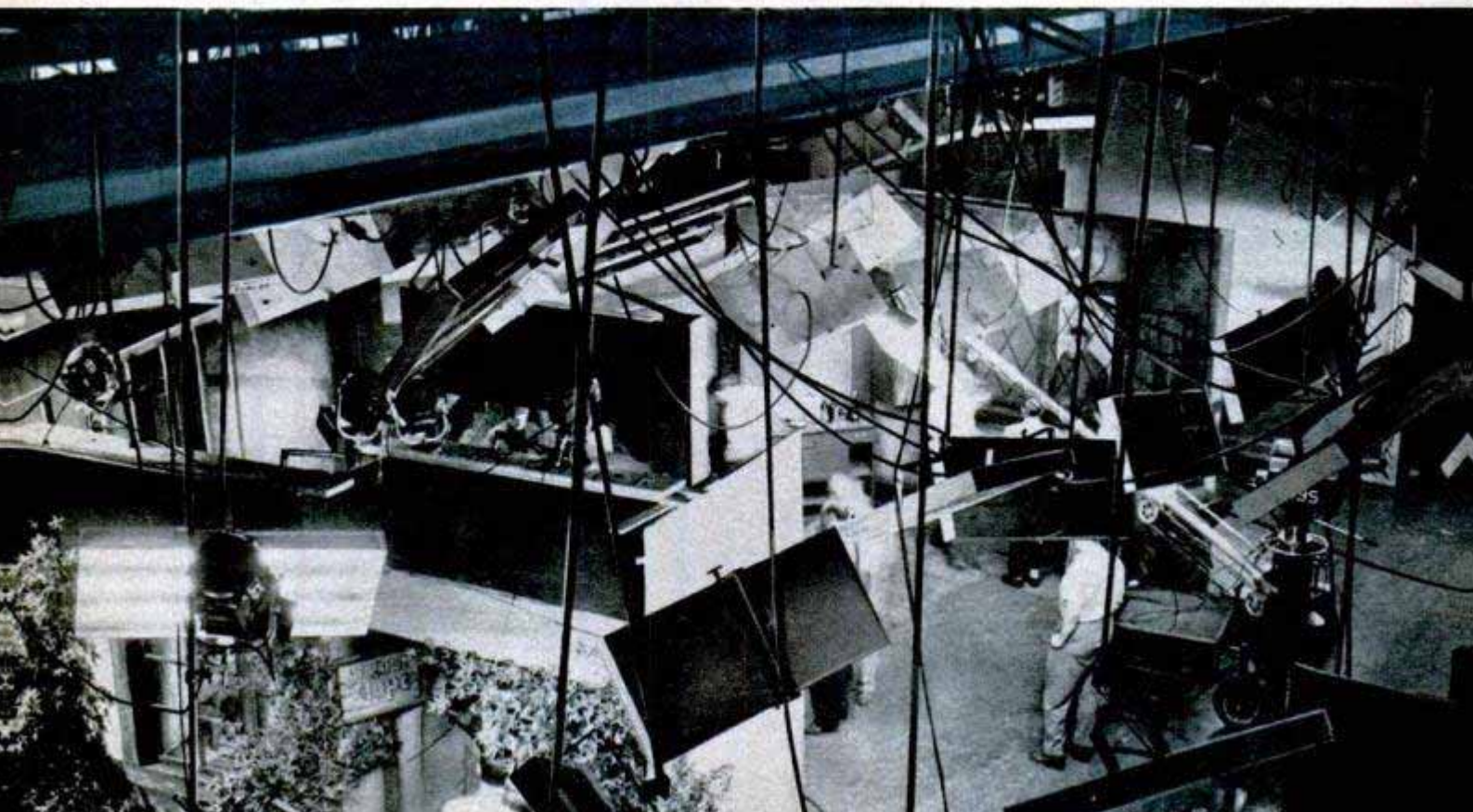

# MEN OF THE TV SCREEN

were stove in. Sparks from an acetylene torch used by rescuers atop the cage came through the roof into the dusty interior. Instantly, the scene shifted to the top of the cab where rescuers frantically tore away chunks of metal.

All this speed, action and instantaneous change of effects was accomplished with real people on a life-size set in a space of about 10 square feet, located in a studio in the recesses above the vaulted ceiling of New York's Grand Central Station. One elevator car, a few "props," some tricky mirrors and two TV cameras did the whole job. How?

One camera was focused on the car. When the doors closed, prop men quickly shoved a specially made "bumper," with curled and twisted pieces of simulated metal stuck around it, into the center of the car. Several catches were released, permitting pre-sprung metal sides to snap into distorted, broken position. Someone threw handfuls of flour in the air to serve as dust. Fire laws prohibit anything like an acetylene torch in the building, so a Fourth of July sparkler, accompanied by a hiss from sound effects, served the rescuers atop the car perfectly. In about three seconds, when the camera flashed to the inside of the car, it viewed a complete "wreck."

Meanwhile, camera number two was set up to take the scene above the cage through a periscopelike system of mirrors.

Today, the very limitations of television are bringing to it some of the most ingenious stunts production engineers have ever been called upon to perform. There's no space. Studios are cluttered with heavy equipment. TV cameras weigh upward of 150 pounds and can't be hoisted, lowered or juggled around easily. Besides, the floor is always strewn with a spaghetti maze of camera cable and batteries of ceiling and boom lights prevent moving a camera up for high shots even if you could hoist it there. That's how come the engineers invented simple periscope mirrors, suspended on a high, light frame. Clumsy pedestal cameras now can focus on the bottom mirror and get a "looking down" picture reflected from the top mirror. The same trick has been used in reverse to get a mouse-eye view of an NBC corpse on the floor.

"People expect the same effects they see in the movies," points out one engineer, "but they forget movie scenes are often shot 30 times to get an effect. Television is shot right now. What the camera sees on the first try, so does the audience."

The worst handicap of all, from the harried TV engineer's viewpoint, is the slim

Tricks make up the TV trade. Left, the CBS split-screen system, using mirrors and one camera. Right, the "gloccamorra" that spins in front of a spotlight to make a studio train appear to be roaring over the tracks

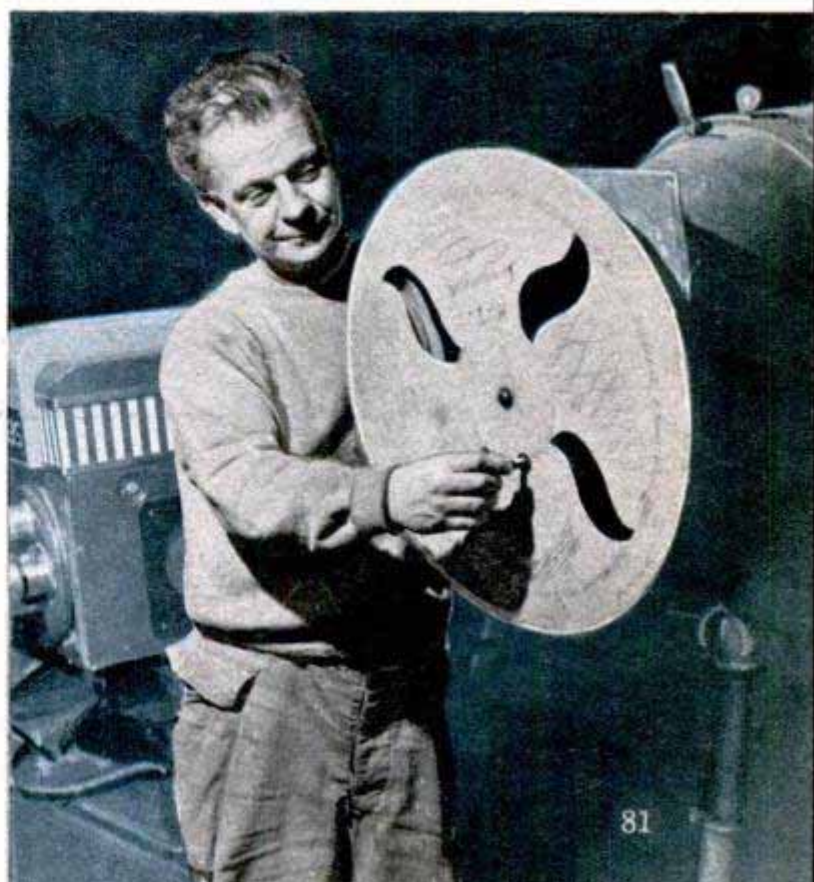
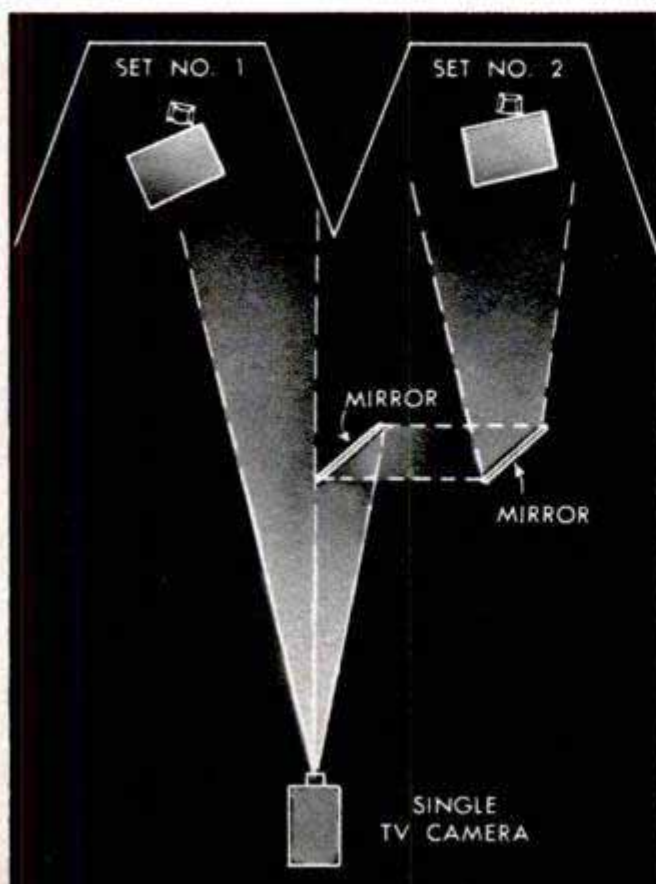

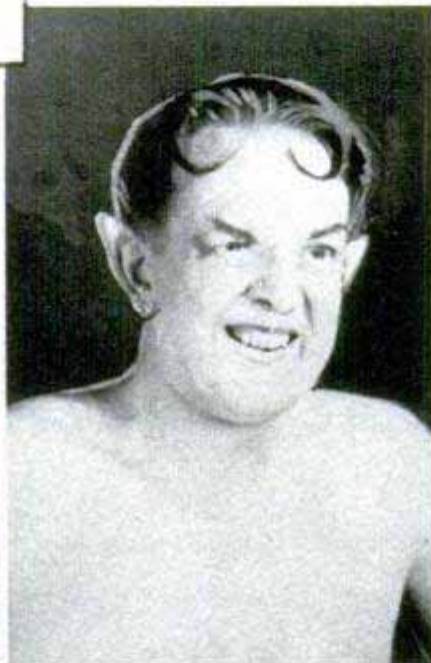
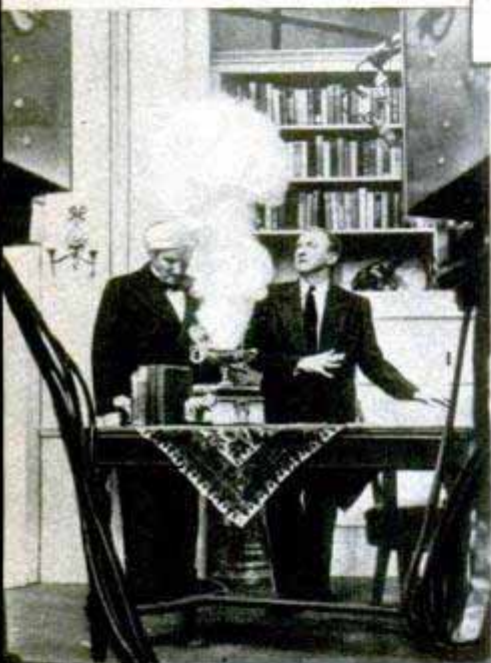

Top, a bodyless head floats in a cloud of smoke for TV, but no magic is required. One camera shoots the smoking bowl, at left; another, the head, right; and combined they create the top scene

Fog is made by placing Dry-Ice in a tray, left, and blowing over it steam given off by pails of hot water



budget with which he must work. When Johnny DeMott, now CBS' manager of program development, was special-effects man for Paramount, he handled the explosion of a mountain top in "For Whom the Bell Tolls" easily. He just bought a mountain—with a small town thrown in—at a total cost of \$16,000. Then he planted 2½ tons of dynamite around the mountain top and blew the whole shebang to Kingdom Come, while cameras ground away for 30 seconds. TV can't afford that sort of extravagance. Total production budget for an average half-hour show is usually about \$1100. Consequently, men like DeMott and Al Ostrander, head of the scenic department at CBS, must bristle with bright ideas.

To get a glittery effect for "King Midas" without buying expensive scenery and costumes, DeMott had the boys aim their cameras at the set through a bowl of jiggling lemon Jello. It worked like a charm. CBS needed hundreds of big iridescent bubbles to glamorize a musical production. Plastic bubbles, like those used in Hollywood and on Broadway for "The Great Ziegfeld," would have cost more than the whole budget. So Johnny threw some detergent into a bowl of green soap, added a little glycerine and coloring and started pumping air in the mixture. "In 10 seconds," he recalls with a chuckle, "everyone in the studio was pushing his way through tough, four-foot bubbles trying to find the doors. That studio was jammed to the I-beams with bubbles."

Dozens of such simple tricks are used regularly to fool the video audience with synthetic realism. Windows are given a frosted, wintry look simply by filling a bug sprayer with stale beer and Epsom salts and squirting the panes. A London fog can be raised in the studio just by fanning steam across a tray of Dry-Ice.

"We need the interior of a railroad car," DeMott was told one day. "But the scene must look like the train is really rolling. Can you do it?"

"I didn't know how, but I told him I could," says Johnny. So he built a "gloccamorra" and did it. The gloccamorra turned out to be a plywood wheel with S-curved openings cut in it at intervals. This was hung in front of a spotlight aimed at the railroad-coach set and turned by a motor. Every time one of the "S" openings passed the lamp lens, light snaked across the set, giving a perfect imitation of telephone pole and tree shadows whisking by as the stationary train "roared" along.

Since most TV stations are located in metropolitan office buildings, there are plenty of regulations that hem in the ever-harried producers.

One of the toughest problems faced recently by DeMott and Ostrander was a wharf scene in "Stolen Empire."

"It was a sort of dead-end set," says Ostrander. "To allow for the action, the scene had to be viewed from the river. That meant water and the people who run the Grand Central Building don't care for water on the floor." There's reason for their prejudice. A year ago, Johnny and Al staged an ice show in the studio. As the ice melted, gallons of water seeped through cracks and drizzled all over crowds of commuters in the main waiting room of the big terminal.

Ostrander, once technical director for Billy Rose's "Jumbo" and production engineer for Ringling Brothers, wasn't stopped, however. He built a huge metal tray, one inch deep, to cover the set floor. A mere five gallons of water filled it. Then he added oil, soap, sticks, cigarette butts, sweeping compound and a little paint to give it a typical river-front scum. An electric fan under the wharf swirled the surface like a flow tide. There were no wet commuters and the five-gallon river was easily pumped into a drain after the show.

Real fire in TV studios is out of the question, of course. Yet script writers are forever turning up with fire and explosion scenes. The boys have found ways to fake these, too. Explosions are usually engineered with flash powder and smoke bombs. For fires, they sometimes use the old stunt of paper strips and electric fans. But one of the most dramatic "fakes" was executed by Fred Coe, producer of NBC's



Above, a cameraman's view of a periscope shot. The camera picks up only the overhead view from mirror

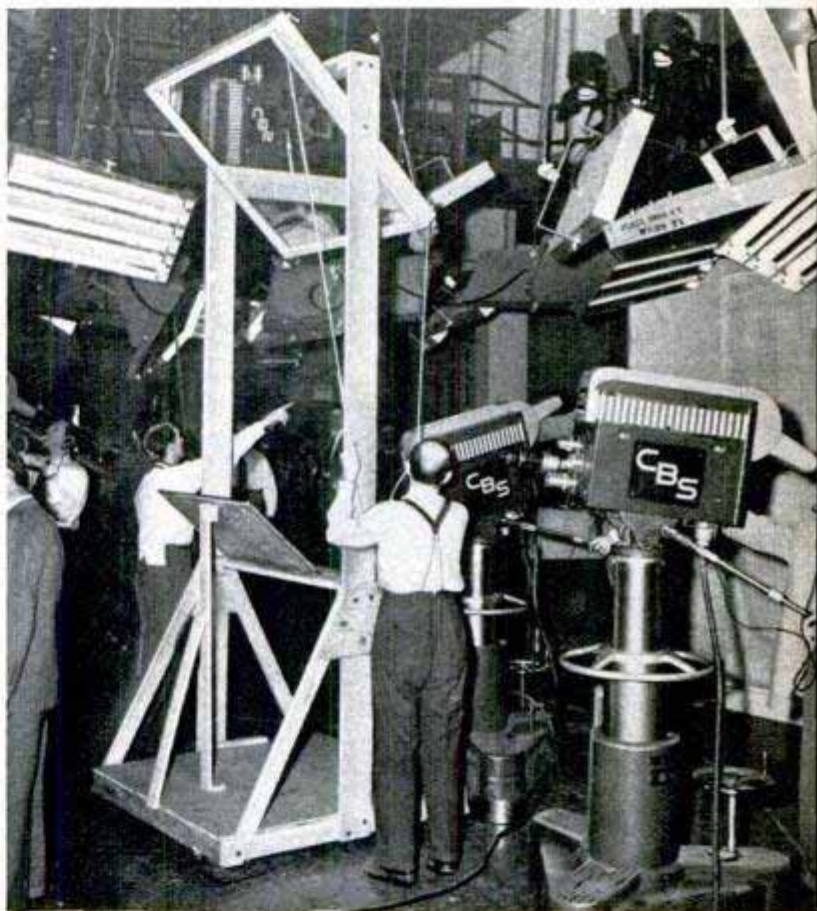

Stagehands adjust the top mirror of the periscope so the camera can shoot an overhead view from below

Philco show. He had to televise two men burning to a crisp in a big blaze. So, he took movies in a burning building. Then, on the set, he simply set up smoke bombs. At show time, the two characters walked across the smoky set, cringed and crumpled. While one camera took this, another was televising the fire film. At the monitoring board, the control engineer superimposed both images and they were viewed on receivers as one hideous sequence of two men burning up in a raging fire.

Getting a girl to swim in a goldfish bowl was accomplished similarly by Johnny DeMott recently. He got a film of Eleanor



**CBS sound-effects room has a variety of windows and doors built into wall to make real slamming noises**

Holm Rose diving into a glass-sided tank and swimming underwater. Then, on show night, in the studio, one video camera took the film while the other shot through a real studio fish bowl against a black background. By imposing a semidissolve on each image and superimposing the pictures, the result was a beautiful sequence of Eleanor among the goldfish.

Production engineers are learning to use

camera and electronic control-room tricks to achieve many new and startling effects. Behind the glass partition of the studio sit two men at panel control boards with enough dials and buttons to run the Queen Mary. In front of each man are two screens, which pick up the image from each of the two cameras. One of these men is the technical director, who can switch cameras as cues are called. The other is the video-control engineer, who does the fading, dissolving, mixing, superimposing and the like. He is the trickster. By changing the pulse, he can blank out the right half of the picture from one camera. A reverse pulse blanks out the left half from the other camera. Then he merges the result and sends out half an image from each camera, so the audience sees two scenes at once.

On the face of it, that sounds silly. But producers can use it. Today, split-screen shows allow Dunninger, televising from New York on half a screen, to act with a person in Washington who occupies the other half. Howdy Doody, occupying half the screen from Chicago, chats with Bob Smith on the other half from New York. NBC even ran a whole show especially written for a split screen. It was a series of phone conversations between a woman

**This sketch of the "Suspense" waterfront set was made for Popular Mechanics by Al Ostrander, head of CBS' scenic department. The "river" in foreground is only an inch deep and contains about five gallons of water**

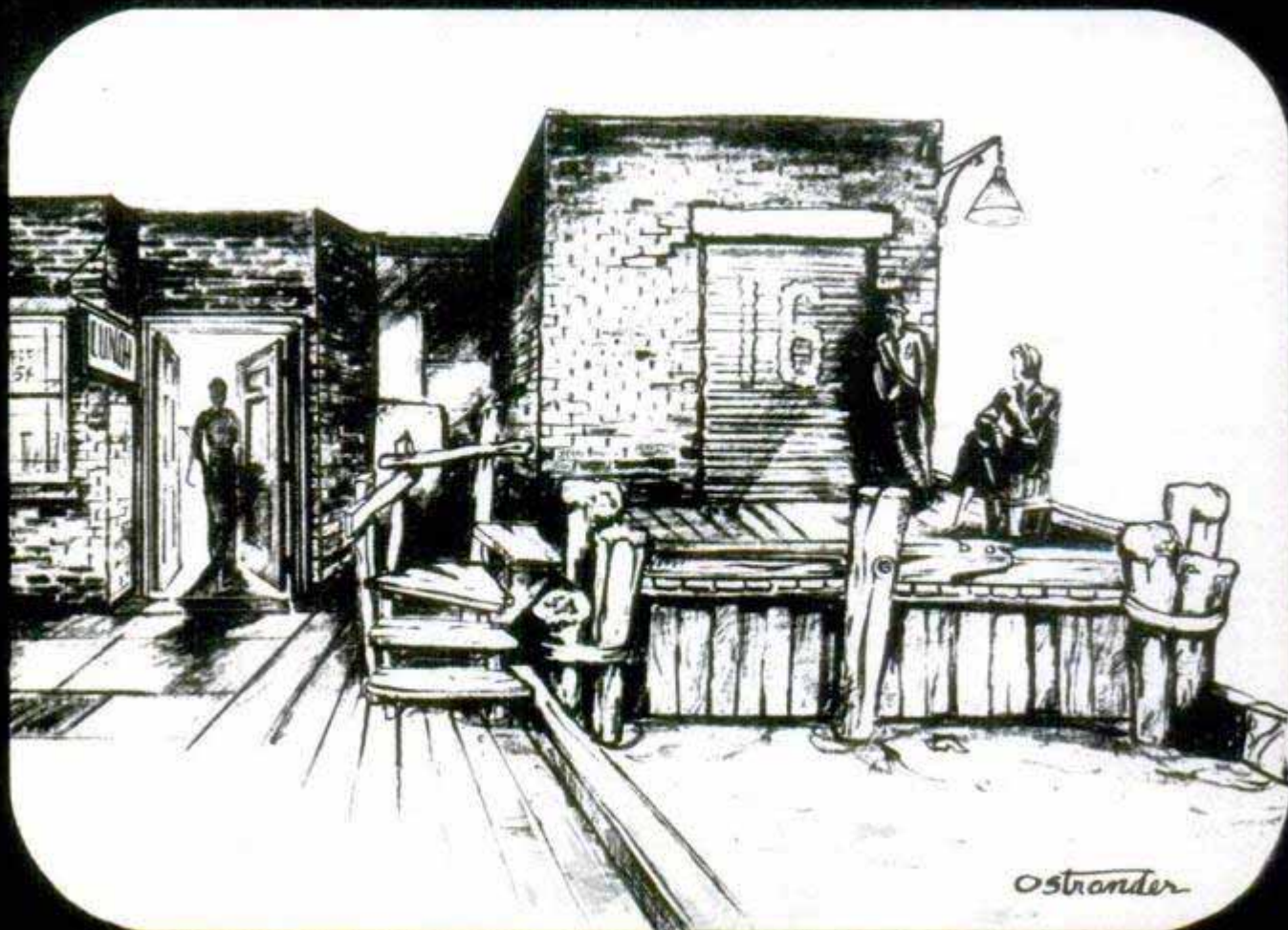

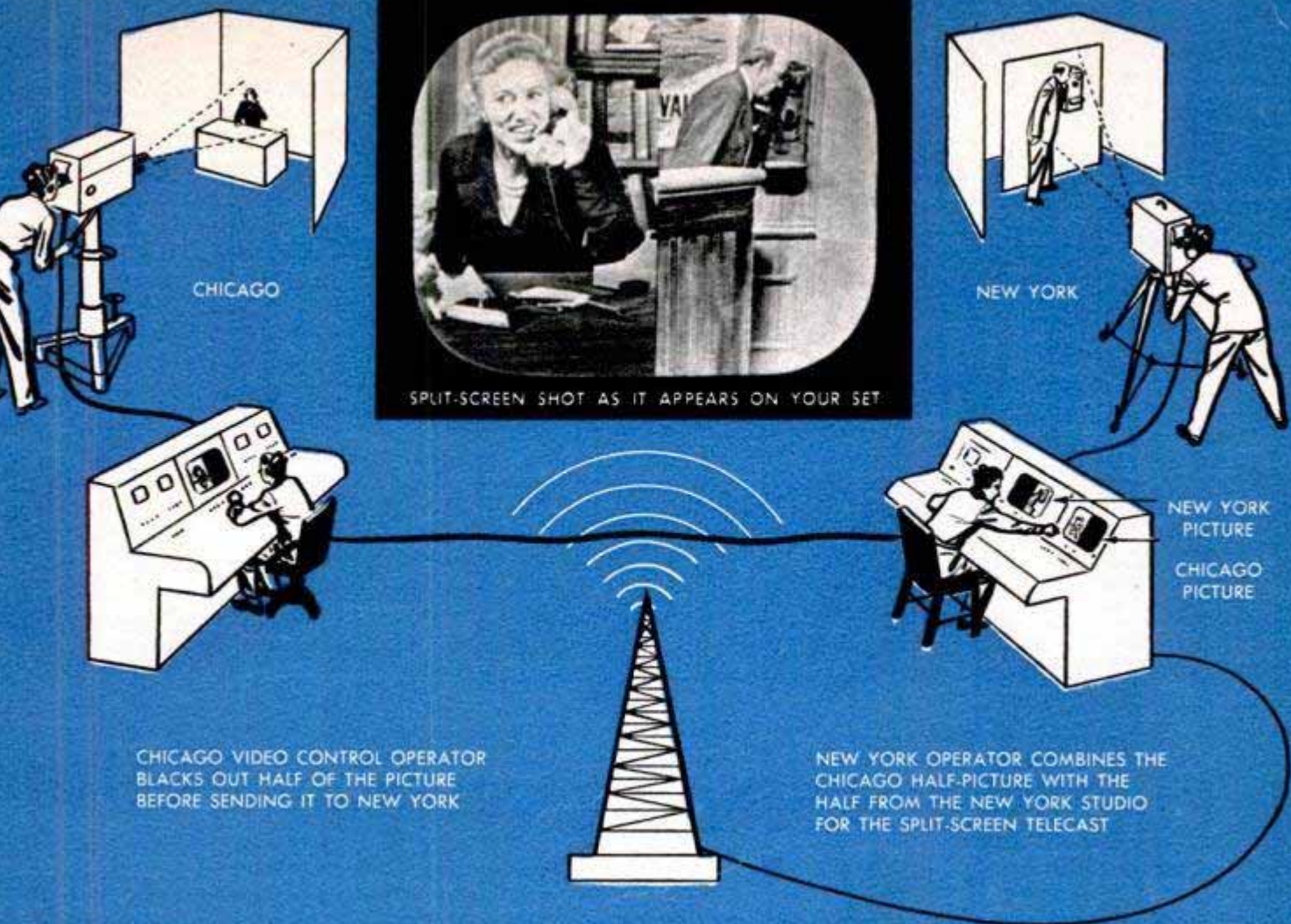

Split-screen shows, such as NBC's "The Clock," can be made from two cities, as shown here, if desired

and a number of persons whom she called.

CBS, too, has run split-screen shows, using a simpler device and only one camera. The scenes were set side by side. The camera was aimed at the left-hand scene, but half the lens field was cut off by the edge of a mirror which reflected the right-hand scene into the other half of the camera.

Control-room tricks are almost entirely responsible for the weird effects on WNBT's "Lights Out" program. Ghosts hover on the screen, crooked people squirm across the sets like creatures out of a Dali dream, heads without bodies hang in the air. How come? The crooked people are normal enough, but the sets are built off-angle. A simple prism on the lens straightens out the set but makes the people walk uphill and stand crooked. It also reverses the image and the cameraman has to think twice before "panning" or he's liable to get a shot of workmen erecting next week's set on the other side of the studio.

Corpseless heads are a simple matter. One camera takes a picture of a man draped in black velvet against a black background, while the other shoots the scene. The two pictures are merged—and lo, a head hovers over the set. Fred Coe, producer of NBC's "Philco Television Playhouse," used this

system to turn a door knocker into Marley's face for his "Christmas Carol" production a few months ago.

It's tougher making a man walk through a wall, though the same principle is used. Two matching sets are constructed and two video cameras are used. The actor walks toward one wall. As he gets to it, the control engineer dissolves the image and switches to the second camera aimed at the similar set with no man. Presto, the man has disappeared through the wall. Great care is required at the control booth to keep both scenes in perfect register during these sequences. If the cameras aren't aimed just right, the audience gets a double image.

There are other camera effects which, while principally designed to cut production costs, are also unusual. In Auto-Lite's "Suspense" production of Dr. Jekyll and Mr. Hyde, for instance, Ostrander had the camera play the part of Mr. Hyde. A hairy hand raised the potion to the eye-level camera lens and poured the brew into the "objective camera's" mouth. The camera addressed people and became an actor. The same stunt went over again on another Auto-Lite Suspense show when the camera played the part of a gangster. An actor off stage spoke for the lens, reached for

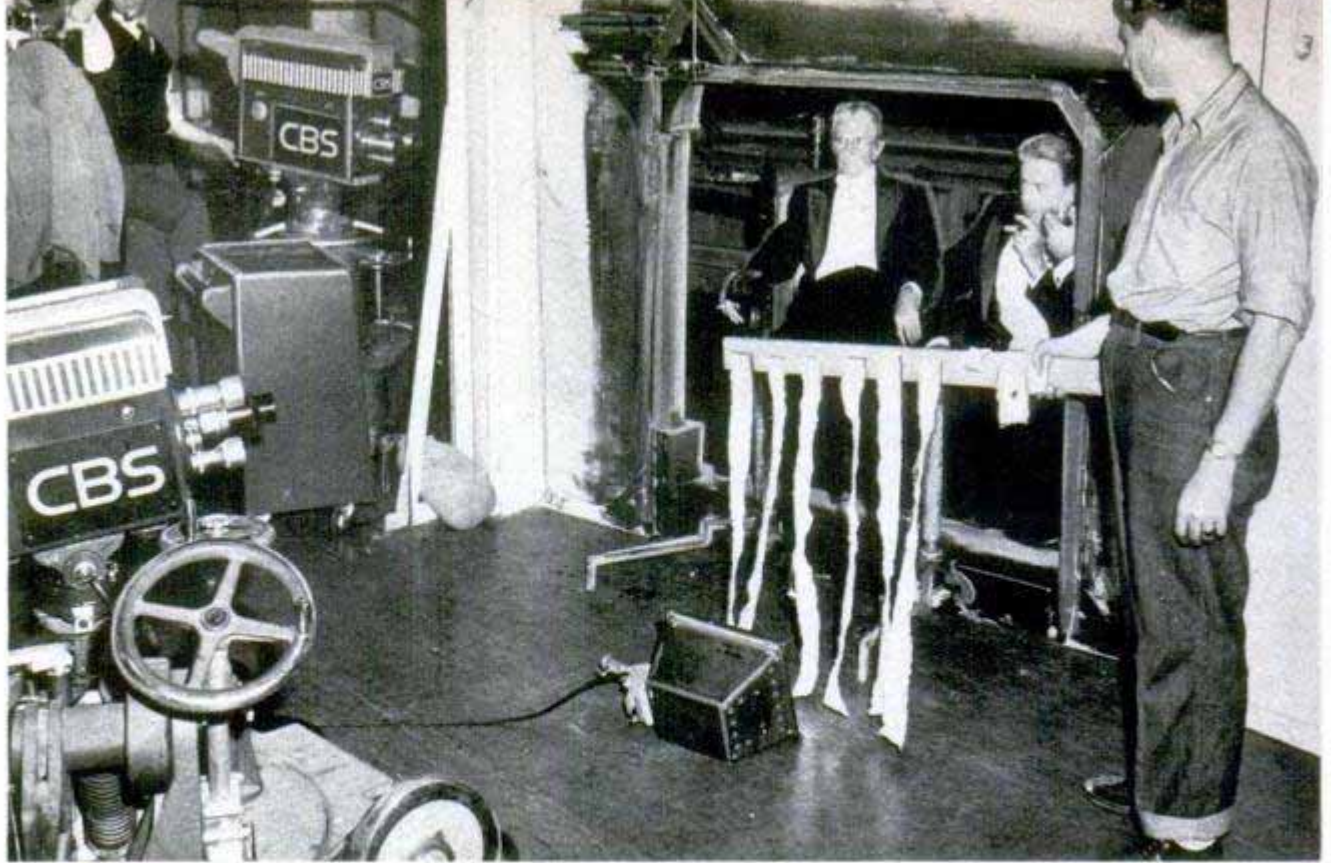

Camera, left, sees men as if from behind fireplace. Cloth strips in front of light simulate flickering flame

objects, brandished and used a gun, which stuck out from under the big box in just the right place, banging away at the victim at whom the camera was looking.

Gun-banging, siren-screaming and background noises are just as important a part of television as they are of radio—and TV has added a few new problems for sound engineers.

Twenty-two radio-trained men manage the CBS sound-effects department, compactly arranged in a tiny space on a balcony overlooking the biggest studio in the Grand Central headquarters. Here, besides the usual array of turntables, is a built-in section of doors for slamming—screen, house, automobile—as well as windows, creaky hinges and the like. The boys love

Periscope in reverse provides camera with a floor-level view of corpse for a television mystery show

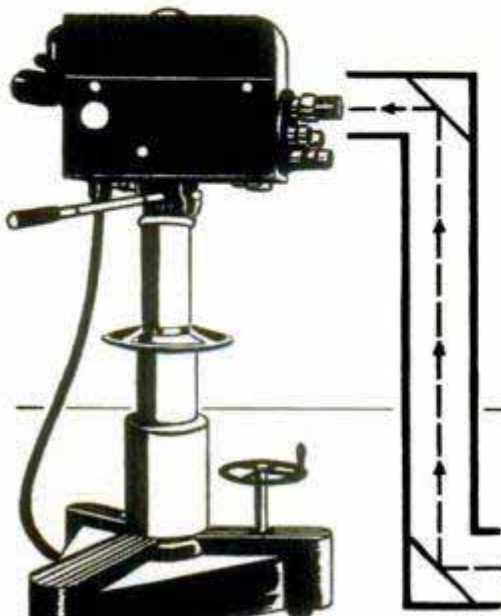

the resounding thud, squeak or rasp of the real thing.

All TV sound men must be on their toes and some are wizards. One tricky job is providing sound to be broadcast with silent films shot on location for parts of some shows like "Studio One" and "Suspense." Vic Rubei, CBS dean of sound, got a late look at a film for a Studio One show. He viewed it once, then went on the air a few hours later with a perfect synchronization of sound and action. Cars screeched around corners, doors slammed, engines roared—all in the right places.

More than one sound man has saved the day by quick thinking. During a "Lucky Pup" show, a piece of monitoring equipment slipped and fell to the floor with a crash. The sound man immediately produced a series of thunder claps, while the glib star of the show grabbed the cue and ad-libbed cracks about the weather.

It doesn't always work out so well. In a production of "Julius Caesar," the chirping of crickets in a night scene kept chirping in a daytime scene that followed. "Kill the crickets," yelled the producer in agony. Only they couldn't be killed. The cricket chirps were being produced by loose bearings in a boom being wheeled around.

Darkest moment in the CBS sound room, however, occurred when action called for

(Continued to page 258)







### Binoculars Worn Like Glasses

Weighing only three ounces, a pair of binoculars with three-power magnification is worn like spectacles, providing a close-up view of action at the ball park, race track or theater. The nosepiece and temples are made of Tenite plastic for comfort and strength. The 25-mm. lenses are mounted in an aluminum frame and are easily focused with a single knurled wheel.

### Cigarette Won't Shed Ashes

There's no need for ash-strewn rugs, according to an inventor in Dusseldorf, Germany, who has developed a cigarette that won't drop its ashes. The secret of the hardy cigarette is its paper, made of glass fibers. While the tobacco burns, the paper keeps the ash intact. And the glass doesn't affect the taste of the smoke, according to the inventor.

☐ In 1949, the United States produced 47 percent of the world's steel, a slight percentage drop from previous years.

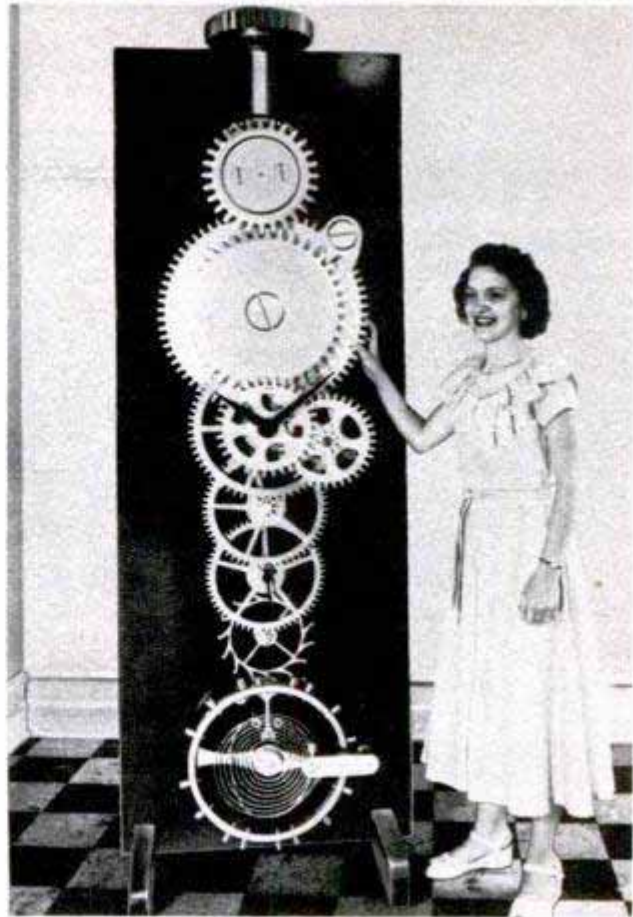

### Plastic Watch Movement

Plastics seem to be everywhere and now they have invaded the watch-movement field. When the Hamilton Watch Company needed a giant-size watch movement for use in a promotional movie, it decided to make the watch of Plexiglas. Containing most of the parts of a real watch, the model, which actually keeps time, is arranged in a straight line to illustrate the flow of power.



### RESERVE YOUR SEMIANNUAL INDEX NOW

Your copy of the complete, cross-referenced index to all articles in POPULAR MECHANICS, January through June 1950, will be reserved for you on receipt of 10 cents to cover the cost of handling and mailing. This index will be mailed to you as soon as it is available, about June first. Orders should be addressed to the Bureau of Information, Popular Mechanics Magazine, 200 East Ontario Street, Chicago 11, Illinois

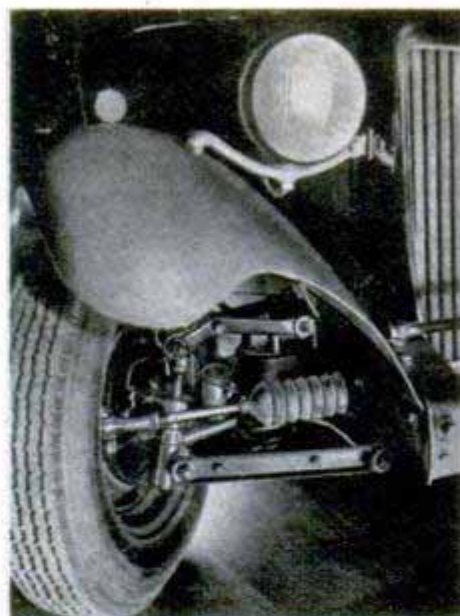
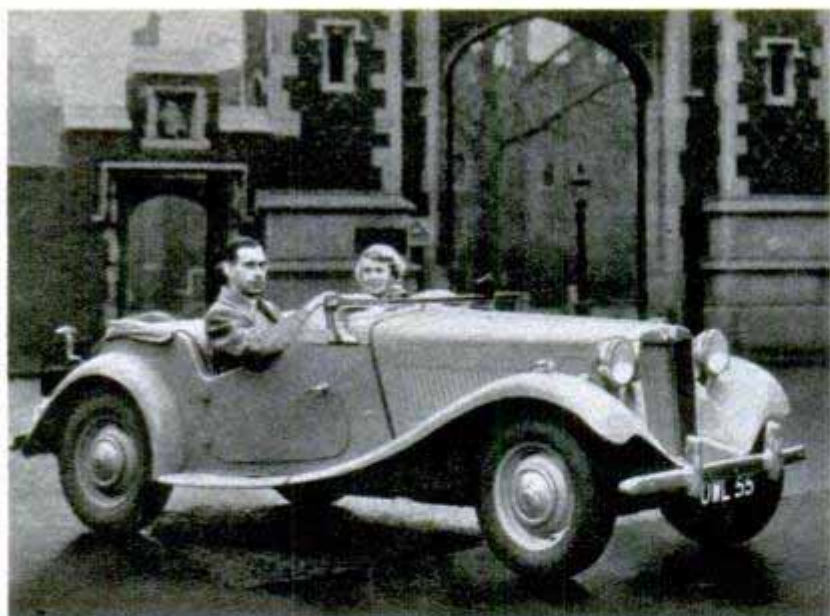

### Midget Sport Car

Added riding comfort and better road-holding qualities have been built into the new M. G. Midget British sport car. The

1950 model has knee-action wishbone and coil springs at the front and a rubber-sleeved rack-and-pinion steering gear. The disk wheels are smaller and the rear of the chassis slopes more gradually.

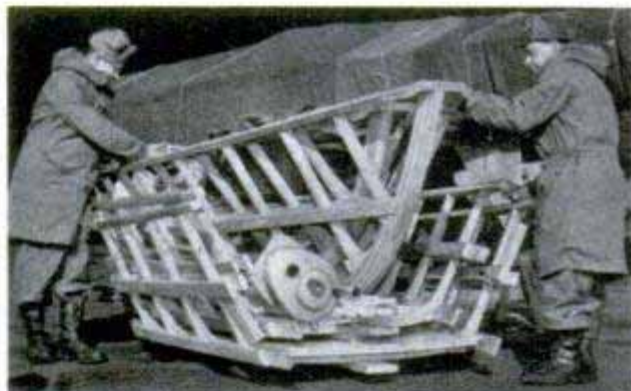

### Army-Style Umiak

Wooden frame sections are assembled and covered with a nylon skin to form a 26-foot craft which the U. S. Army will use for sea rescue work. A modern version of

the Eskimo Umiak, the boat is propelled by an outboard motor and is capable of eight miles per hour. It will carry a load of 11 men or 3000 pounds of cargo. The unit weighs 500 pounds and can be transported by five men.

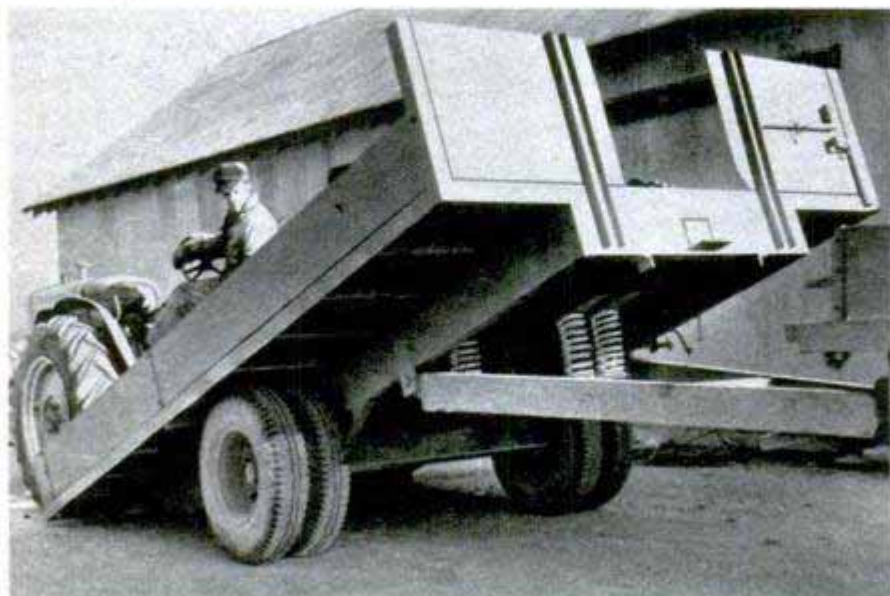

### Springs on Trailer Simplify Loading

Trailer bodies which tilt downward for loading tractors and farm implements are improved by coil springs that prevent the body from swinging upward in the wind. Kenneth Dibbern, Indiana farmer who installed the springs on his trailer, used a set from an old truck. As the tractor is driven on the trailer, the body drops to a horizontal position and locks itself automatically at the front end.

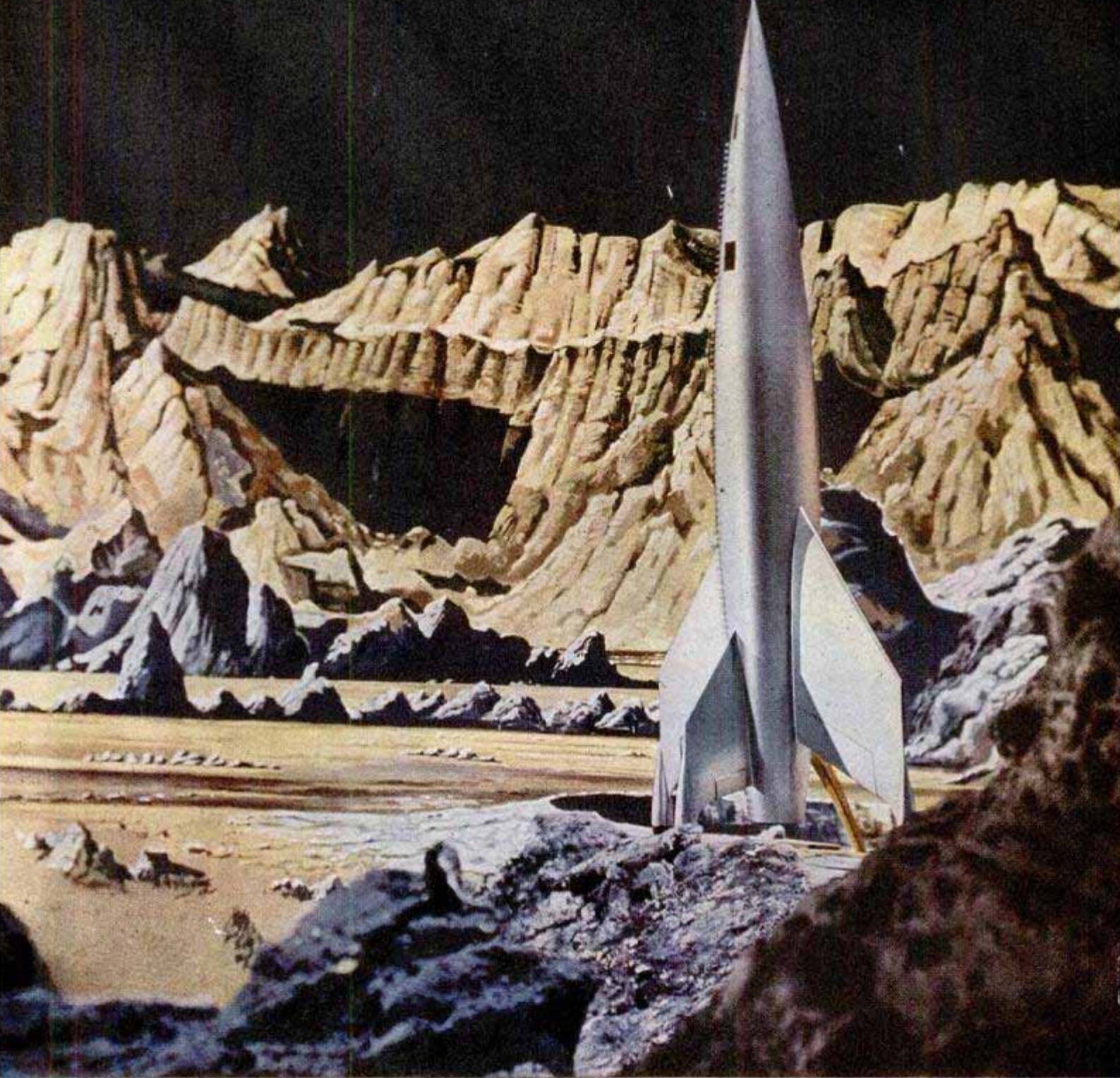

Photos taken on set of motion picture "Destination Moon" by Pal Productions  
Designed after a study of known scientific facts, the movie space ship rests among the craters of the moon

# **ROCKET TO THE MOON**

## **No Longer a Fantastic Dream**

*By Thomas E. Stimson, Jr.*

**E**NGINEERS could start construction this year of a rocket ship capable of zooming outward into space and reaching the moon, if some agency would finance the project. The basic principles of a moon rocket are understood; no major problems remain unsolved.

That is the opinion of Dr. Hsue-Shen

Tsien, Goddard Professor at the Guggenheim Jet Propulsion Center of the California Institute of Technology. He reports that mankind even has enough basic knowledge to build a practical power plant for the interplanetary ship.

A Hollywood motion-picture studio, Pal Productions, has taken the scientists at

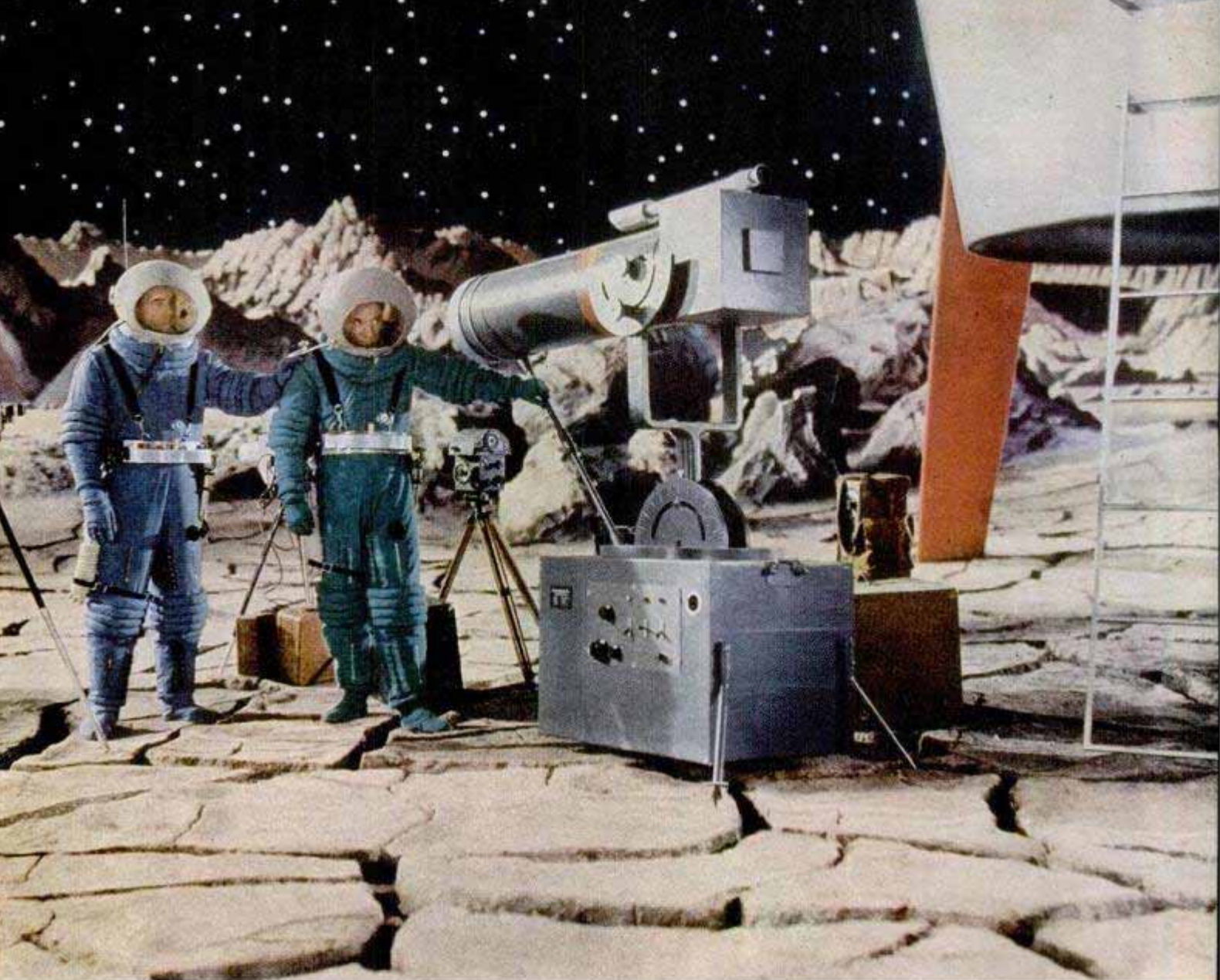

First men on the moon—movie version—prepare to investigate the moon's crinkled surface with cameras and astronomical instruments. Featherweight equipment is easy to carry because gravity is so low. Below, craftsman touches up skeleton model of rocket used in movie



their word and dramatized the journey of a space ship to the moon. The studio assembled all available scientific information in filming a serious, although necessarily futuristic, movie of the round trip. The remaining question is—how futuristic? In nearly all respects the space ship and its journey are possible from the standpoint of present facts and evidence; the main departure from what already has been accomplished in rocket research is that the film ship is powered by an atomic pile. Any other engine would exhaust its fuel on the outward trip and leave its travelers marooned on the moon.

Engineers today could build a 10-passenger rocket that could whoosh from New York City to San Francisco in 45 minutes, if there were

enough demand for such speed to make it pay off in dollar bills. All the information needed for starting construction is at hand, according to Doctor Tsien, who has drawn up plans for such a craft.

Leaving New York at 12 noon, the winged rocket would beat the sun across country and would glide into San Francisco at 9:45 a.m., 2¼ hours ahead of the clock.

The transcontinental passenger carrier would be about 79 feet long and would weigh some 48 tons. Of its gross weight, 36 tons would consist of liquid hydrogen and fluorine fuel. All the fuel would be consumed during the first 60 seconds of travel, at the end of which time the rocket would be ascending at the rate of 9140 miles per hour.

Under that impetus, it would zoom 300 miles up from the earth and would then arch back into the stratosphere at about Des Moines. Enough momentum would remain for the rocket to level off and coast all the rest of the way to San Francisco on its stubby wings. A 5000-pound-thrust turbojet auxiliary engine would be turned on at the last moment to permit maneuvering for a landing at 150 miles per hour. The rocket would roll to a stop like a conventional aircraft, on wheels that would extend from along its side.

No transcontinental passenger rocket is on the drawing boards, but the general specifications for one have been drawn up by Doctor Tsien.

"All the basic problems associated with long-range rockets appear to be solved," Doctor Tsien remarks. "Only engineering details remain to be worked out. Difficult as these are, a solution will be found for each. Even a

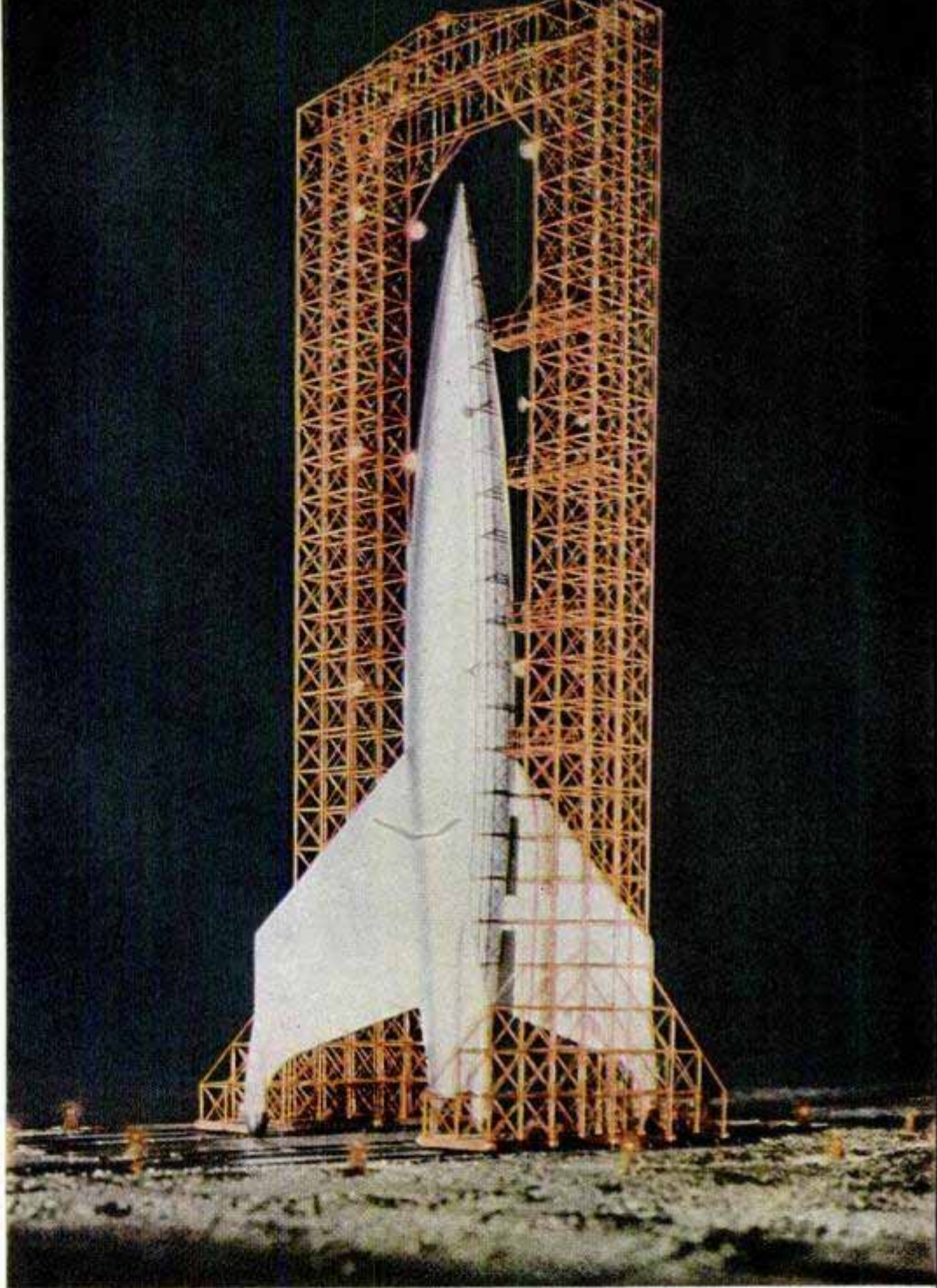

Gantry scaffolding around the 150-foot rocket is used to ready the ship for a predawn take-off. Fuel and equipment are hauled by elevator up the gantry and loaded into rocket. Below, technicians plan a shot which will show rocket ship settling on its jet into a crater





After landing, space navigators step down the retractable ladder. Below, technician points out a section of the atomic engine, only feature of the rocket which has not been developed



space ship that could travel to the moon is no longer a fantastic idea. We have enough knowledge, including a practical power plant, to build a moon rocket now."

Passengers and crew members on a transcontinental rocket would not suffer any adverse effects from their fast trip. Presumably they would recline on acceleration couches to minimize the effects of the six-G pull that would last for one minute. During this period the flesh would sag back on their faces and they would have difficulty in moving their arms and legs. There would be a second period of heavy G at the time the rocket leveled off in the stratosphere for its long glide, after which the people could unstrap themselves and move about.

No human pilots could make calculations rapidly enough for steering the vehicle along its course. Navigation probably would be done by automatic high-speed thinking machines at check points on the ground. Plotting the trajectory by radar as the rocket approached a check point, the machine would figure out any deviation from the desired path, determine the amount of correction that was needed, and instantaneously transmit the correction to the automatic-steering equipment on the rocket.

The guidance problem is one of the reasons why transoceanic military rockets don't yet appear practical. A long-range rocket



that is armed with an atomic warhead or any other explosive is wasted if it misses its target. And there seems to be no way, so far, of making sure that a long-range rocket will pinpoint its objective unless check stations are set up along its course and at the objective.

Sunday supplement conceptions of long-range rockets all make use of handy atomic power plants but any kind of atomic propulsion still seems far in the future to the research people. An atomic hydrogen engine that would develop the same reaction that occurs in the sun would be very convenient but there seems to be no way of stabilizing the reaction. Investigators think that such an engine would simply blow up.

The fact is that atomic power isn't needed for a rocket that could travel from point to point on the surface or that could escape from the earth's gravitational field. Chemical fuels that already have been tested can do the job provided that 50 to 90 percent of the vehicle's gross weight is devoted to fuel. That is the opinion of Doctor Tsien and most others in the field.

A combination of liquid oxygen and fluorine reacts furiously enough for the purpose, as does a combination of liquid hydrogen and fluorine. It is

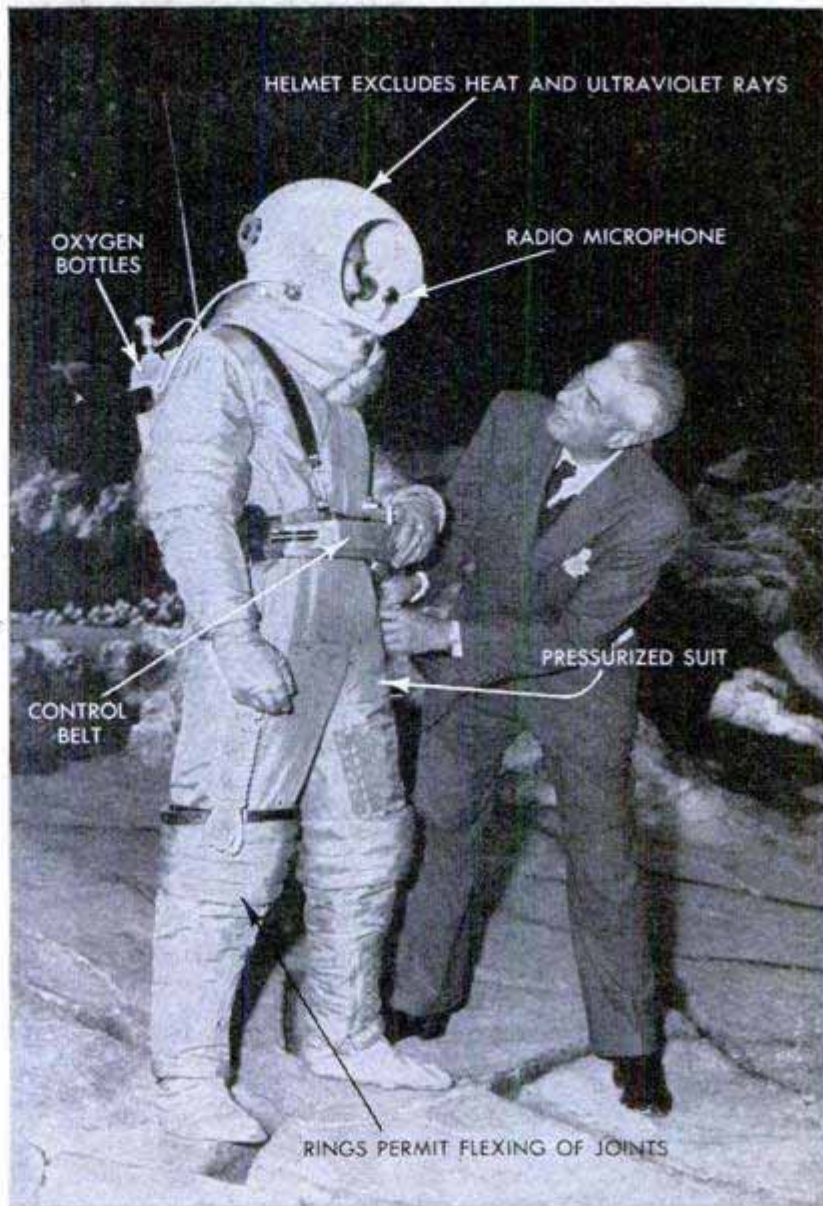

Space suit envisioned in the movie provides oxygen, protection and a means of communication for the first men on the moon. Below, a transcontinental rocket is possible today, scientists state. It would be guided by radio from stations spotted along its course

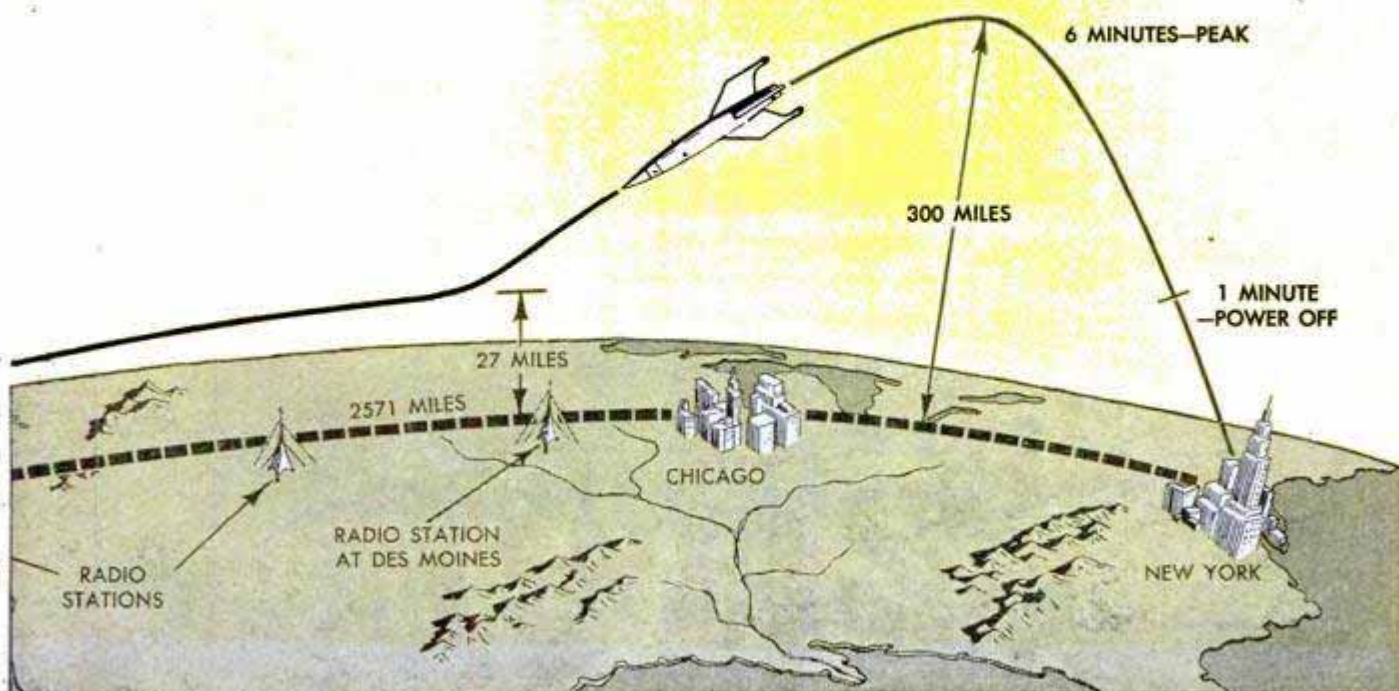

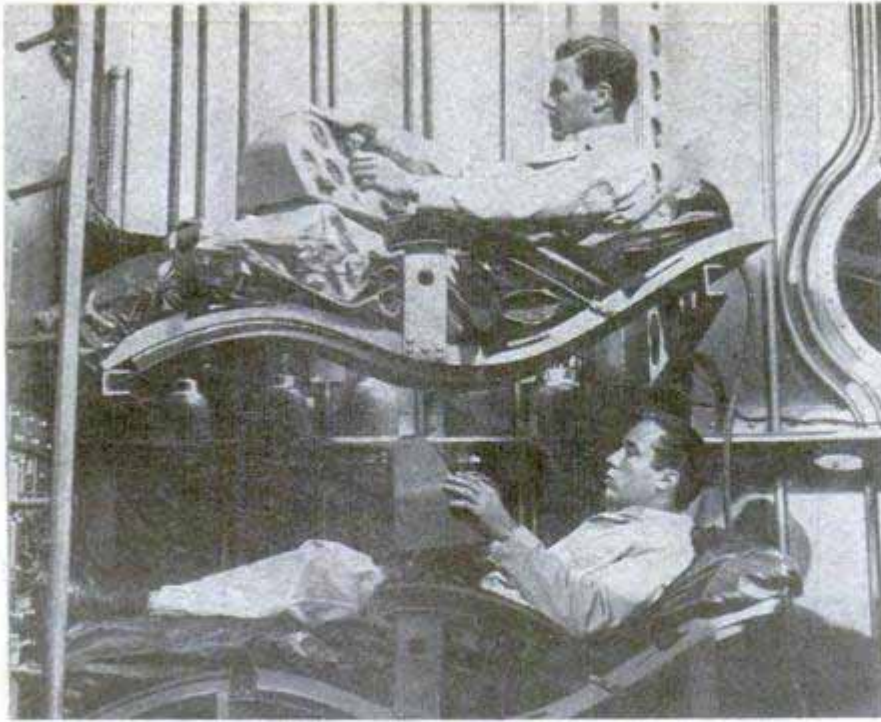

Crew of the space ship reclines on body-shaped "acceleration couches" during the take-off to minimize the heavy six-G pull on their bodies

unlikely that better chemical combinations will be found.

Caltech's jet-propulsion center is concerned mainly with theoretical problems and much of the actual basic experimental work is performed at a separate Caltech jet-propulsion laboratory. Although not directly connected with each other, the center and the laboratory are associated in

the pores of which a coolant liquid would be forced under pressure. The coolant would be constantly evaporated by the interior heat as it reached the inner wall, and it would be constantly replaced. The motor-wall temperatures would be held to safe levels.

Film cooling works somewhat similarly.

(Continued to page 230)

Control compartment was dummied up for filming the movie, then tilted to provide the illusion of floating in space. Right, models depict the approach of rocket to the moon. Ship is guided in space by rocket bursts

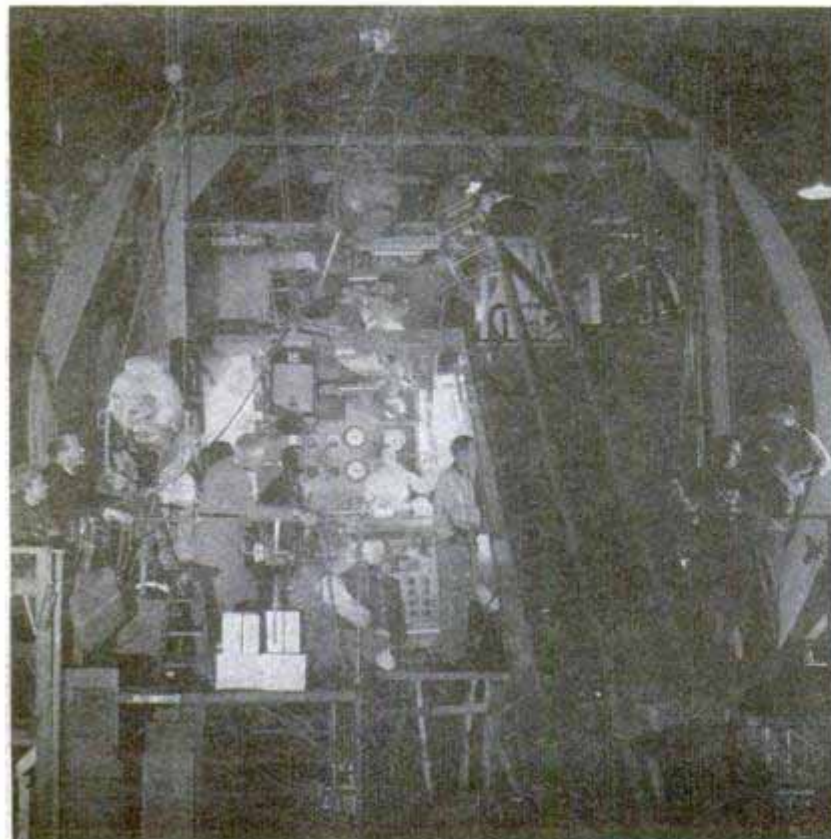



## Track Shoes For Tractors

Tractors and other crawler-type equipment can walk on and off railroad tracks and can cruise along the tracks under their own power when fitted with track shoes that serve as guides. Used by Morrison-Knudsen Company and other railroad-maintenance contractors, the "on and off" plates eliminate the need for special locomotive-drawn work trains when small amounts of spot work along the right of way is to be done. The shoes are permanently attached to the crawler plates and do not impair their use off the tracks. Not only can a single tractor walk along the rails to a point where bank improvement or

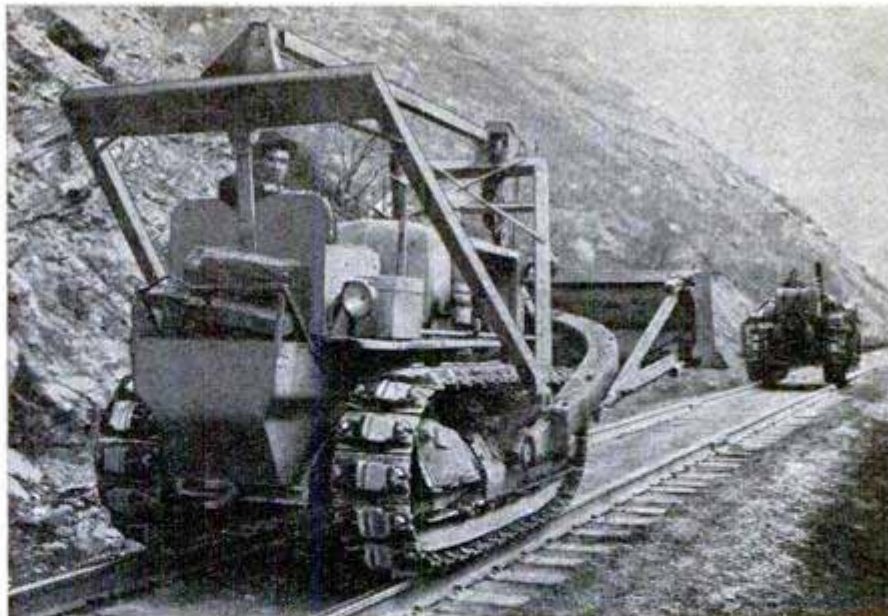

other work is to be done, it can serve as the motive power for a small work train that consists of miniature-wheeled flatcars on which draglines, power shovels and other heavy pieces of equipment are carried.

## Instant-Release Tripod Attachment

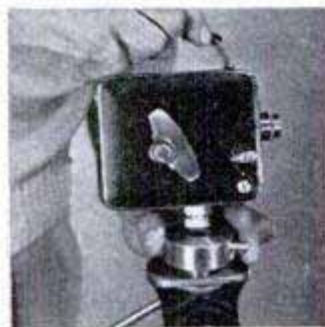

It takes only a second to release your camera from its tripod for sudden action shots when you use a quick-acting lock attachment. An easily accessible plunger releases the camera, eliminating the awkward chore of unscrewing a hard-to-turn locknut. A grooved plug screws into the camera tripod socket and locks securely in the attachment. The device can be used on cameras of all sizes and types.

## Nylon Tire Tube

Reserve protection against punctures and blowouts, almost equal to that of the tire itself, is given by a new automobile inner tube made with two plies of nylon cord. The nylon construction built into the tube wall squeezes rubber around the puncturing object, preventing sudden flats. Despite its unusual strength, the new tube is extremely flexible and light in weight.

## Trap Lures Flies Half Mile Away

Flies a half mile or more away are attracted to destruction in a jar-type trap that has been developed at Pewaukee, Wis. A metal shield, through which the flies enter, screws on to the top of the jar and a strong-smelling fluid and water mixture covers the bottom half inch of the jar. Because of its odor the trap should not be hung closer to a dwelling than 25 feet. For best results, it should be hung two to six feet above the ground in a bush, tall weeds or on a low tree branch. In a month and a half 30 traps in Pewaukee caught 105 quarts of flies.



### SEMIANNUAL INDEX AVAILABLE NEXT MONTH

A thoroughly cross-referenced index to the complete editorial content of POPULAR MECHANICS, January through June 1950, will be available about June first. To reserve your free copy of this valuable booklet, send 10 cents to cover mailing and handling, to the Bureau of Information, Popular Mechanics Magazine, 200 East Ontario St., Chicago 11, Ill., and you will receive your copy as soon as it is off the press

# The IMPACT of the

**By Leslie R. Groves**

**Lieut. Gen. U. S. Army Ret.**

**(Wartime Chief of Atomic Energy Commission  
and Director of Manhattan Project)**

**M**ILITARY implications of the hydrogen bomb lead us far into the unknown. The limitations of the human mind do not permit such an excursion without reference to or guidance from proven facts. It is not difficult to understand the capabilities of a 16-inch gun if one is familiar with those of a 12-inch one; but it is not so easy to understand them if one's experience is limited to a brief acquaintance with a .22-caliber rifle. The destructive power of the atomic bomb, as it was exploded over Japan, and its influence on international affairs since then, gives us the foundation on which we can build our understanding of the hydrogen bomb.

I would like to emphasize first that no one really knows whether a hydrogen bomb can be designed and built; no one can say what effort would have to go into its manufacture; no one can be sure just how difficult it would be to deliver it on a target, nor exactly how great would be its power.

We do know, however, that the first atomic bombs were difficult to design and both difficult and expensive to manufacture. We know that although they were successfully delivered on enemy targets almost 2000 miles away from the take-off base, the enemy air defense was weak. We can say with certainty, that the single atomic bomb, model 1945, dropped on Hiroshima, not only effectively destroyed that city, but killed at least 70,000 Japanese and injured as many more. We also know that the radius of complete destruction of this bomb and of the bomb dropped on Nagasaki was about 1½ miles. Also, it is a fact that the development of the atomic bomb brought the war with Japan to a speedy conclusion, and that it thus saved thousands—possibly hundreds of thousands—of American dead and wounded.

Since V-J Day, the possession by the United States of the atomic bomb has greatly strengthened our international position, particularly with respect to Russia. This has enabled us to remain at peace and without the sacrifice of any of our American ideals.

When we try to anticipate the effects

of weapons as powerful as the hydrogen bomb, we must face its possibilities calmly. We must assume that the hydrogen bomb can be made not only by us but by Russia; that it can be made at a not-too-excessive cost, giving due consideration to the economic capabilities of both nations; that it can be delivered on almost any target on the earth's surface; and that its power will be at least several times as great as that of the atomic bomb. And, possibly—if we are to give credence to recent news reports—it will be as much as 1000 times as powerful.

If we are to explore the problem of the hydrogen bomb intelligently, we must not limit ourselves to the strictly military implications in strategy and tactics, but we must consider the effects in the realms of international statesmanship and of diplomacy, or, as is the case today, in that of the conduct of the cold war.

Only a few years ago we hoped—and most of the world hoped with us—that the victorious conclusion of World War II would bring with it lasting peace. The more optimistic among us thought that there would never again be even the threat of conflict. While our desire for peace may be as strong as ever, today we are doubtful as to its certainty. We have seen that there is at large in the world community, one nation, Russia, which is bent on dominating all others. Treaties, promises and agreements mean nothing to the men in the Kremlin unless they are to their own immediate advantage. We are faced today with the certainty that only the strength of the United States of America stands between Russia and the fulfillment of the Russian dreams of mastering the world. To put it bluntly, we are now faced with the choice of either ultimately submitting to Russia or of maintaining a strong and effective military policy. Our military establishment must be of such strength that Russia will remain convinced of our ability to resist any aggressive action on her part vigorously and successfully.

The ultimate aim of all military operations is the destruction of the enemy's will or determination to fight or to continue his resistance. That aim was realized with the

# Hydrogen Bomb

use of the atomic bombs against Japan when, within eight days after the explosion of the first bomb, the surrender was complete. This was due to several factors, the chief of which was overwhelming surprise coupled with the feeling that loss of face would be minimized in a surrender to a foe possessed of such a weapon.

I do not believe that the use of atomic bombs in the future will bring about such a speedy surrender, unless the nation hit by them is lacking in courage and stamina.

Let us consider the effects of a possible atomic attack on a city such as New York. Seven well-placed atomic bombs or, possibly, one hydrogen bomb of several times the power of one atomic bomb, could effectively destroy downtown Manhattan and all of New York's water-front facilities whether in Manhattan, in Brooklyn or on the Jersey shore. Any attack of such power would effectively destroy New York as a source of military and economic strength to our country. A hydrogen bomb of 1000 times the explosive power of the atomic bomb would extend this destruction farther into residential districts, would destroy more wealth and kill more people, but the military effect would not be much greater. A city like Washington would need only one hydrogen bomb to destroy it effectively as the seat of our government, instead of the three atomic bombs necessary to accomplish the same damage.

Since the conclusion of World War I, we have had with us the horrifying stories put out by the advocates of surprise aerial attacks. We have had pictured to us the thousands of bombing planes striking without warning other than that of strained international relations. And certainly no one has ever assumed that the relations would have to be more strained than those of recent years between Russia and ourselves. I believe that only behind an iron curtain could such attacks be prepared without some inkling of warning leaking out. Fortunately for us, and for those peace-loving nations which depend upon us for their protection from Russia's all-consuming desire for conquest, the iron curtain is still too far away to permit the mounting in



Lieut. Gen. Leslie R. Groves (right) confers with Dr. J. R. Oppenheimer at scene of atomic test blast

the near future of any such large-scale attack. Today, it would even be difficult for Russia to make such a surprise attack with atomic bombs.

The development of the submarine, of the large troop-carrying airplane and of guided missiles, has brought the military safety of England through isolation to an end. Similarly, the further development of the long-range airplane and of the atomic bomb, coupled with the prospects of the hydrogen bomb, have impaired the military safety of our own continental United States.

With the development of the hydrogen bomb, even as few as five or six planes would be able to make an extremely damaging attack without warning. Let me hasten to add that I do not believe such an attack could cause us to surrender overnight, but it could greatly prolong the war which would ensue.

As long as the people of the United States remain in control of our government, we

(Continued to page 270)

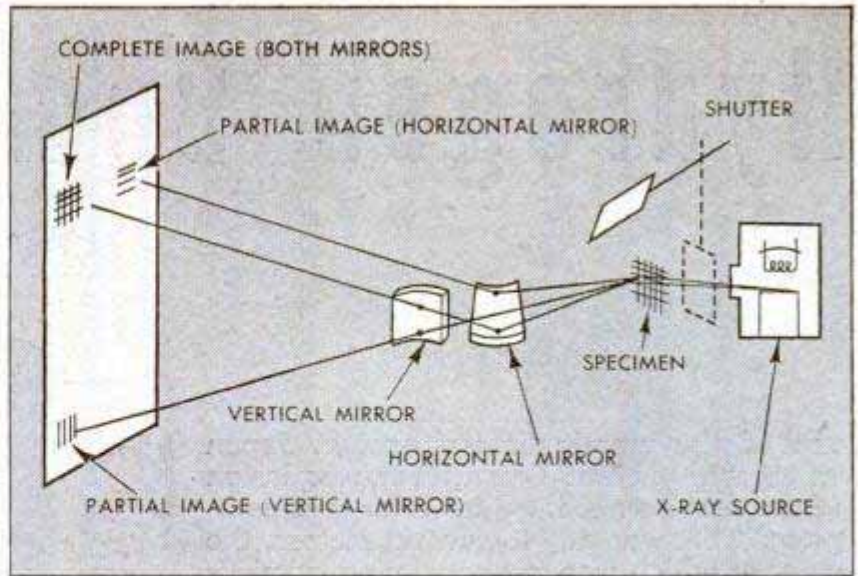

Left, research scientist adjusts the mirrors of the X-ray microscope shown in diagrammatic form at right

## X-Ray Microscope

Internal details of materials through which light rays cannot pass are studied with an X-ray microscope developed by General Electric scientists. Still in the experimental stage, the microscope is expected to produce sharper images and higher magnifications than are possible with visible light. Unlike the electron microscope, the new type does not require that speci-

mens be kept under a high vacuum, thus making it possible to examine living materials at higher magnifications than ever before. Even at the present stage of development, X-rays have produced 100-diameter magnification. The X rays are beamed through the specimen and reflected from a pair of curved mirrors, which the rays strike at an angle. The mirrors bend the beams to cast a magnified X-ray image of the specimen on a photographic film.

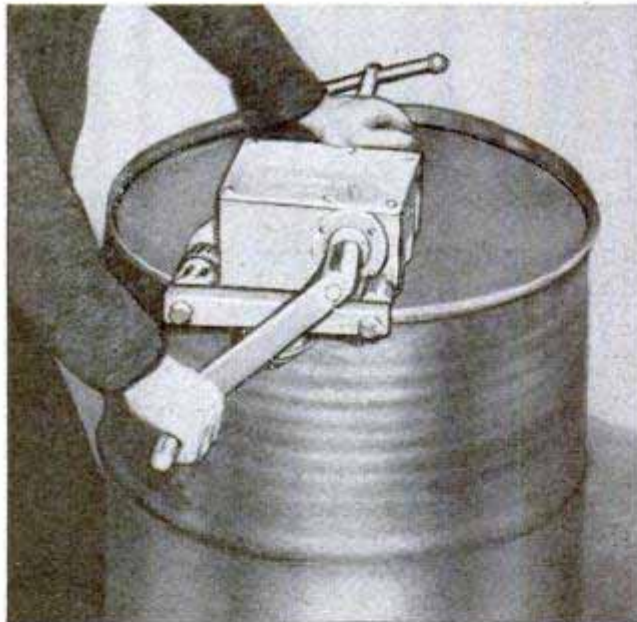

## Giant "Can Opener"

Steel drums of any size are opened in about one minute by a powerful head cutter that looks and works like a giant can opener. The cutter is placed on the top of the drum and, when the hand crank is turned, the cutting blade moves around the rim slicing off the head with no ragged edges. It can be used on filled or empty drums and the blade cuts about 1000 heads before it has to be resharpened.

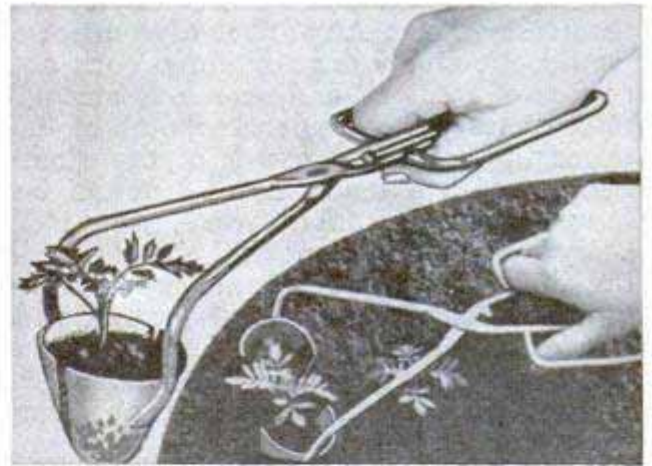

## Seedlings Without Setback

Transplanting plants grown from seed without setback and with proper depth, spacing and alignment requires great care. With a new-type tool designed to make life easier for the gardener, the small plants can be transplanted faster and with fewer losses. The device works like a pair of scissors, scoops up the seedling, makes a hole to the desired depth and sets the plant as the handles of the tool are spread.

☐ In whisking off a single whisker, a razor blade exerts about five tons of pressure against the hair because the contact area is so small.

# INDIANAPOLIS HOPEFULS

JET PLANES and rockets may grab the headlines most of the year in this supersonic age, but on Memorial Day the news spotlight swings to the speedsters that roar around Indianapolis Speedway for 500 grueling miles.

For the first time since 1934, a diesel racer is among the entries that will compete for a place in the starting parade. The Cummins Diesel Special, supercharged descendant of diesels that failed to win in 1931 and 1934, hopes to roar across the finish line ahead of its gas-burning rivals. Its six-cylinder engine, making 4000 revolutions a minute, is only 10 inches longer and 350 pounds heavier than the four-cylinder Meyer-Drake gasoline engines that took the first 10 positions in 1949.

Also seeking the champion's crown is the Kurtis-Kraft entry that finished second in 1949. This year, a new fuel-injection system may bring the sleek racer home in front of the pack.

Top, runner-up in 1949, the Kurtis-Kraft entry, with a new fuel-injection system, may win this year. Right, the engine in Ray Brady's car has a 20-degree slant to make room for its supercharger. Below, Cummins diesel racer under construction

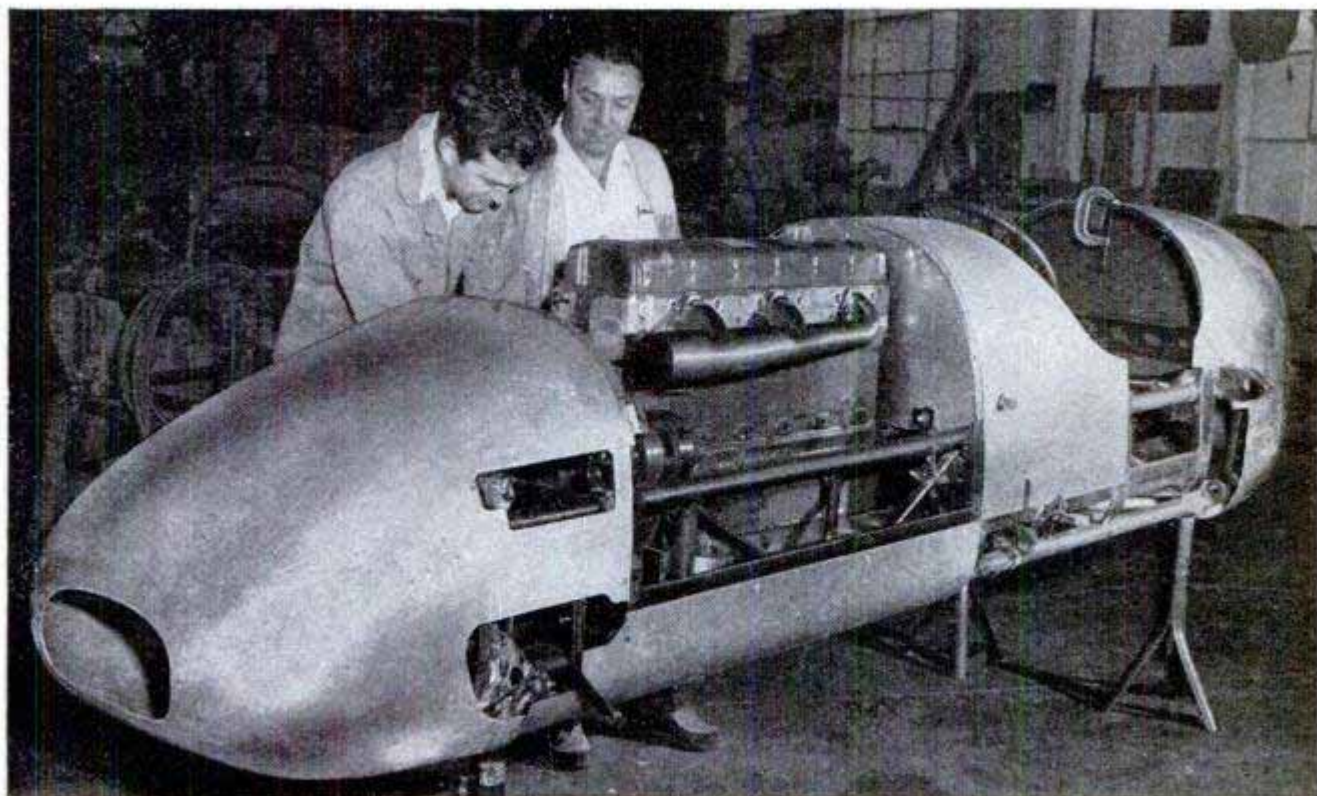
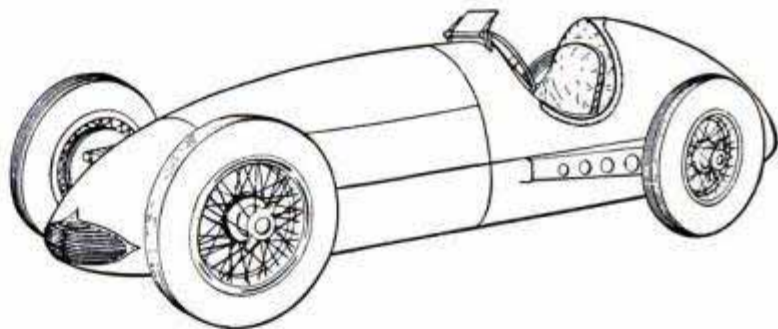
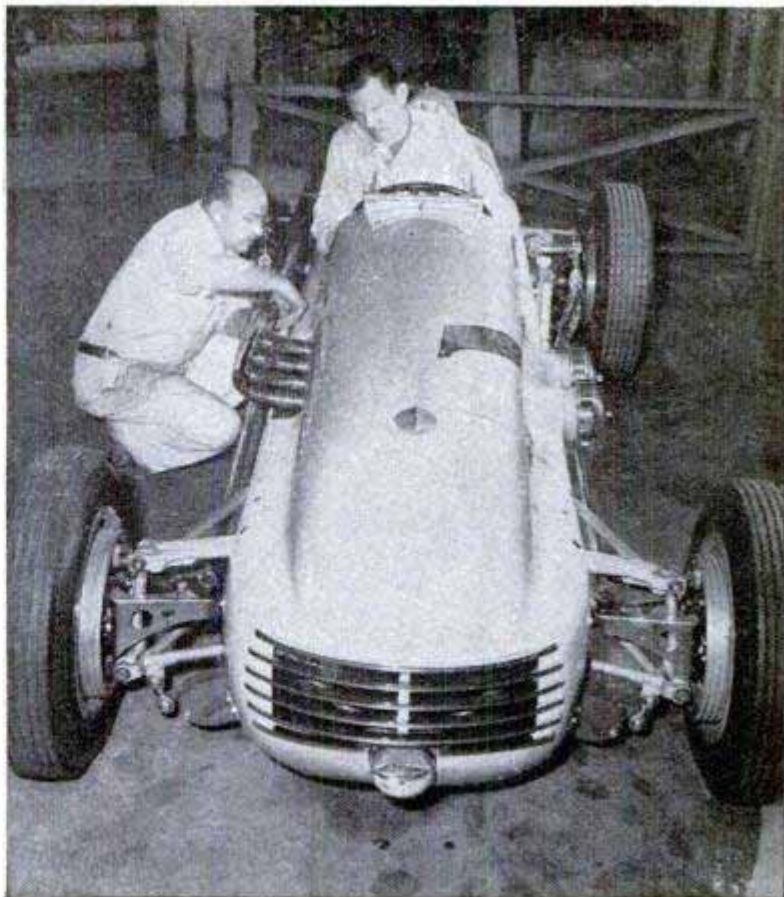

# CALTECH SUPER GREENHOUSE

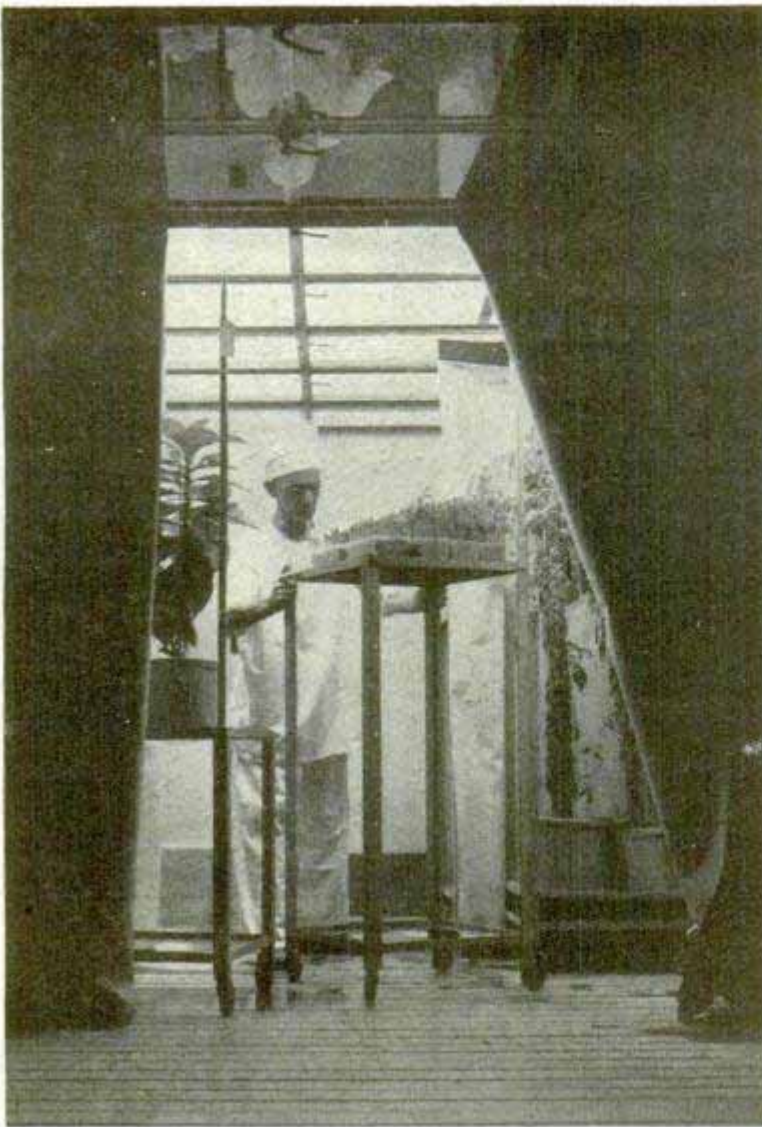

Light-tight canvas partitions divide laboratory rooms into darkness and daylight areas. All workers and visitors wear sterile clothing, including caps. Below, tags on metal stakes above sugar beets tell where plants are to be moved each day



**E**VERY agricultural climate in the world can be reproduced in a new "phytotron"—plant-research laboratory—at the California Institute of Technology. In the numerous growing rooms of the super greenhouse its technicians have created a variety of conditions that include warm days, freezing nights, pea-soup fogs, hot desert winds and cloudbursts or drizzles of rain.

Known as the Earhart Plant Research Laboratory, the \$407,000 structure was financed by the Earhart Foundation of Ann Arbor, Mich. It is administered by Dr. Frits Went, Caltech professor of plant physiology.

The building contains six air-conditioned greenhouses with glass roofs that admit daylight, 13 air-conditioned interior growing rooms illuminated by fluorescent and other lamps in the ceilings, and 11 darkrooms that simulate after-dark conditions. Each room is individually air conditioned to the air temperature and humidity desired.

By moving a group of test plants from room to room, from one environment to another, their reactions can be tested under such conditions as short cool nights and long hot days or the reverse or any other set of factors desired.

Instead of resting on permanent benches, the test plants are carried on small wheeled trucks and are moved from room to room in keeping with their separate schedules. Each truck carries on an upright steel arm a group of colored metal rings that tell at a glance at what hour the truck is to be moved and to what room. Time is measured in centidays, the 100th part of a day, and ordinary weeks, months and years do not exist in the laboratory. The only calendar is the number of days that have elapsed since the building was put to use.

(Continued to page 268)

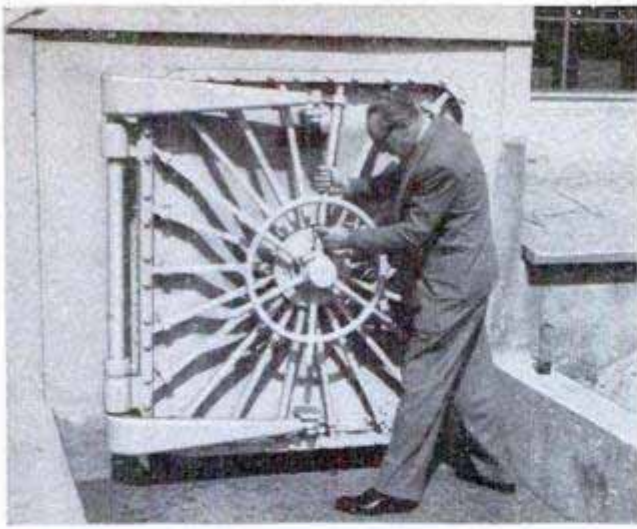

Scientist inspects door to autoclave chamber where all incoming materials are sterilized by steam heat

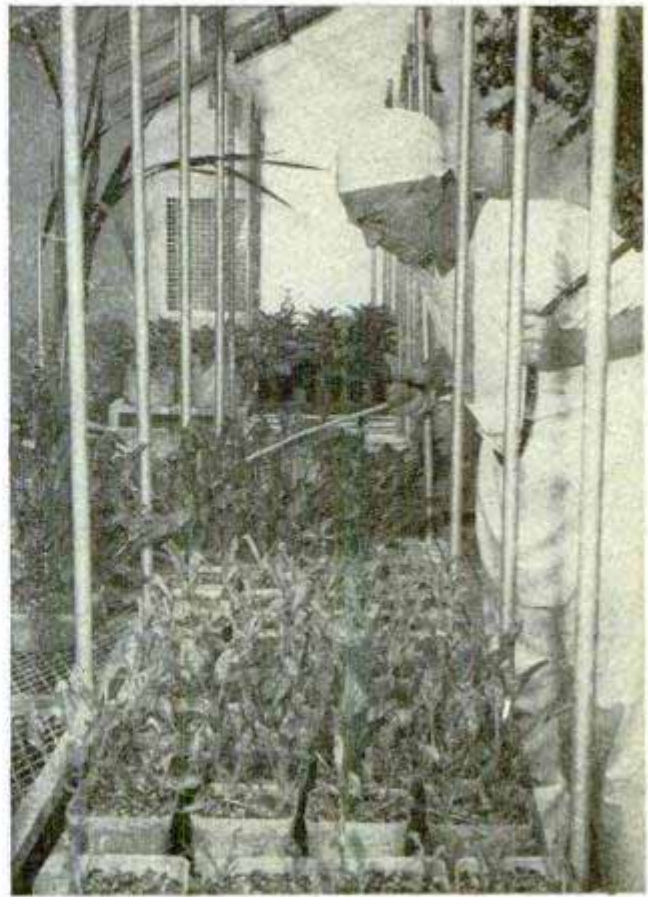

With a tube nozzle from a nutrient supply line, a laboratory "nurse" feeds trays of young sugar beets. Left, in special wind tunnel in lab basement plants are subjected to a 20-m.p.h. breeze. Below, central switch panel helps control all sorts of weather conditions from arctic to desert throughout laboratory

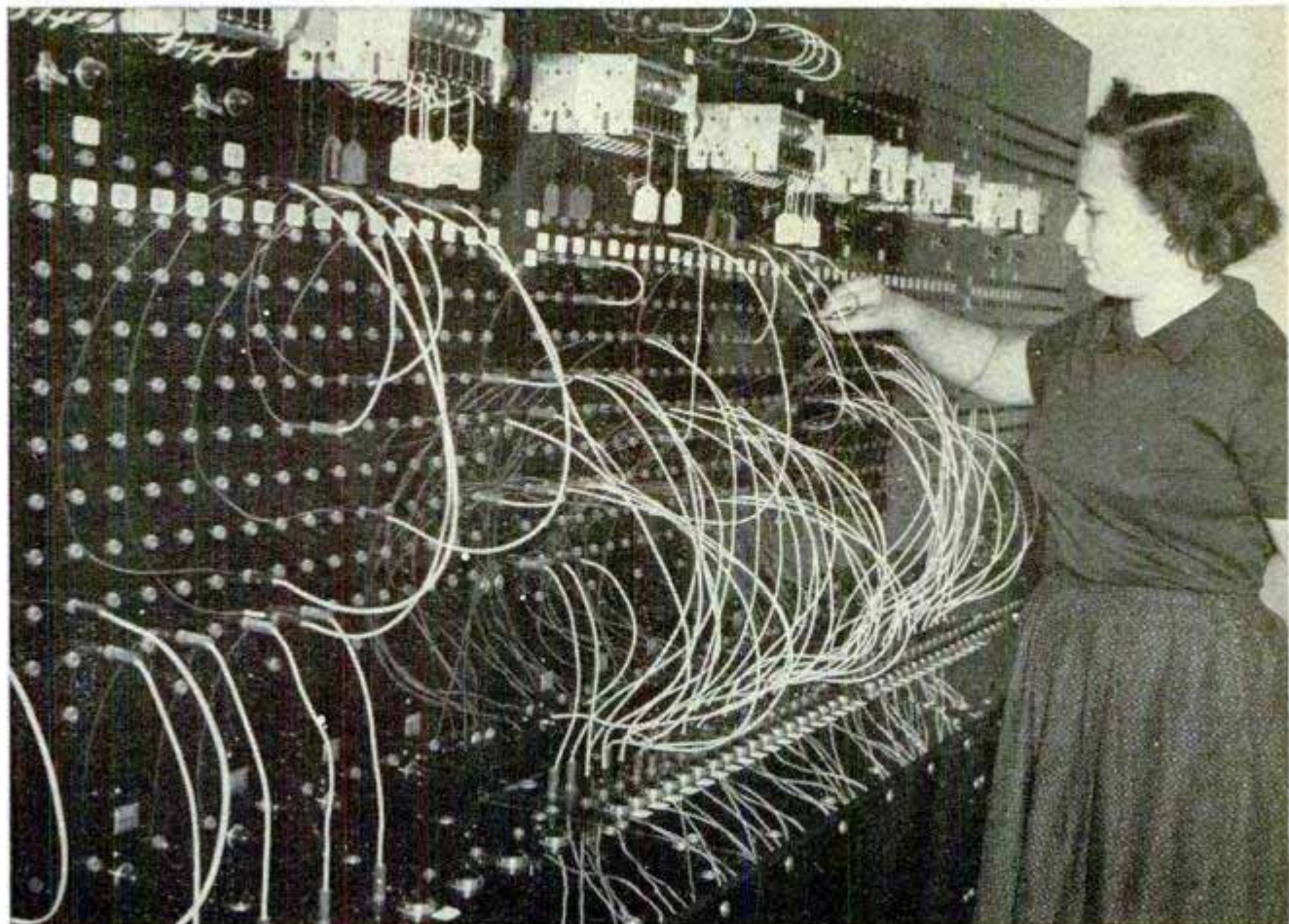

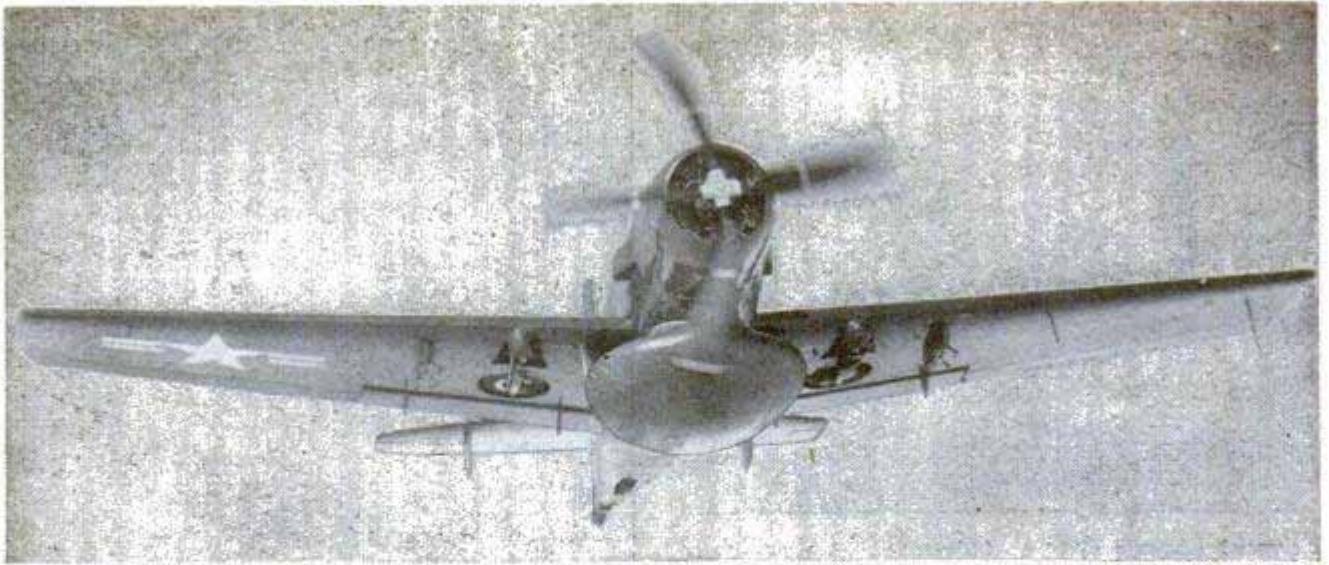

Douglas Aircraft photo



U. S. Air Force photo

## Underbelly Radomes

Added radar equipment has created bulging "waistlines" on two U. S. planes. A plastic-shell radome has been added to the underside of the Navy's carrier-based Sky-

raiders to house radar antenna. A similar bulge beneath the new Air Force T-29, a navigational trainer, contains some of its 18 antennas. Four astrodomes on top of the fuselage are also provided for 14 students and instructors.

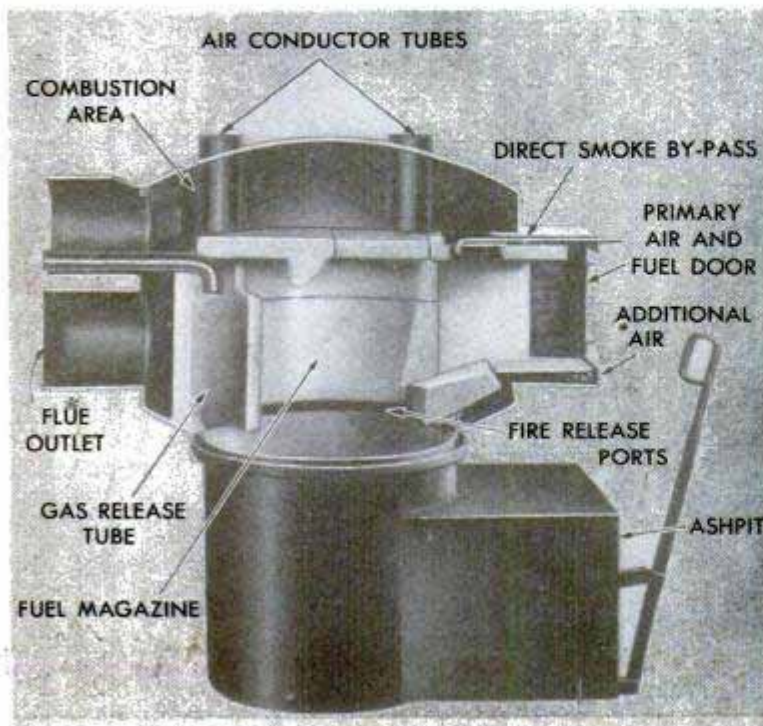

## Smokeless Coal Furnace Operates on Downdraft

Because it uses a downdraft air supply instead of the conventional updraft, a coal-burning warm-air furnace is smokeless in operation. The furnace will operate 24 hours on one filling, eliminating frequent attention. The fuel magazine inside the furnace is filled to the top and, as the air enters through the feed door, the smoke is drawn through the hot coke bed at the grate level and is completely burned, resulting in smokeless firing. There are no motors, blowers or mechanical conveyors to get out of order since coal is fed by gravity.

Left, to show furnace design, the metal casing was removed and firebox cut away



## Golf-Ball Dredge →

Golf balls are scooped from water hazards in large numbers by a paddlelike arrangement of weighted wood and metal strips, or blades. The balls are wedged between the blades as the device, invented by Jack Sawyer of Atlanta, Ga., is dragged through the water by ropes. It has brought in as many as 19 balls on one pull.

## Skim Milk Makes "Horsehair" Fiber

Curled fibers made from skim milk have been developed as a substitute for horsehair in filters, upholstery and textiles. The process was suggested by the Department of Agriculture and developed by Arthur D. Little, Inc., and the Rubberset Company. The skim milk is solidified by an acid and the casein settles out as a curd. After the casein is dried, water is added and it is forced through fine jets. The resulting fiber is hardened, curled and dried to a "permanent wave." A mass of the fibers has a springy quality very similar to horsehair, which is more expensive.



## Tree Hoist

Trees weighing as much as 3000 pounds can be moved in half the usual time by a new three-wheel unit with a tilting boom. It straddles the tree or hole and has a swiveling front wheel that can be swung up out of the way during long hauls, when hitched to a car or truck. The boom and cradle can be tilted 30 degrees forward or backward by a ratchet lever jack. A broad-band sling, adjustable to a maximum diameter of 50 inches, protects the tree ball and minimizes the need for burlapping. Rear wheels of the hoist are adjustable from 52 to 64-inch tread.

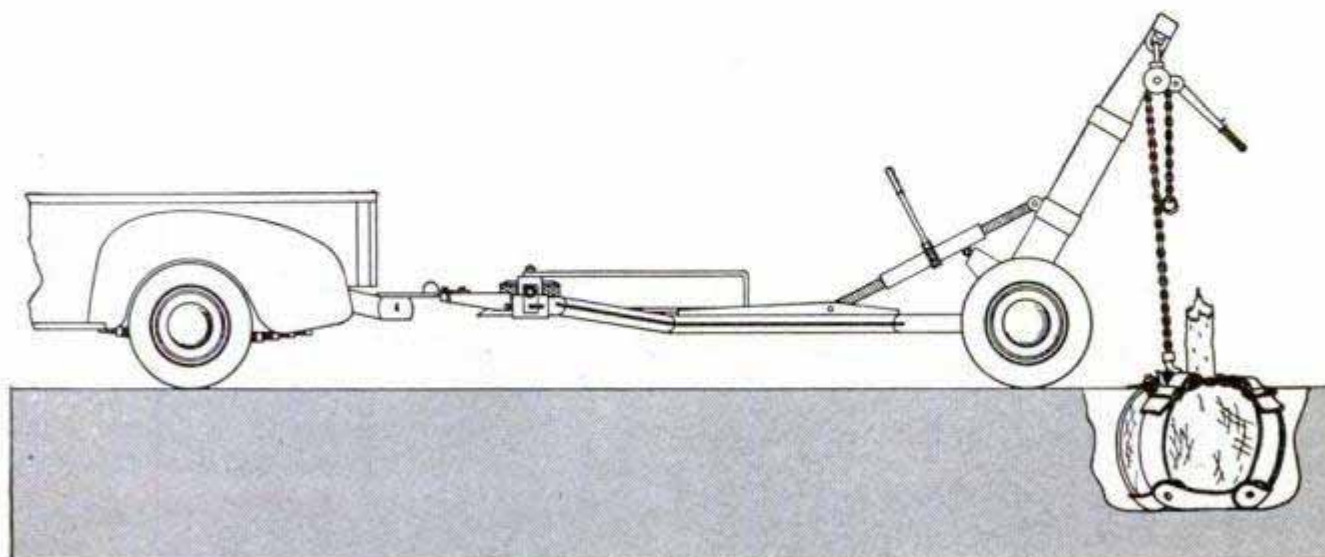

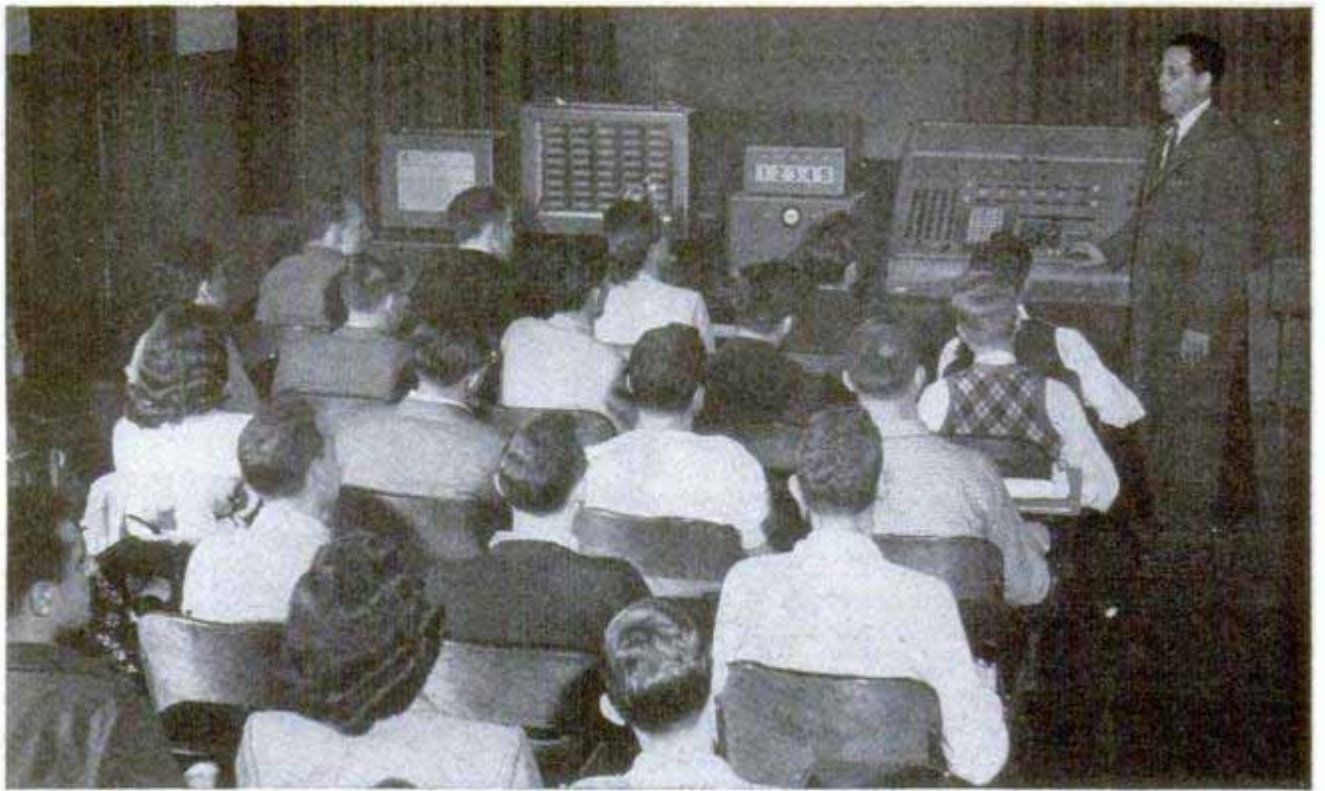

There's no pencil-pushing when these students take a quiz. Collegian thrusts hand inside covered box and punches button corresponding to his answer choice. Below, left, professor merely glances at control board to find out weak points in class knowledge. Right, after test, each student gets mark from individual tabulator



## Mechanical "Quizzmaster"

When it's examination time at Pennsylvania State College, students merely punch buttons to indicate their answers to the quiz questions. A mechanical testing machine then records each student's reply, the score of the classroom as a whole and the reaction time in answering the question. The machine, a maze of wires, dials, lights and numbers was built at the college under the direction of Dr. C. R. Carpenter, professor of psychology. At his desk, each student has a covered answer box, which contains five selector keys.

When a question is asked, each student chooses the answer he believes is correct and presses the corresponding key which records his answer. The lights and dials show the professor at a glance how the class is doing on each question, thus indicating immediately the subjects which require a general review. After the students have irrevocably recorded their answers, the professor can give the correct reply, thereby teaching the students while they are being examined. After the class, each student can obtain his total score on the examination from an individual tabulator on the machine.



A low center of gravity is just one of the many safety features on the new 1950 Nash Rambler convertible

## NASH RAMBLER

REVIVING a famous name in automotive history, the five-passenger Rambler convertible is the first of a new series of Nash cars. Designed to compete in the lowest-priced bracket, the new convertible features a number of safety items. Overhead protection is provided by two heavy steel side rails framing the tops of the side windows. These overhead chrome-trimmed rails form a strong structural bridge-beam for extra body rigidity and also carry built-in tracks for the electrically operated top. The top is push-button operated and is moved by nylon-coated steel cables. It can be secured at any position from closed to fully open. The flexible-plastic rear window folds without damage. Low center of gravity, without loss of headroom, is another safety feature. The Rambler engine, basically the 1949 Nash 600 power plant, is an 82-horsepower, six-cylinder L-head engine with a compression ratio of 7.25 to 1. The car is said to travel 30 miles per gallon of gasoline and farther with the optional automatic overdrive. Specifications include: wheelbase, 100 inches; over-all length, 176 inches; height, 59 $\frac{3}{4}$  inches, and weight, 2500 pounds.



The electrically operated push-button top is advanced by steel cables and can be stopped at any intermediate position. The instrument panel below has compact easy-to-reach arrangement

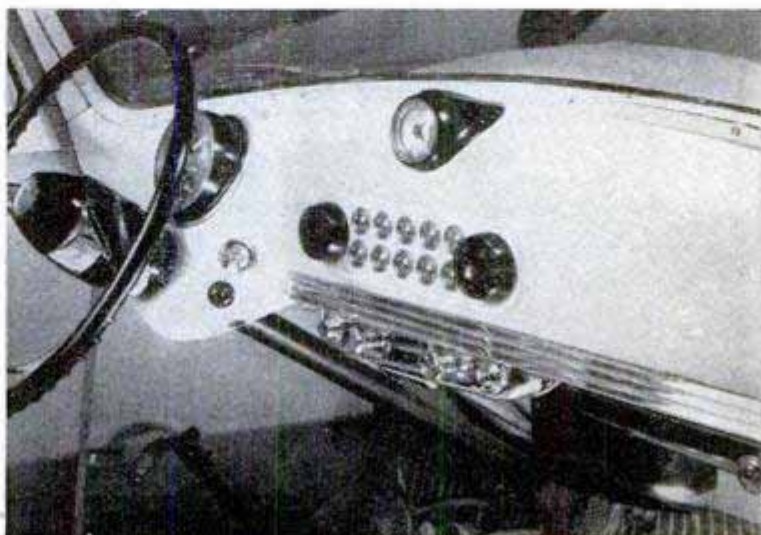

# WHAT'S NEW For Your Home

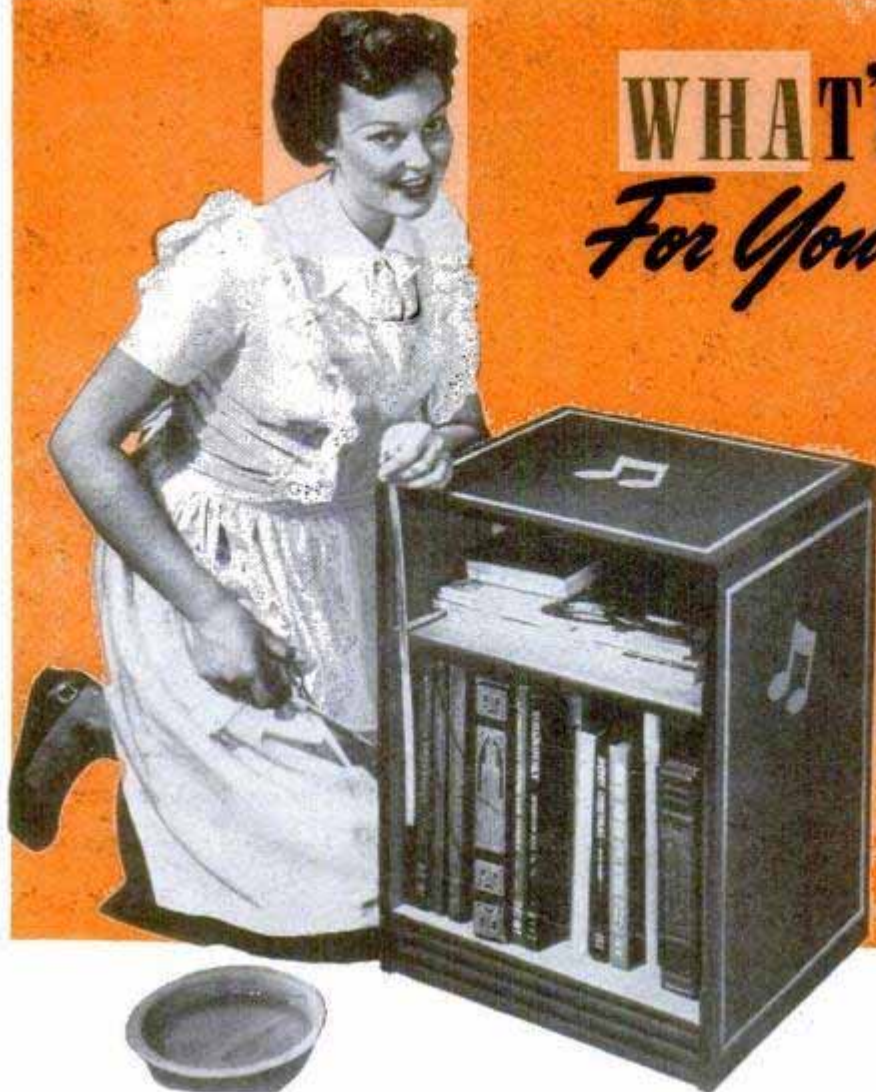

**GOLD DECAL** is 23-carat gold leaf in sheets. It slips off its decal backing, below, to decorate furniture, left, or frames, above.

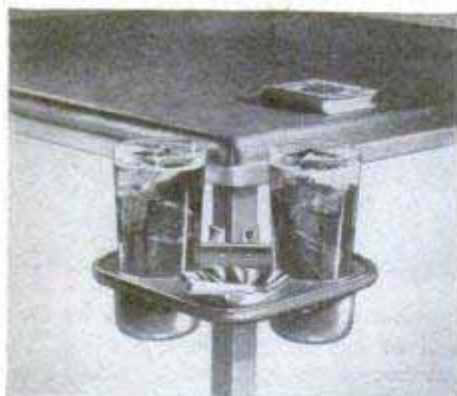

**CLAMP-ON TRAY**, left, clips to the leg of a card table and keeps such hazards as ash trays and glasses out of elbow range.

**CLIP RACK**, lower left, has scores of uses. It screws into the wall and holds everything from screwdrivers to spatulas.



**DISH DRIER**, below, sends a blast of hot air over dishes to dry them in seconds. Oscillating head has a fan and heating unit.

**WINDOW SASH** is held up without weights by a small roller that has an automatic brake. When you push on window, brake releases.

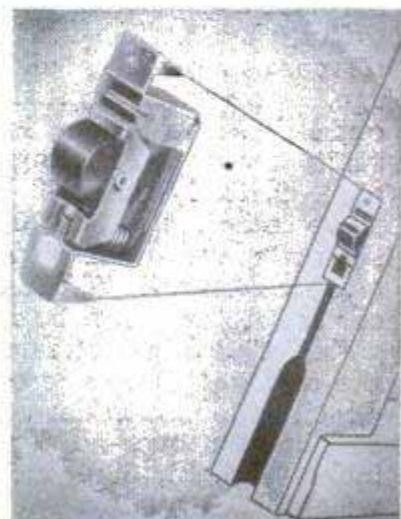
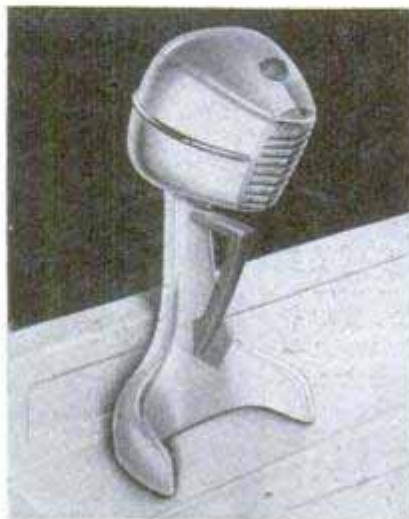
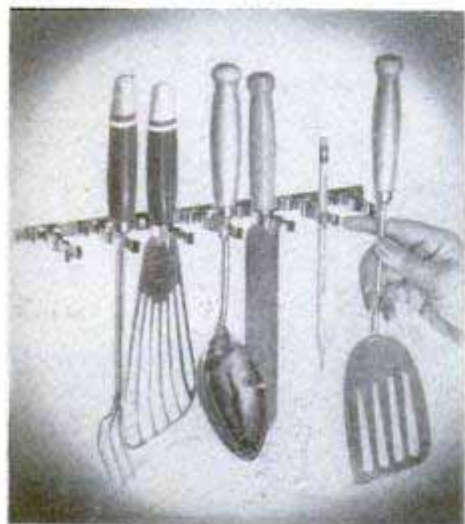



**DISHES OR CLOTHES**, it makes no difference to a combination sink that leads a varied life. Washdays, it is a spin-dry clothes washer that washes and dries in one tub, right. The rest of the week, you replace the clothes tub with a dishwasher, above



**NO-LINE CLOTHESLINE** can be hung anywhere, providing as much drying space as 40 feet of regular line. Fastened to sides of frame are 54 spring-clip clothespins. The closely massed wet clothes cause a downdraft, bringing warm air down from ceiling to dry clothes fast. One hook holds it up and it is so light you can carry it in one hand. It also folds compactly for storage

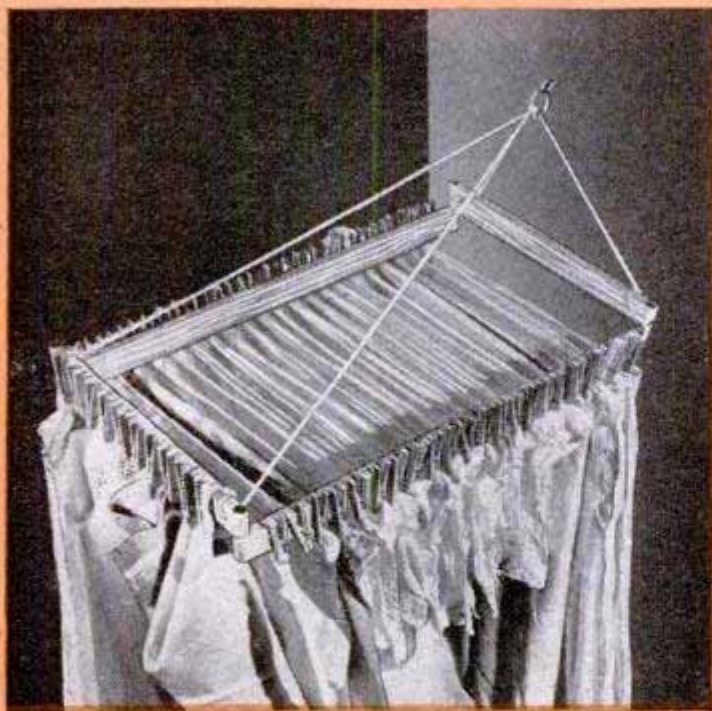



## British Jet Auto

British engineers present the answer to the problem of singed pedestrians and jet automobile engines with a turbine arrangement on the first jet automobile. The power plant on the test model, developed by the Rover Motor Company, Birmingham, is just ahead of the rear axle. It consists of a centrifugal compressor with dual combustion chambers having a single-stage compressor turbine and an independent power turbine. The engine burns kerosene. To start the car, you press an ordinary starter button on the instrument panel and the only control used from standstill to top

speed is the accelerator pedal. A lever on the steering column operates the reverse gear. During tests, the car got away from a cold standing start in 16 seconds, attained a speed of 60 miles per hour in 14 seconds and hit 85 miles per hour with apparent ease. It makes no more noise than an ordinary car and this consists of a low whistle from the exhaust port. The test model, a gray sports coupe with air-intake ports on the sides behind the driver's seat, has a 111-inch wheelbase and a width of 52 inches. The company is still experimenting with the car and does not expect to be turning it out on a production basis for approximately 18 months.

## 1950 Crosley Sports Car Goes 50 Miles on Gallon of Gas

With a distinctly European look, the Crosley Super Sports car is designed to sell for less than \$1000. The two-seater is pow-

ered by a light racing-type four-cylinder engine with a 7.8 to 1 compression ratio. This car will travel up to 50 miles on a gallon of regular gasoline, according to the manufacturer. Mechanical features include combined leaf and coil-spring rear suspension, strut-type hydraulic shock absorbers and hydraulic brakes. The folding bow top permits the forward part to be snapped onto the windshield while the top material is slack. The bows are pressed into position to tighten the top.

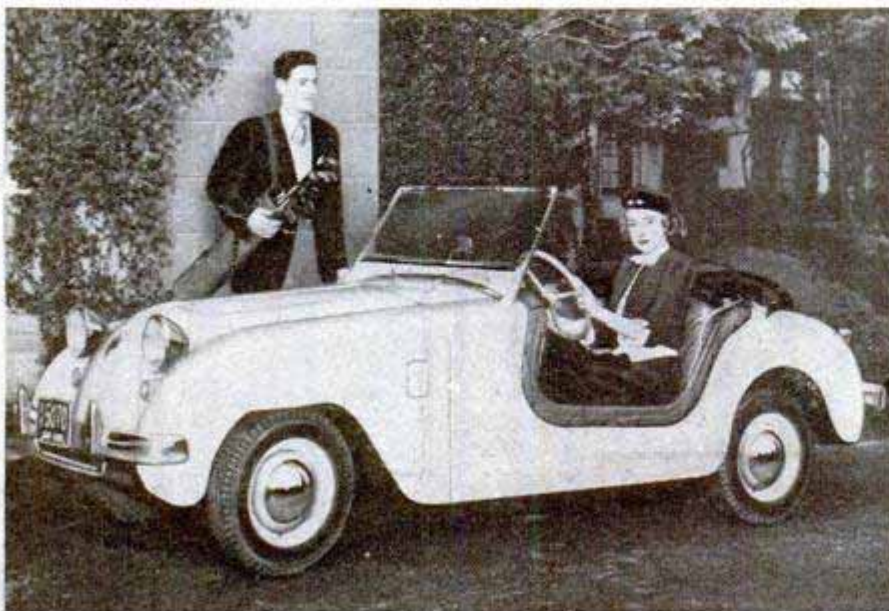

☐ "Keep right" is the traffic law in 101 nations while 85 countries enforce a left-hand rule.

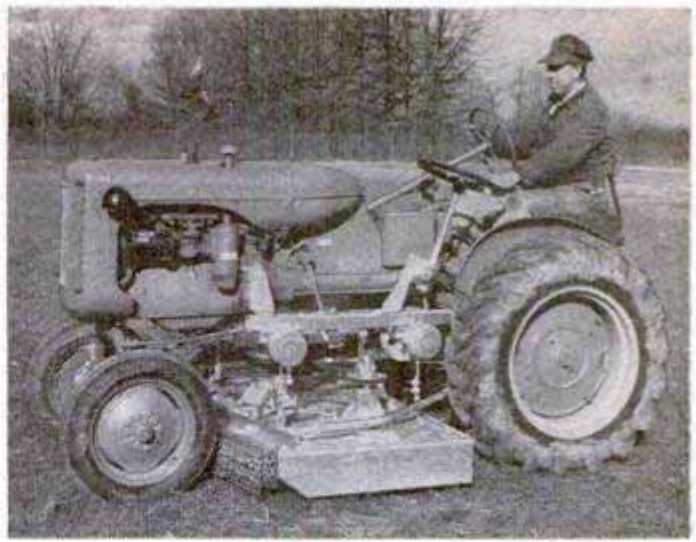

## Under-Tractor Mower

Installed between the tractor wheels, a new rotary mower cuts vegetation from ordinary lawn grass to corn stalks and saplings. The mower has three 22-inch knives which whirl in unison to cut a 58-inch swath through grass, hay, weeds and

brush. The individual blades are driven from the power take-off by a chain and V-belt drive. Chains dangle from the front edge of the mower to separate brush and weeds, preparing the stalks for the blades which pulverize the cuttings and drop them back on the ground. The mower is adjusted by a hand-controlled worm gear.



## Shaft-Driven Motor Scooter

Built in Italy, a speedy little motor scooter has a three-speed automobile-type transmission instead of belts or chains. Power from the little motor is transmitted through a flexible shaft and bevel gears. The scooter holds all official speed records in its class. Safety features of the vehicle include a hand-operated clutch and two-wheel brakes. The rear section, including the saddle, gas tank and baggage compartment, can be swung out of the way to reach the motor and transmission. Springing for the rear wheel combines a coil spring with a hydraulic shock absorber. Top speed of the commercial model of the scooter is about 50 miles an hour, and it will travel 110 miles per gallon of gas at lower speeds. The approximate weight of the scooter is 121 pounds.

*called the "LAMBRETTA"*

## Ultrasonic Iron Solders Aluminum

Aluminum and other light metals and their alloys are soldered easily without flux by an ultrasonic soldering iron that uses high-frequency sound to destroy the oxide film on the metal. The removable copper bit is heated by a conventional resistance winding. It is securely mounted in the core of the transducer, which is powered by an electronic amplifier. The

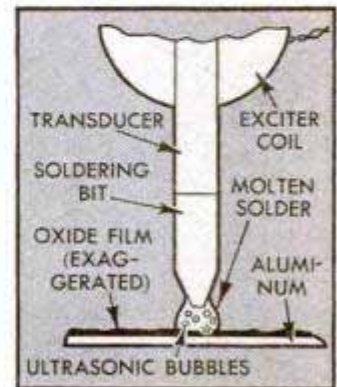

ultrasonic frequency that breaks down the oxide barrier is well above hearing range. The iron was developed in England.

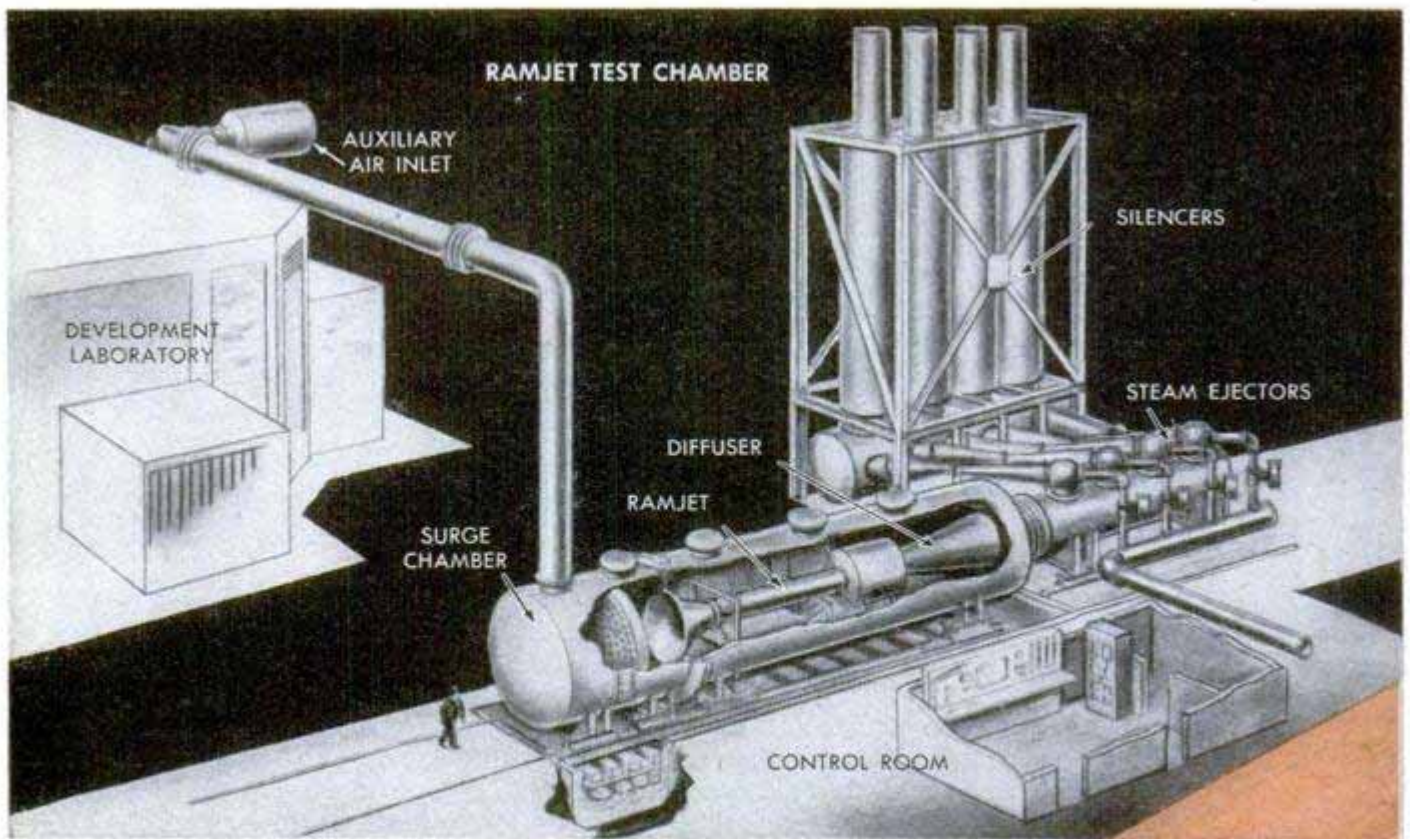

Cutaway drawing of the giant Wright test chamber for the mighty ramjet, shown in a detailed drawing atop the opposite page

## ***Strait Jacket***

**L**IKE SOME prelude to doomsday, a wave of sound rolled across the Texas prairies three years ago. Miles around the Navy's ramjet laboratory in Daingerfield, a lot of Texans had the self-satisfaction scared out of them. Thunderous vibrations cracked dishes in closets eight miles away. People in the vicinity couldn't shout above the continuous roar and be heard. The rumor got around that the Navy was fiddling with atomic power. "Nothing but

splitting atoms could make so much noise," they argued. It seemed logical.

All that racket, however, was coming from a thin steel tube no more than 18 inches in diameter and weighing 300 pounds—one little ramjet engine, the mighty midget power plant whose actual performance is one of the most closely guarded of military secrets.

For years, research on the ramjet's performance was delayed. No one could figure

In the control room, engineers work at top speed during the test. Adjustments are critical since one degree too much heat might explode the whole works. The man in the business suit calls signals for the test run





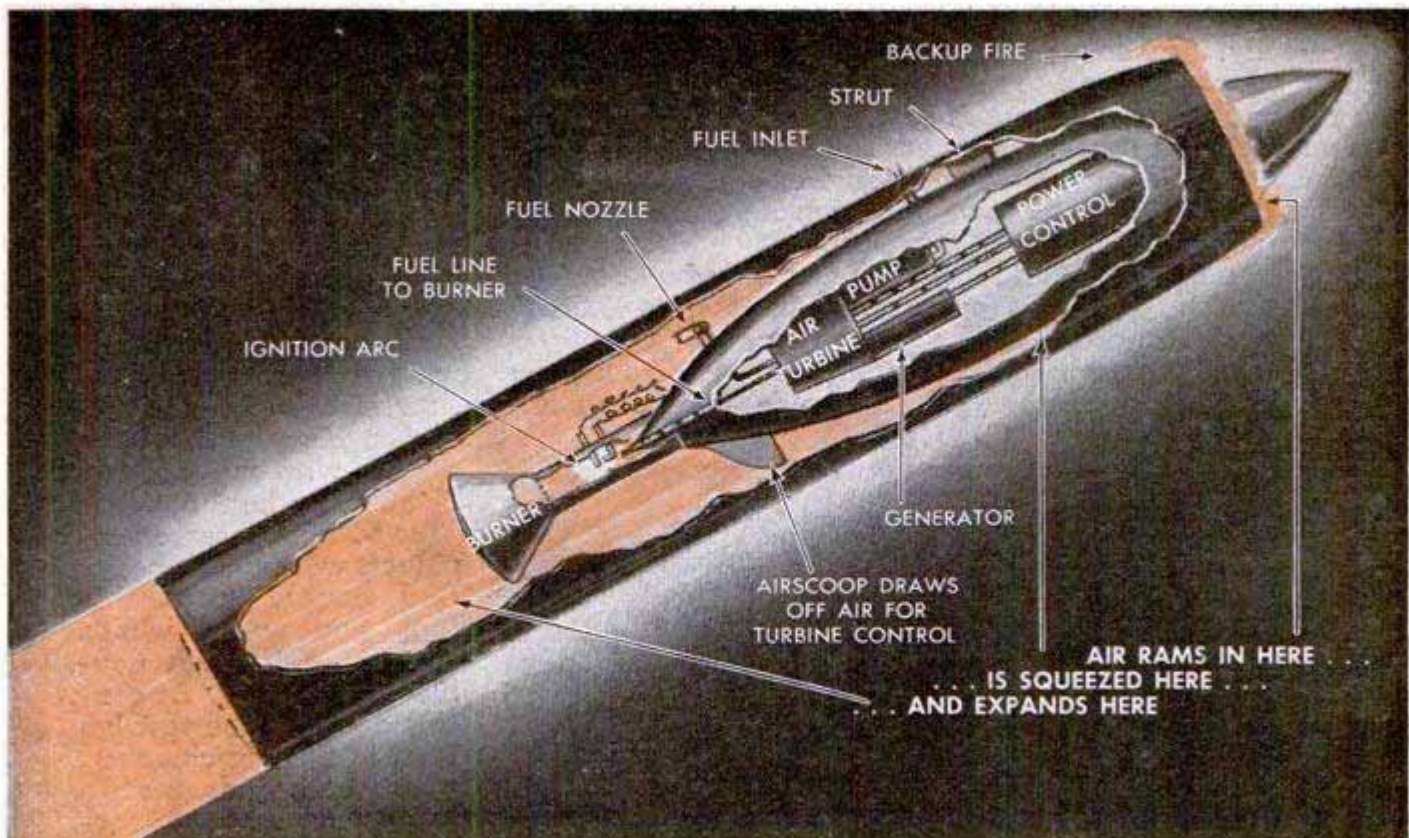

## for a Super Blowtorch

a way to enclose it in a conventional wind tunnel, with proper testing gear. Nor could materials be found to stand the gaff. Hot 4000-degree gases spewing from its fiery tail at supersonic speeds couldn't be exhausted fast enough from any known tunnel. The first lab at Daingerfield, operated by Consolidated-Vultee for the Navy, consisted of an outdoor test rack. The unbelievable noise and vibration not only limited observation by engineers, but raised Cain

**These are the fuel gauges. The ramjet swallows fuel ravenously, burning as much as 6000 gallons an hour**

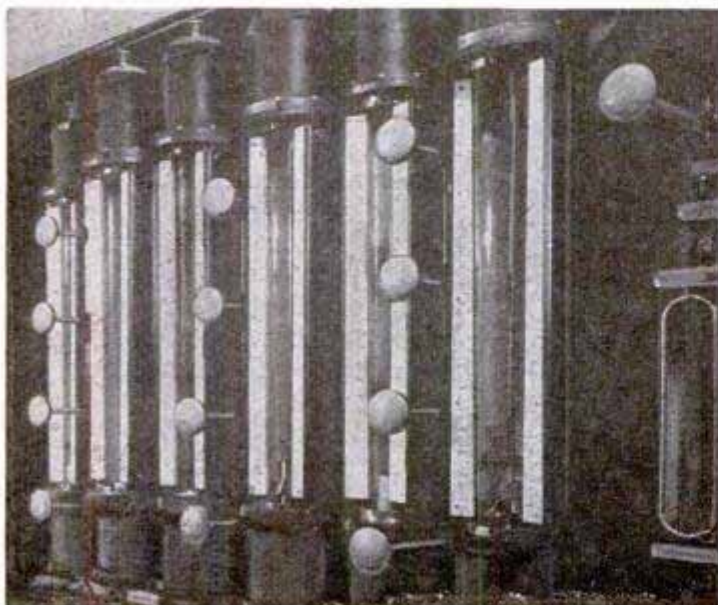

among frightened residents near the lab.

So, when Wright Aeronautical Corp. contracted to produce bigger and better mid-gets at its plant in Wood-Ridge, N. J., last year, engineers knew they'd have to put a soundproof strait jacket on their rams.

Now they've done it. The new lab consists of a monster steel tank, 12 feet in diameter, 96 feet long and honeycombed with water-cooling chambers. Huge turbine compressors pump 140 tons of air an hour into the tank, to simulate flight speeds up to 2600 miles per hour—four times the speed of sound. The rushing wind passes through a surge chamber to reduce turbulence. Pressure control can simulate altitudes up to 80,000 feet (15 miles) inside the tank.

To exhaust voluminous fumes, high-pressure steam, at 150 tons an hour, roars through the exhaust chamber and out through ports that lead to three 45-foot silencer stacks.

The tank is suspended on coil springs to eliminate ground vibration and the whole unit rests on wheels and tracks, since the incredible heat of a busy ramjet causes the test chamber to expand about one inch along its 96-foot length.

Engineers had planned, if necessary, to cover the whole business with earth to drown the noise. They didn't have to. All you hear today is the hiss of steam and a faint rumble, like the sound of a distant train, as the ram surges against its bonds,

trying to take off with the entire works.

Basically, the ram is a simple tube with a center body hung in the middle. Rushing air ramming in at the nose is squeezed in the middle of the tube and expands suddenly in the rear. Tremendous additional expansion is created by continuous ignition of fuel at the rear. All these gases rush out the back end at something like 3000 feet a second, thrusting the unit forward at staggering speeds. In order to ram enough air into the front to sustain proper combustion, the ramjet can't begin to operate until it's

already moving at about 250 or 300 miles an hour. It begins to operate efficiently at about 750 miles an hour!

How fast will it go? The military isn't telling, but there have been reports released from places like White Sands of speed "in excess of" 2500 miles an hour.

You get some idea of the potential when you know that a 20-inch ramjet might generate 42,000 thrust horsepower. A 40-inch might whip up about 100,000 thrust horses, which is about one third of the oomph provided by all the massive engines in the Queen Mary.

Now, with enclosed test chambers, like the one at Wood-Ridge, research engineers work to the steady dull rumble in the big tank and watch what's happening through double-quartz ports. At control desks in the test lab next to the big chamber, they watch dials, push a few buttons and in 30 seconds altitude pressure of 30,000 feet is attained.

So fast do things move that, in the lab, a test "quarterback" stands behind the operators shouting rapid-fire signals as his eyes jump from dial to dial. "Give me two more inches of mercury . . . Give me one ejector . . . Close the by-pass . . ." It's a hair-raising performance.

But the ramjet boys are getting at a dozen problems at last. Keeping a jet burner going in a 2000-mile gale is something like keeping a match lit in a hurricane. They're licking it. Soon, a periscope will lead from inside the chamber to the lab. They'll be able to see exactly what's happening under all conditions.

"We're even hoping to set up color television," says Wright's engineering manager on the project, "so we can watch close-ups of jet performance by remote control."

Engineers at Wright have a confident look. They've got the mighty midget by the tail—and the limit? The sky, of course.

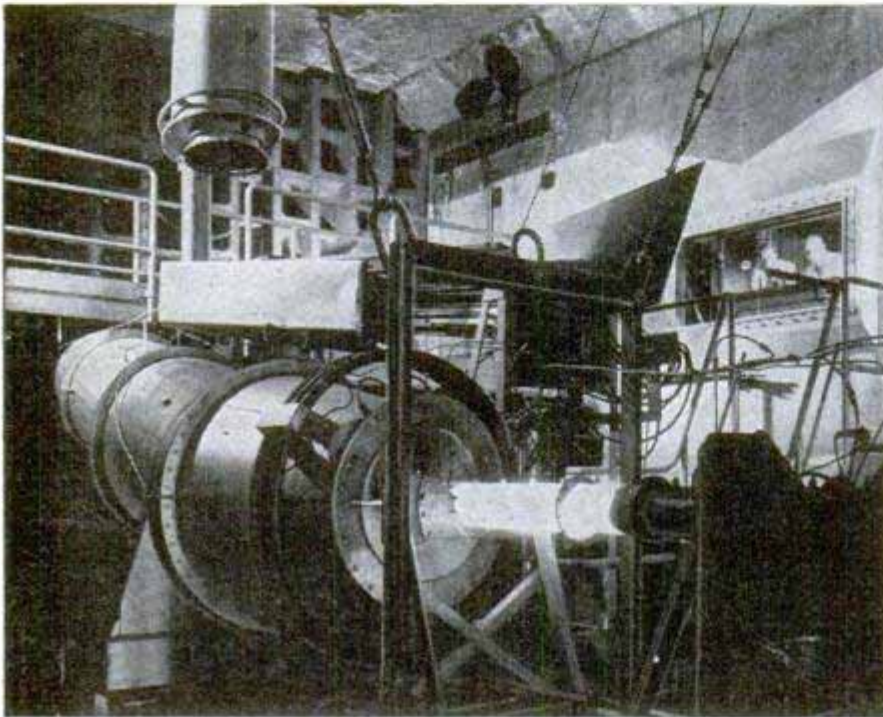

This photo, taken inside a small test lab, dramatizes the terrific heat created by even a baby-size ramjet. Exhaust pipe is glowing white hot!

Mounted on wheels, the chamber opens in the middle to allow the ramjet to be placed inside. Large pipe at the end of the chamber is air intake

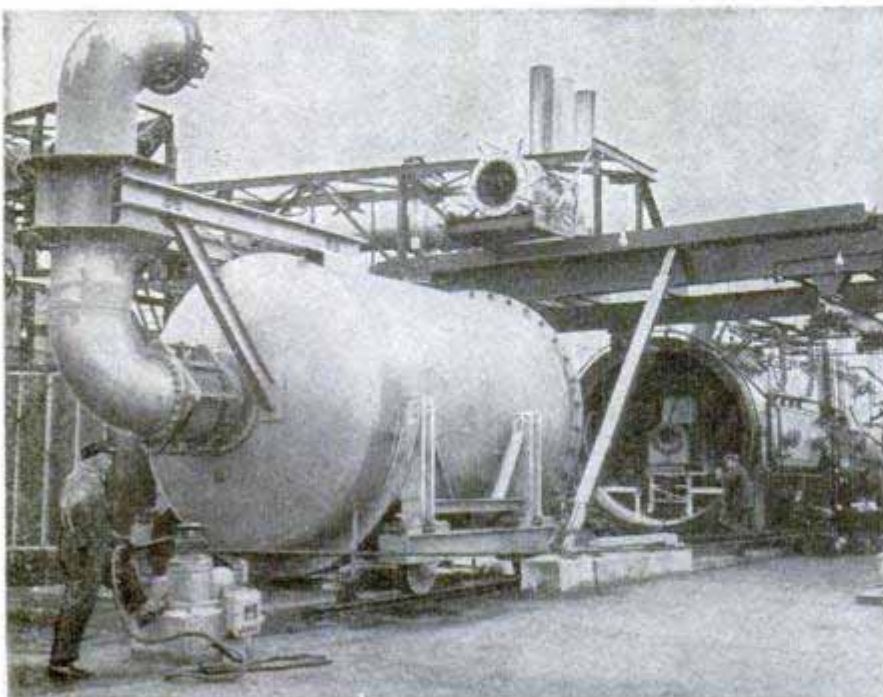

## Barnyard Hay Gun

Farmers can speed the work of storing baled hay in the barn with a pneumatically operated cannon that fires the hay into the loft. The gun is placed 10 to 15 feet from the opening through which the bales are to be shot. In tests, a two-man crew handled 7.7 bales a minute with the gun, compared with 3.2 bales with a conventional grapple fork. The gun will throw a 58-pound bale 21 feet vertically and 48 feet horizontally at an angle of 60 degrees. About two percent of the bales were broken in the test, whereas 3.4 percent were broken when hauled to the mow and dropped from a grapple fork.

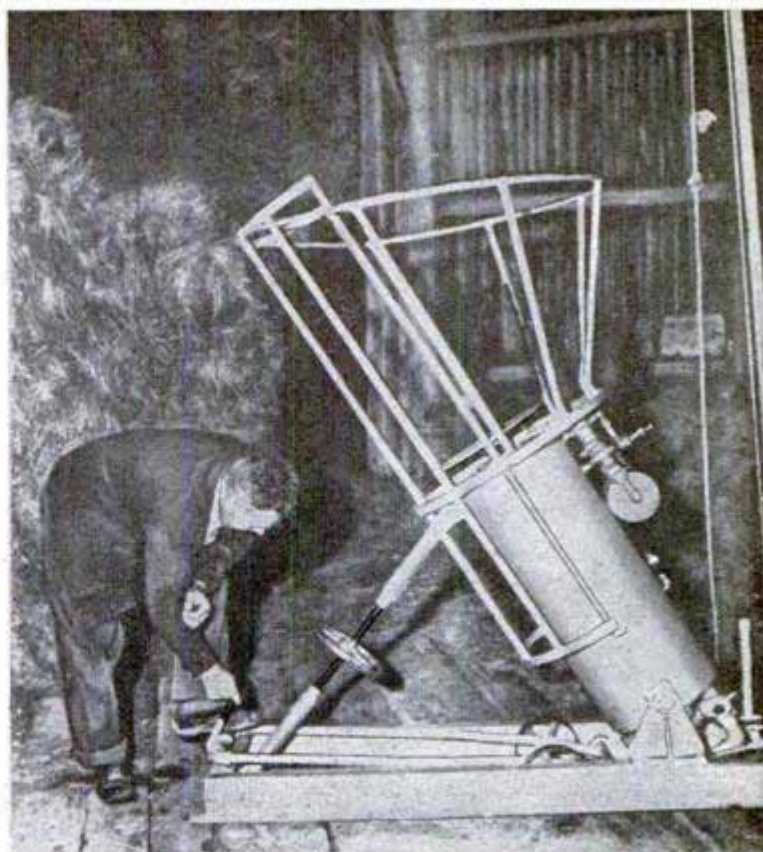

## Rustproof Paint Sprayed Through Flame

Anticorrosion paint, heated and sprayed on by a new technique, produces protective coatings tested to last 15 years or more—three times longer than those applied by present methods. The combination was developed in Germany and perfected in Sweden. The paint is made without solvents, permitting inclusion of rust preventives that cannot be dissolved in them. Tough and waxy at room temperature, it is melted in a spray gun by electrical resistance and sprayed

through a flame so that the mixture bonds intimately with the metal or material, hardening immediately. It has none of the pores which develop in ordinary paints as the solvents evaporate. The combination permits application on wet or damp surfaces, since the flame dries the receiving area, and at any temperature.

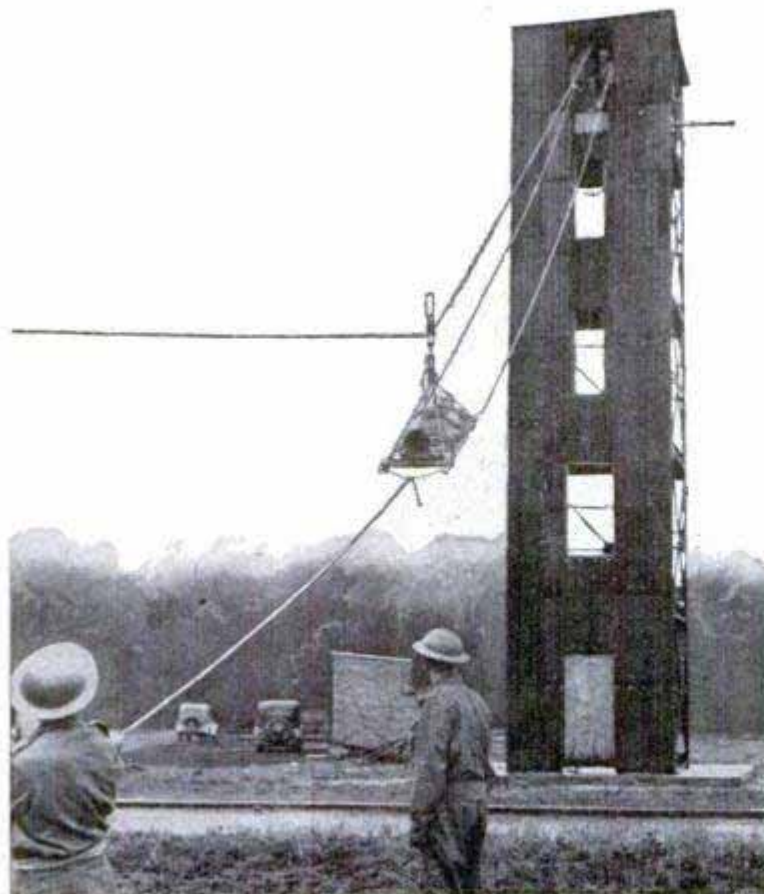

## Rescue Techniques For Atomic War

Civil defense and fire-fighting teams are being given practice in England on new techniques for rescue work in bombed cities. One new method is an adaptation of the breeches buoy, the victim being lowered from a tall building on a stretcher suspended from a pulley that runs along a cable. The students at the training school will be instructors in a nation-wide defense organization to be created among civilians in England.

☞ Since 1940, five states have had a population decrease, with Montana showing the largest drop.

Information not listed on articles in the index, starting on page 10, frequently is listed in the WHERE-TO-FIND-IT INDEX, which is available without charge from Bureau of Information, Popular Mechanics Magazine, 200 East Ontario Street, Chicago 11, Ill.

# Flying Disk Aircraft

**W**HETHER or not there actually are flying saucers, as observers have reported, there is nothing wrong with the principle of a rotating-disk aircraft. That's the conclusion of Dr. E. W. Kay of Glendale, Calif., who is testing a flying disk of his own design.

Doctor Kay estimates that a jet-powered flying disk 18 feet in diameter could rise like a helicopter and fly forward at about 400 miles per hour. The wide rim would rotate at 500 revolutions per minute but the cabin or fuselage would not spin.

His present model is 41 inches in diameter and consists of an aluminum-and-magnesium rim that is built around a central cabin, inside of which is an electric motor. The rim is spun at 400 revolutions

per minute by means of a ring gear and the motor also powers a small conventional propeller for achieving forward motion. The model has a large stabilizer rudder, a feature that would be eliminated in the proposed jet-powered flying disk.

Lift comes from eight vanes or airfoils that fit into slots in the disk and that are arranged like the blades of a fan. The vanes are hinged at each end and their angle of attack varies with the speed at which the disk rotates. When a pair of governor weights on the whirling rim is moved outward by centrifugal force, a collector ring to which they are attached increases the angle of attack of the vanes. The vanes are secured in an open position in the test model.



**Left, Dr. E. W. Kay and 41-inch flying-disk model he designed. Its main operating features are labeled. The inventor has completed drawings for an 18-foot, one-man disk that he hopes to build**

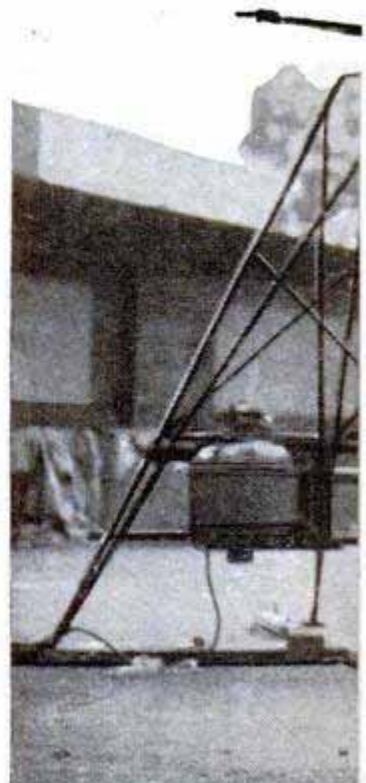

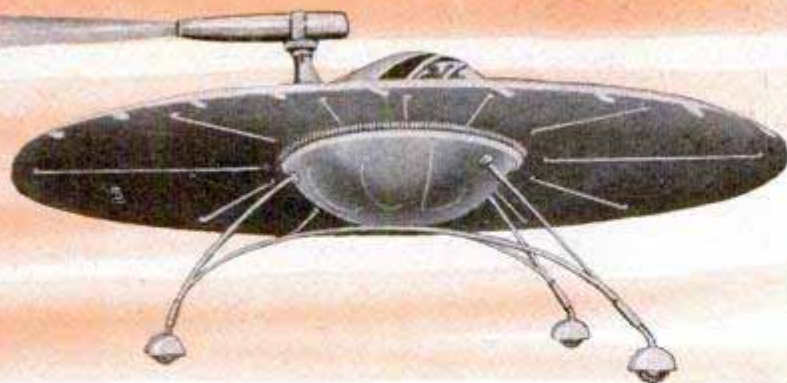

Left, Kay believes that a jet-powered disk 18 feet in diameter would have a forward speed of about 400 miles per hour, after taking off vertically like a helicopter. Below, underside of model shows test landing gear, vanes in their slots and the gear that turns the rim

With the present vane setting, the model takes off like an airplane after a short run and flies around a post, at the end of an 18-foot arm, at speeds up to 72 miles per hour. A higher vane setting would reduce or make unnecessary the take-off run.

Doctor Kay has designed several experimental aircraft. His interest in flying disks was aroused by reports of the so-called flying saucers and he decided to experiment to determine whether the design had merit. Several models proved to be unstable before he arrived at the present design.

Structural difficulties would limit the disks to a maximum diameter of 50 feet, he believes, but these would have enormous weight-carrying possibilities. Their principal value, in his opinion, would be their high top speed in relation to slow landing speed, a combination that not even the helicopter achieves. Doctor Kay hopes to begin construction of an 18-foot, one-man model soon.



Below, whirling around test stand at the end of an 18-foot arm, the flying disk has a speed of 72 m.p.h.

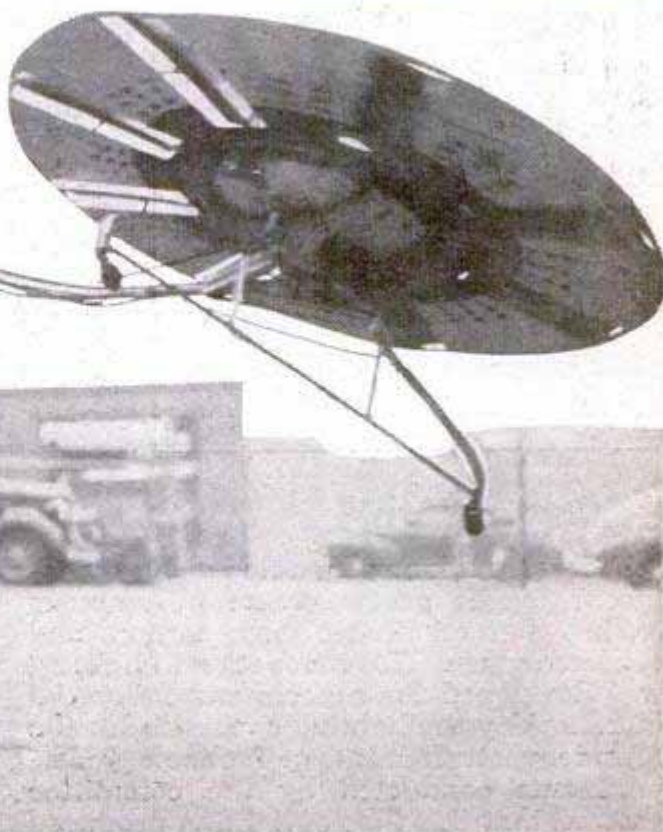

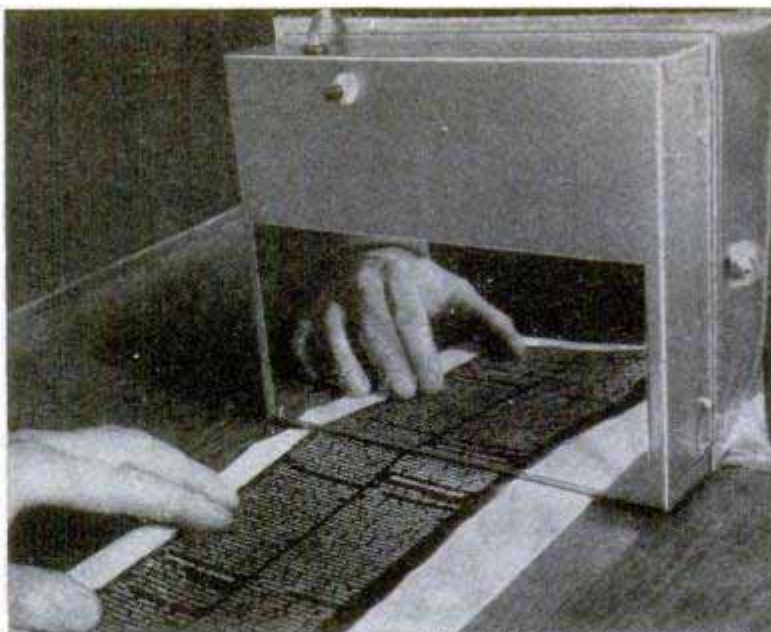

Yale University News Bureau photo

## Compact Copying Camera

Small enough to fit in a briefcase, a new copying device will even make prints from a book page where the paper curves into the binding. Making this possible is a translucent plastic cushion which is inflated to follow the contours of the material being copied. Six bulbs inside the device provide illumination and they can be used

on regular electric lines or with flashlight batteries. A special "slow" photographic paper is used, permitting the device to be used under normal room lighting. The finished print, processed like any photo print, is a reverse of the material. A mirror, attached to the copying device, permits the operator to read directly from the negative print. If desired, this negative can be re-copied, producing a positive.

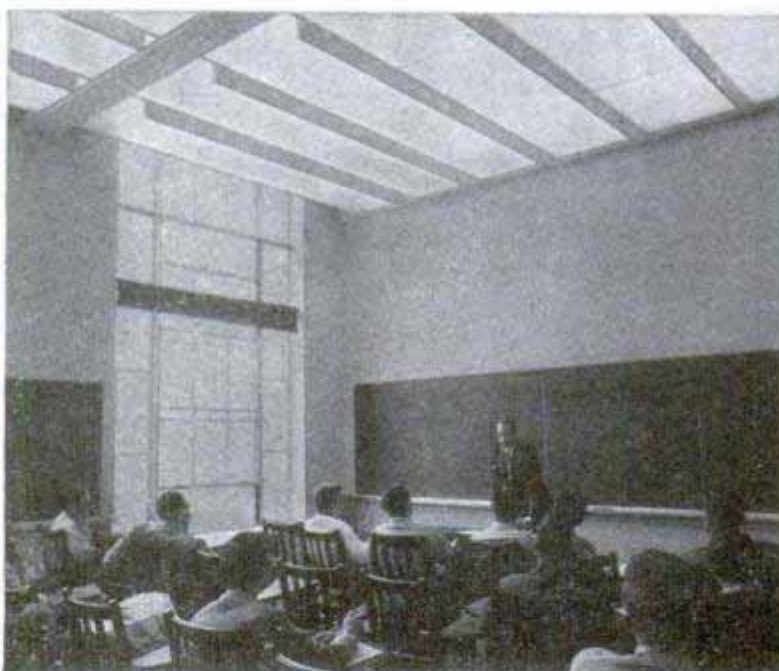
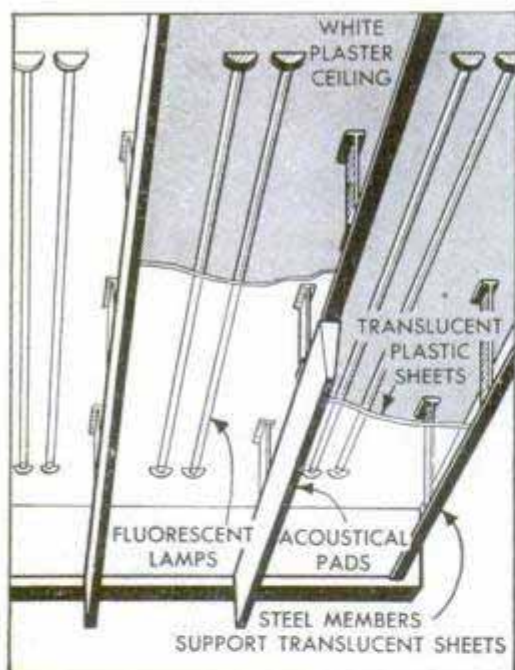

## Ceiling of Light

Fluorescent lamps mounted above translucent plastic sheets create a luminous ceiling that eliminates dark corners and reflected glare. This innovation in lighting was developed for schools and industrial buildings by the lighting committee at the Massachusetts Institute of Technology. Experiments conducted by the committee showed that this type of lighting produced

the best condition for equal brightness at every spot in a room. Fluorescent lamps are mounted on a white painted plaster ceiling and two feet below them the plastic sheets are suspended to form the "ceiling of light." Between the groups of lights and extending below the plastic sheets are seven-inch-deep acoustical pads which compensate for the smooth surface. Installation costs for the ceiling are about the same as for any modern lighting system.

# WANDER WAGON

BUILT on the chassis of a modern delivery truck, a self-powered home on wheels has all the comforts of a house trailer. The interior of the traveling home is 71 inches high, six feet wide and 15 feet long. The cab, built over the engine, has armchair seats for the driver and one passenger. Just aft of the driving compartment are two lounge seats with a table between them big enough to seat six hungry travelers. At night the table can be dropped down to fill the gap between the lounge seats and covered with seat cushions, thereby forming a double bed four feet wide. In the galley are a kitchen sink with a 14-gallon water tank, an icebox, storage cabinets and a butane gas range. A separate compartment holds a lavatory, and a shower tank and curtain can be installed in one of the step-wells. Ten suits on hangers, as well as two or three suitcases, can be stored inside the clothes closet. A portable awning can be erected beside the vehicle to serve as a "front porch." The ventilating windows are equipped with Venetian blinds; door and windshield are fitted with pull shades.

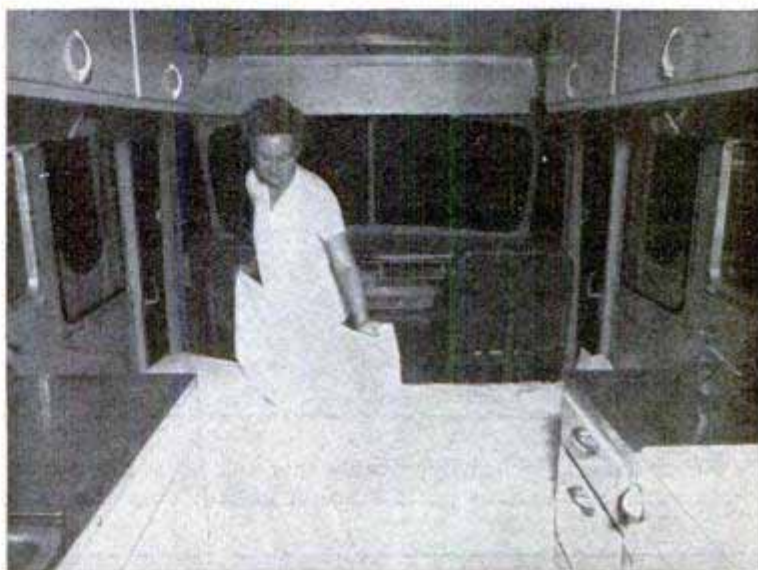

Top, food is prepared in "kitchen" and served on table between lounge seats. Above, at night the table fills gap between seats to form double bed. Below, luggage can be strapped atop vehicle



Unspectacular, perhaps, but one of the wonders of this machine age is . . .



Two men handle the bow-type chain saw as it slices through logs as though they were paper. Below, one-man chain saw with various parts labeled. Bottom strip shows details of the standard and chisel-tooth chains

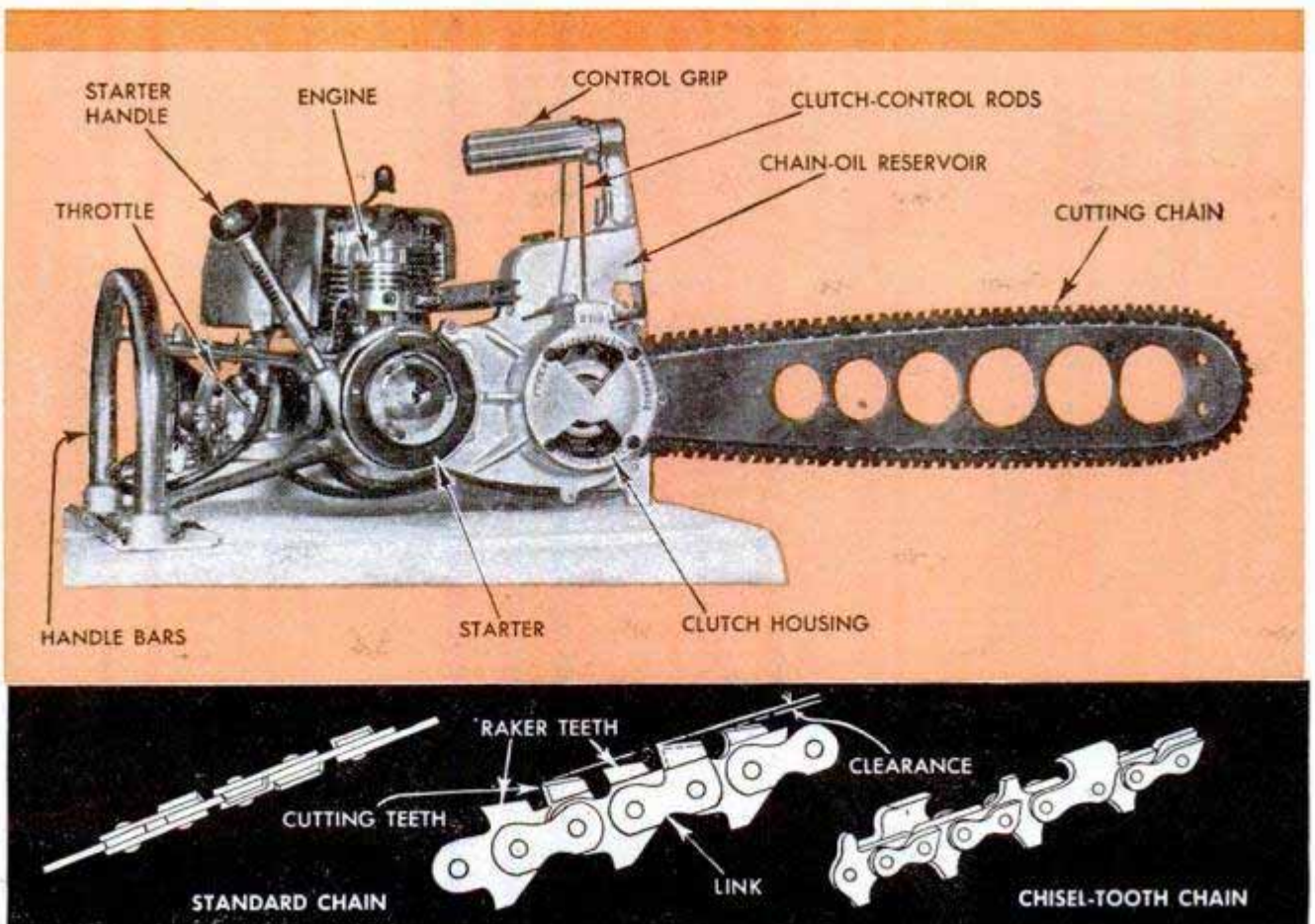



# The Chain Saw

By  
Robert D. Page

**T**REE SURGEONS have to travel light as they scramble among the upper limbs of a tall tree, where one false step may mean death. That's why, if anyone had predicted not too many years ago that these sure-footed human cats would be carrying a gasoline engine to do the muscle-work of sawing limbs, that prediction would have been laughed off as fantastic.

But today the fantastic is already familiar. Making it possible is that ingenious item called the chain saw. Ranking with the important production tools, the chain saw is an endless cutting chain, powered by a gasoline engine or electric motor, that cuts to seconds the job of slicing off a tough limb.

Small chain saws, weighing only 25 pounds, are helping the farmer clear land, cut his own fence posts, saw up firewood and other chores. Construction crews use them to speed production. Loggers use them to trim off branches.

But not all chain saws are small. There are huge, 12-horsepower machines that fell the giant trees of the Pacific Northwest. These powerful giants are two-man machines and, while they may take away some of the glamour of the woods, they get the trees down and to the mill faster and that's what counts.

A one-man chain saw does the work of three to six men using hand tools. The larger models do proportionately more work. All of them are powered by lightweight, air-cooled engines that develop tremendous power for their weight.

Lightness is coupled with strength by the use of magnesium castings. High-strength



Big trees don't frighten this two-man saw. These men are making an undercut prior to felling the tree. Man at left applies pressure to the blade

alloy steels are used in critical parts. Many of the pieces are airplane-type die castings. On some machines, excess weight has been reduced to a point where the handle bars act as oil reservoirs.

One tug on the recoil starter knob, which has the cable permanently attached, quickly starts the high-speed engine by spinning it several revolutions. The starter then automatically rewinds itself, so it will be ready for the next use. The clutch for the chain is a centrifugal, automatic type in most cases. Controls are grouped conveniently for safety and ease of access when the saw is used in awkward positions. Quick starting in cold weather is assured by a push-button primer pump and an efficient magneto ignition.

The saw will cut at any angle, even when inverted. This is done by swiveling the cutting unit or the rear handle on some machines. Some engines will operate upside down due to fuel pump and metering-jet construction.

In chain-saw language, you hear such terms as felling or falling, bucking, underbucking, limbing (trimming off branches)

and ripping. In felling, a wide undercut is first made, then sawing proceeds from the opposite side. A wedge is driven into the kerf if necessary.

Some chain saws are converted for two-man operation by attaching an outer handle or tailstock to the end of the cutter bar. Bars or blades range from 14 inches to 108 inches in length. Engines are all two-cycle, one or two cylinders, and turn up 3000 to 4500 revolutions a minute.

The cutting chain is driven by a sprocket through a compact transmission and clutch. A groove around the narrow cutter bar guides the links of the chain or on some machines, the links straddle the bar. The low teeth, or rakers, do not cut, but simply rake the cut clear of chips.

In operation, a chain saw emits an angry buzzing sound, as the chain cuts through the wood.

Another engineering triumph, the chain saw has taken its rightful place among man's mechanical slaves.

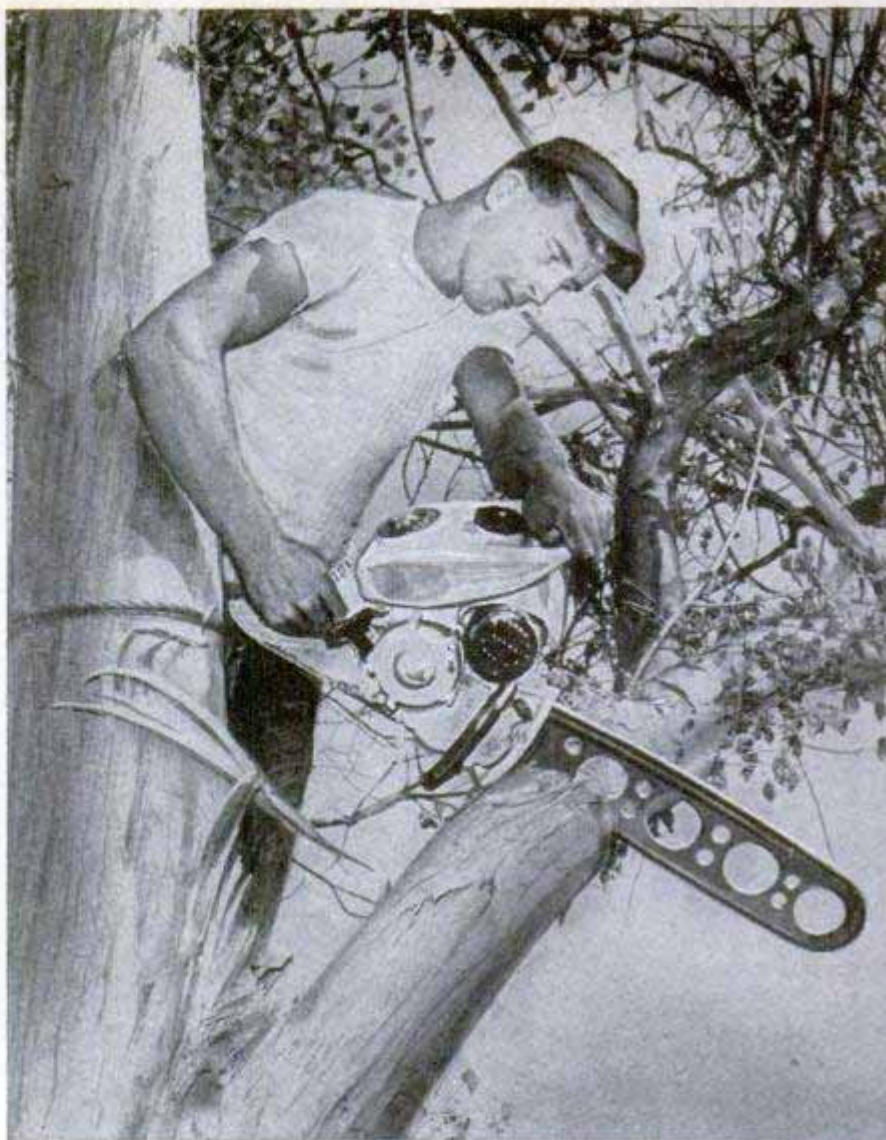

Weighing only 25 pounds, this chain saw makes tree surgery quick work. Below left, a yank on the starter cable is all that's needed to start the engine. Right, "bucking" a log into short lengths with a chain saw



## Mobile "Water Boy" →

Thirsty athletes always get good drinking water under sanitary conditions from a portable bubbler mounted on rubber-tired wheels. A far cry from the old "bucket and ladle" days for sports teams, the water can be iced and it spurts from two jets. The bubbler weighs about 15 pounds and holds five gallons, ordinarily enough to last an entire football game.

## Hybrid Pines Save Forests

Hybrid pine trees are expected to help rebuild the burned-out and cut-over areas of America's forests. According to Victor H. Schoffelmayer, agricultural consultant of the Southwest Research Institute, the seedlings of these trees will outgrow parent trees by 100 to 300 percent in height and by more than that in volume.

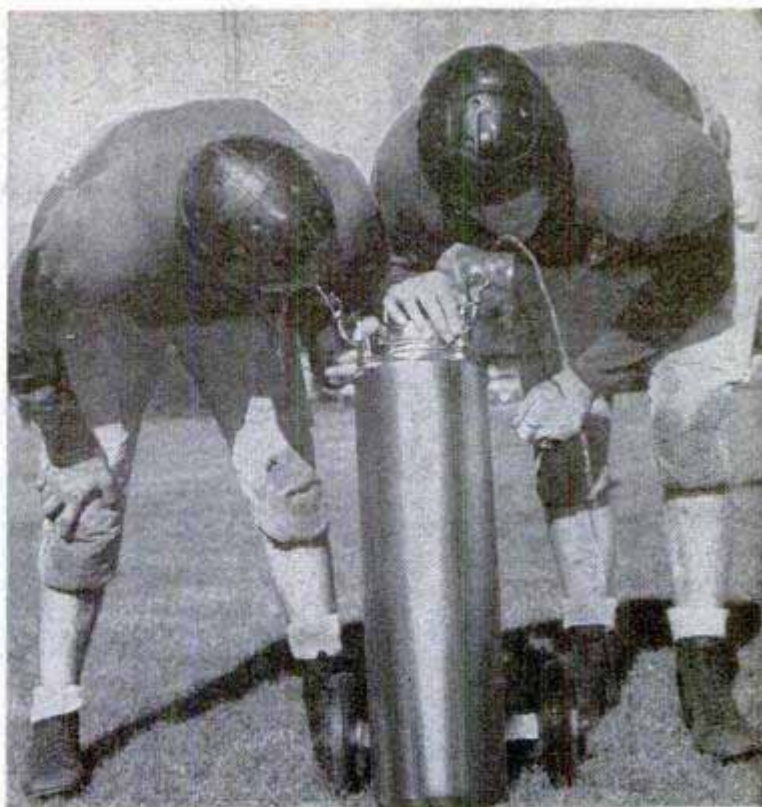

## "Wing Decks" Increase Capacity of Bridge

Cantilevered wings would be added to each side of the upper roadway of the huge San Francisco-Oakland Bay Bridge by a proposal that seeks to increase the capacity of the transbay crossing without the expense of building a new parallel bridge. Already overcrowded in rush hours, the present bridge is considered entirely inadequate for the demands that will be made on it within 10 years. Each wing deck would be surfaced with lightweight concrete or asphalt slabs laid on aluminum battle deck to minimize the weight and each would carry two lanes of traffic. The existing six-lane roadway would be reduced to four lanes so that a safety mall could be built along the roadway's center line. On the lower deck, which now carries

three lanes for trucks and two lanes for interurban electric cars, the truck lanes would be reduced to one in each direction and the rail system would be replaced by two lanes for cars and busses. The net result would be a total of 12 traffic lanes instead of the present nine. The changes would cost approximately \$50,000,000, about one third the estimated cost of a new bridge, and would increase the bridge's possible capacity from the present 5320 vehicles per hour to 8990 vehicles per hour. The present bridge and a parallel structure, it is estimated, would have a combined capacity of 10,500 vehicles per hour. An engineering survey indicates that no difficult structural problems would be encountered in the change.

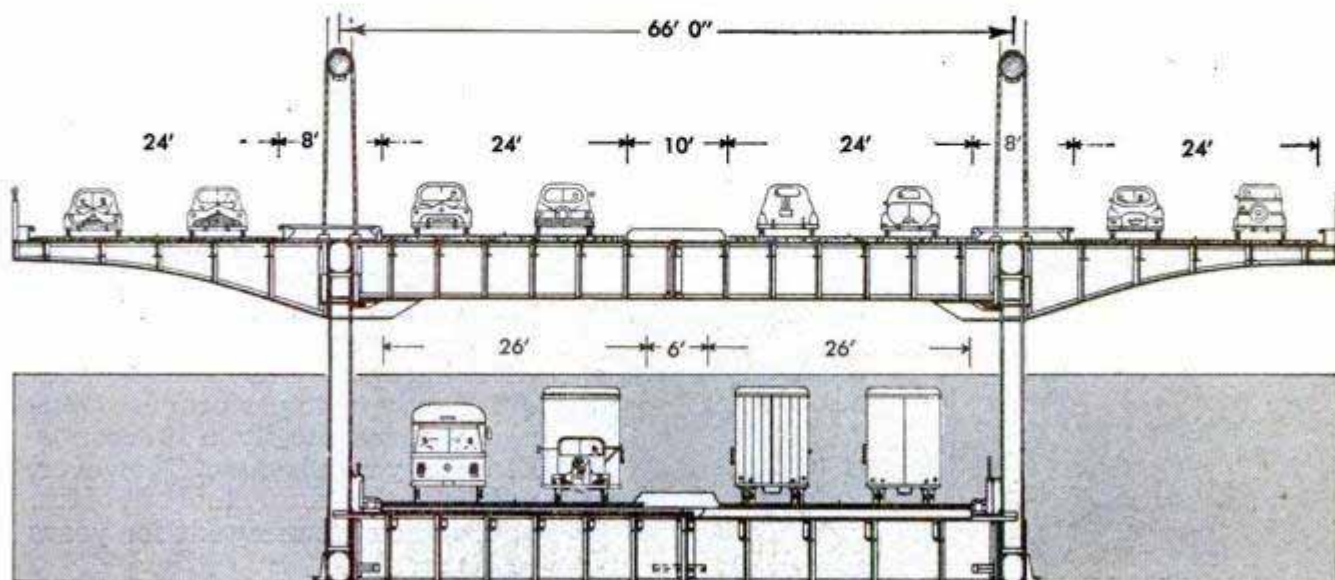



### Dry-Ice Calms "Hot Headed" Well

When an oil well seven miles out in the Gulf of Mexico threatened to blow out because of tremendous oil and gas pressure, it was sealed by freezing it with Dry-Ice. Mud was pumped into the pipe and pulverized Dry-Ice packed around it. In two hours, the mud had frozen solid, making an effective seal against the pressure below. The quick freeze allowed time for the crew to apply standard pressure controls.

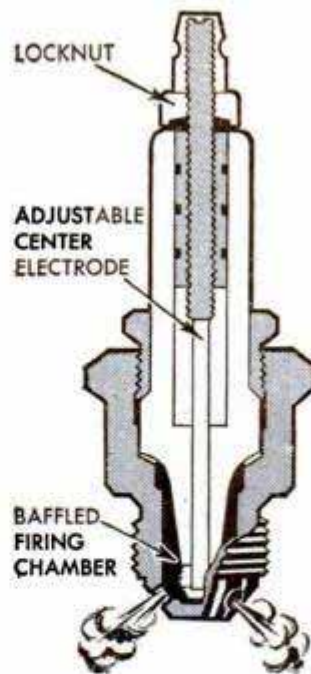

### Spark Plug Has Jet-Firing Action

Producing a jet-firing action that results in instantaneous combustion, a spark plug with a baffled firing chamber is said to produce more head compression and increased horsepower. The spark gap is adjusted by a screw-in center electrode and can be set with the plug in the motor, if desired. To adjust the gap, you screw down the center electrode until it "bottoms" on the inside of the baffle. By unscrewing the electrode one full turn, you open the gap to .030 inch. A locknut holds the electrode, keeping the gap at the proper point.

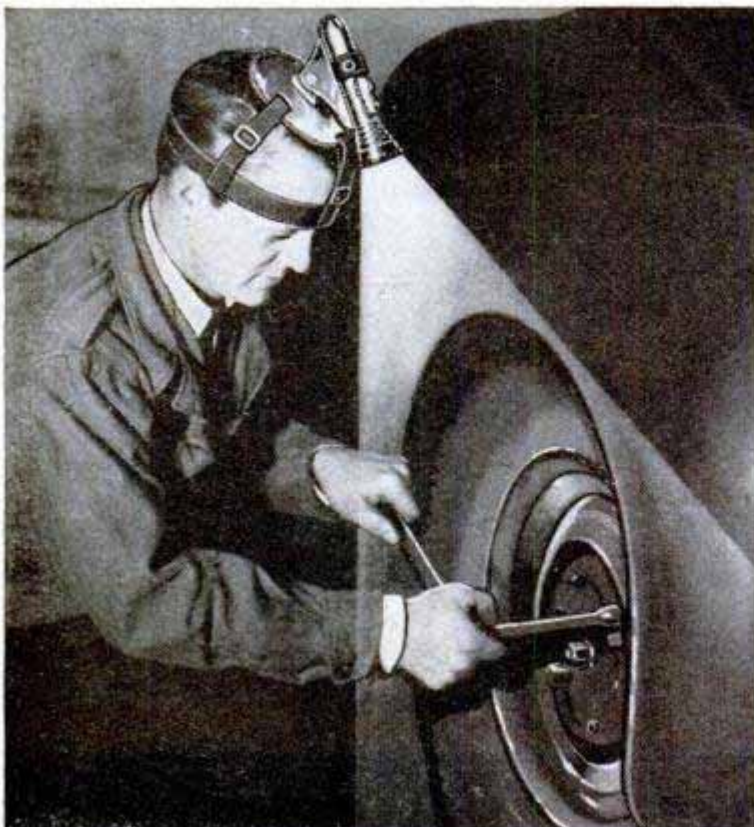

### Mechanic Uses Head To Hold Flashlight

You always have light where you are looking when you use your head to hold the flashlight. An adjustable "cap" with a pivoting rack in which the flashlight is strapped keeps the light beam aimed on the work. Motorists, sportsmen and craftsmen will find the light holder handy because it leaves both hands free.

### Ultrasonics Clean Metal

High-frequency sound waves, pitched too high to be heard, remove grease from metal quickly. Cleaning operations which now require an hour to perform are completed ultrasonically in 10 seconds. Electricity requirements, however, will keep this handy tool out of the housewife's cleaning kit for years to come.

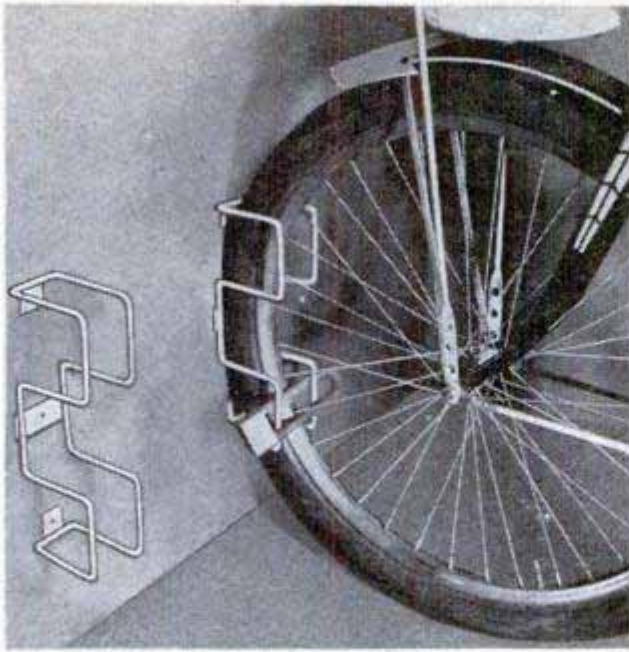

### Bike Rack

Bicycles are held upright and can be locked in a new rack that fastens anywhere with screws. Made of heavy spring steel, it can be attached to walls or floors of the garage or house.

### Tubing Clamp

Designed for attachment on slotted-steel channels used in building construction, a handy clamp holds tubing from 3/16 to one inch in diameter. The spring-steel clamp fastens each tube individually, holding it in place, but permitting expansion and contraction. Since the clamp is easily installed on the channel or removed from it, the tubing can be quickly respaced, relocated or eliminated.

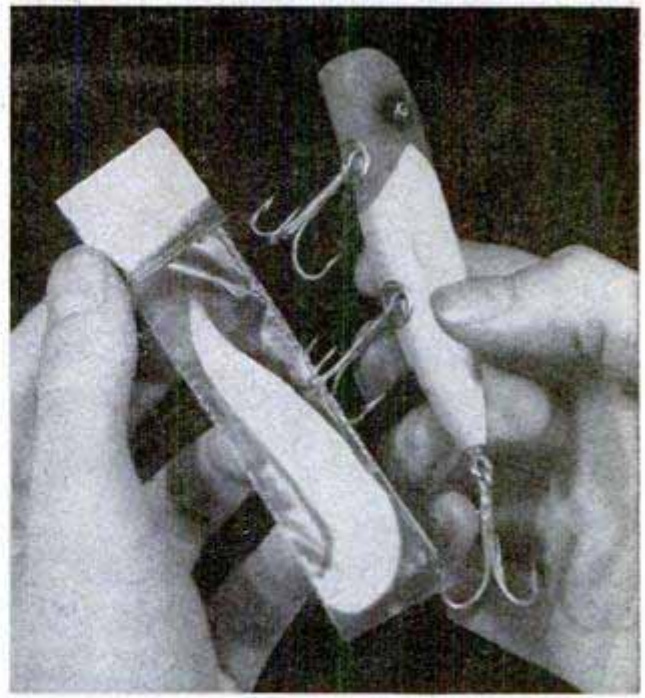
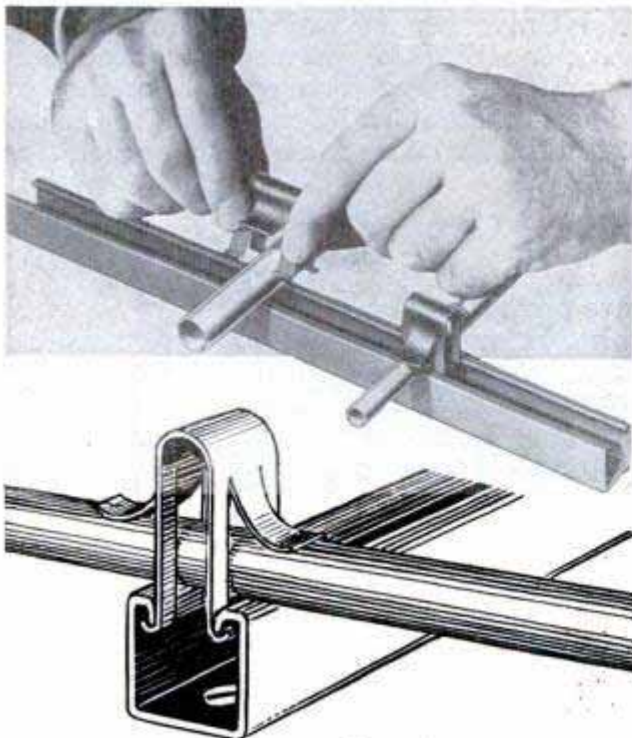

### Individual Bait Boxes

Fishermen can now buy as little pork as they want for bait, using individual rinds sealed with brine in transparent-plastic envelopes. They are more convenient to carry and prevent rust in tackle boxes from leaking jar lids.

### Miniature Addressing Machine

Printing from a roll of master paper, a hand-operated addressing machine transfers hand-written or typewritten addresses onto cards, envelopes or labels with one rolling motion. The paper roll, which goes into the machine the way a roll of film goes into a camera, holds up to 250 addresses of as many as six lines each. A wick inside the machine holds enough liquid for one complete run and the roll will make about 100 impressions before it has to be replaced.





### Transcribed Prescriptions

Druggist J. Robert King of Huntsville, Tex., doesn't worry about faulty note-taking when doctors telephone prescriptions because he makes a recording of the doctor's voice as it comes over the wire. By doing this, King is able to play back the conversation and recheck his notes, assuring the customer of correct prescriptions.

### "Frameless" Hacksaw Makes Inside Cuts

With no conventional frame to limit its action, an unusual hacksaw can make cuts of unlimited length, make circular inside cuts and get into tight spaces. Shaped like a long-barreled pistol, the saw cuts as the blade is forced forward beyond the supporting frame. Return strokes are automatic, the blade being brought back by a spring built into the frame. There are no holding pins to bend or break.

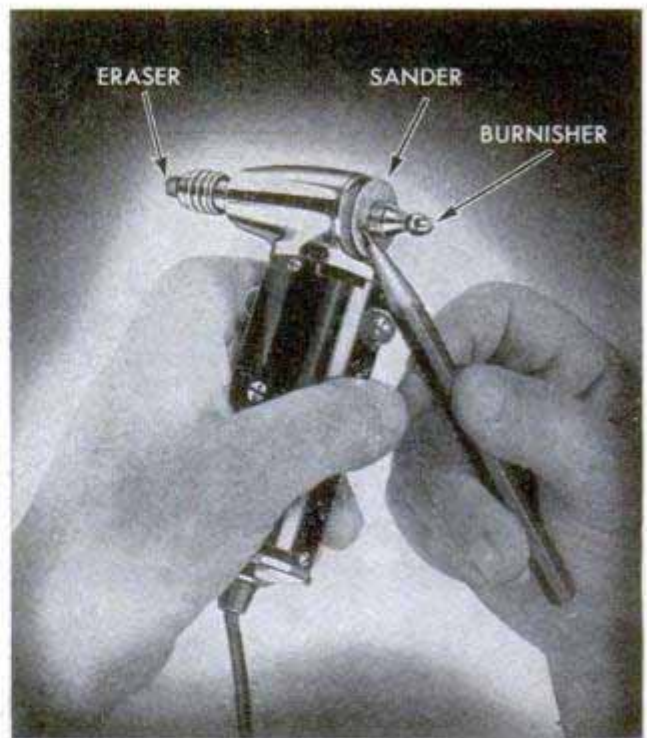
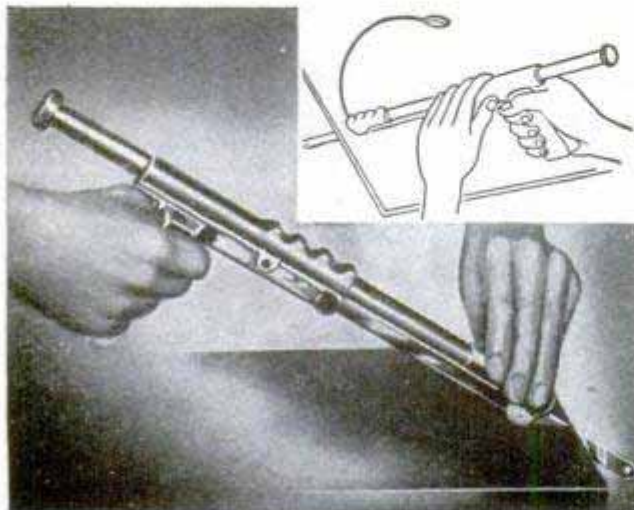

### Electric Eraser

Spinning 3000 times a minute, an electric eraser won't burn or tear paper. It also has a sanding disk for sharpening pencil or compass leads and a ball-point burnisher that smooths erased areas for perfect reinking. The eraser weighs only 12 ounces and has a vibrationless motor to permit accuracy in erasing fine detail.

### Atomic Research Establishes Dates Of Ancient Civilizations

Radioactive carbon in samples of wood, plants and charcoal from ancient Mexican civilizations may help establish an accurate calendar of prehistoric dates. Scientists at the University of Chicago's Institute for Nuclear Studies, where tests are being conducted, have developed a method of determining dates by checking the Carbon 14 in the remains of once-living organisms.

### Rotary Grip for Tools

Hand-tool users are protected from blisters and skin bruises by a rubber sleeve and revolving rubber-cap grip. It permits the tool to be turned against a swivel top rather than against the flesh. The sleeve fits handles from one to 1¼ inches in diameter.

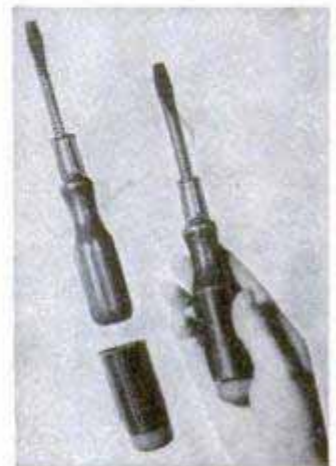



Big tractor with extra-wide tracks claws its way across the barren Arctic, towing a sled train in top-of-the-world maneuvers

**A**CROSS the frozen tundra they roared, like a collection of suddenly derailed freight trains. Their heavy diesel tractor engines snorted and bucked over the drifts, raising individual snowstorms as a howling gale snatched at the white powder snow kicked up by special, deep-biting grousers on their spinning tracks, and sent it swirling into the Arctic sky.

Weaving and rocking behind each pitching monster came its train of strange-looking tow vehicles. There were flat-top sleds laden with fuel oil; stake sleds piled high with odd cargo—sections of experimental portable shelters, arctic clothing and food; sleds that looked like cabooses, carrying compact living quarters or wanigans, lashed to their backs.

Out on the barren wastes in advance of the trains, reconnaissance vehicles on half-tracks and skis scooted like demented beetles, searching for ice cracks, rocks, air spaces and thin spots through which the heavy tractors and sleds of this new polar Army might plunge or founder into icy water.

Where did all this happen? The location is still a military secret, as are many other things about the operation. Enough that it's a long way up there and mighty chilly.

What's it all about? For several years, tough military men in fur-lined parkas, with grease-covered faces pinched by a

wind-whipped frigidity ranging to 60 degrees below zero, have been making the northward trek with an assortment of fantastic track and ski vehicles and other equipment devised by the Army's Transportation Corps Board for arctic use. During the hush-hush missions, this equipment is being tested the rugged way, and our military forces are learning how to operate in a climate where water freezes as it's poured from a bucket, and where the best way to heat a pot of stew outdoors is with a blowtorch.

When T. C. Board investigators returned from their preliminary reconnoiter several years back, they held their heads. It was

**Down she goes! A tractor breaks through thin lake ice and settles into three feet of icy water. She was hauled out with a winch**

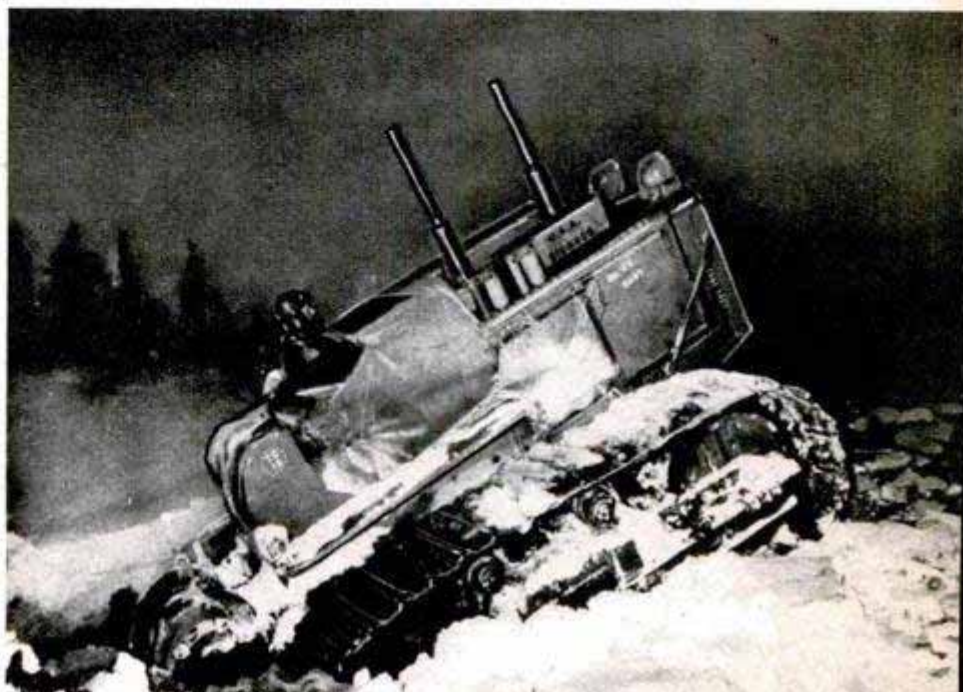



U. S. Army photo

**Newest and speediest work horse of the Arctic is an Army half-track with Caterpillar treads on front wheels**

"impossible," they said, to operate up north.

In that frosty world a wooden gunstock freezes to a man's cheek the minute he presses it there to fire. The shock of a simple flesh wound can kill a greenhorn who hasn't the sense to get indoors. Perspiration from the least exertion will freeze clothes solid in a few minutes.

The toughest problem of all, however, was modification of vehicles to enable

**Traction plates fasten securely around dual tires of the half-track, distributing weight over snow**  
U. S. Army photo

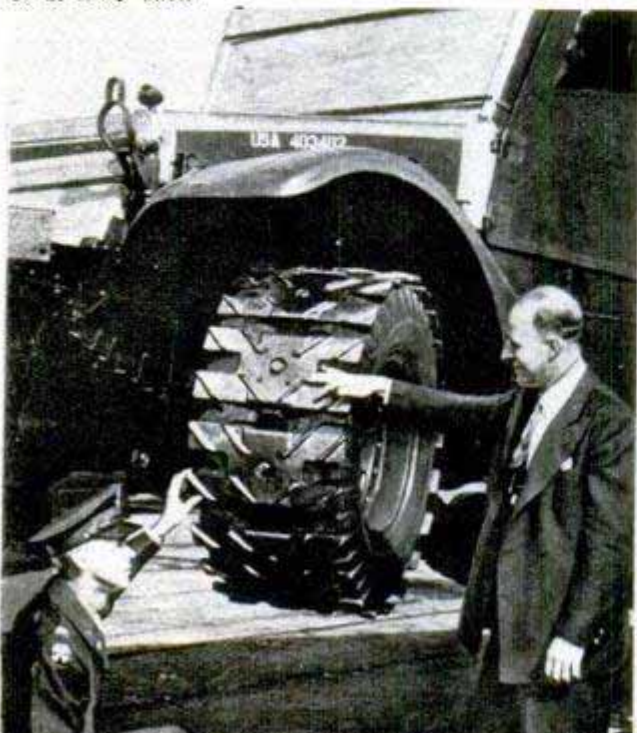

ground forces to move themselves and their equipment across the desolate wastes. On heavy snow, glare ice and spongy muskeg, plain wheels are about as practical as bare feet. Engines become solid chunks of cold metal, bearings and moving parts freeze. Oil flows like thick glue and grease is solid.

Now, however, from the engineering drafting rooms of the T. C. Board, located in huge gray buildings of the New York Port of Embarkation, and from the Ordnance Department of the Corps of Engineers, have come vehicles and equipment that are licking the Arctic Army's transportation problem.

Last winter, when 136 tough, hand-picked men, trained in arctic survival, were ready for another "go" at the north country, there were few hitches.

Special trains, tugged by modified diesel locomotives with special heaters, hauled the mission as far north as the tracks would take them. Here, the railroad crew dug in for winter rail-supply operations. A knock-down shelter, like a big metal igloo, became the repair shop. This new arctic unit consists of prefabricated interlocking aluminum arch panels, about two feet wide. They are double-sided, with a honeycomb core. Lashed down with cables, the sections form a shed 72 feet long and 30 feet wide—big enough to accommodate any of



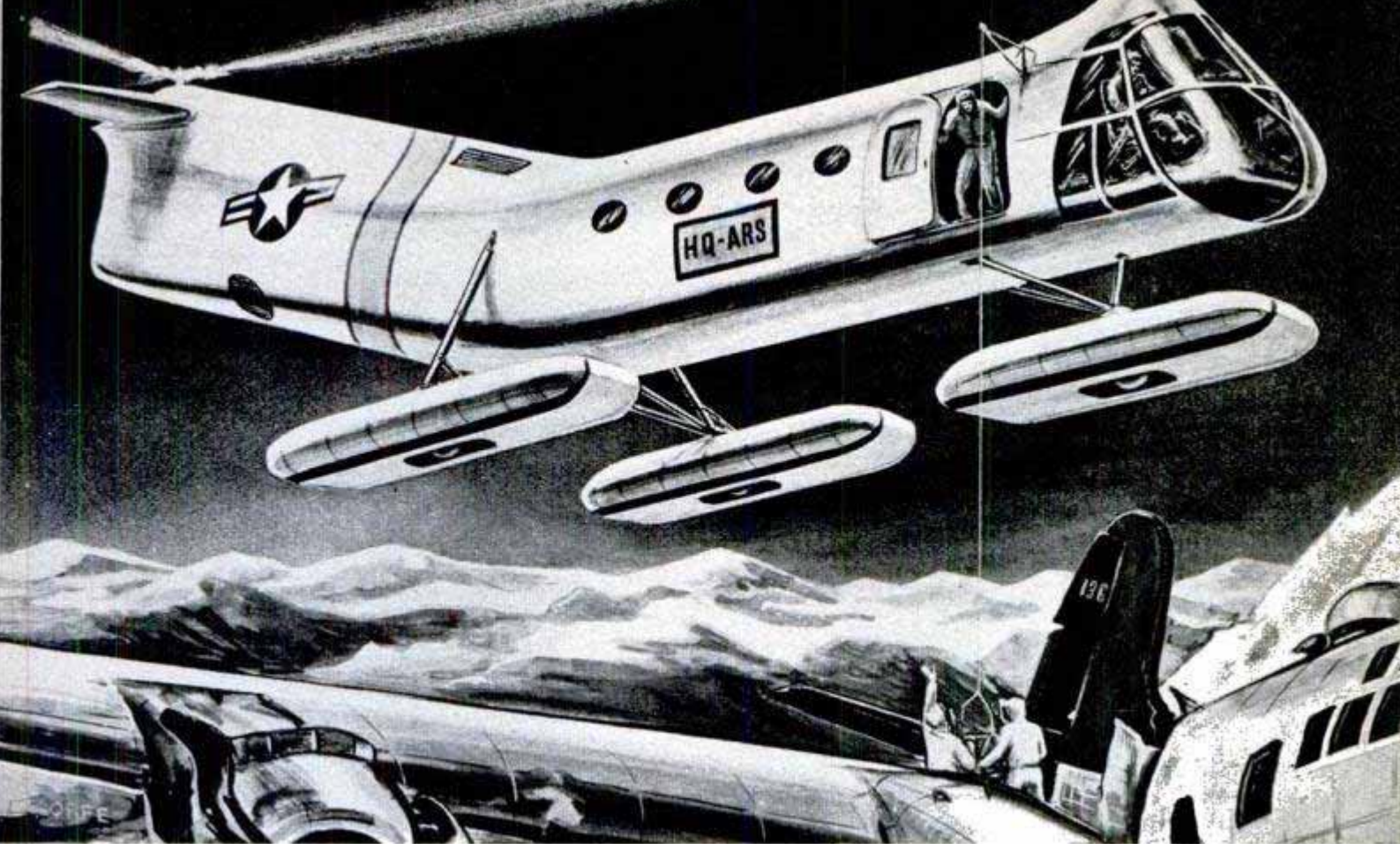

Pictured in action is the first helicopter designed specifically for arctic rescues. Air Force has ordered a number of them. Seating 20, 'copter can land on snow, ice, water, marsh or land with same landing gear

the locomotives. The boys, working in sub-zero weather, and using a boxcar for a scaffold, had it up and operating in three days. It withstood 70-mile gales, and throughout the long arctic winter was kept warm inside with a single oil heater.

In previous years the rail men had trouble getting around on the ice-encrusted tracks with their maintenance car. It kept jumping the rails. This time, the vehicle sported quarter-inch brazed rims around its wheels, which bit into the ice and sent it popping off the rails several feet ahead of the zipping car.

While the base camp prepared its living quarters in converted sleeping, dining, recreation and kitchen cars—with outdoor

sewers that were steam-heated to prevent freezing—the "road" Army headed for the open wilderness.

Basic unit of the new Army is the sled train, adapted from the commercial bush haulers who have been toting trapper and Indian supplies back and forth across the frozen tundra this way for years. But no bush hauler ever saw sled trains like these! Monster tractors haul them. The M4-A1, a 20-ton, full-track affair with curved grousers along its extra-wide tracks, looks like a tank from Mars. Completely enclosed, and with powerful heater, it can pull a train of seven sleds across almost any kind of country.

Just as impressive are the big 18-ton

Big freight sled which tipped over when a runner hit soft snow is righted with the aid of a tractor's winch



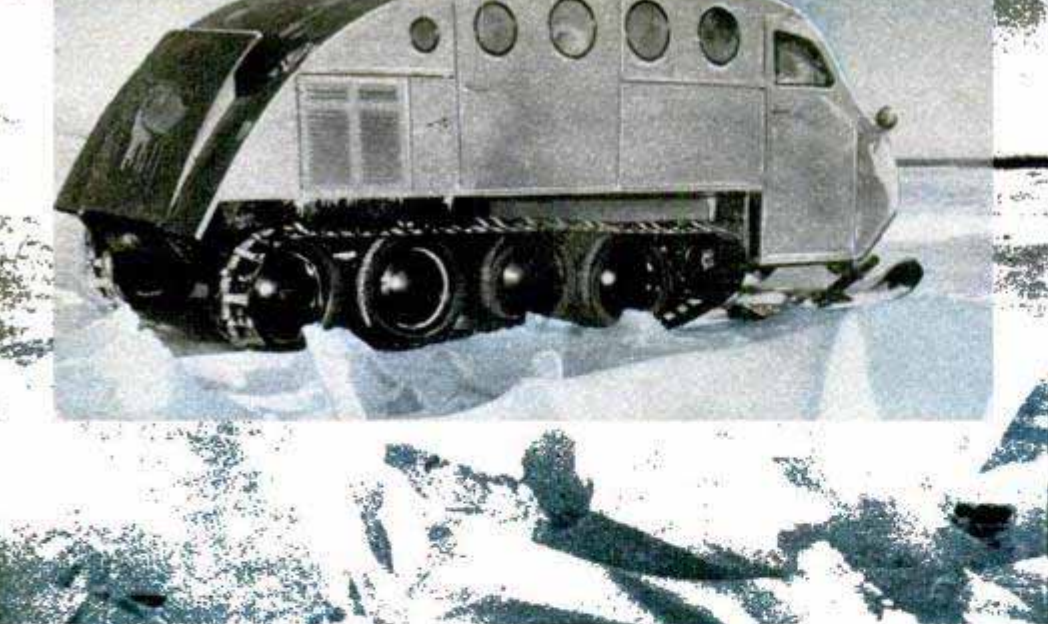

Harry Rowed photo

**Fleet Bombardier snowmobile can hit 60 miles an hour in snow as it races ahead of the sled train to spot areas that spell danger to crews**

standard commercial tractors, with 30-inch tracks, big heaters and simple canvas enclosures around the drivers. The men have solved the problem of freeze-up largely by keeping the engines idling continuously. But the diesels are equipped with warm-up heaters, too. If these don't work, the men build a fire under the vehicle, and shoot a blowtorch flame into the carburetor downdraft to make the frigid fuel vaporize. That usually does it. "But," says the expedition's chief engineer, "the technique is not recommended for civilian practice unless suicide is contemplated."

Behind the tractors, on 24-foot sleds with bob runners, comes all the equipment it takes to run an arctic mission. The last sled on the train usually carries the arctic version of an automobile trainer on skids. Known as a wanigan, this 8 by 24-foot "house" rides pick-a-back on a flat-top sled. It contains, as one Army man puts it, "four bunks, a refrigerator, coal stove, latrine, folding table, sink and built-in cold

feet." This is the train's bunkhouse, mess, hospital, command post and communications center.

There's nothing cozy about a wanigan. It's strictly functional. As in all arctic shelters, including the igloo, the warmth from its heater comes in layers. Men occupying the top bunks roast. Those below wake up with frost on their whiskers. Last year, when the men tried washing a wanigan floor, they wound up with a skating rink before the water could be mopped dry. Icicles formed inside the

metal window frames. "Our wet mukluks froze to the floor every night," one of the men recalls with a shudder, "and the crowded quarters were a constant mess of oily clothes, ashes from the coal range, and bad smells. But when the temperature was 50 below, with a good wind howling, it didn't seem half bad."

To eat in a wanigan being dragged across country is basic training for a juggler. The Army has tried many stunts to make wanigans move easily across the snow. Some are equipped with Caterpillar tracks which are fine until they pick up moisture and the bogeys jam with ice and snow. The most practical versions ride the sleds, but even these are not up to knee-action. The roughest deal for the men comes in the morning when the tractor breaks the runners loose.

As a train rides, friction of the runners melts the snow a trifle, forming a thin film of water between them and the riding surface. This is what makes any sled glide effortlessly. At the halt, however, this film

**Warm blanket made of glass fiber is zipped over a wooden frame to make a snug, portable repair building**

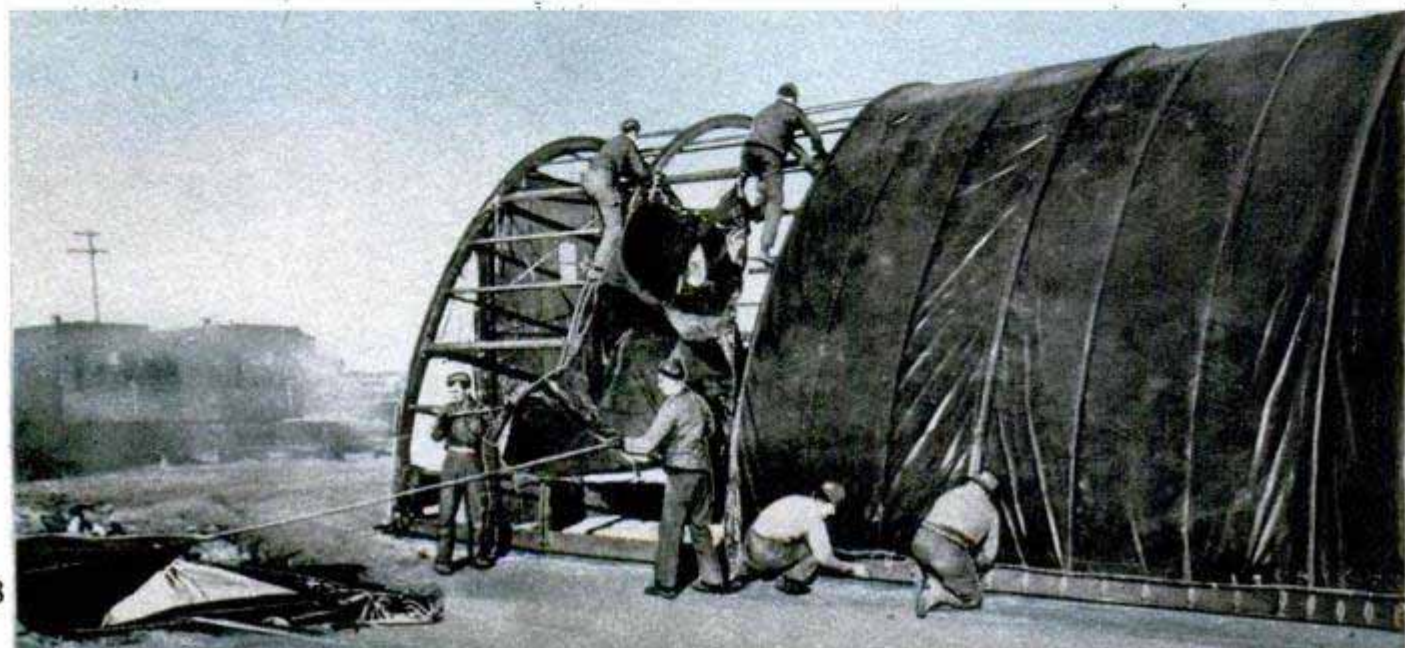



← Big gasoline heater blasts hot air over a tractor engine to warm it up for starting. After about 20 minutes of this heat treatment, the driver tries to turn over the frigid engine

↓ Diesel tractors are hooked together by winches for a rough climb. One will go ahead to firm footing, then pull the other up. The drivers spread black grease on faces to prevent freezing

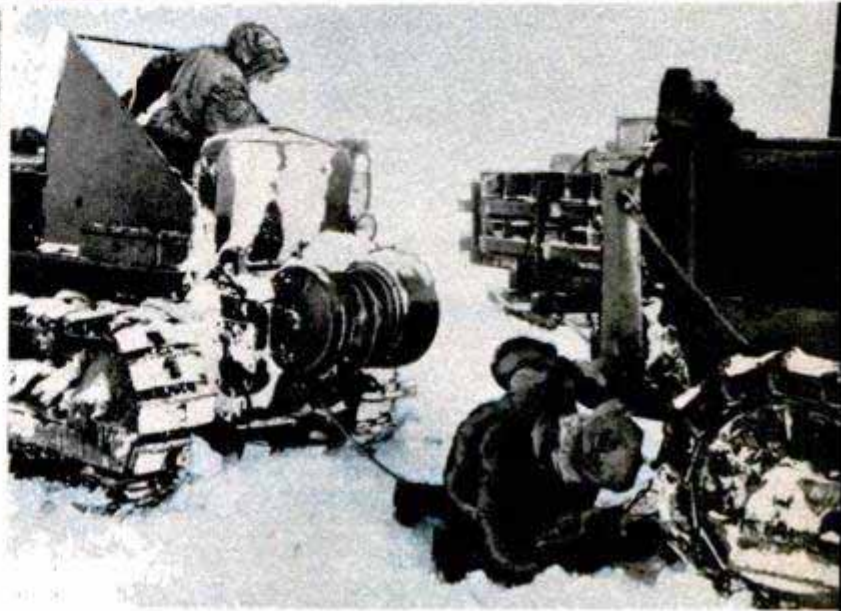

freezes instantly and every sled in the train is firmly glued in place. To break the hold the tractor yanks the first sled loose, backs in the train and whacks the second loose, pulls up and jolts the third loose. Meanwhile, every man in the wanigan caboose is fighting to stay on his hands and knees, and swearing like a trooper. By the time the tractor backs in again to bump the wanigan sled free, any loose pieces of china or shattered false teeth may be disposed of out the rear door, or the escape hatch in the roof with which every wanigan is equipped for exit in case of emergency or submergence.

Even foolproof tractors and sturdy sleds may overturn or crash through ice. Loose brush kicked up by the sled runners has a nasty habit of jabbing through the wanigan floor. So, there's plenty of outdoor work for the men.

The Navy has determined that the efficiency of a man drops two percent with every degree drop of the mercury below zero. To work in sub-zero, men must wear bulky clothing that encumbers them further. Yet they mustn't overexert

(Continued to page 260)

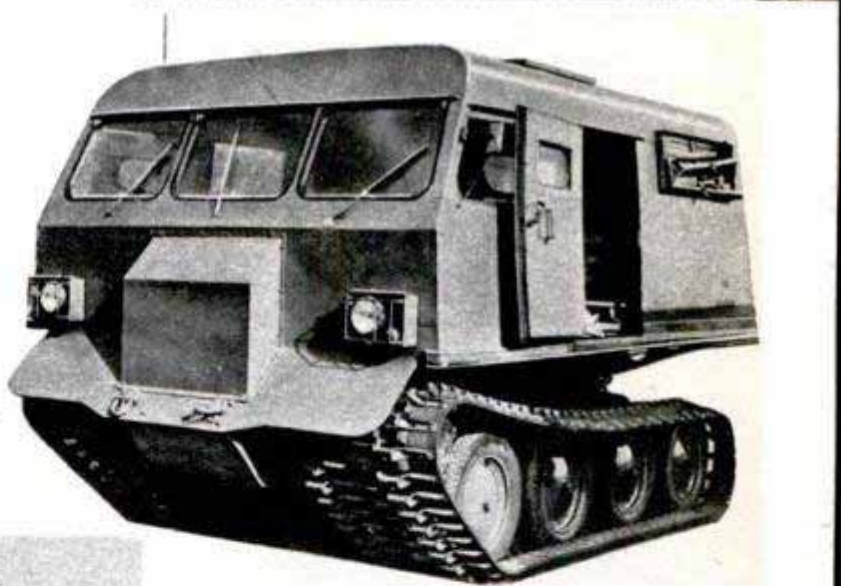

↑ Penguin snowmobile is better than the Bombardier in deep snow. It is steered by braking one of the tracks

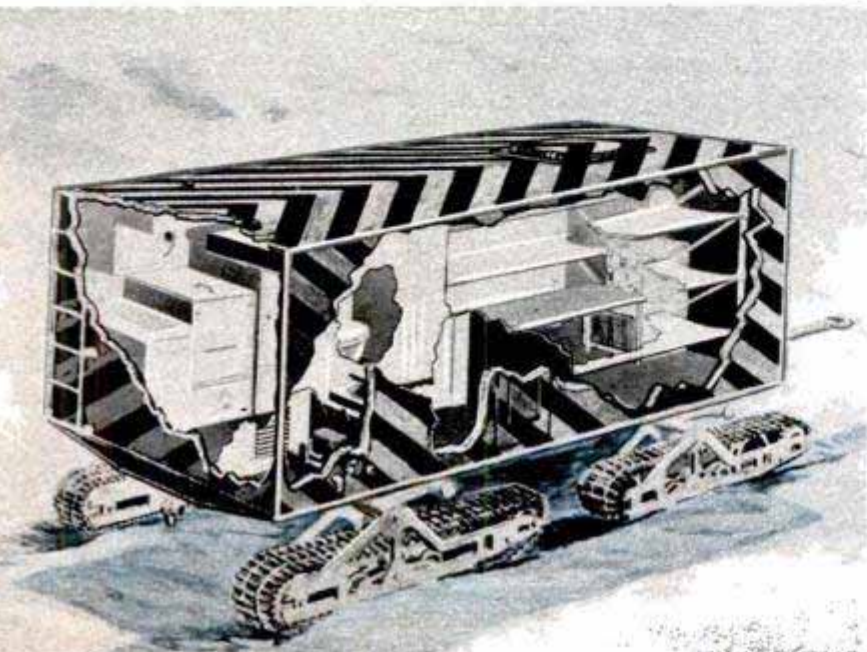

← Cutaway shows a tracked wanigan—a portable home for members of the Arctic Army. It contains four or six bunks, a refrigerator, stove, folding table, sink and built-in cold feet



## Testing Tackle on Mermaids

Members of the Tuna Club at Long Beach, Calif., tell about "the one that got away" with added sighs these days. They tested their skill and fishing tackle on a group of expert girl swimmers recently and landed only two. The mermaids, each wearing a harness attached to a line testing 18 pounds, were given a good start before the anglers applied pressure to their reels, in an effort to slow them. Where

game fish fight back without reasoning, sometimes turning toward the boat and permitting recovery of the line, the female "fish" struggled intelligently, forging steadily away from the anglers. Some lines popped and the unleashed girls swam triumphantly back to the fishing float. The winning angler was William Pigg, using the same technique with which he landed a 175-pound world-record marlin on a nine-pound line. He landed his swimmer, who got almost 100 yards from the float.

## Static Alarm Guards Against Explosions During Surgery

Static electricity has always been a hazard in operating rooms because it can set off an explosion of the anesthetic. Now a static detector has been developed which sounds an immediate warning when any person or object with a dangerous static

charge approaches the anesthetic equipment. It also dissipates any charge which may have been built up in the anesthetic machine, operating table or personnel. An antenna picks up any small voltage and tubes amplify it to produce a warning tone.



## Smotherproof Pillow Protects Infants

Infants who turn over in their sleep and bury their faces in a safety pillow are in no danger of suffocation because they can breathe freely through the thin cotton cover. The pillow has no filling, being formed of a wire frame over which is stretched the open-weave fabric. Comfortable and hygienic, the smotherproof pillow is the invention of an Australian mother and is now being sold in that country.

Popular Mechanics provides two sources of further information concerning the articles published in each issue: the WHERE-TO-BUY-IT INDEX, starting on page 10, and the WHERE-TO-FIND-IT INDEX, which may be obtained without charge by writing Bureau of Information, 200 E. Ontario St., Chicago 11

## Replaceable Grille→

Grilles on the 1950 Dodge cars are made of nine separate pieces that can be easily replaced. The grilles are designed to minimize the cost of front-end damage. The Dodge medallion, formerly on the hood, is mounted on the grille centerpiece.



## Actinium Isolated In Quantities

Atomic research, industry, transportation and the fields of medicine and therapy will benefit from the isolation in commercial quantities of the last of the natural radioactive elements—actinium. Since the activity of this element is 150 times that of radium, it should be of help to nuclear physicists in the production of neutrons. Actinium emits strong rays which show promise in numerous applications, particularly in treating

skin diseases. A large amount of “soft” radiation is present in actinium, but recent experiments have shown that radiation can be largely eliminated by a thin shield of glass or sheet plastic. Actinium has a half-life of 13.5 years.

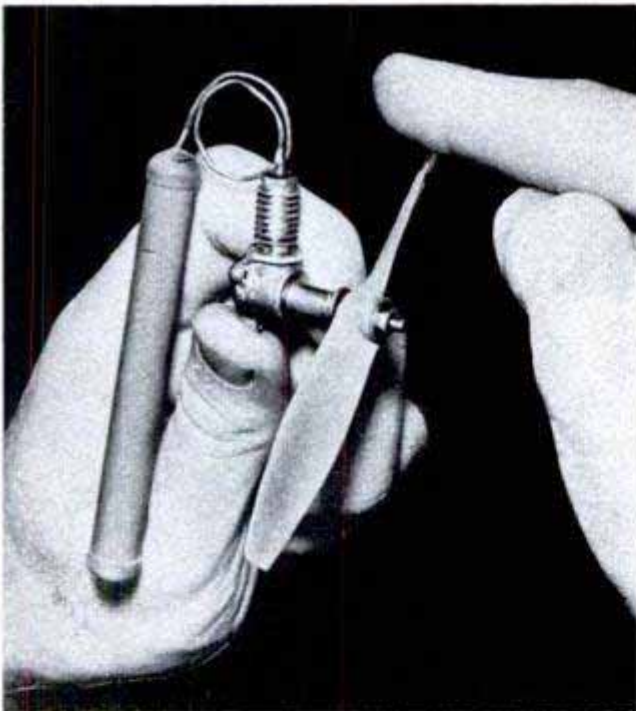

## Model-Airplane Engine Operates on CO<sub>2</sub>

Carbon dioxide powers a miniature engine which will pull model planes with wingspans ranging from 12 inches to 30 inches into the air. A standard capsule of CO<sub>2</sub> supplies power enough for eight or more flights, ensures quick starting and provides low fuel cost. The engines are practically crashproof and make possible take-offs from both land and water.

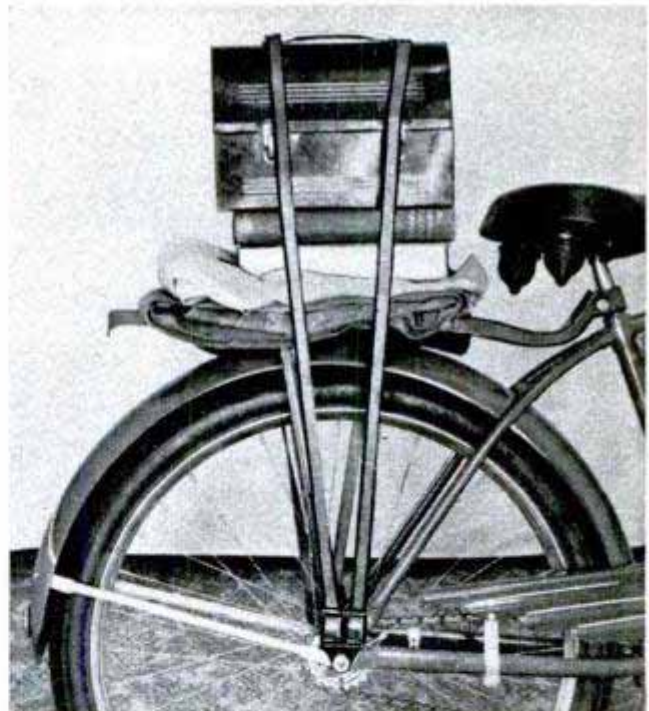

## Rubber Straps on Bike Carrier Bind Gear of Any Shape

Rubber straps bind articles of any shape to the carrier of a bicycle. The two straps terminate in metal plates which are fastened to the bike's rear axle. Then the cyclist can slip clothing, books or lunch box under the straps and they are held securely in place. The higher the load is stacked the more pressure is exerted by the straps to hold it on the carrier.

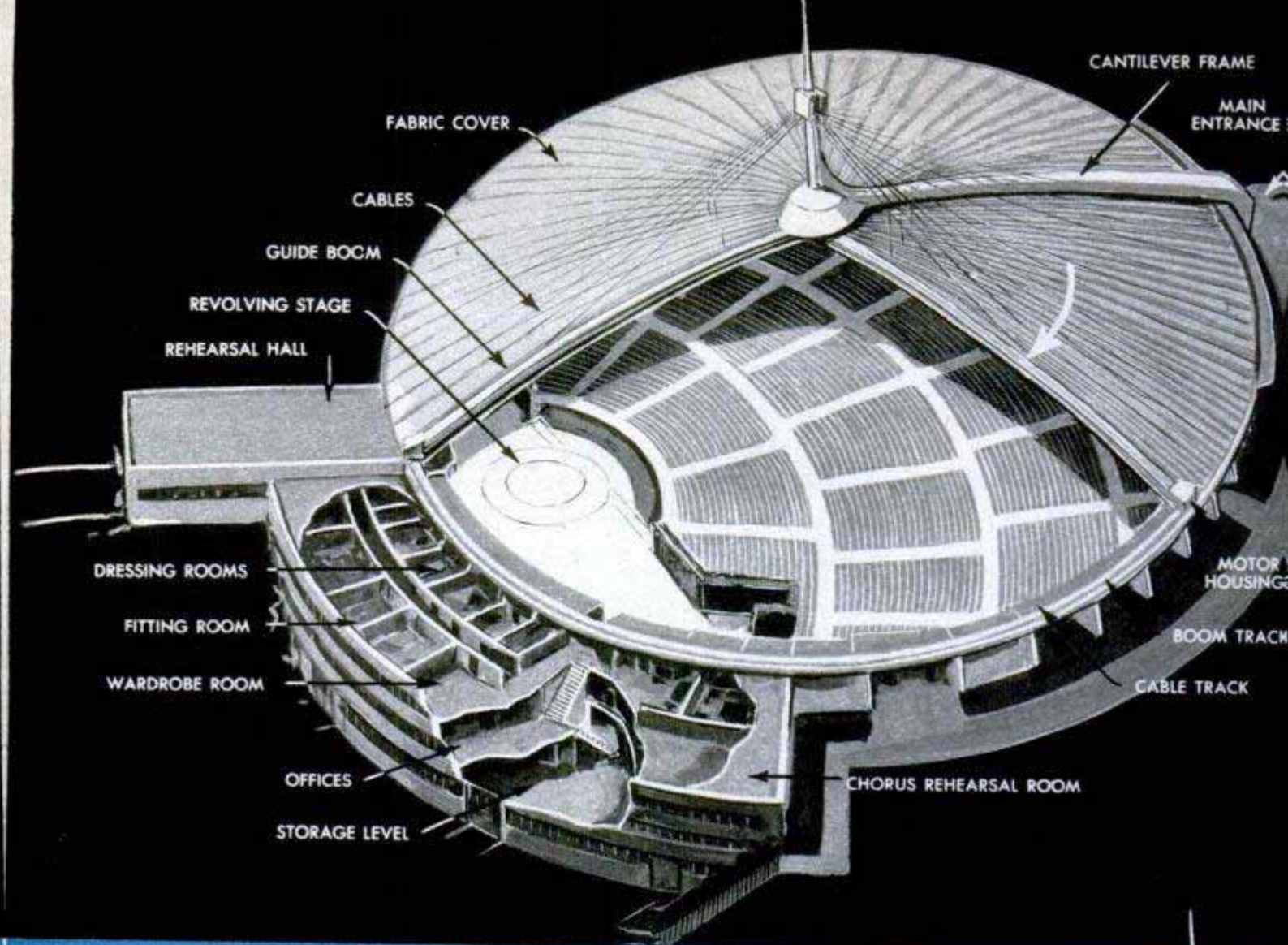

Behind the revolving stage are offices, dressing rooms and other facilities, shown here in cutaway

# UMBRELLA THEATER

Threatening skies won't worry patrons of Pittsburgh's proposed amphitheater. Like a modern convertible, it can put up its top at the first threat of rain

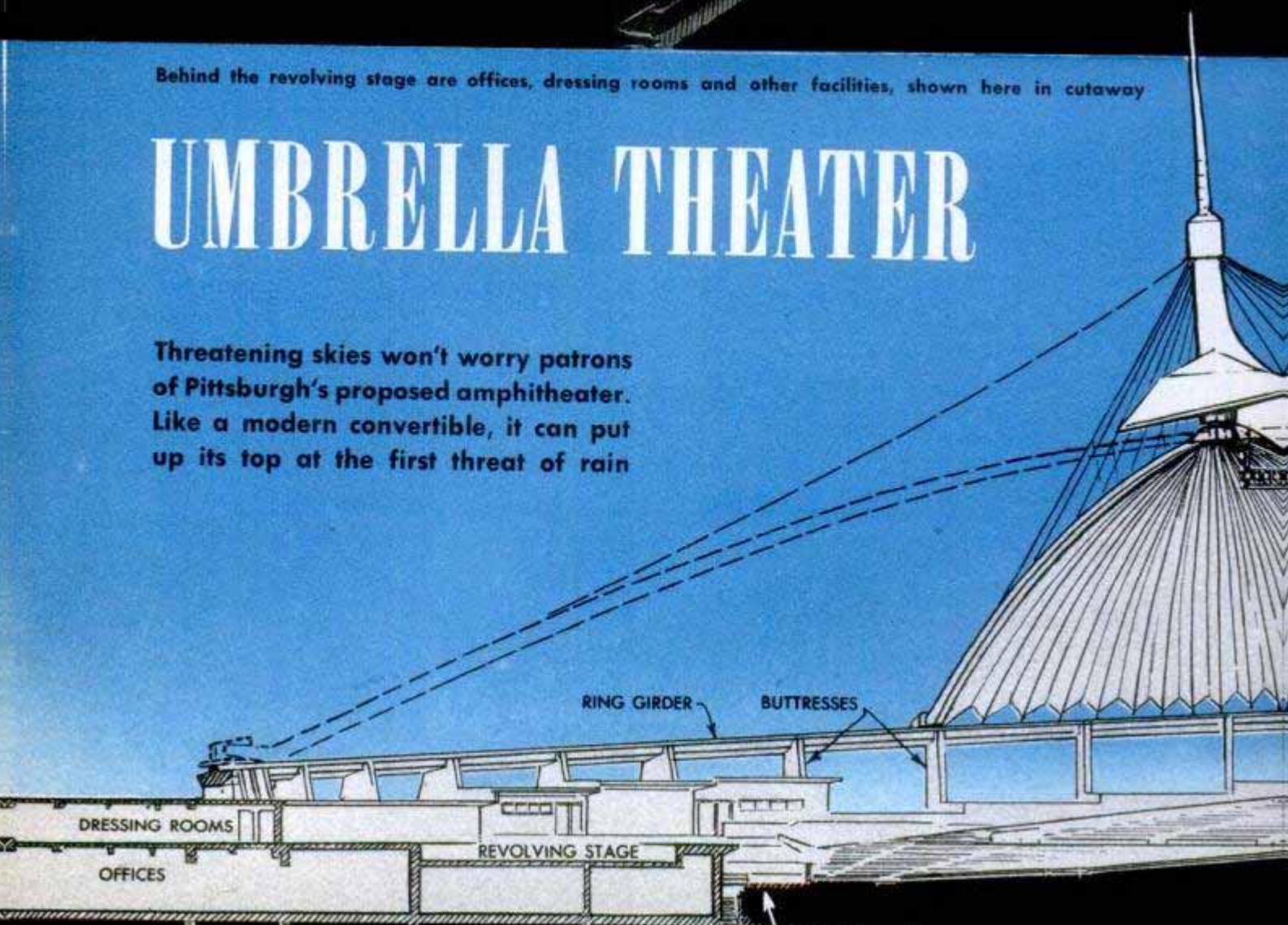

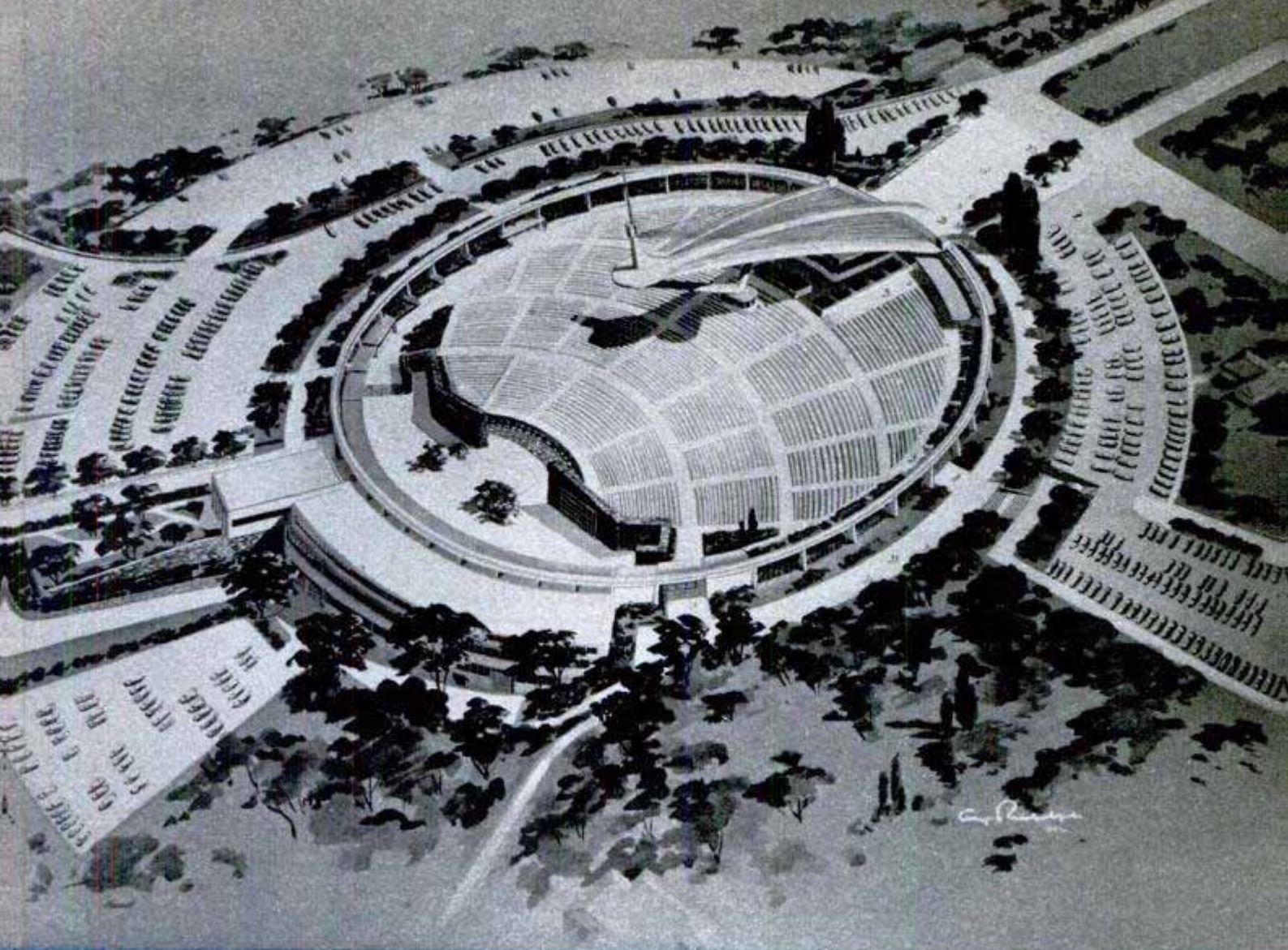

Above drawing from Mitchell & Ritchey, Pittsburgh

On clear nights, the fabric roof is furled neatly under the cantilever truss, providing starlit performances

**R**AIN and outdoor concerts just don't mix! Even dyed-in-the-wool fans admit that. So, when Pittsburgh decided to build an outdoor theater for its summer series of light opera, the architects borrowed a page from the car-manufacturers' book and designed a convertible theater. The circular theater, with a capacity of

9000, will be roofless on clear nights, providing the thrill of performances under the stars. But should a rain-laden cloud show up, the manager touches a button and two electric motors "walk" around the perimeter track, unfolding a giant fabric umbrella. In 2½ minutes, the audience and performers are snug under the big top.

Profile view shows shape of cantilever steel truss that supports the roof structure. From the center mast a network of cables keeps the fabric umbrella taut. Lighting and sound-control booth is suspended from short leg of the truss. The umbrella roof was invented by James A. Mitchell, Pittsburgh architect

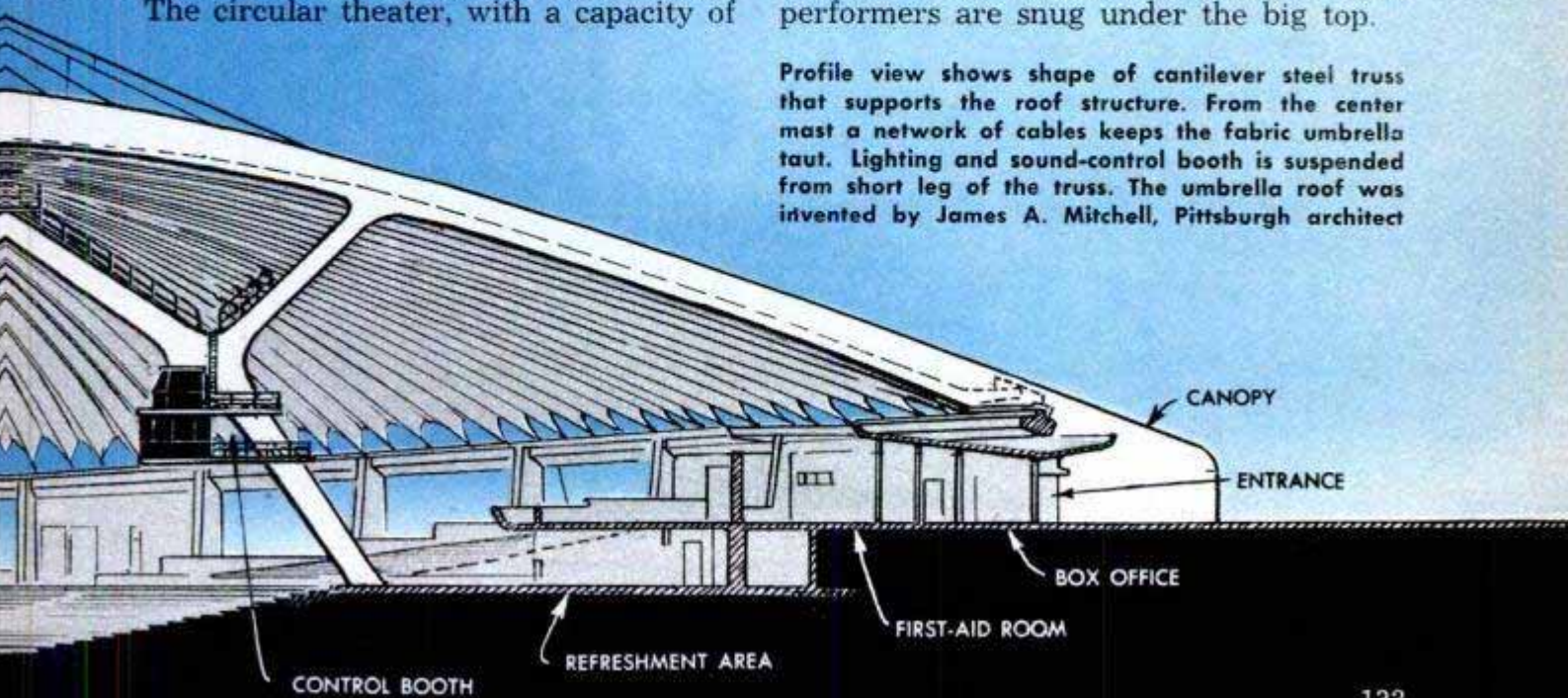

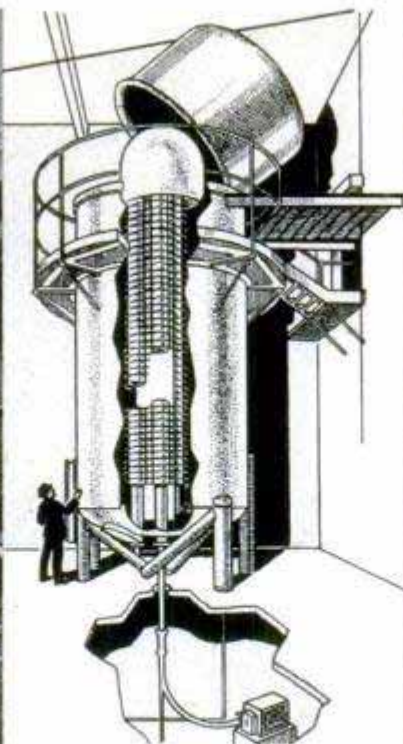

## Five-Million-Volt Generator

A five-million-volt electrostatic generator at the California Institute of Technology is being used for new and precise measurements of atomic forces. One of the most powerful in the world, the generator is contained inside a pressure chamber that stands two stories tall. It delivers its beam of accelerated particles to a working area

one floor below. The generator builds up its static charge similar to the way a person accumulates a charge while walking across a rug in dry weather. In the machine a comblike electrode spreads the energy onto an endless traveling belt that carries the energy to a dome inside the top of the pressure chamber. The energy then propels the particles under study through an evacuated tube to the working area.

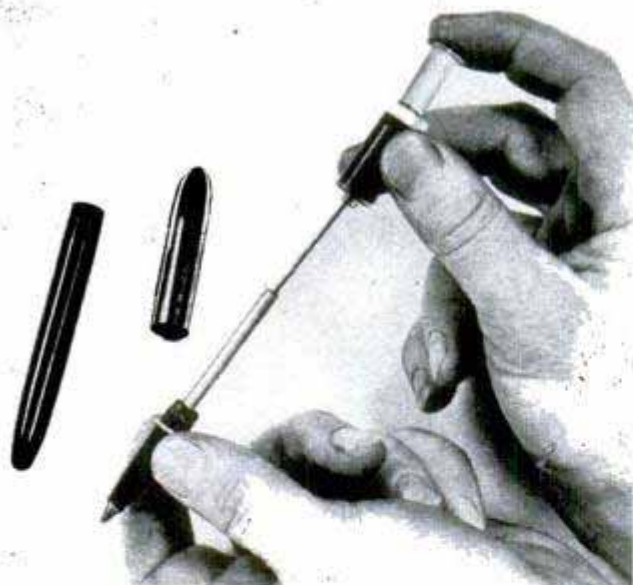

## Ball-Point Pen Refueling Kit

Ball-point pen owners can refill their pens with a kit that contains enough of the thick ink for six refills. The long applicator tube is inserted in the pen's ink cartridge. A plunger that is built into the ink container forces the ink down against the ball point. In this way, smooth, uninterrupted writing is made possible.

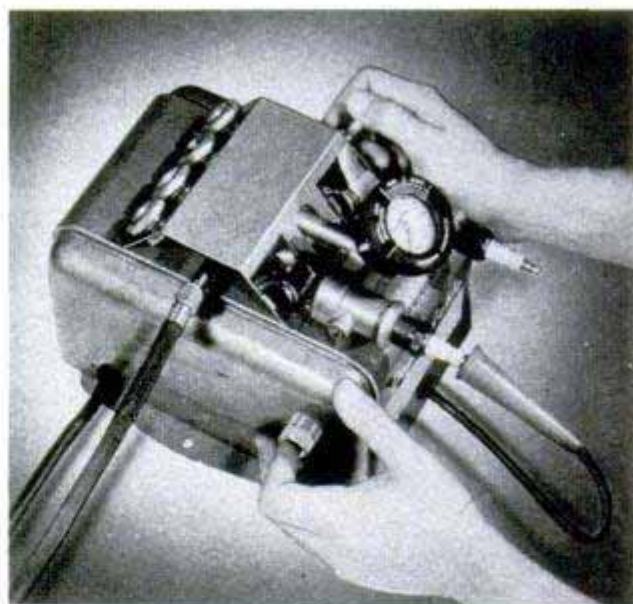

## Spark-Plug Tester

Automobile spark plugs can be checked quickly in a new button-operated tester. A dial shows the sparking efficiency of the plug being tested. A convenient air valve and the switch button give the operator finger-tip control over the tester. The instrument can be bolted to a bench or in a convenient position on the wall.



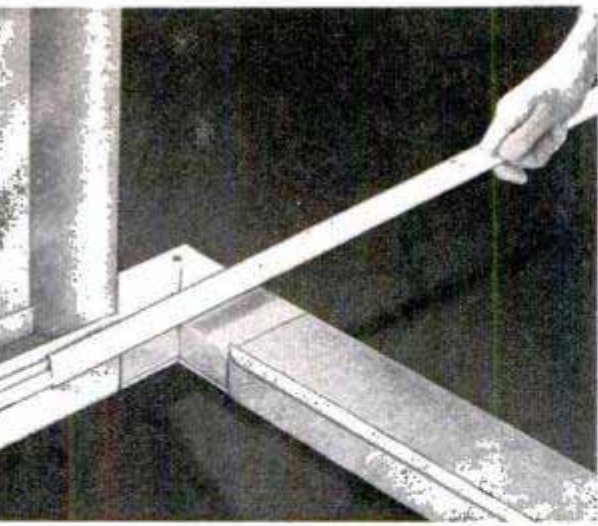

## THREE-HOUR PLAYHOUSE

JUST 180 minutes after you and a couple of friends start erecting the aluminum building shown below, you can have a complete summer cabin, back-yard playhouse or garage. The building, from its framing members to the Venetian-type window screens, is made of aluminum. The little house is 11 feet 8 inches wide and any length, starting with 13 feet 4 inches and adding units of  $2\frac{1}{2}$  feet. An overhead door is available if the building is to be used as a garage. The framing members are fastened to the foundation. Then the remaining parts are drive-cleated in place in the manner shown above. The accessory barbecue, upper right, grills steaks in a vertical position. It can be used to heat the house.



CREASEPROOFING, STABILIZING  
AND SPECIAL FINISHES FOR:  
DRESS GOODS • MEN'S WEAR  
NETTING • SHIRTS • LACE  
GLAZED CHINTZ

WATER AND SPOT  
REPELLENT FINISHES FOR:  
SPORTSWEAR • DRESS GOODS  
INFANTS' WEAR  
MEN'S WEAR

WOOL-SHRINKAGE  
CONTROL IN BLANKETS  
KNIT GOODS • SHIRTINGS  
DRESS GOODS

AIRCRAFT IGNITION  
TABLE TOPS • TABLEWARE  
LIGHTING REFLECTORS  
BUTTONS • PACKAGING

AIRPLANE PARTS • STOVES  
REFRIGERATORS • AUTOMOBILES  
HOSPITAL EQUIPMENT • WASHING  
MACHINES

MAPS • BAGS • TOWELS  
FROZEN-FOOD CONTAINERS  
BARREL LINERS • BLUEPRINTS  
WRAPPING PAPER • CARTONS

STORAGE BATTERIES • PHOTOGRAPHY  
ELECTRONICS • LABORATORIES  
CHEMICAL PROCESSES  
ENGINE COOLANTS

SHOES • GLOVES  
POCKETBOOKS • BELTS  
JACKETS • UPHOLSTERY  
LUGGAGE  
FURNITURE

TEXTILES

PLASTICS

ENAMELS

PAPER

MELAMINE  
RESINS

ION  
EXCHANGE

LEATHER

M  
E  
L  
A  
M  
I  
N  
E

CALCIUM CYANAMIDE

LIME

COKE

NITROGEN

**You may not know it—after all, you can't see it—  
but you can hardly live without . . .**

## ***This Invisible Plastic,***

**I**F YOU'VE KEPT gooey strawberries in a paper bag that didn't come apart, sliced an orange on a plastic table top without leaving a stain, or sponged ink from a pair of new overalls with plain water, then you've met a plastic that is one of the most interesting and versatile of our time.

Today you can hardly turn around without bumping into "melamine" in some form. It may be hidden in your white-leather shoes. It holds that strawberry bag together. It's hiding in diapers, mosquito netting, evening gowns and paint. Cloth treated with it won't wrinkle, and sheds water like a slate roof.

Melamine, combined with formaldehyde, is a synthetic resin belonging to the "thermoset" plastic family—which means that heat "sets" it, and once set it stays put. It is made of ordinary limestone, coke and nitrogen. Its odd characteristics are still being probed by chemists at American Cyanamid, where already it has provided a hatful of surprises. For instance, it would not

## **MELAMINE**

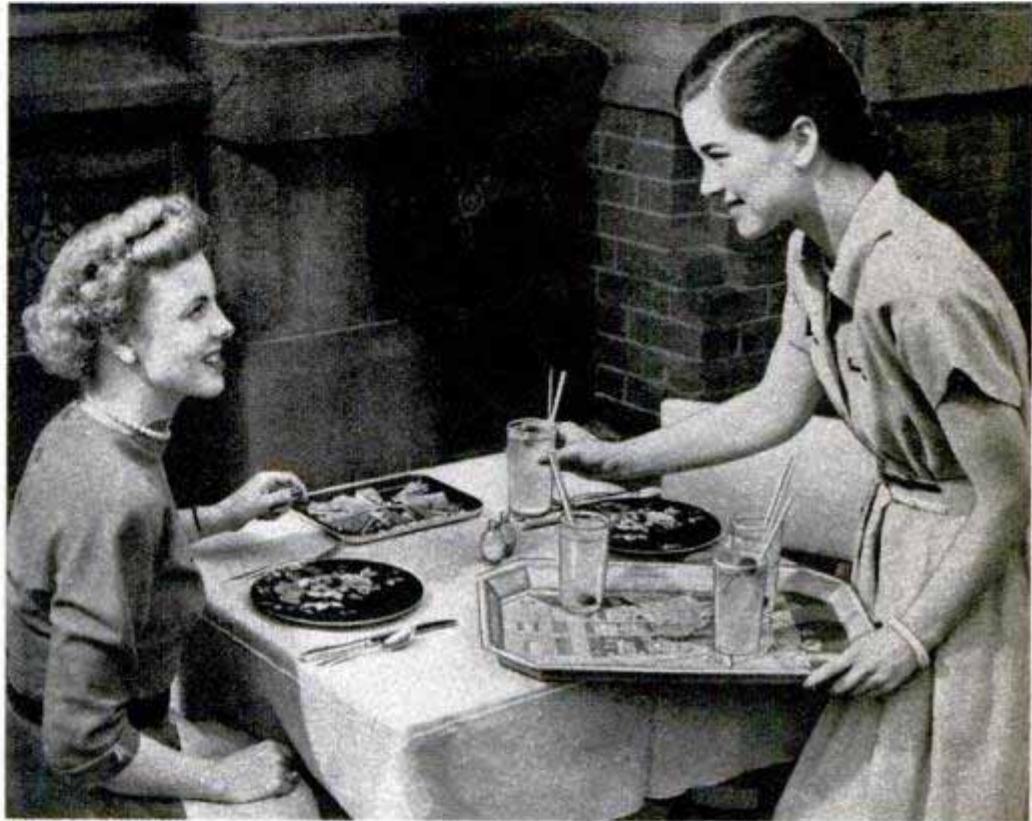

Dishes and trays made of the wonder plastic won't chip or scratch and their designs, buried in the material, won't rub off or discolor. Below, workers spray an auto body with resin-treated enamel. Melamine mix has speeded up drying by 50 percent, produces a harder finish



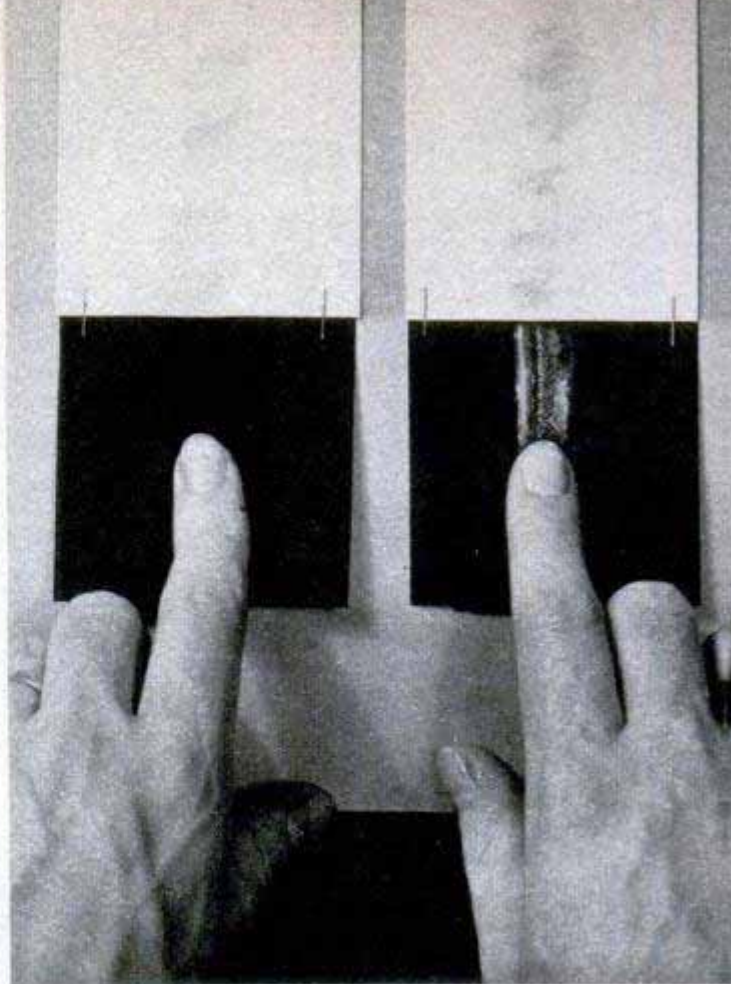

Ice cubes are packed in a paper bag treated with the plastic. Right, water is drawn across two samples of paper. It has no effect on melamine-treated paper at left, but breaks and curls fibers of ordinary paper

dissolve decently; was tough to melt. But, properly coaxed, it made a wonderful fast-drying, hard-surfaced enamel for metal. When a research chemist put it in house paint, however, the stuff peeled off.

**Oops!** No worries in cleaning this melamine-treated dress, though, for milk runs off water-repellent cloth



In spite of its orneriness, Cyanamid chemists are vastly enthusiastic about its magic. What it did to paper was almost unbelievable.

It all started after Pearl Harbor when the government grabbed all the burlap, leaving farmers without any cheap material to surround a bushel of spuds. "Try paper bags," Washington suggested.

In hundreds of laboratories chemists hunted for something to make paper wet-proof. Thousands of tricks were tried with other plastics. In Cyanamid's Connecticut labs, research chemists already had run some 2000 experiments with melamine. The stuff just wouldn't combine with the pulp fibers. Finally, one young chemist dropped a batch in hydrochloric acid. Next morning a blue haze hung in the acid. This blue haze was found to mean that melamine was charged with negative particles of electricity. Pulp, the chemist knew, had a positive charge.

Dry powdered melamine resin mixed with acid was poured in the pulp beaters of a New York paper company. What came out on the rollers is history. It looked and felt like ordinary paper. It soaked up water like ordinary paper. But sopping wet, it was as hard to tear as dry paper.

Still not convinced, the researchers ran tests. A hundred-pound "wet strength" paper sack was filled with flour and thrown

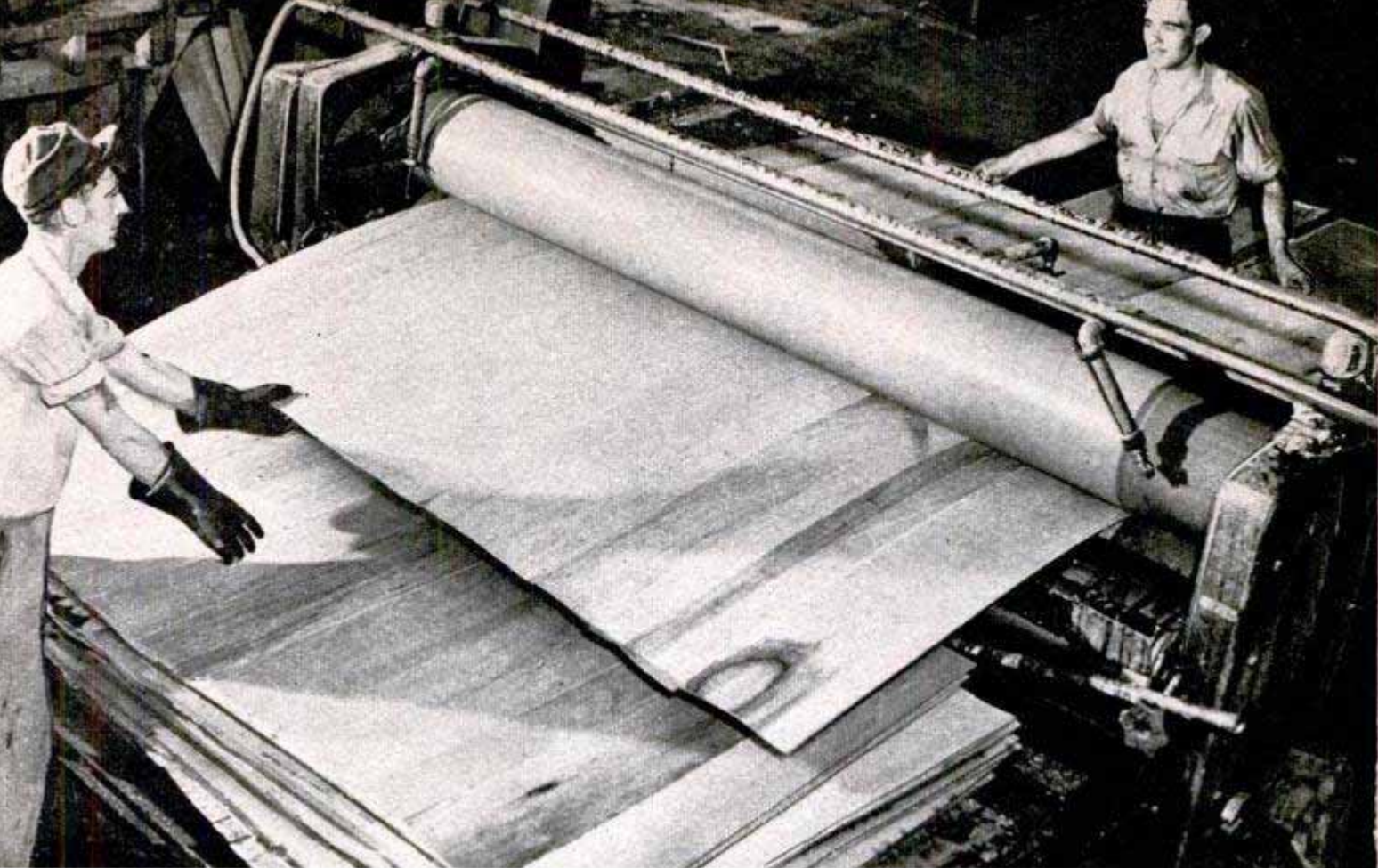

By seeping into the wood fibers, melamine makes an adhesive more rugged than any ever applied to veneers

over Niagara Falls. The pressure of falling water kept the sack churning for seven hours before it could be hauled in. The paper was soaked through but there wasn't a tear in it!

Sample war maps printed on melamine resin wet-strength paper were given to the

Army to test in the field. A young lieutenant put the thing on the floor near a barracks doorway, where hundreds of GIs tramped on it all day long. He had it washed in soapy water and wrung out. He let tanks roll over it, dipped it in gasoline. He slobbered some grease and paint over it,

Melamine plastic cups, virtually unbreakable, are removed from molds where they were formed under pressure

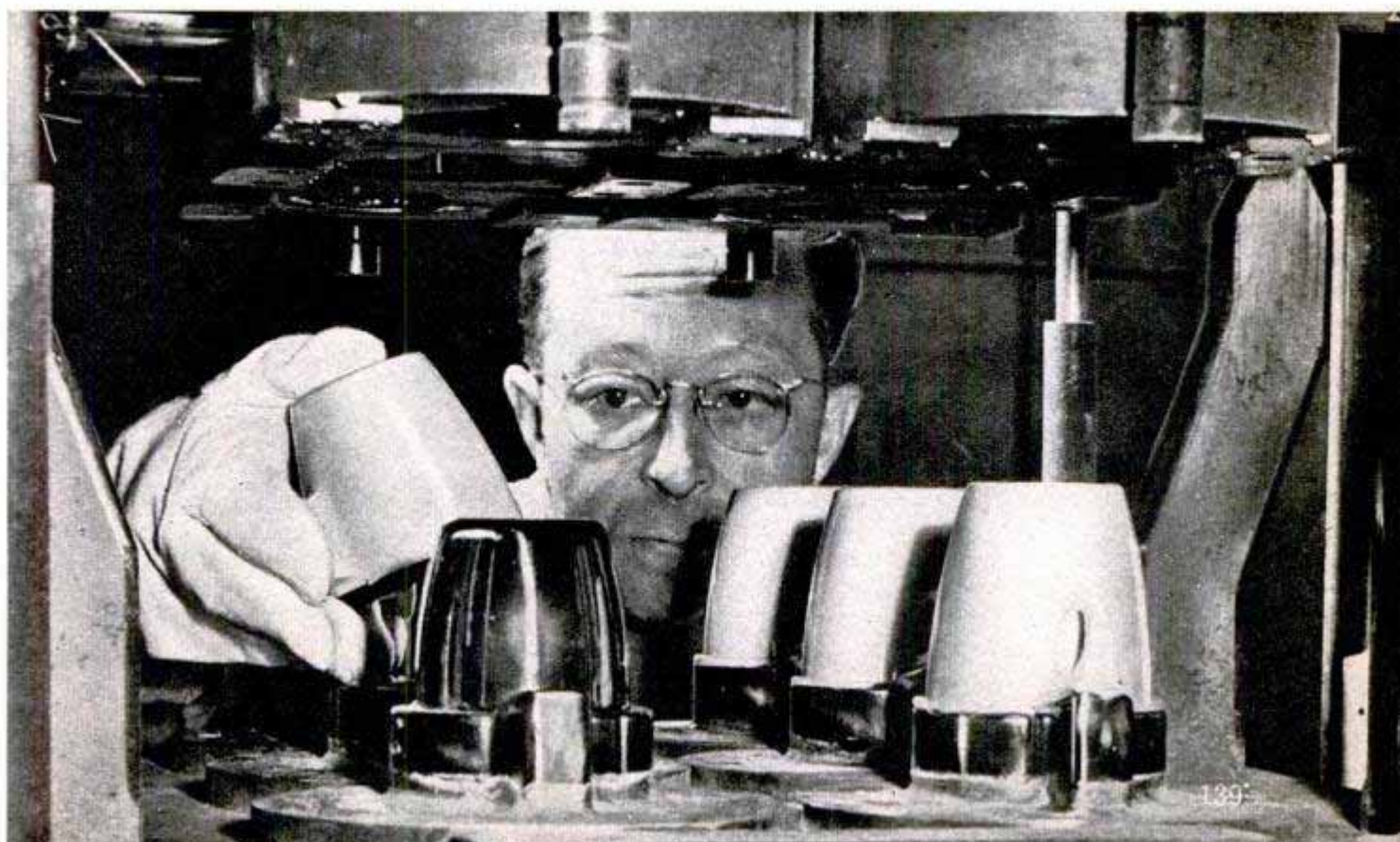

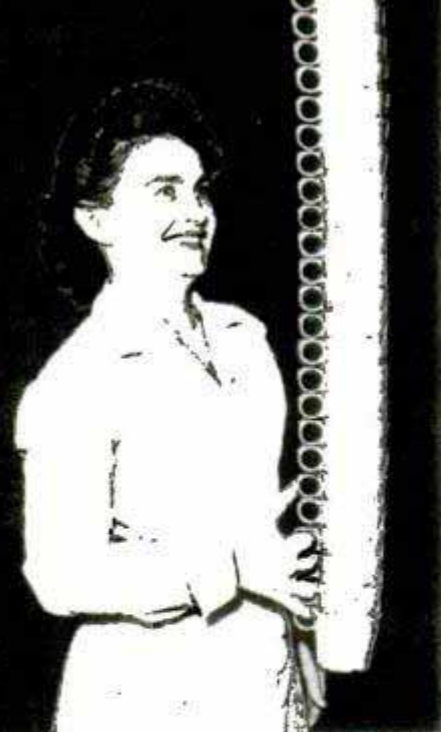

Cups made of the plastic are so light that a waitress can balance a stack that reaches high in air

Melamine-resin adhesives bind this modern furniture. A 300-pound man can safely tip back in the chairs

let it dry, and tried to take the paint off with paint remover. "It caused the map to dim out a little," he reported.

Today, melamine resin is used in soap-impregnated paper washcloths that don't disintegrate, outdoor advertising signs that won't peel in the rain and ice bags that stay in one piece wet or dry. You'll find it in paper towels that are just as absorbent but won't come apart while you are drying your hands.

Biggest trouble with melamine has been to make it do what it's supposed to do. The tiny, saltlike crystals were accidentally

produced 100 years ago by a German scientist named Justus von Liebig. The stuff wouldn't dissolve in anything, and it required great heat to melt them. The old man put his crystals on the shelf, and there they sat until 1937.

It was during the war that a Cyanamid research chemist decided these very same stubborn characteristics might fill a crying need for a tough new plastic that would be fire-resistant, heat-resistant, water-resistant and acid-resistant—if only he could produce the crystals cheaply.

(Continued to page 242)

Each of these curtains was washed five times. Melamine-treated panel kept its color, shape and size

Summer hat treated with the new resin formula sheds water like an umbrella, and the fibers won't fade

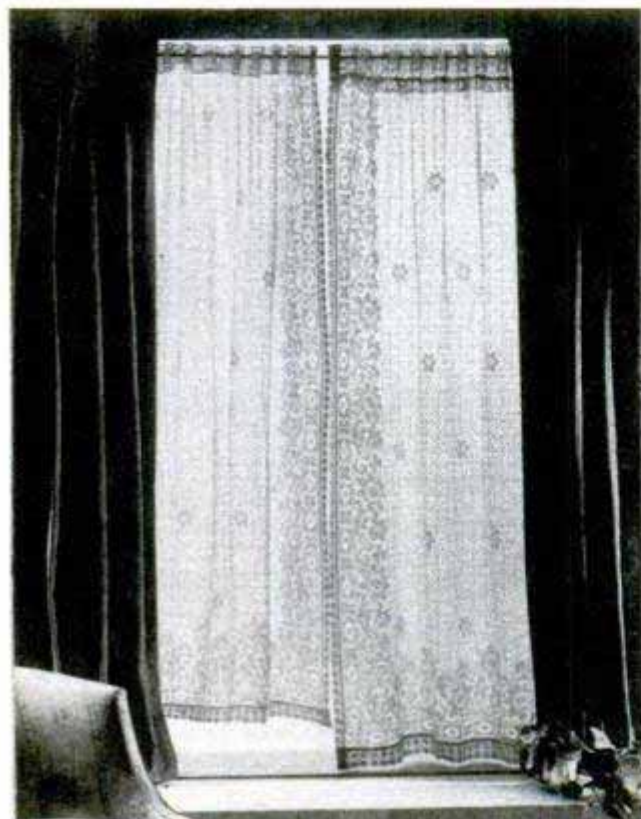

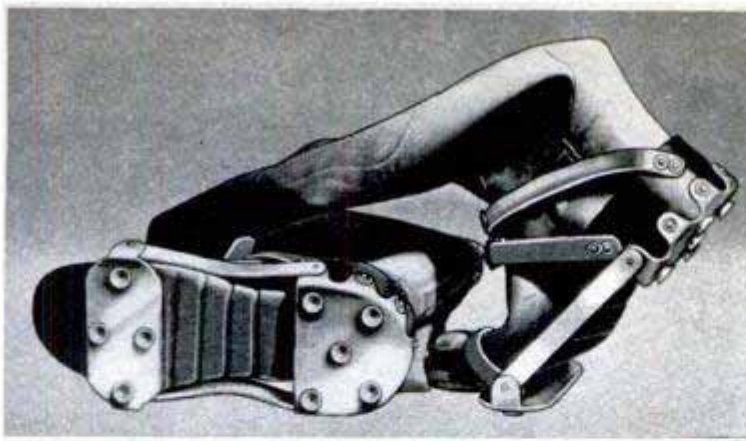

Steel cups shown on each pair of "grips" give the fisherman at right a foothold on slippery surfaces

## Waders With Teeth

Fishermen can be sure-footed in moss, slime and slippery underwater growth, if they wear "grips" which attach to waders and boots. Steel heel and toe plates are pivoted to allow natural foot action and full bearing on broken surfaces. Eighteen steel cutting cups on the bottom of each pair of boots cut through slippery substances to give a solid grip.



## Instrument Records Flight Time of Homing Pigeon

How much time does a homing pigeon spend in flight, and how long does he rest? Dr. D. H. Wilkinson of Cambridge University has developed an ingenious little instrument employing radioactivity to answer these questions. When the bird pumps his wings in flight, a stream of alpha particles strikes a photographic plate. When the

bird is at rest, a steel ball falls into place, sealing off the plate from the radioactivity. Doctor Wilkinson examines the exposed film under a microscope, counting the number of tracks to learn the bird's flight time. He also is working on a built-in compass to record direction and an absorption instrument to indicate time spent on water.

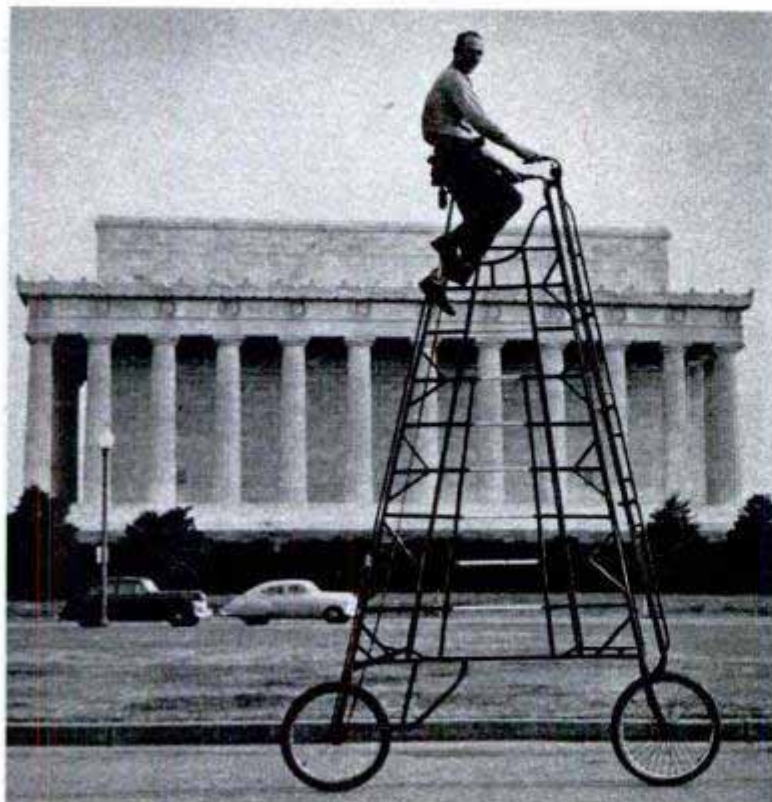

## Bicycle on Stilts

When bus driver Albert R. Smith takes time off from his job, he again rolls along the streets of Washington, D.C.—but on a bicycle 12 feet 4 inches high. Smith's hobby is bicycling. The "hi-cycle" is chain-driven from a sprocket just below the seat. Smith's vantage point gives him a view over the cars on the streets—and the busses, too.

☐ Although often called "white ants" because of their resemblance to those insects, termites are not even related to the ant family—their most devastating enemy.

Information not listed on articles in the index frequently is given in the WHERE-TO-FIND-IT INDEX, available without charge from Bureau of Information, 200 E. Ontario Street, Chicago 11



With a rawhide hammer that leaves no marks, artist Chepourkoff creates two opponents for some bullfighter

# CARICATURES IN METAL

By Lee S. Edson

**F**ROM A HOBBY of making toy animals out of old tin cans, Michael Chepourkoff of San Francisco has developed a unique specialty. He creates humorous and lifelike metal replicas of any zoo inhabitant. His masterpieces are carved from single sheets of metal with the aid of hand tools.

Chepourkoff calls himself an improviser in metal. Although he works from a carefully prepared pattern, he adds to the design as he goes along, utilizing every curl of the cut metal to develop the different parts of his subject. He never uses rivets, solder or welds.

The Russian-born artist-craftsman, who holds an art degree from the University of California, tried his hand at almost every kind of art, from oil painting to ornamental sculpture, before he decided on metal. Today, Chepourkoff turns out animal figures ranging from two-inch bulldogs to two-foot pelicans. Every creature, he points out, is a distinct individual and the secret to a successful reproduction lies in developing a design that captures the animal's personality in the least number of lines. It took him 3½ years and 15 different crea-

tions to design a perfect tiger, but Chepourkoff thinks it was worth it. And he still haunts the zoo to study an animal's movements and attitudes before he attempts a new design.

In starting a job Chepourkoff sketches his subject in pencil on a sheet of paper. Then he cuts out the pattern and shapes it with cellulose tape. After selecting a sheet of metal of the appropriate size he transfers the pattern to it with pen and ink.

The cutting work is done in two stages. First he uses a pair of bulldog snips to block out the general outline of the pattern. This is followed by intricate cutting of the contours, for which he employs two pairs of aviation snips, one pair for the left hand and the other for the right. The snips curl the metal as they cut, leaving sweeps that can be improvised into eyes and ears. Making eyes is difficult—and important for good characterization. Some are round, others diamond-shaped, and some are merely bits of metal.

The artist can offer no rule to follow, except trial and error and a feeling for what is appropriate.





Artist applies finishing touches to heavy-jowled pelican made from a single plate of 12-gauge aluminum. Stainless-steel rooster perched on work stool was carved from single sheet of metal, using only hand tools

Below, left, "metal improviser" Chepourkoff smooths out rough spot on an animal in his metal menagerie, while at right, a bearded billy goat surveys a placid elephant from a lofty perch on the wall of the shop

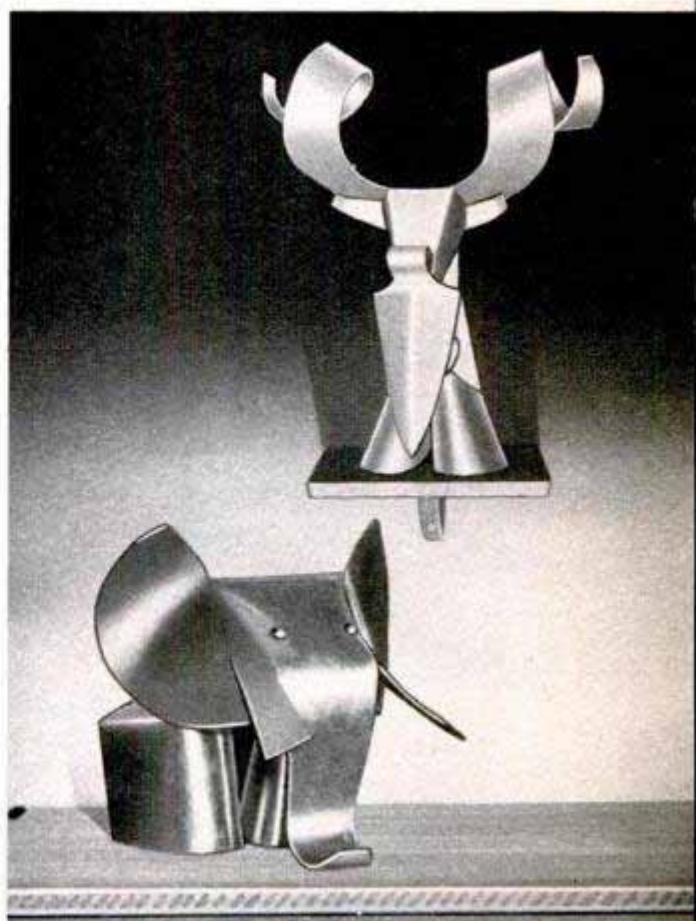

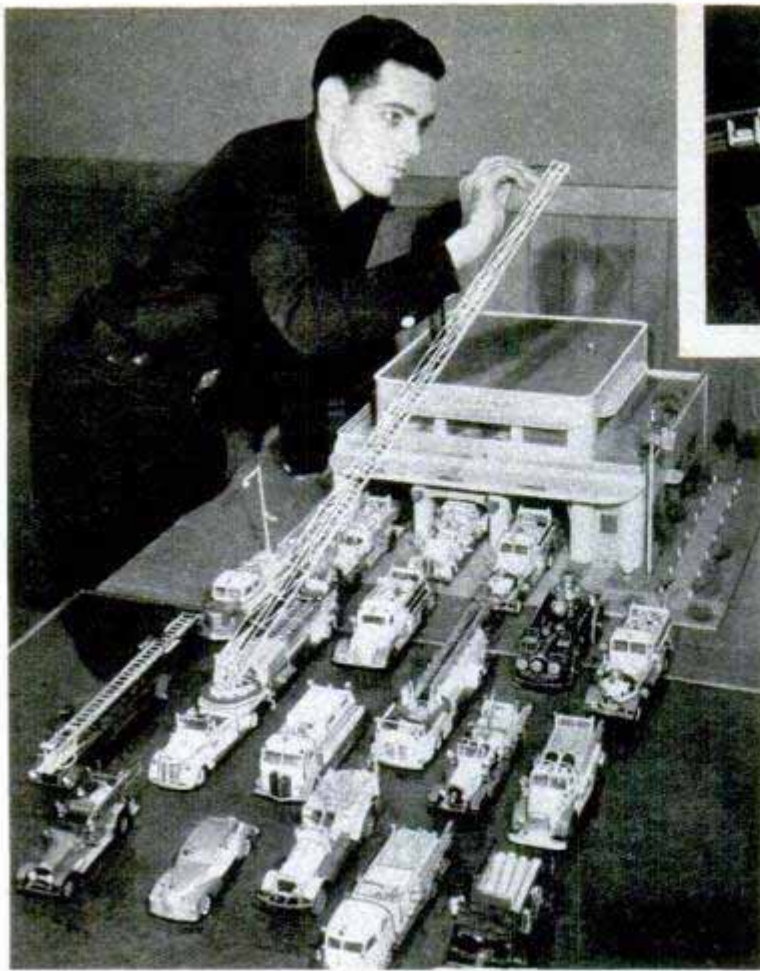

### Lilliputian Fire Department

Ready to move at the first clang of the alarm is a miniature fire department which includes 25 vehicles. The model fire trucks were carved by Tom Showers of the Los Angeles County Fire Department. Showers whittled the apparatus from balsa wood and built a scale-model fire station to house part of the equipment. The vehicles depict various stages of American fire-fighting history from a model of an old horse-drawn hose wagon to a modern pumper. A model 100-foot aerial ladder extends high into the air above the rest of the equipment.

### Projector Throws Image on Artist's Drawing Board

Photographs, art work, physical objects and color transparencies can be projected onto a drawing board in sharp detail by means of a new projector. Capable of enlarging or reducing copy from the size of a postage stamp or smaller, to a double-

page newspaper spread, the image projector eliminates intermediate tracings, and makes possible finished art work directly from the image as it appears on the artist's drawing board. Operating controls are located under the drawing board or table.

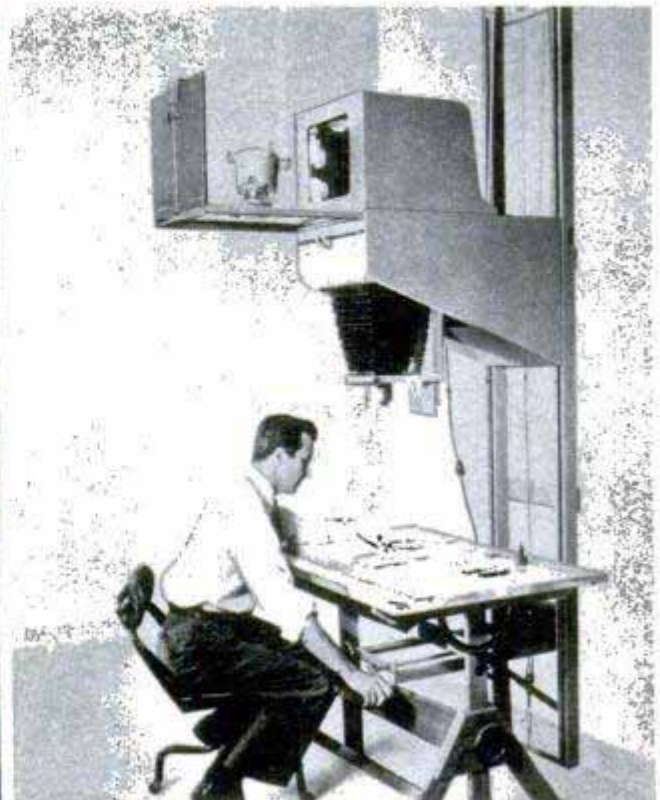
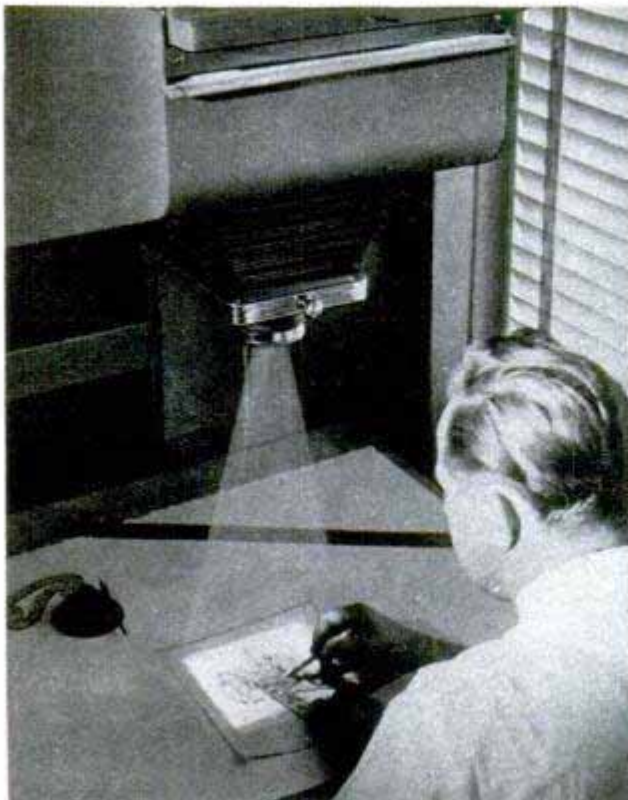

# "MIGHTY MOUSE" —a baby 'dozer

CAPABLE of a smaller-scale version of the same tasks its giant counterparts perform is a midget bulldozer, called the "Mighty Mouse." It will do grading, excavating, backfilling, snow removal and similar work, with the added advantage of being able to operate in close quarters. It can push or pull with power equal to its weight—800 pounds—and carry loads as heavy as 500 pounds. A combination scoop and 'dozer blade, 36 inches wide and 14 inches deep, operates hydraulically and is dumped by means of a finger-tip trigger at the driver's left hand. Each track has a separate drive-and-brake lever and the vehicle turns on either one within an eight-foot circle. An air-cooled, five-horsepower gasoline engine provides forward and reverse speeds up to six miles an hour. When it has to be moved sizable distances, the bulldozer can be driven up detachable ramps into a "tote wagon" trailer, which can also be hooked onto the bulldozer as a load carrier. A built-in jack braces the wagon for loading and a floor canvas simplifies unloading.

Top, right, scooping out narrow trenches is one of the specialties of the "Mighty Mouse." It is only 38 inches wide. Middle, right, a large tread area and a low center of gravity afford good traction over snow, sand and soft ground. Right, the baby 'dozer can exert 800 pounds of thrust in grading work. Below, the entire unit can be driven onto "tote wagon" for long hauls

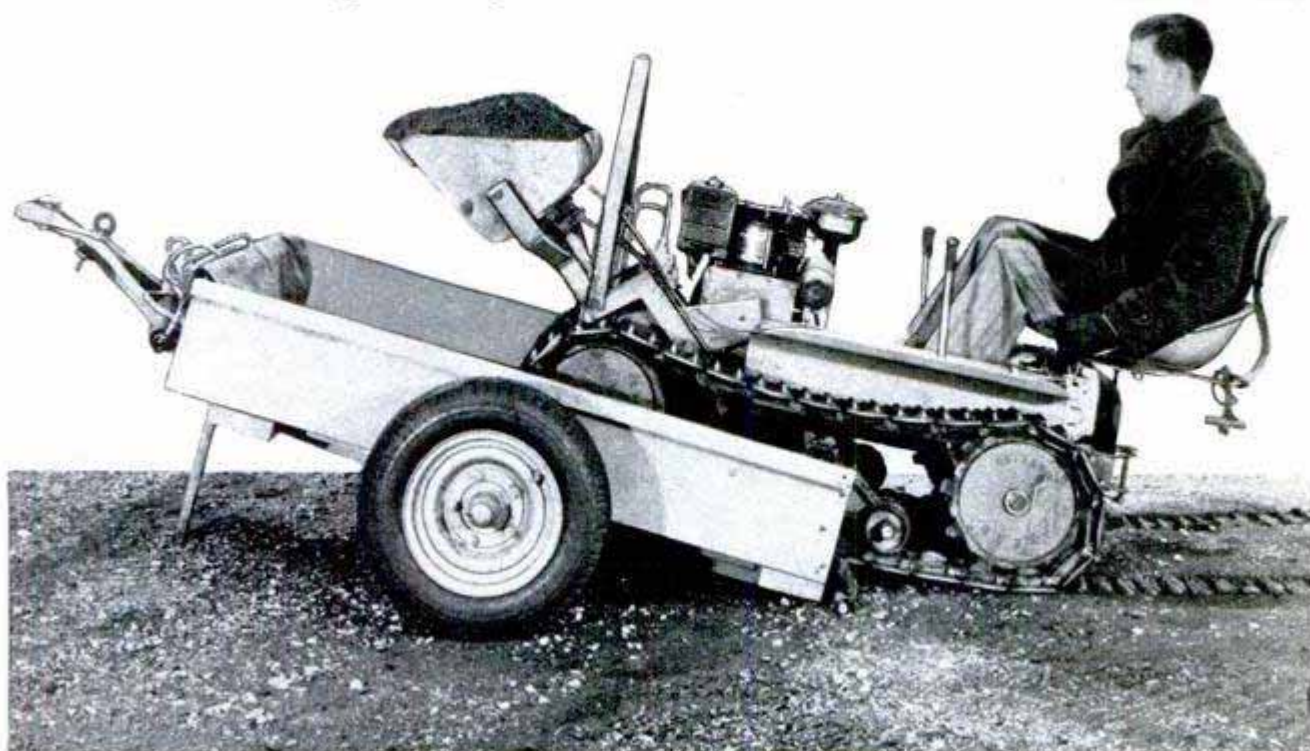



Above, used oil arrives at re-refinery for cleaning. Right, taffylike sludge removed by first stage of re-refining



Below, the acid tank at the Worthington plant. Oil is mixed with acid to settle out sludge shown above



# NINE LIVES

By Harland Manchester

**I**N THE SPRING of 1930 a lanky, irrepressible Hoosier named Walter Ray descended on Long Island City, N. Y., rented a factory site and hooked up an arrangement of tanks, pipes and valves that looked like a plumber's nightmare. An oil-company man next door dropped in and asked him what he was up to.

"I'm going to raise goldfish," he told him. Next, he bought a fleet of tank trucks and gave each driver a list of filling stations in the metropolitan area. At the stations, they pumped out the crankcase drainings from the concrete pits where these automotive leavings accumulate. The dirty oil was then considered refuse and station men were glad to have it hauled away.

In the "oil laundry" which he had built, Ray filtered, chemically scoured and re-refined the black gunk, producing a lubricating oil which he was willing to stack against any virgin oil on the market. But old oil which had been reconditioned for further use had a black eye and at first Ray



# FOR OIL

That dirty old oil comes out of the filter press clean and sparkling, as good as new

Below, fuller's earth is added to the dirty oil to absorb carbon so it can be completely filtered out

had to show customers that his product wouldn't ruin their engines. Railroads, truck fleets and automobile sales agencies tried Ray's oil and were convinced. They all said it was as good as new oil; some said it was better. More orders came in. Ray enlarged his plant, bought more trucks and soon he was shipping sump oil by highway, rail and water from filling stations all the way from Massachusetts to New Jersey.

This was not Walter Ray's first venture in the field. Like many other oil and motor men, he had known for a long time that used lube oil, when properly reconditioned, was as good or better than new and that a lot of money could be made in salvaging it. He entered the business in Chicago in 1914 and later ran a successful plant in Toledo. When he entered the rich New York field with plenty of technical and business experience behind him, he really hit the jackpot. Today, he is one of the country's biggest re-refiners, selling about 4,500,000 gallons a year.

His success inspired others. His brother, John, who started out with him, went to

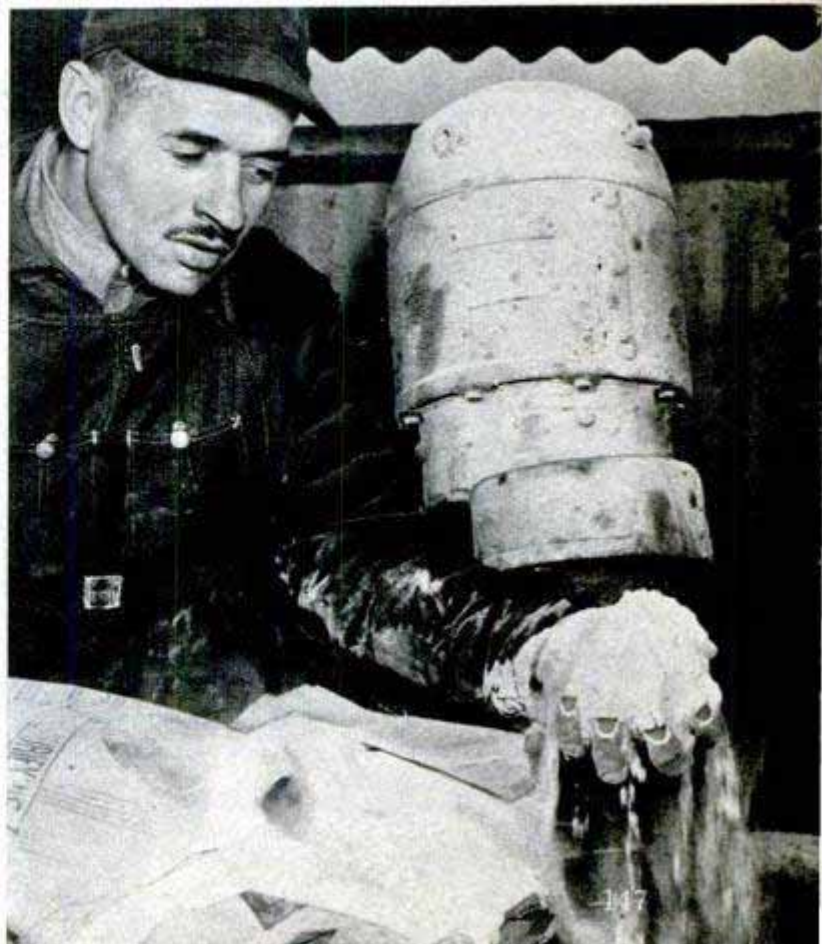



OIL DRAINED FROM YOUR CAR AT FILLING STATION IS . . .

1 DELIVERED BY TRUCKS TO HUGE STORAGE TANKS AT RE-REFINERY

2

IN AGITATOR TANKS, SOLIDS ARE SETTLED OUT BY CHEMICAL ACTION

3

THEN, VOLATILE MATERIALS, SUCH AS GASOLINE, ARE DISTILLED OFF

## RE-REFINING STEPS

Boston and set up his own re-refinery. A former employee set up shop in New Jersey. Since the war, lube-oil re-refining has mushroomed and today about 150 companies throughout the country, as well as 3000-odd transportation firms and manufacturers who do their own re-refining, are coining more millions out of petroleum's long-neglected "garbage cans." Last year an estimated 42,000,000 gallons of lubricating oil was produced from this source even though only a small fraction of the "raw material" was utilized. Every year about 500,000,000 gallons of sump oil are spread on dirt roads to lay the dust, hauled away to dumps, burned as low-cost fuel or poured down the drain. By correct re-refining methods, most oil can be brought back to original specifications or better.

Workman adjusts the fire in a huge still, used to distill diluents, such as gasoline, from the lube



Despite the old notion, still current among many motorists and even garage men, that oil "breaks down" or "wears out" in the engine and is unfit for further use, its permanent lubricating value has been well known to engineers and maintenance men since the first World War. When the famous Liberty airplane motor entered service in 1918, it required a lube oil of very high quality. The pilots, who were exacting about what went into their motors, soon found that a certain re-refined oil with a distinctive odor gave best results. This "burned" odor became so much a hallmark of excellence that several field commanders added it to other oils in order to persuade the fliers to use it. The pilots didn't know it then, but they were demanding oil that had already gone through their engines. The burned odor, later eliminated, came from the reclaiming process then used by the Air Service. As a result of tests of the reclaimed oil made at 24 airfields, 12 commanding officers reported that their engineers and fliers could detect no difference between new and reclaimed oil, while the other 12 preferred the latter. Their tests showed lower oil consumption, cooler and cleaner engines and fewer breakdowns with reclaimed oil, even though some of it was "scrubbed" and re-used as many as a dozen times.

This aviation oil was very superior, uniform stuff to begin with and airplanes don't inhale the dust that automobiles do. Later tests, however, showed that you can take any mixture of dirty sump oil and by careful processing turn it into high-grade lubricating oil. The late William F. Parish, chairman of the Lubricating Engineering Committee of the American Society of Mechanical Engineers, who was a pioneer in the use of reclaimed oil in aviation, tested it also in Delco units, diesel engines and automobiles and reported that it gave better service than new oil.

In Washington, used crankcase oil was being thrown into the Potomac, fouling up

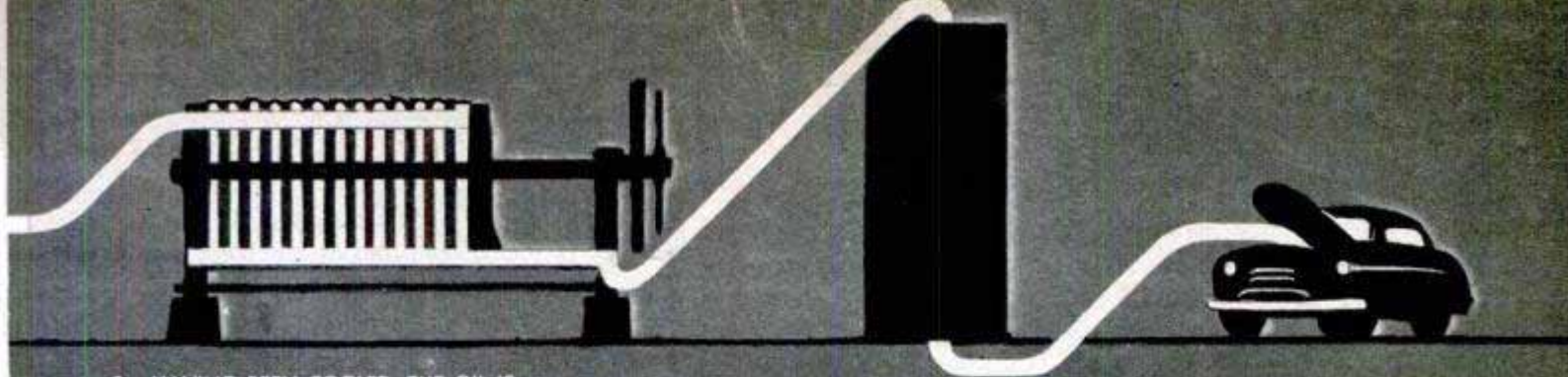

**4** HAVING BEEN COOLED, THE OIL IS FORCED THROUGH A FILTER PRESS TO REMOVE THE CARBON PARTICLES

**5** SCIENTIFICALLY BLENDED TO MEET SPECIFICATIONS, THE CLEAN OIL THEN GOES INTO TANKS . . .

READY TO GO BACK TO WORK IN THE ENGINE OF YOUR CAR

**Right, drawing of filter press shows how the oil is forced through filter paper to remove carbon**

boats and creating a fire menace. Winslow H. Hershel, Bureau of Standards physicist, investigated and stated what has since become a truism—that oil does not wear out, but only gets dirty and he showed how it could be restored to its original quality or better.

Since then many petroleum engineers, chemists and maintenance men have praised re-refined oil, both as a result of laboratory tests and actual operation of cars, busses and planes. Their explanation is simple: The first use in the motor breaks down some of the weaker hydrocarbon molecules and when the oil gets a second refining, those impurities are removed along with gasoline,

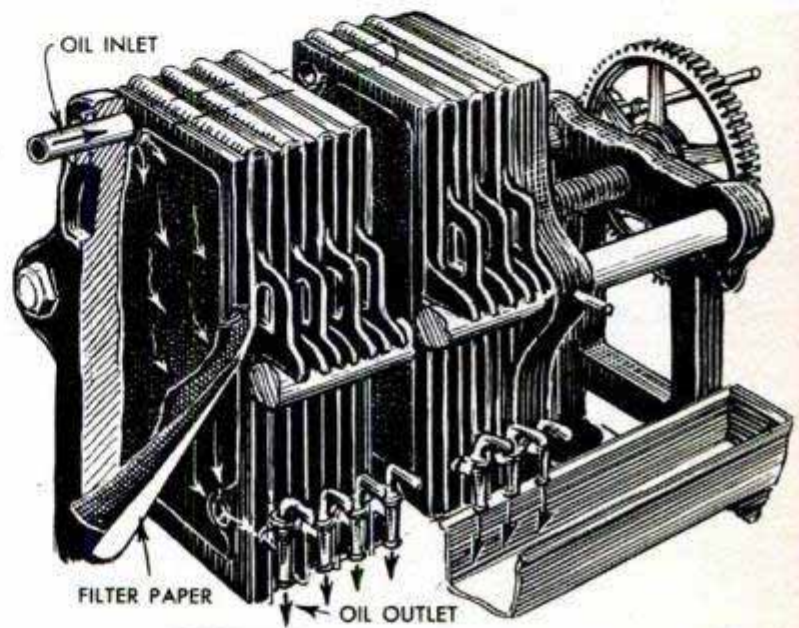

**Fuller's earth, loaded with carbon, is filtered from oil by the filter press, being cleaned here**

**Below, close-up of a chunk of the carbon-loaded fuller's earth that is left behind as oil passes through filters**

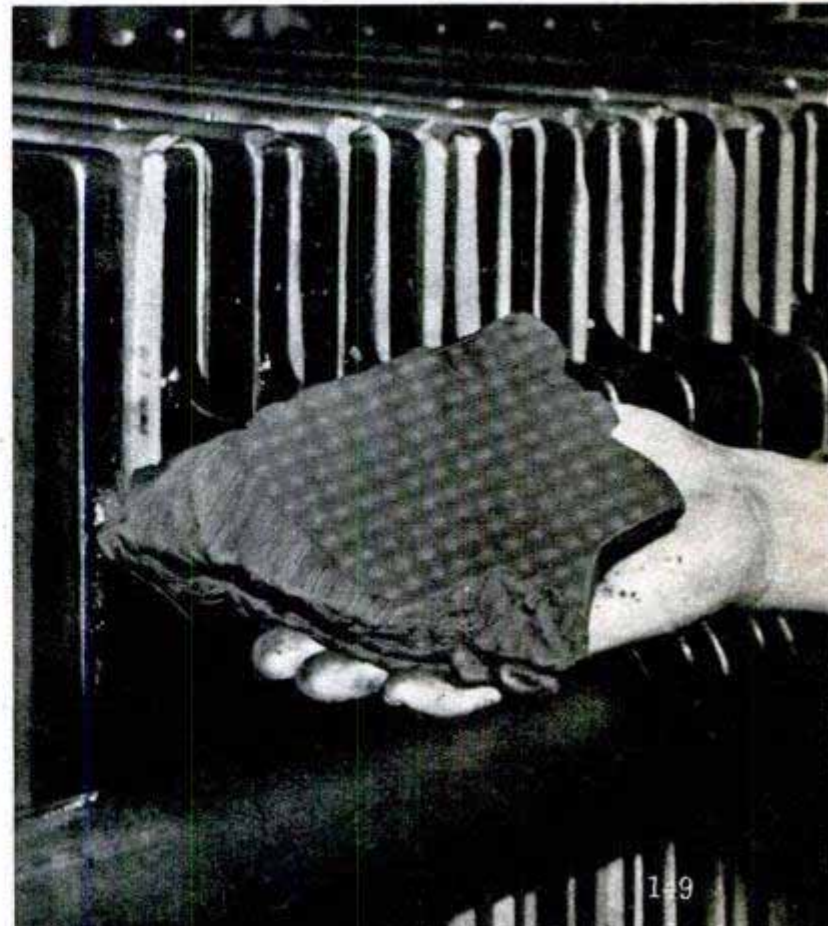



Oil is constantly checked during re-refining process to make sure it meets specifications. Here, viscosity is being measured

Below, experts say oil should be drained only when engine is hot. For best results, use crankcase pump, such as shown here



carbon, dust, water and other accumulations, yielding a more stable lubricant.

The better the quality of the original oil, the better the re-refined product. It cannot be said that all reprocessed oil, no matter how carefully treated, is equal to the best virgin oil. Walter Ray states that the average oil turned out by competent re-refiners is superior to about 80 percent of the virgin oil on the market.

One look at the black mess drawn from filling stations is enough to explain the popular belief that nothing good can come out of it. It contains carbon, dirt, sludge, acids and sometimes differential grease, solvents and occasionally even old nuts and bolts. Even so, it is cleaner than the petroleum from which virgin lube oil is made. There are many ways of partially cleaning it to produce a usable lube oil of sorts. Irresponsible operators once did a quick job of filtering and sold an inferior product which caused considerable engine trouble. Laws were passed in five states requiring that "reclaimed oil" be so labeled and motorists were justly suspicious of it.

Correct re-refining, which brings the oil back to its original specifications, involves many steps. It is filtered to remove solid particles, treated with alkalis to neutralize acids, washed with water, distilled at temperatures of 400 to 600 degrees Fahrenheit to remove diluents such as gasoline, treated to restore the original color and blended to the desired thickness or viscosity. A re-refining plant is actually a small refinery, repeating many of the steps performed in the production of the virgin oil, even adding the special chemicals which were put in the original oil to prevent fouling, corrosion and thickening in cold weather.

American Airlines has been re-refining its lube oil for 19 years and, during the war, set up its own re-refinery at La Guardia Field, cleansing for further use as much as 84,000 gallons a year. They use the laundered oil exactly as they do new oil and estimate that about 30 percent of the oil in their planes flying in and out of New York comes from their re-refinery.

(Continued to page 252)



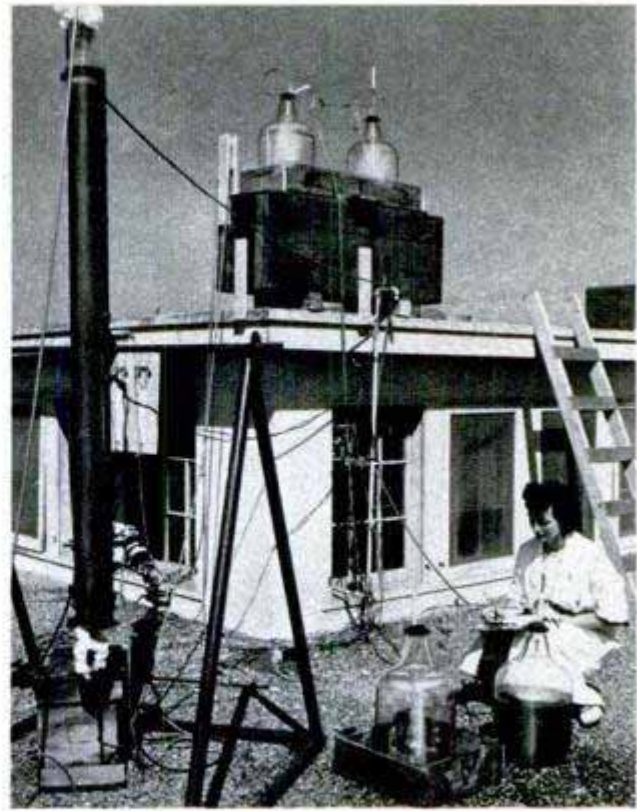
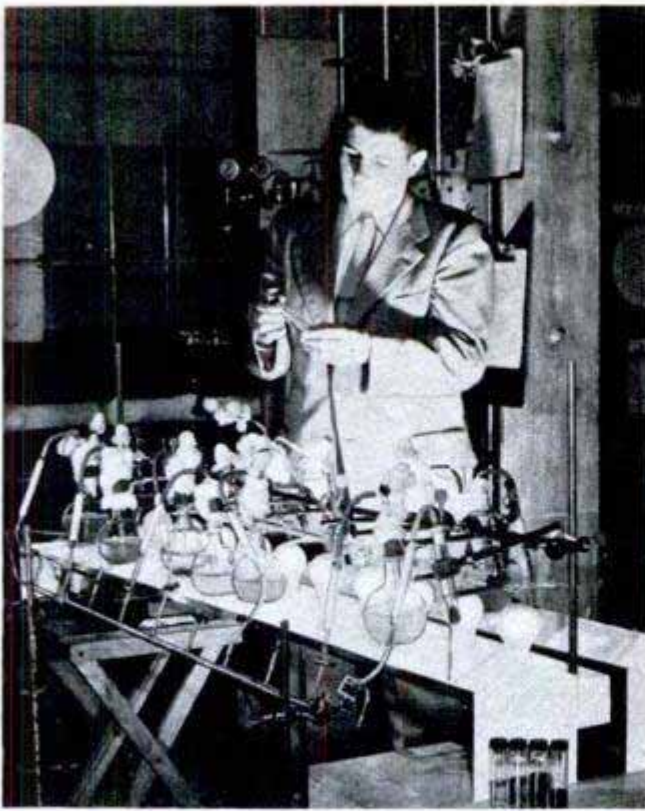

Left, chemist checks alga sample in flask. Right, apparatus for testing effect of sunlight on *Chlorella*

## Protein "Factory"

Scientists are eagerly trying to make more efficient use of the sun's energy. Agriculture is notoriously inefficient since only  $\frac{1}{10}$  of one percent of the sun's energy is converted into organic matter by photosynthesis. At the Stanford Research Institute, scientists are making progress in the search for ways to get more food from sunlight. Although still in the prepilot-plant stage, a complex protein "factory" has been developed that converts more than two

percent of the solar radiation into organic matter, an improvement of 20 times over the agricultural average. By growing *Chlorella*, a common, single-celled alga, in a continuous system, the scientists are opening the way to mass production of organisms with a protein content of more than 50 percent. With a vast array of glass tubing, jars and light bulbs, these researchers may be providing the valuable know-how that will, in years to come, banish the threat of starvation for millions of the world's population.



## Automatic Diabetes Test

Completely automatic, a machine for making clinical tests for diabetes is 10 times faster than medical technicians. Making up to 120 tests an hour, the machine quickly determines the presence of diabetes while the patient waits. A blood sample is placed in a tube and the tube is set in a hole on a disk. As the disk moves automatically, reagents needed to make the test drop into the tube at the proper intervals. When the tube completes its cycle, it is automatically removed into a storage rack—ready for reading by the technician or doctor.

☞ Crickets and other noisy insects become silent when the temperature drops below 40 degrees.



Left, a dropped egg, photographed by pressure plate at the instant of impact. Right, another egg, a split second after impact. Split-second delays are set up by decreasing the weight resting on the microswitch

## how to make "QUICK FREEZE" camera shots

**By Otha C. Spencer**  
*Director of Photography*  
*East Texas State College*

**C**RASH! A bullet breaks through a sheet of plate glass. Your eye, slow as it is, sees only a blur of shattering glass. Even such comparatively slow action as the splattering of an egg as it falls to the floor is too fast for the eye to follow. All you see is the resulting mess!

But you can "quick freeze" action, capturing every detail of the movement in crisp, clear photographs. You can do it with a speed light. Once the darling of the laboratory experimenter, the speed light has become a valuable assistant to the amateur as well as professional photographer. (Instructions for making your own portable speed light were published on page 191 of *Popular Mechanics*, August 1948.)

However, the speed light alone can't do the job. A triggering mechanism is needed to set off the light at the precise instant. To get these dramatic quick-freeze shots, the speed-light user can make a simple but effective device that will trigger the light

and stop action at its peak. In high-speed photography, the eye and reflexes can't work fast enough to click the shutter or set off the light at the peak of action.

Technicians and photographers who use the speed light professionally have various elaborate methods of capturing the exact instant of impact with their cameras. Among these is the electric eye, that takes the picture as the light beam is broken; the microphone that fires the speed light on the sound impulse of the impact; and various other methods using mechanical switches.

The method we are to discuss uses the microswitch. This is a sensitive switch that closes an electrical circuit at the slightest impulse. It is sometimes called an MU or precision switch and can be purchased at any radio-supply shop for \$1.00 to \$1.50. The switch is so sensitive that it takes only four ounces of pressure and a movement of .001 inch to close the contacts. When this switch is placed in the speed-light triggering circuit, the slightest pressure and movement will flash the light and expose the negative.

Action usually falls into two classifica-

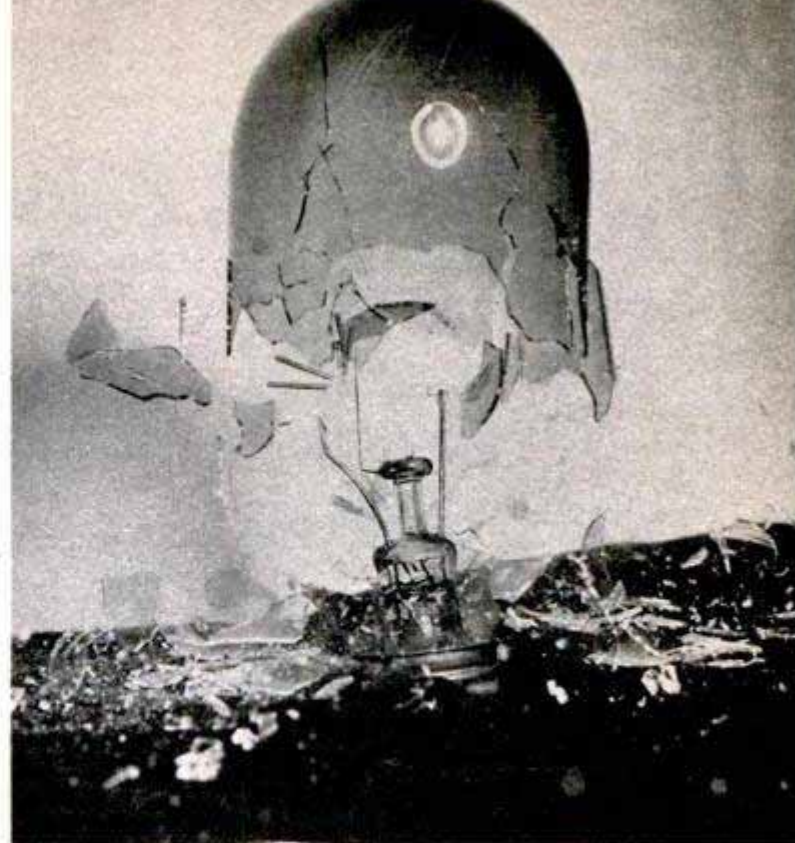
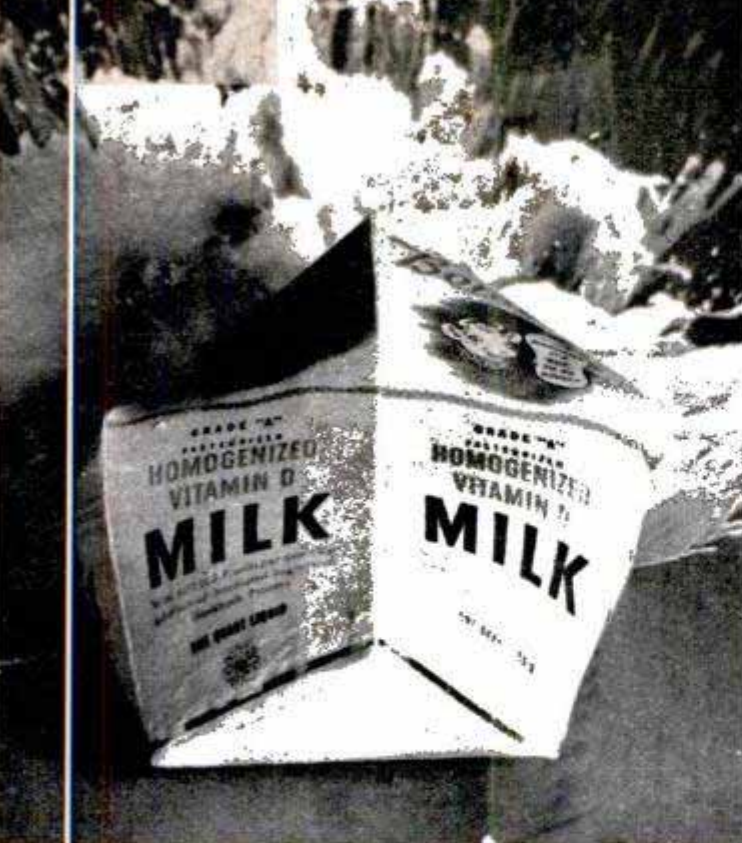

Left, a milk carton bursts open for a 1/5000-second portrait. Like the eggs, this carton was dropped on the pressure plate. Right, a bullet, tearing through this bulb, leaves the top floating in space momentarily

tions for the photographer. Vertical action, which includes falling objects, and horizontal action, such as the flight of bullets.

One word here before we go further: Equipment that will stop a bullet in flight is not yet generally available to the amateur photographer. Most commercially available speed-light units have a flash speed of 1/1500 to 1/30,000 second and it takes speeds from 1/500,000 to 1/1,000,000 second to "freeze" a bullet in flight. But you can photograph the impact of the bullet, getting many unusual shots.

For vertical action, we use the pressure-plate method of triggering the flash. In other words, we let the pressure of the impact actuate the microswitch and take the picture. The switch is placed with the face upward. Over this is placed a piece of wood

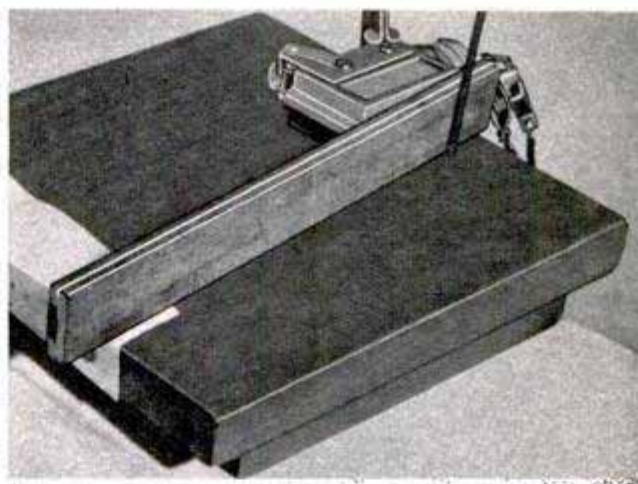

Above, the bullet passes through the trigger lever, forcing it against the microswitch and firing the speed light. Below, diagram of the layout used for the bulb photograph shown at the top of this page

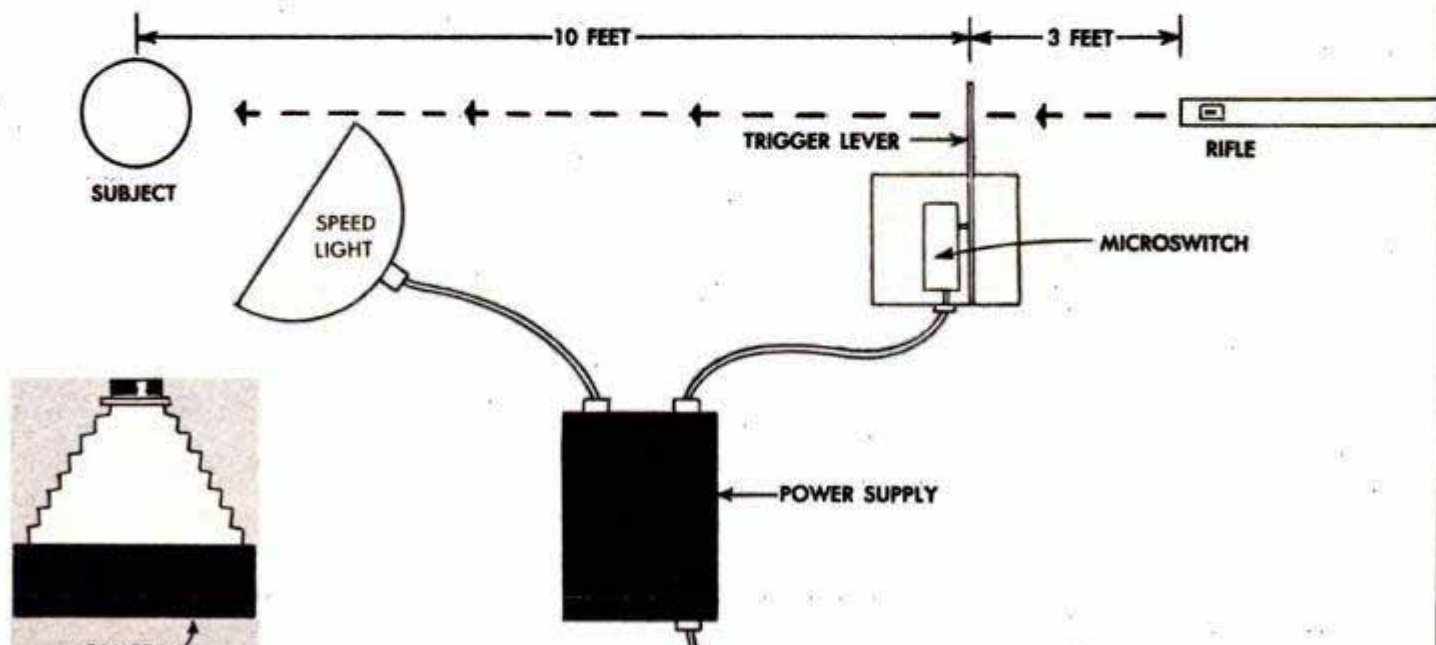

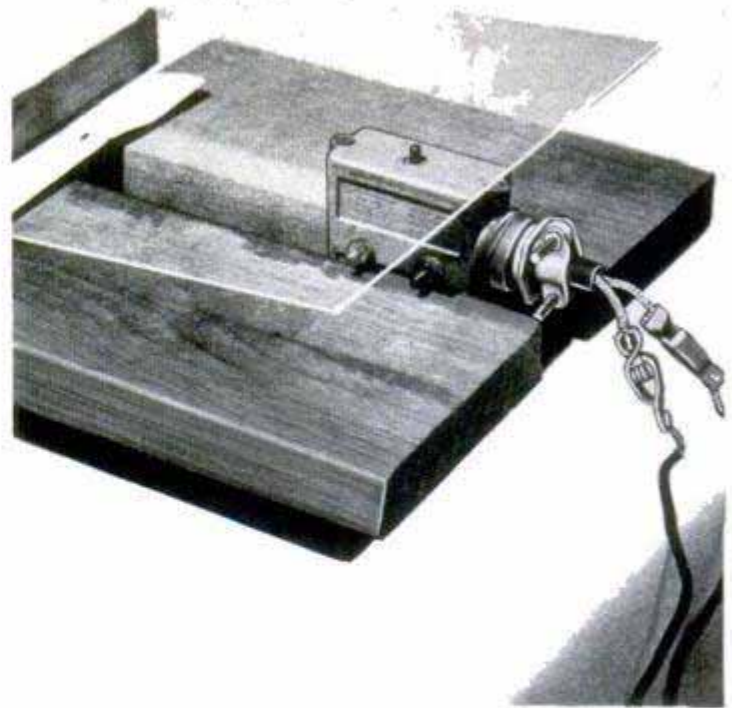
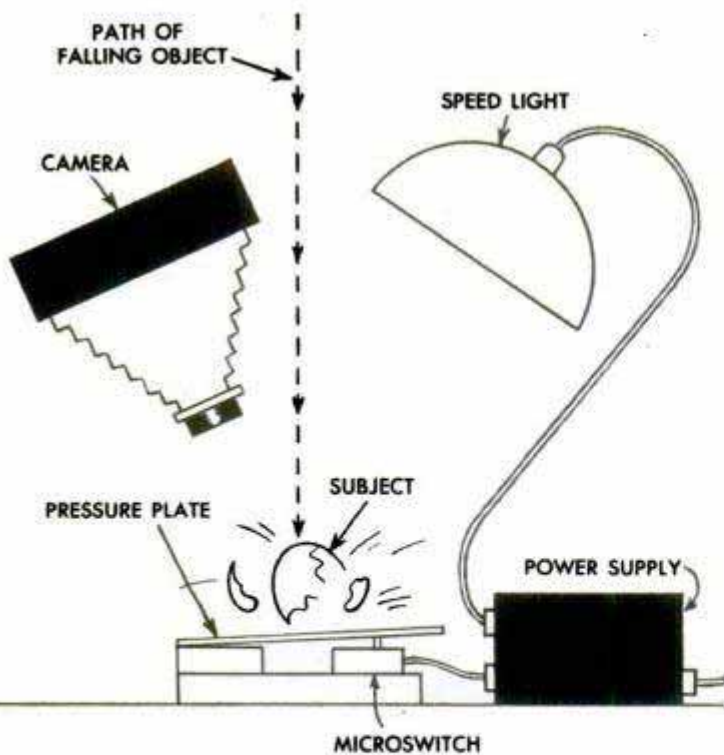

Left, falling-egg shots were made this way. By supporting most of the weight of the plate with a block, you can delay action briefly. Right, the pressure-plate trigger. Glass plate was used here so you can see switch

or metal that is balanced so that it touches the pressure point but does not exert enough weight to close the contact. The slightest pressure will fire the light.

The camera room should be in semidarkness and the camera lens opened for a time exposure while the action is taking place. In this way, there is no problem of shutter synchronization. Because of the short light-to-subject distance, the lens can be stopped down to  $f:22$  or  $f:32$  and no image is recorded on the film except at the instant of the flash. As soon as the flash is over, the lens is closed manually.

Photographing the impact action of a

Close-up of the microswitch used to trigger the speed light. The plunger works with only slight pressure



bullet on an object is simple with speed light. The triggering arrangement is placed about 10 feet from the subject. The bullet passes through a thin wooden lever (the soft pine in apple boxes is just right) and the lever actuates the microswitch, flashing the light. Even though the speed light is an almost instant flash, there is enough delay so that the bullet has already passed through the subject and the shot is taken a split second after the impact.

Observing the ordinary precautions necessary while working with guns, any photographer with a speed light can make interesting pictures using this method of triggering. Avoid shooting into objects that might cause the bullet to ricochet. Also, the triggering lever should not be closer than three feet from the gun as it tends to deflect the bullet slightly when closer to the muzzle.

This lever arrangement is also used to photograph other horizontal motion. A black thread can be tied to the lever and stretched across the path of the motion. As the string is moved, pressure is applied to the lever and the switch contacts close. Other applications of these two basic methods of triggering will suggest themselves to the photographer and almost any type of action can be photographed. With the equipment that photographic technicians have made available, it is now no problem to make fast-action shots that once could be taken only in laboratories.

When you show your action shots to amazed friends, just smile mysteriously when they ask, "How did you know just when to click the shutter?"

## Lensmen's Lift →

Photographers can shoot finish-line pictures from their own elevator now at Hialeah Park horse-racing track in Florida. The elevator lifts as high as seven feet to provide more effective photography angles. Appropriately, the horse selected for the first tryout of the new track-side elevator is named "Free Press."



## Alpine Television Station Will Serve All Switzerland

From its antenna near the summit of the mighty Jungfrau, a 13,642-foot peak, an Alpine television station will broadcast programs to all Switzerland. Work on the new mountain-top station is being started and it is expected that broadcasting will begin in 1953. The world-famous funicular railway will carry the necessary equipment up the mountain, the station site being only a half mile from the rail terminus. The station will also serve as a radio-telephone link with the world communications network and as

a standard radio-broadcasting relay station. It is believed that the effective range of the television station will also include a large portion of southern France and a section of northern Italy.

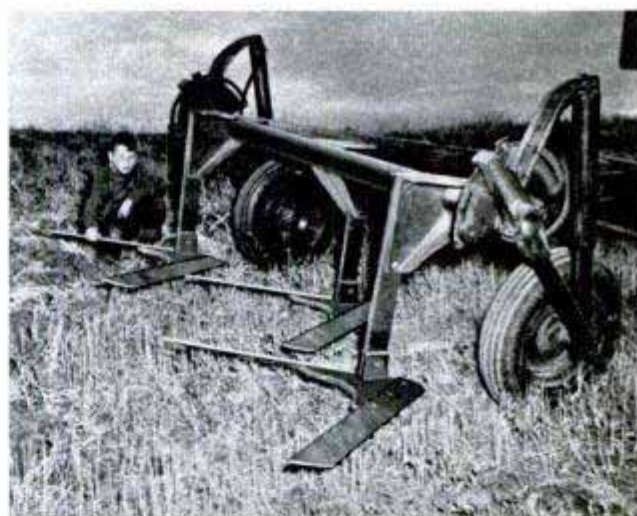

## Mechanical "Gopher" Bores Channel To Retain Water

Boring through the ground at a depth of 30 inches, a mechanical "gopher" forms a loose channel that holds rainwater and prevents run-off and erosion. Built by two Washington farmers, the self-spinning borer follows a chisel through the earth,

backfilling the absorbent channel as it turns. The farmers recommend that channels be cut in the fields every few years to provide maximum water absorption. Another implement built by the farmers is a large duckfoot for subsurface plowing.

## Discarded Railroad Ties Turned Into Paper Sacks

Science, always seeking ways to turn waste material into something usable, has developed a method of making paper sacks and wrapping from discarded railroad ties. Inasmuch as the nation's railroads discard ties and poles amounting to three million tons of raw wood pulp a year, the process could provide one seventh of the country's

pulp needs. The paper made thus far is somewhat weaker than that made from new wood, but further study may lead to a method of increasing its strength. Other substitutes which chemists are trying to salvage from waste include paper from grass, peach and almond flavoring from citrus rinds and stock feed from wood chips.

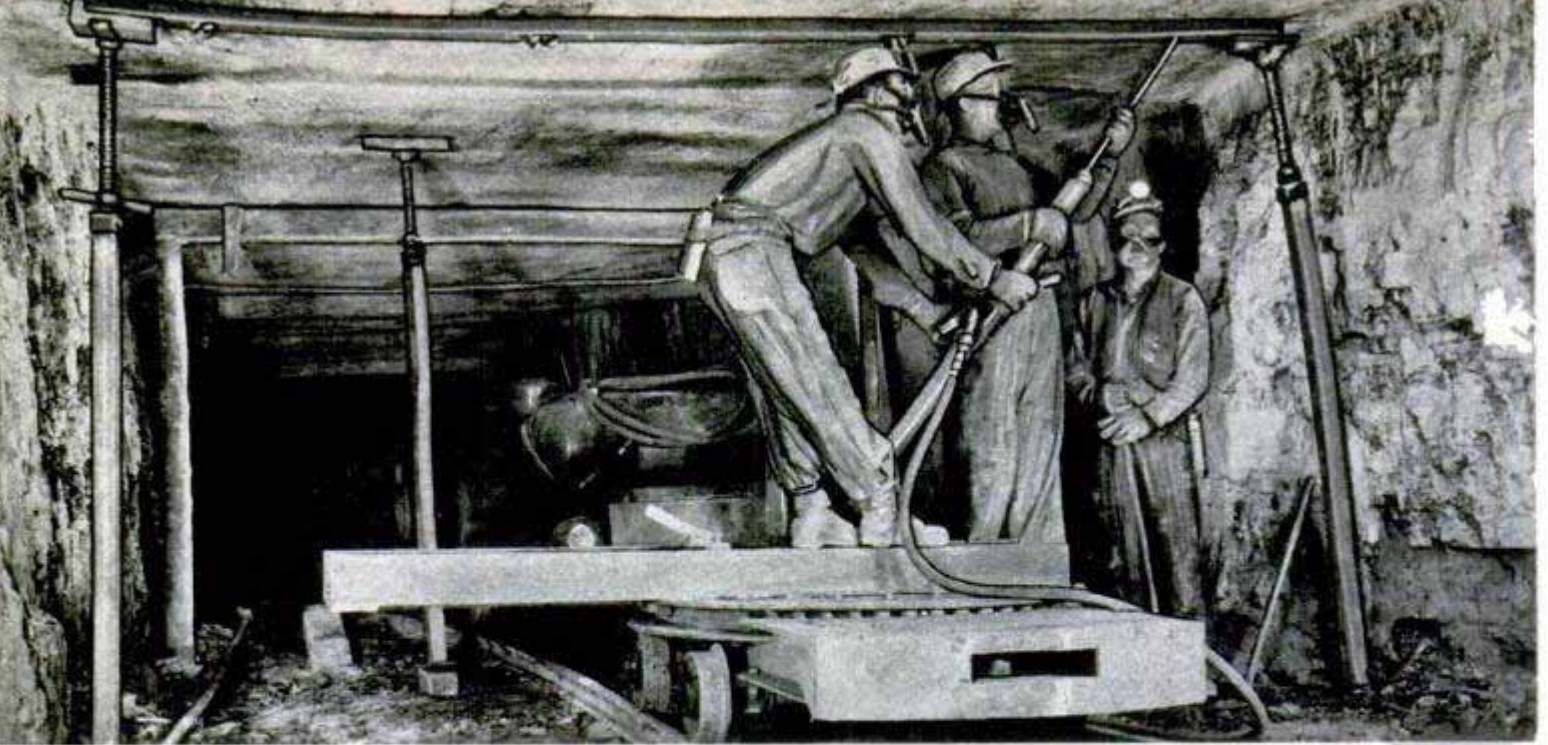

Pin-up rod is driven against expansion wedge by an air hammer. Jacks are used only until installation is complete

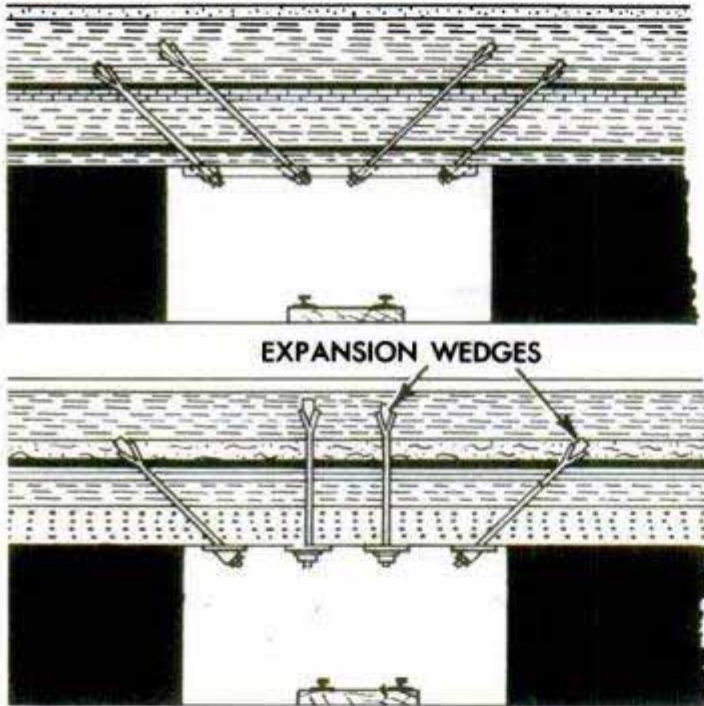

Above, two pin-up methods, showing expansion wedges. Below, foreground, the old system; beyond, pin-ups hold roof



## PIN-UPS for COAL MINES

**F**IRST TIME I ever knew you could "lift yourself by your bootstraps" is how a coal miner described pin-up roof supports. And that is exactly what seems to be taking place. The long expansion bolts hold up the roof of the mine shaft by bolting the roof to itself!

That may sound more like the Indian rope trick than practical mechanics, but it's not magic—it's as practical as plywood. Several layers of slate and shale, each thin and weak, are bolted together to form a strong, solid roof.

Developed by the Bureau of Mines, the pin-up roof supports are steel rods an inch thick and six feet long. They are inserted in holes in the mine roof and driven against a steel wedge deep inside the hole. The wedge opens a slit in the end of the rod, just as a screwdriver opens a cotter pin, jamming the rod tightly against the side of the hole. A steel plate slips over the bottom end of the rod, which is threaded to take a nut. When the nut is tightened, the steel plate compresses the roof layers, forming a solid ceiling. By eliminating roof timbers, the pin-ups increase production because they provide unobstructed working space for mining and loading machines. Widespread use of pin-up supports will reduce roof-fall accidents, the number-one cause of death in coal mines.



Above, the entire floor is a radiator when hollow tiles are used as radiant-heating panels. Below, diagram of a complete system. Arrows show the flow of warm air through the tiles

## Hollow Floor Tiles Provide Radiant Heating

Hollow tiles make the entire floor area of a house serve as a radiator in a radiant-heating system that uses forced warm air. Each tile block covers one square foot and through it run three warm-air channels. Uniform heating of the entire floor area provides a floor that is comfortably warm with temperatures not exceeding 90 degrees even in extreme cold weather. The tile provides 50 percent or more of its heat in the form of radiant energy and the rest by convection. After the warm air has circulated through the tiles, it is returned to the heating plant for reheating. If desired, the tile can be covered with carpeting or linoleum without any decrease in the efficiency of the heating system.

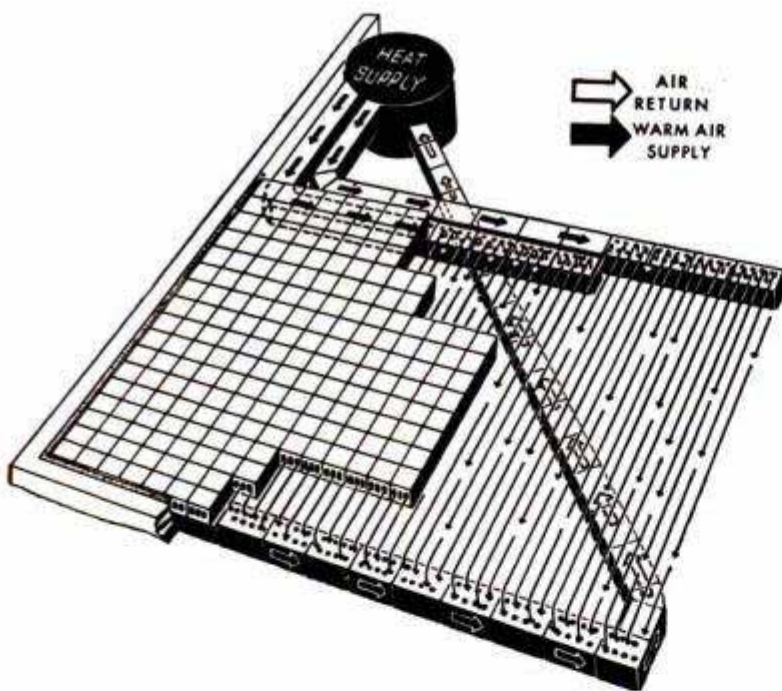

## Berkeley Cyclotrons Do It Again—Another New Element

After four years of research, scientists at the University of California have created a new chemical element, No. 97, the heaviest thus far known. Produced by atomic-particle bombardment in the university's two cyclotrons, the new substance is called berkelium, in honor of the university city. Details of its properties and production were not announced, but it is believed to be short-lived and highly radioactive. The mass of the new element is probably as high as 247 or 248. It was discovered by Drs.

Glem T. Seaborg, Stanley G. Thompson and Albert Ghiorso of the university staff. Berkelium is the ninth chemical element discovered in the past twelve years, five of them being produced at Berkeley.

Information not listed on articles in the index, starting on page 10, frequently is listed in the WHERE-TO-FIND-IT INDEX, which is available without charge from Bureau of Information, Popular Mechanics, 200 East Ontario Street, Chicago 11

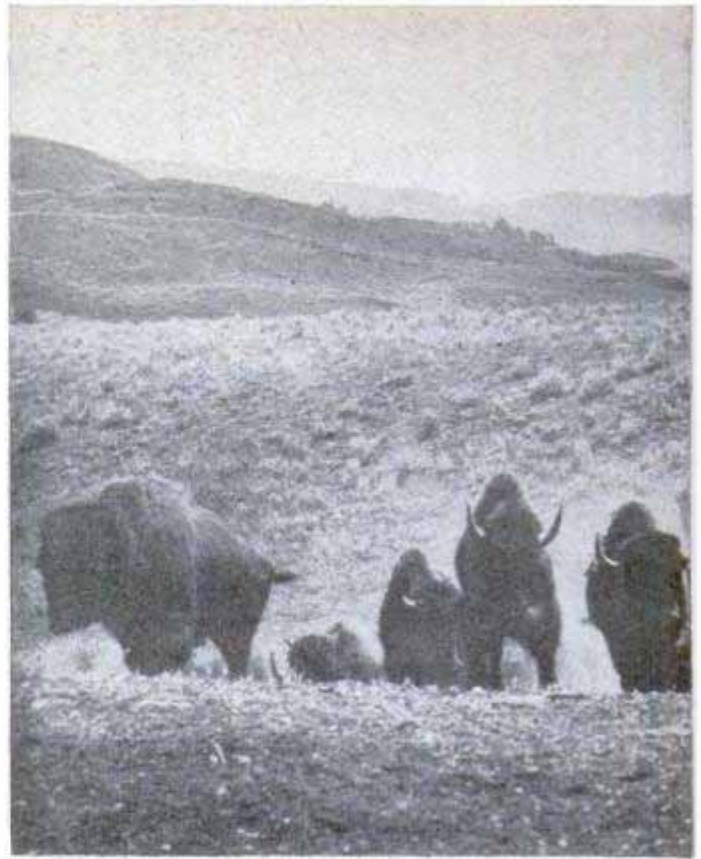

Haynes and his camera are photo historians of Yellowstone

## YELLOWSTONE'S OTHER "OLD FAITHFUL"

**This is the story of two famous photographers, father and son, who have been covering our oldest national park inch by inch for the last 69 years**

**By  
Rafe Gibbs**

**A**S THE cigar-puffing man with granite-gray hair and blending mustache thrust his camera out his car window to take a picture, a tourist chided him:

"So Jack Haynes, the great photographer of Yellowstone Park, is a window picture snapper."

Haynes drew silently on his big cigar for a moment, then replied:

"My derogatory friend, those are betting words. There are 3471 square miles in Yellowstone Park. More than two thirds of this area is nowhere near a road. But you name any Yellowstone mountain peak, any lake, any stream, any canyon, any kind of flower or tree or any animal and I will bet you a hundred dollars that I can produce a stock Haynes photo of it."

The tourist walked away, mumbling an apology.

Asked about the bet later, Haynes smiled.

"That fellow could have won," he said. "There are a couple of flowers in the park which I haven't gotten around to photographing yet."

Jack Haynes' father, Frank Jay Haynes, began photo-



In 1883, a gun was part of the elder Haynes' equipment on picture trips





**As impressive as a painting, this Jack Haynes' shot captured the power of the thundering herd at Yellowstone**

graphing Yellowstone in 1881, nine years after the land of the geysers was established as a park, and kept at it almost until his death in 1921. The son, who has spent every summer in the park since 1888, started taking pictures at 13. The best of the pictures by father and son now make up a priceless collection of 22,000 park scenes, providing the most complete pictorial history of any park in the world.

"Jack Haynes probably knows more about the history of the park than any living man," says superintendent Edmund B. Rogers of Yellowstone. "He is Yellowstone Park history himself."

Through his camera lens, Haynes has seen the park change from a rich-man's rendezvous to a people's playground. He has seen the annual number of visitors rise from 5000 to 1,015,000. He has viewed more

**No candid model, this huge camera was pulled by a horse in 1887! Photographer Frank Jay Haynes is at right**

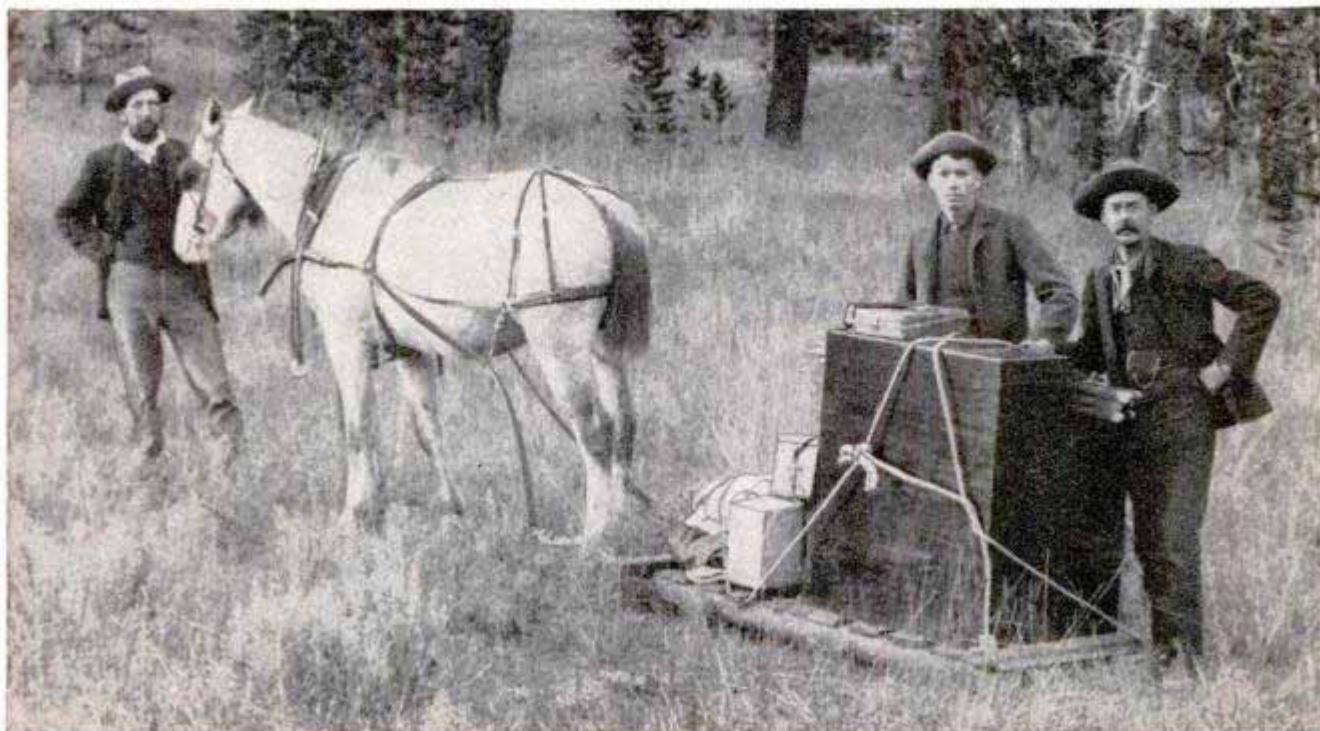



One of Haynes' best sellers is this shot of Mamma Bear and Baby Bear, as unconcerned as a pair of celebrities

dramas of the wild than any movie fan who has attended every Tarzan picture.

Obtaining the park photography concession from the government in 1883, the House of Haynes built a 32-foot-square frame studio and residence on the old Army parade grounds at Mammoth. Today, there are 12 studios scattered throughout the park, employing during the tourist season more than 160 persons who annually sell 10,000,000 Haynes pictures. Haynes' wife,

Isabel, manages the personnel; his 17-year-old daughter, Lida, trains the newcomers, and Haynes himself, now 65, acts as general supervisor—but at heart he is primarily just a photographer.

Countless millions of persons throughout the world have among their souvenirs Haynes photos of Yellowstone. Whether or not park visitors take their own pictures, they buy Haynes photos just in case and Haynes has become the king of park post-

President Arthur, center, and his party posed for a Haynes picture when touring Yellowstone Park in 1883



card makers. His photo plant in Bozeman, Mont., complete with huge fireproof vaults for storing treasured negatives, forms one of the major industries of that town of 12,000.

Haynes' first camera was a simple five by seven plate job. When his father gave it to him on his 30th birthday in 1897, he said:

"Son, you take this and shoot yourself some wild animals. You'll find it's a lot more fun than shooting them with a gun."

The father scored a pictorial bull's-eye.

"Today it would be just as hard for me to shoot an animal with a gun as it would be to shoot a human being," declares Jack Haynes.

But more important than Haynes' feeling toward wildlife is the knowledge he has gained throughout the years of the best ways to photograph it.

Haynes always carries a press camera in his car, with the focus set at infinity, the shutter at  $\frac{1}{50}$  second and a film holder in place. When he sees a wildlife scene he wants, he quickly refocuses if necessary, pulls the slide and shoots.

Another Haynes technique: Don't slam the car door when you are getting out to take a picture of a wild animal.

"If you want to learn how to stalk wild animals, just follow an Indian around wooded areas for a day," advises Haynes.



With his press camera always loaded and ready to shoot, Jack Haynes never misses a chance to photograph wildlife in action

"He moves as silently as a summer breeze."

Haynes has a word of warning, however, in silent stalking. Be sure that the animal has a good means of escape in an opposite direction from you. An animal should never be cornered. He'll probably come out fighting.

"If you mind your own business, the wild animal will usually do the same," says Haynes. "Of course, there are exceptions to this rule. Animals are just like people—

Skis carried Haynes and his camera over deep snow to photograph these elk, two of the 15,000 in Yellowstone



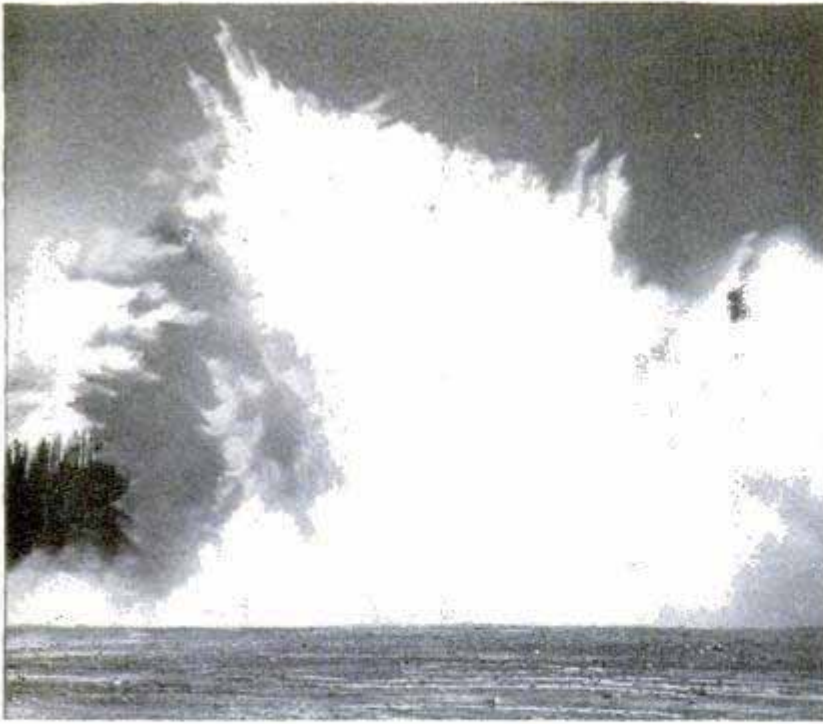

**Biggest of the park's geysers, Excelsior, "posed" for Haynes in 1888. It's been dormant for over 50 years now and this is its only picture**

there always seem to be some crazy ones."

Haynes also has a tip for the photographer when shooting bears.

"Bear pictures are generally underexposed," he says. "People forget that the bear is a pretty dark object and that woods form a dark background."

Many other animals also need more exposure than they usually get. This is especially true of the moose.

"Photographers often complain that a moose has no character," he explains, "but that's because the picture needs more exposure to bring it out."

Most photographed scene in Yellowstone is Old Faithful Geyser spouting 10,000 to

12,000 gallons of water into the sky. But often when the film is developed, the photographer is disappointed.

"Generally, amateurs photograph Old Faithful at too high a rate of speed," Haynes says. "A fiftieth of a second is fast enough on any type of film."

Haynes prefers to photograph the geyser slower than that and some of his views are masterpieces.

When patience is needed to get a picture, Haynes can out-sit an Indian. In 1922, a dormant geyser broke out along the road near Roaring Mountain. Haynes and two other photographers raced to get a picture, but when they arrived there was only a gurgle.

Hoping the geyser would perform again, the three photographers set up their cameras in ankle-deep mud. The wait became hours and, of the trio, only Haynes stuck by his camera. The other two were wandering around when, without warning, the geyser shot water more than 150 feet into the air. Haynes clicked his camera. The geyser has never given a full performance since and Haynes has the only picture of it in action.

He is a stickler for getting the exact effect wanted, having been known to take 90 shots of the same scene and throw away all except one. Once he climbed Bunsen Peak (altitude: 8600 feet) six times to get the right cloud formation. Another time, to

(Continued to page 236)

**President Arthur's party saw the park on horseback. These Army ambulances went along, though, just in case!**



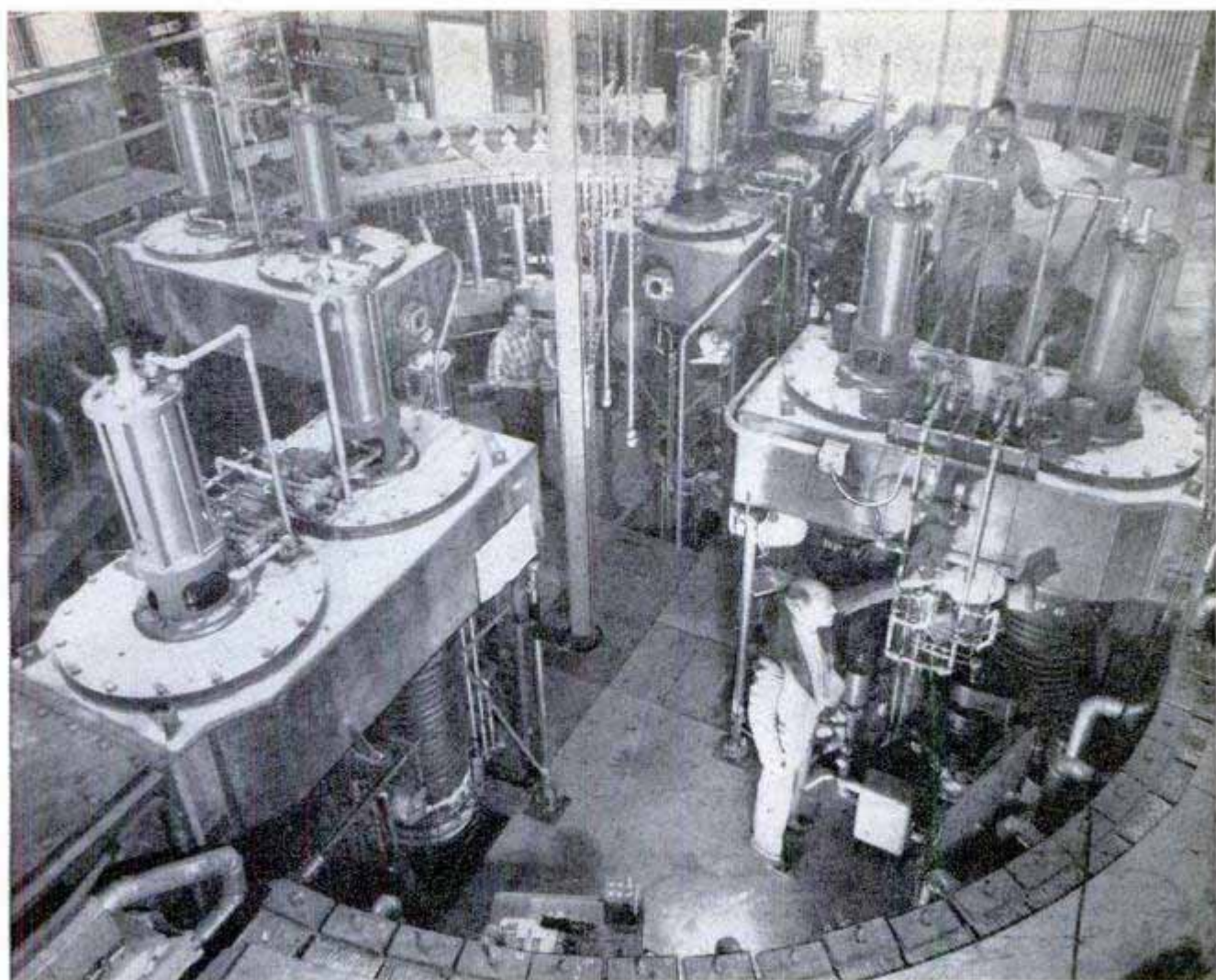

## Pilot Model of Bevatron Gives Scientists "Practice"

Built to provide scientists with experience in the operation of the six-billion-volt bevatron, a quarter-size pilot model is now in operation at the University of California. No midget, although it is only a scale model of the giant now under construction, the pilot model accelerates protons to six million electron volts. The whole assembly, including an electromagnet that is divided into four sections, is 25 feet in diameter and has an accelerating chamber 100 feet long, the longest distance over which atomic projectiles have ever been fired. The full-size bevatron will be completed in about four years. It will have a magnet with a 110-foot diameter and an accelerating track 400 feet long, over which protons will travel 300,000 miles in less than two seconds. The magnet will weigh 10,000 tons, more than twice the weight of the magnet in the giant Berkeley cyclotron, presently the most powerful atom-smasher in the world.

☐ Americans set fire to more than 34,500 tons of cardboard in the form of book matches each day, and burn 125,000,000 wooden matches in 24 hours—enough timber to build 25 six-room houses.

Above, although only a quarter-size model of the 10,000-ton bevatron now under construction, this instrument is a giant itself. Below, a physicist adjusts a vacuum pump inside the magnet. The model gives scientists experience in bevatron operation

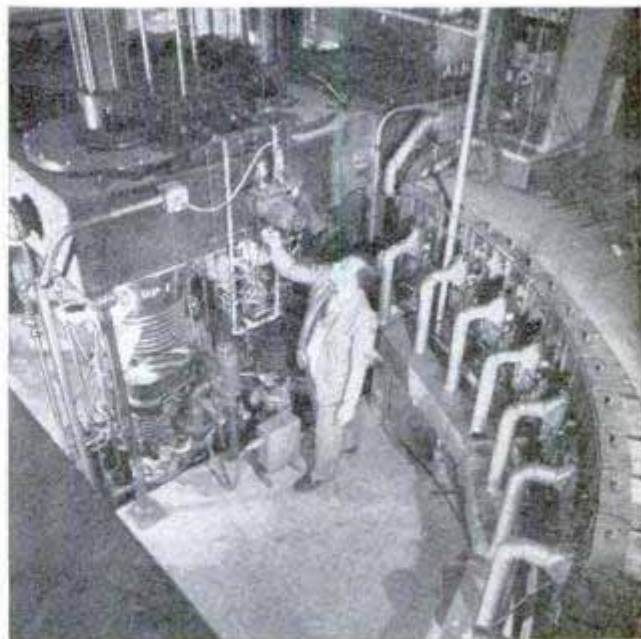

☐ Driving at a speed of 40 miles an hour, a motorist facing the upper beam of a sealed-beam automobile headlight drives "blind" for a period of 12 seconds during which time his car is traveling 725 feet.

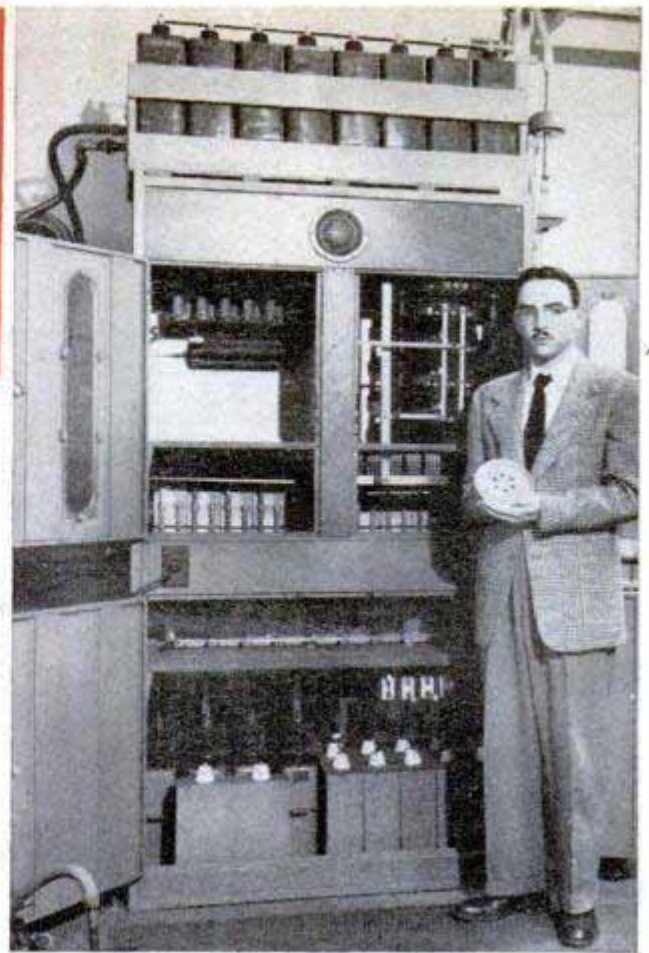
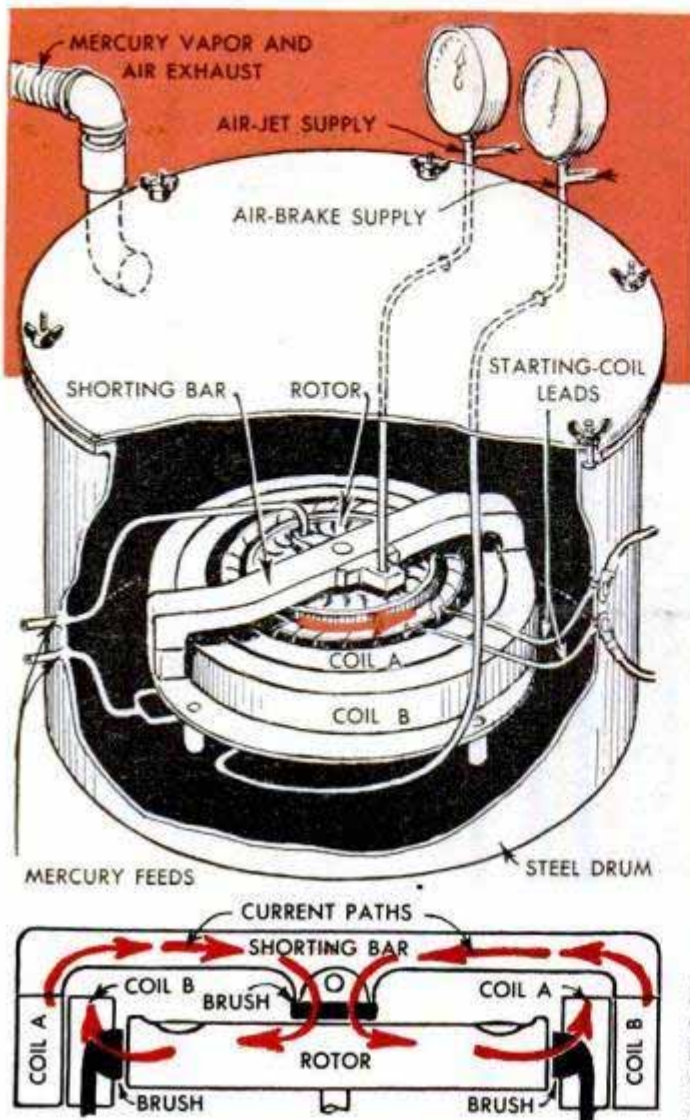

Physicist Strough holds the air-driven rotor used in the experimental generator he developed. This rotor has energy-storage potentialities 100 times greater than the condenser bank behind him. Top, left, cut-away of generator. Left, arrows show current paths

## Generator Has Liquid Brushes

Jets of mercury are the brushes of a rotating-disk generator that develops a magnetic field 6000 times as intense as that of the earth. The generator has possibilities as the magnetic core of an atom-smasher. There is no iron in the magnetic circuit of the generator nor are there any wire windings in the coils. The rotor, a disk made of beryllium-copper because of its tool-steel strength, is driven by an air jet blowing

against "buckets" around the top of the disk, which spins at 17,000 revolutions a minute. The coil "windings" are cast of solid copper. Because of the tremendous energy released by the whirling disk, ordinary copper or carbon brushes cannot be used. Instead, jets of liquid mercury serve as brushes creating dangerous vapors which are removed by a built-in exhaust system. The machine was developed by Robert I. Strough, physicist at Case Institute of Technology.

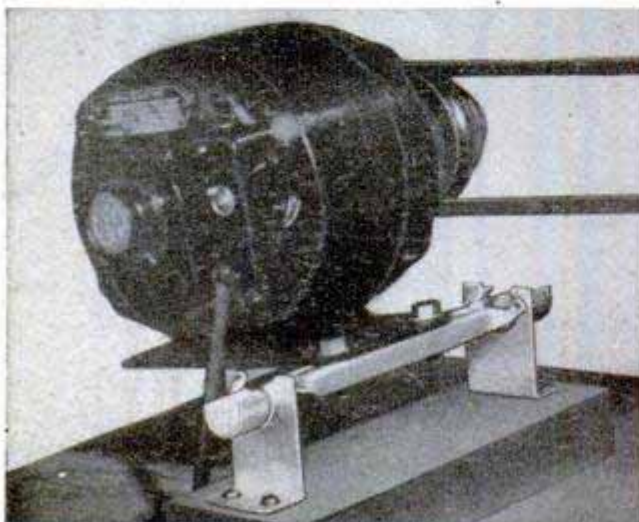

## Quick-Change Motor Mount

Small electric motors are held securely in position yet are readily removable when they are attached to a mount that permits removal of the motor when it is swung to a vertical position. The mount can be used for either horizontal or vertical drive and it automatically compensates for belt wear. With it, you can make one motor serve several machines without undue loss of time in the transfer operation.

Army researchers have developed a 400-cycle generator that produces more current yet weighs less than 60-cycle models.

the

POPULAR  
MECHANICS



# CRAFTSMAN

## *Featuring*

- Art of Making Hand Puppets.....174
- How to Paint Interior Walls.....184
- Tune-Up Time for the Car.....196
- Ways to Get Rid of Sparrows.....202

*New beauty and utility from old furniture. See page 166*

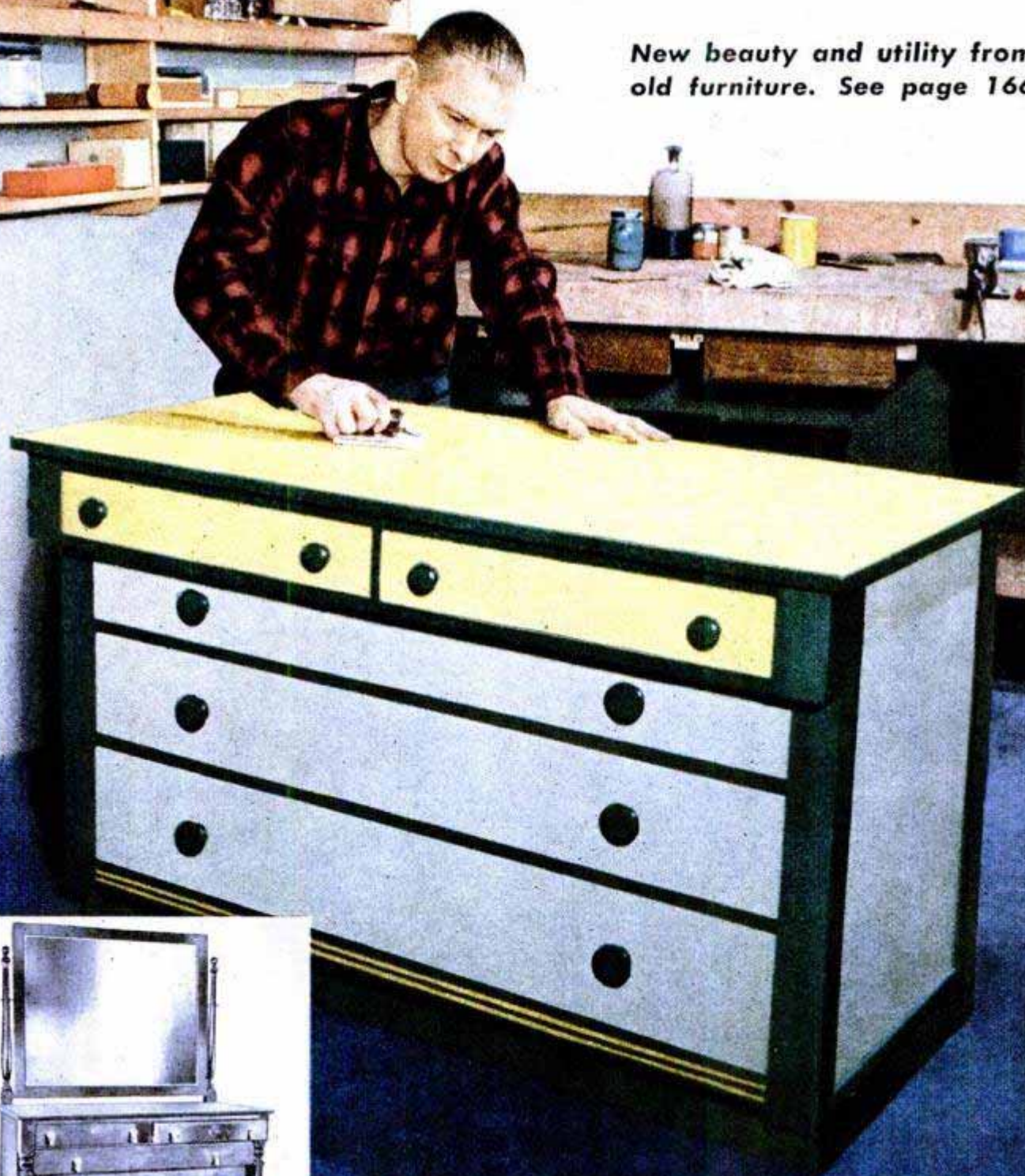



The colorful kitchen storage cabinet shown above came to life by cutting down the legs and removing the mirrored back and doors of an old sideboard. Back was hung invertedly to provide a wall shelf

*Furniture transformation photos in this article by courtesy E. I. du Pont de Nemours & Co., Inc.*

**I**T'S ALMOST unbelievable how quickly a little "surgery" on outdated furniture, discreetly done with a handsaw and a few other tools, can erase the earmarks of by-gone days, and how well-chosen colors can add elegance and distinction. That's how simple it is to make old furniture live again. Such revitalized pieces can be decorated attractively with painted designs in "American folk art" following the simplified technique developed by Peter Hunt, noted artist and decorator of Provincetown, Mass.

Often, only a few slight alterations are necessary, as on the old buffet shown at the upper left. There's nothing difficult in making the simple changes required to modernize old furniture prior to repairing and enameling, and obtaining results such as

These two old pieces were combined to make the gay nursery chest pictured at the left. Legs of buffet were sawed off and the wardrobe unit bolted to top





Modern Furniture  
**NEW LIFE**  
**FOR**  
**OLD FURNITURE**

By  
**E. R. Haan**

Before-and-after views of the "nightmare" at the right show dramatically how the piece can be transformed into a Chinese-modern chest, using two colors. Note that the color photo is shown in a reversed position

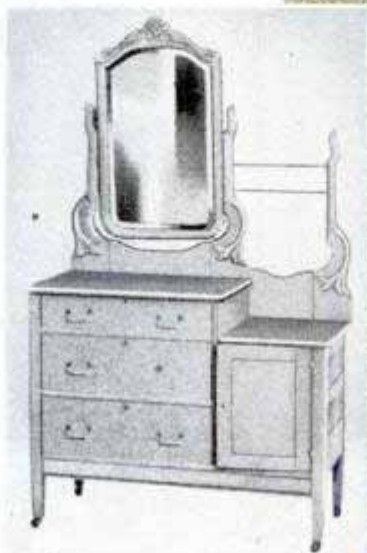

those shown on these pages. Usually, results exceed expectations. When examining an old piece, first decide on the necessary but minimum amount of surgery to give it a snappy, modern appearance. Sometimes a single object like the combination bookcase and the desk, page 169, will make two separate new items. Or, two odd pieces, like the old buffet and battered wardrobe shown on page 166, can be combined into a highly attractive storage unit for clothes, blankets and toys in a nursery or room for older children.

**Repair hints:** When making changes in furniture, avoid toolmarks from hammering or prying on surfaces that will be exposed. Therefore, make it a practice to use a thick, folded paper pad, or a flat piece of thin wood under the hammer or other tool to protect the surface. Tighten loose screws

**Headboards of discarded beds make unusual backs for benches. Endpieces, a seat and apron must be added. Two-color treatment emphasizes carved overlays**





Old ornate picture frames offer many possibilities. The dainty shadow box for miniatures, left, and the recessed plant shelf, above, are two suggestions. The coffee table, below left, serving trays and kitchen bulletin boards are other practical possibilities

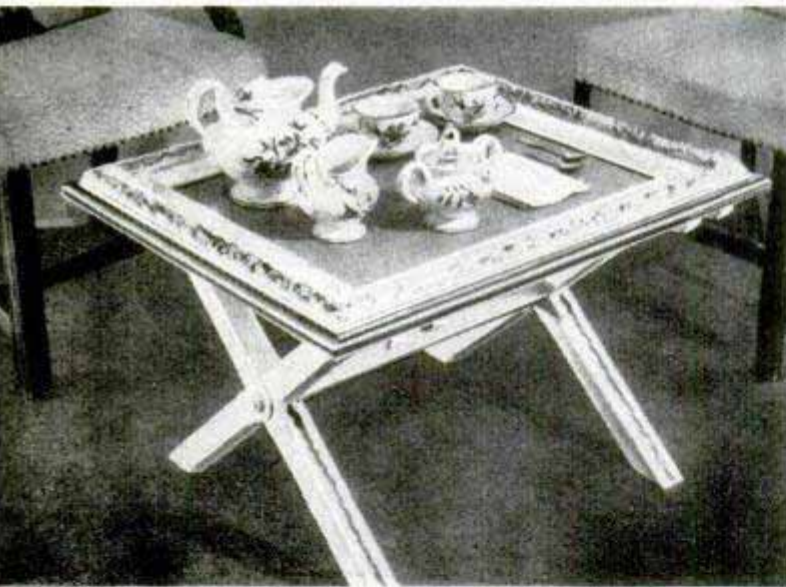

"Frosting" a frame is done by first applying flat light-blue paint, left-hand photo. When dry, flat white is applied over carved portions, right-hand photo. While paint is still wet, it is rubbed off high spots lightly with a soft cloth, center photo

and bolts that hold parts together, such as table legs. If screws are missing, replace them and, if the screw holes are enlarged so that the screws cannot be drawn tight, replace the screws with others that are slightly larger. Sometimes you can reduce the size of a hole by driving in a piece of a wooden matchstick dipped in glue. Or, it may be necessary to drill or ream out a screw hole to permit the insertion of a dowel dipped in glue.

Drive down protruding nails or brads with a nail set. If they are very loose, substitute others of slightly larger size. Often the mortise-and-tenon joints of old furniture are loose and require regluing with waterproof glue to make them strong again. When this is necessary, scrape away the old glue before applying the new. Frequently it is easier and better to substitute new dowels for old ones that are loose and can be pulled out readily. It may be necessary to ream out the dowel holes slightly for new, larger dowels. In other cases where joints are loose and wobbly, metal braces are sometimes useful to obtain rigidity if they can be applied to the piece





where they will not be noticeable.

**Clean thoroughly:** Next, inspect the condition of the old finish. Frequently old varnish or enamel finishes are not excessively scratched, marred or cracked, and in such cases the new finish can be applied over the old. However, a thorough cleaning is necessary to eliminate all dirt, oil, grease, furniture polish and wax. Most of this, except wax, can be removed readily with a solution of cleaning powder applied with a sponge or rag. Wax can be removed effectively with a turpentine-saturated rag, after which the surface is washed with the cleaning solution. Be sure to scrape accumulations of dirt out of corners. After cleaning, the varnished surface is roughened with 2/0 sandpaper. This will provide a better surface than hard, glossy varnish, for the adherence of the undercoat. Some furniture refinishers use a varnish softener, which combines with the varnish and provides a good base to which the undercoat will adhere. One of the advantages claimed for varnish softener is that it minimizes the trouble of enamel chipping off varnished surfaces. In some cases, particularly when the old finish is mahogany, and the surface is marred and scratched, it is advisable to seal the stain under the old finish as it is likely to bleed through where the varnish has been removed. For this purpose you can get a prepared stain sealer. This also is used if the old finish is a varnish stain.

**Varnish removal and crack filling:** Badly checked, marred and

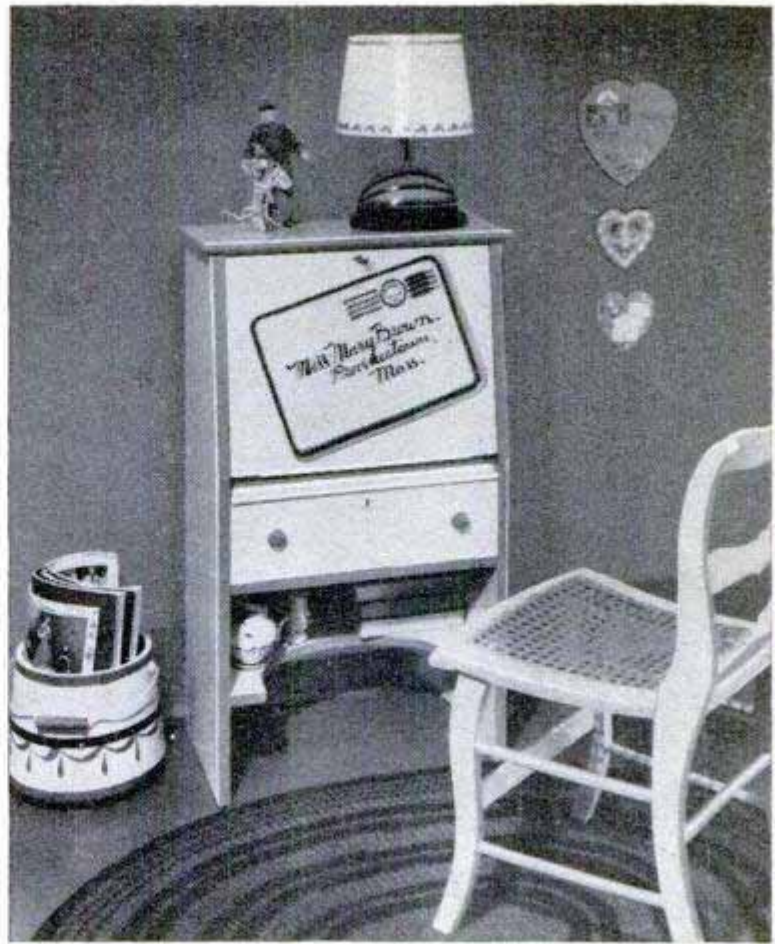

The old combination bookcase, writing desk and mirror, upper left, was sawed apart, legs and mirror removed, to produce the child's desk shown above and the bathroom linen chest shown below. Even the mirror was painted appropriately and used again



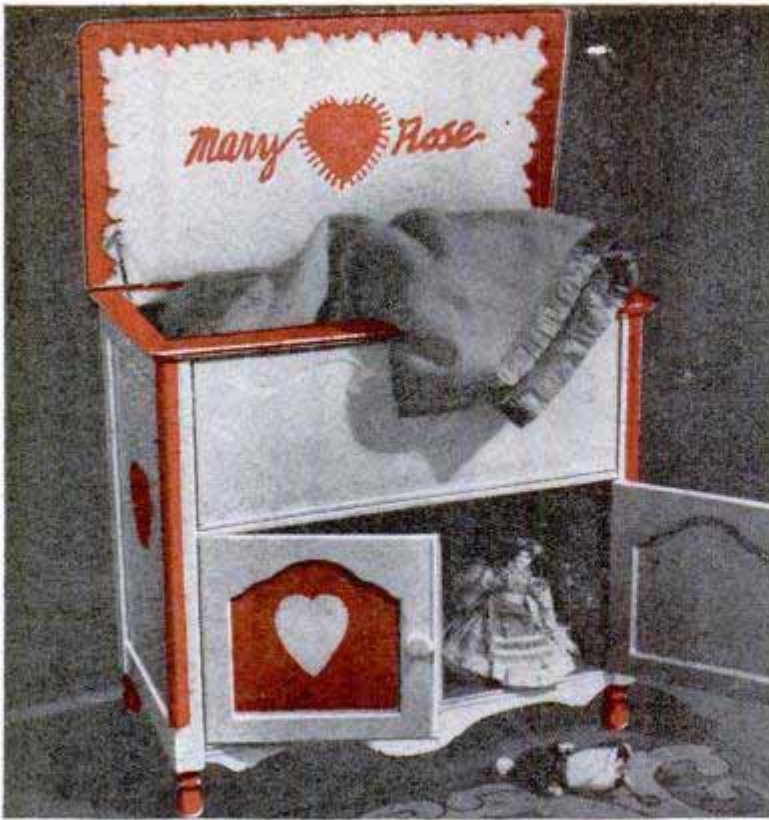

Many outdated radio cabinets require very little surgery to convert them to storage chests for toys and blankets. Photo, center, left, shows lamp bases made from table legs



scaling varnish and enamel finishes should be removed entirely for best results in refinishing. Use a liquid varnish remover, following the directions carefully. Be sure to wash the surfaces thoroughly with turpentine or mineral spirits after the old finish has been removed. Next, fill deep gouges, cracks and holes in the wood with a nonshrinking crack filler or wood putty. When dry, sand the spots flush with adjacent surfaces. If the wood was stained, especially if the stain was mahogany, much of the stain has been absorbed in the wood and cannot be eliminated with varnish remover. Therefore, to prevent this stain from bleeding through subsequent coatings, be sure to apply a coat of sealer.

**Enamel undercoat:** After the surfaces have been reconditioned and are smooth and clean, apply enamel undercoat. This provides a flat coat to which a fairly heavy coat of enamel will cling without



Low coffee table for a sunroom, porch or patio was formerly a round dining table. Note how the original feet were used again by sawing them off and mounting vertically



sagging or running. It is a good idea to add pigment to the undercoat to tint it so that it will be about the same color as the enamel. After brushing the undercoat on smoothly, don't go back over areas already coated because the undercoat sets quickly. Avoid brush marks and skipped places. After it has dried overnight or longer, rub lightly with 4/0 sandpaper to eliminate dust specks, brush marks and other roughened spots. After sanding, wipe away all traces of the sanding dust with a turpentine-moistened cloth.

**Enameling:** When the surface is dry, you are ready to enamel. First decide on colors. Two tones of one color plus a complementary color generally produce a much more pleasing effect than a large mass of one single color. High-gloss enamel gives the most snap and brightness to enliven dull interiors, particularly in kitchens and bathrooms. Also, high-gloss enamel is harder, more wear-resistant and is easier to clean than semigloss enamel.

As semigloss enamel frequently cannot be purchased in half and quarter-pint cans, like most gloss enamels, it is more economical to purchase the latter and add enamel undercoat, if a semigloss effect is desired. To do this, mix one part of undercoat to three parts of gloss enamel. The gloss is reduced still more by increasing the proportion of undercoat. Before mixing, however, color the undercoat to match the enamel by adding pigment. This is obtainable in tubes. If you want to decorate large areas with painted designs, do this directly on undercoat tinted to the desired color. When the decorations are dry, apply a protective coat of clear, transparent varnish, either glossy or dull.

**Antiquing and "frosting":** Some pieces of furniture can be given a soft, mellow appearance by antiquing. This is done by mixing raw umber or similar dark-brown pigment, 3 parts, to clear or rubbed-effect varnish, 2 parts. The mixture is brushed on surfaces that are thoroughly dry, and then wiped off from the high spots with a cloth pad, leaving corners, cracks and depressions dark. A dry brush is used to blend gradually from dark to light areas.

"Frosting" or white glazing, in a sense, is just the opposite of antiquing in that white is used instead of dark, as shown in the photos of the shadow box.

**Avoid dust and dirt:** Enameling of furniture should never be done in a place where dust is stirred up by a draft or by sweeping, etc. Settling of dust on a freshly enameled job can ruin it. It is also important to keep the brushes free from dirt. Each color should be applied with a thoroughly cleaned brush, and each color should be dry before applying the next.

## Method of Coiling Garden Hose Eliminates Twisting

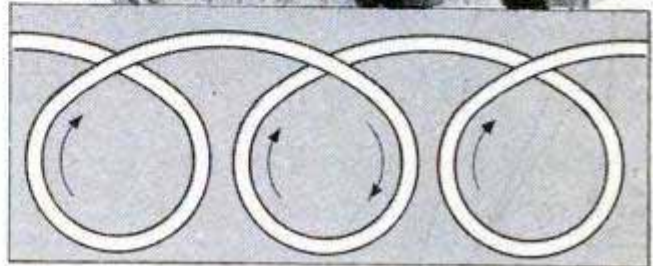

If you keep a garden hose coiled when not in use rather than winding it on a reel, you will appreciate this method of coiling which keeps the hose from twisting as it is pulled from the coil. Form the hose coils as shown in the detail, laying them one on top of the other. Note that each succeeding loop is made in the direction opposite that of the previous loop.

Frank Nelson, Auckland, N.Z.

## Feather Forms Substitute Brush For Drawing Fine Lines

An emergency brush for inking a fine-line drawing can be improvised from a chicken feather. Select a feather which tapers to a sharp point, dip the point in ink and use like an ordinary brush.

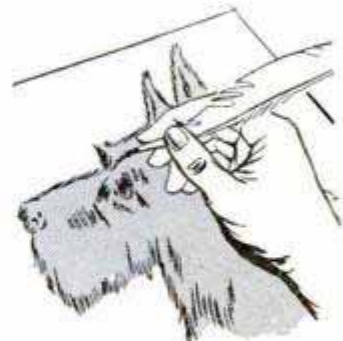

## Cellulose Tape Seals Screen Holes

Small holes in window screens can be patched temporarily with strips of cellulose tape. Cover both sides of the hole with the tape and then press the adhesive surfaces of the tape together. As the tape is transparent, it will not be too noticeable.



### Removable Hopper for Seeder Converts It to Yard Cart

By using a large removable hopper, I now can convert my seed and fertilizer spreader to a yard cart whenever it is needed. The hopper is of plywood reinforced with cleats at the joints, and fits snugly into the spreader hopper. The bottom of the wooden hopper is made flat so that when mounted on the spreader it is high enough to clear the agitator. Rope handles attached to the sides of the hopper facilitate carrying it to and from the cart.

Harold Langereis, Grand Rapids, Mich.

### Grommet Cushions Drill Chuck



When using a hand drill to bore holes in thin material such as sheet metal or hardboard, the sudden breaking through of the bit sometimes causes the chuck to mar the finish of the work. To prevent this, slip a rubber

grommet over the bit before drilling. The grommet will provide a cushion between the bottom of the chuck and the surface of the work.—Harry C. Aichner, Jr., Erie, Pa.

☞ To clean stucco walls, use a solution of muriatic acid, 1 part, and water, 7 parts. Apply the solution with a scrubbing brush.

### Wooden Handle Drives Screw Eyes

If you have a number of screw eyes to drive, the job can be done quickly with a handle made from a section of broomstick or dowel. Cut off a length sufficient to provide a good handgrip and cut a slot in one end wide enough to receive the head of the screw eye.



The latter should be a fairly snug fit in the slot so that the handle will not slip off readily when turning the screw eye.—Roger Isetts, Kenosha, Wis.

### Charcoal Keeps Game Fresh

Even though the weather is warm, you won't have to worry about game birds and small animals spoiling before you get home if they have been treated with charcoal. Dress the game, wash the inner cavity and wipe dry. Then take charcoal from the stove or campfire and solidly pack the inner cavity with it. Wrap each bird or animal separately in several thicknesses of paper and store in the coolest place available. Treated in this way, the game will stay fresh for several days in the warmest weather.—R. A. Jenkins, St. Louis, Mo.

### Dolls Stored in Plastic Hatbox

Hobbyists who collect miniature dolls will find that a large plastic hatbox forms an excellent container that will easily hold eight or more of them. The transparent plastic allows the dolls to be displayed attractively while still protecting them from dust.—H. Leeper, Canton, Ohio.



# BIRD CAFE

By Dick Hutchinson

REMINISCENT of the old buildings found in western ghost towns, this unusual bird feeder forms a novel decoration for the yard in addition to providing an all-weather shelter for a number of birds. The feeder is set on top of a post at least 8 ft. above the ground with the open end at the front of the shelter facing south to afford maximum protection from the elements. The bottom of the platform can be a piece of 1 x 12 and wooden strips are nailed to its edges so that the platform doubles as a feeder tray. The shelter is cut out and assembled with glue and brads as shown in the detail. However, before assembly, the outer surfaces of the front, back and sides and the front portion of the floor are scored with shallow saw cuts to simulate wide boards. The window casing, sign frame and roof shingles are cut from veneer which has been soaked and separated from a piece of plywood. The veneer is glued in place, small brads being used in addition to the glue to insure that the veneer will not come loose. After the shingles have been applied, a ridge roll, also cut from veneer, is fastened along the peak of the roof in the same way as the shingles. Both the shelter and the platform are finished with a coat of reddish-brown oil paint to give an antiquated appearance and, after this has dried, the sign is lettered with black paint. A small screen-wire basket for suet should be tacked to one of the walls inside the shelter. Use a piece of 4 x 4 for a post.

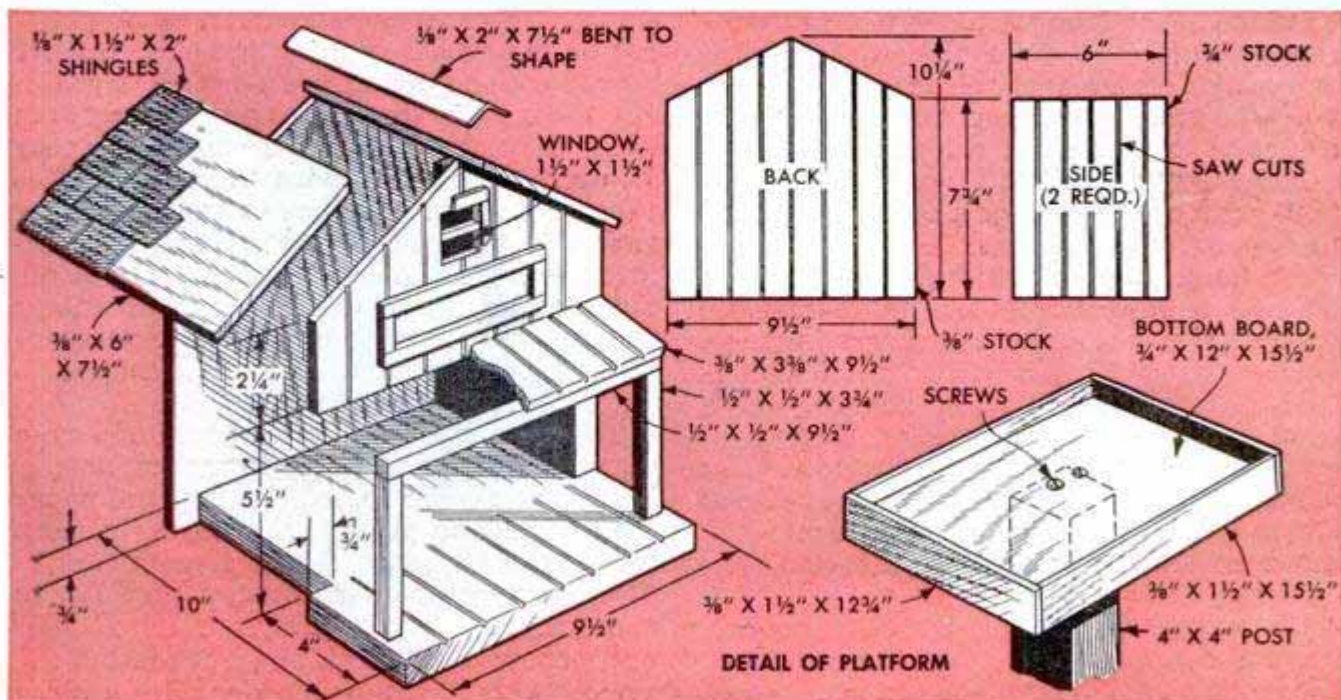
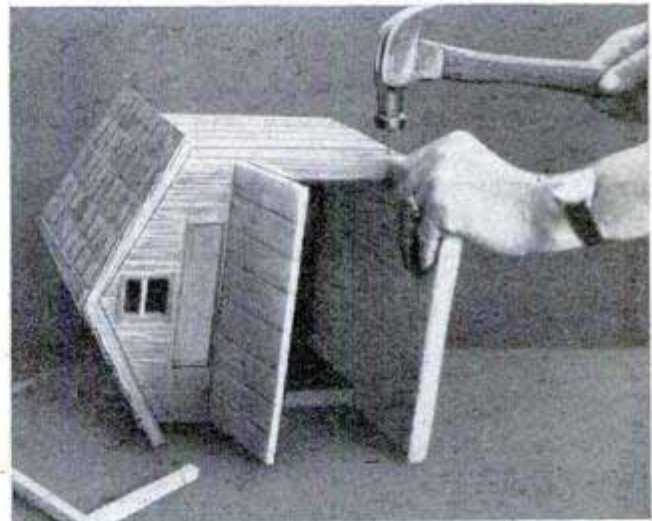

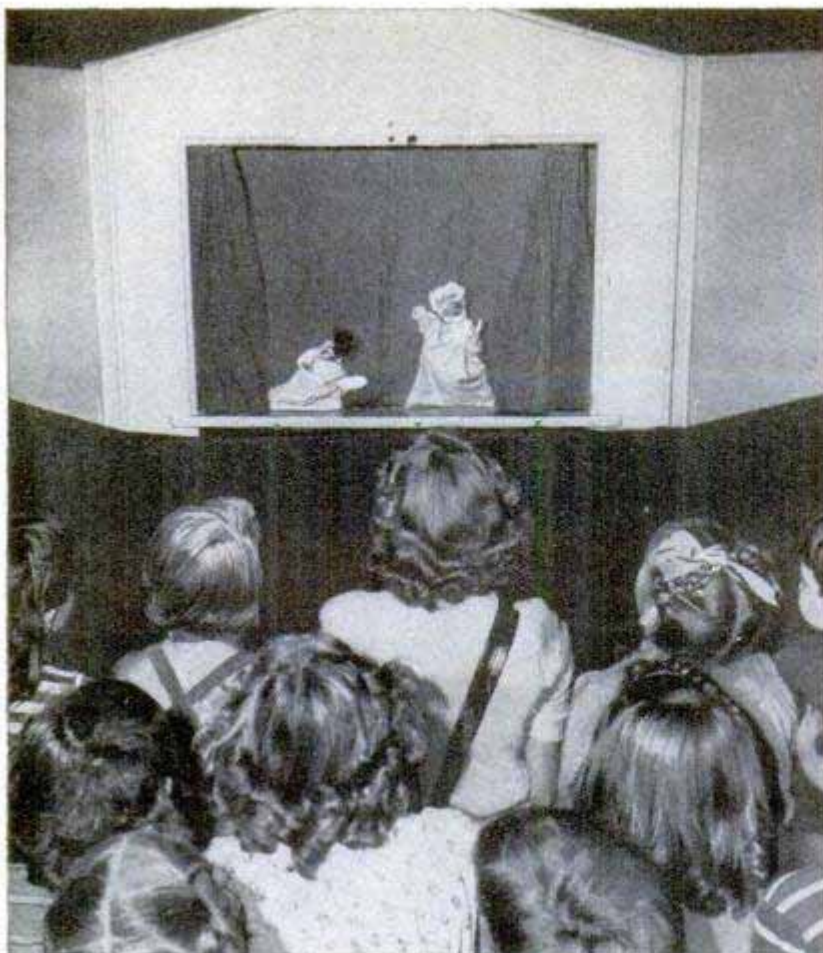

# HAND PUPPETS EASY TO MAKE

By Ed Lundburg

Photos by Jasper Nutter

REVIVED by their popularity on television, hand puppets are fast becoming the rage among the youngsters of the country. Not only are the puppets entertaining but they give the child an opportunity to combine his artistic talents with craftsmanship. Unlike the more elaborate marionettes with their movable joints and involved string arrangements, these puppets are easy to make and the presentation of a show requires little more than a stage front with a curtain backdrop behind which the operator can stand.

Although the actual fashioning of the puppets is surprisingly simple, there is no limit to the variety of characters that can be created with the aid of a little imagination. The puppets consist basically of a head and two hands which are joined together with an appropriate costume. The head, modeled over a hollow core, is placed on the index finger and the arms are mounted on the tips of the thumb and little finger of the operator's hand.

The center of attention and, therefore, the most important part of the puppet is the head. A mache type of material, which

must be specially prepared, is used to model the head, the primary ingredient of the substance being wood dust. Note that this is not ordinary sawdust but the fine dust collected from a sanding machine. Each puppet head requires about a heaping cupful of the wood dust. This is thoroughly mixed with a flour-and-water paste by adding the dust to the paste and working it in until the mass is of sufficient consistency to permit modeling with the hands. It is recommended to use hot water for mixing the paste, primarily because it is more comfortable to work the warm mixture by hand. As soon as the modeling material attains the desired consistency, the mass is applied around a paper core and shaped to the features of the puppet.

To make the core, cut a piece of heavy wrapping paper into a strip approximately 2 in. wide and 18 in. long. Wrap the paper loosely around your index finger to form a cylinder and then fasten it with a strip of cellulose tape or gummed paper. Leave the cylinder on your finger, crumple half of a paper towel and then tie it around the upper portion of the cylinder with a piece



of string, as in Fig. 1. Follow by applying the mache over the towel, as shown in Fig. 2, modeling the features of the head as in Fig. 3. The reason for placing the crumpled paper towel around the upper half of the core is to provide a rough surface which the mache will grip securely when it hardens. Thus, it will not slip off the core. Note that in modeling the head, a collar of mache is formed around the lower portion of the core. It is necessary that this be done, as the collar allows the puppet's costume to be fastened with a drawstring, as in Fig. 7.

After modeling the head, set it aside to dry for about two days and, when it has hardened, sand the contours smooth with fine abrasive as pictured in Fig. 4. As the mache has a high wood content, you will find it easy to sand. Painting the head is the next step and, when doing this, keep in mind that the audience must be able to see the features from a considerable distance. For this reason, use bold lines and colors, Fig. 6, making up the puppets just as carefully as circus clowns. A standard doll wig, or a homemade one of fur or carpeting is glued to the head. However, if a rather large hat is part of the costume, hair can



**Puppet and puppeteer ready for the next performance**

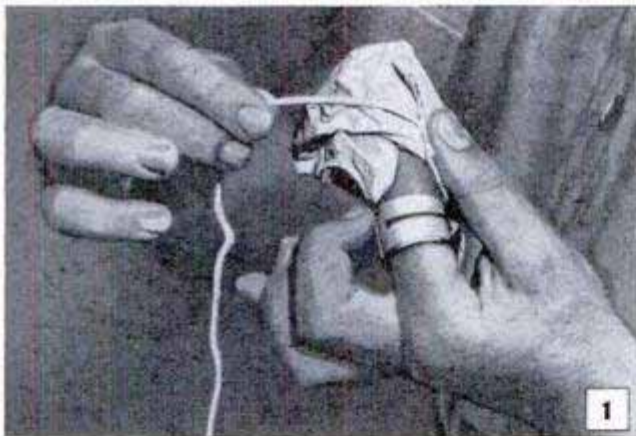

**Crumpled paper towel tied around end of cylinder provides form over which puppet's head is modeled**

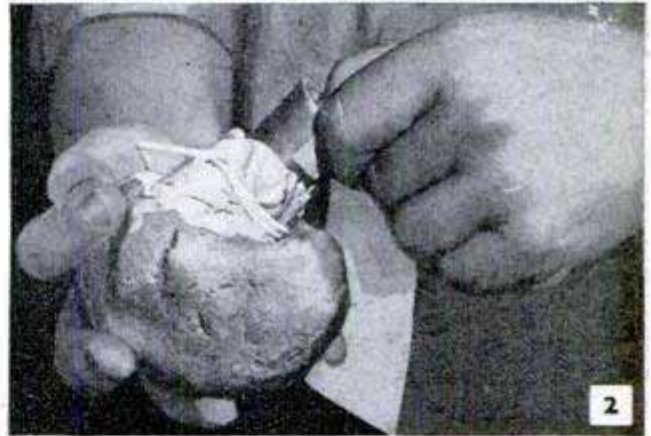

**Head is fashioned from a specially prepared mache type of material, utilizing a cupful of fine wood dust**



**Collar molded at base of the head permits attaching costume simply by tightening drawstring at the neck**



**After the mache has dried for two days, the features are carefully sanded with a very fine abrasive paper**

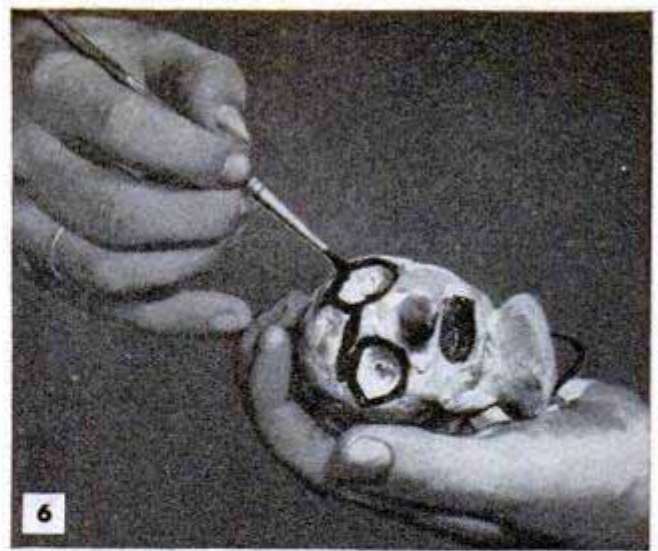

The rear view, left, shows how puppet's costume hides hand and arm of operator. The head of the puppet is painted boldly and in bright colors, as shown above

Below, left, the drawstring at the neck of the costume is pulled taut for attaching to collar on head. Below, arms and head fit on finger tips of puppeteer

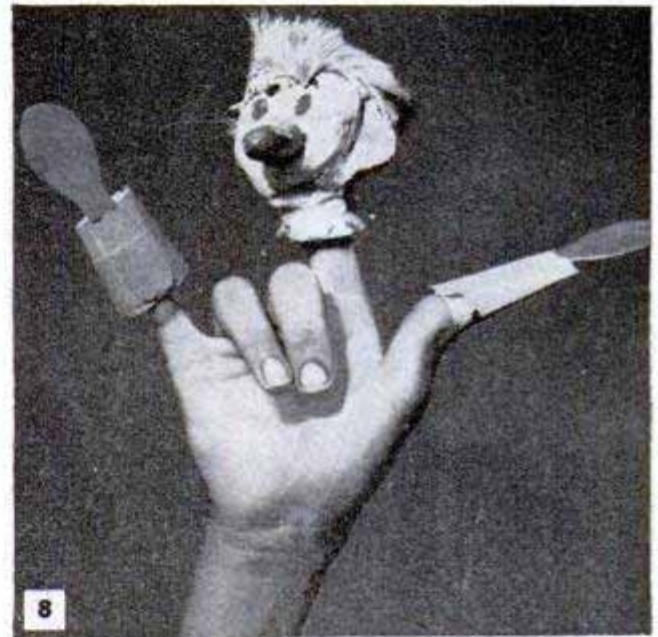

be simulated by painting over the mache. The arms of the puppet are made of wrapping paper in the same way as the core of the head. Wooden ice-cream spoons taped or glued to the cylinders, as in Fig 8, form the hands. These can be notched to simulate fingers or left plain and painted to suit. Suitable costumes for the characters

can be cut and sewed together from cloth remnants, using gay or subdued colors to conform with the personality of the puppet being created. As mentioned before, the neck of the garment as well as the arms are secured with drawstrings. Note in Fig. 5 how the long costume of the puppet hides the operator's hands and arms.

## Acetone Does Thorough Job of Cleaning Varnish Remover From Surface

Next to doing the work in a well ventilated room, the most important step in using varnish remover is to make sure that all traces of the remover are wiped from the surface of the work. I have found that acetone applied with steel wool is excellent for scrubbing the surface clean after the varnish is softened. First, I use a scraper to

remove most of the soft varnish. Then, after applying a second coat of remover, I scrub the surface with steel wool dipped in acetone and follow by rubbing with a cloth dipped in the same solution. A final wiping with acetone and a clean cloth produces a thoroughly cleaned surface.

Herman F. Buegel, Grand Forks, N. D.

# PORTABLE BOX DISPENSES ADMISSION TICKETS

Next time you're on the entertainment committee for a church or lodge social function, you can simplify the job of selling admission and raffle tickets by taking a couple of hours to make this portable ticket box. Two rolls of tickets can be inserted quickly in the box by lifting out the reel and placing the rolls over the ends of the shaft. The first couple of tickets on the rolls are threaded through slots cut in one end of the box. Note in constructing the box that, after the sides and ends have been assembled, a supporting member notched for the reel shaft is nailed to the inner surface of each side. The shaft should be positioned at the center of the box and parallel with the ends. The top of the box is fitted with a hinged cover, rabbeted on all four edges to close snugly, and the ticket reel is assembled by gluing two

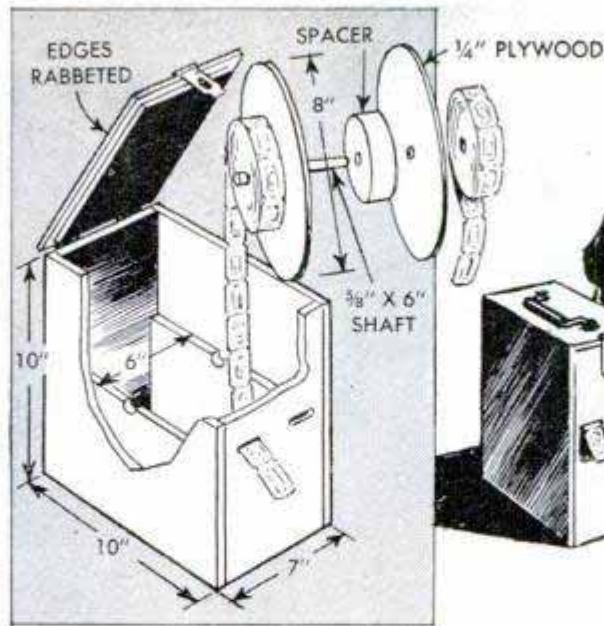

plywood disks and a wooden spacer on a length of  $\frac{5}{8}$ -in. dowel. The spacer must be thick enough to align the tickets with the slots in the end of the box. A carrying handle screwed to the cover and a hasp for a padlock complete construction. The finished box is painted to suit.

D. C. Marshall, Manhattan, Kans.

# Compact Bottle Warmer for Picnics Made From Fruit-Juice Cans

Tucked away in a corner of the trunk or in the back seat of the car, this little picnic stove is easy to carry and provides a quick method for heating baby's formula, boiling water for coffee and warming canned foods. The stove is made from two fruit-juice cans, one of them having a diameter slight-

ly smaller than the other. Cut the top from the larger can and, using a lever-type can opener, make ventholes around the bottom. Then perforate the sides two or three inches above the vents, bending the metal inward to form a rack for a grid. The grid is made by cutting one end, including the rim, from the smaller can with tin snips, the rim providing a reinforced edge for the grid. Perforate the metal, as shown in the upper detail, bending the tabs around the edge with a pair of pliers. To use the stove, drop a heat tablet into the bottom and lower the grid down over the rack. Ignite the heat tablet with a match inserted through one of the ventholes. As no smoke and very little odor is emitted by these tablets, canned goods may be opened and heated directly over the flame. However, a baby's bottle should be heated in a can containing water.

Philip D. Miller, San Lorenzo, Calif.

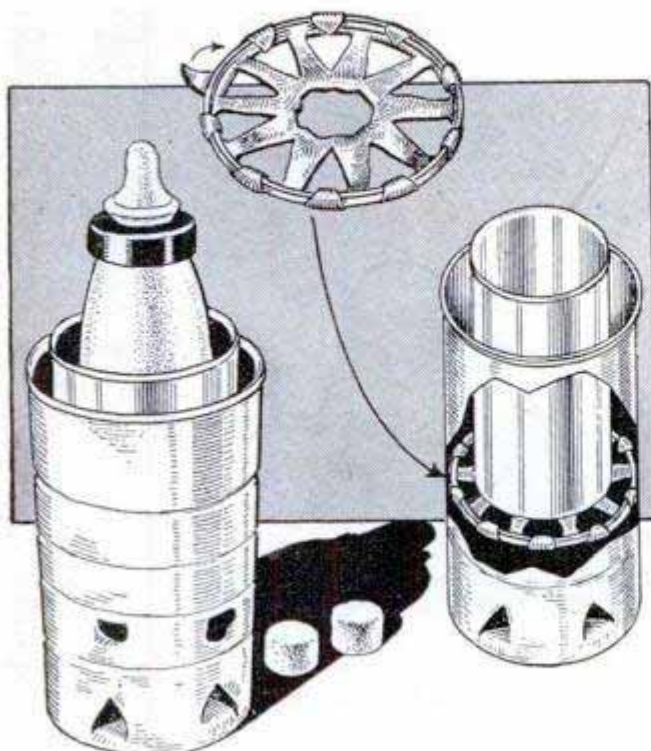

# Checking Refrigerator Light Switch

What happens to the refrigerator light when you close the door? Sometimes it stays on, reducing the efficiency of the refrigerator. If the lamp feels warm right after the door is opened, it has been burning owing to a defective switch which should be replaced as soon as possible.

# Solving HOME PROBLEMS



**WHEN TATTING OR CROCHETING**, stick a hatpin into the arm of the chair and slip the spool of thread over the pin. This will keep the spool from falling to the floor and rolling out of reach



**MOTH-BALL CONTAINERS** for the closet can be fashioned from adhesive-bandage cans. A number of holes are punched in both sides of each can and hung from a clothes pole or hook with string

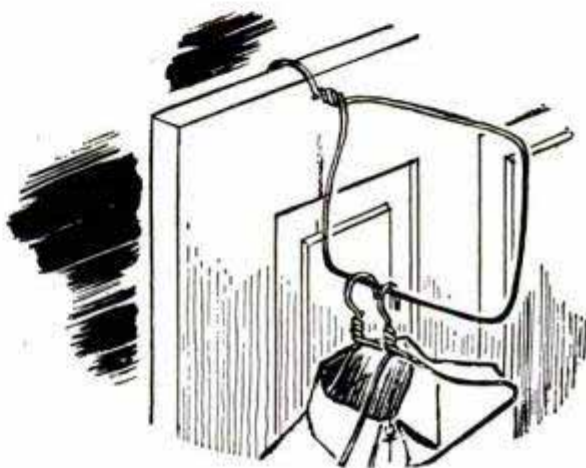

**A TEMPORARY SHIRT RACK** bent from a wire coat hanger is just the thing to hold freshly ironed shirts until they can be put away. Bend the hanger as shown and hook it over top of door



**AN EASY-TO-USE WASH-LINE REEL** that will not twist the line is made in a jiffy from scrap lumber. The reel rotates around a center handle on which it is held with washers and cotter pins



**DOILIES, TABLE RUNNERS** and dresser scarves will not blow out of place in a sudden draft if they are weighted with metal washers. Pockets for weights are sewed to the underside at corners

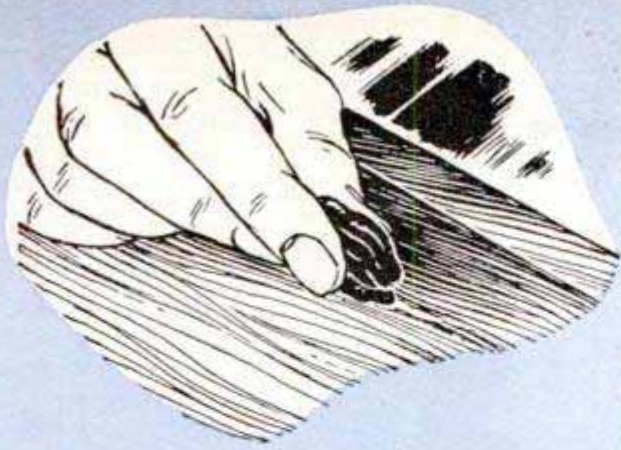

**SMALL NICKS AND SCRATCHES** in darkly finished furniture are hidden by rubbing with the meat of an unsalted pecan or walnut. Just break the nut meat in half and rub the mar with the inside of the meat so that the oil will stain the wood



**POTTED PLANTS** which become dingy looking after a time can be freshened quickly by spraying with water. Apply the water from a bottle having a spray attachment, such as a window-cleaner bottle, washing it out thoroughly before using

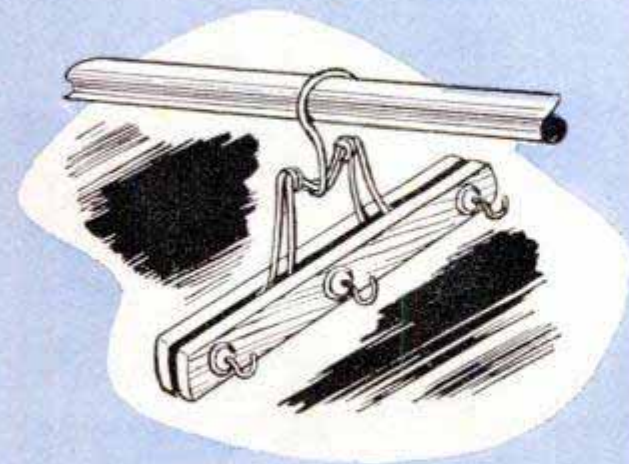

**EXTRA BELTS MAY BE STORED** compactly for immediate selection by hanging them from a closet clothes pole. Provide a suitable rack by turning a number of cup hooks into a spring-type trouser hanger. Several hooks can be turned in each side

Instead of using up valuable space in sewing kits and baskets for storing large spools of thread and balls of mending cotton, just insert the thread in an empty egg carton and place in a dresser drawer

To remove a cork from the inside of a bottle that you wish to use again, pour a little ammonia in the bottle and allow it to remain for several days. The ammonia will crumble the cork for easy removal

If the rubber hose on a bathtub shower spray tends to split at the connection, cut off the damaged portion and wrap the end with waterproof cloth tape. This will reinforce the hose to prevent splitting

Fitting wallboard around outlet boxes is easy to do if the box itself is used to mark the board. Rub chalk over the edge of the box and place the panel in position, pressing it firmly against the outlet box

A spring-type trouser hanger clamped to a paper bag forms a handy disposal container which can be hung conveniently from a doorknob. It's excellent for collecting cigarette butts, etc., after a party

Spoilage of left-over food is reduced by labeling each dish with the date it was placed in the refrigerator. Write the date on a slip of paper and fasten to the side of the dish with cellulose tape

Stains on furniture, rugs and clothing are easier to clean if they have not dried. To speed removal make a chart listing various types of stains and how to remove them, and tape it to a closet wall

Rubbing light oil over the outside of ice-cube trays and the inside of the refrigerator freezing compartment permits removing the trays without difficulty. Clean and dry the surfaces before applying the oil

Next time you break the stem of one of your favorite plants, bind the sections together with cellulose tape. If done in time, the break will heal, restoring the plant to its original healthy condition

Carved decorations on furniture which are difficult to dust in the usual way can be cleaned thoroughly by using a soft-bristled brush dipped occasionally in a shallow container filled with liquid furniture wax

## Portable Stove Cooks Picnic Lunch



Made in a few minutes from a large can of the type in which potato chips and lard are sold, this portable cookstove is just the thing for preparing a warm picnic lunch. The cover is discarded and holes are punched near the top of the can to receive iron rods which provide a grill. A large opening cut near the bottom of the can permits refueling and allows sufficient draft.

Leroy P. Murphy, Spring Hope, N. C.

## Handy Container for Fishhooks

Easy to handle, this wooden container holds a number of fishhooks for convenient selection and prevents the leaders from becoming tangled. The box is made from

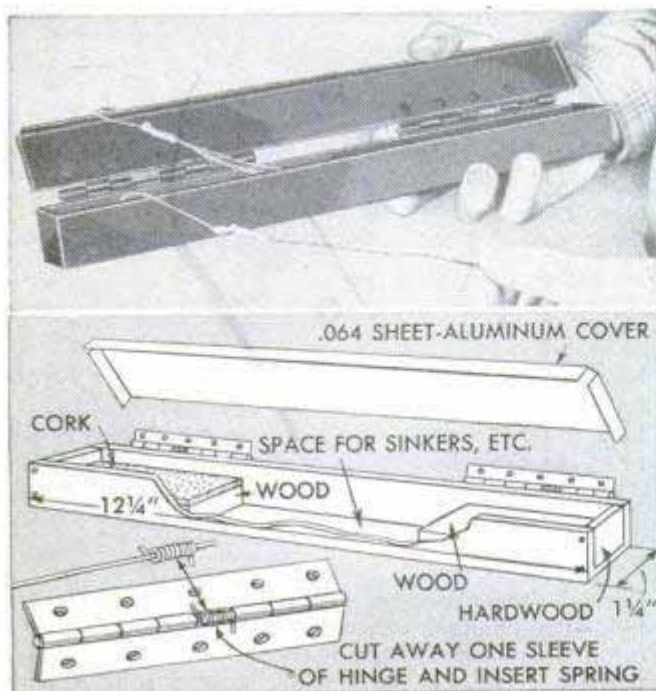

hardwood, as shown in the detail, and fitted with a cover of sheet aluminum. The cover is attached with lengths of piano hinge, one sleeve of each hinge being cut away and a spring inserted to hold the lid closed. The hinges can be riveted to the cover or simply attached with nuts and bolts. The fishhooks are mounted between two wooden blocks nailed to the bottom of the box. Cork is glued to the top of one of the blocks to engage the barbs of the hooks, and brads driven into the other block hold the looped ends of the leaders. The section between the blocks provides space for sinkers and miscellaneous tackle.

R. J. DeCristoforo, New York City.

## Furniture Webbing Drawn Taut With Locking Pliers

Drawing furniture webbing taut before tacking it in place is a simple matter if a pair of locking pliers is used as a lever to pull the material across the frame. Just clamp the webbing between the jaws of the pliers and press the rounded nose

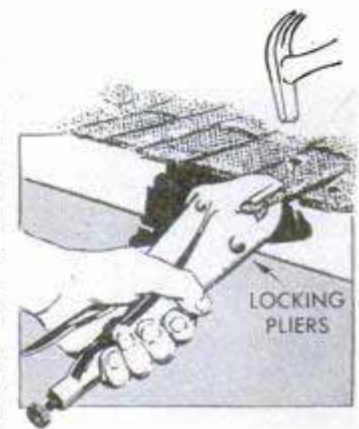

of the tool against the frame while pushing downward on the handle. The webbing can be held taut with the pliers while it is tacked in place. Then cut off about 1 in. beyond the edge of the frame, fold back and retack. Place a wooden block under the pliers so that they do not mar the varnished surface of the frame.

Oliver C. Grant, Springfield, Mass.

## Cleaning White-Bead Jewelry

When necklaces and bracelets made of white beads become soiled, their whiteness and luster can be restored by immersing them in a lukewarm soap-and-water solution. The beads should be left in the soapy water for a few minutes and then rinsed carefully, with clear water to remove all traces of soap. After this, they are hung up until thoroughly dry.



Helen Lemberger, Chicago.

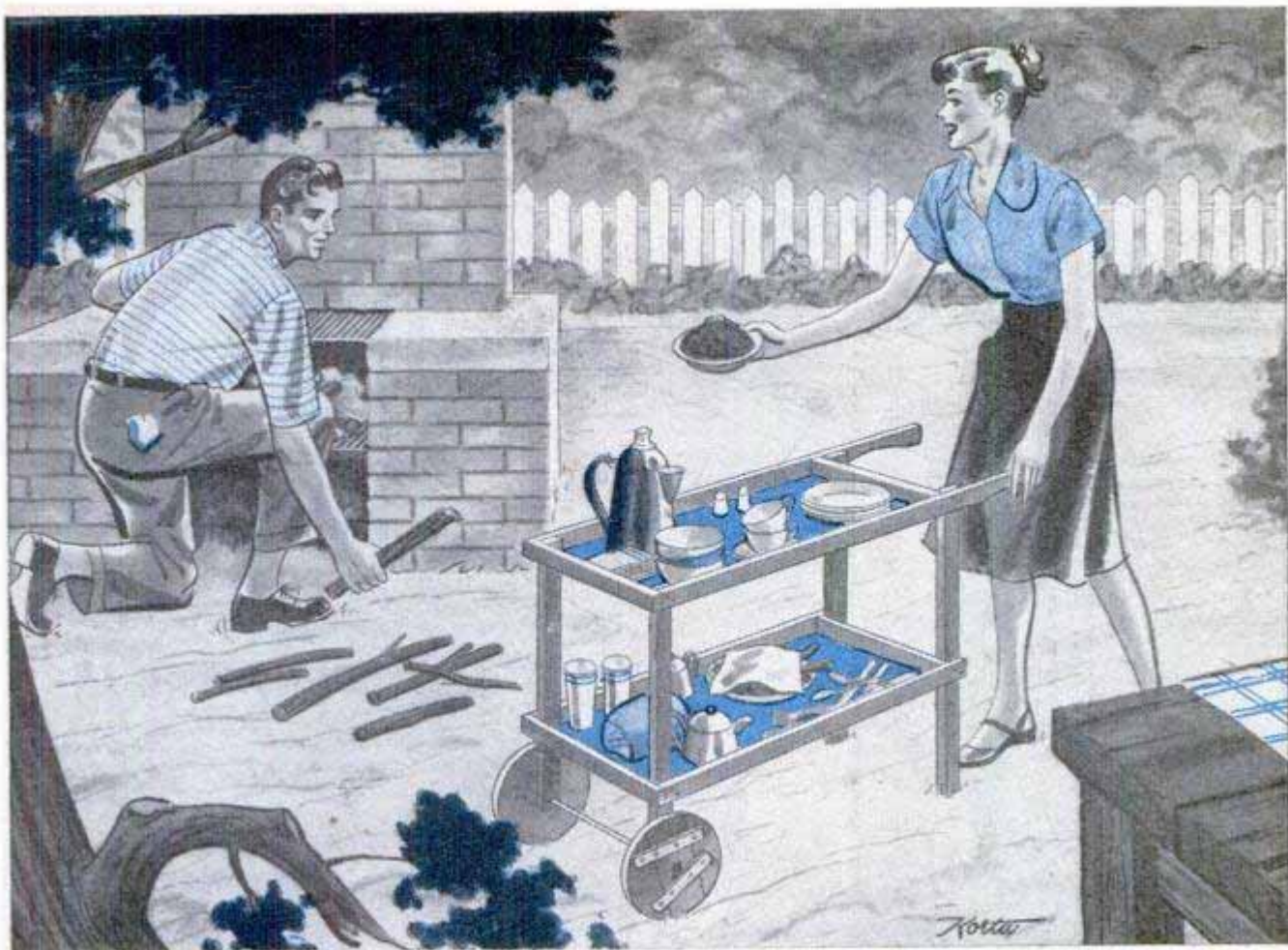

## BAR-B-Q CHUCK WAGON

By Elma Waltner

THIS CHUCK WAGON with its large trays takes care of the transportation problem for both the host and hostess at a garden barbecue. Usually one trip with the wagon from kitchen to outdoor fireplace does the whole job of delivering the necessary dishes, utensils and food. This one is pushed wheelbarrow-fashion and has been specially designed for easy construction. Note in Fig. 3, for example, that at the front end of the framework the two horizontal members of the frame, which also form the ends of the trays, overlap the lengthwise members and enclose the uprights. At the rear of the frame, the two corresponding pieces are placed ahead of the uprights and are butted against the sides of the lengthwise members. This arrangement of parts makes it easy to join the frame with screws and glue without the necessity of cutting mortises or half laps. Assembly of the parts is clearly shown in Fig. 3. Shape handles by rasping away the wood and finishing with sandpaper. The

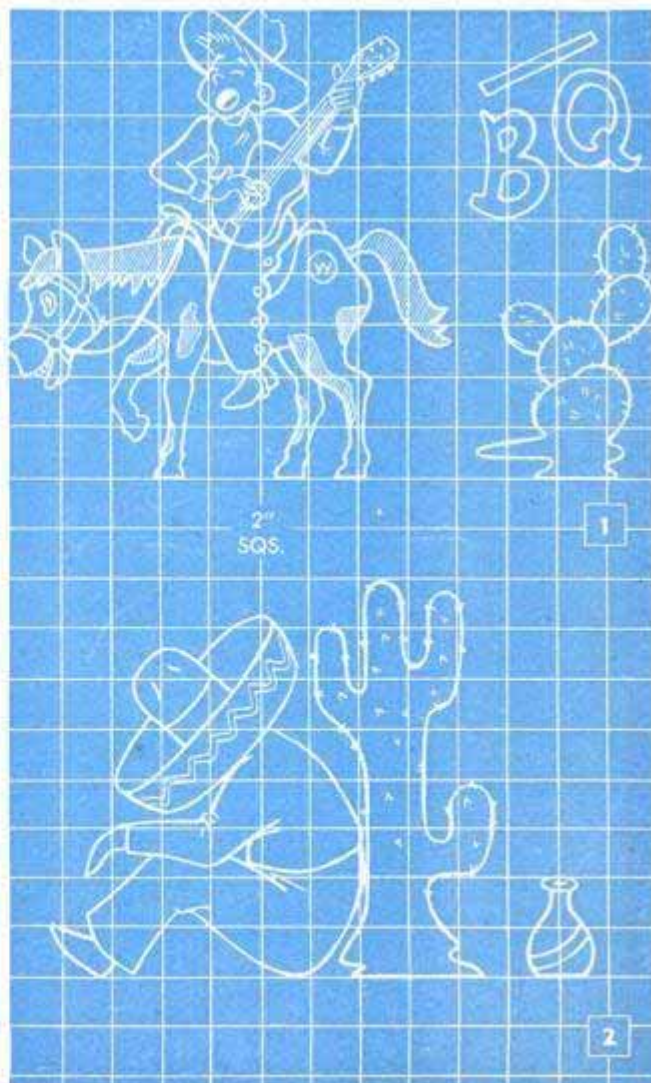

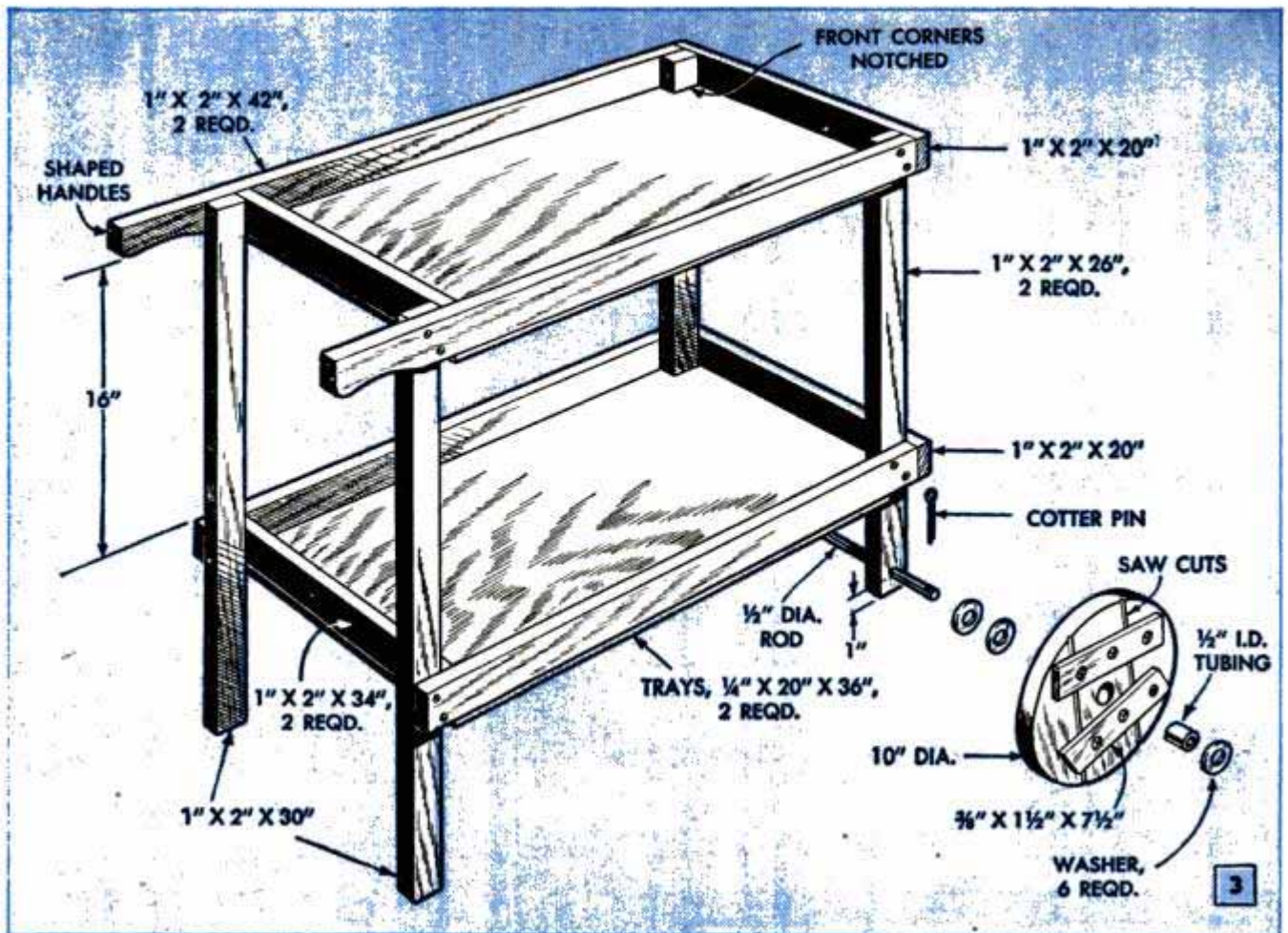

bottoms of the trays are of plywood or hardboard and the corners must be carefully notched to fit around the uprights. Before installing the tray bottoms permanently, they are decorated with the character decorations suggested in Figs. 1 and 2. This can be done by transferring the full-size outlines to the wood with carbon paper and then burning in the outlines or by painting with suitable enamel colors. After completing the trays and framework, all parts are finished with a coat of orange shellac and one of spar varnish. To carry out the chuck-wagon motif a step further,

make the wheels as in Fig. 3. Saw two  $\frac{3}{4}$  x 10-in. disks and center-drill them for  $\frac{1}{2}$ -in. brass or bronze bushings as indicated. After driving the bushings in place, make shallow saw cuts on the outside face of each disk as shown. Then fit two cleats at the angle shown and fasten in place with screws. Drill the front frame uprights for a  $\frac{1}{2}$ -in. shaft, and then assemble the wheels on the shaft with washers and cotter pins. Finish the wheels to match the frame. Although pine is a satisfactory wood to use, oak is best for both the frame and wheels, as it is much more durable.

## Lamb's-Wool Paint Roller Spun on Portable Drill for Quick Cleaning



If you want to clean a lamb's-wool paint roller in a few minutes so that it can be used to apply another color of paint without delay, whirl it on a rod which is chucked in a portable electric drill. Use a length of rod that is about 2 in. longer than the paint roller and one that

will slip through the center hole of the roller. Wind one end of the rod with rubber tape and, holding the taped end, push the rod through the hole in the roller. Press the tape shim snugly into the end of the hole and chuck the other end of the rod in the drill. Then insert the roller into a can or box which is slightly deeper than the length of the roller and turn on the drill for a few seconds. Stop the drill, sprinkle the roller with turpentine and replace inside the can, again turning on the drill. Repeat this operation two or three times or until the roller is thoroughly clean, and it will be ready for applying the new paint.

Carter Robertson, Franklin Park, Ill.



## Cork Fishing Floats Mounted on Croquet Wickets Increase Visibility

To make croquet wickets more clearly visible when the game is being played at dusk, press a cork fishing float over each wicket, positioning it directly at the top of the arc. The holes in most floats are small enough so that they will be a friction fit on the wire and will not readily slip out of place. Paint the corks white or bright yellow before slipping them over the wickets.

G. E. Hendrickson, Argyle, Wis.



## Paste Brush Hung From Pail Rim By Knob Fastened to Side

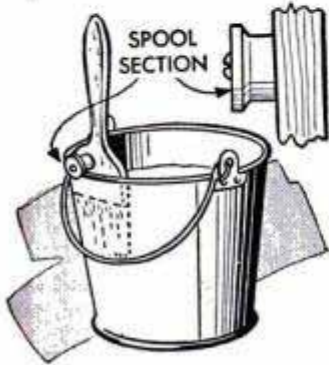

In order to keep a paste brush right with the pail where it is always convenient, one paper hanger suspends the brush inside the pail by hanging it from the rim. A brush hanger was improvised by cutting a wooden

thread spool in half and fastening one of the halves to the side of the brush handle with a screw. The lip of the spool keeps the brush from slipping off the rim of the pail and falling into the paste solution.

## Novel Gate Utilizes Scrap Parts

Here's an excellent example of the interesting ornamental gates that can be made from odds and ends. This particular gate utilizes a section of iron railing, a length of spiral reinforcing rod, wire fenders from a two-horse cultivator and a horseshoe. All the parts are welded together.

A. M. Wettach, Mt. Pleasant, Iowa.

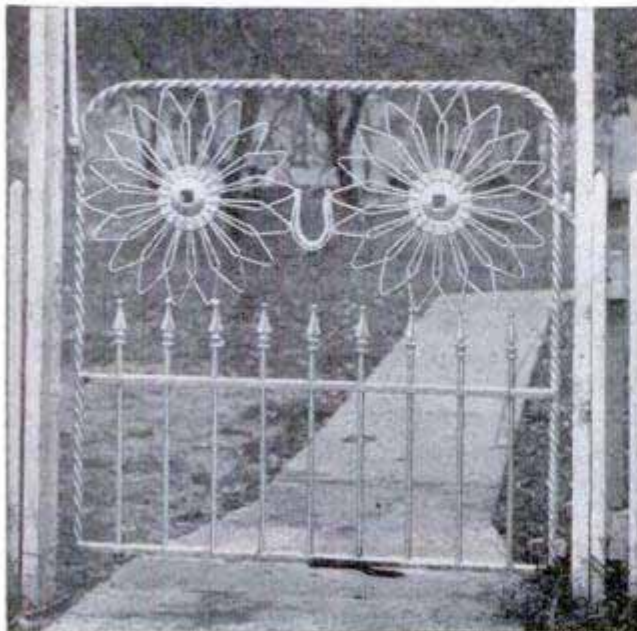

## Emergency Matches for Campers

A number of dry matches kept in readiness for emergency use on a camping trip, will come in handy if the regular supply of matches is ruined by rain or dampness.

To protect the emergency matches from moisture, sandwich each one between two strips of cellulose tape, pressing the edges of the tape tightly together.

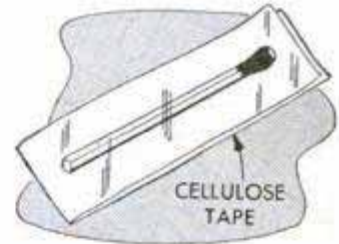

## Toothpick Prevents Spilling Fluid When Filling Cigarette Lighter

Attempting to fill a cigarette lighter from an open-mouthed bottle often results in spilling a considerable amount of the fluid on the floor or table top. To prevent this waste of fluid, hold a toothpick across the mouth of the bottle and place the end in the lighter opening, as shown in the drawing. Pour the fluid slowly so that it will flow along the toothpick and into the lighter.

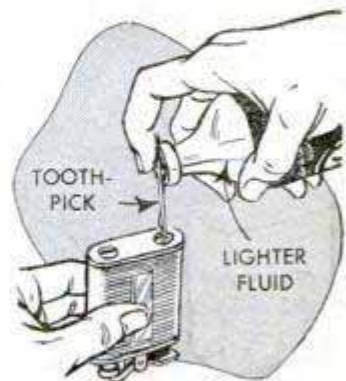

Victor H. Lamoy, Upper Jay, N. Y.



# Repainting INTERIOR WALLS and WOODWORK

**I**T'S EASY for any homeowner to do good interior painting by following the simple but important steps of correct procedure in both preparatory work and painting.

**Kinds of paint:** Paint selection for interior work depends largely on the effect desired—on whether you want a gloss, semi-gloss or flat finish. Today most oil paints and enamels for interior use are relatively fast drying. Gloss finishes, often used in kitchens and bathrooms, dry to a hard finish, shed dust and wash easily. Semigloss or eggshell finishes produce less glare and, therefore, are preferred generally for living, dining and bedrooms. The latest type of semigloss enamels have excellent wearability and are easy to apply. Flat paints eliminate glare almost completely but soil easily and show fingermarks. As they set within a few minutes, they are somewhat difficult for the average layman to apply.

Water-soluble paints come in powder or paste form. They include calcimine and casein as well as the more complex resin-emulsion paints. Most water-soluble paints have excellent hiding power and cover in one coat, although many oil paints of similar consistency will cover equally well. It is possible to clean water-soluble paints fairly well by rubbing lightly with a sponge, clean rag or soft brush moistened with soapy water. The resin-emulsion paints will withstand ordinary cleaning. Calcimine cannot be washed to clean it but must be removed entirely and replaced. Repainting over some types of water-soluble paints with oil paints is possible if a special sealer is first applied. However, in the case of casein paints, the best practice is to remove the old coat with the aid of paint remover. This is neutralized with turpentine which is allowed to dry before oil paint is applied.

Plastic texture paints, available in either water-soluble or oil-base types, are used to improve the appearance of old walls which are in such poor condition that the surface defects and irregularities cannot be concealed by ordinary paints. This type of paint produces rough-textured finishes.

The characteristics of any particular brand of paint and the amount required for

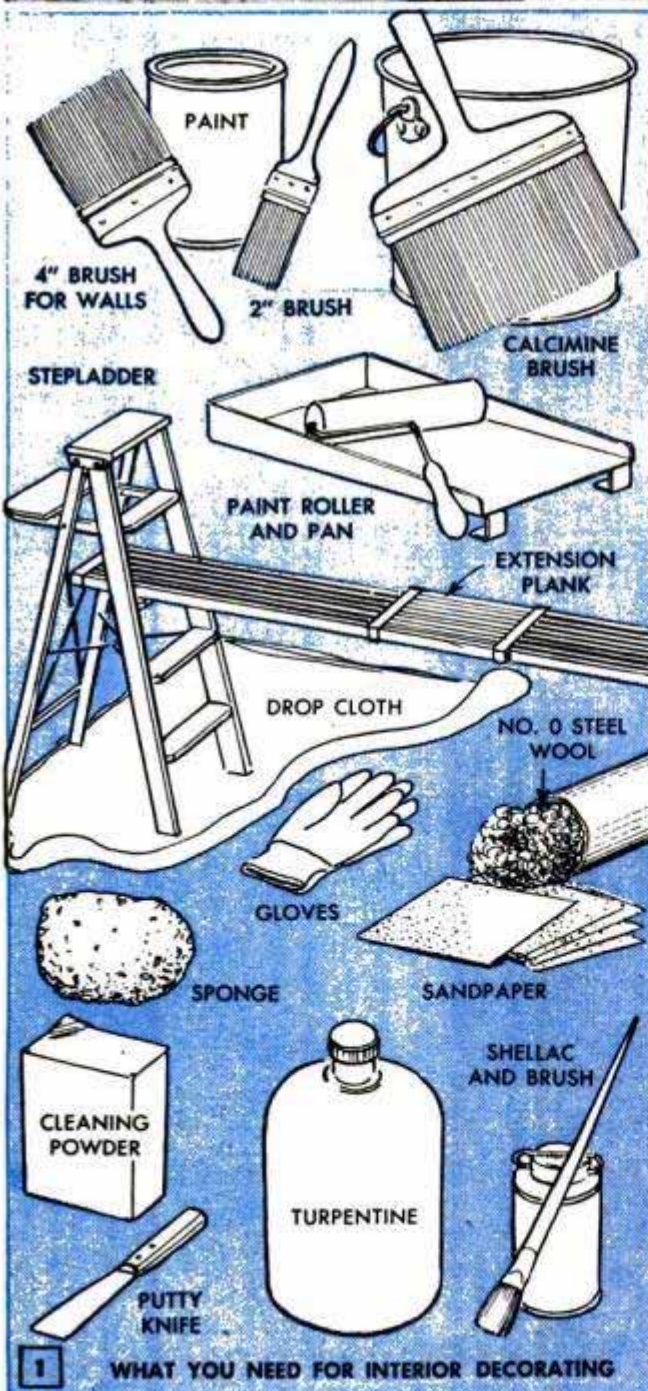

How to get professional results and make big savings by doing the work yourself. Includes important preparatory steps and many little tricks of painting

a job should be taken up with the paint dealer. A one-coat repaint job is often sufficient to cover a previously painted wall of the same or nearly the same color. Two coats generally are required if there is a change in color. When applying two coats, the first should be allowed to dry for 12 to 18 hours before the second is applied.

Often enamel undercoater is applied to a surface prior to enameling it. The purpose is to produce the best possible bond between the two, thereby lessening the tendency of the enamel to chip and also providing a base on which a substantial amount of enamel can be applied with minimum trouble from runs and sags.

**Tools and equipment:** Fig. 1 shows what you need. For fast, uniform coverage of large surfaces, use a 4-in. brush; the 2-in. size is handy for sash and door work. Excellent results on walls and ceilings are possible with a paint roller, supplementing this with a brush to cut in the paint neatly at the woodwork and in corners and to reach into small spaces. For calcimining, use a calcimine brush to get quick, uniform coverage. You can work from a single stepladder, but two 4 or 5-ft. stepladders (or two wooden boxes of the right height) and an extension plank are much more convenient. A drop cloth protects floors and built-in furniture from paint drops, but newspapers can be used. You also need a putty knife, sponge, some 1/0 sandpaper and No. 0 steel wool, a trisodium-phosphate cleaning powder, a box of patching plaster, and either the non-

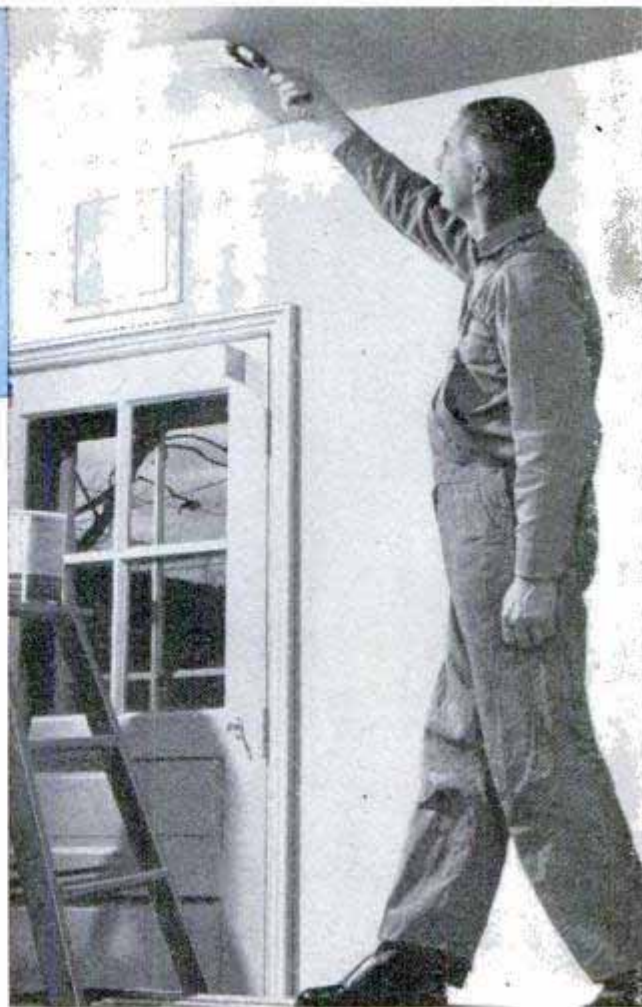

shrinking, plaster-of-paris type of crack filler, or the type that remains somewhat flexible for use where there is movement and vibration of adjoining surfaces. Also get a gallon of turpentine, a bottle of shellac and a small brush. Don't forget a cheap pair of canvas gloves to prevent painful blisters if you're not accustomed to handling brushes, and rubber gloves for protection against strong cleaning solutions.

**Preparations for painting:** Expert results in painting depend largely on the thoroughness of preparatory work, especially cleaning, crack filling and sealing. Remove all loose furniture, drapes, curtains, Venetian blinds, pictures and other fixtures nailed

Lower the light-fixture canopy so that you can paint under it easily



Plates on flush wall switches and outlets must always be removed



All hardware is removed from doors and windows and kitchen cabinets





Reposition the base shoe molds at the floor level if there are wide gaps as shown in details at right

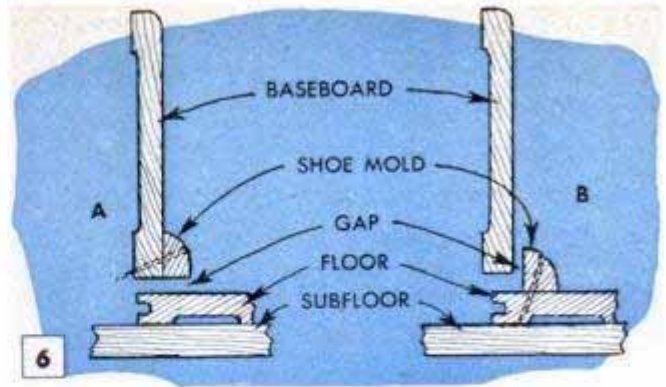

shrinkage of wood and settling of a house, gaps often develop between the shoe mold and floor or baseboard, details A and B of Fig. 6. To correct this, pry off the shoe mold carefully with a wide chisel. If it breaks, replacement is not expensive. Scrape away dirt stuck to the floor or baseboard and replace the shoe at floor level, Fig. 5. Then sandpaper down the rough edge of paint where the mold joined the baseboard.

**Thorough cleaning procedure:** Paint should never be applied to a dirty or greasy surface, nor to one covered with wax. Dirt and grease are washed off with a strong solution of cleaning powder. This also dulls glossy surfaces and puts them in better condition for paint adhesion. Wax is removed with a turpentine-saturated cloth followed by a thorough washing with cleaning solution. When washing a room, do the ceiling first, as in painting. Use a sponge, Fig. 7, on smooth walls; a soft brush is better for rough surfaces. Wring out surplus solution from the sponge to prevent dripping, apply to the surface and let the chemical work. Then rub the surface and wipe up with a sponge wrung out in clean water. Such a washing also removes starch coatings and calcimine. Besides the wall surfaces, all the woodwork is washed thoroughly, scraping away dirt from baseboard corners and the tops of door frames with a putty knife.

**Crack filling:** Cracks, scratches, gouges, as well as nail and screw holes that will not be used again are closed with a crack filler. The kind that remains slightly flexible is used where there is any vibration, expansion or contraction, which would loosen a hard crack filler. Very small cracks can be filled with "spackling" compound. Cracks  $\frac{1}{4}$  in. wide or more, are undercut to inverted V-shape with a putty knife as in detail A of Fig. 8. As the plaster on each edge of large cracks often is raised, dress the raised portions down flush with the rest of the plaster surface, using sandpaper as in detail B. Edges of a crack are wet with water before applying plaster-of-paris type crack fillers or patching plaster. Cracks larger than  $\frac{1}{4}$  in. as well as spots from which loose plaster has been removed, are filled with patching plaster. Smoothing plaster



A thorough washing with cleaning solution assures surfaces that are entirely free from dirt and grease

or screwed to the walls, and extract nails and screws. Loosen the canopies of lighting fixtures and remove plates from wall switches and outlets, Figs. 2 and 3. For a professional appearing job, remove hardware from doors, windows and cabinets, Fig. 4. Chromium hardware can be immersed in a strong solution of cleaning powder until ready to replace it, at which time it is rinsed and dried. Lacquer-coated brass hardware is not subjected to this cleaning treatment. Kitchen-cabinet doors can be taken to the basement for painting. To get behind the kitchen stove when cleaning and painting, turn off the gas supply at the meter, disconnect the stove and move it. Put a cap on the end of the gas pipe.

**Repositioning the shoe mold:** Owing to

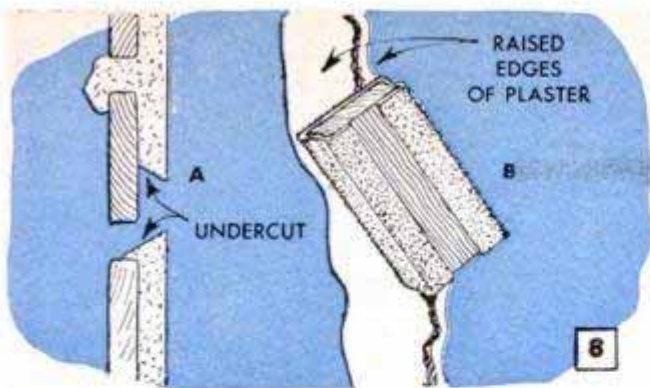

on large patches is done with a trowel. As there may be shrinkage in patching plaster, a second application is sometimes necessary. When using crack filler which sets quickly, mix only enough for ten minutes' use. Setting of the plaster can be retarded by the addition of a little vinegar.

Press the filler into cracks on flat surfaces with a putty knife as in Fig. 9. In corners, this is done more easily with the finger, wearing a finger tip as in Fig. 10, or just putting some adhesive tape over the finger. A water-moistened sponge or rag is drawn over the filler to smooth it immediately after it is applied. When the filler is dry, sandpaper it smooth. Also sand down rough spots, trowel marks left from plastering and spots of dirt and brush bristles stuck to the previous coats of paint. Remove flaky or loose paint and feather the sharp paint edge with sandpaper as in Fig. 11, so it will not show through succeeding coats of paint.

**Sealing the crack filler:** It is necessary to seal the pores of plaster filling and old plaster bared by sandpapering, to prevent excessive paint absorption, which causes dull spots under the finish coat. This is best done with two or three applications of paint, Fig. 12, allowing each coat to dry before applying the next. Before sealing, wipe away all dust and brush the paint to a feather edge around the spot.

**Preparing to paint:** Before applying paint, read the manufacturer's directions, which will vary somewhat with different products. Stir the paint thoroughly. All the pigment which has settled to the bottom of the container must be dissolved completely in the liquid in order to bring the mixture to a uniform consistency. Thin the mixed paint with the recommended thinner or reducer. The container from which you paint should be about half full. Cover the floor and any built-in furniture with a drop cloth or newspapers and arrange the stepladder or ladders and the extension plank. Where possible, it is preferable to work away from a window so that you can see the wet edge of the paint. This position will help you to avoid brush marks, laps and "holidays" (skipped places). Have clean cloths handy



Use a stiff putty knife to press the crack filler into holes, dents and cracks in the plastered walls

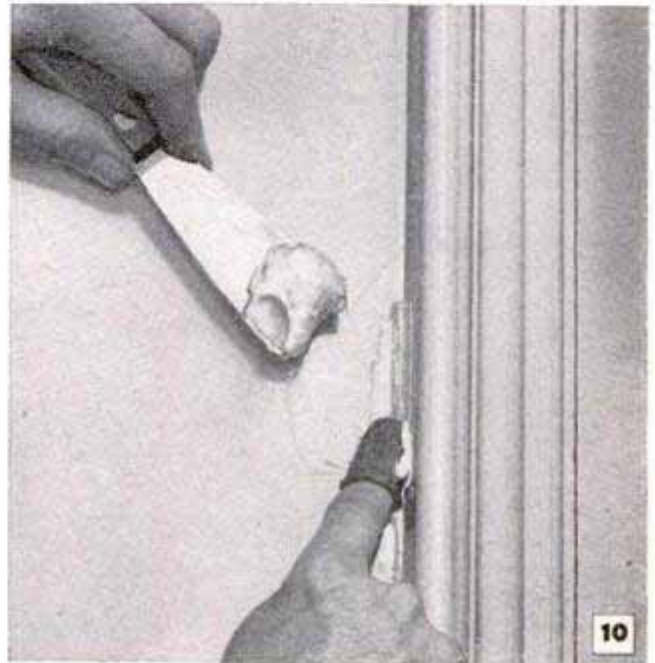

One easy way to apply crack filler in corners is to press it in place with the index finger as shown

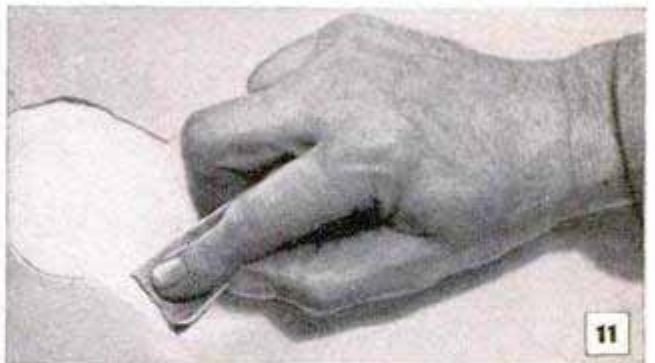

Above, sand off paint blisters and feather the edges. Below, seal the exposed plaster with sealer or paint



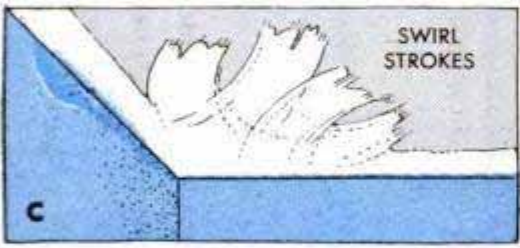
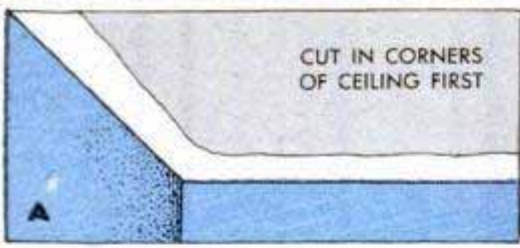

to wipe up drips and unwanted smears immediately before the paint sets. In interior work, the paint is flowed on with a minimum of brushing. However, too heavy an application on vertical surfaces may sag or run before it sets. Avoid applying paint in daubs; rather, dip the brush about 1 in. in the paint and apply to the surface with light strokes until the brush is "empty." Do not brush out the paint as in exterior work. Stroke each separate application just enough to spread it uniformly.

**Paint the ceiling first:** When painting a room, take the ceiling first, setting up ladders and extension plank as in Fig. 13. Usually it's more convenient to work a ceiling in strips from left to right, each painted strip being about as wide as you can reach easily. Remember that in order to get back to a wet edge at the starting point you'll have to work fast. Try to complete each strip across the ceiling before the paint sets at the starting point. If the paint sets, it will be difficult to brush out the lap, as the fresh paint will build on that already applied.

Cut in the corner where the ceiling meets the wall with a single flat stroke of full brush width as in detail A, Fig. 15. A little pressure will be required to "fan out" the bristles when cutting the paint to the corner. Then lay paint on the ceiling with overlapping swirl strokes of the brush as in details B and C, Fig. 15. Once you acquire the knack, you'll find this method of laying on interior paint simple and very fast. Another trick with the brush that's worth learning is shown in detail D. By turning the brush slightly at the end of the stroke the bristles will come off clean without leaving a mark on the fresh

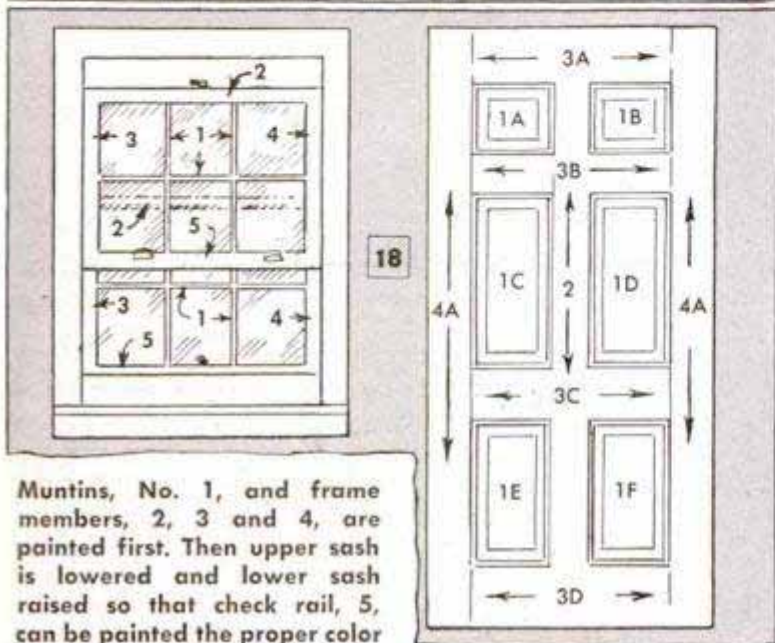
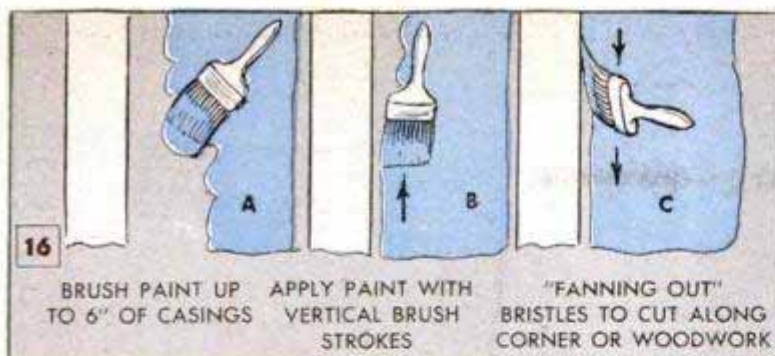

paint. If you are applying flat paint to a large ceiling measuring more than 12 ft. either way, it will be necessary to apply the paint in narrow strips, not more than 18 or 20 in. wide, if you are working alone. On large ceilings the job is best handled by two persons, one beginning in a corner, the other halfway across the ceiling. After this first strip has been painted next to the ceiling edge, you perhaps can work a somewhat wider strip. Do not stop work until the entire ceiling has been finished.

**Walls are next:** Proceed in similar fashion on the walls, starting at your left, and working from the ceiling to the baseboard in 2 or 3-ft. strips, Fig. 14. Use the same overlapping swirl stroke as on the ceiling. Brush bristles are fanned out to cut along woodwork and corners as in detail C, Fig. 16. Work up to the woodwork as in details A and B. Don't stop painting in the middle of a wall as this will cause a conspicuous lap; stop only at a corner or cabinet edge that extends from ceiling to floor, Fig. 14.

**Painting woodwork:** Sand rough spots and gouges, using 1/0 sandpaper on flat surfaces and No. 0 steel wool on curved surfaces. After brushing or wiping off dust, start painting at the top of cabinets, door and windows, and work downwards. Finish doors and windows first, then the frames, Figs. 17 and 18, following the painting sequence outlined in Fig. 18. Paint the top,

bottom and sides of a door while it is open and let it remain open until the paint has dried. The baseboard is painted last, a cardboard or plastic guard being used as in Fig. 21, to prevent getting paint on the floor or dirt on the brush. The guard also is handy when painting windows. When the frame of a room door is a different color on each side, the meeting line of the two colors is made at the stop strip as in Fig. 20. On swinging doors such joints are made midway on the jambs. Use masking tape as in Fig. 19 to assure getting a straight line.

**Preparing varnished woodwork:** Paint applied to varnished or enameled surfaces often chips off in spots. To prevent or minimize this trouble, apply a coat of specially prepared undercoater which combines with the varnish and forms a better base for subsequent coats of paint or enamel. The undercoater also acts as a sealer to prevent bleeding of stain. If woodwork is stained but not varnished—or if the varnish has been removed, exposing the stain—apply a coat of prepared stain sealer. This will prove more dependable than shellac or aluminum paint formerly used for this purpose. When woodwork has prominent grain that cannot be concealed by brushing on paint, the last coat should be stippled. To prepare oil paint for stippling, mix in some white lead. A long-bristled brush is used for stippling. As the ordinary painter's



Masking tape is used to get straight meeting line on swinging-door frame where two colors are used

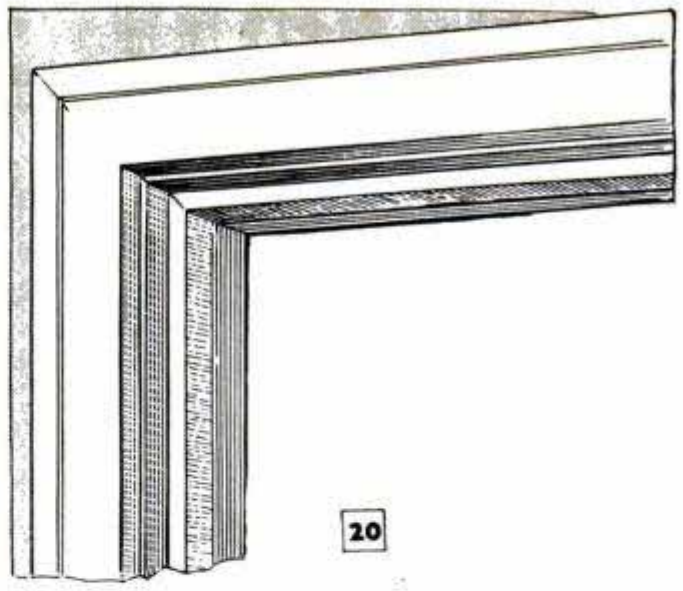

On hinged doors that swing in one direction the dividing line between colors is made at edge of stop

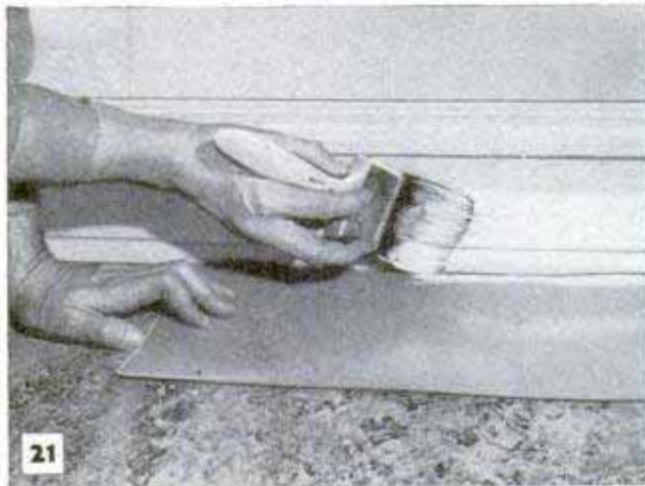

When painting the baseboard and shoe mold, a cardboard guard prevents getting paint on the floor

stippling brush is expensive, use a Dutch type of calcimine brush for this job.

**Removing paint accumulations:** In many older homes, numerous coats of paint and enamel applied throughout the years form thick layers which become badly chipped, scarred, and roughened by paint runs and brush marks. To make such surfaces flat and presentable, you can cover them with canvas. Or, they can be given a rough texture by applying plastic texture paint. The only other alternative for improving such walls is to remove the paint with paste paint remover, which is slow, tedious and messy, but effective. The accumulation of paint can be removed from woodwork in the same way, but in some cases it is simpler to replace the woodwork. Always neutralize paint remover with turpentine and allow to dry before painting.

**Brush and paint cleanliness:** Scrupulously clean brushes are essential to good work. Wash them thoroughly in turpentine before using them for a different color. Paint can be kept from hardening on brushes over-

night by immersing them in water. Wipe off the water on dry newspapers before using the brushes the next day. As soon as a paint job is finished, brushes should be cleaned thoroughly. When not in actual use, paint containers should be kept covered tightly. In case skin forms on paint and cannot be removed completely, stir the paint and strain it through a coarse cloth before beginning to use it.

**Calcimine on ceilings:** Calcimine is used on ceilings, except in the kitchen and bathroom which are painted. Old calcimine is washed off before new is applied and one fresh coat is sufficient. Use a calcimine brush to apply it uniformly in narrow strips and work as rapidly as possible until the entire ceiling is covered. Calcimine can be applied over a previously painted surface but paint should not be applied over calcimine as this will result in peeling.

**Starch-coating over paint:** To protect painted surfaces, particularly in kitchens, you can starch-coat them. Use laundry starch and follow directions for mixing as given on the starch package. However, use a standard measuring cup full of starch to a quart of water. Apply the cool solution with a calcimine brush or paint roller and stipple with a fine-grain sponge or stippling brush before it dries. The coating is transparent and is easy to replace when soiled, as it is simply washed off with warm water, using a sponge for the job.

### Poultry Wire Protects Bulbs

To keep dogs and chickens from digging up bulbs before they have a chance to take root, lay a piece of poultry wire over the plantings. This will prevent the digging, and the wire can be removed when the plants begin to come up.

Jeff Sterns, New Bedford, Mass.



## Water Frozen in Milk Cartons Cools Picnic Lunch Box

A portable refrigerator that will keep your picnic lunch cool for many hours can be improvised quickly by using a couple of empty milk cartons and a cardboard box. The evening before the picnic, fill the milk cartons about three-quarters full of water and, with a warm knife, seal the caps of the cartons so that the water will not run out of them. Then, insert the cartons in the freezer compartment of the refrigerator. When the cartons are removed in the morning, the water will have frozen into a solid block of ice. To pack the lunch, line the cardboard box with several layers of newspaper and lay the cartons and bottled beverages in the bottom of the box, placing the rest of the lunch on top of them. Place a few more sheets of paper over the lunch and close the lids of the box. When the ice in the cartons melts, the water will be retained inside them owing to the tightly sealed caps, thus keeping the box dry.

Donald F. Pecheck, Los Angeles, Calif.



## Brick Impregnated With Kerosene Provides Weatherproof Campfire Fuel

Soaking an unglazed brick in kerosene for a day or two before going on a hunting or fishing trip will enable you to have a roaring campfire almost instantaneously. To carry the brick, wrap it in heavy paper and, when a fire is desired, simply ignite the brick with a match. Because of the

kerosene absorbed by the clay, the brick will burn intensely for an hour or so even in a strong wind or rain. If one end of the brick is buried in a pail of sand or dirt so that the upper half projects, a fire for cooking or warmth can be had with comparative safety in either a boat or tent.

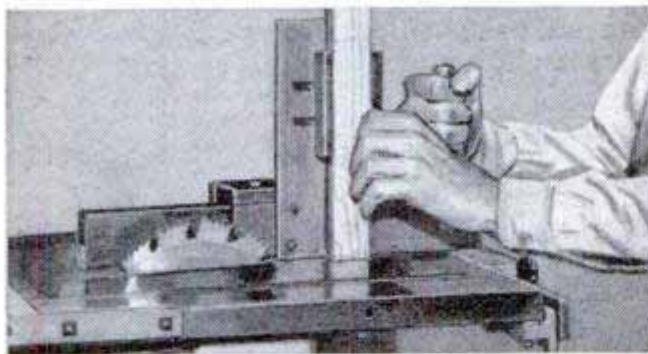

## Tenoning Jig for Small Bench Saw Slides on Ripping Fence

For making cheek cuts on tenons, splining cuts on miters and for making accurate cheek cuts on end half-lap joints, you need a tenoning jig on your circular saw. A serviceable jig for this purpose is easily made in a jiffy by using small pieces cut from  $\frac{3}{8}$ -in. plywood and  $\frac{3}{4}$ -in. solid stock and assembling as in the detail. As pictured, the jig rides on the ripping fence and for this reason some changes may have to be made in the dimensions to adapt the unit for use on different makes of machines. Join all parts except the fixed jaw with screws and glue to assure rigidity. When work must be held at an angle, as is required when grooving a mitered end for a spline, the jaws are removed and the work clamped to the vertical member of the jig with one or two C-clamps.

Donald A. Damon, Bedford, Mass.

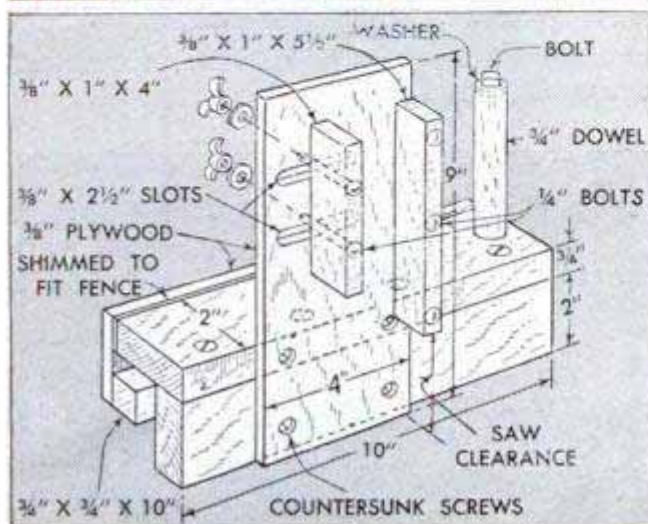

☐ Salt shakers won't clog in humid weather if they are kept in a coffee can containing three or four ounces of silica gel. The can, of course, should be covered.



## Locating Center of Wood Turning

The exact center of a wood turning can be located in a jiffy by using a try square and a straightedge. Just position the square over the end of the turning, as shown, and lay the straightedge along the 45-deg. angle. Then draw a line across the face of the turning. Move the try square and draw a second line approximately at right angles to the first one. The intersection of the two lines will be the center of the turning.

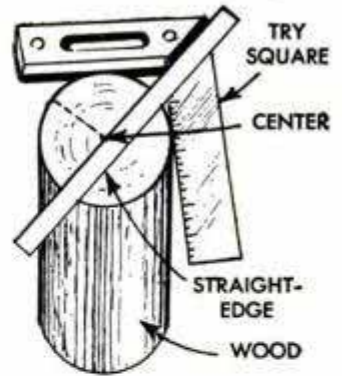

Ralph Frankart, Tiffin, Ohio.

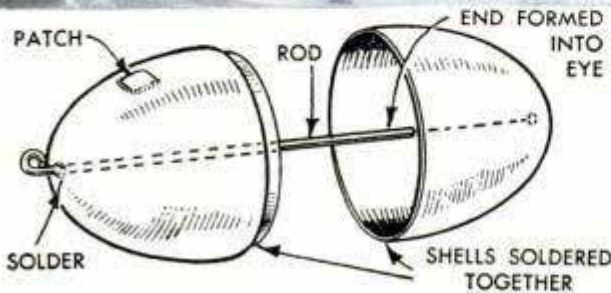

## Shells From Old Auto Headlights Provide Mooring Buoy

An excellent mooring buoy for a small boat or a marker buoy to locate your favorite fishing hole can be improvised from two auto-headlight shells. The latter are soldered together and holes are drilled at each end to take a length of iron rod. After the rod is in place, the ends are bent to form eyes and the openings around the rod are sealed with solder. The holes in the sides of the shell are patched with squares of sheet metal soldered in place. When soldering, be sure to make all joints watertight. The finished buoy is painted bright red or yellow and one eye is tied to an anchor, the other eye riding above the surface of the water for mooring the boat.

## Bells Sewed to Child's Play Suit Form Novel Tinkling Buttons



Round "jingle" bells provide novel buttons for tiny tots' play clothes. They tinkle when the youngster moves and make learning to button his own clothes a pleasant task.

☐ Baking soda is an excellent cleansing agent for glassware as it will leave the surface sparkling. It will not scratch the glass and is harmless to the hands.

## Nails Supported for Starting By Pressing in Clay or Putty

Frequently, nails must be driven in places where it is next to impossible to support them with the fingers while starting. In this case, use a wad of putty or modeling clay to hold the nail in place. Just press the putty onto the surface, insert the nail into the putty and start with the hammer. When the nail has been driven far enough to support itself, remove the putty.

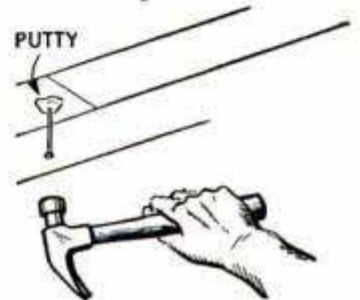

## Ice-Cube Tray Holds Thread Spools

You won't have to spend time rummaging through the sewing box or drawer of the sewing cabinet to find a particular spool of thread if the spools are stored in a plastic ice-cube tray. These inexpensive trays will hold as many as 14 spools of thread, displaying them for quick selection. A few of the sections may be used for thimbles, dress snaps and pins instead of spools.

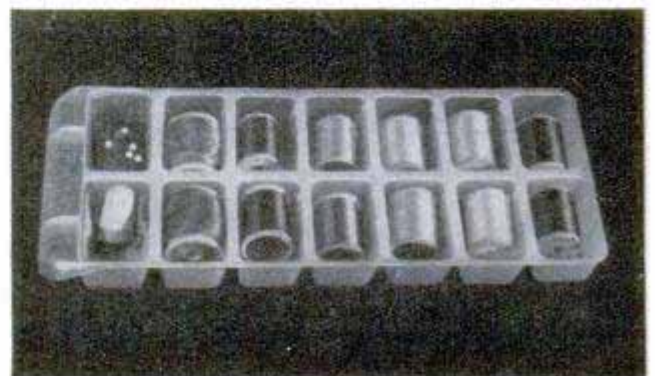



Short lengths of garden hose make handy stakes for marking and identifying seed rows. Just stuff the packet in hose



Punch holes along one side of leaky hose and connect to new hose. Plug open end and you have a handy garden sprinkler



Lengths of hose punched and strung on a rope handle form an excellent kneeling pad for planting seeds and seedlings



A length of perforated hose pressed over the tines of a rake permits cleaning in a jiffy by pulling off the hose

## Tips for the HOME GARDENER

By Harold L. Sherburne

**Save that old garden hose. Here are eight of many uses for it**



Convenient scraper for muddy shoes is had by cutting pieces of hose lengthwise and nailing them to wooden base as shown



Lengths of discarded hose are an almost unlimited source of emergency washers for leaky hose connections. Cut thin slices from hose as needed



Cushion top of spade with hose to relieve foot fatigue. Slit hose lengthwise, notch and slip over spade handle



A length of hose stretched between wheelbarrow legs and screwed under ends keeps legs from sinking into soft ground. Allow a little slack in hose

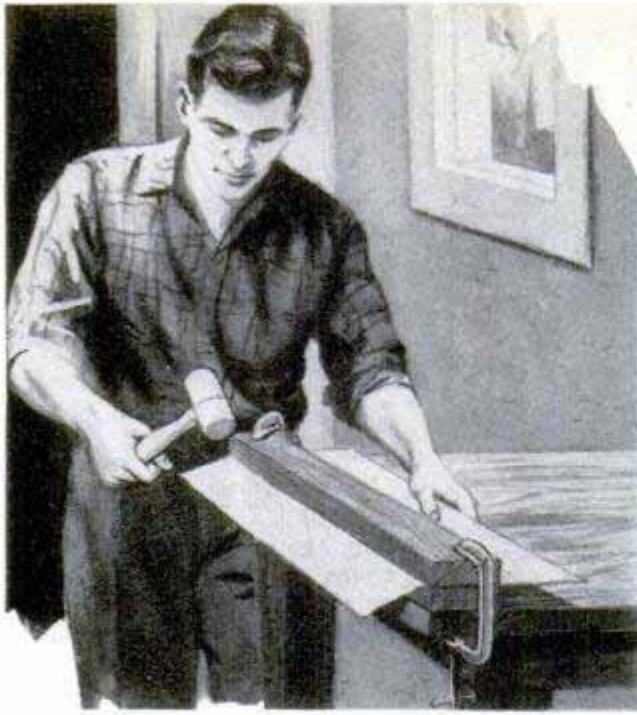

## Bending "Brake" for Sheet Metal Handles Large Work

By clamping sheet metal between two hardwood boards and hammering it with a wooden mallet, large sheets can be bent quickly and neatly without the use of a bending brake. First, select two straight 2 x 4s a few inches longer than the width of the sheet. Then sandwich the sheet metal between the boards with the edges of both boards exactly along the line on which the metal is to be bent. Clamp the boards tightly to the edge of a table top and hammer the overhanging portion of the metal to the desired bend. The result will be a straight bend along the edges of the boards.

Herbert E. Fey, New Braunfels, Tex.

## Celluloid Jackets Protect Books

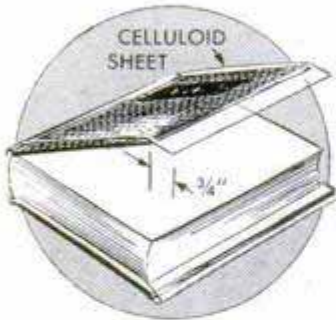

Covering the bindings of school-books as well as volumes kept in a bookcase with celluloid jackets will prevent them from being marred while still permitting the titles to be read clearly. Me-

medium-weight sheets of celluloid, which are sold in stationery stores for ring-binder inserts, provide excellent jackets. These are cut to the exact size of the book binding, except for an extra  $\frac{3}{4}$  in. at each end which is bent around the edges of the front and back covers to hold the jacket in place. These tabs are folded and creased with a paper knife before placing the jacket over the covers of the book.

## Subsoil Irrigator From Scrap Pipe

For watering fruit trees in dry regions where there is little subsoil moisture, this irrigator is just the thing to inject water well below the surface of the ground. The unit consists of a 3-ft.

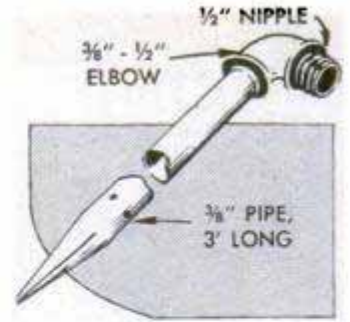

length of  $\frac{3}{8}$ -in. galvanized pipe threaded at one end, a  $\frac{3}{8}$  -  $\frac{1}{2}$ -in. reducer elbow and a  $\frac{1}{2}$ -in. close nipple. The parts are assembled as shown in the drawing, the close nipple being used to attach the irrigator to a garden hose. The free end of the 3-ft. pipe is pointed by cutting the pipe with a hacksaw to form four triangular prongs and then pressing these together. Four holes are drilled through the pipe about 2 in. from the point. To use the irrigator, turn on the water until a stream about 1 ft. long shoots out from the holes. Then, with a twisting motion, sink the pipe deep into the ground near the drip line of the tree.

W. H. McClay, Pasadena, Calif.

## Gooseneck Provides Pin-Up Lamp

Mounting an old gooseneck desk lamp on the wall and fitting it with a shade will result in a handy extra light for the den or workshop. Just drill two holes through the base of the lamp and fasten it securely to the wall with screws as shown in the photo. In this way, the lamp

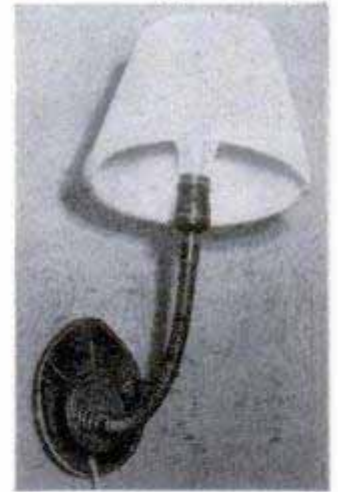

can easily be positioned to best advantage without taking up space on a desk top or workbench.—Bill Dean, Eugene, Ore.

## Baby's Clothes Dried Indoors By Hanging on Playpen

If you do not have a basement or utility room and there is no space in the house to hang the baby's washing when the weather is bad, just turn the playpen on its side and drape the clothes over the rungs. This serves the purpose of a drying rack, holding a surprisingly large number of clothes. However, be sure to do this only with a painted playpen, as the moisture from the clothes will remove varnish.

# QUICK-ACTING LATCHES HOLD BARN-LOT GATES SECURELY

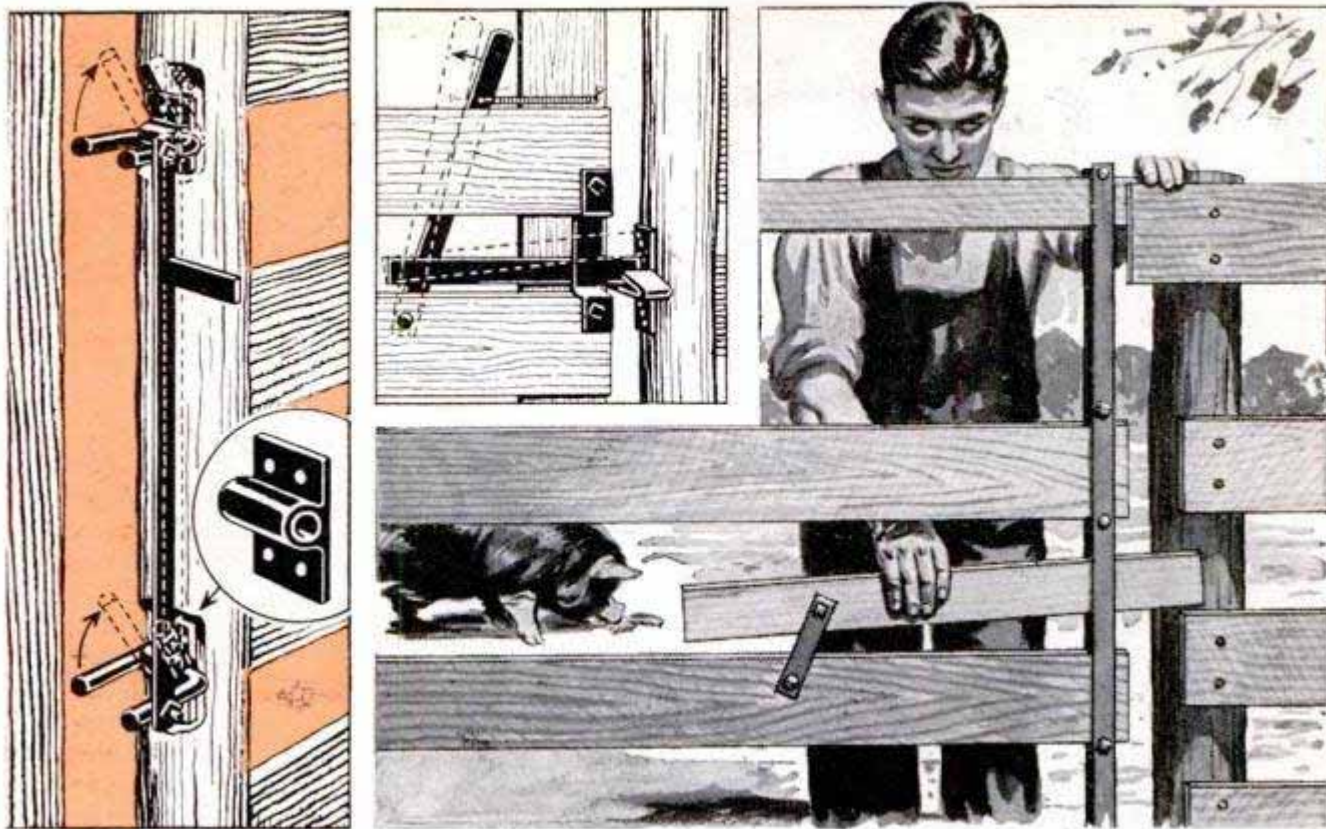

Here are three latches designed by practical farmers to prevent barn-lot gates from being opened by livestock. In the first one, shown in the right-hand illustration, the top horizontal member of the gate strikes the projecting end of the top fence board as the gate is closed. Then a pivoted bolt, made from a piece of hardwood, slides past the fence post as shown, locking the gate securely. Another good latch, of the self-locking type, is shown in the center detail. A short length of flat iron bent back on itself and welded edgewise to a second piece of the same width forms the latch. The horizontal striker is welded to a lever at the point indicated and the lever is pivoted on a  $\frac{3}{8}$ -in. bolt passing through a hole drilled in one of the gate boards. A screen-door spring supplies the necessary tension to keep the striker in the closed position. The

striker guide piece is bent from  $\frac{1}{8}$ -in. flat iron. Pulling back on the lever releases the striker and permits the gate to be opened. The latch locks automatically when the gate swings shut. A third latch, detailed at the left, is specially designed for hog-lot gates. The gate cannot be opened by being raised or by pressure applied from either side. The dual U-shaped latches are bent from  $\frac{3}{8}$  or  $\frac{1}{2}$ -in. iron rod and pivot in special bearings made by welding short lengths of  $\frac{3}{8}$  or  $\frac{1}{2}$ -in. pipe to pieces of flat iron. These are attached to the gatepost with heavy screws and are spaced 18 to 24 in. apart. Short threaded sections are cut from  $\frac{1}{4}$ -in. bolts and welded to one leg of each U-shaped latch to provide a means of attaching the handle which operates both latches simultaneously. Raising the handle lifts the latches and releases the gate.

## Coiling Lengths of Wire Solder Makes It More Convenient to Use

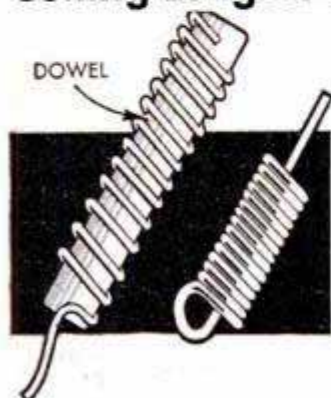

Instead of hunting around for those extra lengths of wire solder, wind them in neat individual coils that are easy to find, and just pull the solder from the coils as needed. To do this, wind the solder in a loose

spiral around a short length of dowel, allowing one end of the solder to stick straight out from the coil for a few inches. Squeeze the loops together to form a compact coil and slip it off the dowel. Then, pull the straight length of solder through the coil so that it extends a short distance from the other end. The coil itself provides a convenient handle for holding the solder when working, and the straight end is simply pulled down through the coil as the solder is needed.



# MOTOR TUNE-UP

Now is the time to ready your car for the open road. This informative three-part story on engine tune-up shows you what to do to keep fuel, compression and ignition systems in top condition

*By C. E. Packer*

## PART I

### Fuel and Exhaust System

**A**UTO SERVICEMEN regard periodic engine tune-up as the most important single item in car care. Regular tune-up keeps the engine performing at top efficiency, resulting in minimum wear, maximum fuel mileage and greatly reduced repair costs. As a rule, a regular tune-up job begins with the fuel system, Fig. 1, the purpose of which is to combine fuel and air in the correct proportions at varying engine speeds, loads and temperatures. A badly clogged air-cleaner element can have the same effect on fuel consumption as driving with the choke in a partly closed position. It's easy to disassemble the air cleaner and just as easy to clean it by proceeding as in Fig. 2. Always re-oil the filter element before replacing it. To clean the oil-bath type of air cleaner, you proceed in much the same way except that generally the entire unit must be removed so that the oil in the reservoir can be drained out and the reservoir washed thoroughly with white gasoline or a suitable cleaning fluid, Fig. 3. When replacing the unit, refill the reservoir with clean engine oil to the level indicated. Be sure all parts are replaced in the proper position and that wing nuts and bolts are tightened to the correct tension.

Fig. 4 pictures the various related units of the fuel and



exhaust system. One of the vital parts of the fuel system is the fuel pump and the sectional view, Fig. 5, shows how it works. In operation, the typical fuel pump is quite simple. An actuating arm riding a special cam on the engine camshaft pulls the diaphragm downward against a compression spring. The suction created by the downward movement of the diaphragm draws fuel from the tank through the inlet valve. As the actuating arm reaches the low point on the cam the compression spring forces the diaphragm upward, discharging fuel through the outlet valve and through the sediment bowl to the carburetor. Mechanical failure of the pump is comparatively rare but suspected cases of pump "failure" may be due to other causes, such as water and sediment in the fuel and pinpoint air leaks. Cleaning the sediment bowl regularly and keeping the fuel tank full in cold weather help to rule out the first two causes of trouble. Air leaks along the fuel line usually call for renewal of the faulty parts.

The engine warm-up period has a direct bearing on fuel mileage and it also is dependent on more than a properly operating cooling-system thermostat. In some cars, the fuel charge is passed over a hot spot cast in the intake-exhaust assembly as indicated in Fig. 6. The purpose of the spot is to pre-heat the fuel charge passing to each cylinder and thus assure complete vaporization during the warm-up period. A butterfly valve, which is operated automatically by a thermostat, controls the temperature of the hot spot by directing hot exhaust gases around it. In a cold engine, the valve is closed, but the automatic control slowly opens the valve by stages as the engine reaches operating temperature. It's important to check the action of this valve regularly to make sure that it is in working order. Apply a few drops of light oil to the valve shaft to prevent sticking. Some servicemen say that dry graphite blown into the bearing surfaces with a special applicator gives better results. Of course, it also is essential to keep the cooling system clean and the thermostat adjusted to give correct operating

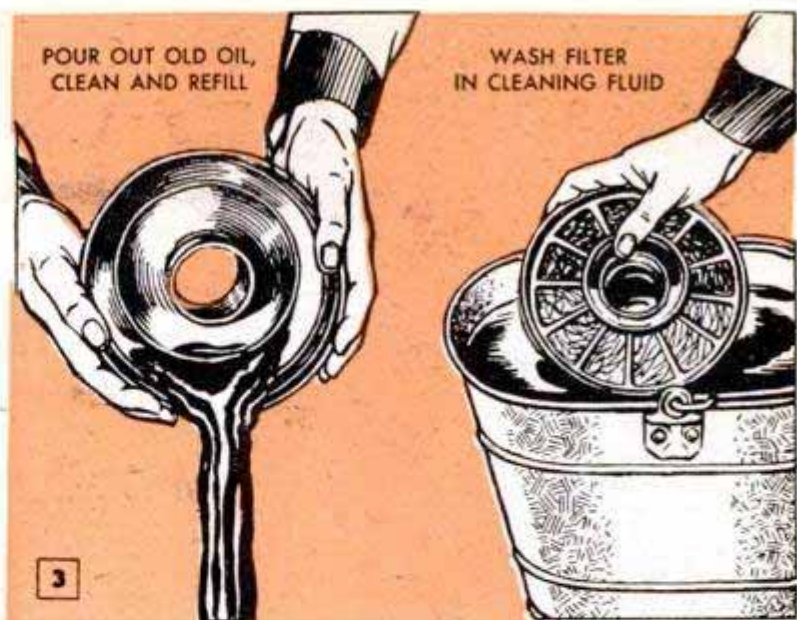

Above, remove the oil-bath air cleaner, drain out old oil and wash the container and the filter elements thoroughly. Refill with new oil. Below, typical units of fuel and exhaust system

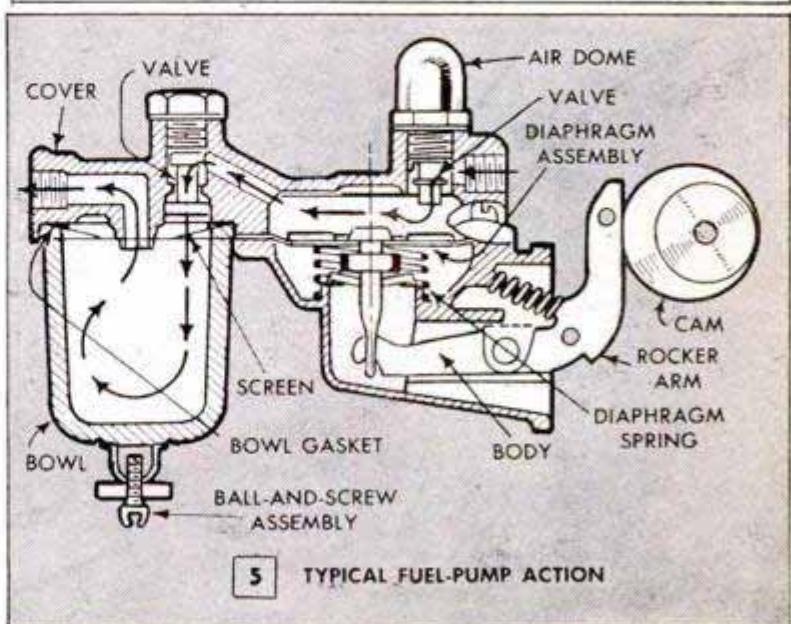
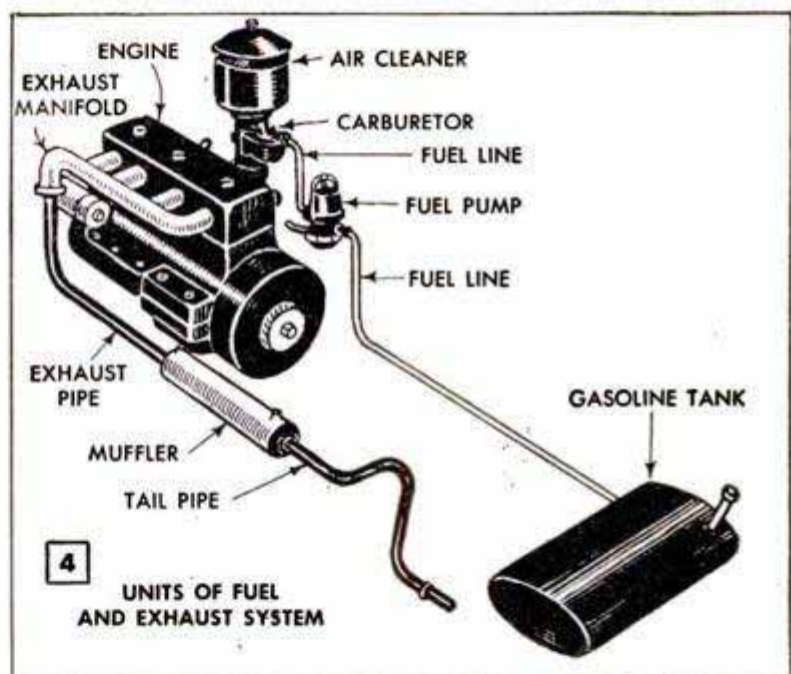

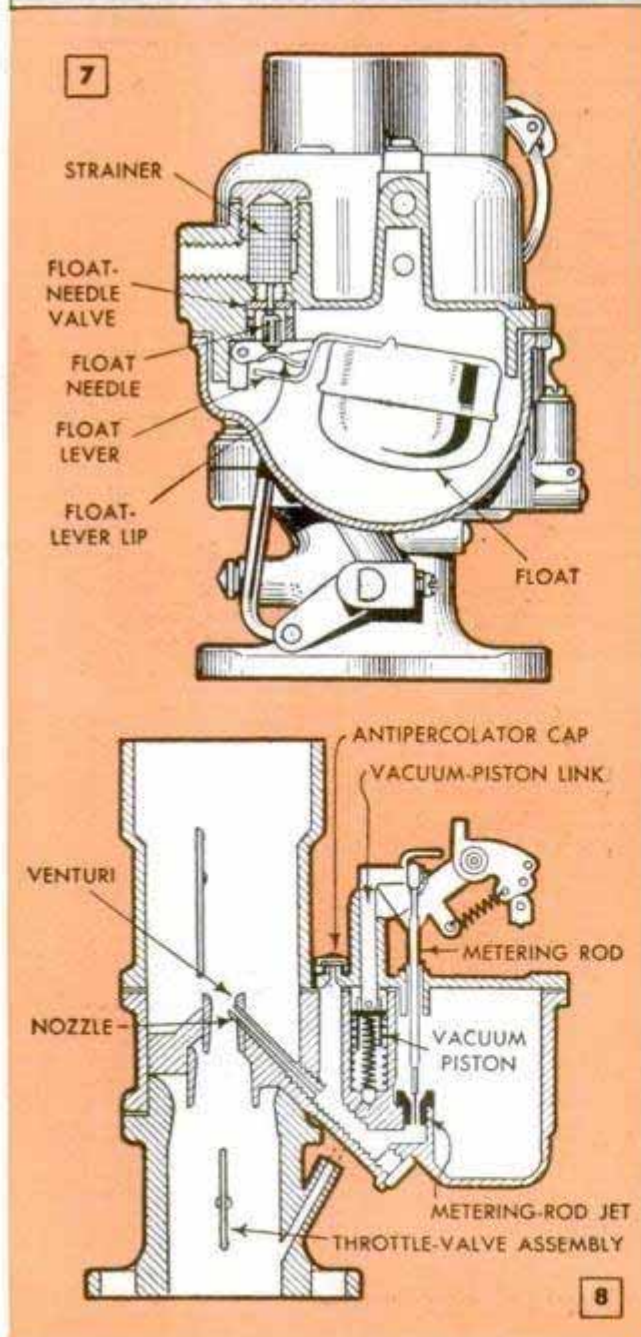
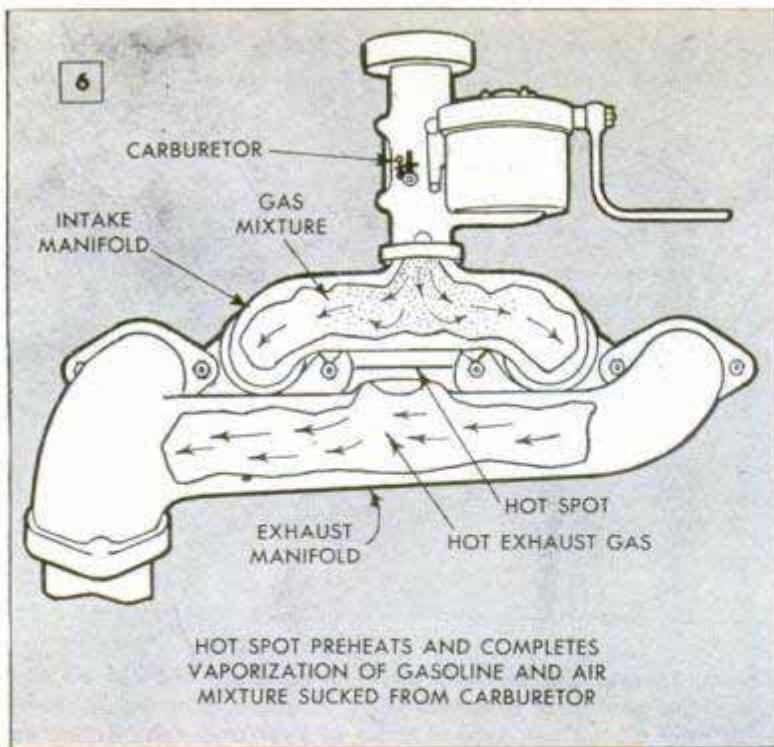

temperature. Should the engine seem sluggish and the ordinary checks turn up no other cause, examine the exhaust pipe, muffler and tail pipe. A broken muffler baffle or a deep dent in either the exhaust or tail pipe can set up sufficient back pressure to cause the engine to overheat. Sticking valves also can result from this defect in the exhaust system.

In any fuel system, the fuel pump and carburetor are designed to work together. The pump maintains a constant level of fuel in the carburetor. The air dome on the pump cushions pump pulsations so that fuel is fed to the carburetor under uniform pressure. One important item on the regular tune-up schedule is inspecting and, if necessary, cleaning the fuel-pump valves, Fig. 5, and also the fuel strainer in the

carburetor, Fig. 7. Accumulations of dirt or sediment in any of these parts are certain to cause trouble. The carburetor float, Fig. 7, controls the needle valve through which liquid fuel is admitted to the carburetor bowl as needed. A low float level causes difficult starting and a constant high level results in a major waste of fuel. As the moving parts wear, the float level changes. That's why it is necessary to check the float at regular intervals. The sectional view of a typical carburetor in Fig. 8 shows the location of the metering rod, vacuum piston and the high-speed nozzle, or jet. The idling jet, which supplies fuel to the engine at idling speed, is not shown. All these parts team up to provide the engine with the correct fuel mixture under varying operating conditions. As a routine check for faulty float level, many servicemen remove the air cleaner and inspect the open end of the high-speed jet while the engine is idling. If fuel appears in any quantity at the end of the jet, it usually is safe to assume that the float level is incorrect. It will be necessary to disassemble the carburetor to adjust the float and whenever the unit is disassembled for repair or adjustment it should be thoroughly cleaned and all openings blown out with compressed air before reassembling. These requirements make carburetor servicing a special job which few car owners care to undertake because of the time, skill and special tools required. For this reason most car owners simply exchange the faulty unit for a new or rebuilt carburetor of a type suited to the car. Reputable service shops offer a sound, money-saving deal on this exchange. However, car owners who like to tinker with precise mechanical gadgets will feel sufficiently challenged by the



complexities of the job to do it themselves. For them, there are available carburetor-rebuilding kits for nearly all modern makes. These kits include all parts necessary to do a complete job of rebuilding.

Faulty operation of the modern automatic choke is rarely due to mechanical failure alone, but the unit does require periodic inspection, careful adjustment and occasional cleaning to keep it working properly. Fig. 9 shows a sectional view of a typical automatic-choke mechanism, the notes on the drawing pointing out and identifying the principal parts. Some units are provided with a summer and winter setting and this adjustment should be carried out on schedule. Although the control mechanism is quite simple, it also is very sensitive. Dirt on the bearing surfaces of the parts interferes with their operation. In late-model cars fitted with automatic chokes, the thermostat controls the choke valve and also operates the fast-idle mechanism during the engine warm-up period. At the time of the cold start, the choke valve is closed and the fast-idle mechanism holds the throttle partly open. As the engine warms to operating temperature the choke valve opens by stages, achieving the full-open position as the engine reaches normal operating temperature. Simultaneously the choke mechanism closes the partly opened throttle and the engine slows to normal idling speed. Parts remain in this position as long as the engine is hot. When the engine cools, the thermostat returns the parts to the cold-start position. Action of the thermostat is controlled by heat from the engine exhaust manifold which is conducted to the thermostat housing through a small tube. Heat from the manifold passes through a screen located in the housing, as in the sectional view. Clogging of this screen is the principal source of trouble with the unit. Periodic inspection and cleaning or renewal of the screen practically rules out the possibility of defective operation.

Late-model cars having automatic transmissions require a precise adjustment of the idling speed and the fuel mixture. Many service shops consider the idling adjustment so important to the satisfactory operation of the car that they use a tachometer to check engine speed when making the adjustment. The idling adjustment on nearly all carburetors is made by means of the adjusting screw shown at A in Fig. 10. Turning the screw in (clockwise) causes the engine to idle faster. The idling mixture is controlled by the screw B, Fig. 10. Turning the screw in "leans" the fuel mixture. Always have the engine at operating temperature before making these adjustments.

(To be continued)

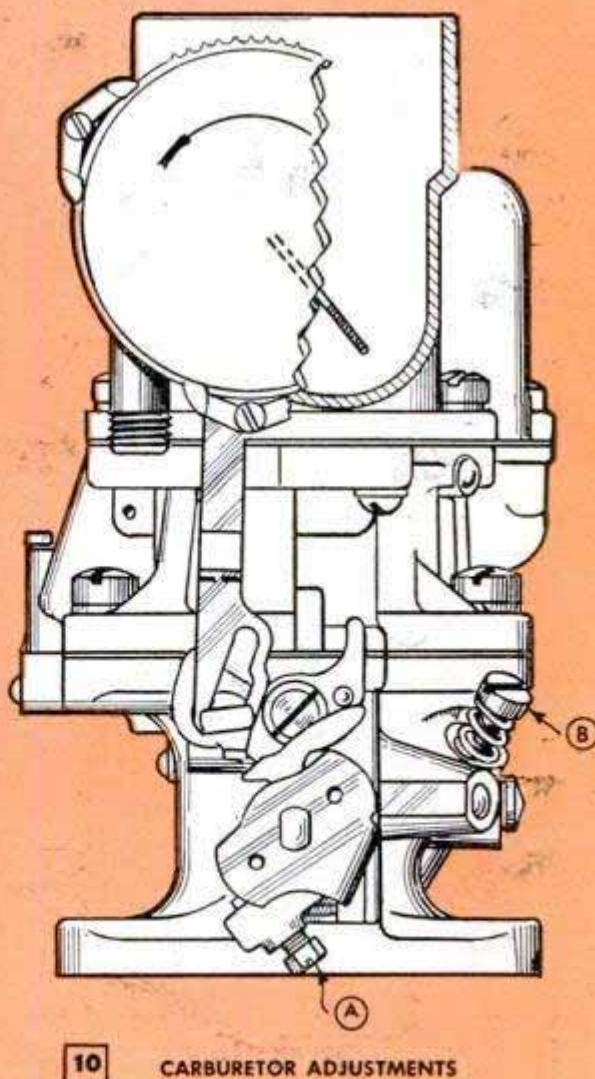
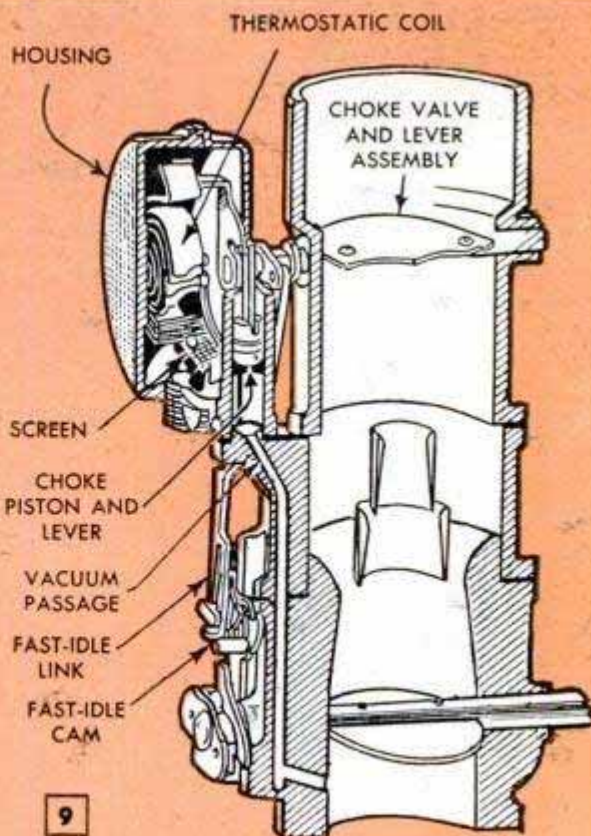

10 CARBURETOR ADJUSTMENTS

## Cardboard Box Taped to Wall Catches Plaster Chips



When cutting a hole in a plastered wall for installing a light switch or wall receptacle, it's always a problem to keep the particles of plaster from falling to the floor and being spread throughout the house. However, by taping a large cardboard box to the wall directly under the spot where the hole is to be cut, practically all of the dust and chips can be caught. Use masking tape or other cloth tape that will not leave a mark when it is removed from the wall.

Kenneth J. Corse, Paterson, N. J.

## Waterproof Fishing-Reel Bags

Cellophane bags of the type used to package dry foods provide handy containers for protecting fishing reels from moisture. Just place each reel in a separate bag and seal the open end by wrapping a rubber band tightly around it.

Warren Norcross, Philadelphia, Pa.

## Twine Facilitates Hanging Picture

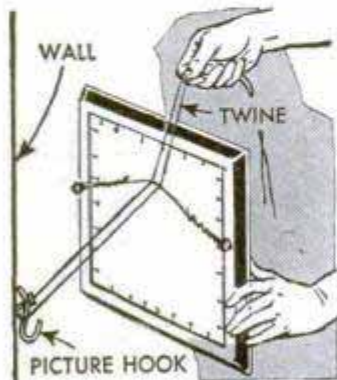

If the wire on the back of a picture is too short to be visible over the top of the frame, use a length of twine to aid in engaging the wire with the wall hook. Double the twine and loop it under the hook. Then slip the ends

of the twine under the picture wire and, holding the twine taut, guide the frame down the twine until the wire engages the

hook. When the picture is in place, release one end of the twine so that it may be pulled from the hook without disturbing the position of the picture.

## Candleholder for Campers

Made in a few minutes from a jar or can cover and a length of stiff wire, this candleholder can be suspended from the top of a tent, a tree branch or a cabin ceiling. One end of the

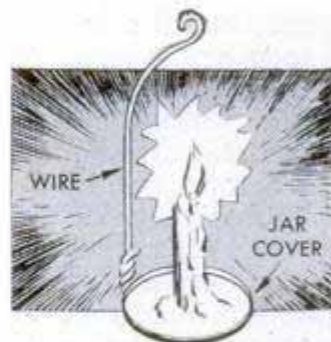

wire is bent and twisted around the rim of the cover and the wire is bent vertical to the cover, forming the hanging bracket. The wire is curved inward toward the center of the cover and the end is bent to form an eye. Suspend the holder with a length of cord, being sure that the distance between the flame of the candle and the eye in the bracket is sufficient to prevent the cord from being burned where it is tied to the bracket.

Stephen I. Griglak, Dayton, Ohio.

## Socket Wrench Forms Nut Driver

By adapting a socket-wrench handle to fit the chuck of a spiral-type ratchet screwdriver, a tool is made that will quickly spin nuts on or off a bolt. The handle is cut off as shown and ground to fit the chuck. Then, using a screwdriver bit as a guide, a flat is ground on the end of the handle and a notch cut slightly below it. To use, chuck the handle in the screwdriver and press a socket of the desired size over the hex end.

Evan Wright, Topeka, Kans.

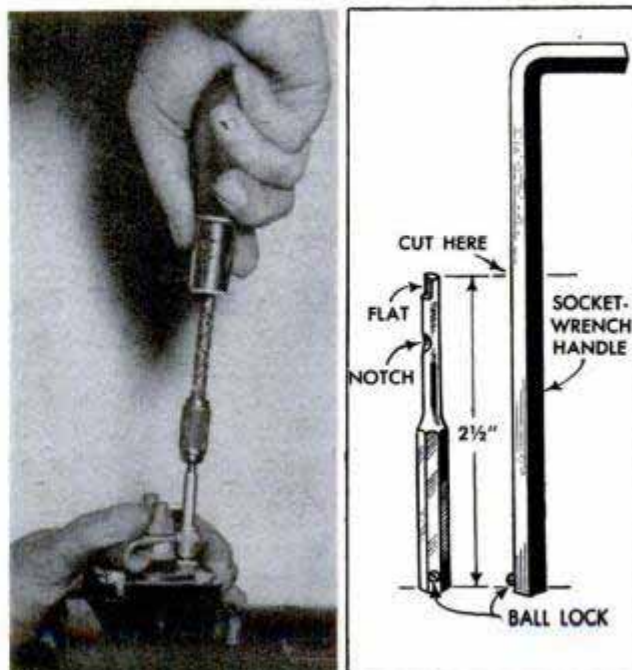

# SEESAW TOY IS SUPPORTED BY CLOWN CUTOUTS

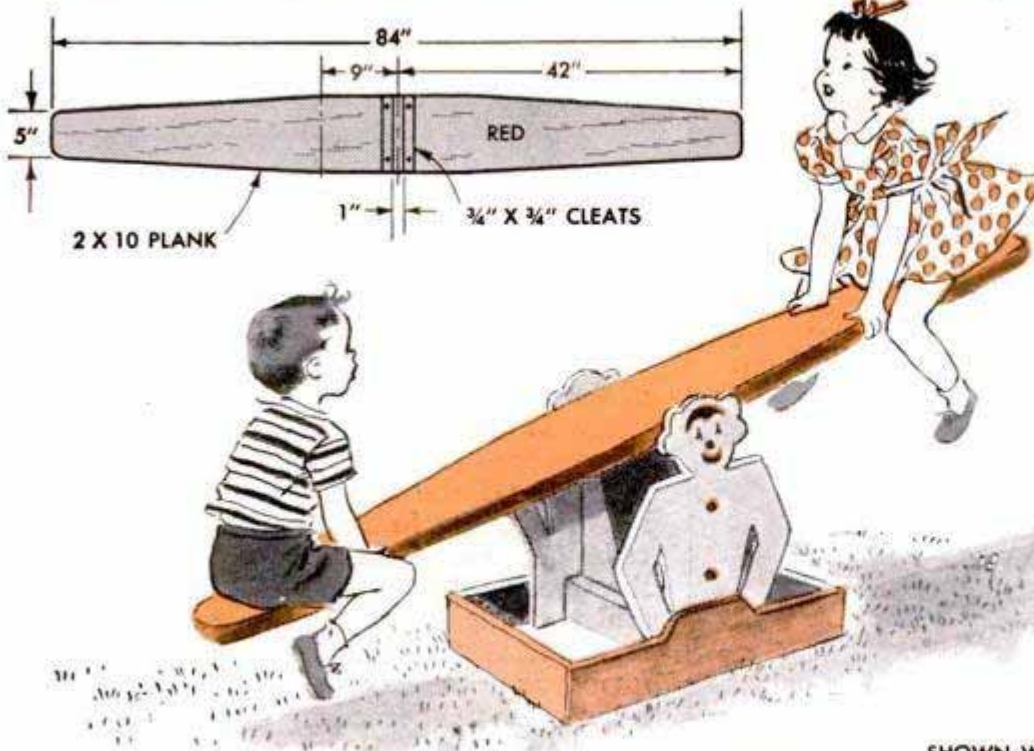

By  
*Marvin  
Hartley*

Youngsters, from toddlers on up, will have a circus with this novel seesaw. Two clown cutouts joined back to back form the pivot for the plank. The complete toy is made from stock lumber, the plank being a 2 x 10, narrowed at each end and sanded smooth to prevent splinters. The pattern for the clowns is enlarged full size and cut from 3/4-in. outdoor plywood. The boxlike base is filled with sand to prevent tipping. Enamel the toy in gay colors

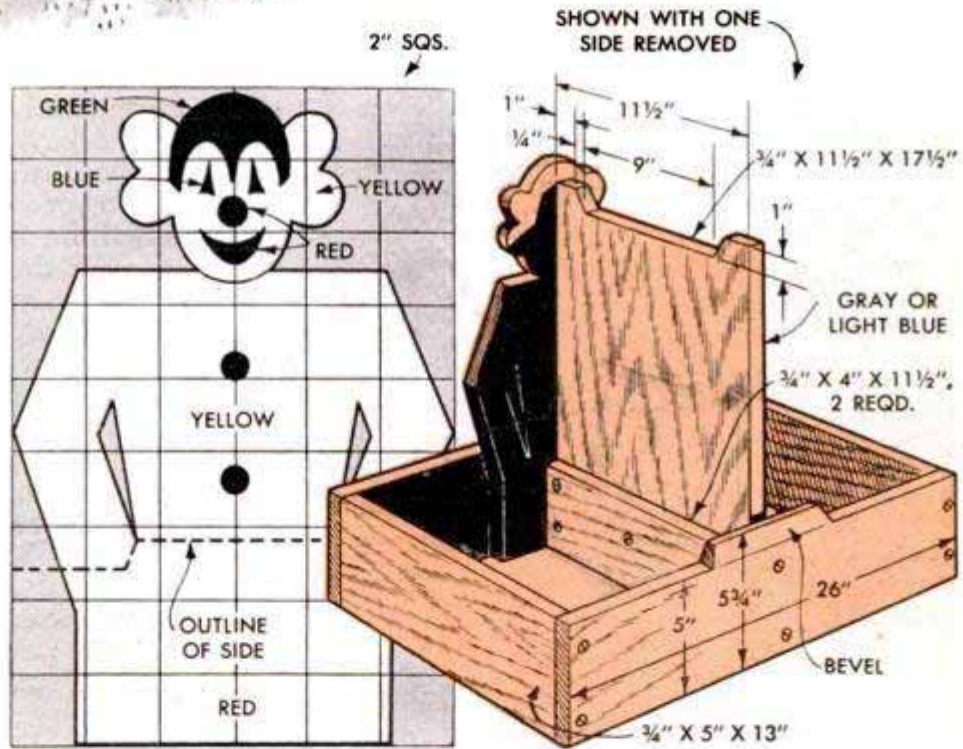

## Sponge-Rubber Feet Under Television Set Absorb Traffic Vibration

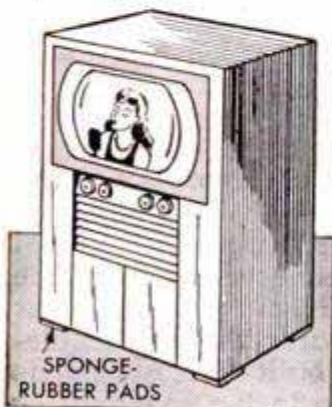

Finding that vibration caused by heavy traffic on the street in front of the house interfered with reception of my television set, I solved the problem in a jiffy by cushioning the set with sponge-rubber feet. I simply cut

four pads, 2 in. square, from a sponge-rubber kneeling pad and placed one of the pads under each corner of the set. Now, even the vibration from passing trucks has little noticeable effect on the picture. Although it is not as effective, thick felt padding may be used instead of sponge rubber.

William F. Gusehl, Milwaukee, Wis.

☞ To facilitate removing pictures from wall hooks, use a notched stick to lift the wires from the hooks. This will save stepping up and down from a chair or ladder.

# RIDDING YOUR PREMISES OF

Farmers, estate owners and suburbanites who are troubled with sparrows will find these suggestions useful in destroying them

By Dale R. Van Horn

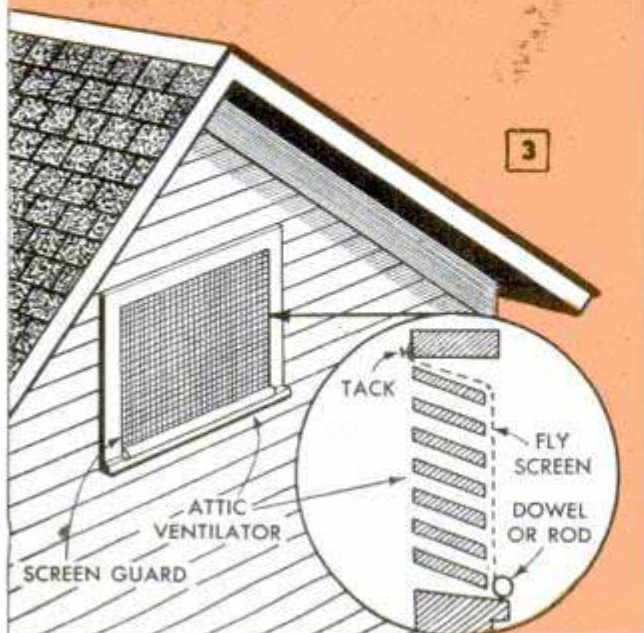
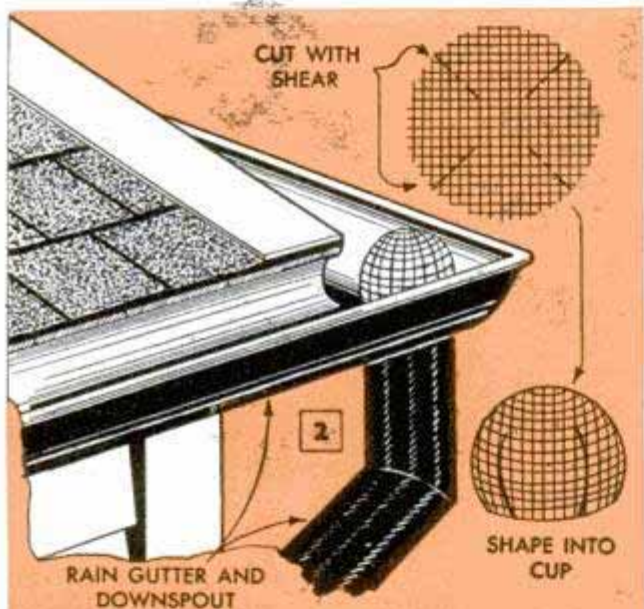
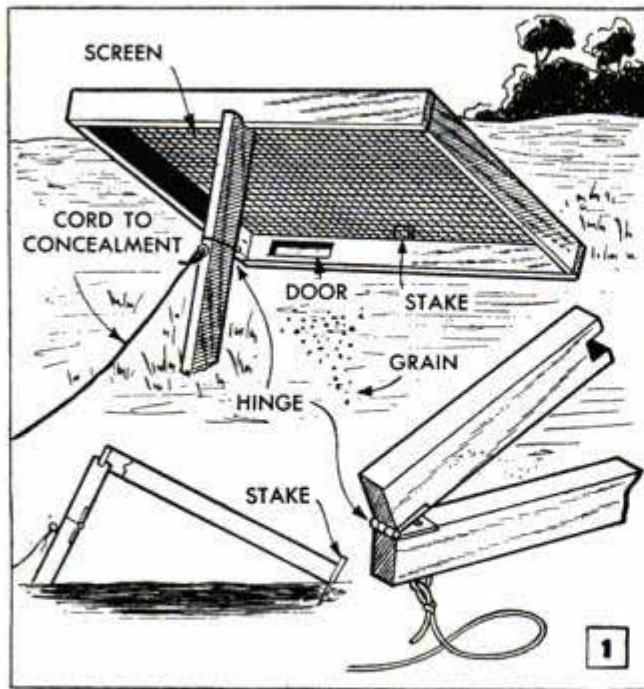

NEARLY everyone living in the country rates the English sparrow as one of the most persistent and aggressive pests there is to deal with, and nature lovers everywhere condemn the sparrows as enemies of all the smaller species of native songbirds. On farms, large flocks of sparrows consume quantities of finely ground livestock feeds the year round, and nesting and roosting habits in and near outbuildings make them a special problem for farmers and estate owners. Bird lovers in town often are forced to provide only large seeds in feeders in order to deprive the sparrows of a steady supply of food. This excludes not only the sparrow but the smaller songsters which cannot crack the shells of the large seeds. Individual nesting boxes and multiple-apartment homes, for such gregarious migrants as the purple martins, will be taken over by the aggressive sparrows during the nesting season. Once sparrows are established in a nesting box or a martin apartment, few native birds will contest the sparrows' occupancy for long. It is then up to the owner either to permit the sparrow squatter's rights for the season or to dislodge them by shooting, trapping or by destroying the nests as fast as they are rebuilt. In addition to taking over nesting boxes by force and driving away other birds, the sparrow also makes use of any other nesting sites available which suit its particular requirements.

Details in Figs. 2 and 3 show effective methods of keeping sparrows out of downspouts and attic louvers, which are favorite nesting sites. Another favored location for the sparrow's bulky nest is inside sliding-door tracks and in boxed cornices. Farmers will be well acquainted with this nuisance, and also with the fire hazard caused by the accumulation of straw and trash which the sparrow uses for a nest and carries into almost inaccessible places about farm buildings. Fig. 2 shows how to make a strainer or guard from heavy galvanized wire for downspout inlets, if you want to save the cost of a purchased one. Cut the wire with tin snips, shape the wire disk as shown and force it into the inlet as pictured. Some louvers built with wide slats seem to be acceptable to the sparrows as

# SPARROWS

roosting accommodations, as the location offers a shelter and some degree of warmth in cold, stormy weather. A length of heavy screen fitted over the outside of the louver keeps the birds out. Keep the ends of sliding or rolling-door tracks closed with caps and close all openings into boxed cornices which are large enough to admit the birds. Of course, all these precautions merely inconvenience the sparrows. However, they do not get rid of them, at least as long as a supply of food is readily available about the home or country estate. But there are other ways to rid the premises of these annoying birds.

Farmers with limited time to spare use the direct approach. They scatter wheat, cracked corn or ground feed in an open spot where shooting is permissible. Preferably, the feed is simply sprinkled lightly in an area not more than 30 in. wide and 15 to 20 ft. long. A single blast from a shotgun directed along the length of this improvised sparrow cafeteria will bag from 10 to 50 birds, and also will frighten any survivors so badly they are not likely to return. Persistent shooting of the individual birds will have the same effect on the sparrow population about the farm or estate buildings. Town and city dwellers should keep in mind that shooting with rifles, shotguns or air guns is not permitted in most cities and towns within the corporate limits. Be careful also on farms and estates as indiscriminate shooting, especially with a rifle, may endanger both persons and livestock.

Probably the simplest and safest method of getting rid of sparrows is by trapping. A deadfall type of trap is detailed in Fig. 1 and, as will be seen, the whole setup is very simple. A square frame of any convenient size is covered on one side with heavy screen, such as hardware cloth, and the frame is supported in the raised, or set, position on a hinged trigger. This unit is placed in an open spot in the set position and grain or birdseed is scattered under the frame. Sparrows are allowed to feed unmolested for several days. By that time a large flock will gather at certain times during the day. Then, from your place of

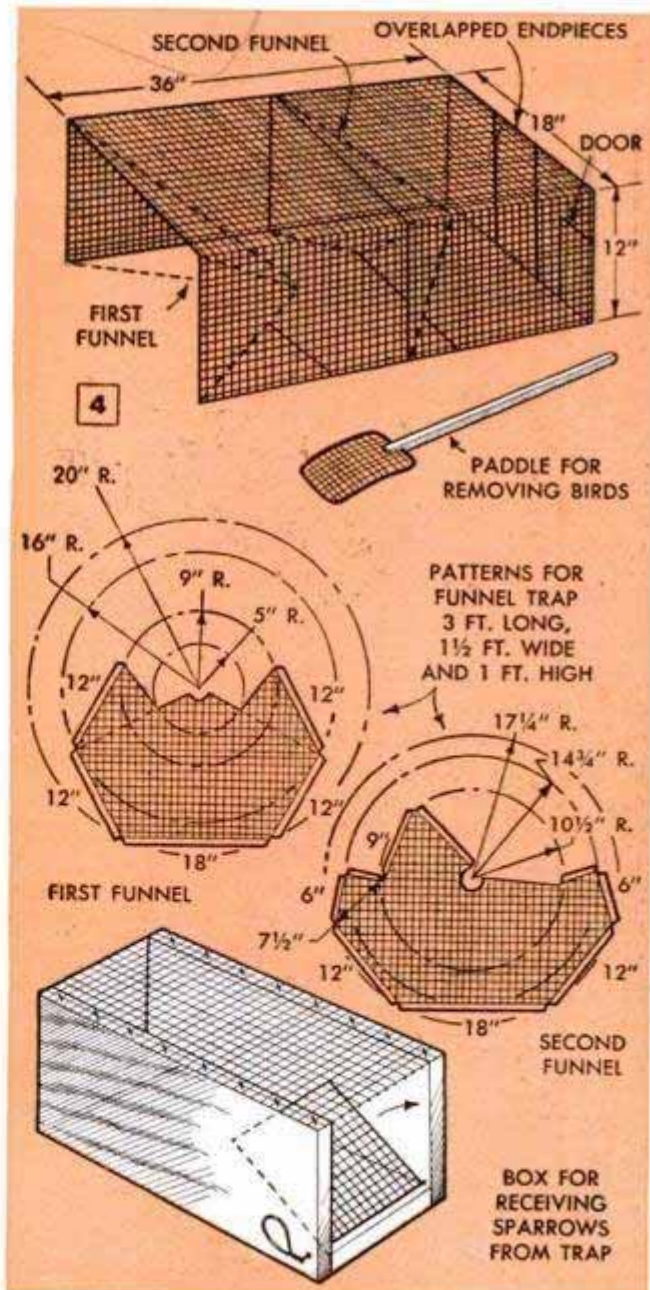
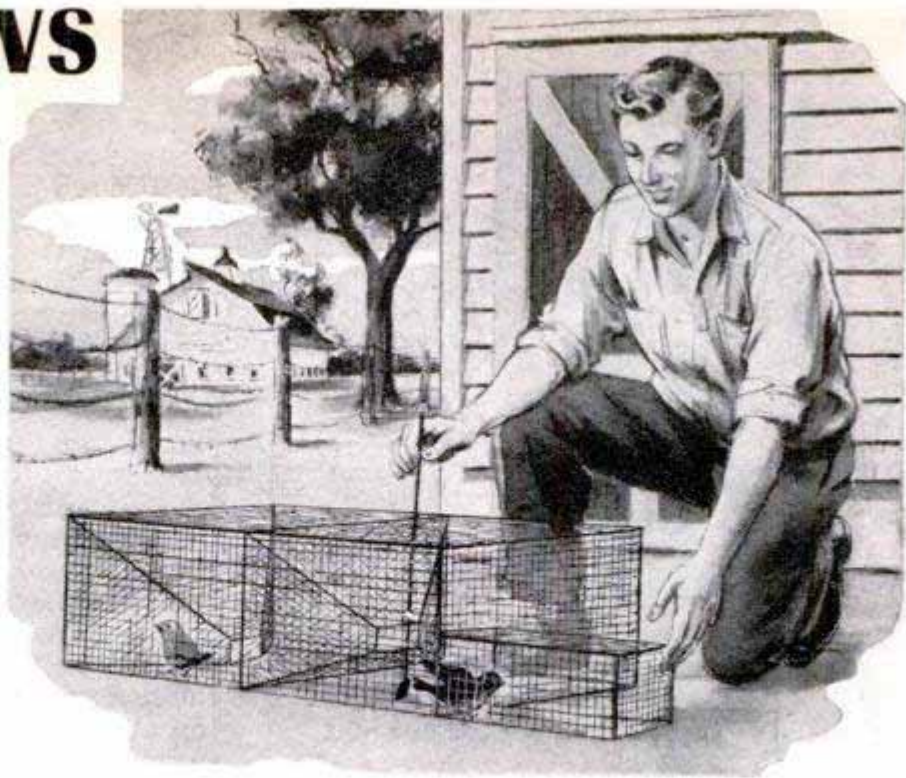

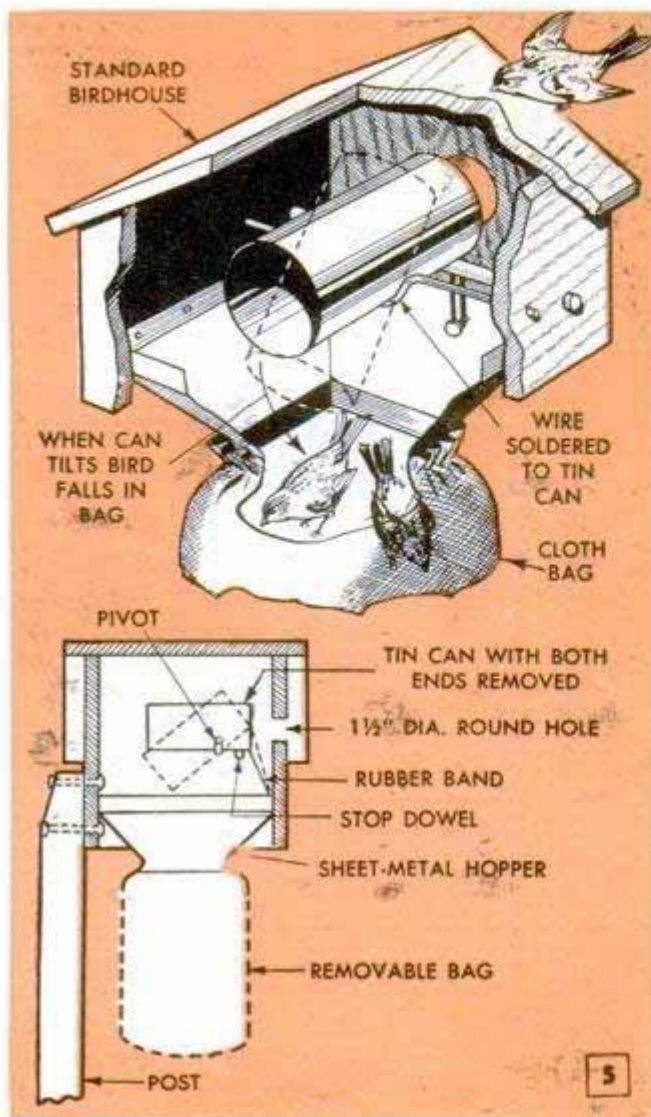

concealment, give the trip cord a quick jerk and there you are. If you wait until just the right instant, it is possible to bag a good-sized flock with one drop of the trap. Few birds are likely to escape. Of course, the one disadvantage of this type of trap is that it requires regular attention.

Where time is limited, the automatic trap is the thing. Fig. 4 details a good one, simple and inexpensive to make and fully automatic in operation; that is, so far as catching sparrows is concerned. You have to provide a regular supply of birdseed or cracked corn to serve as bait. Actually, the sparrows catch themselves in this type of trap. Details in Fig. 4 show how to lay out and cut the funnels which are of the same sized wire mesh as the rectangular body, or cage. The funnels are held in place with short lengths of wire passed through the

wire mesh and twisted tight. A hinged wire door is fitted over an opening cut in the rear of the cage. Note that the position of the funnels divides the cage into two compartments. Unsuspecting sparrows enter through the small inner opening in the first funnel and thus into the first compartment. Owing to the small opening in the wire funnel, it is extremely unlikely that the trapped birds will find their way out again; instead, they will eventually pass through the second funnel into the rear compartment. This type of trap should be placed in an open spot where it is readily seen from all directions and baited with food. It must be left undisturbed for some time until the birds become accustomed to it. During this time you can be making the box for receiving the victims from the trap. This is shown in the lower detail in Fig. 4. To remove the catch from the trap, place the box with its open end against the opening at the rear of the trap and "shoo" the trapped birds into it with the paddle as pictured.

Details of the automatic trap shown in Fig. 5 are self-explanatory. This type of trap makes use of the sparrow's propensity to explore any box having an opening large enough to permit it to enter. A tin can is pivoted inside the fake nesting box and so placed that, when in the horizontal position, one of the open ends is in line with the entrance hole in the box. As soon as the bird steps beyond the pivot point its weight tilts the can as in the lower detail and the victim slides into the bag suspended from the funnel-shaped bottom. There is no escape from this trap, for, once inside, sparrows are birds in the hand. One thing to remember in connection with trapping: In most states it is illegal to trap native songbirds, or to destroy them by shooting or by any other means. Although it is very unlikely that songbirds will enter traps with English sparrows, there is always the possibility. If you find protected native birds in your traps, be sure to release them unharmed, even if you must release a bag of sparrows along with them. Native songbirds are classed among our most valuable wildlife. If you intend to carry out extensive sparrow-trapping operations, it's a good idea to consult your state Department of Conservation before going ahead with whichever method you decide to use.

## Centering Inner Tube in Tire Casing Reduces Possibility of Blowout

Improperly aligning an inner tube in the tire casing is likely to cause a crease or fold in the rubber of the tube which may result in a dangerous blowout. To be sure that the inner tube is accurately centered when it is replaced in the casing, fill the inner tube to

the correct air pressure with the valve core removed from the stem, and then allow the air to escape. After this, just replace the valve core and refill the inner tube with the recommended amount of air.

Wallace White, Stanford, Calif.

Brightly colored coverings which lend eye appeal and durability to plain, inexpensive wastebaskets are just the thing to add a touch of color to children's rooms as well as an easy way to improve the appearance of waste containers used anywhere in the house. Leatherette or oilcloth forms the basic covering, and a wide variety of designs and initials cut from the same material or from colored cloth tape can be mounted over the background. Covering a cylindrical or oval-shaped basket having straight sides is simply a matter of cutting the material to the proper width and length. Then the starting end is taped to the side of the basket, the material brought tightly around and the free end glued in place so that it overlaps the starting end an inch or so. However, a pattern will have to be made prior to cutting out the covering for a basket with tapered sides. This can be done by laying the basket diagonally on a large sheet of paper and wrapping the paper around it. The top ends of the wrapping are folded inside the basket and the lower

## Inexpensive Wastebaskets Decorated Attractively By Covering With Colored Leatherette or Oilcloth



ends across the bottom. Then, the rims of the basket are indicated on the paper by marking their positions with a pencil line. A sharp knife or razor blade is used to cut the wrapping paper vertically down one side of the basket, the paper is removed and the pattern is carefully cut out along the pencil lines. The covering material is cut to size according to the pattern and applied to the basket as before.

## Lever and Clamp on Hand Drill Permit Boring Steel Beams

On a job that required the use of a hand drill to bore several holes through a steel I-beam in his basement, one homeowner experienced difficulty in exerting sufficient pressure on the drill to do the job. However, he solved the problem with an ingenious device made from scrap lumber. One end of a horizontal member is clamped to the lower edges of the beam, this being done by using two bolts inserted through the wood and spaced the width of the beam. Washers are slipped over the bolts and wing nuts are tightened on them to lock the wooden member in place. A vertical member, or lever, is bolted loosely to the drill frame (so that it can be moved back and forth) and then pivoted to the horizontal member with another bolt, as shown in the detail. To exert pressure on the bit, the lever is pulled toward the operator as the hand drill is turned.

Tom C. Hansen, Kansas City, Kans.

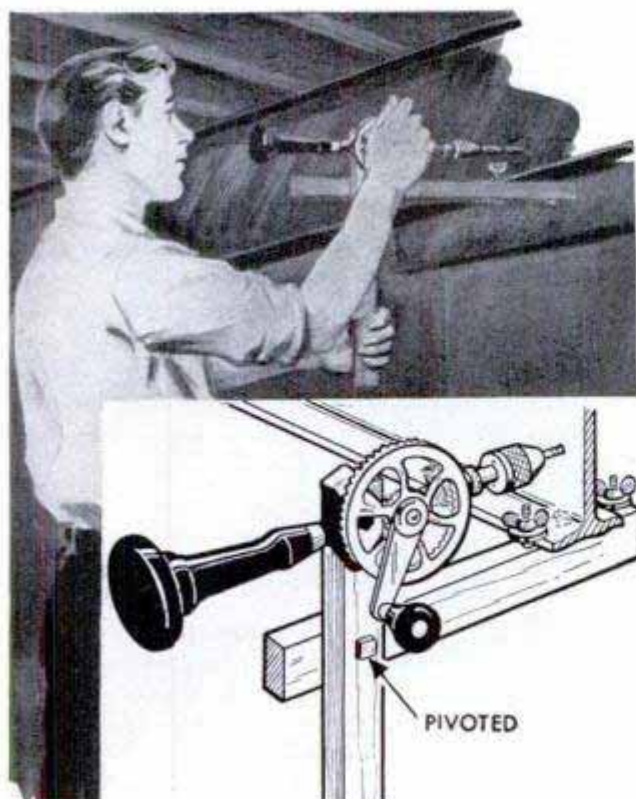

## C-Clamps Exert Pressure on Plywood Panels To Form Press for Flat-Drying Large Prints

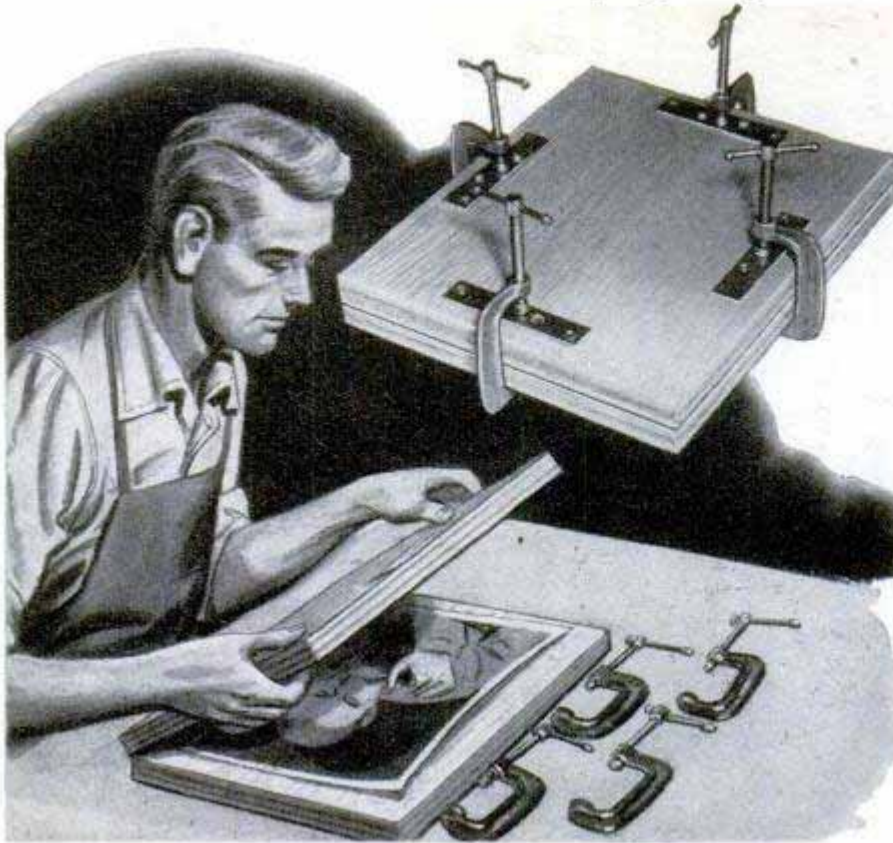

Easily made from two pieces of plywood and four C-clamps, this low-cost photo-press permits obtaining perfectly flat enlargements. The top and bottom panels are of  $\frac{3}{4}$ -in. plywood, cut slightly larger over-all than the size of the largest print to be handled. Four flat steel plates are screwed to each panel to provide bearing surfaces for the jaws of the C-clamps. These plates are positioned approximately at the center of each edge. To use the press, sandwich the partially dry print between two sheets of photo blotting paper and then insert in the press. Tighten the clamps as evenly as possible and allow the print to remain in the press for at least 24 hours.—Edward L. Fisher, Milwaukee, Wis.

## Photo Paper and Coin Tell Whether or Not Safelight Causes Fogged Prints

If you're at a loss as to the cause of dull, muddy-looking prints, try checking the location of the darkroom safelight. To remove any doubt as to whether or not the light is causing partial fogging of the paper, place a small piece of sensitized paper under the safelight, positioning it at normal working distance from the light. Then lay a coin in the center of the paper. Turn on

the light and leave the paper in place for as long as it probably would be exposed during ordinary processing conditions—3 minutes would be a fairly accurate estimate. Then develop the paper like a regular print. If the spot covered by the coin is lighter than the rest of the paper, you will know the safelight is too bright and should be located farther from the developing trays.

## Abrasive Disk Mounted at End of Flash-Gun Case Cleans Bulb Contacts

It's a good idea to rub the base contact of a flash bulb across an abrasive surface several times before inserting the bulb in the gun, thus removing possible corrosion and assuring positive firing action. If the bottom of the flash-gun battery case is not coated with an abrasive, cut a disk from a sheet of emery cloth and cement it to the bottom end of the case.



## Reflector Forms Portable Safelight

Screwing a colored bulb into a clamp-on photoflood reflector provides a portable safelight that can be set up in a moment wherever it is required. Plugged into a wall receptacle, the reflector can be clamped to any convenient object and readily adjusted as needed. Be sure to allow the recommended distance from safelight to print to avoid fogging."

Rep. C. L. B. 144

Rep. C. L. B. 144



# GUN-SIGHT FINDER for fast-action movies

By M. G. Winterton

FOR MAKING movies of birds in flight, panning a racing car or shooting spontaneous action at outdoor games, movie fans need an open-type view finder with which the swiftly moving object can be centered instantly. A new optical gun sight of the reflector type made for use on shot-guns is just the thing for this fast camera work. In use, the sight projects an illusionary dot which provides an aiming point, and its greatest advantage is that there is no small aperture on which the eye must be centered when picking up the action. By making the metal-and-plastic bracket detailed below, the gun-sight finder can be used with the camera mounted on a tripod having a pan head, or attached to a gun-stock aimer as in the photos at the right. Dimensions given below are only general and will have to be changed to adapt the bracket for use with different cameras and types of tripods. To align the reflector-sight dot with the lens, and to make sure that when the dot is on the action the latter is in exact register on the film, it may be necessary to shoot a few test frames and have them developed. Of course, it is possible to align the sight quite accurately by using the camera view finder.

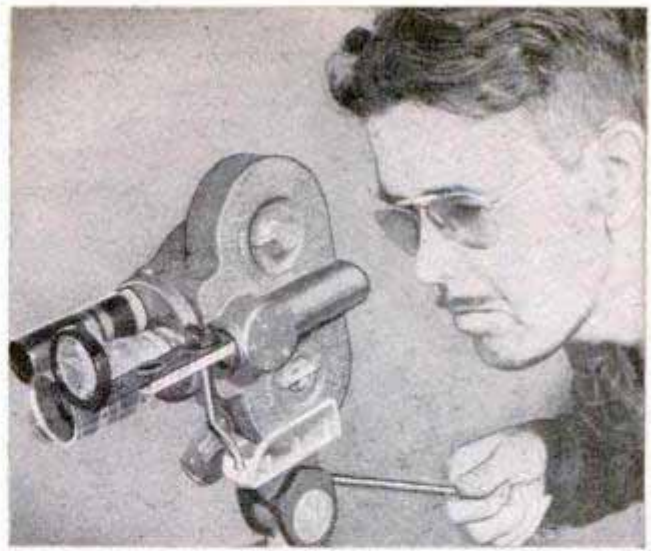

Here's the reflector sight and supporting bracket in use on movie camera mounted on a pan-head tripod



Freehand panning with a gunstock aimer, or pointer, enables the cameraman to record high-speed action

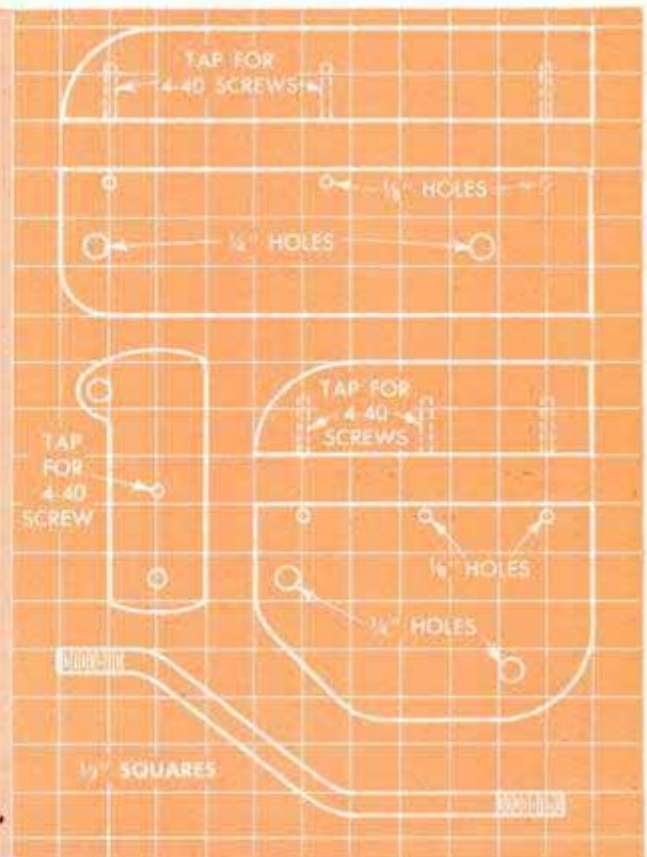
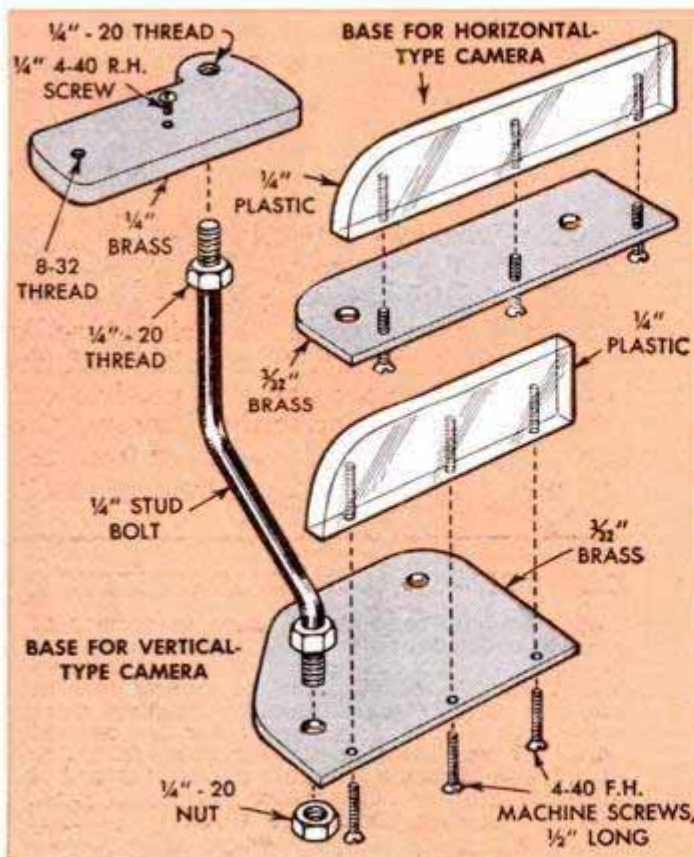

## Lighting Prints From Underside Indicates Trim Line



By moving the trimmer to the edge of the table and placing a light below the table to illuminate the overhanging portion of the print, you can judge within a fraction of an inch just where the knife blade will cut the paper. The light will be clearly visible through the translucent paper, forming a definite line along the edge of the trimmer. A lamp with a reflecting shade, a photo spot or a clamp-on photoflood reflector can be used to throw a bright beam of light against the underside of the print. If the clamp-on reflector is used, it can be mounted on a cleat which is fastened vertically to the end of the table.

Virginia Hanson, Santa Monica, Calif.

## Sunglasses Substitute for Filter



If you're shooting a landscape with interesting cloud formations and don't have a filter to bring them out, use a pair of sunglasses as an emergency substitute. Holding one lens of the glasses in front of the camera lens while taking the picture will produce much

the same effect as using a regular filter. The darker the glasses the more they will darken the blue portion of the sky. However, if the glasses are extremely dark, be sure to use a longer exposure.

## Solutions Stored in Medicine Bottles Are Dispensed With Eye Droppers

Photographic solutions which are used in small quantities are easy to handle if they are stored in medicine bottles having eye-dropper tops. The eye droppers permit measuring out the solutions accurately enough for all practical purposes. This type of bottle can be purchased from most drug stores. Bottles which originally contained medicine can also be used after cleaning.

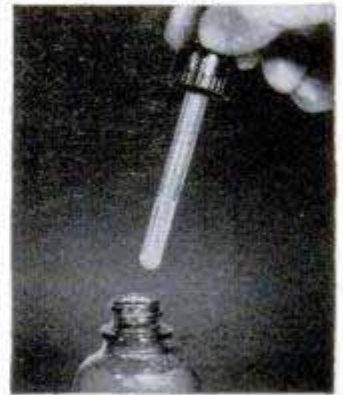

## Signature Printed on Greeting Card

One amateur photographer who makes greeting cards for himself and his friends discovered an easy way of printing the signature right on the sensitized paper. To do this, he cuts a small section from the black, overexposed portion of a negative and also cuts an opening, slightly smaller than the section of film, in a paper card. The negative is taped, emulsion-side-up, over the opening and the signature is written on the negative with a soft pencil. Then, after placing the film against a window-pane or on a ground glass lighted from the underside, the signature is traced with a stylus. The latter, which should have a chisel point, is used to cut through the emulsion only. Finally, the strip of signature film is removed from the card and fastened to the printing mask.



## CAUTION—SHADOWLESS REFLECTOR

Under certain conditions, there is danger of electric shock when using the photo reflector described on page 211 of our March 1950 issue. When wired as shown, the reflector serves as one side of the circuit. This could cause severe electric shock should the reflector be touched while plugged into the electrical source. To be safe, insulated sockets should be used instead of auto taillight sockets, which were suggested, and the sockets should be wired in parallel



## Rotary HEDGE TRIMMER

By Paul Will

**I**NVENTED by L. O. Hansen of Waterloo, Iowa, this novel hedge trimmer really makes the clippings fly. It's operated manually and utilizes a common hand grinder to provide the ready-made mechanism for operating a rotary blade. With one handle pivoted to the crank on the grinder and worked back and forth like a bellows, the blade is rotated at high speed with little effort. Used where electricity is not available, it's the next best thing to a motorized unit, and with practice and proper coordination, a constant speed is easy to maintain, as the momentum of the blade, plus the gears in the grinder, help to keep the blade whirling.

Almost any grinder can be adapted, the clamping bracket being sawed off to leave a suitable stub for attaching the fixed handle. The original trimmer, shown above and detailed in the drawing at the right, was fitted with a special cast-iron yoke, part C, to pivot the movable handle and link it to the crank on the grinder. However, a simplified version of the linkage is given in the drawing on the next page which shows how the yoke can be fashioned from flat iron.

The blade consists of a piece of flat iron, part D, to which a serrated mower section is riveted at each end. The complete blade

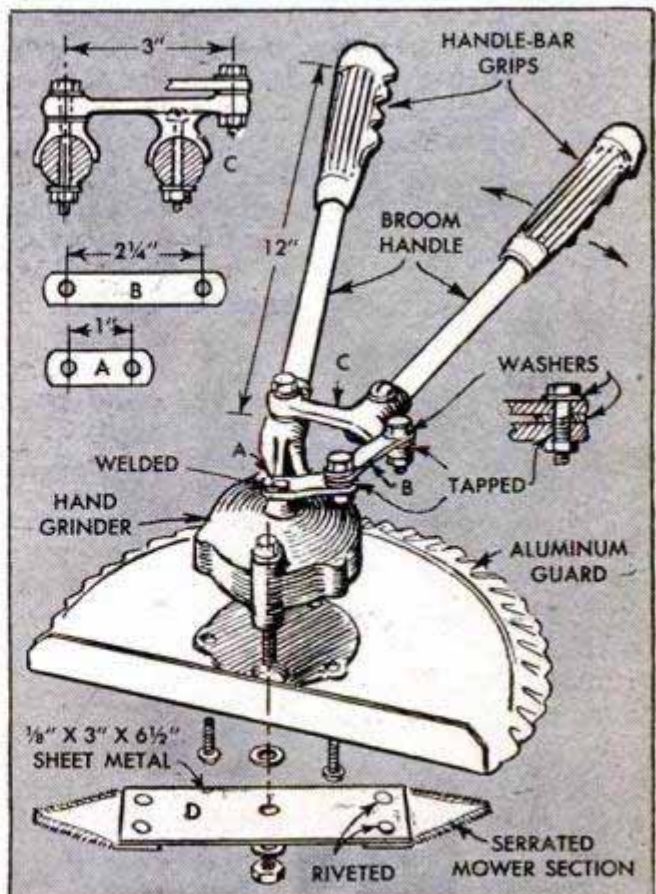

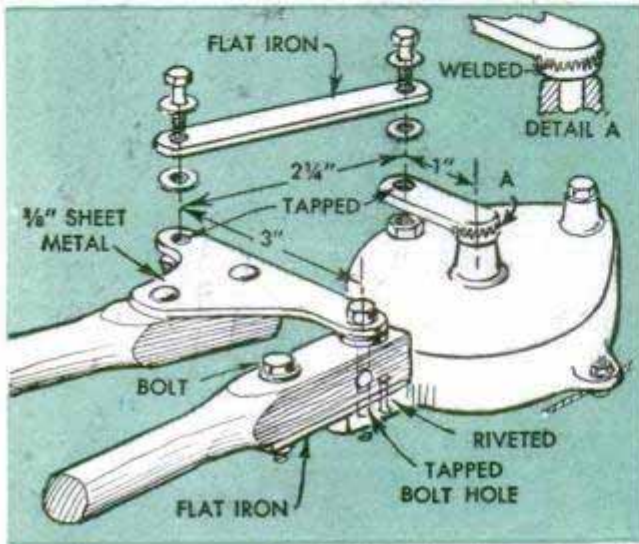
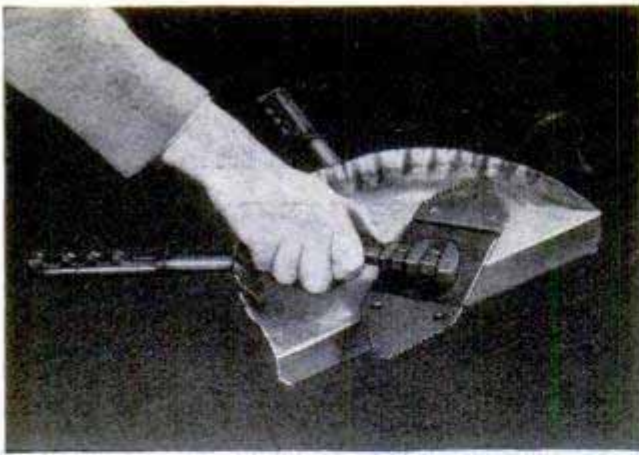

is accurately balanced to locate the exact center and then drilled at this point to fit the diameter of the grinder arbor. Two nuts and lock washers are used to fasten the blade securely to the arbor, after first bolting a sheet-metal blade guard to the grinder with sheet rubber mounted between. At the rear, the guard protects the hands but leaves the whirling blade exposed at the front to allow the trimmer to be fed into the hedge and to permit watching the progress of the trimming. Consequently, care should be exercised to prevent injury through careless use of the exposed portion of the blade. Short lengths of broomstick were used for handles on the original trimmer but, in the alternate version shown at the left, square stock is suggested to simplify attaching the handles. If a wood lathe is available, the square stock can be turned down at the ends to take bicycle handle-bar grips. Note in the details that parts A and C of the linkage are tapped at one end to permit locking the pivot bolts in place with a nut on the underside. Washers are placed on each side of part B and a little grease is applied to the pivot points to provide smooth operation. Part A can be either peened or welded to the arbor, depending on the particular type of grinder used for the trimmer mechanism.

### Container for Pipe Compound Improved From Oilcan

Fitted with a self-contained applicator, an oilcan serves as a convenient dispenser for pipe-joint compound. A large screw eye is soldered into the end of the spout, the latter being cut off if necessary so that the opening will receive the threads. Then,

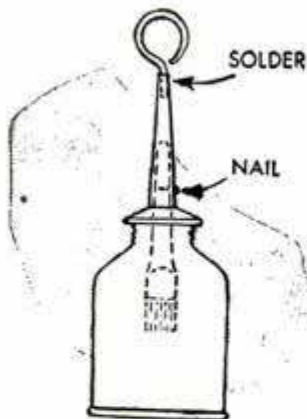

the handle of a small paintbrush is cut down, inserted in the large end of the spout and held in place with a nail. Screwing the cap onto the can holds the brush immersed in the compound and, by means of the screw eye, the dispenser can be hung from a hook in the shop or

truck. Fitted in this way, oilcans also provide excellent glue cans for the home workshop.—Carl Tretinyak, Austin, Minn.

☐ One farmer uses a circular saw to point the ends of fence posts quickly. The post is fed into the saw to make a half-dozen or more tapered cuts around the end.

### Quick-Detachable Long Tongue Fitted to Tractor Trailer

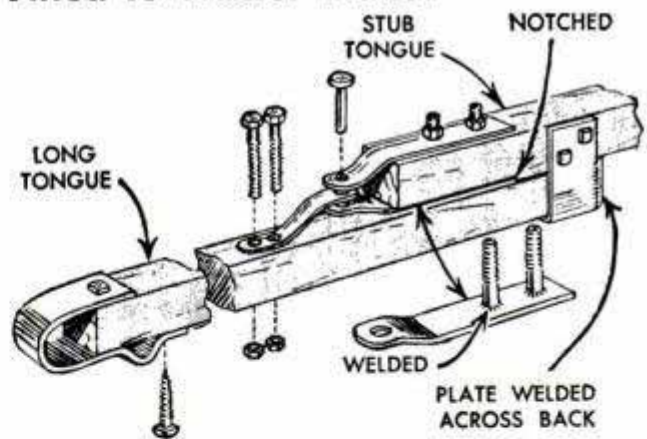

Farmers who still prefer the adaptability of a good team of horses for hauling loaded and empty trailers to and from fields where cornpickers or combines are working, will find this drawbar extension a timesaving accessory. Only one extension is needed to serve a number of trailers. By fitting the drawbar of each trailer with a special loose-pin clevis and a U-shaped holder, as detailed, the extension is quickly changed from one trailer to another. Make all metal parts of heavy flat iron and attach with bolts and lag screws. The fitting at the end of the long tongue is bent to form a lug for the neck-yoke ring. Use hardwood for the tongue extension.

On isolated farms, ranches and in cabins where electric or gas refrigeration is impossible, preserving food and cooling drinks during the hot summer months is easy with this iceless cooler. The unit is essentially a wooden framework draped with cheesecloth or burlap, the cloth serving as a wick to draw water from a sheet-metal tray mounted at the top. Evaporation of water from the cloth lowers the temperature of the air inside the cooler. The framework is simple to build and the shelves are of open, slat-type construction, the size and shelf area being determined by the items which are to be stored. The door

at the front of the unit is made by hinging a wooden frame to one of the posts and covering the frame on both sides with cloth. A second door may be installed on one side of the cooler to facilitate removal of the contents. The bottom shelf is a piece of sheet metal, the corners of which are notched to fit around the posts. The edges of this shelf overhang the framework slightly and are bent downward to drain excess moisture into sheet-metal drip pans fitted around all four sides of the cooler. To keep the floor dry, the entire unit, including the drip pans, is set on a large sheet-metal tray. This is made merely by bending the edges

## Cheesecloth Draped Over Wooden Framework Keeps Food Cool Through Water Evaporation

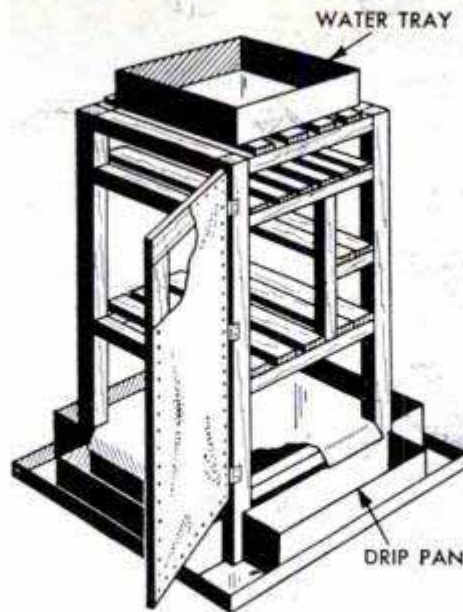

DETAIL OF FRAMEWORK



of the sheet upward and soldering them together at the corners. The cheesecloth is hung over the edge of the water tray at the top of the cooler so that one end remains in the water and the balance of the material hangs down to cover the framework completely. Burlap, though not as neat appearing as cheesecloth, is somewhat more efficient for this purpose. On the original cooler, drinking water was kept in a stone jar stored on the top shelf. A spigot from the base of the jar projected through one of the cloth sides so water could be obtained without opening the doors.

David F. Costello, Fort Collins, Colo.

## Combination Creep Feeder and Sunshade Protects Calves on Open Range

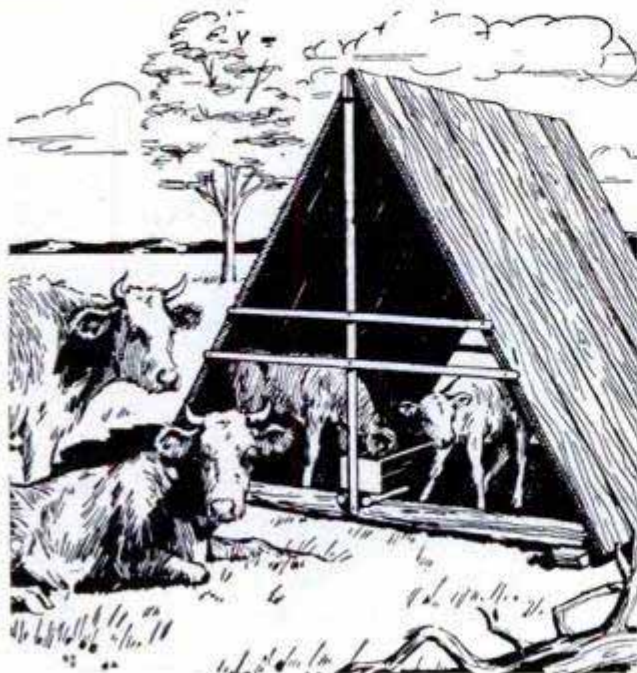

Young calves which are allowed to run with the herd on open range frequently suffer from exposure and insect pests. When they reach the age where they can be rationed dry feeds, they must either be segregated or be subjected to crowding and possible injury by the larger animals at feeding time. A Montana rancher found the solution to this problem by using portable creep feeders which are towed to the range with a tractor. The creeps are simply A-frames made from 2 x 4s and covered with wide boards. Each unit is mounted on 4 x 6-in. skids. Wooden crossbars are nailed across the open ends of each shelter at a height which is sufficient to allow the calves to pass underneath them but low enough to prevent the entrance of the larger animals. A feed trough, or bunk, is placed lengthwise through the center of the shelter.

E. V. Reyner, Townsend, Mont.

# USE THE RIGHT ABRASIVE

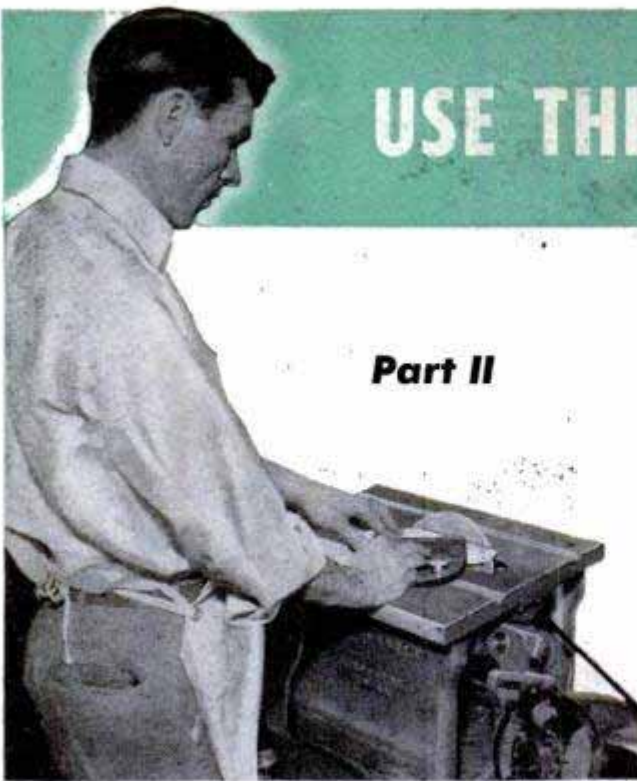

## Part II

By W. Clyde Lammey

**I**N BOTH finishing and refinishing procedures the preparation of the surface by sanding, as outlined in Part I of this series, is one of the most important steps in the whole process. However, the use of coated abrasives continues through the step-by-step procedure right up to the final finishing coat. Use of fine abrasives smooths the finishing material, removing and leveling such defects as small dust specks, air bubbles and the fine ripples which sometimes develop in finishing materials laid on with a brush. By making good use of abrasive know-how, the home craftsman will find that it requires a minimum of effort to prepare new wood for finishing and also to restore scuffed, scratched and chipped finishes to the original luster.

Whether you are sanding down an old varnish finish preparatory to refinishing or are sanding new wood, it's important to begin with the coarse abrasive and progress by separate steps to the fine and very fine grades. The reason for this is that the whole

process is simply that of removing the coarse, medium and fine scratches made by the respective grades of paper until the surface feels satiny smooth to the touch and the scratches can no longer be seen. On the coarse and medium papers, each abrasive grain removes considerable material from the surface at each stroke. This cutting action leaves a tiny groove, or scratch, which casts a shadow in oblique light, making the scratches visible both on the bare wood and under any clear finish. If a stain is used on such a surface, the pigment in the stain will "build" in the scratches and dull the grain pattern, giving the job a flat, unattractive appearance.

Packaged abrasive sheets in various grades ranging from very coarse to very fine make it easy for the home craftsman to keep on hand a supply of garnet, aluminum-oxide and silicon-carbide paper both for planned refinishing jobs and also for those which may turn up unexpectedly. Although the waterproof sanding papers are commonly used in industry for finishing operations on metals and metal-finish undercoats, they are comparatively new to the home workshop. In the finer grades, these papers are considered by most finishers as being superior to pumice for rubbing down final coats of lacquer, varnish and enamel. Now, many experienced home craftsmen use them exclusively for this purpose. Waterproof papers can be used with either rubbing oil or water (the procedure is known to finishers as "wet sanding") and in final rubbing and polishing operations they will produce a low-luster finish of satin smoothness. If a high-luster finish is desired, the process is carried one step farther, using specially prepared polishing compounds.

In the preparation of new wood and the





17

Photos and technical information courtesy "3M" Coated Abrasives Division, Minnesota Mining & Mfg. Co., St. Paul, Minn.

sanding of old finishes to produce a smooth surface for the application of either varnish or enamel, the step-by-step procedure is the same but the grades of abrasive used must be varied according to the nature of the surface and the age of the old finish. If the old finish is smooth, then a light, wet sanding with fine and very fine paper will do the trick. One important point should be kept in mind when sanding down old finishes: It's advisable always to use water as the sandpaper lubricant. Rubbing oil is rather difficult to remove entirely from an enameled or varnished surface which has been cut by sanding. As a rule, oil is used only on the final finish coat. If confronted with a refinishing job, such as a cabinet or

table, on which the finish is very old and oxidized to the point where it is badly checked in addition to being marred and scratched from long use, it is up to the finisher to decide whether to remove the old finish entirely (complete refinishing) or simply sand the old finish down until it is smooth. Very often the latter procedure will produce satisfactory results, that is, so far as the quality of the finish goes. However, if the original finish was clear, or if it has been applied over stain, then the grain of the wood must be considered. Age darkens the wood on old pieces, sometimes to such an extent that the grain pattern is almost obliterated. In this case, it is necessary to take off the old finish with prepared remover



18



19



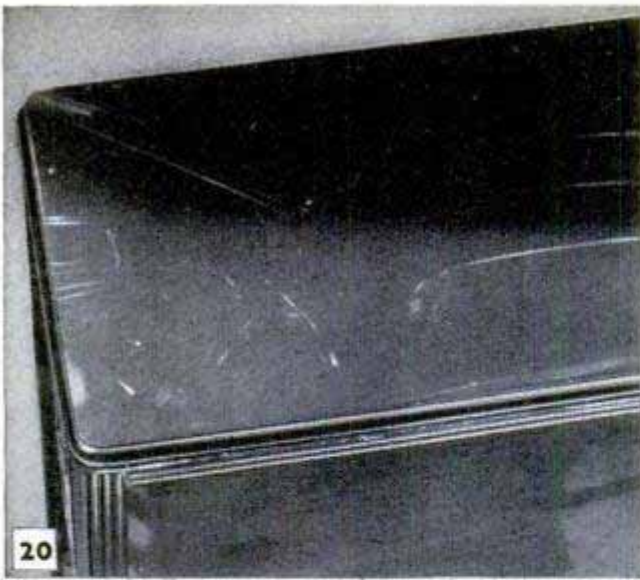

20 To furniture finishers, a complete refinishing job means taking off all the old finish down to the bare wood. The job starts literally "from scratch," with an old occasional table, marred, scuffed and scratched like this one is from long, hard usage

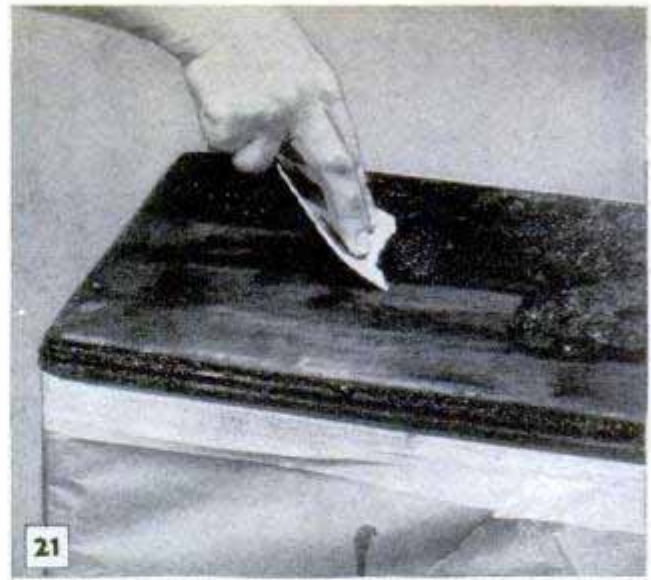

21 The first step is to apply a remover to soften and lift the old finish so that it can be scraped off easily with a wide-bladed scraper. When there are several coats of a pigmented finish, such as enamel, more than one application of remover may be necessary

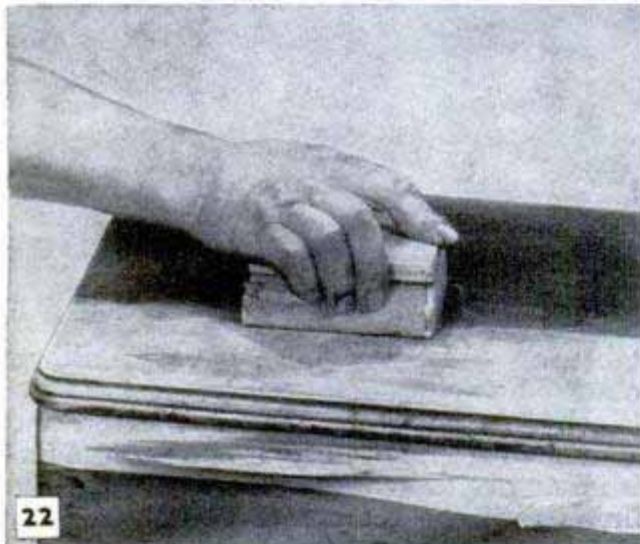

22 Above, the first sanding with coarse abrasive removes discolorations and exposes the wood in its natural color. Successive sanding steps prepare the surface for filler and sealer which are sanded down as in Fig. 23. Below, after applying, the final finish is wet-sanded between coats with very fine sandpaper

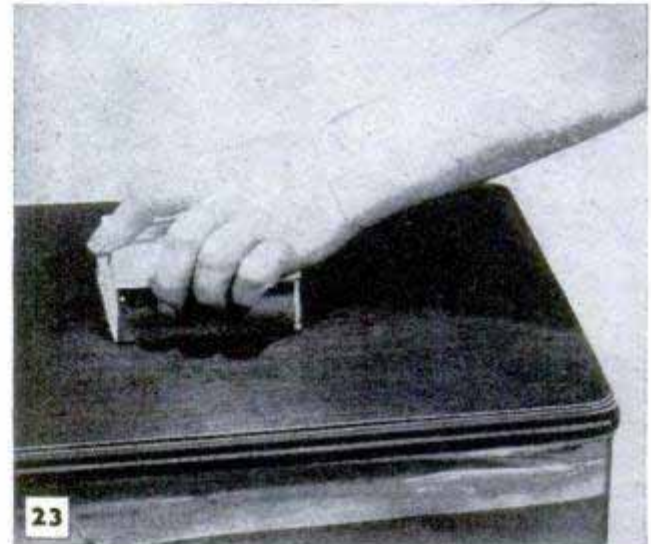

23 Above, after the surface has been prepared by sanding, Fig. 22, the stain and sealer are applied and allowed to dry. Then the surface is sanded lightly to prepare it for succeeding finish coats. If you want a fine, high-luster finish, the final step is rubbing down the finished surface with a polishing compound, below

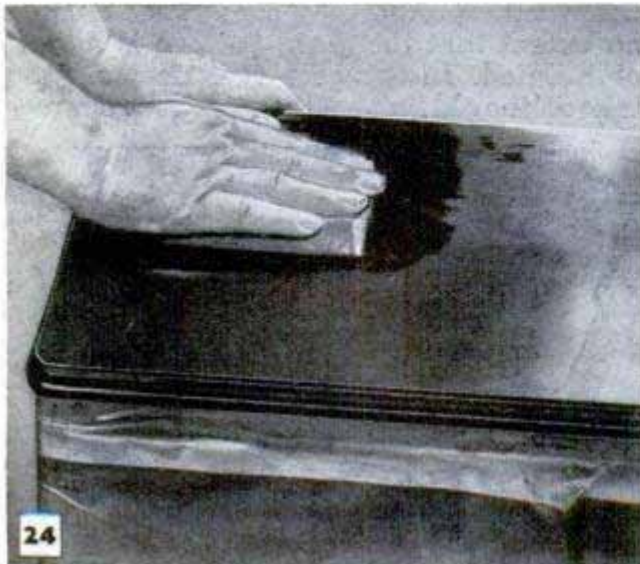



and sand the surface to bring out the grain.

It's comparatively easy to repair scratches on refrigerators, Fig. 17, metal kitchen cabinets, washing machines and ironers by a step-by-step procedure similar to that used on wood. The first step is to feather-edge the area around the scratch with water-proof silicon-carbide paper in the very fine grade. Water is used as a sanding lubricant and the sanding motion is made from the center of the damaged spot to the edges. This operation feathers the finish uniformly down to the bare metal, Figs. 15 and 16. When this step has been completed, the area is coated with metal primer, sprayed on. You can rent a sprayer from any well-stocked hardware store. When dry, the primer is lightly wet-sanded with very fine silicon-carbide paper, Fig. 18, the important thing being the sanding of the outer edges to level them flush with the surrounding surface. After the primer has been leveled, the finish coats of lacquer or enamel are sprayed on. Usually this is done by spraying a mist coat first, followed by a full coat. With the ordinary spray gun, the mist coat is produced by reducing the amount of enamel in proportion to the air volume. After the finish is dry, it is sanded lightly with very fine paper, using either water or oil as a lubricant and paying special attention to the sanding of the edges where the new finish builds onto the old. It takes very careful work here to reduce the finish to uniform thickness without ridges or ripples. Next, the spot is polished with a specially prepared polishing compound, working with a circular stroke and including all the area covered by the new finish, Fig. 19. Polishing blends the new finish into the old so that light reflections are equalized over the whole surface, thus hiding the repair.

Using very fine silicon-carbide paper and polishing compound, enamel finishes on refrigerators and other household appliances,

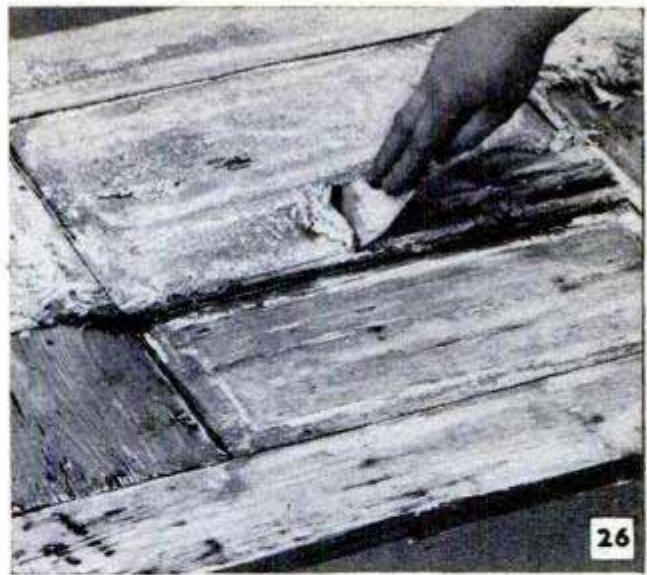

This old door looks pretty messy as you see it here. Several coats of paint have been softened by a paint remover and are being scraped off to expose the bare wood. On some of the older, more difficult jobs, such as this, several coats of remover may be necessary

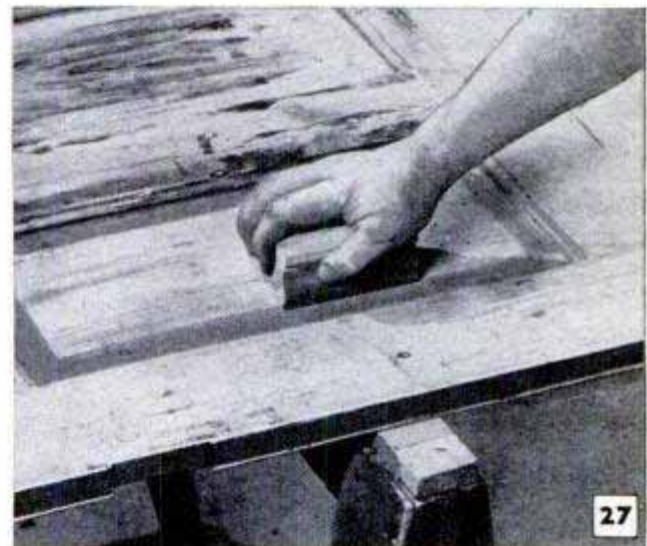

Above, sanding with coarse paper removes discolorations from the wood and levels the surface. Sanding with finer grades of paper smooths the wood and squares up edges of panels and frame. Below, after the rough and smooth sandings have been done, apply a sealer and, when this is thoroughly dry, sand smooth

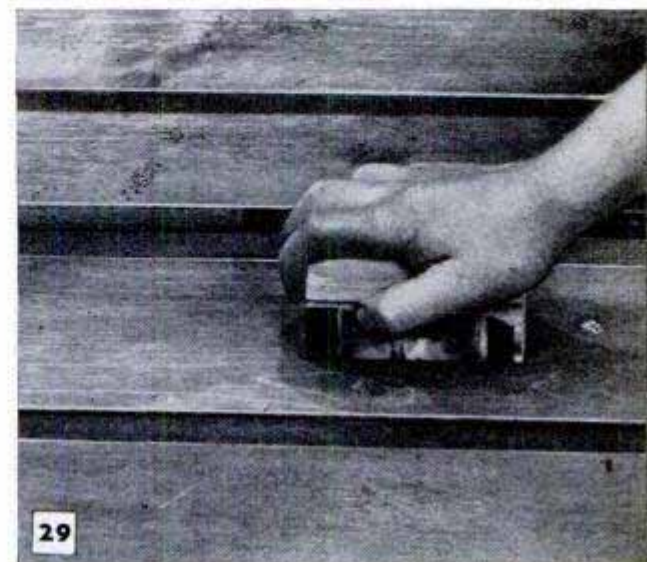
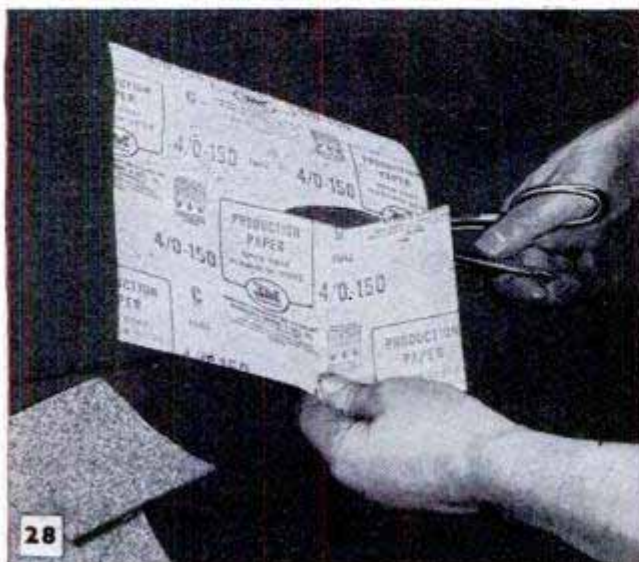



which are discolored with age, can be made to look like new simply by wet-sanding and polishing uniformly over the whole surface. Wet-sanding removes a very thin film from the discolored surface, exposing new pigment. Polishing restores the original luster.

Figs. 20 to 25 inclusive picture the step-by-step procedure in refinishing a small table which has become badly scratched and marred by long use. This is a typical complete refinishing job, as the old finish is first removed entirely as in Fig. 21, using a prepared remover. Next the surface is coarse-sanded, as in Fig. 22, to remove discolorations and restore the original color of the wood. Then the sanding is continued through three more steps to smooth the surface. After the application of stain and sealer, the surface is sanded, Fig. 23, in preparation for the application of the finishing coats, which are sanded down as in Fig. 24. Then if you want a fine, high-luster finish, rub down the surface with a polishing compound as in Fig. 25. As a rule, finishers use polishing compound only on varnish and lacquer finishes. Also, it is better to use the garnet papers rather than silicon-car-

bide papers, which are more commonly used on enamels and other finishing materials applied over metals.

By use of abrasives which are now readily available, you can reclaim old work that looks hopeless in its present condition. The door, Figs. 26, 27 and 29, is a good example. First, the paint is removed as in Fig. 26. Then the preparatory sanding proceeds through the regular steps as in Figs. 27 and 29. Fill all dents and deep scratches with wood filler before the final sanding. Here is a good trick to know when sanding a door such as the one shown: Sand the rails (horizontal members) first, then take the stiles. This procedure will avoid scratches at the joints where the grain of the horizontal and vertical members meets at right angles.

Homemakers have discovered that very fine silicon-carbide paper is just the thing for cleaning blackened kitchen utensils, Fig. 30. A few strokes with the paper brightens the most stubborn discolorations and, after washing and wiping with a soft cloth as shown, pots and pans, skillets and tea-kettles look like new again. In some cases, it may be necessary to use a medium or fine paper, particularly on ironware. In any case, always finish the job with the very fine grade to remove the scratches left by the coarser grit. Do not use the coarser grits on copper or any plated kitchen ware. In the home shop, tools that have become rusted, such as handsaws and chisels, can be cleaned and polished with the fine papers as in Fig. 31. Use a few drops of oil to prevent the abrasive from clogging. Clean the bottom of a rusty hand plane by taping a piece of fine aluminum-oxide paper to the bench top and then stroking the plane lightly over it, with the plane iron raised. Cut abrasive paper into strips or squares with a small pair of tin snips as in Fig. 28. When cutting strips to fit a sanding block of the type shown in Fig. 32, cut the strip slightly wider than the block.

(To be continued)

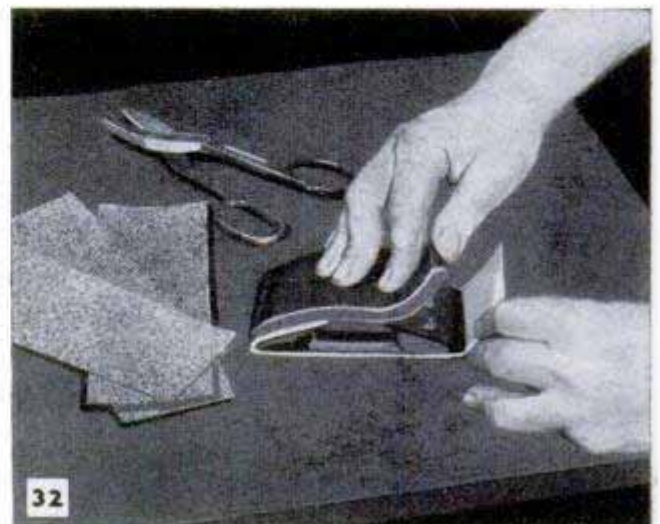

# Hardboard Paint Shield for Lathe Headstock

Slipped over the headstock spindle, this hardboard shield provides protection for both headstock and lathe bed when spraying or brushing a finish on work mounted in the lathe. The shield does not interfere with normal operation of the machine and allows work to be conveniently finished without removal from the faceplate. The shield consists of two pieces of hardboard or heavy cardboard cut large enough to completely cover the front and side of the headstock. A hole  $\frac{1}{4}$  in. larger than the lathe spindle is cut through the front panel and positioned so that the bottom edge of the board will rest on the lathe bed when it is slipped over the spindle. A notch is cut in the rear edge of the front panel to engage any projecting portion of the machine.

This keeps the shield from tilting or moving out of position so that the spindle will not come in contact with the edge of the hole. A second board which covers the side of the headstock is hinged to the front member with cloth tape or with a canvas strip glued to both panels. A piece of wire bolted to the side panel is located so that it can be hooked over a lever or other con-

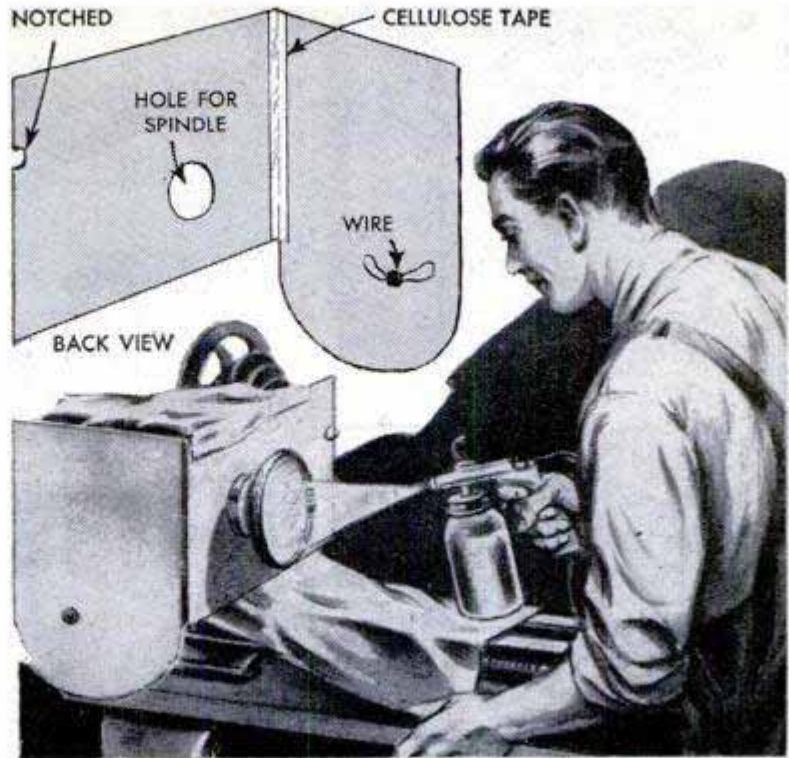

venient projection. Cloth "aprons" are glued to the top and bottom edges of the front panel, the top one being used to cover the headstock, gearbox, etc. The bottom one is pulled out to cover the front portion of the lathe bed. The shield folds flat when not in use, requiring little storage space in a drawer or cabinet.

Roland Cueva, Heyburn, Idaho.

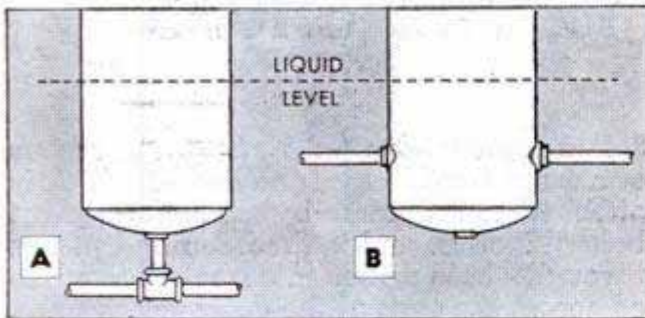

## Straight-Line Connections Dampen Pump Hammer

In a special installation employing a duplex plunger pump, the pump impulses appeared to by-pass the air chamber and were being dissipated throughout the discharge system with resulting damage to valves and other fittings. Called in to remedy the trouble, one plumber, although puzzled at first by the unusual performance of the pump, finally hit upon the cure. He simply removed the pipe tee and riser to the air chamber, detail A, and plugged the outlet. Then he made the discharge-line connections to the air chamber as shown in detail B.—Elton Sterrett, Houston, Tex.

## Straps Polish Tractor Axles

To facilitate sliding the wheels on the axles of his tractor when it is necessary to change the tread, one farmer keeps the axles free from grime by means of leather straps. One strap is fastened around each axle and weighted, as shown in the photo. As the axle revolves, the leather polishes the metal.

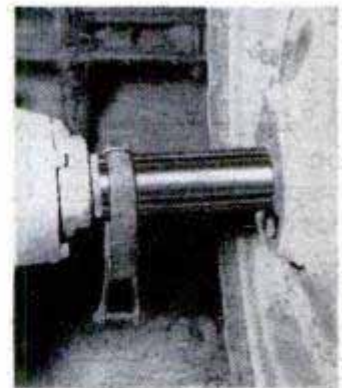

L. H. Houck, Jefferson City, Mo.

## Preventing Rust in Waterpots

The waterpots at the grinding wheels in our shop were becoming lined with rust as a result of the oxidation of steel particles from the tools being ground. To remedy this situation, we simply added a few drops of soluble cutting oil to each waterpot.

Max Levine, Little Rock, Ark.

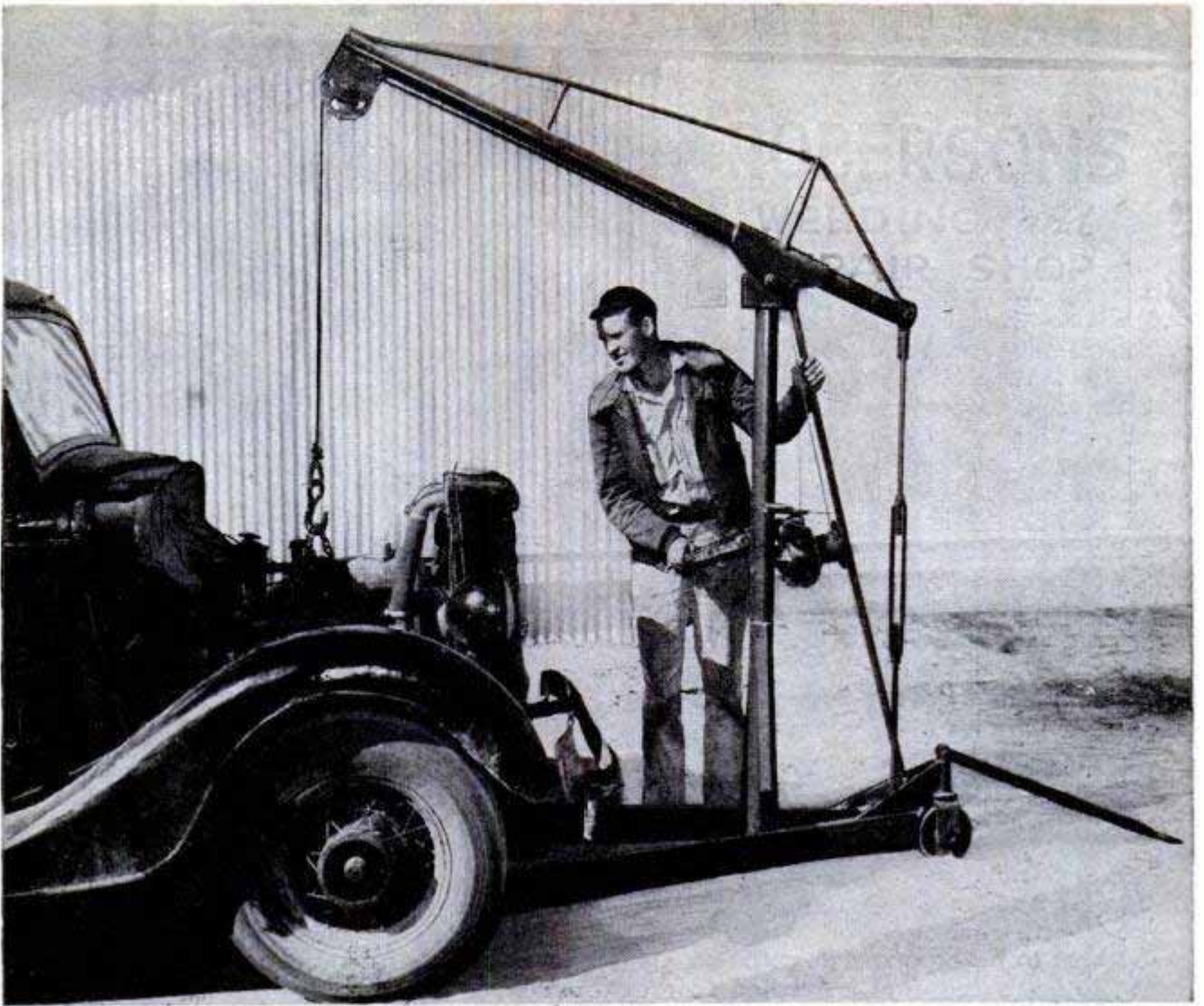

## PORTABLE HOIST for JOB SHOPS

By Hi Sibley

**R**EADILY adaptable for use in any job shop where heavy machine parts must be raised to exact height and rolled or swung into position, this portable hoist has several special features. The adjustable crane is mounted on a three-wheeled dolly having an A-shaped frame made from steel channels welded together as in Fig. 1 to form a rigid unit. The three-point support permits the unit to stand firmly on uneven floors while the hoist is being operated. The low dolly will roll under the front end of any car or truck so that an engine can be swung in or out of the frame by direct vertical lift of a worm-gearred winch. The original hoist was built by Jay Roberson of California for use in his garage repair shop.

The crane pivots on a spindle mounted at the upper end of a supporting column which is braced and welded into the dolly frame, Fig. 1. A 3½-in. rope sheave is mounted on the pivot spindle as shown in the assembly and sectional views in Fig. 1. Dimensions of these parts are given in Fig.

3. The crane is adjusted for height by means of a large turnbuckle, one end of which is attached to the crane by means of a pivot bolt; the other end is threaded and passes through a hole drilled in a steel plate welded across the ends of the dolly side frames. Note that the column brace is slotted to permit the lower turnbuckle rod to pass through it and fasten to the frame.

A caster-type front wheel fitted with a detachable handle makes it possible to maneuver the loaded crane into places where there are only inches to spare. The caster and its supporting arm are built up entirely by welding together members cut from flat steel, pipe and shafting. Note in the left-hand details in Figs. 1 and 2 that pipe is specified both for the caster-wheel spindle and the pivot shaft. If cold-rolled steel shafting is substituted, the assembly will operate more smoothly. The same is true of the rear dolly wheels and shaft. When steel shafting is used, the wheels should be bronze-bushed. If desired, the rope sheaves

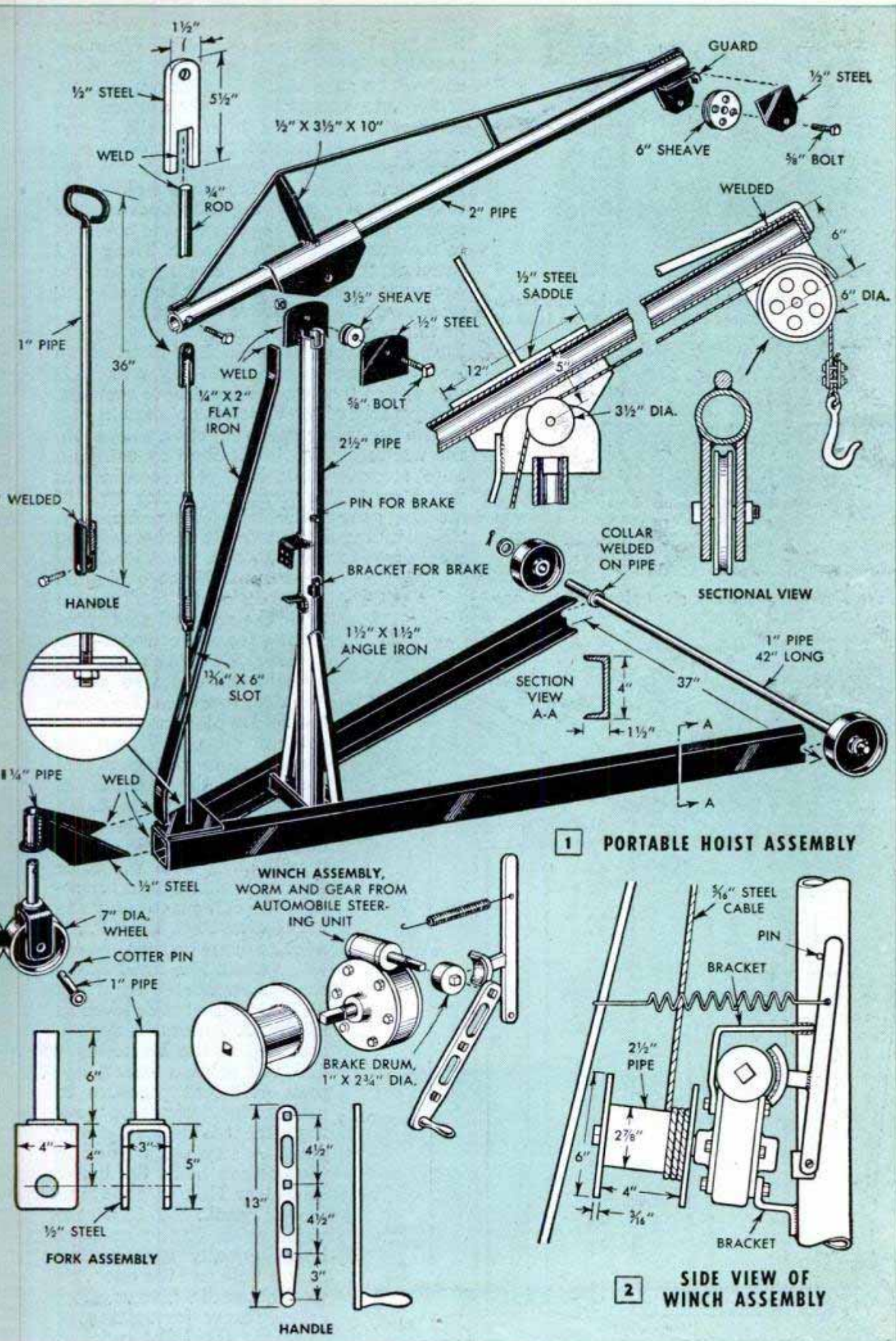

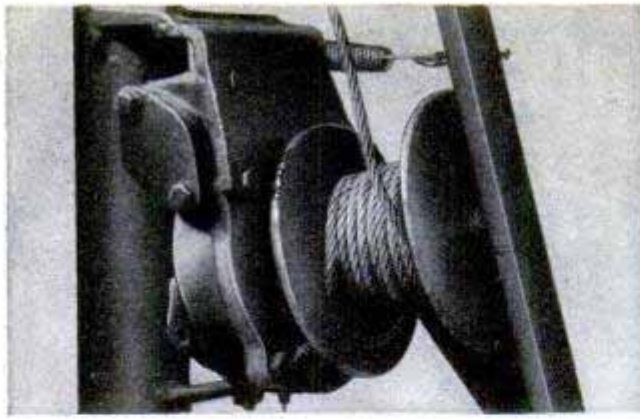

The winch is supported by heavy iron brackets welded to the round column. Note that the drum is tilted

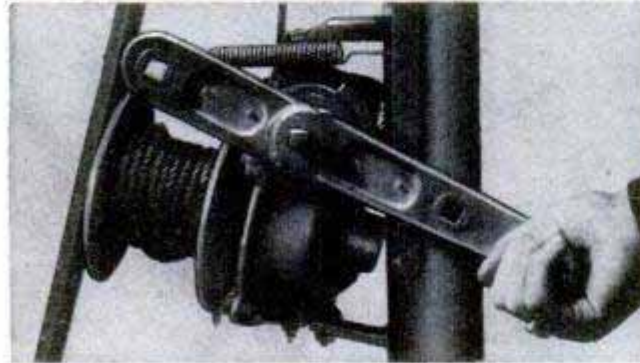

A three-speed hand crank gives plenty of leverage

in the crane also can be fitted with bronze bushings for smoother operation. When assembling the spindle lugs for the 6-in. sheave, be sure that the parts are in line. If the sheave is not correctly aligned, the steel cable will tend to climb the flange causing undue wear on both the cable and sheave and possibly resulting in breakage. Note that a guard, or fender, is welded between the lugs carrying the upper sheave spindle and the free end is bent to conform to the curvature of the sheave. The guard prevents the cable from jumping out of the groove in the sheave when the hoist is being moved, or when the cable is being payed out or taken in without a load. Should the cable jump out of the groove, it may wedge between the sheave and the lug, making it difficult to free the parts without damage.

Assembly of the winch is detailed in Fig. 2. The necessary gear reduction to operate the winding drum is obtained by using an auto steering unit having a continuous worm gear. The worm-and-sector type of steering gear cannot be used satisfactorily. The winding drum is built up by welding steel disks to the ends of a short length of

$2\frac{1}{2}$ -in. pipe. Holes are drilled in the disks and filed square to fit the squared shaft projecting from the worm-gear housing. Provide a cotter pin to hold the drum in place. The drum and gear housings are held in place on the crane column by two brackets shaped from flat iron and welded to the column as shown in Figs. 1 and 2. It's important that the assembly be placed at an angle so that it will align with the idler sheave. Weld another bracket to the column to carry the brake arm, Figs. 1 and 2. Fit a brake drum on the squared worm shaft. The lined brake shoe is supported by a lug welded to the brake lever as in Fig. 2. A torsion spring, attached to the brake lever and the column brace, applies sufficient pressure to prevent the drum from moving after it is stopped at any point. A stop pin welded to the column holds the brake shoe clear. Note that the handle, or crank, Fig. 2, is provided with three squared holes, equally spaced. The center hole and the one next to the handle give a short crank throw for raising or lowering the hoist quickly.

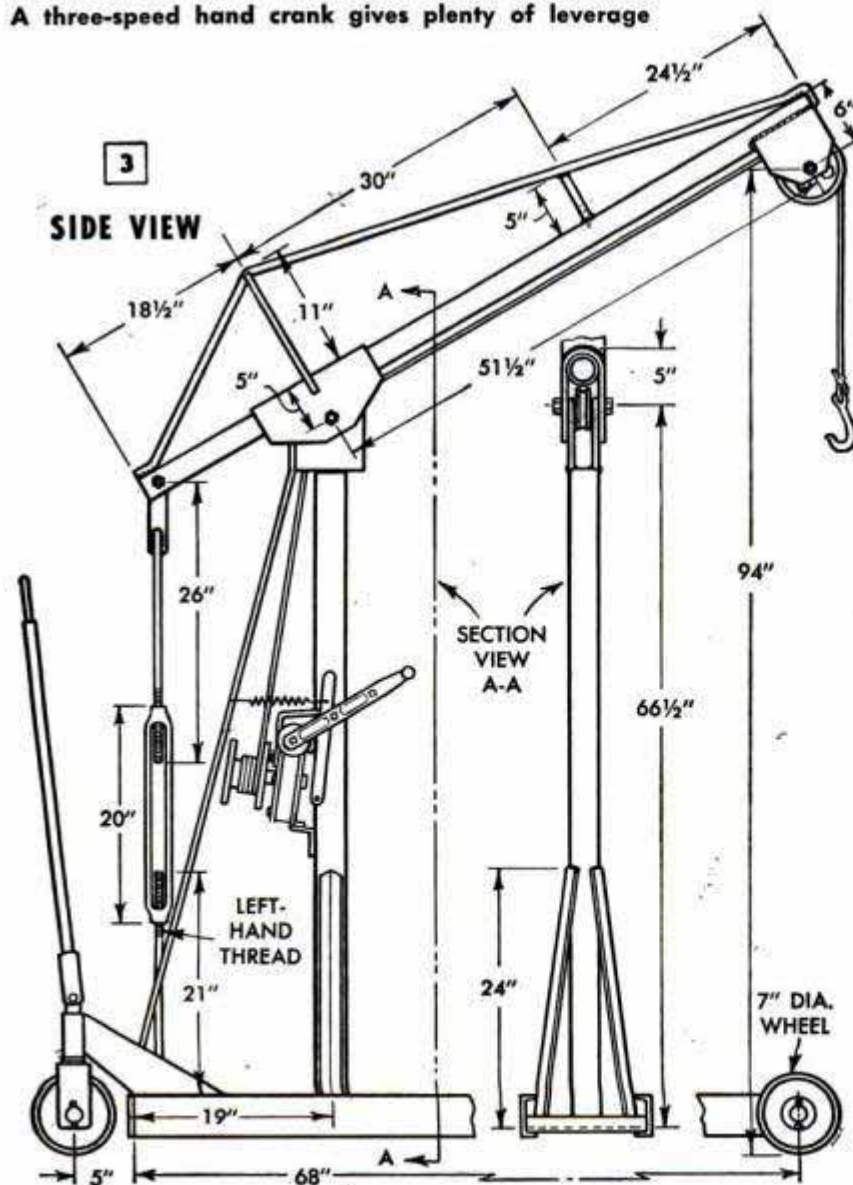

## ELECTRONICS TODAY

**T**ODAY'S clocks can do almost anything—turn your radio receiver on and off, even start your electric percolator and have coffee ready when you wake up to music. They open safes, set off bombs—and now we have one that talks, using an Electronic Narrator shown being installed in the clock in photo A. The recording device consists of an amplifier and a tape recording that permits advertisers to give the time their personal touch; for example, the clock on the First National Bank could bid passers-by the time of day and, at the same time, remind them that money deposited before tomorrow will earn a special dividend. The device repeats the same message or different messages through the loud-speaker system every day at predetermined intervals.

Two new tiny germanium diodes are shown under a magnifying glass in photo B. These crystals in special containers are used in television receivers to replace certain tubes in video detectors and in d.c. restorer circuits. They have longer life than tubes.

An improved type of TV front-end tuning assembly is illustrated in photo C. It covers all 12 channels and is said to eliminate tracking difficulties. It features interchangeable channel inductors, and concentric control shafts for channel selection and fine tuning. It can be installed by any TV serviceman.

Wire recorders are now used for low-cost dictation and provide natural voice playback. The units take up very little room on office desks, as shown in photos D. Foot control and desk "mike" leave hands free.

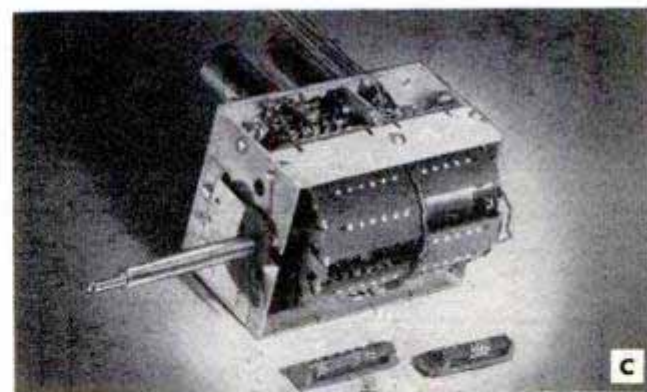
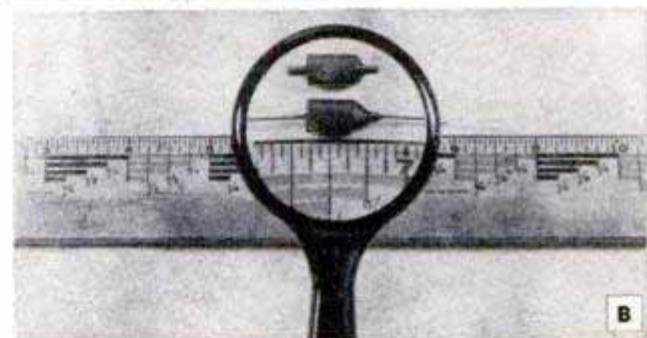



# CAPACITY-OPERATED

By L. M. Dezettel

THIS HIGHLY sensitive capacity-operated electronic relay has many useful applications around the home and in industry. It is easy to construct with ordinary radio and electronic parts that are available from all parts houses. The approach of a person to an antenna wire attached to this unit operates a 110-volt a.c. relay that may be used to turn on a light or start model trains or electrically operated appliances in window displays, as illustrated in sketch A. Passing persons merely place their hand near a 5 or 6-in. metal disk to which the antenna wire is fastened on the inside of the window. As a burglar alarm, it is ideal for turning on floodlights, or ringing a bell, for the protection of persons or property as illustrated in sketches D and E. The antenna or "alarm wire" can be concealed around a window frame or door, or attached to a sheet-metal plate under a walk.

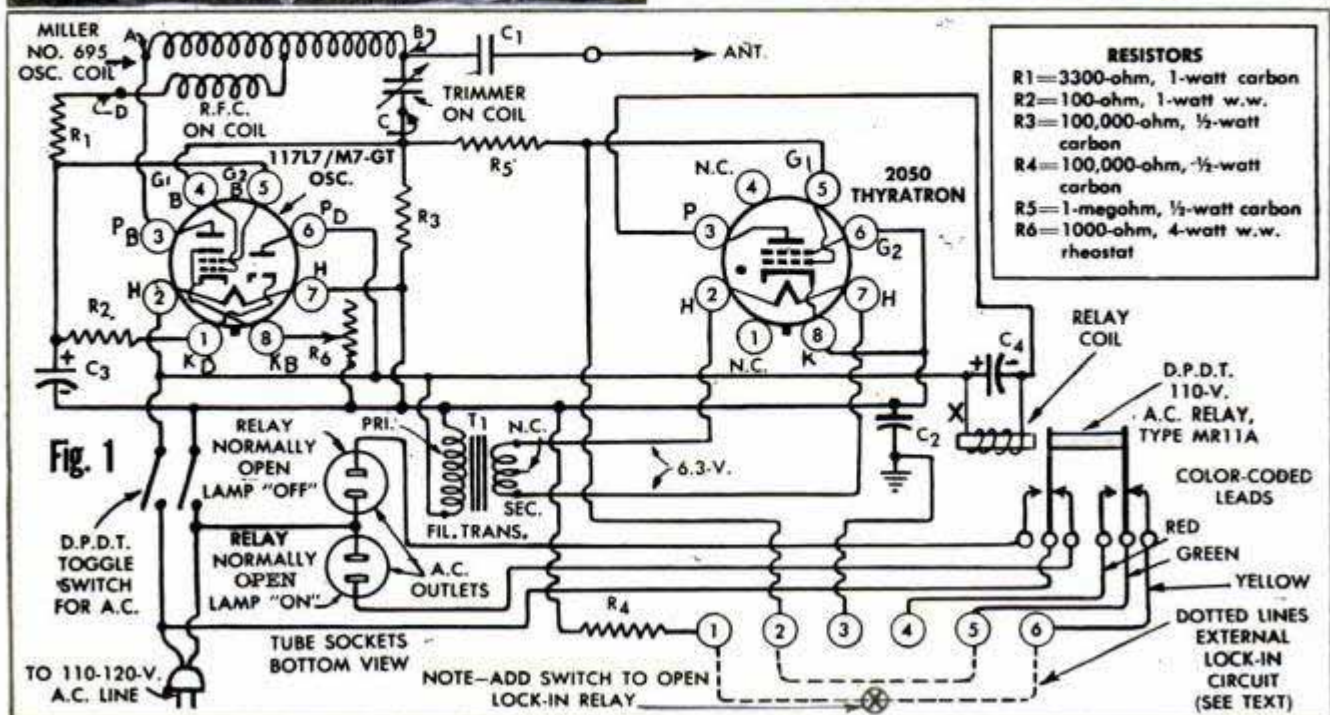
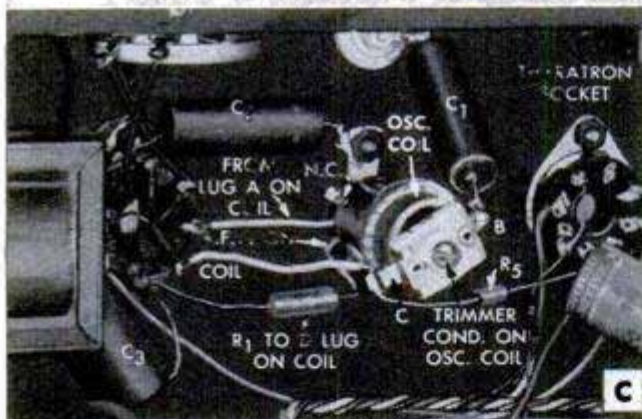
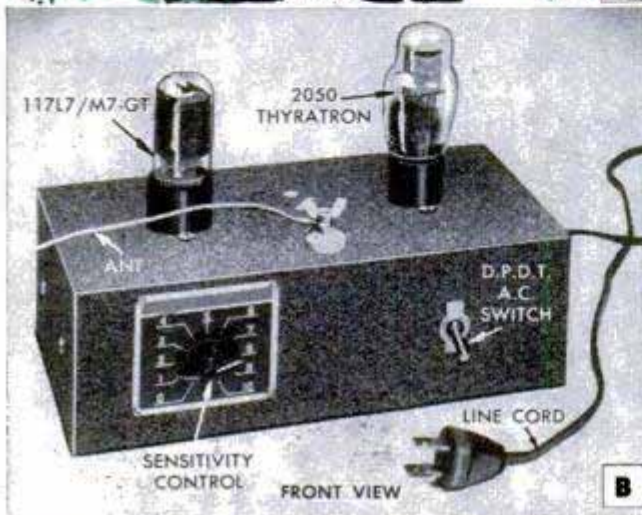



# ELECTRONIC SWITCH

The instrument can be plugged into any convenient 110-120-volt a.c. outlet in the store, home or garage. The remote floodlight, alarm bell or other appliance to be operated is then merely plugged into one of the relay outlets mounted on the rear of the unit. Based on simple electronic principles, this capacity-operated switch shown in Fig. 1 consists of a free-running oscillator connected to an antenna wire. When a person or object comes close to this antenna wire, the additional loading to the oscillator circuit causes a drop in voltage across the grid-leak resistor. This voltage change is transferred to the 2050 Thyatron tube, which operates the relay closing the contacts that supply line current to the devices to be operated. The oscillator tube is the tetrode section of the dual-purpose 117L7/M7GT tube, the diode section being used to rectify the a.c. and convert it into d.c. for more sensitive operation of the oscillator circuit. Antenna wire lengths of about 10 feet will operate nicely with this

(Continued to page 226)

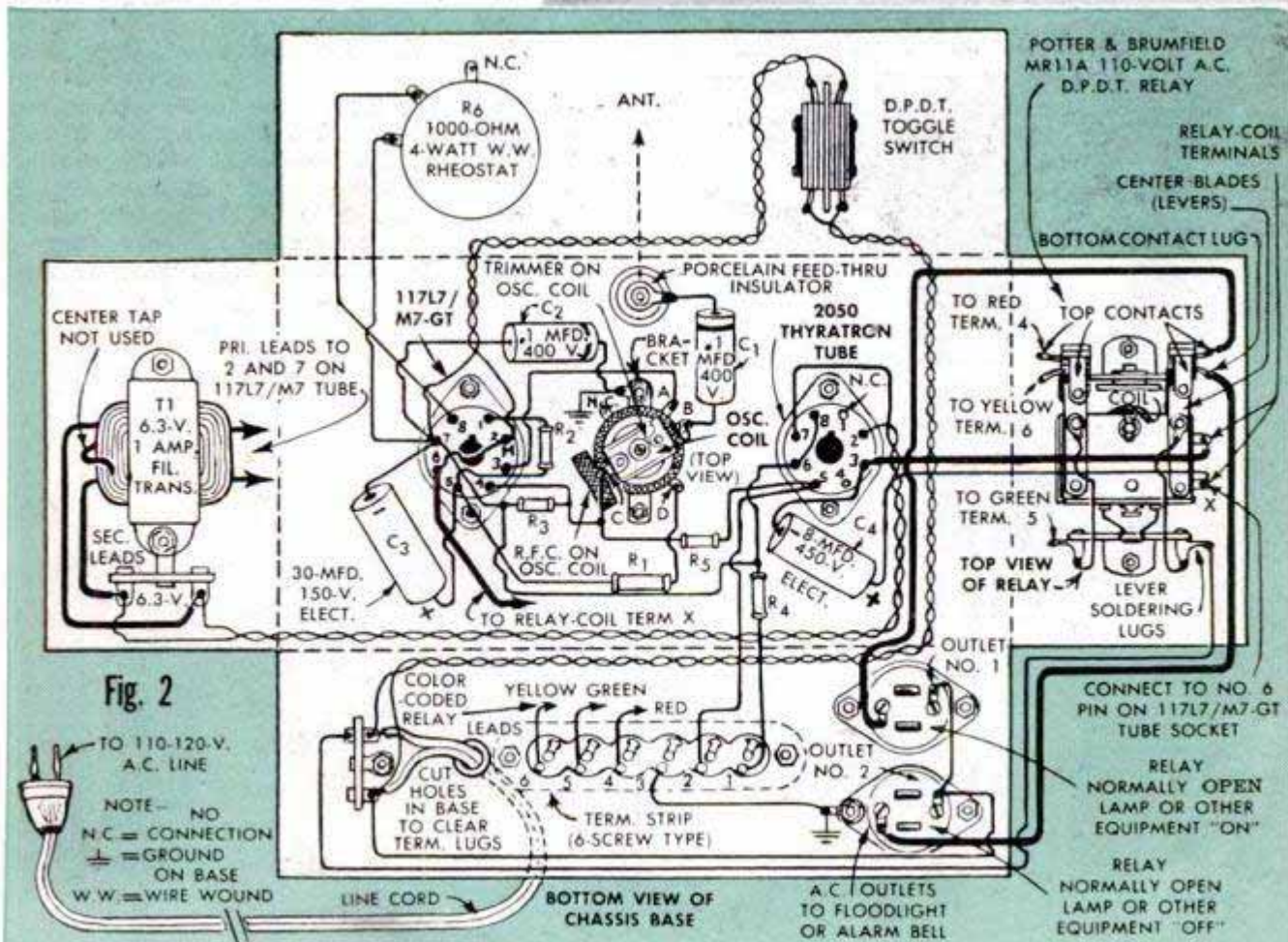
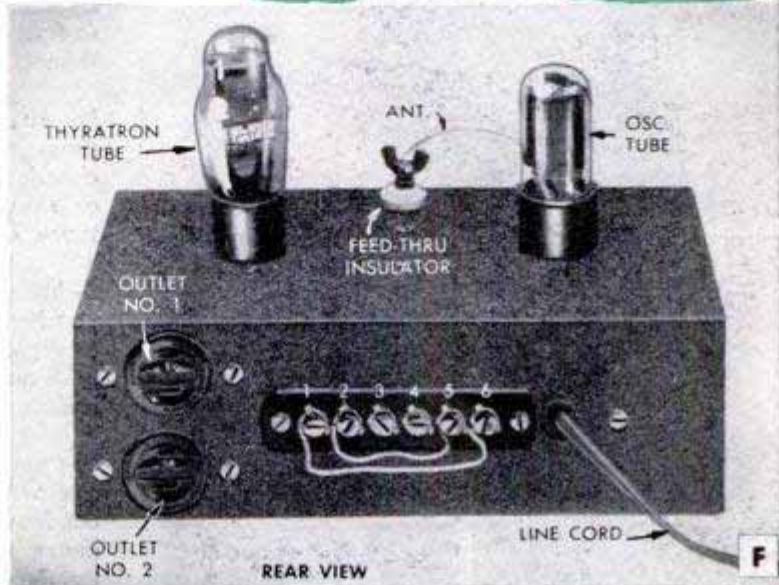

# HOME-SET SERVICE HINTS

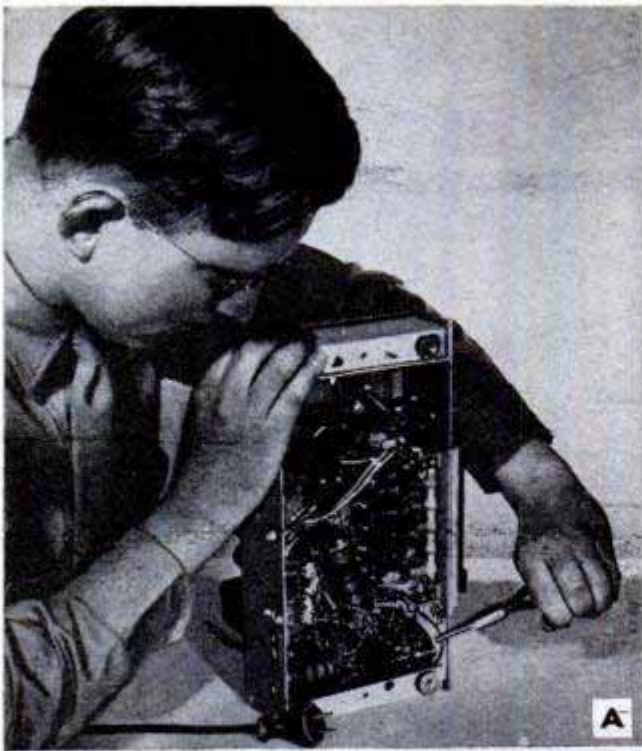

**A**—After making repairs in a short-wave set it is important that all wiring be replaced in the original position, especially wires going to the band switch. These wires should be kept their original length and must not be close to the filament leads

**B**—Ordinary rubber window wedges may be used for radio chassis mounts when the original mounts are lost, as exact replacements are sometimes difficult to obtain. These wedges are tapered. When they are inserted and chassis screws tightened, cut off ends

**C**—Speakers which do not have dust guards over the air gap in the center of the cone may be protected by cementing a disk of cloth to the cone as shown. Cut this circular piece of cloth slightly larger than the opening. Apply cement around edge only

**D**—After installing a new filter condenser or other part, make certain that it is not too close to a chassis mounting flange or bracket. Try the screw as shown in the photo to be sure that it will not touch any part or wire when chassis is mounted

**E**—When no standard tube tester is available and you have a "dead" radio receiver on your hands, an emergency check can be made on the tube filaments with an ordinary ohmmeter as illustrated. If no meter reading is obtained, the filament is burned out

**F**—Paper-type fixed condensers are tested for leakage with an ohmmeter as shown. One lead of the condenser is disconnected in the circuit and the ohmmeter test leads are clipped across the condenser terminals. Use highest ohmmeter scale; good condensers show only slight meter deflection at time of contact, after which needle returns to starting point

**G**—Before replacing the receiver in the cabinet, see that asbestos mat is tacked down so that it will not interfere with the installation of the chassis. Also check to see that the control shafts are centered in their holes in the front of the cabinet before the chassis mounting screws are tightened. Finally, make sure all tubes are tight in their sockets

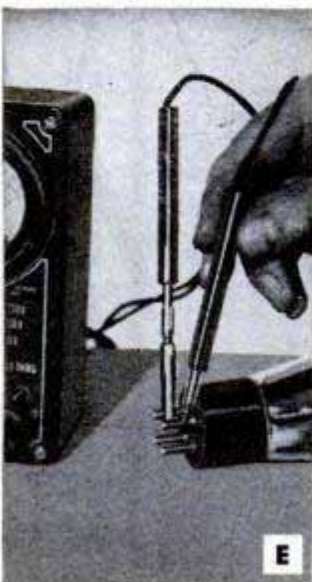
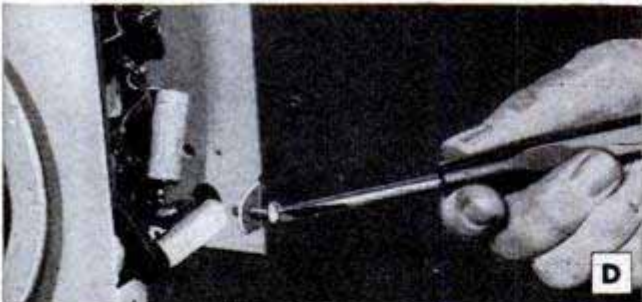
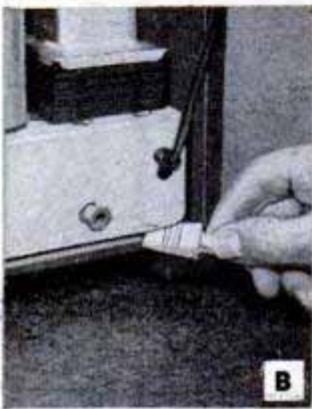

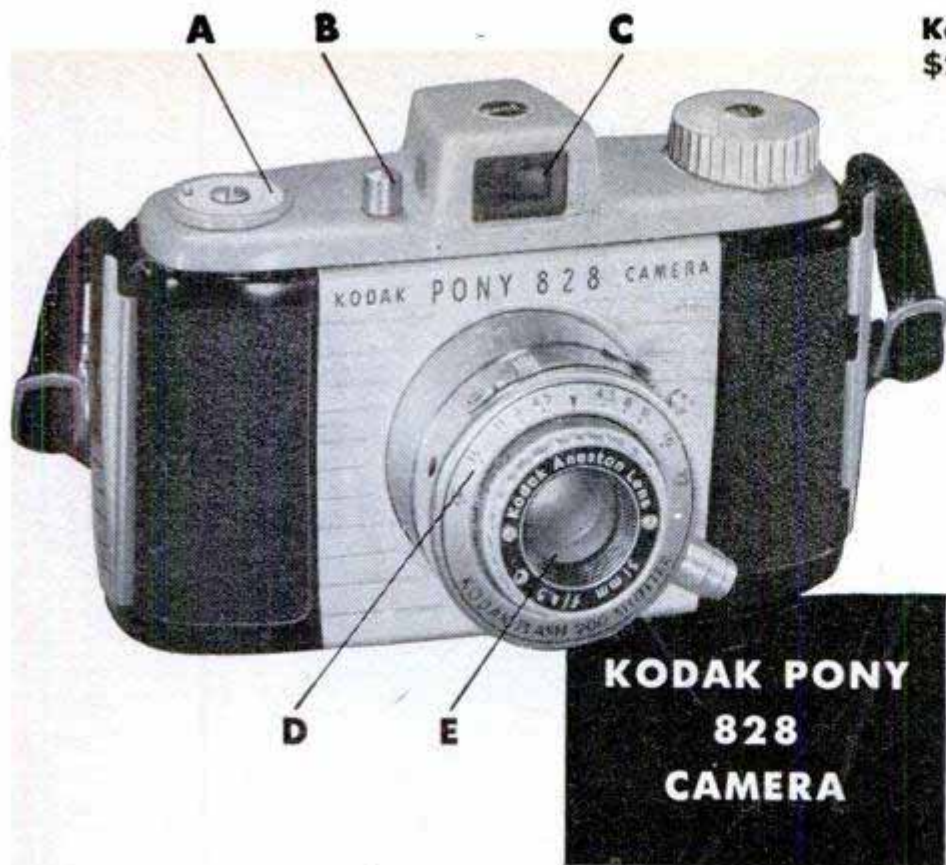

**Kodak's newest f/4.5 miniature  
\$29.95, including Federal Tax**

Just look at these fine-camera features—and then look at the price.

- A** Indicator to show you the type of film in camera.
  - B** Finger-tip shutter release.
  - C** Enclosed optical eye-level view finder, large and brilliant.
  - D** Telescoping lens barrel with easy-to-read lens and shutter speeds, depth-of-field and focusing scales . . . simplified average exposure settings marked in red.
  - E** Color-corrected Kodak Anaston f/4.5 Lumenized Lens, in Kodak Flash 200 Shutter with built-in synchronization.
- See the Pony 828 accessories, too, at your Kodak dealer's—tan leather Field Case for \$6.50; Kodak Flashholder for \$11.08, including Federal Tax; as well as Kodak Combination Lens Attachments and Kodak Metal Cable Releases.

## YOUR LOW-COST COLOR TEAM

**KODASLIDE  
PROJECTOR  
MODEL 1A**



**Lumenization steps up  
screen brilliance 50%**

Projector includes Kodak Projection Ektanon *Lumenized* Lens, 4-inch f/3.5, for big pictures at short distances; *Lumenized* condenser system for over-all image brilliance; 150-watt lamp, slide carrier, and 12-foot cord—all for \$29.50. Be sure to team up the Model 1A with your new Kodak Pony 828 Camera—for your "double reward" in color prints and projection. At your Kodak dealer's.

**EASTMAN KODAK COMPANY, ROCHESTER 4, N.Y.**

**Kodak**  
TRADE-MARK

## Capacity-Operated Electronic Switch

(Continued from page 223)

unit but the longer the wire the more the wire itself loads the oscillator, and the less relative effect a body coming close to the wire will have on the unit. With an antenna

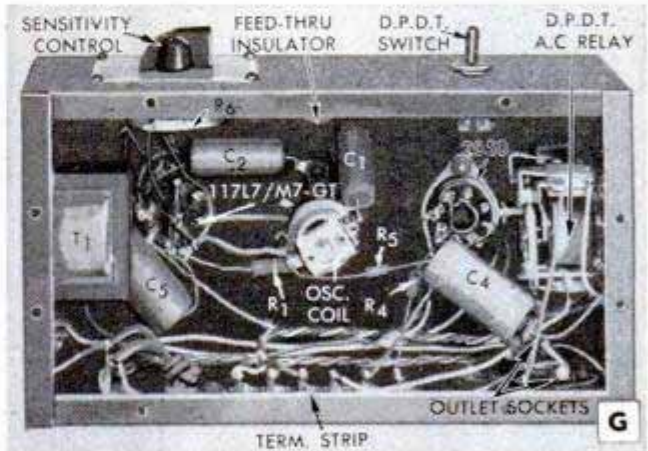

# Care and Feeding of Engines

BY S. P. CORP

## ABOUT CYLINDER SLEEVES

When you have to repair an engine with a cracked cylinder, or with walls scored too deeply to rebore, the answer is, "Sleeve 'em and save 'em!" "Wet" or "dry" cylinder sleeves will make that engine work again. A *wet sleeve* replaces the entire cylinder wall and comes in direct contact with the cooling liquid. A *dry sleeve* is pressed into a bored-out cylinder. Fig 1 shows how a dry sleeve is fitted into a cracked cylinder to provide a new cylinder wall. Write Sealed Power, Muskegon, Mich., for complete instructions.

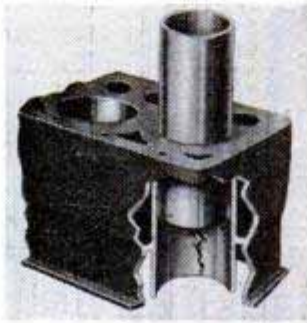

Fig. 1—Dry sleeve

## WHY 3.1 TO 1 GEAR RATIO?

Ever wonder why transmission and rear axle gear ratios should be such odd figures as 3.3 to 1 or 4.1 to 1, when a straight 3 to 1 or 4 to 1 is so much easier to figure? You can discover the answer easily by taking a 2 to 1 timing gear set, marking opposite teeth, and seeing how often they meet—every second revolution. Now take a 4.1 to 1 set from a rear axle and repeat the step. The ring gear has 41 teeth, the pinion 10 teeth, and the marked teeth meet only once in 41 revolutions. If something chips a tooth, the wounded teeth won't mesh again until they have had a chance to be smoothed off by other teeth.



## ALWAYS REMOVE PISTON PINS

Two shopmen were recently hurt severely while machining pistons because they didn't remove the pins. Always be sure to do this before putting a piston in a lathe or grinder. Otherwise, as heat is generated, the piston will expand and the pins will loosen. Nothing is gained by leaving the pins in, as they have to be removed later to attach the rod.

**Now about rings:** Always use Sealed Power Piston Rings when re-ringing. The Sealed Power MD-50 Steel Oil Ring does the world's best job of oil control, even in badly tapered and out-of-round bores. Your dealer has Sealed Power Rings or can get them for you. They save gas, save oil, restore original power to your engine and lengthen its life. A postal to "Sealed Power, Dept. G-5, Muskegon, Mich.," will bring you free a helpful book, "7 Ways to Save Oil."

wire up to about 5 feet long, a body approaching within 2 feet of the wire will trip the relay. When a short piece of wire is attached to a sheet-metal plate about 2 feet square which is concealed under a walk, or on the back of a door, excellent results at high sensitivity are obtained.

The pictorial wiring diagram appears in Fig. 2, and the base is detailed in Fig. 3. Photos B, F and G should be examined carefully before starting construction. The oscillator coil, a close-up photo of which

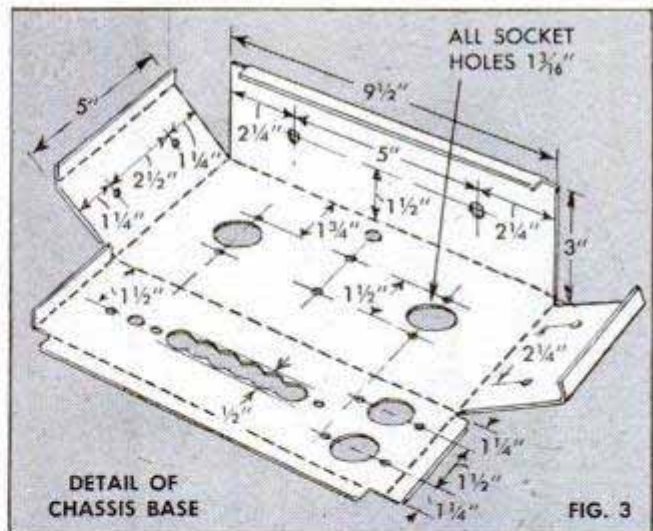

is given in photo C, is a Miller No. 695, especially designed for operation in a capacity-operated relay. When soldering to the terminals of this coil, be careful not to overheat the terminal lugs; use a well tinned hot soldering iron with rosin-core wire solder and ordinary No. 20 insulated hookup wire. The locations of the various

(Continued to page 228)



# POWER *Glide* DRIVE

## HAS EXCLUSIVE NEW FEATURES

A great advance in automatic hydraulic transmissions has been achieved by Chevrolet in a unit of its own design and manufacture called Powerglide. The name describes its operation—a smoothly increasing flow

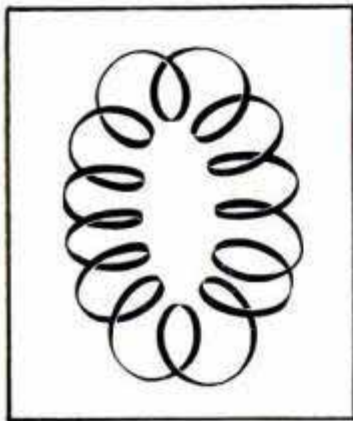

A high-speed whirling flow of oil transmits torque.

of power through an infinite number of drive ratios, uninterrupted by gear changes. In fact, the drive is gearless under all

normal driving conditions, but a set of reduction gears is provided for driving in reverse and for forward driving on extremely steep hills or whenever extraordinary power is required.

One of the most important new features of the Powerglide is an extra set of vanes, which set up a rapid flow of oil when the car is coasting—providing a strong braking effect from the engine, and permitting push-starts at speeds as low as 12 m.p.h.

The Chevrolet unit is made chiefly of stampings, in place of intricate castings. For ease of servicing, the oil-filler is under the hood, easily reached.

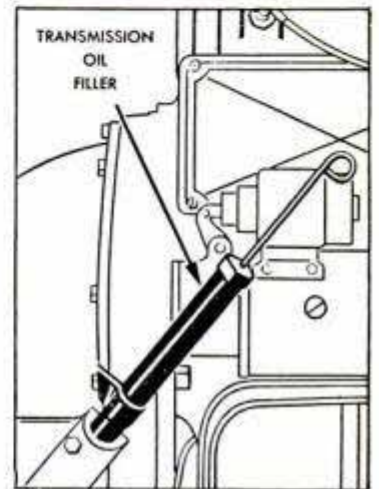

CHEVROLET MOTOR DIVISION  
General Motors Corporation  
DETROIT 2, MICHIGAN

Oil forced from the pump unit is directed against the vanes of the turbine, which turns the propeller shaft.

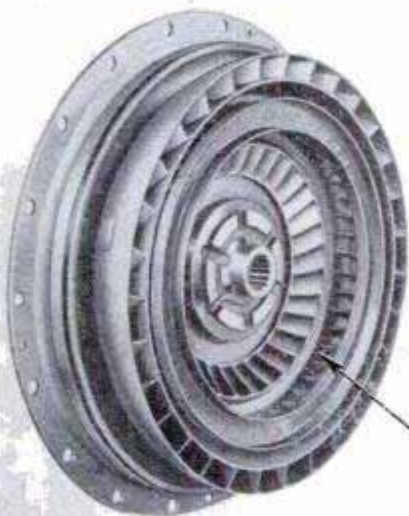

TURBINE



OVERRUN COUPLING

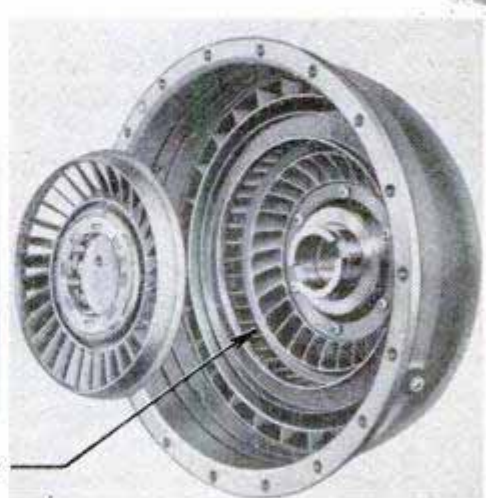

PUMP

# WHO ELSE WANTS BETTER SHAVES AT LESS COST?

NOW! this Top Quality  
FULL-WEIGHT Blade  
in Handy  
DISPENSER

10 FOR 25¢



REGULAR PACK 3 for 10¢

*Make this  
TOUGH SPOT TEST*



• Here's the smoothest-shaving razor blade that money can buy. Try it on hard-to-shave spots. If *any* other blade gives you better shaves than Blue Star, we'll give you double your money back! Get Blue Star blades in handy dispenser today.

## Blue STAR

SINGLE EDGE

DOUBLE EDGE

PRECISION ASR PRODUCTS

AMERICAN SAFETY RAZOR CORP. • BROOKLYN 1, N. Y.

terminals on the coil are clearly shown and identified in the top views in photo C and the pictorial wiring diagram, Fig. 2. The R. F. choke coil and the trimmer condenser are a part of the oscillator-coil assembly.

When all parts are mounted and the wiring is completed, set up the capacity-operated relay unit in a spot near where you want relay operation. Connect a piece of wire to the insulated antenna post and to a sheet-metal plate for preliminary experiments. There are only two points of preliminary adjustment, and only one adjustment need be made after the preliminary ones. Adjust the small mica trimmer condenser on top of the oscillator coil by turning the screw one way or the other, and at the same time adjust the sensitivity control R6 on the front panel until the most sensitive operation is obtained by listening to the clicking of the relay as you place your hand near the metal plate. Try to obtain an adjustment that permits you to operate the relay with the greatest distance possible between your hand and the metal plate. You may find it necessary to ground the chassis base of the unit to a radiator or cold-water pipe. The ground terminal is No. 3 on the terminal strip on the rear of the unit. This grounding prevents capacity effects to the chassis itself from upsetting your adjustments. Once the preliminary adjustment has been made, it is only necessary to adjust the sensitivity control for various conditions of antenna variations. Adjustment should be made only after the unit has had about 3 or 4 minutes of warm-up time.

The circuit has been arranged so that the two a.c. outlet sockets on the back of the unit for the light, alarm or other equipment are each wired differently. One is wired so that the lamp or burglar alarm comes on when the antenna wire is approached. The second is arranged for other applications and the lamp is always on but goes off when the antenna wire is approached. Terminals 4, 5 and 6 on the terminal strip are independent relay contacts that may be used for external switching if desired. When jumper wires, from terminal 1 to terminal 6, and from terminal 2 to terminal 5, are connected as shown in Fig. 1, the unit operates as a burglar alarm in that once a person approaches the antenna wire, the alarm bell starts to ring and continues to ring even though the intruder may leave the vicinity of the antenna wire. Without this jumper arrangement, the bell would stop ringing as soon as the intruder got out of the sensitive area of the antenna wire. Detailed student material list R-389 is available from Popular Mechanics Radio and Electronics department upon receipt of ordinary letter postage.

WHEN YOUR PATCHING  
TURNS OUT LIKE THIS...  
IT'S TIME FOR A NEW TUBE...

and

IF YOUR CAR FEELS LIKE THIS  
...IT'S TIME FOR MARFAK  
CHASSIS LUBRICATION



THAT CUSHIONY FEELING LASTS LONGER WITH MARFAK!

*Marfak* is extra tough and stretchy—specially compounded to cling to bearings and vital wear points. That's why *Marfak* protects the chassis—not for a few hundred miles but for 1,000 miles and *more!* Enjoy that swell “cushiony” driving ease that *lasts*. Applied by chart, never by chance. Get *Marfak* lubrication today at your Texaco Dealer, *the best friend your car ever had.*



**THE TEXAS COMPANY**  
**TEXACO DEALERS IN ALL 48 STATES**  
Texaco Products are also distributed in Canada

TUNE IN . . . TEXACO STAR THEATER starring MILTON BERLE on television every Tuesday night. See newspaper for time and station.

**NEW!**

# NYLON

## paint brushes



When you ask for a paint brush, ask for a NYLON . . .

Nylon paint brushes are made by leading paint brush manufacturers. Sold in paint, hardware and wallpaper stores everywhere, in all popular sizes. Buy a nylon paint brush today!

**NYLON  
PAINT BRUSHES**

*for smooth painting  
...easy cleanup*



Better Things for Better Living  
... through Chemistry

## Rocket to the Moon

(Continued from page 94)

Coolant that is injected through numerous holes in a solid motor wall would spread out into a thin film, would evaporate and be replenished. The effect would be the same as in sweat cooling.

Using one of the new chemical fuels and one of the new methods for preventing the motor and nozzle from melting, engineers could build a step rocket that could roar out into space and never return. The bumper or booster unit would fall back to earth after its power was consumed. The main projectile would attain a velocity in excess of seven miles per second, the estimated velocity of escape. Such a rocket could be aimed to land on the moon and it could even carry a human passenger but there is no possibility with present fuels of making a return trip. Not enough reserve fuel could be carried for taking off from the moon. A round trip will have to wait until a true atomic power plant is developed.

Meanwhile, all the other problems associated with landing on the moon and returning to earth have been studied. The manufacture of a space craft, accommodations for the crew, navigation, the making of safe landings all have been the subject of research by numerous investigators.

The rocket that Pal Productions visualizes for its picture "Destination Moon" is 150 feet tall and has a loaded weight of 250 tons. Of this amount 200 tons is devoted to ordinary water that would be used as the reaction mass in the atomic motor. The space-ship's frame weighs 40 tons and the remaining 10 tons are devoted to crew, accommodations, equipment and insulation against the motor's radiation.

Roaring upward from a western desert before dawn, the space-ship's motor blasts for almost four minutes, at the end of which time the ship would be at a height of 810 miles. At this point the motor would be shut off and the rocket would be in free flight, reaching the moon in an estimated 46 hours. The flight path would be an elongated and modified S-curve because of the gravitational pull of the earth and the moon. Course corrections could be made with rocket power in space if necessary.

Power also would be used for turning the craft around as it approached the moon's surface to permit a tail-first landing, and for reducing its speed so that an eggshell landing could be made. Sufficient fuel would remain, it is estimated, for the rocket to depart from the moon on the return trip to earth.

The picture dramatizes many of the

(Continued to page 236)



# "Fishin' Foursome" by EVINRUDE



● Four great fishing motors, built for trouble-free years of fishin' fun. One is *right* for you . . . right for your boat, your kind of fishing. The "big two" are brand new . . . and pretty special any way you look at them! New Fleetwin with Duo-Clutch gives you new handling ease . . . you start in Neutral, "idle" when you like! New Fastwin gives you Gearshift control with Neutral-Forward-Reverse! For smaller boats, the Sportsman and Sportwin with Evinrude's famed Fisherman Drive that "lets you go wherever there's water to float your boat." See your Evinrude dealer . . . look for his name under "Outboard Motors" in your classified phone book.

Send today for free catalog of the complete Evinrude line of six models. Address . . .

**EVINRUDE MOTORS**  
4482 N. 27th St., Milwaukee 16, Wis.

*In Canada:*  
Evinrude Motors, Peterboro, Ontario



★ **SPORTSMAN** 1.5 H.P.\* For small fishing boats. Full Pivot Reverse, Simplex Starter, Fisherman Drive.

★ **SPORTWIN** 3.3 H.P.\* Smooth alternate firing twin . . . finer than ever for '50! Full Pivot Reverse—Transom Trigger—Fuel Gauge—Fisherman Drive.

★ **FLEETWIN** 7.5 H.P.\* . . . weighs only 45 pounds. New Duo-Clutch for Neutral starting and idling and Soft-Grip Propeller Drive—no pin to shear!

★ **FASTWIN** 14.0 H.P.\* Gearshift Control with Neutral-Forward-Reverse. Separate Cruis-a-Day Tank provides capacity for a full day of "stop-and-go" fishing without refueling.

Send for  
**FREE catalog**



\*O.B.C. certified brake  
H.P. at 4000 R.P.M.

# It's easy to have modern oak floors



Your choice of Block, Strip, or Ranch Plank

**Just lay PREFINISHED Bruce oak flooring right over your old floors . . . no sanding or finishing**

You can give your home new beauty at low cost with a prefinished Bruce Hardwood Floor. Completely finished—even waxed—at the factory, this highest quality oak flooring can be nailed right over old floors. No sanding or finishing . . . no mess or smell. Ready for use as soon as laid. Made in strip, block (parquet), or Ranch Plank design.

**"Scratch Test" Finish** — The Bruce factory-applied finish is baked into the pores of the wood.



The "Scratch Test" will prove to you that this durable finish does not scratch or chip or mar like a surface finish. It outwears other finishes 3 to 1.

**Moderate in cost** — A new Bruce Hardwood Floor will cost you less than a good rug or carpet. Easy to keep clean and beautiful, too. It's just the thing to use in fixing up or adding a room. Let your lumber dealer give you a cost estimate. Mail coupon below for colorful literature.

### MAIL FOR FREE LITERATURE

E. L. Bruce Co., Box 397-AC, Memphis 1, Tenn.  
Send literature and complete information on prefinished Bruce Hardwood Floors.

Name.....

Address.....

City..... State.....



**Bruce Hardwood Floors**

Product world's largest hardwood flooring maker

## Clinic



## for Homemakers

As a service to our readers in solving the hundreds of problems pertaining to a home—inside or out—the editors of *Popular Mechanics* invite you to present your problems to The Clinic Editor for help and advice. Address your questions to The Clinic Editor, *Popular Mechanics Magazine*, 200 East Ontario Street, Chicago 11, Ill.



### Plaster Patch Shows

**Q**—Recently I painted two rooms which had been papered. I had to patch several large cracks and one small opening. After applying two coats of paint the patches still show, both on the walls and ceilings. What causes this and what can I do to remedy the defect?

A.C., Denver, Colo.

**A**—Usually there are two reasons for plaster patches showing through paint: (1) The patching material may not be exactly flush with the surrounding surface. (2) The new patching material may be more porous than the wall plaster and absorb more of the oil in the paint, causing it to dry flat. On a job like yours, painters usually size the patches when dry, or spot them with the same paint that is to be applied to the wall, or apply an undercoater as the first paint coat. Probably in most cases the latter procedure is the best, but in your case you should try spotting the patches, allowing the paint to dry thoroughly, then applying another coat of the same color to the entire room. This procedure may work out satisfactorily and, if so, it will save you the expense of repainting the two rooms with two coats.

### Kerosene Aids Floor Sanding?

**Q**—I have just finished sanding the floors in two rooms, using a rented machine. The floors were in rather bad condition and I had plenty of trouble removing the old varnish as the sandpaper clogged almost as fast as I could renew it. I would like to sand all the floors in my home but hesitate to undertake the job because of the amount of labor and time required. I've been told that kerosene poured on the floor will prevent clogging of the machine. Is this true?—W. W., Seattle, Wash.

**A**—It is true that kerosene applied to the floor will help to prevent clogging of the abrasive on the sander drum, but suppose the abrasive strikes a nail and the resulting sparks ignite the kerosene? Because of the dangerous fire hazard, we could not recommend this procedure. Experienced floor finishers minimize clogging of the abrasive in machine sanding by taking off old varnish in several separate passes of the machine over the floor, using a coarse, or very coarse, open-coated abrasive. The machine is permitted to move over the floor

(Continued to page 234)

STEVENS  
MODEL 87  
Tubular  
Magazine  
.22 Cal.  
Automatic  
Rifle

STEVENS  
MODEL 85  
Clip  
Magazine  
.22 Cal.  
Automatic  
Rifle

# STEVENS

## "22" THE "22" FOR YOU

For rapid fire work at moving targets... for "zinging away" at small running game... for more sport shooting—a Stevens autoloader is the "22" for you.

Savage—"first in the field" to build lightweight, low-priced autoloading rifles—offers you a choice of *tubular* or *clip* magazine models. Either type gives you features (see below) you'll find in *no other "22" autoloader*, regardless of price.

See these two models at your dealer's. Write for free catalog of Savage, Stevens and Fox rifles and shotguns.

SAVAGE ARMS CORPORATION  
Firearms Division, Chicopee Falls, Mass.



SAVAGE • WORCESTER Power and Hand Lawn Mowers



### "FIRST IN THE FIELD" FEATURES OF STEVENS "22" AUTOLOADERS

**THREE RIFLES IN ONE**—instantly adjustable as an autoloader, bolt action repeater or single shot. As autoloader, shoots .22 long rifle cartridges; as bolt action repeater or single shot, .22 long rifle, .22 long or .22 short cartridges.

**MAGAZINES**—Choice of tubular or clip.

**BARRELS**—precision rifled for extreme accuracy... crowned muzzles... takedown.

**STOCK AND FOREARMS**—wood, walnut finish... man's size.

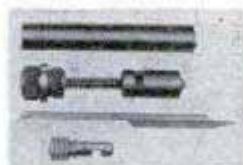

Simplest, most trouble-free action of any "22" autoloader... Easily, quickly disassembled for cleaning without tools.



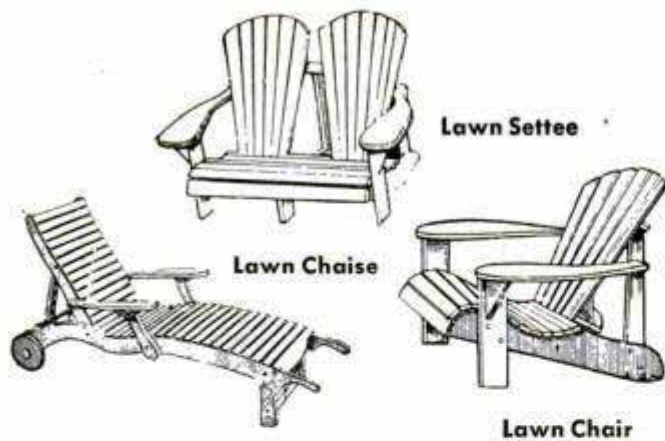

Lawn Settee

Lawn Chaise

Lawn Chair

## SAVE MONEY, HAVE FUN, BUILD LAWN FURNITURE. with EASI-BILD\* Full-size Patterns

You can build this lawn furniture at less than  $\frac{1}{2}$  the store cost—without special tools or skill! Easi-Bild Full-size Patterns are easy to use. It's the dress pattern idea applied to flat lumber. Just trace, saw, and assemble. And for stronger joints throughout, use CASCOPHEN, Casco's new, waterproof glue.

Copr. 1949, Easi-Bild Pattern Co.

### How to choose a glue!



**CASCOPHEN**—waterproof glue for outdoor projects  
**CASCO**—for heavy-duty joints, rough surfaces  
**CASCAMITE**—for stain-free veneering, cabinets  
**CASCOREZ**—fast-set, ready-mix glue for home jobs

SEND COUPON FOR FURNITURE PATTERNS TO:

Casco Pattern Dept. PM-50  
 P. O. Box 215, Pleasantville, N. Y.  
 Enclosed is ..... for patterns checked below.  
 Lawn Chair, Pattern No. 32—25¢  
 Lawn Settee, Pattern No. 39—35¢  
 Lawn Chaise, Pattern No. 78—35¢  
 Pattern book illustrating 94 pattern projects  
 —20¢

Name \_\_\_\_\_  
 Address \_\_\_\_\_  
 City \_\_\_\_\_ Zone \_\_\_\_\_ State \_\_\_\_\_

**THE BORDEN CO. • CHEMICAL DIVISION**  
 Makers of Casco Glues

(Continued from page 232)

faster than in normal usage, with very light pressure on the drum. This avoids heating, which softens the varnish and causes it to stick to the sanding drum. After the first few light cuts, the old varnish usually will come off to the bare wood without further trouble. In some cases it will pay to take the time to remove the varnish with a prepared chemical remover. This is applied to the floor according to the directions and the softened varnish is then scraped off to the bare wood. **Caution:** When applying varnish remover, open all doors and windows, or provide adequate ventilation by means of a fan. The fumes from this chemical are toxic in a closed room. Removing the varnish in this way will prevent clogging of the abrasive on the sander drum.

### Clean Paintbrushes

Q—What's the best way to clean and store paintbrushes after use? I have tried several methods but none have proved entirely satisfactory. The bristles are always stiff with a residue of dried paint. Any attempt to remove this damages the brush. How does one get the brush thoroughly clean?

W. A., St. Louis, Mo.



A—Much of the difficulty of cleaning a paintbrush thoroughly is due to improper methods of handling while the brush is in use, especially when painting a ceiling or cornice. If the brush is dipped deeply into the paint it will gradually accumulate a full load of paint at the base of the bristles. This is difficult to remove entirely, even when fresh. When painting on overhead surfaces, dip the brush lightly and slap off excess paint on the side of the container. Clean the brush immediately after use with a paint solvent. Pure turpentine is good but there are other solvents which are fully as effective and less expensive. Many painters use a lacquer solvent known as "wash thinner." This solvent is ordinarily used to clean spray-painting equipment after use. The brushes are placed in the solvent and allowed to stand for a few minutes, and then they are slapped lightly over the edge of a board to remove both solvent and paint. After cleaning, brushes to be stored should be washed thoroughly in soapy water and laid flat to dry. When dry, wrap the bristles in oiled paper and seal with adhesive tape. Before using, dip the brush in thinner.

### Water Pipes "Sweat"

Q—The cold-water pipes in my basement sweat during the summer months and drip water onto the floor, keeping it constantly wet over a large area under the pipes. What is the cause of this? Will the dampness damage the floor? Is there any inexpensive remedy?

G. T., Columbus, Ohio.



A—The pipes are much colder than the air which surrounds them and for this reason moisture in the air condenses on the cold surface. One way to prevent the condensation is to paint the pipes (when dry) with ordinary oil paint or enamel and before it dries spread fine sawdust or ground cork over the wet paint. It may be necessary to apply two or more coats of paint and sawdust, or cork, in order to coat the pipes uniformly with this covering. Another method is to wrap the pipes with several thicknesses of newspapers, fastening the paper wrappings in place with cord or adhesive tape. Still another and much quicker way is to purchase a ready-mixed pipe coating which is especially made for this purpose. Apply the material according to the manufacturer's instructions.

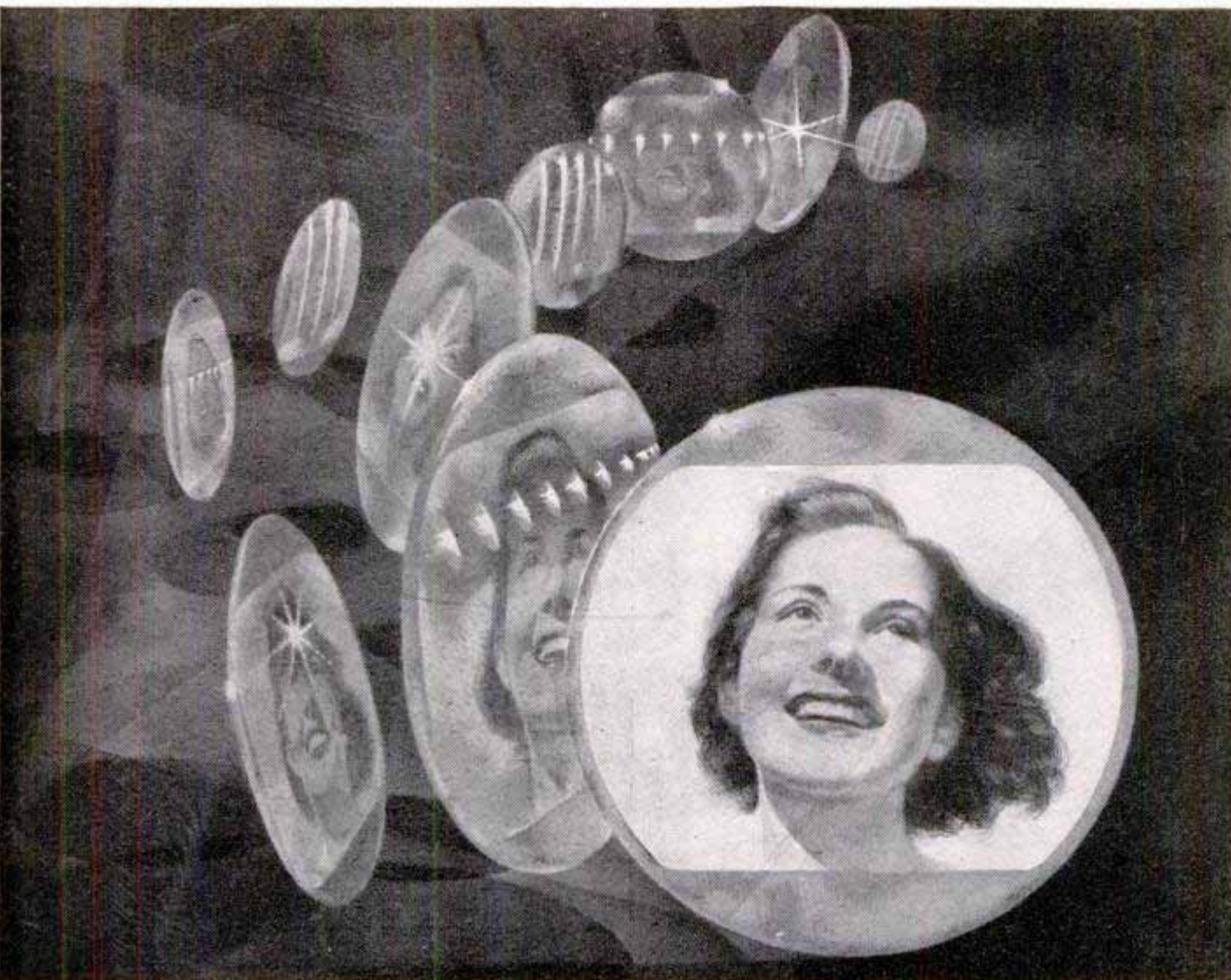

New-type glass for RCA television picture tubes filters unwanted light, to give sharper, clearer images.

*Wayward light is disciplined—for better television!*

Now television pictures gain still greater contrast and definition—through research originally initiated by scientists at RCA Laboratories.

**Their discovery:** That wandering light waves inside a picture tube—and inside the glass itself—may cause halation and blur an image's edges. By introducing light-absorbing materials into the glass, the wayward flashes are absorbed so that only the light waves which actually make pictures can reach your eyes!

Glass companies, following this research, developed a new type of glass for RCA... *Filterglass*. Minute amounts of chemicals give it, when the picture tube is inactive, a neutral tone. In action, images are sharper—with more brilliant contrast between light and dark areas. Reflected room light is also reduced.

\* \* \*

See the latest in radio, television, and electronics at RCA Exhibition Hall, 36 West 49th Street, N. Y. Admission is free. Radio Corporation of America, RCA Building, Radio City, N. Y.



The new Filterglass faceplate gives you more brilliant pictures on today's RCA Victor television receivers.



**RADIO CORPORATION of AMERICA**

*World Leader in Radio — First in Television*

# PACKED with **NEW** **OUTBOARD** **THRILLS!**



Thrilling new maneuverability—compactness—smooth performance—carefree operation—stamina! That's the new 5 h.p.\* Johnson Model TN outboard motor.

It has the new magic of NEUTRAL CLUTCH! Flipping the lever to start in neutral—to GO—to stop and idle—is as easy as flipping a light switch.

Relax with this motor. The new sure-fire Shock Absorber Drive protects against impacts on underwater obstructions (don't worry about shearing pins). The new Vari-Volume Pump varies the flow of water for positive cooling at any speed.

See your Johnson dealer. Look for his name under "Outboard Motors" in your classified phone book. 1950 Johnson prices are lower. Time payments are available.

**NATIONAL OUTBOARD WEEK • MAY 18 - 27**



\*OBC Certified Brake H.P.  
at 4000 r. p. m.

# JOHNSON

**SEA-HORSES FOR DEPENDABILITY**

**FREE HANDY CHART**

Complete description of the five models for 1950, including the sensational 10.0 h.p.\* Model QD with Johnson Gear Shift Control and separate, plug-in Mile-Master Fuel Tank. Sent free. Write!

JOHNSON MOTORS  
400 Pershing Road, Waukegan, Illinois  
In Canada: Johnson Motors, Peterboro, Canada



problems that will confront the first explorers of space; with no gravity to hold them down, the crew members find that they float around almost out of control inside the rocket's pressurized compartments. They use suction-cup shoes to walk from spot to spot inside the space ship. On the moon, of course, they must wear space suits with self-contained oxygen because of the lack of atmosphere, and they can communicate only by means of gestures and walkie-talkie radio.

A safe landing on the earth at the end of the return trip is accomplished by making three deceleration circuits around the globe to bring the speed down to a point at which the lower atmosphere can be entered safely, and then gliding in on the space-ship's vestigial airfoil surfaces.

There isn't much doubt that a trip to the moon and back actually will be made some day; some enthusiasts are convinced that a missile will be landed on the moon in the next 10 or 15 years even if a manned space ship isn't built for the trip by then. The chances are that when the space ship is built that it will be pretty much like the ship that the movie portrays. "Destination Moon" will be released this fall and George Pal jokingly says that he wants to make the release date as early as possible, otherwise the newsreels may beat him to it!

## Yellowstone's Other "Old Faithful"

(Continued from page 162)

get a cloud formation. Another time, to the disgust of two companions, he sat on top of a mountain for three days waiting for the haze to clear—just a little more.

Haynes explains this determination as due to the fact that he is the son of one of the pioneer shutter greats. Today, there are 1.3 cameras per family in the nation, but in the eighties Frank Jay Haynes is believed to have had the only camera in the Territory of Wyoming. In 1883, for instance, he was the only photographer to accompany the historic expeditions into the park by President Chester A. Arthur and Henry Villard, president of the Northern Pacific Railroad.

Photography was then almost as mysterious as the erupting geysers of Yellowstone. Anyone who had mastered the art was usually referred to as "professor."

By 1884, "Prof." Frank Jay Haynes' cameras had grown from small stereoscopic equipment to giant instruments, taking pictures in sizes from 4 by 5 inches to 20 by 24 inches. A horse-drawn sledge was required to move the largest camera. One

(Continued to page 238)

# Beware of the Danger Zone

THE MORE YOU DELAY - THE MORE YOU PAY

## WARNING ZONE

Engine loses pep . . .



### Needs a tune-up

Clean, adjust and re-time ignition. Clean fuel supply and carburetor screens. Adjust carburetor. Adjust tappets and fan belt. Check compression and vacuum readings for symptoms of engine wear.

## DANGER ZONE 1

Engine begins to smoke . . .



### Needs new piston rings and minor engine repairs

Replace piston rings. Align rods. Adjust rods or replace rod bearings. Reseat and reface valves.

Tune engine.

These repairs are comparatively inexpensive and put the engine back in peak condition for thousands of economical miles. Delay puts the engine in Danger Zone 2.

## DANGER ZONE 2

Engine pumps oil badly . . .



### Needs new piston rings and major engine repairs

Replace piston rings. Replace piston pins. Adjust—probably replace—main bearings. Align rods. Adjust rods or replace rod bearings. Reseat and reface valves. Tune engine.

These repairs naturally cost more than those needed in Danger Zone 1, but they put the engine back in condition for thousands of additional miles of satisfactory service. Delay leads to costly Danger Zone 3.

## DANGER ZONE 3

Destructive wear sets in . . .



### Needs new piston rings and complete overhaul

Repairs cost three or four times as much as in Danger Zone 1.

Remove engine. Rebore cylinders. Replace pistons, pins, rings. Replace main bearings. Align rods, refit or replace rods, or replace rod bearings. Overhaul valve lifters, rocker arms. Replace timing chains or gears. Reseat, reface valves. Replace guides and springs. Replace camshaft bearings. Clean oil lines. Overhaul oil pump.

Clean, re-install and tune engine.

Piston rings should be replaced ... *at the first sign of wear!*

When oil-pumping starts in your car, you're driving into the Danger Zone. Your piston rings should be replaced at once.

If you delay—until you're in the second or third Danger Zone—your repair bill will be two to four times as great.

If your car is in the Danger Zone now,

ask your motor service man for Hastings Piston Rings. They *stop* oil-pumping, *check* cylinder wear and *restore* performance.

It's the best money you can spend on your car.

HASTINGS MANUFACTURING COMPANY • HASTINGS, MICHIGAN

Hastings Ltd., Toronto

TOUGH...BUT OH SO GENTLE

# HASTINGS

## STEEL-VENT PISTON RINGS



TOUGH on Oil-Pumping • GENTLE on Cylinder Walls



**Wow!**

**That awful stuff  
in our car?**



**It's in most everybody's car after a winter of hard driving. If you want to duck some expensive repair bills — better get a new PUROLATOR Refill for your oil filter — quick!**

When a filter is constantly freeing your oil from engine-wrecking abrasives, it soon gets choked up itself. So when you change your oil this Spring, start fresh with a *new filter refill*. Be sure you get a Purolator Refill. Filters more *completely*, hence saves more substantially on repair bills. Costs only \$1.38 to \$3.00, depending on make of car. Inserted in a few minutes.

P. S. If your car has no oil filter, a *complete* Purolator, both housing and refill, costs only \$6.50 or a bit more, depending on make of car. Purolator Products, Inc., Rahway, N. J. and Toronto, Ontario, Canada.



\*Reg. U. S. Pat. Off.

man's load was a single 20 by 24-inch heavy glass plate in its holder. Jack Haynes winces today when he recalls carrying the plates for his father.

Haynes received his finest tribute from his father when he was 21. His father had sent him with a horse and buggy 19 miles to West Thumb to photograph the lunch station there. When Jack arrived, the sky was as gray as his grandmother's shawl and snow was slowly sifting down in quarter-size flakes.

Crossing his fingers, Jack set the diaphragm of his camera at "128" and exposed the negative for almost a minute. The result was a beautifully clear picture without a snowflake showing. Because of the long exposure, the moving flakes had not affected the emulsion.

"By gad, Jack," beamed his father, "you'd better take 'em all in the snow."

From photographing lunch wagons, the son eventually progressed to taking pictures of the nation's presidents. He covered the visits to the park of Warren G. Harding, Calvin Coolidge and Franklin D. Roosevelt.

Haynes has photographed hundreds of other famous park visitors, from the Crown Prince of Sweden, who excited his aides by slipping off for a moonlight hike with Haynes, to Thomas A. Edison who upset park officials by declining the honor of having a peak named after him. And he has taken a lot of pictures of "just folks."

The folks didn't start coming to the park in great numbers until automobiles were first permitted to enter in 1915. Before then, the wealthy and scientists on expeditions dominated the visitors.

"The tourist of today, with modern transportation, has an opportunity to get much more out of the park than the visitor of 50 years ago—if he'll take advantage of it," says Haynes. "In the early days, too much time was wasted traveling between points of interest. Now, in many cases, too little time is taken in stopping at the points. Why, some people even go through without seeing Old Faithful."

Haynes adds that today's visitor can also get much more authentic information on the park. Before the Ranger Naturalist Division was established in 1916, information was supplied by stagecoach drivers, bellboys, maids and porters. What "scientific" information you got depended entirely on what stagecoach driver did the expounding.

"I remember one driver telling some tourists about Beryl Hot Spring," says Haynes. "He declared that if you threw a horseshoe in it the shoe would get red hot."

(Continued to page 240)





# MOTORCYCLING— World's Greatest Sport!

Ride a

**HARLEY-DAVIDSON**  
**HYDRA-GLIDE**

**T**HE lure of motorcycling is like nothing else in this world! Once it's in your blood... brother, you'll never be the same again! From then on, nothing can ever equal the fascination of cruising down a scenic country road with a Harley-Davidson purring quietly under you... the he-man thrill of soaring up a steep hill like a climbing jet... the breathless feeling of levelling off for the straight-aways... the sense of power and freedom you get whenever you settle back in the saddle and "give 'er the gun!" In no other sport are friends so loyal, gals so glamorous. Nowhere is fun so easy to find as at exciting race meets, hillclimbs, gypsy tours and other club events. A Harley-Davidson is your ticket to endless good times, to happy, healthful outdoor enjoyment. You can own one on easy terms. So why not get started now? See your dealer today.

**HARLEY-DAVIDSON MOTOR CO., Dept. P, Milwaukee 1, Wisconsin**

Send me FREE copy of ENTHUSIAST Magazine filled with motorcycle action pictures and stories.

Name.....

Address.....

City..... State.....



**DEALERS:** Valuable franchises are now available for the full line of famous Big Twins and the 125 Models. This is your opportunity to line up with the greatest name in motorcycles. Write or wire for complete information today.

DEPEND ON-INSIST ON

# Starrett<sup>®</sup> SATIN CHROME



OUTSIDE MICROMETERS

INSIDE MICROMETERS  
Tubular Rods

INSIDE MICROMETERS  
Solid Rods

MICROMETER DEPTH GAGES

ALL 4 WITH SATIN CHROME FINISH

**Pioneered and Developed by Starrett For  
Faster, More Accurate, No-Glare Measuring**

Improve your work, boost your pay by getting all micrometer readings faster, easier, more accurately. Starrett Satin Chrome Finish means no squinting, no shifting to better light. Markings always stand out sharp, clear and easy to read. And for lasting accuracy, you get the added advantage of high resistance to stains and corrosion. Insist on STARRETT Micrometers with Satin Chrome Finish. It's worth a lot to you.



STARRETT  
No. 231

**Satin Chrome Outside  
Micrometer**

1" Capacity, Tapered Frame,  
Sycamore Case

STARRETT No. 440  
and No. 445

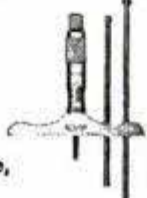

**Satin Chrome  
Micrometer  
Depth Gages**

A Complete Range  
with 2½, 3, 4 or 5  
inch bases



STARRETT No. 823  
Tubular Rods

**Satin Chrome Inside Micrometers**  
Hardened and Ground Contact Surfaces,  
Capacities up to 32 inches.



STARRETT No. 124  
Solid Rods

**HAVE YOU SEEN THIS?**

Another New Starrett Tool For  
Better Precision Measuring.



**STARRETT No. 995 Universal Precision Gage  
With Fine Adjustment (Patented)**

Sensitive Adjustment plus Universal Adaptability To Countless  
Gaging, Scribing, Measuring and Leveling Operations

Get Your FREE Copy

**STARRETT NEW TOOLS BOOKLET**

Describes, illustrates and prices these and many more important new tools. Write for your copy. Address Department AP.

**THE L. S. STARRETT CO. • ATHOL, MASS., U. S. A.**

TRADE MARK  
**Starrett**  
REG. U.S. PAT. OFF.

Since 1880... Standard of Precision

MECHANICS' HAND MEASURING TOOLS AND PRECISION  
INSTRUMENTS • DIAL INDICATORS • STEEL TAPES • HACKSAWS  
BAND SAWS AND HAND KNIVES • PRECISION GROUND FLAT STOCK

Buy Through Your Distributor

A common question of tourists in those days was, "Say, when is this whole place going to blow up?"

Haynes thinks the visitors of the early days were more destructive than those of the present.

"A great pastime used to be carving entwined hearts with initials on the trees," he recalls. "Logs were poked down craters. Trees were stripped of low branches to make beds. In fact, the sprawling juniper was called the campers' mattress. Young trees were cut down to make pole corrals for horses. If damage were done proportionately by each visitor today, we soon wouldn't have any park. The people have been educated to be more careful — and they generally are — but they still do a lot of damage in the park each year.

Probably the biggest problem today is keeping tourists away from bears and vice-versa. It wasn't always thus, explains Haynes. People and bears used to keep their distance, but with the automobiles came the roadside beggar bears and tourists who give them a handout, sometimes ending up without a hand.

Haynes believes Yellowstone has become, in recent years, America's greatest melting pot. In modern sport and outdoor clothes, men and women of all walks of life follow a common trail in Yellowstone.

One thing that hasn't changed in the last half century, however, is the taste of the customer in photographs. Generally, he doesn't want tricky or arty shots, but merely views of scenes as he saw them.

One year Haynes took a picture in Norris Basin from an unusual angle. He photographed some dead trees silhouetted against the steaming background of their destroyers—the geysers. The scene was on the arty and symbolic side. Haynes submitted it to a contest sponsored by the American Museum of Natural History and walked off with a top prize. Pleased, he put the picture on sale in his park studios.

"Hardly sold any," chuckled Haynes. "I had them withdrawn from all studios as they were merely collecting dust. Some of our best sellers were taken from the position the tourist chided me about—leaning out a car window. I have climbed high mountains and snaked down into deep canyons to get unusual views, but that was mostly pleasure—not business."

Asked what picture he was proudest of, Haynes gave a thoughtful puff to his cigar, then said:

"A shot taken last summer of Old Faithful. It's quite a striking view, really. My daughter, Lida, snapped it with a dollar camera. I think she will do well in carrying on the house of Haynes."

# THIS 5 ROOM ALADDIN READI-CUT HOUSE \$1492

FREIGHT PAID

**SAVE 4 PROFITS ON LUMBER, MILLWORK, HARDWARE AND LABOR**

The Aladdin Read-Cut System of Construction enables you to save 18% lumber waste and up to 30% labor costs, and guarantees you will receive the highest quality dry lumber and a COMPLETE house as specified. You can buy your COMPLETE HOUSE, ALL IN ONE SHIPMENT, direct from our mills and save the in-between profits.

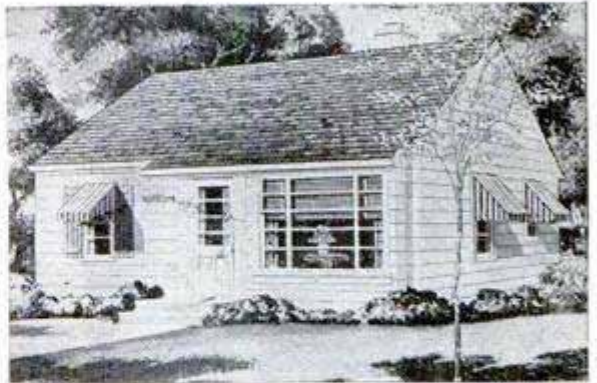

## HOW TO BEAT THE HIGH COST OF BUILDING

Every hour you can put in on the construction of your Aladdin home means a saving to you of from \$2.00 to \$3.00 per hour on its cost. That means a SAVING of from \$15.00 to \$18.00 for every day you work on it! . . . Depending on the size of the house, the carpenter work sums up to from three hundred hours to twelve hundred hours. . . . WITH MOST

OF THE SKILLED LABOR ALREADY PERFORMED when you receive your Aladdin Read-Cut, what an opportunity you have to bring down the cost of your new home to practically a pre-war level. Our drawings and instructions cover everything from the foundation up, so you can save any part, or even all labor costs.

**ALADDIN HOUSES ARE NOT PREFABRICATED**



**PAY YOURSELF THOSE HIGH WAGES**

**71 DESIGNS TO CHOOSE FROM**

## WHAT YOU GET WHEN YOU BUY AN ALADDIN HOUSE

You get ALL THE LUMBER cut to fit by fast machinery-production line methods—marked and numbered, ready to erect practically without the use of a saw; also siding, flooring, interior trim, all millwork,

doors, windows, mouldings, glass, hardware, nails, roofing, paint and complete drawings with instructions. Many Aladdin home buyers erect their own houses.

**MILLS IN MICHIGAN & NO. CAROLINA**

Ranch Houses, Colonials, Cape Cods and Modern plans; also Storage Walls and Expansion Attics.

**IMMEDIATE DELIVERY**

**SEND 25¢ TODAY FOR NEW 1950 CATALOG IN FULL COLOR**

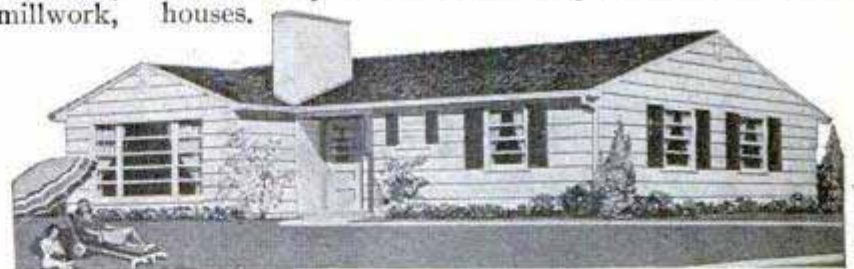

ADDRESS  
**THE ALADDIN CO.**  
BAY CITY, MICHIGAN

SEND FOR  
CATALOG M-5

Name \_\_\_\_\_

Street \_\_\_\_\_

Town \_\_\_\_\_ State \_\_\_\_\_

## M-SCOPE TREASURE -MINERAL LOCATORS

WRITE FOR FREE, ILLUSTRATED 16-PAGE BOOKLET

M-Scope Treasure-Mineral Locators, Geiger Counters. New Low Prices, unsurpassed in efficiency. Full factory guarantee. Immediate shipment.

YOU CAN PURCHASE THESE INSTRUMENTS ON A MONTHLY PAYMENT PLAN



URANIUM



GOLD

**FISHER RESEARCH LAB., INC., PALO ALTO, CALIF.**

**A FISTFUL** of power, this new streamlined beauty makes light work of hundreds of jobs. Drills fast and true. Also swell for wire brushing, polishing, grinding, buffing.

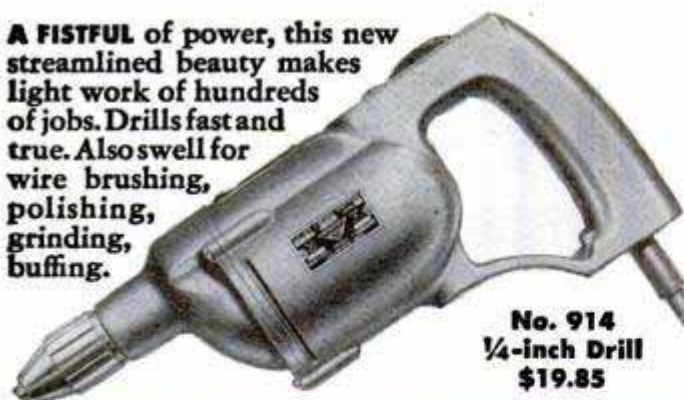

**No. 914**  
**1/4-inch Drill**  
**\$19.85**

## MORE POWER TO YOU CRAFTSMEN

That's just what you get in Millers Falls new Utility Drills. Electrically and mechanically, they are the last word in modern design—engineered for the particular requirements of craftsmen, farmers, home workshop owners and repair shop men. They're lighter, more powerful, better built. Best of all, they're Millers Falls and the biggest dollar values of any drills ever made. Ask for them at your hardware dealer's.

**No. 912**  
**1/2-inch Drill**  
**\$35.00**

**A RUGGED HUSKY** for men who want full 1/2-inch capacity. More powerful than any comparable drill on the market — yet it weighs only 8 lbs. Genuine No. 33B Jacobs Key Chuck. Smooth die cast aluminum frame and attractive grey hammered enamel finish. It's the standout in its class!

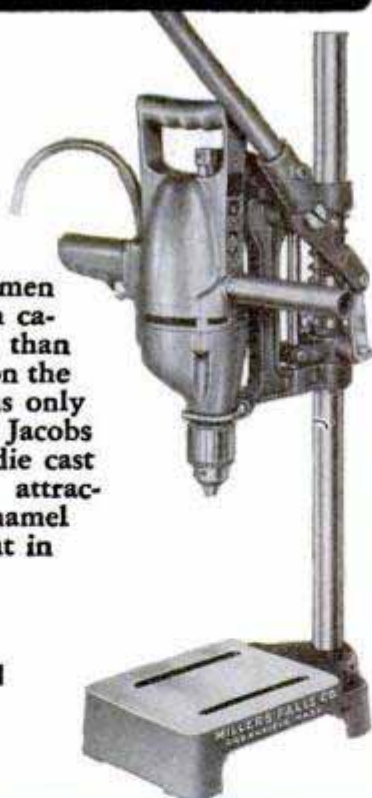

**No. 2912 Stand**  
**\$16.80**

# MILLERS FALLS TOOLS

SINCE  
1868

MILLERS FALLS  
COMPANY

GREENFIELD  
MASS.

## This Invisible Plastic, Melamine

(Continued from page 140)

He had a terrible time. "To produce melamine crystals from basic powders requires tremendous heat and pressure," he recalls. "All we had was an ancient autoclave (like your pressure cooker). But we got our crystals."

Later, when production started in a big two-story stainless-steel autoclave, the whimsical crystals popped out another surprise. They cooked solid. It took two days to chip out the rugged melamine with hammers and chisels.

Once crystals were produced, they would not mix with anything to make molding compound. Finally, chemists quit trying. They simply stirred the stuff in formaldehyde and threw in a little cellulose "filler" to give it body. Then they dried it, placed the mess in a few ash-tray molds under high pressure and temperature. To their surprise, out came three tiny ash trays—like no plastic ash trays ever made! Their high shiny surface looked like cut crystal. Food acid wouldn't mar them. Hot soapy water only made them shinier.

What could be done with such a plastic? Plenty. The war was on. Navy ships and subs needed plastic switch panels that wouldn't burn or shatter. Army planes needed insulation on distributors that wouldn't burn off under arcing of sparks in the high, thin air.

Here was a natural field for melamine plastic, both hard and self-extinguishing. There was one catch. It was brittle—like onyx or crystal. What was needed was some kind of cheap "filler" to increase toughness and prevent chipping. All sorts of strange things were poured into the mix: chopped shirt tails, ground glass, nuts, coconut husks, paper pulp, asbestos, walnut shells and glass fiber.

What came out of those recipes was an assortment of molding plastics that would take all day to list. Asbestos combined with melamine today makes a plastic with ruggedness, heat resistance and high arc resistance. It withstands temperatures from 40 below zero to 400 above.

Glass-fiber filler not only produced fire-proof switch-panel boards for ships, it made the stuff so strong you could drop it on concrete without breaking off more than a few chips.

Even the chopped shirt tails weren't as silly as they sounded. When mixed with melamine formaldehyde resin and molded, they made a mighty tough piece of material. The mottled effect produced by the bits of cotton gave it an odd surface design.

(Continued to page 244)

# SUMMER AHEAD



**INSTALL NEW**

# CHAMPION

## SPARK PLUGS

# Salt Water Duff?



J. A. Coxe 1420-L, with extra spool . . . \$15.00



Coxe Cross-Bolt—lets you change spools without tools—in seconds! Spool floats smoothly, easily around stationary shaft.

Want a salt-water reel with the "expert" feel—then choose a genuine J. A. Coxe. You'll get the result of almost fifty years of precision craftsmanship and fishing experience—plus the greatest features ever developed for salt-water reels!

*or like your fishing fresh?*

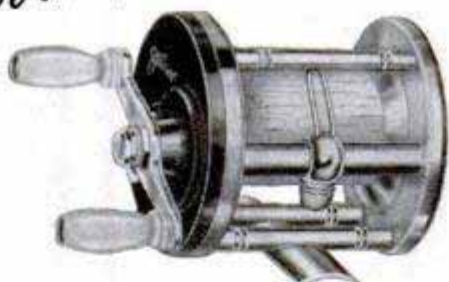

the finest reel money can buy  
J. A. Coxe 25-C . . . \$33.00

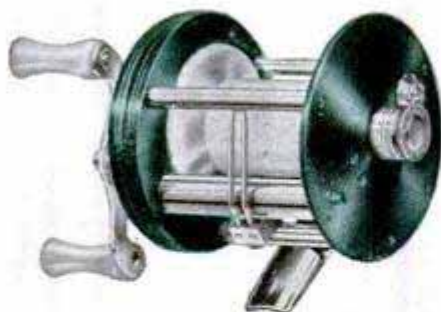

the most reel for the money  
Bronson Green Hornet . . . \$4.95



BRONSON REEL COMPANY  
BRONSON, MICHIGAN



If there was any field in which melamine really did what it was expected to do, it was in the "laminated" department.

Laminates are made by constructing a "plastic sandwich" of paper which has been dipped in resin. These sheets are partially dried, cut to size, laid one on top of another. The pile is then placed in giant hot presses where the mass fuses.

Melamine did everything that previous resins tried to do but couldn't. Stubborn melamine crystals today make counter and table-top surfaces that resist food acid.

Melamine resin also makes an unbeatable glue. For years plywood manufacturers used urea and phenolic resins for bonding layers of wood. Phenol resins were waterproof, but bled through to the surface of the wood, making ugly splotches. Urea resins were clear, but lacked complete water resistance. Melamine resin, the boys knew, was clear and water-resistant. But would it stick?

Various mixtures were prepared, smeared on layers of wood, and run through a hot press. The result: a permanent bonding agent, waterproof, colorless and so rugged that a testing lab hung a Jeep in mid-air, hooked to a two-inch block of wood cemented together with the plastic.

Of all the surprises in melamine's growth, probably none had the chemists as baffled as its odd behavior in leather.

Leather is tanned with chrome salt. Pure white leathers formerly were unobtainable, because chrome treating plus bleaching left the inside grayish. The bleach would not penetrate throughout. Cyanamid chemists had a hunch that melamine, with its intense penetrating powers, might do the job better.

It did—in the lab. But the minute tanners tried it, everything went blooie. First, the resin-tanning solution caked up in the leather. When they licked that, by thinning out the resin with formaldehyde, the leather smelled like a hospital corridor.

They were about to give it up when a tanner up in Gowanda, N. Y., called excitedly one day to tell them he'd gotten wonderful results with a sample of melamine resin that had been sent to him.

"How did you do it?" the chemist asked.

"Never bothered to pickle the hide," replied the tanner. Just went through the delimiting, then tanned the stuff with melamine resin. Cuts out an extra step and works like a charm. My white leather's upgraded about 50 percent."

Today melamine resin is going into white leather for shoes, luggage, fancy pocket-books. Leather treated with it is soft, plump and white clear through.

Melamine's invasion into the paint field

(Continued to page 246)



# NEW! DUNLAP Utility Grinder

OUR OWN TRADE MARK

Look at this convenient feature!



Both wheels extend 1/2-inch beyond motor housing... allows grinding across the face of the machine.

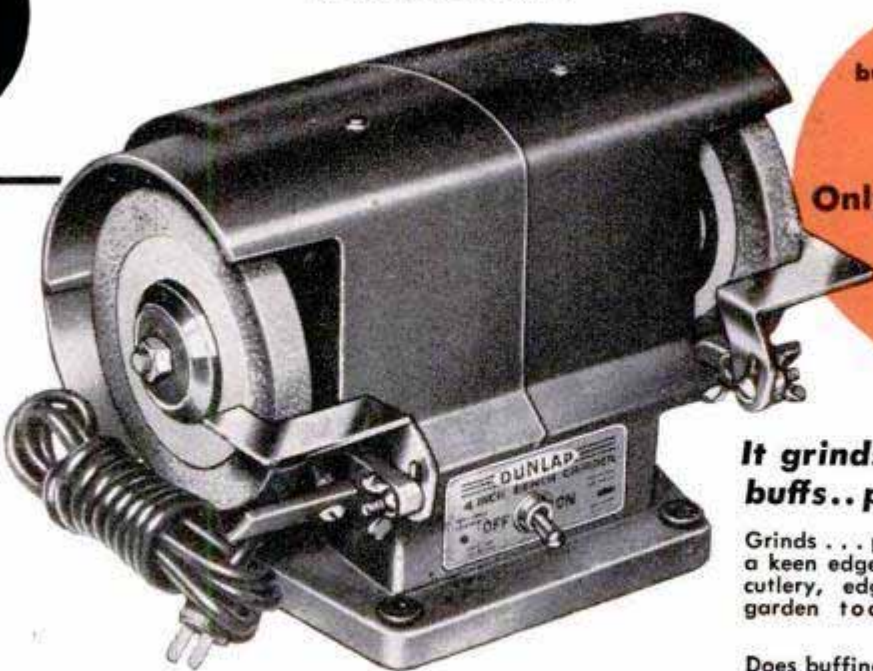

With powerful built-in electric motor and two 4-inch grinding wheels

Only **\$16.95\*** Cash

Complete with 6-ft. cord and plug

**Compact! Handy! Low-priced! Guaranteed!**

Invaluable for light maintenance work in your home, kitchen, farm or shop! Two 4x1/2-in. vitrified grinding wheels; coarse and fine. Bronze bearings. Adjustable, removable steel tool rests. Die-cast housing; rubber cushion feet. Powerful single-phase 110-120-volt 60-cycle A.C. motor with 2 fans. 3500 no-load R.P.M. Off-on switch; 6-ft. cord; plug. 6 3/4-in. between wheels; 6 1/4 in. high. Guaranteed for 1 year against defects in materials and workmanship.

**It grinds... sharpens... buffs... polishes... cleans!**

Grinds... puts a keen edge on cutlery, edged, garden tools.



Does buffing... polishing with cloth buff or rubber wheel.



Cleans; removes rust and paint with a wire scratch wheel.



## CRAFTSMAN Capacitor-type Ball Bearing Electric Motors

Famous for top quality... extra value... extra power... and rugged, long service!

Look at these superior features!



New Departure sealed precision ball bearings!



Built-in overload protector prevents motor burn-outs!



Nylon insulation resists abrasion and heat better!

**CRAFTSMAN Motors are GUARANTEED!**

We know of NO other motors of this quality selling at such low prices! Built-in condenser permits starting loads 50% greater than split-phase motors of same capacity. Operate in any position; easily reversed. Off-on switch in base; double-end shaft. **Guaranteed!** We will repair or replace without charge any SEARS motor showing defects in materials or workmanship within one year. See these motors at your SEARS Retail Store TODAY!

\* Prices slightly higher south of the Ohio and west of the Mississippi Rivers.

Look at these **CRAFTSMAN** Capacitor Motor Values!

1/2-H.P. 1750 R.P.M. **\$24.95\*** Cash

1/2-H.P. 1750 R.P.M. \$21.95\*

1/2-H.P. 3450 R.P.M. \$27.95\*

3/4-H.P. 3450 R.P.M. \$36.95\*

110-120-volt, 60-cycle A.C.

As low as \$2.50 Down on Easy Terms





**DUNLAP Split-phase 1750 R.P.M. Motor**

**1/4-H.P. \$10.50**

Full size, full power. Exceeds N.E.M.A. breakdown torque. Diamond-bored precision bronze bearings. Reversible. For 110-120-volt, 60-cycle A.C. 1/2-in. shaft; 8-ft. cord; plug. Also available in 1/3-H.P. sizes.

## CRAFTSMAN and DUNLAP Tools by SEARS, ROEBUCK and CO.

Famous for fine quality... precision performance... low price!



## YOUR HARDWAREMAN

is your best guide in buying tools. Make his store your tool headquarters. When he sells you a Disston saw he has your best interests at heart. For he, like Disston, stands for quality merchandise.

When you buy a Disston product, you buy Disston Steel, Skill and Service. Disston Steel means longer tool life. Disston Skill means precision tools, to help accuracy. Disston Service means availability as close as your local hardware store.



Deluxe Circular Saws



Back Saws



Compass Saws

**FREE** Disston Saw, Tool and File Manual—the instructive book on "How to Choose and Use Tools." Write for it.



**HENRY DISSTON & SONS, INC.**

511 Tacony, Philadelphia 35, Pa., U. S. A.  
in Canada, write: 2-20 Fraser Ave., Toronto 3, Ont.

**DISSTON**®

was natural. Here, chemists knew that the resin's hardness and durability would be a boon to automobile, refrigerator and washing-machine manufacturers. Assembly lines always slowed down in the paint driers because it took 50 minutes to get a good baked-enamel finish.

But how to turn thick formaldehyde into a thin film that could be added to enamel, sprayed from a paint gun and baked quickly into a hard, durable finish? More than 500 formulations were tried and discarded before tedious trial and error produced results. Bently alcohol turned the trick. Ultimately, melamine resin was found to mix readily in surface coatings.

Auto manufacturers were dubious, recalling what other synthetic resins had done to durability. Cautiously they tested a five-percent dose of the new compound in their precious enamels, and speeded up the driers. Not only did the paint not wrinkle, but it was harder, glossier. They upped the dose (a disastrous process with previous resins) to about 10 percent. Drying time dropped in half and no wrinkles.

Newest application of the wonder plastic is in textiles. Recently, John Derrig, a young chemist at Cyanamid's Bound Brook, N.J., plant, earned himself a neighborhood reputation as an "eccentric." For weeks he walked around in cotton pants, one leg smoothly creased, the other looking like a rumpled dust cloth. His two youngsters were allowed to run around in new clothes, slopping through mud, climbing trees, sliding down dirt and rock embankments. The pay-off came when neighbors caught him squirting water from a hose all over his wife, who was fitted out in a tulle gown. "They thought I had bats," he said.

The chemist, of course, was home-testing fabrics treated with melamine resin. The queer-looking pants had one leg treated, the other untreated.

Melamine resin gets down into the fibers, makes them resilient and "freezes" them to size. Hence, there can be no shrinkage. Oddly, it gives cotton the "feel" of soft wool. Wool treated with it sheds water and won't shrink. Men's summer suits treated with it retain their original "porosity," are cooler and won't wrinkle. In all the treated cloths, the water resistance is amazing.

Where will it end? Not here. New products are in the test tubes. A baked-in resin to make fabrics fire-resistant will appear soon. In Cyanamid's paper division, chemists are at work on a development that, because of melamine's odd electrical quality, may see hardwood pulp used for paper.

Plastics used to be things you could see and touch. Now, it seems, they've gone into hiding, and the possibilities are endless.



Winning  
Fresh  
Laurels



**PATENTED** **CORALOX** **INSULATOR**

MORE NEW CARS AND TRUCKS  
ARE EQUIPPED WITH AC SPARK  
PLUGS THAN ANY OTHER MAKE

AC's patented Insulator—**CORALOX**—is winning fresh laurels from car, truck and tractor owners, because it eliminates the major causes of spark plug trouble.

**CORALOX** is AC's Insulator. It conducts heat 4 times as fast as previous insulators—has 10 times the insulating value at high temperatures—is 3 times as strong—does not attract oxide coating.

That's why AC Spark Plugs perform better at any engine temperature—have greater resistance to fouling—have more scientifically shaped insulator tips—have wider Heat Range per plug.

For easier starting—better idling—faithful firing under heavy loads—use the new AC's with patented **CORALOX** Insulator.



AC OIL FILTERS

AC FUEL PUMPS

*preferred on millions of vehicles*



AC SPARK PLUG DIVISION • GENERAL MOTORS CORPORATION

## New ARMY MINE DETECTOR

An/PRS-1 is a portable device for detecting metallic and non metallic objects. Metals, Buried Cables and sewer Tile.

Our Special Price **\$26.40** with battery  
\$17.50 without battery

By lengthening dipole rods operator will be able to increase the depth sensitivity. This unit comes complete with spare tubes, antenna dipole and reflector, and instructions manual, in wooden chest 9½" height x 28¼" length x 15½" depth. Weight in operation is only 22 lbs. LESS Batteries. Power supply: Three 45 volt and one 6 volt batteries. Uses standard batteries. Original COST \$364.00. Shipping weight appr. 80 lbs. F.O.B. New York. No C.O.D.'s. Send Order to:



**COLUMBO TRADING CO., INC.**

304 CANAL ST. DEPT. P.M. NEW YORK, 13, N.Y.

## REAR ENGINE TRACTOR

### Makes Small Acres Big

Make your acres produce a profit with this low-cost, man-size tractor. Wide selection of inexpensive, easy-on, easy-off implements—plows, planters, cultivators, mower, etc. Earn a tidy income growing vegetables, flowers, fruit, nursery stock, farm crops, and doing work for neighbors. Powerful rear engine gives clear vision, boosts traction. Consumes only 2 to 3 quarts of fuel per hour. Four speeds. It's fun to run! Send coupon for free driving trial and literature.



**ALLIS-CHALMERS**  
TRACTOR DIVISION • MILWAUKEE 1, U. S. A.

Allis-Chalmers Tractor Division  
Milwaukee 1, Wis., Dept. 22

I'm interested in:

Free driving trial       Free literature

Name \_\_\_\_\_

St. or RFD \_\_\_\_\_

City \_\_\_\_\_ State \_\_\_\_\_

## New York Shakes Off Its Bonds

(Continued from page 77)

tip, then plunge beneath the East River and roll out in the Red Hook section of Brooklyn. Eventually, of course, he can keep right on scooting along the rim of Brooklyn, soar across the Narrows Bridge and strike south toward Washington, having saved about 13 miles and at least one hour's time.

Not one, but actually two tunnels 45 feet apart, center to center, lie beneath the river. Each tube, 31 feet in diameter, carries two lanes of traffic along a 21-foot 4-inch roadway. About \$80,000,000 is sunk beneath the river forever, but East Coast motorists say it is worth every penny.

More than 10 years' time (the tunnel was held up by the war) and 13,000,000 man-hours of labor have been expended in sinking the tubes. Since the first excavator bit into the ground, some 1,010,000 cubic yards of material have been hauled away.

Engineers in Manhattan started to blast their way south through rock, while their brothers across the way were tunneling north from Brooklyn through mud and silt. On September 16, 1948, sand hogs "holed through" to complete the excavation of the link. At its deepest point the roadway is 115 feet below mean high water. Two thirds of the tunnel was bored through rock, one third through soft ground.

Compressed air is the only shield between sand hogs and death as they tunnel through mud, clay and sand. They use a steel sleeve powered by hydraulic jacks to bite through the slime. The sleeve fits around the outside of the tube, while the unexcavated material at the working end of the tunnel is dammed by a temporary wooden plug. With tremendous force the sleeve makes a 32-inch leap through the muck beyond the barricade. Then the barricade is taken down from top to bottom one plank at a time, and the mud beyond is shoveled out by hand while compressed air holds back the water. A cast-iron lining then is fitted around the three-foot excavation. This leap completed, the men rebuild the barricade and cock the sleeve for another bite.

Each tube is lined with cast-iron rings which have stiffening flanges up to 14 inches thick. A ring is installed in 3000-pound segments which are shoved into their proper place by a huge erector arm, mounted so it pivots directly in the center of the tube. Then a concrete lining is poured inside the tunnel to protect the metal tube and to provide a convenient surface for installing the roadway and other interior details.

(Continued to page 250)

# GET THIS 1950 CAR ENGINE PROTECTION

## the new **MARVEL** **INVERSE OILER**

### FOR CONSTANT UPPER CYLINDER LUBRICATION

Here's the famous auxiliary lubricating oil system—in a sensational new, low cost, 1 Quart size—that meters MARVEL Mystery Oil to critical upper cylinder engine parts precisely in accordance with the demands of your engine under load. This new, compact OILER, with visible oil supply, functions on the same exclusive MARVEL principle—inversely to manifold vacuum—retarding feed when throttle is closed or at engine idle. You'll keep ring, piston and valve wear down and performance way UP with the MARVEL INVERSE OILER on your car.

#### MARVEL MYSTERY OIL

Learn about MARVEL Mystery Oil too—the nationally recognized leader among oil improving additives. Added to your regular motor oil, it shields vital parts from excessive frictional wear with its great film strength—produces a slow idle, faster engine pick-up and an even power pull.

**WRITE  
FOR THE  
FACTS—  
NOW!**



**EMEROL MANUFACTURING CO., INC.**

242 WEST 69th ST. (Dept. P.M.) NEW YORK 23, N. Y.

**SENSATIONAL NEW  
MODEL Q, 1 QUART  
VISIBLE RESERVOIR  
UNIVERSAL  
BRACKET**  
**Only \$11.20**  
SIMPLE TO INSTALL



### Asbestos Gloves for HOT Jobs

Handle hot things with safety. Wear Industrial's famous 210 asbestos gloves. Made of close woven 2½ lb. Underwriters Grade cloth that resists burning. Big roomy cut, airy and comfortable. One piece construction with no seams at wrist or working edges to burn or pull out. Furnished lined or unlined. Almost 40 years experience designed and made these dependable gloves. Many styles. Write for prices and catalog.

**INDUSTRIAL GLOVES CO.**  
1409 Garfield St., Danville, Ill.

In Canada:  
Safety Supply Company, Toronto

### Smooth Sailing with Old Town



ALL HANDS from new sailor to old salt will take to Old Town's swift-paced lapstrake sailboat. She's 13½ feet long, with 90 square feet of sail. An ample beam assures stability. Built by Down-Easters, easy to handle. Solid deck, full-length decking. Inexpensive upkeep.

**FREE CATALOG** gives the facts on the sturdy lapstrake sailboat. Also shows canoes, outboard boats, dinghies, rowboats.

### OLD TOWN BOATS

645 Elm Street, Old Town, Maine

PLEASE SEND ME FREE CATALOG

Name \_\_\_\_\_  
Address \_\_\_\_\_  
City \_\_\_\_\_ State \_\_\_\_\_

### SOUND POWERED HANDSETS

**FAMOUS NAVY UNITS**  
Operates without batteries!  
No electricity needed!

These famous Navy units have practical uses everywhere. Ideal for television antenna adjustment—kitchen to garage—house to barn, workshop or field—office intercommunication—construction jobs—boats—camps... and hundreds of other uses. Practically no installation—just hook up with a pair of wires.



**\$12.95**

PER PAIR  
Complete with  
6-Foot Cord

25% with order—balance c.o.d. plus postage. Remit in full to save postage and c.o.d. charges.

**WESTERN  
ELECTRONIC CO.**

2797 SHATTUCK AVE.  
BERKELEY 5, CALIF.

SAY YOU SAW IT IN POPULAR MECHANICS

# WHY WASTE TIME...

with  
"temporary  
polishes?"

Simoniz gives lasting beauty  
and protection to the finish  
— with fewer applications!

The amazing sparkle  
Simonizing gives your car  
lasts for months... protects  
and preserves the finish...  
keeps colors from fading!  
Always insist on world-  
famous Simoniz and Simoniz  
Kleener for your car.

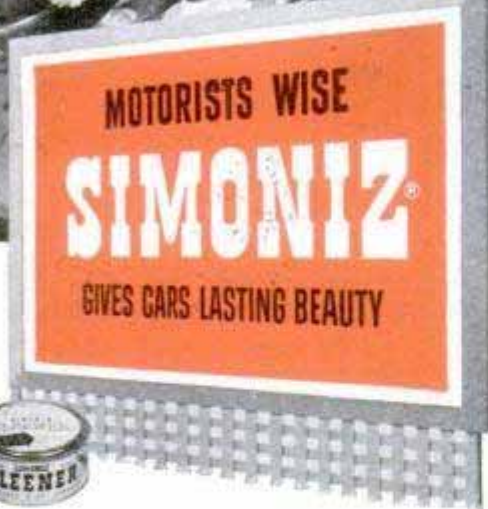
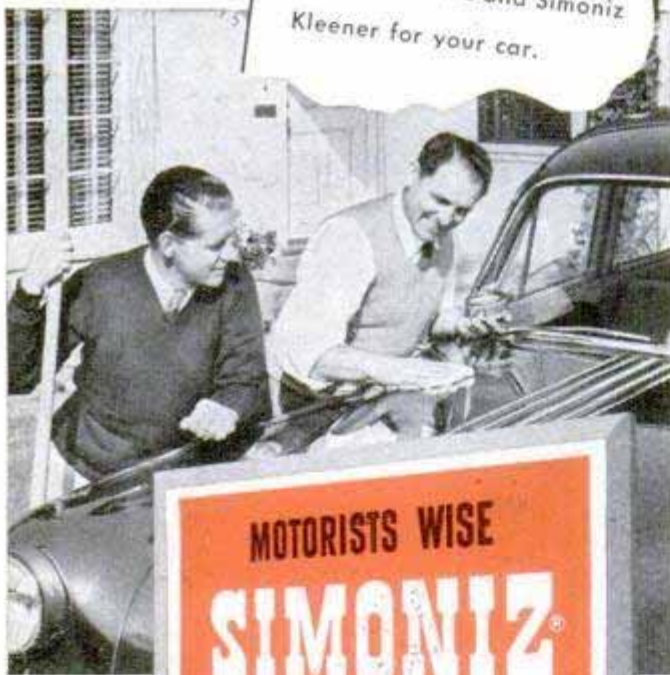

Newer cars need only Simoniz to clean and beautify the finish... a single, simple operation. On older cars, first use Simoniz Kleener (Liquid or Paste) to clean the finish. Then Simoniz for lasting beauty.

THE SIMONIZ COMPANY, CHICAGO 16, ILL

The sooner you Simoniz your car the better!

Ventilating a tunnel the length of the Brooklyn-Battery tube is a real challenge. About 4,200,000 cubic feet of fresh air are puffed into the tunnel every minute when the tubes are carrying rush-hour loads. If air were whiffed longitudinally through the tunnel at this rate, it would blow like a gale to make the motorist uncomfortable and the tunnel dangerous because of the fire and accident hazard.

Because the circular tube is sealed off at the bottom by the roadway and the top by the ceiling, there remain two segments available for ventilation. Air under slight pressure is blown longitudinally beneath the roadway. It then drifts up through flues spaced along the roadway at 10 or 15-foot intervals, and is drawn off through ports in the ceiling to whip along the tube again through the exhaust duct. Result: fresh air, no noise, no fire hazard and a complete change of air every 1½ minutes.

Three buildings on the surface and one underground house the ventilation equipment, including the eight-foot centrifugal fans. One of these buildings is on an artificial island dipped up from the edge of Governor's Island—a brand new landmark in New York Harbor.

Two continuous bands of glowing fluorescent tubes on each side cast light into the tunnel. At the incoming ends, the light is brighter during daylight hours than anywhere else in the tunnel, so drivers won't be suddenly blinded by darkness as they enter the portals. There's a fire hydrant every 125 feet and catwalk in each tube for the use of traffic cops. A building near each portal provides space for maintenance equipment, offices, crash trucks, fire engines and other emergency equipment.

During peak periods 3000 cars can "bore" through the tunnel in each direction each hour. Engineers figure the tube's annual capacity is around 16,000,000 vehicles.

With the tunnel completed, a bridge across the Narrows authorized and improvements already under way on New York's magnificent parkways, city officials feel it won't be long until they have conquered the waterways that have made their metropolis the crossroads of the world, yet have continually befuddled the poor motorist.

## Tinning Paint

No preheating of the metal or use of acid-core solder is needed when a newly developed tinning paint is used. It is brushed on flat or upright surfaces and heated with a torch.

## Make Garden Masonry for Spare-Time Profits

Millions of homes can use these Ornamental products — urns, vases, flower boxes, bird baths, lawn seats, flagstones, etc. Easily made of sand and cement. Permanently glazed in a range of smart colors. Distinctive — attractive — quick selling.

### Eye-Appeal Makes for Cash-and-Carry Sales

Selling prices allow 200% to 300% mark-up on basic costs. Only a small investment needed for supply of molds. Easily set up in shed or garage. Write immediately for catalogue OM and price list.

**COLORCRETE INDUSTRIES, INC.**  
710 Ottawa Ave., Holland, Mich.



### Easier to Wash Windows, Paint, Putty and Repair with Windostep!



No ladders! Strong! Tested, holds 1000 lbs.! Weighs only 12 lbs.! Placed from inside—locked into position by your own weight. Steel safety guard.

**GUARANTEED OR MONEY BACK**

Circular On Request

**9.85** Plus C.O.D. & P.P. or \$10.50 Prepd.

**MORRISON CRAFTERS, INC.**  
702 Miami St., Toledo, Ohio

## THE PERFECT BASS BAIT!



**JOHNSON'S**  
**NEW PORK RIND**  
with **JOHNSON'S**  
**SILVER MINNOW**

For a new fishing thrill, plunk this perfect fish-getting combination into the weeds where the BIG ones lie. The special flared guard brushes the weeds aside, yet won't interfere with the strike. Perfect weight for bullet-like casts. Pork Frog gives irresistible action.

**SNAKES THRU THE WEEDS WITHOUT SNAGGING**

### OTHER JOHNSON LURES

#### SILVER MINNOW TRIPLE HOOK

Flash and action! Interchangeable bucktail trailers. Weedless or non-weedless.

#### SPRITE

For fresh or salt water. Heavy chromium plated.

#### CAPER

Replaceable hook and weed guard. For salt or fresh water. Four sizes.

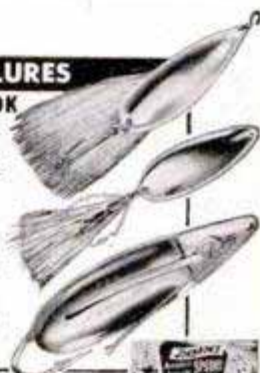

**FREE New Catalog** and Booklet "How to Fish the Johnson Silver Minnow"

**LOUIS JOHNSON CO.**

1215-P Deerfield Rd., Highland Park, Ill.

## PAGE GARDEN TRACTORS

WITH PRECISION TRANSMISSION

RIDING AND WALKING MODELS

TO DO MORE JOBS AT LESS COST!

New economical '50 line with extra features! Riding and walking models, 2 to 6 HP. For spring plowing and dozens of other year 'round jobs. Complete gear drive with reverse, no cheap belts or chains. New reduced prices—easy terms—\$188 to \$440 with cultivator and equipment lift. Get benefits of 25 years experience.

WRITE TODAY FOR YOUR FREE CATALOG!

**PAGE DAIRY and FARM EQUIPMENT**

1904 S. 81st ST.—MILWAUKEE 14, WIS.

## Have Fun with your own Outdoor Fireplace

Build it Yourself — It's EASY

Everyone loves to cook and eat outdoors. For a fireplace that costs less and works right, just fit masonry to this Model OF-28. 21" high, 26" long, 13½"

wide. See your dealer or order direct. Send money order or check.

SEND FOR THIS BOOK OF DESIGNS 52 pages of helpful tips on fireplaces and outdoor cookery... Send 25c for your copy.

**\$17.95** Complete



**The Majestic Company**  
366 Erie Street, Huntington, Indiana



# Be a Wizard with Wood

It's easy to do professional work at home! Here are magical products to aid you—reflecting the experience of United States Plywood Corporation and proven by years of satisfaction.

## Strongest Wood Glue Ever Made



To make things or fix things, use Weldwood Glue for all wood-to-wood bonds. Makes joints stronger than the wood itself. Mixes easily with water. Stain-free, rot-proof . . . highly water-resistant! 15¢, 35¢, 65¢, 95¢ and larger sizes.

**WELDWOOD**  
PLASTIC RESIN GLUE

## A MUST for Finishing Fir Plywood



Tame that wild grain with FIRZITE. It tight-seals the pores . . . virtually prevents grain rise or checking . . . readies the surface satin-smooth for paint, stain or enamel. (For blond, pickled, wiped or tinted effects use White Firzite).

**FIRZITE**

## Newer than Shellac or Varnish



For "natural wood" finishes on furniture or woodwork, there's nothing like Satinlac. Brings out the natural grain and color beauty of any plywood or solid wood. Avoids that "built-up" look, and will never turn yellow or darken with age. "Water-white", easy to brush or spray, dries ready for next coat in 2 or 3 hours.

**SATINLAC**

Ask for Weldwood Glue, Firzite and Satinlac at hardware, paint or lumber dealers.

Send post card for interesting glue and finishing leaflets.

**UNITED STATES PLYWOOD CORPORATION**  
Dept. 52, 55 West 44th St. • New York 18, N.Y.

## Nine Lives for Oil

(Continued from page 150)

Since planes are not always in New York when they need oil, only about 20 percent of the lube oil used in their domestic flights goes back to work, but they expect this figure to go up after they move their re-refinery to American's new maintenance center at Tulsa. As for quality, they see no difference between the new and the old, but pricewise the spread is impressive. They pay about 40 cents a gallon for new oil; re-refining costs 15 cents a gallon.

In the early days of bus-fleet operation, disposal of used oil without creating a nuisance got to be a problem. R. A. L. Bogan, vice-president of the Greyhound Corporation, looked into re-refining and concluded that they were killing a goose which could lay golden eggs. So, in the early '30s, Greyhound set up small 50-gallon plants in their garages at strategic points all the way from Boston to San Francisco. Bogan found that they could recondition oil for about half what they paid for new oil, that the rebuilt oil was as clean or cleaner than new oil and that in all other essentials it was as good as or better than the virgin product. Since then, big commercial re-refineries who are better equipped to do the job have sprung up in many large cities, so Greyhound lets out its washing. After a 10,000-mile hitch in its bus engines, the oil goes to the re-refiner, is separately reconditioned and goes back into the engines for another 10,000 miles. Although much new oil is added between changes to make up losses, there is some oil in Greyhound busses that has been lubricating pistons for 200,000 miles. The fleet is now re-refining about 120,000 gallons of oil a year.

In the last decade, railroads, factories, taxicab companies and bus fleets by the thousand have turned to used oil, which has been cleansed and reconditioned by various methods. Some buy it outright from the big re-refiners; some send their drainings to the cleaners so they get their own oil back and some do their own "washing" in small, 10-gallon stills.

You can dip into their reports and come up with a double handful of enthusiastic endorsements. The Diamond Cab Company of Long Beach, Calif., which launders its own oil, once bought 200 gallons of new oil a week. Now they reclaim 150 gallons at a cost of 10 cents a gallon, reducing the weekly purchase of new oil to 50 gallons. Savings: About \$100 a week. The Northeast Oklahoma Railroad Company began re-refining the old oil from its diesel locomotives and busses nine years ago and since

(Continued to page 254)

# QUALITY POWER MOWERS FOR LESS



• Lightweight "easy to operate"

## GAS MOWER

As shown with 2½ H.P., 2 cycle McCullough engine. Only .....\$119.50 or with 1.8 H.P., 4 cycle Clinton Vertical Engine. Only....\$104.50



ONLY \$3995

• Cast aluminum base with 18" Rotary Blade

## Make Ur-Own POWER MOWER

Just add up to 2 hp gas engine or ½ hp electric motor Easy to install



• Ball-bearing rubber tired wheels

## ELECTRIC MOWER

Comes complete with ½ hp elec. motor and 75 ft of cord. Just plug it in.

F.O.B., K. C. Send check or money order.

**ATLAS EQUIPMENT CO.**

229 S.W. Blvd. Dept. P.M.9  
KANSAS CITY, MO.

ALL MODELS COME COMPLETE AS SHOWN

**Thompson BEATS the World on BOATS**



**Better Built Lower Prices**

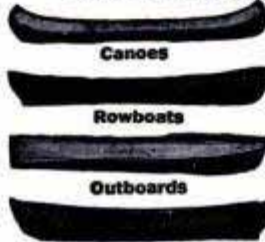

**Safe Boats With Full Length Spray Rails**  
Keep passengers perfectly dry—even at high speeds. Catalog also shows two new models of "Take-Along" Boats. Two big factories—save you freight.

**CATALOG FREE**  
Write for your copy. State kind of boat in which you are interested.  
**THOMPSON BROS. BOAT MFG. CO.** (151)  
213 Ann St. PESHTIGO, WIS. Write to either place. 113 Elm St. CORTLAND, N.Y.

Light Boat for Auto.  
**THOMPSON BROS. BOAT MFG. CO.** (151)  
113 Elm St. CORTLAND, N.Y.

## 500 Pages, 7000 Novelties



10c

Send 10c for mammoth, amazing catalog of 7000 novelties. 1-inch thick, roto picture section, 6-color cover. Carnival, circus, world's fair & science exhibit rolled into one! Includes live animals & pets, scientific supplies, hobbies, funmakers, planes & boats, looms, magic tricks, joke articles, unusual seeds, gadget timesavers, cameras, optical goods, projectors, movies, lucky jewelry, religious novelties, telegraph sets, disguises, musical instruments, stamps, coins, puzzles, fortune tellers, radios, experimental sets, auto & bike accessories, Western wear, telescopes, magnifiers, compasses, banks, smokers' gadgets, artists' supplies, printing sets, engines, motors, shockers, knives, billfolds, fireworks, guns, rifles, sports, money makers, swimming helps, 1000 fascinating books, games, locks, live chameleons, rings, exercisers, curious plants, etc., etc. (DeLuxe Hard Bound Library Edition 25c Postpaid.) Regular paper covered edition 10c. (Stamps accepted.) Sent Air Mail, \$1.00. **JOHNSON SMITH & COMPANY, Dept. 231, DETROIT 7, MICHIGAN**

## U. S. Army Air Force Type SUN GLASSES

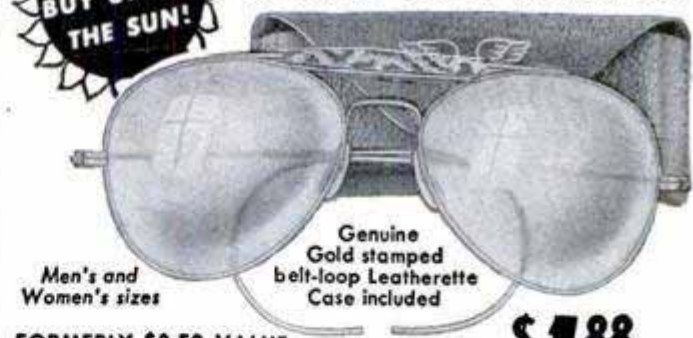

Men's and Women's sizes

Genuine Gold stamped belt-loop Leatherette Case included

FORMERLY \$8.50 VALUE

**\$1.88**

postpaid

**Super-Sensationally Priced at only ...**

- ★ Cool green meniscus curved, polished lenses.
- ★ 24 Karat Gold Plated adjustable frames
- ★ Pearloid Sweat-bar and Nose-pads
- ★ Reinforcing bar for greater durability
- ★ Lenses meet specification of U. S. Gov't. Bureau of Standards.

### LIFETIME GUARANTEE

Included with every pair of glasses

**10-DAY TRIAL • MONEY-BACK GUARANTEE**

**CHICAGO GOGGLE SALES CO., Dept. 301**  
20 E. Delaware Pl., Chicago 11, Ill.

Please send me .... Men's .... Women's Sun Glasses.

Send C.O.D.

Enclosed find \$..... Mail Postpaid.

MAIL THIS

COUPON TODAY!

Name.....

Address.....

Town..... State.....

## PREFABRICATED HOUSE

**ONLY \$2 POSTPAID**

with check or money order



**for your feathered friends!**

No tools needed to assemble this clever, all-metal prefabricated PEEK-A-BOO Bird House! Novel window enables YOU to look right in on bird home-life . . . adjustable entrance accommodates wrens, swallows, bluebirds or other varieties! White and green with gay red roof in weather-resistant Baked-Enamel finish. Bill sharpener, wooden perch, sturdy hanger and ring, sheet of bird lore included. Hang in tree or outside any window.

**POST INDUSTRIES**

75 E. Wacker Drive, Chicago 1, Illinois, Dept. PM1

**NEW!**  
**Klean-Strip Remover**  
**Peels Off Paint**



Throw away messy, dangerous solvents! Klean-Strip, the new-type remover, needs no after-wash, will neither burn nor explode. Just apply with brush, or spray gun . . . then slide off the loose film. That's all there is to it!

Klean-Strip actually breaks the bond between wood or metal and the finish you want to remove. Peels off any paint, enamel, varnish, synthetic or lacquer. Works fast, leaves the surface clean, smooth and dry, ready for a perfect refinish job.

The next time you buy paint, get a can of Klean-Strip, too! Available at better paint, hardware, and department stores everywhere.

W. M. BARR & CO.  
 2354 S. Lauderdale  
 Memphis, Tenn.

**Clean · No-Wash**  
**Non-Inflammable**



Professional Quality  
**Snap-on**  
**MIDGET**  
**PLIER SET**  
 FOR JOBS  
 AROUND CAR,  
 HOME, CAMP



The 4½" Needle Nose reaches into tight places . . . the 4" Side Cutter cuts wires, fish hooks, pins . . . the 4½" Gripper is a general utility plier. All beautifully chrome-plated and fully guaranteed. In fine leatherette kit. . . .

**\$6.65**

Standard Size PL-30K Plier Kit . . . . . \$10.30

**MAIL THIS COUPON TODAY!**

\*T.M. Reg. U. S. Pat. Off.

**SNAP-ON**  
**TOOLS**  
 CORPORATION  
 8062-E  
 28th Ave.  
 Kenosha,  
 Wisconsin

I enclose  Check  Money Order for the following plier kit . . . . .

PLM-30K Plier Kit at . . . . . \$ 6.65

PL-30K Plier Kit at . . . . . \$10.30

Add Local Sales Tax

Name . . . . .

Address . . . . .

City . . . . . State . . . . .

then has saved more than 45,000 gallons at a cost of 11 cents a gallon.

Among Eastern users are the Pennsylvania, New York Central, Boston and Maine and Long Island Railroads and the Public Service Company of New Jersey. These firms get their rebuilt oil from Walter Ray's Triplex Oil Refining Company.

Most of the re-refiners are small businessmen who saw wasted wealth in filling-station pits and seized the chance for a pioneer venture. In Lyons, Ill., west of Chicago, stands the trim modern plant of the Motor Oils Refining Company, set up 10 years ago by Herbert C. Goetsch. Last year, he turned out nearly 1,000,000 gallons which his customers find as good or better than new oil. He does many "custom jobs" for industries, railroads, truck and bus companies, collecting their dirty oil, treating it separately and returning it. The more it is re-refined, he reports, the cleaner it gets and the higher the yield from the used oil. He launders some high-priced industrial oils for one third of their original cost. With a fleet of six tank trucks, Goetsch collects sump oil from about 250 Chicago filling stations and garages and produces a re-refined lubricant which is sold for around 25 cents a quart in a number of Chicago filling stations. This market is limited, says Goetsch, by the popular prejudice against oil that has once been used. If motorists could be convinced, he says, that nothing matters but the tested quality of the oil, he could convert into good motor oil great quantities of drainings which are now being wastefully burned or otherwise jettisoned.

On the bank of the Potomac in Arlington, Va., is the re-refining plant of V. T. Worthington, a native of Utah who once worked on refinery-construction jobs in the West. Later, he took a job in the Department of Commerce and there received so many queries about re-refined oil that he had to study the subject. When he found that oil does not wear out and that used oil can be made into a superior product, he decided that he had found his calling. He gave himself lessons by operating small five-gallon portable units, and then built a small plant of his own design. After two enlargements, he constructed his present plant, which uses a new method involving a tall vacuum fractionating tower and will handle about 9000 gallons a day. Worthington collects sump oil from Washington, Baltimore and Richmond and turns it into a high-grade lubricant.

Like other re-refiners, he is irked by the fact that while he can produce lube of the highest quality, which he can sell at a

(Continued to page 256)



**Cushman**  
MOTOR SCOOTER

## Leads All Ways

Own-operate - maintain for less than 3/4c a mile! World's finest low-cost transportation! Easy to handle—starts fast, slips through crowded traffic. Parks anywhere. Wonderful for getting to work, school, market—doing errands, making deliveries. Many 15-year old Cushman still in use—new 1950 models greatly improved! Surprisingly powerful Cushman long-life engine. Comfortable. Safe.



- 75 Miles Per Gallon
- Up to 35 Miles Per Hour
- Powerful Cushman Engine
- Big Balloon Tires
- Heavy Brakes
- Many Models

Rider Agent Plan Available

CUSHMAN MOTOR WORKS, Dept. M5, Lincoln, Nebr.

## FINE TOOLS NEED FINE OIL!



• Lubricates



• Prevents Rust

• Cleans • Polishes

SOLD EVERYWHERE

## 3-IN-ONE Oil

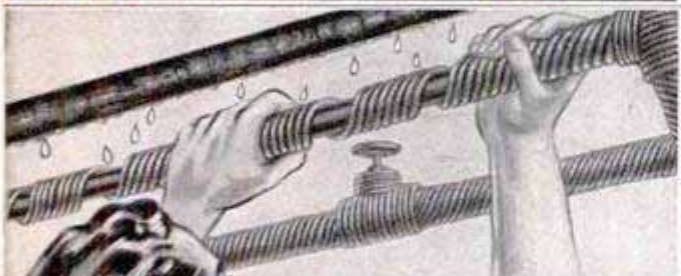

## STOP DRIP

caused from condensation on cold water pipes. Turn idle basement space into play or work rooms. Keep store rooms dry. Just wrap cork-filled NoDrip Tape around

pipes and joints. Do it yourself. Clean and easy to apply. Roll covers about 10 feet of 1/2" pipe, \$1.69. Higher west of Rockies and Canada. Get at Hardware, Department Stores, or sent postpaid. Write for free circular.

**NoDrip TAPE**

J. W. Mortell Co., 522 Burch St., Kankakee, Ill.

SAVE TIME!  
AND WORK!

MAKE EXTRA!  
MONEY!



EASY TO OPERATE

**SHAW**  
"DU-ALL"  
and "PEPPY PAL"  
GARDEN TRACTORS

**PLOW**



**HARROW**

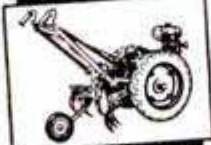

**CULTIVATE**



**MOW**

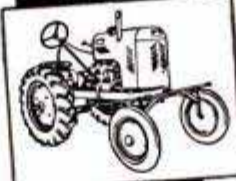

**RIDE**

RW-2

**SHAW MFG. CO.**

These sturdy walking and riding tractors ideal for dozens of uses around the farm, orchard, garden, golf course, estate and poultry farm.

### DO DOZENS OF JOBS

Shaw Du-All or Peppy-Pal tractors do many jobs quickly and easily. Plow, cultivate, harrow, mow, disk, bulldoze, spray, grind, haul and saw wood. New uses discovered every day.

### BUILT FOR RUGGED WORK

Sturdy, extra-strength construction means low upkeep, long life. Patented tool control allows quick shift for crooked rows. Attachments easy to change with improved "Jiffy Hitch."

### CHEAP TO OPERATE

Operates on a few cents an hour. Soon pays for itself in time and labor-saving plus low initial and operating costs.

### NEW LOW PRICES

Buy direct or through your dealer! Almost anyone who has a garden can afford a Shaw Du-All or Peppy-Pal. Full year's guarantee.

### RIDING TRACTORS

Four models, from 5 to 12 H. P., 58 in. wheelbase, 36 in. wide, 24 in. plant clearance. Hand or electric starter. Improved steering device, brakes enclosed in differential housing shaft. Standard hitch for trailers and wagons. Plow, harrow, cultivator, cutter bar, snow plow, bulldozer available.

**PROMPT SHIPMENT** No waiting — order now for immediate delivery.

**FREE:** Illustrated folders giving complete details and price lists. Write today:

4505 Front St., GALESBURG, KAN.  
668-G North 4th St., COLUMBUS, O.

## Double PROTECTION and lasting lubrication



An ounce of FULCRUM is worth a pound of ordinary gun and reel oil. Don't put guns away without first protecting them with FULCRUM. Lubricate all reels before use. FULCRUM will not evaporate, gum or get stringy. Lasting lubrication and protection against corrosion. Big, ounce bottle — \$1.00. At dealers — otherwise postpaid. (\$1.25 refunded if not best you ever used.) 8-oz. Economy size for boats and club use — \$6.50

FULCRUM OIL CO., 1139-E Liberty, Franklin, Pa.



**"Why do it the hard way?  
Get the new Actionglas!"**

● Perfect casts come easy with *Actionglas*—the solid glass rod with *live action*!

It has the perfect balance you want . . . lighter, faster, stronger than any rod you've tried! Moisture can't hurt it—won't rust or take a set!

Your favorite sports store has the new *Actionglas*. Your choice of lengths from 3'7" to 6'1". \$8.95 to \$25.00

ORCHARD INDUSTRIES, INC., DETROIT, MICH.

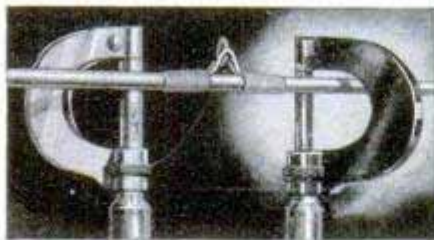

**Micro Tapered**—for strength where you need it, action where you want it!

**Actionglas** is also available in spinning, trolling and fly rods. Solid steel Actionrods from \$3.50 to \$23.50



**Actionrod**

SOLID GLASS WITH LIVE ACTION

moderate price, he cannot market much of it in such a way that drivers can profit. The chief reason is public prejudice against a "second hand" product—a stigma which limits its sales and relegates it to the bottom of the price ladder. On the other hand, much re-refined oil appears on the market through various channels at top prices, since small businessmen often find life simpler if they don't start price wars with giant competitors. Says Worthington, "I would like to sell re-refined lube as good as 40-cent premium for 25 cents a quart and tell the drivers what they are getting. But this would take a big educational campaign and I can't do it alone."

There are only a few dots on the map where drivers can buy back their cleansed oil economically. There are small processors like the Strecker Oil and Solvent Company of Cincinnati, which re-refines about 275 gallons of oil a day and sells it to drivers and filling stations for half the price of virgin oil. But this is exceptional. Probably 99 drivers out of 100 have no chance to buy their oil back and have never heard that it is worth recovering. Although this salvage of wasted wealth has increased fourfold in the last decade, everyone profits except the private-car owner. He pays for the oil, throws it away after one use and lets those who know its value reap the harvest.

Some of the distrust of reconditioned oil is justified because of the sloppy practice by certain operators in the haphazardly mushrooming industry. Leading re-refiners agree that they need a national association to set standards and teach the public the facts about oil's indestructibility.

Today, less than one tenth of the great river of lube oil is being recaptured and sent back to work. Making allowance for drainings in thinly settled areas where collection might be too costly, the harvest of this wasted national asset would eventually rank in importance with the discovery of a new oil field. For we are dealing, not with a single reuse, but with a repeated cycle of use and reconditioning, until nothing is thrown away but impurities.

During the war, large quantities of lube oil were reconditioned in Sweden, England and Germany. In Sweden, where these plants had been operating for years under government authorization and inspection, wartime motorists who turned in their used oil for re-refining were allowed extra oil above their rationing allowances.

We are now importers of petroleum and our domestic oil reserves are limited. Even if it didn't mean dollars in everyone's pocket, the rich, black river should be harnessed in the interest of national security.

**Low-cost,  
portable  
woodworking  
shop!**



Prices **\$195** include motor and switch  
start at

f.o.b. Norwalk, Ohio  
(subject to change without notice)  
**Easy time payments!**

# DELTA® MULTIPLEX

It's a



Rip saw



Tilting-arbor saw



Variety saw



Miter saw

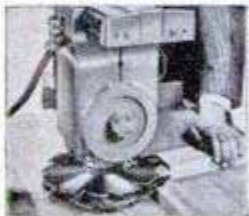

Tenoner

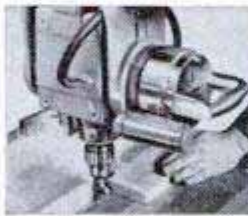

Shaper

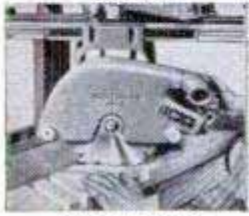

Dado machine

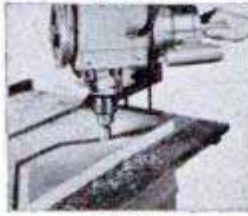

Router

**Exclusive Double Radial Action gives you unequalled capacity and more flexibility!**

**Only 2 movements — instead of the outmoded 3:**

Track swings for miter or rip



Motor tilts for bevel

Helps you meet rising labor costs and unskilled labor problems with these outstanding economies:

1. Reduces your investment — does the work of many tools.
2. Speeds up materials handling — you adjust the saw to the material, not the material to the saw.
3. Reduces set-up time — only 2 simple adjustments.
4. Speeds Cutting—you get production-line efficiency by gang-cutting.
5. Steps up day's output — reduces operator fatigue.
6. Reduces waste — accuracy helps eliminate scrap losses and extra finishing operations.
7. Saves floor space — you can use a Delta Multiplex flush against the wall.

Ask your Delta Multiplex dealer for a power demonstration — or see the new sound movie he can show you. Write for new catalog, "Unlimited Applications."



Look for the name of your Delta dealer under "Tools" in the classified section of your telephone directory.

**POWER TOOL DIVISION**  
**Rockwell**  
Manufacturing Company

802E E. Vienna Ave., Milwaukee 1, Wis.

# UTICA MagneKit

## with Magnetic Tool Holder



3 high quality service tools. A balanced trio that performs a multitude of jobs. With powerful magnetic holder. Ideal for workshop, garage, kitchen, tool house.

3 professional-type tools, plus permanent magnetic holder—

**\$5.85**

Your dealer has them or can get them for you.

You can CUT • PUSH • PULL  
BEND • GRIP • TURN • HOLD • TWIST  
LOOSEN • TIGHTEN • SQUEEZE  
STRAIGHTEN • JOIN • FASTEN  
almost anything in and around  
the house with the Utica MagneKit.

**UTICA** DROP FORGE & TOOL CORPORATION  
UTICA 4, NEW YORK

It pays  
to buy



quality  
tools



**NON-SINKABLE! BLOW 'EM UP  
FLOAT-EES SWIM TRUNKS**  
Swim with Ease with greater safety  
WON'T TIP you upside down\*

Air in Lungs  
BALANCES  
THEY Air on Hips  
FLOAT  
YOU



pontoons and hose  
INVISIBLE  
when worn

\*U. S. Gov't.  
Army, Navy, —  
Swimming Coaches  
Champs proved this  
in Scientific Test. (cutaway view)

**FLOAT-EES:** Smartly Styled Boxer Trunks, concealed pockets with plastic pontoons can be inflated in or out of the water. With these trunks beginners LEARN to SWIM RAPIDLY, swimmers can relax, have fun and swim distances with EASE.

**BLUE—TAN—MAIZE—MAROON**

Men's Sizes.....30 to 44 at \$6.95 each

Boys' Sizes.....6 to 16 at \$5.95 each

Also can be worn by women with bra.

State Color, Size, 2nd Choice. Send Check, M.O., C.O.D.

**FLOAT-EES CORP., Dept. M11**

247 WEST 38TH STREET, NEW YORK 18, N. Y.

## Mystery Men of the TV Screen

(Continued from page 86)

a rock to be blasted. There was to be a flash, a big bang and the prop man was to pull the rock away under the ensuing smoke screen. The sound man's cue was the flash—only the fuse blew out. There was no flash, bang or smoke. A puzzled audience simply watched the rock being hauled away mysteriously by the prop man.

Video boners are not all in the sound department by any means. Johnny DeMott once had three "windows" made of resin wax and sugar candy, so the actor could take two practice dives through it before jumping through the third one from the "sixth floor" on show night. Actually, he landed on a mat right behind the set. He did nicely in rehearsal. But when the real thing was done, he dove through and, instead of lying on the mat, casually stood up and walked off, forgetting he was still in full view of bewildered fans.

Every studio has its share of galloping horrors brought on by video's still experimental striving for effects. NBC engineers constructed a clear-plastic water tank into which Milton Berle was to climb, in his underwear, to test a fountain pen. Everyone forgot that studio lights average about 1400 degrees temperature. By the time Berle climbed in, the water was slightly under a simmer. Stagehands and page boys formed a bucket brigade to the water cooler, while Berle boiled. He looked like a well-done lobster when he climbed out.

But nothing can match the NBC blush that occurred when Lanny Ross was to appear for an ice show in an 8:30 telecast. Eight-thirty arrived, and there was Lanny, sitting on the edge of a barren network of freeze pipes. "Sorry," said Lanny, "No ice—see you later." This went on until 10:30 while frantic plumbers and studio hands bustled around trying everything from prayers to Dry-Ice to make the water congeal. They finally succeeded and the show went on two hours late.

Men like Fred Coe, Johnny DeMott, Al Ostrander and many others are philosophical about these things, however. "We'll never find out what we can do in television unless we try things," they'll tell you. "We're still adapting ourselves to the pace of new shows every week and we seldom see a script more than four or five days before it has to be produced."

They all feel that they've only scratched the surface. "Television," says Fred, "has an advantage of visual immediacy over every medium in existence. As soon as we're out of our swaddling clothes, the possibilities will be endless."



**FISHERMAN'S FLY AND BAIT MAKING KIT**  
Everything you need for making tempting lures and baits. 2 lbs. No. 437. Per Kit..... **\$5.00**

**CLINOMETER**  
**SHOWS DEGREE OF INCLINE**  
The pendulum acts as a plumb bob. It swings back and forth over a calibrated scale that shows you the degree of incline. Use on ships to show amount of roll—may be used for any purpose where it is desired to determine the degree of incline. Plastic body 12 x 7 inches. Brass pendulum in black finish. Shipping weight 3 lbs. Stock No. 393. Each only..... **\$3.95**

**GENIE HANDCRAFT TOOL KITS**  
An amazing array of fine handcraft tools for carving, cutting, punching, drilling, sawing, filing, etc., in wood, plastic, soft metal, leather, cloth, cardboard, etc. Each set includes one or two tool holders with positive grip vise chuck, plus an assortment of tools. Small set includes 4 assorted cutting tools. Set No. 442 includes cutting blades, hole punch and saw. Large set includes all knives, saws, plus drills and hole cutters. Sets are attractively boxed in solid wood box.  
No. 441—Beginners Set. Set of five tools and handle. Each..... **\$2.95**  
No. 442—Advanced Set. Has handle, extra chuck and 11 tools..... **\$6.50**  
No. 443—DeLuxe Set. Has 2 handles and 22 tools. Each..... **\$9.95**

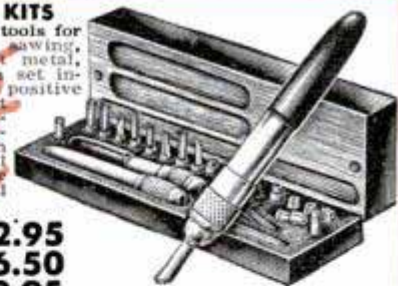

**TRAILER UNDER-CARRIAGE**  
**OVERSIZE TIRES**  
Build your own trailer for boat, camping gear or delivery service. Fitted with 26 x 12 1/2" V.S. Royal Tires. Motorcycle type wheels. Solid steel axle, leaf type springs and body mounting brackets. All brand new! Hitch not included. Folds to fit trunk of car. Shipped express collect only.  
No. 199..... **\$18.95**

**U.S. WAR SURPLUS AND HUNDREDS OF OTHER BARGAINS**



**WAR FAMOUS ALL PURPOSE LIFE BELTS**  
**THE BELT OF 1000 USES**  
Invasion Life Belts purchased from the Navy—all brand new—all guaranteed water-tight. Made of heavy rubberized fabric with two independent air chambers for double safety. May be inflated orally—or automatically with sparklet cartridges. Positive acting valves retain or release air as desired. Belt is adjustable to all body sizes.  
**ALL NEW—AIR TIGHT**  
These belts cost the government many times the low price we are now asking. And remember, they are all brand new and perfect. You'll find hundreds of uses for them. Use them as a life belt when swimming. Use them like an auto inner tube for playing in the water. Lash them to the sides of your canoe as stabilizers. Lash two or more together for a raft. Slip two or three into a cover for an air mattress. You'll find hundreds of other uses for them also.

**BRAND NEW!**  
and only **\$1.00**

**HAND MICROPHONE**  
Top quality hand microphone with control button in handle. Highly sensitive. Has rubber covered cord and tel. plug. Fine for use on home recorders, public address systems, etc. Specially used perfect. Shp. wt. 2 lbs. Stock No. 170. Each.... **\$1.95**

**G. I. PISTOL BELTS**  
Of heavy canvas webbing. Adjustable. Buckled all around. Used but perfect. Wgt. 2 lbs. No. 132, Each..... **98c**

**BELT AND SHOULDER HOLSTER**  
Of heavy cowhide. U.S. Gov't issue. Slightly used but perfect. Specially wanted when ordering.  
No. 900—BELT  
No. 901—SHL'DR.  
**\$1.95**

**OXYGEN TANK**  
Loaded with aviators' breathing oxygen at 1800 lbs. pressure. Tank 10 1/2 x 1 1/2 with rounded ends. Brass fittings. Shipped express only. Wgt. 13 lbs. No. 390, Each..... **\$3.50**

**BRAND NEW B-4 FLIGHT BAGS**  
A sensational buy—brand new, 1950 models, made to Air Force specifications of rugged, plastic impregnated green fabric—rifle-proof, water-proof, rip-proof. Bag excels in pockets measures 24 x 18 x 6 inches. All around zip per opens bag to 3-stuff wardrobe in a jiffy or included. Big outside pockets with full length zippers. Built to take years of knock-about service. Use it for travel, vacationing, hunting or what have you. It's the buy of a lifetime at this special sale price. Shp. wt. 11 lbs.  
Stock No. 438  
EACH ONLY **\$25.00**



**SPARKLET CARTRIDGES**  
Use for automatic inflation of life belts. Belt holds two. May be released together or separately. Furnished in standard boxes of 10. Order a supply with your belts.

**10 FOR 50c**

**ORDER NOW**  
Order your belts now—be ready for the mid-summer season of boating, bathing and other outdoor activities. Buy some extras while this low price is in effect.  
No. 1261  
EACH, **\$1.00**  
ONLY.....  
SIX for only..... **\$5.00**



**ORDER DIRECT FROM THIS AD**

Values galore! Hundreds of hard-to-find items for home, shop and outdoors. Make remittances by money-order, bank draft or personal check. Send 25% deposit on C.O.D. orders. No C.O.D.'s on orders for less than \$5.00. Include sufficient postage on parcel-post orders—any overage will be promptly refunded. All quotations F.O.B. Chicago. Used items and materials are guaranteed serviceable and as described. Your money back if not more than satisfied.

**NEW CATALOG** Now Ready—Send **10c** To Cover Postage and Mailing  
**STARK'S** Dept. PM-5  
509 S. STATE ST. CHICAGO 5, ILL.

**WIRE CUTTER**  
Heavy duty compound leverage. Cuts up to 1/4 inch wire. Upper jaw acts as tender to cutting edges. Insulated handles. Ideal for farm fence work and shop use. Shp. wt. 2 lbs. Stock No. 392—Each... **\$1.95**



**7 LB. EXPERIMENTERS PARTS ASSORT. KIT**  
Valuable radio and electronic parts by weight—resistors, trimmers, condensers, capacitors, etc., plus stamped out metal chassis. Shipped in chassis form with parts ready to dismount as needed. A real bargain surprise package.  
No. 130R—7 lbs..... **\$1.79**

**SILVERED OPTICAL PRISMS**  
Solid glass, with silvered facet precision ground and polished—5/16" long, base 2 1/2 in. wide, sides 1 1/4 inches. Free from scratches, abrasions and imperfections. Use in any type optical system—photography, telescopes, etc. Weight each 3/4 lb. A \$25.00 value.  
Stock No. 556. Each... **\$2.00** Four for **\$5.00**

**ARMY SLIDE RULE**  
An accurately calibrated slide rule with two extra slides—of range for artillery fire. Measures 18 x 3 inches. Provides for wind direction, deflection, trajectory, etc. Shipping weight 2 lbs. No. 544. Each only..... **\$2.50**

**Type A2 LEATHER JACKET**  
The leather coat buy of the year! Brand new Army Air Force Type A2 with full length zipper, shoulder straps, knotted waist band and wrist and cuff satin lining. With our collar—loose tailoring. Order by chest size. Shp. wt. 5 lbs. No. 201—Each **\$19.95**

**ELECTRIC MOTOR**  
Small but powerful. Shaded pole type, designed for the application. 1 1/2" x 60 cycle. Has 1/4 inch shaft, one inch long. Operates at 3050 RPM under no load, 2500 RPM under 1.35 oz. inches load. Full load current .6 amp. Mounting bracket included. Ideal for use on toys, window displays, etc. Shp. wt. **\$1.95**  
1 1/2 lb. No. 555—Ea. only





If you suspect you've been using too much oil, find out with your summer change. Switch to Pennzoil, the 100% Pennsylvania oil that lasts longer, grade for grade.

Over 60,000 better dealers recommend Pennzoil—easy to find at the familiar yellow oval sign. Sound your Z for the genuine.



Member Penn. Grade Crude Oil Assn., Permit No. 2

**TOUGH-FILM PENNZOIL® MOTOR OIL & LUBRICANTS  
AT BETTER DEALERS... COAST TO COAST**

## Trains in the Trackless Arctic

(Continued from page 129)

themselves. Heavy breathing may frost-bite the lungs and result in gangrene. Perspiration freezes clothing as hard as a cake of ice and, unless removed quickly in a warm place, this can cause pneumonia or freezing. The normal shock of a wound concentrates the heat of the body in that area, while the rest of the body freezes.

Speed of freezing is almost incredible. The project engineer was chopping a water hole in the ice one day when the reading was  $-57$  degrees. His pick slipped, fell into the hole and jammed below the water line. As he reached in and pulled it out, ice formed right down his gauntlet.

"Operation Arctic" is not just a matter of battering sled trains across the country willy-nilly. Far in advance of last year's 500-mile test trek, reconnaissance planes scouted the area. Trails were marked out. The country is divided about 50-50 between lakes and dry land or "portage," so the trains must often wait until ice is thick enough to carry the weight of 15 to 18-ton tractors and 10-ton sleds. About 24 inches is considered safe; 40 desirable.

Ahead of the trains, tractors beat the trail. Occasionally, they stop to bulldoze trees which are used to "corduroy" boggy muskeg or to bridge gulleys and streams. Frequently, plows are hooked on front to scrape snow from a frozen lake surface, not only to expose cracks but also because ice will freeze deeper and faster if it's not insulated with a snow blanket.

Across rough portage, men riding advance-guard tractors sometimes "high-road," or pack the trail, by riding back and forth over the soft snow.

Ice on natural waterways is at once a help and hindrance. It is smooth and fast, but treacherous, and a good sled-train man must be an ice expert. "We know," says one veteran, "that sea ice is badly cracked up from the hinging action of tides. Rivers and streams are fine if they're frozen through—but running water beneath may cut thin spots and leave air holes. For safe riding, give us dark blue or black lake ice, laced with tiny "healed" cracks. Good ice pops and booms continually, and when it crackles like popcorn as the vehicles ride over it, we all breathe easily. It's sound as a nut."

The most spectacular horror on lake ice is rarely dangerous. During spring thaw, the ice becomes "candled" or shot through with holes. As the heavy vehicles move over it, their weight presses it down and water geysers up 20 feet in the air all

(Continued to page 262)

**MAKE YOUR ELECTRIC DRILL  
A CIRCULAR SAW!**

**Save time . . .  
Save work . . .  
Save money**



• Right-angle drive with oversize guards is supersafe, perfectly balanced for one-hand use. Attach it to any drill 1/4" and up, in seconds. Full 1 1/8" cut, handles 2" stock by turning over. Machined cutting guide for extra accuracy.

Oilite bearings, sealed gears for longer life. Complete with 4" high speed steel saw blade.

Money-Back guaranteed . . . . . only **\$7.95**

Dealer Inquiries Invited  
POSTPAID—SEND CHECK OR M.O.  
C.O.D.'s ACCEPTED—POSTAGE EXTRA

**GLEAM PRODUCTS (Dept. P-5) Whitestone, L.I., N.Y.**

**BUILD YOUR OWN 5-ROOM HOUSE**

**\$2500**



Price includes lumber, millwork, doors, windows, glass, hardware, roofing, etc. Immediate shipment. Build it yourself and save up to \$3000 or more. Simple step-by-step building instructions furnished. SEND 50c TODAY for Plan Book 149 showing 21 MODERN HOMES—38 FLOOR PLANS with estimates for pre-cut or custom-assembled materials.

**SUPERIOR HOMES, INC.**  
330 CROWDER BLDG. JACKSON, MISS.

**BUILD FINE GRANDFATHER CLOCK NOW**

The simple sensible Red-i-Kut way as thousands have—**SAVE HALF. SHOP TESTED PLANS "SPIRIT OF THE CENTURY"** Narrow waist 8 3/4" tall or stately straight side **"SPIRIT OF AMERICA," EASY-TO-FOLLOW** photopack PLANS tell all—plus **BROCHURE** of heavy brass weight Westminster, tube chime, movements, gongs, dials, 3/4" solid mahogany case kits. Send \$1.00 today—Both Plans \$1.50 NOW.

**KUEMPEL CHIME CLOCK CO., #8 Kuempel Bldg., Minneapolis 16, Minn.**

**STANDARD GARDEN AND TRACTORS**

**RIDE-WALK** Powerful Gas Tractors for Small Farms, Gardeners, Florists, Suburbanites, Fruit and Poultrymen.

1 & 2 Cylinders  
Rubber or Steel Tires.

**Plow  
Seed  
Cultivate  
Mow Haul  
Belt Work**

**Easy Terms — Free Catalog**

**STANDARD ENGINE COMPANY**  
MINNEAPOLIS, MINN. NEW YORK, N. Y.  
3221 Como Avenue 617 West 26th Street

**MODERN LAWN MOWER SHARPENER**

**FOR LAWN MOWER SHOPS  
FIX-IT SHOPS  
GOLF COURSES • PARKS  
101 OTHER JOBS**



Sharpens All Reel Type Mowers • Hand, Power or Gang • 10 to 20 Minutes • No Dismantling • No Extra Attachments Needed.

All reel type mowers, from 5-inch edgers to 36-inch power mowers, are quickly sharpened to extreme ends of both left and right twist blades.

Handle, wheels, roller and motor remain in place when sharpening is in process. Bed knife is sharpened in same brackets. Grinding head rides on five ball bearing races. Easy to operate.

Also sharpens chisels, joiner knives, planer blades. Big profit maker. Own your own business. Send Today for **FREE Illustrated Bulletin No. 10-C**

**ORDER NOW**  
Immediate Delivery

**MODERN MFG. CO.** 160 N. FAIR OAKS AVE. PASADENA 1, CALIFORNIA

PRICE \$241.50 less motor  
\$263.00 with motor

**STOP FAUCET LEAKS PERMANENTLY**

with the **SNAP-IN HOME FAUCET REPAIR KIT**



**It's Simple**

for anyone to fix a faucet with the Snap-In Home Faucet Repair Kit and Snap-In Swivel Washers and Monel Metal Seats. Installed in a jiffy! Just snap the patented Snap-In Washer into the end of the faucet stem as shown here! Hold the seat with the Snap-In seat holder and tap into place!



**Stops Leaks Permanently!**

Snap-In Swivel Washers last 20 to 30 times longer than ordinary washers. Snap-In Monel Metal Seats are so highly resistant to water erosion that our knowledge none has been replaced. Reaming and re-facing unnecessary! Millions in use. Preferred by leading institutions and industrial firms for over 16 years. Kit, complete with tools, washers and seats only \$2.80. Ask your dealer! If not yet available rush \$2.80 (check or money order) for your kit today! Sent postpaid.

**SATISFACTION GUARANTEED.**

**Jobbers' and dealers' inquiries welcomed**

**SNAP PRODUCTS CORP.**  
Dept. 5PM, 153 W. Hubbard St., Chicago 10, Ill.

**CHAMPION V-GLOW PLUGS**

for model engines only



**CHAMPION TERMINAL**—assures better center electrode seal and provides sturdier electrical connection.

**CHAMPION-CERAMIC INSULATORS**—proved dependable in millions of Champion Spark Plugs.

**CHAMPION SILLMENT SEAL**—prevents excessive compression leakage between insulator and shell.

**CHAMPION "THERM-O-FLEX" CONSTRUCTION**—longer element life, more dependable performance.

Follow recommendations of plug types and fuels approved by engine manufacturer.

**CHAMPION SPARK PLUG COMPANY, TOLEDO 1, O.**

**Faster than 10 pairs  
of hands!**



PORTER-CABLE

**Guild**  
A-2 SANDER

only  
**59.50**

f.o.b., Syracuse, N. Y.

**Wt. 9 lbs.**



**Removes Paint Faster . . .** Powerful motor and high belt speed make the work easy.



**Plane-Sands Faster . . .** Perfect for taking off stock to dimension.



**Prepares for Finish . . .** Sands uniformly smooth, fine surface. No waves. Levels perfectly. Cleans blemishes.



**Speeds Screen, Sash and Door Fitting . . .** And gives you a workman-like job.

Guild A-2 Sander has the speed that gets the job done *fast*. Its power relieves operators from "bearing down" for efficient cutting. Its lightness and balance insure effortless handling, in any position. High speed abrasive belts have grits for wood, composition, plastics, metal, glass. Gives a smooth, straight-grain finish — no swirls, no gouges. Takes off paint and varnish in a jiffy — without scraper or messy removers. An easy-to-adjust Bench Stand (extra) converts Guild A-2 Sander into a grinder for tools and knives — also into a machine for squaring, rounding, smoothing butt and mitre joints. See Guild Sander at your hardware or tool supply dealers today — or send in coupon below.



Bench Stand

**Other Guaranteed Guild Electric Tools**



**SAWS**  
(3 sizes)



**PLANE**



**ROUTER**



**COMBO-TOOL**

Send me literature on the Guild A-2 Sander, Bench Stand and other Guild Tools. Also name of my nearest dealer

Name .....

Address .....

City .....

State .....

**Porter-Cable Machine Co.**  
2285 N. Salina St., Syracuse, N. Y.

around. "It's frightening, but harmless," the men explain, "as long as the ice is thick enough."

But the cannon-shot sound of a big contraction crack opening under the train is another matter. Even good lake ice has its hazards. Though 40 inches thick in the center, it may be dangerously thin around the edges. Deceptive shell ice, formed by overflow water that has receded and left an air space underneath, looks sound but won't support anything. It must be smashed out by tractors so the trains can ride on the sound ice supported by water beneath it.

Cracks are worst of all. Expansion cracks, caused by pressure, sometimes rise 15 feet in the air. They must be mounded and smoothed over.

What happens if this isn't done? "As the tractor straddles the crack," explains a veteran Army trooper, "the ice breaks away in two big triangular-shaped pieces fore and aft of the vehicle. Slowly, the pieces open downward, like a big trap door, and majestically lower the machine into the lake—while the driver jumps. Some record leaps were made last year, and it's one reason we like tractors without enclosed driver seats. After dumping the equipment to Davy Jones, the ice then rises slowly back into place, as though someone had pushed another button—presto, no tractor, and the door is shut!"

This happened to one train in 40 feet of water when the mercury stood at 50 below. There was only one way to retrieve the equipment. While the ice over the drowned tractor was broken away, several men stripped naked, covered themselves with grease, and dove in with grappling hooks! This may seem rough, but it has been done many times by commercial haulers. Actually, the water is much warmer than the air. If it wasn't, it would be frozen.

To avoid such polar-bear-club antics, every sled train has its reconnaissance vehicles, continually scouting the area ahead.

For this work, the Army uses a 12-passenger beetle-bodied half-track with four tired bogey wheels, and skis on the front end for turning. In soft snow, it cuts around like a skittering bug. On ice, a good driver has special techniques to make it swing. The vehicle is speeded toward the turn, skis chattering like machine guns. Then, on the instant of turning, he jerks his foot off the gas, throwing the weight of the vehicle forward and down on the skis. They bite into the ice and around she goes.

Also used for reconnaissance is the snowmobile, which looks like a tin box on tank tracks. Four bogey wheels on each side,

(Continued to page 264)



**...speaking of the really hot days in  
JUNE, JULY and AUGUST, my home workshop  
seems the coolest part of the house**



When the temperature is in the 90's, there's nothing like leisure moments spent in a home workshop to take one's mind off the heat—a relaxing hobby is the "key" to hot weather comfort.

Try it, this year—you need not be an expert. As to what to make—there are many interesting and useful projects in the CRAFTSMAN section of every issue of POPULAR MECHANICS.

No home is complete without the constructive economies offered to the whole family by the ownership of tools. The latest, and best available tools are regularly advertised in POPULAR MECHANICS—you can shop for your needs right in the pages of this issue!

*Power tools* are particularly suitable to hot weather home workshop activity . . . a *lathe*,

*band* or *bench saw*, etc., require practically no physical effort to operate, yet completely occupy hand, eye and—most important—mind.

However, a word to the wise: If you install a workshop, complete with power tools, now—there will be less broiling on the beach, less idle sitting, sweltering, this summer. It will prove difficult to lure you from what seems the coolest place in the house—*your* home workshop!

*Jim Ward*  
CRAFTSMAN EDITOR

P.S. I would be pleased to hear from you as to your experiences with summertime home workshop activity—why not write! Simply mark the envelope: Room 512.

JIM

**POPULAR MECHANICS, read by 3,528,000  
home workshop fans, SUMMER and WINTER**  
**200 EAST ONTARIO STREET, CHICAGO 11, ILLINOIS**

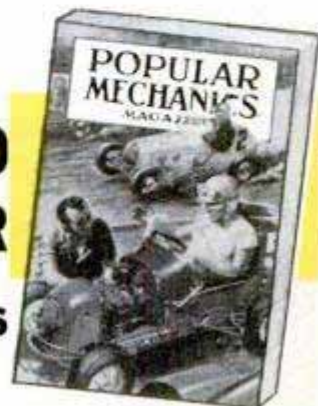

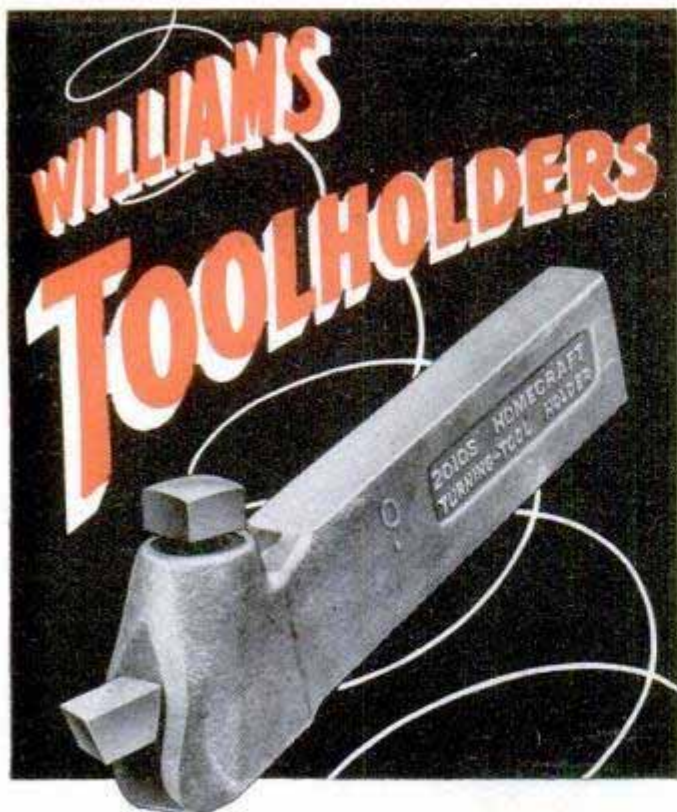

## "HOME-CRAFT" SET

for all regular  
Lathe Operations

Same in design, quality and performance as Williams Industrial Holders but smaller in size for lathes up to 10" swing. Set contains 8 Holders for Turning, Cutting-Off, Boring, Threading and Knurling. All drop-forged, specially heat-treated and hardened. Furnished with High-Speed Steel Cutters...supplied in steel case or mounted on wood panel. Special "Home-Craft" Holders also available for Carbide Cutters. Sold by Hardware Dealers, Automotive and Industrial Distributors. Write for Williams Catalog A60.

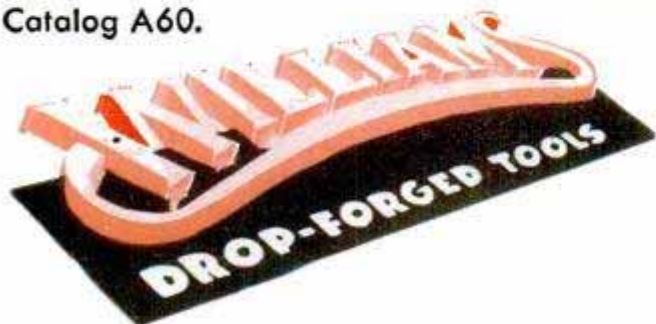

J. H. WILLIAMS & CO., Dept. M, BUFFALO, N. Y.

powered by a V-8 engine, spin the huge tracks and send the Penguin shooting over snow, ice, slush, mud, muskeg and rocks as though they weren't there.

On steep, slippery slopes where even the heavily grousered tracks of the big engines slip under the weight of the trains, the boys use two tractors and "walk" them up the hill. While one holds the load, the second will let out cable and move ahead to a firm footing, then winch the whole works up to it. While this one holds the load, the other moves ahead and repeats the process.

In crossing cracks, to avoid the extra ground pressure of the thumping, pounding tracks, a second tractor will move out ahead and drag the whole train across with the winch.

Little of the new arctic equipment broke down completely last year. But if it had, the T. C. Board had an answer for that, too. The traveling Army carried one of the most compact portable shelters ever devised. Its light, wooden frame pieces, forming a long, parabolic structure, were covered with eight-foot glass-fiber blankets, all of which zippered together to form a snug shelter 20 by 64 feet. A 400,000 BTU-per-hour oil-fired heater kept the shelter snug despite whipping gales and temperatures cold enough to frost your tonsils. That's pretty good when you consider the ferocity of arctic gales. On one particular night, when the wind rose to a howling 70 miles per hour, the shelter began to creep over the snow. It moved a good six inches before the men put a couple of 18-ton tractors against the inside of the windward wall. The shelter quit skiing almost immediately.

Late in April when the "road" Army returned to the base rail camp, they had chalked up a hatful of experiences. Some 30 of them had charged 2000 miles across arctic snow with 11 power vehicles and 35 sleds. They returned completely intact—not without some grief, of course. Twice, tractors had gone through ice, one carrying two sleds and a wanigan with it. But all had been successfully winched out. Sleds overturned, and once a wanigan went over, breaking the hand of a man riding on the roof. Since all trains carried a transmitter in one wanigan, word was sent "outside" and a Bombardier picked up the injured fellow within a week. Meanwhile, his broken bones had been beautifully set by the chief engineer, who became known as "Doc"—and later lived up to it when he fended off a case of appendicitis for several days until a plane could make a pick-up. He did it by applying ice packs which, he says, "were awfully easy to keep filled with fresh ice."

(Continued to page 266)

# BE A



# RIDER-DEALER

## SELL and SERVICE

## A Money-Making Opportunity



"The World's Finest Powercycle"

- 45% More Power
- Aluminum Cylinder
- Twist-Grip Control
- 3-Speed Foot Shift
- Super-Safe Brakes
- 100 Miles on a Gallon

In many communities—and yours may be one of them—there is an opening for a Servi-Cycle Rider-Dealer. You can make profitable sales simply by riding your Servi-Cycle to work and showing it to your friends. A brand-new demonstration machine will cost you less than \$200, Delivered, U.S. Tax Paid—ready to ride, ready to make sales. Write today for complete specifications, and full information about our liberal Rider-Dealer Plan. If you are established in business and would like to sell Servi-Cycle, write on your letterhead for our Distributor Plan.

**SIMPLEX MANUFACTURING CORP.**  
**540 N. Carrollton Ave., Dept. "R"**  
**NEW ORLEANS 19, U.S.A.**

### ZONA CRAFTSMAN'S SAW

\$1.50 P.P.



Designed especially for very fine work such as small joints, dovetailing, making perfect fits for inlays, mitre joints, all types of mouldings, including brass and aluminum; ideal for picture frames, etc. Cuts right to the line, no further sanding or finishing needed. Blade is of finest quality high carbon steel, only .015 inch thick. Indispensable to HOME CRAFTSMEN, finish carpenters and cabinet makers. Needs no sharpening due to hardened steel blade.

Precision mitre box for use with ZONA craftsman's saw—accurate floating head (Pat. Pend.) \$1.00 P.P.  
**SATISFACTION GUARANTEED OR MONEY REFUNDED — DEALER INQUIRIES INVITED**

*Western Arizona Sales*

8841 N. Central Ave., Dept. C. Phoenix, Arizona

### ★ GRAVELLY ★ TRACTOR POWER

ONE TRACTOR DOES 19 JOBS!



FOR YOUR SMALL FARM

5 HP

★ GEAR DRIVEN ★  
 A POSTCARD BRINGS CATALOG FREE!  
 2 SPEEDS FORWARD AND REVERSE

GRAVELLY MOTOR PLOW & CULTIVATOR CO.  
 BOX 563 DUNBAR, WEST VA.

## Be Your Own Boss



There's a great feeling to being in something for yourself, where all the profits go into your own pocket. American floor sanders make it possible for you to realize this ambition without special schooling or a big investment. Begin small and work up to as large an enterprise as you desire... It all depends on your ambition to get ahead.

Ask for "tell-all" booklet entitled "Opportunities in Floor Surfacing". Use coupon and enclose 25 cents in coin or stamps to cover handling.

### AMERICAN FLOOR SURFACING MACHINE CO.

535 So. St. Clair St. • Toledo 3, Ohio

Gentlemen:  
 Enclosed find 25c in stamps or coin for booklet "Opportunities in Floor Surfacing," telling me how I can start my own floor sanding business.

Name \_\_\_\_\_  
 Street \_\_\_\_\_  
 City \_\_\_\_\_ State \_\_\_\_\_



When you use pliers...

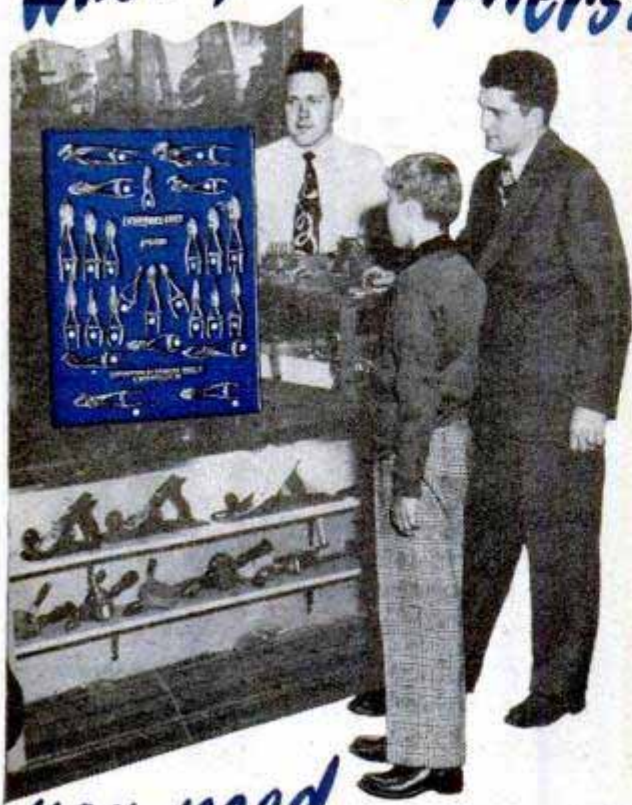

# You need CHANNELLOCK

There are lots of "fussy fix-it" jobs around the house that Dad, Mom or the kids can easily do when Channellock pliers are handy. No matter what—electrical, automotive, plumbing, battery, or anything mechanical—you need Channellock pliers.

Channellock's patented tongue and groove joint gives you these "plus" features: Greater Strength, Longer Wearing, Self-Cleaning, Closely-spaced Adjustments, Visible Adjustment, No Wear on Joint Bolt.

**CHAMPION DEARMENT TOOL CO.**  
MEADVILLE, PA.



Only

**CHAN NEL LOCK**



Send for Catalog  
C-14 today.

The frigidity caused a couple of weird accidents, the most unique when a man merely raised his arm and cracked a clavicle. It later developed that the bone had been broken before and was poorly mended. But why the sub-zero temperature made it break again, no one knows.

Back at base camp, the boys found that the railroaders had had their troubles, too, but without ill effects. Steam lines froze, batteries died, tires cracked and blew—but there were plenty of replacements. And the men used their ingenuity. When one of the steam-heated sewer lines froze, they loosened it up with an acetylene torch.

"The blowtorch," says the chief engineer, "turned out to be our most useful tool. You could make it broil a steak. We used it constantly to heat stew in the open. Simply tilt it under the pot and apply the burner. Some stew! Everything went in those pots—canned fruit, chocolate, meat, potatoes, frozen asparagus. It tasted like a rubber boot, but it was nourishing.

"That blowtorch heated frozen manifolds on engines. It warmed tools so they wouldn't freeze to our skin. It thawed ice crystals in the fuel lines every morning, and melted chunks of ice that tried to jam the engine tracks, winch gears and all moving metal parts."

With the help of the blowtorch, this six-foot man, with a voice like a foghorn, feels that the Arctic can't stop any American Army with know-how. "It's far from barren," he points out. "A man can live off the country if he knows that it's safe to take off his wet clothes and sleep raw in a good sleeping bag, to hunt for edible reindeer lichen under the snow, and fish through the ice for 32-pound lake trout which abound up there."

As you read this the Arctic Army has just returned from the 1950 trek. This year they had with them a new speedy cargo carrier. This vehicle is a modification of the World War II half-track, used by the Army for tank-destroyer units. The conventional track has been widened greatly to reduce ground pressure. Dual wheels in front are covered with contraction plates which are secured to the wheel between the tires. The cargo carrier can tote up to 6000 pounds. It will skim over the snow and ice at speeds far faster than the tractors.

With such ingenious modifications on standard equipment, and with the men at the drawing boards of the T. C. Board in New York Port of Embarkation devising new and better methods and equipment every year, we may soon be seeing some arctic automotive equipment that will beat anything on skis, skids or endless tracks which we have today.

# DREMEL DOES IT AGAIN!

## PRESENTING A POWERFUL COMPANION TO THE FAMOUS DREMEL MODEL "A" SANDER

Dremel's new Model 2000 gives you the finest finish sanding money can buy. For polishing too, this new machine is a superb performer. And now it's yours at the remarkably low price of only \$24.50.

### RUGGED DESIGN • POWERFUL PERFORMANCE FOR INDUSTRIAL, HOME, and HOBBY USERS

Consider these outstanding features: Die-cast aluminum housing with Bakelite cover; only two moving parts—requires no oiling; straight-line (non-rotary or arc) reciprocal action leaves no marks; 21 sq. in. sanding surface; cam-type holder permits changing paper in seconds; weighs only 5 lbs; over-all size 3 1/4" wide x 4 1/2" high x 7" long; 8 ft. Underwriter's Approved cord; operates on 110-120 V. A.C. Truly an indispensable machine for long and faithful sander-polisher service in industry, home or hobby.

### PRICE INCLUDES STURDY CARRYING CASE

Perfect portability of Sander, cord, abrasives, and polishing pads in this sturdy, 3-shelf metal storage case. Price also includes 25 assorted sheets Garnet Paper and a high-grade sheepskin polishing pad.

**WHERE TO BUY—** If your dealer cannot supply you, order direct from factory using handy coupon. Send full remittance and we ship postpaid. Or send \$2 now and pay postman balance plus postage and fee. Money back if not delighted after 5 day's trial.

DREMEL MFG. CO., Dept. 110-E, Racine, Wisc.



### DREMEL Model "A" SANDER-POLISHER

OVER 200,000 NOW IN USE!

A lighter-capacity model that takes all the work out of home or hobby projects. Meets requirements of most users. Same design and construction features as larger model. Furnished in attractive cardboard box. If your dealer can't supply, use coupon to order. \$14.85.



\$14.85

## New DREMEL Electric MODEL 2000 SANDER • POLISHER

ONLY \$24.50

WITH STEEL CARRYING CASE AND COMPLETE ACCESSORIES

14,400 Sanding Strokes per Minute



(Patented)



### USE THIS ORDER—If Your Dealer Cannot Supply You DREMEL MFG. CO., Dept. 110-E, RACINE, WISCONSIN

- Enclosed find \$\_\_\_\_\_ (check or money order) in full payment for items checked below.
- Enclosed find \$2. Ship items checked below C.O.D. I'll pay postman balance plus postage and fee.
- Model 2000 Sander \$24.50.     Model "A" Sander \$14.85.
- Send FREE Catalog of Dremel Tools

Name \_\_\_\_\_

Address \_\_\_\_\_

City \_\_\_\_\_ Zone \_\_\_\_\_ State \_\_\_\_\_

## NEW PACKAGED BOATS 1950 KITS



17 New models. Improved design, skiffs, outboards, inboards, sail boats, Tredronic racers, cruisers. 8 to 16 ft., exclusive features. Preamsembled frames, Tri-Keel construction, Tredronic bottom, full length spray rails, widest beam, simplified construction, easy to build. World's best boat buy! Send 25¢ for new 1950 literature, or send \$1.00 for literature, plus booklet "Plywood Boats."

### BOAT PATTERNS-BLUE PRINTS

1950 Catalog—over 100 modern designs by famous nava. architects. Racing classes, cruisers, inboard, outboard, sail. 6 to 35 ft. Plywood—Steel—Plank. Construction plans, full-size patterns. Send 35¢ for catalog or \$1.00 for catalog and helpful booklet on "Boat Building."

MARINE MART-DEPT. 24-BUFFALO 7, N. Y.



## Little Farmer powered cultivator

\$94.50

F.O.B. ORRVILLE, O.

At last, an effective powered cultivator in the low-price field. LITTLE FARMER is ideal for city or farm garden use. Compact design and fine balance make it easy to operate. Just right for narrow rows where larger equipment may damage plants. Write NOW for complete information. Dealer inquiries also invited.

The Will-Burt Co. ORRVILLE, OHIO  
Department P

## NEW Saginaw BALL-BEARING BUMPER JACK

- SAFEST, STURDIEST BUMPER JACK EVER BUILT!
- PRESSED-STEEL TUBULAR SHAFT—RIGIDLY ATTACHED BASE.
- SAME PRINCIPLE OPERATES AIRPLANE WING FLAPS.
- HANDLE CAN'T SPIN WHILE CAR IS IN AIR—FOLDS OUT OF WAY FOR STORING.
- FITS EVERY BUMPER. ROLLING BALLS REDUCE FRICTION—A CHILD CAN OPERATE IT.

AVAILABLE NOW THROUGH YOUR UNITED MOTORS DEALER OR USE THIS COUPON



United Motors Service, Dept. S-31  
General Motors Bldg., Detroit 2, Mich.  
Send me information about the new Saginaw jack, and where I can buy it.



## Caltech Super Greenhouse

(Continued from page 100)

In addition to the other growing rooms the building contains a fog and rain room, a wind tunnel in which plants may be subjected to breezes up to 20 miles per hour, a gas room in which the effects of smog or other atmospheric conditions on a plant may be studied, and a radioactivity room for conducting tracer experiments.

The laboratory's basic purpose is for studying the effects of climatic factors on the growth and development of plants. Optimum growing conditions for various species will be sought, as well as any changes that occur when particular plants are moved from their native environments to completely different climatic conditions.

Such effects can be measured only in the complete absence of any other conditions that might influence growth, and so elaborate precautions are taken to guard against plant diseases or pests. Doctor Went explains that an accidental infestation of a few plants might cost \$10,000 in re-sterilizing the laboratory, lost operating time and lost research time. As completely as possible the entire laboratory building is maintained in a sterile condition.

Insectproofing includes the use of springs to hold the glass greenhouse panes firmly against their aluminum supports, glass-wool plugs in all drainage holes that lead outside, and the sealing of all small holes and cracks. Windows are not intended to be opened but they are guarded nevertheless with fine-mesh wire screens. A slight positive atmospheric pressure is maintained constantly so that a breeze would blow outward in case a window should be opened. All ordinary air vents are covered with fine screen and the building has been ant and rodentproofed. Air enters the building through a single main air intake and is filtered and then sterilized.

As soon as the laboratory was built and equipped, it was sealed and thoroughly fumigated. Since then nothing has entered the building until after it has gone through a sterilizing treatment.

The tomatoes, peas and other experimental plants that are used are grown in trays or pots filled with sterile sand or gravel. They are watered by hand from overhead hoses and they are fed a standard nutrient solution that is drawn from a faucet in each room. Other nutrient solutions, each deficient in a certain mineral, are also available.

Called phytotron or plant machine, the laboratory is intended to fulfill the same function in the plant sciences as does the cyclotron in physics.



## OWN YOUR BUSINESS

### Start in Spare Time with a FOLEY SAW FILER

Here is a steady repeat CASH business you can start at home in your basement or garage, while you are working at your regular job. No experience is necessary to turn out perfect cutting saws—"the first saw I sharpened came out 100%. I think the Foley Saw Filer is a marvel of perfection," writes Clarence E. Parsons. Every saw you sharpen will bring you new customers. You will find you can make up to \$2 or \$3 an hour—\$20 to \$30 a week in your spare time as a starter.

With a Foley Saw Filer you can file all hand saws, also band and cross-cut circular saws. It is easy to operate—simple adjustments—no eye-strain. Patented jointing principle evens up all irregular teeth and makes an old saw cut just like new.

#### This Free Book

#### Shows How to Start

"INDEPENDENCE AFTER 40!" shows you how to get plenty of saws to file without canvassing, and how you can develop into a general repair shop that will be your own business. This is a helpful, practical book that tells just what to do—send for your free copy today. No salesman will call.



Send For **FREE BOOK**

FOLEY MFG. CO., 516-O Foley Bldg.  
Minneapolis 18, Minn.

Send me free book "INDEPENDENCE AFTER 40!"

Name \_\_\_\_\_

Address \_\_\_\_\_

# "Mister, You're a Genius!"



"A MATTER OF MINUTES AND YOU'VE GOT HER RUNNING LIKE NEW!" I TOLD THE MECHANIC.

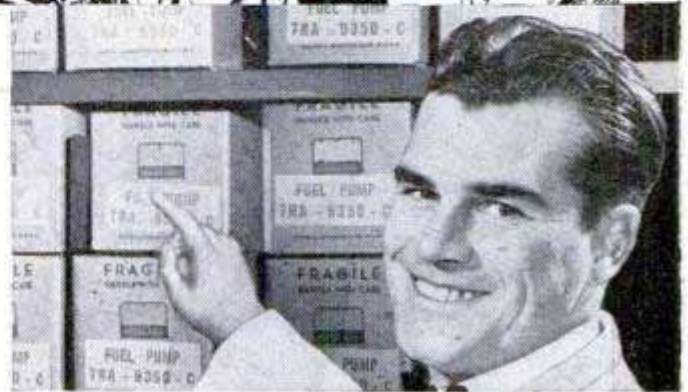

"THAT'S EASY," HE REPLIED. "WHEN YOU'VE GOT THE RIGHT PARTS, THERE'S NOTHING TO IT."

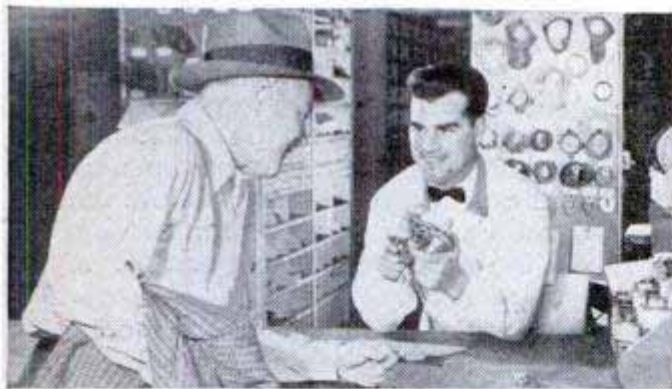

"RIGHT PARTS?" SAID I. "YES, GENUINE FORD PARTS," HE CONTINUED. "THEY'RE MADE RIGHT TO FIT RIGHT TO LAST LONGER."

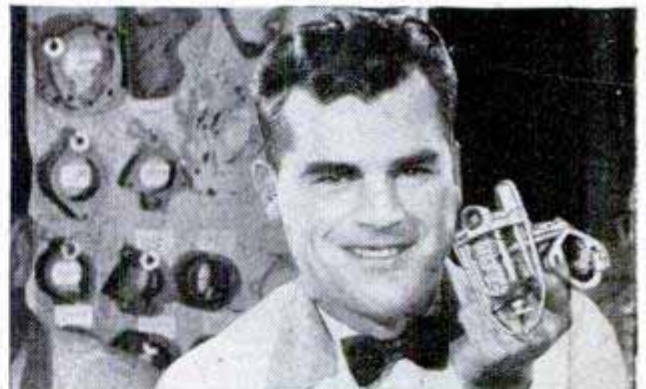

"AND, BECAUSE THEY'RE DESIGNED BY THE MEN WHO DESIGNED YOUR FORD, THEY SAVE YOU TIME AND MONEY."



"THAT'S WHY YOU'RE SMART TO LOOK FOR THIS SIGN (AT FORD DEALERS AND SELECTED INDEPENDENT GARAGES). AND ALWAYS SPECIFY GENUINE FORD PARTS."

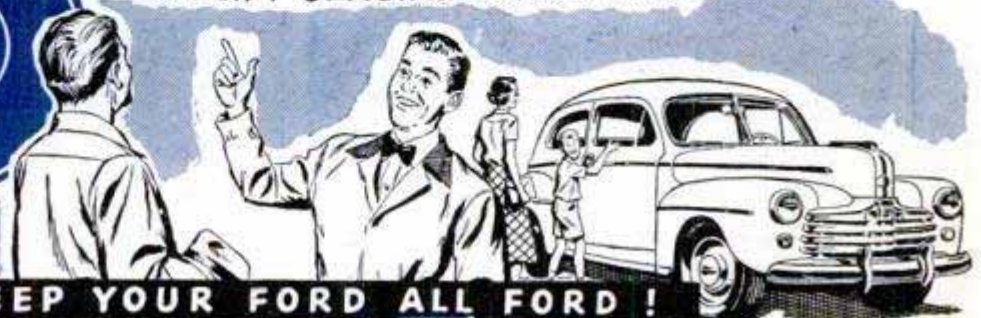

**KEEP YOUR FORD ALL FORD!**



Dependable under trying conditions, the Eskimo dog performs the hardest kind of work. Sturdily built, light in weight, he does the job that would otherwise fatigue his master.

## Dependable PERFORMANCE

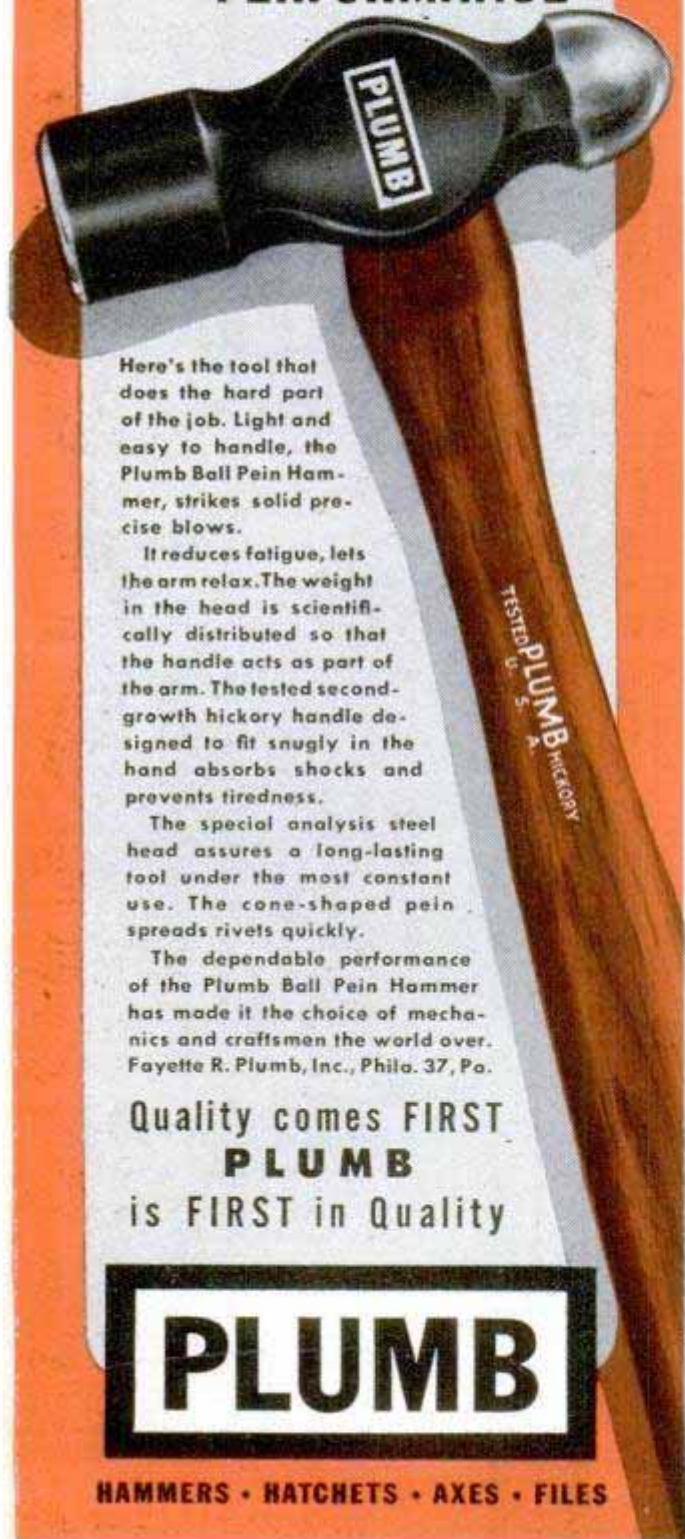

Here's the tool that does the hard part of the job. Light and easy to handle, the Plumb Ball Pein Hammer, strikes solid precise blows.

It reduces fatigue, lets the arm relax. The weight in the head is scientifically distributed so that the handle acts as part of the arm. The tested second-growth hickory handle designed to fit snugly in the hand absorbs shocks and prevents tiredness.

The special analysis steel head assures a long-lasting tool under the most constant use. The cone-shaped pein spreads rivets quickly.

The dependable performance of the Plumb Ball Pein Hammer has made it the choice of mechanics and craftsmen the world over. Fayette R. Plumb, Inc., Phila. 37, Pa.

Quality comes **FIRST**  
**PLUMB**  
is **FIRST** in Quality

# PLUMB

HAMMERS • HATCHETS • AXES • FILES

## The Impact of the Hydrogen Bomb

(Continued from page 97)

will never deliberately attack another nation. This fact is known to our potential opponents and they have taken, and will continue to take, advantage of it. It assures them that they will always have the choice of war or peace, and that if they choose war, they will have the choice of when, where and how it will be initiated. Our reluctance to protect our borders against aliens, no matter how undesirable they may be, greatly increases our vulnerability to saboteurs. And so does our apparent unwillingness, despite the wishes of the vast majority of our citizens, to drive communists and their sympathizers out of public and industrial life. Atomic-bomb parts could be brought in by enemy agents and assembled in spots most dangerous to us. It might be possible, likewise, for hydrogen-bomb parts to be brought in and assembled. Certainly, the assembled bombs, either atomic or hydrogen, could be brought into our harbors in enemy merchant ships and exploded without warning. Atomic or hydrogen bombs, hidden in our cities, could either be exploded without warning, or an ultimatum, disclosing their presence and demanding our complete and immediate surrender, could be issued.

The claim has been made publicly, by certain scientists, that the use of the hydrogen bomb could destroy all life on this planet, and by others that it could destroy the earth itself. I believe that in making these statements, these men were speaking of possibilities and extremely remote ones at that, rather than of probabilities. Personally, I am not alarmed by such gloomy prognostications.

Man's knowledge is constantly increasing. This advance in knowledge will soon lead, if it has not already done so, to weapons so terrible that no sane government would willingly plunge a nation into war when such weapons might be used against her. No one wants to touch a match to a powder keg to kill an enemy when such action will destroy himself as well.

The first half of the 20th century has seen war change from being essentially limited to combat on the field of battle between military forces in uniform. We have seen the beginnings of modern total warfare. We would be closing our eyes to the inevitable if we did not realize that in future wars, if we are so unfortunate as to have them, all elements of the populations of the nations involved will be precipitated into the struggle. Our military strength has become so increasingly dependent upon

(Continued to page 272)



ALL ITEMS BRAND NEW • UNCONDITIONALLY GUARANTEED • SHOP BY MAIL AND SAVE!

### EMERGENCY ELECTRICITY! 750 Watt • 115 Volt • 60 Cycle A.C. LIGHT PLANT

USE FOR:  
Home lighting,  
trailers, tourist  
cabins,  
hunting  
lodges, fire  
truck lighting,  
emergency stand-  
by units. Plenty of  
power for deep freez-  
er, oil burners, incu-  
bator, radio or lights.



(ITEM #86)

**GENERATOR:** Manufactured by Eleor, rated 750 Watts 115 Volts A.C., 60 cycles at 1800 R.P.M. Complete with volt meter regulator. \$249.00 value. These generators, built to exacting Signal Corps specifications, are the answer to your lighting needs.

**GASOLINE ENGINE:** Briggs & Stratton, Model AP, 2 1/4 H.P., 1800 R.P.M. Completely radio shielded, full accessories including air cleaner, muffler, starting rope, killer button remote control wire.  
Shpg. wt. 165 lbs. **139.00**  
Complete unit, \$249.00  
Value. NOW ONLY. . . . F.O.B. Chicago

**GENERATOR ONLY**  
Same as described above. Shpg. wt. 60 lbs. (Item #67)  
F.O.B. Chicago **59.50**

### WATEROUS PUMP

Rated 500 gallons per minute at 120 P.S.I. This high efficiency pump is designed for front end mounting on General Motors, Dodge, Studebaker and Ford trucks and comes complete with gear box and power take-off for easy mounting and attachment to crank shaft. Net weight of pump 500 lbs. Shipping weight 1200 lbs.  
F.O.B. Chicago. . . . . **149.50**

## ARC WELDER

STOP COSTLY  
REPAIR BILLS!  
WELD IT YOURSELF  
AND SAVE!

250 AMPS.—MODEL 252. DESIGNED FOR MANY YEARS OF TROUBLE-FREE SERVICE. FOR ANY WELDING JOB. LIGHT OR HEAVY.

This precision-engineered direct current ELECTRIC ARC WELDER is offered at but a fraction of its original value. It can be mounted permanently or easily transported for portable use. Does the job instantly, where and when you need it.

The War Surplus generators for these Arc Welders were built by General Electric, Westinghouse, and Delco-Remy at a cost of over \$300.00. They are light in weight, have oversized life-time grease-sealed ball bearings; air-cooled commutator; dial type rheostat for easy pinpoint control; high-low range switch; reactor coil for even arc; handles 1/16" to 1/4" rods. Run welder at 2500 R.P.M. from drive pulley or power take-off of tractor, a 7 1/2 H.P. electric motor or a 10 H.P. gas engine. Use two V-belts, or flat belt (on pulley). Continuous welding rating—200 amps.; intermittent rating—250 amps.; 0-30 volts. Now . . . AT A FRACTION OF ITS VALUE. Price includes double or flat belt pulley and instruction book. Ship. wt. 107 lbs. Only one or two jobs will pay for entire welder. F.O.B. Chicago (ITEM #65)



\$300.00 VALUE  
NOW ONLY

**99.50**

**ACCESSORY KIT** including welding helmet, electrode holder, two 10 ft. cables with clamp, and 5 lbs. of assorted welding rods.  
(ITEM #66) F.O.B. Chicago **10.50**

## GROBAN'S Guaranteed WAR SURPLUS BARGAINS

### VANE TYPE — MANGANESE BRONZE Insecticide Pump

For spraying DDT—2,4-D, sulphur compounds, arsenic, oil solutions, etc. Pressures up to 200 P.S.I. delivering 5 gals. per min. at 1200 RPM, 8 gals. per min. at 1800 RPM. Will not rust, pit, foul or freeze up. Standard 1" pipe thread ports. Rotation — either direction. 9"x6"x7". Shpg. wt. 10 lbs. Gov't acquisition cost \$42.00. F.O.B. Chicago NOW **15.00**

### Pneumatic Air Drills Used—Like New

Light, powerful, compact, pistol grip, trigger control. Ideal for shop use where air pressure is available.  
**ITEM #80—Ingersoll-Rand.** Equipped with 1/4" Jacobs key chuck. Overall dimen.: 6 1/2" long, 5" high, 1 1/2" thick. Wt. 3 lbs. F.O.B. Chicago. **14.95**  
**ITEM #81—Chicago Pneumatic, Larger Size, Model A,** equipped with 1/4" Jacobs key chuck. Overall dimen.: 7 1/2" long, 5" high, 2" thick. Wt. 4 lbs. F.O.B. Chicago. . . . . **19.95**



### PUROLATOR OIL FILTER Permanent Type

The perfect oil filter to keep your motor oil or hydraulic fluid clean at all times. Protect your pump or engine with this unit. Just turn the handle and the element is clean. Standard 3/8" inlet and outlet ports to accommodate 12 gallons per minute. Shipping weight 4 lbs. A \$15.00 Value.  
NOW **4.95** Postpaid



### Excellent Hydraulic VALUES!

Large supply of new labor-saving, economical hydraulic equipment in many types and sizes . . . including actuating cylinders, control valves, tanks, pumps, fittings, hose, and data on hydraulic applications. Use these positive, highly efficient, smooth pressure hydraulics on presses, arbors, lifts, brakes, plastic dies, auto frame alignment, etc., etc.

**LOGAN HEAVY DUTY  
HYDRAULIC CONTROL VALVE**  
Has built-in adjustable relief valve, will operate one double-acting hydraulic cylinder or two cylinders as one or a reversible hydraulic motor. Valve handle latches in neutral position. Made of rugged cast aluminum alloy. Open center unloads the pump in neutral position. Throttling control allows operator to regulate the speed of movement of the hydraulic cylinder or motor. Has removable mounting brackets with 4 bolt holes, 3/8" pipe thread connections. Overall dimen.: 12 1/2" H x 8 1/2" D x 8" W. Ship. wt. 17 lbs. Gov't. Acquisition Cost over \$100.00. An Excellent Buy. F.O.B. Chicago **21.95**  
(ITEM #37)

**LOGAN HEAVY DUTY  
HYDRAULIC PUMP**  
For operating hydraulic cylinders and hydraulic motors on tractors, bulldozers, construction machinery, lift trucks, industrial applications, etc. Delivers 8 GPM at 1200 RPM at 1000 P.S.I. using 5 HP. Has 1/2" pipe thread ports. Rotate in either direction. Also use as hydraulic motor. 3/4" shaft with flat and keyway for direct or pulley drive. Has flange with 4 bolt holes for convenient mounting. Ship. wt. 22 lbs. Overall dimen.: 7" L x 5 1/2" H x 5 1/2" W. A \$105.00 value. FOR ONLY. . . . F.O.B. Chicago **22.50**  
(ITEM #29)

**VICKERS HYDRAULIC TRANSMISSION**  
MODEL AA16801A  
Ideal for lathe drive, miniature cars, power machinery, gearing, etc. Rated 2 HP maximum input at 3750 RPM. Output speed continuously variable from 0 to 1/3 of input speed in either direction. Self contained reservoir. All controls external. Even power at all speeds. Complete with two 1/2" shafts with flat for pulley attachment. Shpg. wt. 20 lbs. Gov't. acquisition cost \$325.00. A tremendous value at (ITEM #85) F.O.B. Chicago **25.00**

### HAND HYDRAULIC PUMPS

Item #11— . . . . . **8.95**  
Postpaid. . . . .  
Item #83—Hand hydraulic pump with built-in transfer valve. Postpaid **12.95**



### Brand New GENERAL ELECTRIC 8" Sealed Beam SPOTLIGHTS

300 Watts, 110 Volts, A.C.-D.C.  
Has countless uses for • Homes • Garages • Workshops • Driveways • Outdoor advertising • Displays • Beach lighting • Private air ports • Photography. Wherever you need flood-lighting! Bought by the U. S. Army for signal use. This is the greatest surplus bargain ever offered.  
Lens, reflector and electrode vacuum sealed in one dustproof, air tight unit. 300 Watts, 110 Volts. Weighs only 2 1/2 lbs. List price \$10.50.  
A TREMENDOUS VALUE for . . . **2.75** EA.  
POSTPAID  
(ITEM #8) 12 or more 2.50 ea. postpaid



### Hydraulic Cylinders—Air or Oil

**ITEM #33C—Double action hydraulic cylinder, 1 1/2" bore, 4 1/2" stroke.** Clevis mountings at both ends. Uses 1/4" pipe fittings. Postpaid. . . . . **8.95**  
**ITEM #32—Double action, 1 1/2" bore, 9" stroke,** will lift 1760 lbs. in one second with Logan Pump. Wt. 4 lbs. A \$45.00 value. Postpaid **10.95**  
**ITEM #16—Double acting cylinder, 1 1/2" bore, 2 7/8" stroke.** (Will lift 1760 lbs. in 2 seconds with Logan Pump.) Wt. 8 lbs. A \$55.00 hydraulic cylinder value. . . . . **12.95** for only Postpaid.  
**ITEM #15—Double acting cylinder, 3" bore, 8 1/2" stroke.** All steel hydraulic cylinder, (will lift up to 7000 lbs. in 3 seconds with Logan Pump.) Wt. 12 lbs. A \$78.00 value, Postpaid **19.50**  
**ITEM #31—Double acting cylinder, 3 1/2" bore, 11" stroke.** (Will lift 9600 lbs. in 7 seconds using Logan Pump.) Wt. 15 lbs. A \$92.00 value. . . . . **22.50** Postpaid.  
**ITEM #6—Double action, 3" bore, 2 3/8" stroke,** hydraulic cylinder will lift 7070 lbs. in 5 1/2 seconds using Logan Hydraulic Pump. Especially suited for farm and construction machinery. Clevis mounting for easy use. Wt. 22 lbs. A \$145.00 value. . . . . **27.50** F.O.B. Chicago.  
**ITEM #42—Double action hydraulic cylinder, 4" bore, 18" stroke.** Rated lift capacity with 1000 P.S.I. input is 12,560 lbs. using Logan Pump. Ship. wt. 30 lbs. AN EXCELLENT VALUE for **32.50** F.O.B. Chicago.



**FREE: NEW 44-PAGE CATALOG**  
CHUCK-FULL OF SENSATIONAL WAR SURPLUS "BUYS" AND INFORMATIVE DATA ON HYDRAULIC APPLICATIONS.

ORDER DIRECT FROM AD. SEND PAYMENT OR PURCHASE ORDER, TODAY

GROBAN SUPPLY CO. 1507 SOUTH MICHIGAN AVE. Chicago 5, Ill. Dept. PM-5

# BUILD YOUR OWN POWER MOWER!

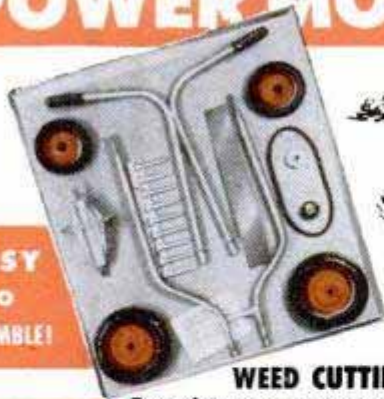

**EASY  
TO  
ASSEMBLE!**

**SAVE  
MONEY!**

**MAKE GRASS AND  
WEED CUTTING EASY, QUICKER**

We supply everything needed: Parts, engines, wheels, etc. to build all types of power mowers.

Complete mower parts kit for either gasoline or electric power. You can easily assemble this highly efficient mower in a few hours. We furnish instructions. Cut your lawn or field quickly at small cost. Does the work of far more expensive mowers. Factory appearance. From the world's largest manufacturer of rotary power mowers.

**WRITE TODAY! FREE INFORMATION!**

**J. G. DOYLE ENGINEERING CO.**  
526 CHERRY ST. DEPT. A KANSAS CITY, MISSOURI

## Is your **Hearing** worth a **3¢ Stamp?**

Discover a new way to HEAR AGAIN with startling clarity—by spending just 3c for a postage stamp! A way that may help you enjoy normal family and social life again . . . win new success and happiness. A way that's *easier* than you've dreamed possible.

### **FREE BOOK** Tells How to **Overcome Hearing Loss**

All you do is mail coupon for valuable FREE book. It reveals amazing secrets of how deafness can now be overcome, thanks to a tiny, new electronic miracle.

#### **No Button Shows In Ear**

Book tells how to hide deafness. Act now to discover what this new way to hear may do for YOU. Mail coupon today for your FREE book. No obligation.



**Beltone** **MONO-PAC**  
SYMPHONETTE  
One-Unit Hearing Aid

Beltone Hearing Aid Co., Dept. PM-5  
1450 W. 19th St., Chicago 8, Ill.

#### **MAIL THIS COUPON TODAY**

Beltone Hearing Aid Co., Dept. PM-5  
1450 W. 19th St., Chicago 8, Ill.  
Please send me FREE book that tells how to overcome hearing loss without a button showing in ear.

Name.....  
Address.....  
Town..... State.....

industrial strength that everyone, regardless of age or sex, will become in effect a part of the war effort. No one who has read the news accounts of the recent trials behind the iron curtain, or of our troubles in Berlin, or of the Russian slave camps, can have any doubt but that the Soviet leaders would do anything they thought might be to their advantage. Moreover, I believe that by now, the average American has become convinced that Russia cannot be depended upon to keep any promise. As long as a nation so ruthless and so opportunistic as the Soviet Union is at large in the international community, we can place little faith in the idealistic theories of many of the politicians of the peace-loving nations of the world. Let us borrow some, but not too much, of Russia's own realism and view the present situation as it is, not as we would like it to be. If we do this, we will not depend upon unenforceable agreements with the Soviets but upon ourselves, upon our military strength, upon our industrial strength and upon the strength of our American way of life.

The development of the atomic bomb has already had a profound influence upon the military thinking; much more so than appears on the surface to the casual reader. The development of a hydrogen bomb will carry this effect still further.

Battleships are no longer the backbone of our Navy. Seacoast defense guns are being abandoned. Questions are being raised as to the value of any role to be played by enormous ground forces.

I do not believe that it would be sound for us to rely solely on the hydrogen bomb, even when we discover that we can make it, nor upon the atomic bomb. We must depend upon a well-balanced national military establishment. We must have air strength sufficient to deliver these super bombs upon the desired strategic targets, no matter where they may be located. We must have ground and sea strength sufficient to seize and hold any bases essential to the efficient performance of the bomb-carrying airplanes. Above all, we must realize that our thinking may be wrong. The hydrogen bomb and the atomic bomb may not be able to bring us through to victory and peace. To insure this, we must maintain other military strength.

We must remember that if Russia attacks us, and we are defeated, our country, our ideals and our people will never have a chance to rise again. With that possible fate confronting us, we must not permit ourselves to become careless. Perhaps it is time to recall the words of the father of our country when he said: "Let none but Americans be on guard tonight."

# NEW! Low Cost Saw-Jointer Unit



**—takes less space!  
—does more work!**



Complete Unit  
**\$112.20**

Including 4 1/2" Jointer, 8" Table Saw with cast iron extensions, stand, V-belts, pulleys. (Motor extra)

This compact new Duro combination unit takes less than 8 square feet of shop space . . . does scores of "extra capacity" home shop jobs. Both tools mounted on a single stand with ample work space between and driven by a single double shaft motor. Operate saw and jointer together or singly. Each tool always ready for instant use. Do ripping, crosscutting, tenoning, dadoing, mitering, jointing, rabbeting and many other operations with "professional" ease and accuracy. 8" Table Saw has over-size 20" x 17 1/8" cast iron tilting table, cuts up to 2 3/8" in thickness. 4 1/2" Ball Bearing Jointer has 11 1/2" table, new center-locking safety fence, planes wood 4 1/2" wide, cuts rabbets to 1/4". Complete unit \$112.20 as shown, less motor. See this new unit at your dealer, or . . .

WRITE TODAY for full details and specifications on this new low cost Duro Power Tool . . . plus the new 1950 catalog showing the complete line of Duro home shop power tools. It's FREE, mail coupon now!

## DURO METAL PRODUCTS CO.

2671 N. KILDARE AVE. CHICAGO 39, ILLINOIS

— MAIL TODAY —

DURO METAL PRODUCTS CO.  
2671 N. KILDARE AVE., CHICAGO 39, ILL.

Gentlemen:  
Please send me full details on your new Saw-Jointer Combination—also the new 1950 Duro catalog of power tools.

Name \_\_\_\_\_

Address \_\_\_\_\_

City \_\_\_\_\_ Zone \_\_\_\_\_ State \_\_\_\_\_

# BANISH BRAKE ADJUSTMENTS!

## INSTALL THE SAFETY AUTOMATIC BRAKE ADJUSTER

**\$5<sup>65</sup>** Fords—1939 thru 1948 models;  
Chevrolets—1936 thru 1950; All  
Chrysler products thru 1941 models.

**\$6<sup>95</sup>** All Chrysler products—1942 thru  
1950; and truck sets for all makes.

The most important brake development since the invention of the hydraulic brake for automobiles . . . a simple device that keeps brakes in constant adjustment at all times.  
Easy to install—provides uniform lining wear—promotes longer lining life.  
Affords safer driving due to automatically controlled adjustment—one of the greatest contributions to highway safety developed in recent times.  
Tried and tested with thousands upon thousands of successful installations. Each kit contains a complete set, together with instruction sheet—material and workmanship fully guaranteed.

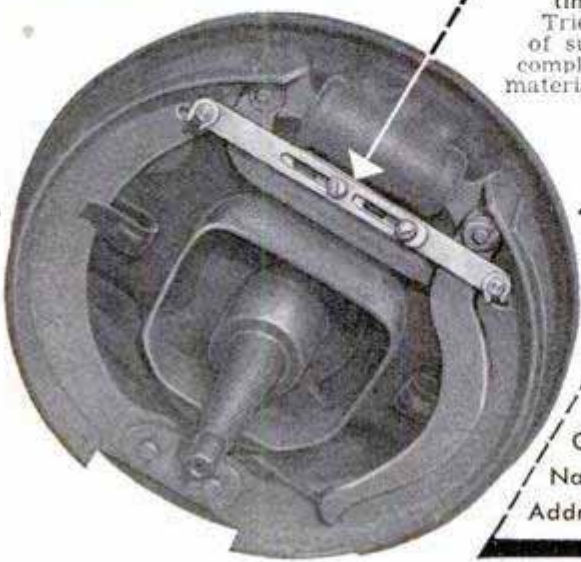

## ADJUSTOBAR

Prices quoted are postpaid and include tax—sorry, no COD's.

**MAIL THIS NOW**

Bonded Shoe Corp., Dept. BS-1, 144 Glendale Blvd., Los Angeles 26, California

Please send me \_\_\_\_\_ sets of ADJUSTOBAR.

Car and Year \_\_\_\_\_

Name \_\_\_\_\_

Address \_\_\_\_\_

Special discounts to dealers

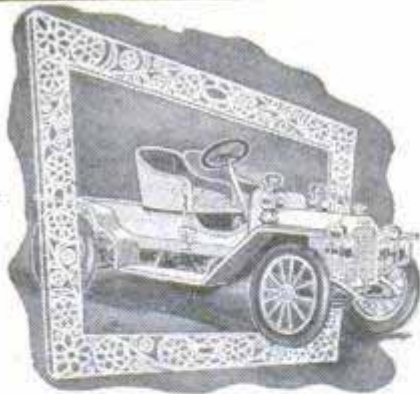

## Build a 1911 Buick "Bug"

COLORFUL ANTIQUE CAR FOR \$2.50

SHOWN above is Grandpa's racy little BUICK "Bug" Roadster! It's one of 9 famous antique autos that make up Hudson Miniatures' "OLD TIMER" line of auto construction sets. They're 3/4" scale models that are fun to assemble and to collect for den or library. Start your collection today!

**FREE!**  
Write for  
Your Copy of  
Our 4-Color  
FOLDER!

1911 Maxwell \$2.50	1910 Model "T"
1903 Model "A" Ford ...\$2.50	1903 Ford ...\$2.50
1904 Olds ...\$1.95	1903 Rambler \$2.50
1909 Stanley Steamer \$2.95	1909 Model "T" Ford ...\$2.95
	1900 Packard \$2.50

SEE them at your local hobby or department store, or write to us direct. Add 25c for postage and handling; no C. O. D.'s, please.

Hudson Miniatures' "OLD TIMERS"  
SCRANTON HOBBY CENTER, Dept. 14, Scranton 10, Pa.

## HUNDREDS OF ITEMS AND IDEAS FOR THE WOODWORKER

A board or carload—Top grade kiln dried Mahogany—Walnut—Wh. Hd. Maple—Cherry—Poplar—Aromatic Red Cedar—Red, White and English Brown Oak—Sapelli—Andiroba—Balsa Wood. **NEW LOW PRICES.**

### HARD TO FIND LUMBER

**BIG NEW NO. 17  
CATALOG FOR  
WOODWORKERS.  
144 PAGES  
OF HARD-TO-FIND  
SUPPLY ITEMS.**

The finest catalog we ever published. Full of unequalled bargains and useful information.

**Greatest Selection of Fine Domestic and Imported Woods**  
Catalog shows in natural color 32 rare and fancy woods, 43 matched veneer designs, multi-colored bandings, inlays, overlays, 275 scroll patterns to choose from, labor-saving machinery and a section for beginner's instruction.

#### OVER 100 NEW ITEMS

My stocks are gigantic—bigger than ever before. Really **FAST SERVICE** on your orders. My new catalog includes a "gold mine" of hard-to-find hardware items. Whatever Wood Craftsmen need—**I HAVE IT.**

**MAIL COUPON TODAY for  
GIANT NEW CATALOG #17**

**Only 15c** Refunded on first order.

Harold F. Hunt, President  
CRAFTSMAN WOOD SERVICE CO.  
2729 S. Mary St., Dept. A-5, Chicago 8, Ill.

I enclose 15c, to be refunded on my first order. Please send me your big new Catalog No. 17.

NAME \_\_\_\_\_

ADDRESS \_\_\_\_\_

TOWN \_\_\_\_\_

ZONE \_\_\_\_\_

STATE \_\_\_\_\_

## Ball-Bearing **SPEED WHEELS**



**JUVENILE WHEELS** (No bearing, solid tires)

4" .....	40c	6" .....	65c
5" .....	45c	7" .....	75c
(Semi-pneumatic tire, ball bearing)			
8 x 1.25 .....	1.85	10 x 1.25 .....	2.20
8 x 1.75 .....	1.95	10 x 1.75 .....	2.30
8 x 2 .....	2.20	10 x 2.00 .....	2.65
		12 x 1.75 .....	3.45

#### INDUSTRIAL WHEELS

Lug Base, Semi-Pneumatic tire			
5 x 1.75 .....	3.65	10 x 2.00 .....	6.10
6 x 2 SW .....	3.45	10 x 2.75 .....	5.15
6 x 2.00 .....	4.00	12 x 2.00 .....	6.90
8 x 2.00 .....	5.20	12 x 3.00 .....	9.20
8 x 2.50 .....	5.40	16 x 4.00 .....	15.15
Smooth Base, Pneumatic tire and tube			
8 x 3.00 .....	11.00	12 x 4.00 .....	12.10
10 x 2.75 .....	6.80	4.00 x 8 .....	13.10
10 x 3.50 .....	10.55	14 x 4.50 .....	13.40

Dealers, Jobbers, and Manufacturers! Our new prices will interest you.

Available Now—CASTERS  
Write for circulars on all wheels.

No c.o.d. orders. Prices F.O.B. our plant.

**JIM BROWN TOY COMPANY**  
1093 HOME AVENUE AKRON 10, OHIO

## \$ Free Course! Big Profits! \$ Flocks & Sandblasts

**Dual Purpose Spray Gun! Uses only 25 lbs. Air Pressure**  
● Thousands of uses in Home, Shop, Industry: Makes Auto Interiors Clean & New, Lines drawers, Marproofs lamp bases, Refinishes any object. All in colorful Flock. Etch & Frost windows, glassware, etc. Removes Paint & Rust from Autos, Tools. Guaranteed! Send \$19.75 or write for free information. Flocking supplies!

**BLASTO SPRAY GUN MFG.**  
Dept. PM-5, 7007 Haas Avenue, Los Angeles 47, Calif.

## POWER HACKSAW \$47.25

**LESS MOTOR**  
F. O. B. Benton Harbor

● Rugged cast iron construction. Wt. 56 lbs. bronze bearings. Draw cut. Auto. return lift. Auto. shut-off. Vise swivels 45°. Cap. 4"x4".

Send for full details and name of nearest dealer.

**EXCEL MACHINE TOOLS** Dept. PM-50  
BENTON HARBOR, MICHIGAN

BECAUSE IT'S EASY TO BE ON THE RIGHT ROAD BUT IN THE WRONG DIRECTION—DRIVE BY

## HULL AUTOMOBILE COMPASS

Beaconlite illuminated \$5.95 Streamline standard \$3.95  
Ideal gift for any occasion.  
At your dealer's. Write for literature.

HULL MFG. CO., P. O. Box 246-D5, Warren, Ohio

## Print Your Own

Cards, stationery, circulars, tags, labels, photo and movie titles, advertising, etc. Save money. **Print for Others, Good Profit!** easy rules sent. Raised Printing like Engraving, too. Sold direct from factory only. Write for free catalog of outfits and all details. **KELSEY PRESSES, M-37, Meriden, Conn.**

## Say You Saw It in Popular Mechanics

## CONVERT HAND MOWERS TO POWER MOWERS

Takes less than 3 hours

The Handy-Dandy Lawn Mower Kit fits any hand mower from the 16 to the 20 inch size. Complete with all necessary parts. Kits can be purchased separately, complete with engines or complete with Pennsylvania mower.



Also manufacturers of a complete power mower and garden cultivator attachments.

**DEALERS WANTED**  
**LE CLAIRE MFG. CO., Le Claire, Iowa, Dept. PM**

# WELD

BRAZE, SOLDER, CUT quickly...easily

**The FOUR-WAY PORTABLE ARC-WELDER**

COMPLETE ONLY \$9.95 F.O.B.  
10 DAY TRIAL

YOU'LL BE AMAZED by the work you can do on your first job! Plugs into any convenient properly wired 110 volt A.C. or D.C. line. Follow simple directions. Work on iron, steel, bronze, brass, aluminum and other metals. Save money doing own repairs. Make money repairing for others. Thousands of users among maintenance and repair men, farmers, tinsmiths, engineers, home and auto owners, etc. Pays for itself over and over. Order on ten-day trial or send for details.

MAKE OR REPAIR HOME & FARM APPLIANCES FENDERS BICYCLES METAL FURNITURE & 1001 ITEMS

**FOUR-WAY WELDER CO., Dept. F2-EA**  
2326 So. Michigan Avenue • Chicago 16, Illinois

**FREE Full Details SEND TODAY**

## HOLLYWOOD MUFFLER

THE TONE YOU LOVE TO HEAR

**MORE SPEED—POWER—MILEAGE**

are yours with a Hollywood Muffler . . . plus a tone you'll love to hear! Not a gutted muffler. Easy to install.

Hollywood Mufflers: Trade-mark Reg. U. S. Pat. Off.

IMPROVED DESIGN PRECISION MADE ELECTRIC WELDED!

Outlasts ordinary mufflers 3 to 1

Ford, Chevrolet, Plymouth \$6.00  
All other cars . . . . . \$8.00

Duals, Ford & Merc. \$24.50. Also Fender Skirts, \$10.95. Order direct. Send check or M.O. and save postage.

Dealers Write **WILKINSON MUFFLER CO.** 811 WILT STREET FT. WAYNE, IND.

## OTTAWA Buzz Master

**7 MODELS—\$99.00 up**

Greatest offer made in our 46 years of manufacturing. A model to fit your needs and your pocketbook. Free details.

**OTTAWA MFG. CO., 2-027 Brush St., Ottawa, Kans.**

No Other Like It!

## STOPS LEAKS PERMANENTLY

Cut your fixture replacement, water and fuel bills with Economy Renewable Seats. Make economical, permanent repairs quickly and easily with the Junior Kit (illus.). Repair bathroom, kitchen and laundry fixtures. Everything you need included in steel box. This is a natural for the "Fixit" shops—get extra income from making permanent repairs on your customers' faucets.

Senior Master Kit also available—repairs faucets and valves up to 1" pipe. Write for illustrated circular and prices.

**NEW "JIG-A-VISE"**

3 tools in one—a Jig . . . a Jack, and a Vise. Ideal for handymen, model makers, home workshops. Use it for holding any piece for drilling, finishing, assembly. Assures accurate work as all surfaces are ground true. Write for complete information and illustrated circular.

**ECONOMY VALVE SEAT CO.**  
3122 N. California Ave., Chicago 18, Ill.

# GET THE WORLD'S GREATEST RADIO & TELEVISION CATALOG!

**FREE**

**ALLIED'S**

**196-PAGE GUIDE TO EVERYTHING IN RADIO & TV AT LOWEST PRICES**



Send for the 1950 ALLIED Catalog showing the world's largest stocks of Radio and Television equipment, at lowest money-saving prices! See the latest TV releases, home radios and radio-phonos, Amateur equipment, P. A. Systems and High-Fidelity Sound, tape and wire recorders, test instruments, builders' kits—thousands of parts, tubes, tools, books and diagrams. Get more for your money from the World's Largest Radio & TV Supply House. Get your **FREE** Catalog today!

### HELPFUL RADIO BOOKS!



**Dictionary of Electronic Terms.** All-new reference guide has definitions of over 2500 terms used in television, radio, electronics and nucleonics. Invaluable for engineers, students, experimenters. Has useful data appendix. Published and made available by ALLIED at minimum cost.

No. 37-756. Only **25c**

- Radio Formulas & Data . . . . . No. 37-752 . . . 10c
  - Simplified Radio Servicing . . . . . No. 37-755 . . . 10c
  - Radio Builders' Handbook . . . . . No. 37-750 . . . 15c
  - Radio Circuit Handbook . . . . . No. 37-753 . . . 25c
  - Radio Data Handbook . . . . . No. 37-754 . . . 25c
- All 6 Books No. 37-799 Only **\$1.00**

## ALLIED RADIO

ALLIED RADIO CORP., Dept. 5-EE-0  
833 W. Jackson Blvd., Chicago 7, Ill.

**FREE CATALOG**

Rush FREE Catalog

Send Dictionary No. 37-756

Send Books checked above \$ . . . . . enclosed

Send 6 Books No. 37-799 (All book prices postpaid)

Name . . . . .

Address . . . . .

City . . . . . Zone . . . . . State . . . . .

# New **POWER KING** 8" TILT/ARBOR BALL BEARING SAW

A New Standard of Value from *Atlas*

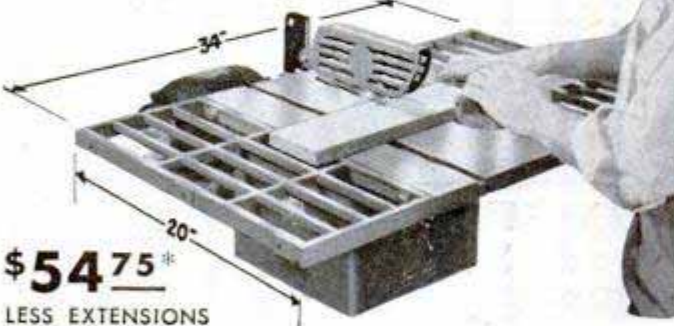

**\$54.75\***

LESS EXTENSIONS

Has the capacity you need for any type of construction for your home. Cuts  $2\frac{5}{8}$ " deep. Precision-ground grey-iron table, full-length rip fence, tilting/arbor, sealed ball bearings. \*Price, F.O.B. Kalamazoo, less motor, extensions, only \$54.75 — \$67.75 with two extensions as shown. Send a postcard for new catalog.

**ATLAS PRESS COMPANY**

535 N. Pitcher St., Kalamazoo, Mich.

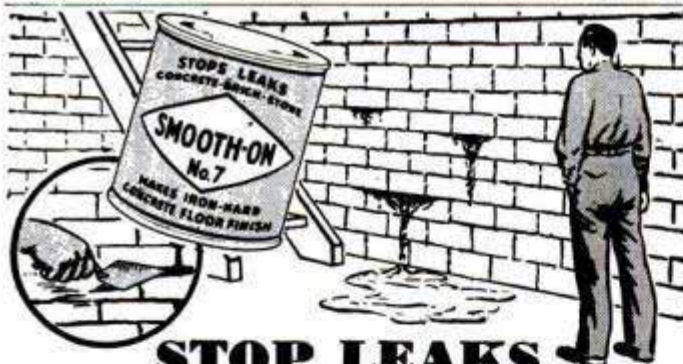

## STOP LEAKS IN CELLAR WALLS

Do it with Smooth-On No. 7 Cement! Apply with trowel or stiff brush to leaky cracks, holes, porous spots, seams or other leaks in concrete, brick or stone walls and floors. The leaking will stop and Smooth-On will "stay put", for it expands slightly as it hardens. May be applied to wet or dry surfaces, indoors or outside. Use Smooth-On No. 7, too, to seal openings around pipes passing through walls. Buy Smooth-On No. 7 by name and number in 1-, 5-, 25- or 100-lb. size. If your hardware store hasn't it, write us.

### FREE Leaflet and Handbook

We'll send you leaflet showing No. 7 uses, also the famous 40-page Smooth-On Repair Handbook describing other Smooth-On Cements and showing many helpful home repairs. 170 illustrations. Write today.

SMOOTH-ON MFG. CO., Dept. 37E  
570 Communipaw Ave., Jersey City 4, N. J.



Do it with  
**SMOOTH-ON**  
NO. 7 CEMENT

## HYDRAULIC Power Transmission WITH Infinitely VARIABLE SPEEDS, Clutch and INSTANT REVERSE—OUTPUT TORQUE ADJUSTMENT UP TO 180 inch POUNDS

This positive displacement Hydraulic Torque Converter is the ideal fluid drive with thousands of uses . . . Output Speeds Infinite . . . 0 to 550 R.P.M. . . . in either direction . . . Change Speeds WHILE RUNNING . . . Control and Transmit your power this SMOOTH Oil-Way . . . Will handle  $\frac{1}{4}$  H.P. to  $1\frac{1}{2}$  H.P. Motor, Industrial or Home & Farm Use . . . Cost government \$300, High Quality Precision Workmanship. Buy this unit to get the most for your money. Case measures  $7\frac{1}{2}$ " long  $7$ " high  $6\frac{1}{2}$ " wide. Input & Output Shafts  $\frac{5}{8}$ " dia. Beautiful Red Crackle Finish Case.

### FINGER TIP CONTROL

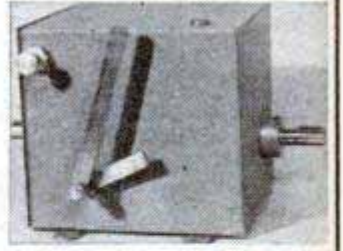

Shipping Wght. 25 pounds

Only **\$54.50**

If C.O.D. is requested a 10% Deposit must accompany order and we ship F.O.B. Chicago.

$1\frac{1}{2}$ "-8 thread lathe  
Chuck Adapter, \$3 extra

PREPAID  
2 quarts oil included FREE

DIRZIUS MACHINE SHOP "B" 1423-25 So. 62nd Ave., Cicero 50, Ill.

## Make Personalized **HOUSE, LAWN MARKERS** For Fun Or Profit



17 new silhouette cutouts (3 shown plus 14 other novel designs) complete alphabet and numbers, ready to trace onto wood. Sawing is easy. Marker with name or address is distinctive personalized

gift or addition to your home. Make markers for fun and to sell. Set of 17 full-size, ready-to-use patterns, alphabet, numbers, only \$1.00, postpaid. Money Back Guarantee.

Clip This Ad and Mail With **CRAFTPLANS** Dept. P-168, Chicago 5, Ill.  
Dollar Bill or Check TODAY 1321 S. Michigan Ave.

## INCREASE SAW SHARPENING PROFITS!

Sharpens  
Saws  
5"—30"

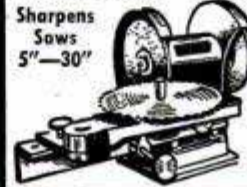

**REYNOLDS CIRCULAR SAW GRINDER**  
Produces top quality results in fraction of time usually necessary for resharpening, jointing, gumming and tooth forming. Any hook or pitch of tooth and depth of cut is quickly adjusted. Both hands are free to control position of saw while grinding. Write now for free circular!

**PROVIDENCE SAW & KNIFE COMPANY**  
305 Eddy St. Providence 3, R. I.



**TRAILER PARTS**



**BULL DOG Hitches, Parking Jacks and Axles for all types of trailers!**

Write for **FREE Catalog**

**Hammer Blow Tool Company**  
Wausau 13, Wisconsin

# K-R-O KILLS RATS

• K-R-O BIS-KITS are ready-made, easy to use; containing fortified red squill, they're safer around livestock, pets, and poultry. K-R-O POWDER is 100% fortified red squill; economical to use in badly infested areas when mixed with natural baits. BIS-KITS, 35c and \$1.00; POWDER, 75c at drug, seed, and feed stores. Money-back guarantee. The K-R-O Company, Springfield, Ohio.

**GENSCO****Swedish  
WOOD CHISELS**

Finest Imported Swedish Steel Blades

- Prices Now Lower than Most American Chisels.
- Hand-Honed and Polished.
- Unbreakable machined plastic handles.

Fine Swedish quality in accurate cutting chisels that every craftsman will appreciate. Gensco chisels take and hold the finest edge for better work.

**PROTECTIVE  
PLASTIC  
COATING**

keeps blades clean and sharp. Strip it off when ready for use.

The GENSCO LINE also includes  
**BUSHMAN**

Swedish Hand, Bow and Pruning Saws

See Your Dealer or Write Direct

11 SIZES  
FROM 1/4" to 2"

**GENSCO TOOL DIVISION**

General Steel Warehouse Co., Inc.

1832 North Kostner Avenue • Chicago 39, Illinois

**HANDEE**

*Tool of 100 Uses*

The original tool of this type and today's finest. Choice of mechanics, repairmen and craftsmen for 18 years. Handee is the best tool investment you can make.

IT RUNS COOL — Smooth, controlled power when you want it, as you like it. Non-fatiguing because it is perfectly balanced and has 7-bar armature rather than only 3. Speed 25,000 r.p.m. Wt. 12 oz.

Handee with 7 accessories \$19.95

Handee with 51 accessories in steel case... \$24.95

At your dealer's or order today postpaid on money-back guarantee. Write for catalog. Chicago Wheel & Mfg. Co., Dept. P.M. 1101 Monroe St., Chicago 7, Ill.



A Whole  
Toolshop  
in 1 hand

GRINDS, DRILLS  
ENGRAVES, CUTS  
POLISHES, SAWS  
ROUTS, SANDS

**A TOOL... NOT A BRUSH**

**\$1.00 POST PAID**

**NOW!  
PAINT  
STRIPING  
MADE  
EASY!**

**PAINTERS'  
STRIPING TOOL**

Easy to use as a pencil! Draws parallel lines, straights, curves, circles with paint, enamel, lacquer, etc. Do your own striping on autos, furniture, toys, bikes, model planes, signs, linoleum... make wall board look like tile. Painters - craftsmen, order today! Type "M" Master Painters' Striping Tool complete with tip for 1/16" stripe, \$1.00. Other tools complete with following tips: 1/64", 1/32", 3/64", 5/64", 3/32", 1/8"; \$1.50 each. Extra tips 75c ea. Entire kit with tool and 7 tips—\$5.00. (CGD's postage collect.) Dealers write!

**WENDELL MFG. CO.**  
4234-B Lincoln Ave., Chicago 18, Illinois

WHEN YOU BUY YOUR  
POWER LAWNMOWER  
OR GARDEN TRACTOR

**BE SURE THIS EMBLEM  
IS ON THE ENGINE**

4  
CYCLE

The Precision Built

**CLINTON**

AIR COOLED  
ENGINE

THE CLINTON  
MACHINE CO.  
CLINTON  
MICH.  
U.S.A.

WORLD'S QUICKEST STARTING,  
MOST RELIABLE  
SMALL GASOLINE ENGINE

CLINTON MACHINE CO.  
CLINTON, MICHIGAN

**CLINTON  
ENGINES**

**EASY PROFIT IN PAINT SPRAYING**

PISTON TYPE COMPRESSOR

Paints walls, ceilings, screens, furniture and machinery faster, better. All complete as shown less motor. Carry anywhere. Fully guaranteed. Could be used with 1/4 H.P. motor or less. Price \$35.00 less motor F.O.B. Chicago. \$5.00 deposit balance C.O.D. or see your dealer. With motor \$55.00.

**IDEAL AUTOMATIC PUMP CO., Dept. P.M. 8**  
801 W. Washington Blvd. Chicago 7, Ill.

SAY YOU SAW IT IN POPULAR MECHANICS

**2  
DRILLS  
IN 1**

This attachment gives you two drills in one. It converts any 1/4 inch electric drill to 1/2 inch capacity. Reduction gears reduce the drill speed 5 to 1, the average speed of a 1/2 inch drill, and thereby increases the power. Absolutely indispensable for all shop work and home craftsmen. Satisfaction guaranteed. Order yours now.

**\$11.95** post paid

Send check or Money Order with order. Jobbers write for special information.

**G. M. CO. MANUFACTURING, INC.**  
1308 43rd AVE. LONG ISLAND CITY 1, NEW YORK

# NEW DUMORE GRINDER

Low Cost - Dual Purpose  
Combines Lathe & Bench Grinding

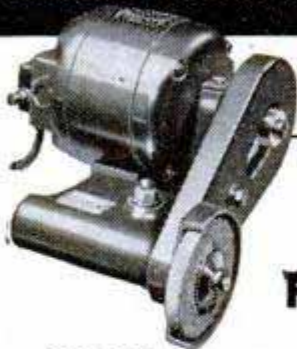

**\$67.50**  
Slightly higher west of Rockies

**FULL 1/4 HP**

## .0002" Accuracy . . . Full Shift Stamina

The versatile, new Dumore Utility Grinder converts your 9" - 13" lathe to a precision external grinding machine. Bench or vise mounted, it serves as bench grinder, polisher, wire brusher, or buffer. It's a natural for small machine shops and general shops as well as metal working hobbyists. It gets those occasional special grinding jobs as well as production jobs finished fast and at **LOW COST!**

## Grind It In Your Own Shop—FASTER—CHEAPER

With Utility Grinder garages, repair-shops, fleet operators and maintenance shops can now do fast and low-cost valve grinding, resizing after metalizing, welding clean-up and similar operations requiring precision grinding as well as the every day production jobs. Write for literature to:

The **DUMORE COMPANY**, Dept. E-74  
RACINE, WISCONSIN

Now ALL SHOPS CAN AFFORD PRECISION GRINDING!

# STRIPS PAINT

and all finishes

**CLEAN, QUICK, EASY**

One coat usually lifts off all paint, varnish, and synthetic finishes.

Stays wet longer. Semi-paste

— will not run or drip; needs no after-wash. Harmless

to hands or surface. Pint

65c, does a large

table. Sold where

you buy paints.

IT'S ORANGE!



Write for **FREE CIRCULAR**

**SAVOGRAN**  
DEPT. 27, BOSTON 16, MASS.  
**STRYPEEZE**

# KING MIDGET

HOME ASSEMBLED AUTO



## WORLD'S LOWEST PRICED AUTOMOBILE!

80-90 MI. PER GAL.—45-50 MI. PER HR.

Drive for as low as 50c per week. Precision built parts direct from factory with beautiful all steel body. Get the facts on this amazing small auto—send 25c for detailed circular with large picture, 3 view drawings and price of all parts, or send \$1 (refunded first order) for this plus actual assembly book with 42 photos, drawings; blueprints of snow, ice conversions, information on mini-midget racing, etc.

MIDGET MOTORS MFG. CO., ATHENS 1, OHIO

King Midget is ideal for errands, sports use, to work, short business or pleasure trips, or second-car utility for the whole family. Also tops for mini-midget racing. Room for six footer.

## TODAY'S BIGGEST PREFAB BOAT BUY

Build a better boat than you can buy. Save up to 55%. See OZARKA'S new 1950 line of trim, top-quality 12- and 14-footers with laminated rib construction, all-oak frame and other exclusive features, for motors up to 25 H. P. Send 25c for complete Boat & Accessory Catalog, to be refunded on first purchase. OZARKA, Inc., 650 Borden Lane, Woodstock, Illinois.

**\$39.50**  
AND UP



**FREE**  
Bargain  
Book

Packed with hundreds of sensational bargains—new and used—in still and movie photo equipment and accessories. Write for your free copy today to

**Central Camera Co.**

Dept. BE, 230 S. Wabash, Chicago 4, Ill.

Photographic Headquarters Since 1899

## ELECTRIC SHEAR SHARPENER

Over 65,000 Sold—It Must Be Good!



Genuine Carborundum wheel ideal for shop or home use. Send remittance with order and shipment will be made at once, prepaid to your door, complete with electrical goods catalogue.

Motor driven  
**\$9.75**

complete with vise

**WILLIAM MARVY COMPANY**  
477 St. Peter Street St. Paul 2, Minn.

## New 1950 Plastics Supplies Catalog

Just off press. Get details on Plexiglas, Lucite, rods, sheets, tubes, Acetates, cements, dyes, buffs, molding sets, tools, carving kits, everything in plastics. Lowest prices. Price 10c, stamps or coin, with ad for catalog.

Plastics Mfg. & Supply Corp., Dept. PM-5, 4707 Euclid Ave., Cleveland, Ohio

# SPEED & MILEAGE MANUAL

200 Illustrations



Easily Get Super Speed, Acceleration, Mileage—Top Racing Performance From Any Automobile!

Famous New Book shows simplified Soup-up Methods—Speed Tuning—Economy Secrets—"Customizing Plans"—Latest Proven Methods for all cars! Tells how to build your own SPEED EQUIPMENT! FAST SPORT CARS! "CALIFORNIA HOT RODS"! 200 H.P. ROAD & TRACK CONVERSIONS! Complete Instructions on building inexpensive Superchargers! Dual Manifolds! "Water Injectors"! High Compression Heads! Twin Mufflers! Economizers! All about—Fast Engines, Gas Saving, Restyling, "Cam Secrets," Multiple Carburetion, Fuels, Porting, Ratios, Frames, "Offys"! BRAND NEW METHODS, Plans, Formulas, "Racing Tricks"—"STOCK CAR SPEED SECRETS"! Reveals 100 ways to save gas! Shows latest "HOLLYWOOD CUSTOM STYLING"! Streamlining! Sport Changes! Lowering! Speed Conversions! Including—California Roadster Plans! Racer Diagrams! Working Drawings! Performance Charts! Granhs! Beautiful Photographs! Etc.!

Large manual (plus) "California Equipment Catalog" and Hot Rod Handbook.

**ALL THREE \$1.98** Post-paid

ALMQUIST AUTOMOTIVE ENGINEERING, Milford 52P, Pa.



**GOLD BOND**



**WHOLESALE GUARANTEED EXCEPTIONALLY GOOD USED TIRES DIRECT TO YOU**

10% discount on 2 or more tires if you send this ad with order

**TUBE DELIVERED WITH TIRE AT NO EXTRA COST FOR 15" AND 16" PASSENGER TIRES**

Safe — Our tires used on school buses and ambulances

**EXCEPTIONALLY GOOD TREAD — NO RECAPS**  
GUARANTEED FOR 24 MONTHS

600-16	\$5.49	700-16	\$6.79	525-18	\$6.69	750-20(10)	\$15.98
600-16 (6 ply)	6.49	650-15	5.79	600-20	9.89	825-20	16.98
650-16	5.49	700-15	5.79	650-20	9.98	900-20	17.79
650-16 (6 ply)	6.79	550-17	7.79	750-16	12.50	1000-20	18.29
600-16—6 ply Military—Mud and Snow Tire							\$6.37

**ALL GOOD TIRES**  
GUARANTEED FOR 12 MONTHS

600-16	\$3.59	550-17	\$5.69	700-20(8)	\$9.29	825-15(14)	\$14.98
650-16	3.89	750-16	8.40	700-20(10)	12.48	825-20	11.19
650-15	3.89	600-20	7.98	750-20(8)	11.79	900-20	11.89
700-15	3.98	650-20	7.99	750-15(10)	11.97	1000-20	12.89

**GOLD BOND SPECIAL — 750-20 MILITARY TIRES**

Will fit 650 x 20	700 x 20 (8 & 10 ply)	34 x 7 (8 & 10 ply)	
Special	\$10.49	Guaranteed 12 months	
Superior Quality	12.98	Guaranteed 18 months	
Gold Bond Finest	14.98	Guaranteed 24 months	
900 x 16 Special	9.03	900 x 16 extra	11.19

Send check or money order with this ad

**GOLD BOND TIRE CO., Dept. PM 24**  
512 NORTH 1ST ST., RICHMOND, VA.  
"A gold bond written guarantee with every tire"

**Pioneers** **AIR RIFLES** **BENJAMIN** **AIR PISTOLS** **Leaders**

**SHOOT WITH SAFETY**

**BE SAFE—SHOOT WITH COMPRESSED AIR—ALWAYS READY** No Cartridges or Tanks to Replace or Recharge. If you want the most PRACTICAL GUN to use anywhere—inside or outdoors—get a SAFE—CLEAN—ECONOMICAL BENJAMIN with Adjustable Power and Amazing Accuracy. Send for Free Folder of Latest Models Today. **BENJAMIN AIR RIFLE CO., 890 MARION ST., ST. LOUIS 4, MO.**

**Bonaly TILLIVATOR**  
**TILLS AS IT CULTIVATES**

- Goes Between Rows
- Keeps Garden Free of Weeds
- Conditions Soil in Dry Weather
- So Easy to Operate a Child Can Handle

Patent Applied For

Includes Cultivator and Lister



Only **148<sup>50</sup>**

f.o.b. K.C. Mo.

Major members made of tough manganese bronze. Can't break, bend or rust. All moving parts equipped with sealed precision ball bearings. Powered with Power Products Corp. 1 HP Easy Starting Engine. Attachments include cultivators and lister for making rows. Quick, detachable wheel for wheeling to and from the garden. Nothing else to buy. Width of tilling reel 10" Weight 85 lbs.

**BONALY POWER MOWER**

Weights so little (33 lbs.) your wife can handle it easily—a snap to start—lifts easily over steps and rocks—maneuverable in rough ground. Heavy duty, ball bearing Power Products, 1 h.p. engine, 16" blade adjustable to 3 cutting heights. Safety clutch.



Only **78<sup>50</sup>** f.o.b. K.C. Mo.

**WRITE TODAY FOR FULL PARTICULARS**  
**Cromb & Gagel, Inc., BOX 166, KANSAS CITY, MO.**  
Dealer Franchises Available

**NOW!** **WALTCO**  
**Glasscaster**  
**SOLID FIBRE-GLASS FISHING RODS**

**NEW...**

**WALTCO PROCESS**

**PERFECTS SOLID FIBRE-GLASS**

**RODS AT LOWEST PRICE YET!**



**FROM \$9<sup>95</sup>**

In 5 lengths: 3 1/2'—\$9.95; 4'—\$10.95; 4 1/2'—\$11.95; 5'—\$12.95; 5 1/2'—\$13.95; includes case with dowel.

Practically indestructible, solid fibre-glass is the most remarkable rod material known. Lightness, live-action, extra strength and power combine to give new thrills to fishing. You'll say the new **Glasscaster** makes all other rods obsolete.

- Won't take a "set." Can't rot or rust.
- Power, strength with permanent live-action.
- Exclusive Waltco Pistol Grip.
- Finest stainless steel guides and tip, nylon windings, triple lacquered.

**1 YEAR REPLACEMENT GUARANTEE**

If dealer can't supply, send check or money order to:  
**WALTCO PRODUCTS, Dept. 68-E**  
2300 W. 49th Street, Chicago 9, Illinois

**BINOCULARS**

BRAND NEW. Military type—Achromatic lens! Have precision ground optics, lightweight metal bodies. Moisture—Dust proofed.

7x35 Coated	\$49.50
7x40 Coated	52.50
7x50 Regular	42.50
7x50 Coated	49.50
10x50 Regular	52.00
10x50 Coated	62.00
12x50 Coated	69.50



6x25 Regular	\$26.00
6x30 Regular	31.50
6x30 Coated	37.50
8x30 Regular	33.00
8x30 Coated	39.50
8x40 Regular	49.50
8x40 Coated	55.50



**6 POWER PRISM BINOCULAR FITS PALM OF HAND**

Coated! Dynamic in power

370 ft. field at 1000 yds! Achromatic lenses. Individual eye focussing. Weighs 4 ozs. All metal construction. Adjusts all eye widths. Quality binoculars that bear the United seal on their frame. Because they are made to rigid UNITED specifications. America's leading binocular house—selling by mail since 1937. **\$19.50.**



All binoculars have individual eye focussing. Prices include genuine leather case and straps.

**TRY FOR 20 DAYS AT OUR RISK!**  
If not fully satisfied return for full refund! Cash orders rushed post-paid. On C.O.D.'s include \$2.00 deposit. Add Federal Tax. **UNITED BINOCULAR CO., 7941 S. Halsted, Dept. ARF-1508, Chicago 20.**

# CALK THOSE CRACKS WITH *Nu-CALK* **SPEED LOAD**



Seal out  
drafts,  
dust,  
around  
windows  
and  
doors



Here's the easy way to calk your home. Just slip a handy Speed Load into the calking gun and you're ready. It's the fastest, most economical way to apply the world's finest calking compound.

USE *Nu-Glaze*  
INSTEAD OF PUTTY



Macklanburg-Duncan Co., Okla. City, Okla.

BUY THROUGH YOUR LOCAL  
HARDWARE, LUMBER OR BUILDING  
SUPPLY DEALER

A complete shop in one precision machine!

## The IDEAL LAWNMOWER SHARPENER

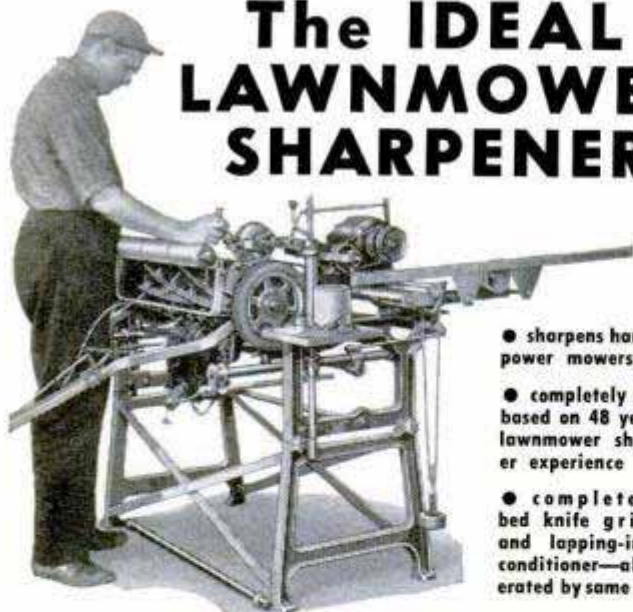

- sharpens hand and power mowers
- completely new—based on 48 years of lawnmower sharpener experience
- complete with bed knife grinder and lapping-in Reconditioner—all operated by same motor

You can do precision lawnmower sharpening faster and easier than ever before on the Model 300 Ideal Sharpener. No disassembling needed, place the entire mower in the machine. You can make more money and do better work with an Ideal. Get all the facts, compare, no other sharpener offers as much as the Model 300 Ideal.

Write Today For Free Catalog

**THE FATE-ROOT-HEATH COMPANY**  
DEPT. H-3, PLYMOUTH, OHIO

## Own a \$25 CUSTOM FLY ROD

Now you can own the fine custom fly rod you've always wanted. Build *only \$7.95* it yourself—easily, quickly—from complete materials furnished you by H-I at a fraction of the cost of an assembled rod.

HERE'S  
WHAT  
YOU  
GET

POSTPAID



Everything you need to build a quality fly rod: Butt, middle and two tip sections of finest, top grade, seasoned Tonkin bamboo, flame tempered; glued ready for mounting. Locking reel seat and shaped cork grip. Fitted ferrules of nickel silver. Hardened steel guides. Pear shaped steel tip tops. Two spools of nylon winding. Jar of special rod varnish. Stick of ferrule cement. Cloth carrying bag. Complete directions. ALL for *only \$7.95* postpaid. Satisfaction guaranteed. See your dealer or send check or money order (no C.O.D. please) direct to Dept. 22, Horrocks-Ibbotson Co., Utica, New York, manufacturers of the world's largest line of fishing tackle.

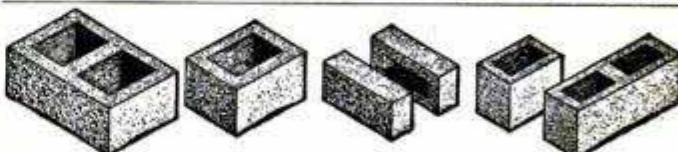

## Make Concrete Blocks and Bricks

New superior method makes square, true, easy-to-lay units which will pass any building code. Small investment, high production, big profits. One \$30.00 machine will make four 5"x8"x12" blocks per minute—1000 per day. Pays for itself in a few days. Sell blocks or save 2/3 building cost by making and laying your own.

POST CARD BRINGS FREE FOLDER

**Economy Manufacturing Company**  
Dept. P Stone Mountain, Georgia



## BARGAIN! BRAND NEW! SPINNER!

only **\$42.50** Save **\$40!** REG. \$82.50  
7-in. disc

Direct From Manufacturer—

Uses 7-in. or 9-in. disc—Sands, grinds, wire brushes, etc. Makes tough jobs easy. 1/2 h.p., Heavy Duty Motor. 10-day, money-back guarantee. No C.O.D. Send check or M.O. TODAY—while they last! Californians add 2% State Sales Tax

651 20th Street 272 Badger Avenue  
**HOLT MFG. CO.** Oakland 12, Calif. Newark 8, New Jersey

## Freeland METAL BOATS

Rugged, low up-keep boats that feature electronic seam weld; spray rails, styrofoam safety floats; removable flooring. 12 and 14 ft. lengths.



Models from \$65.00. Write Dept. 75 for folder, prices.

GALVANIZED  
STAINLESS  
STEEL

**FREELAND SONS CO.** Sturgis, Mich.

## Amazing Freedom PRESTO-FLEX

Quickly converts your motor—  
Electric Drill or Drill Press into a  
FLEXIBLE SHAFT TOOL



ATTACHED OR REMOVED in a jiffy!

- Precision made. Gets into tight, hard to reach places, because the PENCIL-SIZE HANDPIECE provides deft, positive control. Convert your old motor, Electric Drill, or Drill Press into a handy FLEXIBLE SHAFT TOOL with amazing PRESTO-FLEX. For use on motor, specify shaft diameter and add 50c for coupling. (Available for 3/4", 5/16", 3/8", and 1/2" shafts.) No. 50 Accessory Set \$1.50 extra.
- Write Today for Free Catalog No. 1129-E, showing how you too can profitably employ Freedom Machines. Quality Tested Since 1922.

ONLY  
**\$5.95**

**FOREDOM ELECTRIC CO.** Dept. 1129-E, 27 Park Place  
New York 7, New York



## PEEL PAINT TO BARE WOOD WITH ONE EASY STROKE

NEW ELECTRICAL TOOL removes 1 to 10 or more coats of paint from any wood surface as easy as cutting butter with a hot knife. No scraping, cutting, burning, sanding, or chemicals. The new Lectro Paint Peeler instantly softens paint electrically and peels it off the surface clean to the bare wood with one easy stroke. It's faster than a blow torch—there's no danger of fire—will not scorch or burn delicate wood surfaces. Makes no mess—no smell—it's even fun to use. Removes any paint, enamel quickly and easily. Sturdily constructed to last for years. Sent complete with extra long, quality electrical cord. Simply plug into any A.C. or D.C. outlet—let heat for several minutes and remove paint to the bare wood on exterior or interior painted surfaces, floors, woodwork, cupboards, furniture, antiques, boats, window-sills, screens, doors—a hundred other uses. Price \$4.95 postpaid—nothing else to buy. Full money back guarantee. For immediate shipment—send check, cash or money order to:

**LECTRO WELD, INC.**

Dept. PM5

3495 West 140th St.

Cleveland 11, Ohio

## MILLER ROTARY HI-SPEED (OPE-SAW) DRILL-BIT IT SAWS CUTS REAMS

SAWING, CUTTING AND REAMING SECTION

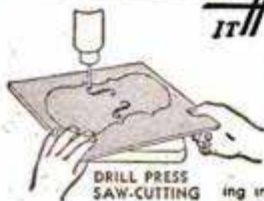

DRILL PRESS SAW-CUTTING

ELECTRICIAN'S HANDY CUTTER



SAWS, CUTS, REAMS Light sheet metal, wood, plastic, etc. Amazing high speed combination bit and saw fits high speed electric 1" drill or drill press, takes place of up to \$50 in tools. Drills own starting hole to quickly cut, saw or ream an opening in material. Easy to operate. Ideal for auto mechanics, electricians, plumbers, hobby workers, many others. Drill is 1" in diameter with overall length of 3 3/4" Cutting sections 2" long.

SEND CASH, CHECK OR M.O.

Order Now

International Twist Drill Corp., Dept. PM-3  
7th & Wyandotte • Kansas City 6, Mo.

PRICE \$3.95 POSTPAID

## EVER BETTER...

### Buy Schult for Value!

Choose wisely, for value in relation to price, not over-glamorized gadgets. LIVING in a Schult, you'll appreciate the all-season comfort, day-by-day convenience, easy towing, and years-lasting ruggedness of your quality-built Schult... A great dollar-value!



Free... "HOW TO BUY A TRAILER COACH"

Send today for new booklet. Tells what to look for... how to judge values... protect your investment... and make your dollars go farther.

### SEE NEW MODELS... BEST VALUES EVER!

Now at dealers—new 1950 models with metal exteriors like fine autos. Or write for free catalogs showing choice of floor plans, Schult "Heat-Saver" and other unique features for livability.

SCHULT CORP., Dept. 3205, Elkhart, Ind.



Say You Saw It in POPULAR MECHANICS

## SUPER 1950 PRONTO POWER CUTTING EQUIPMENT — WITH 20" CUT



\$42.50 less Engine. \$79.50 with 4 cycle 2 H.P. Engine.



\$12.50 comp. FOB H.D. Roller bearings. Shipping wt. 15 lbs.

\$89.50. Only one moving part, aside Engine and wheels. 2 H.P. 4 cycle Engine.



For all grass and weeds. Send check or Money Order. No COD's. We have no dealers or representatives. Crating charge for Mower's \$5.00 extra.

## PRONTO MOWERS, Oldsmar, Florida

**FREE** 152-PAGE RADIO-TELEVISION CATALOG OF SETS, KITS, PARTS! LATEST HAM, HI-FI AUDIO, RECORDING DATA! LOWEST PRICES!

WRITE FOR YOUR COPY!

GET THE WHOLE STORY IN THIS FREE CATALOG —

Radio Shack bargain mail-order catalog is best in the U.S.A. Profusely illustrated! An encyclopedia of radio-electronic equipment, tools, books, sound systems, plus war surplus and special buys! Rush request today. — Ask for free catalog 50-PM. —

DELCO (G-M) DUAL AC BLOWERS



**SALE!** NOW ONLY

\$14.85 POSTPAID

Brand new! FAR below regular price! Ideal for darkrooms, cooling xmt tubes, draft boosting, humidifiers, dryers, ventilation, suction, shipboard, etc. Continuous duty, brushless, 115 V 60 cy. Operates at 2800 rpm. 200 cfm free vol. air delivery. 62 watts input. Over-all 10 1/2" by 5 1/2" by 6 1/2"



DEMAND INDICATOR ONLY \$2.49

Made by Stewart-Warner, No. 748A-RD, worth 5-10 times our POSTPAID sale price! 20 amp range, thermally operated, 2-wire, for 600 volts or less. Accurately checks transformer loading, load distribution, etc. Metal case 4 1/2 x 5 1/2 x 2 3/4.



CRYSTAL MIKE!

Record-Low-Price Lowest price EVER. Exclusive special purchase of a famous-maker's \$6.50-value crystal mike (crystal element alone is exact replacement for his \$10 units)! Excellent response 100-6000 cycles. Ideal for public address, entertainers, ham, recording, etc. Streamlined metal case. 6 1/2 ft. cable. Sensitive!

POSTPAID! \$2.85

**RADIO SHACK CORP.** 165 Washington Street, Boston 8, Mass.

Just off the Press  
-and **FREE!**

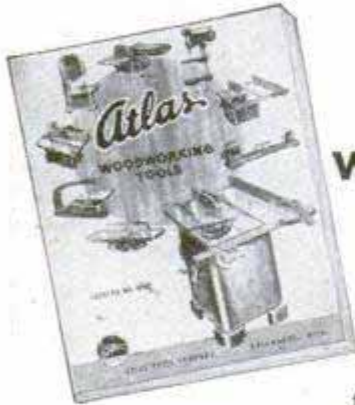

**Atlas**  
**WOODWORKING**  
**CATALOG**

Gives you complete information and operating views of these "industrial quality" tools for home shops. Atlas tools can help you this summer on your home building, improving.

SEND A POSTCARD FOR YOUR COPY

**ATLAS PRESS COMPANY**

543 N. Pitcher St., Kalamazoo, Mich.



**MATCHED PRECISION TOOLS FOR**  
**WOODWORKING AND METALWORKING**

**Keep Brushes like New**

**BEFORE**  **AFTER** 

• 5c  
• 10c  
• 25c

**DICA DOO**  
**PAINT**  
**BRUSH**  
**BATH**

Clean and Restore  
PAINT BRUSHES

Perfect for  
**NYLON BRUSHES, too!**  
**At Paint, Hardware, Dept., and 5 & 10c Stores**  
Patent Cereals Co. Geneva, N. Y.

**FOR**  
**FASTER WORK**  
**IN HOME OR**  
**SHOP...**

**HOLD-E-ZEE**  
The Original **AUTOMATIC GRIP**  
**SCREWDRIVERS**



See these popular, high-quality drivers with the exclusive Gripper that holds, starts and sets up screws in unhandy places!

**New Models FOR RECESSED**  
**HEAD SCREWS** 

At Leading Dealers Everywhere  
**UPSON BROS., INC., ROCHESTER 4, N. Y.**

**BUILD YOUR OWN FAN**



One-piece cast aluminum propellers for cooling and ventilating. Bore

Size	Polished	Unpolished	Bore				
Inches 2 Blade 2 Blade 2 Blade 3 Blade			Inches				
15	\$3.00	\$4.00	\$2.50	\$3.00	1/2	3/8	3/4
18	3.75	4.50	3.00	3.50	1/2	3/8	3/4
20	4.00	5.00	3.25	4.00	1/2	3/8	3/4
24	4.50	5.50	4.00	4.50	1/2	3/8	3/4

Let us give you our prices on your aluminum castings.

Write for pamphlet on larger fan blades, wire guards, fan bases, shutters, pillow blocks, exhaust fan frames, etc. Shipped prepaid if money accompanies order. Dealers write for discount.

**KLOPPENBORG ALUMINUM FDY., Dept. PM50, Davenport, Iowa**



**FREE SAMPLES!**  
**GLOW IN THE DARK!**

**BIG PROFITS** showing amazing Luminous Specialties—house numbers, pictures, plastic novelties, religious and nursery objects, ash trays, key-holders, etc. Large manufacturer. Enormous demand. Sell on sight. **WRITE AT ONCE** for FREE samples. **Madison Mills, 303 4th Ave., Dept. J-4, New York 10, N. Y.**

**OTTAWA Tiller & Mower**

Patented **Powerful 2 H-P Red Seal Continental Motor.** Attachments for mowing, tilling, power take-off, cultivating and spraying. Lowest prices in history. Two speeds and free wheeling. Thousands in use. Rotary mower only \$89. Made by men with know-how. Now in our 47th year. Free details.

**OTTAWA MFG. CO., 5-027 Lawn Ave., Ottawa, Kans.**

**MAGNETS** OF ALL TYPES—10c UP  
AMAZINGLY POWERFUL!  
3 oz. Alnico Magnet, lifts 10 lbs. \$1.00. Our Leader, 15 oz. Magnet, lifts 40 lbs. \$2.50. New alloy—will not weaken! Useful for lifting valuables from tanks, lakes, or rivers easily! 7 small magnets \$1.10 with list of many shop and home uses. Satisfaction guaranteed.  
**R. EYRICH, 2566 N. 49TH ST., MILWAUKEE 10, WIS.**

**NATIONAL HARDWARE WEEK**  
**SPECIAL**

**EAGLE**  
**FOLDING**  
**RULES**

APRIL 28  
TO  
MAY 6



69c to \$1.25

AN ASSORTMENT FOR EVERY PURSE AND PURPOSE  
... AND EVERY MEMBER OF EVERY FAMILY  
DON'T JUST ASK FOR A RULE  
ASK FOR AN EAGLE RULE  
**EAGLE RULE MFG. CORP. NEW YORK 59, N. Y.**



# COMPLETE LOCKSMITH SHOP \$99.00

**NEW POPULAR STANDARD EQUIPMENT**  
**START YOUR SHOP NOW!** AT HOME, GARAGE, BASEMENT, OR RENT A SMALL STORE, OR ADD A KEY DEPARTMENT TO YOUR PRESENT BUSINESS

- |   |                                      |   |
|---|--------------------------------------|---|
| 1 Precision key machine complete with three cutters | 1000 Popular key blanks and cut keys | 1 Assortment of pins and springs          |
| 1 Heavy plywood key display board with 100 hooks    | 3 Locksmith Instruction books        | 1 Assortment of disc tumblers and springs |
|   | 1 Automotive lock manual             | 1 Misc. set of locksmith tools            |

**ALL FOR ONLY \$99.00 — EASILY WORTH \$130.00!**

Slightly higher out of U. S. A. 25% deposit on C.O.D. orders.  
 Start making money at once! Order your outfit today! Complete satisfaction guaranteed.  
 Write for FREE Catalog today!

REPAIR SHOP SERVICE • Box 264-C • Skokie, Illinois

## AMAZING NEW 1950

# Powell P-81

## NOW 4 BEAUTIFUL COLORS



10 HP AT 3400 RPMs! Thrill to 50 mph cruising—faster pickup than a car. **AUTOMATIC CLUTCH** with Powermatic Drive gives sensational performance. **No gears to shift!**

Safe, smooth Brakes—50 miles per gallon — Length 71" — Height 41" — Weight 196 lbs.

DEALER INQUIRIES INVITED

ONLY \$289.44

AT COMPTON, CAL. INCLUDING EXCISE TAX

WRITE FOR FREE FOLDER AND NEAREST DEALER

POWELL MANUFACTURING CO. Dept. PM550, Compton, Calif.



## CAPE COD CHAIRS TRELLISES • ARBORS DUTCH WINDMILLS

Chairs style B-C-A PLANS 50c Ea., all 3 only \$1.00. 12 different Dutch Windmill Detailed PLAN only 75c. Unique 40" high Light-house having copper lantern, ideal for garden or on lake shore of summer home. Large detailed PLAN 75c.

SPECIAL ALL PLANS ABOVE \$3.00 VALUE ONLY \$2.50

SEND 10c for catalogue of many fine projects. Dept. P16

CRAFTSMAN'S MODEL CO. DELAFIELD, WISCONSIN

## SPECIAL OFFER!

LOCK-STITCH SEWING AWL

\$1.

Postpaid

Famous, patented lock-stitch sewing awl complete with needles, waxed thread and direction folder. Hundred uses — sewing, repairing leather goods, canvas, belting, harness, saddles, gun cases, awnings, golf bags. Extra needles and thread available. Satisfaction guaranteed or money back. Send currency, check or money order. Yates Mfg. Co., 611-H Main St., Lake Geneva, Wisconsin

## MARCOT KEY MACHINE

Immediate Delivery



MARCOT No. 8 KEY MACHINE, mounted on Cabinet, less motor, \$ 95.00  
 Auto Code Book and Depth Keys. 12.50  
 100 Dz. Popular Key Blanks. . . . . 60.00  
 Set — Key File, Follow-Through Rods, Lock Picks, Bit Key Gauge, Thimble, Pins, Springs. . . . . 10.50  
 "Locksmith Trade Books": . . . . . 6.75  
 How to Open Locks without Keys or Picks; Secret of Locksmithing; How to Make Keys by the Impression Method; Master Key Systems.  
**TOTAL COST. . . . . \$184.75**

A. J. MARCOTTE CO., 1200 N. Kedzie Ave., Dept. PM, Chicago 51, Ill.

## NEW! Trash Disposal Unit Burns Refuse Safely



• A new type outdoor dispose-all unit safely and quickly burns garbage and trash in any weather. All refuse, damp, green or dry is fully consumed. Scientific draft design completely eliminates fire hazard of flying ash, sparks, burning, blowing bits of paper. Intense combustion removes neighbor-annoying nuisance of flying scraps, smoke, smell.

Sturdily built to last for years. Nothing to get out of order. Needs no watching. Will not blow over. Will not destroy grass or shrubs. Ends refuse hauling and fire hazards to quickly pay for itself. Measures 23" square at base by 40" high. Weighs 23 lbs. Over 2 bu. capacity. Recommended by Bureau of Fire Prevention. Full price \$9.95—nothing else to buy. Sent F.O.B. Cleveland. Money back guarantee. Send check, cash, or money order to:

ALSTO COMPANY, Engineers Bldg., Dept. PM-5, Cleveland, Ohio

as featured in  
 Aug. 15 LIFE  
 pages 52-54

## Sailfish Trade Mark SPORTABOUT

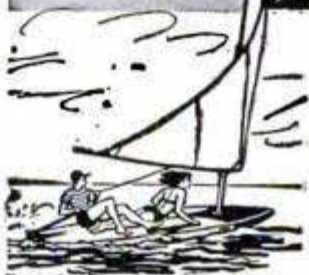

Now the fast, brilliant "Sailfish" comes knocked down for easy home assembly at a big saving! Safe-T-Plane hull can't sink or swamp. Carries conveniently on car top. Precision pre-cut and pre-formed parts of high quality materials go together quickly. All hardware included. **HULL KIT, \$69.75. SAIL KIT, with centerboard, rudder, spars, rigging and finished sail, \$49.75. ASSEMBLED BOAT, factory-finished and complete with sail, \$189.** All prices are f.o.b. Waterbury, Conn. Illustrated literature on request.

Dept. S, ALCORT, INC., Waterbury, Conn. also mfd. by

CALIFORNIA SAILFISH CO. Newport Beach, Calif.

## EVERY ELECTRIC DRILL

### A PORTABLE SAW

Just try it! You won't use a hand saw anymore

Fits Any 1/4", 5/16", 3/8" Electric Drill



At Better Hardware Stores Everywhere

Patent Pending

**ARCO SAW** \$9.95  
 Compl. with 4" "HYCARBON" Blade.

"ARCO-SAW" is a rugged precision woodcutting tool with right angle gear drive. (No clumsy, dangerous direct drive with drill sideways or makeshift gear box.) Works like high priced Portable Saw. Safety Yoke connects drill and saw. Absolutely Safe.

Cuts 1-3/16", 2 x 4 By Turning Over

Only ARCO-SAW Gives You All These Features:

- CAN BE USED WITH ONE HAND.
- BIG HANDLE affords firm grip for two hand operation.
- PRECISION ONE PIECE GREASE-PACKED GEAR BOX.
- SELF LUBRICATING LIFETIME BEARINGS.
- ABSOLUTE SQUARE CUTS.
- FULL VIEW OF CUTTING POINT guarantees precision work.
- GENUINE ARCO "HYCARBON" 4" BLADE cuts cleaner and faster.
- 90-DAY FACTORY GUARANTEE, backed by manufacturer of ARCO Quality Tools.

DEALERS—Write for name of nearest jobber

Extra Crosscut Blade, will Rip & Mitre, \$1.60  
**ORDER TODAY** at your dealer or send us check or M.O. (Postpaid). C.O.D.'s—postage extra.

Manufactured By—

UNCONDITIONAL 10-DAY MONEY BACK GUARANTEE

## ARROW METAL PRODUCTS CO.

Dept. PM5, 140 West Broadway, N. Y. 13, N. Y.

# PRESSURE QUEEN

*Outperforms them all!*



THE only portable air compressor having 4 cylinders in space usually required for one—absolutely no pulsation. Does more painting in an hour than hand brushing in a day. Lubricates machinery, inflates tires. Ideal for home, farm, service station, machine shop and contracting painter. Powered by gas engine or electric motor.

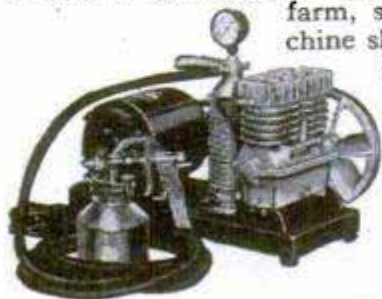

Write for Literature and Prices

**THE CAMPBELL-HAUSFELD CO.**

1046 RAILROAD AVENUE HARRISON, OHIO

## "MOTO-MOWER"

Best known name in power lawn mowers for thirty one years



There's one to fit every pocketbook  
\$79.95\*  
POWER CUT  
f.o.b. factory



24" Lawn Keeper  
22" Scout for every size LAWN  
20" Moto-Boy  
18" Ace  
\*17 1/2" Power Cut  
other models up to 71"



- and anyone in the family can use it!  
Write for catalog and name of nearest dealer  
**The MOTO-MOWER Company**  
4615 Woodward Detroit 1, Mich.

## Remove Toughest Paint!

In refinishing woodwork, furniture, etc., be sure to remove all cracked or peeling portions of the old finish. It's easy with

### WONDER-PASTE REMOVER

Applied with a paint brush, this remarkable solvent softens up the toughest finish—paint, varnish, enamel, shellac, etc. Turns it into a soft sludge that comes off easily. Long a favorite with painters. Get Wonder-Paste at paint and hardware stores

Wilson-Imperial Company, 119 Chestnut Street, Newark 5, N. J.

## The BERETTA

Vest-Pocket Featherweight  
**AUTOMATIC PISTOL**

25-calibre • 3 Safeties  
including Squeezer Grip **\$39.75**

At your dealer or write to

**J. L. GALEF & SON, Inc.**

85 Chambers St., N. Y. 7, N. Y. Dep't K-2



## SHARPEN CIRCULAR SAWS LIKE AN EXPERT



\$6.95

No experience needed. Two simple adjustments. Gets hollow-ground, cross-cut or combination saw blades true and sharp. Fits 6" to 12" blades with 1 1/2" to 1 3/16" centers. Includes file and complete instructions. \$6.95 postpaid. (Check or money order) C.O.D.s postage extra. Guaranteed—Money back if not satisfied after 10 day trial. A money maker for fix-it shops. Soon pays for itself. Order today. Free folder. **SURE SHARP MFG. CO., Dept. M-50**  
P. O. Box 24 Santa Ana, Calif.



### GENUINE KEY TYPE DRILL CHUCK

**ALMOND**  
fits B&D Utility Drill or any other having hex-key type chuck. Also, all size chucks to fit any size elec. drill, drill press or lathe.

1/4" Capacity \$4.00 Give make, model and capacity of drill when ordering  
1/2" Capacity \$6.00  
"Original Maker of Today's Standard Drill Chuck"

**ALMOND COMPANY, Ashburnham, Mass.**

## LIQUID MARBLE

COMPOSITION FLOORS  
FLEXIBLE MOLDS

Mold, Brush, Trowel, Spray It! MOLD novelties, Statuary, Art Goods in Flexible Plastic Molds; 5c

material makes \$1 seller. Make Marbleized floors, Tile Walls. Colorful, glossy, amazing! Easily learned; start in garage or basement. Particulars free.

**MARBLEIZING SERVICE, Dept. 10-F, Edwardsville, Ill.**



## ONAN Portable ELECTRIC PLANTS

FOR CABINS, TRAILERS, CONTRACTORS, BOATS

Light weight, compact, air-cooled, engine-driven. Furnish regular city-type A.C. electricity for lights, appliances, radios, etc. Can be carried by hand. Fit trunk of car. Plug-in receptacles on plant. Larger models for farms, homes, businesses beyond highlines. Catalog shows over hundred models. 350 to 75,000 watts.

**GASOLINE OR DIESEL POWERED**  
Prices begin at \$169.50

WRITE FOR CATALOG

**D. W. ONAN & SONS INC.**

5833 Royalston Ave., Minneapolis 5, Minn.



## Get this free SHOPMASTER Power Tool Catalog

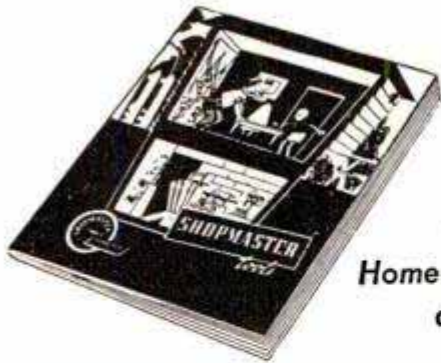

Start your  
Home Workshop  
at low cost

SHOPMASTER Home Workshop Power Tools are priced to meet every family's purse. Make your spare time relaxing and profitable. Build furniture, repair your home, build toys and playthings for the children.

Start your shop now at little cost. See your SHOPMASTER Dealer. He has full information. Write today for the complete twenty-eight page full color descriptive book.

**SHOPMASTER, INC.**  
1214 Third St. S., Minneapolis 15, Minn.

## I need 500 Men to wear **SAMPLE SUITS!**



**Pay No Money — Send No Money!**

My plan is amazing! Just take a few easy orders for my sensational values in made-to-measure suits. Get your own suits **WITHOUT A PENNY COST** and make money too! Men can't resist the outstanding style, long wear and low price of my made-to-measure suits. You need no experience. Spare time pays big profits. Rush name and address today for complete details, big **FREE SAMPLE**. **OUT-FIT** contains more than 100 actual woolen samples, style illustrations, etc. Write today!

**PIONEER TAILORING CO., Dept. E-1116**  
Congress & Throop St., Chicago 7, Illinois



### NEW MOBY DICK "FIRE HEAD" LURE

The famous Moby Dick Fire-Head finished in daylight fluorescent lacquer, glows in water like fish scales.

### MOBY DICK'S INTRODUCTORY OFFER

One Moby Dick Fire-Head **PLUS** your choice of any other Moby Dick live-action bait listed below, **PLUS** transparent bait box **FREE** . . . a \$4 value for only \$2.20. Choose second bait from Red Head, Black Head, Yellow Perch, Silver Minnow, Frog, Orange Black Scale, Minnow. All treated with "Armor-Coat" won't peel or chip. Order Today!

ALL  
for only  
**\$2.20**

Jobbers, Dealers write for information.

**Moby Dick Manufacturing Co.**  
Dept. 32, 5501 S. 36th St., Omaha, Neb.

## BUILD AN EXTRA ATTIC ROOM



**H**ERE'S the quick, low-cost way to build an extra bedroom or two in your attic. Nail big, fireproof panels of Gold Bond Gypsum Wallboard right to the studs or over the old material. Gold Bond Gypsum Wallboard saws like lumber, resists moisture, won't expand, contract or warp. Seal joints with Gold Bond Tape Joint System and decorate with Gold Bond Sunflex, the one-hour wall paint. Or if you prefer, Gold Bond Gypsum Wallboard takes wallpaper beautifully. For further details, write Div. W, Dept. PM-5.

Available at your local Gold Bond  
lumber and building materials dealer!

**NATIONAL GYPSUM COMPANY**  
BUFFALO, 2, NEW YORK

## MANUFACTURE THIS BEAUTIFUL CONCRETE OUTDOOR FIREPLACE Right In Your Own Back Yard

**\$4.00 Worth of  
Sand & Cement  
produces this  
Attractive  
Fireplace.**

**Sells on Sight  
from \$60. to  
\$80. Easy to  
start your own  
Profitable Bus-  
iness.**

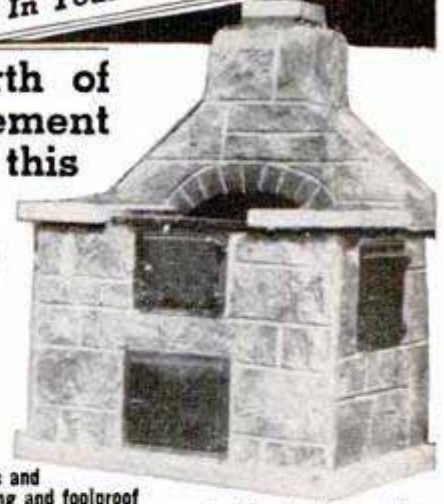

The General Fireplace Molds and Process are the most amazing and foolproof ever invented. Simple to operate, two men can produce five fireplaces a day.

### BIG DEMAND!!

Sell all you produce to Department Stores, Homeowners, Parks, Nurseries and Picnic Groves. Fireplaces sell on sight. No experience necessary, we supply full operating instructions and equipment plus the know how that spells **BIG PROFITS**. This is an outstanding opportunity for men of vision and small capital to get into a busy rich paying field. Don't delay, be the only exclusive manufacturer in your own home town. Mail coupon at once for full details as to how you can reserve your territory.

**GENERAL ENGINES CO., Inc., Dept. P8F**  
307 HUNTER ST. • GLOUCESTER CITY, N. J.

Mr. Tor of Phila. writes:  
Sold 250 in first 4 months. Selling to  
Sears Roebuck, John Wanamaker &  
Gimbel Bros. in Phila. area.

Name .....

Address .....

City..... Zone .... State .....



**NOW!**

**EVERYONE CAN MAKE TRAYS..COASTERS..GIFTS OF BEAUTY**

with **PRE-FORMED METAL CIRCLES**

Pre-cut, pre-formed circles of Aluminum and Copper — ready to transform quickly and easily into colorful trays, coasters and other items with the Metal Goods Dek-All Color Kit. No cutting or forming. IT'S EASY—JUST TRACE ON DESIGN... THEN PAINT WITH "DEK-ALL" COLOR SET. The brilliant colors are chip-resistant, will not wash off.



**WRITE TODAY** for literature and price list

**METAL GOODS CORPORATION**

628 Rosedale Ave. St. Louis 12, Mo.

*America's* **BOUNTIFUL FOLBOT**

Has Everything **YOU** and **YOUR Family Want!**

14 feet of yachtsmart Craft, wide beam, large decks, low gravity center, sturdy, greatest safety record. Lightweight, carries 1200 lbs., seats four adults plus gear, but 1 person can handle. Erected in jiffy without tools. Tops with any outboard, easily rowed or paddled. New SALT-WATER-PROOF construction most practical & durable, rock & leak proof. Luxurious easychair comfort. For 18 years, thousands of FOLBOTS used in every kind of water. No upkeep or fees.

Also Other Paddle & Sail Models



Folds in 2 Light Bags. Fits **INSIDE** car trunk or rides erect on top.

**BIG \$275 CRAFT**

**NOW ONLY \$159**

**SPECIAL OFF-SEASON PRICE**

**FREE** Large Catalogue with Action Pictures and Full Information. Mail Coupon.

TO: FOLBOT 42-09 PM HUNTER STREET Long Island City 1, N.Y.

Name.....

Address.....

City..... State.....

**NOW DADO ANY WIDTH**

**WITH DA-DALL!**  
Pat. Pend. U.S.A. & For

A simple turn of a screw adjusts your saw to any desired Dado cut! DA-DALL cannot slip, is self-tightening, self-adjusting, of all-steel construction. Does a clean, true job!

**ONLY \$4.95**

DA-DALL cuts hard or soft wood, plywood, without chipping! No blades or complicated dials. All arbor sizes.

**RULE-WAGNER CO.**

Box 694, Dept. D.I. Walnut Creek, Calif.

Dealers, Jobbers Write for Information



**make your own Gems** 29.50 F.O.B.

All necessary lapidary equipment is furnished, including a super-charged diamond blade for sawing, and all wheels for grinding, shaping and polishing; also complete instructions. The complete equipment as shown, less motor and belt, for only \$29.50, f.o.b., Burlington, Wisconsin. Write today for information and literature.

**B&I MANUFACTURING CO.**  
Dept. S Burlington, Wis.



**RETAIL PRICE \$125.00**  
**FACTORY TO YOU \$59.95**

**SUPERSHOP** includes precision-built 8" tilting table saw, vertical and horizontal drill press, 30" lathe, sander, grinder. 100% BALL BEARING. Write for **FREE** catalog, full details, trial plan.

**POWER TOOLS, INC.**  
111 YATES AVENUE  
BELOIT, WIS.



**PISTONS**

**ALUMINUM ALLOY.** For Every Make Engine, Any Year, Odd or Foreign! For auto, "hot rod", racing, truck, tractor, motorcycle, scooter, bike, outboard, marine, compressor, industrial. Send sample or specifications.

**JUDSON MFG. CO., 1709 Gillingham, Phila. 24, Pa.**



**HANDI-GROMMET-KIT**  
Make Your Own Repairs To Your Canvas

This Kit is complete with Tools and 4 dozen Grommets for making quick, easy repairs to TENTS, AWNINGS, TARPAULINS, BOAT SAILS, SHOWER CURTAINS, etc. Grommets are available in either Natural Brass or Nickel Finish.

Size	I.D. Hole	Price
0	1/4	\$2.00
1	5/16	2.25
2	3/8	2.35
3	7/16	2.50

Send check or M.O. Shipped postpaid.

**LORD & HODGE, MIDDLETOWN, CONN.**

**OXYGEN BREATHING SET**  
ORIGINALLY COST \$100 — NOW ONLY \$7.95!

**BRAND NEW SURPLUS.** Ready to use. Portable with Automatic "Demand" type valve. The type set our Air Force depended on! A must for airmen, mountaineers, firemen, paint shop workers and others who on occasion need extra oxygen. This popular "demand" type oxygen outfit requires no technical knowledge for use—just breathe into the mask provided and the regulator automatically delivers the oxygen you need as you breathe into the mask! Complete set includes D-2 type shatter-proof steel bottle 6x24 inches; demand type regulator AN-6022-1; 0-500 lb. oxygen gauge and type A-10 demand oxygen mask with hose. Net weight 7 lbs. Shipping weight 10 lbs. Outfit as described above but with empty tank shipped parcel post each \$7.95. With oxygen filled tank (mailable by express only) \$9.95. Refiller hose, orifice and valve for charging tank with oxygen \$2.00. 6 foot flexible extension hose with fittings \$2.00 F.O.B. Houston. Send check, money order.

**AERO PARTS SUPPLY CO., Dept. PM-4**  
8102 LOCKHEED, HOUSTON, TEXAS



# GRINDING WHEEL KITS

HUNDREDS OF ASSORTED ITEMS—WORTH OVER \$50!

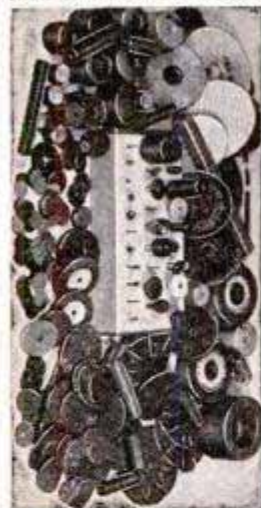

FOR GRINDING, CUTTING, POLISHING AND SHAPING—METAL, PLASTIC OR WOOD, WHILE THEY LAST—COMPLETE KIT ONLY. Approx. wgt. 8 lbs. f.o.b. Chicago

**\$7.95**

**KIT INCLUDES OVER 300 ITEMS**  
 25 Grinding and Cut-off Wheels, sizes 1" to 5", 1/8 to 1" arbor holes, 10 Mounted stones 3/32, 1/8, 1/4" shank, 3 Steel Cutters 1/8" shank, 5 Steel Cutters 3/32" shank, 1 Circular saw 1" dia. mounted on 1/8" mandrel, 1 Drum sander 3/4" mounted on 1/8" mandrel, 6 Abrasive bands for Drum sander, 6 Cut-off Wheels and 1/8" mandrel, 1 Buffing Wheel 1" on 1/8" mandrel, 1 High Speed rotary file 1/4" shank, 1 Abrasive belt, 2 Leather bobs, 1 Tampico Wheel, 2 Sharpening stones, 100 Paper sandstones, 50 Cloth abrasive discs and buttermilkies 1" to 7" dia., 15 Abrasive rolls, 2 Muslin buffs 3" and 8", 5 Rubber wheels, 1 Wire wheel 4" dia., 1 Wire wheel 1" dia.

ORDER TODAY! Send check or money order. All orders shipped by Ry. Exp. Illustrated Bargain Catalog—10c

SCHUPACK SUPPLY CO. 7331 Cottage Grove Avenue Dept. M-5, Chicago 19, Ill.

# TRAILER AXLES



✓ No Swaying  
 ✓ Level Load

One piece solid forging steel SAE 1040

**\$39.50**

F.O.B. LOS ANGELES

Includes wheels, hubs and bearings. 2000 lb. capacity

Heavy springs coiled around axle cushion every shock . . . distributes any load evenly on both springs . . . assures maximum safety through even load and low center of gravity. Write for details on our complete line of axles.

Satisfaction guaranteed or money refunded!  
**LINCO AXLE TRAILER CO.**

7528 S. BROADWAY  
 LOS ANGELES 3, CALIF.

## OVER 500 SURPLUS BARGAINS



## NEW! CATALOG

TERRIFIC BARGAINS for Sportsmen — Farm & Home greatest stock of Gov't Surplus for everyday use in America!

SEND 10c FOR YOUR CATALOG TODAY!

**FISLER SALES CO.** 723 Walnut St. Kansas City 6, Mo.

## BUILD YOUR OWN GEIGER COUNTER!

And SAVE 2/3 of Cost!

NO special knowledge necessary! You need NO additional parts!

It's EASY to build your own Searchmaster Geiger Counter with this COMPLETE kit. Contains everything you need! Headset, tubes, geiger-counter tube, batteries, plus smart metal case 9 1/2" x 4" x 3 1/2". All parts laboratory tested! Sensitive to both beta and gamma radiation! Fully guaranteed! Illus. instructions show you how to assemble parts quickly.

### SPECIAL FREE OFFER!

Radioactive specimen sent FREE with each order. Plus FREE literature, showing you how to locate uranium with your Geiger Counter and win \$10,000!

Write for details or order your Searchmaster Geiger Counter Kit now! Postage prepaid with check or money order, C.O.D. orders: send \$5, bal. on arrival.

Superior to many Counters selling for MORE than \$100!



COMPLETE KIT \$29.95



**KIT COMES COMPLETE Nothing Else to Buy!**

Easy-to-follow instructions Come with each Searchmaster Kit

Kit guaranteed to operate perfectly when assembled per instructions!

**SCIENCE KITS LTD.**

5514-P Hollywood Blvd. • Hollywood 28, Calif.

# THROW AWAY NICOTINE

When the Filter in Medico Pipes or Cigarette Holders turns brown, throw it away with the nicotine, tars, juices and flakes it has trapped. Insert a fresh Filter for cooler, cleaner, dryer, purer smoking!



Real Filters ... not mere hollow tubes!

10 for 10c

**MEDICO V. F. Q. (VERY FINE QUALITY)**

Pipes of specially selected imported briar. \$2  
 Wide variety of shapes. With 10 filters...  
 Also Frank Medico "Standard"...

America's Outstanding Dollar (\$1) Pipe

Frank Medico Cigarette Holders \$1 & \$2

# MEDICO

**FILTERED SMOKING**

Write to S. M. Frank & Co., New York 22, for booklet M

ALL MEDICO PIPES NOW MADE OF PRE-WAR QUALITY IMPORTED BRIAR

## IT'S EASY TO CONVERT YOUR MOWER TO A POWER MOWER

### MAKES LAWN MOWING FUN

Equip your hand mower with a LeJay MidgeTractor. It snaps on in a jiffy. It's ready to go! Backs up and maneuvers amazingly easy. Costs far less than regular power mowers. Unheard of low price—Only \$54.95 complete. Or, \$29.70 less engine . . . use your own engine (any make 3/4-1 1/2 HP or 1/3 HP electric motor). Free literature. Guaranteed with money back 5-day trial offer. Order your LEJAY MidgeTractor from this ad, do it today. (Sold by mail order only.)



If you are a handyman, send 35c for PLAN "Build Your Own MidgeTractor", literature included.

**LEJAY MANUFACTURING CO.**  
 2947 S. Emerson, Minneapolis 8, Minn.

# PALMGREN

## No. 000 ANGLE VISE For MILLING—DRILLING—GRINDING FITTING—FILING

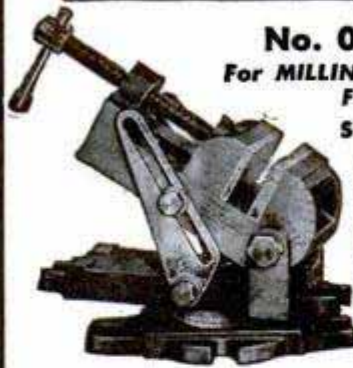

### Solve Difficult Angle Jobs

Quick, accurate set-ups at any angle. End make-shift methods—time loss—rejections. Ideal for tool rooms or home workshop. Accurately machined and graduated. Once set it stays locked. Jaws of steel—2 1/2" wide, plain or grooved. PRICE \$12.05 complete with Swivel Base—Vise only \$8.75. Write for other styles and sizes.

## DRILL PRESS VISES

For tool room, machine shop, school shop, home shop or repair shop. Accurately machined. Best semi-steel castings. Adjusting screw of hardened steel with fine pitch thread and long bearing. Jaws of steel, grooved or plain. Sizes 1 1/2" — 2 1/2" — 4" Jaws.



No. 6  
1 1/2" GROOVED STEEL  
JAW. \$3.30.

## No. 83 ROTARY TABLE with . . . DUAL CROSS FEED and ROTARY FEED



Has 8" Circular Table with full 360° movement and 4" crossfeed travel. Free moving adjusting wheels and dials graduated in degrees. Crossfeed adjusting screws have Acme threads with adjustable dials graduated in thousands. Four slots in base and key slots for bolting to table.  
No. 83 Rotary 8" Table . . . \$49.50  
No. 82 Dual crossfeed—with-out rotary . . . \$39.75

**IMMEDIATE DELIVERY** Write for Circular No. 12 — Order from dealer or direct postpaid if he can't supply.

## CHICAGO TOOL AND ENGINEERING CO.

8365 South Chicago Avenue Chicago 17, Illinois  
Telephone — Saginaw 1-9675

WE FURNISH ALL MACHINED METAL PARTS, EVERY SCREW,  
NUT, BOLT, WASHER, AND COMPLETE PLANS FOR THIS...

## BIG 10" POWER SAW

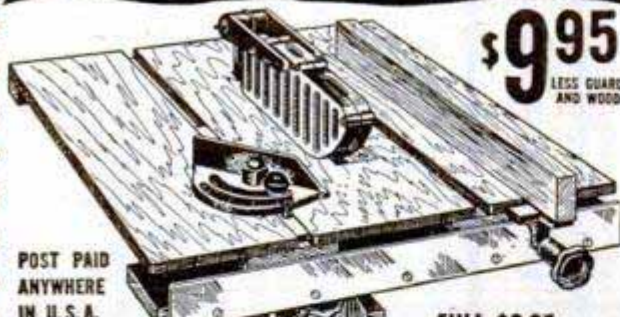

\$9.95  
LESS GUARD  
AND WOOD

POST PAID  
ANYWHERE  
IN U.S.A.

FULL \$9.95  
REFUND IF  
NOT SATISFIED  
WITHIN 10 DAYS

ASSEMBLE IT YOURSELF WITH  
SIMPLE HOUSEHOLD TOOLS!

TABLE 24" x 20" • TILTS TO 45°  
CUTS 0" TO 3/4" DEEP • TAKES 10" BLADE

COMPLETE PLANS (WITHOUT PARTS) 10c

MARCUS • POLLAK DEPT. 44  
ROYERSFORD, PA.

## SAVE UP TO 25% ON QUALITY BALL-BEARING WHEELS!

Bilt-Rite wheels roll smoothly and easily, are semi-pneumatic, ball-bearing, painted red; guaranteed top quality—and you save up to 25%! Compare Bilt-Rite's quality and price—then get your order in today! Dealer inquiries invited.



### BILT-RITE BARGAINS ON BALL-BEARING WHEELS

(For 1/2-inch Axles)			
6 x 1.00.....	\$1.30	10 x 1.25.....	\$1.95
8 x 1.25.....	1.65	10 x 1.75.....	2.15
8 x 1.75.....	1.80	10 x 2.00.....	2.45
(For 5/8-inch axle)			
6 x 1.50.....	\$1.50		
6 x 2.00.....	\$3.95	8 x 2.50.....	\$4.45
		10 x 2.75.....	Only \$4.65!

**Bilt-Rite Guarantee**  
No better wheels are made regardless of price; 10 day return privilege.

If size you need isn't listed, write for Folio A

**ORDER TODAY**—Send cash, check, or M.O.—Pay postage on arrival.

**BILT-RITE WHEEL COMPANY**  
520 EAST MISSOURI AVE. KANSAS CITY 6, MISSOURI

## DAISY FOUNTAIN BRUSH

Attaches to your garden hose. Wash your car in 5 minutes. Keep yourself dry. Rinses as it washes—leaves no streaks or scratches. It's not a gadget. Money back guarantee.

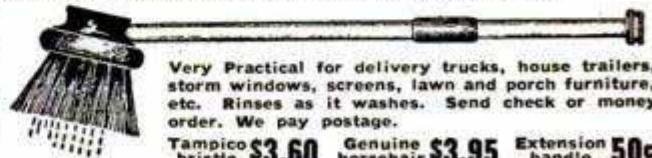

Very Practical for delivery trucks, house trailers, storm windows, screens, lawn and porch furniture, etc. Rinses as it washes—leaves no streaks or scratches. It's not a gadget. Money back guarantee.

Tampico bristle \$3.60 Genuine horsehair \$3.95 Extension handle 50c

DEALERS AND SALESMEN WRITE

**THAD G. SMITH**

11780 CAMDEN AVE. (National Distributor) DETROIT 13, MICH.

BRAND  
NEW



## 30 DAY FREE TRIAL

## 7x50 Prizm BINOCULARS

Finest Precision Optics  
Buy Direct From Importer  
Money Back Guarantee

Many other models  
AS LOW AS \$6.00 \*  
(\* plus 20% fed. tax)

7 x 50  
\$36\*  
with leather  
case

FREE Illustrated Catalog & Book,  
"How To Select Binoculars"  
Dealers: Write for discounts.

**BUSHNELL Importers**

43 E. Green St., Dept. M-5  
Pasadena 1, California

**ENSHRINE THEIR MEMORIES WITH  
U.S. MONUMENTS**

There is none better. Our free catalog is ready for you. Write today. A-18, U. S. Marble & Granite Co., Oneco, Fla.

Erected. Freight paid.

## Say You Saw It in Popular Mechanics

## AMAZING NEW LIQUID RUBBER SEAL

**Sealex** INSULATES • STOPS CORROSION  
SURFACE DRIES IN 1 HOUR

Hundreds of uses in Auto, Home, Shop. Use it for battery terminals, television aerial connectors, for weatherproofing spark plugs, to repair weatherstripping, leaky windshields, leaky fuel and oil lines, leaky gas tanks, frayed insulation, forms new wetting between fenders and body of car, etc.

Sold With Money Back Guarantee  
If dealer cannot supply—order from factory  
**RUBCO AUTOMOTIVE PRODUCTS CO.**



TWO  
HANDY TUBES  
\$1.98

Postpaid  
Send check or M.O.

65-48 Freshmeadow Lane  
Flushing, New York



**ASSEMBLE YOUR OWN MOWER**  
 . . . We Furnish All Parts,  
 Completely Finished and Painted,  
 Including NEW CLINTON 1.8-2 H.P.  
 VERTICAL ENGINE  
**SAVE 40%**  
**\$69.60**  
 F. O. B. FACTORY

Here's your opportunity to save some real money on a high-class quality product.

**CAST ALUMINUM BASE**

This is a modernized streamlined and nicely finished product. Two-tone baked enamel. Full 20" cut, hardened steel, one-piece cutting blade with safety clutch. Ball bearing, rubber tired wheels.

**CUTS TALL GRASS**

Will mow to carpet smoothness tall rough, grass. Cuts close to fence. Three cutting heights. Can be assembled in 30 minutes. Easy to operate. Guaranteed satisfaction or money back. Clinton engine alone retails for \$60.00. Price mower complete . . . \$69.60 f. o. b. factory.

No C. O. D.'s. Cash or money order must accompany order. Order today!  
 Reference: Fourth National Bank

NEFF EQUIP. CO. . . . 400 Petroleum Bldg. . . . Wichita, Kansas



**HANDY CALCULATOR FOR WOODWORKERS.. ONLY 10c**

Just set dial, quickly solves countless problems. Converts linear to board feet, compares workability of various woods, shows bit sizes, nail specifications. Also tool sharpening tips, etc. 6" diameter heavily varnished cardboard. Send 10c to Greenlee Tool Co., 2105 Columbia Av., Rockford, Ill.

**GUARANTEED USED-REBUILT HARLEY-DAVIDSONS**  
 ALL MODELS - LOW PRICES



Parts, accessories, oil, tires, service by experts. Parts for obsolete models. Send 25c for Accessory & Motorcycle Bulletin.

**KNUTH'S** 2491 W. FOND DU LAC AVE. MILWAUKEE 6, WIS.

**SUMP PUMPS** CAPACITY 2,200 GALLON  
 1 1/4" outlet - No screen to clog - fool proof

The time tested Lokomona sump pump is absolutely automatic—has a special fool proof trap at the intake—rubber bearing at the bottom. Made of aluminum castings. It's 42" high and carries a 1/4 H.P. 110 V. A.C. heavy duty motor. The pump is designed for continuous dependable service. Any standard motor will fit this pump. Order yours today. COD. If cash with order, we pay postage.

**\$36.00 COMPLETE**  
**\$22.00 LESS MOTOR**  
**\$18.00 PUMP ONLY**

**MONEY BACK GUARANTEE**  
 LOKOMONA PUMP CO., P.O. BOX 86, ROYAL OAK 1, MICH.

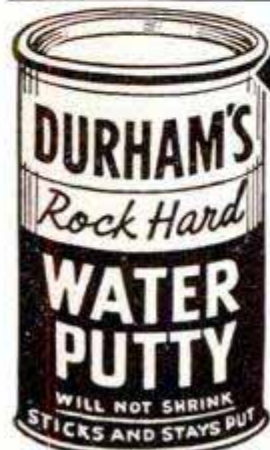

**The Modern PLASTIC for lasting Home Repairs**

PERMANENTLY mends cracks or holes in wood, tile, stone or plaster. Sticks and stays put—Does not chip, shrink or fall out. Easy to use. Economical. Mold it, chisel it, polish or paint it. If unobtainable from your lumber, paint or hardware dealer, the big 4-lb. can will be sent you post-paid (in U.S.) for only \$1. Full money-back guarantee, order now.

**DONALD DURHAM CO.**  
 Box 804-Q, Des Moines, Iowa

**Everybody's talking about a \$1,000 car - BUT ONLY CROSLLEY IS BUILDING IT!**

Building cars in the \$1,000 price range is one thing. And we've built 70,000 of them. Announcing that you are considering building such a car is quite another thing. The Crosley is not a plan on paper or a showroom pilot model. It's a reality—the only \$1,000 car on the road today.

The Crosley car is not built to a demand that will reach a million cars a year in production. It's built for that one family out of a hundred, sophisticated, down-to-earth people who want 35 to 50 miles per gallon and other low upkeep features. It's built for intelligent buyers who want a new, shiny, practical car instead of someone's beat-up secondhand (or fourthhand) car.

The promises of a "big" car for less than \$1,000 create an unfair picture of the industry's ability to deliver more for the dollar than is humanly possible with current labor and material costs. You just can't build a big car and sell it at the price of a small car.



Drive the newest Crosley Station Wagon. All-steel, seats 4 or 2 with 1/4 ton load.



**CROSLLEY**  
 a FINE car

**FREE!** Latest 1950 CROSLLEY CATALOG. Write Crosley Motors, Inc., 2530-HR Spring Grove Ave., Cincinnati 14, Ohio.

"You see them everywhere!"

**Handee**  
 CAR WASHER

**Quickest Way to Wash Your Car!**

Give your car a professional wash in minutes with a HANDEE CAR WASHER—a rubberized mitt with rubber sponge attached. Easy to use—just connect to garden hose and turn on water. Rinses as it washes. Youngsters will enjoy keeping the family car sparkling clean with a HANDEE! No splashing or cold, wet hands. Cannot scratch the car finish. Save time and money! **\$1.98** At your dealer's or mailed postpaid.

**TRI-PRODUCTS COMPANY**

310 S. Broad St. Dept. PM  
 Holly, Michigan



# WAR EQUIPMENT MAIL SALE!

**WE PAY ALL FREIGHT AND MAIL CHARGES**  
Gigantic mail sale. Hundreds pieces new equipment at fraction of original cost. Send Card for free Catalog.

- **Power Plants.** 110-v. 60-C. 3,000-W. Remote switch self starter. Easily made full automatic. Army's finest plant. 4-cyl. Hercules engine. Ideal farmers, sportsmen, cabin camps. Cost **\$345.00** Gov't over \$1,000. Sale.....
- **Engine Driven Compressor.** Portable Briggs 1.5 h.p. eng. driving 2 cyl. Westinghouse compressor. World's finest unit for farmers, contractors, painters. Paint, clean, inflate tires, pressure grease farm machinery. Complete with regulator, gauge, hose, etc. Buy now as only 78 units left. Our most popular item. Gov't cost over \$275.00. Sale **\$99.50**
- **Winch (2 ton).** Made for Jeeps. Powerful has 80 to 1 gear ratio. Finest construction. Size 12"x14"x9". Useful for jeeps, trucks, boat yards, wagon unloaders, etc. Mount on front end of jeep or truck drive through crank hole. Gov't cost **\$24.95** over \$100.00. Sale.....
- **Welding Generators.** 25 to 350 amp. Genuine G.E. units. Ready to operate. Complete with pulley, heat control, etc. Build and repair your own machinery. Do professional welding for pay. Drive with tractor, old car engine, motor. Complete with instructions on "How to Weld". **\$89.90** Gov't cost \$276.00. Sale.....
- **Generator with helmet, rods, holder, cables, clamps.**.....Sale **\$104.50**

- Some of the other many items in our catalog**
- A-C Generator, 110-V. 60-C. 750-Watt. Many uses..... **\$59.50**
  - Electric Chain Saw, 110-V. 750-Watt. Does work of 3 men... **\$9.95**
  - Briggs Gas Engine, 3.5 h.p. Ideal grain elevators, boats... **75.80**
  - Briggs Model N 1.5 h.p. Engine..... **45.90**
  - Weed Spray Boom Assembly. All brass. Complete with filter **32.90**
  - Direct Drive Tractor Spray Pump. Guaranteed to outperform all others. Any pressure or volume over wide range..... **39.95**
  - Bronze Flex-roller Spray or Water Pump. 1 1/2" Size..... **12.90**
  - Bronze Flex-roller Spray or Water Pump. 3/4" Size..... **16.99**
  - Complete Shallow Well Pump System. 110-Volt. A buy..... **59.50**
  - Complete 110-V. Vibro-Electric Spray Unit. Paint furniture, etc. **8.98**
  - Electrical Circuit Tester. Pocket Size. Complete..... **1.69**
  - Popular Brand 3/4" Electric Drill with 15 Attachments..... **21.70**
  - Norton Abrasive Stone Assortment (\$25.00 list)..... **4.89**

- RED HOT ITEMS**
- |  | SALE    |
|--|---------|
| A. Utility clutch, 0 to 6.5 h.p.       | \$13.95 |
| B. Modern Rural Line Telephone         | 12.40   |
| C. Genuine Quincy Air Compressor       | 18.15   |
| D. Heating Element, 110-V., 2000 Watts | .99     |
| E. City Wall or City Desk Phone        | 4.99    |
| F. Complete Spray Outfit—110-volt      | 19.90   |
| G. Aqua 3/4" Centrifugal pump          | 6.50    |

Hundreds other items including... fire-burglar alarms, photo cells, meters, scizable shafts, selenys, thermostats, etc.

**WE PAY ALL TRANSPORTATION CHARGES IN THE U.S.A.**  
**BURDEN SALES COMPANY**  
807 '00' ST. LINCOLN, NEBR.

## AIR CONDITION

**Any CAR TRACTOR CAB TRUCK**



**PLANS SHOW YOU HOW . . . \$1.50**  
HOT OUTSIDE . . . COLD INSIDE. Enjoy pleasure driving in cool comfort in scorching outside temperatures, with real mechanical refrigeration. (Not a dry ice or window unit.) Easily installed by anyone handy with tools. No experience necessary. Powered direct from your engine. Completely automatic.

**PATENT FEATURE CONTROLS TEMPERATURE**  
...FROM **IDLE...TO** **100 MPH.**

**BUILD AND INSTALL IT YOURSELF!**  
Keeps your automobile comfortable, Tractor cab cool, Truck Cooled for hauling perishables. Send \$1.50 for your set of PLANS now. DO IT TODAY!  
**LeJay Manufacturing Co.**  
547 LeJay Building  
Minneapolis 8, Minnesota

**\$1.50 COMPLETE PLAN... PARTS LIST KIT PRICES**

**Can any other tool do this?**  
Genuine **WISE-GRIP** WRENCH  
**Does it EASILY!**



Just lock **WISE-GRIP's** Ton-Grip jaws to stubborn nuts, even in closest quarters, and see how easily they turn! Does difficult jobs like magic! Does jobs no other tool can do! Only the genuine **WISE-GRIP** has these features. **Involute Jaw** **WISE-GRIP** holds all shapes, with remarkable ease. **Knurled Jaw Tips** hold to the very tip. **Thin Nose, Super Wire-Cutter**. Specially hardened alloy steels, nickel plated finish. With cutter—No. 7W, 7", \$2.25; No. 10W, 10" \$2.50. Without cutter—No. 7C, 7", \$1.85; No. 10C, 10", \$2.25. If not at your dealer's, order direct: **PETERSEN MFG. CO., Dept. P-5, DeWitt, Nebr.**

**DO MORE PLANING JOBS WITH LOW-COST BELSAW \$195.**

**AMAZING 12 1/4-IN. PLANER Does All Ordinary Planing Mill Jobs.** Provides attachments for Jointing, Rabbeting, Tongue, Groove, Matching. 12 1/4 x 6-in. capacity. 3-knife solid round all-steel cutterhead. Power feeds at 24 feet per minute, 42 cuts per inch. Provides for full line of accessory attachments—Grind and Joint knives IN THE CUTTERHEAD WITHOUT REMOVING.

**BELSAW MACHINERY CO.**  
81012 Field Bldg., 315 Westport Rd., Kansas City 2, Mo.

**FREE BOOK**

**BRUSH PLATING OUTFITS**

- for re-plating articles in the home and shop. No tanks necessary. Free particulars.

**GUNMETAL CO., AVE. M, DECATUR, ILLINOIS**

**GENUINE DIAMOND SCRIBER!**



**\$2.00** Postpaid  
Writes on glass, metals, plastics. Hex. Aluminum 6". Money back guarantee. Agent inquiries invited.

**CLIPPER DIAMOND TOOL CO., INC.** 21-B W. 46 ST., N.Y. 19

**CAST your own LEAD HAMMERS**



**1000 USES AROUND SHOP OR FARM** Simple, easy, quick. Use short length of pipe for handle and this accurately finished, cast iron mold. Lasts a lifetime. Also makes brass faced hammers. Available two sizes: 3 1/4" lb. \$3.50; 1 3/4" lb. \$3.00. Order both for \$6.00. Postpaid if cash with order, otherwise C.O.D. plus postage. Send check or money order TODAY.

**AIR CAPITAL PATTERN WORKS • 1612 SOUTH ST. FRANCIS • WICHITA 11, KANSAS**

**\$10,000 REWARD**  
Earn the government bonus by locating **Radio-Active Ores** with a **P.R.I. GEIGER COUNTER**

The most sensitive portable Geiger counters made. Weight only 2 lbs. Battery lasts a year. Prospecting book included free. Priced from \$49.50 complete.

**PRECISION RADIATION INSTRUMENTS, INC.**  
5478-P Wilshire Blvd. Los Angeles 36, Calif.  
DEALER INQUIRIES INVITED

**SAY YOU SAW IT IN POPULAR MECHANICS**

**TENTS & CAMPING EQUIPMENT**

New Tents: 2-man mountain style, nylon \$15.95; canvas \$11.95. 5 x 7 wall \$10.95; 7 x 7 \$12.50. War Surplus, used, reconditioned: Pup tents, single flap \$2.95; double flap \$3.95. 9 x 9 wall \$21.95; 16 x 16 \$32.95. Poles & Stakes included. Check or M.O. Money Back Guarantee. Free Tent & Camping Catalog

**MOR-SAN-SALES** 10-19 E 50th AVENUE LONG ISLAND CITY 1, N. Y.

# Sensational New Motor Bike **WHIZZER** SPORTSMAN

Get Whizzer Sportsman, and get up to 100 miles on a gallon! 5 to 40 miles per hour! Big frame; 20" wheels; built-in generator; dual spring front fork; rear brake foot controlled. Ask your dealer about easy purchase plan.

**\$23950**

plus tax,  
F.O.B. Pontiac



- ★ Big 3 horsepower, 138 c.c., 4-cycle motor
- ★ 2-Speed automatic transmission
- ★ Kick starter
- ★ Large, auto type brakes



### Also NEW—3 BIG H.P. MOTOR FOR YOUR BIKE!

Motor, complete with attachments

**\$10997**

F.O.B. Pontiac

Fits any man's size bike! Precision-built! America's finest bike motor. Ride one, and you'll buy one.

Look for the  
**WHIZZER**  
display at your  
dealer's, or write!

WHIZZER MOTOR CO.; 304 S. SANFORD ST., PONTIAC, MICH.

## POWER MOWERS & KITS **FREE PLANS**



LOW FACTORY PRICES  
DIRECT TO YOU

on America's finest Lawn Mowers and Easy-To-Assemble Kits and Parts. TRIANGLE Mowers are quality-built and powered high for easy cutting and long wear.

- SAVE MONEY 3 WAYS**
1. Buy complete assembled mowers in 3 or 4 wheel models, 18" and 20" sizes.
  2. You assemble complete mower from our precision built Kits and Parts.
  3. Build your own from our FREE PLANS using Triangle Kits, Parts, Engines, Wheels, Etc.

WRITE TODAY for full facts, Free Plans, Parts List, and LOW, Factory Prices.

**TRIANGLE MFG. CO.**  
Dept. M-D, Box 185  
Fort Scott, Kansas

## DRAINS CELLARS, WASH TRAYS CIRCULATES OIL

Pumps 1800 GPH 300 gal.  
30' high, use 1/8 to 1/2 HP **\$650**  
motor. Will not clog.



Postpaid if cash with order.  
(Add 50c for west of the Mississippi.)

Thousands in use since 1936.

LABAWCO PUMPS, BELLE MEAD 7, N. J.

SAY YOU SAW IT IN POPULAR MECHANICS

## MONEY MEN **ALL DATA FREE**

THE PLASTEX Industry needs manufacturers on small scale and for big production of Lamp and Clock Stands, Art Goods and Novelties in Plastex and Marble imitation. Experience unnecessary. 1/2c material makes regular 10c store sellers. Rubber moulds furnished for speed production. Small investment brings good returns. Big chain store orders now being placed. Ambitious men have chance for real prosperity. Our Free booklet will interest and benefit you.

**PLASTEX INDUSTRIES, Dept. A**  
3400 Third Ave. New York 56, N. Y.

Make 100% to 150% Profit!

## MANUFACTURE BUILDING BLOCKS In Your Own Back Yard



**AMAZING GENERAL  
BLOCK MACHINE**

CAPACITY 1000 BLOCKS PER DAY

only **\$199** LESS MOTOR  
F.O.B. PLANT

SHIPPING WEIGHT 400 lbs.

Here is an outstanding opportunity for men of vision and small capital. Cinder and concrete blocks are in great demand. Millions used for homes, factories, public buildings. Sell all you produce at 100% to 150% mark-up.

### PEAK BUILDING DEMAND!

The General Block Machine is amazingly practical, foolproof. Simple to operate indoors or outdoors. Rugged all steel construction. Vibrator mounted in sealed ball bearings. Produces up to 1,000 blocks per day. Superior 3 Core Type that meets all building code requirements. Can produce 4 x 8 x 16, 8 x 8 x 16, 12 x 8 x 16 blocks. All materials obtainable anywhere. All operating instructions and mixing formulas supplied. Full details FREE without obligation.

**HOW TO  
BUILD  
YOUR OWN  
CONCRETE  
BLOCK  
HOME**  
Only 1 Prepaid

Wonderful  
Book Written  
& Illustrated  
by Experts

## GENERAL ENGINES CO.

DEPT. P-8 • 307 HUNTER ST. • GLOUCESTER, N. J.

Includes floor plans for 4 beautiful, easy to build concrete block bungalows. Shows ways to save money. How to lay blocks, lay out building lines, mix concrete, build steps, porches and concrete floors. Mail coupon at once with \$1.

Name.....

Address.....

City.....Zone...State....

# SURPLUS COMPRESSORS



(Item 10)

**\$23.95**  
COMPLETE

Powerful Senior Model—genuine Westinghouse. Dependable source of compressed air for paint spraying, orchard spraying, 2-4D, also tire inflating, air tools, air brushing, etc. Reg. price comparable equipment \$88.50. 2 cyl., piston type, ball bearing—800 to 1200 r.p.m. 3.5 to 6.6 cu. ft. Up to 100 lbs. press. Built-in filter delivers clean oil-free air. Requires 1/2 h.p. motor or equiv. gas engine or can run from tractor, car or truck power. Wt. 28 lbs. Compressor, 20 ft. heavy duty air hose; detachable Shrader tire chuck, complete mounting kit, paint spray manual, only \$23.95. Lowest price ever offered.

If you want a tank with compressor (Item 11), send only \$32.50. Includes, in addition to above equipment, a 12"x24" stainless steel tank, air gauge, pop valve, flexible air line and fittings to connect.



**FRAM** Oil Filter (Item 12), Model F21. Big 73 cu. in. size. Ample capacity for all cars, trucks, tractors. Universal mounting bracket and standard openings. Fram filters are so superior there is no comparison. Easy to install. Wt. 8 lbs. Retail \$7.95—now \$3.75.

**ELECTRIC MOTOR** (Item 14) Barber Colman Fan Motor; 110 V., A.C.—2800 rpm. Powerful continuous duty. 3/16" dia. shaft, completely wired; perfect for fans, heat boosters, revolving displays, models, polishing, grinding, etc. Easy to mount. Wt. 2 lbs. Reg. retail \$7.50—now \$2.75.

**GREASE FITTINGS** (Item 15) Assortment of standard Alemite and Zerk fittings, both straight and angle. Wt. 2 lbs. Actual retail value \$7.50—now only \$2.75.

**EXTENSION CORD** (Item 16) 40 ft. heavy duty, made of specially insulated No. 14 2-conductor wire. So tough that you can drive over it and yet amazingly flexible and easy to handle. Resists oil grease or water. Extend electricity up to 400 ft. without voltage drop. Use indoors or out. Complete with heavy rubber plug and outlet. Wt. 2 1/2 lbs. Reg. price \$4.50—Special 40 ft. \$1.95. Comb.: 2-40 ft. and 1-20 ft. (total 100ft.) \$4.75.



**TARPAULINS** (Item 18) 9'x10' complete with ropes and tie-down flaps. Right size for pickup truck. Heaviest qual. 15 oz. green duck for long wear. Waterproofed, treated against mildew. Wt. 30 lbs. Chain stores get \$17—our spec. \$9.50.

**OUTBOARD MOTOR COVERS** (Item 19) 36" long, flexible rubberized fabric. Snaps shut. Covers entire motor right on boat. Also used as carrying case. Good for covering engines on balers, pumps, lawn mowers, etc. Wt. 2 lbs. \$4.95 value—only \$1.75.

**CLIP BOARD** (Item 17) with self-adjusting spring hinge to hold up to 100 sheets of 8 1/2"x11 paper. Constructed of heavy Masonite. Push cover back for instant release. Flip cover shut and notes or drawings are protected. Perfect for engineers, students, truck drivers or artists. Wt. 2 1/2 lbs. Reg. \$2.95—Special \$1.00. All items brand new surplus. Prices f.o.b. Chicago area. Money back guarantee. Send check or M. O.

**THE A & K EQUIPMENT & SUPPLY CO.**  
DEPT. 39, BURLINGTON, WIS.

SAY YOU SAW IT IN POPULAR MECHANICS

**MONEY BACK GUAR.**

**7x50 PRISM BINOCULARS**  
PRECISION OPTICS—BRAND NEW  
**\$36\***

**6x50 ACHROMATIC FIELD GLASSES**  
**\$16\***

\*20% Federal Tax  
Send for Free Catalog of Binoculars, Telescopes and Microscopes

**BROWNSCOPE CO.**  
Dept. 5M, 24 W. 45th St.  
New York 19, N. Y.

7x50  
\$36  
Illustrated

**FENDER SKIRTS . . . . . \$9.95 PER PAIR**

For 95% of all cars. Beauty your car . . . bring out the flowing lines designed in it. Sparkling beauty you'll like. Constructed of heavy gauge body steel, finished in prime. Perfect fit. Prompt delivery.

**SANDEE MUFFLER CO.**  
5643 Corryne Place  
Culver City, Calif.  
Gentlemen: Please send me one set of Sandee Fender Skirts to fit my \_\_\_\_\_ (year and make of car).  
 Check or M.O. for \$9.95 enclosed. No C.O.D.s at this low price, please.

**OUT OF PAWN**  
**GENUINE DIAMONDS**  
SAVE UP TO 50% AND MORE  
Money-Back Guarantee

Approx. 1/2 Ct. Incl. Tax  
**\$95**  
\$200 VALUE

SEND FOR **FREE** Diamond Catalog

**BERMAN'S Illustrated Catalog**  
Diamonds from estates, banks, unredeemed pledges offered at substantial savings  
VALUES FROM \$10 TO \$10,000

All diamonds reset in new mountings.  
**BERMAN'S DIAMOND LOAN BANK**  
DEPT. P  
BERMAN BLDG., BALTO. 1, MD.  
Reference: Your Own Bank or Any Mercantile Agency

**DUST-O-VAC** FOR ALL MACHINES  
**\$19.95**

For Home Workshops & Industry. DUST-O-VAC collects & bags wood & plastic chips, wood & metal dust, wood shavings. Free Bag. Attaches to circular saw, planer, band saw, grinder, belt or disc sander, shaper, drill press with shaper or sander attachment, spindle shaper, wood lathe, jig saw. 110 A.C., D.C. Send for mounting instr. for all machines.

Free Ship. east of Miss. West of Miss., add \$1. Check, M.O.

**HEAVY CAST ALUMINUM BLOWER — ONLY \$9.75**  
110V., AC 50-60 cycles, cont. duty motor, deliver app. 100 C.F.M. For workshop, lab, kitchen, cellar, etc. Install yourself. Send for circular.

**UNIVERSAL YONKERS CORP., 137 Alexander St., (M5), Yonkers 2, N. Y.**

**AGENTS 300% Profit SIGN LETTERS**  
For Store Fronts and Office Windows. Anyone can put them on. Free Samples. Liberal Offer to General Agents.  
**METALLIC LETTER CO., 430 N. Clark, Chicago 10**

**All Purpose PLYWOOD CHEST**

The Army bought too many. You can have it for less than cost to build, with 1/2" marine plywood, steel reinforced corners and edges. Drop handles on ends; snap fasteners on lid. Painted O. D. Weighs 110 lbs. Size inside 27 1/2" long, 24" wide, 22 1/2" deep. Partitions, padding easily removed. Rush your orders; subject to prior sale. Bargain price \$6.75 each, F. O. B. Canton, Ohio.

**\$6.75 FOB**

**CANTON CONTAINERS, INC.**  
1101 - 9TH STREET, S. E. \* CANTON, OHIO  
10 other sizes. Ask for catalog.

**TOOTHACHE?** TOOTH GUM  
Ask your Druggist for **DENT'S** TOOTH DROPS  
POULTICE

**NO SWEAT** **KEEPS WATER PIPES DRY**

No more dripping, sweating water pipes. Genuine Fiberglas insulation, covered with vapor seal tape. Easy to apply. Keeps basement dry—tools don't rust, even in hot, humid weather. Use on hot water pipes to cut heat loss. Neat installations. If dealer can't supply you, send his name and \$1.50 for enough to cover 20 ft. of 1/2" pipe. Postpaid. Satisfaction or money back.

NOTE: For root blocked sewers ask your dealer for DIG-NO-MORE. Folder on request. Associated Specialties, 10658 Gratiot, Detroit 13, Mich.

**Start Quickly** BIG MONEY ROLLING WITH **LIFE CHARGE**

MAKE PLEASANT, DIGNIFIED CONTACTS

The MIRACLE Chemical that helps Batteries stay AUTOMATICALLY charged. Adds Months of useful service. Eliminates freezing, overheating and cable corrosion. Revives old Batteries. Saves time and money for user. EAGER BUYERS EVERYWHERE! Fleet owners, garage, service stations and individuals all buy. FOUR EASY SALES A DAY NETS YOU \$144.00 WEEKLY! Advertising and Promotional Material free. Sold on satisfaction guaranteed or money back plan. Send \$1.00 for special sample offer enough for two batteries, or write for free details. GET IN THE BIG MONEY FIELD! DO IT NOW. DON'T DELAY. WRITE TODAY!

**BATTERY CHARGE PRODUCTS COMPANY**  
728 W. Peachtree Street, Dept. M Atlanta, Georgia

# WAR SURPLUS AND OTHER BARGAINS



## PNEUMATIC RIVETER & CHIPPING HAMMER

Mfd by Ingersoll-Rand, Chicago Pneumatic and Ther... Pistol grip. Ideal for fender, brake lining, concrete breaking work. Like new! Six rivet sets and bucking bar included, making a complete combination. Wgt. 9 lbs. Each \$6.95



## INSIDE MICROMETER 2" to 8"

Precision made of tool steel. Hardened tips on all six measuring rods. One 1/2" spacer. Chrome finish. Complete with case . . . . . \$6.95

**MICROMETERS** Chrome plated, precision engineered and carefully tolled to give long life. All new

- 0-1" cap. . . . . each \$2.25
- 1-2" capacity . . . . . each 3.50
- 2-3" capacity . . . . . each 5.50
- 3-4" capacity . . . . . each 6.50

**HIGH SPEED DRILLS** All New. Fractional & numbered. Orig. Val. \$15. Nationally known brand Ast'd. sizes. Set 30, \$3.50

**CAMPERS' SPECIAL** Fancy briar pipes from the Quarter Master Corps. Ass't'd shops and sizes. All popular makes. Close out, set of 10 . . . \$3.50

**EXTENSION DRILLS** High Speed Steel, like new. Ass't'd sizes from No. 1/4 to 40. Lengths from 6" to 12". Approximately \$20 value. Set of 12 . . . . . \$3.75



**ELECTRIC BELLS**—Vibrating type, high pitch. 115 V., 60 Cycle. Ideal for use indoors or outdoors—on ranches, for schools, plant installations, as signal systems, burglar alarm systems, etc. Nationally known Mfr. ALL NEW in orig. Pkgs. Solid brass clapper & 8 1/2" gong. Wt. 8 lbs. Govt. cost about \$67.50. Close out at . . . \$7.95  
Send check, money order or cash. 25% deposit required on C.O.D. orders. All prices F.O.B. Culver City, Calif. Send 25c for Illustrated Catalog.

**AIRBORNE SALES CO., INC.** DEPT. PM CULVER CITY, CALIF.

# CARBURETOR TOO RICH MAKES MOTORIST TOO POOR



Car owners who are wasting money and not getting proper gas mileage due to over-rich mixtures will be pleased to learn how to save gasoline by VACU-MATING over-rich mixtures. VACU-MATIC fits all cars, trucks and tractors. It is automatic and operates on the supercharge principle. Easily installed in a few minutes.

**SALESMEN WANTED!** Big Profits! Send name, address on penny postcard for free particulars and how to get yours for introducing.

VACU-MATIC CO., 7617-1599 W. State St., WAUWATOSA, WIS.

# \$4.95 REAL ENGINE VALUE



A miniature gas engine that really operates. Thousands of Buzz "B" gasoline engines have been sold at twice the price. Now is your chance to buy a real 1/6 H.P. gas engine for only \$4.95. Turns up over 8,000 r.p.m. For Boats, planes, midget cars, etc. Guaranteed and ready to run. Includes Champion spark plug and tank. Send only \$1.00, engine shipped collect for balance, same day.

WRITE FOR FREE CATALOG OR SEND 10c FOR NEW MAMMOTH ILLUSTRATED CATALOG OF THOUSANDS OF HOBBY ITEMS.

America's Hobby Center, Inc., Dept. B-50, 156 West 22nd St., N. Y. 11

# FLASH Your Turns

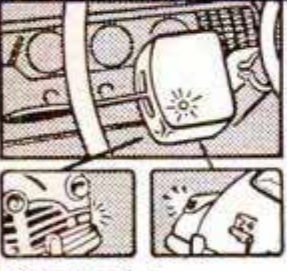

## ELIMINATE HAND SIGNALLING ENJOY SAFE — COMFORTABLE DRIVING WITH THE SIMPLEX DIRECTIONAL SWITCH

Here is a safe and comfortable way of signalling your intention to make a left or right turn. Flashes from 60 to 80 times per minute.

Kits furnished with all necessary material for perfect installation. No outside mounting of any kind. . . . uses your present parking and tail lights. Either of our two models fit most cars from 1942 to 1949.

**\$7.95** Send check or money order. Postage extra on C.O.D.'s. Post-paid in U.S.

**A PRACTICAL GIFT FOR MOTORISTS!** Specify year and make of car. Money back guarantee. Tested and Approved to meet SAE requirements. DEALERS INQUIRIES INVITED

**SIMPLEX SALES COMPANY** 1303 W. Jackson Blvd. Dept. A.G., Chicago 7, Illinois

**\$200 to \$300 extra profit monthly from YOUR OWN BUSINESS if you use Hobart "Simplified" ARC WELDING A.C. or D.C.**

... small payment starts you ... extra profits do the rest

For years, HOBART has been helping men like yourself get into the highly profitable and expanding field of arc welding.

### NOW MORE OPPORTUNITY THAN EVER!

Builders, contractors, farmers, all kinds of businesses are aware of the advantages of arc welding. They need and want the services of welders who have their own equipment and can do "on the job" welding.

### BUILD YOUR OWN PORTABLE OUTFIT

With a new HOBART Arc Welding Generator of the size and type you need you can rig up your own outfit in spare time. You'll save \$\$\$\$ and have a welder that will out-perform most factory built units.

Don't let lack of welding experience hold you back. HOBART "Simplified" Arc Welders are famous for easy operation. Thousands who never welded before become expert in a short time. Ask about welding school.

Ask about Hobart's liberal "PAY OUT OF EXTRA EARNINGS" PLAN — Send a card today!



D.C. Welding plus Aux. D.C. Power A.C. Welding or A.C. Power Unit

Help yourself... Write today!

**HOBART BROTHERS CO.,** Box M-50, Troy, Ohio

**HOBART** "one of the world's largest builders of arc welders"



# Handy Flexible SHAFT

Converts any motor, drill press, electric drill, electric fan (10 inch or larger) into a handy rotary tool

**ONLY \$2.95**

Attach ROTA-SHAFT in a jiffy. Use for grinding, polishing, sharpening, cleaning, engraving, making tools, carving on metal, plastic, wood, glass. Convenient handlepiece for easy handling . . . with 1/8 inch Adjustable Chuck. 40-inch overall length. Complete with buff and sanding disc ready to use in a drill press chuck. Order today!

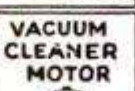
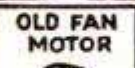

**SEND NO MONEY!** Mail your order. Pay postman only \$2.95 plus postage on delivery. Try 10 days—if not delighted, return for money-back. For use on motor, add 35c for Special Coupling and state shaft diameter.

**STRADER PRODUCTS CO.** DEPT. R-101 259 Strader Ave. Cincinnati 26, Ohio

THOUSANDS BUILD AT 1/2 THE PRICE



# 20 MODELS U-MAK-IT BOAT KITS

EASY TO BUILD

## ROWBOATS

8 TO 14 FT.

Special Models For Fishermen



## PRAMS



## OUTBOARDS

Fast Round or V Bottoms  
12 TO 16 FT. Newest Assembly Methods



## INBOARDS & CABIN CRUISERS

For Fishing, Racing or Cruising 16 TO 23 FT.



SEND 25c (coin)  
ORDER TODAY YOUR  
NEW CATALOG

U-MAK-IT PRODUCTS 703P-WHITTIER ST.  
New York 59, N. Y.

## The JIFFY metal CABINET

YOUR ANSWER TO  
SMALL ITEMS STORAGE  
at home, office, and shop  
(IDEAL GIFT, TOO)

So handy to keep nuts,  
bolts, screws, nails,  
parts, washers, stamps,  
hobbyists' needs, etc.,  
at your fingertips.



THIS 32 DRAWER UNIT ONLY \$5.95 POSTPAID

Stop searching, get a 32 or 64 drawer Jiffy to keep those small items that usually get mislaid. Spot welded steel, gray enamel finish, metal drawer guides. Dividers included with aluminum drawers make possible three compartments per drawer. Looks good anywhere. Send check or money order, please—no C. O. D.'s. Prices below. Your money refunded if not satisfied. Dealers write for quantity discount.

SPECIFICATIONS	WITH ALUMINUM DRAWERS	WITH CARDBOARD DRAWERS
<b>32 Drawer Unit</b> 6" Deep 12 3/4" Wide 15 1/4" High	<b>Dividers and Index Cards Included</b> One piece rustproof aluminum drawers for heavy service—good for work bench and industry use.	Suitable for most home uses. Heavy board kraft covered. Metal drawer pulls.
<b>64 Drawer Unit</b> 6" Deep 25 1/2" Wide 15 1/4" High	<b>32 drawer - \$8.95</b> <b>64 drawer - \$15.95</b> OHIO ORDERS ADD 3% SALES TAX Marproof Rubber Feet included with all cabinets	<b>32 drawer \$5.95</b> <b>64 drawer \$9.95</b>
<b>Drawer Size</b> 1 1/4" Deep 2 3/4" Wide 6" Long	POSTAGE PAID	POSTAGE PAID

KAYTEE PRODUCTS, Dept. M, Box 588, Canton, O.

## ASSEMBLE THIS PROFESSIONAL ELECTRIC EYE

HUNDREDS OF USES — EASY DIRECTIONS  
Save Many Dollars **\$9.95** POSTPAID



- Burglary protection
- Door opener
- Start-Stop control
- On-off switching
- Safety check
- Train director
- Light regulator
- Many more

Assembles quickly and easily. Ideal for home, industrial and scientific usages. Kit is complete: High quality telephone relay; Type 50L6 tube; Caesium photocell tube; Sockets; Resistors; Condensers; Chassis; Line cord wire and solder. All parts are top quality—worth many times price of kit. Order TODAY! Sent complete with 8 page Illustrated Booklet showing many uses, and applications. Send \$9.95 for kit postpaid. Or, if preferred, kit will be sent C.O.D. plus postal charges.

LECTRO MAX GENEVA, ILL.



750' 2-PLY NYLON 25 lb. T  
150' 3-PLY NYLON 85 lb. T  
250' 3-PLY NYLON 45 lb. T  
300' SILK LINE 30 lb. T  
500' 3-PLY Nylon 35 lb. T  
500' Linen Line 24 lb. T

### BRAIDED NYLON LINE

200' 15 or 20 lb. Test  
175' 35 lb. Test  
150' 50 lb. Test  
125' 75 lb. Test  
100' 100 lb. Test  
50' 200 lb. Test

110 ft. Nylon Drop Line, 100 lb. Test—50c  
Pachner & Koller Lightweight Fly Reel \$1.00  
All lines available in longer lengths. Send Check, Money Order. We pay Postage.

MAC-MILLS, Dept. K-5, Pleasant Valley, New York, N.Y.



Ask Your Hardware Store for  
**FULLER'S**  
Unbreakable Amber Handle  
SCREW DRIVERS

America's most popular line of moderately-priced screw drivers! Wide range of sizes.  
FULLER TOOL COMPANY, Inc.  
911 Faile St. New York 59  
World's largest makers of Amber-Handle Tools

## BUILD AN ARC WELDER FROM OLD GENERATOR

For Light or Heavy Work. 75-200 amps. No previous experience needed. Complete PLANS and valuable Catalog 35c.  
LEJAY MANUFACTURING CO.  
1347 LeJay Bldg., Minneapolis 8, Minn.

SET OF TWIST DRILLS

Set No.	No. of Drills	Range of Sizes	H.I. Speed Steel	Carbon Steel	Folding Container
1	13	1/16" to 1/4" by 64ths	3.85	2.15	1.00
2	21	1/16" to 3/8" by 64ths	9.35	4.60	2.35
3	15	1/16" to 1/2" by 32nds	10.45	5.20	2.35
4	29	1/16" to 1/2" by 64ths	19.80	10.30	3.00
5	60	Wire gauge Nos. 1-60	15.40	X	2.50
6	26	Drills Sizes A to Z	19.25	10.00	2.75

1st Quality Drills at fraction of regular prices

10 Day Money Back guarantee. Send Check or Money Order. NY City residents add 3% Sales Tax. Order Now. Parcel Post 25c extra

MARMAX TRADING CO., 464 W. Broadway, N.Y. 12, N.Y.

## Say You Saw It in POPULAR MECHANICS

### LOOK AT THESE VALUE FEATURES

1 HP. EMERSON REPULSION INDUCTION  
3450 R.P.M.  
EXTRA HEAVY DUTY NEW MOTORS  
3/4 Inch SHAFT  
EASILY REVERSED \$37.50 Fob. Chgo.

110/220, 60 Cy 1 Ph.  
250% Overload Cap.  
LATEST DESIGN  
Wgt. 63#  
SPLASH PROOF

NEW, heavy duty repulsion induction 1 H.P., 3450 RPM, 110/220 V, 60 Cy., 1 Ph., A.C. motor for shapers, planers, circular saws, etc. #EH-1 LOW PRICED at \$37.50 Fob. Chicago.  
NEW 3/4 H.P. Wagner repulsion induction, 3450 RPM, 110/220-V, 60 Cy., 1 Ph., A.C., 3/8" shaft... #WH-7... Only \$29.75 Fob. Chicago.  
NEW 1/2 H.P. Wagner induction type, 3450 RPM, 110 volt, 60 cycle, 1 Ph., A.C., 5/8" shaft... #WH-5... Only \$19.75 Fob. Chicago.  
WORKSHOP MOTOR... 1/4 H.P. Leland, Delco, Westinghouse, Sunbeam and others. Induction type motors. A.C. 110 volt, 60 cycle single Ph., 1725 RPM. Like new. Fully Guaranteed... #B-1... Only \$6.50 Fob. Chgo.  
WRITE FOR BARGAIN MOTOR CIRCULAR AND SAVE MONEY. We have large stock of Standard & Special Motors: all sizes.  
C. MARSHALL SALES, 3546 W. Fullerton Av., Dept. P-5, CHICAGO 47



# GARAGEMEN, SERVICE STATION OPERATORS, CAR OWNERS!

## SAVE UP TO 50% ON THESE NATIONALLY-KNOWN AUTOMOTIVE SERVICE ITEMS



**\$39.**

For better than 30 years, the KRW Direct-to-User Policy has **SAVED MILLIONS** for **THOUSANDS** of Garage and Service Station Operators and Car Dealers. KRW manufactures hundreds of specialized tools and equipment which have been factory-approved by Ford and other car manufacturers. KRW Tools are used the world over. See our rating in Dun & Bradstreet. It's tops.

### KRW SIX AMPERE SLOW CHARGER

Handles 1 to 12 3-Cell Batteries or Equivalent. Complete ready to use.

This heavy-duty battery charger is ideal for safe charging of all types of car, truck and aircraft batteries. It incorporates all the latest design and construction features. Comes complete with bulb, wiring and connectors, ready to plug in and operate. Case is 11" x 13" x 6". Operation is simple and fool-proof. Plug and Jack arrangement, like a telephone switch-board. You merely plug in to the jack corresponding to number of batteries on the line. Thousands now in use. Operates on 110 Volt, 60 Cycle.

### KRW FASTCHARGER

FULLY AUTOMATIC. OPERATES ON 110 VOLTS A.C.

Simplest and most efficient on the market. Only one knob to turn, one dial to watch. New electric timer is foolproof in operation... it automatically discharges, fast charges, slow charges and shuts off. Customer can be shown exact condition of battery on the easily understood full-color dial. You can do this under proper load without danger of buckling plates. Use it also for "cycling" batteries that are badly sulphated. Equipped with 8" fan and heavy-duty motor. Lowest priced dependable unit on market. Money back if not satisfied after 30 days.

**\$130.**



### KRW GARAGE JACK

**SOLD WITH 30-DAY MONEY-BACK GUARANTEE**

Lowest Price only **\$90.**

This outstanding Jack value meets every requirement of strength, fast lifting, quick spotting and dependability. Lifting capacity 3-tons. Weight 195 lbs. Length overall including handle 88". Length of chassis 53". Floor to top of rest pad 4" minimum. Raises to 24" maximum. Equipped with Self-cleaning Release Valve, Tamper Proof Safety Valve, Crowned, Roller Bearing Front Wheels and Ball Bearing Swivel Rear Wheels, Finger-tip Control Button.

### KRW AIR COMPRESSORS. TWO STAGE

Highest Quality. 4 Models—9.75 to 38.3 cu. ft. Displacement.

Why pay \$200 to \$300 Premium. For 35 years, KRW has passed these savings on to users. Every feature which can contribute to maximum efficiency and long life has been "built in". Cylinders are nickel-chrome alloy iron. Crankshafts drop-forged with integral counterweights. Timken Roller Bearings. Lynite Connecting Rods. Semi-steel Pistons with 3 compression and one oil ring. Constant level oiling system. Plate-type Valves. Automatic Air Breather. Combination Filter and Air Cleaner. Pressure Unloader for Easy Starting. Pressure Control Switch and Thermal Relay protects motor against overloading and undervoltage. 200 lbs. pressure ASME Tanks. **PRICES FOLLOW:**  
 2 H.P. 9.75 c.f.m., 80 gal. tank **\$375.00**    7½ H.P. 28.4 c.f.m., 80 gal. tank **\$654.00**  
 5 H.P. 20 c.f.m., 80 gal. tank **\$440.00**    10 H.P. 38.3 c.f.m., 80 gal. tank **\$685.00**

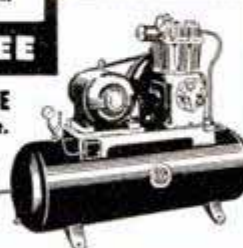

**TERMS:** Cash with order. If C.O.D., 25% must accompany order. Concerns with established credit sold on open account. All PRICES F. O. B. Factory. (Subject to change without notice.)

**SATISFACTION OR MONEY BACK GUARANTEE** All Tools or Equipment described in this advertisement are sold subject to your trial for 30-days after receipt. If you are then not thoroughly satisfied, return the goods to us and your money will be immediately REFUNDED.

**K·R·W·I·L·S·O·N** 213 MAIN ST. BUFFALO 3, N. Y.  
 WORLD'S LARGEST MANUFACTURER OF GARAGE TOOLS AND EQUIPMENT

**SERVICE AVAILABLE IN ALL PRINCIPAL CITIES**

## SEND ONLY 10c for **BIG CATALOG** of WAR SURPLUS **OPTICAL BARGAINS**

Build Your Own RIFLESCOPE, BINOCULARS, TELESCOPES, ETC.  
 We Furnish Optics and Instructions

- LENSES, PRISMS & RETICLES
- EYEPIECES and OBJECTIVES

Send \$1.00 for Stock #2-H 10-Piece Lens Kit and Big Instruction Booklet.

We Have Numerous Types of Assembled Optical Instruments including BINOCULARS and RIFLESCOPES. CHECK OUR BARGAINS . . . Mail 10c for CATALOG H

**EDMUND SALVAGE COMPANY**  
 BARRINGTON, NEW JERSEY

mail coupon today for

## free booklet

about new-design, smartly styled height-increasing shoes



that make you almost 2 INCHES

# taller

These New Design "ELEVATORS" look as smart and feel as comfortable as any other fine shoes. But what a difference in how they make you look and feel! Wonderfully . . . but wonderfully taller. Instantly! They cost no more than other fine shoes. Write for Booklet.

THE ORIGINAL AND GENUINE **ELEVATORS** TRADE MARK®  
 HEIGHT-INCREASING SHOES  
 "YOUR PERSONAL PEDESTAL"  
 TRADE MARK OF STONE-TARLOW CO., INC.

STONE-TARLOW CO., INC., Dept. PM-5, Brockton 68, Mass. 50

Please send me Free Booklet and name of nearest dealer.

NAME \_\_\_\_\_ (Please Print)

ADDRESS \_\_\_\_\_

CITY \_\_\_\_\_ STATE \_\_\_\_\_

SAY YOU SAW IT IN POPULAR MECHANICS

## BUILD YOUR OWN POWER LAWN MOWER

WHY BREAK YOUR BACK MOWING FIELD OR LAWN?

WRITE FOR **FREE** Building Instructions The Rite-Way Mower Attachment Ball Bearing

SAVE MONEY SAVE TIME

Now anyone can save time and effort mowing field or lawn by building their own whirl type power mower. Build according to your own ideas and needs at small cost. Cut close to fences, walks, buildings, etc. Build in short time with parts and instructions we furnish. Save hours of time and back breaking labor.

WRITE TODAY FOR FREE INFORMATION  
 T & H MFG. CO., Dept. MPB-5  
 811 E. 31, Kan. City 3, Mo.



**SHOOT WITH A  
MOSSBERG  
SCOPE!**

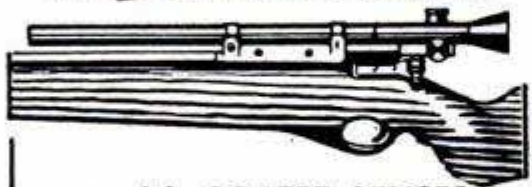

now with **COATED LENSES**

Rifle owners — enjoy the fun of scope shooting — and bag more game. All Mossberg lens surfaces are hard coated, increasing light transmission 34%. Mossberg 4-power, coated lens scopes fit almost all makes of rifles up to .25-.20 caliber.

Only  
**\$9.35**

SEE them at your dealer's.

Write for **FREE** catalog.

No sales  
at  
factory.



6505 St. John St., New Haven 5, Conn.

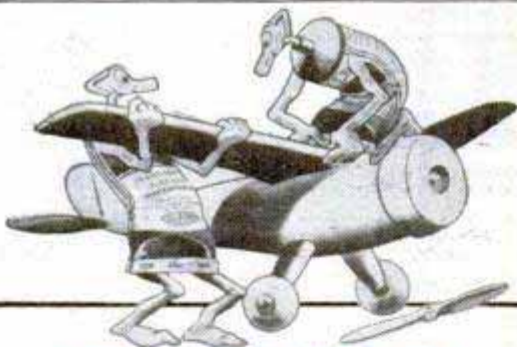

**BUILD**  
STRONGER MODELS

It's transparent, waterproof  
flexible and durable.  
Get a tube  
today.

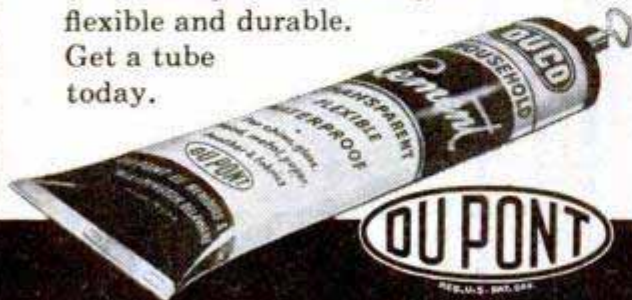

**DUOCO CEMENT**

REG. U. S. PAT. OFF.

**POWER MOWERS**

Only  
**\$69.50**  
DEALER'S PRICE

**Powerful—Streamlined**

Complete with Maytag, Power Products or Briggs-Stratton Engine—18" rotary tool-steel, fully guarded blades—cast aluminum body. Cuts grass and weeds, wet or dry—does all trimming—chops grass into fine mulch, eliminating raking. Send check with order, or specify C.O.D.. Write Dept. M-4 for free literature.



SALES  
REPRESENTATIVES  
WANTED

**HARTMAN Corp.**

1100 SOUTH KIRKWOOD ROAD • ST. LOUIS COUNTY 22, MO.

Longer Lasting Jobs at Trifling Cost

Use **E-L-A-S-T-I-C "33"**

Unlike putty, "33" Glazing Compound stays E-L-A-S-T-I-C. Won't crack or crumble. Never gets rock-hard. Use it on wood or metal windows for **LASTING** protection. Get "33" from your hardware or lumber dealer. Try it! **ARM-STRONG CO., Chicago 9.**

**FREE** AMAZING NEW BOOK  
**"HOW TO ANSWER ADS"**



Never before have you seen anything like this. Tells you in simple language the correct way to answer ads. Gets you quicker replies—better results, and greater satisfaction. Will save you time and money and it's **ABSOLUTELY FREE**. No obligation whatever. Every reader of advertising should have this booklet. Send a postcard for your copy **NOW**. Advertising Department, Popular Mechanics Magazine, 202 East Ontario Street, Chicago 11, Ill.



**Amazing Power  
No "Pumping"**

CO<sub>2</sub> is the "power" secret of the new Crosman Pistol and Rifle—sensational "recoil-less" guns you can shoot safely with pin-point accuracy indoors or out. See your Crosman dealer. Literature on request.

Crosman Arms Co., Inc., Rochester 7, N. Y.

**LAWN ORNAMENT-NOVELTY PATTERNS**

28 Lawn Ornament Patterns, 25c. Other patterns; 15-20" high; Dutch Girl, Dutch Boy, Pirate, Bull Terrier, Mexican Girl, Mexican Boy, Dwarf, Penguin, Flower Girl, 10c each. 25 Novelty Patterns, 30c. All 62 Full Size Patterns, \$1.00 Postpaid. Strother Pattern Service, Dept. BR-8, Box 128, Belington, W. Va.



**EARN EXTRA PROFITS  
WITH YOUR JEEP**  
Convert Your Jeep into a

**MOBILE ARC  
WELDER**

**\$345**

Here's your chance to pick up some easy extra money. Use your jeep as a mobile arc welder. Complete arc welding generator kit, 68 component parts including 200 amp GE welding generator. COMES WITH POWER TAKE-OFF, GOVERNOR, 65 foot ground and lead cable, electrode holder and many miscellaneous parts. Fits any jeep, military or civilian. Doesn't impair other duties of jeep. Jeep engine furnishes power for generator.

Complete easy instructions furnished. Can also be used with gasoline engine for stationary work without additional parts. WRITE FOR INFORMATION. Complete jeep arc welding units available at \$845 also.

**WELDERS SUPPLY  
COMPANY**

Dept. PM-5

4409 LORAIN  
CLEVELAND, O.

# SPRAYING MADE EASY

## BECKER *Self-Contained* PRESSURE GUN

### Saves Cost of Compressor and Motor

TAKE IT ANYWHERE—the first completely portable spray gun. Needs no compressor, motor, or electrical outlet. Pressure-powered with an inexpensive CO<sub>2</sub> cartridge that sprays up to 21 liquid ounces, depending on viscosity. Extra cartridges, 10 for \$1, postpaid, or buy from your local hardware dealer.

### PAINTS • VARNISHES • ENAMELS MOTH-PROOFS • INSECTICIDES

Every home needs a Becker Spray Gun for dozens of jobs in the house, workshop, garden or garage. Complete instructions furnished for effective results. Order yours today for the season ahead.

**HOW TO ORDER**—If your dealer can't supply, send \$15.95 and we ship postpaid—or \$2 now and pay postman balance plus postage and fee. Money back if not delighted after 5 days' trial.

**SULLIVAN-BECKER CO.**  
Dept. 110-E, Kenosha, Wisc.



ONLY  
**\$15.95**  
with 3  
cartridges



**5** big-capacity  
power tools  
in  
**1** precision-  
built unit



Write for free, 16-page, profusely illustrated book.

SHOPSMITH, Dept. 125-B, 12819 Coit Rd., Cleveland 8, O.



## CUT COSTS on building

Learn about this new method of building houses, hunting camps, garages, beach cabins or any 1-story frame structure at a saving up to **40 per-cent.**

Amateur and professional builders will profit by copyright instruction book.

Write for free information or send \$1 for instruction book.  
5-day trial money back guarantee  
ITOC CO., P.O. Box 713, Mobile 4, Ala.



Only  
**\$498**

## OTTAWA Mule Team Tractor

Finest low-cost tractor. Costs too little to do without. Engines burn gasoline or kerosene. Starter and lights available. Other larger Models to choose from. Over 4,000 in world-wide use. Time-proved and tested. At low cost they easily mow, plow, disc, harrow, plant, cultivate, etc. Sold only direct to user. Write for FREE details.

OTTAWA MFG. CO., 2-027 Garden St., Ottawa, Kansas

SAY YOU SAW IT IN POPULAR MECHANICS



"I made \$4,000 Profit  
THE FIRST YEAR... with my

## GRAHAM

LAWN MOWER SHARPENER" — J.C.

You can make \$15 to \$25 a day with a GRAHAM GRINDER... And this is the big money-making season! Let GRAHAM make you independent; you invest only \$271.00—no extras to buy, no special tools required. This one precision model sharpens all hand, power, or tractor driven mowers. Comes complete with 1/2 H.P. 110V. A.C. motor.

ACT NOW—send for literature and FREE plan: "Profits and Security Unlimited" through your own lawn mower sharpening service.

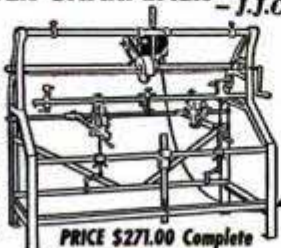

PRICE \$271.00 Complete

**GRAHAM MFG. CO.** 502 BRIDGE STREET  
EAST GREENWICH, R. I.

# THE BIGGEST SURPLUS BARGAINS IN YEARS

**ELECTRIC MOTOR 1/2 H.P.** 27 V.D.C. R.P.M. 4000 No. 750. For Intermitter or Continuous Duty. 5/8" SHAFT. VARIABLE SPEED MOTOR CAN BE ADAPTED TO 110 V. A.C. or R.E.A. line by simple arranging armature brush leads. UNUSED. Instructions incl. **\$5.50**

**ELECTRIC MOTOR 1/2 H.P.** 24 Volt D.C. R.P.M. 2500. Amp. 22 #75.00. Brand New **\$3.50**

**ELECTRIC MOTOR 1/4 H.P.** 28 Volt D.C. R.P.M. 4000 #2832 with simple instructions to convert to 28-32 Volt A.C. Gov't cost \$82.84. Brand New **\$3.50**

**ECLIPSE MOTOR & GEAR UNIT** Brand New. This is a 24 V. D.C. motor with built in planetary and bevel gear reduction. Has 1- horizontal and 1- vertical take off shaft. Overall gear ratio to motor is 40-1 can be adapted for 2-1 or 20-1 ratio. Unit can be operated from 32 D.C. Farm light plant. Ideal as OVER-HEAD GARAGE DOOR OPERATOR, DRIVE FOR SMALL HOIST WELL PUMP JACK, LAWN MOWER DRIVE, DRIVE FOR POST DRILL, etc. Wt. 23 lbs. Gov't. cost \$221.00. (Instructions incl.) Only **\$12.50**



**WEAVERS HYDRAULIC HAND PUMP**— BRAND NEW. For hydraulic Jacks, presses, hoist, etc. For operating hydraulic cylinders, to pump oil or hydraulic fluid under pressure. Has built in check valve, and is capable of delivering 1000 lbs. pressure. Wt. 10 1/2 lbs. A \$50.00 value. Instructions incl. **\$8.50**

**THOMPSON BOOSTER PUMP** Built with direct connected motor. Runs on 24 Volt A.C. or D.C. Explosion proof, constructed. For pumping gasoline, fuel transfer. Ideal as hot water heating circulator. As coolant pump, Fuel booster, oil pump, etc. Discharge connections are 1". Rated 300 G.P.H. Stock #1200. Price only **\$7.50**



**STRATOPOWER CONSTANT DISPLACEMENT HIGH PRESSURE PUMP** For operating Hydraulic cylinders, hydraulic motors on tractors, Bulldozers, Construction machinery. Lift trucks. For fuel or oil transfer. Industrial Applications, etc. Delivers up to 400 G.P.H. at 3750 R.P.M. Rated 1250 to 1400 P.S.I. 3750 to 4500 R.P.M. HAS BUILT IN RELIEF AT HEAD. Rotation either direction without adjustment. Can be used as hydraulic motor. \$85.00 value. Stock #1250. Wt. 8 lbs. Price f.o.b. K.C., Mo., Only **\$12.50**

**AIR OR OIL HYDRAULIC CYLINDERS** STOCK NO. 10 Here's a double action 1" Bore, 3" Stroke, 3/8" Shaft, Clevis mounting. Overall length 9". Capacity 700 lbs. with 1000 P.S.I. input. Has a capacity of 9800 lbs. with our STRATOPOWER PUMP 1400 P.S.I. It's perfect for applications such as door openers, positioners, small loaders, control units, etc. A REAL TERRIFIC VALUE **\$4.50**

STOCK NO. 11 Double Action 1 1/2" Bore, 6" Stroke, 5/8" Dia. Shaft Clevis mounting base and shaft end. Capacity 1160 lbs. with 1000 P.S.I. input. Has a capacity of 1825 lbs. with our STRATOPOWER PUMP 1400 P.S.I. A \$50.00 value **\$9.50**

STOCK NO. 32 A double action hydraulic cylinder. 2" Bore, 3 1/4" Stroke, 3/8" Shaft, Clevis mounting on both base and shaft ends. Capacity 3100 lbs. with 1000 P.S.I. input. Has a capacity of 4340 lbs. with the STRATOPOWER PUMP **\$12.50**

**HYDRAULIC CYLINDER SPECIAL** Stock No. 12 Gives 12560 lbs. with 1000 P.S.I. input. Capacity 17584 lbs. with our STRATOPOWER PUMP 1400 P.S.I. or will produce 34168 lbs. with 3000 line pressure. Can also be operated on low pressure system 4" Bore, 8 3/4" Stroke, 1-5/16" Shaft. Clevis mounting. Gov't cost \$300. A tremendous Bargain only **\$19.50**

**HYDRAULIC CYLINDER SWIVEL VALVE** For Connecting cylinders when the cylinder is required to be movable. Such as Carrying oils, liquids, Loading attachments, plow lifts, etc. Brand New. Stock No. 3915 **\$2.50**

**HYDRAULIC CHECK & RELIEF VALVE** **\$2.50** Postpaid

**VICKERS UNLOADING VALVE** Brand New — By passes full amount output of the pump while the cylinder is not in operation. Takes starting load off of elec. Postpaid **\$4.95**

**BRAND NEW HYDRAULIC CONTROL VALVE** This is a TWO CYLINDER DOUBLE ACTION VALVE with unique arrangement allowing the operator to raise both cylinders simultaneously, to lower them simultaneously or to raise one and lower the other at any predetermined rate and speed. A \$75.00 value, **\$8.95** Postpaid

**ADEL PRECISION VALVE BRAND NEW** This is for a double end cylinder control or for two single cylinders that are to work in opposition to each other. When pressure is applied on one line, it will open opposite check valve so that pressure in that line can be relieved. **\$4.95** Postpaid

**AMPLIDYNE MOTOR GENERATOR** #5AN31NJ18A—Use as 24/32 Volt D.C. motor, pulls 1/2 H.P. or 6/60 V. D.C. Generator Belt driven will deliver 30/40 amps. Can be adapted to 110 V. A.C./D.C. 10,000 R.P.M. 1/2 H.P. by simple changes in connections. Unused, instructions incl. (Stock #790). Gov't Cost \$140.00 **\$5.50**

**Brand New PUROLATOR GASOLINE FILTER** Aircraft Permanent type Refines & Filters gasoline. For all cars, trucks, tractors or motor-boats, in- structions incl., postpaid. **\$4.95**

**CUNO OIL FILTER BRAND NEW.** Aircraft type. Filter oil without cartridge replacements. Standard 3/8" inlet and outlet ports. Install at home in a few minutes. STOP CHANGING OIL. Instructions **\$4.95** Post- incl. (Stock #507). Now only **\$4.95** paid

Send check or Money order. No c.o.d.'s. Prices f.o.b. K.C. except when marked postpaid.

**GENERAL SALVAGE COMPANY**  
Dept. 5-17, 2922 E. 27th St. Kansas City, Mo.

# PARTS FOR MILITARY TRUCKS



4 or 6 Wheel Drive at a SAVINGS—  
1/4 ton to 20 ton.

Parts List Available  
on Most Makes  
Military Trucks and Jeeps  
Write stating model  
Prices Quoted are Net Wholesale  
Brand New — Weatherizing Kits

## JEEP TOPS and CURTAINS

Fits all military jeeps, also adaptable to civilian jeeps.  
Tops only with back curtain attached.  
Waterproof O. D. color.  
Our low price, only.....

Side curtains to match with doors  
and windows, only..... **\$20.00**

Also available—Complete top with back  
curtain and side curtains with doors  
and 5 windows. Less steel  
Bows. Complete set, only..... **\$49.50**

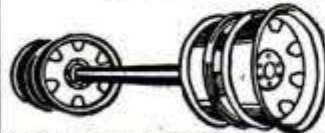

## TRAILER AXLE

Heavy duty trailer axle suitable  
for many types of trailer con-  
struction. Also excellent for  
building of heavy farm trailers  
and wagons. It is a 12,000 lb.  
capacity square type straight  
trailer axle complete with Timken roller bearings, hubs, and 6  
hole 750 x 20 Budd Wheels. Without brakes. Axle is 2  
inches square and 69 inches between wheel mounting flanges.  
Std. width.

With Single Wheels. \$59.50 With Dual Wheels. \$69.50

**WINCH CABLE, 1/2", 250 ft.....\$30.00**

Hundreds of Other Truck & Jeep Parts and Supplies  
All prices quoted good 30 days FOB, Kansas City, 25%  
Deposit Required on All Orders.

# American AUTO PARTS CO.

1830 LOCUST — DEPT. PM  
KANSAS CITY, MISSOURI.



# BUILD YOUR OWN TILTING ARBOR SAW!

Exclusive GIL-BILT Build-It-Yourself Features

- No machining—build easily with hand tools only
- No blueprint reading—step-by-step pictorial plans, full scale patterns, actual photographs
- Sturdy wood, aluminum, and steel construction
- Capacity and performance of commercial saws selling for \$60 and up

**SAVE \$50 OR MORE**

## GIL-BILT 10-INCH TILTING ARBOR SAW



- 27x28 in. table, 13 1/2 in. capacity in front of blade
- 10 in. blade cuts 3 1/4 in. deep, tilts full 45 degrees
- Floor model 34" high, table always stays level

- New Departure ball bearing arbor, 3/4" bore blades, alum. housing, shipped ready to run
- Jackscrew and 4 1/2 in. dia. handwheel lowers and raises blade
- Cast aluminum miter gauge and self-aligning rip fence guide

GIL-BILT Metal Parts Kit includes Plans, ball bearing arbor, miter gauge and bar, rip fence guide, dado insert, lock knobs, jack screw mechanism and handwheel, and all other metal parts (less blade)..... **\$20.95**  
Same Kit with 10" Combination Blade **\$24.90**  
Same Kit with 8" Combination Blade **\$23.90**

## GIL-BILT 12-INCH BAND SAW



- Cuts to center of 24 inch circle
- Handles stock up to 6 inches thick
- 18x18 inch table tilts 45 degrees
- Lower wheel and drive pulley runs on sealed New Departure Ball Bearings; Upper wheel runs on two 5/8" bore Oilite Bronze bearings.
- Upper wheel tension and tilt mechanism of cast aluminum, completely assembled.
- Upper and lower blade guides. Each has ball thrust bearing, self-lub bronze jaws
- Rubber tired wheels. Choice of cast aluminum or make-your-own wood wheels on metal hubs.
- Uses standard 78 inch blades up to 3/8 in. wide.
- Fully enclosed mechanism for utmost safety.

GIL-BILT Metal Parts Kit includes Plans, rubber tires, 1/4 inch blade, hubs for wood wheels, ball bearing spindle, tilt mechanism, guides, table tilt segments and all other metal parts..... **\$16.95**  
Same Kit with two machined ready-to-install 12" cast aluminum wheels..... **\$20.95**

Return Kits in 10 days for refund if not satisfied.  
(Prices include postage within 600 miles. Over 600 add 5%)

Also available—Plans and Parts Kit for 8" Tilt/Table saw. Order Plans at \$1.00 each—sent postpaid anywhere in the world or write for FREE descriptive catalog.

**GILLIOM POWER TOOLS** P. O. Box 1-PE, Lambert Field St. Louis 21, Missouri

# ARC WELDING FOR PROFIT OR PLEASURE

60 LBS. OF READY MADE PARTS

Only \$24.95

## BUILD YOUR OWN HEAVY DUTY WELDER

SAVE Buy Only NECESSARY PARTS

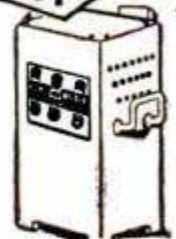

All necessary parts Ready-Made and easy to assemble. You can do all around welding on steel, cast iron and other metals after only a few hours practice. Illustrated instruction manual included. Sold on 30-Day Money-Back Guarantee!

**FREE:** Write today for fully illustrated Pamphlet P-5

**ATOMIC ARC WELDER CO.**  
1037 So. 19th St. OMAHA, NEBR.

Gives 100% penetration. Welds are stronger than original metal. Operates on 110 or 230 AC.

## NU-WAY HEAVY DUTY CUTTING UNIT with Timken Roller Bearings

PRICE **\$16.50**  
WHY PAY MORE



Build your own rotary type lawn or weed cutter. Take the hard work out of weed cutting. Build yourself an up-to-date weed and lawn mower with the Nu-Way heavy duty unit.

Write for Free Circular—We Supply Cutting Unit Complete  
**TRACTOR-LITE MFG. CO., Spirit Lake, Iowa**

## SAVE MONEY

Build this 18 ft. House Trailer yourself \$286.00.

Blueprints, Building instructions and 1950 parts catalog 50c. Don't Delay, Write Today



**NATIONAL TRAILER EQUIPMENT COMPANY**  
Dept. PM-5, 1007 N. WATER STREET, MILWAUKEE, WISCONSIN

## Build your own JET ENGINE!



Order these plans today

1. JET PROPELLED BICYCLE. Assemble your own. Photo and instructions \$1.00.
2. HOW TO MAKE EXPERIMENTAL JET ENGINES. Seven sheets drawings with information and instructions \$2.95.
3. BOTH OF ABOVE in one order \$3.75. SEND NO MONEY. Order both at once \$3.75 C.O.D. in USA plus c.o.d. postage. Send check or Money Order and we pay postage. Get other information too. Rush Order.

**J. HOUSTON MAUPIN, Dept. 55, Tipp City, Ohio**

# WAR SURPLUS BARGAINS

Substantial Savings on WAR SURPLUS and other MERCHANDISE  
**OVER 200 TIMELY ITEMS**  
**FREE FOR CIRCULAR**  
**SIoux FALLS SURPLUS STORE**  
**SIoux FALLS S.D.**

# george 2 H.P. TRACTOR



## LOWEST PRICE EVER!

Here's everything you've ever wanted at a price that can't be beat. Top quality, NEW design George Tractor . . . for all lawn and garden work. Full 2 HP gasoline engine . . . heavy duty 6 1/2" wide tread. A complete, powerful, sturdy lawn and garden tractor.

**Only \$99.50**

F.O.B. SULLIVAN, ILLINOIS with Briggs or Clinton engine ATTACHMENTS . . . NEW designs at new low prices . . . Tool Hitch for lawn mower, \$3.95 . . . new 2-in-1 Cultivator, \$7.95 . . . also Sickle Bar Mower and Bulldozer Blade.

WRITE for COMPLETE FACTS and PRICES . . . here's the buy of the year! COMMUNITY INDUSTRIES ASS'N. SULLIVAN, ILLINOIS

**MONEY BACK**  
If Not Delighted  
In 10 Days  
WEAR AT OUR RISK

**AMERICA'S BEST WATCH VALUES**  
WHOLESALE PRICES • DIRECT TO USER

ORDER WITH CONFIDENCE  
**5 YEAR WRITTEN  
GUARANTEE**

**17 JEWEL SELF WINDING**  
ORIGINALLY \$71.95

Factory Surplus NOW ONLY

One of World's finest. Needs no winding. Winds self as you move. Water and shock resistant. Anti-magnetic. Ace value at former \$71.95 price. Now only \$24.95, plus \$2.50 tax. Order now.

**\$24.95**



MEN'S OR WOMEN'S **BULOVA**

**15 or 17 JEWEL**  
movement

Originally \$59  
Sold up to \$59

OUR PRICE ONLY  
**\$16.95**  
Plus \$1.70 Tax

Also

- BENRUS
- GRUEN
- WALTHAM
- or ELGIN WATCHES



TRIAL OFFER!  
Wear At Our Risk!

Genuine Bulova, Benrus, Gruen, Waltham, Elgin and other famous wrist watches in latest style Yellow Gold Cases. You get these unredeemed 5-year Guaranteed FAMOUS MAKE WATCHES now at truly enormous savings because we bought out SURPLUS STOCKS of leading New York and Maryland Jewelers. Order now while they last. State make preferred. Order men's or ladies'. Only \$16.95 plus \$1.70 tax. Order now.

**17 JEWEL 2 Push BUTTON CHRONOGRAPH**  
ORIGINALLY \$71.50

Thousands sold at \$71.50  
2-push button combination wrist watch, stopwatch, telemeter, tachometer.

Factory Surplus Now Only

**\$21.95**

Incablock shock resistant feature. Sweep second hand. Anti-magnetic. Radium dial. Stainless steel back. Unbreakable crystal. Only \$21.95 plus \$2.29 tax. Order now.



**Sturdy WRIST WATCH**

- Sweep Second Hand
- LUMINOUS DIALS
- WATER-PROOF PLASTIC BAND

OUR PRICE  
Now Only

**\$4.95**

Sturdy guaranteed men's watch. Built to keep accurate time. Many formerly sold at double this price and more. Yours now at only \$4.95 plus 50c tax. Order now for self and gifts.



**17 JEWEL SHOCK PROTECTED WATER RESIST**

INCABLOCK—Shock Protected  
ORIGINALLY \$59.00  
OUR PRICE NOW ONLY

**\$16.95**

Handsome accurate. Has sweep second hand. Non-magnetic. Kept accurate time after 72-hour test under water. Amazing value at \$16.95 plus \$1.70 tax. Order now.



**FREE!**

Handsome expansion band included free with your order. Write for FREE Watch & Diamond Ring Catalog. Practically wholesale prices to user direct.

ORDER DIRECT FROM THIS AD, FOR SELF AND FOR THRILLING GIFTS. Lowest prices ever, for these guaranteed watches! Order now on famous 5-year written guarantee. Send only \$1 down payment with order. Pay balance to postman on arrival plus postage. Or we pay postage if you enclose full payment plus tax with your order.

MARYLAND DISTRIBUTORS, Dept. 82, 501 E. Baltimore St., Baltimore 2, Md.

**TIME SAVER**

**SPRAY RADIATORS WITH ALUMINUM ENAMEL**  
... it's fast and easy

Give your radiators a fresh, clean look! Brighten them with easy-to-use Aluminum Enamel in handy spray cans available from any paint dealer. Ideal for all quick touch-up jobs on interior surfaces, for painting hard-to-get-at places. Aluminum Enamel is also available in standard containers. Use it for the hundreds of places around the home where you want good appearance, lasting protection with one-coat coverage. Remember, there is a difference in aluminum paints. For assurance of quality, buy the brand that displays the Alcoa symbol of quality. For detailed information on the right type for any job, write for book, "Paint It Bright". ALUMINUM COMPANY OF AMERICA, 1717E Gulf Building, Pittsburgh 19, Pa.



Look for this shield on  
aluminum paints made  
by many paint manufac-  
turers using ALCOA PIGMENTS



# EARN BIG MONEY AND BE YOUR OWN BOSS Sharpening Lawn Mowers

Build a Business of Your Own With

## A UNIVERSAL GRINDER

In your own garage or basement, and earn \$3.00 to \$5.00 a day. Mr. Hardy writes, "I am doing a fine business with the UNIVERSAL GRINDER. One customer sends another. I spent 40c for a newspaper ad and have done nearly \$500.00 worth of business." Mr. Helmeck of Texas writes, "We sharpened 750 mowers last year and are 1056 on this year's run. The Universal surely makes satisfied customers." Mr. Barton of California says, "The lawn mower business, with the Universal Grinder, has been a gold mine these last two years."



A Complete Single Unit • No Attachments Necessary  
• Precision-Built • Simple to Operate • Sharpens  
Reel Blades at Proper Angle • Grinds a Keen  
Cutting Edge Full Length of Blade

Only on the UNIVERSAL GRINDER can the inside face and edge of the stationary blade, as well as the reel blades, be ground to proper clearance

**ALL IN ONE SET-UP**

WITHOUT REMOVING ANY BLADE FROM THE MOWER

Write for FREE Folder today!

Rogers Mfg. Co., Dept. M-50, Lindsey, Ohio



**BETTER MEASURE  
WITH LUFKIN**

**BE "Precision Proud" with  
LUFKIN TOOLS!**



Be "Precision Proud" of all your work—in the shop or at home—by using Lufkin precision tools. Every single Lufkin tool, several of which are pictured above, is well designed, sturdily constructed, carefully finished, and critically inspected. First with scores of improvements and features, Lufkin precision tools are preferred by mechanics who have tried them all!

**See Them—Buy Them at your local tool dealer.**

**Buy LUFKIN**

72D  
THE LUFKIN RULE CO. • TAPES • RULES • PRECISION TOOLS  
SAGINAW, MICHIGAN • NEW YORK CITY • BARRIE, ONTARIO

## WOOD FASTENERS



Don't split wood—Use amazing new "CHEVRONS"—A new type hardened steel fastener for wood joining (miter joints). Scientifically designed to draw wood together eliminating doweling, mortising, nailing. Just drive in with ordinary hammer—"Presto"—A firm joint! No wobble, no distortion. Narrow surface outline of fastener lends artistic appearance. Can easily be countersunk and concealed with wood fillers. Permits planing of wood on all sides. Can be used in hard wood where others fail. Handy, easy-to-use for mill workers, artisans and HOME CRAFTSMEN for making and repairing screens, doors, sash, frames, cabinets, chests, furniture, moulding, etc. Hurry—Order now from your dealer or send Only 75c (no stamps) for box of 100, 3/8" depth, suitable for thickness of wood up to 1 1/4 inch, or send \$1.00 for our GIANT-Size box. NOW! Money back if not delighted.

**E. B. PACKARD CO., Inc., Dept. PM4**  
139 CEDAR ST. NEW YORK 6, N. Y.  
Dealers—Send for our folder "A."

## \$70 Buys ALL This

**EMRICK**

You Get **EMERICK 5-in-1 MACHINE** with 1/2 H.P. Motor, Drive Pulley, V-belt, 7" Saw Blade, Saw Blade Guard, 6 Turning Tools, 2 Steel Bench Legs, Buffing Wheel, 12 Abrasive Discs and Distic. 115 pounds of real machinery. Purchase direct from Emrick and save both jobber and dealer profits. 10-day FREE Trial. Money-Back Guarantee. Easy Time Payment Plan. Write for FREE illustrated literature. **EMRICK, Inc., 1526, Clinton, Kalamazoo, Mich.**



**5-in-1**

## 30" AND 36" BRAKES

Forms angles, flanges, and Pittsburgh locks. Bends 26 gauge steel. Heavier copper and aluminum. Cam locking. Portable, can be clamped to edge of truck. All steel, reinforced. Wt. 42 lbs. Express collect. . . . . \$26.50  
36" Size, Wt. 52 lbs. . . . . \$31.00

12" BRAKE. Fits in vise to form difficult compound bends, up to 20 gage steel. . . . . \$12.50 PP.  
18" CURVE FORMER. Capacity—16 gage steel. . . . . \$10.00  
SHEET METAL PLIERS, 2 1/2" wide, . . . . . \$3.00  
IRON BENDER, Forms hooks, braces, eyelets. Bends 1/2x2, \$10.00  
Immediate Delivery. Order direct, cash or C.O.D. or send for folder.

**WISE BRAKE MFG. CO., P-1116 So. 27th St., Omaha 5, Nebr.**

**Start a NEW BUSINESS!**  
or Add to your present  
Repair Business

**SHARPEN DULL PIPE WRENCHES**  
PIPE TAPS & DIES  
"GUM" CIRCULAR SAWS  
Write for Information

**J. C. MOORE INDUSTRIES**  
BOX M 276 FREDONIA, PA.

**SPECIAL OFFER to Hobbyists**

**ONLY 4<sup>95</sup>**

Hard Angle Jobs Set-up in 5 Seconds  
Save TIME! MONEY! Drill, mill, grind, etc., round, square, irregular pieces at any angle—Quickly—Easily—Accurately with **PALMGREN "HOBB-E" ANGLE VISE** Accurately machined and graduated. 1 1/2" Jaws, 1-Plain, 1-Grooved. Order NOW! Only \$4.95. Write for "HOBB-E-TOOL" Circular.

**CHICAGO TOOL & ENGINEERING CO.**  
8365 SOUTH CHICAGO AVE. CHICAGO 17, ILL.



## 1/6 H. P. JACK & HEINTZ MOTOR

**With Automatic Overload Protection**

**DOES WORK OF 1/4 H. P.**



**\$7.95**  
Exp. Col.

A C 110 V.  
1750 RPM  
60 Cyc.  
1/2" Shaft  
Continuous Duty

Use it for Bench Saw, Band Saw, Jointer, Lathe, Drill Press, Grinder, Blower, Pump, etc.

Send Check or Money Order  
**MARTY'S MACHINERY & TOOL CO.**  
608 ARCH STREET PHILA. 6, PA.

# THORESEN NATIONALWIDE SALE

BUY DIRECT AND SAVE



**Thoresen's De-Luxe 17 JEWEL PRECISION 14.98** tax paid!  
Masterpiece of superb styling and workmanship! Streamlined 14 Karat Rolled Gold Plate case, stainless steel back. Gilt numerals, curved dome crystal. Genuine Lever 17 JEWEL Precision movement of amazing accuracy. 5 YEAR free service guarantee! Recent list price \$59.50. REDUCED for quick sales! Tax paid price—14.98—no extras!



**WATER & SHOCK Resist Case—G. I. Style! 8.80** tax paid!  
Military style! Drop it! Bang it! We guarantee it 3 years against any and all breakages—because of exclusive Swiss INSULATOR invention. 7 jewels. Luminous hands & numerals. Unbreakable crystal. Sweep-second. Heavy Chromed. Thin, smart! Marvelous accuracy. Long satisfying service. Tax paid, only 8.80  
15 JEWEL Model tax paid—no extras . . . 14.33  
17 JEWEL Model (5 year guarantee!), tax paid 17.65

**Fulcra-Matic Stop CHRONOGRAPH 7.97** tax paid!

Genuine Fulcra-Matic Stop Chronograph & Wrist Watch combined, gives accurate, long satisfying service. Times Races, autos, planes, Sports, etc. 10 WONDER FEATURES: Tachometer, Telemeter & Stop Watch. Luminous Dial, Unbreakable Crystal, Sweep-second hand. Stainless steel expansion band. Best of all—Fulcra-Matic finger tip control! Instructions given. 3 year guarantee. Tax paid, only—7.97.



**Thoresen's 17 Jewel FULL AUTOMATIC 29.88** tax paid!

De-Luxe model—fully automatic! Set it, then forget it! It winds itself as you wear it. Patented Incabloc. Anti-Magnetic. Sweep second. Luminous dial. WATER & SHOCK resistant. All stainless steel back case. 17 jewels. Near-miracle accuracy. Thin! Handsome! 5 YEAR GUARANTEE. Formerly \$75.00. Thoresen's direct-to-you price, only—29.88—no extras for tax. Rush! Supply limited!



2.97

**Initial Men's Ring**  
Extra special! Genuine sterling silver with gold plate sides. Your own initial in raised gold effect flanked by 2 pseudo ZIRCONS of sparkling brilliance. Tax paid—2.97



1.98

**"WEIRD" SKULL**  
Ruby color eyes flash "weirdly" in semi-darkness! Perfect miniature of skull & bones. Rich 14 Karat Gold Plated. It's the attention-getting ring. Our tax paid price — 1.98



3.55

**"Big 5" Men's Ring**  
Wins distinction! Extra heavy simulation of a Solid Gold 5 Diamond Ring. Made to endure. Rich \$500.00 appearance. Imported stones of amazing brilliance! Tax paid—3.55

**FREE 10 DAY TRIAL**

Price promptly refunded if not thrilled within 10 days after receiving. ALL prices tax paid—NO EXTRAS! Not a penny's charge for "handling," postage, parts or repairs on watches! THORESEN makes lifetime friends! References: Bank of Athens, New York, or any bank in America.

**3 SYNCHRO DIAL Precision-made SWISS CHRONOGRAPH**

Outstanding value! Sleek, handsome, 3 Dial CHRONOGRAPH. Amazing accuracy! Ideal for hobbyists, mechanics, scientists, doctors, sportsmen, students, aviators, etc. 20 SUPER FEATURES: 3 Synchro Dials! 30 min. register! 1/5th second calibration! Rugged shock-resist case, sweep second, luminous dial. Built-in tachometer & telemeter. Measures speed & distance planes, autos, horses, photos, etc. without stopping movement! 3 Year Guarantee. Formerly 39.95. Now at slashed price of 14.95, tax paid. No extras.



14.95 tax paid

THORESEN · Direct Sales, Dept. 6E-200, 131 West 33rd St., NEW YORK 1, N.Y.

**DUAL TAIL PIPE EXTENSION**  
Fits all cars — chrome plated  
**DEEP TONE**  
produced by 2 1/2 inch outlets **\$2.95**  
Postage free on prepaid orders  
TRADE INQUIRIES INVITED  
LYONS PRODUCTS COMPANY  
PAT. PEND. 2426 So. LaBrea Ave., Dept. PM-5, Los Angeles 16, Calif.

## Attention Leathercrafters

LOOK WEST, to the home of Leather Carving and Stamping. More than 100 LEATHERCRAFT KITS in finest Tooling and Carving Leathers. Best assortment of tools and accessories in U.S.A. Other handcraft materials also.

SEND 10c FOR 96-PAGE ILLUSTRATED CATALOG.

GRIFFIN CRAFT SUPPLIES (since 1924)

5626-A Telegraph Avenue Oakland 9, California

### YOU CAN BUILD A PICNIC TABLE LIKE THIS



With our PRE-FABRICATED MODERN STYLED 1 1/2" BENT PIPE FRAME

Assemble your Picnic Table in a few minutes with our kit containing all metal parts, hardware and plans. Makes Table 7 ft. long. Seats 5 people, will not upset! Prime coated, easily moved about, disassembles for winter storage.

Send for descriptive folder F. O. B. Niles, O. Wt. 80 lbs. In Ohio Add 3% Sales Tax. Sorry No C. O. D.'s **\$14.95**

DAUM & OFFUTT, Dept. M, P. O. BOX 203, NILES, OHIO

Make Money SELLING Eshelman Kulti-Mowers and DOING GARDEN WORK

PLOWS CULTIVATES HARROWS HAULS SPRAYS MOWS CUTS 1-2-3 H.P. ROLLS RAKES

**ESHELMAN** FOR BETTER LAWN and GARDENS also POWER MOWERS and RIDING TRACTORS Women can operate it.

Write to Dept. 63 Eshelman Co. 119 Light St., Balto., Md.

Excitingly New

THE  FIFTIES



It's the ultimate in mobile living comfort—and it's taking the country by storm! Now in 21, 25, 33 and 40-foot models, the NEW New Moon incorporates dozens of advanced engineering and design features for better living...all at amazingly low cost! See New Moon for yourself at your nearest dealer's, or write for Free illustrated literature—Today!

**REDMAN TRAILER CO.**  
38 BRIDGE ST., ALMA, MICH.



**A book every hobby crafter should have**



**May we send it to you? Send 10¢ for mailing cost.**

It's the new 28-page X-acto Catalog, handsomely illustrated, giving sizes, prices, contents of entire X-acto line.

**KNIVES & TOOLS**  
**KNIFE & TOOL SETS**  
**LEATHERCRAFT TOOLS**  
**PLEXON ARTCRAFT STRIP**  
**METALCRAFT KITS**  
**WOODCARVING KIT**  
**TRIX and ELEKTRIX**  
 Model Engineering System

*Points the way to a lifetime of fun with hobbies. Send for it today.*

# X-acto

\*Reg. U. S. Pat. Off.

## HOBBY KNIVES and TOOLS

X-acto Crescent Prod. Co., Inc. 440 4th Ave., N. Y.

# Snap-on DWARF BOXOCKET WRENCHES

"SHORT HANDLES FOR WORK IN CLOSE PLACES"



**\$7.65**

Plus local tax

A short, strong, sturdy set. Each tool has two wrench sizes. Set ranges from 5/16" to 3/4". Durable polished chrome finish. In kit bag.

\*Snap-on is the trademark of Snap-on Tools Corp.

**SNAP-ON TOOLS CORPORATION**  
 8062-E 28th Ave.  
 Kenosha, Wisconsin

Please send me the XS-606-K Dwarf Boxocket Set.

I enclose  Check  Money Order

Name.....

Address.....

City.....State.....

# RUBBER HOSE SALE



Brand new genuine Neoprene Hose—outlasts ordinary rubber 3 to 1. Reinforced with super tough cotton cord plies. Flexible, easy to handle. Easy Flo brass couplings with standard pipe threads for quick connections, included. Pump water for irrigation, stock, tanks, home, barn, fire fighting, etc. (Inside Diam.) 1 1/4 in. 1 1/2 in. Length 25 ft. 40 ft. 30 ft. Price \$8.75 13.75 13.75

**TERRIFIC VALUES!**

**AIR HOSE** 1/4" Diam. heavy duty double braid suitable for gas stations, spray painting, air-tools, etc. 20 ft. with swivel couplings and tire chuck. Reg. \$6.50 val.—only **\$2.75** (Item B)  
**WIRE** Heavy duty, No. 14, 2 conductor, stranded. Specially made to resist oil, grease, moisture and abrasion. Encased in black loom which defies breaks or short circuits. Perfect for running extra lights or outlets, wiring power tools, exten. cords, wiring lights on cars, trucks or tractors. 40 ft. spools. Wt. 2 1/2 lbs. Retail price, \$4. Special, 40 ft. **\$1.60** (Item C)—120 ft. **\$4.50** (Item D).

**HYDRAULIC HOSE** High pressure, heavy duty, complete with swivel fittings. **INSIDE DIAM. ANY LENGTH DESIRED**

1/4"—40c per ft.	Min. order —	\$1.00	Specify
3/8"—50c per ft.	Min. " —	1.25	flare or
1/2"—70c per ft.	Min. " —	1.50	pipe thread
3/4"—90c per ft.	Min. " —	2.00	connections

**FLEXIBLE GAS & OIL LINES** Packaged assortment of 10 highest qual. Neoprene 1/4" flex. gas or oil filter lines ranging from 6" to 24" long. Ass't'd. connections. Fits most any application. Wt. 2 lbs. Ret. Val. \$10.00—Our Spec. **\$3.00** (Item E)

**RADIATOR HOSE ASSORTMENT** —tough, durable, 3 ply reinforced. Resists heat, antifreeze, oil and grease. Kit includes 30 pcs. All sizes 1" to 2" and various lengths to 3 ft. 6 adjustable Nuc-out hose clamps incl. free. Ret. val. \$15, Spec. **\$3.25**. Wt. 5 lbs. (Item F)

**GAS AND OIL LINE Flexible Hose** — highest quality Neoprene 1/4" in. diam. 3 ft. lgths. Make up lines to suit job using hose clamps or fittings. Reg. price 24 ft. \$14.40—our special price 24 ft. only **\$3.60**. Wt. 4 lbs. (Item G)

**ALL NEW MERCHANDISE. PRICES F.O.B. CHICAGO AREA. SATISFACTION GUARANTEED. REMIT BY CHECK OR M.O.**

**MASTER MECHANIC CO., Dept. 24, Burlington, Wis.**



## GERSTNER Tool Chests

A Gerstner chest will make the work of machinists and toolmakers more pleasant by keeping tools in order—and safe. Free catalog.

**GERSTNER TOOL CHESTS**  
 450 COLUMBIA ST. DAYTON 7, OHIO

## GUARANTEED REBUILT JEEP MOTOR BLOCKS COMPLETE WITH PAN (Less Head)



This motor is completely rebuilt with all new parts. Guaranteed for 90 days or 4000 miles against defective parts or workmanship. You must prepay freight when shipping old block to us. Add \$2.50 for crating to above prices.

**\$88.50**  
 Exchange **\$107.50**  
 Outright **\$17.50**

## BRAND NEW CAPSTAN WINCHES



**NEW LOW PRICES**  
 6000 lb. capacity. Accurately machined gears provide for smooth efficient operation. Suitable for both front or rear mounting. May be used on amphibious jeeps or trucks. All units are brand new and fully guaranteed.

6 or more **\$15 ea.**  
 Each **\$17.50**

## New RADIATOR ASSEMBLY



Complete with Shroud. Interchangeable with Civilian jeeps.

**\$27.00**

## SPRING SPECIAL USED CANVAS TOPS



Slightly Soiled A3216—GPW1152700 **\$12.50**

## BIG, FREE CATALOG WRITE FOR YOUR COPY TODAY

Thousands of other parts and accessories available. SHOP BY MAIL — Order direct from this ad today.

**TERMS:** Net cash with order. Open account to rated firms only. C.O.D. shipments should have 25% deposit with order. All prices are F.O.B. our yards, Chicago, Illinois.

World's Largest Stocks of Jeep Parts



Write for Your Special Requirements—

**BERG TRUCK & PARTS CO., INC.**

1607 So. Wabash Avenue, Dept. M-5, Chicago 16, Ill.



# SAVE! SAVE! SAVE!

## UNSURPASSED VALUES IN USED AUTO PARTS

Never before in our 30 years history have we had such a tremendous stock of good used guaranteed auto parts for practically all makes and models.

### SPECIAL NOTICE—SPECIAL SAVINGS

We have secured a large quantity of new fender skirts at a tremendous saving which we are happy to pass on to you. No holes to drill, arm type locking device, makes installation and removal instant and simple. Rubber beading prevents rattle; 22 gauge body steel; prime finish ready to paint.



**\$6.95**  
PER PAIR

WILL FIT PRACTICALLY  
ALL CARS — ALL MODELS

### LARGEST STOCK — IMMEDIATELY AVAILABLE EXCEPTIONAL VALUES IN GUARANTEED USED PARTS

Year	Make	Motors	Trans.	Rear Ends
'37-'38	Chev	\$45.00	\$18.75	\$18.75
'40-'41	Chev	56.25	22.50	18.75
'37-'38	Ply	37.50	20.80	15.00
'40-'41	Ply	63.75	22.50	18.75
'37-'38	Ford	56.25	18.75	18.75
'40-'41	Ford	75.00	26.25	26.25

Above prices are NET WHOLESALE to POPULAR MECHANICS readers. Other models at comparable low prices

**WE SHIP ANYWHERE PROMPTLY AND PROPERLY**  
All merchandise fully guaranteed as represented. Order direct from this ad and receive commercial discount. Prices F.O.B. San Bernardino, California. Pay by Postal money order or check. 50% deposit on C.O.D.'s. California orders add 3% retail sales tax.

**SAN BERNARDINO AUTO WRECKING**  
239 ARROWHEAD AVE. SAN BERNARDINO, CALIF.

### Say You Saw It in POPULAR MECHANICS

## NEW Cyclo-Junior HAND DUSTER

Employs New "CYCLONE" PRINCIPLE  
for easier more efficient dusting



PRICE  
**\$2800**

Less 2% F. O. B.  
Middleport  
Send check or  
money order

To better protect the things you grow from insects and plant diseases, buy the new **CYCLO-JUNIOR** today. It employs a new principle—use of an unusually large volume of air at low velocity. Result: a powerful air blast assuring thorough distribution of dust materials. Power is provided by an effortless hand-cranking operation. Rotating fan case permits dusting up or down, forward or back. Comfortable wide-web harness supports duster.

**MULTIPLE USES**—medium-sized fruit trees, vegetables and other crops, shade trees, shrubs, flowers. The **CYCLO-JUNIOR** is Niagara's latest development—the result of 46 years of experience in manufacturing orchard and crop dusters, fungicides and insecticides.

**FREE LITERATURE.** Write for special dust and spray guide.



FOOD MACHINERY AND CHEMICAL CORPORATION

28 Niagara Street

Middleport, New York

MAY 1950

## SURPLUS POWER PUMPS POWER FLUID PUMP

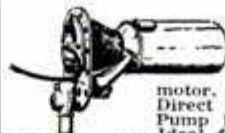

Capacity 3 GPM at 30 PSI. Delco 1/8 H.P. bearing. 8000 RPM. 24 volt DC-AC electric motor. 75° C. temperature rise—continuous duty. Direct connected to pump. Filter intake system. Pump has swivel neck with 3/4" pipe connection. Ideal for sump pump or inflammable fluids (complete enclosed spark-proof motor). Original cost over \$100.00. Perfect condition, ready to run . . . **\$9.25**

### BRAND NEW HYDRAULIC UNIT

Complete with Pesco 1P203 pump and 2 1/4 H.P., 4000 RPM, 24 volt DC electric motor. Will work on 12 or 32 volt DC. Pump capacity 1 GPM at 1500 RPM at 1875 PSI or 3 GPM at 3750 RPM. Weight 23 lbs. **\$19.95** POSTPAID. Priced at only . . . . .



## SURPLUS CUTTING TOOLS

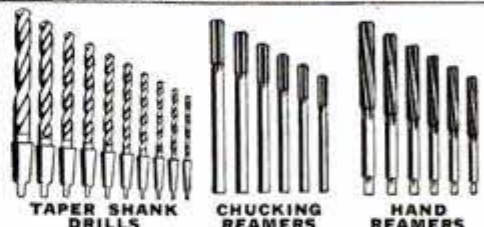

SET 1	12 different size Hand Reamers up to 1". New and slightly used surplus. Priced at only . . . . .	<b>\$6.59</b>
SET 2	8 Different size Hand Reamers up to 1/2". Brand new. Priced at only . . . . .	<b>\$3.75</b>
SET 3	10 different size High Speed Morse Taper Shank Chucking Reamers up to 1". New and slightly used surplus. Priced at only . . . . .	<b>\$4.79</b>
SET 4	10 different size High Speed Hand Taps up to 5/8". New and slightly used surplus. Priced at only . . . . .	<b>\$2.00</b>
SET 5	10 different size Straight Shank Drills from 3/8" to 1". Extra long drills. New and slightly used surplus. Priced at only . . . . .	<b>\$4.75</b>
SET 6	10 different size High Speed Morse Taper Shank Drills 1" to 2". \$180.00 value. New and slightly used surplus. Priced at only . . . . .	<b>\$39.95</b>
SET 7	10 different size High Speed Straight Shank Chucking Reamers up to 1". New and slightly used surplus. Priced at only . . . . .	<b>\$4.79</b>
SET 8	10 different size High Speed Morse Taper Shank Drills, No. 1 and No. 2 taper. Up to 5/8". New and slightly used surplus. Priced at only . . . . .	<b>\$4.79</b>
SET 9	10 different size High Speed Morse Taper Shank Drills, No. 3, 4 and 5 taper. From 5/8" to 1 1/8". New and slightly used surplus. Priced at only . . . . .	<b>\$24.95</b>

### NEW CARBON STEEL MORSE TAPER SHANK DRILLS

1"	—\$1.25	1-9/32"	—\$1.79	1-3/8"	—\$2.25
1-1/16"	—\$1.49	1-5/16"	—\$2.00	1-7/16"	—\$2.35
1-1/8"	—\$1.59	1-11/32"	—\$2.15	1-15/32"	—\$2.50
				1-9/16"	—\$2.70

### Slightly Used CARBON STEEL MORSE TAPER SHANK DRILLS

2-3/8"	—\$6.50	2-5/8"	—\$8.70	3-1/2"	—\$10.50
2-1/2"	—\$7.95	2-7/8"	—\$9.60		

**AIR CHECK VALVES:** Ball type check, made of brass. 1/4" male tubing connections. brand new. 75c ea.; two for \$1.25 and 12 for \$6.25 postpaid.

## MILLING CUTTERS



## HIGH SPEED

### SIDE MILLING CUTTERS STAGGER TOOTH MILLING CUTTERS

Dia.	Width	Arbor Hole	Price Ea.
2	1 1/2	5/8	\$1.20
3	3/16	5/8	1.25
3	7/16	1	2.10
4	1 1/2	1 1/4	2.95

We have over 500 of both the 2 x 1 1/2 x 5/8 and 2 x 3/16 x 5/8 and offer discounts in quantity.

### PLAIN MILLING CUTTERS (without side chip clearance)

Dia.	Width	Arbor Hole	Price Ea.
1 3/4	3/8	1	\$1.00
1 3/4	1/2	1 1/4	1.05
2 1/2	3/4	1 3/4	3.00
4	1 1/4	2	3.00

### Slightly Used

Dia.	Width	Arbor Hole	Price Ea.
4	1 1/2	1 1/4	\$4.00
5 3/4	5/8	1 1/4	6.10

1 1/2" dia. x 5/16" dia. x 5/8" arbor, high speed concave cutter . . . . . **\$1.75**

Left Hand Corner Cutter 2 1/4" dia. x 3/8" arbor x 1/4" radius . . . . . **\$1.05**

The above cutters are slightly used but in sharp condition.

All merchandise is sold with money back guarantee and is shipped POSTPAID.

**T & T TOOL, 111 West Archer, Tulsa, Oklahoma**



## ELECTRIC WELDER

AC or DC 110 Volts

"The Little Marvel" All-Metal welder. 5-year written guarantee. Welds 1/8" thick metal or money back. Repairs tanks, tools, fenders, machine parts, etc. Comes complete with everything, rods, unit, eye shield, and directions. We

also make a welder for 16 to 22 gauge metal . . . \$3.95 complete. On C.O.D., postage extra.

ESSAY MFG. CO., Inc., Dept. 51, Quincy 69, Mass.

**\$6.45**  
Complete

# DELTA MILWAUKEE **HOMECRAFT**®

No. 11-120

**\$4395**

Motor extra  
Subject to change  
without notice

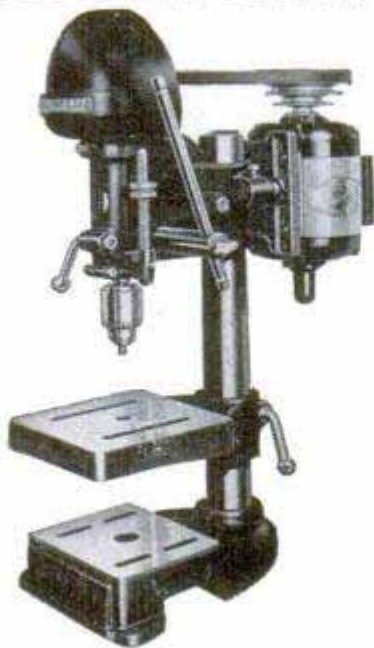

## Do 7 jobs with 1 low-cost Delta® Homecraft 11" Drill Press

Drill, mortise, rout, carve, sand, shape, grind — safely, accurately, inexpensively. Speed range, 700 r.p.m. to 4700 r.p.m. Sturdy quill has stop-rod, for repetition depth drilling. Many extra-value features. Complete accessories available. Ask your dealer to demonstrate this quality Delta Homecraft 11" Drill Press today.

POWER TOOL DIVISION



**Rockwell**

Manufacturing Company

802E5 East Vienna Avenue

MILWAUKEE 1, WISCONSIN



**Free Book!**

"How to Start Your Home Workshop." Write for your copy today.

HM-82

SAY YOU SAW IT IN POPULAR MECHANICS

## WITTE slashes cost-per-HP almost in half

Improvements in design of Witte's Series AD Diesel Power Units have increased the horsepower output from 4 HP to 6.8 HP. There's no increase in price so the saving is all yours... cost-per-horsepower has been cut almost in half.

And the same savings are available to electric power users, for this new Witte Diesel has been incorporated in the Series AD Diesoelectric Plant. Its 4.25 KW-DC (5.3 KVA-AC) output cuts the cost-per-KW almost in half.

For the complete story on these new savings, write for Bulletin 5504, describing Series AD Diesel Power Units, or Bulletin 5519, describing Series AD Diesoelectric Plants.



WITTE ENGINE WORKS, KANSAS CITY 3, MO.  
Division of Oil Well Supply Company

UNITED STATES STEEL

## BUILD YOUR OWN *Belt Driven* ATTIC OR WINDOW FAN

**\$48**

OR MORE

## Sensational New PEDESTAL ASSEMBLY

COOLS 5-ROOM HOME... USING 24" x 40 DEG. PITCH NATIONALLY KNOWN TORRINGTON BLADE...

**\$19.95**



Now it's a cinch to build your own attic or window fan with this sensational new pedestal assembly. Pedestal comes completely assembled with blade and all necessary parts excepting motor and easy-to-make wood cabinet. All you do is house assembly for attic or window using four 1/4" bolts, install motor, and you'll have an efficient, dependable cooling fan. Pedestal can be mounted in various positions. Nothing like it anywhere!

**24" ASSEMBLY INCLUDES**

Torrington blade, steel shaft, V-belt, pulleys, special aluminum alloy pedestal with precision-fitted Oilite bearings.

**CAPACITY**  
5000 CFM of air at 560 RPM.

### FREE Plans

included with assembly show how to build wood cabinet for attic or window, and various ways to mount motor and assembly.

## 20 INCH, 2-SPEED **\$29.95** WINDOW FAN

Shipped Ready to Plug-in Except for Easy-to-Make Window Panel... Compares with Fans Selling for \$59 or More! Features:

- Torrington blade
- Rubber Mounted Redmond motor
- Heavy gage wire guard with foot stand
- 2-speed switch (high, low and off)
- 8 ft. rubber cord UL appd.
- Moves 3000 CFM of air
- Rubber grommets, bolts furnished for mounting unit on panel
- Plans included for making panel to fit any window

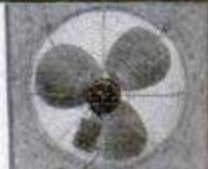

**ORDER FROM THIS AD!** Send check, cash or M. O. plus \$1.50 for express and handling charges. RETURN IN 10 DAYS FOR FULL REFUND IF NOT SATISFIED!  
Write for FREE Literature!

ARTRA Aluminum Fdry. & Mfg. Co. 16 E. MADISON, ST. CHARLES, MO.

## ELECTRIC MOTOR BARGAINS!



1/2 HP. 1750 RPM **\$15.00** 1-HP. 3450 RPM **\$34.50**  
3/4 HP. 1750 RPM **\$26.00** 1-HP. 1750 RPM **\$35.00**

Every Motor Fully Guaranteed

Heavy Duty, Repulsion Induction or Capacitor Types, 110-220 Volts, 60-cycle, Single-phase, Standard Makes (G.E., Wagner, LeLand, Westinghouse, etc.). Rush your order TODAY—large stock of motors—1 & 3 phase. 32-v. direct current bargains. Prices f.o.b.

ROBERTS ELECTRIC CO., 7232 Madison, Forest Park 5, Ill.

## New! AUTO CLIMB INDICATOR



Amazing safety device. Fits inside any automobile! Know grade percentage climbing or descending. 2" reading dial—handsome plastic & steel case. Money-back guarantee! \$2.95 postpaid. COD postage extra. MAHAR CO., 502 NORMANDY, SANTA ANA, CALIF.

## Find HIDDEN TREASURES



GEIGER COUNTERS for Uranium Detection. Sensational new low cost models. METAL DETECTORS for Gold, Silver. Light weight, highly sensitive. None finer at ANY PRICE.

Detection co. Dept. 5-B  
5637 Calhenga, No. Hollywood, Calif.

## CRESCENT TOOLS

Give Wings to Work

ASK YOUR  
HARDWARE  
DEALER

## "THE ORIGINAL" MAUSER PRECISION VERNIER CALIPER

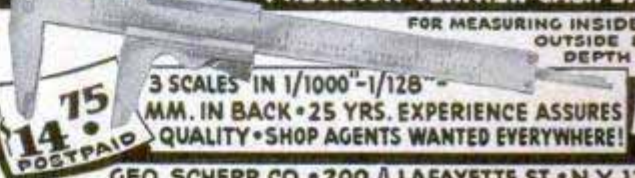

FOR MEASURING INSIDE, OUTSIDE & DEPTH!  
3 SCALES "IN 1/1000" - 1/128" - MM. IN BACK • 25 YRS. EXPERIENCE ASSURES QUALITY • SHOP AGENTS WANTED EVERYWHERE!

GEO. SCHERR CO. • 200 A LAFAYETTE ST. • N.Y. 12  
POPULAR MECHANICS

**Sensational NEW... ELECTRO-MATIC SPRAYER**

**NO MOTOR...NO COMPRESSOR NEEDED**



ONLY  
**\$9.95**

Postpaid in U.S.  
Postage extra on C.O.D.'s

**HERE'S A SPRAYER THAT REALLY WORKS!**

Just fill this amazingly simple sprayer with J enamel, lacquer, varnish, stain, light oil, insecticide, moth or fly spray, plug it in to 110-125 volt AC 60 cycle current, and you are ready to do a professional job of painting furniture, automobiles, shop equipment, farm machinery, bicycles, screens, woodwork, etc. Use it for disinfecting, mothproofing, fly sprays, livestock sprays, rust proofing, too. Precision engineered for long service, fully guaranteed. Replaceable mason jar. Weight 2½ lb.

**LESTER Products Co.** 1743 MILWAUKEE AVENUE  
BOX M-5E, CHICAGO 47, ILL.

No. 1712



**You own the BEST money can buy... when it's P&C**

**Square Opening**

Movable jaw has full bearing surface on channel with any nut for greatest strength. Both chrome and semi-finish forged from tough alloy steel.

Square opening grips square or hex nuts better.

There is a P&C tool for every job. Ask your hardware dealer for P&C punches, pliers, sockets, wrenches and screwdrivers—the BEST tools money can buy.

**FREE TOOL BOOKLET** gives valuable information for every tool user. Send for your *free copy!*

**P&C P&C HAND FORGED TOOL COMPANY**  
PORTLAND 22, OREGON

**FIX UP Around Home with ELECTRIC WORK-SAVING TOOLS**

During NATIONAL HARDWARE WEEK and Every Week!



**Exclusive DOUBLE ARC MOTION**

\$14.50

**SYNCR0**  
ELECTRIC

**COMPARISON PROVES IT BEST**

**SANDER-POLISHER and MASSAGER**

Let SYNCR0'S 240 strokes a second do the work—just guide it! Exclusive Double Arc Motion prevents scratches, "loading." For all high-polish, light sanding jobs in corners, around mouldings and on flat, curved, irregular surfaces. Also marvelous for body massage! A quality tool.

With 10 sheets sandpaper, polishing pads, cord—\$14.50



**—and HONE HOME TOOLS SHARP!**

**SYNCR0 HONE**

The only electric hone with stones that m-o-v-e 240 short strokes a second! Speeds honing home tools, knives. Safe

\$12.50

With BUILT-IN MOTOR, 4 stones, \$12.50

**The SAFE FAMILY PROJECT TOOL**

**SYNCR0 ELECTRIC JIG SAW**

Safe for children ideal for adult workshops. Thousands used by schools, institutions, families, "tinkerers." Saws any length ½" wood, thin metals, plastic. Portable. Easily adjustable stroke. With BUILT-IN MOTOR. \$17.50.



\$17.50

Arm in normal position →

**THAT'S The Name To Ask For!**

**SYNCR0**  
QUALITY TOOLS

Operate on 60 cycle, 110-120 volt, AC only. Buy at dealers. If none near, send article price, we'll ship POSTPAID. (Dealers write for information.)

**SYNCR0 CORPORATION**

Dept. D-50, Rochester, Michigan, U. S. A.



**#2 HAWAIIAN WIGGLER**  
LANDS RECORD CATCH—101¾ LBS. OF BASS!



"It takes the old No. 2 to drag the mossbacks out of the pads, moss, tree tops and stumps," write Jim Ledbetter, Sr. (left) and Bill Day, veteran Memphis anglers. "We took our two-man limit of 20 bass on your No. 2 Hawaiian Wiggler. This catch is an all-time record for Horseshoe Lake, Arkansas. Practically all our bass for 2 years were taken with Hawaiian Wigglers. It's tops in our estimation."

SHALLOW RUNNER WON'T HANG UP

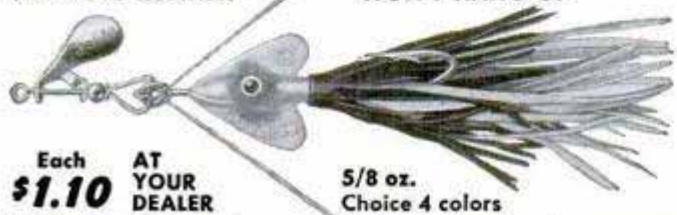

Each AT \$1.10 YOUR DEALER 5/8 oz. Choice 4 colors

With Double Spinner for Extra Flash—\$1.21 each

WRITE FOR FREE FULL-COLOR BAIT CATALOG

**FRED ARBOGAST & CO., INC.**  
1605 WEST NORTH STREET • AKRON 3, OHIO

OUR 258th ADVERTISEMENT

**REAL DIESEL ENGINE!**

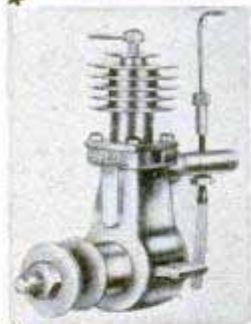

**\$2.95**  
You can't beat this price!

- Ideal for planes, boats, midget cars
- Actually runs at 7500 RPM, produces 1/7 HP
- Precision machined for smooth operation
- Comes to you completely assembled, ready for operation

MAYBE WE'RE CRAZY, giving away a precision diesel engine, complete with cylinder and piston, carburetor, crankshaft, connecting rod, etc. for ONLY \$2.95. But we're selling thousands of DEEZILS all over the world, and that keeps our production costs down. DEEZIL is streamlined, compact, rugged. Starts quickly, easy to install, runs for years! Fast delivery if you ORDER DEEZIL TODAY!

Send \$2.95 plus 25c postage

**GOTHAM HOBBY CORP.** DEPT. P, 107 E. 126th ST., NEW YORK 35, N. Y.

**GEARED TOOLS FOR THIS ATOMIC AGE**

Are Saving USERS \$s — Energy Making BIG MONEY for AGENTS . . .

Eifel-Line Super-Tools with the Amazing 4X, EXPANDO-Jaw



The NEW '4X' Jaw

Above Composite Cut shows 2 Positions. The Exclusive Parallel EXPANSION-Grip has countless new uses.



- A3-Jaw, 7" Pliench KIT and 8 1/2" PRIME and MASTER KITS with 3 to 8 Jaws, etc.: Universal, Pipe, Wire; for a Million Sizes 0"-13 1/4", and
- GIANT UNIV., '4X' and PIPE Jaws (Range 1" to 3"):
- Tub'g Ctr., Grip-Clamp, etc. . . 1-Oz. to 1-TON grips! . . . Do Thousands of Jobs, Quicker, Better and Easier.
- 8 1/2" Items FIT EIFEL-GEARED Plienches . . . '33 and later. Sold SINGLY or in ANY Combination.



GET the Most Amazing Gripping-tool Facts Ever

MAIL this COUPON TODAY . . .

(ON A POSTCARD WILL DO) . . .

- Print your Address . . . Get FREE
- 1) The 15-Picture MANUAL—M.
  - 2) The 120-Picture CATALOG—C.
- With OFFER as marked —
- PART-TIME AGENT  USER
- FULL-TIME DISTRIBUTOR



**AMERICAN PLIERENCH CORP'N**  
4611 N. RAVENSWOOD AVE., CHICAGO 40, ILL., DEPT. PM-05

3) Also FREE (in U.S.A.) this 3", 8-Edge, End-and-Angle Screwdriver, etc. . . often more Valuable, Useful than a Pocketknife!

SAY YOU SAW IT IN POPULAR MECHANICS

**ONE-MAN SAWMILL** LOW \$50.00 AS . . . \$50.00 DOWN



Take BELSAW Portable Sawmill right to the trees—turn out valuable lumber for local yards—do "custom sawing" for neighbors. BELSAW lasts a lifetime. No crew needed. Power with old auto engine. Beginners get excellent results. Send postcard for FREE BOOK, "How To Make Lumber."

**BELSAW MACHINERY CO**  
811 Field Bldg., 315 Westport Rd., Kansas City 2, Mo.

**OIL FACTS!!** Tells the TRUTH about lubricating oils; written by an insider. 32 pages, 25c; refunded if you don't agree it's worth as many dollars! I DO NOT SELL OIL!  
REMANCO, 5083 Elston Ave., Dept. 30, Chicago 30, Ill.

**New BELT SANDER** ONLY \$10.95



Stationary and Portable

Ideal all-purpose sander for home or shop! Stop-Fence Unit adjusts to 4 positions—tilts to 45°. Sturdy aluminum construction. May be powered by electric motor, drill, lathe, etc.

Send for free circular NOW!

**JOHNSON Mfg. Co., Dept. 1C, Lincoln Park 7, R. I.**

Tune in the **AUTO-LITE** Show { **"Suspense!"** THURSDAY NIGHTS—CBS

Make Your Own **POWER LAWN MOWER** with this DRIVE CUTTER ASSEMBLY

Constructed for those who desire to build their own mower or to replace your old cutter assembly. Complete with 18" blade and double ball bearing drive, only. Add 50c to cover handling & shipping. No COD's

**\$11.95**



**ATLAS EQUIPMENT CO., Dept. PM55**  
229 SW BLVD. KANSAS CITY, MO.

# 2 Sensational Buys!

Here is a COMPLETE welding unit that has hundreds of uses at a price that can't be beat. UL approved. 115V, AC, 4 stage, 30-40-50-65 amps. Unit includes: Helmet, 8' welding cable, 8' ground cable, electrode holder, ground clamp, 6' power cable, wall receptacle, and instructions. Will weld flat, vertical, or overhead. Excellent for cold cast, sheet metal, or 1/4" steel plate. DO YOUR OWN WELDING. Mfg. by Puwling & Harnischfeger. Weighs 62 lbs. GUARANTEED. YOUR PRICE ONLY \$74.50. Worth many times more.

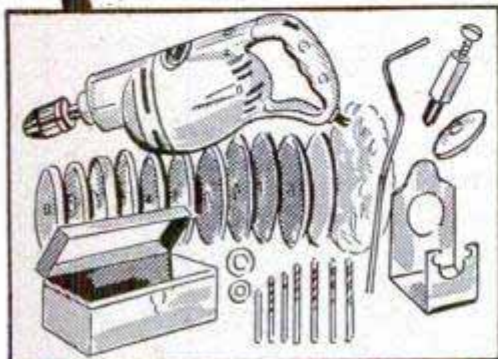

## COMPLETE DRILL UNIT BARGAIN

1/4" drill complete with kit. 2200 RPM drawing 2 amps., including 29 pieces—drills, buffer, sander, etc. ONLY \$19.95 with privilege of 70 more workshop items valued at \$27.50 for only an additional \$5.95. Don't wait—these bargains will soon be sold out. Get your order in today; send check or money order. WRITE FOR FREE CATALOG listing hundreds of dollar-saving bargains.

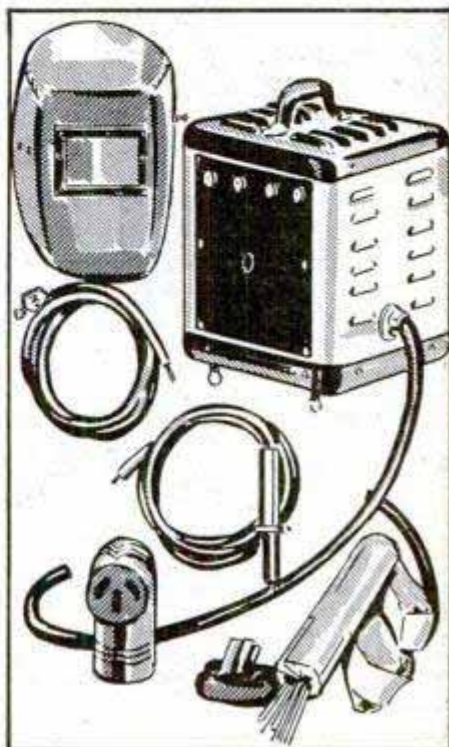

## C & H ELECTRIC Co.

434 W. JUNEAU AVE.  
MILWAUKEE 3, WISCONSIN

## Electric HOME-UTILITY Tools for HOMES • FARMS • WORKSHOPS

Products of the Black & Decker Mfg. Co.

SAY YOU SAW IT IN POPULAR MECHANICS

### DO MORE *at* LESS COST!



**4 STYLES OF GARDEN - SMALL FARM TRACTORS**  
Walking or riding models. Dozens of attachments for plowing, sowing, fertilizing, raking, harrowing, wood-sawing, snow-plowing, etc. Uses world-famous Clutch-Driving Action (no belts, no chains).

Clutch Driven  
Bar Tread Tires  
Attachments for  
ANY job  
Fully Guaranteed

**EASY TERMS**—Write today for big, colorful catalog FREE . . . and learn about the new e-a-s-y way to get your RED-E on amazing pays-for-itself Plan! SPECIAL: Discount to User-Agents!

RED-E TRACTOR CO. Richfield, 2. Wis.

### SENSATIONAL BARRON SPEED-VISE!

**AN ALL-PURPOSE BENCH VISE Only \$195**

- Slickest, handiest, all-metal vise. Screws or bolts to any bench. A work shop 'must' for planing, sawing, drilling, filing, sanding woods, plastics, metals—paper thin to 3" wide, any length.

It's permanent, portable for carpenters, pattern and cabinet makers, home craftsmen. Try it on 10 day money back guarantee. Barron Tools convert any Drill Press into a Planer Sander Shaper Jointer Router at 1/10th the cost. Our Free Workshop Guide tells you how!

**BARRON TOOL CO., INC.**  
300 Architects Bldg., Detroit 1, Mich.

FREE Power Tool CATALOG

BUY the BEST — Buy

**Darra-James POWER TOOLS**

SEND FOR FREE BROCHURE NOW

**TOOLKRAFT CORP., SPRINGFIELD, MASS.**

DEPT. M5: Rush Darra-James Brochure!

NAME .....

ADDRESS .....

CITY ..... STATE .....

**THE CHOICE OF THOSE WHO WELD FOR PLEASURE AND PROFIT!**

## DYNAMIC Super Charged ARC-WELDER

OVER 50,000 SATISFIED USERS

DOES WELDING, BRAZING, SOLDERING, CUTTING  
It's the finest, precision built heavy duty transformer-welder available for home, farm, or shop use. Does work you'd expect from costlier machines. EASY TO OPERATE. Do expert work; follow simple instructions. Works on iron, steel, brass, bronze, aluminum and other metals. Operates from any properly wired 110 volt 50/60 cycle AC line. Save time, Make money—Build or repair auto, home, farm or shop equipment, etc. for yourself and others in spare or full time. Comes complete Ready-To-Operate. Order today for 10 day trial on money back guarantee or write for Free Particulars. DYNAMIC WELDER CO., Dept. D2-EA4, 15 E. 23rd St., Chicago 16, Ill.

GIFT WORTH \$6.80 INCLUDED

FOR PROMPT ACTION SEND TODAY

\$40<sup>30</sup> VALUE Only \$28<sup>50</sup> F.O.B. COMPLETE

# BIG PROFITS FOR YOU

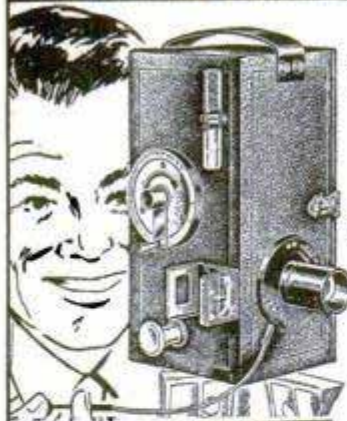

**Making  
Finished Photos  
in 2 Minutes!  
Wonderful  
Photo Invention  
P D Q  
CHAMPION  
PHOTOMASTER**

**COMPLETE PORTABLE  
PHOTO STUDIO**

Size 4 1/2" x 5" x 10"  
Weights only 6 lbs.

**OVER 700% PROFIT!**

Beautiful, everlasting photos — black and white or sepia, size 2 1/2 x 3 1/2 in. Guaranteed not to fade. No dark room needed. Photos are taken DIRECT on "SUPER SPEED" direct positive paper. Loads enough paper for 50 shots in half a minute — in broad daylight.

**BE A P.D.Q. PHOTOGRAPHER**

No experience required. Simple directions teach you quickly. Work at home or travel. Make expenses plus extra profits. Pictures cost you only 2c. Sell for 15c to 25c. Folks just grab for 'em. They are amazed to see their own photos come to life in broad daylight. Photomaster "shoots" any subject — individuals or groups — buildings and scenes. This new and fascinating business offers unheard-of money-making opportunities everywhere — every day throughout the year. **DETAILS FREE! WRITE**

**P D Q CAMERA COMPANY**

1161 N. Cleveland Ave., Dept. PM-5, Chicago 10, Ill.



**It's the CUT that COUNTS**

and Capewell's Exclusive "Statistical Quality Control" Gives You 10% More Cutting

When you buy Capewell hack saw blades you get a bonus of 10% additional cutting because Capewell's "Statistical Quality Control" eliminates sub-standard blades. Another exclusive Capewell advantage—the printed blade, carrying instructions for proper use.

Always ask for Capewell hack saw blades and frames, band saws (in coils or welded), Dafilis, ground flat stock, compass and keyhole saws and hammers.



THE CAPEWELL MFG. CO.  
Dept. 95  
Hartford 2, Conn.



- **BLAST DIRT WITH RICH SUDS!**
- **KILL GARDEN PESTS!**
- **ENRICH YOUR SOIL!**

with the amazing new **SUDS-O-MATIC**

Year 'round nozzle-washer-sprayer that fits any garden hose . . . . . **\$4.95**

**BLASTS DIRT WITH SOAP-'N-WATER!** No rubbing or scrubbing—water pressure does the work for you! Ideal for cleaning your car, house, screens, storm windows, porch, basement, patio, lawn furniture, rugs, etc.

**WAX PROTECTS YOUR CAR FINISH!** Wax impregnated detergent cuts grease and road film, gives your car a high lustre without hand polishing!

**SUDDEN DEATH TO INSECTS!** Spray DDT on your lawn, flowers, shrubs, porch, patio, basement, etc.—merely by turning on your hose!

**ENRICH YOUR SOIL!** Stimulate plant growth by spraying fertilizer on your lawn or garden and soaking it into the subsoil—all in one easy operation.

**USE IT AS A NOZZLE ALONE!** Turn lower nozzle on whenever you need rinse water. Adjustable from fine spray to steady stream.

At the press of a button, Suds-O-Matic does all the hard and dirty work for you. Fits any garden hose. Easy to load with pellets of detergents, DDT or fertilizer. Made of non-corrosive alloys, chrome-plated finish. Comes complete with package of Suds-O-Clean and package of Film-O-Wax pellets, only \$4.95!

**ORDER ADDITIONAL PELLETS**

- 5 Suds-O-Clean pellets for cleaning . . . . . 24c
- 5 Film-O-Wax pellets for car wash . . . . . 49c
- 65 fertilizer tablets . . . . . \$1.00
- 55 DDT pellets . . . . . \$1.00

Send cash, check or M.O. for prepaid shipment

**BERTRAM G. ENGINEERING CO.**

3121 Main Street Kansas City, Mo.

**\$ RETOOTHING SAWS PAYS BIG \$**

**EARN \$15.00 HOURLY . . .** as automatic retoothers cuts new 4 pt. to 16 pt. rip or cross-cut teeth on hand saws in 50 seconds. Requires less space, less time and less effort . . . while doing a perfect job. Gives a lifetime of service and has a 1 year guarantee. **WRITE FOR FREE FOLDER.**



**SAW SHOP CHARGES COAST TO COAST**

**WRITE FOR VALUABLE BOOK**

Automatic Retoother

Send 25c in coin for Burr's Blue Book of saw shop charges and other valuable information.

**BURR MFG. CO.** Dept. PM5, 8933 VENICE BLVD. LOS ANGELES 34, CALIF.

**\$4.95 JIG SAW**

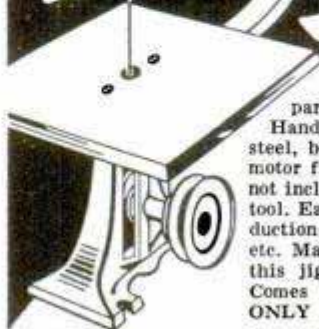

Jig, saber saw, and filing machine. Precision built. Has cast iron base, steel table 8" x 8", hardened working parts. Cuts to center of 20" circle. Handles 1 inch wood stock; cuts sheet steel, brass, plastic, etc. Operates on any motor from 1/8 H.P. and larger. (Motor not included). Not a toy—but a fine power tool. Easy to operate. Can be used for production work, hobby work, model builders, etc. Make money in your spare time with this jig saw turning out things to sell. Comes complete with jig saw blades for **ONLY \$4.95. Order Today!**

**SEND NO MONEY!** Just mail your order. Pay postman \$4.95 plus postage on delivery. Try 10 days—if not delighted, return for money-back.

**STRADER PRODUCTS** Dept. E-302, 259 Strader Ave., Cincinnati 26, Ohio

# "Wellworth" Sensational Offer! Compressor Outfit...

## FOR FARM AND HOME WORKSHOPS

Compressor, pressure tank, air gauge, air chuck, 20-ft. hose, pop valve, copper tubing with 4 brass flared fittings for connecting compressor to tank, 4-way cross and 3 nipples. **COMPLETE OUTFIT, wt. 42 lbs. All Brand New Equipment**

## DESCRIPTION of AIR COMPRESSOR

Both valves in head. bronze bearings. splash lubrication, "V" belt drive, intake muffler and cleaner. Compressor has 2" bore, 1 1/4" stroke, 2.8 cfm up to 150 Lb. pressure. Motor required: 1/4 h.p. at 100 lbs.; 1/2 h.p. at 125 lbs.; 3/4 h.p. at 150 lbs. or equivalent gas engine. **One Year Guarantee.** Replacement parts always available.

# \$29.95

For The  
**COMPLETE  
OUTFIT**

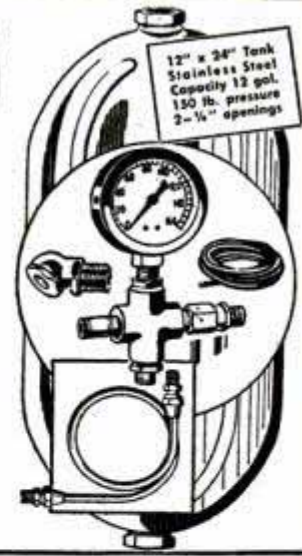

COMPRESSOR  
ONLY  
Wt. 16 lbs.  
**\$17.50**

Equipment  
less compressor  
Wt. 25 lbs.  
**\$12.50**

## PNEUMATIC AIR TOOLS

Used—  
Like New!  
**CHICAGO PNEUMATIC RIVETER  
& CHIPPING HAMMER**

CP4X Pistol grip handle. Takes up to 3/16" rivet. Weight 6 lbs. List price \$73.00.

Ideal for work on fenders and auto bodies

**SPECIAL PRICE..... \$8.95**

Same as above, **\$22.50** brand new.....

**Ingersoll  
Rand  
AIR DRILL**  
Used—like new.  
Lever or Pistol type  
With 1/4" Jacob Chuck. Wt. 2 lbs. List price \$55.00. Only **\$14.95**

## SAVE 33 1/3% ON GAS ENGINES!

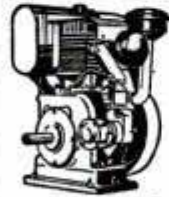

Wisconsin Model VE4 with clutch. H.P. .13 to 20.5. List \$342.00. Price..... **\$228.00**

Wisconsin Model AEH. H.P. 3.3 to 6.1. List \$130.95. Price.. **\$87.00**

Wisconsin Model A.B. H.P. 1.7 to 3. List Price **\$60.00**

All Brand New Equipment

## 6 FT. STOW FLEXIBLE SHAFT

Heavy Duty, 3/8" Core. Best piano wire. Ball bearing handle and arbor rubber covered housing; for 1/2" motor shaft; for 1/2" bore wheels. Operates on 1/4 H.P. Motor at 1725 or 3450 R.P.M. \$29.00 Value. **\$14.50**. Wt. 8 lbs.



## "WELLWORTH" V-BELT CLUTCH

Takes starting load off engines or motors. When speed is reached, a flip of handle shifts clutch from idling to driving position. Handles "A" belts, 2.35" pitch diameter, 3/8" bore. Ideal for use with lawn mowers, garden tractors, home workshop motors, etc. 3 1/4" long. Safe, easy to mount, sealed bronze bearings, positive action. Shpg. wt. 3 lbs. **\$7.50**

## Portable Automatic Paint Spray Unit

Spray paint your home, car, garage, etc.

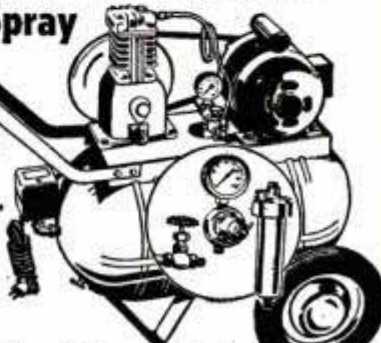

Complete outfit including Spray Gun. **\$89.50**  
\$150.00 Value.

Same unit, stationary, \$79.50

Use also for spraying insecticides on plants and flowers. 1/2 H.P. heavy duty capacitor motor. AC 110/220 volt, 60 cycle, 2 x 1 3/4 inch piston type compressor, splash feed lubrication. 12 1/2 x 24 inch tank, automatic pressure switch. CFM 2.8 at 100 lbs. pressure, or 150 lbs. pressure for intermittent duty. Check valve, safety valve, air regulator with gauge and filter, spray gun with 20 ft. air hose and air chuck for inflating tires. V belt drive. Mounted on 2 wheels, ball bearing, with 2" x 10" pneumatic tires. Portable, with handle. Shipping wt. 90 lbs. Regular \$150.00 value. **ONE YEAR GUARANTEE.** Only \$89.50 complete.

## PARTS SOLD SEPARATELY

Compressor..... **17.50** wt. 16 lbs.  
Automatic pressure switch..... **7.50** wt. 3 lbs.  
Regulator, gauge and filter..... **8.50** wt. 5 lbs.  
Spray gun..... **9.95** wt. 4 lbs.  
Tank, wheels and base..... **17.50** wt. 32 lbs.  
20 ft. hose..... **2.95** wt. 6 lbs.  
1/2 H.P. Cap. motor..... **22.50** wt. 28 lbs.  
Air gauge... **1.75** Adjustable pop valve... **1.50**  
1/4" check valve..... **2.75** wt. 2 lbs.

## BARGAINS IN BLOWERS



Quiet operating. Double wheel inlet, double width blower. For heating, ventilating, cooling, air washing, exhausting and forced draft. **DIMENSIONS:** 10" wheel; outlet 13 1/4" x 11 3/4"; inlet 8 3/4".

Height 19". Width 18". Depth 16 1/2". C.F.M. 1/4" S.P. 1600; outlet vel. 1575; motor 1/4 H.P. with overload relay; cord & plug, 110 v. 60 cy. AC. Ship. wt. 67 lbs. Special price.... **\$39.50**

## 140 CFM "Wellworth" Blower

Single-inlet blower gives top performance on heating, ventilating, cooling, drying, etc. 5 1/4" x 4" mounting flange with 2 1/2" square discharge. 3 1/2" dia. blower wheel powered by direct-connected 1/15 H.P., 110 V., 60 C., A.C. motor with conduit box and 20" leads. 7 1/2" wide less flange by 7 1/4" H. x 6 3/4" D. Suited for hundreds of new and replacement uses. Shpg. wt. 6 lbs. **\$14.20**



## "Wellworth" COMPRESSORS

Build your own compressor unit. Sizes 12, 17.3, 30 and 45.7 c.f.m. at 100 lbs. per sq. inch. Timken bearings, splash lubrication, automatic unloading and idling. Built-in loadless starting for automatic stop and start operation or constant speed suction unloader for continuous operation. Single stage duplex cylinder with intake filter. 1 Year Guarantee.

size	c.f.m.	price	ship. wt.	motor required
2 1/2 x 2 1/2	12	\$102.05	140	2 HP
3 x 2 1/2	17.3	113.75	160	3 HP
3 1/2 x 3	30	153.85	210	5 HP
4 x 3 1/2	45.7	246.55	310	7 1/2 HP



## Send for our 68 page book

A handy buyer's guide for home and factory workshop. Unusual bargains in motors, air compressors, electric tools, and many more items. Send 10c for postage and handling.

## AIR TANK and ACCESSORIES

Air receiver, stainless steel, 12 1/2" x 24". 400 lb. test. Ideal for carrying on trucks, autos and wherever compressed air is needed. Equipped with 500 lb. air gauge, tire chuck, 3 ft. high-test air hose, air inflation valve with core for retaining pressure in tank, and fittings. Complete outfit..... **\$7.50**  
Shipping wt. 20 lbs.

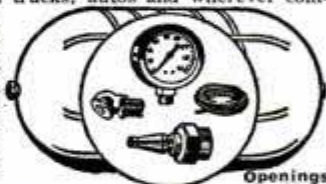

Same unit but with 6" x 24" tank..... **\$6.50**  
Shipping wt. 10 lbs.

Prices f.o.b. Chicago. Immediate delivery. All items sold on money back guarantee. Send check or money order today.

# WELLWORTH TRADING CO.

DEPT. D-5  
1831 S. STATE ST. CHICAGO 16, ILL.

## "Wellworth" Two Stage COMPRESSOR UNIT

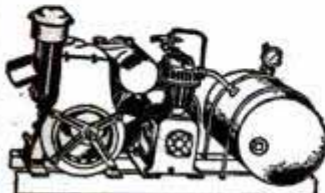

Ideal for paint spraying and general use. Compressor: Size 3 1/2 x 2 1/2 with unloader for continuous pressure service; displacement 10 C.F.M. at 200 lbs. pressure. Unloader set at 150 to 165 lbs. Compressor idles when 165 lbs. is reached, starts pumping again when pressure is down to 150 lbs. Wisconsin Gasoline air cooled, easy starting engine 3 1/2 H.P. at 1800 R.P.M. 4 1/2 H.P. at 2400. Air Tank: A.S.M.E. 200 lbs. working pressure; size 16" x 20" with safety valve, drain, two 3/4" globe valves and pressure gauge. 2 "V" belts and pulley. 40 ft. air hose and fittings. **\$225.00**  
Wt. 350 lbs. Reg. price \$400, less base.....

92 PAGE CATALOG:  
War Surplus - Tools, Machinery, Raw  
Materials, Clothing, etc. Illustrated with  
valuable info., tables, charts & data.  
Send 25¢ to cover handling & postage.

# SAVE UP TO 85% IN WAR SURPLUS

**PALLEY FAMOUS MIXES!** Prepared especially for the HOME CRAFTSMAN, HOBBYIST, INVENTOR, GADGETEER or SHOP MECHANIC.

**GADGET MIX** - Rivets, Spacers, Bolts, Screws, Gears, Wheel bearings, Springs and Clamps. No. 106, 5 lbs. .... **1.19**

**BEARING MIX, No. 170A.** Approx. 20 needle, Ball & Roller Bearings, New & Used. Sizes: 1/2" to 4". Some of these cost Gov't \$10 a piece. Never such a value! 5 lbs. ONLY ..... **1.59**

**HINGE MIX, No. 170H.** 12 pairs of Strap and Butt Hinges, Hops, 1" x 1" to 7/8" x 10" in length and 8" strap, 2 lbs. .... **1.09**

**ABRASIVE AND GRINDING WHEEL MIX** - 50 pieces including honing stone, pencil rolls, wheels, etc. A sharp value. No. 170AG **99c**

**SPRING MIX, No. 206** - Torsion, Compression & Tension Springs. Ass'd. sizes. A treasure trove for emergencies. 2 lbs. for ONLY ..... **89c**

**RIVET MIX - 3 POUNDS** - Consisting of sizes from 1/4" long to 3" long in many diameters & alloys. **1.19**

**FILE MIX** - Ten assorted Files, 4" to 12", includes 3 Vixens, half rounds, bastard, mills, etc., in seconds and used but in good condition. 1 Vixen alone worth our price for entire mix. F-1 **99c**

**PULLEY MIX, No. PM-1** - You'll want this one around. 10 micarta & metal pulleys ranging from 1" to 5" with ball and one piece bearings. These are aircraft pulleys, the best made with 100's of uses. A WONDERFUL BUY!!! **2.95**

**COUNTERSINK MIX, No. 168.** Wide assortment. Excellent condition. High speed steel. Assortment of ten 100° and 110° with pilot sizes ranging from 3/32" to 3/16" No. CM-1 **2.69**

**SCREW MIX** - 5 lbs. incl. 2 1/2 lbs. wood screws & 2 1/2 lbs. machine screws. All sizes. Save dollars and always have plenty of screws on hand. **1.39**

**NUT MIX NM-1-3** lbs. approx. 500 nut Anchor, Lock, Castle, Hex, Elastic Stop Nuts, etc. You'll always have plenty of Nuts in the shop. NM-1 **1.39**

**SUPER COMBO MIX** - No. SC2. Here's a real bargain. All eleven above mixes for ONLY ..... **13.95**

**REAMER MIX** - No. 168. Reamer assortment: Special Taper line finish Reamers. High Speed Steel. Slightly used but in excellent condition. Ten assorted sizes ranging from .168x.165 & .244x.215 to .425x.385 & .432x.403. One alone worth our selling price of ten. For set of ten Reamers... **4.49**

**PLASTIC Mallet** CLEAR PLASTIC with 2" dia. x 4" head & 12" handle. For soft metal or plastic work where non-mark or light tapping is desired. **79c ea.**

**15 MONKEY WRENCH** Adjustable Jaw - Opens to 4" Drop Forged. Auto Type. Cadmium Plated **89c** Black **79c**

**PIANO HINGE**  
Overall Width Length Price Ea.  
1 1/4" (5/8" side) 72" alum. \$1.00  
2" (1" side) 9" alum. \$1.75  
3 1/2" (1-3/4" side) 54" stainless \$1.69  
**BRASS HINGE** - 1 1/4" (5/8" side), 040 Any length at ..... **29¢ per ft.**

**PALLEY SUPPLY COMPANY**  
6321 SAN FERNANDO RD.  
DEPT. PM5 GLENDALE 1, CALIF.

**JUNCTION BOX**  
Formerly used in aircraft electrical circuits. Have many uses around home & shop. All brand new!!  
13 1/4" x 11 1/2" x 4" --- .064 Alum. \$2.75 ea.  
12 1/2" x 10 1/4" x 6" --- .064 Alum. \$2.69 ea.  
7 1/2" x 5" x 4" --- .040 Alum. 99¢ ea.

**AIR COMPRESSOR**  
Thousands now in use for spraying, inflating, industrial use, trucks, tractors - air tools, laboratory, garage, etc. Lightweight but powerful, can be run by 1/2 H.P. Motor or Gas Engine. Operates in either direction of operation. Gives approx. 3.27 CFM at 600 RPM, 6.54 CFM displacement at 1200 RPM. Has 2 inch bore, 1 1/2" stroke. Suggested pressure 75 P.S.I. Size: 9" x 12" x 16 1/2". Wt. approx. 23 lbs. **AT THIS NEW LOW PRICE 210¢**  
Motors, Tanks, Fittings to adapt this unit also available **AT GREAT SAVINGS TO YOU!**

**NEW PRESSURE TANKS**  
Stainless Steel, Shatterproof & Rustless. Ideal for painting, cooking, spraying, ocean buoys, underwater fishing, or diving.  
G-1-12 1/2" x 24 inches. 2100 Cu. In. capacity ..... **NEW 4.75**  
F-1-10 x 18 inches. 1000 Cu. In. capacity ..... **USED 4.19**  
F-2-6 x 45 inches. 1000 Cu. In. capacity ..... **NEW 3.95**  
D-2-6 1/2" x 24 inches. 500 Cu. In. capacity. Stainless Steel Construction ..... **USED 3.49**  
D-2A-Corrosion resistant steel. Same as D-2 ..... **NEW 2.49**  
A-6-5 1/2" x 15 inches. 280 Cu. In. capacity ..... **USED 2.25**  
A-4-5 x 8 inches. 104 Cu. In. capacity ..... **NEW 1.35**  
NOTE: All tanks listed as used are guaranteed serviceable and free from leaks or dents.

**FIRE EXTINGUISHER**  
Kiddie Lux CO<sub>2</sub> Type. Built to Gov't spec. Shatter-proof, heavy case. Fully re-charged, with horn.  
No. 602A - 7 1/2 lb. \$35 Value. **19.25**  
No. 603 - 10 lb. A \$65 Value. .... **25.75**  
No. 605-A - 15 lb. New. Break disc Type. A \$75 Value ..... **29.75**  
No. 605-B - 15 lb. Wheel Control Type ..... **32.95**  
No. 605-C - 15 lb. New. Squeeze Grip Type. \$85 Value ..... **39.95**  
Note: Weights listed are capacity extinguisher charge.

**PNEUMATIC AND AIR TOOLS**  
10,000 in various popular makes, sizes, types, Cleco, Aro, Ingersoll Rand, Chicago, Pneumatic, Buckeye, etc.

**RIVET GUNS**  
Pistol & Gooseneck Type  
Gooseneck \$55 **\$8.95**  
SPECIAL ARO Pistol Air Drill or Air Motor with 1/4" Jacobs chuck. **\$17.95**

**Pressure Bottle**  
Steel - Tested to 3000 P.S.I. For spray painting, portable welding, etc. All have std. pipe port.  
H-3 9 1/2" x 3 1/4" dia. .... **\$1.75**  
H-4 18" x 3 3/4" dia. .... **\$2.75**  
H-5 - 22 cu. ft. cap. internal vol. 295 cu. in. Shatterproof 20" long x 5" OD ..... **\$3.75**  
H-1 For Diving or Inflating tires, with CO<sub>2</sub> - has dial gauge. 36" hose. **2.29**

**NEW CLAMP**  
Carpenters, Cabinet makers, Wood workers need this one! Opens to 8" with 2 3/4" thumb screw. All Steel sturdy and dependable. Handy for gluing, etc. **ONLY \$1.59**

**METAL SNIPS**-Hard steel blades. Compound action. Expansion spring & lock's device. Right and Left hand types .. **\$2.59**

**TWO HEAT SOLDERING IRON**  
World's Hottest Iron Value  
Two soldering irons in one with button heat control. Push the button-Select 150 or 300 Watt heat for light or heavy work. Complete with tip, bench holder, 5' asbestos cord. 110V AC. A \$15.00 Value For... **3.95**

**HANDY REPAIR KIT**  
Here's one for every purpose & useful tools... a steel trimming knife-pair of genuine WISS Heavy Duty scissors, - a sealing roller for cementing fabrics, 2-12" half round files & a burnishing brush. Ideal for wallpaper, malleum, etc. Comes in compact cloth roll. A \$9.50 Value For... **3.29**

**U.S. NAVY BATTLE LANTERN**  
A powerful lamp complete with 2 1 1/2 volt dry cell batteries. Size: - 7" x 4" .... **3.29**

**4-WAY VALVE**  
Poppet Type. Valve shuts off at neutral position. Has 3/8" AC Tube Ports - 9/16 - 20 thread. Will stand 1,500 P.S.I. **4.75**

**TACHOMETER** - Type C-9A. Operates on direct drive with flexible shaft. Range is 0 to 4500 RPM. Ideal for use on single engine planes or boats, autos, etc. Drives direct from crankshaft. .... **4.75**

**Sperry Aircraft Directional GYRO COMPASS**  
Dial is 360° swing calibrated 1/10° (6 min). Panel Mount 4 1/2" square with 3" luminous dial. Can be used in autos, planes, or boats by attaching one tube to intake manifold for required vacuum. Complete with reset caging knob. Gov't. overhauled - ONLY ..... **\$449**

**D. C. GENERATORS**  
Suitable for adaption to home welding units, portable and rural lighting, power plant on boats, etc.  
TYPE AMPS VOLTS  
P1 200 27 1/2 **17.95**  
R1 300 30 **29.75**  
ESA 50 12 **14.95**  
Above used, but in guaranteed condition.  
03 NEW 100 24 **18.95**

**D. C. METERS**  
AMMETERS VOLTMETERS  
- 30 - 0 - 30 + 0 - 120  
- 60 - 0 - 60 + 0 - 240  
- 120 - 0 - 120 + 0 - 300  
Your choice 3.95 ea.

**COMBINATION VOLTMETER - AMMETER**  
30V - 30 AMP **\$4.95**  
30V - 60 AMP  
All meters 2" face except 0-300 which is 3" face.  
SHUNTS - Required for use with D.C. Ammeters 30-60-120-240-300 **\$1.00**  
SOLD ONLY WITH METERS.

**NEW ELECTRIC MOTORS**  
No. 500 - New 1/2 HP - 27 Volt DC-AC. This motor can be readily adapted to deliver up to 1/2 HP on 110 Volts AC by the simple method of rearranging armature brushes. Free diagram with each order. A sensational Value ..... **\$5.95**  
No. 500-A - Converted to 110 Volts-AC Equipped with plug and 3 1/2 ft. Heavy Duty Cord ..... **\$8.49 ea.**  
No. 502 - 2 HP-24V. DC Motor Used ..... **8.95**

**AIRCRAFT CABLE**  
Rust resistant alloyed steel, extra flexible, preformed - 7 x 19 strand-on reels.  
1/16" ..... 3¢ ft. 1/4" ..... 8¢ ft.  
3/32" ..... 4¢ ft. 9/32" ..... 9¢ ft.  
1/8" ..... 4 1/2¢ ft. 3/8" ..... 12¢ ft.  
5/32" ..... 5¢ ft. 1/2" ..... 15¢ ft.  
3/16" ..... 6¢ ft. 1/4" Bronze 14¢ ft.  
1/8" Stainless Steel, per. foot .. 12¢  
1/4" Stainless Steel .. 21¢ per ft.  
Aircraft control cable 18 ft. long, 3/16 in. diam. with turnbuckle ends. **99c**

**NEW HYDRAULIC CYLINDER SPECIAL**  
Gives 20,000 lb. thrust (push pull) using 1500 PSI line pressure as obtained from our hyd. pumps. Or will produce 40,000 lb. thrust with 3,000 lb. line pressure. CAN ALSO BE OPERATED ON LOW PRESSURE AIR SYSTEMS. 4" Bore, 1 1/2" dia. piston shaft, 18" stroke, length 30 1/2". Equipped with ball bearing loaded clevis type mounting and swivel type high pressure steel pipe bracket for easy use. Ideal for road, farm & shop machinery, presses, etc. Cost Gov't \$390.00 **22.50**

**No. 9-E HYDRAULIC CYLINDER**  
Double action cylinder. Has a bore of 1-3/8" and shaft of 1". Stroke is 9". Overall length 15 1/2". Built for 1500 lbs. continuous duty, 3000 lbs. intermittent duty. Will lift or push up to 2300 lbs. Can be adapted to hundreds of jobs. **NOW 8.95**

**No. 3 HYDRAULIC CYLINDER**  
Double action. Bore is 1". Shaft 5/8". Has a stroke of 2 1/2 to 4". Stroke can be adjusted with internal sleeve stops. Overall length is 8 1/2". Will take 1500 lbs. continuous duty, 3000 lbs. intermittent. Will lift or push up to 1100 lbs. **3.75**

**BENDIX HYDRAULIC HAND PUMP**  
Provides an instantaneous source of tremendous power for almost any heavy work. Double action stroke. Delivers .30 cu. in. per cycle at 3000 PSI. Max. press. 5000 PSI. Built-in Reservoir cap. 2 1/2 qts. 3/8" pipe outlets. Has Pressure Release Valve. 7 1/2" dia. by 23 3/16" overall ht. Weight 15.2 lbs. A **\$15.95**  
\$40.00 Value for... **11.95**  
Used - In Good Condition...

**Vickers Hydraulic Transmission**  
Self contained, 2 H.P. constant torque at all speeds with variable volume reversible, piston pump (controlled by outside lever) supplying piston hydraulic motor. Automatic pressure, dash pot for smooth control. Power output R.P.M. - 0 to 1/3 input R.P.M. in both directions. Input R.P.M. 1800 continuous 4000 intermittent. Dash pot can be removed for greater R.P.M. Ideal for Lathes, Duplicator Setup on Mills, Conveyors, Small Cars, Drives, Gearing, etc. Includes 2-4" Spline Shafts for input & power take-off - Cost Gov't. approx. \$400. **127.50**

**GEAR BOXES VTG-1 - 90°**  
Bevel gear 1 1/2 to 1 reduction, size 7" x 6". A Lifetime Value. .... **\$3.95**  
VTG-2 - Inline spur gear 16 to 1 reduction, thru 4 gears. Final take-off 4 1/2" dia. 26 tooth. 3/4" Alum. spur gear. .... **\$6.49**  
Both above gear boxes have lever control for engaging & disengaging positive clutch. Dust proof housing. Pre-lubricated bearings. Both can be adapted to Vickers Transmission.

**ELECTRONIC TRANSMISSION GEAR TRAIN**  
GT-1 Containing approx. 50 Bronze Spur & Pinion Gears - ranging from 3/8" to 4" dia., 5 sets of 7 cluster gears, 2 complete worm & worm gear drive sets, 40 N.D. ball bearings from 1/2" to 1 1/2" dia. watch springs, bushings, posts, face plates, housings - Micro Switches, 2 miniature, controlled clutches, etc. 19 lbs. Of Pleasure and profit. A Tremendous Gadget Mine. **ONLY \$8.49**  
Gears in above train are all in multiple size & sequence with identical teeth ratio giving 100's of ideal gear reduction comb.

**TROUBLE LIGHT**  
With heavy duty reflector guard, all-rubber covered socket with built-in switch and female outlet. NEW **2.29**  
With 25 ft. extension cord. .... **3.99**  
With 50 ft. extension cord. .... **3.99**

THE LARGEST FIRM OF ITS TYPE IN THE WORLD



# ORDER FROM WORLD FAMOUS GADGETEERS HEAVEN BY MAIL

## NEW BEARINGS

These are the Finest, Precision, AIRCRAFT BEARINGS!! We have more than 168 types and sizes in TREMENDOUS QUANTITIES!! Needle, Roller, Recessed, Rod End, Shielded, Unshielded, Self-aligning, etc. Made by some of the WORLD'S LEADING MANUFACTURERS OF BEARINGS. Years at a FRACTION of COMMERCIAL PRICES. . . . Write for complete lists.



## CAMPERS' KIT



**14 PC. All Aluminum 895**  
Here is a real cooking must for the camper, winter cabin, home or hotel. Has 14 gleaming aluminum pieces which fit into the largest kettle with frying pan for cover. Consists of 3 kettles, 2 fry pans, coffee pot, 4 plates and 4 cups. Nested size 8" x 9". Wt. 5 1/2 lbs. Only 8.95

## PRESSURE FEED PAINT TANK

**BINKS MODEL Q - TYPE D-5307** . . . For conveyance of large quantities of paint or finishing materials to the spray gun. Keeps the material under constant pressure & agitation at all times. Consists of 10 gallon tank with air motor, agitator, safety valve air regulator & a 150 PSI gauge. **125.00**



**SPEEDY SPRAY TANK** - For full pressure painting or spraying systems. Holds 3 gallons of material. All steel construction with brass hose fittings and relief valve. Easy to clean and fill. Has carrying handle and 10 ft. of air and paint hose. Complete Only **18.95**

**NEW 1950 TOOL CATALOG**  
72 pages of Machine Tools (saws, drills, dies, reamers, etc.) Hydraulic cylinders Air tools. Send 25¢ for your copy today.

## AIR COMPRESSOR



General Electric, 2 stage AC - DC. Rated pressure 1000 lbs. per sq. in. with 1/3 H.P. 27 volt, 7 AMP series wound motor with fan for cooling. Thousands now in use for spraying, inflating, laboratory use, etc. Can be adapted to 110 volt A.C. with transformers

A tremendous value at approx. 5% of original cost . . . . . **22.50**  
We also have transformers for above.

## TINY MITE WINCH HOIST

This mighty little giant lifts up to 1000 lbs. with its 30 to 1 Bronze Gear drive. Cable drum is 4" x 1 1/4". Ratchet handle - Safety and release pin. Ideal for Boats, Farm, Factory, Home or Garage. Save your back for . . . . **10.49**



## 6 in 1 HAMMER

A very handy household or shop tool for man or woman. Ideal for hundreds of Fix-it jobs. Has 4 graduated screwdrivers in the handle, from 1/8" to 5/16" Steel hammer head & knurled brass handle. A Bargain at . . . . **89c**

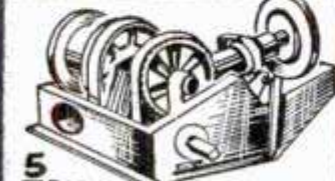

## 5 TON POWER DRIVE HOIST

Here's a real, rugged power unit! Combines a cable drum winch with a separate power pulley drive & 2 individual, 1 1/2" square power take-off shafts. A "throw-in" clutch operates the winch & both take-off shafts. Ideal for use on trucks or boats or as a stationary hoist. . . . . **79.89**  
A \$300 VALUE for . . . . **ONLY**

## 1/4" HEAVY DUTY MALL OF THOR Electric Drills

**A \$35.00 VALUE 17.95**  
Again we are able to offer a limited supply of these Genuine Govt Surplus Drills. Made to take the most rugged abuse. Used but in excellent condition. 110V A.C. - 60 cycle - 1 phase, Ball Bearing Motors turning 2500 R.P.M. Finest 1/4" Jacobs Chuck . . . . **DON'T MISS THIS BUY!!!**

**WHEELS** For Wagons, Dollies, Handtrucks, Wheelbarrows, etc. 10" dia., with 1/2" center hole. (can be drilled out to take 5/8" axle) Wheel is 1/8" steel with 10 x 1.75 heavy duty, semi-pneumatic cushioned rubber tire. . . . . **\$1.75**

## BEADING TOOL

Made for the U.S. NAVY. For turning an edge bead on all kinds of metal up to 18 gauge thickness. Has high grade steel faces, hardened & polished. Easily removable from shafts. Back gearing drive is enclosed in case. Top shaft adjustable for thickness & pressure. 5 faces furnished include Nos. 0 - 01, 1, 2 & 3. Has 1-1/4" hexagon shaft for bench mandrel. **17.95**

## INSTRUMENT MIX

**6 DIFFERENT TYPES 6**  
Contains 1 each of the following items. Flight Check-off • Position Indicator Selsyn Fuel Gauge • Air Speed Indicator Fuel/Air Ratio • Oxygen Regulator These instruments contain sensitive meter movements, jewels, bearings, gears & valves. **COST THE GOV'T MORE THAN \$500.00 SPECIAL!! ALL 6 FOR ONLY 5.95**

## RUBBER Neoprene Sheet Stock

Thickness	Approx. Width	Price per run yd.
#325 .020	1/64" 36"	\$1.75
#328 .032	1/32" 22"	1.38
#330 .064	1/16" 36"	2.39
#331 .093	3/32" 36"	3.39
#329 .125	1/8" 46"	4.75

Note: No. 329 is Laminated rubber sheet with cloth center. Flexible & very fine for heavy wear.

No. 332 - Grey Neoprene Rubber Floor Mat. Has raised non-skid Diamond pattern with durable cloth backing. Stock size: 36" x 48" x 1/16" thick **\$1.95 EA.**

# We've gone NUTS!!

Just Purchased 150,000 lbs. of the FINEST PRECISION Made ELASTIC & FIBRE LOCK NUTS!! All are NEW!! Here's your chance to "STEAL" Aircraft Quality STOP NUTS at less than the cost of common commercial hex nuts. They're ALL NEW Cad plated Steel and a large quantity are even pre-tapped for easier wrenching. ELASTIC or FIBRE LOCK SEAL gives a Positive . . . Shake-proof . . . Vibration & Rust Resistant fastener. No lock washer necessary . . . One operation does the job. Just run on the nut. Ideal for use in all types of metal fabrication, assembly, construction etc. . . .

## AND LOOK AT THESE PRICES FOR ELASTIC or FIBRE LOCK NUTS

Prices per 100 in these quantities - Special Discount for larger quantities -

	100	1,000	10,000	25,000	50,000	100,000	500,000
640	\$ .49	\$ .25	\$ .21	\$ .19	\$ .17	\$ .15	\$ .13
836	.59	.31	.28	.25	.23	.21	.19
1032	.59	.31	.28	.25	.23	.21	.19
1/4-28 FL	.63	.39	.36	.33	.30	.27	.25
1/4-28 PT	.63	.39	.36	.33	.30	.27	.25
5/8-24PT	.84	.64	.61	.58	.56	.54	.49
3/8-24PT	.94	.74	.71	.68	.66	.64	.59

Note: FL means Fiber Lock (not pre-tapped.) PT means Pre-tapped, ESSNA Brand.

**SAVE! SAVE! SAVE!** - We have TREMENDOUS quantities of AIRCRAFT Quality BOLTS - SCREWS - RIVETS & BEARINGS. Our huge stocks include a great variety of sizes and lengths. PRICED LOWER THAN YOU PAY FOR ORDINARY COMMERCIAL QUALITY!

## CLECO PLIERS

Cleco Pliers - For inserting and removing Cleco type skin fasteners. Heavy block enamel finish. NEW **69c**

## TANK

Made of Dural. Has welded seams, 2" filler with cap, and two standard pipe ports for hook-up. Visible liquid level gauge on one side. An ideal tank for Gas, Oil, Water or as a "spare" on your auto, tractor, truck, boat or plane. Sturdy - Lightweight. **4.95**

## GROUND ROD

Made by a leading manufacturer of electrical conductors. This rod is all new and in excellent condition. Most commonly used as ground conductor on high power lines, telephone poles, etc. Has solid iron core covered with non-rusting Copperweld. **1.00**

## RADIO HEADSET

Excellent condition. Low impedance. Adjustable leather covered headband. Ideal for amateur radio. **Only 1.59**

## Boat Fender 21" long, 5" dia.

Give your boat the protection it deserves!! These rugged hemp & manila fenders are cheap insurance. **1.95**  
A \$6.50 Value. Only **2.95**  
DOCK BUMPER - 15" Diam. Ball Type. Like New. . . . **2.95**

## TUBE BENDER

Made by Parker Appliance Co. For bending thin wall seamless tubing of soft Copper, Brass, Aluminum Alloy or fully annealed steel. Ideal for Plumbers, Auto & Aircraft Mechanics, Steam Fitters, etc. Makes bend from 0 to 180 deg. No. 5 - 5/16" Capacity . . . **5.45**  
No. 6 - 7/8" Capacity . . . **7.65**

## COMFO RESPIRATOR

Approved by the U.S. Bureau of Mines for DUST and MIST! Very high filtering efficiency is obtained thru unusually large filter area. New cushion face-piece fits comfortably and permits the wearing of goggles & helmets. Easy vision - adjustable head strap. Single filter for all dust. Respirator plus 10 extra filters. Complete ONLY . . . **1.59**

## NEW DUST RESPIRATOR

M-1 Valve Type. Rubber on inside, felt filter outside. Rubber valves. Adj. headband. Light-Comfortable. . . **29c**  
Many other Respirators in Stock Write for complete information

## 2 TON WINCH

Can be Hand or power operated. Has large capacity steel drum for cable. Powerful gear - reduction drive and manual brake. . . . . **36.50**

## VALUABLE GEAR BARGAINS!

8 to 1 ratio, spindle drive #110 . . . . . **\$2.98**  
6 to 1 with screw shaft #111 . . . . . **\$4.98**  
85 to 1 (can be used for radio, antennae, etc.) . . #112 . . **\$3.95**  
#G-11 - 10-1 gear ratio . . . . **\$3.95**

## UTILITY HAMMER

For use as masonry chisel, a take driver, sledge, etc. Head is special forged steel, with sharp cutting edge. Handle is select hardwood. **79c**  
2 lb. with 21" handle. . . . **99c**

## MICARTA TUBE

Ideal for insulating or Bushing Stock. 36" x 1/4" wall x 1" O.D. Original use was for trailing antenna - F 10. Use for swivel rack, bearings, etc. **59c ea.**

## RAWHIDE MALLET

Weights 2 1/2 lbs. Has metal collar with rolled leather insert head. Used for working soft metal, plastic driving pins, etc. Leather is replaceable. **ONLY 1.09**

## New SUN VISOR

Made of clear gm plastic. Adjustable arm & swivel head. Holds firmly. Can be swung in any direction. Made for the Air Corp. Very useful on your Car, Tractor, Truck or Boat. SPECIAL **1.29**

find many uses that make these worth much more than our price . . . Set of 2 **7.95**  
Same as above, but uses 2 flashlight batteries, on each set for power. . . . . **Set of 2 7.25**

Order from this Ad. All sales final. All Prices F. O. B. Glendale. Pay by M.O. or Check. P.O.'s Accepted, from D & B. firms. 1/2 deposit with C.O.D's.

# New- SOUTH BEND LIGHT TEN Precision LATHES

A completely new, moderately priced, 10" swing lathe designed for the efficient machining of small, precision parts. Available in four models, and four bed lengths. Send for information at once — use coupon below.

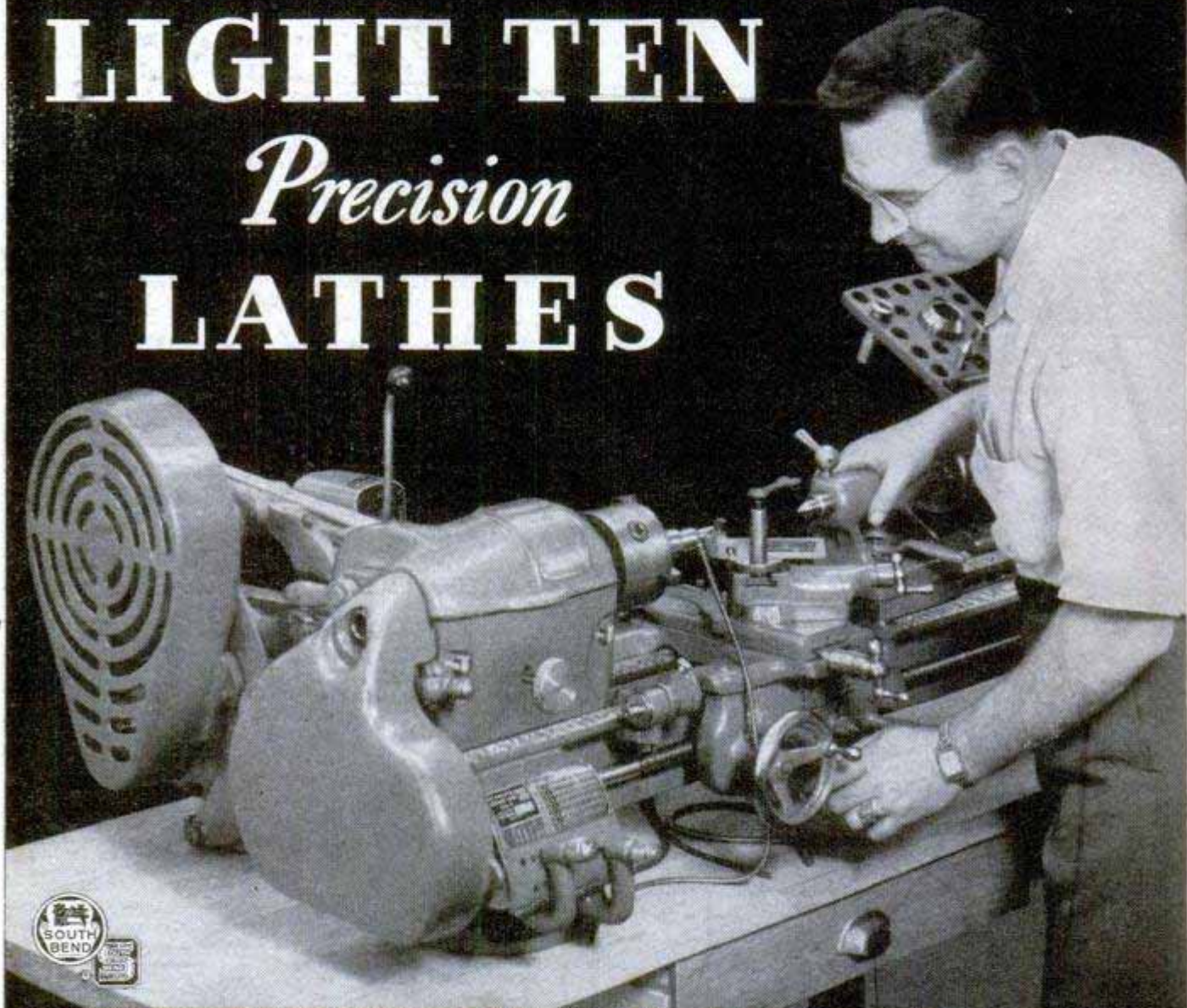

Building Better Tools Since 1906 • SOUTH BEND LATHE • South Bend 22, Ind.

### Send Information Checked:

- LIGHT TEN LATHES
- LATHE ATTACHMENTS
- TIME PAYMENT PLAN



9" and 10" BENCH LATHES



10" to 16-24" FLOOR LATHES

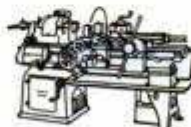

1/2" and 1" Collet TURRET LATHES



14" DRILL PRESSES



7" BENCH SHAPERS

Name \_\_\_\_\_

Company \_\_\_\_\_

Street \_\_\_\_\_

City & State \_\_\_\_\_

Printed by Popular Mechanics Company, Chicago, Ill., U. S. A.



NOW... LIGHT  
WHEN YOU NEED IT!

Ray-O-Vac leak-proof batteries  
stay fresh for years!

(because they're sealed in steel!)



© 1950 BY RAY-O-VAC COMPANY, MADISON, WIS. RAY-O-VAC, CANADA LTD., WINNIPEG, MAN.



## See how much more you get

in these truly modern batteries. Each Ray-O-Vac Leak-Proof starts with a powerful, well made battery. Then . . .

1. Steel bottom is added.
2. And a steel top.
3. Next—multi-ply insulation. Many layers of protection against corrosion.
4. Last—a steel jacket. This completes an air-tight seal, to stop corrosion and keep the battery fresh and powerful. Only Ray-O-Vac builds batteries with all four of these safeguards.

**GUARANTEE** on every Ray-O-Vac Leak Proof: "If your flashlight is damaged by corrosion, leakage or swelling of this battery, send it to us with the batteries and we will give you FREE a new, comparable flashlight with batteries."

Ask for Ray-O-Vac Leak Proofs

**Buy Spares...** *they stay fresh*

NOTED THROAT SPECIALISTS REPORT ON 30-DAY TEST OF CAMEL SMOKERS . . .

# Not one single case of throat irritation due to smoking **CAMELS!**

Yes, these were the findings of noted throat specialists after a total of 2,470 weekly examinations of the throats of hundreds of men and women who smoked Camels — and only Camels — for 30 consecutive days.



"As a singer, naturally I smoke the cigarette that agrees with my throat...CAMEL!"

*LANNY ROSS*

The golden tenor voice that has entertained millions explains: "The 30-day test showed me how much fun smoking can be! Camels suit my throat, and they're a great-tasting smoke."

R. J. Reynolds Tobacco Company, Winston-Salem, N. C.

"ON MY JOB, MY THROAT GETS A WORKOUT. THAT'S WHY I MADE MY OWN 30-DAY TEST AND CHANGED TO CAMELS FOR KEEPS!"



TELEPHONE OPERATOR MRS. ETHEL JAMES

"THROAT IRRITATION DOESN'T GO IN MY JOB—I SMOKE ONLY CAMELS. THEY'RE RIGHT FOR MY THROAT— THEY'RE COOL AND MILD!"



COSMETIC DEMONSTRATOR MADELINE OSTROWE

"I TALK TO THOUSANDS OF SHOPPERS. WHEN I SMOKE, I HAVE TO THINK OF MY THROAT. THAT'S WHY CAMEL IS MY CIGARETTE. CAMELS ARE SO MILD!"



MUSEUM GUIDE WALTER McGRATH

"30-DAY MILDNESS TEST? I'VE SMOKED CAMELS FOR 17 YEARS AND I KNOW THEY AGREE WITH MY THROAT! THEY'RE A GREAT-TASTING CIGARETTE, TOO!"

RADIO ANNOUNCER GEORGE ANSBERG



● You have the word of Camel smokers . . . of noted throat specialists . . . but test Camels for yourself in your "T-Zone" (T for Taste and T for Throat). See if you don't agree that Camels are the mildest, best-tasting cigarette you ever smoked!

## Start your own 30-Day Camel MILDNESS Test Today!