

ANC



# POPULAR MECHANICS MAGAZINE

WRITTEN SO YOU CAN UNDERST

REG'D. TRADE MARK, GREAT BRITAIN, No. 410426

REG. U.S. PAT. OFF.

**HEAVYWEIGHT  
CHAMPION LOGGER**

*Page 130*



HOW 'YA TRADE  
COUSIN?

NOT FOR A  
DOZEN!

# MONTA MOWER

*Mows and Trims*

# LAWNS

## IN ONE EASY OPERATION

I wouldn't trade my MontaMower for a dozen ordinary lawn mowers!"

The above statement is a direct quotation from one of thousands of unsolicited testimonial letters received from MontaMower owners every year.

And little wonder MontaMower owners are so enthusiastic! MontaMower represents the first basic advancement in lawn mowing devices during the past half century. It is a new and different kind of lawn mower that mows and trims in one easy operation.

Actually, the MontaMower is a live, 8 1/4 lb. precision machine that smoothly and quietly cuts a full 16" swath through grass, dandelions, spike grass and tall lawn weeds (including the ones that ordinarily pop back-up to cause you extra work).

**AND WHAT'S MORE** — MontaMower does what no conventional mower can do! It cuts right up to walls, fences, trees and posts — practically eliminates hand trimming. It cuts under foliage, around flower gardens and close-quarter borders which cannot be mowed successfully with conventional hand or power mowers.

The MontaMower is so light, so sturdy and responsive, that even women and children can operate it easily and efficiently. Owners tell us that with their new MontaMowers they cut their lawns in half the time — with less than half the effort.

Learn these facts about the MontaMower from actual experience... it's sold under a liberal "Written Guarantee" which permits you to try it on your own lawn... makes you the sole judge of its merits. Get the complete facts about the moderately priced MontaMower. **AT ONCE!** Just fill out the coupon below and mail it today.

ONLY MONTA MOWER  
TRIMS AS IT CUTS

## SAVE TIME AND LABOR WITH A MONTA MOWER



Weight  
only 8 1/4 lbs

## SOLD DIRECT — ON APPROVAL

MONTA MOWER DISTRIBUTING CO.

Sales and General Offices

P-M 04 KEELER BUILDING • GRAND RAPIDS 2, MICHIGAN

Gentlemen: Without obligation, kindly send me complete descriptive literature, price, guarantee information, and full details of Approval Offer.

NAME \_\_\_\_\_

ADDRESS \_\_\_\_\_

CITY \_\_\_\_\_ STATE \_\_\_\_\_

## Here's HOW IT WORKS

The new, improved MontaMower has eight pairs of sharp-edged, precision made and fitted, tool-steel cutting disks, slightly overlapping and self-sharpening, working as a unit. Each pair revolving toward each other gathers the grass and cuts it cleanly at the intersection of the disks. The new improved model is easily and quickly adjustable to cutting height! It's as modern and efficient as an electric razor!

The MontaMower is sold only by direct mail to users (no agents or dealers... no foreign sales at present.)

Feels like America's  
costliest cars—



the '50 FORD

Its Quiet  
whispers  
Quality...

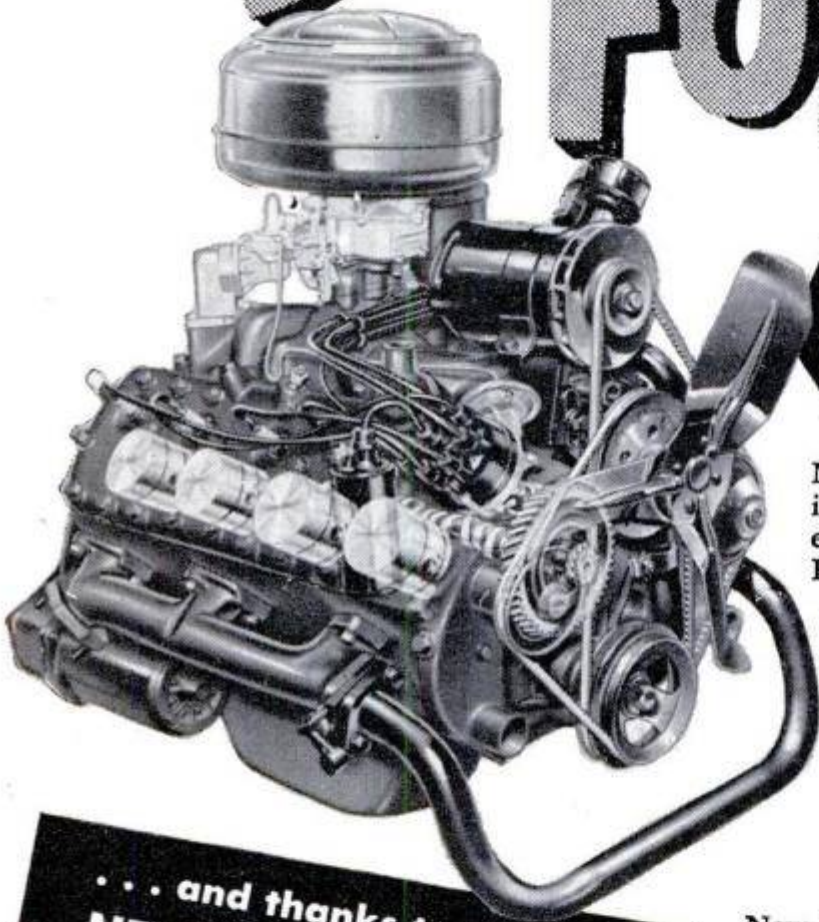

thanks to the super-quiet  
**100-h.p. V-8 ENGINE**

New "super-fitted" pistons with steel struts in cam-ground skirts to control expansion, permit closer clearances. Result—longer life, extra quiet.

New "hushed" laminated composition timing gear meshes with metal gear on crankshaft for practically noiseless operation.

New "quiet-contoured" camshaft lobes soft-pedal valve action.

Perma-quiet valve assemblies with one-piece valve guides and shot-peened valve springs require no adjustment, operate more quietly.

New 3-blade, silent-spin fan cools with maximum efficiency and minimum sound.

... and thanks to the  
**NEW "HUSHED" RIDE**

... a "Mid Ship" Ride away from the wheels, in the 13-ways stronger "Life-guard" Body that's "sound-conditioned" against road noise, and cradled on "Hydra-Coil" and "Para-Flex" Springs that soak up the bumps.



**"Test Drive" the '50 FORD**

**AT YOUR FORD DEALER'S**

Enjoy the World's Finest

# TECHNICAL TRAINING IN AVIATION

and Earn While You Prepare for a Career in the U.S. Air Force



ILLUSTRATION F-80 SHOOTING STAR

Scientific aptitude tests help direct you to use your talents most effectively. Earn good pay right on the job as you learn under skilled experts. If you can qualify you may go to an Air Force technical school for training in one of the many great career fields. Enjoy new opportunities for education, experience, advancement. Ask about the new Airman Career Program today.



VISIT YOUR NEAREST AIR FORCE BASE OR U. S. ARMY AND U. S. AIR FORCE RECRUITING STATION

## U. S. AIR FORCE

### Choose Your Opportunities from many AIRMEN CAREER FIELDS

RADIO AND RADAR MAINTENANCE  
AIRCRAFT AND ENGINE MAINTENANCE  
AIRCRAFT ACCESSORIES MAINTENANCE

WEATHER

ARMAMENT SYSTEMS

FOOD SERVICE

TRAINING DEVICES MAINTENANCE

PHOTOGRAPHIC

AIR TRAFFIC CONTROL AND WARNING

WIRE MAINTENANCE

MISSILE GUIDANCE SYSTEMS

COMMUNICATIONS OPERATIONS

PHOTOMAPPING

INTRICATE EQUIPMENT MAINTENANCE

INTELLIGENCE ROCKET PROPULSION

MUNITIONS AND WEAPONS SUPPLY

VEHICLE MAINTENANCE PRINTING

METAL WORKING TRANSPORTATION

FABRIC LEATHER AND RUBBER

PROCUREMENT ADMINISTRATIVE

PERSONNEL EDUCATION MEDICAL

ENTERTAINMENT MANAGEMENT METHODS

BUDGETARY ACCOUNTING AND DISBURSING

STATISTICAL AND MACHINE ACCOUNTING

GROUND SAFETY MARINE FIREFIGHTING

SECURITY AND LAW ENFORCEMENT

# Popular Mechanics Magazine

Registered in U. S. Patent Office and Canada

H. H. WINDSOR, *Founder*

H. H. WINDSOR, JR., *Editor and Publisher*

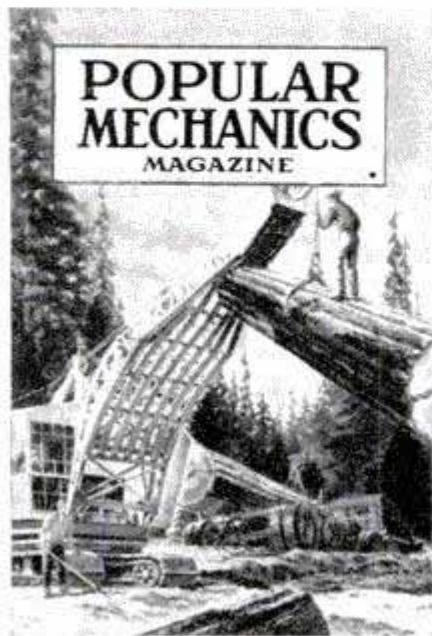

## this month's cover

ONCE UPON a time the King of Sweden asked Paul Bunyan to clear all the timber off the state of North Dakota to make room for all the good Swedish farmers. Paul cut the logs out at a rate of a million feet an hour and stomped all the stumps into the ground. When the farmers came across they found a mighty clean piece o' dirt waiting for them. There never has been another lumberjack as mighty as Paul, but that big logger on our cover rates a close second. Biggest thing in the woods today, it can flip 30-ton logs through the air like matchsticks or jerk a 90,000-pound log straight up out of a crevasse. The job done, it waddles off under its own power like Paul Bunyan hiking the timber trails in search of a new task. Artist Lou Nulsen, who has studied logging operations at close range, depicted the behemoth on our cover, and you'll find more views of the logger on page 130

Published monthly by Popular Mechanics Company, 200 E. Ontario St., Chicago 11, Ill. H. H. Windsor, Jr., president; William Harrison Fetridge, vice president; D. F. Windsor, vice president and secretary-treasurer; Clover L. Perkins, advertising manager; Alan M. Deyoe, circulation manager. Single copy in the United States and Canada, 25 cents; subscription rates in United States and possessions, Canada, Philippines and countries of the Pan-American Postal Union, 1 year, \$1.50; 2 years, \$6.00; 3 years \$8.00. To all other countries add \$1.00 a year over United States prices for overseas postage. If you plan to move, notify us at least 30 days in advance so you will not miss an issue. Give both old and new addresses. Entered as Second Class Matter, September 15, 1903, at the Post Office at Chicago, Illinois, under Act of March 3, 1879. Entered as Second Class Matter at Post Office Dept., Canada. Copyright 1950 by Popular Mechanics Company. Copyright under International Copyright Union. Copyright in France. All rights reserved under Pan-American Copyright Union. Printed in the United States of America.

Volume 93                                      APRIL 1950                                      Number 4

Managing Editor.....Roderick M. Grant  
Assistant Managing Editor.....Wayne Whittaker  
Shop Notes and Crafts Editor.....James R. Ward  
Radio-Television, Electronics Editor.....Frank L. Brittin  
Associate Editor, Aviation.....Aubrey O. Cookman, Jr.  
Associate Editor.....Clifford B. Hicks  
Art Director.....Frank Beatty  
Director, Bureau of Information.....Allan Carpenter

### Assistant Editors

Donald R. Brooks            Dorothy E. Hoffmann            Arthur R. Railton  
    H. H. Windsor III

### Assistant Editors, Shop Notes and Crafts

W.ClydeLamney    WayneC.Leckey    FrankN.Stephany    A.E.Youngquist  
Eastern Editor.....Richard F. Dempewolff  
Empire State Bldg., Room 2906, New York 1, N. Y.

Western Editor.....Thomas E. Stimson, Jr.  
3872 Franklin Ave., Los Angeles 27, Calif.

Representative in Great Britain.....Douglas W. Wedderspoon  
77 Baker St., London W. 1, England

## IN THIS ISSUE

They Stumbled on Success	- - - -	81
You Think You're Going Crazy	- - - -	88
Hall of a Thousand Illusions	- - - -	97
Thunder in a New Package	- - - -	110
Small Town Television	- - - -	114
What's New for Your Home	- - - -	118
Are We Running Dry?	- - - -	122
Radio Up Your Sleeve	- - - -	133
Shooting the Grand Canyon in a Power Boat	- - - -	144
Commute by Jet	- - - -	149
Back-Packing in the Mountains	- - - -	161
New Machines Fight for Your Health	- - - -	166

## For the Craftsman

"New Look" in Garden Furniture	- - - -	174
What to Do About Clogged Drains	- - - -	188
Moving-Day Pointers	- - - -	201
Pour Your Own Flagstone Walk	- - - -	206
Use the Right Abrasive—Part I	- - - -	213
Keeping Handsaws Sharp	- - - -	222
Nine Speeds Forward for Your Bicycle	- - - -	226
Radio-Television, Electronics	- - - -	229
Clinic for Homemakers	- - - -	240

Other items, and manufacturers of available products described, are listed on pages 10, 12 and 14

**CRESTOLOY DUCK  
BILL PLIERS.**  
No. 23, in 7" size only.



**CRESTOLOY LONG  
FLAT NOSE PLIERS.**  
No. 1034, in 6" size only.



**CRESCENT  
COMBINATION PLIERS.**  
No. 1000, in 8, 10 & 12" sizes.



**CRESTOLOY END  
CUTTING NIPPERS.**  
No. 72, in 6 & 7" sizes.



**CRESCENT SCRATCH AWL.**  
No. 73 in 6<sup>5</sup>/<sub>8</sub>" size only.



**CRESCENT SNIPS.**  
No. 5412, 12<sup>3</sup>/<sub>4</sub>"; other  
sizes and patterns  
from 7 to 16".

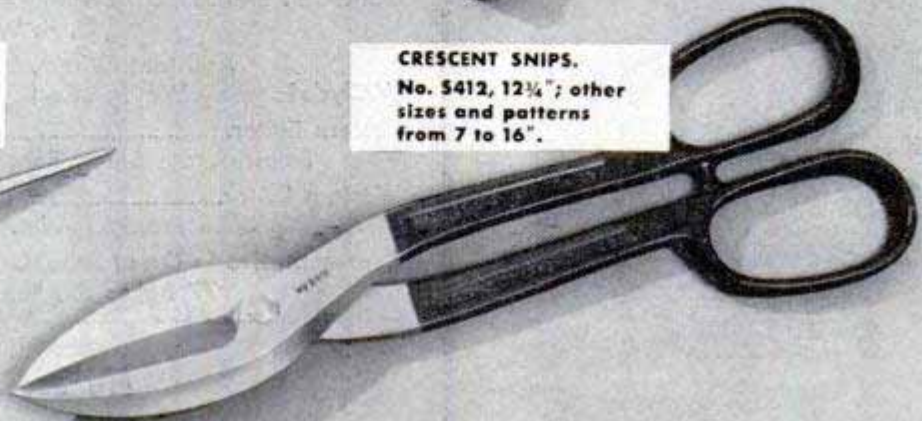

Write for your copy of  
this little folder which  
illustrates 21 popular  
patterns of Crescent and  
Crestoloy Pliers

## GOOD TOOLS

*...save time...reduce costs*

Users of Crescent and Crestoloy Tools have long since learned the economy of paying just a little more (than "cheap" tools cost) to get a whole lot more in hand tool quality. Superior tool design not only reduces worker fatigue but produces more and better output. The longer life of Crescent and Crestoloy Tools definitely reduces maintenance and replacement costs.

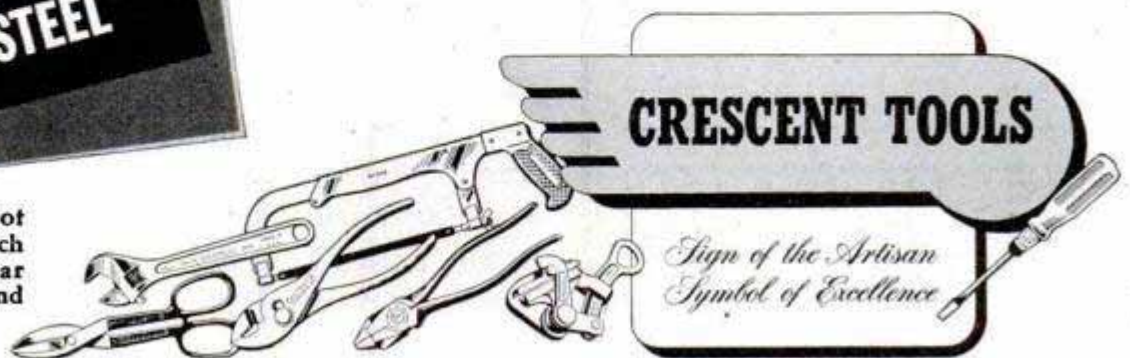

**CRESCENT TOOLS**

*Sign of the Artisan  
Symbol of Excellence*

THIS IS  
A G-E  
"ALL-GLASS"  
HEADLAMP

THIS CUTAWAY  
SHOWS WHY  
A G-E  
HEADLAMP  
DOES NOT  
GROW DIM!

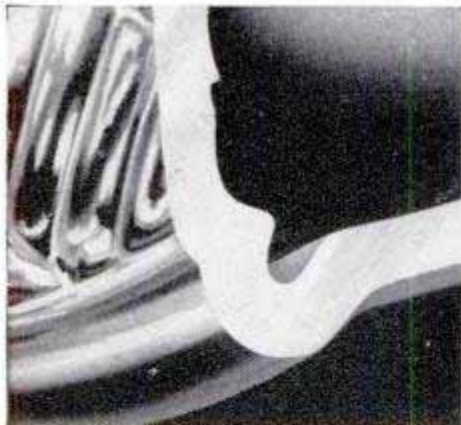

**1. RUGGED, ONE-PIECE** construction keeps dirt and moisture from getting in to steal the light. General Electric headlamps average 99% of original light output at end of life.

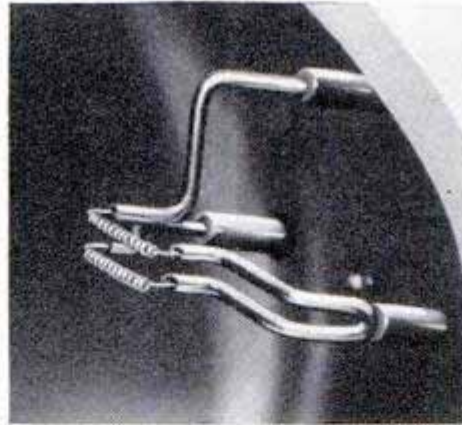

**2. IMPROVED FILAMENTS** give 12% more light on the road for driving—16% more light for passing. They're firmly anchored so they won't shake loose on bumpy roads.

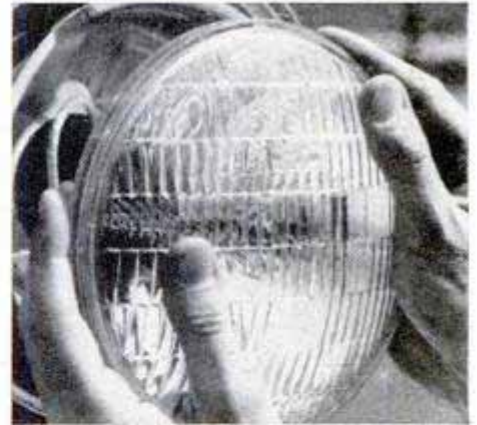

**3. HARD-GLASS LENS** resists shock—is precision-built to throw maximum light on the road. Have lights checked next time your car is serviced—and insist on G-E lamps for replacement.

*You can put your confidence in—*

**GENERAL**  **ELECTRIC**

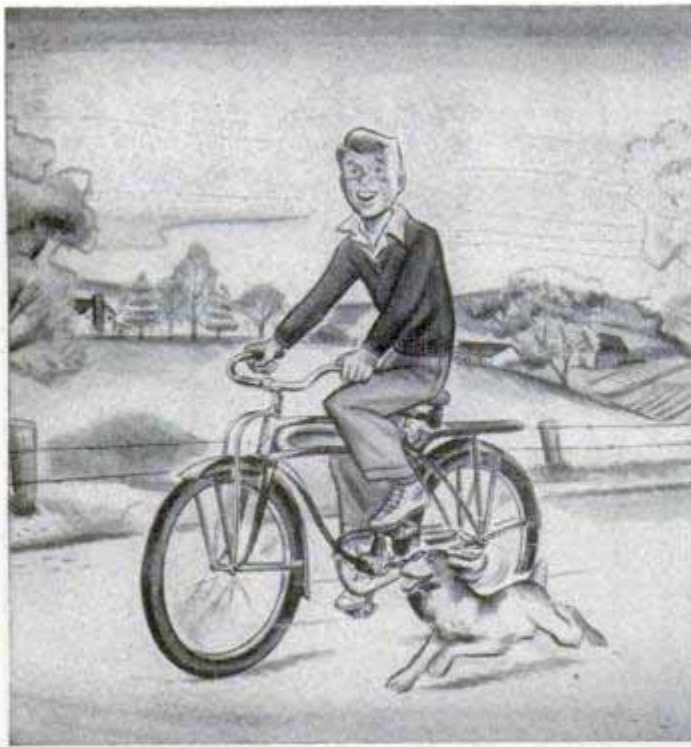

## A Boy, a Dog... and a Bike

A gleesome threesome if there ever was one! You're really going places, you're really doing things when you and your pup roll out the bike to see what's going on down the road.

Fun? You just know you'll have barrels of it, and so does Dad—good safe fun, too, because the New Departure safety brake affords constant control.

It brings any bike to a...



**New Departure**  
**SAFETY BRAKE**   
a product of  1876

New Departure • Division of General Motors • Bristol, Connecticut

in this corner.....  
**THE EDITORS**

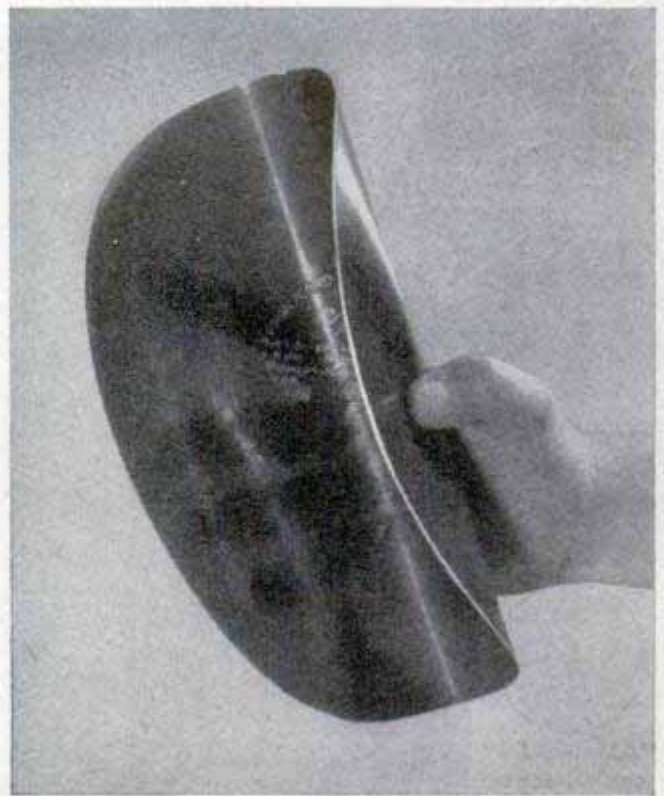

### Letter to the Editor:

Dear Sir:

I found the attached German record in a shop here in town and, since I consider it highly interesting, I am sending it to *Mecanica Popular* for examination.

It was the last record in the shop and I had to pay 30 Patacas (about \$5) to convince the shop owner to part with it...

Daniel de Guerrero,  
Rua Sanches de Miranda #2,  
Macao, Col. Portuguesa, China.

*The flexible plastic record, imprinted "Made in Germany" and grooved with two fox trots recorded by "Missouri Jazz-Band, New York" arrived in our Chicago office in an envelope, in excellent playing condition despite its long trip from the Portuguese colony adjacent to Canton, China. The above letter was written in Portuguese to the editor of our Spanish language edition, Mecanica Popular.*

\* \* \*

### VIPs at Princeton

About the time that our Dick Dempe-wolff of New York shipped to us the story of Princeton's roomful of optical illusions (You Think You're Going Crazy, page 88),

(Continued to page 8)



# Why be a BOOKKEEPER?

... *When Accountancy offers more Money and Success...*

If you are a bookkeeper, you are right on the threshold of a profession that pays far above average—where there's real opportunity to get ahead and move up fast.

Why not step *UP* from bookkeeping—be an accountant—make *real* money!

You can learn Accountancy by the interesting LaSalle Problem Method—in your convenient spare time, at home, without losing a day from your work. You learn by *doing* . . . you study Accounting principles and solve Accounting problems under the clear guidance of experienced C.P.A.'s. You cover Accountancy from the basic principles right up through Accounting Systems and Income Tax Procedure—to advanced training for the C.P.A. degree if you so desire. And as you go along step-by-step, you master the principles of auditing, business law, statistical control, cost accounting, organization, management, finance, etc.

You go as fast or as slowly as you choose. And you may start "cashing in" on your new ability long before you complete the training—as thousands of others have proved. Many advance quickly to better positions, even before they are half way through. And that is only the *beginning* of a growing and continuing success for the rest of your business life.

Why remain "just a bookkeeper" when Accountancy holds so much for you? Our free 48-page booklet, "ACCOUNTANCY, THE PROFESSION THAT PAYS," tells you what you must know to be an Accountant, and how you can prepare in your

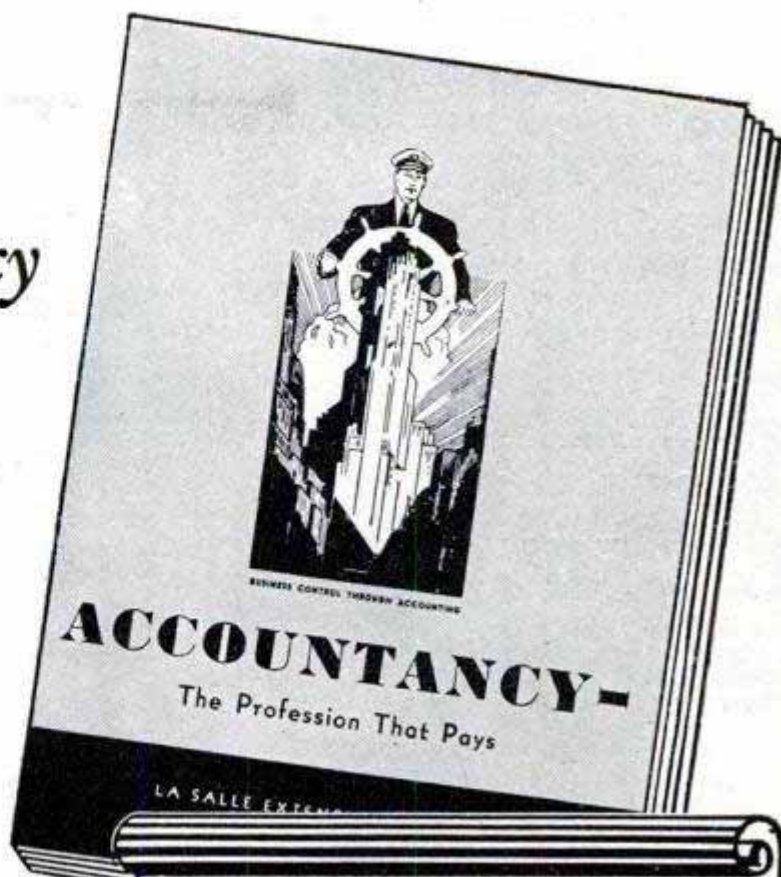

## LASALLE Extension University

*A Correspondence Institution*

Dept. 464-HR • 417 S. Dearborn • Chicago 5, Ill.

Send me your free 48-page booklet, "Accountancy, the Profession That Pays"—plus "Ten Years' Promotion in One"—a book which has helped many men.

### Higher Accountancy

#### Other LaSalle opportunities:

- |  |  |
|--|--|
| <input type="checkbox"/> C.P.A. Coaching     | <input type="checkbox"/> Traffic Management            |
| <input type="checkbox"/> Bookkeeping         | <input type="checkbox"/> Foremanship                   |
| <input type="checkbox"/> Law: LL.B. Degree   | <input type="checkbox"/> Industrial Management         |
| <input type="checkbox"/> Business Management | <input type="checkbox"/> Stenotypy (Machine Shorthand) |
| <input type="checkbox"/> Salesmanship        |  |

Name..... Age.....

Address .....

City, Zone, State.....

**LASALLE EXTENSION UNIVERSITY**

*A Correspondence Institution*

Dept. **464-HR** 417 S. Dearborn St.  
Chicago 5, Illinois

leisure time, at moderate cost and on easy terms.

Send the coupon today and we'll include "Ten Years' Promotion in One"—a book which has helped many men. Get all the facts and judge for yourself. There is no obligation. You are already started in this field . . . find out how you can rapidly go to the top! Mail coupon NOW!

**P**—is for Pyroil—lubrication's best friend

**Y**—Your car's protection, so little to spend

**R**—is for Riding with a motor that's singing

**O**—is for Oil, Pyroil helps to keep clinging

**I**—is Insurance against rust and drain

**L**—is for Long, Lasting miles you will gain

## Pyroil

—the perfect partner for lubrication, because it gives oil the property of clinging to metal surfaces at all times.

*Add Pyroil — Add miles to your car.*

### Pyroil for Aircraft Engines

Use Aircraft Pyroil B for lubricating oil, Aircraft Pyroil A for gasoline.

**GIVEN!** An attractive Pyroil metal savings bank, takes coins up to 50c pieces. **MOTORISTS**, it's yours for the asking—sent postage paid.

Manufactured and Guaranteed by Pyroil Company, 102 Pyroil Bldg., La Crosse, Wisconsin

Canadian Distributors: Central Purchasing Agencies, Ltd., Toronto, Ontario



#### PYROIL COMPANY

102 Pyroil Bldg., La Crosse, Wisconsin

I want my car to last and run properly. Please tell me more about Pyroil and how it can accomplish this for me.

Name \_\_\_\_\_

Address \_\_\_\_\_

City or Town \_\_\_\_\_ State \_\_\_\_\_



(Continued from page 6)

this letter came to us from Bill Reiche of RCA:

"Dear Sir:

"The Eastern Editor of your splendid magazine travels in fast company these days.

"In the Public Relations Department of Princeton University recently the day's agenda of visitors and activities posted on the wall read as follows:

The Shah of Iran  
Dempewolf

"Sincerely,  
"William Reiche,  
Department of Information,  
Radio Corporation of America."

\* \* \*

### Antidote for Sparrows

To the Editor:

I recently received a letter from one of your personnel telling me I was an old reader of your magazine. Quite true; perhaps 30 or 40 or more years—so long I don't remember when I began. But I like it better than any magazine I ever purchased. It never ceases to be interesting and useful. I read through the ads as well as the other material . . .

I am 73 years of age now . . . in wonderful condition . . . I am going to have a shop where I shall use many of the ideas I gleaned from the pages of your wonderful magazine.

At present I am bothered with sparrows; they have become a pest. Have you any diagrams of bird traps that I can build and put in an inconspicuous place either on my back porch or on a window sill? I do not want to use poison that might kill other birds or be picked up by small children or dogs or cats.

Sincerely,

A. J. Lillis Walkup,  
4327 W. Kamerling Ave.,  
Chicago 51.

(How to get rid of sparrows is the subject of an article in the Craftsman Section next month.)

\* \* \*

### Man of the Year

James H. Rand III of Cleveland was featured in the leading article of our March issue as the "Inventor in a Carriage House." A note from Walter E. Burton of Akron, author of the article, tells us Rand has been named Cleveland's "outstanding young man of 1949" by the Junior Chamber of Commerce.

# I. C. S. training was his "BRIDGE TO SUCCESS"

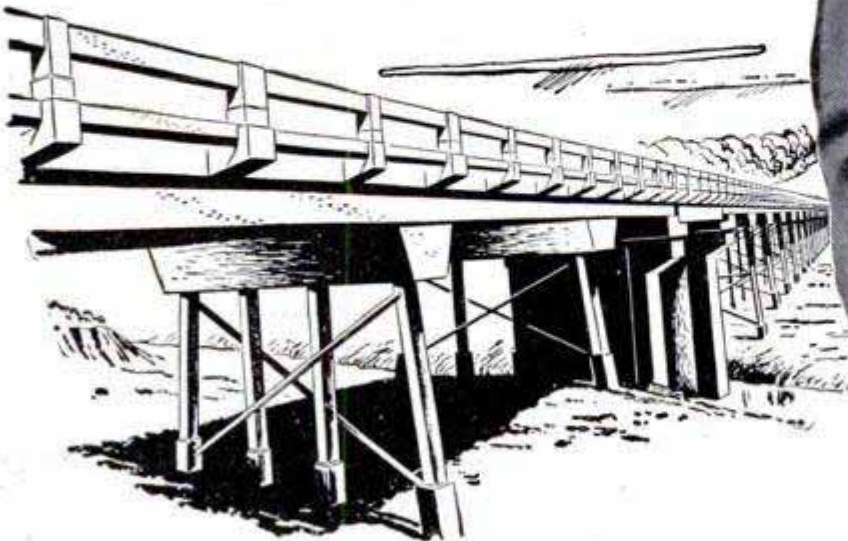

**HAYDEN M. HARGETT** took his first I. C. S. course while he was still a student in high school.

He is now County Engineer of Franklin County, Alabama. Last year Mr. Hargett designed 27 homes, two theaters, a bus station and three bridges. He supervised fifty miles of highway construction and the paving of one hundred thousand square yards of city streets.

**Mr. Hargett recently enrolled for another I. C. S. course**

Listen to what he has to say about I. C. S. training: "It's more practical—more flexible than any training I've had. I can't speak highly enough of my I. C. S. training."

Mr. Hargett says his first I. C. S. course was his "bridge to success." "There might not have been much of a career," he said, "if it hadn't been for that first I. C. S. course."

**I. C. S. training can be your "bridge to success." Mail the coupon today!**

## INTERNATIONAL CORRESPONDENCE SCHOOLS

**APPROVED**  
under the  
**G. I. BILL**

BOX 5673-K, SCRANTON 9, PENNA.

Without cost or obligation, please send me full particulars about the course BEFORE which I have marked X:

- |   |   |  |  |
|---|---|--|--|
| <p><b>Air Conditioning and Plumbing Courses</b></p> <p><input type="checkbox"/> Air Conditioning<br/><input type="checkbox"/> Heating<br/><input type="checkbox"/> Refrigeration<br/><input type="checkbox"/> Plumbing<br/><input type="checkbox"/> Steam Fitting</p> <p><b>Chemical Courses</b></p> <p><input type="checkbox"/> Chemical Engineering<br/><input type="checkbox"/> Chemistry, Analytical<br/><input type="checkbox"/> Chemistry, Industrial<br/><input type="checkbox"/> Chemistry, Mfg. Iron &amp; Steel<br/><input type="checkbox"/> Petroleum Refining<br/><input type="checkbox"/> Pulp and Paper Making<br/><input type="checkbox"/> Plastics</p> <p><b>Civil Engineering, Architectural and Mining Courses</b></p> <p><input type="checkbox"/> Architecture<br/><input type="checkbox"/> Architectural Drafting<br/><input type="checkbox"/> Bridge and Building Foreman<br/><input type="checkbox"/> Building Estimating<br/><input type="checkbox"/> Civil Engineering<br/><input type="checkbox"/> Coal Mining<br/><input type="checkbox"/> Contracting and Building<br/><input type="checkbox"/> Highway Engineering<br/><input type="checkbox"/> Lumber Dealer<br/><input type="checkbox"/> Reading Structural Blueprints<br/><input type="checkbox"/> Sanitary Engineering<br/><input type="checkbox"/> Structural Drafting</p> | <p><input type="checkbox"/> Structural Engineering<br/><input type="checkbox"/> Surveying and Mapping</p> <p><b>Communications Courses</b></p> <p><input type="checkbox"/> Electronics<br/><input type="checkbox"/> Practical Telephony<br/><input type="checkbox"/> Radio, General<br/><input type="checkbox"/> Radio Operating<br/><input type="checkbox"/> Radio Servicing<br/><input type="checkbox"/> Television<br/><input type="checkbox"/> Telegraph Engineering</p> <p><b>Electrical Courses</b></p> <p><input type="checkbox"/> Electrical Drafting<br/><input type="checkbox"/> Electrical Engineering<br/><input type="checkbox"/> Electric Light and Power<br/><input type="checkbox"/> Lighting Technician<br/><input type="checkbox"/> Practical Electrician</p> <p><b>Internal Combustion Engines Courses</b></p> <p><input type="checkbox"/> Auto Technician<br/><input type="checkbox"/> Diesel-Electric<br/><input type="checkbox"/> Diesel Engines<br/><input type="checkbox"/> Gas Engines<br/><input type="checkbox"/> Aviation</p> <p><b>Mechanical Courses</b></p> <p><input type="checkbox"/> Aeronautical Engineer's, Jr.<br/><input type="checkbox"/> Aircraft Drafting<br/><input type="checkbox"/> Forging<br/><input type="checkbox"/> Heat Treatment of Metals<br/><input type="checkbox"/> Industrial Engineering<br/><input type="checkbox"/> Industrial Instrumentation</p> | <p><input type="checkbox"/> Industrial Metallurgy<br/><input type="checkbox"/> Machine Shop<br/><input type="checkbox"/> Mechanical Engineering<br/><input type="checkbox"/> Mold-Loft Work<br/><input type="checkbox"/> Patternmaking—Wood, Metal<br/><input type="checkbox"/> Reading Shop Blueprints<br/><input type="checkbox"/> Sheet-Metal Drafting<br/><input type="checkbox"/> Sheet-Metal Worker<br/><input type="checkbox"/> Ship Drafting<br/><input type="checkbox"/> Tool Designing<br/><input type="checkbox"/> Welding Engineering<br/><input type="checkbox"/> Welding—Gas and Electric</p> <p><b>Railroad Courses</b></p> <p><input type="checkbox"/> Air Brake<br/><input type="checkbox"/> Diesel Locomotive<br/><input type="checkbox"/> Locomotive Engineer<br/><input type="checkbox"/> Locomotive Fireman<br/><input type="checkbox"/> Locomotive Machinist<br/><input type="checkbox"/> Railroad Section Foreman<br/><input type="checkbox"/> Steam-Diesel Loco. Eng.</p> <p><b>Stationary Eng'r's Courses</b></p> <p><input type="checkbox"/> Boilermaking<br/><input type="checkbox"/> Combustion Engineering<br/><input type="checkbox"/> Engine Running<br/><input type="checkbox"/> Marine Engineering<br/><input type="checkbox"/> Power Plant Eng'r's</p> | <p><input type="checkbox"/> Mech. Drafting<br/><input type="checkbox"/> Rayon Weaving<br/><input type="checkbox"/> Textile Designing<br/><input type="checkbox"/> Woolen Manufacturing</p> <p><b>Textile Courses</b></p> <p><input type="checkbox"/> Cotton Manufacturing<br/><input type="checkbox"/> Loom Fixing<br/><input type="checkbox"/> Textile Designing<br/><input type="checkbox"/> Woolen Manufacturing</p> <p><b>Business and Academic Courses</b></p> <p><input type="checkbox"/> Accounting<br/><input type="checkbox"/> App. Psychology<br/><input type="checkbox"/> Business Administration<br/><input type="checkbox"/> Bus. Correspondence<br/><input type="checkbox"/> Certified Public Accounting<br/><input type="checkbox"/> Commercial<br/><input type="checkbox"/> Cost Accounting<br/><input type="checkbox"/> Federal Tax<br/><input type="checkbox"/> Foremanship<br/><input type="checkbox"/> Good English<br/><input type="checkbox"/> Higher Mathematics<br/><input type="checkbox"/> Industrial Supervision<br/><input type="checkbox"/> Motor Traffic<br/><input type="checkbox"/> Retailing<br/><input type="checkbox"/> Salesmanship<br/><input type="checkbox"/> Sign Lettering<br/><input type="checkbox"/> Spanish<br/><input type="checkbox"/> Traffic Management</p> <p><input type="checkbox"/> Advertising<br/><input type="checkbox"/> Bookkeeping<br/><input type="checkbox"/> Bus. Law<br/><input type="checkbox"/> Commercial Art<br/><input type="checkbox"/> First Year College<br/><input type="checkbox"/> French<br/><input type="checkbox"/> High School<br/><input type="checkbox"/> Illustration<br/><input type="checkbox"/> Postal Civil Service<br/><input type="checkbox"/> Retail Bus. Management<br/><input type="checkbox"/> Secretarial<br/><input type="checkbox"/> Stenography</p> |
|---|---|--|--|

Name \_\_\_\_\_ Age \_\_\_\_\_ Home Address \_\_\_\_\_

City \_\_\_\_\_ State \_\_\_\_\_ Working Hours \_\_\_\_\_ A.M. to \_\_\_\_\_ P.M.

Present Position \_\_\_\_\_ Employed by \_\_\_\_\_

Length of Service in World War II \_\_\_\_\_ Enrollment under G.I. Bill approved for World War II Veterans. Special tuition rates to members of the Armed Forces. Canadian residents send coupon to International Correspondence Schools Canadian, Ltd., Montreal, Canada.

# One Step AHEAD!



with  
**EMBRY-RIDDLE**  
Training

## AIRCRAFT & ENGINE MECHANICS

An urgent need exists for properly trained A & E Mechanics throughout commercial aviation. Our C. A. A. approved school with a quarter-century of experience assures your quickest advancement. Embry-Riddle students learn fast with modern equipment...working on live aircraft in airline-size hangars.

## AERONAUTICAL ENGINEERING

Embry-Riddle's 2-yr. Aeronautical Engineering Course provides training at the technical instrument responsibility level. Engineers with management salaries! enjoy highest

## A & E COMBINED \* WITH COMMERCIAL

Airmen with dual pilot-engineering ability are needed by aviation companies and operators. Embry-Riddle combination training offers you the most in your aviation career. \*Not available to veterans, but combined courses may be taken consecutively with proper justification.

## COMMERCIAL PILOT

Embry-Riddle trained pilots benefit from our years of experience with 30,000 students...the best instructors, up-to-date aircraft, superb year-round flying weather... qualifications unexcelled anywhere. Instrument and instructor's ratings also available.

Never has there been such opportunity for properly trained men in commercial aviation. Put yourself one step ahead of the crowd. Start your career now at Embry-Riddle -- dormitories directly on the airport. For full information fill in the coupon below and mail today!



Dean of Enrollments - Dept. 99  
Embry-Riddle School of Aviation  
Miami 30, Florida

Please Print

NAME \_\_\_\_\_

ADDRESS \_\_\_\_\_

City \_\_\_\_\_

State \_\_\_\_\_ Age \_\_\_\_\_

I am interested in...

- A.&E. Mechanic  
 Commercial Pilot  
 Engineering  
 A.&E. Combined with Commercial Pilot \*  
 Flying Mechanic \*  
 Drafting & Design

Check One  Veteran  Non-Veteran

**TRAIN IN MIAMI--AIR CAPITAL OF THE WORLD**

## WHERE-TO-BUY-IT INDEX

Source of supply appears after items commercially available

### AUTOMOBILES AND TRAILERS

Trailer-hitch guard (John Hill Plating Co., 830 River St., Lansing, Mich.).....	95
Traffic's "private eye".....	108
Low-priced model featured by Kaiser (Kaiser-Frazer Corp., Willow Run, Mich.).....	109
Memo pad for cars (Bennett Industries, Inc., Peotone, Ill.).....	129
Nonacid storage battery may last 25 years.....	129
Powered trailer gives Jeep six-wheel drive (Willys-Overland Motors, Inc., Box 903, Toledo 1, Ohio).....	132
Sub's compressor may power auto.....	139
Trailer truck pivots on one front wheel (Scammell, Inc., 60 Wall St., New York City).....	148
Auto heater-cooker operates from manifold (Alessandro Heater Co., Inc., 534 W. Perkins Ave., Sandusky, Ohio).....	158
Round-the-town car (T. P. Hall Engineering Corp., 601 Harbor Insurance Bldg., San Diego, Calif.).....	158
Ocean auto.....	172
Low-slung sports car (Healy Cars, Ltd., Cape Warwick, England).....	172
Reverse hot rod.....	172

### AVIATION

Tomorrow's control tower.....	94
"Banana" lifesaver.....	95
Single-engine amphibian stresses safety features.....	153
Ocean travelers take to air.....	155
Nose doors simplify work on helicopter engine.....	171

### FARM

Rubber springs for tractor (Bostrom Mfg. Co., 133 W. Ogden Ave., Milwaukee, Wis.).....	86
Baled-hay loader.....	96
"Cowfeteria".....	105
Garden cultivator fits in car (The Will-Burt Co., Orrville, Ohio).....	138
Homemade power shovel.....	142
Aluminum grain bins (Permanente Products Co., Inc., Kaiser Bldg., 1924 Broadway, Oakland 12, Calif.).....	153

### HOUSE AND HOME

Electric dishwasher rolls on casters (General Electric Corp., Bridgeport 2, Conn.).....	96
Self-opening lid on garbage pail (Washington Steel Products, Inc., Tacoma 2, Wash.).....	118
Boot drier (Deschutes Specialties, Inc., Bend, Ore.).....	118
Ceiling washer (Tucker Mfg. Co., Cedar Rapids, Iowa).....	118
Aluminum awning-shutter (Outside Venetian Blind Co., 2625 Elm St., Dallas 1, Tex.).....	118
Clothes bucket carried by shoulder strap (E. J. Horton Co., San Diego, Calif.).....	119
No-stoop rake (L. M. Bussey, 3937 Somerset Drive, Los Angeles 8, Calif.).....	119
Food slicer (Miller and Sons, Valley City, N. D.).....	119
Steak roller (Don McRae, Box D, Los Angeles 41, Calif.).....	119
Storage-jar holder (Ideas, Inc., 30 Minor Cross, Stratford, Conn.).....	120
Heating ducts of aluminum prove best in lab tests.....	138
Student's home is a bus.....	164

### INDUSTRY

Dip process produces "mirror" finish on aluminum.....	121
Heavyweight champion logger (Washington Iron Works, 1500 6th South, Seattle, Wash.).....	130
"Mining" coal with fire.....	140
Light-duty ditcher (Badger Machine Co., Winona, Minn.).....	142
Leaf eliminator.....	143
"Painting" lake ice black lengthens shipping season.....	154
Printing with cardboard "type" (Phototype, Inc., 1414 Roscoe St., Chicago 13).....	154
Electronic warning protects boom operators (Electro-Alarm Sales Co., 14th and Farnam, Omaha 2, Neb.).....	155
Kenaf—the new fiber crop.....	156
Barges ride elevator on canal trip.....	158
Folding trailer is its own ramp (Martin Machine Co., Ke-wanee, Ill.).....	160
Jellied gasoline gets peacetime job.....	165
Maze packaging stops insects.....	278

### NOVELTIES

Biggest "sweet potato".....	117
Lawn-mowing scooter.....	143
Bicycle coach.....	154
Clock that tells all.....	159
Dial a light.....	159

### OUTDOOR RECREATION

Figure skating with roller skates.....	86
Flying game warden.....	87
Four-position tee rests atop ground (Four-Up-Tee Co., 100 Stevens Ave., Mount Vernon, N.Y.).....	139

(Continued to page 12)

# WHAT Every AUTO MECHANIC Wants to Know

A motor vehicle is a machine of many parts, each part designed and constructed for its own special function. All good mechanics, like good doctors, should know the working theory and operation of each part and understand what causes trouble and how to remedy it.

## LET AUDELS AUTO GUIDE SOLVE YOUR PROBLEMS

Every auto mechanic, helper, serviceman and operator can use AUDELS AUTO GUIDE. The information it gives saves time, money and worry. Highly endorsed by all users. It presents the whole subject of auto mechanics from A to Z in plain language and simple terms.

This Big Practical Book gives full information with working diagrams covering the principles, construction, ignition, service and repair of modern cars, trucks and buses.

A complete Guide of 1800 pages, with over 1500 illustrations showing inside views of the working parts, with instructions for service jobs. Diesel engines, Fluid and Hydra-matic drives fully explained.

## IT PAYS TO KNOW HOW TO

How to fit pistons—How to locate engine knocks—How to fit connecting rod bearings—How to service main bearings—How to recondition valves—How to time valves—How to adjust fan belts—How to adjust carburetors & chokes—How to rebuild a clutch—How to service automatic transmissions—How to service brakes—How to adjust steering gear—How to cope with ignition troubles—How to service distributors—How to time ignition—How to "tune up" an engine.

## INFORMATION IN A HANDY FORM

73 INTERESTING CHAPTERS—Read this partial list of subjects on which practical information is fully given for quick reference under the headings as shown below. Ready Reference Index.

All Parts of an Automobile—Automotive Physics—The Gas Engine—Gas Engine Principles—Multi-Cylinder Engines—Horse Power—Automobile Engines—Stationary Parts—Moving Parts—Pistons—Piston Rings—Connecting Rods—Crank Shafts—Valves—Valve Gear—Cams and Cam Action—Valve Timing—Cooling Systems—Fuel Feed Systems—Dual Fuel Feed—Mixture—Carburetors—Carburetor Service—Automatic Choke—Super-Chargers—Transmissions—Special Transmissions—Fluid and Hydra-matic Drives—Clutches—Universals and Propeller Shafts

A Ready Reference

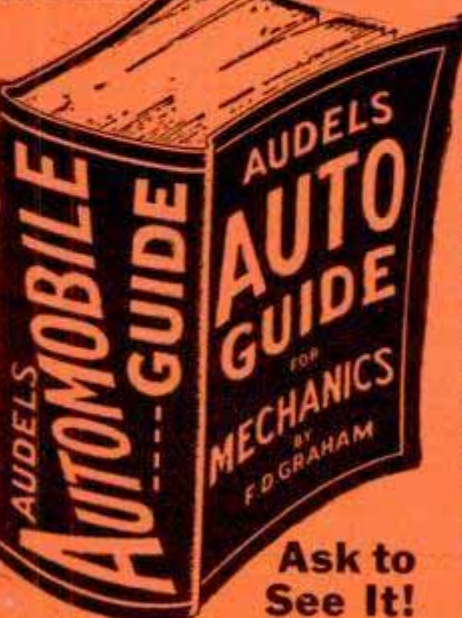

Ask to See It!

—The Differential—Rear Axles—Rear and Front Suspension—Running Gear—Brakes—Wheel Alignment—Knee Action—Steering Gear—Tires—Lubricants and Lubrication—Automotive Electricity—Ignition Systems—Magneto Ignition—Spark Plugs—Ignition Coils—Distributors—Automatic Spark Control—Ignition Timing—Generators—Starters—Generator and Starter Testing—Lighting Systems—Storage Batteries—Charging and Testing—Diesel Engines and Trouble Shooting.

**7 DAYS' FREE TRIAL**  
TO GET THIS ASSISTANCE FOR YOURSELF SIMPLY FILL IN AND MAIL COUPON TODAY.

**\$4 COMPLETE PAY \$1 A ONLY 1 MO.**



## Sent on 7 Days Approval

Step up your own skill with the facts and figures of your trade. Audels Mechanics Guides contain Practical Inside Trade Information in a handy form. Fully Illustrated and Easy to Understand. Highly Endorsed. Check the book you want for 7 DAYS FREE EXAMINATION. Send No Money. Nothing to pay postman.

## CUT HERE MAIL ORDER

AUDEL, Publishers, 49 W. 23 St., NEW YORK 10, N. Y.

Please send me postpaid for FREE EXAMINATION books marked (x) below. If I decide to keep them I agree to mail \$1 in 7 Days on each book or set ordered and further mail \$1 monthly on each book or set until I have paid price, otherwise I will return them.

- AUTO GUIDE**, 1800 Pages \$4
- DIESEL ENGINE MANUAL, 400 Pages 2
- WELDERS GUIDE, 400 Pages 1
- MACHINISTS Handy Book, 1600 Pages 4
- POWER PLANT ENGINEERS Guide, 1500 Pages 4
- ENGINEERS & FIREMANS EXAMS, 528 Pages 4
- PUMPS, Hydraulics & Air Compressors, 1658 Pgs. 4
- MARINE ENGINEERS Handy Book, 1280 Pages 4
- ENGINEERS & Mechanics Guides (8 Book Set) 12
- Answers on Practical ENGINEERING, 254 Pages 1
- ELECTRIC WIRING DIAGRAMS, 210 Pages 1
- ELECTRICIANS EXAMINATIONS, 250 Pages 1
- ELECTRICAL DICTIONARY, 9000 Terms 2
- ELECTRIC MOTOR GUIDE, 1000 Pages 4
- HANDY BOOK OF ELECTRICITY, 1440 Pages 4
- ELECTRICAL POWER CALCULATIONS, 425 Pgs. 2
- RADIOMANS GUIDE, 914 Pages 4
- ELECTRONIC DEVICES, 216 Pages 2
- ELECTRIC LIBRARY, 7000 Pages (12 Book Set) 18
- Vols. I, II, III, IV, V, VI, VII, VIII, IX, X, XI, XII \$1.50 Ea.
- OIL BURNER GUIDE, 384 Pages 1
- HOUSE HEATING GUIDE, 1000 Pages 4
- CARPENTERS & Builders Guides (4 Book Set) 6
- PLUMBERS & Steamfitters Guides (4 Book Set) 6
- MASONS & Builders Guides (4 Book Set) 6
- BLUE PRINT READING, 416 Pages 2
- PAINTERS & DECORATORS MANUAL 450 Pgs. 2
- GARDENERS & GROWERS Guides (4 Book Set) 6
- REFRIGERATION & Air Conditioning, 1280 Pgs. 4
- SHEET METAL WORKERS Handy Book, 388 Pgs. 1
- SHEET METAL PATTERN LAYOUTS, 1100 Pgs. 4
- AIRCRAFT WORKER, 240 Pages 1
- MECHANICAL DRAWING GUIDE, 160 Pages 1
- MECHANICAL DRAWING & DESIGN, 480 Pgs. 2
- MATHEMATICS & CALCULATIONS, 700 Pgs. 2
- MECHANICAL Dictionary, 968 Pages 4
- MILLWRIGHTS & Mechanics Guide, 1200 Pgs. 4

Name \_\_\_\_\_  
 Address \_\_\_\_\_  
 Occupation \_\_\_\_\_  
 Employed by \_\_\_\_\_

AUDEL, Publishers, 49 W. 23 St., New York 10, N. Y.



# GOVERNMENT JOBS START

## As High As \$3,450.00 Year

Prepare NOW for 1950 Examinations

### City Mail Carriers, Post Office Clerks

Clerks and Carriers now get \$2,870.00 the first year of regular employment and automatically increase \$100 a year to \$3,670.00. Open to men—women 18 to 50.



### Patrol Inspectors

Men 21 to 35. Entrance salary \$3,450.00 year. Appointments to positions along the nation's borders are made from this examination.

### Railroad Postal Clerks

Railway Postal Clerks get \$3,170.00 the first year of regular employment, being paid on the first and fifteenth of each month. (\$132.08 each pay day.) Their pay is automatically increased yearly to \$3,970.00. Advance may be had to Chief Clerk at \$5,970.00 a year. (\$248.75 each pay day.) Veterans only.

## RAILWAY POSTAL CLERKS



3 Days On—3 Days  
Off—Full Pay

Railway Postal Clerks on long runs usually work 3 days and have 3 days off duty or in the same proportion. During this off duty their pay continues just as though they were working. They travel on a pass when on business. When they grow old, they are retired with a pension.

### Many Other Positions

Many other positions are obtainable. Those wishing these positions should prepare at once.

### Get Free List of Positions

Fill out the following coupon. Tear it off and mail it today—now, at once.

Although not Government controlled this small investment can result in your getting a big-paid Government job.

**FRANKLIN INSTITUTE, Dept. C-83, Rochester 4, N. Y.**

Rush to me, entirely free of charge (1) a full description of U. S. Government Jobs; (2) Free copy of illustrated 40-page book, "How to Get a U. S. Government Job"; (3) List of U. S. Government Jobs; (4) Tell me what to do to prepare for one.

Name \_\_\_\_\_

Address \_\_\_\_\_ Vet. ? \_\_\_\_\_

Use This Coupon Before You Mislay It. Write or Print Plainly.

(Continued from page 10)

### PHOTOGRAPHY

Miniature reflex fits in palm of hand (Miura Shoji K.K., 4 Ginza 6-Chome, Chuoku, Tokyo, Japan).....	105
Color-film processor is fully automatic.....	160
Darkroom filter (Jayemm Co., Burlington, Ky.).....	164
C-clamp "tripod" has swivel head (F. Biel Corp., 129 Pearl St., New York City 6).....	164
Cold-light enlarger uses circular lamp (Eastman Kodak Co., Rochester 4, N. Y.).....	171

### RADIO AND TELEVISION

Radio in a bottle.....	86
Mushrooming TV.....	117
TV antenna mast balances on ball bearing.....	120
Powerful radio station uses mountain as antenna masts.....	121

### TOOLS

Trammelheads make four-in-one tool (Engineering Research Associates, 3475 E. Nine Mile Rd., Hazel Park, Mich.)....	95
V-belt measurer.....	148
Hand sander smooths contours (Merit Products, Inc., 4373 Melrose Ave., Los Angeles 27, Calif.).....	154

### MISCELLANEOUS

"Oil" made of metal (The Lockrey Co., Lubricants Div., College Point 1, N. Y.).....	14
"Tracer" atoms used to study formation of rust.....	94
Hydrogen bomb.....	106
Link ruler (Linkrule Corp., 937 Book Bldg., Detroit 26, Mich.)	108
Grandma's right about the weather.....	126
One-legged mountain climber.....	128
Ladder-jeg equalizer (Anderson Products Co., Box 691, Tulare, Calif.).....	129
Dental "sandblasting" makes drilling painless.....	132
Music is newest instrument in the doctor's black bag.....	137
Tests settle recoil controversy.....	137
Ultramodern desk.....	138
Glass bottle that fits in cup keeps coffee hot (McKee Glass Co., Jeannette, Pa.).....	139
Ultrasonic fountain.....	142
Pocket ray detector.....	148
Spray-gun artist.....	155
Elevator "pilot" rides in cockpit.....	155
Remote radiation detection.....	159
Awning "garage" (Kool-Vent Metal Awning Corp. of America, Keystone Bldg., Pittsburgh, Pa.).....	160
Plastic envelopes help plot water currents.....	165
Radio waves speed germination.....	270

## Craftsman and Shop Notes Index

### FARM

Remote control for tractor varies engine speed.....	218
Sheet-metal planter extensions form oversize seed hoppers.....	218
Sagless ball-bearing gate.....	220
Hose section in incubator tray keeps eggs from rolling.....	220
Hinged farm-building ventilators.....	220
Drum-type feeder for hog lot anchored to concrete platform.....	220
Brake rods provide posts for electric fence.....	225
Check planting four rows with short markers.....	225
Tank fitted with float valve provides automatic waterer.....	228
Green siding seasoned while in use.....	228

### FISH AND FISHING

Raise your own bait worms.....	196
Screen disk covers fish bowl.....	196
Bait sack attracts catfish.....	205

### HOUSE AND HOME

Inner tube connected to downspout provides flexible extension.....	186
Pin aids threading drawstring.....	186
Cleaning equipment kept dust-free.....	186
Clothes pole kept from slipping by inserting rubber liner.....	194
Weatherproof order board.....	194
Sheet-metal hanger permits individual replacement of broken roof tiles.....	195
Scraps of soap salvaged for laundry.....	198
Reducing fruit-jar breakage.....	198
Opening jar covers.....	198
Mothproof storage for woollens.....	198
Revitalizing house-plant leaves.....	199
Make the catchup flow out easily.....	199
Method for keeping broiler clean.....	199
Brush for fingernails made from old toothbrush.....	199
Container permits carrying salad in lunch box.....	199
Attractively upholstered youth seat fits dining-room chairs.....	200

(Continued to page 14)

**IMPORTANT NOTICE**—It is the intention of this magazine to provide its readers with information regarding the latest developments in the mechanical arts. We take no responsibility as to whether the disclosures contained in our articles are covered by patents and advise readers to investigate this subject before making, using, or selling any of the products, machines, or processes described in order to avoid possible liability for patent infringements.

## You Practice COMMUNICATIONS

I Send You Parts To Build This Equipment



As part of my new Communications Course I send you parts to build your own transmitter. Conduct actual procedure demanded of Broadcast Station Operators, make experiments, learn how to put a transmitter on the air.

**NEW**

## You Practice Radio SERVICING

On This Modern Radio You Build With Parts I Send

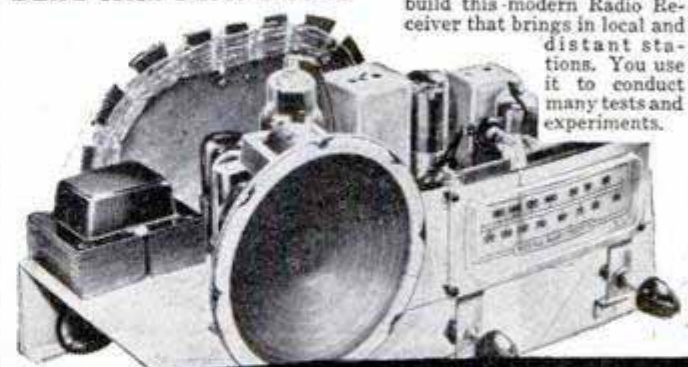

As part of my Servicing Course, I send you the speaker, tubes, chassis, transformer, loop antenna, EVERYTHING you need to build this modern Radio Receiver that brings in local and distant stations. You use it to conduct many tests and experiments.

# BE A RADIO-TELEVISION TECHNICIAN

Learn Servicing or Communications by Practicing in Spare Time with **MANY KITS OF PARTS I Send**



J. E. SMITH, Pres. National Radio Institute

Do you want a good-pay job in the fast growing RADIO-TELEVISION Industry? Or do you want to have your own money-making Radio-Television Shop? Here is your opportunity. I've trained hundreds of men to be successful Technicians . . . MEN WITH NO PREVIOUS EXPERIENCE. My tested and proved train-at-home method makes learning easy. You learn Radio-Television principles from my illustrated lessons. You get practical experience building, testing and experimenting with parts I send. All equipment yours to keep.

### Make Extra Money In Spare Time

The day you enroll, I start sending you SPECIAL BOOKLETS that show you how to make \$5, \$10 a week or more EXTRA MONEY fixing neighbors' Radios in spare time while learning. From here, it's a short step to your own shop or a good-pay Radio-Television servicing job. Or be a licensed Radio-Television Operator or Technician. In 1945, there were 943 Radio Stations. Today about 2700 are on the air! RESULT—THOUSANDS OF QUALIFIED MEN STEPPED INTO GOOD JOBS. Another example—only 19 Television stations were on the air in 1947. Today, more than fifty. Within a few months, 150, say the experts—and 1000 within three years. Then add developments in FM, Two Way Radio, Police, Marine, Aviation, Microwave Relay Radio. Think what this means! New jobs, more jobs for qualified men.

### Mail Coupon For Books Free

Act now! Send for my FREE DOUBLE OFFER. Coupon entitles you to actual lesson, "GETTING ACQUAINTED WITH RECEIVER SERVICING." It shows how many pictures and diagrams are used to make learning at home easier, practical. You also get my 64-page book, "HOW TO BE A SUCCESS IN RADIO-TELEVISION." It tells more about YOUR opportunities . . . details of my Course . . . what my graduates are doing and earning . . . how quickly you can be on your way to good pay, success, a bright future. Send coupon in envelope or paste on penny postal. J. E. SMITH, President, Dept. ODP, National Radio Institute, Pioneer Home Study Radio School, Washington 9. D. C.

**YOU BUILD** this tester as part of my Servicing Course. It soon helps you earn \$5, \$10 and more a week EXTRA MONEY fixing neighbors' Radios in spare time while learning.



**YOU BUILD** this Power Pack as part of my new Communications Course. Use it to conduct fascinating experiments with frequency amplifiers, multipliers, buffer stages, etc.

**YOU BUILD** this Superheterodyne Receiver Circuit and conduct Frequency Modulation experiments and many other tests as part of my Servicing Course.



**YOU BUILD** this Signal Generator as part of my Servicing Course for more valuable experience. It provides amplitude-modulated signals for many interesting tests and experiments.



## VETERANS

GET THIS TRAINING WITHOUT COST UNDER G. I. BILL MAIL COUPON

**YOU BUILD** this Wavemeter as part of my new Communications Course. Use it with Oscillator you also build that furnishes basic power to transmitter and determines transmitter frequency.



## I TRAINED THESE MEN AT HOME

"My first job was operator with KDLR, obtained for me by your Graduate Service Dept. Am now Chief Engineer, WQOX." —T. S. Norton, Hamilton, O.

"I received my 2nd Class Radiotelegraph License and worked on ships. Now with Station WEAN as control operator." —R. Arnold, Rumford, R. I.

"Today I am considered an expert Radio-Television Technician. Have 4 employees. Radiorepair business has doubled." —P. G. Miller, Toledo, Ohio

"N. R. I. has been my stepping stone from a few hundred dollars a year as a Radio Engineer." —A. B. Michaels, Trenton, Georgia.

"Two months after starting, took a part-time job. Now working full time. Make \$200 a month plus commission on servicing." —L. McNeil, Rockdale, Texas.

"While learning, made \$5, \$10 a week in spare time. Now have spare-time shop at home and earn up to \$25 a week." —Leander Arnold, Pontiac, Michigan.

MAIL COUPON! FIND OUT ABOUT THIS TESTED WAY TO BETTER PAY

## Good for Both—FREE

MR. J. E. SMITH, President, Dept. ODP, National Radio Institute, Washington 9. D. C.

Mail me Sample Lesson and 64-page Book about How to Win Success in Radio-Television—both FREE. (No Salesman will call. Please write plainly.)

Name.....Age.....

Address.....

City.....Zone.....State.....

Check if Veteran Approved for training under G. I. Bill



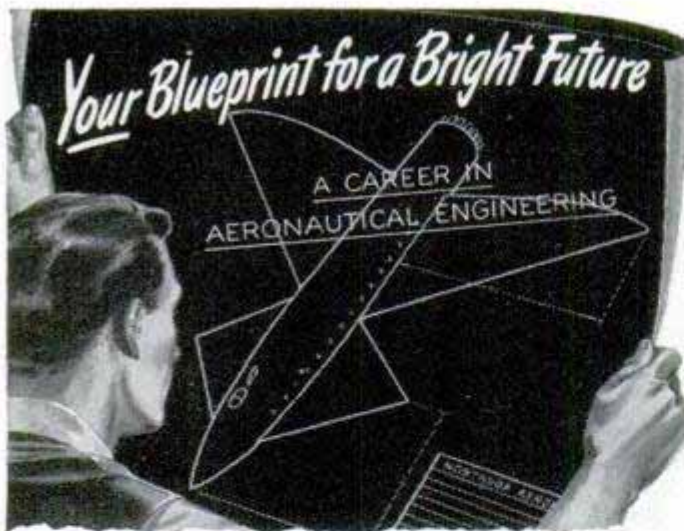

Blueprints guide the great aerial parade of spectacular new planes and aircraft power plants. Back of those blueprints is the *Aeronautical Engineer*. His original ideas, creative talents, technical knowledge, and professional skill produce the improved designs and new aircraft that give wings to the great *Air Age*. A career in the fascinating profession of *Aeronautical Engineering* can be *YOUR* blueprint for a bright future.

#### Lifelong Adventure—and Rich Rewards

Besides fascinating duties, you enjoy these practical rewards—good pay from the start... wide-open opportunity for quick advancement... the satisfaction of putting your own original ideas into action... the security of a field already huge, and still growing. *Northrop* graduates are enjoying these rich rewards, throughout *Aviation*. Hundreds hold good jobs with ALL leading aircraft manufacturers and airlines.

You are already IN *Aviation* when you train at *Northrop*. You enjoy many important practical advantages, such as illustrated by the training scenes at left and below... with many "live" aircraft giving *Northrop* students first-hand knowledge of aircraft construction and power-plant installation... and with actual aircraft

design projects providing *advance* experience in engineering duties. Get full details in the big, profusely illustrated Institute catalog. Classes start every 8 weeks—you can start *YOUR* training soon.



Send Coupon for this Catalog NOW

APPROVED FOR VETERANS

# Northrop

## Aeronautical Institute

Division of Northrop Aircraft, Inc.  
1527 EAST BROADWAY, HAWTHORNE,  
LOS ANGELES COUNTY, CALIFORNIA

#### NORTHROP AERONAUTICAL INSTITUTE

1527 East Broadway, Hawthorne, Los Angeles County, Calif.  
Please send information on opportunities in Aeronautical Engineering, your catalog, and starting dates of classes. I am interested in:

Aeronautical Engineering     Aircraft & Engine Mechanics

Name \_\_\_\_\_ Age \_\_\_\_\_

Address \_\_\_\_\_

City \_\_\_\_\_ Zone \_\_\_\_\_ State \_\_\_\_\_

Check one:  Veteran     Non-Veteran

(Continued from page 12)

### OUTDOOR RECREATION

Set your watch with a compass.....	200
Boat pulley prevents rope chafing.....	200
Camp foodstuffs kept ant-free in covered cans hung from ceiling.....	205
Hunting dogs ride safely in this trunk carrier.....	221

### PAINT AND PAINTING

Amount of paint left in can indicated by pencil mark.....	193
Painting rusted galvanized roof.....	200
Easily handled airbrush colors provided by clothing dyes.....	218

### PHOTOGRAPHY

Timer-switchboard for your darkroom.....	209
Movie-camera setups.....	210
Darkroom tray from plastic dish prevents twisting of roll film.....	212
Tape identifies developing tank.....	212

### TOOLS

Sheet-metal wire splicer.....	186
Sheet-metal setting plate facilitates chucking irregularly shaped castings.....	193
Bench-top cabinet for small tools has convenient slanted shelves.....	194
Adjustable fence for homemade shaper.....	219
One-piece depth stop for collet chuck quickly locates short work.....	221
Protecting edges of balancing ways.....	228
Holes tapped on drill press.....	228

### TOYS AND NOVELTIES

Stainless ink for children's play made from laundry bluing.....	182
Toy cement mixer for small-fry contractors.....	183
Tumblers individually initialed with colored cloth tape.....	186
Crafting with glass blocks.....	187
Knotted hangers suspend decorative bottles to hold trailing vines or artificial flowers.....	193
Sandbox with built-in seats doubles as table.....	195
Toy pistol shoots rubber bands.....	196
Finger trap.....	197
Pipe extension lowers swing rope to compensate for slant of limb.....	208

### MISCELLANEOUS

More light from old lamps.....	184
Hidden switch foils car thief.....	194
Use paraffin as a lubricant.....	194
Handle at end of lunch box aids carrying in crowds.....	196
Prolonging cut-flower life.....	196
Soldering without distortion.....	200
Comb marks leather for punching.....	205
Improvised dropping bottle.....	205
Varnish remover softens filler.....	208
Disposable glue-can cover.....	208
Pendulum holder on drawing board keeps ink bottle level.....	218
Tie-rod tension springs correct wandering of four-wheel trailer.....	227
Potato holds parts for welding.....	228

## Radio-Television, Electronics

Rectangular picture tube in 1950 TV sets (Television receivers for 16-in. picture tube, Motorola Inc., 4545 W. Augusta Blvd., Chicago; rectangular picture tube, Owens-Illinois Glass Co., Toledo 1, Ohio).....	229
No. 2 progressive all-wave a.c. "overseas dxer" for students.....	230
Low-cost battery charger employs selenium rectifiers.....	232

## "Oil" Made of Metal

Practically indestructible at high temperatures and pressures, a new lubricant, said to be three times as efficient as oil, has a base of the "greasy" metal, molybdenum. This metal has the peculiar faculty of "plating" itself on any friction surface, protecting the surface from scoring or seizing even when all oil is removed. The new molybdenum-base lubricant comes in liquid form and can be used alone or added directly to the crankcase oil. According to the manufacturer, tests show that friction surfaces run one-third cooler when the new lubricant is used than when lubricated by ordinary oil.



# INVENTORS

**L**earn how to protect your invention. The U. S. Patent Laws provide that any new and useful art, machine, article of manufacture, or composition of matter, or any new and useful improvement thereof, may be patented if the act of invention is involved. Therefore, every inventor with a valuable invention should take advantage of the Patent Laws and proceed for patent protection in order to safeguard his rights.

A patent gives the inventor the exclusive right to prevent others from making, using, or selling the invention claimed in the patent for a period of seventeen years.

The Patent Laws were enacted for the benefit of the inventor to give him protection for the features of his invention which are patentable. These features must be properly and concisely set forth and claimed in a formal application for patent, in order to comply with the requirements of the Patent Laws. For that reason, unless the inventor is familiar with patent matters, he should engage a competent registered patent attorney or agent to represent him. We are registered to practice before the U. S. Patent Office and are prepared to serve you in the handling of your patent matters.

A specially prepared booklet entitled "Patent Guide for the Inventor", containing detailed information with respect to patent protection and procedure, together with a "Record of Invention" form will be promptly forwarded to you without obligation upon request.



4WHW-YT2-A9W8

**CLARENCE A. O'BRIEN & HARVEY JACOBSON**

*Registered Patent Attorneys*

01-D DISTRICT NATIONAL BUILDING • WASHINGTON 5, D. C.

*Patents • • Trademarks • • Copyrights*



# LET YOURSELF GO!

**C.T.I. Training Points the Way to Greater Income and Success**



## Learn a Well-Paid Trade in the C.T.I. Shops or thru Home Study

*Stop holding yourself back!* If you want a well-paid job, or a shop of your own, *you must train for it.* Top incomes usually go to men who are *qualified*—to men who *know their business!* You can easily acquire technical skill either by training at the famous C.T.I. residential school, or thru C.T.I.'s Shop-Proved Home Study methods . . . *And you can do it in a matter of months!*

These comments by C.T.I. graduates *prove* that training pays splendid rewards in the form of higher income and greater security—*often in an amazingly short time.* Listen!—

"Before going to C.T.I., I averaged \$45 to \$50 a week. *Today I average \$75 to \$125 a week.* C.T.I. sure helped my income and brought security!" . . . "Your training is great. I now make \$75 weekly." . . . "Before I attended C.T.I., I never made more than \$100 a month. Today, I am Electrical Superintendent for two towns. *I'd never be where I am if it wasn't for C.T.I.*" . . .

"My training at C.T.I. enabled me to go into business for myself, and thus increase my earning ability. More power to you." . . . "If I had not taken a course at C.T.I., I never would have had a business of my own—or even a job. I'll never need unemployment relief!" . . . "C.T.I. training not only added dollars to my pay-check, but it gave me a fine sense of well-being. I am grateful for these benefits."

"I want to thank C.T.I. for the good teaching job it did for me. *I am now in charge of a full shift where I work.* What I learned has helped me out of a lot of tough spots." . . . "My C.T.I. schooling prepared me for the good job that I have today with a big steel company. *My wages are excellent.*" . . . Most of these C.T.I. men had no technical skill before attending C.T.I. All they had was mechanical aptitude plus ambition to get ahead. *You have the same opportunities . . . and you, too, are invited to write C.T.I. for complete information on your chances for success in a leading industry. Better mail the coupon to C.T.I.—better do it today!*

**FILL OUT - CUT OUT - MAIL TODAY**

Mr. R. C. Anderson, President  
 COMMERCIAL TRADES INSTITUTE, Dept. E2-4  
 1400 Greenleaf Ave., Chicago 26

Veteran  
 Non-Veteran

Send free illustrated Brochures and other information about the field I have checked below:

<input type="checkbox"/> Automotive Mechanics	<input type="checkbox"/> Electricity & Electronics
<input type="checkbox"/> Body & Fender Rebuilding	<input type="checkbox"/> Radio & Television
<input type="checkbox"/> Diesel Mechanics	<input type="checkbox"/> Building Construction
<input type="checkbox"/> Refrigeration & Air Conditioning	<input type="checkbox"/> Mechanical Drafting

Name \_\_\_\_\_ Age \_\_\_\_\_  
 Address \_\_\_\_\_  
 City \_\_\_\_\_ State \_\_\_\_\_

### C.T.I. TRAINING IS G.I. APPROVED

All C.T.I. courses, both residential and home study, are fully approved by the Veterans Administration—which means that eligible veterans will have their tuition paid by the government.



R. C. Anderson  
President

**COMMERCIAL TRADES INSTITUTE, Dept. E2-4**  
 1400 Greenleaf - Chicago 26



# INVENTORS

If you believe that you have an invention, you should find out how to protect it. The first step is to have a search made of the prior pertinent U. S. patents. If a report on this search indicates that the invention appears patentable you can apply for a patent, and the specifications and claims should be prepared.

The firm of McMorrow, Berman & Davidson, with offices in Washington, D. C., is qualified to take the necessary steps for you. We can make a preliminary search on your invention, advise you whether we think it can be patented, and prepare your application for patent.

Unless you are fully familiar with the U. S. Patent Laws, we recommend that you engage the services of a Registered Patent Attorney to protect your interests. The patent laws are *your* laws. A patent gives you the right to prevent others from making, using or selling the invention claimed in your patent for a period of 17 years.

Use these patent laws for your protection. Investigate whether your invention can be patented. If you have what you believe to be an invention, we suggest that you have this firm make a search for you.

*Send for a copy of our Patent Booklet entitled "How To Protect Your Invention," containing information about patent protection and patent procedure. Along with this we will also send you an "Invention Record" form, for your use in writing down and sketching details of your invention. We will mail them promptly. No obligation. They are yours for the asking.*

**McMORROW, BERMAN & DAVIDSON**

*Registered Patent Attorneys*

**PATENTS • COPYRIGHTS • PATENTS**

**135-B VICTOR BUILDING, WASHINGTON 1, D. C.**

# The 97 Pound Weakling

who became "The World's Most Perfectly Developed Man"

"I'll Prove that YOU, too, can be a NEW MAN!"

*Charles Atlas*

I KNOW, myself, what it means to have the kind of body that people pity! Of course, you wouldn't know it to look at me now, but I was once a skinny weakling who weighed only 97 lbs.! I was ashamed to strip for sports or undress for a swim. I was such a poor specimen of physical development that I was constantly self-conscious and embarrassed. And I felt only HALF-ALIVE.

Then I discovered "Dynamic Tension." It gave me a body that won for me the title "World's Most Perfectly Developed Man."

When I say I can make you over into a man of giant power and energy, I know what I'm talking about. I've seen my new system, "Dynamic Tension," transform hundreds of weak, puny men into Atlas Champions.

### Only 15 Minutes a Day

Do you want big, broad shoulders—a fine, powerful chest—biceps like steel—arms and legs rippling with muscular strength—a stomach ridged with bands of sinewy muscle—and a build you can be proud of? Then just give me the opportunity to prove that "Dynamic Tension" is what you need.

No "ifs," "ands," or "maybes." Just tell me where you want handsome, powerful muscles. Are you fat and flabby? Or skinny and gawky? Are you short-winded, peppy? Do you hold back and let others walk off with the prettiest girls, best jobs, etc.? Then write for details about "Dynamic Tension" and learn how I can make you a healthy, confident, powerful HE-MAN.

"Dynamic Tension" is an entirely NATURAL method. Only 15 minutes of your spare time daily is enough to show amazing results—and it's actually fun! "Dynamic Tension" does the work.

**My Illustrated Book is Yours—Not For \$1.00 or 10c—But FREE**



Send NOW for my famous book, "Everlasting Health and Strength." 48 pages, packed from cover to cover with actual photographs and valuable advice. Shows what "Dynamic Tension" can do, answers many vital questions. Page by page it shows what I can do for YOU.

This book is a real prize for any fellow who wants a better build. Yet I'll send you a copy absolutely FREE. Just glancing through it may mean the turning point in your whole life! Rush the coupon to me personally: Charles Atlas, Dept. 84, 115 East 23rd St., New York 10, N. Y.

**CHARLES ATLAS, Dept. 84, 115 East 23rd St., New York 10, N. Y.**

Send me—absolutely FREE—a copy of your famous book, "Everlasting Health and Strength"—48 pages, crammed with actual photographs, answers to vital health questions, and valuable advice to every man who wants a better build. I understand this book is mine to keep, and sending for it does not obligate me in any way.

Name \_\_\_\_\_ Age \_\_\_\_\_  
 (Please print or write plainly)  
 Address \_\_\_\_\_  
 City \_\_\_\_\_ State \_\_\_\_\_



**CHARLES ATLAS**  
 Holder of Title  
 "The World's Most Perfectly Developed Man"

## BE AN AUTO MACHINIST



**Practical Shop Training**  
 Learn to operate the very latest shop machinery. Friendly instructors take a real interest in preparing you for a good job.

**Draw Top Pay • No Job Worries**

Earn more money in auto mechanics—Specialize! New FREE booklet tells how to prepare for good jobs with high pay and job security. Our modern equipment and practical instructions make it easy to learn—get experience in

**ENGINE REBUILDING or GENERAL AUTO MECHANICS**

**VETERANS**  
 American is a G.I. approved school.

Job Placement Service FREE

**WRITE TODAY FOR FREE BOOKLET**

**AMERICAN TRADE SCHOOL**  
 2411 McGee Kansas City, Mo.



## Bar Bells

Buy Direct From Factory

Write for free booklet and price list

**\$8.95** up

**INDEPENDENT IRON WORKS**

2416 East 23rd Street, Dept. B  
 Los Angeles 11, Calif.

## TRI-STATE COLLEGE

**B. S. DEGREE IN 27 MONTHS**

Founded 1884

World-Wide Enrollment

Civil, Elect., Mech., Chem., Aero., Radio and Telev., Engineering; Bus. Adm., Acct. Visit Campus, see well equipped labs. Low cost. Prep. courses. Personalized instruction. Grads. successful. Enter June, Sept., Jan., March. Catalog 440 College Ave., Angola, Ind.



## LEARN MEAT CUTTING

through actual practice. Profitable Meat Cutting and Self-Service Meats taught easily, quickly. LEARN BY DOING at Toledo in just eight short weeks under actual market conditions. For beginners or men with experience. All subjects taught thoroughly and completely. Diploma. Job help. Get store of own. People must eat. School in operation over 25 years. Approved for GI training. Send today for FREE illustrated catalog. No obligation; NATIONAL SCHOOL OF MEAT CUTTING, Dept. 50-D, Toledo 4, Ohio

## LEARN MONEY-MAKING CARTOONING

IN SPARE TIME — by Easy Picture Chart Method

Same Simplified Method that has helped train creators of "Terry & Pirates," "Freckles," "Out Our Way," "Winnie Winkle," "Reg'lar Fellers," "Strange As It Seems," "The Neighbors," and many others. Earn while learning. Send 10c for Picture Chart (to test your ability), and full details. (State age.)

THE LANDON SCHOOL, 5004 Cleve. Transit Bldg., Cleveland, O.



## YOU CAN SUCCEED BY KLOK TRAINING

There is no other practical training in the wood industry whereby you can succeed so quickly as through our training. You can study either at home by correspondence or come to Grand Rapids and study with us here. The KLOK Course teaches you Sketching—Drafting—Rod Making—Time Study—Cost and Production Scheduling. The training will enable you to run your own shop more successfully or enable you to get a top position in the furniture and woodworking industry. Write NOW for free booklet, "Stepping Stones to Top Positions in the Woodworking Industry." State preference—Home Study or Resident Training—Age, and if you are a Veteran.

FREE G.I. TRAINING



**KLOK INSTITUTE**

Louis St., N. W., Grand Rapids, Michigan



*How do you  
rank in your  
new outfit?*

You've been in civvies for some time now. How are you doing? Are you moving ahead as fast as you want? Or have you struck a snag? You may have found that there are things you have to know — training you have to have — before you can move up.

You can get that training — without leaving your job — from I.C.S. When you study with I.C.S. you study at home in your spare time — with the world's largest educational institution.

I.C.S. training has put others at the top. How about you? If you want to matter in your new outfit, start by filling in the coupon and mailing it, *today!*

## INTERNATIONAL CORRESPONDENCE SCHOOLS

**APPROVED**  
under the  
**G.I. BILL**

**BOX 5674-K, SCRANTON 9, PENNA.**

Without cost or obligation, please send me full particulars about the course BEFORE which I have marked X:

- |   |  |   |  |
|---|--|---|--|
| <p><b>Business and Academic Courses</b></p> <ul style="list-style-type: none"> <li><input type="checkbox"/> Accounting</li> <li><input type="checkbox"/> App. Psychology</li> <li><input type="checkbox"/> Business Administration</li> <li><input type="checkbox"/> Bus. Correspondence</li> <li><input type="checkbox"/> Certified Public Accounting</li> <li><input type="checkbox"/> Commercial</li> <li><input type="checkbox"/> Commercial Art</li> <li><input type="checkbox"/> Cost Accounting</li> <li><input type="checkbox"/> Federal Tax</li> <li><input type="checkbox"/> First Year College</li> <li><input type="checkbox"/> Foremanship</li> <li><input type="checkbox"/> Good English</li> <li><input type="checkbox"/> Higher Mathematics</li> <li><input type="checkbox"/> Industrial Supervision</li> <li><input type="checkbox"/> Motor Traffic</li> <li><input type="checkbox"/> Retailing</li> <li><input type="checkbox"/> Salesmanship</li> <li><input type="checkbox"/> Sign Lettering</li> <li><input type="checkbox"/> Spanish</li> <li><input type="checkbox"/> Air Conditioning and Plumbing Courses</li> <li><input type="checkbox"/> Heating</li> <li><input type="checkbox"/> Refrigeration</li> </ul> | <p><b>Chemical Courses</b></p> <ul style="list-style-type: none"> <li><input type="checkbox"/> Chemical Engineering</li> <li><input type="checkbox"/> Chemistry, Analytical</li> <li><input type="checkbox"/> Chemistry, Industrial</li> <li><input type="checkbox"/> Chemistry, Mfg. Iron &amp; Steel</li> <li><input type="checkbox"/> Petroleum Refining</li> <li><input type="checkbox"/> Pulp and Paper Making</li> </ul> <p><b>Civil Engineering, Architectural and Mining Courses</b></p> <ul style="list-style-type: none"> <li><input type="checkbox"/> Architecture</li> <li><input type="checkbox"/> Building Estimating</li> <li><input type="checkbox"/> Civil Engineering</li> <li><input type="checkbox"/> Contracting and Building</li> <li><input type="checkbox"/> Highway Engineering</li> <li><input type="checkbox"/> Lumber Dealer</li> <li><input type="checkbox"/> Reading Structural Blueprints</li> <li><input type="checkbox"/> Sanitary Engineering</li> <li><input type="checkbox"/> Structural Drafting</li> <li><input type="checkbox"/> Structural Engineering</li> <li><input type="checkbox"/> Surveying and Mapping</li> </ul> <p><b>Communications Courses</b></p> <ul style="list-style-type: none"> <li><input type="checkbox"/> Electronics</li> <li><input type="checkbox"/> Prac. FM and Television</li> <li><input type="checkbox"/> Radio, General</li> <li><input type="checkbox"/> Telegraph Engineering</li> </ul> | <p><b>Electrical Courses</b></p> <ul style="list-style-type: none"> <li><input type="checkbox"/> Electrical Drafting</li> <li><input type="checkbox"/> Electrical Engineering</li> <li><input type="checkbox"/> Electric Light and Power</li> <li><input type="checkbox"/> Lighting Technician</li> <li><input type="checkbox"/> Practical Electrician</li> <li><input type="checkbox"/> Power House Electric</li> <li><input type="checkbox"/> Ship Electrician</li> </ul> <p><b>Internal Combustion Engines Courses</b></p> <ul style="list-style-type: none"> <li><input type="checkbox"/> Auto Technician</li> <li><input type="checkbox"/> Diesel-Electric</li> <li><input type="checkbox"/> Diesel Engines</li> </ul> <p><b>Mechanical Courses</b></p> <ul style="list-style-type: none"> <li><input type="checkbox"/> Aeronautical Engineer's, Jr.</li> <li><input type="checkbox"/> Aircraft Drafting</li> <li><input type="checkbox"/> Forging</li> <li><input type="checkbox"/> Heat Treatment of Metals</li> <li><input type="checkbox"/> Industrial Engineering</li> <li><input type="checkbox"/> Industrial Instrumentation</li> <li><input type="checkbox"/> Industrial Metallurgy</li> <li><input type="checkbox"/> Machine Shop</li> <li><input type="checkbox"/> Machine Shop Inspection</li> <li><input type="checkbox"/> Mechanical Drafting</li> <li><input type="checkbox"/> Mechanical Engineering</li> </ul> | <ul style="list-style-type: none"> <li><input type="checkbox"/> Mold-Loft Work</li> <li><input type="checkbox"/> Patternmaking—Wood, Metal</li> <li><input type="checkbox"/> Reading Shop Blueprints</li> <li><input type="checkbox"/> Sheet-Metal Drafting</li> <li><input type="checkbox"/> Sheet-Metal Worker</li> <li><input type="checkbox"/> Ship Fitting</li> <li><input type="checkbox"/> Toolmaking</li> <li><input type="checkbox"/> Welding—Gas and Electric</li> </ul> <p><b>Railroad Courses</b></p> <ul style="list-style-type: none"> <li><input type="checkbox"/> Air Brake</li> <li><input type="checkbox"/> Diesel Locomotive</li> <li><input type="checkbox"/> Locomotive Engineer</li> <li><input type="checkbox"/> Locomotive Fireman</li> <li><input type="checkbox"/> Locomotive Machinist</li> <li><input type="checkbox"/> Railroad Section Foreman</li> <li><input type="checkbox"/> Steam and Diesel Loco. Eng.</li> </ul> <p><b>Stationary Engineering Courses</b></p> <ul style="list-style-type: none"> <li><input type="checkbox"/> Boilermaking</li> <li><input type="checkbox"/> Combust. Engrg.</li> <li><input type="checkbox"/> Marine Engineering</li> <li><input type="checkbox"/> Power Plant Engr.</li> </ul> <p><b>Textile Courses</b></p> <ul style="list-style-type: none"> <li><input type="checkbox"/> Cotton Manufacturing</li> <li><input type="checkbox"/> Rayon Weaving</li> <li><input type="checkbox"/> Woolen Manufacturing</li> </ul> |
|---|--|---|--|

Name \_\_\_\_\_ Age \_\_\_\_\_ Home Address \_\_\_\_\_

City \_\_\_\_\_ State \_\_\_\_\_ Working Hours \_\_\_\_\_ A.M. to \_\_\_\_\_ P.M.

Present Position \_\_\_\_\_ Employed by \_\_\_\_\_

Length of Service \_\_\_\_\_ Enrollment under G.I. Bill approved for World War II Veterans. Special tuition rates to members of the Armed Forces.  
in World War II \_\_\_\_\_ Canadian residents send coupon to International Correspondence Schools Canadian, Ltd., Montreal, Canada.

# INVENTORS

If you consider your invention to be something of importance—if you have invented any new and useful art, machine, manufacture or composition of matter or improvement thereof—you are advised to protect your invention by applying for a U. S. patent.

A patent is a valuable right. It grants you a monopoly—the right to exclude others from making, using or selling your invention as claimed for a term of seventeen years.

The specification and claims of a patent, particularly if the invention be at all complicated, constitute one of the most difficult legal instruments to draw with accuracy. Therefore, unless you are thoroughly familiar with such matters, you are advised to employ a competent registered patent attorney or agent.

This firm is registered to practice before the U. S. Patent Office and is available to assist in the preparation and prosecution of your patent application.

The "Evidence of Invention" form mentioned below is offered as a convenience to you in making your disclosure to us for search purposes.

You should date and sign your disclosure and have it witnessed by two or more persons who are capable of understanding your invention.

Your disclosure should be mailed to us together with a letter authorizing us to conduct a preliminary

search among previously granted U. S. patents for similar types of invention.

We then make this search and prepare a report of the probable patentability of your invention. If such report is favorable, we recommend the further course for you to take.

The "Evidence of Invention" form and booklet are suggested as conveniences to you and us in starting action on your invention.

**VICTOR J. EVANS & Co.** *Merlin M. Evans*  
REGISTERED PATENT ATTORNEY

530-D MERLIN BUILDING, WASHINGTON 6, D. C.

We shall be glad to send you promptly and without obligation, an instructive booklet, "Patent Protection for Inventors", which was prepared to give inventors detailed information and steps to take toward patent protection—also our convenient "Evidence of Invention" form. Use address Victor J. Evans & Co., 530-D Merlin Building, Washington 6, D. C.

PATENTS COPYRIGHTS TRADEMARKS

# Command Bigger Money! STUDY LAW

STUDY AT HOME for BUSINESS SUCCESS and LARGER PERSONAL EARNINGS. 40 years expert instruction — over 114,000 students enrolled. LL.B. Degree awarded. All text material furnished. Easy payment plan. Send now for FREE BOOK — "Law and Executive Guidance." It explains the course — how you may enroll and the many ways you can profit from Law Study. Write TODAY to:

AMERICAN EXTENSION SCHOOL OF LAW  
Dept. 25-PM, 646 N. Michigan Ave., Chicago 11, Ill.

## REAL ESTATE

BE A BROKER

**PAYS BIG! SEND FOR FREE, BIG, ILLUSTRATED CATALOG NOW!** No obligation. Graduates report making substantial incomes. Start and run your own business quickly. Men, women of all ages, learn easily. Course covers Sales, Property Management, Appraising, Loans, Mortgages, and related subjects. **STUDY AT HOME** or in our classrooms in big cities. Diplomas awarded. G.I. approved. Nationally known.

WEAVER SCHOOL OF REAL ESTATE (Est. 1936)  
15 E. Pershing Road Dept. PM Kansas City, Mo.

FREE BOOK TELLS HOW

## LEARN WATCH REPAIRING



**AT HOME.** By our modern and original system of instruction you can learn every part of the **WATCH REPAIRING TRADE AT HOME.** Prepare yourself for a well-paying position or start in business after completing our course of instruction. Good watch repairers are in demand and generally earn very good salaries. For particulars apply to the **WISCONSIN SCHOOL OF WATCH REPAIRING** 759 North Milwaukee St., Milwaukee 2, Wis.



## LABORATORY TECHNICIAN

**BE A LABORATORY SPECIALIST;** complete course. Big demand from hospitals, doctors, clinics. We teach all branches of medical laboratory work, including **Medical and Dental X-Ray.** Approved by **American College of Medical Technologists** Co-educational Free Placement Bureau Free Catalog Accredited for "veteran" training

**CHICAGO COLLEGE OF LABORATORY TECHNIQUE**  
Dept. P.M., 431 S. Wabash Ave. Chicago 5, Illinois



## MAKE MONEY!

RAISE CHIN-CHIN CHINCHILLA RABBITS

Pedigreed! Valuable Breeders!  
PROFITABLE! EASY! PLEASANT!  
Free Illustrated Booklet — WRITE TODAY!  
SELLERSVILLE 36, PA.

ROCK HILL RANCH

## Enjoy a hobby that's fun!

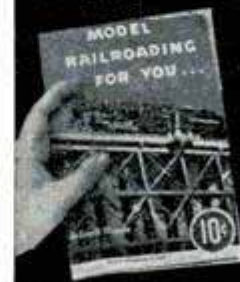

Get this picture-packed book on Model Railroading now!

• It's simple — this book will tell you how you can have your own railroad in your basement, attic, or even a corner. It's inexpensive — surprisingly little money is needed. It's constructive — hobbyists from 17 to 70 spend absorbing hours with the world's fastest-growing hobby.

Fully illustrated — this book explains how you, too, can start. Send 10c today for your copy of "Model Railroading for You," written by a well-known authority. **MODEL RAILROADER MAGAZINE, DEPT. 1540, Milwaukee 3, Wis.**

# THESE MEN ARE GETTING PRACTICAL TRAINING IN **ELECTRICITY**



*On Real:*

**A.C. and D.C. MOTORS  
GENERATORS  
SWITCHBOARDS  
CONTROLLERS  
WIRING JOBS  
APPLIANCES  
ELECTRONIC UNITS**

*(Shown at left—Instructor demonstrating latest type of Test Unit for checking the efficiency of a Motor.)*

# AND **RADIO-TELEVISION**

*On Real:*

**TELEVISION SETS  
RADIO RECEIVERS  
F.M. (Frequency Modulation)  
RECORD CHANGERS  
AUTO RADIOS  
AIRPLANE RADIOS  
PUBLIC ADDRESS Systems**

*(Right—Instructor explaining operation of 20-inch Cathode Ray tube used in Dumont Television Set.)*



## Just Like YOU Can Get in the Great SHOPS of COYNE

Prepare NOW for a real future the quick, practical way. Come to the Great Shops of COYNE in Chicago. Largest and best equipped school of its kind—now celebrating our 51st Anniversary. GI approved. Finance plan for non-veterans. **Mail coupon.**

**NOT "HOME-STUDY" COURSES!** At Coyne you learn on real, full-size equipment. Trained instructors show you how, then you do typical jobs yourself. We don't teach by mail.

**CLIP COUPON NOW** for big new illustrated Coyne book on either **ELECTRICITY** or **RADIO-TELEVISION** or both. No obligation; no salesman will call. Get the facts now!

**B. W. COOKE, Pres.  
ELECTRICAL & RADIO-TELEVISION SCHOOL**

500 S. Paulina St., Dept. 40-72H  
Chicago 12, Ill.

**COYNE**



**Mail Coupon for  
FREE BOOKS!**



B. W. COOKE, President  
COYNE ELECTRICAL &  
RADIO-TELEVISION SCHOOL  
500 S. Paulina St., Chicago 12, Ill. Dept. 40-72H

Send FREE, the book checked below, and details of your training offer. This does not obligate me and no salesman will call.

ELECTRICITY       RADIO-TELEVISION

NAME .....

ADDRESS .....

CITY.....STATE.....

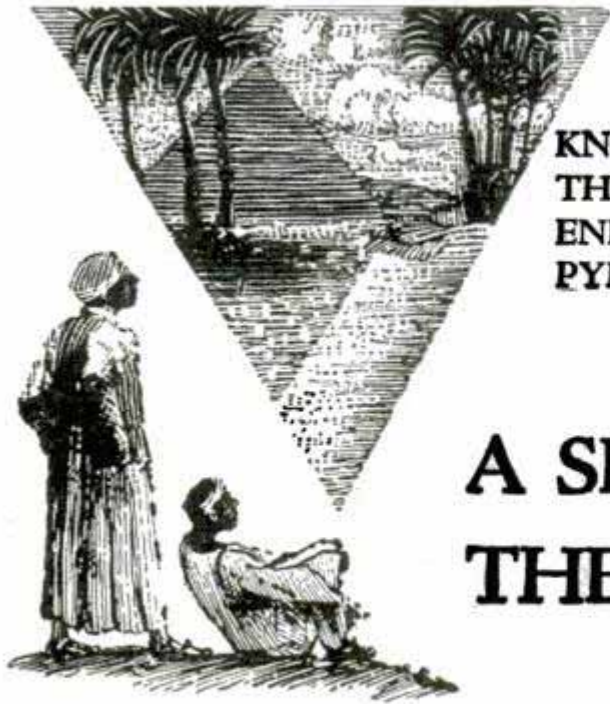

**KNOWLEDGE  
THAT HAS  
ENDURED WITH THE  
PYRAMIDS**

## **A SECRET METHOD FOR THE MASTERY OF LIFE**

**W**HENCE came the knowledge that built the Pyramids and the mighty Temples of the Pharaohs? Civilization began in the Nile Valley centuries ago. Where did its first builders acquire their astounding wisdom that started man on his upward climb? Beginning with naught they overcame nature's forces and gave the world its first sciences and arts. Did their knowledge come from a race now submerged beneath the sea, or were they touched with Infinite inspiration? From what concealed source came the wisdom that produced such characters as Amenhotep IV, Leonardo da Vinci, Isaac Newton, and a host of others?

Today it is known that they discovered and learned to interpret certain *Secret Methods* for the development of their inner power of mind. They learned to command the inner forces within their own beings, and to master life. This secret art of living has been preserved and handed down throughout the ages. Today it is extended to those who dare to use its profound principles to meet and solve the problems of life in these complex times.

### **This Sealed Book—FREE**

Has life brought you that personal satisfaction, the sense of achievement and happiness that you desire? If not, it is your duty to yourself to learn about this rational method of applying natural laws for the mastery of life. To the thoughtful person it is obvious that everyone cannot be entrusted with an intimate knowledge of the mysteries of life, for everyone is not capable of properly using it. But if you are one of those possessed of a true desire to forge ahead and wish to make use of the subtle influences of life, the Rosicrucians (not a religious organization) will send you **A Sealed Book** of explanation without obligation. This Sealed Book tells how you, in the privacy of your own home, without interference with your personal affairs or manner of living, may receive these secret teachings. Not weird or strange practices, but a rational application of the basic laws of life. Use the coupon, and obtain your complimentary copy.

## **The ROSICRUCIANS**

SAN JOSE

(AMORC)

CALIFORNIA



**AMENHOTEP IV**  
Founder of Egypt's  
Mystery Schools

*Use this  
coupon for  
FREE  
copy of book*

-----  
SCRIBE R.A.C.  
The Rosicrucians (AMORC)  
San Jose, California

Please send free copy of Sealed Book,  
which I shall read as directed.

NAME.....

ADDRESS.....

CITY.....



GET INTO

# DIESEL-AUTO MECHANICS

Master All Phases

**JOBS LIKE THESE ARE AVAILABLE TO TRAINED MECHANICS. CHOOSE THE FIELD YOU LIKE BEST**

### Get Complete Training

Diesel Fuel Injection  
 Automotive Motor Tune-up  
 Diesel Engine Rebuilding  
 General Garage Mechanic  
 Agricultural Implements  
 Auto Engine Rebuilding  
 Auto Elec. Service  
 Public Utilities  
 Parts Dealers  
 Bus & Truck Lines  
 Industrial Maintenance  
 Contracting & Excavating  
 Business of Your Own  
 AND MANY other similar openings.

As a National Schools graduate, you are trained for ALL opportunities in the Diesel & Auto Industries

### EARN WHILE YOU LEARN

With our practical Master Shop-Method Home Training, you study at home in your spare time. You receive Spare Time Work Lessons, which show you how to earn while you Learn . . . for extra money and experience. You Learn by DOING.

### TOOLS AND EQUIPMENT

To make your training complete, we give you selected mechanic's tools and equipment, illustrated below, including all-metal toolbox — as a regular part of your instruction.

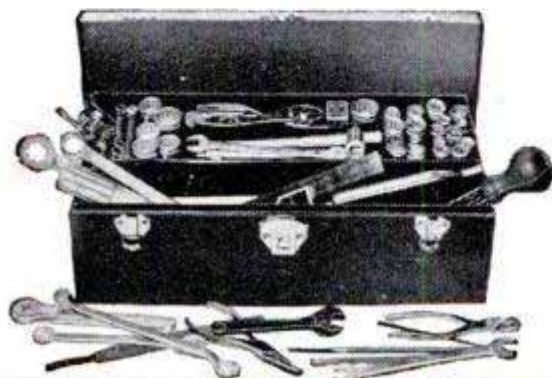

**WE GIVE YOU TOOLS OF YOUR TRADE**



### Shop-Method Home Training by an Established Resident School Prepares you for Many Good Jobs

Opportunity is everywhere for the trained Diesel-Auto Mechanic. Highways throng with cars, busses, trucks, tractors. Garages and Service Stations are kept busy. Factories, ships, farms, railroads, general industry, are dependent upon engine power. Here's a dynamic, fast-growing field that needs trained men who know ALL phases: installation, operation, maintenance and repair. Now—National Schools offers you a practical, all-embracing Diesel-Auto Mechanic's Course, including all of these advantages:

### Complete training, covering—Diesels, High Speed and Heavy Duty; Semi-Diesels, Gasoline and Special Fuel Engines AND Allied Mechanics,

- Basic Lesson Texts
- Diesel Installation
- Operation - Maintenance
- Diesel Chart Manual
- Spare Time Lessons
- Engine Service Manuals
- Engine Repair
- Drive Systems
- Diesel Electric Power
- Thermodynamics

### TOOLS AND EQUIPMENT

INVESTIGATE  
Secure Full Information

**NEW, ILLUSTRATED BOOK & SAMPLE LESSON SHOW HOW WE TRAIN YOU . . . SEND FOR THEM TODAY!**



NO COST

NO OBLIGATION

APPROVED FOR VETERANS

Check coupon below

## NATIONAL SCHOOLS

LOS ANGELES 37, CALIF. • EST. 1905



### FIND OUT NOW... MAIL COUPON TODAY

NATIONAL SCHOOLS, DEPT. PMD-4  
4000 South Figueroa Street  
Los Angeles 37, California

(Mail in envelope or paste on penny postcard)

Mail me FREE the book, YOUR FUTURE IN DIESEL-AUTO MECHANICS, together with the Sample Lesson. I understand I may keep and use the information with no obligation.

Name \_\_\_\_\_ Age \_\_\_\_\_

Address \_\_\_\_\_

City \_\_\_\_\_ Zone \_\_\_\_\_ State \_\_\_\_\_

Check here if Veteran or World War II

# Lots of DIESEL

IN THE PACIFIC NORTHWEST



Yes, DIESEL is BIG business in Oregon, Washington, and adjoining states where industries and populations are growing so incredibly fast.

**DIESEL IS THE KING OF POWER** . . . on our railroads, highways, waterways and in our industries.

**MEN WHO ARE** equipped with the thorough training they get at the **ADCOX SCHOOL**, are prepared for a splendid future in the great Northwest. A fine place to live and enjoy life.

**NEWEST FACILITIES AND EQUIPMENT**, Advanced Instruction Methods by highly paid, Expert Instructors, combined with my 40 YEARS of trade school experience, enable me to turn out **REAL DIESEL ENGINE TROUBLE SHOOTERS**. When you receive your Adcox Diploma you are ready to begin your career in Diesel.



L. L. ADCOX, President

**I PRODUCE DIESEL MEN IN 3 SHORT MONTHS**

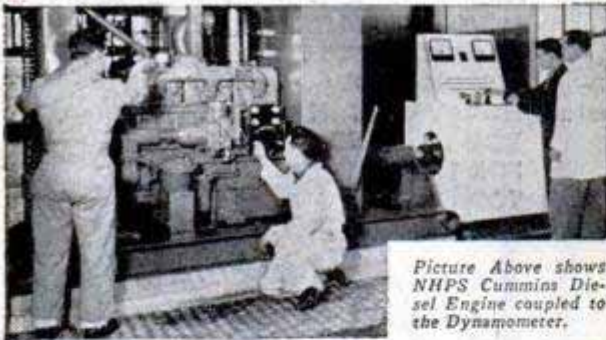

Picture Above shows NHPS Cummins Diesel Engine coupled to the Dynamometer.

**YOU LEARN ENGINE CONSTRUCTION FROM THE GROUND UP.** Special laboratory for Injection, Fuel Pumps, Nozzles and Governors. Trouble Shooting under full Dynamometer Load (as shown in picture).

This kind of training puts ADCOX out in front!

**CLASSES LIMITED** — Latest type equipment (no obsolete engines). Skilled Instructors — combine to insure best possible training. You learn Diesel **RIGHT**, and you learn it **FAST** . . . in this Nationally Famous School!

APPROVED FOR VETERANS

**DIESEL SCHOOL CATALOG FREE**

L. L. ADCOX, President  
**ADCOX SCHOOL**  
237 N. E. Broadway, Portland 12, Oregon

Without obligation, send **FREE** Catalog No. PM

Name \_\_\_\_\_

Address \_\_\_\_\_

Town \_\_\_\_\_

State \_\_\_\_\_

If World War II Veteran, Check Here



## Tells How You Can Learn to MOUNT BIRDS!



**FREE BOOK**

**Learn At Home**  
Men, Boys, Hunters, Fishermen, mount and save your lovely wild-game trophies. Be a Taxidermist. Mount Birds, Animals, Heads, Fish, Tan skins. YOU learn easily, quickly in spare time. Have a grand home-museum. The finest and the greatest hobby known, for sportsmen. Fun, real profits.

## FREE BOOK

Yes, **FREE**, Beautiful strange, valuable **Book**, telling all about Taxidermy. Contains over 100 beautiful game-pictures. And it's yours **FREE**, if you rush your request. You can mount all kinds of wild-game, and common specimens too. We can positively **TEACH YOU**. So **GRASP** this opportunity. **RUSH** letter or postal for this amazing **FREE BOOK**. Don't delay. State your **AGE**. **N. W. SCHOOL OF TAXIDERMY, 2504 Elwood Bldg., Omaha 2, Neb.**

## Save Your Feet



Thousands relieved from pain walk freely with **HEEFNER ARCH SUPPORTS**. Write for Free Booklet "FOOT FACTS"

## EASY TO LEARN CODE

Learn or increase speed with an Instructograph — the Radio-Telegraph Code Teacher that takes the place of an operator-instructor and enables anyone to master code without further assistance. Available tapes from beginners alphabet to typical messages on all subjects. Speed range 5 to 40 WPM. Always ready — no QRM. Thousands have "acquired the code" with the Instructograph System. Write today for convenient rental and purchase plans.



**INSTRUCTOGRAPH COMPANY**

4701-V Sheridan Road, Chicago 40, Illinois

## BE A LOCKSMITH

**LEARN LOCKSMITHING and KEYSMAKING from EXPERTS in YOUR SPARE TIME at HOME!**

Locksmiths in big demand! No layoffs, no slow seasons! Age or physical handicap no disadvantage. Year-round, steady income in this permanent, respected field. Full or part time. Practical, illustrated lessons show you how to make money even while learning! All materials and special tools supplied. Send for **FREE BOOKLET**.

**INSTITUTE OF LOCKSMITHING, Dept. P-5**  
55 Park Ave., Rutherford, N. J.

## CARPENTRY BRICKLAYING

APPROVED FOR VETERAN TRAINING • **FREE CATALOG**  
**PENNSYLVANIA INSTITUTE SCHOOL OF TRADES**  
30th & MARKET STS. PHILA. 4, PENNA.

## How to Make Money with Simple Cartoons



A book everyone who likes to draw should have. It is free; no obligation. Simply address **FREE BOOK**

**CARTOONISTS' EXCHANGE**  
Dept. 94-D Pleasant Hill, Ohio

## Learn BAKING At Home

Baking is one of America's high industries in wages. Nearly depression-proof. Thorough basic home course lays sound foundation. If you have aptitude, write for **FREE BOOKLET**, "Opportunities in Commercial Baking." **National Baking School, 1315 Mich. Ave., Dept. 1354, Chicago 5**



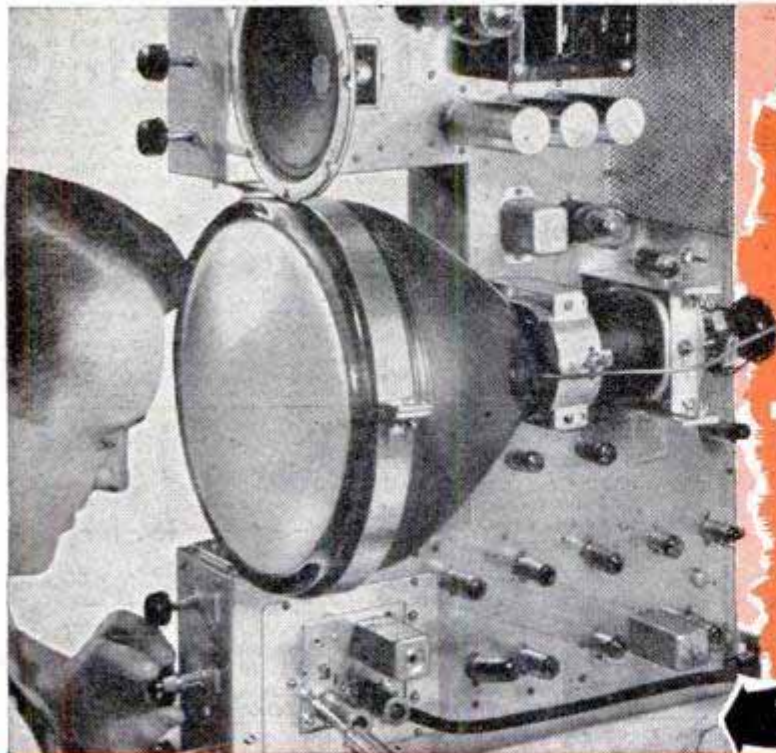

Only D.T.I.  
offers you the  
**"BIG 5"**  
**TELEVISION**  
RADIO-ELECTRONICS  
Laboratory Type  
**HOME TRAINING**

Build and Keep 10, 12½ or 16 inch Picture Tube Quality TELEVISION RECEIVER as you prepare for a Profitable Future

Here is everything you need to prepare you at home for FASCINATING WORK, GOOD MONEY and a THRILLING FUTURE in one of America's most promising fields.

This includes the opportunity to build and keep the top quality Television Receiver shown above—with choice of a 10, 12½ or 16 inch picture tube that gives big, bright, sharp, steady pictures. This is an optional feature—available when you complete your training described below. Get the complete facts. See how D.T.I.'s wonderfully practical "BIG 5" method meets industry's needs: No previous experience needed. Mail coupon today!

**16 Big Shipments of Parts — Plus Lessons**

Work over 300 electronic experiments and projects from 16 big shipments of parts. This includes building and keeping all test equipment and radio set shown at left side of page. Modern easy-to-read lessons with handy fold-out diagrams simplifies your entire training.

**You Also Use Home Movies**

D.T.I., alone, includes the modern, visual training aid . . . MOVIES to help you learn faster, easier at home. See electrons on the march and other fascinating "hidden action"—a remarkable home training advantage that speeds your progress.

**EMPLOYMENT SERVICE**

When you complete your training, our effective Employment Service helps you get started toward a real future in Television-Radio-Electronics.

**Modern Laboratories**

If you prefer, you can get ALL your preparation in our new, Chicago training laboratories . . . one of the finest of its kind. Ample instructors . . . modern equipment. Write for details!

6 Tube  
Radio  
Receiver

OPTIONAL  
FEATURE

You Learn-By-Doing  
from D.T.I.'s  
HOME LABORATORY



You Learn-by-Reading  
from D.T.I.'s MOD-  
ERN LESSONS



R-F Signal  
Generator

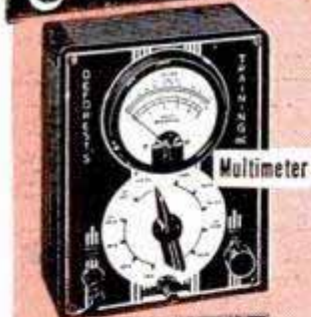

Multimeter



Oscilloscope



6 Tube  
Radio  
Receiver

**DeFOREST'S TRAINING, INC.**

Chicago 14, Illinois  
A DeVry Institution

**MAIL THIS COUPON TODAY!**

DeFOREST'S TRAINING, INC. PM-G-4  
2533 North Ashland Avenue,  
Chicago 14, Illinois.

Without obligation, give me complete facts showing how I may make my start in Television-Radio-Electronics.

Name \_\_\_\_\_ Age \_\_\_\_\_

Street \_\_\_\_\_ Apt. \_\_\_\_\_

City \_\_\_\_\_ Zone \_\_\_\_\_ State \_\_\_\_\_

# FREE

get it now—

## ALLIED'S 1950 TV & RADIO CATALOG!

196 PAGES OF BIG VALUES

EVERYTHING IN RADIO AT LOWEST PRICES



Send for **Radio's Leading Buying Guide**

Save money on every radio need! Get the new 196-page 1950 ALLIED Catalog, preferred and used by everyone in radio. See the world's largest stocks of top-quality equipment, all at low, money-saving prices! Latest TV releases, home radios and radio-phonos, Amateur equipment, PA systems and High-Fidelity Sound, recorders, test instruments, builders' kits—plus thousands of parts, tubes, tools, books and diagrams. Have all the advantages of quick delivery, complete selections, big savings and expert personal help from the World's Largest Radio Supply House. Send today for your FREE copy of the 1950 ALLIED Radio Buying Guide!



TELEVISION AND HOME RADIOS



SERVICE SUPPLIES BUILDERS' SUPPLIES



AMATEUR GEAR



AMPLIFIERS, P.A. SYSTEMS, RECORDERS

## ALLIED RADIO

ALLIED RADIO CORP.  
833 W. Jackson Blvd., Dept. 5-DD-0  
Chicago 7, Illinois

Rush FREE 1950 ALLIED Catalog

Name .....

Address .....

City.....Zone.....State.....

FREE CATALOG

## Learn WATCH REPAIRING

Earn while AT HOME you Learn

Learn this fascinating and profitable trade in your spare time at Home through our Correspondence Department. Each individual student receives individual attention! Post-Graduate course at resident school optional for correspondence students. OUR MOTTO: Not how quickly, OR how thoroughly we can train you.

### AT OUR RESIDENT SCHOOL

APPROVED FOR G. I. TRAINING

Our school is set up on an individual basis where every student receives individual attention from our competent instructors in a home-like and cheerful atmosphere.

Write TODAY FOR FREE INFORMATION: JOHN VAN PUFFELEN, Director  
American Institute of Specialized Watch Repair  
270-276 East Bldg., Grand Rapids 6, Michigan

### WHAM-O SPORTSMAN

\$1.00 postpaid

HITS LIKE A .22 RIFLE — KILLS RABBITS, SQUIRRELS. For Hunting, Target, Roving Pests.



### HUNTING SLINGSHOT

Powerful, silent, accurate.

Complete with 40 pellets and extra rubber straps. Send \$1.00 today to—Wham-O Mfg. Co., Box 2P, South Pasadena, Calif. PROFESSIONAL MODEL OF THE NATL SLINGSHOT ASSN.

Dealers Write

HEAVY DUTY STOCK

## RAZOR BLADE BARGAIN

Buy your double-edge razor blades retail at wholesale prices. Made of fine surgical steel and precision ground. GUARANTEED—complete satisfaction or your money refunded. Order yours today—introductory offer 100 blades for only \$1.25.

MYLONO AGENCY, P. O. Box 59, Bronx 53 N. Y.

## LEARN TO WRITE

a Good Hand!

FOR BUSINESS AND SOCIAL SUCCESS!

Easy to improve your handwriting at home quickly with my new instruction books just off the press. Master all the secrets of better penmanship. Simple and easy, fully illustrated, highly endorsed. Begin today. Write for:  New Free Book, "How to Become a Good Penman," or check books wanted, \$1.00 each.  Business Writing  Artistic Writing  Card Writing  Engraving Alphabets  Bird and Design Flourishing  Complete Set \$4.50  Enclose 10c for your name beautifully written and special penpoint for shaded writing.

S. A. Ziller, President, TAMBLYN SCHOOL OF PENMANSHIP, 441 Ridge Bldg. In Business Over 52 Years Kansas City, Mo., U.S.A.

## FREE BERRY'S NEW POULTRY BOOK



BABY CHICKS or STARTED. Champion-Mated, Licensed-Inspected, B.W.D. TESTED, 52 BREEDS, 7 CROSSES. Sexed or straight, Mature fowls, Hatching Eggs and Remedies. LOW PRICES. The ORIGINAL Berry's Farm—over 50 years' service. LARGE BEAUTIFUL BOOK FREE. Stamps appreciated. BERRY POULTRY FARM, Bx. 29, CLARINDA, IOWA

## X.L. RUBBER MOLDS

will realize you great profits quickly!

WRITE FOR NEW FREE CATALOG

GREAT PROFITS MAKE YOUR OWN RUBBER MOLDS

YOU can EASILY learn to cast thousands of perfect plaques, book ends, figurines, ash trays, etc. IT'S EASY, FUN, PROFITABLE! X.L. Rubber, Pts. \$2.00; Qts. \$3.50; Gallons \$8.95; Models and enough rubber for 3 molds \$1.50 postpaid.



SEND FOR FREE FACTS

PLASTIC ARTS STUDIO Address Dept. 2 3403 S. Madison St.,

Muncie, Ind.

NATION'S LARGEST EXCLUSIVE ELECTRICAL SCHOOL

## "LEARN-BY-DOING" ELECTRICITY

PRACTICAL TRAINING NOT "HOME STUDY"

G.I. APPROVED

Get actual experience in great shops of M.T.I. Learn all phases Practical Electricity; Housewiring, Motors, Const., Maintenance, etc. Living arrangements, Part-time jobs, etc.

A post card brings the story, MICHIGAN TECHNICAL INSTITUTE, Dept. PM-4 2281 W. Fort St., Detroit 16, Michigan

SAY YOU SAW IT IN POPULAR MECHANICS

## Learn PHOTOGRAPHY at Home

Splendid opportunities. Prepare in spare time. Practical basic training. Long-established school. Send for free book, "Opportunities in Photography." No obligation.

AMERICAN SCHOOL OF PHOTOGRAPHY 1315 S. MICHIGAN AVE. Dept. 1354 CHICAGO 5, ILL.



**FREE 7-DAY TRIAL!**  
Return and Pay Nothing  
If Not Completely Satisfied

**MOTOR'S  
AUTO  
REPAIR  
MANUAL**

Now Any  
**AUTO REPAIR JOB**  
Can Be "Duck Soup" For You!



See How to Repair—Quickly and Easily—Any Car Built Since 1935! Over 200,000 Service and Repair Facts—More than 2100 "How-to-Do-It" Photos, Drawings, Diagrams! Over 200 "Quick-Check" Tables! 800 Pages of Easy, Step-by-Step Instructions!

HERE'S the huge, illustrated "How-to-Do-It" volume you NEED to "whiz through" any service or repair job on any make or model car built from 1935 thru 1949! Save work on those "ornery" jobs that can be such a "headache!" Make MORE money by doing more jobs in LESS time!

Whether you're a trained specialist or a beginner mechanic, you'll quickly get the "know-how" from MoToR's Auto Repair Manual. Just look up the make, model and job in the Instant-Reference Index. Then go to it! Easy step-by-step pictures make every operation "duck soup" for you!

**LIKE 150 SHOP REPAIR MANUALS IN ONE!**

Here, in detailed "Quick-Reference" tables and concise "How-to-Do-It" words and pic-

tures, are the official facts and instructions you MUST HAVE to tune up, service or repair any car! Priceless help that saves you "guess-work"—eliminates trial and error!

Factory engineers from every automobile plant in America worked out these time-saving standard procedures for their own motor car line. Now the editors of MoToR have gathered together this wealth of "Know-How" from over 150 Official Factory Shop Manuals, "boiled it down" into clear, readable terms in one handy, indexed book!

**EVERYTHING YOU'LL NEED TO KNOW**

MoToR's Manual takes nothing for granted. Starts at the very beginning; tells you how to identify all 697 car models. More than 2100 easy-to-follow Photos, Drawings, and Diagrams guide you step-by-step right through each operation. 800 big, readable pages are crammed with Factory Specifications and Adjustment Tables, Tune-up Charts, Tables of Measurements and Clearances, Overhauling and Replacement facts, and Much MORE!

**SEND NO MONEY**

Just mail coupon! When the postman brings book, pay him nothing. First, make it show you what it's got! Unless you agree this is the greatest time-saver and work-saver you've ever seen—return book in 7 days and pay nothing. Mail coupon today! Address: MoToR Book Dept. Desk 1D, 250 West 55th Street, New York 19, N. Y.

- Used By U. S. Army and Navy
- COVERS ANY CAR BUILT SINCE 1935!**
- |              |         |
|--------------|---------|
| American     | Cord    |
| Bantam       | Crosley |
| Auburn       | De Soto |
| Austin       | Dodge   |
| Buick        | Ford    |
| Cadillac     | Frazer  |
| Chevrolet    | Graham  |
| Chrysler     | Hudson  |
| Hupmobile    |         |
| Kaiser       |         |
| Lafayette    |         |
| La Salle     |         |
| Lincoln      |         |
| Lincoln      |         |
| Zenith       |         |
| Mercury      |         |
| Nash         |         |
| Oldsmobile   |         |
| Packard      |         |
| Pierce Arrow |         |
| Plymouth     |         |
| Pontiac      |         |
| Reo          |         |
| Studebaker   |         |
| Terraplane   |         |
| Willys       |         |



ABOVE: Showing operation of Buick Dyna-Flow — and, BELOW: How to adjust Ford Clutch. Every moving part is covered in simple words and BIG, CLEAR 8 1/2" x 11" Pictures.

**Just 2 of the Many Letters of Praise**



"MoToR's Manual paid for itself on the first 2 jobs, and saved me valuable time by eliminating guesswork." — **W. SCHROP, Ohio**



"Instructions so clear have no trouble learning anything about any car. Now working as mechanic in big plant." — **SAM ORDONEZ, Cal.**

**MAIL COUPON NOW FOR 7-DAY FREE TRIAL**

**MoToR BOOK DEPARTMENT**  
Desk 1D, 250 West 55th Street, New York 19, N. Y.

Rush to me at once: (Check box opposite book you want)

MoToR's AUTO REPAIR MANUAL. If O.K. I will remit \$1 in 7 days, (plus 35c delivery charge), then \$2 monthly for 2 months, and a final payment of 95c a month later. Otherwise I will return book postpaid in 7 days. (Foreign price, remit \$8 cash with order.)

MoToR's TRUCK REPAIR MANUAL. (Described at left.) If O.K. I will remit \$2 in 7 days, and \$2 monthly for 3 months, plus 35c delivery charge with final payment. Otherwise I will return book promptly. (Foreign price, remit \$10 cash with order.)

Print Name.....Age.....

Print Address.....

City & Zone No.....State.....

SAVE 35c delivery charge by enclosing WITH COUPON check or money order for full payment of \$5.95 for Auto Manual (or \$8.00 for Truck Manual). Same return-refund privilege applies.

**Same FREE Offer on MoToR's TRUCK MANUAL**  
Covers EVERY job on EVERY truck made from 1936 thru 1946. 1400 pictures, 952 pages, 300,000 facts. Gasoline Engines, Truck Diesels, Hesselmans, Fuel Systems, Governors, Lubrication, Ignition, Starters, Clutches, Axles, Brakes, etc.

ALSO covers many buses, tractors, contractor and road building equipment, stationary power machinery. Check box in coupon.



**MoToR** Published by MoToR, The Leading Automotive Business Magazine.

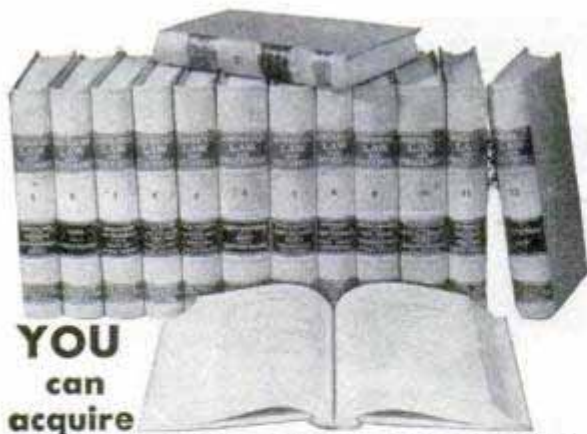

**YOU  
can  
acquire**

## **LAW NIGHTS AT HOME!** **L. L. B. DEGREE**

LaSalle's famous Law Library—used as reference in many Law libraries and Law offices—has enabled thousands to master Law surprisingly fast, in spare hours at home, for business and professional advancement.

These 14 remarkable volumes, compiled by leading professors and lawyers, cover the whole basic field of Law in condensed, orderly, simplified manner.

You advance rapidly with this great library, plus special lectures furnished. We guide you step-by-step with personalized Problem Method of instruction . . . you learn by doing—handling legal problems—not by memorizing rules.

Send for two FREE 48-page booklets, "Law Training for Leadership," and "Evidence," answering questions about Law and its value to you, and telling how LaSalle Law graduates are winning rapid advancement in business and public life. Mail coupon below. No obligation.

### **LA SALLE EXTENSION UNIVERSITY** *A Correspondence Institution*

417 S. Dearborn St., Dept. 464-L, Chicago 5, Ill.

Send me your two FREE booklets described above, without obligation.

Name.....Age.....

Street.....

City, Zone & State.....

## **BIG PAY JOBS**

for men who qualify in

# **DIESEL**

**ASSURE YOUR FUTURE.** Steady, high-pay jobs await men qualified in Diesel, Tractor, and Heavy Equipment. Are you qualified for job and advancement opportunities in this fast-growing field? You can qualify!

**COMPLETE DIESEL COURSE NOW AVAILABLE.** If you are ambitious and want to get ahead in this big money field, you'll want to know about the complete Diesel home training course now offered by Interstate Training Service. Covers all phases of operation, repair, service. Easy to master in spare time. No interference with present job. Up-to-the-minute. Regularly revised to cover new developments. We invite comparison of material offered. Free placement advisory service.



**YOU OWE IT TO YOURSELF** to investigate Interstate Training Service Diesel Training. Thousands agree it has helped them to better jobs—better pay. It can do the same for you!

**SEND FOR FREE BOOK TODAY!**

INTERSTATE TRAINING SERVICE, Portland 13, Ore.  
Please see that I receive FREE 24-page book, (K-4)  
"Getting Ahead in Diesel."

NAME.....AGE.....  
ADDRESS.....  
CITY.....ZONE.....STATE.....

## **BOOK WORTH \$3,500**



**FREE!**  
READING OFFER

**A YEAR  
TO YOU!**

## **BIG PAY JOBS WAITING**

for High School Graduates. Big 1250 page book shows you how to qualify quickly in only 15 minutes a day spare time reading! Records prove High School Graduates average \$3500, a year more than untrained men and women. "High School Subjects Self Taught" makes it easy to learn more and earn more. No tedious study, but fascinating reading. No class room examinations. You "Pass" Yourself! Write now! Get Book that can mean a small fortune to you.

**SEND NO MONEY.** Pay postman \$9.95 plus postage, or send money order or check and book will be sent postpaid. Read book for 5 days. Show friends, High School Teachers, Students. If you don't agree this Book is best investment you ever made, return for full refund by next mail.

Mail order today and we'll include FREE 150-page book of study material to help you take and pass test for a **HIGH SCHOOL EQUIVALENCY DIPLOMA** (legally equivalent of diploma issued upon graduation after four years' high school), now possible without high school attendance, in practically every State. Don't delay. Send order now to: NATIONAL SELF-STUDY INSTITUTE, INC., 90-61 Sutphin Boulevard, Jamaica 2, N. Y.

## **LEARN TO MOUNT BIRDS**



### **ANIMALS, FISH, PETS**

Be a Taxidermist. Save your hunting TROPHIES. Have a fine home-museum. Hunters, save and MOUNT your beautiful DUCKS, QUAIL, DEER, TAN skins, FURS. Great Fun. Spare-time PROFIT. **FREE BOOK** Tells ALL about it. 100 fine wild-game pictures. 48 pages. SEND TODAY, don't delay. Get this WONDERFUL FREE BOOK, MEN AND BOYS. Learn Taxidermy. Double your hunting pleasure. Rush letter or POSTAL today. STATE YOUR AGE. N. W. SCHOOL OF TAXIDERMY, Dept. 2564, Omaha, Neb.

## **WELDING SHOP**

### TRAINING

G. I. APPROVED—GAS AND ARC

Classes start on Monday each week. Payment Plan for Non-Vets. Welders needed in practically every industry—train for a field where you have greater assurance of Steady Work, Good Pay. Write for Free Information.

**A & S VOCATIONAL WELDING SCHOOL**

1212 E. 63rd Street, Dpt. PM-4, Chicago, Illinois

## **HOMESITES \$300 LOW TERMS**

In California's loveliest Garden Spot, on scenic shores of beautiful Morro Bay. Enjoy future independence with excellent soil, soft water, wonderful fishing, hunting, boating, bathing, etc. Grow fruits, vegetables, poultry. Perfect temperate climate. Congenial community. Finest investment. Free literature.

**RICHARD S. OTTO**

DEPT. M SAN LUIS OBISPO, CALIFORNIA

## **NEW! LOW COST! RESPIRATOR**

Wear when sanding, grinding, paint spraying, sweeping, dusting, furnace cleaning, etc. Handy as a pair of glasses. Just keep mouth closed and breathe through nose is all you do to operate. Protects against nuisance dusts, lint, coal, cement, grain dust, hay fever pollen, Haze 2 sq. in. filter. For EYE protection against paint spray, dusts, gases, fumes, smoke, order our Fog-Proof Rubber GOGGLES \$1.65 p.p. (All prices postpaid in U.S.A.)



JERRY BRYANT, Dept. PM  
919 N. Michigan Ave. Chicago 11, Ill.

Order Today \$1.00 POST PAID

## **CHEMISTRY**

**LEARN AT HOME...** Chemical knowledge is essential for thousands of good jobs in industry, business, science. IPC enables you to master practical chemistry. It's the ONLY home study chemistry course which enables you to learn by performing actual experiments—using chemicals and apparatus supplied with the course—in addition to your IPC textbook studies. Compares with recognized college courses in General Chemistry. Write today for free descriptive booklet.

**INSTITUTE OF PRACTICAL CHEMISTRY**  
3 PROSPECT AVENUE, HAGERSTOWN, MD.



Get  
Into

# TELEVISION, RADIO ELECTRONICS

Master ALL Phases



YOU RECEIVE THIS  
PROFESSIONAL MULTITESTER  
YOU BUILD ALL THESE AND  
MANY OTHER UNITS WITH  
PARTS WE SEND YOU!

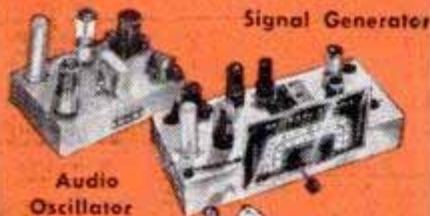

Signal Generator

Audio  
Oscillator

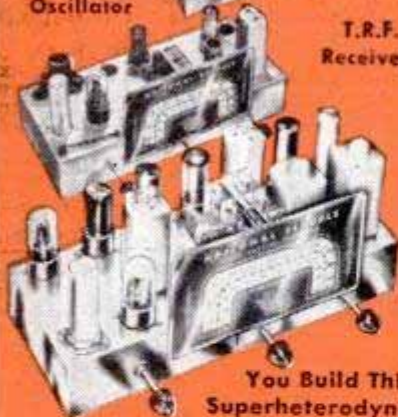

T.R.F.  
Receiver

You Build This  
Superheterodyne

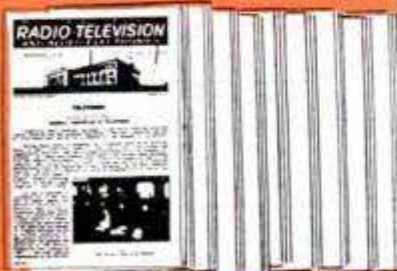

You Receive a Special Series  
of Modern Lessons in TELE-  
VISION, all a part of your  
course: you master all phases.

**Get Complete Training. You Receive and Keep All  
Tubes, Equipment, Parts and Lessons. No Extra Charges.**

**GOOD PAY  
and Unlimited Opportunities  
in JOBS LIKE THESE:**

Business of Your Own  
Radio Manufacturing, Sales, Service  
Broadcasting Telecasting  
Television Manufacturing,  
Sales, Service  
Laboratories: Installation, Mainte-  
nance of Electronic Equipment,  
Electrolysis, Call Systems  
Garages: Auto Radio Sales, Service  
Sound Systems and Telephone Com-  
panies; Oil Well and Drilling  
Companies; Engineering Firms  
Theatre Sound Systems Police Radio  
And scores of other good jobs  
in many related fields

**YOU CONDUCT MANY  
EXPERIMENTS LIKE THESE!**

Checking action of condensers  
Experiments with AF and RF ampli-  
fiers.  
Experiments with resonance  
Producing beat frequencies  
Calibrating oscillators  
Experiments with diode, grid-bias, grid-  
leak and infinite impedance detectors  
Practical experience in receiver trouble  
shooting  
Application of visual tester in check-  
ing parts and circuits  
Experiments with audio oscillators  
Advanced trouble-shooting  
... and many, many others

**Complete Training by Practical  
Resident Trade School, Est. 1905**

The same highly trained faculty, in-  
struction materials and methods used  
here in our large, modern resident  
school, are adapted to your training  
in your own home. Shop Method Home  
Training has been proved by hundreds  
of successful graduates.

**Both Resident and Home Study  
Courses Offered**

**YOU  
LEARN BY  
DOING**

You receive  
special labora-  
tory experi-  
ment lessons  
to show you  
how to build  
with your own  
hands various  
experimental  
units such as  
those shown at  
left, and how  
to conduct  
many tests.

You will find all lessons easy to under-  
stand because they are illustrated  
throughout with clear diagrams and  
step-by-step examples that you work  
out yourself. Every piece of the equip-  
ment and complete lesson material we  
send you is yours to keep and enjoy,  
including the multitester, experimental  
equipment, all parts of the Superhet-  
erodyne, tube manual, radio dictionary,  
and complete, modern Television texts.  
All parts are standard equipment.

**Shop Method Home Training . . .  
Earn While You Learn**

With our practical resident Shop  
Method Home Training, you study in  
your spare time. You receive Spare  
Time Work Lessons, which show you  
how to earn while you learn. Service  
neighbors' radios and TV receivers, ap-  
pliances, etc., for extra money and ex-  
perience. Many National students pay  
all or part of their training with spare  
time earnings!

**DON'T DELAY! The Radio-Television  
Industry needs trained men NOW!**

**APPROVED  
FOR  
VETERANS!  
Check coupon below!**

For quick action,  
mail coupon  
today and we'll  
rush you full in-  
formation.

**Free!**

NEW, ILLUSTRATED  
OPPORTUNITY  
BOOK AND SAMPLE  
LESSON SHOW YOU  
HOW WE TRAIN  
YOU . . . SEND FOR  
THEM TODAY! NO  
COST. NO  
OBLIGATION.



**NATIONAL SCHOOLS**

LOS ANGELES 37, CALIF. • EST. 1905

**FIND OUT NOW . . . MAIL COUPON TODAY**

National Schools, Dept. PM-4  
4000 South Figueroa Street  
Los Angeles 37, California

Send me your FREE book "Your Future in Radio" and  
the sample lesson of your course. I understand no sales-  
man will call on me.

NAME..... AGE.....

ADDRESS.....

CITY..... ZONE..... STATE.....

Check here if Veteran of World War II

Mail in envelope  
or paste on  
penny postal.



# EARN MORE IN DRAFTING



More  
Opportunities  
for  
Employment  
and  
Promotion

"Here I am at work making good money as a draftsman. I'm glad I sent the coupon to Chicago Tech for that Free Trial Lesson and found out how easy it is to learn Drafting in spare time at home. Today I feel secure in my job because the draftsman's work comes first on any new project. And, in addition, draftsmen can't be replaced with machines. What's more, I feel I'm slated for promotion and more pay, because I see so many draftsmen advancing to high-pay jobs."

## LEARN IN SPARE TIME—AT HOME! (or at the College in Chicago)

A few hours of pleasant home study every week—that's all. No interference with your present job. All the tools you need; drawing outfit included. With Chicago Tech's help, you train yourself step by step. This tested method—developed over 46 years of C.T.C. progress—prepares men quickly for good positions in industry.



### FREE INFORMATION—SEND COUPON

To prove to you how easy it is to learn Drafting at home by the Chicago Tech method, we will send you this FREE TRIAL LESSON. No charge for this lesson, now or later. Fill out and mail coupon, or send post card today.

## CHICAGO TECHNICAL COLLEGE

D-213 Tech Bldg., 2000 S. Michigan Ave., Chicago 16, Illinois

Mail me FREE Lesson with information about big opportunities in DRAFTING.

Name \_\_\_\_\_ Age \_\_\_\_\_

Address \_\_\_\_\_

City \_\_\_\_\_ Zone \_\_\_\_\_ State \_\_\_\_\_

## ENGINEERING DEGREE IN 27 MONTHS

### Big Demand for Graduates

Aeronautical, Chemical, Civil, Electrical, Mechanical and Radio Engineering (including Television)

Hundreds of young men are earning engineering degrees in this recognized institution each year—continuous operation. New terms start quarterly. Many students earn a major part of their college expenses in this large industrial center.

Low tuition. Competent instruction. Thorough intense practical program. Modern laboratory facilities including new physics lab. and modernized wind tunnel. Individualized instruction emphasized.

Approved for Veterans. Engineering preparatory courses. Students from 48 states and 21 foreign countries. Enter June, September, December or March. Send coupon for free catalog and full information. Enroll now.

SEND COUPON TODAY

## INDIANA TECHNICAL COLLEGE

540 E. Washington Boulevard  
Fort Wayne 2, Indiana

Please send me free information on B.S. Engineering Degree in 27 months as checked.

- Aeronautical,  Chemical,  Civil,  Electrical,  
 Mechanical,  Radio-Television.

Name \_\_\_\_\_

Address \_\_\_\_\_

BEFORE



Be An  
Invisible  
Re-Weaver

AFTER



## MAKE BIG MONEY AT HOME

Earn over \$20 daily, full or part time—repair cuts, tears, burns in clothing or any fabric so damage can NOT be seen, BIG demand, big profit, uncrowded field. Complete low-cost home-study course including lifetime equipment. Easy-to-learn, pay-as-you-earn—can mean lifetime income. Write for free details today—now.

FABRICON COMPANY DEPT. N-2  
8342 S. Prairie Ave., Chicago 19, Ill.

## LAW FREE BOOK



Your FREE copy of "The Law-Trained Man" shows how to gain prestige and greater earnings through Blackstone's home law study. All instruction material furnished including 18-volume Law Library written by 65 well-known law authorities. Lawyers, judges among our graduates. LL.B. degree. Low cost; easy terms. Write today.

BLACKSTONE COLLEGE OF LAW 225 N. Michigan Ave.  
Dept. 54, Chicago 1, Ill.  
A Correspondence Institution Founded in 1890

## STAMMERER?

New booklet, "Stammering, and How to Stop It," sent free to any stammerer upon request. Write today. BENJAMIN N. BOGUE, Dept. 504, Circle Tower, Indianapolis 4, Ind.



## FREE AMAZING NEW BOOK "HOW TO ANSWER ADS"



Never before have you seen anything like this. Tells you in simple language the correct way to answer ads. Gets you quicker replies—better results, and greater satisfaction. Will save you time and money and it's ABSOLUTELY FREE. No obligation whatever. Every reader of advertising should have this booklet. Send a postcard for your copy NOW. Advertising Department, Popular Mechanics Magazine, 200 East Ontario Street, Chicago 11, Ill.

## Learn TELEVISION-ELECTRONICS RADIO

2 Big Books  
FREE

Train at Home—Get Big Kits of Radio Parts! Prepare now in spare time. Practical instruction. Approved for Veterans. Write for details and 2 Radio Books—ALL FREE! Rush name today! SPRAYBERRY ACADEMY OF RADIO  
Dept. 10-H 20 N. Wacker Drive, Chicago 6, Illinois



## LEARN MEAT CUTTING At Home—In Spare Time

Get into the vital meat industry. Concise, practical Home Training based on 25 years proven instruction methods used at National's famous resident school. Prepares you for bigger pay as Meat Cutter, Supervisor, market manager or more money in your own store. Go as rapidly as your spare time permits. Diploma. Start NOW to turn your spare hours into money. Send for FREE bulletin today. No obligation.

NATIONAL SCHOOL OF MEAT CUTTING, INC., Div. U-115, Toledo 4, Ohio

## it's fun to earn RAISING HAMSTERS

Cash in on the growing demand for SYRIAN GOLDEN HAMSTERS recently introduced into the U. S. Ideal pets . . . big laboratory demand. Hardy, clean, odorless. Easily and profitably raised anywhere.



AKOPIAN HAMSTERY  
the largest in the West  
7358 H VARNA AVE. • NORTH HOLLYWOOD, CALIF.

write for  
FREE booklet

SAY YOU SAW IT IN POPULAR MECHANICS

## "YOU ARE UNDER ARREST!"



## Help Bring Crooks to Justice Through Scientific CRIME DETECTION!

We have taught thousands this exciting, profitable, pleasant profession. Let us teach you in your own home. Learn Finger Printing, Firearms Identification, Police Photography, Secret Service Methods thoroughly, quickly, at small cost. Over 800 of all American Bureaus of Identification employ I. A. S. students or graduates. We can prepare you for this fascinating work, during spare time. Write today, stating age, for "Blue Book of Crime."

INSTITUTE OF APPLIED SCIENCE, 1920 Sunnyside Ave., Dept. 1354, Chicago 40, Ill.



**\$200 GROSS IN MY  
FIRST WEEK!**



**Some Make More, Some  
Less . . . Start This Busi-  
ness for YOUR OWN**

Would YOU like to own a permanent, year-round business in which it is possible to take in as much as \$200 gross the first week, as did L. A. Eagles? R. E. Traynor says, "I made \$62 gross in one day." R. R. Newlin reports, "I have averaged \$173 gross per week." Others report gross from \$100 per week to \$12,000 per year.

Surely YOU will want to investigate a golden opportunity like that. You need not have any special skill or experience, but if you are ambitious, honest and courteous, we will help you to start and succeed in YOUR OWN money-making business where net profits are high.

**No Shop Necessary**

Our Electric Rug Washer cleans rugs and carpets like new right on the customer's floor. This quick, thorough and highly efficient method removes dirt and grime, thus restoring the natural, fresh beauty of floor coverings. Anyone can run it. Rugs and carpets are not harmed.

There are hundreds of possible customers in YOUR vicinity. Most of them have several rugs needing regular cleaning. To get a quick start,

**FREE BOOK! MAIL COUPON**

**VON SCHRADER MFG. CO.  
410 PL, Racine, Wis.**

Send at once (no obligation) your FREE booklet containing information about your Electric Rug Washer and how I can own my own permanent, profitable business.

Name \_\_\_\_\_

Address \_\_\_\_\_

City \_\_\_\_\_ (Zone) \_\_\_\_\_ State \_\_\_\_\_

shampoo a few rugs or carpets. These customers tell their friends and soon you should have an independent, prosperous business, and you should be able to keep it growing. Send the coupon RIGHT NOW for booklet that explains everything.

**Every Machine Guaranteed  
and Easy to Own**

You take no risk. These wonderful, fully guaranteed machines have been used and endorsed by largest hotels, railroads—also used by U. S. Government. Many individuals have built up successful businesses that made big profits. Mail the coupon TODAY and we will send complete information, including how to start and succeed in YOUR business without a large investment. Don't delay your BIG opportunity. Send the coupon AT ONCE.



**MAIL COUPON TO**

**VON SCHRADER MFG. CO., 410 PL, RACINE, WIS.**

**WHICH OF THESE Opportunities  
INTERESTS You MOST?**



● Today, choose the job you want—and prepare for it. Or if you are already engaged in the work you like best, start training now for quicker promotion. Acquire the knowledge that will help you to get ahead faster, make more money and have greater security.

American School, founded in 1897 as an educational institution not for profit, can help you to reach your goal just as it has helped others during the past fifty-three years. Check the coupon at right, add your name and address and mail it at once. The school will send you details on its training plan and outline of study prepared by specialists. There is no charge, no obligation, so send the coupon immediately.

**CHECK, CLIP AND MAIL COUPON NOW**

**AMERICAN SCHOOL, Dept. G445, Drexel at 58th, Chicago 37, Ill.**

Without obligation, Please send FREE and postpaid, bulletin and details of the Subjects checked:

- |  |   |  |
|--|---|--|
| <input type="checkbox"/> PLASTICS ENGR'            | <input type="checkbox"/> Accounting                   | <input type="checkbox"/> Drafting and Design for Men and Women |
| <input type="checkbox"/> Refrigeration             | <input type="checkbox"/> Electrical Engr.             | <input type="checkbox"/> Radio                                 |
| <input type="checkbox"/> Architecture and Building | <input type="checkbox"/> Electricity-Pract.           | <input type="checkbox"/> High School                           |
| <input type="checkbox"/> Contracting               | <input type="checkbox"/> Electronics, Industrial      | <input type="checkbox"/> Air Conditioning                      |
| <input type="checkbox"/> Practical Plumbing        | <input type="checkbox"/> Bookkeeping                  | <input type="checkbox"/> Mechanical Eng.                       |
| <input type="checkbox"/> Automotive Engr.          | <input type="checkbox"/> Private Secretary            | <input type="checkbox"/> Shop Management                       |
| <input type="checkbox"/> Aviation Drafting         | <input type="checkbox"/> Diesel Engineering           | <input type="checkbox"/> Tool Making                           |
| <input type="checkbox"/> Aviation                  | <input type="checkbox"/> Sheet Metal Pattern Drafting | <input type="checkbox"/> Better Foremanship                    |
| <input type="checkbox"/> Business Management       | <input type="checkbox"/> Railway Training             | <input type="checkbox"/> Machine Shop Operations               |

Name \_\_\_\_\_ Occupation \_\_\_\_\_

Address \_\_\_\_\_ Age \_\_\_\_\_

City \_\_\_\_\_ State \_\_\_\_\_

**AMERICAN SCHOOL**

Dept. G-445, Drexel at 58th Street, Chicago 37

# Learn A Trade NOW! PRACTICAL SHOP TRAINING!

## In Our Chicago Shops

- |   |  |
|---|--|
| <input type="checkbox"/> AUTO MECHANICS   | <input type="checkbox"/> WELDING—ARC and GAS |
| <input type="checkbox"/> DIESEL MECHANICS | <input type="checkbox"/> MACHINIST           |
| <input type="checkbox"/> REFRIGERATION    | <input type="checkbox"/> PIANO TUNING        |
| <input type="checkbox"/> BODY-FENDER      |  |

Above Approved For G. I.'s and Civilians

One of America's Leading Practical Schools  
7 Floors of Fully Equipped Shops  
Over 48,000 Successful Graduates  
Expert Individual Instruction  
Learn by Doing—Low Living Expense  
Established 1902—Day and Evening Classes

## Also the following Home Study Courses

- |                                  |  |                                 |
|----------------------------------|--|---------------------------------|
| <input type="checkbox"/> PLASTIC | <input type="checkbox"/> REFRIGERATION | <input type="checkbox"/> DIESEL |
|----------------------------------|--|---------------------------------|

— CALL IN PERSON OR MAIL THIS AD TO —

## GREER SHOP TRAINING

(Desk 10) 460 South State St., Chicago 5, Ill.

Please send without obligation free information regarding trade checked above. (Specify whether you are a Veteran  or Civilian )

Name \_\_\_\_\_ Age \_\_\_\_\_  
Address \_\_\_\_\_  
City \_\_\_\_\_ State \_\_\_\_\_

# 9 BIG BUILDING BOOKS



12th EDITION FOR  
EXAMINATION  
SEND NO MONEY

Learn to draw plans, estimate, be a live-wire builder, do remodeling, contracting. These 9 practical, profusely illustrated books cover subjects that will help you to get more work and make more money. Masonry, concrete forms, carpentry, steel square, roof framing, construction, plumbing, heating, painting, decorating and many other subjects. More than 4000 pages—2750 illustrations.

## BETTER JOBS — BETTER PAY

A nationwide building boom is in full swing and trained men are needed. Big opportunities are always for MEN WHO KNOW HOW. These books supply quick, easily understood training and handy, permanent reference information that helps solve building problems.

## Coupon Brings Nine Big Books for Examination

AMERICAN TECHNICAL SOCIETY—Publishers since 1898  
Dept. G419 Drexel at 58th Street Chicago 37, Ill.

You may ship me the Up-to-Date edition of your nine big books, "Building, Estimating and Contracting," without any obligation to buy. I will pay the delivery charges only, and if fully satisfied in ten days, I will send you \$2.00, and after that only \$3.00 a month, until the total price of only \$34.80 is paid. I am not obligated in any way unless I keep the books.

Name \_\_\_\_\_  
Address \_\_\_\_\_  
City \_\_\_\_\_ State \_\_\_\_\_

Please attach a letter stating your age, occupation, employer's name and address, and name and address of at least one business man as a reference. Men in service, also please give home address.

# 500 Pages, 7000 Novelties



10c

Send 10c for mammoth, amazing catalog of 7000 novelties. 1-inch thick, roto picture section, 6-color cover. Carnival, circus, world's fair & science exhibit rolled into one! Includes live animals & pets, scientific supplies, hobbies, funmakers, planes & boats, looms, magic tricks, joke articles, unusual seeds, gadget timesavers, cameras, optical goods, projectors, movies, lucky jewelry, religious novelties, telegraph sets, disguises, musical instruments, stamps, coins, puzzles, fortune tellers, radios, experimental sets, auto & bike accessories, Western wear, telescopes, magnifiers, compasses, banks, smokers' gadgets, artists' supplies, printing sets, engines, motors, shockers, knives, billfolds, fireworks, guns, rifles, sports, money makers, swimming helps, 1000 fascinating books, games, locks, live chameleons, rings, exercisers, curious plants, etc., etc., etc. (Deluxe Hard Bound Library Edition 25c Postpaid.) Regular paper covered edition 10c. (Stamps accepted.) Sent Air Mail, \$1.00. JOHNSON SMITH & COMPANY, Dept. 225, DETROIT 7, MICHIGAN

## Learn CARTOONING

HAVE FUN! MAKE MONEY! Cash in on your sense of humor at HOME—BY MAIL. No experience needed to start. Write today for FREE TRIAL LESSON and full particulars.

MOON Gag Cartoon School, Dept. E, Fall Creek, Wis.



## RAISE HAMSTERS

The new wonder animals from Syria. Often called Toy Bears. Delightful pets. Everyone wants them. Laboratories need thousands. Clean, odorless. Raise anywhere. A profitable and interesting hobby or business. We furnish breeding stock with manual of instructions.

Write today for free illustrated literature.

GULF HAMSTERY, 1536 BASIL, MOBILE, ALA.



## FEET HURT?

Get QUICK RELIEF! Dr. Barron's Foot Cushions RELIEVE painful pressure from CALLUSES, CORNS, SORE HEELS, support WEAK ARCHES, absorb foot shocks. Light, ventilated, spongy. Like Walking On Pillows! Wear in any shoes. Dr. Barron says: "Relieves tired, aching feet from heel to toes." SEND NO MONEY! Pay postman \$1.98 for PAIR plus postage (or send \$1.98, we pay postage). State shoe size and if man or woman. 30-DAY TRIAL. Money back GUARANTEE if no blessed relief! Order NOW! ORTHO, INC., 2700 BROADWAY, Dept. 49E, N.Y.C. 25

## FREE BOOK ON REQUEST

"HOW TO USE CEMENT AROUND THE HOUSE"

Shows how to mix and pour concrete in all forms  
El Sereno Machine Works, 727 Vernon, Azusa, Calif.

## Learn PHOTOGRAPHY

There's big money in PHOTOGRAPHY—and an action-packed career for you. Our HOME STUDY COURSE is your spare-time SHORT CUT TO SUCCESS! Or, if you wish—PERSONAL ATTENDANCE TRAINING at our famous New York School is available with subsistence under the G. I. Bill. Our 40th year. Write immediately!

NEW YORK INSTITUTE OF PHOTOGRAPHY

Dept. "49," 10 West 33 Street, New York 1, N.Y.

## STUDY AIRBRUSH AT HOME

Learn to Earn in Art and Photography. Take advantage of today's opportunities.

GRAPHICRAFT PUBLICATIONS, Dept. K  
378 CHANNING STREET FERNDALE 20, MICH.

## Be an INVESTIGATOR

JAMES S. BOLAN, FORMER POLICE COMMISSIONER OF NEW YORK CITY offers MEN & WOMEN an attractive opportunity to prepare for a future in Investigation & Criminology by comprehensive Home Study Course. Free placement service assists graduates to obtain jobs. APPROVED UNDER G. I. BILL OF RIGHTS.

Write for Free Booklet PM.

THE BOLAN ACADEMY, INC.  
EMPIRE STATE BLDG., NEW YORK 1, N.Y.

LEARN HOW TO MAKE REAL MONEY IN

# TELEVISION

RADIO & ELECTRONICS

**AT NO EXTRA COST!**  
**YOU GET A ROUND TRIP TO**  
**NEW YORK CITY**  
**FROM ANYWHERE IN THE U. S. OR CANADA**

After you have completed the home study section of your course, your transportation to *New York City*—both ways— from any point in the United States or Canada will be paid by RTTA. At our affiliated training shops in New York City you'll get 2 solid weeks—50 hours of intensive laboratory work—on the most modern and scientific equipment. You'll live in New York City, the heart of the television industry, where the headquarters of the National Broadcasting Company,

American Broadcasting Company, Columbia Broadcasting System, Mutual Broadcasting System and many large television and radio companies are located.

### FREE EMPLOYMENT HELP

Upon completing your laboratory resident course, you will personally be recommended for a position by our placement director, who will help you get started toward a money-making future in television, radio and electronics.

**RTTA FURNISHES EVERYTHING—TUBES, BATTERIES, and LARGE TV PICTURE TUBE**

**IN-DOUBLE QUICK TIME**  
**EARN BIG PAY,**  
**OWN YOUR OWN BUSINESS**

NOW—you can qualify for a money-making career, through RTTA's sensational plan. In addition to becoming a CERTIFIED TELEVISION TECHNICIAN, you build yourself a complete large screen television set of the finest commercial quality, for your own use. You get 15 BIG KITS to enable you to get practical experience, build the equipment illustrated, including a radiotelegraph and radiotelephone transmitter, and many other testing units.

No matter where you live, no matter what you do, RTTA's effective methods can help you toward a FAT PAY CHECK or YOUR OWN BUSINESS. Previous experience is unnecessary.

### ALL EQUIPMENT FURNISHED

The kits you will receive contain all the necessary TUBES and BATTERIES . . . a complete set of tubes for your TELEVISION RECEIVER including the PICTURE TUBE. In addition, you'll receive everything needed to build a complete TV set, and many more testing units.

### EARN WHILE YOU LEARN

You will learn how to *earn money* in your spare time, without interfering with the work you are now doing. From the very beginning,

the RADIO TELEVISION TRAINING ASSOCIATION's plan is a practical MONEY-MAKING COURSE. We will show you how to cash in on your new knowledge, even while you are learning. Act now by clipping the coupon to find out how you can become a CERTIFIED TELEVISION TECHNICIAN and earn extra money.

### WE PREPARE YOU FOR YOUR FCC LICENSE

RTTA prepares you to qualify for your FCC license. Pay is higher for the FCC license holder because only a comparative few of the thousands of men in radio-television today hold FCC tickets.

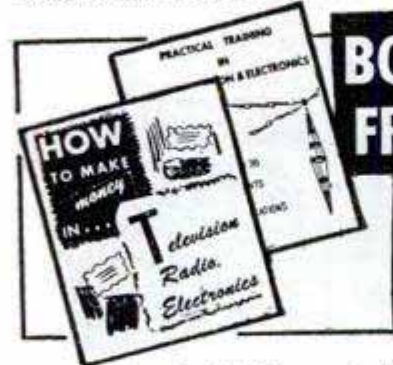

Yours absolutely FREE—an actual SAMPLE LESSON! Send for it today! You'll receive also our FREE catalog "How to Make Money in Television," telling how you can train for a money making job. Mail Coupon Now!

**BOTH FREE!**

**RADIO TELEVISION TRAINING ASSOCIATION**  
972 BROAD STREET NEWARK 2, NEW JERSEY

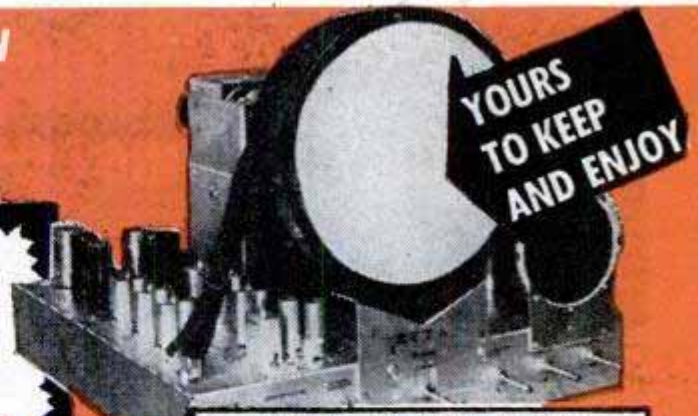

**YOURS TO KEEP AND ENJOY**

**YOU BUILD THIS LARGE SCREEN TELEVISION RECEIVER**

**YOUR CHOICE** OF 10, 12½ OR 16 INCH PICTURE TELEVISION TUBE

**CAN BE CONVERTED FOR COLOR TELEVISION**

**STUDY AT HOME IN YOUR SPARE TIME**



R. F. SIGNAL GENERATOR

**YOU GET 15 BIG TELEVISION-RADIO KITS AT NO EXTRA COST. YOU BUILD THESE ILLUSTRATED UNITS**

AUDIO OSCILLATOR

**YOU KEEP ALL EQUIPMENT**



MULTITESTER

6 TUBE SUPER-HETERODYNE

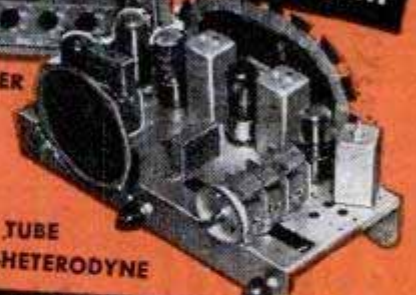

### FREE SAMPLE LESSON COUPON

RADIO-TELEVISION TRAINING ASSOCIATION, DEPT. 144  
972 Broad Street, Newark 2, N. J.

Rush me the FREE Sample Lesson of your practical Home Television Course—together with your FREE Catalog "How to Make Money in Television" in SPARE TIME while learning. No obligations! I understand no salesman will call. (PLEASE PRINT.)

NAME \_\_\_\_\_ AGE \_\_\_\_\_  
ADDRESS \_\_\_\_\_  
CITY \_\_\_\_\_ ZONE \_\_\_\_\_ STATE \_\_\_\_\_

# MORE PAY through HOME STUDY TRAINING in SPARE TIME

Do you want a better position—a larger salary? They are within your reach—now. LaSalle experts will guide you step by step in gaining business training which leads to greater earnings.

The time-saving, interesting LaSalle Problem Method helps you prepare at home, without interference with your present duties.

Simply mark on the coupon the field in which you desire success, and we will mail you a valuable book describing the opportunities in that field—plus "Ten Years' Promotion in One"—a book which has helped many men. Let us tell you how we have started thousands of average men and women on the high road to success and more money. Check and mail the coupon now.

## LASALLE EXTENSION UNIVERSITY A Correspondence Institution

417 S. Dearborn St., Dept. 464-R, Chicago 5, Ill.

Send me full information regarding the course I have marked—without obligation—plus "Ten Years' Promotion in One."

- |  |   |
|--|---|
| <input type="checkbox"/> Higher Accountancy  | <input type="checkbox"/> Salesmanship                     |
| <input type="checkbox"/> C.P.A. Coaching     | <input type="checkbox"/> Traffic Management               |
| <input type="checkbox"/> Bookkeeping         | <input type="checkbox"/> Foremanship                      |
| <input type="checkbox"/> Law: LL.B. Degree   | <input type="checkbox"/> Industr'l Management             |
| <input type="checkbox"/> Business Management | <input type="checkbox"/> Stenotypy<br>(Machine Shorthand) |

Name.....Age.....  
Address.....  
City.....Zone.....State.....

### LEARN MOVIE PROJECTION THEATRE MANAGEMENT

The Motion Picture Theatre Business offers big opportunities for trained men. Get into a fascinating field with a promising future. Train at home in spare time. Free Catalog. Established 20 years.

**THEATRE SCHOOL, 370 Washington St., Elmira, New York**

TRAIN NOW... FOR AN

# AVIATION CAREER

IN SUNNY SOUTHERN CALIFORNIA

**AERONAUTICAL ENGINEERING • MASTER AVIATION MECHANICS**  
**MAXIMUM TRAINING IN MINIMUM TIME**  
America's Finest Aeronautical Institute... Est. 1929... 7300 successful graduates... **EARN MORE MONEY**... Approved for Veterans... Board and Room available. **MAIL COUPON TODAY**—for full information and catalog, **FREE** and without obligation.

NAME.....AGE.....  
ADDRESS.....  
CITY.....ZONE.....STATE.....

**CAL-AERO TECHNICAL INSTITUTE**  
GRAND CENTRAL AIR TERMINAL • GLENDALE 1, CALIFORNIA

## PRINT YOUR OWN POST CARDS

**COMPLETE OUTFIT only \$7.50**

Amazing results in sales, inquiries and contacts... saves time and money... very easy to use **GEM STENCIL DUPLICATOR** is ideal for Advertising, Announcements, Notices, Labels, Forms, Price Lists—hundreds of uses for every type of business and organization. Comes complete with all supplies, instructions and 60-page Book of Ideas.

**FREE TRIAL OFFER:** Try it before you buy it! Write and a GEM OUTFIT will be sent you postpaid. After 10 days, send only \$7.50 or return the GEM, no questions asked. The GEM must sell itself; you be the judge.

**BOND EQUIPMENT CO. • Dept. 135**  
6633 Enright • St. Louis 5, Mo.

**SEND NO MONEY • FREE TRIAL OFFER**

## Play GUITAR in 10 DAYS

**TRY IT ON MONEY BACK OFFER!**  
Let ED SALE, Radio's Foremost Guitar Player, show you how! MOST "courses" have 8 to 10 pictures, but ED'S new method has 53 photos—angle camera shots of the hand of a master guitarist that teaches and shows the exact places to put your fingers, etc. Most "methods" offer a few songs—ED includes 110!—selected for their Radio and Television popularity so you can sing and play right along with your favorite program or records.

**SEND NO MONEY!** Just name and address to ED **\$1.69** plus C.O.D. and postage, or to save C.O.D. send \$1.69 now! Accompany yourself in solo the very first day. Be playing beautiful music you always dreamed of in 10 days or get your money back. Write today! **ED SALE, Dept. M-4, Point Pleasant, New Jersey.**

# Rupture Troubles Ended

Advanced method has healed thousands. No leg straps, no elastic, no plasters. No pressure on hips or spine. Flexo-pad. Entirely different. Endorsed by doctors, mechanics, clerks. Very light. **INEXPENSIVE. GUARANTEED.** Write for information and trial.

**SMITH MANUFACTURING COMPANY**  
EST'D 1893 DEPT. PM PRESTON, ONTARIO

## LEARN POULTRY BUSINESS AT HOME!

Thorough knowledge can mean greater success in this \$3½ billion business. Our interesting, practical, home-study courses have trained thousands during past 29 years. For full information on courses, methods, opportunities—Write Today to Dept. 50

**FREE CATALOG**

**NATIONAL POULTRY INSTITUTE Adams Center, N.Y.**

## SPEED AND POWER Handbook

**50 CHAPTER LIBRARY EDITION**  
Build Fast Stock Cars! California Roadsters! 160 MPH Rods! Covers Crosleys to Cadillacs—all makes. Breathtaking Methods. Authentic—Direct from California!

**SAVE MANY DOLLARS**  
Build your own Dual Manifolds! Superchargers! Hot Cams! Water Injectors! Hi-Compression Heads! Mileage Devices! Get up to ten more miles per gallon! Get racing speed, lightning acceleration, dynamic power increases from any make passenger automobile! Get construction drawings! Tuning techniques! Speed tricks! Economy secrets! Ingenious formulas! Covers "Racing Frames"—"Reciprocating Masses"—"Jet Engines"—"Braking Characteristics"—"Dynamometers"—"Dual Pipes, Gears, Fuels, Manifolds, Porting, Relieving, Lowering! Balancing. Including 1950 Racing Equipment Catalogues!"

Includes: "CALIFORNIA AUTOMOBILE CUSTOMIZING"—Drawings! Photographs! Diagrams! Newest Ideas! Conversions! Carson Topal! Restyling all makes! Streamlining! Chopping! Channeling! Complete—\$1.98 Postpaid.

**NEWHOUSE AUTOMOTIVE INDUSTRIES**  
5805 EAST BEVERLY BLVD. DEPT. B4  
LOS ANGELES 22, CALIF.

# BUILDERS

## TRADE GUIDES



4 Vols. \$6

### AUDELS CARPENTERS AND BUILDERS GUIDES—4 VOLS. \$6

Inside Information for Carpenters, Builders, Joiners, Building Mechanics—all Woodworkers. 1600 pages; 3700 diagrams; flexible; pocket size. Short-cut instructions, new methods, ideas, solutions, plans, systems—money saving suggestions. An easy progressive course for the apprentice. A practical daily helper and Quick Reference for the master worker. A Helping Hand to Easier and Better Work and Better Pay. To get this aid for yourself, simply fill in and mail the FREE COUPON below.



How to use steel square; How to file and set saws; How to build furniture; How to use mitre box; How to use chalk line; How to use rules; How to make joints; Carpenters' arithmetic; Mensuration problems; Estimating

#### INSIDE TRADE INFORMATION ON:

strength of timbers; How to set girders and sills; How to frame houses and roofs; How to estimate costs; How to build houses, barns, garages, bungalows, etc.; How to read and draw plans; Drawing up specifications; How

to excavate; How to use settings 12, 13 and 17 on the steel square; How to build hoists and scaffolds—skylights; How to build stairs; How to put on interior trim; How to hang doors; How to lath—lay floors; How to paint.

"Audels Guides worth four times their price—handy, too as I carry them in pocket for reference." W. J. Bates, Knoxville, Pa.



4 Vols. \$6

### AUDELS PLUMBERS AND STEAMFITTERS GUIDES—4 VOLS. \$6

A new edition—just out! A practical, illustrated, Reference Library and Study-Course for Master Plumbers, Journeymen and Apprentice Steamfitters, Gas Fitters and Helpers, Sheet Metal Workers, Draughtsmen, Master Builders, Engineers and all Building Trade Students. 1670 pages; 3642 diagrams; flexible; pocket size. Guides explain all the principles, advances and short cuts of the Plumbing and Heating trade. Contains instructions on how to figure and estimate jobs. Use FREE COUPON below to examine, without obligation, this valuable work.



Air Conditioning. Soldering, tinning. Joint wiping, bending, beating. Pipe—iron—steel, threading. Mathematics, tables, physics. Materials—iron, steel, copper, brass, lead, tin, antimony. Sheet metal—galvanized—plate. Sanita-

#### INSIDE TRADE INFORMATION ON:

tion, siphonage, tanks. Drainage, sewage, purification. Fixtures—bath—kitchen. Pipe fittings, soil pipe, tools. Laying out work. Roughing. Screwed fittings, flanges, joints. Pipe bending, examples. Elbows. Heating, ven-

tilation, refrigeration. Water supply, mains, wells, tanks. Gas-fittings. Underwriters. Sheet metal work, problems, methods, Brazing, beating, lead burning. Welding, various welds, methods. Blacksmithing, forges, tools.

"Audels Guides are practical, easy to understand, reliable. Cover the field in plain language." W. F. Arminger, Annapolis, Md.



4 Vols. \$6

### AUDELS MASONS AND BUILDERS GUIDES—4 VOLS. \$6

A complete, illustrated trade reference library, for Bricklayers, Cement Workers, Plasterers, Tile Setters and Stone Masons, including a practical outline of Steel Construction. 1100 pages; 2067 diagrams; flexible; pocket size. A practical Trade Assistant explaining modern methods of masonry construction. Easy to understand and apply. A reliable and authentic reference work and study-course for Master Journeyman and Young Mechanic. Use FREE COUPON below and find out for yourself, without obligation, whether this set will benefit you.



#### INSIDE TRADE INFORMATION ON:

Bricklaying, tools, materials; Brick designs, patterns, bonds; Setting frames and foundations; Mortars, scaffolds, estimating; Mortars and mortar mixing; Tile setting, mosaic, hollow tile; Straight edge test, trow-

eling; How to figure brick work; Safe loads, piers, chimneys; Boiler settings, anchors, fire stops; Labor tables; Concrete, forms; How to figure concrete work; Stucco—on old and new buildings; Plastering—wood lath—metal;

Plasterers agreement; Plastering on various surfaces; Stone masonry; Cutting, finishing, estimating stone; Derricks, rigging; Steel construction; Fire proof; How to read blue prints.

"Audels Masons Guides are the best books on the subject. Have laid brick 12 years and am able to judge." H. A. Sonnett, Corliss, Pa.



### PRACTICAL ELECTRICITY—1 VOL. \$4

Audels Handy Book of Practical Electricity is a simplified Ready Reference and Study Course in one pocket size volume—for Engineers, Professional Electricians and Students. 1040 pages; 2600 diagrams; flexible bound. A reliable authority and handy helper for every electrical worker. Contains important and valuable wiring diagrams, calculations, machine sketches, helps on maintenance and repair. Use this FREE COUPON today and find out, without obligation, how this handy book will help you in your daily work.



Complete in one handy, red leather bound volume

1040 Pages 2600 Diagrams

#### INSIDE TRADE INFORMATION ON:

Electro-Therapeutics, X-Rays, Shocks, Welding, Brazing, Radio Hook-ups, Motion Pictures, Telephone, Telegraph, Cranes, Bells, Elevators, Pumps, Tools, Ship Drive, Railways, Vehicles, Automobile Electric Systems, Ignition, Generation, Lighting, Plant Management, Power Plans, Armature Winding, Repairing, A. C. Motors and Apparatus, D. C. Motors and Apparatus, Alternator Construction, Dynamos, Wiring, Diagrams, Sign Flashers, Cable Splicing, Power Wiring, Outside Wiring, Switches, Lighting, Rectifiers, Converters, Transformers, Fuses, Circuit Breakers, Rheostats, Electro Plating, Electrolysis, Storage Batteries, Magnetism, Electrical Energy, Conductors, Insulators, Static, Dynamic, Radio

### Learn More and You Will Earn More!

Know your job and you'll never be without one. The skilled man is always in demand. Knowledge is power. Learn your trade thoroughly by easy reading. This coupon is your opportunity for advancement and better pay. You risk nothing in sending for Audels Guides for free examination. Send it NOW!

FREE EXAMINATION COUPON

**THEO. AUDEL & CO.**  
49 W. 23 ST., NEW YORK CITY  
Please mail me for free examination the books marked (x) below. If I find them satisfactory, I agree to mail \$1 in 7 days, on each set ordered, and to further mail \$1 monthly on each set until I have paid the purchase price.

- 4 CARPENTERS GUIDES \$6 |  4 PLUMBERS GUIDES \$6  
 4 MASONS GUIDES \$6 |  1 ELECTRICIANS HANDY BOOK \$4

NAME.....  
ADDRESS.....  
OCCUPATION.....



Put your Future  
in your own hands

# BE AN ARTIST

Here's the amazing way we  
teach you step by step to draw  
at home in your spare time

Prepare now for a pleasant, profitable Art career. Trained Artists are capable of earning \$65, \$80 and more a week. **COMMERCIAL ART, DESIGNING, CARTOONING**—all in one complete home study course. Good art positions available in this great field. Become your own boss. Many earn extra money while learning. No previous art experience necessary. **TWO ART OUTFITS** included with training. Low tuition—only \$5 monthly. See how easily, quickly you can get started. **FREE BOOK**—tells about our course, what our graduates say, and commercial opportunities for you.

G.I. APPROVED

## FREE BOOK gives details

WASHINGTON SCHOOL OF ART  
Studio 124W, 1115 15 St., N.W.  
Washington 5, D. C.

Please send me full information and Free Book,  
"Art for Pleasure and Profit." (Please print.)

Name \_\_\_\_\_  
Street \_\_\_\_\_ Age \_\_\_\_\_  
City \_\_\_\_\_ Zone \_\_\_\_\_ State \_\_\_\_\_

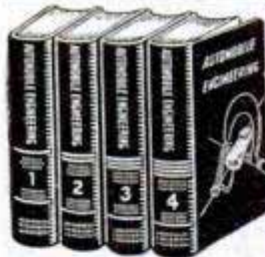

# AUTO BOOKS ON APPROVAL

**SEND NO MONEY.** Just mail the coupon for a complete set of 4 Big, Thick Auto Books. 20th Edition. Over 2700 Pages! Whether you are a mechanic or helper, expert or apprentice, auto owner or driver, take immediate advantage of this **FREE EXAMINATION OFFER.**

## MAKE GOOD MONEY NOW HOLD A PERMANENT JOB

America wants its automobiles kept in good repair. Men with "know how" are in demand, at big pay. These books will help you get and hold an important job, or give you a chance to go into business for yourself now or later. Any man who half tries to improve himself can learn auto servicing and repairing by this quick reference method. Use the **JIFFY INDEX** to find easily understood answer to any auto problem. These wonder books prepared by eleven of America's great automobile engineers. Many hundreds of valuable illustrations. Send the coupon **TODAY.**

**A year's consulting privileges with our engineers now given with these books without extra charge.**

*Publishers Since 1898*

**AMERICAN TECHNICAL SOCIETY, Dept. A419**  
Drexel Ave. at 58th St., Chicago 37, Ill.

I would like to examine your 4-Volume Set of Auto Books. I will pay the delivery charges only, but if I choose I may return them express collect. If after 10 days' use I prefer to keep them, I will send you \$2 and pay the balance at the rate of only \$3 a month until \$24.80 has been paid. Include consulting service as offered above.

Name \_\_\_\_\_  
Address \_\_\_\_\_

City \_\_\_\_\_ State \_\_\_\_\_  
Please attach letter stating age, occupation, employer's name and address and name and address of at least one business man as reference. Men in service, also please give home address.

# Yes, More Brilliant Than a Diamond!

No Other Gem Like It!  
Amazing New Discovery



Write today for the full story of the latest miracle of science, discovered in the laboratories of one of the world's largest corporations. The story of the Kenya Gem that so closely resembles a diamond that only an expert can tell the difference.

They are more brilliant than the finest diamond of equal size, yet you can now own an unmounted-Kenya Gem for only \$24 (1 carat) to \$96 (4 carats); also beautiful rings and earrings for as little as \$45. **Easy Payment Terms.**

Kenya Gems are the marvelous discovery you read about in The Sat. Eve. Post, Jewelers' magazine and N. Y. Times, "the only thing on earth more brilliant than a diamond." Write today for **FREE** illustrated literature.

**KENYA LABS, Dept. 284**

18 W. Chelton Ave.

Philadelphia 44, Pa.

# Wear Sample Suit NOT 1¢ TO PAY!



Here's an amazing plan! Write me today and I'll show you how to get a fine, all-wool made-to-measure suit for yourself—to wear and show to friends. Just take a few orders, that's all! Here's an easy way to get your own suit without paying 1¢, and also make fine cash profit on every order you take. You send no money, now or ever. Just rush name and address for Sample Woollens and Valuable Sample Suit Coupon. Act now.

**W. Z. GIBSON, 500 S. Throop Street**  
Dept. D-516, Chicago 7, Illinois

## MAKE MONEY

**RAISE Pedigreed RABBITS FOR US!**  
Grinstead's Famous ANGORAS, GIANT CHINCHILLAS and NEW ZEALANDS (World's Most Profitable Rabbits) We buy ALL you raise—ALL the time! Write today for **FREE INSTRUCTIONS**, Illustrated Literature, and Prices.  
**GRINSTEAD FARMS, Dept. 70, Edwardsville, Ill.**

## GREAT PROFITS

with the **SANI-SERV Ice Cream Freezer**

**START YOUR OWN BUSINESS** quickly, profitably, let us show you how! Meet the tremendous demand for "soft" ice cream with the continuous Sani-Serv, ideal for hundreds of locations. Write for **FREE** illustrated folder, complete details.



**GENERAL EQUIPMENT SALES Inc.** 824 S. WEST STREET  
INDIANAPOLIS 2, INDIANA

## Learn REFRIGERATION and AIR CONDITIONING

Prepare yourself for a fine paying job. Get practical training at home—plus 4-full weeks in the ITI Shops. Job placement help. **FREE** book—write  
**INDUSTRIAL TRAINING INSTITUTE** Dept. H-1, 2130 Lawrence Ave.,  
Chicago 25, Ill.

**SAY YOU SAW IT IN POPULAR MECHANICS**

## SHOE REPAIR OFFERS BIG INCOME LEARN IN 12 WEEKS TIME



You can own your own shop or earn big income as skilled shoe repairman. Growing demand everywhere at top wages for men who know how. We teach you quickly by actually working on shoes and modern machines. School open to all from 18 to 60 years of age. **FREE BIG 20 PAGE BOOK** explains everything. Send for your copy today. Chicago & Los Angeles schools only approved for Vets.

**MODERN SHOE REBUILDING SCHOOL**  
Established 1927 Dept. PM  
2937 Belmont Ave., Chicago. 361-12th St., Oakland, Calif.  
806 So. Figueroa St., Los Angeles 14, Calif.

**YOU BUILD THIS  
23-TUBE  
TELEVISION  
RECEIVER**

**NOW!**

FOR THE FIRST TIME YOU CAN GET  
Real Practical HOME TRAINING In

# TELEVISION

## RADIO AND ELECTRONICS

**RTS LEADS THE WAY**

WE GIVE YOU

**11 BIG**

**TELEVISION**

**AND RADIO KITS**

**AT NO EXTRA COST**

**YOU WORK AND LEARN  
WITH REAL TELEVISION  
AND RADIO EQUIPMENT**

RADIO-TELEVISION TRAINING SCHOOL'S master Technicians guide you. Located in the very heart of America's Television, Broadcasting, Radio and Sound Industries, RTS is right "on-the-spot" where new technical improvements are first introduced; is in the best possible position to bring students ACTUAL METHODS and practices developed by the RADIO-TELEVISION industry, leading to real money making opportunities. The 11 BIG KITS RTS gives you enable you to do many practical jobs, build the equipment illustrated; perform more than 100 other fascinating, valuable experiments. These jobs you do give you ACTUAL SHOP experience so vitally necessary to your future success. Thus RTS methods assure you BALANCED TRAINING—Theory PLUS Real Experience.

**OPPORTUNITIES NOW  
WIDE OPEN FOR  
Properly Trained Men**

Latest reports estimate 400 MILLION new television and radio sets will be built in the next 10 years . . . more than 72 million dollars is being spent RIGHT NOW just for radio repairs ALONE! When you are thoroughly trained by RTS Experts—who have their fingers on the pulse of the Radio-Television industry—a field of unlimited opportunities will open up for you in Your Own Radio-Television Sales & Service Business, F.M., Equipment Manufacturing, Communications and allied fields.

**EARN EXTRA MONEY  
while learning at HOME**

Under the RTS amazingly easy, practical home-training plan there is no need for you to quit your present job. You study in SPARE TIME ONLY! RTS Experts show you how

to earn WELCOME EXTRA CASH, even BEFORE FINISHING YOUR TRAINING! In fact, when friends and neighbors know you are studying Radio-Television you may—like many RTS students—actually get MORE REPAIR WORK THAN YOU CAN HANDLE.

**27 YEAR  
SUCCESS RECORD**

Backed by over a quarter-century of experience in home training, RTS (formerly Radio Training Association of America) offers practical "Learn-by-doing" methods, assuring you quick step-by-step progress. Begin preparing for your future in Radio-Television now while the time is ripe. If you are at all mechanically inclined—and have a grammar school education, RTS can teach you how to MAKE GOOD in Radio-Television.

**GET THE FACTS**

Send for FREE BOOK which tells you all about the RTS "time-tested" home-training plan, developed by technicians in the heart of the Radio-Television field. Fill out the coupon now—TODAY! and your FREE BOOK entitled "How To Make Good in Radio-Television" will go out to you AT ONCE. No Obligation. No salesman will call. Act now!

**YOU BUILD THIS  
6-TUBE STANDARD  
SUPER HETERODYNE  
RADIO SET with  
SHORT WAVE  
CONVERTER**

**YOU  
KEEP ALL  
EQUIPMENT  
—it's Yours!**

**★  
SEND  
FOR THIS  
30-PAGE  
FREE  
BOOK  
★**



**RADIO-TELEVISION TRAINING SCHOOL**  
5100 SO. VERMONT AVE., LOS ANGELES 37, CALIF., U.S.A.  
ESTABLISHED 1922 — 27 YEARS AGO

RADIO-TELEVISION TRAINING SCHOOL, DEPT. PM-4  
5100 South Vermont Avenue, Los Angeles 37, Calif., U.S.A.

Send FREE Illustrated Book showing how I can make good in TELEVISION and Radio through training under the guidance of expert RTS Technicians. No obligation. (No Salesman will call).

NAME \_\_\_\_\_ AGE \_\_\_\_\_  
ST. & No. \_\_\_\_\_  
CITY \_\_\_\_\_ ZONE \_\_\_\_\_  
STATE \_\_\_\_\_

# INVENTORS

Before you make any effort to market your invention, you should take the first steps toward proceeding for patent protection.

The usual first step is to have a search of the U. S. patent records conducted, so that I can report to you on the question of patentability.

I shall be pleased to furnish you with information relative to patent procedure and also on the matter of trade-mark registration, upon request from you, and this will be without any obligation on your part.

## PATRICK D. BEAVERS

(Formerly RANDOLPH & BEAVERS)  
Registered Patent Attorney

934 Columbian Building Washington 1, D. C.

# INVENTORS

IF YOU WISH TO PROTECT YOUR INVENTION, You should take steps to protect it by a U. S. Patent. Write me for "RECORD OF INVENTION" form.

## CARL MILLER

REGISTERED PATENT ATTORNEY

WOOLWORTH BLDG., 35th FLOOR, 40A,  
NEW YORK CITY

Say You Saw It in Popular Mechanics

TRADE MARKS •  
COPYRIGHTS •

# PATENTS

The Time to Contact  
a Patent Attorney is Promptly  
After You Have Finished Your Invention

Write for FREE "INVENTOR'S GUIDE" & "Record of Invention"

FRANK LEDERMANN Registered Patent Attorney

154 Nassau St. • 20th Floor • New York 7, N. Y.

# PATENTS PATENT LAWYER

COPYRIGHTS

GUSTAVE MILLER

40-PM WARNER BLDG.

WASHINGTON 4, D. C.

ASSOCIATE EXAMINER

U. S. PATENT OFFICE 1922-1929

Patent Attorney and Advisor

U. S. NAVY DEPT. 1930-1947

REGISTERED PATENT ATTORNEY

Send for PATENT INFORMATION  
book and "INVENTOR'S RECORD"  
without obligation

# INVENTORS

Whether an invention is patentable can be substantially determined by a search of the U.S. Patent records. Without obligation, write for information explaining the steps you should take to secure a patent.

## JOHN N. RANDOLPH

Registered Patent Attorney

201 Columbian Building, Washington 1, D. C.



**PATENTS  
AND TRADE MARKS**  
**C.A. SNOW & CO.**  
REGISTERED PATENT ATTORNEYS  
WRITE FOR INFORMATION TO  
428 SNOW BUILDING, WASHINGTON 1, D. C.

# INVENTING

**-FOR PROFIT!** If you have an inventive turn of mind, write for free 28-page booklet explaining how the Institute of American Inventors is helping inventors pre-test the profit possibilities of proposed devices to fill today's unprecedented demand for useful new inventions.

**INSTITUTE of AMERICAN INVENTORS**

Dept. 4, 631-E St., N.W., Washington 4, D. C.

# INVENTORS

Protect your invention, by a U. S. Patent. Write me for information

SHERMAN LEVY

620-21-VICTOR BLDG. 724 9th ST., N.W., WASH., D.C.

# BE AN INVESTIGATOR

WORK HOME or TRAVEL. Experience unnecessary.

INVESTIGATOR Particulars FREE. Write to  
GEO. M. P. WAGNER, 125 W. 86th St., N. Y.

# HIGHEST ROYALTIES and CASH

# FOR YOUR INVENTIONS

(Patented and Patent Pending Only)

Write for FREE booklet without obligation

**UNIVERSAL MARKETING CO.**

354 S. SPRING ST. (Suite M)

LOS ANGELES 13, CALIF.



# To those who think LEARNING MUSIC is hard...

SEE HOW EASY IT IS!

MY COUNTRY 'TIS OF THEE,  
SWEET LAND OF LIBERTY

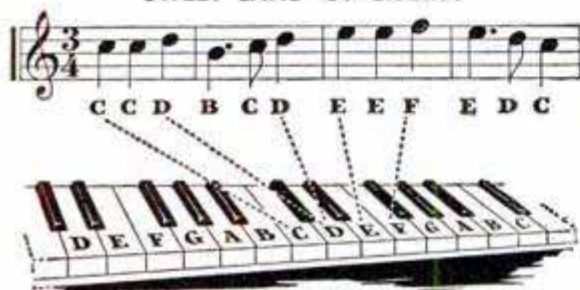

Strike these notes and you're playing  
"America." TRY IT — IT'S FUN



Enrolling for 3rd Course

"I learned more from your course than many of my friends who studied under private teachers have for years. The fact that I've already taken 2 courses and am now enrolling for a third should speak for itself."

\*F. A. S., Indiana



Plays from Start

"Your advertisements are true to the letter. I can actually play my favorite instrument even though I'm only at the beginning. How can I ever express my joyful gratitude."

\*F. R. O., Illinois

\*Actual names on request.  
Pictures by Professional Models.

## Easy as A·B·C this print and picture way

• Perhaps you think learning music is a tedious grind. It isn't any longer! Long hours of practicing humdrum scales and hard-work exercises are over and done with.

You have no excuses... no alibis whatsoever for not getting started toward musical good times *now!* For, through a new, easy, pleasant method, you can now learn to play right at home — without a private teacher—for only a few cents a day.

### Learn to Play by Playing

The lessons come to you by mail from the famous U. S. School of Music... complete instructions, large, clear diagrams and all the music you need. You study with a smile. You learn to play by playing real tunes by note. And it's all so easy to understand. First you are *told* how to do a thing. Then a picture *shows* you how. Then you do it yourself and *hear* it.

If you're tired of just looking on at parties — if you've envied those who could enter-

tain others — if learning music has always been a never-to-come-true dream — let this time-tested home-study method come to your rescue.

Over 850,000 people have studied music this modern, easy as ABC way. And remember, no matter what instrument you choose, the cost will average only a few cents a day.

Our illustrated Free Booklet fully explains this remarkable course. It shows how you can learn to play quickly, and for a mere fraction of the cost of old, slow methods. So mail the coupon today. The Free Booklet will be sent to you at once together with a "Print and Picture" Sample. (Instruments supplied when needed, cash or credit.) U. S. School of Music, 74 Brunswick Bldg., New York 10, N. Y.

### FREE PRINT AND PICTURE SAMPLE

U. S. School of Music, 74 Brunswick Bldg., N. Y. 10, N. Y.

Please send me Free Booklet and Print and Picture Sample. I would like to play instrument checked below.

(Do you have instrument \_\_\_\_\_)

Piano	Accordion	Trumpet	Ukulele
Violin	Mandolin	Trombone	Clarinet
Guitar	Saxophone	Tenor Banjo	Other Instrument

Mr. \_\_\_\_\_

Miss \_\_\_\_\_

Mrs. \_\_\_\_\_ (PLEASE PRINT)

Street \_\_\_\_\_

City \_\_\_\_\_ State \_\_\_\_\_

Note! If you are under 16 yrs. of age parent must sign coupon

Save 2c—Stick Coupon on penny postcard

# NOW! You Can LEARN ELECTRIC MOTOR REPAIR!

A Good Paying Modern Profession

Only \$5 for the COMPLETE TRAINING How to troubleshoot, repair, rewind all types of electric motors

It pays to specialize in something different! Every day more and more electric motors and control systems are being used everywhere—and the fellow who can install, repair and rewind them is a valuable, well paid man!

LEARN FAST... No Lessons to Wait for

Based on what can be learned quickly at home from the big, 560-page ELECTRIC MOTOR REPAIR Book, you can train for profitable electric motor work. Everything is explained clearly in text and by hundreds of illustrations. Covers all AC and DC motor types, DC generators, etc.; also motor controls. Quick reference guides show exactly how to handle specific jobs. Recommended by leading vocational schools!

560 pages  
900 illustrations  
SHOWS YOU HOW EVERY STEP OF THE WAY!

Ideal for beginners. No previous training needed.

A handy Study Guide booklet—sold separately for 25c—is FREE with your request for ELECTRIC MOTOR REPAIR. It's yours to keep, whether you keep book or not!

FREE STUDY GUIDE

Dept. PM-40, MURRAY HILL BOOKS, Inc.,  
232 Madison Ave., New York 16, N.Y.

Enclosed find \$5 (\$5.50 outside U.S.A.) for a copy of ELECTRIC MOTOR REPAIR book, including FREE Study Guide; or send C.O.D. for this amount plus postage. In either event, if book is not what I want, I may return it in 10 days and you guarantee to refund my \$5. (Cash only outside U.S.A., same return privilege.)

Name \_\_\_\_\_

Address \_\_\_\_\_

City, Zone, State \_\_\_\_\_

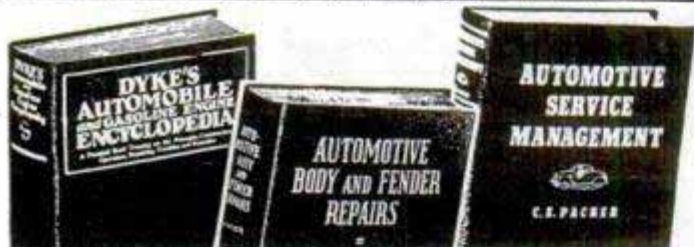

Order TODAY Under Money Back Guarantee

## PAY RAISING AUTO BOOKS

These famous books will help you on every job—prepare you for a better job—bigger pay—a business of your own.

### DYKE'S Auto Cyclopedea

Leading auto book for 32 years. Now new 21st edition. 1483 pages, 4600 illustrations. Complete instruction in auto mechanics—trouble shooting, testing, adjusting, repairing. Combines practical instruction with basic principles. New edition includes passenger cars, 1948 buses, tractors, diesels, Buick Dynaflow and other new developments. (Book No. 1) \$7.50.

### Auto Service Management

Every detail of profitable auto service station management drawn from hundreds of successful operators. Tells how to start—how to get capital—how to run a service shop or station and make money out of it. Can easily be worth hundreds of dollars to any man who is looking forward to a business of his own or a managerial position. 470 pages, 223 illustrations. (Book No. 3) \$5.00

### Auto Body-Fender Repair

Completely covers this big, profitable field. Includes all approved methods, tools, equipment, materials, how to do a professional job, operate a shop. Ideal for mechanics who want to earn more. 325 pages, 332 pictures. (Book No. 2) \$3.50.

**MONEY BACK IF NOT SATISFIED.** Draw circle around number wanted in coupon below and mail today.

Goodheart-Willcox Co., Dept. 122  
1321 S. Michigan Avenue, Chicago 5

Send books circled below. ( ) C.O.D., I will pay postman plus charges (C.O.D. in U.S. only). ( ) Remittance enclosed. Send postpaid. If not O.K., I will return in 5 days and you will refund purchase price.

1 2 3

Name \_\_\_\_\_

Address \_\_\_\_\_

City \_\_\_\_\_ State \_\_\_\_\_

## NEW! AUTOMATIC!

OPEN DOOR... Light's ON!

CLOSE DOOR... Light's OFF!

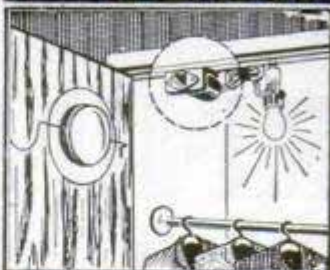

Fine for shop, garage, closets, pantry and dozens of other places. Easily installed in 5 minutes. Plugs into present light. No wires to splice or electrical connections to make. Complete instructions included. Works same as light in electric refrigerator. Saves cur-\$195 rent. Postpaid.....

The DOR-LITE Company

320 S. Christiana Ave.  
Chicago 24, Illinois

## Become a Doctor of PSYCHOLOGY

Win the degree of Ps.D. Teach the secret of contentment, happiness. Solve mental worries. Experience the revelation of truth. Chartered college. Individual help. Write for FREE book. COLLEGE OF UNIVERSAL TRUTH, 5153-B North Clark St., Chicago.



## BARBELLS

Save Money—Buy the finest barbell equipment direct from our foundry—No other company can match our low price or value!

Send to-day for our FREE Barbell Catalog

BUR BARBELL CO.

Lyndhurst 16, New Jersey

## STUDY AT HOME

WITH AN EDUCATIONAL INSTITUTION

Courses in **ENGINEERING**: Electrical, Civil, Mechanical, Drafting, Architectural, Automotive, Steam, Diesel, Aeronautical, Radio, Structural, Mining, Industrial, Petroleum, Marine, Refrigeration, Air Conditioning, Chemical.

Courses in **ARTS AND SCIENCES**: Philosophy; Education; Letters; Public Health; Medical Jurisprudence; Psychology; Sociology; Physics; Chemistry; Geology; Pol. Science; Theology; Law; Business and Commerce; Accounting; Mathematics; Statistics, Agriculture.

McKinley-Roosevelt Incorporated, 4610-K3, Sheridan Rd., Chicago 40, Illinois

## RADIO ENGINEERING

Broadcasting, Television, FM, Servicing, Electronics, Aviation, Marine & Police Radio taught thoroughly. Engineering course equivalent to 3 years' college radio work. Approved Veteran Training. Catalog free.

VALPARAISO TECHNICAL INSTITUTE, Dept. D, Valparaiso, Ind.

Always write your name and full address clearly when answering advertisements

## SPEED & MILEAGE MANUAL

140 Illustrations



Easily Get Super Speed, Acceleration, Mileage—Top Racing Performance From Any Automobile!

Famous New Book shows simplified Soup-up Methods—Speed Tuning—Economy Secrets—Customizing Plans!—Latest Track Proven Methods for all cars! Tells how to build your own SPEED

EQUIPMENT! FAST SPORT CARS! "CALIFORNIA HOT RODS"! 200 H.P. ROAD & TRACK CONVERSIONS! Complete Instructions on building inexpensive Superchargers! Dual Manifolds! "Water Injectors"! High Compression Heads! Twin Mufflers! Economizers! All about—Fast Engines, Gas Saving, Restyling, "Cam Secrets," Multiple Carburetion, Fuels, Forging, Ratios, Frames, "Offy's"! BRAND-NEW METHODS, Plans, Formulas, "Facing Tricks"—"STOCK CAR SPEED SECRETS"! Reveals 100 ways to save gas! Shows latest "HOLLYWOOD CUSTOM STYLING"! Streamlining! Sport Changes! Lowering! Speed Conversations! Including—California Roadster Plans! Racer Diagrams! Working Drawings! Performance Charts! Graphs! Beautiful Photographs! Etc.!

Large manual (plus) "California Equipment Catalog" and Racing Handbook.

ALL THREE \$1.98 Postpaid

ALMQUIST AUTOMOTIVE ENGINEERING, Milford 42P, Pa.



# START YOUR OWN BUSINESS!

You don't need elaborate fixtures or expensive equipment to be a successful electrical appliance service technician. Start NOW in a corner of your kitchen, basement or garage. Thousands have started at home in their spare time with CTS training, the oldest and largest electrical appliance school in the nation.

## SHOP METHOD HOME TRAINING

Repair electrical appliances for friends and neighbors. Service electrical equipment for factories, stores, etc. Work full or part time as you prefer. CTS teaches you by having you work with your hands, building, testing, repairing. All instructions profusely illustrated with detailed drawings and photographs.

### Electronic Kit Furnished

"CHRISTY" Trouble Tracer Electronic Kit, Element Kit sent to you.

### EARN AS YOU LEARN

Many graduates report having paid for entire course from earnings made while still learning!



**MILLIONS OF ELECTRICAL APPLIANCES NEED REPAIR**  
**THE MECHANICALLY INCLINED MAN'S OPPORTUNITY FOR MAKING BIG MONEY!**

## SEND FOR FREE BOOK

CHRISTY TRADES SCHOOL, Dept. D-8003  
 4432 N. Kedzie Ave., Chicago 25, Ill.

Rush me big FREE BOOK and special form for getting service kits, illustrated instructions on new, easy payment EARNINGS WHILE LEARNING PLAN.

Name..... Age.....

Address..... Zone..... State.....

# NEON SIGN SCHOOL

**G. I. APPROVED**

Learn Neon. Interesting, clean work, BIG PAY—\$1.50 to \$2.00 an hour to start. 12½ week Job-Practice Course gives you training in Glass Blowing, Neon Tube Bending, Color Gassing, other branches. FREE FOLDER explains. Write today.

### ACME NEON INSTITUTE (Write Nearest Office)

330 S. PAULINA ST., Dept. D-3  
 CHICAGO 12, ILL.  
 G. I. Approved

418½ W. Olympic Blvd., Dept. D-3  
 Los Angeles 15, Calif.  
 Write for G.I. Information

**LEARN IN 12½ WEEKS**

## BE A PHOTO-ENGRAVER

We furnish complete equipment and supplies. Learn at home or in our modern, friendly APPROVED school in MISSOURI. Get into this big demand, high profit, high wage field. You can start your own profitable, full time or part time PHOTO-ENGRAVING business right in your own home.

Be independent, be your own boss or pave the way to a high pay job with experience gained in your own shop.

TASOPÉ TRAINING and TASOPÉ EQUIPMENT has enjoyed world wide recognition since 1931. Write for descriptive literature today. No obligation.

THE AURORA SCHOOL OF PHOTO-ENGRAVING, DEPT. 9PM., TASOPÉ BLDG., AURORA, MO.



# Watchmakers MAKE MONEY!

Higher pay and more security in a dignified position that often leads to ownership of a watch repairing and jewelry business, are yours as a Master Watchmaker.

Learn Watchmaking the expert "Sweazey way" — quickly and successfully — in one of America's oldest watchmaking schools. Resident or Home Study.

### SEND FOR FREE BOOK NOW →

Since 1908, Chicago School of Watchmaking graduates have been in constant demand. Write today for your free copy of our new illustrated book about the big opportunities in watch repairing, gem setting and engraving.

CHICAGO SCHOOL OF WATCHMAKING, 1608 Milwaukee Avenue, Chicago 47, Illinois, Dept. 140

Please send your new book, "Master Watchmakers Wanted" without cost or obligation.

- I am interested in attending residence school.
- I am interested in home study.
- I am a veteran.  I am a non-veteran.

NAME.....

ADDRESS.....

CITY..... ZONE..... STATE.....



**New for 1950**  
**FACTORY-TO-YOU**  
**MIDWEST TELEVISION**

**NEW GIANT 16" PICTURE TUBE**

Immense 151 square-inch screen on new 16" metal-glass tube ... clear, steady, bright pictures ... Synchronized sound and picture that a child can tune in perfectly ... Long Distance FM Circuit ... Big 12" Electro-Dynamic Panasonic Speaker ... Available in beautiful consoles or in complete chassis (not a kit). Buy direct at Low Factory Prices, with Low Down Payment and Long Easy Terms ... and on 30 Days Trial! Send for 32-page, 4 color catalog today.



**30 DAYS TRIAL**  
**EASY TERMS**



A Complete Line of Beautiful Consoles or Complete Chassis

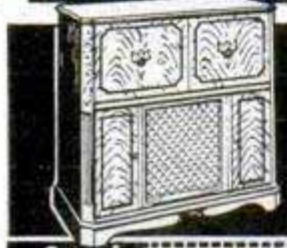

... Also a Complete New 1950 Line of  
**MIDWEST RADIOS**  
 with new long distance FM Circuit and new 3-Speed Phonograph.

Send for **FREE** 32-Page 4 Color CATALOG

**MIDWEST RADIO & TELEVISION CORP.**  
 Dept. X259, 909 Broadway, Cincinnati 2, Ohio

NAME \_\_\_\_\_  
 ADDRESS \_\_\_\_\_  
 CITY \_\_\_\_\_ ZONE \_\_\_\_\_ STATE \_\_\_\_\_

**WHY DON'T YOU WRITE?**

Writing short stories, articles on business, politics, sports, shop crafts, local and club activities, etc., will enable you to earn extra money. In your own home, on your own time, the New York Copy Desk Method teaches you how to write the way newspaper men learn — by writing. Our unique "Writing Aptitude Test" tells whether you possess the fundamental qualities essential to successful writing. You'll enjoy this test. Write for it, without cost or obligation.  
**Veterans: This course approved for Veterans' Training.**  
**NEWSPAPER INSTITUTE OF AMERICA**  
 SUITE 5590-D, ONE PARK AVENUE, NEW YORK 16, N. Y.

**High School at Home**

**Many Finish in 2 Years**

No classes. No time wasted going to and from school. Progress as fast as your time and abilities permit. Standard H. S. texts supplied. Thousands enroll each year in this 52-year-old school. Send for FREE descriptive booklet.

**AMERICAN SCHOOL, Dept. H445**  
 Drexel at 58th St., Chicago 37, Ill.

Without obligation, please send FREE descriptive booklet.

Name \_\_\_\_\_  
 Address \_\_\_\_\_

**Now CHEAP OIL BURNER**  
 FOR HEATING AND COOKING STOVES • FURNACES



**HEAT YOUR HOME, COOK YOUR MEALS WITH CHEAP FURNACE OIL**

**NO MORE SHOVELING COAL OR ASHES.** Sensational Fuelizer Starter Vaporizing System turns Cheap No. 1 Furnace Oil, also Range, Heater, Tractor Distillate, Kerosene and like oils into oil heat—one of the quickest, hottest fires known. **LIFETIME GUARANTEE. \$1.00 Bonus Offer for Testing.** We will let you try it in your own stove or furnace for one month. Get yours for introducing. Big profits QUICK. Be first. Send in your name today for details and cash in on the tremendous demand for this Amazing Invention.

**NORTHWEST MFG. CO., 730-D, Mitchell, S. Dak.**

Imported **CHRONOGRAPH** multi purpose  
 Swiss Stop **WRIST WATCH** \$6.90  
 Plus 69c Fed. Tax  
**1 Year Written Guarantee and Instructions**  
**GIVEN STAINLESS STEEL EXPANSION BAND**

"Wonder" Watch. Used to time autos, airplanes, horse races, athletic events.  
 • Tachometer • Telemeter • Hands & Nos. Glow in Dark • Unbreakable Crystal • Large Red Sweep • Hand • Tells Time • Measures Speed & Distance • Stop Watch • Precision Made

**SENT ON APPROVAL.** Deposit \$6.90 plus tax and postage with postman or send money order, save postage. (Same money back privilege.)

**THE JEWELBOX, Dept. NT-, 1674 Broadway, N.Y. 19, N.Y.**

**PLAY GUITAR LIKE THE COWBOYS DO...**

Just out—very latest guaranteed, simple, easy method. Play cowboy songs the Western way in a few minutes by ear. Surprise and amaze your friends. Be in big demand at parties, camps, public entertainments, on the radio, etc. 12 Complete Lessons.

**SEND NO MONEY.** Pay postman only \$1.00 plus postage and C.O.D. charges, or send \$1.00 and get EXTRA SONGS all postpaid. (Canada, \$1.25 money order only.) Nothing else to buy. Positive money back guarantee. Rush order today.  
**WESTERN RANGER STUDIOS, Dept. 154, Hutchinson, Kans.**

**LIFE AFTER DEATH**  
 "Heaven and Its Wonders, and Hell"  
 by **EMANUEL SWEDENBERG**, with a brief biography of this famed theologian, philosopher and scientist. 632 page book, treating fully of life hereafter, will be sent for **5c** List of publications free.

**The SWEDENBERG FOUNDATION**  
 Room 1618, 51 E. 42nd St., New York 17, N.Y.

**EARN \$30 A DAY LIGHTING FREE CIGARETTES**

**227 MEN AND WOMEN DIVIDED \$167,000 in 2 months** demonstrating Sensational New Invention that **Automatically Hands You Lighted Ready-to-Smoke Cigarettes While You Drive.** Nationally advertised. Patented. Exclusive. Nothing like it. **FREE SAMPLE, FREE CIGARETTES.** No investment risk. Full time or spare time. No experience needed. No age limit. **HURRY!** Write Dept. PM4. **PRES-A-LITE DIRECT SALES, 79 Madison Ave., N.Y. 16, N.Y.**

**BIG-MONEY PROFESSION FOR YOU**  
**EARN IN FULL OR SPARE TIME LEARN AT HOME**

Large incomes in Scientific Swedish Massage, working for doctors, hospitals, sanitariums, clubs or in your own private practice. Hydrotherapy and Electrotherapy included in easy-to-learn course. Prepare for Diploma and Security in this interesting and profitable field. Write for facts and Success Book—FREE.

**THE COLLEGE OF SWEDISH MASSAGE**  
 Dept. 064D, 41 E. Pearson, Chicago 11

**SAY YOU SAW IT IN POPULAR MECHANICS**

**Thrilling Work COLORING PHOTOS**

Fascinating vocation learned at home by those with aptitude. Thrilling pastime. National method brings out life-like colors. Free booklet.

**NATIONAL PHOTO COLORING SCHOOL**  
 1315 S. Michigan, Dept. 1354, Chicago 5



## FULLY GUARANTEED TIRES COST LESS!

Nationally famous FIRESTONE, GOODRICH, U.S. ROYAL, GOODYEAR, and other makes. Every tire selected and inspected for your safety.

<b>Military New Tread</b> Guaranteed 24 months	<b>New Tread Tires Guaranteed 24 Months</b>
600x16 7.98	600x16 6.95
750x20 19.98	750x20 7.95
	550x17 6.95
	650x15 7.95
	710x15 8.95
	700x15 8.95
	760x15 9.95

<b>Military All Purpose Treads Guaranteed 12 Months</b>
900x20 13.98
1000x20 14.98
1100x20 16.98
1000x22 14.98

<b>Good Used Tires. Guaranteed 12 Months. Tube Free with These Tires.</b>			
600x16 3.58	700x16 4.98	32x6(8) 8.98	825x20 11.48
650x16 3.78	750x16 6.88	32x6(10) 10.88	900x20 11.78
650x15 3.68	650x20 7.58	750x20(8) 8.18	1000x20 12.78
700x15 3.88	700x20(8) 8.98	750x20(10) 9.98	1100x20 13.78

### AAA PREMIUM GRADE GUARANTEED 18 MONTHS TUBE FREE WITH THESE TIRES

600x16 5.18	750x16 7.58	650x20 9.88	825x20 15.68
650x16 5.38	600x16(6) 6.48	700x20 10.88	900x20 14.98
650x15 5.28	650x15(6) 6.98	32x6(8) 10.48	1000x20 16.48
700x15 5.48	700x17 8.88	32x6(10) 12.48	1100x20 11.58
820x15 6.98	750x17 10.88	750x20(8) 10.88	1100x22 18.78
700x16 6.18	600x20 9.18	750x20(10) 12.88	1400x20 22.98

<b>MILITARY SPECIAL</b>	900x16 8.98	750x20 8.98
TRACTOR—IMPLEMENT—INDUSTRIAL—SOLID and AIRPLANE TIRE and TUBES — WRITE FOR OUR LOW PRICES		

Largest stock of used tires in the East. Thousands of satisfied customers. Write for sizes not listed.  
SEND MONEY ORDER OR CHECK WITH ORDER.

**PYRAMID TIRE CO.**  
1333-35 North 5th St.  
Dept. M, Phila. 22, Pa.

## WATCHMAKING

★ Watch Repairing ★ Jewelry Engraving ★ Jewelry Repairing

Combination men earn top pay. Learn in school fully accredited by Horological Institute of America in Washington, D. C. and United Horological Association of America. Approved for veterans. Receive tools, tuition and subsistence while learning.

Established 1935. Write for FREE booklet

## The Baronian School, Inc.

2116 WALNUT ST. (DEPT. C) PHILA. 3, PA.

## STRENGTHEN Your VOICE!

YES—you can now build yourself a powerful speaking and singing voice with this amazing new scientifically sound tested method. Self-training . . . no music or piano required. Results GUARANTEED. Just send your name for the sensational details. FREE chart of your vocal mechanism included! Please state your age.  
PERFECT VOICE INSTITUTE, Studio D-2, 1141 S. Wabash Ave., Chicago 5, Ill.

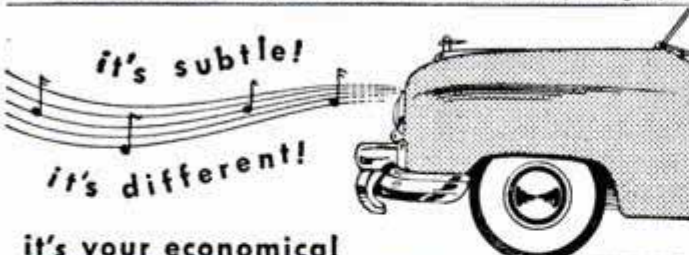

## it's your economical BULB-TYPE AUTO WARNING WHISTLE

BE THE FIRST to have one on your car! It's fun! A non-blaring, loud, clear warning signal to pedestrians — gentle but firm! (Not a wolf whistle or siren.) Install it on any car — does not hook up to engine. At the surprisingly low price of

ONLY \$1.25 POSTPAID  
ORDER YOURS TODAY!

Send \$1.25 or order C.O.D. paying postman \$1.25 plus postage and C.O.D. charges.

A. M. GOHMAN CO., BOX 241 • WINDOM, MINN.



## PLASTICAST

THE GREATEST THING IN PLASTICS!



## A NEW HOME INDUSTRY AND HOBBY!

We have started THOUSANDS of people in a wonderful new kind of business! Here are 4 reasons why:  
(1) The work is pleasant and very easy . . . actually as easy as pouring water out of a glass!  
(2) VERY LITTLE investment is required; imagine, less than \$5.00 is required in order to start you off in your own manufacturing business!  
(3) Can be started ANYWHERE . . . at home, garage, basement, etc. and most important  
(4) The things you can make in QUANTITY PRODUCTION are not only exceptionally attractive and useful but are always in big demand every season of the year!

### YOU CAN MAKE ANYTHING!

What is this new business? It is CASTING . . . casting with liquid plastics. CASTING is a method of production manufacturing WITHOUT MACHINERY OR TOOLS! CASTING is the exceedingly simple process of pouring liquids into molds . . . it is as simple as that! Like making Jello, only these liquid plastics SOLIDIFY in a few minutes after mixing into extremely HARD, DURABLE and ATTRACTIVE articles such as Jewelry, Novelties, Giftware, Figurines, Statuary, Knickknacks, Baby Shoes, Souvenirs, Ceramics, Imitation Marble, Bookends, Lamps, Pensets, Cigarette Lighters, Toys, Dolls, Banks, Fishing Lures, Tools . . . A THOUSAND USEFUL THINGS! The field is really unlimited. We supply EVERYTHING . . . Casting Materials, Molds, Accessories, Instructions and LISTS OF BUYERS!

### 1000 GOLDEN OPPORTUNITIES!

Regardless what you are doing now you can get into the CASTING BUSINESS in your spare time or evenings. We assure you, once you do, you will be eagerly devoting all of your time to this very easy, fascinating and HIGHLY PROFITABLE OCCUPATION until it leads into a dependable business all your own! BUT LET US PROVE IT. Send only 25c for our big 40 page Catalog of Casting Materials, hundreds of Molds, etc. We will also send you FREE an attractive CASTING to show you what can be done with liquid plastics in a few minutes! We will also send you FREE a valuable book giving you details on the ART AND BUSINESS OF CASTING which shows you how to cast and get started! All this for only 25c, but write for it today. This may be the lucky coin that will start the most fascinating and profitable phase of your life!

### COMPLETE OUTFIT — Only \$3.50

If you want to get started at once without delay send only \$3.50 for a complete CASTING OUTFIT that contains everything you need for making about \$50.00 worth of beautiful clear transparent jewelry and novelties! Outfit includes 3 MOLDS, accessories and Instruction Manual. **PLASTICAST OUTFIT No. 434, POSTPAID . . . . . \$3.50**

COMBINATION CASTING OUTFIT consists of 2 different liquid plastics, clear and Ivory, 8 MOLDS and complete accessories for making over \$100.00 worth of jewelry and novelties. **COMBINATION CASTING OUTFIT No. 636, complete and postpaid . . . . . \$4.95**



An attractive Casting and valuable BOOK shown at the right sent FREE with our Catalog! See 3rd paragraph above.

### PLASTICAST COMPANY (DEPT. C)

4637 N. Kedzie Ave. (Write to P. O. Box 987  
Chicago 25, Ill. nearest address) Palo Alto, Calif.  
CANADIAN CUSTOMERS, please order directly from CANADIAN INDUSTRIAL PLASTICS, LTD., 1056 1/2 Pender West, Vancouver, B.C.

### Say You Saw It in Popular Mechanics

Utilities  
Engineering  
Institute

Founded 1927

### Diesel • Auto Body & Fender REFRIGERATION • AIR CONDITIONING

Practical training in these big pay trades covers overhauling, troubleshooting, installation, maintenance techniques. Proved, easy-to-follow method prepares you at home in spare time, follows with actual shop practice. Also G.I. approved resident courses.

Full information FREE! Write today  
2525 Sheffield Ave., Dept. C-4, Chicago 14, Ill.



It's Fun! Assemble This Miniature Antique 1900 Packard for \$2.50!

BE "The man who owns one"

You'll be proud of your Packard, too. This authentic, 3/4" scale model, priced at \$2.50, is one of 8 famous antique autos that make up Hudson Miniatures' "OLD TIMER" line of auto construction sets. Colorful, accurate in detail, easy to assemble, economical to buy. Start your collection today. Write for FREE 4-Color Folder.

See them at your local hobby store or write to us direct. In ordering, please add 25c for postage and packing.

1911 Maxwell.....\$2.50	1910 Model "T" Ford.....\$2.50
1903 Model "A" Ford.....\$2.50	1903 Rambler.....\$2.50
1904 Oldsmobile.....\$1.95	1909 Model "T" Ford.....\$2.95
1909 Stanley Steamer.....\$2.95	

**Hudson Miniatures' "OLD TIMERS"**  
SCRANTON HOBBY CENTER, Dept. 14, Scranton 10, Pa.



**MADE \$14 PER DAY While Still Learning**

"By the time I finished half your course, I was making \$14.00 per day. I have made enough on the side to more than pay for the course—"  
T.E.H.—West Virginia

# LEARN ELECTRIC APPLIANCE

**We Teach**  
How to Repair  
Washing Machines  
Vacuum Cleaners  
Electric Ranges  
Lamps, Motors  
Irons, etc.  
REFRIGERATION and  
House Wiring  
At Home  
In Your  
Spare Time!

## REPAIR & SERVICE

For a man handy with tools, and happiest when working with his hands, OPPORTUNITY is Wide Open Today in this great and growing field. Everyone is a customer for the man trained to service electric appliances.

## OPEN YOUR OWN SHOP

Our practical HOME COURSE teaches you this business from A to Z—preparing you to take a well paid job or open your own shop. You can actually start in your basement or garage with the tools I send you . . . before finishing.

We Include An  
**ELECTRICAL APPLIANCE TESTER**

A Big Kit of Tools at

**NO EXTRA COST**

**MAIL THIS COUPON for FREE BOOK**

PACIFIC TRAINING SCHOOL  
7217 So. Broadway, Dept. P-504, Los Angeles 3, Calif.

Dear Sirs: Please send me, without obligation, your free booklet and complete details.

Name .....

Address ..... Zone .....

City ..... State .....

**OUT OF PAWN**

**GENUINE DIAMONDS**

**SAVE UP TO 50% AND MORE**  
Money-Back Guarantee



All diamonds reset in new mountings.

**BERMAN'S DIAMOND LOAN BANK**

DEPT. P  
BERMAN BLDG., BALTO. 1, MD.

Reference: Your Own Bank or Any Mercantile Agency

SEND FOR FREE  
**FREE**  
Diamond Catalog

**BERMAN'S Illustrated Catalog**

Diamonds from estates, banks, unredeemed pledges offered at substantial savings

VALUES FROM \$10 TO \$10,000

## Learn ACCOUNTING BOOKKEEPING

This nationally renowned school has demand for graduates in good salary positions thru National-wide recognition and placement service. Write / Department PMK today for Big 32 page Success Book to be sent to you **FREE**



**Hills BUSINESS UNIVERSITY AND EXTENSION SCHOOL**  
619 W. MAIN ST. OKLAHOMA CITY 2, OKLAHOMA

## HOW to Make Your Own FIGURINE MOLDS

Here's a quicker, easier way to make exact reproductions of an object in any quantity. No heat curing required; no shrinking of materials. Objects of clay, plaster, wood, metal, glass or stone like ashtrays, bookends, medals, souvenirs, plaques, sculpture can be copied exactly right at home! Perfect for reproducing Dresden figurines. No previous experience needed. No special tools required. Our new Brochure 324 gives exact, step-by-step instructions anyone can follow. Send 10c for it to SCULPTURE HOUSE, 304 West 42 Street, New York 18, N. Y.



## BARBELLS

Finest Quality.....\$8.98 up  
**FREE CATALOG**

Send today for big new 4 color fully illustrated free catalog of BARBELLS, Dumbbells and Health equipment. Free—world famous \$15.00 Dan Lurie Barbell and Dumbbell training courses with every purchase.

**DAN LURIE BARBELL CO.**  
Dept. 159 D

1729M4 Rockaway Parkway, Brooklyn 12, N.Y.

## ANGORAS FOR QUICK MONEY

Angoras cheaply and easily raised. Thousands needed for breeders in new industry furnishing wool for textile mills. Free illustrated booklet shows sales opportunities, success stories, etc. Write—

**WILSONS, Stanton 17, California**

## CIRCLE SHOOTING ACCURACY

PAT. SPOTSHOT PEND.

Bead sight, Die Cut one piece rubber sling. The sportsman's choice for hunting and target shooting. Model #2—Shoots 5/16 steel Pellets 3 3/8 circle—Postpaid \$1.69. Shipped complete with sling and pellets. Send check or money order today. Dealers inquiries invited.

WEST MANUFACTURING COMPANY, LONDON, OHIO  
ESTABLISHED 1899



Say You Saw It in Popular Mechanics

## RUPTURE



**RELIEF...OR YOUR MONEY BACK**  
Simple, easy to wear truss made by old surgical house. You risk nothing. Write for free booklet. Don't delay.

WEB TRUSS CO. Dept. M-4 Hagerstown, Md.

# Auto DIRECTION SIGNAL



Flashes front and rear lights

**\$9.95** **\$10.95**  
Brown Chrome

Postpaid in U.S. Send check or money order. Postage extra on C.O.D.'s. SPECIFY MAKE AND YEAR.

## Flash Your Turns Electrically

- NEW DELUXE MODEL—flashes parking and tail lights.
- Readily installed on most cars since 1941.
- No lights to mount, sockets to change, holes to drill.
- No interference with regular lights.
- Each kit complete — NOTHING ELSE TO BUY.
- Easy-operating chrome lever, sturdy die-cast housing.
- Built to last for years — money back guarantee.

**LESTER Products Company**

Box M-4, 1743 Milwaukee Avenue, Chicago 47, Illinois



## FOOT-SWITCH

**Complete Your Home Workshop**  
Really mechanize your workshop, get instant start-and-stop control of power tools with famous Smith FOOT-SWITCH. Now complete with cord and plug. No soldering or wiring. Heavy duty tungsten points, bronze spring. Just \$3.00 postpaid or send \$1.00 for C.O.D. plus fee. (Foreign \$4.00). Money back guar.

In Calif. include 3% Sales Tax

**NATHAN R. SMITH MFG. CO.** 105 S PASADENA AVE. SOUTH PASADENA, CALIF.

## SALESMEN! \$5940 a Day

with **EVERSPRAY Underground Sprinkler System**



First UNDERGROUND Sprinkler System for private lawns priced at less than \$50.00. Every home owner wants it — and can afford it! Buyer installs system himself in few hours. Six pop-up heads water up to 1,000 square feet. Only 3 sales a day net you \$59,40! Chance for big quick cash clean-up. Write for FREE offer of Sensational Pocket DEMONSTRATOR and details of "Jack Pot" Pyramid Sales Plan that turns every first order into 10 or more! Everything FREE. Rush name to **John Oakman, EVERSPRAY, 2001 Carroll Ave., Dept. 2-D, Chicago 12, Ill.**

## WRITERS

Conscientious sales service for your short stories, articles, books and plays. Send today for FREE circular "Your Road To Writing Success."

**DANIEL S. MEAD LITERARY AGENCY**  
Dept. PM4 419 4th Ave., N.Y.C., 16

## NYLON LINE FOR YOUR HOBBY

**SAILORS-SPORTSMEN-CAMPERS**

Now Genuine Nylon Line. Strong as wire—yet easy to work with. Mildew-proof—resists salt water and abrasion—dries quickly. Tough, rugged, just can't rot. **DIRECT from MILL IDEAL FOR** Fishing, Rod Winding, Net Making, Weaving, Tent Repairs, Model Making, Stitching leather, canvas & plastics. All heavy duty sewing (Machine & Hand). **CHOICE OF 12 LOVELY COLORS.** White, Light Tan, Dark Tan, Pink, Yellow, Blue, Black, Green, Scarlet, Brown, Navy, Grey. **EACH SPOOL A FULL 1/5 OF A LB.** 5 SIZES — TEST — Size 30 . . . 9 lbs., 20 . . . 16 lbs., 10 . . . 25 lbs., 5 . . . 50 lbs., 3 . . . 68 lbs. Send No Money. Send Name and Address. SPECIFY SIZE AND COLOR. Giant Spool shipped C.O.D. — \$1.69 (2 for \$3.29) plus C.O.D. postage or SEND MONEY—WE PAY POSTAGE. Satisfaction guaranteed or your money refunded.



**LEEWARD MILLS DEPT. 49D**  
189 W. Madison St., Chicago, 2, Ill.

Owners are making

# BIG MONEY



WITH A VERY SMALL INVESTMENT

## operating this FRANCHISED ROADSIDE STAND

One of the greatest opportunities in America! A business you can start with very little capital . . . and make thousands of dollars if you follow our *proved* methods of stand building and operating. A 28-page folder shows plans, testimonials from owners . . . gives hundreds of other essential facts. Send for your *free* copy!



**RICHARDSON Corp.,**  
Dept. PM-4  
Rochester 3, N. Y.  
Please send me FREE folder on RICHARDSON stand.

Name \_\_\_\_\_  
Address \_\_\_\_\_  
Place \_\_\_\_\_  
Phone \_\_\_\_\_



## NOW! CLEAN—CLEAR WATER Right from YOUR FAUCET



**SCIENTIFIC TESTS PROVE—**  
**THE AQUA-MITE FILTER REMOVES**

**RUST, SILT, DIRT, ALGAE, Chlorine Tastes, Disagreeable Odors**

Get sparkling clear, spring fresh tasting water from kitchen or bathroom faucet. Rid drinking water of obnoxious tastes and odors. The mighty AQUA-MITE, an amazing scientific discovery, actually performs miracles . . . yet costs so little. Order an AQUA-MITE filter today! Taste the difference . . . see the difference in your drinking water! AQUA-MITE is precision-built, guaranteed by Del-Mar Services of Chicago, Illinois.

AQUA-MITE is duo-action (chemical & mechanical), filters hot and cold water. 20 vari-mesh monel screens, inside casing, are rust and corrosion proof. Approved chemicals do not need replacement. No messy cleaning, simply reverse and flush.

**COSTS ONLY \$6.95 LASTS FOR YEARS**

**ORDER NOW!**  
ENJOY CLEAN, PURE, TASTY, HEALTHFUL WATER

See your local dealer or send check or money order—AQUA-MITE will be mailed prepaid.

**DEL-MAR SERVICES**  
3937 Milwaukee Ave., Chicago 41, Ill.

Please send . . . . . AQUA-MITE filters.  
. . . . . check . . . . . money order enclosed.

Name . . . . .  
Address . . . . .  
City . . . . . State . . . . .

# EARN MORE MONEY IN ELECTRICITY!

with APPLIED PRACTICAL ELECTRICITY



Coyne's new set helps men get ahead in Electricity. 8 great books give you complete A to Z know-how, explained in easy-to-follow language with hundreds of charts, examples, pictures. Covers all branches of electricity including appliance repairing; AC and DC equipment; electrical refrigeration; industrial electronics and much more. Brings you 10,500 electrical facts; 3,400 subjects; hundreds of wiring diagrams, tables, formulae, short-cut methods. Backed by 50 years of Coyne experience in training that has put hundreds of men on the road to top earnings.

Sent on **FREE TRIAL**

**USE SET FREE FOR 7 DAYS!**

You have to SEE these books to know how much they'll help you. See them FREE! Just fill out coupon below and mail it in. SEND NO MONEY. Examine the set for 7 days AT OUR RISK!

## HANDBOOK OF RESIDENTIAL WIRING FREE FOR PROMPT ACTION



Act promptly and we will include FREE, the valuable new booklet, "Handbook of Residential Wiring Design". If you return the Set at our expense in 7 days, you owe nothing. To keep Set, send either \$23.75 in cash or \$3.00 after 7 days and \$3.00 per month until \$25.50 is paid. Either way, you keep the Residential Wiring Book FREE! Coupon below is just a request to see APPLIED ELECTRICITY Set and to get FREE Wiring Book for doing so. Mail coupon AT ONCE!

## FREE TRIAL COUPON—MAIL NOW!

Educational Book Publishing Division,  
COYNE ELECTRICAL & RADIO SCHOOL,  
500 S. Paulina St., Dept. 40-R6, Chicago 12, Ill.  
YES! Send Coyne's new, 8 volume set, "Applied Practical Electricity" to me, postpaid, for 7 days FREE TRIAL per your offer. Include "Handbook of Residential Wiring" FREE.

Name \_\_\_\_\_ Age \_\_\_\_\_  
Address \_\_\_\_\_  
Town \_\_\_\_\_ Zone \_\_\_\_\_ State \_\_\_\_\_

Here's How CREI Prepares You for a Professional Career with Industry-Recognized Training in a Minimum of Time

# TELEVISION RADIO-ELECTRONICS ENGINEERING

**G**RADUATES of CREI residence school are preferred by industry because of their training and ability. This recognition is the reason that CREI men quickly find good jobs. With 23 years of practical teaching experience in these highly technical fields, CREI offers an outstanding faculty, modern and complete laboratories, shops and equipment. New students are accepted twice monthly and each may advance as rapidly as he is capable. The basic course with one specialized course requires an average of 20 months to complete.

CREI is recognized as one of the country's leading technical institutes. Its work is of college level. It prepares the young man for a good job in industry in a minimum of time.

G. I. Approved

## CAPITOL RADIO ENGINEERING INSTITUTE

An Accredited Technical Institute Founded in 1927

Mail coupon for Free Catalog

Capitol Radio Engineering Institute, Dept. 174B  
16th & Park Road, N.W., Washington 10, D. C.  
Please send me your residence school catalog and complete details. (If interested in Home Study check below.)

Name \_\_\_\_\_

Age \_\_\_\_\_ If in school, what term? \_\_\_\_\_

Street \_\_\_\_\_

City \_\_\_\_\_ Zone \_\_\_\_\_ State \_\_\_\_\_

I am entitled to training under G.I. Bill.  Send information on Home Study Courses.

**NOTICE!** You Can't Buy Better Quality at any price. We sell just **GOOD TIRES**—No fancy promises. **ONE Quality—ONE Price—Why take less? Our Tires used on Buses & Trucks for every purpose—One Trial Will Convince You.**



**WRITTEN GUARANTEE**  
Sent with every Tire You Buy  
**TUBE GIVEN WITH EACH TIRE**  
**10% Discount May Be Taken on 1 or more tires if you SEND THIS AD**  
Be Wise — Read this Before You Buy!  
**OUR EXPERIENCE ASSURES YOU THE BEST BUY IN GOOD ORIGINAL TREAD USED TIRES — BUY IN CONFIDENCE POPULAR BRANDS Positively Not Re-Caps or Re-Molds**

6.50-17 . . . . \$5.02	6.70-15 . . . . \$6.75	7.50-16 . . . . \$7.45
6.00-16 . . . . 5.02	6.70-16 . . . . 6.75	7.60-15 . . . . 7.62
6.50-15 . . . . 5.02	7.00-15 . . . . 5.20	7.60-16 . . . . 7.62
6.50-16 . . . . 5.02	7.00-16 . . . . 5.95	8.20-15 . . . . 6.75

Good Tread—No Re-Caps. These Tires Will Carry You Twice as Far!

6.50-20 (6) . . \$9.22	8.25-20 (10) \$14.55	11.00-20(12) \$15.75
7.00-20 (8) . . 10.52	9.00-20 (10) . 14.75	11.00-22(12) 15.75
7.50-20 (8) . . 10.52	10.00-20 (12) 15.75	32x6 (8) 10.25

750-20 MILITARY 8 PLY REGULAR \$8.75—SUPER \$12.92  
900-16 MILITARY 8 PLY REGULAR \$8.45—SUPER \$10.72

Thousands of Tires Shipped to Satisfied Customers Throughout United States. Send check or Money Order Dept. 2.

**STANDARD 834 N. Broad St., Philadelphia 30, Pa.**

# WANTED TO MAKE OR SELL

Large midwestern automotive parts manufacturer with complete sales and distribution setup wants new product to make, sell or distribute. Interested in any item kindred to automotive field. What have you to offer?

Write full details to

400 PARKWOOD RD. KIRKWOOD 22, MO.

## New Chrome Combination Lock Gas Cap

Uses dependable combination lock. No keys to lose. Limited supply. Theft and moisture-proof. Will last for years. Order now. Specify make and model car. Pay postman \$2.00 plus few cents C.O.D. charges.

S & P SPECIALTY CO., Box 269, N. Olmsted, O.

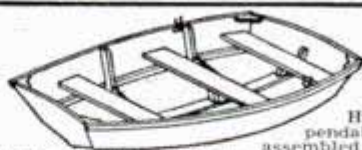

**8' BOAT KIT**  
only **\$29.95**

Hundreds of these proven dependable small prams have been assembled by amateur home builders using but the simplest of tools. First quality marine plywood—each kit individually packed in a corrugated carton—all wooden parts, screws, glue, oarlocks and instructions included. Easily shipped.

Write for Descriptive Circular

SMALL-CRAFT, Tenean St., Dorchester, Mass.

## HOLLYWOOD MUFFLER

THE TONE YOU LOVE TO HEAR

### MORE SPEED—POWER—MILEAGE

are yours with a Hollywood Muffler . . . plus a tone you'll love to hear! Not a gutted muffler. Easy to install.

Hollywood Muffler; Trade-mark Reg. U. S. Pat. Off.

IMPROVED DESIGN  
PRECISION MADE  
ELECTRIC WELDED!



Outlasts ordinary mufflers 3 to 1

Ford, Chevrolet, Plymouth \$6.00

All other cars . . . . . \$8.00

Duals, Ford & Merc. \$24.50. Also Fender Skirts, \$10.95. Order direct. Send check or M.O. and save postage.

Dealers Write **WILKINSON MUFFLER CO. 811 WILT STREET FT. WAYNE, IND.**





## PEEL PAINT TO BARE WOOD WITH ONE EASY STROKE

NEW ELECTRICAL TOOL removes 1 to 10 or more coats of paint from any wood surface as easy as cutting butter with a hot knife. No scraping, cutting, burning, sanding, or chemicals. The new Lectro Paint Peeler instantly softens paint electrically and peels it off the surface clean to the bare wood with one easy stroke. It's faster than a blow torch—there's no danger of fire—will not scorch or burn delicate wood surfaces. Makes no mess—no smell—it's even fun to use. Removes any paint, enamel quickly and easily. Sturdily constructed to last for years. Sent complete with extra long, quality electrical cord. Simply plug into any A.C. or D.C. outlet—let heat for several minutes and remove paint to the bare wood on exterior or interior painted surfaces, floors, woodwork, cupboards, furniture, antiques, boats, window-sills, screens, doors—a hundred other uses. Price \$4.95 postpaid—nothing else to buy. Full money back guarantee. For immediate shipment—send check, cash or money order to:

**LECTRO WELD, INC.**

Dept. PM

3495 West 140th St. Cleveland 11, Ohio

# BIG FREE CATALOG of WAR SURPLUS OPTICAL BARGAINS

Build Your Own RIFLESCOPE, BINOCULARS, TELESCOPES, ETC.  
We Furnish Optics and Instructions

- LENSES, PRISMS & RETICLES
- EYEPIECES and OBJECTIVES

Send \$1.00 for Stock #2-H  
10-Piece Lens Kit and Big  
Instruction Booklet.

We Have Numerous Types of Assembled Optical Instruments Including BINOCULARS and RIFLESCOPES.

CHECK OUR BARGAINS . . . Request CATALOG H

**EDMUND SALVAGE COMPANY**  
BARRINGTON, NEW JERSEY

**Not Wood—Unbreakable Aluminum!**

Lots of fun—  
for everyone!

Springshot! — powerful! ideal for target practice, small game. Aluminum alloy construction, 1st quality live rubber impeller band, flexible leather pouch; extra impeller band and ammunition with each. Order today!

Order Springshot by mail (\$1.19 ppd.) from

**SPRINGSHOT, Dept. PM**  
P. O. Box 3085  
Burbank, California

Send check, money order or cash (No COD's)

**\$1.19 ppd.**

**NEW AUTOMOTIVE DISCOVERY**

# FREE TRIAL IN YOUR CAR!

THE OBJECTIVE IS TO GIVE YOUR CAR

- ✓ MORE MILEAGE
- ✓ FASTER PICK-UP
- ✓ EASIER STARTING
- ✓ BETTER IDLING

REPLACES IDLE ADJUSTMENT SCREW IN YOUR CARBURETOR HOLDS FOR AIR FLOW

Patent Pending

INSTALL IT YOURSELF in a Few Minutes

THE AMAZING NEW GANE "air-flow" NEEDLE

**ABOUT 1/2 MILLION NOW IN USE!**

Up to 25% MORE MILEAGE, EASIER STARTING, FASTER PICK-UP and SMOOTHER IDLING are reported by many users of this new SENSATIONAL Automotive Product. (Hundreds of such letters have already been received.) However, they do not show improvement in some cars—Therefore we want you to try them in your car AT OUR EXPENSE. TRY BEFORE YOU BUY. Just mail card or coupon below and TRY THEM FREE for 10 days. Then check your mileage and engine performance. If satisfied, send only \$1.50 per needle (8 cyl. cars take 2). If not entirely satisfied—just return them and YOU OWE US NOTHING—FAIR ENOUGH? - TRY BEFORE YOU BUY

**MAIL TODAY SEND NO MONEY PAY POSTMAN NOTHING**

**NATIONAL AUTOMOTIVE RESEARCH CORP.**  
Dept. J-4, Venice, California

RUSH Gane "Air-Flow" Needle for my FREE TRIAL. I SEND NO MONEY —I PAY POSTMAN NOTHING. I will try them for 10 days in my car. Then, if satisfied, I will send only \$1.50 per needle (8 cyl. cars take 2). If NOT SATISFIED, I will return them and I OWE YOU NOTHING.

Name \_\_\_\_\_

Address \_\_\_\_\_

City \_\_\_\_\_ State \_\_\_\_\_

Make of Car \_\_\_\_\_ Year \_\_\_\_\_

No. of Cylinders \_\_\_\_\_ Make of Carburetor \_\_\_\_\_

## WAR EQUIPMENT MAIL SALE

### G.E. D-C Welding Generator

Outstanding welding unit. 0 to 300 amperes. Brand new. Complete with drive pulley, heat control, rheostat, etc. Build and repair your own machinery, do professional work for pay. Drive with tractor, old auto engine or electric motor. Hundreds uses. Complete with full instructions on "How To Weld."

- Generator only (Frt. Ppd.) Cost Govt. over \$275. Sale . . . . . \$80.90
- Generator with G.E. helmet, rods, holder, cables, etc. . . . . 104.50
- Genuine Allmand 0-250-amperes A-C Welder, complete with all accessories, 220-volt, 60-cycle. Special. . . . . \$149.50

Hundreds other bargains. Rush card for big free catalog.

**BURDEN SALES COMPANY**  
806 "O" ST. LINCOLN, NEBR. We Pay All Freight Charges

# Say You Saw It in POPULAR MECHANICS

**New Easy Way TO MAKE BIG MONEY! AT HOME FULL OR SPARE TIME**

**Costs You Only 5¢-You Get \$5.00**

Now is the time to cash in on this big-paying, easy-to-operate year 'round business, and you need no experience! Metallize Baby Shoes in real GOLD, SILVER, BRONZE, and PEARL. Everything furnished so YOU can start earning money at once—up to \$1,000 per month full time, or \$50 to \$75 per week spare time—at \$5 per hour. They will last FOREVER, and there are 10 million eager customers every year waiting to buy. FREE DETAILS—send no money—a postcard with your name will bring all the facts. Don't pass up this opportunity to start your own business on a shoestring—so ACT NOW. Write at once to

**KIKTAVI COMPANY, Dept. PM-4**  
2111 W. MANCHESTER BLVD., LOS ANGELES 44, CALIFORNIA

- Big Income
- Huge Demand
- Sales Plans
- Future Security
- Your Own Boss
- Money Back Guarantee
- Most Successful Name in Metallizing

**FREE! INSPECTION**  
3 way profit plan yours to inspect at my risk for 7 days. Includes two actual metallized baby shoes—or a pair of your own metallized at no extra cost.

Write Now

## GARDEN TRACTORS

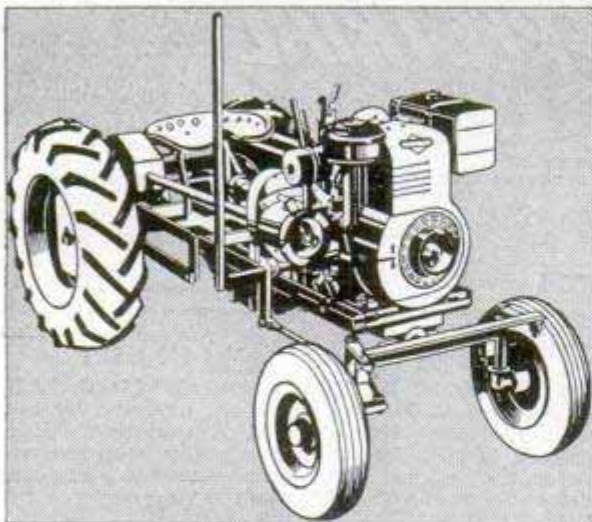

### LOOK--SPEEDEX AGAIN PAVES THE WAY TO LOWER PRICES IN GARDEN TRACTORS

**FOUR--** MODELS 1.9 H. P., 3 H. P., 5 H. P. and our famous 8 H. P. four wheel riding type.

Prices start at only \$119.50 to \$350.00 for the powerful 8 H. P. Rider

**ALL--** Speedex Garden Tractors are built with enclosed gears running in oil, powered with popular-make engines and equipped with the latest type rubber tires.

**JUST--** for the asking we will mail you absolutely FREE a circular illustrating and describing these tractors.

**WHY--** not write today. Please use a penny post card.

**SPEEDEX GARDEN TRACTOR CO.**  
BOX 216-D1 Ravenna, Ohio  
P-1149-34

## HOW TO MAKE MONEY!



RAISE HIGHLY PROFITABLE Angora Rabbits backyard easy way. Multiply fast. No experience required. Wool brings TOP PRICE. Plenty markets. Write TODAY for FREE INFORMATION, PRICES & WHERE to SELL.

**WHITE'S RABBITRY**  
NEWARK 10, OHIO

## WANT TO Write Stories

FREE LESSON  
shows how you  
learn at home

Articles  
Mysteries?



The demand for writers is creating great new opportunities for people with an urge to write. It's not as hard to succeed as you may imagine. Most famous authors come from ordinary walks of life. At home, you too may learn fiction writing, the best basis for all fields—short stories, features, articles, technical, mechanical and business items. Palmer Institute's Home Study Training (Established 1917) is endorsed by Rupert Hughes, Gertrude Atherton, Keith Monroe, and other famous authors and by scores of successful graduates. Complete instruction material and professional coaching to develop your own style. FREE book and lesson show how you may enjoy an ideal part time or full time career. Write today (no salesman will call). Veterans: advise us if you are eligible for G.I. Training.

**PALMER Institute of Authorship • Est. 1917**  
Approved for Veterans 1680 NO. SYCAMORE, Dept. T-40  
HOLLYWOOD 28, CALIFORNIA

## ELECTRIFY any SEWING MACHINE

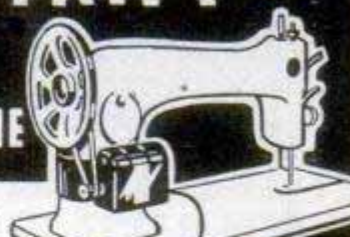

MAKE YOUR PRESENT SEWING MACHINE INTO A MODERN ELECTRIC WITH THIS SIMPLE-TO-INSTALL KIT.

Anyone, including children, can easily attach this unit. Wired and ready for immediate use.

Lowest price conversion unit on the market. This price possible only because you are buying direct from Sewing Machine Conversion Unit Co. GUARANTEED FOR 1 YEAR.

You get:  
• AC-DC Universal Motor • Carbon Type Speed Control Rheostat • 3 Genuine Rubber Belts • Steel Pulley • 2 Mounting Brackets • Underwriters Cord Set with Plug & Socket • Complete very simple instruction sheet.

**FREE**—Beautiful, non-glare finest quality sew light as a special bonus if you act now. Worth \$2.75.

**FREE TRIAL OFFER**—If not completely satisfied return kit within 10 days for full refund immediately. \$10.95 complete including everything postpaid. If C.O.D., send 25¢ with order, balance C.O.D. plus postal charges. State whether handwheel turns toward or away from you.

**SEWING MACHINE CONVERSION UNIT CO., Dept. PM-4**  
366 MADISON AVE. NEW YORK 17, N. Y.

DIRECT FROM  
MANUFACTURER  
**\$10.95**  
POSTPAID

## SAVE ON PRINTING

Letterheads, Forms, Catalogs  
1000—8 1/2 x 11— \$5.95  
5000—8 1/2 x 11— 3.50/M  
10,000—8 1/2 x 11— 2.90/M  
Both sides add— 60%  
2—Color add— 70%  
16 lb. White Bond. Litho offset from copy ready for Camera  
1000—POST CARDS—\$4.95  
5000— \$3.10/M  
10,000— \$2.45/M  
2—Colors add 70%. 2 sides— 60%. Layout ready for Camera.

2—Color SHIPPING LABELS  
300—Size 2 1/4 x 4 1/2—\$1.00  
1000—\$2.95; 5000—\$9.95  
Blue and Red Ink, Gummed Stock  
Save Labor, use one-time carbon Snap-Out forms. Get our prices. No chg. for Pictures & Drawings. Include Postage: Letterheads & Post Cards—9¢/M, Labels 1¢/M  
**FREE** Samples. Prices on all Printing, Catalogs, Booklets. 25% cash with C.O.Ds.

JACKSON PRINTING CO., 2011-BD Yale Ave., St. Louis 17, Mo.

**YOU CAN BE AN All Around HE-MAN** All 5 famous courses by George F. Jowett, world's greatest body builder in 1 complete muscle building volume (valued at \$5 each) now only 10¢. Packed with How-to-Do-it pictures. 1. How to Mold a Mighty Arm. 2. Mighty Chest. 3. Mighty Back. 4. Mighty Grip. 5. Mighty Legs. Free strong men photo book. Quick results or money back! Send 10¢ name, address, age.  
**JOWETT INSTITUTE, Dept. PM-04, 230 Fifth Avenue, New York City**

## Learn CARPENTRY BRICK LAYING

Big money in the Building Trades. Learn now while opportunities are greatest. Train in our completely equipped shops under expert instructors. Vets attending school entitled to G.I. Benefits. Write for FREE Catalog.

**MIDWEST SCHOOL OF BUILDING TRADES, Dept. PM-4**  
411 N. Center St. Bloomington, Ill.

SAY YOU SAW IT IN POPULAR MECHANICS

## REDUCE EYESTRAIN

3 Times More Light

Amazing new lens clips on electric light bulb. Fits 25 to 100 watt incl. Focuses 3 TIMES MORE LIGHT. Fastens securely at any angle. INCREASES LIGHT—REDUCES WATTAGE. Ideal for work or study. Send check or money order today!

**\$1.00**

Postpaid

**LIGHT INTENSIFIER CO.**  
Dept. P, 1525 Crane Ave., Detroit 14, Mich.



**MEN! WOMEN!**  
**New Car given  
 as Bonus!**



TAKE ORDERS for  
 Nationally Advertised

**NYLONS**

GUARANTEED NINE MONTHS

Sensational Guarantee creating a tremendous demand for Wilknit Nylons! If they run, wear out or even snag from any cause whatever... within NINE MONTHS... depending on quantity... they are replaced FREE OF CHARGE. No wonder it's easy to quickly build up fine, steady, year-round income. Earnings start immediately. Look at these exceptional figures—Ralph Shearer made \$67.11, **first week**—Mrs. Paul Estes, \$42.92—Mrs. Ivey Gentry, \$43.37. Doris Jensen in addition to making as much as \$17.00 in a single day, earned two cars as EXTRA BONUSES. Learn how you can make money in your full or spare time without a bit of previous experience.

**SEND NO MONEY... Just Hose Size**

When you send for Selling Outfit, I also send your choice of Nylons or Socks for your personal use. Don't lose a minute. Rush name on penny postcard for full money-making facts on Sensational Sales Kit. Send hose size, too. **Lowell Wilkin, WILKNITHOSIERY CO., 304 Midway, Greenfield, Ohio**

**EARNED  
 TWO NEW CARS**

... and as much as  
 \$120.00 in one week

That's the exceptionally fine record of Chas. Mills with the famous Wilknit hosiery line. Offer of New Chevrolet as a bonus open to EVERYONE. Send name for facts FREE!

**FREE  
 Bargain  
 Book**

Packed with hundreds of sensational bargains—new and used—in still and movie photo equipment and accessories.

Write for your free copy today to

**Central Camera Co.**

Dept. 8D, 230 S. Wabash, Chicago 4, Ill.

Photographic Headquarters Since 1899

**STOP-LIGHT FLASHER** **MAKES STOPLIGHT FLASH**  
**GIVEN! EXTRA** **ON and OFF AUTOMATICALLY**  
 LIKE FIRE AND POLICE DEPTS. FITS ANY CAR. BOTH POP-OUT LIGHTER AND FLASHER (TO INTRODUCE) ONLY \$1.00 POSTPAID  
**ALCO MFG. CO.**  
 927 ARGENTINE BLVD.  
 DEPT. P, KANSAS CITY, KANSAS

**"BIG SHOT" SLINGSHOT**

NOT a toy. Kills crows, squirrels, rabbits, etc. No noise. Get extra shots at game. Get high scores on your target.

Packed with pellets and spare bands. Start your fun today. See your dealer, or send \$1 now to:

**BOND PRODUCTS CO., Dept. M4**  
 13139 Hamilton Ave., Detroit 3, Mich.



SEND ONLY \$1

**Wash Cars NEW Scientific Way**

Storm Sashes, Screens, Etc., Etc. **with Spra-A-Wash**

Without a doubt here is the simplest, quickest and most scientific way to wash any car. Simply insert **SPRA-A-WASH** in the nozzle of the water hose and the combination softens the water, softens the dirt and in a matter of minutes the dirt washes away and without wiping dry; leaves a bright clean finish. You will be amazed at the result. Users are enthusiastic and tell their friends. This opens up a new field for Big Business and BIG PROFITS.

**DISTRIBUTORS WANTED** MAKES NO DIFFERENCE WHAT YOU HAVE SOLD OR IF YOU NEVER SOLD ANYTHING BEFORE. HERE IS A REAL OPPORTUNITY.

**SPRAY-A-WASH, 1043 Chicago Ave., Dept. P. EVANSTON, ILL.**

in a few minutes

CONNECTS TO ANY GARDEN HOSE INSTANTLY

We also supply Retainer

ORDER YOURS TODAY

Sold on... **MONEY BACK GUARANTEE** Plenty for 12 Washes

only **\$1.00**

Postpaid in U.S.A.



**Become an  
 Electrical Engineer**

*B. S. Degree in 36 Months*



**MAJOR in POWER or ELECTRONICS**

Important advantages are yours at this nonprofit Technical Institute and College. A valuable year is saved by gaining your B.S. degree in 36 months of continuous study. You get both practical, specialized training in well-equipped laboratories—and a solid education in Electrical Engineering and related arts.

In 12 months, the world-famous concentric system equips you for specific occupations and brings the valued Electro Technician or Electronics Technician Certificate which is credited toward your B.S. degree.

**Military, Academic or Practical Training** is evaluated for advanced credit. Preparatory courses are also available.



Faculty of 85 specialists. 1555 currently enrolled from 48 states and 23 foreign countries. Over 35,000 alumni. Terms open July, Oct., Jan., April.

**MILWAUKEE  
 SCHOOL of ENGINEERING**

Technical Institute • College of Electrical Engineering

Write for free 110-page catalog and 48-page pictorial booklet, "Your Career".

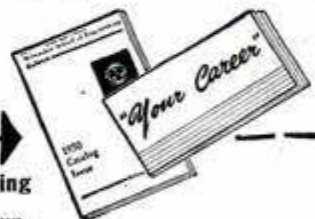

**Milwaukee School of Engineering**  
 Dept. PM-450  
 1020 N. Broadway, Milwaukee, Wis.

Without obligation, send me the 110-page catalog and 48-page "Your Career" booklet.

(Check 6 to 36 month courses which interest you)

Electrical Engineering:  Power  Electronics  
 Radio-Television  Electricity  Welding  
 Air Conditioning  Heating  Refrigeration

NAME \_\_\_\_\_ AGE \_\_\_\_\_

ADDRESS \_\_\_\_\_

CITY \_\_\_\_\_ ZONE \_\_\_\_\_ STATE \_\_\_\_\_

Check if World War II Veteran

**DO ANY JOB ..  
EASIER .. QUICKER  
MAKE MORE MONEY** in the **FIELDS of  
BIG OPPORTUNITIES**

*This Low Cost Help is All You Need to Learn to Fill a Top Job*

Free Trial in Your Own Home  
Used by Army, Navy, Other  
Government Depts., 200  
Schools and Industrial Firms

You, too, can get the **BIG PAY** help you need from these famous books—**EASY—QUICK—AT LOW COST.** Select **YOUR** books now on sure money-back plan.

**DYKE'S AUTO BOOK—New 21st Edition**  
New Material on Transmissions, Trucks, Tractors

Millions of old cars need repairs and thousands of men needed to keep them going. Get famous **DYKE Auto Book**. New 21st Edition covers principles, construction, repair, adjustment, testing, troubles and remedies of all cars. Covers Diesel powered cars and trucks and passenger car specifications.

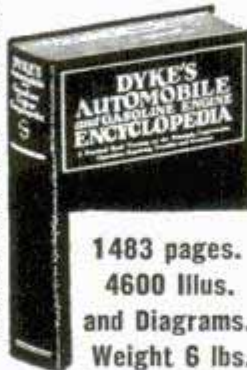

1483 pages.  
4600 illus.  
and Diagrams.  
Weight 6 lbs.

**DYKE'S FAMOUS CARBURETOR BOOK**

Best pay for those who specialize in this work. Standard guide for years. New edition covers engine tune-up, ignition, carburetion, fuel pump, valves, etc. 244 pages, 549 illustrations. \$3.50.

\$7.50

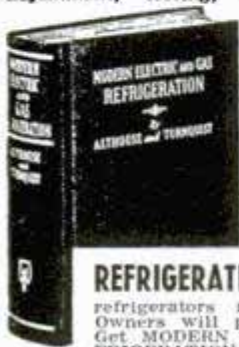

**REFRIGERATION** Repair and service all types. Millions of old refrigerators must be kept operating. Owners will pay big for good service. Get **MODERN GAS AND ELECTRIC REFRIGERATION** now. Over 1000 pages. 408 illus. 17 Diagrams in color. New edition. Up to date information. \$5.00.

**AUTO Body-Fender Repairs** Covers every phase of auto body and fender repair work including use of tools, latest approved procedure. Shows how to do a professional job. Also how to operate a shop successfully. 325 pages, 689 illus. \$3.50.

**Send No Money**

Select books wanted. Remit price or pay postman price plus postage on delivery. Money back in five days if not satisfied.

**GOODHEART-WILLCOX CO., Dept. 123, 1321 S. Michigan Ave., Chicago 16, Ill.**

**Would YOU Like to Make  
\$1,000 A MONTH?**

*That's what Stanley Hyman is making selling the amazing new PRESTO Fire Extinguisher!*

**OVER** 11,000 people died in fires last year. An eager public has been waiting for a practical new kind of fire extinguisher. Now it's here! Tiny "Presto" is about the size of a flashlight. Does the job of bulky extinguishers that cost 4 times as much and are 8 times as heavy. Ends fires fast as 2 seconds. Fits in palm of hand. Never corrodes. *Guaranteed for 20 years!* Sells for only \$3.98!



**Stanley Hyman**

You can make good money showing this new discovery to owners of homes, cars, boats, farms, etc. Stanley Hyman reports making over \$1000 a month. H. J. Kerr, \$20 a day. William Wydallis, \$15.20 an hour.



Science's New Midget Miracle "PRESTO"

What's the secret of "Presto's" amazing power? It's a new wonder chemical developed during the war, found to be 1.5 to 6 times as effective as chemical contents of other extinguishers on an equal-weight basis. Makes possible, for the first time, an extinguisher that is small, light, and amazingly effective.

Help supply the demand for this important new discovery. Write for **FREE** Sales Kit. No obligation; no capital required. But don't put it off. Every day you hesitate may cost you \$10, \$15, or even \$50 you could be making. Send postcard or letter to:

**MERLITE INDUSTRIES, Inc., Dept. 54,  
201 East 16th St. New York 3, N. Y.**

(If you want demonstration sample, too, send \$2.50. Money back if you wish. **FREE** re-fills for your Demonstrator.)

**NEW! Trash Disposal Unit Burns Refuse Safely**

• A new type outdoor dispose-all unit safely and quickly burns garbage and trash in any weather. All refuse, damp, green or dry is fully consumed. Scientific draft design completely eliminates fire hazard of flying ash, sparks, burning, blowing bits of paper. Intense combustion removes neighbor-annoying nuisance of flying scraps, smoke, smell. Sturdily built to last for years. Nothing to get out of order. Needs no watching. Will not blow over. Will not destroy grass or shrubs. Ends refuse hauling and fire hazards to quickly pay for itself. Measures 23" square at base by 40" high. Weighs 23 lbs. Over 2 bu. capacity. Recommended by Bureaus of Fire Prevention. Full price \$9.95—nothing else to buy. Sent F.O.B. Cleveland. Money back guarantee. Send check, cash, or money order to:

**ALSTO COMPANY, Engineers Bldg., Dept. PM-4, Cleveland, Ohio**

**AMAZING NEW WOOD-TURNING TOOLS**

**SHARPEN ONCE IN 12-YEARS! (UNDER NORMAL USE)**

These remarkable tools tipped with **TUNGSTEN CARBIDE** will astound you with their performance. They work **FREE HAND** equally well in wood, plastic or soft metals—and at the same time hold their razor-like edge almost indefinitely. Tests show that they will turn wood or plastic for days and days **CONTINUOUSLY** without showing any signs of dulling. They are the finest tools available at any price. Beautifully finished 5" blade—flush ground, polished tip—finest brass tube ferrule—9" hardwood handle—over all length 14"—25 tools to choose from: round & square nose from 1/4" to 1 1/2"; 1/4" and 3/16 cut off; 1/4"x30° skew, spear, r. & l. skew, turning and parting. Amazingly Low Prices! Write at once for free literature.

**JOHNS MFG. CO., DUNELLEN 8, N. J.**

**TAKE 3-DIMENSIONAL PICTURES WITH YOUR OWN 35 MM CAMERA**

**NOW ONLY (Outfit No. 101, was \$22.50 plus tax)**

**STEREO-TACH \$17.70** Plus \$2.09 Fed. Tax

and 3-D slide viewer. Make marvelous color or bl. & w. slides. Get Stereo-Tach from your dealer or direct. Money back guarantee.

**Dept. PM4, ADVERTISING DISPLAYS, INC., Covington, Ky.**

**NEW! COLOR ON YOUR TELEVISION!**

Simply attach **TELECOLOR FILTER** to front of your set, and enjoy favorite programs in a glorious color tone, instead of dull black and white. "TELECOLOR" Filter is one of the latest discoveries. It has a special formula fluorescent coloring, that gives brilliant pleasing color tone. You will find new happiness in the enjoyable color depth, reduced glare, fog, snow and less eye strain. Everyone is talking about and waiting for 3 color Television costing hundreds of dollars. For a small sum you can enjoy coloring new.

**TELECOLOR FILTER** is a wonderful gift to friends or relatives who own sets.

10" tube \$3.00 • 12 1/2" tube \$4.00 • 16" tube \$6.00

**HARVARD LAB., 659 Fulton St., Dept. PM4, Brooklyn 1, N. Y.**

**New Advertising Machine Prints Post Cards**

**FREE** LEARN HOW thousands of business men, in every line, boost sales in spite of conditions—with ads printed on postcards by amazing new patented **CARDMASTER** advertising machine. Low price, sold direct. Guaranteed 5 years. **SEND NAME** for **FREE** illustrated book, new money-making ideas and complete, unique advertising plans.

**Cardmaster Co., 1920 Sunnyside, Dept. 134, Chicago 40, Ill.**

**Say You Saw It in Popular Mechanics**

**FOAM RUBBER**

**For Experimenters, Home Craftsmen, Hobbyists**

**LOWEST PRICES—SAVE 50%**

16 x 16 x 1 1/4" .ea. \$1.25	<b>AUTO SEAT TOPPER PADS</b>
16 x 22 x 1 1/4" .ea. 1.55	Place on seat cushion and cover with your seat cover.
18 x 24 x 2" .ea. 2.00	24" x 60" x 1 1/4" ea. \$5.00
24 x 24 x 2" .ea. 2.75	24" x 60" x 2" ea. 7.50

Use for furniture cushion fillers, mattresses, mattress pads, cushions. Foam Rubber is available in any size or thickness. Send For Free Price List. Immediate delivery. No C.O.D.'s. **ADD 10% FOR POSTAGE & HANDLING TO ABOVE PRICES**

**RIOR RUBBER COMPANY, Dept. P-4  
50 E. Cermak Road Chicago 16, Ill.**

**REMEMBER it's DANGEROUS** to pay less if you want safe, balanced matched tires. **WE REPEAT**—Consider your family's safety, not just PRICE. You see our adv. every month. Positively not recaps. We serve ambulances, fire trucks, school buses, trucks and cars. "Out-of-Town folks" buy now and take 10% discount. Your car is only as **SAFE** as your tires.

**GOOD YEAR** **Firestone**  
**Goodrich** **U. S. ROYAL**

& others. Original good tread. Slightly worn. Extra fine track. Our policy is to select your tires as carefully as if our very future depended on the service given by that particular tire.

**FREE Tube** with each tire

**26 MONTHS GOLDEN RULE GUARANTEE BOND**

These are genuine "Many Purpose" "AAA" Tires. Read that top line again! You'll save MORE than \$

600-16	\$5.55	650-16	\$5.95	700-15	\$5.85	475-19	\$5.95
600-16(0)	6.50	700-17	9.99	650-15	5.75	525-18	5.95
700-16	6.85	750-16	7.95	550-17	6.75	550-16	5.55

America's great Lo-Price Value 12 Months Guar. Limited Supply

600-16	\$3.45	650-16	\$3.65	700-16	\$5.40	650-15	\$3.85
		700-15	3.75	750-16	5.95	550-17	5.75

**LO-PRICE TRUCK TIRES 12 MONTHS GUARANTEE**

32x6(8)	\$8.65	750-20(10)	\$9.25	1100-20	\$13.20	650-20	\$7.75
32x6(10)	10.75	825-20	11.10	700-20	9.10	900-20	11.15
						1000-20	12.65

**SUPERCUSHION TIRES (24 lb. air) to fit your present wheels**

670-15 (650-15)	\$6.25	760-15 (700-15)	\$7.45	670-16 (600-16)	\$6.66
710-15 (650-15)	6.85	820-15 (700-15)	6.25	760-16 (650-16)	7.50

**WE ARE TRUCK-TIRE EXPERTS**

Matched Tires. Truck-owners the world over, depend on us to keep their trucks rolling ON TIME. TRUCKERS—Paying these few cents more will mean thousands of extra miles to you.

6-8-10-12-14-16 ply "Many Purpose" "AAAA" Grade

**GOLDEN RULE 26 MONTHS REPLACEMENT GUARANTEED BOND**

600-20	\$9.95	32x6 (8)	\$10.95	900-20	\$16.66	1000-22	\$16.66
650-20	9.95	32x6 (10)	13.95	1000-20	17.77	1100-22	17.77
700-20	10.95	750-20 (10)	13.95	1100-20	18.88	1100-24	18.88
750-20	10.95	825-20	17.77	750-15	11.45	700-17	13.33

**MILITARY "AAAA" Guar. 30 mos. (Supers 14 mos.)**

750-16	900-18	750-20
Super \$9.75	Super \$8.60	Super \$8.48
"AAAA" 12.22	"AAA" 10.90	"AAAA" 13.00
Military Rugged 600-16 \$7	750-20 \$16	

**BLATT GIRARD & LANCASTER AVES., Dept. PM**  
**BLATT BLDG., PHILADELPHIA 31, PA.**

Send ck. or money order and this ad for rush shipment. We won't ship a tire we wouldn't use ourselves. Instant shipment down South, Far West and the world over. The name to trust in rubber.



**COPY ANY PICTURE WITH THE AMAZING PANTOGRAPH**

The ideal method of reproducing maps, pictures, diagrams, etc. Just place original design under the tracer point and simply trace it. Makes faithful accurate copies from 25% to 425% larger than original. Comes ready for use with extra pencil. Sent Postpaid, anywhere in U. S. for only \$1.00. Order today. No C.O.D.'s accepted.

**DAVID W. WOLF**

P. O. Box 113-P, Lefferts Sta. Brooklyn 25, N. Y.

Always write your name and full address clearly when answering advertisements

**PLASTICIZE YOUR CAR**

with

**PLASTIC-SHINE**



SEND FOR LARGE CAN

ONLY **98¢**

CASH OR MONEY ORDER

• DEALERS EXCLUSIVE TERRITORIES OPEN!

Write for Details

At last, an easy to apply car polish made from PLASTIC! Puts a super-brilliant gloss on your car that lasts up to one year. Give your car a PLASTIC-SHINE... ORDER A CAN TODAY!

will not waterspot • finger-mark • fade

Write to Dept. M

**PLASTIC-SHINE LABS.**

7516 N. W. 7th AVE., MIAMI 38, FLORIDA

**Get into BUSINESS for Yourself!**

**METALIZING BABY SHOES AT HOME IN SPARE TIME**



Get facts about amazing money-making Warner Success Plan that shows you every easy step in completely charted path to personal independence—with your home as your headquarters... This proved and tested Plan is working like magic. It's backed by an old, reliable company... And we send it to you on a No-Risk Trial Money Back Guarantee.

**QUICK CASH WAITING**

Demand for METALIZED Baby Shoes and other keepsakes is growing bigger daily. Our Tested Plan Shows How to Do the Work, How to Bring in the Business, How to Make as much as \$5 an Hour. Spare or full time, big steady profits are waiting for you. Send penny postcard or mail coupon for FREE Facts. Act! Time is precious.

**FREE offer of COMPLETE MONEY MAKING PLAN • SEND NO MONEY Just Mail COUPON**

**Ray Brandell, Mgr., Warner Electric Co., 1512 JARVIS AVE., DEPT. 3-D, CHICAGO 26, ILL.**

Please rush complete details about your No-Risk Trial Money Back Plan for Metalizing Baby Shoes. Everything you send is FREE and costs me nothing—now or ever.

NAME \_\_\_\_\_  
ADDRESS \_\_\_\_\_  
CITY \_\_\_\_\_ ZONE \_\_\_\_\_ STATE \_\_\_\_\_

**U. S. Army Air Force Type SUN GLASSES**

**BEST BUY UNDER THE SUN!**

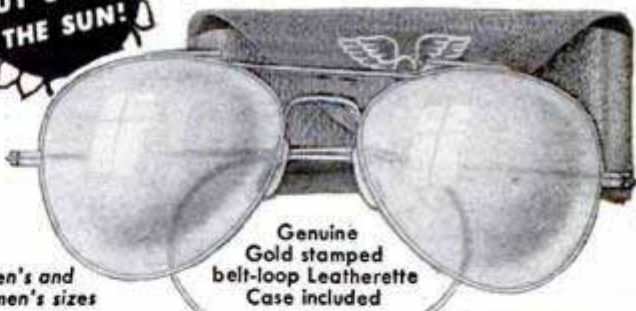

Men's and Women's sizes

Genuine Gold stamped belt-loop Leatherette Case included

FORMERLY \$8.50 VALUE

Super-Sensationally Priced at only ...

**\$1.88**

postpaid

- ★ Cool green meniscus curved, polished lenses.
- ★ 24 Karat Gold Plated adjustable frames
- ★ Pearlloid Sweat-bar and Nose-pads
- ★ Reinforcing bar for greater durability
- ★ Lenses meet specification of U. S. Gov't. Bureau of Standards.

**LIFETIME GUARANTEE**

Included with every pair of glasses

**10-DAY TRIAL • MONEY-BACK GUARANTEE**

**CHICAGO GOGGLE SALES CO., Dept. 201**  
**20 E. Delaware Pl., Chicago 11, Ill.**

Please send me ... Men's ... Women's Sun Glasses.

Send C.O.D.  
 Enclosed find \$..... Mail Postpaid.

NAME THIS COUPON TODAY!

Name \_\_\_\_\_  
Address \_\_\_\_\_  
Town \_\_\_\_\_ State \_\_\_\_\_

# PAINT YOUR CAR

2 FULL COATS for ONLY **\$2.95**  
ONE QUART DOES ENTIRE JOB

or any other Metal or Wood Surface

WITH **WYPE** TRADE MARK REG.

NO SPRAYING · NO MASKING · NO BRUSHING

**AMAZING NEW BRUSHLESS AUTO ENAMEL**  
You **JUST WIPE ON** with a POWDER PUFF instead of Brushing or Spraying

**Get Beautiful Mirror-Like Finish That Looks Like Spray Job!**

No previous car-painting experience necessary. You get a beautiful high-gloss job that gives you an expensive finish such as is sprayed on by Professional Auto Painters. With WYPE you need **NO BRUSH, NO SPRAY, NO MASKING!** Just **WIPE ON** with Powder Puff—which we furnish at no extra charge. You get a brilliant, glossy finish that is truly "factory-like." No streaks. No lap-marks. Guaranteed for TWO years not to crack, peel, chip or fade, if simple directions are followed. Takes about an hour to apply. Dries dust-free in an hour. Goes over any other color, lacquer or enamel.

**MOST POPULAR COLORS**  
Black Brewster (dark) Green  
Maroon Jewel (light) Green  
Red Washington (dark) Blue  
Gray Monticello (light) Blue  
White Sun Beige (light) Tan

**\$2.95 PER QUART**

**\$1.75 a Pint—2 pints Do a 2-Tone Job**

**SEE YOUR DEALER or ORDER DIRECT SEND NO MONEY - Get WYPE Today!**

If your dealer can't supply you, just send us a postcard. We'll ship C.O.D. Just pay mailman for Wype, plus postal charges. Or send remittance with order and WE pay postage.



**Dries Dust Free One Hour · No Streaks or Lapmarks**

**ANYONE CAN DO BEAUTIFUL JOB**

**TESTED & APPROVED by Leading Laboratories**

The world's foremost scientific testing laboratories have tested and approved WYPE. Based on the published facts, no other brushless enamel has passed as many tests by as many laboratories.

**OVER 500,000 CARS PAINTED WITH WYPE** and thousands more being painted. Mrs. Noma M. Burnette, Parris Island, S. C., writes: "Congratulations to Wype for production of the marvelous new paint, Wype. Wype has been definitely satisfactory. My husband was astonished, but, oh, so pleased. We realized about \$200 more on our car when we sold it. Any lady who can apply her own make-up can certainly paint her own car."

**2-YEAR GUARANTEE**  
We Guarantee WYPE against cracking, peeling, fading or chipping for two years after application, if applied according to directions furnished. Your money cheerfully refunded if WYPE does not live up to this Guarantee.

COPYRIGHT, WYPE CORP.



**APPLY in ONE HOUR — DRIES to GLISTENING PROFESSIONAL FINISH**

WYPE is a new Miracle Enamel for Autos. It is NOT a wax or polish but a hard high lustre ENAMEL finish! With WYPE ANYONE can do a beautiful job! Order a quart to paint your car or to get started in this BIG-MONEY Business!

**NO STREAKS OR LAPMARKS LOOKS LIKE SPRAY JOB**

**Hundreds of other uses for WYPE!**

- Paint Anything At Home
- Repaint outdoor & indoor furniture, bicycles, hardware, damaged white enamel stoves, refrigerators, etc., and any other article of steel or wood.

**DEALERS & JOBBERS WANTED Write Today**

**Some of the FAMOUS DEPARTMENT STORES that Sell WYPE**

- VISIT OR PHONE THE STORE IN YOUR CITY . . .**
- If you live in one of the cities shown here, it will be more convenient to buy from your favorite dealer. Ask your dealer! Leading merchants and gas stations everywhere sell WYPE.
- Abilene, Tex.:** Thornton's; **Akron:** M. O'Neil; **Baltimore:** May Co.; **Bethlehem, Pa.:** Bush & Bull; **Binghamton, N. Y.:** McLean's; **Buffalo, N. Y.:** J. N. Adam; **Burlington, Vt.:** Abernethy-Clarkson-Wright; **Charleston, W. Va.:** The Diamond; **Chicago:** Goldblatt's, Wieboldt's; **Cleveland:** May Co.; **Dallas:** Sanger Bros.; **Denver:** May Co.; **Detroit:** People's Outfitting; **Duluth:** Glass Block Store; **El Paso:** Popular Dry Goods; **Elwood, Ind.:** R. L. Leeon & Sons; **Erie, Pa.:** Trask's; **Fall River, Mass.:** R. A. McWhirr; **Flint, Mich.:** Smith-Bridgman; **Ft. Wayne:** Wolf & Deussauer; **Ft. Worth:** W. C. Stripling; **Grand Rapids:** Herpolsheimer; **Hartford, Conn.:** G. Fox; **Haverhill, Mass.:** Mitchell & Co.; **Huntington, W. Va.:** Anderson-Newcomb; **Indianapolis:** Wm. H. Block; **Johnstown, Pa.:** Glosner Bros.; **Joplin, Mo.:** Christman Dry Goods; **Kansas City, Mo.:** Jones Store; **Lawrence, Mass.:** A. B. Sutherland; **Lexington, Ky.:** Purcell Co.; **Little Rock:** Gus Blas; **Los Angeles:** May Co.; **Louisville, Ky.:** Kaufman-Straus; **McKeesport, Pa.:** The Famous; **Meadville, Pa.:** A. R. Wolf & Son; **Millwaukee:** Schuster's; **Minneapolis:** Donaldson's; **Mobile, Ala.:** Hammel Dry Goods; **Montgomery, Ala.:** Montgomery-Fair; **Nashua, N. H.:** Speare Dry Goods; **New Haven, Conn.:** Edw. Malley; **New Orleans:** Maison-Blanche; **Oakland, Cal.:** Hale's; **Ogden, Utah:** C. C. Anderson; **Oklahoma City:** Kerr's; **Omaha:** Phillips; **Owatonna, Minn.:** The Kelly Co.; **Owosso, Mich.:** D. M. Christian; **Philadelphia:** Lit Bros.; **Pittsburgh:** Kaufmann's; **Portland, Ore.:** Meier & Frank; **Poughkeepsie:** Dising's; **Providence, R. I.:** Shepard Co.; **Rapid City, S. Dak.:** Donaldson's; **Reno, Nev.:** Reno Mercantile; **Richmond, Va.:** Miller & Rhoads; **Sacramento, Cal.:** Hale's; **St. Louis:** Famous-Barr; **St. Paul, Minn.:** Golden Rule; **St. Petersburg, Fla.:** Maas Bros.; **San Antonio:** Joske's; **Scranton:** Seranton Dry Goods; **Seattle:** Bon Marche; **Sheboygan:** Lion Dry Goods; **Topeka:** Pelletier Stores; **Traverse City, Mich.:** J. W. Milliken; **Trenton:** E. F. Hooper; **Warren, O.:** Griswold's; **Washington, D. C.:** Lansburgh & Bros.; **Washington, Pa.:** Caldwell Store; **Waterbury, Conn.:** Howland-Hughes; **Wausau, Wis.:** Sippl Bros.; **Wheeling, W. Va.:** Stone & Thomas; **Wichita:** Buck's; **Wilkes-Barre:** La serus Store; **Youngstown, O.:** Strous-Hirshberg.

**WYPE CORP., Dept. 16-D 2214 DOLMAN ST. ST. LOUIS 4, MO.**

**WORLD'S  
BEST  
WANT AD  
MEDIUM**

# CLASSIFIED Advertisements



Advertisements in this section 75 cents per word, each insertion, minimum 10 words, payable in advance  
To be inserted under proper classification, copy must be in our office the 22nd of the  
second month preceding date of issue

F. W. Johnson, Manager, Classified Advertising  
Popular Mechanics Magazine, 200 East Ontario Street, Chicago 11, Illinois

## 1142

## CLASSIFIED ADVERTISEMENTS

## 1142

## OPPORTUNITIES FOR YOU

### AUTOMOBILES, MIDGET CARS

**DASHBOARD** Controlled garage door operator. "Build Yourself" pamphlet, \$1.00, refundable. Kaytor Laboratories, Lynwood, California.

"GENUINE Crosley parts." Rebuilt engines—46-49 models. \$99. Exchange. Hydraulic brake kits, 46-49 models \$75. Cast iron block kits \$48.85. Water pump assembly (packless) \$9.25. Write Walraven Motors, "King of the Crosleys," Marion, Ohio.

**CALIFORNIA** Custom accessory headquarters. Buy direct from original designers and save. Solid hood sides, grille panels, lowering kits, fender skirts, dual pipes, chrome motor accessories, speed equipment, push button door conversions, chrome dash panels. Custom catalog, 34 illustrated pages, new low prices—25c. Eastern Auto Supply, 3319-A South Grand, Los Angeles 7, Calif.

**INTERESTED** In automobiles? Write for free sample copy. Franson's Weekly Motor News, Box 254, Eugene, Oregon.

"OX-O-JET"—Obtains sensational power from ordinary and low grade fuels. Different. Plans \$1.50. Henry Albert, Cambria, Virginia.

**SPEED** And custom equipment at rock bottom prices. Hollywood Powertone mufflers, large chrome echo cans, high compression heads, dual manifolds, cams, Mal-lory coils, gears, convertible tops. Save big money. Send 25c for literature and deduct it from your first order. Jack Hubbard, Dept. PM4, 9440 Mackenzie Road, St. Louis 23, Mo.

"HOLLYWOOD" Deeptone mufflers. "Straight-thru" design increases efficiency, speed, acceleration, mileage! Singles, all cars \$4.85. Finest V-8 duals \$15.90. Satisfaction guaranteed. Speed equipment catalog 25c. Almqvist Engineering, Milford 44 P, Pennsylvania.

**FORD** Owners and mechanics, we supply several simple replacement parts making Ford and Mercury Brakes free floating, super powerful with soft pedal; eliminating squeal, chatter and groan—\$4.25-\$6.90. All models, 1928-1948. Easily installed by yourself. Write for details. Super Brake-Floater Company, 4022 West Lake Street, Chicago 24, Illinois.

**NEW Clymer** books. Latest Clymer Motor Scrapbook (No. 6) \$2.00. Pictorial Grand Prix Racing with 48 action photos \$1.00—Catalog of all American automobiles, 120 photos, every car with complete specifications \$2.00—Catalog '49-'50 all British cars, \$2.00—Ford Owner's Handbook gives complete servicing information all Fords 1932 to 1950, \$1.50—Complete Service Manual Model "A" Ford \$1.00, Model "T" \$1.50—Life of Ted Horn, American Automobile Racing Champion, \$2.00—Complete Outboard Service Manual covers all makes, \$3.50—Revised Hot Rod Book, \$1.50—Steam Traction Engine Album, 160 pages, describes, illustrates 105 historical steam vehicles, \$2.50—How to Obtain Speed \$1.50—Power and Speed \$2.50—Indianapolis Race History, 360 pages, 1909 to date, \$3.50—How to Build Racing Automobile, \$2.00. All postpaid. Specify books wanted. Clymer Motorbooks, Dept. 4-A, 1268 S. Alvarado, Los Angeles 6, Calif.

**WANT** To drive a race car? "Racing Drivers Handbook" tells how. Driver instructions, association listings, purse pay-offs, specifications and rules. Price \$2.00. J & J Speed Publications, Box 188Y,

**LATEST Ford** Speed Manual! 128 pages full of cutaway construction drawings, photos and understandable technical data. Includes information on installing V-8 motor in Model A chassis, hydraulic brakes for any Ford, roadster and fast car information. How to rework V-8, Mercury, Ford 6, Zephyr, Model A engines for speed. Finest Ford manual published. \$2.00 postpaid. California Bill, Box PM-4, Eaglerock, Los Angeles.

**JUST Out!** Get the largest auto accessory and parts catalog in the world. Over fifteen thousand items, including Hollywood accessories, hi-speed equipment, rebuilt engines; all parts and accessories for all cars and trucks. New, used and rebuilt! We have that hard-to-get-part! Completely illustrated, jam-packed with bargains. Send 25c. J. C. Whitney & Co., 1919 Archer Ave., Chicago 16, Ill.

**JUST Published!** Clymer's No. 6 Motor Scrapbook. Latest and best. Heretofore unlisted antique cars, motorcycles. \$2.00—History Motorized Vehicles, data on early gasoline, steam, electric cars, steam engines and motorcycles. \$2.00 postpaid. Clymer, Dept. 4-A, 1268 S. Alvarado, Los Angeles 6, Calif.

**FREE Trial**, 10 days. Latest Chevrolet Speed-Power Manual! Ninety pages of accurate information on increasing speed and power of any 1937 thru 1950 Chevrolet. Learn how to install late engines in pre-1937 chassis. Full data on cams, high compression, multiple carburetion, supercharging, ignition, etc. Proves that your Chevrolet can have superior power and speed. If you don't agree this is the finest Chevrolet manual you've ever seen—just send it back within 10 days. If satisfied, send \$2.00 to California Bill, Box PM-4, Eagle Rock, Los Angeles.

**AIR Horns.** Gleaming "neverust" chrome. Auto or boat. 30" seven miler \$29.95. 16", \$15.95. 26", \$25.95. Control-installation kit \$11.50. Air tank \$11.50. No c.o.d.'s. Foghorn, Old Saybrook, Conn.

**HORSELESS** Carriage Caravan Book. Information Harrah's Club Reno 1949 tour with 50 antique cars through historical mining districts of Nevada. Descriptions every entrant. Photos participating cars. Interesting, educational. \$1.50 postpaid. Clymer, Dept. 4-A, 1268 S. Alvarado, Los Angeles 6, Calif.

**SEE** Our ad under Motorscooters for midget car bargains. Midget Motors Directory, Athens, Ohio.

**SPEED & Mileage Manual**—New edition! 140 illustrations, drawings, charts, photographs! Guaranteed finest, most authoritative book! Easy, inexpensive ways to build speed equipment! California hot rods! Beautiful custom cars! 200 h.p. road, track conversions! Superchargers! Dual manifolds! Racing heads! Twin mufflers! Water injectors! Economizers! Get super speed, mileage, acceleration, top racing performance from any car! Complete instructions with working diagrams on fast engines, speed tuning, restyling, customizing, gas saving, racing tricks, cams, fuels, balancing, porting, ratios, frames, Offys! Learn 100 ways to save gas! Reveals stock car speed secrets! California speed shop methods! Custom styling information! Streamlining! Lowering! Sport changes! Hollywood roadster plans! Speed conversions! Covers all cars. Large manual plus equipment catalog plus racing handbook all three only \$1.98. Almqvist

**NEW Big catalog!** Over 500 racing, hot rod, speed equipment, auto parts and Hollywood accessories! Pictures! Speed data! Customizing tips! Lowest prices! Illustrated catalog 25c. Almqvist Engineering & Mfg., Milford 83, Pennsylvania.

**DIRECT** From California. Dual manifolds for Willys Jeeps to Oldsmobile Rockets. Finned heads, three carburetor manifolds, over 150 different makes and models. Speed and dress-up equipment for passenger automobiles. Magneto ignitions, aluminum flywheels, racing camshafts, water injectors, crash helmets, exhaust headers. New 1950 illustrated speed catalogue. 25c. (Dealers, request wholesale catalogue). Newhouse Automotive Industries, 5805-BT East Beverly, Los Angeles 22.

"**SPEED Equipment**" bargains—California mufflers \$4.50, V-8 duals \$15.90, chrome carburetor stacks 98c, dual manifolds \$9.95, chrome echo cans \$1.65, racing camshafts \$29.95 exchange, water injectors \$12.95, hi-compression heads \$19.75. All popular brands! Big illustrated catalog 25c. Dealers wanted. Almqvist Engineering & Mfg., Milford 82, Pennsylvania.

**HOT Rod**—The only monthly magazine about building roadsters, streamliners, etc. Sample copy 25c. \$3.00 yearly. Hot Rod, 548 S. San Vicente, Los Angeles 48, Calif. Dept. PM.

**SPEED & Power Handbook**—50 chapter library edition! Diagrams! Breathing methods, authentic, direct from California. Covers Crosleys to Cadillacs, all makes. Build your own dual manifolds. Superchargers. Hot cams. Water injectors. Hi-compression heads. Mileage devices. Save many dollars! Get racing speed, lightning acceleration, dynamic power increases from any make passenger automobile! Build fast stock cars. California roadsters. 160 m.p.h. rods! Get construction drawings! Tuning techniques! Speed tricks! Economy secrets! Ingenious formulas! Covers Racing Frames, Reciprocating Masses, Jet Engines, Braking Characteristics, Dynamometers. Also dual pipes, gears, fuels, porting, relieving, lowering, balancing! Includes 1950 speed equipment catalogues! Also California Automobile Customizing, photographs. Drawings. Newest ideas. Conversions. Carson tops. Re-styling all makes. Streamlining. Chopping. Channeling. Complete \$1.98 postpaid. Newhouse Automotive Industries, 5805-B2 East Beverly, Los Angeles 22. (See page 34, Display Advertisement.)

**FROM** Speedway to roadway! Track-proved hi-speed heads and manifolds now available for your passenger car! No special tools needed! Increase horsepower 25%! Astounding getaway! Free illustrated catalog. Speedsport, 6215P Diversey, Chicago 39.

**AUTOMOBILE** Racing book, fifth edition, well-illustrated. Building bodies, frames, engines, Ford conversions. Plans. Roadsters. Indianapolis cars. \$1.00 postpaid. Popular Mechanics Press, 200 E. Ontario St., Chicago 11, Ill.

"**WATER Injection.**" Also speed, power, economy methods! Free descriptive, illustrated, information. Neher Industries, La Verne, California.

**RACING** Car equipment for all cars. engines, racing heads, manifolds, carburetors, mufflers, etc. Speed instructions and literature \$1.00—refund first order. Lee Motorcraft Co., 1412-D Great Northern Bldg., Chicago 4, Ill.

**AUTOMOBILE** Racing, sixth edition. 100 illustrations. Drawings, building instructions Ford-60 midget, California roadster, Offenhauser racer. World's record 158.5 m.p.h. car. \$2.00 postpaid; \$2.40 c.o.d. Popular Mechanics Press, 200 E. Ontario St., Chicago 11, Ill.

**NEW Sensational seat cover.** Mono. 6545 Santa Monica Blvd., Hollywood, California.

**WE Sell direct to customer, speed parts** manufactured by us. Fords, Studebaker Champion, Chevrolet and Willys, complete engines for race cars and boats. \$1.00 for illustrated literature and price sheet. R. & R. Mfg. Co., Robert M. Roof, Box 546, Anderson, Indiana.

**SAVE Gasoline!** Sensational Gane needles. Free trial. See page 47.

### AUTO SUPPLIES AND EQUIPMENT

**1950 SUPERIGNITIONITER:** Starting, pep, mileage, \$4.50. EG Mfg., Elmsford, N. Y.

**SHATTERPROOF Glass!** Factory savings! Write requirements. Cooper's, 3124 Lawrence, Chicago 25.

**BATTERY Chargers.** \$3.95 up. L. Alexander, 780 E. 214th St., New York 67.

**WELDING Training pays.** Operating under V.A. contract. Free catalog. Box 279-M-403, Troy, Ohio.

**WELDING Bodies, frames, fenders.** Pays with Hobart arc welders. Easy terms. Free catalog. Box 279-M-402, Troy, Ohio.

**GASOLINE Expensive?** Simple device totals miles, gasoline, calculates miles per gallon as you travel. Complete \$1.00. United Manufacturing Associates, 3605 Canyon Ridge, Fort Worth 3, Texas.

**FIAT, Simca, English Ford-Austin, Renault parts, service.** Witkin-Wolf Co., 217 So. LaBrea, Los Angeles 36, Calif.

**"SMITHY'S Mufflers."** Send for list. Buck's Auto Parts, 1296H, Merced, Calif.

**MOTORISTS Save gasoline by Vacuuming overhitch mixtures.** Fits all cars. For free particulars write Vacuumatic, Dept. 1591, Wauwatosa, Wis.

**DOUBLESEAL Insulator seals gaps under overhead doors.** Why worry drafts, rain damage, freezing down? Edwards Industries, Dept. 105, 4268 Shenandoah, St. Louis 10, Mo.

**ACCELERATOR Functions normally!** Simple gadget under-hood adds comfortable foot rest at speed you preset it at. Write for details. R. Harper, 745 E. Woodruff, Hazel Park, Mich.

**GOLD Finished metal initials, adhere to car door.** 6 for \$1.00. Nostrand, 1223 Nostrand, Brooklyn 25, N. Y.

**SENSATIONAL New accessory for cars with overdrive!** Free details. Signalite, 3908-J Berteau, Chicago.

**STARTERS, Generators.** Guaranteed rebuilt original equipment, for most cars and trucks from 1928 to 1939. Abbot Auto Electric, 4215 Grand River, Detroit 8, Michigan.

**ECONOMETER For autos, trucks, boats.** An accurate flowmeter that actually meters the gasoline at the carburetor. Indicates gallons per hour used on electrical dash gauge. Simple installation. \$22.50. Ringelstetter Co., Plain, Wis.

**BIG Bargains!** Fender skirts for most cars \$9.95 pair. 6 volt electric siren with push button \$10.95. Send deposit. Send 25c for new illustrated 15,000 item automotive catalog. J. C. Whitney & Co., 1919da Archer, Chicago 16.

**SPEEDOMETERS.** We rebuild any make, \$4.95. Western Speedometer Rebuilders, 10452 Magnolia, No. Hollywood, Calif.

**BUICK Parts—Enjoy new-car pep and power in your old Buick.** Same day service from world's largest stock of new (not rebuilt) Buick parts and engines. Ship anywhere. Dime brings catalog. Write today. Robertson Buick Co., 1001 S. Wash Ave., Chicago 5, Ill.

**LACHAPELES Motor and motor fuel treatment (patented U. S. and foreign), stops ping, gives more miles per gallon, more miles per motor.** 100,000 miles treatment. \$3.00 postpaid. Ferns Products, 8120 Walnut Dr., Los Angeles 1, Calif. (Data sheet on request.)

**"AIRFLOW Needles."** Save gasoline! Free trial! If satisfactory, \$1.50. Specify car, carburetor. Neher Industries, La Verne, California.

**CHEVROLET Parts.** Scarce motor, body, sheet metal parts. Grossman Chevrolet, Minneapolis, Minnesota.

**AUTOMOTIVE Surplus tool specials!** Pullers, wrenches, socket sets, reamers. Other bargains. Nationally advertised merchandise. Send dime for catalogue. Glenco Supply, 7521 Myrtle Avenue, Glendale 27, N. Y.

**AUTO And truck parts.** New and used. Lowest prices. Complete stock. Prompt replies. Babbitt Auto Parts, 2833 Chicago Ave., Chicago 22, Ill.

**NEW And used guaranteed parts for civilian and army cars and trucks.** Largest stock in America. Mail orders. Pioneer Auto Wrecking Co., 734 W. 13th Ave., Denver, Colorado.

**BRUSH Plating outfits connect to a battery.** No tanks or shop required. Free particulars. Gunmetal Co., Avenue J, Decatur, Illinois.

**GOVERNMENT Surplus.** Low voltage circuit tester in steel box. Cost \$202.00. Our price \$27.50. Will test batteries, starters, generators, voltage regulators, grounds, short circuits. Wilt Electrical Company, 7829 S. Racine Ave., Chicago 20, Ill.

**SAVE Gasoline!** Sensational Gane Needles. Free trial. See page 47.

**"LEKTRON" Atomic coil booster saves gas!** Instant starting, smoother power. Guaranteed. \$2.00. Electronic Industries, Cleveland 11, Ohio.

### AUTO TRAILERS

**TRAIL Hut folding camp trailer is easy to build.** We have complete kits, parts. Plans \$1.00. Send for free folder, price list. Trail Hut, Dept. PM-4, 600 Sixteenth Street, Oakland 12, California.

**TRAILERS: \$49.50 F.O.B. less tires.** Shipped knockdown. Big 4x7 bed, ton capacity. With new 8 ply tires \$62.66. Free catalogue. Selma Trailer Mfg., Inc., Selma, Calif.

**BUILD Your own trailer! Save money!** Have every feature you want! Plans for house, sport, camp and utility trailers. Catalog describing 9 models 10c. 15c in Canada and overseas. Jim Dandy, Box 125-A, Wausau, Wisconsin.

**TRAILER Coaches.** Save money. Buying? Building? Sound engineering construction, chassis, bodies, furnishings. Travel, dwelling, trailer plans. \$1.50 postpaid. Popular Mechanics Press, 200 E. Ontario St., Chicago 11, Ill.

### MOTORCYCLES, BICYCLES, MOTORSCOOTERS AND SUPPLIES

**ACCESSORIES, Parts—Whizzer, Cushman, Salsbury.** List 25c. Ray George, 3322 South Grand, Saint Louis, Missouri.

**CYCLE—Monthly motorcycle enthusiasts' magazine.** Road tests, technical data, foreign and domestic. Many illustrations. Sample copy 25c. One year—\$3.00. Cycle, 548 S. San Vicente Blvd., Los Angeles 48, California, Dept. PM.

**DOODLEBUG Motorscooter \$5,** three wheeled motorscooter \$15, midget racer \$30, less engine; Whizzer motorbike \$25, Servicycle \$30, motorscooter \$30, complete and serviceable. Engines \$3 up. Outboards \$5 up. Midget car kit \$25. Four balloon tires \$3. Plenty new motor scooters, midget cars, homebuilders parts, plans, transmissions, clutches, engines, sprockets, etc. at factory prices. Mailorder only. Send 25c for illustrated catalogue Number 34 just out listing these and hundreds of other bargains, new and used. (35c by first class mail.) Midget Motors Directory, Athens, Ohio.

**KNEEACTION Motorbike \$15;** midget car (steel frame) \$25; Moto-Scoot \$15; Whizzer motorbike with all attachments \$25; Indian motorcycle \$30. Other motorscooters \$8 up, motors \$3 up. Send 25c for new catalog #944 listing many other sensational bargains in used motors, motorscooters, motorcycles, parts, etc. Associated, Box 1764-CS, Toledo, Ohio.

**MOTORCYCLE Magazine—** Worldwide coverage. Yearly subscription \$1.00. Sample 15c. Motorcycle News, 5424-A Sawyer, Chicago 25.

**HARLEY-Davidson parts, accessories, repair manuals on all models.** 24 hour service. Authorized factory dealer. Philadelphia Harley-Davidson Company, 857 North Broad Street, Philadelphia 23, Penna.

**WHIZZERS \$20 Each;** Cushman motorscooter \$15; Shaw bicycle motor \$15; midget car \$15; 1946 motorscooter \$22.50 (needs painting); complete motorbike \$30. Rush 25c for new spring catalog #16 listing many other amazing bargains in wheels, motors, motorscooters, midget cars, motor-

**WORLD'S First jet turbine bicycle engine.** Fits any bike. Smooth, economical, \$150.00. Dealers wanted. Literature 25c. Jet Engine Co., St. Augustine, Fla.

**RECONDITIONED Motorcycles and motors.** Chromium accessories. Complete stock Indian parts. Expert rebuilding. Fast service. Indian Motorcycle Sales, Kansas City 1, Mo.

**HARLEY-Davidsons—Used, guaranteed.** Genuine Harley-Davidson parts, accessories, obsolete model parts, expert service. Send 25c for motorcycle and accessory bulletins. \$2.25 for 45" Army Motorcycle Manual. Knuth's, 2491 Fondulac, Milwaukee, Wis.

**TIRES And industrial wheels, suitable for scooters, wheelbarrows, farm equipment, etc.** All sizes. Bicycles and accessories. Send dime for list. Cycle Transport Company, 1241 So. Michigan Ave., Chicago 5, Illinois.

### AVIATION

**NEW Automatic pilot controls, sacrificed \$1.00.** Air Transport, Mineola, N. Y.

**PROPELLERS, Plans, supplies, for ice sleds, snow sleds, air boats.** Literature 20c. Banks-Maxwell, Box 3301E, Ft. Worth.

**PROPELLERS—For sleds, airdrive boats.** Literature. Standard Aircraft, Box 387, Ft. Worth, Texas.

**NATIONAL Air Race Sketchbook.** Covers all air races 1929-1949 complete with full details, 190 sketches, charts, drawings and 14 winning airplane plans. \$2.00 postpaid. Clymer, Dept. 4-A, 1268 S. Alvarado, Los Angeles 6, Calif.

### BATTERIES, GENERATORS

**EDISON Nickel batteries, 37 to 600 ampere.** Also kits with Edison plates: make your own. Interesting literature. Hawley Smith Co., Croton Falls 1, New York.

### ELECTRICAL SUPPLIES

**FANS, Parts, kits, G.E. motor bargains, precision balanced blades, bearings, pulleys, etc.** Free literature. Rich Fan Manufacturing Co., 2401 San Jacinto, Houston 4, Texas.

**BUY Lamp parts wholesale—Parts you need for building, repairing, or assembling.** Save money on large or small orders. New catalog for 10c. Gearon Company, Dept. 300-B4, 27 South Desplaines, Chicago 6, Ill.

**"ULTRA Violet" kit makes sunlamp, mineral detector.** Many uses. Including tube, instructions \$1.25. Ultraco, 1472 Broadway, New York 19, N. Y.

**TRAFFIC Appliance parts, wholesale catalog and handbook, \$1.00 (refunded on \$5.00 order).** C-U's Supply, 2512-I Prevost, Ft. Worth 7, Texas.

**AMAZING Discovery, re-light "burned-out" fluorescent tubes.** Plans \$1. William Beck, 205 Hinkle St., Thomasville, N. C.

**LAMPS—Build own originals, parts wholesale, any amounts.** Catalogue 10c. Brown Lamp Co., Box 501, Wellston, St. Louis 12, Mo.

**"AUTOMATIC Closet light."** Battery powered. (Just like light in refrigerator.) \$1.25 postpaid. Akrit Industries, Inc., P.O. Box 75, Detroit 2, Michigan.

**ELECTRIC Pencil: Engraves all metals \$1.25.** Beyer Mfg., 10511-H Springfield, Chicago 43.

**MAGNET Wire, insulation, transformer lamination.** Morton Electrical Service, Maywood 8, Illinois.

**32 VOLT Appliances—World's largest line.** Catalog free. Haines Corporation, Dept. N, Minneapolis, Minn.

**LAMPS—How to build lamps from vases, pitchers, etc.** Chart for top and bottom lighting, alternately or together. How to wire oil lamps, all in 56 page illustrated catalog of all lamp parts, 25c. Gyro Lamps, 5402P Clark, Chicago 40.

**FREE Catalog—Motors, generators, welders from aircraft generators, water softeners, many other electrical bargains.** LeJay Company, Minneapolis, Minnesota.

**ELECTRIC Motors, free bargain list, Plenge, 9 Stuyvesant Oval, New York 9, N. Y.**

### WELDING, SOLDERING, PLATING

**WELDING Builds paying business with Hobart "build-your-own" portable.** Free catalog. Box 279-M-404, Troy, Ohio.

**BUILD Your own arc welder.** Inquiries



**P-1 WESTINGHOUSE** Generators, 200 amp., 28 volt, 2500 r.p.m. Guaranteed new in original boxes. Thousands have been converted into low speed lightweight welders. Easy with our plans. Generator and plans \$28.50. Shipping weight 62 lbs. Also parts for conversion. Free list. Thorndyke Mfg. Co., Pipestone, Minn.

**OXYGEN-ACETYLENE** Welding outfit. Complete with ICC test cylinders \$77.50. Fully guaranteed. Cutting attachment additional. Write for literature. Welders Supply, Inc., PM-4, 4409 Lorain Ave., Cleveland, Ohio.

**200 AMPERE** Welding generators. Free literature. Lewis Short, Burrton, Kansas.

**RECTIFIERS** 0-4 V.D.C. \$9.50, 0-8 V.D.C. \$12.50, 0-12 V.D.C. \$18.50. All 0-100 amps. Starkweather, Ottawa, Kansas.

**RADIATOR** Repairing books, supplies, equipment, gasoline torch. Write, Curfman Co., Maryville, Mo.

**BUY** Direct from factory. Welding and cutting equipment. All makes of equipment repaired. Established 1913. Box 331, Hamilton, Ohio.

**ELECTROPLATING** Salts and rectifiers. Mirror resilvering and chipped glass nameplate supplies. John Sprinkle, V55, Marion, Indiana.

### MACHINERY, TOOLS, SUPPLIES

**1/2" CHUCK** Fits 1/4" Drills, \$2.95. Wells, 2224 NE 18th, Oklahoma City, Oklahoma.

**BALL** Bearing bench saws \$10.95. Write Rexroat Products, Salem, Indiana.

**PORTABLE** Lawn-mower sharpener. Precision built. \$85.00 less motor. Not a lapping machine. Free particulars. Luts, Box 211, Ontario, Calif.

**NEW 1/4" Electric** drill \$9.75. Wholesale price lists and complete catalog, 25c. Belmont Electric, 202 Hinsdale St., Brooklyn 7, N. Y.

**SANDING** Belts, 6" x 54 1/2", fine, coarse, 37c; \$4.00 dozen. Raynix, 5736 Calmont, Ft. Worth 7, Texas.

**A.C. Welders,** power mowers, parts. Bargains. Holgerson's Service, Canton, Kans.

**AMAZING!** "New" self-locking pier! 1000 sizes automatically! Unequaled! Slip joint. Powerful 7 1/2" length. \$1.98 postpaid. Sarvie Tool Co., Alexandria, Minn.

**INSTRUCTIONS** For "Keeping circular saws sharpened" 10c. Harry Van Dick, Little Falls, New Jersey.

**WHY** Pay more? 3 1/2 concrete mixer \$47.50. Square, Excelsior, Minn.

**2" UNIVERSAL** Lathe chuck, \$14.00 value, only \$2.95. Drill chuck 0 to 1/2", nationally known make, less than 1/2 price, only \$3.45. Precision ball bearings 1" o.d. 1/2" i.d. 10 to package, \$11.00 value, only \$2.85. Check or money order. Har-Mur, 2349 Devon Ave., Chicago 45, Ill.

**DRILL** Grinder for twist drills, \$2.95. See ad on page 275.

**FOUR** Brand new Onan electric plants, 3 phase, 60 cycle, 25,000 watts, driven by 6 cylinder gasoline engine. Priced one half of today's cost. The Eastern Machinery Co., Cincinnati 29, Ohio.

**INDICATORS**—For lathe work. New, surplus. (Cost government \$6.75). Inside, outside, reads .015"-\$1.49, postpaid. Jackools, 2011-B Yale, St. Louis 17, Mo.

**BALL** Bearings 1/4 list price. Free list. Burgess, Box 168, Ferguson, Mo.

**SAW** Blades—Factory prices. Free catalog on all types. Tubergen Saw Co., 1912 Jerome Ave., Grand Rapids 7, Mich.

**SURPLUS**—Electric drills, 1/4" \$16.95; 1/2" \$29.95. (Jacobs geared chucks.) 6" electric portable hand saws with case \$56.00. Send check or M.O. Money back guarantee. Send 10c for illustrated folder. Byron Tool Company, 1609 Unionport Road, New York 60, New York.

**FLOOR** Sanders; rebuilt; \$50.00 up. Mutual, Box 202, Kansas City, Mo.

**CHUCKS,** Independent, universal; threaded 1 1/2"-8, 1"-8, 1"-10, 1"-12, or with adapter recess. Other chucks to 16" diameter. Write for quotation and free literature. No obligation. Westcott Chuck Co., 3600 Walnut, Oneida, N. Y.

**HOME** Lathe owners—Build your own attachments. Send for picture, sample of work and list of blueprints. Cut gears, ratchets, etc. Make neat screws easy way. The Home Shop, 415 Raymond Ave., Glendale 1, Calif.

**HARDWARE,** Tools, drills, taps, dies, electric motors, pumps, belts, pulleys,

### BOATS, OUTBOARD MOTORS

**AIRDRIVE** Boat engines, airplane radial type \$98.00. Write for descriptive literature. Gaare Supply, Box 1377, Vernon, Texas.

**RUBBER** Boats, accessories and paint. Write Karl Ort, Thomasville, Penna.

**SAVE** On your boating needs. Large stock of rebuilt outboards from 2 to 50 hp. Inboard marine engines from 5 to 200 hp. Send 10c for either list, specify choice. Big marine supply book, 225 pages, fully illustrated. Send only \$1.00. W. L. Masters & Son, Dept. P, 212 W. Chicago Ave., Chicago 10, Ill.

**SAVE 50%**—Boat kits for easy home assembly. Also complete plans, templates for famous Schneider speedsters, sailboats, rowboats, hunting skiffs. Latest designs, finest materials, lowest prices. Illustrated literature 25c. Schneider Boats, Dept. P, 1913 W. Vliet, Milwaukee 5, Wis.

**COMPLETE** Building plans 30 foot outboard power houseboat, March Rudder, 40 cents. The Rudder, 15 Murray Street, New York 7.

**BUY** Our conversion parts to change your auto engine into a high-grade marine engine. Marine manifolds, transmissions changed to high speed reverse. Marine bronze pumps, propellers, shafts, couplings, stuffing boxes, struts, rudders, etc. Buy direct from the factory and keep the dealers profit for yourself. Money back guarantee. Conversion Parts Co., 278 Adams St., Boston 22, Mass., U.S.A.

**BOAT** Builders! Boat owners! The world's most complete marine catalogs covering hardware, windshields, steerers, propellers, fittings, engine conversions, plywood, boat lumber, marine paint and finishing materials. Send 25c. Special offer: All marine catalogs plus valuable booklet on boat building and 250-page boatman's guide, send \$1.00. Marine Mart, Buffalo 7-B, Buffalo, N. Y.

**220** PAGE Marine hardware catalog beautifully illustrated for \$1.00. Money refunded with first order plus 10% discount. Marine Products, 7 Longfellow St., Baldwin, Long Island, New York.

**WOOD** Hulls can be permanently waterproofed with our Fiberglass-Plastic treatment. Eliminates leaking, caulking, splitting, painting. Easily applied, complete instructions. Cost only \$4.75 square yard hull or deck. Save time and maintenance costs. Enjoy a dry boat this summer. Industrial Plastics, 3807 Harrison, Oakland, California.

**KNOCK-DOWN** Boat kits. Outboards, inboards, sails, hydroplanes. Easy to assemble. Minimum cost. Catalog with specifications, prices, 25c. Brooks Boat Company, Carrollton, PM, Michigan.

**BUILD** Your own—Three point racing hydroplanes, others. Informative literature 25c. Champion Boats, P.O. Box 7132, Long Beach 7, California.

**FULL** Size, cut to shape boat patterns, blueprints, 7 1/2-38 feet. Illustrated "Build a Boat" catalog, 25c (coin). "How to Build Boats" book, \$1.00. PolyWog houseboat plans \$10. Marine catalog \$1.00. Marine Specialty Mfg. Co., 3107 Detroit Ave., Cleveland 13, Ohio.

**CONVERT** Fords and Jeep to 100% marine engines with Osco's world famous Convo-Kits. Deluxe catalogue 25c (coin). Oscomotors, 2020B Orleans, Philadelphia 34, Penna.

**REBUILT** Outboard motors—Late models. We specialize in new-used parts. Write for price quotations giving us description of parts needed. Money back guarantee. Standard and oversize outboard motor pistons. Outboard Motor Mart, 309B Atlantic Avenue, Boston 10, Mass.

**STERING** Wheels, windshield brackets, from \$6.95. Modern fittings at lowest prices. Complete pre-cut plywood boats. Bargains galore. Folder 10c. Marine, Box 681, Mendota, Minnesota.

**SAVE 3/4** Cost. Build your own boat with our ready cut parts by the Welch system. No experience necessary. Rowboats to cruisers. Illustrated catalog 25c. Midwest Boat Company, Menomonee Falls, Wisconsin.

**OUTBOARD** Motors—Used bargains, \$45 up, free list. Used parts, most models, save money! Boat and motor equipment and accessories. Big catalog, send dime. Crandall-Hicks, 911 Commonwealth, Boston, Mass.

**NEW,** Used, rebuilt marine motors. Marine conversions, fittings. Free catalog.

**MARINE** Conversions for Ford and Jeep engines. Catalog 10c. Lehman Manufacturing Company, Department D, Newark 2, New Jersey.

### ENGINES, MOTORS, DYNAMOS

**BARGAINS.** A.C. or D.C., engine or electric drive, portable or stationary. Write needs to Box 279-M-405, Troy, Ohio.

**NEW 1/15 H.P.,** 110 volt, 60 cycle, 1800 r.p.m., 5 lb., heavy duty motors. \$20 value for \$4.50 or \$6.00 with 11 inch balanced fan, postpaid. Kaynine Konvoy Co., P.O. Box 11302, Los Angeles 48, Calif.

**WATER** Motors—All sizes for any purpose. Duplex Motors, Burlington, Iowa.

**WELDING** Generator, 150 ampere, \$35.00. Motors, 1/2 horse, \$15. 1 horse \$30. Water pumps \$12.50. Butler, 1885 Milwaukee, Chicago 47.

**MOTOR** Winders, free bulletins, winder and tester equipment. Motor Industries, Quincy, Illinois.

**CLOSE-OUT** Sale new 1 h.p. gasoline engines. Never unpacked. Motorize lawn mower, saw, pump, sprayer. Check, c.o.d. \$27.50. Jedway Corporation, Acton, Indiana.

**WINDING** Data, listing 225 motors, single and three phase, \$1.00. Motor Data Co., Box 7631, Kansas City 3, Mo.

### ATHLETIC EQUIPMENT, BODY BUILDING COURSES

**ACROBATS!** Strength, health. Free booklet. Write! Knoff, 450A, Pewaukee, Wisconsin.

**GREAT** Strength easily obtained. See page 75 Dec. issue 1949.

**BARBELLS**—Finest quality, \$7.98 up. Free catalog. Lurie Barbell Co., 1729-M4 Rockaway Parkway, Brooklyn, New York.

**FREE** Information. Be one to three inches taller. New scientific system now developed. Gordon, Box 577, P.S.C., Davenport, Iowa.

**FREE** Illustrated catalogue—10c for postage and handling appreciated. Dr. Frank Thompson, Dept. 10, 919 Fourth, Manhattan, Kans. World's leading dealer.

**DEADLY** Judo—Fiercest fighting technique. Trick knockouts! (Over 200 illustrated pictures.) Expert instructions; three volumes. Complete \$2.25. Variety House, Box 46-B Wall Station, New York 5.

**BARBELLS,** Exercise equipment. Courses. Free booklet. Good Barbell Co., Reading, Penna.

### SPORTING GOODS, GUNS, FISHING TACKLE, ARCHERY, TRAPPING

**OFFICIAL** Gun book! It's new! It's terrific! Contains more words, more pictures on every type gun ever assembled. Written by famous experts. Yours for only \$1.50. Order quickly! Book Readers' Circle, Div. M, 80 East 11th Street, New York 3.

**SEND** 10c For list 100 used guns. Prayseth's, Willmar, Minn.

**FISHERMEN**—Make your own sinkers with our molds. Free illustrated booklet. Reading Instrument Co., Box 78, Reading, Penna.

**MOLDS** "For fishermen, sinker, squids, jigs, and lures" handled and hinged, quality fishing tackle, free catalogue. Sweets Molds, Tonawanda, New York.

**OLD** Elmer, 4422A Summit, Kansas City, Mo. want 500 fishermen to try his new "Girdle Hook." Send your name today.

**WHITE** Navy blankets. 100% all wool genuine surplus. Made to rigid navy specifications. Slightly used, condition excellent. \$15.00 value for \$6.95. Postage prepaid. 1/2 deposit on c.o.d. orders. Drive In War Surplus, 8505 So. Western Ave., Los Angeles 47, Calif.

**STOP** Digging. Spray ground. Worms appear like magic. Formula 50c. Charles G. Hyde, Ballston Spa, N. Y.

**WHY** Wait? Send four bucks now for our salesmen assortment of twelve casting lures. Undersell all competitive items while doubling your money. Write Ace Specialty, 409 Elm St., Buffalo 3, N. Y.

**SNOOPERSCOPE** Book. Shows army, navy sniperscopes, snooperscopes. \$1.50 each. Infrared filters 15c. Precise, 942 Kings Highway, Brooklyn 23, New York.

**FREE** Catalog—21 different, complete spun glass rod kits. Build your own, save 60%. Simple instructions. Write Trimline Tackle Company, 508-Z Tinton Avenue, New York City 55.

**FISHERMAN**—Lead sinkers. High quality, low cost, guaranteed. Free information. Wechsel, 5858 Deane, Toledo 13, Ohio.

**FREE** Guidebook, "Top Tips For Fishermen." Send now for this fascinating, new, free, Richardson 32-page booklet containing 357 fishing tips, compiled by the expert fishermen who make Richardson rods—the fishing rods that are tagged with the "Sign of the Fish!" For your copy, sent without cost or obligation, print your name and address on a penny post card and mail to Richardson Rod & Reel Co., 3166 N. Sawyer Ave., Chicago 18, Ill.

**LEARN** Gunsmithing! Details, copy "Guns and Gunsmithing" 25c. Gunsmith, Palatine, Illinois.

**FREE** 50 Page catalog—Fly-tying, lures, spinners, rod making materials, hooks, fishing supplies. Scueilly Tackle Co., 3436 W. 5th Ave., Chicago 24, Ill.

**GUN** Replacement parts, state your needs. Jos. Claudio, 67 West 101 Street, New York.

**AMMUNITION**, Foreign-American; firearms. List 25c. Frank Farish, Vicksburg, Miss.

**190 PROFUSELY** Illustrated pages antique and modern pistol, sword, etc. values, 50c. Robert Abels, A860 Lexington Ave., New York 21.

**SHOTGUNS**, Rifles, revolvers, over 500 modern, obsolete. Also cartridges, list 10c coin. Ed Howe, 52 Main, Coopers Mills, Maine.

**5000 BARGAINS**, Firearms, binoculars, war relics, Catalog 40c. Smith Firearms, Runnemed, New Jersey.

### **BINOCULARS, TELESCOPES, MICROSCOPES, MAGNIFIERS**

**BINOCULARS**—Maps, globes, Sport, travel, reference books. Free catalogs. Belanger's, 51-Z Talcott, Rockville, Conn.

**SAVE 50%** On new binoculars! Free catalog. Free book, "How to Select Binoculars." Write today! Bushnell Importers, 43-M4 East Green, Pasadena 1, California.

**IMPORTED** Precision microscopes, power 80X. New. Complete set, with biological slide. Wooden boxed. \$6.95 postpaid. Transworld, 565 Fifth Ave., New York City 17.

**WAR** Surplus bargains—Binoculars, telescopes, sextants, millions of lenses, prisms, reticles, eyepieces, objectives, etc. Request free "Catalog CH." Send \$1.00 for Stock CH—10-piece lens kit and big instruction booklet. Edmund Salvage Co., Barrington, N. J.

**ASTRONOMICAL** Telescopes, binoculars, microscopes; bought, sold, repaired. Books. Lists 10c. Rasmussen-Reece, Amsterdam, N. Y.

**GIANT** Astronomical telescope with 6 ft. tripod \$15.00, f.o.b. factory. 100 power. (10,000 area magnification). Clear vision, full power guaranteed. Ready for use. Suffolk Science Service, Dept. BT, Riverhead, N. Y.

**BINOCULARS**, Telescopes, watches, guns. Buy, sell, trade. Schweer's, Donnellson, Iowa.

**REFLECTING** Telescopes, 60X, completely assembled \$25.00. Guaranteed observatory clearness. Free information. Skyscope, 475 Fifth Avenue, New York 17.

**TELESCOPES**, Binoculars, microscopes, big bargain catalog free. Brownscope Company, 24 West 45th Street, New York.

**POWERFUL** Astronomical telescopes easily made. Perfect lenses and instructions; 100X \$3.00; 100X and 200X \$4.00; 100X, 200X and 400X \$6.00. Full power, clear vision guaranteed. Instructions alone 10c. Suffolk Science Service, Riverhead, N. Y.

### **PETS—DOGS, BIRDS, RABBITS, HAMSTERS, ETC.**

**MAKE** Money raising Angoras. Circular free. Vaughn's Rabbitry, Otley, Iowa.

**RAISE** Guinea pigs. Have home hobby-business. Booklet free. Taylor B426A, Hapeville, Georgia.

**MINK** Raising—Valuable booklet pen plans \$1.00. Lake Ontario Mink Ranch, Gravel Road, Webster, N. Y.

**\$3000 YEARLY** Raising Angora rabbits. Markets furnished for your output. Particulars free. Kise's Enterprises, St. Paul 8, Minn.

**A MONEY** Maker. Raise Hamsters. Free book. Literature on request. Pet Hamstery, ND Sta. Box 7, Dayton 4, Ohio.

**HAMSTERS**, Finest quality breeding stock at reasonable prices. Free illustrated literature. Past service. Mount Clemens Hamstery, 94 Church, Mount Clemens, Mich.

**RAISE** Hamsters for pleasure and profit. Low feeding costs, waiting markets. Market plans and 80 page book given free with each pair. Write for free illustrated literature. Pat's Hamster Farm, Waterford 3, New Jersey.

**BOOKLET**—"Secrets Hamster Marketing-Profits" 25c coin. Literature. Select stock \$1.50 up. Wisconsin Hamstery, Pewaukee, Wisconsin.

**SEE** Gulf Hamstery ad on page 32. Shows picture of Hamster.

**MAKE** Big money! Raise Chinchilla rabbits. Cash markets supplied for your production. Write today! Rockhill Ranch, Sellersville 15, Penna.

**RAISE** HDS rabbits. Howard O'Neill, Brookville, Penna. received \$713.50 in 3 months from three rabbits. Why not you? Details, 10c. Hansen's Rabbit Institute, 1347 Miller Ave., Salt Lake City 6, Utah.

**CAPONIZE** Chemically, no surgery tenderizes, flavorizes four to eight weeks all age roosters. Free simple instructions. Golden Valley Hatchery, Dept. 14, Parkville, Missouri.

**HAMSTERS**: No finer breeder or pet stock at any price. \$2.50 pair, \$3.75 trio. Free folio. Valley Hamstery, 734 North Milam, San Benito, Texas.

**RABBITS**: New Zealand whites. Ringland Rabbitry, 1726—30th, Des Moines 3, Iowa.

**\$300 MONTHLY** Raising Angoras for our market. Particulars free. Wilson, Stanton 17, Calif.

**RAISE** Chinchilla rabbits! Real profits from breeders, meat, furs, laboratories. Markets supplied! Write today! Rockhill Ranch, Sellersville 15, Penna.

**RAISE** Rabbits. Four pound fryers in eight weeks. Ready market for meat, fur, wool. Illustrated book, describing leading breeds, housing, breeding, feeding, marketing. By America's largest rabbit association 10c. American Association, 12 AR&CBA Building, Pittsburgh 17, Penna.

**\$1.00 FOR** Booklet "Canary, Its Care, Breeding and Training," and three copies cage-bird magazine. American Canary, 2839PM N. Halsted, Chicago 14, Ill.

**MINK** Raising information free. Complete. Lake Superior Mink Farm, Superior, EEl, Wisconsin.

**\$400 MONTHLY** Raising Angora rabbits. No experience required. Details free. White's Rabbitry, Newark, Ohio.

**GRINSTEAD'S** Famous Angoras! Giant Chinchillas! World's most profitable rabbits. Finest pedigree, heavy-producing, prize-winners. Literature free. Grinsteads, Edwardsville, Illinois.

**INCREASE** Your income by raising domestic rabbits. Small space needed. Ready market for delicious meat, fur and wool. Largest magazine in the industry tells you how. \$1.50 per year. Sample 15 cents. No stamps. Small Stock Magazine, Lamoni 20, Iowa.

### **PLANTS, SEEDS, NURSERY AND GARDEN SUPPLIES**

**REMOVE** Any tree stump for as low as \$1.00. New sensational compound—No blasting, chopping or digging. 4 oz. \$1.00 (enough for stump up to 36" in diameter); 8 oz. \$1.50; 1 lb. \$2.75; 5 lbs. \$12.50. Order today. Get rid of ugly stumps the easy way. Send no money. Pay postman or send cash with order and save c.o.d. charges. Money back if not satisfied. H. D. Campbell Co., Rochelle 7, Illinois.

**GROW** Lovely flowers, invest in earthworms, nature's fertilizer. Write for folder. J. W. Porter, 1452 South Third St., Louisville 8, Ky.

**WORLD'S** Finest hand transplanter and weeder. Free circular. Proper Mfg. Co., Webster, New York.

**GINSENG**, Goldenseal. Hundred seeds \$1.50; thousand \$5. Dozen plants \$1.50; hundred \$9. Growing-selling instructions included. F. M. Collins, Viola, Iowa.

**CACTI**, Succulents; colorful, thornless. Ideal house plants. 7 for \$1.00, 17 for \$2.00 prepaid. All different. Munsil's Gardens, Vista, Calif.

### **FARMS, FARM LANDS, REAL ESTATE**

**FLORIDA**. Beautiful homesites in new Lake County development, \$245 at \$10 monthly. Near Ocala National Forest, many pretty lakes, streams, pavement. World's best bass fishing, wonderful hunting. Folder free. Howard Vernor, DeLand, Florida.

**FREE** Spring catalog, farm bargains, many equipped, illustrated, several states! United Farm Agency, 1408-PM Consumers Bldg., 220 South State St., Chicago 4, Ill.

**GOOD** Farms—Ranches. Washington, Minnesota, Montana, Idaho, Oregon, North Dakota. Dependable crops, favorable climate. Write for literature, lists describing typical farm opportunities. Specify which state. J. W. Haw, 119 Northern Pacific Ry., St. Paul 1, Minn.

**FREE** Fertile lands in South-America, yielding four annual crops. Homesteads, large plantations, 25,000 acre ranches, obtainable free. Make your fortune growing sugarcane, tobacco, cereals, bananas, coffee, fruits, timber, cattle, sheep. Send 25c (coin) for illustrated booklet "100,000 Square Miles Free!" Valles, 395-XT Broadway, New York 13.

**HOMESITES** \$300—Convenient payments. California's finest garden section. On Morro Bay's scenic shores. Wonderful fishing, hunting, boating, bathing. Fertile soil, softest water, temperate climate, congenial community. Free literature. Richard Otto, Department M, San Luis Obispo, California.

**\$5.00 MONTHLY** Buys 40 acres near town; price \$200. Free list. Box 425-F, Carthage, Mo.

**STROUT'S** Golden anniversary farm catalog. Over 2800 outstanding bargains. Coast-to-coast, 32 states. Mailed free. Strout Realty, 7 So. Dearborn St., Chicago 3, Ill.

**GOVERNMENT** Lands \$2.00 acre up. Information all states twenty-five cents. National Tax Service, 901-A Majestic Bldg., Detroit.

**CANADIAN** Tax sale lands for two dollars an acre and up. Small monthly payments. Farms, timber, hunting and fishing camps, minerals. Limited number of properties. Write at once for free catalogue. Tax Sale Service, Room 105, 120 Bloor St. W., Toronto 5, Canada.

**FARM** Manual shows you how to make extra profits from your farm. 284 pages of farming lore, \$3.00. Popular Mechanics Press, 200 E. Ontario, Chicago 11, Ill.

**SOLD** For taxes. Calif., Oregon, Washington timber, grazing, ranch and mining lands. 25c to \$3 acre min. bid. 10c (coin) brings circulars, photos, maps. Pacific Lands, Box 2350-PM, Hollywood, Calif.

**FLORIDA** Campsites—\$95.00 at \$5.00 monthly buys nice, high dry lot in Lake County (world's best bass fishing, wonderful hunting) near Ocala National Forest, St. Johns River, beautiful lakes, pavement. Folder free. Howard Vernor, DeLand, Florida.

**FARMS**, Ranches, lodges, resorts. Big selection, Milwaukee Road territory. Washington, Idaho, Montana, Dakotas, Minnesota, Iowa, Missouri, Michigan, Wisconsin, Illinois, Indiana. Free colorful descriptive folders, price lists. L. H. Robbins, 738J Union Station, Chicago 6, Ill.

### **FARM MACHINERY AND SUPPLIES**

**FOR** Sale—Recker push off wagon unloader. Will unload chopped hay, ensilage, and all other farm crops in 3 to 8 minutes and return endgate to front in 6 seconds. Write for free lit. F. B. Recker Co., Hopkinton, Iowa.

### **POULTRY, FARM SUPPLIES**

**KNOW** How to raise poultry for profit. Read Poultry Industry. Every issue packed with helpful hints and practical suggestions. Latest articles on breeding, feeding and management. Subscribe now. 1 year 65c. 2 years one dollar. foreign subscriptions \$1.00 a year. Poultry Industry, Dept. P.M., 376 Boylston St., Boston 16, Mass.

**DUCKLINGS**, Goslings, eggs, breeders. Safe shipment anywhere. Bulletins, magazines, on hatching, raising, selling. Peytons Duck and Goose Farm, Route 2DM, Duluth, Minnesota.

**BABY** Chicks, champion mated, 52 varieties, 7 crosses, licensed inspected, bloodtested. Rush postal, large colored book free, low prices. Berry's Farm, Route 12, Clarinda, Iowa.

**RAISE** Fryers new easy way. One man

**RAISE** Turkeys the new way. Write for free information explaining how to make up to \$3000 in your own backyard. Address—National Turkey Institute, Dept. 3, Columbus, Kansas.

### PROFITABLE OCCUPATIONS

**MUSHROOMS** Grown boxes, barrels. Instructions 50c. Spawn \$1.00. Manureless process. \$2.00. Gordons, 553 William, Winnipeg, Manitoba.

**ALASKA**—Last great American frontier. \$1.00 brings 1950 copyrighted directory and government map free. Big construction projects; fishing; mining; aviation; hunting-fishing-game rules; fur-farming; lumber; live stock; agriculture. Homestead land and highway information. Listing firms hiring. Application form. Alaska Opportunist, P.O. Box 883-P, Hollywood 28, Calif.

**INTERESTED** in Latin America and foreign employment? \$1.00 brings 1950 copyrighted "Foreign Service Directory," world wide listings in construction; oil; mining; aviation; steamships; manufacturers; transportation; exporters, importers. Hot list firms hiring. How-when-where to apply. Application form free. Global Reports, P.O. Box 883-P, Hollywood 28, Calif.

**LEARN** Gunsmithing! Details, copy "Guns and Gunsmithing" 25c. Gunsmith, Palatine 3, Illinois.

**MAKE** Flexible molds! Cast plaques, novelties! Bookends! Free sample! H. Tooker, Hamilton 9, Ohio.

**RAISE** Fishworms. Easy, profitable. Send 25c in coin for complete instructions. Huffman Worm Ranch, Rives Junction 2, Mich.

**MEN**—Women, "everybody likes candy." Learn to make professionally. Our 40th year. Ragsdale Candies, D6, East Orange, New Jersey.

**MASONIC** Book ends, manufacture at home by ornamental casting. Large sales, big profits, easily learned. Plastercraft, 395 9th St., San Francisco.

**FREE** Book "How to Make Money With Home Workshop" describes amazing methods used by hundreds of successful craftsmen. Tells what to make, how to sell workshop output spare time. Write at once for details. Remember it's free! Craftsman, 115-A3 Worth St., New York City.

**\$250 WEEK** Reported! Free illustrated book "505 Odd, Successful Businesses." Work home! Expect something odd! Pacific-E, Oceanside, California.

**MAKE** Money at home—Casting fast-selling plastex novelties and metallizing baby shoes. Tremendous possibilities—full, spare time. No experience needed. Full instructions given. Write: Leonard Moese, 161-A Madison Ave., New York 16, N. Y.

**FOREIGN** Employment. Construction men, building trades, mechanics, helpers, office men. Good workers interested in foreign development projects. Pipe lines, dams, power plants, roadways, shipping, oil refineries, etc. Transportation and quarters furnished; high wages. Listings of firms actively working on projects in Arabia, Persian Gulf, Africa, Alaska, Canada, South America, Europe, etc. Send \$1.00 for foreign construction compendium and application forms. Foreign Service Bureau, Dept. PM4 (Employment), P.O. Box 295, Metuchen, N. J.

**DOMESTICATED** Earthworms produce richest soil. Unexcelled bait. Amazing booklet 10c. Midwest Earthworm Farms, Box 999J, Wichita 1, Kansas.

**PROFITS** Galore casting faces direct from life! Write Komar Company, LaPorte, Indiana.

**PROFITS** From inventions. What to invent and how. How to sell or manufacture. Ten lessons and special services. Free information. Cunningham, Box 1132, Chicago 90, Ill.

**GINSENG** And seal growing instructions, dime. Specialty Farm, Rockford, Minn.

**REPLATE** Worn silverware. Profitable spare time occupation. Complete instructions, \$1.00. R. Timmerman, Box 660, Pasadena, Texas.

**EXCELLENT** Profits. Make sell-on-sight chenille holiday flowers, palms, dolls. Literature free. Velva, 324-M East 14, New York City 3.

**HAVE** Fun! Make money! "Working With Leather"—64-page booklet tells how. Send 25c for copy. Free catalog and valuable information included. Wilder-Craft, 1039 Crosby, Chicago 10.

**LOCKSMITHING** Secrets! Key fitting, lock repairing, opening; prices, sources. Locksmith, Box 90, Waukegan, Ill.

**LEARN** Reweaving! Free details. Frank Harris, 2502 St. Thomas, New Orleans, La.

**"FROG Raising!"** New book tells how! Illustrated literature free. Marlboro-A, Box 7002, New Orleans 19, Louisiana.

**GET** Big money for old phonograph records. Listings free. C. Carr & Co., Dept. R, Beverly, New Jersey.

**BE** The Popular Mechanics representative in your neighborhood and earn big profits in your spare time. Write Popular Mechanics Magazine, Room 408M, 200 E. Ontario St., Chicago, Ill.

**\$400 MONTHLY** Raising Angora rabbits. No experience required. Details free. White's Rabbitry, Newark, Ohio.

**\$46 FROM** Square foot plywood; jigsaw necessary. Write, Woodarts, P-38, Bridgewater, Mass.

**OWN** And operate mirror shop! Supplies for resilvering mirrors, making chipped glass nameplates and electroplating. John Sprinkle, V50, Marion, Indiana.

**TYPISTS**, Profitable business at home. Complete copyrighted information 50c. Rosdahl Industries, 72-A W. Washington St., Chicago 2, Ill.

**\$40.00 WEEKLY** Made growing mushrooms, fresh, dried. Dominion patent 331583. Free spawn. North American, 169P Yonge, Toronto, Canada.

### BOOKS, PERIODICALS, PICTURES, POSTCARDS

**FREE** Catalogue. Special interesting books. Melvin Powers, 1324 Wilshire, Hollywood 17, California.

**ANY** Book promptly supplied! Catalog free. Write—Arden Publications, 210a Fifth Avenue, New York 10, N. Y.

**ENTERTAINMENT** Package, 3 wonderful books: Puzzle Paradise, Self-Entertainment, Coronet Quiz Book, \$3.75 value, all yours for just \$1.00. Supply limited. Rush order. Book Readers' Circle, Box M, 80 East 11th Street, New York 3.

**POSTCARDS**—Roberts Kodachrome process. Beautiful, historical. U. S., Alaska, Hawaii. 25—\$1.00; 80—\$3.00. Satisfaction guaranteed. Ernest Hall, Box 3660, San Francisco 19.

**MOTOR** Trend Magazine—Custom, foreign, domestic, sports cars. Road testing, racing, auto shows, etc. Sample copy 25c. Full year \$3.00. Motor Trend, 548 S. San Vicente, Los Angeles 48, Calif., Dept. PM.

**HOW-To-do-it** books on every subject. Written in Popular Mechanics' famous easy-to-understand style and profusely illustrated. Subjects include workshop planning and practices, projects, hobbies, household repairs, motoring, outdoor sports, photography, home building and many others. Also booklets on specific topics. Write for free illustrated catalogue. Popular Mechanics Press, 200 E. Ontario, Chicago 11, Ill.

**BOOKHUNTERS!** All subjects. Send wants! Jaher Book Service, 620-P East 178 Street, New York 57.

**BOOKFINDERS!** (Scarce, out-of-print, unusual books). Quickly supplied. Send wants. Clifton, Box 1377-PM, Beverly Hills, Calif.

**NATIONAL** Geographic Magazine 1888-1949. Any issue, Box 327-PM, Periodical Service, Swarthmore, Penna.

### GAMES, TOYS, NOVELTIES

**PATENTED**—Unique. Hunting simulating toy. Write, H. Pangborn, 513 So. Wall St., Sioux City, Iowa.

**ROLL-O-KITE!** Giant spool type kite. Spins as it flies. Amazing performance. 50c. Roll-O-Kite, 737 So. Westlake, Los Angeles 5, Calif.

**INDIAN** Squaw with papoose or Indian chief dolls—14" high, only \$3.50 each postpaid. Full chief headdress \$2.50. Satisfaction guaranteed. Seneca Lodge, Watkins Glen, N. Y.

### MAGIC TRICKS, PUZZLES, JOKER NOVELTIES

**SEND** For free list of magic tricks and joker novelties. Smilin Jim, 125 N. Gallatin, Uniontown, Penna.

**FOUR** Of the best pocket magic tricks, each complete with instructions. Send only \$1.00. Matthews, 69 Dix St., Waltham 54, Mass.

**VENTRILOQUIST** Dummies. Catalogue 25c. Be a ventriloquist. Free literature. State age. Maher, Box 36-M45, Kensington Station, Detroit 24, Michigan.

**GAGS**, Acts, scripts! Catalog, 10c. Gags, Box 90, Waukegan, Ill.

**500-PAGE** Catalogue of 2500 tricks, pocket, parlor, stage. World's finest magic. Send \$1.50 for catalogue (refunded first \$6.00 order). Kanter's, M-1311 Walnut, Philadelphia 7.

**SNAKE** Peanut brittle! Three five-foot "snakes" jump from can. \$2.00 postpaid. Sensational illustrated joker catalogue 25c (refunded). Fink Specialty Co., B-1618, Philadelphia 5, Penna.

**SEND** 10c for latest joker trick and catalog of 300 tricks. Laramie Sales, 4800 S. Laramie Ave., Chicago, Ill.

**CHANGING** Spots and colors card trick, 25c coin. Duke, Box 927-M, Rocky Mount, N. C.

**500 TRICKS**, Douglas famous catalog 27 now only 10c. Unequaled service to magicians for 30 years. Send 10c today. Douglas Magicland, Dept. 1, Dallas, Texas.

**LEARN** Magic. 25c brings clever card trick and catalog. Edmar's, 418 Boush, Norfolk, Va.

**200 ELECTRIC** Stunts, 110 volts, \$1. Kutting Sons, Los Altos, Calif.

**5000 UNUSUAL** Novelties, magic tricks, jokes. Mammoth catalogue, complete magic kit—25 cents. Fun-Land, Box 1182, Beverly Hills, California.

**16 CARD** Tricks and catalog 25c. Sterling Magic, Royal Oak, Mich.

**MAGIC** Tricks, puzzles, books, cards, punch boards. Catalog 10c. Specialty, Box 671, St. Louis 1, Mo.

**WORLD'S** Largest professional magic shop, keeps you in touch with latest tricks. To receive mailings, send 50c for new catalog. Holden's, M220 West 42nd St., New York.

**BE** A magician. Large professional magic catalog of latest tricks, 35c. Ireland, C-109 North Dearborn, Chicago 2.

**PROFESSIONAL** Catalog, 124 pages, 25c. Williams, 900 Plymouth, Ellwood City, Penna.

**VENTRILOQUISM** Taught, 3c stamp bring particulars. Smith, 801 Bigelow, Peoria 5, Ill.

### COINS, TOKENS, CURRENCY

**SCARCE** Lincoln cents—1912S, 1913S, 1914S, 1915S, 1921S, 1923S, 1924S, 1926S, 1931D, 1932D, 1933D 10c each. 11 for \$1.00. Reynolds Coins, Flint 3, Michigan.

**WORLD'S** Greatest magazine for coin collectors and two wooden nickels 10c. Lawrence Brothers, Anamosa, Iowa.

**OLD** Money wanted. Will pay fifty dollars for nickel of 1913 with liberty head (no buffalo). We pay cash premiums for all rare coins. Send 4c for large coin folder. May mean much profit to you. Numismatic Co., Dept. 20, Fort Worth, Texas.

**LOOK!** 1947 P halves—Regularly \$1.00 now 75c. Uncirculated! Price list, coin and banknote 10c. Ray's, 109 Mathilda, Sunnyvale, Calif.

**OLD** Coins wanted—Gold, silver, copper. Cook Coin Company, Box 181, Jackson, Mississippi.

**60 DIFFERENT** Coins, bills, \$1.00. 100 different coins, bills, \$1.50. Oddehon, Box 482, St. Louis, Mo.

**BARGAINS!** 20 Different dates Indian cents with complete buying-selling catalogue \$1.00. Catalogue alone 25c. 15 different dates large cents \$3.00. 18 different dates liberty head nickels \$2.00. 10 different types Jackson's cents \$3.00. 5 different dates 2c pieces \$1.00. 1864-L cent \$2.00. 1901-S—½ or 1938-D—\$1.00. 1821 cent \$1.00. 1909-S cent \$1.00. 6 different dates shield nickels \$3.00. 3 different types half cents \$2.00. 5 different types large cents \$3.00. 1853 quarter \$1.00. 20c piece \$2.00. 1931-S cent \$1.00. 1919 quarter \$1.00. 1904-S dime \$1.00. Colonial coin before 1790—\$1.00. Worthy Coin Corporation, 294 Washington, (D-211), Boston, Mass.

**COINS** Bought, sold, exchanged. Domestic-foreign. Honest dealings. Satisfaction guaranteed. Nelson, Box 346-M, Rye, N. Y.

**CANADA**, Newfoundland coins. List 10c. Coin Exchange, Box 35, Terminal A, Toronto, Canada.

**INDIAN**, Lincoln cents bought, sold. Send 25c today for bargain list and Indian cent. Dept. PM5, Guarantee Coin Company, Box 6370A, Chicago 80.

**43 MIXED** Indian cents \$1.00. 33 diff. foreign coins \$1.00. Chelsea, 40 West 18, New York City 11.

**20 DIFF.** Coins 50c, free lists, approvals upon application. Bishop, Box 2201, Kansas City, Mo.

FREE! Foreign coin, banknote and coin collectors illustrated catalog to approval service applicants. Send 3c postage. Tatham Coinco, Springfield 30, Mass.

GET Profit and pleasure in collecting old coins. Send 10c for 56 page illustrated coin catalog. You'll be delighted with it. Send for it now. B. Max Mehl, 370 Mehl Bldg., Fort Worth, Texas. Largest rare coin establishment in U. S. Established 50 years.

16 PAGE Coin bargain list and Mexican 10 peso bill, all for dime. Coin Shop, 31 North Clark, Chicago 2, Illinois.

COINS Wanted, will pay up to \$2000 for certain coins, send 25c for catalogue. Burton's, 111 So. Third, Columbus, Ohio.

COMMEMORATIVE  $\frac{1}{2}$ , Oregon, Texas, Kentucky, Cleveland, Long Island, \$2.00 each. Illustrated catalogue 25c. Norman Shultz, Salt Lake 9, Utah.

## STAMP COLLECTING

STAMPS 100 Years old. Every collector should have at least a few stamps nearly 100 years old. Although hard to get, we offer a wonderful selection of ten old 19th century foreign stamps and also the blue re-issue of the 100 year old first U. S. stamp, the famous 5c Franklin. All for only 10c. Kindly state whether approvals shall consist of U. S. or foreign stamps or both. Globus Stamp Company, 268 Fourth Avenue, Dept. 212, New York 10, N. Y.

STAMP Collectors. First day covers. Valuable and interesting 16 page booklet free telling all about this fascinating hobby. Fleetwood Cover Service, Box 212B, Pleasantville, N. Y.

FREE—Famous Americans set, Flag set, National Parks set, and Presidential set to \$5.00. A total of 90 stamps free to customers for our unsurpassed U.S. and foreign selections. Send 3c for 15 of the above stamps and full particulars. Triboro Stamp Co., 145 Nassau St., Dept. 104, New York.

SAN Marino collection free—25 different, old and new issues, airmails, commemoratives, high values. Absolutely free with approvals. Viking, 130-ZZ Clinton St., Brooklyn, N. Y.

200 DIFFERENT Including Roosevelt triangle, 5c to approval applicants. M. Avalon Stamp Company, Springfield, Mass.

PENNY Approvals with something special. Sturgeon, 2112 Dodson, Fort Smith, Arkansas.

GOYA Nude (2) 5c. Approvals. Hanay's, 310 Quail, Albany 3, N. Y.

50 COUNTRIES. Abyssinia-Zanzibar 3c. to approval applicants. Mohawk, Box 141P, West Springfield, Mass.

10 ASSORTED U. S. Commemorative 15c. Five U. S. Air Mail 15c. 10 Famous Americans 25c. All for 50c. Ideal Stamp, Box 179, Park Ridge, Illinois.

ZANZIBAR, Pitcairn Islands, Turks, Caicos, Gilbert, Ellice, Solomon, Leeward, Gambia, Tanganyika and others. Complete collection free. Send 5c for postage. Gray Stamp Company, Dept. PM, Toronto 5, Canada.

FINE Approvals. Fast, personal service. What countries do you prefer? I'll send their stamps. Skinner, 438 Locust, Long Beach 12, Calif.

FREE! Illustrated album with first section approvals. I. Moulblow, 740 Hegney, Bronx 56, N. Y.

PENNY Bargains on approval. Also advanced material. Sunnyco, 1267 Tutwiler, Memphis 7, Tenn.

60 DIFFERENT Italy 10c. approvals. Kress, Box 144, Hanover, Penna.

PALESTINE! Egypt! Andorra! Free! Approvals. Colonial, Box 326A, Passaic, N. J.

1000 MIXED Foreign or U. S. on and off paper, 50c. C. Ritchie, Watertown, So. Dak.

WHOLESALE Lists to dealers, 3c postage. Grossman, 100 West 42nd, New York 18.

EXCHANGE Stamps universe. Particulars free. "Exchangers," Bry 126, Seine, France.

USED British colonials wholesale. Approvals against references. Barrington Smith, Halfwaytree-22, Jamaica, B.W.I.

750 FRANCE And colonies stamps 10c. Littleton Stamp Co., Littleton 25, N. H.

UPSIDE-Down triangle, mixture samples, free, approvals. Knott, 434 East 76th, New York 21, N. Y.

SURPRISE! 10c With free premium approvals. Robert Ewing, Wapakoneta, Ohio.

307 ALL Different 10c. Beautiful collection of commemoratives, triangles, high values, bicolored stamps, etc. only 10c. Garcelon, Box 400, Calais, Maine.

FREE! Liberia triangle airmails. Approvals. Greenwood, 441 Washington, Miami Beach, Florida.

SWITZERLAND! 25 Different 5c to approval applicants. Kardell, 209 Bower, Santa Fe, New Mexico.

COLORFUL Scandinavian set 25c. No approvals. Penniston, 9137 Moritz, Brentwood, Mo.

BULGARIA Set, catalogue \$1.87, for 10c plus approvals. Kingman, Highbridge, Box 42, New York 52.

FRENCH Colonies, 50 large pictorials, 10c with approvals. Fields, 1939 E. 85, Cleveland 6, Ohio.

FREE Collection—Over 100 different stamps of the world—commemoratives, she-wolf, camels, giraffes, ships, rare Austria race horse, others all to approval buyers; also Scott International Albums, stamp catalogs. Bell Stamp Service, Dept. S-2, Box 190, Bell, California.

HITLER Occupies Russia! Set catalogues \$1.64. With approvals, 10c. Colony Stamp, 126-B North Main, Waterbury, Conn.

"GOYA Nude" set. (Catalogs 55c.) 15c. Approvals. Royal Stamp Company, Tamaqua, Penna.

BOY Scout set complete, 1937, Netherlands, 10c with approvals. Vargo Stamps, 6044 South Fairfield, Chicago 29, Illinois.

25 DIFFERENT Ecuador, including 70 Centavo air mail 5c. Approvals included. Ranson, 721 Maple, Compton 4, Calif.

500 MIXTURE 20c. All different, 100—10c; 1000—80c. Dimond Co., 3152 Cuthbert Ave., Oakland 2, Calif.

FLAG Stamp free with your request for U. S. approvals. Wenigman, 1933 Patterson, Chicago 13.

FREE Sample—Newsy, informative stamp weekly. Southern Philatelist, Miami 35, Florida.

500 MIXED Stamps and surprise packet only 10c with approvals. Fahsing, Dept. PM, Topanga, California.

PAY Less, buy more, books of 1,000 at 1c and 2c each. Very good fillers. Attractive stamps. Adults only. Daniel Grave-line, 14702 Troester, Detroit, Michigan.

WALLET With 100 stamps—10c. Northeast, Box 6618, Kansas City, Mo.

RARE Austria War Prisoners free to approval buyers. Plymouth, F4, Bell, California.

ARMENIA, Ten bicolored stamps, value 75c free to approval buyers. Apex Stamps, Box 2188, Miami 13, Florida.

SENSATIONAL! Set each Honduras, Martinique, Guadeloupe, Guiana, also \$2,000,000.00 stamp. Brunel, over 100 different others. Everything 10c with approvals. Whitehead, 315P So. 5th Ave., Canton, Ill.

50 DIFFERENT U. S. 10c. No approvals. Pricelist free. Seidenberg, Baroda, Mich.

1010 DIFFERENT Stamps \$1.00. Approvals, Bargain lists. Buckley, 208 Ludlow Bldg., Dayton 2, Ohio.

WORLDWIDE Stamps. All different. 1000, \$1.00; 2000, \$2.50; 5000, \$12.50. Beacon Sales, Northboro 2, Mass.

FREE "Stamp Finder." Tells instantly country to which any stamp belongs. 36 pages profusely illustrated. Garcelon, Calais, 17, Maine.

PROFUSELY Illustrated 76 page! U. S. catalogue, 25c deposit. Miller Stamp, Malden 48, Massachusetts.

EVERYONE Different, 25 Canada, 25 U. S., 25 Switzerland. All 3c with approvals. Alatelo, Maynard, Massachusetts.

IMPROVE Your collection with my medium priced nice condition foreign approvals. Newcomb, Box 7036T, Kansas City 2, Missouri.

GERMANY! "War issue," planes, Hitlers, (20) free with approvals. William Deems, Ravenswood, West Virginia.

BARGAIN! \$2,000,000.00 China stamp, and over 100 different others cataloging up to 60c each. Everything only 10c with approvals. Paul, 19 Dover, Cranston, R. I.

FREE! The Case Bulletin—World's greatest source of valuable stamp information! Conklin, Dept. PM, Osage, Iowa.

HEARD About Roscoe? Well, try Roscoe

ABSOLUTELY Free! Five valuable triangles! With approvals. Caribbean, Box 498, Miami 42, Florida.

FREE U. S. \$1 Lincoln Memorial to approval applicants. Litten, 318 North Fifth Avenue, Maywood, Illinois.

FREE! United States commemorative price list. Historical Stamp Company, 110 West 42nd, New York 18.

BEAUTIFUL Morocco pictorials. Free list. Dollar bill brings superb assortment. Idap, 26, Hollande, Tangier, Morocco.

FREE U. S. catalogue. Over 500 illustrations. Stone, Box 52-P, Dorchester, Boston 24, Mass.

ATOMIC Bomb airmail and 100 all different war-issues, airmails, etc. from war-torn China! 10c to approval applicants. Star Stamp Company, Jamestown, New York.

FREE! Canadian sets, royal visit, George VI, George V, coronation, jubilee, others, to approval applicants. Ensign, Box 118-M, South Orange, N. J.

FREE: 320 Different, fascinating stamps from all over the world with our famous quality approvals. Lincoln Stamp Co., Dept. B, 105 Tyler Street, Rochester 21, N. Y.

199 DIFFERENT—33 Countries, including 38 19th century; diamonds, airmails, jubilees, 10c. Approvals. Brooks, 2352B East 23rd Street, Brooklyn 29, New York.

100 DIFFERENT World-wide, 5c. Approvals. Stearns, 26970-B Princeton, Inkster, Michigan.

FREE! Big packet! With catalog! Stamp-mart, Box 2071, Hartford 1, Conn.

FREE Philatelic supply list. Penny approvals on request. Reed, Box 980E, Chicago 90, Illinois.

FREE! Volcano pictorial! Madagascar! Burmese! Nigeria! Approvals. Keating, 637-P Bergen, Jersey City, New Jersey.

25 ALL Different stamps 10c. Tunis, 54 Wakeman, Newark 4, New Jersey.

WONDERFUL Offer 7 complete mint sets, Manchukuo, Bohemia and Moravia for only 10c with approvals. Reich Stamp Co., 4647 Kenmore, Chicago 40, Ill., Dept. M23.

PAYING High prices for approvals? If your collection numbers under 15,000 try our 1c and 2c approvals. In books of 1000 different. Lots to choose from at lowest prices. Also special offer to customers. Clark, Box 544-P, Muskegon, Mich.

WORLDWIDE, 500 Different 25c. Unique approvals. Niagara Stamps, Niagara-on-Lake 11, Canada.

HAVE Fun, build your stamp collection inexpensively. Write for economy 1c approvals. Joseph Goldman, Lynbrook, N. Y.

FREE Watermark detector and perforation gauge with U. S. approvals. Manning, 3259 Decatur Ave., New York 67, N. Y.

INTERESTING Premium free with approvals. Niagara Stamps, Niagara-on-Lake 10, Canada.

"HOW To Recognize Rare Stamps." Free book, illustrated! Kenmore, Arlington 74-H8, Mass.

RARE Bargain. Six mint German sets, 50c value. Only 10c to approval applicants. Stamp Mart, 1412 Great Northern Bldg., Chicago.

FREE. Scott's International album, valuable colorful collection, hinges, other big premiums. Full particulars with approvals. Raymax, 123-Z William St., New York 7.

FREE Catalog! Illustrated. Forty pages. United States. Foreign. Albums. Supplies. "How to Collect," etc. Harrisco, 202 Transit Bldg., Boston 17, Mass.

TOPS! Our book "How To Collect Stamps." Send for your free copy today! Littleton Stamp Co., Littleton 37, N. H.

1000 WORLD Wide 67c. Pacific, P.O. Box 5704, Los Angeles, Calif.

200 BRITISH Empire stamps plus valuable publications only 3c. Kenmore Stamps, Arlington 74-B17, Mass.

FREE—Cuba Roosevelt issue and illustrated catalog. Maynard, Littleton 12, N. H.

EXCHANGE! Send 25 U. S. commemorative duplicates. Receive 200 different world. Sundman, Littleton 6, N. H.

POSITIVELY Greatest free offer—Latest Scott's international \$6.00 stamp album, covering entire world, contains 36,000 illustrated descriptive spaces. Scott's New Standard \$7.00 catalogues "Philately's Encyclopedia"—absolutely free to applicants for foreign approvals becoming cus-

STAMP Magazine! Copy free! "Stamp Post," S. Catalina, Pasadena 1, Calif.

10,000 DIFFERENT 1c Each! Gordon Davison, Box 1019S, Manchester, N. Hamp.

GIFT—Tokelau Is. complete mint to approval applicants. Deane Stamps, Box 87, Miami 35, Florida.

110 DIFFERENT Hitlers, Roosevelt, Liberia, Vatican, etc. 10c. Buckey, 208 Ludlow Bldg., Dayton 2, Ohio.

WORLD—500 Diff. 50c, 1000-\$1.00, 75 Canada 25c. Approvals, lists. Victoria Stamp Company, London 4, Canada.

\$1-\$2-\$5 UNITED States, commemoratives, airmail, high values in large collection United States stamps only 5c to applicants United States approvals, Metropolitan, 140B Nassau, New York 7.

UNITED States stamps nearly 100 years old, Roosevelt set, others, 40c value—only 5c to applicants United States approvals, Wakonda, 140G Nassau, New York 7.

MAGNIFIER, Big stamp magazine; first U. S. commemorative; plus unused \$5000 Foreign Legion, diamond, giant, and other worthwhile stamps. Everything free to approval buyers. Capital Stamp Company, Little Rock 2, Arkansas.

300 DIFFERENT Given free with approvals. Postage 3c. Windsor Stamps, 1435 East 67th Place, Chicago 37.

FREE—Illustrated catalog! Kenmore Stamps, Arlington 74-C7, Mass.

FREE! Powerful magnifying glass—To approval applicants; also big bargain lists. Jamestown Stamp Co., Dept. 207, Jamestown, New York.

200 DIFFERENT Stamps 10c with approvals. 500 mixed United States 25c. Carlton's, Tujunga, Calif.

DEALERS—Wholesale list. Postage 3c. Frank, 5031 Queensberry, Baltimore 15, Md.

1c EACH And less! Thousands of bargains! Cole, 43-A Rinewalt, Buffalo 21, New York.

ZOWIE-E! A barrel of fun for only a dime. 500 United States stamps—absolutely unopened and unsorted—just as received from church missions. Many varieties, including large commemoratives, airmails, high denominations up to \$5.00! Stampdom's biggest package of fun—and you might find something really valuable! Price only 10c to serious approval service applicants. Money back if not delighted. Illustrated bargain lists with each order. Mystic Stamp Company, Dept. 80, Camden, New York.

WOW! \$10.00 Worth of fun 10c! What a treasure hunt! Big package 500 foreign stamps, including airmails, pictorials and others from the world over; stamps worth up to 25c each. This offer sent for 10c to approval applicants only. Jamestown Stamp Co., Dept. 22, Jamestown, New York.

U. S. Price list. Send postage. State Stamp Service, 1225 Park Building, Pittsburgh 22, Penna.

FREE U. S. price list, postage 3c. Mark Hanna, 335 5th Ave., Pittsburgh 22, Penna.

WORLD'S Largest stamp (7½x14 inches). A real curiosity! Retail for 50c, only 3c to approval applicants. Tatham Stamp Co., Springfield 30, Mass.

STAMP Collections wanted. Complete collections, duplicate lots, surplus stock, mint and used. Prefer trade for printing or other items, buy outright if priced right. What have you, what's wanted? Vanroy Shirk, Lebanon, Penna.

FREE! 100 Worldwide different stamps to approval buyers. Big U.S. and illustrated bargain lists sent with approvals. Bookman, Maplewood, N. J.

#### ANTIQUES, RELICS, INDIAN GOODS, CURIOS

8 ANCIENT Indian arrowheads \$1.00, tomahawk \$1.00. List free. Lear's, Glenwood, Arkansas.

#### PRECIOUS STONES, MINERALS

"GENUINE" Deep red Arizona rubies (garnets). Send quarter for packet. Bitners, Box 2651, Phoenix, Arizona.

COLLECT Fossils—Interesting, educational. Beautiful specimen of fern leaf \$1.00. Don Lasswell, Wilmington, Ill.

GUARANTEED Genuine topaz crystals as found in desert. All crystals at least one carat, 3 for dollar. Charles J. Barkley, 230 East 3 South, Provo, Utah.

AGATES, Cutting machines, mountings.

ROSE Quartz, jasper, agate and catalogue. Quarter. Gemco, Elkhart Lake, Wisconsin.

MINERAL—Treasure locators—Geiger counters. Can be purchased on monthly payment plan. Free literature. Fisher Research Lab., Inc., Palo Alto, Calif.

GEMSTONES, Mineral specimens. Every variety. Lowest prices. Postcard brings free booklet. Plummer's, 2183C Bacon, San Diego 7, California.

METAL Detectors. The very latest circuit. Send 25c for literature. Hedden Metal Detectors, 3329 Liberty Ave., Pittsburgh 1, Penna.

#### HOBBIES AND COLLECTIONS

50 DIFFERENT Army embroidered patches \$1. Other bargains. Insignia Mart, 703A Broadway, New York 3, N. Y.

PENNANT Collecting—Fascinating hobby! Write Komar Company, M-4, LaPorte, Indiana.

POSTCARDS Your hobby? 50 different \$1.00. Samples, 25c. Wilkins, 417 Hill, London 13, Canada.

DRESDEN CRAFT, Ethel M. Johnson's complete course! Supplies, figurines. Add-A-Craft, 2082 Wellesley, St. Paul 5, Minn.

BLACK Light as a hobby. Astound your friends, latest criminology device. Send \$7.95 for kit. Includes ultra violet lamp and fixture plus assorted fluorescent chemicals. Central States Laboratories, P.O. #5761, Chicago 7, Illinois.

UNUSED Matchbook covers—100 different \$1.00. Catalog 10c. Charles Edelman, 1311C East 84, Cleveland 3, Ohio.

INVENTING Can be an interesting and profitable hobby. Write for complete particulars. Institute of American Inventors, Dept. 40-E, 1926-Eye St. N. W., Washington 6, D. C.

#### CAMERAS, PHOTO SUPPLIES

BUY Photographic supplies wholesale. Free catalog. Expert camera repairing. Capital Photo Supplies, 2428 Guadalupe, Dept. 2, Austin, Texas.

LEICA Cameras and lenses wanted, urgent, cash immediately, highest prices paid. Altman Camera Co., 502 S. Wabash, Chicago, Illinois.

KODACHROMES On approval. Yellowstone, Grand Canyon, other national parks. Douglas Whiteside, Yosemite National Park, California.

COLOR Film—35 mm., 127, 116, 616, 620, 120. Free literature. Sample roll 25c. More Film, Hemlock, N. Y.

FREE Photographic bargain book packed with hundreds of sensational values in still and movie cameras, lenses and latest accessories. Super savings for you in new and used equipment. Liberal trade-in allowances, too, on your equipment. Write now for your free copy to Central Camera Company, Dept. 9D, 230 S. Wabash Ave., Chicago 4. (Photographic headquarters since 1899.)

ADD "Spice" to home projection shows with old-time Nickelodeon slides. 2x2. Kodachrome. Write for free list. Nickelodeon Co., New Fliedner Bldg., Portland 5, Oregon.

SAVE On cameras, projectors, etc. Send name and address on postcard for list. (No exports.) Photo Sales Co., P.O. Box 21, St. Louis 19, Mo.

PHOTOMURALS, Giant transparencies, photos on canvas. Your negatives, photos, or ours. We satisfy nation's leading photographers. 1950 catalogue, 25c refunded on orders. Photomammoth Murals, 12048 Vanowen St., North Hollywood, Calif.

PHOTOCOPY Anything, papers, books. No darkroom, 8½" x 11" complete, \$6.95. Fotoflek, 4801 Yarmouth, Cincinnati 29, Ohio.

BASS Says: Bargaining 257 ready and waiting for you. The book which tells all. The finest in new and used camera equipment, a veritable encyclopedia. Write, phone or call the sign of the old "Horse Trader." 39th year of satisfaction or your money back dealing. Bass buys, sells and trades. Bass Camera Company, Dept. AG, 179 W. Madison St., Chicago 2.

#### PHOTO FINISHING

16 ENLARGED, Jumbo, oversize, deckled prints from any 6-8-12-16-20 or 36 exposure roll film developed; only 35c and this ad. Electronically exposed. Enlargement coupon free. Skrudland, 6444-R Diversey, Chicago.

NEW Negative and two 5x7 enlargements

BEAUTIFUL 8x10 Enlargement from photo or negative 50c. Originals returned. Quick service. Hanson Photo, 3133 Logan, Chicago 47, Ill.

SPECIAL! Five quality 8x10 enlargements \$1.00. Surgals, 3300 Beach, Chicago 51.

40 REPRINTS \$1.00. Five 8x10s \$1.00. Professional Portraits, Albany, Wisc.

16 x 20" ENLARGEMENTS \$1.50; 4-8 x 10 Enlargements \$1.00; copy negative, 3-5/7 enlargements \$1.00; copy negative, 8x10 enlargement hand colored \$1.00. Jackphoto, 2011-B Yale, St. Louis 17, Mo.

8 HOUR Service. Your 8 exposure roll printed jumbo or regular size 30c; 12 exposures 35c; 16 exposures 50c; 20 exposures 75c; 36 exposures \$1.00. Reprints 3c. Fine grain developing. Send for mailers. Quality Photo Service, Box 468A, San Francisco 1, Calif.

PRIVATE Laboratory. Amateur art. Black-white and color. 35mm. specialists. GK Laboratories, Box 127, Catskill, N. Y.

THE Photo Mill. Immediate service! No delay! Eight exposure roll developed and printed for thirty cents, plus valuable coupon for eight reprints, four jumbos or two 5x7 enlargements for a slight additional charge. Film developed and eight jumbo prints 35c. Thousands of satisfied customers send us their work year after year. The Photo Mill, Dept. K, 1511 Hennepin, Minneapolis, Minnesota.

STAMP Size photos. Sheet of 100 gummed perforated stamp photos from any size picture or negative \$1.25 original returned. Bay Photo Service, Box 210, Oakland 12, Calif.

16 CONTACT Prints from 8 exposure roll 35c. Reprints 3c each; 40, \$1.00. Double size prints in album book. 8 exposure roll, 35c; 12, 50c; 16, 65c. Reprints 4c each. Apex Photo Service, Box 197, Bronx 51, N. Y.

FREE Price list on quality developing, printing, enlarging. Write for it today. Bryan's Photo Shop, Dept. M, Panama City, Florida.

AUTOMATIC Photo-electric finishing. 8-25c; 12-40c; 16-55c. Oversize, add 10c. Mississippi Finishing, 2212 East 12th, Davenport 4, Iowa.

35MM Rolls developed. Enlarged 3½x5 prints, 36 exposures \$1.00, 20 exposures 65c. 8 exposure rolls developed, printed oversize 30c, 12 exposures 45c, 16 exposures 55c. MacDonald's Photos, Box 30-J, Wheaton, Illinois.

FREE 5 x 7 Enlargement with each roll developed and printed. 6 or 8 picture roll 35c. 12 or 16 picture roll 55c. Send coin with roll. No c.o.d. If you fail to get pictures on your roll of film, we will mail a new roll to you at no additional cost. Overnight service. Mailers sent free on request. Deluxe Film Service, Box 1268, Shreveport, Louisiana.

8 BEAUTIFUL Double size pictures and roll developed 30c. 8 hour service. Free mailers. Pacific Photo Service, Box 666, San Francisco, Calif.

2 BEAUTIFUL Hi-Gloss prints each good negative and enlarging coupon with each 8 exposure roll developed 28c. Free mailers. Owlphoto Co., Weatherford, Oklahoma.

#### MOTION PICTURES AND SOUND EQUIPMENT

SNOW White movie screen paint. Free literature. 126½ West Main, Danville, Illinois.

"BEARS!" 8MM. 50' film produced in Rockies by famed Eberhart organization. Send \$1.75. Receive "Bears!" plus free wild game films list. Wild Life Films, Dept. 4-PM, 6063 Sunset Blvd., Hollywood, California.

MAKE Films for television. Learn at home. A huge new market insures large income for those able to produce. Write today for free catalogue. Motion Picture Institute, Birmingham 7, Michigan.

WORLD'S Best Passion Play, sound; silent, 16-35 mm. prints only. Bay State Film, 36 Melrose, Boston, Mass.

BRILLIANT Kodachrome movie titles. Free samples. List. Elite, Box 526-M, Minneapolis.

BARGAINS! Guaranteed, reconditioned 16mm. Sound projectors. Robert Salmon, 3558 So. 11th East, Salt Lake City, Utah.

BIGGEST 16MM. sound film bargain. 12 100' used musical films, \$9.95. Other assortments, \$13.95, \$15.95. Postage extra. Big list free. Other bargains. Blackhawk Films, Dept. PMA, Davenport, Iowa.

**SAVE 50%**—On movies. Free circulars. Fromaders, Box 637-A, Davenport, Iowa.

**MAGAZINES, 16MM.** new! Empty, 50c. Loaded fresh film, \$1.25! Processing service. 10% discount six lot! Catalog. Eso-S, 47th Holly, Kansas City 2, Missouri.

**UNUSUAL 8 And 16mm.** films, used by many art students. Write for free catalogue. Send 25c for sample strip. Friart, 140-A-Liberty Street, New York 6.

**MOVIE Making instruction (8mm., 16 mm.)** ACL movie book, 12 monthly issues Movie Makers Magazine, all ACL membership services only \$6.00 a year. Write Mr. Hale, Amateur Cinema League, Graybar Building, New York 17, N. Y.

**SELL** Cameras, projectors, film, typewriters, pens. Revere, DeJur, Kodak, Royal, Parker. 25-40% commissions. Diamond Company, 17 East 42 Street, New York 17, N. Y.

**BETTER 8MM.** and 16mm. movie camera film. Free equipment catalog. Better Films, 742 New Lots, Brooklyn 7, N. Y.

**2 NEW** Autry home movies! "Indian Up-rising" "Loaded Guns." \$1,000,000 cast! Send \$1 for sample reel and catalog. (State projector size.) 200' reel, 8mm. \$4.25. 100' reel 16mm. \$2.75. 400' reel sound \$17.50. Other sizes available. Your dealer or Hollywood Films, 6060-K Sunset Blvd., Hollywood 28, Calif.

**SENSATIONAL Bargains;** over 2000 subjects, every type. Mammoth 8-16 mm. catalogue (largest ever compiled), samples—ten cents. Fabulous Films, 6411 Hollywood Boulevard-0, Hollywood 28, Calif.

**16MM.** Sound features \$25.00. Shorts \$5.00. Bedner, 5300 So. Taiman, Chicago.

**"JUDO Girl!"**—Rough, tough, fast, slambang action bout movie. 8mm. \$2, 16mm. \$4. For free list just drop a card. Peerless Sales, Box 171-A, Canal St. Sta., New York City 13.

**GUARANTEED** Fresh anti-halo outdoor movie film! Weston 16! Daylight loading! Processing free! Three spools double 8 mm. \$4.50! Six single 8 mm. for Univex. \$4.60! Postpaid! Catalog. Eso-S, 47th Holly, Kansas City 2, Missouri.

**CLEARANCE 16MM.** sound projectors \$95.00 up, sound films. Write promptly for free listing. Harris, 303 West 42nd Street, New York 18.

**SOUND Rentals 16mm.** Free catalog. National Cinema, 69 Dey St., New York City 7.

**RENT 16MM.** sound films. 50c reel. Large selection; free catalog. Film Service, 128 Chestnut St., Roselle Park, N. J.

**"THE World's Greatest Passion Play."** 8mm., 16mm. and 35mm. Specify silent or sound. Rent or purchase. Hemenway Film Co., 33-F Melrose St., Boston 16, Mass.

**FREE Movies.** Thousands of subjects. Interesting. Entertaining. Fascinating. New directory—only 50c. International Cine Society, 126 Lexington Ave., Dept. M, New York 16, N. Y.

**8-16MM.** Silent-sound films. Complete rental library. All latest subjects. Free catalogue, (sample film 10c). Garden Film, 317 West 50th, New York 19.

**MOTION Picture technique at home.** Big money. Special registration for veterans. Free catalog. Motion Picture Institute, Birmingham 4, Mich.

**BASS Says:** 39 years of leadership guarantees satisfaction. Finest cine equipment, 8mm., 16mm., and 35mm., silent and sound. Write the old "Horse Trader." Satisfaction or your money back always! Bass Camera Company, Dept. A, 179 W. Madison St., Chicago 2.

**LEARN** Movie projection, management. Free catalog. Theatre Institute, Elmira, N. Y.

## MUSIC AND MUSICAL INSTRUMENTS

**POEMS** Wanted for musical setting. Send poems for free examination. Five Star Music Masters, 630 Beacon Bldg., Boston, Mass.

**SONGWRITERS**—Publication collaboration. Newark Publishers, G.P.O. Box 1226, Syracuse, N. Y.

**VOICE** Secrets! Free information! Studio, 14356-B Jersey Avenue, Norwalk Calif.

**ENTERTAIN** Friends with Calypso. New catchy tunes and lyric. Play on any instrument. \$1.00 two books tunes. Music Cop., P.O. Box 417, P.O.S. Trinidad, B.W.I.

**SONGWRITERS** Best service. Art Music Co., 1658 Broadway, New York 19, N. Y.

**PLAY** Harmonica in 15 minutes or money back. "Ed Sales" discovery how to play, plus nationally advertised key of C metal professional harmonica, with book of instructions and 200 songs, words and music all for \$1.69. Try 7 days. If not playing songs at once return for refund. Send no money, pay postman \$1.69 plus c.o.d. postage. Ed Sale Harmonica Co., Dept. PM-4, Point Pleasant, New Jersey.

**PLAY** Piano by ear in one week. Amazing new system. Easily mastered. Free details. Johnston Service, North Church Street, Colby, Wisconsin.

**SONGWRITERS!** Outstanding, ethical offer. Hibbeler, C5, 2157 N. Avers, Chicago 47.

**SONGWRITERS**—Honest, outstanding music writing offer. Len-Tex Studios, Leonard, Texas.

**POEMS** Wanted, Melodies, arrangements furnished. Terry Tune Master, 709½ PM North Broadway, Oklahoma City 2.

**SONGWRITERS!** Send poems, songs. Music Service, 243 West 72nd St., PM, New York 23.

**PHONOGRAPH** Records 15c. Catalogue. Paramount, TA-313 East Market, Wilkes-Barre, Penna.

**\$1.00 RECORDS** Your song! Send music. Urab-D, 245 West 34th, New York 1.

**1950 ACCORDIONS**—Wholesale. Free catalog. American Accordion Center, 5329 Belmont, Chicago.

**POEMS** Wanted to be set to music. Free examination. Send poems. McNeil, Master of Music, 510-PM S. Alexandria, Los Angeles, California.

**MUSIC** Arranged, songs printed. Frank Wildt, Music Publisher, Lancaster, Penna.

**WRITE** Songs. Big money and reputation. Write for information. J. Gordon Pub. Co., 201 N. Hoyne Ave., Chicago.

## RADIO AND TELEVISION

**FIX** Any radio. Amazing new instrument locates radio troubles double quick. Simple instructions show you how. Thousands now in use. Free. Write today for 32-page illustrated technical manual. "The Inside Story." Feiler Engineering Co., Dept. 4PM5, 1601 S. Federal St., Chicago 16, Ill.

**COLOR** Television. Get the real low-down on converting your television to color Columbia system. Diagram and literature \$1.00. Tel-A-Quip Co., 935 Cincinnati St., Dayton, Ohio.

**A 60 Foot** mast plus antenna, total height 70 feet, brings in television programs clearly from stations 175 miles distant. Plans for building rotating mast \$2.00. cash, postpaid. Shaw Manufacturing Company, Galesburg, Kansas.

**ONE-TUBE** Receiver plans (SW record 9956 miles) 25c, including "Radiobuilder," catalog. Laboratories, 578-C, San Carlos, California.

**TELEVISION** Buyer's guide. What to look for when you buy your television set. \$1.00 postpaid. Television Research Labs., Box 486, Detroit 31, Michigan.

**RADIO-TV-Electronic** buyers! Save money. Write today for our flyers on special bargain and standard brand merchandise. Star Electronic Distributors, Inc., 7736 S. Halsted St., (Dept. PM2), Chicago 20, Ill.

**MAKE** Simple, tubeless, batteryless, distance-getting crystal radios. Crystal and illustrated instructions 25c postpaid. Allen, 427-P, Clinton, Mo.

**SEND** For our bargain bulletins on radio and electronic components. Never under-sold. Buyers Syndicate, 30 E. Taylor St., Springfield 3, Mass.

## BUSINESS OPPORTUNITIES

**ONE** Volume course teaches air conditioning. Write, Don Nelson, Warner Robins, Georgia.

**GOLDEN** Opportunity to handle fast selling novel line. Write for catalog. Gordon Mfg. Co., Dept. PM, 110 E. 23 St., New York 10, N. Y.

**MONEY** Making opportunities, free details. Acheson, Box 23, Boston 17, Mass.

**SPECIAL** Rubber for making molds. Literature and sample free. Universal, Box 1076-A, Peoria, Ill.

**START** Home manufacturing business making cleaning compounds, soaps, insecticides, cosmetics, polishes, food flavors. No machinery. Literature free. Kemix, Park Ridge, Ill.

**MAKE** Perfume—Simple, free plan for

**PLATING** Equipment and rectifiers. Unique opportunity to start own business or cultivate hobby. Surprisingly small investment. Plate or replate baby shoes, jewelry, etc. Write for free information. Box 125, New York 51, N. Y.

**START** Your own business on credit. Always your own boss. 1554 dealers, sold \$5,000 to \$26,500 in 1948; their average \$6,742. We supply stocks, equipment on credit. 200 home necessities. Sales experience not needed to start. Wonderful opportunity to own pleasant, profitable business backed by world-wide industry. Write Rawleigh Co., Dept. D-U-PPM, Freeport, Ill.

**BE** independent, be secure, have your own profitable business—earn \$10.00 and more a day making beautiful, fast-selling lamps at home. No equipment needed. Illustrated course teaches you quickly. Course, parts catalog, wholesale price list, only \$2.00. Gearson Company, Dept. 200-B-4, 27 South Desplaines, Chicago 6, Ill.

**BIG** Money! Spare or full time in your home. No selling! Spray new miracle finishes, plush and suede, on signs, radios, automobiles, figurines, lamps, toys, etc. Our business is booming. Help us fill huge demand. New easy Flok-Kraft methods. Material costs few pennies. You get dollars. Free samples, complete powerful money-making plan free. Write now! Coast, 1002E S. Los Angeles St., Los Angeles 15, Calif.

**SPECIAL** Supply source information on any article or material made in United States, \$1.00. Full refund if unable to furnish information. Research, 407 Washington, Shreveport, Louisiana.

**PROFITABLE** Business making and building with easy-laying interlocking building blocks. Rex Products, Dept. 10, Piqua, Ohio.

**COLOR** Concrete with chemicals. Make marble-glazed cement pottery, without molds. Home, shop. 10c brings sample, pictures. Hollywood Cementcraft, 8527-R Wonderland, Hollywood 46, California.

**"MAIL** Order Manual" tells how and what to sell by mail. Free details. Write! Dobbins, 6631 South Hartwell, Chicago 37.

**WANT** A business of your own? Make \$20 to \$30 a week extra money at home! Thousands do! Interesting service cleaning upholstery and rugs—and mothproofing. Big demand. No selling. "Free illustrated folder tells how." Americlean Company, Inc., Dept. G-27, 211 North 7th Street, St. Louis, Missouri.

**EARN** Extra money during spare time by selling magazine subscriptions. Full kit of supplies free. The Instructor Subscription Agency, Dept. PM, Dansville, New York.

**NATURAL** Molding Latex. Extra thick. Free sample. W. Wooley, 115-A Donald, Peoria, Ill.

**TRADE** And class magazines help you get ahead. Latest copies. More than 1150 covering every business, trade, profession, sport, hobby or other interest available through our easy-to-get-acquainted service. Particulars and price-list free. Commercial Engraving Publishing Co., 34C North Ritter, Indianapolis 19, Indiana.

**MAKE** Flexible molds! Cast plaques, novelties, bookends! Free sample! H. Tooker, Hamilton 9, Ohio.

**THOUSANDS** Articles wholesale. "Supply Source Directory" 10c. Ideal Service, Park Ridge 30, Illinois.

**LEARN** Piano tuning, repairing—at home in 30 days. Unlimited income. Phonograph recordings, tools and instructions furnished. Write Capitol City Tuning Co., Department C-434, 129 East Michigan, Lansing 16, Michigan.

**SEWING** Machine business tops. Big money—not crowded. Spare time home set-up. Repair course, new machines, motors, etc., wholesale. Taylor Service, PM, Hamilton, Ohio.

**BE** independent—Operate America's lowest price penny vending machine. Big profits. Immediate shipments. Write for bulletin and prices. Fielding Mfg. Co., Desk 30, Jackson, Mich.

**MAKE** Rubber stamps, metalize baby shoes, repair dolls, silver mirrors, make plaster novelties. Catalogue of "30 Ideas" free! Universal, Box 1076-A, Peoria, Ill.

**BUY** It wholesale. Manufacturers, distributors offer 850,000 items. Literature free. Olsen, 1231A E. Third St., Duluth 5, Minn.

**SAWDUST.** Turn it into cash. Six methods. Instructions 25c. Charles Co., 12-AWG, Norwood, Ohio.

**RUBACREAM!** Natural latex cream! Makes molds quicker! Thicker! Free sam-

**BRONZED** Baby shoe mountings, equipment and supplies. We manufacture world's largest assortment of all metal mountings. Wholesale only. Ramyr selenium platers \$49.50. Complete baby shoe plating assemblies low as \$59.50. Write for free copy of electroplating instructions. Tech. Dept., Hollywood Bronze Supply, 1766-70 N. Vermont Avenue, Hollywood 27, Calif.

**MAKE** Your fortune with food specialties. Others have. People have to eat. Enter \$1,000,000,000 industry with no experience, small capital. Gaynor, 4406 Cottage, St. Louis 13, Missouri.

**MAIL** Selling opportunities galore! Free! Wehner, Box 142-A-5, Roxbury 19, Massachusetts.

**WHOLESALE** Baby shoe electroplating. Best work, lowest prices. Warren, 9608 Laurel, Los Angeles 2.

**ELECTRICALLY** Inclined men. Average \$50 weekly working few hours daily. No selling. Sensational opportunity. Write, Manhattan, Box 6, New York 35, New York.

**BRONZE** Baby shoe instructions, supplies, custom plating and Pearlucite finishing. Schoettle, Friendship, Ohio.

**REGRAIN**—Refinish automobile dashboards, garnish mouldings. Complete detailed instructions \$5.00. Jim Outman, 4323 South 38th, St. Louis 16, Mo.

**WORK** At home. "How to" book and mail order magazines 25c. Hogan, 922 North Lewis, Waukegan, Ill.

**MEN**—Women. "Everybody likes candy." Learn to make professionally at home (Our 40th year.) Ragsdale Candies, D5, East Orange, New Jersey.

**SALES** Representatives territory open. Product for hotels, motels. Tremendous field. Large profit margin. Sells itself. Aldington Co., Inc., 1628 N. Industrial Blvd., Dallas, Texas.

**ELECTRICALLY** Inclined? Make \$100-\$250 weekly installing, maintaining fluorescent lighting. Exclusive, inexpensive, illustrated instructions. Cash in on this fast growing industry. Request impressive evidence. Distin "Fluorescent," 712-A, State Tower Bldg., Syracuse 2, N. Y.

**FREE!** Successful beginner's mail order plan. Lynn, 5710-M Bankfield, Culver City, California.

**\$250 WEEK** Reported! Free illustrated book "505 Odd Successful Businesses." Work home! Expect something odd! Pacific-E, OceanSide, California.

**FIX** Typewriters, full or part time. Inexpensive copyrighted home study course quickly trains you for high earnings. Factory methods cover all phases with drawings and illustrations. No curiosity seekers. Typewriter Repair, 4915 Corbet, Tarentum, Pennsylvania.

**MAKE** Perfume. Men, women. Write Carey Laboratories, 1914 Chouteau PM4, St. Louis 3, Missouri.

**POPCORN** Poppers, peanut roasters, copper candy, carameltcorn kettles. Northside Co., Indianola, Iowa.

**MAKE** Tough, durable plastic—1c pound. Makes attractive floors, walls, built-ins, roofs. Build good home, \$150 room. Bays Laboratory, Oklahoma City 9.

**FISHWORMS.** How raise, sell, hundreds, millions. Surface without digging. Instructions 50c. Charles Co., 12-AWH, Norwood, Ohio.

**SELL** Catalog describing plans for home, farm equipment and devices. Long profits. Handbook, details 25c (refundable). Kimo, Box 307JJ, New York 19.

**WHY** Job worry? Start electroplating, metal finishing business. Free booklet, trade secrets. M. Hyde, 327 West 120th Street, Los Angeles 61, California.

**MAILORDER** Dealers: National manufacturer needs 25 aggressive dealers for two new, non-competitive, quick-repeating necessities. High, steady profits. Protected. Jesse and Jesse, Inc., P.O. Box 936, 1715 West Second, Wichita, Kansas.

**MONEYMAKING** Ideas, opportunities galore. Particulars free. Peterson, Rix Lodge, North Platte, Nebraska.

**MAILING** Lists! 1000 names \$5.00. Research, 407 Washington, Shreveport, Louisiana.

**MAKE** Money with synthetic rubber molds. Handbook only \$1.00. Boruski, 505-H Fifth Avenue, New York City.

**UNPAINTED** Figurines. Free list. Arbo Products, 44 W. Cook, St. Paul 3, Minn.

**START** Own profitable mailorder busi-

**METALLIZING** Baby shoes is a profitable business. Details. Schwieger, Coloma 1, Wis.

**BETTER** Jobs in plating. Free details. Joseph Kushner Electroplating School, Stroudsburg 770, Pennsylvania.

**HOME** Workers. Hand-spin Angora wool into yarn. Either sex. House of Angora, PM, Springfield, Illinois.

**COLLECT** Those tough past-due accounts for yourself and others, proven money-getting system. Quick action, no personal calls on debtors. We guarantee profits or will refund. Instructions and 4-kits \$1.00. Merrick Publishers, Sibley, Iowa.

**MORE** Money—Easier! Revolutionary methods make public bookkeeping easy, interesting, profitable. Earn to \$5.00 hourly within short time! Simple, complete instructions. Full-spare time. Success-revealing information free. Auditax Systems, 10775-3 Tabor, Los Angeles 34.

**MAKE** Men's and ladies' plastic wallets. Earn sparetime profits. Details free. Lakeshore Supply, Dept. PM4, 534 Surf St., Chicago 14, Ill.

**ELIMINATE** Financial worries, with the biggest money making opportunity you've ever seen. Ages, West Liberty, Iowa.

**MADE** \$24,500 Using money making plans from Schemer Magazine, Box 775M, Alliance, Ohio. Year \$2.00. Sample 20c.

**"MAGIC** Mirrors" made from any ordinary window or door glass. You can see out—no one can see in! Complete instructions, in booklet form, 8 1/2 x 11, \$1.00. Dougherty, Bx-12, Phillipsburg, N. J.

**OWN** Your mailorder business, envelopes, bags. Big profits. Omaha Envelope, 4721-B California, Omaha 3, Nebr.

**HOME** Business. Sell merchants and doctors "Collection Aids" by mail. Samples, plans 25c. Siocumb, Box 801, Macon, Ga.

**BUY** Wholesale—Million articles. Supply source directory, dime. Neiko, 4724 N. Virginia Ave., Chicago 25, Ill.

**BUSINESS** Information Center, Chesterland, Ohio, will locate sources of any manufactured product you need. \$1.00 brings you 10 sources, guaranteed satisfaction.

**MAKE** Money at home by mail. Amazing books tell how. Literature free. Porter Sales Co., 127 Sager Road, Michigan Center, Michigan.

**WHAT** To sell by mail, answered free! Paragon, 69-P, Sumner, Brooklyn 6, N. Y.

**LOOP** Rug sewing machine \$200. Sample of rug sent free. Floyd Sayers, Pompano Beach, Fla.

**WANTED**—Good products to sell by mailorder. Veda, 1413 Germantown, Philadelphia 22, Penna.

**PEARL** Finishing—New, amazing; huge profits. Start making big money first day. Free facts show easy way to \$25 to \$50 per day at home. No experience needed. No course of instruction to buy. Be first, scoop the market. Write Pearl-Kote, Dept. R, 2111 West Manchester, Los Angeles 47, Calif.

**BEST** Source for nylons. Rich Supply, 215 W. 98, New York 25.

**MEN**—Women! Make big money spare or full time at home. Flock and pearl finishing offers you opportunity of a lifetime. Write today for free sample and free catalog. Bing Products, 88-PM4 Broad, Boston 10, Massachusetts.

**SENSATIONAL** Nylons guaranteed against runs. Nationally advertised. Not sold in stores. No experience or money needed. Also lingerie, robes, men's hosiery. Outfit, sample, etc. free. Wonderful opportunity earn big money spare or full time. See our full page advertisement on page 71. Kendex Co., Babylon 646, New York.

**OWN**—Operate late model Wurlitzer 24-record coin-operated phonographs. Price, \$300 each. Cigarette vending machines, \$90 each. Candy bar machines, \$100 each. Write Cameo Vending, 432 West 42d St., New York.

**COIN-OPERATED** Machines for sale. Write Walter Hoffman, 721 First Avenue North, Great Falls, Montana.

**200** NEW Money making plans, tips, ideas for increasing your income. Folio free. Reynard Pub., Smithfield 3, Ohio.

**BE** Wealthy. Get business self-starters. Own self-paying homes. Midco, 67 S. Harris, Columbus 4, Ohio.

**BRONZED** Baby shoe mountings; metals, onyx, plastics, hardening solution. Wholesale, Box 2095, Wichita, Kansas.

**EARN** Money by mail with my plan. Free

**LIKE** To make extra income at home? Proven mailorder plans show how. Free details. Perry Publications, Wenatchee 1, Washington.

**RESURFACE** Butchers' chopping blocks with easy, fast working, portable electric machine. Unique service in wide demand with little competition. Large steady profits from full or part time work. Hill Machine Company, Box 677B, Rockford, Ill.

**MAIL** Order offers amazing opportunities. Write Benson Barrett, 1151 Taylor, Detroit 2, Mich.

**THREE** Million new prospects yearly for our personalized baby record books and readi-cut, wool baby shoes. Mail dealers use same successful literature we do; yours practically at cost. Get going big, fast with proved sellers. No-Co-Ro, Oakland 6, California.

**BRONZING** Baby shoes is big business. Start your own business for \$5.95 includes materials and instructions. No equipment required. Particulars free. Metaloids, Box 2095, Wichita, Kansas.

**"HOW** To start a successful mail order business." The guide to sound, profitable mail merchandising. 25c. Manhattan House, 126-B Lexington, New York 16.

**START** Home plaster novelty business. Amazing course tells how. Literature free. Kemo-Courses, 3745 N. Odell, Chicago 34, Illinois.

**A** FACTORY In your home, garage! Mfg. and sales rights, mechanics' waterless hand cleaner, glass cleaner, and amazing "Lazybones" auto cleaner-polish, \$500-\$800 monthly. No special equipment necessary. All formulas free. Western Aircraft Mfg., Dept. D, Los Angeles 6, Calif.

**PIANO** Tuning taught by mail. Write Piano Technician, 708 Rawlings, Carbondale, Illinois.

**CLEVER.** Resultful mail order circulars, ads, letters. Reasonable. O'Malley Advertising, 309 Rittenhouse NW, Washington, D. C.

**EARN** Money cleaning automobile upholstery. Free information. Write Lambert, 5531 Plover, St. Louis 20, Missouri.

**BRONZE** Baby shoes. 2000% profit. New, easy method assures success. Literature free. Metallizing Industries, Box 263, Hagerstown, Maryland.

**GET** Your copy of the new 1950 edition of the Official Concessionaires Guidebook. 76 pages, jam-packed with money making formulas, m.o. ideas, games and equipment for concessionaires, roadside stands, carnivals, etc. Send \$1.00 to: Concessionaires Guidebook, Station H, Zone 13B, Toledo 6, Ohio.

**YOUR** Own profitable home business. Preserve live flowers to last forever. New simple discovery. Enormous demand all year 'round. Tremendous profits! Light fascinating work. Send \$2.00 for working equipment, instructions, and valuable sales plans. Satisfaction guaranteed or money promptly refunded. Alfred Hermansen, 210 Fifth Ave., Suite 1102A, New York 10, N. Y.

**METAL** Book ends for mounting bronze baby shoes, \$2.50 pair. Urban's, 2806 Holiday, Wichita Falls, Texas.

**BOOKKEEPERS** Earn \$100.00 week operating your "bookkeeping service." Simplified plan. Information free. Bookkeeping Service, Box 664-M, Springfield, Missouri.

**YOUR** Home as headquarters make a product to clean dirty mechanic hands in 30 to 50 seconds without water. Big profit. Postcard gets free folder. Harbin, Box 4624, Atlanta 2, Ga.

**EARN** Money at home with your typewriter! Spare time. Details free! Edwards, Publisher, 3915-P, 12th, Des Moines 13, Iowa.

**EARN** Money at home; full, part time. Listman, Box 2160, Seattle 11, Wash.

**REACH** Spanish-speaking mail-order buyers. Great new market for your merchandise. Your classified ad in the Spanish Edition of Popular Mechanics will bring you some nice business from this new field. Rate only 25c per word. Circulation 100,000 copies. Mail a trial ad right now. Popular Mechanics Magazine (Spanish Dept.), 200 E. Ontario Street, Chicago 11, Ill.

**WANT** A mailorder business? Avoid mistakes by reading "Mailorder Pitfalls." Send for free circular. Better Sales Co., 2139 Clifton Ave., Cincinnati, Ohio.

**\$25** WEEKLY Working two hours daily. No canvassing. No manufacturing. Lycke, Box 2471-A, Cleveland 12, Ohio.

**HOME Business** making statuettes, plaques, artificial marble, rubber molds. Metallizing baby shoes. Silvering mirrors. Formulas. Folder free. Creative, 236-L, Winnetka, Illinois.

**EARN** At home casting novelties. Free instructions using latex molds. Major Chemical Co., 164 Portland St., Cambridge 39, Mass.

**"WATERLESS (Lanolin) Hand Cleaner."** (Oil base.) Make, sell. No machinery. Build profitable business. Complete formula \$1.00. Ideal Service, Park Ridge 1, Ill.

**CO-PUBLISH** And advertise in The Central Mail Advertiser. Sample copy 10c. Low rates. Large circulation. Bagby Printing Co., Georgetown, Ohio.

**EARTHWORM** Breeding. Valuable bulletins on successful methods mailed free. Earthmaster Publications, Dept. 14, Sun Valley, Calif.

**MAKE** Money spare or full time, casting metal toys and novelties. Big wholesale and chain store demand for cast metal autos, soldiers, ashtrays, banks, etc. keeps manufacturers busy. Production moulds furnished for up to 100 and more castings per hour. No experience or special place necessary. Write for full information and illustrations of patterns needed. Metal Cast Products Co., Dept. A, 1696 Boston Road, New York 60, N. Y.

**POPCORN** And potato chip equipment. Long Eakins Company, 5060 High, Springfield 99, Ohio.

**PIANO** Tuning learned at home. Free information. Empire School, Champaign, Illinois. (Est. 1935.)

**QUICK** Money! "Repairing car batteries!" At home! Easy too! Batteryman, Grand Junction, Colorado.

**HOW** And where to obtain capital. Small and large loans. Free particulars. Star Service, Wapakoneta, Ohio.

**DRESDEN** Craft figurine molds and many others, natural liquid rubber, statuary plasters, flock finishes, etc. Illustrated catalog and "Plastercraft" manual free. Blue Rapids Supply, Blue Rapids, Kansas.

**WANTED** Unused U. S. postage stamps, small discount. Advance Stamp Co., 24 East 23rd St., New York.

**LIQUID** Marble—Colorful, glossy! Molded, brushed, sprayed! Cast novelties, statuary, colored tiles. Flexible molds. Composition floors. Particulars free. Marbleizing Service, Edwardsville, Illinois.

**EXTRA** Money. No selling; operate vendors. Amazing profits, details free. Silver King, Suite B, 622 Diversey, Chicago 14.

**UNPAINTED** Bookends, plaques, statues, figurines. List. Haverty Products, 1219 8th Ave., Altoona, Penna.

**RESILVER** Mirrors at home. Formula 25c. Ideal Service, Park Ridge 8, Illinois.

**UNPAINTED** Figurines—Wholesale, retail. Illustrated list free! Oman, 642L Broadway, St. Paul 1, Minnesota.

**HOW** To set up and run a mirror shop! Resilver mirrors. Make chipped glass nameplates. Electroplating salts and rectifiers. John Sprinkle, V60, Marion, Indiana.

**CASH** For your idea, 280 manufacturers need inventions, patented or unpatented. List free. Invention Bureau, 208M Clinton, Oak Park, Illinois.

**MAKE** Money making new greaseless doughnuts at home on electric machine. Wholesale to grocers, drug stores, cafes, hamburger shops. Send for free recipes and plans. M. Ray Company, 3605 South 15 Ave., Minneapolis 7, Minnesota.

**RECAST** Old batteries into new. Latest achievements. Battery Laboratories, Minneapolis.

**ENVELOPES** Addressed accurately, reasonably. Fast service. We have capable addressers in your city. Glenway System, 5713-Y Euclid, Cleveland 3, Ohio.

**LIQUID** Rubber. Make flexible molds. Free sample. Chaney, 1130 E. 16th St., Jacksonville 6, Fla.

**MOLDING** Rubber for hobbyists, industry, classroom projects! Flexible molds easily made from the best quick-drying white liquid rubber! (Gallon, \$7.95; quart, \$2.95; sample half-pint \$1.00) prepaid parcel post! Plastercraft Supply Co., 3051 St. Clair Ave., Cleveland 14, Ohio.

**FREE!** Illuminating folder "A Business Gold Mine." Real dividends for your spare time in lucrative business. No personal selling. Kabel, 1413 W. Tioga St., Philadelphia 40, Penna.

**WHERE** To buy 500,000 articles wholesale. Details free. Krueger, 3418A Wolcott, Chicago 13.

**PROFITABLE** Home business. Start on small capital with latest tested formulas. Interesting booklet free. Pont. Box 635-XM, Terre Haute, Indiana.

**MAKE** Money at home decorating greeting cards. We supply instructions, Powell, 5713-C Euclid, Cleveland 3, Ohio.

**VENDING** Machines earn big money! An investment as low as \$10.50 will start you in this fascinating, profitable business that can lead you to the road of success and independence. Routes can be established and operated in either full or spare time with no experience needed. Write for full details and our free catalog illustrating our nut, candy, gum and stamp vendors; also pin ball machines, music boxes, etc. Write immediately to Parkway Machine Corporation, Dept. 7, 623 W. North Avenue, Baltimore 17, Maryland.

**READ "Advance"**—The voice of mail order. Offers money-making opportunities, sources of supply, personal guidance, etc. Issued monthly. Sample copy 25c. Yearly subscription \$2.00. Advance Publishing Company, 313 East 21st Street, Suite 450, New York 10, N. Y.

**A BUSINESS** in your own home! Our chemicals, plus free water and cheap "grocery store" materials can bring you over \$500 monthly earnings. Plans and formulas free. Chemica Division, 1269 S. Norton, Los Angeles 6.

**START** Mailorder bookshop—Everything furnished. 25c brings booklet, samples, exciting ideas. General Publications, Ossining, N. Y.

**OPERATE** Profitable mail order business. Write Walter Service, 4159-A East 112th, Cleveland 5, Ohio.

**COLORGLAZED** Concrete pottery made without molds. Patented method. Cemetery products, novelties, tiles. Basement leak-sealing. Money-making projects. Booklet, details free. Men only. National Potteries Company, Grand Rapids, Minnesota.

**137 WAYS** To make money, in home or office, business of your own. Full particulars free. Elite Co., 220 Grand St., New York 13.

**COPUBLISH** Leading m.o. paper. Latest copy Mail Sale Advertiser and proposition, dime. Vanroy W. Shirk, Lebanon, Penna.

**BRUSH** Plating outfits connect to a battery. No tanks necessary. Good paying business at home plating autoparts, bathroom fixtures, bicycles, reflectors, silvering mirrors. No shop or experience required. Outfits furnished. Free booklet. Gunmetal Co., Ave. H, Decatur, Ill.

**MAILING** Postcards selling repeat merchandise is profitable. Everything supplied. Details free. Gordan Publishers, Box 23, Pawtucket, R. I.

### MONEYMAKING OPPORTUNITIES

**SELL** By mail, 40 page booklet of instructions and advice. 25c. F. Pfeiler, 4456 N. Beacon, Chicago 40, Illinois.

**SELL** Latin America by mail! Idea folder tells how. 25c. Agencia Pan-Americana, 1830 E. Rio Grande, El Paso 2, Texas.

**FASTEST** Selling fan bargains. Free literature. Rich Pan Manufacturing Co., 2401 San Jacinto, Houston 4, Texas.

**MONEY**, Success, independence. Operate own business. Home, shop, full, part time. Send \$1.00 "Fifty Tested Businesses." Wade, 6215 University, Chicago 37, Illinois.

**MONEY** Making proposition! Write! National Mail Order, Box 598, Minneapolis 1, Minnesota.

**EXPORTING**—Importing big money, represent buyers-sellers without capital, hundreds overseas connections, list \$1. Stoute, 35E, Pasadena 8, California.

**SELL** Delicious snowballs. 400% profits. Ice shaver, flavors for 500, instructions \$2.25 postpaid. Satisfaction guaranteed. Free folder. Snowball Company, 9534A Lemturner, Jacksonville 8, Florida.

**"INDUSTRIAL** Hand cleaner!" (Without ammonia, kerosene!) Manufacturing, distributing information free. "Rythmo-C-Ex." Kingsport, Tennessee.

**EARN** Money evenings, copying and duplicating comic cartoons for advertisers. Adservice, Argyle 1, Wisconsin.

**START** Now, at home, with small capital. Sell by mail and get ahead. 25c (coin) brings valuable information. Act now. Willis Book Shop, 1401-B Whitelock St., Baltimore 17, Md.

**\$250 WEEK** Reported; Free illustrated book "505 Odd Successful Businesses." Work home! Expect something odd! Pacific-E, Oceanside, California.

**CONCRETE** Birdbath. Metal production mold meets any competition. \$20 postpaid Gardenware, 404 Stiliz, Louisville, Ky.

**OPERATE** Concessions at fairs, shows, carnivals. Concessionaire's Guidebook \$1. Descriptive free. Stampico, Detroit 4, Mich.

**CANDLEMAKING** Is profitable! Detailed instruction manual \$1.00. Particulars free! Robins, 991 Sylvan Lake, Mundelein, Illinois.

**SKY'S** The limit selling our wonderful personalized perfumes! Repeat business sensational! Write Komar Company, P-4, LaPorte, Indiana.

**BIG** Profits yours! Sell "different," unique items by mail; otherwise, Real pullers! Sales aids furnished. Details, beneficial literature free! Parker Specialties, Sauk City, Wisconsin.

**\$300. MONTHLY**, Raising earthworms backyard. Complete instructions 25c. Marvin Dickman-L, Willow Springs, Mo.

**FREE** Facts!—How you can make big money in new, different, exciting home mail business! Smith, Box 2592-A, Hines, Illinois.

**\$3,000 A Year** can be yours! Sell by mail. I'll show you how. Free details. Ralph H. Swafford, Box 212, Rossville, Georgia.

**HOME** Book shop opportunity—Get orders by mail. New! Different plan! Big profits. Everything furnished! National, Box 88-K, Dorchester, Mass.

**RECEIVE** Letters daily containing quarters. Plans, formulas \$1.00. McCray's, 1919B-3rd St., Milwaukee, Wis.

**BABY** Shoes. Copperized. Instructions, material for naturally preserving two pairs. \$2 postpaid. Owen, 404 Stiliz, Louisville, Ky.

**FREE** Particulars many profitable spare-time "home business projects." Cottage Industries, 2804-E Hanover, Omaha 12, Nebr.

**MAKE** Money repairing and building batteries. Start at home. Illustrated battery manual and other valuable information \$1.00. Battery Instruction & Supply Bureau, Box 1100 Portal, Oakland 10, Calif.

**RAISE** Ginseng. Roots bring fortunes. How to grow, where to sell. Write Fezler Seed Co., Patchogue, N. Y.

**\$5-\$15 CASH** Hourly for you! No investment, selling, experience. Dollar book tells how. It works! Proof: Aichner, 267-A Maple, New Wilmington 2, Penna.

**INCREASE** Your monthly income as much as \$100 a month. Money Making Hobbies published by Popular Mechanics contains 132 projects you can make at home in spare time. Over 600 illustrations, photos, diagrams. Projects of wood, metal, glass, plastics, fiber, etc. \$1.98. Popular Mechanics Press, 200 East Ontario Street, Chicago 11, Illinois.

**BIG** Money, easy work, spare time. Meixell, Box 261, Boothwyn, Penna.

**CHURCHES**, Organizations, clubs, \$130.00 free plus 24 card tables. Unique Gift Club Plan, Pine Hill, New Jersey.

**MONEY-MAKING** Hobbies earn extra income. Free literature. Benson Barrett, 1151 Taylor, Detroit 2, Mich.

**CO-PUBLISH** Opportunities preferred, many sources of profit. Details free. Sample copy 25c. Rinehart, 235 Baltimore St., Hanover, Penna.

**LEARN** Professional candy making, also marketing system. Details 10c. Pate, Kissimmee, Florida.

**ELECTRICIANS** Make big money. Earn while you learn. Students supplied with materials at wholesale prices. For complete information, send fifty cents for one of our dollar bantam flashlights. Credit allowed on course. McCarty Electric Corporation, Kalamazoo, Michigan.

**PRIZE** Contests! How and where to win your share! 25c coin (refundable). National Contest Bulletin, Box 2685-P, Miami 16, Florida.

**EARN** Money by mail, like I do! Free details. House of Friendship, Bowen Court, Douglas, Mass.

**HUGE** Profits using easy to apply luminescent products. Catalog, liberal samples 25c. Glowelco, 475-B Fifth Ave., New York 17, N. Y.

**"OPPORTUNITIES** Preferred Magazine" tells how. Sample, 25c. Glen, Howel 3, Kentucky.

**"WESTERN** Advertiser" offers many worthwhile moneymaking opportunities.



**EASY** Ways to earn extra income are described in Money-Making Hobbies. 132 projects you can make at home and sell anywhere. 160 pages, \$2.00. Popular Mechanics Press, 200-MH East Ontario, Chicago 11, Ill.

**MAKE** Flexible arch supports. Profitable business. Tunis System, 1341 Kwis, Puente, Calif.

**WANT** Notary Public appointment? Official in usually 10 days. Stationers Exchange, Boerne 50, Texas.

**UNPAINTED** Figurines. Free list. Progress Company, 4033-P Chowen, Minneapolis 10, Minn.

**DOLLARFUL** Ideas for you every month in advance—"Voice of Mail Order." Leads the field in exclusive supply sources. Plans for mail order operation; new products, etc. Details free. Advance Publishing Company, Suite 350, 313 East 21st Street, New York 10.

**WIN** Contest money. General Contest Bulletin gives hundreds of tips. Lists current contests and rules. Sample 25c. General Contests, 1609½ East 5th, Duluth, Minn.

**PUBLISH** Your own magazine. Hand-some 52 page format, well edited, illustrated. Cost low as \$1.00 month. Brings you prestige, profits. 25c brings sample, details. National, Ord, Nebr.

**EARN** Money at home! Thousands do! "Home Worker Magazine" tells how. Sample, 25c. Sizemore, Box 7, 4917 Kostner, Chicago 30, Ill.

**READ** Progressive Mailtrade, the magazine that tells how to make money by mail. Dime brings sample and special offer. Progressive Mailtrade, Box 357, Sheboygan, Wisconsin.

#### FORMULAS, PLANS, ETC.

**FREE** Formula catalog. Anything analyzed \$20.00. Western Chemical, Salem, Oregon.

**10,000** FORMULAS And trade secrets. Free literature. Stillman, 555 Kingston Ave., Brooklyn 3, N. Y.

**HOT** Tamale. Making for profit. Particulars, Box 384, Altus, Okla.

**ANY** Formula \$1. O. S. McCollum, 383 Miller Street, Vaux Hall, N. J.

**FREE** Formulas for making 3 types of waterless hand cleaner. Also glass cleaner and amazing "lazybones" auto cleaner-polish. Organic Chemicals, 1269 S. Norton Ave., Los Angeles 6.

**MAKE**—Sell cleaners, soaps, polishes, flavors, cosmetics. No machinery. Formula literature free. Kemico, Park Ridge 16, Illinois.

**FORMULAS** For nearly everything. Catalog free. Write Creative, Winnetka, Ill.

**TESTED** Formulas. Interesting descriptive booklet free. Pont, Box 635-PM, Terre Haute, Indiana.

**REAL** Manufacturing formulas. Lists free. Cummings, Chemist, Gordon Ave., Syracuse 4, N. Y.

#### PLASTICS

**PLASTIC** Materials and supplies for your hobby or business. Catalog and internal carving instructions free. Art Plastics of Calif., 8125 East 14th Street, Oakland 3, Calif.

**EMBED** Real flowers, butterflies, shells, photos, to make unusual coasters, plaques, tiles, jewelry, buttons, other objects with new liquid plastic. Crystal clear or colors. Saw, carve, turn, drill. Use only home tools. Big, picture-packed manual shows how to make things very first day. Book also explains proved 6-point success plan for starting your own profitable plastics business. Send 35c for "A Success Plan for You." Castolite, Dept. D-101, Woodstock, Illinois.

**MAKE** Non-shrinking molds with synthetic rubber. Handbook only \$1.00. Boruski, 505-D Fifth Avenue, New York City.

**REAL** Money making plastic casts, flexible moulds, pottery, etc. Professional course, including marketing procedure, \$1.00. Plastic Parts, 1157-S Kingshighway, St. Louis, Mo.

**AMAZING** Liquid plastic kit \$3.25. Embed photographs, keepsakes, coins. Makes solid objects, clear, colors. Beautiful results in half hour. Easily tooled. Inexpensive hobby. Send 15 cents for catalogue. Kristalon Plastics, Dept. Z-40, Box 29, Wilmette, Illinois.

**ADHESIVES** For thermoplastic materials. Lucite, polystyrene, celluloses. Half

**PLASTIC:** Sheets, cut pieces, and scrap in clear and colors. Rod, tubing, acetate, dies, jewelry findings. Send \$1.00 for 4 pound scrap assortment and fabricating manual. Regal Plastic Supply, 720 Main, Kansas City, Missouri.

**INTERNAL** Carved roses, orchids, swans, goldfish, butterflies, etc. Jewelry and gifts. Crystal Floral Novelty Co., Bound Brook, New Jersey.

**SPECIAL** Prime masked 6" x 12" Plexiglas sheets 3 for \$1.25 postpaid. Carving drills 1/16" 75c; 1/8" 85c each postpaid. Free catalogue. Craft Plastics, Somerville, New Jersey.

**EARN** Money with plastics. New book, "Money-Making Hobbies," shows you how. 160 pages, \$2.00. Popular Mechanics Press, 200 E. Ontario, Chicago 11, Ill.

**LUCITE** Plexiglas. Any size sheets, masked. Square foot (12 x 12) cost, 1/16", 96c; 1/8", \$1.25; 3/16", \$1.52; 1/4", \$1.80. Colors add 10%. Include 10% postage. Almac Plastics, 230 Fifth Ave., New York 1, N. Y.

**PLASTIC**, Sheets, rods, tubes, etc. Free list. Plastics Supply Co., 2901 N. Grand Blvd., St. Louis 7, Mo.

**WHOLESALE** Plastics supply catalog. 10c. Lucite, clear, colored. Metallic acetate, 15 colors. Thick lucite cutoffs, polished blanks for carving. Metal findings, tools, ideas, bargains galore. Quantity prices on casting plastic. Gem-O-Lite, Box 686S, North Hollywood, Calif.

#### CHEMISTRY

**USEFUL** Laboratory item, catalog of chemicals, laboratory apparatus, kits, 10c. Rex Laboratories, 2849-A Birchwood, Chicago 45, Illinois.

**AMATEUR** Chemists, Join new club. No dues. Free publication. Write: Amateur Chemist, Westwood, Lassen Co., Calif.

**SNOOPERSCOPE** Book. Shows army, navy sniperscopes, snooperscopes. \$1.50 each. Infrared filters 15c. Precise, 942 Kings Highway, Brooklyn 23, New York.

**USEFUL** Laboratory item, catalog of chemicals, laboratory apparatus, 10c. Rex Laboratories, 2849A Birchwood, Chicago 45, Illinois.

**NEW** Idea chemical and apparatus outfits for home experimenting. Photo-scales, microscopes, chemicals, biological and laboratory supplies in small quantities. Catalog 15c. Established 1931. John H. Winn, 124A West 23rd Street, New York, N. Y.

**ILLUSTRATED** Catalog: Chemistry, mineralogy, biology, 10c. Tracey Laboratories, Evanston, Illinois.

**CHEMICALS** And apparatus for industrial, analytical, and private laboratories. Catalog 15c. Dept. M-50, Biological Supply Co., 1176 Mt. Hope Ave., Rochester, 20, N. Y.

**NEW** Laboratory supply catalog of chemicals and apparatus. Contains many thousands of items with illustrations. Send 25c. Standard Science Supply Company, 1232 N. Paulina St., Chicago 22, Ill.

#### AGENTS WANTED

**STAINLESS** Steel burglar-proof window guard. Sample: 25c. Free details. Artware Corporation, 11110 Ventura, North Hollywood, Calif.

**MEXICAN** Feather pictures. Big profits! No investment! Free details. Sample 10c stamps. Silvia-Pa, Apartado 9036, Mexico City.

**SEND** \$1.00. Receive six pair rayon samples mens sport Sox. Demonstrators. Yale Clothing, Meriden, Conn.

**EVERYDAY** Cards. Earn \$5.00 with every ten \$1.00 boxes of everyday cards you sell. Also new plastic cards, note paper and wrappings. Send for samples today. Howard P. Ellis, Dept. PM-4, Pitman, N. J.

**INFORMATION**—Money-making plans and wholesale supply sources will increase your income! Write, Reynard Service, Smithfield 4, Ohio.

**SELL** Ultra-blue stock signs to stores. 1000 slogans, comedy, general, religious, "7x11" cost 6c, sells 55c. Make money. 15 samples \$1.00 postpaid. Lowy, 8 West Broadway, Dept. 532, New York.

**AGENTS**—Sell finest food products direct to homes. Successfully sold for 25 years. Big profits. Powerful combination sales plans make sales easy. Permanent repeat business. Powerful premiums and free door openers for easier sales. Samples furnished. Live territories open to dis-

**START** Your own business on credit. Always your own boss. 1554 dealers, sold \$5,000 to \$26,500 in 1948; their average \$6,742. We supply stocks, equipment on credit. 200 home necessities. Sales experience not needed to start. Wonderful opportunity to own pleasant profitable business backed by world-wide industry. Write Rawleigh Co., Dept. D-U-PPM, Freeport, Ill.

**LOOK** Here! Wanted—Men to start in business on credit. Sell some 200 farm-home products. Thousands our dealers now make quick sales, big profits. For particulars write Rawleigh's, Dept. D-192-PPM, Freeport, Ill.

**NYLON** Uniforms. Immediate delivery, immediate profits. Sell to doctors, dentists, nurses, waitresses, beauticians, housewives. Free sales kit. Superior Fabrics, Dept. P4, 3936 Market, Philadelphia 4, Penna.

**FREE** Samples, and amazing plan, giving you gorgeous dress without penny cost. Rush name today, with dress size. Harford, Dept. B-535, Cincinnati 25, Ohio.

**ABSOLUTELY** Free! Big package actual sample fabrics and style presentation of dresses, lingerie, hosiery, etc. Take orders. Commissions big. Send no money. Melville Co., Dept. 5430, Cincinnati 3, Ohio.

**DOUBLE-DUTY** Shopping bag. Zips open. Instantly changes small to large size. Samples sent on trial. Kristee 147, Akron, Ohio.

**LENS** Glo. Amazing new eye glasses cleaner. Sell individuals and wholesale to stores. Whirlwind repeat seller. Big profits. Carhoff, 9321 Buckeye, Cleveland, Ohio.

**LOOK!** Sell initialed individualized belts, buckles, cap badges, tie holders, etc., choice 2000 emblems. Write special outfit offer. Hook-Fast, Box 1425PM, Providence, R. I.

**PROFITS** To 100%. Show lovely greeting cards, plastics, metallics, personalized stationery, napkins, coasters, novelties. Approval sample. Torres, 373A Fulton St., Brooklyn 1, N. Y.

**AT** Last! Something new and sensational in everyday cards. Make extra money fast! Show gorgeous satin velour metallic cards. Get orders easy. Scented stationery, charmettes, napkins, kiddie cards. 50 other assts. retail 60c to \$1.25. Samples on approval. Puro Co., 2801 Locust, Dept. 040-D, St. Louis 3, Mo.

**AMAZING** Offer—\$40 is yours for selling only 50 boxes. Also entirely different, new deluxe all-occasion assortment with television card. Little pearls, hankie gift greetings, other surprise items. Feature boxes on approval. Free samples imprinted stationery and rose scented notes. Write today. It costs nothing to try. Cheerful Card Co, 1297 White Plains, N. Y.

**EXTRA** Money! Sell new, different greeting cards. Complete line includes Regal plastic assortment, metallics, "stand-up" and "double" cards. Free samples exclusive imprinted and engraved stationery. Sales kit on approval. Regal Greetings, Dept. PM-14, Hazel Park, Mich.

**MAKE** Money fast selling biggest line gorgeous greeting cards—21 for \$1.00 all-occasion, birthday, Mother's Day, friendship, anniversary, comics, relative, Catholic, new metal and \$1.00 plastic cards. Little pearls, twice as nice, lustre beauty, bright spots, nifty gifties, scented stationery, children's books, gift wrappings, ribbons, gifts. Plastic thread box, draperies, handkerchiefs, imported napkins, Ever-sharp pen sets. Everyone a prospective customer. Amazing profits for agents, church groups, clubs. Extra cash bonus plan. Experience unnecessary. Write today for samples on approval and special offer. Hedenkamp, 361 Broadway, Dept. PM-5, New York.

**100,000** FULL Fashioned nylons 8c up in volume. Stock list 25c. Sibert Wholesalers, Chattanooga 4, Tenn.

**HOUSE** Paint—Your name on label. Agents wanted. Experience unnecessary. Free sample. Certified Products, Louisville, Ky.

**"SOLVEX"** Cleans dirty hands quickly. Exclusive territory. Solvex, Monticello, Iowa.

**BUY** Thousands of nationally advertised products direct from manufacturers and distributors. Write for "Buy Direct and Save." Service Publishing, 218-A Investment Bldg., Pittsburgh 22, Penna.

**BUILDING** Maintenance, you may enjoy steady increasing life income, in your own business. Pioneer, 1828 Columbus, Cleveland 13, Ohio.

**MAKE 100% Profit!** Sell the new "Marks-All" mechanical pencil. Ten second demonstration sells on sight. Heavy duty shop pencil marks on plastics, glass, metals, tile—anything! \$1.00 retailer. 7c sample charge refundable first order or postcard for details. Studwell Products Company, Dept. A.W., 70 East 45th Street, New York 17, New York.

**I'LL Put a "shoe store business" in your pocket!** Nation's leader trains you to make big money! Fit men, women. Free sample outfit. Write today! Consolidated Shoe System, Dept. S-542, Chippewa Falls, Wis.

**DRESSES, 18c;** Coats \$1.00, blouses 35c. Free catalog. Crown, 164-P Monroe Street, New York.

**EVERY Housewife needs "300 Household Hints."** Lightning 25c seller. Sample 10c. King, 55-P Oleander, West Springfield, Mass.

**TRANSPARENT Liquid rubber coating non-slip, speed drying, for floors, walls, woodwork, linoleum.** Damp proofs base-ments. Costs 98c, sells \$2.98. Big demand. Rubber Products, Inc., Station A, New Haven, Conn.

**\$1 STARTS You in business.** Sell top quality \$1.00 ties. Now only \$7.20 dozen, your profit \$4.80 dozen. Regular \$1.50 up values. Send \$1.00 for introductory offer two ties. Catalog complete line free. Philip's Neckwear, 20 West 22nd St., Dept. K-42, New York 10.

**SPARE Time, \$50,** selling top line every-day greeting, personalized stationery, napkins, coasters. Victory Studios, Mt. Vernon, N. Y.

**STEADY Profits—No investment.** Earn \$50-\$75 weekly spare time. \$100-\$250 full time. Plastic aprons, tablecloths, etc. Free catalog. Halliday Co., Dept. M-4, 347 Broadway, Passaic, New Jersey.

**NYLONS Given free if SheerKraft hosiery doesn't live up to amazing three month written guarantee enclosed with every order!** Over 570 styles, sizes, colors! Big commissions. Big bonuses. Sheer-Kraft, Box 72-E, Newark, N. J.

**NEW, Miracle household deodorizer kills offensive odors instantly.** Big profits. Amhar Industries, Plant 5G, Huntington, New York.

**JOIN Manufacturers "Products-of-the-Month Association,"** and get California's hottest selling lines. Sponsored by manufacturers. Dollar bill brings Hollywood's newest \$1.95 automotive accessory and membership. Director, Box 2470-PM, Hollywood, California.

**BIG Money selling tooth powder.** J. Walker, 633 Plymouth Co., Dept. 1, Chicago 5, Ill.

**FREE Literature—Thousands wholesale supply sources.** Money-making business ideas. Wilkin Company, Hillsboro 4, Ohio.

**AGENTS: Sell fast moving lawn mower sharpener.** Write for details. Accurate Sharpener Mfg. Co., Milwaukee 12, Wis.

**PROFIT Making novelties.** Two samples \$1.50. Folder free. Roger Enterprises, 7 Waverly, Tuckahoe, N. Y.

**ELECTRIC (1/2-Hp.) mowers—\$59.50.** Sensation. Thousands sold. Delivered. Rotacut, R-2004, Excelsior Springs, Mo.

**EXCLUSIVE Agency.** Power mowers—\$59.50. Delivered. World's cheapest. Modern, 7401-AD, North Kansas City, Mo.

**GREETING Card moneymakers.** Mother's Day, birthday, everyday. Catalog free. Greenport Art Company, Brooklyn 15, New York.

**POWER Mowers, sample \$74.50;** garden tractors \$77.00. Seasonal selling means easy sales. Power Equipment, Wakeman, Ohio.

**"BASEBALL" By Connie Mack.** New red hot seller! Thrilling inside story of America's national game by "Mr. Baseball" himself—"My 66 Years in the Big Leagues." Large book; 300 pages. Beautifully illustrated. Sells on sight! Big cash daily. Write for starting outfit! Universal House, 1012-BB Arch, Philadelphia, Penna.

**AMAZING Low-priced reflecting house numbers** sell like wildfire. 30,000 glass lenses to square inch! Self-applying, or sell complete with bracket. Low as 80c. Your profit 100%. Prospects and profits everywhere. Write Nite-Brite, 216 N. Wabash, Dept. 30, Chicago 1, Illinois.

**SENSATIONAL Earnings,** selling granite memorials. Lowest prices. Delivered. Guaranteed. Mihelik Memorials, St. Cloud, Minn.

**SENSATIONAL Nylons guaranteed** against runs. Nationally advertised. Not sold in stores. No experience or money needed. Also lingerie, robes, men's hosiery. Outfit, sample, etc. free. Wonderful opportunity earn big money spare or full time. See our full page advertisement on page 71. Kendex Co., Babylon 646, New York.

**SERIOUS Offer:** spare time, fun, excellent profits. Dollar bill brings samples. Idap, 26 Hollande, Tangier, Morocco.

**NAME Plates sell fast.** 3 designs. 100% profit. Demonstrating samples free. Barkers, 949 Greenwood, Zanesville, Ohio.

**BOYS! Earn big money easy,** spare time selling brass name plates for neighbor's doors. Write Hubstamp, 359-C Congress, Boston, Mass.

**\$85.00 WEEKLY Selling 4 pair shoes** daily direct. Free outfit. Samples. No investment. Experience unnecessary. Advance commissions, bonus. Paragon Shoes, 739 Columbus, Boston, Mass.

**BUY Nylons direct from mill.** Make good profits on fast selling nylons. Quick delivery on any quantity. Write for confidential wholesale price list. Joy Hosiery Mills, Delawanna 13, New Jersey.

**SPARETIME Profits** operating your own magazine subscription agency from home. Also handle all type greeting cards, stationery. Big confidential catalog and supplies free! It costs you nothing to try! Cassell Service, Westfield 3, N. J.

**NEW! Birthday party pack.** Be first! Sell this sensational new assortment. Contains everything but the food. The invitations, table cover, napkins, nut baskets, place cards, snapper hats, cups, plates, game booklet and six different games; a complete party for eight. Sample \$1.25. Also America's leading greeting card line featuring personalized stationery, napkins, book matches and exclusive new wedding invitations. Free samples. Elmcraft Chicago, 5930 S. Western, Chicago 36, Illinois.

**SELL New clothing.** Lowest prices. Operate from home, auto, store. Enormous profits. Big catalog free. National Mail Order, 1219-F South Jefferson, Chicago.

**SELL Balloons! Combs! Novelties!** Excellent sideline. Carleton House, Texas City, Texas.

**WHERE To buy 800,000 articles** and nationally advertised merchandise direct from manufacturers and jobbers. Sent free. "Buy direct and make bigger profits." Glass Pub. Co., Ellwood City 7, Penna.

**\$100.00 FAST—Easy.** New office necessity does it. Hudson, 934 Lakeside, Chicago 40.

**BE Renewal headquarters** for all magazines. Handle everything at home. Big profits. No experience—no capital needed. Free catalog tells how. Write: McGregor Magazine Agency, Dept. 500A, Mount Morris, Ill.

**DOUBLE Your income—Sell wool** and cotton uniforms, badges, initial buckles, belts, etc. Write Hook-Fast, Box 480PM, Roanoke, Va.

**FREE Samples.** Big profits showing amazing glow-in-the-dark specialties. House numbers, pictures, plastic novelties, ashtrays, keyholders, religious and nursery objects, etc. Madison Plastics, 303 Fourth Ave., New York 10, N. Y.

**JEWELRY Factory** desires salesmen, distributors, jobbers. Pickcraft, 19 Bank Street, Attleboro, Mass.

**SCHOOL Seniors!** Your postal will bring our wonder, Kwick-Sell cardalog of popular graduation name cards. Biggest profits! Only firm giving free souvenir chest and card case. Don't miss out! Hurry that postal! Craftcards, Box 235 (L), Pittsburgh 30, Pennsylvania.

**AGENTS: Stamping names** on key protectors. Sample 25c. Stamping outfits, checks, social security and name plates. Hart Mfg. Co., 303 Degraw St., Brooklyn, N. Y.

**SELL Big money-maker** to men and women. Easy handwork makes fast-selling useful articles. Sunmade Company, Brockton 64, Mass.

**SCHOOL Seniors—Earn 40% commission** selling classmates America's most beautiful graduation name cards. Largest selection. Outsell all others. Free sample kit. Printercraft, Dept. M, 1425 E. Elm St., Scranton 5, Penna.

**SEWING Machine electrification kit.** Nationally advertised. Has Good House-keeping Guaranty Seal. Can be demonstrated and sold in 5 minutes. Make at least \$5 per sale. For complete details write today to Brownell Distributors, Inc.

**FREE Water and our concentrates,** make flavors, lotions, shampoos, 125 products, labels, bottles supplied. Qualco, E20030 Russell, Detroit.

**MAGIC Cleaner—Laundry soap** deal. Hotter than a firecracker. Big profits. Sample free. Bestco, 4642 No. Central, Chicago.

**GOLD Lacquered window sign letters.** Large sizes penny each. New foils. Absolutely beautiful. Free samples. Atlas, 544 W. 79th, Chicago 20.

**EXCELLENT Sideline** for printing and advertising salesmen. Decalcomania name plates in small quantities. Great demand. Also, make money with our line of automobile initials and sign letters. Free samples. "Ralco" XL-Roxbury, Boston 19, Mass.

**PHOTO-Salesmen-agents.** Sell beautiful hand-colored plastic enlargements. Collect deposit, we deliver. Profitable sideline. Send card, for free sample kit. Novel Portrait Co., 3343 North Ave., Chicago, Ill.

**AGENTS—300% Profit** selling genuine gold window letters; stores and offices. Free samples. Metallic Letter Co., 438-B North Clark, Chicago.

### HIGH-GRADE SALESMEN

**IF You sell, you need Opportunity Magazine—the "salesman's bible,"** packed with down-to-earth ideas that boost your earnings; filled with hundreds of announcements of new, fast selling items and lines. Send your name and tell us what you're selling now for free copy of latest issue. No obligation. Opportunity, 28 E. Jackson, Dept. 32, Chicago 4, Ill.

**SALESMEN: Have you had experience** selling stocks, franchises, real estate or vending machines? Our low man earned \$750 last month. Write for free information. Fortune Enterprises, Inc., 1060 Broad, Newark, New Jersey.

**BIG Cash profits** for men and women introducing Flexiclogs, sensational new flexible footwear. Experience unnecessary. Nationally advertised styles for women, children, men. Excellent sideline, no investment. Easy to average hundreds of dollars weekly. Free sales helps and sample offer. Get details now! Flexiclogs, Dept. L-4, New Holstein, Wisconsin.

**EARN Big money fast!** Sell finest-quality advertising work uniform to garages, factories, filling stations, etc. Free selling kit. Topps, Dept. A-40, Rochester, Ind.

**ADVERTISING Book matches—Cash** in on big demand; sell union label matches. Cuts for all businesses and political parties. Free powerhouse selling kit, low prices, protection guaranteed on repeat orders. Cash commissions. Superior Match Co., Dept. M-450, 7530 Greenwood, Chicago.

**SELL Drill saw attachments** calling on mechanics, all trades. Stackhouse, 219 N. 63 St., Philadelphia 39, Penna.

**SALESMEN—Sideline.** Earn \$3,000 next 5 months selling calendars, advertising specialties. Buyers everywhere. Big comm. advanced. Samples free. Continental Calendar, 542-A South Dearborn, Chicago.

**OVER \$500 Weekly** for several weeks for Ruffo and Maurice. \$250 weekly common, selling patented 31 to 1 power tool. Prospects everywhere. 2-min. demonstration. Palcoseal Co., Ltd., Massena P2, N. Y.

**SALESMEN—Absolutely make \$50 a day.** New sensational utility item for every food, beverage outlet, etc. Samples furnished. Johnson-Hill, 53-R West Jackson, Chicago.

**SENSATIONAL Nylons guaranteed** against runs. Nationally advertised. Not sold in stores. No experience or money needed. Also lingerie, robes, men's hosiery. Outfit, sample, etc. free. Wonderful opportunity earn big money spare or full time. See our full page advertisement on page 71. Kendex Co., Babylon 646, N. Y.

**BIG Money taking orders.** Shirts, ties, Sox, pants, jackets, sweaters, shoes, uniforms, etc. Sales equipment free. Experience unnecessary. Nimrod, 4922-AN Lincoln, Chicago.

### EDUCATIONAL AND INSTRUCTION

**3800 LATEST Used** correspondence courses. Catalog 50c. EG, Elmsford, N. Y.

**USED Correspondence courses** and books sold and rented. Money back guarantee. Catalog free. (Courses bought.) Lee Mountain, Pisgah, Alabama.

**EXPORT—Import!** Big-money and world-travel opportunities. Represent buyers, sellers. International mail order without capital. Practical inexpensive course teaches you outside the home. In preparation.

"HOW To Break and Train Horses"—A book every farmer and horseman should have. It is free; no obligation. Simply address Beery School of Horsemanship, Dept. 1104, Pleasant Hill, Ohio.

LEARN The collection agency business. Highly profitable. Easily mastered. Free folder. Cole Associates, Syracuse 2, N. Y.

INVESTIGATOR—Criminology courses. Free literature. Allied Schools, 14 No. East, Indianapolis.

JOIN. Salesman's club. Educational, social. Fraternal. Application. Professor Martin, Bonners Ferry, Idaho.

MAKE Up to \$35-\$45 week as a trained practical nurse! Learn quickly at home. Booklet free. Chicago School of Nursing, Dept. M-4, Chicago.

BE A real estate broker through home study or classroom instruction. Write for free book. Approved for veterans. Weaver School of Real Estate, 15 E. Pershing Rd., Box CP-4, Kansas City 8, Missouri.

ACCOUNTING: Become an accountant. Learn at home and have your own accounting business or a good accounting position. National Training School, 343 S. Dearborn, Chicago 4B.

HOW To make decisions logically. New! This instruction is in its first year of publication. Very few things in life are more important than being able to make sound decisions. Price \$2.00. Smith Publications, Box 184, Terre Haute, Indiana.

U. S. Civil Service jobs. Start high as \$66.35 week. Secure positions. Men, women. Qualify now for many expected openings. Experience usually unnecessary. Free 40-page book shows jobs, salaries, sample tests. Write: Franklin Institute, Dept. D-24, Rochester, N. Y.

OPERATE A collection agency. Pays big. Easily learned by mail. Free bulletin. Franklin Credit School, Roanoke 7, Virginia.

FREE: Bookkeeping lesson; particulars. Buchalter, 1280 Ocean Avenue, Brooklyn 30, N. Y.

READ With speed! New amazing method. Saves hundreds of hours yearly. Free home test. No obligation. Rush postcard. Brownson, 9109 Hoynes, Chicago 20.

SALESMANSHIP New action method. Free lesson. Garden State Industries, 684 Catalpa, Teaneck, N. J.

USED Correspondence courses and educational books bought, sold, rented. Catalog free. Educational Exchange, Summerville, Ga.

PHOTOGRAPHIC Mind with Super-memory. Write Thor Books, M-4, Box 1210, Chicago.

PRINTING Course. Thorough, complete. Send stamp for details. Director Courses, Box 941, Meriden 13, Conn.

WANT To be a television director, actor, announcer? Send for free pamphlets. Hollywood Radio Publishers, 6411 Hollywood Blvd., Hollywood 28, California.

LINGUAPHONE Makes languages easy. At home learn to speak Spanish, Portuguese, Italian, French, German, Russian, by quick, easy Linguaphone Conversational Method. Save time, work, money. Send for free book. Linguaphone Institute, 83 Radio City Bldg., New York 20, N. Y.

LEARN Railroad telegraphy by mail, spare time. Railroads need men badly. Complete course, written illustrated by practical telegraphers easily mastered. \$3.85 postpaid. Details free. American School Railroad Telegraphy, 501, Wenatchee, Wash.

STUDY To be a doctor of psychology or metaphysics. Obtain Ps.D., Ms.D., D.D. or Ph.D. degree. Chartered by state. Write for free book telling how. The Neotarian Fellowship, Dwight Building, Kansas City 6, Missouri.

MIND Asleep? Try "Thinking-Alpha-bet." Write Frank Tibolt, 17M, Philadelphia 20.

HOME Bible course. Simple, helpful, instructive. Total cost \$4.00 includes textbooks, stationery, examinations, certificate. \$1.00 starts you, or simply request prospectus. The Bible Study School, 378 Van Houten Street, Paterson 1, N. J.

HOME Study course, drugless therapy. Free literature. Institute of Drugless Therapy, Tama, Iowa.

INVESTIGATOR Training. Phillips Secret Service System, 1917-B North Kenneth, Chicago 39.

BOOKKEEPERS! Increase your earnings! Operate your own simplified "dollar-a-week" bookkeeping and tax service. Full or spare time. Details free. No obligation.

USED Correspondence courses. Bought, Sold, Rented. Free literature. Baker, 5509-B Winthrop, Chicago 40.

PIANO Tuning pays. Learn this profitable profession at home. Our Tonometer and mechanical aids make learning easy. No knowledge music necessary. Diploma granted. Largest and oldest school—52nd year. G.I. approved. Write for booklet. Niles Bryant School, 78 Bryant Bldg., Washington 16, D. C.

SECRET Investigation. Experience unnecessary. Investigators particulars free. George Wagner, M 125 West 86th, New York.

MEDICAL Laboratory Technicians in great demand. We train you in your own home. Catalogue free. Imperial Technical Institute, Box 973-J, Austin, Texas.

REFRIGERATION—Learn to service. Big money. Self-teach full course with Follett's Guide with quizzes and the Manual. Both texts, 929 pgs. Easy, thorough, fascinating. Complete, \$7.50. Follett, Dept. PM, 1255 S. Wabash, Chicago. See ad page 76.

### PLAYS, STORIES, MANUSCRIPTS

NEW Writers wanted! Learn easiest way to write for pay. Receive checks for \$3 to \$100, offered daily. No experience necessary. Write for free details and how to get free Writer's Market Guide! Comfort Writer's Service, Dept. 2-L, 200 S. 7th St., St. Louis, Mo.

I WANT New writers to cash checks of \$1 to \$100 offered daily. The easiest way to write for pay. No previous experience necessary. Free details. Saunders M. Cummings, 468-11 Independence Bldg., Colorado Springs, Colo.

### INFORMATION

WHERE To buy most anything. We furnish supply sources. Single item, 25c. 5 for \$1.00. Service Bureau, 2624-P N. Albany, Chicago 47, Ill.

### BUSINESS SERVICE

MIAMI Postmark! Letters 25c each; \$3.00 monthly. McDowell, 504 Pacific Building, Miami 32, Florida.

LETTERS Remailed 25c (coin). James Paige, 7 Elena St., Santurce, Puerto Rico.

WE Will represent you in New York City—Buying, selling, legal, advertising, business, personal, unusual. Strictly confidential. Write Continental Research Service, 305 Seventh Avenue, New York 1, New York.

DIME Mailing list. Henderson's Directory, P.O. Box 221, Maywood, Illinois.

### SPECIAL SERVICES

CANADIAN Mailing. Kelowna, B. C. postmark. Letters received, forwarded, 25c each. Ritchie, Box 686, Kelowna, B. C., Canada.

WASHINGTON, D. C., Baltimore, Md. Letters remailed 25c each. Bernhardt, Box 4045, Baltimore 22, Md.

WHEN Others fail, have "The Watch Doctor" repair your watch. Information free. Hunter Watch Service, P.O. Box 4008, Denver 9, Colorado.

USE Your name, my address. Letters forwarded. Confidential secretarial service. Crown, Box 7041, Kansas City 2, Mo.

CHICAGO Address for your mail. Business or personal. Information free. Schultz House, 3116 Seminary, Chicago 13.

EXTRA Business! Prestige! Rent Toronto branch office \$20.00 yearly. Remailing service. Enterprises, Toronto 12, Canada.

CUBA—Letters remailed, 25c each. R. Morejon, Box 1291, Havana.

ATTENTION Manufacturers, home shop operators, hobbyist, salesmen. Let us show you where you can buy everything you want, have parts made, sources of supplies, tools, machinery, etc. This is not a mailing list. We choose reliable manufacturers, suppliers, importers that can furnish exactly what you want. Save time and money by buying direct. List of five for only \$1.00, additional 15c each. Minimum order \$1.00. Guaranteed prompt service. Tell us what you want. We'll furnish names and addresses of reliable sources or refund your money. John Allis, Box 214, Mount Clemens, Michigan.

INVESTIGATION And cash liquidation—Old or recent stock certificates, bonds, bank books, promissory notes, deeds, wills, financial documents of every description. Send us your list for appraisal. National Evaluators, P.O. Box 5852, Cleveland 1.

TANGIER Postmark! Letters reairmailed 3 for dollar bill. Idap, 26, Hollande, Tangier, Morocco.

### CARTOONING, COMMERCIAL ART, SHOWCARD WRITING, SIGN PAINTING

SIGNWRITING Simplified—Ten alphabets, 7 numerals. Catalogue, \$1. Demonstrators, 639P Paulina, Chicago 12.

CARTOON Your way to success! Internationally known instructor, Raye Burns, will personally teach you to create salable, original cartoons at home. Course of 26 lessons only \$2.85. Send remittance with order or write for free details and addresses of successful students. Raye Burns School, Box 3583-M, Cleveland 18, Ohio.

"HOW To Make Money With Simple Cartoons"—A book everyone who likes to draw should have. It is free; no obligation. Simply address Cartoonists' Exchange, Dept. 94-C, Pleasant Hill, Ohio.

LEARN Professional lettering. Easy, experience unnecessary. Amazing mechanical process. Complete instructions, 75 alphabets, 250 designs \$1.00. Major-Art System, 3510-D Palmer, Chicago 47.

9 ALPHABET 3 Numeral pattern sets and catalog. \$1.00. Sign Letter Distributors, P.O. Box 101, Mineola, N. Y.

EARN Money evenings, copying and duplicating comic cartoons for advertisers. Adservice, Argyle 1-B, Wisconsin.

BARGAIN, Quick landscape painting, poster art—lettering, art lessons, catalog 10c. Art Book Shop, Arnold 8-D, Missouri.

TALENT Test, information. Give age. Art, Box 8066, Dallas 8, Texas.

SIGN Painting taught at home. Test lesson free. Ben Kerns, Box 812-T, Greenville, S. C.

CHALK Talks. Laugh producing program, \$1.00. Catalog 10c. Balda The Cartoonist, Oshkosh, Wisconsin.

### ADVERTISING AGENCIES, LETTER WRITERS, FOR ADVERTISERS

ADVERTISE: 24 Words, 40 newspapers \$3.50. Lists free. Advertising Bureau, 10511-C Springfield, Chicago 43.

ADVERTISING Layouts, artwork, sales letters, folders. A complete service designed to get results. Robert James Agency, Wysor Building, Muncie, Indiana.

25-WORD Classified advertisement in "Business Guide." \$2. Business Press, Baldwinville, N. Y.

BETTER Sales letters—Stronger ads. Complete advertising service any size budget. Write fully. Monroe, Box 1002, Chicago 90.

TRADEMARKS Designed complete with cut, \$10.00. Rough sketch, \$1.00. Catalog free. Burke, 3208 McKinney, Dallas.

MAILING Lists; \$5.00-1000 up. Write Dixie Service, King, N. C.

ADVERTISERS! Reach nearly 18,000,000 readers. 25 Sunday national key newspapers, 18 words, \$51.50. "Terrific pullers." 20 popular newspapers, \$10.00. "Free booklet." Special—One inch display 2-821,198 circulation, \$48.30. Newmark's Advertising Agency, (Established 1893), 217-7th Ave., New York 11.

AVOID Costly advertising mistakes. Get enlightening Ad-Guide and Ratebook leading newspapers, magazines, mailing lists, 10c. Chicago Advertising Agency, (Established 1900), Chicago 4.

24 WORDS In 50 weeklies, \$4.96. J. Darnell, 730 Hays, Jackson, Tennessee.

REACH Spanish-speaking mail-order buyers. Great new market for your merchandise. Your classified ad in the Spanish Edition of Popular Mechanics will bring you some nice business from this new field. Rate only 25c per word. Circulation 100,000 copies. Mail a trial ad right now. Popular Mechanics Magazine (Spanish Dept.), 200 E. Ontario Street, Chicago 11, Ill.

ADS Placed in out of town newspapers and magazines. Low rates. Catalogue free. Ideas that pay. Baker Advertising Agency, Successors Ankrum Agency, 189 W. Madison, Chicago 2.

### TYPEWRITERS, DUPLICATORS, OFFICE DEVICES

PRINTOMATIC Selffeeding post card printing duplicator \$13.50. Envelope addressing machines \$24.50. Pittsburgh Typewriter Company, 336-R Fourth Avenue, Pittsburgh 22, Penna.

**TYPEWRITERS**, Adding machines, cash registers. Ray George, 3322 South Grand, Saint Louis, Missouri.

**LOY'S Abacus**, low-cost fast adding calculator for home or office. \$3.50, \$6.50. Free details. Loy's, Dept. PM, 1317 R.I. Ave., N.E., Washington 18, D.C.

**TYPEWRITERS** \$17.50. Duplicators \$9.95; adding machines \$12.50. Typewriters, 118-N Spruce, Wichita, Kansas.

**RECONDITIONED** Typewriters, printing devices. Write Dixie Service, King, N. C.

### RUBBER STAMPS AND OFFICE SUPPLIES

**MIMEOGRAPH** Paper, 68c ream, samples. Brookman, 56-A West 24th, New York 10.

**BUSINESSMAN'S** Rubber stamp kit—11 stamps and pad. \$1.39. Free details. Eddy Co., Southington 13, Conn.

### PRINTING, MULTIGRAPHING, MIMEOGRAPHING, GUMMED LABELS

**MIMEOGRAPHING**, Addressing, samples, price list. Merlen Terwilliger, 303 Chestnut Street, East Bound Brook, N. J.

**MIMEOGRAPHING**, Letterheads, letters, envelopes. Martin Mimeographing, 3212 Harper, Saint Louis, Missouri.

500 **LETTER** Heads. \$3.00. Project Co., Box 6371, Chicago, Ill.

500 **NAME**—Address stickers 50c. Kay Press, 1560 South Fifth, Milwaukee 4, Wis.

**MIMEOGRAPHING**, Vari-typing, cut printing costs! Free prices, samples. Loyal Brush, 3303 Paseo, Kansas City 3, Missouri.

1000 **BEAUTIFULLY** Embossed business cards \$3.25. Avery Printery, Wichita 12, Kansas.

**BUSINESS** Stationery. Reasonable. Samples, price lists free. How, 721-23 Eunice, Webster Groves 19, Missouri.

500 **8 1/2 x 11** **LETTERHEADS** \$2.75. Universal Printing Embossing, 203 Avon Avenue, Newark 8, New Jersey.

**PRINTING**, 100 Envelopes, 100 letterheads \$3.00. V. Baker, Alexis, Illinois.

**QUALITY** Printing. Low prices. Anything in any quantity. Free price list. Albert Wilcox, Nichols, Georgia.

250 **LETTERHEADS** Or envelopes \$2.70; 1000 statements \$3.85. Estimates free. Mullins Letter Press, Robinson, Ill.

1000 **BUSINESS** Cards (embossed) \$2.95 postpaid. Zephyr Printing, Box 312pmm, Venice, California.

1000 **BUSINESS** Cards \$1.85 prepaid. CPR Sales, 914 East 217 Street, New York 67.

**MIMEOGRAPHING** — Reasonable. Any copy. Mailers Service, Box 606-E, Chicago 90, Ill.

**MIMEOGRAPHING!** Unparalleled. White. Colored. Bond, 8 1/2 x 11, 250, \$2.00, 500, \$3.25. Delivered. Hanna, 915M Kalamazoo, Petoskey, Michigan.

**SAMPLES** — Letterpress and offset. Backus, 209 S. Laurel, Richmond, Va.

**PRINT-Style** Mimeographing. Vari-typing. Photo offset paste-ups. Variety type styles, sizes. Squared margins. Write for samples, prices. Letter Shop, 3846 Monteth, Detroit 8, Michigan.

**FREE**. Beautiful bakelite desk holder with year's supply (2000) memo sheets printed to your order. Write name plainly. Send no money. Pay postman \$2.95 plus postage. Memos, Bovey, Minn.

1000 **BUSINESS** Cards \$2.50 prepaid. Samples free. Reliable Print Shop, 905 East Jefferson, Louisville 6, Ky.

50 **TYPEWRITTEN** Letters (mimeographed) \$1.00. Additional 50's, 25c. Smalley's, Tunkhannock, Penna.

1000 **BUSINESS** Cards \$1.85 postpaid. Satisfaction guaranteed. Woodprint, Washington, Mich.

**BUSINESS** Or personal monogram stationery. Send copy for estimate. Nif-T-Pak, Box 455, Toledo 1, Ohio.

**MATCH** Books, blotter business cards, memorandum books, others. Best advertising producers. (Free samples.) Nixdorf, 1849 Howard, Pittsburgh 12, Penna.

\$5.95 **DELIVERED**. Letterheads, envelopes, billheads, statements, etc. Prompt service. Honest treatment. Excellent work. Send copy and remittance. Proofs submitted if desired. Bixler, 754 Benson, Frankfort, Kentucky.

**DIRECT** Mail. 1c postals, 39 designs, 6 colors. Your printed copy. 150 words. Samples 10c (refundable). Dauphin, South St., Rockland R.F.D., Mass.

**EMBOSSD** Cards, envelopes, letterheads. Samples. Spada Enterprises, 4 Eastview, Rocky Hill, Conn.

1000—6 1/4 **WHITE** Wove envelopes \$3.75 f.o.b. Ideal Printing Company, 225 State, Hudson 7, New York.

100 **8 1/2 x 11** **HAMMERMILL** Letterheads and 100 envelopes, \$1.85. Herbert Hudson, Centredale, R.I.

**QUALITY** Printing. We specialize in publications, newspapers, tabloids. Send copy for estimate. Bagby Printing Co., Georgetown, Ohio.

5000 **6 1/4** **ENVELOPES** Printed \$2.75 per thousand, price list free. Michel, Box 76F, New York 16.

**SEND** 10c Now, for our 48 page 1950 price list—refund first order. McCalk Press, 1326 South 27th, Omaha, Nebraska.

500 **3 1/2 x 2 1/4** **FOUR** Line gummed stickers 35c; red border 50c. Moritz Printery, Saginaw, Mich.

**MIMEOGRAPHING**—Letters, pricelists, formulas, instructions. Lowest prices. Lem's Letter Shop, 5710 Stanton, Detroit 8.

### PRINTING OUTFITS AND SUPPLIES

**PRINTING** Presses, type, supplies. Details free. Kelsey Presses, K-11, Meriden, Conn.

**PRESSES**, Supplies, paper. Catalog 10c. Printers Supply, 211, Springfield, Missouri.

**MAKE** Your own rubber printing cuts. Self-molding process. Plexirubber, Argyle 1, Wisconsin.

**PRESSES**, Type, cabinets, supplies. List for stamp. Lincoln Press Company, 220-I Hartwell, Fall River, Mass.

**PRINTING** Presses, type, supplies. Lists 3c. Turnbaugh Service, Loysville, Penna.

### PATENT ATTORNEYS

**INVENTORS**—If you consider your invention to be something of importance, take steps to protect it with a United States Patent which gives you the right to exclude others from making, using and selling your invention as claimed. "Patent Protection for Inventors" outlines steps to take to secure patent protection. Mailed promptly without obligation. Victor J. Evans & Co., Merlin M. Evans, Registered Patent Attorney, 531-D Merlin Building, Washington 6, D. C.

**INVENTORS**: Learn how to protect your invention. Unless the inventor is familiar with patent matters, he should engage a competent registered patent attorney or agent to represent him. We are registered to practise before the U.S. Patent Office and prepared to serve you in handling your patent matters. "Patent Guide for the Inventor" containing detailed information concerning patent protection and procedure with "Record of Invention" form will be forwarded to you upon request—without obligation. Clarence A. O'Brien & Harvey Jacobson, Registered Patent Attorneys, 01B-D District National Building, Washington, D. C.

**INVENTORS**—If you believe you have an invention, you should find out how to protect it. The firm of McMorrow, Berman & Davidson with offices in Washington, D. C., is qualified to take the necessary steps for you. Send for copy of our patent booklet "How to Protect Your Invention." We will also send you an "Invention Record" form. No obligation. They are yours for the asking. McMorrow, Berman & Davidson, Registered Patent Attorneys, 134-2 Victor Building, Washington 1, D. C.

**REGISTERED** Patent attorney offers services. Sanders, 6430 Evans, Chicago 37, Ill.

**PATENT** Information book and inventor's record, free. Gustave Miller, 40-A Warner Building, Washington 4, D. C.

**PATENTS** — Irving L. McCathran, 315 McLachlen Bldg., Washington 1, D. C. Registered Patent Attorney.

**PATENTS**, "Proof of Invention" folder mailed without obligation. E. E. Vrooman, Registered Patent Attorney, 507 McKim Building, Washington 5, D. C.

**HERMAN** Lewis Gordon, Registered Patent Attorney, Patent investigations and opinions. Warner Building, Washington, D. C.

**CANADA**—Ramsay Company Registered, 273 Bank Street, Ottawa, Canada.

**PETER** Fries, Jr., Registered Patent Attorney. Patents, trademarks, novelty

**INVENTORS**: When you are satisfied that you have invented something of value write me, without obligation, for information as to what steps you should take to secure a patent. Write Patrick D. Beavers (Formerly Randolph & Beavers) Registered Patent Atty., 935 Columbian Bldg., Washington 1, D. C.

**C. A. SNOW & Co.**—M-427, Snow Building, Washington 1, D. C. Registered Patent Attorneys. Write for information.

"**INVENTOR'S** Guide" free on request. Frank Ledermann, Registered Patent Attorney, 154 Nassau St., New York 7, N. Y.

**INVENTORS**: Without obligation, write for information explaining the steps you should take to secure a patent. John N. Randolph, Registered Patent Attorney, 203 Columbian Bldg., Washington 1, D. C.

**INVENTORS**: Write for free brochure "Evidence of Invention." Labiner, World Building, New York 7.

**PATENT** Practice before U. S. Patent Office. Validity and infringement investigations and opinions. Booklet and form "Evidence of Conception" forwarded upon request. Lancaster, Allwine & Rommel, Registered Patent Attorneys, Suite 411, 815-15th Street, N.W., Washington 5, D. C.

**INVENTORS**. For "Record of Invention" form, contact Carl Miller, Registered Patent Attorney, Woolworth Building, New York.

### FOR INVENTORS

**SUCCESS** Guaranteed. Inventors with patented and patent pending inventions for sale or lease, request our free book. No obligation. Dept. 1-F, Universal Marketing Co., 354 South Spring St., Los Angeles 13, Calif.

**INVENTORS**—If you believe you have an invention, you should find out how to protect it. The firm of McMorrow, Berman & Davidson with offices in Washington, D.C., is qualified to take the necessary steps for you. Send for copy of our patent booklet "How to Protect Your Invention." We will also send you an "Invention Record" form. No obligation. They are yours for the asking. McMorrow, Berman & Davidson, Registered Patent Attorneys, 134-Y Victor Building, Washington 1, D. C.

**INVENTORS**: Learn how to protect your invention. Unless the inventor is familiar with patent matters, he should engage a competent registered patent attorney or agent to represent him. We are registered to practise before the U.S. Patent Office and prepared to serve you in handling your patent matters. "Patent Guide for the Inventor" containing detailed information concerning patent protection and procedure with "Record of Invention" form will be forwarded to you upon request—without obligation. Clarence A. O'Brien & Harvey Jacobson, Registered Patent Attorneys, 01A-D District National Building, Washington, D. C.

**PATENT** Searches \$5.00, includes patent copies. Same reliable search as conducted for patent attorneys. Free protection forms, 48 hour service. Patent Service Institute, 945-A Pennsylvania Avenue, Washington 4, D. C.

**INVENTORS**—This firm is registered to practise before the United States Patent Office and is available to assist you in the preparation and prosecution of your patent application. "Patent Protection for Inventors" booklet containing detailed information and steps to take toward patent protection will be sent upon request. No obligation. Victor J. Evans & Co., 532-D Merlin Building, Washington 6, D. C.

**INVENTORS** Having patented, patent pending development to offer manufacturers. Booklet, information free. Market Contacting & Data Service, 11106-A3 Longwood, Chicago 43.

"**OUTSTANDING** Publication"—"Value plus" say readers. First hundred requesters can examine before paying. Return book or \$2 within 5 days. Write: Directory of Inventor Aids, Drawer 1289U, Clearwater, Florida.

**INVENTORS**. Protect your invention by a U.S. patent. Write me for information. Sherman Levy, 620-21 Victor Building, 724 9th Street N.W., Washington 1, D. C.

**I.F.I.** Creative co-operation includes: Super-scope patent searches; commercial prospects analysis; pre-patent priority protection; invention-improving; finding backers; invention-styling for sales-leadership, plus the promoting, marketing, and selling of inventions for maximum cash and royalties. Write today for free information. Inventors-for-Industry Inc., 750 5th Street, New York 17, N. Y.

**SELL** Your patented invention. Give patent number in letter. P.O. Box 106, Webb City, Mo.

**PATENT** Searches \$5.00. Reports air-mailed within 4 days. Invention protection forms free. Write Miss Ann Hastings, Patent Searcher, P.O. Box 176, Washington 4, D. C.

**PATENT** Searches \$5.00. Reports air-mailed within 4 days. Invention protection forms free. Write Raymond L. Smith, Patent Searcher, 410 Bond Building, Washington 5, D. C.

**PATENT** Searches \$5.00. Includes nearest patent copies. 48-hour service. Free protection forms. Patent Research Engineering, 318 Evans Building, Washington 5, D. C.

**COMPLETE** Services for inventors. Patent searches including analysis, patent copies. Inventions, patents marketed. Protection forms free. Industrial Patent Reports, Box 1081, Massachusetts Avenue and North Capitol, Washington 13, D. C.

**INVENTORS:** If you have an invention for sale, patented or unpatented, write Institute of American Inventors, Dept. 40A, 1926 Eye St. N.W., Washington 6, D. C.

**INVENTIONS** Wanted. Prominent manufacturers and national distributors look to us for new products. You can also benefit by having us assist you with your invention from the idea stage through to the developed product, fully protected. Ask for Booklet "M." Elo Development Co., Chatham Phenix Bldg., Long Island City 1, New York.

**PATENT** Owner Representative. Years of experience. Can I help you? Charles A. Scott 773PM Garson Avenue, Rochester 9, N. Y.

**INVENTORS:** Without obligation, write for information explaining the steps you should take to secure a patent on your invention. John N. Randolph, Registered Patent Attorney, 202 Columbian Bldg., Washington 1, D. C.

**CASH** For your idea. 280 manufacturers need inventions, patented or unpatented. List free. Invention Bureau, 208M Clinton, Oak Park, Illinois.

"**INVENTOR'S** Guide" free on request. Frank Ledermann, Registered Patent Attorney, 154 Nassau St., New York 7, N. Y.

**INVENTORS.** For "Record of Invention" form, contact Carl Miller, Registered Patent Attorney, Woolworth Building, New York.

**INVENTORS:** The usual first step is to have a search of the U. S. Patents conducted, so I can report on patentability. Write, without obligation, Patrick D. Beavers (Formerly Randolph & Beavers), Registered Patent Atty., 936 Columbian Bldg., Washington 1, D. C.

## INVENTIONS WANTED

**HIGHEST** Royalties—Cash. Patented and patent pending inventions only. Request our free book. No obligation. Dept. 1-W, Universal Marketing Co., 354 South Spring St., Los Angeles 13, Calif.

**INVENTORS** Marketing assistance. Circular free. Stanley Hull, 7829-K Euclid, Cleveland 3, Ohio.

**GOOD** Inventions, practical ideas wanted for promotion. Write Jenisch, Burlington, Kentucky.

**INVENTORS**—What have you, patented, patent pending to offer manufacturers? Booklet, information free. Market Contacting & Data Service, 11106-A2 Longwood, Chicago 43.

**THE** U. S. patent system does not compel inventors into rash "patent (s)pending." The intent of the patent law is to give you the chance of making a pre-patent test of the worth of your ideas. And high-character priority protection for this purpose can be obtained through: Inventors-for-Industry Inc., Dept. P.M.4, Suite 501, 1947 Broadway, New York 23. Write today for free information.

**MANUFACTURER** Seeks invention or practical ideas for household, notion or needleware fields, under royalty or outright purchase. Homestead Mfg. Corp., 107-09 Northern Blvd., Corona, N. Y.

**INVENTIONS.** Gadgets, patented, unpatented. Free offer. Grayland, 5312B Grace, Chicago 41.

**INVENTIONS** Promoted. Patented or unpatented. Write Adam Fisher Company, 61 Enright, St. Louis, Mo.

**INVENTORS:** Hundreds of manufacturers have requested our assistance in locating marketable new products. Complete information, free. Institute of American Inventors, Dept. 40-D, 1926 Eye St.

**CASH** For your idea. 280 manufacturers need inventions, patented or unpatented. List free. Invention Bureau, 208M Clinton, Oak Park, Illinois.

**INVENTIONS** Wanted. Patented or pending only. Inventors' Exchange-B, Hartford 1, Conn.

## PATENTS FOR SALE

**INVENTORS:** Test the commercial value of your patented or unpatented inventions, quickly and inexpensively. Write for free information. Institute of American Inventors, Dept. 40-B, 1926 Eye St. N.W., Washington 6, D. C.

## MANUFACTURING

**LABEL** With artisan decal transfers! Free quotations. Artisan Signs, Box 657, El Cerrito, Calif.

**NAMEPLATES,** 1/2 x 1 1/4" Metal, plastic, laminated. 10, \$1.00; 100, \$5.95; 1000, \$40.00 postpaid. Any lettering or design. Samples free. Jacktools, 2011-C Yale, St. Louis 17, Mo.

**MODELS,** Tools, dies. Experimental work. Small manufacturing. Domm Machine Works, 1700 77th Street, North Bergen, N. J.

**ENGRAVING**—Nameplates, plastic or metal. Complete service. Christian, Box 39, Stratford, Conn.

**MODELS**—Small lot manufacturing. Metals, plastics, etc. Milburn, Burlington, Kentucky.

## MODELS, MODEL SUPPLIES

**SHIP** Modelers—Are you looking for authentic, precision-made kits? Send 35c for richly illustrated catalog describing more than 30 models retailing from \$3.95. Clipper ships to modern cruisers. Also decorative authentic naval and field gun kits from \$4. Address Marine Model Co., Dept. B, Halesite, Long Island, N. Y.

**MINIATURE** Engines, castings and drawings. Catalog world's largest selection 25c. Miniature Engine Laboratories, 200-A Cement Ave., Sandusky, Ohio.

**BUILD** Historic ship models, complete kits 39c to \$9.00. Catalog 10c. Ideal Models, 19 West 18th, New York 11, N. Y.

**SHIP** And yacht model fittings; blueprints. Send 25c for illustrated catalog No. 25—listing hundreds of items. A. J. Fisher, 1002-1 Etowah Ave., Royal Oak, Mich.

**READY!** Our 1950 catalog of ship model kits and fittings; sail, steam, diesel. Send 25c for catalog. Model Shipways Folio, 60, 476 Main St., Fort Lee, N. J.

**BRASS** Gears and model supplies for the inventors. Send 10c for catalog. Pierce Model Works, Tinley Park, Ill.

**RAILROADERS**—50c Gets new Catalog Reference Manual. State O or HO gauge. Walthers, 247 Erie, Milwaukee 2, Wis.

**STEAM** Locomotives, 1 1/2", 3", 1 1/2", 1 1/4" scales. Castings, parts, rail, steam fittings! Thorough drawings with instructions. Catalog 35c. Little Engines, Lomita, Calif.

**LIONEL** Trains catalog 10c. 36 pages illustrated. Hobby Shop, 72 West Washington, Chicago 2, Illinois.

**SHIP** Models and yacht supplies complete. Large 64 page catalogue 30c. Bill Wild's, 510 East 11 St., New York City 9.

## HOME CRAFTSMEN

**JIGSAW** Owners attention! Start earning money at home cutting out wooden novelties and souvenirs. Write H. Cook, 4407 S. Normal Ave., Chicago 9, Ill.

**LEATHERCRAFTSMEN:** Free catalog listing western belts, handbag designs, leathers, small projects, handbag locks, tools, books, etc. Ester Leather Co., 145 St. Paul St., Rochester 4, New York.

**OZARK** Wood samples. Eleven useful identified varieties. Prepaid \$1.25, check or cash to Davis Lumber, Cabool, Mo.

**90 ALL** New, full size lawn ornament and novelty patterns, up to 20" high, \$1.00. 68 popular plans with necessary full size patterns of toys, novelties, furniture, lawn chairs, garden figures, etc. \$1.00. 16 new lawn chairs, 22 picnic tables, benches, trellises, etc. All 38 plans, with necessary full size patterns, \$1.00. Mastercraft 4M, 7041 Olcott, Chicago 31, Ill.

**LEATHER,** Retail mail orders, catalog, tools, lacing, supplies. National Handicraft Co., 199 Williams St., New York 7, N. Y.

**LEATHERCRAFT** Supplies, leather and tools, low prices. Send 10c for catalog. Jones Handicraft Co., Dept. M-4, 32 Frank-

**OPTICAL** Finishes. Complete, illustrated instructions how to obtain super highly polished surfaces. Wood, metals, plastics. S. H. Greer, 117 E. 60 St., New York 22, N. Y.

**LEATHER** Carving. Fascinating, highly-paid art; age-old secrets now taught for first time in home study course. For hobby, profession or profitable business, write: Baird School of Leather Carving, Box 1367-H, Manitou Springs, Colo.

**ARTIFICIAL** Leaves and flower supplies. Free catalog. Herbert Diamond Co., Box 4619, Miami 31, Florida.

**LEATHERCRAFT** Tools, supplies. Free catalog. Harte's Craft Shop, Holyoke, Colorado.

**SHELLS,** Plastics, findings. Low prices. Catalog 5c. Frances Jones, Box 251, Sarasota, Fla.

**PERSPECTIVE** Charts enable you to sketch your project accurately without previous training. Set of four, 11 x 14, \$1.00. Domesticraft, Russell, Mass.

**ARTIFICIAL** Leather, novelty fabrics. Bind your old books, make toys. Upholster furniture, card tables. Send 10c for samples and list of supplies. Edwin Mayhew, Islington, Mass.

**MAKE** Beautiful plastic bracelets on metal bands, for gifts, church fairs, etc. No tools needed. Kit for making four bracelets, with instructions, prepaid \$1.00. Catalogue 25c. National Craft and Hobby, New Orleans 15, La.

**MING** Trees. Complete kit with beautiful pottery container, \$3.25. Large kit, 4 1/2" Chinese figurine, 14" Manzanita, moss, etc. \$5.50. Instructions and sketches, suggested markets, alone, 50c. Price list materials free. Also wholesale. Ming Craft, Loomis, Calif.

**TURN** Your workshop into cash. Send dime for catalog describing hundreds novel things to make for fun and profit. Craft-plans, 1321-P South Michigan Avenue, Chicago 11.

**LEATHERCRAFT** Bargain list! Francis Byrd, 3406 Montrose Ave., Richmond, Virginia.

**BIGGEST** Values in America. Quality punched wallet kits 80c. R-G polishes. Catalogue 20c. Roy Govan Leathercraft Supplies, 3908 Grove Street, Oakland 9, California.

**FREE** Catalog! Unpainted, painted figurines, lamp bases. M. Katon, 7807—21st Ave., Brooklyn 14, N. Y.

**SWISS** Musical church kit complete \$3.95 postpaid. Piltzecker Swiss Imports, Wood-Ridge, N. J.

**ANYTHING** You want? 4 sources of supply \$1.00. Henry, 2815 Blvd., Jersey City 6, N. J.

**MAKE** Money—Sew Read-Cut baby shoes and aprons at home. Fast, easy. Help supply the demand. Liebig Industries, Beaver Dam 5, Wisconsin.

**TOOLING** Calif. Grade AAA. Eleven colors, \$1.30 per square foot. Money back guarantee. Northwest Leather, 2110 West Juneau Ave., Milwaukee, Wisconsin.

**LUMBER** For home craftsmen. Cut to order. Write Forest Products Company, Box 341, Binghamton, New York.

**BRONZE** Anchor candlesticks. Rough castings only. File, polish and sell them yourself. \$3.25 postpaid, others, circular. Major Foundry Service, 22 Reardon, W. Quincy 69, Mass.

**SWISS** Music movements, finest make, assorted tunes, \$1.90. Direct imports. Helake Company, 233 West 72 Street, New York.

**BANDSAW,** Jigsaw owners, let your machine bring extra profits, fun. Free details. Nu-Art, Dept. B, Box 2235, Boston, Mass.

"**GOLD** Leaf"—A new product. Genuine gold leaf 23K. Easily used as decal. 100 sq. in. Postpaid \$1.00. Craft Service, 337 University Avenue, Rochester 7, New York.

**NEW** 96 Page leather and craft catalog. 1000's of items. Send 10c. Russo Handicraft Supplies, Dept. 4D, 245 South Spring, Los Angeles, California.

**SAVE** \$8.00. Children's rocking horse, Easi-Bild design, all parts ready to assemble, unpainted, \$3.75 prepaid. No c.o.d.'s. Cooler King, 6013A 13th, Brooklyn 19, N. Y.

**CRAFT** Catalog free. "Arctcraft's Little Giant." 6500 items covering several crafts. "Tops in our field." Arctcraft Leather, Dept. PM, 271 12th St., Oakland 7, Calif.

**LAWN** Ornaments. Ready cut patterns, full size, 20 assorted \$1.00 postpaid. Lincoln Craft Studio, Farmington, Conn.

**ILLUSTRATED** Catalog of burs, cutters, stones, polishing supplies, equipment for working metal, wood or carving plastic 50c, credited first order. Any accessory for handgrinders or flexible shaft. Brass sheet, rod, nickel silver, phosphor bronze, for model makers. Gold, silver, amateur jewelers supplies. Catalog and 48 assorted recut dental drills \$2.00, gross \$4.50 postpaid. Schrader Instrument Company, Independence 1, Iowa.

**8 BEAUTIFUL** Full-size whatnot patterns 25c. Joanness, P.O. Box 141-M, Omaha 7, Nebr.

**80 FULL** Sized patterns. Lawn ornaments, toys, novelties \$1.00. Modern Woodcraft, Saginaw, Mich.

**LEATHERCRAFT**, Copper tooling, textile painting. Materials, tools, supplies. Free illustrated catalog. Kit Kraft, 7377 Melrose, Los Angeles 46, California.

**MAKE** Gifts from rare and beautiful Oregon myrtlewood, free price list. Myrtlecraft Studio, Grants Pass, Ore.

**WHOLESALE** Shellcraft Book 15c. Large shellcraft kit \$1.69 postpaid. Shell-Art Novelty, Dept. PM, 5th and Moore, Philadelphia 48, Penna.

**SHELLCRAFT**—Free catalogue and instructions. Complete line shells. Smooth beautiful colors. Findings. Rice's Shellcraft, Dept. B, 114 S. Court, Orlando, Fla.

**LEATHER**, Retail, mail orders, catalog, tools, lacing, supplies. National Handicraft Co., 30 Frankfort St., New York City 7.

**\$46 FROM** Square foot plywood. Jigsaw necessary. Write, Woodarts, C-38, Bridgewater, Mass.

**KNOCKDOWN** Cedar chests. Lumber and veneers. Free price list. Giles & Kendall Company, Huntsville, Ala.

**PROFIT** With Larson Leathercraft. Belts, purses, 100 other ideas. Largest supply in U. S. Catalog 10c. Larson, Dept. C, 824 S. Tripp, Chicago 24.

**JEWELRY** Findings, rhinestones, pearls, sequins, cameos, J & M Novelties, Box 464P, Griffith, Ind.

### MAKE IT YOURSELF

**ROC-WOOD**—Sensational new flooring material laid with trowel on any surface! 90% genuine hardwood fibers. Sand, varnish, paint. Very low-cost home, basement, garage, shop. Roc-Wood, 333 North Michigan Ave., Chicago 1, Illinois.

**FAN** Kits, parts, bargains. Free literature. Rich Fan Manufacturing Co., 2401 San Jacinto, Houston 4, Texas.

**JUST OFF** the press—8-page folder illustrating 6 beautiful, popular lamps you can make: for yourself, for Xmas gifts, or to sell others. It's fun, highly profitable; as hobby, or part or full time basis, 8-page folder, 32-page parts catalog, wholesale price list only 25c; refundable first order. Gearon Company, Dept. 400-B4, 27 South Desplaines, Chicago 6, Ill.

**BUILD** Your own "tractor." Easy plans, instructions. Walking, riding. Farming-gardening books. Send postcard. Free information. Eltraco D-1, Camptonville, California.

**"STONE** House." Build for \$2500. Instructions \$1. Rock Haven Homes, 2708 Granada, San Diego 4, California.

**STEAM** Cleaner. Build your own from our plans. Low cost, easy to build. Steam pressure in 90 seconds. Plans and instructions only \$1.50. Connery Mfg. Co., Adrian, N. Dakota.

**WINDOW** Fans easily built, send \$1.00 for proven plans. "How to build" complete kits at a tremendous saving. Roy's Electric, 7015 Manchester, St. Louis 17, Mo.

**WREN** Houses—Big profits. Patterns \$1.00. Guy Kuns, Greenville, Ohio.

**\$600 BUILDS** Cozy 4 rooms and bath. Concrete block, stuccoed. Instructions and blueprint \$1.00. L. H. Farrow, G83, Box 645, Columbus 16, Ohio.

**FREE** Handbook, build sawmills, block machines, freezers, tractors, scooters, 250 shop, farm, home machines. Nichols Co., Dept. C-601, Purvis, Miss.

**BUILD** Your own work bench, picnic table using electrically welded steel legs. So simple, just apply lumber and it's complete. Literature free. East Moline Metal Products, Department S2, East Moline, Illinois.

**CONCRETE** Septic tanks, no machinery. Sanitary Engineer, 169 Pawtuxet Ave., Providence, Rhode Island.

**GRANDFATHER** Clock easily built. Big savings. See ad on page 275.

**ASSEMBLE** Your own all-aluminum storm windows and save \$12.50 or more on each window! Or build your own aluminum storm window business. Make weekly spare-time profits of \$50 to \$200! For the first time, you can get the precision-built Kay-D all-aluminum combination storm and screen window in handy kit form, custom-cut to any size. Easily assembled—no special tools needed—everything included but glass. No puttying, painting, cutting, drilling, or nailing! Just assemble the most perfect storm window ever designed. Self-storing, perfect-fitting. Write Kay-D Co., 864 Home-wood Ave., Baltimore 2, Maryland.

**OVER 300** Plans and blueprints in Popular Mechanic's big 32 page Plan Catalog. Furniture, boats, trailers, tools, toys, gun rack, home freezer, many more. Send 3c stamp for copy. Popular Mechanics Press, 200 East Ontario Street, Chicago 11, Ill.

**BUILD** A guitar player. Leaves both hands free. Information free. Plans \$1.00. Electric, Box K-103, Salmon, Idaho.

**SAVE 50%-75%** Building your Zeolite home water softener. Details 10c. Carson Products Company, Room 202, Minneapolis 18, Minn.

**BUILD** Your own concrete blockmaker. Easy. Inexpensive. Motor or hand. Make block per minute. Write, C. Lee, Mountain View, Okla.

**SOLAR** Water heater systems efficient any locality. Standard materials, low cost. Free facts. Solar Water Company, Box 175, Coral Gables, Florida.

**"CONCRETE** Block Homes." 32 page booklet on how to build. \$1.00. H. C. Lightfoot, Civil Engineer, Richboro 1, Penna.

### PLANS AND BLUEPRINTS

**MAKE** Own home, farm devices and equipment. Booklet describing plans 25c. Kimo, Box 307J, New York 19.

### SURVEYING INSTRUMENTS

**GUARANTEED** Factory rebuilt transits and levels, sale or rent, with purchase option. We will repair, trade or buy old instruments. Write for list M-04. Warren-Knight Co. (Manufacturers of Surveying Instruments), 136 North 12th St., Philadelphia 7, Penna.

### WATCHES, OLD GOLD, JEWELRY

**WATCHMAKERS'** Tools, materials, sold-bought. Catalogue! Bengal Company, Culver City, California.

**BIG** Money—Learn watch-clock repairing at home. Inquire Modern Technical Supply, 55-PM West 42nd Street, New York 18.

**WANTED** Old gold for cash, or watches, new jewelry. Send old gold, highest prices paid. Reim, 54A, Pana, Ill.

**JEWELRY**, Rosary supplies. Instructive illustrated catalog 10c. Kit \$1.00. Doremby Findings, Chisholm, Maine.

**GOLD**, Highest cash paid—Mail now, old broken jewelry, gold teeth, watches, rings, silverware, diamonds, spectacles. We hold shipment 10 days for your approval of our offer. You must be satisfied. Government licensed. Van Smelting Co., Burlington, Iowa.

**WATCHMAKERS'** Beginners. Watches! Movements! Descriptive price list, 15c. Box 1874, Chicago 90, Illinois.

**GOLD** Plated jewelry supplies—Rhinestones, pearls. Illustrated catalog 10c. Barry's, 47-A Branford Place, Newark 2, N. J.

**HIGHEST** Prices paid for old gold, silver, platinum, diamonds, watches, gold teeth, spectacles. Cash immediately. Goods returned if offer unsatisfactory. Government licensed. United Smelting Works, (The Old Reliable), 39-B South State, Chicago 3.

**DIAMOND** Like zircons; Alexandrites; rubies; others. Fiery sample zircon \$2.00; c.o.d.'s accepted, \$1.00 deposit. Free price list. Imhusex, Box 232, Dept. PM, White Plains, N. Y.

**WATCHMAKERS'** Journal contains helpful hints on watch repairing. Sample

**HIGHEST** Cash paid for old, broken jewelry, gold teeth, watches, silverware, diamonds, spectacles, platinum. Free information. Satisfaction guaranteed. Government licensed. Rose Smelting Company, 29-A East Madison, Chicago.

### TOBACCO, SMOKERS' SUPPLIES

**FREE** Literature. Pipes and pipemakers' supplies. Carvapipe, 2829 Dixie, Hamilton 2, Ohio.

**HANDCARVED** Initial and service club pipes. Free catalogue. M. K. Products, Box 552, Mount Vernon, N. Y.

**EXPERT** Pipe making instructions. Kits, gadgets. Free literature. Buildapipe, PM4, Ivoryton, Conn.

### RAZORS, BLADES, SHARPENING

**100 RAZOR** Blades \$1. Sample. Specialties, Box 1524, Waterbury, Conn.

### FOR THE HOME

**CUCKOO** Clocks, 10" high, directly from importer, \$8.50 postpaid; free catalog. Nes-salc Company, 4 East 41st Street, New York 17, N. Y.

**YOUR** Name, beautifully engraved on a heavy polished brass doorplate, 1 3/4" x 9", postpaid \$2.00. H. V. Ackerman, Malden on Hudson, N. Y.

**PREVENT** Dirty walls. Inquire. Heating Expert, 177 Hill, Detroit 3, Michigan.

**WEATHERSTRIPPING**. Metal, inexpensive. Details and illustration from E-Z-On, 1009 Harvard, Evanston 39, Ill.

**EXOTIC** Cuban gifts for you and friends. Free information. Francisco Odio, 561 Aguiar, Habana, Cuba.

**ASPHALT** Tile—Congowall paint brushes. Wholesale prices. Free catalog. Shriber's, 4316 Butler, Pittsburgh 1, Penna.

**GREATEST** Home invention since electricity. Illustrated literature free. Robert Poarche, 1034-A N.E. Russet St., Portland 11, Oregon.

### OF INTEREST TO WOMEN

**WE** Replate tableware, bracelets, revolvers, etc. Globe Company, Fitzgerald, Ga.

**SWEDISH** Meatballs—None better! Favorite, long-tested recipe, 25c. C. Nelson, 4724 N. Virginia Ave., Chicago 25, Ill.

**EARN** On your kitchen table demonstrating sensational product. Good earnings. Send no money. Styleco, Dept. 93, Cincinnati 10, Ohio.

**OUTDOOR** Toilets, cesspools, septic tanks cleaned, deodorized with amazing new product. Just mix dry powder with water; pour into toilet. Safe, no poisons. Save digging and pumping costs. Postcard brings free details. Burson Laboratories, Dept. P-44, 955 Willard Ct., Chicago 22, Ill.

**1000** WAYS To save time, money, labor. Amazing new book "Short-Cuts to Better Housekeeping." 160 pages packed with ideas every housewife will appreciate. Well illustrated. Only 60c postpaid. Popular Mechanics Press, Dept. 8C, 200 E. Ontario St., Chicago 11, Illinois.

### FOR SALE—MISCELLANEOUS

**FOR** Sale—Small mfg. business of patented farm disc transport. Geisler Bros. Mfg. Co., Nevada, Iowa.

**DRESSES** 18c; Coats \$1.00; blouses 35c. Free catalog. Crown, 164-PA Monroe Street, New York.

**FREE** Catalog! Save money. Surplus clothing bargains. N. Y. Clothing Co., New York 29.

**NEW** White nylon parachute canopies, over 50 square yards, \$13.95 postpaid. 4 panels \$3.95. Write for catalog. Ted Berman Co., Box 926 P.M., Sacramento, Calif.

**WAR** Surplus, aircraft items. Shop equipment, machinery and a million other items. Send 10c for 64 page catalog. Atlas Equipment, 229 Southwest Blvd., Kansas City 8, Mo.

### WANTED—MISCELLANEOUS

**WANTED** Surplus stocks, motors, electric tools, compressors, bench machinery, any kind of equipment. Write General Equipment Co., Box 34, Detroit 21, Mich.

**WANTED**—Scrap mercury (quicksilver), tantalum, bismuth, tungsten, Metallurgi-

## PERSONAL

**BORROW** By mail. Loans \$50 to \$300 to employed men and women. Easy, quick. Completely confidential. No endorsers. Repay in convenient monthly payments. Details free in plain envelope. Give occupation. State Finance Co., 210 State Finance Bldg., Dept. G-14, Des Moines 8, Iowa.

**"INTERESTING Mails"**—25c keeps name on mailing list three months. Bentz, Jr., Desk B/12, Chatawa, Mississippi.

**LOANS** By mail. \$50 to \$300. Quick easy, confidential to employed men and women. No endorsers. Easy monthly payments. Write for free information sent in plain envelope. Postal Finance Co., Dept. 45-B, Sioux City, Iowa.

**PERSONAL Success.** Golden booklet plus charming photo cards, 30c. Booklet plus 7 extremely interesting outdoor pictures \$1. Circulars. Mailaddress service free. Bersil, 436 New York Ave., Brooklyn 25, N. Y.

**JOIN** The California Tie of the Month Club and wear the most terrific ties in the country. Ties are \$2.50 values and are yours for \$1.35. For full particulars write, California Tie of the Month Club, Box 429, Culver City, California.

**MAILADDRESS Service.** Novelties, free sample. Bersil, 436 New York Ave., Brooklyn 25, N. Y.

**FREE Gift and gadget folder.** Useful articles. Send postcard, name and address. Perks, 226A Murdock, Baltimore 12, Maryland.

**WIN Friends and influence** with "Harrison's Better Memory." Write Harrison's, 726H North Fifteenth, Waco, Texas.

**MEXICAN Mailing service.** Your letters remailed, received 20c. Mystify friends. Photographic postcards 10c. Tillotson, Apartado 1405, Guadalupe, Jalisco, Mex.

**MEXICAN Law.** General Practice Attorney, 1203 Arizona Street, El Paso, Tex.

**"HOW Can I find out?"** You can! Information discreetly developed. Any matter, person, problem, anywhere. Worldwide. Officially licensed, bonded service. Established 1922. Reasonable. Confidential. William Herman, 170 Broadway, New York.

**PENMANSHIP Corrector!** Improves your penmanship in 3 hours. Proof free. Ozment 9, St. Louis, Mo.

## MISCELLANEOUS

**ALL-PLASTIC Safety goggles,** formerly \$2.00, closing at \$1.00 each, postpaid. Features snap-in lens and adjustable plastic headband. Money back guarantee. No c.o.d. Write Standard Safety, 232 W. Ontario, Chicago 10, Ill.

**ELECTRIC Shavers repaired.** One day service. Trade-in allowance. Write for details. Shoppers Shaver Service, 426 State, Madison 3, Wisconsin.

**RECEIVE Interesting mail and beautiful post cards from Mexico.** Absolutely free. Send name and address. Letters received, forward service 25c. Universal Distributing, Apartado 10510, Mexico City.

**PANNING Gold—Beginners booklet** 36 pages; catalogue, supplies, mining books, maps "where to go." 25c. Old Prospector, B-306 Dutch Flat, Calif.

**"WATERLESS (Lanolin) Hand Cleaner."** (Oil base.) Make, sell. No machinery. Build profitable business. Complete formula \$1.00. Ideal Service, Park Ridge 3, Ill.

**SENSATIONAL New line of Geiger counters** for uranium detection. All types, all prices. No finer selection. Also new gold, silver and mineral detector available. Complete information free. Detectron Co., 5637 Cahuenga, Dept. B-4, North Hollywood, California.

**DUCT-Pipe fittings!** Submit sketch, specify metal. Quotations free! Franklyn Jacobson, 78-25 Metropolitan Ave., Middle Village, New York.

**AMAZING New shampoo—Keeps scalp clean.** Checks dandruff. Beautifies hair. Whirlwind seller. Great repeater. Write quick. Louis Cox, 1202 Highland, Lexington, Mo.

**TRAVEL Free throughout world** in post-war Merchant Marine. Vacation or exciting career. Salaries high. Men. Women. 1950 guide tells how. Only \$3. American Seamans Guide, 545 Fifth Avenue, New York City.

**RAZOR, Newest 50c.** Free premium. Philips, 1468 Montpelier, Baltimore 18, Md.

**SEEK Uranium, minerals, buried treasure!** Free literature describing latest low cost, super-sensitive equipment. Glen Scientific, Box 151-B, Glen Ellyn, Illinois.

**"MYSTIFY Friends"**—Connecticut postmark. Letters remailed. 25c each. Kent, 5 Forest Street, Norwalk.

**HAND Laced wallets.** Unborn calfskin (with hair on) \$8.50 each. Raymond Kinsey, Route 1, Buford, Georgia.

**SAVE Money on paint brushes.** Buy direct. Post card brings descriptions and prices. Kenmore Brushes, P.O. Box 53, Kenmore 17, N. Y.

**DRAFTING Supplies catalog** 20c. Loonin, 3001 West First, Brooklyn 24, N. Y.

**LOST Car keys cause great expense.** Hide-A-Key holds 3 keys. Lifetime magnetic case attaches to any metal surface on car, bumper, grill, frame. Will not jar loose. Send \$1.00 to Benedix, 124 North H. St., Madera, Calif.

**GENUINE Buckskin coin purse and illustrated buckskin catalogue** both for only 15c. Berman Buckskin Co., 227 N. 1st, Minneapolis, Minn.

**INFORMATION.** Any subject. The Roxbys, 747 S. New Hampshire, Los Angeles 5.

**VERMONT Maple syrup and sugar,** new crop, 100% pure, list. H. Marshall, Poulney, Vt.

**FLOCKED, Nursery wall plaques,** gay colors, \$1.00 ea. Postpaid. Vel-Tex, Wausau, Wis.

**WHERE To buy most anything.** We furnish supply sources. Single item, 25c, 5 for \$1.00. Service Bureau, 2624-M N. Albany, Chicago 47, Ill.

**ALUMINUM Nails—Never stain, never rust.** All sizes. Large assortment \$1.00. W. W. Sales, 503 Deming C-1, Chicago, Ill.

**TREASURE, Mineral locators.** Goldak now offers treasure locators for \$75.00. Geiger counters reduced to \$95.00. Write the Goldak Co., 1541 West Glenoaks Blvd., Glendale 1, Calif.

**DO Your own paperhanging—120 illustrations** shows all. Book \$1.50. Details free. Gilton Books, Box 4638, Philadelphia 27, Penna.

**URANIUM Locator.** \$10,000 government reward, a guaranteed market and profitable prices are yours for the discovery of uranium. Easy to detect with the Keleket "Prospector." Simple to operate. This durable, 2 lb. prospecting instrument costs less, is made by company famous for 50 years. Complete with headphones. Price \$48.50. F.O.B. factory. (Dealers: Write for excellent proposition and open territories.) The Kelley-Koett Instrument Division, 22 East 6th Street, Covington, Ky.

**METAL Craft.** Sensational, colorful finish, copper. Easy. Instructions \$1.00 cash, m.o. Rt. 3, Box 135, Orland, Calif.

**SAVE—Make money, buy everything wholesale.** Free information. Orysen, 1147 Sunkist, Waukesha, Wisconsin.

**SMALL Mailing cartons, shipping labels,** postal scales. List. Fountainhead, 1049 Bluff Street, Beloit, Wisconsin.

**YOUR Leather jacket renovated** by our craftsmen expertly, reasonably. Request free descriptive circular No. 8. Berlew Mfg. Co., Freeport, N. Y.

**IMPROVED Hybrid popcorn,** 4 lbs. \$1.00 p.p. Lee Feil, Riverton, Iowa.

**FREE—Amazing new book, "How to Answer Ads."** Never before have you seen anything like this. Tells you in simple language the correct way to answer ads. Gets you quicker replies—better results, and greater satisfaction. Will save you time and money and it's absolutely free. No obligation whatever. Every reader of advertising should have this booklet. Send a postcard for your copy now. F. W. Johnson, (Room 600), 200 East Ontario Street, Chicago 11, Ill.

**URANIUM Prospecting equipment.** New, improved Geiger counters, \$48.50 to \$125. Scintilliscopes \$5.95. Mineralights from \$12.50. Complete with accessories and radioactive specimens. Prepaid. Improved metal detectors for gold and silver, from \$128.50. Western Radiation Laboratory, 1107 West 24th Street, Los Angeles 7, Calif.

**TREASURE—Mineral locators—Geiger counters M-scope type for arctic-tropic use.** Unsurpassed in efficiency. Factory guarantee. Lowest prices. Can be purchased on monthly payment plan. Free literature. Fisher Research Lab., Inc., Palo Alto, Calif.

**LUMINOUS Reflective paints glow day and night in technicolor!** New angle money-maker. Assorted color samples 25c. Research, 1842-PM Byron, Chicago 13.

**GEIGER Counter plans plus prospecting manual** \$1.00. Satisfaction or refund. Box 486, Detroit 31, Michigan.

**SQUARE Dance instructions.** 40 dances, \$1.00. Wesley Rader, 1922 Grant, Denver, Colorado.

**"RECEIVE Mail,"** Moneymaking offers, opportunities, catalogs. Name listed 10c. Ideal Service, Park Ridge 10, Ill.

**70 BIBLE Lessons,** 25c. Bulletin, Box 87, Cathedral Station, New York 25.

**TATTOOING Outfits, supplies.** Illustrated list free. Zeis, 728 Lesley, Rockford, Illinois.

**TATTOOING Machines, outfits.** Free catalogue. Jensen, 120 West 83rd Street, Los Angeles 3.

## NEW! BIG FIELD FOR PROFIT AND PLEASURE COPPER TOOLING & ETCHING

**EARN BIG MONEY—SPARE OR FULL TIME**  
No experience needed—start at once. BIG MONEY waiting in COPPER ART field. Plaques, Bowls, Trays, Gifts, Souvenirs of all kinds. Start on the road to success NOW! Here is an opportunity to get started in your own Big Paying Business—FREE DETAILS don't wait—WRITE NOW!  
**Hollywood Copper Art Studios**  
4257 Beverly Blvd., Dept. PM-4, Los Angeles 4, Calif.

## ELECTRICAL TRAINING

Intensive 32 weeks' residence course in fundamentals of industrial electrical engineering, including radio, electronics. Prepares for technician, engineering aides. Approved for veteran training. 57th year. Enter September 5. Catalog.

**BLISS ELECTRICAL SCHOOL**  
7630 TAKOMA AVENUE  
WASHINGTON 12, D. C.

## IS YOUR JOB DEPRESSION PROOF?

Can you lose employment because of depression, business failure or old age? Learn watchmaking, the mechanical profession called "depression-proof for trained men" by impartial national authorities. Old age brings increased respect rather than insecurity. Study veteran training approved courses in watch and clock repair, jewelry engraving, chronograph repair at the world's largest, best-equipped watchmaking school.

SEND FOR FREE 116-PAGE INFORMATION PACKET

**WESTERN PENNSYLVANIA HOROLOGICAL INSTITUTE**  
WORLD'S LARGEST WATCHMAKING SCHOOL  
Desk 40, Chamber of Commerce Bldg., Pittsburgh, Pa.  
SAY YOU SAW IT IN POPULAR MECHANICS



# Have YOUR OWN BUSINESS

This New Easy Way

## Make Big Profits with Magic Liquid Plastic

STRIKES, LAY-OFFS, having to deal with Pinch-Penny Bosses—these things often hit some of us mighty hard. But there may be a way out for you like many others. Here's your chance to see about having a business of your own. Instead of "having all your eggs in one basket," get going on a SECOND source of income. Begin at home in spare time. Make swell things with Castolite, new, magic liquid plastic. Profits run 300% to 700% above material cost. Make \$3.00 to \$5.00 an hour in your extra time. Exciting, interesting, different. Embed real flowers, photos, shells, butterflies, coins, medals, to make distinctive costume jewelry pieces, hi-style buttons, coasters, baby shoe sets, wall plaques, book ends, lamp-bases, desk accessories—other things that **SELL ON SIGHT**.

### Quits Job — Now Has Own Business

Pat Queen, Mt. Vernon, Wash., quit his job and started making key chain tags (like one shown here). Queen writes: "My key chains have sold fast right from the beginning. I now make several times as much as when I had a job." Others also succeeding far better than they expected. Start small. Grow big. Use your home as headquarters. Proved Success Methods bring business fast. Use only home tools. Big, new 32-page book shows how to make things; how to sell at handsome profit. Send 25c today for your copy of "A Way to Success."

**THE CASTOLITE CO.**  
Dept. D-1, Woodstock, Ill.



Real pansy embedded in Castolite



Real Ocean Crab embedded in Castolite



Child photo embedded in Castolite



Baby Shoe Set made of Castolite

## BE A NOTARY PUBLIC

Old legal-supply house, 22 cities, helps you get appointment by governor if you qualify, equips you fully. Pay after appointment (2 payments \$12.50 each). Respected public office. You certify legal papers, use official seal made with your name, collect your fees. Easy, Inquire—**STATIONERS EXCHANGE** **HELOTES, TEXAS**

## LEARN BY MAIL THIS UNIQUE, EASY WAY.

You don't have to be talented. NINE PROFESSIONALS teach you sure-fire tricks of the trade — BY MAIL. Have fun drawing your friends, and make money, too — in your spare time! Better than conversation for winning new friends and putting across ideas. Costs less per lesson than price of a good movie—and lots more fun. 45 easy-to-do lessons. **VETERAN APPROVED.**

Write for free sample lesson

**DRAWING PEOPLE IS FUN... and profitable**



**THE PROFESSIONAL SCHOOL OF CARTOONING, INC.**  
Dept. P, 505 Fifth Avenue, New York 17, N. Y.



## NOW YOU CAN SHAVE IN YOUR CAR!

**Car Shaver Motor**— Use your electric shaver in your car! Dynamotor will supply 110-120 Volt DC approx. 15 Watt current from 6 Volt DC auto battery and will operate most types of AC-DC Shavers. Also has many other uses, such as operating small 3 way portable radios in car, etc. Used by Gov't. to supply voltage to radio equipment. **ORDER NO. PM-4250** **\$2.00**

Send Remittance with Order • Shipping Charges C.O.D.

## FAIR RADIO SALES

132 SOUTH MAIN ST.

LIMA, OHIO

## YOU say you want more for your money!

See Marlin's 80th Anniversary big-value .22 cal. repeating rifles. 8-shot clip magazine only \$22.30\*; 18-25 tubular magazine \$27.15\*; 15-shot automatic \$29.95\*. They're marvels of modern production methods—sturdy, safe, dependable. New, illustrated catalog **YOURS ON REQUEST**. Send 3¢ stamp to cover postage, handling. \*Slightly higher west of Rockies.

**THE MARLIN FIREARMS CO., Dept. 61, New Haven, Conn.**



## G. I. DIVERS!

**DON'T LET YOUR TRAINING GO TO WASTE. COMMERCIAL DIVERS EARN UP TO \$80 A DAY.**

In your spare time you can do odd jobs—clean pools or tanks, retrieve golf balls or outboard motors, locate sunken boats, etc. Very **LOW COST** complete Gov't surplus **EQUIPMENT** available—either deep water or shallow water. Catalog 15c on request.

Other marine surplus — sextants, barographs, bells, life preservers, M & T barge units, anchors, etc.

**M & E MARINE SUPPLY CO.** P. O. BOX 601-Y  
CAMDEN, NEW JERSEY

## LOCKSMITHING & Key Making



**PRACTICAL UP-TO-DATE COURSE—ONLY \$3.95**

Easy-to-learn modern information for self-instruction. How to work on locks, de-code, make master-keys, repair, install, service, etc. For every handyman, home owner, carpenter, mechanic, service station operator, fix-it shop, hardware dealer, gunsmith. 53 plain illustrated lessons. **FULL PRICE ONLY \$3.95. SEND NO MONEY.** We'll ship postpaid. Satisfaction guaranteed or refund. **NELSON-HALL CO., 1139 S. Wabash Ave., Dept. D-2, Chicago 5, Ill.**

## 2-WAY COMMUNICATION SYSTEM



**NO Electricity!**

**NO Batteries!**

Self Generated  
Utility Telephone

**\$20 VALUE only**

**6.95**  
postpaid

High fidelity communication system that is as clear and sharp as your telephone—and costs nothing to maintain. Works on a "Sound Power" principle successfully used by the Armed Forces. Now use this new development on farm, home, factory and office. No electricity or batteries needed. Only \$6.95 a set, including 50 Ft. wire. Two sets for \$11.95.

Remit cash or M.O. We pay postage. Sent C.O.D. plus postal charges, if preferred.

**LECTRO MAX, 15 S. First St., GENEVA, ILL.**



# YOU CAN'T LOSE!

## HAVE A PROFIT MAKING BUSINESS OF YOUR OWN

NATIONALLY  
ADVERTISED  
PRODUCTS

NO  
EXPERIENCE  
NECESSARY

NO  
MONEY  
TO  
INVEST

FREE  
SAMPLE  
OUTFITS

FULL  
OR  
PART  
TIME

### A LIFETIME FUTURE

Man or woman—young or old, YOU can earn a steady income in full or spare time as an independent Kendex dealer. Amazing and almost "impossible" earnings can become a reality for you. Herbert Armstrong of Tenn. earned \$202 in 9 days. C. O. Watkins of Oregon sent 92 orders in one day. You have the same opportunity to duplicate these exceptional earnings. Over one million dollars will be earned in 1950 by Kendex dealers—why not let us establish you in your own business and get a share of these wonderful earnings?

### KENDEX NYLONS REPLACED FREE . . .

if they run or snag within guarantee period up to three months! Impossible? It's true! No matter what the cause—hard use or deliberate abuse—whether it is fault of the hose or the wearer—Kendex nylons are replaced FREE if they run, snag or become unfit for wear within the guarantee period. How could any woman resist a positive guarantee of satisfaction when she can obtain it without paying any more than other standard advertised brands? Kendex nylons are NOT sold in stores, so you have no competition. Complete line includes everything from heavy 70 denier service weight to gossamer luxurious ultra sheer 15 denier 60 gauge. Proportioned sizes and lengths. Latest colors plus white.

### LINGERIE - ROBES - HOUSECOATS - MEN'S HOSE

In addition to the sensational Kendex nylons, you will have a complete line of glamorous lingerie, beautiful robes and housecoats plus a complete line of Kentcraft mens' hosiery guaranteed for one full year. Any pair or pairs of men's hose that does not give satisfactory wear within one year of purchase will be replaced FREE!

### NATIONALLY ADVERTISED

Kendex will spend over \$350,000.00 in 1950 to tell millions of readers of the advantages in buying from you. Almost every issue of Good Housekeeping, Saturday Evening Post, McCall's, Women's Home Companion and Ladies' Home Journal carry our advertising in addition to many others. Kendex has advertised in Life, Look, Collier's, etc. Awarded Good Housekeeping Seal. Thousands of orders are shipped daily from coast to coast.

### EVERYTHING GIVEN FREE

Risk nothing! Mail coupon and we will send you, free and prepaid, complete money-making outfits including sample nylon stocking, samples of lingerie, robes, housecoats and men's hose fabrics and everything you need to immediately start making money. Complete outfits become your property even if you don't send any business. Simply write orders, we deliver and collect. Advance cash plus huge bonus. No money or experience needed. Mailing the coupon is all you need to start on the road to a 52-weeks-of-the-year high paying business of your own. You have everything to gain and nothing to lose.

**FREE  
NYLON  
STOCKING**

**KENDEX COMPANY, BABYLON, 646, N.Y.**



### FOUR MONEY-MAKING LINES

- WOMEN'S NYLON HOSIERY
- GLAMOROUS LINGERIE
- HOUSECOATS - ROBES
- MEN'S HOSIERY

MAIL  
TODAY

NOTHING  
TO  
PAY

NO  
OBLIGATION

**KENDEX COMPANY  
BABYLON 646, N.Y.**

Date \_\_\_\_\_ 1950

Send me, free and prepaid, everything I need to make money as a Kendex dealer, including sample stocking etc. There is nothing for me to pay now or later and I am under no obligation in accepting your money-making outfits.

Name \_\_\_\_\_

Address \_\_\_\_\_

City \_\_\_\_\_ State \_\_\_\_\_



## NOW— MAKE YOUR HOME EASY TO FIND AT NIGHT!

Why risk missing important callers or deliveries because others may not be able to find your home after dark. Be first in your neighborhood to install Illum-Addrex, the handsome sensational new house number that shines day and night for less than a penny a week. Dresses up any home... Soft glow aids you in finding keys.

Illum-Addrex is made of sparkling but tough weather proof translucent plexiglass molding. Light from within illuminates ebony black numbers. Electric bulb, type known to have shined continuously for two years, easily replaceable. Connects to doorbell system. Over all dimensions 9 3/4" x 4 1/4" x 2".

### INSTALL **ILLUM-ADDREX**

**SENSATIONAL NEW ILLUMINATED  
NUMBERS—SHINES DAY & NITE**

**ORDER NOW.** Take advantage of special introductory price. Simply send name & address, along with \$4.95 remittance. We pay postage. Satisfaction guaranteed.

**WANTED—Agents.** Big profits showing Illum-Addrex. Many uses. Help make your city safer. Write for FREE Agents Plan.

**ONLY  
\$4.95**

**SPECIAL — MAKE YOUR OWN ILLUM-ADDREX**

Assemble Illum-Addrex yourself and save. Kit, complete, only \$3.45 postpaid. No special skill needed. Everything provided.

### LAKE ILLUM-ADDREX CO.

995 ORCHARD AVENUE

SAINT PAUL, MINNESOTA



## Your BLUEPRINT FOR PROFIT

**NELS IRWIN**  
Will help you start your own successful, lifetime business.

**BIG PROFITS**  
Rich profits are waiting to be tapped in this new field. New MIRACLE Finish gives a velvety, luxurious surface to radios, lamps, toys, store displays, figurines, auto dashboards, and hundreds of other items. Make old objects beautiful and salable—make new things worth much more with this soft, rich covering that can be applied to any surface, even if old and worn.

**START RIGHT AWAY**  
Yes, you can learn in a few days to start MAKING MONEY! Everything you need is furnished including fully detailed, illustrated instructions that are complete and easy to understand. Every point is explained, to show you how to start on the road to big money, full or spare time, right in your own home.

**EVERYTHING COMPLETE**  
In addition to full instructions you get a complete set of materials that enables you to start at once. A few cents worth of materials can mean many dollars in return to you—you can earn up to \$5 per hour and more spare or full time. Add to your income from your present job or start a profitable business of your own. Our Business is Booming. Help us fill HUGE DEMAND.

**ACT NOW**  
Grasp this opportunity TODAY—Start your own business. It's too good to miss! SEND NO MONEY—fill out the coupon and stick it on a post card or in an envelope and mail today for full details. FREE samples of FLOK-KRAFT covered material and hundreds of useful and profitable IDEAS. Do it NOW—be first!

**COVERS WOOD, FABRIC, METAL, GLASS, PLASTER, PLASTIC OR ANY SURFACE**

**USE COUPON FOR FREE SAMPLE**  
COAST INDUSTRIES Dept. 24  
1004 S. Los Angeles St., Los Angeles 15, Calif.  
Gentlemen, Please rush me all the details.

**FREE!**  
**A PLAN FOR  
YOUR  
SUCCESS**







**FLOK-KRAFT**

NAME \_\_\_\_\_  
STREET \_\_\_\_\_  
CITY \_\_\_\_\_ STATE \_\_\_\_\_

## "ROCKET PERFORMANCE" FOR ANY CAR with "Vapojet"

The revolutionary new VAPOJET is designed on the war developed principle of water injection which was so effective in increasing the speed, power and improving the efficiency and range of our fighter aircraft. Ideal for use on all cars especially those with HIGH COMPRESSION engines. Thousands of VAPOJETS are now in use and some users who write claim faster pick-up, smoother running power and BIG mileage increases on regular gas... a double saving. Complete, easily installed kit fits all cars, tractors, stationary engines. 30 day money back GUARANTEE.



U.S. Patent 2,188,175

**AGENTS WANTED**

VAPOJET MFG. CO. 11424 Biona Dr., Dept. PM-4  
Los Angeles 34, California

Designed To Help Your Car Attain

- More Power
- More Speed
- More Mileage

By Reducing Carbon Engine Wear

**ORDER TODAY only \$9.95** post paid.

Send check or money order and save postage. \$1 deposit on C.O.D. List car, year, and no. of cylinders.

## TENTS & CAMPING EQUIPMENT

New Tents: 2-man mountain style, nylon \$15.95; canvas \$11.95. 5 x 7 wall \$10.95; 7 x 7 \$12.50. War Surplus, used, recon. ditioned: Pup tents, single flap \$2.95; double flap \$3.95. 9 x 9 wall \$21.95; 16 x 16 \$32.95. Poles & Stakes included.

Check or M.O. Money Back Guarantee. Free Tent & Camping Catalog

**MOR-SAN-SALES** 10-19 E 50th AVENUE  
LONG ISLAND CITY 1, N. Y.



## Learn to Write at Home in spare time

YOU can easily, quickly improve your Business Writing and become an Expert Penman in both Business & Ornamental Writing, etc., by my Simplified Method for YOUR PLEASURE & PROFIT. Write today for my FREE BOOK, "How to Become an Expert Penman." Tells about my Simplified Method. Shows photos of what others learned My Way. If you enclose 40c, I'll write your name with a flourished bird on a card—and include a Shading Penpoint.

**WRITE TODAY**

Box 25K, CHILLICOTHE, Mo.

## Salesmen

### WONDER RAT BOARDS

Sales agents are wanted to earn good money selling WONDER RAT BOARDS. This is a new-type trap which catches rats and mice like flies are caught on flypaper. No poisons—safe anywhere. No disagreeable odors. Agents price \$5.00 per dozen; retails \$9.00 per dozen.

Write today for free information on all territories.

**STAR EXTERMINATING CO., 2958 Nostrand Avenue, Brooklyn 29, New York**

## Learn Upholstering

**A MONEY-MAKING VOCATION OR A BUSINESS OF YOUR OWN**

Practical home training. You get materials to make and upholster a fine Ottoman with your lessons. Professional upholsterer's tools available. Write today for free, illustrated booklet.

**WEST COAST UNIVERSITY, Extension Dept. PM-40**  
1601 S. Western Ave. Los Angeles 6, Calif.

## 10 BALL POINT PENS for \$1

Cheaper Than Refills. Good Quality. Long Lasting. Assorted Colors. Regular Size. REMIT TO

**ARTHUR LEE CO., Dept. M**  
16 Court St., Brooklyn 2, N. Y.

## Learn CRIME Detection!

Learn Scientific Criminology AT HOME. Opportunities in Investigation and Detective work—Identification—Finger Printing—Homicide Investigation—Infrared Photography—Photo-micrography for law enforcement. Send for FREE Book.

Institute of Scientific Criminology  
310 So. Robertson Blvd., Los Angeles 48, Calif., Dept. PM-4

Name \_\_\_\_\_ Age \_\_\_\_\_  
Address \_\_\_\_\_

**GOLD BOND**



**WHOLESALE GUARANTEED  
EXCEPTIONALLY GOOD  
USED TIRES DIRECT TO YOU**

10% discount on 2 or more tires if you send this ad with order

**TUBE DELIVERED WITH TIRE AT NO EXTRA COST FOR 15" AND 16" PASSENGER TIRES**

Safe — Our tires used on school buses and ambulances

**EXCEPTIONALLY GOOD TREAD — NO RECAPS  
GUARANTEED FOR 24 MONTHS**

600-16	\$5.49	700-16	\$6.79	525-18	\$6.69	750-20(10)	\$15.98
600-16 (6 ply)	6.49	650-15	5.79	600-20	9.89	825-20	16.98
650-16	5.49	700-15	5.79	650-20	9.98	900-20	17.79
650-16 (8 ply)	6.79	550-17	7.79	750-16	12.50	1000-20	18.29
600-16—6 ply Military—Mud and Snow Tire.....							\$6.37

**ALL GOOD TIRES  
GUARANTEED FOR 12 MONTHS**

600-16	\$3.59	550-17	\$5.69	700-20(8)	\$9.29	825-15(14)	\$14.98
650-16	3.89	750-16	8.40	700-20(10)	12.48	825-20	11.19
650-15	3.89	600-20	7.98	750-20(8)	11.79	900-20	11.89
700-15	3.98	650-20	7.99	750-15(10)	11.97	1000-20	12.89

**GOLD BOND SPECIAL — 750-20 MILITARY TIRES**

Will fit 650 x 20    700 x 20 (8 & 10 ply)    34 x 7 (8 & 10 ply)

Special	\$10.49	Guaranteed 12 months	
Superior Quality	12.98	Guaranteed 18 months	
Gold Bond Finest	14.98	Guaranteed 24 months	
900 x 16 Special	9.03	900 x 16 extra	11.19

Send check or money order with this ad

**GOLD BOND TIRE CO., Dept. PM 24**  
512 NORTH 1ST ST., RICHMOND, VA.  
"A gold bond written guarantee with every tire"

**RUBBER HOSE SALE**



Brand new genuine Neoprene Hose—outlasts ordinary rubber 3 to 1. Reinforced with super tough cotton cord plies. Flexible, easy to handle. Easy Flo brass couplings with standard pipe threads for quick connections, included.

Pump water for irrigation, stock, tanks, home, barn, fire fighting, etc.

(Inside Diam.) 1 1/4 in. 1 3/4 in. 1 1/2 in.

Length	25 ft.	40 ft.	30 ft.
Price	\$8.75	13.75	13.75

**TERRIFIC VALUES!**

If specified we will send special hose for gas or oil at same prices. All prices f.o.b. Chicago area. Satisfaction guaranteed. Send check or money order.

**AIR HOSE, 1/4" I. Diam.** heavy duty double braid suitable for gas stations, spray painting, air-tools, etc. 20 ft. with swivel couplings and tire chuck, Reg. \$6.50 val.—special only \$2.75 f.o.b.

**MASTER MECHANIC CO., Dept. 23, BURLINGTON, WIS.**

SAY YOU SAW IT IN POPULAR MECHANICS

**BUILD YOUR OWN  
GEIGER COUNTER!**

And SAVE 2/3 of Cost!

NO special knowledge necessary!  
You need NO additional parts!

It's EASY to build your own Searchmaster Geiger Counter with this COMPLETE kit. Contains everything you need! Headset, tubes, geiger-counter tube, batteries, plus smart metal case 9 1/2" x 4" x 3 1/2". All parts laboratory tested! Sensitive to both beta and gamma radiation! Fully guaranteed! Illus. instructions show you how to assemble parts quickly.

**SPECIAL FREE OFFER!**

Radioactive specimen sent FREE with each order. Plus FREE literature, showing you how to locate uranium with your Geiger Counter and win \$10,000!

Write for details or order your Searchmaster Geiger Counter Kit now! Postage prepaid with check or money order. C.O.D. orders, send \$5, bal. on arrival.

only \$29.95

**SCIENCE KITS LTD.**  
5514-P Hollywood Blvd.    Hollywood 28, Calif.

Superior to many Counters selling for MORE than \$100!



COMPLETE KIT \$29.95

**KIT COMES COMPLETE  
Nothing Else to Buy!**

Easy-to-follow instructions  
Come with each Searchmaster Kit

Kit guaranteed to operate perfectly when assembled per instructions!

**YOU CAN DRAW!**

You've dreamed of owning books like these... don't deny yourself this opportunity!

**THEY'RE APPROVED!**

Yes, both the Calif. State Board of Education and the Veterans Admin. have approved these same books as A CORRESPONDENCE COURSE THAT SOLD FOR \$200.00 (with supplies and lesson correction which are not now included) which definitely proves their value. Now these books are available to you in their entirety just as originally approved.

Compare this value with anything you've ever seen! Now is your chance of a lifetime as we have brought the cost of this nationally famous art course, including all 15 books and study assignments (ALL 90 LESSONS) down to such a low, low price that every man, woman and child can now afford to satisfy their desire to learn to draw. Whether to learn so as to enter this high paying profession or just to "dabble a bit," the ease by which you can learn to draw from these self-teaching books will amaze you! Think of it... now at last a complete commercial art course can be yours at a price you can afford to pay!



The only approved art course selling at popular prices!  
Why pay more?

- Basic Drawing
- Shades & Shadows
- Wash Drawing
- Elementary Perspective
- Advanced Perspective
- Figure Drawing Anatomy
- Anatomical Surface Planes
- Construction of Lettering
- Finished Lettering
- Figure Drawing
- Layout
- Design & Color
- Photos From Life
- Studio Hints
- Illustration & Cartoons

**15 ART BOOKS - PLUS - 90 STUDY LESSONS!**

**BOOK-A-MONTH PLAN** Here is an opportunity to obtain a complete art course for only \$1.00 A MONTH. Now no one can deny himself an art education. We will send you the first book immediately and then on the first of each following month the next book will be sent you C.O.D. until you have received all 15 books. Lessons are included with each book.

**WRITE TODAY!** Please send me at once in accordance with your special offer:

All 15 books and the 90 lessons, \$12.95 sent postpaid.

A Book-A-Month until I have received a complete set of all 15 books and the 90 lessons. Total price \$15.00.

Please send postpaid—payment of \$\_\_\_\_\_ is enclosed.  
Calif. residents add sales tax.

Please send C.O.D. (Charges are to be paid by me.) Payment must be enclosed with all foreign orders.

**ONLY \$12.95**

For a complete Commercial Art Course

**HOLLYWOOD SCHOOL OF ART**  
6533 Hollywood Blvd., Hollywood 28, Calif.

NAME \_\_\_\_\_  
ADDRESS \_\_\_\_\_  
CITY \_\_\_\_\_ ZONE \_\_\_\_\_ STATE \_\_\_\_\_



# Learn A Trade NOW! PRACTICAL SHOP TRAINING!

## In Our Chicago Shops

- |   |  |
|---|--|
| <input type="checkbox"/> AUTO MECHANICS   | <input type="checkbox"/> WELDING—ARC and GAS |
| <input type="checkbox"/> DIESEL MECHANICS | <input type="checkbox"/> MACHINIST           |
| <input type="checkbox"/> REFRIGERATION    | <input type="checkbox"/> PIANO TUNING        |
| <input type="checkbox"/> BODY-FENDER      |  |

Above Approved For G. I.'s and Civilians  
One of America's Leading Practical Schools  
7 Floors of Fully Equipped Shops  
Over 48,000 Successful Graduates  
Expert Individual Instruction  
Learn by Doing—Low Living Expense  
Established 1902—Day and Evening Classes

## Also the following Home Study Courses

- |                                  |  |                                 |
|----------------------------------|--|---------------------------------|
| <input type="checkbox"/> PLASTIC | <input type="checkbox"/> REFRIGERATION | <input type="checkbox"/> DIESEL |
|----------------------------------|--|---------------------------------|

—CALL IN PERSON OR MAIL THIS AD TO—

## GREER SHOP TRAINING

(Desk 16) 460 South State St., Chicago 5, Ill.

Please send without obligation free information regarding trade checked above. (Specify whether you are a Veteran  or Civilian )

Name \_\_\_\_\_ Age \_\_\_\_\_  
Address \_\_\_\_\_  
City \_\_\_\_\_ State \_\_\_\_\_

# YOU ARE IN DEMAND IF YOU CAN DRAW!



If you like to sketch, write for FREE TALENT TEST. Splendid opportunities for trained artists. Find out if you have talent worth developing.



## ART INSTRUCTION, INC.

Dept. 4130 • Minneapolis 15, Minnesota

Send me your FREE Talent Test.

Name \_\_\_\_\_ Age \_\_\_\_\_  
Address \_\_\_\_\_  
City \_\_\_\_\_ Zone \_\_\_\_\_  
County \_\_\_\_\_ State \_\_\_\_\_  
Occupation \_\_\_\_\_ Phone \_\_\_\_\_

# BUILD THIS HOUSE Yourself



## The Famous Popular Mechanics House

The picture below is from an actual photograph of the Build-It-Yourself House with breezeway and garage, as built by Jack Brownson, 23-year-old veteran, in Aurora, Illinois.

Designed by Popular Mechanics and Famous Architects. Every Detail Simplified and Explained. No Previous Experience Needed!

Can you use everyday tools as well as the average Popular Mechanics reader? Then you, too, can easily build this modern house in any of its five designs, doing every part of the job yourself. The new Popular Mechanics Book, "Your Home—How to Build It Yourself" will show you how.

### Space for Living and Family Growth

This beautiful, modern house is 1½ stories, with basement, living room, kitchen, dining nook, two bedrooms, bath, plenty of closets and space for two additional bedrooms on second floor. The house itself is 35' 9" x 28' 11"; breezeway 20' 10" x 8'; garage 20' 10" x 12'.

### The House That Has Everything

Designed for easy construction and the most living space for the least cost, the Build-It-Yourself House is also most attractive and suitable for any community and most income groups. The basic plan is adaptable to four other exterior designs.

### Get Book and Plans Now—Build When You Can

You may never have thought about actually building a house yourself, but now that building restrictions have been lifted, it is easier than you think. So order book and plans today. Even if you engage a contractor to build for you, you will need the plans. And you certainly will want the book which can easily save you hundreds of dollars, whether you build this or any other house.

## Mail Coupon for New Book and Plans!

Build It Yourself  
or Have It Built  
—Save Hundreds  
of Dollars!

### PLANS YOU CAN READ AND FOLLOW

Plans consist of ten working-size blueprints—floor plans, elevations, construction notes, framing, joints, lumber and mill list, specifications, plumbing and wiring diagrams. Every measurement is marked—every detail made clear as ABC. Book has 100 pages—three-fifths are photographs and drawings. Some sections in colors, showing just how your house will look when finished.

BIG BOOK  
8½ x 11 inches



## MAIL COUPON FOR BOOK AND PLANS

### POPULAR MECHANICS PRESS

200 E. Ontario St., Chicago 11

I enclose \$\_\_\_\_\_. Send me the items checked at once.

- |   |         |
|---|---------|
| <input type="checkbox"/> Your Home and How to Build It Yourself.....        | \$ 3.00 |
| <input type="checkbox"/> Complete set of plans for Popular Mechanics Home.. | 12.50   |
| <input type="checkbox"/> Book and plans at reduced price.....               | 14.00   |
| <input type="checkbox"/> Duplicate sets of plans.....                       | 5.00    |

Name \_\_\_\_\_  
Address \_\_\_\_\_  
City \_\_\_\_\_ Zone \_\_\_\_\_ State \_\_\_\_\_

## YOU, TOO, CAN EARN \$100 to \$300 per week as an AUCTIONEER

### IMPOSSIBLE? *We Can Prove it!*

Men and women all over the country are doing it every day in the fascinating and rapidly expanding business of *auctioneering*.

**it's EASY TO LEARN AUCTIONEERING WITH PACIFIC INSTITUTE'S NEW AND ORIGINAL SIMPLIFIED HOME STUDY COURSE.**



This complete course (same as taught at resident school at world's largest auction sale, Auction City, L. A. County, Calif.) written and prepared by America's most successful practicing Auctioneers and requires only a few minutes of your time each day to put you in this well-paying profession.

**AUCTIONEERS ARE CONSTANTLY IN DEMAND . . .** There is an actual shortage of Auctioneers! Be assured of steady work at top flight pay. . . *Act Now! Don't Delay! Be the first full-fledged auctioneer in your city.*

**FULL TIME OR PART TIME . . .** If you are now employed. . . you can still earn extra money as an auctioneer, evenings or weekends, build a nest egg so you can own your own auction house, become a professional man. . . age can be an asset!



**READ WHAT THESE NOW SUCCESSFUL AUCTIONEERS HAVE TO SAY ABOUT THIS COURSE . . .**

"I earned enough in 2½ hours to pay for the entire course. . ." B.F. Powell

**Here is your opportunity to make top money as an auctioneer. Learn how you can get into this fascinating and highly paid profession.**

Write for free booklet on Auctioneering —  
**PACIFIC INSTITUTE OF AUCTIONEERING**  
133 So. Central Ave., Glendale 4, Calif.

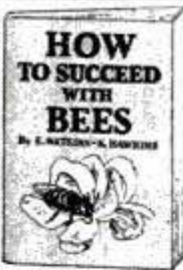

## BEE RAISING PAYS BIG PROFITS

Get **HOW TO SUCCEED WITH BEES**, written by two outstanding experts, which gives more than 190 successful plans to produce big crops of honey. Join the ranks of spare time money-makers and send for this guaranteed 96-page book today. Tells all about queens, equipment, summer, winter and spring management, swarming, increasing colonies, how to produce section honey and extracted honey, etc. 19th edition, fully revised, only \$1.00.

**POPULAR MECHANICS PRESS**  
200 E. Ontario St. Chicago 11, Ill.



**Good Pay — Your Own Business!**

## Electric APPLIANCE REPAIR AND SERVICE

**This May Be Your Golden Opportunity**

Every town—every city neighborhood—needs a specialist on electric appliances. The man who knows how to service and make quick repairs on washing machines, vacuum cleaners, heaters, toasters, stokers and household motors and gadgets of all kinds can make big money right now. Get into this pleasant, easy and good pay work. Get this sensational new book—**Electric Appliance Repair and Servicing**.

### No Experience Needed

An investment of only \$3.00 will positively get you started in this vital field in a good pay job or help you build up a profitable business of your own. Run it from your home—kitchen, garage or basement. No starting capital needed. No experience in electricity required. The book shows all—tells all. Explains how to diagnose and locate trouble and how to fix it. 302 fact-packed pages. 188 how-to-do-it illustrations. This is no come-on—no exaggeration. You can follow the simple instructions and you can make \$2, \$3, even \$5 or more for a few minutes of your time. One job will pay for the cost of the book.

### Millions of Appliances

Modern households have three to a dozen electric appliances. You can be one of the well-paid specialists who keep them in working order.

### Money Back Guarantee

Clip this ad and mail with only \$3.00, currency, check or M. O. or we will send C.O.D. Use the book for five days. See how easily you can make it pay for itself hundreds of times over. Then if you are not fully satisfied—send it back and we will refund your money quick. Rush order today. Get started at once.

**DRAKE & CO., Dept. 14, 117 Green Bay Road, Wilmette, Ill.**

## Don't Envy The PLUMBER—Be One

**Make \$15 to \$50 a Day (and work every day)**



Every skilled workman will tell you Plumbers have the best of it. WINTER and SUMMER the Plumber is busy at top wages. No skilled Plumber is ever out of a job . . . compare his opportunities with any trade, and decide where your opportunity is.

The Plumber Protects the Health of the Nation

## Own Your Own PLUMBING BUSINESS

No other business offers you the opportunity of starting in your own business, and making good profits, with little other investment than Universal's training and a kit of tools.

## JOURNEYMAN PLUMBER

**Gets Good Salary**

Master Plumbers own their own shop. A Journeyman works for a Master. With Universal's training a journeyman can depend on high wages from the start.

## FREE

**DETAILS SHOW YOU HOW TO START**

You can start now to success as a plumber by simply filling out the coupon and mailing it . . . or just write Universal Plumbing School, 877 Holmes, Kansas City, Mo. **FREE** details showing how will be sent by return mail.

Plumbing, to the man with know how, means profit. Investigate Universal's unique "Shop Method" system . . . This system, developed over a quarter century ago by a master plumber, offers you the opportunity to quickly get into the plumbing business. This is not a "war born school" . . . but a plumbing school developed and operated by plumbers since 1923.

## BE A PLUMBER In Just 32 Weeks

Now, just 32 weeks of intensive training equips you to be a plumber. No need ever serve an apprenticeship. Don't envy the plumber's big profits . . . enjoy them.

### System Shows How With Tools . . . Not Books

Universal's highly developed method makes plumbers by a special developed system showing how to use plumbing tools . . . not books. Every instructor is a Licensed Master Plumber capable of showing every trick of the trade . . . Lead Work . . . Blueprint for plan reading, etc. This offers a wonderful opportunity for the man who likes to work with tools.

### Over 7,000 Successful Plumbers Recommend This School

This system has made more than 7,000 plumbers. Each will testify it was the Universal Plumbing School that started him on the road to profits. Investigate our past performance . . . then decide. Universal is the largest and only school in America devoted exclusively to plumbing. It was established in 1923 under a system developed by a plumber and is owned and operated by licensed plumbers.

Don't waste your time looking over "war born schools" . . . investigate this system . . . then get into the profitable plumbing business.

## JUST MAIL COUPON

Send me **FREE** details about the plumbing business and tell me how to make profits as a plumber . . . I understand there is no obligation.

Name \_\_\_\_\_

Address \_\_\_\_\_

City \_\_\_\_\_ State \_\_\_\_\_

G. I. Approved. Established 1923

## UNIVERSAL PLUMBING SCHOOL

877 HOLMES

KANSAS CITY, MO.

**SAY YOU SAW IT IN POPULAR MECHANICS**

## ABOUT HEART WEAKNESS

Bernarr Macfadden, at 81, astonished the entire medical world by leaping into the air at 3000 feet in a parachute jump and landing without injury.

As an advisor in health-building he has had 65 years' experience as a student-teacher, and for more than 15 years was an acting supervising practitioner in large sanatoriums, never losing as a publisher his intense interest in natural health-building.

Although thousands sought his advice, he had personal experience in rebuilding his own heart and he claims that at this time his heart is stronger than it was 25 years ago. He discovered a method through the science of Kinestherapy that can be depended upon to greatly strengthen this vitally important organ.

If you are enduring discomfort of any kind in the upper left chest—the location of the heart—send a postal card to Bernarr Macfadden Foundation, Inc., Dept. 144, 535 Fifth Ave., New York 17, N. Y., and information will be sent you that may ultimately be life saving in character.



## REAL ESTATE BE A BROKER

**PAYS BIG! SEND FOR FREE, BIG, ILLUSTRATED CATALOG NOW!** No obligation. Graduates report making substantial incomes. Start and run your own business quickly. Men, women of all ages, learn easily. Course covers Sales, Property Management, Appraising, Loans, Mortgages, and related subjects. **STUDY AT HOME** or in our classrooms in big cities. Diploma awarded. G.I. approved. Nationally known.

**WEAVER SCHOOL OF REAL ESTATE (Est. 1936)**  
15 E. Pershing Road. Dept. PMB. Kansas City, Mo.

FREE  
BOOK  
TELLS  
HOW

## OIL FILTER REFILLS...10c



Here's News! Ordinary toilet paper makes an ideal oil filter. Laboratory tests prove it cleans oil faster and better than popular makes of filter elements. All you need is a simple set of Retlif Adapter Plates... and you can start using toilet paper rolls (costing about 10¢) in your present oil filter. For proof and descriptive literature, send name and address to:

**RETLIF CORPORATION, Dept. 12**  
1239 No. Highland Ave., Los Angeles 38, Calif.

## LEARN EXPORT



Buy and sell world-wide without capital. Travel abroad if desired. Export men and women in demand. Your own business — profits unlimited. Salaried jobs in many branches of Export-Import. Practical, low cost **WORLD TRADE COURSE** teaches you quickly at home in spare time. No previous special experience or schooling needed. World Trade Certificate awarded. Write today for **FREE BOOKLET**. No obligation. State if veteran. Air-mail reaches us overnight. **THE MELLINGER CO., Exporters-Importers, 1418-CA Westwood, Los Angeles 24, Calif.**

## Be A REFRIGERATION Service Man

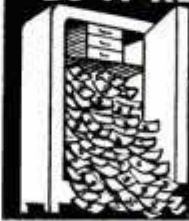

... a qualified **EXPERT** in Refrigeration! Self-teach easily from this great set of books. Draw big pay or run your own service business. The **MANUAL** is complete, authoritative... by Edward R. Magnus and Grace D. Marlott. 688 pages, 139 drawings, 21 tables. The **GUIDE**, a separate volume is 241 pages of organized Quiz materials. Easy to understand. Space for answers. **Move AHEAD** in Refrigeration! Start now! Take this course, only \$7.50 complete. Order today on 5 day trial. If not completely satisfied, return for full refund. COD, or remit, we pay postage. Act now!

**FOLLETT, Dept. PMM, 1255 S. Wabash, Chicago.**



## Happy Highways Ahead!

With Popular Mechanics new **MOTORIST'S HANDBOOK**. 160 pages of authoritative advice to keep your car rolling smartly—longer. Brakes, body, spark plugs, battery, starter—every automotive part is covered in this up-to-the-minute manual of year 'round driving pleasure.

Your news dealer has the 60c paper edition. Order the clothbound \$2.00 volume from

**POPULAR MECHANICS PRESS**  
200 E. ONTARIO ST. CHICAGO 11

Say You Saw It in Popular Mechanics

## Bet You Don't Know This About Advertising

by Susan

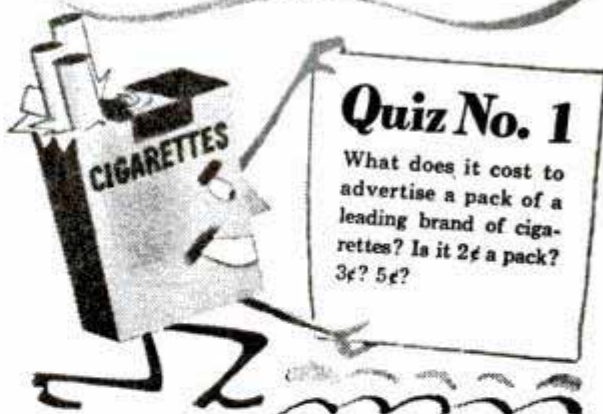

### Quiz No. 1

What does it cost to advertise a pack of a leading brand of cigarettes? Is it 2¢ a pack? 3¢? 5¢?

**Answer:** It costs less than 1/2¢ a pack to advertise the big brands of cigarettes.

That's only half the story. Advertising lowers your cost two ways:

*Cuts the selling costs. And by helping make mass production possible, lowers the production costs, too.*

So advertising saves you many times that 1/2¢ per pack.

# Bet You Don't Know This About Advertising

by Susan



## Quiz No. 2

How much does it cost per dozen to advertise the well-known brands of oranges? Is it 2¢? 3¢? 5¢ a dozen?

**Answer:** It costs less than 1/3¢ a dozen to advertise the big-name brands of oranges.

That's only half the story. Advertising lowers your cost two ways:

*Cuts the selling costs. And by helping make mass production possible, lowers the production costs, too.*

So advertising saves you many times that 1/3¢ per dozen.

## Handy Mail Order List

### Little Library of Useful INFORMATION

5 for \$1.00  
12 for \$2.00  
25¢ Each

Here at amazingly low cost is the practical help and information you have always wanted. Articles in previous issues of Popular Mechanics have been classified according to subject and are now available in these handy reprint booklets.

- |   |                                       |
|---|---------------------------------------|
| How to Use Measuring Tools—Micrometers, Calipers, etc.—106. | Working With Plastics—61              |
| Power Driven Saws—74.                                       | Simple Home Improvements—104          |
| Drill Presses, Grinders, Etc.—79.                           | Ridding Home of Insect Pests—107      |
| Wood, Metal Turning—Lathes—81.                              | Children's Room Furniture—51.         |
| Filing Machine, Hacksaw, Cutoff Wheel, Shaper—82.           | Jigsawed Novelties—57.                |
| Lathe Tools You Can Make—101.                               | Doll House & Doll Furniture—60.       |
| Workbenches—Tool Cabinets—47.                               | 25 Shelves You Can Make—64.           |
| Spray Painting—94.  | Novelties Turned on Lathe—62.         |
| From Pattern to Casting—91.                                 | Inlay Pictures—Veneering—63.          |
| Tool and Saw Sharpening—92.                                 | Wood, Soap Carving—65.                |
| Sharpening Drills, Wood Bits—90.                            | Windmills & Weather-vanes—68.         |
| Successful Wood Turning—32.                                 | Lamps from Wood, Metal—69.            |
| How to Read Blueprint—71.                                   | Rustic Furniture—18.                  |
| Metal Turning Lathe Kinks—99.                               | Wood Finishing—40.                    |
| Operating a Metal Lathe—100.                                | How to Fix Electrical Appliances—111. |
| Heat Treating, Hardening—102.                               | Painting Your House—117               |
| Working With Glass—103.                                     | Build Your Own Relays—123             |
| Servicing Elec. Motors—75.                                  | Rowboats, Small Dinghy—83.            |
| Electromagnets & Solenoids—44.                              | Small Sail Boats—84.                  |
| Transformer Construction—41.                                | Two Outdoor Runabouts—85.             |
| The Boy Electrician—43.                                     | Build Own Canoe, Kayak—30.            |
| Soldering and Brazing—17.                                   | Build Class-E Ice Yacht—22.           |
| Arc and Spot Welders—5.                                     | Auto Kinks, Shortcuts—10.             |
| Electroplating With Nickel, Chromium, Cadmium, Etc.—86.     | Lawn and Garden Equipment—124         |
| Plating Leather, Wood, etc.—87.                             | Motor-Driven Midget Cars—34.          |
| Lower Your Fuel Costs—31.                                   | Stop Auto Elect. Troubles—95.         |
| Curing Leaky Basements—45.                                  | Photo Printers and Dryers—25.         |
| Fitting Home Game Room—55.                                  | Photo Darkroom Equipment—96.          |
| Indoor & Outdoor Fireplaces—88.                             | Trick and Table Top Photos—97.        |
| Backyard Gardening—39.                                      | Home Movie Equipment—118              |
| Lawn and Garden Novelties—72.                               | Poultry Houses—108.                   |
| Trellises, Pergolas, Fences—76.                             | Guns and Decoys—109.                  |
| Lawn and Garden Furniture—77.                               | Re-Silvering Mirrors—70.              |
| Playground Equipment—73.                                    | Chemical Experiments—93.              |
| How to Use Your Drill Press—125                             | Log Cabins, Tourist Houses—14.        |
| Making Serving Trays—53.                                    | Using Basic Tools—120                 |
| Knits and Rope-work—105.                                    | Farm and Garden Tractors—8.           |
| Sanders—80.   | Building Extra Attic Rooms—23.        |
| House Wiring—89.  | Attractive Basement Rooms—24.         |
| Hanging Wallpaper—38.                                       | Small Tables—54.                      |
| Built-in Fixtures—78.                                       | Smoking Stands—56.                    |
| Bird Houses—7.  | Desks—58.                             |
| Magazine Racks—49.  | Book Cases—59.                        |
| Clock Cases—50.   | Action Toys—66.                       |
| Book Ends—52.   | High Flying Kites—67.                 |
|   | Telescopes—20.                        |
|   | Metal Craft—28.                       |
|   | Small Looms—37.                       |
|   | Gem Cutting—42.                       |
|   | Photo Enlargers—1.                    |
|   | Photo Kinks—98.                       |
|   | Cleaning Formulas—11.                 |
|   | Taxidermy—9.                          |
|   | Photo Lighting—119                    |
|   | Training Dogs—35.                     |
|   | Small Furnaces—36.                    |

Check Titles Wanted, Clip, Mail with Remittance to

POPULAR MECHANICS PRESS, Dept. 635, 200 E. Ontario, Chicago 11

## BUILD MODEL HOMES FOR FUN OR PROFIT!

It's so easy with low cost ARCHITECTURAL MODEL MATERIALS

WITH professional Architectural Model Materials it's simple to build all kinds of miniature homes, factories, farm buildings, doll houses - - of your own design. White plastic doors, door frames, windows, shutters and window boxes...and...plywood panels of brick, siding, and shingles are perfect for constructing 1/4", 1/2" and 3/4" scale models. They make model building easy, save hours of time, and are low in cost. For fun or profit send 25c for details and samples.

SEND 25¢ FOR DETAILS AND SAMPLES



ARCHITECTURAL MODEL MATERIALS, INC.  
4339 Diversey Ave., Chicago 39, Ill.

# PROFIT from PEARL FINISHING BIG MONEY RIGHT AT HOME

## AMAZING NEW PEARL FINISH

Simple method starts you on the road to success in your own lifetime business—new, BIG PROFIT field. Beautiful PEARL finish applied to ANY article—leather, wood, plastic, plaster, paper, glass, metal, etc. Beautify baby shoes, statuettes, figurines, picture frames, book ends, jewel boxes, radio cabinets. Goes on new objects or renews and beautifies old, worn objects. Make unusual costume jewelry. Make things for sale in quantity to stores. All this at big profits for you.

### BABY SHOES

Big - New - Terrific Demand. Baby Shoes are so much more precious when finished with Pearl Kote in baby's own colors. Baby Pink, Baby Blue and Ivory.

### HELP FILL HUGE DEMAND!

Start small and grow big. Spare or full time. NO COURSE OF INSTRUCTIONS TO BUY Complete, step-by-step instructions included with materials. NO EXTRA COST! BIG demand—help us fill it.

### FREE DETAILS

Fantastic profits waiting if you act NOW - it pays to BE FIRST... It costs you nothing to get the free facts. Scoop the market with this quick, easy way to big money overnight. Mail coupon today.

PEARL-KOTE COMPANY, Dept. PM-4,  
2111 W. Manchester Blvd.,  
Los Angeles 47, California.



LAMPS



BOOK ENDS



PICTURE FRAMES



COSTUME JEWELRY



JEWEL CASES



BABY SHOES

PEARL-KOTE CO. Dept. PM-4,  
2111 W. Manchester Ave., Los Angeles 47, Calif.

Okay! RUSH me FREE FACTS at once. I understand there is NO INSTRUCTION COURSE TO BUY!

Name \_\_\_\_\_  
Address \_\_\_\_\_  
City \_\_\_\_\_ Zone \_\_\_\_\_ State \_\_\_\_\_

# BIG NEWS! More PROTO\* Octopullers!!



## NEW Pullers! NEW Features!!

Our Octopuller has several new brothers, to help you do more jobs—better and faster. Only a few are illustrated but the list includes four "live center" screw tips, a bearing separator-puller, fourteen hollow shaft step plates, three new jaws and five improved jaws. Arm yourself with these new time savers at your PROTO\* dealers.

Write for catalog to  
**PLOMB TOOL COMPANY**

2255W Santa Fe Avenue,  
Los Angeles 54, Calif.



4022TS  
"Live Center" Screw Tip



4032  
Bearing  
Separator-  
Puller Plate



4040—1 to 14  
Puller Step Plates

\* **PROTO** means **PRO**fessional  
**TO**ols. It's the new name for the tools  
that have been preferred for 43 years.

5085

**PROTO**  
Professional Quality  
**TOOLS**  
LOS ANGELES



## NEW IMPROVED...AMERICANIZED JUDO

TWO BIG BOOKS FULLY ILLUSTRATED  
1220 SHOW-HOW PHOTOS, 71 LESSONS  
MANY NEW HOLDS

Protect yourself and others. Size and strength mean nothing. Knowledge and skill enable you to master any situation even against biggest bullies or armed thugs. Written and illustrated by one of the world's great Judo experts. Volume 1, basic and advanced holds. Volume 2, very advanced... each volume \$1.50.

Big Combination  
Offer!  
**SAVE...**

**BOTH BOOKS \$2.50 POSTPAID**  
OR C.O.D. PLUS POSTAGE  
5-day Money Back Offer. **ACT NOW!**

DEPT. PM-4  
**IMPROVED JUDO, INC.** P.O. Box 7355, Sta. L, Los Angeles, Calif.

*Always write your name and full address  
clearly when answering advertisements*

## HELPFUL BOOKS

Send post card asking for **FREE** catalog

Popular Mechanics Press, 200 E. Ontario, Dept. 601, Chicago 11



### 1950 Shop Notes Now Ready!

Popular Mechanics **SHOP NOTES** is always sought after and this year it is better than ever. 240 interest-packed pages for electrician, carpenter, mechanic, painter, auto-worker, welder, farmer, plumber and home craftsman. The 1950 issue contains data on drilling, fenders, batteries, clamps, milling, gauge block, making arc welder, making bandsaw, belt sander, etc. **Hundreds of articles—Hundreds of ideas.** See your newsdealer or order direct from

**POPULAR MECHANICS PRESS — \$1.00**  
200 East Ontario Street \* Chicago 11, Illinois

## FURNITURE FOR YOUR BEDROOM

YOU'LL BE THE ENVY of your neighbors with this beautiful bedroom suite in honey maple, oak or walnut! Here's a bed with storage space... a three-piece vanity with cosmetic compartment and makeup mirror... a Mr. and Mrs. dresser... twin night stands with drawers!



Send for  
Complete  
PLANS  
Only  
**\$2.00**

**YOU MAKE IT YOURSELF!** Only two power tools, a saw and a jointer, are needed to turn out this modern bedroom furniture. No other project of Popular Mechanics Magazine in recent years has captured the fancy of home craftsmen as has this easy-to-build suite. Letters demanding detailed plans poured in after the suite was pictured in Popular Mechanics. And now the plans are ready! They're detailed scaled drawings—a complete set of 4. Send for them today!

**POPULAR MECHANICS PRESS**  
200 East Ontario Street, Chicago 11, Illinois

I enclose \_\_\_\_\_ for a complete set of plans for making the modern bedroom suite illustrated above.

Name \_\_\_\_\_

Address \_\_\_\_\_

City \_\_\_\_\_ Zone \_\_\_\_\_ State \_\_\_\_\_



# ATOMIZED POWER FOR YOUR CAR!



Automatic

## GASOLINE INJECTOR

PATENT PENDING



\$9.95

More power, Greater acceleration, Top engine efficiency at all speeds. Stops Gas Waste—"cracks" fuel for fullest power! Dynamometer tests show up to 15% power increase resulting in decreased fuel consumption.

- MORE POWER
- QUICKER STARTING
- GREATER MILEAGE
- FASTER ACCELERATION
- LESS CARBON
- LONGER MOTOR LIFE

Quickly and Easily Installed

**SOLD ON AN ABSOLUTE MONEY BACK GUARANTEE**  
Complete illustrated step-by-step instructions included

Send postal card for complete information. When ordering—state car make, year and model. **WESCO** Box A—1665 Mission San Francisco 3, Calif.

## CATALOG OFFER!

Send only 25c for Klein's Big Sports Catalog—loaded with Bargains in fishing, hunting and camping equipment. All the latest dope & pictures of all Guns, Rods, Reels, etc., at Rock-bottom prices. Thousands of one-of-a-kind Guaranteed New & Used Guns at the lowest prices anywhere! 65th Annual Clearance Sale now in progress! Catalog contains up-to-the-minute details on Klein's famous Gun-Trading Department—also Credit Terms! Send only 25c (coin or stamps) to cover mailing and handling charges. Your Catalog will be rushed to you by return mail. Send 25c to Klein's Sporting Goods M-227 W. Washington St., Chicago 8, Illinois.

**WITH EACH CATALOG, YOU'LL GET A SPECIAL GIFT WORTH FOUR TIMES THE QUARTER IT COST YOU!**

50,000 NOW LETTING THIS BOOK BUILD FOR THEM

## BUILD

HOW TO BUILD A BETTER HOME

Here is the answer to how to build—The WORKS—how to plan, construct, supervise. Simply, clearly, explained step-by-step. Hundreds of clear-cut, complete diagrams. Only \$3.98, Post-Paid. Your money returned via AIR MAIL. If not completely satisfied, Order Now. The Westport Publishing Co., Dept. MP5, Westport, Conn.

## HELPFUL BOOKS

Send post card asking for FREE catalog

Popular Mechanics Press, 200 E. Ontario, Dept. 601, Chicago 11



## TRAILER COACHES

Here's everything you want to know about trailers, with plenty of pictures and plans and instructions for building three different types. Covers also, history of trailers, trailer parks, camps and overnight-stops information, furniture, furnishings, materials and engineering data. If you want to build a trailer, live in a trailer, or just want to know more about trailers, get this book. Only \$1.50 postpaid. Rush order to:

**POPULAR MECHANICS PRESS** • Dept. 350, 200 E. Ontario St., Chicago

## Build it Yourself!

Complete Trailer Book and Construction Data for 10, 16 and 22 Foot Trailers — Only \$1.50

**Partial Contents**

Trailer Parks—Living in a Trailer—Towing a Trailer—Floor Plans—Service—Classifications—Balance—Dollies—Jacks—Weight Distribution—Construction—Working Drawings for a Two-Place, Standard Travel and Standard Dwelling Trailers. Size 8 1/2 x 11 1/4 inches.

## PARTITION OFF AN EXTRA ROOM



Provide more usable space in your home by turning a large room into two smaller ones. For example, partition off a large double parlor into two rentable bedrooms or a small apartment. You can do it easily at low cost with Gold Bond Gypsum Wallboard. Nail the sturdy fireproof panels to a 2 x 4 framework. Seal joints with Gold Bond Tape Joint System and paint with Gold Bond Sunflex—the one hour wall paint. Or, if you prefer, Gold Bond Gypsum Wallboard takes wallpaper or texture beautifully. For further information, write Div. W, Dept. PM-4a.

Available at your local Gold Bond lumber and building materials dealer

**NATIONAL GYPSUM COMPANY**  
BUFFALO 2, NEW YORK

## GET INTO BIG PAY ADVERTISING BUSINESS

Collect big cash income every day as an expert in Display Advertising. No training or experience needed. Simply demonstrate "Fire Writing" to merchants in your territory. Most sensational Advertising Display ever invented. Spectacular "Walk-in—Walk-out" Demonstration makes it easy to call on 30 to 50 prospects daily. Make from \$7.65 to \$11.00 and more on every sale. Sell only 4 a day for a daily cash profit of as much as \$45.00!

**Merchants Know "IT PAYS TO ADVERTISE"**

Yes, you make as high as \$11.45 on every order. Simply write on glass with "Magic Crayon" and Presto!—a 5-color Advertising Message takes fire and "BURNS" like brilliant Neon. Most sensational Advertising Display Sign ever offered to Merchants. Four sales a day is for "lazy" men, **Workers can make twice as many! Free Sales Kit.** Don't send a penny. Rush name on penny postcard for information that tells how you can get into the Display Advertising Business for the biggest earnings of your life. **Plus Big Sales Kit—ALL FREE.** Time is precious. Good territories going fast. Write today!

**MAXILUME** COMPANY, 125 W. HUBBARD ST., Dept. L-84, CHICAGO 10, ILLINOIS



## A Chorus of Praise

Because most spark plug troubles are insulator troubles, thousands of car, truck and tractor owners are loud in their praise of *CORALOX*.

*CORALOX* is AC's patented Insulator, from 3 to 10 times better than previous insulators. It is 3 times stronger—has 4 times greater heat conductivity—has 10 times the insulating value at high temperatures.

Consequently, AC now offers you a better spark plug—with wider Heat Range—greater freedom from fouling and oxide coating—surer firing under all operating conditions.

Use AC's in your car, truck or tractor engine—and you, too, will be loud in your praise of *CORALOX*.

MORE NEW CARS AND TRUCKS ARE  
EQUIPPED WITH AC SPARK PLUGS  
THAN WITH ANY OTHER MAKE

**PATENTED**

**AC**  
**SPARK PLUGS**  
**CORALOX**  
**INSULATOR**

AC SPARK PLUG DIVISION

GENERAL MOTORS CORPORATION

# POPULAR MECHANICS

APRIL  
1950

WRITTEN SO YOU CAN UNDERSTAND IT  
VOL. 93 NO. 4

By A. J. Cutting

ONE EVENING back in 1903 a French chemist, Dr. Edouard Benedictus, was straightening up his laboratory. As he reached up to rearrange some bottles on a shelf, his arm hit one and sent it crashing to the floor.

When he stooped down to pick up the pieces, the scientist was amazed to find that though the glass radiated cracks, the bottle was intact with not a splinter detached. Chemicals which the bottle had contained had dried to form a film inside, holding the fragments together.

Benedictus made a note of the chemicals and promptly forgot about the incident. Then, within a short space of time, he witnessed two automobile accidents in which victims were badly cut by flying glass. He remembered the falling bottle.

"I realized the possibilities the incident opened up and dashed to my laboratory," he said later. "The creation of the first

A flask of chemicals that fell to the floor without shattering led to development of modern safety glass

## THEY STUMBLED ON SUCCESS

Here is the "fruit" of Dr. Benedictus' laboratory accident: a bowling ball dropped on a pane of shatterproof glass is held by its plastic "sandwich," the safety factor that has saved the lives of countless motorists

Libby-Owens-Ford Glass Co. photo

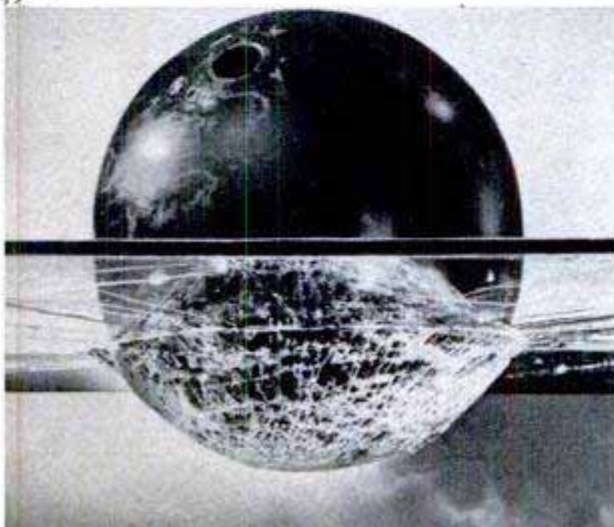

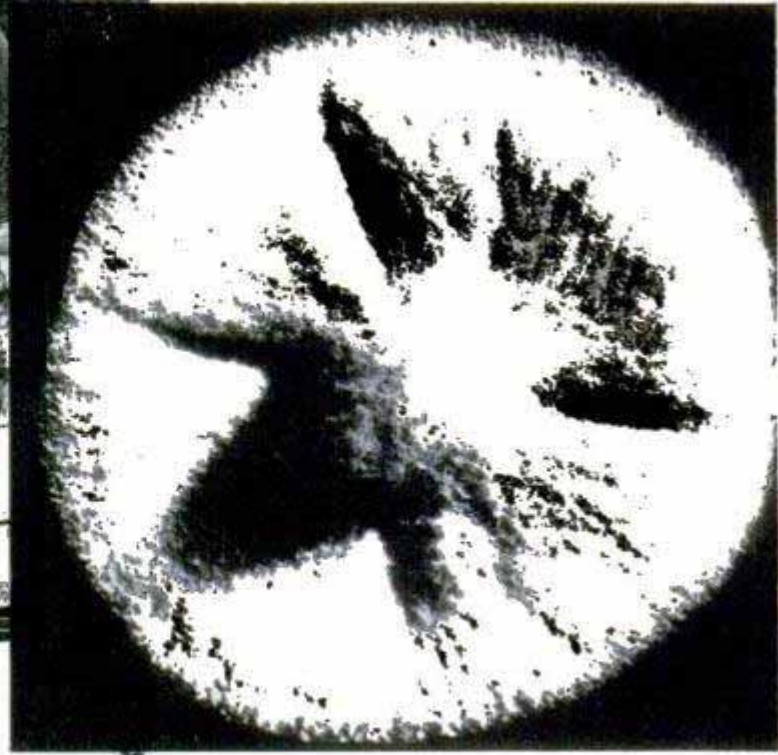

Lady Luck placed a speck of mold in a bacteria culture which Dr. Alexander Fleming later examined. The mold, which is shown above, prohibited the growth of bacteria. This led to the discovery of the wonder drug, penicillin

piece of laminated glass was the result."

His crude piece of "sandwiched" glass, with transparent binder between two sheets of glass, was the forerunner of safety glass, which since its introduction in 1926 has saved countless thousands of lives.

A surprising number of the world's most important inventions and discoveries came about because of accidents, or because Lady Luck was looking over the shoulder of an inventor or scientist.

In 1929 an eminent English bacteriologist at the University of London, Dr. Alexander Fleming, set aside a culture of bacteria with which he had been working and went on to other duties. When he examined the

plate several hours later under a microscope, he noticed that part of the culture was contaminated by a blue-green mold.

Many researchers would have tossed the plate away to the accompaniment of a few harsh words. Doctor Fleming didn't. He studied the culture and noted that the germs had not grown for some distance around the mold, and guessed that the mold contained something that held back their development. Further experiments showed that the mold offered protection against bacterial infection.

The doctor named the drug penicillin, but did little with it because it was difficult to get pure cultures of the substance.

**DDT has killed billions of insects. Chemical formula discovered accidentally was filed away for 65 years**



Ten years later, when the war created an acute need for a better antiseptic, penicillin's great possibilities were realized. The miracles worked by this wonder drug both among war casualties and sick and injured civilians are well known. And they were made possible because a scientist happened to notice the accidental contamination of a bacteria culture.

The list of helping hands doled out by Fate goes on almost endlessly. For example, take the electric generator or dynamo that produces electricity for mills and factories, radio and telephones and so many other purposes. We have it because a Danish professor, Hans Christian Oersted, accidentally pushed a compass under a wire connected to a battery and noticed that the needle swung at right angles to the wire instead of pointing north. It proved to him that electricity and magnetism were intimately related, and led to the principle of the electric generator.

A formula, filed away and forgotten for 65 years, gave the world one of its most useful chemicals. Back in 1874 a young student of chemistry, Othmar Zeidler, was working in a laboratory in Strasbourg. During his experiments he produced a new chemical which he labeled "dichloro diphenyl trichloroethane." Seeing no use for his discovery he made a few notes on the formula and filed them away.

In 1939 Swiss farmers were having great trouble with huge swarms of insects at a time when there was a severe shortage of the normally used insecticides. In their desperation to find something to combat the destructive pests, Swiss scientists looked into every possibility. Finally, a young chemist, Paul Mueller, came across Zeidler's old formula. Small quantities of the chemical were produced and tried. To the amazement of researchers, it mowed pests down upon the slightest contact.

We know that chemical as DDT, the insecticide that has been so potent in killing mosquito larvae, disease-bearing flies and other insects.

The line-up of famous inventions that owe a vote of thanks to Fate is an imposing one. A shirt drying over an open fire tipped off Joseph Montgolfier to the principle which led to the first balloon. He was relaxed in front of the fire idly watching the flames when the shirt, inflated by the heated air, swelled up and began to rise.

Montgolfier and his brother, Etienne, tested the discovery by building fires under small paper bags. Not long after, in 1783, they sent their first great balloon skyward.

Because of an accident, we ride on rubber tires, wear rubberized raincoats and use thousands of other articles in which rubber



Oersted accidentally pushed a compass near a wire connected to an early battery. The needle didn't behave as a good compass should. Discovery of principle behind this behavior led to giant generators

Bureau of Reclamation photo





Copyright Bettman Archive

Galvani's wife noticed frog muscles twitch when they were touched by scalpel which had been in contact with electrical machine. This led to galvanic battery

is a material. Charles Goodyear tried for years to find a way of treating the gummy material so it would withstand heat and would not deteriorate.

One day in 1839 he was sitting in front of a stove. Goodyear was thoughtfully fondling a piece of rubber treated with sulphur when it slipped from his hand and fell on the hot metal. When he examined the lump he found that the rubber had become hard and tough and that the stickiness was gone. This was the clue he needed, and the accident guided him to experiments that produced his vulcanization process.

The legs of a dissected frog led Luigi Galvani to the principle of the galvanic battery. Galvani's wife noticed that the muscles twitched when she touched the frog leg with a scalpel that had been in contact with an electrical machine. Professor Galvani started experimenting, and discovered that contact with two metals such as iron and copper would produce the convulsive movement of the frog legs.

George Westinghouse hit upon the principle of his revolutionary railway air brake through reading an article in a magazine he did not want to buy.

One day while sitting in his father's shop eating his lunch, a young lady asked him to buy a subscription to a magazine.

"I never read magazines," Westinghouse told her.

As he talked with the girl he casually flipped through the pages of one of her samples. Suddenly he saw an article that stopped him. It described how compressed air had been used to operate drills for cutting through rock.

Out of that chance reading of the article came the inspiration for his great contribution to safe rail travel, patented in 1869.

Dame Chance can take credit also for the

versatile photoelectric cell which opens and closes doors, starts alarms ringing and does a hundred-and-one other jobs.

In 1873 an Englishman, Willoughby Smith, discovered quite by accident that the electrical resistance of the metal selenium was lowered when light fell on it. Further experiments proved that it was possible to hook up a selenium cell with a relay and an electric motor so light falling on it would start the motor.

While there have been great improvements in photoelectric cells, and newer principles have since been applied, this accident brought about the development of the first such device.

The great Galileo Galilei discovered the value of the pendulum for measurement of time because he chanced to watch the swinging motion of a lamp hung from a cathedral roof. And no less an authority than Voltaire tells us that Sir Isaac Newton really did hit upon the law of gravitation because an apple fell on his head.

Keep your eyes open and your mind alert. Entirely by accident you may stumble upon some history-making development. For, if Lady Luck has a mind to do so, she can drop fame right smack in anyone's lap.





Copyright Bettman Archive

Goodyear Tire & Rubber Company photo

Goodyear chanced to drop a piece of sulphur-treated rubber on a hot stove. When he picked it up it was fused into a tough, flexible chunk. This discovery of vulcanization gave rise to the huge rubber industry

Montgolfier was drying a shirt in front of a fire when the hot air carried it toward the ceiling. Why, then, couldn't hot air carry a man aloft? Early Montgolfier balloon, shown below, was the result of his observation

Copyright Bettman Archive

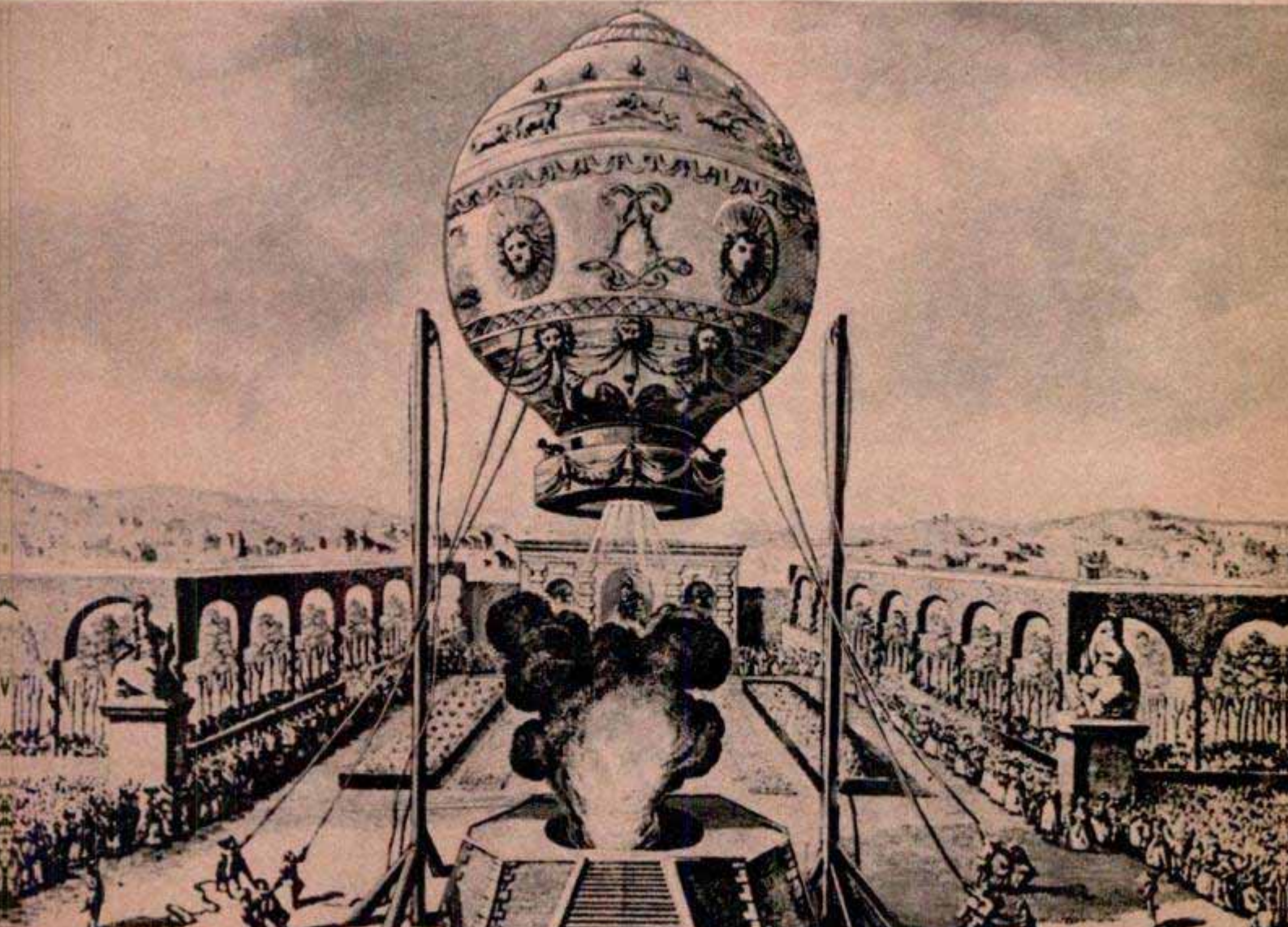



### Radio in a Bottle

Building ship models inside bottles is old-fashioned now that a British company is producing a five-tube radio inside an ordinary wine bottle. Displayed at a British radio show, the receiver has its speaker in the plastic base. Tuning is accomplished by turning the "cork."

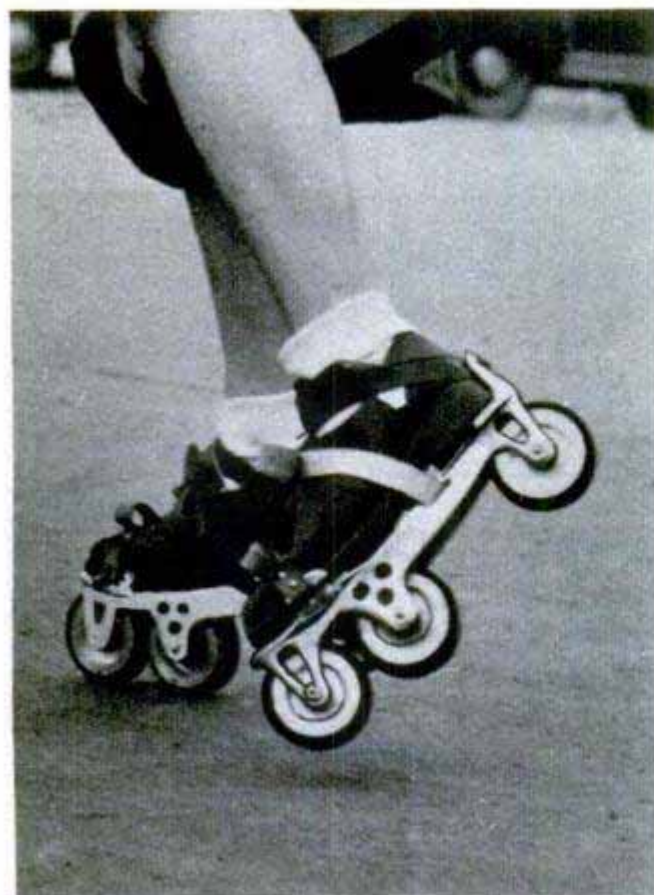

### Rubber Springs for Tractors

Taking the jerks and bumps out of tractor-riding, a newly developed rubber-spring system works on the torsional-shear principle. A thick layer of rubber is sandwiched between two metal plates. As the tractor rides over rough ground, the rubber twists and turns with each jolt, cushioning initial shock and leveling out the sharp rebound. Mounted in two cylinders under the tractor seat, the springs can be adjusted for various weights from a 100-pound farm girl to a 275-pound husky.

### Figure Skating With Roller Skates

Figure skating on roller skates is possible with a new product on the market in Japan. The new skate has three wheels in line, instead of two wheels in parallel. Only the middle and rear wheels are used for ordinary skating; if a skater wishes to do figures, he uses the middle and front wheels. A ratchet gear prevents the front wheel from turning backward so that quick turns are possible.

☞ For servicing vehicles in the field, the Air Force has developed a knockdown grease rack which can be easily moved to any area where permanent greasing facilities aren't available.

Popular Mechanics provides two sources of further information concerning articles published in each issue: the WHERE-TO-BUY-IT INDEX, starting on page 10, and the WHERE-TO-FIND-IT INDEX, which is available to readers without charge. Just address your request for a copy of the latter index to Bureau of Information, Popular Mechanics, 200 East Ontario Street, Chicago 11, Ill.



# FLYING GAME WARDEN

**T**HREE hunters, stalking ducks and geese out of season, recently were the amazed victims of a three-way blitz. An automobile laden with game wardens rolled up to seize them, while a boat circled just offshore to prevent their escape by river and overhead a plane dipped down with another warden inside.

The game violators were apprehended by a three-way assault which is producing real results for the Illinois Department of Conservation. Key to the successful operations is a reconnaissance plane which spots suspected violators, then radios the information to the ground forces in boats and autos.

In the case of the three hunters, the pilot of the plane dipped down to investigate the trio, hunting in an area thick with ducks. The suspects, unaware that the warden was breathing down their necks, waved a greeting and went on hunting.

The pilot relayed the information to investigators in an automobile marked with a huge cross so the pilot can keep track of it at all times. The warden in the radio-equipped boat also picked up the news.

In one test, nearly 100 investigators participated in a three-day maneuver. Illegal hunters swept up in the dragnet didn't have a chance.

The three-way blitz is especially successful because the investigators are unknown in the areas in which they operate. And the chief inspector, when asked about the present location of the enforcement group, tags it a "military secret."

Another officer cruises along the river in a boat which also has radio equipment. He closes in on signal to prevent escape of game violators by water



Pilot of the plane spots hunters suspected of game violations, transmits instructions to ground forces



Airborne warden has instructed men in marked car to investigate truck. They apprehended hunters near by. Below, wardens receive another radio tip from plane



# You Think

By Richard F. Dempewolf

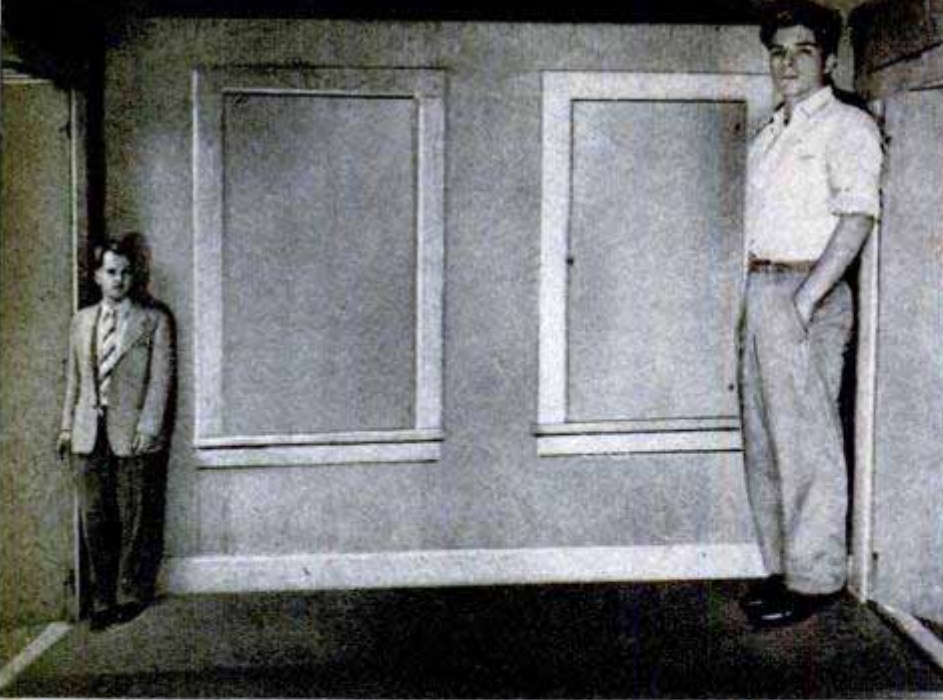

Above, illusion room puts man at right eight feet from lens, makes him seem a giant. Man at left is 16 feet from lens, appears a midget. Below, giant becomes a midget as men change places

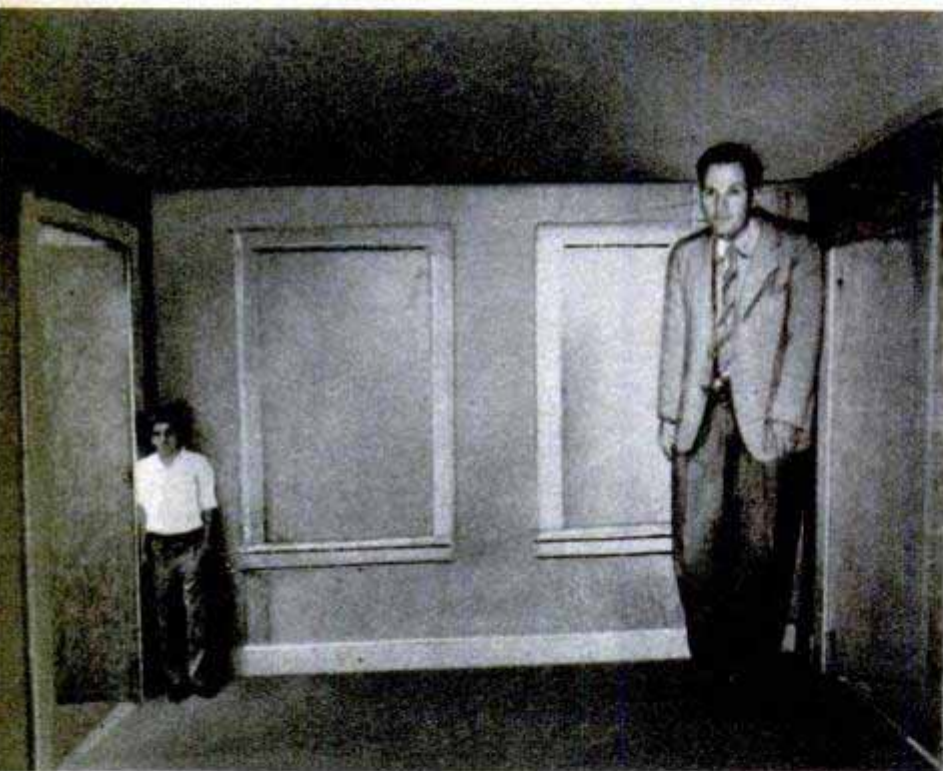

**I**N A DARKENED basement room, appropriately dubbed "the dungeon," beneath Princeton University's ivy-covered Laughlin Hall, there's a whole world of confusion which completely blasts the old theory that "seeing is believing."

Here, in a strange Alice-in-Wonderland laboratory of mental hocus-pocus, people can trick themselves into seeing a two-foot midget grow into a 10-foot giant while crossing a room. Hideously distorted rooms look absolutely square. Stationary balloons can be seen swiftly moving back and forth. Close objects seem far away, and distant objects seem close. In utterly square rooms, you can watch the floor fall away at an angle as frighteningly precipi-

tous as the walls of the Grand Canyon. Marbles roll uphill at an alarming rate. Firmly anchored ceilings descend on your head, and you stagger out into the comfortably familiar world wondering if it's really there and if you'll ever trust your eyes again.

The optical-illusion laboratory, originally conceived by an optical physicist, Adelbert Ames of Hanover Institute, New Hampshire, was not designed just to confound people like a Coney Island House of Horrors. Its purpose is as deadly serious as the atom bomb. It represents a pioneering expedition into the nether regions of the mind, headed up by a group of scientists, among them Prof. Merle Lawrence, a tall, husky young Princeton psychologist whose fame in the field is growing by leaps and bounds. The way we interpret and act upon what we see, these scientists believe, may furnish information about the brain mechanisms behind human behavior.

Doctor Lawrence explains it this way: "The experiments show that what you see when you look at something depends not so much on 'what is there' as on the assumptions you make when you look."

Take the giants and midgets, for instance. Anyone knows a man can't walk across a square room and grow a foot with every step he takes—not outside of Hollywood, anyway. Yet, in that Princeton room it seems to happen. There are no mirrors involved; you see it in a full-size room through a peephole with your naked eye. The experiment has variety, too. Sometimes two normal-size men will enter the room, standing against opposite walls. The man on the left has suddenly become the size of a peanut. The other is a grotesque monster. When they swap sides, the giant becomes a midget and vice versa.

In a smaller edition of the same room in the Laughlin Hall "dungeon," you can see the identical thing happen with a pair of rubber mice that creep across the floor

# You're Going Crazy...

but it's merely an optical illusion. What the scientists at Princeton have concocted to confuse you outdoes any Coney Island House of Horrors

growing and shrinking. Meanwhile, an attendant psychologist is casually dropping marbles in a chute which traverses the room at a steep pitch. It would be fine if the man were dropping the "immies" into the high side and letting them roll down. But he's not. He's dropping them into the low side and they're rolling up! Or are they?

Of course not. No more than people and mice are growing and shrinking. The answer is, despite what your eyes tell you, that neat little room is about as square as a 10-sided barn on the verge of collapse. It is constructed somewhat like a pyramid laid on its side, with the peak cut off. The floor and ceiling fan out to the left at sharp angles so that the left side is about twice as high as the right. The left side goes back about twice as far, too. Windows, moldings—all appurtenances—increase in size as they approach the high side. Normally, of course, if a room recedes on one side, you get a distance perspective. Things farther away approach a "vanishing point." But Professor Lawrence's room has been fiendishly designed to eliminate this clue. Everything about the room gets bigger as it gets farther away, thus

White painted areas of wires merge in three-dimensional perspective to form object that the eye sees as a chair identical to the real chair viewed through peephole No. 1

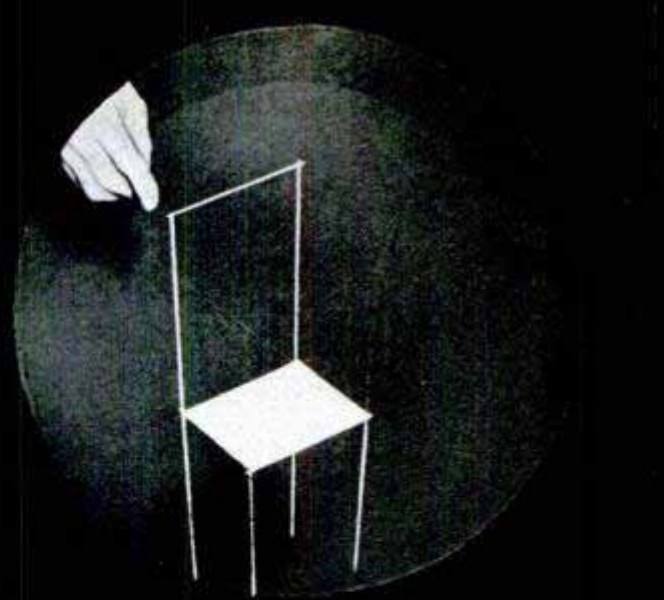

Above, through peephole an observer sees a three-dimensional chair. Below, what he really "sees" is a group of wires painted white in spots to form a two-dimensional chair in distorted perspective. Readers can get same effect with this drawing by punching small hole one inch from edge of blotter, placing blotter on end, with hole right above point A, and peeping through

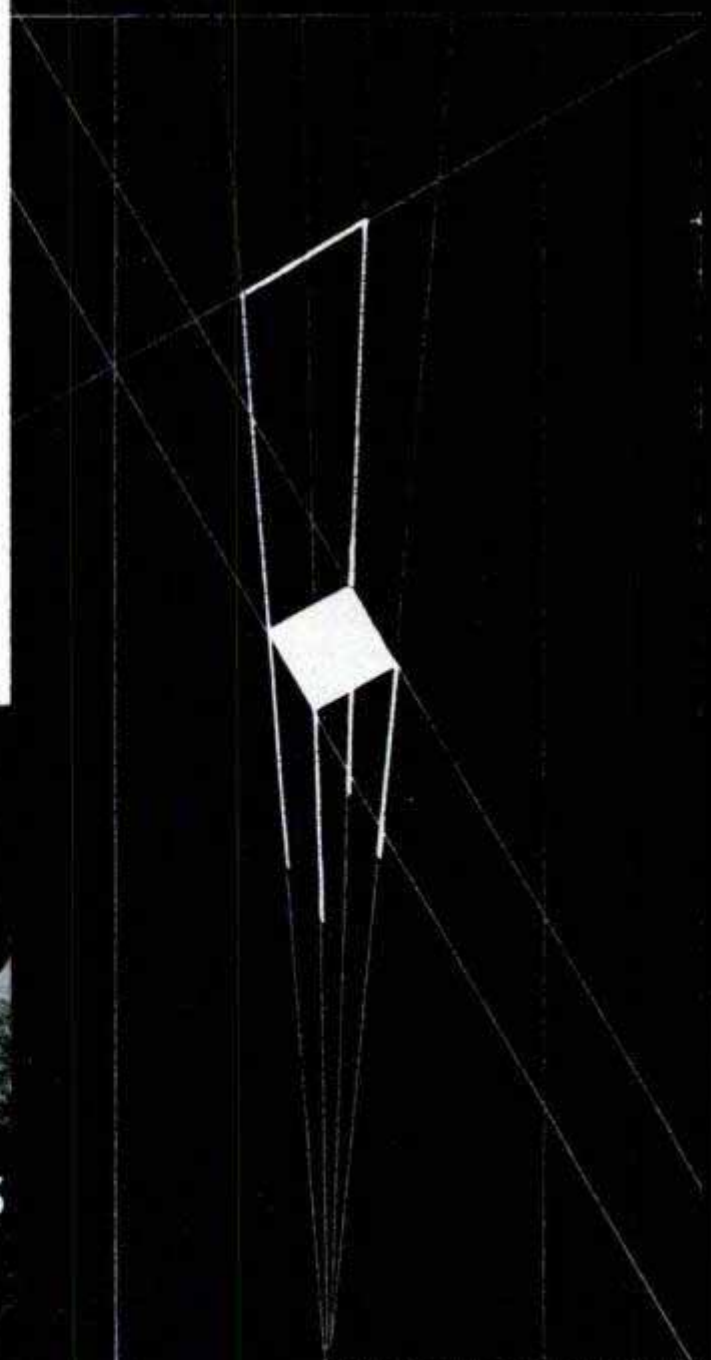

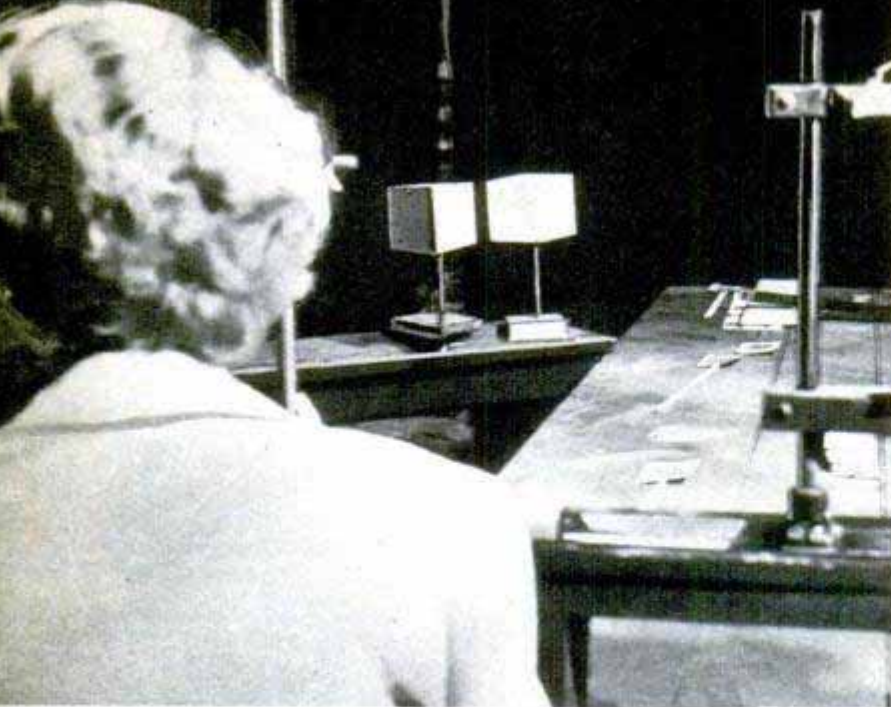

Is seeing believing? Here, a student looks through an eye-piece at a pair of cubes—at least she thinks they are cubes and so does the camera. Below, the "cubes" as they really are

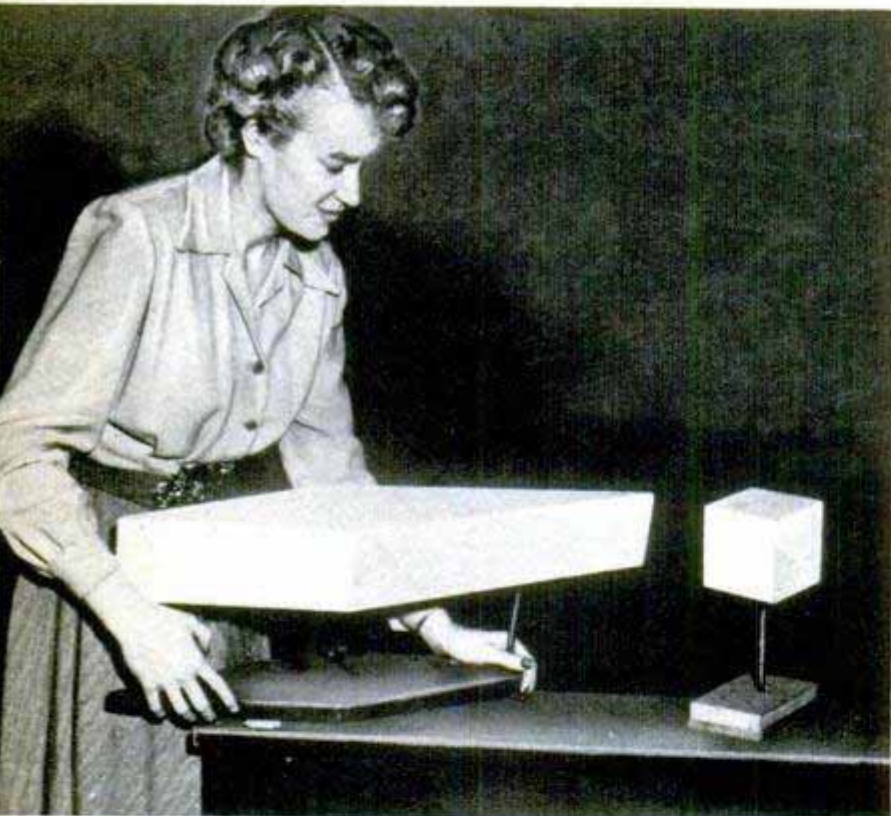

neutralizing perspective. So, when the room is viewed through the peephole or by a projected image on a camera film it looks square. Normal objects—like people and mice—on the far side, therefore, look tiny, although we know they can't be. "But," says Professor Lawrence, "from all our experience we are so accustomed to a square or rectangular room, that our minds insist on making the room square rather than let us see people in their true proportions."

In other words, as Doctor Lawrence explains it, a person builds up a storehouse of past experiences, which tell his brain what he is seeing, hearing and feeling right now. According to the professor, what he perceives is no more than a guess at what's really there, based on what his past experience tells him it should be. Psychologists call this the assumptive world. So, when this poor fellow (you and I) is confronted with Professor Lawrence's distorted rooms and deceptive distances, his assumptive world goes all to pot. Things he sees with his own eyes don't "jell"; facts he has established (he thinks) contradict each other all over the place, and he winds up with midgets, giants, gravity in reverse and a host of things he knows should be impossible. But there they are. Occasionally, people see through the deceptions, but always with good reason.

The professor cites the case of a woman who watched her husband in the room. She was so familiar

Below, left, furniture in the illusion room, while somewhat crude, looks natural. In photo at right, however, the same furnishings in a room of normal proportions, unaccustomed to a flat floor, look weird





Special "aniseikonic" glasses (left) create a confusing world for wearer—floors slope away and ceilings are at crazy angle. Above, student wears glasses in "leaf room" which becomes place of peril. Thick S-shaped lenses (right), give student feeling he faces downhill



with his size that she actually saw him properly, and consequently saw the true distortions in the room. When a strange man went in a moment later, however, she got the illusion.

What about those uphill marbles? They really go downhill, of course. The strange angles of the room simply make the chute appear to be pitching in a direction opposite to the way it is really slanted.

Some people have accused the Hanover and Princeton group of trickery. "Since you make victims squint at the room with one eye, you're denying them the three-dimensional effect they would normally have with binocular vision," they claim. Lawrence and his confreres say nonsense. To prove it, they are now building a weird thing up in Hanover, which will be known as the Hyperbolic House. It's made up of complicated curves. If it comes out as the scientists hope it will, a person will be able to look into it with both eyes wide open and get the same odd effects. Walls, floors and ceilings curve inward, with all the proper varying molding and window sizes to destroy normal perspective. The builder, who wasn't told the purpose of the house, completed one section a few weeks ago and walked into Ames' office with a worried

frown. "Something aww-fully funny about that place," he told the professor. "We made it just like you said—all curves. There's not a straight line in the whole thing. But we just stood back to look at the work a minute ago and, darn if it didn't come out square as a crackerbox."

Normal objects moving across the Hyperbolic room will appear to observers to start out pint-size, grow to twice their size in the center, then shrink again as they approach the opposite wall. "According to all known mathematical calculations, this can't happen," says Lawrence, "but it does."

Maladjusted people show up quickly when exposed to the distorted room illusions. One man, given a stick, was told to strike at the rubber mouse on the right, or small side of the illusion room. He took a swipe and, as everyone does on the first try, hit the back wall, which came in toward the mouse at a sharp angle. He tried again, without making any allowances. He did it again and again until finally, in a rage, he climbed right in on top of the poor rubber

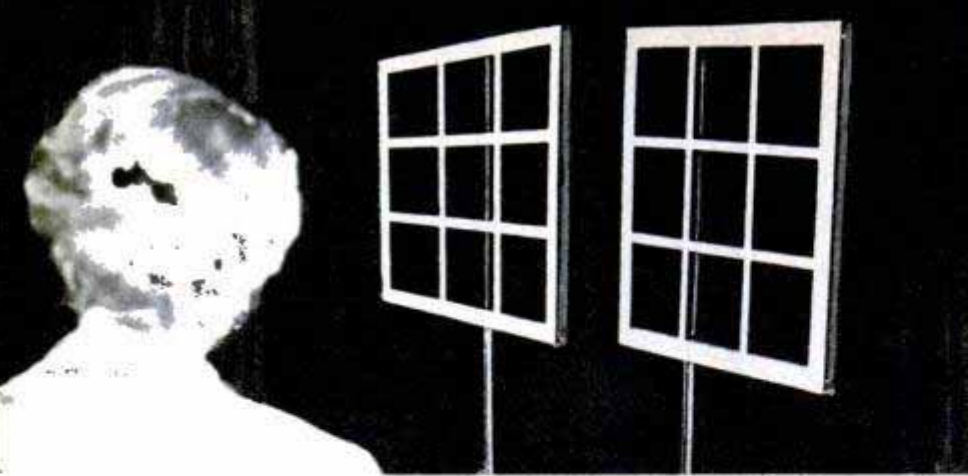

Window at right is square and stationary; window at the left, shaped like a trapezoid, is mounted on a vertical rod and is moved with strings operated by the victim. Problem is to make edges parallel



mouse and beat it to a pulp. "That man," says Lawrence. "was not well adjusted. Obviously, it wasn't the mouse's fault."

There are many other illusions in old Laughlin Hall, which help to prove that what we see may have absolutely no resemblance to the thing we are looking at. In one big closetlike affair, there are three peepholes. In each hole, the observer sees a small, three-dimensional wire chair with a white seat. The chairs are identical. Then, he goes around back to find out that he hasn't been looking at any such thing. The first is a true chair, all right, made of wires and a white paper seat. But the second is the greatest crisscross of floating wires in three dimensional Dali pattern that you ever saw, with a trapezoidal-shaped patch of white paint on the backboard. When viewed from the angle of the peephole, however, all those wires fall into a pattern and the splotch of paint becomes the seat of a chair that seems identical to the first one. So does the third one, which is an ordinary two-dimensional pattern of wires.

Again, proof that previous experience determines what the viewer sees is borne out by the fact that, although nearly everyone sees three-dimensional chairs, an architect recently stopped at number 3, and

said: "That's a two dimensional chair in perspective."

"Architects," explains Lawrence, "spend all of their work hours using two-dimensional lines to give a three-dimensional effect. Hence, this man was not taken in by an illusion that will fool practically anyone else. His storehouse of experience told him exactly what he should be looking at. And he was."

Another interesting experiment is the "leaf room," a perfectly square room completely lined with red oak leaves to make it unfamiliar. While developing queer S-shaped lenses to correct an eye abnormality known as "aniseikonia," in which each eye records a different image on the brain, Hanover scientists discovered that the glasses also worked in reverse. They could give a normal person aniseikonic vision. These aniseikonic glasses are worn in the leaf room, and do weird things, depending on the type lens used. In some cases, the ground rises up at a rugged 45-degree angle, and the victim feels nine feet tall. Walls

slope up and away. The ceiling soars off into the firmament. With others, the man feels a midget, the ground slopes away like a coal chute, walls rise up in a peak and crowd in around his head. The ceiling tilts crazily. The wearer finds himself crouching and dodging to avoid a collapsing world.

Worn outdoors, the glasses do even stranger things which are mightily signifi-

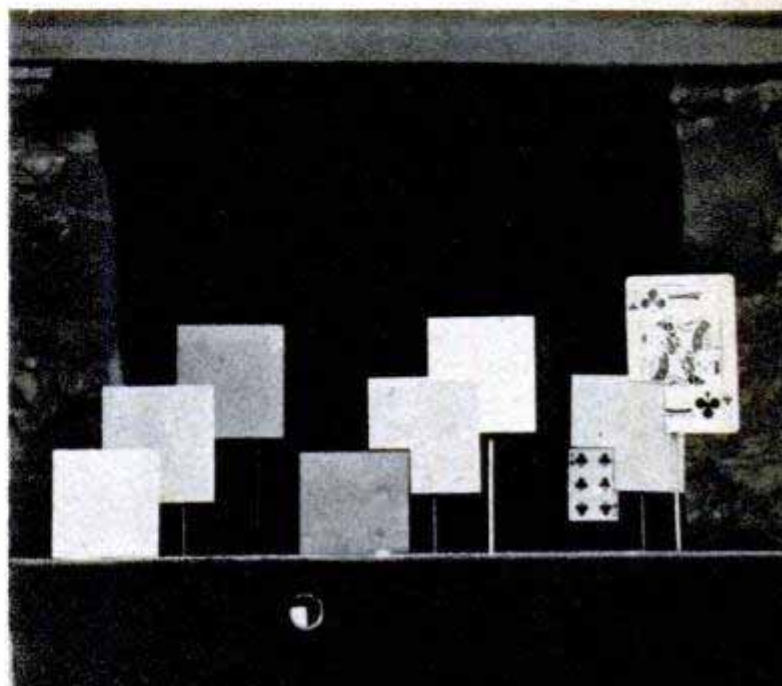

cant. Similar objects may look entirely different. A level lawn, for instance, will tilt away like a tip table, while a lake in the same scene, just as flat and expansive, will not tilt at all. Why? That storehouse of experience is working again, Professor Lawrence explains. Land might possibly tip away, so the mind accepts the evidence given by the lensed eyes. But, experience says, you can't tip water without spilling it, and that water isn't spilling. So the lake stays flat. To compensate for that, tiny ripples on the lake may look like monstrous waves through these glasses. Something has to give when the facts don't add up. With some of the lenses, to make the rest of the world stand up the way it should, the poor aniseikonicized mind will make a woodland stream rush madly uphill.

In all these experiments, the thing we are most sure must be so is the one that wins out when the mind is being fooled. These are known as the "dominant cues." In the dungeon there are the yellow spheres to illustrate this. The viewer, sitting in a darkened

(Continued to page 266)

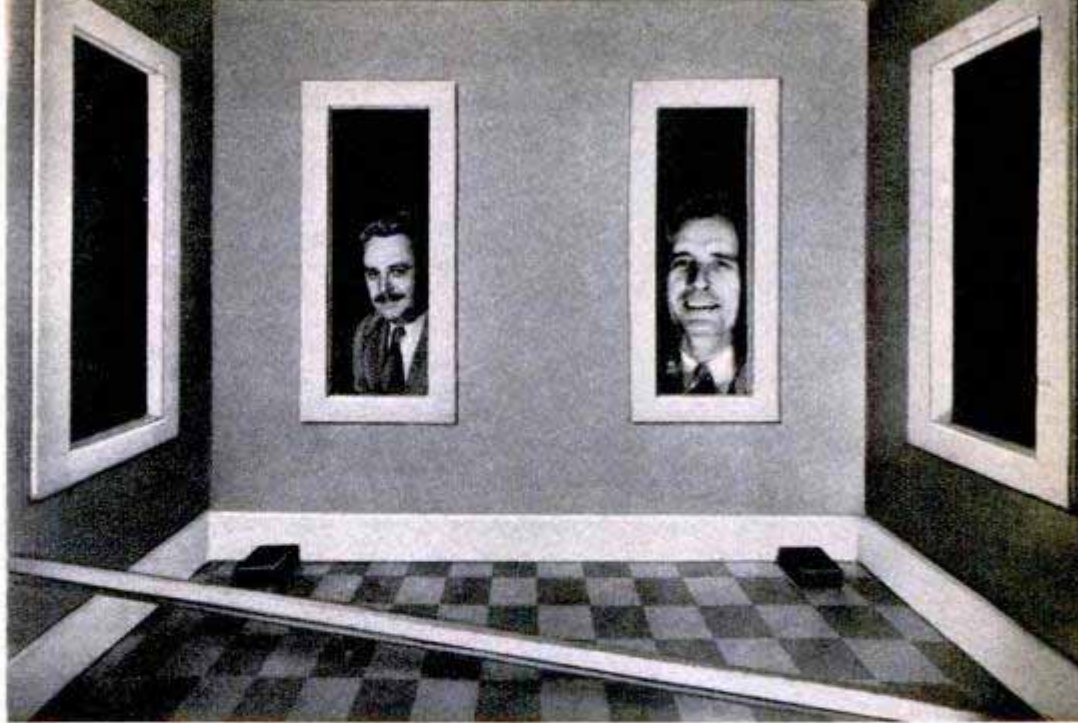

Marbles seem to roll uphill along metal trough in illusion room. Actually, trough is sloping the other way and they move from right to left by gravity. This is eye-level view of room

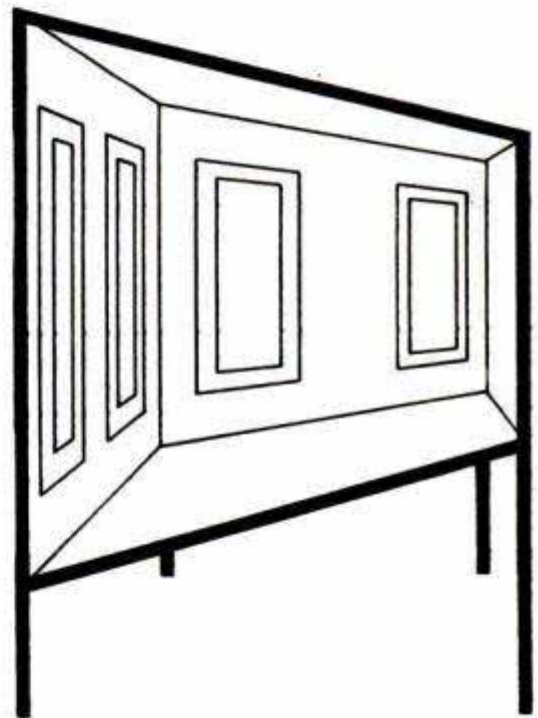

Sketch shows actual shape of an illusion room. The left side is about twice as deep as the right side and floor and ceiling fan away from the right side at a wide angle to kill perspective

Viewer looks through peephole at overlapping cards which are notched to give illusions both as to their order, according to color, and size. Opposite page, camera view through peephole

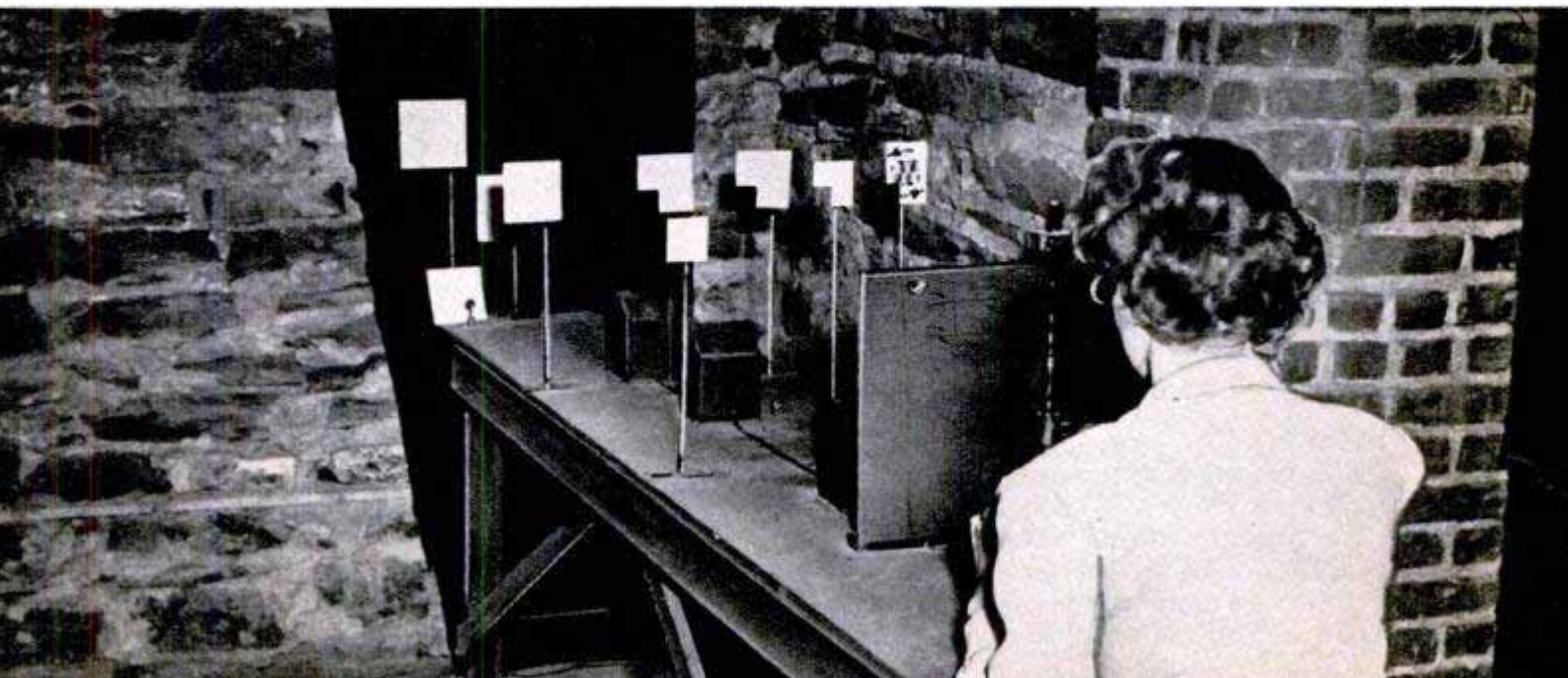

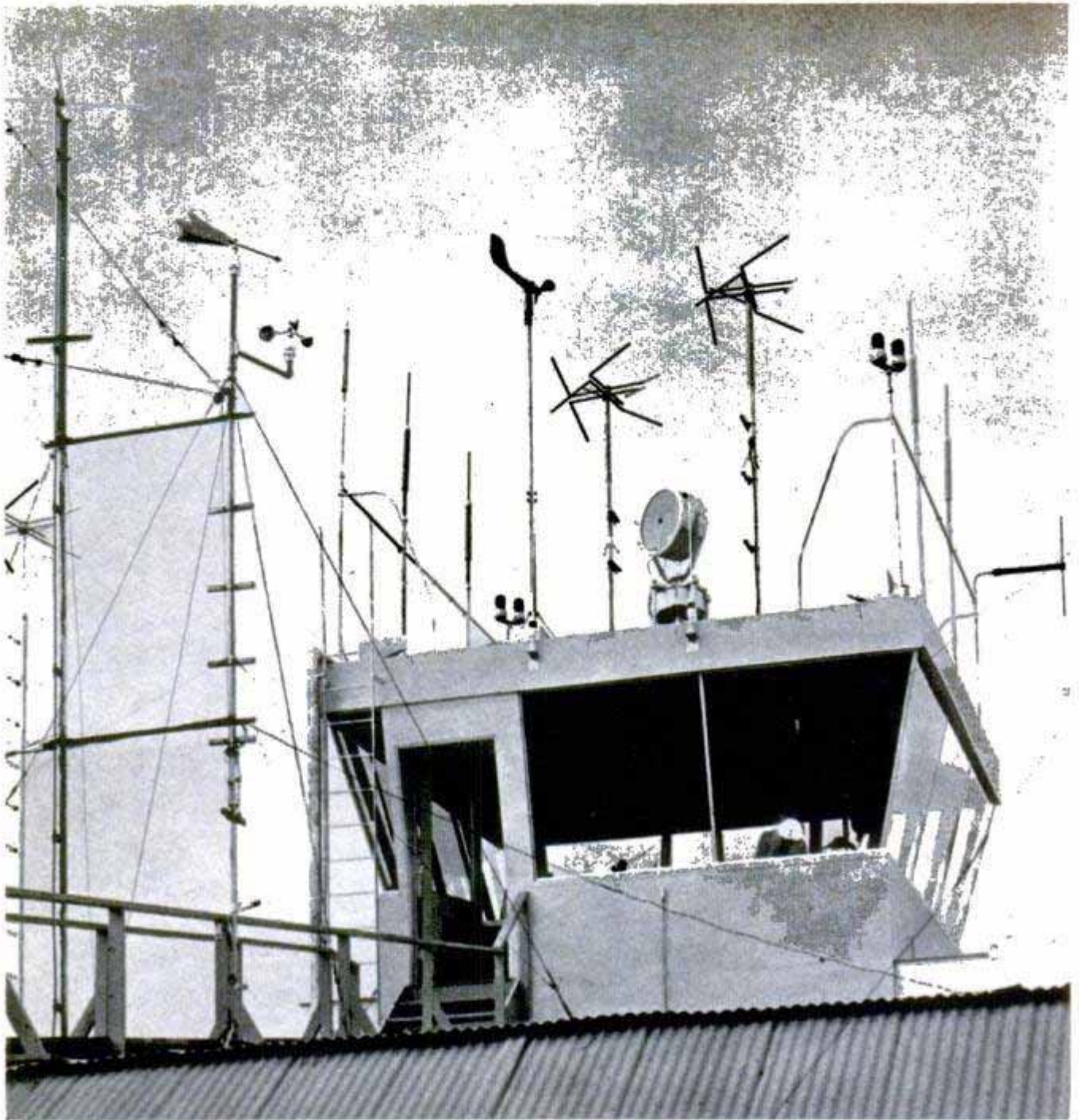

United Air Lines photo

## Tomorrow's Control Tower

Previews of tomorrow's correctly equipped airport can be had at Reno, Nev. There, the Civil Aeronautics Administration is operating complete electronic equipment that is expected to set the pattern for future installations of similar size and scope. The tower has polarized angled windows to eliminate glare, air conditioning, soundproofing, and very-high-frequency

receivers and transmitters on all frequencies for contact with private, military and commercial aircraft. A counter device keeps daily totals on all air traffic. Telephone links the tower directly or through relays with all others in the CAA's western circuit, keeping it advised of all aircraft en route to Reno. Built by United Air Lines, which uses the field, the compact tower's floor measures 16 feet square and its ceiling 20 feet square.

## "Tracer" Atoms Used to Study Formation of Rust

Radioactivity may teach science how to control common rust, according to General Electric engineers. In experiments they are using "tracer" atoms to photograph rust. A solution holding radioactive iron is electroplated on the surface of the metal to be studied. A photographic plate is placed

against this surface and left for several days. During this time, the radioactive material exposes the plate, and as the metal rusts, a decrease in radiation results, showing up as light areas on the plate. Through these pictures the engineers can study the formation of the rust.





## "Banana" Lifesaver

Increased stability as a midair rescue platform is achieved by the new HRP-2 helicopter, built by the Piasecki Corp. It is the prototype of a higher-powered craft intended for rescues of entire bomber crews

that have crash landed on water or in the Arctic wastes. The banana-shaped craft in emergencies could carry up to 27 on the floor of its central, 20-foot-long cabin. A tandem arrangement of rotors makes it better balanced so large loads can be added or dropped while in hovering flight.

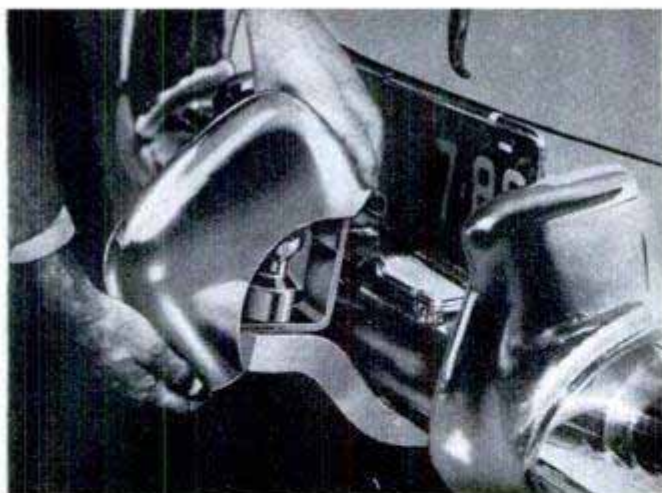

## Trailer-Hitch Guard

Trailer hitches, often grease-coated and ugly on the rear bumper of a shiny automobile, can now be covered with a shiny chrome guard that will fit almost any car on the road. Large enough to cover the entire hitch assembly, the guard also serves as an additional bumper guard and prevents hooked bumpers that result when the hitch locks under another car's bumper. Spring tension holds the cover in place.

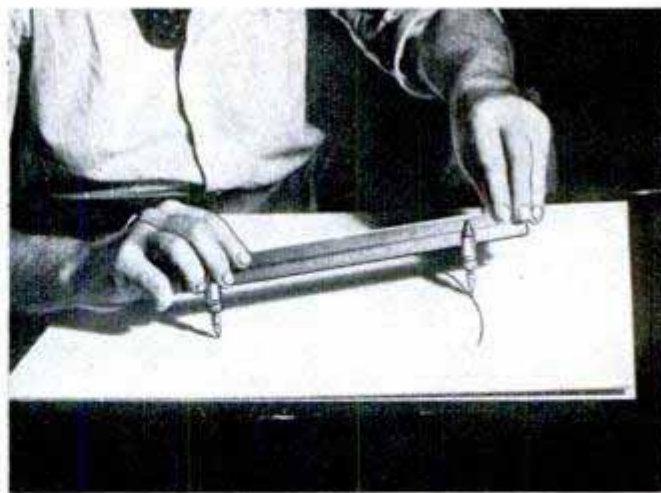

## Trammelheads Make 4-in-1 Tool

Used with any combination square or scale, a set of trammelheads provides an accurate compass, height gauge, inside or outside calipers or scribe. The sets come complete with scribe points, pencil tips and caliper points.

☐ Heat output of a typical jet airplane engine is equivalent to that of steam plants needed to heat a 4000-room office building.



## Electric Dishwasher Rolls on Casters

Apartment dwellers as well as homeowners can now have an electric dishwasher that requires no installation and can be rolled around the kitchen on casters. All the housewife has to do is connect the rub-



ber inlet hose to the faucet and plug in the electric cord. The drain hose is attached to the inlet hose and centers over the sink when the inlet is attached. Less than five gallons of hot water are used in the entire cycle, consisting of a five-minute wash and two short rinses. A detergent dispenser automatically adds the proper amount of cleaner during the wash process.

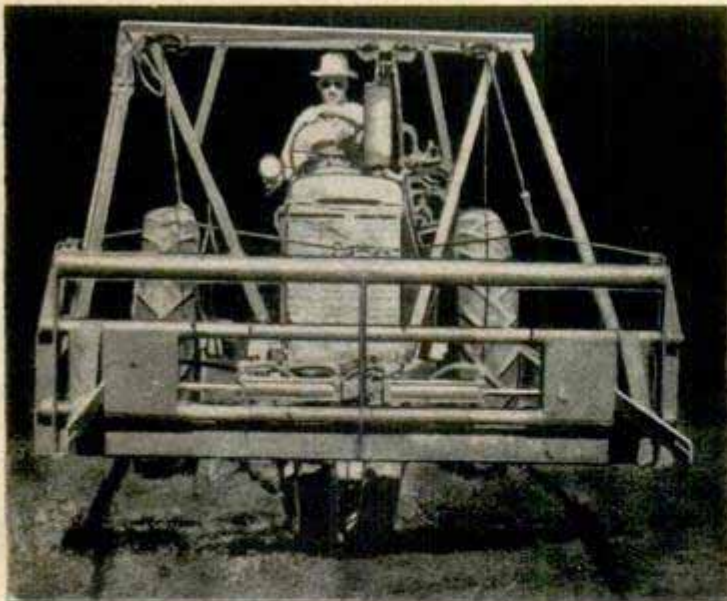

## Baled-Hay Loader

As many as seven bales of hay at a time are loaded by a homemade lift that stacks them as high as 21 feet. Developed by Frank and Erwin Billeter of Ellensburg, Wash., the lift consists of a tubular frame attached to the front end of the tractor. A fork on the face of the frame holds the bales

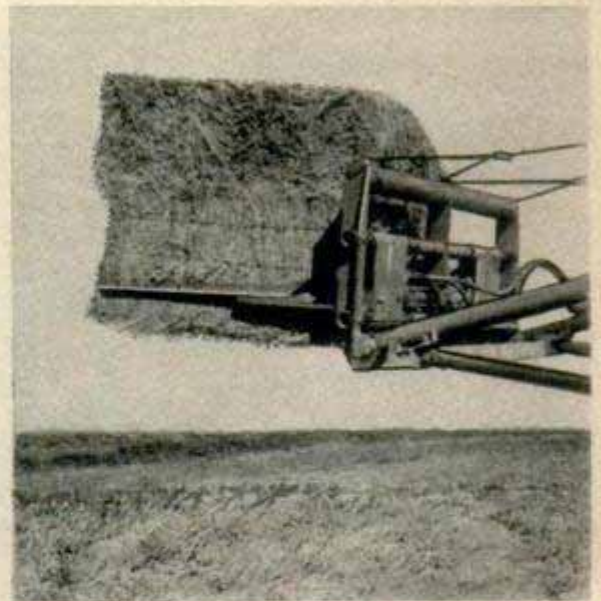

securely by squeezing them between two hydraulically operated arms. Two double-acting hydraulic cylinders are used to power the squeeze fork.

Edible wrappings for bars of food are under development by the Army Quartermaster Corps for use in cold climates where removal of foil wrappings is difficult.



This fireworks display in Radio City Music Hall cost \$50,000, took two years to build and required 24,000 incandescent bulbs

By *Richard F. Dempewolff*

HIGH ABOVE a revolving carrousel, studded with gaudy incandescent bulbs, skyrockets burst in star-spangled glory. Staccato explosions banged a tympanic din over a musical background provided by a 65-piece orchestra, a 30-voice chorus and the rumble of the biggest organ in existence. Showers of colored light twinkled over the dazzling face of a whizzing pinwheel. Aerial bombs let go a barrage of fiery streamers. Then, with one great boom, a hundred-foot wall of colored light cascaded over everything, as the applause of 6000 spectators joined the tidal wave of sound tumbling across the gold-plated dome of light overhead.

This was no outdoor Coney Island fireworks display. It was one of the outstanding indoor spectacles produced by the largest and most incredible theater in the world: Radio City Music Hall.

Because it is even more grandiose than the grandeur it produces, the famous theater must always outdo itself in the extravaganza department. Any ordinary show would be lost in the cavernous maw of its 60 by 100-foot proscenium arch, which backs off over the heads of the audience in a series of concentric golden coves depicting a vast stylized sunset. From auditorium doors to curtain is a city block's distance; its massive stage is nearly half the size of a

## Hall of a Thousand Illusions

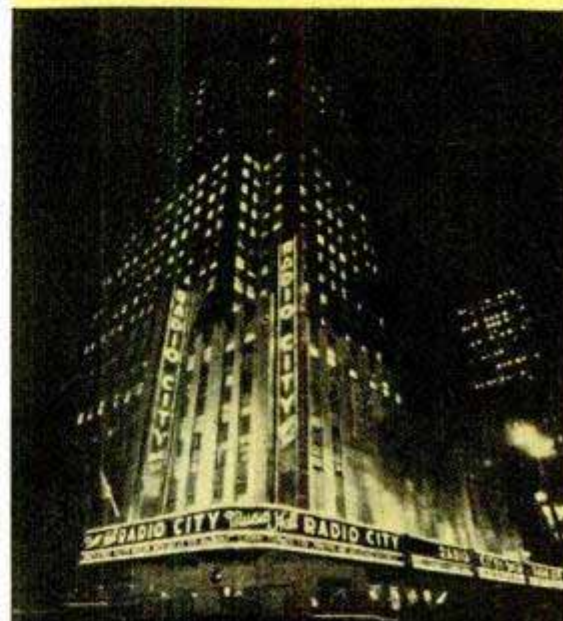

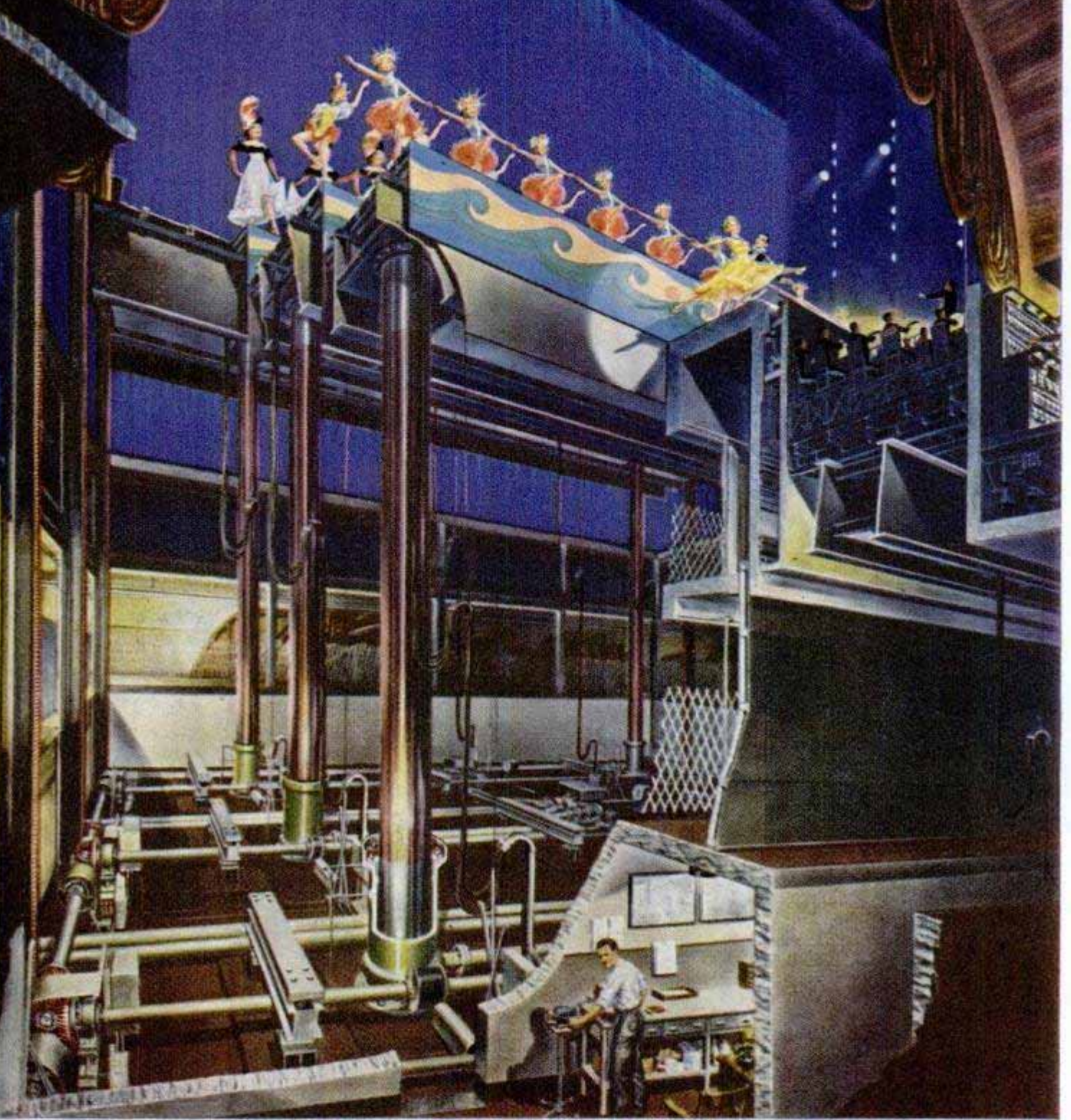

Courtesy Socony Vacuum Corp.

Some of the magic of Music Hall staging is made possible by the three stage elevators which operate on 57-foot pistons. The famous dancing Rockettes are shown above performing on three different levels (also below across the two pages). The 65-piece orchestra rides a separate elevator and sits in sort of a band wagon on wheels that moves across the stage elevators to front or rear sections much to the surprise of the audience. To the right of the orchestra is part of the light console which has 4305 switches for presetting any of 20 different light combinations on any of the units in the huge theater. There are 25,000 bulbs in the place





Audience gasped when an observation car appeared on the stage. Below, light technician rides mobile stand

football field. More than 2000 lights illuminate that stage, and its contour curtain weighs three tons.

Eight million people a year, half from out of town, pour through the Music Hall's air-conditioned five-story foyer to fill its 6200 seats daily, and it takes miracles like the recent fireworks to keep them coming.

To stage such gaudy displays, the theater's producers: Leon Leonidoff, Russell Markert, Florence Rogge and an army of some 60 technical assistants, don't spare the horses. Those fabulous rockets and bombs could not have been the genuine "made-in-China" variety, or there'd have been a few scorched patrons. So, for two years and at a cost of \$50,000, the stage-lighting director, Eugene Braun, and his men worked over a maze of bewildering blueprints in the hall's own shops to construct twelve 600-pound lighting panels. When finished, they towered 42 feet against the back wall of the stage, filling it from side to side.

The dazzling 3½-minute display called for 24,000 incandescent bulbs in eight

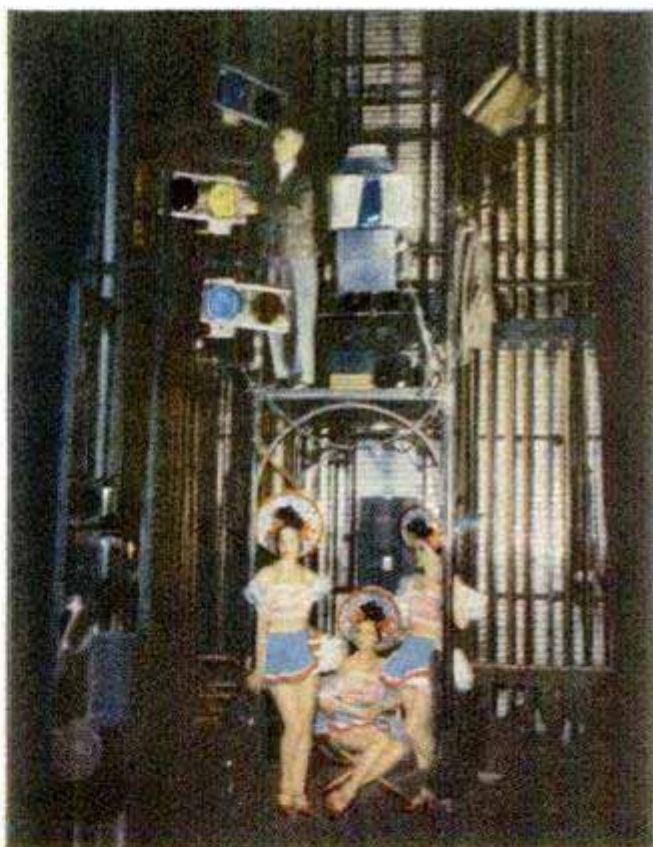

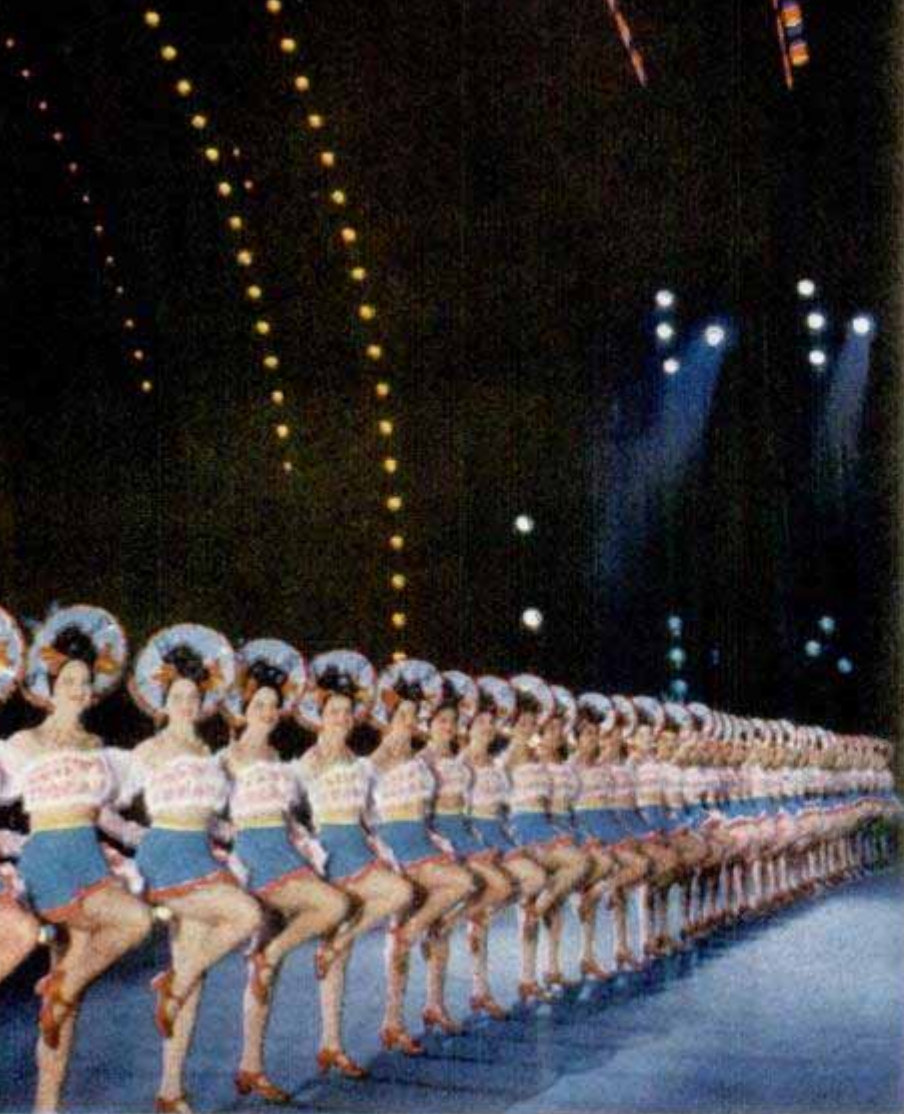

Spotlights from booth on third mezzanine throw beam 190 feet to stage where the beautiful Rockettes are doing precision dance

colors, 300,000 feet of copper wiring, a nightmare of automatic relays run on a battery of electric motors, thousands of blank cartridges and an automatic synchronized firing device that would chal-

the wings. The water is trapped in a tarpaulin over a slightly lowered elevator and drained off. A phony but impressive Niagara Falls has disgorged itself into a monstrous hidden drain from huge tanks of an

Behind railing at stage level is a full-size swimming pool. Divers operated from boards at left end of pool



lenge an Einstein. The whole thing had to go through its automatic routine at the touch of a single button.

For 17 years, Leonidoff, Braun and other Music Hall geniuses have been staggering a goggle-eyed public with stage trickery that beggars description. Daily, the orchestra pit containing its quota of Maestro Alexander Smallens and 65 artists is swallowed up by the floor. It may reappear a few minutes later, slowly rising out of the back of the stage—or the front. Once, without dropping the curtain, an entire scene depicting outdoor circus grounds suddenly changed to an interior of the big top, with cages of wild animals, while the baffled audience blinked 12,000 eyes during a brief five-second blackout.

Regularly, the famous Rockettes, whirling in gorgeous costume, rise out of the stage floor and silently disappear beneath it, while other acts replace them as mysteriously. Whole sets rotate and change before your eyes.

Hurricanes, with drenching rain (from perforated pipes high above the stage), have swept across the place, blown by a 10-foot propeller-type fan located in

agitated soap solution. An ocean-going ship was once torpedoed on the stage, broke in two and sank beneath the waves as pretty as you please. Another time, a life-size observation car of a train was hauled off the stage by a chugging locomotive, and a moment later the whole train was seen winding its way across the rolling hills in the background. Elephants, helicopters, a troupe of 30 horses and a full-size swimming pool—all have been accommodated from time to time.

Much of the magic of the Music Hall can be laid to the hydraulic mammoths beneath its stage. There, in the dungeonlike subcellar where footsteps of Rockettes dancing overhead are never heard, and blaring music comes as a muffled thrum, a hydraulic engineer keeps an eye on the real magicians—eight gigantic pistons, whose shiny steel sides glisten with oil in the gloom. Each piston, almost two feet in diameter, and 57 feet high, fits into a cylinder whose casing plunges 67 feet down into bedrock. The ponderous shafts can move the stage in whole or in part, from 27 feet below stage level to 13 feet above it, at the touch of buttons on the master control board located behind the wings upstairs.

The stage itself really consists of three hydraulic elevators which divide it lengthwise into 70-foot strips, about 15 feet wide. There are two pistons per elevator. The fourth pair is for the elevator on which the orchestra sits in front of the apron. Any one of the elevators can be raised or lowered independently—or all three stage elevators can be locked together and moved. That way, a whole show can disappear from sight.

And how does the orchestra

**Top, sound-board operator in booth on third mezzanine sets dials as he watches show. Center, light-control console directly in front of orchestra. Right, Leon Leonidoff, producer, directs show rehearsal. Board enables him to talk to anyone in the theater**

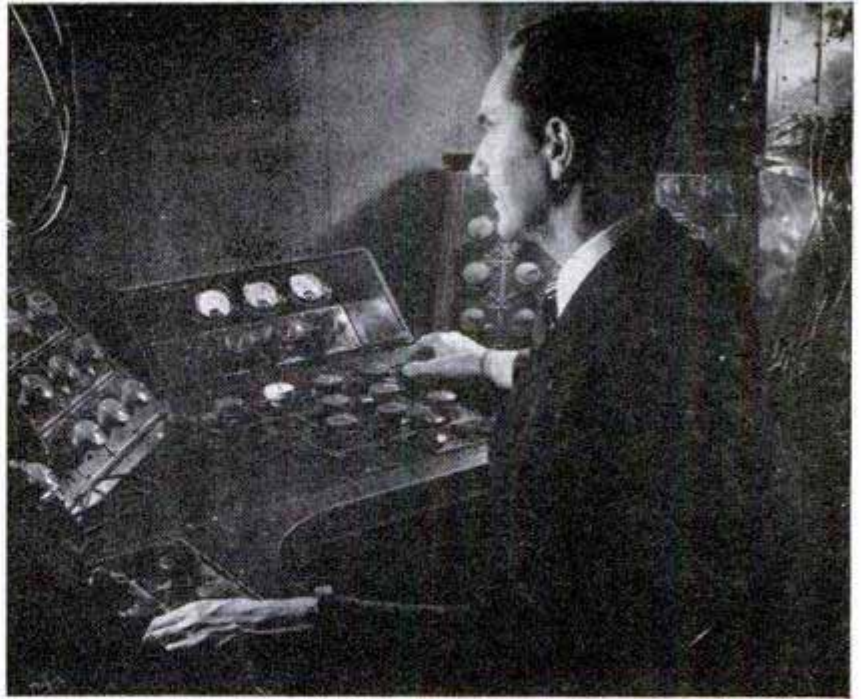

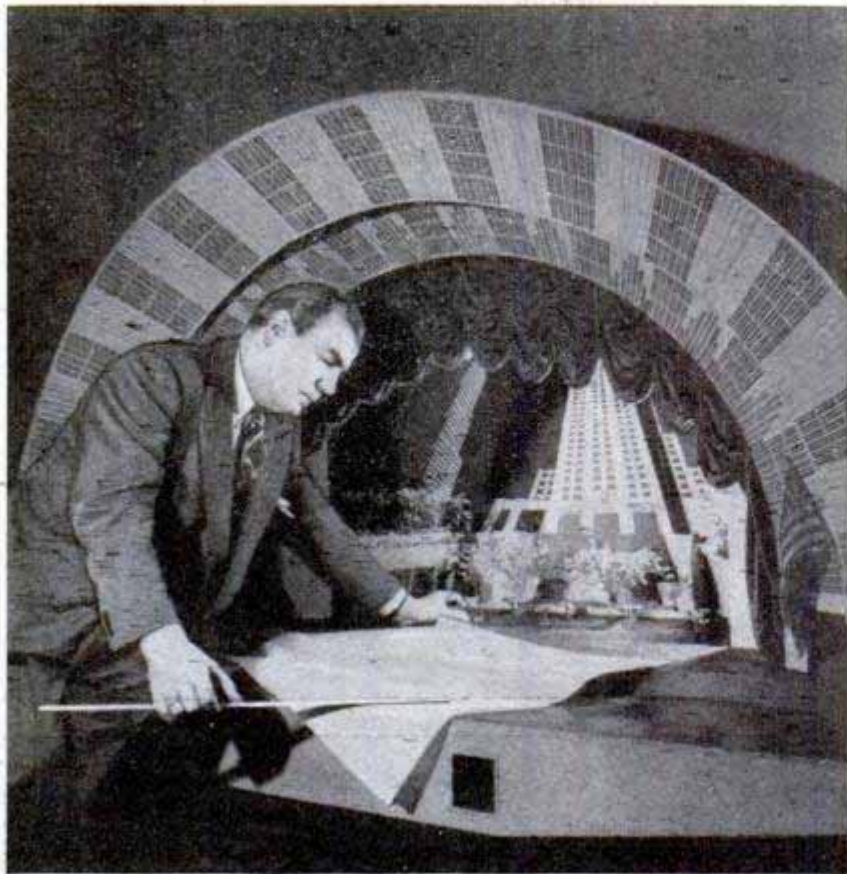

All scenes are worked out on a model stage. Here Bruno Maine, art director, works out a skyscraper scene. Stage even has elevators

Proscenium arch, 60 feet high and 100 feet long, frames theater's renowned 36 Rockettes. Sunburst coves of ceiling extend to the back

get moved around so eerily? Atop the orchestra elevator sits something known as the "band wagon," a sort of self-propelled boat on wheels. While the overture is going on, the whole stage is lowered to basement level. When it's over, the orchestra subsides to the same depth. An electric motor on the band wagon sends the whole shebang scuttling across the lowered stage elevators to the desired position on the front or rear section (the middle one is too narrow to take it), and up goes the stage. The whole operation only takes a minute or so and, when the curtain goes up, there's the orchestra blithely sawing away where no one ever expected to see it.

The band wagon can also be raised to stage level and go gliding across the elevators in stage position.

That's not all the acrobatics the stage can perform. Cut into the top of the three stage elevators, like a freshly cut cookie waiting to be lifted

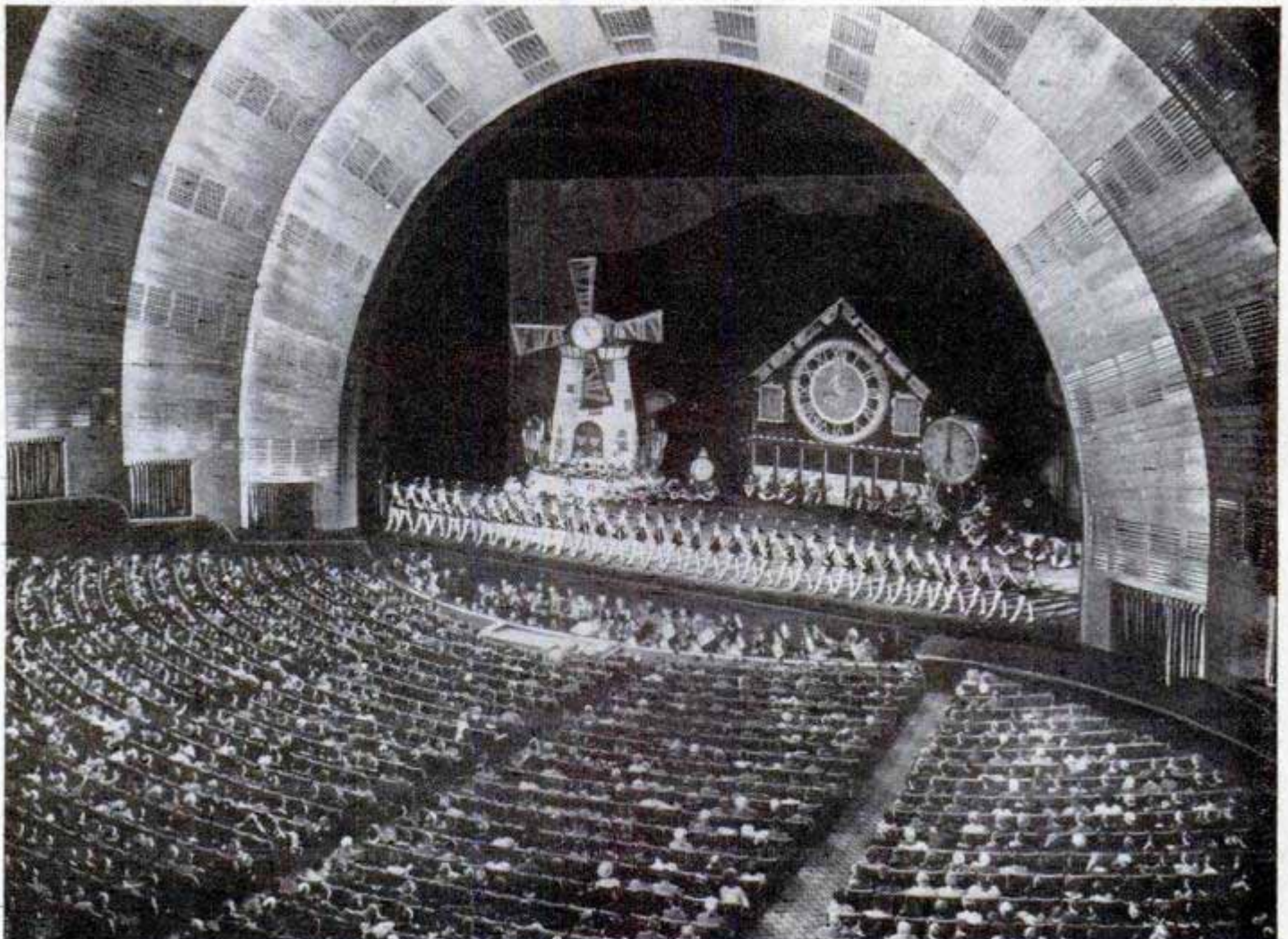





Central panel on stage-manager's control board regulates giant curtain; sliding buttons show preset pattern

from a sheet of dough, is a 43-foot turntable. Of course, the elevators must be at the same level before it can operate, since it is made up of sections from all three elevators. Fastened to the underside of the center stage section, off to one side of the turntable, is an electric motor that turns a shaft, which, in turn, meshes into a ring gear beneath the turntable. A hundred and two little rollers on three guide tracks under the turntable carry the big circle of stage around like a pie tin twirling in water.

It was by using the turntable that the circus exterior became an interior so quickly. On one side of the circle sat the tents; on the other side, the animal cages.

The audience takes all this magic machinery pretty much for granted. But not the producers or the stage manager, Irving Evans, who must keep the magic within the limitations of the Music Hall machinery. Every show is worked out in detail beforehand on a working model of the complicated stage in the office of Bruno

Ingenious turntable is made in three sections extending over the three stage elevators; it is 43 feet wide

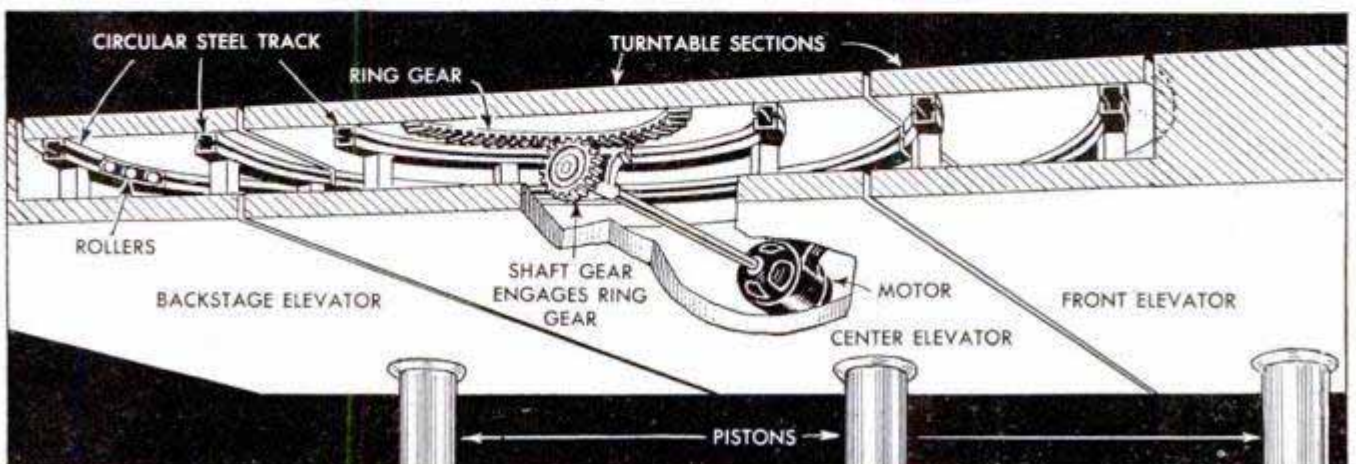



**Giant Music Hall stage easily takes in entire East Side dead-end street on full scale including washlines**

Maine, art director. The model is scaled 1½ inches to the foot and will do everything the big stage does. Its tiny pistons work by air pressure, send the elevators up and down at a lively clip. It has an electrically controlled curtain, lights and all. Every set is built in miniature and tested

on the model before it goes into production.

After that, the problem falls on the hydraulic engineers down in their jungle of pipes and pistons. The show must not be too heavy for this equipment. Special water, treated against bacteria, is pumped through a spaghetti maze of pipe at 400 pounds pressure per square inch by a pair of humming 250-horsepower pumps. The huge system, including the great 20,000-gallon pressure tank, is built to raise or lower 190 tons of stage. Above that, the elevators can hoist a weight of 96,000 more pounds. Any more, and somebody might get wet. Twice, the head of one pump has blown with a crack like a cannon and the deluge was something fearful.

The hydraulic engineer watches his show weights carefully. When Leonidoff and Maine planned the swimming pool for an Eleanor Holm (Rose) exhibition, they wanted a realistic set. The scene was the foredeck of a ship; the back elevator lifted to represent the bridge, the center section lowered to take the big steel swimming pool so it would be flush with the deck. Mirrors at an angle along the ship's bridge would give everyone in the audience a bird's-eye view of what Eleanor did in the pool.

(Continued to page 238)



**Through the big projection machines run 5000 miles of movie film a year; booth is 190 feet from screen**

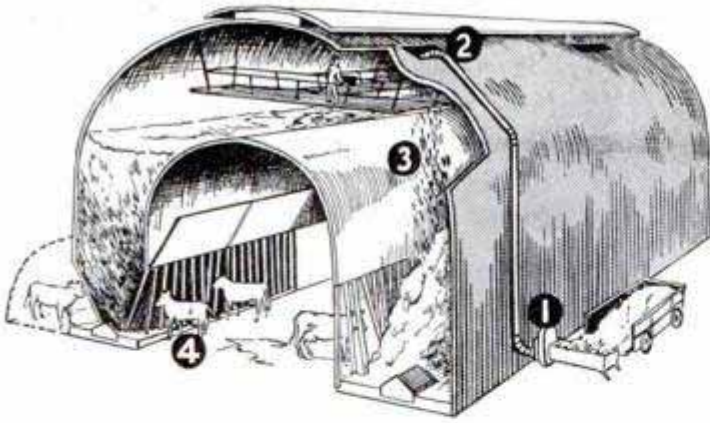

Above, blower (1) forces cut grass to top of barn (2) where it is distributed in storage space (3), allowing cattle (4) to feed themselves. Right, barn exterior. Below, cattle at feeding gates



## "Cowfeteria"

Cattle serve themselves in a scientifically designed barn that saves hundreds of man-hours of labor each year and permits them to satisfy their hunger at will just as they do in the pasture. A winter's supply of hay is stored in the top of the barn, which is essentially a small Quonset building placed inside a larger one. The cattle feed at the bottom through gates and the weight of the hay keeps the feeding racks filled. There is enough play in the vertical gates to dislodge small amounts of hay when a cow nudges them with her head. A duct system, built into the barn, dries the hay in the barn, taking only three or four days. In a test, it took only four man-hours of labor to feed 70 tons of dry hay to 44 steers.

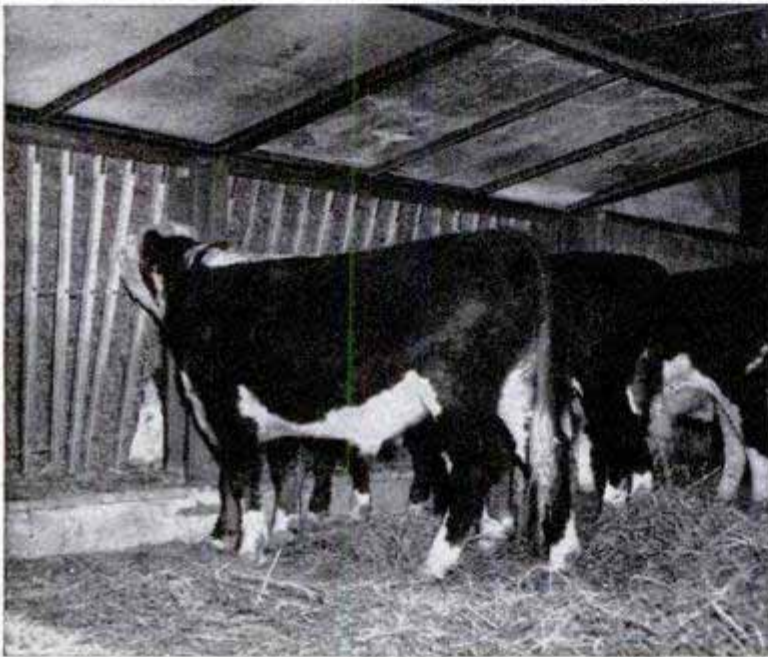

## Miniature Reflex Fits in Palm of Hand

Operated like a full-size model, a midget reflex camera that fits in the palm of your hand lets you focus and compose the picture on the ground glass right up to the moment of exposure. Made in Japan, the camera is only 1 inch wide and 2½ inches tall. It has shutter speeds up to 1/100 second and uses 10-exposure roll-type film.

Information not listed on articles in the index, starting on page 10, frequently is listed in the WHERE-TO-FIND-IT INDEX, available without charge from Bureau of Information, 200 E. Ontario St., Chicago 11, Illinois

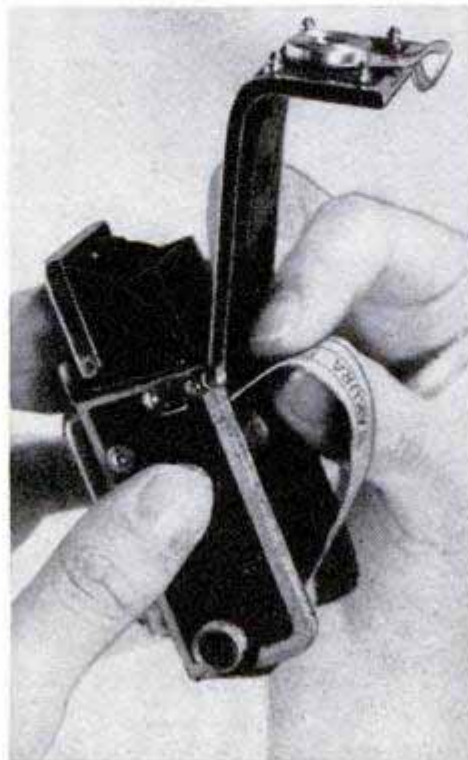

# HYDROGEN BOMB

WHERE does the hydrogen bomb get its kick? Its potential destructive energy has shocked the world with its possibilities. Scientists tell us the action of the bomb is similar to the atomic reaction that takes place in the sun and that makes life on earth possible; also, that the action is just the opposite of that of the "old fashioned" plutonium or atom bomb. In the atom

Artist's conception of an H-bomb with an atom-bomb fuse; map below shows comparative destruction areas

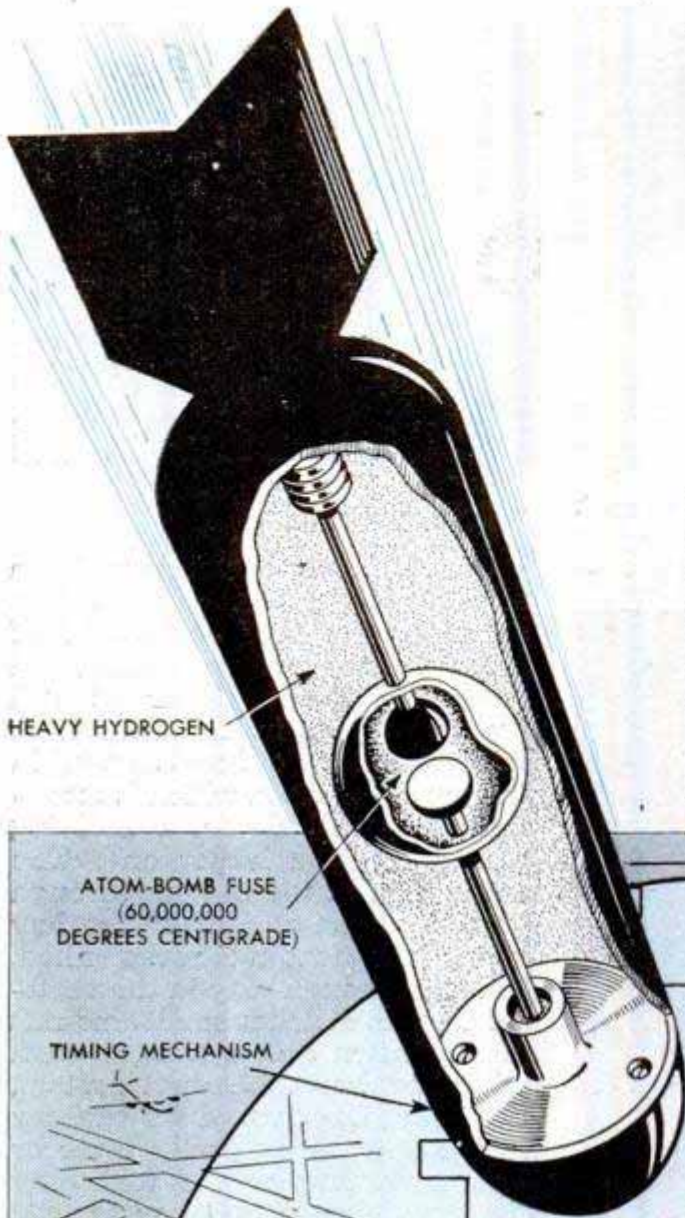

HEAVY HYDROGEN

ATOM-BOMB FUSE  
(60,000,000  
DEGREES CENTIGRADE)

TIMING MECHANISM

OAK PARK

CICERO

CHICAGO

EVANSTON

COMPARATIVE AREAS  
OF DESTRUCTION

SUPER H-BOMB—  
1000 SQUARE MILES

"PRACTICAL" H-BOMB—  
100 SQUARE MILES

ATOM BOMB (NAGASAKI TYPE)  
—10 SQUARE MILES

WHITING

EAST CHICAGO

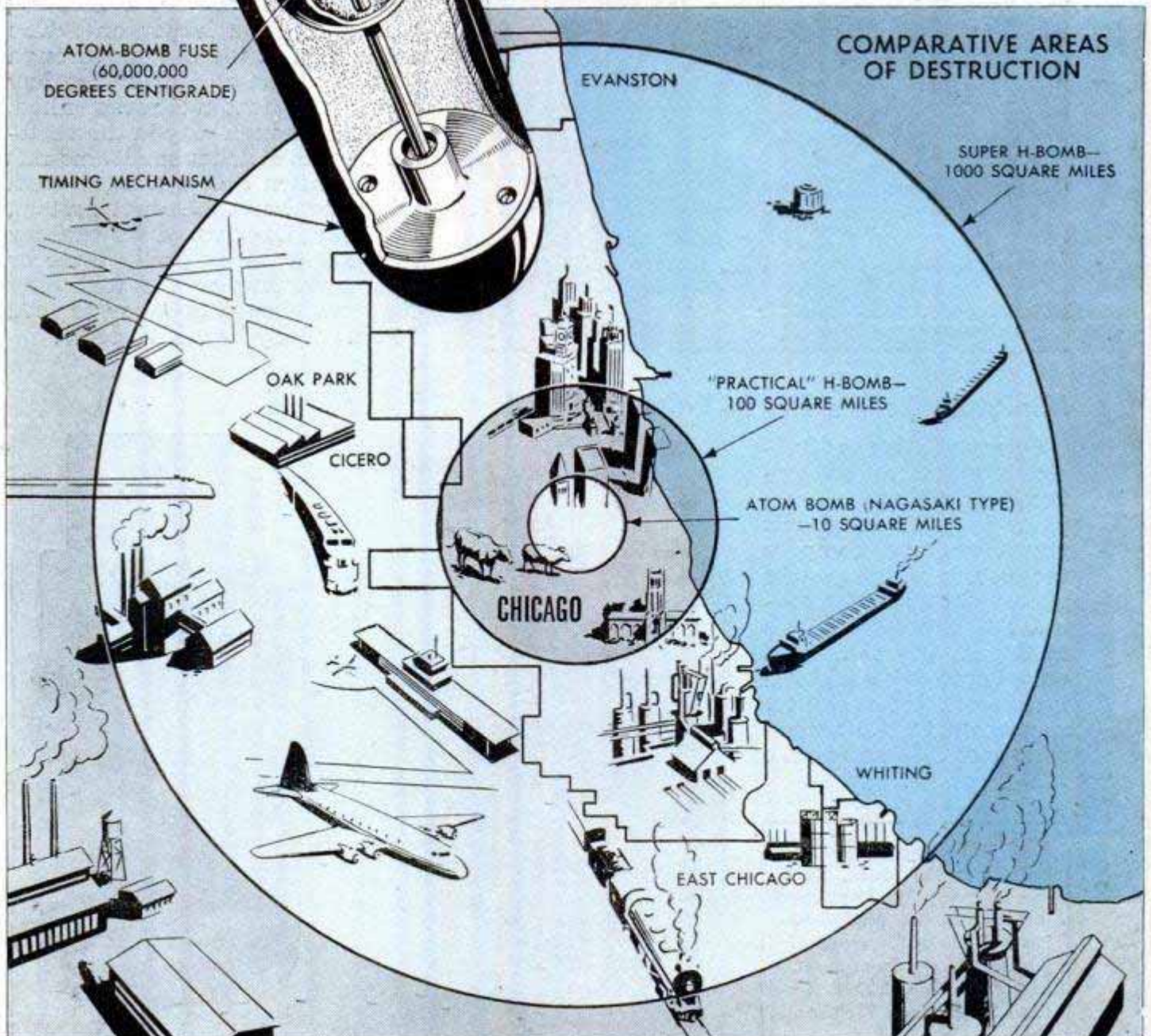

bomb, fission (splitting of atoms) takes place to produce energy; in the hydrogen bomb, fusion (joining of atoms) is the basic principle.

Scientists of the Los Alamos Energy Commission Laboratory have made public a finding known as the hydrogen-tritium reaction. There are three kinds of hydrogen atoms: ordinary hydrogen, an atom twice as heavy called deuterium, and an atom three times as heavy known as tritium. Whether the super bomb will be composed of deuterium or tritium has not been announced, but the chances are it will be the latter due to the excessive costs mentioned in connection with the project. Tons of deuterium have been manufactured and it is comparatively plentiful, while tritium is very rare and is produced today only in a few uranium piles in minute amounts.

Tritium packs the big wallop of the heavy hydrogens. When tritium is bombarded with hydrogen protons, fusion takes place and an upset tritium atom becomes an atom of helium, and from a single atom gamma rays shoot out carrying 20,000,000 electron volts of energy. It is this punch multiplied millions of times and limited only by the size of the H-bomb that has stunned the world.

Although scientists have known the theory of the hydrogen bomb for years, it wasn't until the atom bomb was built that it became a real possibility. There was no known source of heat great enough to ex-

plode a hydrogen bomb. On the sun where hydrogen fusion takes place constantly, the temperature is 20,000,000 degrees Centigrade. No such heat had ever been generated on the earth until the atom bomb was exploded with an estimated temperature at the center of the explosion of 60,000,000 degrees Centigrade. What makes the H-bomb possible is that an atom bomb will serve as its fuse!

The power of the H-bomb, made of either deuterium or tritium, runs into astronomical figures and many scientists believe that such a bomb can be built which may be 100 to 1000 times more destructive than the atom bomb. This is based on the fact that 2.2 pounds of hydrogen when transmuted into helium would yield about 200,000,000 kilowatt-hours of energy. This would set off an explosion about the same as 160,000 tons of TNT. Using only 10 times as much hydrogen—22 pounds—would result in an explosion equivalent to 1,600,000 tons of TNT or 80 times the power of the first atom bomb dropped on Japan. This can be extended within reason to a hydrogen bomb weighing one ton which would equal 20,000,000 tons of TNT.

Leading scientists differ on the after effects of an H-bomb explosion. Some say that after the blast the radiation would die out quickly. Dr. Albert Einstein warns that "radioactive poisoning of the atmosphere and hence annihilation of any life on earth has been brought within the range of technical possibilities."

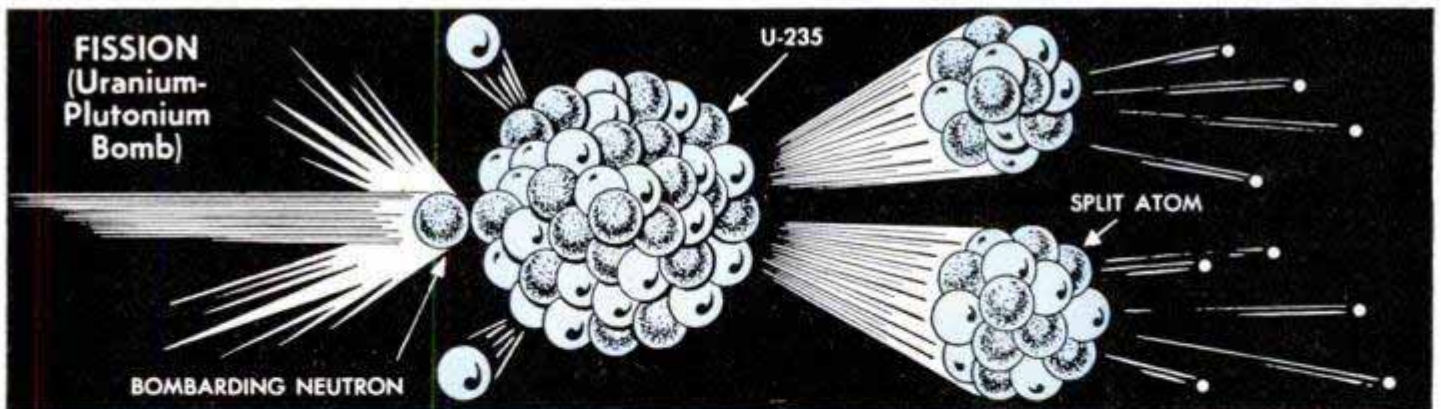

Both fission (above) and fusion (below) release tremendous energy but in different ways. The fusion reaction of the H-bomb is similar to constant explosions in the sun where hydrogen atoms are changed to helium

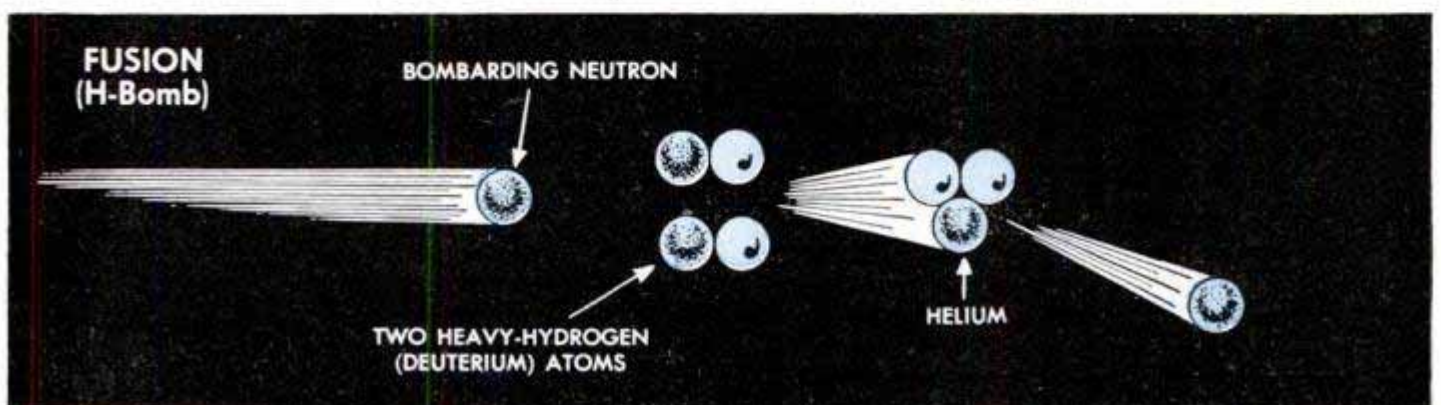

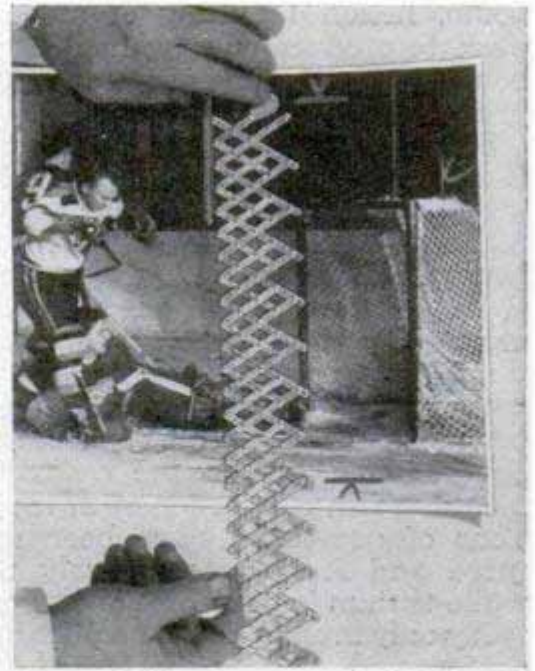

## Link Ruler

Picture editors can measure art work in proportion for reduction or enlargement with a new link-type ruler invented by Paul E. Broner, layout man for the Detroit Times. By extending the ruler across the width of a photograph so that its scale shows the desired width for printing in a magazine or newspaper, then turning the

extended ruler across the picture vertically, the exact depth of the finished engraving can be measured in advance. The Linkruler is six inches long when contracted and extends to slightly over two feet, with its three sets of measuring scales always remaining proportionate. One scale gauges reductions up to half size, another is for extreme reductions and the third is for all enlargements.

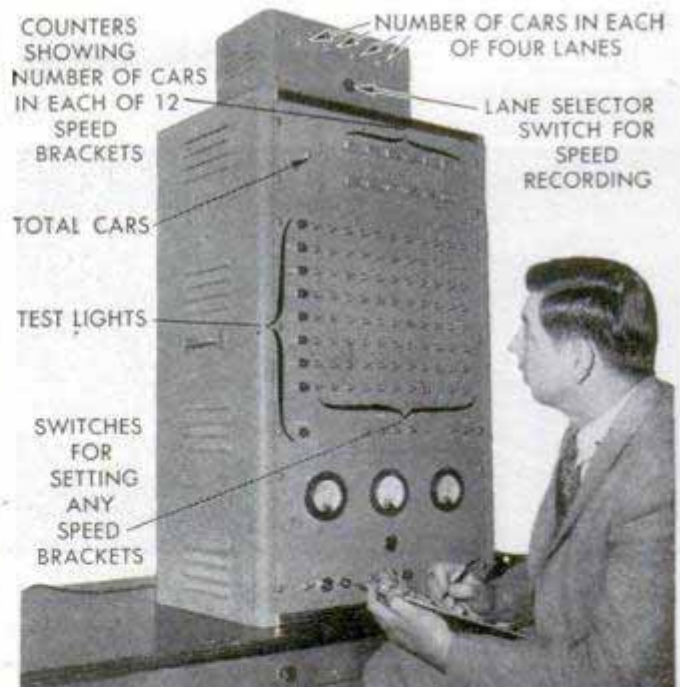
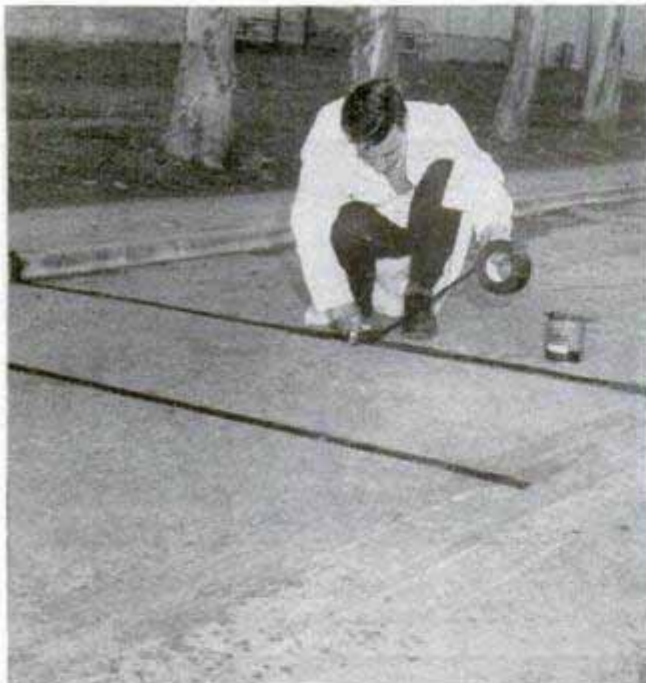

Detector wires, left, are cemented in place across each lane and are connected by wires to computer, right

## Traffic's "Private Eye"

Cars have everything but their "fingerprints" taken by an electronic robot that counts cars according to lane position and speed levels, as well as computing total traffic. Two parallel tapes, consisting of a pair of metal conductors that are forced together by the car's weight, are placed

across each lane. Impulses, triggered when the pressure of a car closes the circuit, go into an electronic computer which analyzes the information, recording it on dials to show the number of cars in each lane, the total number using the highway and the number moving in each of 12 speed brackets. The device was built by the engineering staff of the University of California.



## Low-Priced Model Featured by Kaiser

All new from bumper to bumper, the 1951 Kaiser-Frazer line includes 20 body styles and the small low-priced Kaiser. The small car, scheduled for the assembly line late in June, will first appear as a five-passenger, two-door sedan with either a four or six-cylinder engine. All trimmings and gadgets will be eliminated and the rear trunk has no outside opening. Hydra-Matic transmissions will be available on all the Kaiser-Frazer line with the exception of the small model. Later this year, the company has announced, plans have been made to switch to a Borg-Warner automatic transmission.

Thirty to 35 miles per gallon is promised for Kaiser's new low-priced model which is 60 inches high and powered with a new Supersonic engine. Rear seat folds for more trunk space. Below, "tuck away" tire well in K-F line has floor for cover



1951 Frazer Manhattan has "airplane" styling on front end, fancy glass pillar posts and "hop-up" fenders



# THUNDER

## IN A NEW PACKAGE

Gas rocket at Princeton looks like a super blowtorch, which is really what it is. It is used to test exact scale performance. When the fuel doesn't mix properly, it shatters with the crack of a 16-inch naval gun

Below, though earmuffs help deaden the roar of the intermittent ramjet, an exclusive Princeton development, it is still loud enough to cause headaches. Injecting the fuel in spurts provides much higher compression

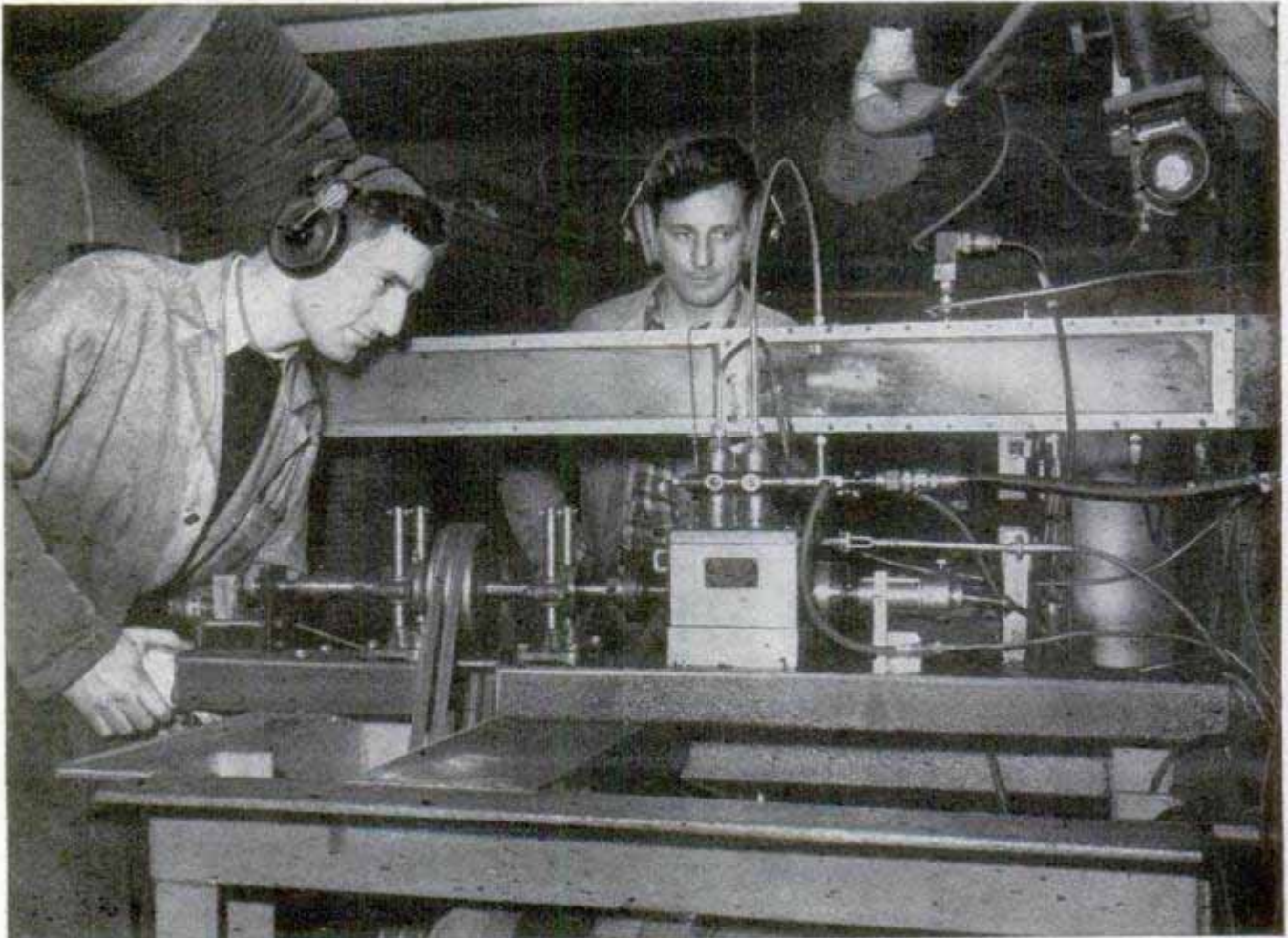



**I T STARTED QUIETLY**—like a hundred motorcycles running at the same time. Two miles away Princetonians coming out of the village post office stopped and gazed apprehensively at the sky. “We thought,” said one villager, “that any minute a crippled B-36 would fly by at about 500 feet and crash into the street.”

That was a few months ago. Today, townspeople in Princeton, N. J., are familiar with the big thunder that shatters the air for miles around the university campus. It's coming from an assortment of brand new experimental rockets and jets that poke hot, vicious exhaust stacks through two-foot concrete walls. In one cold dungeon there's a wicked-looking “ram rocket” stabbing its pointed metal nose from a stovepipe sleeve that flares out like a stainless-steel lily at one end. There's nothing lilylike about its performance.

By applying the ram principle to rockets, Princeton has come up with a device that may increase rocket efficiency by 50 percent. Unlike the ramjet, the ram rocket can start from zero speed under its own steam like any rocket. “The difference is,” explains one of the scientists, “that at 350 miles per hour, the air ramming through the sleeve makes the rocket think it's a ramjet. That extra oxygen compressing into the sleeve burns up fuel that would be blown away in an ordinary rocket.

In another building sits a second contribution to supersonic engines—the intermittent ramjet. Stretching 10 feet across



Rocket fabricator John Ashworth holds in his hands examples of steel shells before and after blowouts

Below, in addition to utilizing its fuel more efficiently, the ram rocket can start operating from a standstill, instead of at 350 m.p.h., as ramjets must

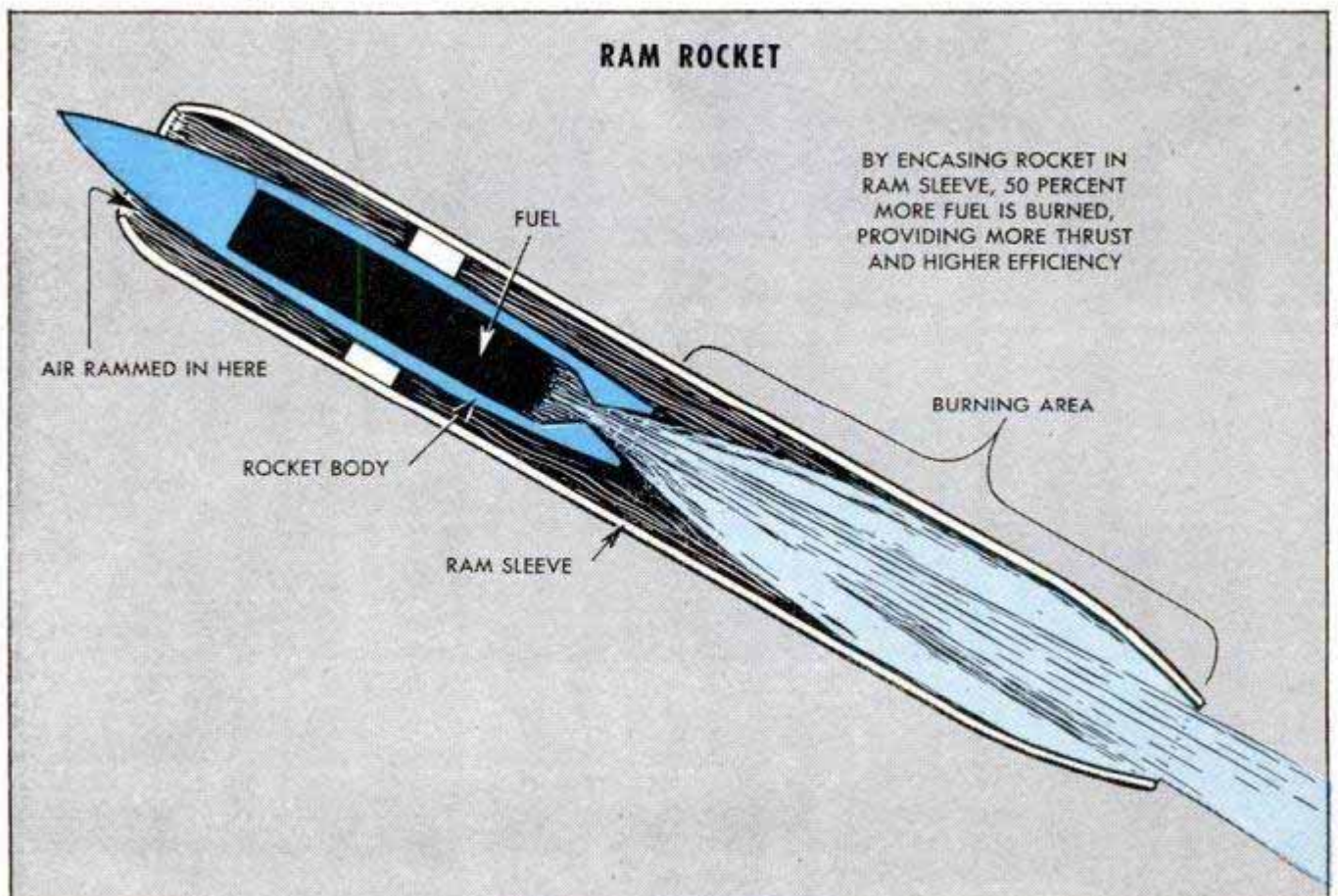

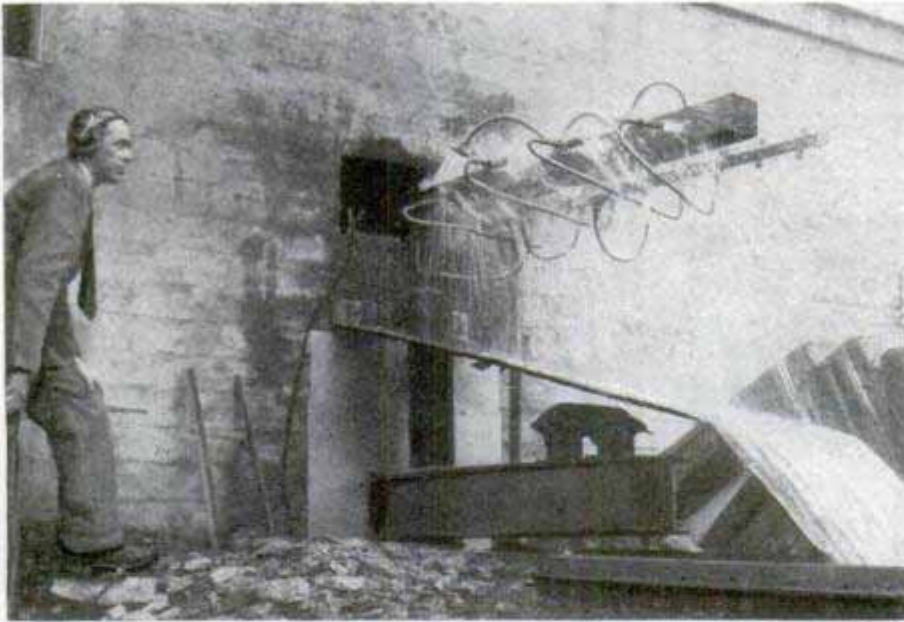

Above, ingenious scientists have rigged up an octopuslike water sprinkling system, using garden spray nozzles, to cool exhaust stack of ramjet

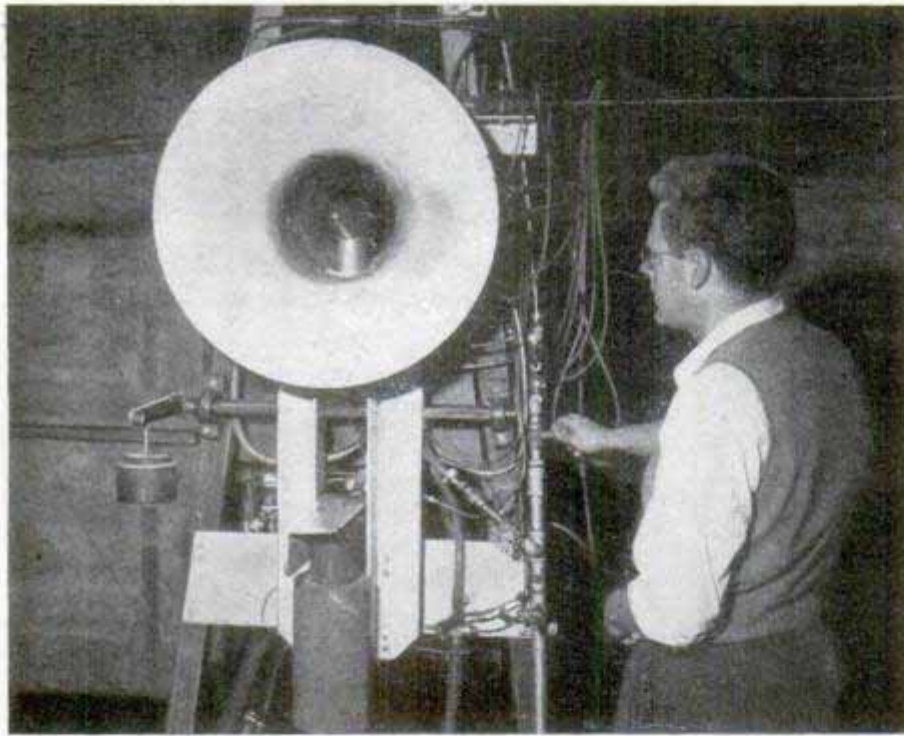

Above, bell-like front of stationary ram rocket, being readied for test. Below, cutaway of intermittent ramjet, illustrating sequence of operation

the room, it resembles a misplaced I-beam with thick glass and bolted steel sides. Instead of breathing a steady spurt of flame, the ramjet builds up twice the oomph of its more ordinary cousin by firing a series of rapid explosions. A complicated fuel-injection system sends the mixture into the tube in spurts—3600 every minute.

There's another concrete-bound midget known as a gas rocket whose fiery exhaust will drill a hole through a brick in less than a second. There's a brand new wind tunnel, too, capable of simulating flow conditions over airfoil shapes at speeds from 1000 to 3500 miles per hour and at altitudes from sea level to 20 miles above the earth's surface—a range of conditions greater than that of any other supersonic tunnel.

All these new projects are sponsored by the Office of Naval Research, located at Princeton's Guggenheim Jet Propulsion Center, and spearheaded by Dr. Daniel Sayre, chief of the university's aeronautical engineering department. Most interesting is the rocket program, under the title "Project Squid."

"It started in 1948," says Sayre, "when a few

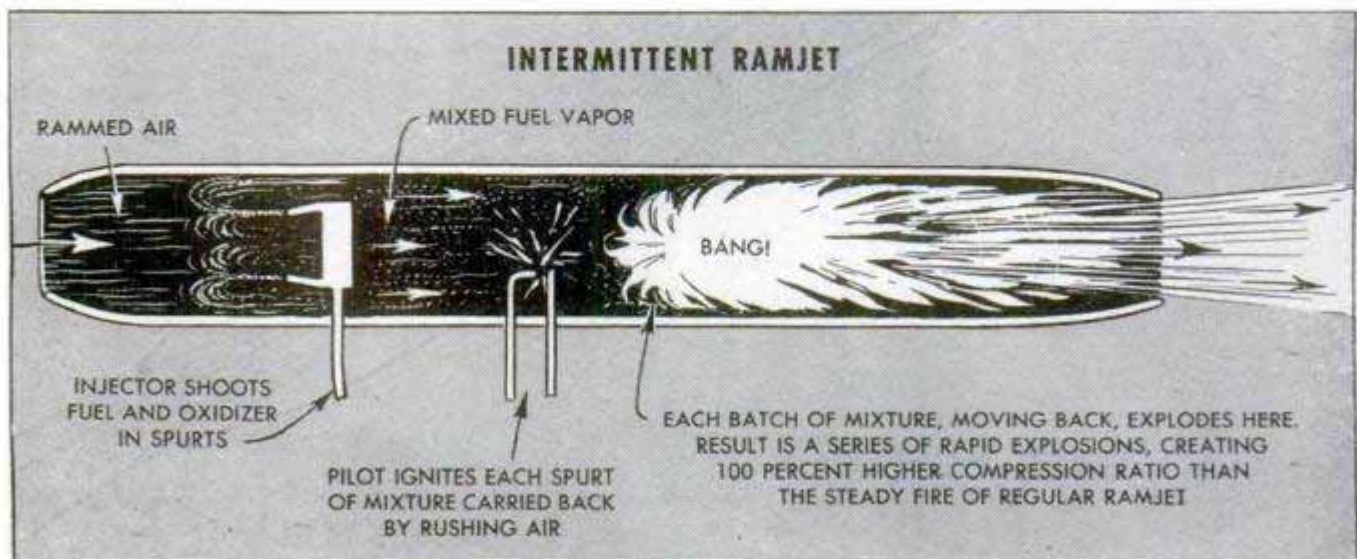

Princeton scientists decided something might be done about rocket and jet efficiency." Ordinary rockets are only about five percent efficient. The supersonic flame at the tail blows much of the fuel out into the air unburned. "We knew that a few people," he recalls, "had tried putting a sleeve over the rocket to confine and burn the gases—with some success. It seemed like a good idea."

Professor Larry Poole, a man with an imagination as long as his six-foot-six-inch frame, scouted the Army and Navy surplus stores in New York. He chugged back with sections of old B-29 exhaust stacks for the rocket sleeve. Tin stovepipe, flared six to eight inches, became the sleeve ends.

Before going to the expense of actual powered rockets, Poole simply formed a hollow miniature, bottle-shaped rocket shell of stainless-steel tubing, about a foot long and one inch in diameter. Then he got some compressed-air tanks. He set the rocket shell inside the B-29 exhaust stacks and ran a pipe from the air tank into the front of the rocket shell. The air would simulate rocket exhaust.

He opened the valve. Whish! a blast of air rocketed through the rear nozzle of the shell at about 3000 miles per hour. The most important result was that for every pound of air shooting out of that nozzle, the thin stream was "entraining," or pulling with it, 15 pounds of air through the big sleeve—enough oxidizer to burn practically all the fuel any rocket might squirt from its tail. The rush of entrained air crushed the flared stovepipe against the rocket.

"Now we knew that our ducted ram rocket would work," says Sayre. "It was time to invest in powered rockets. It was tough. Nobody in the department had even seen a rocket. We couldn't afford a big one, and even if we could, the noise would be frightful. So, they went scouting for miniatures. One company had six tiny rockets for sale at \$30,000. "We couldn't afford even one," says Poole.

Once again Poole started shopping. Surplus stores yielded stainless-steel tubing. A shop, made up of surplus machine tools, was built on the campus. On these machines, engineers now press-form their own rocket shells for \$5 to \$10 apiece. Cheap brass tubing forms the water jacket. Other parts of the fuel-injection system are machined from scrap steel. Today \$25 buys a whole Princeton rocket, made up of several parts bolted together—another advantage over the welded one-piece commercial jobs. Burned parts can be replaced.

Last winter Poole was ready for his first run. The ram rocket sat proudly in its concrete chamber. Behind two-foot concrete walls, scientists watched instruments

which would measure heat along the sleeve, fuel consumption, combustion and a host of other things. The men peered through a periscope into the chamber. "Then," says Poole with a wry smile, "we sat around scratching our professorial pates, wondering how we were going to start the thing."

Finally, he got a blowtorch and tied it with bailing wire to the tail of the sleeve, lit it, and pointed the flame up toward the rocket nozzle. Then he went back and threw the switch. The flame caught with a roar like a subway train. But it caught halfway across the room, in mid-air. The force of the fuel blast wouldn't let the flame back to the rocket nozzle. "We leaned the mixture, tried two blowtorches, and the flame jumped back and forth," says Poole. "Then we leaned the mixture some more and the whole shebang blew up with a high pitched crack, like the wallop of a 75-mm. cannon."

On a new rocket, Poole tried a different ignition trick. He took welding rod, stuck it down through the rocket nozzle, and touched off a spark actuated by a Model-T ignition coil.

The rocket lit like a charm. The only trouble was that the 3000-degree temperature melted the welding rod and blew it out the rear like a shot. Today, the ram rocket is fired by model-airplane spark plugs, and more than 200 successful runs have been logged. The rugged little engine, with its secondary stream of air whipping through the ram sleeve, burns ethyl alcohol, gasoline or diesel fuel, along with its liquid oxygen, at a highly efficient rate. The tiny rocket motor itself, only a foot long, produces a 50-pound thrust. By converting to full scale, rocketeers may be able to turn that efficiency into higher speeds, or longer flights, for supersonic missiles.

The same ingenuity and abandon accompanied the development of the intermittent ramjet—a brand new idea in jets exclusive with Princeton. In 1947 Professors Lester Lees and Abraham Kahane looked at the V-1 pulsating rocket which, though it threw a steady stream of fuel, gained better compression by use of flutter valves which let in the air in spurts. Result was a series of explosions, each one building up a high peak of compression, rather than one long roar of fire. Why not get the same advantages—plus fuel saving and efficiency—by making the fuel spurt instead of the air?

Since their jet would be stationary they had to blow air into the ram tube to simulate flight. From War Assets they got two big blowers, connected them and fed the air stream through a pipe to the front of the ramjet. They whipped up a 350-mile-an-hour breeze, and the blowers proved so

(Continued to page 280)

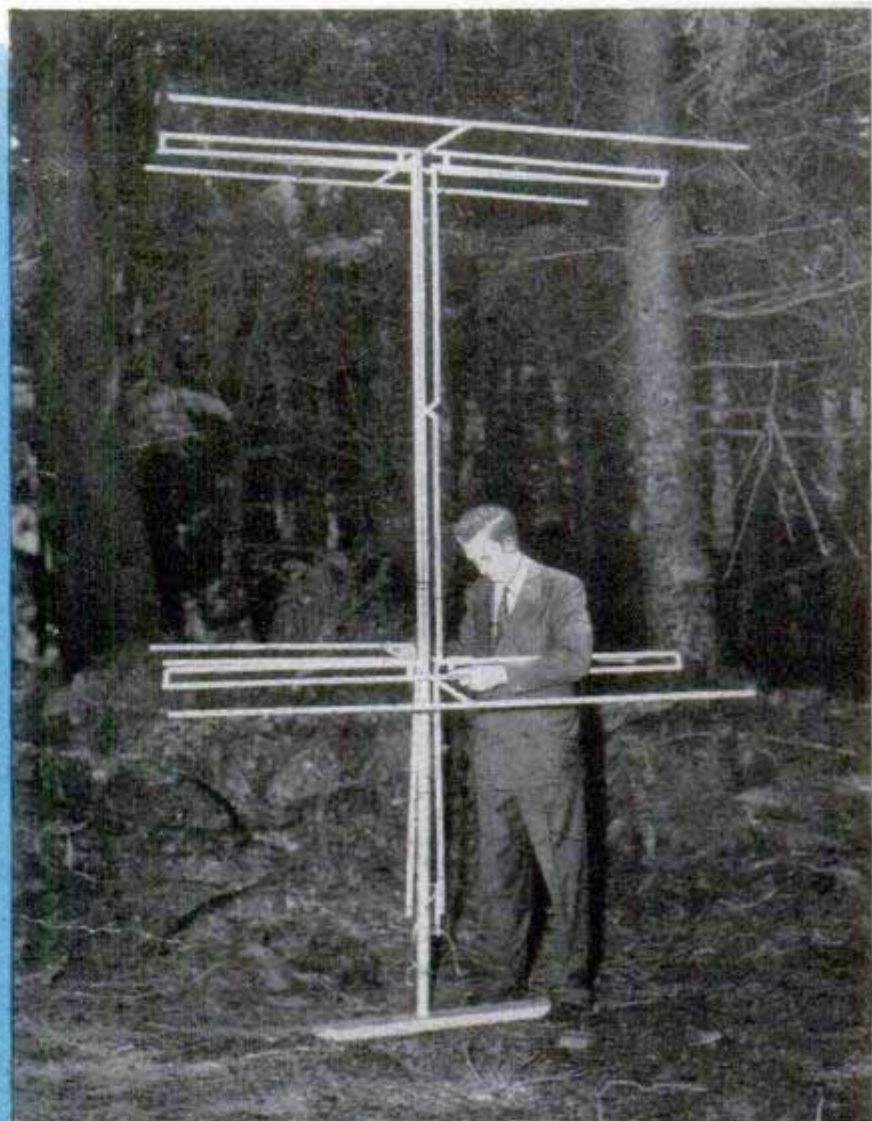

## SMALL TOWN

By Rafe Gibbs

When Ed Parsons decided to bring TV from Seattle to Astoria, he didn't let 140 miles of mountainous terrain (see map, left) discourage him. Above, he sets up a test antenna on one of the pine-covered hills near his home town

TELEVISION is going to town—your town. Never mind if your town is only hamlet-size, or more than 100 miles from a metropolis with a television station, or is hemmed in by some first-rate mountains. Television now looms as a distinct possibility for that corner by your fireplace.

What is the basis for such statements? It is the fishing port of Astoria, Ore. Astoria is located at the mouth of the Columbia River, just a couple of jumps above sea level. It is 140 air miles from Seattle, which has the nearest television station. Pine-covered mountains between Astoria and Seattle stand 4000 feet high, but folk in Astoria are enjoying telecasts from Seattle. And reception is good!

Who is responsible for bringing TV to Astoria? Some Astorians give credit to Ed Parsons; some to his wife. Here is why:

Mrs. Parsons, an attractive, dark-haired and dark-eyed former Canadian newspa-

perwoman, remarked to her husband one day at breakfast in the summer of 1948, "Ed, I wish we had pictures with our radio."

Parsons frowned.

"We live in Astoria, you know. It just isn't being done here this season."

"But I still say I'd like television—and I know someone who could bring it to Astoria if anyone could."

Mrs. Parsons' eyes were on her husband.

As a youth, Parsons was a ham radio operator. As a man with prematurely gray hair that has difficulty staying in place, he still is—W7FKZ. He is best known as the owner and manager of Astoria's commercial radio station, KAST. But to some 1500 Astoria fishing-boat skippers, he is the man who sees that their radar, depth finders, automatic pilots and direction finders keep working. He also provides maintenance for aircraft and air-navigation aids. Owner and operator of Radio and Electronics

Mrs. Parsons actually started it all one day by telling her electronics-minded husband that she wanted "pictures with our radio." Today, she has TV and so have many of her neighbors and friends

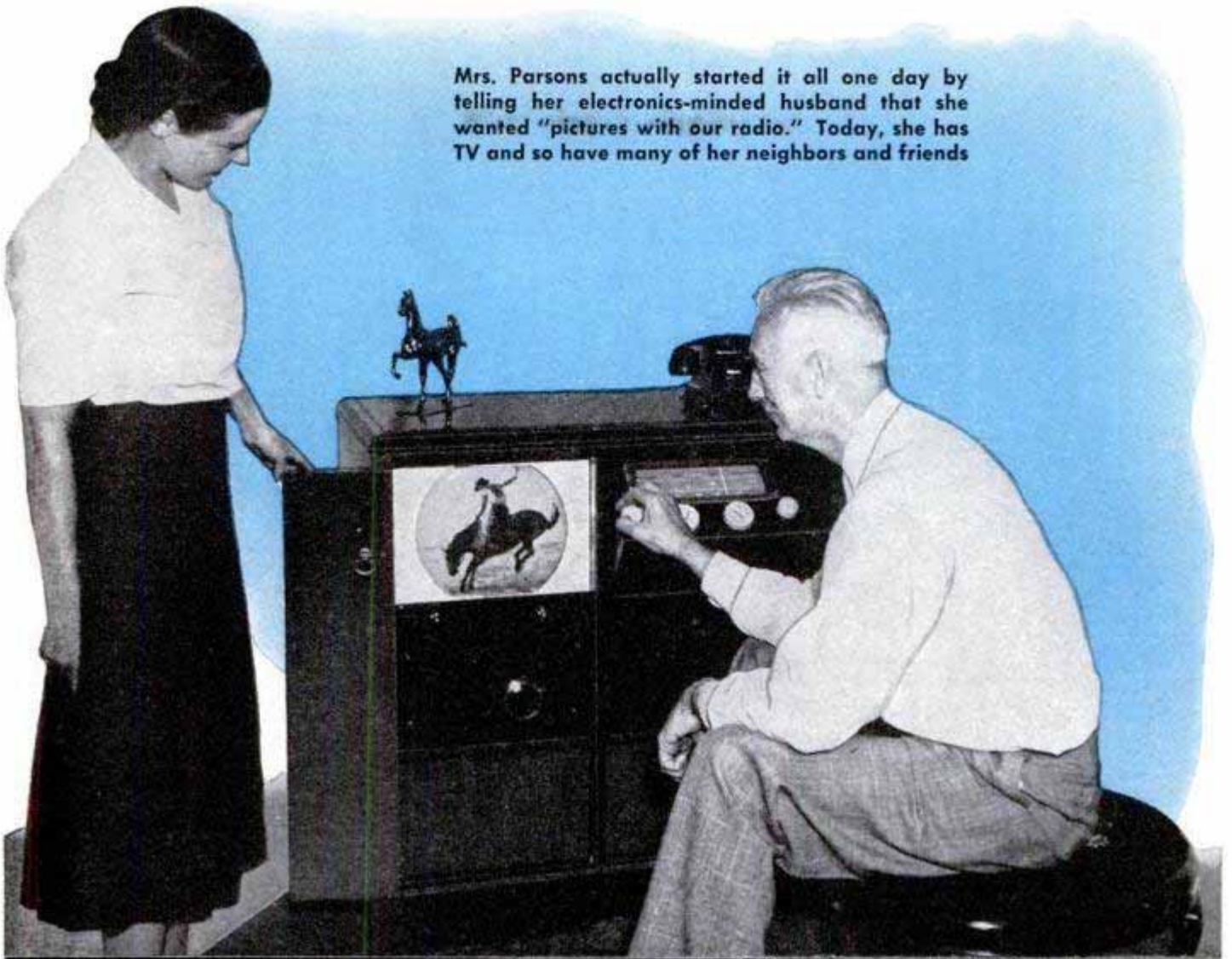

## TELEVISION

Company in Astoria, he is one of the West Coast's top electronics engineers.

If anyone could bring television to Astoria, Parsons was the man. But could it be done? Fifty miles over fairly level terrain was generally considered as the maximum radius for consistent television transmission. There have been receptions in different parts of the United States from as far away as England, but they were freaks that flickered briefly in the night.

Nevertheless, to please his wife, Parsons decided to look into the matter. Television Station KRSC in Seattle was then about to go on the air and was making test telecasts. Parsons began to conduct some experiments of his own.

First, he had to find out whether there were any usable signals in Astoria from the Seattle station. Loading his car with frequency-survey equipment, Parsons prowled the streets of Astoria with all the sleuthing patience of a patrolman. Matter of fact, before he was through, Parsons covered all of Clatsop County.

With this compact eight-tube receiver-sender of his own design, Parsons picks up TV signals from Seattle and sends them out over coaxial cable to other sets



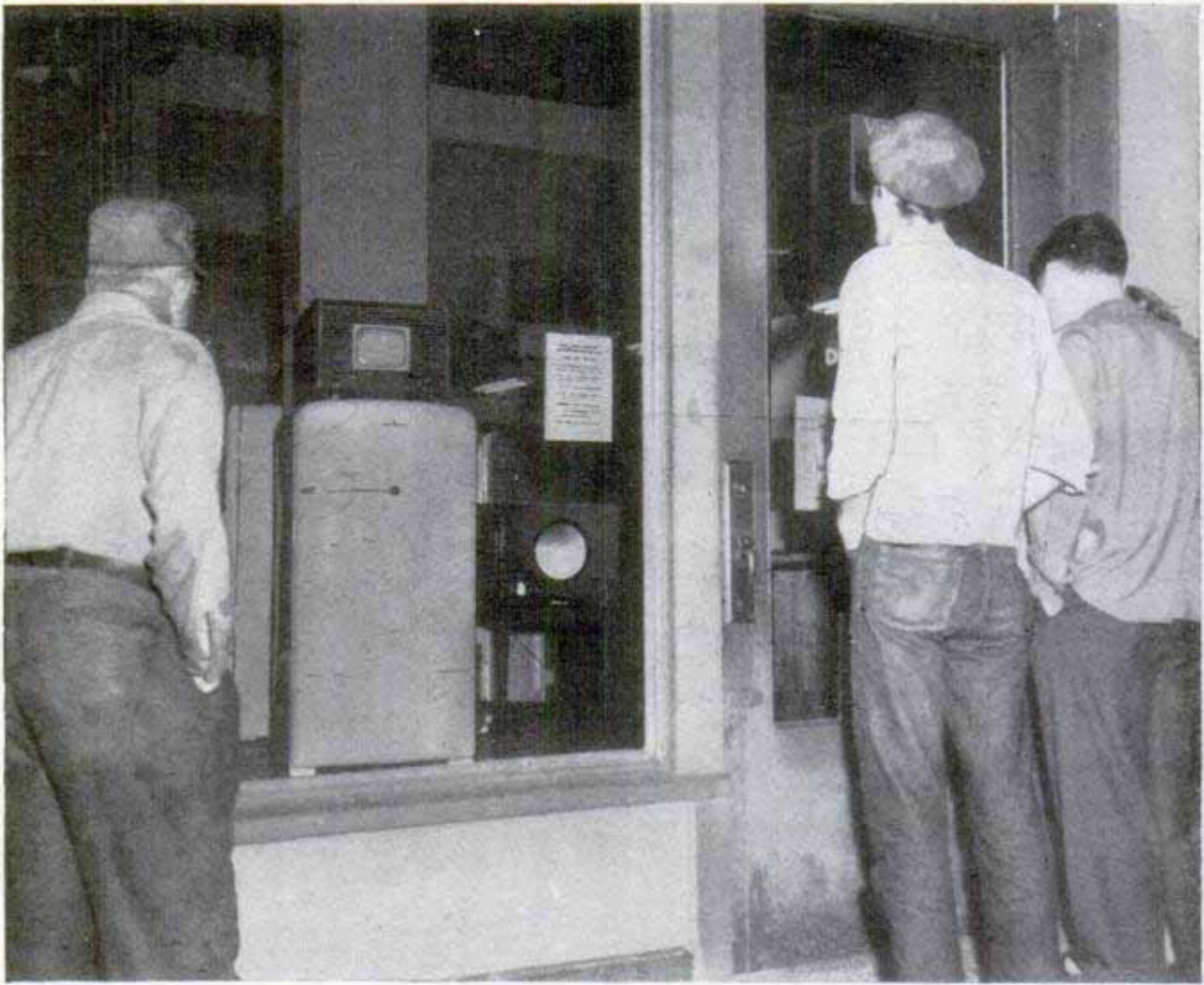

Stores in Astoria now sell TV sets and, just as in the big towns, passers-by stand outside, watching the show. Below, Parsons is well known among fishermen who bring their radio equipment to him for repair



The most logical place to pick up signals would seem to be hilltops, but it just wasn't that way. Parsons found signals on the sides of hills, in valleys and in other assorted spots. The KRSC signals seemed to come to Astoria in fingerlike bands. These bands were one to two city blocks wide. Within each band, the signal was constant from street level to building tops, but the signal in some bands was stronger than in others.

Invariably, the signals were in awkward places for experiments. But, finally, after testing the whole county, Parsons got around one day to working with his survey equipment at his own home, a penthouse atop a two-story building right in the center of Astoria. He picked up a signal, which meant a television "finger" was pointing right at his roof top. The signal was weaker than some of the others he had found, but for experimental purposes it would do and now he had a handy place to work.

To his home "laboratory," Parsons brought a standard television set and a variety of television aerials. He tried one aerial after another, but got no television. Most men would have given up at this point, but not Parsons. He is slow to quit. Ask the Astoria fishermen. When a skipper

comes into his shop with an electronics problem that can't be solved on land, Parsons goes to sea himself for the answer.

He kept on with his television experiments. He began to devise his own aerials, his own booster equipment. Then he installed telephone service from the roof of the penthouse to the living room where the television set stood, its screen as blank as a wall.

While Parsons experimented with aerials on the roof, his wife sat in front of the set. Making an adjustment, Parsons would telephone his wife:

"See anything?"

"Not a shadow."

This went on for weeks. The Parsons house became a clutter of aerials and other equipment. Then one day, Parsons called down to his wife and got the answer:

"A flicker."

The flicker progressed into faint images, into pictures, into consistently good reception with the touch of a dial. Mrs. Parsons, who had asked for pictures with her radio, had them from Station KRSC, now regularly on the air in Seattle, 140 miles away over the mountains.

The word got around town and its echo was the steady ringing of the doorbell at the Parsons' penthouse. Both friend and stranger came to hear, to see and to believe.

At first, Mrs. Parsons served refreshments to the guests—invited and uninvited—but soon their numbers made this impractical. It got so that when the doorbell rang, the Parsons would just call, "Come in, and have a seat," without even going to the door.

"You asked for it," Parsons told his wife, then added: "Something will have to be done."

Parsons had proved that television could be picked up efficiently over a considerable distance that traversed mountains. But now, somewhat in self-defense, he decided to try another experiment—to see if he couldn't send out what he picked up in Astoria to other residents of the town.

He began development of a receiving-sending unit. Starting with a three-tube system, he worked his way up to one with eight tubes. The unit was kept relatively simple. Relatively small, too, with a 12 by 14-inch chassis. And Parsons made it work.

He had no FCC license to resend a telecast, but there was no law against piping KRSC programs by coaxial cable to other residents of Astoria. He strung cable up buildings, down elevator shafts, through underground tunnels carrying utility lines. The cable went into private homes, taverns, stores. About 2000 feet is the limit of transmitting for Parsons' present equipment,

(Continued to page 268)

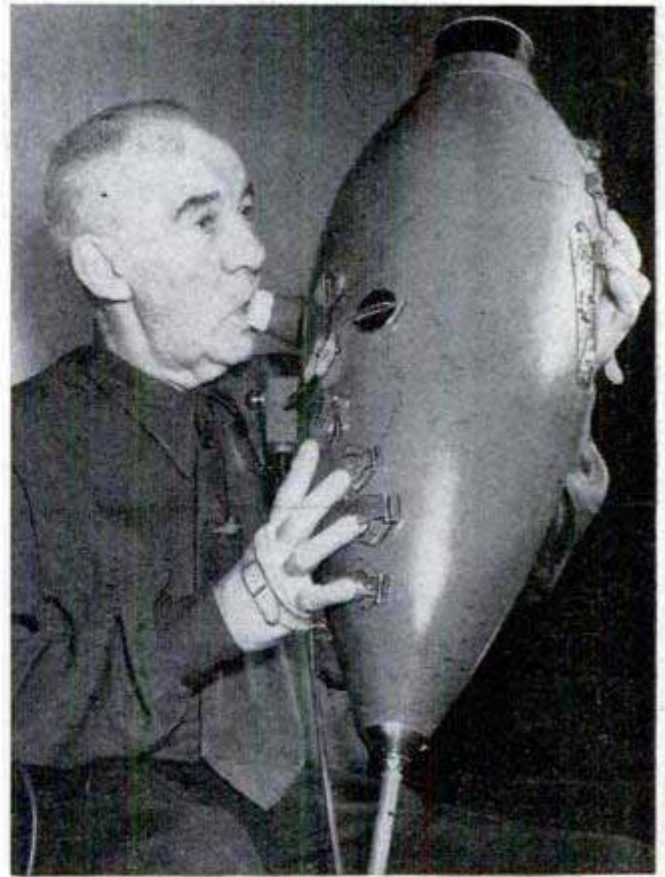

### Biggest "Sweet Potato" in World

Resembling a Navy blimp in form, an ocarina designed and built by Charles Lindsay of Washington, D. C., is made of wood and weighs 11 pounds. Lindsay says it is the largest ocarina in the world, and with it he can play any sort of tune. The instrument took about 500 hours to build.

### Mushrooming TV

With television antennas springing up like mushrooms on the nation's roof tops, there are over three million TV receivers in use today and 42 cities have video broadcasting stations, according to the annual report of the Federal Communications Commission. TV network facilities link 24 cities. Using microwave, 136 relay stations send programs between cities and from studios or remote pickups to transmitters. Biggest advance during the year covered by the report was the linking of eastern and midwestern coaxial-cable systems. Simultaneous networking of programs could make possible the viewing of a program by about one-third of the nation's population. Frequency-modulation stations have also increased in number and now more than 100 million persons are within range of broadcasts from FM transmitters.

Our spinning earth is about 3,350,000,000 years old according to the estimate of Dr. Arthur Holmes of the University of Edinburgh, who used the rate of decay of uranium for working out the figure.

# WHAT'S NEW *For Your Home*



**SELF-OPENING LID** on garbage pail permits use of both hands for scraping dishes. Mounted high on cabinet-sink door, it eliminates stooping. The lid closes automatically as the door swings shut



**BOOT DRIER**, made of a rustproof metal, holds the boot upright so the moisture escapes freely. It is useful for hanging up any type of footwear

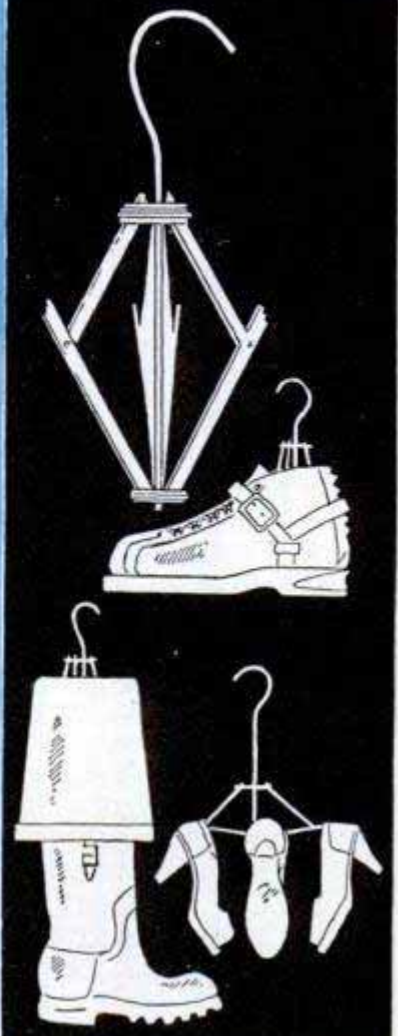

**CEILING WASHER** is nondripping. You don't even have to cover the furniture when you are using it! A rubber bulb near the end of the adjustable handle forces cleaning fluid up into the head when squeezed

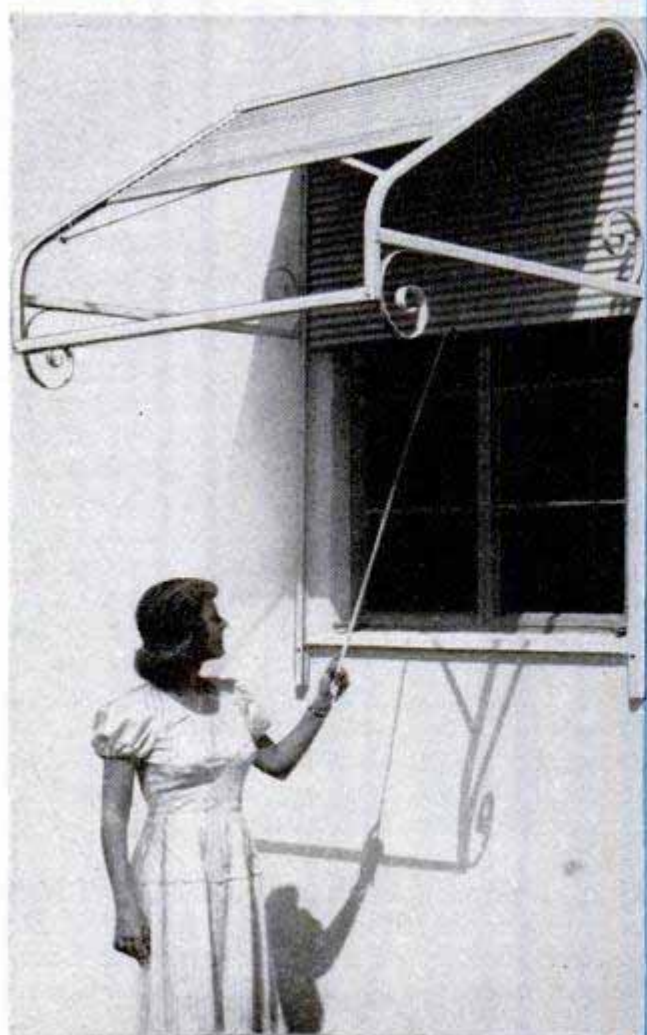

**AWNING-SHUTTER** has a double life. Pulled up, it is an attractive and serviceable awning. If a big storm threatens, a quick downward pull converts it into a shutter. Made of aluminum, it is available in many colors





→  
**CLOTHES BUCKET** for washdays is carried by a shoulder strap. It holds a washing-machine load of clothes and has a clip-on clothespin tray. It is made of a lightweight metal



↓  
**NO-STOOP RAKE** makes cleaning up the yard easy on the back! It picks up leaves, sticks and paper a half bushel at a time

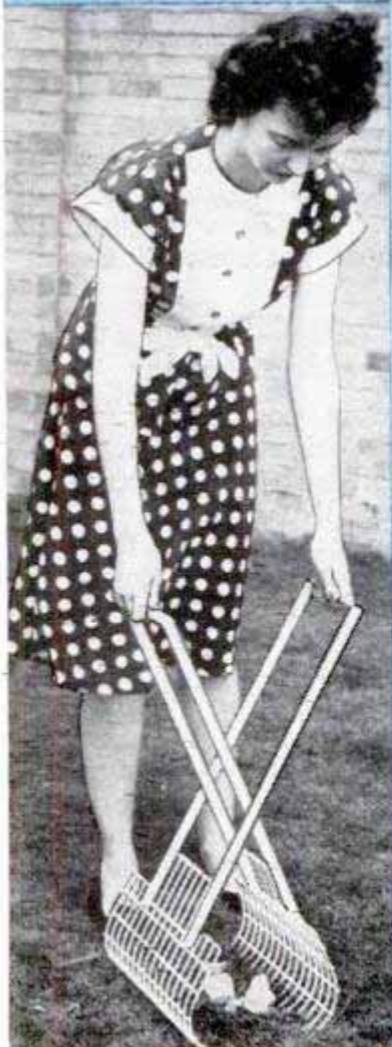

→  
**FOOD SLICER** with an adjustable guide rod is designed so even the man of the house can slice a loaf of bread neatly. It has a sturdy Tenite plastic handle. The very thin blade always stays sharp

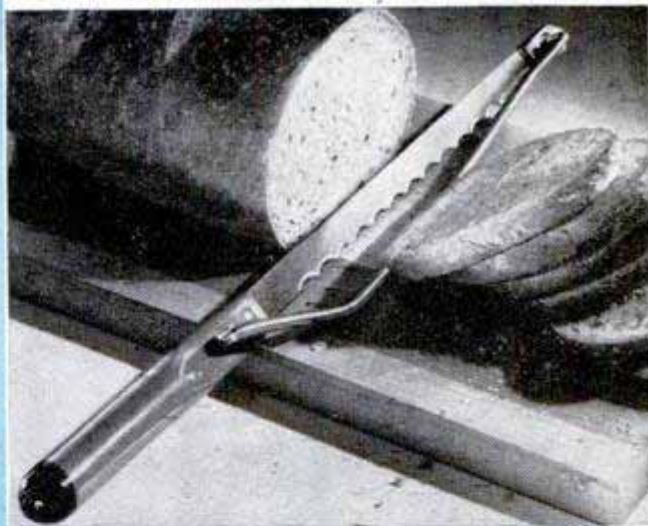

→  
**STEAK ROLLER** makes tough steaks tender, but does it without any loss of juices. Used like the rolling pin, it cuts the fibers without smashing them. It works fine for breaded meat dishes, too

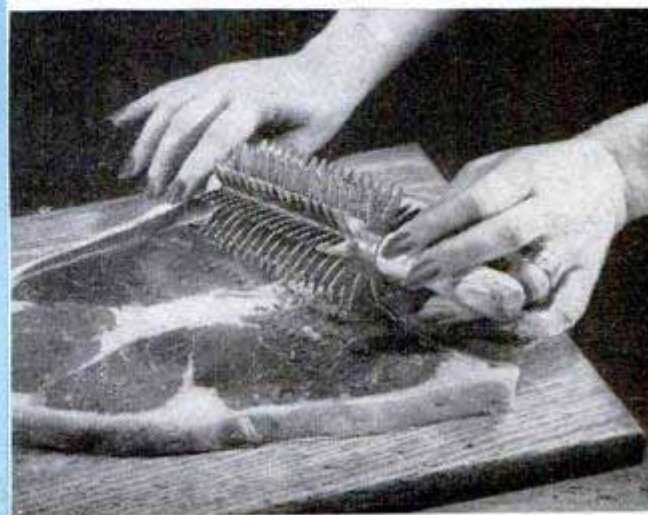

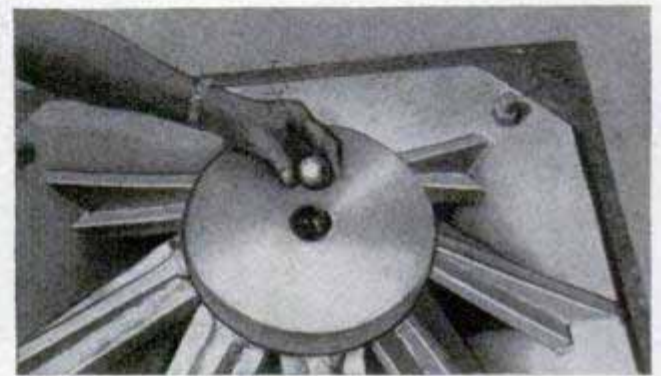
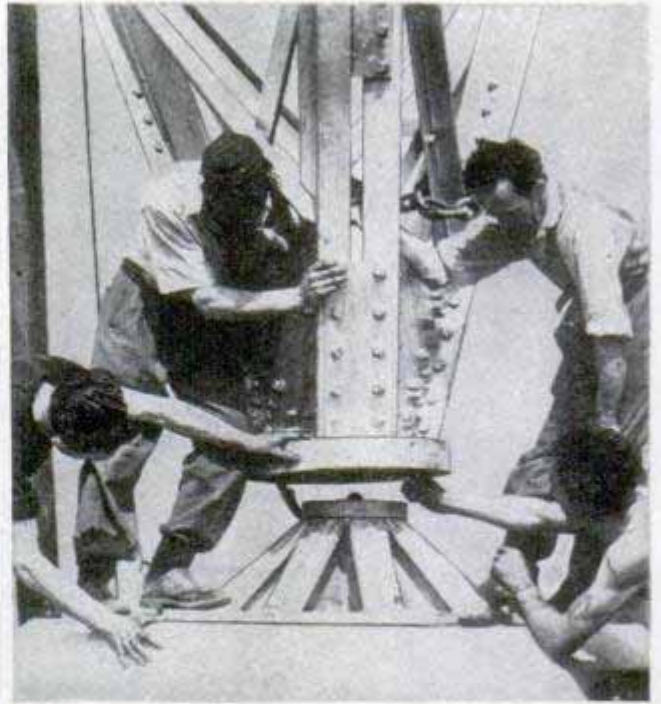
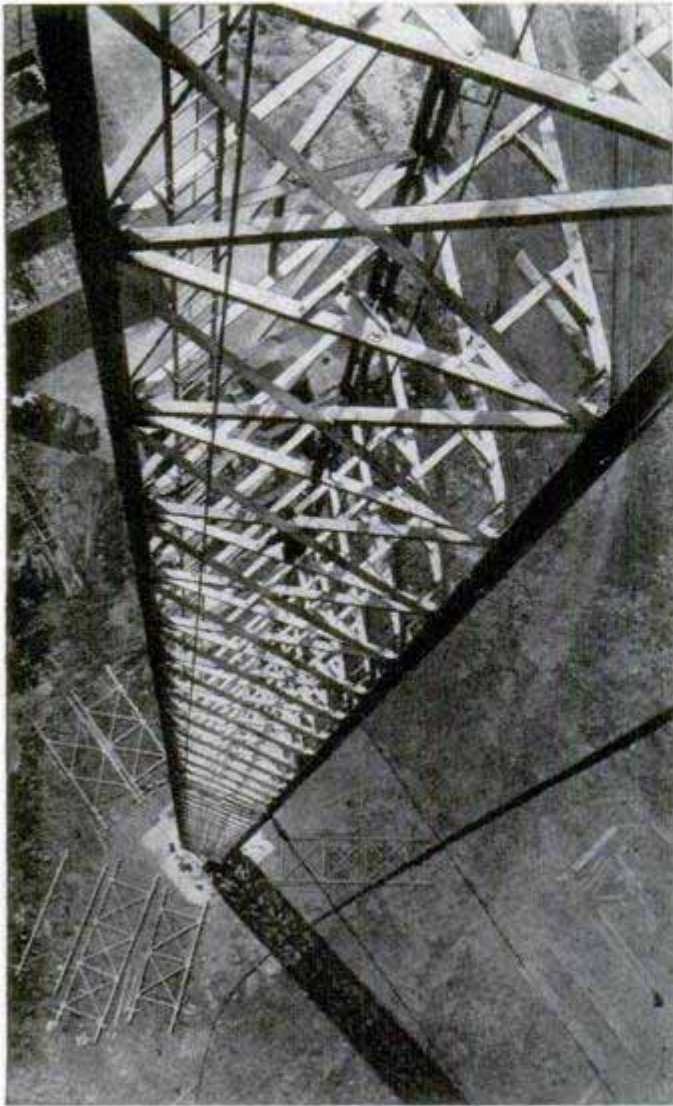

## 750-Foot TV Antenna Mast Balances on Ball Bearing

Pivoting on a ball bearing only two inches in diameter, a 750-foot television mast, erected in England, is designed to allow it to sway in strong winds without damage. Programs originating in London will

be relayed from the antenna, located near Birmingham, to a potential audience of over six million. The mast, which weighs about 100 tons, is the tallest television antenna in England.

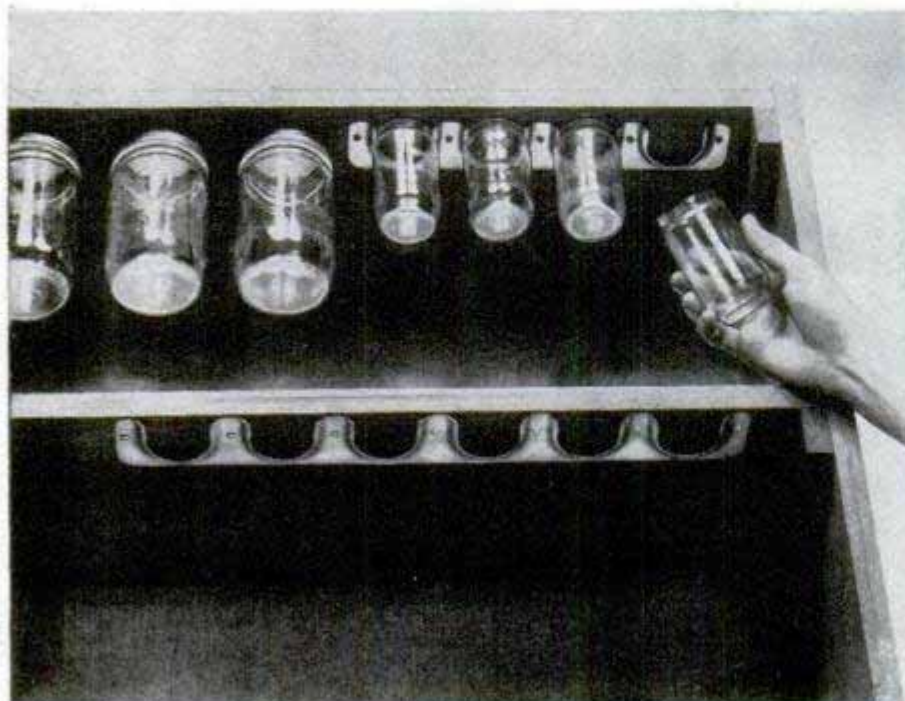

## Storage-Jar Holder

Held in position by a newly designed bracket, strained baby-food jars are excellent containers for small parts in the home workshop, factory or garage. The jars can be removed or replaced in a single motion and are locked in position against vibration and shock. Made in either steel or a chrome-plated brushed brass, the brackets come in four or six-jar sizes.

☛The oil in your car should be changed only when the engine is thoroughly warm.

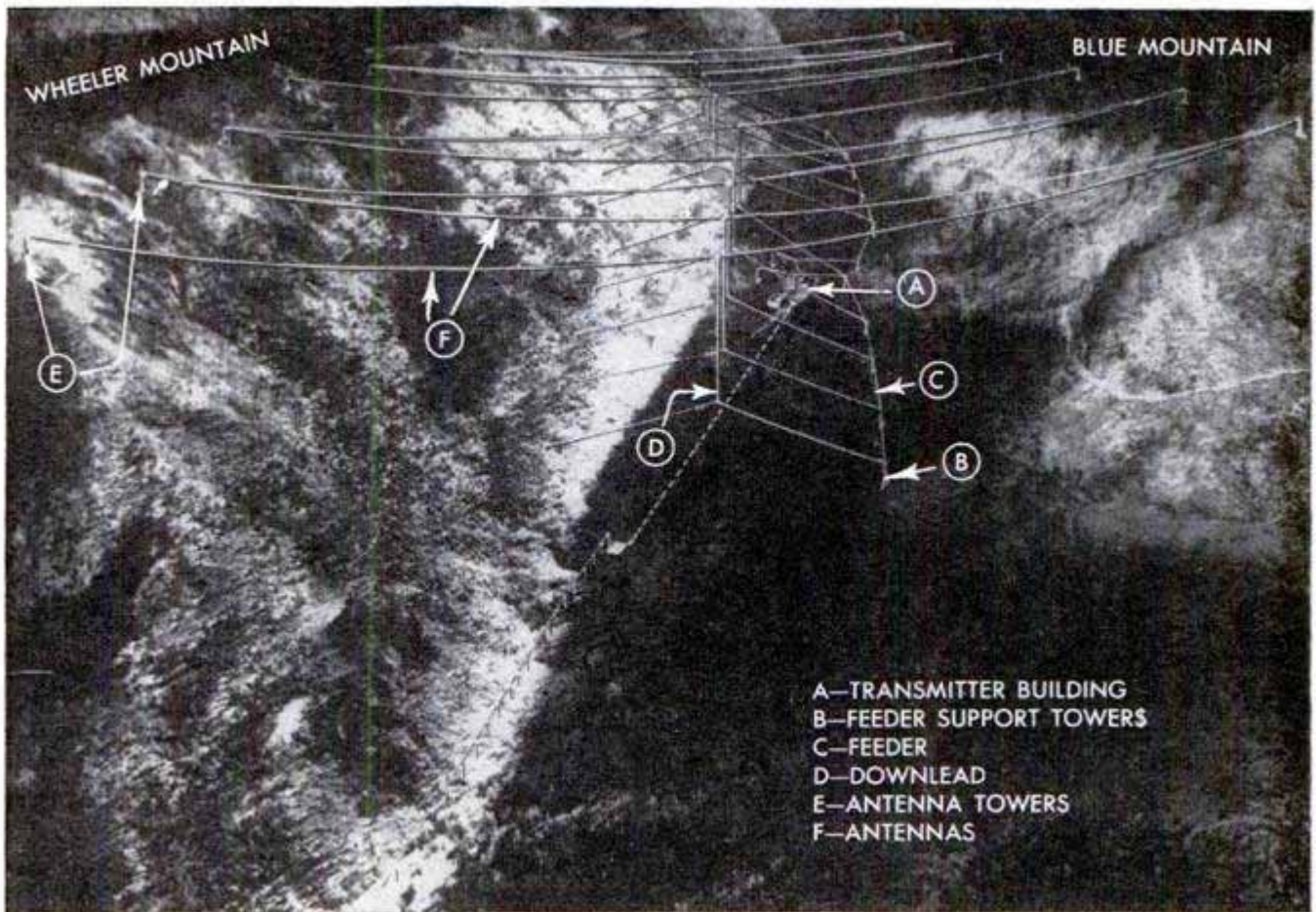

Artist's conception of how the Navy's million-watt radio station will use two mountains to support antennas

## Powerful Radio Station Uses Mountains as Antenna Masts

Mountains are used as "masts" to hold up a series of antennas that will transmit low-frequency radio waves for the Navy at Jim Creek, Snohomish County, Wash. Two mountains, each about 2000 feet high, form a valley in which the station will be built. Said to be the most powerful in the world, the station will develop over a million watts to provide effective all-weather communications throughout the Pacific area. Relatively short towers, only 200 feet high, will be constructed on the mountain ridges. Stretched across the valley will be a network of antennas ranging up to  $1\frac{3}{4}$  miles long. Vertical down-leads will be suspended from the midpoint of each span.

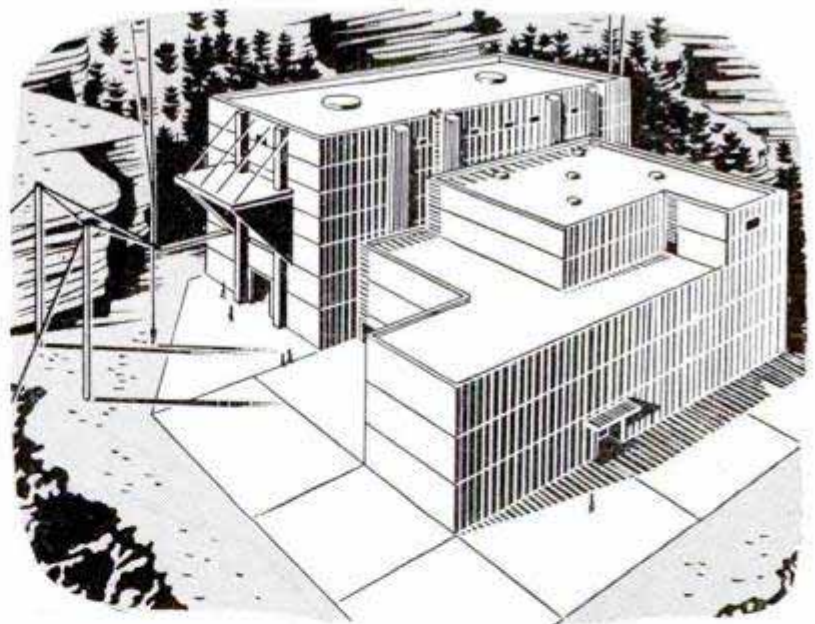

Above, the transmitter building. Because of the remote location, living quarters will have to be provided for operating personnel

## Dip Process Produces "Mirror" Finish on Aluminum

Mirror finishes and protective coatings are added to aluminum and its alloys by immersing the metal in certain chemical solutions. In addition to the mirror-type finish, a further treatment involving anodizing and coloring produces the brilliant effects of gold, silver, chromium and other

colors. This process gives the metal a corrosion resistance which is said to be much greater than the best plated metals and requires no after-lacquer. The operation, which is relatively simple, is available to industry as well as for private use and does not require a chemist.



Photo by Colin McAllister

When wells go dry around Danbury, Conn., they call the fire department's new tank truck to replenish them

# ARE WE RUNNING DRY?

By **Wayne Whittaker**

**R**ECENTLY an exploring party in a remote section of western India discovered a ghost city. It had once had a population of about 200,000, but several centuries ago its springs and wells had gone dry. The inhabitants moved away and the city died and was forgotten.

This could happen to any American city,

industrial area or farm region that is wholly dependent on underground water. Only in recent years has America awakened with a shock to the fact that in certain districts ground water is being used with an abandon comparable only to the ravage of our great forests in the latter part of the 19th century.

Sketch shows how sea water seeped into wells on Long Island before pumping was corrected (opposite page)

U. S. Geological Survey

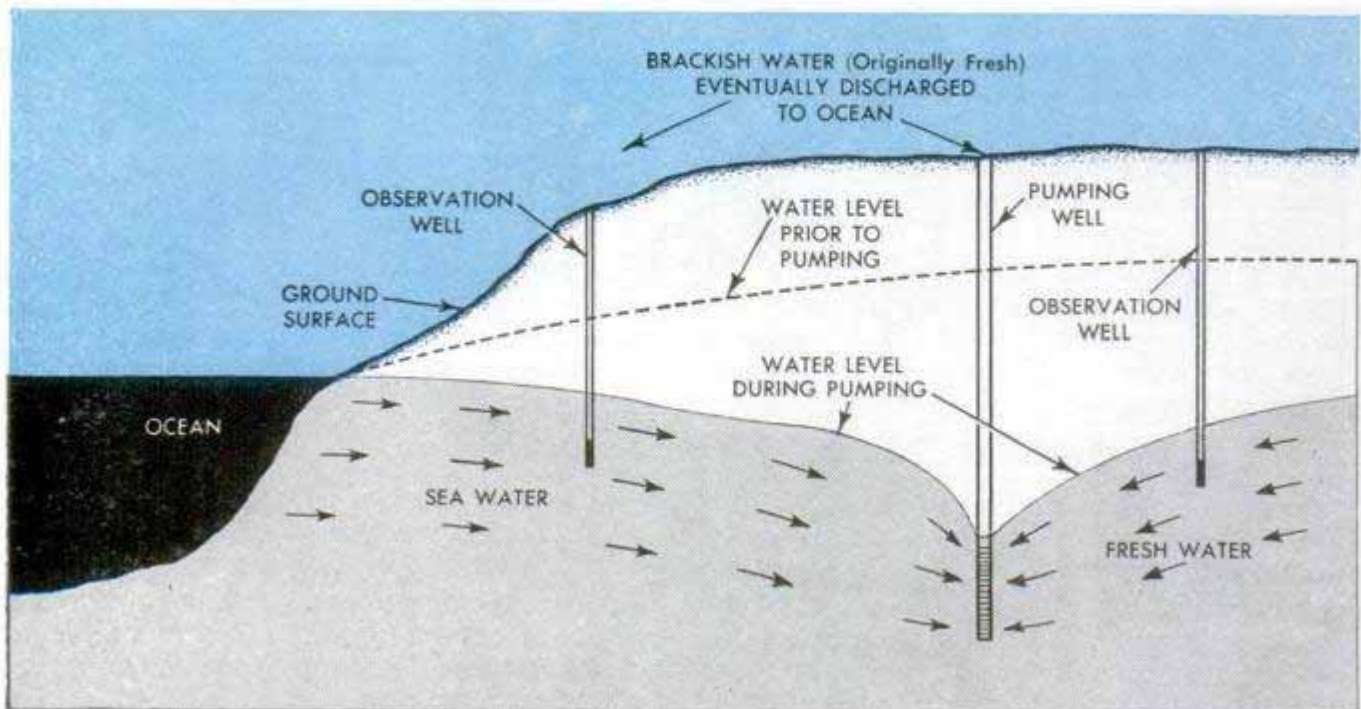

Tremendous underground storehouses of water have been built up over many years. In some areas, the level of this water is being lowered day by day with the withdrawals far in excess of the natural replacement. This can lead only to ultimate disaster — unless drastic steps are taken. The alert United States Geological Survey, an agency of the Interior Department that investigates water supplies, is on the job to help regions that will heed its warnings and follow suggestions. Expert geologists say that America's water problems, in many instances, are the result of poor planning and reflect the old adage of "famine in the midst of plenty."

There is the case of Louisville, Ky., where war industries mushroomed during the early '40s, particularly synthetic-rubber plants. At one period 75 million gallons a day were being pumped from the ground — more than double the pumpage of the '30s. The water level dropped at an alarming rate in the rubber-manufacturing district. It was discovered in 1943 that there was only a two-year

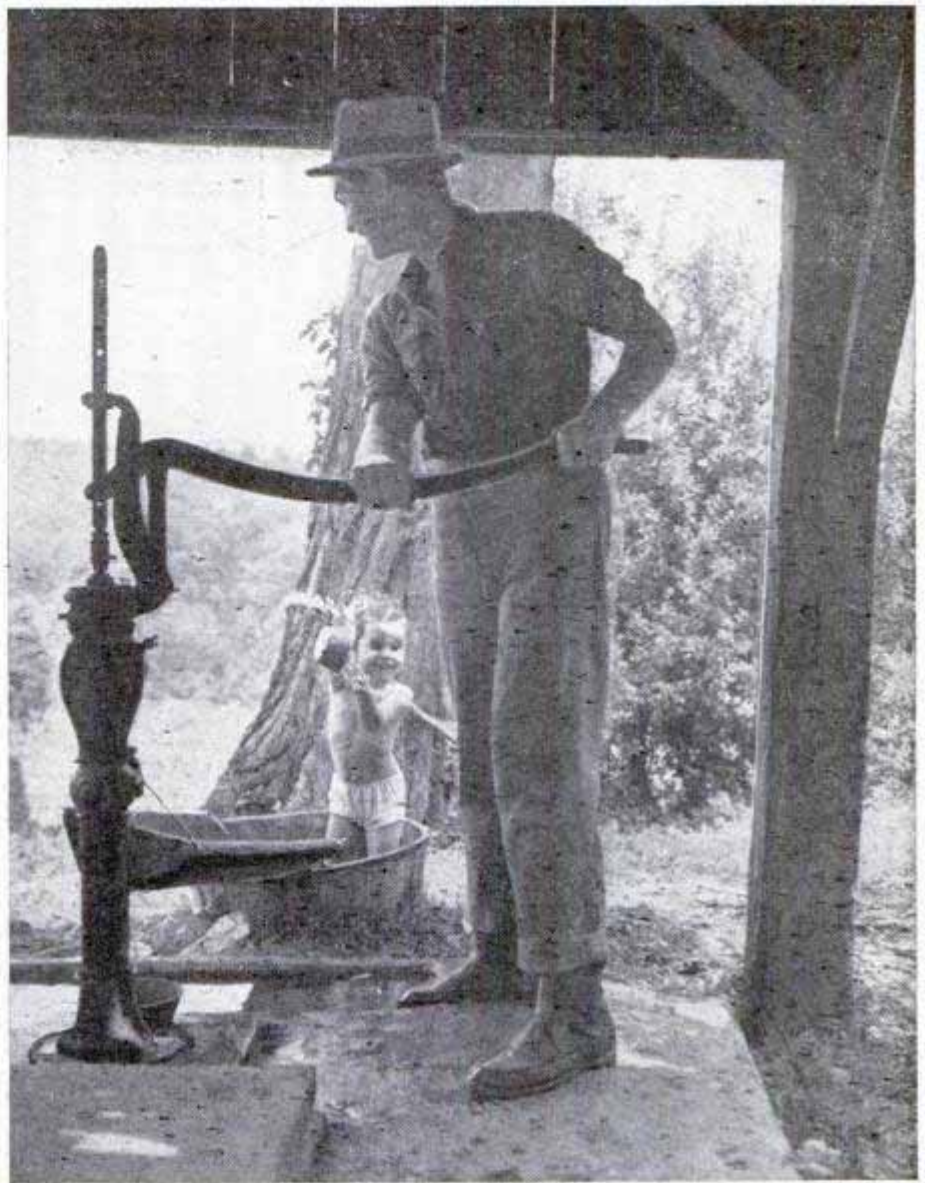

The old hand pump may be a stranger to city dwellers, but it's still in use in rural areas. This one is on an old estate near Howardsville, Va.

Sketch below shows how recharging of wells corrected encroachment of salt water from ocean as shown on opposite page. The water level in this Long Island district has been raised so fresh water moves toward sea

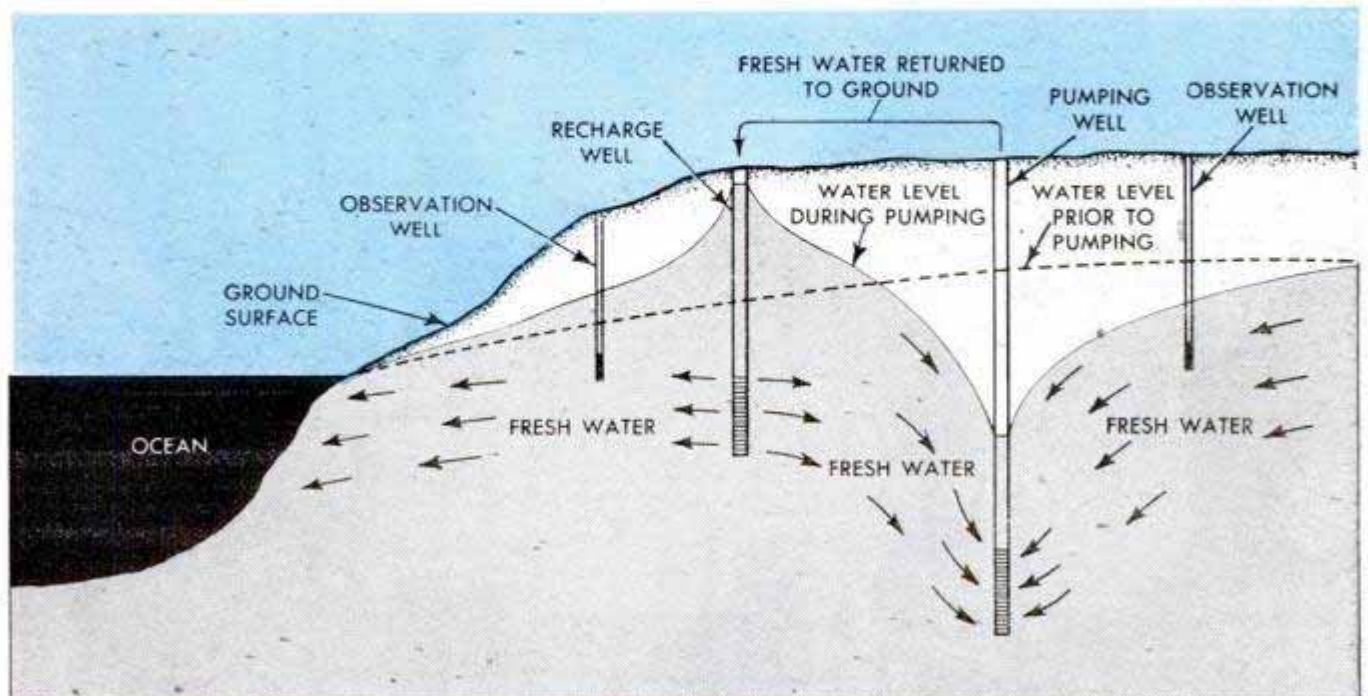

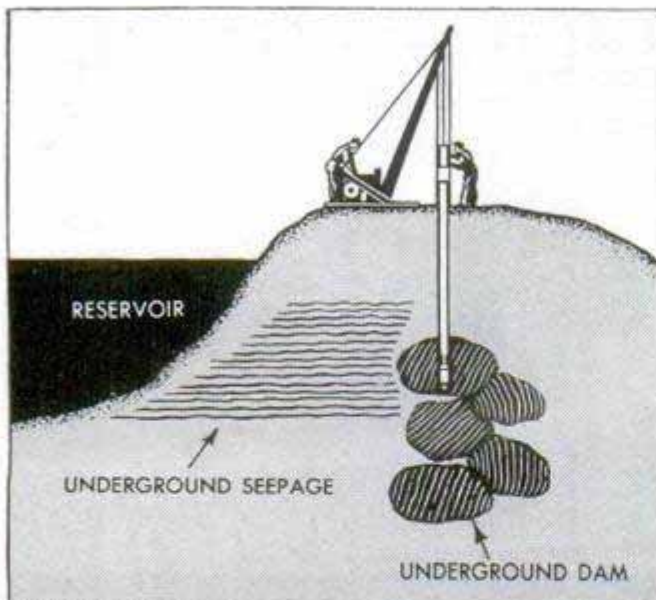

Courtesy Shell Oil Co.

**To stop water seepage from reservoir an asphalt mix is injected by pipe into earth without excavation**

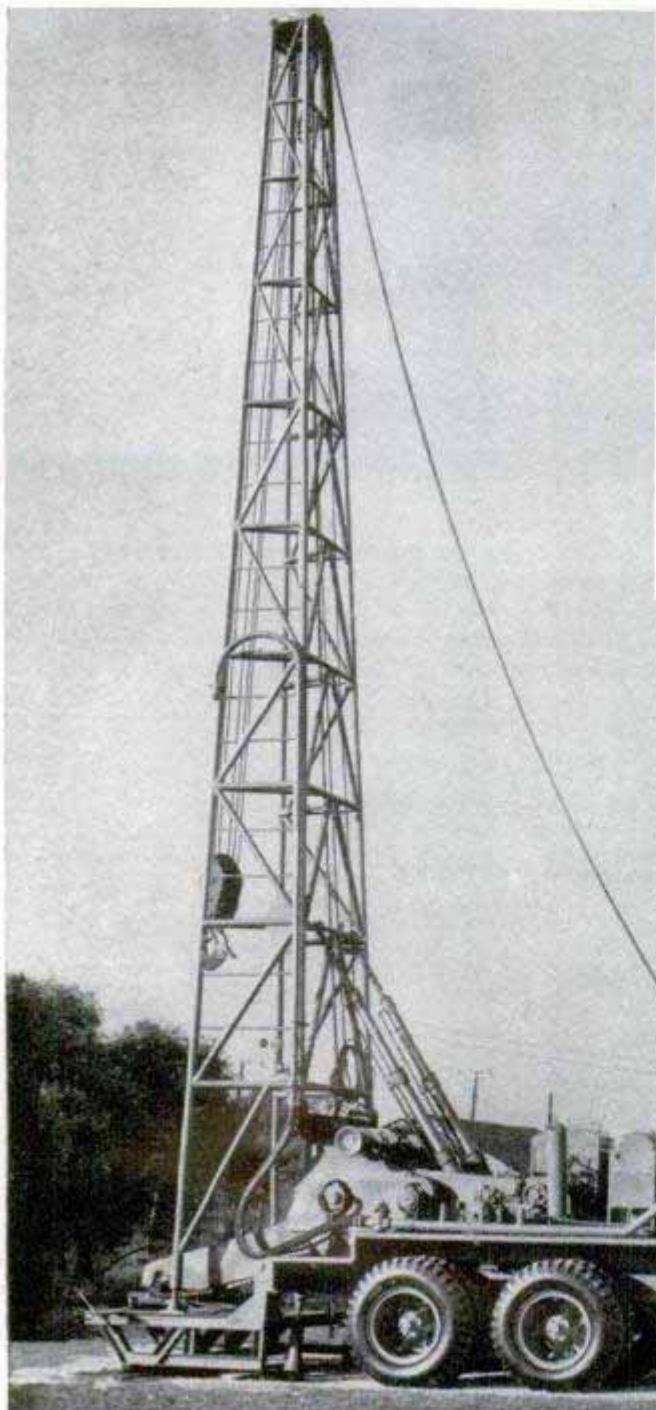

supply of water left in the underground reservoirs. The Geological Survey was called in and discovered that the recharge of the reservoirs was only 40 million gallons a day. The industries took expensive action in a hurry. Water-saving measures were introduced in the form of cooling towers and recirculation; new wells were drilled closer to the Ohio River; surface water (from the river) was purchased from the city and some wells were recharged with the city water. In two years the industrial pumpage was reduced to 45 million gallons a day (at a cost of \$5,000,000) and today it is less than 40 million daily. The irony of the Louisville situation is that had the industrial region been located a few miles north or south of the city with the wells close to the river there would have been several hundred million gallons of cool water available every day. Manufacturers all over the U. S. learned a valuable lesson from the Louisville area.

Across the nation there are hundreds of glaring examples of high-priced bad planning. Near Chicago a big manufacturing plant was built that required thousands of gallons of cool ground water every day. The water level dropped quickly and farmers and others in the vicinity found their wells drying up. In the Texas Panhandle today irrigation farmers are pumping water from the ground 15 times faster than it is being replenished. In 14 years the water level has dropped 40 feet. The story is similar in Arizona and California where

**This portable 48-foot-high well-digging rig operates around Corpus Christi, Tex., and is mounted on a 10-ton diesel truck. The rig drills to 3000 feet**

great quantities of water are used for irrigation. It takes nearly a million gallons of water a year to irrigate a single acre of orange trees.

Twenty billion gallons—more than half our daily water supply—comes from the ground. The use of ground water which is naturally cool (60 degrees) and bacteria free has doubled since 1935. The U. S. Geological Survey reports that 10 billion gallons a day are used for irrigation, five for industry, three for municipalities (66 percent of our cities depend on it exclusively) and two billion gallons a day are consumed in rural areas, excluding irrigation.

The ground water of the subterranean reservoirs should not be confused with the surface water of our lakes and streams. Both have the same origin—rainfall (including snow). The average annual rainfall of 30 inches would cover our entire three million square miles to a depth of 30 inches—or 15 million billion gallons. In some parts of the South where rainfall is heaviest (seven states of the Tennessee Valley), some 6000 tons of water fall on each acre of land in one year. These figures make a water shortage anywhere in the U. S. seem almost incredible. However, the National Water Well Association reports that 50 years ago a good municipal supply of water could be had 150 to 200 feet down; today the common depth for drilling is 600 feet.

Ask the average man how much water it takes to keep him going for 24 hours and he will probably answer: "Five or ten gal-



Pumping unit on raft behind Gibraltar Dam supplied water to local residents during California drought

lons." The actual figure set by waterworks engineers is 100 gallons a day per person. This includes industrial and farm uses for any area. After all, every use of water is to support needs of man, directly or indirectly. The industries which use the most ground water are oil refining, chemical

(Continued to page 272)

Dots on map explain why places like California and Arizona—big ground-water users—face water trouble

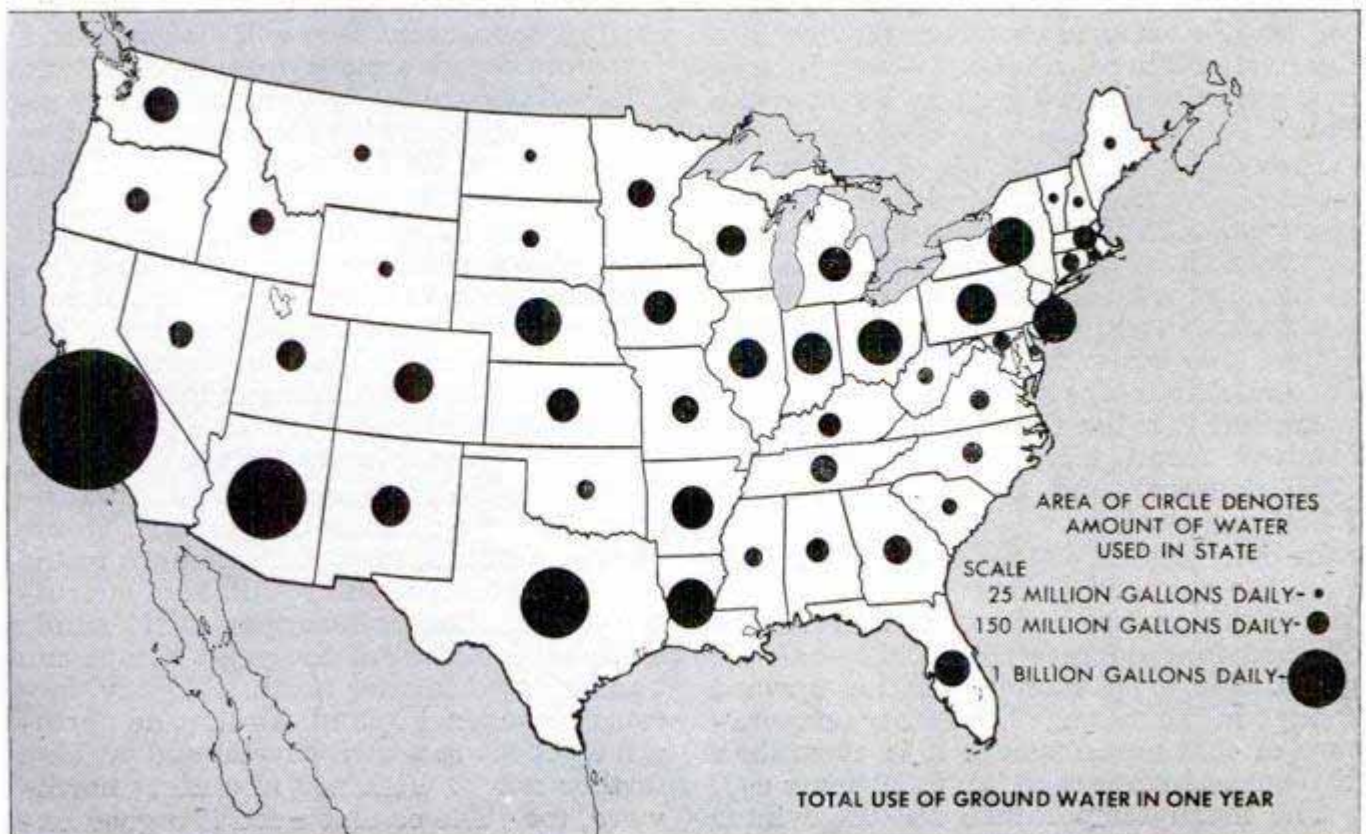

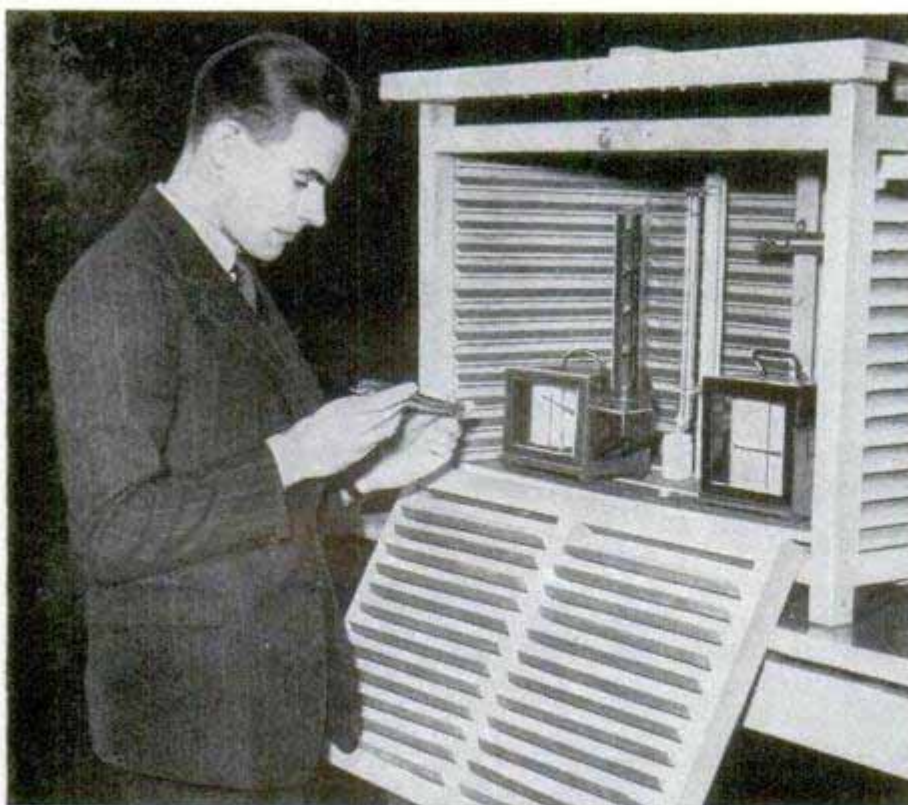

## GRANDMA'S RIGHT ABOUT THE WEATHER

Prof. George Kimble of McGill University, shown here at one of his weather recording stations, says Grandma's memories can be substantiated by facts

**M**ILD WINTER, EH? Things aren't like they were when you were a kid? Skating isn't what it used to be, there isn't half the fun of tobogganing and sleigh rides, nothing like the blizzards and sub-zero spells you remember.

Maybe you're right. And maybe Grandma is right when she tells you winters aren't what they were in her day.

Weather-Bureau records do indicate that we're in a warm-up cycle. The harbor of Spitzbergen, once frozen nine months of the year, is now open to shipping nine months instead of three. Glaciers are receding. Forests and crops are moving into the Arctic. Where will it end—with Siberia in the tropics and wheat growing near the Poles?

Prof. George E. T. Kimble of the Department of Geography at McGill University, Montreal, tells of the upward trend of temperatures in a book being published this spring. In the last hundred years, he points out, the mean annual temperature in Philadelphia has risen from 52 degrees to 56 degrees. A four-degree rise may not appear great, but it is the difference between the January mean temperature in Chicago (25.0 degrees) and Santa Fe, N. Mex., (29.2) degrees.

In Spitzbergen, 400 miles north of Norway, the change has been more dramatic. There the annual mean temperature has climbed four degrees since 1912—only 38 years. More spectacular is the upward change in the average December temperature of that arctic island; it is more than 10 degrees higher than it was 30 years ago.

The mean temperature for the winter

months in Oslo, Norway, is up four degrees since 1850. Montreal has only half as many sub-zero days as it did 75 years ago and the mean temperature for March is up more than six degrees. During the 20 years ending with 1892, Washington, D. C., had a total of 354 days with freezing temperatures from March to June, but in the 20 years ending with 1933, the number had dropped to 237.

All over the world, with one or two exceptions (most notable of which is southeastern Alaska), glaciers are receding. Professor Kimble points out that some are melting so fast that they will disappear in a few more decades under present conditions.

Snowfalls are less severe, also. In Montreal, the winter's average is now considerably less than 100 inches as compared with 130 inches in the 1880s.

However, there are some exceptions to the rule of rising temperatures and decreasing precipitation. The tropical and subtropical zones have, if anything, become a little cooler in the past 50 years. Large parts of the Arctic and the monsoon regions of southeast Asia have shown increases in annual precipitation.

What does all this mean? It has tremendous economic consequences and, if the trend continues, important changes in the world's commerce will result. Many northern ports, like Spitzbergen, will handle shipping for most of the year. Crops can be cultivated farther north. Already, forests in Sweden, Finland, Alaska and northern Quebec are growing faster and pushing farther north. Fish are migrating northward, too. The common cod is a good ex-



10-YEAR MOVING-AVERAGE ANNUAL TEMPERATURES FOR THE U. S.

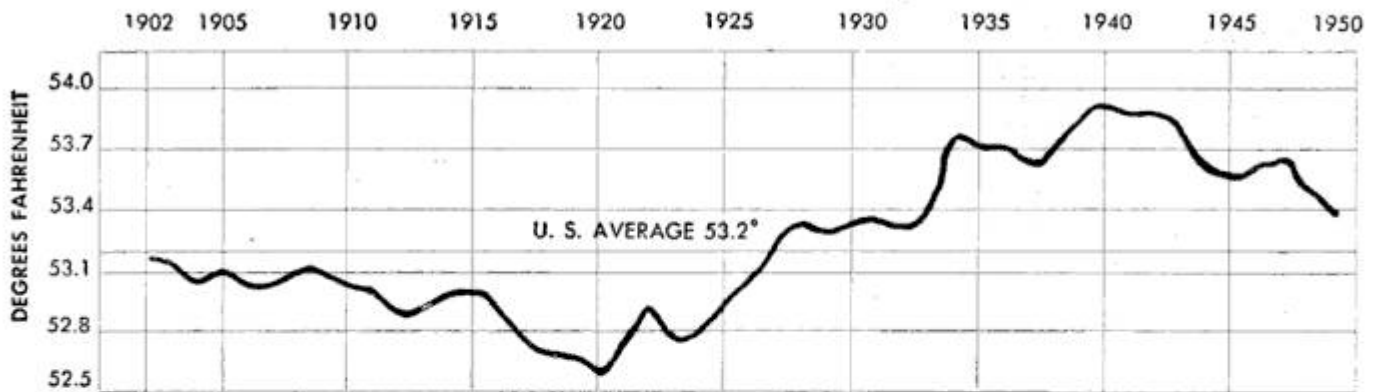

Charts from J. B. Kincer, Washington, D. C.

This chart, based on thousands of records from all over the country, shows that the temperature has been above the U. S. average since the late '20s. The winter of 1948-49 caused the sharp drop at extreme right

ample. At the beginning of the 20th Century, the cod was found at only a few places in the waters off southwest Greenland and then only in small numbers. By 1920, it was beginning to frequent the waters off the island as far north as Godthaab (64 degrees north latitude) and by 1930 it had reached 70 degrees north. Today, it is found as far north as 73 degrees. The cod catch of west Greenland totaled only 5 tons in 1913; in 1946, the catch was 13,000 tons.

According to Dr. Clarence A. Mills of the University of Cincinnati, the period of rising temperatures may result in smaller adults in the U. S., reversing a trend that has continued for centuries. There may also be a retardation of mental keenness and the rate of development. The trend will mean that northern countries such as Canada, Russia, Alaska and those in Scandinavia will be opened up to greater trade with the world. The vast resources of the Arctic and Antarctic will become accessible as temperatures rise.

However, there is a note of caution in Professor Kimble's book. Some portion of these changes may be due to man-made conditions. To some extent, higher tem-

peratures in towns and cities may result from the loss of heat by buildings. Heat engineers estimate that in a city the size of Montreal the amount of man-made heat escaping into the lower atmosphere on a day when there is good inversion could raise temperatures three or four degrees.

The Canadian geographer hastens to add that our weather records go back only a short distance into history—actually only seconds on the clock of the earth's life span.

Whether next year, the year after or 10 years hence will bring cooler days is anybody's guess. The severe winter of 1948-49, which will probably be remembered in some parts of the United States as the year of the Great Blizzard, provides some evidence of an impending temperature recession. However, one year's evidence is not enough to support a prediction of a reversal in the generation-old trend toward warmer weather.

Grandma is right about the weather and she has plenty of proof in the files of the Weather Bureau. But don't get rid of your overshoes and snow shovel—there's still a lot of fight in Mother Nature, even though she may be calming down in her old age!

20-YEAR MOVING-AVERAGES HOT AND COLD DAYS IN WASHINGTON, D.C.

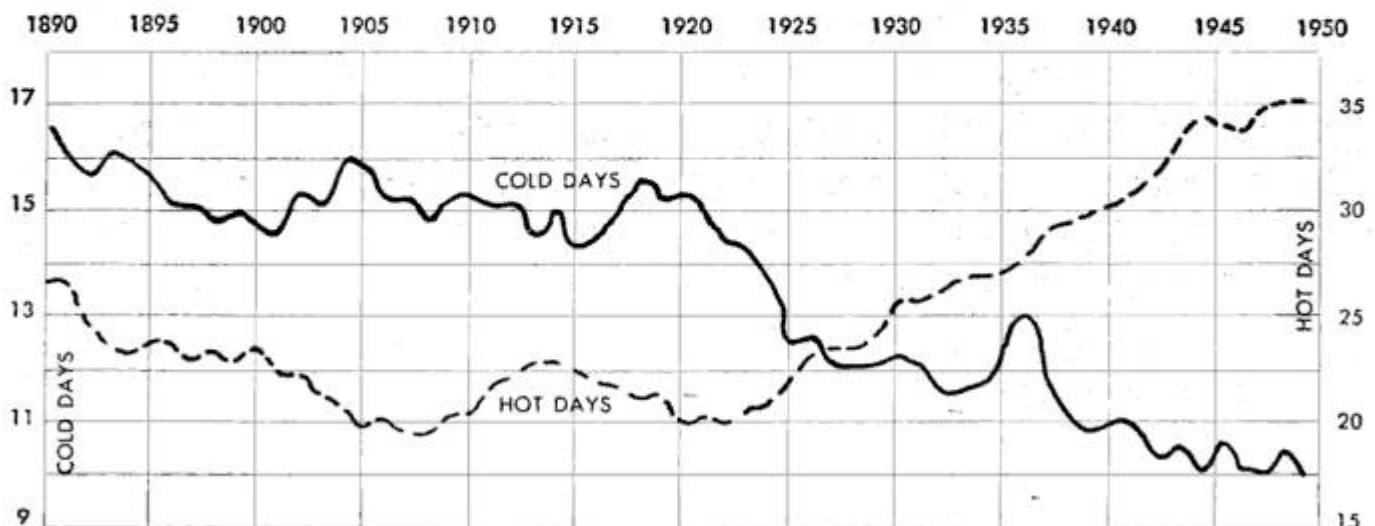

Moving average of hot days (maximum temperature of 90 degrees or above) increased from 20 in 1905 to 35 in 1949. Moving average of cold days (continuously below 32 degrees) dropped from 16 to 10 in the same period



**ONE-LEGGED MOUNTAIN CLIMBER**, Roger Tschumi, of Switzerland, is proof that you can't keep a good man down. Tschumi recently fulfilled a dream he has cherished for years—he made the difficult Mont Blanc climb in the Alps. To top off his achievement, he did acrobatics on top of the "needles"—Alpine spires rising almost vertically from the mountains. Tschumi does his climbing on special crutches he made himself. He skied most of the way to the mountaintop on one long ski, with two shorter skis attached to his crutches. Then he made the final hazardous ascent to the top by crutch and rope, aided by a mountain-climbing friend

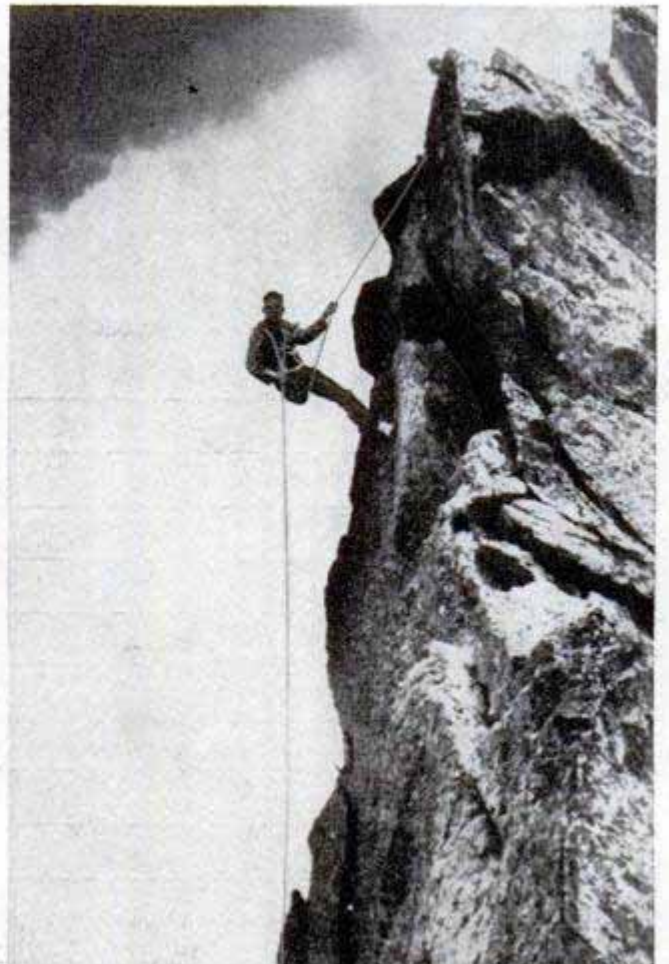

148 West 2nd South St.  
Salt Lake City, Utah

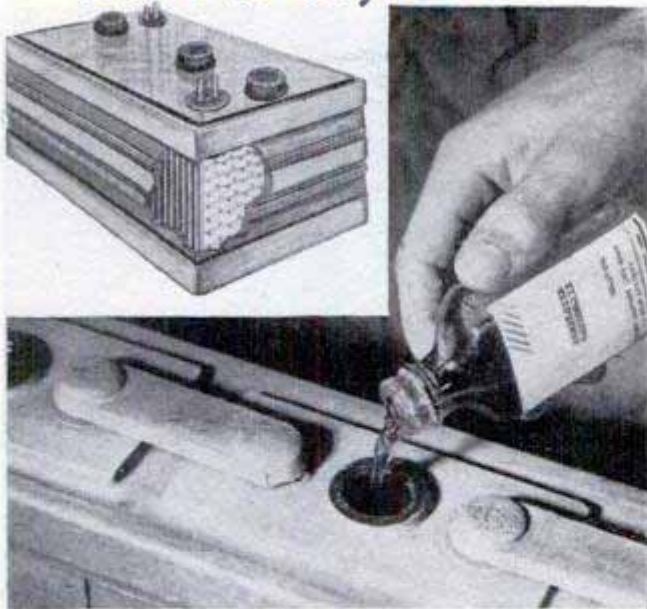

### Nonacid Storage Battery May Last 25 Years

Storage batteries using plates of copper-lead alloy are said to give continuous service up to 25 years. The copper-lead battery uses a vanadium electrolyte which does not eat away the plates as the conventional acid solution does in the lead-plate battery. It has nonconducting plastic separators and a lined aluminum case. Corrosion is entirely eliminated on terminals and holders. The battery can be quick-charged at rates up to 100 amperes for an hour without damage and it can be stored for long periods without loss of charge. The manufacturer is also producing a vanadium electrolyte that can be used in conventional acid-type storage batteries. The regular electrolyte is poured out and one ounce of the vanadium electrolyte is poured in each cell. Distilled water is then added to bring the level up to the full mark. After a five-minute charge from the generator, the battery is ready for service. The new electrolyte is said to add life to any battery because it does not destroy the lead plates and it completely eliminates corrosion.

**MEMO PAD FOR CARS** enables salesmen and others who spend a great deal of time on the road to jot down ideas as they drive along. Fastened to the dashboard by three self-tapping screws, the steel-backed pad provides a firm writing surface and holds a pencil. The pad also can be installed in the home near the telephone

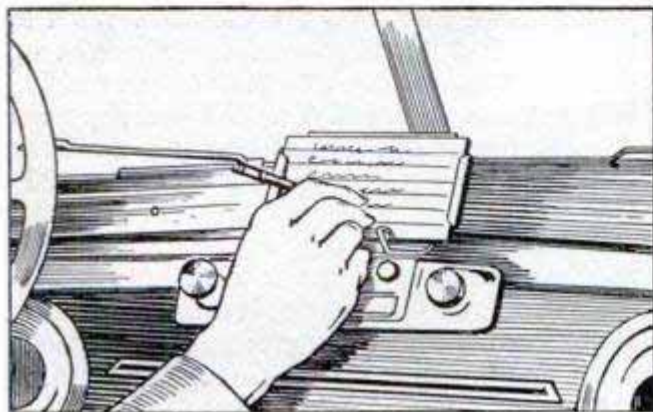

### Ladder-Leg Equalizer

Adding a level-equalizer attachment permits ladders to be solidly based on hill-sides, stairways or other uneven surfaces. Consisting of two interconnected hydraulic units, it allows oil to flow from one leg to the other to compensate for height differences. A valve, easily operated by foot, locks the ladder into any desired position. The steel attachment, weighing only six pounds, supports 500 pounds and can be installed on any type ladder, wood or metal. A ball-and-socket shoe that can be tipped on end for ice, slippery asphalt or soft ground also helps conform to irregularities.

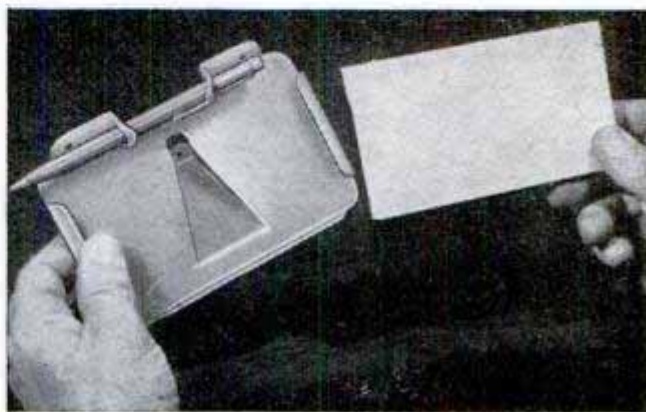



Effortlessly, the new champion holds a huge log above a tractor and arch, once biggest of logging machinery

No fleet-footed mountain goat, the Trakloader moves its 135,000 pounds slowly but surely along the trail



## HEAVYWEIGHT CHAMPION LOGGER

**E**VEN rough-and-ready lumberjacks, accustomed to superhuman exploits in fact and legend, stand in awe of a heavy-weight champion logger that tosses 30-ton logs around like matchsticks. Shaped vaguely like a prehistoric dinosaur, this giant loader is the biggest thing in the woods today that moves under its own power.

One man operates the Goliath. With it, he can lift a 90,000-pound log straight up out of a crevasse in low gear or juggle 70,000 pounds in high. The 200-horsepower diesel engine can't stall because speed is automatically adjusted to loads up to 96,000 pounds.

Eliminating the rigging of booms, the mechanical strongman does in hours what once required days to do. It crawls through Washington forests, loading huge trucks with mammoth Douglas-fir logs and amazing lumbermen with its power.



**Husky logger looks almost puny as he rides aloft with his spikes dug into this three-foot Douglas-fir log, a mere morsel for the powerful jaws of the hoist. Its 28-foot gooseneck boom is made of railroad steel**

**There's enough lumber in these two logs to build a house! It takes only a few minutes to load a big logging truck with the Trakloader. The operator, in the windowed cab, has complete control of the log at all times**





## Dental "Sandblasting" Makes Drilling Painless

Patients scarcely realize their teeth are being "drilled" with a technique that uses a high-pressure stream of abrasive particles instead of the rotary drill. The abrasive powder, aluminum oxide, is mixed in a stream of carbon-dioxide gas and "fired" against the tooth to cut away the decayed portion. Almost no pressure is exerted on the tooth by the stream of particles. Vibration and bone-conducted noise are completely overcome and heat generated by friction is almost entirely eliminated. Although it cuts teeth readily, the abrasive does not damage the soft tissue of the mouth. Invented by Dr. Robert B. Black of Corpus Christi, Tex., the technique was recently demonstrated at the University of Michigan. To prevent the abrasive from entering the patient's mouth, a rubber guard is placed behind the tooth. A suction tube, held near the mouth by the dentist's assistant, removes the particles while the "drill" is operating. By substituting dolomite for the aluminum oxide, the dentist can use the "drill" to clean the teeth.

## Powered Trailer Gives Jeep Six-Wheel Drive

Linked to a Jeep engine by a special drive shaft, a small trailer provides its own traction when the going gets rough. Designed by Willys-Overland to be pulled by the Jeep, the trailer mounts a 52-percent grade

when loaded to its one-ton capacity. The drive shaft runs from the Jeep's power take-off to the trailer wheels, making possible six-wheel traction. The trailer drive can be disengaged for highway use.

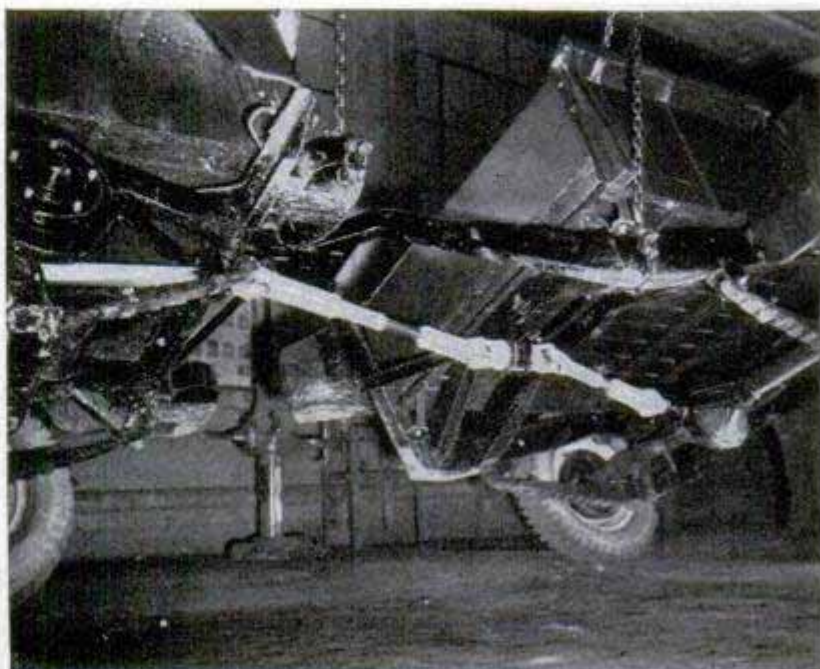



# RADIO up your SLEEVE

Dr. Brunetti holds tiny receiver to ear and transmits with a "large" five-tube set

By Thomas E. Stimson, Jr.

**WHEN DETECTIVE** Dick Tracy introduced his famous "wrist radio" to his fans a few years ago, everyone wondered if tiny personal radios actually would be available someday.

The fact is that Tracy's useful two-way voice set was based on techniques already perfected. The little radios are not on the market, but all the tiny components are available.

Depending on how many ounces of battery the operator wants to carry in his pocket, he can hold conversations with a companion up to a mile away. For communicating over a few hundred feet he can come up with a set hidden entirely in his fist.

The vacuum tubes are thinner than a lead pencil and weigh  $\frac{1}{10}$  ounce each. Condensers are  $\frac{1}{4}$ -inch disks, almost paper thin. Resistors and connecting wires are lines of a conductive paint on a ceramic or other insulating surface. "A" cells are of the mercuric-oxide type, each the size of a lima bean. Layer-built B-batteries deliver about 30 volts.

Even though it is subminiature, a walkie-talkie must conform to the radio laws. Information on frequencies available, such as the 465-

megacycle citizen's radio band, can be obtained from the Federal Communications Commission, Washington, D. C.

Subminiature electronic circuits were developed during the war and they made possible, among other things, the tiny radio apparatus that is carried in the nose of a proximity shell and that detonates it when close to the target. Proximity-fuse development was conducted at the National Bureau of Standards by a group of scientists of which Dr. Cleo Brunetti was a leading member. Often called the world's leading genius in reducing the size and

Here are midget amplifier, receiver, transmitter and microphone

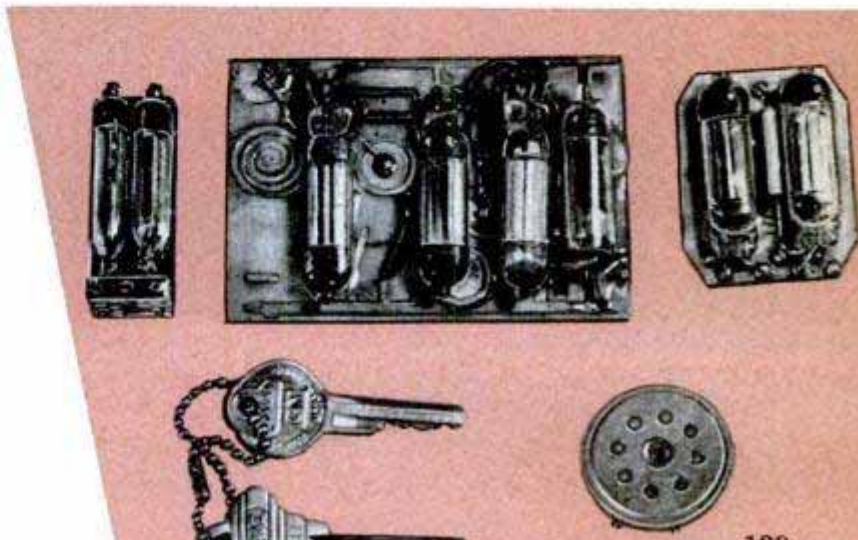

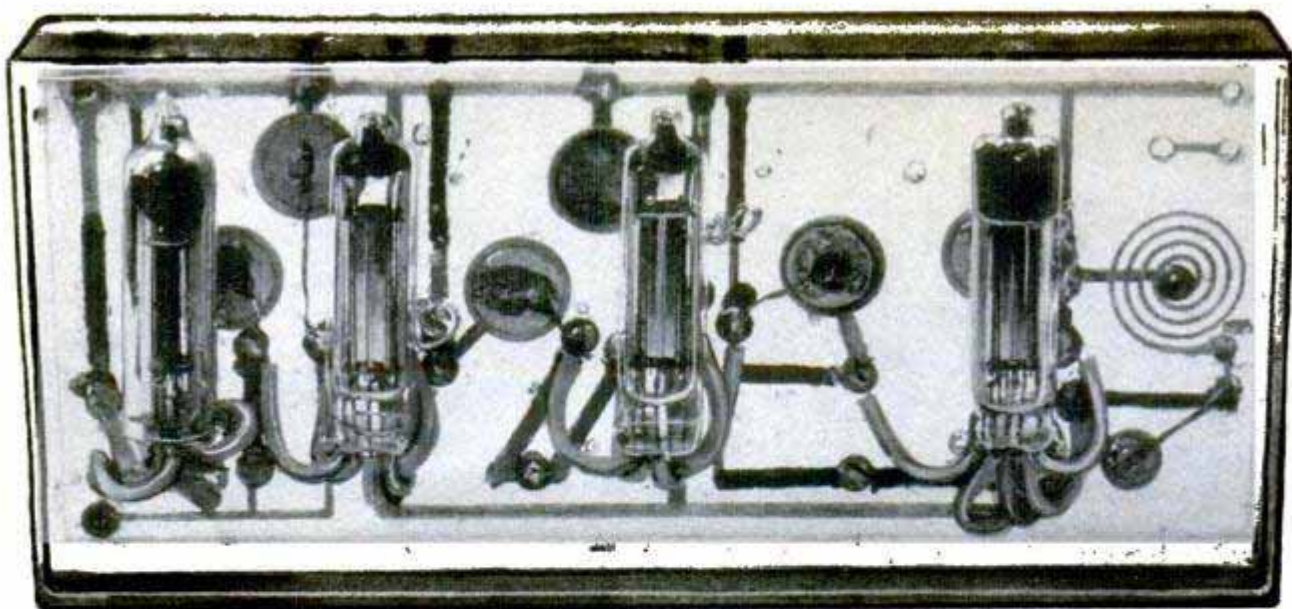

Four-tube receiver is embedded in block of plastic only five inches long. Spiral at right is the tuning coil

weight of electronic equipment, Doctor Brunetti is now an associate director of Stanford Research Institute in California where more research in subminiaturization is being conducted in a new laboratory.

When Doctor Brunetti lectures on small-scale radio equipment, he often carries an entire network of transmitters and receivers in his pockets. To illustrate a point in his talk he may hold up, between his fingers, a thumb-size chunk of plastic which

contains a complete two-stage amplifier. It does the same work as equipment that may measure four by five by six inches. Because it is buried in plastic it is protected against moisture and accidental breakage. It is fitted with a plug-in base so that it may be removed from a set and replaced in a couple of seconds.

From the same pocket Doctor Brunetti pulls a cigarette package that contains a complete three-tube transmitter including microphone, collapsible antenna and power supply. It has a clear and reliable service range of three blocks. A four-tube receiver is even smaller, about the size of a calling card.

Next, he displays a true "sub-subminiature," a one-tube transmitter with its connectors, resistors and capacitances printed on the glass envelope of the vacuum tube. Without microphone, antenna or power, it is mounted inside an ordinary lipstick container. With one exception, Doctor Brunetti remarks, it is probably the smallest practical transmitter ever built. Then with a grin he produces the exception from between his fingers, a still smaller vacuum tube and circuit that rests inside a tinier lipstick container.

Subminiature transmitters and receivers are of short range when paired together, Doctor Brunetti explains, but range is multiplied many times when a more powerful unit is used at one end. That is, a pocket transmitter can be picked up at a considerable distance by a receiving set of good sensitivity. Similarly, good reception of an ordinary broadcast station a number of miles away can be obtained

Hunter of the future? He wears a tiny radio in his helmet for communication with the other members of the hunting party







With the help of a laboratory magnifying glass a technician checks the internal structure of a subminiature radio tube. It will be fastened directly to the material upon which the circuit is printed

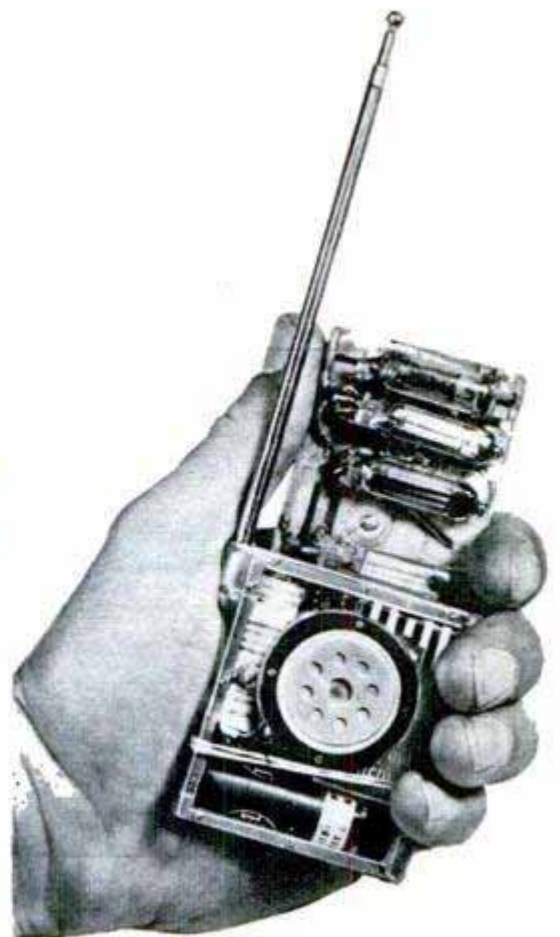

Combination transmitter and receiver, including batteries, can be held in one hand. Below, that's not a radio tube in his fingers, but a control circuit that does work of all standard components on table

with a subminiature receiver.

Sometimes a member of an audience suggests that the diminutive radios are interesting but, he asks, have they practical value?

Doctor Brunetti can give half a dozen or more practical applications with hardly a pause for breath. Beside being suited for short-range communication on the new citizen's radio frequency, he says, they could be employed for many special purposes. Waitresses could use them for relaying orders direct to the kitchen. Tuned to the frequency of an aircraft's communication circuit, a hand-size radio could be used by a ground crew member in advising the pilot where to park. Deer hunters in the field could use them to check on the whereabouts of each member of the party.

Doctors could make electrocardiographs of a person's heart action while the patient exercised instead of lying at rest on a table. People in adjacent offices could use their transmitters to dictate to a common recording machine.

Eventually, Doctor Brunetti



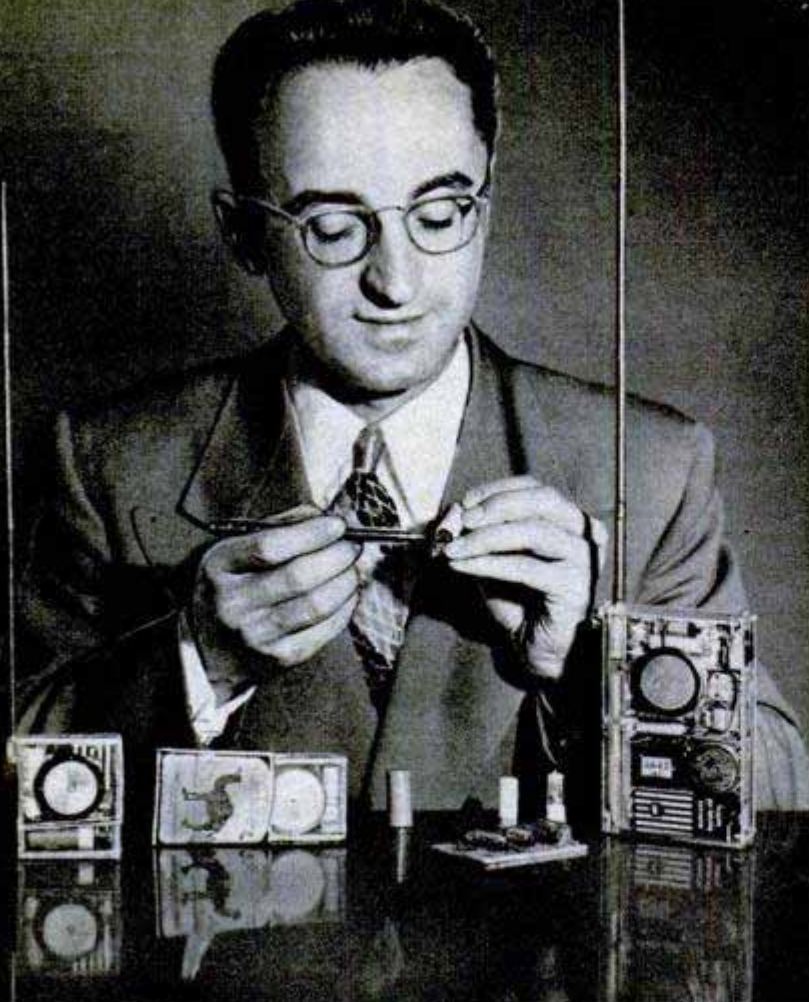

↑ Flashlight powered by mercuric-oxide cells in black case will glow several hours  
 ← Brunetti's subminiatures include cigarette-pack receivers, lipstick transmitters

suggests, a "universal" subminiature set that weighs no more than a pound will serve as a broadcast receiver, a two-way radiotelephone, a hearing aid and a remote control for such tasks as opening or closing the windows at home or opening the garage doors.

Another application may be a cordless hearing aid for the hard-of-hearing. At present a deaf person's earplug is connected by a cord to an amplifier box that is usually carried in a pocket. Sometime it

**Complicated electronic circuit is made of silver foil on piece of paper. Beside it is proximity fuse for mortar**

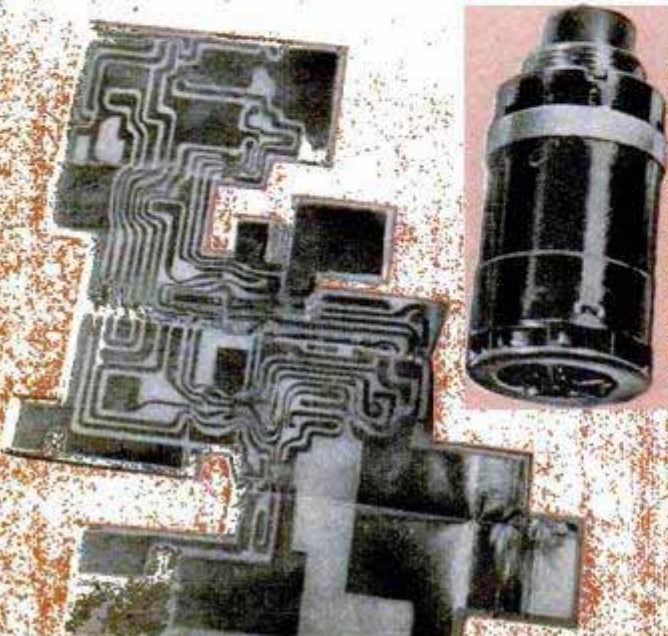

may be possible to broadcast from the pocket to a complete but tiny receiver contained in the earplug, without the nuisance of the connecting wire.

There is a possibility, too, that batteries can be eliminated completely for some portable sets, although this is not in the true field of subminiaturization. Doctor Brunetti and Robert Eichberg, a former colleague, have done some exploratory work on the principle of "powerless wireless." Instead of requiring battery power, receivers and possibly transmitters would be energized by the heat of an ordinary stove or campfire.

A broadcast receiver of this sort might look something like a kettle and would begin to play as soon as it warmed up. The vacuum tubes would have special "combustion heated" filaments that would operate efficiently when heated to several hundred degrees. B-batteries would be replaced by tiny thermocouples that would generate B-voltage when heated. No such radio has actually been built, but the underlying principles seem feasible.

Not all portions of some electronic circuits can be subminiaturized, as yet. For instance, heat dissipation from a subminiature tube that must carry high wattage is such a problem that tubes of ordinary size commonly are used in the final stage of any powerful system.

Too, some of the components are not

(Continued to page 248)

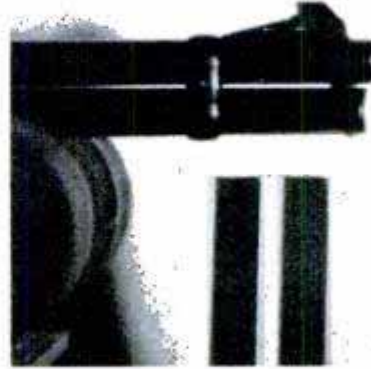
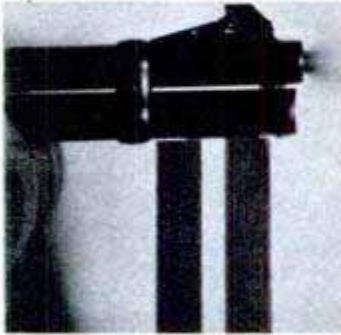

Left, bullet is shown leaving muzzle of gun with no visible recoil as muzzle rests firmly on the support. Photo at right shows recoil of gun after bullet is 30 feet away. Below, recoil testing device in laboratory

## Tests Settle Recoil Controversy

Does the visible recoil of a gun occur before a bullet leaves the muzzle and spoil the aim or after the bullet is well on its way to the target? A Winchester carbine, a camera of the type used by newspaper photographers and a photographic light that makes camera shots at three millionths of a second were used in recent tests to settle the old controversy over recoil. The carbine was mounted in a recoil rest to simulate the conditions under which a rifle is fired from a man's shoulder. The stock of the rifle rested in a steel pocket lined with sponge rubber, and the muzzle was supported on a hard-rubber cylinder and a block of wood. A thin copper wire was stretched vertically before the gun,  $2\frac{1}{2}$  inches from its muzzle, directly in the path of the bullet. The wire was connected electrically with the photo light. A picture was made of the gun at rest in this position, and then the gun was loaded with a 30-30 cartridge of 2200-feet-per-second muzzle velocity and a shot fired. Another picture was taken as the bullet cut the wire. This photo showed the bullet more than two inches away from the muzzle and no recoil in the gun. The gun was reloaded and a third picture made when the bullet severed a second wire 30 feet in front of the rifle. This

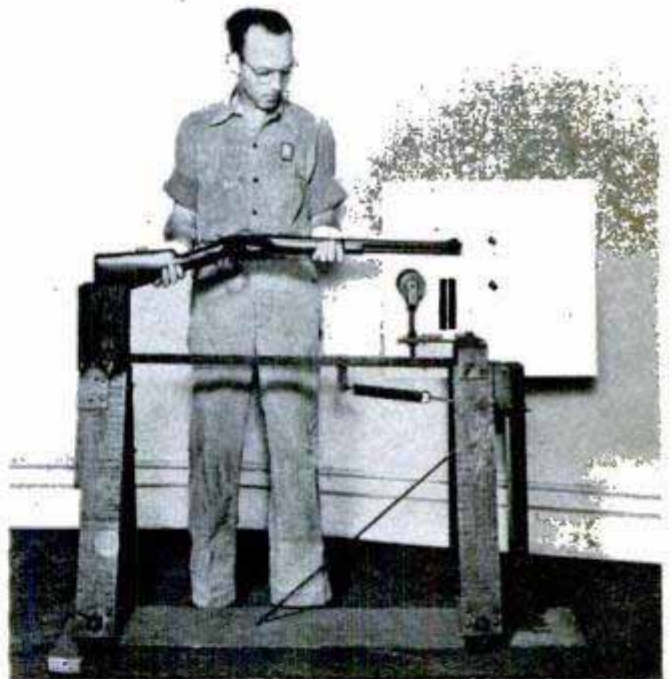

picture showed that visible recoil had raised the muzzle approximately  $\frac{3}{4}$  inch above the wood block. It is explained, however, that a gun reaches maximum recoil in about sixteen thousandths of a second. Since everything happens in such a short space of time, it is no wonder some shooters will blame recoil for a miss. The tests were made in the laboratory of the Western Cartridge Co., division of Olin Industries.

## Music Is Newest Instrument in the Doctor's Black Bag

Doctors are using music in operating rooms and in treating patients with mental illness, heart disease and a number of other ailments. Handled by a trained therapist, the musical "treatments" have shown important successes. If the patient likes

music, he is given earphones when he enters the operating room and he goes to sleep to music. In mental treatments, music is used to calm violent patients. Cardiac patients who require relaxation are given soothing music in their rooms.



## Ultramodern Desk

Hidden elevators and pivoting drawers give Allen B. Gellman fingertip control over everything in his desk. Gellman, president of the Elgin American Company, designed the desk himself. The large, curved top is uncluttered and attractive. At one

end is a telephone shelf which pivots toward the executive when he wants to place a call. Similarly, a filing drawer twists out for accessibility. When Gellman presses a button, the front section of the desk rises to reveal pigeon holes for correspondence. The secretary slides back panels to find her work already sorted.



## ← Cultivator Fits in Car

Weighing only about 100 pounds, a power garden cultivator fits inside the trunk of most automobiles. The cultivator is designed for use on city and farm gardens too small to require full-size tractor equipment. It is powered by a four-cycle gasoline engine which operates a chain drive.

## Heating Ducts of Aluminum Prove Best in Lab Tests

Aluminum ducts to carry heat from furnace to rooms are superior to those of other materials, according to comparative tests made at the University of California. They are also cheaper because they need no insulation and actually function more efficiently without it. The tests also showed that asbestos-paper-covered ducts can be raised to a level comparable with that of bare aluminum ducts by adding an additional wrapping of aluminum foil, sealed at the joints with aluminum tape.

## Sub's Compressor May Power Auto

Cheap to build and operate, a free-piston engine, formerly used as an air compressor in a German submarine, may lead to a new type of automobile or truck engine. Tests being conducted on the captured engine at Stanford University show that engines can be made in any size from that of a passenger car to the largest diesel, using the same principle. Besides being inexpensive to build and operate, the engine is lightweight and runs almost without vibration. So smoothly does it operate that a coin can be balanced on the engine while it is running. For use in a car, the engine would produce hot exhaust gases at a pressure of 100 pounds per square inch and these gases would drive a turbine to power the ve-

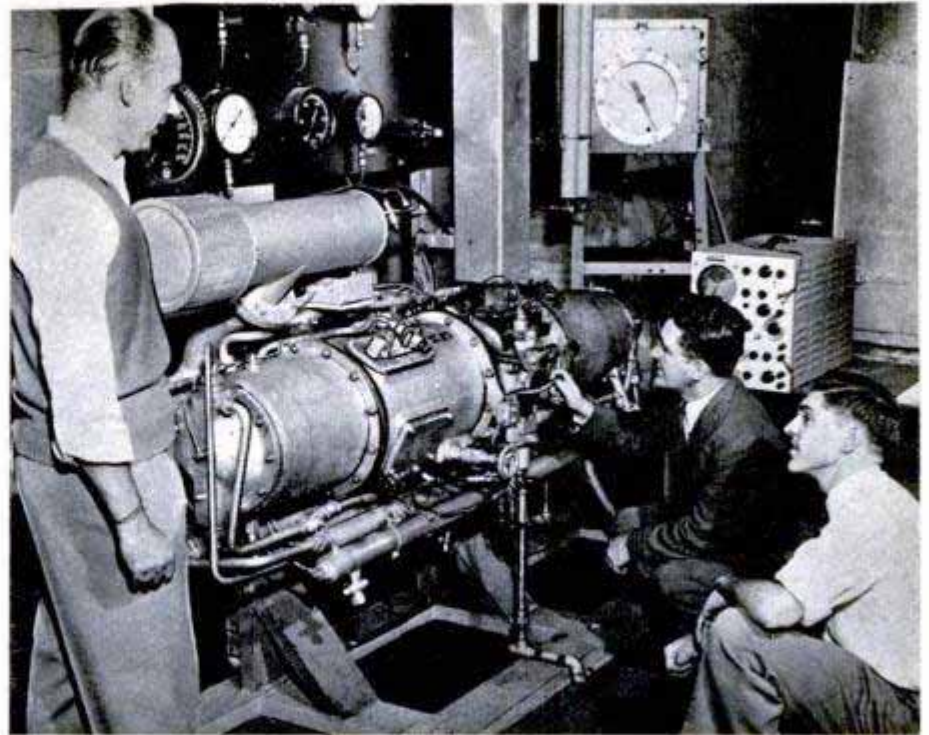

hicle. Used as a compressor, the engine takes 70 cubic feet of free air a minute and compresses it to 3000 pounds per square inch. In the submarine, it was used to produce compressed air for torpedo launching.

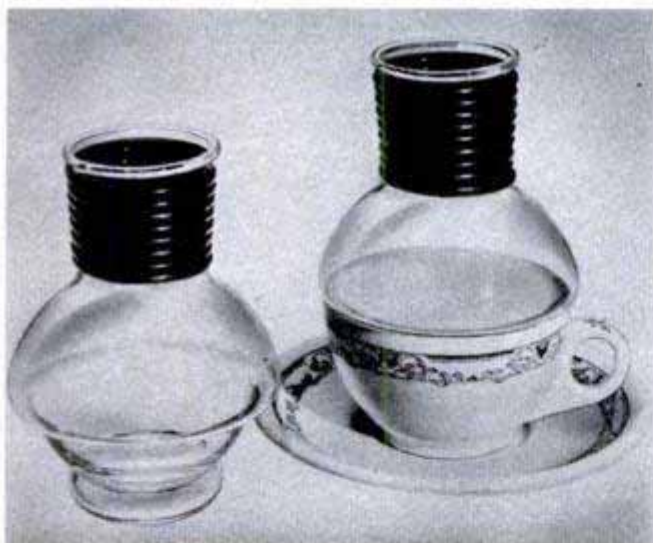

## Glass Bottle That Fits in Cup Keeps Coffee Hot Until Drunk

Diners pour their coffee hot—and when they want it—from a glass bottle that fits in the cup. It also keeps the cup warm until the first coffee is poured. The Hottle (coined from "hot bottle") holds 10 ounces, enough for two cups. Plastic insulation around the neck gives protection in handling when filled with hot liquid. On trains, ships and planes, where the motion of the carrier often slops coffee into the saucer, it has the added advantage of allowing a traveler to pour out only half a cup at a time and yet have sufficient hot coffee on hand when more is needed.

## Four-Position Tee Rests Atop Ground

Four different cups at varying heights are provided in a single golf tee which rests on top of the ground. The plastic tee consists of four prongs joined together with a cup at the end of each one. The three prongs not occupied by the golf ball form a tripod for the tee. Thus, the golfer can always tee his ball at the same height.



# "MINING" COAL WITH FIRE

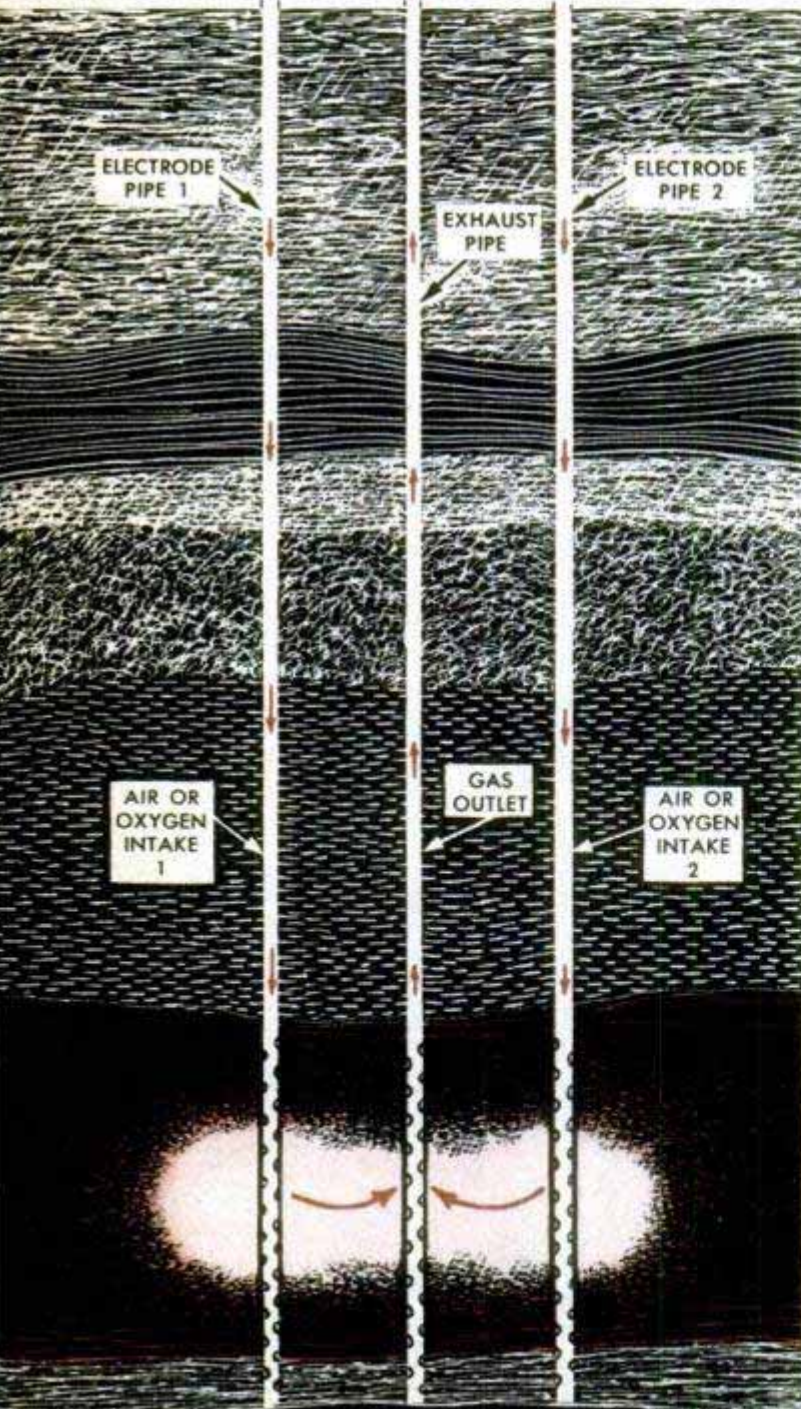
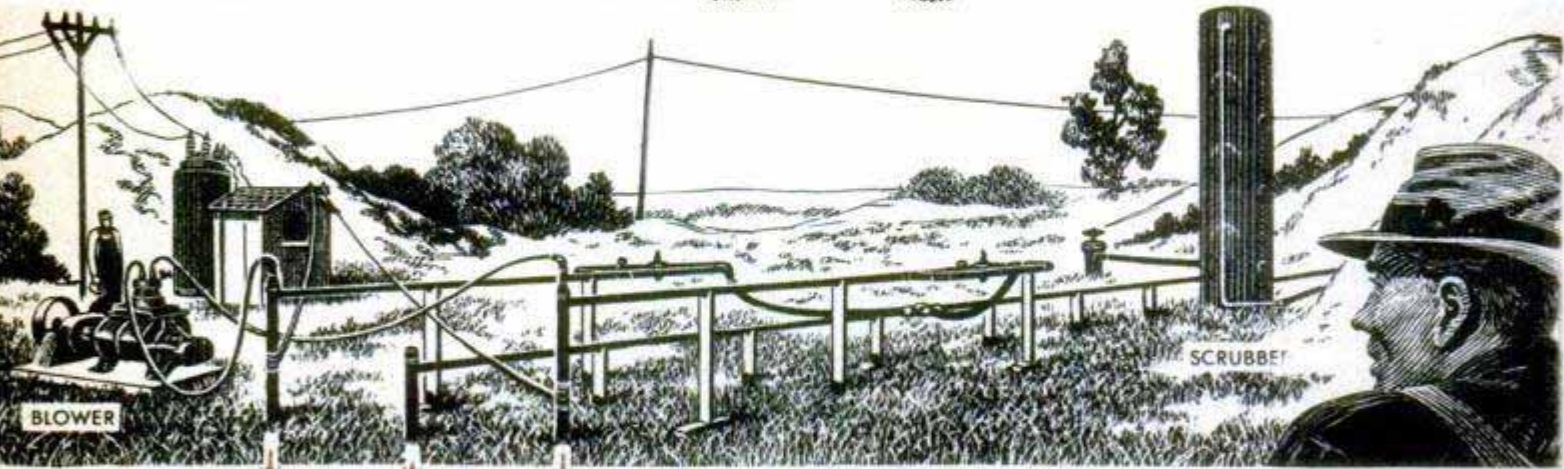

Two electrode pipes, sunk into the Hume coal seam, carry the current which heats the coal. Then, air is pumped down them to support combustion. The gas which is released is forced up through a third pipe

**T**OMORROW'S coal miner may never go underground. He'll probably work on the surface, turning over the dirty and dangerous underground task to his subterranean "slave," a controlled fire, that will bring up the coal in the form of gas.

Two important experiments now being conducted may lead to this revolution in mining. Instead of burrowing into the earth, chipping the coal loose and hauling it up for distribution to the nation's furnaces, we may convert the coal into fuel gas underground, burn the gas at the mine-head to produce electricity which can be "shipped" at a fraction of the cost of hauling coal.

At Hume, Mo., the University of Missouri is gasifying coal by forcing a high-voltage electric current through the seam, heating the coal until it is ready to ignite. Then, air or oxygen is pumped into the seam through iron pipes, which also serve as electrodes for the current, causing the coal to burn. The gases released by this incomplete combustion are forced upward through an exhaust pipe and converted into a heating fuel similar to coke-furnace gas manufactured in commercial plants.

In a similar experiment at Gorgas, Ala., the Bureau of Mines has been producing fuel gas by underground gasification of coal. There, electricity is not used, the combustion being started by an incendiary bomb dropped into a tunnel in the coal seam. Air under pressure is forced into the tunnel to feed and spread the fire, forcing the gases out an exhaust stack where they can be captured and processed.



Left, at the Gorgas experiment, a miner checks the fire's progress through a vision slot. Right, dropping a fire bomb into the coal seam to start combustion

Below, cutaway drawing of the Gorgas test. Air and steam are forced in, first from one end then the other, to produce an even combustion of the coal seam.

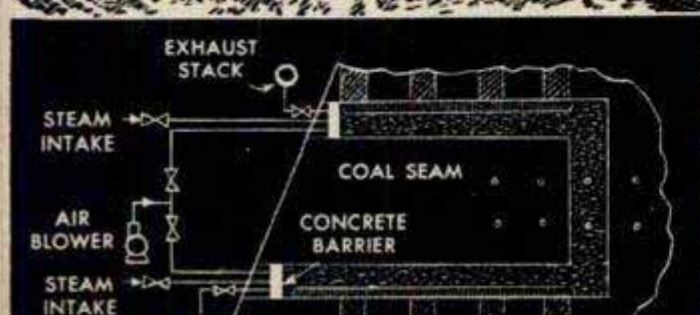
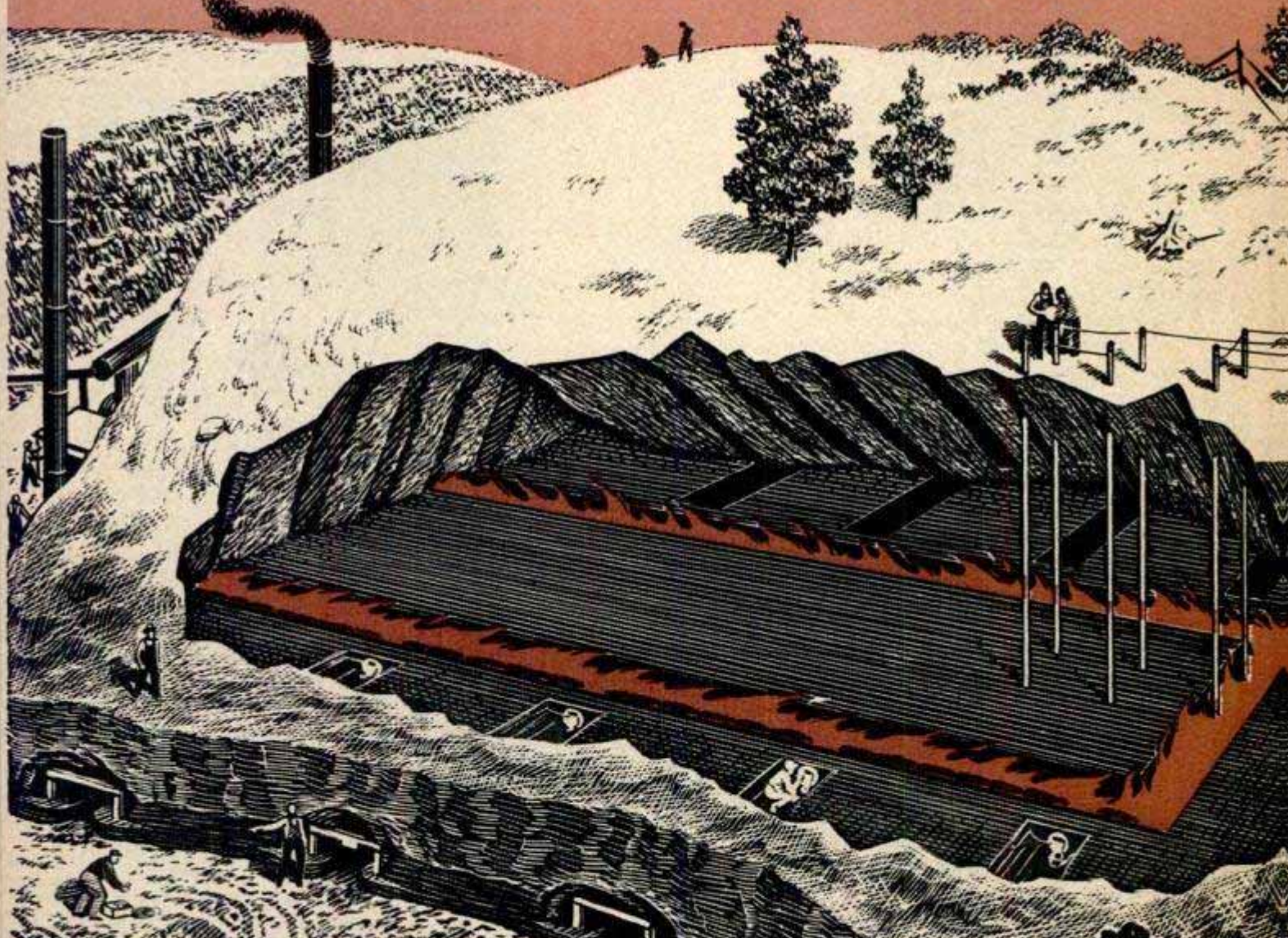

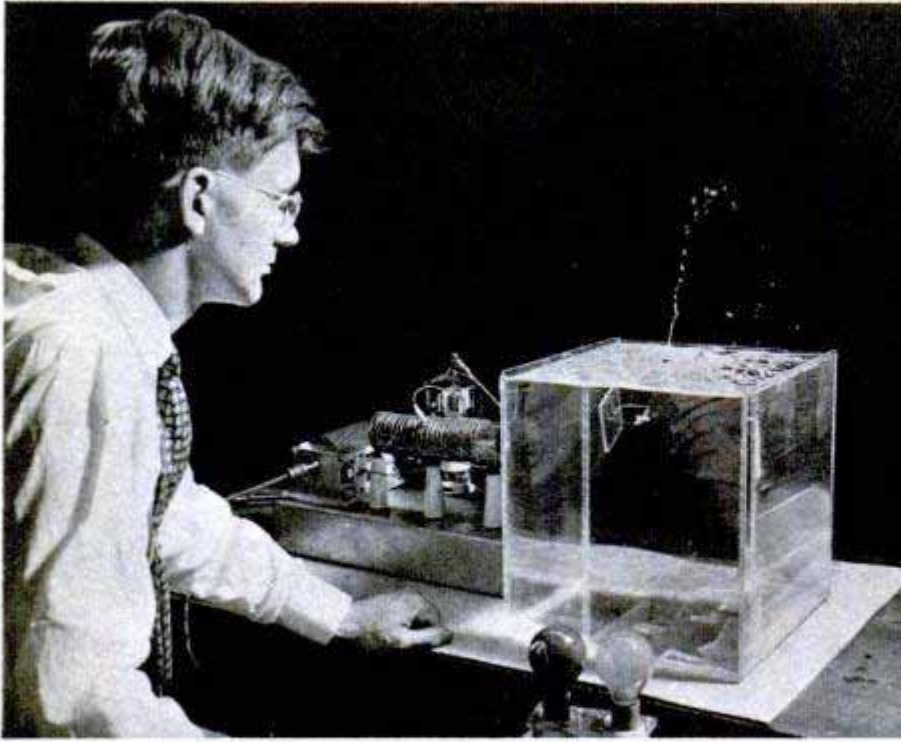

### Ultrasonic Fountain

Sound waves, pitched so high the human ear can't hear them, operate a miniature fountain, throwing a jet of water several inches into the air. The apparatus was designed by General Electric engineers to study ultrasonics. Heart of the fountain is a dime-size disk of barium titanate suspended in the tank. When voltage is applied, it vibrates at almost 3,000,000 cycles per second. As the disk is slightly concave, the waves are focused upward, producing the water jet. The sound waves manufacture fog unless soap is placed in the water. According to engineers, soap forms a film, which prevents fog droplets from forming.

### Homemade Power Shovel

There's a little of almost everything from a B-24 bomber to a broken-down bridge in a power shovel made by a Missouri farmer who runs a rock-crushing business on the side. Using an old farm tractor as a base, he mounted the hydraulic-lift cylinder from a worn-out dump truck just behind the motor and hooked it to a fuel pump from a war-surplus B-24. The bucket came from a discarded scraper and the arms of the shovel were once girders on an old iron bridge. Double steel wheels on the rear axle provide the extra traction necessary for digging into the broken rock.

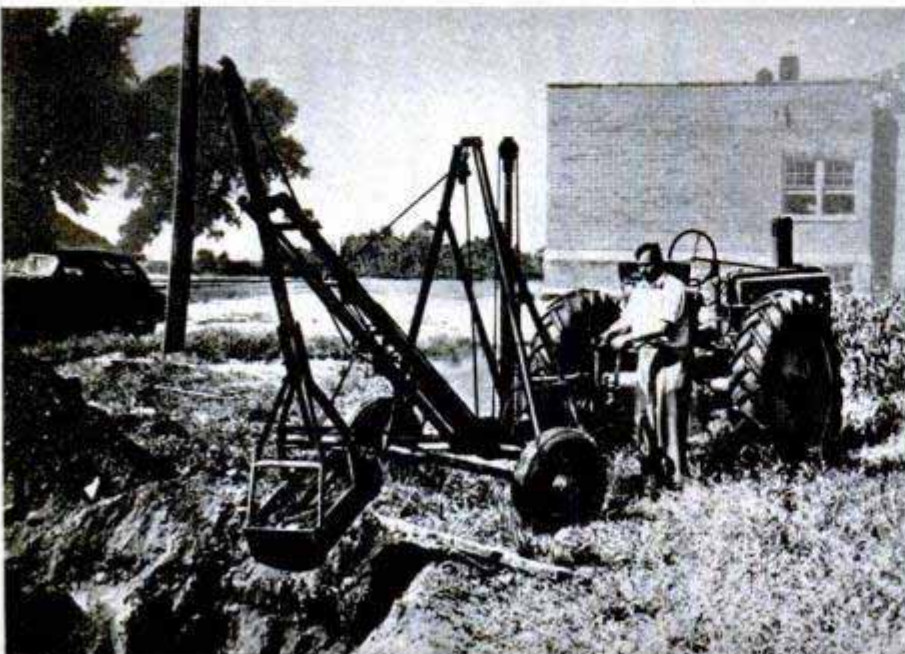
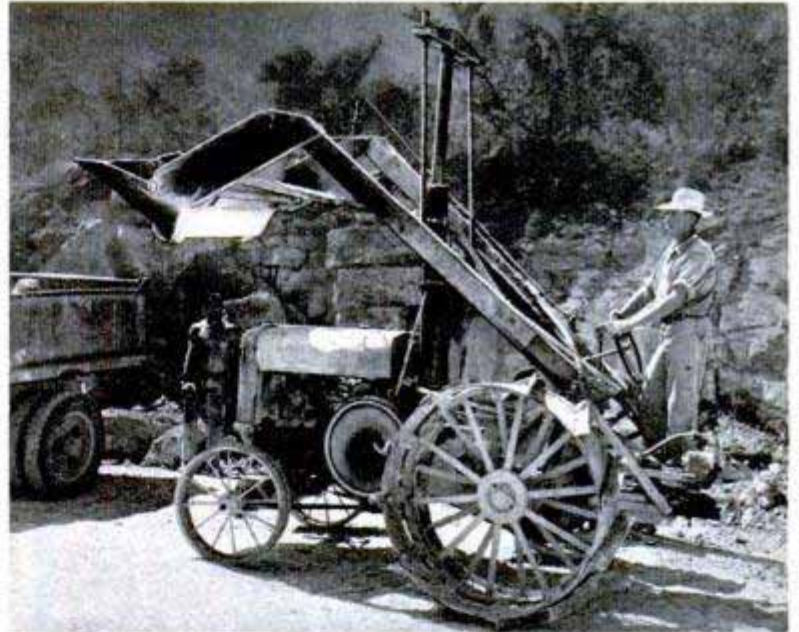

### Light-Duty Ditcher

Completely hydraulic, a new ditcher can be operated with any tractor, truck or Jeep with a power take-off. Digging at its maximum depth of nine feet, it can work 25 feet in an hour. By changing the depth to four feet the ditcher can be made to dig 100 feet an hour. The machine carries a bucket 17 inches wide and has a reach of 17 feet 9 inches. It has a swing of 180 degrees, is 8 feet 6 inches long and weighs 1850 pounds.

☞ In 1949, an airliner took off or landed every five seconds, night and day, in the world network of scheduled airlines.



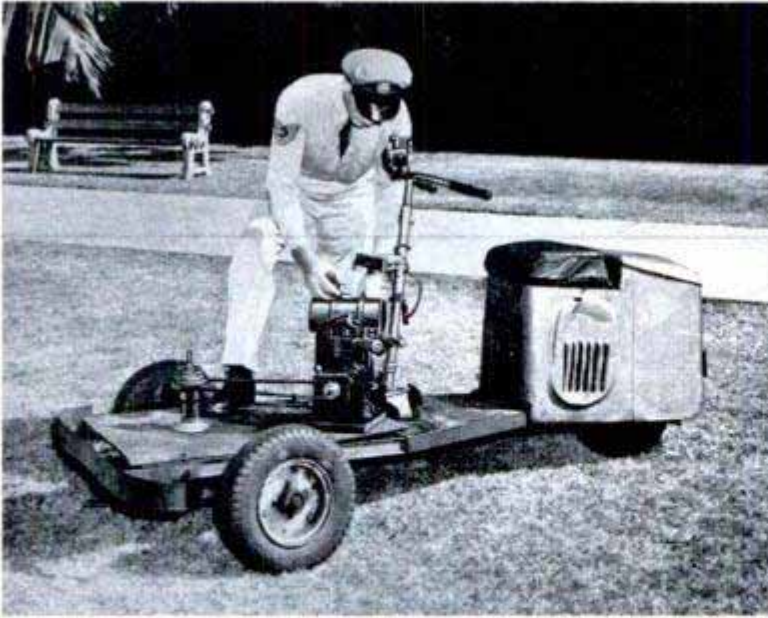

Above, left, Sergeant Chew fills gas tank preparatory to cutting lawn. Belt goes from motor to rotary spinner and sharpened spring. Right, the scooter operating as a lawn mower. Below, underside view of the machine  
U. S. Air Force photos

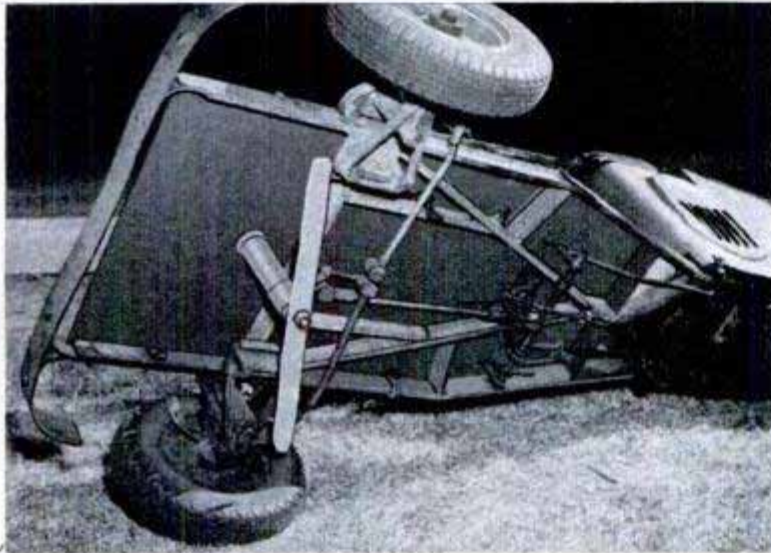

## Lawn-Mowing Scooter

With a model-T spring, some surplus parts, one dollar in cash and four hours work, Sgt. Robert Chew of Hickam Air Force Base, Honolulu, built a motor scooter which mows lawns or supplies transportation. He made a forward section with two wheels and attached it to the front of the scooter. In the center of the platform he built a rotary spinner and attached it to a sharpened spring on the underside of the platform. To cut the lawn, he attaches a belt from the motor to the spinner.

## Leaf Eliminator

Over 1000 pounds of leaves or street debris can be sucked up in a single load by a giant "vacuum cleaner" developed by Harry Clemens of La Porte, Ind. It can be installed on any Ford tractor and operated by one man. An agitator at the front breaks up all packed debris before the vacuum picks it up. A fine wire mesh, covering the hopper, permits the air to be dissipated so that the leaves, which are being blown out a tube at the rate of 6000 feet a minute, won't be scattered back into the street.

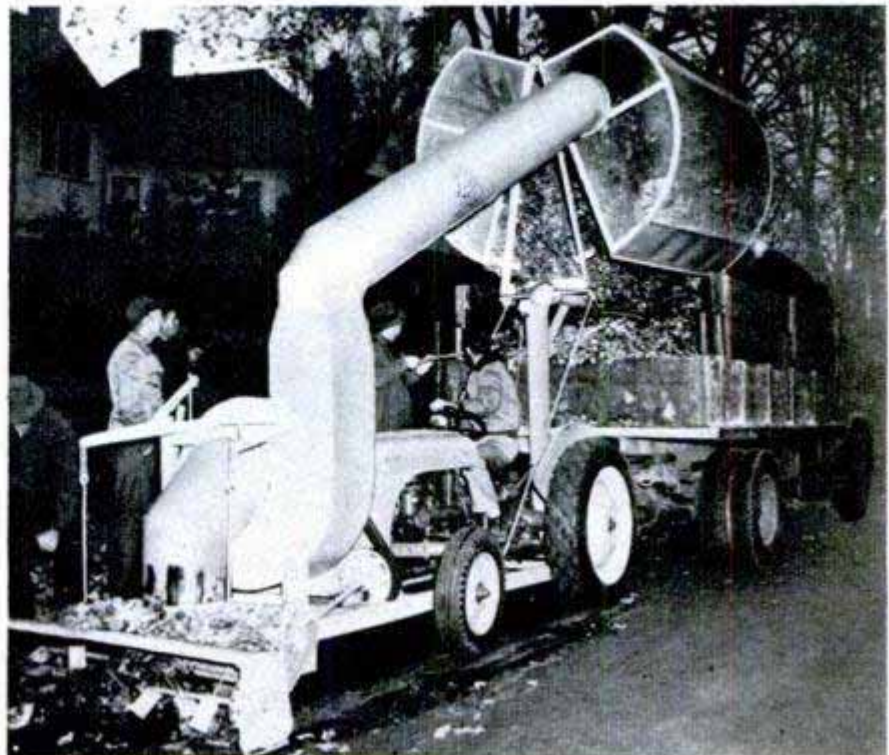

# Shooting the Grand Canyon in a Power Boat

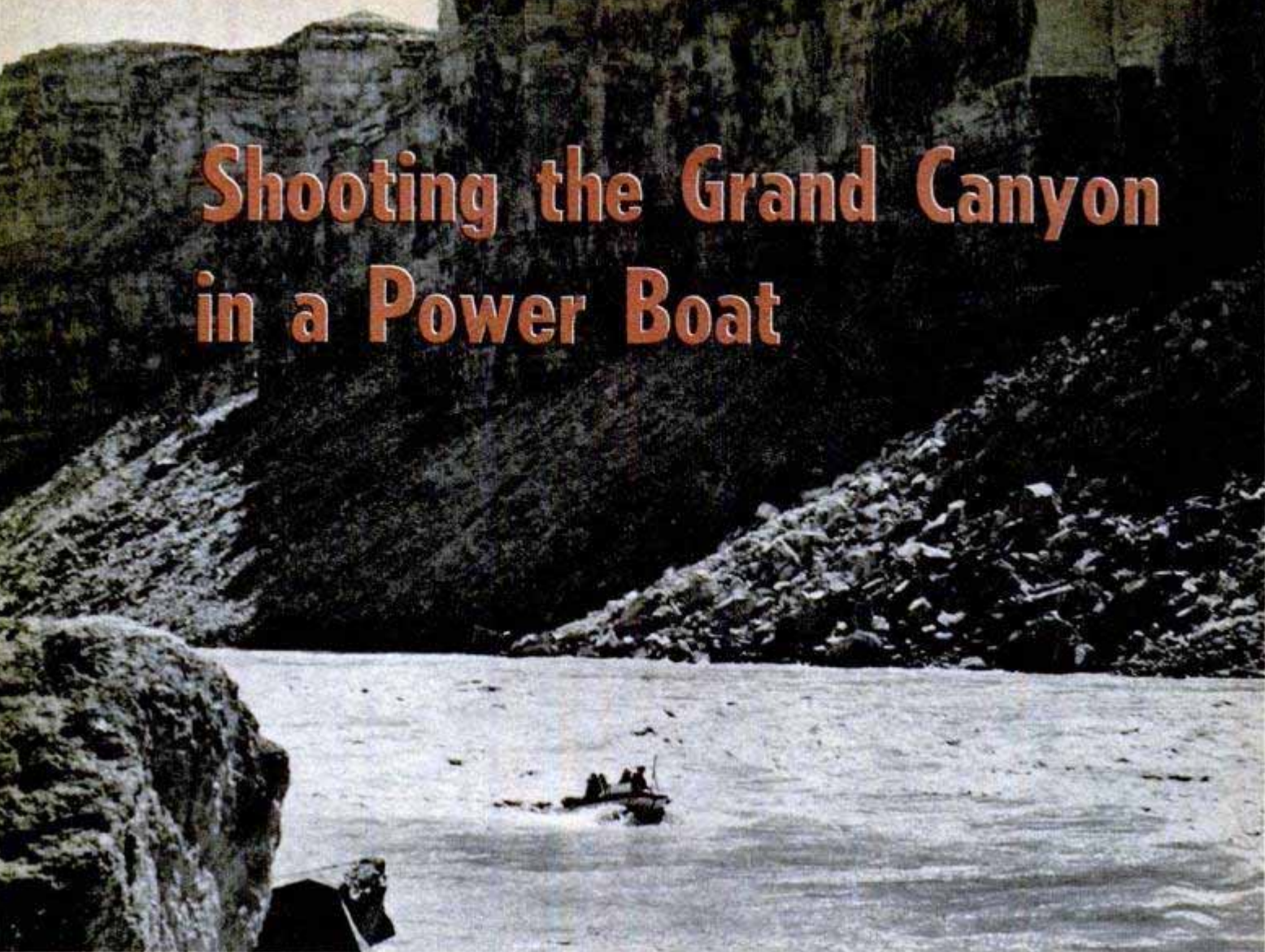

By Gene Segerblom

**F**OR THE first time the descent of the treacherous Colorado River has been mastered by a power-driven boat. The craft not only set a new record for the 290-mile run, but proved that motorboats were practicable for negotiating the world's deepest gorge.

The *Esmeralda II*, with five adventurers, made the trip in only five days. The course started at Lee's Ferry in the Grand Canyon and ended at Pierce Ferry, at the mouth of the canyon where the Colorado enters Lake Mead.

The sportsmen making the voyage, all Californians, were Ed Hudson, Paso Robles druggist, and his son, Ed, Jr.; Otis Marston, Berkeley investment counselor, making his fourth trip down this portion of the Colorado; Wilson Taylor, Berkeley businessman and Bestor Robinson, Oakland attorney. Hudson was the pilot and Marston did the navigating.

Since Maj. J. W. Powell made the first expedition 80 years ago, only 100 persons have come down safely. Many daredevils have been lost and neither boat nor crew found. The Hudson-Marston party's completion of the course raised the total to 105 lucky or skillful boatmen to reach safety.

The 19-foot plywood boat was especially designed and built for the trip by Hudson, enabling it to take the rapids without serious damage. It has a Gray marine 125-horsepower motor and a two-layer bottom for added protection. According to Marston, who has had considerable experience with river boats, it is the finest boat ever built for such trips.

Although battered by huge waves, the craft suffered only minor damage. The propeller was bent from contact with sharp rocks in the rapids, but the worst damage was done to the propeller shaft. It had been worn down  $\frac{1}{16}$  inch by the silt from the Colorado penetrating the bearings.

The engine, although encased, drowned out several times. By the time they reached Pierce Ferry, they had it so well wrapped that it took Hudson 10 minutes to get the engine uncovered. A small hand pump, as well as buckets and rags, were kept going almost continuously to keep the boat from swamping.

The party had originally planned the downstream run only to leave caches of food and gasoline for a proposed trip back up—a fete unaccomplished as yet. However, the trip down posed more obstacles

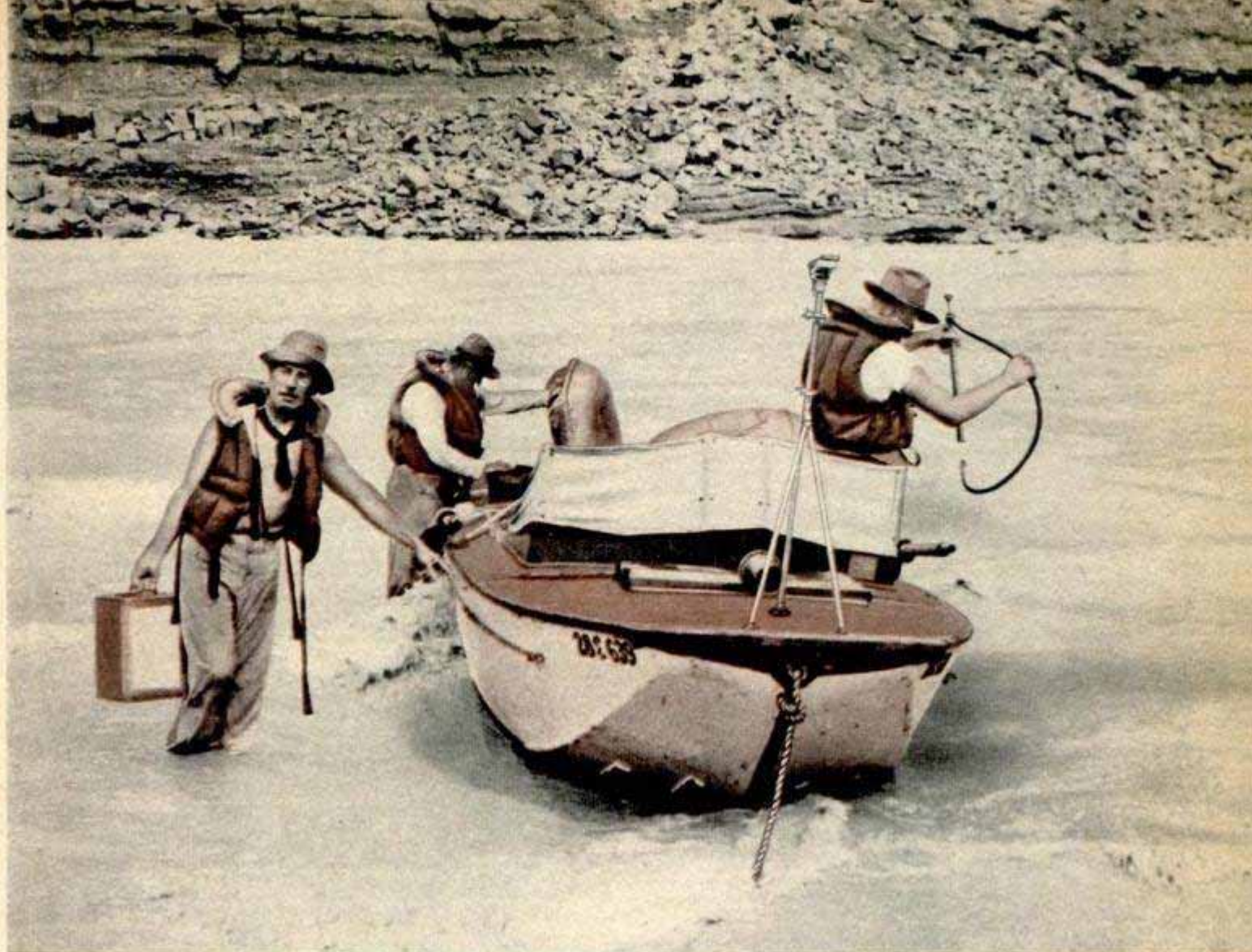

Above, the river runners pause in the Grand Canyon to replenish gasoline from supply hauled in by mule-pack train. The sides of the cockpit were lined with shelves for five-gallon cans. Below, billows as high as 15 feet were encountered, but the boat came through with only minor damage

than had been prepared for. When they set out from Lee's Ferry, the river runoff was 55,000 cubic feet. By the time they were halfway down the gorge, it had increased to more than 88,000 feet.

The increased runoff also added the hazard of masses of dislodged driftwood. Many pieces were larger than the 19-foot vessel itself and could have sunk it with a blow.

Although the power craft was easier to handle in the rapids than other boats, and its speed was greater, it had the disadvantage of needing gasoline to run. The gas mileage was extremely poor, averaging about 1½ to 2 miles per gallon.

"What we need in the canyon for a motorboat trip," declared "Doc" Marston, who knows the river well, "are a few well-spaced gas stations."

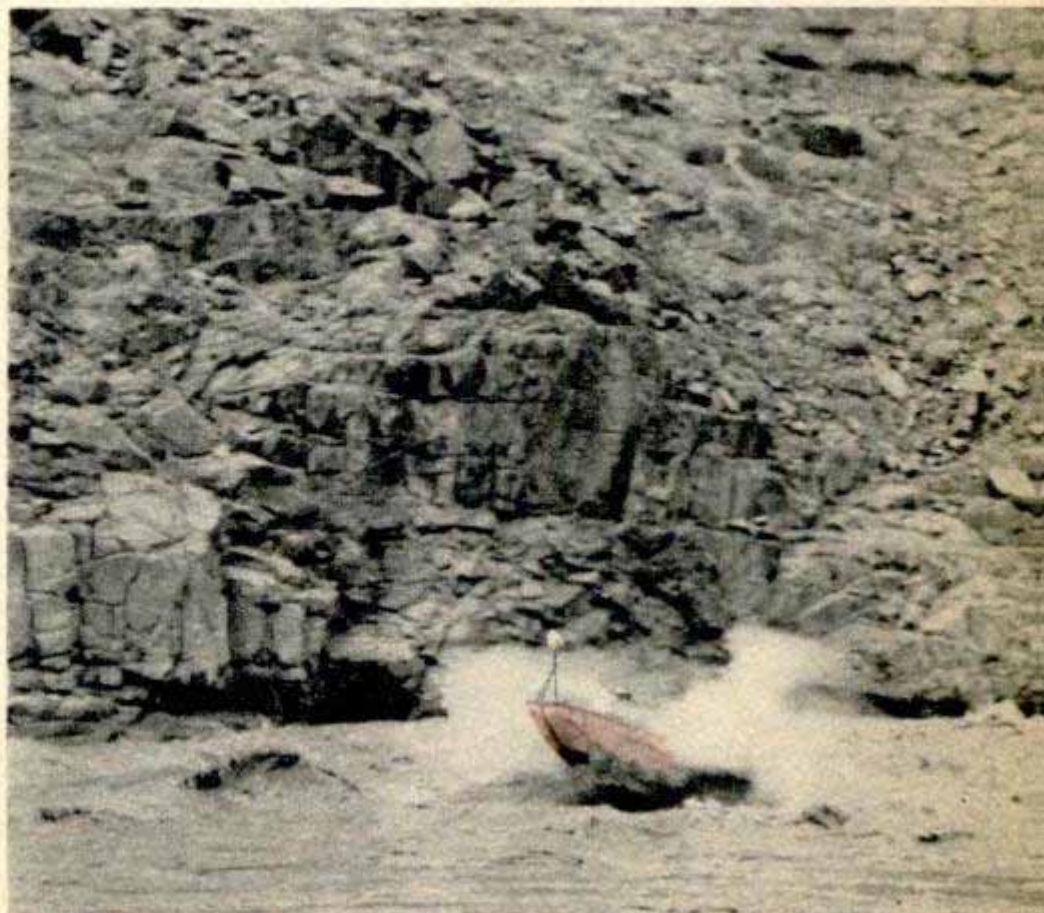

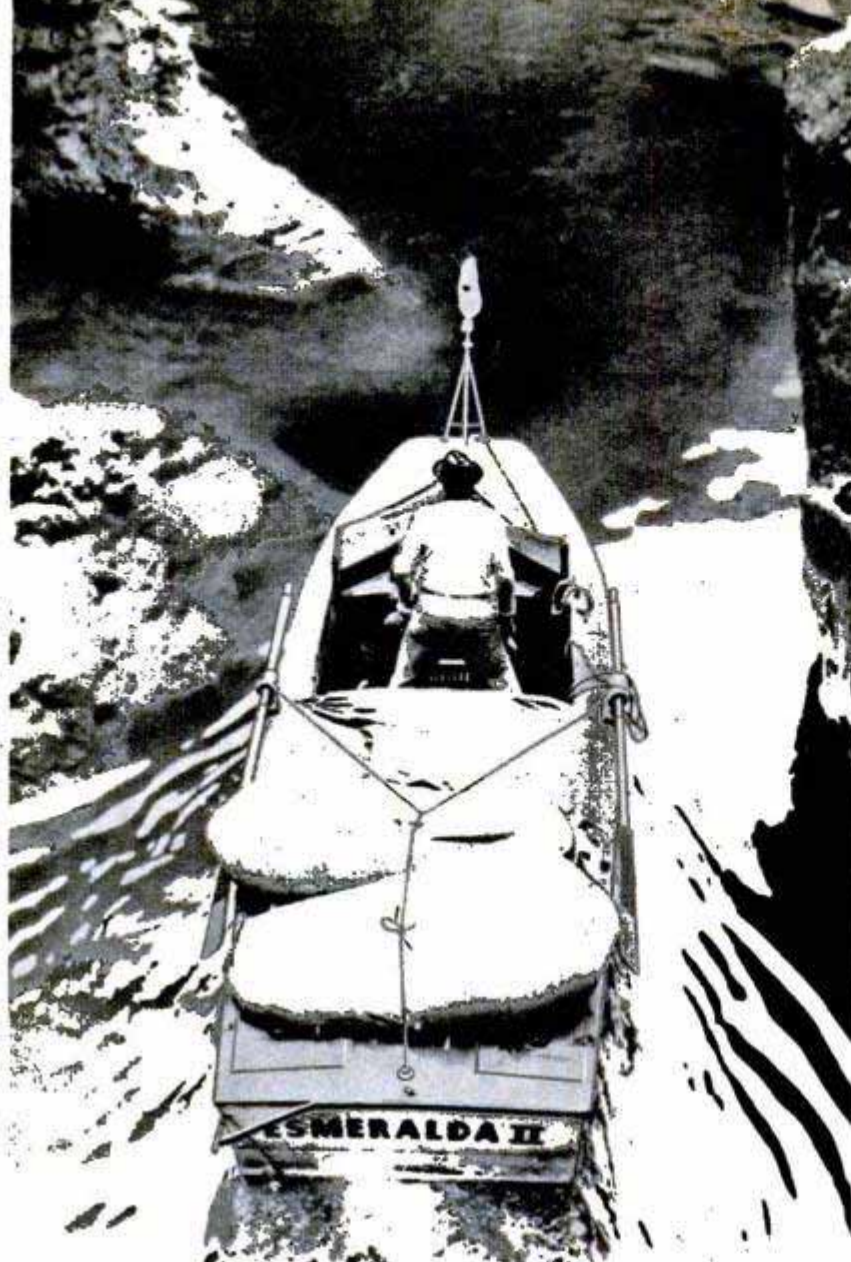

Above, narrow going into a side canyon at the mouth of Havasu Creek. Marston, the navigator, has made four trips down the Colorado River. Below, almost hidden by billows, the Esmeralda II battles the first major rapids on the descent. There were nearly 300 rapids en route

The sides of the cockpits were lined with shelves to hold five-gallon cans of gasoline. On one billow, the boat hit with such a thud the shelf in the front cockpit was knocked down. Fortunately, the gas didn't spill.

Gas was packed in by mules at several strategic points along the course for the downstream trip. At that they just got through, using nearly 50 percent more gas than had been anticipated.

The only serious mishap of the adventure occurred to one of the mule trains hauling gasoline down the side of Grand Canyon for the boat party. Gasoline evidently leaked from one of the cans strapped on a mule, burning his back. The mule went berserk on the narrow trail leading from the top of Grand Canyon to the river.

Before the excitement subsided, every can in the mule train had been punctured on the sharp rocks. It was necessary for a plane to fly to Phoenix for new cans to send down the needed gasoline before the party reached that point of their trip.

The series of nearly 300 rapids in the river course consists of tumultuous swells



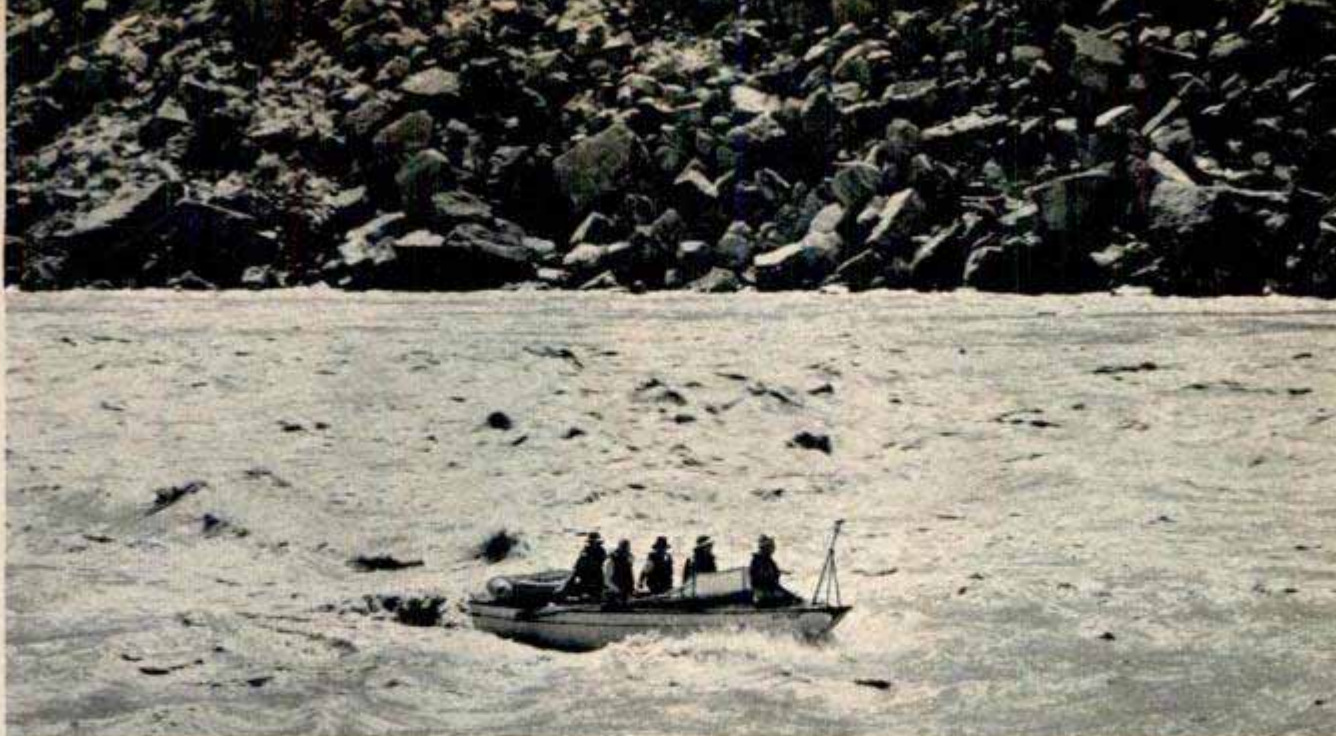

In Marble Canyon, the first motorboat to conquer perilous Grand Canyon churns along the 290-mile course

capable of smashing the sturdiest of craft to fragments. Anything under five feet in height is considered by river runners as a mere riffle. This year's flow of water made the Lava Falls rapid—the toughest stretch of the run—churn up billows nearly 15 feet high.

As soon as they reached Pierce Ferry, the expedition made minor repairs and started back up. However, the runoff had by then reached 101,000 cubic second feet, causing them to call a halt at Mile 242.

Running upstream the 125-horsepower motor took three times as much gasoline as they had made provisions for. Last year, the same men, with the exception of Robinson, were able to get to Mile 217 in the

same boat, before being halted by lack of power. This time the 75-horsepower engine had been replaced by a 125-horsepower motor. They had tested the boat's power at Lava Falls rapid on the way down and had made it easily.

The five dauntless men were not discouraged over the failure of this second attempt to go up the Colorado River. They all plan to return shortly for a third try.

Although their down-river record stands at 5 days and 10 minutes, they actually spent only 4½ days on the water, having spent half a day and a night at Bright Angel. And they could have done even better if they had not stopped now and then to leave supplies for the upstream trip.

On placid Lake Mead, after completing perilous canyon descent. The 19-foot plywood craft was specially designed for the trip

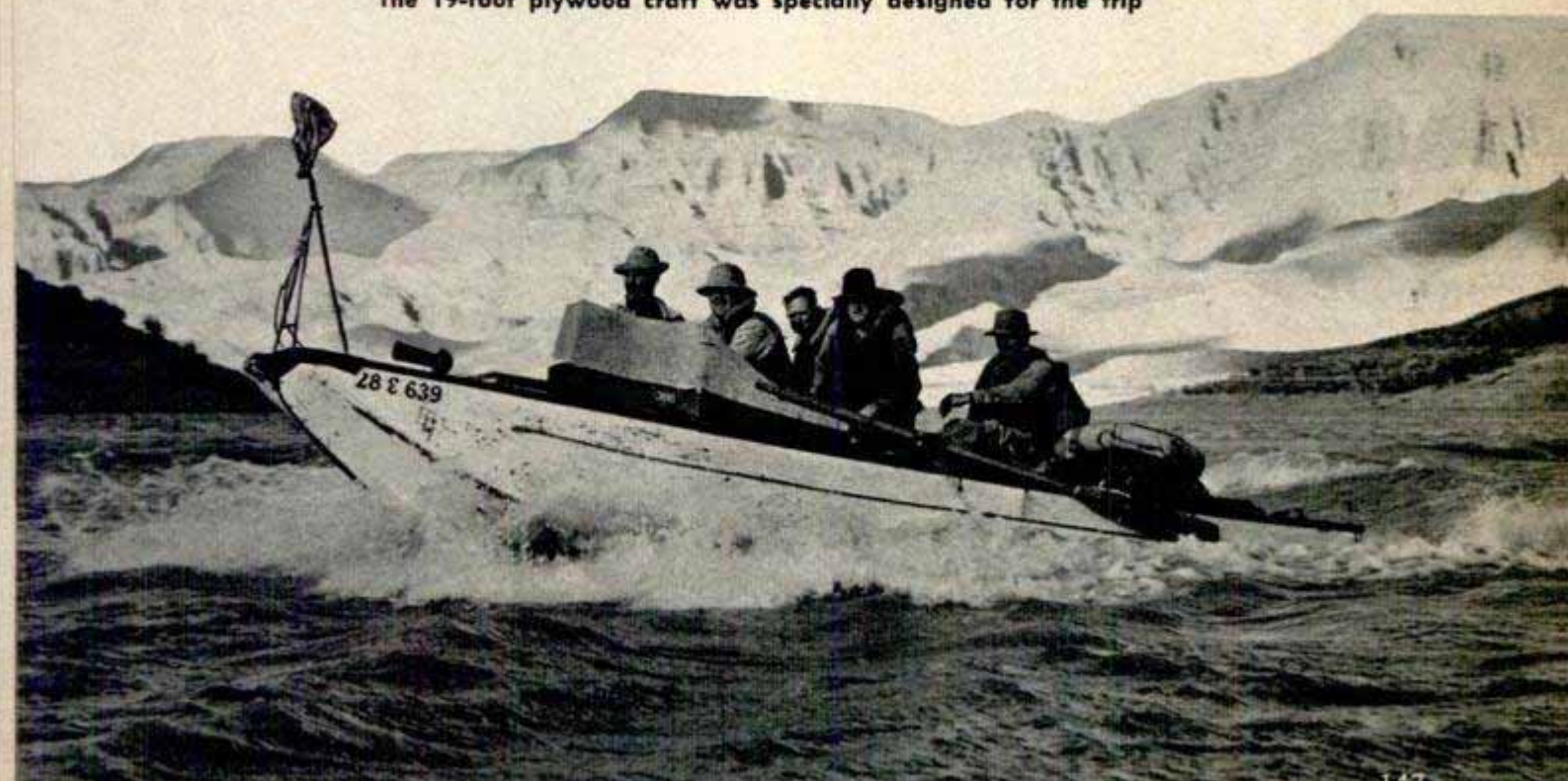

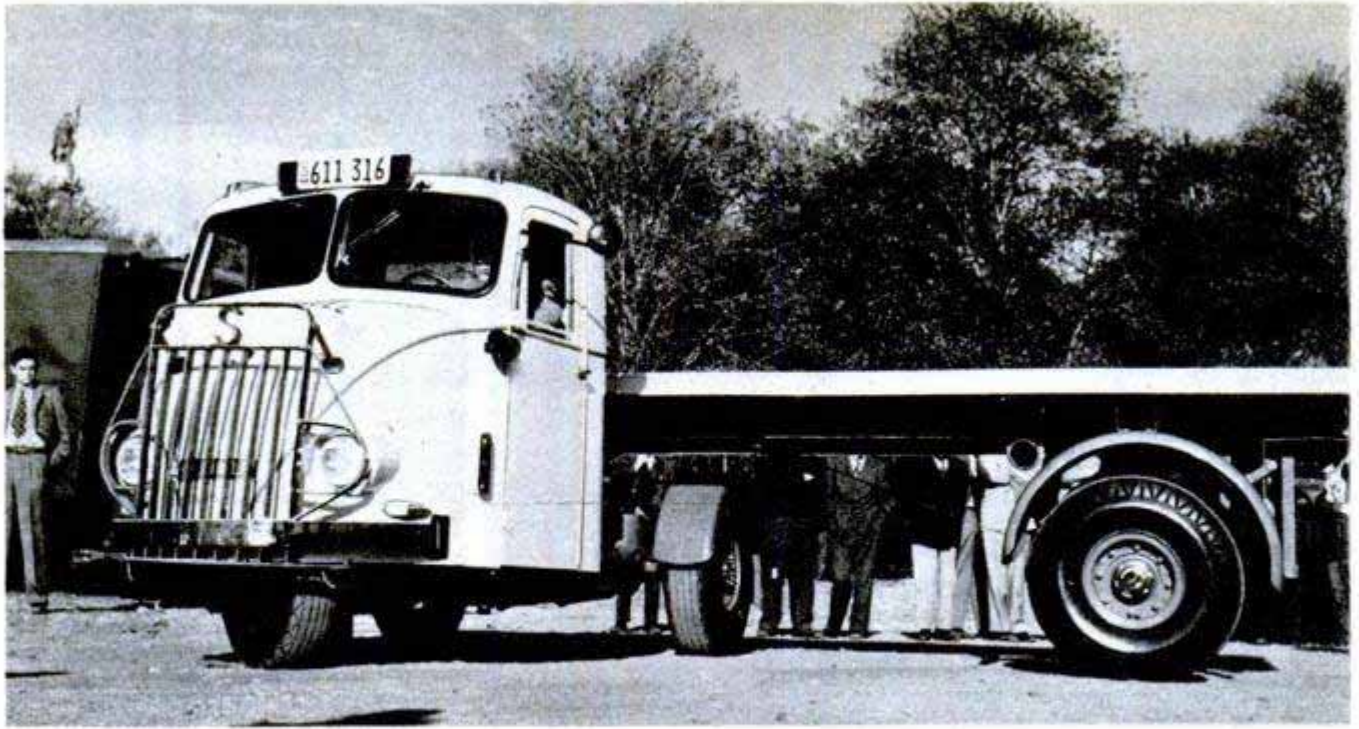

## Trailer Truck Pivots on One Front Wheel

Agile as a motor car is a British semi-trailer truck with only one front wheel. The truck is small in size and has a trailer measuring only 15 feet. The single front wheel and the short length of the tractor

and trailer permit the truck to be maneuvered easily into a parking space or unloading dock. By cramping the single wheel in one direction, the driver can make a U-turn in a space only 19 feet wide.



## Pocket Ray Detector

Radioactivity is detected and measured by a British instrument about the size of a fountain pen. The detector is used in radium-treatment rooms and research laboratories. Instead of a Geiger counter, the instrument has a quartz fiber electrometer which moves up a scale according to the degree of radioactivity. The fiber is tough enough to withstand heavy shocks.

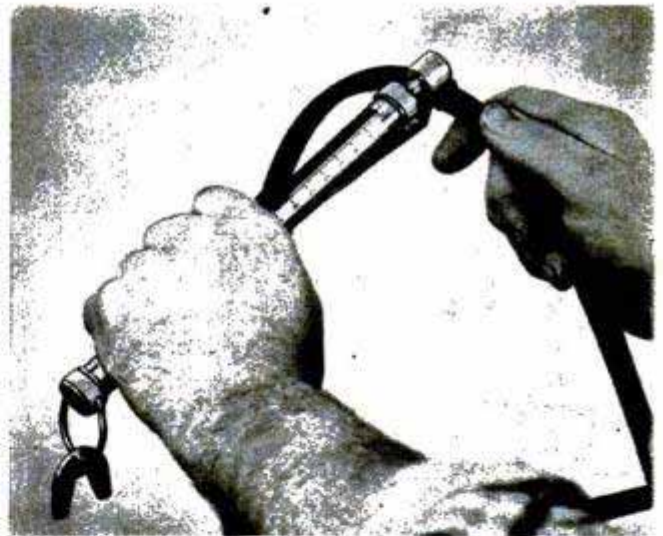

## V-Belt Measurer

Operating on the same principle as an automobile-mileage indicator, a meter measures the length of V-belts. Any light-duty V-belt is clipped against a wheel and pulled through its cycle. As the belt moves through, the wheel rotates and indicates the length on an easily read gauge.

Sources of available products described in this issue are listed on pages 10, 12 and 14. Sources of further information on other articles are listed in the WHERE-TO-FIND-IT INDEX, which is available without charge from Bureau of Information, 200 East Ontario Street, Chicago 11, Ill.

Artist's impression of jet B-47 as an airliner. Boeing may add fuel tanks under the wings and convert 600-m.p.h. bomber into a transport



# Commute by Jet

By Aubrey O. Cookman, Jr.

**I** WONDER WHAT it's like?" How many airline passengers, looking out the window at jet fighters and bombers "whooshing" by in the distance, have asked that question? And, in the same breath, "how soon will I be doing it?"

Those jets, many with wings swept back like wild geese in flight, are lifting the curtain on new and almost staggering vistas of speed in transportation. A generation of travelers, just becoming accustomed to the time schedules of conventional planes, have a jolt in store for them. Not tomorrow, but unquestionably jets will begin scheduled operations by 1952.

Every major advance in transportation has changed man's life by telescoping time and distance. Ox cart—horse and buggy—locomotive—automobile—piston-engine planes—and now, jets. Everything points toward as big a change from today's airplanes to tomorrow's jets, and perhaps rockets, too, as from the horse and buggy to the automobile.

At already-achieved jet-propulsion speeds any corner of the world will be accessible in a matter of hours. Before this century ends, an air traveler leaving London to spend a week end in New York may be able to say: "Well, goodbye. I'll

arrive in New York City 25 minutes ago."

Confusing? Yes, but perfectly possible with jet speeds. Racing with the sun he actually will arrive in New York 25 minutes earlier than he left London. Breakfast and dinner at places 5000 miles apart, like Istanbul and Brooklyn, won't be an exciting enough travel event to warrant space in the newspaper.

Today's air-traffic rules will be obsolete. Jets, with their terrific rate of fuel consumption, can't waste valuable time being stacked over airports waiting until there is space for them to come in and land. A jet-engine transport the size of the DC-6 would burn four times as much fuel per hour in a holding stack as does the DC-6.

They'll be quieter than today's piston-engine airliners, will vibrate much less and fly much higher. There will be many difficulties to overcome, too, before this high-speed newcomer can be absorbed into the world's transportation system, but we're not talking of fantasy. Two pure jet liners are already here, and flying.

Heading the parade, as the world's first passenger-carrying turbojet, is Britain's de Havilland Comet. Still experimental, it whipped from London to North Africa and back, nearly 3000 miles, at an average speed

# DE HAVILLAND COMET JET AIRLINER

LENGTH, 93 FEET SPAN, 115 FEET

HEIGHT OF TAIL,  
27 FT. 10 IN.

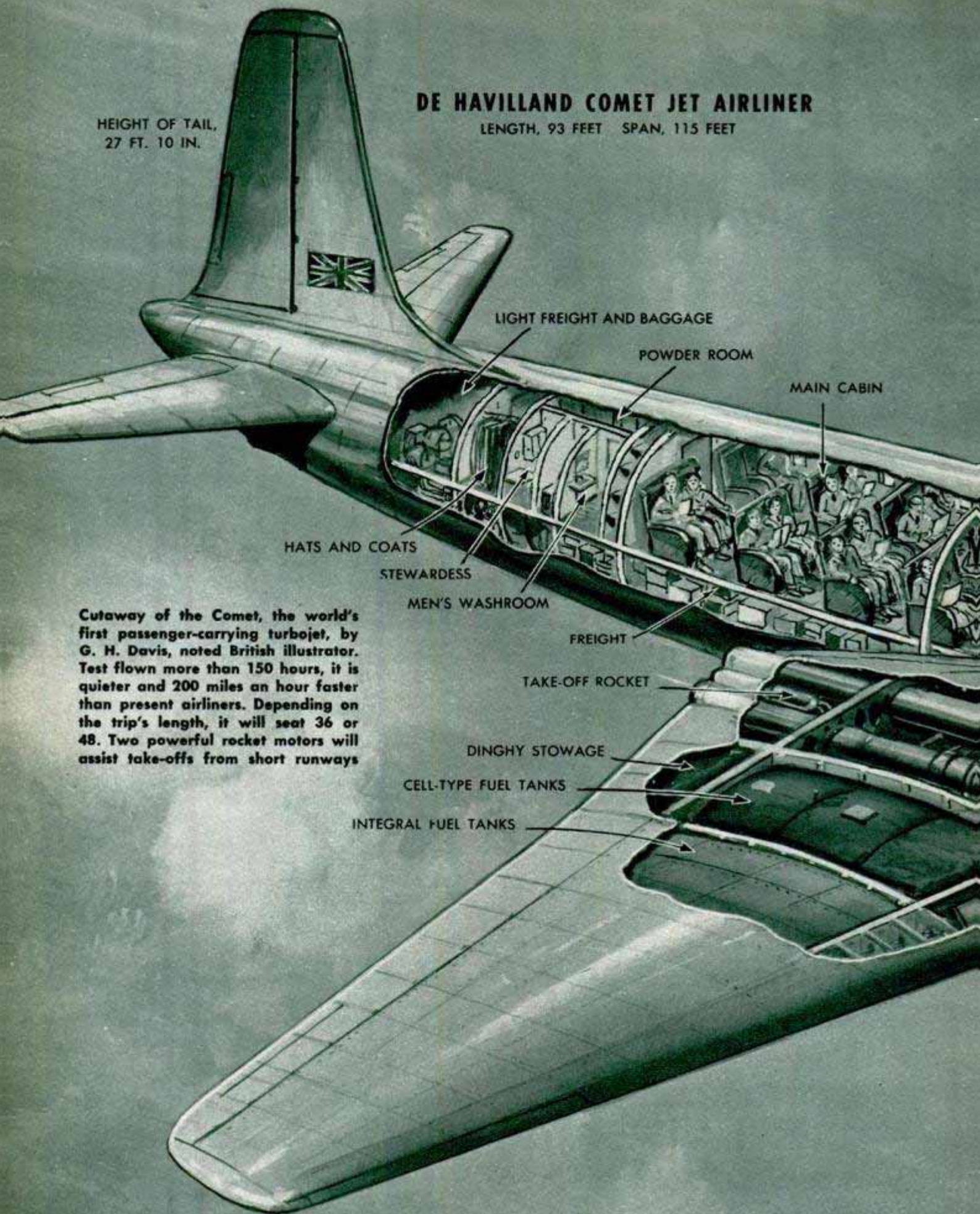

LIGHT FREIGHT AND BAGGAGE

POWDER ROOM

MAIN CABIN

HATS AND COATS

STEWARDESS

MEN'S WASHROOM

FREIGHT

TAKE-OFF ROCKET

DINGHY STOWAGE

CELL-TYPE FUEL TANKS

INTEGRAL FUEL TANKS

Cutaway of the Comet, the world's first passenger-carrying turbojet, by G. H. Davis, noted British illustrator. Test flown more than 150 hours, it is quieter and 200 miles an hour faster than present airliners. Depending on the trip's length, it will seat 36 or 48. Two powerful rocket motors will assist take-offs from short runways



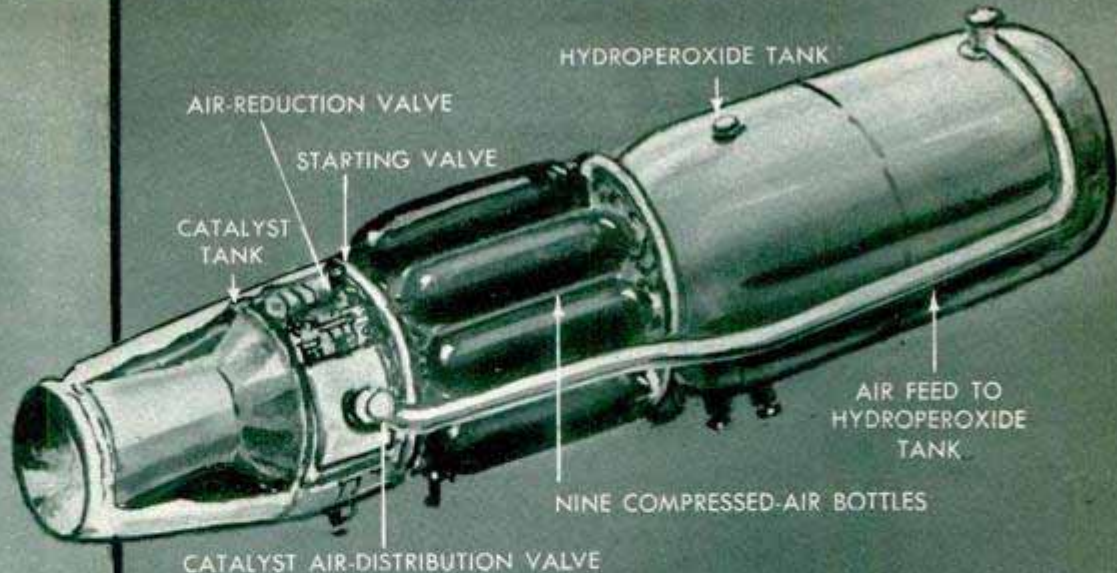

**"SPRITE" ROCKET MOTOR**

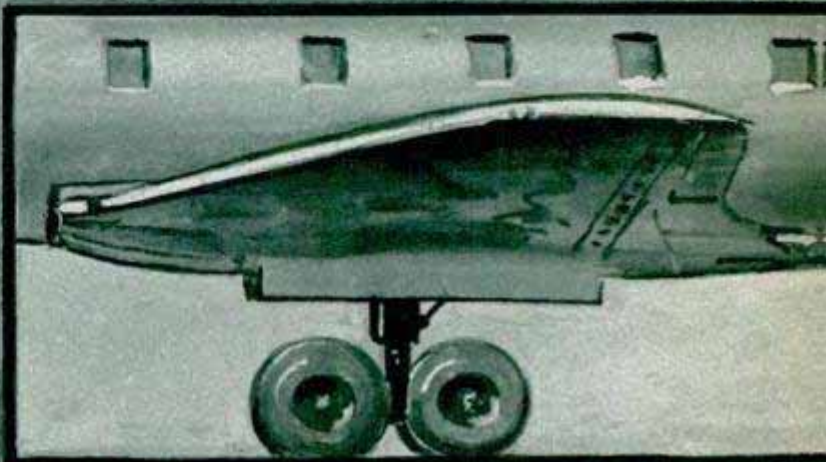
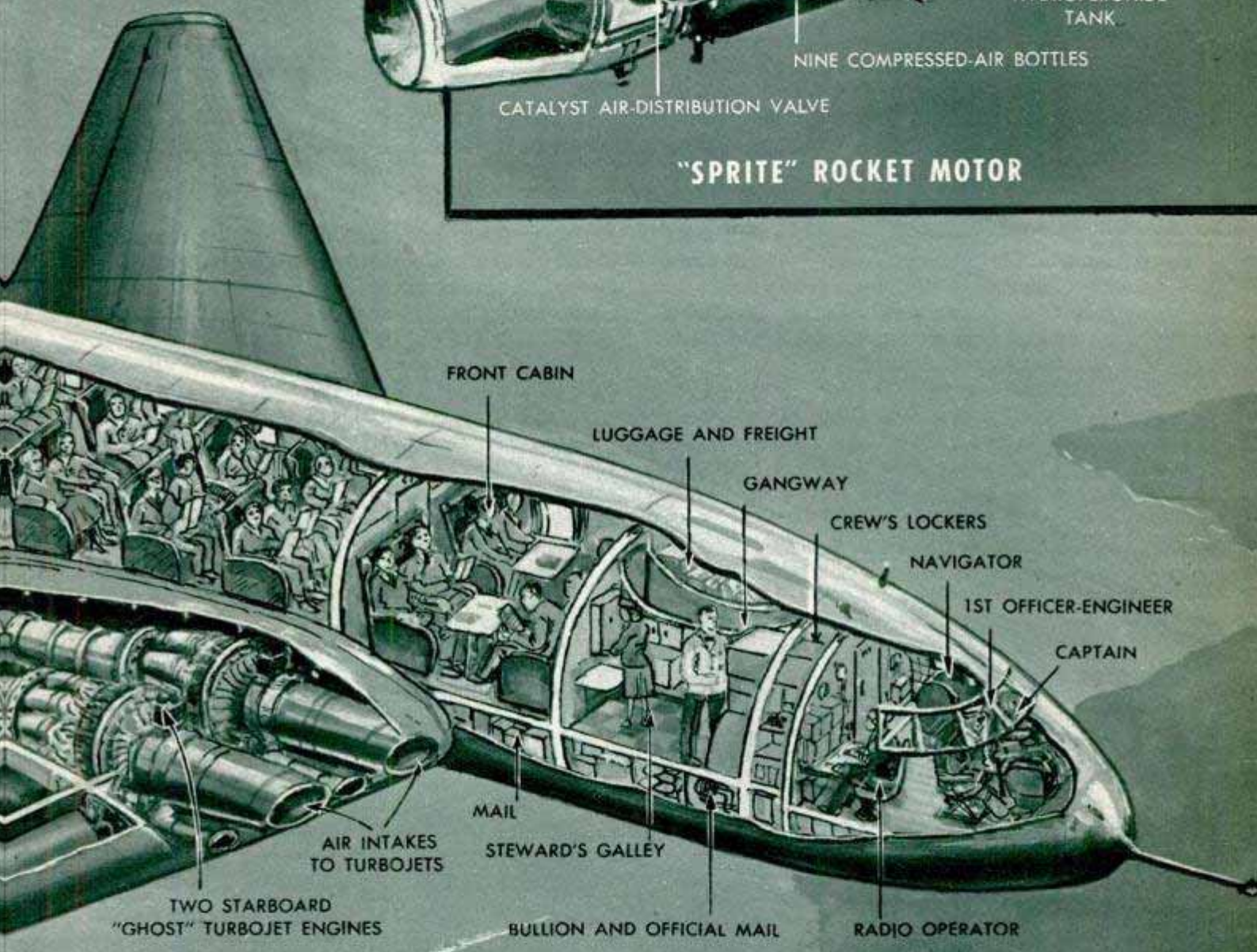

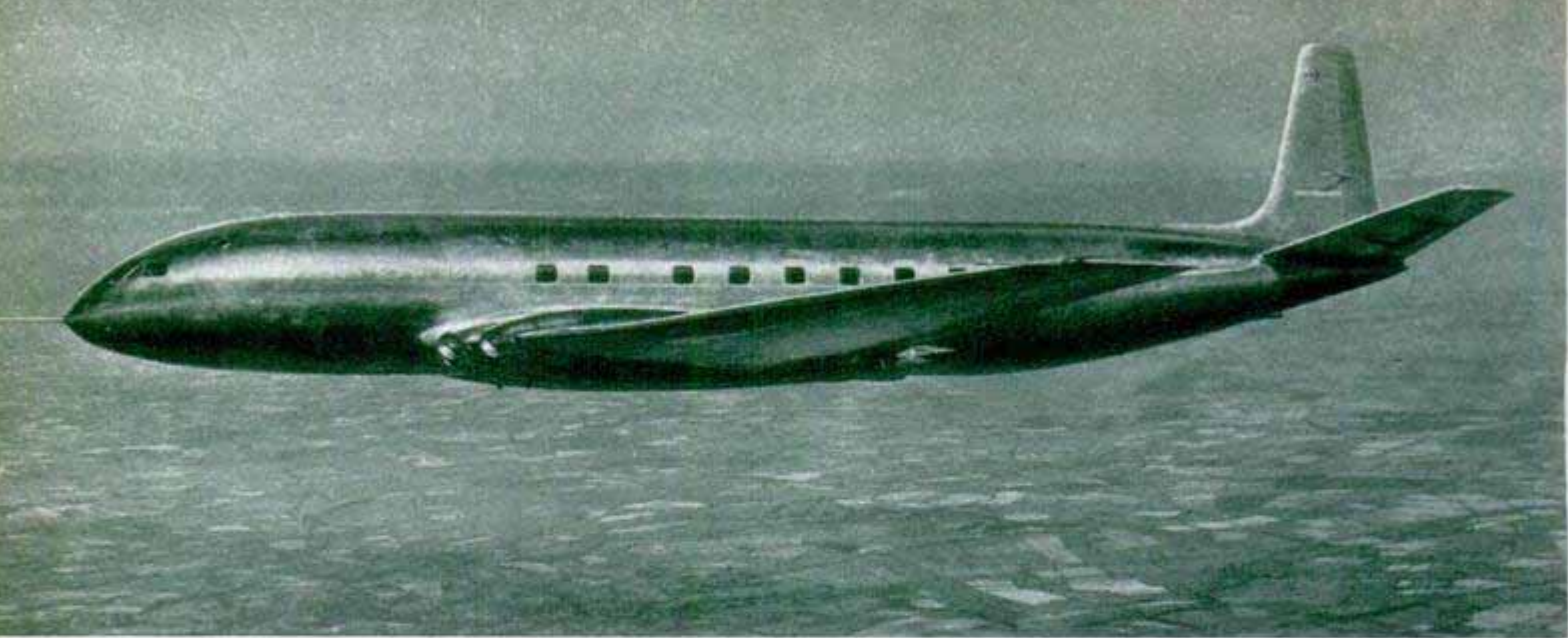

de Havilland Aircraft Co. photo

**Engines only 53 inches in diameter are almost completely buried within the Comet's relatively thin wing**

above 450 miles an hour. Since then it has cruised at nearly 500 miles an hour, approximately 200 miles an hour faster than today's fastest commercial planes.

Just as the first motor cars looked much like the buggies they were to replace, the Comet has few radical "body" changes. Not revolutionary in appearance, the plane is beautifully streamlined. An American Air Force officer, watching it execute a tight 60-degree bank, said, "We haven't a fighter any cleaner than that baby!"

The four power plants are buried in a thin wing, only moderately swept back. A stubby undercarriage, made possible by the absence of propellers, allows the plane to be closer to the ground—simplifying loading and unloading.

Jets operate most economically at great altitude, so the Comet will fly as much as possible at 40,000 feet—nearly twice as high as present air travel. This meant building a

fuselage for a pressure differential of over eight pounds per square inch. Instead of rivets, surfaces are bonded together with a resin-and-plastic combination, applied with great heat and pressure.

The 105,000-pound de Havilland liner will be able to operate from present, average-size airports. For fuel it is using a 99-percent kerosene and one-percent oil combination, used safely in British fighter craft for several years. The plane's "Ghost" engines, the first jets approved for public transportation, set the present world's altitude record of 59,446 feet in a fighter. Comets will normally operate with a crew of four and 36 passengers.

The world's other flying turbojet transport, Canada's Avro jetliner, is lighter than the Comet and intended for shorter, 200 to 800-mile routes. In rate of climb and at level speed the 50-passenger Avro outdoes two

(Continued to page 262)

**Built for trips up to 800 miles, Canada's Jetliner cruises at 450 m.p.h. It is expected to be in service in 1952**





Workmen in photo at left install roof of grain bin while in picture at right conveyors fill bins as soon as they are finished. Below, roof of bin is built first and tiers are added below it to form structure

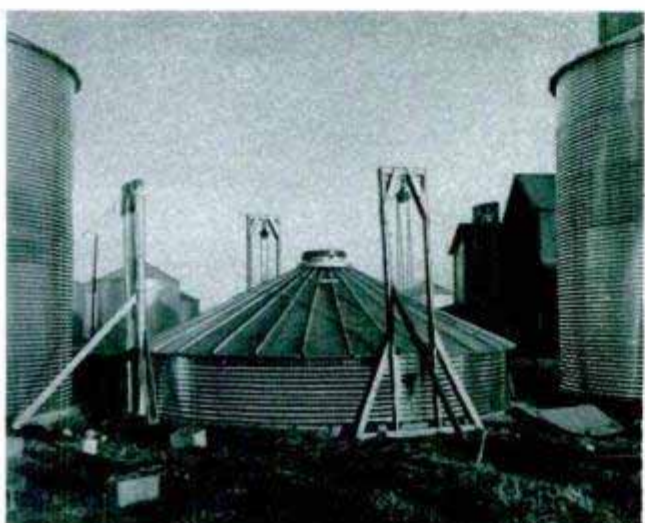

## Aluminum Grain Bins

Some 83,000,000 bushels of grain of the 1949 harvest were saved from possible loss by the construction of nearly 26,000 aluminum grain bins, each with a capacity of 3250 bushels. The bins were formed in the fabricating plants of strong corrugated aluminum, light enough to be shipped and constructed with ease. It is anticipated that the aluminum with its capacity to reflect heat will protect the grain from deterioration. Since aluminum does not rust, maintenance costs should be at a minimum. The bins are filled by portable conveyors which empty into a center roof opening.

## Single-Engine Amphibian Stresses Safety Features

Seats built into the plane's structure and a control stick that bends forward with body impact are crash-safety features of the new Colonial Skimmer. Location of the single-engine amphibian's wings behind the cockpit also helps by affording better visibility. Cruising at 110 miles an hour and landing at slightly over 50, the Skimmer has a range of 600 miles.



Length of the new all-metal amphibian is 23 feet and the wingspan is 34 feet. Its three landing wheels are retractable

When taxiing into sun, the hinged canopy can be pushed aside to avoid glint from sun reflecting off water onto the Plexiglas

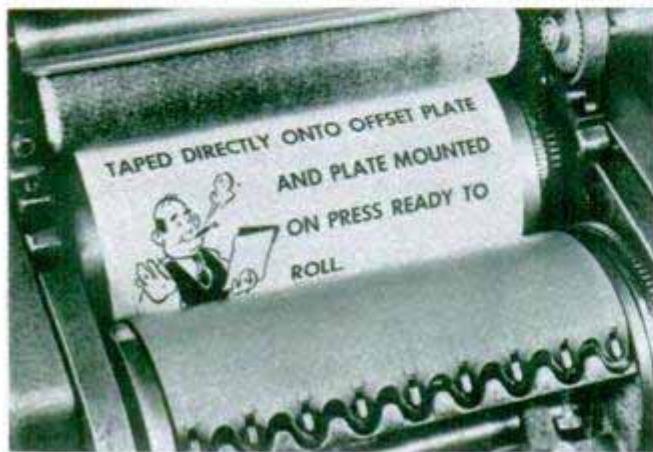

### Printing With Cardboard "Type"

Offset printing can be done quicker and cheaper by a phototype process that requires no photography. Individual letters and numerals, printed on cardboard, are set in a composing stick to form words. A double-coated tape holds the type on the direct-image plate and printing, by offset, is done directly from the cardboard letters. Art work can be attached and printed in the same manner.

### Bicycle Coach →

Latest bicycling novelty in France is a coach which fits over the bike to protect the rider from the weather. Made of oilcloth, the coach is held in place by a metal framework. It has a swinging door on one side and windows all around which give the cyclist a view in every direction.

### "Painting" Lake Ice Black Lengthens Shipping Season

By coating the ice-covered Great Lakes with black powder or liquid, scientists at Armour Research Foundation hope to open them to shipping weeks earlier each year. The black "paint" increases the absorption of the sun's heat. Still being sought is a cheap material that will accomplish this without causing water pollution.

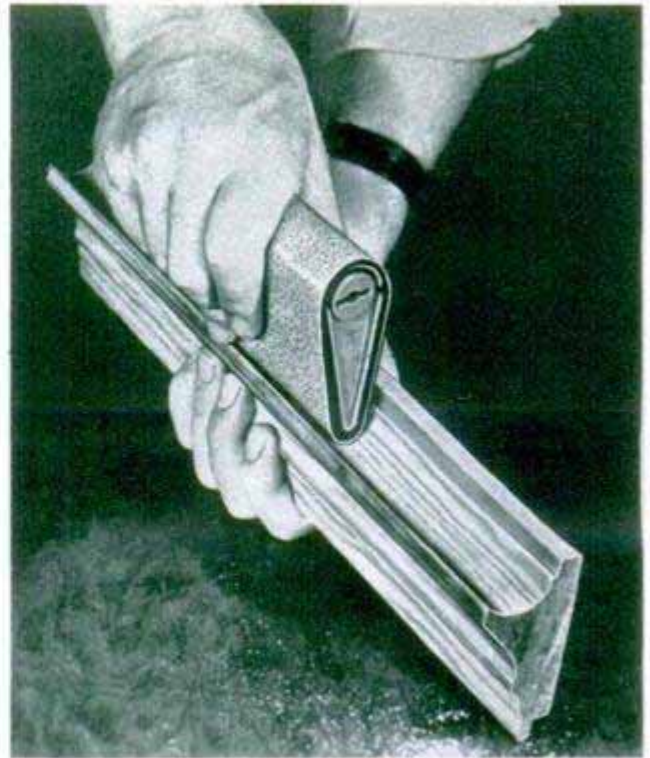

### Hand Sander Smooths Contours

Home craftsmen can smooth irregular surfaces by hand with a new sanding block which is adjustable in shape. Made of plastic, the sander has a wedge-shaped body. It is covered with a rubber sleeve, ranging in thickness from  $\frac{1}{16}$  to  $\frac{3}{16}$  inch, which cushions the sandpaper. When the rubber sleeve is rotated, the radius at each end of the sander is changed from a minimum of  $\frac{1}{8}$  inch at the narrow end to  $\frac{3}{4}$  inch at the wide end. Thus the curve of the sanding surface can be adjusted to the curve of the work surface.



## Elevator "Pilot" Rides in Cockpit

Elevator operators can see better and don't interfere with passenger traffic in a new elevator that has a control compartment built into one side. The compartment is a foot above the floor level to provide better visibility. Door openings on the new elevators are seven feet wide, two feet wider than standard doors in store elevators. The elevators have been installed in Jordan Marsh's new department store in Boston.

## Electronic Warning Protects Boom Operators

Boom operators have an extra pair of "eyes" that keeps constant watch for power lines and sends out a shrill warning when the boom swings dangerously close to the wires. Easily set for any distance by the operator, the warning device is sensitive enough to operate at 50 feet from a 10,000-volt power line. If desired, the actuating distance can be lessened when circumstances require. A sensitive trigger is mounted on the end of the boom and picks up signals from the power line.



When the boom moves within the danger area, the trigger sends a signal to the control unit in the cab, setting off a loud warning horn that blows as long as the boom remains inside the danger area. The device can be set to protect against any voltage from 110 to 110,000.

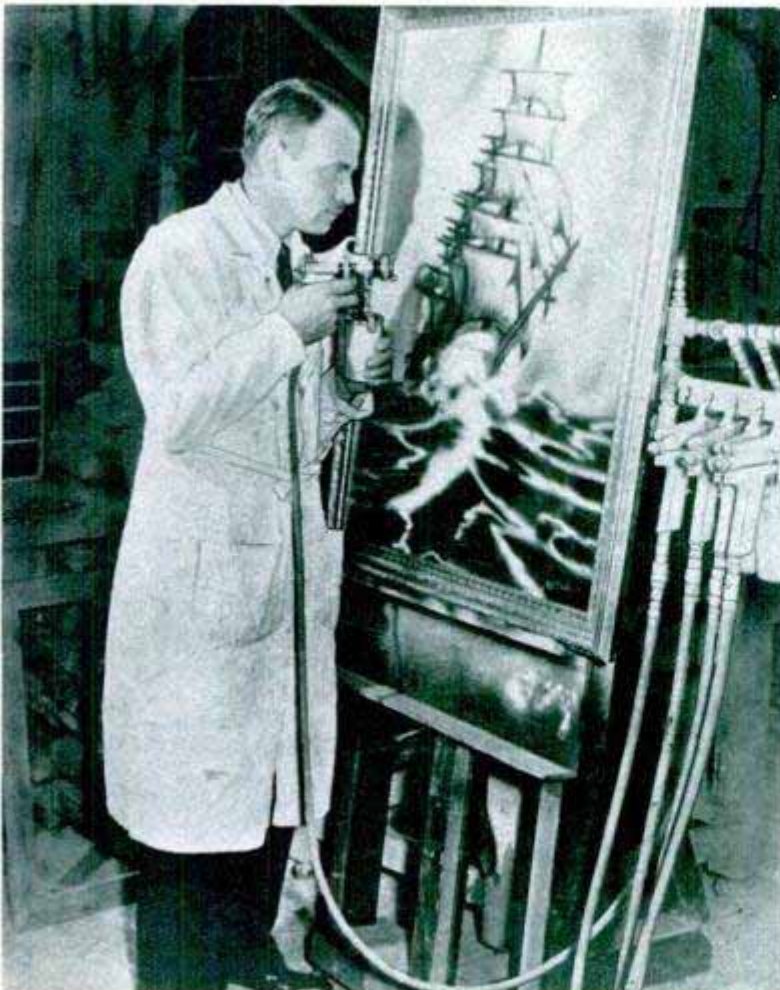

## Spray-Gun Artist

Conventional spray guns — the kind found in auto repair shops — serve as brushes for Ralph DeGayner, an artist of Silver Lake, Mich. With fine control over the gun's trigger, DeGayner sprays his pictures on canvas. Very small air guns frequently are used in art work, but DeGayner uses a bank of conventional guns that are not modified in any way. He uses no stencils or other equipment. His paints are the standard automotive enamels, and he obtains sharp details by controlling the trigger and not by reducing pressure on the gun.

## Ocean Travelers Take to Air

Overseas airlines are cutting deeply into steamship trade. Over half of the travelers going overseas to and from the U. S. went by plane in 1948. Most popular are flights between here and Latin America which carried 78 percent of all passengers in 1949.

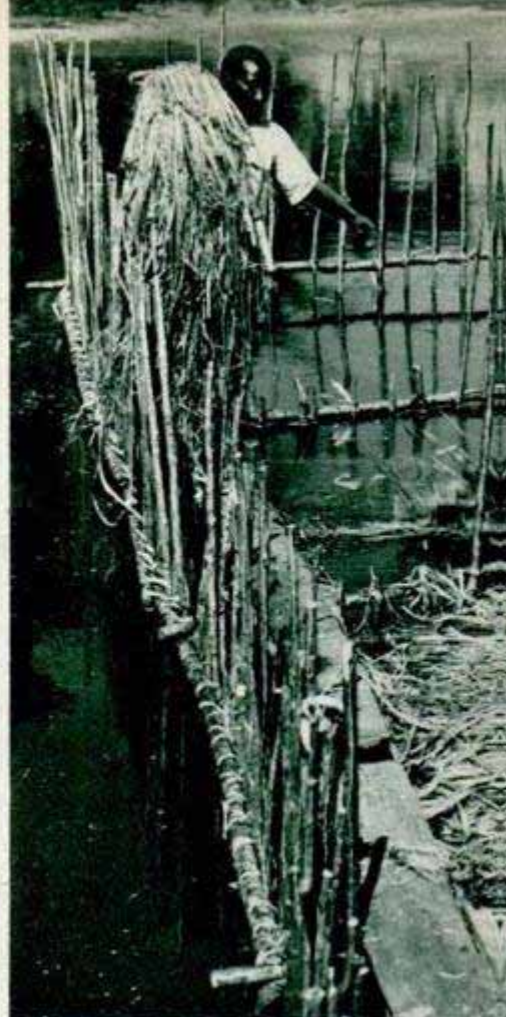
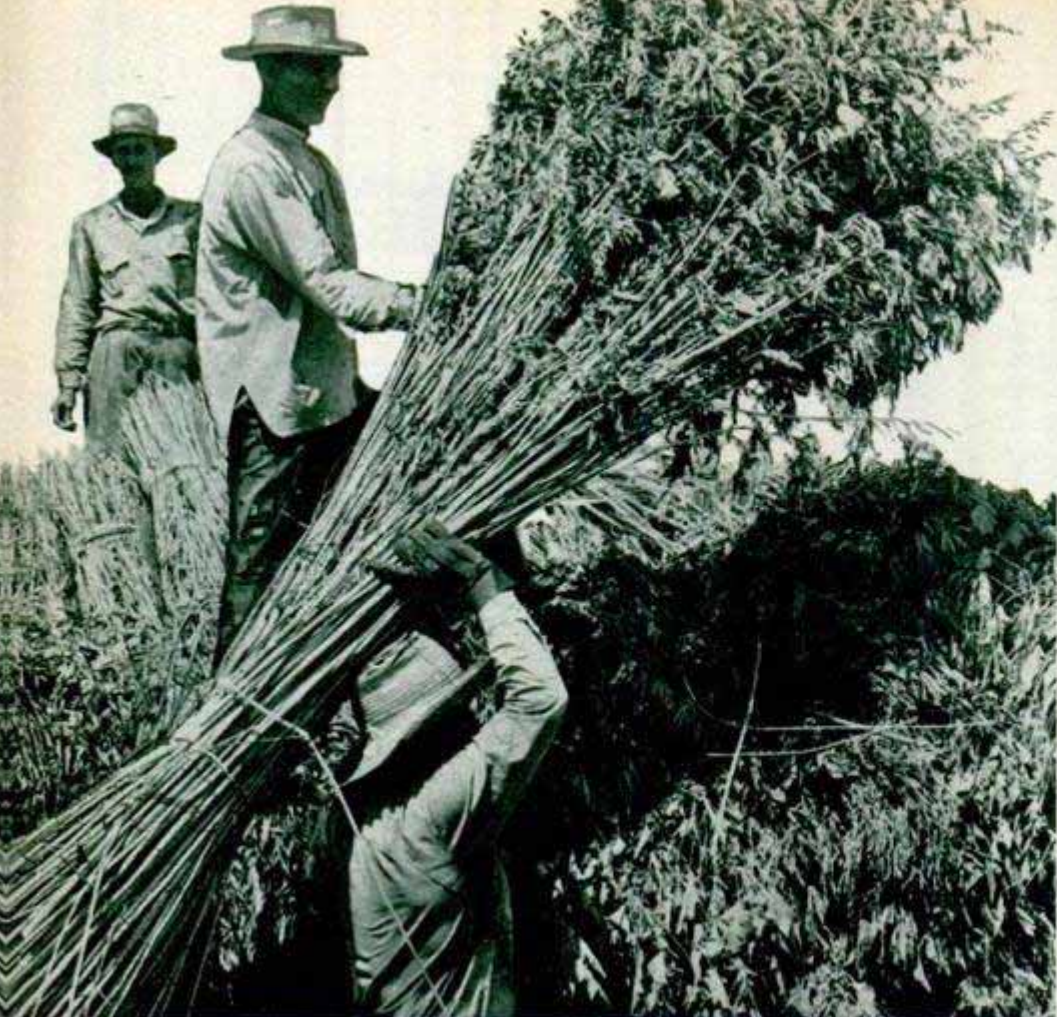

# KENAF.

Top, left, only 100 days old, these 10-foot kenaf stalks are on their way to processing

Above, bark ribbons, in retting stalls in a river, are the fiber-bearing parts of stalk

Left, a modified hemp harvester and binder cuts a crop of kenaf, jute's new competitor

Below, experimental plantings like this one provide data on best method of growing crop



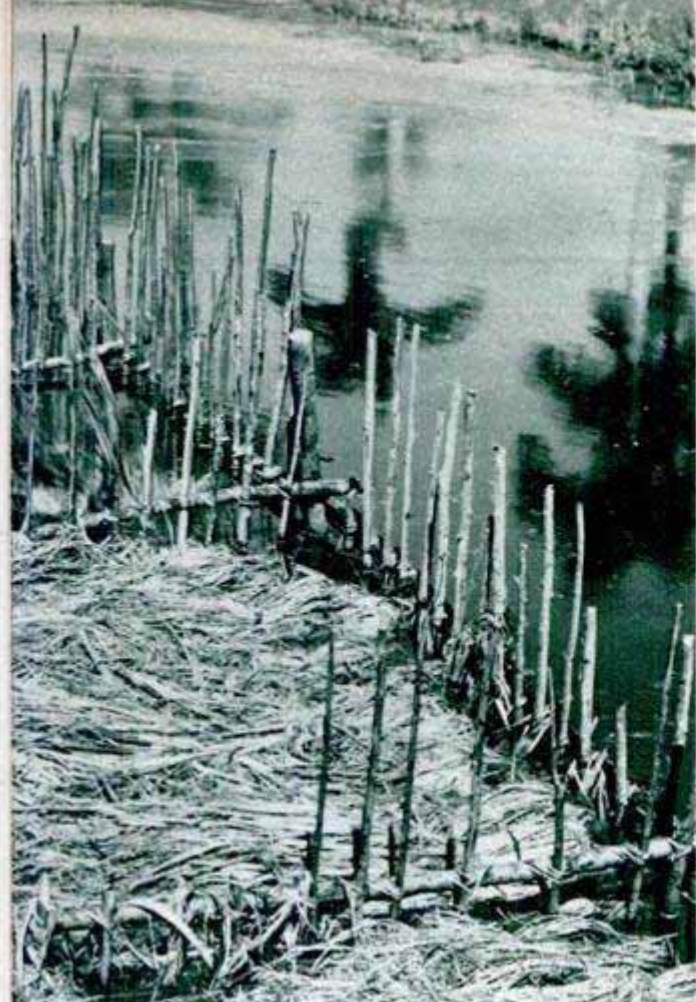

Above, the stalks are first crushed and then this beater removes woody centers, leaving fiber-bearing bark ribbons

## THE NEW FIBER CROP

**D**OWN in Cuba, there's a revolution brewing — happily, it will be peaceful! Leading the revolt is kenaf, a fiber crop that is bidding to replace jute as the source of cordage and bagging material.

Demand for jute fiber is tremendous. The U. S. alone needs 165 million pounds annually for rugs, matting, sacks, electric cables and other uses. Cuba needs 40 million jute sacks a year for its sugar crop. Latin America uses 300 million sacks. About 98 percent of the world's jute is grown in India and Pakistan but, as jute fields are converted to food crops, the supply is dropping.

Fast-growing kenaf is competitive to jute in yield, cost and strength. Yields in Cuba are expected to be about one ton of fiber per acre. Its seed yields an oil comparable to cottonseed oil. Drop tests show it withstands falls that split open jute sacks. With new machinery being developed, kenaf may soon bring about a desirable revolution in the fiber world.

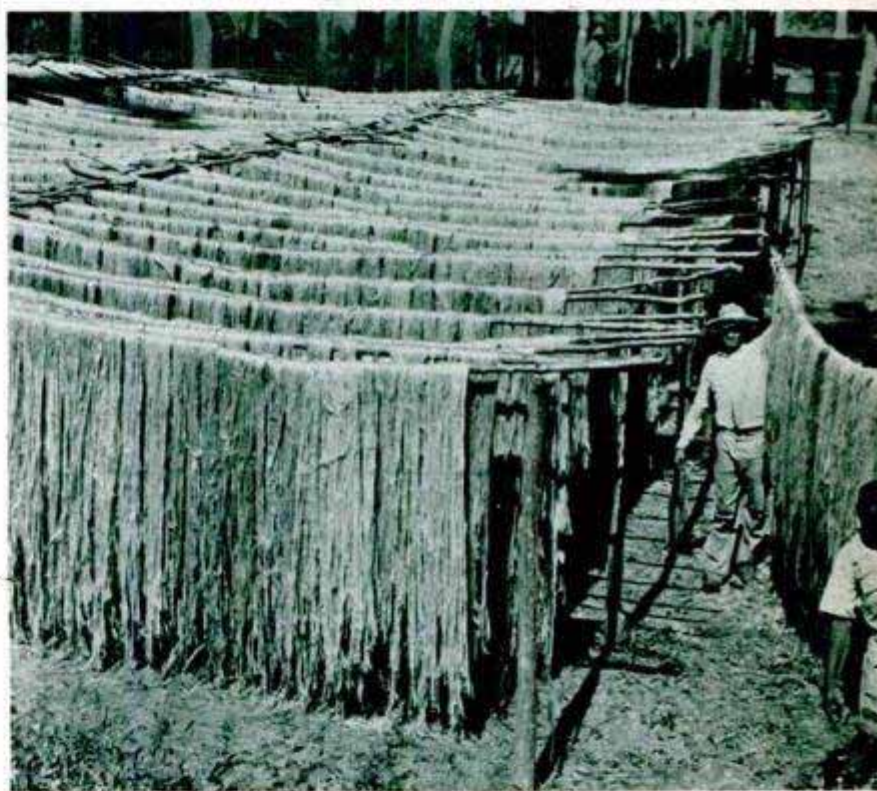

Long strands of kenaf hang on racks for drying in the sun. The fiber crop grows during the off season for sugar, thus will give new opportunities for employment in Cuba. Below, this loom is weaving kenaf yarn into a strong sack material

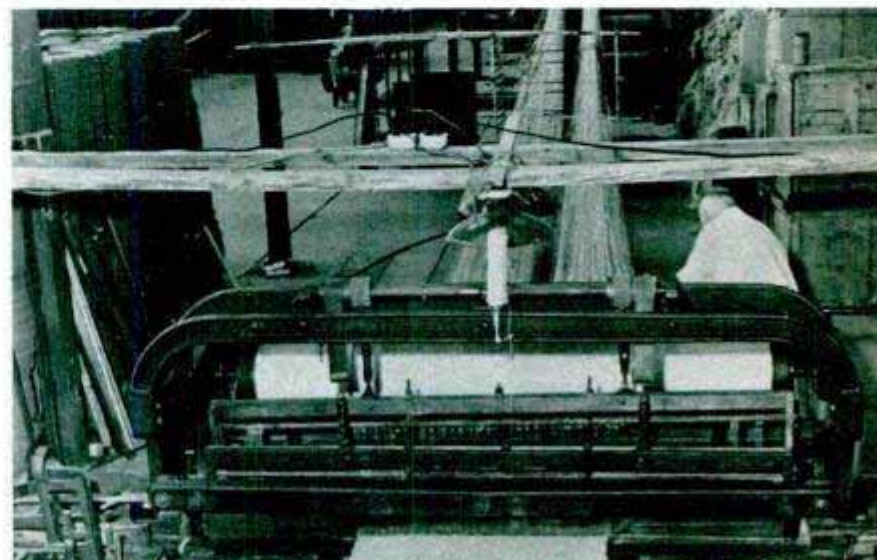



## Round-the-Town Car Has Air-Cooled Engine

Remember the Hall flying automobile? Its inventor, T. P. Hall of San Diego, Calif., has designed and built a lightweight rear-engine car for about-town transportation. It is powered by a 10-horsepower air-cooled aluminum engine and the transmission is connected to the engine through a fluid drive. Both rear wheels are chain driven. Not yet being manufactured, the car travels 45 miles on a gallon of fuel and will go 45 miles an hour. It is 158 inches long and 58 inches wide, carries two or three persons and has compartments for storage behind the cushioned seat and in the forward section. Aluminum-alloy and plastic materials kept the weight of the car down to 775 pounds. Excellent visibility is afforded through a big safety-glass windshield.

## Automobile Heater-Cooker Operates From Manifold

Manifold gas operates a heater-cooker which will serve four persons a complete meal. Designed for use in automobiles, the cooker is adaptable by sizes to airplanes, busses, trucks or boats, and is said to be safe. A cooking tube is inserted into a larger

tube, resembling a rural mailbox, which is equipped with coils through which the manifold gas circulates to produce intense heat. Dashboard controls operate valves which increase or decrease the degree of heat as desired.

## Floor Please? Barges Ride Elevator on Canal Trip

Barges now are lifted by elevator during their trip up a southern Belgium canal. The elevators hoist the 300-ton barges 48

feet from the lower to the upper level of the canal. The elevator ride requires only 20 minutes.

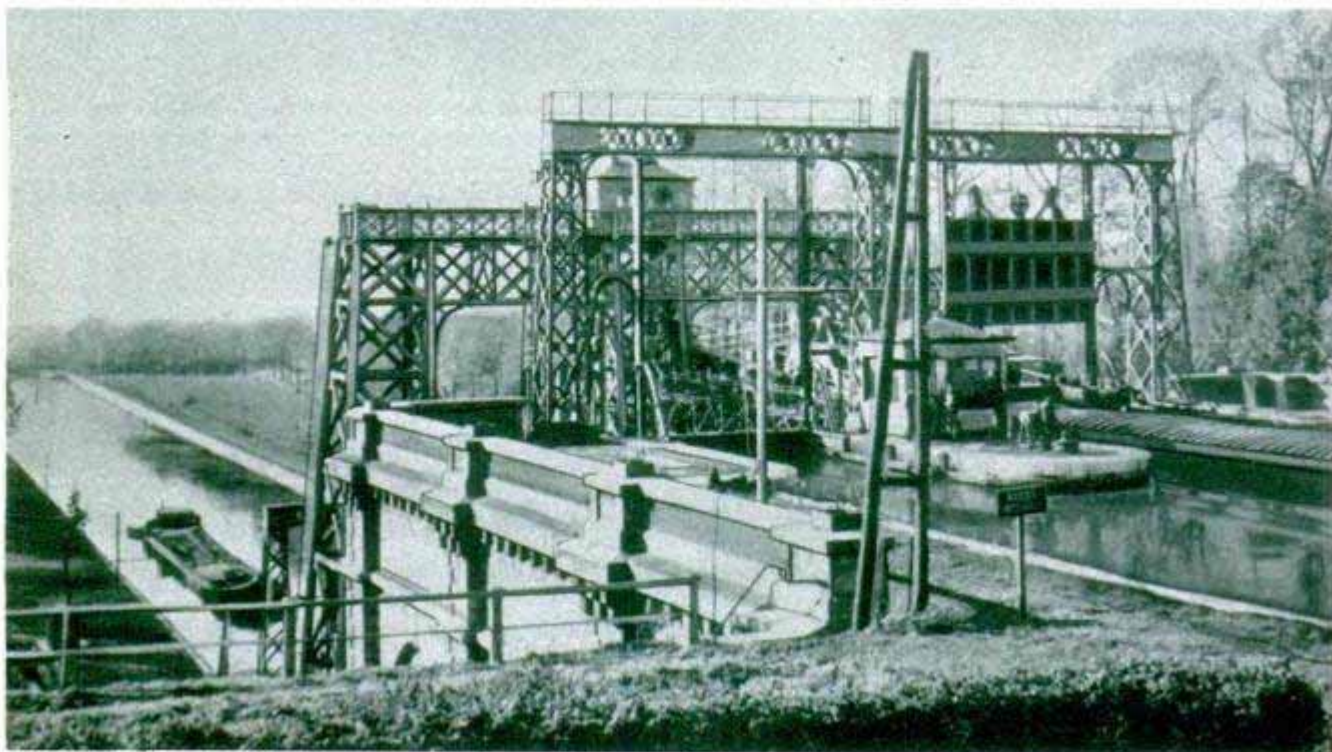





### Remote Radiation Detector

Shaped like a long-barreled pistol, a new radiation detector has a probe that is four feet long to permit detection of radiation from a distance. Developed by General Electric engineers, the detector has an electronic tube at the tip of the long probe. Attached to the tube is a phosphor, a material which gives off light in the presence of radioactivity, and this light is converted into electrical energy to activate a meter mounted above the pistol-type grip. The detector is powered by batteries carried in a box fitted with a strap so it can be slung over the operator's shoulder.

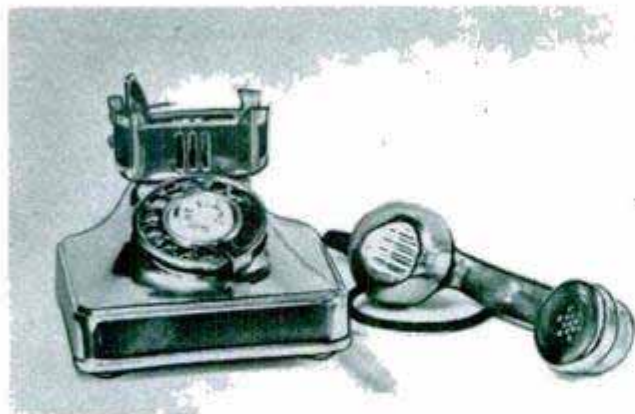

### Dial a Light

From Japan comes a novel smoking accessory—a cigarette lighter that looks like a telephone. Measuring only 2½ inches long and 2½ inches high, the little telephone has a miniature receiver and a dial. The smoker lifts the receiver off the hook and spins the dial, which releases a spring-type lid and ignites the wick. The lighter is chromium plated.

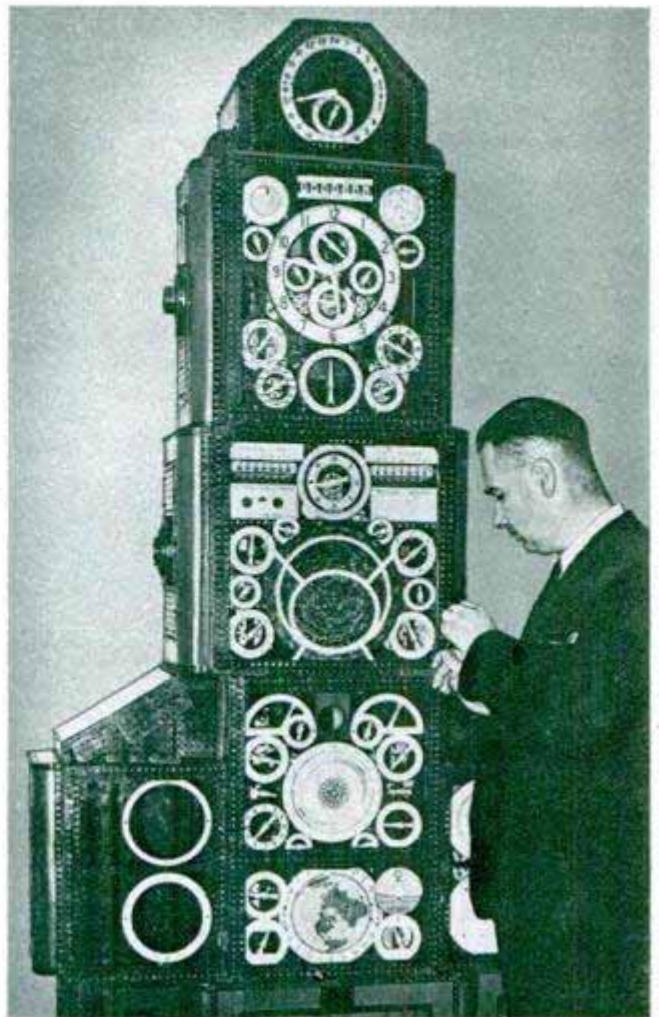

### Clock That Tells All

Almanacs are unnecessary in the house of John Nowlan, a British chemist, who has built a clock that tells just about anything you would find in those handy reference books. It took him four years to build the giant machine that stands in his living room. Among the data provided by the multidialed clock are the time, day, date, season, times of sunset, sunrise, moonset and moonrise, phases of the moon, dates of next eclipse and known comets. It also gives the state of the tides in any important coastal town in England and shows what stars and planets are visible overhead at any given moment. The clock also shows what time it is anywhere in the world as well as the correct time for Nowlan's town of Becontree, Essex.

¶ Termites come from a big family, according to the Smithsonian Institution, which has issued a catalogue listing a total of 1932 species of these wood-eating insects.

Popular Mechanics provides two sources of further information concerning articles published in each issue: the WHERE-TO-BUY-IT INDEX, starting on page 10, and the WHERE-TO-FIND-IT INDEX, available without charge from our Bureau of Information, 200 East Ontario Street, Chicago 11



## Awning "Garage"

Ventilated aluminum awnings are doubling as car port and patio coverings in areas where winters are not severe. They are fireproof and have a baked-enamel finish that can easily be cleaned with a damp cloth. A patented design feature keeps summer temperatures under the awning 10 to 20 degrees cooler. Custom-made, they also serve as canopies and as protection for windows, porches and store fronts.

## Color-Film Processor Is Fully Automatic

Inconsistent reproduction, one of the chief bugaboos of color photography, is believed solved by a new electrically controlled processor. Racks of film are automatically "dunked" in a series of 12 tanks, each holding 3½ gallons of solution that is automatically agitated for prescribed lengths of time. Duration of immersion is fixed by presetting individual timers above each tank, and the temperature of the contents is held constant at the ideal 68 degrees Fahrenheit.



U. S. Air Force photo

## Folding Trailer Is Its Own Ramp

Providing its own loading ramp, a new heavy-duty trailer eliminates the need for cumbersome cribbing and planking. The "gooseneck" front end of the trailer unfolds to provide a smooth, gradual ramp for unloading. The trailer is available in capacities up to 100 tons and only one man is needed to operate it.

☛ There were 15,478,570 licensed fishermen in the United States in 1949 with Michigan and California in the lead.





Relaxing after a day's tramp are the author, right, and a companion. Their two-man tent weighs only 3½ lbs.

## BACK-PACKING in the MOUNTAINS

**E**VERY YEAR the army of back-packing vacationers is growing and the recruiting — all unintentional — goes something like this.

"Joe, how about telling us about your pack trip last summer and that little trout lake you found where you caught your limit in 10 minutes."

Joe grins and his eyes shine with fond recollection. "You mean the place where we filed the barbs off the hooks and caught 'em just for fun and tossed them back? Oh, I'll never forget that day. It was the same morning the bears almost got our bacon."

By this time Joe has the attention of everyone in the group and they lean forward eagerly to hear a good yarn. Back-packing is another word for guaranteed good vacation stories. It is adventure with an old-fashioned dash of something close to nature and is a far

cry from resort hotels, summer cottages by a lake or 5000-mile automobile trips.

After Joe has reported on the fisherman's paradise he discovered and how the bear almost—but not quite—got the bacon out of a tree, someone wants to know:

"You mean you and your friend walked on this trip and carried all your stuff on your back?"

"Sure," Joe says. "We were gone 10 days. Both of us carried 28 pounds of gear in addition to 20 pounds of food. We figure two pounds of food per day per man. If you have a good pack your back isn't nearly as tired at night as sitting behind a steering wheel for 10 hours."

Later in the evening you will see Joe cornered by two or three converts who are taking notes on the backs of envelopes. They are smart because back-packing into the mountains is not just a case of slinging a lot of miscellaneous food

By Charles McDermind



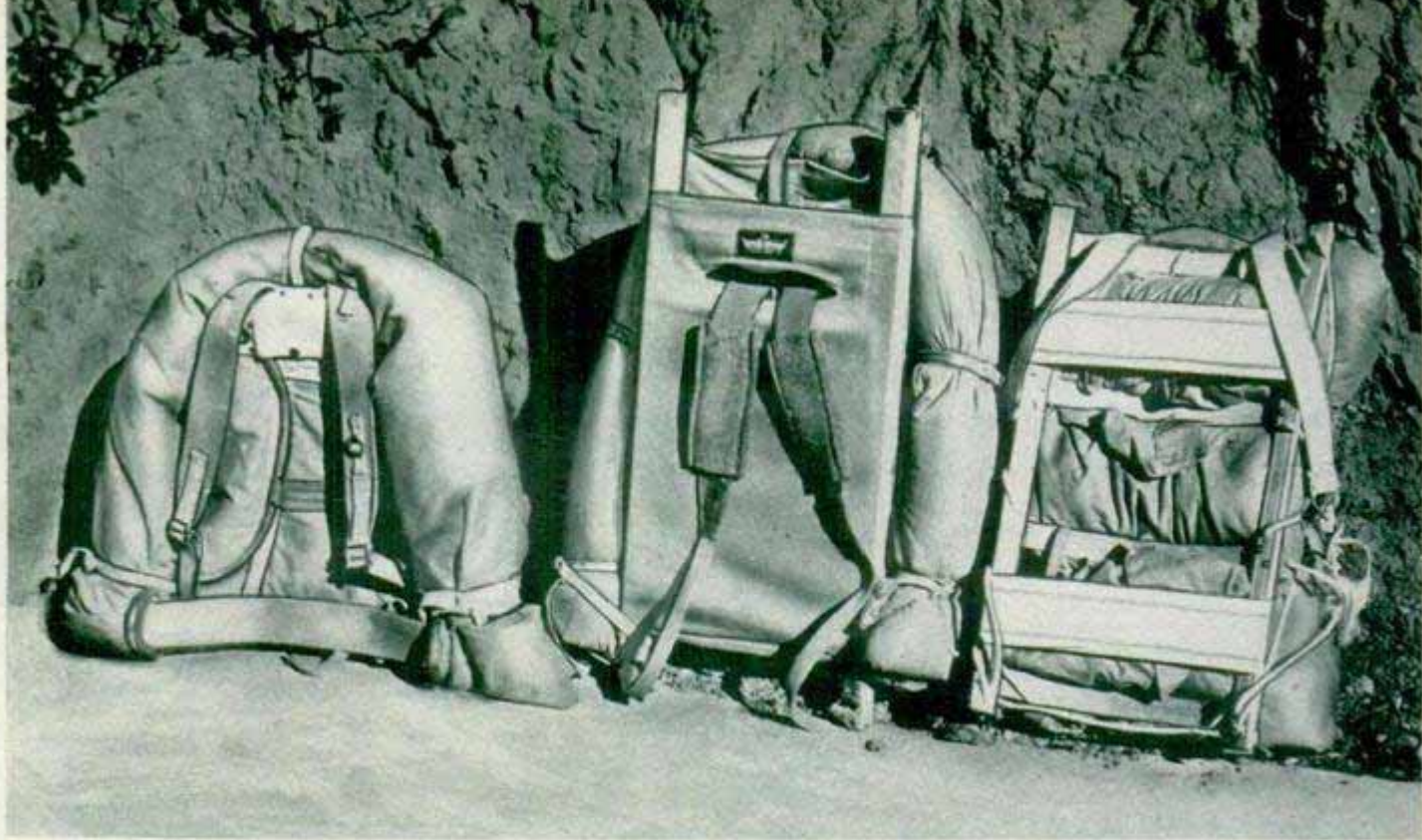

Left to right, Army rucksack, Trapper Nelson pack described in this article, and Boy Scout type pack board

and equipment over one's shoulder. If you have taken the wrong stuff, or forgotten salt or a raincoat or any one of a hundred necessary items, it's just too bad.

First thing you'll need is a pack board. One of the most practical and comfortable consists simply of a pair of wooden uprights connected by three curved horizontal ribs, like rungs on a ladder. Canvas is drawn

over the wooden frame and tightened by a lacing. The curved ribs, arching away from your spine, keep tin cans, skillets and other hard objects from digging into you. Equipped with broad pack straps and a waterproof sack, the board handles loads up to 60 pounds comfortably.

War-surplus rucksacks, designed for ski troops, are not recommended. They keep

Back-packing takes you to virgin trout streams. Trout rods in cases are taped to uprights of the pack board

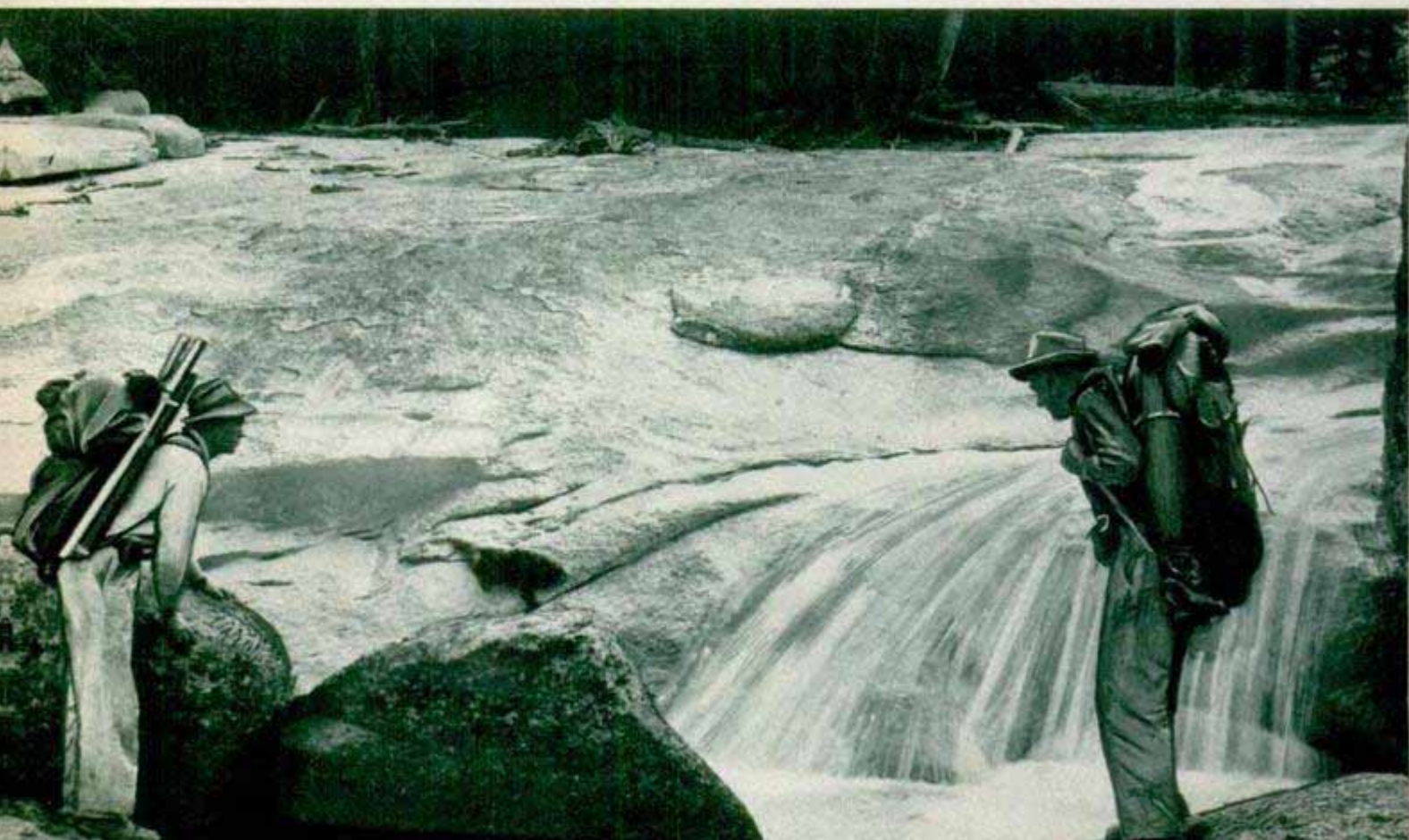



**Left, here's what one man can carry comfortably with a pack board. The load includes a 3½-pound tent and a 5-pound sleeping bag. Right, on cold nights you heat rocks around the fire and take them to bed with you**

the weight low to help the skier balance, but when you're tramping you'll want the weight high for comfort.

Next on the list is a light tent or tarpaulin. Surprise storms frequently develop in mountain country and you can't risk being caught shelterless. Army ponchos, being light and waterproof, are fine for this. Nylon tarps are also good and are available in many surplus stores. Light tents are available—some weighing as little as 3½ pounds. Don't forget that you'll need a lightweight raincoat if you carry a tent instead of a poncho.

Your sleeping bag should be of the streamlined, mummy shape to eliminate unnecessary weight. Make sure its filling is down, or a mixture of down and ordinary duck feathers, to keep its weight below six pounds. Wool and kapok bags are too heavy for back-packing. On cold nights you can keep warm by heating a couple of rocks for an hour or so and wrapping them in a towel before slipping them into your "sack."

Be careful with clothing selection. At altitudes above 7000 feet, even on bright days, winds are cutting and it's always cold

(Continued to page 250)

**Warmed and wrapped in towels, the rocks keep you warm through the night. Pack boards are seen in rear**

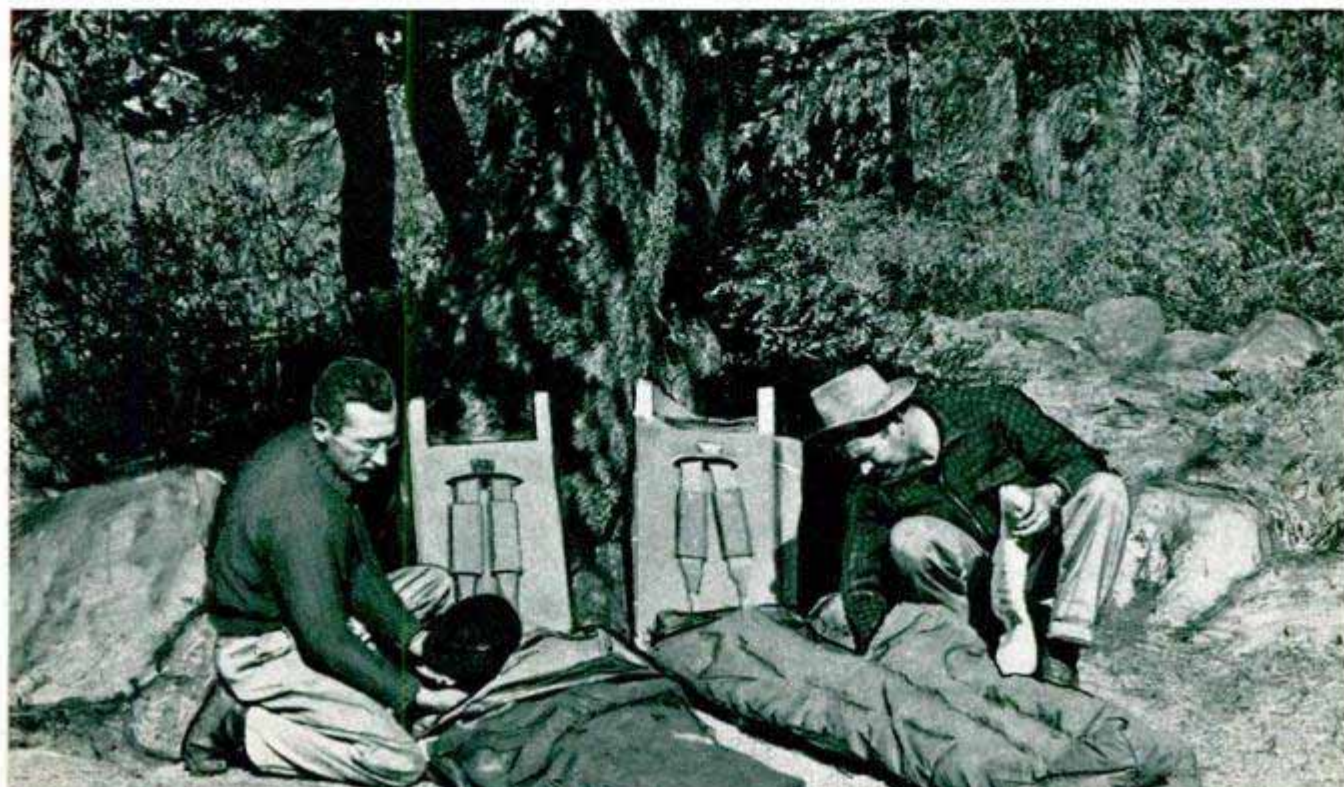



## Student's Home Is a Bus

College student David McNair of Winnetka, Ill., moves his room to and from the University of Illinois campus every day. His home is a 23-foot discarded bus which he bought for \$350, overhauled and remodeled. Inside the bus are a bed, stove,



desk, bookcases, sink and storage facilities. But the feature is a full-size piano which the young music student uses in his studies each day. At night McNair parks on a farm outside the university town. In the morning he drives to the campus where he can study, practice on the piano, eat or sleep only a few steps from the classroom.

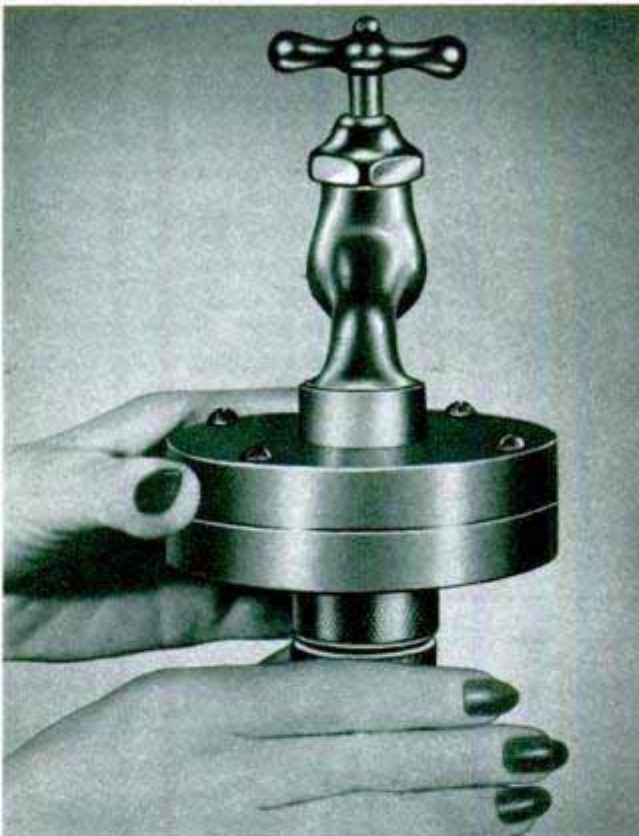

## Darkroom Filter

Photographic negatives are protected from grit damage by a simple filtering device that screws on the faucet. Filter pads, which can be replaced in two minutes, will efficiently filter the wash water for as much as six weeks, depending upon the amount of use. By using the filter, the photographer does not have to swab his negatives before drying and is assured of crystal-clear water at all times.

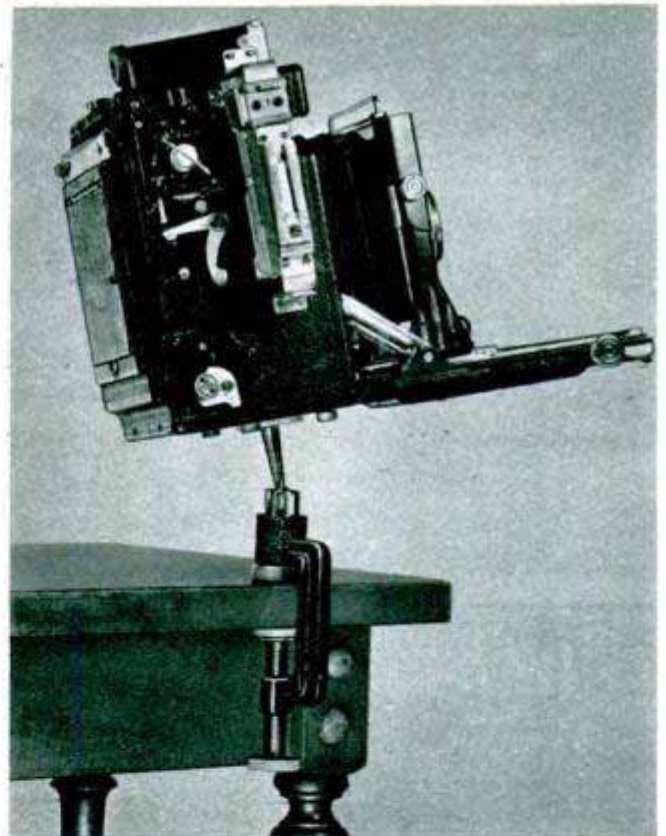

## C-Clamp "Tripod" Has Swivel Head

Clamped to a table, chair or car window, a swivel-head camera support provides a means of taking pictures at a variety of angles and frequently eliminates the need for carrying a tripod. The grippers on the C-clamp support are padded with rubber to prevent scratches. It also can be used as a swivel top for any standard tripod as there is a threaded socket in the knob end of the take-up screw.

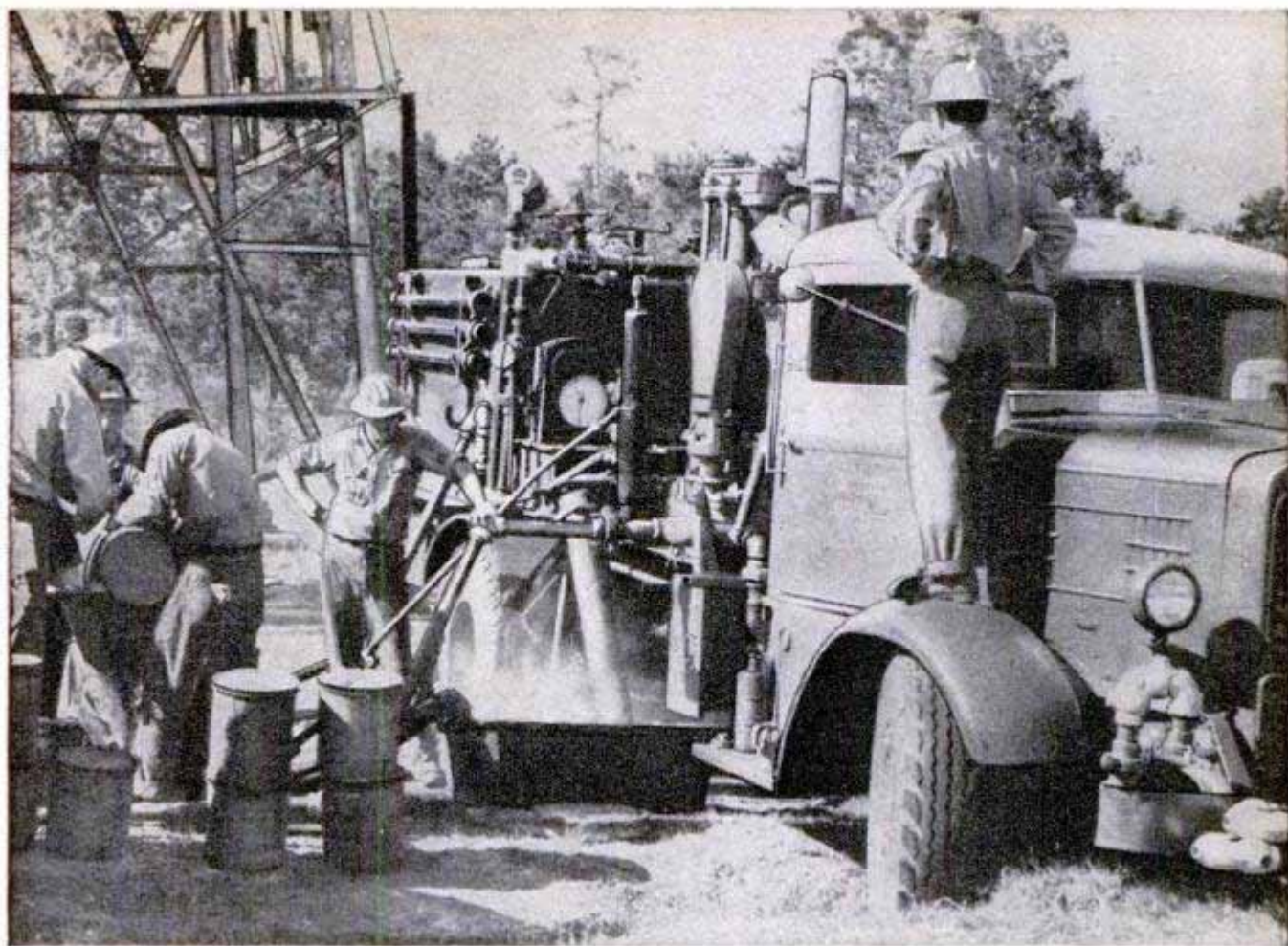

## Jellied Gasoline Gets Peacetime Job

Jellied gasoline—which looks like thick mush and was used to make terrifying incendiary bombs in World War II—has been put to work in the oil fields. It is used to “crack” rocks thousands of feet underground and make the oil flow into the hole being pumped. This system, known as Hydrafrac, was developed by the Stanolind Oil and Gas Company and may substantially increase the amount of oil recovered from many formations. Jellied gasoline is pumped into a well under high pressure which splits the rock formations. The sand suspended in the mush keeps the cracks from closing after a liquid chemical breaks the mush up into a liquid again. The gasoline that was used in the gel flows out with the oil. Engineers in Stanolind’s Tulsa

Workers mix powder with gasoline to form the thick mush which is pumped into the well. Drawing shows: (1) jellied gas under high pressure; (2) it opens a big crack in the rock layer; (3) gel breaker liquefies mixture. Gas and oil flow out together

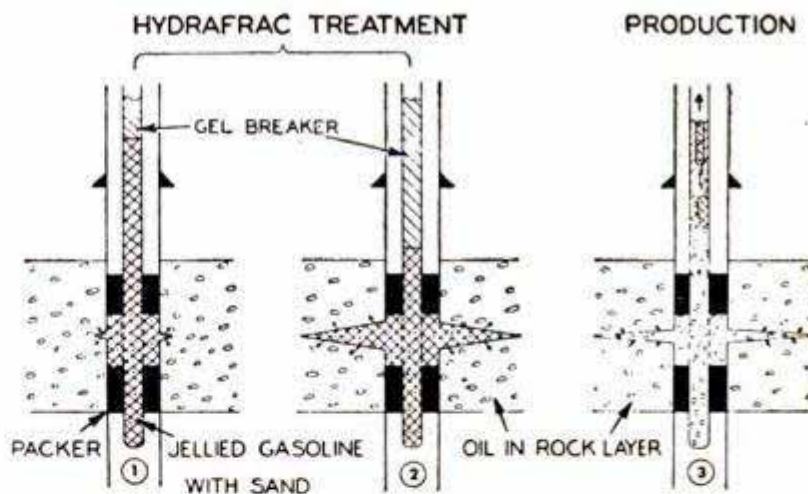

research laboratories report field tests with excellent results. At Frannie, Wyo., the Hydrafrac treatment increased production on one well from 60 to 160 barrels per day. This well has kept up the higher production for the last year.

## Plastic Envelopes Help Plot Water Currents in Lake Erie

Waterproof envelopes made of polyethylene are helping investigators study the water currents in Lake Erie. The envelopes, six inches long, won't break and don't blow in the wind. More than 1500 of

them have been stuffed with self-addressed cards and set adrift. Finders have mailed 600 of the cards to the investigators, who compute water currents by noting the place of release and recovery of each of them.

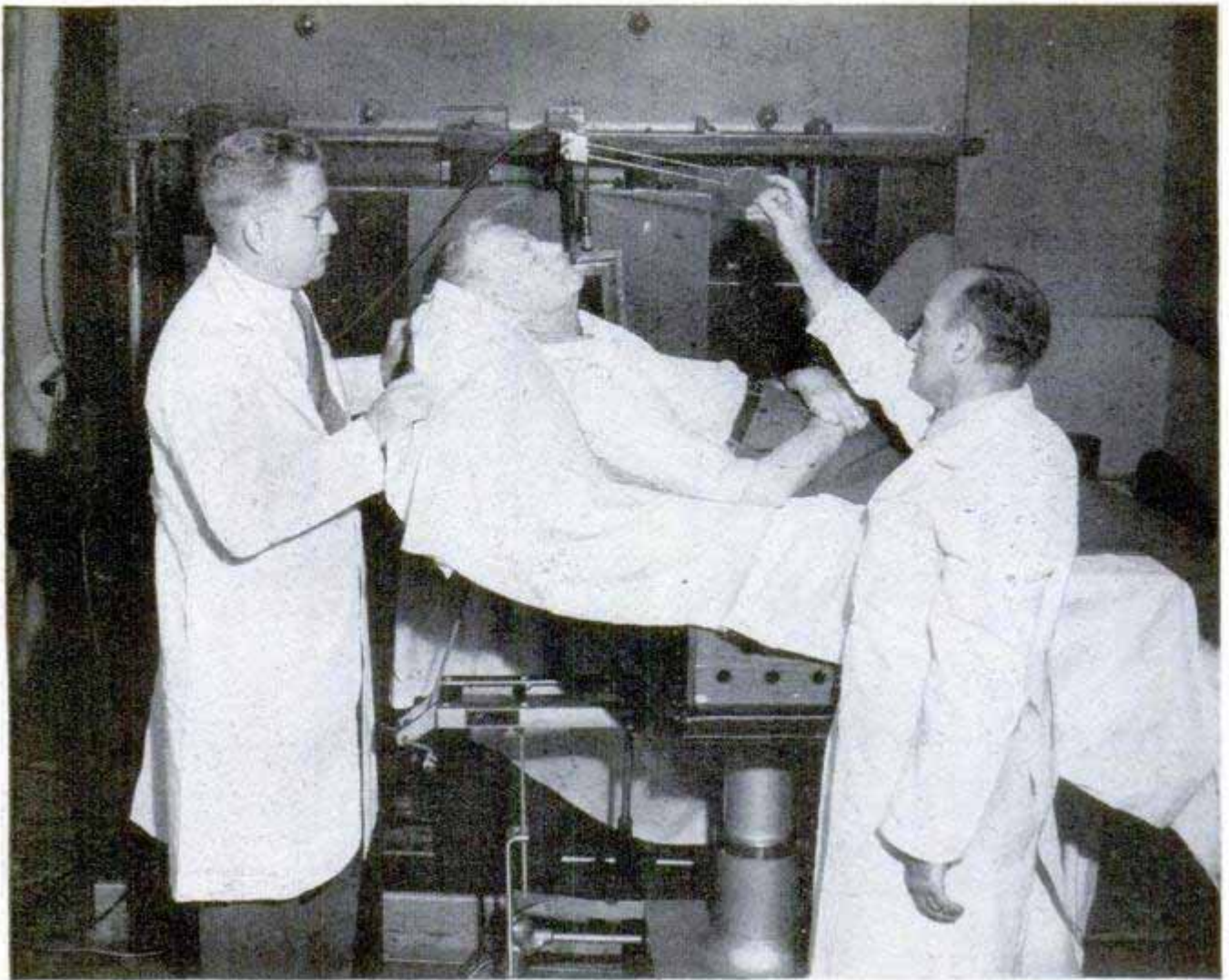

Positioning a throat-cancer patient for treatment by 25-million-volt betatron at the University of Illinois

## NEW MACHINES FIGHT for

By Aubrey O. Cookman, Jr.

**T**HROUGH a narrow slit in a thick barrier, I watched the first treatment of a cancer patient with a betatron. Three feet of concrete and four inches of lead shielded me from the dangers of scattered radiation.

A few short bursts of noise from the super X-ray machine—less than 10 minutes and the treatment was over. More were to follow, every other day, if he lived.

The patient was old, 72, and illness had piled the marks of even more years on a thin body. He had an inoperable throat cancer, doctors said, that would soon suffocate him if left untreated. The big machine at his side dwarfed the frail old man.

His eyes and those of his wife, a small woman who had led him into the room, mirrored the long odds against recovery for advanced-cancer cases. This experiment, on the University of Illinois' vast Chicago medical campus, was a desperate last-ditch effort.

Fourteen weeks later that man's ulcer-

ated throat was healed. The betatron—a giant machine with a 25-million-volt wallop—has scored in the great world fight against cancer.

Dr. Roger A. Harvey, head of the radiology department at the university, won't say he's cured—yet. The medical profession acknowledges a "cure" only after five years of no recurrence. Doctor Harvey admits the results are encouraging, but hastens to point out that the university has had too few cases to properly evaluate the betatron in cancer therapy.

Three other cancer patients using the betatron give additional reason for hope. With afflictions centered in the jaw, throat and brain respectively, their condition ranges from arrested to uncertain.

Betatron rays are superior to X rays because they project their greatest intensity—and curative powers—well into the body, at the point actually being treated. The Illinois instrument, with the most powerful



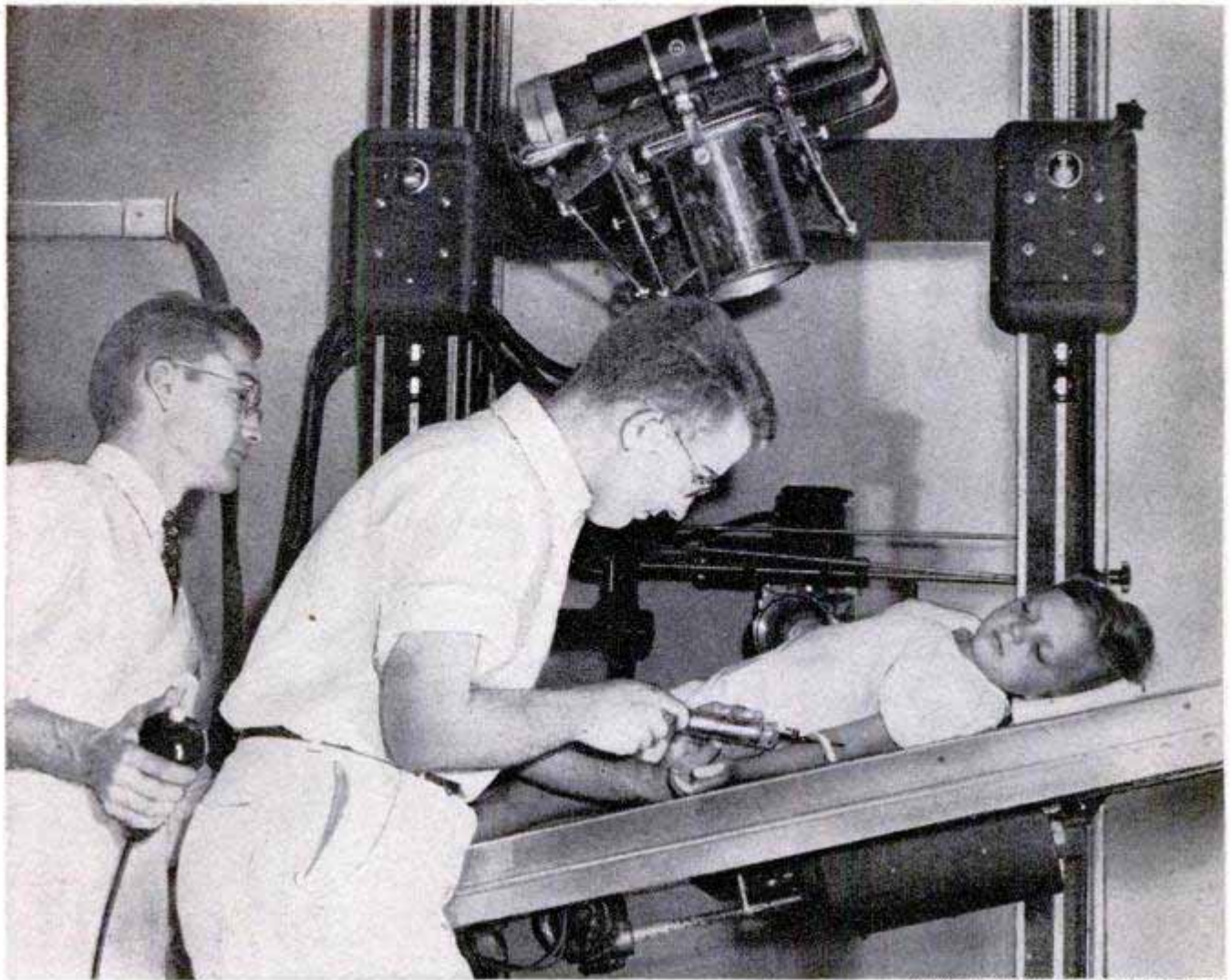

American Medical Association photo

To detect defective hearts in children, wartime aerial camera (beneath table) makes 20 X-rays in 10 seconds

## your HEALTH

medically used voltage in the world, can be utilized with complete safety. Conventional X-ray, which develops its maximum intensity at the surface of the skin, can damage healthy tissue when used at high voltage.

A long list of electrical and mechanical newcomers, like the betatron, are helping man's fight for better health. Every year the equipment exhibits at the American Medical Association's convention attract more attention and use more space. The campaigns against cancer, heart ailments and polio — all widespread killers — have been among those benefiting most from the new aids.

An electrical detection method, taking only about 25 minutes, has been found to be about 85 percent

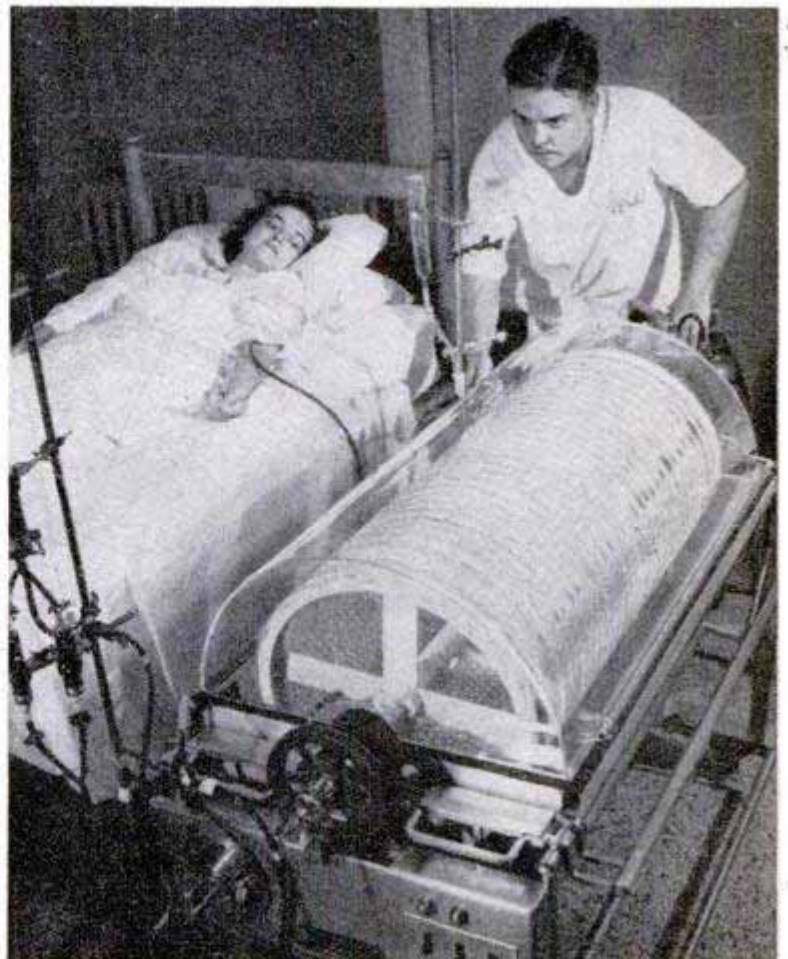

Allis-Chalmers photo

When the real ones aren't working, mechanical "kidney" removes wastes from the blood



Above, diagnoses of heart ailments can be made by measuring flow of blood in the fingers and toes. Below, a child hears for the first time over a new auditory training unit built especially for schools

accurate in discovering cancer in the female genital tract. The originators, Dr. Harold S. Burr of Yale University and Dr. Louis Langman of New York University, believe it will apply to all forms of the disease.

It is based on the same principle used in making electrocardiograms of the heart and brain waves in the head, that the body has electrical activity. Burr and Langman reasoned that healthy, nonmalignant tissue must have different electrical activity from cancerous, malignant tissue, and the contrast would show in instrument readings.

An associate aided the next step by designing equipment to take such readings, using a microvoltmeter. On one side are electrodes, which are attached to the patient's abdominal regions, and on the other side is a photoelectric recorder. Used on 616 patients, the simple test proved correct 611 times.

A mechanical "substitute kidney" prevents death from uremic poisoning when the human kidneys aren't able to carry poisonous wastes from the body. Its main part is a large cylindrical drum, around which 140 feet of cellophane tubing are wound spirally. The drum revolves constantly in a bath of rinsing fluid.

A small tube in the patient's forearm carries blood to the cellophane tubing. As



*W. H. H. Co.*

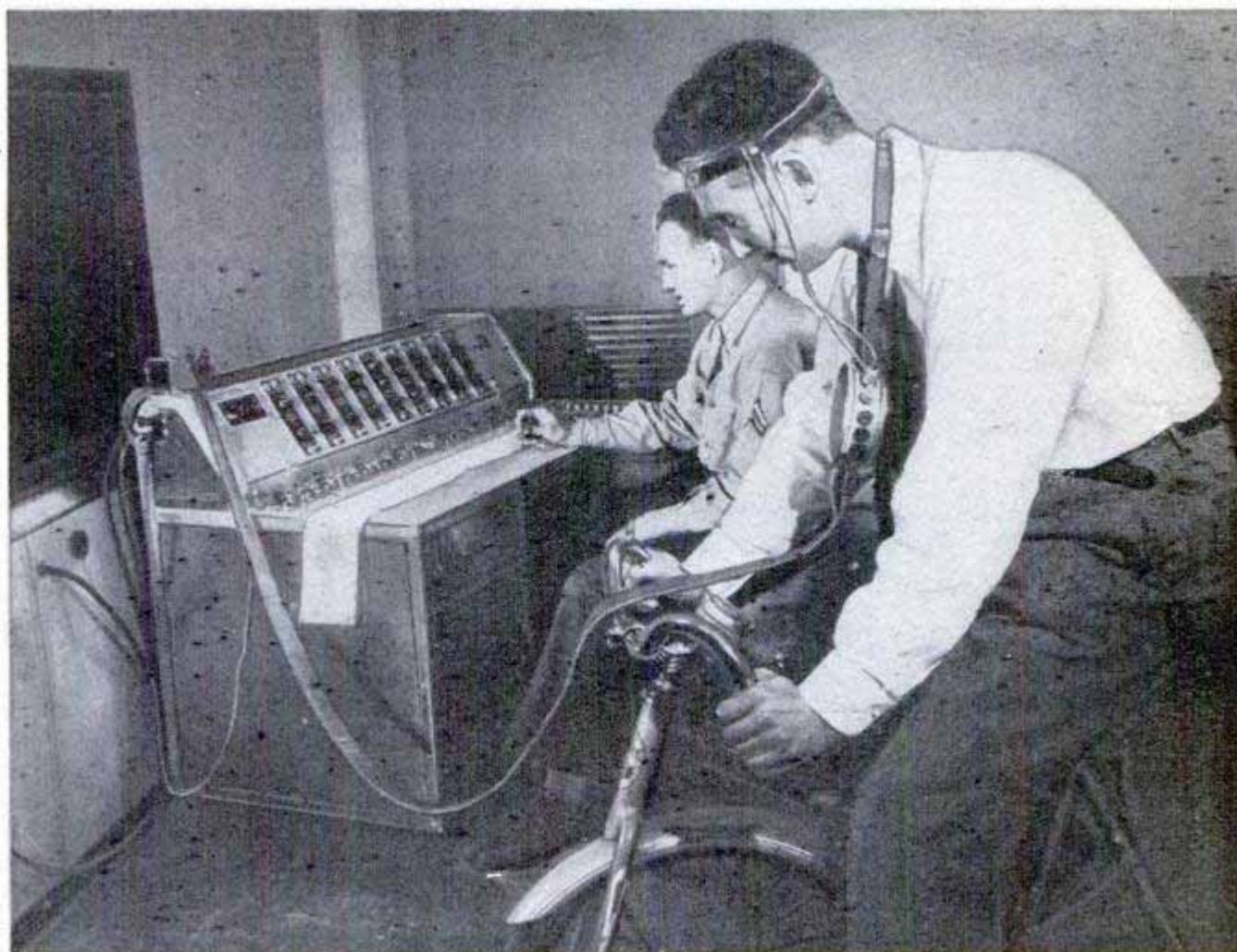

the blood moves along, tiny particles of poison seep through the tubing into the rinsing fluid. As much as a pound of poison may be removed by the time the blood re-enters a vein in the patient's leg or arm. The first "kidney," donated by its builders — the Allis Chalmers Manufacturing Company — to Milwaukee, Wis., is expected to save 20 lives yearly in that city alone.

Harvard's School of Public Health, where the "iron lung" was born 20 years ago, has come up with another remarkable breathing aid. Called an electrophrenic respirator, it is about the size of a portable radio and operates on ordinary house current. It induces breathing by sending an electric current through a nerve in the neck to the breath-controlling muscles of the diaphragm. Smaller and simpler to operate than other respirators, it is not intended to replace the iron lung, but is useful in some cases where the lung is ineffective. In bulbar polio, for

**Above, cardiac conditions and epilepsy can be diagnosed over the telephone with the aid of a sensitive device that is hung around patient's neck while he exercises**

**Below, a new camera that develops, fixes, washes and dries can turn out accurate cardiograms in approximately four seconds**





Above, a "baby lung" is helping doctors learn why premature infants breathe in short, irregular gasps



Above, screen shows path of tube being inserted in heart to detect abnormalities. Below, the flick of a switch smoothly hoists an electric bed, in use at Chicago's Passavant Hospital, to examination height

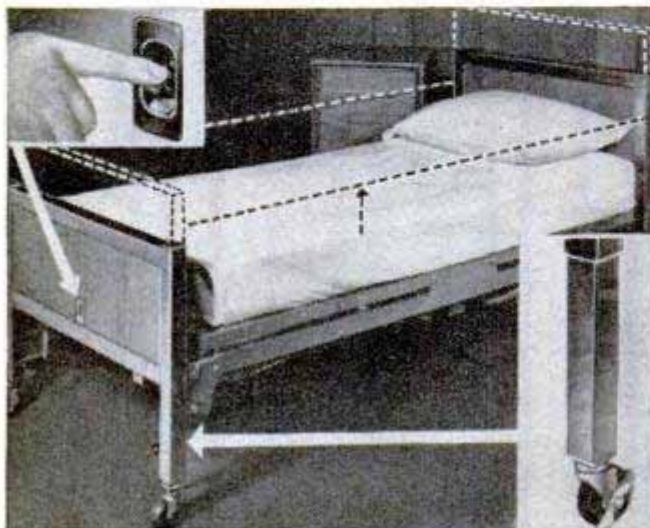

— example, it suspends irregular breathing—something the iron lung cannot always do—and starts regular, controlled respiration. Compact and light, it can also be rushed to the scene of accidents, to revive victims of drownings, asphyxia and electrocution.

Researchers at the University of Michigan are using a miniature iron lung to learn why premature babies breathe in gasps or jerks. It apparently is caused by oxygen not reaching the brain tissue which controls respiration. In the school's lung, with an atmosphere up to 80 percent oxygen, 9 out of 10 early babies quickly develop normal, "adult type" breathing.

Even normally born babies of the future may not have to put up with the resounding slap usually administered in the delivery room to start breathing. A "resuscinette," operating on the simple mechanical process of expanding oxygen, will start the lungs operating. The machine adjusts itself to any size lung and also provides the correct heat and humidity for the tiny infants.

Almost positive diagnoses of heart disease can be made from supersensitive electronic measurement of blood flow through the fingers and toes. Dozens of wires, sprawling out from a machine called a pneumo-plethysmograph to plastic cups on the fingers and toes, detect the changes. A recorder used with it, for complete analysis, correlates data on the heart rate, pulse volume, blood pressure, skin temperature and perspiration. This combination helps doctors decide when amputation is necessary by indicating whether or not the blood flow is sufficient to nourish the limb.

Both cardiac conditions and epilepsy can be diagnosed over the telephone with an electroencephalograph used at the U. S. Air Force School of Aviation Medicine. Hung around the neck of a patient while exercising, it permits transmission of heart waves by telephone. Patients had to be motionless with the bulky, older machines.

At Chicago's Presbyterian Hospital physicians are detecting and treating abnormalities that used to be discovered only by autopsy—too late to do the patient any good. The surgeon inserts a flexible tube into the patient's arm, watches its progress on a fluoroscope, and gradually works it through a vein into the heart. Blood samples taken there tell the exact location of the trouble. The procedure, done under local anesthesia only, is safe and painless.

Cameras are getting wider use as heart-trouble detectives. One turns out completely developed cardiograms in four seconds. The entire process—developing, fixing, washing and drying—takes place within the camera.

For children born with defective hearts,

(Continued to page 258)

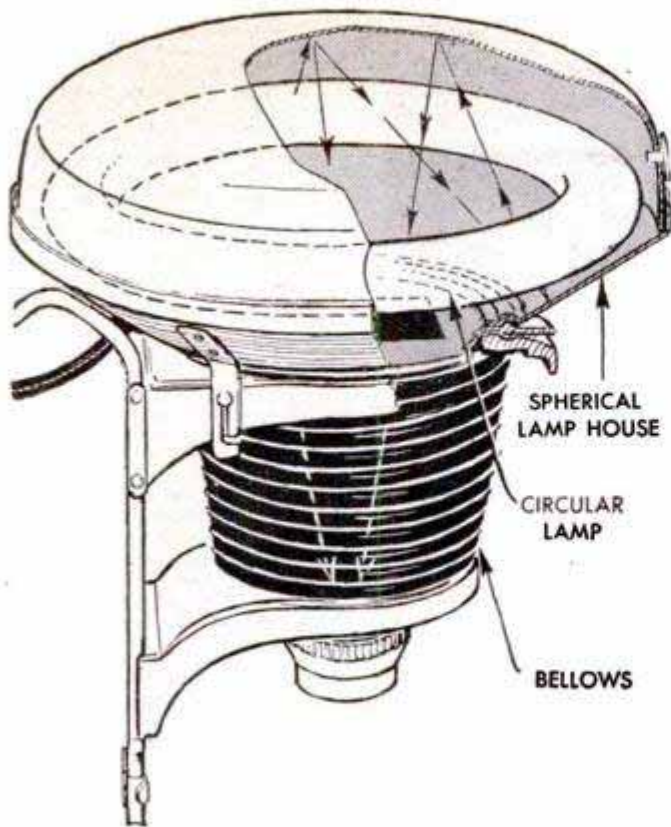

### Cold-Light Enlarger Uses Circular Lamp

Using a circular fluorescent lamp inside a spherical lamp house, a new photographic enlarger combines the advantages of both condenser and diffusion-type enlargers. The lamp house, shaped like a hollow sphere, completely diffuses the light rays without ground glass or condensing lenses. Highly reflective paint inside the lamp

house reflects and re-reflects the light rays for even distribution. No direct rays from the lamp hit the negative because of the position of the nonflicker tube. The enlarger has approximately the same speed and contrast as the condenser type plus the ability of the diffusion type to minimize specks and defects.

### Nose Doors Simplify Work on Helicopter Engine

Clamshell nose doors simplify access to the engine of a new helicopter and permit maintenance work to be done from the ground. Location of the passenger-cargo

cabin in the 12-place Sikorsky is directly below the main rotor, at the center of gravity, allowing loads to be added or removed without affecting the craft's balance.



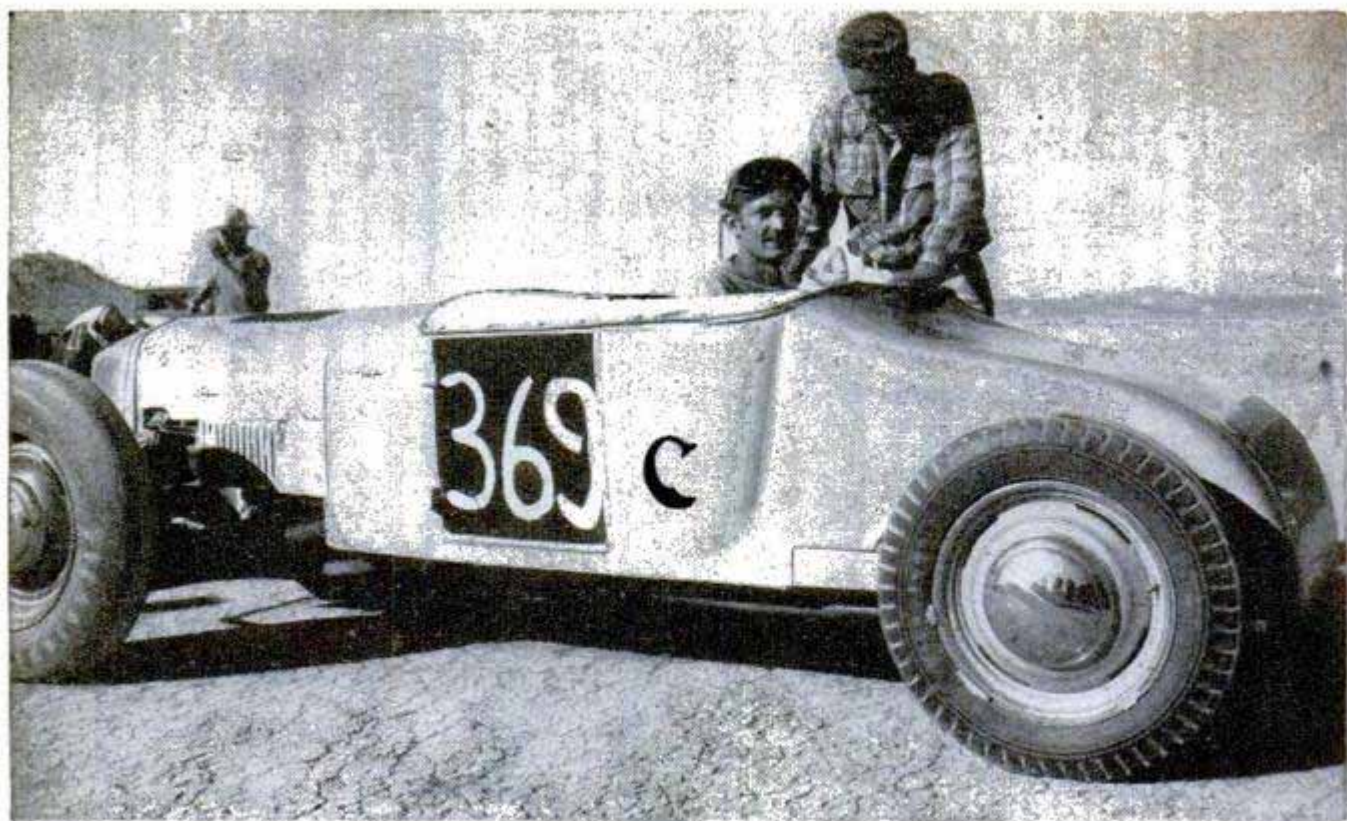

**REVERSE HOT ROD** races backward. By turning the body of his car around for better streamlining the driver made 148.51 miles per hour, 11 miles faster than his best time previously. Car is now a rear-engine job

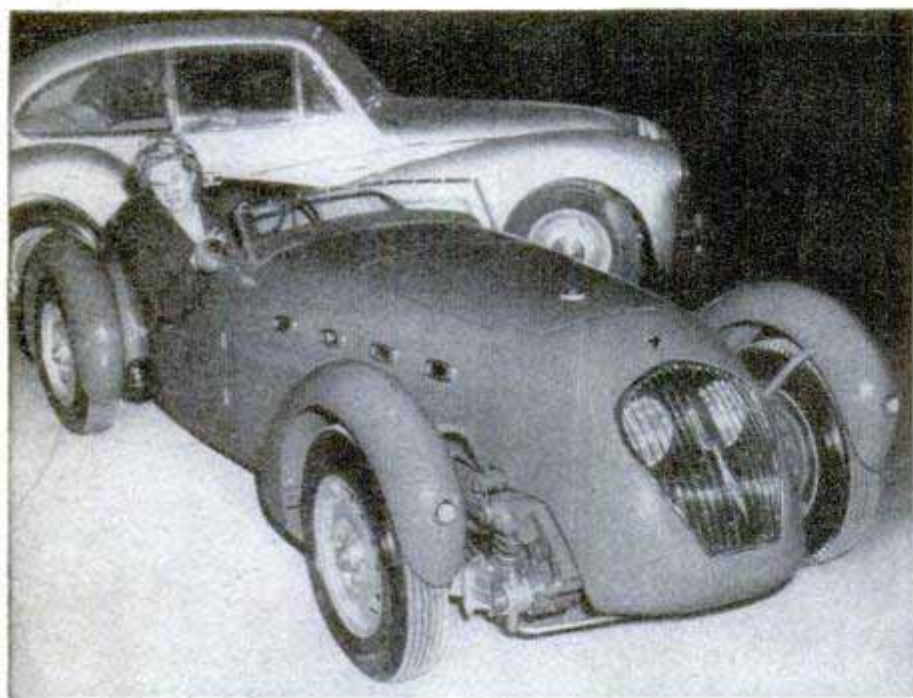

← **SPORTS CAR**, low-slung and racy in appearance, is one of the latest autos to appear in England. It zips along British highways at 100 miles an hour

**OCEAN AUTO** designed by a Berlin man makes 40 miles an hour in the water and more than 80 when driven on the highway. After testing it in the Havel River in Germany, the designer told of plans to cross ocean in motor car



the

POPULAR  
MECHANICS



# CRAFTSMAN

## Featuring:

What to Do About Clogged Drains	188
Helpful Hints for Moving Day	201
Getting the Most From Abrasives	213
Keeping Your Handsaws Sharp	222



The "new look" in lawn furniture—see following pages for complete group



Korda



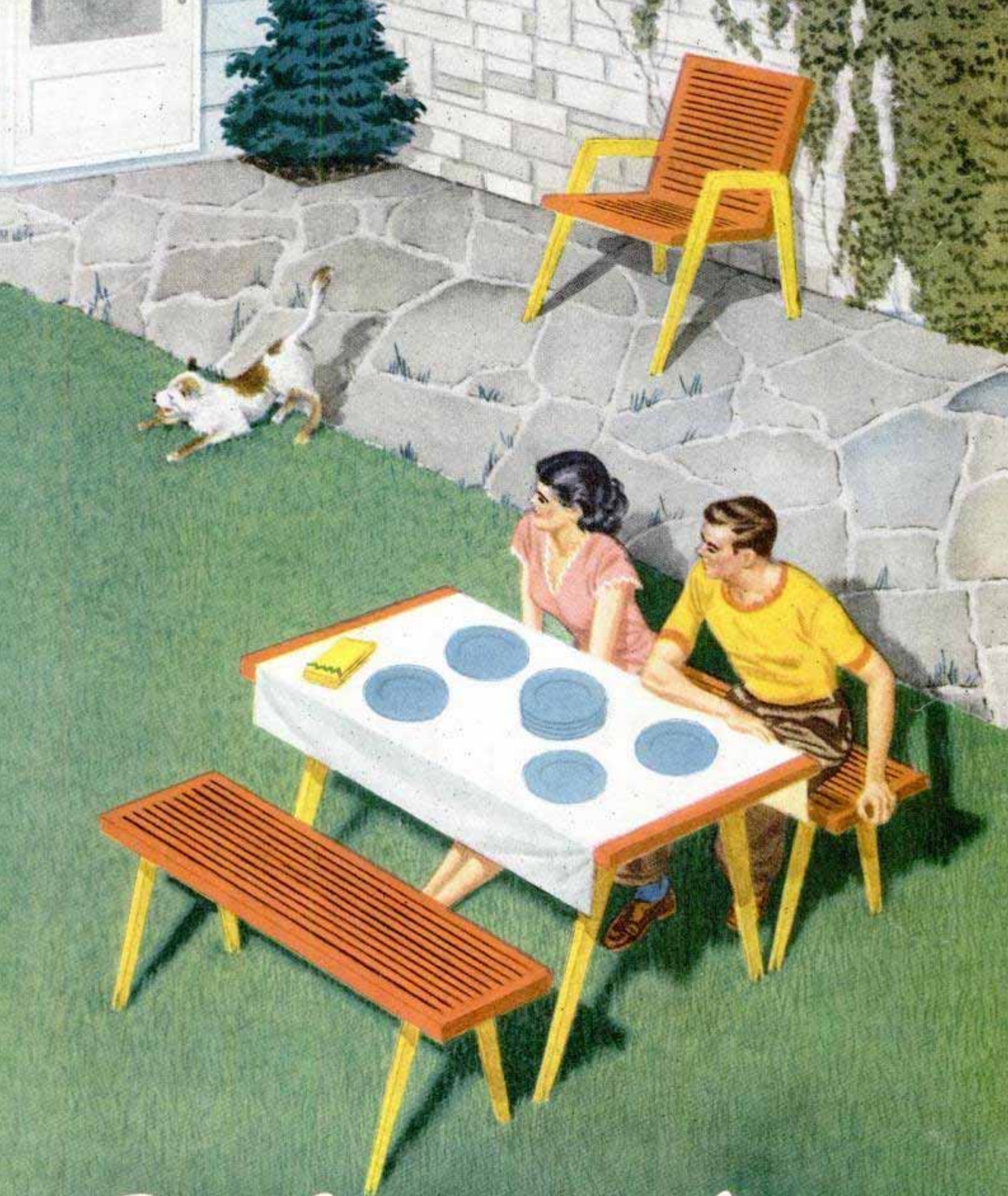

# *For Outdoor Living*

Here's real living-room comfort—a smart  
6-piece lawn ensemble, designed for stock lumber  
and ready-made cushions of weatherproof plastic

Blueprint # 1120 - 2.00  
 6 pieces of lawn furn.

# "New Look" in LAWN FURNITURE

By Wayne C. Leckey



NOT SATISFIED with presenting the commonplace in outdoor furniture, the craft editors of *Popular Mechanics* commissioned a well-known furniture stylist to come up with something new and exciting which would feature knockdown construction to lick the problem of winter storage. Gay, comfortable and easy to dismantle, this striking lawn furniture incorporates the use of ready-made waterproof cushions. These can be purchased from department stores in sizes to fit the various pieces of the group. Shown in full color on this and the preceding pages, the complete ensemble features six pieces, including an Adirondack-type chair, porch chair, serving cart, garden lounge, porch glider and a table-and-bench set. Several of the pieces, such as the porch chair, lounge and glider, also can be used during the winter on an enclosed porch or in a sunroom. Both the lounge and the Adirondack chair have tilting

Styled by John Bergen,  
noted furniture designer

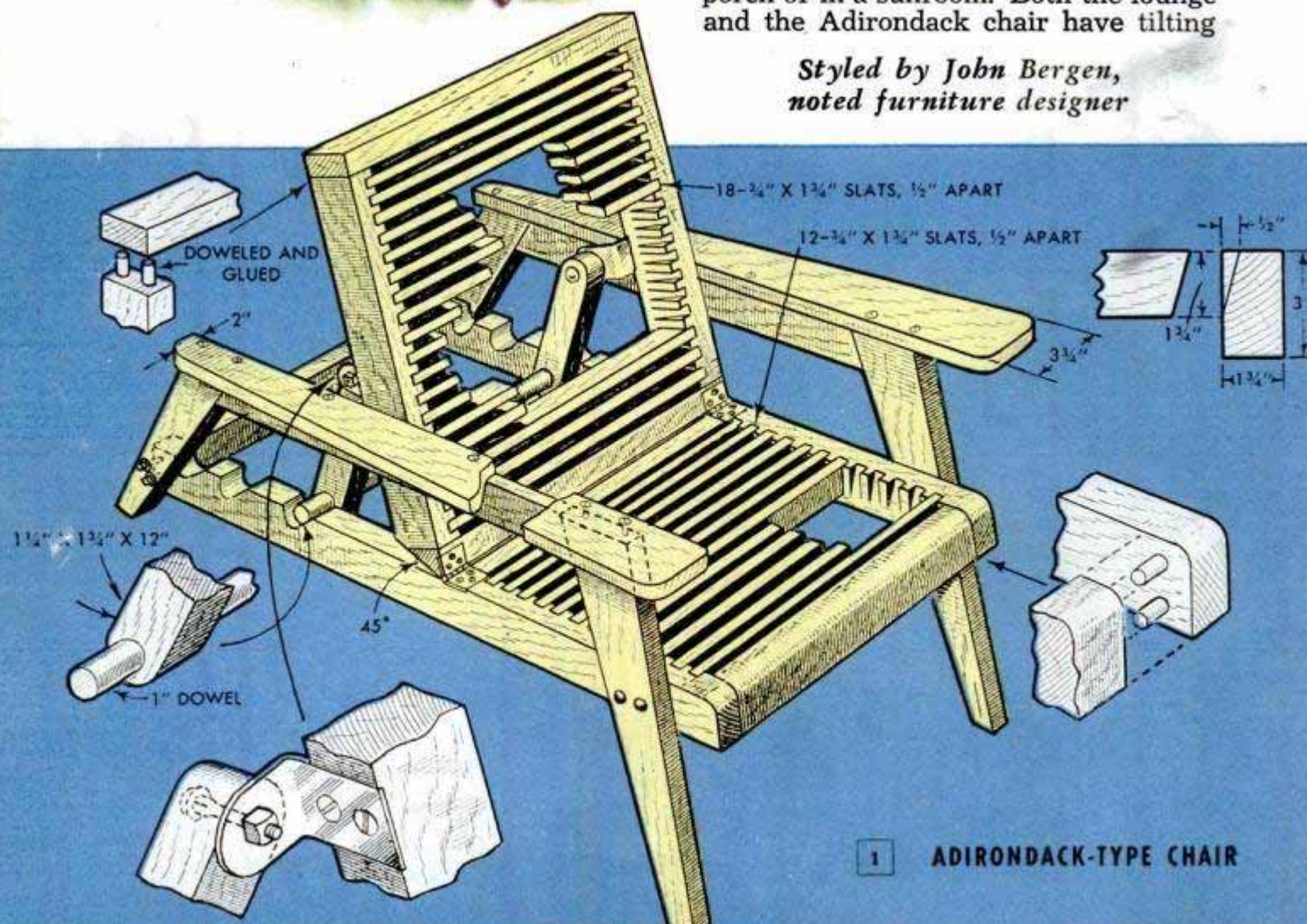

1 ADIRONDACK-TYPE CHAIR

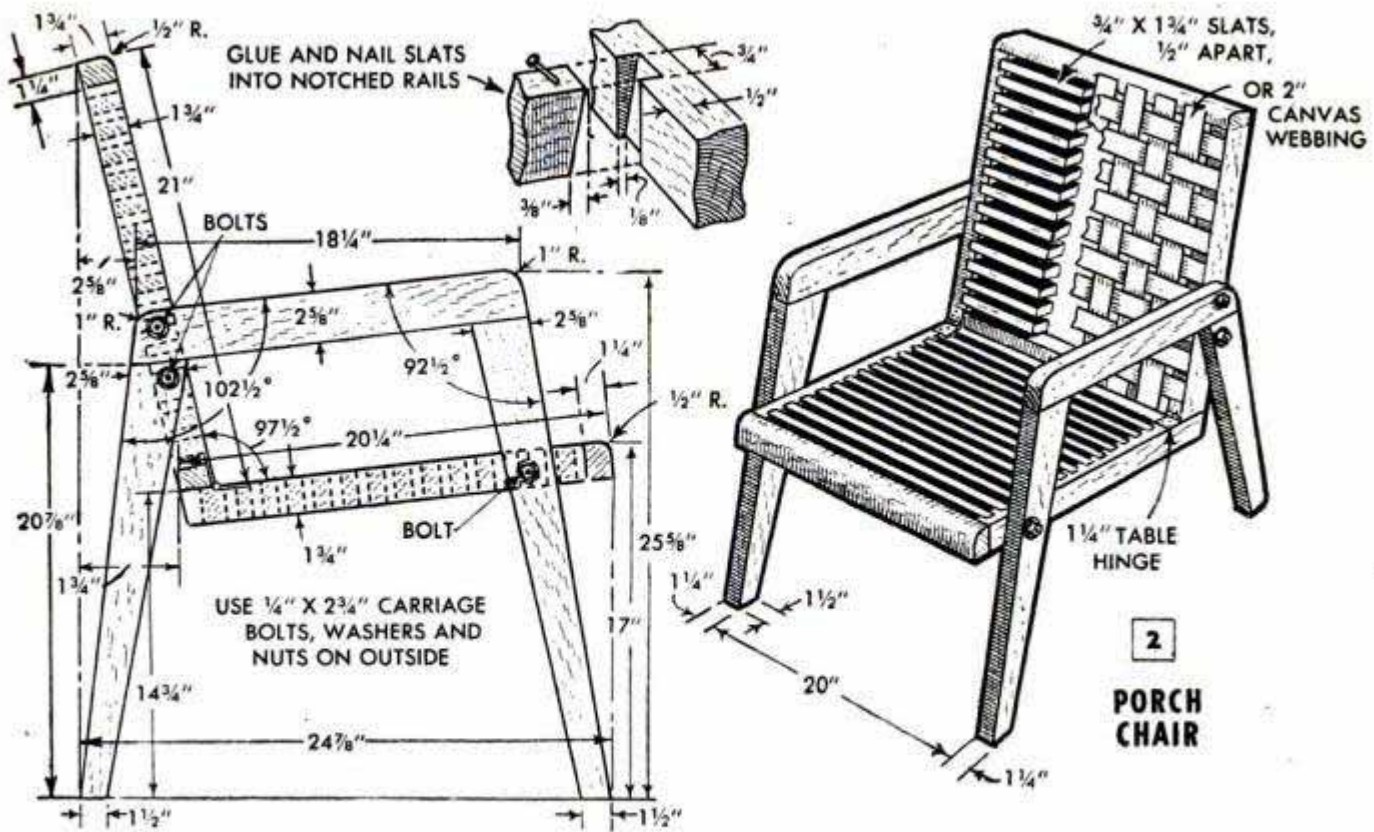

backs that can be adjusted to suit the comfort of the individual. Except in the case of the garden table-and-bench set, a choice of slats or webbing is given in constructing the seats and backs of the furniture. Both types are partially indicated in most of the drawings, and this should not be confused with actual construction details.

While redwood or cypress are two of the

most durable woods, especially suitable for outdoor furniture, common lumberyard stock, such as yellow pine or fir, is perfectly satisfactory if the pieces are kept well painted. The material list on page 182 itemizes the amount of lumber needed for each piece, and, for those who prefer to work from plans larger than magazine size, large black-and-white prints are available.

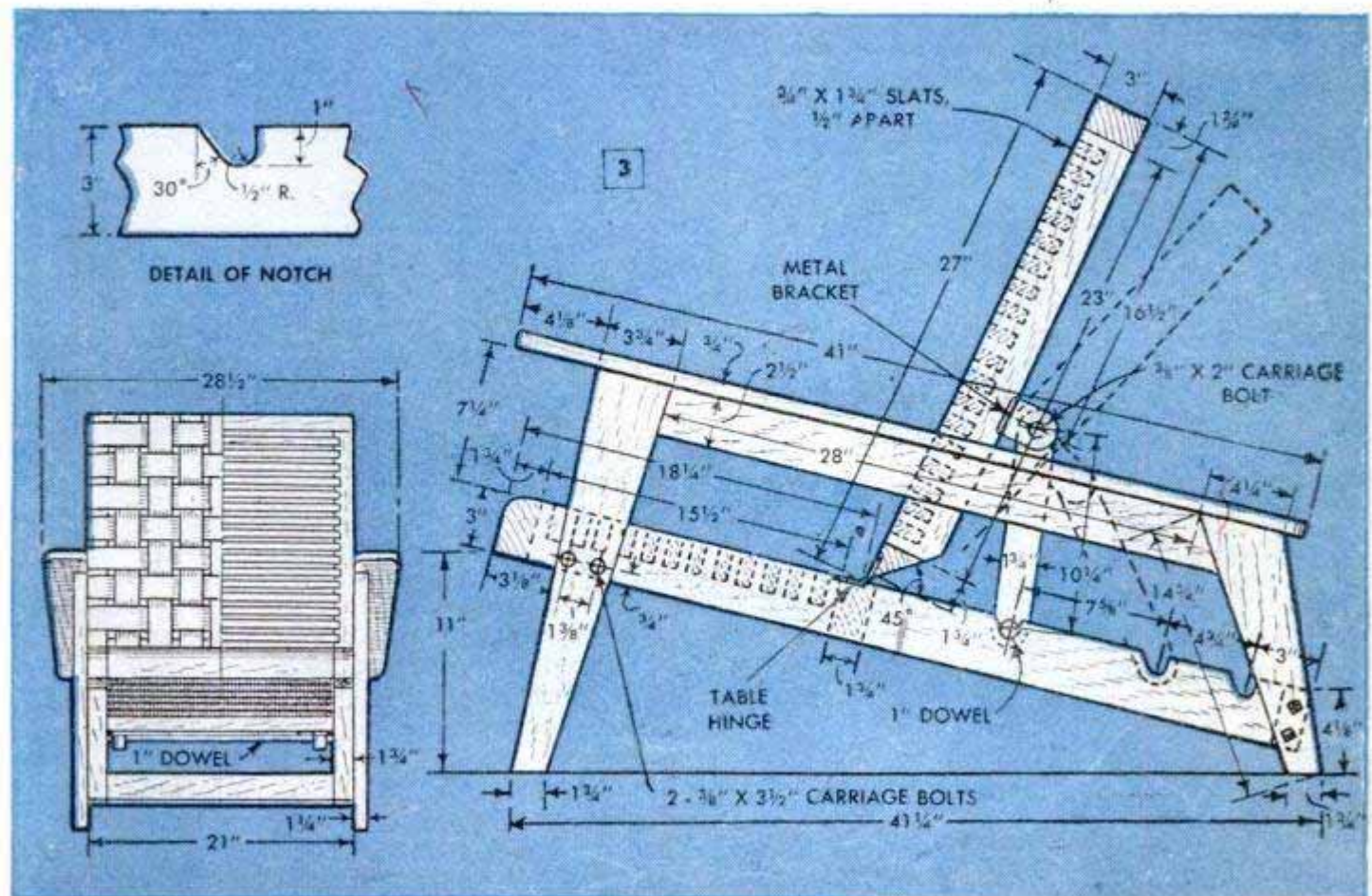

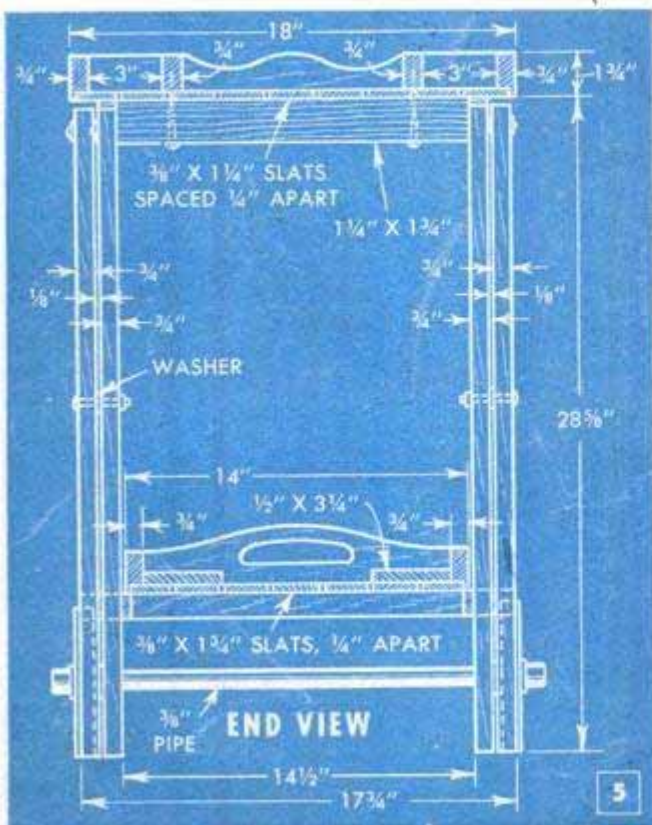
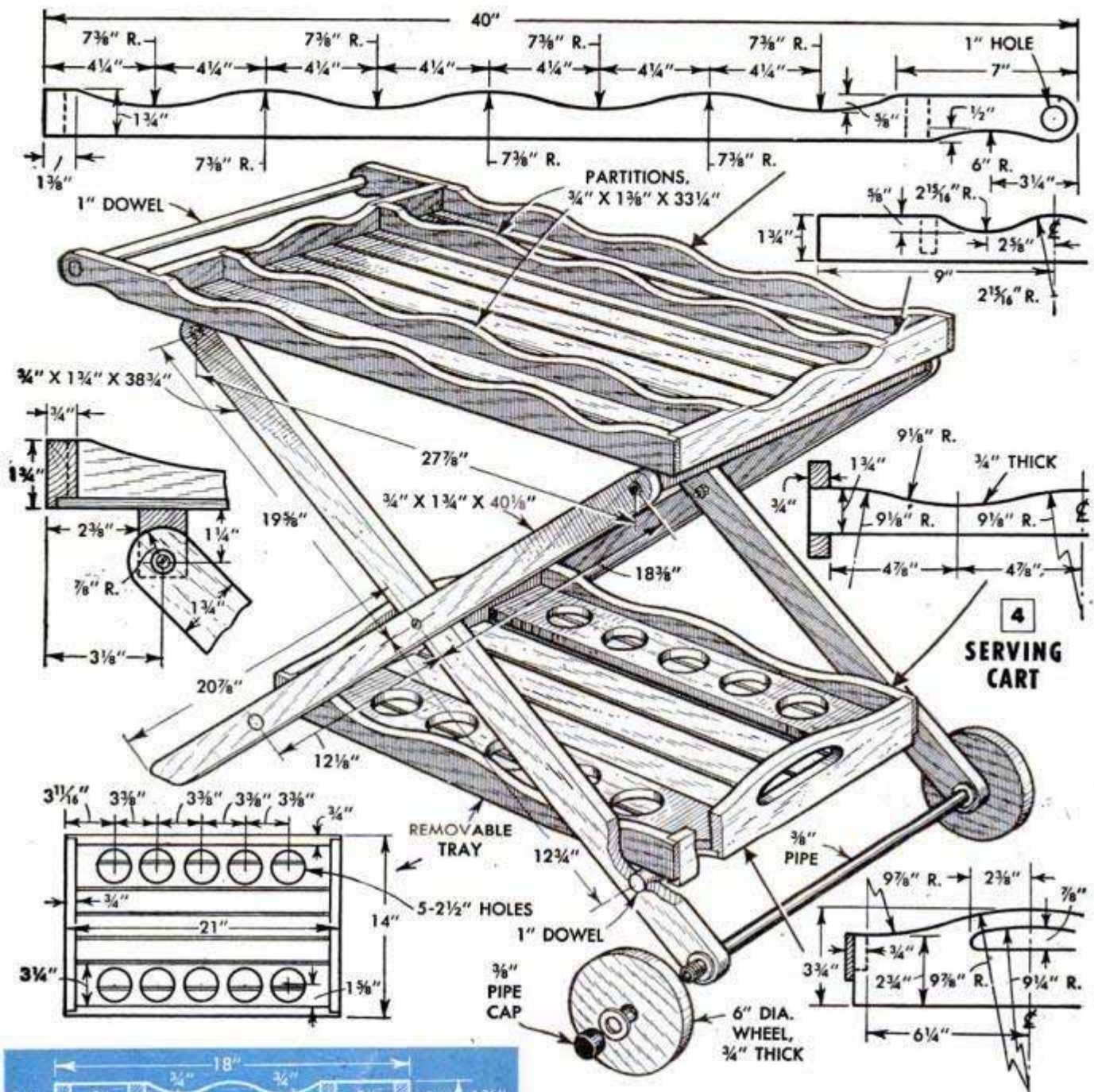

The Adirondack chair, detailed in Figs. 1 and 3, has a tilting back which can be adjusted to three reclining positions. The framework for both the seat and the back of the chair is made from 2 x 4 material, while the legs, and the rails which support the arms, can be of 1 1/8 or 1 1/4-in. stock. Each framework is made as a separate unit and the back is hinged to the seat with 1 1/4-in. table hinges, set flush. If slats are used instead of webbing, the slanting notches for them must be made before the frames are doweled and glued together. These can be cut with a 3/4-in. dado head on a circular saw by utilizing a narrow strip tacked temporarily to the face of the work along the rear edge. The strip is positioned to tilt the work at an angle that will produce a notch 1 3/4 in. long. The slats are cut from common 1 x 2 lumber, the ends being sawed off at an angle to fit the slanting notches and then nailed in place, flush with the surface. The support for the tilting back

is pivoted to it with sheet-metal brackets in the manner shown in Fig. 1. If webbing is preferred to the slats, use either nylon parachute webbing or common canvas webbing and interlace it as shown. The ready-made cushions will hide the tacks used in fastening webbing to the frames.

**The porch chair, Fig. 2,** is somewhat similar in construction. The seat and back are hinged together to fold flat for storing, while the legs and arms can be taken off as single units by removing only six nuts and washers. Frames for the seat and back are assembled from  $1\frac{1}{4}$  x  $1\frac{3}{4}$ -in. stock, notched if slats are used, before doweling and gluing together.

**The serving cart, Figs. 4 and 5,** can be wheeled about and features a removable beverage tray which rides on two rungs

fitted between the crossed legs. Each pair of legs are duplicates and registering holes for the pipe axle, dowel rungs and screw fastenings are bored at one time through each set. The upper ends of the legs are pivoted with wood screws to  $1\frac{1}{4}$  x  $1\frac{3}{4}$ -in. cleats which support the upper tray.

**The garden lounge, Figs. 6 and 7,** like the Adirondack chair, has a tilting back which is supported in the same manner except that it is adjustable to four positions. The bed frame of the lounge, including the tilting back, is made of 2 x 4 material, with a second frame of lighter stock being bolted to the underside. This second frame carries the wheel axle and also the notches which engage the tilting back support. The end-view detail shows how the pipe axle is bolted in place with lag screws. The arms of the

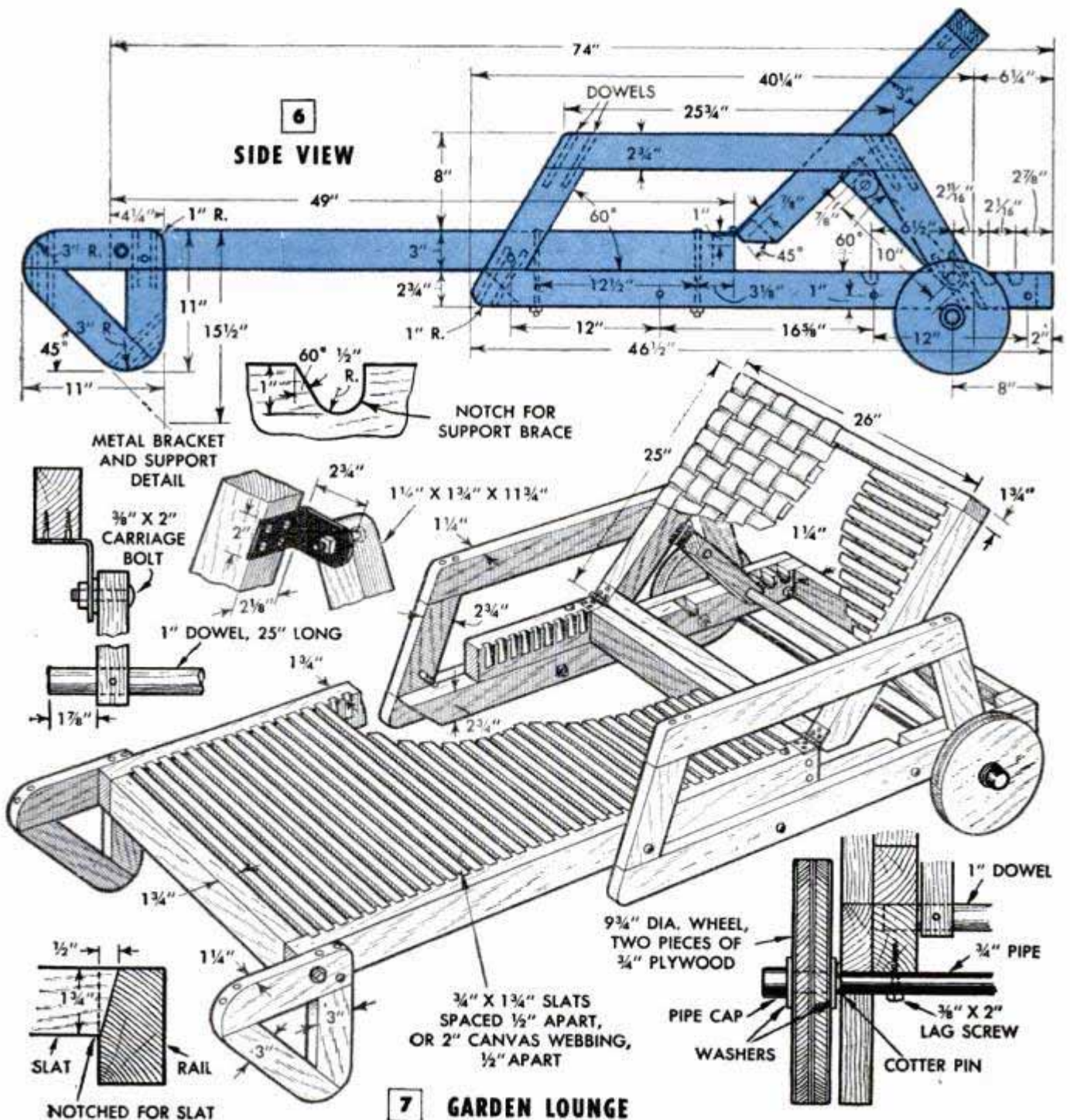

**8 PORCH GLIDER**

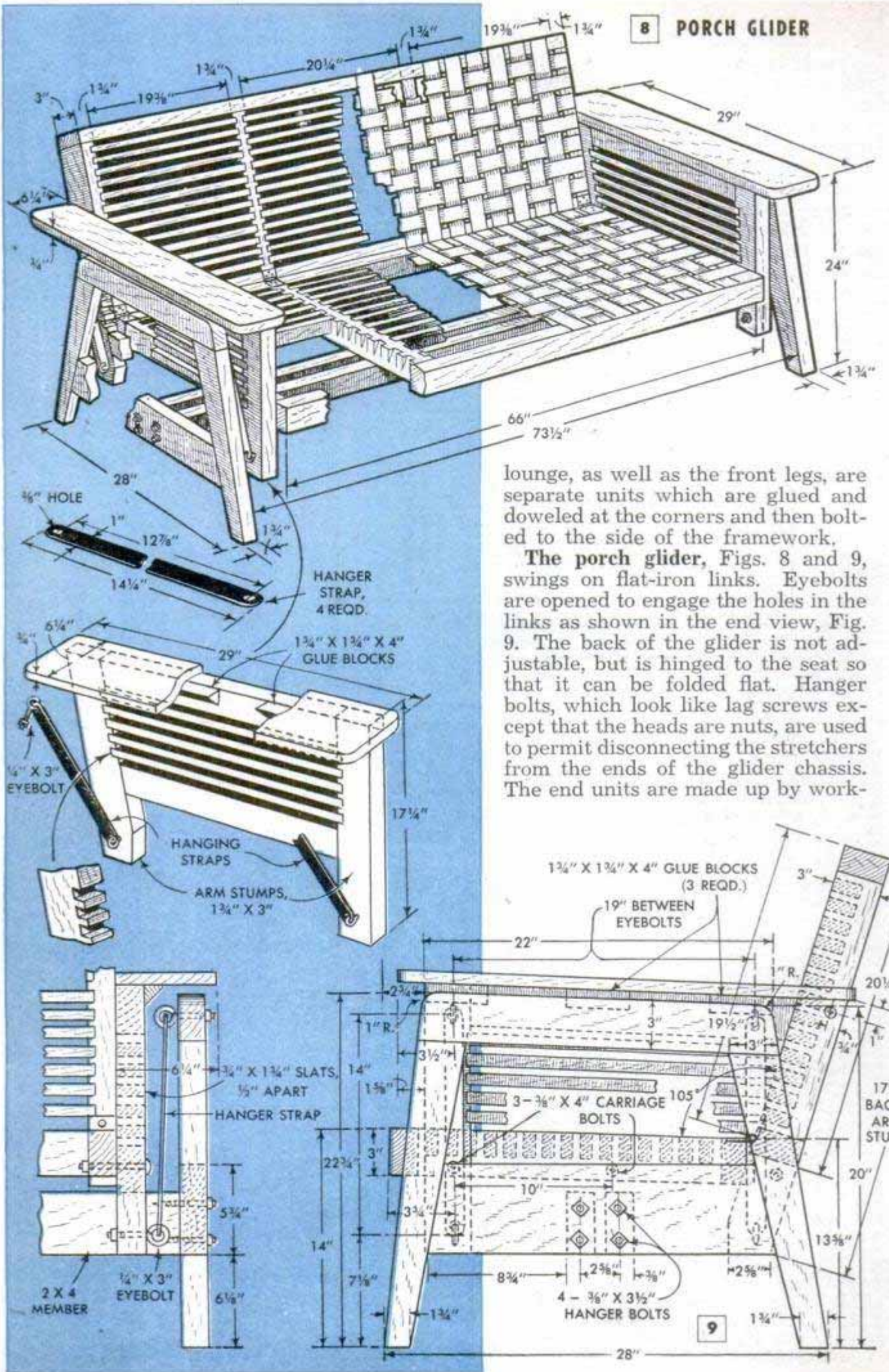

lounge, as well as the front legs, are separate units which are glued and doweled at the corners and then bolted to the side of the framework.

The porch glider, Figs. 8 and 9, swings on flat-iron links. Eyebolts are opened to engage the holes in the links as shown in the end view, Fig. 9. The back of the glider is not adjustable, but is hinged to the seat so that it can be folded flat. Hanger bolts, which look like lag screws except that the heads are nuts, are used to permit disconnecting the stretchers from the ends of the glider chassis. The end units are made up by work-

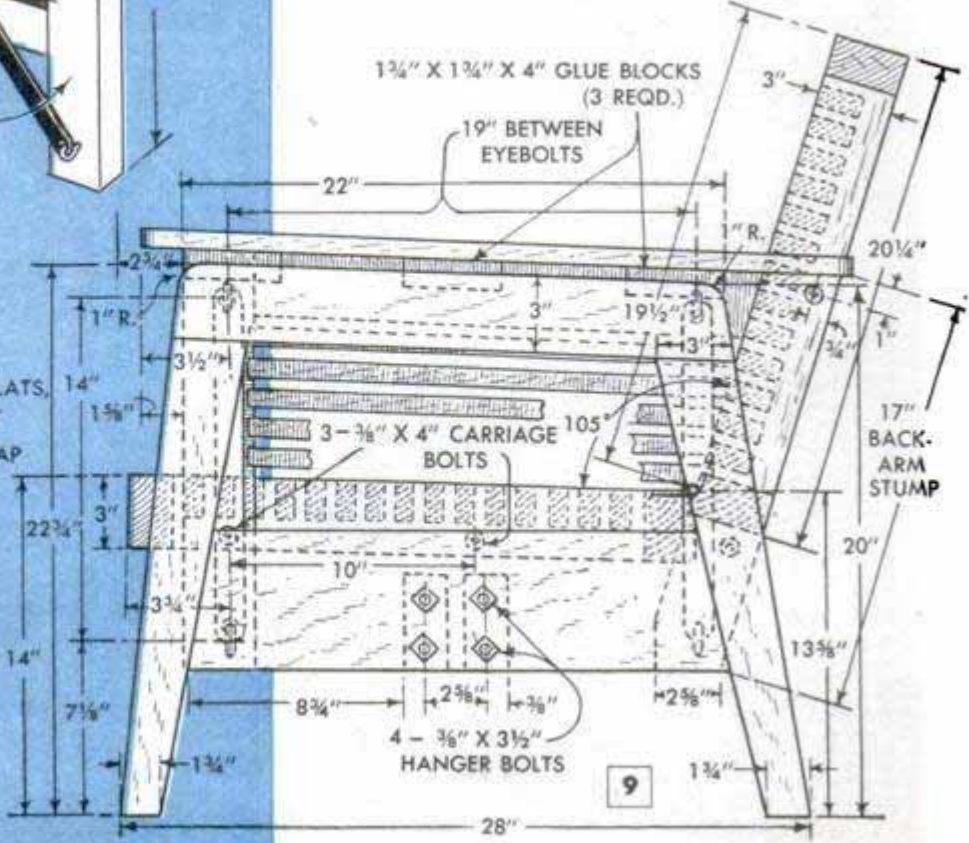
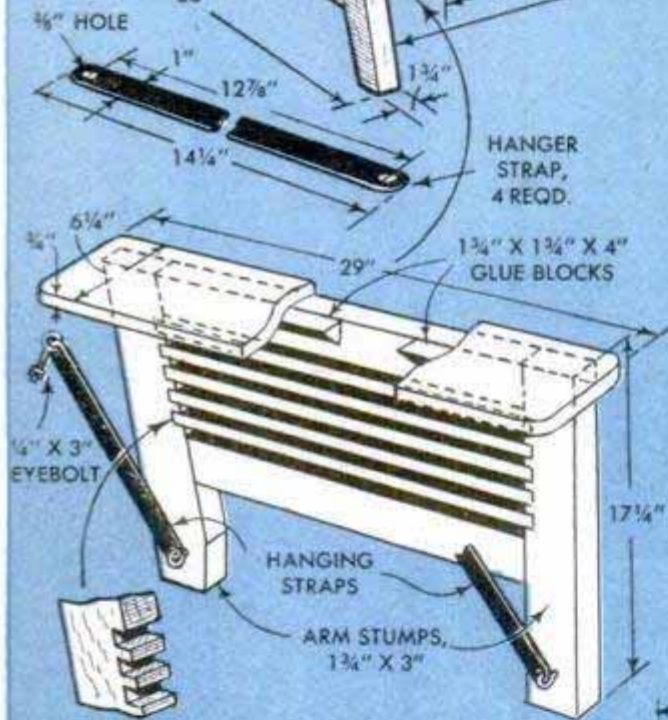

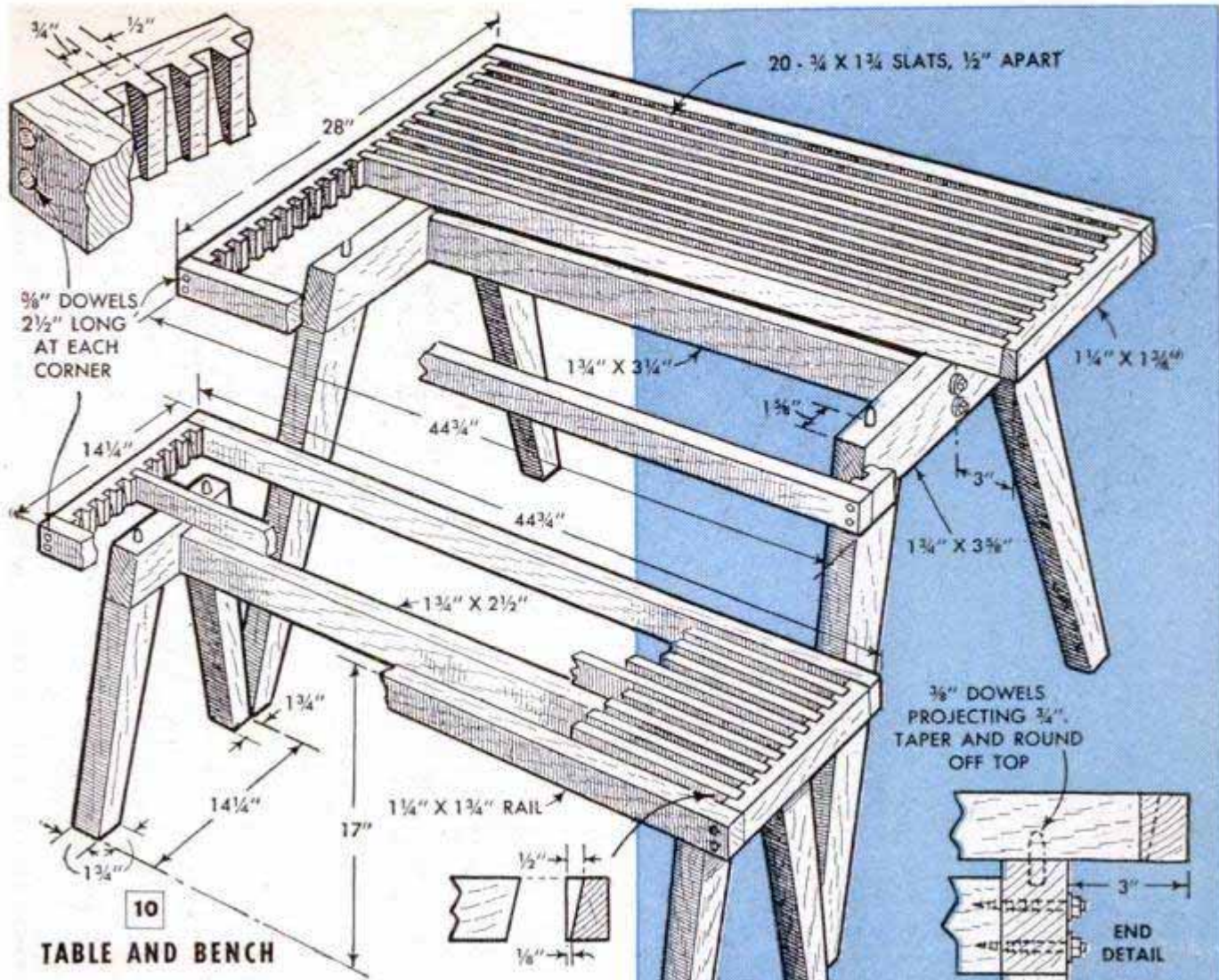

10  
TABLE AND BENCH

ing from a full-size paper pattern laid out according to Fig. 9 and placing the pieces right over the pattern to obtain the correct slant for the legs and top arm rails.

The picnic table-and-bench set, Fig. 10, also can be taken completely apart for storing. The tops of both the table and benches lift off, being held in place merely by stub pins which engage registering holes. Hanger bolts in the ends of the center stretchers permit the U-shaped legs to be removed in a jiffy. Except for size, the construction of the three pieces is exactly alike. As the slats are spaced 1/2 in. apart, it is best to paint them before they are nailed in place. Note that here the tapering notches are cut the full width of the end rails. This can be done with a small dado head by gluing a strip of beveled siding temporarily to the inside face of the work to bring the line of cut parallel with the saw table. The siding strip is glued with paper between it and the work so that it can be pried off easily when all the notches have been cut. However, to simplify the job, the notches can be cut straight through and the 1 x 2 slats glued in place and nailed from the outside face. The legs are cut from 2 x 4 material and glued and doweled to the apron pieces. Screws can be used instead of dowels at the corners of the bench tops.

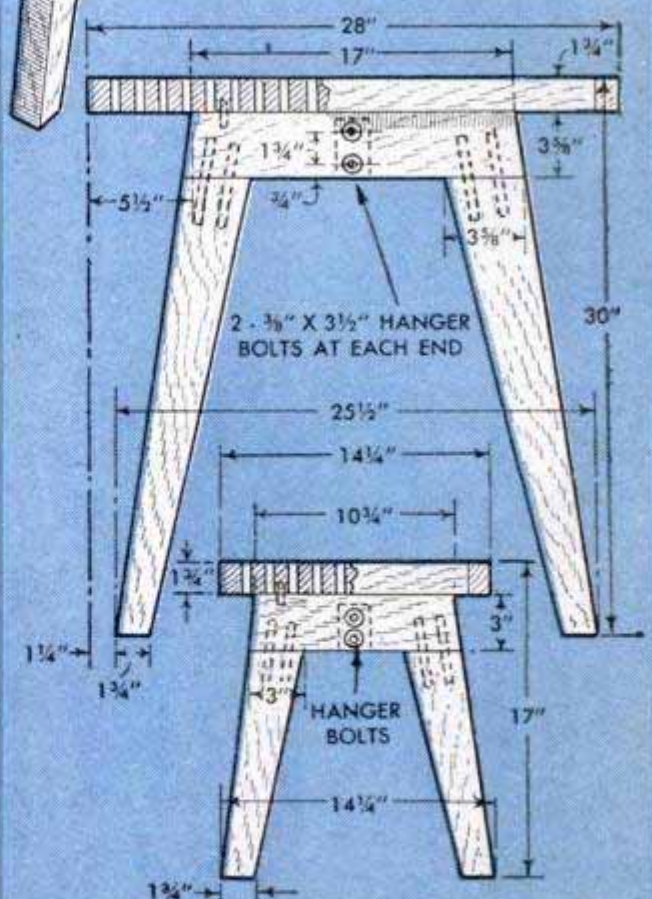

END VIEWS OF TABLE AND BENCH

## LUMBER LIST FOR LAWN FURNITURE

### ADIRONDACK CHAIR

2 pcs.  $1\frac{3}{4}$  x 3 x 42 in.—Side seat rails  
 1 pc.  $1\frac{3}{4}$  x 3 x 21 in.—Front seat rail  
 1 pc.  $1\frac{3}{4}$  x 3 x 17 $\frac{1}{2}$  in.—Center seat rail  
 1 pc.  $1\frac{3}{4}$  x 3 x 17 $\frac{1}{2}$  in.—Back seat rail  
 2 pcs.  $1\frac{3}{4}$  x 3 x 27 in.—Side back rails  
 1 pc.  $1\frac{3}{4}$  x 3 x 21 in.—Top back rail  
 1 pc.  $1\frac{3}{4}$  x 2 $\frac{1}{4}$  x 17 $\frac{1}{2}$  in.—Bottom back rail  
 30 pcs.  $\frac{3}{4}$  x  $1\frac{3}{4}$  x 18 $\frac{1}{2}$  in.—Seat and back slats  
 2 pcs.  $1\frac{1}{4}$  x 3 $\frac{3}{4}$  x 22 in.—Front legs  
 2 pcs.  $1\frac{1}{4}$  x 3 $\frac{3}{4}$  x 14 $\frac{5}{8}$  in.—Back legs  
 2 pcs.  $1\frac{1}{4}$  x 2 $\frac{1}{2}$  x 29 $\frac{3}{8}$  in.—Arm aprons  
 2 pcs.  $\frac{3}{4}$  x 3 $\frac{3}{4}$  x 41 in.—Tops of arms  
 2 pcs.  $1\frac{1}{4}$  x  $1\frac{3}{4}$  x 12 in.—Back stays  
 1 pc. 1-in. dia. x 20 in. long—Dowel rung  
 33 yds. 2-in. canvas webbing—Seat and back covering

### PORCH CHAIR

2 pcs.  $1\frac{1}{4}$  x  $1\frac{3}{4}$  x 20 $\frac{1}{4}$  in.—Side seat rails  
 1 pc.  $1\frac{1}{4}$  x  $1\frac{3}{4}$  x 20 in.—Front seat rail  
 1 pc.  $1\frac{1}{4}$  x  $1\frac{3}{4}$  x 17 $\frac{1}{2}$  in.—Back seat rail  
 2 pcs.  $1\frac{1}{4}$  x  $1\frac{3}{4}$  x 21 in.—Side back rails  
 1 pc.  $1\frac{1}{4}$  x  $1\frac{3}{4}$  x 20 in.—Top back rail  
 1 pc.  $1\frac{1}{4}$  x  $1\frac{3}{4}$  x 17 $\frac{1}{2}$  in.—Bottom back rail  
 27 pcs.  $\frac{3}{4}$  x  $1\frac{3}{4}$  x 18 $\frac{1}{2}$  in.—Seat and back slats  
 2 pcs.  $1\frac{1}{4}$  x 2 $\frac{5}{8}$  x 23 $\frac{1}{2}$  in.—Front legs  
 2 pcs.  $1\frac{1}{4}$  x 2 $\frac{5}{8}$  x 21 $\frac{3}{4}$  in.—Back legs  
 2 pcs.  $1\frac{1}{4}$  x 2 $\frac{5}{8}$  x 19 in.—Arms  
 20 yds. 2-in. canvas webbing—Seat and back covering

### SERVING CART

2 pcs.  $\frac{3}{4}$  x  $1\frac{3}{4}$  x 40 in.—Top side rails  
 2 pcs.  $\frac{3}{4}$  x  $1\frac{3}{4}$  x 17 in.—Top end rails  
 2 pcs.  $\frac{3}{4}$  x  $1\frac{3}{8}$  x 33 $\frac{1}{4}$  in.—Partitions  
 7 pcs.  $\frac{3}{8}$  x  $1\frac{3}{4}$  x 33 $\frac{3}{4}$  in.—Bottom slats  
 2 pcs.  $\frac{3}{8}$  x  $1\frac{3}{8}$  x 33 $\frac{3}{4}$  in.—Bottom slats  
 1 pc.  $1\frac{1}{4}$  x  $1\frac{3}{4}$  x 14 $\frac{1}{2}$  in.—Brace  
 1 pc.  $1\frac{1}{4}$  x  $1\frac{3}{4}$  x 16 $\frac{1}{2}$  in.—Brace  
 2 pcs.  $\frac{3}{4}$  x  $1\frac{3}{4}$  x 38 $\frac{3}{4}$  in.—Legs  
 2 pcs.  $\frac{3}{4}$  x  $1\frac{3}{4}$  x 40 $\frac{1}{8}$  in.—Legs  
 4 pcs.  $\frac{3}{4}$  x 6 x 6 in.—Wheels  
 2 pcs.  $\frac{3}{4}$  x  $1\frac{3}{4}$  x 21 in.—Tray sides  
 2 pcs.  $\frac{3}{4}$  x 3 $\frac{3}{4}$  x 13 $\frac{1}{2}$  in.—Tray ends  
 7 pcs.  $\frac{3}{8}$  x  $1\frac{3}{4}$  x 20 in.—Tray bottom  
 2 pcs.  $\frac{1}{2}$  x 3 $\frac{1}{4}$  x 19 $\frac{1}{2}$  in.—Glass holders  
 1 pc. 1-in. dia. x 17 $\frac{1}{2}$  in.—Dowel  
 1 pc. 1-in. dia. x 17 in.—Dowel  
 1 pc. 1-in. dia. x 17 $\frac{3}{4}$  in.—Dowel

### GARDEN LOUNGE

2 pcs.  $1\frac{3}{4}$  x 3 x 49 in.—Seat side rails (front half)  
 2 pcs.  $1\frac{3}{4}$  x 3 x 22 $\frac{1}{2}$  in.—Seat end rails (front half)  
 1 pc.  $1\frac{1}{4}$  x 3 x 22 $\frac{1}{2}$  in.—Seat end rail (back half)  
 2 pcs.  $1\frac{3}{4}$  x 3 x 23 $\frac{1}{4}$  in.—Seat side rails (back half)

1 pc.  $1\frac{3}{4}$  x 3 x 26 in.—Top rail for back  
 1 pc.  $1\frac{3}{4}$  x 2 $\frac{1}{2}$  x 22 $\frac{1}{2}$  in.—Bottom rail for back  
 2 pcs.  $1\frac{3}{4}$  x 2 $\frac{3}{4}$  x 44 $\frac{3}{4}$  in.—Back side rails  
 2 pcs.  $1\frac{1}{4}$  x 2 $\frac{3}{4}$  x 29 in.—Tops of arms  
 2 pcs.  $1\frac{1}{4}$  x 2 $\frac{3}{4}$  x 46 $\frac{3}{8}$  in.—Bottoms of arms  
 2 pcs.  $1\frac{1}{4}$  x 2 $\frac{3}{4}$  x 14 $\frac{1}{4}$  in.—Front arm stumps  
 2 pcs.  $1\frac{1}{4}$  x 2 $\frac{3}{4}$  x 11 $\frac{1}{8}$  in.—Back arm stumps  
 2 pcs.  $1\frac{1}{4}$  x  $1\frac{3}{4}$  x 11 $\frac{3}{4}$  in.—Back supports  
 2 pcs.  $1\frac{1}{4}$  x 3 x 15 $\frac{1}{2}$  in.—Front leg horizontals  
 2 pcs.  $1\frac{1}{4}$  x 3 x 8 in.—Front leg uprights  
 2 pcs.  $1\frac{1}{4}$  x 3 x 17 $\frac{1}{2}$  in.—Front leg diagonals  
 53 pcs.  $\frac{3}{4}$  x  $1\frac{3}{4}$  x 23 $\frac{1}{2}$  in.—Seat and back slats  
 4 pcs.  $\frac{3}{4}$  x 9 $\frac{3}{4}$  x 9 $\frac{3}{4}$  in.—Wheels  
 1 pc. 1-in. dia. x 25 in. long—Dowel rung  
 60 yds. 2-in. canvas webbing—Seat and back covering

### PORCH GLIDER

4 pcs.  $1\frac{3}{4}$  x 3 x 20 $\frac{3}{8}$  in.—Legs  
 2 pcs.  $1\frac{3}{4}$  x 3 x 22 $\frac{3}{4}$  in.—Top leg rails  
 2 pcs.  $1\frac{3}{4}$  x 5 $\frac{3}{4}$  x 22 in.—Lower leg rails  
 2 pcs. 2 x 4 x 73 $\frac{1}{2}$  in.—Leg stretchers  
 2 pcs.  $\frac{3}{4}$  x 6 $\frac{1}{4}$  x 29 in.—Arms  
 2 pcs.  $1\frac{3}{4}$  x 2 $\frac{1}{2}$  x 20 $\frac{3}{4}$  in.—Top arm rails  
 2 pcs.  $1\frac{3}{4}$  x 3 x 18 in.—Lower arm rails  
 2 pcs.  $1\frac{3}{4}$  x 3 x 17 $\frac{1}{4}$  in.—Front arm stumps  
 2 pcs.  $1\frac{3}{4}$  x 3 x 17 $\frac{3}{4}$  in.—Rear arm stumps  
 1 pc.  $\frac{3}{4}$  x  $1\frac{3}{4}$  x 108 in.—Arm slats  
 1 pc.  $1\frac{3}{4}$  x  $1\frac{3}{4}$  x 4 in.—Arm glue blocks  
 1 pc.  $1\frac{3}{4}$  x 3 x 66 in.—Front seat rail  
 1 pc.  $1\frac{3}{4}$  x 3 x 62 $\frac{1}{2}$  in.—Rear seat rail  
 2 pcs.  $1\frac{3}{4}$  x 3 x 23 in.—Side seat rails  
 2 pcs.  $1\frac{3}{4}$  x 3 x 19 $\frac{1}{2}$  in.—Center seat rails  
 1 pc.  $1\frac{3}{4}$  x 3 x 66 in.—Top rail for back  
 1 pc.  $1\frac{3}{4}$  x 3 x 62 $\frac{1}{2}$  in.—Lower rail for back  
 2 pcs.  $1\frac{3}{4}$  x 3 x 22 $\frac{3}{8}$  in.—Side rails for back  
 2 pcs.  $1\frac{3}{4}$  x 3 x 16 $\frac{3}{4}$  in.—Center rails for back  
 56 pcs.  $\frac{3}{4}$  x  $1\frac{3}{4}$  x 20 $\frac{3}{8}$  in.—Side back and seat slats  
 28 pcs.  $\frac{3}{4}$  x  $1\frac{3}{4}$  x 21 $\frac{1}{4}$  in.—Center back and seat slats  
 105 yds. 2-in. canvas webbing—Seat and back covering

### TABLE-AND-BENCH SET (table)

2 pcs.  $1\frac{1}{4}$  x  $1\frac{3}{4}$  x 44 $\frac{3}{4}$  in.—Top side rails  
 2 pcs.  $1\frac{1}{4}$  x  $1\frac{3}{4}$  x 25 $\frac{1}{2}$  in.—Top end rails  
 20 pcs.  $\frac{3}{4}$  x  $1\frac{3}{4}$  x 43 $\frac{1}{4}$  in.—Slats  
 4 pcs.  $1\frac{3}{4}$  x 3 $\frac{5}{8}$  x 25 $\frac{3}{8}$  in.—Legs  
 2 pcs.  $1\frac{3}{4}$  x 3 $\frac{5}{8}$  x 18-1/16 in.—Leg rails  
 1 pc.  $1\frac{3}{4}$  x 3 $\frac{1}{4}$  x 35 $\frac{1}{4}$  in.—Brace

### (Material per bench)

2 pcs.  $1\frac{1}{4}$  x  $1\frac{3}{4}$  x 44 $\frac{3}{4}$  in.—Top side rails  
 2 pcs.  $1\frac{1}{4}$  x  $1\frac{3}{4}$  x 11 $\frac{3}{4}$  in.—Top end rails  
 9 pcs.  $\frac{3}{4}$  x  $1\frac{3}{4}$  x 43 $\frac{1}{4}$  in.—Slats  
 4 pcs.  $1\frac{3}{4}$  x 3 x 11 $\frac{3}{4}$  in.—Legs  
 2 pcs.  $1\frac{3}{4}$  x 3 x 11 $\frac{1}{2}$  in.—Leg rails  
 1 pc.  $1\frac{3}{4}$  x 2 $\frac{1}{2}$  x 35 $\frac{3}{4}$  in.—Brace

## Stainless Ink for Children's Play Made From Laundry Bluing

Children can be allowed to write and draw with ink at a tender age without danger of ruining clothing and tablecloths if laundry bluing mixed with water is substituted for ordinary ink. The bluing provides a legible writing medium but, unlike the permanent stains of ink, it can be washed out easily if it is spilled.

R. F. Donovan, Jersey City, N. J.

☞ Applying wax to the heels and toes of women's stockings will reduce wear at these points, making them last longer. Rubbing with a candle will serve the purpose.





# TOY CEMENT MIXER

## for small-fry contractors

YOUNGSTERS with an urge to build things will have a lot of fun mixing and casting concrete with this pint-size equipment. The set consists of a hand-operated mixer of 1-qt. capacity, a cart for wheeling the grout to the "job" and several different molds for casting bricks, pedestals, columns and other miniature building material. A 1-qt. fruit-juice can is ideal for the mixer barrel. The details in Fig. 2 show how the barrel is supported and pivoted so that it can be dumped like the real thing. However, you'll notice that the barrel remains stationary, while the blades are rotated by a crank. The barrel is fastened to the flat-iron yoke with two small machine screws and the bearing for the blade shaft is soldered to both the bottom of the barrel and the yoke, as indicated in the sectional detail. A washer brazed to the shaft provides a shoulder to permit drawing the shaft up snugly in the bearing with a nut. Note that the four blades are brazed and pinned in a spiral pattern around the shaft. The wing nuts at the ends of the yoke permit the barrel to be locked in any desired position. The method of making the various casting forms is shown in Fig. 1. The brick mold is merely an open frame which has an ejector for pushing the bricks out the bottom after they have set. The mold should be soaked in oil to prevent the cement from sticking. A small trowel will come in handy, and a flat can, such as a deviled-ham can, will serve as a measure.—Hi Sibley, Nuevo, Calif.

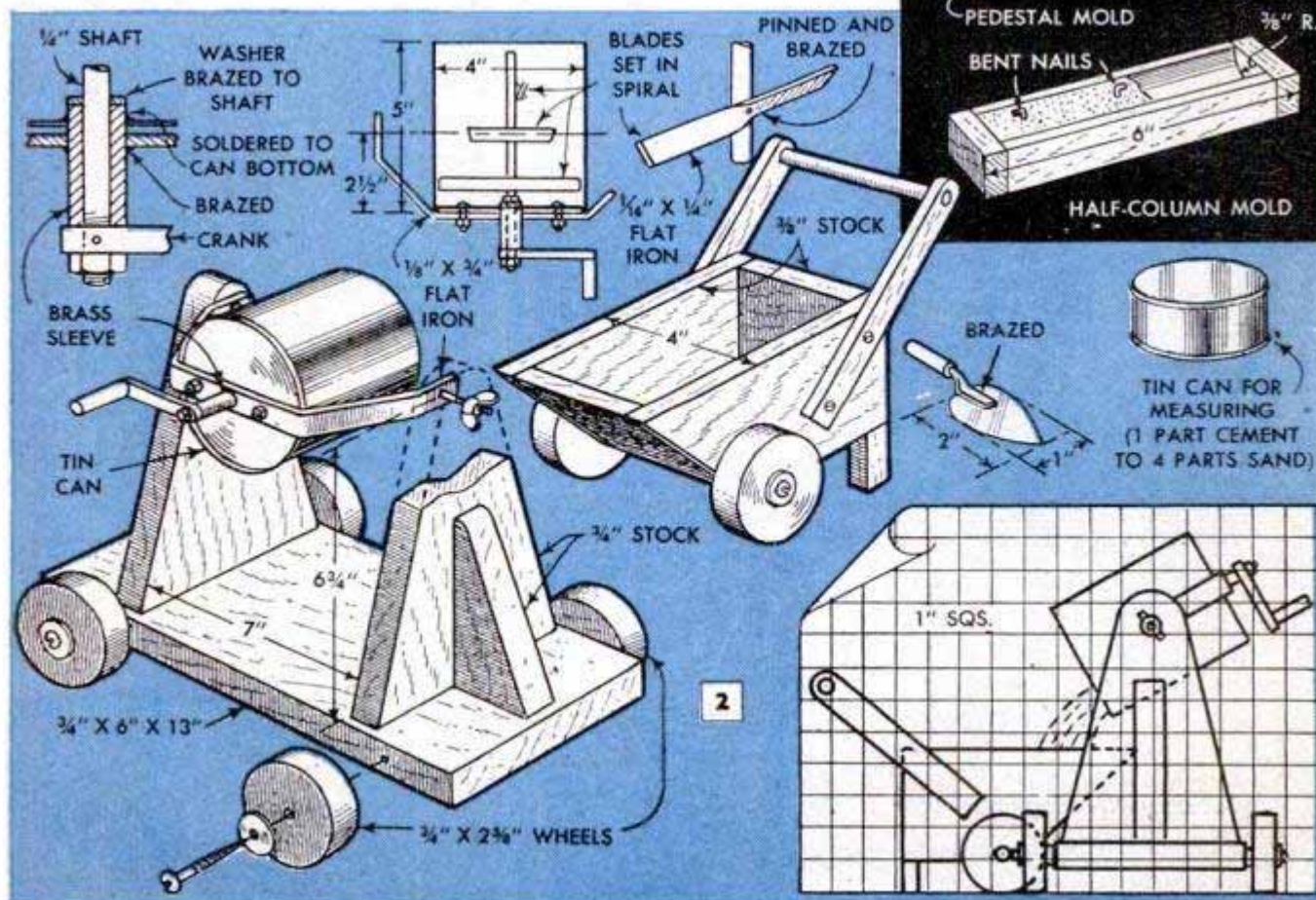
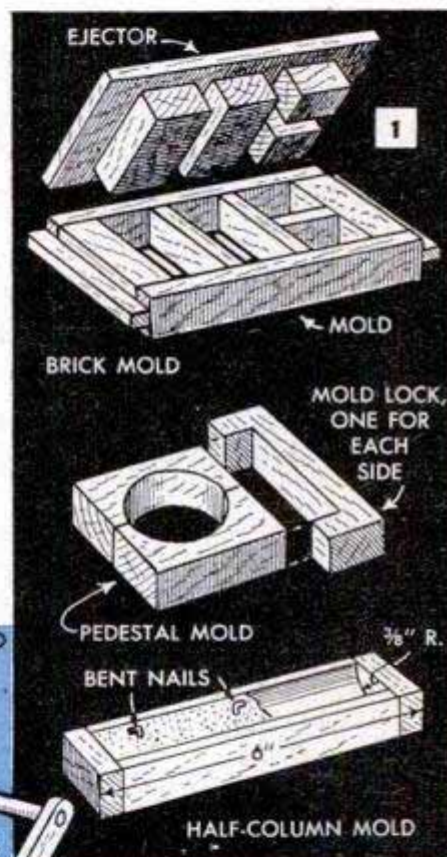



Here's the converted lamp ready for its shade. Lamp will now give twice as much downward light and considerably more upward light

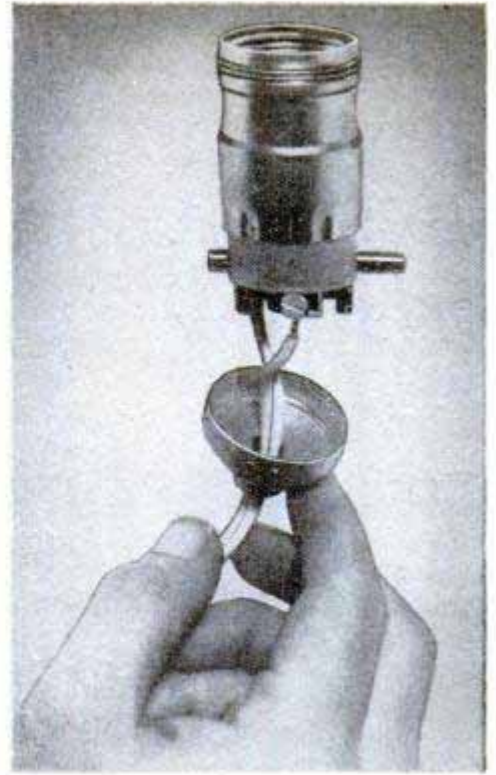

1. Separate top of socket from bottom by pressing on the sides of upper half

**E**YESIGHT is our most precious possession and yet, according to Miss Myrtle Fahsbender, the director of home lighting for Westinghouse, 60 percent of the lamps used for reading and other close work are not doing right by the eyes. However, converting these lamps from little more than purely decorative accessories

5. Replace the old harp with new wide one and rethread cord through socket

more LIGHT  
from old LAMPS

Courtesy Westinghouse Electric Corp.





**2. Remove shell from top half and pull out about 6 in. of lamp cord**



**3. With screwdriver, loosen the terminal screws and detach wires**



**4. Unscrew bottom of socket from lamp and remove the narrow harp**

to excellent reading lamps comes easy for anyone who is handy with a screwdriver. The parts are obtainable in kit form, including the new mushroom-shaped, 150-watt bulb, and their almost negligible cost pays off big dividends in saving eyesight. Of all common-type lamps, the easiest to convert is the single-socket table lamp. For best results, the base of the lamp should be at least 12 in. high and the bottom diameter of the shade should measure 14 in. or

more. Primarily, the conversion consists of replacing the old narrow harp with a wide one to take the new mushroom bulb which gives a more diffused and less glaring light. If the new harp is lower than the old one, an extension is furnished to add height to the finial. The series of photos presented here show you how it is done, step by step. This "new look" gives old lamps twice as much downward light and considerably more upward light.

**6. Reconnect the lamp cord, snap socket together; replace on lamp**

**7. If new harp is lower than old one, add finial to raise shade**

**Best illumination is had when the lamp base is at least 12 in. high**



## Inner Tube Connected to Downspout Provides Flexible Extension



Instead of allowing water from the downspout to collect in pools at the corner of the house, one homeowner uses a flexible extension made from lengths of inner tube to divert the water where desired. In this way, the water can be piped to the flower garden or it can be directed to a particular shrub or hedge that is in need of extra watering. The connector to the downspout and the couplings for joining the lengths of inner tube are made from tin cans. After both ends of the cans have been removed, the cans are inserted in the ends of the inner-tube sections. The portion of the inner tube around each can is wrapped tightly with strong cord to keep the can from slipping out.—Gordon Wilson, Myrtle Station, Ont., Can.

## Tumblers Individually Initialed With Colored Cloth Tape



To add a novel touch to your next informal party, supply each guest with a personalized drinking glass. This can be done simply by cutting the initials or first name of the guest from waterproof cloth tape and sticking the tape to the side of the tumbler. The tape, which is available in a variety of bright colors, will not wash off but may be re-

moved quickly, when desired, by pulling it from the glass. Use a pencil to outline the initials directly on the colored side of the tape and then cut them out with a scissors or razor blade, cutting slightly inside the pencil lines. If a razor blade is used, place the tape adhesive side down on a glass or china surface to provide a suitable backing.—Helen Lemberger, Chicago.

## Pin Aids Threading Drawstring

If a large needle is not available to thread ribbon through a drawstring top, fasten a safety pin to one end of the ribbon to aid in threading. Use a pin that is a little narrower than the width of the slits.



## Cleaning Equipment Kept Dust-Free

For more efficient cleaning with brooms and feather dusters, it is a good idea to protect them from accumulating dust when not in use. To do this, slip a large paper bag over the head of the broom or duster and fasten it with string or a rubber band slipped over the handle. Hang the implement from a wall hook by means of a loop of twine tied through a hole drilled near the end of the handle.

## Sheet-Metal Wire Splicer

This handy tool, cut and bent from heavy sheet metal, does a fast and neat job of splicing the ends of fence wire or metal clothesline. To begin the splice, just bend the ends of the wire 90 deg. so that they engage each other, and then use the tool, as shown in the drawing, to wrap the ends spirally around the lengths of wire. The notch at the lower end of the splicer should be deep enough to clear the top of the wire as it is being wrapped.

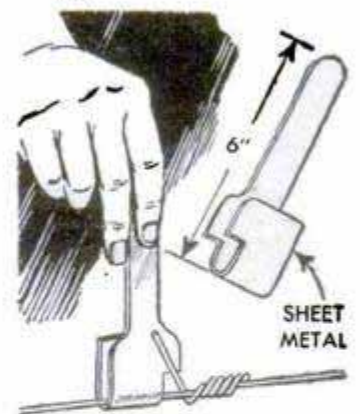

Herbert E. Fey, New Braunfels, Tex.

☛ Stuff all-rubber galoshes with crumpled newspaper before storing them for the summer. This will help them hold their shape and prevent wrinkling and cracking.

# Crafting with GLASS BLOCKS

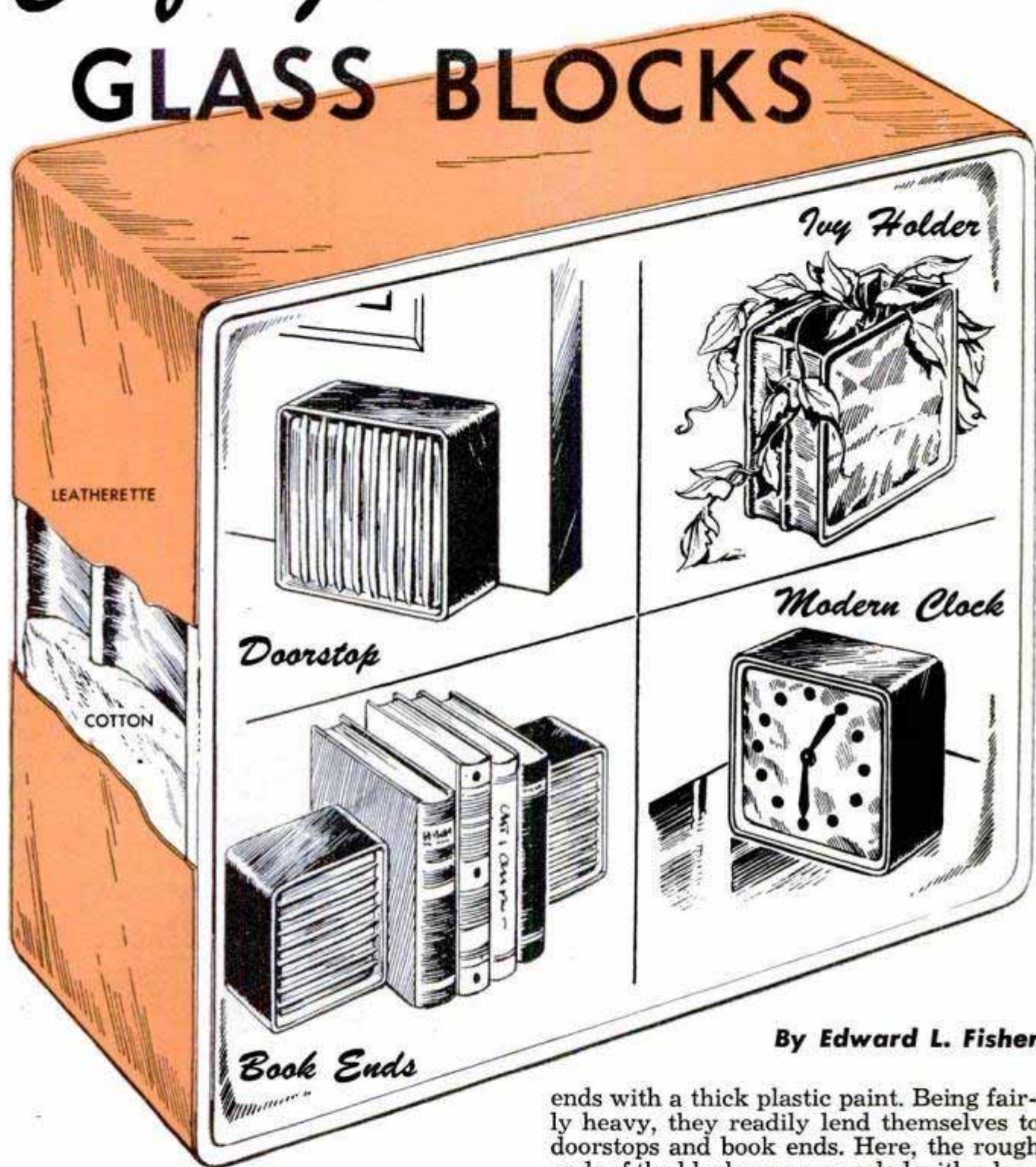

**A**LTHOUGH primarily used in wall construction, structural glass blocks in themselves provide the home craftsman with an unusual craft material—one which challenges his ingenuity. Being both decorative and inexpensive, the blocks can be put to many practical purposes, among which are the four suggestions shown above. Consisting of two hollow sections fused together, the blocks provide excellent and smart-looking containers for ivy, requiring nothing more than carefully breaking out the top and coating the rough

ends with a thick plastic paint. Being fairly heavy, they readily lend themselves to doorstops and book ends. Here, the rough ends of the blocks are concealed with a layer of cotton and a wrapping of leatherette. The latter is cemented to the edges of the block, pulled around firmly and lapped on the underside. The clock-case idea involves breaking out the back of a block to take a small movement and drilling a hole through the face of the block for the hands. The drilling is done with a three-cornered file which is ground to a long tapered point and rotated with an auger brace. Putty around the hole forms a well for turpentine which lubricates the file. Numerals on the clock face are dots of paint, and the edges of the block are covered with leatherette.

By Edward L. Fisher

# What to do about MECHANICAL AND CHEMICAL



Remove all grease and residue from frying pans and discard with garbage. Don't pour it down the drain

By E. R. Haan

**F**EW EMERGENCIES in modern homes cause greater inconvenience to the entire family than clogged drains and sewers. However, in most cases, it's not necessary to call a plumber, as the average homeowner frequently can correct the trouble at a fraction of the cost of the plumber's fee. In this article, the author explains how comparatively simple it is to clean a clogged drain and also gives a number of precautions that will help prevent clogging.

**Why sink drains clog:** Most stoppages in kitchen sinks are caused by hardened accumulations of cooking fats and oils that are washed down the drain with the dishwasher. Coffee grounds and other solid particles are caught in this grease coating and gradually build up a deposit which, in time, closes the drain completely. Generally, the trouble occurs in a horizontal length of pipe such as pictured at B, Fig. 1, which does not have sufficient drainage pitch. A sink trap, detail A, Fig. 1, seldom clogs owing to the hot water that runs through it every day. However, these frequent flushings of hot water have practically no effect in cleaning the pipe beyond the trap as the water cools rapidly and thus fails to melt the grease clinging to the pipe.

**Disposal of waste fats:** Fat and oil never should be discarded in a sink or lavatory drain. Make it a practice to pour or scrape fats from cooking utensils into cans or onto

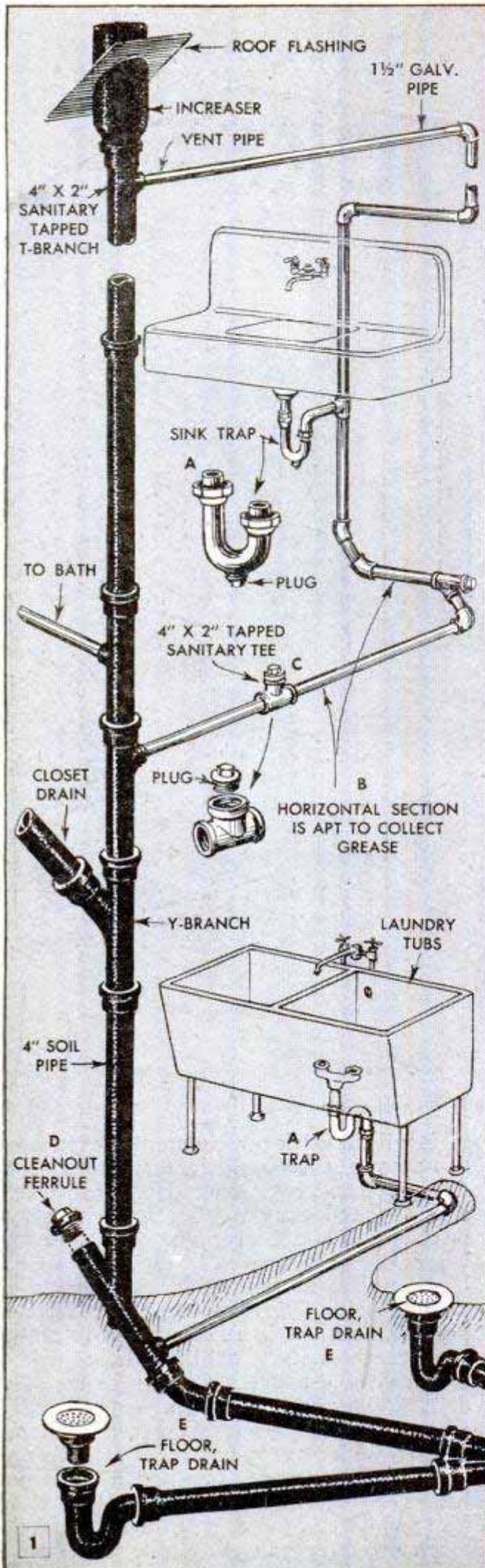

# CLOGGED DRAINS

MEASURES THAT EVERY HOMEOWNER CAN APPLY

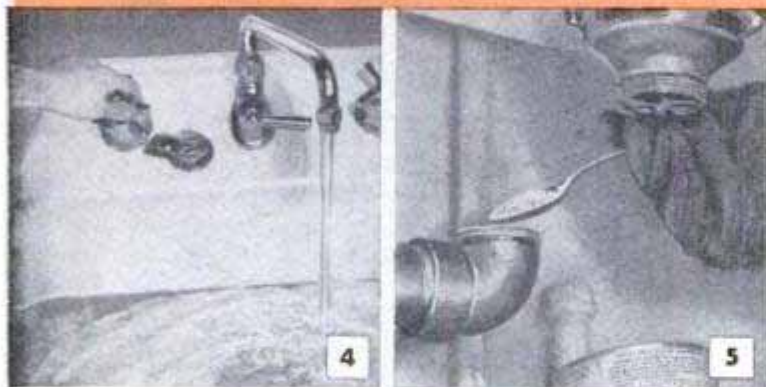

Flush the drain daily with plenty of hot water. Use chemical-type cleaner before drain clogs completely

paper for disposal, Fig. 2. Then wipe away remaining oil with a paper towel before washing the utensil. Also, be sure to collect and discard all food leftovers and other solids with garbage, Fig. 3. *Never wash them down the drain.*

**Flushing drain with hot water:** A kitchen sink very seldom clogs when scalding water is poured down the drain daily, Fig. 4. It's a good idea, after washing dinner dishes, to let hot water run from the faucet for 2 or 3 minutes to melt away any formation of grease. When water drains very slowly from a kitchen sink, practically an entire tankful of scalding water should be run through the drain. Set the water-temperature control at "high" about an hour or so before flushing to bring the water to the scalding point. In the case of a lavatory where the accumulation of hair helps cause stoppage, run a length of wire with a hooked end into the drain. If this does not help, remove and clean out the trap. Many lavatories have a metal pop-up drain plug which must be removed to permit cleaning the pipe from the bowl to the trap. To remove the plug, merely unscrew the short lever which is connected to the lower end of the pop-up extension, pull out the lever and lift out the plug.

**Chemical drain cleaners:** If the scalding-water treatment does not open the drain, use a strong drain-cleaning chemical. Most commercial cleaners consist of sodium hydroxide (caustic soda), with bauxite or other ingredients added to intensify action. When added to water, the chemicals effervesce violently and produce considerable heat. This, plus the caustic quality of the alkali, breaks up and eats away obstructions. Another chemical, potassium hydroxide (caustic potash), also is effective but is available only at chemical or drug-



The alternate pressure and suction of a rubber plunger frequently will open a completely clogged drain

supply houses. As these cleaners are caustic, they must be handled with extreme caution. *Avoid getting the chemicals or solution on the hands, arms and face.*

Chemical cleaners should be used only in drainpipes that are almost but not completely clogged. They are most effective when used with a small quantity of water, for when in solution form, the cleaner comes in direct contact with the obstruction. Pouring the chemical into a sink merely lets it lodge in the trap. Therefore, it is better to pour it into the pipe beyond the trap, particularly when the obstruction is in a horizontal section. To add the cleaner to the pipe, remove the trap, Fig. 7, and screw an elbow on the end of the pipe, placing it with an open end up, Fig. 5. Add the cleaner to the pipe, remove the trap, Fig. 7, and screw an elbow on the end of the pipe, placing it with an open end up, Fig. 5. Add the cleaner with an old spoon and work it into the pipe. Use about a fourth of the can of chemical and wash it down the pipe to the obstruction by slowly pouring in a



7 Removing the sink trap and pipe elbow makes it considerably easier to run a drain auger through pipe



8 Push the auger into the pipe and turn the crank. The crank is moved back as the auger is advanced

quart of water. After 15 or 20 minutes, replace the trap, (wearing gloves to prevent getting any chemical on the hands) and then test the pipe for drainage. If the pipe is still clogged, repeat the treatment as often as necessary. When good drainage starts, flush the pipe with scalding water for 5 minutes.

**Completely stopped sink drains:** When a sink or lavatory drain is completely clogged, mechanical means must be employed to force out the obstruction. First, try a suction-cup plunger, Fig. 6. In doing so, be sure that there is enough water in the sink to afford good suction. If the use of a plunger does not do the trick, examine the sink trap. If it has a drain plug, detail A, Fig. 1, place a pail under the trap to catch the water and remove the plug. Then insert a length of wire and work it around in the trap to make sure that it is clean. If so, remove the trap, Fig. 7, and insert a coiled spring-wire drain auger in the pipe, Fig. 8. When purchasing such an auger, obtain one about 15 to 25 ft. long and  $\frac{3}{8}$  in.

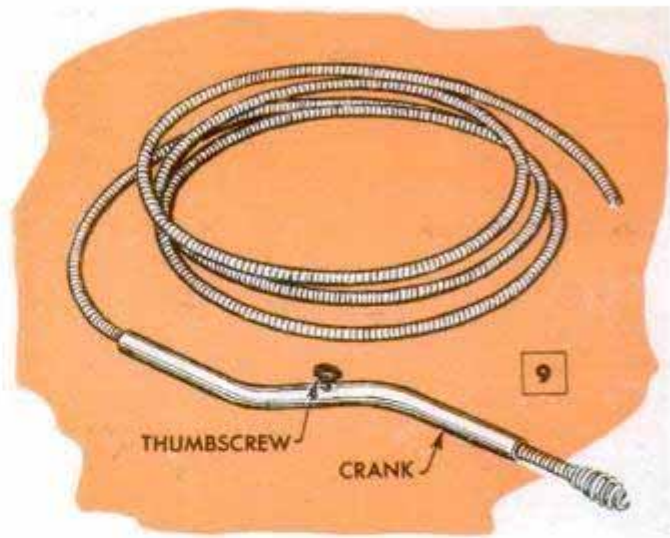

9 The drain auger consists of a coil of spring-steel wire 15 to 25 ft. long and about  $\frac{3}{8}$  in. in diameter

in diameter and select one equipped with a tubular handle crank like that shown in Fig. 9. The crank fits over the wire and can be tightened to it at any point with a thumbscrew. Start using the auger by placing the crank about 4 ft. from the working end. Then rotate the auger and, at the same time, push it slowly into the pipe. When the crank reaches the end of the pipe, loosen it and move it back a foot or so on the spring wire, and continue as before until an opening is bored through the obstruction. If you find that you are unable to reach the obstruction from the trap end of the pipe, try to reach it from the first cleanout opening in the basement, working toward the trap. A cleanout opening is usually located at a turn in the pipe as shown in Fig. 1. If such a cleanout is not provided, it may be necessary to drill a hole in the pipe to admit the auger. The hole should be at least  $\frac{5}{8}$  in. in dia. and tapped to take a standard  $\frac{3}{4}$ -in. pipe plug. Note the cleanout, detail C, which is inserted in a long horizontal run of pipe.

**Plumbing traps:** Sinks, bathtubs, shower stalls, toilets, laundry tubs and floor drains all are provided with traps. In time, water will evaporate from the traps in seldom used drains, allowing the passage of sewer gas. These traps can be kept sealed by occasionally pouring a gallon or more of water down the drain. Toilet traps are integral with the fixture and when water overflows the bowl it's an indication that there is an obstruction that must be forced out of the trap by mechanical means. A suction-cup plunger is generally effective, but sometimes a drain auger is required.

Floor-drain traps in basements and garages, detail E, Fig. 1, may become clogged with dirt and floor sweepings. When a floor drain is slow acting, first remove and clean the strainer. Then dig out the dirt with a spoon, after which use a drain auger and,



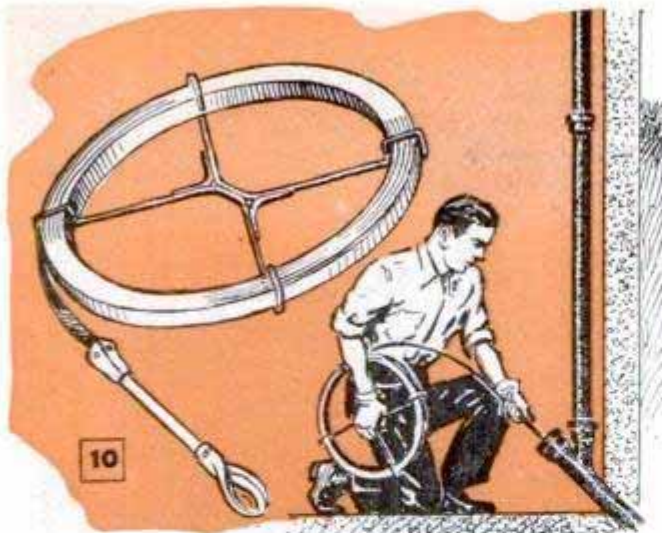

This pictures a 50-ft. flat spring-steel "snake" having a rotating spear end and a self-adjusting handle

finally, follow with a chemical flushing.

**House-to-street sewer stoppages:** Waste water backing up through the basement floor drain indicates a clogged pipe from the house to the street sewer, or to the septic tank in the case of an individual disposal system. Among the causes of such stoppages are sagged drainpipes, Fig. 13, cement left projecting inside the pipe, Fig. 14, and tree roots. Usually, there are clean-out openings in the basement as shown at detail D, Fig. 1, where a drain auger can be inserted. Another effective tool to use in clearing the soil pipe is a plumbers' "snake," Fig. 10. This is a flexible steel band which is available in various sizes, and is used by pushing it through the sewer with a back-and-forth motion. However, if the use of this tool does not start drainage, it will be necessary to have a plumber take over with larger and stronger equipment.

**Tree roots in sewers:** The majority of stoppages in vitrified clay-tile drains running from the house to the street are caused by tree roots. Some trees, particularly willows, poplars and cottonwoods, often send their roots out as far as 20 or 30 ft. A slight crack in a joint between the sections of pipe, which may have been caused by settling, permits tiny roots to work into the tile, Fig. 12. Once inside, the roots send out countless shoots, eventually filling the tile completely and often even breaking it as pictured in Fig. 11. Such root growths can be cut or torn loose with an auger or snake, but this is a laborious and time-consuming job. Here, it is recommended to have a plumber clear the pipe with a motor-driven rotary cutter.

**Root eradication with chemicals:** It is possible to prevent root growth by using chemicals, some of which are specifically prepared for this purpose. Also, repeated applications of caustic drain-cleaning chemicals, previously discussed, will be



A sewer tile completely clogged and even broken by the dense growth of tree roots, some  $\frac{1}{4}$  in. thick

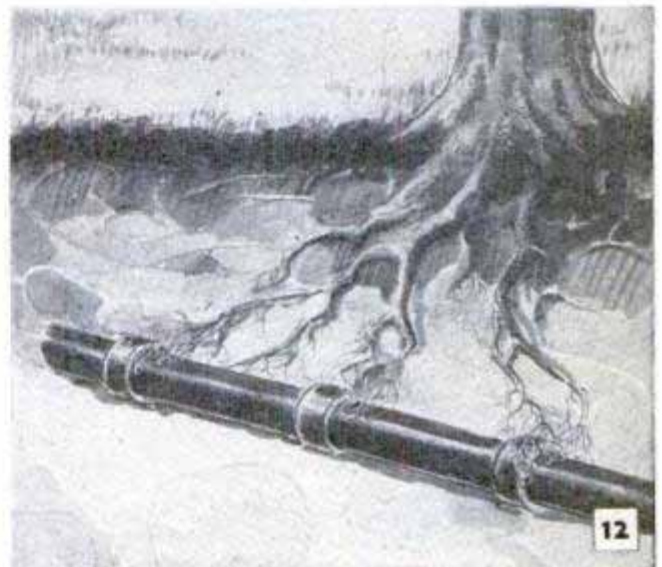

Hair ends of roots from trees located as far as 20 ft. from tile often work way through tiny cracks

found effective in "burning" and eating away tree roots. Copper sulphate, too, has been found effective for killing roots, after which they break off and wash away. However, copper sulphate should be used only in drains which are free from grease, as the chemical coagulates with grease and forms a nonsoluble, fatty-acid substance which can clog a drain. The chemicals can be applied at any cleanout or drain opening, and should be used regularly to keep the roots from spreading. Application should be more frequent in spring and early summer when growth is rapid.

Removing roots from pipe by either mechanical or chemical means is only a temporary measure and must be continued persistently to forestall trouble. Such measures are of value particularly during winter months when the ground is frozen and the work of digging up a pipe is a major and costly undertaking. Of course, for a permanent solution of the problem, the pipe should be repaired or replaced. If it can be located, the portion of pipe that is nearest

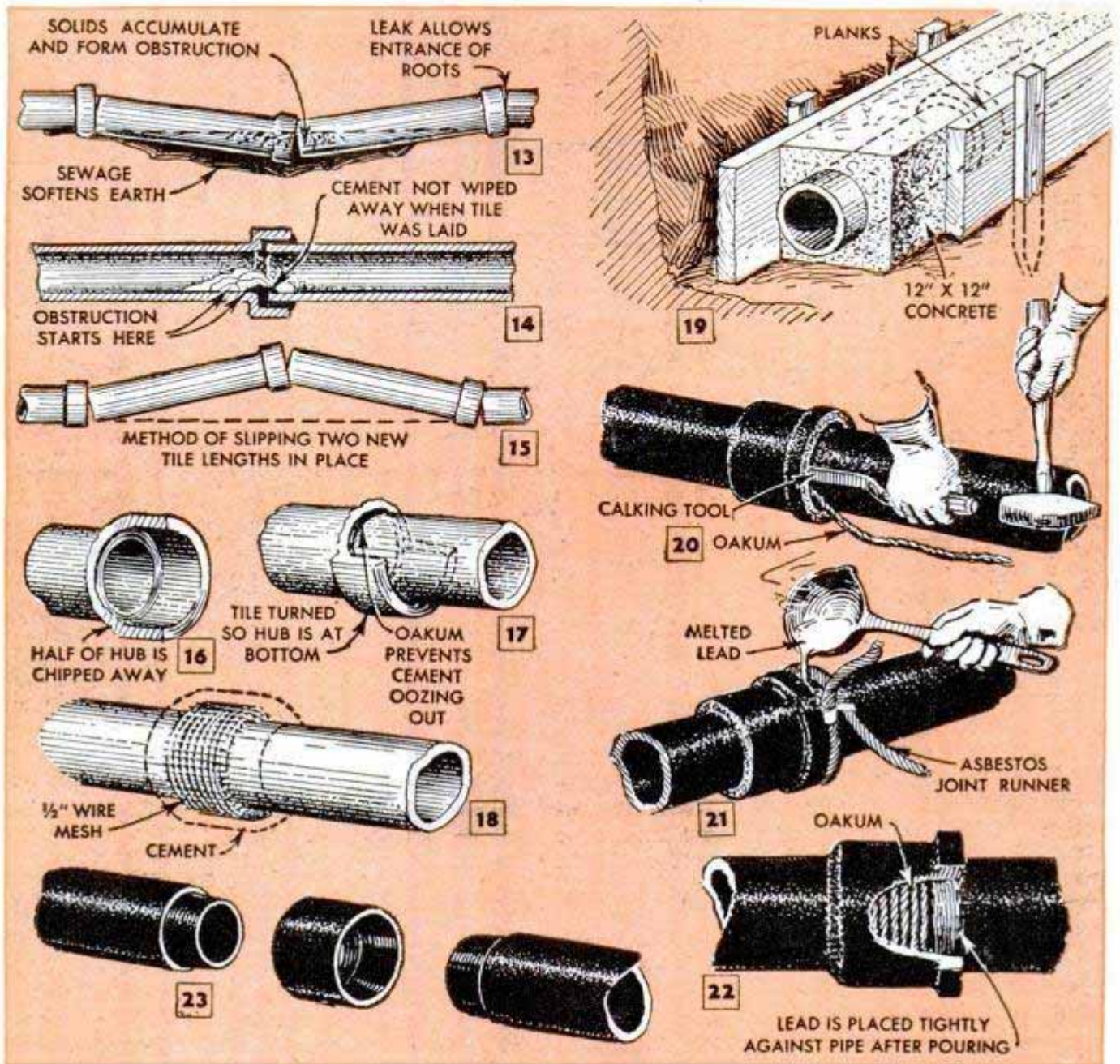

to the offending tree should be uncovered first, instead of digging up the entire line as is often done. The roots are cut away from the pipe which then is examined for possible damage.

#### Repairing and replacing outside pipe:

Damaged tile pipe usually must be replaced. After removing the cement from the ends of the pipe to which the new lengths are to be joined, the latter are slipped together by holding them at an angle as shown in Fig. 15. The best method of sealing the joints is to use oakum first and then cement. The oakum prevents the cement from oozing inside the pipe as shown in Fig. 14. If only one length of tile needs replacing, remove half of the hub with a cold chisel, Fig. 16, permitting the pipe to be slipped into place, after which it is turned so that the remaining portion of the hub will lie under the adjacent pipe as in Fig. 17. Then wrap the joint with wire mesh, Fig. 18, and finish by applying cement. If the pipe is not seriously damaged

by tree roots, clean out the joint where the root entered and simply plug it with thick asphalt roofing cement before pouring a sleeve of concrete around it. This method, shown in Fig. 19, is relatively inexpensive.

A still more permanent method of eliminating all future drainage trouble caused by tree roots is to install regular soil pipe and "yarn" the joints with oakum, as shown in Fig. 20. The oakum is twisted to form a rope and about five or six turns are tamped tightly into the hub with a calking tool. This is followed by pouring melted lead over the oakum to within 1/2 in. of the end of the hub. An asbestos joint runner, Fig. 21, is needed to hold the lead in place until it solidifies. As the lead shrinks slightly in cooling, it is necessary to pack the lead tightly against the sides of the pipe with a calking tool and hammer. The finished joint is shown in Fig. 22. A hard composition pipe is sealed against the entrance of tree roots as shown in Fig. 23. The pipe ends are tapered to fit snugly into couplings.

W L M - 51

If you have an attractive glass decanter or a deep bowl, it can be displayed to best advantage by using it as a hanging plant holder or, if decorative enough in itself, it can be hung empty from a wall bracket. An eye-catching hanger that will conform to the shape of the container is easy to make from heavy colored wrapping cord. Using eight strands of cord, each about 1 yard long, knot them all together  $1\frac{1}{2}$  in. from one end to form a tassel at the bottom of the hanger. Then, dividing the strands into four pairs, knot each pair of strands together and knot one of the strands from each pair to the adjacent strand of the next pair. Thread colored wooden beads on the pairs of strands formed by the last knots and slip them down as far as they will go. Weave the upper 12 in. of all the strands together and bring the end of the braid

## Knotted Hangers Suspend Decorative Bottles To Hold Trailing Vines or Artificial Flowers

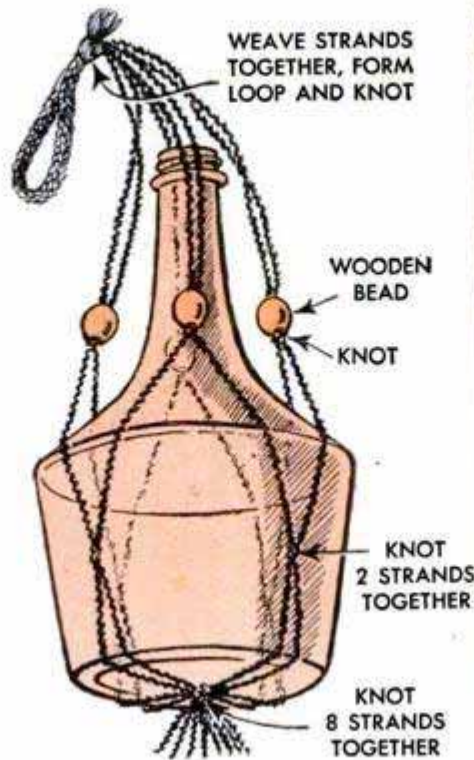

around, knotting or sewing with matching thread to form a loop. A large tapestry needle will be helpful in threading the beads on the strands of cord.

around, knotting or sewing with matching thread to form a loop. A large tapestry needle will be helpful in threading the beads on the strands of cord.

## Sheet-Metal Setting Plate Facilitates Chucking Irregularly Shaped Castings

This simple setting plate has proven to be a time and labor saver for machinists in job shops where it often is necessary to chuck a run of castings of irregular shape for machining. The problem, of course, is how to center the castings in a four-jaw chuck without resort to repeated use of the trial-and-error method. To speed up the job, cut a circular plate from heavy sheet metal to the same diameter as the chuck body. Center a light punch mark on the plate and scribe perpendicular lines using the mark as a center. Then scribe equidistant concentric lines the same distance apart as those on the face of the chuck

body. Center a hole through the plate of the same diameter as the hole in the casting. To use, place the work on the plate and center it by passing a rod or shaft through the hole in the casting and into the hole in the plate. Turn the work by hand to determine the best position for chucking. Then, by noting the position of the work with respect to the intersecting perpendicular and concentric lines on the plate, it is easy to set the chuck jaws to take the shape by simply running the jaws down to lines on the chuck body which correspond with those on the plate. Once the position of the jaws has been located to take the first casting, duplicate castings can be chucked rapidly and with sufficient accuracy for ordinary machining operations.

H. Moore, Hamilton, Ont., Can.

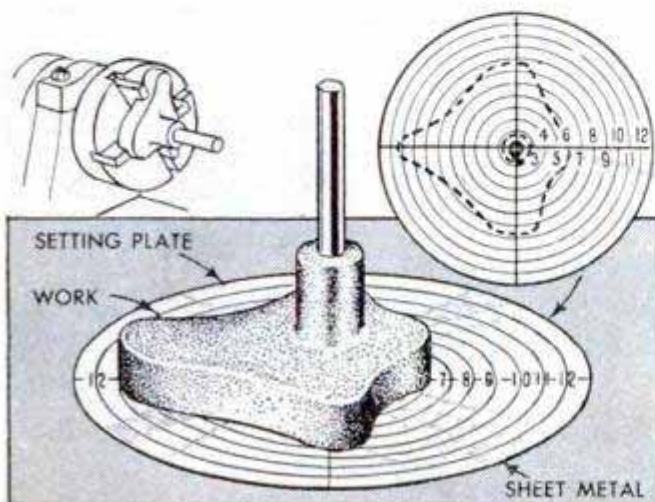

## Amount of Paint Left in Can Indicated by Pencil Mark

Before recapping a partially used can of paint, check the level of the contents and indicate it on the outside of the can by marking with a red pencil. Then, when you need paint in the future, you can tell at a glance whether or not there is a sufficient amount of the desired color on hand.

Ira M. Freeman, New Brunswick, N. J.

## Bench-Top Cabinet for Small Tools Has Convenient Slanted Shelves



Set at a rear corner of the workbench or table top, this little tool cabinet holds screwdrivers, chisels, files and bits for immediate selection. Note that the shelves of the cabinet are slanted forward at an angle of approximately 45 deg., the tools being retained by cleats fastened along the front edges of the shelves. In addition to allowing the tools to be seen at a glance, the slanted shelves make it necessary to store the tools side by side and handle end down, thus protecting the cutting edges of chisels, gouges and similar razor-sharp tools.

Paul Will, Chicago.

## Hidden Switch Foils Car Thief

Installed in one lead wire of the solenoid starter switch, this hidden car switch differs from the usual variety in that it will prevent a thief from starting the motor by connecting a jumper wire between the battery and ignition coil. The switch is con-

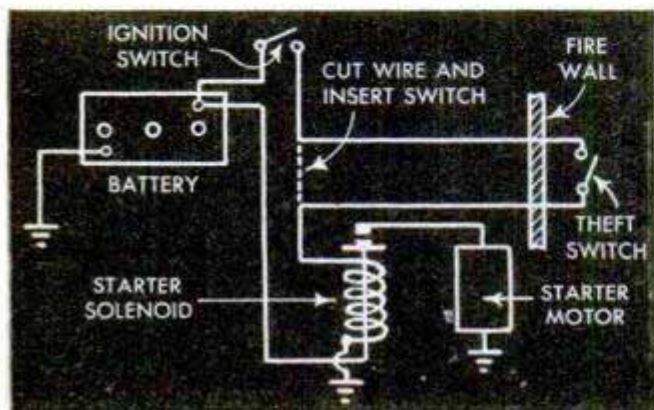

cealed in the glove compartment or under the dashboard and the leads are brought through a hole in the fire wall. The leads are taped and located under the other wiring so that they are inconspicuous. Thus, unless the potential thief is able to locate the leads or the hidden switch, he would have to push the car to move it.

H. Zave, Chicago.

## Clothes Pole Kept From Slipping By Inserting Rubber Liner

To keep a clothes pole from slipping sideways or blowing down, fit the notched end of the pole with a rubber liner. Cover the inner surfaces of the notch with inner tube, fastening it in place near the ends with stainless-steel or copper tacks. Then trim the rubber flush with the sides of the pole.

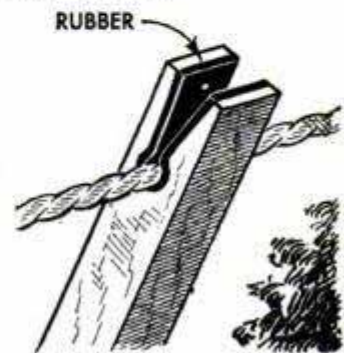

N. C. Darling, Orleans, Mass.

## Use Paraffin as a Lubricant

A block of paraffin is a handy item to keep around the house. In many cases, it can be used as a lubricant, being ideal to correct sticking window sash. Rubbed on the screw threads of a car jack, it will lubricate them and prevent rust and, also, it is an excellent lubricant for saw blades.

B. Halpern, Jackson Heights, N. Y.

## Weatherproof Order Board

Orders for the milkman, laundryman and other delivery people can be hung on the back porch without fear of their blowing away or being made illegible by rain if this plastic-covered order board is used. It consists of a plywood or hardboard backing, a sheet of plastic of the same size and a large paper clip.



The note is sandwiched between the backing and the plastic and the parts are clamped together with the paper clip. Then the clip is hung from a screw hook turned into the door casing with a pair of pliers.

Robert Hertzberg, Jackson Heights, N. Y.

# Sandbox With Built-In Seats Doubles as Table

Resembling a miniature picnic table, this novel sandbox features a removable top which can be replaced when it rains or used to convert the box into a neat outdoor play table. Except for the bottom which is sheet metal, the entire box is constructed from common lumberyard material, the legs being pieces of 2 x 4, the ledges at the ends 1 x 4, with practically all the rest of the members being cut from 1 x 6 stock. A piece of 3/4-in. waterproof plywood will serve as a top or one can be built up from several boards. Two flat-iron cleats, fastened to the underside, serve to hook the top in place.

R. V. Stewart, Cleveland, Ohio.

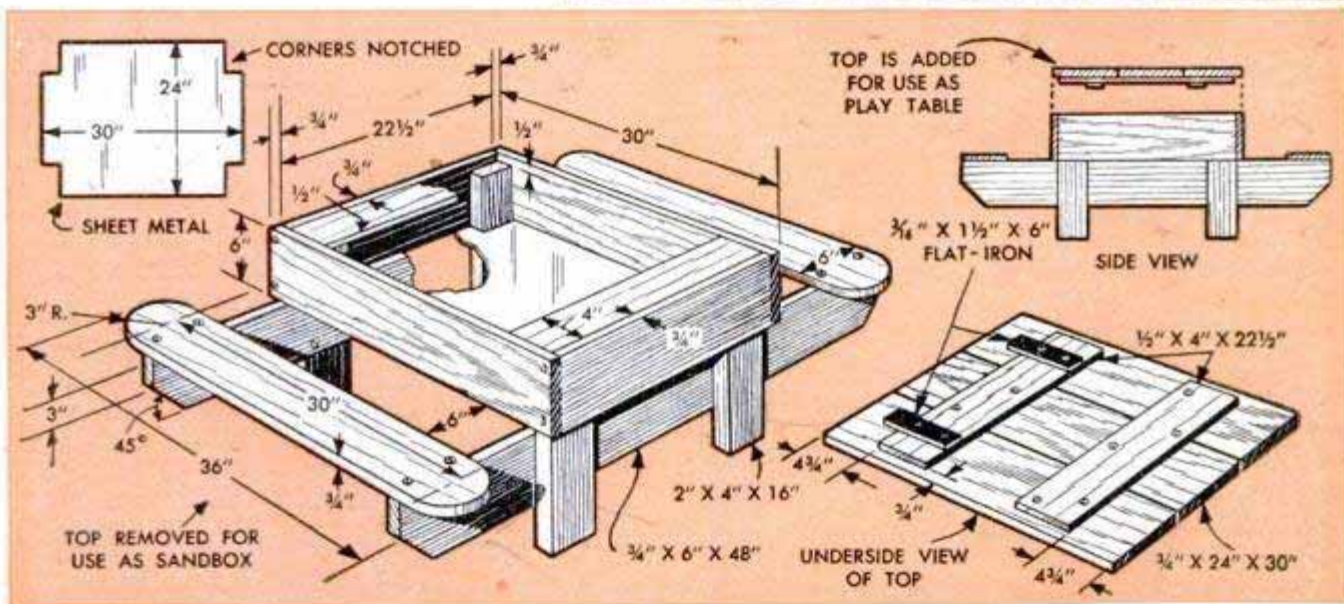

# Sheet-Metal Hanger Permits Individual Replacement of Broken Roof Tiles

It's not necessary to remove half the tiles from a roof to replace one or two broken ones if you use this easy method of attaching the new tile with a sheet-metal hanger. The first step is to remove the broken tile by sawing or cutting through the nail which holds it in place. Fitting a hacksaw blade with an improvised handle, by bolting and taping a piece of flat iron to it, provides a handy saw. The blade can be worked back and forth under the tile. A second method is to cut a notch near the end of an old hacksaw blade to form a hook. The edges of the notch are sharpened and the other end of the blade is wrapped with tape. With the notch hooked over the nail, a sharp downward pull of the blade will cut the nail in two, permitting removal of the tile. To install a new tile, nail a galvanized-iron strip to the roof, as in the left-hand detail. Then, slip the tile into position and

bend the end of the metal up and around the lower edge of the tile to clamp it tightly in place.

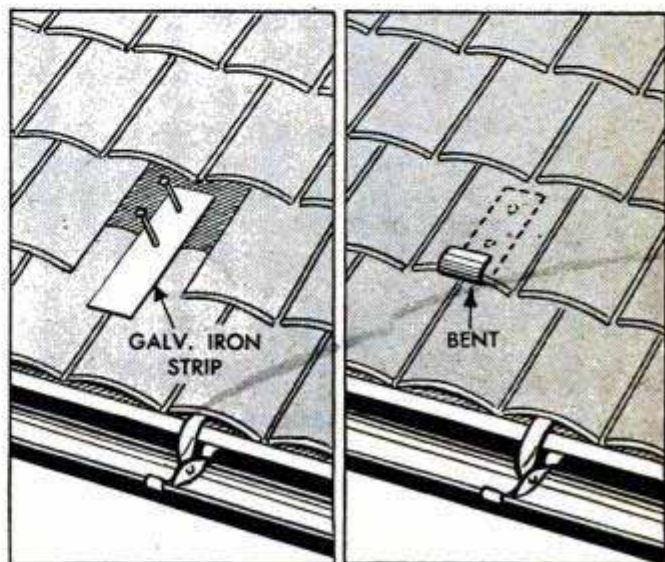

## Toy Pistol Shoots Rubber Bands

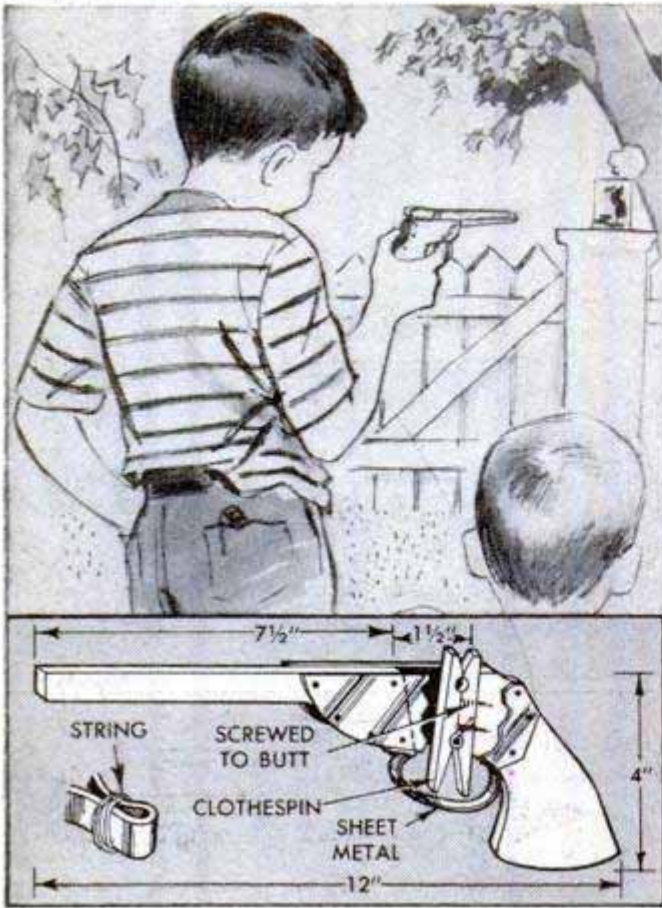

Made from two pieces of wood, sheet metal and a spring-type clothespin, this rubber-band pistol provides an entertaining toy. The wooden barrel and butt are joined with two sheet-metal plates fastened to the wood with brads. Before assembling the barrel and butt, the clothespin is taken apart and one arm screwed to the face of the butt. Then the clothespin is reassembled to form the trigger. A strip of sheet metal serves as a trigger guard. Note in the lower left-hand detail that the rubber bands which are cut from an old inner tube are wound with string at one end. When loading the gun, the ball formed by the string is gripped by the clothespin jaws. —Georges Normandin, Shawinigan Falls, Que., Can.

## Raise Your Own Bait Worms

WINDOW SCREEN



MIXTURE OF  
LEAF MOLD AND SOIL

knot holes, line it with window-screen wire and then fill it with a mixture consisting of equal parts of leaf mold and rich, loamy

A plentiful supply of bait worms will be available even in dry weather when they are hard to find, if you start a worm farm in a wooden box or half of a barrel. If the container has large cracks or

soil. A farm the size of a half barrel will accommodate about 300 worms. Dig them from rich garden soil, if possible, and place them on top of the earth in the barrel. The healthy worms will soon dig themselves into the soil, those that have been injured remaining on top. The latter should be removed and discarded. Keep the soil damp, but not too wet and store the barrel in a cool place. Baby-chick meal boiled for about 10 min. is an excellent food for the worm farm. When cool, this should be placed just below the surface of the soil. The worms are fed only once a week, and the uneaten food removed after 24 hours, as it otherwise will rot and cause the soil to become sour.

## Screen Disk Covers Fish Bowl

Small fish bowls can be filled almost to the top if they are covered with a screen disk to keep the fish from jumping out. Cut the disk from copper, aluminum or galvanized window screen and bend the edges down over the rim of the bowl. Then fasten a drawer knob to the center of the disk. This will serve as a handle and also as a weight to hold the lid in place.



Arthur Trauffer, Council Bluffs, Iowa.

## Handle at End of Lunch Box Aids Carrying in Crowds

If the corners of your lunch box jab fellow passengers in crowded busses or subways, attach a second strap at one end so the box can be carried vertically and, thus, take up less room. Cut two slits in the end of the box to receive a leather strap and bolt or rivet the strap securely to the sheet metal.

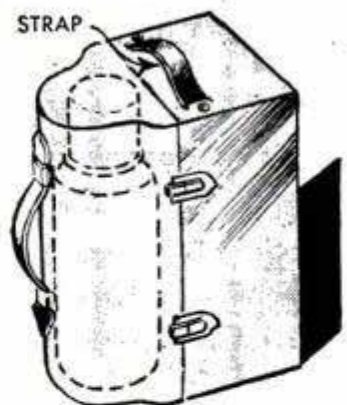

Harold Gould, Toronto, Ont., Can.

## Prolonging Cut-Flower Life

To get maximum life from cut flowers, keep them fresh longer by placing a couple of ice cubes in the water. Drop two or more ice cubes in the vase two or three times a day so that the water will remain cold.

Valentine Zadnik, Mantua, Ohio.

# FINGER TRAP

By Allan Carpenter

**F**UN TO PULL on your friends but difficult for them to pull off, this finger trap will provide an entertaining gadget to bring out at an informal get-together. When a finger of each hand is inserted into the ends of the trap, Fig. 4, the more the victim pulls to free his fingers, the tighter the trap grips them. The secret of getting loose, of course, is to push rather than pull and then gently ease the fingers out. To weave a trap, take eight strands of thin cane, strong paper or tape  $\frac{5}{16}$  in. wide and 36 in. long and double each strip in half. Next, insert the doubled strands through one another as in step A, Fig. 5, making four pairs, and then thumbtack them evenly around a  $\frac{1}{2}$ -in. dowel as shown in Fig. 1 and step B, Fig. 5. Now, treating each double strand as a single one, weave the right-hand strand over the top strand of the adjacent pair. This pattern of weaving is indicated in step C, which shows the four pairs stretched out. The step is repeated the full length of the trap, Fig. 2, watching to see that each "over" strand is followed on the next round of braiding by an "under" strand and vice versa. When the trap is about 6 in. long, Fig. 3, finish up the loose ends by inserting the top strand B between the strands of end A and tuck A under as shown in the right-hand detail, Fig. 5. Strands B are tucked the same way to complete the trap.



Each pair of doubled strands is laced through one another. Then pairs are spaced around a  $\frac{1}{2}$ -in. dowel and thumbtacked in place to hold them for braiding



An over-and-under weaving technique is used the full length of the trap. Four of the eight pairs of cane strands can be colored to produce a varied pattern

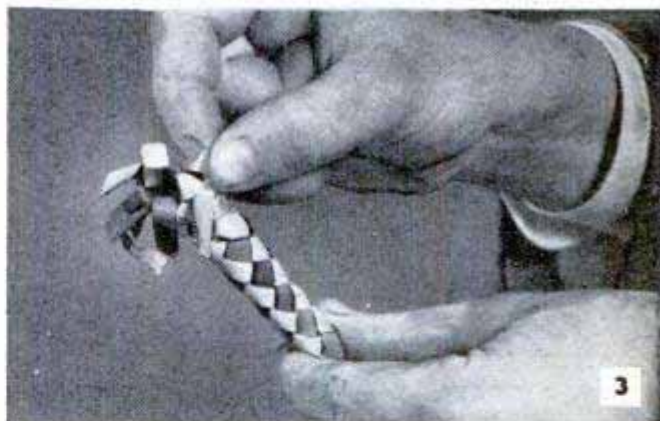

Above, when the trap is braided about 6 in. long, the loose ends are folded over and tucked under. Below, the more the fingers are pulled, the tighter the trap grips. Secret is to push and gently ease fingers out

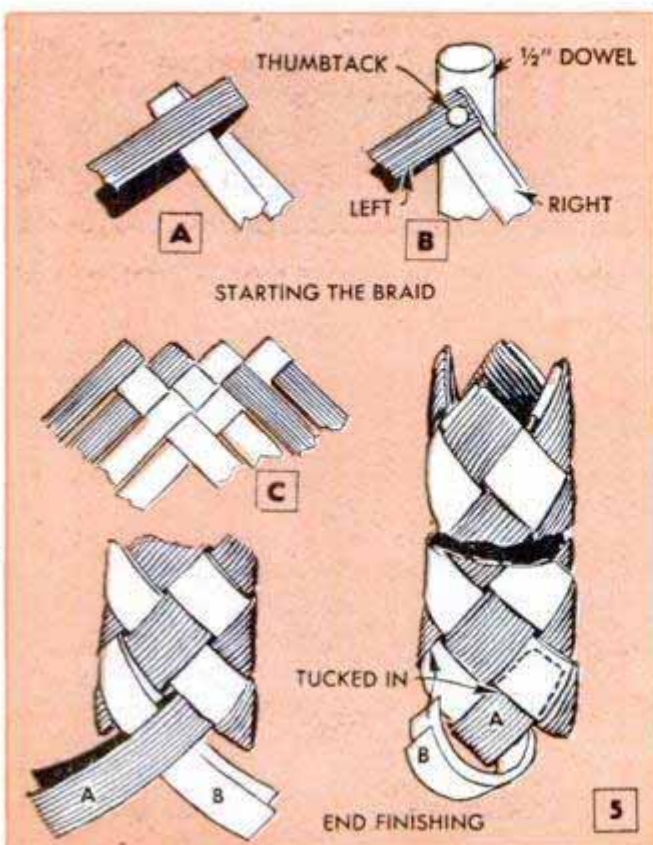

★

# ***Solving* HOME PROBLEMS**

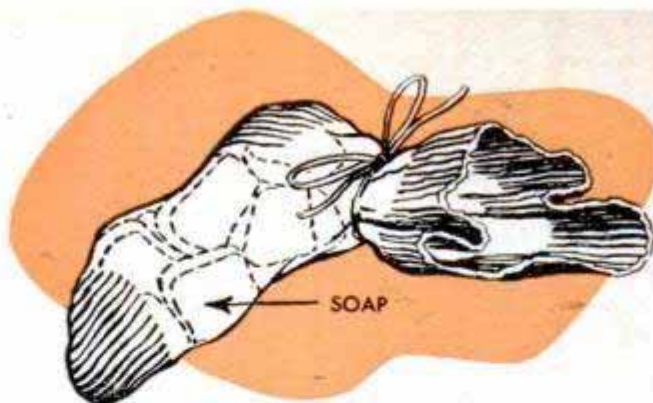

★

**ECONOMIZE ON LAUNDRY SOAP** by saving small scraps of toilet soap and tying them in an old sock. In this way, suds is obtained from the scraps without small pieces of soap being caught in the clothes



**FRUIT-JAR BREAKAGE** caused by jars bumping in boiling water is reduced by slipping a rubber over each jar

**FRICION-FITTING JAR COVERS** can be removed without bending out of shape if a knife blade is laid across the cover with the tip under the end of the can opener

**MOTHPROOF STORAGE** for woolens is had by placing them, along with moth balls, in tightly capped fruit jars. This is ideal for gloves, scarves and sweaters







**TO RESTORE THE NATURAL COLOR** to house-plant leaves, give them an occasional shower under faucet. Slit a square of oilcloth and place it around the stems of plant to keep the soil from being washed away



**POUNDING A CATCHUP BOTTLE** to remove obstinate contents is both hazardous and unnecessary. Next time, merely tap the neck of the bottle gently with the forefinger and watch the catchup flow out smoothly

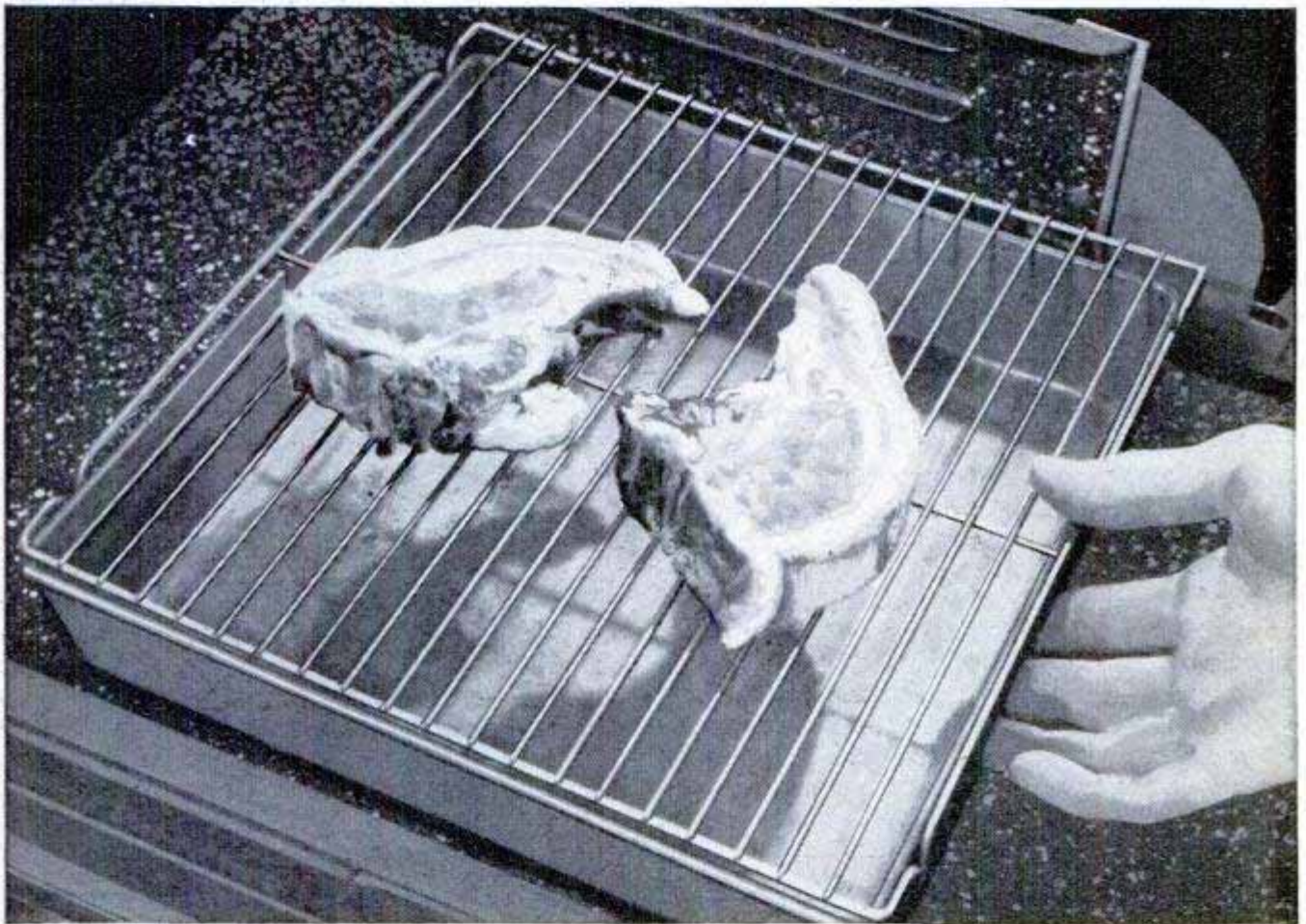

**USING SMALL CAKE PAN** and rack to broil a couple of chops saves the trouble of cleaning out the broiler

**FOR QUICKLY REMOVING GRIME** from fingernails, try using an old toothbrush. To stiffen the bristles sufficiently, cut them down to about  $\frac{1}{4}$  in. long

**A STURDY CONTAINER** made from bottom sections of two milk cartons permits carrying salad in lunch box. Crimp corners of one section and use other as cover

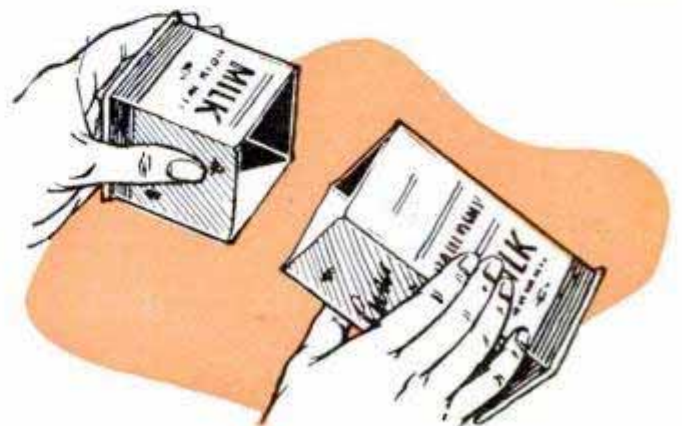
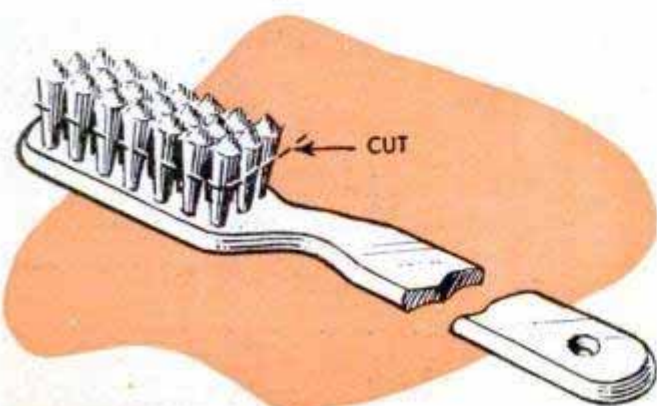

## Attractively Upholstered Youth Seat Fits Dining-Room Chairs



If dinner guests frequently bring their youngsters with them or if lack of space makes it difficult to use an extra youth chair in the dining room for your own child, make this raised seat which is upholstered to match the dining-room furniture. The seat is better looking and more comfortable than the heavy books or telephone directories usually used for this purpose and also is less dangerous, as it cannot slip off the chair. The seat is upholstered over a simple hardwood frame. First, furniture webbing is drawn taut across the top of the frame and then burlap is tacked over the webbing. Layers of moss and cotton are used for padding and the cotton is covered with fabric, the corners of the latter being cut and sewn together or folded so that the laps are at the front and back of the seat. The fabric is brought completely around the frame and tacked to the lower edge. Four hardwood cleats, which hold the seat on the chair, are finished to match the chairs and are attached with screws driven from the inside of the frame.

Victor H. Lamoy, Upper Jay, N. Y.

## Set Your Watch With a Compass

Should your watch stop while out on a hunting or fishing trip, it can be set to local time fairly accurately by employing the sun and a compass. Keeping the hour hand of the watch pointed directly at the sun by moving the hands, turn the watch until a pencil or a straight twig, placed halfway

between the hour hand and 12 o'clock, points north and south. The direction of the pencil, of course, must be checked carefully with the needle of the compass.

D. E. Horn, River Forest, Ill.

## Boat Pulley Prevents Rope Chafing

When a small boat is moored to a buoy or pier where there is considerable tide, the movement of the boat causes chafing of the rope and wearing of the gunwale strip. Rope replacement and wear can be reduced to a minimum by using a pulley to replace the chock. Obtain a pulley to suit the diameter of the rope and mount it on an axle welded to two iron side plates. Then, simply bolt the pulley assembly to four galvanized corner irons mounted at the proper angle on the gunwale.

Steve Wilson, Los Angeles, Calif.

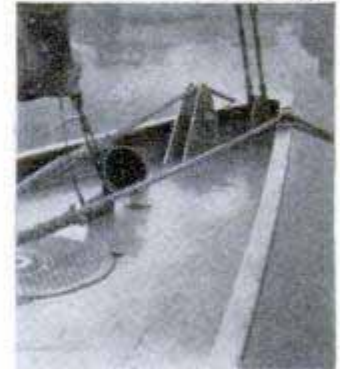

## Painting Rusted Galvanized Roof

Prior to painting a rusted galvanized roof, brush off as much of the rust as possible. Then, apply an iron-oxide or aluminum paint having a linseed-oil base, being careful to apply it very thin so that the paint completely surrounds rust or scale particles. Iron-oxide paint, which has excellent weathering properties, should last several years, while the reflective qualities of aluminum paint serve to keep the interior of the structure cooler in summer, also reducing the rate of deterioration.

## Soldering Without Distortion

By heating the work indirectly, silver-soldering or brazing small parts can be done without danger of distorting the metal. Stand a couple of bricks on end or provide some other means to support a piece of sheet metal. The work is prefluxed

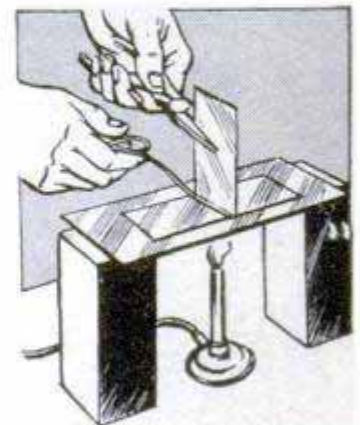

and the parts are held in position on the sheet-metal plate. A Bunsen burner is used to heat the underside of the plate and, when the work has reached the proper temperature, filler rod is applied to the joint.

Ernest A. Iversen, Westchester, Ill.

# MOVING-DAY POINTERS

Accumulating a small mountain of household items is a source of satisfaction, but moving them is a real headache unless you have the know-how. If you remember these tips from the experts—the members of the National Furniture Warehousemen's Association—moving day will pass without serious mishap

By Frank N. Stephany

**M**OST OF US move from one home to another at least once during a lifetime, and the moving job usually ends in a confusion of boxes and barrels, broken china and jangled nerves. All of this is unnecessary if you plan the job carefully and take a few simple precautions to assure that even the most fragile household items can be handled with safety.

Whether you do the moving job yourself or hire a furniture warehouseman to transport the furnishings, proper packing of breakables is of primary importance. Dinnerware and glassware as well as silverware and kitchen utensils should be packed in strong barrels or drums. When packing dinnerware, pad the bottom of the drum with a thick layer of excelsior or shredded newspaper. Then wrap the pieces in excelsior and several thicknesses of paper. Heavy dishes, such as dinner and soup plates, are packed first, standing the plates on edge instead of laying them flat. After the first layer of dishes has been packed, another bedding of excelsior is laid over it and a layer of medium-sized dishes, wrapped and packed in the same way, is added. The lightest pieces of dinnerware are packed nearest the top of the drum and covered with a thick layer of excelsior and newspaper.

Glassware is packed in a separate drum, using the same general procedure as for the dinnerware. However, if space permits, the glassware



Do not pack dresser drawers with heavy items. This makes the piece difficult to handle and may result in drawer breakage

Pillows folded double and placed inside a dresser drawer are lightweight and will hold the drawer in place while moving





Electrical appliances should be wrapped separately and packed in boxes or barrels. Note pads of folded newspapers inserted between the waffle-iron grids

Securely tie handles of brooms, mops and carpet sweeper to form a neat bundle. Curtain rods can be conveniently included. A used oil mop or oily rags should not be moved with the rest of the furnishings



Inside of stemware is filled and stem is padded with a liberal amount of excelsior or shredded newspaper. Piece is then wrapped with newspaper or tissue paper



As many as six or seven plates of the same size can be stacked and wrapped in a bundle. Use heavy padding of excelsior between plates and around stack

After wrapping, plates are packed on edge in a drum or barrel. Heavy pieces are placed at bottom and progressively lighter ones are packed as drum is filled





Rolling mattress can result in damaged springs and torn fabric. Instead, insert mattress in special carton provided by warehouseman. It's also a good idea to protect the mattress with a sheet or a mattress cover

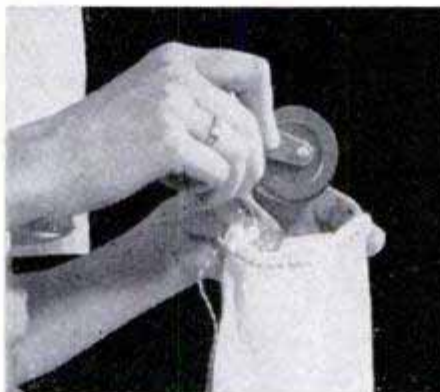

Each item which is not to be moved should be labeled accordingly. Suitable tags are supplied by the mover

Casters from each piece of furniture are removed and tied together or are placed in a special sack

Appropriate labels should be pasted to carton top and sides to insure careful handling of fragile items

For safety and ease of handling, books are packed on end and one row deep in strong cartons or boxes, left. Note bindings are placed back to back. Framed pictures may be packed between layers of linens, right





**Jewelry and cash should not be packed, but personal papers can be moved safely by locking in desk drawer**



**Above, lamp shades are wrapped individually with tissue paper and packed in a large carton. Below, a special wardrobe provided by the mover prevents wrinkled clothing and permits dustproof handling**



may be packed on the top layer of the dinnerware drum. Glassware is padded with excelsior and then wrapped with newspaper or tissue paper and, in the case of stemware, the stem of each glass is protected with a liberal padding of excelsior and wrapped with paper. Stemware is always packed on the top of the other glassware, that is, in the final layer placed in the drum.

Large framed pictures, mirrors and marble or glass furniture tops should be wrapped and crated, padding them carefully with excelsior. Linens, curtains, blankets and wearing apparel are packed in trunks or cartons, the latter being lined with brown wrapping or tissue paper to protect the contents from dust. Do not use newspaper as a liner, as the ink may soil the fabric. A dustproof wardrobe, which can be obtained from the mover, will solve the problem of packing and safely transporting suits, coats and dresses.

Cramming dresser drawers with linens or filling them with heavy objects not only makes the piece hard to handle but might result in breakage of the drawers. Instead, leave the normal amount of linens in the drawers or pack a few items of bric-a-brac in them. Placing a couple of pillows, folded double, in each drawer is the best way of utilizing the space. The extra weight is negligible and the pillows tend to keep the drawers from slipping out of the dresser. Bedding should be placed in a separate carton or bundled and wrapped in a sheet. The trick in moving your books without damage is to pack them on end in a strong box or carton. Books should be packed one row deep in each carton, with the bindings back to back. Wrap the most valuable books individually. Do not overpack cartons, baskets or barrels or they may be too heavy for the mover and will not permit stacking in the van.

Have the refrigerator serviced and the motor bolted down before moving and then have it checked and reserviced before using it at the new location. Be sure that the refrigerator has been defrosted before moving. Casters should be removed from furniture and, to avoid confusion later, each set should be tied together and labeled. Don't pack anything inflammable and do not take the chance of moving partially used containers of liquids that might spill and damage the furnishings.

Remember to give your new address to the post office, bank and newspapers and magazines to which you subscribe. Order your telephone and public utilities discontinued. Finally, inventory your household items, briefly listing the contents of boxes and barrels. Have a plan as to where the furnishings are to be placed in the new home and instruct the mover accordingly.

## Camp Foodstuffs Kept Ant-Free in Covered Cans Hung From Ceiling

Sugar, jars of jam and small amounts of other foods used in the camp can be protected from ants by placing them in covered cans suspended from the cabin ceiling. Cut sections of dowel just long enough to fit between the sides of the cans, so that they engage the rims, and tie lengths of cord to the dowels. Slip cardboard disks over the cord to provide covers for the cans and hang the cord from hooks turned into the ceiling. To obtain the food from the cans, simply raise the covers a few inches and tilt the dowels to disengage them from under the rims of the cans.

Mrs. Alba Dias Desouza, Bombay, India.



## Bait Sack Attracts Catfish

If you want to bring home your limit of channel cats or 50 to 100-lb. flatheads, don't try to do it by hunting down the fish. Instead, make them come to your bait. To do this, fill a burlap or grain sack half-full of a mixture consisting of equal parts of cottonseed meal and hog tankage. Both items ordinarily can be obtained at the local feed store. Place a heavy stone in the bag and tie it. Attach a bottle float to the sack with a long line so you can locate it easily and then drop the bag in from 10 to 25 ft. of water. The catfish, attracted by the odor of the bait, will come long distances to try to reach the contents of the sack. As the fish will be in the vicinity of the sack, just lower your baited hook and you are sure to bring in a good catch. If the stock bait mixture is not available, use chicken or fish-market refuse or bloody meat scraps. In this case, place the sack out in the sun and allow the bait to ripen before dropping it in the water.

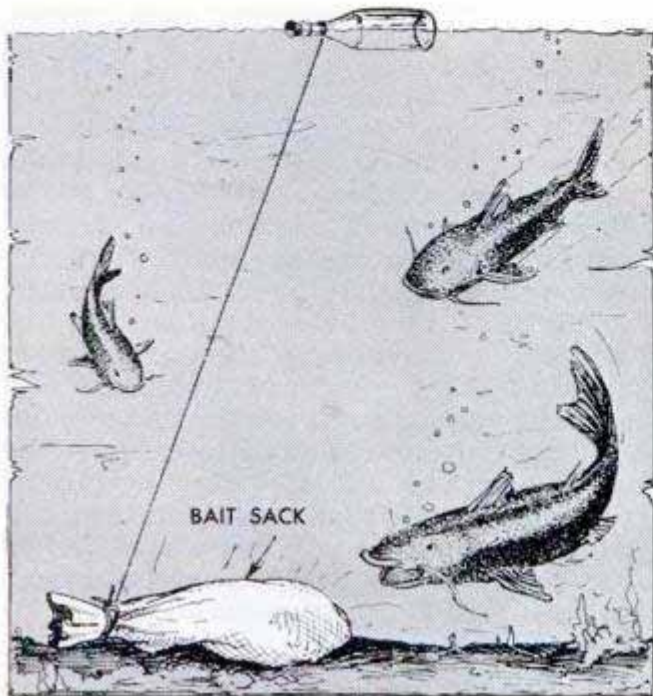

## Comb Marks Leather for Punching

Index marks for punching leather prior to lacing two pieces together can be made quickly and evenly with a coarse-tooth comb. Press the comb on the leather so that the teeth leave a row

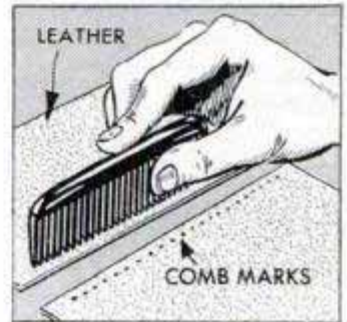

of clear impressions and punch through the impressions with an awl or other sharp instrument. To make sure that the holes are spaced identically in both pieces, the indented piece can be positioned over the other one before punching the holes.

## Improvised Dropping Bottle

When it is necessary to dispense a liquid one drop at a time and an ordinary dropping bottle is not available, one can be improvised quickly by using an eye dropper and a stopper. Bore a hole through the center of the cork and, after removing the bulb from the eye dropper, press the latter through the hole, as shown in the drawing. Be sure that the stopper is a tight fit in the neck of the bottle.

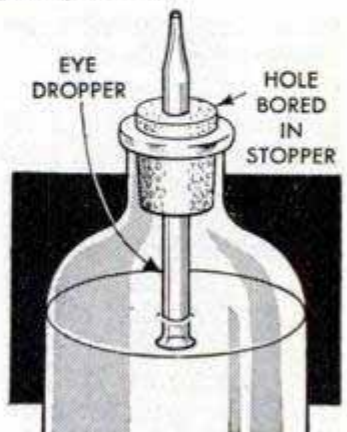



## *Pour Your Own*

By W. Arthur Heacock

# FLAGSTONE WALK

**W**HY PAY OUT a lot of money for flagstones when you can cast them realistically in concrete? It requires no special skill. A trowel and a shovel are the principal tools needed and the work is actually fun. The series of photos on the opposite page take you through the steps involved and illustrate convincingly what a simple job it is. The "stones" are cast right in place, using metal molds resembling large cookie cutters. The molds are bands of sheet metal which are bent into irregular shapes to closely resemble actual flagstones. These are fitted together like the pieces of a puzzle, being spaced about 2 in. apart and held in position with dampened soil. After each stone has been cast and allowed to set 24 hrs., the molds are removed and reused. The first thing to do is to lay out the width and desired curve of the walk, using a garden hose to establish its outline. Small stakes are driven along the outside of the hose and used to guide the placing of the molds. If a lawn already exists where the walk is to be located, the sod is removed to a depth of about 1½ in. Take out only enough sod to accommodate the number of stones to be laid at one time. In this way, the walk can be built in stages

to suit your spare time without having the lawn torn up. The molds consist of sheet-metal strips 2½ in. wide and 5 or 6 ft. long. The ends of each mold are wired together through holes punched in the metal with a nail. Keep the molds large and varied in shape, no two being alike nor smaller than 1½ ft. across.

A 1-2-3 mix is recommended for the concrete fill, that is, one measure of portland cement, two of sand and three of pea gravel. Tamp the concrete firmly in the molds so that it puddles at the top and then rake off any surplus flush with the top of the molds, using the edge of a straight board. A little crown is preferred in troweling the stones so that they will shed water. Avoid using an edging tool around the outer edges of the molds. It is better to let the mold chip the edge of the concrete as it is removed so that it resembles a regular hand-cut flagstone. The molds usually can be removed the following day by merely cutting the wires that hold them together. After the metal bands have been pulled free, some of the dirt is scooped out from between the stones and replaced with strips of sod, keeping the latter lower than the tops of the stones.



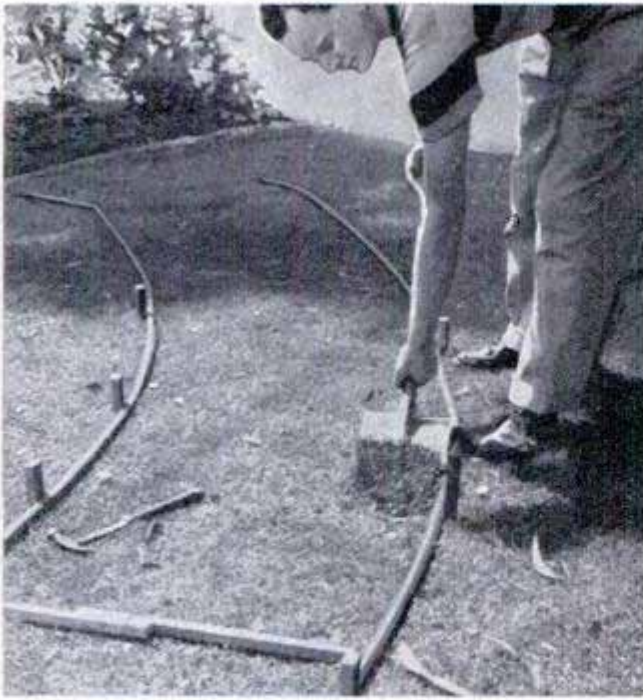

1st. A garden hose is used to establish the outline of the walk. This is staked in position and then the sod is removed, some of which is saved for filling in around the flagstones after the molds are removed



2nd. The sheet-metal bands which form the molds are made "endless" and then bent into irregular shapes, no two being alike. The ends of the bands are wired together and molds are placed as desired 2 in. apart

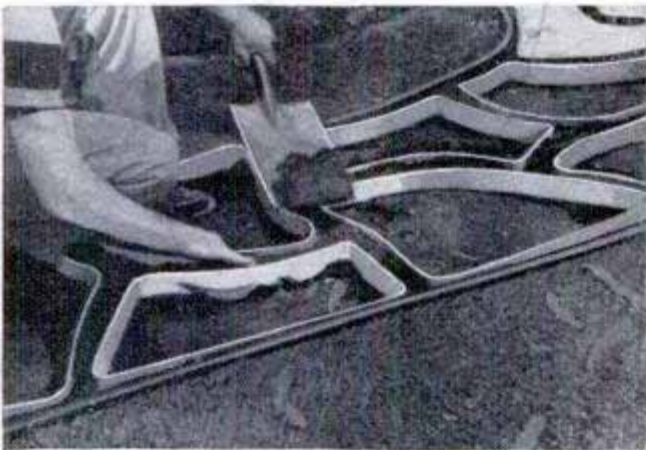

3rd. Wet soil is used to hold the molds in position. Part of this is later removed and replaced with sod



4th. Molds are filled level with concrete, tamped and troweled. Straightedge is used to rake off excess

5th. Removal of the sheet-metal molds is easy. Just cut the wire holding the ends and jerk the strip free



6th. The edges of the "stones" are scraped lightly and sod is placed between them  $\frac{3}{4}$  in. below top

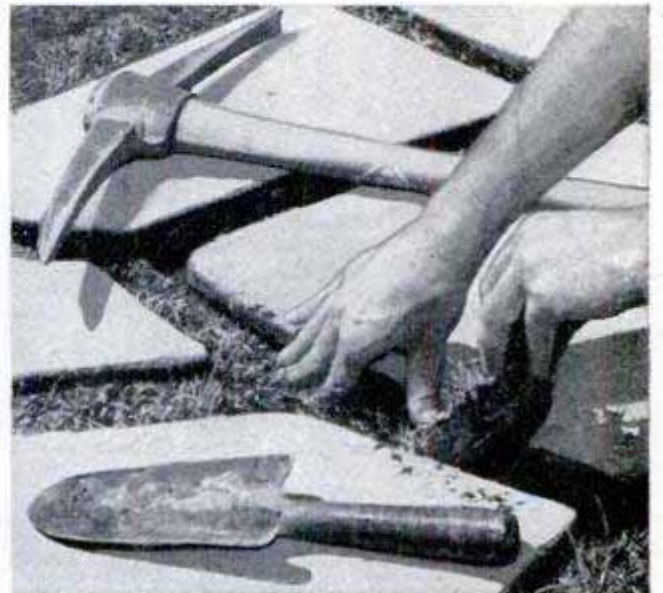

## Pipe Extension Lowers Swing Rope To Compensate for Slant of Limb

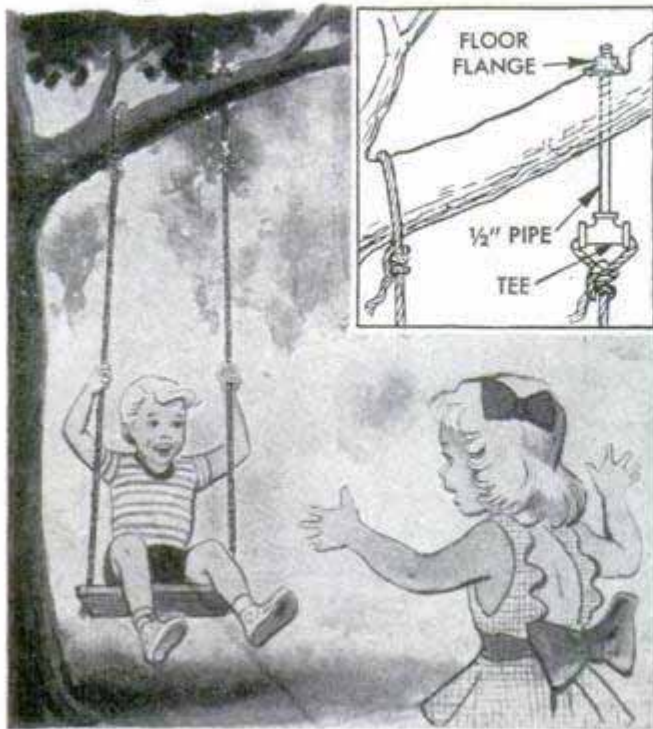

To make the ropes pivot at the same level when hanging a child's swing from the slanted limb of a tree, tie the outer rope to a pipe extension. Hung in this way, the swing will move in a straight arc. Cut a flat on the upper portion of the limb at the point where the outer rope is to be hung and drill down through the flat to permit inserting a length of 1/2-in. threaded pipe. Pass the pipe through the hole and fasten it with a floor flange as shown in the detail. Then turn a tee on the lower end of the pipe and tie the swing rope through the hole in the tee. The extension should lower

the outer rope so that it pivots at exactly the same level as the inner rope.

Dr. Bernard Matzen, Napa, Calif.

## Disposable Glue-Can Cover

A square of wax paper placed over the top of a glue can provides an easily removed and disposable cover. The glue left on the rim of the can will hold the paper in place tightly enough to prevent the glue inside from hardening. The paper is quickly torn off when the glue is to be used and then replaced with a new piece.



Benj. Nielsen, Aurora, Neb.

## Varnish Remover Softens Filler

When refinishing an old piece of furniture, varnish and paint remover will take off the old finish. However, the stain and filler still remaining in the wood present a hard glazed finish that quickly dulls the edge of a scraper. The surface can be scraped without difficulty if a thin coat of varnish remover is applied to the wood before scraping. When working on a large surface, apply the remover to only one section at a time so it does not dry out before scraping is begun. Be sure to clean the tool thoroughly after the job has been completed.—Earl W. Hill, London, Ont., Can.

## • Popular Mechanics Build-It-Yourself Homes •

IF YOU CAN use a hammer and saw and mix concrete, you can build one of these homes yourself and save at least 50 percent of its cost, just as other Popular Mechanics readers are doing. Enlist the aid of your friends and go to work now so that you can move into your new home next fall. You have a choice of a masonry or a frame home. Plans and a book that give step-by-step instructions on building each house are available from Popular Mechanics Press, 200 E. Ontario St., Chicago 11.

### MASONRY HOME FOR \$3650

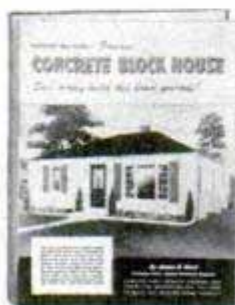

This modest home has two bedrooms, bathroom, utility room, large living room and cabinet kitchen. It has concrete floors and is insulated. Walls and concrete floors are vapor-sealed to prevent penetration of moisture. The home was built of lightweight concrete blocks complete with kitchen cabinets and a gas-fired furnace at a cost of \$3650 for materials. It also can be built of brick or other masonry materials. The book,

\$2.00. A set of 10 blueprints, \$12.00. Book and plans ordered together, \$12.50. Extra sets of blueprints can be purchased for \$5.00 per set.

### FRAME HOME FOR \$7000



A larger and more pretentious home than our masonry home, this frame-type house was built as pictured complete with two bedrooms, living room, cabinet kitchen and dining nook, plus breezeway and garage, at a cost of approximately \$7000 for materials, including hot-air furnace. There is space upstairs for three additional rooms. This home can be built in four other styles at less cost by leaving off breezeway and garage. The book for this house is \$3.00; blueprints, \$12.50 per set. Book and plans together are \$14.00. Extra sets of plans are \$5.00 per set.

# TIMER-SWITCHBOARD

*for your darkroom*

By Richard C. Collins, Jr.

**F**EATUREING finger-tip control for your various photo processing equipment, plus a built-in electronic print timer, this compact darkroom switchboard fits in a standard sloping-front instrument case measuring only  $4\frac{1}{2} \times 4\frac{1}{2} \times 7\frac{1}{2}$  in. Besides the timer, gang switches and outlets are provided for a print drier, safelight, enlarger, clock, enlarger meter and a white light, all of which plug in from the back. In addition, the switchboard has an enlarger-focusing switch, a push-button exposure switch and a master switch to turn the unit on and off. The timer, which is wired so that the safelight remains on except during the actual exposure period, requires a warm-up period of 20 to 30 min. and, when it is first turned on, the enlarger lamp will light, but shortly afterwards it will automatically turn off. The exposure period is controlled by a potentiometer which is first set by a pointer to the desired interval and then the exposure button is pushed. This causes the plate current in the grid tube to drop and the relay to cut in to light the enlarger. Actual exposure time is the time required for the plate current to build up again to the point where it actuates the relay and automatically breaks the circuit. The dial of the timer is calibrated from 2 to 60 seconds by plugging a self-starting electric clock into the enlarger outlet and setting the pointer at various positions on the dial. The elapsed time determined by the sweep second hand is marked on the timer dial.

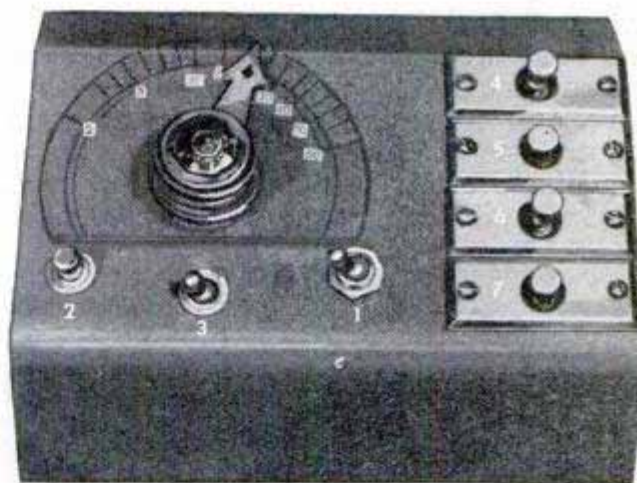
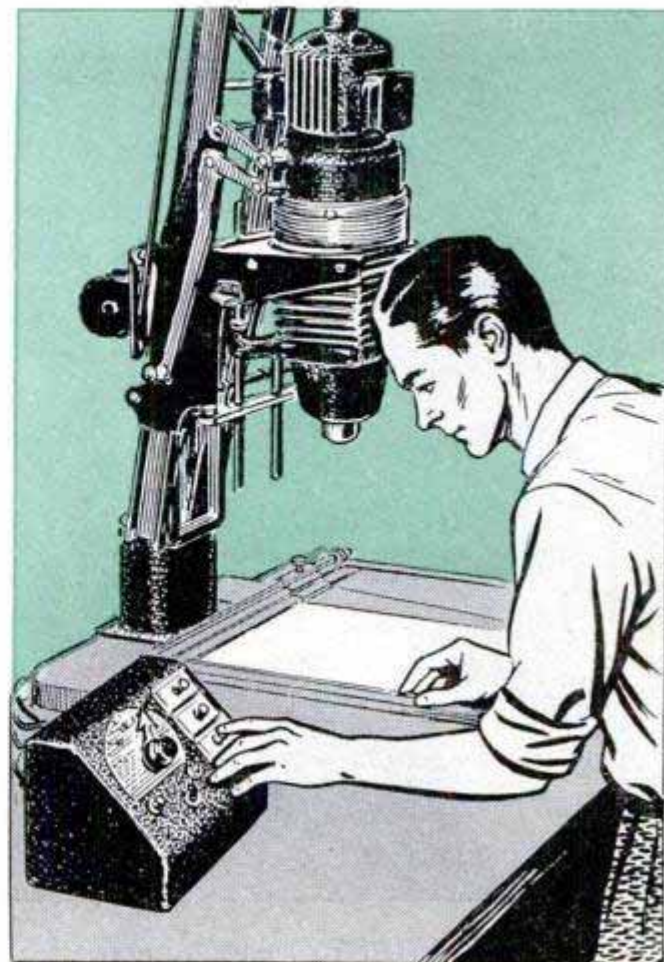

**KEY**

- 1. Timer sw. 2. Exposure sw. 3. Focusing sw. 4. Clock sw. 5. Drier sw. 6. Shut-off sw. 7. White-light sw.

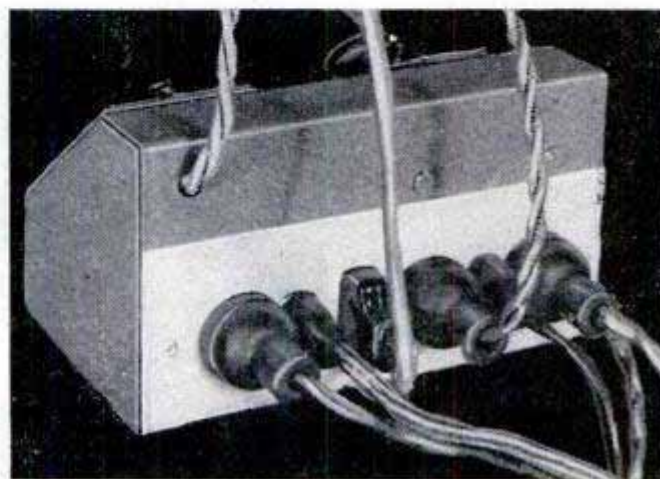
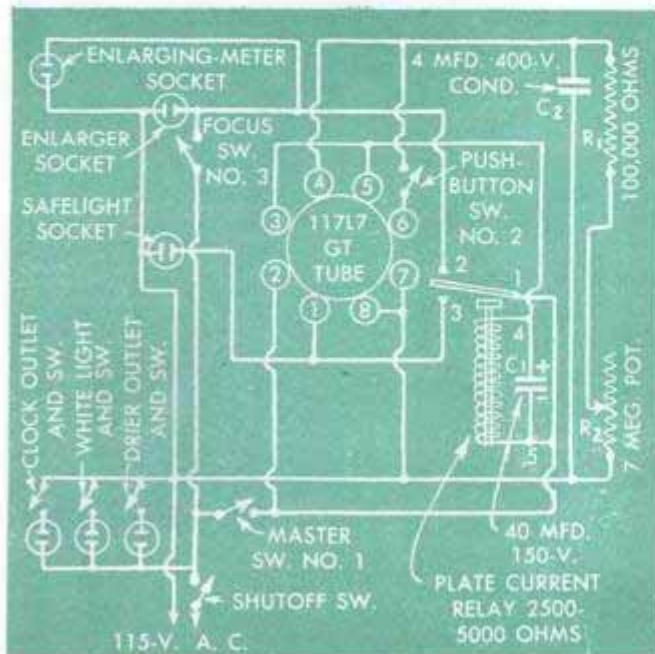

W T M - S W

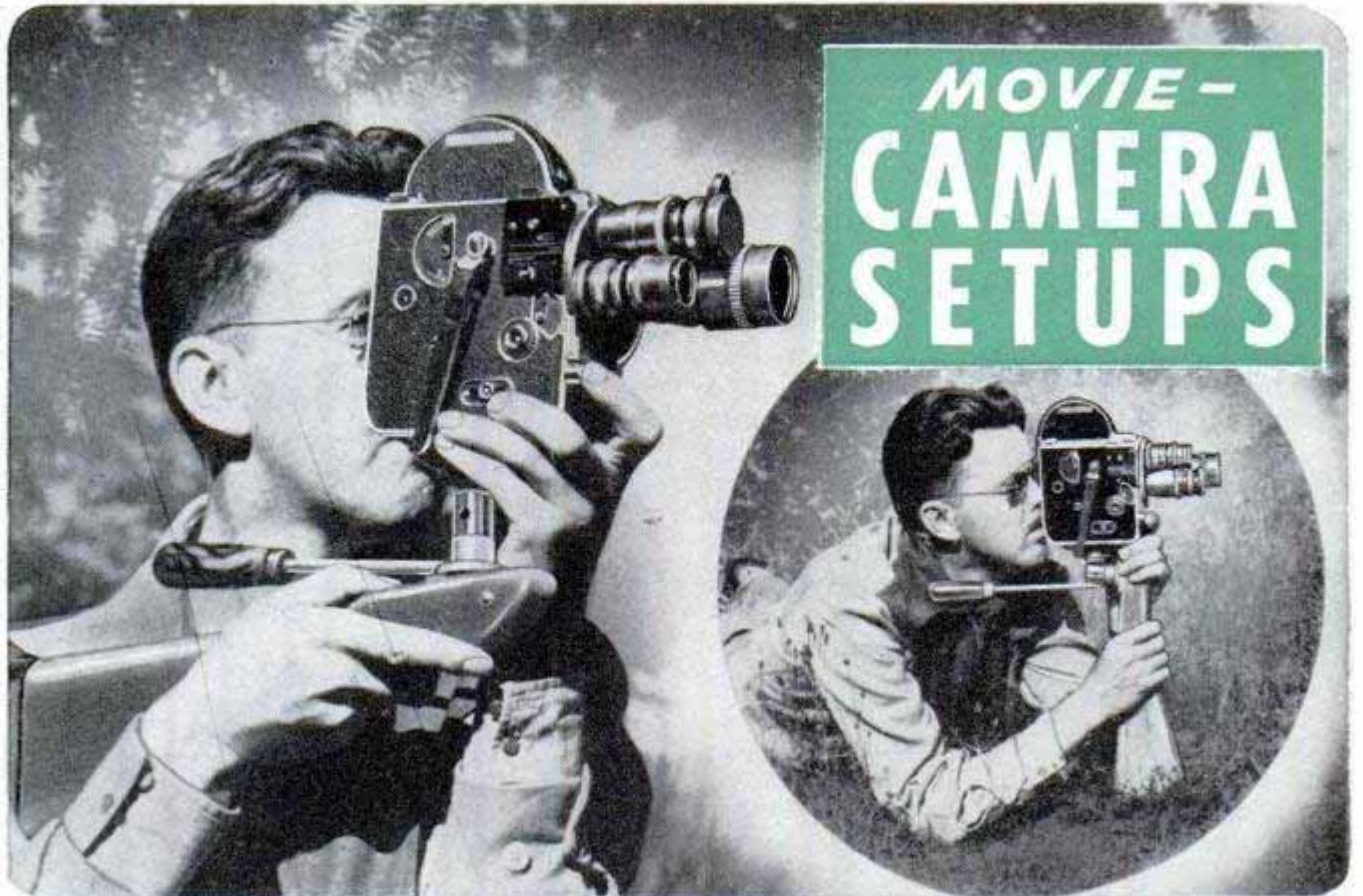

**MOVIE -  
CAMERA  
SETUPS**

**T**HE ENTHUSIASTIC cameraman who goes in for home-movie making in a big way will find these special camera setups and equipment not only helpful in filming the subject, but also a means of injecting novel and interesting effects into ordinary shooting techniques. For example, those who like to shoot close-ups of flowers, gems, mineral and insect specimens, tropical fish,

Above, fitting a pan head to the end of an old gunstock provides an excellent camera mount for stalking animal shots where instant readiness means getting the picture. The pan head makes the mount quickly adaptable to aiming the camera in a prone position

Below, to inject a bit of animation in an otherwise dead subject, this stunt will appeal to cameramen who shoot flowers, specimens, etc., close-up. Subject is filmed on disk supported by hand drill and rotated manually or by friction drive on projector

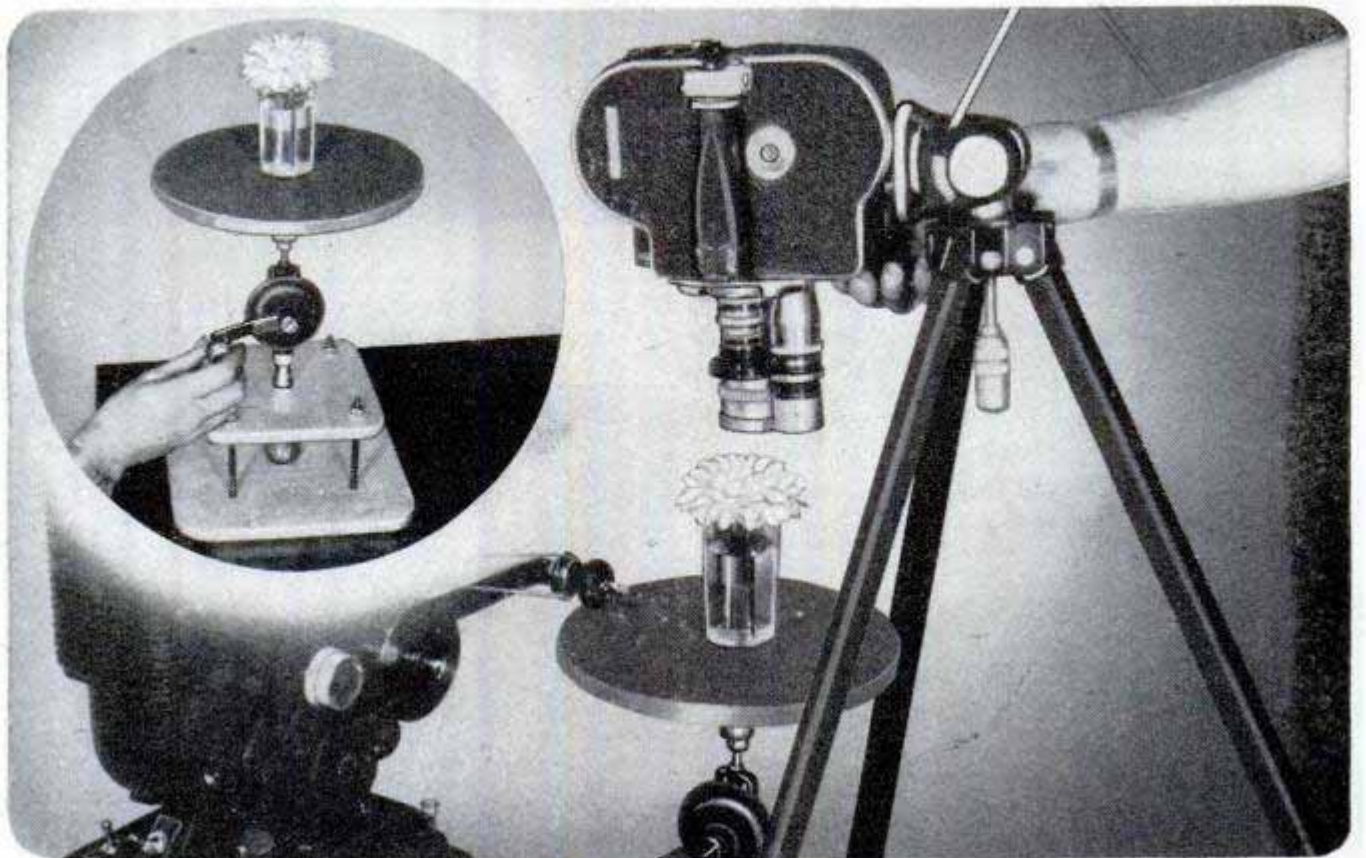

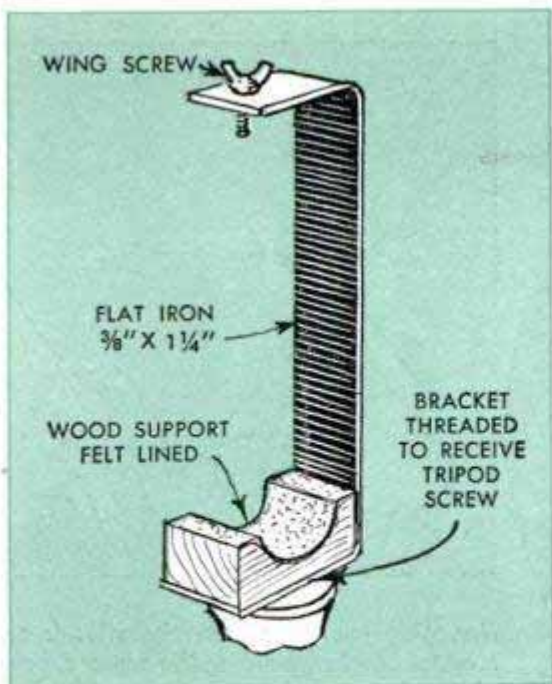

Above, right, shooting with the camera supported upside down and splicing-in the take will add considerable entertainment value to the presentation and, at the same time, eliminate the inconvenience of having to reverse the projector and then backtracking to resume showing. A simple bracket to hold the camera in an inverted position is detailed above. It's bent U-shape to fit the camera and both ends drilled and tapped, the upper one for a wing screw, the lower one for tripod screw. A padded block cushions the camera



Right, set up in the conventional manner, many tubular-type tripods, even when collapsed all the way, still do not permit extreme close-up shots of subjects close to the ground, such as growing flowers. However, by utilizing the handle of the pan head as an additional leg, the camera can be practically brought right on top of the subject. This still permits regular use of the pan handle, even if the handle is partially embedded in the ground to prevent accidental tipping of the camera



Right, many excellent still pictures that otherwise would be lost while making movies, especially action shots, can be taken simultaneously by mounting a still camera alongside the movie camera. A light auxiliary-type tripod head is used to support the still camera in line with the view finder of the movie camera, and a long cable release permits snapping the picture at the critical moment. Both cameras are attached to a special plate which, in turn, is fastened directly to the top of the tripod pan head



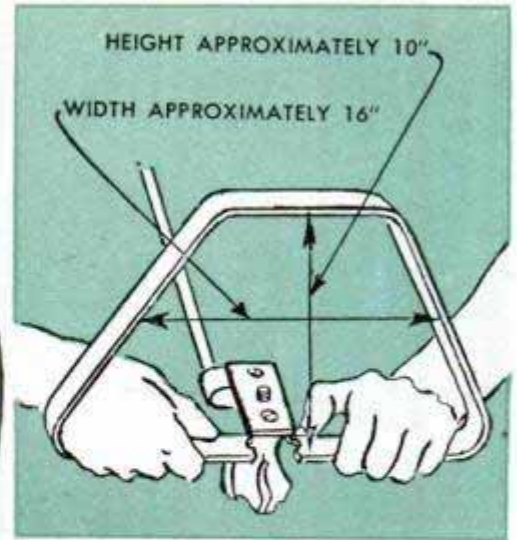

Mounting your clamp-on photofloods on a metal bracket, framing the camera, provides an extremely convenient method of following the movements of the camera with the lights. Method of attaching the bracket is determined by the camera, the one shown being held under the tripod base plate with a small machine screw

etc., will find that by shooting them on a rotating platform, as on page 210, the subject will take on animation and be exceedingly more interesting to view on the screen. Among the special equipment that can be made, the lamp holder pictured above provides an exceptionally convenient way of taking the lights with you. Tri-

angular in shape, the metal bracket frames the camera and permits three or more photofloods to be clamped to it. The holder is especially convenient when the tripod is mounted on a dolly, as the lights will travel right with the camera, eliminating the need for constantly moving lamps, as is the case when they are supported individually.

## Darkroom Tray From Plastic Dish Prevents Twisting of Roll Film

The tendency of roll film to twist when it is first immersed in the developer makes processing it in an ordinary tray a trouble-

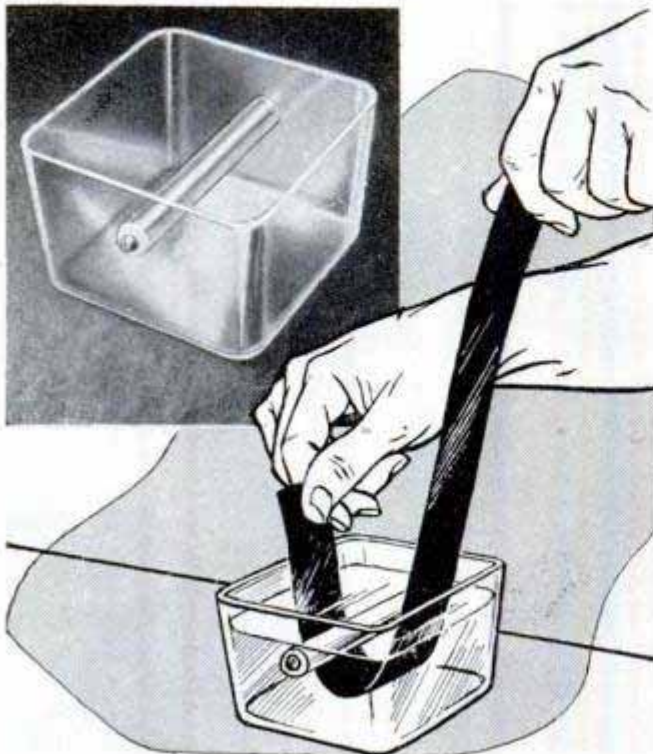

some job. This difficulty can be eliminated by using a small plastic utility dish as a developing tray. The dish, which measures about 4 in. square and 2½ in. deep, may be purchased for a few cents. A short length of ¼-in. plastic rod is fastened between two sides of the dish to serve as a film guide. Roundheaded brass machine screws are passed through holes drilled in the sides of the dish and threaded into undersize holes bored in the ends of the plastic rod. The screws must be drawn up tightly so the solution will not leak through the holes in the dish. It is not necessary that the rod revolve, as there is little friction and the smooth surface of the plastic will not scratch the film.

## Tape Identifies Developing Tank

To minimize the danger of contaminating developer with hypo, use a separate tank for each solution and never interchange them. Stick a piece of tape to the end of the tank used for the developer. In this way, you can identify the tank even in total darkness simply by feeling for the tape.



Photos and technical service courtesy "3M" Coated Abrasives Division, Minnesota Mining & Mfg. Co., St. Paul, Minn.

## Use The Right ABRASIVE

Part I

By W. Clyde Lammey

**S**ANDING the surface is one of the most important operations preparatory to finishing home-workshop projects built of wood. This must be done to remove hand-tool or machine-tool marks and also to smooth the surface of the wood so that reflective properties of the finishing materials are equalized to bring out the full beauty of the wood grain. By taking time to do a good job of sanding, using correct procedures and selected grades of abrasives, you can expect a finish of professional appearance and quality. In small home shops with limited equipment, sanding must be done entirely by hand, making selection of the abrasive and the manner of using it the most important steps in the finishing procedure. For sanding by hand on bare (unfinished) wood, there are four sandpaper grades, or grits in common use. Fig. 7 classifies these in sizes ranging from coarse to very fine. The table, Fig. 7, also gives the grit numbers by which

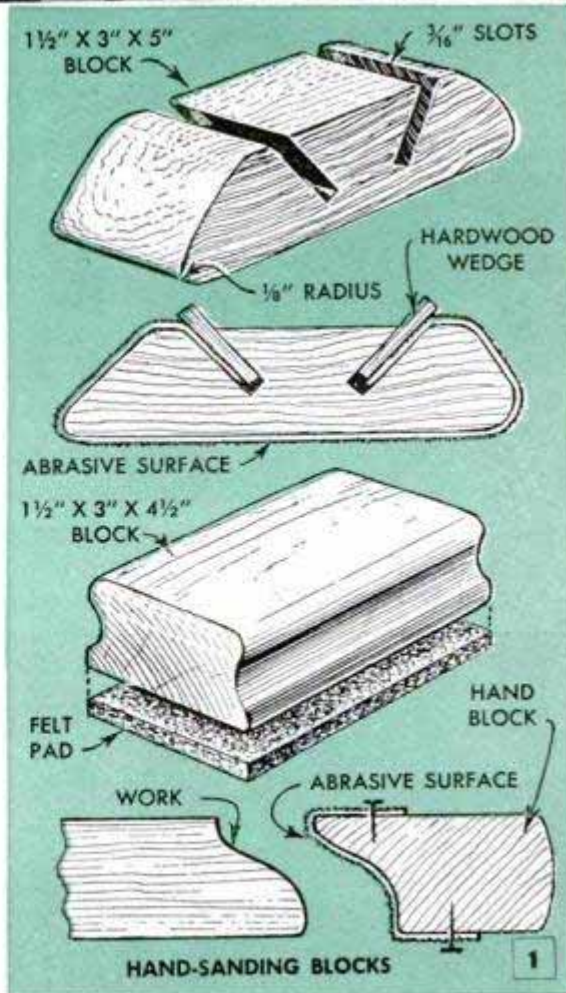

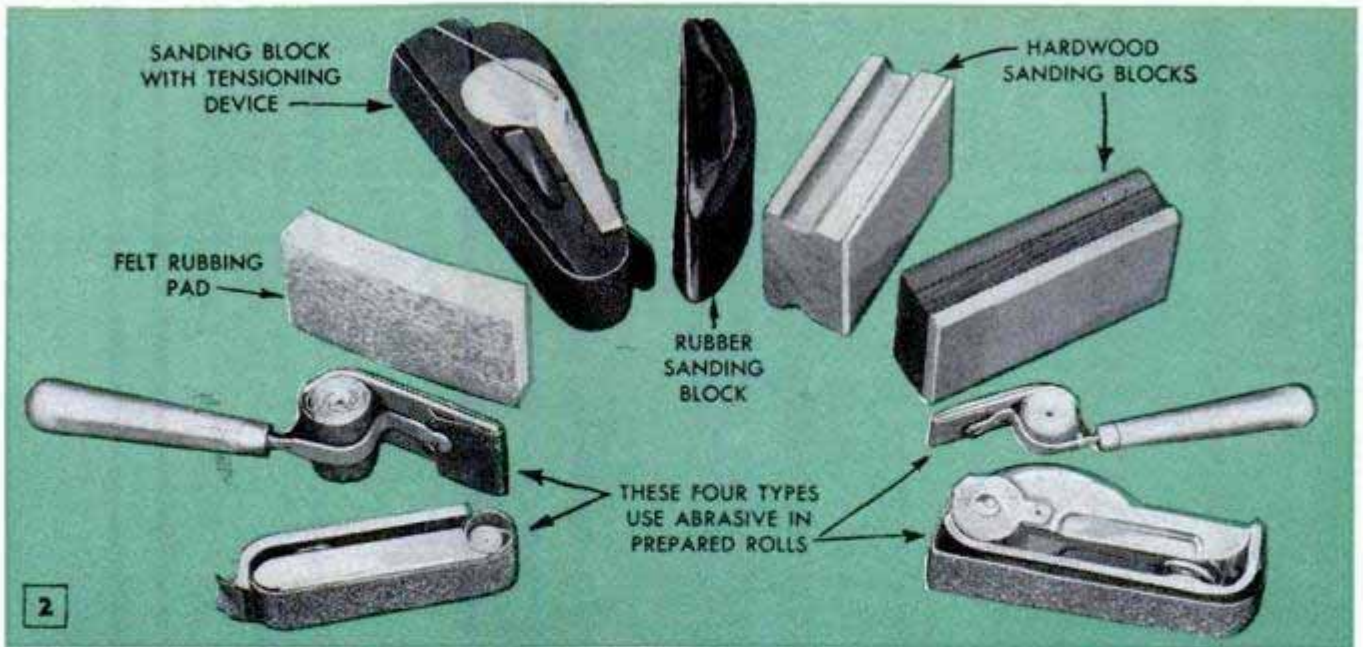

The all-rubber sanding block pictured above is especially useful for general handwork because it is flexible. Various types designed for abrasives in prepared rolls are handy for sanding corners and edges

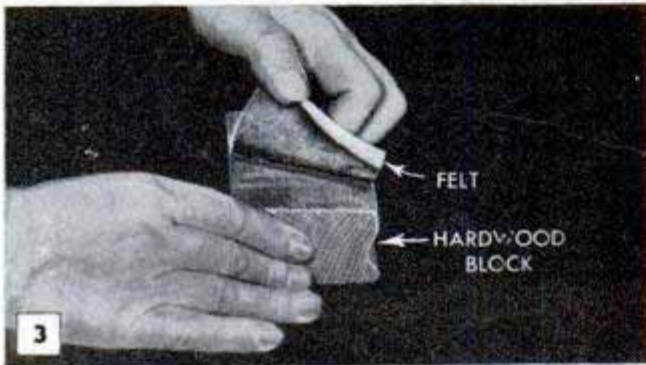

A hardwood block fitted with a felt backing makes a very efficient hand-sanding tool. Felt backing is glued in place and can be from  $\frac{1}{8}$  to  $\frac{3}{8}$  in. thick

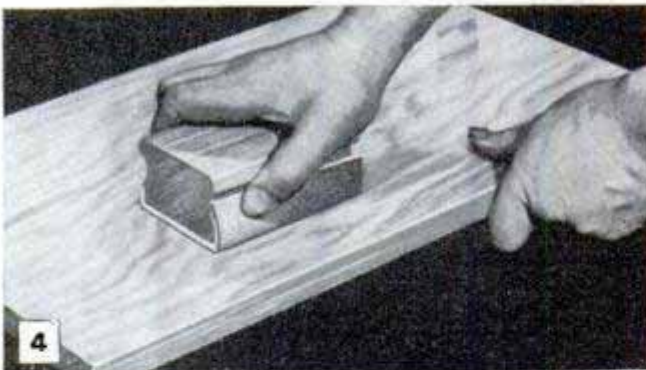

Above, except on open-grained woods, finish-sanding is done with the grain. Below, sand at an angle to the grain to remove ridges and other irregularities

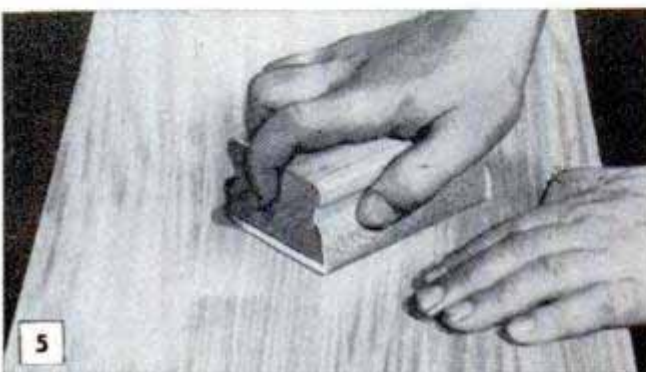

these abrasives are commonly known. There also is a very coarse grade for special purposes, but this is not generally used in hand sanding because of the difficulty of removing the surface scratches with finer grades of sandpaper. Although it is still available and is listed in Fig. 7 and pictured in Fig. 6, the flint paper has been largely replaced by the faster cutting garnet and aluminum-oxide abrasives for use in hand sanding. Most of the abrasives used in handwork are paper-backed and usually are designated as A, C, D and E. The first, or A grade, is known as "finishing paper." The C and D grades are referred to as "cabinet paper" and the E grade as "roll stock." The latter is heavyweight with a stiff paper backing and is only occasionally used in handwork. The A grade is light and flexible and in the coarser grits is used for light smoothing on paint and other finish coatings. The C and D weights have a heavier and less flexible paper backing and are most commonly used on bare wood. A general classification and recommendation for grades of paper to be used on various types of work is given in Fig. 10.

To obtain a smooth and uniform action with any of these sandpapers on flat surfaces, the paper must be backed with a hand-fitting block made either of wood or metal. Two excellent types of hand-sanding blocks are shown in the three upper details in Fig. 1. One block has no felt pad and is especially suited to cutting down ridges and other irregularities on wide widths of stock. The rigid backing causes the abrasive to cut very fast with a leveling action on the whole area being sanded. The second block, also shown in Figs. 2 and 3, is fitted with a felt pad and is suitable for rough-sanding the stock at an angle with



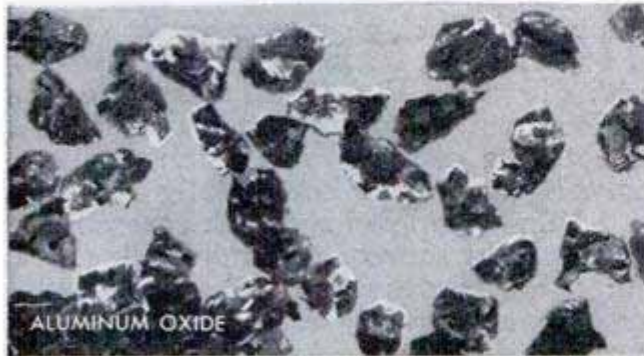
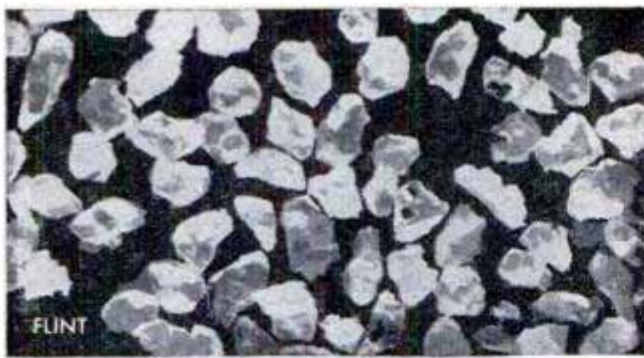

Greatly enlarged photos show the variations in the grain characteristics of the more commonly used abrasives. Although it is still available, flint is being largely replaced by the garnet and aluminum oxide

the grain as in Fig. 5, and for finish-sanding with the grain as in Fig. 4. All the various types of hand-sanding blocks and pads shown in Fig. 2 are readily available. Four of these are designed for prepared cloth-backed rolls in narrow widths and are especially handy for working in corners, on rounded edges and on wide moldings. The rubber sanding block pictured is just the thing for sanding flat surfaces and it also works particularly well on curves of long radius. Owing to its flexibility, it readily conforms to the curve of the surface. Of course, the ordinary wooden block, fitted with a thick felt pad glued on as in Fig. 3, is equally effective for surface-sanding large work, but the sandpaper must be held in place with the thumb and fingers, as in Figs. 4 and 5. All the ready-made blocks are provided with a means of holding the sandpaper securely in place.

Before starting a sanding job it's a good idea to have on hand a supply of the grades of sandpaper ranging from coarse to very fine. For average work, a good selection includes No. 1 coarse garnet or aluminum oxide, 2/0 medium, 4/0 fine and 6/0 or 8/0 very fine. A typical example of hand-sanding procedure in the home shop would be that used on a small table top similar to that pictured

in Figs. 4 and 5. Usually the top has been built up by gluing together several narrow strips. There will be slight ridges at the glue joints which must be leveled and the wood sanded down to a glass-smooth surface. Begin sanding with No. 1 coarse paper at an angle with the grain as in Fig. 5. This step will level the ridges and remove the glue stains and other discolorations. Continue sanding with the coarse paper until the surface has been leveled. The coarse abrasive will leave fine scratches over the entire surface at an angle with the grain. Now, discard the coarse abrasive and follow with the medium grit, either 1/0 or 2/0, and sand with the grain as in Fig. 4. If the top is made from a coarse, open-grained wood such as chestnut or red oak, sand at a

7 GRITS	FLINT	EMERY	GARNET AND ALUMINUM OXIDE	ALUMINUM OXIDE AND SILICON CARBIDE
Very fine			10/0	500
				400
				360
				320
				280
				240
Fine	4/0		6/0	220
	3/0	3/0	5/0	180
	2/0	2/0	4/0	150
Medium			3/0	120
	1/0	1/0	2/0	100
	½	½	1/0	80
Coarse		1		
		1½	½	60
		2	1	50
	2	2½	1½	40



Above, abrasives rather than scrapers are now commonly used in preparing old work for refinishing. Below, on some types of work a felt backing is used

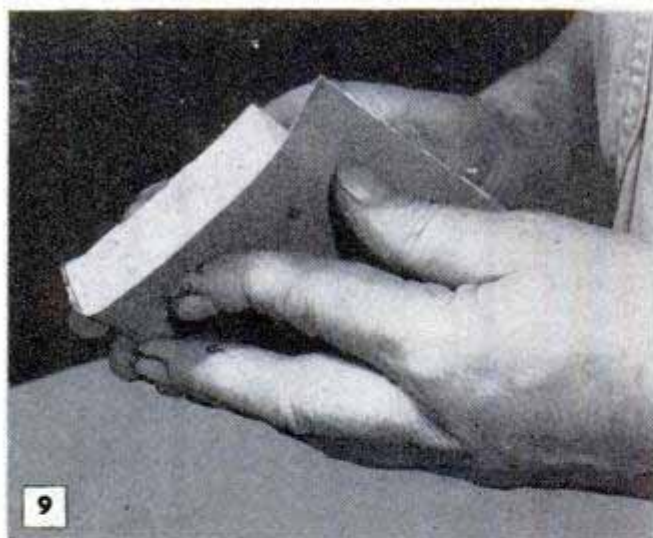

slight angle to the grain to avoid enlarging the individual pores of the wood by rounding the edges. This should be kept in mind when hand-sanding all open-grained woods, as individual grains of the abrasive passing through the tiny elongated pores parallel to their length tend to enlarge them. This leaves the surface rough and, in some cases, even changes the pattern of the grain to some extent. The second step should be continued until all fine scratches produced by the first sanding have been eliminated. Next, change to the fine grade of paper, about 4/0 grit, and sand directly with the grain, Fig. 11. At this stage, the surface will be approaching a degree of smoothness capable of reflecting oblique light. Hold the work horizontally at a point just below eye level and look across it toward a light source. Any minor ridges or other irregularities will show up quite clearly and can be pencil-marked on the outlines of the high points and then sanded down with the fine abrasive until the reflection of light is uniform over the whole surface. Before the final sanding with very fine finishing paper, some experienced craftsmen prefer to apply a thin wash of shellac or sanding sealer. Some finishers also dampen the wood with a sponge to raise the grain. After drying, the raised grain is sanded smooth and either sealed or shellacked with a very light wash coat before proceeding to the final sanding. The latter is done with either the 6/0 or 8/0 paper, depending on the degree of smoothness required. When working with open-grained woods that require staining and filling many finishers apply stain and filler, allow to dry and then finish-sand the surface. In this procedure it will be necessary to apply a few drops of rubbing oil to the sandpaper occasionally to prevent clogging. Care must be used in this method to avoid cutting through the stain and exposing bare wood. Succeeding applications of the finishing materials are sanded lightly between coats.

Essentially the same procedure is used when refinishing old work which has been varnished or painted, Fig. 8. After removing the old finish to the bare wood, begin

with the coarse abrasive to remove discoloration and surface irregularities, then follow with the finer grits in the same sequence as on new wood. On some types of both old and new work, the abrasive can be advantageously used with only a thick felt backing, Figs. 9, 12 and 13. Note in Fig. 13 that the craftsman is sanding a curved molding with the four fingers

10	HANDWORK	TYPE OF PAPER	GARNET AND ALUMINUM OXIDE	SILICON CARBIDE
	First sanding, woodwork	Cabinet	Coarse or medium	
	Second sanding, woodwork	Cabinet	Medium	
	Dry sanding sealers and finishes between coats	Finishing	Medium to very fine	
	Wet sanding sealers and finishes between coats	Waterproof finishing		Very fine
	Rubbing down after finish coat	Waterproof finishing		Very fine

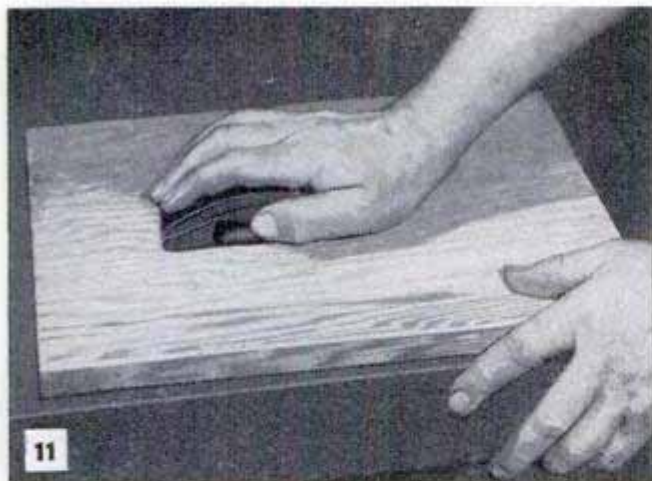

When finish-sanding with very fine paper, make the stroke directly with the grain of the wood. Apply uniform pressure the full length of sanding stroke

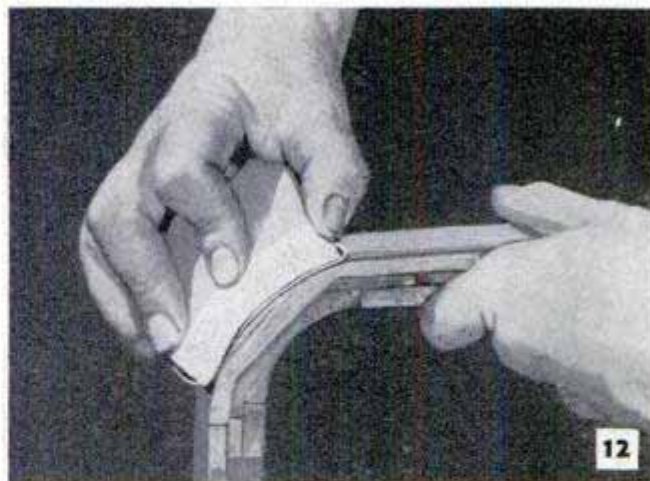

When sanding short-radius curves, the flexibility of the thick felt pad allows the abrasive paper to conform to the curved surface across its full width

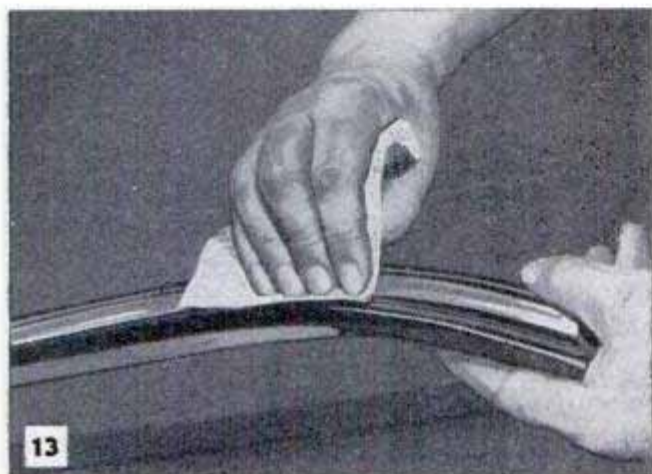

By backing the sandpaper with a thin felt pad you can sand curved moldings preparatory to refinishing. Note position of fingers to maintain uniform pressure



A sanding block with one edge shaped in a reverse relief of the molded edge makes it possible to remove old varnish or enamel from the mold curves

of his right hand held directly in line to equalize the pressure on the concave surface. Fig. 12 pictures another practical application of the flexible felt pad on a built-up corner having a short-radius curve. On old work it often is necessary to sand molded shapes. This is quite easily done by making a special wooden block with one edge shaped in reverse relief so that it conforms to the molded shape, Fig. 1. Usually this can be done with hand tools, such as inside and outside gouges and, if care is used to bring the shape to exact reverse relief, sandpaper wrapped around the block as in Fig. 14 will clean up a molded edge as good as new.

The trick in producing a true, flat surface by hand sanding is to adopt a sanding stroke of uniform length and equalized pressure. If you stroke the sandpaper as far as you can reach in both directions on a large surface, the pressure will fall off near the end of the individual stroke, resulting in an uneven surface. Some experienced finishers sand with short, straight strokes and, by moving back and forth along the length of the work being sanded,

the strokes are made to overlap continually. This technique produces a true, flat surface on large work, such as a table top. When sanding to an edge, the sanding block should not be allowed to extend beyond the edge more than one fourth its length on each stroke as, otherwise, a rounded edge will result. Whether sanding large or small work, the strokes should overlap about half the width of the sanding block and should progress uniformly in one direction at right angles to the direction of the stroke. On old work where it is desired merely to smooth the old finish preparatory to varnishing or enameling, finishers generally use a fine waterproof ("Wetordry") sandpaper, applying water or rubbing oil as a lubricant and also to prevent the paper from clogging with loosened particles of the old finish. In some cases, open-coated abrasives are used when hand sanding on enameled surfaces preparatory to resurfacing. The open-coated papers have the abrasive grains widely spaced to prevent clogging and also to make the abrasive cut faster on rough work where scratches will later be removed.

(To be continued)

## Remote Control for Tractor Varies Engine Speed

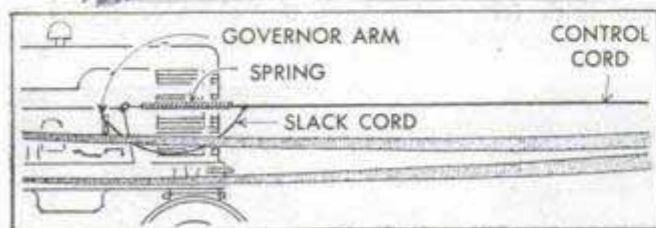
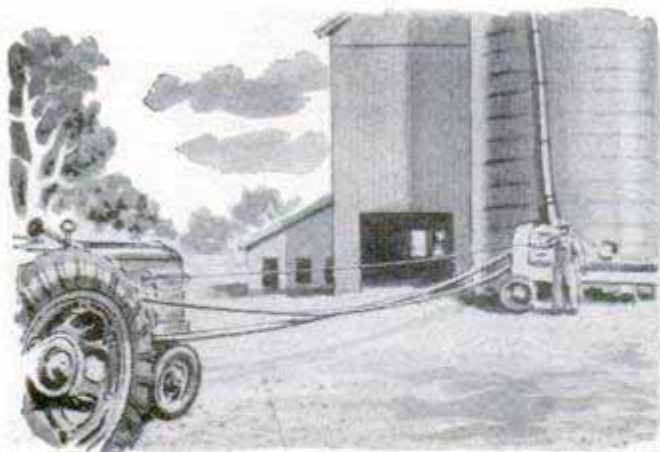

When tractors are belted to stationary machines, such as silo fillers and grain blowers, remote control of the engine speed often is an advantage for the operator, as it enables him to save time, fuel and steps to and from the tractor to adjust the throttle when the driven machine is running empty. To rig a simple remote control device, tie a coil spring (a screen-door spring will do) to a length of strong cord. The cord should reach from the tractor to the machine. Tie the spring to the tractor at some point back of the governor arm and tie the other end of the cord to the machine within handy reach. Then tie one end of a separate short length of cord to the governor arm and the other end to the long control cord near the end of the spring, leaving the short cord slack. When the operator pulls the control cord at the machine, the spring permits the slack cord to tighten and move the governor arm, thus slowing the engine to idling speed. This arrangement is particularly helpful when operating a silo filler, as considerable fuel can be saved by idling the tractor engine during the interval when a new load is being pulled up to the machine.

P. R. Wilson, Brooklin, Ont., Can.

## Easily Handled Airbrush Colors Provided by Clothing Dyes

Inexpensive and easy to handle, packaged clothing dyes provide excellent colors for airbrush work. The dye solution should be mixed about ten times as strong as that used for dyeing fabric. However, the solution can be thinned as desired and the tint, of course, controlled with the airbrush. As these colors are transparent, various hues

can be obtained by using only the primary colors, white or light-colored backgrounds giving the best results.

## Pendulum Holder on Drawing Board Keeps Ink Bottle Level

If kept on top of a pivoted block attached to the edge of a drawing board, a bottle of ink is always convenient, and yet out of the way. In addition, the bottle remains level regardless of the angle of the board. The bottle holder is a length of 2 x 2 which is nailed loosely to the edge

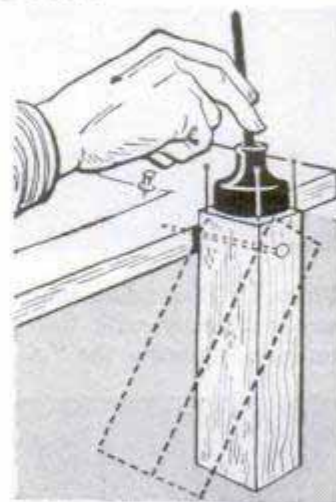

of the board so that it will always hang in the vertical position. The bottle is set on top of the holder and held in place with four finishing nails, one driven near each corner of the block.

W. R. Black, Contact, Nev.

## Sheet-Metal Planter Extensions Form Oversize Seed Hoppers

While planting exceptionally long rows in a terraced field one farmer found it necessary to refill the seed hoppers on his corn-planter before completing a single "round." To avoid the necessity of stopping in the middle of the field, often some distance from his supply of seed, he fitted the seed hoppers with sheet-metal extensions which doubled their capacity. To do this, he removed the covers of the regular hoppers and made extensions in the form of sleeves which fit snugly over the tops of the hoppers as illustrated. The extensions are held securely in place by tying them down with lengths of twisted wire.

A. M. Wettach, Mt. Pleasant, Iowa.

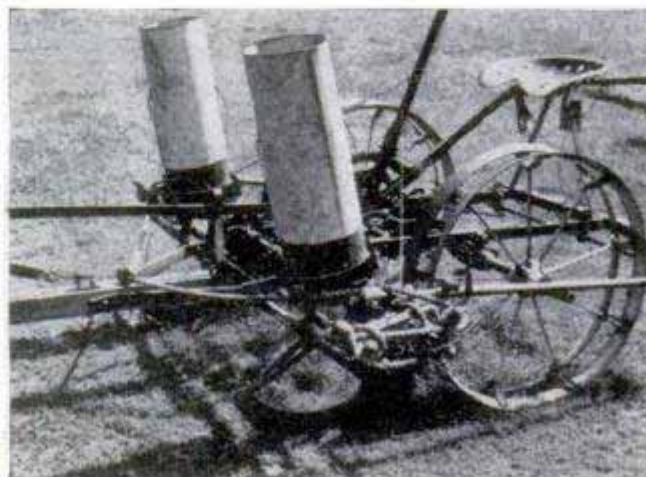

# Adjustable Fence for Homemade Shaper

By Roy Rogers

THE FENCE on any home-built power tool usually leaves much to be desired, especially in the case of a shaper where it is almost a must that the fence be adjustable. The one detailed below is an excellent fence and provides all the essential adjustments found on commercial tools. The fence itself consists of two parts, each adjustable in two directions so that the faces either can be lined up or offset and at the same time spaced to allow clearance for shaper cutters of various sizes. Two brackets, made from short lengths of 2 x 4s, are grooved on the underside and slotted as indicated. The grooved brackets ride on guide strips attached to a base piece with screws, one screw in each strip being turned into an oversize hole so that the strip can be pivoted slightly to align the fences. The brackets are held in position by wing nuts turned onto carriage bolts which pass through the base piece as shown in the perspective details. Heads of the bolts must be countersunk flush with the bottom surface of the base. Note, below, in the top view that the ends of the fence members are cut at an angle of 45 deg. and that a semicircular section is cut out of the base piece so that it will clear the molding cutters. While the table can be fitted with clamping studs, the fence can be held in place with two C-clamps which provide a quick means of removing it when work is to be run freehand.



Above, shaper fence is adjustable in two directions for depth of cut and varying sizes of shaper cutters. Below, adjustable guide strips screwed to the base hold the two units of the fence in alignment. Brackets are locked in place with bolts and wing nuts.

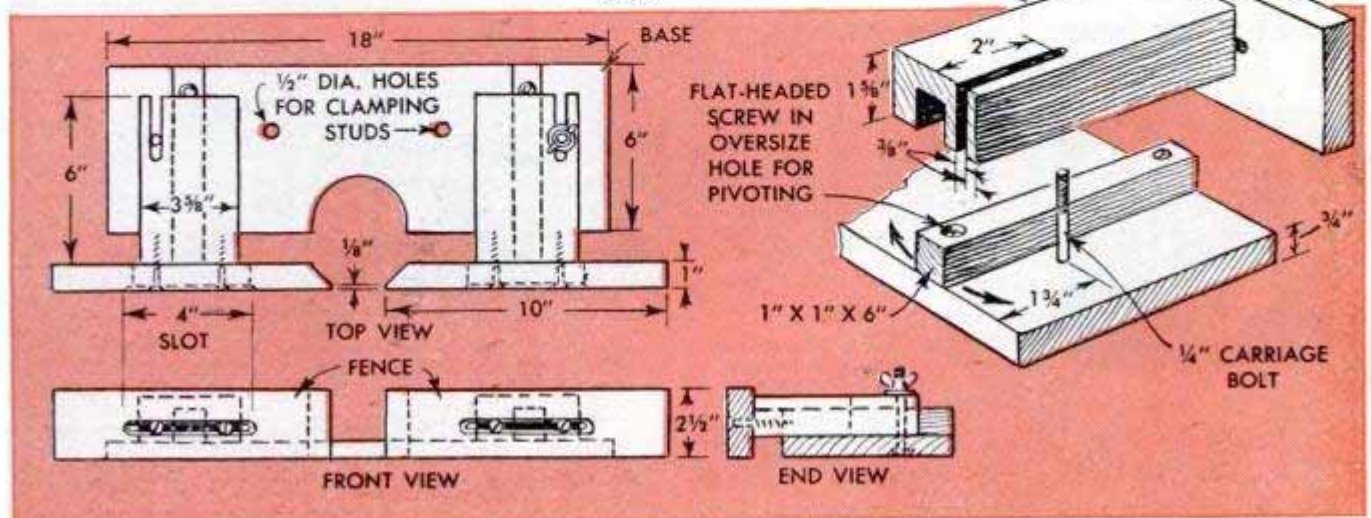
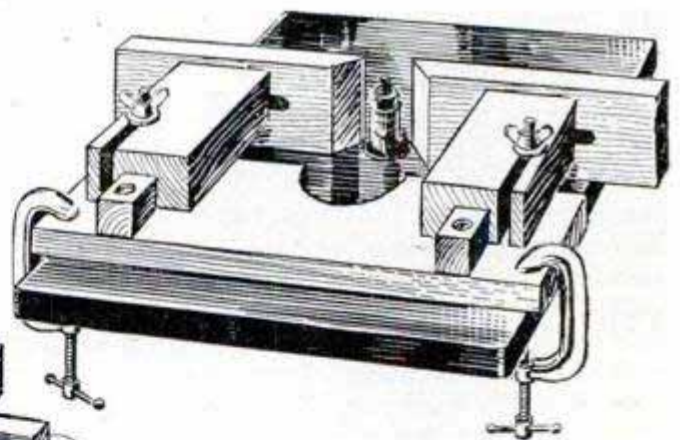
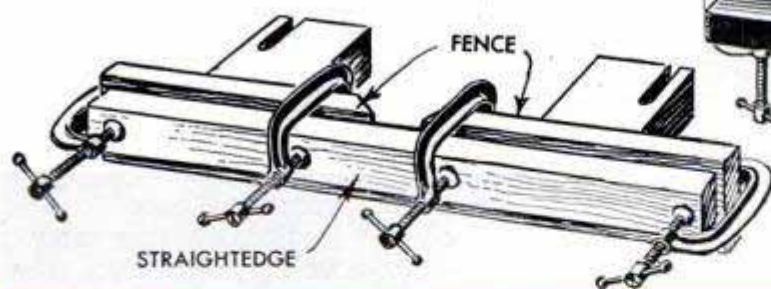

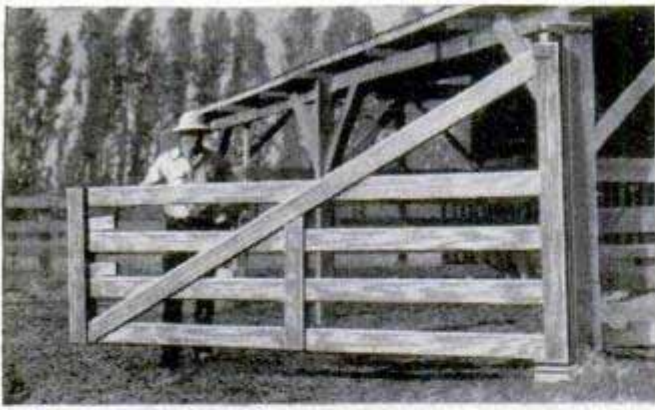

## Hinged Farm-Building Ventilators

Low-cost hinged ventilators are easy to install in farm buildings having vertical siding. Remove one of the boards and cut out a short section forming a tongue at the top end. Then drill



each edge of the projecting portions of the siding for a nail which is driven through the hole and into the tongue of the ventilator to form the hinge. After renauling the siding, nail a cleat under the lower inside edge of the ventilator to provide a stop and fasten a latch on the outside to hold the ventilator closed.

## Drum-Type Feeder for Hog Lot Anchored to Concrete Platform

One successful hog raiser prefers this type of self-feeder for use in small feed lots. It takes up the minimum of space for the amount of feed dispensed, and it can be anchored to a concrete platform, thus promoting cleanliness and preventing the hogs from upsetting it. The hopper is a 55-gal. oil drum with the ends cut out. A flat-rim implement wheel having a single row of spokes forms the compartmented feed tray. Select a wheel with a rim about twice the diameter of the drum. The latter is attached to the wheel spokes by passing heavy wire around each spoke and through a hole drilled in the drum near the rim. Each length of wire is tightly twisted to hold the drum firmly in place. As the concrete platform is poured, a length of pipe is placed upright in the center of the form as shown in the detail sketch. When the feeder is set up, the wheel hub is slipped over the end of the projecting pipe. If desired, the hopper can be fitted with a sheet-metal or wooden cover to protect the dry feed in bad weather.

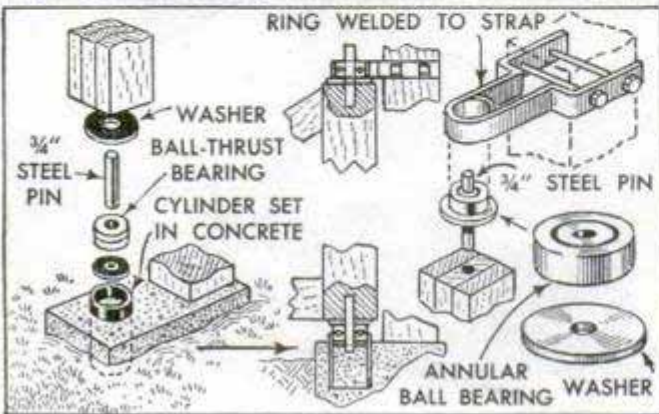

## Sagless Ball-Bearing Gate

Designed and built by George Hamerschmidt, California cattle rancher, this heavy farm gate swings on ball bearings fitted at the top and bottom of the gate stile. As detailed, the construction permits the gate to swing open in either direction. An annular ball bearing carried on a steel pin, or shaft, at the lower end of the stile, takes the thrust. It is housed in a metal sleeve embedded in concrete. A large metal washer is placed between the stile and the bearing to provide adequate support for the heavy gate. The top bearing likewise is carried on a pin inserted in a hole drilled in the top end of the stile and is housed in a yoke which is made from flat iron and bolted to the gatepost. To support a gate of this size and weight, the gatepost should be set in concrete.

U.I. '51

## Hose Section in Incubator Tray Keeps Eggs From Rolling

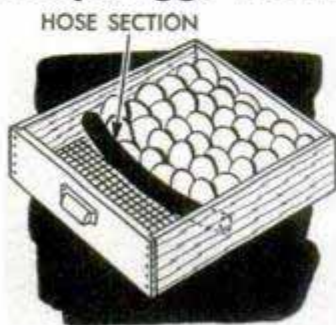

After infertile eggs are removed from an incubator tray, the remaining eggs are likely to roll and be broken if the tray is not handled with extreme care. To eliminate this danger, wedge a section of garden hose between the sides of the tray so the eggs are held snugly together.

G. E. Hendrickson, Argyle, Wis.

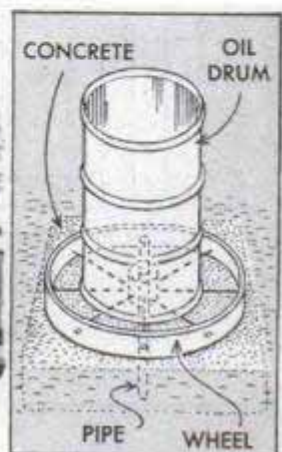

# Hunting Dogs Ride Safely in This Trunk Carrier

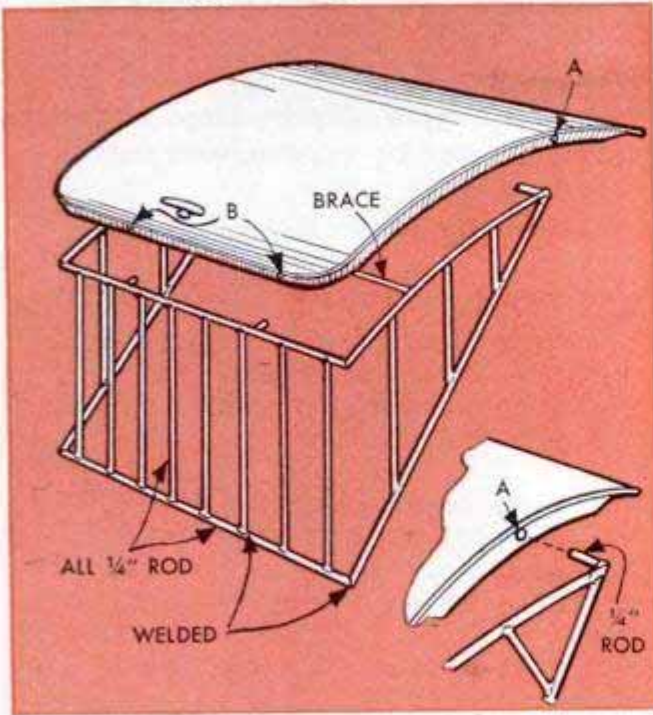

Bird hunters and others who must transport dogs for long distances will find this trunk carrier a handy accessory to the hunting equipment. It consists of a simple grille made from  $\frac{1}{4}$  or  $\frac{3}{8}$ -in. metal rods and shaped to fit inside the car trunk. The lower frame is U-shaped with straight side members welded to an endpiece as shown. The upper frame is made in the same way, except that the side members are curved to the same radius as the car-trunk deck, or lid. Holes for  $\frac{1}{4}$ -in. iron rods are drilled

through the lip of the trunk lid at points A and B. After the grille has been assembled by welding the brace and vertical bars in place, short lengths of  $\frac{1}{4}$ -in. rod are welded to the upper frame in the positions indicated. These enter the holes drilled in the trunk lid and hold the grille securely in place. The grille supports the trunk lid about 18 in. high at the back. No dimensions are given, as the grille must be made to fit the car on which it is to be used.

Wm. H. Hubbard, Modesto, Calif.

## One-Piece Depth Stop for Collet Chuck Quickly Locates Short Work

Fast, accurate facing and shouldering operations on duplicate short pieces held in a collet chuck are accomplished with this

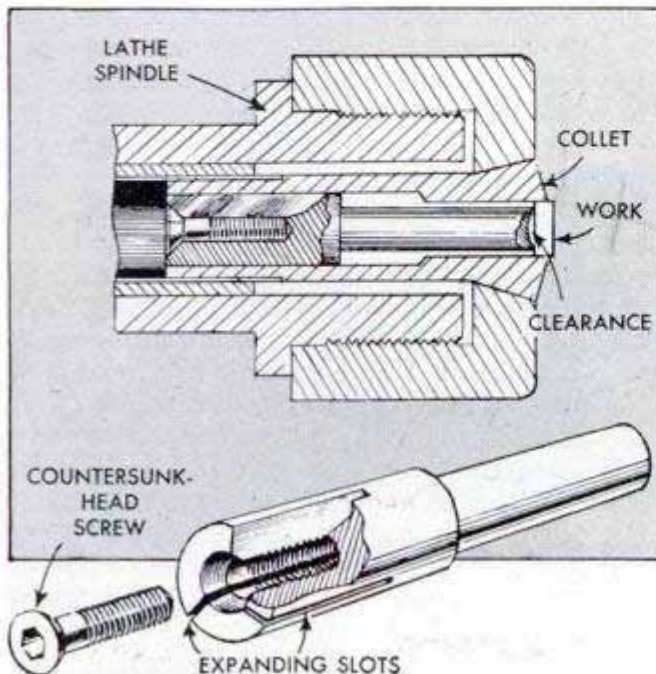

one-piece depth stop. To determine the size of the stop, measure the length and inside diameters of the collet. Then machine and shoulder a piece of tool steel to a close, sliding fit in the large inside diameter of the collet. Machine a clearance recess in the small end of the stop. Drill, counterbore, tap and slot the large end as shown in the details. Tap with an N. C. (National Coarse) thread to take a socket setscrew with a countersunk head of the type detailed. As the final operation, slip the stop into the collet and press it forward until the recessed end projects beyond the collet. Tighten the locking screw in the stop to hold it firmly in position. Assemble the collet chuck in the lathe spindle and run a light, facing cut across the recessed end of the stop. This cut should leave a narrow, flat rim around the recess against which the work locates. To use the stop, simply locate it in the collet, tighten the locking screw and then locate the carriage stop and the tool for the desired cut.

Clifford T. Bower, Decatur, Ga.

# KEEPING HAND-

Filing a handsaw is easy to do if you follow a simple step-by-step procedure recommended by experienced craftsmen

By Nash Chandler

**S**HARP HANDSAWS cut true and fast and enable the user to turn out finished work of an accuracy and quality very nearly equal to that produced on power-driven machines. Common handsaws are of two types, one being designed for ripping stock lengthwise with the grain and the other for cutting across the grain or at an angle to it. Backsaws, dovetail saws, keyhole saws and others are simply variations of the crosscut handsaw designed for a specific purpose. On the ripping saw, each tooth cuts like a chisel, severing only the wood fibers which are directly in the path of the tooth as it is forced through the wood. Teeth of a crosscut saw cut the wood fibers at right angles to the direction of travel and for this reason they must be sharpened in such a way as to give each tooth two cutting edges or, more specifically, a leading cutting edge and a sharp, cutting point. This double-cutting edge is produced by merely changing the angle of the file.

**Jointing:** Before any handsaw can be properly filed it is necessary that the teeth be made uniform in height. This operation is known to saw filers as jointing and it is done by passing a file over the points of the teeth in one direction as in Fig. 3. Steady the file with a small block of wood, as shown, to prevent it from tipping sidewise and rounding the points. After the first few light strokes of the file it will be seen that some of the tooth points have been flattened on the top while others have been only slightly tipped by the file. Continue the jointing until all flattened points can be seen clearly. The amount of jointing necessary must be judged by the condition of the saw. If the saw has been properly filed and the teeth are regular in shape and uniform in height, jointing may be unnecessary. On a saw in this condition only light filing will be required. On the other hand, if the teeth are uneven and incorrectly shaped, it may be necessary to reshape the teeth by jointing and filing several times at short intervals during periods of use. As a rule, it is best to joint the teeth lightly each time the saw is filed.

**Setting:** Some experienced saw filers prefer to set the teeth of handsaws before jointing. Others joint the teeth lightly both

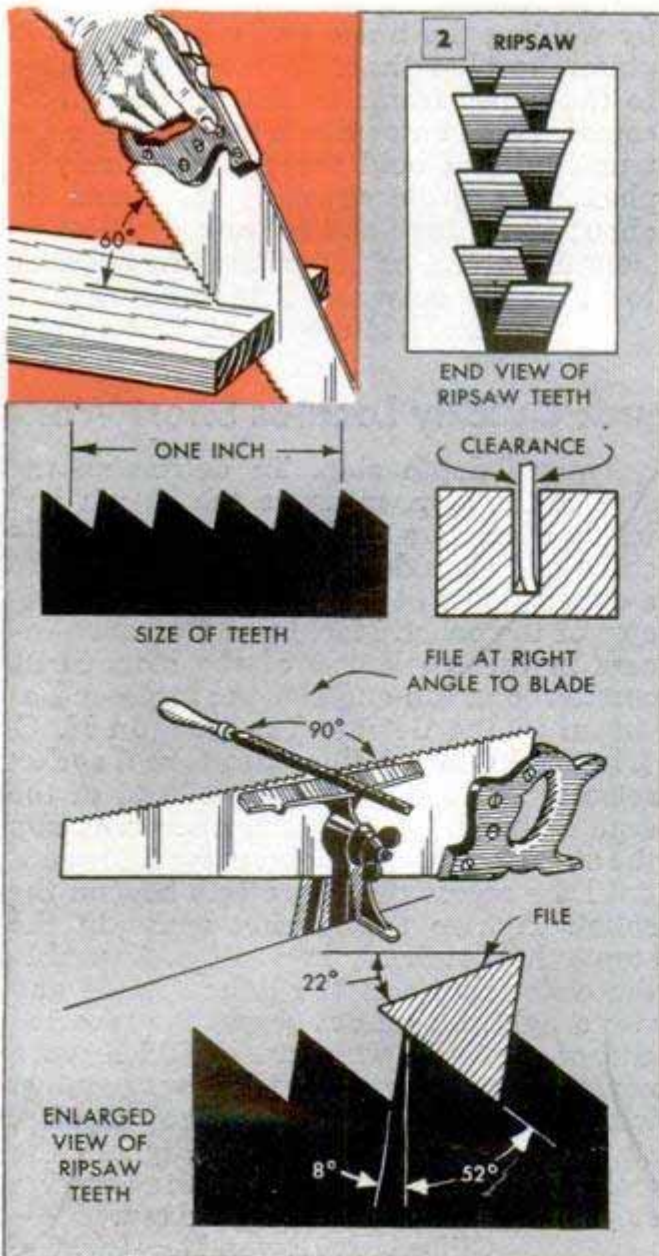
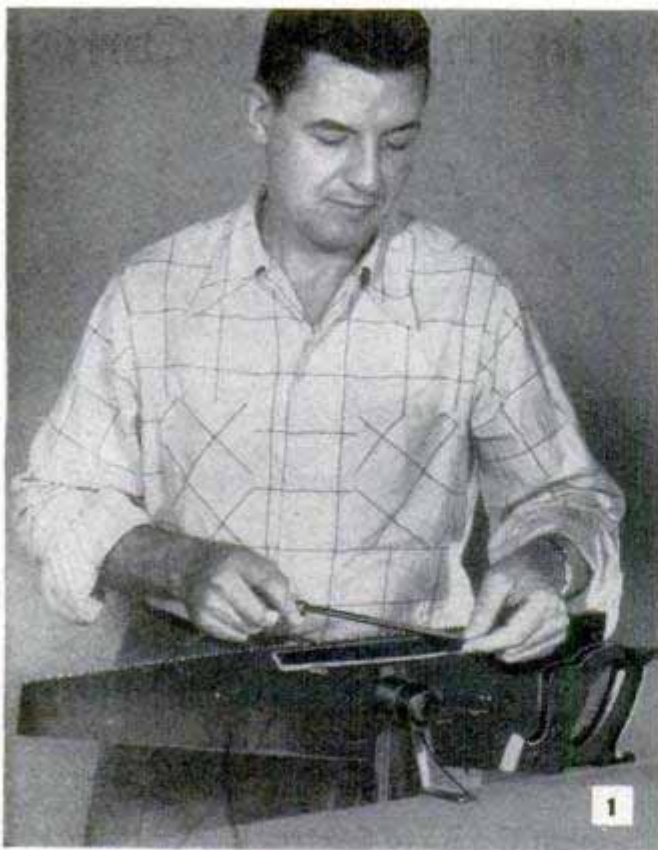



# SAWS SHARP

before and after setting, especially when sharpening rip saws. The reason for this is shown in Fig. 2. Note in the detail that the leading edges of the teeth are parallel, one with another. As in jointing, the necessity of setting and also the amount of the set is determined by the condition of the saw and the nature of the work which is to be done with it. For example, a rip saw used exclusively on hardwood requires less set than one which is used only on softwood, or on soft and hardwood alternately. In general, the same is true of the crosscut saw, but the width of the set will vary owing to the variations in the number of teeth per inch, and also to the purpose for which the saw is intended. Setting tools of the type shown in Fig. 6 are commonly used on handsaws. The purpose of the set is to cause the teeth to make a cut slightly wider than the thickness, or gauge, of the blade. This gives clearance and prevents friction and binding of the blade between the cut edges of the wood. In relation to the length of the tooth, the depth of the set should never be greater than half the length of the tooth measured from the point to the bottom of the space, or gullet, between alternate teeth. A deeper set may break the tooth. Saw sets of the type shown in Fig. 6 have fine adjustments for regulating the depth and width of the set on handsaws with a varying number of teeth per inch. Be sure that the setting tool is correctly adjusted to give the depth and width of set required. Begin at the heel of the blade (the end next to the handle) and place the setting tool on the first tooth bent away from you. Then, after setting the first tooth, skip one and place the setting tool on the next tooth bent away from you. Proceed in this manner to set the teeth, along the full length of the blade. Then turn the blade end for end and repeat the procedure. The trick in obtaining a uniform set is to apply equal pressure to the handles of the setter for each tooth.

**Filing crosscut saw:** Because of the variety of saw-tooth shapes, the variation in angles and bevels and the number of teeth per inch on crosscut saws designed for different purposes, a careful selection of the file is necessary as the size and type of the file determines the tooth shape. On crosscut handsaws having four, five and six points to the inch, use a 7-in. three-cornered (triangular) file of the type known as "slim taper." Use a 6-in. slim-taper file on saws having seven and eight points to the inch; and on handsaws having fine teeth running nine to twelve points to the inch, use a 5-in. file. To determine the number of teeth to

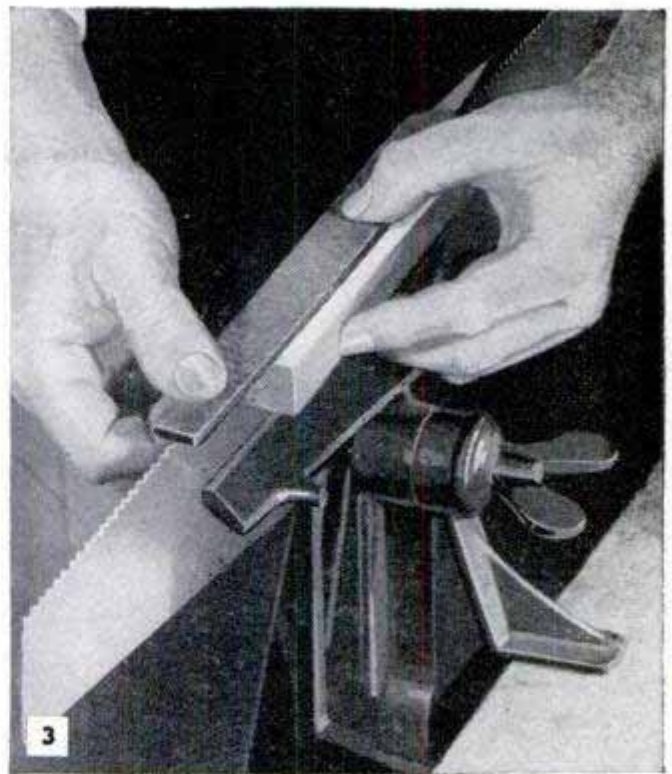

Before filing, the teeth of a handsaw are jointed with a file so that all of them are the same height

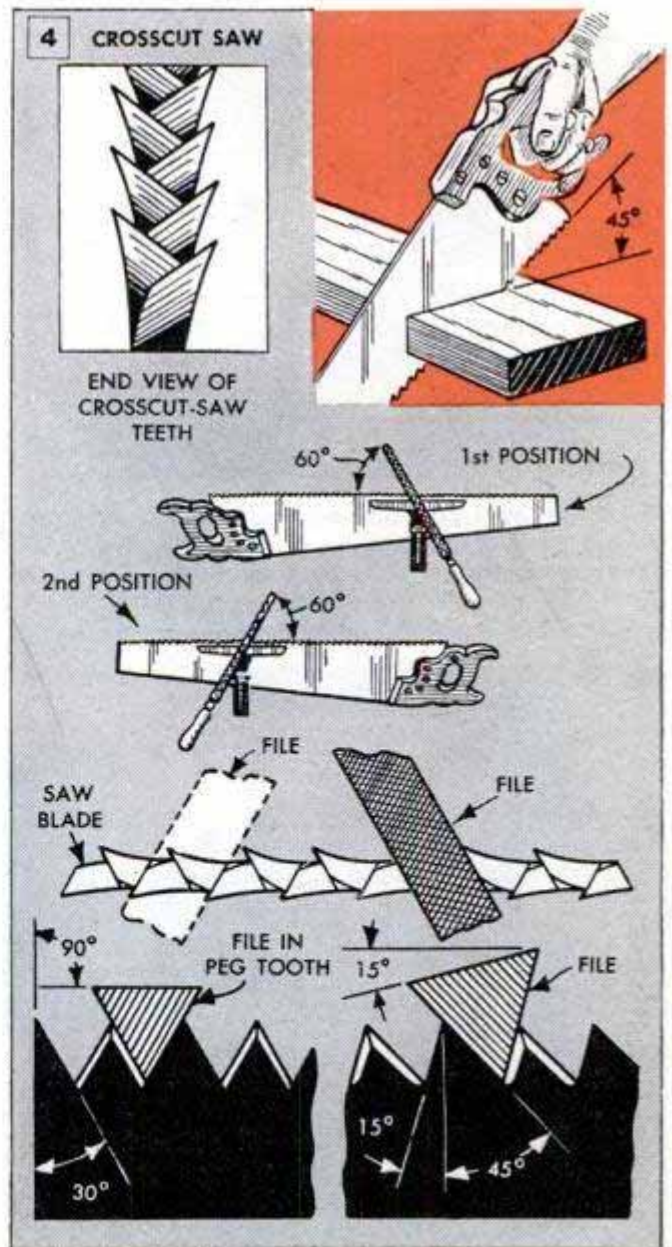

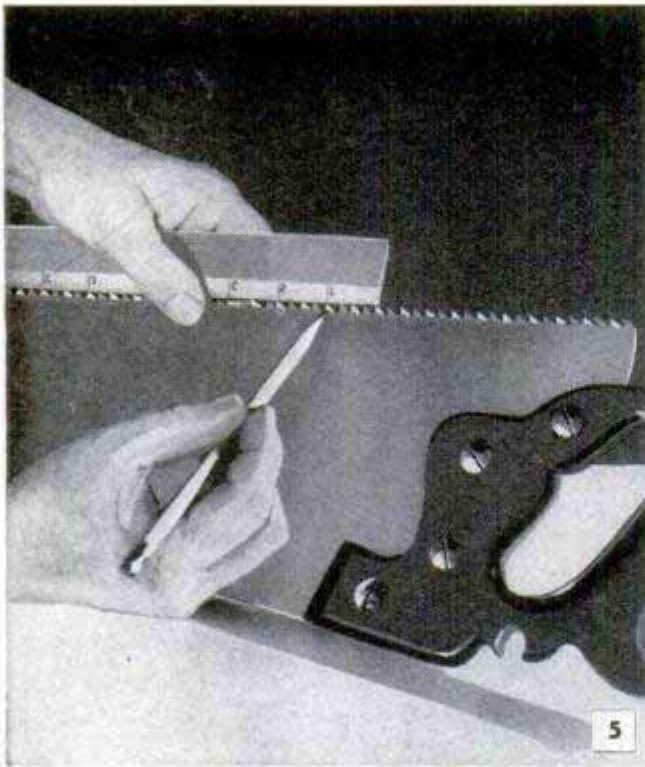

To determine the number of teeth per inch, measure 1 in. from the point of any given tooth with a ruler and count number of teeth within the 1-in. distance

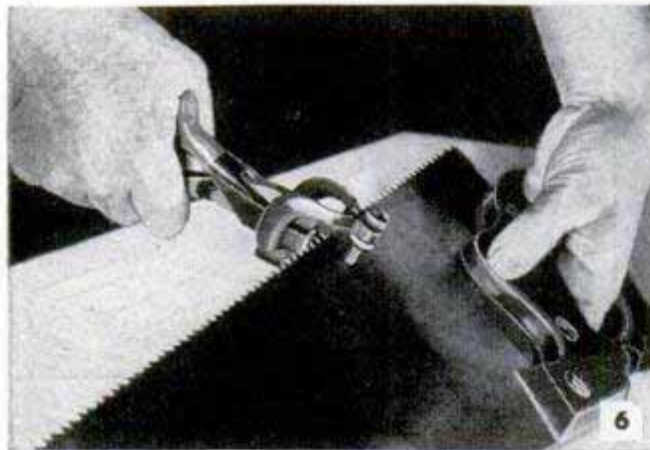

Above, on both crosscut and ripsaws adjacent teeth are set, or bent, in opposite directions to give clearance for the blade. Below, as a finishing operation after filing, the teeth are side jointed with an oilstone to align points and make saw cut smoothly

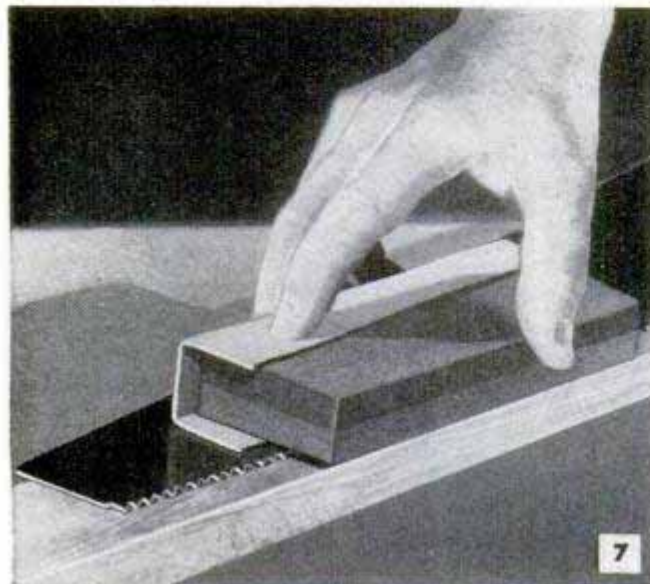

the inch, measure 1 in. from the point of any tooth and count the number of teeth within the 1-in. distance, as in the left-hand center detail in Fig. 2, and also Fig. 5.

Place the saw in a filing vise of the type shown in Fig. 1, with the handle at the left as in the first position shown in Fig. 4. (A suitable vise can be improvised from C-clamps and two strips of hardwood.) The vise jaws should close on the blade at a point about  $\frac{1}{8}$  in. below the bottom of the spaces between the teeth. The tip of the blade should not extend beyond the end of the vise jaws at the first setting. Begin filing by noting the first tooth at the tip that is set, or bent, away from you. Place the file in the space to the left of this tooth and then swing the file to the right so that its angle with the blade is approximately 60 deg. Hold the file level at this angle and make the first stroke. Lift the file at the end of the stroke, return it to the original position and place it in the same space, or gullet. Make the second stroke in the same way. At this point it is important to allow the file to find its own bearing against the teeth. Do not twist the file or maintain any pressure on it except that necessary to move it on the forward stroke against the resistance of the metal being cut. Note also that the file is cutting on one face of two adjacent teeth, the points of which have been flattened by the jointing operation. The trick is to adopt at this point a uniform stroke of the file that will remove only half of the flattened portion of the tips of adjacent teeth. On saws that are in good condition with teeth of nearly uniform length, it also is necessary to use an equal number of file strokes per tooth. The exception to this is on saws having teeth in poor condition where the flattened points of adjacent teeth vary, making it necessary to reshape the teeth, at least partially, as filing progresses. Continue filing to the end of the blade, skipping a space, or gullet, after filing adjacent teeth and placing the file in the gullet to the left of the next tooth bent away from you. When one side has been finished, turn the blade end for end and proceed as before. Filing the blade from this side should bring each tooth to a sharp point. The operation on each tooth should be carefully watched to avoid the possibility of removing too much metal and getting the teeth on one side shorter than those on the other. Be sure to hold the file level and keep the length of the stroke uniform. At this stage, many filers joint the teeth lightly and again touch them up to assure perfect uniformity in length and sharpness. However, this is rarely necessary unless the teeth were in bad condition before filing. It also should be noted that some experienced filers begin filing with

the blade placed in the reverse position from that given in the center details in Fig. 4, that is, the handle is placed first at the filer's right, instead of his left, as shown. Some manufacturers recommend this position, and filers who prefer this method say that it is easier to maintain a uniform stroke of the file. In this case, start filing at the heel of the blade, placing the file in the space to the left of the first tooth bent toward you.

**Filing rip saw:** In general, the procedure in jointing, setting and filing a rip saw is the same as that used in sharpening a cross-cut saw except that the file stroke is made straight across with the file held level and exactly at right angles with the blade. This position of the file points the teeth with parallel chisel edges. The file is tilted with its top face at an angle of 22 deg. as shown in the lower detail, Fig. 2. This position of the file gives the leading edge of each tooth a negative rake of approximately 8 deg., which is commonly accepted practice on hand rip saws used for average work. Some carpenters like a rip saw with plenty of "bite" and to accomplish this they reduce the negative rake from 8 to 5 deg. or even less. This angle of the teeth makes the rip saw really take hold, but it is more difficult to control in softwood and is not suitable for use in hardwood. With the teeth filed as in the lower detail, Fig. 2, the rip saw will cut smoothly in either hard or softwood. It is easily controlled for close following of gauge lines and requires less pressure on the downward stroke.

As a final operation when sharpening both crosscut and rip saws for fine work where the sawed edges must be left smooth, filers side joint the teeth with an oilstone as in Fig. 7. This operation dresses the points of the teeth to exact alignment. Use the fine side of the oilstone and wrap cloth or cardboard around one side of the stone to protect the blade from scratches. Two or three light strokes of the stone on each side of the blade usually are sufficient.

## Brake Rods Provide Posts For Electric Fence

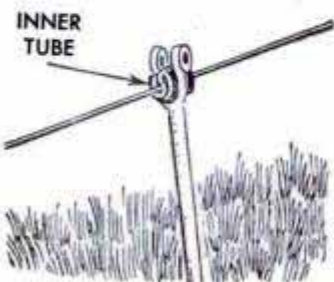

A number of old automobile brake rods obtained from a junk yard provide easily moved posts for a temporary electric fence. Drive the rods into the ground and string the wire, wrapping it with pieces of inner tube at the points where it is inserted into the clevises of the brake rods to insulate it from the metal.

## Check Planting Four Rows With Short Markers

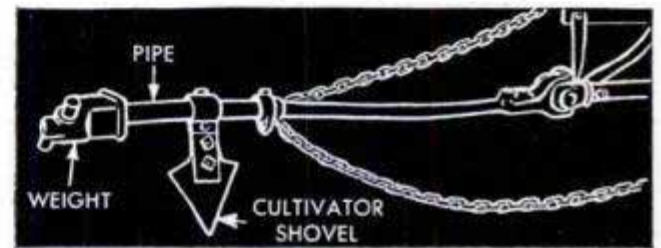

After using his four-row tractor planter several seasons with the regular row markers, one farmer decided it would be less tiring to substitute shorter markers which would enable him to guide the tractor with the drive wheel instead of the front wheels running in the planter mark, as is the regular practice. After some experimenting he came up with the arrangement detailed, which, he says, enables him to do a more accurate job of spacing the "guess" rows and at the same time permits a somewhat shorter turn at the row ends, resulting in a narrower headland. As will be seen from the sketch, the construction is quite simple. A short arm (the length will depend to some extent on the row spacing) pivots on a small universal joint attached to the planter frame. The marker is simply a cultivator sweep of the narrow-wing type attached to a flat-iron standard. The latter is welded to a clamp which fits around the arm and is clamped in place by two short bolts. This assembly permits the sweep to swing back on striking an obstruction, thus preventing breakage.

Loose-pin door hinges can be lubricated neatly by using petroleum jelly instead of oil. Remove the pins individually and give each one a light coating of the jelly.

# 9

# SPEEDS FORWARD

By M. G. Winterton

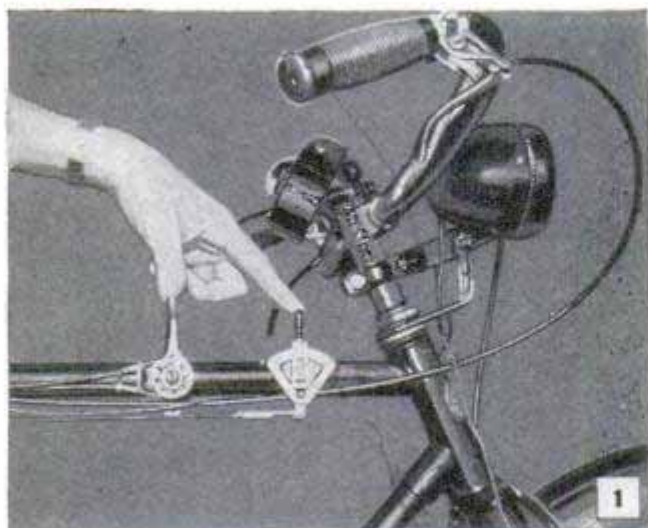

Sprocket ratio is selected by dual control levers which operate cables leading to shifts on rear wheel

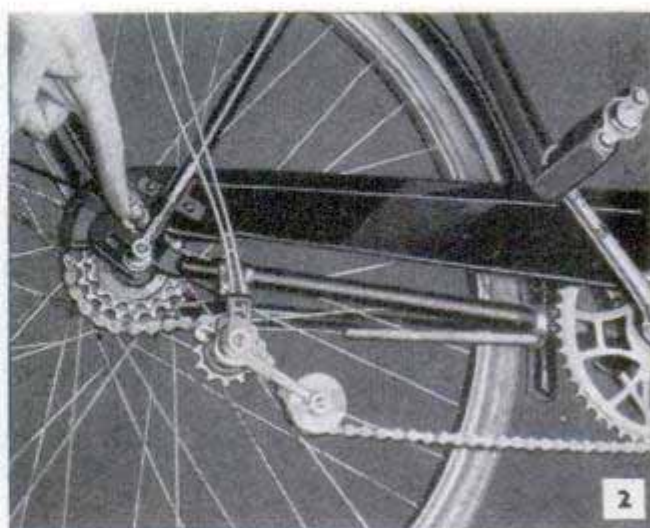

Combining both 3-speed shifts gives nine speeds. The shifting requires no momentary pause in pedaling

This view shows the sprocket shift in low-gear position. Note that the chain is on the inside sprocket

Here, the shift sprocket is shown in high-gear position. Note that the chain is on the outside sprocket

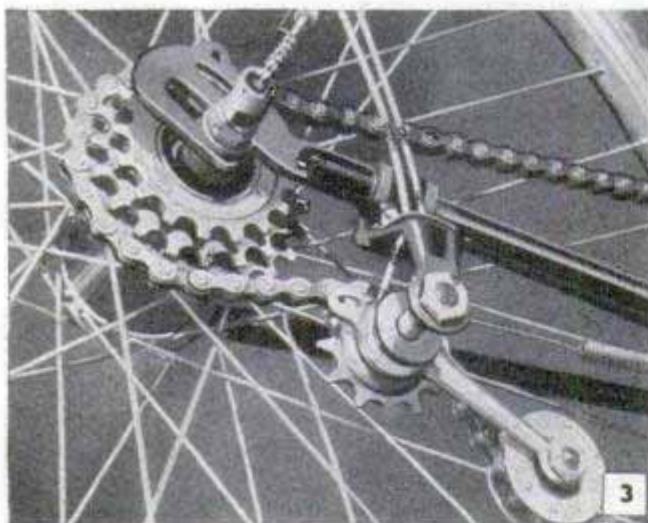

Below, close-up view identifying component parts of mechanism. The shifting sprocket and takeup idler which are integral clamp directly to bicycle frame

Below, shifting sprocket, operated by cable, travels sideways to throw chain from one sprocket to another. The idler takes up slack in chain when shifting

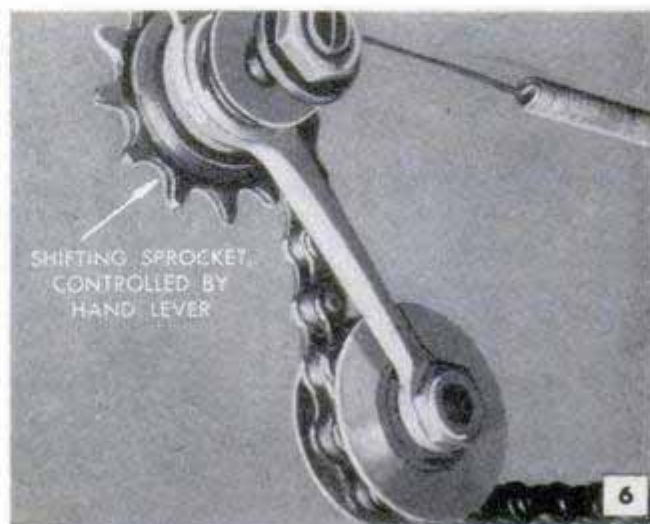
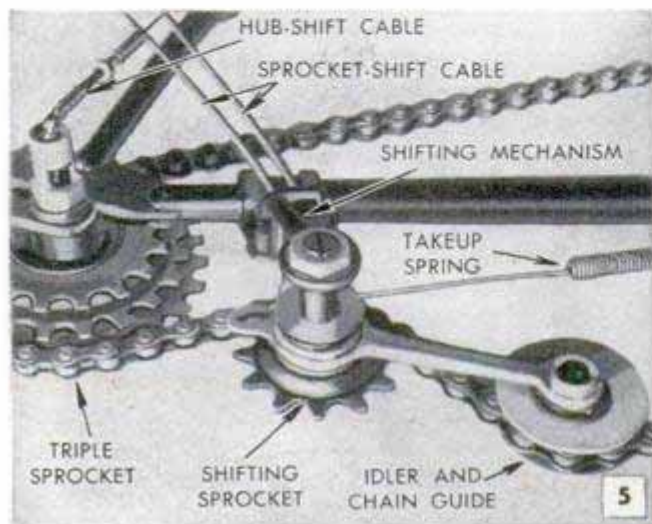

# for your bicycle

WHEN your bike is fitted with a 9-speed "transmission," that steep grade ahead becomes level ground and on a straightaway you can really make speed. A standard replacement kit, pictured in Figs. 1 to 6, can be installed on any bike to provide a total of nine forward speeds ranging from a very slow low gear to an extremely fast high gear. Installation consists of removing the coaster brake and replacing it with a three-speed hub, a triple-sprocket unit and a chain "derailer." By means of flexible cables, the rider can throw the chain from one sprocket to another as he pedals along. The cables are operated by levers clamped to the crossbar, Fig. 1, enabling the rider to select the best "gear" combination for any road condition. If the bike is already equipped with a three-speed hub, all you have to do is replace the single sprocket on the hub shift with the three-sprocket assembly. The latter is available in different diameters, 16, 18 and 24-tooth sprockets being recommended. The triple-sprocket shift affords two additional speeds to each one of the three speeds provided by the hub shift, making a total of nine speeds. Fig. 7 shows assembly of the two 3-speed shifts and how they are mounted in the bicycle frame, the spokes, tire and chain being omitted for clarity. Slight variations, such as the elimination of some of the spacer washers, may be necessary and some bikes may require using a hub axle of greater length.

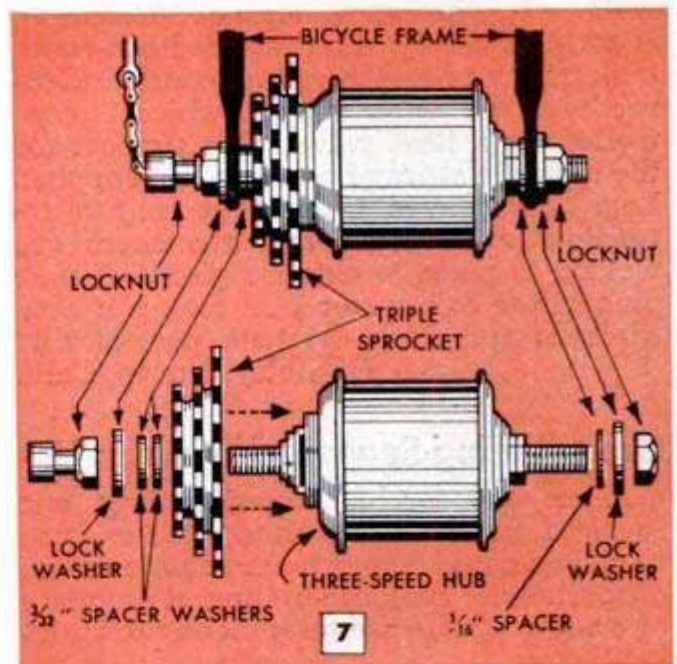

## Tie-Rod Tension Springs Correct Wandering of Four-Wheel Trailer

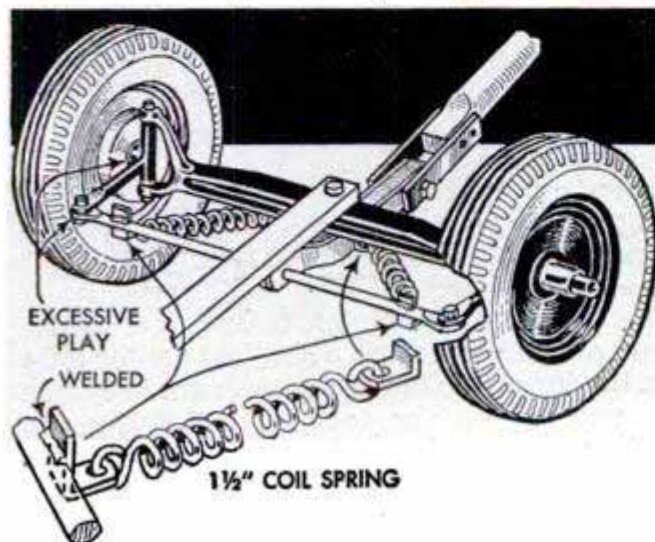

Four-wheel trailers made by converting old car axles often tend to wander from side to side when being towed on the highway. This generally is due to excessive play in the tie-rod yokes and in other parts of the front axle. On rough ground and in fields, the play sometimes causes whipping of the drawbar, especially when the trailer is loaded. One owner cured these troubles by installing heavy coil springs in the manner shown. Metal brackets were welded to both sides of the drawbar and also to the tie rods as closely as possible to the yokes. The brackets must be spaced to equalize the tension on the springs when the latter are hooked in place.

## Tank Fitted With Float Valve Provides Automatic Waterer

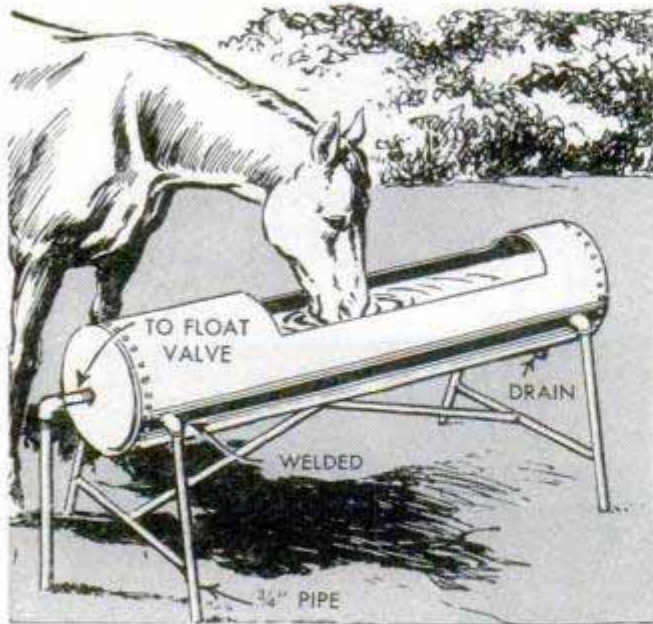

One keeper of a boarding stable for riding horses devised this simple automatic waterer for the convenience of his charges. It consists simply of a discarded hot-water tank cut away as shown and connected directly to the water supply, which is controlled by a float valve. The support for the tank is a sturdy frame made from pipe. Legs are splayed to prevent easy overturning, and braces and stretchers are welded in place to obtain rigidity. A pipe plug in the cold-water inlet makes it easy to drain and flush the tank periodically.

Hi Sibley, Nuevo, Calif.

## Green Siding Seasoned While in Use

After considerable experimenting, one farmer found that unseasoned lumber, such as siding, could be put to immediate use on outbuildings by loose-nailing it in place and allowing it to season right on the building. He claims that in this way new lumber from the wood-lot sawmill or unseasoned lumber from the yard can be utilized with only the normal shrinkage and a minimum

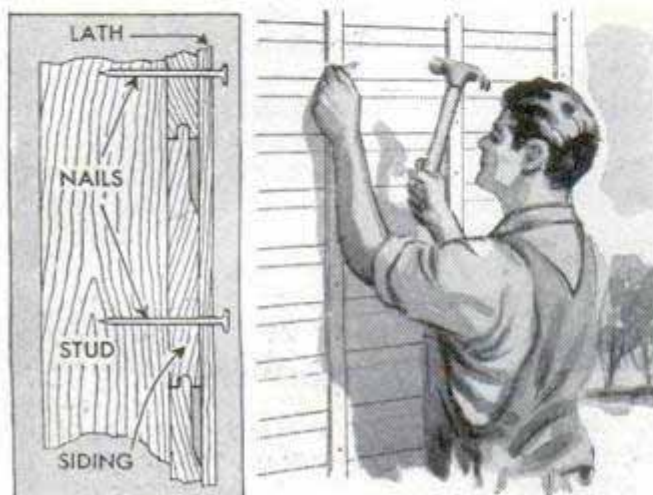

of checking and warping. The boards are nailed to the building studding with a single nail to each stud, the nail being driven through a wooden lath as shown in the detail. The nails are driven only part way in, as indicated and scaffold nails can be used for this first nailing if desired. After the siding has seasoned sufficiently, the nails are withdrawn and the siding renailed in the regular manner. The laths, of course, are removed when the nails are withdrawn preparatory to renailing. — Ray Harrison, Fort Qu'Appelle, Sask., Can.

## Protecting Edges of Balancing Ways

When balancing ways are not in use, their sharp edges can be protected from damage by sheathing them with lengths of garden hose. Cut a piece of hose to suit the length of the ways and slit it along one side. Then, simply press the hose over the edge of the ways.

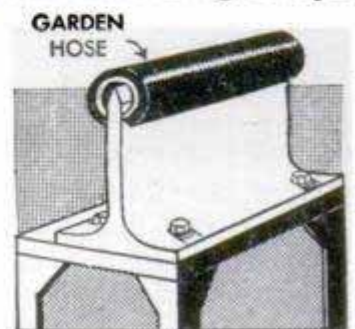

Earl R. Goddard, Denver, Colo.

## Potato Holds Parts for Welding

Using a large potato to hold small parts for welding, brazing or soldering provides a firm support along with efficient cooling. Cut the potato so one side forms a flat base and then press the parts into the potato at a convenient working angle.

Roy E. Bedbury, Seattle, Wash.

## Holes Tapped on Drill Press

Accurate tapping or reaming can be done quickly by clamping the work to the drill-press table and leaving it in position after the hole has been drilled. The drill is removed and a small pointed rod is chucked in the drill press. Then the tap is placed in the hole and the chuck is lowered so the end of the rod enters a shallow center hole in the top of the tap or tap wrench. Pressure is exerted on the tool by weighting the drill-press handle with a wrench or clamp, and the tap wrench is turned by hand.

E. Campbell, Edmonton, Alta., Can.

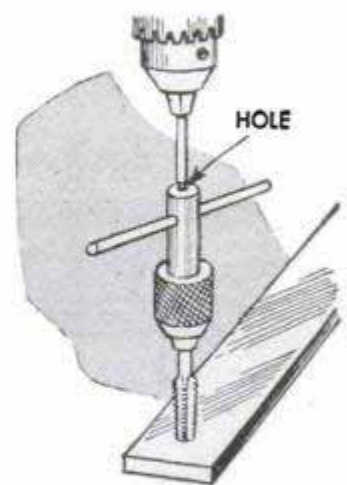

## RECTANGULAR PICTURE TUBE IN 1950 TV SETS

SEVERAL manufacturers are featuring the new all-glass 16-in. rectangular television picture tube in their 1950 TV receivers. It is perhaps the most outstanding feature to be found in the new sets. The rectangular tube face eliminates the formerly wasted surface which is unavoidable when a rectangular picture is presented in a round bulb. The compact new tube shown in photo D is claimed to make possible smaller TV-set cabinets without reducing the size of the picture. Made automatically, it is said to be no more costly than a round bulb of comparable size, and it is designed to receive the shape of the transmitted picture exactly as the TV camera sees it.

The television-radio-phonograph combination shown in photo A employs one of the 16-in. rectangular tubes and includes a three-speed record changer of advanced design which is illustrated in photo B. The tone arm of this changer cannot be damaged by being moved or held while in cycle. A special spindle is inserted for 45 r.p.m. records. This new combination console model sells for about \$400. The same manufacturer recently introduced the table-model TV set shown in photo C. This model features the 16-in. rectangular TV picture tube in a cabinet only 20 in. wide by 19 in. high and 18<sup>9</sup>/<sub>16</sub> in. deep. It also includes a new "fly-wheel" automatic frequency control to provide greater picture steadiness, and a built-in antenna.



# No. 2 PROGRESSIVE ALL-WAVE A.C.

DISTANT short-wave reception, commonly known as "DX" by short-wave listeners, and also standard broadcast-band programs can be tuned in with excellent quality and good loudspeaker volume with this a.c. No. 2 progressive student receiver. Those who built the No. 1 set R-385 that was described in the January 1950 issue will only have to add the few extra parts and the wiring shown in red on diagrams Figs. 2, 3 and 4. The only change in the windings on the plug-in coils is a reduction in the number of turns on the L3 winding on each coil. These are shown on the coil-winding data chart and in Fig. 5; no other coil windings are changed. If the builder is careful, it is possible to transform set No. 1 into set No. 2 without rewiring the

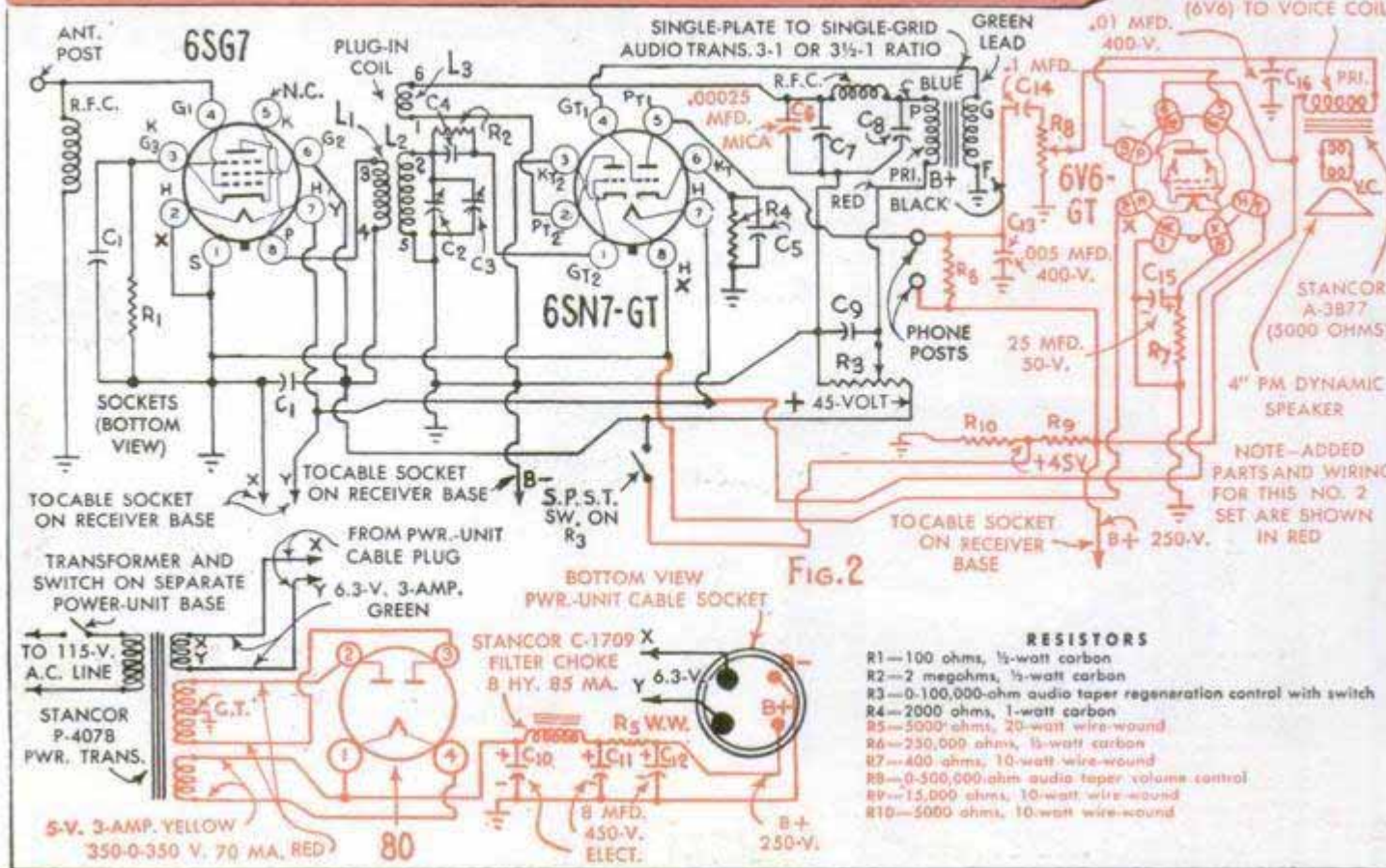
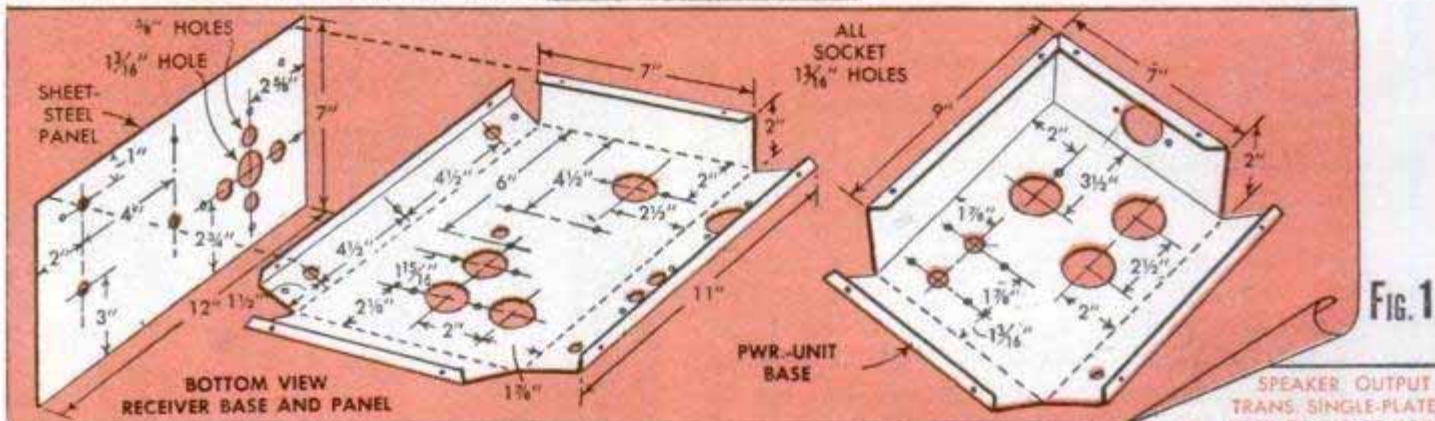
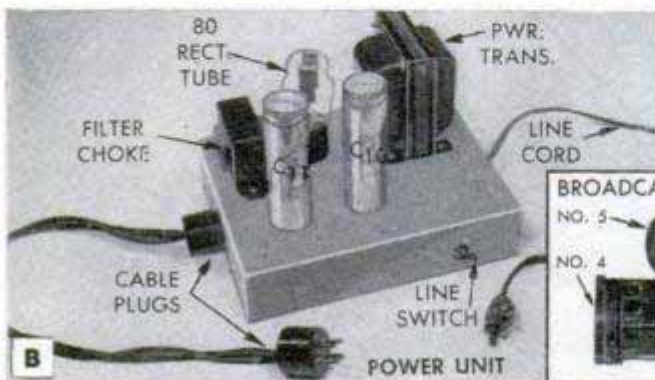
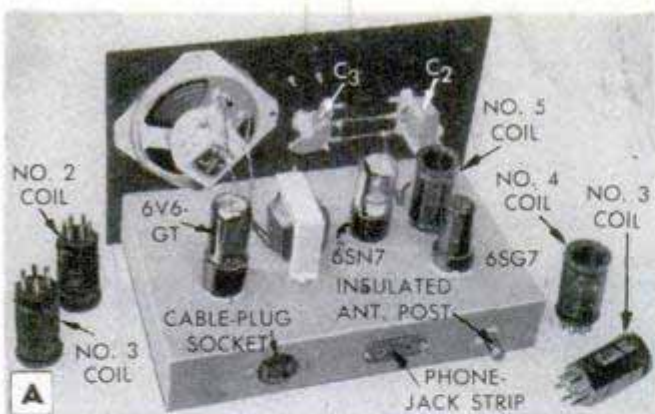



# "OVERSEAS DXER" FOR STUDENTS

first set. By noting the added parts and wiring in red on the circuit diagrams Figs. 2 and 4, the builder will see that the amplifier stage, which is added, simply picks up the signal at the old phone terminals and boosts it for loudspeaker operation. The separate power unit now supplies both the original 45 volts for the first two tubes and approximately 250 volts of well filtered d.c. for the plate of the added 6V6-GT amplifier tube. The added resistors R9 and R10 form a voltage-divider circuit which is tapped to provide the 45 volts formerly supplied by the 45-volt B-battery. Students who did not build the first set will now follow these complete circuit diagrams. The only part that was changed in the original circuit is the fixed condenser C6.

The power unit makes the set completely a.c. line operated and, as it is a separate unit, hum is thus kept at a minimum. The loudspeaker is mounted on the front panel behind a grille formed by one standard

(Continued to page 234)

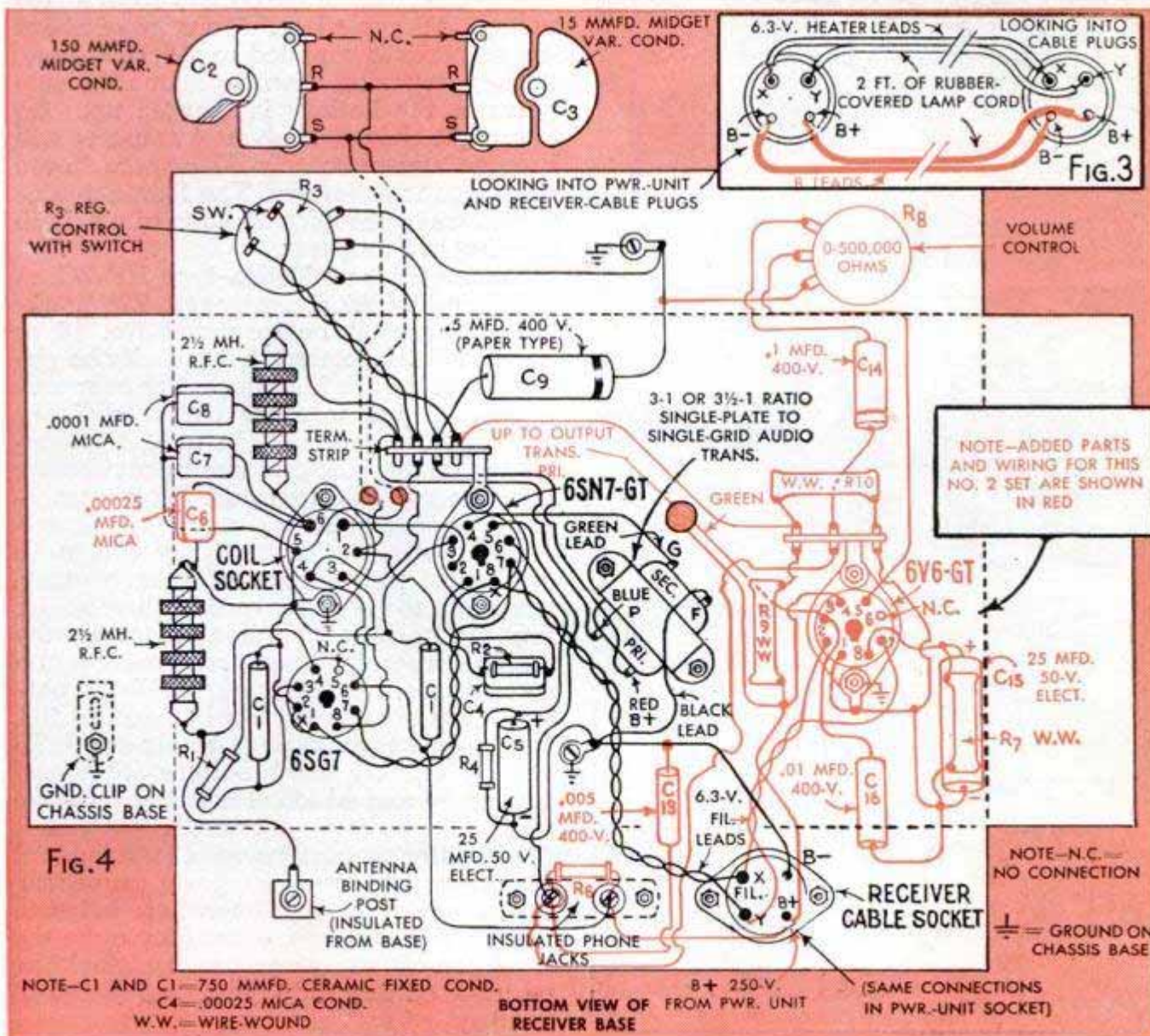
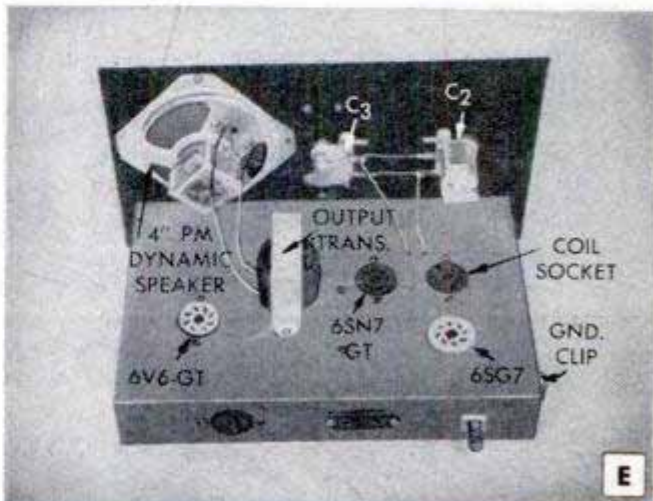
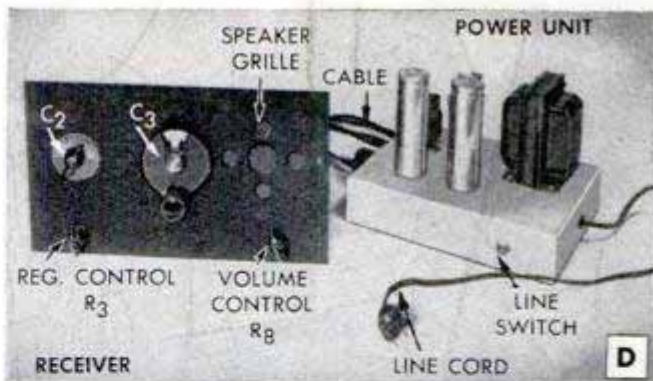

## Low-Cost Battery Charger Employs Selenium Rectifiers

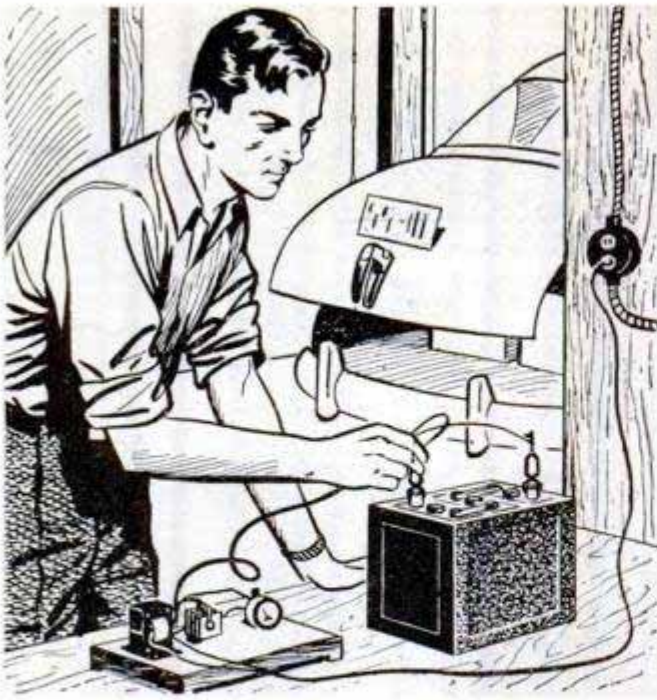

THERE is nothing like a fully charged storage battery to snap over your car motor on a frosty morning. When the car generator cannot keep the battery up to par, a good charger is a handy unit to have around the garage. Many radio amateurs operating mobile transmitters have to keep auxiliary storage batteries charged without depending upon the generator in the car. The simple inexpensive battery charger illustrated will meet all requirements for such service.

Assembly is made on a  $\frac{3}{4}$ -in. wooden baseboard  $5\frac{1}{2}$  in. wide and  $8\frac{1}{2}$  in. long. This open form of mounting permits adequate ventilation. Photos A and B show front and back views of the unit, and the schematic circuit diagram appears in Fig. 1. The charger employs a rectifier consisting of four Federal-type 4D2814AS selenium cell sections connected in parallel. It will supply from  $3\frac{1}{2}$  to  $4\frac{1}{2}$  amperes of d.c. to any 6.3-volt storage battery from a 115-volt a.c. 60-cycle line. A charge of about  $4\frac{1}{2}$  amperes is supplied to a dead storage battery, tapering down to about  $3\frac{1}{2}$  amperes as the battery is charged up. An overnight charge of about 4 amperes will provide approximately 40 ampere hours of charge to a battery. The filament-type transformer provides 10 volts of a.c. with a rating of 5 amperes.

The meter is an Emico-type NF-2C, or similar 0-10 amp. d.c. ammeter. The hook-up wire should be insulated No. 18 or larger. It is important that polarity be observed on the rectifier stack. The four sections are held together by an ordinary 6-32 machine screw  $1\frac{1}{4}$  in. long; a soldering lug on this machine screw provides the common negative terminal. When assembling, be sure to file the center washers on their top surfaces so that they will make good electrical contact with each other. Assemble the sections so that their solder lugs are upright. To operate, connect the a.c. plug; there will be no current flow and no indication on the meter until the battery leads are clipped to a battery. At this point, some caution must be observed. To identify quickly which battery-cable lead is positive and which is negative, clip the leads to a battery and watch the meter. The position which draws the least amount of current is correct. Properly connected, the current will read somewhere between  $3\frac{1}{2}$  and  $4\frac{1}{2}$  amperes, depending upon the condition of the storage battery. Mark the positive battery clip with red paint to identify it for future use.

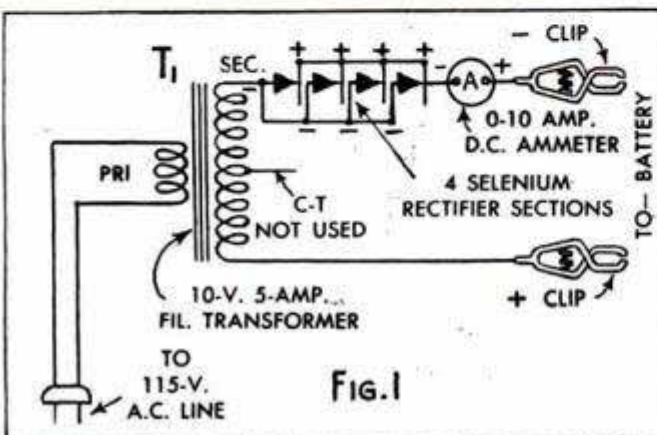
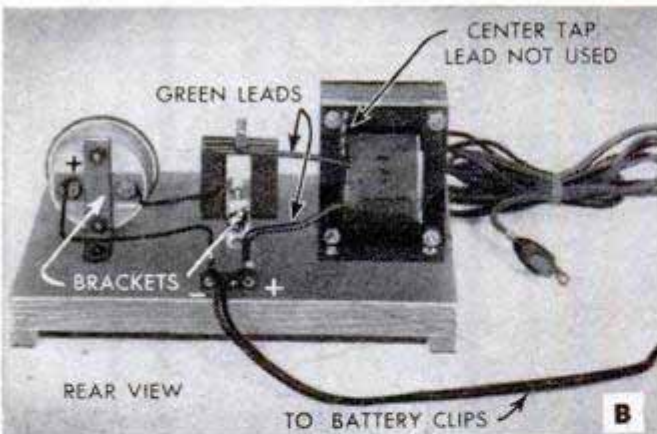
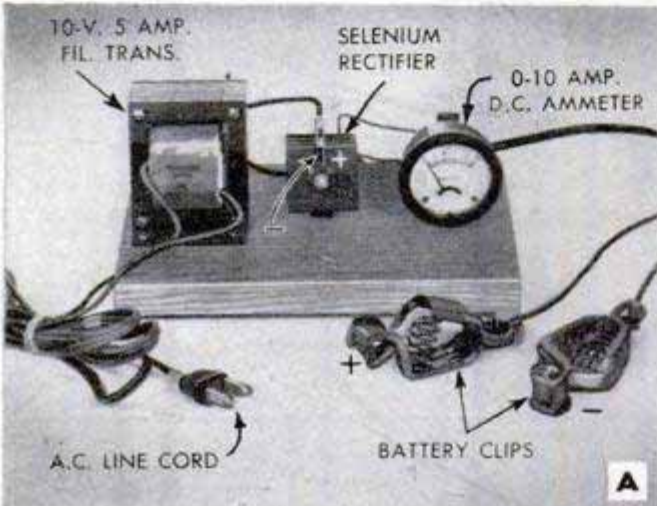

# IT'S THE NEW KODAK FLUROLITE ENLARGER

A magnificent enlarger that does many other jobs! Fluorescent circline lamp gives instant "on and off" cold light ... properly balanced for all color processes. "Integrating-sphere" type lamp-house and special inside coating give uniform light distribution; paper storage compartment in base of enlarger. Without lens, \$112.50, including Federal Tax. 7 lenses available separately. See it at your Kodak dealer's.

**EASTMAN KODAK COMPANY  
ROCHESTER 4, N. Y.**



**A VIEW CAMERA ...** the Kodak Flurolite Camera Bed and Camera Back Adapter A (used as accessories) give a sturdy setup for  $2\frac{1}{4} \times 3\frac{1}{4}$  pictures. Use Kodak 35mm. Film Adapter A for miniature color photography.

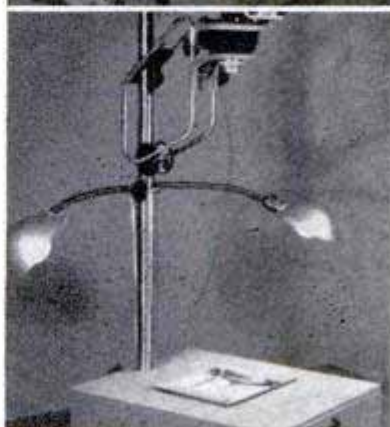

**COPYING AND CLOSE-UPS ...** use the enlarger as a camera, with the accessory Kodak Copying Lights, Model 2. Fully adjustable.

## Enlarging Plus...

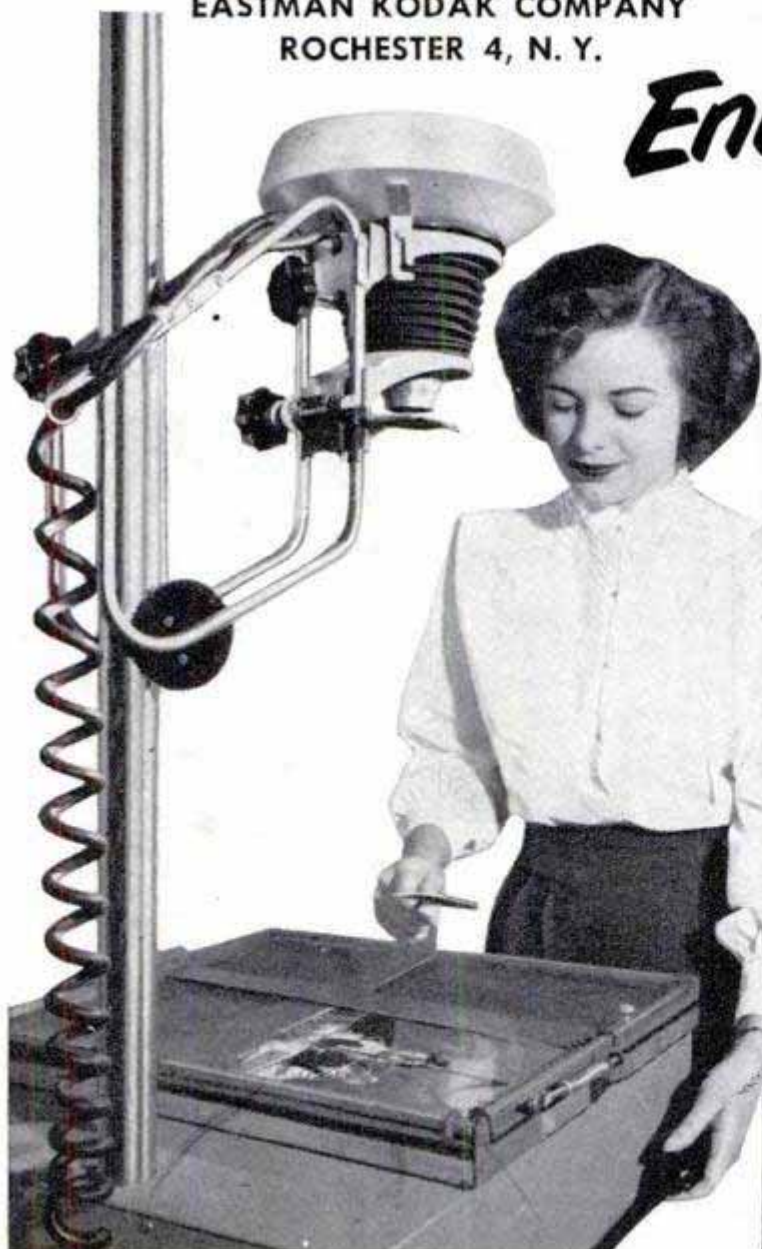

**PHOTOMICROGRAPHY, MICROFILMING, CLINICAL PHOTOGRAPHY ...** in this illustration, the Kodak Microscope Attachment replaces the enlarger lens and makes a light-tight connection with the microscope.



**CINE-TITLING ...** the inclined arm on the stand assembly supports a Cine-Kodak camera for making titles.

**Kodak**  
TRADE-MARK



# Care and Feeding of Engines

BY S. P. CORP

## THE CASE OF THE VANISHING OIL

Fast oil consumption does not always mean worn piston rings. Rev up the engine to a 40-mile rate and take a look at the exhaust. If there is no blue smoke, look for oil leaks. Fig. 1 shows you some places where leaks can develop. If, at any of these points, you see deposits of oil and dirt, wash and dry the area.

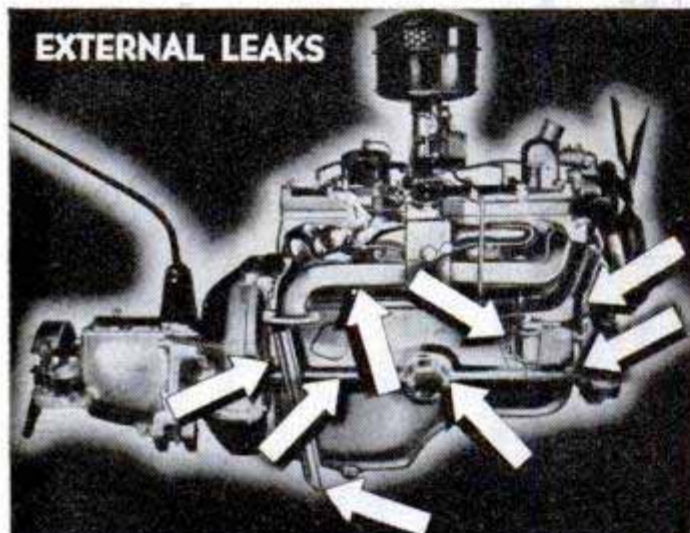

EXTERNAL LEAKS

FIG. 1

Then hang a white cloth below the engine to show drippage. Be sure the oil level is up, otherwise leaks may not show. Then drive car a few miles, and examine cloth. Leaks will be shown up by oil drips.

## CHECK OIL GAUGE LINE

Be sure to check for a plugged oil filler breather cap, a plugged muffler, or bent tailpipe, as these can cause back pressure, forcing oil vapor out the crankcase ventilator. One of the most treacherous spots is the flexible tube in the oil gauge line, Fig. 2. Check the vacuum booster pump for a cracked diaphragm, too.

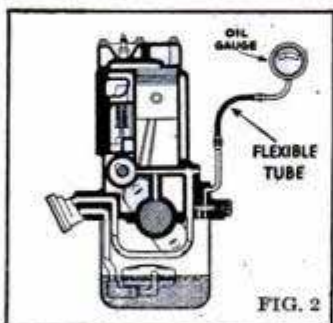

FIG. 2

## BEST RINGS FOR RE-RINGING

When you re-ring, use the best piston rings built—use Sealed Power Piston Rings. There has never been such a ring for oil control as the Sealed Power MD-50 Steel Oil Ring—the only ring with the FULL-FLOW SPRING. This amazing ring controls oil even in badly tapered and out-of-round cylinders. There is a set specifically engineered for your car, whatever the make, model, or wear-condition. Ask your dealer.

## No. 2 Progressive All-Wave A. C. "Overseas DXer" for Students

(Continued from page 231)

socket-punch hole and four holes made with a 5/8-in. drill as indicated in Fig. 1. The grille is backed up with a piece of cloth. The only additional part on the panel is volume control R8. The original volume control R3 is used as a regeneration control. Photos A, B, D and E show various views of the completed units; photos G and F are underside

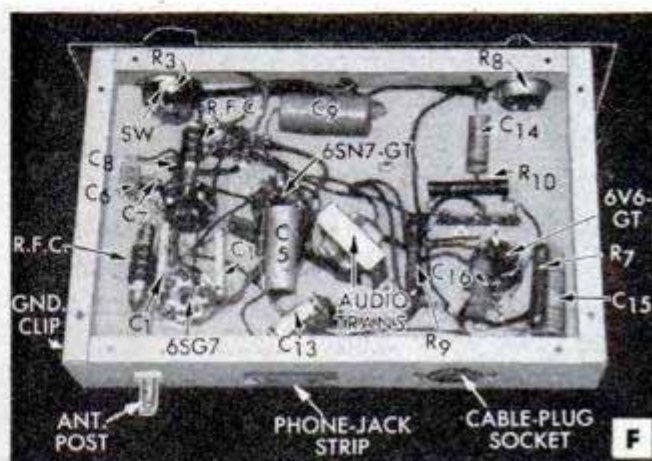

views. Three plug-in coils cover the short-wave bands from 1.6 to 15 megacycles; two coils, photo C, cover the entire broadcast band. The position of the padder condenser in coil No. 5 is indicated by the arrow. Builders of set No. 1 will note that resistor R20 is mounted directly on the headphone jack-strip terminals, and this is the logical

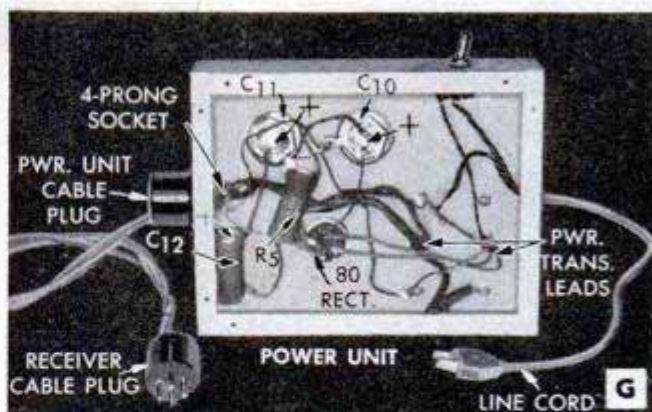

point to start wiring. At the same time, the 45-volt lead which ran from the power-plug socket is clipped (this is the wire that originally ran to control R3). This lead now connects to the 45-volt tap on the voltage divider mentioned previously.

For maximum selectivity on local broadcasting stations, it is important that this set be used with a very short antenna, only 5 or 6 feet being required. A 25-ft. indoor or outdoor antenna will pull in foreign stations in the short-wave bands with ease.

(Continued to page 236)

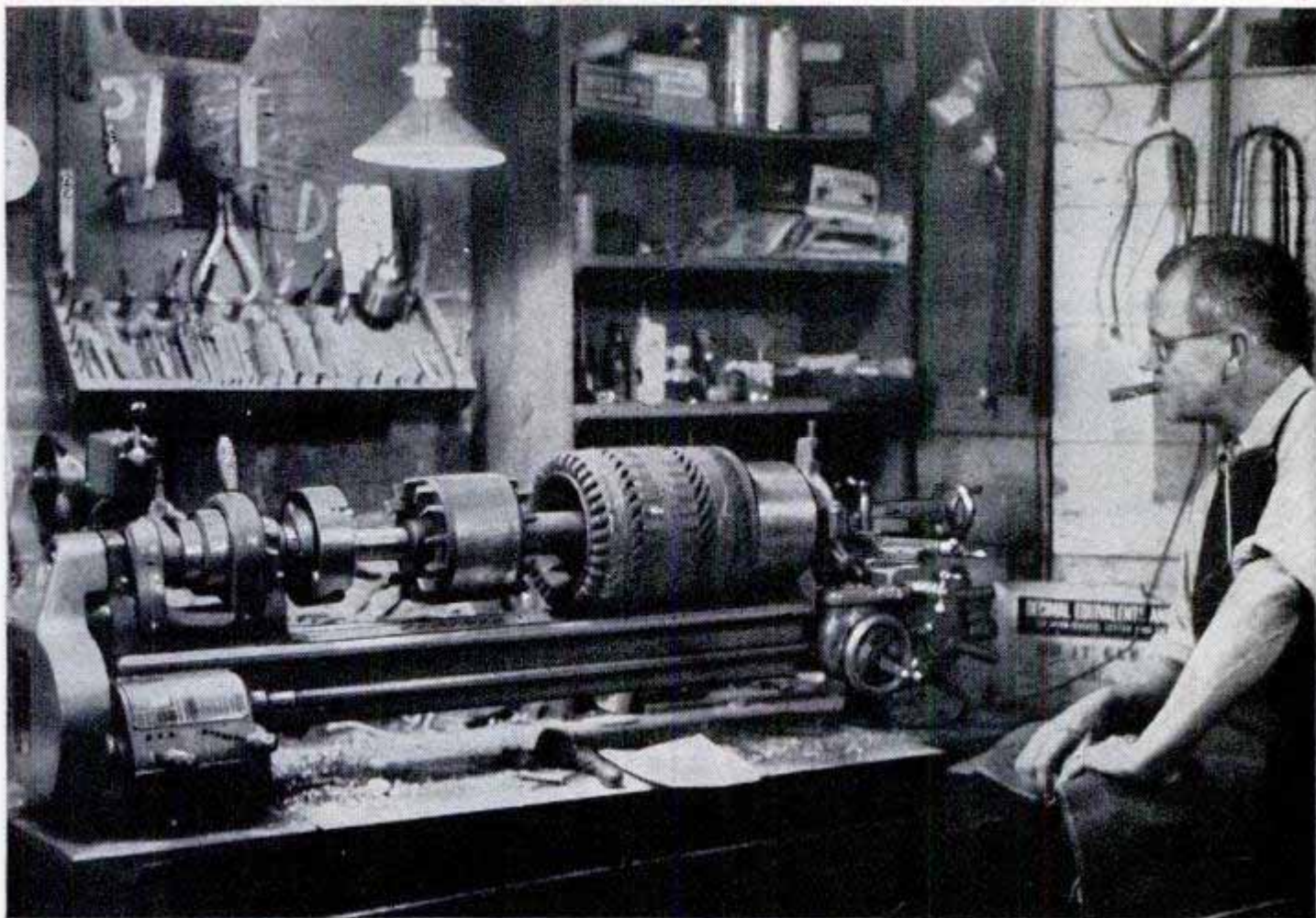

195 pound welder armature being machined in a South Bend 9" Bench Lathe

## *Small Lathe Does Big Job*

**Unusual repair job demonstrates profitable possibilities for doing maintenance work in your home workshop**

*Dewey Elmore, plant manager of the Hornaday Milk Co., Indianapolis, Indiana, recently sent us the picture reproduced above and the following letter.*

Gentlemen:

This picture was taken by my son who thought I was doing such an unusual job on a 9" South Bend Lathe. The armature I was turning weighed 195 pounds, was 34" long and 8½" in diameter. The armature was out of a direct motor drive, 300 amp. D.C. welder, which had three armatures mounted on the same shaft, the drive motor armature, the main welding generator armature and the exciter generator armature. The shaft was broken between the two generator armatures and I was unable to get parts, as the welder was obsolete. If I had made a new

shaft, it would have been necessary to have special jigs and fixtures to press armatures on and off. I supported end of armature shaft in steady rest and chamfered for welding, drilled ½" hole in ½" deep in main shaft. The stub shaft to be welded on was large enough to allow for warping. I chamfered this shaft leaving ½" nub on end to drive in to hole in old shaft. After electric welding, I turned to size.

I am real proud of this job, and the welder is back in service as good as new.

I am employed by the Hornaday Milk Company. I have a No. 644-R lathe in my hobby shop at home in my basement and for the past several years have done about all the maintenance machine work for the milk plant.

DEWEY ELMORE

*How about the equipment in your shop? If you are interested in lathes, drill presses, or shapers, write for our catalog.*

**South Bend Lathe Works  
South Bend 22, Indiana**

# NOW! this FULL WEIGHT Blade in Handy Dispenser

at this  
amazing  
low  
price!

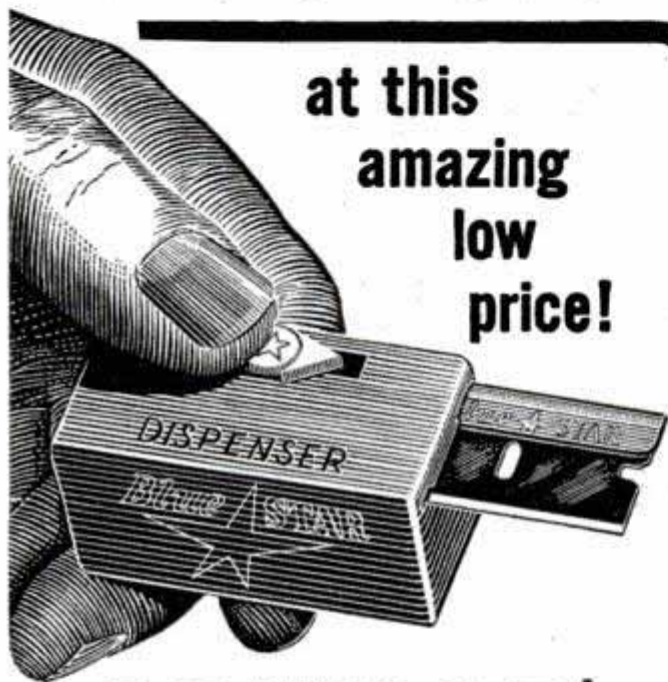

**10** BLADES IN  
DISPENSER **25¢**

REGULAR PACK 3 for 10¢

Try this sturdy, full-weight Blue Star on those tough, hard-to-shave spots. If any blue steel blade, at any price, gives you better shaves than Blue Star, we'll give you double your money back.

## Blue STAR

SINGLE EDGE

DOUBLE EDGE

PRECISION **ASR** PRODUCTS

AMERICAN SAFETY RAZOR CORP. BROOKLYN 1, N. Y.

COIL-WINDING DATA				
COIL 1	L1	L2	L3	All No. 26
	6 turns	10 turns	3 turns	Enam. Wire
COIL 2	L1	L2	L3	No. 26
	8 turns	18 turns	7 turns	Enam. Wire
COIL 3	L1	L2	L3	
	21 turns	40 turns	7 turns	
COIL 4	L1	L2	L3	All No. 30
	50 turns	85 turns	20 turns	Enam. Wire
COIL 5	L1	L2	L3	All No. 30
	60 turns	100 turns	25 turns	Enam. Wire

NOTE—S.W.—space-wound

In the two high-frequency short-wave coils No. 1 and No. 2, the "grid" winding (L2) is space-wound to the length specified; the "R.F." winding (L1) is wound between the turns of L2. In the two broadcast-band coils No. 4 and No. 5, (L1) and (L3) are random-wound in order to get the specified number of turns on the standard plug-in coil forms. Coil dope is used on the random winding to hold it in place. In coils Nos. 3, 4 and 5, space L1, L2 and L3 about 1/8" apart. In the short-wave coils Nos. 1 and 2, space L3 1/8" from the combined L1 and L2 coils. Fixed padder condenser across coil L2 inside coil form No. 5 should be a silver-mica type. If 150 mmfd. is not available use a 50 mmfd. and a 100 mmfd. connected in parallel. No padder condenser is necessary in Coil No. 4.

All Coils Close-Wound Unless Otherwise Specified

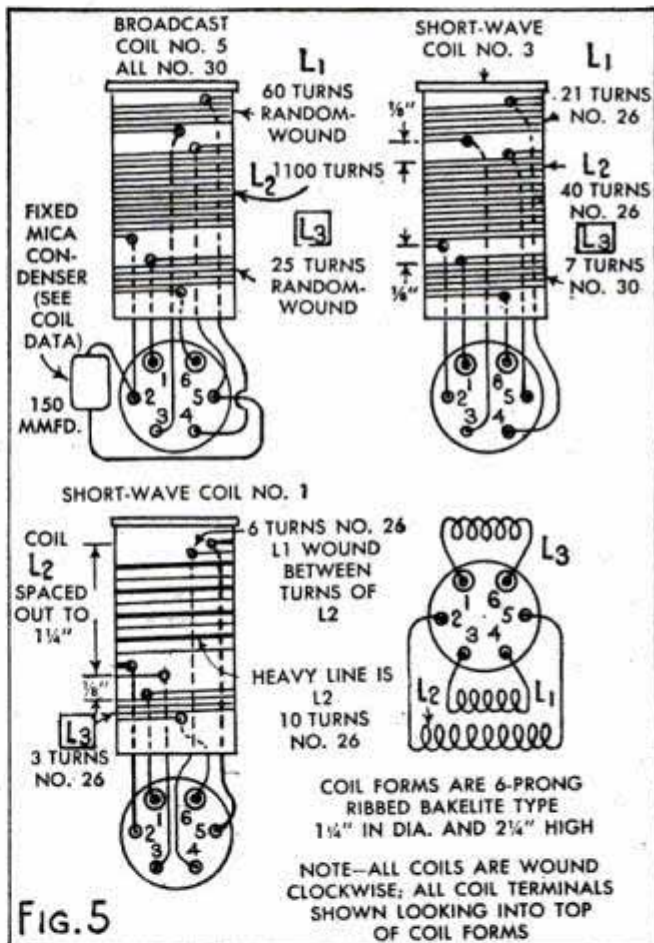

If a long outdoor antenna is used, a 100 mmfd. variable condenser should be connected in series with it and adjusted for the point which gives the best signal strength without introducing interference from other stations. Test receiver both with and without an external ground for best results in your location. Detailed student material list R-388 for this No. 2 progressive set is available from Popular Mechanics Radio and Electronics department upon receipt of ordinary letter postage.

Only wide-gap Auto-Lite Resistor Spark Plugs give you

**SMOOTHER PERFORMANCE**

**DOUBLE LIFE and GREATER**

**GAS SAVINGS**

Cut-away view shows the 10,000 ohm Resistor which permits wider initial gap settings and makes these advantages possible. Double life under equal conditions as compared with regular type spark plugs.

**M**ILLIONS of car owners from coast to coast are switching from narrow-gap spark plugs to the sensational new wide-gap Auto-Lite Resistor Spark Plug. They want smoother performance—money-saving gas economy—improved starting in extreme cold weather. They want the *Built-in Resistor* that doubles spark plug life and reduces interference with radio and television reception.



To get these remarkable benefits for your car, see your Auto-Lite Spark Plug Dealer today. You're always right . . . with Auto-Lite.

Tune in "Suspense!"... CBS Radio Thursdays... CBS Television Tuesdays

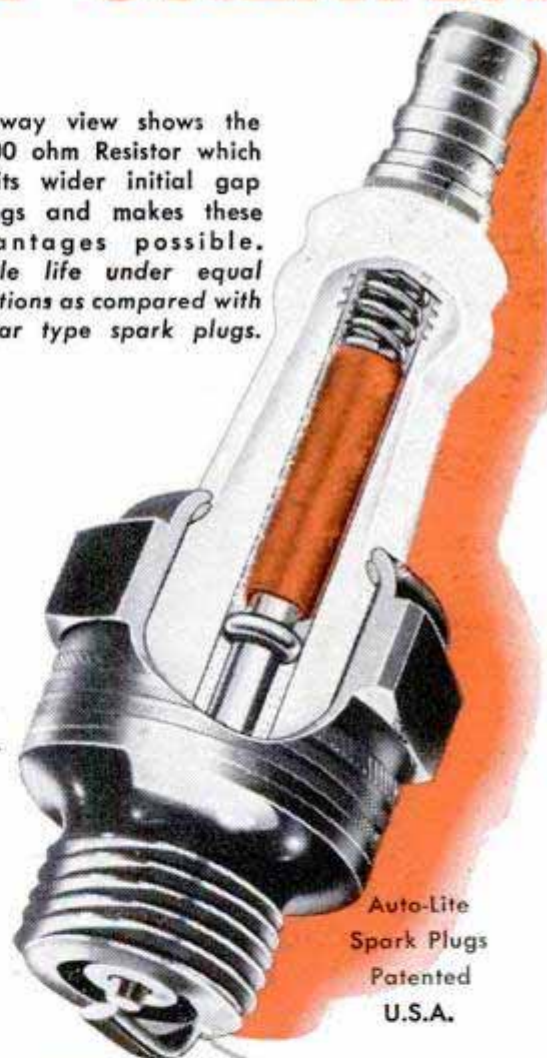

Auto-Lite  
Spark Plugs  
Patented  
U.S.A.

**AUTO-LITE** *Resistor*  
**SPARK PLUGS**

RESISTOR, REGULAR AND TRANSPORT TYPES

**Now it's EASY  
to have modern  
oak floors**

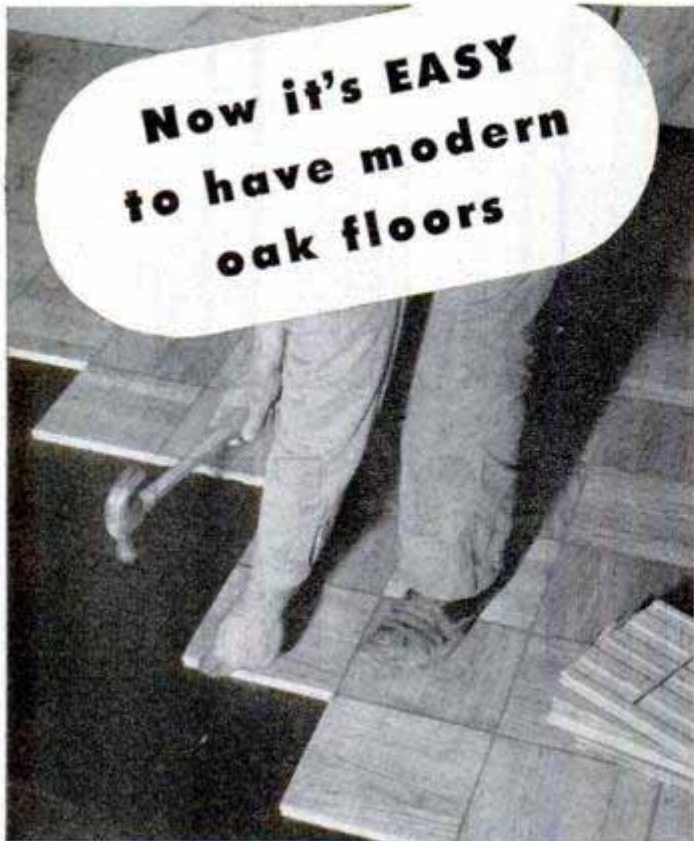

*Your choice of block or strip design*

**Just lay prefinished Bruce oak flooring right over your old floors...no sanding or finishing**

You can give your home new beauty at low cost with a prefinished Bruce Hardwood Floor. Completely finished—even waxed—at the factory, this highest quality oak flooring can be nailed right over old floors. No sanding or finishing...no mess or smell. Ready for use as soon as laid. Made in strip or block (parquet) design.

**"Scratch Test" Finish** — The Bruce factory-applied finish is baked into the pores of the wood. The "Scratch Test" (left) will prove to you that this durable finish does not scratch or chip or mar like an ordinary floor finish.



**Moderate in cost** — A new Bruce Hardwood Floor will cost you less than a good rug or carpet. Easy to keep clean and beautiful, too. It's just the thing to use in fixing up or adding a room. Let your lumber dealer give you an estimate. Mail coupon below for colorful literature.

**MAIL FOR FREE LITERATURE**

E. L. Bruce Co., Box 397-AB, Memphis 1, Tenn.  
Send complete information on prefinished Bruce Hardwood Floors.

Name.....

Address.....

City..... State.....



**Bruce Hardwood Floors**  
Product world's largest hardwood flooring maker

**Hall of a Thousand Illusions**

*(Continued from page 104)*

The catch was that the filled pool weighed several tons too many. To handle it, the center stage had to be lowered in advance, shored up with timbers, and the pool set up on it. Temporary flooring was thrown over the gaping hole so the current show could go on uninterrupted.

Then there was the show with the elephants—six of them. They were to be taken aboard in the subbasement and raised two to an elevator, to the show level, where all they had to do was stand in formation and look like elephants. The elevators could stand their weight, but sagged somewhat. That's what the pachyderms didn't like. The first time aboard, they backed off, impelled by some instinct that told them something was hollow under that floor. They milled around, conferred a little and were coaxed to try again. Finally assured that they wouldn't plunge to Kingdom Come, they lumbered aboard like veterans and rode up and down several times a day for the duration of the show.

What the hydraulic personnel hate are the snowstorms that occur above them around Christmas time.

"They've got the biggest snow bag in the world up there in the flies," growls the engineer, "It's a hundred feet long, like a hammock, with dribble holes along the top edges. It stretches the width of the stage. They fill that thing with flameproofed confetti and work it back and forth on a counterweight frame. It might look swell from the audience, but down here it doesn't look so good. That paper sifts through the stage-section cracks, gums up the grease around the pistons, flutters into the automatic switches and insulates them so they won't make contact. We spend a week cleaning house afterward."

Other factors than the stage help produce Music Hall sleight-of-hand. Many quick scene shifts would be ineffective without proper lighting. To handle this the theater has the most elaborate system ever devised. A total of 25,000 bulbs from 2 to 5000 watts illuminate the place, contributing to the hall's annual 6,000,000-kilowatt-hour consumption—enough to light the entire city of Emporia, Kans.

Ten thousand of the lamps have to do with the stage or auditorium, and are remotely controlled from a 15-foot light console right in front of the orchestra pit. The console looks like a super complex telephone exchange, studded with 4305 switches for presetting any of 20 different light combinations on any of the units in the house.

*(Continued to page 244)*



# what a difference in Boating Fun

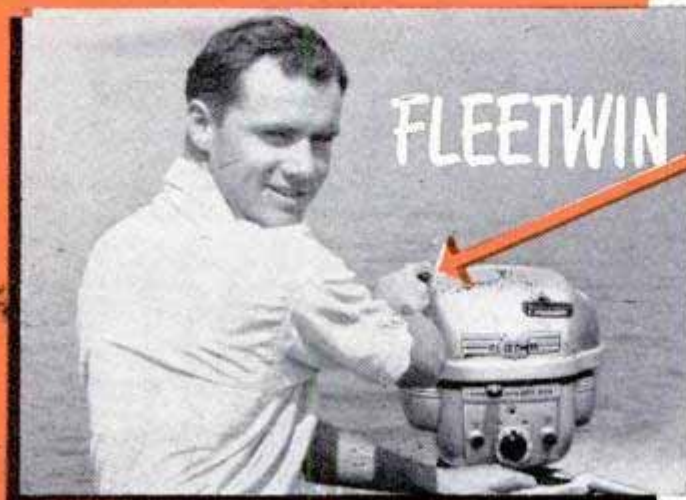

## with **DUO-CLUTCH**

You start in *Neutral* and idle when you like... *what a difference!* No fuss when you get underway! Load passengers and fishing gear. Then "press the button" and head for fun! Open the throttle and thrill to the performance of a motor that's ALL NEW... packed with power... wonderfully smooth right down to mile-an-hour trolling speed! New FLEETWIN with *Duo-Clutch* weighs only 45 pounds, develops 7.5 certified horsepower.\*



## with **GEARSHIFT**

*What a difference...* when there's *Gearshift Control* at your fingertips... with *Neutral-Forward-Reverse* to give you new starting ease—new maneuverability—new handling convenience! Enjoy the difference... with *Gearshift Control* in the great new Evinrude FASTWIN! 14 horsepower\* for superb performance on fast boats. With separate 6-gallon *Cruis-a-Day Tank* that gives you hours and hours of running without refueling.

## by **EVINRUDE**

...the first name in outboard motoring... the name that's known the world over for fine motors and responsible service. Your Evinrude dealer will gladly show you these new models, and the complete Evinrude line for 1950. Two light motors with exclusive FISHERMAN DRIVE—SPORTSMAN, 1.5 H.P.\* and SPORTWIN, 3.3 H.P.\* Two high powered models—SPEEDITWIN, 22.5 H.P.\* and SPEEDIFOUR, 33.4 H.P.\* Ask your dealer about time payments. Look for his name under "Outboard Motors" in your classified phone directory.

### WRITE FOR FREE CATALOG!

Yours, free—this full-color catalog of the complete Evinrude line. Write for it today!

### EVINRUDE MOTORS

4443 N. 27th Street,  
Milwaukee 9, Wisconsin

In Canada: Evinrude Motors,  
Peterboro, Ontario



\*O.B.C. certified brake  
H.P. at 4000 R.P.M.

# Build A FIREPLACE

How To Install The  
Fyro-Place  
Warm Air Circulating Unit

around this scientifically designed steel form which also provides circulating heat that assures perfect fireplace operation.

## free folder tells how

TELLS HOW TO BUILD YOUR FIREPLACE—Step by Step

- Foundation
- Steel heat-circulating form
- Cold and warm air ducts
- Chimney and flue construction
- Mantel or decorative front

ASK FOR BOOK  
"100 FIREPLACE IDEAS"

- Beautiful fireplace designs modern and conventional—shows artistic use of available material.

Enjoy circulating heat and the radiance of an open fire in your Home, Playroom, Cottage or Camp.

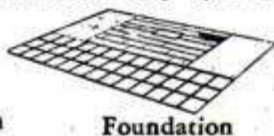

Foundation

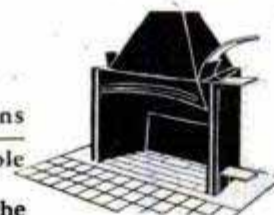

Fireplace form including firebox, damper, down draft shelf and smoke dome.

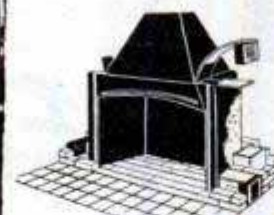

Brick, stone or cement block can be used around the form.



- Send free directions for building heat-circulating fireplace.
- Send Book "100 Fireplace Ideas." Pocket size book, sent free.
- Send larger book, 8½ x 11, beautifully illustrated, 25c.
- Send outdoor fireplace folder with 10 beautiful designs Free.

Name .....

Street .....

City .....

Sold Through Leading Building Materials Dealers

**PRICE FIREPLACE HEATER & TANK CORP.**  
150 W. Austin Street, Buffalo 7, New York

## Clinic



## for Homemakers

As a service to our readers in solving the hundreds of problems pertaining to a home—inside or out—the editors of *Popular Mechanics* invite you to present your problems to The Clinic Editor for help and advice. Address your questions to The Clinic Editor, *Popular Mechanics Magazine*, 200 East Ontario Street, Chicago 11, Ill.



### Inkstains on Marble

Q—I have a marble-topped table, or stand, which must be very old. There is a dark stain near the center of the marble top that I'm quite sure is an inkstain. It defies removal by any means I know of and I've tried everything I've heard about. Can you solve this one?

R.H., Centralia, Ill.

A—If you are sure the stain has been caused by ordinary writing ink, removal should be quite easy. There are several prepared ink removers available and as they are not expensive you might try one of these solutions, applying it as directed on the container and noting the results. However, we are rather doubtful about the full effectiveness of these preparations when used for this special purpose, especially if the inkstain is old. Another method which we believe would prove more satisfactory is to dissolve 1 oz. of oxalic-acid crystals in clear water (rain water is preferable) and add sufficient white flour to form a creamy paste. If it is available locally, obtain and add ½ oz. of antimony trichloride (butter of antimony) to the solution before adding the flour. **Caution:** Add both the antimony and oxalic-acid crystals to the water. Don't pour the water on the crystals. Apply the creamy mixture to the inkstain with a small brush and allow to stand for 30 minutes or so. Then wash off with clear water. It probably will be necessary to repeat this application several times in order to remove all traces of the stain and, because of the slow corrosive action of the chemicals, the marble top must be polished after this treatment. **Caution:** Dispose of all unused portions of the creamy paste, as the mixture is poisonous and the fumes from the chemicals are toxic. Wear rubber gloves.

### Moss on Terrace

Q—Our home is on a wooded lot and the lawn is terraced along the north side. Most of the terrace is covered with moss which apparently prevents grass from growing there. Does this covering of moss mean that the soil is poor? How does one get rid of the moss?—B.C., Ann Arbor, Mich.

A—Frequently moss takes over when the available plant food in the soil is depleted to the point where it will no longer support a healthy sod.

(Continued to page 242)



# CRAFTSMAN Tilting-Arbor Saw

REG. U.S. PAT. OFF.

## Big ... accurate ... low-priced!



**CRAFTSMAN**  
8-in. Tilting-Arbor  
Bench Saw

Saw only  
**\$54<sup>50</sup>\***  
Cash

\$5.50 Down, \$5 Monthly on Easy Terms

**\$104<sup>50</sup>\*** Complete  
Cash as shown

\* Prices slightly higher in the South,  
and west of the Mississippi  
River

**Free!**

SEARS new 1950 Power  
Tool and Mechanics' Tool  
Catalogs ... free! Get  
yours NOW. at the Hard-  
ware Dept. of your near-  
est SEARS Retail Store!

- CRAFTSMAN**  
Power Tool  
Bench  
only **\$10.95** \*
- Side-Table  
Extension**  
only **\$6.25** \*
- Front or  
Rear Roller  
Extension**  
only **\$4.75** \*

**We know of NO finer, more complete  
Outfit at anywhere near this low price!**

A superb heavy duty CRAFTSMAN tilting-arbor saw outfit that meets the most rigid requirements of professional and amateur craftsmen! Big, accurate! New design, construction and exclusive features! Large, 20x17-inch smooth-ground table of cast semi-steel, with removable dado insert. Depth of cut up to 2½ in. 26-7/32 in. long; 17 in. wide; 14⅞ in. high. Saw has automatic leveling guard, non-kickback pawls, splitter, accurate miter gauge and rip fence; 8-in. combination blade (½-in. bore), 2-in. machine pulley, and motor mount. Complete with ½-H.P., 3450 R.P.M. ball bearing capacitor motor (110-120-volt, 60-cycle, A.C.); 2½-in. motor pulley; ½x40 in. V-belt; side-table extension; front or rear roller extension; and steel power tool bench (height adjustable, 22 to 32 in.). Saw, motor, motor pulley, V-belt, bench and extensions are available separately, if desired.

**Feature for Feature,  
CRAFTSMAN gives you  
more for your money!**

NEW! Exclusive!  
Tilting, raising  
and lowering of  
saw blade are all  
controlled by a  
SINGLE conven-  
ient hand wheel  
at front of saw!



NEW! Floating  
motor mount  
fastens to bench  
for easier tilting.  
Controls belt ten-  
sion; reduces saw  
vibration; lessens  
the strain on saw!



Work stays level!  
Blade and guard  
(not table and  
work), tilt any  
angle up to 45°,  
for much faster,  
easier, more ac-  
curate operation!



See this sensational bench saw and accessories at your nearest Sears, Roebuck Retail Store TODAY!  
Buy and enjoy this saw NOW! SEARS Easy Terms make it much easier to pay for . . AS YOU USE IT!

**CRAFTSMAN** Hand and Power Tools by **SEARS, ROEBUCK and CO.**  
Famous for fine quality . . . precision performance . . . low price!

**NEW!**

# NYLON

## paint brushes



When you ask  
for a paint brush,  
ask for  
a NYLON . . .



**Smoothest painting**



**Easy to clean**



**Ideal for  
nearly all finishes**



**Durable bristles...  
won't break off**

Nylon paint brushes are made by leading paint brush manufacturers. Sold in paint, hardware and wallpaper stores everywhere, in all popular sizes. Buy a nylon paint brush today!

**NYLON**  
**PAINT BRUSHES**  
*for smooth painting  
...easy cleanup*



Better Things for Better Living  
... through Chemistry

Usually terraces, as well as flat surfaces, infested with moss are poorly drained, and also are shaded during a part of each day by trees or buildings. The only effective remedy is to dig up the affected area either by hand or with a rotary tillage machine and once the soil has been loosened and aerated, work in quantities of humus in the form of compost, peat moss, or manure mixed with straw. Then level the soil, apply prepared lawn-grass fertilizer in accordance with the manufacturer's directions and seed the terrace. To prevent the soil and seed from washing away before germination takes place, apply a mat to the slope. Special mats are available for this purpose.



### Aged-Pine Finish

**Q**—I am finishing a room in knotty pine with the walls paneled in random widths and having two built-in bookcases. I want to color, or stain the wood in a medium-dark tone like the mellow old-pine woodwork one often sees on the walls of the older homes. What is a pickled-pine finish? How is it produced?—I.M., Cedar Rapids, Iowa.

**A**—The so-called pickled-pine finish does not mean the same thing to everyone. We gather from your letter that you are thinking of this as being a dark finish. Although there are several methods, the pickled finish generally is produced by coating the wood with ordinary white lead and oil and then wiping off the coating with a soft cloth until the desired tone results. By "walls paneled in random widths" we assume you mean you are using knotty-pine boards in random widths with one molded edge. Only good-quality white pine will take a satisfactory finish of the type you require. Probably the simplest procedure is to apply a mixture of equal parts of raw linseed oil and turpentine to which sufficient burnt umber (oil color) has been added to produce the color desired. Add the oil color and test the stain on waste stock to get just the shade you want. Apply the mixture to the boards with a soft cloth and wipe off the excess as you go along. Do not allow the coating to set even partially before wiping, and be especially careful near large knots and on areas where oblique grain runs out at the surface. On these areas the stain will "take" much faster. After the stain has thoroughly dried, sand the surface lightly and finish with paste wax.

### Veneer Blister

**Q**—The veneer on our dining-table top is raised, or blistered, in two places near the edge of the top. Each blister is about 1 x 2-in. over-all size and is raised above the surface 1/4 in. or more. Is there any way to repair these defects and restore the top to its original smoothness?—C.U., Providence, R.I.



**A**—As a rule, such defects as you describe can be repaired by simply slitting the veneer, with the grain, with a sharp knife and forcing glue underneath the raised portion. Then immediately cover with two or more thicknesses of paper (newspaper will do) and place a weight over the paper to force the veneer back into place. Several bricks or a large kettle filled with sand will serve as a weight. After the glue is dry (allow at least 24 hrs.) remove the weight, wet the paper so that it can be scraped off and then sand the spot lightly with fine sandpaper, working from the center of the blistered area toward the edges. If the wood has not been badly discolored or lightened by whatever caused the blister, this simple procedure should result in a satisfactory repair.

# NEW POWER-JET CARBURETOR BOOSTS PERFORMANCE OF 1950 CHEVROLETS

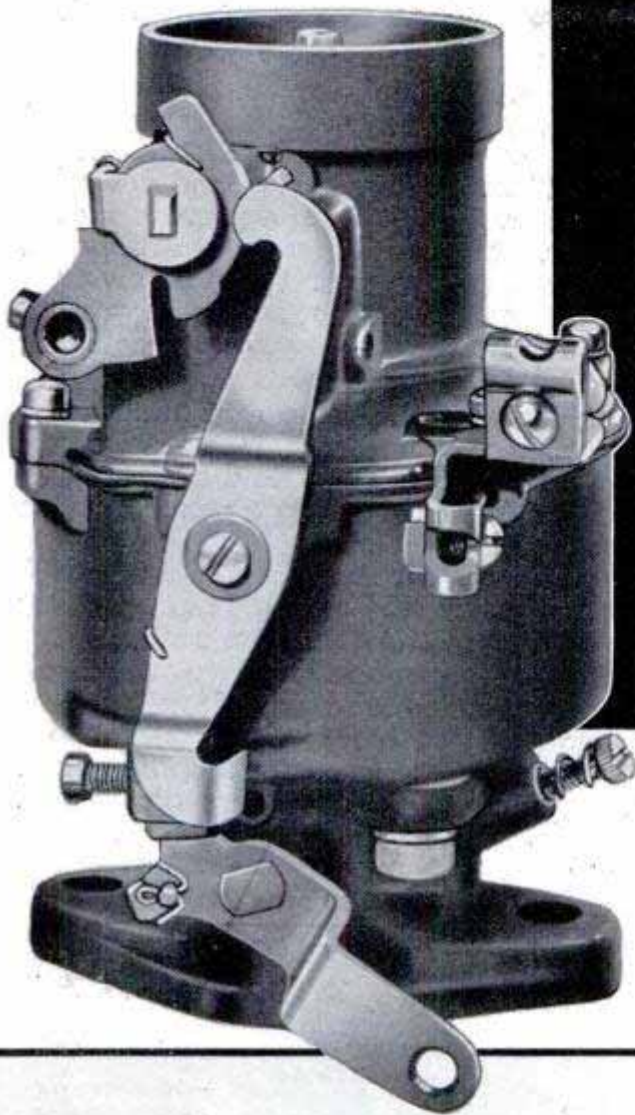

Chevrolet's 1950 cars are equipped with a carburetor of new design that has many distinctive features.

Because the float bowl is concentric with the carburetor throat, the fuel level in the nozzle passages remains virtually constant, regardless of steep grades and sudden stops or turns.

Advantages gained by the new design include smooth acceleration while turning, easier hot-weather starting, continuous fuel flow, better acceleration response in hot or cold weather, and freedom from fuel loss on any incline. No metering adjustments are ever required, and the only external adjustment is for regulating the idling mixture and speed.

The new Power Jet carburetor is just one of the many features which make the 1950 Chevrolet first and finest at lowest cost.

CHEVROLET MOTOR DIVISION  
General Motors Corporation  
DETROIT 2, MICHIGAN



**On Sharp Turns**

**On Steep Hills**

The new Power-Jet with concentric float bowl design contributes importantly to smoother performance on sharp turns, on steep hills and on sudden stops.

**On Sudden Stops**

Once preset, the operator can change colors by a master switch. House lights shift to green, then dim; stage lights move into red; the prima donna gets bathed in gold—and so on for a whole show.

To control color on the 206 spotlights in the hall, a unique trick is employed. These lamps are five feet long and are equipped with a boxlike arrangement in front, holding a frame containing four gelatin color sheets. The frames are mounted on tiny geared tracks and move back and forth in front of the lens, powered by small motors. The electrician sitting at the console pre-sets for blue, throws the master switch, and all over the house tiny motors whir, color frames travel across lenses and soon the whole house is bathed in blue light.

In an ordinary theater, blackout is easy. But in the Music Hall, many of the spots are of the arc type—two sticks of carbon barely separated. When current is passed through them it jumps the gap and creates an arc of light. Eventually, the carbon gets white hot. Shut them off and they glow awhile. One isn't bad, but the 36 in the Music Hall create quite an afterglow. To squelch them, the same system is used as for the color slides. The operator simply throws a switch, and tiny motors automatically roll black slides or "blackout doublers" along the little tracks in front of each arc-

light lens. Result: No glow. Stages can go up and down unnoticed, turntables can whirl and in a few seconds when lights come on, miracles have been performed.

Dozens of other features make the Music Hall the most fantastic showplace on earth. Its three-ton curtain, with 2000 yards of fireproof lining, has nearly a mile of steel cable running through rings sewn in its seams. It can be hauled up and down by three separate motors in a predetermined pattern that is set at the same control board that runs the elevators. When a new curtain was made a year or so ago, it was too big to haul through New York streets and had to be delivered in three sections.

Besides the theater's rain and snow makers, three cloud machines send wispy billows across the stage, and a pipe along the footlights delivers up a steam curtain when desired.

Four projection machines deliver 5000 miles of movie film a year in relays over the 190-foot gap to a monster screen.

To distribute sound evenly in the theater's 1,800,000 cubic feet, the largest mixer in the world carries it from 60 microphones through a series of booster amplifiers and out through 23 loudspeakers distributed through the hall, so that sound reaches top-most seats in the balcony—a city block

(Continued to page 246)

*Don't just paint it—let's use it!*



Remember Weldwood Glue when you need dependable wood-to-wood bonds. Quick and easy to mix with cold water... tremendously strong... stain-free... rot-proof... and *permanent*. At paint, hardware, variety stores and lumber yards. 15¢, 35¢, 65¢, 95¢ and larger sizes.

**WELDWOOD** PLASTIC RESIN GLUE

United States Plywood Corporation, New York 18, N. Y.

**ALSO HANDY FOR  
WOOD HOBBYISTS!**



**Firzite**

—to give you smooth finishes on fir plywood and other soft woods.

A pre-finishing material that seals the wood pores... tames the wild grain... virtually eliminates checking and grain raising. An excellent base for stain, paint or enamel. White or clear. White Firzite provides an easy, low-cost way to achieve "blond," "bleached" or "wiped" finishes.



**Satinlac**

—to preserve the beauty of all woods.

An inexpensive coating for the proper finishing of Weldwood Hardwood Plywood and similar woods. Clear. No brush marks. Brings out all the natural beauty of wood. Does not yellow or darken with age.

FIRZITE and SATINLAC are available from paint, hardware and lumber dealers. Write for leaflet No. 4 on finishing plywood.

# BE A CHAMPION DRIVER

COOPERATE WITH THE WORLD'S SAFEST DRIVERS—THE CROSS-COUNTRY TRUCKERS



When you're not certain that it's safe to pass a truck, give him a couple of short "toots" or blink lights at night. *Stay back.* He'll signal you — **when it's safe to pass!**



If you start by a truck and the driver waves you back, he's warning you that there's danger ahead! Stay behind until he signals that all is clear. **That's the safe way!**



If you are driving slowly and a truck passes you, flick your lights as soon as the rear end is clear of your car. This signal tells the driver that he can turn back into the right lane. **He'll appreciate this courtesy!**



Whenever you are *obviously* in distress on the road, you'll find the cross-country trucker will be the first to offer you expert help. You can repay this courtesy by always cooperating with him. **Be a Champion driver! It pays!**

Commercial truckers constantly make comparative tests of spark plugs because they know that good spark plugs maintain engine efficiency, economy and dependability. The fact that the vast majority use dependable Champion Spark Plugs is positive proof that you can save money with Champions in your car.

**... BE A CHAMPION DRIVER — IT PAYS!**

**FOLLOW THE EXPERTS—**

*Demand*



Mr. Jess L. Osburn, Houston Transit Company's superintendent of equipment, writes: "We use dependable Champions exclusively. They helped us win the 1948 National Bus Transportation Maintenance Award in the 501 to 750 bus group."

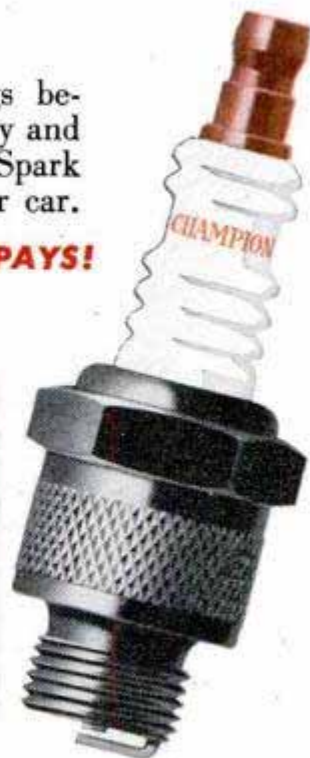

CHAMPION SPARK PLUG COMPANY, TOLEDO 1, OHIO

Listen to the CHAMPION ROLL CALL . . . Harry Wismer's fast sportscast every Friday night, over the ABC network

from the stage— $\frac{1}{8}$  second after the screen image. Presiding over the mixer, in a booth over the third mezzanine, the sound engineer watching the show through binoculars, adjusts the battery of dials that control each whisper.

About the only thing that doesn't need amplifying is the organ. This mammoth, with two consoles that roll out on tracks from either side of the stage, has pipes varying from 32 feet high to the size of a pencil stub. It requires eight separate rooms to house them all. Special deodorant is sprayed through the lofts regularly to keep musty smells from wafting over the customers when it starts blowing its 60 blower fans.

The only time there was really any smell potential in the theater was when the producers moved in a cast of 30 Arabian horses, three jackasses and a camel. All had to be housed in the hall. A special ventilating system was installed over the stage. Paddocks of tanbark were built in the wings for the horses. Dressing rooms became tack rooms. The camel was relegated to the subbasement and sprayed regularly with everything from perfume to kerosene, and the donkeys won the animal room—a ceramic-tiled chamber built especially for four-legged performers—located below the stage level. Nobody in the

audience smelled a thing but pure air.

Ordinarily, the theater's own air-conditioning system takes care of odors quite adequately. Some 280,000 cubic feet of fresh air every minute is hauled into the theater by massive subbasement machinery. It drifts evenly over the audience from ceiling apertures, and is sucked out through vents under the chairs.

When the show is all over, and the house darkens, it takes a crew of 100 to clean up the day's debris—which is likely to include everything from chewing gum to diamond bracelets. Anything lost is usually found, however. All trash is sucked through 60 outlets to which cleaners attach vacuum hose. The pull, generated by a pair of 15-horsepower motors downstairs, makes a hiss like a steam engine when all the vents are closed. Everything sucked into the tubes is whipped down to a pair of 10-foot dust tanks in the cellar. Before they're dumped, the dust and dirt is sifted for valuables. One woman, who lost three  $1\frac{1}{2}$ -carat diamonds in the inch-thick pile of the luxurious rugs, got them back next day after the dust had been sifted.

"I knew this place could produce miracles," she announced. "But I still don't know how you do it." Like most Music Hall patrons, she never got a look behind the scenes.



Every Mechanic Needs a

**Snap-on\***

MIDGET

**WRENCH SET**

for small assembly work

**Set Contains These 19 Most Needed Wrenches**

When you have small nut-turning jobs, lay aside those "too-big" tools and put speed, safety, and working convenience into your hands with this 19-piece Standard Midget set. You get a Nut Spinner, 2" and 6" Extension Bars, Ratchet, Plastic Grip Handle, Sliding Bar, Universal Joint, nine hexagon sockets ( $\frac{3}{16}$ " to  $\frac{1}{2}$ ") and three square sockets ( $\frac{1}{4}$ " to  $\frac{3}{8}$ ").

\*"Snap-on" is the trade mark of Snap-on Tools Corp.

**\$17.75**

Plus Local Sales Tax



SNAP-ON TOOLS CORP., 8062-D 28th Ave., Kenosha, Wis.

Please send me the 119-TM-B Midget Standard Set

I enclose  Check,  Money Order,  
 Company Purchase Order.

NAME .....

ADDRESS .....

CITY.....STATE.....





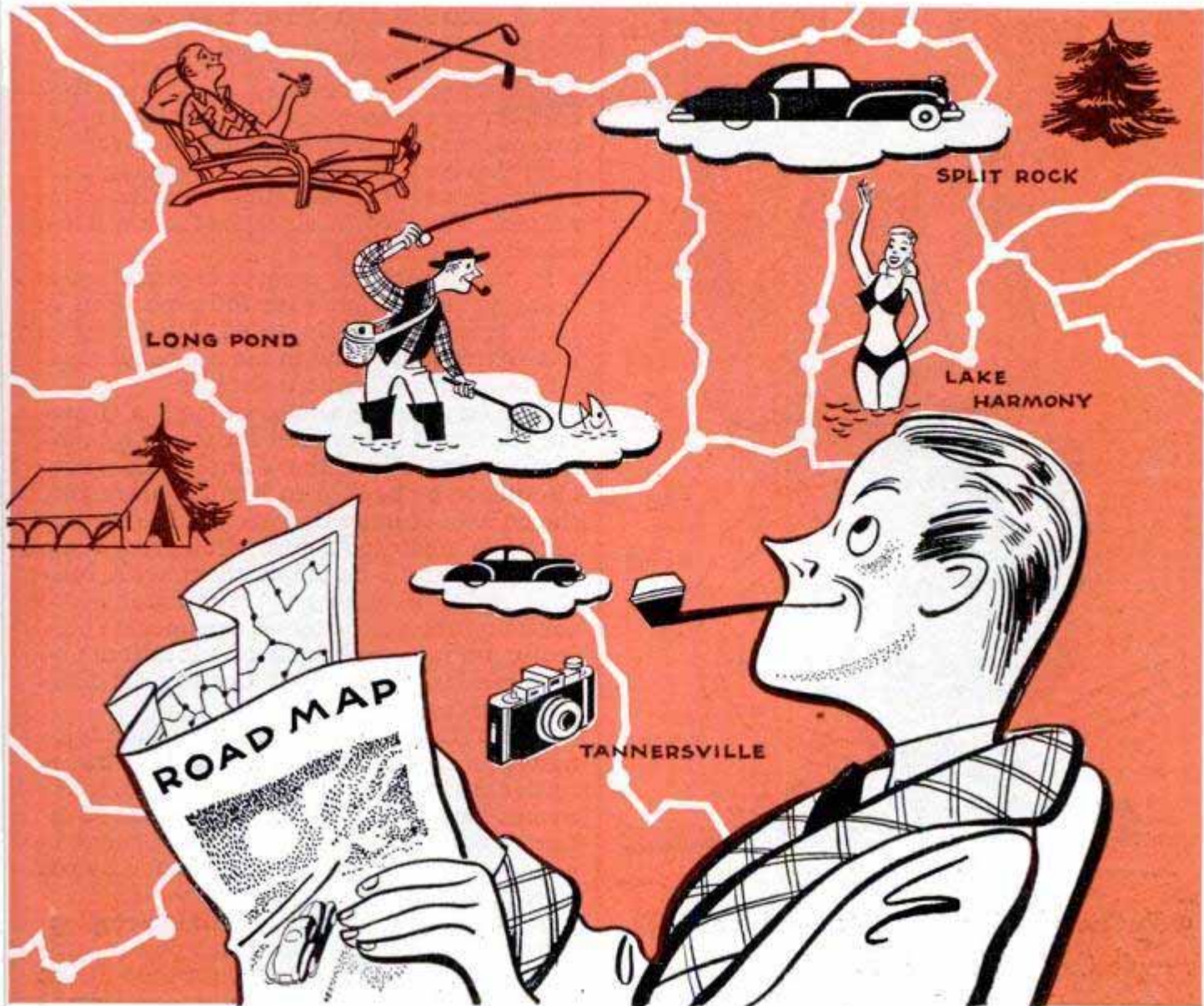

## Whatever you plan to do this summer be sure your battery won't let you down

Time moves fast... and there's always so much to do during the last minute's rush. Give a thought to your battery now. Wait too long and it may let you down when you're far from home. Don't take a chance! Let the Exide dealer give your battery a complete check-up today. It takes but a short while... costs you nothing.

*Remember*, a single starting failure can be far more costly than the little extra you pay for a trustworthy Exide Battery.

THE ELECTRIC STORAGE BATTERY COMPANY, Phila. 32  
Exide Batteries of Canada, Limited, Toronto



"Exide" Reg. Trade-mark U. S. Pat. Off.

1888... DEPENDABLE BATTERIES FOR 62 YEARS... 1950

WHEN IT'S AN

**Exide**

...YOU START

## PUT *Spring* IN YOUR HORSEPOWER

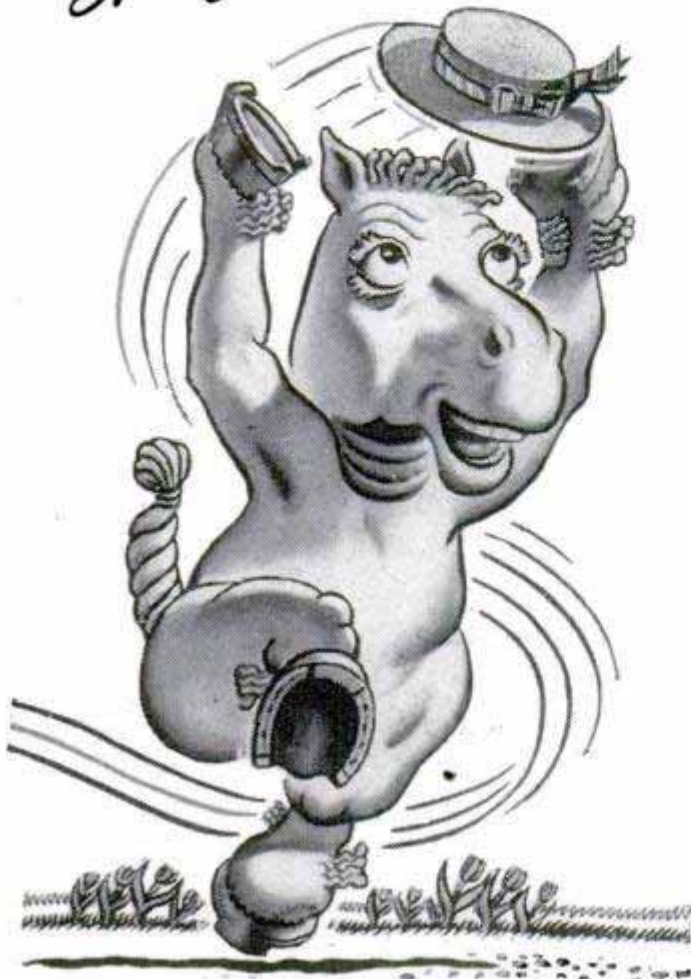

● Put new life in your motor—with a quick, simple Casite Treatment.

Casite through the carburetor air-intake frees sticky valves and rings, lets the power zoom through.

Casite in the crankcase keeps your engine clean and free-running—speeds lubrication—retards engine wear and cuts repair bills.

THE CASITE CORPORATION • HASTINGS, MICHIGAN

75¢  
A PINT

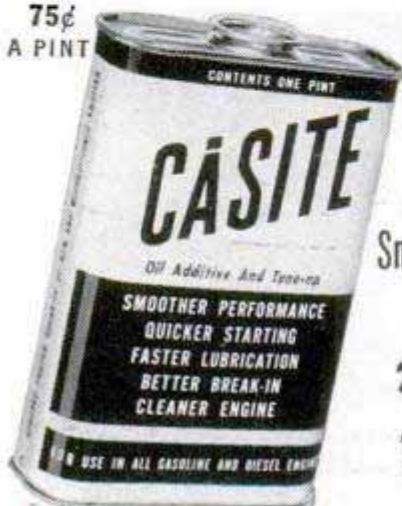

Better and  
Smoother Performance

or

Double-Your-  
Money-Back

## Radio Up Your Sleeve

(Continued from page 136)

satisfactory when reduced. A subminiature speaker can't reproduce the low notes that are emitted by a large speaker. Eventually, this may be remedied by designing a subminiature speaker that creates harmonics. These could simulate the low notes satisfactorily.

In the meantime, subminiaturization is being widely adopted for those portions of circuits for which it is suited. Hearing aids have shrunk in size with the use of subminiature parts and printed circuits.

Guided missiles would be only a futuristic dream if it were not for the new techniques that allow the complicated radio circuits to be packed in small spaces. Too, the control of huge rockets and the receiving of telemetered information from them in flight would be impractical with full-size radio equipment. A subminiature vacuum tube, for instance, can operate perfectly under conditions of vibration and acceleration that might destroy its full-size counterpart.

One of the newest developments in telemetering is a high frequency FM transmitter that weighs less than a pound, is 5½ inches long and 2 inches in diameter. Carried inside a small rocket, it has a range in excess of 50 miles. It was developed by the Pacific Division of Bendix Aviation Corporation as part of a 12½-pound telemetering package that also contains power supplies and such sensing instruments as motion and pressure pick-ups, accelerometer and altimeter gauge. A portion of the missile's air frame is used as the antenna, and as many as 48 unknowns can be measured and transmitted to the ground.

Except for the vacuum tubes, most parts needed for subminiature circuits can be bought for a few cents each. Due to the limited quantities in which they are manufactured, tubes average about \$3.50 each, list price. Few radio supply houses stock the small parts as yet and it is best to order direct from the manufacturers. A list of manufacturers can be obtained by writing to the National Bureau of Standards, Washington 25, D. C., and asking for a copy of the March 1, 1949, bulletin titled "General Information on Printed Circuits and Subminiature Radio Transmitters and Receivers."

The subminiature art is still so new that additional and important developments are occurring all the time. Eventually, it may come close to fulfilling a military request made during the war: "We want electronic equipment that takes up no space, weighs nothing, but will do everything!"

# Wonderful fun — ENDLESS GOOD TIMES



## RIDE A **HARLEY-DAVIDSON** *HYDRA-GLIDE*

**N**EW pleasures await you in motorcycling, world's greatest sport! Adventure, travel, thrills, fascinating friends! Every trip is delightfully different, every moment one to be remembered as you take in exciting races, hillclimbs, endurance runs and go on gypsy tours, sightseeing trips and other club events.

And what a difference it makes when you're riding a Harley-Davidson *Hydra-Glide*! Roughest roads smooth out like magic, hills fade away, day-long riding is really comfortable! Get your share of this exhilarating fun. You can own a Harley-Davidson on easy terms. See your dealer today.



HARLEY-DAVIDSON MOTOR CO., Dept. P, Milwaukee 1, Wis.

Send me *free* copy of ENTHUSIAST Magazine filled with motorcycle action pictures and stories, also literature on latest models.

Name.....

Address.....

City..... State.....

**DEALERS:** Valuable franchises are now available for the full line of famous Big Twins and the 125 Model. This is your opportunity to line up with the greatest name in motorcycles. Write or wire for complete information today.

All the Difference  
in the World!



**JOHNSON**  
*Neutral  
Clutch*

**MOTOR'S RUNNING • BOAT  
IS STANDING STILL.  
YOU'RE IN NEUTRAL!**

It's a new experience—running the 5 h. p.\* Johnson outboard motor with Neutral Clutch!

Start in neutral. Flip the lever, and GO! Stop, quick, with your motor running, when a big one strikes. Maneuver easily in and out of tight places.

New sure-fire Shock Absorber Drive lets you go through shallows without a care. New Vari-Volume Pump

keeps your motor cool at any speed. 32 outstanding features give you the performance and DEPENDability you expect in a Johnson.

See your Johnson dealer. Look for his name under "Outboard Motors" in your classified telephone directory. 1950 Johnson prices are lower!

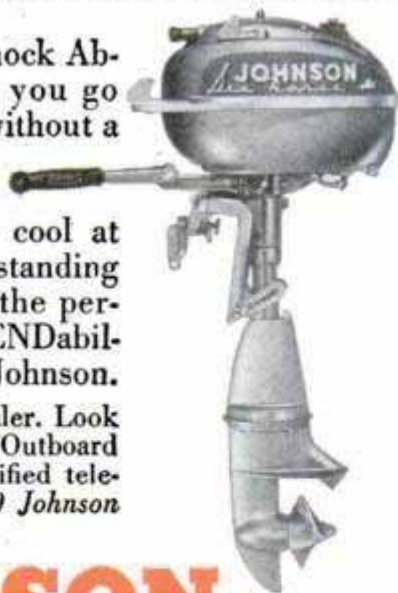

**JOHNSON**  
**SEA-HORSES FOR DEPENDABILITY**



\*OBC Certified Brake H. P.  
at 4000 r. p. m.

**FREE HANDY CHART**

Complete description of all five 1950 models, including the sensational

Model QD with Gear Shift Control and Mile-Master Fuel Tank. A post card gets it. Write today!

JOHNSON MOTORS, 400 Pershing Road, Waukegan, Illinois  
Johnson Motors of Canada, Peterboro, Canada

## Back-Packing in the Mountains

(Continued from page 163)

in the shade. A lightweight woolen shirt and a down vest or loose-fitting sweater are good insurance against chills. For an outer garment, wear a windproof jacket. A stocking cap is fine to wear around camp on chilly mornings and evenings and in bed on cold nights—especially if your hair is getting thin!

You'll need the usual hiking shoes, jeans or khaki trousers, an old felt hat and four pairs of heavy wool socks. These socks are the only extra clothing you should take. Don't weight yourself down with extra trousers and shirts.

Sunglasses are an excellent "extra" for tramping high on mountains. In many cases, when well above the timber line, they are essential and it's good policy to carry an extra pair, just in case. Mosquito lotion is good insurance, too, especially in the early part of the summer.

You'll need a first-aid kit, including a snake-bite suction device, if you're in rattler country. Be sure you know how to use it before you start. Don't wait until a rattler strikes! First-aid materials should include bandages, adhesive tape, disinfectant, dental poultices, aspirin and a few sleeping pills to aid an injured person to rest. Put a couple of sturdy needles and some strong thread in the first-aid box.

Unless you're carrying a tent that requires stakes, you won't need a hand ax. It would be handy, of course, but you can pick up loose deadwood, known as squaw wood, for your fires. Don't bother with a heavy hunting knife, either. A sharp pocketknife is more useful. It's wise to carry an extra one of these, too. You can lose a knife, you know!

In addition to a stock of matches carried in waterproof packages, distributed through each pack, it's wise for each member of the party to carry a waterproof matchbox in his pocket at all times. Then, if he wanders away and gets lost, he can always build a fire to keep warm until someone spots the smoke or flames. A few candle stubs or a package of commercial fire kindler will make fire-starting easier in wet weather.

Every member of the party should have a map and compass with him at all times. And, he should know how to use them.

If you're in bear country, all food must be placed in a pack board and hung high in a tree at night and when you're away from camp. For this purpose, you should carry a light, 50-foot length of rope.

You'll probably plan to do some fishing

(Continued to page 254)

# DREMEL *Electric* SANDER-POLISHER

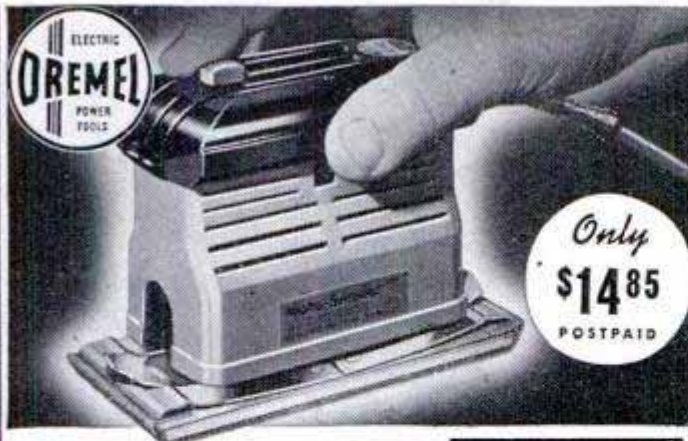

## SAY GOODBYE TO HAND SANDING!

This patented, miracle machine is so easy to handle, a child can use it. Craftsmen and housewives find (1) As a sander, it takes the effort out of sanding walls, woodwork, furniture, workshop projects, etc. Its straight-line (non-rotary) action will not burn or scratch surfaces. (2) As a polisher, it does a professional job on waxed surfaces of cars, furniture, etc. (3) As a massager, it's ideal for tired or sore muscles.



Works Easily in Awkward Places

## COMPARE THESE OUTSTANDING DREMEL FEATURES

Dremel Sander delivers 14,400 strokes per minute, weighs only 2½ lbs.; it's foolproof (has only two moving parts . . . never needs oiling). Dremel Sander operates on 110-120 Volt, 60 cycle, AC. Thousands and thousands of satisfied users prove its outstanding value.

**SATISFACTION GUARANTEED** —Dremel Sander comes complete with 6 sheets assorted grade Garnet Paper for sanding, plus felt pad and sheepskin for polishing. If your dealer cannot supply you, use coupon to order direct from factory. Money back if not delighted after 5 days' trial.

## USE THIS ORDER — If Your Dealer Cannot Supply You DREMEL MFG. CO., DEPT. 110-D, Racine, Wisconsin

- Enclosed find \$\_\_\_\_\_ (Check or money order) in full payment for items checked below.
- Enclosed find \$2. Ship items checked below C. O. D. I'll pay postman balance plus postage and fee.
- Dremel Sander \$14.85.  Dremel Coping Saw \$5.85. Send FREE catalog  Dremel Sander  Dremel Saw

Name \_\_\_\_\_

Address \_\_\_\_\_

City \_\_\_\_\_ Zone \_\_\_\_\_ State \_\_\_\_\_

# DREMEL *Electric* COPING SAW

CUTS SCROLLS LIKE MAGIC—SANDS AS IT SAWS

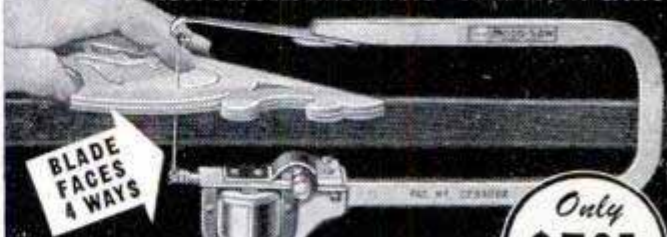

SAFE as a HANDSAW

JUST GUIDE IT!

For home, hobby, repair work—no other tool pleases so much for so little cost. Works in any direction—delivers 7,200 strokes per minute smoothly, effortlessly. Saws through ¾" medium-hard wood at foot-a-minute speed. Touch-of-the-trigger, foolproof action. Only two moving parts, never needs oiling. Operates on 110-120 V. AC. FREE PROJECT PLANS packed with each saw. If your dealer can't supply you, use coupon to order on MONEY BACK GUARANTEE five day trial.

# GARAGEMEN, SERVICE STATION OPERATORS, CAR OWNERS!

## SAVE UP TO 50% ON THESE NATIONALLY-KNOWN AUTOMOTIVE SERVICE ITEMS



\$39.

For better than 30 years, the KRW Direct-to-User Policy has SAVED MILLIONS for THOUSANDS of Garage and Service Station Operators and Car Dealers. KRW manufactures hundreds of specialized tools and equipment which have been factory-approved by Ford and other car manufacturers. KRW Tools are used the world over. See our rating in Dun & Bradstreet. It's tops.

### KRW SIX AMPERE SLOW CHARGER

Handles 1 to 12 3-Cell Batteries or Equivalent. Complete ready to use.

This heavy-duty battery charger is ideal for safe charging of all types of car, truck and aircraft batteries. It incorporates all the latest design and construction features. Comes complete with bulb, wiring and connectors, ready to plug in and operate. Case is 11" x 13" x 6". Operation is simple and foolproof. Plug and Jack arrangement, like a telephone switchboard. You merely plug in to the jack corresponding to number of batteries on the line. Thousands now in use. Operates on 110 Volt, 60 Cycle.

\$130.

### KRW FASTCHARGER

FULLY AUTOMATIC. OPERATES ON 110 VOLTS A. C.

Simplest and most efficient on the market. Only one knob to turn, one dial to watch. New electric timer is foolproof in operation . . . it automatically discharges, fast charges, slow charges and shuts off. Customer can be shown exact condition of battery on the easily understood full-color dial. You can do this under proper load without danger of buckling plates. Use it also for "cycling" batteries that are badly sulphated. Equipped with 8" fan and heavy-duty motor. Lowest priced dependable unit on market. Money back if not satisfied after 30 days.



### KRW GARAGE JACK

3 TON CAPACITY

## SOLD WITH 30-DAY MONEY-BACK GUARANTEE

Lowest Price only \$90.

This outstanding Jack value meets every requirement of strength, fast lifting, quick spotting and dependability. Lifting capacity 3-tons. Weight 195 lbs. Length overall including handle 88". Length of chassis 53". Floor to top of rest pad 4" minimum. Raises to 24" maximum. Equipped with Self-cleaning Release Valve, Tamper Proof Safety Valve, Crowned, Roller Bearing Front Wheels and Ball Bearing Swivel Rear Wheels, Finger-tip Control Button.

### KRW AIR COMPRESSORS. TWO STAGE

Highest Quality. 4 Models—9.75 to 38.3 cu. ft. Displacement.

Why pay \$200 to \$300 Premium. For 35 years, KRW has passed these savings on to users. Every feature which can contribute to maximum efficiency and long life has been "built in". Cylinders are nickel-chrome alloy iron. Crankshafts drop-forged with integral counterweights. Timken Roller Bearings. Lynite Connecting Rods. Semi-steel Pistons with 3 compression and one oil ring. Constant level oiling system. Plate-type Valves. Automatic Air Breather. Combination Filter and Air Cleaner. Pressure Unloader for Easy Starting. Pressure Control Switch and Thermal Relay protects motor against overloading and undervoltage. 200 lbs. pressure ASME Tanks. PRICES FOLLOW:

2 H.P. 9.75 c.f.m., 80 gal. tank \$375.00 7½ H.P. 28.4 c.f.m., 80 gal. tank \$654.00  
5 H.P. 20 c.f.m., 80 gal. tank \$440.00 10 H.P. 38.3 c.f.m., 80 gal. tank \$685.00

WRITE FOR LITERATURE WITH DETAILED SPECIFICATIONS



**TERMS:** Cash with order. If C.O.D., 25% must accompany order. Concerns with established credit sold on open account. All PRICES F. O. B. Factory. (Subject to change without notice.)

**SATISFACTION OR MONEY BACK GUARANTEE** All Tools or Equipment

described in this advertisement are sold subject to your trial for 30-days after receipt. If you are then not thoroughly satisfied, return the goods to us and your money will be immediately REFUNDED.

**SERVICE AVAILABLE IN ALL PRINCIPAL CITIES**

**K·R·WILSON** 213 MAIN ST. BUFFALO 3, N. Y.  
WORLD'S LARGEST MANUFACTURER OF GARAGE TOOLS AND EQUIPMENT

# SHOPSMITH OUTPERFORMS SAWS, SANDERS, LATHES, DRILL PRESSES COSTING \$500<sup>00</sup>

It's a performance-proved fact! With SHOPSMITH you can do more jobs, actually do better work, than with any \$500 combination of single-purpose tools with motors. And here's why:

**SHOPSMITH IS VERSATILE!** It converts into five big, heavy-duty power tools. Takes all standard accessories. Can do 116 wood, plastic and metal working operations.

**SHOPSMITH IS EASY TO OPERATE!** Even without practice you can change it from tool to tool in less than sixty seconds.

**SHOPSMITH TAKES BIG WORK!** Its effective table width is so great you can saw to center of 8-foot plywood panels, sand and drill room-length pieces—with no interference from other tools. Lathe turns work bigger than a nail keg.

**SHOPSMITH IS PRECISION-BUILT!** It combines features found only in the finest tools. Grease-sealed ball-bearing action. Induction hardened spindle tip. Centerless ground steel ways. A score of precision features that assure hairline accuracy, lifetime service.

**SEE SHOPSMITH DEMONSTRATED!** At any Montgomery Ward, leading hardware or department store. And write for free 16-page, fact-packed illustrated booklet.



## \$169.50

complete except for motor. With special, 1/2-hp., capacitor type motor (shown). \$199.50

**CONVENIENT TERMS**



## JIGSAW FOR SHOPSMITH

*The finest precision  
jigsaw you could own*

Rugged construction. 18" throat. Large tilting table. Built-in blower. Attaches quickly with one bolt. Can be used also for saber sawing, machine filing. Complete attachment, \$29.95

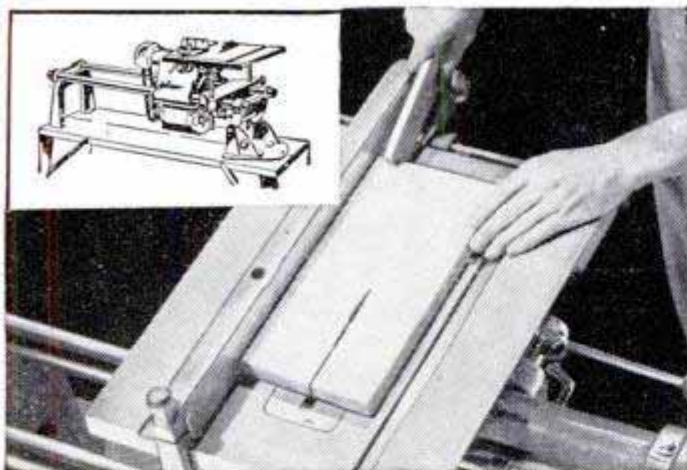

**1 8-inch Circular Saw.** You'd pay \$120 for a saw of equal quality, equal capacity. Effective table width, fence to blade, up to 48". Depth of cut 2 1/4". Sturdy tilting table with ball-crank raiser. Precision-tooled miter gauge with automatic stops. Self-aligning rip-fence.

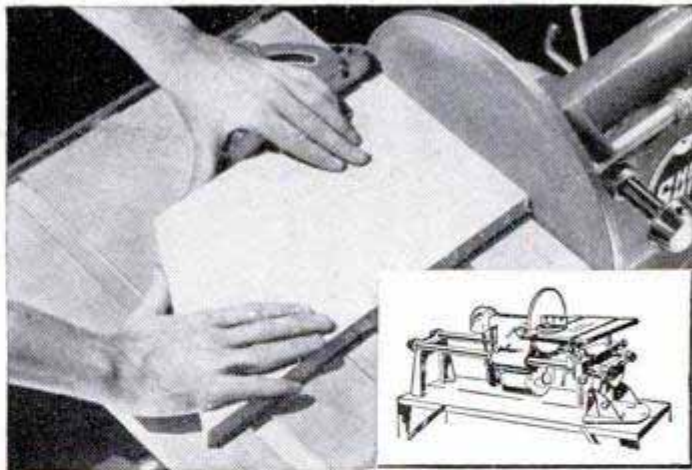

**2 12-inch Disc Sander.** No other disc sander can match it. None has 12" precision balanced disc, 14 1/2" x 17" tilting table, both miter gauge and fence. And with SHOPSMITH you can feed disc into workpiece with feed lever for greater accuracy, speed and safety.

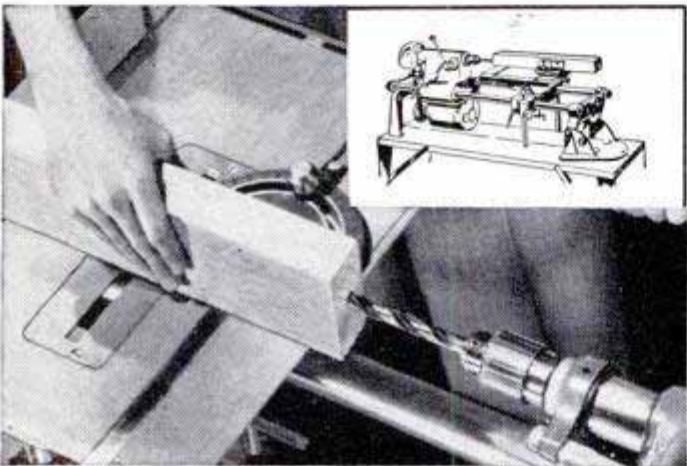

**3 Horizontal Drill Press.** Ever try to drill the end of a table leg? Dowel stock for table tops? Mortise doors for locks? You can do it quickly and easily with SHOPSMITH. Work lies flat on table, no special jigs needed. Speeds from 875 to 3500 rpm. 4" quill feed.

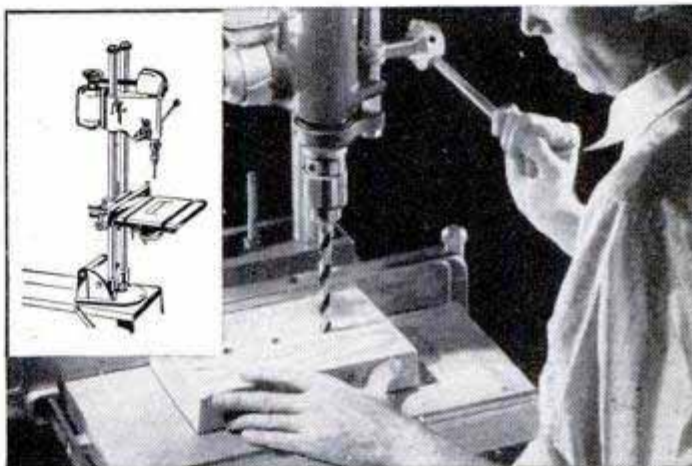

**4 Vertical Drill Press.** In vertical position, SHOPSMITH is both a bench and floor-type drill press. Drills to center of 15" circle. Has 4" spindle feed with right or left hand feed lever. Jacobs key chuck takes drills from 5/64" to 1/2" in diameter. Extra-large table.

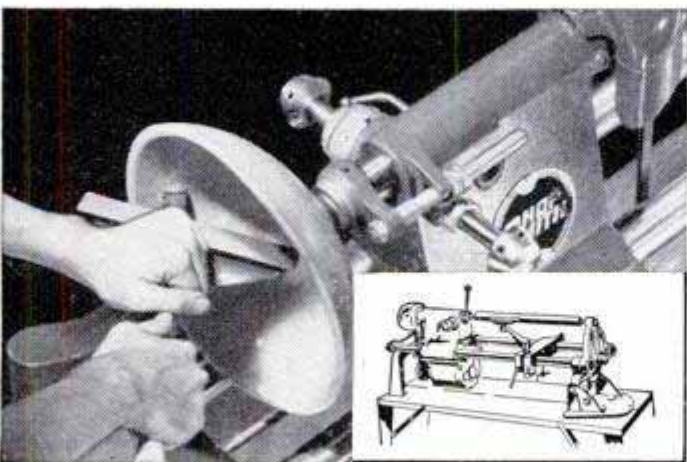

**5 33-inch Wood Lathe.** Turns stock up to 15" in diameter, 3" more than most heavy-duty lathes. Swivel-arm tool rest slides parallel to ways, lever-locks in position. Absolutely rigid lathe bed assures maximum accuracy—tubular steel ways each take over one-ton stress.



**FREE**

**GET ALL THE FACTS!** Compare before you buy! Fact-packed, 16-page booklet brings you detailed specifications, describes SHOPSMITH'S many operations. Send for it! It's FREE!

Address:

**SHOPSMITH**

Dept. 113-B, at factory nearest you:  
12819 Coit Rd., Cleveland 8, Ohio, OR  
417 Montgomery St., San Francisco, Calif.

Name \_\_\_\_\_

Address \_\_\_\_\_

City \_\_\_\_\_ Zone \_\_\_\_\_ State \_\_\_\_\_



That  
muck  
in  
my car?

In most everybody's car, Mister, this time of year  
And it can cost you an expensive overhaul. You need  
a new Purolator Refill for your oil filter—quick!

If your oil filter is to keep on keeping your oil free from engine-wrecking abrasives, you must start fresh with a new refill when you change your oil this Spring. Be sure you get a Purolator Refill. Filters more *completely*, hence saves more substantially on repair bills. \$1.38 to \$3.00, depending on make of car, inserted in a few minutes.

P. S. If your car has no oil filter, a *complete* Purolator, both housing and refill, costs only \$6.50 or a bit more, again depending on make of car. Purolator Products, Inc., Rahway, N. J. and Toronto, Ontario, Canada.



\*Reg. U. S. Pat. Off.

on the trip—both for the sport and to add delicious variety to your menu. If so, be sure to carry a repair kit for putting back into action a broken rod and reel. A spare pawl and pinion nut for a casting reel are good insurance against a fishless holiday.

Make sure the cooking utensils you get are general purpose and lightweight. Several excellent kits are available and these have the advantage of nesting together to reduce space requirements. Soap, a razor, tobacco, towel and maybe even a pair of slippers will fill out the load.

When you get these items together, you'll find that your pack already adds up to 25 or 30 pounds. And that doesn't include food. But all of it is essential and will be needed on a week-end jaunt or a two-weeks' trip. So you might as well face the fact that the back-packer's load is not light. That's why an efficient comfortable pack board is essential.

Food is a personal matter. Everyone has his likes and dislikes and what you carry won't be what the next man might want. But, roughly, two pounds of food a day is ample for the back-packer. If he augments his supply with fish, he won't need that much, but you'd better have it along.

While some men go all out for dehydrates, the lightest of foods, experience shows that staple foods are best in the long run. Even canned goods should be taken if the trip is not over a week long. A can of chicken fricassee, beef stew or tomatoes is so tasty after a few days out on a rough trail that it more than makes up for its added weight!

Dry soups weigh very little in relation to their food value. If you run out of all other food, soup will sustain you until a supply point is reached. If any excess food is carried, it should be soup and candy. Both are good tasting and provide quick energy.

Breakfasts should consist of hot cakes or biscuits, coffee, bacon and maybe some dehydrated apples stewed the night before. Lunches are simple. Dried fruits, cheese, candy, crackers and nuts provide nourishment on the march. Dinners are the choice meals. You should plan to have fish, spaghetti or biscuits, dried beef and vegetable stew. Every few days, a can of chicken, beef stew, corned beef or tomatoes will add zest to your diet.

Bacon is the backbone of the menu. Indispensable for breakfast, it is good in dehydrated stew or chowder and its fat is the all-important frying agent for hot cakes, biscuits and fish. On cold days, hot bacon fat tastes good on hot cakes and biscuits. Carry margarine instead of butter because it keeps better.

(Continued to page 256)



# OWN Your Own Business



PATENTED  
PORTABLE  
EQUIPMENT

## Lifetime Income

Clean and Mothproof rugs and upholstery "in the home" or public buildings. Start full or part time. Gross profits up to \$15 and \$20 a day on EACH of your service men. Easy to learn . . . quickly established.

**DURACLEAN** cleans by absorption! No scrubbing, soaking or shrinkage. Dirt and grease vanish . . . matted pile rises . . . colors revive. Furnishings used again same day.

**DURAPROOF** resists moths and carpet beetles. Your service backed by a National Money Back 4 Year Warranty.

We furnish enough material to return your total investment. EASY TERMS. Territories limited. Send for **FREE** booklet . . . full details.

**Duraclean Co.** 0-164 Duraclean Bldg.  
Deerfield, Ill.

**NEW!**

**EVERY MOTORIST  
Wants  
"DASH-A-NOTE"  
for only \$1.00**

### SELL IT AND EARN GOOD PROFITS!

"Dash-A-Note" is a handy metal holder with memo pad and pencil. It has three suction cups that attach in 10 seconds to automobile dashboard, truck panel or home telephone stand. It's always right where you need it. Sells

on sight to motorists, truckers, taxicab drivers, filling stations and homes. You make 40% profit on every dollar sale. Send \$1 for your sample (refunded with your first order for 1 doz. or more at 40% discount). Address: PM

**BENNETT INDUSTRIES, INC. PEOTONE, ILL.**

## BUILD YOUR OWN 5-ROOM HOUSE \$2500



showing 21 MODERN HOMES—38 FLOOR PLANS with estimates for pre-cut or custom-assembled materials.

**SUPERIOR HOMES, INC.**

226 GALE BLDG.

JACKSON, MISS.

Price includes lumber, millwork, doors, windows, glass, hardware, roofing, etc. Immediate shipment. Build it yourself and save up to \$3000 or more. Simple step-by-step building instructions furnished. SEND 50¢ TODAY for Plan Book 149

## PAGE GARDEN TRACTORS



WITH  
PRECISION  
TRANSMISSION



RIDING AND WALKING MODELS

TO DO MORE JOBS AT LESS COST!

New economical '50 line with extra features! Riding and walking models, 2 to 6 HP. For spring plowing and dozens of other year 'round jobs. Complete gear drive with reverse, no cheap belts or chains. New reduced prices—easy terms—\$188 to \$440 with cultivator and equipment lift. Get benefits of 25 years experience.

WRITE TODAY FOR YOUR FREE CATALOG!

**PAGE DAIRY and FARM EQUIPMENT**

1904 S. 81st ST.—MILWAUKEE 14, WIS.

THE RIGHT FILE  
FOR COMBINATION  
CIRCULAR SAWS

6" CANTSAW  
FILE

IF YOU have a bench saw in your workshop, you know what a difference a smooth-cutting, well-sharpened blade can make. And for filing most types of circulars, the Nicholson or Black Diamond Cantsaw File is just the thing. It bites clean and fast. Points a worn tooth or sets a bevel with one or two light strokes.

What's more, this Cantsaw file meets the Nicholson standards for uniformity—in shape, tooth cut, sharpness, hardening, balance. Your hardware dealer has it along with special files for Handsaws, Bandsaws, Auger Bits; wood, plastics and all kinds of metals. Write us for—

"FILE PHILOSOPHY," the famous Nicholson 48-page book on kinds, care and use of files. It includes a section on filing circular saws. Post card request brings you your copy — *FREE*.

**NICHOLSON FILE COMPANY**

**NICHOLSON** 22 Acorn St.  
U.S.A. Providence 1, R. I.



(In Canada, Port Hope, Ont.)

**NICHOLSON  
FILES** FOR EVERY PURPOSE

# Cuts most ANYTHING-



## most ANYWHERE

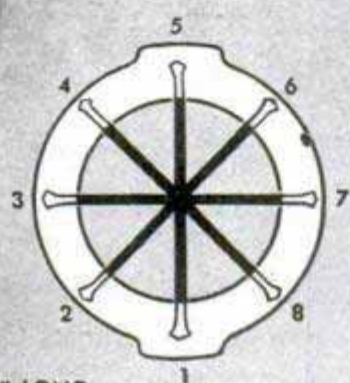

15 1/2" LONG

### BLADE TURNS AND LOCKS IN 8 POSITIONS

Steel, iron, bolts, pipes, wood, plaster, bone, fibre board—they're all one to Millers Falls new metal-cutting Keyhole Saw. Works like magic in corners and cramped quarters. Ends skinned knuckles. Flexible, tough "Tuf-Flex" alloy steel blade — easily interchangeable. Get one today—only \$2.00 at your hardware dealer's.

## MILLERS FALLS TOOLS

SINCE 1868

MILLERS FALLS COMPANY

GREENFIELD MASS.

A little dehydrated milk or eggs will make your hot cakes taste better. Maybe you'll like dehydrated eggs as a breakfast dish, but you'd better try them out first before hauling a supply of them with you.

If the trip is more than a week long, most canned goods must be eliminated. In this case, increase the amount of bacon, dried beef, dehydrated vegetables and soup.

Experience teaches you many tricks, but it's good to know a few of them before you start. Dehydrated vegetables and dried beef make a good stew if presoaked well. The vegetables plus some trout and bacon provide a tasty chowder. Brown sugar is excellent on hot cakes or biscuits, either dry or made up into a syrup. For syrup, add only a tablespoon of water to three tablespoons of sugar. Bring to an easy boil. If more water is used, the syrup is too thin. Three spoons of sugar make enough syrup for one man's hot cakes.

The handiest salt and pepper shakers are ordinary pepper cans. Their tops close tightly. One ounce of black pepper is plenty for two men on a week's trip. A four-ounce pepper can filled with salt will last two men a week. Always turn the cans upside down at night so dew won't collect on the tops and clog them.

Foods and such items as camera film, tobacco and matches are carried in light waterproof bags. Bacon, margarine or butter are always carried this way to prevent the grease from working through.

Baking good biscuits without an oven is a problem for the tenderfoot back-packer. An acceptable biscuit can be baked—or rather, fried and baked—in a frying pan. Mix prepared biscuit flour with enough water to form a consistency between that of hot-cake batter and biscuit dough. After heating a little bacon grease in a frying pan, drop in four tablespoons of dough, individually, and pat until it is about twice as thick as a hot cake. When the bottoms of the biscuits are brown, flip them over and bake the other side.

All you need for a thrilling, back-packing vacation is to follow these simple rules: 1. Carry useful, lightweight equipment and use a simple pack board to distribute the load; 2. Don't overdo it the first couple of days; 3. Get an early start on the trail each morning; 4. Climb slowly on the steep stretches—slow enough so you don't puff strenuously.

Remember that with careful planning, back-packing is not another name for back-breaking! If you follow these simple rules you'll get up to the unspoiled wilderness of the rugged mountain country and come back with some first-rate adventure stories of your own.



# You're driving into the Danger Zone

## WARNING ZONE

Engine loses pep . . .

## DANGER ZONE 1

Engine begins to smoke . . .

## DANGER ZONE 2

Engine pumps oil badly . . .

## DANGER ZONE 3

Destructive wear sets in . . .



### Needs a tune-up

Clean, adjust and re-time ignition. Clean fuel supply and carburetor screens. Adjust carburetor. Adjust tappets and fan belt. Check compression and vacuum readings for symptoms of ring wear.

### Needs new piston rings and minor engine repairs

Replace piston rings. Align rods. Adjust rods or replace rod bearings. Reseat and reface valves.

Tune engine.

These repairs are comparatively inexpensive and put the engine back in peak condition for thousands of economical miles. Delay puts the engine in Danger Zone 2.

### Needs new piston rings and major engine repairs

Replace piston rings. Replace piston pins. Adjust—probably replace—main bearings. Align rods. Adjust rods or replace rod bearings. Reseat and reface valves. Tune engine.

These repairs naturally cost more than those needed in Danger Zone 1, but they put the engine back in condition for thousands of additional miles of satisfactory service. Delay leads to costly Danger Zone 3.

### Needs new piston rings and complete overhaul

Repairs cost three or four times as much as in Danger Zone 1.

Remove engine. Rebore cylinders. Replace pistons, pins, rings. Replace main bearings. Align rods, refit or replace rods, or replace rod bearings. Overhaul valve lifters, rocker arms. Replace timing chains or gears. Reseat, reface valves. Replace guides and springs. Replace camshaft bearings. Clean oil lines. Overhaul oil pump.

Clean, re-install and tune engine.

**The more you delay - the more you pay!**

**Piston rings should be replaced... *at the first sign of wear!***

You'll be money ahead if you replace your piston rings when your car first gets into the Danger Zone. But if you delay until the second or third Danger Zone, repairs cost two to four times as much.

In any Danger Zone, ask your motor service man

for Hastings Piston Rings. They *stop* oil-pumping, *check* cylinder wear and *restore* performance.

It's the best money you can spend on your car.

HASTINGS MANUFACTURING COMPANY • HASTINGS, MICH.  
Hastings Ltd., Toronto



# HASTINGS

## STEEL-VENT PISTON RINGS



**TOUGH on Oil-Pumping • GENTLE on Cylinder Walls**

# PEEL OFF PAINT

WITH KLEAN-STRIP

**Amazing new-type remover  
is fast, safe, easy-to-use**

Klean-Strip changes any finish into loose, wrinkled film. Use only a brush or putty-knife to peel off all layers of the old finish at one time.

Klean-Strip leaves the surface clean, smooth and dry. No sticky mess to wash off, no waxy residue to scrape. And Klean-Strip is absolutely safe: will neither burn nor explode.

Klean-Strip is brand new . . . not like any paint remover you've ever used. Takes all the danger and drudgery out of refinishing. Buy Klean-Strip whenever you buy paint. Available at better paint, hardware and department stores, everywhere.

Product of  
W. M. BARR & CO.  
2352 S. Lauderdale  
Memphis, Tennessee



**New! No-Wash!  
Non-Inflammable!**

## YOU NEED THESE SMALL FORMED OILSTONES

You've wanted them often for many small and intricate jobs of stoning—machine and metal parts, sharpening auger bits, countersinks, special woodcarving tools, etc. When you need a stone like this, nothing else will do. NORTON INDIA® formed oilstones come in all sorts of shapes and sizes—round, square, triangle, etc., for every type of stoning job. Your hardware dealer can get the ones you want. They're all described in the informative booklet—

**"HOW TO SHARPEN"**—Send for it today. 48 pages packed full of illustrative data on sharpening. Send 10¢ to Dept. PM-4.

**NORTON**  
abrasives



**BEHR-MANNING**  
TROY, N. Y.

ALSO MANUFACTURERS OF COATED ABRASIVES

## New Machines Fight for Your Health

(Continued from page 170)

about two percent of all infants at birth, wartime aerial-camera magazines have been adapted to an ingenious use. It bypasses the difficulties of getting youngsters to remain perfectly still and to stop breathing, as adults do, for X-ray pictures.

The magazine is loaded with continuous-strip X-ray film, altered at the top with the addition of fluorescent radiograph screens and placed under the examination table. An opaque chemical, easily identified on film,



With a "resuscitator," there is no longer need for the traditional slap to start a newborn baby breathing

is injected into a vein in the child's arm. Even though the child fidgets and breathes, the 20 X-ray exposures the camera makes in 10 seconds give doctors enough information to determine the size and location of the abnormality.

Color television of surgery, first demonstrated last year over a closed circuit to doctors and the writer, is recognized as a potentially great tool for medical teaching. It will enable larger numbers of students to get close-up views of operations, and the color adds depth far superior to that of black-and-white equipment. The image on the receiving screen is several times larger than what the surgeon himself sees.

A machine that gets its signals from the brain and heart warns when the life of a patient on the operating table is in danger

(Continued to page 260)

# GET THIS 1950 CAR ENGINE PROTECTION

## the new **MARVEL** **INVERSE OILER**

### FOR CONSTANT UPPER CYLINDER LUBRICATION

Here's the famous auxiliary lubricating oil system—in a sensational new, low cost, 1 Quart size—that meters MARVEL Mystery Oil to critical upper cylinder engine parts precisely in accordance with the demands of your engine under load. This new, compact OILER, with visible oil supply, functions on the same exclusive MARVEL principle—inversely to manifold vacuum—retarding feed when throttle is closed or at engine idle. You'll keep ring, piston and valve wear down and performance way UP with the MARVEL INVERSE OILER on your car.

#### MARVEL MYSTERY OIL

Learn about MARVEL Mystery Oil too—the nationally recognized leader among oil improving additives. Added to your regular motor oil, it shields vital parts from excessive frictional wear with its great film strength—produces a slow idle, faster engine pick-up and an even power pull.

**WRITE  
FOR THE  
FACTS—  
NOW!**



**EMEROL MANUFACTURING CO., INC.**  
242 WEST 69th ST. (Dept. P.M.) NEW YORK 23, N. Y.



**SENSATIONAL NEW  
MODEL Q, 1 QUART  
VISIBLE RESERVOIR  
UNIVERSAL  
BRACKET**  
**Only \$11.20**  
SIMPLE TO INSTALL

# RUPTURED?

## Get Relief This Proven Way

Why try to worry along with trusses that gouge your flesh—press heavily on hips and spine—enlarge opening—fail to hold rupture? You need the Cluthe. No leg-straps or cutting belts. Automatic adjustable pad holds at real opening—follows every body movement with instant increased support in case of strain. Cannot slip whether at work or play. Light. Waterproof. Can be worn in bath. Send for amazing FREE book, "Advice To Ruptured," and details of liberal truthful 60-day trial offer. Also endorsements from grateful users in your neighborhood. Write:

**CLUTHE SONS, Dept. 31, Bloomfield, New Jersey**

SAY YOU SAW IT IN POPULAR MECHANICS

**BE  
YOUR  
OWN BOSS!** *Make*  
**UP TO \$50.00 PER WEEK**  
**IN YOUR SPARE TIME**

Mr. B. of California writes "The lawn mower grinding business, with my Universal Grinder, has been a gold mine these last two years." Mr. J. L. P. of Pennsylvania says "Thank you for getting me started in this wonderful business . . . I averaged \$100.00 per week for the month of May."

## ONLY ON THE UNIVERSAL LAWN MOWER GRINDER

. . . can the inside face and edge of the stationary blade, as well as the reel blades, be ground to proper clearance

### ALL IN ONE SET-UP

**WITHOUT REMOVING ANY  
BLADE FROM THE MOWER**

Users who have tried them all acclaim the UNIVERSAL far above any grinder on the market. Write today for full details of our Proved Success Plan. It's Free.

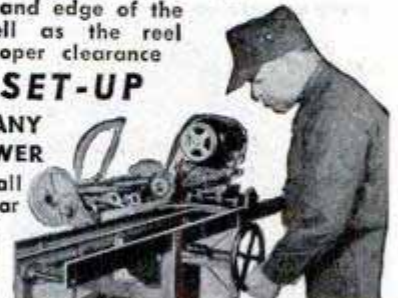

**ROGERS MFG. CO., DEPT. M-40, LINDSEY, OHIO**

## SEND THIS COUPON NOW

**ROGERS MFG. CO., Dept. M-40, Lindsey, Ohio**  
Please send me full details about the profit possibilities of Lawn Mower Sharpening.

NAME \_\_\_\_\_  
ADDRESS \_\_\_\_\_  
CITY \_\_\_\_\_ STATE \_\_\_\_\_

**Thompson**  
**BEATS**  
**the World**  
**on BOATS**



**Better Built  
Lower Prices**

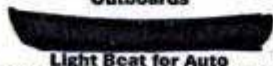
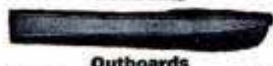
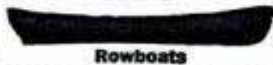

**Safe Boats With  
Full Length Spray Rails**  
Keep passengers perfectly dry—even at high speeds. Catalog also shows two new models of "Take-Along" Boats. Two big factories—save you freight.

**CATALOG FREE**  
Write for your copy. State kind of boat in which you are interested.

**THOMPSON BROS. BOAT MFG. CO. (151)**  
213 Ann St. PESHTIGO, WIS. Write to (either place) 113 Elm St. CORTLAND, N.Y.

*Time for a new tobacco pouch?*

# Rogers

the finest in  
smokers' accessories



Combination Model



Daily Model

• **Rogers**  
**air-tite**®

Enjoy a pouchful of fresh tobacco with a Rogers Air-tite tobacco pouch—with its patented inner pouch of seamless rubber that "seals as it closes"... The largest selling tobacco pouch made. Exquisitely created in many styles and leathers.

Above: Combination Model pouch of Brazilian Peccary \$10 (Killarney Pipe \$5). Other models, \$1.50 to \$20. At left: Daily Model holds one day's supply compactly. Beaver Calfskin, illustrated \$2.50. Other leathers, and other models for full pack of tobacco, \$1.50 to \$15.

**Rogers** imports, Inc., N. Y. 16, N. Y.  
The finest in smokers' accessories

*Peterson's* PIPES  
LONDON • DUBLIN

*Custombilt* PIPES  
NO TWO ALIKE

from the anesthetic. Developed at Mayo Clinic, it spots signs of approaching death two minutes earlier than breathing and pulse observation does.

Nicknamed "Tillie the Tin Technician," an automatic device built at the suggestion of the U. S. Public Health Service for mass tests, does the chemical processing of a blood sugar test for diabetes. Tubes with blood specimens are placed in holders on a wheel and revolved through the six stations of a test cycle, stopping 30 seconds at each. In three minutes the subject knows whether or not he has diabetes.

Two simple, much-needed measuring devices have been developed by Dr. Louis B.



Using a new tester, therapists can easily gauge how well injured muscles are responding to treatment

Newman, of the Veterans Administration Hospital at Hines, Ill. One indicates to therapists how muscles are responding to treatment. It is cylindrical, with a shaft and button extending from one end and a gauge at the other. Inside is a hydraulic-pressure converter. To measure a muscle's strength the therapist applies the tester against the member it controls with sufficient force to overcome the muscle's resistance.

The other Newman device, two flexible steel tapes connected to a swivel joint, simultaneously measures the expansion of both halves of the chest. It will be helpful in tuberculosis and pleurisy, where the side of the chest affected may have considerably less movement in breathing.

For deaf children, an auditory training unit, designed for schools for handicapped children, reproduces sounds up to 140 decibels for the students with less than one percent distortion. The youngsters wear headphones and the teachers use microphones. The system can be "tuned" to the hearing capabilities of each listener and even to the difference between their two ears.

## Manufacturing Opportunities in Concrete Products Industry

The great building industry is your profitable market for masonry products. Low investment...high returns...wide-open opportunity to establish a lifetime business. The biggest building years in the nation's history are just beginning. New construction, involving billions of dollars, means huge demands for block, drain tile, and other masonry products which YOU can manufacture locally, from local materials with local labor for local consumption. Remember, MASONRY products mesh with today's demands.

Use our modern machines and equipment to insure the finest quality products at pared-to-the-bone manufacturing costs. Sold direct. Backed by 40 years of manufacturing. Write for catalog. Gives prices and full information.

**CONCRETE EQUIPMENT CO.**  
512 Ottawa Ave., Holland, Mich.

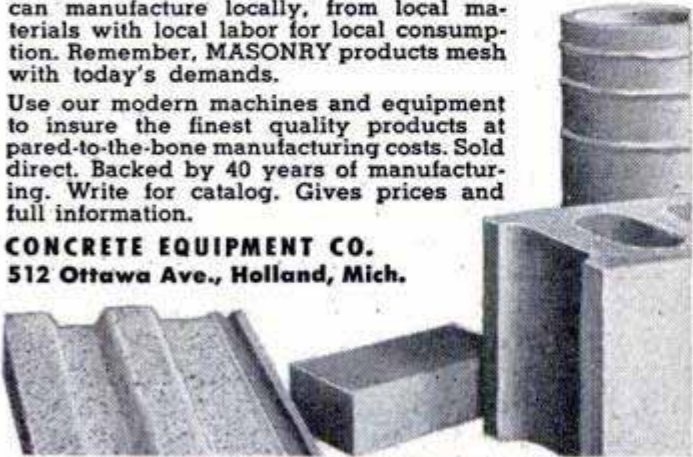

## STOP AUTO ACCIDENTS



**with new STOP LIGHT FLASHER!**

**MAKES YOUR STOP LIGHT FLASH 115 TIMES A MIN.**

**FREE OFFER TO YOU!** The "Stop-It" warns cars behind—makes your stop light flash on & off, on & off! Completely automatic, acts instantly when you step on foot brake...attaches in 5 minutes to any car or truck. Approved by safety engineers, used by Police & Fire depts. Non-rusting, dust, oil, vapor, waterproof. Write NOW for free introductory offer—no obligation. Get this amazing "Stop-It" for your car at no cost to you! Dealers, salesmen wanted.

MACCHI & CO., Dept. MD, 927 Larkin St., San Francisco 9, Calif.

## ACE TOOLS

No. 8-A SET



Be permanently  
tooled-up for every operation  
on your Metal Cutting Lathe.

No. 8-A Ace Tool Set  
for 9" and 10" Swing  
Lathes—fits shank size  
3/4" x 3/4". Includes Turning,  
Cutting-off, Boring,  
Knurling and Threading

Tools with high speed cutters,  
blades and wrenches. 8 complete tools  
in fitted steel case—nothing else to buy  
See your local dealer or order direct.

**ARMSTRONG BROS. TOOL CO.**  
5268 W. Armstrong Ave., Chicago 30, Ill.

**\$24<sup>25</sup>**

## CONVERT HAND MOWERS TO POWER MOWERS

**Takes less than 3 hours**

The Handy-Dandy Lawn Mower Kit fits any hand mower from the 16 to the 20 inch size. Complete with all necessary parts. Kits can be purchased separately, complete with engines or complete with Pennsylvania mower.

Also manufacturers of a complete power mower and garden cultivator attachments.

**DEALERS WANTED**

**LE CLAIRE MFG. CO., Le Claire, Iowa, Dept. PM**



# get the world's greatest RADIO & TELEVISION CATALOG! **FREE**

## ALLIED'S

**196-PAGE GUIDE  
TO EVERYTHING  
IN RADIO & TV AT  
LOWEST PRICES**



TELEVISION AND  
HOME RADIOS



SERVICE SUPPLIES  
BUILDERS' SUPPLIES



AMATEUR GEAR



AMPLIFIERS, P.A.  
SYSTEMS, RECORDERS

*Everything for Experimenters,  
Builders, Amateurs, Service-  
men, Engineers, Soundmen*

Save money on every radio need! Get the 196-page 1950 ALLIED Catalog featuring the world's largest stocks of top-quality equipment, at low, money-saving prices! Latest TV releases, home radios and radio-phonos, Amateur equipment, PA systems and High-Fidelity Sound, recorders, test instruments, builders' kits—plus thousands of parts, tubes, tools, books and diagrams. Get more for your money from the World's Largest Radio Supply House. Send today for your FREE copy of the 1950 ALLIED Radio Buying Guide!

## ALLIED RADIO ★

ALLIED RADIO CORP.  
833 W. Jackson Blvd., Dept. 5-D-O  
Chicago 7, Illinois

**FREE  
CATALOG**

Rush FREE 196-Page Catalog

Name.....

Address.....

City.....Zone...State.....

Experienced Craftsmen Say:  
**"YOU CAN'T FINISH WITH A DISC SANDER!"**

The disc sander is excellent for roughing, hogging off, removing paint, and for other coarse sanding. But any experienced craftsman will tell you that these same characteristics prohibit its use for finishing, because of swirling, scorching, gouging and other blemishes caused by the disc sander's high speed.

**OSCILLATING MOTION IS THE *only* MOTION FOR A PERFECT FINISH!**

THE DU-FAST<sup>®</sup> SANDER AND POLISHER produces quick, easy, perfect finishes at low cost. It requires no special skill or knock. You get an industrial type finish on wood, metal, plastics, plaster and composition materials the first time and every time you use DU-FAST! USE DU-FAST TO REMOVE DISC SWIRLS.

Model BDHU 1 attaches in seconds to either the Home Utility 1/4" Electric Drill or the Home Utility 5" Disc Sander-Polisher. (Products of Black & Decker Mfg. Co.) Model SK\*1 fits the Skill Home Shop 1/4" Electric Drill manufactured by Skil Saw, Inc.



Manufactured by  
**DU-FAST, INC.**  
 32 EAST FOURTH STREET, NEW YORK 3, N. Y.

DU-FAST SANDERS ARE AVAILABLE  
 AT ALL BETTER HARDWARE DEALERS

**Be Your Own Boss**



There's a great feeling to being in something for yourself, where all the profits go into your own pocket. American floor sanders make it possible for you to realize this ambition without special schooling or a big investment. Begin small and work up to as large an enterprise as you desire... It all depends on your ambition to get ahead. Ask for "tell-all" booklet entitled "Opportunities in Floor Surfacing". Use coupon and enclose 25 cents in coin or stamps to cover handling.

**AMERICAN FLOOR SURFACING MACHINE CO.**

535 So. St. Clair St. • Toledo 3, Ohio  
 Gentlemen:  
 Enclosed find 25c in stamps or coin for booklet "Opportunities in Floor Surfacing," telling me how I can start my own floor sanding business.

Name \_\_\_\_\_  
 Street \_\_\_\_\_  
 City \_\_\_\_\_ State \_\_\_\_\_



**Commute by Jet**

(Continued from page 152)

of the last war's outstanding fighters, the Spitfire and Hurricane. In less than a minute it can climb 6000 feet, then zoom along at a true air speed of 426 miles an hour—using only 90 percent of its available power. And the Avro's engines are about a third less powerful than those in the Comet!

On a flight like Miami to New York, the Canadian plane would be capable of 2 1/2 trips daily, because of its speed, compared with one for the present-day airliner. Fewer planes would be needed to handle the same volume of traffic, or the same number could handle two to three times today's passenger volume.

Britain has five other jet transports, four of them turbo-propeller combinations.

Where does America stand in developing a pure jet airliner? Far behind. There is talk, but not much action. An outstanding possibility for modification to fit the role is Boeing's B-47, the world's fastest jet bomber. Roughly equivalent to the B-29 in size and powered by six engines, a B-47 sped across the continent in less than four hours, at an average speed of 607.8 miles an hour. Jets 25 percent more powerful, the first of the axial-flow type approved for commercial use, have since been installed.

U. S. manufacturers are hesitant about risking the tremendous capital needed to develop a wholly new type of airplane like the jet transport. Wellwood E. Beall, chief engineer of Boeing, who says his company could build and fly a prototype of a 500-mile-an-hour jet liner in 18 months, is one of the many who believe government financial aid is essential.

Until turbojets cut their fuel appetite appreciably, Beall believes their first important airline role will be as 40 to 50 passenger, intercity planes. For the immediate future he is inclined to favor the larger piston and turbo-prop planes for long-distance, transocean flying. As a broad rule of thumb, most engineers believe now that 500 miles an hour is the point above which turbojet performance is superior to all propeller-driven planes, insofar as speed alone is concerned.

Consolidated-Vultee is building a turbo-prop version of its Convair-Liner. It may be ready for test flights this summer.

Hall Hibbard of Lockheed says that a jet transport his company now has on the drawing board will fly 600 miles an hour and cruise at 50,000 feet. He even goes so far as to estimate the cost of developing that first plane at \$25,000,000—which doesn't sound so high when the same firm admits

(Continued to page 264)



IF YOU  
WANT TO

# MAKE MONEY

IN YOUR SPARE  
OR FULL TIME

and **HAVE FUN** doing it . . .

. . . Be a  
**RIDER-  
DEALER**



Sell and Service "The World's Finest Powercycle"—SERVI-CYCLE. Your machine will cost you less than \$200, Delivered, U.S. Tax Paid, ready to ride. Make profitable sales simply by riding it to work and showing it to your friends. Write today for Specifications and our Rider-Dealer Plan. Give your age, occupation, and hobbies.

**SIMPLEX MANUFACTURING CORPORATION**

538 N. CARROLLTON AVE.  
NEW ORLEANS 19, U.S.A.

It's NEW —  
It's WONDERFUL  
**PALM-GRIP**  
with Built-in Ratchet for  
**SCREW DRIVER**

"Palm-Grip" chucks into top of screw-driver handle. Makes screw driving and removal amazingly easy, fast. Also fits any standard  $\frac{3}{16}$ " drive socket wrench.

Write for Folder  
Dealers Invited

**FIRELANDS**  
BOX 416



**No. 4 SET**

Includes "Palm-Grip" Ratchet and three screw drivers, 12 $\frac{1}{2}$ ", 9", 5 $\frac{1}{2}$ " with socket insert in heads. Heavy duty tool steel bits. Non-inflammable Tenite handles.

Complete Set **\$650** postpaid

Only

Palm-Grip **\$295** each

Only

**INDUSTRIES**

NORWALK, OHIO

## HUNDREDS OF ITEMS AND IDEAS FOR THE WOODWORKER

A board or carload—Top grade kiln dried Mahogany—Walnut—Wh. Hd. Maple—Cherry—Poplar—Aromatic Red Cedar—Red, White and English Brown Oak—Sapeli—Andiroba—Balsa Wood. **NEW LOW PRICES.**

### HARD TO FIND LUMBER

**BIG NEW NO. 17  
CATALOG FOR  
WOODWORKERS.  
144 PAGES  
OF HARD-TO-FIND  
SUPPLY ITEMS.**

The finest catalog we ever published. Full of unequaled bargains and useful information.

**Greatest Selection of Fine  
Domestic and Imported Woods**

Catalog shows in natural color 32 rare and fancy woods. 43 matched veneer designs, multi-colored bandings, inlays, overlays, 275 scroll patterns to choose from, labor-saving machinery and a section for beginner's instruction.

#### OVER 100 NEW ITEMS

My stocks are gigantic—bigger than ever before. Really **FAST SERVICE** on your orders. My new catalog includes a "gold mine" of hard-to-find hardware items. Whatever Wood Craftsmen need—I HAVE IT.

**MAIL COUPON TODAY for  
GIANT NEW CATALOG #17**

**Only 15c** Refunded on first order.

Harold F. Hunt, President  
**CRAFTSMAN WOOD SERVICE CO.**  
2729 S. Mary St., Dept. A-4, Chicago 8, Ill.

I enclose 15c, to be refunded on my first order. Please send me your big new Catalog No. 17.

NAME \_\_\_\_\_

ADDRESS \_\_\_\_\_

TOWN \_\_\_\_\_

ZONE \_\_\_\_\_

STATE \_\_\_\_\_

**SAY YOU SAW IT IN POPULAR MECHANICS**

## FILE SAWS FOR PROFIT!

### New Rapid Saw Filer

Opens the door to extra income. Easy to operate. Fast, efficient BeMaCo power filer for hand saws. Priced right! Does a beautiful job. Operator has complete control.

### BeMaCo Automatic Saw Set—

Uniformly sets 400 teeth per minute. Perfect hammer and anvil action. No tooth breakage.

**BEAVER MFG. CO.**

802-K ISIS AVE.

INGLEWOOD, CALIF.



WRITE FOR  
DETAILS  
TODAY



These are just a few of the more than 3000 fine precision tools that make skilled work easy for millions of American craftsmen. See them all at your Starrett Tool distributor's.



New "Satin Chrome" Micrometer No. 230, 1" capacity, Tapered Frame, Sycamore Case.



Starrett 12" Bench Level. Double plumb, accurate vials, base grooved for cylindrical work.



Starrett Combination Set No. 9. 12" blade, eight handy tools in one.

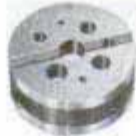

No. 129 Bench Block. 3" diameter, holes from 1/8" to 3/8", grooved for round work, knurled for easy handling.



Precision Screw Drivers No. 555. For model work, instruments, watchmaking, etc. Swivel top, knurled handle, replaceable blade, six blade sizes; .025" to .100". Grooved ends for quick size identification.

**GET THIS MECHANIC'S HAT  
only 15¢**

Wear an official Starrett hat—the badge of a precision craftsman—on the job, in your home shop, working around the car, etc. Send 15¢ in coin to cover handling and mailing. Please specify head size. Address Dept. AP.



**THE L. S. STARRETT CO. • ATHOL, MASS., U. S. A.**

TRADE MARK  
**Starrett**  
REG. U.S. PAT. OFF.

Since 1880... Standard of Precision

MECHANICS' HAND MEASURING TOOLS AND PRECISION  
INSTRUMENTS • DIAL INDICATORS • STEEL TAPES • HACKSAWS  
BAND SAWS AND BAND KNIVES • PRECISION GROUND FLAT STOCK

Buy Through Your Distributor

spending \$40,000,000 on the Constellation.

The timetable of jet development is running ahead of what most experts anticipated. The first combat-type jet didn't fly until late in 1942 and Gloster Meteors that were pitted against flying bombs in 1944 had a maximum speed of only 410 miles an hour. Today's jet fighters are flirting with 700 miles an hour.

The United States already has 34 jet types, the British displayed 24 at a recent show and Russia is believed to have eight jet types flying.

Along with this astonishing progress, new problems have been created, both operational and mechanical. Pilots have been pushed along to a higher and faster world of flight, and the effects of sustained flying at high speeds and extreme altitude on humans are only partially understood.

Along with reducing fuel consumption, building engines that can better stand the extreme heats generated has been a vexing problem for jet designers. "Metal chefs" at Westinghouse—weighing, mixing and melting alloys with a precision that allows no error greater than one-tenth of one percent—have produced three promising alloys. Discaloy is being used for the heavy rotor disks, Refractaloy in the blades and K42B is being made into bolts. They have operated well at temperatures as high as 1500 degrees Fahrenheit.

Another approach, already tested on an aluminum turbine, has been to circulate a cooling fluid through the blades. It has permitted engine run-ups to 2000 degrees, 600 degrees above aluminum's melting point.

Cockpits that heated to unbearable temperatures from the friction of air pushing past the plane at high speed posed another puzzler for designers. At 600 miles an hour, that adds 60 degrees to the temperature and at 1500 miles an hour—a speed still well in the future—it is expected to make a difference of about 400 degrees Fahrenheit. Cockpits can be cooled and pressurized. That is just another problem for the engineers. But for jet transports they must be foolproof. There can be no taking of chances on sudden failures that might cook or quick-freeze the customers in a jet liner or expose them precipitately to oxygen starvation by a cabin "puncture" at 40,000 feet.

Don't start pestering the airlines for jet-plane passage when you've laid aside this magazine. Even the more optimistic agree it will be two or three years before the first officially begins service. And then there'll be relatively few.

But tomorrow's jet transports are already flying out of the dream stage and on the beam toward your local airport.

NEW  
*Capehart*

SAW  
GIDE

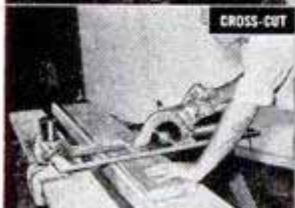
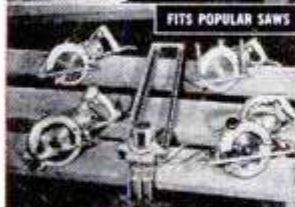
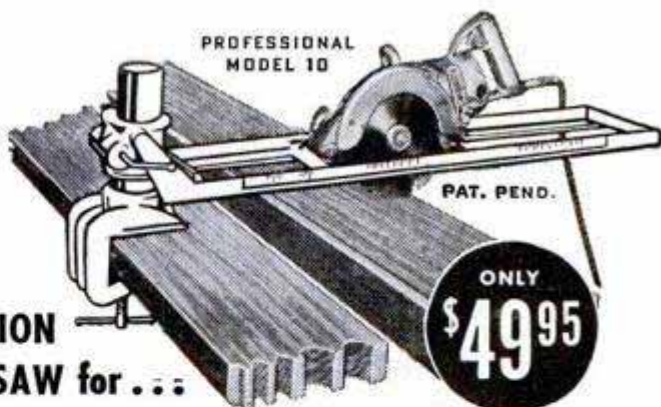

**Converts Your Portable  
Electric Saw into a PRECISION  
PORTABLE RADIAL ARM SAW for . . .**

The new Capehart SAW GIDE (story and pictures in *February Popular Mechanics*, page 96) fills the crying need for a top-quality, portable, precision "on the job" saw guide—the tool of 1001 uses that does everything you can do with the big, unwieldy, high-priced radial arm saws—plus some things you can't do with them:

**Cross-cuts . . . bevel cross-cuts . . . mitres . . . bevel mitres . . . rips . . . bevel rips . . . notches . . . dados\* . . . ploughs\* . . . rabbets\* . . . bevel rabbets\*!** All these operations, and more, the new Capehart performs with speed, precision and ease! (\* with proper cutting head — also cuts stone, metal, composition, etc.)

Now, for the first time, you can have the Capehart professional SAW GIDE with all the advanced features demanded by skilled craftsmen—carpenters, contractors, tile & ceramic workers, industrialists, stone masons, metal workers, etc.—at the sensational low price of only \$49.95, complete, including ripping attachment.

Write for FREE fact-packed brochure. If your dealer doesn't stock SAW GIDE, send check or money order today for shipment direct . . . freight prepaid. Satisfaction guaranteed or money back.



FREE!

**FREE BROCHURE**

Fact-packed, authoritative. Learn how you can do better work, easier, with less fatigue. Write today!

**YOUR ORDER MAIL TODAY!**

only  
**\$49.95**

Ship My Capehart Saw Gide At Once. I enclose (check or money order) for \$49.95. If my Capehart Saw Gide does not do everything your advertisement claims—and more—it is my privilege to return in 5 days, undamaged, for complete refund of purchase price. (C. O. D. orders shipped freight collect.)

Name \_\_\_\_\_  
Address \_\_\_\_\_  
City \_\_\_\_\_ Zone \_\_\_\_\_ State \_\_\_\_\_  
Make and Model of Your Saw \_\_\_\_\_

PACKARD MANUFACTURING CORP.  
Dept. PM1 • Noble at Market • Indianapolis, Indiana  
Including Ripping Attach.

**10 SHELF PLANS**  
NEW FULL SIZE

New, full size, easily built, beautiful wall shelf plans ready to trace on lumber, cut out and assemble. Corner and wall racks with 1 to 3 shelves. Stores charge about \$75.00 for these shelves. Make money selling them. Finest selection available. PLUS BONUS of 48 other novel cut-outs, Dutch Boys, Girls, Toys, etc., etc. PLUS FREE latest Handicraft Catalog. Send only \$1 to

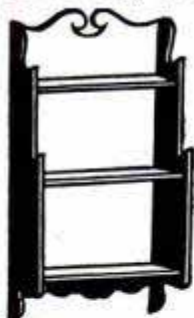

**JACKSON, Dept. 17**  
3933 N. 28th St.  
Milwaukee 10, Wis.

**YOUR "DREAM HOUSE"**



**ALREADY PLANNED FOR YOU**

You will find it in the brand new HOME PLAN BOOK of the Home Building Plan Service.

This new book contains plans never before published. You will find the house of your dreams among the many plans, which include starter homes, small homes, and large homes, in a wide variety of contemporary and traditional designs for both frame construction and block masonry.

Complete working blueprints are available for any home illustrated in the Home Building Plan Service books. Send \$1 for each book.

**HOME BUILDING PLAN SERVICE**

2454-Q NE SANDY, PORTLAND 12, OREGON

they look and feel

just like the shoes you are now wearing



and they make you

almost 2 INCHES

**taller**

These New Design "ELEVATORS" look as smart and

feel as comfortable as any other fine shoes. But what a difference in how they make you look and feel! Wonderfully . . . but wonderfully taller. Instantly! They cost no more than other fine shoes. Write for Booklet.

THE ORIGINAL AND GENUINE  
**ELEVATORS**  
TRADE MARK  
HEIGHT-INCREASING SHOES  
"YOUR PERSONAL PEDESTAL"  
TRADE MARK OF STONE-TARLOW CO., INC.

STONE-TARLOW CO., INC., Dept. PM-4, Brockton 68, Mass. 50

Please send me Free Booklet and name of nearest dealer.

NAME \_\_\_\_\_  
(Please Print)  
ADDRESS \_\_\_\_\_  
CITY \_\_\_\_\_ STATE \_\_\_\_\_

ASK YOUR DEALER

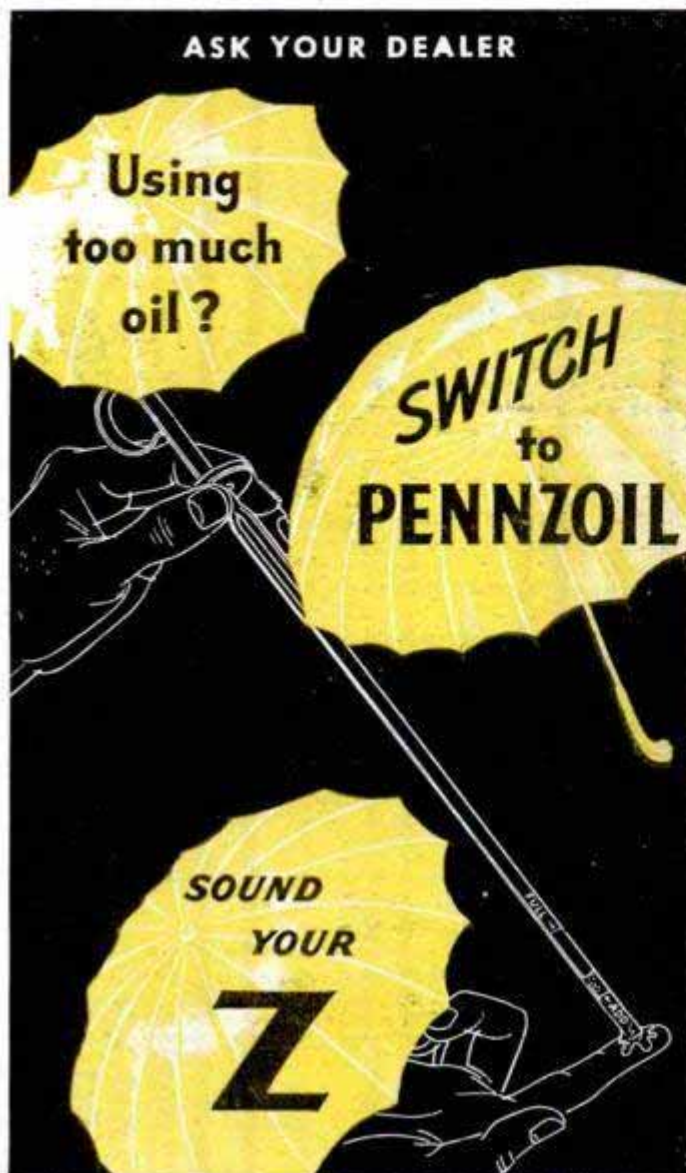

If you suspect you've been using too much oil, Spring is the time to find out. Switch to Pennzoil, the 100% Pennsylvania oil that lasts longer, grade for grade.

Over 60,000 better dealers, coast to coast, recommend Pennzoil. It's easy to find at the yellow oval sign. For the genuine—Sound your Z.



Member Penn Grade Crude Oil Assn., Permit No. 2

TOUGH-FILM PENNZOIL® MOTOR OIL & LUBRICANTS  
AT BETTER DEALERS... COAST TO COAST

## You Think You're Going Crazy . . .

(Continued from page 93)

room, sees a pair of identical dimly lit orbs in front of him, about 10 feet away. First thing you know those orbs are scooting back and forth like mad toward the viewer's head. One man saw them travel a full 25 feet each way, zipping like comets. The room is only 20 feet long.

The truth of the matter is that neither sphere is going anyplace. They're stationary balloons. An operator working a rheostat handle and a pump handle is simply blowing and deflating them, brightening and dimming them alternately. It's the bigness and brightness that makes one balloon seem closer than the other. Pull a switch, so that one dims as it grows, and the deflating one brightens, and the viewer gets all mixed up for a while. Soon, though, the one that's growing still seems to be approaching, dimmer or not. Why? Because bigness is a more reliable cue than brightness. A bright object might be farther away, says the old brain—but a big one? Hardly. About 90 percent of us rely on changing size rather than changing brightness to determine distance of an object.

Other weird gadgets in the dungeon room play similar tricks on the mind. There are cubes, which aren't cubes at all but great, long objects which, beside a real cube, look genuine. There's a table with two rows of cards. In one row they are orange, green and blue, in that order from the viewer. In the other, the order is reversed, and the cards grow in size toward the back. The viewer, looking through a peephole, however, sees two identical rows of even-size cards—orange, green and blue, in that order. How can this be? In the right row, remember, the near card is little, in the left row, the near card is much bigger. The viewer should at least be tipped off by the size differential, but he isn't. How come?

The gimmick is that the cards on the right are so notched that they seem to overlap exactly the same way as those on the left. So strong is this overlap "cue"—the same cue that tells us one tree is in front of another if its branches cut the other one off in spots—that the cards reverse and the sizes correspond to the sizes of the images in the eye of the cards on the left. The mind makes them all look alike, to conform with that strong overlap cue.

Probably the most frustrating of all the dungeon's tricks is the "trapezoidal window." This fiendish device, designed to test a person's assurance in what he thinks he knows, consists of one square stationary

(Continued to page 268)

Puts *Wings* on your boat!



NOW —  
More than ever  
MERCURY Sets  
the Pace

**NEW** KIEKHAEFER

**MERCURY**

**"Super 10" HURRICANE**

Never before such pep, power, and all around performance in a light outboard.

Crack the throttle and sample the thrill of commanding a "Hurricane!" Pour on the coal. Mercurys are built to take it. This 1950 package of power was built to outrun—built to outlast. It packs ready, confident Full Jeweled Power\* to command any kind of outboarding—fishing, water skiing or just zooming along.

**IT'S LOADED WITH NEW FEATURES:**

**NEW "HI-REV"** micro-mounted connecting rods of drop forged chrome nickel-moly steel, heat treated, hardened, tempered, precision ground and micro-honed to just the right scientific finish.

**NEW Improved Porting** to permit easier flow of fuel and gases.

**NEW Drop Forged Unbreakable Aluminum Clamp and Swivel Brackets**, heat treated to the strength of steel.

**NEW High RPM Magneto** — **NEW 8 Reed Valve Cage** — **NEW Larger Crankcase Opening**. And many other New Features that add up to new thrills in outboarding.

Drive it! Only a demonstration will prove why the Hurricane—or any MERCURY, Right Down the Line — is your best buy, by far!

KIEKHAEFER CORPORATION, Fond du Lac, Wis.

Write for Free Folder  
"Right Down the Line"



\*Ball and Roller Bearing Construction Throughout for Easier Starts, More Performance Per Horsepower, Greater Operating Efficiency, Slower Trolling, Longer Trouble-Free Life.

Features of Mercury outboard motors are protected by issued or pending patents.

Motors built for many jobs—  
built to do them

# BETTER!

Whatever your workshop requirements, you'll find a Hoover Electric Motor to meet them. There are Hoover Motors for every job—from easy-to-start, quick-to-accelerate applications to hard-to-start, continuous-duty applications.

Every model is engineered and built with the same care and efficiency that go into the world-famous Hoover Cleaner. Hitch up a Hoover and you hitch up the best!

A typical Hoover capacitor-start motor for hard-starting, continuous-duty applications. Split-phase and poly-phase motors are also available.



Check these features of the Hoover line:

- Capacitor-start, split-phase and poly-phase types
- Ratings from  $\frac{1}{4}$  to  $1\frac{1}{2}$  H.P., some with double-end shafts
- Single or dual voltage, 1725 or 3450 R.P.M.
- Ball or sleeve bearings
- Rigid or resilient mounts that meet NEMA specifications
- Service and parts available from authorized agencies and dealers

# HOOVER®

# MOTORS



THE HOOVER COMPANY, North Canton, Ohio  
Kingston-Conley Division, North Plainfield, N.J.

window. Another window, shaped like a trapezoid, is set on a vertical rod and can be swiveled by the victim, who sits about 15 feet away and tugs at strings attached to each side of the thing.

At a recent demonstration, the strings were handed to a reporter, who was told to sit down, close one eye, and adjust the trick window by pulling the strings, until it seemed parallel to its mate. He fussed for 15 minutes without success, finally gave up.

Professor Lawrence reassured him that he was entirely normal. He explained that the man was suffering a mental conflict due to his assumption that if he pulled one string one way, it would turn the window in the direction which all his past experience told him it should. The gagged-up shape of the window, however, created an optical illusion that kept him from achieving the result he wanted, gave him an un-sureness, and finally prevented him from acting.

What does it all add up to? Confusion confounded for the victims of the dungeon, for one thing. But Lawrence and his associates hope they're on the threshold of a more complete understanding of human behavior, which may help to solve some of the conflicts and neuroses that make many people miserable. "So far," he says, "many psychologists have been spending their time trying to find out what makes abnormal people abnormal. Now, for the first time, we're trying to find out what makes so-called normal people normal. In short, why do we behave like human beings?"

## Small Town Television

(Continued from page 117)

but within that distance reception is good.

Stores selling television sets are able to turn them on in their show windows and forget them. And the interest is great. Skippers of tuna clippers are now cogitating as to whether one of these days Parsons will be able to rig their craft with television. Although one old salt commented:

"My boys spend too much time at the radio now. Television would be worse."

What does Station KRSC think about this picking up of its programs and re-broadcasting them? It has cooperated—with delight. The Parsons system has simply extended the station's coverage. Astoria is only one town—the beginning—but what works in Astoria may work all over the Northwest and the nation, too.

"High-frequency signals penetrate almost everywhere," declares Parsons. "There are always some signals. It's merely

(Continued to page 270)

**STRIPE  
WITH  
PAINT  
EASY  
AS  
USING  
A  
PENCIL**

## PAINTERS' STRIPING TOOL

NOW you can do your own expert striping on furniture, bikes, model planes, bulletins, autos, toys, signs, linoleum, wall board . . . make plain walls look like tile! It's easy to paint straight, curved, circular, even parallel lines with any color. Handiest paint tool in your workshop! Type "M" Master Painters' Striping Tool complete with tip for 1/16" stripe, \$1.00. Other tools complete with following tips: 1/64", 1/32", 3/64", 5/64", 3/32", 1/8"; \$1.50 ea. Extra tips 75c ea. Entire kit with tool and 7 tips, \$5.00. (C.O.D.'s postage collect.) Dealers write! WENDELL MFG. CO., 4234-B Lincoln Ave., Chicago 18, Ill.

**A TOOL . . .  
NOT A BRUSH**

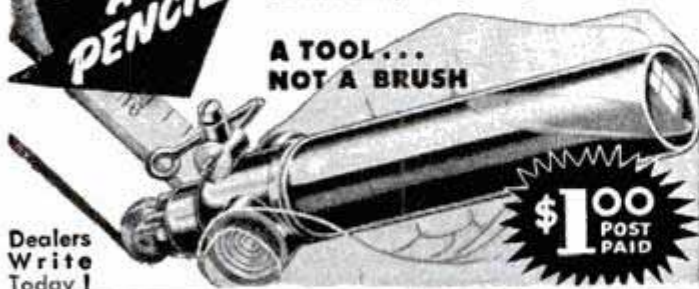

**\$1.00  
POST  
PAID**

Dealers  
Write  
Today!

## POWER MOWERS & KITS

**FREE  
PLANS**

**LOW FACTORY PRICES  
DIRECT TO YOU**



3  
Wheel  
Model

4  
Wheel  
Direct  
Drive

on America's finest Lawn Mowers and Easy-To-Assemble Kits and Parts. TRIANGLE Mowers are quality-built and powered high for easy cutting and long wear.

### SAVE MONEY 3 WAYS

1. Buy complete assembled mowers in 3 or 4 wheel models, 18" and 20" sizes.
2. You assemble complete mower from our precision built Kits and Parts.
3. Build your own from our FREE PLANS using Triangle Kits, Parts, Engines, Wheels, Etc.

**WRITE TODAY** for full facts, Free Plans, Parts List, and LOW, Factory Prices.

**TRIANGLE MFG. CO.**  
Dept. M-C, Box 185  
Fort Scott, Kansas

## BETTER PERFORMANCE FOR OUTBOARD MOTORS



Enjoy more speed, smoother performance, greater carrying capacity by equipping your motor with the Michigan propeller recommended for your particular motor and type of boat used. Write for FREE copy of 1950 catalog — "Outboarder's Bible" covers all motors old and new. Describes the "Aqua-Jet," super speed wheel for racing runabouts. For finer inboard performance investigate our "Aqua-Master." Write NOW! Michigan Wheel Co., Dept. 1-1 Grand Rapids 3, Michigan.

## Up to \$18.00 in an Evening's Spare Time!



29,000,000 prospects waiting for amazing refrigerator control! EXCLUSIVE D-Frost-O-Matic ends messy, wet defrosting . . . Saves Food . . . Saves Electricity. Safe, Automatic—GUARANTEED TWO FULL YEARS!

**SURE-FIRE SALES PLAN**—Clicks 95 times in 100 in Homes, Apartments. Harry Smith of Florida made \$1,500 in 1st two weeks. How much do you want? Write for FREE DETAILS—TODAY! Specify Territory.

**D-FROST-O  
MATIC**

6 N. Michigan Ave.,  
Dept. PM-3, Chicago 2, Ill.

Give your son  
a gun he'll be  
proud of

No other name in firearms says "quality . . . dependability . . . craftsmanship" so surely as Winchester. This single-shot, bolt action Winchester Model 67 is a truly fine 22, designed as a beginner's rifle . . . yet its high accuracy has won the admiration of experts.

The Model 67 shoots 22 Short, Long, and Long Rifle cartridges interchangeably. It is a light, finely-balanced rifle with a full man-sized stock and sporting type forearm of genuine American walnut. Extra safe . . . the Model 67 does not cock upon opening or closing the bolt; it must be cocked manually. See it at your dealer's.



**FREE!** Folder giving full details of all Winchester 22 caliber sporting and target rifles. Address: Dept. 342-A, Winchester Repeating Arms Co., Division of Olin Industries, Inc., New Haven 4, Conn.

ANOTHER  
**OLIN**  
PRODUCT

The World Famous Model 67  
**WINCHESTER**  
TRADE-MARK  
SPORTING RIFLE



**DO EVERY JOB**  
*better-faster-  
cheaper-*  
WITH  
**COMPRESSED AIR**

**Paint Buildings, boats, tractors, trucks; refinish furniture and fenders; inflate tires; grease and lubricate motors, engines, implements. Destroy weeds. Rid livestock, poultry and pens of pests with portable air power.**

**Free Literature** explains relative advantages of 4-cylinder **PRESSURE QUEEN** and single-cylinder **PRESSURE PRINCESS** spray painting outfits. Tells how to save material, time and money by using the proper outfit at the right price.

*It Is Yours For The Asking  
Write Today*

**THE CAMPBELL-HAUSFELD CO.**  
1046 RAILROAD AVE. HARRISON, O.

**A complete shop in one precision machine!**

## The IDEAL LAWNMOWER SHARPENER



- sharpens hand and power mowers
- completely new—based on 48 years of lawnmower sharpener experience
- complete with bed knife grinder and lapping-in Reconditioner—all operated by same motor

You can do precision lawnmower sharpening faster and easier than ever before on the Model 300 Ideal Sharpener. No disassembling needed, place the entire mower in the machine. You can make more money and do better work with an Ideal. Get all the facts, compare, no other sharpener offers as much as the Model 300 Ideal.

*Write Today For Free Catalog*

**THE FATE-ROOT-HEATH COMPANY**  
DEPT. H-3, PLYMOUTH, OHIO

a problem of finding a signal, building it up and feeding it out."

Technically, Parsons picks up KRSC telecasts on one channel (No. 5—76 to 82 megacycles), and sends them out over another channel (No. 2—54 to 60 megacycles). The change is made so the outgoing signal will not interfere with the incoming.

Parsons figures his receiving-sending unit with coaxial-cable system to service 10 television sets could be manufactured to sell for about \$1000. That means if 10 neighbors got together they could have television from a distant city at a cost of \$100 each.

The system, too, looms as an answer for city apartment dwellers who draw frowns from landlords for cluttering up roof tops with aerials. One aerial could suffice for a whole apartment house, with telecasts piped to apartments via coaxial cable.

Although one of Parsons' receiving-sending units with coaxial cable is designed to take care of only 10 sets located within a radius of 2000 feet, additional units could be utilized to extend coverage in multiples of 2000 feet. The system will make pickups from satellite rebroadcasting stations as well as from parent stations.

That's Parsons' next move—erection in Astoria of a satellite station for receiving and sending telecasts over the air without use of cable. The proposed noncommercial, experimental satellite station in Astoria, for which FCC approval is required, would cover a radius of 20 miles. Ordinary television sets could not get reception from this station, says Parsons, but he has worked out a device to attach to sets so that they will.

He is putting in three receiving units so that he can switch from one to another if there is interference in any one area. It is technically feasible, adds Parsons, for as many as four satellites to pick up from one another.

A satellite station costs little in comparison with even the down payment on a full-fledged station. The "coax" system costs still less. With a network including all three, Parsons envisages in the not-too-far-distant future television for everybody.

## Radio Waves Speed Germination

By subjecting seeds to a brief dose of high-frequency radio waves, scientists at the University of California have speeded germination by nearly 100 percent. The technique promises increased farm crops in regions of short growing seasons. This radiation affects the internal chemistry of the seed. Because only short exposures are necessary, the treatment is especially suitable for large-scale operators.



In a tight spot?

"YANKEE"

Offset Screw Driver  
Drives . . . draws screws  
in close quarters!



Get 'em out or drive 'em easily in tight places with a "Yankee" Offset Ratchet Screw Driver! Lever action gives more power than a regular 8" screw driver. No. 3400 illustrated has 1/4" and 3/8" blades for slotted screws; other models for Phillips Recessed Head Screws. At your Stanley dealer's. Write for free "Yankee" Tool Book.

"YANKEE" TOOLS  
NOW PART OF

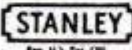

THE TOOL BOX  
OF THE WORLD

NORTH BROS. MFG. CO., Philadelphia 33, Pa.

**NEW! ROYAL ROTARY MOWER**

**BUY DIRECT AT FACTORY PRICE**

20 inch cut pulverizes grass and weeds—no raking or after work—adjustable cutting height. Foolproof 4 cycle 2 H.P. engine. Thousands in use. Sensational price can't be equalled. Completely guaranteed.



**Mower Power Attachment**

Fits any size or make hand mower, for either electric or gasoline engine. Chain drive — no welding required. Easily installed. Sold direct only. **\$20.00**

Write for Folder

**ROYAL OAK LAWN MOWER SHOP**

P. O. BOX 48 ROYAL OAK 1, MICHIGAN

**BUILD YOUR OWN FAST FREEZER**

PLANS \$1

It's easy to build this household appliance with LeJay Plans. Made from new or used parts. Save up to 75%. No expert knowledge needed. Plans show 5 sizes and are easy to follow. All details clearly explained. Enjoy making one of these freezers. Mail \$1 for set of plans and catalog. **LEJAY MFG. CO., 447 LeJay Bldg., Minneapolis 8, Minnesota.**



5 sizes  
8 to 40 cu.ft.

**MAKE YOUR OWN!**  
WITH

**Griffin READCUT LEATHER PROJECTS**

Over 100 KITS in every kind of Tooling and Carving Leather, accurately cut, all parts included. Only Top Grade Leathers used. You do the choosing. You do the tooling, carving, stamping, the punching and assembling.



SEND FOR COMPLETE CATALOG  
Please send 10¢ to cover mailing.

SINCE 1924

OUT OF THE WEST, THE HOME OF LEATHER CARVING

**Griffin CRAFT SUPPLIES**

5626-A TELEGRAPH AVE.  
OAKLAND 9, CALIFORNIA

**EVERYTHING FOR THE LEATHER WORKER**

Largest, most complete stock of Leathercraft Tools and Accessories in U.S.A.



HIDES AND SKINS of Craft Leathers of every kind if you prefer to cut your own.

**The finest reel money can buy**

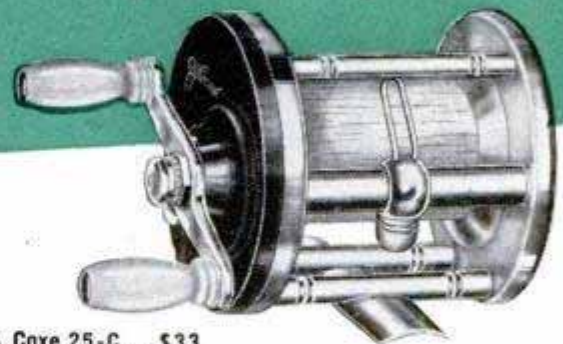

J. A. Coxe 25-C . . . \$33

● Here's the world's only automatic free spool casting reel—the J. A. Coxe 25-C. This is the professional reel, the reel we designed not for a price but for quality that's unmatched anywhere! Exclusive Coxe cross-bolt construction gives you perfect spool alignment—10-second take-down—adds extra years of wear. If you're ready for the finest reel money can buy—ask your dealer for the J. A. Coxe 25-C.



**...your finest reel for the money**



Bronson "Green Hornet" . . . \$4.95

● It's the Bronson Green Hornet—the popular-priced reel with premium features. Beautifully designed with green anodized head and tail plate, and new lightweight snap-on plastic arbor. Bronson's easy-to-reach dial drag lets you pinpoint the correct tension with one simple turn. Just set the dial before you cast—the reel does the rest!

35 fresh and salt water models to choose from

Bronson made  
*J. A. Coxe*  
FISHING REELS

**Bronson**  
FISHING REELS

**BRONSON REEL COMPANY • BRONSON, MICHIGAN**

World's Largest Makers of Fine Fishing Reels

**5 YEAR WRITTEN GUARANTEE**  
**17 JEWEL CHRONOGRAPH**  
 2 PUSH BUTTON

**ORIGINALLY \$71.50**

- Post-War Surplus
- WRISTWATCH
- STOPWATCH
- TELEMETER
- TACHOMETER

Precision 4 in 1 Timepiece. Incabloc shock resistant feature. Sweep Second hand. Anti-magnetic. Radium Dial. Stainless steel back. Perfect for physicians, scientists, technicians, engineers, aviators, photographers, broadcasters, navigators, sportsmen, servicemen, etc. Thousands sold at \$71.50. Order now while they last at this record breaking low price.

Our Price  
Now Only

**\$21.95**  
Plus  
**\$2.20**  
Tax



**5 YEAR WRITTEN GUARANTEE**  
**17-JEWEL WRIST WATCH** **\$16.95** PLUS \$1.70 TAX

**ORIGINAL PRICE \$59**

SHOCK  
INCABLOC—PROTECTED  
WATER REPELLENT . . .

Sacrificed Because

They're POST-War Surplus

Luminous dial . . . sweep second hand . . . Super Accurate . . . Imported Swiss precision movement and case. You get these Men's New 5 Year Guaranteed Watches now for a small fraction of the original price. Don't delay! Order now . . . while they last.

**TRIAL OFFER!** Wear at our risk! Money back in 5 days if not delighted. Send only \$1 down payment with order. Pay balance to postman on arrival plus postage. Or we pay postage if you include full payment plus tax with your order.

**FREE!** Handsome Expansion Band Included. **ORDER NOW!**

**MARYLAND DISTRIBUTORS, Dept. 30**

501 EAST BALTIMORE STREET BALTIMORE 2, MD.



"SAVE IT AND  
FIX IT"

**MENDS**

**DISHES, FURNITURE, LUGGAGE**

It's transparent, water-proof, flexible and durable. Get a tube today.

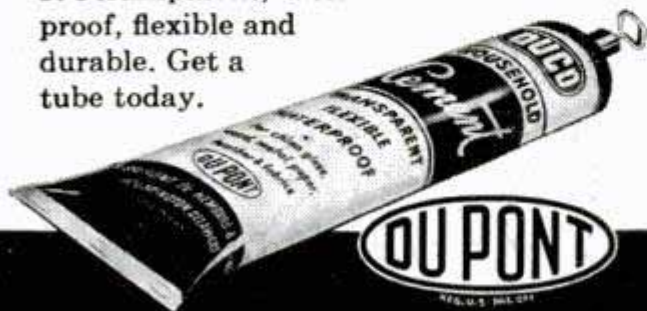

**DUCO CEMENT**

REG. U. S. PAT. OFF.

**Are We Running Dry?**

(Continued from page 125)

manufacturing, paper manufacturing, metalworking, air conditioning, distilling, ice making and cold storage, food processing, rubber manufacturing, meat packing, brewing, railroads, gas and electricity.

Here are some facts that help explain the doubling of our consumption of ground water during the last 15 years: a single large paper mill can consume 50 million gallons a day—more than enough for a city of 500,000.

Electric-power generation by steam requires 600 to 1000 tons of water for every ton of coal—or 80 gallons per kilowatt-hour. To produce the annual total of about 182 billion kilowatt-hours of steam-generated current requires the handling of some 15,000 billion gallons of water.

One rubber plant uses 120,000 gallons of water a minute.

About 65,000 gallons of cooling are needed to produce one ton of steel.

Despite the fact that water is cheaper than dirt (purified water is delivered retail to most customers at five cents a ton or less), on weight and volume handled, water is the biggest business in the world.

Many of the larger cities in the U. S. luckily do not depend on ground water for municipal purposes. New York City, which consumes a billion gallons a day, gets its supply from a system of huge storage reservoirs containing surface water. When these reservoirs dropped to 40 percent of capacity last winter, the New York "water famine" was on. Chicago takes its water from Lake Michigan and purifies it. Philadelphia depends on the Delaware and Schuylkill Rivers for its "chlorine cocktail." The crystal-pure water in St. Louis and New Orleans actually comes from the muddy Mississippi River. Los Angeles and other leading cities in southern California get surface water from the 238-mile Owens River aqueduct (the water is from the Sierra Nevada Mountain watershed) and an aqueduct from the Colorado River.

Let's take a swing around the U. S. with Carl G. Paulsen, chief hydraulic engineer of the Geological Survey, who is probably the country's foremost water expert. First of all Mr. Paulsen likes to make clear that there is no serious over-all shortage of ground water in the United States. In fact, he is more than a little annoyed with scare stories to this effect. However, there are danger areas in the country that may have serious trouble if present conditions are allowed to continue.

The danger areas are found in California,

(Continued to page 274)

# GROBAN'S WAR SURPLUS BARGAINS!

ALL BRAND NEW - UNCONDITIONALLY GUARANTEED!

115 Volts - 60 Cycle  
A. C. LIGHT PLANT

## GENERATOR

IDEAL FOR: Home Lighting, Hunting Lodges, Stand-By Electricity, Running All AC Electrical Appliances including: Fans, Motors, Electric Razors, Refrigerators, Incubators, etc. 750 Watts at 1800 RPM using 1 1/2 HP gasoline engine.  
0-150 Voltmeter with Regulator; 1" diameter shaft with keyway for direct or belt drive, carried in two bearings, one bronze and one ball-thrust bearing. Protection for emergencies to operate oil burner, stoker, freezer, water pump, and lights. These units, built to exacting Signal Corps specifications, are the answer to your lighting needs. Shipping wt. 60 lbs. AN OUTSTANDING VALUE

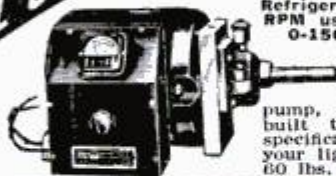

(ITEM #67)

**59.50**  
F.O.B. Chicago

## GEAR TYPE-ALL MANGANESE BRONZE INSECTICIDE PUMP

FOR SPRAYING D.D.T., 2,4-D, SULPHUR COMPOUNDS, ETC.

Pressures up to 200 lbs. and 14 gallons per minute - at 1200 R.P.M. Will not rust, pit, foul or freeze up. Use rubber hose inlet, 3/4" pipe outlet. Equipped with double mounting bracket. Weight 24 lbs. Dimen. 8"x7"x10". Standard 1" manganese bronze shaft with keyway. U. S. Govt. Acquisition Cost \$62.00. NOW... FREE - complete instructions and performance data with each pump.



(ITEM #50)

**15.00**  
F.O.B. Chicago

## PNEUMATIC AIR DRILLS

USED-LIKE NEW

Light, powerful, compact, pistol grip, trigger control. Ideal for shop use where air pressure is available.

ITEM #80 - Ingersoll-Rand, equipped with 1/4" Jacobs key chuck. Overall dimen. 6 1/2" long, 5" high, 1 1/2" thick. Wt. 3 lbs. F.O.B. Chicago..... **14.95**



ITEM #81 - Chicago Pneumatic, larger size Model "A", equipped with 1/4" Jacobs key chuck. Overall dimen. 7 1/2" long, 5" high, 2" thick. Wt. 4 lbs. F.O.B. Chicago..... **19.95**

## WATEROUS PUMP

Rated 500 gallons per minute at 120 P. S. I. This high efficiency pump is designed for front end mounting on General Motors, Dodge, Studebaker and Ford trucks and comes complete with rear box and power take-off for easy mounting and attachment to crank shaft. Net weight of pump 500 lbs. Shipping weight 1200 lbs. F.O.B. Chicago..... **149.50**



(ITEM #71)

## NEW AIRCRAFT QUALITY

# HYDRAULIC EQUIPMENT

## UNCONDITIONALLY GUARANTEED

Large supply of new labor-saving, economical hydraulic equipment in many types and sizes... including actuating cylinders, control valves, tanks, pumps, fittings, hose, and data on hydraulic applications.

Use these positive, highly efficient, smooth pressure hydraulics on presses, arbors, lifts, brakes, plastic dies, auto frame alignment, etc., etc.

- ITEM #70 - Purolator hydraulic oil filter postpaid..... **4.95**
- ITEM #33C - Double action hydraulic cylinder, 1 1/2" bore, 4 1/2" stroke. Clevis mountings at both ends. Uses 1/4" pipe fittings. postpaid..... **8.95**
- ITEM #16 - Double acting cylinder, 1 1/2" bore, 27" stroke. (Will lift 1760 lbs. in 2 seconds with Logan Pump.) Wt. 8 lbs. A \$55.00 hydraulic cylinder value for only **12.95** postpaid.....
- ITEM #17 - Double acting cylinder, 2 3/8" bore, 8" stroke. (Will lift 4500 lbs. in one second with Logan Pump.) Will withstand 1300 P.S.I. against wall. Wt. 7 lbs. A \$65.00 value..... postpaid **14.50**
- ITEM #15 - Double acting cylinder, 3" bore, 8 1/2" stroke. All steel hydraulic cylinder, (will lift up to 7000 lbs. in 3 seconds with Logan Pump). Wt. 12 lbs. A \$78.00 value..... postpaid **19.50**



(ITEM #42)

- ITEM #31 - Double acting cylinder, 3 1/2" bore, 11" stroke. (Will lift 9600 lbs. in 7 seconds using Logan Pump.) Wt. 15 lbs. A \$92.00 value... postpaid **22.50**
  - ITEM #42 - Double action hydraulic cylinder, 4" bore, 18" stroke. Rated lift capacity with 1000 P.S.I. input is 12,560 lbs. using Logan Pump. Ship. wt. 30 lbs. AN EXCELLENT VALUE for..... F.O.B. Chicago **32.50**
  - ITEM #61 - Double acting Hanna air cylinder, 5" bore, 26 1/2" stroke, 40 1/2" overall length closed. With 100 lbs. input will lift 1900 lbs. Net wt. 89 1/2 lbs. Gov't. acq. cost \$101.85..... F.O.B. Chicago **39.50**
- HI-PRESSURE FITTINGS for cylinders and valves available at 35c ea. for 3/4" pipe and 50c ea. for 1/2" pipe.

## VICKERS MODEL AA16801A HYDRAULIC TRANSMISSION

Ideal for lathe drive, miniature cars, power machinery, gearing, etc. Rated 2 hp. maximum input at 3750 RPM. Output speed continuously variable from 0 to 1/4 of input speed in either direction. Self contained reservoir. All controls external. Even power at all speeds. Complete with two 1/2" shafts with flat for pulley attachment.

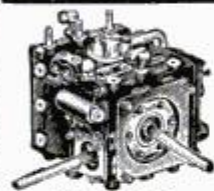

(ITEM #85)

Shipping weight 20 lbs. Gov't. acquisition cost \$325.00. A TREMENDOUS VALUE AT..... **25.00**

F.O.B. Chicago

## Hydraulic Control Valves

ITEM #24. Four-way control valve with built-in relief valve, for use with one double action hydraulic cylinder, may be used with 1500 P.S.I. hydraulic system to open and close hydraulic cylinders. Ship. wt. 8 lbs. A \$38.00 value..... **7.95** postpaid

ITEM #26. Four-way control valve for use with two hydraulic double-action cylinders. Each cylinder may be operated independently of the other or in conjunction with the other. Oil may be locked in any of the cylinders to hold the piston at any required position. Ship. wt. 6 lbs. A \$60 value postpaid..... **10.95**

ITEM #28. A two cylinder double action valve with a unique arrangement, allowing the operator to raise both cylinders simultaneously to lower them simultaneously or to raise one and lower the other at any predetermined rate and speed. Ship. wt. 8 lbs. A \$75.00 value, postpaid..... **14.95**



## LOGAN HEAVY DUTY HYDRAULIC PUMP

For operating hydraulic cylinders and hydraulic motors on tractors, bulldozers, construction machinery, lift trucks, industrial applications, etc. Delivers 8 GPM at 1200 RPM at 1000 P.S.I. using 5 HP. Has 1/2" pipe thread inlet, 3/8" pipe thread outlet, 3/4" shaft with flat drive. Has flange with 4 bolt holes for convenient mounting. Ship. wt. 22 lbs. Overall dimensions: 7" L x 5 1/2" H x 5 1/2" W. A \$105.00 value. FOR ONLY..... **22.50**



(ITEM #29)

F.O.B. Chicago

## HAND HYDRAULIC PUMP

ITEM #11 Postpaid..... **8.95**  
ITEM #83 - Hand hydraulic pump with built-in transfer valve. Postpaid **12.95**



## LOGAN HEAVY DUTY HYDRAULIC CONTROL VALVE

Has built-in adjustable relief valve, will operate one double-acting hydraulic cylinder or two cylinders as one or a reversible hydraulic motor. Valve handle latches in neutral position. Made of rugged cast aluminum alloy. Open center unloads the pump in neutral position. Throttling control allows operator to regulate the speed of movement of the hydraulic cylinder or motor. Has removable mounting brackets with 4 bolt holes, 3/8" pipe thread connections. Overall dimen.: 12 1/2" H x 8 1/2" D x 8" W. Ship. wt. 17 lbs. Gov't. Acquisition Cost over \$100.00. An Excellent Buy. **21.95** (ITEM #37)



(ITEM #37)

NOW... It's Easy to Weld with this handy

## ARC WELDER

250 AMP. MODEL 252

Designed for many years of trouble-free service.

Handles anything from light gauge sheet metal to 1/2" plate



ITEM #65

## FOR ANY WELDING JOB, LIGHT OR HEAVY

This precision-engineered direct current ELECTRIC ARC WELDER is offered at but a fraction of its original value. It can be mounted permanently or easily transported for portable use. Does the job instantly, where and when you need it.

The War Surplus generators for these Arc Welders were built by General Electric, Westinghouse, and Delco-Remy at a cost of over \$300.00. They are light in weight, have oversized lifetime grease-sealed ball bearings; air-cooled commutator; dial type rheostat for easy pinpoint control; high-low range switch; reactor coil for even arc; handles 1/16" to 1/4" rods. Run welder at 2500 R.P.M. from drive pulley or power take-off of tractor, a 7 1/2 H.P. electric motor or a 10 H.P. gas engine. Use two V-belts, or flat belt (on pulley). Continuous welding rating—200 amps.; intermittent rating—250 amps.; 0-30 volts. NOW... AT A FRACTION OF ITS VALUE. Price includes double V or flat belt pulley and instruction book. Ship. wt. 107 lbs. Only one or two jobs will pay for entire welder. F.O.B. Chicago **99.50**

ACCESSORY KIT including welding helmet, electrode holder, two 10 ft. cables with clamp, and 5 lbs. of assorted welding rods. (ITEM #66) F.O.B. Chicago **10.50**  
Remember. Satisfaction is Guaranteed

## FREE: NEW, 44-PAGE CATALOG

Chuck-full of sensational War Surplus "buys" and informative data on hydraulic applications. WRITE FOR YOURS TODAY!

ORDER DIRECT FROM AD—SEND PAYMENT OR PURCHASE ORDER TODAY

SATISFACTION GUARANTEED

GROBAN SUPPLY CO. 1507 SOUTH MICHIGAN AVE. Chicago 5, Ill. Dept. PM-4



*The Right Tool for  
a Right Job*  
**IN YOUR WORKSHOP  
EMPIRE LEVELS**



Get more value  
for less money! Make  
Your Choice an Empire Level

No. 151 Aluminum Level. Extremely accurate with adjustable-interchangeable vials. Has 2 levels, 2 plumbs, and a choice of 2 45° vials or 2 additional plumbs. Beautifully finished, easy to work with. A tool you can be proud to own.

18" ... \$6.40    24" ... \$6.80    28" ... \$7.80

Order EMPIRE Levels from your local dealer,  
or write for complete information.



Dept. PM    10930 W. Potter Rd., Milwaukee 13, Wis.

## REAR ENGINE TRACTOR

### Makes Small Acres Big

Make your acres produce a profit with this low-cost, man-size tractor. Wide selection of inexpensive, easy-on, easy-off implements — plows, planters, cultivators, mower, etc. Earn a tidy income growing vegetables, flowers, fruit, nursery stock, farm crops, and doing work for neighbors. Powerful rear engine gives clear vision, boosts traction. Consumes only 2 to 3 quarts of fuel per hour. Four speeds. It's fun to run!

Send coupon for free  
driving trial and  
literature



**ALLIS-CHALMERS**  
TRACTOR DIVISION - MILWAUKEE 1, U. S. A.

**Allis-Chalmers Tractor Division  
Milwaukee 1, Wis., Dept. 22**

I'm interested in:

Free driving trial     Free literature

Name \_\_\_\_\_

St. or RFD \_\_\_\_\_

City \_\_\_\_\_ State \_\_\_\_\_

north central Oregon, south central Washington, Arizona, the Texas Panhandle, parts of Illinois, southwestern Louisiana, parts of Kentucky, Florida and — until recently — the west end of Long Island. There are many other isolated spots where ground-water supply is a problem, but these places are too widely scattered to group under one heading.

Paulsen points out that first of all in the West the ground-water problem is aggravated by the fact that all available surface water has been appropriated. If industries are to expand or irrigated acreage to grow the only remaining source of water lies beneath the ground. This has led to abuses that threaten entire rich areas.

Take California. There are approximately 1,550,000 acres under irrigation in the upper San Joaquin Valley. Tests conducted by the Geological Survey show that the water supply is sufficient for irrigating only 1,170,000 acres. Unless some way is found to recharge the ground reservoirs, thousands of acres may have to be abandoned. Along the Coastal Plain in Los Angeles and Orange Counties water is pumped from alluvial sand and gravel. This is one of the most heavily developed ground-water areas in the country. In the West Basin southwest of Los Angeles the current withdrawal is about twice the fresh-water recharge. The result is that salt water from the ocean is seeping into the depleted underground reservoirs. Already some wells two miles inland have been contaminated with salt. When this happens to a rancher's wells, there is nothing he can do except move on.

This district is looking hopefully across the nation to western Long Island, mainly Brooklyn, which was seriously hit with a similar encroachment of salt water a few years ago. For some years the pumpage had been as high as 300 million gallons a day for the entire island. The result was that the water table fell below sea level in an area of more than 80 square miles. Many wells were salted and others threatened. The Geological Survey was called in and a successful program of pumpage reduction and artificial recharge was introduced. Today more than 60 million gallons of water a day (used for cooling) are returned to the ground through a closed recharge system. The California situation is much more serious, but engineers are seeking ways to solve the problem.

Arizona's ground-water problem is second to none. In several areas the water level has dropped 50 feet in five years. Over most of the state water is being pumped from the ground twice as fast as

(Continued to page 276)

# KING MIDGET

HOME ASSEMBLED AUTO



## WORLD'S LOWEST PRICED AUTOMOBILE!

80-90 MI. PER GAL.—45-50 MI. PER HR.

Drive for as low as 50c per week. Precision built parts direct from factory with beautiful all steel body. Get the facts on this amazing small auto—send 25c for detailed circular with large picture, 3 view drawings and price of all parts, or send \$1 (refunded first order) for this plus actual assembly book with 42 photos, drawings; blueprints of snow, ice conversions, information on mini-midget racing, etc.

MIDGET MOTORS MFG. CO., ATHENS 1, OHIO

King Midget is ideal for errands, sports use, to work, short business or pleasure trips, or second-car utility for the whole family. Also tops for mini-midget racing. Room for six footer.

## Who Ever Heard of POWER TOOLS

Only \$8<sup>00</sup> Each?

EMRICK WORKSHOP includes Big, Heavy-Duty 30" Lathe, Drill Press, Saw Arbor, Grinder, Sander — in ONE machine, using ONE motor. Equals in performance single units up to \$200.00. Factory price only \$39.95 cash, or on Easy Payments. 10-Day Free Trial. MONEY-BACK Guarantee. Write for FREE literature on new 1950 features and New Low Priced Specials.

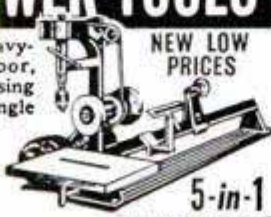

NEW LOW PRICES

5-in-1

MACHINE

EMRICK, INC., 1956 Clinton, Kalamazoo, Mich.

## NONE BETTER! SUPER DRILL GRINDER

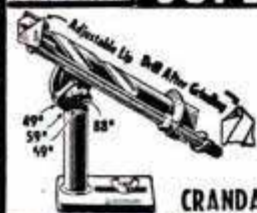

Sharpens round shank drills from 3/32" to 1/2" in diameter, up to 6" long. Grinds old drills like new in 4 different point angles, using hand or power grinding wheels. Money-back guarantee.

Price only \$2.95  
At Dealers or Postpaid

CRANDALL MFG. CO. 1512 W. Slauson, Dept. FA-47, Los Angeles 44, Calif.

## STOP ANNOYING FAUCET LEAKS PERMANENTLY



with **SNAP-IN SWIVEL WASHERS**  
Famous

Satisfaction guaranteed or money refunded. Send \$1.00 for complete service for 4 faucets and instructions for easy installation. No special tools needed.

SNAP PRODUCTS CORP.

Dept. 4PM, 153 W. HUBBARD STREET, CHICAGO 10, ILLINOIS

## BUILD FINE GRANDFATHER CLOCK NOW

The simple sensible Red-i-Kut way as thousands have—SAVE HALF. SHOP TESTED PLANS "SPIRIT OF THE CENTURY" Narrow waist 83" tall or stately "SPIRIT OF AMERICA" straight side model. EASY-TO-FOLLOW photo-pack PLANS tell all—plus BROCHURE of heavy brass weight Westminster, tube chime, movements, dials, 34" solid mahogany case kits. Send \$1.00 today—Both Plans \$1.50 NOW. KUEMPEL CHIME CLOCK CO., #8 Kuempel Bldg., Minneapolis 16, Minn.

## MODERN LAWN MOWER SHARPENER

FOR LAWN MOWER SHOPS  
FIX-IT SHOPS  
GOLF COURSES • PARKS  
101 OTHER JOBS

Sharpens All Reel Type Mowers • Hand, Power or Gang • 10 to 20 Minutes • No Dismantling • No Extra Attachments Needed.

All reel type mowers, from 5-inch edgers to 30-inch power mowers, are quickly sharpened to extreme ends of both left and right twist blades.

Handle, wheels, roller and motor remain in place when sharpening is in process. Bed knife is sharpened in same brackets. Grinding head rides on five ball bearing races. Easy to operate. Also sharpens chisels, joiner knives, planer blades. Big profit maker. Own your own business. Send Today for FREE Illustrated Bulletin No. 10-C

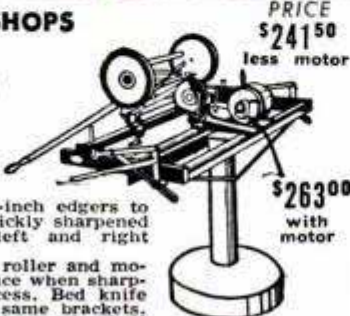

PRICE \$241<sup>50</sup> less motor

\$263<sup>00</sup> with motor

ORDER NOW  
Immediate Delivery

MODERN MFG. CO. 160 N. FAIR OAKS AVE. PASADENA 1, CALIFORNIA

## STOP CELLAR WALL LEAKS



Smooth-On No. 7 Iron Cement stops your cellar wall leaks. You can apply Smooth-On No. 7 with a trowel or stiff brush, to cracks, holes, porous spots or seams in concrete, brick, stone walls or floors. This effective Smooth-On Cement will stay in place, because it expands slightly as it sets. You can also use Smooth-On No. 7 to stop leaks in cisterns, swimming pools, troughs, fountains, septic tanks, etc. Use it too, to seal openings where piping passes through walls. Sold in 1, 5, 25, and 100 lb. sizes.

**FREE REPAIR HANDBOOK** 40 pages packed with helpful suggestions for repairs all around the home, shop and car. Also ask for leaflet describing the uses of Smooth-On No. 7. Write today.

SMOOTH-ON MFG. CO., Dept. 37D  
570 Communipaw Ave., Jersey City 4, N. J.



Do it with  
**SMOOTH-ON**  
NO. 7 IRON CEMENT

## Keep Brushes like New

BEFORE

AFTER

• 5c  
• 10c  
• 25c

**DICA-DOO**  
**PAINT BRUSH BATH**

Clean and Restored  
PAINT BRUSHES

KEEPS BRUSHES SPRINGY AND  
HELPS REMOVE PAINT

Perfect for  
**NYLON BRUSHES, too!**  
At Paint, Hardware, Dept., and 5 & 10c Stores  
Patent Cereals Co. Geneva, N. Y.

"FISH CAN'T HIDE FROM THIS WEEDLESS WONDER"

## #3 HAWAIIAN WIGGLER

"Your No. 3 Hawaiian is the only bait the bass were hitting among 8 of us at the Circle D," writes Roy Jacobs of Houston, Texas. Streamlined No. 3 casts like a bullet—goes right into the thickest cover, where other lures can't go. Guarded hook lets it wiggle right thru the weeds, rushes and "gooey"—brings out the big ones! Rubber Hula Skirt gives terrific action.



**GENUINE WEEDLESS BAIT**  
AT YOUR DEALER

**\$1.10**  
Each



Choice 6 colors

With Spinner for extra flash and action—\$1.21 ea.

► WRITE FOR FREE FULL-COLOR BAIT CATALOG ◀

**FRED ARBOGAST & CO., INC.**  
1614 WEST NORTH STREET • AKRON 3, OHIO

# DEAF?

## HEAR BETTER PAY LESS

Why pay \$150 to \$200 for a hearing aid when the new Zenith "Miniature" at only \$75.00 is guaranteed to give you all the power and performance you need if your hearing can be helped by a hearing aid.

The Zenith "Miniature" is as new and advanced as Zenith's Radio, FM, and Television Sets—world famous for top quality. Tiny, jewel-like, beautiful—weighs only 6¼ oz. with batteries. Needs no "fitting." Comes ready to wear. Let a trial of this new, sensationally-priced Zenith prove it can save you real money two ways—on original cost and on upkeep expense. Surprisingly economical. Here's Zenith's amazing guarantee: If any \$200 hearing aid outperforms Zenith in efficiency or economy, your money back—under our 10-Day Return Privilege. Dealers in all principal cities. For Authorized Zenith Hearing Aid Dealer in your locality consult your classified telephone book; or write for complete coast-to-coast dealer list. Don't live in a world of silence when it is now possible for the hard-of-hearing to even hear a whisper. For free descriptive literature, address:

Zenith Radio Corporation, Hearing Aid Division  
Dept. 491, 5801 West Dickens Avenue • Chicago 39, Illinois  
Makers of World Famous Zenith Radio, FM and Television Sets

it is replenished and in some places 18 times as fast. Arizona's big farming district is concentrated in 1200 square miles around Phoenix where more than half of the water to irrigate the desert comes from the ground. The reservoirs of the Santa Cruz and Salt River Valleys are seriously depleted. Paulsen estimates the current annual withdrawal at 2½ million acre-feet (an acre foot is one acre covered with one foot of water). The condition here is so serious that the permanence of irrigation farming is threatened. The state legislature recently passed a law to control drilling and use of new irrigation wells. The Geological Survey considers this just the first step toward solving the problem.

Arizona does not have to look far to find a successful example of controlling ground-water supplies in desert country. Over in the Roswell artesian basin of New Mexico the ranchers know exactly how much water can be safely removed from the ground each year. The state legislature has passed stringent controls based on figures supplied by the Geological Survey. Before the Survey was called in, wells and farms valued at \$5,000,000 had to be abandoned. Today, an area once threatened with economic disaster has an assured future.

In the High Plains of Texas south of Amarillo, irrigation farming has been expanding at a faster rate than any other area in the U. S. In 1943 there were 300 wells in this area irrigating 16,000 acres. Last year there were about 10,000 wells irrigating more than a million acres. In this region the underground reservoirs are replenished at a very low annual rate. A lot of people are getting rich but the water level is dropping at an alarming rate. Paulsen says that eventually a decision will have to be reached as to how long the stored water should be made to last.

Down in Louisiana in the land of torrential near-tropical rains one would not expect a water problem. However, a serious ground-water shortage exists in the southwestern part of the state. Years ago the rice growers irrigated with surface water, but now half the area is irrigated by pumpage. The result has been a gradually receding water level and the intrusion of salt water from the Gulf of Mexico. There are other scattered spots along the Gulf Coast in Georgia and Florida also troubled with the salt-water problem.

Over on the east coast of Florida, at Miami, an underground battle is being won over the salt intruder. Ten years ago hundreds of private wells and two municipal wells had been lost to salt-water encroachment. One ruined well was eight miles

(Continued to page 278)

# STOPS THIEVES AMAZING WAY



**FOR CARS  
•  
HOMES  
•  
FARM  
BUILDINGS**



A South Dakota manufacturer has discovered an easy way to protect cars, homes, farm buildings from Burglars, sneak and chicken thieves. The manufacturer is so sold on his sensational DEVIL DOG Burglar Alarm that he is willing to let you try it for ten days and will offer you \$1.00 for testing it. New sales plan promises big

money to hustlers. Be first to get your DEVIL DOG Burglar Alarm for introducing in your territory. CASH-IN on the tremendous demand this device will create. Shipped prepaid from factory on ten year guarantee. Rush name and address for details to  
**NORTHWEST ELECTRIC CO., Dept. 110-D, Pukwana, S. Dak.**

**COMPLETE  
HOLLYWOOD  
SPRINKLER  
SYSTEM**

ONLY  
**\$9<sup>95</sup>**



Complete unit easily attached to your hose or faucet in a jiffy. Covers 1000 sq. ft. Fits any shape lawn. Weighs only 5 lbs. Consists of 18 ft. heavy-duty hose, 3 adjustable spray units. Will not tip, turn or damage turf. Nothing else to buy. 10-day free trial. 5-year guarantee. Only \$9.95 postpaid. (Calif. add 3% tax) C.O.D.'s accepted. Additional single units \$3.50 each. Dealer inquiries invited.

**TROUP ENGINEERING, Dept. E-4**  
3201 E. Pacific Coast Hwy., Long Beach 4, California

## You Can Have Local Manufacturing Rights

Here's an outstanding manufacturing opportunity for men with vision, energy and a little capital. Brikcrete is sweeping the country because it has beauty, long life and ultra comfort. Truly the world's most modern masonry. Distinctively different. Yet costs less than lumber because it is locally manufactured of local materials by local labor for local building needs.



## 100%-150% Mark-Up on Costs

You can be one of a national chain of local plants. High income potentials. Can be started on moderate investment. Wide-open market. Requires no experience; no skilled labor. We supply all equipment. Easy terms, if necessary. We work with you to put it across. Write for Brikcrete Book No. 2 today... free.



**Brikcrete Associates, Inc.**  
4679 Division Ave., S.  
Grand Rapids 8, Mich.

**BRIKCRETE**

THOUSANDS BUILD AT 1/2 THE PRICE



**20 MODELS  
U-MAK-IT BOAT KITS**

**EASY  
TO BUILD**

**ROWBOATS**

8 TO 14 FT.

Special Models  
For Fishermen



**PRAMS**

**OUTBOARDS**

Fast Round or V Bottoms

12 TO 16 FT. Newest

Assembly Methods



**INBOARDS &  
CABIN CRUISERS**

For Fishing, Racing or  
Cruising 16 TO 23 FT.



**SEND 25c (coin)  
ORDER TODAY YOUR  
NEW CATALOG**

**U-MAK-IT PRODUCTS** 703P-WHITTIER ST.  
New York 59, N. Y.

*"I'll take the WHITE one  
every time!"*



WYTEFACE Steel Tapes, with their jet black markings on a white background, are easier to read in any light. They are rust-resisting, hard to kink and easy to clean.

Protected by U. S. Patent 2,089,209

**WYTEFACE**

TRADE MARK

**STEEL TAPES**

**KEUFFEL & ESSER CO.**

# Eliminate Motor PING

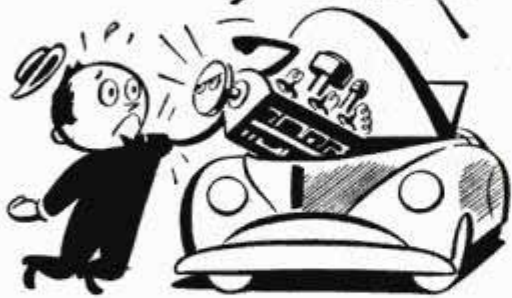

*Before You Pay the Price*

Add **BARDAHL**  
*to Your Crankcase Oil*

WHEN your engine hollers, give it help—**RIGHT AWAY!** Simply add one quart of **BARDAHL** to regular oil.

Instantly **BARDAHL** goes to work at the point of friction. Forms tough protective film on moving parts to halt further wear. Relieves dangerous heat that may cause breakdown.

**BARDAHL** intensifies ordinary good oils. Makes engines sound better, run better, last longer.

Ask the best mechanic in town about **BARDAHL**. He's been using it for years!

**BARDAHL**  
**OIL**

*Reduces Friction  
to a Fraction*

**BARDAHL OIL COMPANY**  
Seattle • St. Louis



# It's Bright-

*It's Pocket Size!*

It's palm-size—shaped to lie flat in small spaces. Brilliant light! Rust-proof. Dent-resistant.

Luminous switch. Uses 2 standard 1¼-inch flashlight batteries. Price, less batteries . . . **\$1.75**

**DELTA ELECTRIC CO., MARION, IND.**

**Delta BUDDY** LITTLE ELECTRIC LANTERN



from the seashore. The Geological Survey was called in and found that water-bearing formations below 300 feet contain only saline artesian water. The Survey also found that the canals draining the Everglades had lowered the fresh-water level which must be kept to a height of three feet above sea level. Engineers of Miami and Dade County designed adjustable and removable dams to be placed in the seaward ends of the tidal canals. These raised the water table and closed the canals to sea water.

New England's ground-water situation is generally good. In the Middle West there are "critical areas" and although water levels have been dropping, new techniques in pumping and drilling provide a better water supply than at any time in the past. Industrial areas give rise to most water problems. In the Chicago area the ground-water table is receding at the rate of seven feet a year, according to the Illinois State Water Survey Division. However, Lake Michigan water is always available in tremendous quantities and some communities inland are now depending on it. The most critical area in Illinois is at Peoria where the Illinois Survey is now conducting tests pertaining to artificial recharge.

Hydraulic engineers point out that our sudden awakening to ground-water shortages is one of America's growing pains. We are becoming a more densely populated nation and natural resources can no longer be lavishly used without a thought for the future. There are two simple answers to our ground-water problems: knowledge of what lies in the subterranean storehouses and wise controls over its usage.

## Maze Packaging Stops Insects

British scientists have discovered that one way to protect food from insects is to wrap it in a cellulose material folded many times to form a maze of tunnels. The cellulose is coated with DDT and, as the insect wanders through the tunnels, it picks up a fatal dose of the insecticide. Even insects that can bore their way through ordinary wrapping were stopped by the maze wrapping because of the natural tendency of insects to wander through tunnels and constricted openings. Instead of boring straight through the wrapping to the food, the insects would start roaming around in the material and soon die.

Scientists in Australia, by a study of solar radiation over a wide range of wavelengths, have confirmed that the sun's temperature is about 1,000,000 degrees Fahrenheit.



**OWN YOUR OWN HOME!  
COMPLETE 5 ROOM HOUSE**

**\$2895<sup>00</sup>**

F.O.B. Marlette,  
Michigan

**Complete  
Information  
FREE  
Send Us  
A Post Card**



**THE "SCOTCHMAN" IS AVAILABLE  
WITH TWO OR THREE BEDROOMS**

Start realizing your dream home—make it a reality. Why wait 'til you can afford high contractor prices? Save on both material and labor. We are even prepared to equip your house from furnace to faucets. We'll send you proof in the form of the experience of others. Write Today. Get the home you want NOW!

**L. H. RIEDEL LUMBER CO.  
DEPT. A2 • MARLETTE, MICHIGAN**



**SUMP PUMPS** 2,200 GALLON CAPACITY  
1 1/4" outlet — No screen to clog — fool proof

The time tested Lokomona sump pump is absolutely automatic—has a special fool proof trap at the intake—rubber bearing at the bottom. Made of aluminum castings, it's 42" high and carries a 1/4 H.P. 110 V. A.C. heavy duty motor. The pump is designed for continuous, dependable service. Any standard motor will fit this pump. Order yours today. COD. If cash with order, we pay postage.  
**MONEY BACK GUARANTEE**  
**LOKOMONA PUMP CO., P.O. BOX 86, ROYAL OAK 1, MICH.**

**\$36.00** COMPLETE  
**\$22.00** LESS MOTOR  
**\$18.00** PUMP ONLY

**ARC WELDING**  
**FOR PROFIT OR PLEASURE**

**60 LBS. OF READY MADE PARTS** Only \$24.95

**BUILD YOUR OWN  
HEAVY DUTY WELDER**

**SAVE**  
Buy Only  
NECESSARY  
PARTS

All necessary parts Ready-Made and easy to assemble. You can do all around welding on steel, cast iron and other metals after only a few hours practice. Illustrated instruction manual included. Sold on 30-Day Money-Back Guarantee!

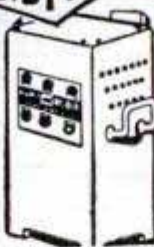

**FREE:** Write today for fully illustrated Pamphlet P-4

Gives 100% penetration. Welds are stronger than original metal. Operates on 110 or 220 AC.

**ATOMIC ARC WELDER CO.**  
1037 So. 19th St. OMAHA, NEBR.

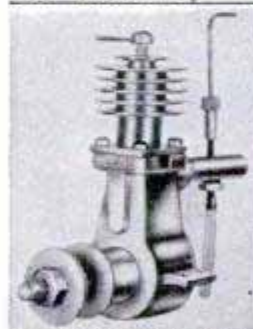

★ ★ ★ ★ ★ ★ ★ ★ ★ ★  
**OUR 249th ADVERTISEMENT**  
**REAL DIESEL ENGINE!**

**\$2.95**

You can't beat this price!

• Ideal for planes, boats, midjet cars  
• Actually runs at 7500 RPM, produces 1 1/7 HP  
• Precision machined for smooth operation  
• Comes to you completely assembled, ready for operation

**MAYBE WE'RE CRAZY**, giving away a precision diesel engine, complete with cylinder and piston, carburetor, crankshaft, connecting rod, etc. for ONLY \$2.95. But we're selling thousands of DEEZILS all over the world, and that keeps our production costs down. DEEZIL is streamlined, compact, rugged. Starts quickly, easy to install, runs for years! Fast delivery if you ORDER DEEZIL TODAY!

**Send \$2.95 plus 25c postage**

**★ GOTHAM HOBBY CORP.,** Dept. P, 107 E, 126th St., New York 35, N. Y.

★ ★ ★ ★ ★ ★ ★ ★ ★ ★

**Carboloy Used in  
Shakespeare**

**PRESIDENT REEL**

**Outwears Toughest Steel**

**100 to 1**

**\$3500**  
List Price

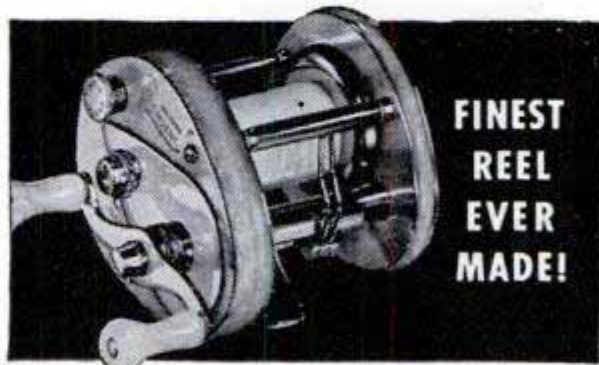

**FINEST  
REEL  
EVER  
MADE!**

**The Longer You Use It,  
The Smoother It Seems to Run**

The President is the *only* reel in all the world using Carboloy! Hardest metal known, Carboloy outwears toughest steel 100 to 1—and it's Carboloy that's used in the bushings of the Shakespeare President Reel.

No wonder Dad can use it all *his* fishing days, then hand it down to his son—with performance as s-m-o-o-t-h and whisper-quiet as the day he bought it. Yes, it's built not for one, but *two* angling lifetimes!

Have the President's nine better fishing features demonstrated at your sports store.

**BOTH FREE!** 1950 Tackle Book and Fishing Calendar — Show best days to fish, best ways to fish, best rods, reels, lines, bait. Casting lessons, fishing tips by U. S. Champion Ben Hardesty. Mail coupon.



**Shakespeare**

**RODS, REELS, LINES, BAITS**

Shakespeare Company, Dept. PM-4  
Kalamazoo 2, Michigan

Send me your free 1950 Tackle Book and Pocket Fishing Calendar.

Name.....  
Address.....

**HONOR BUILT SINCE 1897**

**SAY YOU SAW IT IN POPULAR MECHANICS**

**FREE Lafayette Radio**  
**164 PAGE CATALOG**  
**FOR 1950**

**FAMOUS-MAKE TV & RADIO EQUIPMENT.** The trade's leading buying guide for 29 years. Saves you anywhere from a few cents to several dollars on most every purchase. Components for Custom-Built High-Fidelity Radio-Phonographs. TV and Radio Parts. Record Changer Equipment. Public Address Systems. Intercoms. Tools. Ham Gear. Test Equipment, etc.

If you are a radio engineer, service man, set builder, ham, serious amateur or high-fidelity enthusiast, you should not be without this valuable 164-page reference book. To get your FREE personal copy of the 1950 Lafayette catalog, drop a postcard to Dept. LD-50;  
**LAFAYETTE RADIO**  
901 W. Jackson Blvd., Chicago 7, Ill.



# YOU CAN BUILD A KIT-CRAFT BOAT

**SAVE  
over  
50%**



**Complete for  
Easy Home  
Assembly**

**No Experience Necessary**

**EASY TO FOLLOW PHOTO DIRECTIONS WITH EVERY KIT!**

Kit-Craft boats are easier for you to build, all difficult boat carpentry, framing, standard-beveling and transom assemblies are completed at the factory for you. All Kit-Craft boat kits are complete—there is nothing extra for you to buy! All wooden parts have been pre-cut for you at the factory, only finest marine plywood panels and hardwood parts are used.



**12' SKIFF** — a large 3 seater still in the car-top class.....Kit **\$53.80**

**14' SKIFF** — comfortable 4 seater, strongly reinforced to carry heavy loads.....Kit **\$59.95**

Send 10¢ for fully illustrated catalog and step-by-step photo direction for building Kit-Craft. Convince yourself — see before you buy. Address Dept. E



## 10' SKIFF

—3 seat model—ideal as car-top boat. Easy to transport to your favorite fishing spot.

Kit **\$49.50**

## 8' PRAM

—Ideal for Yacht use. Easy-to-tow. Will not dry out on davits.

Kit **\$32.35**

**Roberts INDUSTRIES INC. Durham, Conn.**

**PISTON TYPE COMPRESSOR**



## EASY PROFIT IN PAINT SPRAYING

Paints walls, ceilings, screens, furniture and machinery faster, better. All complete as shown less motor. Carry anywhere. Fully guaranteed. Could be used with 1/4 H.P. motor or less. Price **\$35.00** less motor F.O.B. Chicago. \$5.00 deposit balance C.O.D. or see your dealer. With motor \$55.00.

**IDEAL AUTOMATIC PUMP CO., Dept. P.M. 8**  
801 W. Washington Blvd. Chicago 7, Ill.

## Baseball Uniforms

**Buy direct—Save nearly 1/2**



**EXTRA!**  
100% Wool Melton Warm-up Jacket with every order of 12 or more uniforms!

**\$11.95 Uniforms \$6.95**

Lettering at no extra cost

Order direct, save on big-league-cut tough cricket cloth uniforms. 10 sewn letters at no extra cost! Write for free illustrated catalog with swatches. Big savings on all baseball equipment

**BACHARACH RASIN CO.**

Dept. R1, 14 North Howard Street, Baltimore 1, Maryland

## Thunder in a New Package

(Continued from page 113)

efficient on the first run that all the air was sucked from the laboratory. "Air," recalls one of the researchers, "was hissing through every crack, and the roof was creaking. We had to knock holes in the back wall, finally."

As with all jets and rockets, the men have trouble with the high heats generated by their new baby. Pyrometers, hooked up to thermocouples in the firing chamber, registered beautifully for the first few runs, except that the tiny pen ran off the paper at 2500 degrees. Then, adding insult to injury, the thermocouples melted and blew out the tail along with the exhaust.

An incredible cooling system, with copper tubing encircling the pipe like the arms of an octopus, squirts a dozen sprays of water over the 1/4-inch steel exhaust stack, through garden spray nozzles from the 5 and 10-cent store. A virtual waterfall cascades over the hot pipe. Even so, it's beginning to warp.

One of the most persnickety gadgets is the gas rocket—used exclusively for the study of scale effects. It is really a super blowtorch. When its high-powered fuel spray doesn't mix the liquid oxygen properly with the fuel, tiny globules of jelly—with a potential of nitroglycerine—form inside the rocket chamber. In a split second you'll have a burn-out.

Popular Mechanics' photographer set up his camera near the door, to get a picture of the standing shock waves visible in the rocket's supersonic exhaust. Just as the thing was about to be fired, Poole tapped him on the shoulder. "Better move over until she's going," he said. "These things have been known to blow up." The man stepped aside just as the switch was thrown. There was an ear-splitting crack, and a spray of hot shrapnel zinged through the doorway. There's no picture of standing waves to go with this article, but Popular Mechanics still has all its staff members.

Though there are tunnels and tunnels, Princeton's new wind tunnel is unique. The compressors and the 47 laminated-steel air-storage tanks came from Navy torpedo plants. The settling chamber once was the breech cylinder of a 16-inch gun.

So, while the rocket men work on the problem of getting more oomph out of fuels and general design, the wind-tunnel men at Princeton work on the shapes that will make the most of that added efficiency in high-speed flight. Out of it all should come bigger and better supersonic engines, higher flights and, they hope, a little less thunder in the blue skies.

**ELECTRIC SIREN**

6 volt. Complete with push button... **\$10.95**

**Fender Skirts for All Cars**

Give year, make & model of car when ordering.

All Metal. Prime finish. Rubber beading prevents rattle.

Easy to install. **\$9.95 PAIR**

**Illuminated Chrome Plated DELUXE FENDER FINS**

Get that Cadillac Look! For 1949-50 Chev., Ford, Pontiac, 1950 Plym., Dodge, Chrysler, DeSoto. Red reflector lens. Contoured to fit rear fenders perfectly. **\$9.95 PAIR**

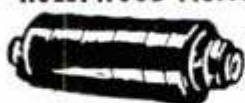
**HOLLYWOOD MUFFLERS**

FOR ALL CARS

Gives that Motorboat Tone. Universal type to fit all cars, ea... **\$4.45**

**NEW CONVERTIBLE TOPS & REBUILT MOTORS** for all Cars. Write for Prices.

Send 25% Cash With Orders, Balance C.O.D.

**JUST OUT!** Get the largest Auto Accessory & Parts Catalog in the world. Over fifteen thousand items, including Hollywood Accessories, Hi-Speed Equipment, Rebuilt Engines, all parts & accessories for all cars & trucks. We have that Hard-to-Get-Part! Completely illustrated. Jam packed with bargains. Send 25c.

**J. C. WHITNEY & CO.**

1917 ARCHER AVE.

CHICAGO 16, ILL.

**GENIE Home-Hobby Tools... THE GEM OF ALL HAND TOOLS**

Precision engineered for particular home-hobby craftsmen. GENIE 22-in-1 Tool performs 9 different types of operations: It notches, saws, cuts V-shapes, drills, cuts razor thin, chisels, cuts holes, carves on all kinds of materials.

Send Check or M. O. Add Tax on Orders in Calif.

14 pc Set \$6.50-24 pc Set \$9.95-Free Catalog on Request



DEALERS INQUIRIES INVITED  
**Tool Craft Co.**  
629 South Hill Street  
Los Angeles 14, Calif.

**STANDARD GARDEN AND SMALL FARM TRACTORS**

Plow  
Seed  
Cultivate  
Mow Hay  
and Lawns

Powerful Gas Tractors for Small Farms, Gardeners, Florists, Poultrymen, Fruit Growers, Suburbanites.

**1 & 2 Cylinders**

High Wheels, Rubber or Steel Tires. Walk or Ride.

Easy Terms—Free Catalog

**STANDARD ENGINE CO.**  
MINNEAPOLIS, MINN.  
3221 Como Avenue

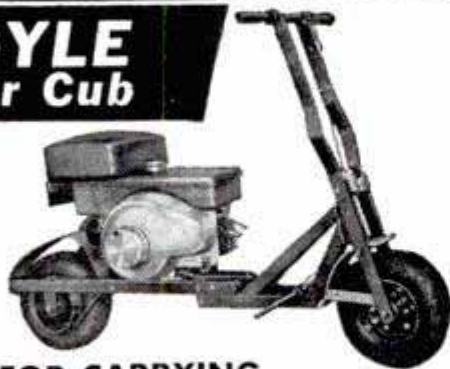

NEW YORK, N. Y.  
617 West 26th Street

**ARGYLE Scooter Cub**

FOLDS FOR CARRYING . . .

UNFOLDS FOR RIDING . . . in 15 seconds!

Carry it anywhere — in your car, boat, plane or trailer. Amazingly compact — 15" x 18½" x 24". Weighs only 50 lbs.

**400 LB. CAPACITY!** Will carry 2 heavy people. Sturdy steel frame . . . ruggedly built throughout.

**100 MILES PER GAL.** for highest transportation economy. Speed up to 25 mph. Powerful 2 cycle Power Products engine.

**AUTOMATIC CLUTCH** . . . positive brake . . . comfortable 3" sponge rubber seat.

WRITE FOR LOW PRICE. Dealer inquiries invited.

**ARGYLE MANUFACTURING CO. COLCHESTER, ILLINOIS**

# The case of the STARVING CONNECTING ROD..

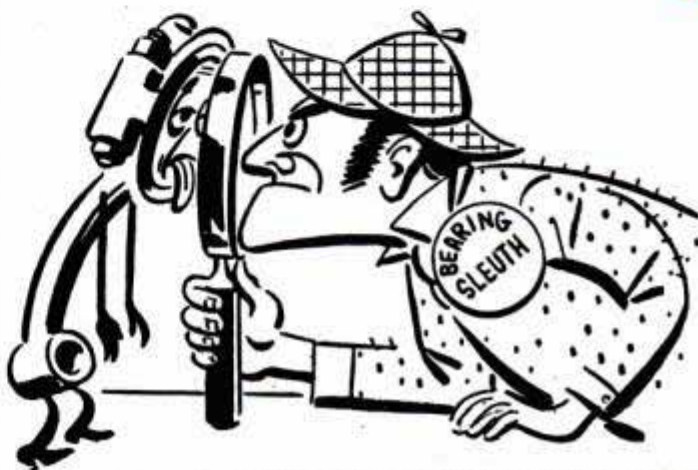

**ONE worn main bearing can ruin a rod, damage the crankshaft!**

In your car engine oil-clearance between bearings (connecting rod and main) and crankshaft provide correct internal lubrication. Oil passes from main to rod bearings. Worn bearings let too much oil escape. ONE badly worn main bearing can "oil starve" the adjacent rod bearings so that they "burn out", have to be replaced. It may cause costly shaft damage. When your car pumps oil, has smoky exhaust, check for worn engine bearings. Replace with Federal-Mogul Oil-Control Bearings to restore power, pep and economy. They're engineered for the job. Ask your mechanic!

**FEDERAL-MOGUL SERVICE**  
(Division of Federal-Mogul Corporation)  
DETROIT 13, MICHIGAN

Control Oil Pumping  
where it starts...replace with  
**FEDERAL-MOGUL**  
OIL CONTROL BEARINGS





**BETTER MEASURE  
WITH LUFKIN**

**NEW MEASURING EASE—  
FAMOUS MEZURALL AND  
WIZARD, JR. TAPE-RULES  
WITH CHROME-CLAD  
BLADES!**



Easy to  
Read Markings  
That Are Durable

**CHECK THESE  
OUTSTANDING FEATURES**

- 1—Exclusive Lufkin Chrome-Clad satin finish blades.
- 2—Black markings razor-sharp against chrome white background.
- 3—Rust and corrosion resistant.
- 4—Will not crack, chip, or peel.
- 5—Self-adjusting hook permits accurate butt-end and hook-over measuring.
- 6—Replaceable blades.
- 7—Smooth manual blade operation.
- 8—Improved heavily plated cases.

**ASK FOR THEM BY NAME—ASK FOR A MEZURALL  
OR WIZARD, JR. CHROME-CLAD TAPE-RULE**

**Buy LUFKIN**

THE LUFKIN RULE CO. • TAPES • RULES • PRECISION TOOLS  
SAGINAW, MICHIGAN • NEW YORK CITY • BARRIE, ONTARIO

**PARTS FOR MILITARY TRUCKS**

**4 or 6 Wheel Drive at a SAVINGS—  
1/4 ton to 20 ton.**



Parts List Available on Most Makes  
Military Trucks and Jeep Models  
Write stating model of Truck

Prices Quoted are Net Wholesale  
To Popular Mechanics Readers

Write for **FREE** Catalog

**Brand New — Weatherizing Kits  
JEEP TOPS and CURTAINS**

Fits all military jeeps, also adaptable to civilian jeeps.  
Tops only with back curtain attached.

Waterproof O. D. color. **\$29.50**

Our low price, only.....

Side curtains to match with doors **\$20.00**

and windows, only.....

Also available—Complete top with back  
curtain and side curtains with doors  
and 5 windows. Less steel **\$49.50**

Bows. Complete set, only.....

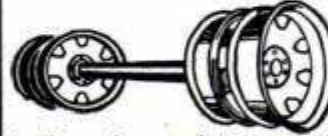

**TRAILER AXLE**

Heavy duty trailer axle suitable  
for many types of trailer con-  
struction. Also excellent for  
building of heavy farm trailers  
and wagons. It is a 12,000 lb.  
capacity square type straight

trailer axle complete with Timken roller bearings, hubs, and  
6 hole 750 x 20 Budd Wheels. Without brakes. Axle is 2  
inches square and 69 inches between wheel mounting flanges.  
Std. width.

With Single Wheels. \$59.50 With Dual Wheels. \$69.50

**WINCH CABLE, 1/2", 250 ft. \$30.00**

Hundreds of Other Truck & Jeep Parts and Supplies  
All prices quoted good 30 days FOB, Kansas City, 25%  
Deposit Required on All Orders.

**American AUTO PARTS CO.**  
1830 LOCUST — DEPT. P.M.  
KANSAS CITY, MISSOURI.



**WELD**  
BRAZE, SOLDER, CUT  
*quickly...easily*

**The FOUR-WAY  
PORTABLE ARC-WELDER**

**COMPLETE ONLY \$9.95 F.O.B.  
10 DAY TRIAL**



**YOU'LL BE AMAZED** by the work you can do on your first job! Plugs into any convenient properly wired 110 volt A.C. or D.C. line. Follow simple directions. Work on iron, steel, bronze, brass, aluminum and other metals. Save money doing own repairs. Make money repairing for others. Thousands of users among maintenance and repair men, farmers, tinsmiths, engineers, home and auto owners, etc. Pays for itself over and over. Order on ten-day trial or send for details.

**MAKE OR REPAIR HOME & FARM APPLIANCES FENDERS BICYCLES METAL FURNITURE & 1001 ITEMS**

**FREE** **FOUR-WAY WELDER CO., Dept. F2-DA**  
2326 So. Michigan Avenue • Chicago 16, Illinois  
**Full Details SEND TODAY**

**KEEP YOUR CAR CLEAN!**

**HANDEE CAR WASH MITT**



Attach to any garden hose. Rinses as it washes. Soft rubber sponge protects car finish. No chamois needed. Water-proof mitt keeps hands dry. Send \$1.98 with order and save C.O.D. fee.

**1.98**  
POST PAID

**McCALLUM INDUSTRIES**  
506 ELLEN ST., FENTON, MICHIGAN

**CAR OWNERS**

Here's How to DISCOVER a WRONG TURN Before You Make It!

**HULL AUTOMOBILE COMPASS**

Beaconlite Illuminated \$5.95 Streamline standard \$3.95

Ideal gift for any occasion. At your dealer's. Write for literature.

**HULL MFG. CO., P. O. Box 246-D4, Warren, Ohio**



**GLUE INJECTOR COMPLETE WITH DRILL**

Drill in handle makes a tiny hole in heart of joint — plunger forces glue through hollow tip and hole into and around joint under great pressure. Mends furniture and toys quickly, cleanly and without disassembly. Model Worker's Dream. Satisfaction guaranteed. **\$1.25**

PPD. Sorry no COD's. **ARTCRAFT PRODUCTS CO., Box 876, CLEVELAND 22, OHIO**

**\$ Free Course! Big Profits! \$ Flocks & Sandblasts**

**Dual Purpose Spray Gun! Uses only 25 lbs. Air Pressure**  
● Thousands of uses in Home, Shop, Industry: Makes Auto Interiors Clean & New, Lines drawers, Marproofs lamp bases, Refinishes any object. All in colorful Flock, Etch & Frost windows, glassware, etc. Removes Paint & Rust from Autos, Tools. Guaranteed! Send \$19.75 or write for free information. Flocking supplies!

**BLASTO SPRAY GUN MFG.**  
Dept. PM-4, 7007 Haas Avenue, Los Angeles 47, Calif.

*Always write your name and full address clearly when answering advertisements*

**PLYWOOD BOAT KITS**

**\$87.50**  
(Freight Included)



Build this 12-ft. sport runabout from ready-cut parts. Kits include all hardware, paint, etc., to complete the boat shown. Send for free folders of all models as low as \$29.95 freight included.

**TAFT MARINE WOODCRAFT**  
Dept. L, 636 39th Ave., N. E., Minneapolis 21, Minn.



**SURPRISE VALUE**  
**100 Pieces \$1.00**  
**FOR ELECTRIC GRINDERS**

Post Paid in U.S.A.

Grinding Wheels, Cut-off Wheels, Sanding Discs, Mounted Stones, Sharpening and Honing Stones, Rotary Cutting Burs, Abrasive Cartridges, and many other items. Rush check or Money Order.



**2 CIRCULAR SAWS**  
 ON 2 MANDRELS—  
**ALL AT ONE LOW PRICE \$1.50**

Post Paid in U.S.A.

1" diameter saws on 1/2" Mandrels. For cutting wood, plastic, or soft metals. Order at once! Send Check or Money Order for this big bargain.



**18 ROTARY CUTTERS**  
**\$5.85**

Post Paid in U.S.A.

Value \$13.50

Assorted sizes cutter on 1/2" or 3/32" shank. Will fit all hand grinders. Ideal for cutting wood, metal, or plastic. Brand new. Send Check or Money Order. ILLUSTRATED BARGAIN CATALOG 10c SCHUPACK SUPPLY CO., 7331 Cottage Grove, Dept. M-4, Chicago 19, Ill.

**WOODWORKERS ... Get this**  
**CONSTANTINE MASTER MANUAL**



**Get the Most Fun From Your Hobby**  
 Indispensable to woodworkers. Newest, biggest edition, more pages, more color, helpful how-to-do-it articles, pre-war and new items, more bargains. Send 25c today and we will include **FREE! FULL YRS. SUBSCRIPTION** to Chips and Chats, published bi-monthly. Keeps you up-to-date on everything in woodworking, offers big money-saving bargains. Send now. ALBERT CONSTANTINE & SON, Inc., Dept. PM4 797 East 135th Street, New York 54, N. Y.

**GUARANTEED USED-REBUILT HARLEY-DAVIDSONS**



**ALL MODELS - LOW PRICES**  
 Parts, accessories, oil, tires, service by experts. Parts for obsolete models. Send 25c for Accessory & Motorcycle Bulletin.  
**KNUTH'S 2491 W. FOND DU LAC AVE. MILWAUKEE 6, WIS.**

**MAGNETS OF ALL TYPES—10c UP**  
 AMAZINGLY POWERFUL!!

8 oz. Alnico Magnet, lifts 10 lbs. \$1.00. Our Leader, 15 oz. Magnet, lifts 40 lbs. \$2.50. New alloy—will not weaken! Useful for lifting valuables from tanks, lakes, or rivers easily! 7 small magnets \$1.10 with list of many shop and home uses. Satisfaction guaranteed.  
**R. EYRICH, 2566 N. 49TH ST., MILWAUKEE 10, WIS.**

**QUALITY POWER MOWERS FOR LESS**

**Make-Your-Own Rotary POWER MOWER**

**SHIPPED ASSEMBLED AS SHOWN**  
 Model 50M Just add your elec. motor or gas engine. Concealed 18" blade for safety. 3 cutting heights. Ball bearing wheels.



Model 50CM with 2 1/2 H.P. McCullough gas engine...\$119.50

Model 50GVC with Clinton Vertical 1.8 H.P., 4 cycle.....\$104.50

Model 50E with 1/2 H.P. electric motor, 75 ft. cord.....\$69.50

America's Greatest Power Mower Values Fully Guaranteed

**Order Model Desired NOW!**  
 F.O.B., K. C. Send check or M.O.

**ATLAS EQUIPMENT CO.**

229 S.W. Blvd. Dept. E Kansas City, Mo.



**ONLY \$39.95**

**TODAY'S GREATEST SAW VALUE!**



**DOUBLES YOUR WORK RANGE!**

**TRIPLES YOUR FUN!**

**\$39.50**

F. O. B. Kalamazoo, less motor. Price includes motor rail, belt, pulley, mitre gauge, fence, splitter, guard. Extensions \$3.50 each.

**POWER KING #3001**

**BALL BEARING TILT/ARBOR SAW**

Dollar for dollar, here's the greatest saw value on the market today! It's fast, accurate, easy to operate—ruggedly built—with features usually found only on saws costing much more!

Handles big range of work—cabinets, cupboards, bookcases, shelves, home repairs, model building—makes fine woodworking easy and more fun. Quickly pays for itself in the money you save.

*Tilt/arbor design keeps work and table flat. Blade cuts 2 1/4" deep. Table is 25 1/2" x 16" with two low-cost extensions. Sheet steel base—precision ground grey iron table. Quick-positioning rip fence and sealed ball bearings.*

See the great PK 3001 at your Power King dealers soon, or send today for free catalog.



Name \_\_\_\_\_  
 Address \_\_\_\_\_  
 City, State \_\_\_\_\_



**ATLAS PRESS CO.**  
 435 N. Pitcher St., Kalamazoo, Mich.



**MATCHED PRECISION TOOLS FOR WOODWORKING AND METALWORKING**



## CALL TO ADVENTURE

You're a wilderness ranger in your Old Town Canoe. Paddle to hidden pools and cast your line where the big ones rise. Trust to your Old Town Canoe to get you there—and back. Birchbark-light, yet wiry-strong. Perfectly balanced. Built to last.

**FREE CATALOG** shows all kinds of canoes for paddling, for sailing, for outboards. Also sailboats, outboard boats, dinghies, rowboats. Send for it today. Address Old Town Canoe Company, 644 Elm St., Old Town, Maine.

*"Old Town Canoes"*

### OTTAWA Buzz Master

**7 MODELS—\$99.00 up**

Greatest offer made in our 46 years of manufacturing. A model to fit your needs and your pocketbook. Free details.

**OTTAWA MFG. CO., 2-027 Brush St., Ottawa, Kans.**



No  
Other  
Like It!

**SANDEE**

Mufflers—All Ford, Chev., Ply....\$4.45

All Buick, Pont., Olds., Chrys.,  
Dodge, Hudson, K.F., Pack., etc....\$5.45

V-8 and Merc. Duals  
(32-49 incl.)

**\$15.95**

ONE

DEALERS  
WANTED



**SPORTONE**  
(Reg. U. S. Pat. Off.)  
**MUFFLERS**

DURABILITY

Beautiful  
SANDEE  
Fender Skirts  
**\$9.95**

A SANDEE Sportone will outlast two ordinary mufflers and give More Power! More Speed! More Mileage!—plus a tone quality unsurpassed.

Please ship (item): \_\_\_\_\_ Price \_\_\_\_\_  
Car and Year \_\_\_\_\_ Name \_\_\_\_\_  
Address \_\_\_\_\_

**SANDEE MUFFLER CO. 5643 Corryne Pl. Culver City, Calif.**

## OVERSTOCK SALE

**Chronograph Wrist Watch**

**\$6.75**

PLUS TAX



(DeLUXE MODEL — FORMERLY \$9.95)

Sweep Second Hand; Precision Workmanship; Rugged Shock-resistant case; Radium hands and numerals; Leather strap. It measures distance, speed of cars, planes, horses and other moving objects. It's a time keeper, stop watch, telemeter, tachometer. **ONE YEAR WRITTEN GUARANTEE** and full operating instructions enclosed with each watch. **SEND NO MONEY.** Mail your order today. Pay postman \$6.75 plus 10% Federal tax. Total \$7.43 plus postage. Or send cash (money order or check) with your order and save postage charge.

**MARDO SALES CO., Dept. 1708**

480 LEXINGTON AVE., NEW YORK 17, N.Y.

Pioneers

Leaders

**AIR RIFLES**

**BENJAMIN**

**AIR PISTOLS**

WITH SAFETY LOCK

**SEND FOR FREE FOLDER OF LATEST MODELS TODAY**

If you want a REAL GUN for PRACTICAL USE inside or outdoors, get a **SAFE—CLEAN—ECONOMICAL—BENJAMIN** with Adjustable Power and Amazing Accuracy. Use **BENJAMIN H-C PELLETS** for BEST RESULTS in all rifled models. **WRITE AT ONCE.**

**BENJAMIN AIR RIFLE CO., 812 MARION ST., ST. LOUIS 4, MO.**

## New 1950 Plastics Supplies Catalog

Just off press. Get details on Plexiglas, Lucite, rods, sheets, tubes, Acetates, cements, dyes, buffs, molding sets, tools, carving kits, everything in plastics. Lowest prices. Price 10c, stamps or coin, with ad for catalog.

**Plastics Mfg. & Supply Corp., Dept. PM-4, 4707 Euclid Ave., Cleveland, Ohio**

### HAUCK FLAME GUN KILLS WEEDS



**KILL WEEDS**, crab grass, Canada thistle—stalks, seeds and roots. Destroy brush, caterpillar nests, diseased trees, grasshoppers, chinch bugs, etc. Clear irrigation ditches, split rocks, burn tree stumps. . . Sterilize poultry houses, kennels, barns. Use as portable home forge. Melt ice, thaw pipes. Safe, inexpensive. Burns only 6% kerosene, 94% air! Thousands satisfied users. 7 models. Write for **FREE CATALOG.**

**HAUCK MFG. CO., 76 Tenth St., Brooklyn 15, N.Y.**



### Gerstner TOOL CHESTS

Gerstner Chests are built sturdily for long life. They are attractive, too. Free catalog for machinists and toolmakers.

### GERSTNER TOOL CHESTS

450 Columbia St. Dayton 7, Ohio

### SAW SHARPENER



Table model, adjustable for any degree of bevel. Takes saws up to 20" and can be used to face off inserted point teeth and other type saws. 1/4 h.p. motor, total weight only 60 lbs.

**\$64 F.O.B. Portland**

**P. T. HOBBS Machinery**

8375 N. Interstate Ave., Portland 3, Ore.



## HOME PLANS THAT SAVE YOU MONEY

YOUR NEW HOME PLANS.....50c

Modern homes for 1950

BLUE RIBBON HOMES.....50c

Chosen most popular in sales

ALL AMERICAN HOMES.....50c

More than 150 styles, all types

RANCH AND SUBURBAN.....50c

141 designs, town and country

YOUR HOME IN BRICK.....\$1.00

Excellent selections, all brick

ALL 22 GARLINGHOUSE Plan Books contain-

ing over 1,250 designs. A \$13.25 Value for... **\$10.00** Post-

paid

Order any of above beautifully illustrated books or SAVE MONEY

by ordering complete sets as described. Working drawings, material lists, specifications, available for each plan—AT LOW COST.

NEW POPULAR BOOKS  
SHOWING ALL TYPES  
OF HOME DESIGNS

All 5 Books for **\$2.50**  
for Postpaid

Many designs in color

**\$10.00** Post-

paid

Order any of above beautifully illustrated books or SAVE MONEY

by ordering complete sets as described. Working drawings, material lists, specifications, available for each plan—AT LOW COST.

**L. F. GARLINGHOUSE CO., INC., Box PM-7 TOPEKA, KANSAS**

# NATIONAL HARDWARE WEEK SPECIAL

## EAGLE FOLDING RULES

APRIL 28 TO MAY 6



69c to \$1.25

AN ASSORTMENT FOR EVERY PURSE AND PURPOSE . . . AND EVERY MEMBER OF EVERY FAMILY

DON'T JUST ASK FOR A RULE ASK FOR AN EAGLE RULE



EAGLE RULE MFG. CORP. NEW YORK 59, N.Y.

Save HALF!

Slight Imperfect Factory Dress PANTS



Genuine GABARDINE Imperfections very slight—hardly noticeable—positively do not affect wear. Ideal for dress, school, play, work. Firm hard finish. Virgin wool and rayon blended. Wrinkle and shine resistant. Retains neat press. Zipper front. Roomy pockets. Blue, Tan, Sand, Lt. Brown, Dk. Brown & Blue-Gray. Waist 28 to 42.

SEND NO MONEY Send name, waist size, 1st, 2nd & 3rd color choice, light or dark. Pay postman only \$4.95 plus small postage. Or send money and save postage. Money-Back Guarantee.

Worth \$10

\$4.95

LINCOLN TAILORS, Dept. PM1, Lincoln, Nebr.

ENSHRINE THEIR MEMORIES WITH

U.S. MONUMENTS

Erected. Freight paid.

There is none better. Our free catalog is ready for you. Write today. A-18, U.S. Marble & Granite Co., Oneco, Fla.

"33" STOPS SASH DECAY



Miles Ahead of Putty

ARMSTRONG'S "33" Glazing Compound is permanently E-L-A-S-T-I-C (secret formula). Unlike putty, it won't crack or crumble. Never gets rock-hard. Use it on wood or metal windows for LASTING protection. Easy to apply. Costs little. Get "33" from your hardware or lumber dealer. Try it! ARMSTRONG CO., Chicago 9, Illinois.

AGENTS 300% Profit SIGN LETTERS

For Store Fronts and Office Windows. Anyone can put them on. Free Samples. Liberal Offer to General Agents.

METALLIC LETTER CO., 430 N. Clark, Chicago 10

Always write your name and full address clearly when answering advertisements

ONAN Portable ELECTRIC PLANTS

FOR CABINS, TRAILERS, CONTRACTORS, BOATS

Light weight, compact, air-cooled engine-driven. Furnish regular city-type A.C. electricity for lights, appliances, radios, etc. Can be carried by hand. Fit trunk of car. Plug-in receptacles on plant. Larger models for farms, homes, businesses beyond highlines. Catalog shows over hundred models. 350 to 55,000 watts.

Gasoline or Diesel Powered

WRITE FOR CATALOG

D. W. ONAN & SONS INC.

5832 Royalston Ave., Minneapolis 5, Minn.

BUILD YOUR OWN POWER MOWER!



EASY TO ASSEMBLE!

SAVE MONEY!

MAKE GRASS AND WEED CUTTING EASY, QUICKER

We supply everything needed: Parts, engines, wheels, etc. to build all types of power mowers.

Complete mower parts kit for either gasoline or electric power. You can easily assemble this highly efficient mower in a few hours. We furnish instructions. Cut your lawn or field quickly at small cost. Does the work of far more expensive mowers. Factory appearance. From the world's largest manufacturer of rotary power mowers.

WRITE TODAY! FREE INFORMATION!

J. G. DOYLE ENGINEERING CO.

526 CHERRY ST. DEPT. A KANSAS CITY, MISSOURI

55% SAVING IN MAN-HOURS

BY USING DAKE 70H PRESS

Here Dake's 70H Hydraulic stamps designs on steel molds for manufacturing rubber bath mats. Results: Time saving of 5 hrs. per plate, no worker fatigue, improved precision, work quality.

WRITE FOR BULLETIN ON THIS JOB

70H is compact, speedy for pressing, straightening, many assembly jobs.

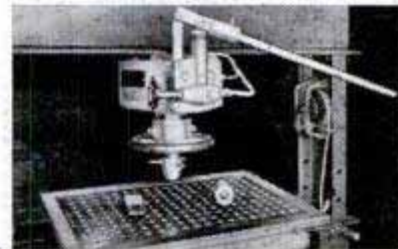

DAKE  
armor and hydraulic  
PRESSES

DAKE ENGINE COMPANY  
Grand Haven Michigan



Motor Oil Changes

ENTIRELY UNNECESSARY after attaching

RECLAIMO The World Famous HEATED Oil-Filter and Re-Refiner!!

(Cast Aluminum) Makes short work of solids and liquid impurities—after 150 miles you won't believe it's the same oil! REMEMBER—"Oil does not wear out mechanically", states U. S. Bureau of Standards.

Convince yourself—just read our "Oil Facts", 32 pages, FREE on request.

RECLAIMO MFG. CO.  
5083 Elston Ave., Dept. 27, Chicago 30, Ill.

Dealers Wanted

Oil Return (to crankcase)

Heat Inlet (from manifold)

Heat Outlet

Oil Inlet

# TERRIFIC Surplus BARGAINS

## Officers PINKS

Yes, they are the same type that the officers wore. Beautifully tailored of 18 oz. elastique material. Sizes 29 to 42. Add 15c postage.

**9.99**

## OFFICERS SHOES

**5.99**

New low price. Best quality uppers, Goodyear welt, oak bend sole. Add 22c postage.



## 16,000 U.S. ARMY all wool serge SHIRTS-PANTS

JUST THINK OF IT! These 100% all wool serge shirts and pants at less than the price of the cheapest work garment. They are used but in perfect wearing condition. Some have slight repairs. True, the sizes are limited, but they are ideal for growing boys and for smaller and medium-sized men. Add 12c per garment postage.



SHIRTS PANTS  
SIZES SIZES  
13-15 27 to 32

**\$1.66 \$1.99**



SURPLUS SADDLES  
**12.99**  
COMPLETE

BRAND NEW. \$60.00 value. Best quality russet leather. Complete with cinch and stirrups. Add \$1.00 postage.

## SURPLUS ALL-WOOL 20-oz. MELTON PANTS

BRAND NEW. Regular \$12.00 value. 100% 20 oz. all wool Melton. O.D. trousers. Sizes 28 to 34 only. Add 18c postage.

**4.99**



## Extra SPECIAL!

GEN. NYLON 50 FT 550 lb. tensile strength, 3/16" diameter. Ideal for clotheslines, ventilation blinds and drapery cords. Many other uses. Add 5c postage.

50% WOOL SOX  
Khaki and natural. Medium weight. A real bargain. Add 3c postage. **39c** 10 PAIR **3.79**

PARATROOPERS BOOTS **8.88**

Full grain elk or rein uppers. Brown. Goodyear stitch, leather and extra comp. tap sole. 10" high. Add 27c postage.

COMBAT BOOTS **6.33**

Light and comfortable. Reinforced uppers. Full oak sole with extra composition rubber top. 10" high. Add 27c postage.

MAIL ORDERS  
Please send remittance with order. Be sure to include postage. Satisfaction or money back. FREE CIRCULAR ON REQUEST

## Sioux Falls SURPLUS STORE SIOUX FALLS, S.D.

## BOAT BLUEPRINTS & FULL SIZE PATTERNS

and specifications. Designed by Naval Architect. Cruisers, runabouts, sloops, outboards, sailing canoe, etc. Low prices. Send 25c (coin) for illustrated catalog. SPECIAL: Send \$1.00 for "HOW TO BUILD BOATS" book, postpaid. PolyWog Houseboat Plans, \$10. Marine Catalog \$1. Cleveland Boat Blueprint Co., Dept. 686, Cleveland 13, Ohio

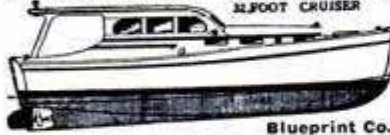

## A MAN'S BEST FRIEND IS HIS POCKET KNIFE

And CAMILLUS means top quality. Many styles, at your dealer's. \$1.50 up.



**CAMILLUS**  
has the edge!

No. 5  
Fisherman's Luck.  
5/8 closed. About \$2.00

CAMILLUS CUTLERY COMPANY, CAMILLUS, N. Y.

## SAVE UP TO 25% ON QUALITY BALL-BEARING WHEELS!

Bilt-Rite wheels roll smoothly and easily, are semi-pneumatic, ball-bearing, painted red; guaranteed top quality—and you save up to 25%! Compare Bilt-Rite's quality and price—then get your order in today! Dealer inquiries invited.



BILT-RITE BARGAINS on BALL-BEARING WHEELS			
(For 1/2-inch Axles)			
6 x 1.00.....	\$1.30	10 x 1.25.....	\$1.95
8 x 1.25.....	1.65	10 x 1.75.....	2.15
8 x 1.75.....	1.80	10 x 2.00.....	2.45
6 x 1.50.....\$1.50			
(For 5/8-inch axle)			
6 x 2.00.....	\$3.95	8 x 2.50.....	\$4.45
10 x 2.75.....Only \$4.65!			

**Bilt-Rite Guarantee**  
No better wheels are made regardless of price; 10 day return privilege.

If size you need isn't listed, write for Folio A

ORDER TODAY—Send cash, check, or M.O.—Pay postage on arrival.

**BILT-RITE WHEEL COMPANY**  
520 EAST MISSOURI AVE. KANSAS CITY 6, MISSOURI

## CARBURETOR TOO RICH MAKES MOTORIST TOO POOR



Car owners who are wasting money and not getting proper gas mileage due to over-rich mixtures will be pleased to learn how to save gasoline by VACU-MATING over-rich mixtures. VACU-MATIC fits all cars, trucks and tractors. It is automatic and operates on the supercharge principle. Easily installed in a few minutes.

**SALESMEN WANTED!** Big Profits! Send name, address on penny postcard for free particulars and how to get yours for introducing.

VACU-MATIC CO., 7617-1590 W. State St., Wauwatosa, Wis.

## FREE AMAZING NEW BOOK "HOW TO ANSWER ADS"



Never before have you seen anything like this. Tells you in simple language the correct way to answer ads. Gets you quicker replies—better results, and greater satisfaction. Will save you time and money and it's ABSOLUTELY FREE. No obligation whatever. Every reader of advertising should have this booklet. Send a postcard for your copy NOW. Advertising Department, Popular Mechanics Magazine, 202 East Ontario Street, Chicago 11, Ill.



## RE-STRING RACKETS AT HOME—EARN MONEY.

EASY — PLEASANT — PROFITABLE  
**FREE** Write for 1949 Catalog and Instruction Sheet NOW.

W. A. BICKEL & CO., 803 S. Boulevard, Dept. F-53, Oak Park, Ill.

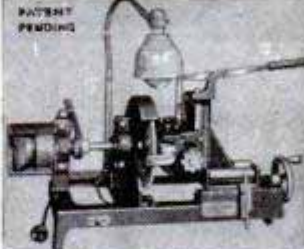

## Start a NEW BUSINESS!

or Add to your present Repair Business  
**SHARPEN DULL PIPE WRENCHES**

PIPE TAPS & DIES  
"GUM" CIRCULAR SAWS  
Write for Information

**J. C. MOORE INDUSTRIES**  
BOX M 276 FREDONIA, PA.

Only **3/4c** per mile total operating cost!

No wonder you see so many Cushman's, everywhere! They're **Amazingly Economical!** Up to 75 miles per gallon! That's cheaper than shoe leather! Besides, Cushman is dependable, safe, comfortable. Ideal for getting to work, school or market—doing errands—making deliveries. Easy to handle—easy to park. Famous long-life Cushman engine. Powerful brakes. Leader 15 yrs. See your Cushman dealer. Or, mail card for Free Folder. Rider Agent Plan Available



**CUSHMAN MOTOR WORKS**  
DEPT. M-4, LINCOLN, NEBR.

**Cushman**



# Local Colorcretors Can Earn High Incomes

COLORCRETE is today's biggest business opportunity in the building field. High returns from a low investment. Easy, fascinating work. Large waiting market because Colorcrete is applied over all kinds of old and new masonry surfaces — exterior and interior.

Beautifies and Protects All Types of Buildings



Pneumatic pressure sprays plastic-like Colorcrete to give enduring beauty and water-resistant values. Range of 30 gleaming colors; many textures. Easy to wash. Smartly modern. Write or wire today for Opportunity Portfolio, which gives complete story.

COLORCRETE INDUSTRIES, INC.  
710 Ottawa Ave., Holland, Mich.



## KEEPS BASEMENT PIPES DRY

Just wrap "NO SWEAT" insulation around water pipes and seal with special Vapor Seal Elastic Tape. Pipes will stay dry even in hot, humid weather. Workshop and darkroom stay dry. Tools won't rust. Easy to apply. No fuss. No mess. No sticky tape. No tools required. Neat, clean, attractive installation. Send \$1.50 for enough to protect 20 feet of 1/2" pipe. Full instructions included. We mail postpaid. **MON- EY BACK** if you are not completely satisfied.

**NO SWEAT**

ASSOCIATED SPECIALTIES, 10658 Gratiot, Detroit 13, Mich.

## MACHINE SHOP EQUIPMENT

The No. 49 edition of the famous Center Tool Co. Catalog is now ready! Every workshop owner should have a copy. 240 pages full of illustrations, descriptions, and prices of the latest tools made by best known manufacturers in U. S. You pay the cost of printing—50c. We refund your 50c with your first order of \$10.00 or more. Prompt delivery on most tools. Send check or money order today!

CENTER TOOL CO.

153 Centre Street, Dept. C, New York 13

FISH IN THE **WEEDS**

WHERE THE BIG ONES LIE

with the "PERFECT BASS BAIT"

**JOHNSON'S**

SILVER MINNOW and PORK FROG

A perfect fish-getting combination! Casts like a bullet. Weed guard keeps hook from fouling. Pork Frog provides irresistible action.

FREE New Catalog and Booklet "How to Fish the Johnson Silver-Minnow"

LOUIS JOHNSON CO.

1215-P Deerfield Rd., Highland Park, Ill.



**YOU'RE ALWAYS SURE OF A JOB...**

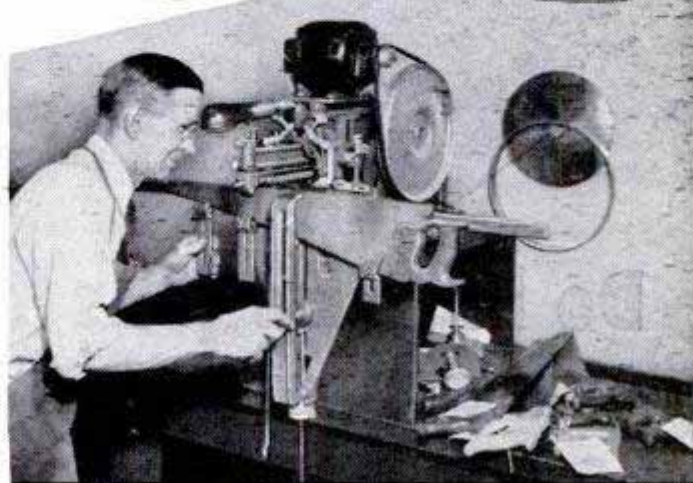

.. if you have your own **SAW FILING BUSINESS**

## Make up to \$2 or \$3 an hour with the FOLEY SAW FILER

Be your own boss! There's nothing like the satisfaction of seeing pleased customers come back time after time. Then you won't worry about your present job or future income. Start in spare time with a Foley Saw Filer—set it up in your garage or basement. No canvassing necessary—"I advertised in our local paper and got in 93 saws"—says M. L. Thompson. "I made \$765 last year filing saws—I do this work in spare time", writes J. B. Williams. And listen to this from Chas. C. Hough, a full-time operator: "Last year's profits amounted to \$3000—not so bad for a one-man outfit!"

### Get this book "INDEPENDENCE AFTER 40"

You can file hand, band and cross-cut circular saws with a Foley Saw Filer. This book shows how you can get business from home owners, farmers, carpenters, schools, factories, etc. With a small investment, no overhead, no stock of goods to carry, you can get right into a cash business—and possibly later on develop into a full-time repair shop. Send coupon today for Free Book. No salesman will call.

**FREE BOOK shows How to Start**



FOLEY MFG. CO., 416-O Foley Bldg., Minneapolis 18, Minnesota  
Send FREE BOOK—"Independence After 40"

Name \_\_\_\_\_

Address \_\_\_\_\_

**MAIL COUPON FOR FREE BOOK**

SAY YOU SAW IT IN POPULAR MECHANICS

# DELTA HOME CRAFT<sup>®</sup>

MILWAUKEE



No. 34-500  
\$64.95

Table extension, motor, saw guard and splitter extra.  
Subject to change without notice.

## Do big-saw jobs at small-saw cost!



### Delta<sup>®</sup> Homecraft 8" Tilting-Arbor Saw

Cross-cut and rip stock up to 2 1/4" thick. Miter, bevel, dado, make mouldings. Maximum 12" in front of blade. Blade tilts 45° right. Precision-ground cast-iron table. Lubricated-for-life ball bearings. Have your dealer demonstrate the Delta Homecraft 8" Tilting-Arbor Saw!

POWER TOOL DIVISION

**Rockwell**  
Manufacturing Company  
8025 East Vienna Avenue  
MILWAUKEE 1, WISCONSIN



**Free Book!**  
"How to Start Your Home Workshop." Write for your copy today.

HM-81

## HOW TO Get MULTIPLE UTILITY When You Buy a SMALL GRINDER

**BUY THE FOREDOM MODEL 100 FLEXIBLE SHAFT MACHINE \$16.95**

For \$16.95, no more than most ordinary grinders cost, you get PLUS VALUES galore. With machine (or later) you can buy Drill Press Attachment, for only \$4.95 extra, quickly converting to power drill press, or the B-R-S Attachment, only \$3.50 more, which makes it serve as bench grinder, router and shaper. Pencil-size handpiece gives utmost handling ease — Chuck guard protects fingers, gives sensitive, finger-tip control. Foot Rheostat \$4.85 extra. Motor not dwarfed to fit hand so—more power, longer motor life.

Grind, Polish, Drill, Saw, Sand, Carve, Etch, Clean, Engrave, etc., on all Metals, Wood, Plastics, Glass, Leather, Linoleum, etc.

Since 1922 FOREDOM ELECTRIC CO., Dept. 1128-E  
27 Park Place, New York 7, N. Y.



35" Flexible Shaft

Complete With Motor

MODEL 100

## B-M POWER MOWERS

### FOR MODERN LAWN CARE

Choose from three models of our fine rotary mowers for your special cutting needs. The D-3 (pictured here), the self-propelled PD models, or our light VD mower with vertical shaft engine and direct blade drive. Dependable 4-cycle engines, lifetime construction. Prices, complete with engine, \$89.00 and up.

Prompt Shipment  
+  
Low Factory Prices  
+  
Fully Guaranteed  
+  
Model D-3

Write for free literature.

B-M MOWER CO., Box 66-PM, Blue Mound, Kansas



## How Many Men Will Wear this SAMPLE SUIT

and Make up to \$15.00 in a Day? Amazing plan! Wear sample suit and take orders for handsome made-to-measure tailoring from friends, neighbors. Just take a few orders—earn big cash profits and get your own suits Without 1c Extra Cost! Send no money; pay no money. Write for free outfit containing actual samples, styles, full instructions. Write now! J. C. FIELD & SON, INC., Dept. D-1716 Harrison & Throop Sts., CHICAGO 7, ILL.

## A \$50 A DAY BUSINESS IN YOUR SPARE TIME



Take BELSAW Portable Sawmill right to the trees—turn out valuable lumber for local yards—do "custom sawing" for neighbors. BELSAW lasts a lifetime. No crew needed. Power with old auto engine or tractor. Beginners get excellent results. \$62.50 down. Send postcard for FREE BOOK, "How To Make Lumber."

BELSAW MACHINERY CO  
811-Z Field Bldg, 315 Westport Rd, Kansas City 2, Mo.

## \$10,000 REWARD

Earn the government bonus by locating Radio-Active Ores with a

### P.R.I. GEIGER COUNTER



The most sensitive portable Geiger counters made. Weight only 2 lbs. Battery lasts a year. Prospecting book included free. Priced from \$49.50 complete.

PRECISION RADIATION INSTRUMENTS, INC.  
5478-P Wilshire Blvd. Los Angeles 36, Calif.  
DEALER INQUIRIES INVITED

## TODAY'S BIGGEST PREFAB BOAT BUY

Build a better boat than you can buy. Save up to 55%. See OZARKA'S new 1950 line of trim, top-quality 12- and 14-footers with laminated rib construction, all-look frame and other exclusive features, for motors up to 25 H. P. Send 25c for complete Boat & Accessory Catalog, to be refunded on first purchase. OZARKA, Inc., 640 Borden Lane, Woodstock, Illinois.

\$39.50 AND UP



## HYDRAULIC Power Transmission WITH Infinitely VARIABLE SPEEDS, Clutch and INSTANT REVERSE—OUTPUT TORQUE ADJUSTMENT UP TO 180 inch POUNDS

This positive displacement Hydraulic Torque Converter is the ideal fluid drive with thousands of uses . . . Output Speeds Infinite 0 to 550 R.P.M. . . . In either direction . . . Change Speeds WHILE RUNNING . . . Control and Transmit your power this SMOOTH Oil-Way . . . Will handle 1/4 H.P. to 1 1/2 H.P. Motor. Industrial or Home & Farm Use . . . Cost Government \$300. High Quality Precision Workmanship. Buy this unit to get the most for your money. Case measures 7 1/2" long 7" high 6 1/2" wide. Input & Output Shafts 3/4" dia. Beautiful Red Crackle Finish Case.



FINGER TIP CONTROL

Shipping Wght. 25 pounds Only \$54.50

If C.O.D. is requested a 10% deposit must accompany order and we ship F.O.B. Chicago.

1 1/2"-8 thread Lathe Chuck Adapter, \$3 extra

PREPAID 2 quarts oil included FREE

DIRZIUS MACHINE SHOP "A" 1423-25 So. 62nd Ave., Cicero 50, Ill.

# Make your own TUBULAR STEEL CHAIR FOR AS LITTLE AS \$17.3 COMPLETE!

Make metal chairs, tables, chaise lounge, child's bed, wheelbarrow, many other useful articles for family and friends. Earn money spare time! Use tubular steel, aluminum, iron pipe. Make smooth bends quickly, easily, with HANDY Tube Bender. No other tools needed. Not a toy! HANDY Tube Benders used daily by thousands of plumbers. A guaranteed precision tool! Many uses around the home.

**FREE!** With Model B4-16 HANDY Tube Bender (for 1" O.D. tubing) we include simple instructions for making tubular chair, table, many other home furnishings. Send check or M.O. for only \$17.70 —

we pay postage. Get your HANDY Tube Bender NOW. Make your own tubular steel furniture. It's easy! It's fun! Save money! Send order to:  
**HOLSCLAW BROS., Inc.**  
407 Willow Road  
EVANSVILLE 11, INDIANA

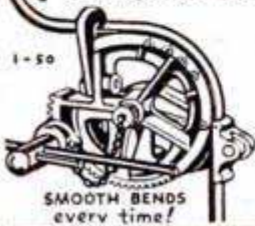

## NEW AUTO WASHER

Your car sparkling clean—in a jiffy—magic "sponge" cleaning-cloth. Simply glide over car. PRESTO! Dust, grease, dirt, and grime disappear in a jiffy. Leaves finish clear, lustrous. Autos gleam like a mirror.

### SAMPLES for AGENTS

Sample offer sent immediately to all who send name at once. Penny postal will do. Send no money—JUST YOUR NAME.  
**KRISTEE CO., 697 Bar St., Akron, Ohio**

## MONEY for MEN ALL FREE

THE PLASTEX Industry needs manufacturers on small scale and for big production of Lamp and Clock Stands, Art Goods and Novelties in Plastex and Marble imitation. Experience unnecessary. 1/2 material makes regular 10¢ store sellers. Rubber moulds furnished for speed production. Small investment brings good returns. Big chain store orders now being placed. Ambitious men have chance for real prosperity. Our Free booklet will interest and benefit you.

**PLASTEX INDUSTRIES, Dept. A**

3400 Third Ave. New York 56, N. Y.

## \$100 BREATHING OXYGEN SET \$7.95

Brand new surplus

★ Ready to use

★ Portable

with Automatic "Demand" Type Valve



A find for airmen, mountaineers, firemen, paint shop workers and others who on occasion demand extra oxygen. This popular "demand" type oxygen outfit requires no technical knowledge for use—just breathe into the mask provided and the regulator automatically delivers such oxygen as you demand. Set consists of D2 type shatter-proof steel bottle 6 x 24 inches; demand type regulator ANGO22-1; 0-500 lb. oxygen gauge and type A10 demand oxygen mask with hose. Net weight 7 lbs. Condition, NEW war surplus. Shipping weight 10 lbs.

<b>OXYGEN FILLED</b> Complete as described above with oxygen loaded tank. By express only—not available. Each complete . . . . .	<b>LESS OXYGEN</b> Complete outfit as described but with empty tank. Can be shipped parcel post. Each complete . . . . .
<b>\$9.95</b>	<b>\$7.95</b>

Refiller hose, orifice and valve for charging tank with oxygen. Set only **\$2.00**

Six foot flexible extension hose, with fittings. . . . . **\$2.00**

F.O.B. Houston; send Check, Money Order.

**AERO PARTS SUPPLY, Dept. PM-3**  
8102 LOCKHEED, HOUSTON, TEXAS

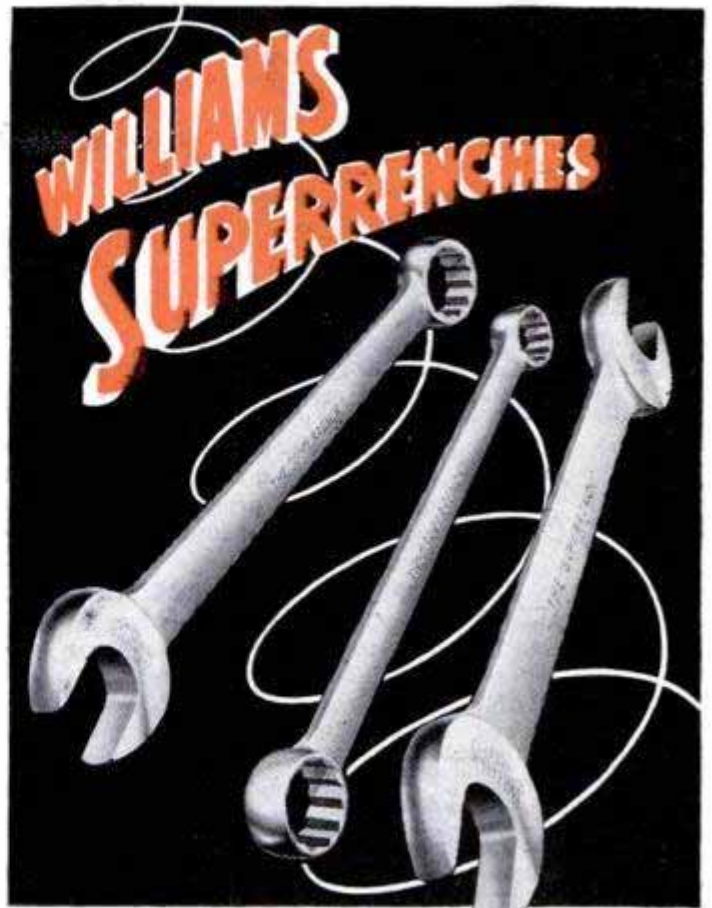

## LIGHT, TOUGH, STRONG

**FORGED FROM SELECTED ALLOY STEEL**

Williams "Superrenches" provide great strength with minimum bulk and weight. Drop-forged from selected alloy steel and heat-treated, they are available in a wide range of sizes and many patterns. Chrome-plated over nickel with highly polished heads.



WRITE FOR WILLIAMS CATALOG A-50



**J. H. WILLIAMS & CO., Dept. M, BUFFALO, N. Y.**



**MAKE BEAUTIFUL TRAYS, COASTERS, GIFTS**

of Aluminum, Brass, Copper, Stainless Steel

*Easily! Quickly! at Low Cost!* For beginners and experienced craftsmen—here's a complete supply of quality metals pre-cut to the size you want . . . and at lowest metal warehouse prices!

**ALUMINUM and COPPER CIRCLES. RECTANGULAR SHEETS** of Aluminum, Brass, Copper and Stainless Steel. Easy to work, ready to be formed into trays, coasters and hundreds of useful items and gifts.

**BRACELET BLANKS** of Aluminum, Brass, Copper and Stainless Steel. Perfect for jewelry, ornaments . . . simple to work into attractive handicraft.

**FREE BOOKLETS!** "Making Aluminum Trays and Coasters", and "Copper Metalcraft" give complete directions for making beautiful metalcraft items easily and quickly. Send for your Free Copy Today!



**METAL GOODS CORPORATION**  
Dept. PM 5239 Brown Ave. St. Louis, Mo.

JON CULVER in his SPEEDLINER, winner Class B, National Outboard Utility Races.



**SPEEDLINER**

Runabouts and Fishing Boats

**More Speed Per H.P.**

• SPEEDLINERS set 5 world records in APBA National Stock Outboard Utility Races in Florida. Nothing finer for marathon racing and pleasure. Models from \$126 to \$425 F.O.B. St. Joseph, Mo., uncrated. Write for Free Folders. Use coupon.



SPEEDLINER M-714 Marathon, Free-for-all winner in National Races.



PAUL WEARLY in his SPEEDLINER, Class A winner in National Races.

**GENERAL MARINE COMPANY**

Dept. 553 6th and OAK STS. St. Joseph 14, Mo.

Send me details on SPEEDLINER Boats.  I am interested in a Dealer Franchise.

NAME \_\_\_\_\_

ADDRESS \_\_\_\_\_

CITY \_\_\_\_\_ STATE \_\_\_\_\_



**NEW MOBY DICK "FIRE HEAD" LURE**

The famous Moby Dick Fire-Head finished in daylight fluorescent lacquer, glows in water like fish scales.

**MOBY DICK'S INTRODUCTORY OFFER**

One Moby Dick Fire-Head PLUS your choice of any other Moby Dick live-action bait listed below, PLUS transparent bait box FREE . . . a \$4 value for only \$2.20. Choose second bait from Red Head, Black Head, Yellow Perch, Silver Minnow, Frog, Orange Black Scale, Minnow. All treated with "Armor-Coat" won't peel or chip. Order Today!

ALL for only \$2.20

Jobbers, Dealers write for information.

**Moby Dick Manufacturing Co.**

Dept. 31, 5501 S. 36th St., Omaha, Neb.

**BRUSH PLATING OUTFITS**

• for re-plating articles in the home and shop. No tanks necessary. Free particulars.

**GUNMETAL CO., AVE. M, DECATUR, ILLINOIS**

**NU-WAY HEAVY DUTY CUTTING UNIT with Timken Roller Bearings**

PRICE **\$16.50**

WHY PAY MORE



Build your own rotary type lawn or weed cutter. Take the hard work out of weed cutting. Build yourself an up-to-date weed and lawn mower with the Nu-Way heavy duty unit.

Write for Free Circular—We Supply Cutting Unit Complete

**TRACTOR-LITE MFG. CO., Spirit Lake, Iowa**



**USE YOUR BEACH SAW**

With Our six in. tool steel cutters. Make mouldings, casings, drop-leaf tables, grooves beading & jointing 1" wide \$1.75, 1 1/2" \$2.25, Postpaid. State size hole, List & folder free. John A. Sandstrom, Rt. 2-D, Clearwater, Fla.



Say You Saw It in Popular Mechanics

**K-R-O KILLS RATS**

• K-R-O BIS-KITS are ready-made, easy to use; containing fortified red squill, they're safer around livestock, pets, and poultry. K-R-O POWDER is 100% fortified red squill; economical to use in badly infested areas when mixed with natural baits. BIS-KITS, 35c and \$1.00; POWDER, 75c at drug, seed, and feed stores. Money-back guarantee. The K-R-O Company, Springfield, Ohio.

# Big 6 HORSEPOWER ROTARY TILLER

**\$299**

No Extras to Buy

The Mulsifier Rotary Soil Tiller! Unsurpassed for tilling and cultivating. Makes it easy to work 1 to 20 acres. Prepares the soil in one operation. Nothing to do but guide it. High-powered—adequate for all soils. Unbreakable tines. Gives you more horsepower per dollar than any other garden tractor. Attachments—available. Money-Back Guarantee. Send postcard for circular.



**MULSIFIER IMPLEMENT CO.**  
7758 HAMILTON, DETROIT 2, MICH.

\*Trade Mark Reg. U. S. Pat. Off.

Free CIRCULAR

*Mulsifier*  
**ROTARY SOIL TILLER**

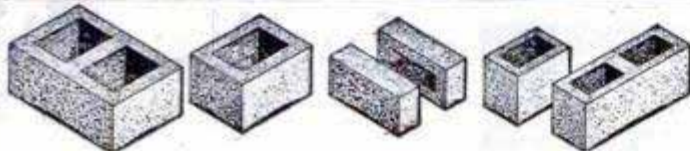

## Make Concrete Blocks and Bricks

New superior method makes square, true, easy-to-lay units which will pass any building code. Small investment, high production, big profits. One \$30.00 machine will make four 5"x8"x12" blocks per minute—1000 per day. Pays for itself in a few days. Sell blocks or save 25 building cost by making and laying your own.

POST CARD BRINGS FREE FOLDER

**Economy Manufacturing Company**  
Dept. P Stone Mountain, Georgia



Start *Quickly* BIG MONEY ROLLING WITH LIFE CHARGE

—MAKE PLEASANT, DIGNIFIED CONTACTS

The MIRACLE Chemical that helps Batteries stay AUTOMATICALLY charged. Adds Months of useful service. Eliminates freezing, overheating and cable corrosion. Revives old Batteries. Saves time

and money for user. EAGER BUYERS EVERYWHERE! Fleet owners, garages, service stations and individuals all buy. FOUR EASY SALES A DAY NETS YOU \$144.00 WEEKLY! Advertising and Promotional Material free. Sold on satisfaction guaranteed or money back plan. Send \$1.00 for special sample offer enough for two batteries, or write for free details. GET IN THE BIG MONEY FIELD! DO IT NOW. DON'T DELAY...WRITE TODAY!

BATTERY CHARGE PRODUCTS COMPANY

728 W. Peachtree Street, Dept. M Atlanta, Georgia

# Speedy Power Tool Does 1000 Jobs In a Jiffy!



Removing Paint

Polishing Car



Waxing Furniture



HOME-UTILITY  
5" Electric SANDER-POLISHER

**\$29.95**

(with sanding-polishing attachments)

## No Handier Tool for Your Home-Farm Use!

Polishing cars and silverware; waxing furniture; removing paint—you can speed up a raft of jobs with attachments supplied with this versatile Tool! A 1/4" Jacobs Chuck (only \$3.45) converts it for drilling in metal, wood, plastics. Other low-cost attachments equip it for sharpening tools, cutlery, mower blades; removing rust; grinding, buffing and burnishing. Quality-built for A.C. or D.C. use by BLACK & DECKER, world-famous maker of electric tools.

Try it at your hardware, electrical or implement dealer. See how this compact, well-balanced, easy-to-handle tool can speed up many home and farm repair jobs. Look at other Home-Utility Tools for sawing, grinding, drilling. Write to: THE BLACK & DECKER MFG Co., Dept. H4M, Towson 4, Md.

Products of The BLACK & DECKER Mfg., Co.

ELECTRIC  
**HOME-UTILITY TOOLS**



1/4" Drills

1/2" Drills

6" Saws

Drill Kits

Bench Grinders

**BASS IS BEST**  
WEEJUNS  
LEISURE COMFORT



**BASS IS BEST**  
QUAIL HUNTERS  
FIELD and STREAM



**BASS IS BEST**  
SKI BOOTS  
EXTRA CONTROL



**BASS IS BEST**  
SPORTCASINS  
GOOD GOLF STRATEGY



**G. H. BASS & CO.**  
60 MAIN STREET  
WILTON, MAINE

## M-SCOPE TREASURE-MINERAL LOCATORS

WRITE FOR FREE, ILLUSTRATED 16-PAGE BOOKLET

M-Scope Treasure-Mineral Locators, Geiger Counters. New Low Prices, unsurpassed in efficiency. Full factory guarantee. Immediate shipment.

YOU CAN PURCHASE THESE INSTRUMENTS ON A MONTHLY PAYMENT PLAN



URANIUM

**FISHER RESEARCH LAB., INC., PALO ALTO, CALIF.**



GOLD

# SAND-O-BLOK

PAT. & PAT. PEND

*the sensational*  
**New Sander**  
with an adjustable radius!



Now for the first time, Sand-O-Blok gives you an amazing hand sander that sands contoured and irregular shapes as well as flat surfaces. A Neoprene rubber sleeve wraps around a plastic wedge-shaped block and cushions the sandpaper. By rotating the rubber sleeve around the body, the radius at each end can be changed for intricate contour sanding.

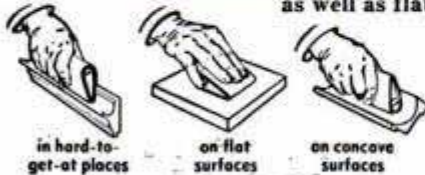

Sand-O-Blok can be adapted to a wide variety of uses. Use it on flat or curved surfaces. Comes equipped ready for use. Price \$1. Additional sandpaper sleeves available in coarse, medium and fine Garnet paper that wears and wears.

Note how rubber sleeve changes radius—from  $\frac{1}{4}$ " at the narrow end to  $\frac{3}{4}$ " at the opposite end. An internal cam action expands the sander as the slotted "lock" is tightened to keep sandpaper from slipping. A brand new idea. Coin, washer, screwdriver, etc., tightens or loosens lock.



Write for catalog. See Sand-O-Blok at your hardware dealer or where Sand-O-Flex sanding wheels are sold. Both are products of...

**MERIT PRODUCTS, INC.,**  
4023 Irving Place, Culver City, California

## CALK THOSE CRACKS WITH *Nu-CALK* **SPEED LOAD**



Seal out drafts, dust, around windows and doors



Here's the easy way to calk your home. Just slip a handy Speed Load into the calking gun and you're ready. It's the fastest, most economical way to apply the world's finest calking compound.

USE *Nu-Glaze*  
INSTEAD OF PUTTY



Macklanburg-Duncan Co., Okla. City, Okla.

**BUY THROUGH YOUR LOCAL  
HARDWARE, LUMBER OR BUILDING  
SUPPLY DEALER**

SAY YOU SAW IT IN POPULAR MECHANICS

## SO EASY TO STRIP PAINT

To get good results, strip off all cracked or peeling paint. It's easy when you use Wonder-Paste. This powerful paste-like remover, applied with a paint brush, softens up paint, varnish, lacquer, shellac, etc. Turns it into a soft sludge that comes off easily. Leaves surface in perfect condition. Harmless to hands. At leading paint and hardware stores.



Write for **WONDER-PASTE** leaflet

Wilson-Imperial Company, 119 Chestnut Street, Newark 5, N. J.



### HANDY CALCULATOR FOR WOODWORKERS.. ONLY 10c

Just set dial, quickly solves countless problems. Converts linear to board feet, compares workability of various woods, shows bit sizes, nail specifications. Also tool sharpening tips, etc. 6" diameter heavily varnished cardboard. Send 10c to Greenlee Tool Co. 2104 Columbia Av., Rockford, Ill.



### SUPERETTE DUAL VACUUM AUTO HORNS

ONLY  
**\$8.95**  
POSTPAID

The voice of authority and commanding warning for safer highway driving. One BLAST and those "Road Hogs" really move over. Installed under the hood or on the front fender. Beautiful lacquer finish. Operates from intake manifold. No tank needed. Only \$8.95 complete with cylinder head bracket, steering column lever, hose, fittings etc. Send check or money order today. We pay postage. \$1.00 deposit required on all C.O.D. orders.

Compare with  
\$25 to \$100  
Air Horns

THE PROTECTUROD CO.  
Dept. 432, 4033 Windsor Road, Youngstown 7, Ohio



### CUT COSTS on building

Learn about this new method of building houses, hunting camps, garages, beach cabins or any 1-story frame structure at a saving up to 40 per-cent.

Amateur and professional builders will profit by copyright instruction book.

Write for free information or send \$1 for instruction book.

5-day trial money back guarantee

ITOC CO., P.O. Box 713, Mobile 4, Ala.

### BURIED TREASURE, MINERALS. AMAZING NEW GOLDAK LOCATORS

**SENSATIONAL NEW MODEL!**  
ONLY 11 pounds weight! One hand operation! Money-Back Guarantee of Superiority. Write for full details.

**THE GOLDAK CO.**  
1542 WEST GLENOAKS BLVD.  
GLENDALE 1, CALIFORNIA

World's largest  
maker  
of fine  
locators.



## WAR SURPLUS BARGAINS

**\$500,000.00 INVENTORY  
for QUICK LIQUIDATION**

Surplus items—hundreds of them for home, shop, factory, farm and outdoor use. New items, used items, reconditioned items—all at tremendous savings—all priced for quick sale.

**Page After Page of Values**

This big catalog shows page after page of amazing money saving values. Write for your copy today. Send 10c to cover postage, mailing, etc. Write today!

**SEND  
TODAY  
FOR YOUR  
COPY**

**10c**

**STARK'S** Dept. PM4 509 So. STATE STREET  
CHICAGO 5, ILLINOIS

**THEY'RE NEW—THEY'RE DIFFERENT**

**STEEL BITS UP TO 1/2" FOR YOUR 1/4" ELECTRIC DRILLS**



Make your drills do double duty. We have available for you, for the first time, steel drill bits up to 1/2" for use in your 1/4" chuck. Made by one of the world's largest manufacturers of cutting tools, this new set consists of one each 1/4", 5/16", 3/8", 7/16" and 1/2" bits. Priced at only... **\$3.95**

Drills are 5" long with 1/4" SHANKS. Same set also available in high speed steel for only... **\$6.60**

1/2" shank drill sets. Eight steel drill bits from 9/16" through 1" by 1/16ths. In heavy canvas and plastic case. Priced at only... **\$15.80**

Also available in high speed steel.

1/2" shank drill sets. Four steel drills from 1-1/16" through 1-1/4" by 1/16ths. Priced at only... **\$12.00**

All sets shipped postpaid if check or money order accompanies order. COD's shipped postage due. Dealers solicited.

**PRECISION TOOL SALES** 101 WEST ARCHER TULSA, OKLAHOMA



MODEL B10

Authentic 40" High Dutch Windmill Detailed Plan \$0.75

**BUILD PRACTICAL PROJECTS FROM DETAILED PLANS**

Unique 40" High Lighthouse—Plan \$0.75  
 ML. Vernon Martin House—31 Family—Plan \$1.00  
 Beautiful Wheelbarrow Lawn Chair—Plan \$1.00  
 Novel Dutch Windmill—Wings operate  
 Girl Churning Butter—Plan \$0.50



LAWN CHAIRS B-C-A Plans 50c each. All 3—only \$1.00  
 12 different Trellis designs—Plan of all 12 only 0.50

SPECIAL—ALL PLANS IN THIS AD \$5.50 VALUE FOR ONLY \$4.75

Send 10c for Catalog illustrating over 100 fine projects.

**CRAFTSMAN'S MODEL COMPANY, Dept. P15, DELAFIELD, WIS.**

**GUARANTEED REBUILT JEEP MOTOR BLOCKS COMPLETE WITH PAN (Less Head)**



This motor is completely rebuilt with all new parts. Guaranteed for 90 days or 4000 miles against defective parts or workmanship. You must prepay freight when shipping old block to us. Add \$2.50 for crating to above prices. **\$88.50**

**BRAND NEW CAPSTAN WINCHES**



NEW LOW PRICE  
 6000 lb. capacity. Accurately machined gears provide for smooth efficient operation. Suitable for both front or rear mounting. May be used on amphibious jeeps or trucks. All units are brand new and fully guaranteed. **\$17.50** Each

**BIG, FREE CATALOG WRITE FOR YOUR COPY TODAY**

Thousands of other parts and accessories available. SHOP BY MAIL — Order direct from this ad today.  
**TERMS:** Net cash with order. Open account to rated firms only. C.O.D. shipments should have 25% deposit with order. All prices are F.O.B. our yards, Chicago, Illinois.

World's Largest Stocks of Jeep Parts Write for Your Special Requirements—

*The King of Jeeps*



**BERG TRUCK & PARTS CO., INC.**

1607 S. Wabash Avenue, Dept. S-4, Chicago 16, Ill.

**Outboard News**

About the new Scott-Atwater **SHIFT** motors

**Outboard skippers everywhere**

are learning how much easier it is to pilot a Scott-Atwater with the complete Shift—Neutral, Forward, Full Control Reverse. To back up, you just Shift the lever (instead of swinging the whole motor around). All controls are always at your fingertips. Every Scott-Atwater Shift motor has the complete Shift. Why settle for less?



**ASK THE MAN WHO RENTS ONE!**

"Our boat livery equipment is constantly in service. Our Scott-Atwaters run day after day with perfect performance and a minimum of trouble. They're tops for carefree performance."—E. C. Lowell, Camdenton, Mo.

**FOUR SHIFT MODELS**

—All with the complete Shift—Neutral, Forward, Full Control Reverse—plus single knob control, push-button carburetor drain!



**1-16 SHIFT**  
5 HP\* TWIN  
**\$179.50†**

**NEW!**

**1-30 SHIFT**  
16 HP TWIN  
(TO BE CERTIFIED)  
1 TO 30 M.P.H. **\$349.50†**

**1-20 SHIFT**  
7½ HP\* TWIN  
1 TO 20 M.P.H. **\$199.50**

**1-14 SHIFT**  
4 HP\* SINGLE  
1 TO 14 M.P.H. **\$149.50†**

**1-12 Non-Shift**  
3.6 HP SINGLE  
1 TO 12 M.P.H. **\$99.50**

†WEST COAST PRICE SLIGHTLY HIGHER      \*\*OBC CERT. AT 4000 RPM

**BUY TODAY—12 MONTHS TO PAY!**

• The new Scott-Atwater "Year-to-Pay" installment plan is available at most dealers'. Includes low-cost insurance. See your dealer!



**FREE BOOK**

64 pages showing "How to get the most out of an Outboard." Packed with pictures, written by experts. Write for your copy now!

SEE FOR YOURSELF... SHIFT FOR YOURSELF...

**SHIFT**



**to Scott-Atwater**

Dept. 67, Scott-Atwater Mfg. Co., Inc., Minneapolis 13, Minn.

No. 79

# SpeedWay



**\$19.95**

This phenomenal drill embodies advanced engineering and radically new drill construction with die-cast revolver type frame, that has cast-in oil impregnated bearings, served by cast-in oil lines, cast-in fan housing and baffle, trigger switch, with switch lock, chuck lock, chip blower, 3 wire (underwriters approved) cord and plug . . . and big drill power—delivers 150 watts at drill point.

Sold by leading hardware, electrical and mill supply dealers.

WRITE FOR CIRCULAR

**SpeedWay Manufacturing Co.**  
1863 South 52nd Avenue • Cicero 50, Illinois

## AMBROID Stays stuck!

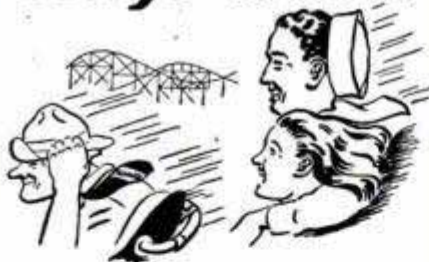

When you build or mend with Ambroid—it really sticks. Ready to use, quick drying, waterproof, flexible, transparent, a Hercules for extra strength. Heat and corrosion resistant, too!

Invaluable for assembling or repairing. The standard liquid cement for 40 years. Leading favorite among handcrafters and hobbyists. So reliable it is specified for countless uses in big industry.

Keep a tube of Ambroid handy. Ask your dealer—or send 25c for big 2 oz. tube postpaid. Complete satisfaction guaranteed or your money back.

Also 50c 4 oz. tube, Pts., Qts., Gals., for Industrial Use. **Build It—Fix It with Ambroid!**

**AMBROID CO.**

303 Franklin St. EST. 1910 Boston 10, Mass.

## ELECTRIFY your SEWING MACHINE



**NEW LOW PRICE!**  
**\$11.50** 1 YR. GUARANTEE

Buy direct from manufacturer and save! Kit comes fully wired, installed in a jiffy. Fits all machines! You get these all-new parts:

- Motor & Bracket
- AC-DC 115v. 80c
- Steel pulley & belt
- Multi-speed foot control
- Cord set & block
- Easy instructions

**FREE . . . reg. \$2.95 chrome SEWLITE given with every kit.**

**10 DAY FREE TRIAL — ORDER NOW!**

Send no money, pay COD or send money order and we'll pay postage. Please state whether wheel on your machine turns toward you or away from you. Shipping wt. 6 lbs.

**CONTINENTAL SALES CO.**

83 GRAHAM AVENUE Dept. PMS BROOKLYN 6, N. Y.

## OTTAWA Tiller & Mower

Patented

Powerful 2 H-P Red Seal Continental Motor.

Attachments for mowing, tilling, power take-off, cultivating and spraying. Lowest prices in history. Two speeds and free wheeling. Thousands in use. Rotary mower only \$89. Made by men with know-how. Now in our 47th year. Free details.

Rotary Mower

**OTTAWA MFG. CO., 5-027 Lawn Ave., Ottawa, Kans.**

## PISTONS



**ALUMINUM ALLOY.** For Every Make Engine. Any Year, Odd or Foreign! For auto, "hot rod", racing, truck, tractor, motorcycle, scooter, bike, outboard, marine, compressor, industrial. Send sample or specifications.

**JUDSON MFG. CO., 1709 Gillingham, Phila. 24, Pa.**

## LAWN ORNAMENT-NOVELTY PATTERNS

28 Lawn Ornament Patterns, 25c. Other patterns; 15-20" high; Dutch Girl, Dutch Boy, Pirate, Bull Terrier, Mexican Girl, Mexican Boy, Dwarf, Penguin, Flower Girl, 10c each. 25 Novelty Patterns, 30c. All 62 Full Size Patterns, \$1.00 Postpaid. Strother Pattern Service, Dept. BP-8, Box 128, Belington, W. Va.

RETAIL PRICE \$125.00

**FACTORY TO YOU \$59.95**

**SUPERSHOP** includes precision-built 8" tilting table saw, vertical and horizontal drill press, 30" lathe, sander, grinder. 100% BALL BEARING. Write for FREE catalog, full details, trial plan.

**POWER TOOLS, INC.**

110 YATES AVENUE  
BELOIT, WIS.

Say You Saw It in Popular Mechanics

## NEW PACKAGED BOATS 1950 KITS



17 New models. Improved design, skiffs, outboards, inboards, sail boats. Tredronic racers, cruisers. 8 to 16 ft., exclusive features. Preassembled frames, Tri-Keel construction, Tredronic bottom, full length spray rails, widest beam, simplified construction, easy to build. World's best boat buy! Send 25c for new 1950 literature, or send \$1.00 for literature, plus booklet "Plywood Boats."

## BOAT PATTERNS-BLUE PRINTS

1950 Catalog—over 100 modern designs by famous naval architects. Racing classes, cruisers, inboard, outboard, sail, 6 to 35 ft. Plywood—Steel—Plank. Construction plans, full-size patterns. Send 35c for catalog or \$1.00 for catalog and helpful booklet on "Boat Building."

**MARINE MART-DEPT. 24-BUFFALO 7, N. Y.**



**THE BIGGEST VALUE**

# DYNAMIC ARC-WELDER

*Super Charged*

**ON THE MARKET DIRECT FACTORY TO YOU**

**DOES WELDING, BRAZING, SOLDERING, CUTTING**

This is one of the finest scientifically designed and precision-built genuine heavy duty transformer-welders on the market today! Made by an old established firm. High efficiency, heavy-duty output does work you'd expect from costlier machines. It's EASY TO OPERATE. Do expert work in a jiffy by following the simplified instructions furnished. Works on iron, steel, brass, bronze, aluminum or other metals. OPERATES from any convenient properly wired 110 VOLT A. C. line. **SAVE TIME AND MONEY...** build or repair your own auto, home, farm, or shop equipment and appliances, etc. Make big money doing work for others in spare or full time. **OVER 50,000 SATISFIED USERS** all over the country, hobbyists, maintenance and repair men, farmers, tinsmiths, engineers, home and auto owners. Order today on 10-day trial or send coupon for full details.

\$40<sup>30</sup> VALUE  
Only  
**\$2850** F.O.B.

**GIFT WORTH \$680 INCLUDED**



For Prompt Action  
**SEND ORDER TODAY**



**SEND TODAY FOR FREE DETAILS**

Send Free details on Dynamic and Gift Offer.  
 Send Dynamic and 10 day trial Enclosed \$28.50 or \$... deposit send C.O.D. for balance. Include Gift Offer.

Name.....  
Address.....  
City..... State.....

DYNAMIC WELDER CO., Dept. D2-DA4, 15 E. 23rd St., Chicago 16, Ill.

## GEIGER COUNTERS • TREASURE DETECTORS

LOW COST BATTERIES • LIGHT WEIGHT • 3-WAY SIGNAL • GTD. 1-YEAR



**Detron GEIGER COUNTERS**  
Sensational new models; low cost operation, light weight, sensitive to all uranium minerals. We have a model in YOUR price range.

**Detron TREASURE DETECTORS**  
reach deeper. Lightweight, portable yet positive. Highly sensitive. Low operating cost. No expensive batteries. None finer at any price.



Write Today for Free Descriptive Literature  
**Detron Co.** - 5637 CAHUENGA Dept. 4-B NORTH HOLLYWOOD, CALIF.



## SET THE PACE WITH THE

- Cruises at 45 MPH—with faster pickup than car
- 39" high, 71" long overall, wt., 190 lbs.
- 8 HP motorcycle engine
- 50 miles to the gallon
- Automatic clutch
- Internal expanding brakes—handle-grip throttle controls

*Powell*  
**P-81!**  
ONLY **\$247<sup>34</sup>**  
AT COMPTON, CALIF.  
EXCISE TAX INC.

Write for FREE folder and name of nearest dealer

**POWELL MANUFACTURING COMPANY**  
DEPT. PM450 • COMPTON, CALIF.

Dealer Inquiries Invited



## WIND-MASTER PLASTIC WIND-DEFLECTOR

★ For comfortable driving, keeps wind off driver and passengers. Beautiful transparent WIND-MASTER has 12 great features: No rattles, adjustable in or out, no interference with windows or signals, 100% vision with no distortion, shatterproof, non-combustible, safe, theft-proof, easy to install, 7 models, chrome fittings. Specify make and model of car to be fitted.

DEALER INQUIRIES INVITED

★ Startling New Low Price—\$5.50 per pair, postpaid. Ck. or M.O.

R. M. BRYCE, 8424 MELROSE PLACE LOS ANGELES 46, CALIF.

# Clean-up Time

...for car cooling systems, too!

Avoid engine overheating on hot summer days

with *Warner* care



**WARNER RADIATOR CLEANER**—Thoroughly cleans cooling system of rust, oil-muck and grease. Harmless to metals, hose and car finish.

**WARNER COOLING SYSTEM PROTECTOR**—Prevents rust and corrosion—keeps cooling system clean for maximum efficiency.

"Just Shake . . . Pour . . . and Fret No More"  
See your service man or do it yourself.

Warner-Patterson Company, 920 S. Michigan Ave., Chicago 5

WE FURNISH ALL MACHINED METAL PARTS, EVERY SCREW, NUT, BOLT, WASHER, AND COMPLETE PLANS FOR THIS...

## BIG 10" POWER SAW

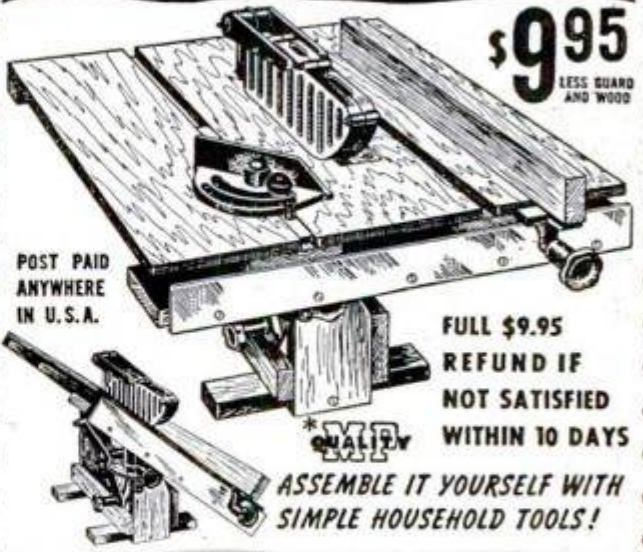

**\$9.95**  
LESS GUARD AND WOOD

POST PAID ANYWHERE IN U.S.A.

FULL \$9.95 REFUND IF NOT SATISFIED WITHIN 10 DAYS

**QUALITY** ASSEMBLE IT YOURSELF WITH SIMPLE HOUSEHOLD TOOLS!

TABLE 24" x 20" • TILTS TO 45°  
CUTS 0" TO 3/4" DEEP • TAKES 10" BLADE

**COMPLETE PLANS (WITHOUT PARTS) 10c**

**MARCUS • POLLAK DEPT. 44 ROYERSFORD, PA.**



# PFLUEGER BAITS

## For Better Fishing

You put ACTION into fishing when you use PFLUEGER Baits. Designed from Pflueger's long experience and knowledge of fish feeding habits. Ask your tackle dealer for these leading Pflueger numbers:

### Pflueger Chum Spoon

Bright metal—easy to cast—weedless. Ideal for shore line fishing. 4 sizes—\$0.65 to \$1.20



### PFLUEGER Pal-o-Mine Minnow

Floater—Diver—Wiggles—Wobbles. Acts like struggling minnow. Several styles and finishes—Solid and Jointed \$1.15 to \$1.50

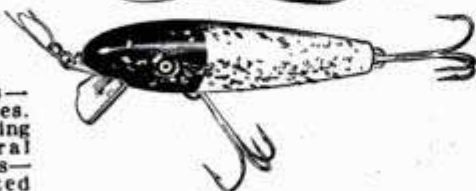

### Pflueger Mustang

For underwater popping or Floating Surface Lure. Several styles and sizes—\$1.10 to \$1.60

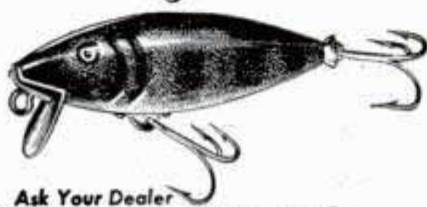

Ask Your Dealer

THE ENTERPRISE MFG. CO., AKRON, OHIO

# PFLUEGER

pronounced "FLEW-GER"

A GREAT NAME IN TACKLE

NO. 604



You own the BEST  
money can buy...  
when it's **P&C**

SMOOTH handles  
DEEP grooves give a better grip  
UNBREAKABLE plastic  
SWAGED blades will not turn  
SPECIAL alloy forged steel, chrome plated  
GROUND, polished bits fit screw slots perfectly

There is a P & C tool for every job. Ask your hardware dealer for the finest wrenches, sockets, punches, pliers and screwdrivers made—P & C—"the BEST tools money can buy".

FREE FOLDER shows the right size blade for every screw you use. Send for your copy.

**P&C** P&C HAND FORGED  
TOOL COMPANY  
PORTLAND 22, OREGON

**WE'LL PAY YOU \$1.25 if**  
**fulcrum** gun & reel **Oil** IS NOT THE BEST YOU EVER USED!

Get big 1-ounce Applicator Bottle today. Use it on gun barrel, firing pin, inside and outside your reels. Expose equipment to dampness—even salt water and air. Use six months. If it is not the BEST you ever used, return unused portion and we'll refund not only \$1.00 purchase price, but we'll add another 25 cents to your dollar for any inconvenience.



### OUR GUARANTEE . . .

FULCRUM Special Formula Gun & Reel OIL provides perfect, lasting lubrication and prevention against rust and corrosion—even salt water and air, as no other oil can do. Acid-free. Will not gum or get stringy. It lasts. Little does it. Most economical you can use. At dealers, or sent, with above guarantee, for \$1.00 postpaid. 8-ounce Economy size, for boats and club use, \$6.50 postpaid.

**FULCRUM OIL CO.**

1139-D Liberty, Franklin, Pa.

## HIGH POWER TELESCOPE

60 POWER - ALUMINUM TUBES - OPENS TO 33"

Variable Power Eyepiece Adjustable to 15X, 30X and 60X.

\$4.50



Leather Case Included

5 Sections. 4 Ground & Polished Lenses. Also used as 50X Microscope. Ready to use, only \$4.50 POSTPAID. **BROWSCOPE CO.** Dept. 4M, 24 W. 45th St. NEW YORK 19, N. Y.

## MARCOT KEY MACHINE

Immediate Delivery



MARCOT No. 8 KEY MACHINE, mounted on Cabinet, less motor, \$ 95.00  
Auto Code Book and Depth Keys, 12.50  
100 Dz. Popular Key Blanks . . . 60.00  
Set — Key File, Follow-Through Rods, Lock Picks, Bit Key Gauge, Thumb Pins, Springs . . . 10.50  
"Locksmith Trade Books"; . . . 6.75  
How to Open Locks without Keys or Picks; Secret of Locksmithing; How to Make Keys by the Impression Method; Master Key Systems.  
**TOTAL COST . . . \$184.75**

A. J. MARCOTTE CO., 1200 N. Kedzie Ave., Dept. PM, Chicago 51, Ill.

BUILD YOUR OWN

## ARC-WELDER

For Light or Heavy Work

No rewinding necessary—use coils taken from old auto generators. Works on 110 or 220 A.C. Has 20 different heats. Complete plans and BIG Catalog 35c. **LEJAY MFG. CO.** 3347 LeJay Bldg.



Minneapolis, Minn.

## MILLER ROTARY

1/2" SPEED COPE-SAW DRILL-BIT  
IT SAWS & CUTS & REAMS

Drills even holes

SAWING, CUTTING AND REAMING SECTION



DRILL PRESS SAW-CUTTING

ELECTRICIAN'S HANDY CUTTER

Drills even holes

SAWING, CUTTING AND REAMING SECTION

SAWS, CUTS, REAMS Light sheet metal, wood, plastic, etc. Amazing high speed combination bit and saw fits high speed electric 1" drill or drill press, takes place of up to \$50 in tools. Drills own starting hole to quickly cut, saw or ream an opening in material. Easy to operate. Ideal for auto mechanics, electricians, plumbers, hobby workers, many others. Drill is 1" in diameter with overall length of 3 1/2". Cutting sections 2" long.

SEND CASH, CHECK OR M.O.

PRICE \$3.95

Order Now

International Twist Drill Corp. Dept. PM-2  
7th & Wyandotte • Kansas City 6, Mo.

# 8" BALL BEARING TILT ARBOR SAW MOVEMENT

SIMPLY FASTEN THIS COMPLETE UNIT TO ANY SIZE TABLE

Makes Either Bench or Floor Model

**\$22.75**

F.O.B. ROYERSFORD  
Less Motor, Guard

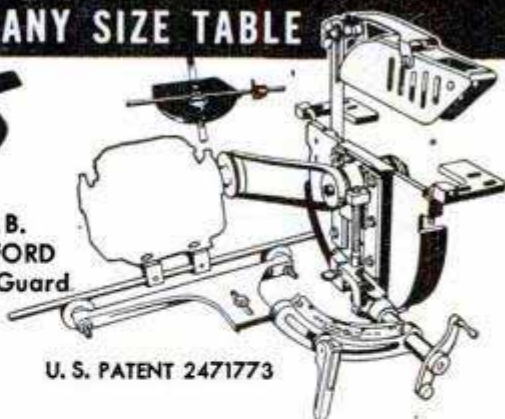

U. S. PATENT 2471773



BLADE  
TILTS  
To 50°  
•  
TABLE  
STAYS  
LEVEL

SAVE  
**\$50**

Full \$22.75 Refund if not satisfied within 10 days.

COMPLETE PLANS and CATALOGUE

25¢



QUALITY

NO OTHER SAWS AT ANY PRICE CONTAIN THESE FEATURES

Shielded (Greased For Life) Ball Bearings • Takes 8" Blade • 5/8" Ground Arbor • Precision Etched Segments On Cradle & Mitre Gauge • All Gray Iron • Acme Screw & Bevel Gears Control Depth Of Cut • Front and Rear Fence Lock • Ball Bearing Motor Drive • Polished Hand Wheels • Height Lock For Dadoing • Built-In Switch • Complete Plans And Instructions.

Write to ... **MARCUS-POLLAK** DEPT. 47 **ROYERSFORD, PA.**

The First Major Tilt Arbor Saw Improvement in 75 Years

Hand Saw Filer

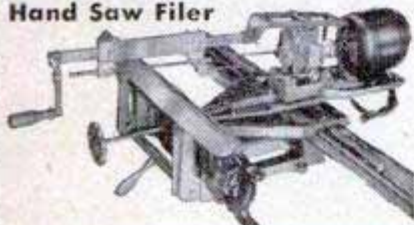

## SAW FILING BUSINESS PAYS BIG PROFITS

Independence, security . . . a business of your own—all can be yours by making a small investment in a part or full time saw shop.

For better, faster, and easier hand saw filing, the precision engineered, motor driven Burr hand saw filer is a MUST. No time-killing adjustments necessary . . . fast, accurate, operator controlled file arm, will file from both sides. This fine machine will give a life-time of service and has a one year guarantee against defective workmanship or materials. WRITE FOR FREE HAND SAW FILER FOLDER.

BURR MFG. CO., Dept. 4, 8933 Venice Blvd., Los Angeles 34, Calif.

Write for Valuable

Burr's Blue Book of  
**SAW SHOP CHARGES**  
coast-to-coast

Send 25c in coin

# Reg. \$9.95 OHIO GRINDER \$3.95

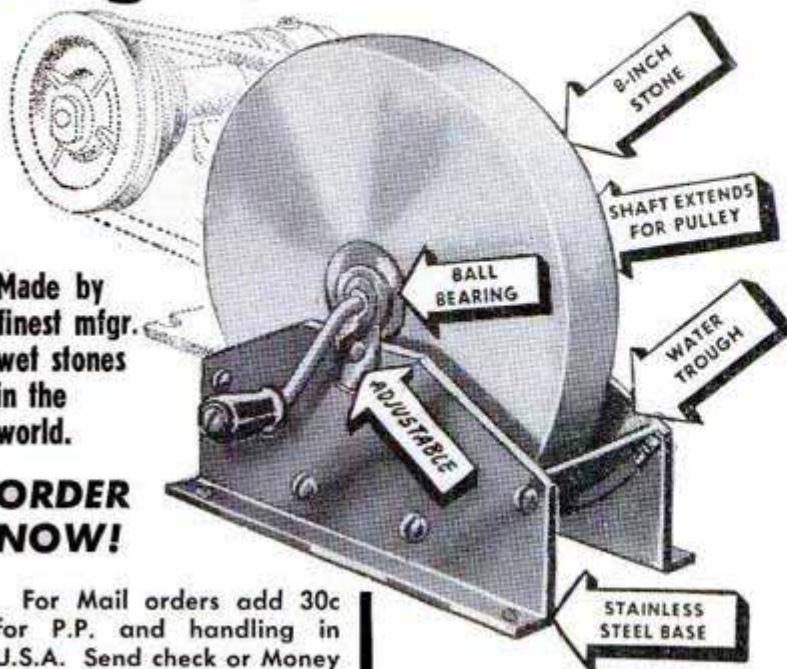

Made by finest mfr. wet stones in the world.

**ORDER NOW!**

For Mail orders add 30c for P.P. and handling in U.S.A. Send check or Money Order.

**BALL BEARING**  
8" x 1 1/2" WET STONE  
Genuine Bera Stone

## THE BUY OF A LIFETIME!

- A practical hand operated sharpener for Homes, Farms and Work shops.
- Sturdy, Engineered and Adjustable.
- Brand new, first quality.
- No Temper removed.
- For precision sharpening.
- Weight 8 lbs., easy to assemble.
- EASILY CONVERTED TO POWER DRIVE (as shown in illustration but not included)

**MARTIN ELECTRIC T & S COMPANY**

604 Arch Street Dept. P.M. Phila. 6, Pa.

**\$295** WITH **5 H.P.**  
**ENGINE**

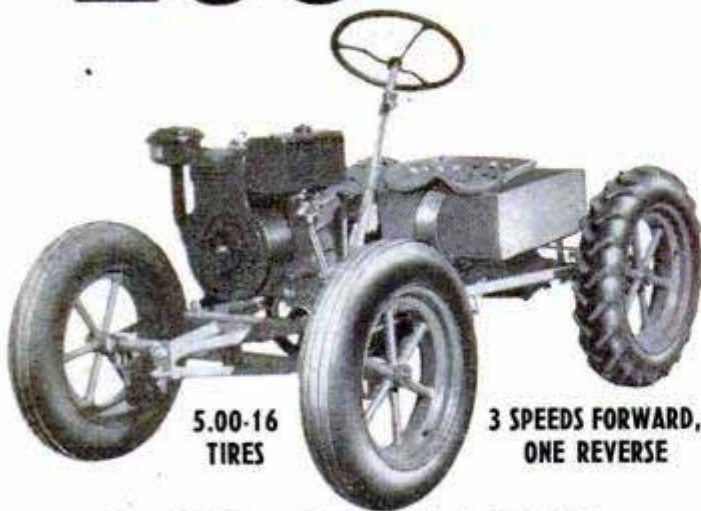

5.00-16  
TIRES

3 SPEEDS FORWARD,  
ONE REVERSE

**2 TO 20 M.P.H.**

**SICKLE MOWER, BULLDOZER,  
PLOW, ETC. ALSO AVAILABLE**

WRITE FOR CIRCULAR

**MAYRATH, INC.**  
DODGE CITY KANSAS

**CLEAN PAINT BRUSHES**

in Minutes with NEW

**Kwikeeze**

- SOFTENS hardest brushes—usually less than 30 minutes.
- CLEANS OUT fresh paint instantly!
- DISSOLVES all paint finishes easily.
- HARMLESS to hands and brushes.

Pint Can only 50c  
CLEANS SEVERAL  
BRUSHES

For  
Free  
Circular  
Write

**SAVOGRAN**

25 HUNTINGTON AVENUE, DEPT. 28, BOSTON 16, MASS.

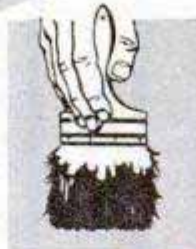

**HANDEE**  
*Tool of 1001 Uses*

The original tool of this type and today's finest. Choice of mechanics, repairmen and craftsmen for 18 years. Handee is the best tool investment you can make.

IT RUNS COOL—Smooth, controlled power when you want it, as you like it. Non-fatiguing because it is perfectly balanced and has 7-bar armature rather than only 3. Speed 25,000 r.p.m. Wt. 12 oz.

Handee with 7 accessories \$19.95  
Handee with 51 accessories in steel case... \$24.95

At your dealer's or order today postpaid on money-back guarantee. Write for catalog. Chicago Wheel & Mfg. Co., Dept. PM, Chicago 7, Ill.



A Whole  
Toolshop  
in 1 hand  
GRINDS, DRILLS  
ENGRAVES, CUTS  
POLISHES, SAWS  
ROUTS, SANDS

**ELECTRIC SHEAR SHARPENER**

Over 65,000 Sold—It Must Be Good!



Genuine Carborundum wheel ideal for shop or home use. Send remittance with order and shipment will be made at once, prepaid to your door, complete with electrical goods catalogue.

Motor driven

**\$9.75**

complete  
with vise

WILLIAM MARVY COMPANY  
477 St. Peter Street St. Paul 2, Minn.

**Practical Economical Winter Travel**



**Special Sale**

on YC-2 65 h.p. two passenger  
SnowCars — \$995.00.

CALLAIR, Afton, Wyoming

**SIX MILLION**

mufflers are torn out yearly. Original SIMPLEX Repair Guards will save you tearing out yours, saving time, money, labor, inconvenience. Do not confuse with former cheap, flimsy affairs. Easily and quickly installed. Fits all diameters both oval and round. Protects, reinforces; stops noise instantly. Heavy gauge, cold-rolled steel, treated against rust; asbestos lined. Stays put; lasts indefinitely. Order yours now. Send \$1.50 plus 15c postage. We ship by return mail. Good deals still available for qualified specialty men. Write today.

PARKER LABORATORIES Sta. H CLEVELAND 8, OHIO

**IF YOU ARE BOTHERED BY  
"GURGLING" TOILET TANK**

TRY

**MILL-SET TOILET TANK BALL**

SEND \$1.00 TO

**MILL-SET COMPANY**

P. O. BOX 6

NEW BRUNSWICK, N. J.

Say You Saw It in Popular Mechanics

**make your own Gems** 29<sup>50</sup>  
F.O.B.

All necessary lapidary equipment is furnished, including a super-charged diamond blade for sawing, and all wheels for grinding, shaping and polishing; also complete instructions. The complete equipment as shown, less motor and belt, for only \$29.50. f.o.b., Burlington, Wisconsin. Write today for information and literature.

**B&I MANUFACTURING CO.**  
Dept. S Burlington, Wis.

## Carbide Tipped STAINLESS STEEL SCRIBERS

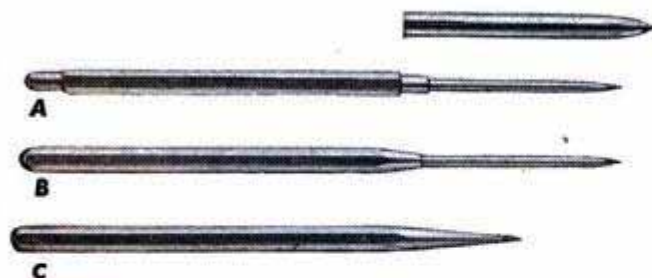

### For Marking Metal, Plastics or Glass

These new stainless steel, carbide tipped scribers are outstanding values. Rustless, highly polished, they are much harder than ordinary hardened tips. Will last longer, mark better and resist breakage better. Prices: Style A (with cap) \$2.25; Style B, \$2.10; Style C, \$2.10. Complete set only \$6.00. Full satisfaction guaranteed or money refunded. Order direct (either C.O.D. or remit with order) from

**P T I, INCORPORATED,**  
Dept. 24, 401 Broadway, New York 13, N.Y.

### SPECIAL OFFER to Hobbyists

#### Hard Angle Jobs Set-up in 5 Seconds

Save TIME! MONEY! Drill, mill, grind, etc., round, square, irregular pieces at any angle—Quickly—Easily—Accurately with **PALMGREN "HOBB-E" ANGLE VISE**. Accurately machined and graduated. 1 1/4" Jaws, 1-Plain, 1-Grooved. Order NOW! Only \$4.95. Write for "HOBB-E-HELPS" Circular. **CHICAGO TOOL & ENGINEERING CO.** 8365 South Chicago Ave., Chicago 17, Ill.

ONLY  
**4.95**



## NOW! FILE YOUR OWN SAWS

Do expert saw filing at home. Precision filing easy without experience. Two simple adjustments. Keeps any hand saw extra sharp and true-cutting. Complete with file. Money back guarantee. Cash with order, prepaid. (COD postage extra.) Order today. \$2.95. **ANOTHER SPEEDCOR TOOL THE SPEED CORP. PM-4** 512 N.E. 73 Ave., Portland 16, Oregon

**\$2.95**  
EACH

## UPHOLSTERING SUPPLIES

- Magnetic Tack Hammer ..... \$1.95
- Spring Twine—6 ply-lb ball ..... 79c
- Webbing Stretcher..... 95c
- Jute Webbing..... 25 yds. 2.98
- 5" Carved Queen Anne Feet..... 45c

Send for complete Price List

**THE TYCON COMPANY, Dept. 4M, CHALFONT, PA.**

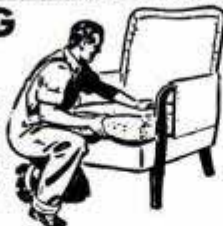

### New Welding Outfit

COMPLETE like picture \$45.00  
ELECTRIC WELDER .. \$39.00  
**EAGLE WELDING, Dept. 40**  
5085 BROADWAY, CHICAGO 40, ILL.

Always write your name and full address clearly when answering advertisements



## FREE SAMPLES! GLOW IN THE DARK!

**BIG PROFITS** showing amazing Luminous Specialties—house numbers, pictures, plastic novelties, religious and nursery objects, ash trays, key-holders, etc. Large manufacturer. Enormous demand. Sell on sight. WRITE AT ONCE for FREE samples. **Madison Mills, 303 4th Ave., Dept. H-4, New York 10, N.Y.**

# NOW "Factory" Quality ON YOUR FURNITURE BUILDING

## Atlas 6" JOINTER-PLANER



Now — get "factory" quality on all your fine furniture and cabinet work! This new Atlas 6" Jointer-Planer has the capacity you need — the "production shop" features you want — for expert planing, rabbeting, tonguing, and other jointer work. There's simultaneous blade positioning — entire cutter head raises or lowers. The rear table is stationary for permanent alignment with the front table and cutter head.

And look at these features! Big 42" precision-ground grey iron table, 32" two-way tilting fence, sealed ball bearings. For complete facts on this outstanding new Atlas tool, send postcard or coupon below.



### 8" TILT/ARBOR SAW

The lifetime saw for big or small projects. Ask your Atlas dealer.

## SEND FOR FREE CATALOGS

**ATLAS PRESS CO.**

443 N. Pitcher St., Kalamazoo, Mich.

Please send free catalogs on

6" Jointer  Tilt/Arbor Saw

Name \_\_\_\_\_

Street and No. \_\_\_\_\_

City, State \_\_\_\_\_

**ATLAS PRESS CO.**

443 N. Pitcher St., Kalamazoo, Mich.



**MATCHED PRECISION TOOLWORKING AND**

# IT'S GREAT TO BE REGULAR



## ALL-VEGETABLE Makes the Difference

Thousands of modern men and women in all parts of America have turned to Nature's Remedy, NR Tablets for dependable, yet gentle relief, when a laxative is needed. They know that the all-vegetable idea is so right. They find an NR at night produces thorough morning regularity with no perturbing effects. It's so kind to the system.

Try NR at our expense. 25 tablets only 25c. Buy a box at any drug store. Try them. If not completely satisfied, return box with unused tablets to us. We will refund your money plus postage.

# NR

*Nature's Remedy*  
NR-TABLETS-NR

## GEARED TOOLS FOR THIS ATOMIC AGE

.. Are Saving USERS \$s - Energy Making BIG MONEY for AGENTS ..

.. Eifel-Line Super-Tools with the Amazing 4X, EXPANDO-Jaw



The NEW '4X' Jaw

Above Composite Cut shows 2 Positions.  
• The Exclusive Parallel EXPANSION Grip has countless new uses.



- A 3-Jaw, 7" Plierench KIT and
- 8 1/2" PRIME and MASTER KITS with 3 to 8 Jaws, etc.: Universal, Pipe, Wire; for a Million Sizes 0"-1 3/4", and
- GIANT UNIV., '4X' and PIPE Jaws (Range 1" to 3"):
- Tub'g Ctr., Grip-Clamp, etc. . . 1-Oz. to 1-TON grips! . . . Do Thousands of Jobs, Quicker, Better and Easier.
- 8 1/2" Items FIT EIFEL-GEARED Plierenches . . . '33 and later. Sold SINGLY or in ANY Combination.

OUTSIDE GRIP 0" TO 3"  
EXPANDING GRIP 1/2" TO 2 1/4"

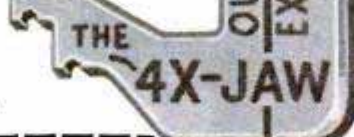

Most Amazing Pricetool Facts Ever

1) The DUPON TODAY . . . PART-TITCARD WILL DO . . . FULL-T . . .  
2) Get FREE MANUAL-M, CATALOG-C, marked USER   
3) Also FREE (in U.S.A.) this 3", 6-Edge, End-and-Angle Screwdriver, etc. . . . often more Valuable, Useful than a Pocketknife!



FREE OPENER

300

AMERICAN CORP'N  
4611 N. RAEBUTOR AVE., CHICAGO 40, ILL. PM-04

# HOW TO SHARPEN CIRCULAR SAWS YOURSELF

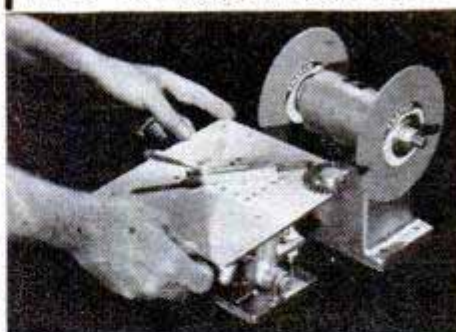

Also Many Carbide Tip Tools And Cutters

This all-purpose, practical circular sharpening fixture is the ultimate in simplicity. Easiest, fastest sharpening method available. Precision built for precision sharpening.

Now, you can keep your saws and tools always sharp for cleaner cuts. Sharpening is a business opportunity, too.

Send check or money order . . . money-back guarantee . . . nothing to lose . . . shipped prepaid with complete operating instructions

MODEL 135 (illustrated above) only \$29.95 for 1 1/2" to 12" diameter saws and cutters.

MODEL 160 only \$49.50 for 1 1/2" to 16" diameter saws and cutters.

(Tables on above models tilt either side to sharpen angular faces.)

MODEL 280 EX only \$8.95 for 7" to 8" diameter saws.

MODEL 100 EX only \$10.95 for 7" to 10" diameter saws.

MODEL 130 EX only \$17.50 for 2" to 12" diameter saws.

MODEL 550 Swivel Vise graduated to 180° only \$9.95.

Grinder stand and grinding wheels not included in price of fixture.

MODEL 300A Dust Proof Ball Bearing Grinding Wheel Stand with 30" x 1/2" Belt \$15.95 (illustrated above). Cast Aluminum

Guards only \$6.50 a pair. 2 Grinding Wheels \$5.00 extra.

MODEL 600 Saw Swedge only \$9.95.

TREYCO PRODUCTS

262 Hartford Ave. Dept. PM-4 Buffalo 23, N. Y.

## Make Personalized HOUSE, LAWN MARKERS For Fun Or Profit



17 new silhouette cutouts (3 shown plus 14 other novel designs) complete alphabet and numbers, ready to trace onto wood. Sawing is easy. Marker with name or address is distinctive personalized gift or addition to your own home. Make markers for fun and to sell.

Set of 17 full-size, ready-to-use patterns, alphabet, numbers, only \$1.00, postpaid. Money Back Guarantee.

Clip This Ad and Mail With DOLLAR BILL or Check TODAY Dept. P-162, Chicago 5, Ill. 1321 S. Michigan Ave.

## POWER HACKSAW \$47.25

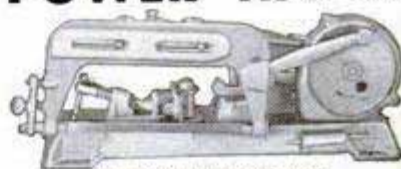

LESS MOTOR F. O. B. Benton Harbor

• Rugged cast iron construction. Wt. 56 lbs. bronze bearings. Draw cut. Auto. return lift. Auto. shut-off. Vise swivels 45°. Cap. 4"x4".

Send for full details and name of nearest dealer.

EXCEL MACHINE TOOLS BENTON HARBOR, MICHIGAN Dept. PM-40



Seen the NEW Crosman CO2 PISTOL & RIFLE?



They're sensational . . . a revolutionary, new idea in "power without powder" guns that is sweeping the country. Ask your Crosman dealer to demonstrate their many exclusive features. Write for literature.

Crosman Arms Co., Inc. • Rochester 7, N. Y.

## BUILD YOUR OWN POWER LAWN MOWER

WHY BREAK YOUR BACK MOWING FIELD OR LAWN?

WRITE FOR FREE Building Instructions The Rite-Way Mower Attachment Ball Bearing

SAVE MONEY SAVE TIME

Now anyone can save time and effort mowing field or lawn by building their own whirl type power mower. Build according to your own ideas and needs at small cost. Cut close to fences, walks, buildings, etc. Build in short time with parts and instructions we furnish. Save hours of time and back breaking labor.

WRITE TODAY FOR FREE INFORMATION

T & H MFG. CO., Dept. MP8-4 811 E. 31, Kan. City 3, Mo.



# 101 HANDY HOME USES



**BEAUTIFIES**  
natural wood,  
pine paneling

**POLISHES**  
furniture,  
woodwork



**PROTECTS**  
wood and  
metal surfaces



**IMPROVES**  
paint jobs

**89¢ QUART**  
49¢ PINT



**EASY!**  
**QUICK!**  
**ECONOMICAL!**

Has more than 101 practical home uses. Available at all stores.

Write for free folder.



**ARCHER-DANIELS-MIDLAND COMPANY**  
MINNEAPOLIS 2, MINNESOTA

**YES!**

**SEAMAN ROTARY TILLAGE**

pays on as few  
as 10 acres!

WITH THE

**SEAMAN HEAVY DUTY ROTARY TILLIT**

Pays big, on 10 acres — on up, with wheel tractors of 20 H.P. on up ... New SEAMAN TILLIT brings medium, fine or coarse tith as best for soil or crop • saves labor • builds humus • revitalizes old pastures.\*

Built to take hard punishment ... extra heavy gears ... friction clutches protect tines from rock, prevent excessive wear ... Write for full information.

\*Profitable uses for Seaman Tillage ... shown in this FREE BOOK "Benefits of ROTARY TILLAGE." Write.

Tills path 3 ft. wide track. Depth can untill soil, leaf



**SEAMAN MOTORS, INC.**

364 N. 25th Street  
Milwaukee 3, Wis.

ONLY \$4



**ATTENTION SHOPMEN!**  
*Power-Flex*  
**GETS MORE WORK DONE**

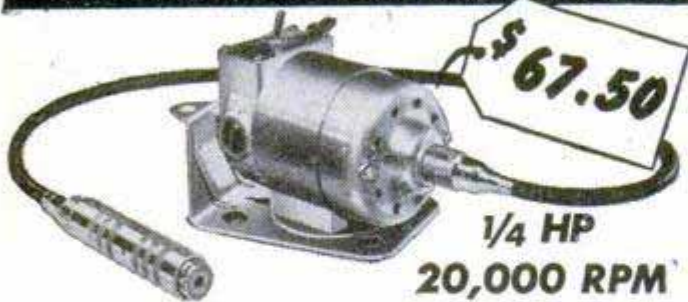

**1/4 HP  
20,000 RPM**

**GRIND—BURR—FILE—SAND—ETC.**

Watch your output increase when you put the power plant on the bench and hold the light-weight, smooth-running handpiece in your hand. With the Power-Flex you get a popularly-priced, "full shift" production tool with all these advantages:

- Handles carbide cutters
- Gives finger tip control
- Handles all 1/4 and 1/8" mounted accessories
- Decreases work fatigue
- Gets in those tight places
- Leaves both hands free to work
- Ideal for women operators

Dumore Power-Flexes are job-tested... hundreds in use. See this flexible-shaft power house today at your Industrial Distributor or write

*Write today*  
DF-2

**THE DUMORE COMPANY**  
DEPT. D-74 RACINE, WIS.

**NEW Cyclo-Junior HAND DUSTER**  
Employs New "CYCLONE" PRINCIPLE  
for easier more efficient dusting



PRICE  
**\$2800**  
Less 2% F. O. B.  
Middleport  
Send check or  
money order

To better protect the things you grow from insects and plant diseases, buy the new **CYCLO-JUNIOR** today. It employs a new principle—use of an unusually large volume of air at low velocity. Result: a powerful air blast assuring thorough distribution of dust materials. Power is provided by an effortless hand-cranking operation. Rotating fan case permits dusting up or down, forward or back. Comfortable wide-web harness supports duster.

**MULTIPLE USES**—medium-sized fruit trees, vegetables and other crops, shade trees, shrubs, flowers. The **CYCLO-JUNIOR** is Niagara's latest development—the result of 46 years of experience in manufacturing orchard and crop dusters, fungicides and insecticides.

**FREE LITERATURE.** Write for special dust and spray guide.



**Niagara**  
CHEMICAL DIVISION



**ROD MACHINERY AND CHEMICAL CORPORATION**  
Street Middleport, New York



**CROSLEY**  
**CUTS ALL**  
**1950**  
**PRICES!**

Now, get U. S. manufacturing know-how in the new lower-priced Crosley cars. Station Wagon cut \$105! Big price reduction on ALL models. And you get MORE—hundreds of improvements, including Hydradisc (airplane type hydraulic) Brakes and Crosley engine with rugged cast iron block—8-to-1 compression ratio. See, drive the newest Crosley Station Wagon. All steel. Seats 4, or 2 with 1/4 ton load. Gives you 35 to 50 miles on a gallon of regular gasoline, plus all new-car economies and safety features! Dealers and driver agents wanted!



**FREE!** Just out! 1950 **CROSLEY CATALOG.** Write Crosley Motors, Inc., 2530-HQ, Spring Grove Ave., Cincinnati 14, Ohio.

**CROSLEY** a FINE CAR "You see them everywhere!"

**Jiffy electric paint SPRAYER**

A Plastic head with vibrator motor  
B Easy control nozzle  
C Comfort-grip handle  
D Push button switch  
E Syphon tube  
F Replaceable mason jar  
G 8 foot flannel covered cord  
H Special free nozzle for small areas

**ONLY \$8.95** Orders shipped day received... PRE-PAID. If not completely satisfied, full purchase price will be refunded. Send check or money order, save C.O.D. charges. WRITE FOR FREE CATALOG FOLDER.

**ROBIN-PAIGE CO.** DEPT. 77B, P.O. Box 608, Richmond 5, Va.

**DRAINS CELLARS, WASH TRAYS**  
**CIRCULATES OIL**

Pumps 1800 GPH 300 gal.  
30' high, use 1/8 to 1/2 HP **\$6.50**  
motor. Will not clog.

Postpaid if cash with order.  
(Add 50c for west of the Mississippi.)  
Thousands in use since 1936  
**LABAWCO PUMPS, BELLE MEAD 7, N. J.**

**KINKADE GARDEN TRACTOR**  
and Power Lawnmower

A Practical Power Plow and Cultivator for Suburbanites, Gardeners, Florists, Estates, Fruit, Nursery & Poultrymen.

**Easy Terms - Write Today**  
**American Farm Machine Co.**  
1058 33rd Ave. S. E. Minneapolis, Minn.

**Catalog Free**

**Own a \$25 CUSTOM FLY ROD**

Now you can own the fine custom fly rod you've always wanted. Build it yourself—easily, quickly—from complete materials furnished you by H-I at a fraction of the cost of an assembled rod.

**only \$7.95** POSTPAID

**HERE'S WHAT YOU GET**



Everything you need to build a quality fly rod: Butt, middle and two tip sections of finest, top grade, seasoned Tonkin bamboo, flame tempered; glued ready for mounting. Locking reel seat and shaped cork grip. Fitted ferrules of nickel silver. Hardened steel guides. Pear shaped steel tip tops. Two spools of nylon winding. Jar of special rod varnish. Stick of ferrule cement. Cloth carrying bag. Complete directions. ALL for only \$7.95 postpaid. Satisfaction guaranteed. See your dealer or send check or money order (no C.O.D. please) direct to Dept. 22, Horrocks-Ibbotson Co., Utica, New York, manufacturers of the world's largest line of fishing tackle.



## EVERY ELECTRIC DRILL A PORTABLE SAW

*Just try it! You won't use a hand saw anymore*

**Fits Any 1/4", 5/16", 3/8" Electric Drill**



**Patent Pending**  
**ARCO**

"ARCO-SAW" is a rugged precision woodcutting tool with right angle gear drive. (No clumsy direct drive with drill sideways or makeshift gear box.) Works like high priced Portable Saw. Safety Yoke connects drill and saw. Absolutely Safe.

**Cuts 1-3/16", 2 x 4 By Turning Over**

**Only ARCO-SAW Gives You All These Features:**

1. CAN BE USED WITH ONE HAND.
2. BIG HANDLE affords firm grip for two hand operation.
3. PRECISION ONE PIECE GREASE-PACKED GEAR BOX.
4. SELF LUBRICATING LIFETIME BEARINGS.
5. ABSOLUTE SQUARE CUTS.
6. FULL VIEW OF CUTTING POINT guarantees precision work.
7. GENUINE ARCO "HYCARBON" 4" BLADE cuts cleaner and faster.
8. 90-DAY FACTORY GUARANTEE, backed by manufacturer of ARCO Precision Tools.

Extra Crosscut Blade, will Rip & Mitre, \$1.60  
ORDER TODAY at your dealer or send us check or M.O. (Postpaid). C.O.D.'s—postage extra.  
DEALERS: Write for name of nearest jobber.  
**UNCONDITIONAL 10-DAY MONEY BACK GUARANTEE**

Manufactured By—  
**ARROW METAL PRODUCTS CO.**  
Dept. PM4, 140 West Broadway, N.Y. 13, N.Y.

# Screen costs are SLIGHT



# with LUMITE saran screening!

because it's...

- \* RUSTPROOF** Guaranteed never to rust, rot or mildew... unaffected by salt air or smoke, rain, snow or industrial fumes! It's the ideal screening for every exterior use.
- \* STAINPROOF** Lumite is guaranteed stainproof because it's rustproof. It never needs protective painting. It cleans easily.
- \* LASTS AND LASTS** Lumite offers long range economy... costs only 11½ to 12¢ a square foot... when adequately framed gives years of trouble-free screen protection! Sold by hardware, lumber, and building supply dealers.

# LUMITE<sup>®</sup> SARAN SCREENING

\*Registered Trade-mark

**SEND FOR FREE SAMPLE TODAY**

**LUMITE DIVISION,**  
Chicopee Manufacturing Corp. of Ga.  
40 Worth Street, New York 13, N. Y.

Please send me information and FREE sample of Lumite Screening.

Name.....  
Address.....  
City.....Zone.....State.....

## WAR EQUIPMENT MAIL SALE!

**Buy Direct By Mail — SAVE**  
SAVE 50% to 75% on gigantic closeout sale of 100s of guaranteed items. All shipping charges prepaid.

- A Utility Clutch, up to 6.5 h.p. \$13.95
- B Magneto Rural Telephones... 12.40
- E City Wall or Desk Phones... 4.99
- \* Burglar Alarm System... 6.99
- \* Aqua Centrifugal Pump... 6.49
- \* Power Winch cap. 5000 lbs... 21.95
- \* New Briggs 3.5 h.p. engines... 75.50
- \* New Engine Driven Compressor 99.50
- \* Multi-speed 110-v. 60-c Motor 8.75

\* Electric Chain Saw \$94.50

Order direct from ad. Satisfaction guaranteed. Or, rush card for sensational mail-sale catalog. Doz. electronic, mechanical bargains.

**BURDEN SALES COMPANY** WE PAY  
806 "O" ST. LINCOLN, NEBR. ALL FREIGHT

## GENUINE DIAMOND SCRIBER!



**\$2.00** Postpaid  
Writes on glass, metals, plastics. Hex. Aluminum 6". Money back guarantee. Agent inquiries invited.

**CLIPPER DIAMOND TOOL CO., INC.** 21-B W. 46 ST., N.Y. 19

## WAR SURPLUS

Below are just a few of the many items we have in stock at sensationally low prices.

Pumps	Extension cords	LIGHT PLANTS, ALL SIZES
Grinders	V pulleys	GAS OR DIESEL
Air compressors	All size light plants	Briggs and Stratton Marine engine 2½ H.P. \$72
Air tanks	Generators	1 H.P. gas engine Power Prod. MFY. \$29.50
Spray outfits	Fire pumps	

**A TERRIFIC BUY!  
GAS ENGINES**

Briggs & Stratton NEW in original crates. Model AP 1¼ to 2½ HP. List Price \$102. Your Price... \$54.50  
Model ZZP with pulley. 3 to 7 HP. List Price \$141. Your Price... \$89.50

Write TODAY for our free catalog listing thousands of MONEY SAVING bargains.

**C & H ELECTRIC Co.**  
434 W. JUNEAU AVE.  
MILWAUKEE 3, WISCONSIN

# BUILD YOUR OWN TILTING ARBOR SAW!

## Exclusive GIL-BILT Build-It-Yourself Features

- No machining—built easily with hand tools only
- No blueprint reading—step-by-step pictorial plans, full scale patterns, actual photographs
- Sturdy wood, aluminum, and steel construction
- Capacity and performance of commercial saws selling for \$60 and up

SAVE  
**\$50**  
OR MORE

## GIL-BILT 10-INCH TILTING ARBOR SAW



- 27x28 in. table, 13 1/2 in. capacity in front of blade
- 10 in. blade cuts 3/4 in. deep, tilts full 45 degrees
- Floor model 34" high, table always stays level
- New Departure ball bearing arbor, 3/4" precision shaft turned down for 5/8" bore blades, alum. housing, shipped ready to run
- Jackscrew and 4 1/2 in. dia. handwheel lowers and raises blade
- Cast aluminum miter gauge and self-aligning rip fence guide

GIL-BILT Metal Parts Kit includes Plans, ball bearing arbor, miter gauge and bar, rip fence guide, dado insert, lock knobs, jack screw mechanism and handwheel, and all other metal parts (less blade)..... **\$20.95**  
Same Kit with 10" Combination Blade **\$24.90**  
Same Kit with 8" Combination Blade **\$23.90**

## GIL-BILT 8-INCH TILTING TABLE SAW

- 21x27 in. table tilts full 45 degrees, 13 in. capacity in front of blade
- 8 in. blade cuts from 0 to 2 1/2 inches
- New Departure ball bearing arbor, 3/4" precision shaft turned down for 1/2" bore blades, alum. housing, ready to run
- Cast aluminum miter gauge and self-aligning rip fence guide (same as above)



GIL-BILT Metal Parts Kit includes Plans, Ball Bearing Arbor, Miter Gauge and Bar, Rip Fence Guide, Machined Lock Knobs, Tilt Support Segments and All Other Metal Parts (less blade)..... **\$15.95**  
Same Kit with 8" Combination Blade..... **\$18.90**

## GIL-BILT 12-INCH BAND SAW



- Cuts to center of 24 inch circle
- Handles stock up to 6 inch thick
- 18x18 inch table tilts 45 degrees
- Lower wheel and drive pulley runs on sealed New Departure Ball Bearings; Upper wheel runs on two 5/8" bore Oilite Bronze bearings.
- Upper wheel tension and tilt mechanism of cast aluminum, completely assembled.
- Upper and lower blade guides. Each has ball thrust bearing, self-lub bronze jaws
- Rubber tired wheels. Choice of cast aluminum or make-your-own wood wheels on metal hubs.
- Uses standard 78 inch blades up to 3/8 in. wide.
- Fully enclosed mechanism for utmost safety.

GIL-BILT Metal Parts Kit includes Plans, rubber tires, 1/4 inch blade, hubs for wood wheels, ball bearing spindle, tilt mechanism, guides, table tilt segments and all other metal parts..... **\$16.95**  
Same Kit with two machined ready-to-install 12" cast aluminum wheels..... **\$20.95**

NO DEALERS—ONE LOW FACTORY PRICE! Return Kits in 10 days for refund if not satisfied. Prices include postage within 600 miles. Over 600 miles add 5%. Send cash check, or money order for parts kit, or send \$1.00 for Step-by-Step Plans and order kit later less cost of Plans. Plans sent postpaid anywhere in the world.

## GILLIOM POWER TOOLS

P. O. Box 1-PD, Lambert Field, St. Louis 21, Missouri

COMPLETE  
PLANS  
only  
**\$1.00**  
EACH

# TRACTOR - DRIVEN WELDER

To be mounted on tractor and driven from belt pulley. 250 amp. D. C. continuous-duty type, fan-cooled welder equipped with dial amperage adjustment, 0-300 ammeter, low heat tap. Furnished with mounting bracket to fit your particular make tractor, combine, jeep or engine. . . . Complete with highest quality accessories, helmet, triple-V pulley, belts, two 20-ft. cables, electrode holder, ground clamp, 10 lbs. of 1/4" to 1/8" electrodes. \$147.50 complete. 10-day trial, 1-year guarantee. Dealer inquiries invited.



HADDICAN MFG. CO.  
SANTANTA, KANSAS

## Say You Saw It in POPULAR MECHANICS



## INCREASE YOUR BUSINESS and SOCIAL PRESTIGE

Yes—you too can write like this and improve your business ability and chances for advancement. Just a few minutes a day is all it takes to become an expert penman using C. P. Zaner's **Ornamental Penmanship**—96 pages of instructions, diagrams and illustrations that show how to improve your writing. Send in for your copy of **Ornamental Penmanship** today and begin improving your writing and increasing your business and social prestige. Quantity limited. **\$1.50.**

POPULAR MECHANICS PRESS, 200 E. Ontario St., Chicago 11, Ill.

Got an Idea? An Inventive Mind? . . .  
Want to Cash In on It? . . .

THEN GET

CLOTH  
BINDING  
**\$2.50**

**MONEY  
from IDEAS**

**MONEY FROM IDEAS** by Myron P. Laughlin, is a down to earth, informative and useful book for every man with an active, inventive mind, who believes he has ideas that can be patented.

Get this book to determine what inventions are needed for today's market, and how to go about inventing them; how to get a patent, protect it, sell it and make money out of it.

144 pages, well illustrated, indexed, and contains an appendix of patent forms, most valuable for the sale, assignment or licensing of patents.

### Vital, Informative and Practical Help!

Inventions and How They Are Patented—What Inventions Can Do For You—The Growth of an Idea—Let Others Experience Guide You—An Invention, How It Was Developed—An Invention, How It Was Protected—An Invention, How It Paid Its Way in the World—How to Make Money From Inventions—Invention is a Business—Specialization—Sources of Information, A Where-to-Find-It Index—Records of Progress—Development Work—Starting a Business—Selling Patent Rights—Selecting a Patent Attorney—Patent Forms—Form of Assignment and Royalty Agreement—Form of License—Helpful Books.

Order from  
POPULAR MECHANICS PRESS



## 5 YEAR WRITTEN GUARANTEE BULOVA 15 JEWEL

ORIGINALLY SOLD  
AS HIGH AS

**\$59.50**

- Also Choice of
- BENRUS
  - WALTHAM
  - or ELGIN WATCHES



CHOICE  
**\$16.95**

Genuine Bulova, Benrus, Waltham, Elgin and other famous wrist watches in latest style Yellow Gold Cases. You get these unredeemed 5 year guaranteed lifetime quality famous make watches at truly enormous savings because we bought out SURPLUS STOCKS of leading New York and Maryland Jewelers. Order now, while they last. State make preferred. Order men's or Ladies'.

**TRIAL OFFER! WEAR AT OUR RISK! Money Back in 5 Days If Not Delighted! SEND ONLY \$1 down payment with order. Pay balance to postman on arrival, plus postage. Or we pay postage if you enclose \$16.95, plus \$1.70 tax. Handsome expansion band included with prepaid orders. Order now.**

**MARYLAND DISTRIBUTORS, Dept. 68**  
501 E. Baltimore St., Baltimore 2, Md.

**FREE FOLDER:** America's best Watch and Diamond Ring Values. Practically Wholesale Prices to User Direct.

ONLY  
**\$16.95**  
Plus \$1.70  
Tax

15 or 17 Jewel  
Wrist Watch  
Waterproof,  
Shockproof  
with Swiss precision  
movement. Originally  
**\$30.**  
Our Price Now  
**\$9.95**  
plus \$1 tax.

**COMPARE THESE SURPLUS Closeouts!**

**AIR COMPRESSORS**

Lowest-Ever Closeout Price!

**WESTINGHOUSE**

Reg. \$60.50 **1850**  
Model T-1 Complete

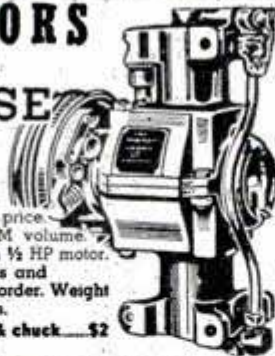

Brand New Surplus Special at an amazing low price. Westinghouse Double-piston type, 6.54 CFM volume. Mounts on truck or car engine—or operate with 1/2 HP motor. For farm, home, industry, painters. Instructions and spare parts kit included. Send check or money order. Weight 26 lbs. We carry a complete line of spare parts.

**AIR HOSE**—to fit, 25-ft. length with fittings & chuck...\$2

Only Surplus Dealer with full line genuine parts

**Gov't Surplus Pneumatic Tools**

**All Guaranteed Like N-E-W AIR GRINDERS**

For filing, grinding, sanding, buffing, polishing wire brushes, burrs, etc. All complete with Jacobs Collet Chuck, variable speed regulators, automatic oilers.



1/4" Collet Chuck  
2" Wheel Capacity

\$115.00 List Price **ONLY \$14.85**

3/8"—1/4" Collet Chuck  
3/8"—1 1/2" Wheel Capacity

\$65.00 List Price **ONLY \$8.50**

for any of the following:

- Ingersoll-Rand Size 0
- Thor Model 00D
- Thor Model 10-18
- Aro Model 221
- Rotor Model 9006
- Master Model 20

for any of the following:

- Ingersoll-Rand Size 00
- Thor Bantam
- Aro—Turbine Grinder
- Kipp Model H
- Kipp Model BB
- MB Model SS-SR

These basic power units will take other attachments for additional uses. Large Grinders on request.

**CHICAGO PNEUMATIC Riveters & Chipping Hammers**



For chipping, riveting, hammering, peening, auto body work, concrete breaking, etc.

USN 16-Pc. Rivet Set for Riveters; \$15 val. \$2.85

CP3X—Pistol Grip with air control. 1/2" Bore, 3" Stroke. \$8.50  
Wt., 6 lbs. \$80 list price



CP4X—1/2" Bore, 4" Stroke...\$10.50  
CP9X—3/4" Bore, 4" Stroke...\$12.85

CP-351—Compression Riveter with Alligator or C-type yoke. 6,000 lb. squeeze force...\$255.00 list price, **\$19.50**

**SCREW DRIVERS** Ingersoll Rand No. 0N **\$110.00** list price **only \$15**

**AUTOMATIC PRESSURE SWITCH**



"Cutler-Hammer" Double Pole set at 110 to 150 lbs. pressure. Built-in overload protection for motor. Wt. 4 lbs. **ONLY \$6.50**

**WILLARD WET PLATE BATTERY**

This extra long life rechargable battery is ideal for mobile units, portable radios, bell circuits, alarm systems, rural telephones, etc. 2V 20 Amps. 5" high. Visible ball float hydrometer built in Lucite case. Shipped dry. Any battery service will supply standard battery electrolyte. Used singly or in multiples. Wt. 4 lb. All new, \$14.50 list price, **\$2.75**



All prices FOB Pittsburgh, Pa. Send check or Money Order. One-third deposit required on COD orders.

**NATIONAL ARMY STORES**  
200 SMITHFIELD ST. DEPT. M—PGH. 22, PA.

**5 reasons why good craftsmen prefer the Walworth**

**GENUINE Stillson**



1. It's zinc plated
2. It's perfectly balanced
3. It has the latest metallurgical improvements
4. It is low priced
5. It has been the standard of quality for farm . . . home . . . and industrial use since 1869

Get a Walworth *Genuine Stillson* . . . feel its balance . . . check its teeth . . . and find out why hobbyists and workmen all over America sing the praises of the Walworth *Genuine Stillson*. Order your *Genuine Stillson Wrench* from your local hardware store, today.

*No shop is complete without Genuine Stillson Wrenches*

— The Stillson Diamond Trademark identifies the Walworth *Genuine Stillson*

**WALWORTH**

New York, N. Y.

VALVES . . . PIPE FITTINGS . . . WRENCHES

**MILL IT  
ON YOUR LATHE**



WITH A **PALMGREN**

**MILLING ATTACHMENT**

**Convert Lathe in 10 Seconds**

Now — you can do milling, slotting, grinding, grooving, squaring shafts, sawing at angles, and many other important operations on your lathe. PALMGREN MILLING ATTACHMENT is a necessary fixture for small shops, schools and emergency work in large plants. Fits South Bend, Atlas, Craftsman, Logan, Sheldon and all other makes. It has graduation for rotary angle adjustments, also graduated feed and adjustment screw. Easily mounted by straddling lathe's regular tool post. Try one—it will quickly pay for itself.



**IMMEDIATE DELIVERY**

Nos.	Width Jaws	Depth Jaws	Jaws Open	Weight Pounds	Base Opening	Price F.O.B. Factory
150	1 1/2"	1"	1 3/4"	6 1/2	1"	\$18.75
250	2 1/2"	1-7/16"	2 1/2"	11	1 1/4"	24.75
400	4"	1 1/2"	4"	25	2"	39.75

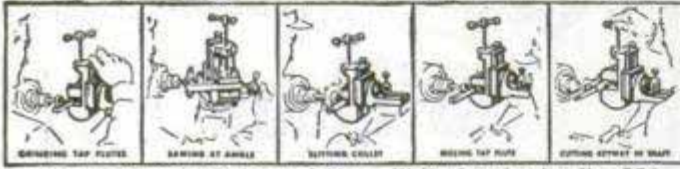

Order from your dealer or jobber. Write for circular No. 354

**CHICAGO TOOL AND ENGINEERING CO.**

Mfrs. of PALMGREN PRODUCTS for Over 25 Years

8365 South Chicago Avenue Chicago 17, Illinois

**Better, Easier, Quicker  
GROOVE CUTTING or  
CABINET-MAKING**

with *Warren* DADO SAWING WASHERS

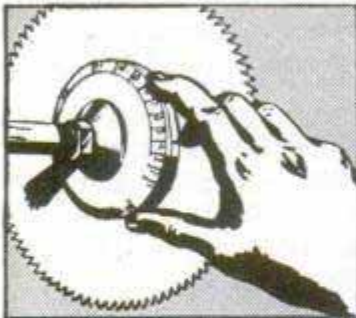

*Just dial*  
**DESIRED CUT**

Cut accurate, parallel grooves—any width, any angle. Just dial desired width with Micromatic adjustment. Cuts smooth

and clean—no burning or chewing to mar fine wood. Just four simple washers. Available in 5 sizes—1/2", 3/4", 5/8", 1", 1 1/8". Free booklet on request. See your dealer or write direct. Absolutely guaranteed! In Canada, send money order for \$4.95 (duty and sales tax extra).

**\$4.95  
A SET**

Dealers, Jobbers, Write for Information!

**WARREN DADO SAWING WASHERS CO.**

70 Medbury, Dept. 24, Detroit 2, Michigan

**LOOK AT THESE VALUE FEATURES**

**1 HP. EMERSON REPULSION INDUCTION**  
3450 R.P.M. 110/220, 60 Cy  
1 Ph.  
**EXTRA HEAVY DUTY—NEW MOTORS**  
250% Overload Cap.  
LATEST DESIGN  
Wgt. 63#  
SPLASH PROOF  
EASILY REVERSED \$37.50 Fob. Chgo.



NEW, heavy duty repulsion induction 1 H.P., 3450 RPM, 110/220 V, 60 Cy., 1 Ph., A.C. motor for shapers, planers, circular saws, etc. EH-1 LOW PRICED AT \$37.50 Fob. Chicago.  
NEW 3/4 H.P. Wagner repulsion induction, 3450 RPM, 110/220-V, 60 Cy., 1 Ph., A.C., 5/8" shaft... #WH-7... Only \$29.75 Fob. Chicago.  
NEW 1/2 H.P. Wagner induction type, 3450 RPM, 110 volt, 60 cycle, 1 Ph., A.C., 5/8" shaft... #WH-5... Only \$19.75 Fob. Chicago.  
NEW 1/2 H.P. Delco induction type, 3450 RPM, 110 volt, 60 cycle, 1 Ph., A.C., double shaft 1/2" x 7/8"... #DDH-5... Only \$21.75 Fob. Chgo.  
WORKSHOP MOTOR... 1/2 H.P. Leland, Delco, Westinghouse, Sunbeam and others. Induction type motors. A.C. 110 volt, 60 cycle single Ph., 1725 RPM. Like new. Fully Guaranteed... #S-1... Only \$6.50 Fob. Chgo.  
WRITE FOR BARGAIN MOTOR CIRCULAR AND SAVE MONEY. We have large stock of Standard & Special Motors; all sizes.  
C. MARSHALL SALES, 3546 W. Fullerton Av., Dept. P-4, CHICAGO 47



**\$87.50  
LESS  
MOTOR**

**HEAVY DUTY, PRODUCTION  
SWING SAW**  
NATIONALLY KNOWN

Just the tool for contractors, lumber yards, shipping rooms, etc. Cross-cuts, miters, rips and dados. Swivels 0° to 90° right or left. 4" depth of cut with 12" blade, 10" blade supplied. Ball bearing arbor lubricated for life. Portable—wt. 115 lbs. Order today! 1/3 cash with order, balance C.O.D.

**IMMEDIATE DELIVERY!**

LEWIS MACHINE TOOL CO., Dept. M, 3217 Union Pacific Ave., Los Angeles 23, Calif.

**MONEY  
BACK  
GUAR.**



**7x50 PRISM BINOCULARS**  
PRECISION OPTICS—BRAND NEW

**\$36\***

**6x50 ACHROMATIC  
FIELD GLASSES  
\$16\***

+20% Federal Tax

Send for Free Catalog of Binoculars, Telescopes and Microscopes

**BROWNSCOPE CO.**

Dept. 4M, 24 W. 45th St. New York 19, N. Y.



**BRONZE FOUNDRY**

Schools and Home Workshops  
Make your own castings of aluminum, copper, bronze, silver. Foundry sets are available in three sizes including 2400 Deg. F. blast Furnaces. \$22.50; \$29.50; and \$42.00. f.o.b. Kansas City. Free Circular.

KANSAS CITY SPECIALTIES CO. P. O. BOX 6022, DEPT. P-3 KANSAS CITY, MO.

**ANSWER TO SHOPMAN'S PRAYER**

**Revolutionary One-Piece Neg'ator Clamp**

Made from new type spring described in leading engineering journals. Use it to grip parts during gluing, welding or brazing; to string wires and cords; to hold articles upright. Constant clamping pressures from 5 ounces to 18 lbs. Automatically takes up. Has enormous expandability, flexibility of fit.

Send \$3.00 for Kit of 11 Different Clamps

Dept. P. M.  
**HUNTER SPRING CO.**  
Lansdale, Pennsylvania

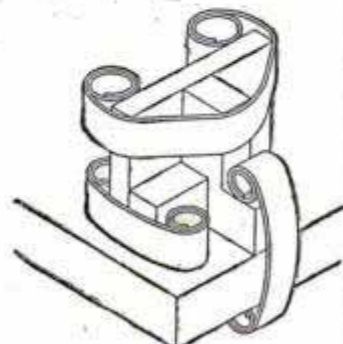

The Clamp of 1001 Uses



PUT THIS NEW

**WHIZZER MOTOR**

ON YOUR BIKE

*3 big horsepower*

4-Cycle — 138 c.c.

40 Miles an Hour

Up to 100 Miles per Gallon

Motorize your bike with America's famous Whizzer motor, and get the thrill of real riding pleasure—no more pedalling! Packed with power, precision-built, air-cooled. It's thrifty, it's rugged, it's America's finest bike motor. Fits any adult-sized bike.

MOTOR COMPLETE

**\$109<sup>97</sup>**

F.O.B. Pontiac

*Ride One and You'll Buy One!*

**ALSO SEE THE WHIZZER "SPORTSMAN" • A NEW MOTORBIKE!**

Whizzer's new star of the lightweights! Powered by Whizzer's 3 h.p. motor! A complete motorbike with 2-speed transmission, automatic shift, kick starter, auto-type brakes, many other

features! See, ride, buy the great, new Whizzer Sportsman. \$239.50 plus tax F. O. B. Pontiac. Ask your dealer *today* about liberal trade-in, easy payments.

WHIZZER MOTOR COMPANY, 302 S. SANFORD, PONTIAC 20, MICHIGAN

**ADD LIFE**



**PROTECT YOUR  
DOWNSPOUTS and  
GUTTERS**

Here's an inexpensive way to add years of life to downspouts and gutters—keep them bright and attractive.

FREE BOOK TELLS HOW—Send for free copy of "Paint It Bright"—the 24-page book full of helpful painting hints. And remember, there is a difference in aluminum paints, Downspouts and gutters, for example, call for Aluminum Metal & Masonry Paint. It's available from the dealer who displays the Alcoa Symbol of quality on the brand he sells.

MAIL THIS COUPON

Paint Service Bureau, ALUMINUM COMPANY OF AMERICA,  
1718D Gulf Building, Pittsburgh 19, Pa.  
Please send me free copy of "Paint It Bright".

Name (please print) \_\_\_\_\_

Address or RFD No. \_\_\_\_\_

City \_\_\_\_\_ State \_\_\_\_\_

I want to paint the following: \_\_\_\_\_



Experts tell in "Paint It Bright" how to obtain best painting results with aluminum paints. For free copy, mail coupon.



Look for  this shield on aluminum paints made by many paint manufacturers using **ALCOA PIGMENTS**



**CALLING ALL CARS...**

## SAV-A BATTERY

Three transparent plastic caps feed water as needed into your battery. You can see at a glance when more water is required.

- Prevents battery from running dry.
- Shows if battery is using too much water and voltage regulator needs adjustment.
- Ensures maximum life of a battery.
- Easily attached — just screw 'em in.
- Pays for itself over and over.
- May save the price of a new battery generator or points.
- Protects clothes from spilled battery acid.

Every car owner should have  
**SAV-A-BATTERY**

Satisfaction Guaranteed or Money Returned. **Order Today \$1.50 set postpaid**

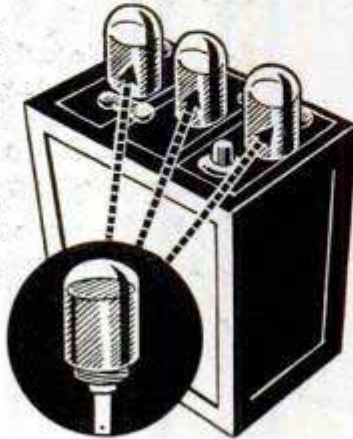

**HUMANIC BRANDS, INC., SUMMIT, NEW JERSEY**

Please send me \_\_\_\_\_ Set(s) Sav-A-Battery @ \$1.50 per set

Name of Battery \_\_\_\_\_ Size of Cap Thread \_\_\_\_\_

Name \_\_\_\_\_

Address \_\_\_\_\_

City \_\_\_\_\_ Zone \_\_\_\_\_ State \_\_\_\_\_

**TURN SPARE TIME INTO SPARE CASH**  
start your own welding business at home

**MAKE WELDED REPAIRS FOR NEIGHBORS**  
Repair Torn Fenders . . . Fix Toys . . . Braze and Solder Broken Parts . . . Charge Batteries with the

## NEW Low Priced LINCOLN ARC WELDER

- Plugs into 110 volt light socket.
- Easy to weld, cut, braze or solder.
- Approved by Underwriters Laboratories.
- Built by The Lincoln Electric Company, world leader in arc welding.



"Lincwelder 60" and accessories

PRICE ONLY  
**\$45.00**

Fill out order and mail to

The Lincoln Electric Company, Cleveland 1, Ohio.

- Ship me the "Lincwelder 60" with accessories \$45.00  
Enclosed is  check  money order
- Send me free bulletin on the new "Lincwelder 60"

Name \_\_\_\_\_

Address \_\_\_\_\_

City \_\_\_\_\_ State \_\_\_\_\_



## YOU CAN MAKE THESE WITH POPULAR MECHANICS PLANS AND BLUEPRINTS

- 501—Colonial Grandfather's Clock. 25c
- 507-508—Doll-House, 5-Rooms, Open staircase, fireplace. . . 50c
- 526—Queen Anne Coffee Table: True replica of antique. . . 25c
- 528—Duncan Phyfe Console Table: 30 in. high. . . 25c
- 529—Lawn Chair: Southern style. 25c
- 593—Three Attractive Corner Shelves: Scroll-sawed. . . 25c
- 596—Three Hanging Type Shelves: Hold books, china, etc. . . 25c
- 661—Rocking Horse: Scroll-sawed from plywood. . . 25c
- 707—12 Ft. Rowboat: Flat-bottom, four seats. . . 25c
- 795—Two Handsome Cedar Chests 25c
- 811-812—16 Ft. Canoe: Canadian type, cedar planking. . . 50c
- 813-814—Pops Outboard Racer: 10 ft. long, stepped bottom. . . 50c
- 828-835—Sovereign of the Seas: English warship model. . . \$2.00
- Sovereign of the Seas: Instruction Book. . . \$1.00
- 836—12 in. Bandsaw: Uses plywood, cuts two in. stock. . . 25c
- 839—Melrose Corner Cabinet: Old Colonial design. . . 25c
- 846-848—Governor Winthrop Desk: True copy of original. . . 75c
- 896-897—Three Easily Made Workbenches—Simplified construction. 50c
- 906-909—Midget Auto: 58 in. wheelbase, 1/2 to 3/4 h.p. . . \$1.00
- 910—Circular Saw Table: Hardwood, 24" x 36", Stationary. . . 25c
- 917—Outdoor Fireplaces: Several simple but practical. . . 25c
- 920-922—Lawn and Garden Furniture: Swings, arbors, tree seat. 75c
- 923—Indoor Fireplaces: Standard Sizes. . . 25c
- 926-927—Venetian Blinds: Three different styles. . . 50c
- 930—Hooked Rug Frame—Quilting Frame. . . 25c
- 933—Cape Cod Cupboard: 4 ft. wide, 5 ft. 8 in. high. . . 25c
- 935—Knee-Hole Desk: 40 in. long, 30 in. high, 31 1/2 in. wide. . . 25c
- 936—Modern Coffee Table: 24 in. long, 15 in. wide. . . 25c
- 952—Child's Crib in Maple. . . 25c
- 958—Colonial Corner Cupboard: 6 ft. 8 in. high. . . 25c
- 961—Hanging China Cabinet: 38 in. long, 40 in. high. . . 25c
- 969—Combined Chest and Writing Desk: 35 1/4 in. high. . . 25c
- 970—Modern Clothes Chest: Built of plywood. . . 25c
- 977—Bookcase in Chippendale Style: 47 in. high, 10 in. wide. 25c
- 978—Lawn Chair on Wheels: Lightweight, easy to wheel. . . 25c
- 981—Colonial Wall-Shelf: 30 in. high, 19 in. wide. . . 25c
- 984—Duncan-Phyfe Drop-Leaf Table: Reproduction of historic piece. 25c
- 986-987—Utility Trailers: Built of old auto parts. . . 50c
- 989-990—Speedy Motor Scooter: Gas engine, 40 to 60 miles on gal. of gas. . . 50c
- 991—Gun Cabinet: Handy cabinet includes rack for rifles. . . 25c
- 993—Twin-Deck Beds: 6 ft. 4 in. long, 31 1/2 ft. wide. . . 25c
- 1106-1112—SEACRAFT — 25 FT. CABIN CRUISER: Adaptable as sport fisher, express cruiser, or utility boat. Cruises at 15 knots with marine engine or converted auto engine. Cabin sleeps four. Galley has fresh-water tank, sink, and cook stove. Set of seven large-sized blueprints scaled 1 in. per ft. plus 40-page two-color illustrated booklet, only. . . \$10.00
- 1011—Fireplace Fittings: Andirons, log rack, etc. . . 25c
- 1080-1081—Banta: 12 Ft. Ply-wood Runabout: Vee-Bottom, 3-passenger. . . 50c
- 1086—Black Forest Corner Shelf: Scroll-sawed. . . 25c
- 1089-1090—Home-Constructed Freezing Unit: reaches 30 degree temp. . . 50c
- 1091-1096—17 ft. trailer, 7 ft. wide. Steel chassis. . . \$1.50
- 1102-1105—Midget Trailer: "Tear-drop" body. Sleeping quarters for two. . . \$1.00
- 1113-1114—Gold Rush of '47: The A.M.A. Open Class B Record Holder Plane Model. . . \$1.00

**FILL OUT AND MAIL THIS COUPON NOW**

POPULAR MECHANICS CO.  
200 E. Ontario St., Chicago 11

Please send the following plans \_\_\_\_\_

I am enclosing \$ \_\_\_\_\_

Name \_\_\_\_\_

Address \_\_\_\_\_

**OVER 448 CUBIC INCHES of planned drawer space  
MADE OF HEAVY GAUGE THROUGHOUT**



**30 COMPARTMENTS TEN DRAWERS**

The ideal cabinet for office, shop, store, laboratory, workshop, workbench, service station, garage, sewing room, kitchen, hobby shop, etc. Designed to keep your tools, small parts, nuts, bolts, screws, nails, and all other small parts at your fingertips and under the proper label.

Baked enamel finish Olive green Labelholders on each drawer. Rubber feet to prevent marring. Outside dimensions, 8"x8"x7". Inside drawer dimensions, 3-3/8" Wide, 1-3/16" High, 7-7/8" Long.

Other size cabinets available

Send for Large **FREE** Catalog  
Special price for quantity orders

Special Price For Limited Time

Ten drawer unit { # 101 Without dividers **\$4.95** } FOB Chicago  
                          { # 201 With 20 Dividers **\$5.35** }

SEND CHECK OR MONEY ORDER — SATISFACTION GUARANTEED

**AMERICAN METAL PRODUCTS**  
1018 W. 86 St. Chicago 20, Illinois

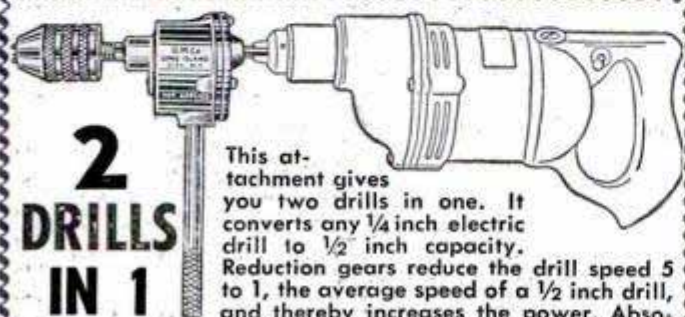

**2  
DRILLS  
IN 1**

This attachment gives you two drills in one. It converts any 1/4 inch electric drill to 1/2 inch capacity. Reduction gears reduce the drill speed 5 to 1, the average speed of a 1/2 inch drill, and thereby increases the power. Absolutely indispensable for all shop work and home craftsmen. Satisfaction guaranteed. Order yours now.

**\$11.95**  
post paid

Send check or Money Order with order. Jobbers write for special information.

**G. M. CO. MANUFACTURING, INC.**  
1308 43rd AVE. LONG ISLAND CITY 1, NEW YORK

**FLASH Your Turns**



**ELIMINATE HAND SIGNALLING  
ENJOY SAFE — COMFORTABLE  
DRIVING WITH THE  
SIMPLEX DIRECTIONAL SWITCH**

Here is a safe and comfortable way of signalling your intention to make a left or right turn. Flashes from 60 to 80 times per minute. Kits furnished with all necessary material for perfect installation. No outside mounting of any kind. Uses your present parking and tail lights. Either of our two models fit most cars from 1942 to 1949.

**A PRACTICAL GIFT FOR  
MOTORISTS!**

Specify year and make of car. Money back guarantee. Tested and Approved to meet SAE requirements.

**DEALERS INQUIRIES INVITED**

**\$8.95**  
Post-paid in U.S.  
Send check or money order. Postage extra on C.O.D.'s

**SIMPLEX SALES COMPANY** 1303 W. Jackson Blvd. Dept. MS, Chicago 7, Illinois

**BIG VALUES  
IN SMALL DIESELS**

Dollar for dollar, Witte Diesels are the best power investment you can make. They'll deliver reliable power for a few cents an hour . . . year in and year out.

Witte Diesel Power Units are offered from 4 to 12 H.P. And Witte Dieselectric Plants . . . a package unit consisting of a Witte Diesel and a direct-connected or belted constant voltage generator . . . range from 3 to 10 KVA-AC; 2.4 to 8 KW-DC.

Specify the type of unit and the horsepower or KVA you need. We'll send you the specifications, prices and the name of your Witte dealer.

**WITTE ENGINE WORKS**

Kansas City 3, Mo., U. S. A.

Division of Oil Well Supply Company



**UNITED STATES STEEL**



**Really  
a Joy  
to  
Use!**

**ATKINS**

*"Silver Steel"*

**SAWS**



**ATKINS  
Mechanic-  
Kut Circular  
Saws**



**ATKINS  
Narrow  
Band Saws**



**ATKINS  
No. 36  
Nest of Saws**



**ATKINS No. 37  
Compass Saw**



**ATKINS No. 400**

America's finest hand saw

(Shown at top)—ATKINS No. 3000 Hand Saw with Plastic Handle



Write for **FREE** Booklet—"SAW SENSE"

**E. C. ATKINS AND COMPANY**

402 South Illinois Street, Indianapolis 9, Indiana

**OF ALL FINE SAWS — THE FINEST ARE ATKINS "SILVER STEEL" SAWS  
SAY YOU SAW IT IN POPULAR MECHANICS**

# AIRCRAFT INVENTION

ROLLS YOUR CAR INTO THE AIR

## LIFTS AND LIFTS—

There is no other automobile jack like it. This Saginaw super-jack literally rolls a car into the air. Ball-bearings, rolling between the raceway-shaped threads, reduce effort through increased efficiency—give you remarkable lifting power.

## EXTRA SENSIBLE—

There's common sense in buying a Saginaw jack. Added to safety and ease of operation, there is real economy in a jack built to last for years. One good jack is worth more—costs less—than several poor ones.

## GET YOURS NOW—

See your nearest United Motors service station.



# SAGINAW Recirculating-Ball BUMPER JACK

## LASTS AND LASTS—

Tested and proved, this exclusive principle actuated bomb bay doors and wing flaps in thousands of warplanes. The heavy base is permanently attached—can't come loose. The rugged steel construction is built to outlast your car.

## EXTRA SAFE—

Won't slip, won't spin, no fluid to leak, no notches to wear. Recirculating balls hold your car where you want it. No kneeling or stretching to prop it under your car. It fits every bumper. Safety like this can mean more than money to you.

UNITED MOTORS SERVICE, DEPT. S-31  
General Motors Building, Detroit 2, Michigan  
Send me more information about the new Saginaw jack and where I can buy it.

# WAR SURPLUS AND OTHER BARGAINS



## PNEUMATIC RIVETER & CHIPPING HAMMER

Mfd by Ingersoll-Rand, Chicago Pneumatic and The Pistol grip. Ideal for fender, brake lining, concrete breaking work. Like new Six rivet sets and bucking bar included, making a complete combination. Wgt. 9 lbs. Each \$6.95

### MICROMETERS

Chrome plated, precision engineered and carefully tool to give long life. All new

0-1" cap. . . . .	each \$2.25
1-2" capacity . . . . .	each 3.50
2-3" capacity . . . . .	each 5.50
3-4" capacity . . . . .	each 6.50

### HIGH SPEED DRILLS

All New, Fractional & numbered. Orig. Val. \$15. Nationally known brand. Ast'd. sizes. Set 30, \$3.50

### 6" VERNIER CALIPERS

Imported from Sweden of finest steel. Made by master tool makers to "Rockwell C 60" hardness. Precision lapped measuring surfaces. Finely engraved graduations in 1/1000" for outside, inside, depth and thread measurements up to six inches. Wonderful value for machinists, die makers, etc. Accuracy unconditionally guaranteed

6" VERNIER CALIPER, postpaid . . . . \$14.95  
Imported grained leather case, postp'd 1.25

### EXPANSION REAMERS

Spiral Flute. Mfd. by Alvord Polk Tool Co. All New, original pack. 1/4"-3/8". 7/16" Recommended expansion limit. .006" Orig. value \$12. Set of 3 \$4.95

### 50 POWER POCKET MICROSCOPE

Imported Hand Microscope gives clear 50-X magnification with bright illumination and absolutely no distortion. Precision-made with 2-piece achromatic lenses. Baked enamel cylinder with chrome fittings. Not a toy—a practical instrument for die-makers, machinists, engravers, watch-makers and in mineralogy, textiles, botany, precision instrument work, etc. Complete with instructions, postpaid, \$5.95

### PIPE SMOKERS GET THIS!..

Fancy briar pipes purchased from govt. Assorted shapes, sizes. All popular makes. Close-out—Set of 10 . . . . . \$3.50

Send Check, Money Order or Cash 25% deposit required on C. O. D. orders. Unless otherwise stated all prices are F. O. B. Culver City, Calif  
Send 25c for Illustrated Catalog.

**AIRBORNE SALES CO., INC.** DEPT. P M 40 CULVER CITY, CALIF.

# TORP JR. Model Airplane Engine

AMERICA'S FASTEST GROWING HOBBY  
AN IDEAL GIFT FOR YOUR YOUNGSTER

Come on, get acquainted with model flying. You'll have fun . . . if you equip your plane with K & B's Torp Jr. This little engine has everything and is designed for all types of flying, Free Flight, U-Control, Stunt, Speed and Scale . . . readily adaptable for model race cars and boats. Torp Jr., really easy to operate, yet outperforms any engine in its class.

**INFANT** Also available The Infant .020, World's Smallest Production made Glo Ignition Engine. This engine, now world famous, is interchangeable with the Torp Jr. Complete with Glo Plug and fuel tank only **\$4.95**

**\$550** COMPLETE WITH GLO PLUG AND GAS TANK



Fully Guaranteed Glo Plug Ignition .035 Cu. In. Displacement Turns 15,000 RPM Weighs only 1-1/16 oz. Easy to Start Famous K & B Quality Thoroughly tested in factory and field.

See your model dealer today or for dealer information write to  
**K & B MANUFACTURING CO.** 6901 S. Eastern Ave. Bell Gardens, Calif.

# 30" SHEET METAL BRAKE

Forms angles, flanges, seams. Bends 26 gauge steel. Heavier copper and aluminum. Cam locking. Portable, can be clamped to edge of truck. All steel. Wt. 42 lbs. Express Collect. . . \$24.50  
36" size . . . . . \$29.00



12" BRAKE. Fits in vise to form difficult compound bends, up to 20 gauge steel. . . \$12.50 PP.  
CUTTER. Cuts 18 gauge steel any length and width, \$12.50 PP.  
SHEET METAL PLIERS. 2 1/2" wide, \$2.00; 5", \$3.00.  
IRON BENDER. Forms hooks, braces, eyelets. Bends 1/4x2, \$10.00  
Immediate delivery. Order direct, cash or C.O.D., or send for folder.

**WISE BRAKE MFG. CO., P1116 So. 27th St., Omaha 5, Nebr.**

<b>WALL MODEL</b> 	<b>TELEPHONES</b> We can meet any inter-communication telephone requirement. Telephone set, 2\$17.95 of either model. Complete with batteries, wire, etc. Telephone supplies and parts of every description. 25% deposit with order, balance C.O.D., F.O.B. Brooklyn. INQUIRIES WELCOMED	<b>DESK MODEL</b> 
<b>EASTERN TELEPHONE CO.</b> Dept. PM-8, 284 Fourth Ave., Brooklyn 15, N. Y., MAIn 4-1882		

# SAY YOU SAW IT IN POPULAR MECHANICS WHEELS - WHEELS

5" Disc Wheel 5/8" Tire 5/16" or 3/8" sleeve . . . . .	30c ea.
6" Disc Wheel 5/8" Tire 5/16" or 3/8" sleeve . . . . .	35c ea.
7" Disc Wheel 3/4" Tire 3/8" sleeve . . . . .	45c ea.
8" Disc Wheel 1 1/8" Tire 1/2" sleeve . . . . .	70c ea.
7" Disc Wheel 1" Tire 1/2" ball bearing . . . . .	80c ea.
8" Disc Wheel 1 1/8" Tire 1/2" ball bearing . . . . .	\$1.00 ea.
8" Disc Wheel 2" semi-pneum. T. 1 1/2" B.B. . . . .	\$1.35 ea.
10" Disc Wheel 1.75 semi-pneum. T. 1 1/2" B.B. . . . .	\$1.50 ea.
12" Disc Wheel 1.75 semi-pneum. T. 1 1/2" B.B. . . . .	\$1.85 ea.

Above wheel prices include hub cap.  
Plus Postage, 20% - C.O.D.'s accepted.

**UNITED WHEEL STAMPING CO., PM-4**  
2756 W. 115th STREET CHICAGO 43, ILLINOIS

# BATTERIES! - START

—a factory at home and re-cast junk batteries into new; latest achievement. We supply complete instructions and everything needed. Big Profits!

**BATTERY LABORATORIES, Dept. PM, Minneapolis 4, Minn.**

# FREE World's Finest TRACTOR

32 Page Illustrated Catalog

3-4 1/2-5 1/2 Horse Power and NEW 4 1/2 H. P. Riding Model  
Manufactured for 28 years  
Plows Deeper Furrows  
CULTIVATOR INCLUDED  
AT NO EXTRA CHARGE

You get a BIG DISCOUNT if you buy direct from factory. Send Penny Post Card TODAY for Big FREE 32-page Catalog.

**RED-E**

- NO BELTS
- NO CHAINS
- ALL GEAR DRIVEN
- NEARLY 50 ATTACHMENTS
- CLUTCH FOR EACH WHEEL
- POWER TURNING

**RED-E TRACTOR CO.**  
53 Fond du Lac Road  
Richfield, Wisconsin

Fully Guaranteed



## STOPS LEAKS PERMANENTLY

Cut your fixture replacement, water and fuel bills with Economy Renewable Seats. Make economical, permanent repairs quickly and easily with the Junior Kit (illus.). Repair bathroom, kitchen and laundry fixtures. Everything you need included in steel box. This is a natural for the "Fixit" shops—get extra income from making permanent repairs on your customers' faucets.

Senior Master Kit also available—repairs faucets and valves up to 1" pipe. Write for illustrated circular and prices.

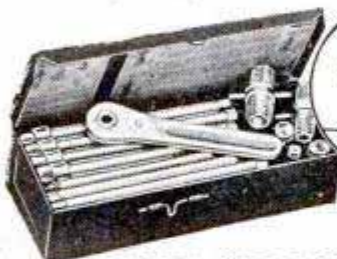

### NEW "JIG-A-VISE"

3 tools in one—a Jig . . . a Jack, and a Vise. Ideal for handymen, model makers, home workshops. Use it for holding any piece for drilling, finishing, assembly. Assures accurate work as all surfaces are ground true. Write for complete information and illustrated circular.

### ECONOMY VALVE SEAT CO.

3122 N. California Ave., Chicago 18, Ill.

## 100s of "Impossible" Jobs are Quick and EASY with VISE-GRIP WRENCH

Turning Close-To-Wall Pipe



The most amazing hand tool ever built, gives your hand Terrific Power! LOCKS to work with more than Ton-Grip. Does "impossible" jobs QUICK and EASY! Does jobs no other tool can do! Insist on the genuine VISE-GRIP. Only the genuine has these features. Involute Jaw Curve holds all shapes with unbelievable ease. Knurled Jaw Tips hold work at the very tip. Thin Nose. Super Wire-Cutter. Fine alloy steels, specially hardened. Nickel plated finish. With cutter—No. 7W, 7-in., \$2.25; No. 10W, 10-in., \$2.50. Without cutter—No. 7C, 7-in., \$1.85; No. 10C, 10-in., \$2.25. If not at your dealer's order direct.

PETERSEN MFG. CO., Dept. P-4, DeWitt, Nebr.

Say You Saw It in Popular Mechanics

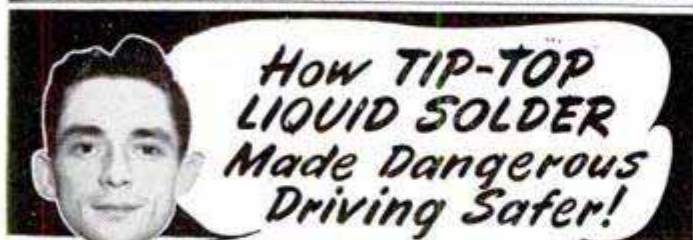

How TIP-TOP LIQUID SOLDER Made Dangerous Driving Safer!

"A sudden rainstorm caught me returning from a nearby town. My wipers wouldn't work and I couldn't see the road ahead of me. I stopped, and when the rain let up a little, I found a leak in the copper tubing of the vacuum line. Tip-Top Liquid Solder mended the leak immediately. The wipers began operating again and kept the windshield clear during the downpour that followed."—C. R., Colorado.

Tip-Top Liquid Solder is perfect for hundreds of emergency repairs. Forms perfect joint in metals, woods, glass, and fabrics. Water and gasoline-proof . . . sticks where others fall. Keep Tip-Top handy at home—in the shop. If your dealer doesn't have Tip-Top, mail us 25c for a tube, along with your dealer's name, today. Tip-Top Products Co.—Omaha, Nebraska.



## MEET THE NEW BULL SAW!

Convert your electric drill into a powerful, portable saw for only \$9.95

Your electric drill becomes a portable saw with power to spare when you attach the new Bull Saw! It's sturdy, rigid—yet light enough for one-hand operation. New visual guide lets you see where you're going; new extra wide shoe plate keeps saw blade on the straight-and-narrow. One-piece safety guard of polished aluminum . . . blade of high-carbon steel . . . double bearings for long life. Fits rigidly on any 1/4" electric drill. Depth of cut: 1 1/8". Complete, ready to use in drill.

**\$9.95**

(When ordering, ask for Model BS-C)

## IF YOU ALREADY OWN A BULL BUFFER

you can make your own Bull Saw for only \$7.50! Here's how: order the saw housing (photo 13) and attach it to the angle-head of your Bull Buffer, following the simple directions we send you. That's all—it only takes 30 seconds to change your Bull Buffer into a powerful, portable saw! The housing you need comes complete, only . . .

**\$7.50**

(When ordering, ask for Model BS-H)



13

## COMPLETE POLISH-SAND-'N-SAW KIT

Includes (photo 2) Bull Buffer\*, famous right-angle polisher-sander complete with rubber pad, sheepskin bonnet, 2 sanding discs and (photo 13) Saw Housing that fits on Bull Buffer angle head to give you a powerful Bull Saw. A \$19.90 value, yours for only . . .

**\$14.95**

(When ordering, ask for Model BS-K)



2

\*Bull Buffer only, with sheepskin bonnet and 2 sanding discs, \$9.95. At your dealer, or send cash, check or M.O. for prepaid shipment

### BERTRAM F. ENGINEERING CO.

3121 MAIN STREET

KANSAS CITY, MO.

## SAVE MONEY

Build this 18 ft. House Trailer yourself \$286.00.

Blueprints, Building instructions and 1950 parts catalog 50c. Don't Delay. Write Today

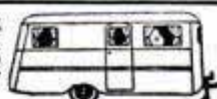

NATIONAL TRAILER EQUIPMENT COMPANY

Dept. PM-4, 1007 N. WATER STREET, MILWAUKEE, WISCONSIN

## Get this free SHOPMASTER Power Tool Catalog

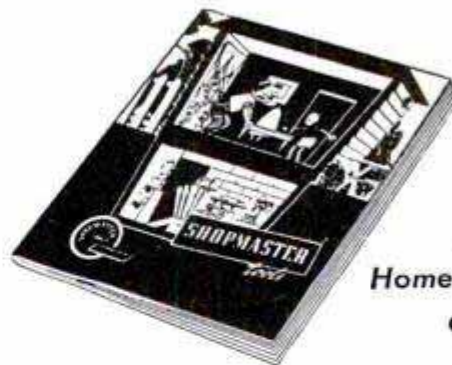

Start your Home Workshop at low cost

SHOPMASTER Home Workshop Power Tools are priced to meet every family's purse. Make your spare time relaxing and profitable. Build furniture, repair your home, build toys and playthings for the children.

Start your shop now at little cost. See your SHOPMASTER Dealer. He has full information. Write today for the complete twenty-eight page full color descriptive book.

## SHOPMASTER, INC.

1214 Third St. S., Minneapolis 15, Minn.

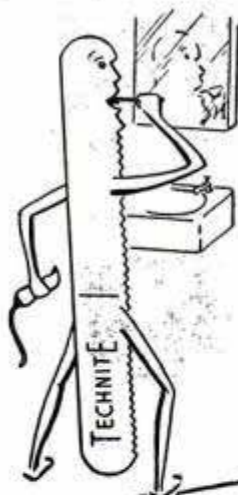

AMMONIATED TOOTH PASTE

**DIDN'T HELP THESE HACK SAW TEETH**

BUT CAPEWELL INTRODUCED "STATISTICAL QUALITY CONTROL" WHICH GIVES A 10% SAWING BONUS

Capewell's exclusive "Statistical Quality Control" assures a bonus of 10% additional cutting because it raises standards and eliminates sub-standard blades. Another Capewell exclusive—the Blade Selector stamped on every blade—enables you to select the hack saw blade with the right number of teeth for each cutting job. Always ask for...

ASK YOUR DISTRIBUTOR ABOUT:

Capewell hack saw blades, hack saw frames, band saws, Dofiles, spiral saws, band saw machines, ground flat stock, hammers, coping saws and key hole saws.

**1881 CAPEWELL**  
THE KEY TO ECONOMY

THE CAPEWELL MFG. CO. DEPT. 94  
HARTFORD 2, CONN.

**The JIFFY metal CABINET**

YOUR ANSWER TO SMALL ITEMS STORAGE at home, office, and shop (IDEAL GIFT, TOO)

So handy to keep nuts, bolts, screws, nails, parts, washers, stamps, hobbyists' needs, etc., at your fingertips.



THIS 32 DRAWER UNIT ONLY \$5.95 POSTPAID

Stop searching, get a 32 or 64 drawer Jiffy to keep those small items that usually get mislaid. Spot welded steel, gray enamel finish, metal drawer guides. Dividers included with aluminum drawers make possible three compartments per drawer. Looks good anywhere. Send check or money order, please—no C. O. D.'s. Prices below. Your money refunded if not satisfied. Dealers write for quantity discount.

SPECIFICATIONS	WITH ALUMINUM DRAWERS	WITH CARDBOARD DRAWERS
<b>32 Drawer Unit</b> 6" Deep 12 3/4" Wide 15 1/4" High	<b>Dividers and Index Cards Included</b> One piece rustproof aluminum drawers for heavy service—good for work bench and industry use.	Suitable for most home uses. Heavy board kraft covered. Metal drawer pulls.
<b>64 Drawer Unit</b> 6" Deep 25 1/2" Wide 15 1/4" High	<b>32 drawer - \$8.95</b> <b>64 drawer - \$15.95</b>	<b>32 drawer \$5.95</b> <b>64 drawer \$9.95</b>
<b>Drawer Size</b> 1 1/4" Deep 2 3/4" Wide 6" Long	OHIO ORDERS ADD 3% SALES TAX Marproof Rubber Feet included with all cabinets POSTAGE PAID	POSTAGE PAID

KAYTEE PRODUCTS, Dept. M, Box 588, Canton, O.

LAWN MOWER SHARPENER



Lawn mower sharpening at low cost!  
**\$4750**

less motor,

turn spare time into dollars

Order direct from  
**QUAD CITY PRODUCTS Company, Inc.**  
Box 42, Rock Island, Ill.

Make Your Own LOW COST POWER TOOLS

Use Wood, Scrap, Discarded Materials—Make Practical, Proven Machines

Order today the new "Forty Power Tools You Can Make." Even though you have the older edition, get this new book with twenty brand new tools—40 in all. Make your own motorized lathe, drill press, sander, shaper, circular, band, scroll and jig saws from old auto and other discarded parts. Make forty different tools following simple instructions, diagrams and photos and have an efficient, up-to-date shop. Save money, time and hard work and do a better job with low-cost power tools. Sent postpaid for only \$1.50 with order. Avoid high C. O. D. charges.

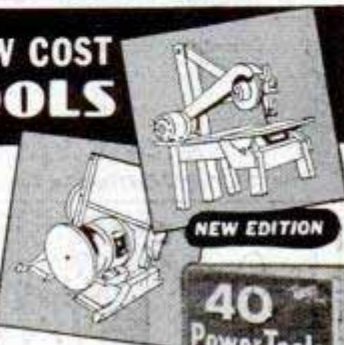

NEW EDITION

40 Power Tools YOU CAN MAKE

POPULAR MECHANICS PRESS  
200 E. ONTARIO ST., CHICAGO 11, ILLINOIS

Boy! What a Picture!



And boy, what a book is Popular Mechanics new PHOTO HANDBOOK. Gives you the big three of superior photography:

1. The secret of taking better shots.
2. The technique of clearer developing.
3. The way to build better photo equipment.

Be an expert! Have fun! Save money!  
Paper covered edition on all newsstands...60c  
Order colorfully bound library volume from  
**POPULAR MECHANICS PRESS...\$2.00**  
200 E. ONTARIO ST. CHICAGO 11

**GENSCO** Swedish WOOD CHISELS

Finest Imported Swedish Steel Blades

- Prices Now Lower than Most American Chisels.
- Hand-Honed and Polished.
- Unbreakable machined plastic handles.

Fine Swedish quality in accurate cutting chisels that every craftsman will appreciate. Gensco chisels take and hold the finest edge for better work.

PROTECTIVE PLASTIC COATING

keeps blades clean and sharp. Strip it off when ready for use.

11 SIZES FROM 1/4" to 2"

The GENSCO LINE also includes **BUSHMAN** Swedish Hand, Bow and Pruning Saws

See Your Dealer or Write Direct

**GENSCO TOOL DIVISION**

General Steel Warehouse Co., Inc.  
1832 North Kostner Avenue • Chicago 39, Illinois

## NEW BAND SAW CUTS METAL, FIBER, PLASTIC FASTER, MORE ACCURATELY AND AT LOWER COST!



NOW every shop can have the advantages of band sawing. Wells new Model 49A is a rugged, horizontal cut-off saw that will do a man sized job. Welded steel frame and tubular base along with

many design features proved in Wells' widely used larger machines make it portable and easy and economical to operate. Automatic shut off at end of cut. Capacity—rectangular, 3 1/2" x 6 3/8"; rounds, 3 1/2" diameter. Shipped ready to operate complete with heavy-duty 1/6 H.P. Motor.

**WELLS MANUFACTURING CORP.**  
95 Mechanic Road • Three Rivers, Michigan

## POWER MOWERS

Powerful—Streamlined

Complete with Maytag, Power Products or Briggs-Stratton Engine—18" rotary tool-steel, fully guarded blades—cast aluminum body. Cuts grass and weeds, wet or dry—does all trimming—chops grass into fine mulch, eliminating raking. Send check with order, or specify C.O.D. Write Dept. M-4 for literature.

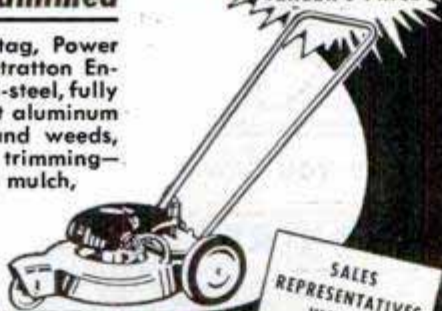

**HARTMAN Corp.**

1100 SOUTH KIRKWOOD ROAD • ST. LOUIS COUNTY 22, MO.

Earn \$250 to \$350 extra Profit Monthly

## ARC WELDING



D-C Shop Welder Electric Drive

A-C Shop Welder Transformer Type



D-C Field Welder Gasoline Drive



A-C Generator Only Welding or Power

### Own your Own Business on "Pay out of earnings" Terms

Get into big pay welding jobs with practically no outlay on your part. The new Hobart Arc Welders make you independent of any power supply. Gasoline Engine Driven, electric self-starting and auxiliary power. If you wish, for making your own current for lights—tools—motors, etc.

With good, up-to-date, ample capacity welding equipment, you can get the big pay jobs. There is a size and model to meet every welding requirement or you can save \$300 to \$500 by building your own arc welder, using the Hobart generator only and belting or coupling to a good used auto engine. Write today for free catalog.

Hobart Bros. Co., Box M-40, Troy, O.

Easy, "pay out of profits" terms Helps you to get welders and accessories you need

START NOW!

BUT LITTLE CAPITAL REQUIRED

PLENTY OF REPAIR WORK

CONTRACT WORK!

**HOBART**

Send for FREE details, let Hobart help you!

"One of the world's largest builders of arc welders."

SAY YOU SAW IT IN POPULAR MECHANICS

## PRECISION INSTRUMENTS

### REMOTE CONTROL THERMOMETER



For automobiles, homes, refrigerators, milk coolers, brooders, orchards, workshops, etc. Temperature bulb at end of 5 or 15 ft. flexible tube (state which). Dial thermometer glows in dark—non electric—very sensitive—40° to +50° C. and -40° to +125° F. on same dial. Aircraft quality—worth many times.....\$3.50

### ALTIMETER



Modernize your car. Fine desk ornament. Reads up to 20,000 feet. Fluorescent dial glows at night—no connections of any kind required—self contained—Suitable as a laboratory standard instrument—Same as used in airplanes. Brand new—cost gov't many times.....\$3.50

### PIANO HINGE

For doors, cabinet work, tool boxes. In full lengths only. Width measured open. Undrilled.

#### Stainless Steel

3/4" x 4' 1 1/16" x 4' 1 1/4" x 6'

#### Aluminum Alloy

3/4" x 3' 1 1/4" x 6' 1" x 6' 2" x 6' 1 1/4" x 6'

Any size, per foot.....20c

### EMERGENCY PULL-OUT LIGHT



Use on car, boat, darkrooms, workshop, airplanes. White or red light. Small size 3"x3 1/2"x4 1/4". Also pulls out 6 ft. on self winding reel. Takes 6, 12, or 24 volt bulb. In durable plastic case. Only.....\$2.50

### MANIFOLD PRESSURE GAUGE



Indicates manifold pressure in your automobile, boat or stationary engine—allows you to operate your engine at maximum operating efficiency and gas economy. Connects to windshield wiper hose or manifold. Complete with connections, hose and instructions. BRAND NEW!.....\$7.50

### PRESSURE GAUGES

For air, oil, hydraulic, gas, etc. Aircraft quality, with 2 1/4" dials. Any range: 0-5, 0-15, 0-25, 0-30, 0-100, 0-120, 0-150, 0-200 0-400, 0-1000, 0-1400, or 0-2000 lbs. Also Suction Gauges 0-10 lbs. BRAND NEW.....\$2.50



### STORAGE BATTERY



6 volt Willard, rechargeable, clear plastic spillproof case, has self contained charge indicators for each 2 volt cell. For radios, experimenting, cars, models, 7x7x4 1/2 inches. 12 1/2 lbs. Brand New.....\$6.95

### ASTROGRAPH with case

New B-29 Navigation instrument which can easily be used to make a good contact printer, strip map holder, etc. The plywood case 11 1/2"x11"x10" high is perfect as tool kit, camera projector case, or for building a portable phonograph, picnic kit, make-up case, etc. Has leather handle, reinforced cover, eight covered compartments in bottom. Cost Gov't \$125.00. Add postage for 22 lbs.....\$3.95



Enclose sufficient postage—Excess will be refunded—No COD's

**AIRCRAFT COMPONENTS, Inc.**

1000 Woodland Avenue Benton Harbor, Michigan

### RUSH ORDER BLANK

PLEASE SEND CIRCLED ITEMS:

Name \_\_\_\_\_

Address \_\_\_\_\_

# WhiskER®

THE ELECTRIC SHAVER THAT'S  
SOLD BY BARBERS



ONLY  
**\$12.95**  
RETAIL

Now! Smooth, Close Shaves . . . For the Man Who  
Shaves Once a DAY — or, Once a WEEK

Barbers know a good shave when they see one. That's why they recommend and sell WhiskER. WhiskER whisks away any length beard, clean as a whistle, without pulling or stalling. It uses a time-tested hair clipping principle, with an extremely, close-shaving blade. Operates quietly on 110 v, 60 cycle AC; no radio interference. The next time you visit your barber or beautician, ask to see the WhiskER. If he does not have WhiskER, he can order it for you on a 5 day trial.

**MADE BY WELL KNOWN MANUFACTURER OF  
QUALITY BARBER AND BEAUTY TOOLS**

. . . that's your guarantee of a precision product and long, satisfactory performance. Ladies: Buy WhiskERs at your favorite beauty shop for gifts or for personal depilatory use.

**ELECTRO TOOL CORPORATION**  
DEPT. 520-D RACINE, WISCONSIN

## HELPFUL BOOKS

Send post card asking for FREE catalog  
Popular Mechanics Press, 200 E. Ontario, Dept. 601, Chicago 11

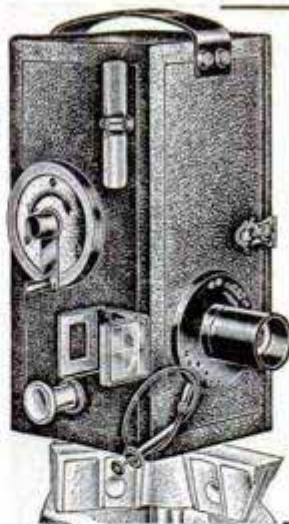

**Finished Photos  
in 2 Minutes!**  
**Great Quick Photo  
Invention**  
**P D Q CHAMPION  
PHOTOMASTER**

Takes and finishes 30 to 40 everlasting, black and white or sepia photos an hour. No dark room. Guaranteed not to fade. Photos taken on "SUPER-SPEED" direct positive paper. Picture size 2 1/2 x 3 1/2 in. Complete, easy-to-operate portable photo studio. **700% PROFIT.** Write quick, get details about the great PHOTOMASTER.

**P D Q CAMERA CO.**  
1161 N. Cleveland Ave., Dept. PM-4  
Chicago 10, Ill.



Stratopower Constant Displacement High Pressure  
**HEAVY DUTY PUMP . . . BRAND NEW**

For operating Hydraulic cylinders, hydraulic motors on tractors, Bulldozers, Construction machinery, Lift trucks. For fuel or oil transfer, Industrial Applications, etc. Delivers up to 400 G.P.H. at 3750 R.P.M. Rated 1250 to 1400 P.S.I., 5750 to 4500 R.P.M. HAS RELIEF AT HEAD. Rotation either direction without adjustment. Can be used as hydraulic motor. \$85.00 value. Only \$12.50. Stock #37. Wt. 8 lbs.

Write for Hydraulic listing. Send check or money order  
**GENERAL SALVAGE COMPANY**  
DEPT. 47 2922 E. 27 ST. KANSAS CITY, MO.

## SHARPEN CIRCULAR SAWS LIKE AN EXPERT



No experience needed. Two simple adjustments. Gets hollow-ground, cross-cut or combination saw blades true and sharp. Fits 6" to 12" blades with 1/2" to 13/16" centers. Includes file and complete instructions. \$8.95 postpaid. (Check or money order to C.O.B.S. postage extra. Guaranteed—Money back if not satisfied after 10 day trial. A money maker for fix-it shops. Soon pays for itself. Order today. Free folder.  
**SURE SHARP MFG. CO., Dept. M-40**  
P. O. Box 24 Santa Ana, Calif.

SAY YOU SAW IT IN POPULAR MECHANICS

## \$4.95 REAL ENGINE VALUE

A miniature gas engine that really operates. Thousands of Buzz "B" gasoline engines have been sold at twice the price. Now is your chance to buy a real 1/6 H.P. gas engine for only \$4.95. Turns up over 8,000 r.p.m. For Boats, planes, midget cars, etc. Guaranteed and ready to run. Includes Champion spark plug and tank. Send only \$1.00, engine shipped collect for balance, same day.

WRITE FOR FREE CATALOG OR  
SEND 10c FOR NEW MAMMOTH ILLUSTRATED  
CATALOG OF THOUSANDS OF HOBBY ITEMS.  
America's Hobby Center, Inc., Dept. B-40, 156 West 22nd St., N. Y. 11

## Freeland METAL BOATS

Rugged, low up-keep boats that feature electronic seam weld; spray rails, styrofoam safety floats; removable flooring. 12 and 14 ft. lengths.



Models from \$65.00.  
Write Dept. 74 for folder, prices.

**FREELAND SONS CO. Sturgis, Mich.**

## SUPER 1950 PRONTO POWER CUTTING EQUIPMENT — WITH 20" CUT



◀ \$42.50 less Engine. \$79.50 with 4 cycle 2 H.P. Engine.



▲ \$12.50 comp. FOB H.D. Roller bearings. Shipping wt. 15 lbs.

\$89.50. Only one moving part, aside Engine and wheels. 2 H.P. 4 cycle Engine. ▶



For all grass and weeds. Send check or Money Order. No COD's. We have no dealers or representatives. Crating charge for Mower's \$5.00 extra.

**PRONTO MOWERS, Oldsmar, Florida**

## TWO CYLINDER BRAND NEW AIR COMPRESSORS

Fully Guaranteed, Backed By 44 Yrs. Air Equipment Experience



FULLY AUTOMATIC—BEST BUY IN YEARS!

**TWIN CYLINDER** for double power, faster compression, smoother operation. Displ. 3.5 C.F.M.

**TWIN CAPACITORS** for stronger starting, power against pressure, 1 1/2 H.P. Holtzer-Cabot Motor.

**TWIN VOLTAGE** can be operated on 110 or 220 Volts.

**TWIN "V" BELTS** for max. power drive.

**TWIN GAUGES**, 1 reserve tank gauge and 1 gauge with adjustable pressure regulator.

**REGULATOR** for pressure adjustment from 0 to 100 lbs. Safety valve, drain valve and 1 1/2"x30" horiz. tank with 1/4" hose conn. **FULLY AUTOMATIC.** It's a husky, sturdy unit, complete with motor, ready for use. Built for industrial use in shops, factories, garages, for spraying paint, cleaning, blowing, tire inflation and many other compressed air uses. Attractively finished in metallic blue. Ready for use.

1/2 HP—12"x24" TANK. One cyl. 2.86 CFM Displ. **\$63.00** COMPRESSOR

1 HP—16"x30" TANK. Two cyl. 7.30 Displ. **\$159.50** COMPRESSOR

**89.85**

Regular \$155 Value



**BIG VALUE! 2 WAY VENTILATOR-BLOWERS**

250 CFM 4 3/4" dia. in-take, 3 1/4"x5 3/8" discharge. 110V AC. motor. . . . . **\$13.95**

100 CFM 3" dia. in-take, 2" discharge. 110 V-AC. motor. . . . . **\$7.95**

F.O.B. WAREHOUSE—SEND CHECK OR MONEY ORDER. Write for Bargain List

**ELECTRIC TRADING CO., 313 PM-2 CANAL ST., NEWYORK, N.Y.**

## Make Your Own POWER LAWN MOWER

with this DRIVE CUTTER ASSEMBLY

Constructed for those who desire to build their own mower or to replace your old cutter assembly. Complete with 18" blade and double ball bearing drive, only . . . . . **\$11.95**



Add 50c to cover handling & shipping. No COD's  
**ATLAS EQUIPMENT CO., Dept. P.M.4**  
229 SW BLVD. KANSAS CITY, MO.

## WAR EQUIPMENT MAIL SALE! We Pay Freight

### Sale 100-V, 60C New POWER PLANTS

- 3,000-watt. Push-button start, 4-cyl. eng. FULL Instrument panel Cost Gov't. \$756. Sale, \$345.
- 2,500-watt. Leland Generator. Ideal for emergency plant. Complete, ready to operate. Gov't. Cost, \$275 Sale, \$129.50
- 800-watt Pioneer Generators. For cabins, chain saws, contractors. Gov't. Cost, \$144, Sale, \$62.90.

All plants fully guaranteed.

**BURDEN SALES COMPANY**  
806 "O" ST. LINCOLN, NEBR.

## Build your own JET ENGINE!

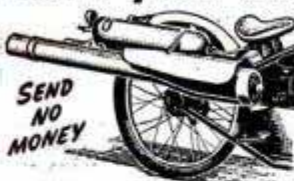

Order these plans today

1. JET PROPELLED BICYCLE. Assemble your own. Photo and instructions \$1.00.
  2. HOW TO MAKE EXPERIMENTAL JET ENGINES. Seven sheets drawings with information and instructions \$2.95.
  3. BOTH OF ABOVE. In one order \$3.75.
- SEND NO MONEY. Order both at once \$3.75 C.O.D. in USA plus e.p.d. postage. Send check or Money Order and we pay postage. Get other information too. Rush Order.

**J. HOUSTON MAUPIN, Dept. 55, Tipp City, Ohio**

## EARN EXTRA PROFITS WITH YOUR JEEP



### Convert Your Jeep Into a MOBILE ARC WELDER

Here's your chance to pick up some easy extra money. Use your jeep as a mobile arc welder. Complete

are welding generator kits. 68 component parts including 200 amp. welding generator. Comes with spare parts for generator, cable, electrode holder, ground clamps. Fits any jeep, military or civilian. Doesn't impair other duties of jeep. Jeep engine furnishes power for generator. Complete easy instructions furnished. Can also be used with gasoline engine for stationary work. **WRITE FOR INFORMATION.** Complete jeep arc welding units available at \$845 also.

**WELDERS SUPPLY COMPANY** Dept. PM-04 **4409 LORAIN CLEVELAND, O.**

**\$345**

## BUILD YOUR WIFE A FRUIT CABINET



You'll benefit too from the mouth-watering preserves your wife can put up if she has a clean, handy place to store them. It's easy and inexpensive to build a fruit cabinet with Gold Bond Gypsum Wallboard. Big, sturdy panels nail up fast—right to a 2 x 4 framework. Gold Bond Gypsum Wallboard is completely fireproof, unaffected by cellar dampness and easy to keep clean. For more information, write Div. W, Dept. PM-4.

Available at your local Gold Bond lumber and building materials dealer

**NATIONAL GYPSUM COMPANY**  
BUFFALO, 2, NEW YORK

## Make 100% to 150% Profit!

### MANUFACTURE BUILDING BLOCKS In Your Own Back Yard



**AMAZING GENERAL BLOCK MACHINE**  
CAPACITY 1000 BLOCKS PER DAY

Only **\$199** LESS MOTOR F.O.B. PLANT

SHIPPING WEIGHT 400 lbs.

Here is an outstanding opportunity for men of vision and small capital. Cinder and concrete blocks are in great demand. Millions used for homes, factories, public buildings. Sell all you produce at 100% to 150% mark-up.

#### PEAK BUILDING DEMAND!

The General Block Machine is amazingly practical, foolproof. Simple to operate indoors or outdoors. Rugged all steel construction. Vibrator mounted in sealed ball bearings. Produces up to 1,000 blocks per day Superior 3 Core Type that meets all building code requirements. Can produce 4 x 8 x 16, 8 x 8 x 16, 12 x 8 x 16 blocks. All materials obtainable anywhere. All operating instructions and mixing formulas supplied. Full details FREE without obligation.

**HOW TO BUILD YOUR OWN CONCRETE BLOCK HOME**  
Only \$1 Prepaid

Wonderful Book Written & Illustrated by Experts

## GENERAL ENGINES CO.

DEPT P-7 • 307 HUNTER ST. • GLOUCESTER, N. J.

Includes floor plans for 6 beautiful, easy to build concrete block bungalows. Shows ways to save money. How to lay blocks, lay out building lines, mix concrete, build steps, porches and concrete floors. Mail coupon at once with \$1.

Name.....  
Address.....  
City.....Zone.....State.....

# BARRON Drill Press TOOLS

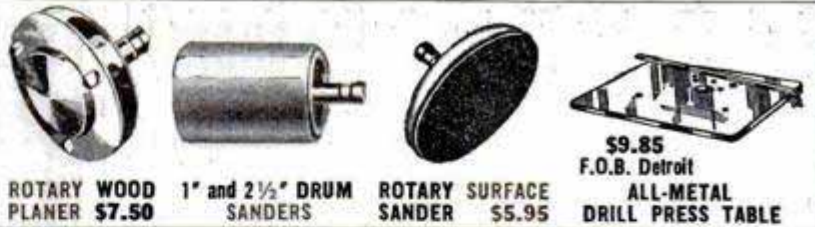

ROTARY WOOD PLANER \$7.50    1" and 2 1/2" DRUM SANDERS    ROTARY SURFACE SANDER \$5.95



\$9.85 F.O.B. Detroit ALL-METAL DRILL PRESS TABLE

ALL-METAL SHAPER FENCE \$8.25 F.O.B. Detroit



ROUTER & MORTISING BITS \$9.50 per set of six

SHAPER CUTTERS \$9.00 including 3 sets Blades

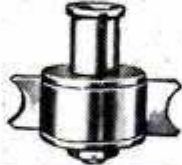

## 15 ESSENTIAL WORKSHOP OPERATIONS . . .

You can convert any standard make drill press into your most versatile, useful, low cost workshop tool. Barron Precision Tools now enable you to perform 15 indispensable shop operations—surface—plane woods and plastics—rabbet—tenon—panel—bead—groove—bevel—mortise—route—cut dovetail—sand surfaces and contours—shape—cut moldings—grind and buff. Over 200,000 Barron Tool users. Every tool sold on full 10 day money back guarantee.

See Your Dealer . . . Or Write Direct

BARRON TOOL COMPANY, INC.  
869 Architects Bldg., Detroit 1, Mich.

FREE Workshop Guide & Catalog



## SENSATIONAL BARRON SPEED-VISE!

PERMANENT—PORTABLE

Slickest, handiest, most useful all-metal work bench vise. A workshop "must" for—  
PLANING • SAWING • DRILLING • SANDING • FILING • ETC.

Only \$175

Include 20c for shipping

Won't mar, mark or dent woods, plastics, metals. No piece too small or too large. 10 Day Money Back Guarantee. BARRON TOOL CO. Dept. MP DETROIT 1, MICH.

## CENTRIFUGAL PUMP—SERIES 130

All Purpose, ALL BRONZE Pump—At a fraction of original cost. With Adjustable Pulley. Remit with order. We Prepay Freight. Free Literature.

2" Brand New ONLY \$21.90



While They Last—RUSH ORDER the freight

ARGO-SUMMIT SUPPLY CO., 7418 W. Archer Ave., Dept. 4, Summit, Ill.

## ELECTRIC MOTOR BARGAINS!



1/2 HP. 1750 RPM \$15.00    1-HP. 3450 RPM \$34.50  
3/4 HP. 1750 RPM \$26.00    1-HP. 1750 RPM \$35.00

Every Motor Fully Guaranteed  
Heavy Duty. Repulsion Induction or Capacitor Types, 110-220 Volts, 60-cycle, Single-phase. Standard Makes (G.E., Wagner, Le-land, Westinghouse, etc.). Rush your order TODAY—large stock of motors—1 & 3 phase. 32-v. direct current bargains. Prices f.o.b.

ROBERTS ELECTRIC CO., 7232 Madison, Forest Park 8, Ill.

## OWN A Printing Business

Cards, Tickets, Stationery, etc. Good profit in spare time. PRINT YOUR OWN greeting cards, movie titles, church work, etc. Save money. Easy rules supplied. Raised printing like engraving too. Have home shop. Sold direct from factory only. Pays for itself in short time. Write for free catalog of outfits, and all details.

KELSEY PRESSES, 0-37, MERIDEN, CONNECTICUT

## 25 POWER—PRECISION MICROSCOPE

COMPOUND OPTICAL SYSTEM using 4 precision lenses.

\$2.79

A Professional Instrument. Pocket Size. 5" long.



Postpaid Ideal for Machinists • Hobbyists • Photographers • Engineers • Students • Naturalists

ALUMINUM CASE Money-back GUARANTEE—Same Day Shipment GANES MANUFACTURING CORP. Dept. PM-4, 2414 Atlantic Ave., Brooklyn, N. Y.

## MAKE YOUR ELECTRIC DRILL A CIRCULAR SAW!

Save time . . .  
Save work . . .  
Save money



• Right-angle drive with oversize guards is supersafe, perfectly balanced for one-hand use. Attach it to any drill 1/4" and up, in seconds. Full 1 1/8" cut, handles 2" stock by turning over. Machined cutting guide for extra accuracy.

Oilite bearings, sealed gears for longer life. Complete with 4" high speed steel saw blade. Money-Back guarantee . . . only \$7.95

Dealer Inquiries Invited  
POSTPAID—SEND CHECK OR M.O.  
C.O.D.'s ACCEPTED—POSTAGE EXTRA  
GLEAM PRODUCTS (Dept. P-4) Whitestone, L. I., N. Y.

## SENSATION'S New Model G 72 Mower . . . Cuts Lawn Care Time 1/2

### Close Trimming Easy

Move the "swing about" wheels forward. Then you can run the side of the mower along fences and foundations for close clipping. Hand trimming is greatly reduced.



### Make Short Work of Weeds and Brush

The steel guard and front section of the chassis fold back to make the cutting of tough, tall weeds easy. Sensation has ample power to cut small trees.



## MAIL COUPON TODAY

Please send me Illustrated Folder explaining work-saving, time-saving features of Sensation gasoline and electric mowers.

NAME \_\_\_\_\_

ADDRESS \_\_\_\_\_

CITY \_\_\_\_\_

SENSATION MOWER, INC. RALSTON, NEBRASKA  
BOX PM 450

## CUTS ANY KIND OF GRASS

Sensation has more useful mechanical features than any other mower. Adjusta-Hi-Cut enables operator to vary cutting height from 1/2" to 4" in two minutes. Lawns cut longer than normal grow thicker . . . healthier. Sensation's whirling blade chops clippings into lawn building mulch . . . no raking required.

SENSATION MOWER, INC.  
BOX PM 450, RALSTON, NEBR.

# "Wellworth" Sensational Offer! Reg. \$60.50 WESTINGHOUSE AIR COMPRESSOR

Model T-1 Brand New — 2  
CYLINDER PISTON TYPE. Operates with 1/2 H.P. Motor or equivalent gas engine.

Compressor, pressure tank, air gauge, air chuck, 20-ft. hose, pop valve, copper tubing with 4 brass flared fittings for connecting compressor to tank, 4-way cross and 3 nipples. COMPLETE OUTFIT, wt. 52 lbs.

**\$32.50**

Equipment less Compressor, \$12.50. Compressor separately, \$21.50  
Compressor has 2" bore, 1 1/2" stroke, ball bearing, 3.27 CFM at 600 R.P.M. Capacity up to 6.54 CFM. Size 9"x11 7/8"x6 3/4". Wt. 26 lbs. Ideal for spraying paints, insecticides, etc., inflating tires, operating air tools, and other uses. All new equipment. U.S. government surplus. Replacement parts available. Amazing buy. Don't miss it.

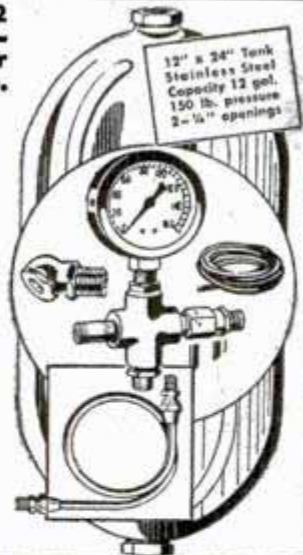
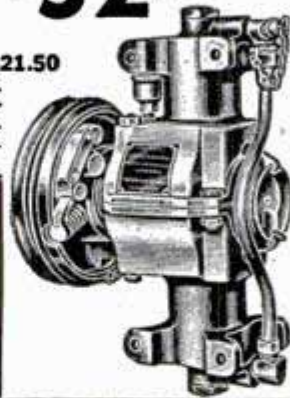

12" x 24" Tank  
Stainless Steel  
Capacity 12 gal.  
150 lb. pressure  
2-1/4" openings

## PORTABLE SPRAY OUTFIT

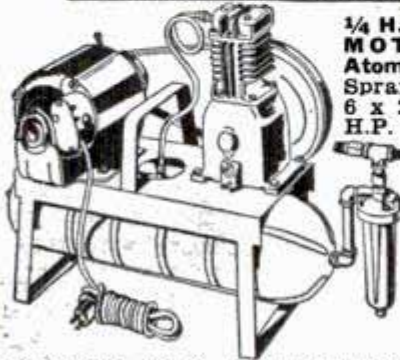

1/4 H.P. HEAVY DUTY MOTOR External Atomizing Gun Paint Sprayer mounted on 6 x 24 inch tank, 1/4 H.P. 110 V. 60 cy. Heavy duty motor with overload relay, 10 ft. cord and plug, V belt drive. Piston type Compressor with 2 Compression rings, 1 oil ring, 2 inch Bore, 1 3/4 inch stroke, displacement 2.86 C.F.M. at 60 lbs. pressure. Safety Valve. Gun external atomizing. Flat and round spray, quart cup; maintains 35 to 40 lbs. working pressure. Oil and water extractor, 1



air gauge, 20 ft. heavy duty 2-braid air hose with leak proof fittings, complete with carrying handle. Net weight 54 lbs., ship. wt. 60 lbs. Outfit less motor. Wt. 30 lbs.

**\$57.50** Complete Outfit

## PNEUMATIC AIR TOOLS



Used—Like New!  
CHICAGO PNEUMATIC RIVETER & CHIPPING HAMMER

CP4X Pistol grip handle. Takes up to 3/16" rivet. Weight 6 lbs. List price \$73.00.

Ideal for work on fenders and auto bodies

SPECIAL PRICE **\$10.95**

Same as above, brand new **\$22.50**



Ingersoll Rand AIR DRILL  
Lever or Pistol type

With 1/4" Jacob Chuck, Wt. 2 lbs. List price \$53.00. Only **\$14.95**

## SAVE 33 1/3% ON GAS ENGINES!

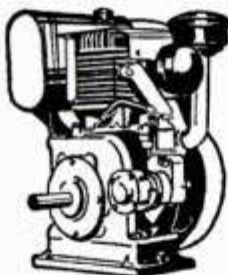

All Brand New Equipment  
Wisconsin Model VE4 with clutch, H.P. 13 to 20.5. List \$342.00. **\$228.00**  
Price.....  
Wisconsin Model AEH, H.P. 3.3 to 6.1. List \$130.95. **\$87.00**  
Price.....  
Wisconsin Model A.B. H.P. 1.7 to 3. List Price \$90.00. **\$60.00**  
Price.....

## GENERATOR and ENGINE FOR LIGHT PLANT

Brand new! Generator and gas engine bargain! Climax Generator. 2500 to 3000 Watts 110 Volt A.C. with 6.5 H.P. Wisconsin Gas Engine. **\$225.00**  
Price value. \$230 value.  
Price only.....

## Portable Automatic Paint Spray Unit

Spray paint your home, car, garage, etc.

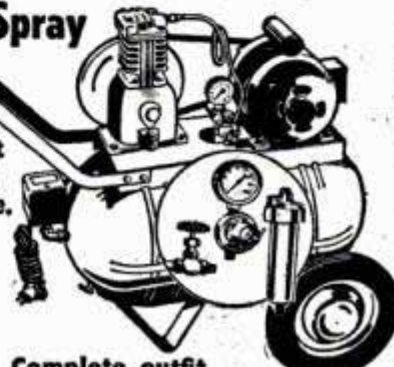

Complete outfit including Spray Gun. **\$89.50**  
\$150.00 Value.

Same unit, stationary, \$79.50  
Use also for spraying insecticides on plants and flowers. 1/2 H.P. heavy duty capacitor motor. AC 110/220 volt, 60 cycle, 2 x 1 3/4 inch piston type compressor, splash feed lubrication, 12 1/2 x 24 inch tank, automatic pressure switch, CFM 2.8 at 100 lbs. pressure, or 150 lbs. pressure for intermittent duty. Check valve, safety valve, air regulator with gauge and filter, spray gun with 20 ft. air hose and air chuck for inflating tires. V belt drive. Mounted on 2 wheels, ball bearing, with 2" x 10" pneumatic tires. Portable, with handle. Shipping wt. 90 lbs. Regular \$150.00 value. ONE YEAR GUARANTEE. Only \$89.50 complete.

### PARTS SOLD SEPARATELY

Compressor.....17.50 wt. 16 lbs.  
Automatic pressure switch.....7.50 wt. 3 lbs.  
Regulator, gauge and filter.....8.50 wt. 5 lbs.  
Spray gun.....9.95 wt. 4 lbs.  
Tank, wheels and base.....17.50 wt. 32 lbs.  
20 ft. hose.....2.95 wt. 6 lbs.  
1/2 H.P. Cap. motor.....22.50 wt. 28 lbs.  
Air gauge.....1.75 Adjustable pop valve.....1.50  
1/4" check valve.....2.75 wt. 2 lbs.



6 FT. STOW FLEXIBLE SHAFT  
Heavy Duty, 3/8" Core. Best piano wire. Ball bearing handle and arbor, rubber covered housing; for 1 1/2" motor shaft; for 1 1/2" bore wheels. Operates on 1/4 H.P. Motor at 1725 or 3450 R.P.M. \$29.00 Value, **\$14.50**. Wt. 8 lbs.

All items advertised on this page are guaranteed BRAND NEW

Reduced Price  
Only **\$14.50**

## AIR TANK and ACCESSORIES

Air receiver, stainless steel, 12 1/2"x24", 400 lb. test. Ideal for carrying on trucks, autos and wherever compressed air is needed. Equipped with 500 lb. air gauge, tire chuck, 3 ft. high-tens air hose, air inflation valve with core for retaining pressure in tank, and fittings. Complete outfit... Shipping wt. 20 lbs. Tank only.....**\$6.95**

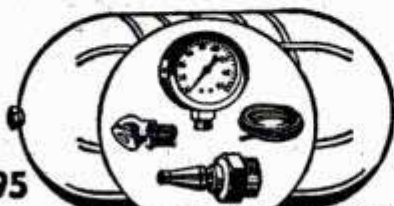

Openings 2-1/4"

## SEND FOR OUR 68 PAGE BOOK

A handy buyer's guide for home and factory workshop. Unusual bargains in motors, air compressors, electric tools, and many more items. Send 10c for postage and handling.



## "WELLWORTH" BLOWER at a Bargain Price

Quiet operating. Double wheel inlet, double width blower. For heating, ventilating, cooling, air washing, exhausting and forced draft. DIMENSIONS: 10" wheel; outlet 13 1/8"x11 3/8"; inlet 8 3/4". Height 19". Width 18". Depth 16 1/2". C.F.M. 1/4" S.P. 1600; outlet vel. 1575; motor 1/4 H.P. with overload relay; cord & plug, 110 v. 60 cy. AC. Ship. Wt. 67 lbs. Special **\$39.50** price.....

## "WELLWORTH" V-BELT CLUTCH

Takes starting load off engines or motors. When speed is reached, a flip of handle shifts clutch from idling to driving position. Handles "A" belts, 2.35" pitch diameter, 5/8" bore. Ideal for use with lawn mowers, garden tractors, home workshop motors, etc. 3 1/4" long. Safe, easy to mount, sealed bronze bearings, positive action.

**\$7.50**



SUMP PUMPS. ALL SIZES. BARGAINS. SEE CATALOG

Prices f.o.b. Chicago. Immediate delivery. All items sold on money back guarantee. Send check or money order today.

## WELLWORTH TRADING CO.

1831 S. STATE ST. DEPT. D-4 CHICAGO 16, ILL.

On lawn furniture . . . boats and cabinets . . . use

# SKIL Home Shop Tools!

TAKE ALL THE WORK OUT OF SANDING AND FINISHING!



## 2 1/4" SKIL Home Shop Belt Sander

the perfect finisher on home and home shop projects

Do expert sanding 10 times faster than by hand with SKIL Home Shop Belt Sander. Put an end to sore backs and stiff arm muscles. Produce satin-smooth, ripple-free surfaces every time . . . on wood, metal, plastics, compositions. Just guide SKIL Home Shop Belt Sander over the work . . . and the work is done! Your hardware store has it now.

## 6" SKIL Home Shop Sander-Polisher

It Sands! . . . It Polishes! . . . It Drills!

Does fast, fine sanding, yet is easy to use as a 1/4" drill. With its soft, lambswool bonnet it polishes the car, furniture and metals. Here's your one tool workshop that drills, buffs, rubs, grinds, stirs paint and scours pots and pans. Your dealer will be glad to show you SKIL Home Shop Sander-Polisher, tool of 1,000 uses, today.

SKIL Home Shop Tools made only by  
**SKILSAW, INC.**  
Home Shop Division  
5033 Elston Ave., Chicago 30, Ill.



# SKIL home shop Tools

See the complete SKIL Home Shop line at your Hardware dealer

Drills—  
1/4 and 1/2 inch  
6" Saw  
Saw Table  
Drill Kit  
Bench Stands  
Hedge Trimmer

SKILSAW, INC.  
Home Shop Division, Dept. C-4  
5033 Elston Ave., Chicago 30, Ill.  
Please send me full information on SKIL Home Shop Tools and name of my nearest dealer.

Name . . . . .  
Address . . . . .  
City . . . . . Zone . . . . . State . . . . .

# We've gone NUTS!!



Just Purchased 180,000 lbs. of the FINEST PRECISION Made ELASTIC & FIBER LOCK NUTS!! All are NEW!!



Here's your chance to "STEAL" Aircraft Quality STOP NUTS at less than the cost of common commercial hex nuts. They're ALL NEW Cad plated Steel and a large quantity are even pre-tapped for easier wrenching. ELASTIC or FIBER LOCK SEAL gives a Positive . . . Shock-proof . . . Vibration & Rust Resistant fastener. No lock washer necessary . . . One operation does the job. Just run on the nut. Ideal for use in all types of metal fabrication, assembly, construction etc. . . .

### AND LOOK AT THESE PRICES for ELASTIC or FIBER LOCK NUTS

Prices per 100 in these quantities - Special Discount for larger quantities -	100	1000	10,000	25,000	50,000	100,000	500,000
640	\$.49	\$.25	\$.21	\$.19	\$.17	\$.15	\$.13
836	.59	.31	.28	.25	.23	.21	.19
1032	.59	.31	.28	.25	.23	.21	.19
1/4-28 FL	.63	.39	.36	.33	.30	.27	.25
1/4-28 PT	.63	.39	.36	.33	.30	.27	.25
5/16-24PT	.84	.64	.61	.58	.56	.54	.49
3/8-24PT	.94	.74	.71	.68	.66	.64	.59

Note: FL means Fiber Lock (not pre-tapped). PT means Pre-tapped, ESSNA Brand.

SAVE! SAVE! SAVE! - We have TREMENDOUS quantities of AIRCRAFT Quality BOLTS - SCREWS - RIVETS & BEARINGS. Our huge stocks include a great variety of sizes and lengths. PRICED LOWER THAN YOU PAY FOR ORDINARY COMMERCIAL QUALITY!

### TUBE BENDER



Made by Parker Appliance Co. For bending thin wall seamless tubing of soft Copper, Brass, Aluminum Alloy or fully annealed steel. Ideal for Plumbers, Auto & Aircraft Mechanics, Steam Fitters, etc. Makes bend from 0 to 180 deg.

No. 5 - 5/16" Capacity . . . **5.45**

No. 6 - 3/8" Capacity . . . **7.65**

### BEADING TOOL

Made for the U.S. NAVY. For turning an edge bead on all kinds of metal up to 18 gauge thickness. Has high grade steel faces, hardened & polished. Easily removable from shafts. Back gearing drive is enclosed in case. Top shaft adjustable for thickness & pressure. 5 faces furnished include Nos. 0 - 01, 1, 2 & 3. Has 1-1/4" hexagon shaft for bench mandrel.

**17.95**

### AIR COMPRESSOR



General Electric, 2 stage AC - DC. Rated pressure 1000 lbs. per sq. in. with 1/3 H.P. 27 volt, 7 AMP series wound motor with fan for cooling. Thousands now in use for spraying, inflating, laboratory use, etc. Can be adapted to 110 volt A.C. with transformers or 4 1000 watt heating elements. A tremendous value of approximately 5% of original cost. . . . . **22.50**

### 6 in HAMMER

A very handy household or shop tool for man or woman. Ideal for hundreds of Fix-it jobs. Has 4 graduated screw-drivers in the handle, from 1/8" to 5/16" Steel hammer head & knurled brass handle. A Bargain at . . . . **89c**

### CLECO PLIERS



Cleco Pliers - For inserting and removing Cleco type skin fasteners. Heavy black enamel finish. NEW **69c**

### Ellinwood "44" GAS ENGINE

This engine is rated from 4.4 to 5 HP. Has optional power take-off of 1 to 1 from crankshaft or 2 to 1 reduction from camshaft. Makes an ideal auxiliary power plant or can be used to drive pumps, generators, compressors, small boats, etc. Lightweight rugged and contains such fine component parts as Bendix-Timken-Air Maze, etc. . . . . **ONLY \$52.95**

### NEW TARPS - HEAVY CANVAS

Mildew & Flame Resistant, Cheap Outside Storage. They are Really Moving at These Prices

5' x 7'	<b>\$3.95</b>	16' x 32'	<b>\$39.95</b>
8 1/2' x 10'	<b>\$8.50</b>	16' x 22'	<b>\$29.95</b>

Rubberized Linen 7' x 11' NEW **\$5.95**

Only 3 lb. light weight yet waterproof Ideal for outside car storage.

### RUBBER Neoprene Sheet Stock

Thickness Approx. Width Price per run yd.

#325 .020 1/64" 36"	\$1.75
#328 .032 1/32" 22"	1.38
#330 .064 1/16" 36"	2.39
#331 .093 3/32" 36"	3.39
#329 .125 1/8" 46"	4.75

Note: No. 329 is Laminated rubber sheet with cloth center. Flexible & very fine for heavy wear.  
No. 332 - Grey Neoprene Rubber Floor Mat. Has raised non-skid Diamond pattern with durable cloth backing. Stock size: 36" x 48" x 1/16" thick **\$1.95 EA.**

### INSTRUMENT MIX

6 DIFFERENT TYPES 6  
Contains 1 each of the following items:  
Flight Check-off Position Indicator  
Selsyn Fuel Gauge Air Speed Indicator  
Fuel/Air Ratio Oxygen Regulator  
These instruments contain sensitive meter movements, jewels, bearings, gears & valves.  
**COST THE GOV'T MORE THAN \$500.00**  
**SPECIAL!! ALL 6 FOR ONLY 5.95**

### TANK

Made of Dural. Has welded seams, 2" filler with cap, 1/4" stan'd pipe ports on top and bottom. Visible liquid level gauge on one side. An ideal tank for Gas, Oil or Water as a "spare" on your auto, tractor, truck, boat or plane. Sturdy-Lightweight. **4.95**

**PALLEY SUPPLY CO** SEE OPPOSITE PAGE FOR TERMS **CATALOG**  
6321 SAN FERNANDO RD. 92 PAGES-ILLUSTRATED  
DEPT. PM 4 GLENDALE 1, CALIF. SEND 25c TODAY!

Say You Saw It in Popular Mechanics



**SAVE UP TO 85%**

**IN WAR SURPLUS from "GADGETEERS" HEAVEN**

**92 PAGE CATALOG**  
War Surplus - Tools, Machinery, Raw Materials, Clothing, etc. Illustrated with valuable info., tables, charts & data. Send 25c to cover handling & postage.

**TV Antenna KIT** Mod. "B"  
Set up your own antenna at tremendous savings! Kit contains all parts & instructions

Model "A" KIT - Features "V" Cone conical type head with 3 ft. x 1 1/2" Hard Aluminum mast, 775

Model "B" DeLux Kit - Has phenolic head with Di-pole separator. Patented receiving elements. 8 ft. aluminum mast, reflector, 60 ft. lead-in wire, 25 ft. guy wire and full instructions... **1225**

**IMPORTED BINOCULARS**  
One of the FINEST 6 POWER BINOCULARS MADE! Small & compact, yet has the same high magnification power as the larger 6 power glasses. Field of view is 370ft. at 1100yds.

1950 Eyepieces adjust individually. Ideal for Hunters, Sports Fans, etc. Weights only 6 ozs. Size is 2" x 3 1/4".

**NAVY Type 7 x 50 BINOCULARS** - Big, rugged 7 POWER BINOCULARS with full 50 mm objective lenses that insure maximum brightness, sharp definition & extra wide field of vision. Individual eye focusing. Complete with case. . . . . **ONLY 4995**

**U.S. NAVY OFFICER'S JACKET**

Just received! This fine summer weight, grey twill jacket. Hip length. Has four patch pockets. All New. **5.95**

**NAVY EISENHOWER JACKET**

Same as above but made on Eisenhower style. Has two breast pockets, close fitting button-waist band. An amazing value. **6.95**

**TV LEAD-IN WIRE** - Best quality, flat rubber covered, double strand wire. 300 Ohm. A PALLEY SPECIAL per ft. **03c**

**NEW WATCH** - Has Shock Absorbing jewel movement. Sweep Second Hand, luminous dial, stainless steel case. Guaranteed for 1 year. **6.95**

**Genuine ARMY AIR FORCES SUNGLASSES** HERE'S THE REAL McCoy!

**ARMY AIR FORCE 6** bosey Precision Polished & Ground, Glare-free lens with leather case to be attached to belt. Gold plated adjustable frame. ONLY Pearlized sweat bar & pads. **\$3.95**

**NAVY WADING NEW SUIT**

Here's one that will make stream and surf fishing a pleasure. Made of rubberized canvas with vulcanized seams, it keeps you absolutely dry. Has rubber gloves at the cuffs and 3/4 length rubber boots at pants legs. Air tight Buoyancy pockets inside keep you balanced in deep water. Has 100% waterproof liner. Guaranteed condition. **ONLY 6.95**

**16mm MOVIE GUN CAMERA.** Has semi-telephoto 1 3/8" (35 mm) lens with yellow filter - 3 shutter speeds for normal (16 frames) semi-slow motion (32 frames) and slow motion (64 frames per second). Uses any standard Eastman film magazine or Type 'G' AAF magazine. Takes Black & White or Full color pictures. Operates on 24V (dry cell) batteries & require slight conversion for hand use. Diagram furnished. **2450**

**7 jewel - sweep sec. hand metal face. Radium Dial & Numbers # SW-1 \$7.95**

**SG-2 AIR FORCE Type GLASSES** - 4 base, ground & polished, processed glass lenses. Gold Plated frame, Pearlized sweat bar and nose pads. Cable ear pieces, simulated leather case. . . . **1.95**

**AIR CORPS BRIEF CASE**

This is a genuine piece of AAF equipment. Made of best grade Brown Leather in a handsome Pebble finish with a light canvas liner. Has two full length map or paper compartments and three smaller pockets. An ideal case for students, salesmen, artists, etc. Full heavy duty zipper closure. 12" x 16", Shpg. Wt. 3 lbs. **ONLY 2.95**

**CONVERTED GUN CAMERA** - Fully reconditioned with start switch on front. Choice of finishes - Gray, Black, Blue. . . . . **33.95**

**15 jewel - Waterproof. Radium dial & hands. sweep sec. hand. stainless steel screw back. A terrific buy at \$12.95**

**NIGHT DRIVING GLASSES**

With 57mm yellow amber, 6 base lenses. Optically Precision Ground and Polished! Your doctor will recommend these. Not a Cheap "Process" Lens. Reduces headlight glare & sharpens 'object focus' during night driving. In Men's size or Ladies Hatterquin style. ND-1 **\$16 VALUE \$4.59**

**AAAF CASE 2.95**

Genuine top grade leather. Multi-compartment. Lock and Straps. Ideal for Artists, Students, Salesmen, etc. Used, good condition. **7.95**

**VIEW FINDER** - Calibrated for above lens. **8.75**

**17 jewel - AUTOMATIC WINDING. SHOCKPROOF WATERPROOF SWISS WATCH.** Sweep sec. hand. stainless steel screw back. radium dial & hands. Body movements keep it properly wound. **#AW-1 \$23.95**

**Aviators (AN-6500) Windproof & Distorted GENUINE GOGGLES**

Rubber or chamois covered frame. Clear or Green GRIND LENSES are interchangeable. Adjustable nose bar. Ideal for Flying, motorcycling, etc. **1.69**

**FILM** - Standard, type "G" magazine - Fits gun camera and many other standard 16mm cameras - Loaded with 50 ft. black and white film - Price includes processing. **225**

**Chronograph**

**17 jewel - One of the finest made anywhere. Cased in Switzerland. Sweep sec. hand. stop & re-set buttons. Measures distance, airspeed, ground speed, races. Ideal for the sportsman. Special at #CH-1. \$21.95**

**GO-1 GOGGLE KIT**

New! U.S. Navy - One piece sponge rubber frame. With 4 polaroid lenses green, 1 clear, 1 red. A fine snow goggle **89c**

**16 POCKET VEST**

Sturdy, Yet Light Wt. Satin Lined with Tie Straps, 14 Outside Pockets, Plus Knife, gun, or Tool, Leather Holder, 2 large 11" x 8" Pockets Inside, Wonderful Hunting, Fishing, or Mechanic. A Steel **\$2.49**

**MESS TRAY**

6 Compartment - Stainless Steel - Rustproof. Wonderful for Outdoor Serving, Barbecue, etc. Saves dish-washing. Ideal for use in the home, hospital, 'roughing'. **NEW 1.07**

**START A PROFITABLE PLASTIC HOBBY**

**Kit #1** contains 2 lbs. plexiglass & Lucite sheet in various shapes, 1 oz. bottle of clearset cement, and 5 bottles of colors in Orchid, Red, Yellow, Peach, etc. Also a Plastic Handbook of uses & instructions. This set easily worth \$5.50. Our Price - **\$2.19**

**HUNTING KNIFE**

6" chrome vanadium blade handle, leather grip. In leather sheath **\$5.98 Value For Only \$1.89**

**FOAM RUBBER**

Molded & pre-shaped. Can be cut to fit your Chair seat, Boat, Auto, Truck or Trailer Seats. Ideal for all Sports Events. 25" x 62" x 1 1/2" . . . . . **\$6.45**  
25" x 65" x 2" . . . . . **\$8.45**  
25" x 65" x 1 3/4" . . . . . **\$7.45**

**Kit #2** contains 1 1/2 lbs. of plastic sheet, a 1 oz. bottle of clearset cement, and the Plastic Handbook. A \$2.50 Value for **ONLY 99c**

**BOLO KNIFE**

10" x 2" Parkerized blade. 5" Grippled Handle. Weight 1 1/2 lbs. . . . Ideal for Hunting, Clearing Brush or Trails. With Case **\$1.19 ea.**

**LEATHERETTE**

To cover Chairs - Nooks - Auto Seats, etc. **SPECIAL 54" Ivory Leatherette. Per Run Yd. . . . . 1.29**

**PLEXIGLASS & NASCOLITE clear plastic shts.**

**NASCOLITE** - Full sheets app. 1/8" x 37 1/2" x 49 1/2", app. 10 1/2 lbs. each **\$12.50**

**PLEXIGLASS** - Full Sheet 5/16" x 36" x 24" . . . Per Sheet. **\$13.00**  
5/16" x 36" x 48" . . . Per Sheet. **\$25.00**

**Hand COMPASSES**

#152 - MATCHBOX - both jewel & liquid floating dial **39c**

#151 - NEW! JEWEL Watch Pocket Compass **1.59**

#154 - WRIST STRAP Compass . . . . . **69c**

**RADIO HEADSET**

**HS-16A** - New! Low Impedance 200 Ohm headset. Ideal for amateur radio, crystal sets, or professional use. Adj. earphones, extra long 5' plug-in cord. **2.25 ea.**

**HS-30U** - Two Magnetic Type receivers in watertight brass case. Soft rubber inserts in each receiver to fit into wearers' ear. Pliable steel head band. Ideal for communications, divers, workers in noisy compartments, etc. **NEW 1.59**

**AAF RUBBER BOATS**

Made to rigid Gov't specifications. An ideal boat for ocean lake or pool. Each boat is complete with carrying case, oars and hand pump. **1 MAN 10.95 2 MAN 26.95 4 MAN 31.95 7 MAN 44.95 OARS 1.95 PUMP 2.95**

**NYLON FISHLINE Special**

Strong - Lightweight - 2 ply NYLON FISHING LINE. ROT-PROOF and WATERPROOF. . . . Especially treated for strength and long life. ON SPOOLS.

25 lb. test, 1000 ft. green **\$1.59**  
50 lb. test, 400 ft. green **1.19**  
72 lb. test, Braided, black and grey, 300 ft. **3.49**  
100 lb. test, 300 ft. white **3.79**

**Loose Leaf BINDER**

3 metal post. Cylindrical locking heavy duty 3/16" fabricated hinged cover. End identification window. Ideal for price books, salesmen catalogues, photo albums, students, publications, Reference books, etc. Will hold 500 sheets, 8" x 11". **59c ea.**

**CLAMP-ON ANYWHERE LAMP** With adjustable ball and socket swivel head, long rubber covered cord and wall plug.

The All Purpose Lamp. Wonderful for Indoor Photography, Floodlights, Baby Spot or Large Spot, Personal Bed Reading, Workbench, Garage, etc. Lamp Alone **99c**  
Highly Polished 9" diameter Parabolic Reflector or 5" diameter Spot Reflector at **Only 85c ea.**

**NAVIGATORS LAMP**

A handy light for desk, work bench, chart table, engine room, etc. Can be used on 6-12-24-110 V by changing bulb. 3 ft. shaft has 4 joints to adjust position. . . . **ONLY \$2.95**

**NAVY Sealed Beam LAMP**

US Navy Portable Pistol Grip, Sealed Beam, Search, Spot or Emergency Lite. 12 volt, Light weight. Ideal for Auto, Boat, Trailer, Farm, etc. Cost Gov't \$35. OUR PRICE **\$2.95**

Set of 3 extra filters, Red, Grn, Amber **99c**

**RIFLESCOPE** - Finest precision Acromatic optics 5 double element lenses, color corrected, spherical aberration. Dot reticle. Magnification 3 power. Length 9", tube dia. 7/8", objective lens 1 1/2", eye lens dia., 25mm. **\$8.95**

**PALLEY SUPPLY CO**  
6371 SAN FERNANDO RD.  
DEPT. P.M.4 GLENDALE 1, CALIF

**LARGEST FIRM OF ITS TYPE IN THE WORLD**

Order from this Ad. All sales final. All Prices F.O.B. Los Angeles. Pay by M.O. or Check. P.O.'s Accepted from D & B. First 1/2 deposit with C.O.D.'s.



No. 34-260

**\$149<sup>50</sup>**

Motor and switch extra  
Subject to change without notice

**Low down payment!**  
**Easy credit terms!**

**DELTA**  
**MILWAUKEE**  
®

## Big table — big cut — small floor space



... For sign shops

For maintenance departments ...



... For shipping departments

For carpenters ...



... For hobbyists

For everybody who cuts wood!

### Quality 8" Tilting-Arbor Saw — accurate, safe, economical

Everything you look for in a circular saw. Unsurpassed Delta quality — your assurance of long-time, trouble-free performance. Compact floor model. Cuts full 2-5/16" thick. Big cast-iron table. Features include: Lubricated-for-life ball bearings. Full-length rip fence. Adjustable table insert. Auto-Set miter gage. "Super-safe" saw guard. See this Delta-Milwaukee 8" Tilting-Arbor Saw today!

HM-79



Look for the name of your Delta dealer under "Tools" in the classified section of your telephone directory.

POWER TOOL DIVISION



**Rockwell**

Manufacturing Company

802D East Vienna Avenue

MILWAUKEE 1, WISCONSIN

Printed by Popular Mechanics Company, Chicago, Ill., U. S. A.

Do Scores of Hard Jobs the Quick, Easy Way

**COST Less TO BUY--COST Less TO USE**

Famous **SHAW** TRACTORS

**DU-ALL** and **PEPPY-PAL**



**RIDING MODELS--5 to 12 H.P.**  
HYDRAULIC CONTROLS OPTIONAL

Just the Tractors for Gardens, Nurseries, Estates, Poultry Farms, Golf Courses and Cemeteries

**EASY TO OPERATE**



**WALKING MODELS**

**1½ to 5 H.P.**



**In Use Throughout the Nation and in Many Foreign Lands... Saving TIME, MONEY and WORK!**

Right now is the time to plan ahead... plan to do your work easier, in less time and at less cost this year. Plan to get a famous SHAW Tractor... the machine that does scores of hard jobs the quick, easy, better way! No other investment will pay you better dividends year after year.

**TRIED AND PROVED RIGHT!** For nearly a half-century SHAW Tractors have proved their value throughout the Nation and in foreign countries. They are built right... to do the job right... with quality materials and expert engineering. Equipped with high-grade air-cooled gasoline or oil engines. You get a full year guarantee against any defect in material or workmanship. They serve faithfully for many years.

**LOW-COST DEPENDABLE WORKERS**—SHAW Tractors have proved dependable, versatile, low-cost helpers on scores of jobs... ideal workers on small farms, in gardens, truck farms, nurseries, orchards, cemeteries, golf courses, poultry farms and estates. Great for plowing, cultivating, discing, seeding, harvesting, spraying, mowing; operate cutter bars and lawn mowers. Riding tractors with bulldozer also used in foundries and by building contractors for moving sand, dirt, etc. For power on belt jobs... sawing wood, pumping water, grinding feed and running belt machinery. First cost is low and low operating cost will surprise and please you.

**EASY TO OPERATE**—You'll find a SHAW "Peppy Pal" or "Du-All" Tractor just fitted to your needs... 1½ to 12 H.P. And you'll find that a SHAW will do things a big tractor can't. Easy to operate by elderly persons, boys and girls. Easy to change from one piece of equipment to another. We can supply many attachments at low prices.

**GET FULL DETAILS**—Get all the facts and you'll get a SHAW! Plan now to do your hard jobs the easy way. Have a SHAW Tractor to do a better job... easier and quicker. It will serve you well... it will give you years of satisfactory, trouble-free, willing service... at amazingly low cost. Many dealers throughout the U. S. sell SHAW Tractors. See them... see their many great, exclusive features. In the meantime, fill out and mail coupon for FREE folders, prices, etc. Get all the SHAW Facts now!



**PLOW**

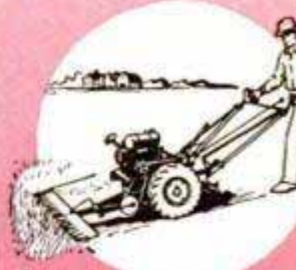

**MOW**



**CULTIVATE**

**FILL OUT, CLIP and MAIL COUPON**

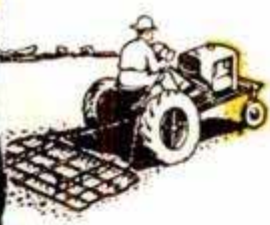

**HARROW**

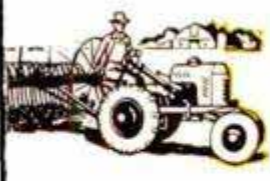

**RAKE**



**BULLDOZE and LOW SNOW**

**SHAW Saws and Grinds Feed and Does Belt Jobs**

**FREE FOLDERS and PRICES**

**SHAW MANUFACTURING CO.**  
4504 Front St., Galesburg, Kans., or 668G N. 4th St., Columbus,  
Send me Free Folders and Prices on SHAW Tractors.

**NAME** \_\_\_\_\_

# "Camels agree with my throat"

say these famous **20-GAME WINNERS OF BASEBALL**



**MEL PARNELL**

BOSTON RED SOX (WON 25)

Top winner in the major leagues last season, left-hander Mel Parnell made the Camel 30-day mildness test, and reports: "Camels agree with my throat. They're a mild, great-tasting smoke. Camels for me!"



**VIC RASCHI**

NEW YORK YANKEES (WON 21)

The "Big Wheel" of the World Champions, Vic Raschi, smokes Camels—because, "Camel mildness agrees with my throat. There's nothing so cheering as a Camel—that flavor hits the spot!"



**HOWARD POLLET**

ST. LOUIS CARDINALS (WON 20)

"The throat specialists' findings in the 30-day test don't surprise me," says this veteran southpaw. "I've smoked Camels for many years. I know they're mild—they're always right for my throat. And Camels have the flavor I like."

**BOB LEMON**

CLEVELAND INDIANS (WON 22)

"The 30-day test really opened my eyes," says Bob, only major league hurler to win 20 or more games in each of the past two seasons. "Camel mildness is welcome to my throat."



R. J. Reynolds Tobacco Co., Winston-Salem, N. C.

NOTED THROAT SPECIALISTS REPORT ON 30-DAY TEST OF CAMEL SMOKERS . . .

Not one single case of throat irritation due to smoking **CAMELS**

Yes, these were the findings of noted throat specialists after a total of 2,470 weekly examinations of the throats of hundreds of men and women who smoked Camels—and only Camels—for 30 consecutive days.