

ANC



POPULAR MECHANICS

MAGAZINE

WRITTEN SO YOU CAN UNDERSTAND IT

RAIN. NO. 410426

REG. U.S. PAT. OFF.



PILOT FINDS OLD SANTA FE TRAIL
Read his great story-Page 88

BE A CHAMPION DRIVER

LET YOUR INSTRUMENTS MAKE YOU A BETTER DRIVER

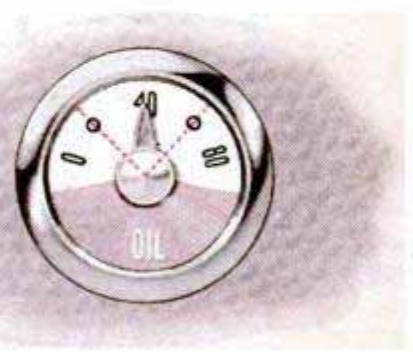

Your instrument panel is a thing of beauty, but primarily it is a practical aid to better driving. Your instruments tell you all you need to know about the operating efficiency of your engine. Cultivate the habit of **checking them frequently.**

Oil pressure is vital, it registers the "blood pressure" of your engine. If too low, it indicates low oil level, oil too thin or oil pump inoperative. If pressure is too high, oil is stiff from cold or too heavy. In either case **it's a danger signal—heed it.**



There is no instrument in your car to check your spark plugs—but most Champion dealers have a Spark Plug Service Unit with *Sparkling Comparator. Have yours tested and cleaned at regular intervals—it improves engine performance . . . **and saves money.**

A champion driver observes simple fundamentals, and maintains the life, pleasure, economy and performance of his car. Real experts like racing champions use dependable Champion Spark Plugs . . .

... BE A CHAMPION DRIVER—IT PAYS.

FOLLOW THE EXPERTS—



Johnny Parsons,
1949 AAA racing
champion, says:
"I used Champions
exclusively to win
my championship."

Demand



CHAMPION SPARK PLUG COMPANY, TOLEDO 1, OHIO

Listen to the CHAMPION ROLL CALL . . . Harry Wismer's fast sportscast every Friday night, over the ABC network



Deep are their **roots**

With television you see beyond the horizon. Radio brings you sounds from around the world. Electron microscopes peer deep into an infinitesimal world.

These, and other "leaves" on our new tree of knowledge are rooted in creative research—as carried out at RCA Laboratories in Princeton, N. J. Here, research scientists seek new scientific principles, improve on old ones, or put them to new uses.

Already on their achievement list are hundreds of basic developments in electronics, television, radio, loran, electron tubes, radar, and recorded music. RCA research works continually to give you better products.

Examples now working for you include: Today's sharp-eyed Image Orthicon television cameras, television picture tubes, compact portable radios made possible by tiny electron tubes, the 45 rpm record-playing system with the fastest record changer ever devised and distortion-free records.

Research in your behalf: Creative research into new principles is another way in which RCA Laboratories work to improve your way of living. Leadership in science and engineering adds *value beyond price* to any product or service of RCA and RCA Victor.

Examples of the newest advances in radio, television, and electronics—in action—may be seen at RCA Exhibition Hall, 36 West 49th Street, N. Y. Admission is free. Radio Corporation of America, Radio City, N. Y. 20.



RADIO CORPORATION of AMERICA

World Leader in Radio — First in Television

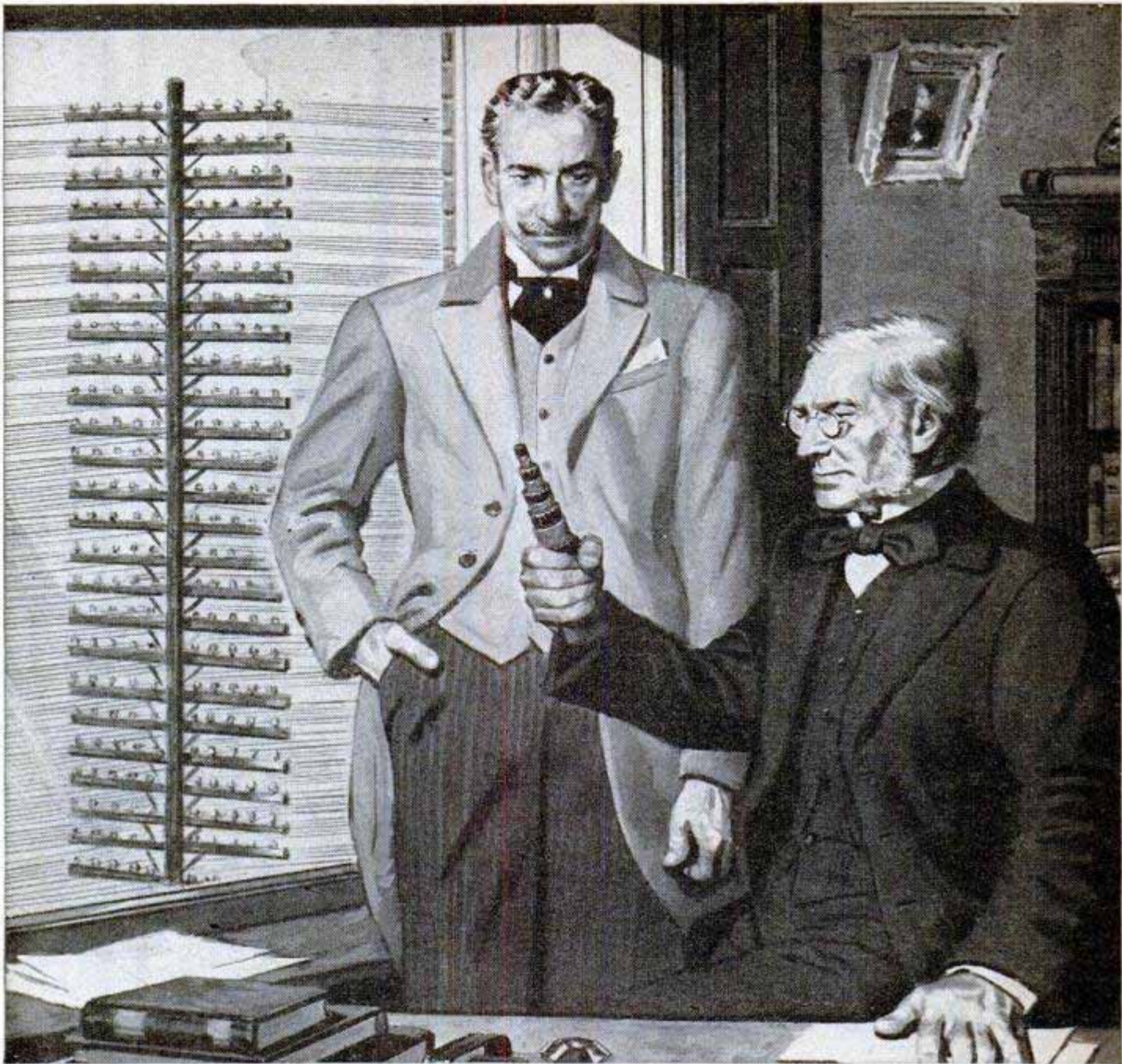

They Packed a Pole Line Into a Pipe

Back in the eighties, telephone executives faced a dilemma. The public demanded more telephone service. But too often, overloaded telephone poles just couldn't carry the extra wires needed, and in cities there was no room for extra poles. Could wires be packed away in cables underground?

Yes, but in those days wires in cables were only fair conductors of voice vibrations, good only for very short distances. Gradually cables were improved; soon

every city call could travel underground; by the early 1900's even cities far apart could be linked by cable.

Then Bell scientists went on to devise ways to get more service out of the wires. They evolved carrier systems which transmit 3, 12, or even 15 voices over a pair of long distance wires. A coaxial cable can carry 1800 conversations or six television pictures. This is another product of the centralized research that means still better service for you in the future.



BELL TELEPHONE LABORATORIES EXPLORING AND INVENTING, DEVISING AND PERFECTING, FOR CONTINUED IMPROVEMENTS AND ECONOMIES IN TELEPHONE SERVICE

Popular Mechanics Magazine

Registered in U. S. Patent Office and Canada

H. H. WINDSOR, *Founder*

H. H. WINDSOR, JR., *Editor and Publisher*



this month's cover

WE DIDN'T KNOW we had a portrait artist of front rank on our own art staff until Bob Korta came in with our cover painting for January. Working from the photographs that appear in the article beginning on page 88, with one or two brief looks at Captain Heath Proctor himself, Artist Korta produced a portrait that any airline pilot or stewardess between Chicago and Los Angeles will recognize. Proctor is portrayed as he photographed the ancient ruts of the Santa Fe Trail from the cabin window of his DC-6, which he sometimes steers a bit off the direct airline course in order to show his passengers the historic trail. Like a postman on vacation, Bob Korta spent his next week ends, after doing the Proctor painting, in a project more important to Mr. and Mrs. Korta: a portrait of their five-year-old daughter, Barbara. It's a honey, and so is she

Published monthly by Popular Mechanics Company, 100 E. Ontario St., Chicago 11, Ill. H. H. Windsor, Jr., President; William Harrison Petrigo, vice president; J. F. Windsor, vice president and secretary-treasurer; Clover L. Perkins, advertising manager; Alan M. Coyne, circulation manager. Single copy in the United States and Canada, 35 cents; subscription rates in United States and possessions, Canada, Philippines and countries of the Pan-American Postal Union, 1 year, \$3.50; 2 years, \$6.00; 3 years \$8.00. To all other countries add \$1.00 a year over United States prices for overseas postage. If you plan to move, notify us at least 30 days in advance so you will not miss an issue. Give both old and new addresses. Entered as Second Class Matter, September 15, 1903, at the Post Office at Chicago, Illinois, under Act of March 3, 1879. Entered as Second Class Matter at Post Office Dept., Canada. Copyright 1950 by Popular Mechanics Company. Copyright under International Copyright Union. Copyright in France. All rights reserved under Pan-American Copyright Union. Printed in the United States of America.

Volume 93 JANUARY 1950 Number 1

Managing Editor.....Roderick M. Grant
Assistant Managing Editor.....Wayne Whittaker
Shop Notes and Crafts Editor.....James R. Ward
Radio-Television, Electronics Editor.....Frank L. Brittin
Associate Editor, Aviation.....Aubrey O. Cookman, Jr.
Associate Editor.....Clifford B. Hicks
Art Director.....Frank Beatty
Director, Bureau of Information.....Allan Carpenter

Assistant Editors

Donald R. Brooks Dorothy E. Hoffmann Arthur R. Railton

Assistant Editors, Shop Notes and Crafts

W.Clyde Lammey Wayne C. Lecky Frank N. Stephany A.E. Youngquist

Eastern Editor.....Richard F. Dempewolff
Empire State Bldg., Room 2906, New York 1, N. Y.

Western Editor.....Thomas E. Stimson, Jr.
3872 Franklin Ave., Los Angeles 27, Calif.

Representative in Great Britain.....Douglas W. Wedderspoon
77 Baker St., London W. 1, England

IN THIS ISSUE

- A Half Century of Miracles - - - - - 81
An Airline Pilot Rides the Wagon Trail - - 88
Rainbow on the TV Screen - - - - - 97
I Fly Faster Than Sound - - - - - 108
What's New for Your Home - - - - - 118
Dry-Land Submarine School - - - - - 127
Homestead on the Range - - - - - 133
The Dizzy Merry-Go-Round of Industry - - 144
On the Trail of the Bat - - - - - 151
Oil Drillers Throw Curves - - - - - 160
CID—the Army's Crime Bureau - - - - - 166

For the Craftsman

- Tooled-Leather Writing Case - - - - - 174
Occasional Furniture - - - - - 181
Window Upkeep - - - - - 194
Tire Care Means Long Wear - - - - - 202
Sliding Shaper Jig - - - - - 213
Vapor-Zone Grinding - - - - - 217
Disk and Spindle Sander - - - - - 224
Radio-Television, Electronics - - - - - 229
Clinic for Homemakers - - - - - 240

Other items, and manufacturers of available products described, are listed on pages 10, 14 and 18



**KNOWLEDGE
THAT HAS
ENDURED WITH THE
PYRAMIDS**

A SECRET METHOD FOR THE MASTERY OF LIFE

WHENCE came the knowledge that built the Pyramids and the mighty Temples of the Pharaohs? Civilization began in the Nile Valley centuries ago. Where did its first builders acquire their astounding wisdom that started man on his upward climb? Beginning with naught they overcame nature's forces and gave the world its first sciences and arts. Did their knowledge come from a race now submerged beneath the sea, or were they touched with Infinite inspiration? From what concealed source came the wisdom that produced such characters as Amenhotep IV, Leonardo da Vinci, Isaac Newton, and a host of others?

Today it is known that they discovered and learned to interpret certain *Secret Methods* for the development of their inner power of mind. They learned to command the inner forces within their own beings, and to master life. This secret art of living has been preserved and handed down throughout the ages. Today it is extended to those who dare to use its profound principles to meet and solve the problems of life in these complex times.

This Sealed Book—FREE

Has life brought you that personal satisfaction, the sense of achievement and happiness that you desire? If not, it is your duty to yourself to learn about this rational method of applying natural laws for the mastery of life. To the thoughtful person it is obvious that everyone cannot be entrusted with an intimate knowledge of the mysteries of life, for everyone is not capable of properly using it. But if you are one of those possessed of a true desire to forge ahead and wish to make use of the subtle influences of life, the Rosicrucians (not a religious organization) will send you *A Sealed Book* of explanation without obligation. This *Sealed Book* tells how you, in the privacy of your own home, without interference with your personal affairs or manner of living, may receive these secret teachings. Not weird or strange practices, but a rational application of the basic laws of life. Use the coupon, and obtain your complimentary copy.

The ROSICRUCIANS

SAN JOSE

(AMORC)

CALIFORNIA



AMENHOTEP IV
Founder of Egypt's
Mystery Schools

*Use this
coupon for
FREE
copy of book*

SCRIBE M.Q.Y.
The Rosicrucians (AMORC)
San Jose, California

Please send free copy of *Sealed Book* which I shall read as directed.

NAME _____

ADDRESS _____

CITY _____

POPULAR MECHANICS

Books of Practical Help and Information

Give You Pride in
Your Work--
Hobbies, Home
Improvements,
Home Workshop.

Help You
EARN MORE
on Any Job!

Now you can have Popular Mechanics famous HOW-TO-DO-IT instruction in permanent, bound form, lavishly illustrated with photos, diagrams and plans. Select from this list of some of the most popular books of all time for workshop fans, hobbyists, home owners—others on skills and trades that make all jobs easier—help you earn more.

MONEY-MAKING HOBBIES

Tells how to make hobbies pay their own way, using leather, plastics, wood, ceramics, weaving, metal and paper craft. Illustrated. \$2.00.

PLANNING YOUR HOME WORKSHOP

Edited by Sam Brown. Shows how to set up a home workshop on a limited budget. Illustrated. \$2.50.

FORTY POWER TOOLS YOU CAN MAKE

Explains how to make forty different machines, such as lathes, drill press, jig saw, band saw, circular saw, sanders, from pipe fittings, old auto parts, wood, etc. \$1.50.

YOUR HOME and How to Build It Yourself

One of the most unusual books ever published. Step-by-step instruction by which anyone with ordinary knowledge of use of hand tools can build a five-room house, complete. Profusely illustrated—many plates in color. Spiral bound. \$3.00.

CONCRETE BLOCK HOUSE

Second of the sensational "Build-it-Yourself" home books. Complete instruction for building a five-room concrete block house for less than \$3650.00. Many illustrations and cover in colors. Plastic bound. \$2.00.

CHRISTMAS HANDBOOK

An exciting collection of ideas, gifts, decorations, toys, greeting cards, etc., to make at home. Christmas wrappings, hints for hostesses, etc. Illustrated in colors. \$2.00.

MOTORIST'S HANDBOOK

Packed with helpful, proven articles on operation, service and repair of all cars. \$2.00.

CONCRETE HANDBOOK

How to do all types of concrete work and make ornamental things of cement. \$1.50.

WELDING, BRAZING and SOLDERING

How to construct welding equipment and use it effectively. Small arc welder, spot welder, arc torch, tricks of soldering, brazing, heat treating iron and steel. \$1.25.

PAINTING, FURNITURE FINISHING and REPAIRING

A book for craftsmen and home owners. Covers repairs and finishing, restoring antiques, spray and brush painting. \$1.50.

BUILD A BOAT

How to build 17 low-cost boats—power, sail or rowboat. Prepared especially for inexperienced builders with limited tools. \$1.50.

WHAT TO MAKE—Volumes 1 to 11

Popular Mechanics annual Craftsman's Guide. Shows what to make and how to make hundreds of things. Set of 11 books, \$16.50. Single volumes \$1.75 each.

MONEY FROM IDEAS

A primer of inventions and patents. A must for every man of inventive mind who believes his ideas can be patented. \$2.50.

FARM MANUAL

Hundreds of articles on making farm implements and equipment, maintaining the home, farm workshop, live stock and poultry, many farm hints and kinks. 284 pages. Hundreds of illustrations. \$3.00.

PHOTO HANDBOOK

An excellent all 'round guide to better pictures. Features darkroom technique, gadgets to make. \$2.00.

OUTDOOR SPORTS MANUAL

220 helpful articles and hints for fishermen, hunters, campers, trappers, archers and boatmen. 334 illustrations. \$2.00.

THE BOY MECHANIC

Describes hundreds of things for boys to do and make. Develops natural talents and industry. Illustrated. \$2.00.

THE YOUNG CRAFTSMAN

The book that thrills, entertains and trains young minds and hands. Over 450 easy craft projects—things to make—things to do. Hundreds of pictures. \$1.50.

WHAT TO MAKE FOR CHILDREN

A timely book on making toys, dolls, dollhouses, slides, seesaws, rocking horses and pieces of furniture. 175 easy-to-make things designed to amuse and delight your child. \$2.00.

GARDEN BOOK

How to build trellises, fences, lawn furniture, outdoor fireplaces, attractive ornaments, etc. \$1.25.

At Leading Booksellers Everywhere or Order by Mail from the Address Below



Popular Mechanics Press

200 East Ontario Street, Chicago 11, Illinois



remember PYROIL forget

"dry starts"
"battery drain"
"rust and corrosion"
"friction wear"
"fouled spark plugs"

Make your winter-time driving easier on your nerves and easier on your car with Pyroil. Pyroil provides the "extra protection" you need when using low temperature oil. Pyroil improves lubrication because it gives oil the property of cohering to cylinder walls.

When you stop for gas or oil, remember to add Pyroil—add extra trouble-free miles to your car.

Pyroil for Aircraft Engines

Use Aircraft Pyroil B for lubricating oil, Aircraft Pyroil A for gasoline.

GIVEN! An attractive Pyroil metal savings bank—takes coins up to 50c pieces. **MOTORISTS**, it's yours for the asking—sent postage paid.

Manufactured and Guaranteed by Pyroil Company, 99 Pyroil Bldg., La Crosse, Wisconsin.

Canadian Distributors:
Central Purchasing Agencies, Ltd.
Toronto, Ontario



PYROIL COMPANY

99 Pyroil Bldg., La Crosse, Wisconsin

I want my car to last and run properly. Please tell me more about Pyroil and how it can accomplish this for me.

Name _____

Address _____

City or Town _____ State _____



in this corner.....

THE EDITORS



Signing out the borrowed Jeep at Dodge City, Kans.

OUR "cover story" began one night, months ago, when the managing editor bumped into his neighbor, Heath Proctor. The talk got around to his latest "discovery," the Santa Fe Trail.

Several years ago, when he was flying an airliner between Chicago and Washington, Proctor had spotted the Mason and Dixon Line. Most of us had assumed it was an imaginary line drawn through our history

(Continued to page 8)

Pilot Heath Proctor boards the Super-Chief "cockpit"

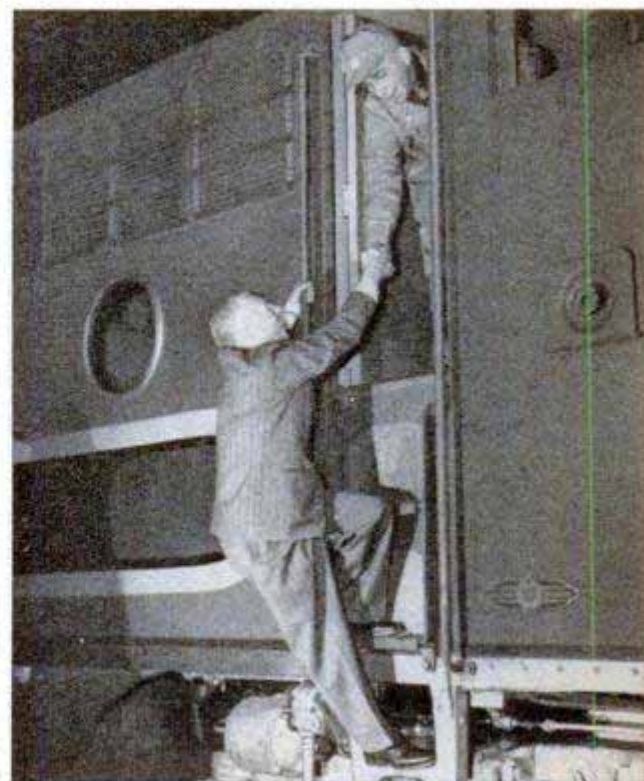

Why be a BOOKKEEPER?

*... When Accountancy
offers more Money
and Success...*

If you are a bookkeeper, you are right on the threshold of a profession that pays far above average—where there's real opportunity to get ahead and move up fast.

Why not step UP from bookkeeping—be an accountant—make *real* money!

You can learn Accountancy by the interesting LaSalle Problem Method—in your convenient spare time, at home, without losing a day from your work. You learn by *doing* . . . you study Accounting principles and solve Accounting problems under the clear guidance of experienced C.P.A.'s. You cover Accountancy from the basic principles right up through Accounting Systems and Income Tax Procedure—to advanced training for the C.P.A. degree if you so desire. And as you go along step-by-step, you master the principles of auditing, business law, statistical control, cost accounting, organization, management, finance, etc.

You go as fast or as slowly as you choose. And you may start "cashing in" on your new ability long before you complete the training—as thousands of others have proved. Many advance quickly to better positions, even before they are half way through. And that is only the *beginning* of a growing and continuing success for the rest of your business life.

Why remain "just a bookkeeper" when Accountancy holds so much for you? Our free 48-page booklet, "ACCOUNTANCY, THE PROFESSION THAT PAYS," tells you what you must know to be an Accountant, and how you can prepare in your

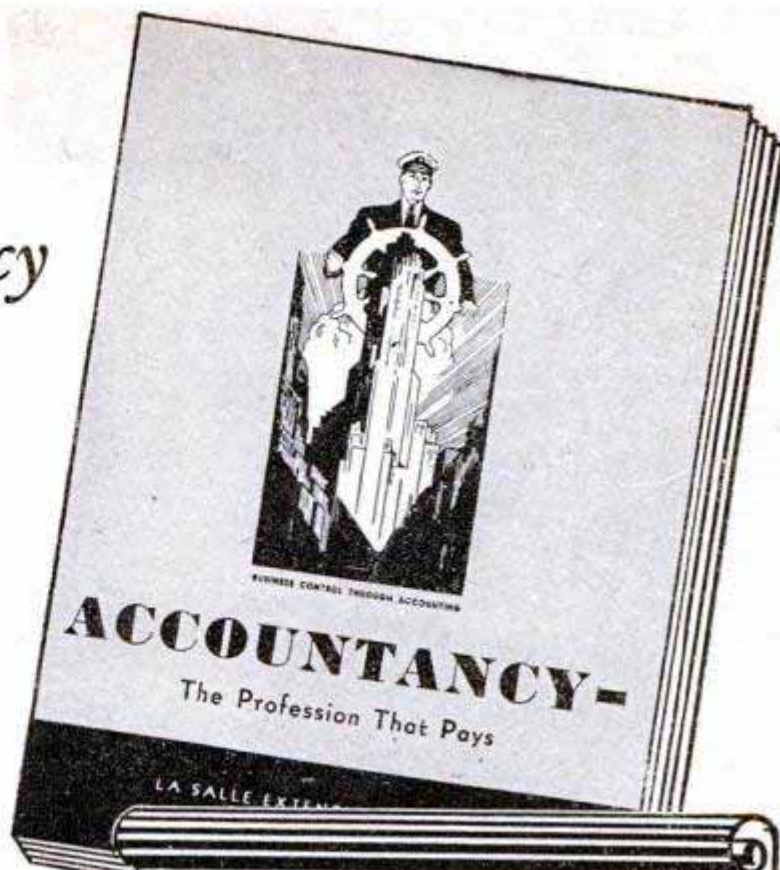

LASALLE Extension University

A Correspondence Institution

Dept. 164-HR • 417 S. Dearborn • Chicago 5, Ill.

Send me your free 48-page booklet, "Accountancy, the Profession That Pays"—plus "Ten Years' Promotion in One"—a book which has helped many men.

Higher Accountancy

Other LaSalle opportunities:

- | | |
|--|--|
| <input type="checkbox"/> C.P.A. Coaching | <input type="checkbox"/> Traffic Management |
| <input type="checkbox"/> Bookkeeping | <input type="checkbox"/> Foremanship |
| <input type="checkbox"/> Law: LL.B. Degree | <input type="checkbox"/> Industrial Management |
| <input type="checkbox"/> Business Management | <input type="checkbox"/> Stenotypy (Machine Shorthand) |
| <input type="checkbox"/> Salesmanship | |

Name..... Age.....

Address

City, Zone, State.....

LASALLE EXTENSION UNIVERSITY.

A Correspondence Institution

Dept. 164-HR 417 S. Dearborn St.
Chicago 5, Illinois

leisure time, at moderate cost and on easy terms.

Send the coupon today and we'll include "Ten Years' Promotion in One"—a book which has helped many men. Get all the facts and judge for yourself. There is no obligation. You are already started in this field . . . find out how you can rapidly go to the top! Mail coupon NOW!

One Step AHEAD!



with
EMBRY-RIDDLE
Training

AIRCRAFT & ENGINE MECHANICS

An urgent need exists for properly trained A & E Mechanics throughout commercial aviation. Our C. A. A. approved school with a quarter-century of experience assures your quickest advancement. Embry-Riddle students learn fast with modern equipment...working on live aircraft in airline-size hangars.

ENGINEERING

Embry-Riddle's Design Engineering and Maintenance Course offers you A & E certification eligibility plus basic engineering knowledge necessary to fill such positions as Field Service, Project or Maintenance Engineer.

A & E COMBINED WITH COMMERCIAL

Airmen with dual pilot-engineering ability are needed by aviation companies and operators. Embry-Riddle combination training offers you the most in your aviation career.
*Not available to veterans, but combined courses may be taken consecutively with proper justification.

COMMERCIAL PILOT

Embry-Riddle trained pilots benefit from our years of experience with 30,000 students...the best instructors, up-to-date aircraft, superb year-round flying weather... qualifications unexcelled anywhere. Instrument and instructor's ratings also available.

Never has there been such opportunity for properly trained men in commercial aviation. Put yourself one step ahead of the crowd. Start your career now at Embry-Riddle -- dormitories directly on the airport. For full information fill in the coupon below and mail today!



Embry Riddle
International
SCHOOL OF AVIATION
MIAMI 30, FLORIDA

Dean of Enrollments - Dept. 99
Embry-Riddle School of Aviation
Miami 30, Florida

Please Print

NAME _____

ADDRESS _____

City _____

State _____ Age _____

I am interested in...

- A.&E. Mechanic
- Commercial Pilot
- Engineering
- A.&E. Combined with Commercial Pilot *
- Flying Mechanic *
- Drafting & Design

Check One Veteran Non-Veteran

TRAIN IN MIAMI--AIR CAPITAL OF THE WORLD

(Continued from page 6)

books. He found it was really there, visible, a surveyor's cut through a forest dividing the Old North from the Old South. He photographed it from the air, and the pictures were "front page" in 1500 newspapers and magazines.

Now Proctor, senior pilot of his line, flies a Douglas DC-6 between Chicago and Los Angeles. History being a hobby with him, he had looked for and found the old wagon tracks of the Santa Fe Trail, and was itching to explore them.

So the managing editor treated him to a camping trip over the trail with an associate editor and photographer. The Santa Fe Super Chief deposited them in Dodge City, Kans., where they borrowed a Jeep from Tyson and Reinert, Inc., local Willys-Overland dealer, and took off over the wagon ruts.

Airline Captain Proctor—he was a colonel of the U. S. Air Transport Command in India during the war—has been flying commercial airliners since 1927.

* * *

We're Sorry

On page 112 of last November's P.M. we described an engine heater for easy cold-weather starting. Mistakenly, the "Where-to-buy-it" index listed the manufacturer as "British Railways, Rugby, England."

The heater is sold by Roscoe Industries, Roscoe, Ill.

Our apologies to all at Roscoe.

* * *

You Can Still Crunch

One of the latest boons to suffering humanity is a noiseless popcorn bag. It's paper, but of a porous texture that will give noise-making youngsters at the afternoon movies a sense of frustration. It won't pop, because you can't blow it up. And you can't fill it with water and bomb the folks below the balcony. Someone is always taking the joy out of one person's life and putting it in another's.

* * *

Chicks Fly the Atlantic

Three dozen baby chicks now growing up at an English agricultural college will probably boast to their grandchildren about the 2000-mile flight they made back in 1949. But they'll probably never fly again—and they weren't looking out the window as they flew the Atlantic in a BOAC Constellation. They were still in the shell, 36 eggs of the wingless chickens bred by Peter Baumann of Des Moines, Iowa.

YOU UNIVERSITY TRAINING

KEY TO SUCCESS IN BUSINESS AND INDUSTRY

Air Conditioning and Plumbing Courses

Air Conditioning
Heating Plumbing
Refrigeration
Steam Fitting

Chemical Courses

Chemical Engineering
Chemistry, Analytical
Chemistry, Industrial
Chemistry, Mfg. Iron and Steel
Petroleum Refining
Plastics
Pulp and Paper Making

Civil Engineering, Architectural and Mining Courses

Architectural Drafting
Architecture
Building Estimating
Civil Engineering
Coal Mining
Contracting and Building
Highway Engineering
Lumber Dealer
Reading Structural Blueprints
Sanitary Engineering
Structural Drafting
Structural Engineering
Surveying and Mapping

Communications Courses

Electronics Television
Practical Telephony
Radio, General
Radio Operating
Radio Servicing
Telegraph Engineering

Electrical Courses

Electrical Drafting
Electrical Engineering
Electric Light and Power
Lighting Technician
Power House Electric
Practical Electrician
Ship Electrician

Internal Combustion Engines Courses

Auto Technician
Aviation
Diesel-Electric
Diesel Engines
Gas Engines

Mechanical Courses

Aeronautical Eng'r's, Jr.
Aircraft Drafting
Flight Engineer
Forging Foundry Work
Heat Treatment of Metals
Industrial Engineering
Industrial Instrumentation

Industrial Metallurgy
Machine Shop
Machine Shop Insp.
Mechanical Engineering
Mold-Loft Work
Patternmaking—
Wood, Metal
Reading Shop Blueprints
Sheet-Metal Drafting
Sheet-Metal Worker
Ship Drafting
Ship Fitting
Tool Designing
Toolmaking
Welding Engineering
Welding—Gas and Elec.

Railroad Courses

Air Brake
Car Inspector
Diesel Locomotive
Locomotive Engineer
Locomotive Fireman
Locomotive Machinist
Railroad Section Foreman
Steam-Diesel Loco. Eng.

Stationary Engineering Courses

Boilermaking
Combustion Engineering
Engine Running
Marine Engineering
Power Plant Engr.
Steam Engineering

Textile Courses

Cotton Manufacturing
Loom Fixing
Rayon Weaving
Textile Designing
Woolen Manufacturing

Business and Academic Courses

Accounting Advertis'g
App. Psychology
Bookkeeping
Business Administration
Business Correspondence
Business Law
Cert. Pub. Accounting
Commercial
Commercial Art
Cost Accounting
Federal Tax
First Year College
Foremanship French
Good English
High School
Higher Mathematics
Illustration
Industrial Supervision
Motor Traffic
Postal Civil Service
Retailing
Retail Bus. Mgmt.
Salesmanship
Secretarial
Sign Lettering
Spanish Stenography
Traffic Management

APPROVED UNDER THE G.I. BILL

IF YOU CAN READ AND WRITE
AND ARE WILLING TO STUDY

I. C. S. CAN TEACH YOU!

• Special service and attention are always given to the student who may need extra help in order to understand.

Coupon Brings Full Information

The successful man DOES today what the failure INTENDS to do tomorrow. Mail this coupon NOW!

INTERNATIONAL CORRESPONDENCE SCHOOLS

BOX 5667-K, SCRANTON 9, PENNA.

Please send complete information on the following subject:

(Write above Technical, Business or Academic Subject in which you are interested.)

Name _____ Age _____

Address _____

City _____ State _____

Present Position _____ Working Hours _____ A. M. _____ P. M.

Employed by _____

Length of Service in World War II _____

Enrollment under G.I. Bill approved for World War II Veterans.
Special tuition rates to members of the Armed Forces.

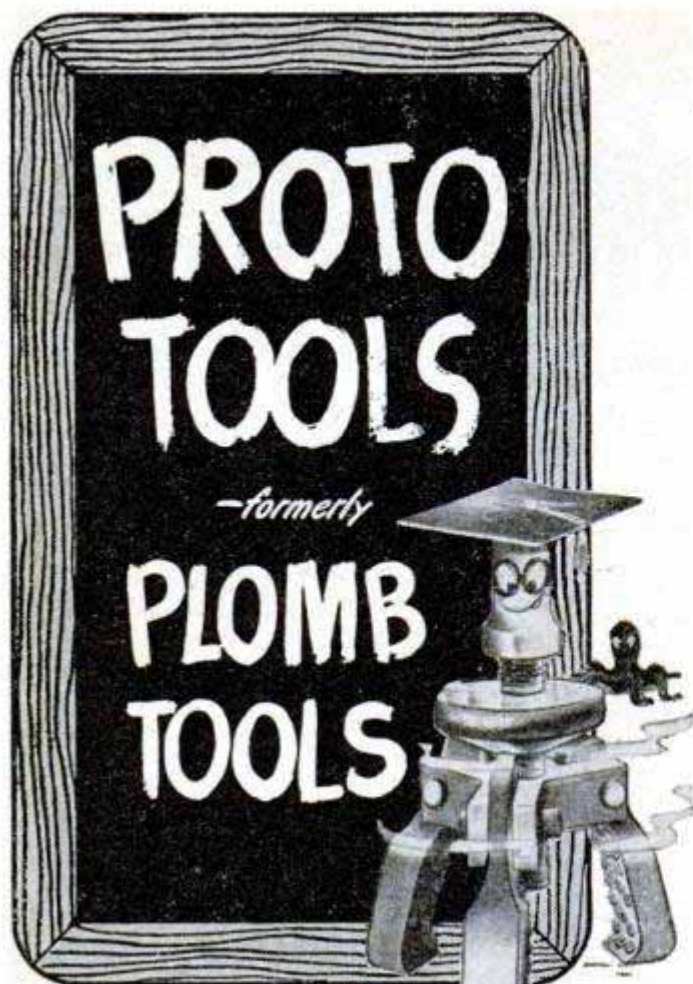

NOW!

**a different name for
your old friends!**

In PROTO tools—formerly Plomb tools—you get just what the name means, PROfessional TOOLS. They have the designs, special steels, scientific heat treating and over-all quality that have made them professionals' favorites for 42 years. Buy the best! Buy PROTO from your dealer now.

Write for catalog to

PLOMB TOOL COMPANY

2255P Santa Fe Ave., Los Angeles 54, Calif.

4987



WHERE-TO-BUY-IT INDEX

Source of supply appears after items commercially available

AUTOMOTIVE

Windshield glass stops glare, heat.....	18
Retread design makes worn tires skidproof (Robert B. Sommer, 1731 Townsend Ave., Apt. 1A, Bronx 53, N. Y.).....	106
Dashboard pressure gauge checks tires remotely (Henry Addy, 1543 N. Cass St., Milwaukee, Wis.).....	131
Strap-on chain applier (J. Randolph & Co., 526 Liberty Road, Englewood, N. J.).....	132
Australian auto has front-wheel drive.....	158

AVIATION

Aerial tree planting.....	114
Sperry zero reader.....	114
Air "gas stations" stretch plane range.....	125
Lampighter with a 25-mile reach.....	154
Spray kills insects in planes.....	264

FARM

Modern Peter Piper picks from old car.....	87
Chemical kills hardy weeds (E. I. du Pont de Nemours & Co., Inc., Wilmington 98, Del.).....	158
Barrage balloons store grain crop (J. W. Berger Co., 3305 Broadway Ave., Cleveland, Ohio).....	165

HOBBIES, NOVELTIES AND TOYS

Ride 'em kids!.....	104
Satin tape (Freydberg-Strauss, Inc., 419 4th Ave., New York City).....	122
Model rotary press prints newspapers.....	139
Four-acre rock garden.....	140
Model tram.....	165

HOUSE AND HOME

Weathertight window (Anderson Corp., Bayport, Minn.).....	87
Home is where they park it.....	115
Detergent makes rinsing of laundry unnecessary (Lever Brothers Co., 50 Memorial Drive, Cambridge, Mass.).....	117
Air deodorizer shaped like wick lamp (Metro Specialties Co., 363 Broadway, New York City 13).....	118
Kitchen counter rolls on casters (Moorex Industries, Inc., 1419 E. Main St., Richmond 19, Va.).....	118
Clothesline winder worn like apron (Bok Machine Products Co., 845 Walnut St., Fort Wayne 6, Ind.).....	118
Ice-cube tray (Cube Drawer Corp., 1301 Kentucky Ave., Akron 14, Ohio).....	119
Reel-type plug (Page Industries, Box 927, Hollywood 28, Calif.).....	119
Toy sewing machine (Betsy Ross Sewing Machine Corp., 666 Lake Shore Drive, Chicago 11).....	119
Slack hanger holds six pairs (Kit Mfg. Co., 668 S. Coronado St., Los Angeles 5, Calif.).....	119
Deep-fat fryer (Dulane Mfg. Co., 754 W. Jackson Blvd., Chicago 6).....	120
Automatic home pasteurizer (Guard-It Mfg. Co., 1501 S. Lafflin, Chicago).....	120
Ice-water tap operates without opening door of refrigerator (KoolerKoil, 101 Chataqua Blvd., Santa Monica, Calif.).....	120
Clothes hook has folding arm (R-Kay, 411 Provident Bldg., Cincinnati 2, Ohio).....	120
Automatic lock for window (Novel Products Corp., 19 W. 44th St., New York City 18).....	120
Skillet rings for eggs (Benmatt Organization, Merchandise Mart, Chicago 54).....	121
Electric mat safe on wet ground (Dan Morey, Dept. P-6, 814A S. Robertson Blvd., Los Angeles 35, Calif.).....	121
Indoor gardens with aluminum frames (Edmund C. Hanley, 215 W. Larch Ave., Muskegon, Mich.).....	121
Ladder has adjustable back legs (B. F. Pratt, 290 Mill Road, Falmouth, Mass.).....	121
Twin-bladed knife for grapefruit (Conklin Products Corp., 215 W. 7th St., Los Angeles 14, Calif.).....	121
Hanger for car or home (The Gayelon Co., 2848 W. Pico Blvd., Los Angeles 6, Calif.).....	122
Heating cord for blankets (Alva T. Smith Co., 161 W. Wisconsin Ave., Milwaukee, Wis.).....	122
No more KP duty (Miller's Pre-Prepared Potato Co., Inc., Box 268, Blue Island, Ill.).....	150
Rain closes windows.....	155
Hand-shaped chair.....	158
Rust preventive (Temperature Equipment Corp., 4505 Euclid Ave., Cleveland 3, Ohio).....	165
Tile with cutout center (Fremont Rubber Co., McPherson Highway, Fremont, Ohio).....	170

INDUSTRY

Flexible pipe-line support.....	106
Bridge shift.....	107
Duplicate tape recordings made by "contact printing" (Minnesota Mining & Mfg. Co., St. Paul, Minn.).....	125
Fluorescent-tube disposal device.....	131
Giant treadmill tests locomotives.....	138
Graphite coating for engine parts (Electrofilm Corp., 7116 Laurel Canyon Blvd., North Hollywood, Calif.).....	138
X-ray orange grader detects frost damage (Automatic X-Ray Corp., 5138 Jefferson Ave., Los Angeles, Calif.).....	139
Machine tops man.....	142
"Water wheel" boosts voltage.....	143
Gas-turbine engine pumps pipe-line gas.....	143
Injection engine burns cheap oil.....	150

(Continued to page 14)

WHAT Every AUTO MECHANIC Wants to Know

A motor vehicle is a machine of many parts, each part designed and constructed for its own special function. All good mechanics, like good doctors, should know the working theory and operation of each part and understand what causes trouble and how to remedy it.

LET AUDELS AUTO GUIDE SOLVE YOUR PROBLEMS

Every auto mechanic, helper, serviceman and operator can use AUDELS AUTO GUIDE. The information it gives saves time, money and worry. Highly endorsed by all users. It presents the whole subject of auto mechanics from A to Z in plain language and simple terms.

This Big Practical Book gives full information with working diagrams covering the principles, construction, ignition, service and repair of modern cars, trucks and buses.

A complete Guide of 1800 pages, with over 1500 illustrations showing inside views of the working parts, with instructions for service jobs. Diesel engines, Fluid and Hydra-matic drives fully explained.

IT PAYS TO KNOW HOW TO

How to fit pistons—How to locate engine knocks—How to fit connecting rod bearings—How to service main bearings—How to re-condition valves—How to time valves—How to adjust fan belts—How to adjust carburetors & chokes—How to rebuild a clutch—How to service automatic transmissions—How to service brakes—How to adjust steering gear—How to cope with ignition troubles—How to service distributors—How to time ignition—How to "tune up" an engine.

INFORMATION IN A HANDY FORM

73 INTERESTING CHAPTERS—Read this partial list of subjects on which practical information is fully given for quick reference under the headings as shown below. Ready Reference Index.

All Parts of an Automobile—Automotive Physics—The Gas Engine—Gas Engine Principles—Multi-Cylinder Engines—Horse Power—Automobile Engines—Stationary Parts—Moving Parts—Pistons—Piston Rings—Connecting Rods—Crank Shafts—Valves—Valve Gear—Cams and Cam Action—Valve Timing—Cooling Systems—Fuel Feed Systems—Dual Fuel Feed—Mixture—Carburetors—Carburetor Service—Automatic Choke—Super-Chargers—Transmissions—Special Transmissions—Fluid and Hydra-matic Drives—Clutches—Universals and Propeller Shafts

A Ready Reference

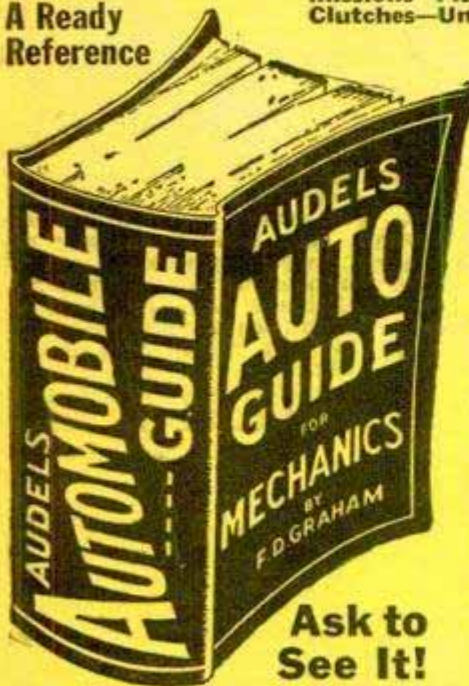

Ask to See It!

—The Differential—Rear Axles—Rear and Front Suspension—Running Gear—Brakes—Wheel Alignment—Knee Action—Steering Gear—Tires—Lubricants and Lubrication—Automotive Electricity—Ignition Systems—Magneto Ignition—Spark Plugs—Ignition Coils—Distributors—Automatic Spark Control—Ignition Timing—Generators—Starters—Generator and Starter Testing—Lighting Systems—Storage Batteries—Charging and Testing—Diesel Engines and Trouble Shooting.

7 DAYS' FREE TRIAL
TO GET THIS ASSISTANCE FOR YOURSELF SIMPLY FILL IN AND MAIL COUPON TODAY.

\$4 COMPLETE
PAY \$1 A
ONLY 1 MO.



Sent on 7 Days Approval

Step up your own skill with the facts and figures of your trade. Audels Mechanics Guides contain Practical Inside Trade Information in a handy form. Fully illustrated and Easy to Understand. Highly Endorsed. Check the book you want for 7 DAYS FREE EXAMINATION. Send No Money. Nothing to pay postman.

CUT HERE MAIL ORDER

AUDEL, Publishers, 49 W. 23 St., NEW YORK 10, N. Y.

Please send me postpaid for FREE EXAMINATION books marked (x) below. If I decide to keep them I agree to mail \$1 in 7 Days on each book or set ordered and further mail \$1 monthly on each book or set until I have paid price, otherwise I will return them.

- AUTO GUIDE**, 1800 Pages . . . \$4
- DIESEL ENGINE MANUAL, 400 Pages . . . 2
- WELDERS GUIDE, 400 Pages . . . 1
- MACHINISTS Handy Book, 1600 Pages . . . 4
- POWER PLANT ENGINEERS Guide, 1500 Pages. 4
- ENGINEERS & FIREMANS EXAMS, 528 Pages. 1
- PUMPS, Hydraulics & Air Compressors, 1658 Pgs. 4
- MARINE ENGINEERS Handy Book, 1280 Pages 4
- ENGINEERS & Mechanics Guides (8 Book Set). 12
- Answers on Practical ENGINEERING, 254 Pages 1
- ELECTRIC WIRING DIAGRAMS, 210 Pages . . . 1
- ELECTRICIANS EXAMINATIONS, 250 Pages. 1
- ELECTRICAL DICTIONARY, 9000 Terms . . . 2
- ELECTRIC MOTOR GUIDE, 1000 Pages . . . 4
- HANDY BOOK OF ELECTRICITY, 1440 Pages 4
- ELECTRICAL POWER CALCULATIONS, 425 Pgs. 2
- RADIOMANS GUIDE, 914 Pages . . . 4
- ELECTRONIC DEVICES, 216 Pages . . . 2
- ELECTRIC LIBRARY, 7000 Pages (12 Book Set). 18
- Vols. I, II, III, IV, V, VI, VII, VIII, IX, X, XI, XII \$1.50 Ea. 1
- OIL BURNER GUIDE, 384 Pages . . . 1
- HOUSE HEATING GUIDE, 1000 Pages . . . 4
- CARPENTERS & Builders Guides (4 Book Set). 6
- PLUMBERS & Steamfitters Guides (4 Book Set). 6
- MASONS & Builders Guides (4 Book Set). 6
- BLUE PRINT READING, 416 Pages . . . 2
- PAINTERS & DECORATORS MANUAL, 450 Pgs. 2
- GARDENERS & GROWERS Guides (4 Book Set). 6
- REFRIGERATION & Air Conditioning, 1280 Pgs. 4
- SHEET METAL WORKERS Handy Book, 388 Pgs. 1
- SHEET METAL PATTERN LAYOUTS, 1100 Pgs. 4
- AIRCRAFT WORKER, 240 Pages . . . 1
- MECHANICAL DRAWING GUIDE, 160 Pages. 1
- MECHANICAL DRAWING & DESIGN, 480 Pgs. 2
- MATHEMATICS & CALCULATIONS, 700 Pgs. 2
- MECHANICAL Dictionary, 968 Pages . . . 4
- MILLWRIGHTS & Mechanics Guide, 1200 Pgs. 4

Name _____
Address _____
Occupation _____
Employed by _____

AUDEL, Publishers, 49 W. 23 St., New York 10, N. Y.

I Trained These Men



M. JOSEPH, Sacramento, Calif., says, "Before starting your course I was making \$10 a week in spare time. After graduating I am now manager of station."



V. MARCHESA, Philadelphia, Pa., writes, "After finishing my N.R.I. course I have been busy servicing and installing television."



S. W. DINWIDDIE, Chicago, Ill., writes, "After finishing course, working in servicing shop. Now Chief Engineer of WCUN Police Radio Installation."



A. HERR, New Castle, Pa., writes, "Have doubled my salary since starting in Radio full time. Am employed by Station WKBO as transmitter operator. Future looks bright to me."



L. M. HAUGER, San Bruno, Calif., tells us that "N.R.I. helped qualify me for job as Radio Mechanic with United Airlines. Have my Radio-telephone 2nd Class License."



L. ARNOLD, Pontiac, Mich., says, "While learning, I made from \$5 to \$10 a week in spare time. Now I am earning as high as \$25 a week in my own spare time shop!"



M. LINDEMUTH, Ft. Wayne, Ind., writes, "When I started N.R.I. Course, didn't know a condenser from a resistor... but was soon averaging over \$9 a week in my spare time."



H. B. MILLS, Washington, Ohio, finds, "Word traveled fast in regard to my N.R.I. training. Have been doing Television installation and servicing, tracing out and eliminating interference, etc."



C. STAETH, Fort Madison, Iowa, informs us, "Do Radio Servicing full time in my own shop and am making more money than ever before. I owe this to N.R.I."



T. S. NORTON, Hamilton, Ohio, says, "My first job was obtained for me by your Graduate Service Department. Am now Chief Engineer, Station WQOX."



W. R. NICK, writes from... in control



MODERN RADIO

I'll Train You RADIO-

PRACTICE SERVICING OR COMMUNICATIONS I Send You Many Kits

For both my Servicing Course and my NEW Communications Course, I send you many Valuable Kits of Parts for PRACTICAL EXPERIENCE. They "bring to life" theory you learn in my illustrated texts. Some equipment from both courses is shown below. As part of my Servicing Course, you build a complete, powerful Radio Receiver, a Set Tester useful in earning extra spare time money, an A. M. and F. M. Signal Generator, etc. In my Communications Course, you assemble a low-power Broadcasting Transmitter that shows how to put a station "on the air," a Wavemeter, an Electronic Multitester for measuring voltage, current, impedance, etc. This and other equipment you build with Kits I send is yours to keep.



You Can Have a Business of Your Own
Many N.R.I.-trained men each year start their own Radio-Television sales and service business without capital. Let me show you how you, too, can be your own boss, have a good income from your own shop. Robert Dohmen, of New Prague, Minn., shown above standing in front of his store, writes that he is "now tied in with two Television outfits and does warranty work for dealers."



SIGNAL GENERATOR



POWER UNIT



SET TESTER



WAVEMETER



MULTITESTER

AT HOME for Good Jobs in TELEVISION

There is Success--Good Pay--Security for You in America's Fastest Growing Industry



Make Extra Money Fixing Radios in Spare Time While Learning

I send you SPECIAL BOOKLETS that show how you can earn \$5, \$10 a week in your spare time fixing neighbors' Radios and I send you parts to build SET TESTER that helps you do it. Frank J. Lhotsky, of Cicero, Ill., shown above in his workshop, was one of my many students who earned money while training.

VETERANS

GET THIS TRAINING WITHOUT COST UNDER G. I. BILL

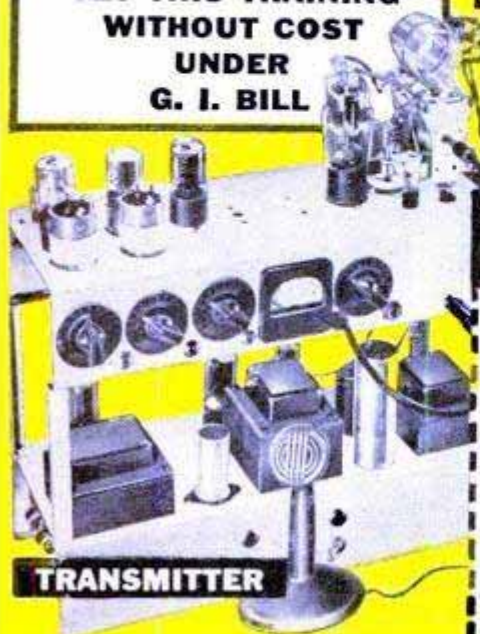

Do you want a good-pay job in the fast growing RADIO-TELEVISION Industry? Or do you want to have your own money-making Radio-Television Shop? Here is your opportunity. I've trained hundreds of men to be successful Technicians . . . MEN WITH NO PREVIOUS EXPERIENCE. My tested and proved train-at-home method makes learning easy. You learn Radio-Television principles from my illustrated lessons. You get practical experience building, testing and experimenting with MANY KITS OF PARTS I send. All equipment yours to keep.

Make Extra Money In Spare Time

The day you enroll, I start sending you SPECIAL BOOKLETS that show you how to make \$5, \$10 a week or more EXTRA MONEY fixing neighbors' Radios in spare time while learning. From here, it's a short step to your own shop or a good-pay Radio-Television servicing job. Or be a licensed Radio-Television Operator or Technician.

Television Offers Bright Future

In 1945, there were 943 Radio Stations. Today, about 2700 are on the air! RESULT--THOUSANDS OF QUALIFIED MEN STEPPED INTO GOOD JOBS. Another example--only 19 Television Stations were on the air in 1947. Today, more than fifty. Within a few months, 150, say the experts--and 1000 within three years. Then add developments in FM, Two-Way Radio, Police, Marine, Aviation, Microwave Relay Radio. Think what this means! New jobs, more

jobs for qualified men. The man who prepares NOW can reap rich rewards in this changing, developing, fast growing field!

Find Out What N. R. I. Can Do For You

Act now! Send for my FREE DOUBLE OFFER. Coupon entitles you to actual lesson, "GETTING ACQUAINTED WITH RECEIVER SERVICING." It shows how many pictures and diagrams are used to make learning at home easier, practical. You also get my 64-page book, "HOW TO BE A SUCCESS IN RADIO-TELEVISION." It tells more about YOUR opportunities . . . details of my Course . . . what my graduates are doing and earning . . . how quickly you can be on your way to good pay, success, a bright future. Send coupon in envelope or paste on penny postal. J. E. SMITH, President, Dept. OAP, National Radio Institute, Pioneer Home Study Radio School, Washington 9, D. C.

Actual Lesson and 64 page Book BOTH FREE

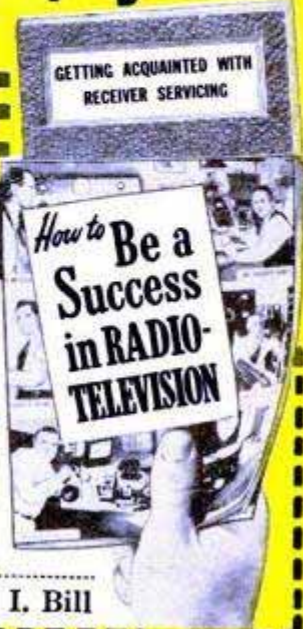

Mail Coupon Now!

MR. J. E. SMITH, President, Dept. OAP
National Radio Institute, Washington 9, D. C.

Mail me Sample Lesson and 64-page Book, "How to Win Success in Radio-Television"--both FREE. (No salesman will call. Please write plainly.)

NAME.....AGE.....

ADDRESS.....

CITY.....ZONE.....STATE.....

Check if Veteran Approved Under G. I. Bill

DON'T Sell Your Invention

—UNTIL YOU READ THIS BOOK!

THIS book will tell you how to get your rightful share of royalties — when dealing with hard-headed business men and shrewd investors. It will tell you WHERE to go, WHOM to see, and HOW to sell your idea for the *quickest* and *biggest* royalties. And when the time comes for drawing up contracts and making business arrangements, it may mean the difference to you between a pittance and a fortune!

FAMOUS INVENTOR RAYMOND F. YATES Tells You How to Develop, Protect, and Sell Your Ideas

This brand-new book, "Yates' Guide To Successful Inventing," tells you everything you want to know to develop, protect, and market profitable inventions. 26 big chapters give you valuable tips on getting advances, making favorable price and royalty arrangements, selling unpatented inventions, how to steer clear of unprofitable or already patented ideas, and how to find and sell the right manufacturer. Includes model forms for patent petitions and royalty contracts, patent helps from official sources, warnings against invention racketeers and patent infringements.

TRY IT FREE FOR 5 DAYS

If you aren't convinced—in just 5 days—that this book can show you how to develop, protect, and get the biggest possible profits from your invention, simply return it and pay nothing. Otherwise send only \$2.95 plus a few cents postage as complete payment. Mail coupon today. If you already have developed an invention or are working on one now, this book may be worth a fortune to you. Mail coupon to Wilfred Funk, Inc., Dept. S491, 227 East 44 Street, New York 17, N. Y.

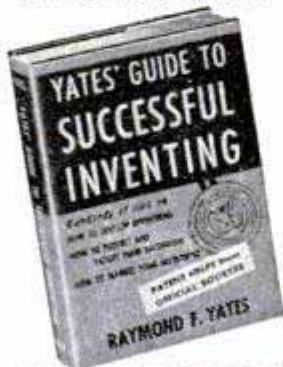

HUNDREDS OF TIPS ON:

- How To Protect and Patent Your Invention
- How To Take Out Your Own Patent
- How To Price Your Invention
- How To Find The Right Manufacturer
- How To License or Rent Your Invention

... plus hundreds of helpful hints on the right **TIME**, **PLACE**, and **PERSON** to sell your invention for the most profit.

Same FREE 5-Day Offer on Ray Yates' "2100 NEEDED INVENTIONS"

This other book by Ray Yates lists and describes the 2100 inventions that are surest to make money. Any one of these ideas can bring somebody a fortune. Maybe it can be YOU! (Check coupon to get it.)

WILFRED FUNK, Inc.
Publishers, Dept. S491,
227 East 44 Street, New York 17, N. Y.

Please send me YATES' GUIDE TO SUCCESSFUL INVENTING for FREE EXAMINATION. If I keep the book I will send you \$2.95 plus few cents postage. Otherwise I will return it within 5 days without further obligation.

Send me Ray Yates' Book, "2100 NEEDED INVENTIONS," for 5 days' FREE EXAMINATION. If I decide to keep it I will send you \$2.50 plus a few cents postage. Otherwise I will return it, owe nothing.

Name _____

Address _____

City _____ Zone No. _____ State _____

Check here if enclosing payment in full WITH this coupon, as per prices above. Then WE pay all postage charges. Same 5-day return-for-refund privilege applies.

(Continued from page 10)

Boats on dry land store drilling mud.....	159
Arctic tires.....	159
Heating with paint (Electrofilm Corp., 7116 Laurel Canyon Blvd., North Hollywood, Calif.).....	170

MOTORCYCLES

Motorcycle convertible.....	117
Cycle salesman tows his wares.....	143
"Flying egg".....	154

OFFICE, SHOP AND STORE

Paper sorter (Keith Macey, 6830 Beersford Ave., Parma Heights, Ohio).....	86
Pen-size stapler (The Fastener Corp., Chicago 14).....	106
Carton tongs (Kenworth Mfg. Co., 3455 N. Holton St., Milwaukee 12, Wis.).....	131
Overhead screen door.....	142

PHOTOGRAPHY

Film editor on hinged base folds into compact case (Craig Manufacturing Co., 1053 Olive St., Los Angeles 15, Calif.).....	87
Photo trimmer guides let you cut in dark (Webster Instrument Co., 11856 Mississippi Ave., Los Angeles 25, Calif.).....	106
Midget German camera.....	132
Trick photo effects made with shutter-shade (Workrite Products Co., Dept. H, 808 W. Doran St., Glendale, Calif.).....	132
Resin filter permits reuse of photo wash water.....	139
Speed light kit (The Anglo Corp., 4234 Lincoln Ave., Chicago 18).....	142
Camera with a roving eye.....	156
Quick test for synchronizer (Conway Camera Co., 34 N. Clark St., Chicago).....	170

TOOLS

Stand converts wrench into vise (Hartmann Mfg. Co., 1637 Gould St., Racine, Wis.).....	96
Drying agent protects tools (Tamms Silica Co., 228 N. La Salle St., Chicago 1).....	116
"No bounce" hammer has plastic tips (Tahlen Metal Industries, Ltd., 643 E. Hastings, Vancouver, B.C., Can.).....	165

MISCELLANEOUS

You can still crunch (Riegel Paper Corp., 342 Madison Ave., New York City 17).....	8
Carry-or-roll golf cart (Burns Specialties Co., Fort Pierce, Fla.).....	86
Dog in splints.....	96
Paintbrush box has wringer (Y & N Manufacturing Co., Wooster, Ohio).....	96
Cardboard umbrella.....	96
Kids like this dentist.....	107
Ladderless painting.....	114
Giant "eye" gets second test.....	116
Funnel-shaped theater built like an airplane hangar.....	117
Sun cooks food.....	122
Skater leaps through "egg beater".....	123
Caltech tunnel is fastest in world.....	124
Hydraulic exerciser (Physical Services, 10830 Santa Monica Blvd., Los Angeles 24, Calif.).....	154
Radioactive trees test effectiveness of chemical.....	155
Germ powder emits light.....	155
Radar "measuring tape".....	158
Balloon tests weather at 99,000-foot altitude.....	159
Ultrathin slices for microscopic study.....	172
Trigger conversion unit for military rifles (Dayton-Traister Co., 34 S.E. 66th Ave., Portland 16, Ore.).....	172

Craftsman and Shop Notes Index

AUTOMOTIVE

Preventing ignition-lock trouble.....	192
Extension handle on car heater aids turning control knob.....	200
Jeep seat cushions of looped foam rubber.....	221

DRAFTING AND DRAWING

Double-pencil lettering.....	193
Storing artists' brushes.....	215
Clock spring aids drawing arcs.....	216

FARM

Small oil drums double for large storage tank.....	177
Rats attracted by grain camouflage drown in barrel.....	215
Barrel canopy protects rock salt.....	216
Quarter round saves poultry feed.....	216
Nipple insures that pail-fed calves will drink slowly.....	221
Tractor low-load platform.....	222

HOUSE AND HOME

Match-book covers level furniture.....	177
Clothespin belt holds washcloths within easy reach.....	177
Keep needle with each spool of thread.....	178
Window shades protected when top sash is opened.....	178
Cellulose tape aids threading curtains on rods.....	178

(Continued to page 18)

IMPORTANT NOTICE—It is the intention of this magazine to provide its readers with information regarding the latest developments in the mechanical arts. We take no responsibility as to whether the disclosures contained in our articles are covered by patents and advise readers to investigate this subject before making, using, or selling any of the products, machines, or processes described in order to avoid possible liability for patent infringements.



INVENTORS



Learn how to protect your invention. The U. S. Patent Laws provide that any new and useful art, machine, article of manufacture, or composition of matter, or any new and useful improvement thereof, may be patented if the act of invention is involved. Therefore, every inventor with a valuable invention should take advantage of the Patent Laws and proceed for patent protection in order to safeguard his rights.

A patent gives the inventor the exclusive right to prevent others from making, using, or selling the invention claimed in the patent for a period of seventeen years.

The Patent Laws were enacted for the benefit of the inventor to give him protection for the features of his invention which are patentable. These features must be properly and concisely set forth and claimed in a formal application for patent, in order to comply with the requirements of the Patent Laws. For that reason, unless the inventor is familiar with patent matters, he should engage a competent registered patent attorney or agent to represent him. We are registered to practice before the U. S. Patent Office and are prepared to serve you in the handling of your patent matters.

A specially prepared booklet entitled "Patent Guide for the Inventor", containing detailed information with respect to patent protection and procedure, together with a "Record of Invention" form will be promptly forwarded to you without obligation upon request.

CLARENCE A. O'BRIEN & HARVEY JACOBSON

Registered Patent Attorneys

01-Ath DISTRICT NATIONAL BUILDING • WASHINGTON 5, D. C.

Patents

Trademarks

Copyrights

CLARENCE A. O'BRIEN & HARVEY JACOBSON
Registered Patent Attorneys

01-A District National Bldg., Washington 5, D. C.

Please send me copy of "Patent Guide for the Inventor" and also "Record of Invention" form. This request does not obligate me.

Name _____

Address _____

City _____ State _____

(Please write or print plainly.)

YOU Need My **PRACTICAL** Training to Make Money in

TELEVISION- RADIO and ELECTRONICS!



I'll Send You
8 BIG KITS of
Radio Parts and Equipment

Learn at
HOME
IN YOUR
SPARE TIME

Now is the Time to Get Into This Fast
Growing Industry—Prepare for a Fine
Paying Job or Your Own Business!

I have trained hundreds of men to become technicians—and I'm ready to do the same for you. Whether your goal is a fine paying job in one of Radio's many branches—or a successful Radio and Television business of your own—you need the kind of training I offer! My training is practical and down to earth. YOU NEED NO PREVIOUS EXPERIENCE. I start you with basic fundamentals and give you plenty of practical shop-bench training with many kits of parts I send you. This is the training that sticks with you and makes money for you on the job!

GET PAID FOR SPARE TIME WHILE LEARNING

Soon after you start training I send you my famous **BUSINESS BUILDERS** that show you how to make money in spare time doing interesting Radio jobs. I send you 8 big kits of Radio parts and equipment and help you build step-by-step a powerful 6-tube superhet radio, a 16-range test meter, plus other mighty useful equipment for Radio and Television servicing. You will perform over 175 fascinating experiments while training. You will learn about Television—so that you will be qualified to step into this fast growing, profitable field. I also send you many valuable service manuals, diagrams, and my book telling exactly how to set up your own Television and Radio shop. Clip and mail the coupon below for my two big **FREE** Radio books. I employ no salesmen—and nobody will call on you.



HAVE A BUSINESS OF YOUR OWN

A profitable Radio and Television Service Shop may be started with little capital. I will show you how to get started. At left is pictured one of my graduates, Mr. Merrit C. Sperry, Fairmont, Minn. in his own shop.

Radio and Television Industry Booming

You couldn't pick a better time to get into Radio-Television and Electronics. New Television stations are going on the air to serve every major city—hundreds of new AM and FM Radio broadcasting stations are also on the air. All this creates new and bigger opportunities for the trained man who knows Radio-Television and Electronics.

VETERANS

THIS TRAINING AVAILABLE TO YOU UNDER THE G.I. BILL

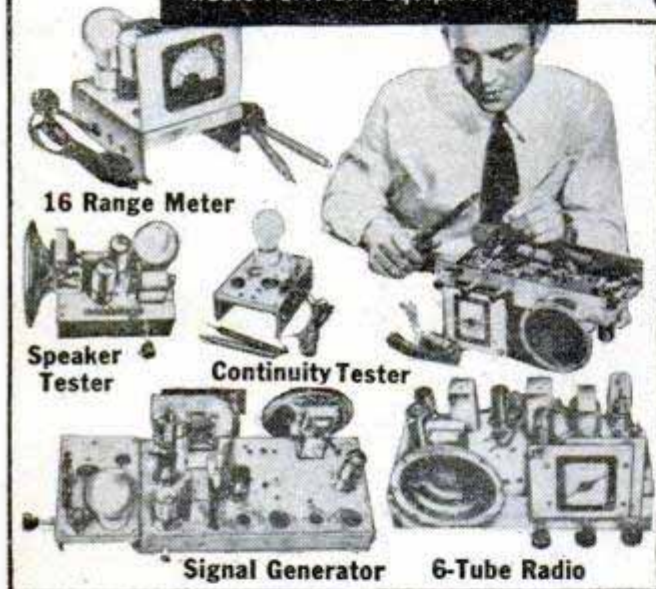

All Kits Are **YOURS TO KEEP**

Each of the hundreds of Radio parts and other items I send my students is theirs "for keeps." You may use this equipment in your Radio and Television service work and save many dollars by not having to buy expensive "ready-made" test equipment.



CALVIN SKINNER of New Orleans, La. tells us he makes \$5 to \$10 in spare time repairing radios. He is now also working with a Television set.



LOREN D. SAUCIER of Coloma, Mich. reports that my training has made it possible for him to repair large numbers of Radio and Television sets.

RUSH COUPON Today!

My Training Includes . . .
Television, FM (Frequency Modulation), Public Address and High Frequency Applications



These Two Big FREE! Radio Books

Just mail coupon for a **FREE** sample Sprayberry Lesson and my big **FREE** book, "How To Make Money In Radio-Television and Electronics." Learn why my really practical training is best of all for you. Discover what's ahead for you in Radio-Television and Electronics. No obligation. Don't delay! Mail the coupon now—and count on me for fast action.

SPRAYBERRY ACADEMY OF RADIO
111 N. CANAL, DEPT. 10-E CHICAGO 6, ILL.

Name.....Ago.....
Address.....
City.....State.....
() Check here if you are a Veteran

INVENTORS

Patent laws encourage the development of inventions.

We recommend that an inventor employ a registered Patent Attorney or agent, if the inventor is not familiar with patent matters. This is because the value of a patent depends largely upon the skillful preparation of the specification and claims in the patent application.

The firm of McMorrow, Berman and Davidson is registered to practice before the United States Patent Office. Additionally it engages patent attorneys able to readily understand inventors' disclosures, to advise concerning patentability, and to prepare appropriate specifications and claims.

If an inventor believes he has an invention, a search of the most pertinent prior U. S. patents should be made and a report obtained relative to its patentability. Where such report indicates that the invention appears patentable, in order to secure protection, diligence should be exercised in making application for a patent.

Send for a copy of Patent Booklet entitled "How To Protect Your Invention." This booklet contains information on patent protection and procedure. You will also receive an "Invention Record" blank. This will be promptly forwarded to you upon request—no obligation.

McMORROW, BERMAN & DAVIDSON

Registered Patent Attorneys

PATENTS • TRADE MARKS • COPYRIGHTS

1358 VICTOR BUILDING, WASHINGTON 1, D. C.

McMORROW, BERMAN & DAVIDSON

Registered Patent Attorneys

1358 Victor Building, Washington 1, D. C.

Send me your Patent Booklet, "How To Protect Your Invention", and also "Invention Record" form at once. I understand this request does not obligate me.

Name.....

Address.....

City.....

(WRITE OR PRINT NAME CLEARLY)

A GREAT NEW

PLASTIC MANUAL

is ready
for **You**

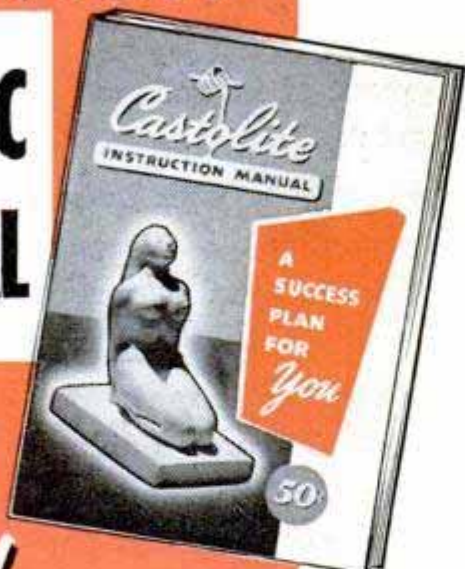

BRAND NEW SUCCESS SECRETS

Here at last is a Plastics Manual that gets right down to business. Explains doing all kinds of things with a new, lately perfected Liquid Plastic. See how to embed real flowers, photos, shells, butterflies, coins, medals, specimens; how to make tiles, trays, jewelry, coasters, paper weights. Or create lamp bases, candle holders, desk sets, etc. Also plasticize baby shoes and make striking silhouette profile plaques. No end of things are possible.

Get the 6-POINT SUCCESS PLAN

But this book tells more. Also contains valuable, Success Secrets and proved 6-point Success plan for starting a plastics business of your own. See how to begin, how to grow. Do like John Zack of Chatham, N.J. He writes, "I sold the things I made at a handsome profit and have decided to go into manufacturing." Or succeed like Gladys Smith of Steveston, B.C. She says: "I made buttons, brooches, and wall plaques and took them to our leading department store. The manager was enthusiastic and asked me to make up articles to sell to their trade. Your wonderful product and clear instructions made my success possible." Many others are having fine experiences.

EASY TO START

You, too, may start making things the very first day. But first, get this big, new, factful manual, combined with an amazing Home Success Plan. No special tools, no previous experience necessary. Hundreds succeeding. Every step fully explained in this big, new fact-and-photo book. Send 35¢ today for "Plastics Manual—A Success Plan for You."

The CASTOLITE CO.

Dept. A-1

WOODSTOCK, ILLINOIS

Easily made things worth \$31.50



DEALERS

Many recognized Plastics Materials Dealers are now handling Castolite. There may be an opportunity for you. Inquiries welcomed from financially responsible firms.

(Continued from page 14)

Adhesive tape reinforces plastic shower curtains.....	178
Handy spot for recipes while cooking.....	178
Efficiency tip for Venetian-blind cleaning.....	179
Olive oil removes paper from varnished surface.....	179
Watering house plants while on vacation.....	179
Reset loose picture-frame nail with help of cloth strip.....	179
Basement windows kept cleaner with concrete splash aprons.....	180
Concrete laundry tubs repaired by waterproof crack filler.....	180
Rubber bumper for stepladder.....	180
Kitchen knife fashioned from hacksaw blade.....	190

OFFICE, SHOP AND STORE

Coffee can forms lamp shade.....	192
Light socket taped to C-clamp forms portable shop lamp.....	207
Rubber-stamp rack is automatic.....	216
Compound girder improvised by sheathing beams.....	221
Sheet-metal clip on platform scale holds weighing slips.....	223

OUTDOOR RECREATION

Underspring trap concealed in top of stump outsmarts fox.....	177
Pencil erasers sheathe fishhooks.....	192
Outdoor gym.....	206
Take care of your camp ax.....	207

PHOTOGRAPHY

"Positive negatives" for projection.....	208
"Flash" pictures from photoflood lamps.....	210
Photo paper held between pages of magazine.....	210
Adding household detergent to final wash water improves glossy prints.....	210
Carrying wet news films.....	210
Transparency viewer doubles as retouching stand.....	211
Handy photo-paper dispenser has individual compartments.....	212
Film identified on holder slide.....	212
Detergent speeds drying.....	212
Swabbing insures clean negatives.....	212
Reducing dense areas in negative.....	212

TOOLS

Dowel wound with strip of sandpaper provides efficient spindle sander.....	190
Pipe held securely in bench vise to facilitate threading.....	192
Clock gears used in craftwork.....	200
Table listing spindle speeds mounted on lathe headstock.....	207
Variety of hammers turned from automobile axles.....	215
Miter-box base prevents clogging.....	216
Taper-measuring gauge for lathe.....	223
Correct punching strengthens belt.....	223
Chalk-line reel drilled to prevent unwinding.....	223

TOYS AND NOVELTIES

Whittled salt and pepper shakers provide novel decoration.....	180
Rattail file aids stuffing toys.....	180
Eight-sided cupola improves garage roof lines.....	191
Metal clips screwed to toy provide wheel mounts.....	200
Weighted toy clown swings precariously on rail.....	201
Arrow inserted through heart provides bewildering puzzle.....	201
"Crazy jug" covered with baubles is interesting novelty.....	207

MISCELLANEOUS

Paper clip forms bookmark.....	177
Asphalt tile cut in saw vise.....	190
Warped boards forced in place by C-clamp and pry bar.....	191
Safety pin locks lunch box.....	192
Door held during lock fitting by sand-filled sack.....	200
Milk carton holds patching plaster.....	200
Removing gum from shoe soles.....	201
Wood screw kept from loosening.....	207
Mounting test meter on turntable facilitates reading dial.....	214

Radio-Television, Electronics

Utility television today (Three-unit TV receiver for any cabinet, National Company Inc., 61 Sherman St., Malden, Mass.; television set for the kitchen, Motorola Inc., 4545 W. Augusta Blvd., Chicago).....	229
No. 1 progressive all-wave "overseas dxer" for students.....	230
"Black" tube for sharp-contrast TV pictures ("Black" face glass for TV tubes, Pittsburgh Plate Glass Co., 632 Duquesne Way, Pittsburgh 22, Pa.; TV set employing "black" tube [photo B], Zenith Radio Corp., 6001 Dickens Ave., Chicago).....	232

Windshield Glass Stops Glare, Heat

Excluding more than 15 percent of the sun's infrared rays without distorting vision, a new glass for car windshields will reduce driver fatigue. A slight bluish-green tint, derived from chemicals mixed with the raw materials in manufacture, kills much of the glare of bright sunshine. By cutting down on the infrared rays, the glass makes driving more comfortable in hot weather and also reduces upholstery fading.

POPULAR MECHANICS

ARTHUR GODFREY SAYS:

"I. C. S. made the impossible—easy!"

YOU'VE often heard Arthur Godfrey, famed "Huck Finn of Radio," on his coast-to-coast "Talent Scouts" and other CBS programs—now winning new renown on television. But this is the first time you've heard the star on the subject of I. C. S.:

"I had to quit high school before the end of my second year. Later in life, at the U. S. Naval Materiel School at Bellevue, D. C., I had to master a working knowledge of math, all the way from simple decimals and fractions through trigonometry, in the first six weeks or be dropped from the course. So I took an I.C.S. Course and finished at the head of the class! I.C.S. made the impossible—easy!"

As usual, the former Navy radio operator and present Lt. Commander in the U. S. Naval Reserve knows what he's talking about. As an I.C.S. graduate, Mr. Godfrey is in the best of all positions to tell you about the educational system that's served so long as talent scout for American industry.

Study his statement. Then mark your interest on the coupon and mail it today for full information on what I.C.S. can do for you!



INTERNATIONAL CORRESPONDENCE SCHOOLS

APPROVED
under the
G.I. BILL

BOX 5668-K, SCRANTON 9, PENNA.

Without cost or obligation, please send me full particulars about the course BEFORE which I have marked X:

- | | | | |
|---|---|---|---|
| <p>Business and Academic Courses</p> <ul style="list-style-type: none"> <input type="checkbox"/> Accounting <input type="checkbox"/> Advertising <input type="checkbox"/> App. Psychology <input type="checkbox"/> Bookkeeping <input type="checkbox"/> Business Administration <input type="checkbox"/> Bus. Correspondence <input type="checkbox"/> Bus. Law <input type="checkbox"/> Certified Public Accounting <input type="checkbox"/> Commercial <input type="checkbox"/> Commercial Art <input type="checkbox"/> Cost Accounting <input type="checkbox"/> Federal Tax <input type="checkbox"/> First Year College <input type="checkbox"/> Foremanship <input type="checkbox"/> Good English <input type="checkbox"/> French <input type="checkbox"/> Higher Mathematics <input type="checkbox"/> High School <input type="checkbox"/> Industrial Supervision <input type="checkbox"/> Illustration <input type="checkbox"/> Motor Traffic <input type="checkbox"/> Postal Civil Service <input type="checkbox"/> Retailing <input type="checkbox"/> Retail Bus. Management <input type="checkbox"/> Salesmanship <input type="checkbox"/> Secretarial <input type="checkbox"/> Sign Lettering <input type="checkbox"/> Stenography <input type="checkbox"/> Spanish <input type="checkbox"/> Traffic Management <p>Air Conditioning and Plumbing Courses</p> <ul style="list-style-type: none"> <input type="checkbox"/> Air Conditioning <input type="checkbox"/> Heating <input type="checkbox"/> Plumbing <input type="checkbox"/> Refrigeration <input type="checkbox"/> Steam Fitting | <p>Chemical Courses</p> <ul style="list-style-type: none"> <input type="checkbox"/> Chemical Engineering <input type="checkbox"/> Chemistry, Analytical <input type="checkbox"/> Chemistry, Industrial <input type="checkbox"/> Chemistry, Mfg. Iron & Steel <input type="checkbox"/> Petroleum Refining <input type="checkbox"/> Plastics <input type="checkbox"/> Pulp and Paper Making <p>Civil Engineering, Architectural and Mining Courses</p> <ul style="list-style-type: none"> <input type="checkbox"/> Architecture <input type="checkbox"/> Architectural Drafting <input type="checkbox"/> Building Estimating <input type="checkbox"/> Civil Engineering <input type="checkbox"/> Coal Mining <input type="checkbox"/> Contracting and Building <input type="checkbox"/> Highway Engineering <input type="checkbox"/> Lumber Dealer <input type="checkbox"/> Reading Structural Blueprints <input type="checkbox"/> Sanitary Engineering <input type="checkbox"/> Structural Drafting <input type="checkbox"/> Structural Engineering <input type="checkbox"/> Surveying and Mapping <p>Communications Courses</p> <ul style="list-style-type: none"> <input type="checkbox"/> Electronics <input type="checkbox"/> Prac. FM and Television <input type="checkbox"/> Prac. Telephony <input type="checkbox"/> Radio Operating <input type="checkbox"/> Radio, General <input type="checkbox"/> Radio Servicing <input type="checkbox"/> Telegraph Engineering | <p>Electrical Courses</p> <ul style="list-style-type: none"> <input type="checkbox"/> Electrical Drafting <input type="checkbox"/> Electrical Engineering <input type="checkbox"/> Electric Light and Power <input type="checkbox"/> Lighting Technician <input type="checkbox"/> Practical Electrician <input type="checkbox"/> Power House Electric <input type="checkbox"/> Ship Electrician <p>Internal Combustion Engines Courses</p> <ul style="list-style-type: none"> <input type="checkbox"/> Auto Technician <input type="checkbox"/> Aviation <input type="checkbox"/> Diesel-Electric <input type="checkbox"/> Diesel Engines <input type="checkbox"/> Gas Engines <p>Mechanical Courses</p> <ul style="list-style-type: none"> <input type="checkbox"/> Aeronautical Engineer's, Jr. <input type="checkbox"/> Aircraft Drafting <input type="checkbox"/> Flight Engineer <input type="checkbox"/> Forging <input type="checkbox"/> Foundry Work <input type="checkbox"/> Heat Treatment of Metals <input type="checkbox"/> Industrial Engineering <input type="checkbox"/> Industrial Instrumentation <input type="checkbox"/> Industrial Metallurgy <input type="checkbox"/> Machine Shop <input type="checkbox"/> Machine Shop Inspection <input type="checkbox"/> Mechanical Drafting <input type="checkbox"/> Mechanical Engineering | <ul style="list-style-type: none"> <input type="checkbox"/> Mold-Loft Work <input type="checkbox"/> Patternmaking—Wood, Metal <input type="checkbox"/> Reading Shop Blueprints <input type="checkbox"/> Sheet-Metal Drafting <input type="checkbox"/> Sheet-Metal Worker <input type="checkbox"/> Ship Drafting <input type="checkbox"/> Ship Fitting <input type="checkbox"/> Tool Designing <input type="checkbox"/> Toolmaking <input type="checkbox"/> Welding Engineering <input type="checkbox"/> Welding—Gas and Electric <p>Railroad Courses</p> <ul style="list-style-type: none"> <input type="checkbox"/> Air Brake <input type="checkbox"/> Car Inspector <input type="checkbox"/> Diesel Locomotive <input type="checkbox"/> Locomotive Engineer <input type="checkbox"/> Locomotive Fireman <input type="checkbox"/> Locomotive Machinist <input type="checkbox"/> Railroad Section Foreman <input type="checkbox"/> Steam and Diesel Loco. Eng. <p>Stationary Engineering Courses</p> <ul style="list-style-type: none"> <input type="checkbox"/> Boilermaking <input type="checkbox"/> Combust. Engrg. <input type="checkbox"/> Engine Running <input type="checkbox"/> Marine Engineering <input type="checkbox"/> Power Plant Engr. <input type="checkbox"/> Steam Engineer <p>Textile Courses</p> <ul style="list-style-type: none"> <input type="checkbox"/> Cotton Manufacturing <input type="checkbox"/> Loom Fixing <input type="checkbox"/> Rayon Weaving <input type="checkbox"/> Textile Designing <input type="checkbox"/> Woolen Manufacturing |
|---|---|---|---|

Name _____ Age _____ Home Address _____

City _____ State _____ Working Hours _____ A.M. to _____ P.M.

Present Position _____ Employed by _____

Length of Service _____ Enrollment under G.I. Bill approved for World War II Veterans. Special tuition rates to members of the Armed Forces.
in World War II _____ Canadian residents send coupon to International Correspondence Schools Canadian, Ltd., Montreal, Canada.

INVENTORS-PATENTS

Unless an inventor is thoroughly familiar with such matters, he is advised to employ a competent registered patent attorney or agent as the value of patents depends largely upon the skillful preparation of the specification and claims.

For his guidance, the following are the usual preliminary steps which the inventor takes toward patent protection.

The "Evidence of Invention" form mentioned below is offered as a convenience to the inventor in making his disclosure of invention.

The inventor should date and sign his disclosure and have it witnessed by two or more persons who are capable of understanding his invention. The disclosure should then be mailed to the registered patent attorney or agent whom he selects to assist him. The disclosure should be accompanied by a letter authorizing the patent attorney or agent to conduct a preliminary search among previously granted U. S. patents for similar types of invention. The patent attorney or agent then prepares a report of the probable patentability of the invention and recommends the further course the inventor should take, provided the report indicates possible patentability.

This firm is registered to practice before the U. S. Patent Office and is available to assist inventors in the preparation and prosecution of their cases. The coupon below is suggested as a convenience to the inventor in starting action on his invention.

VICTOR J. EVANS & Co. *Merlin M. Evans*
REGISTERED PATENT ATTORNEY
530-A MERLIN BUILDING, WASHINGTON 6, D. C.

• • • • •

• VICTOR J. EVANS & CO.
• 530-A Merlin Building, Washington 6, D.C.

• Please send me without obligation a copy of your
• booklet "Patent Protection For Inventors" together
• with your convenient "Evidence of Invention" form.

• Name.....

• Address.....

• City and State.....

• • • • •

PATENTS TRADEMARKS COPYRIGHTS

PRINT YOUR OWN POST CARDS

COMPLETE
OUTFIT
only
\$7.50

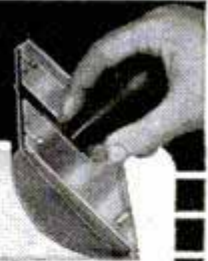

Amazing results in sales, inquiries and contacts . . . saves time and money . . . very easy to use GEM STENCIL DUPLICATOR is ideal for Advertising, Announcements, Notices, Labels, Forms, Price Lists—hundreds of uses for every type of business and organization. Comes complete with all supplies, instructions and 60-page Book of Ideas.

FREE TRIAL OFFER: Try it before you buy it! Write and a GEM OUTFIT will be sent you postpaid. After 10 days, send only \$7.50 or return the GEM, no questions asked. The GEM must sell itself; you be the judge.

BOND EQUIPMENT CO. • Dept. 135
6633 Enright • St. Louis 5, Mo.

SEND NO MONEY • FREE TRIAL OFFER

LEARN TO WRITE *a Good Hand!*

FOR BUSINESS AND SOCIAL SUCCESS!
Easy to improve your handwriting at home quickly with my new instruction books just off the press. Master all the secrets of better penmanship. Simple and easy, fully illustrated, highly endorsed. Begin today. Write for: New Free Book, "How to Become a Good Penman," or check books wanted, \$1.00 each. Business Writing Artistic Writing Card Writing Engrossing Alphabets Bird and Design Flourishing Complete Set \$4.50 Enclose 10c for your name beautifully written and special pinpoint for shaded writing.

S. A. Ziller, President, TAMBLYN SCHOOL OF PENMANSHIP
441 Ridge Bldg. In Business Over 52 Years Kansas City, Mo., U.S.A.

LAW FREE BOOK



Your FREE copy of "The Law-Trained Man" shows how to gain prestige and greater earnings through Blackstone home law study. All instruction material furnished including 18-volume Law Library written by 65 well-known law authorities. Lawyers, judges among our graduates. LL.B. degree. Low cost; easy terms. Write today.

BLACKSTONE COLLEGE OF LAW 225 N. Michigan Ave. Dept. 51, Chicago 1, Ill.
A Correspondence Institution Founded in 1890



Bar Bells

Buy Direct From Factory \$8.95 up

Write for free booklet and price list

INDEPENDENT IRON WORKS
2416 East 23rd Street, Dept. B
Los Angeles 11, Calif.

Say You Saw It in Popular Mechanics

YOU CAN SUCCEED BY KLOK TRAINING

There is no other practical training in the wood industry whereby you can succeed so quickly as through our training. You can study either at home by correspondence or come to Grand Rapids and study with us here. The KLOK Course teaches you Sketching—Drafting—Rod Making—Time Study—Cost and Production Scheduling. The training will enable you to run your own shop more successfully or enable you to get a top position in the furniture and woodworking industry. Write NOW for free booklet, "Stepping Stones to Top Positions in the Woodworking Industry." State preference—Home Study or Resident Training—Age, and if you are a Veteran.

FREE G.I. TRAINING



KLOK INSTITUTE
Louis St., N. W., Grand Rapids, Michigan

THESE MEN ARE GETTING PRACTICAL TRAINING

IN **ELECTRICITY**

On Real:



**A.C. and D.C. MOTORS
GENERATORS
SWITCHBOARDS
CONTROLLERS
WIRING JOBS
APPLIANCES
ELECTRONIC UNITS**

(Shown at left—Instructor demonstrating latest type of Test Unit for checking the efficiency of a Motor.)

AND **RADIO-TELEVISION**

On Real:

**TELEVISION SETS
RADIO RECEIVERS
F.M. (Frequency Modulation)
RECORD CHANGERS
AUTO RADIOS
AIRPLANE RADIOS
PUBLIC ADDRESS Systems**

(Right—Instructor explaining operation of 20-inch Cathode Ray tube used in Dumont Television Set.)



Just Like YOU Can Get in the Great SHOPS of COYNE

Prepare NOW for a real future the quick, practical way. Come to the Great Shops of COYNE in Chicago. Largest and best equipped school of its kind—now celebrating our 51st Anniversary. GI approved. Finance plan for non-veterans. **Mail coupon.**

NOT "HOME-STUDY" COURSES! At Coyne you learn on real, full-size equipment. Trained instructors show you how, then you do typical jobs yourself. We don't teach by mail.

CLIP COUPON NOW for big new illustrated Coyne book on either **ELECTRICITY** or **RADIO-TELEVISION** or both. No obligation; no salesman will call. Get the facts now!

COYNE **B. W. COOKE, Pres.**
ELECTRICAL & RADIO SCHOOL
500 S. Paulina St., Dept. 10-72H
Chicago 12, Ill.



**Mail Coupon for
FREE BOOKS!**



**B. W. COOKE, President
COYNE ELECTRICAL &
RADIO SCHOOL, Dept. 10-72H
500 S. Paulina St., Chicago 12, Ill.**

Send **FREE**, the book checked below, and details of your training offer. This does not obligate me and **no salesman will call.**

ELECTRICITY **RADIO-TELEVISION**

NAME

ADDRESS

CITY.....STATE.....

WHO WANTS TO BE A RUNNER-UP?

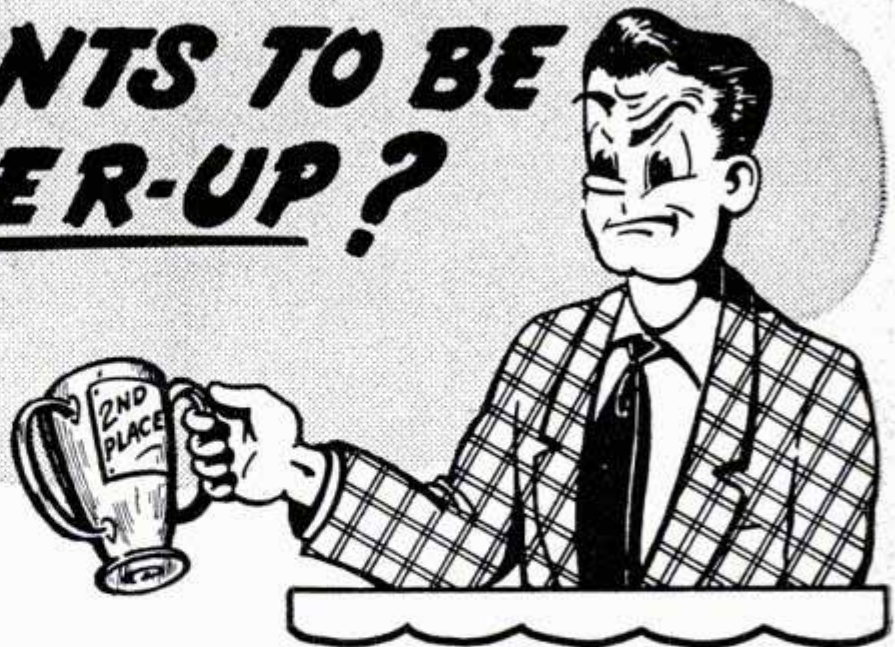

BE FIRST—

TO WIN THAT JOB TO EARN THAT PROMOTION TO MAKE BETTER MONEY



R. C. Anderson
President

You don't have to be told that there's little glory in *almost* landing a good job or earning a promotion that you had your heart set on. You've got to be *first!* And there's no reason why you can't be *first!* So often the difference between steady advancement and failure is *merely the difference in training.* The fellow who

has the technical skill and knowledge always stands in a good way to improve his position and better his income.

You can acquire the skill you need to get ahead by *learning a trade through C.T.I.* You can learn either at home in your spare time, or in our vast Chicago shops. These unsolicited comments by C.T.I. students and graduates prove that *planned, shop-proved training methods* eventually can make a tremendous difference in your income status:

"Your training has been of great assistance in helping me get ahead. Since beginning your course I have *more than doubled my earnings.*" . . . "Your course was very satisfactory. *I own my own shop now,* and I can truthfully say that if I don't succeed, it will be my own fault!" . . . "I have gained a lot of knowledge

through C.T.I. and it shows up in the work I do *and in my pay check.*" . . .

"I have learned a lot of things that would have required years of experience to gain otherwise." . . . "I'm sending you a letterhead that I just had printed, and I'm proud of it. *I now have a small shop* and as soon as I finish my training I'll be ready to start in business. C.T.I. made this possible." . . . "*I am beginning to have confidence in myself.* I now have the feeling that in the future I will be in a position to give my children the education and the opportunities that they deserve."

"*I have been offered a job already—*although I've been a student of C.T.I. for only three weeks! I'm very proud to be a student in one of the best schools in America." . . . "I'm very grateful to C.T.I., for your course has helped me in a great many ways. *It helped me get started in business.*" . . . "Through the efforts of C.T.I., *I received a job that I like very much.*"

If you're tired of being a "bench-warmer" . . . if opportunity is passing you by . . . you need training *and you need it now!* Choose the field that appeals to you (see list at right). Then write C.T.I. for full information. *Better still, mail the coupon.* We'll tell you about your opportunities for advancement, and how you can train to take advantage of them. *Act today. Mail coupon now!*

C.T.I. OFFERS PRACTICAL TRAINING IN

- AUTOMOTIVE MECHANICS
- BODY & FENDER REBUILDING
- DIESEL MECHANICS
- REFRIGERATION & AIR CONDITIONING
- ELECTRICITY & ELECTRONICS
- RADIO & TELEVISION
- BUILDING CONSTRUCTION
- MECHANICAL DRAFTING

FILL OUT - CUT OUT - MAIL TODAY

Mr. R. C. Anderson, President
COMMERCIAL TRADES INSTITUTE, Dept. E2-1 Veteran
1400 Greenleaf Ave., Chicago 26 Non-Veteran

Send free illustrated Brochures and other information about the field I have checked below

- | | |
|---|--|
| <input type="checkbox"/> Automotive Mechanics | <input type="checkbox"/> Electricity & Electronics |
| <input type="checkbox"/> Body & Fender Rebuilding | <input type="checkbox"/> Radio & Television |
| <input type="checkbox"/> Diesel Mechanics | <input type="checkbox"/> Building Construction |
| <input type="checkbox"/> Refrigeration & Air Conditioning | <input type="checkbox"/> Mechanical Drafting |

Name _____ Age _____

Address _____

City _____ State _____

G.I. APPROVED—All C.T.I. courses, both residential and home study, are fully approved by the Veterans Administration—which means that eligible veterans will have their tuition paid by the government. Remember, there's a time limit on when training must begin—so, act now!

**COMMERCIAL TRADES
INSTITUTE, Dept. E2-1**

1400 Greenleaf - Chicago 26



GET INTO

DIESEL-AUTO MECHANICS

Master All Phases

JOB LIKE THESE ARE AVAILABLE TO TRAINED MECHANICS. CHOOSE THE FIELD YOU LIKE BEST

Get Complete Training

Diesel Fuel Injection
Automotive Motor Tune-up
Diesel Engine Rebuilding
General Garage Mechanic
Agricultural Implements
Auto Engine Rebuilding
Auto Elec. Service
Public Utilities
Parts Dealers
Bus & Truck Lines
Industrial Maintenance
Contracting & Excavating
Business of Your Own
AND MANY other similar openings.

As a National Schools graduate, you are trained for ALL opportunities in the Diesel & Auto Industries

EARN WHILE YOU LEARN

With our practical Master Shop-Method Home Training, you study at home in your spare time. You receive Spare Time Work Lessons, which show you how to earn while you Learn . . . for extra money and experience. You Learn by DOING.

TOOLS AND EQUIPMENT

To make your training complete, we give you selected mechanic's tools and equipment, illustrated below, including all-metal toolbox — as a regular part of your instruction.

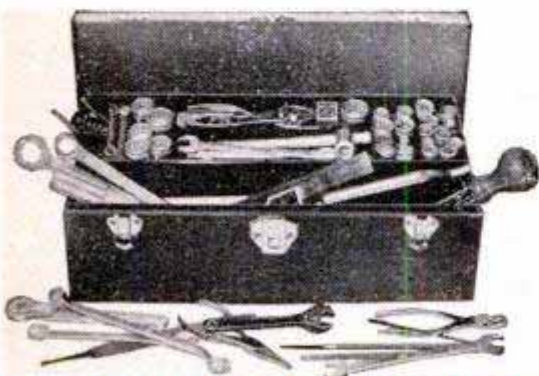

WE GIVE YOU TOOLS OF YOUR TRADE



Shop-Method Home Training by an Established Resident School Prepares you for Many Good Jobs

Opportunity is everywhere for the trained Diesel-Auto Mechanic. Highways throng with cars, busses, trucks, tractors. Garages and Service Stations are kept busy. Factories, ships, farms, railroads, general industry, are dependent upon engine power. Here's a dynamic, fast-growing field that needs trained men who know ALL phases: installation, operation, maintenance and repair. Now—National Schools offers you a practical, all-embracing Diesel-Auto Mechanic's Course, including all of these advantages:

Complete training, covering—Diesels, High Speed and Heavy Duty; Semi-Diesels, Gasoline and Special Fuel Engines AND Allied Mechanics.

- Basic Lesson Texts
- Diesel Installation
- Operation - Maintenance
- Diesel Chart Manual
- Spare Time Lessons
- Engine Service Manuals
- Engine Repair
- Drive Systems
- Diesel Electric Power
- Thermodynamics

TOOLS AND EQUIPMENT

INVESTIGATE
Secure Full Information

NEW, ILLUSTRATED BOOK & SAMPLE LESSON SHOW HOW WE TRAIN YOU . . . SEND FOR THEM TODAY!



NO COST

NO OBLIGATION

APPROVED FOR VETERANS

Check coupon below

NATIONAL SCHOOLS

LOS ANGELES 37, CALIF. • EST. 1905



FIND OUT NOW... MAIL COUPON TODAY

NATIONAL SCHOOLS, DEPT. PMD-1 (Mail in envelope or paste on penny postcard)
4000 South Figueroa Street
Los Angeles 37, California

Mail me FREE the book, YOUR FUTURE IN DIESEL-AUTO MECHANICS, together with the Sample Lesson. I understand I may keep and use the information with no obligation.

Name _____ Age _____

Address _____

City _____ Zone _____ State _____

Check here if Veteran of World War II



"The Jowett System is the greatest in the world," says R. F. Kelly, Physical Director.
Atlantic City

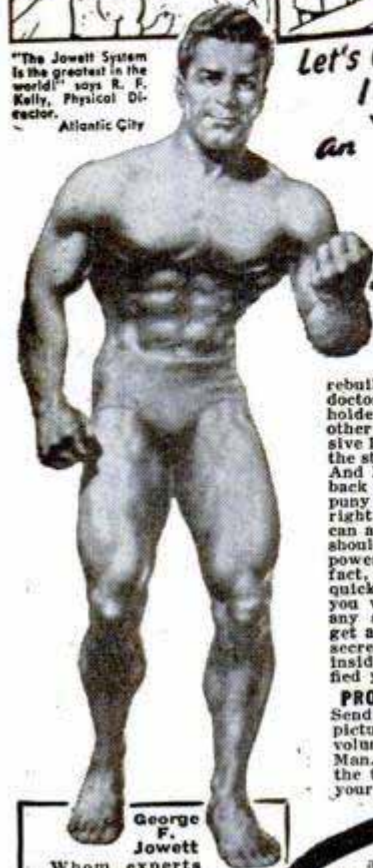

George F. Jowett
Whom experts call "Champion of Champions"

- World's wrestling and weight lifting champ at 17 and 19.
- World's Strongest Arms.
- 4 times World's Perfect Body — plus other records.

10 DAY TRIAL! Think of it—all five of these famous courses now in one picture-packed muscle-building volume for only 10c. If you don't actually FEEL results within ONE WEEK, send it back and your money will be promptly refunded! Photo Book Of Famous Strong Men!

FREE! Photos that inspire you to might and muscle. Free with order.



George F. Jowett
Champion of Champions

FREE GIFT COUPON!

Jowett Institute of Physical Culture DEPT. PM-01
230 Fifth Avenue, New York 1, N. Y.

Dear George:—Please send by return mail, pre-paid, FREE Jowett's Photo Book of Strong Men, along with all 5 Muscle Building Courses. 1. Molding a Mighty Chest. 2. Molding a Mighty Arm. 3. Molding a Mighty Grip. 4. Molding a Mighty Back. 5. Molding Mighty Legs—Now all in One Volume "How to Become a Muscular He-Man." Enclosed find 10c for postage and handling. No C.O.D.'S.

NAME _____ AGE _____

ADDRESS _____

Amazing get-acquainted offer—YOURS for only

10c

INSTEAD OF \$1 FOR ALL 5 COURSES

Let's Go, Pal! I'll prove I can make YOU an "ALL-AROUND" HE-MAN
FAST—OR NO COST!
says George F. Jowett
World's Greatest Body Builder

Enjoy My "Progressive Power" Strength Secrets! Give Me 10 Easy Minutes a Day—Without Strain! I'll teach you the "Progressive Power Method" through which I rebuilt myself from a physical wreck the doctors condemned to die at 15, to the holder of more strength records than any other living athlete or teacher! "Progressive Power" has proven its ability to build the strongest, handsomest men in the world. And I stand ready to show you on a money back basis—that no matter how flabby or puny you are I can do the same for you right in your own home. Let me prove I can add inches to your arms, broaden your shoulders, give you a man-sized chest, powerful legs and a Rock-like back—in fact, power pack your whole body so quickly it will amaze you! Yes, I'll jam you with power and confidence to master any situation—to win popularity—and to get ahead on the job! Through my proven secrets I bring to life new power in you inside and out, until YOU are fully satisfied you are the man you want to be.

PROVE IT TO YOURSELF IN ONE NIGHT! Send only 10c for my 5 easy-to-follow, picture-packed courses now in 1 complete volume "How to Become a Muscular He-Man." Try it for one night! Experience the thrilling strength that surges through your muscles.

I am making a drive for thousands of new friends fast—REGARD-LESS OF COST!
SO GET NOW MY 5 Muscle COURSES
(Valued at \$5 each)
All in 1 Great Complete Volume
Packed With How-To-Do-It Pictures!
Now, this "get-acquainted," extremely low price of only 10c is your chance to build a body you'll be proud of! Follow Jowett's easy method of muscle building NOW!
For **Only 10c**



PROFITABLE HOBBIES



Let us show you how extremely easy it is to make beautiful and useful things out of LIQUID PLASTICS, LIQUID MARBLE, LIQUID IVORY, LIQUID GLASS, CERAMICS, ETC. . . as easy as pouring water out of a glass! Make novelties, jewelry, gifts, artware, toys, tools, dies, gadgets, ceramics . . . a million useful things! We supply everything—MATERIALS, INSTRUCTIONS and BUYERS! Send only 25c for 1. Big catalog of 300 casting materials, molds and accessories. 2. A beautiful CAMEO free (to show you what you can do), and 3. Actual INSTRUCTIONS on how to cast and start in the CASTING BUSINESS! Send 25c today—this may be the lucky coin that will start the most fascinating and profitable phase of your life! (Catalog only—10c).

PLASTICAST COMPANY (DEPT. C)
4637 N. Kedzie Ave. (Write to Chicago 25, Ill. nearest address)
P. O. Box 957 Palo Alto, Calif.
CANADIAN CUSTOMERS, please order directly from: CANADIAN INDUSTRIAL PLASTICS, LTD., 1036 1/2 Pender West, Vancouver, B. C.

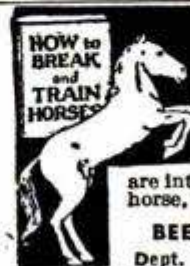

SEND FOR THIS **FREE!**

Make money. Know how to break and train horses. Write today for this book FREE, together with special offer of a course in Animal Breeding. If you are interested in Galting and Riding the saddle horse, check here () Do it today—now.

BEERY SCHOOL OF HORSEMANSHIP
Dept. 1101D Pleasant Hill, Ohio

NEW! LOW COST! RESPIRATOR



Wear when sanding, grinding, paint spraying, sweeping, dusting, furnace cleaning, etc. Handy as a pair of glasses. Just keep mouth closed and breathe through nose is all you do to operate. Protects against nuisance dusts, lint, coal, cement, grain dust, hay fever pollen. Has 9 sq. in. filter. For EYE protection against paint spray, dusts, gases, fumes, smoke, order our Fog-Proof Rubber GOGGLES \$1.65p.p. (All prices postpaid in U.S.A.)

JERRY BRYANT, Dept. PM Chicago 11, Ill.
919 N. Michigan Ave.

Order Today \$1.00 POST PAID



AMAZING NEW **MAGIC CATALOG**

350 pages of mystifying, easy-to-do tricks and illusions. 600 illustrations. Send \$1.00 now for catalog, credited on your first \$5.00 purchase.

NATIONAL MAGIC CO.
119 S. State St. Dept. M-11 Chicago 3, Ill.



AJAX LIGHT BRAHMAS

Wonderlay Strain Egg-show winners. Gigantic size. Quick growing. Heavy layers. Exceptional big capons. U. S. Approved-Pullorum Controlled. Thousands hatching weekly. Low farm prices. Catalog FREE. Write TODAY.

AJAX HATCHERY, Box 916, QUINCY, ILLINOIS

Say You Saw It in Popular Mechanics

Now is the Time to Learn CUSTOM TAILORING and Manufacturing Methods

RESIDENT TRAINING IN EXTENSIVELY EQUIPPED SHOPS

There are exceptional opportunities for good pay, steady work, and advancement in Custom Tailoring. The well trained man can also go far in this industry in his own business.

You Learn Ladies' and Men's Custom Tailoring by Making Actual Garments

Write today for free information. Get the full facts about the unusual opportunities in this old, established, growing industry.

Approved for Veterans — Payment Plan for Non-Veterans
GUILD VOCATIONAL INSTITUTE
32 N. STATE ST. DPT. PM-1 CHICAGO, ILL.



NOW! Build and Keep
Big Screen Top Quality
Television Receiver at Home
as You Prepare for a
Profitable job in
**TELEVISION
RADIO-ELECTRONICS**

Choice of 10, 12½ or 16 inch picture tube

Now you can get this amazingly practical aid for learning Television at home, to help you get started toward **FASCINATING WORK . . . GOOD MONEY . . . a THRILLING FUTURE**—in a real job, or your own sales and service business. * When you complete our regular home training—described below—you can build and keep a top quality commercial-type Television Re-

ceiver. Standardized chassis is adaptable for a 10, 12½ or 16 inch direct view tube that gives big, bright, sharp, steady pictures. This is an optional training advantage—designed to provide the utmost in practical “learn-by-doing” home training in Television. Mail coupon for complete details. See why you owe it to your “Television Future” to enroll for DeForest’s Training, Inc.

Mail Coupon NOW for FREE Information!

See how D. T. I.’s amazingly effective methods help start you toward a **GOOD JOB** or your **OWN BUSINESS** in one of America’s most promising fields—including Television, F.M. Radio, Aviation, Train, and Taxi Radio, Broadcast Radio, Industrial Electronics. Get modern lessons . . . plus 16 shipments of Radio-Electronic parts. Work over 300 experiments and projects—including building of (1) commercial-type **OSCILLOSCOPE** for practical

T-V circuit training, (2) double-range R-F **SIGNAL GENERATOR**, (3) jewel-bearing **MULTIMETER**, (4) quality 6-tube **SUPERHET RADIO**. Then build and keep that big new Television Receiver. Here’s **EVERYTHING YOU NEED** for real laboratory type training . . . **AT HOME!**

You also build and keep this Professional Type Equipment

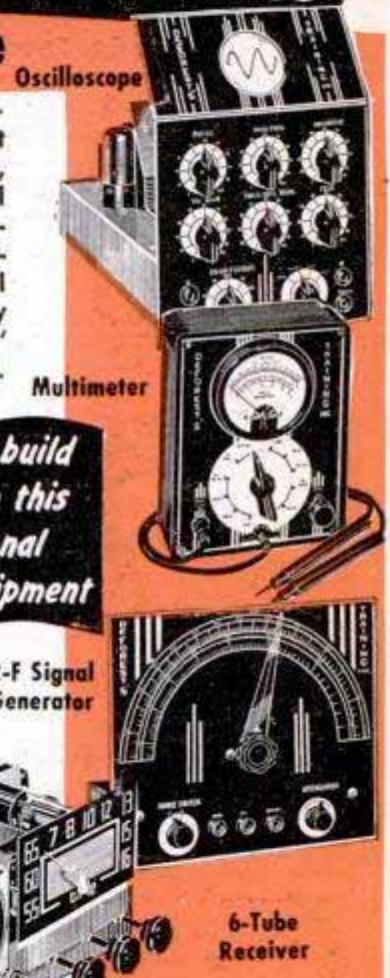

Modern Chicago Laboratories

* If you prefer, you can get **ALL** your preparation in our new, Chicago training laboratories . . . one of the finest of its kind. Ample instructors . . . modern equipment. Write for details!

Employment Service

* When you complete your training, our effective Employment Service helps you get started toward a real future in Television—Radio—Electronics.



You also use HOME MOVIES! a D. T. I. Exclusive!

D. T. I. alone includes the modern, visual training aid . . . **MOVIES** . . . to help you learn faster, easier at home. See electrons on the march and other fascinating “hidden action”—a remarkable home training advantage that speeds your progress.

De FOREST’S TRAINING, INC.
CHICAGO 14, ILLINOIS
A DE VRY Institution

MAIL THIS COUPON NOW!

DeFOREST’S TRAINING, INC.
2533 North Ashland Avenue, Dept. PM-G1
Chicago 14, Illinois

Without obligation, give me complete facts showing how I may make my start in Television-Radio-Electronics.

Name..... Age.....
Street..... Apt.....
City..... Zone..... State.....

1950 GOVERNMENT JOBS!

**RAILWAY
POSTAL
CLERKS**

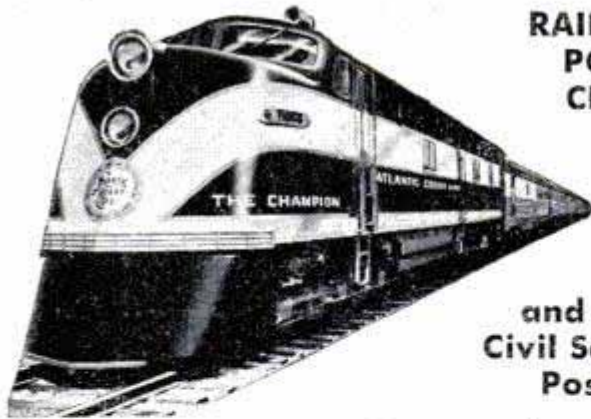

**and other
Civil Service
Positions**

Start as high as \$3,351 A YEAR

(Veterans Get Special Preference)

Get Ready Now for 1950 Examinations

City Mail Carriers, Post Office Clerks

Clerks and Carriers now get \$2,550 the first year of regular employment and automatically increase \$100 a year to \$3,550. Open to Men—Women 18 to 50. Clerks and Carriers can be promoted to other postal positions paying as high as \$7,550.00.

Railway Postal Clerks

Railway Postal Clerks get \$2,750 the first year of regular employment, being paid on the first and fifteenth of each month. (\$114.60 each pay day.) Their pay is automatically increased yearly to \$3,850 and \$4,050 in large organizations. Advance may be had to Chief Clerk at \$5,850 a year. Male Veterans only.

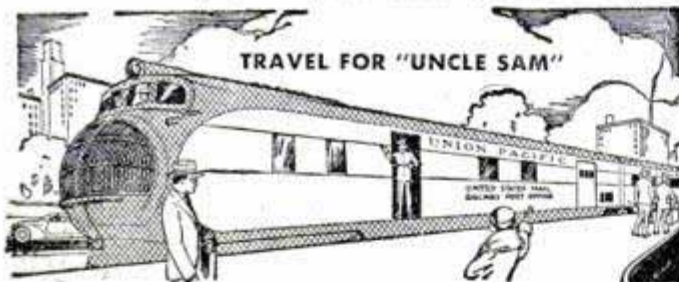

3 Days On—3 Days Off—Full Pay

Railway Postal Clerks on long runs usually work 3 days and have 3 days off duty or in the same proportion. During this off duty their pay continues just as though they were working. They travel on a pass when on business. When they grow old, they are retired with a pension.

Many Other Positions

Many other positions are obtainable. Rural Carriers—Stenographers—Typists—Patrol Inspectors—Assistant Statistical Clerks—etc. Those wishing these positions should qualify at once.

Get Free List of Positions

Fill out the following coupon. Tear it off and mail it today—NOW, at once.

Although not government controlled, this can result in your getting a big paid government job.

FRANKLIN INSTITUTE, Dept. Z-83, Rochester 4, N.Y.

Rush to me, entirely free of charge (1) a full description of U. S. Government Jobs; (2) Free copy of illustrated 40-page book, "How to Get a U. S. Government Job" with (3) List of U. S. Government Jobs; (4) Tell me how to qualify for one of these jobs.

Name _____

Address _____ Veteran? _____

Use This Coupon Before You Mislaid It. Write or Print Plainly.

Learn to MOUNT Birds and Animals



**FUN-FASCINATION
PROFITS—IN SPARE TIME**

Learn **TAXIDERMY** at home **BY MAIL**. Save your hunting trophies, decorate your home and den, have a grand **HOBBY**. This old reliable school (with 250,000 students) will teach you at home to mount **BIRDS, ANIMALS, FISH, GAME-HEADS**—and to **TAN** hides and furs by wonderful **KROME-TAN** system, also **NOVELTY TAXIDERMY**, using common specimens—no wild game needed.

FREE BOOK 100 beautiful pictures. Tell how **YOU** can learn Taxidermy easily, quickly, at home. Tells how to **EARN FINE PROFITS** in spare time. Rush letter or postal for this strange marvelous **FREE BOOK**. Write **NOW—TODAY**. State **AGE**.

N. W. School of Taxidermy • 2501 • Omaha, Neb.

**NATION'S
LARGEST
EXCLUSIVE
ELECTRICAL
SCHOOL**

"LEARN-BY-DOING"
ELECTRICITY

**PRACTICAL TRAINING
NOT "HOME STUDY"**

G.I. APPROVED Get actual experience in great shops of M.T.I. Learn all phases Practical Electricity; Housewiring, Motors, Const., Maintenance, etc. Living arrangements, Part-time jobs, etc.

A post card brings the story,
**MICHIGAN TECHNICAL INSTITUTE, Dept. PM-1
2281 W. Fort St., Detroit 16, Michigan**

REAL ESTATE BE A BROKER

PAYS BIG! SEND FOR FREE, BIG, ILLUSTRATED CATALOG NOW! No obligation. Graduates report making substantial incomes. Start and run your own business quickly. Men, women of all ages, learn easily. Course covers Sales, Property Management, Appraising, Loans, Mortgages, and related subjects. **STUDY AT HOME** or in our classrooms in big cities. Diploma awarded. G.I. approved. Nationally known.

**WEAVER SCHOOL OF REAL ESTATE (Est. 1936)
15 E. Pershing Road Dept. PM Kansas City, Mo.**

**FREE
BOOK
TELLS
HOW**

IT'S FUN TO DO MAGIC!

MAGIC TRICKS BE POPULAR! AMAZE—MYSTIFY—ENTERTAIN! FOR 30 YEARS DOUGLAS HAS SATISFIED CUSTOMERS ALL OVER THE WORLD. NOW YOU CAN ENJOY THIS FASCINATING HOBBY. ONLY 25¢ BRINGS OUR CATALOG. 500 TRICKS—CONTAINING BRAND NEW TRICKS FOR POCKET, PARLOR, STAGE.

JOIN IN THE FUN... SEND 25¢ TODAY

DOUGLAS MAGICLAND, DEPT. K, DALLAS, TEXAS



NEW
IMPROVED...AMERICANIZED
JUDO

**TWO BIG BOOKS FULLY ILLUSTRATED
1220 SHOW-HOW PHOTOS. 71 LESSONS
MANY NEW HOLDS**

Protect yourself and others. Size and strength mean nothing. Knowledge and skill enable you to master any situation even against biggest bullies or armed thugs. Written and illustrated by one of the world's great Judo experts. Volume 1, basic and advanced holds. Volume 2, very advanced... each volume \$1.50.

**BOTH BOOKS \$2.50 POSTPAID
OR C.O.D. PLUS POSTAGE
5-day Money Back Offer. ACT NOW!**

**Big Combination
Offer!
SAVE...**

**DEPT. M-1
IMPROVED JUDO, INC. P. O. Box 7355, Sta. L, Los Angeles, Calif.**

Now Any AUTO REPAIR JOB Can Be a "Push-Over" for You!

Free
7-DAY OFFER!



IN LESS TIME—WITH LESS WORK—AND MORE PROFITS!

NOW, tackle anything from carburetor to rear end on ANY car built from 1935 thru 1949. And fix it quick, easy, right the **FIRST** time! Just look up make, model, and job in quick index of MoToR's **brand-new** **AUTO REPAIR MANUAL**. Clear, illustrated instructions lead you step by step all the way.

ONLY Manual of Its Kind!

The engineer-editors of MoToR Magazine condensed all the meat of over 150 official factory manuals for you. They dug out all the information you need—made sure every word and picture is crystal clear—and put the whole "works" into this one big 795-page book.

Used by
U. S. Army
and Navy

Contains 200,000 service, repair, tune-up facts. 35,000 essential dimensions! More than 2100 cut-away photographs, diagrams, charts show what the clear text tells.

Win Prestige! Earn More Money!

MoToR's Manual makes every operation so easy that you'll find yourself tackling jobs you wouldn't think of doing before. And you'll win added prestige and more money in the bargain.

Beginners will find usable helpful guidance on every kind of repair and service job imaginable. Experts will be amazed by the time and labor-saving short cuts.

This **GIANT** Manual is used by Army, Navy, Technical Schools, and thousands of successful auto-repairmen. Now **YOU** can try it **FREE**—for 7 days. Learn first-hand how it can *pay for itself* the first few times you use it!

SEND NO MONEY

Mail coupon below — *without money!* When your book arrives — *make it show you what it's got!* Unless you agree it's the greatest time and work saver you've ever seen—return book in 7 days and pay nothing. Mail coupon **NOW!** MoToR Book Department, Desk 1A, 250 West 55th Street, New York 19, N. Y.



Just 2 of the Many Letters of Praise



"MoToR's Manual paid for itself on the first 2 jobs, and saved me valuable time eliminating guesswork." — **W. SCHROP, Ohio**



"Instructions so clear have no trouble learning anything about any car. Now working as mechanic in big plant." — **SAM ORDONEZ, California**

COVERS ANY CAR BUILT SINCE 1935!

- | | |
|-----------|------------|
| Auburn | Frazer |
| Austin | Graham |
| Buick | Hudson |
| Cadillac | Hupmobile |
| Chevrolet | Kaiser |
| Chrysler | Lafayette |
| Cord | La Salle |
| Crosley | Lincoln |
| De Soto | Mercury |
| Dodge | Nash |
| Ford | Oldsmobile |
| | Packard |
| | Pierce |
| | Arrow |
| | Plymouth |
| | Pontiac |
| | Reo |
| | Studebaker |
| | Terraplane |
| | Willys |

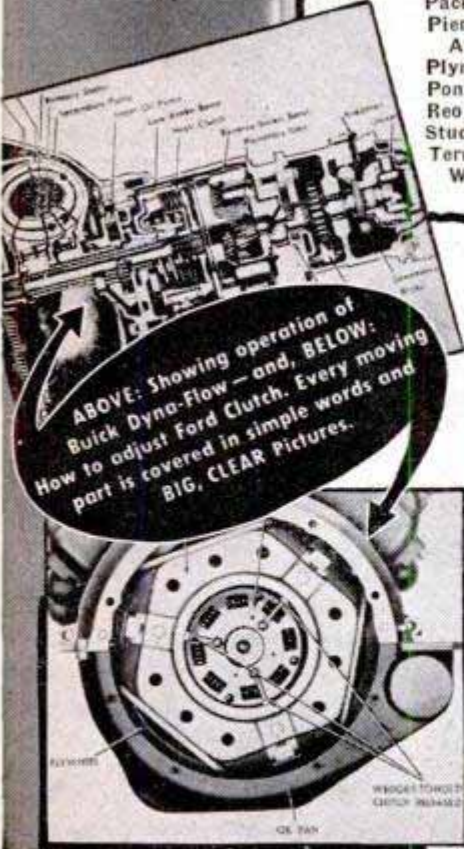

ABOVE: Showing operation of Buick Dyna-Flow — and, **BELOW:** How to adjust Ford Clutch. Every moving part is covered in simple words and **BIG, CLEAR** Pictures.

Same FREE Offer on MoToR's TRUCK MANUAL

Covers **EVERY** job on **EVERY** truck made from 1936 thru 1946! 1400 pictures, 952 pages, 300,000 facts. All types Gasoline Engines, Truck Diesels, Hesselmans, Fuel Systems, Governors, Lubrication, Ignition, Starters, Clutches, Axles, Brakes, etc., etc.

ALSO covers many buses, tractors, contractor and road building equipment, stationary power machinery. Check box in coupon at right for 7-day **FREE** trial.



Published by MoToR, The Leading Automotive Business Magazine.



MAIL COUPON NOW FOR 7-DAY FREE TRIAL

MoToR BOOK DEPT.
Desk 1A, 250 West 55th St., New York 19, N. Y.

Rush to me at once (check box opposite book you want):
 MoToR's **NEW AUTO REPAIR MANUAL**. If O.K., I will remit \$1 in 7 days (plus 35c delivery charges), \$2 monthly for 2 months and a final payment of 95c one month after that. Otherwise I will return the book postpaid in 7 days. (Foreign price, remit \$8 cash with order.)

MoToR's **TRUCK REPAIR MANUAL**. (Described at left.) If O.K., I will remit \$2 in 7 days, and \$2 monthly for 3 months, plus 35c delivery charges with final payment. Otherwise I will return book postpaid in 7 days. (Foreign price, remit \$10 cash with order.)

Print Name.....Age.....

Print Address.....

City..... State.....

Check box and save 35c delivery charge by enclosing WITH coupon entire payment of \$5.95 for Auto Repair Manual (or \$8 for Truck Repair Manual). Same 7-day return-refund privilege applies.



**Make
this
YOUR
DESIGN
for
SECURITY
and
SUCCESS**

Fascinating work and rich rewards can be yours, from the very start, in AERONAUTICAL ENGINEERING. Here is the career field that offers everything you could ask for, if you have the foresight and ambition to grasp its BIG opportunities.

The past foretells the future. The aircraft production figure for 1949 is expected to be SIX times greater than for 1939. The passenger-miles flown by U. S. airlines last year is estimated at ELEVEN times more than in 1939. Things to come in the NEXT 10 years defy your imagination. In those 10 years YOU can grow with Aviation—in personal achievement, earnings, security—with a successful lifetime career stretching on ahead.

Of those 10 years you need only two years—not four—to complete your Northrop course in Aeronautical Engineering. You train in an outstanding technical school conducted by an aircraft company world-famous for history-making aviation achievements.



You enjoy many important practical advantages—like the up-to-the-minute training in Jet Power Plants being received by the students shown in the picture at the left...and the first-hand study of advanced all-wing aircraft design being made by students in the picture below, as they inspect a 60-ft. scale model Flying Wing

and an experimental "buzz bomb." Northrop training has won choice jobs for graduates with ALL leading aircraft manufacturers and airlines. You can start YOUR training soon—

new classes start every 8 weeks.

APPROVED FOR VETERANS

Send Coupon for this Catalog NOW

Northrop
Aeronautical Institute

Division of Northrop Aircraft, Inc.
1527 EAST BROADWAY, HAWTHORNE,
LOS ANGELES COUNTY, CALIFORNIA

NORTHROP AERONAUTICAL INSTITUTE

1527 East Broadway, Hawthorne, Los Angeles County, Calif.

Please send information on opportunities in Aeronautical Engineering, your catalog, and starting dates of classes. I am interested in:

Aeronautical Engineering Aircraft & Engine Mechanics

Name _____ Age _____

Address _____

City _____ Zone _____ State _____

Check one: Veteran Non-Veteran

**BE AN EXPERT REPAIRMAN
OF MUSICAL INSTRUMENTS**



**MANY JOBS NOW OPEN
FOR TRAINED MEN...
BIG OPPORTUNITIES!**

Over 3,000,000 amateur and professional musicians are potential customers. You can make good money twelve months of the year... even start your own business. We'll train you. Course approved by U. S. Veterans Administration. Get complete information NOW, without obligation.

SEND FOR
FREE
SCHOOL CATALOG
F-31

CONN VOCATIONAL SCHOOL
127-129 S. Main St., Elkhart, Indiana, Div. of C. G. Conn Ltd.

Free
Book



RAISE HAMSTERS

The new wonder animals from Syria. Often called Toy Bears. Delightful pets. Everyone wants them. Laboratories need thousands. Clean, odorless. Raise anywhere. A profitable and interesting hobby or business. We furnish breeding stock with manual of instructions.

Write today for free illustrated literature.

GULF HAMSTERY, 1536 BASIL, MOBILE, ALA.

ELECTRICIANS' SCHOOL

HOUSE AND COMMERCIAL WIRING • MOTOR REPAIR
AND REWINDING • ELECTRIC REFRIGERATION

Approved for Veterans Training

PENNSYLVANIA INSTITUTE **SCHOOL OF
ELECTRICITY**
42nd and SPRUCE STS. PHILADELPHIA 4, PENNA.



Learn to Write at Home
in spare time

Write for FREE BOOK, "How to Become an Expert Penman," showing what others learned by my Simplified Method. You can greatly improve your writing, or become an Expert Penman. For Full Details without cost or obligation check or state Courses interested in: Business Writing Ornamental Writing Bird, Eagle, and Swan Flourishing. Send 10c for Special Postcard, your name and a flourished bird written on a card.



Box 25K, CHILLICOTHE, MO.

CHICKS ON A 30 Days Trial

guarantee. Money refunded on any chicks not true to breed. No need to take chances. You get 30 days to make sure chicks are as represented. Male or pullet chicks furnished. Low prices. All varieties. B. W. D. bloodstock. Easy buying plan. **BARGAIN PRICES and CHICK MANUAL FREE!** MISSOURI STATE HATCHERY, Box 189, BUTLER, MO.

SEXED

**Command Bigger Money!
STUDY LAW**

STUDY AT HOME for BUSINESS SUCCESS and LARGER PERSONAL EARNINGS. 40 years expert instruction — over 114,000 students enrolled. LL.B. Degree awarded. All text material furnished. Easy payment plan. Send now for FREE BOOK — "Law and Executive Guidance." It explains the course — how you may enroll and the many ways you can profit from Law Study. Write TODAY to:

AMERICAN EXTENSION SCHOOL OF LAW
Dept. 22-PM, 646 N. Michigan Ave., Chicago 11, Ill.



Get
Into

RADIO, TELEVISION and ELECTRONICS

Master ALL Phases

**YOU
Build This
Superheterodyne**

You receive complete standard equipment, including latest type High-Mu Tubes, for building various experimental and test units. You progress step by step until you build a complete Superheterodyne Receiver. It is yours to use and keep.



YOU RECEIVE THIS PROFESSIONAL MULTITESTER!

You will use this professional instrument to locate trouble or make delicate adjustments—at home—on service calls. You will be proud to own this valuable equipment. Complete with test leads.



SIGNAL GENERATOR

You construct the Transiron Signal Generator shown here, demonstrating Transiron Principles in both R.F. and A.F. stages. You study negative type oscillators at firsthand.

AUDIO OSCILLATOR:

An electronic device, which produces audio-frequency signals for modulating R.F. (radio frequency) carrier waves, testing A.F. (audio frequency) amplifiers, speakers, etc.



T.R.F. RECEIVER

You build several T.R.F. Receivers, one of which, a 4-tube set, is shown here. You learn construction, alignment, make receiver tests, and do trouble shooting.

Get Complete Training. You Receive and Keep All Equipment, Parts and Lessons. No Extra Charges.

GOOD PAY and Unlimited Opportunities in JOBS LIKE THESE:

Business of Your Own
Radio Manufacturing, Sales, Service
Broadcasting Telecasting
Television Manufacturing,
Sales, Service
Laboratories: Installation, Maintenance of Electronic Equipment, Electrolysis, Call Systems
Garages: Auto Radio Sales, Service Sound Systems and Telephone Companies; Oil Well and Drilling Companies; Engineering Firms
Theatre Sound Systems Police Radio
And scores of other good jobs in many related fields

YOU CONDUCT MANY EXPERIMENTS LIKE THESE!

Checking action of condensers
Experiments with AF and RF amplifiers.
Experiments with resonance
Producing beat frequencies
Calibrating oscillators
Experiments with diode, grid-bias, grid-leak and infinite impedance detectors
Practical experience in receiver trouble shooting
Application of visual tester in checking parts and circuits
Experiments with audio oscillators
Advanced trouble-shooting
... and many, many others

Complete Training by Practical Resident Trade School, Est. 1905

The same highly trained faculty, instruction materials and methods used here in our large, modern resident school, are adapted to your training in your own home. Shop Method Home Training has been proved by hundreds of successful graduates.

**Both Resident and Home Study
Courses Offered**

YOU LEARN BY DOING

You receive special laboratory experiment lessons to show you how to build with your own hands various experimental units such as those shown at left, and how to conduct many tests.

You will find all lessons easy to understand because they are illustrated throughout with clear diagrams and step-by-step examples that you work out yourself. Every piece of the equipment and complete lesson material we send you is yours to keep and enjoy, including the multitester, experimental equipment, all parts of the Superheterodyne, tube manual, radio dictionary, and complete, modern Television texts. All parts are standard equipment.

Shop Method Home Training . . . Earn While You Learn

With our practical resident Shop Method Home Training, you study in your spare time. You receive Spare Time Work Lessons, which show you how to earn while you learn. Service neighbors' radios and TV receivers, appliances, etc., for extra money and experience. Many National students pay all or part of their training with spare time earnings!

DON'T DELAY! The Radio-Television Industry needs trained men NOW!

**APPROVED
FOR
VETERANS!**

Check coupon below!

For quick action, mail coupon today and we'll rush you full information.

Free!

**NEW, ILLUSTRATED
OPPORTUNITY
BOOK AND SAMPLE
LESSON SHOW YOU
HOW WE TRAIN
YOU . . . SEND FOR
THEM TODAY! NO
COST. NO
OBLIGATION.**



NATIONAL SCHOOLS

LOS ANGELES 37, CALIF. • EST. 1905

FIND OUT NOW . . . MAIL COUPON TODAY

National Schools, Dept. PM-1
4000 South Figueroa Street
Los Angeles 37, California

Send me your FREE book "Your Future in Radio" and the sample lesson of your course. I understand no salesman will call on me.

NAME..... AGE.....

ADDRESS.....

CITY..... ZONE..... STATE.....

Check here if Veteran of World War II

Mail in envelope
or paste on
penny postal.



EVERYTHING

You Want to Know About

SHOPWORK

Short-Cuts to Better Work—Bigger Pay

NEW Shopwork Guide makes it easy to master and to do better, quicker work with hand and machine tools, on metal-work, woodwork, wiring, wire-splicing, ropework, etc.

The ABC's of Shop Operations

"Introductory Shopwork" explains shop tools, operation, processes. 366 step-by-step pictures and diagrams show use of grinding, sharpening, measuring, gaging, and marking equipment. How to use modeling and forming tools; to shape curved and irregular surfaces; do pipe work, soldering, sheet metal work, vise and bench work. Metal-drilling tools; lathes, milling machines; painting, finishing, glazing.

FREE 10-DAY EXAMINATION—Coupon will bring you "Introductory Shopwork" to examine FREE—without obligation. Mail it NOW!

Some FREE EXAMINATION Offer On "Carpentry for the Building Trades." Tells how to plan and do carpentry for house building, remodeling. Blueprint reading, framing, bracing, roofing, etc. Only \$2.95 on easy terms.

Tells CARE and USE of:

Hand and Machine Tools. Also Tool Grinding and Sharpening; Planing, Smoothing; Wood Chisels; Wood Fastening; Metal Drilling Tools; Safety Precautions.



McGraw-Hill Book Co., Inc., Dept. PMD-1
327 West 41st St., New York 18, N. Y.

Send me "Introductory Shopwork" for 10-DAY FREE EXAMINATION. If not satisfied, I will return it—pay nothing. Otherwise, I will keep it—and send only \$1.00 then (plus few cents postage) and \$1.95 one month later.

SAVE POSTAGE—Check here if enclosing \$2.95 WITH this coupon. Then WE will prepay all postage charges. Your money back if you return book.

Name _____

Address _____

City _____ State _____

CHECK HERE to get "Carpentry for the Building Trades" for 10-DAY FREE EXAMINATION. PMD-1

OIL BURNER

INFORMATION IN A HANDY FORM

JUST OUT!

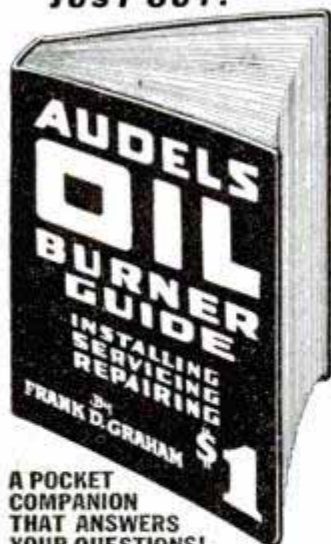

A POCKET COMPANION THAT ANSWERS YOUR QUESTIONS!

AUDELS OIL BURNER GUIDE

— A new practical, concise treatise, 384 pages—31 Chapters—321 Diagrams and Illustrations—covering Domestic and Industrial Oil Burners.

New from Cover to Cover, for mechanics interested in Oil Burners. Gives practical inside working knowledge of theory, construction, installation, operation, testing, servicing and repair of all types of oil burners. Includes electrical hook-ups and wiring diagrams of automatic control systems.

PRICE \$1 POSTPAID

Get this information for yourself. Mail coupon today. No obligation unless satisfied.

ASK TO SEE IT

AUDEL, Publishers, 49 W. 23rd St., New York 10, N. Y.

Please mail AUDELS OIL BURNER GUIDE (Price \$1). If satisfactory, I will remit \$1 on its safe arrival, otherwise I will return the book.

Name _____

Address _____

Occupation _____

Employed by _____ PM

"YOU ARE UNDER ARREST!"



There's a Thrill in Bringing a Crook to Justice Through Scientific

CRIME DETECTION!

We have taught thousands this exciting, profitable, pleasant profession. Let us teach you, too, in your own home. Learn Finger Printing, Fire Arms Identification, Police Photography and Criminal Investigation thoroughly, quickly and at small cost.

Be A FINGER PRINT Expert

Over 800 of All American Bureaus

of Identification employ students or graduates of I. A. S. You, too, can fit yourself to fill a responsible crime detection job with good pay and steady employment. But don't delay—get the details now. Let us show you how easily and completely we can prepare you for this fascinating work, during spare time, in your own home. You may pay as you learn. Write today . . . Now . . . Be sure to state age.

FREE!!!

Send for Thrilling "BLUE BOOK OF CRIME"

INSTITUTE OF APPLIED SCIENCE

1920 Sunnyside Ave., Dept. 1351, Chicago 40, Ill.

AMAZING SECRETS REVEALED TO EVERY POULTRY RAISER



ABSOLUTELY FREE BOOK. My new Picture Tour Book telling all about one of America's largest and best Poultry Breeding Farms and Hatchery organizations. I know you'll enjoy it, and profit in your poultry work by reading it.

Tells latest methods of profitable chicken raising, feeding and especially about pure-breds, cross-breds and hybrids. If you want to know about better and more profitable chickens, be sure to write me TODAY for your FREE copy. Just a postcard will bring it.

MRS. HARRY HAM, Route 56, Atchison, Kansas

MONEY MEN ALL FREE

THE PLASTEX Industry needs manufacturers on small scale and for big production of Lamp and Clock Stands, Art Goods and Novelties in Plastex and Marble imitation. Experience unnecessary. 1/2c material makes regular 10c store sellers. Rubber moulds furnished for speed production. Small investment brings good returns. Big chain store orders now being placed. Ambitious men have chance for real prosperity. Our Free booklet will interest and benefit you. PLASTEX INDUSTRIES, Dept. A, 3400 Third Ave., New York 56, N. Y.

LEARN WATCH REPAIRING



AT HOME. By our modern and original system of instruction you can learn every part of the WATCH REPAIRING TRADE AT HOME. Prepare yourself for a well-paying position or start in business after completing our course of instruction. Good watch repairers are in demand and generally earn very good salaries. For particulars apply to the Wisconsin School of Watch Repairing 759 North Milwaukee St., Milwaukee 2, Wis.



Is this real or a model?

Get the answer in this picture-packed book on Model Railroad only 10c

• Learn about the greatest of all hobbies. Model railroading is the hobby that fascinates hundreds of thousands of men all over the world.

This exciting book tells you that model railroading is simple, is inexpensive, and is constructive. Fully illustrated. Send 10c today for your copy of "Model Railroad for You," written by a well-known authority. The MODEL RAILROADER, DEPT. 1537 Milwaukee 3, Wis.

WHICH OF THESE *Opportunities* INTERESTS *You* MOST?

Accounting
Air Conditioning
Architecture & Building
Automotive Engineering
Aviation—Practical
Aviation Drafting & Design
Better Foremanship
Bookkeeping
Business Management

Contracting
Diesel Engineering
Drafting & Design
Electrical Engineering
Electricity—Practical
Electronics, Industrial
High School Courses
Machine Shop Operations
Mechanical Engineering

Plastics Engineering
Plumbing—Practical
Private Secretary
Radio Operating & Servicing
Railway Training
Refrigeration
Sheet Metal Pattern Drafting
Shop Management
Tool Making

... In Job Competition
Where Do You Stand?
**Specialized Training Will Help You to
GET AHEAD and STAY AHEAD!**

● Have you noticed that more and more the important, good-pay jobs are held by those who have had specialized training? Have you realized that Uncle Sam has turned out technically trained men by the thousands? Do you know that competition for jobs and promotions is strong now and will continue to grow stronger? Where do you stand now? *Where will you stand two, three, five years from now?* Can you keep up with job and promotion competition?

For more than 50 years we have trained men, in spare time at home, for better jobs . . . higher pay . . . brighter futures.

We can do the same for you. Right now choose the job you want and prepare for it. Or if you are in work you like best, start training for quicker promotion. Then check that subject on coupon, add your name and address and mail it at once and we will send full details on our training plan.

PRACTICAL, EFFECTIVE HOME - STUDY TRAINING SINCE 1897

Take This First Easy Step

CHECK, CLIP AND MAIL COUPON NOW

AMERICAN SCHOOL, Dept. G-145, Drexel at 58th, Chicago 37, Ill.
Without obligation. Please send FREE and postpaid, bulletin and details of the Subject checked.

<input type="checkbox"/> PLASTICS ENG'R	<input type="checkbox"/> Railway Training	<input type="checkbox"/> Drafting and Design for Men and Women
<input type="checkbox"/> Refrigeration	<input type="checkbox"/> Accounting	<input type="checkbox"/> Radio
<input type="checkbox"/> Architecture and Building	<input type="checkbox"/> Electrical Engr.	<input type="checkbox"/> High School
<input type="checkbox"/> Contracting	<input type="checkbox"/> Electricity-Pract.	<input type="checkbox"/> Air Conditioning
<input type="checkbox"/> Practical Plumbing	<input type="checkbox"/> Electronics, Industr.	<input type="checkbox"/> Mechanical Eng.
<input type="checkbox"/> Automotive Engineering	<input type="checkbox"/> Bookkeeping	<input type="checkbox"/> Shop Management
<input type="checkbox"/> Aviation Drafting	<input type="checkbox"/> Private Secretary	<input type="checkbox"/> Tool Making
<input type="checkbox"/> Aviation	<input type="checkbox"/> Diesel Engineering	<input type="checkbox"/> Better Foremanship
<input type="checkbox"/> Business Mngment	<input type="checkbox"/> Sheet Metal Pattern Drafting	<input type="checkbox"/> Machine Shop Operations

AMERICAN SCHOOL
Dept. G-145, Drexel at 58th Street, Chicago 37

Name _____ Occupation _____
Address _____ Age _____
City _____ State _____

Become an ELECTRICAL ENGINEER

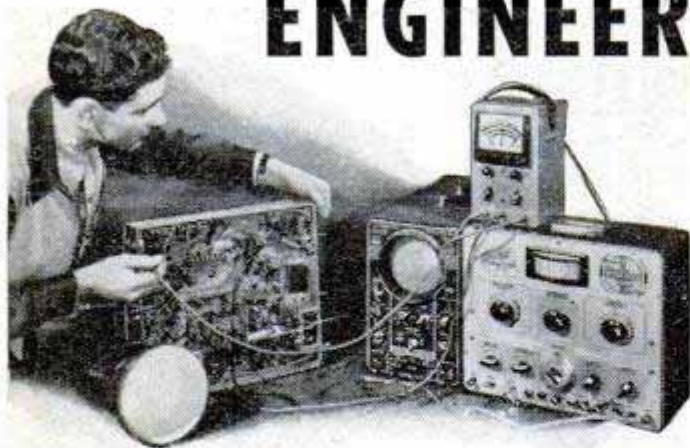

Major in Electronics or Power ... B.S. Degree in 36 Months

The Electrical Engineering course offered by this non-profit, well-equipped Technical Institute and College is world-famous. Here you can earn your Bachelor of Science Degree in 36 months of continuous study. You get both practical, specialized training and a solid educational background in the basic sciences and Electrical Engineering. And, under the concentric curriculum, you become a certified Electro Technician or Electronics Technician in 12 months.

Choose the Course That Interests You Most

SERVICE

6 to 12 months

- Electricity
- Welding
- Refrigeration
- Heating

TECHNICIAN

12 to 24 months

- Radio and Television
- Electronics
- Electrotechnics (Power)
- Welding
- Refrigeration, Heating, Air Conditioning

PROFESSIONAL

36 months

- Electrical Engineering — B.S. Degree; Major in Electronics or Power

Radio-Television Technicians

are needed in America's fastest growing industry. This certificate can be yours in 18 months. All technician courses are credited toward the B.S. Degree.

* * *

Practical, military or academic training will be evaluated for advanced credit.

Faculty of 85 specialists. Over 1500 currently enrolled. 35,000 former students.



Write for new 48-page Pictorial Bulletin... "Your Career"

MILWAUKEE SCHOOL of ENGINEERING

Founded 1903 by Oscar Werwath

MILWAUKEE SCHOOL OF ENGINEERING
Dept. PM-150, N. Broadway & E. State, Milwaukee, Wis.
Without obligation send free bulletin "Your Career." I am interested (course).

NAME _____ AGE _____

ADDRESS _____

CITY _____ ZONE _____ STATE _____

Check if World War II Veteran

4 WK. OLD AUSTRALIAN WHITE PULLETS



Original Cross. Sensational profit chicken of the century. From pedigreed high egg record strains. Begin laying at 4½ months, year around. Healthier, thrifty, rugged as a mule vitality. U. S. Approved — Pullorum controlled. Investigate these new HIGH ENERGY MONEY-MAKERS. Write for Free Poultry Book and low prices to:

BETTER and CHEAPER THAN YOU CAN RAISE THEM!

Write for Free Poultry Book and low prices to:

DAY-OLD ROOSTERS LOW AS \$3.90 100 — F.O.B.

GEORGE BERRY, 907 Ajax Rd., Quincy, Ills., or ERNEST BERRY, 907 Sunflower Rd., Newton, Kans.

LEARN MEAT CUTTING



through actual practice. Profitable Meat Cutting and Self-Service Meats taught easily, quickly. LEARN BY DOING at Toledo in just eight short weeks under actual market conditions. For beginners or men with experience. All subjects taught thoroughly and completely. Diploma, Job help. Get store of own. People must eat. School in operation over 25 years. Approved for GI training. Send today for FREE illustrated catalog. No obligation. NATIONAL SCHOOL OF MEAT CUTTING, Dept. 50-A, Toledo 4, Ohio



MAKE BIG MONEY Become An Artist!

CASH IN ON BIG ART MARKET! LEARN Cartooning, Commercial Art, Lettering, Showcard Writing, Photo Coloring, etc. QUICKLY with our NEW, EASY METHODS.

Interesting Catalog FREE

NATIONAL ARTISTS BUREAU

Dept. A, P.O. Box 4248, Dallas 8, Texas



X.L. RUBBER MOLDS

will realize your great profits quickly!

WRITE FOR NEW FREE CATALOG

YOU can EASILY learn to cast thousands of perfect plaques, book ends, figurines, ash trays, etc. IT'S EASY, FUN, PROFITABLE! X.L. Rubber, Pts. \$2.00; Qts. \$3.50; Gallons \$8.95; Models and enough rubber for 3 molds \$1.30 postpaid.

Address Dept. 2

3403 S. Madison St.,



SEND FOR FREE FACTS

Muncie, Ind.

HYDROPONICS

BIG FREE Illustrated Book



Fascinating Hobby! • Profitable Business!

You can grow vegetables, flowers or rare plants WITHOUT SOIL (Hydroponics) every day of the year. Learn the fast, clean, pleasant way to grow any plant indoors or out. No experience needed. Realize BIG RETURNS from a limited space. Amazing opportunity for real profits. Send postcard today for free picture book showing how others from every state are succeeding in this wide open field. Don't delay! Act now!

GILBERT & COMPANY, 846 X WEST IVY STREET, SAN DIEGO 7, CALIFORNIA



LEARN TO DRAW FUNNY FACES

In 5 Evenings—It's loads of Fun—grand hobby—develop your talent, train yourself, improve your drawing ability—be popular—wow your friends—Earn EXTRA MONEY, too. Send \$1 for Complete Course. Included Free 32 Money Making Plans. Satisfaction guaranteed or money back. FUNNY FACES, MODESTO 8, CALIFORNIA

SAY YOU SAW IT IN POPULAR MECHANICS



BOYS! Make Your OWN RADIO!

Learn Interesting Details

You may start a successful career in RADIO. Send 25c

Fun, interest and education in making your own simple, tubeless, batteryless crystal radio. Send 25c for a genuine Melomite crystal with complete illustrated instructions for making your own set. Compete with others for long distance reception. Crystal sent postpaid with instructions and our own publication "The Magic Crystal" which is full of news, diagrams, questions and answers of interest. Send 25c TODAY.

ALLEN RADIO, Dept. 129, Clinton, Mo.

And to think they used to call me

SKINNY!

**Give Me 15 Minutes A Day
And I'll Give You A NEW BODY**

PEOPLE used to laugh at my skinny 97 lb. body. I was so embarrassed at my weakling build that I was ashamed to strip for sports or for a swim. Girls snickered and made fun of me behind my back. THEN I discovered my marvelous new muscle-building system—"Dynamic Tension." And it turned me into such a complete specimen of MANHOOD that today I hold the title "THE WORLD'S MOST PERFECTLY DEVELOPED MAN."

That's how I traded in my "bag of bones" for a barrel of muscle! And I felt so much better, so much on top of the world in my big, new, husky body, that I decided to devote my whole life to helping other fellows change themselves into "perfectly developed men."

WHAT'S MY SECRET?

When you look in the mirror and see a healthy, husky, strapping fellow smiling back at you — then you'll be astonished at how short a time it takes "Dynamic Tension" to GET RESULTS!

"Dynamic Tension" is the easy, NATURAL method that you can practice in the privacy of your own room — JUST 15 MINUTES EACH DAY — while your scrawny shoulder muscles begin to swell . . . those spindly arms and legs of yours bulge . . . and your whole body starts to feel "alive," full of zip and go!

Your shoulders will broaden, your back will ripple with muscles, your whole muscular system will become developed INSIDE AND OUT! You can add inches to your chest, build a viselike grip, make those legs of yours lithe and powerful. Your old backbone will be shot full of new strength, your body crammed so full of pep, vigor and red-blooded vitality that you won't feel

there's even "standing room" left for weakness and that lazy feeling! Before you're through, you'll have your whole frame "measured" to a nice new, beautiful suit of muscle!

No "ifs," "ands," or "maybes." Just tell me where you want handsome, powerful muscles. Are you fat and flabby? Or skinny and gawky? Are you short-winded, pepless? Do you hold back and let others walk off with the prettiest girls, best jobs, etc.? Then write for my FREE Book about "Dynamic Tension" and learn how I can make you a healthy, confident, powerful HE-MAN.

Thousands of other fellows are becoming marvelous physical specimens — my way. I give you no gadgets or contraptions to fool with. When you have learned to develop your strength through "Dynamic Tension," you can laugh at artificial muscle-makers. You simply utilize the dormant muscle-power in your own body — watch it increase and multiply into real, solid LIVE MUSCLE.



CHARLES ATLAS
Holder of title, "The World's Most Perfectly Developed Man."

FREE BOOK Tells How to Get a Body Men Respect, Women Admire

My book, "Everlasting Health and Strength," tells you exactly what "Dynamic Tension" can do. And it's packed with pictures that SHOW you what it does. RESULTS it has produced for other men. RESULTS I want to prove it can get for YOU! If you want to learn how you can actually become a NEW MAN, right in the privacy of your own home and in only 15 minutes a day, then man! — get this coupon into the mail to me as fast as your legs can get to the letterbox! CHARLES ATLAS, Dept. 81, 115 East 23rd St., New York 10, N. Y.



**CHARLES ATLAS, Dept. 81,
115 E. 23rd Street, New York 10, N. Y.**

I want the proof that your system of "Dynamic Tension" will help make a New Man of me — give me a healthy, husky body and big muscular development. Send me your free book, "Everlasting Health and Strength."

Name..... Age.....
(Please print or write plainly)

Address.....

City..... State.....



Start

YOUR OWN BUSINESS

Learn

BE INDEPENDENT

Why work for others at the wages they want to pay you? A victim of layoffs, strikes, depressions. Learn a trade that pays big money. A trade for which there is an ever-growing demand. Determine how many hours per day you work.

The rates you get paid. Be your own boss. The field of electrical appliance servicing and repair offers any mechanically inclined man the opportunity of a lifetime. There are millions of electrical appliances in this country. Refrigerators, vacuum cleaners, washing machines, irons, toasters, lamps, motors, etc., etc. All will eventually need repair. Millions of new appliances come on the market each year. Electric blankets, ranges, television sets, humidifying cleaners are all recent electrical developments. That is why electric service technicians are in such great demand. Why the need continues to grow. Why servicemen are paid so well.

WHAT YOU NEED

To become a successful electrical appliance service technician is to be mechanically inclined (can hold and use tools) plus ambition and the willingness to devote a few of your spare time hours . . . learning this fascinating big money business. CHRISTY TRADES SCHOOL has already trained thousands of successful technicians. The training and kits we sent these men, which put them on the road to success and independence, can be yours. Age should be no barrier nor should a minor physical handicap. You don't need expensive equipment or elaborate fixtures to be a successful serviceman. Many started in a corner of their kitchen, basement or garage. After they were well established they opened those big shops you now see.

CTS GIVES YOU

From our 14 years of experience (CTS is the oldest school in electrical appliance servicing) we know that men learn quicker, retain what they learn, when they work with their hands. See for themselves how and why various electrical theories work. Build, test and repair kits and appliances.

Learn how to calculate the correct size and make needed elements. Gain priceless electrical knowledge building the valuable time saving, trouble tracing "CHRISTY"

Electronic Kit. A Kit you will use for years to quickly locate shorts, current consumption, continuity of electrical circuits, etc. CTS sends you manuals profusely illustrated with photographs and detailed drawings. Shows you how to quickly make the repair. Act now!

Mail the handy coupon on the next page today.

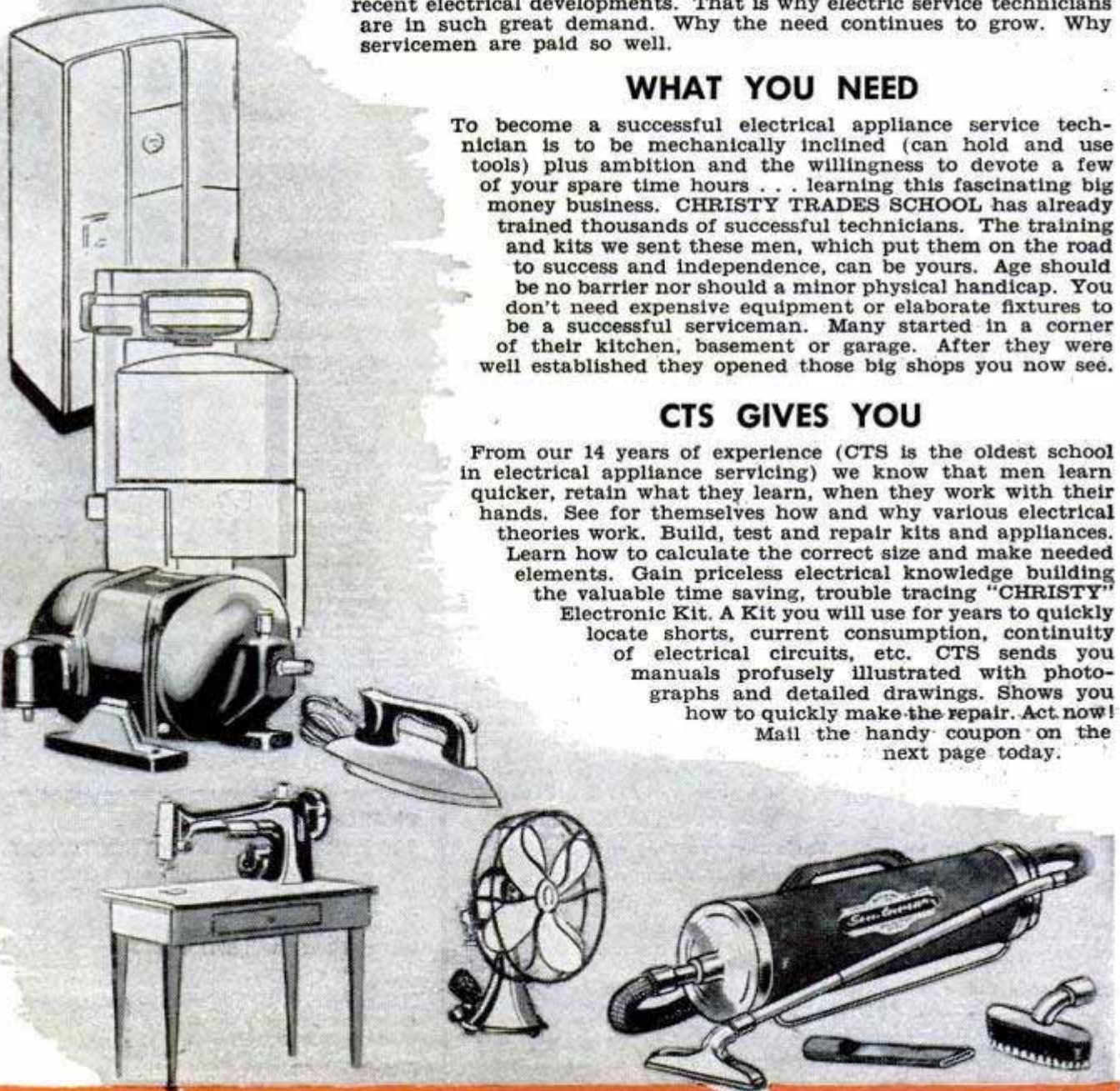

ELECTRICAL APPLIANCE REPAIRING

EARN BIG MONEY

Repairing electrical appliances for friends, relatives, neighbors and strangers offers any ambitious man a real future. It is not unusual for repairmen to charge on the basis of \$5.00 to \$6.00 per hour. Knowing how to repair appliances is often a stepping stone for owning or operating an electrical appliance store.

Factories always can use men with electrical "know how." Pay them well. Electrical power tools must be kept in good condition. Maintenance men get the "pick" of the work. You can be one. Be in the position for gaining wanted job promotions. Sign the coupon below and mail today.

MAKE YOUR OWN TOOLS

CTS teaches you how to build the power tools you need from spare parts. How to make your own AC Welding Equipment . . . Portable DC equipment. You are taught how to weld, how to do Nickel Plating, Saw, Scissor and Skate sharpening, general appliance repair. CTS teaches you trades that are good part time or full time businesses. Assure you of extra dollars when you need them. CTS gives you the knowledge for owning a full time Fix-It shop.

SUPPLIES EXTRA INCOME

CTS has filled the need of many men who wanted to add extra money to their regular income. CTS training has been a boon for many men on a pension. Electrical Appliance Servicing is light, easy pleasant work and PAYS WELL.



FREE BOOK SENT

Completely illustrated. Shows exactly what CTS does for you. Explains how you can pay from "Earnings While Learning" plan.

MAIL COUPON TODAY

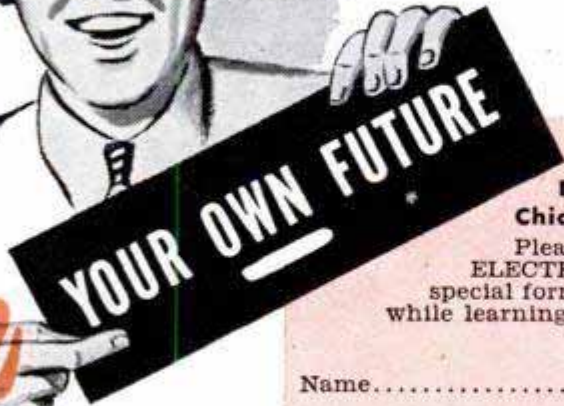

Assure

CHRISTY TRADES SCHOOL,
Dept. D-7703, 4432 N. Kedzie Avenue,
Chicago 25, Ill.

Please send me FREE illustrated book on ELECTRICAL APPLIANCE REPAIRING and special form so I can pay later from earnings made while learning.

Name..... Age.....
Address.....
City..... State.....

FIX YOUR OWN CAR

SAVE MONEY On Repairs
—AVOID Car Lay-Up

WHY pay out good money every time something goes wrong? YOU can easily keep car in A-1 condition. Just follow clear directions, simple ABC diagrams.

Fix-It-Yourself Directions—
Simple, Complete

New fix-it-yourself guide, "Everyday Automobile Repairs," tells how every part operates, how to fix it. How to recognize any trouble in a jiffy; make on-the-spot repairs. 187 easy-to-follow diagrams show how to find ignition troubles, unclog fuel systems, charge batteries, recognize danger signals of slow warm-up, overheating, fuel, lubricating, cooling, transmission, steering system troubles. Hundreds of maintenance tips to save wear and tear on parts. How to check mechanics on major repair jobs—save up to 1/3 of cost.

FREE 10-DAY EXAMINATION—

Coupon will bring you "Everyday Automobile Repairs" to examine FREE—without obligation. Mail it NOW!



Some FREE EXAMINATION Offer On—
AUTOMOTIVE ELECTRICAL EQUIPMENT. Covers every electrical unit repair job on passenger cars, trucks, buses. Only \$2.40.
AUTOMOTIVE MECHANICS. 672-page guide to disassembly and reassembly, major repairs. 714 pictures, diagrams. Only \$4.95 on easy terms.

McGraw-Hill Book Co., Inc., Dept. PMA-1
327 West 41st St., New York 18, N. Y.

Send me "Everyday Automobile Repairs" for 10-DAY FREE EXAMINATION. If not satisfied, I will return it—pay nothing. Otherwise, I will keep it—send only \$1.00 (then plus postage) and \$1.95 one month later.

SAVE POSTAGE—Check here if enclosing \$2.95 WITH coupon. Then WE prepay postage. Money back if you return book.

Name _____
Address _____ PMA-1
City _____ State _____

CHECK HERE for which of these OTHER books you want for 10-DAY FREE EXAMINATION

Automotive Electrical Equipment Automotive Mechanics

Do you want

- ..to go to College?
- ..or to enter a Profession?
- ..or get an Office Position?

(Such as Accounting, Architecture, Nursing, Dentistry, Teaching, Social Work, Osteopathy, Beauty Culture, Optometry, Embalming, Chiropody, Law, Medicine, etc.)

To get anywhere, you practically MUST finish High School FIRST. You can complete our simplified High School Course in SPARE time at home, as FAST as your time and abilities permit. Equivalent to resident school work—prepares you for college, pre-professional examinations, business, industry. Standard texts furnished. Diploma. Credit for H. S. subjects already completed. Single subjects if desired. Low tuition, easy terms. American School, Chicago, est. 1897—endorsed by educators. Finish your high school education NOW. Write TODAY!

High School Course at Home

Many Finish in 2 Years

American School, Dept. H145, Drexel Ave. at 58th St., Chicago 37, Ill.

Gentlemen: Send me FREE information covering special training in subjects checked below. No obligation on my part.

- | | |
|--|--|
| <input type="checkbox"/> High School Course | <input type="checkbox"/> Diesel Engineering |
| <input type="checkbox"/> Architecture and Building | <input type="checkbox"/> Drafting and Design for Men & Women |
| <input type="checkbox"/> Automotive Engineering | <input type="checkbox"/> Plastics |
| <input type="checkbox"/> Business Management | <input type="checkbox"/> Private Secretary |
| <input type="checkbox"/> Electrical Engineering | <input type="checkbox"/> Mechanical Engineering |
| <input type="checkbox"/> Elec. and Gas Refrigeration | <input type="checkbox"/> Aviation |
| <input type="checkbox"/> Air Conditioning | <input type="checkbox"/> Salesmanship |
| <input type="checkbox"/> Railway Training | <input type="checkbox"/> Radio |
| <input type="checkbox"/> Electronics, Industrial | |

Name.....

Address.....

WILL'S Beautiful SEED BOOK Free!

Ready now, the marvelous new 1950 WILL'S CATALOG celebrating our 67th year. 80 pages, FREE. Beautiful, colorful, filled with finest illustrations and valuable information about Will's hardy, dependable Pioneer Seeds and Plants. Everything in flowers, vegetables, fruits, berries, trees, evergreens, farm seed and original Pioneer Hybrid Corn. Many lovely floral novelties from our Great Plains country—rich, meaty "High C" Tomato and other exclusive vegetable varieties. SPECIAL LOW PRICES on orders by mail. Write today for your free copy.

OSCAR H. WILL & CO., Box 45, BISMARCK, N. DAKOTA

LEARN AT HOME TO MOUNT BIRDS



Animals, Heads, Fishes, Pets; to TAN. Be a Taxidermist. Profit and FUN.

Hunters, save your valuable TROPHIES. Mount ducks, squirrels, everything. Learn to TAN for leather and furs. Wonderful HOBBY Have a HOME MUSEUM.—BIG PROFITS mounting for others. INVESTIGATE NOW.

FREE BOOK With 100 fine game pictures. NOW absolutely FREE. Write TODAY.

Send Postal TODAY for FREE BOOK. State AGE. N. W. SCHOOL OF TAXIDERMY, Dept. 2561, Omaha, Nebr.



SHORTHAND in 6 Weeks at Home

Famous Speedwriting system. No signs; no symbols; no machines; uses ABC's. Easy to learn; easy to write and transcribe. Low cost. 100,000 taught by mail. For business and Civil Service. Also typing. 27th year. Write for free booklet to:

Speedwriting

Dept. 1501-A, 55 W. 42 St., New York 18

LEARN RAILROAD TELEGRAPHY

Prepare quickly for top pay railroad job. Starting pay approx. \$265.00 monthly. 5-Day Week. Paid vacations. Free travel passes. Go anywhere. Railroads need men constantly. FREE particulars.

AMERICAN SCHOOL RAILROAD TELEGRAPHY
301 PHIPPS BLDG. WENATCHEE, WASH.

Say you saw it in POPULAR MECHANICS IS YOUR JOB DEPRESSION PROOF?

Can you lose employment because of depression, business failure or old age? Learn watchmaking, the mechanical profession called "depression-proof for trained men" by impartial national authorities. Old age brings increased respect rather than insecurity. Study veteran training approved courses in watch and clock repair, jewelry engraving, chronograph repair at the world's largest, best-equipped watchmaking school.

SEND FOR FREE 116-PAGE INFORMATION PACKET

WESTERN PENNSYLVANIA HOROLOGICAL INSTITUTE

WORLD'S LARGEST WATCHMAKING SCHOOL



Desk 40, Chamber of Commerce Bldg., Pittsburgh, Pa.

**YOU BUILD THIS
23-TUBE
TELEVISION
RECEIVER**

NOW!

FOR THE FIRST TIME YOU CAN GET
Real Practical HOME TRAINING In

TELEVISION

RADIO AND ELECTRONICS

RTS LEADS THE WAY

WE GIVE YOU

**11 BIG
TELEVISION
AND RADIO KITS
AT NO EXTRA COST**

**YOU WORK AND LEARN
WITH REAL TELEVISION
AND RADIO EQUIPMENT**

RADIO-TELEVISION TRAINING SCHOOL'S master Technicians guide you. Located in the very heart of America's Television, Broadcasting, Radio and Sound Industries, RTS is right "on-the-spot" where new technical improvements are first introduced; is in the best possible position to bring students ACTUAL METHODS and practices developed by the RADIO-TELEVISION industry, leading to real money making opportunities. The 11 BIG KITS RTS GIVES you enable you to do many practical jobs, build the equipment illustrated; perform more than 100 other fascinating, valuable experiments. These jobs you do give you ACTUAL SHOP experience so vitally necessary to your future success. Thus RTS methods assure you BALANCED TRAINING—Theory PLUS Real Experience.

**OPPORTUNITIES NOW
WIDE OPEN FOR
Properly Trained Men**

Latest reports estimate 400 MILLION new television and radio sets will be built in the next 10 years . . . more than 72 million dollars is being spent RIGHT NOW just for radio repairs ALONE! When you are thoroughly trained by RTS Experts—who have their fingers on the pulse of the Radio-Television industry—a field of unlimited opportunities will open up for you in Your Own Radio-Television Sales & Service Business, F.M., Equipment Manufacturing, Communications and allied fields.

**EARN EXTRA MONEY
while learning at HOME**

Under the RTS amazingly easy, practical home-training plan there is no need for you to quit your present job. You study in SPARE TIME ONLY! RTS Experts show you how

to earn WELCOME EXTRA CASH, even BEFORE FINISHING YOUR TRAINING! In fact, when friends and neighbors know you are studying Radio-Television you may—like many RTS students—actually get MORE REPAIR WORK THAN YOU CAN HANDLE.

**27 YEAR
SUCCESS RECORD**

Backed by over a quarter-century of experience in home training, RTS (formerly Radio Training Association of America) offers practical "Learn-by-doing" methods, assuring you quick step-by-step progress. Begin preparing for your future in Radio-Television NOW while the time is ripe. If you are at all mechanically inclined—and have a grammar school education, RTS can teach you how to MAKE GOOD in Radio-Television.

GET THE FACTS

Send for FREE BOOK which tells you all about the RTS "time-tested" home-training plan, developed by technicians in the heart of the Radio-Television field. Fill out the coupon now—TODAY! and your FREE BOOK entitled "How To Make Good in Radio-Television" will go out to you AT ONCE. No Obligation. No salesman will call. ACT NOW!

**YOU BUILD THIS
6-TUBE STANDARD
SUPER HETERODYNE
RADIO SET with
SHORT WAVE
CONVERTER**

**YOU
KEEP ALL
EQUIPMENT
—it's Yours!**

★
**SEND
FOR THIS
30-PAGE
FREE
BOOK**
★

RADIO-TELEVISION TRAINING SCHOOL

5100 SO. VERMONT AVE., LOS ANGELES 37, CALIF., U.S.A.

ESTABLISHED 1922 — 27 YEARS AGO

RADIO-TELEVISION TRAINING SCHOOL, DEPT. PM-1
5100 South Vermont Avenue, Los Angeles 37, Calif., U.S.A.

Send FREE Illustrated Book showing how I can make good in TELEVISION and Radio through training under the guidance of expert RTS Technicians. No obligation. (No Salesman will call).

NAME _____ AGE _____

St. & No. _____

CITY _____ ZONE _____

STATE _____

INVENTORS

Before you make any effort to market your invention, you should take the first steps toward proceeding for patent protection.

The usual first step is to have a search of the U. S. patent records conducted, so that I can report to you on the question of patentability.

I shall be pleased to furnish you with information relative to patent procedure and also on the matter of trade-mark registration, upon request from you, and this will be without any obligation on your part.

PATRICK D. BEAVERS

(Formerly RANDOLPH & BEAVERS)
Registered Patent Attorney

934 Columbian Building Washington 1, D. C.



LEARN MOVIE PROJECTION THEATRE MANAGEMENT

The Motion Picture Theatre Business offers big opportunities for trained men. Get into a fascinating field with a promising future. Train at home in spare time. Free Catalog. Established 20 years.

THEATRE SCHOOL, 370 Washington St., Elmira, New York

BE AN INVESTIGATOR

WORK HOME or TRAVEL. Experience unnecessary.

INVESTIGATOR Particulars FREE. Write to GEO. M. P. WAGNER, 125 W. 86th St., N. Y.

INVENTORS

IF YOU WISH TO PROTECT YOUR INVENTION, You should take steps to protect it by a U. S. Patent. Write me for "Record of Invention" form.

CARL MILLER
REGISTERED PATENT ATTORNEY

Woolworth Bldg., 35th Floor, Dept. 10A, New York City
Please send me "Record of Invention" form.

NAME _____

ADDRESS _____

TRADE MARKS •
COPYRIGHTS •

PATENTS

The Time to Contact a Patent Attorney is Promptly After You Have Finished Your Invention

Write for FREE "INVENTOR'S GUIDE" & "Record of Invention"

FRANK LEDERMANN Registered Patent Attorney

154 Nassau St. • 20th Floor • New York 7, N. Y.

INVENTORS

Whether an invention is patentable can be substantially determined by a search of the U. S. Patent records. Without obligation, write for information explaining the steps you should take to secure a patent.

JOHN N. RANDOLPH

Registered Patent Attorney

201 Columbian Building, Washington 1, D. C.

PATENTS PATENT LAWYER

TRADE MARKS
GUSTAVE MILLER
10-PM WARNER BLDG.
WASHINGTON 4, D. C.

ASSOCIATE EXAMINER
U. S. PATENT OFFICE 1922-1929
Patent Attorney and Advisor
U. S. NAVY DEPT. 1930-1947
REGISTERED PATENT ATTORNEY
Send for PATENT INFORMATION book and "INVENTOR'S RECORD" without obligation



PATENTS AND TRADE MARKS

C. A. SNOW & CO.

REGISTERED PATENT ATTORNEYS

WRITE FOR INFORMATION TO
428 SNOW BUILDING, WASHINGTON 1, D. C.

INVENTING

—FOR **PROFIT!** If you have an inventive turn of mind, write for free 28-page booklet explaining how the Institute of American Inventors is helping inventors pre-test the profit possibilities of proposed devices to fill today's unprecedented demand for useful new inventions.

INSTITUTE OF AMERICAN INVENTORS

Dept. 4, 1926 Eye St., NW, Washington 6, D. C.

BE A NOTARY PUBLIC

Old legal-supply house, 22 cities, helps you get appointment by governor if you qualify, equips you fully. Pay after appointment (2 payments \$12.50 each). Respected public office. You certify legal papers, use official seal made with your name, collect your fees. Easy. Inquire—

STATIONERS EXCHANGE

BOERNE 51, TEXAS

HIGHEST ROYALTIES and CASH

FOR YOUR INVENTIONS

Write for FREE booklet without obligation

UNIVERSAL MARKETING CO.

354 S. SPRING ST. (Suite M)

LOS ANGELES 13, CALIF.

**AUDELS
ELECTRIC
LIBRARY
VOL
VII
HOUSE
LIGHT
POWER
WIRING**

House Wiring

Vol. VII TELLS HOW!

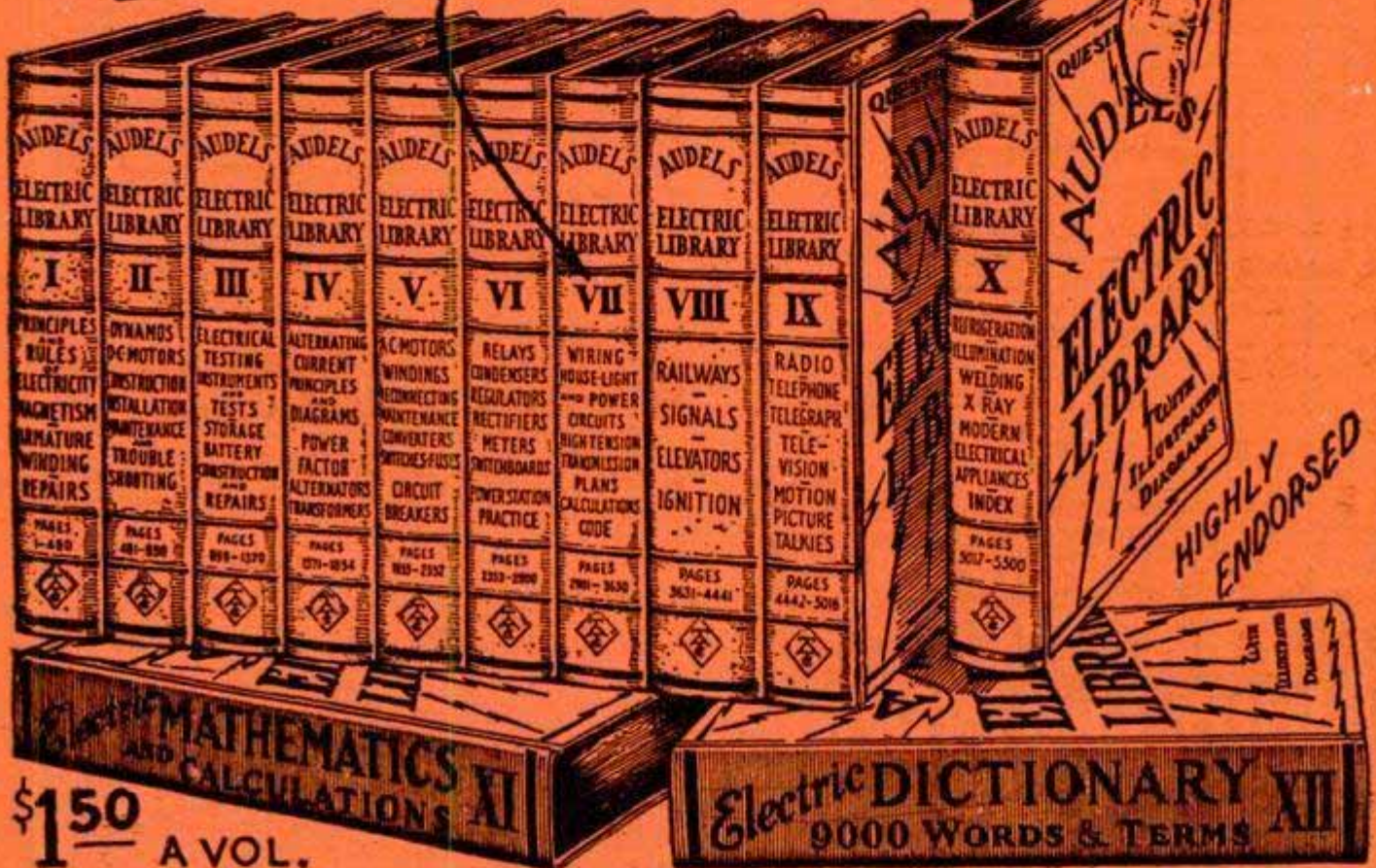

\$1.50
A VOL.

HERE ARE THE ANSWERS

MAIL THIS COUPON TODAY

Audels Electric Library gives thousands of answers to your electrical problems. Every Electrician, Engineer, Mechanic, Maintenance Man and Student should know about these very helpful books.

The 12 volumes contain 9500 clear, simplified illustrations of the Theories and Applications of Electricity, and 7200 interesting pages of Practical Trade Information relating to Construction, Operation and Maintenance. Valuable for Ready Reference or Home Study. Price only \$1.50 a volume, sold separately.

Audels Electric Library is truly a progressive home study course in Practical Electricity. Devote 15 to 30 minutes a day to its easy reading - acquire a practical working knowledge of Electricity in all its branches. Written in plain language.

AS A REFERENCE LIBRARY it is valuable. The Quick Finder Index helps you locate the desired information quickly. These books have helped thousands of men by giving them a broader knowledge of the whole field of Electricity. Take this opportunity to use our Book-A-Month Plan; mail the coupon today. No obligation unless satisfied.

AUDELS BOOK-A-MONTH PLAN
You will receive your first book for 7 days' Free Trial and Examination. If you are satisfied, send us only \$1.50. If not O.K., return the book to us and you owe us nothing. When we receive your payment for the first book, we send you the second book.

REMEMBER: You can Start Your Subscription with Any Number you choose or Stop at Any Time. Not a cent to pay until you get the books. No obligation to buy unless satisfied.

AUDELS PUBLISHERS
49 West 23rd St., New York 10, N.Y.

Please enter my subscription for AUDELS ELECTRIC LIBRARY, price \$1.50 a volume. Mail one volume each month, for which I will remit \$1.50 promptly.

Start with Volume Number _____
Name _____
Address _____
Occupation _____
Employed by _____

AUDELS PUBLISHERS, 49 WEST 23rd ST., NEW YORK 10, N. Y.

PM

Learn this Profitable Profession



IN 90 DAYS AT HOME

Money-Making Career Open to Men and Women, 18 to 50

Hundreds of men and women between 18 and 50 make \$10 to \$20 in a single day giving scientific Swedish Massage and Hydro-Therapy treatments. There is big demand from doctors, hospitals, sanatoriums and clubs. Graduates earn large full time incomes from these or in private practice in their own offices. Others make good money from home treatments given in spare time. Learn this interesting, money-making profession in your own home, through our home study course. Same instructors as in our nationally known resident school. You can win independence and prepare for future security by qualifying for your Diploma. Course can be completed in 3 to 4 months. Many earn while they learn. Begin your training at once.



Anatomy Charts & Booklet FREE

Enroll now and we will include, at no extra cost, many needed supplies. Fit yourself to help meet growing demand for Scientific Swedish Massage. Send the coupon at once for complete details. Anatomy Charts and 32-Page Illustrated Booklet, FREE, postpaid.

THE COLLEGE OF SWEDISH MASSAGE
Dept. 064A, 41 E. Pearson, Chicago 11, Illinois

Please send me FREE and postpaid, Anatomy Charts, 32-page Booklet and complete details on Home Training.

Name _____ Age _____

Address _____

City _____ State _____

Learn A Trade NOW! PRACTICAL SHOP TRAINING!

In Our Chicago Shops

- | | |
|---|--|
| <input type="checkbox"/> AUTO MECHANICS | <input type="checkbox"/> WELDING—ARC and GAS |
| <input type="checkbox"/> DIESEL MECHANICS | <input type="checkbox"/> MACHINIST |
| <input type="checkbox"/> REFRIGERATION | <input type="checkbox"/> PIANO TUNING |
| <input type="checkbox"/> BODY-FENDER | |

Above Approved For G. I.'s and Civilians

One of America's Leading Practical Schools
7 Floors of Fully Equipped Shops
Over 48,000 Successful Graduates
Expert Individual Instruction
Learn by Doing—Low Living Expense
Established 1902—Day and Evening Classes

Also the following Home Study Courses

- | | | |
|----------------------------------|--|---------------------------------|
| <input type="checkbox"/> PLASTIC | <input type="checkbox"/> REFRIGERATION | <input type="checkbox"/> DIESEL |
|----------------------------------|--|---------------------------------|

— CALL IN PERSON OR MAIL THIS AD TO —

GREER SHOP TRAINING

(Desk 10) 460 South State St., Chicago 5, Ill.

Please send without obligation free information regarding trade checked above. (Specify whether you are a Veteran or Civilian)

Name _____ Age _____

Address _____

City _____ State _____

FREE

MONEY-MAKING OUTFITS WITH ACTUAL SAMPLES

Man or woman—young or old, YOU can earn steady income in full or spare time. Everything you need is furnished FREE and prepaid. Simply write orders for nationally advertised Kendex nylon hosiery sold with amazing guarantee that gives free replacement if hose runs or snags (regardless of cause) within period up to 3 months. Complete line including sheerest 60 gauge. Carries Good Housekeeping Guarantee Seal. Also 3 additional lines (1) beautiful lingerie (2) wonderful robes at amazing direct to wearer prices (3) complete line men's hose guaranteed one full year or replaced free. No money or experience needed to build your own business. We deliver and collect. Advance cash plus huge bonus. Postcard will bring you sample nylon stocking, samples of lingerie-robe fabrics and complete money-making outfits. Nothing to pay now or later. No obligation. Write: **KENDEX COMPANY • BABYLON 346, N. Y.**



WATCHMAKING

★ Watch Repairing ★ Jewelry Engraving ★ Jewelry Repairing

Combination men earn top pay. Learn in school fully accredited by Horological Institute of America c/o U.S. Bureau of Standards, Washington, D. C. and United Horological Association of America. Approved for veterans. Receive tools, tuition and subsistence while learning.

Established 1935. Write for FREE booklet



2116 WALNUT ST. (DEPT. C) PHILA. 3, PA.

TRI-STATE COLLEGE

B. S. DEGREE IN 27 MONTHS

Founded 1884
World-Wide Enrollment

Civil, Elect., Mech., Chem., Aero., Radio and Telev. Engineering; Bus. Adm., Acct. Visit Campus, see well equipped labs. Low cost. Prep. courses. Personalized instruction. Grads. successful. Enter Jan., March, June, Sept. Catalog. 410 College Ave., Angola, Ind.

BARBELLS

95 lb. SET \$10.80

Extra plates 10c lb.



Save Money—Buy the finest barbell equipment direct from our foundry—No other company can match our low price or value!

Send to-day for our FREE Barbell Catalog

BUR BARBELL CO.
Lyndhurst 13, New Jersey

BE AN AUTO MACHINIST



Draw Top Pay • No Job Worries

Earn more money in auto mechanics—Specialize! New FREE booklet tells how to prepare for good jobs with high pay and job security. Our modern equipment and practical instructions make it easy to learn—get experience in

ENGINE REBUILDING or GENERAL AUTO MECHANICS

VETERANS American is a G.I. approved school.

Job Placement Service FREE

Practical Shop Training Learn to operate the very latest shop machinery. Friendly instructors take a real interest in preparing you for a good job.

WRITE TODAY FOR FREE BOOKLET

AMERICAN TRADE SCHOOL
2411 McGee Kansas City, Mo.



\$350 IN A SINGLE
WEEK

GROSS

IN
MY OWN
BUSINESS



**Some Make More, Some Less . . .
Start This Business for YOUR OWN**

**George Held earned \$350 in one week
with**

ELECTRIC UPHOLSTERY CLEANER

• Here's YOUR chance to start a money-making, year-'round business of your own and make the success you've dreamed about. R. O. Donnelly took in \$40 in seven hours. O. W. Ware landed a \$750 hotel job and made a fine profit. J. S. Corbit grossed \$279.50 his first month. P. D. Ash cleaned 23 auto seats at \$5 each in one week. And so it goes. Homes, hotels, offices, clubs, all places where furniture is used, offer you big profit possibilities. Auto seats and interiors, also.

NO SHOP OR OFFICE NECESSARY

You clean furniture on customers' premises. No hauling costs. No high rents. Supplies are in-

FREE BOOK! MAIL COUPON

**VON SCHRADER MFG. CO.
41A Pl., Racine, Wisconsin**

Send at once (no obligation) your FREE booklet containing information about your Electric Upholstery Cleaner and how I can own my own permanent, profitable business.

Name _____

Address _____

City _____ Zone _____ State _____

expensive and you operate, at low cost, from your home. What you take in is mostly profit. Surely YOU will want to investigate an opportunity like that — right away. Own your own business. Be your own boss. If you are ambitious, honest and courteous, we will help you to start and succeed.

FULL INFORMATION FREE MAIL COUPON TODAY

Send the coupon or write for Furniture Cleaner Booklet. It tells all about this electric cleaner—how to start YOUR business—how to make a profitable success. Don't delay. It's your BIG opportunity.



MAIL COUPON TO

VON SCHRADER MFG. CO., 41A PL., RACINE, WIS.

BE A PHOTO-ENGRAVER

We furnish complete equipment and supplies. Learn at home or in our modern, friendly APPROVED school in MISSOURI. Get into this big demand, high profit, high wage field. You can start your own profitable, full time or part time PHOTO-ENGRAVING business right in your own home.

Be independent, be your own boss or pave the way to a high pay job with experience gained in your own shop.

TASOPÉ TRAINING and TASOPÉ EQUIPMENT has enjoyed world wide recognition since 1931. Write for descriptive literature today. No obligation.

THE AURORA SCHOOL OF PHOTO-ENGRAVING, DEPT. 9PM., TASOPÉ BLDG., AURORA, MO.

LEARN MEAT CUTTING EASILY - QUICKLY At Home—In Spare Time



The steady, dependable trade of Meat Cutting taught easily, quickly by improved HOME METHOD. National School, established over 25 years, has organized its famous "Learn By Doing" Classroom, Cutting room and Retail Market training system into sound, practical HOME STUDY form.

Now, by the miracle of this EXTENSION TRAINING you can prepare in Your Spare Time At Home, for a better job, bigger responsibilities or success and security in a store of your own. Remember, PEOPLE MUST EAT!

Buying, cutting, percentage, pricing, advertising, selling—a complete meat education. For beginner or men with ex-

perience. Thousands of successful graduates. Send coupon for FREE Bulletin NOW!

MAIL THIS COUPON TODAY FOR FREE BULLETIN

National School of Meat Cutting Div. U-112, Toledo 4, Ohio

Send me your FREE Bulletin on Meat Cutting and Meat Merchandising. No obligation. No Salesman will call.

Name _____

Street _____

City _____ State _____

BE A CLERK all my life? NOT ME!!



Of course you say you won't. But you may be unless you do something about it.

Hoping and wishing won't get you a better job and more money. You must prepare for that step ahead—be ready to make promotion come.

We have helped thousands of ambitious men and women get ahead in the business world—perhaps we can help you.

At least you should investigate. It may be the turning point in your life to a better job and more money. So send the coupon without delay. Check the field of your choice and we'll send you without obligation the requirements and opportunities in that field—plus "Ten Years' Promotion in One"—a book which has helped many men.

LASALLE Extension University A Correspondence Institution

417 S. Dearborn St., Dept. 164-R, Chicago 5, Ill.

I want to know whether you can help me get ahead in the field I have checked below. Send free 48-page booklet and full information about your home-study training—plus "Ten Years' Promotion in One."

- | | |
|--|--|
| <input type="checkbox"/> Higher Accountancy | <input type="checkbox"/> Salesmanship |
| <input type="checkbox"/> C.P.A. Coaching | <input type="checkbox"/> Traffic Management |
| <input type="checkbox"/> Bookkeeping | <input type="checkbox"/> Foremanship |
| <input type="checkbox"/> Law: LL. B. Degree | <input type="checkbox"/> Industrial Management |
| <input type="checkbox"/> Business Management | <input type="checkbox"/> Stenotypy |
| | (Machine Shorthand) |

Name..... Age.....
Address.....
City..... Zone..... State.....

BIG PAY JOBS for men who qualify in DIESEL

ASSURE YOUR FUTURE. Steady, high-pay jobs await men qualified in Diesel, Tractor, and Heavy Equipment. Are you qualified for job and advancement opportunities in this fast-growing field? You can qualify!

COMPLETE DIESEL COURSE NOW AVAILABLE. If you are ambitious and want to get ahead in this big money field, you'll want to know about the complete Diesel home training course now offered by Interstate Training Service. Covers all phases of operation, repair, service. Easy to master in spare time. No interference with present job. Up-to-the-minute. Regularly revised to cover new developments. We invite comparison of material offered. Free placement advisory service.



YOU OWE IT TO YOURSELF to investigate Interstate Training Service Diesel Training. Thousands agree it has helped them to better jobs... better pay. It can do the same for you!

SEND FOR FREE BOOK TODAY!

INTERSTATE TRAINING SERVICE, Portland 13, Ore.
Please see that I receive FREE 24-page book, "Getting Ahead in Diesel." (K-3)

NAME _____ AGE _____
ADDRESS _____
CITY _____ ZONE _____ STATE _____

SPEED & POWER HANDBOOK

Build California Roadsters! Hollywood Sport Cars! 160 MPH Rods!
Breathtaking Methods — Authentic — Direct from California!

SAVE MANY DOLLARS

Build your own Dual Manifolds! Superchargers! Hot Cams! Water Injectors! Hi-Compression Heads! Mileage Devices! Get up to ten more miles per gallon! Get racing speed, lightning acceleration, dynamic power increases from any make passenger automobile! Get construction drawings! Tuning techniques! Speed tricks! Economy secrets! Ingenious formulas! Including "Racing Frames"—"Reciprocating Masses"—"Jet Engines"—"Braking Characteristics"—"Dynamometers"—"Dual Pipes, Gears, Fuels, Manifolds, Porting, Relieving, Lowering! Balancing, Including complete Racing Equipment Catalogues!"

Includes "CALIFORNIA AUTOMOBILE CUSTOMIZING"—Glossy photographs! Diagrams! Newest Ideas! Conversions! Re-Styling all makes! Streamlining! Chopping! Channeling! Customizing!
50 CHAPTER LIBRARY EDITION—complete—\$1.98 Postpaid.

NEWHOUSE AUTOMOTIVE INDUSTRIES
5805-B4 EAST BEVERLY BLVD. LOS ANGELES 22, CALIF.

How to Make Money with Simple Cartoons

A book everyone who likes to draw should have. It is free; no obligation. Simply address

FREE BOOK

CARTOONISTS' EXCHANGE
Dept. 91-D Pleasant Hill, Ohio

CODE SPEED SHORT CUT

Be an expert. Learn to be a Telegraph or Radio Operator. Qualify for amateur or commercial license. Intensely interesting work—good pay. Learn at home or wherever you are, quickly, easily with the famous Candler Speed System. Book of particulars Free.

CANDLER SYSTEM CO., Dept. 5-A, Box 928, Denver 1, Colo., U.S.A.

MAKE MONEY IN LANDSCAPING

Thorough training by Internationally known Landscape Architect to start your own business, improve your home or advance in this well paid field. Many Opportunities. Approved for Veterans. Send for FREE BOOK.

NATIONAL LANDSCAPE INSTITUTE
Dept. P-1, 310 So. Robertson Los Angeles 48, Calif.

AJAX AUSTRALORPS

SENSATIONAL WORLD CHAMPION LAYERS
Mature fast. Excellent roasters-capons. Massive size. U.S. Approved-Pullorum Controlled. Low farm prices. PROFIT SHARING PLAN. Catalog FREE. Write today.
AJAX HATCHERY, Box 914, QUINCY, ILLINOIS

it's fun to earn

RAISING HAMSTERS

Cash in on the growing demand for SYRIAN GOLDEN HAMSTERS recently introduced into the U. S. Ideal pets . . . big laboratory demand. Hardy, clean, odorless. Easily and profitably raised anywhere.

AKOPIAN HAMSTERY
the largest in the West
7358 H VARNA AVE. • NORTH HOLLYWOOD, CALIF.

write for FREE booklet

Say You Saw It in Popular Mechanics

Learn

WATCH REPAIRING

Earn while AT HOME you Learn

Learn this fascinating and profitable trade in your spare time at Home through our Correspondence Department. Each individual student receives individual attention! Post-Graduate course at resident school optional for correspondence students.

OUR MOTTO: Not how quickly, **OR** but how thoroughly we can train you.

AT OUR RESIDENT SCHOOL

APPROVED FOR G. I. TRAINING
Our school is set up on an individual basis where every student receives individual attention from our competent instructors in a home-like and cheerful atmosphere.
JOHN VAN PUFFELEN, Director
American Institute of Specialized Watch Repair

Write TODAY FOR FREE INFORMATION: 270-276 East Bldg., Grand Rapids 6, Michigan



I MADE
\$14 PER DAY
While still learning!

T. E. H.—WEST VIRGINIA



I MADE
\$800 IN 3 MONTHS
While taking your course!

F. V.—NEW YORK

Get into the

ELECTRIC APPLIANCE REPAIR & SERVICE BUSINESS



OPEN YOUR OWN SHOP
As soon as you enroll, I send you my New Book "How to Open Your Own

Business" at no extra cost. PTS training is more than a home study course in electric appliance repair and service. It gives you the "know how" on the operation of your shop from a business standpoint: What to charge, how to get customers. Everything possible is done to start you on the road to success.

WE TEACH YOU:

Electric motors, house wiring, refrigerator, auto ignition, automatic washers, garbage disposals, fluorescent lights, irons, cleaners, etc., at home.

FULL OR SPARE TIME

SEND FOR THIS FREE BOOK

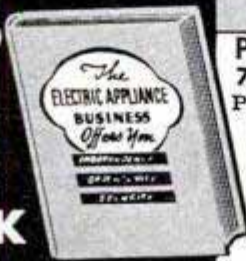

SPARE OR FULL TIME

You can actually increase your income while still learning—spare or full time

ACT NOW

Want a good-paying business—a job in a fast-growing industry? Send now for your **BIG FREE BOOK**—"My Plan for your Success." Get started **NOW**

EASY TO LEARN

Men of all ages, yes, even the man of 69 can get into this expanding field. A **REAL OPPORTUNITY** for the practical man who wants the **BETTER THINGS IN LIFE**. The easy PTS Home Study Plan prepares you for greater earnings **NOW!**

I SEND YOU A

BIG KIT of TOOLS at No Extra Cost

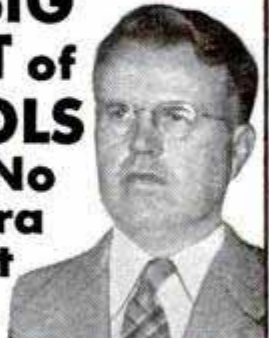

H. T. ARMSTRONG

MAIL THIS COUPON TODAY

PACIFIC TRAINING SCHOOL H. T. ARMSTRONG
7219 So. Broadway, Dept. P-501, Los Angeles 3, Calif.
Please send me, without obligation, your free booklet and details.

Name _____

Address _____

City _____

Zone _____ State _____

Learn THE SCIENCE OF SALESMANSHIP

This nationally renowned school has demand for graduates in good salary positions thru Nationwide recognition and placement service. Write Department PMH today for Big 32 page Success Book to be sent to you **FREE**



Hills BUSINESS UNIVERSITY AND EXTENSION SCHOOL
619 W. MAIN ST. OKLAHOMA CITY 2, OKLAHOMA

Learn CARPENTRY BRICK LAYING

Big money in the Building Trades. Learn now while opportunities are greatest. Train in our completely equipped shops under expert instructors, or by Home Study. Vets attending school entitled to G.I. Benefits. Write for **FREE** catalog.

MIDWEST SCHOOL OF BUILDING TRADES, Dept. PM-1
411 N. Center St. Bloomington, Ill.

ANALYZE HANDWRITING

NEW, uncrowded, fascinating field. Gratifying earnings reported by graduates in Employment, Credit, Social Service, Police and Entertainment fields. Others have developed profitable private practice, full or spare time, as Personal and vocational Counselors. Send for 3,000-word **TEST LESSON** and **PROOF** book **FREE**. Write today!



I.G.A.S., Inc., 303 Wilhoit Bldg., Springfield 4, Mo.

WOULD \$400 PER MONTH INTEREST YOU?



It is easily possible to earn \$400 to \$500 a month raising **ANGORA RABBITS**. No experience required. Wool brings top price. Plenty markets. **WRITE TODAY** for **FREE INFORMATION, PRICES** and **WHERE TO SELL**.

WHITE'S RABBITRY
NEWARK 10, OHIO

PEARL

FINISHING OFFERS YOU

BIG MONEY

RIGHT AT HOME

AMAZING NEW PEARL FINISH can be instantly applied to any article—leather—wood—plastic—glass—metal, etc.

BABY SHOES preserved for life in beautiful Baby Pink, Blue, and Ivory thrill mothers and bring immediate sales.

Nothing else like it! Costume jewelry, buttons, earrings, treasured mementos, etc., etc., take on new splendor and beauty at once.

TREMENDOUS DEMAND—Help us fill it—Fantastic profits await those who act **NOW**. Be First! Scoop the market. Never before has such an opportunity been offered. Never before such Big Profits made so quickly.

DON'T PASS THIS UP—It costs Absolutely Nothing to get the **FREE FACTS** that show you the **EASY WAY** to **QUICK, BIG MONEY** overnight. Mail Coupon **TODAY!**

PEARL-KOTE CO. Dept. PM-1
2111 W. Manchester Ave., Los Angeles 47, Calif.

Okay! **RUSH** me **FREE FACTS** at once.

Name _____

Address _____

City _____

Zone _____ State _____

9 BIG BUILDING BOOKS

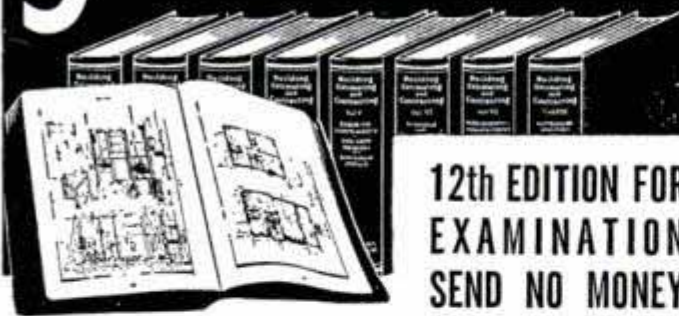

12th EDITION FOR EXAMINATION
SEND NO MONEY

Learn to draw plans, estimate, be a live-wire builder, do remodeling, contracting. These 9 practical, profusely illustrated books cover subjects that will help you to get more work and make more money. Masonry, concrete forms, carpentry, steel square, roof framing, construction, plumbing, heating, painting, decorating and many other subjects. More than 4000 pages — 2750 illustrations.

BETTER JOBS — BETTER PAY

A nationwide building boom is in full swing and trained men are needed. Big opportunities are always for MEN WHO KNOW HOW. These books supply quick, easily understood training and handy, permanent reference information that helps solve building problems.

UP-TO-DATE EDITION

These books are the most up-to-date and complete we have ever published on these many subjects.

Coupon Brings Nine Big Books for Examination

AMERICAN TECHNICAL SOCIETY—Publishers since 1898
Dept. Q119 Drexel at 58th Street Chicago 37, Ill.

You may ship me the Up-to-Date edition of your nine big books, "Building, Estimating and Contracting," without any obligation to buy. I will pay the delivery charges only, and if fully satisfied in ten days, I will send you \$2.00, and after that only \$3.00 a month, until the total price of only \$34.80 is paid. I am not obligated in any way unless I keep the books.

Name _____

Address _____

City _____ State _____

Please attach a letter stating your age, occupation, employer's name and address, and name and address of at least one business man as a reference. Men in service, also please give home address.

Secure YOUR FUTURE 3 TRADES IN 1 CAREER



WATCHMAKING • JEWELRY- ENGRAVING • STONE SETTING •

Each trade can be a full-time job; together they assure numerous high paying opportunities, or a business of your own. Profit by the *Nationally Recognized Training Methods* of the *Kansas City School of Watchmaking*.

ENROLLMENTS NOW AVAILABLE

Clip and Mail this Coupon Today

KANSAS CITY SCHOOL OF WATCHMAKING
1218 Admiral Blvd.
Kansas City 6, Missouri

Please send me, without obligation, complete information on training in the above courses.

Name _____

Street _____

City _____ State _____

Check if Veteran G. I. Approved

ACCOUNTANT

BECOME AN EXPERT

Executive Accountants and C. P. A.'s earn \$3,000 to \$10,000 a year. Thousands of firms need them. We train you *thoroughly at home* in spare time for C. P. A.'s examinations or executive accounting positions. Previous experience unnecessary. Personal training under supervision of staff of C. P. A.'s. Placement counsel and help. Write for free book, "Accountancy, the Profession That Pays."

LASALLE Extension University, 417 So. Dearborn St.
A Correspondence Institution Dept. H-290, Chicago 5, Ill.

WHY DON'T YOU WRITE?

Writing short stories, articles on business, politics, sports, shop crafts, local and club activities, etc., will enable you to earn extra money. In your own home, on your own time, the New York Copy Desk Method teaches you how to write the way newspaper men learn — by writing. Our unique "Writing Aptitude Test" tells whether you possess the fundamental qualities essential to successful writing. You'll enjoy this test. Write for it, without cost or obligation.

Veterans: This course approved for Veterans' Training.

NEWSPAPER INSTITUTE OF AMERICA
SUITE 5590-A, ONE PARK AVENUE, NEW YORK 16, N. Y.

Get PAID for SPARE TIME!

Make extra money like magic! Take orders for exquisite new "Flower Basket", other big value Greeting Cards Assortments. Low prices, stunning designs, convenience make friends want to buy! You earn up to 100% on fast sales! Large line, including Humorous, Gift Wraps, newest PLASTIC and Metallic Cards, Personal Stationery, others, boosts your income. Sample Boxes sent ON APPROVAL. FREE Imprint Samples. Write now!

Sell ARTISTIC Everyday Cards

ARTISTIC CARD CO., Inc., 820 Way St., Elmira, N. Y.

HOMESITES \$300 LOW TERMS

In California's loveliest Garden Spot, on scenic shores of beautiful Morro Bay. Enjoy future independence with excellent soil, soft water, wonderful fishing, hunting, boating, bathing, etc. Grow fruits, vegetables, poultry. Perfect temperate climate. Congenial community. Finest investment. Free literature.

RICHARD S. OTTO

DEPT. M SAN LUIS OBISPO, CALIFORNIA



AJAX WHITE GIANTS

FAMOUS MEAT-EGG PRODUCERS

Extra big profit breed. Contest-show winners. Massive capons, quick maturing. U. S. Approved-Pullorum Controlled. Low farm prices. **PROFIT SHARING PLAN.** Colored catalog FREE. Write TODAY.

AJAX HATCHERY, Box 915, QUINCY, ILLINOIS

SANDEE CHROME SILENTIP®



\$2.95
EACH

FOR QUIETER PERFORMANCE

An exhaust tailpipe extension that is actually a small muffler. Chrome plated. Will make a sport muffler or dual set quieter and still give straight thru performance.

SANDEE MUFFLER CO., 5643 Corryne Pl., Culver City, Calif.

ANY BOOK IN PRINT

Delivered at your door. We pay postage. Standard authors, new books, popular editions, fiction, reference, medical, mechanical, children's books, etc. **Guaranteed savings.** Send for Clarkson's 1950 catalog.

FREE Write for our great illustrated book catalog. A short course in literature. The buying guide of 300,000 book lovers. Free if you write now—today!

CLARKSON PUBLISHING COMPANY
Dept. PMS01, 1257 So. Wabash Ave., Chicago, Ill.

Say You Saw It in POPULAR MECHANICS

Learn BAKING At Home

Baking is one of America's high industries in wages. Nearly depression-proof. Thorough basic home course lays sound foundation. If you have aptitude, write for **FREE BOOKLET**, "Opportunities in Commercial Baking." National Baking School, 1315 Mich. Ave., Dept. 1351, Chicago 5



They Never Knew It Was SO EASY To Play

Thousands Now Play Popular Songs Who Didn't Know a Note of Music Before

You, too, can learn your favorite instrument at home, without a teacher, this quick, easy, money-saving way

THINK of the fun YOU are missing! The popularity, friendship, good times! Why? Because you think it's *hard* to learn music. You have an idea that it's a slow, tedious task, with lots of boring drills and exercises.

That's not the twentieth-century way! Surely you've heard the news! How people all over the world have learned to play by a method so simple a child can understand it—so fascinating that it's like playing a game. Imagine! You learn without a teacher—in your spare time at home—at a cost of only a few cents a day! You learn by the famous print-and-picture method—every position, every move before your eyes in big, clear illustrations. You CAN'T go wrong! And best of all, you start playing real tunes almost at once, from the very first lesson.

No needless, old-fashioned "scales" and exercises. No confused, perplexing study. You learn to play by playing. It's thrilling, exciting, inspiring! No wonder hundreds of thousands of people have taken up music this easy way. No wonder enthusiastic letters like those reproduced here pour in from all over the world.

Sound interesting? Well, just name the instrument you'd like to play and we'll prove you CAN! (Instruments supplied when needed. Cash or Credit.) Mail the coupon or write. Do it now! 52nd year.

U. S. SCHOOL OF MUSIC
71 Brunswick Bldg.
New York 10, N. Y.



Learned Quickly at Home. "I didn't dream I could actually learn to play without a teacher. Now when I play for people they hardly believe that I learned to play so well in so short a time." *H. C. S., Calif.

Music is the magic key to friendship, fun, romance. The person who can play a musical instrument is always sure of a welcome. Why not let music open up a new world for you. Thousands have discovered unexpected pleasure and profit in music, thanks to the unique method that makes it amazingly easy to learn.

Send for FREE Booklet and Print and Picture Sample

See for yourself how this wonderful self-instruction method works. Sit down, in the privacy of your own home, with the interesting illustrated booklet, "How to Learn Music at Home." No salesman will call—decide for yourself whether you want to play this easy way.



WELL WORTH MONEY

"The course is fully self-explanatory. When one is finished with it there is little one need learn. It is well worth the money and I fully believe you have the finest course on the market today." *R. E. G., Clarksburg, W. Va.



INVITED TO PARTIES

"Before I took your course I didn't know one note of music. Then three months later I started to play for dances. I've been invited to many parties. The course is easy and interesting." *R. M., Vancouver, B.C.

U. S. SCHOOL OF MUSIC
71 Brunswick Bldg., New York 10, N. Y.

I am interested in music study, particularly in the instrument indicated below. Please send me your free booklet, "How to Learn Music at Home" and the free Print and Picture Sample.

Piano	Reed Organ	Modern
Guitar	Tenor Banjo	Elementary
Hawaiian Guitar	Ukulele	Harmony
Violin	Clarinet	Mandolin
Piano Accordion	Trombone	Practical Finger
Saxophone	Flute	Control
Trumpet, Cornet	Piccolo	

Mr. _____ Have You
Miss _____ This Instr.?
Mrs. _____ (PLEASE PRINT)

Address _____

City _____ State _____

Note: If you are under 16 yrs. of age, parent must sign coupon.

SAVE 2c—Stick coupon on penny postcard.

*Actual pupils' names on request. Pictures by Professional models.

Do Wonders

WITH METAL

It's Easy For ANYONE To Make These 55 Beautiful Art Objects

MAKE candlesticks, lamps, trays, cake plates, mugs, fruit dishes, mail boxes, platters, coasters, flowerpot holders, cigarette boxes, pitchers, etc.—AT A COST OF PENNIES INSTEAD OF DOLLARS! To beautify your home—or for gifts—or to sell for profit.

500 HOW-TO-DO-IT PICTURES AND DIAGRAMS

No art ability needed! "Art Metalcraft" gives hundreds of simple diagrams to copy—shows how to make beautiful things of silver, brass, copper, aluminum, pewter. Special chapters on unusual finishes, lovely etched designs.

FREE 10-DAY EXAMINATION—Coupon will bring you "Art Metalcraft" to examine FREE—without obligation. Mail it NOW!

McGraw-Hill Book Co., Inc., Dept. PMC-1, 327 West 41st St., New York 18, N.Y.

Send "Art Metalcraft" for 10-DAY FREE EXAMINATION. If not satisfied, I will return it—pay nothing. Otherwise, I will keep it—send only \$1.50 then (plus postage) and \$2 one month later.

SAVE POSTAGE—Check here if enclosing \$3.50 WITH coupon. Then WE prepay postage charges. Money back if you return book.

Name _____
Address _____
City _____ State _____
_____ State _____
_____ State _____

CHECK HERE to get "Jewelry, Gem Cutting and Metalcraft" for 10-DAY FREE EXAMINATION.



Same FREE EXAMINATION Offer On—
"Jewelry, Gem Cutting and Metalcraft." How to cut, polish, mount gem stones. How to make art and novelty jewelry, metalware. Only \$2.95 on easy terms.

THRILLING NEW SPORT BOAT!

as featured in
Aug. 15 LIFE
pages 52-54



Now the fast, brilliant "Sailfish" comes knocked down for easy home assembly at a big saving! Safe-T-Plane hull can't sink or swamp. Carries conveniently on car top. Precision pre-cut and pre-formed parts of high quality materials go together quickly. All hardware included. **HULL KIT, \$69.75. SAIL KIT, with centerboard, rudder, spars, rigging and finished sail, \$49.75. ASSEMBLED BOAT, factory-finished and complete with sail, \$189.** All prices are f.o.b. Waterbury, Conn. Illustrated literature on request.

Dept. S., ALCORT, INC., Waterbury, Conn.

ACCOUNTANT

BECOME AN EXPERT

Executive Accountants and C. P. A's earn \$3,000 to \$10,000 a year. Thousands of firms need them. We train you thoroughly at home in spare time for C. P. A's examinations or executive accounting positions. Previous experience unnecessary. Personal training under supervision of staff of C. P. A's. Placement counsel and help. Write for free book, "Accountancy, the Profession That Pays."

LASALLE Extension University, 417 So. Dearborn St. A Correspondence Institution Dept. H-289, Chicago 5, Ill.

GET THIS SUIT AS A BONUS!

YOU PAY 1/2 • WE PAY 1/2

Sell popular Smith tailored-to-measure suits. Make up to \$10-\$15 daily, taking orders from friends. As an extra bonus, get your own suit at HALF-wholesale cost. No experience needed. Send for FREE selling kit and sample line. Send no money. Write fully, state age, etc.

W. D. SMITH & CO., Dept. D
833 W. Jackson Blvd., Chicago 7, Ill.



HIGH PAY • SECURITY When You LEARN A TRADE



Get ready for a well-paid, lifetime job or a business of your own in one of these FIVE ESSENTIAL TRADES. Complete training under expert instructors with practical experience prepares you to step into a good paying job with a future and security.

ELECTRICITY: Basic electricity, Residential and Industrial Wiring and Appliance Repair.

PLUMBING: Every phase—pipe cutting and threading to complete installations, blue print reading.

AUTOMOTIVE & TRACTOR: Engine overhaul, Transmissions, Carburetion, Generator-Ignition Systems, Tune Up.

DRAFTING: College level training in general Machine and Architectural Drafting

SHOE REPAIRING: Complete practical training includes reconditioning and rebuilding.

Approved For Veteran's Training

NATIONAL TRADE SCHOOL

2610 Grand • Kansas City 8, Mo.

Without obligation to me please send full information on the course checked

.....Automotive and Tractor Technician .. Drafting
.....PlumbingElectricityShoe Repairing

Name.....Age.....
Address.....
City.....State.....
Veteran?.....

1000 ROUTINES & TRICKS
IN OUR
400 pg. CATALOG
ACTUALLY FREE!
Your dollar refunded
with first \$5 00 order

AMAZE YOUR FRIENDS

SECRETS OF

MAGIC

\$1.00

LOUIS TANNEN

120 W. 42nd ST.
NEW YORK 18

Say You Saw It in Popular Mechanics

SHOE REPAIR OFFERS BIG INCOME LEARN IN 12 WEEKS TIME



You can own your own shop or earn big income as skilled shoe repairman. Growing demand everywhere at top wages for men who know how. We teach you quickly by actually working on shoes and modern machines. School open to all from 18 to 60 years of age. FREE BIG 20 PAGE BOOK explains everything. Send for your copy today. Chicago & Los Angeles schools only approved for Vets.

MODERN SHOE REBUILDING SCHOOL
Established 1927
2937 Belmont Ave., Chicago. 361-12th St. Oakland, Calif.
806 So. Figueroa St., Los Angeles 14, Calif.

ABOUT HEART WEAKNESS

Bernarr Macfadden, at 81, astonished the entire medical world by leaping into the air at 3000 feet in a parachute jump and landing without injury.

As an advisor in health-building he has had 65 years' experience as a student-teacher, and for more than 15 years was an acting supervising practitioner in large sanatoriums, never losing as a publisher his intense interest in natural health-building.

Although thousands sought his advice, he had personal experience in rebuilding his own heart and he claims that at this time his heart is stronger than it was 25 years ago. He discovered a method through the science of Kinestherapy that can be depended upon to greatly strengthen this vitally important organ.

If you are enduring discomfort of any kind in the upper left chest—the location of the heart—send a postal card to Bernarr Macfadden Foundation, Inc., Suite 803-21, 535 Fifth Ave., New York 17, N. Y., and information will be sent you that may ultimately be life saving in character.



NEW! BIG FIELD FOR PROFIT AND PLEASURE COPPER TOOLING & ETCHING

EARN BIG MONEY — SPARE OR FULL TIME
No experience needed—start at once. **BIG MONEY** waiting in **COPPER ART** field. Plaques, Bowls, Trays, Gifts, Souvenirs of all kinds. Start on the road to success **NOW!** Here is an opportunity to get started in your own **Big Paying Business—FREE DETAILS** don't wait—**WRITE NOW!**

Hollywood Copper Art Studios
4257 Beverly Blvd., Dept. PM-1, Los Angeles 4, Calif.

DO IT AT HOME

EASY TO LEARN CODE

Learn or increase speed with an Instructograph—the Radio-Telegraph Code Teacher that takes the place of an operator-instructor and enables anyone to master code without further assistance. Available **tapes** from beginners alphabet to typical messages on all subjects. Speed range 5 to 40 WPM. Always ready—no QRM. Thousands have "acquired the code" with the Instructograph System. Write today for convenient rental and purchase plans.

INSTRUCTOGRAPH COMPANY
4701-V Sheridan Road, Chicago 40, Illinois

SAY YOU SAW IT IN POPULAR MECHANICS

WATER & SHOCK RESISTANT Ruby Jewels For Main Bearings

SCREW CASE
STEEL BACK
LUMINOUS HANDS and NUMERALS

ANTI-MAGNETIC
40 HOUR RUNNING POWER

\$10.95
Fed. Tax Included
REG. PRICE \$21.25

10 Day RETURN PRIVILEGE SERVICE

3 YEAR GUARANTEE

UNBREAKABLE, NON-DISCOLORING CRYSTAL
Enclose remittance, or C.O.D. plus Postage Satisfaction Guaranteed!

IMPEXTRA, 551 FIFTH AVE. (Dept. PM-3) New York 17, N.Y.

JANUARY 1950

TIRED OF WORKING FOR SOMEONE ELSE?



Be your own Boss!

\$5500 INVESTMENT CAN BRING YOU \$9630 ANNUALLY!

Investment covers cup vending equipment and supplies such as Coca Cola, Hires Root Beer and Canada Dry—completely automatic—makes change. Big Profits. Thirst knows no season... the amazing Cole-Spa 3-Flavor Beverage Cup Dispenser also serves hot chocolate. We provide locations—no experience needed. Deliverers drink at almost half the bottle cost. If you really want security, easy hours, and life-long prosperity—send today for full details.



MAIL TODAY!

COLE PRODUCTS CORP., Dept. JPM-50
39 S. La Salle St., Chicago 5, Ill.

Without obligation, send me full details

Name

Address

City

State



Photography for PLEASURE or PROFIT



Learn at home. Spare time. Practical basic training. Long-established school. Many have earned while learning. Send coupon below for free booklet, "Opportunities in Modern Photography" and full particulars.

AMERICAN SCHOOL OF PHOTOGRAPHY

1315 Michigan Avenue Dept. 1351 Chicago 5, Illinois
Send booklet, "Opportunities in Modern Photography," full particulars and requirements. No salesman will call.

Name

Address

City

Zone

State

FREE

get it now—

ALLIED'S 1950 TV & RADIO CATALOG!

196 PAGES OF BIG VALUES

EVERYTHING IN RADIO AT LOWEST PRICES



Send for Radio's Leading Buying Guide

Save money on every radio need! Get the new 196-page 1950 ALLIED Catalog, preferred and used by everyone in radio. See the world's largest stocks of top-quality equipment, all at low, money-saving prices! Latest TV releases, home radios and radio-phonos, Amateur equipment, PA systems and High-Fidelity Sound, recorders, test instruments, builders' kits—plus thousands of parts, tubes, tools, books and diagrams. Have all the advantages of quick delivery, complete selections, big savings and expert personal help from the World's Largest Radio Supply House. Send today for your FREE copy of the 1950 ALLIED Radio Buying Guide!



TELEVISION AND HOME RADIOS



SERVICE SUPPLIES BUILDERS' SUPPLIES



AMATEUR GEAR



AMPLIFIERS, P.A. SYSTEMS, RECORDERS

ALLIED RADIO

ALLIED RADIO CORP.
833 W. Jackson Blvd., Dept. 5-A-0
Chicago 7, Illinois

Rush FREE 1950 ALLIED Catalog

Name

Address

City.....Zone.....State



FREE!! HOW TO MAKE BIG MONEY

METALIZING BABY SHOES AND OTHER PRECIOUS KEEPSAKES AT HOME

FREE FACTS SHOW HOW TO MAKE \$5 PER HOUR, UP TO \$25—\$50 PER DAY. START EARNING AT ONCE. YOUR OWN BIG PAY BUSINESS STARTED AT HOME ON A SHOESTRING. DON'T PASS THIS UP. WRITE FOR FREE DETAILS TODAY!

KIKTAVI CO.
2111 W. MANCHESTER, LOS ANGELES 47, DEPT. PM-1

STRENGTHEN Your VOICE!

YES—you can now build yourself a powerful speaking and singing voice with this amazing new scientifically sound tested method. Self-training . . . no music or piano required. Results GUARANTEED. Just send your name for the sensational details. FREE chart of your vocal mechanism included! Please state your age. PERFECT VOICE INSTITUTE, Studio A-2, 1141 S. Wabash Ave., Chicago 5, Ill.

Is Your Life Crowned With Success?

LEXIPOWER



WE THINK IN WORDS. THOUGHT IS POWER. Let this New Science show you how to **WIN WITH WORDS**—financially, socially, culturally. Develop a **MASTERFUL VOCABULARY**. Influence others, improve your personality, manifest your latent ability. You are judged and rated by every sentence you utter. Start using the **POWER OF LEXIPOWER** after your first Lesson. Write **NOW** for **FREE** details! **LEXI-POWER. Dime-a-Day LESSON CLUB.**

LEXIPOWER LESSON CLUB
517-K W. Deming Place Chicago 14, Illinois

LEARN LANDSCAPING

Profitable, healthful career — absorbing hobby, for men, women. Thorough 45-lesson home-study course takes 8-12 months spare time. Continuous free consultative service. Hundreds of successful graduates all over the world. 34th year. Send for **FREE** catalog. American Landscape School, 6570 Grand Ave., Des Moines, Iowa

DRIVER-AGENTS WANTED

Earn big money. Drive and demonstrate Crosley Station Wagon or Hotshot. Full or part time. Discount on demonstrator. Write



CROSLY MOTORS, INC.
2532-HO Spring Grove Ave., Cincinnati 14, Ohio

APTITUDE TESTS

discover the kind of work or studies best for your success! You get a personal report—a guide for life—more happiness—more prosperity. For men, women, boys and girls. Write for complete facts. VOCATIONAL COUNSELING INSTITUTE
956 Maccabees Bldg., Detroit 2, Michigan

Say You Saw It in POPULAR MECHANICS

MICRO-VOX . . . THE WIRELESS "MIKE"

Broadcasts Over Any Radio Within 50 Feet!

Here's a fascinating complete miniature transmitting system that will delight everyone! Round table discussions . . . Baby listener . . . Practical jokes and dozens of other uses that will astonish one and all! Complete with tube, batteries, tuner and built-in high-fidelity microphone. Clear, Life-like tone. Easy to operate!



SAVE MONEY! Send Check or M.O. \$6.95 COMPLETE
We Pay Postage. C.O.D. Plus Postage.

TRUSOUND, INC. (Dept. PM-1L) 630 W. Randolph St. Chicago 6, Ill.

STUDY AT HOME

With An Educational Institution

Men with specialized training win higher positions, insure larger earnings, and are bigger successes in business and public life. Opportunities NOW greater than ever before. Send for our Catalog.

ARTS and SCIENCES

Courses in Philosophy; Education; Letters; Public Health; Medical Jurisprudence; Psychology; Sociology; Physics; Chemistry; Geology; Political Science; Theology; Business and Commerce; Accounting; Mathematics; Statistics; Agriculture.

ENGINEERING

Courses in Electrical, Civil Mechanical, Drafting, Architectural, Steam, Aeronautical, Radio, Structural, Mining, Industrial, Petroleum, Marine, Chemical, Diesel, Automobile, Refrigeration, and Air Conditioning Engineering.

LAW

Complete Professional Law Course includes 18 Hornbook Series college grade textbooks. Courses also in Commercial Law, Patent Law and Medical Jurisprudence.

McKinley-Roosevelt Incorporated, 4610-K, Sheridan Rd., Chicago 40, Ill.

Be an INVESTIGATOR

JAMES S. BOLAN, FORMER POLICE COMMISSIONER OF NEW YORK CITY offers MEN & WOMEN an attractive opportunity to prepare for a future in *Investigation & Criminology* by comprehensive Home Study Course. Free placement service assists graduates to obtain jobs. APPROVED UNDER G. I. BILL OF RIGHTS. Write for Free Booklet PM.

THE **BOLAN ACADEMY, INC.**
EMPIRE STATE BLDG., NEW YORK 1, N. Y.

LOCKSMITHING & KEYSMAKING

PRACTICAL HOME TRAINING OUTFIT INCLUDES EVERYTHING NECESSARY TO GET STARTED IN YOUR OWN BUSINESS. Excellent full or part time earning opportunities. Professional outfit includes supplies, tools, key cutting machine. Get practical training from Master Locksmiths on house locks, auto locks, padlocks, etc. Learn to cut keys by code, master locks, change combinations, quickly, identify key blanks, many profitable "tricks of the trade." Booklet of Information FREE. Write today. UNITED SUPPLY & SERVICE, 3327 Madison St., Dept. PM-1, Chicago, Illinois.

Learn PHOTOGRAPHY

There's big money in PHOTOGRAPHY — and an action-packed career for you. Our HOME STUDY COURSE—famous throughout the world — is your spare-time SHORT CUT TO SUCCESS! Or if you wish . . . PERSONAL ATTENDANCE TRAINING at our famous New York Studios is available with subsistence under G. I. BILL. Our 40th year. Write immediately!

NEW YORK INSTITUTE OF PHOTOGRAPHY

Dept. "49", 10 W. 33 St., New York 1, N. Y.

BIG FREE CATALOG

of WAR SURPLUS

OPTICAL BARGAINS

Build Your Own RIFLESCOPE, BINOCULARS, TELESCOPES, ETC.
We Furnish Optics and Instructions.

- LENSES, PRISMS & RETICLES
- EYEPIECES and OBJECTIVES

Send \$1.00 for Stock #2-H
10-Piece Lens Kit and Big
Instruction Booklet.

We Have Numerous Types of Assembled Optical Instruments Including BINOCULARS and RIFLESCOPES.

CHECK OUR BARGAINS . . . Request CATALOG H

EDMUND SALVAGE COMPANY
BARRINGTON, NEW JERSEY

MEN! Will You Trade A Few Hours Weekly Toward



A CAREER IN

DIESEL

Learn While You Keep Your Job

Get set for a future in DIESEL! Opportunities for trained men are growing as industries switch to Diesel for low cost, efficient power. Trucks, busses, tractors, railroads, ships, power plants—are "going Diesel." In large towns and small, on farms and in factories, all over America and elsewhere—this economical, dependable power is building greater demand for men trained in operation and repair of Diesel engines. Get the facts on how you can prepare for Diesel opportunities in just a few hours weekly.

LEARN FASTER BY EASY LISTENING METHOD!

If you are mechanically inclined, you can get thorough, individual instruction in the fundamentals of Diesel in your spare time. Now UEI Audio Training method brings your instructor's voice into your home on records! Fully illustrated, easy-to-follow lessons and regular tests speed your progress as you learn engine operation, fuel systems, repairs, auxiliary equipment, other Diesel basics and SCIENTIFIC MOTOR TUNE-UP. Your instructor on records and the practical lessons are always handy to repeat important points until you are sure of them.



SHOP PRACTICE, TOO

After your personalized training at home you can get intensive practice on actual Diesel equipment in our big, modern shops under skilled instructors. UEI has a fine record of training men for specialized careers since 1927. Get all the facts on UEI Diesel Training now without cost or obligation. Just send the coupon. ACT TODAY.

NEW! SCIENTIFIC MOTOR TUNE-UP

Special training included gives you modern short-cut methods for testing and trouble shooting internal combustion as well as Diesel engines.

UTILITIES ENGINEERING INSTITUTE
DEPT. DC-7, CHICAGO 14, ILL.

MAIL COUPON FOR FREE FACTS!

UTILITIES ENGINEERING INSTITUTE
2521 Sheffield Ave., Dept. DC-7, Chicago 14, Ill.

I'm interested! Rush FREE FACTS on UEI Training and opportunities in Diesel!

Name _____ Age _____

Address _____

City _____ Zone _____ State _____

Check here for special information if under 17.

EARN MORE IN DRAFTING



Steady Employment
•
More Opportunities for Promotion

"Here I am at work making good money as a draftsman. I'm glad I sent the coupon to Chicago Tech for that Free Trial Lesson and found out how easy it is to learn Drafting in spare time at home. Today I feel secure in my job because the draftsman's work comes first on any new project. And, in addition, draftsman can't be replaced with machines. What's more, I feel I'm slated for promotion and more pay, because I see so many draftsmen advancing to high-pay jobs."

LEARN IN SPARE TIME—AT HOME! (or at the College in Chicago)

A few hours of pleasant home study every week—that's all. No interference with your present job. All the tools you need; drawing outfit included. With Chicago Tech's help, you train yourself step by step. This tested method—developed over 45 years of C.T.C. progress—prepares men quickly for good positions in industry.



FREE INFORMATION—SEND COUPON

To prove to you how easy it is to learn Drafting at home by the Chicago Tech method, we will send you this FREE TRIAL LESSON. No charge for this lesson, now or later. Fill out and mail coupon, or send post card today.

CHICAGO TECHNICAL COLLEGE

A-213 Tech Bldg., 2000 S. Michigan Ave., Chicago 16, Illinois
Mail me FREE Lesson with information about big opportunities in DRAFTING.

Name _____ Age _____
Address _____
City _____ Zone _____ State _____

ENGINEERING DEGREE IN 27 MONTHS

Big Demand for Graduates

Aeronautical, Chemical, Civil, Electrical, Mechanical and Radio Engineering (including Television)

Hundreds of young men are earning engineering degrees in this recognized institution each year—continuous operation. New terms start quarterly. Many students earn a major part of their college expenses in this large industrial center.

Low tuition. Competent instruction. Thorough intense practical program. Modern laboratory facilities including new physics lab. and modernized wind tunnel. Individualized instruction emphasized.

Approved for Veterans. Engineering preparatory courses. Students from 48 states and 21 foreign countries. Enter March, June, September or December. Send coupon for free catalog and full information. Enroll now.

SEND COUPON TODAY

INDIANA TECHNICAL COLLEGE

510 E. Washington Boulevard
Fort Wayne 2, Indiana

Please send me free information on B.S. Engineering Degree in 27 months as checked.

Aeronautical, Chemical, Civil, Electrical,
 Mechanical, Radio-Television.

Name _____
Address _____

HOLLYWOOD MUFFLER

THE TONE YOU LOVE TO HEAR

MORE SPEED—POWER—MILEAGE

are yours with a Hollywood Muffler . . . plus a tone you'll love to hear! Not a gutted muffler. Easy to install.

Hollywood Mufflers
Trade-mark Reg.
U. S. Pat. Off.



IMPROVED DESIGN
PRECISION MADE
ELECTRIC WELDED!

Outlasts ordinary mufflers 3 to 1

Ford, Chevrolet, Plymouth \$6.00
All other cars \$8.00

Duals, Ford & Merc. \$24.50. Also Fender Skirts, \$10.95. Order direct. Send check or M.O. and save postage.

Dealers Write **WILKINSON MUFFLER CO.** 811 WILT STREET FT. WAYNE, IND.

Let Me Send You THIS TAILORED SUIT

AND MAKE UP TO \$12.00 IN A DAY!

YOU CAN GET this fine, tailored-to-measure suit as a bonus, without paying one penny cash, by taking a few orders from friends. My plan also helps you make up to \$12.00 in a day without experience or house-to-house canvassing. Big opportunity full or spare time. FREE—Send for Samples and "Sure-Fire" MONEY-MAKING plans. For quick action write fully giving age, etc. Send no money. H. J. Collins, PROGRESS TAILORING CO., 500 S. Throop St., Dept. A-216, Chicago 7, Ill.



Learn ACCOUNTING BOOKKEEPING

This nationally renowned school has demand for graduates in good salary positions thru nationwide recognition and placement service. Write Department PMG today for Big 32 page Success Book to be sent to you **FREE**



Hills BUSINESS UNIVERSITY AND EXTENSION SCHOOL
619 W. MAIN ST. OKLAHOMA CITY 2, OKLAHOMA



BARBELLS

FINEST QUALITY \$8.98 up

FREE CATALOG

Send today for big new 4 color fully illustrated free catalog of BARBELLS, Dumbbells and Health equipment. Free—world famous \$15.00 Dan Lurie Barbell and Dumbbell training courses with every purchase.

DAN LURIE BARBELL CO.
DEPT. 159A 1729-M1 ROCKAWAY PARKWAY
BROOKLYN 12, N. Y.

JET POWER YOUR CAR!

Merrick's Multi-jet fuel atomizer gives your car worlds of added power . . . quicker starting and take-off . . . smoother, quieter performance . . . plus more miles per gallon of gas. Install it yourself in a few moments in manifold. Try it for ten days and if you are not delighted with results, return it. Will gladly refund money. When ordering give make and year of car. Prepaid any place—\$7.75

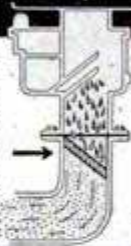

MERRICK ENGINEERING CO.

6700 IMPERIAL AVE. SAN DIEGO, CALIF.

FENDER SKIRTS \$9.95 PER PAIR

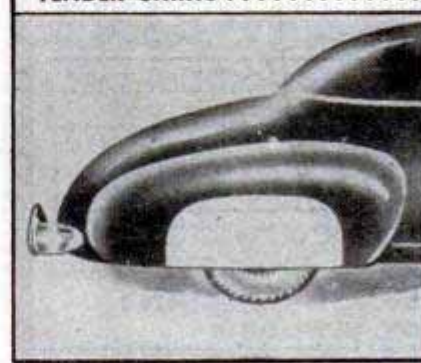

For 95% of all cars. Beautify your car . . . bring out the flowing lines designed in it. Sparkling beauty you'll like. Constructed of heavy gauge body steel, finished in prime. Perfect fit. Prompt delivery.

SANDEE MUFFLER CO.
5643 Corryne Place
Culver City, Calif.
Gentlemen: Please send me one set of Sandee Fender Skirts to fit my _____ (year and make of car).
 Check or M.O. for \$9.95 enclosed. No C.O.D.s at this low price, please.

WATCH REPAIRING

Be A Master Watchmaker

Large earnings with no dull seasons and a steady secure future are yours as a Master Watchmaker! The famous Sweazey System teaches you how . . . expertly, quickly, successfully . . . at home or in our modern school.

FREE BOOK

Write today for your free copy of "Master Watchmakers Wanted." Tells about big opportunities in Watch Repairing, Gem Setting and Engraving.

CHICAGO SCHOOL OF WATCHMAKING

Famous Since 1908

DEPT. 110 — 1608 N. MILWAUKEE AVE., CHICAGO 47

PRINCE ALBERT

★ THE NATIONAL JOY SMOKE ★

CHEMISTRY

LEARN AT HOME...Chemical knowledge is essential for thousands of good jobs in industry, business, science. IPC enables you to master practical chemistry. It's the ONLY home study chemistry course which enables you to learn by performing actual experiments—using chemicals and apparatus supplied with the course—in addition to your IPC textbook studies. Compares with recognized college courses in General Chemistry. Write today for free descriptive booklet.

INSTITUTE OF PRACTICAL CHEMISTRY
3 PROSPECT AVENUE, HAGERSTOWN, MD.

SAY YOU SAW IT IN POPULAR MECHANICS

CORTINAPHONE
makes it FUN to Learn

French-Spanish GERMAN - ITALIAN

BIG OPPORTUNITIES and **JOBS** await Americans who can speak a foreign language. Millions being spent by gov't and industry in Europe, Latin America. Travel booming.



Only 15 Minutes a Day Listen to **this Record!**

Speak **FRENCH, SPANISH, German** or Italian like a native! **CORTINAPHONE METHOD**, famous for 67 years, teaches you—**BY LISTENING** to **CORTINA RECORDINGS**. Right in your own home, relaxed and at ease.

Sent on 5 Days Approval

THOUSANDS have learned a second language this quick, easy way for **PLEASURE** and **BUSINESS!** **FREE** 32-page book describes this famous method; tells how you can try it at home for 5 days. **NO COST IF NOT DELIGHTED.** Send for free book **NOW!**



Count Cortina

VETS! FRENCH OR SPANISH COURSE AVAILABLE UNDER G. I. BILL

CORTINA ACADEMY (Language Specialists for 68 Years)
Dept. 641, 105 W. 40th St., New York 18, N. Y.

Please send me—without obligation—your free book. I am interested in (check language interested in)

French Spanish German Italian

Name

Address

Check here if you are a VETERAN

Put your future
in your own hands



BE AN ARTIST

Here's the Amazing
Way We Teach You
Step-by-Step to Draw
At Home in Spare Time

Draw for money. You will enjoy W. S. A. training and can progress rapidly. **COMMERCIAL ART, DESIGNING, CARTOONING**—all in one complete, modern home study course. No previous art experience necessary. We start you from the beginning. Good art jobs available in advertising, television, newspaper and magazine publishing, department stores, art studios, etc. You can become your own boss. For 36 YEARS our graduates have been "making good"—**WHY NOT YOU?**

Trained Artists Are Capable of Earning \$65-\$80 and MORE a WEEK

Write for **FREE BOOK**, "Art for Pleasure & Profit"—tells about our course, instruction service, material furnished, what our graduates say, and commercial opportunities for you. **TWO ART OUTFITS** and other features included with training. **Low cost—only \$5 monthly.**

VETERANS! Course G.I. Approved

FREE BOOK gives details!

WASHINGTON SCHOOL OF ART, Studio 121W
1115—15th St., N.W., Washington 5, D.C.

Please send me full information and your Free Book, "Art for Pleasure and Profit." (Please print name, etc.)

Name _____ AGE _____

Street _____

City _____ Zone _____ State _____



TRAIN NOW FOR AN

AVIATION CAREER

IN SUNNY SOUTHERN CALIFORNIA

MAXIMUM TRAINING IN MINIMUM TIME

Specializing in **AERONAUTICAL ENGINEERING** and **MASTER AVIATION MECHANICS** since 1929. America's Finest Aeronautical Institute. 7000 successful graduates. **MAKE MORE MONEY** MAIL COUPON TODAY APPROVED FOR VETERANS. Board and Room now available.

Without obligation, send free catalogue with full information.

NAME _____ AGE _____ PM-1

ADDRESS _____

CITY _____ TOWN _____ STATE _____

CAL-AERO TECHNICAL INSTITUTE
GRAND CENTRAL AIR TERMINAL • GLENDALE 1, CALIFORNIA



FASCINATING ART HOBBY

Offers you a New and Interesting Way to turn
YOUR SPARE TIME INTO MONEY

YOU CAN MAKE THESE AND HUNDREDS OF OTHER BEAUTIFUL ART OBJECTS—WITHOUT PREVIOUS EXPERIENCE OR ARTISTIC TRAINING



SIMPLE PROCESS ENABLES YOU TO MAKE YOUR OWN MOLDS FROM ANY STATUE, PLAQUE, FIGURE OR OTHER OBJECT OF ART—THEN MAKE HUNDREDS OF FAITHFUL REPRODUCTIONS.

This amazing process is your first step to a new and fascinating hobby—it opens the door to a field that's rich in profits. You master the secrets of a method that allows you to reproduce practically ANY object—Statuettes, Book Ends, Trays, Plaques, Radio Ornaments and Novelty Figurines—art objects that will beautify your own home and make wonderful gifts for friends. AND, these beautiful reproductions can be sold in quantity to gift shops, variety stores, gift departments, drug stores and many others. The profits you make on them are BIG. For just a few CENTS worth of material can bring many DOLLARS in return.

Make Castings Like These
Shown above is an example of the type of work you will be doing in just a short time. Only 8¢ worth of material was required to produce ALL these figures. Properly finished by you they can sell retail for as much as \$2.00 or \$3.00 each!

\$4.45 STARTS YOU ON THE ROAD TO A BUSINESS OF YOUR OWN!

Think of being able to start this fascinating, money-making hobby for only \$4.45. One payment pays for EVERYTHING—the Big, Plastic bound, FULLY ILLUSTRATED Instruction Book, the Special Molding Compound and a beautiful Metal Statuette to serve as your first model. With these materials you make your own molds. Then from these molds you turn out countless reproductions, using common plaster-of-paris, available anywhere for just a few cents a pound, to cast your figures. Color your castings to suit your own tastes. Finish them in colorful paints or watercolors, felt flocking, or give them a gleaming coat of genuine metal by Electroplating. Every step—from the making of your molds to the final finishing of your castings is thoroughly covered in your big, Step-by-Step Book of Instructions.



MONEY BACK ... DELIGHTED!

For the complete outfit that will get you started immediately, send only \$4.45 or mark the coupon and we'll ship C.O.D. You pay the postman when he delivers your outfit.

AND—if after reading the Instruction Book from cover to cover you don't say that this is the most interesting hobby work you've ever seen, return the entire outfit and we'll refund your \$4.45 by the next mail. So don't put off another minute... get started NOW!

**WARNER ELECTRIC COMPANY, 1512 Jarvis Ave.
Dept. PC 21 Chicago 26, Illinois**

WARNER ELECTRIC CO., 1512 Jarvis Ave.,
Dept. PC-21, Chicago 26, Illinois

Send me the complete outfit so that I may get started immediately. I understand that if I am not completely satisfied after reading the book I may return the entire outfit and you will refund my \$4.45 by the next mail.

- I am enclosing remittance in full (\$4.45). You pay postage.
- I am enclosing \$1.00. Ship C.O.D. for balance.
- I am enclosing \$1.00 for the Instruction Book only. I understand that if I am not completely satisfied after reading it I may return it and you will refund my \$1.00.

Name.....
Address.....
City..... Zone..... State.....

NOW...



BIGGER PREFAB BOAT VALUES

Build a better boat than you can buy for the money! Complete parts, expertly cut to size, ready for quick, easy assembly by following simple blueprints. Many models to choose from—\$39.50 to \$199.50. Send 25¢ for complete Boat & Accessory Catalog, to be refunded on first purchase. OZARKA, Inc., 610 Borden, Woodstock, Ill.



EXCLUSIVE laminated rib construction

Only Ozarka gives you laminated oak ribs, preformed and mortised, in all models of 12 ft. or more. No shrink! No warp! No weakness! No extra cost! Investigate the Ozarka plan before you buy!



TOOTHACHE?



Ask your Druggist for

DENT'S

TOOTH GUM
TOOTH DROPS
POULTICE

I WANT EVERY READER of this Paper to have my big new SENSATION TOMATO



"KING OF THE EARLIES"

Big solid, scarlet fruit, disease resistant, heavy yielder. Ideal for table or canning. Send 3¢ stamp for 125 seed and will include Seed and Nursery Catalog.

FREE CATALOG

R. H. SHUMWAY SEEDSMAN, Box 686, Rockford, ILL.



ITALIAN ACCORDIONS

Hand Made. Very Best. Buy Direct from Factory Representative at lowest wholesale prices and Save Money. Send Name and Address for FREE catalog.

ITALIAN ACCORDION MFG. CO.

7600 Cottage Grove Ave., Dept. PM-1, Chicago 19, Ill.



FREE TO HOME PLANNERS

"Little Red Booklet" of 29 popular plans sent FREE to acquaint you with our MONEY SAVING home planning service which includes 1200 Tested Designs; beautifully illustrated plan books; working drawings; material lists; specifications—all at LOW COST. Write today for FREE RED BOOKLET and complete information. America's pioneer residential plan service.

Small Homes Plan Book—68 beautiful designs
All American Homes—158 tested designs, all types

TWO POPULAR BOOKS BOTH FOR \$1.00

L. F. GARLINGHOUSE CO., INC., Box PM-4 TOPEKA, KANSAS

LEARN POULTRY AT HOME

Poultry provides a good full—or part-time income—for thousands of men and women. Thorough training and "Know-How" can mean the difference between success and failure. That's why thousands have obtained their poultry education from N.P.I. home-study courses during past 29 years. Courses are easily understood, interesting, practical—bring students the hard-earned experience of experts in every phase of this \$3½ billion industry. If you have chickens, or wish to enter the poultry business, you should get our free catalog describing courses, methods, service, opportunities. Write today to Charles N. Burmaster, Mgr., Dept. 50.



Write for Free CATALOG



NATIONAL POULTRY INSTITUTE Adams Center, N.Y.

**WORLD'S
BEST
WANT AD
MEDIUM**

CLASSIFIED Advertisements



Advertisements in this section 75 cents per word, each insertion, minimum 10 words, payable in advance
To be inserted under proper classification, copy must be in our office the 22nd of the
second month preceding date of issue

F. W. Johnson, Manager, Classified Advertising
Popular Mechanics Magazine, 200 East Ontario Street, Chicago 11, Illinois

1067 CLASSIFIED ADVERTISEMENTS 1067 OPPORTUNITIES FOR YOU

AUTOMOBILES, MIDGET CARS

CALIFORNIA Custom accessory headquarters. Buy direct from original designers. Push button door conversions, speed equipment, chrome motor accessories, solid hood sides, grille panels, lowering kits, fender skirts, dual pipes. Revised catalog, 32 illustrated pages, new low prices—25c. Eastern Auto Supply, 3319A South Grand, Los Angeles 7, California.

SPEED & Mileage Manual—New edition! 140 illustrations, drawings, charts, photographs! Guaranteed finest, most authoritative book! Easy, inexpensive ways to build speed equipment! California hot rods! Beautiful custom cars! 200 h.p. road, track conversions! Superchargers! Dual manifolds! Racing heads! Twin mufflers! Water injectors! Economizers! Get super speed, mileage, acceleration, top racing performance from any car! Complete instructions with working diagrams on fast engines, speed tuning, restyling, customizing, gas saving, racing tricks, cams, fuels, balancing, porting, ratios, frames, "Offys!" Learn 100 ways to save gas! Reveals stock car speed secrets! California speed shop methods! Custom styling information! Streamlining! Lowering! Sport changes! Hollywood roadster plans! Speed conversions! (Covers all cars). Large manual plus equipment catalog plus racing handbook, all three only \$1.98. Almuist Engineering, Milford 82, Pennsylvania.

SEE Our ad under Motorscooters for midget car bargains. Midget Motors Directory, Athens, Ohio.

NEW: Ford Speed Manual. 128 pages of cutaway construction drawings, photos and easily read, understandable technical data. Includes complete data on installing V-8 motor in Model A chassis, hydraulic brakes for any Ford, roadster and fast car information. Tells how to rework V-8, Mercury, Ford 6, Zephyr, Model A engines for speed. Finest Ford manual on market. Only \$2.00 postpaid. California Bill, Box L-M1 Eaglerock, Los Angeles 41.

JUST OUT! Get the largest auto accessory and parts catalog in the world. Over fifteen thousand items, including Hollywood accessories, hi-speed equipment, rebuilt engines; all parts and accessories for all cars and trucks. New, used and rebuilt! We have that hard-to-get-part! Completely illustrated, jam-packed with bargains. Send 25c. J. C. Whitney & Co., 1919 Archer Ave., Chicago 16, Ill.

"SPEED & Power" Amazing new invention—Ox-o-Jet. Plans and instructions, postpaid \$1.50. Henry Albert, Cambria, Virginia.

DIRECT From California—The very latest in speed equipment for all makes of passenger automobiles! All of the nation's leading racing accessory manufacturers represented in one catalogue! See and compare brands, specifications, costs! We ship all over the world. Wholesale, retail. Picture catalogues, speed, power, and mileage information 50c complete. Newhouse Automotive Industries, 5805-B7 East Beverly, Los Angeles 22.

HOLLYWOOD Deeptone mufflers—Straight-thru design increases efficiency, speed, acceleration, mileage! Singles. All cars \$4.85. Finest V-8 duals \$15.90. (Satisfaction guaranteed). Speed equipment catalog 25c. Almuist Engineering, Milford 8A, Pennsylvania.

"WATER Injection." Also speed, power, economy methods! Free descriptive, illustrated, information. Neher Industries, La Verne, California.

NEW Chevrolet Speed Manual. Ninety pages of factual information on how to increase speed, acceleration and power of any 1937 thru 1949 Chevrolet. Learn how to install late engines in pre-1937 chassis. Full data on cams, high compression, multiple carburetion, supercharging, ignition, etc. The finest Chevrolet manual ever written. Now your Chevrolet can have the power and speed of other cars! Only \$2.00 postpaid. California Bill, Box L-M1 Eaglerock, Los Angeles 41.

"SPEED Equipment" bargains—California mufflers \$4.50, V-8 duals \$15.90, chrome carburetor stacks 98c, dual manifolds \$9.95, chrome echo cans \$1.65, racing camshafts \$29.95 exchange, hi-compression heads \$19.75. All popular brands! Big illustrated catalog 25c. (Dealers wanted). Almuist Engineering & Mfg., Milford 62, Pennsylvania.

NEW Clymer books. National Air Race Sketch and History Book, 190 sketches, charts, drawings. Information all national air races 1930-1949 inclusive. \$2.00—Pictorial Grand Prix Racing with 48 action photos \$1.00—Catalog of 1949 automobiles, 120 photos every American car with complete specifications compares all cars in one book, \$2.00—Catalog '49-'50 all British cars, \$2.00—'49 Chevrolet test report and survey \$1.50—Ford Owner's Handbook gives complete servicing information all Fords 1932-1949, \$1.50—Complete Service Manual Model "A" Ford \$1.00, Model "T" \$1.50—Life of Ted Horn, three-time American Automobile racing champion, \$2.00—Complete Outboard Service Manual covers all makes, \$3.50—Revised hot rod book 1946, 1947, 1948 records, \$1.50—Steam traction engine album, 160 pages, describes, illustrates 105 historical steam vehicles, \$2.50—How to Build Racing Automobile, \$2.00. All postpaid. Specify books wanted. Clymer Motorbooks, Dept. 1-A, 1268 S. Alvarado, Los Angeles 6, Calif.

NEW Catalog—Over 400 racing, hot rod, speed equipment, custom items! Pictures! Speed data! Customizing tips! Bargains galore! Big catalog 25c. Almuist Engineering & Mfg., Milford, Pennsylvania.

"SPEED & Power" Handbook—50 chapter library edition! Breathtaking methods. Authentic. Direct from California! Covers Crosleys to Cadillacs—all makes! Build your own dual manifolds! Superchargers! Hot cams! Water injectors! Hi-compression heads! Mileage devices! Save many dollars! Get racing speed, lightning acceleration, dynamic power increases from any make passenger automobile! Build fast stock cars! California roadsters! 160 m.p.h. rods! Get construction drawings! Tuning techniques! Speed tricks! Economy secrets! Ingenious formulas! Including "racing frames," "reciprocating masses," "jet engines," "braking characteristics," "dynamometers." Also pipes, gears, fuels, porting, relieving, lowering, balancing! Includes 1950 speed equipment catalogues! Also "California Automobile Customizing," photographs! Diagrams! Very newest ideas! Conversions! Re-styling all makes! Streamlining! Chopping! Channeling! Customizing! Complete, \$1.98 postpaid. Newhouse Automotive Industries, 5805-B2 East Beverly, Los Angeles 22.

RACING Car equipment for all cars, engines, racing heads, manifolds, carburetors, mufflers, etc. Speed instructions and literature \$1.00—refunded first order. Lee Motorcraft Co., 1412-D Great Northern Bldg., Chicago 4, Ill.

NEW Sensational seat cover. Mono. 6545 Santa Monica Blvd., Hollywood, California.

WE Sell direct to customer, speed parts manufactured by us. Fords, Studebaker Champion, Chevrolet and Willys, complete engines for race cars and boats. \$1.00 for illustrated literature and price sheet. R. & R. Mfg. Co., Robert M. Roof, Box 546, Anderson, Indiana.

SPEED And custom equipment. Hollywood mufflers, duals, singles, large chrome echo cans, heads, manifolds, cams, fender skirts and other hi-speed and custom equipment. Also pictures and information on customizing cars and souping up engines economically. All in one handbook. Send \$1.00 for the handbook and receive full credit for it on your first \$5.00 order. Jack Hubbard, Dept. PM-1, 9440 Mackenzie Rd., St. Louis 23, Mo.

AUTOMOBILE Racing book, fifth edition, well-illustrated. Building bodies, frames, engines, Ford conversions. Plans. Roadsters. Indianapolis cars. \$1.00 postpaid. Popular Mechanics Press, 200 E. Ontario St., Chicago 11, Ill.

DUALTONE'S New muffler—The "California 99;" now ready in singles or duals. Superior in every way, yet no increase in price! Dealers inquiries invited. Catalogue 20c. Dualtone Mufflers, 2636 C India Street, San Diego 1, California.

AUTOMOBILE Racing, sixth edition. 100 illustrations. Drawings, building instructions Ford-60 midget, California roadster, Offenhauser racer. World's record 158.5 m.p.h. car. \$2.00 postpaid; \$2.40 c.o.d. Popular Mechanics Press, 200 E. Ontario St., Chicago 11, Ill.

FROM Speedway to roadway! Track-proved hi-speed heads and manifolds now available for your passenger car! No special tools needed! Increase horsepower 25%! Astounding getaway! Free illustrated catalog. Speedsport, 6215AA Diversey, Chicago 39.

AUTO SUPPLIES AND EQUIPMENT

GENUINE Aircraft instruments which glow at night for your automobile dash. New thrills! Beautiful! Airspeed, compass, R.P.M. tachometer, cylinder temperature, fuel-air ratio, turn and bank, rate of climb, combination fuel-oil pressure, sensitive altimeter, manifold pressure, voltmeter, ammeter, carburetor temperature. \$9.95 each. Any five for \$39.00. Hurry! They won't last long at these bargain prices! Check or money order. Gaare Supply, Box 1377, Vernon, Texas.

BURGLAR Alarms! For your automobile. Protects you from theft. Electrical! Automatic! Guaranteed! \$4.95. Particulars free. Write! Grand, 2506M-52nd, Kenosha, Wisconsin.

"SMITHY'S Mufflers." Send for list. Buck's Auto Parts, 1296H, Merced 14, Calif.

MASTER Keys. General motors, Yale, Basco. Details free. Hill, 4406 Fair, St. Louis 15, Missouri.

HYAMP Helps weak batteries! Guaranteed. \$1.00. Electronic Industries, Cleveland 11, Ohio.

GARAGES. Dealers, distributors send for literature on our 1950 line of custom exhaust accessories. Write on your letterhead. Southern California Muffler Service, 11142 Washington Place, Culver City 4, California.

NEW Miracle automobile chrome protector. Free information. Turke Industries, Hinsdale 5, Illinois.

POWDER Puff car enamel \$2.75. 511 West Bryan, Savannah, Georgia.

PERSONALIZE Your car. Any lettering desired in red Scotchlite letters 1 1/4" high. Glows when light strikes it. Plate attaches to license or bracket. Limit fourteen letters. Only \$1.50 for postpaid delivery. Tucker Novelcraft Products, 1725 Long Pond Road, Rochester 6, N. Y.

CHEVROLET Repairmen, troubled by ignition, carburetor low-speed surge, jerk, buck. I satisfy new customers every day. Perfected easy method. \$2.00. Carter, 1816 W. Olive, Burbank, Calif.

SAVE Gasoline! Sensational Game needs. Free trial. See page 268.

WHILE They last, 6 volt auto heaters motors with fan blade \$1.00 ea. 3 for \$2.50. Check or money order. Har-Mur, 2349 Devon Ave., Chicago 45, Ill.

ECONOMETER. Actually measures gasoline used at the carburetor. Indicates rate on an electrical dash gage. Useful for determining gasoline mileage at any time for any speed, fuel comparisons and motor condition. Helps your gasoline dollar get you farthest. Easy to install. Complete postpaid \$22.50. Ringelstetter Co., Plain, Wis.

MOTORISTS Save gasoline by Vacuumating overrich mixtures. Fits all cars. For free particulars write Vacuumatic, Dept. 1554, Wauwatosa, Wis.

REBUILT Voltage regulators, original equipment, \$4.75, exchange. Roy's Accessory Shop, 164 Main St., Fort Kent, Maine.

SELL Safety switch for cars, brand new, guaranteed, patented, prevents fire, theft. \$9.95. Sample \$6.00. Quantity prices. Safety Switch Co., Box 6024, Kansas City, Missouri.

BATTERY Chargers—5 amp. selenium rectifier. Can be used for electroplating. \$6.95 postpaid. Regency Sales, 5316 S. Justine, Chicago 9, Illinois.

CONVERTIBLE Top covers. Tailored. Snap-on. \$19.50. Vassar, Cleveland 5, Ohio.

"AIRFLOW Needles." Save gasoline! Free trial! If satisfactory, \$1.50. Specify car, carburetor. Neher Industries, La Verne, California.

FOR Speed, m.-per-gal., and long wear use in Crosley engines the new patent hydraulic pistons. Complete set, rings, pins, etc. \$38. W. Smiley Adams, Inc., Haverford, Penna.

"LEKTRON" Coil booster saves gas! Quick winter starting for cars, trucks, tractors. Easily installed. \$2.00. Guaranteed. Electronic Industries, Cleveland 11, Ohio.

DOUBLESEAL Closes gaps under overhead doors. Stops drafts. Edwards Industries, Dept. 101, 4268 Shenandoah Ave., St. Louis 10, Mo.

AUTOMOTIVE Surplus tool specials! Pullers, wrenches, socket sets, reamers. Other bargains. Nationally advertised merchandise. Send dime for catalogue. Glenco Supply, 7521 Myrtle Avenue, Glendale 27, N. Y.

AUTO And truck parts. New and used. Lowest prices. Complete stock. Prompt replies. Babbitt Auto Parts, 2833 Chicago Ave., Chicago 22, Ill.

NEW And used guaranteed parts for civilian and army cars and trucks. Largest stock in America. Mail orders. Pioneer Auto Wrecking Co., 734 W. 13th Ave., Denver, Colorado.

BUICK Parts—Enjoy new-car pep and power in your old Buick. Same day service from world's largest stock of new (not rebuilt) Buick parts and engines. Ship anywhere. Write today. Robertson Buick Co., 1001 S. Wabash Ave., Chicago 5, Ill.

CHEVROLET Parts. Scarce motor, body, sheet metal parts. Grossman Chevrolet, Minneapolis, Minnesota.

BRUSH Plating outfits connect to a battery. No tanks or shop required. Free particulars. Gunmetal Co., Avenue J, Decatur, Illinois.

GOVERNMENT Surplus. Low voltage circuit tester in steel box. Cost \$202.00. Our price \$27.50. Will test batteries, starters, generators, voltage regulators, grounds, short circuits. Wilt Electrical Company, 7829 S. Racine Ave., Chicago 20, Ill.

AUTO TRAILERS

TRAIL Hut folding camp trailer sleeps four. Plans \$1.00, guaranteed. Information free. Trail Hut, 600 Sixteenth Street, Oakland 12, California.

TRAILER Plans—House, utility, boat, etc. Axles, chassis, hitches, windows, etc. Catalog with booklet. "Trailer Hints," \$1.00. Catalog only, 50c. Marine Mart, Buffalo 7-B, New York.

TRAILER Coaches. Save money. Buying? Building? Sound engineering construction, chassis, bodies, furnishings. Travel, dwelling, trailer plans. \$1.50 postpaid. Popular Mechanics Press, 200 E. Ontario St., Chicago 11, Ill.

BUILD Your own trailer! Save money! Have every feature you want! Plans for house, sport, camp and utility trailers. Catalog describing 9 models 10c. 15c in Canada and overseas. Jim Dandy, Box 125-A, Wausau, Wisconsin.

MOTORCYCLES, BICYCLES, MOTORSCOOTERS AND SUPPLIES

SALISBURY Motorscooter \$25, shop built motorscooter \$15, midget racer less motor and wheels \$10; Whizzer motorbike complete \$35; Indian motorcycle \$25; Bantam panel truck \$40; Briggs Stratton engine \$3.50. Plenty new motorscooters, midget cars, homebuilders parts, plans, automatic clutches, transmissions, engines, tires, etc., at factory prices. Special sale, four balloon tires for \$3. Over 5000 tires in stock. Mailorder only. Send 25c for big new war-bargain catalogue Number Thirty-Three just out, listing these and hundreds of other bargains. (35c by first class mail.) Midget Motors Directory, Athens, Ohio.

WHEELS! Build wagons, scooters, mowers, trailers, wheelbarrows, grocery carts. 4" to 16". Free list. T & H Mfg. Co., Inc., Dept. CPA-1, 811 East 31st, Kansas City, Mo.

HIGH Speed heads and cams for Cushman, Whizzer, Mustang. Send 10c for catalog! Weber Tool Co., 4200-B Whiteside St., Los Angeles 33, Calif.

ACCESSORIES. Parts, Cushman, Whizzer, Salisbury, Powell. Raycycle Company, 3322 South Grand, Saint Louis, Missouri.

BICYCLE Supplies, wholesale, retail. Toys. List 10c. Universal, 4713 Virginia, St. Louis, Missouri.

WHIZZER Bike-motor \$25; Cushman motorscooter \$15; midget racer \$40; Shaw bicycle motor \$15; Harley-Davidson motorcycle \$15; Smith motor-wheel \$25; Good motorscooter (twist grip) \$22.50. Rush 25c for new catalog #15 listing many other amazing bargains in motorscooters, used motors, midget cars, parts, wheels, etc. Gail, 538 Erie, Toledo, Ohio.

WORLD'S First jet turbine bicycle engine. Fits any bike. Smooth, economical, \$150.00. Dealers wanted. Literature 25c. Jet Engine Co., St. Augustine, Fla.

MODERN Motorcycle Mechanics Book. Latest edition 600 pages, 275 illustrations, covers all British and American motorcycles. \$4.00 postpaid. Nicholson Bros., Saskatoon, Canada.

KNEE-ACTION Motorbike \$15; midget car (steel frame) \$25; Moto-Scout \$15; Whizzer motorbike with all attachments \$25; Indian motorcycle \$30. Other motorscooters \$8 up, motors \$3 up. Send 25c for new catalog #944 listing many other sensational bargains in used motors, motorscooters, motorcycles, parts, etc. Associated, Box 1764-CS, Toledo, Ohio.

FLASHLIGHT Size rechargeable batteries. Write! Kimley, 103 Highland, Williamsville 21, N. Y.

RECONDITIONED Motorcycles and motors. Chromium accessories. Complete stock Indian parts. Expert rebuilding. Fast service. Indian Motorcycle Sales, Kansas City 1, Mo.

MOTORCYCLE Journal—Worldwide coverage. Illustrated. Year's subscription \$1.00. Sample 15c. Motorcycle News, 5424-A Sawyer, Chicago 25.

TIRES And industrial wheels, suitable for scooters, wheelbarrows, farm equipment, etc. All sizes. Bicycles and accessories. Send dime for list. Cycle Transport Company, 1241 So. Michigan Ave., Chicago 5, Illinois.

AVIATION

RAM Jets—Be a contributor to our nation's ram jet know-how. Send post card for free information. Decker Engine Works, Dept. PM-1, Plasterco, Va.

SEE Our ice-snow sled engine advertisement under Engines. Gaare Supply, Box 1377, Vernon, Texas.

SNOW Sleighs and air boats—Build your own for \$350. Propellers, plans, skis, engines, complete sleighs. Literature 20c. Propeller clocks \$12.50. Banks-Maxwell, Box 3301E, Ft. Worth, Tex.

PROPELLERS—2-3 Blade for sleds, air-drive boats. Catalog. Standard Aero Craft, Box 387, Ft. Worth, Texas.

BATTERIES, GENERATORS

GENUINE Edison batteries. Fifteen year life. Unconditionally guaranteed. Free literature. See-Jay Company, 3522 Webster Avenue, New York 66, N. Y.

EDISON Nickel batteries, 37 to 600 ampere. Also kits with Edison plates; make your own. Interesting literature. Hawley Smith Co., Croton Falls 1, New York.

ELECTRICAL SUPPLIES

BUY Lamp parts wholesale—Parts you need for building, repairing, or assembling. Save money on large or small orders. New catalog for 10c. Gearon Company, Dept. 300-B1, 27 South Desplaines, Chicago 6, Ill.

MAGNET Wire, insulation, transformer lamination. Morton Electrical Service, Maywood 1, Ill.

LAMPS—How to build lamps from vases, pitchers, etc. Chart for top and bottom lighting, alternately or together. How to wire oil lamps, all in 56 page illustrated catalog of all lamp parts, 25c. Gyro Lamps, 5402P Clark, Chicago 40.

LAMPS—Build own originals, parts wholesale, any amounts. Catalogue 10c. Brown Lamp Co., Box 501 Wellston, St. Louis 12, Mo.

LAMP Parts—Extra money modernizing, converting, repairing lamps at home. 3c stamp for illustrated folder. Lamp Shop, 1348 Richmond, Des Moines, Iowa.

FREE Catalog—Motors, generators, welders from aircraft generators, water softeners, many other electrical bargains. LeJay Company, Minneapolis, Minnesota.

ELECTRIC Pencil: Engraves all metals \$1.25. Beyer Mfg., 10511-H Springfield, Chicago 43.

ELECTRIC Motors, free bargain list. Plenge, 9 Stuyvesant Oval, New York 9, N. Y.

LEARN Electrical appliance repair. House wiring, motors, washers, cleaners, refrigerators, lamps, auto ignition, etc., complete illustrated course. Tools furnished. Free booklet. Pacific School, 7219 South Broadway, Los Angeles 3.

WELDING, SOLDERING, PLATING

OXY-ACETYLENE Torches with 12 tips, used, heavy duty \$14.00 cash f.o.b. Air and oxy-acetylene hose, pumps, drills, etc. Send for list. Acme Tool Co., 229-78th St., Brooklyn, New York.

P-1 WESTINGHOUSE Generators, 200 amp, 28 volt, 2500 r.p.m. Guaranteed new in original boxes. Thousands have been converted into low speed light-weight welders. Easy with our plans. Generator and plans \$28.50. Shipping weight 62 lbs. Also parts for conversion. Free list. Thorn-dyke Mfg. Co., Pipestone, Minn.

LOWEST Prices on new a.c. welders. Holgerson's Service, Canton, Kans.

ACETYLENE Welding outfits new \$45.00, used \$25.00; arcwelders \$46.50. Eagle Welding, Dept. PM, 5085 Broadway, Chicago 40, Ill.

200 AMPERE Welding generators. Free literature. Lewis Short, Burrton, Kansas.

WELDERS, 110 V. Welds 1/2". \$29.50. Morris, 1850A State, Schenectady 4, N. Y.

RECTIFIERS 0-4 V.D.C. \$9.50, 0-8 V.D.C. \$12.50, 0-12 V.D.C. \$18.50. All 0-100 amps. Starkweather, Ottawa, Kansas.

RADIATOR Repairing books, supplies, equipment, gasoline torch. Write, Curfman Co., Maryville, Mo.

BUY Direct from factory. Welding and cutting equipment. All makes of equipment repaired. Established 1913. Box 331, Hamilton, Ohio.

ELECTROPLATING Salts and rectifiers. Mirror resilvering and chipped glass nameplate supplies. John Sprinkle, V55, Marion, Indiana.

RADIATOR Repairing, cleaning, recoring. How to equip small shop at low cost. Supply sources, trade secrets, instructions. Now only \$3.50 postpaid. Radiator Service, McBain, Mich.

MACHINERY, TOOLS, SUPPLIES

MACHINE Tools for wood and metal. We specialize in small machinery. Sorry no hand tools. Tell us your needs, we will quote. Kandler, Kalamazoo 14, Mich.

HYDRAULIC Cylinder double acting, 2 1/2" bore, 16 1/2" travel, 1-3/16" shaft, brand new \$11.00. Discount ten or more. Spencer Aircraft, 8410 Dallas, Seattle, Wash.

CONCRETE Block machines. Standard sizes. \$39.50. Average 400 daily. Free catalog. Concrete Machine Company, 5129 South Compton, St. Louis 11, Mo.

TUNGSTEN-Carbide pencil point graving tool. \$1.50 postpaid. Hiatt's, 4102 Fifth Ave., Chicago 24, Illinois.

AUTO Mechanics: Free catalog, new, time saving, unusual service tools, mechanics inventions, developed by Atmars Tool Co., 2411 Chestnut Street, Oakland, California. Agents wanted.

YOUR Own machine shop will enable you to make your own parts, repairs, etc. and your neighbors will pay you \$3.00 to \$4.00 an hour to do their work. 6 ft. engine lathe \$150; South Bend 16" x 8' \$310; Brainard, Garvin milling machines \$240—have one at \$180; 21" Sibley drill press \$110; Putnam 24" shaper \$290; motors, tools, vises, General Elec. 300 amp. arc welder \$145.00. Money back guarantee. Conversion Parts Company, 278 Adams Street, Boston 22, Mass., U.S.A.

FLOOR Sanders; rebuilt; \$50.00 up. Mutual, Box 202, Kansas City, Mo.

LATHES 10-11-12" Will swing 8" larger diameter with geared center raiser. Write Production Machine, 629 East Pearl, Cincinnati 2, Ohio.

"LUG-ALL"—You've waited years for this lightweight winch hoist (made of aluminum alloy). 1½ ton guaranteed capacity, yet weighs only 8½ lbs. Special feature permits working around corners and in tight quarters. \$29.50. Lincoln Precision Machining Co., North Grafton, Mass. Send for folder P.

SURPLUS Circular saw blades:—8" diameter. ¾" hole. Guaranteed. \$2.00 each. Van Dick, Little Falls, New Jersey.

BALL Bearings ¼ list price. Free list. Burgess, Box 168, Ferguson, Mo.

WHILE They last, universal precision lathe chuck, 2" only \$2.95, actual \$14.00 value. Check or money order. Har-Mur, 2349 Devon Ave., Chicago 45, Ill.

CHUCKS, Independent, universal; threaded 1½"-8, 1"-8, 1"-10, 1"-12, or with adapter recess. Other chucks to 16" diameter. Write for quotation and free literature. No obligation. Westcott Chuck Co., 3600 Walnut, Oneida, N. Y.

HOME Lathe owners—Build your own attachments. Send for picture, sample of work and list of blueprints. Cut gears, ratchets, etc. Make neat screws easy way. The Home Shop, 415 Raymond Ave., Glendale 1, Calif.

POWER Tools, equipment wholesale prices. Free bulletin. Homecrafters Cooperative, Grand Rapids 6, Michigan.

BOATS, OUTBOARD MOTORS

KNOCK-DOWN Boat kits. Outboards, inboards, sails, hydroplanes. Easy to assemble. Minimum cost. Catalog with specifications, prices, 25c. Brooks Boat Company, Carrollton P12, Michigan.

REBUILT Outboard motors—Late models. We specialize in new-used parts. Write for price quotations giving us description of parts needed. Money back guarantee. Standard and oversize outboard motor pistons. Outboard Motor Mart, 309B Atlantic Avenue, Boston 10, Mass.

TWENTY Plywood boat plans \$1.00. Catalog of boatbuilding plans 10c. The Rudder, 15 Murray Street, New York 7.

SAVE 50%—Assemble your own boat. Famous Schneider speedsters, rowboats, sailboats, hunting skiffs, in easy to assemble kits. Also boat plans and templates. Illustrated literature 25c. Schneider Boats, 1913 W. Vliet, Milwaukee 5, Wis.

P38 BELLY Tanks, steel, 10 foot, unused. \$9.95. Free picture. Anzio Boat Co., 1625 "T," Merced, Calif.

SAVE ¾ Cost. Build your own boat with our ready cut parts by the Welch system. No experience necessary. Rowboats to cruisers. Illustrated catalog 25c. Midwest Boat Company, Menomonee Falls, Wisconsin.

OUTBOARD Motors—Used bargains, \$45 up, free list. Used parts, most models, save money! Boat and motor equipment and accessories. Big catalog, send dime. Crandall-Hicks, 911 Commonwealth, Boston, Mass.

NEW, Used, rebuilt marine motors. Marine conversions, fittings. Free catalog. Stokes Marine Supply, Dept. 24, Coldwater, Michigan.

MARINE Conversions for Ford and Jeep engines. Catalog 10c. Lehman Manufacturing Company, Department D, Newark 2, New Jersey.

STEERING Wheels, windshield brackets, from \$6.95. Modern fittings at lowest prices. Complete pre-cut plywood boats. Bargains galore. Folder 10c. Marine, Box 681, Mendota, Minnesota.

ENGINES, MOTORS, DYNAMOS

ICE-SLED Engines, capable of speeds considerably over 150 m.p.h., war surplus. Complete with magnetos, carburetors, electric starters, generators, motor mounts, and 7½ foot propellers, excellent running condition, ready to go! Small Jacobs air-cooled airplane radial type, very light weight for power, ideal for your ice-snow sled, air-drive boat, or airplane, special \$168.00. Estimated original cost \$4000.00. Hurry! They won't last long at this price. Payment with order. Gaare Supply, Box 1377, Vernon, Texas.

WELDING Generator, 150 ampere \$47.50. Motors ½ horse \$15; 1 horse \$30. Water pumps \$12.50. Butler, 1885 Milwaukee, Chicago 47.

MOTOR Winders, send for testing and winding bulletins. Motor Industries, Quincy, Illinois.

WINDING Data, listing 225 motors, single and three phase, \$1.00. Motor Data Co., Box 7631, Kansas City 3, Mo.

MAKE Your own 5 h.p. gas engine. Machine your own castings. Prints and instructions. Free literature. Keenest Motors, Antioch, Illinois.

ATHLETIC EQUIPMENT, BODY BUILDING COURSES

HAND Balancing and tumbling made easy. Fifty cents. Lishora, 3914 Madison, Hyattsville, Maryland.

BARBELLS—Finest quality, \$7.98 up. Free catalog. Lurie Barbell Co., 1729-MI Rockaway Parkway, Brooklyn, New York.

GREAT Strength easily obtained. Write Joseph Dryer, Box 5527-P, Chicago 80.

DEADLY Judo—Fiercest fighting technique. Trick knockouts. (Over 200 illustrated pictures.) Expert instructions; three volumes. Complete \$2.25. Variety House, Box 46-B Wall Station, New York 5.

BARBELLS, Exercise equipment. Courses. Free booklet. Good Barbell Co., Reading, Penna.

SPORTING GOODS, GUNS, FISHING TACKLE, ARCHERY, TRAPPING

FISHWORMS Raised simple, easy. Postcard brings details. Tennessee Worm Hatchery, Box 265-A9, Nashville 2, Tenn.

TWELVE Utility boxes, assorted sizes, sturdy crystal plastic, \$1.00. Tackle catalog included. Woodlore, Bradley Beach, N. J.

CATAPULL—World's finest slingshot. Cast aluminum crotch, pistol grip, heavy duty slings. Steel ball ammunition included. \$2.95 postpaid. F. B. Hodge Co., 4 Sylvan, Pleasant Ridge, Michigan.

SNOOPERSCOPE Tube. Permits nighttime vision. Tube and complete instructions \$14.95. Limited quantities. Infrared filters 15c. Precise, 942 Kings Highway, Brooklyn 23, New York.

MOLDS For fisherman's sinkers, jigs, squids and lures, completely machined and fully guaranteed. Write for free catalogue to E. L. Sweet & Son, Dept. 8, Tonawanda, New York.

AN Ideal Christmas gift for the fly fisherman—Fly-tying sets and tools for either the professional or amateur. Try our famous line of fly-tying vises and gadgets. New beginner's vise with instruction sheet \$1.00. Send 10c for catalog. D. H. Thompson, 335 Walnut Avenue, Elgin, Illinois.

PISTOLS, Revolvers, firearms, ammunition. List 25c. Frank Farish, Vicksburg, Miss.

FISHERMEN—Make your own sinkers with our molds. Free illustrated booklet. Reading Instrument Co., Box 78, Reading, Penna.

LEARN Gunsmithing! Details, copy "Guns and Gunsmithing" 25c. Gunsmith, Palatine, Illinois.

190 PROFUSELY Illustrated pages antique and modern pistol, sword, etc. values. 50c. Robert Abels, A860 Lexington Ave., New York 21.

5000 BARGAINS, Firearms, binoculars, war relics. Catalog 40c. Smith Firearms, Runnemed, New Jersey.

SHOTGUNS, Rifles, revolvers, over 500 modern, obsolete. Also cartridges, list 10c coin. Ed Howe, 52 Main, Coopers Mills, Maine.

TAXIDERMISTRY

"MODERN Taxidermist Magazine," Greenfield Center, N. Y. Devoted exclusively to taxidermy. Two sample copies 25c.

BINOCULARS, TELESCOPES, MICROSCOPES, MAGNIFIERS

SNOOPERSCOPE Tube. Permits nighttime vision. Tube and complete instructions \$14.95. Limited quantities. Infrared filters 15c. Precise, 942 Kings Highway, Brooklyn 23, New York.

GIANT Astronomical telescope with 6 ft. tripod \$15.00, f.o.b. factory, 100 power. (10,000 area magnification). Clear vision, full power guaranteed. Ready for use. Suffolk Science Service, Dept. BT, Riverhead, N. Y.

SAVE 50% On new binoculars! World's greatest values. Free catalog. Write today! Bushnell Importers, 43-MI East Green, Pasadena 1, California.

POWERFUL Astronomical telescopes easily made. Perfect lenses and instructions; 100X \$3.00; 100X and 200X \$4.00; 100X, 200X and 400X \$6.00. Full power, clear vision guaranteed. Instructions alone 10c. Suffolk Science Service, Riverhead, N. Y.

WAR Surplus bargains, binoculars, telescopes, sextants, millions of lenses, prisms, reticles, eyepieces, objectives, etc. Request free "Catalog CH." Send \$1.00 for Stock CH—10-piece lens kit and big instruction booklet. Edmund Salvage Co., Barrington, N. J.

BINOCULARS, Telescopes, watches, guns. Buy, sell, trade. Schweer's, Donnellson, Iowa.

REFLECTING Telescopes, 60X, completely assembled \$25.00. Guaranteed observatory clearness. Free information. Skyscope, 475 Fifth Avenue, New York 17.

ASTRONOMICAL Telescopes, binoculars, microscopes; bought, sold, repaired. Books. Lists 10c. Rasmussen-Reece, Amsterdam, N. Y.

TELESCOPES, Binoculars, microscopes, big bargain catalog free. Brownscope Company, 24 West 45th Street, New York.

PETS—DOGS, BIRDS, RABBITS, HAMSTERS, ETC.

SAINT Bernards and Boxers, A.K.C. Schwarzwald Hof Kennels, 5136 Cascade Road S.E., Grand Rapids 6, Mich.

BREED Mink—Booklet, pen plans free. Lake Ontario Mink Ranch, Gravel Road, Webster, N. Y.

HAMSTERS—Finest pedigreed stock. Reasonably priced. Free illustrated literature. Mount Clemens Hamstery, 94 Church, Mount Clemens, Mich.

MAKE Money raising angoras. Circular free. Vaughn's Rabbitry, Otley, Iowa.

RAISE Guinea Pigs. Make extra money. Booklet free. Taylor, Box 426A, Hapeville, Georgia.

CHINCHILLAS (No rabbit). Easily raised anywhere. Pleasant, profitable business. Information. Chinchilla Ranch, Ithaca, Michigan.

SEE Gulf Hamstery ad on page 28. Shows picture of Hamster.

REAP The golden harvest with golden Hamsters, breeds in 16 days, large profits, free literature. Pat's Hamster Farm, Waterford 3, N. J.

MONKEYS Are the best pets—Intelligent, easily trained, inexpensive. Send for catalog. Tropical Hobbyland, 1527 N.W. 27th Ave., Miami.

RAISE Rabbits. Four pound fryers in eight weeks. Ready market for meat, fur, wool. Illustrated book, describing leading breeds, housing, breeding, feeding, marketing. By America's largest rabbit association 10c. American Association, 12 AR& CBA Building, Pittsburgh 17, Penna.

\$1.00 FOR Booklet "Canary, Its Care, Breeding and Training," and three copies cage-bird magazine. American Canary, 2839PM N. Halsted, Chicago 14, Ill.

MINK Raising information free. Complete. Lake Superior Mink Farm, Superior, EE1, Wisconsin.

\$400 MONTHLY Raising Angora rabbits. No experience required. Details free. White's Rabbitry, Newark, Ohio.

GRINSTEAD'S Famous Angoras! Giant Chinchillas! World's most profitable rabbits. Finest pedigreed, heavy-producing, prize-winners. Literature free. Grinsteads, Edwardsville, Illinois.

MAKE Money! Raise Chinchilla rabbits. Experience unnecessary. Valuable breeders. Extra profit from laboratories, furs, delicious meat. Pleasant hobby. Write today! Rockhill Ranch, Sellersville 15, Penna.

\$3000 YEARLY Raising Angora rabbits. We buy your output. Contract particulars free. Kise's Enterprises, St. Paul 8, Minn.

MAKE Extra cash. Raise Giant Chinchilla rabbits. Waters Rabbit Farm, Glennville, Ga.

SPORTSMEN: 200 Pointers, setters, straight cooners, combination hunters, rabbit and fox hounds. Reasonable. List free. Ramsey Creek Kennels, Ramsey, Ill.

\$300 MONTHLY Raising Angoras for our market. Particulars free. Wilson, Stanton, Calif.

INCREASE Your income by raising domestic rabbits. Small space needed. Ready market for delicious meat, fur and wool. Largest magazine in the industry tells you how. \$1.50 per year. Sample 15 cents. No stamps. Small Stock Magazine, Lamoni 20, Iowa.

PLANTS, SEEDS, NURSERY AND GARDEN SUPPLIES

RAISE Your own trees and shrubs from seed for shade, windbreak, erosion control, etc. Write for free planting guide and price list. Woodlot Seed Co., Norway 4, Michigan.

POTTING Soil for house plants; North Dakota virgin soil with proper amount of food, humus and drainage added. Prepared by long experienced florists. 4 lbs. \$1.25 ppd. Special violet mixture. 4 lbs. \$1.55 ppd. Martin & Hanson, 413 So. 12th St., Bismarck, N. D.

WE Sell on the installment plan. Best varieties peach and apple trees, low as 12c; grapevines 4c; shrubs 13c; evergreens 15c. Berries and plants. Catalog free. Benton County Nursery, Box 542, Rogers, Arkansas.

FARMS, FARM LANDS, REAL ESTATE

STROUT'S Golden anniversary farm catalog. Over 2800 outstanding bargains. Coast-to-coast, 32 states. Mailed free. Strout Realty, 7 So. Dearborn St., Chicago 3, Ill.

BIG Free winter catalog! Farm and country real estate bargains, good pictures, many states, easy terms, many equipped, crops included. For special service, state requirements, desired location. United Farm Agency, 1408-PM Consumers Bldg., 220 S. State St., Chicago 4, Ill.

\$5.00 MONTHLY Buys 40 acres near town; price \$200.00. Free list. Box 425-P, Carthage, Mo.

FREE List farms, ranches central Arkansas. Owen Farm Agency, Conway, Ark.

FLORIDA Campsites—\$95.00 at \$5.00 monthly buys nice, high dry lot in Lake County (world's best bass fishing, wonderful hunting) near Ocala National Forest, St. Johns River, beautiful lakes, pavement. Folder free. Howard Vernor, DeLand, Florida.

GOOD Farms—Ranches, Washington, Minnesota, Montana, Idaho, Oregon, North Dakota. Dependable crops, favorable climate. Write for literature, lists describing typical farm opportunities. Specify which state. J. W. Haw, 119 Northern Pacific Ry., St. Paul 1, Minn.

FARMS, Ranches, lodges, resorts. Big selection, Milwaukee Road territory, Washington, Idaho, Montana, Dakotas, Minnesota, Iowa, Missouri, Michigan, Wisconsin, Illinois, Indiana. Free colorful descriptive folders, price lists. L. H. Robbins, 738J Union Station, Chicago 6, Ill.

POULTRY, FARM SUPPLIES

BABY Chicks, champion mated, 52 varieties, 7 crosses, licensed inspected, bloodtested. Rush postal, large colored book free, low prices. Berry's Farm, Route 12, Clarinda, Iowa.

RAISE Fryers new easy way. One man home plan earns \$3000 yearly. Circular free. Poultryman's Institute, 1046 So. Olive, Los Angeles 15, Calif.

KNOW How to raise poultry for profit. Read Northeastern Poultryman. Every issue packed with helpful hints and practical suggestions. Latest articles on breeding, feeding and management. Subscribe now. 1 year 65c, 2 years one dollar, foreign subscriptions \$1.00 a year. Northeastern Poultryman, Dept. P.M., 376 Boylston St., Boston 16, Mass.

RAISE Turkeys the new way. Write for free information explaining how to make up to \$3000 in your own backyard. Address—National Turkey Institute, Dept. 3, Columbus, Kansas.

PROFITABLE OCCUPATIONS

BE An invisible re-weaver—Learn profitable trade, earn over \$20 daily, full or part time; repair cuts, tears, burns in clothing or any fabric so damage cannot be seen. Big demand, big profit, uncrowded field. Complete low-cost home-study course includes lifetime equipment. Easy-to-learn, pay-as-you-earn; can mean lifetime income. Details free. Fabricon, Dept. N-1, 8342 S. Prairie Ave., Chicago 19, Ill.

MUSHROOMS Grown boxes, barrels. Instructions 50c. Spawn \$1.00. Manureless process. \$2.00. Gordons, 553 William, Winnipeg, Canada.

FOREIGN Employment. Construction men, building trades mechanics, helpers, office men. Good workers needed for oil projects, mining, pipe lines, dams, power plants, roadways, shipping, etc. Transportation and quarters furnished; high wages. Listings of firms actively working and hiring on projects in South America, Arabia, Asia, Africa, Alaska, Central America, etc. Send \$1.00 for foreign construction compendium and application forms. Foreign Service Bureau, Dept. PM-1 (Employment), P.O. Box 295, Metuchen, New Jersey.

ALASKA—The great American frontier, offers unlimited opportunities. \$1.00 brings 1950 copyrighted report and government map. Business directory listing big construction projects; fishing; mining; aviation; hunting-fishing-game rules, fur-farming, lumber; agriculture; live stock raising; transportation; homestead and highway information. Hot list of firms hiring. Alaska Opportunist, P.O. Box 883-P, Hollywood 28, Calif.

AMAZING New illustrated book shows how to make perfect plaster faces of you and your friends for thrilling wall decorations! Ideal for gifts, no artistic ability required, profit possibilities unlimited! Send \$1.00 (refunded if not delighted) to Komar Company, M-14, La Porte, Ind.

LOCKSMITHING Secrets! Keyfitting, lock repairing, opening; prices. Sources. Illustrated book \$1.00. Wechsler, 7 West 36 St., New York City.

DELIGHTFUL Plans! Australia, South America. Free book "372 Unusual Worldwide Businesses." \$800 month reported! Work home (U.S.A.)! Get surprise! Publishers, 9G, Carlsbad, Calif.

FREE List. "400 Profitable Occupations." Tanner Enterprises, Incorporated, Gainesville, Texas.

INTERESTED In Latin American and foreign employment? \$1.00 brings 1950 copyrighted "Foreign Service Directory" with new complete listings in U. S. and Canadian construction companies; worldwide oil firms, mining, aviation, steamship, transportation; manufacturers; importers and exporters; domestic and foreign listings. Special daily listing of firms hiring. Tells how-when-where to apply, application form. Global Reports, P.O. Box 883-P, Hollywood 28, Calif.

RUSH \$1.00 For your copy "How to Make Money With Hobbies." Enjoy your hobby and make money. Willis Book Shop, 1401 Whitelock St., Baltimore 17, Md.

FISHERMEN, Bait dealers, gardeners, poultryman; Domesticated earthworms will insure your future income. Write today for valuable 10c booklet, Midwest Earthworm Farms, Box 999D, Wichita 1, Kansas.

EXTRA Money at home selling by mail. Complete instruction sheets \$1. George Millan, Box 29, New York 34, N. Y.

\$100.00 STARTS Novelty lamp business. Equipment wholesale. Box 5911 Homewood Br., Birmingham, Alabama.

LOCATE Missing persons. Be a skip tracer. Interesting. Profitable. Job opportunities, instructions, \$1. R. Mac Callum, 492-44th Street, Oakland, California.

EARN \$1.00 Per minute! No sleight coin act; folder of magic tricks 50c. Konjurors Kabin, 8871 18th Ave., Brooklyn 14, N. Y.

LEARN Professional candy making. Profitable home occupation. Details 10c. Pate, Kissimmee, Florida.

REFRIGERATION And air conditioning. Complete, illustrated course. Free booklet. Mechanics School, 7219 South Broadway, Los Angeles 3.

MEN—Women. "Everybody likes candy." Learn to make professionally. Our 39th year. Ragsdale Candies, D6, East Orange, New Jersey.

"WATERLESS Hand Cleaner." (Oil base.) Make, sell. No machinery. Build profitable business. Complete formula \$1.00. Ideal Service, Park Ridge 15, Ill.

WOULD You pay 3%—First \$350 made? Book "505 Odd, Successful Enterprises" free! Work home. Expect something odd! Pacific, Oceanside, Calif.

\$400 MONTHLY Raising Angora rabbits. No experience required. Details free. White's Rabbitry, Newark, Ohio.

MAKE Flexible molds! Cast plaques, novelties, bookends! Free sample! H. Tooker, Hamilton 9, Ohio.

FOREIGN Employment? Latest bulletin, overseas directory and application forms: \$1.00. (C.O.D. \$1.32.) Foreign Service Institute, P.O.B. 3934, Miami, Fla.

\$46 FROM Square foot plywood; jig saw necessary. Write, Woodarts, P-38, Bridgewater, Mass.

OWN And operate mirror shop! Supplies for resilvering mirrors, making chipped glass nameplates and electroplating. John Sprinkle, V50, Marion, Indiana.

RAISE Fishworms. Easy, profitable. Send 25c in coin for complete instructions. Huffman Worm Ranch, Rives Junction, Mich.

TYPISTS, Profitable business at home. Complete copyrighted information 50c. Rosdahl Industries, 72-A W. Washington St., Chicago 2, Ill.

BE The Popular Mechanics representative in your neighborhood and earn big profits in your spare time. Write Popular Mechanics Magazine, Room 408M, 200 E. Ontario St., Chicago, Ill.

\$40.00 WEEKLY Made growing mushrooms, fresh, dried. Dominion patent 331583. Free spawn. North American, 169P Yonge, Toronto, Canada.

BOOKS, PERIODICALS, PICTURES, POSTCARDS

BOOKS. Out-of-print. Hard-to-find. Banker Book Co., Dept. 9, Sherman Oaks, Calif.

HOME Craft course series. 31 books, step by step easy to follow instructions. Many illustrations, some in full color. Write Mrs. Keyser, Plymouth Meetings, Penna.

PAGE Review—Dale Carnegie lecture, 10c. How to remember names 35c. Harrison Books, 726 N. Fifteenth, Waco, Tex.

FREE: Particulars of the interesting books of Secret Guerilla Self Defensive. The Concessionaires Guidebook. The Law of the Higher Potentials. Michael P. Wrona, 2027 N. Park Ave., Tucson, Ariz.

MAGAZINES, Pocket novels. Swap ten 50c. Exchange, 1031 Railroad Avenue, Conway, Arkansas.

BOOKS For collectors. Paramount Book Service, 39-P Hopedale Street, Allston 34, Boston, Mass.

FREE Catalog! Any book promptly supplied. Arden, 210-A Fifth Avenue, New York 10.

BOOKS On gems, gem cutting, jewelry making, watch repairing. Catalog. McMullen, 328 E. 11th St., New York City.

BOOKS! Many subjects. General list free! Messa, Box 55-D, New York 19.

QUICK Profits taking magazine subscriptions, handling greeting cards. Cassell Publishers Service, Westfield, New Jersey.

FREE Catalogue. Special interesting books. Powers, 1324 Wilshire, Hollywood 14, California.

HOW-To-do-it books on every subject. Written in Popular Mechanics' famous easy-to-understand style and profusely illustrated. Subjects include workshop planning and practices, projects, hobbies, household repairs, motoring, outdoor sports, photography, home building and many others. Also booklets on specific topics. Write for free illustrated catalogue. Popular Mechanics Press, 200 E. Ontario, Chicago 11, Ill.

POCKET Novels, swap fifteen, one dollar. Youmans, Box 118, Lima, Ohio.

BOOKFINDERS! (Scarce, out-of-print, unusual books). Quickly supplied. Send wants. Clifton, Box 1377-PM, Beverly Hills, Calif.

NATIONAL Geographic Magazines 1888-1949. Any issue, Box 327-PM, Periodical Service, Swarthmore, Penna.

SELF-EXPLAINING Bible: Illustrated circular free. Box 446-P, Minneapolis, Minn.

BOOKHUNTERS! All subjects. Send wants! Jaher Book Service, 620-P East 178 Street, New York 57.

GAMES, TOYS, NOVELTIES

ROLL-O-KITE! Giant spool type kite. Spins as it flies. Amazing performance. 50c. Roll-O-Kite, 737 So. Westlake, Los Angeles 5, Calif.

CHESKERS. A game of skill, livelier than checkers. Designed for checker and skill game enthusiasts. For box, checker board, instructions and checkers \$2.00. Guerin Games, 212 Maple Ave., Irvington 11, N. J. Dept. A.

MAGIC TRICKS, PUZZLES, JOKER NOVELTIES

VANISHING Coin and magic catalog 50c. Larry's Magic, 324 First, Milford, Michigan.

500 TRICKS You can do! Send 25c for Douglas famous catalog, best in magic at lowest prices. Unequaled service to magicians for 30 years. Douglas Magicland, Dept. 1, Dallas, Texas.

DISAPPEARING Spots card trick 25c. Duke, Box 728M, Petersburg, Va.

SEND 25c For 10 latest joker's tricks. Yakity Yak talking teeth \$1.00. Catalog 300 tricks free. Laramie Sales, 4800 S. Laramie Ave., Chicago 38, Ill.

VENTRILOQUIST Dummies catalogue 10c. Be a ventriloquist. Free particulars. State age. Maher, Box 36-M15, Kensington Station, Detroit 24, Michigan.

FREE Magic catalog. World's finest magic since 1910. Your name on a one cent postcard will do. Chicago Magic Company, 541-H Division St., Chicago 10.

SURPRISING Deluge of enchantment. World's largest gigantic fun and magic sheet. New, amazing, pleasing. 10c deposit refunded first order. The Magician, 2463M Kensington Ave., Philadelphia 25, Penna.

LATEST And best tricks described in our new large catalog. Send 25c to Jeffries Magic Company, 17 North Hudson Street, Oklahoma City, Okla.

500 TRICKS Catalog and book "84 Card Tricks," both only 50c. Robbins Co., 131-P W. 42nd Street, New York.

200 ELECTRIC Stunts, 110 volts, \$1. Kutting Sons, Los Altos, Calif.

400-PAGE Catalogue of 2000 tricks, pocket, parlor, stage. World's finest magic. Send \$1.00 for catalogue (refunded first \$5.00 order). Kanter's, M-1311 Walnut, Philadelphia 7.

MAGIC Tricks, puzzles, books, cards, punch boards. Catalog 10c. Specialty, Box 671, St. Louis 1, Mo.

LEARN Magic, ventriloquism, mind-reading. Write for particulars. Quackenbus, Big Flats, N. Y.

WORLD'S Largest professional magic shop, keeps you in touch with latest tricks. To receive mailings, send 50c for new catalog. Holden's, M220 West 42nd St., New York.

16 CARD Tricks and catalog 25c. Sterling Magic, Royal Oak, Mich.

BE A magician. Large professional magic catalog of latest tricks, 35c. Ireland, C-109 North Dearborn, Chicago 2.

PROFESSIONAL Catalog. 124 pages, 25c. Williams, 900 Plymouth, Ellwood City, Penna.

VENTRILOQUISM Taught. 3c stamp bring particulars. Smith, 801 Bigelow, Peoria 5, Ill.

TELL Fortunes for fun or profit. Easy instructions \$1.00. Farrow, G79, Box 645, Columbus 16, Ohio.

COINS, TOKENS, CURRENCY

FREE! Foreign coin, banknote and coin collectors illustrated catalog to approval service applicants. Send 3c postage. Tatham Coinco, Springfield 30, Mass.

GET Profit and pleasure in collecting old coins. Send 10c for 56 page illustrated coin catalog. You'll be delighted with it. Send for it now. B. Max Mehl, 370 Mehl Bldg., Fort Worth, Texas. Largest rare coin establishment in U. S. Established 50 years.

THOUSANDS Of dollars paid for old coins. Will pay \$5 for \$2.50 gold piece, \$30 for \$20. Wooden nickel and "Coin Collector's Magazine" 10c. Lawrence Brothers, Anamosa, Iowa.

OLD Money wanted. Will pay fifty dollars for nickel of 1913 with liberty head (no buffalo). We pay cash premiums for all rare coins. Send 4c for large coin folder. May mean much profit to you. Numismatic Co., Dept. 20, Fort Worth, Texas.

\$1,116.66 FACE Value, Jap-U.S. invasion money, \$2. Approvals. Tatham Coin Company, Springfield 30, Mass.

35 COINS \$1.00. 100 Bills, \$1.00. 20 coins and bills, 25c. Oddehon, Box 482, St. Louis, Mo.

HUGE Price list, uncirculated foreign coin, banknote—All for 10c. Tousseau, 109 Mathilda, Sunnyvale, Calif.

4 WHITMAN Coin albums \$1.00; 125-page handbook 75c. 100 different foreign coins \$3.95. Giant bargain list 10c. Olson, 5800 Lake, Chicago 44.

BARGAINS! 15 Different dates United States large cents \$3.00. 30 different dates Indian cents \$2.00. \$3.00 gold piece \$13.00. 1723 Colonial coin \$1.00. 1780 Colonial bill \$1.50. 1820 dime \$1.00. 1932-D quarter 75c. \$100.00 Confederate bill \$1.00. 6 different dates 2c pieces \$1.00. 5 different dates 3c pieces \$1.00. 1809 half cent \$1.00. 1864-L cent \$1.00. 1909-S cent \$1.00. 1913-S nickel \$1.00. 1826 \$1/2 cent \$1.50. 1798 cent \$1.00. Lexington \$1/2 \$1.50. 1837 Jackson cent 75c. Ancient Roman coin, over 1500 years old and our complete buying-selling catalogue \$1.00. Catalogue alone 25c. Worthy Coin Corporation, 294 Washington (D-205), Boston, Mass.

20 DIFF. Coins 50c, free lists, approvals upon application. Bishop, Box 2201, Kansas City, Mo.

BARGAINS—3-legged Buffalo Nickel \$1.25. 1932-D Quarter \$1.00. 1932-S Quarter \$1.00. Large \$1.00 Bill \$1.60; Large \$2.00 Bill \$3.40. 4 Whitman Folders \$1.00; Handbook 75c; 254 page Guidebook \$1.50; New Type Folder \$1.00. Large Retail Catalogue 15c. Bebee Coin Company, 1180 East 63rd, Chicago 37, Illinois.

16 PAGE Coin bargain list and Mexican 10 peso bill, all for dime. Coin Shop, 31 North Clark, Chicago 2, Illinois.

COINS Wanted, will pay up to \$2000 for certain coins, send 25c for catalogue. Burton's, 111 So. Third, Columbus, Ohio.

COMMEMORATIVE \$1/2, Oregon, Texas, Kentucky, Cleveland, Long Island, \$2.00 ea. Illustrated catalogue 25c. Norman Shultz, Salt Lake 9, Utah.

STAMP COLLECTING

\$5.00 CATALOG Price for 10c! (1) Big collection 112 all different stamps from Africa, South America, South Sea Islands, (2) Four desirable unused U. S. cataloging 40c. (3) Fine packet 25 British Colonies; Burma, Solomon Islands, etc. (4) U. S. \$5.00 high value. Everything (all four items) only 10c with approvals. Crystal, Littleton 41, New Hampshire.

FREE—Famous Americans set, Flag set, National Parks set, and Presidential set to \$5.00. A total of 90 stamps free to customers for our unsurpassed U.S. and foreign selections. Send 3c for 15 of the above stamps and full particulars. Triboro Stamp Co., 145 Nassau St., Dept. 101, New York.

PAYING High prices for approvals? If your collection numbers under 15,000 try our 1c and 2c approvals. In books of 1000 different. Lots to choose from at lowest prices. Also special offer to customers. Clark, Box 544-P, Muskegon, Mich.

EXCITING Airmail sports parade! Football, yachting, etc. Portrayed on beautiful new Nicaraguan set of five. Only 5c. Airmail approvals included. "Air-Approvals," 4472 North 39th Street, Milwaukee 9, Wisconsin.

ABSOLUTELY Free—Gilbert Ellice, Cook Islands, Tonga, Seychelles, Ascensions, free to approval applicants. Viking, 130-Z Clinton St., Brooklyn, N. Y.

FREE. Scott's International album, valuable colorful collection, hinges, other big premiums. Full particulars with approvals. Raymax, 123-Z William St., New York 7.

FREE Catalog! Illustrated. Forty pages. United States. Foreign. Albums. Supplies. "How to Collect," etc. Harrisco, 202 Transit Bldg., Boston 17, Mass.

FREE Set 3 Liberia triangles, plus set 4 China ship stamps, plus Falklands map stamp of South Pole, plus stamps cataloging over \$1. Extra! Romania miniature sheet cataloging 25c to first 100 replying, all with approvals. Moublow, 740 Hegney, Bronx 56, New York.

FREE! Collection over 100 stamps of world—odd stamps, planes, camels, cavalry charge, leprosy stamp, new Leipzig Fair set, many others all to approval buyers; plus Scott International Albums, stamp catalogs. Bell Stamp Service, Dept. S, 4248 Elizabeth St., Bell, Calif.

UNUSED Commemorative stamp collection including airmails, pictorials, high values, sets. Only 3c. Approvals. Sunlite, Box 1259-M, Grand Central, New York 17.

FREE! Canadian sets, royal visit, George VI, George V, coronation, jubilee, others, to approval applicants. Ensign, Box 118-M, South Orange, N. J.

200 BRITISH Empire stamps! Norfolk, Tokelau Islands, Grahamsland, Pakistan, Nepal, big stamp of murdered Mahatma Gandhi; many others. Stamps cataloging up to 20c each! Only 10c! Kenmore Stamps, Arlington 74-A8, Mass.

TOPS! Our book "How to Collect Stamps." Send for your free copy today! Littleton Stamp Co., Littleton 37, N. H.

WHOLESALE List on Canada and Newfoundland. Free on request. Empire Stamp Company, Dept. PM, Toronto 5, Canada.

750 FRANCE And colonies stamps 10c. Littleton Stamp Co., Littleton 25, N. H.

POUND Stamps containing thousands \$1.00. Longacre Shop, 108 West 42nd, New York 18.

EXCHANGE Stamps universe. Particulars free. "Exchangers," Bry 126, Seine, France.

1000 DIFFERENT And 17 Mint Hitler \$1.00 to approval buyers. Bacon, 8221 Page, St. Louis 14, Missouri.

FREE! 100 Different with approvals. Bailey, 317-B Boylston, Daytona Beach, Florida.

SERBIA! Silesia! Bulgaria! Free! Approvals. Colonial, Box 326A, Passaic, N. J. 25 DIFFERENT Vatican 10c; quality approvals. Chase, 1026 Walker Ave., Oakland 10, California.

U. S. Bargains—To 90% discounts. List free. No approvals accompany. Chassy's, 38 Park Row, New York City 7.

RARE Austria war prisoners free to approval buyers. Plymouth F4, Bell, Calif.

25 DIFFERENT Ecuador, including 70 Centavo air mail 5c. Approvals included. Ranson, 721 West Maple, Compton 4, Calif.

PENNY Approvals with something special. Sturgeon, 2112 Dodson, Fort Smith, Arkansas.

LOW Priced packets. List free. Shannon's, 505 Franklin, Nutley 10, New Jersey.

INTERESTING Stamp Weekly. Next thirteen issues 25c. Southern Philatelist, Miami 35, Florida.

FREE! Liberia triangle airmail set, package hinges, approvals. Greenwood, 263 Meridian, Miami Beach, Fla.

HAVE Fun, build your stamp collection inexpensively. Write for economy 1c approvals. Joseph Goldman, Lynbrook, N. Y.

ILLUSTRATED Price lists free. Herget, 92 Arden, Buffalo 15, New York.

GIANT Packet list, free. Stephen Hall, 15 Trobridge, Cambridge 38, Mass.

TASMANIA Included! Stamps from forty countries, 10c. No approvals. Elose, Bowling Green, Ohio.

1000 WORLD Wide 67c. Pacific, P.O. Box 5704, Los Angeles, Calif.

1500 WORLD Stamps, surprises galore \$1.00. Arrowhead, Box 82, San Antonio, Texas.

ALBUM, 100 Stamps, premiums—20c. Northeast, Box 6618, Kansas City, Mo.

GIVEAWAY! 155 Different—30 countries, 10c. Approvals. Brooks, 2352B East 23rd Street, Brooklyn 29, New York.

NO Junk here. Thousands famous 1 and 2c approvals. Send card today. Quality Stamps, Prospect Place, Bristol, Conn.

CANADA Peace set 10c with attractive approvals. Rheume, 8949 Routhier, Montreal 12, Canada.

STAMP Magazine! Copy free! "Stamp Post," S. Catalina, Pasadena 1, Calif.

WORLDWIDE Stamps. All different. 200, 25c; 500, 50c; 1000, \$1.00; 2000 \$2.75; 5000, \$13.50. Beacon Sales, Northboro 2, Mass.

BOY Scout set complete, 1937, Netherlands, 10c with approvals. Vargo Stamps, 6044 South Fairfield, Chicago 29, Illinois.

600 DIFFERENT. 500 Foreign, 100 U. S. 50c. Burtner, 709 Washington, Reading 2, Penna.

FREE U. S. \$1 Franklin to approval applicants. Litten, 318 North 5th Avenue, Maywood, Illinois.

U. S. Catalogue free. S. Stone, Box 52-P, Dorchester, Boston 24, Mass.

500 FREE Stamps with 1000 all different only \$1.00. Dimond Co., 3152 Cuthbert, Oakland 2, Calif.

WANT Lists filled—United States, Germany, British Colonies. Reference. Brooks, 2352 East 23rd Street, Brooklyn 29, New York.

100 DIFFERENT United Stamps 25c. Illustrated U. S. price list free. Park City, Box 11, Bridgeport 1, Connecticut.

FREE! Volcano pictorial! Madagascar! Burmese! Nigeria! Approvals. Keating, 637-P Bergen, Jersey City, New Jersey.

GRAND Value packet with five foreign sets, free. Stoll Stamp Service, 2632 Burnett, Louisville 10, Kentucky.

FREE China Confucius issue with foreign approvals. Modern, Box 123, Wakefield Station, N. Y.

200 WORLDWIDE Different, 13c. 500 United States assortment, 25c. Charlie Seifert, Box 1672, Reading, Penna.

FREE Triangles, Vatican, Argentina, others. Approvals, JAF Stamps, 2369 28 Street, Astoria 5, New York.

FINE U. S. mint Roosevelt, defense and flag sets. All three. \$1.00. Quinn, 570, Madison 1, Wis.

25 DIFFERENT French Colonies large pictorial 10c with penny approvals. Roscoe Stamp, 1321 Roscoe, Chicago 13.

THOUSANDS Of beautiful stamps 1c each. Why pay more when you can get the best for less. Write today for trial selection. Thrifty Stamp Service, P.O. Box 1610, Long Beach, California.

307 ALL Different free. Commemoratives, triangles, bicolored beauties, high values. Strange countries. New varieties galore. Free to approval buyers. Garcelon, Box 500, Calais, Maine.

FREE—Cuba Roosevelt issue and illustrated catalog. Maynard, Littleton 12, N. H.

EXCHANGE! Send 25 U. S. commemorative duplicates. Receive 200 different world. Sundman, Littleton 6, N. H.

BELIEVE It or not: 25 different British, West Indies stamps are yours for the asking. Beautiful pictorials, 19th and 20th century, including free monthly magazine. Send only 5c for postage. Empire Stamp Company, Dept. PM, Toronto 5, Canada.

U. S. Complete price list free. Containing mint, used, plate blocks, and blocks. Lush, 12863C Caldwell, Detroit 12, Mich.

100 DIFFERENT 10c With approvals. Jacobsen, 59 Nagle Ave., New York 34, N. Y.

POSITIVELY Greatest free offer—Latest Scott's international \$6.00 stamp album, covering entire world, contains 36,000 illustrated descriptive spaces, Scott's New Standard \$7.00 catalogues "Philately's Encyclopedia"—absolutely free to applicants for foreign approvals becoming customers. Plymouth Specialty Co., Dept. A-9, Box 510, Bell, California.

GENUINE "Goya Nude" set (catalogs 55c) 15c with approvals. Royal Stamp Company, Tamaqua, Penna.

FREE, United States, premium plan approvals. Send want list. Warriner, 7139 Apex Station, Washington, D. C.

500 U. S. Commemoratives 50 varieties, \$1.00. Polzin's, Box 1069, Milwaukee, Wis.

10,000 DIFFERENT 1c Each! Gordon Davison, Box 1019S, Manchester, N. Hamp.

TRY 'Em, you'll buy 'em—1, 2, 3, 4, 5 cent approvals. Best for less. Roger Gregg, Canastota, N. Y.

FREE "Stamp Finder." Tells instantly country to which any stamp belongs. 36 pages profusely illustrated. Garcelon, Calais 17, Maine.

FREE \$25.00 Outfit. Latest large Scott album, valuable collection of 1050 all different beautiful stamps, airmails, triangles, diamonds, high values, etc. Plus watermark detector, tongs, "stamp finder" magnifying glass, perforation gauge, hinges—actual value over \$25.00—but all absolutely free when you become a customer. Write for our foreign stamps on approval now. America's Stamp Service, Redlands, California.

BARGAINS! 2000 Foreign stamps \$1.00; 5000, \$2.00; 2000 U. S., \$1.00; 5000, \$2.00. Postal Sales Company, Washington 13, D. C.

UNPICKED: 5000 U. S. \$2.00; 5000 foreign \$3.00. Kuhn, 81-10 Broadway, Elmhurst, New York.

500 MIXED Stamps and surprise packet for 10c, with approvals. Fahsing, Dept. PM, Topanga, California.

U. S., Canada, Newfoundland, Mexico: "Gold Nugget approvals." Nothing like them! Write today. 312 mixed U. S. only 10c. Kessel's, Folsom, California.

10 ASSORTED U. S. Commemorative 15c. Five U. S. Air Mail 15c. 10 Famous Americans 25c. All for 50c. Ideal Stamp, Box 179-K, Park Ridge, Illinois.

U. S. Mixture 70c pound; foreign 1/2 lb. \$1.00. Nichols, 746 River, Mattapan 26, Mass.

SENSATIONAL Bargains, sent on approval, mostly foreign. N. H. Philatelic Assoc., Leavitts Hill, N. H.

RARE Bargain. 300 world, 25 Vatican City, all different, only 10c to approval applicants. Stamp Mart, 1412 Great Northern Bldg., Chicago.

GIFT—Tokelau Is. complete mint to approval applicants. Deane Stamps, Box 87, Miami 35, Florida.

ZEPPELIN, Roosevelt, Columbian, Hitler airmail, etc., 10c. Foreign approvals included. Thirdeo, 101 3rd Ave., Newark 4, New Jersey.

PENNY Approvals. Bargains. Free premiums. Ruches, 941 Enfield, Thompsonville, Conn.

110 DIFFERENT Hitlers, Roosevelt, Liberia, Vatican, etc. 10c. Buckley, 208 Ludlow Bldg., Dayton 2, Ohio.

ATOMIC Bomb airmail! Is only one in this collection of 100 all different airmails, pictorials, war issues, etc., from war-torn China! Only 10c to approval applicants! Star Stamp Company, Jamestown, New York.

MONACO Nudes set—10c! Approvals. Atlas, 3210-Y Republic, Racine, Wis.

SELECT 25c Worth "free" from foreign approvals in complete, mint sets. William Deems, Ravenswood, West Virginia.

\$1-\$2-\$5 UNITED States, commemoratives, airmail, high values in large collection United States stamps only 5c to applicants United States approvals. Metropolitan, 140B Nassau, New York 7.

UNITED States stamps nearly 100 years old, Roosevelt set, others, 40c value—only 5c to applicants United States approvals. Wakonda, 140G Nassau, New York 7.

WHOLESALE—Dealers list. 3c postage. Whitlow, 3535 Clarendon, Dallas 11, Texas.

STAMP Catalog profusely illustrated. 3c. Century, Box 418, Beverly Hills, California.

WORLD—500 Diff. 50c, 1000-\$1.00, 75 Canada 25c. Approvals, lists. Victoria Stamp Company, London 4, Canada.

FLAG Stamp free, if you request my U. S. approvals. Wenigman, 1933 Patterson, Chicago.

PROFUSELY Illustrated U. S. catalogue 10c. Miller Stamp Company, Malden 48, Massachusetts.

EXOTIC Collection—Fezzan Ghadames, Togoland, Cameroons, Andorra, Reunion, Miquelon, Algeria, Somalis, Guadelope, Guiana. Natives, maps, ships, idols, snakes, rhinoceros, others 5c. Imperial Stamps, Tampa, Florida.

MAGNIFIER, Big stamp magazine; first U. S. commemorative; plus unused \$5000 Foreign Legion, diamond, giant, and other worthwhile stamps. Everything free to approval buyers. Capital Stamp Company, Little Rock 2, Arkansas.

10,000 PENNY Approvals waiting for you. Many from exotic countries, pictorials, airmails, new issues. Tilbury, Box 862, Newark 1, N. J.

ILLUSTRATED Stamp magazine, 26 weeks 25c. Stamp Journal, Kalamazoo, Michigan.

300 DIFFERENT Given free with approvals. Postage 3c. Windsor Stamps, 1435 East 67th Place, Chicago 37.

FREE—Illustrated catalog! Kenmore Stamps, Arlington 74-C7, Mass.

FREE! Powerful magnifying glass—To approval applicants; also big bargain lists. Jamestown Stamp Co., Dept. 207, Jamestown, New York.

200 DIFFERENT Stamps 10c with approvals. 500 mixed United States 25c. Carlton's, Tujunga, Calif.

TRAINS! Trains! Trains! 12 train stamps and packet of 100 different stamps for 10c with approvals. Reich Stamp Company, 4647 Kenmore, Dept. M20, Chicago 40, Illinois.

DEALERS—Wholesale list. Postage 3c. Frank, 5031 Queensberry, Baltimore 15, Md.

25 ALL Different stamps 10c. Tunis, Wakeman Ave., Newark 4, New Jersey.

YOU Need these! All six for 10c! To introduce our exceptional approval service, we'll send you: 1. Pocket stock book. 2. Watermark detector. 3. Stamp tongs. 4. Perforation gauge. 5. Book for duplicates. 6. Package of stamp hinges. All only 10c to approval applicants. Free! Big list other bargains. Jamestown Stamp Co., Dept. K, Jamestown, New York.

1c EACH And less! Thousands of bargains! Cole, 43-A Rinewalt, Buffalo 21, New York.

ZOWIE-E! A barrel of fun for only a dime. 500 United States stamps—absolutely unpicked and unsorted—just as received from church missions. Many varieties, including large commemoratives, airmails, high denominations up to \$5.00! Stampdom's biggest package of fun—and you might find something really valuable! Price only 10c to serious approval service applicants. Money back if not delighted. Illustrated bargain lists with each order. Mystic Stamp Company, Dept. 80, Camden, New York.

FREE! United States commemorative price list. Historical Stamp Co., 1280 Ocean Ave., Brooklyn 30, N. Y.

50 DIFFERENT U. S. 10c. No approvals. Pricelist free. Seidenberg, Cassopolis, Mich.

AIRMAIL Packet—Worldwide. Big bargain. With approvals 5c. A. Wirth, Norwichtown, Conn.

CASH For your duplicates! Particulars free. Goliath, Bethlehem 7, N. H.

FREE! Illustrated United States catalog. Low prices! Americo, Bristol, Conn.

WOW! \$10.00 Worth of fun 10c! What a treasure hunt! Big package 500 foreign stamps, including airmails, pictorials and others from the world over; stamps worth up to 25c each. This offer sent for 10c to approval applicants only. Jamestown Stamp Co., Dept. 22, Jamestown, New York.

UNITED States approvals complete coverage, fine quality, attractive prices. Seminole Stamps, Box 1138-P, Coral Gables, Florida.

U. S. Price list. Send postage. State Stamp Service, 1225 Park Building, Pittsburgh 22, Penna.

200 DIFFERENT Including Roosevelt triangle, 5c to approval applicants. M. Avalon Stamp Company, Springfield, Mass.

FREE U. S. price list, postage 3c. Mark Hanna, 335 5th Ave., Pittsburgh 22, Penna.

WORLD'S Largest stamp (7 1/2 x 14 inches). A real curiosity! Retail for 50c, only 5c to approval applicants. Tatham Stamp Co., Springfield 30, Mass.

STAMP Collections wanted. Complete collections, duplicate lots, surplus stock, mint and used. Prefer trade for printing or other items, buy outright if priced right. What have you, what's wanted? Vanroy Shirk, Lebanon, Penna.

FREE! 100 Worldwide different stamps to approval buyers. Big U.S. and illustrated bargain lists sent with approvals. Bookman, Maplewood, N. J.

PRECIOUS STONES, MINERALS

AGATES, Gems and mountings. Free list. North West Gems, Box 305, Tacoma 1, Wash.

GEMS—Save money, buy direct. Zircons and other semi-precious stones. List 10c. J. Lavinger, P.O. Box 1034, Redwood City, California.

GEMSTONES, Mineral specimens. Every variety. Lowest prices. Postcard brings free booklet. Plummer's, 2183C Bacon, San Diego 7, California.

GEMS, Precious and semi-precious, all genuine, from world wide sources. Deal direct, no overhead, save money. Catalog 10c. Hill Co., Route 7, Salem, Oregon.

METAL Detectors. The very latest circuit. Send 25c for literature. Hedden Metal Detectors, 3329 Liberty Ave., Pittsburgh 1, Penna.

HOBBIES AND COLLECTIONS

BOOKBINDING As a hobby. It's easy. For catalog of supplies send 10c to House of Gane, Box M, 1335 West Lake St., Chicago 7.

EMBROIDERED American and foreign emblems, 30 for 50c including pricelist. Hobbyguild, 57B Sumner, Brooklyn, N. Y.

WANTED Old cigarette cards. Write Charles Bray, East Bangor, Penna.

NEW—15 Different match covers 10c. Box 202, Rochester 1, N. Y.

PENNANT Collecting is a thrilling hobby! Send for free list! Komar Company, M-14, La Porte, Indiana.

UNPAINTED Plaster ornaments. Loxite for moulds. Free literature. Midwest Novelty, Box 788-A, Anaconda, Montana.

MATCHBOOK Covers. 50 assorted, 25c. Warth, P.O. Box 222, Rochester 1, N. Y.

SWAP—Sell-Buy anything! Opportunities galore! Free information. Swappers' Guide, Box 415, Evansville, Indiana.

GEM Hobbyists supplies, materials, tools. Lowest prices. Gemco, Elkhart Lake, Wisconsin.

UNUSED Matchbook covers—100 different \$1.00. Catalog 10c. Charles Edelman, 1311C East 84, Cleveland 3, Ohio.

INVENTING Can be an interesting and profitable hobby. Write for complete particulars. Institute of American Inventors, Dept. 40-E, 1926-Eye St. N. W., Washington 6, D. C.

CAMERAS, PHOTO SUPPLIES

ROLL Film adapters, graphic type, 2 1/4 x 3 1/4, \$16.71. Also many other items. California Photo Supply, Dept. P, Box 211, Altadena, Calif.

KODACHROME Slides. Beautiful coast scenes. Lists and sample 40c, with three samples \$1.00. Maine Photos, Box 1622G, Portland, Maine.

PHOTOGRAPHY For pleasure or profit. Learn at home. Practical basic training. Long established school. Write for free booklet. American School of Photography, 1315 Michigan, Dept. 3432, Chicago 5.

ENLARGERS, All sizes, lowest prices. Booklet "A" free. J. B. Photo, 41-09 19th Ave., Long Island City, N. Y.

AMAZING Pixie camera. Complete outfit with flashgun \$7.95. Write for circular and catalog. Dept. PM-1, Town Fotoshop, Mt. Vernon, N. Y.

YOUR Name on every photo. Send one dollar for Kodak plate to fit your printer or easel. Made to your specifications. Money back guarantee. Ben Parker Co., 510 W. 6th St., Los Angeles 14, Calif.

WILL You risk 25c for mammoth photographic catalog? Deductible from first \$2.50 order. Bloom's Camera Center, 1657-PM Main, Springfield, Mass.

PHOTOCOPY Anything, papers, books. No darkroom. 8 1/2" x 11" complete, \$6.95. Fotoflex, 4801 Yarmouth, Cincinnati 29, Ohio.

PHOTO Handbook tells you how to take, develop and print your own pictures, build your own enlarger, etc. For the amateur and professional photographer. 160 pages, \$2.00. Popular Mechanics Press, 200-PF East Ontario, Chicago 11, Illinois.

BUY Photographic supplies wholesale. Free catalog. Expert camera repairing. Capitol Photo Supplies, 2428 Guadalupe, Austin, Texas.

BASS Says: Bargaingram 257 ready and waiting for you. The book which tells all. The finest in new and used camera equipment, a veritable encyclopedia. Write, phone or call the sign of the old "Horse Trader." 39th year of satisfaction or your money back dealing. Bass buys, sells and trades. Bass Camera Company, Dept. AG, 179 W. Madison St., Chicago 2.

PHOTO FINISHING

ROLL Developed and 4x6 or 3 1/4 x 4 1/2 oversize glossy Velox prints. 8 exposure 35c, 12 exposure 55c, 16 exposure 70c. Clemet Photo Service, 1318 W. Columbia Avenue, Philadelphia 22, Penna.

PERSONAL 1950 Photo calendars or valentines made from your negatives 10c each including envelopes. Roll developed 8 prints and two enlargements 25c. Young Photo Service, 405-V, Albany 2, N. Y.

OIL Coloring photographs can be a fascinating hobby or profitable sideline for those with artistic talent. Learn at home. Easy simplified method. Send for free booklet. National Photo Coloring School, 1315 Michigan, Dept. 3432, Chicago 5, Ill.

PRIVATE Laboratory. Amateur art. Specialists 35mm-828-127 split. Black-white and color. GK Laboratories, Box 127, Catskill, N. Y.

FOUR Beautiful 8"x10" enlargements \$1.40 reprints \$1. Surgals, 3300 Beach, Chicago 51.

ENLARGEMENTS—5x7 Double weight, silk finish, 6 for \$1.00. Rudy Leefsma, 375 Riverside Drive, New York 25.

BONDED Double size photos. 8 exp. rolls, 30c. 12—45c. 16—60c. Honest quality photo finishing. Satisfaction, or money back. Try Bonded Photo Service, Box 29, Inglewood, California.

"ALBUM Prints"—They're new, different, smart. Roll developed and 8 oversized prints in handsome album folder 35c; 12 exposure 50c; 16 exposure 65c; 20 exposure 75c; 36 exposure \$1.25; reprints 5c. Techni-Foto, Lorain, Ohio.

16 CONTACT Prints from 8 exposure roll 35c. Reprints 3c each; 40, \$1.00. Apex Photo Service, Box 197, Bronx 51, N. Y.

FREE Price list on quality developing, printing, enlarging. Write for it today. Bryan's Photo Shop, Dept. M, Panama City, Florida.

NEW Negative and two 5x7 enlargements from your photo, \$1.00. Complete service list free. Photo-Lab, 1204 Sutter, San Francisco 9, Calif.

AUTOMATIC Photo-electric finishing. 8-25c; 12-40c; 16-55c. Oversize, add 10c. Mississippi Finishing, 2212 East 12th, Davenport 4, Iowa.

35MM Rolls developed. Enlarged 3 1/2x5 prints, 36 exposures \$1.00, 20 exposures 65c. 8 exposure rolls developed, printed oversize 30c. 12 exposures 45c, 16 exposures 55c. MacDonald's Photos, Box 30-J, Wheaton, Illinois.

FREE 5 x 7 Enlargement with each roll developed and printed. 6 or 8 picture roll 35c. 12 or 16 picture roll 55c. Send coin with roll. No c.o.d. If you fail to get pictures on your roll of film, we will mail a new roll to you at no additional cost. Overnight service. Malters sent free on request. Deluxe Film Service, Box 1268, Shreveport, Louisiana.

8 BEAUTIFUL Double size pictures and roll developed 30c. 8 hour service. Free mailers. Pacific Photo Service, Box 666, San Francisco, Calif.

EXPERT Finishing. Roll developed and 8 prints 30c. Rancho Photo, Dept. P, Ontario, Calif.

2 BEAUTIFUL Hi-Gloss prints each good negative and enlarging coupon with each 8 exposure roll developed 28c. Free mailers. Owlphoto Co., Weatherford, Oklahoma.

MOTION PICTURES AND SOUND EQUIPMENT

BIGGEST 16MM. sound film bargain! Twelve good used 100' "soundies" musicals, \$9.95 plus postage. Hundreds of titles available at \$1.49 each. Write for our big list. Blackhawk Films, Davenport, Iowa.

RARE Medicals, oldtimers. Free catalogue. International, 2120 Strauss, Brooklyn, New York.

FREE, Movie catalog, sample films; bargains now. Goodwill Company, Jackson, Tennessee.

YOU Develop it. Get a 33 ft. developing rack, safe light, all chemicals, trays and instructions for \$5.85. Fully guaranteed. Free circulars and film samples. Fromader Genera, Davenport, Iowa.

WANT A real buy in 16 mm. sound films? Take advantage of the I.C.S. 1949 clearance sale of 16 mm. sound features, comedies, cartoons, novelties, musicals; new, used. Specify. Send for our giant list "A" today stating machine you own (make and model). Institutional Cinema Service, Inc., 1560 PM Broadway, New York 10, N. Y.

WORLD'S Wonder movie screen paint. Free literature. 126 1/2 West Main, Danville, Illinois.

RENT 16 MM. sound films. Complete programs features—shorts low as \$4.95. Write our nearest office for complete list. Dept. PME Eastin Pictures, Davenport, Iowa; Colorado Springs, Colorado; Chattanooga, Tenn.

MOVIES—Black and white, color, sound or silent: \$1.00 up. Large selection includes famous Disney cartoons. Write laboratory for free catalog. (State 8 mm., 16 mm. or sound.) Hollywood Films, 6060-K Sunset Blvd., Hollywood 28, Calif.

YOUR Film looks better, runs better, lasts longer with Film-O-Nize. Send \$1.25 to Film-O-Nize Laboratories, Box 7771, Chicago, Ill.

BARGAINS In 16 mm. sound films. Big new list out each month. Blackhawk Films, Davenport, Iowa.

1c HOME Movie sale. Send 10c, receive one pound mail chock full of fun in photography. Sterling's, 679 Northampton, Easton, Pennsylvania.

SOUND Rentals 16mm. Free catalog. National Cinema, 69 Dey St., New York City 7.

"THE World's Greatest Passion Play." 16mm. and 35mm. Specify silent or sound. Rent or purchase. Hemenway Film Co., 33-F Melrose St., Boston 16, Mass.

MAKE Films for television. Learn at home. A huge new market insures large income for those able to produce. Write today for free catalogue. Motion Picture Institute, Birmingham 7, Michigan.

GUARANTEED Fresh anti-halo outdoor movie film! Weston 16! Daylight loading! Processing free! Three spools double 8 mm. \$4.50! Six single 8 mm. for Univex, \$4.60! Postpaid! Catalog. Filmcraft, 47th Holly, Kansas City 2, Missouri.

BETTER 8MM. and 16mm. movie camera film. Lower prices. Better Films, 742 New Lots, Brooklyn 7, N. Y.

8-16MM. Silent-sound films. Complete rental library. All latest subjects. Free catalogue, (sample film 10c). Garden Film, 317 West 50th, New York 19.

MOTION Picture technique at home. Big money. Special registration for veterans. Free catalog. Motion Picture Institute, Birmingham 4, Mich.

FREE Movies. Thousands of subjects. Interesting. Entertaining. Fascinating. New directory—only 50c. International Cine Society, Dept. 102-M, 1300 Taylor N. W., Washington 11, D. C.

BASS Says: 39 years of leadership guarantees satisfaction. Finest cine equipment, 8mm., 16mm., and 35mm., silent and sound. Write the old "Horse Trader." Satisfaction or your money back always! Bass Camera Company, Dept. A, 179 W. Madison St., Chicago 2.

LEARN Movie projection, management. Free catalog. Theatre Institute, Elmira, N. Y.

I BUY, Exchange, swap movies. What have you? What do you want? Lowest exchange rates in world. Catalogue \$1.00. Refundable. Harvey Iris, Box 539, Brockton, Mass.

MUSIC AND MUSICAL INSTRUMENTS

1950 ACCORDIONS—Wholesale. Free catalog. American Accordion Center, 5329 Belmont, Chicago.

RECORDS Guaranteed new. Hillbilly, popular, spirituals. 4 for \$1.00. Free record with first order. Free catalog. Mailorc, Dept. 39, 570 N. Gay St., Baltimore 2, Md.

POEMS Wanted. Splendid offer. Rush! Radio Composers, WPMM, Clinton, N. C.

POEMS Wanted for musical setting. Send your poem for immediate examination and rhyming dictionary. Richard Brothers, 24 Woods Building, Chicago.

HILBILLY, Polka, popular records—12c up. Guaranteed. Collectors. Catalog 3c. F-L, Box 19-L, New York 35, N. Y.

RADIO Singers: Want songs; poems for folios. Our folio \$1.00. Four records \$2.50. 332 Chicago St., Fairmont, W. Va.

SONGWRITERS—Song poems wanted to be set to music. Immediate consideration. Free examination. Milano Music Co., Dept. A-1; 5537 Suburban, St. Louis, Mo.

POEMS Wanted for musical setting. Send poems for free examination. Five Star Music Masters, 630 Beacon Bldg., Boston, Mass.

PHONOGRAPH Records 15c. Catalogue. Paramount, TA-313 East Market, Wilkes-Barre, Penna.

SONGWRITERS! Outstanding, ethical offer. Hibbeler, C5, 2157 N. Avers, Chicago 47.

MUSIC Arranged, songs printed. Frank Wildt, Music Publisher, Lancaster, Penna.

SONGWRITERS—Publication collaboration. Newart Publishers, G.P.O. Box 1226, Syracuse, N. Y.

WRITE Songs. Big money and reputation. Write for information. J. Gordon Pub. Co., 201 N. Hoyne Ave., Chicago.

POEMS Wanted to be set to music. Free examination. Send poems. McNeil, Master of Music, 510-PM S. Alexandria, Los Angeles, California.

RADIO AND TELEVISION

MAKE Simple, tubeless, batteryless, distance-getting crystal radios. Crystal and illustrated instructions 25c postpaid. Alien, 427-P, Clinton, Mo.

5c MAKES Clear, loud mike. Plays thru radio, phonograph. Instructions 25c. Mondo Enterprises, 289 Grandview Avenue, Buffalo 14, New York.

LOUDEST Crystal radio: \$2.00. Make loudest crystal radios; instructions, loudest crystal, catwhisker, catalog: 25c. Amorose, Route Four, Richmond, Virginia.

SEND For our bargain bulletins on radio and electronic components. Never under-sold. Buyers Syndicate, 30 E. Taylor St., Springfield 3, Mass.

WESTERN Electric fixed crystal. Excellent for crystal sets. Powerful, long distance. 99c. Radio City Labs, 30 Church Street, New York, N. Y.

MAKE New 1-tube FM receiver. Complete instructions 50c. M. Herrick, 26 Upton Park, Rochester, N. Y.

150 ASSORTED Radio parts. Satisfaction guaranteed. \$2.00 postpaid U.S.A. Buyers Syndicate, 30 Taylor St., Springfield 3, Mass.

FREE—Money Saving Bargain Catalogs in radio and television sets, record changers, tubes, parts, amplifiers, speakers, etc. Write today. Radionic Equip't Corp., Dept. 2001, 170 Nassau St., New York 7, N. Y.

MAKE A crystal radio. Easy, economical. We supply x-tra long distance crystal and instructions. 25c. DX-150, Box 201, Marshall, Mo.

FREE 196-Page radio and television catalog! World's largest stocks. Lowest prices. Complete supplies for builders, experimenters, amateurs, servicemen. Latest radios, phonos, television, recorders, sound equipment. Thousands of parts, tubes, test instruments, books, diagrams. Top quality money-saving values. Get it now! Allied Radio, 833 W. Jackson, Dept. 34, Chicago 7, Ill.

PIX Any radio. Amazing new instrument locates radio troubles double quick. Simple instructions show you how. Thousands now in use. Free. Write today for 32-page illustrated technical manual, "The Inside Story." Feiler Engineering Co., Dept. 1PM5, 1601 S. Federal St., Chicago 16, Ill.

MAKE Your own tubeless, batteryless, crystal radios. Genuine crystal and instructions for two sets, 25c postpaid. Banas, R3, Skaneateles, N. Y.

BUSINESS OPPORTUNITIES

CONVERT Hand mowers to power mowers. Do it now, this winter. Sell the Handy-Dandy conversion kits. Easily installed on 16 to 20" mower. Use any small gasoline or electric motor. Quick delivery. Kits purchased with or without engines. Also new garden cultivator. Cultivates 3" deep. Attachments available; weed cutter, lawn mower and snow plow. Retail \$124.50 with cultivator 1 hp. engine. Snow plow only \$11.95. Discount to dealers. LeClaire Manufacturing Company, LeClaire, P.M.1, LeClaire, Iowa.

TRADE Magazines help you get ahead. Latest copies. More than 1100 covering every trade, business or interest available through our easy-to-get-acquainted service. Full particulars and price list free. Commercial Engraving Publishing Co., 34C North Ritter, Indianapolis 19, Indiana.

START Salted nut business. Amazing money-maker. Easily learned. Work at home. I'll teach you all. 15 years experience. Low cost will surprise you. Free details. Reed, Box 823, Louisville, Ky.

BE Independent, be secure, have your own profitable business—earn \$10.00 and more a day making beautiful, fast-selling lamps at home. No equipment needed. Illustrated course teaches you quickly. Course, parts catalog, wholesale price list, only \$2.00. Gearon Company, Dept. 200-B1, 27 South Desplaines, Chicago 6, Ill.

"ELECTROPLATING Know How" gives you a future! Learn easily. Free particulars. Joseph Kushner, Electroplating Engineer, Stroudsburg 9m, Penna.

MAKE Money spare or full time, casting metal toys and novelties. Big wholesale and chain store demand for cast metal autos, soldiers, ashtrays, banks, etc. keeps manufacturers busy. Production moulds furnished for up to 100 and more castings per hour. No experience or special place necessary. Write for full information and illustrations of patterns needed. Metal Cast Products Co., Dept. A, 1696 Boston Road, New York 60, N. Y.

MEN Install, sell booster fans, forces heat in cold rooms for gas and coal furnaces. Kelly Service, 407 Charlotte, Detroit 1, Mich.

ELECTRICALLY Inclined? Make \$100-\$250 weekly installing, maintaining fluorescent lighting. Rebuild fixtures. Make beautiful lights for 50c each. Establish own sales service and fixture fixit shop. Exclusive, inexpensive, illustrated instructions with free sample materials enables you to cash in on this fast-growing industry. Request impressive evidence and convincing free literature on this proven business opportunity. Get the facts. Wilber Distin "Fluorescent," 400 Foote Bldg., Syracuse 2, N. Y.

MEN—Women. "Everybody likes candy." Learn to make professionally at home. Instruction and outfit. (Our 39th year.) Ragsdale Candies, D5, East Orange, New Jersey.

POPCORN And potato chip equipment. Long Eakins Company, 5060 High, Springfield 99, Ohio.

PEARL Finishing—New, amazing. Huge profits. Start making big money first day. Free facts show easy way to \$25 to \$50 per day at home. Absolutely no experience. Be first; scoop the market. Write Pearl-Kote, Dept. R, 2111 W. Manchester, Los Angeles 47, Calif.

SEWING Machine business tops. Big money—not crowded. Spare time home set-up. Repair course, new machines, motors, etc., wholesale. Hurry. Taylor Service, PM, Hamilton, Ohio.

START Home manufacturing business making cleaning compounds, soaps, insecticides, cosmetics, polishes, food flavors. No machinery. Literature free. Kemix, Park Ridge, Ill.

MORE Money—Easier! Revolutionary methods make public bookkeeping easy, interesting, profitable. Earn to \$5.00 hourly within short time! Simple, complete instructions. Full, spare time. Success-revealing information free. Auditax Systems, 10775-B Tabor, Los Angeles 64.

EXCELLENT Opportunities in profitable mail order business. Details free. Burnett's Mail Service, P.O. Box 2231, Greensboro, N. C.

LEARN The letter shop and addressing business. Complete copyrighted information; \$2.00. Rosdahl Industries, 72 W. Washington St., Chicago 2, Illinois.

HOME Envelope addressers! Latest list: "100 Mail Order Houses." Price \$1.00. Lists, Box 443, Seattle 11, Wash.

BE Independent—Operate America's lowest price penny vending machine. Big profits. Immediate shipments. Write for bulletin and prices. Fielding Mfg. Co., Desk 10, Jackson, Mich.

BIG-Paying home mailorder business. Details free. Jackson, Newfoundland, Kentucky.

PROFITABLE Mail order plan. Details free. Stanley Skinner, Star Route, Nicholson, Penna.

BOOKKEEPERS Earn \$100.00 week operating your "bookkeeping service." Simplified plan. Information free. Bookkeeping Service, Box 664-M, Springfield, Missouri.

ASSEMBLE And sell electric bed warmers. 400% profit. Altozee Co., 7811 Guthrie, Cleveland 2, Ohio.

MAKE Money by mail. Particulars free. Dawson, 1308F, The Dalles, Oregon.

MILLION Articles wholesale. Directory 25c (refundable). Publisher's, Box 1302, Detroit 31.

BABY Shoe metallizers make money! Details free. Joseph Kushner, Electroplating Engineer, Stroudsburg, 90m, Penna.

FIX Typewriters, full or part time. Inexpensive copyrighted home study course quickly trains you for high earnings. Factory methods cover all phases with drawings and illustrations. No curiosity seekers. Typewriter Repair, 1915 Corbet, Tarentum, Pennsylvania.

MAKE Perfume—Profitable home or mailorder business. Information free. Men, women, write. Carey Laboratories, 1914 Chouteau PM1, St. Louis 3, Mo.

PIANO Tuning learned at home. Free information. Empire School, Champaign, Illinois. (Est. 1935.)

NEW Lawn mower sharpeners. Details for stamp. Anton Wellert, 142 Gaylord Street, Binghamton, N. Y.

START Home mailorder business. Details. Gedgard, Box 798-L, New York 1, N. Y.

START Your own business on credit. Always your own boss. 1554 dealers. sold \$5,000 to \$26,500 in 1948; their average \$6,742. We supply stocks, equipment on credit. 200 home necessities. Sales experience not needed to start. Wonderful opportunity to own pleasant, profitable business backed by world-wide industry. Write Rawleigh Co., Dept. A-U-PPM, Freeport, Ill.

QUICK Money! "Repairing car batteries!" At home! Easy too! Batteryman, Grand Junction, Colorado.

SELL Publications by mail. Small capital, five way profits. Free advertising. Complete plan 10c. With samples 25c. Shaw, 660 N.E. 8th St., Hialeah, Fla.

\$10,000 YEARLY. Renewing carpets, upholstery scientifically. Tremendous demand, repeats. Puraclean, 17-N East 42nd, New York 17.

BIG Money in established mail order business. Call on our experience to help you. Mathews, 4501 Oakmont, Philadelphia 36, Penna.

SAWDUST. Turn it into cash. Six methods. Instructions 25c. Charles, 12-APY, Norwood, Ohio.

DEALERS: New imprint, a few dealerships, in business bringing 200 orders first ad. Grant Lovell, 2166 South Shore, Erie 22, Penna.

GET Orders by mail for real merchandise. Plenty first—repeat business. Everything furnished! Write: Edgar Burdeau, 32-P Walnut, Northampton, Mass.

YOUR Own plastic business at home. Produce costume jewelry, novelties, statuettes. Liquid plastic, liquid marble. Flexible molds. Write for free book. American Trades, Box 1473-A, Cincinnati 1, Ohio.

BIG Money. Spare or full time in your home. No selling! Spray new miracle finishes, plush and suede, on signs, radios, automobiles, figurines, lamps, toys, etc. Our business is booming. Help us fill huge demand. New easy Flok-Kraft methods. Material costs few pennies. You get dollars. Free samples, complete powerful money making plan free. Write now! Coast, 1010 S. Los Angeles St., Los Angeles 15.

MAIL Selling opportunities galore! Write Wehner, Box 142-A3, Roxbury 19, Mass.

MAKE Money in profitable home operated mail business! Thousands do. Rush name for revealing literature. Smith, Box 2592-A, Hines, Illinois.

NICE Income. Learn designing, modeling, molding from ceramics, plaster, plastics. Simplified commercial methods. Inexpensive. Write Plastics Digest, 2925-B2 Michigan, Kansas City 3, Mo.

TIN Cans. Turn them into cash. Nine methods. Instructions 50c. Charles, 12-APZ, Norwood, Ohio.

OWN Your mailorder business, envelopes, bags, wholesale. Good profits. Omaha Envelope, 4721-E California, Omaha 3, Nebr.

START Home mail business. Sensible way. Join "United Mail Dealers." Circular free. Albert Daufeldt, Atalissa, Iowa.

LEARN Dresdencraft by mail. Five lesson course \$1.50. Unpainted figurines, supplies. Free list! Add-A-Craft, 2082 Wellesley, St. Paul 5, Minnesota.

START Your own business in home or office. Tested business plans. Full particulars free. Ideal Mail Service, 617 Belmont Ave., Newark 8, N. J.

BUSINESS Opportunities galore, hundreds successful! Interesting details free. Stout, 1110A Caesar, Pasadena 10, Calif.

MAKE Perfume—Simple method. Write "International," 6347 Parnell-PM-1, Chicago 21, Illinois.

RAZOR Blade vending machines. Vends four popular brands. Cost \$49.50 each. Will sacrifice for best offer. Hodakoski, 719 Westminister Hill Rd., Fitchburg, Mass.

SENSATIONAL Suede finished letter opener \$1.00. Agents wanted. Artistic's Products, Room 5, 2251 North 21st Street, Milwaukee, Wis.

METALLIZE Baby shoes. Excellent profits. New system assures success. Free details. Treasures Forever, 38-B Michigan Ave., Lynn, Mass.

PROFIT From your hobby! Plan your mail order business by using practical system. Price \$1.00. Green's, 115 Oxford St., Toronto, Canada.

SEND Postcard for "1001 Ways to Make Money." 1001 Opportunities Club, Dept. "C," 1495 Westchester Ave., New York 59.

\$5000 YEARLY Selling by mail books. Dollar orders filled, 2c each. Mail 25c for samples and details. Acme, P.M. 2441 N. Patton St., Philadelphia 32, Penna.

MAKE Money by mail! Write! Peterson, Box 598, Minneapolis 1, Minn.

COLLECT \$300 Weekly by mail. Details. Credit Bureau, Elizabethtown, Ky.

LUMINOUS Paint or bronze baby shoe paint. \$1 a bottle. Giffhouse, Box 4550-L, Coral Gables, Florida.

\$50 TO \$150 A week with amazing new plan. Write for free details. Foster Publications, 115 North Broadway, Quinton, Okla.

MANUFACTURE Automobile accessories. 700% profit, gasoline station buys 300. Sample, dime. Ralph Kelley, Box 583, Clearwater, Fla.

HOME Business making statuettes, plaques, artificial marble, rubber molds. Metallizing baby shoes. Silvering mirrors. Formulas. Folder free. Creative, 236-L, Winnetka, Illinois.

"HOW To start a successful mail order business." The guide to sound, profitable mail merchandising. 25c. Manhattan House, 126-B Lexington, New York 16.

INEXPENSIVE Manual teaches air conditioning. Write Don Nelson, Warner Robins, Georgia.

BIG Money regraining, refinishing automobile dashboards, garnish moldings. Write Outman Service, 4323 So. 38th, St. Louis 16.

LOCATE Anything made in U.S.A. \$1.00. Research, 407 Washington, Shreveport, Louisiana.

LUCRATIVE Business plans. Free particulars. Imocony, Box 344, Flushing, N. Y.

EARN At home casting novelties. Free instructions using latex molds. Major Chemical Company, 164 Portland Street, Cambridge 39, Mass.

"HOW To Raise Worms for Bait." Booklet, 25c coin. El Sobrante Earthworm Farm, 749-A Rincon, El Sobrante, Calif.

MAKE Tough, durable plastic—1c pound. Makes attractive floors, walls, built-ins, roofs. Build good homes, \$150.00 room. Bays Laboratory, Oklahoma City 9.

LIQUID Rubber. Make flexible molds. Free sample. Chaney, 1130 E. 16th St., Jacksonville 6, Fla.

NATURAL Molding Latex. Extra thick. Free sample. W. Wooley, 115-A Donald, Peoria, Ill.

WHERE To buy 800,000 articles wholesale! Details free. Schibani, Box 1576, Birmingham 1, Alabama.

EARN Extra money working with figures. Jimmy Sherrod, Pavo 1, Ga.

"FROG Raising!" New book tells how! Illustrated literature free. Marlboro-A, Box 7002, New Orleans 19, Louisiana.

DOLLARS Three ways with "Kitty-Kat" readi-cut baby shoes. Complete local and mail order plans. Write No-Co-Ro, Oakland 6-K, California.

MOLDING Rubber for hobbyists, industry, classroom projects! Flexible molds easily made from the best quick-drying white liquid rubber! (Gallon, \$7.95; quart, \$2.95; sample half-pint \$1.00) prepaid parcel post! Plastercraft Supply Co., 3051 St. Clair Ave., Cleveland 14, Ohio.

LEARN Electrical appliance repair. House wiring, motors, washers, cleaners, refrigerators, lamps, auto ignition, etc., complete illustrated course. Tools furnished. Free booklet. Pacific School, 7219 South Broadway, Los Angeles 3.

SELL By mail. Good deal with nice profits. Home City Services, Box 1062-PM, Springfield, Mass.

REFRIGERATION And air conditioning. Complete, illustrated course. Free booklet. Mechanics School, 7219 South Broadway, Los Angeles 3.

WOULD You pay 3%—first \$350 made? Book "505 Odd, Successful Enterprises" free! Work home. Expect something odd! Pacific, Oceanside, Calif.

OWN A printing business. Good profit printing cards, stationery, etc., in spare time. Easy rules furnished. Have home shop. Write for details. Kelsey Corp., Meriden 24, Conn.

MANUFACTURERS Getting rich with new post-war products, all lines. You can easily make them at big profit from guaranteed, chemist-developed formulas and analyses. Literature free! Miller, Analytical Chemist, Tampa 6, Florida.

WHERE To buy 500,000 articles wholesale. Details free. Krueger, 3418A Wolcott, Chicago 13.

BABY Shoe metalizing. Modern, simplified practical system. Schoettle, Friendship, Ohio.

MONEY Making opportunities. Free literature. L.R.A. Products Co., Biggs, Calif.

FREE! Illuminating folder "A Business Gold Mine." Real dividends for your spare time in lucrative business. No personal selling. Kabel, 1413 W. Tioga St., Philadelphia 40, Penna.

CASH In your spare time. Make big money sharpening circular saw blades with powered gummer. Free instructions. No experience necessary. Small investment. Start with as little as \$13.50. Big demand—you earn immediately. Free catalog. Belsaw, 315-H Westport Road, Kansas City, Missouri.

GROW—Sell potted flowers, vegetable plants. Details free. Shiffer Associates, Box 129, Millersburg, Penna.

FIGURINES And all supplies for Dresden painting. Gift ornaments. Unpainted, many to choose from. Start a profitable business; hobby. Send 25c for catalog. Will refund on first order. Suiter Art Industries, 314 Westport, Kansas City, Mo.

PROFITABLE Home business. Start on small capital with latest tested formulas. Interesting booklet free. Pont, Box 635-XM, Terre Haute, Indiana.

ALUMINUM Name plates. Polished letters. Etched background, \$1.50. Agents wanted. Jack Kester, Deckerville, Mich.

10,000 FORMULAS And trade secrets. Free literature. Stillman Co., 555 Kingston Ave., Brooklyn 3, N. Y.

START Home plaster novelty business. Amazing course tells how. Literature free. Kemo-Courses, 4862 Catalpa, Chicago 30, Illinois.

SPECIAL Rubber for making molds. Literature and sample free. Universal, Box 1076-A, Peoria, Ill.

MAKE Money at home decorating greeting cards. We supply instructions. Powell, 5713-C Euclid, Cleveland 3, Ohio.

HOME Workers. Hand-spin Angora wool into yarn. Either sex. House of Angora, PM, Springfield, Illinois.

MAKE Flexible molds! Cast plaques, novelties, bookends! Free sample! H. Tooker, Hamilton 4, Ohio.

HOW And where to obtain capital. Small and large loans. Free particulars. Star Service, Wapakoneta, Ohio.

DRESDEN Craft figurine molds and many others, natural liquid rubber, statuary plasters, flock finishes, etc. Illustrated catalog and "Plastercraft" manual free. Blue Rapids Supply, Blue Rapids, Kansas.

WANTED Unused U. S. postage stamps, small discount. Advance Stamp Co., 24 East 23rd St., New York.

EXTRA Money. No selling; operate vendors. Amazing profits, details free. Silver King, Suite B, 622 Diversey, Chicago 14.

UNPAINTED Bookends, plaques, statues, figurines. List. Haverty Products, 1219 8th Ave., Altoona, Penna.

LIQUID Marble—Colorful, glossy! Molded, brushed, sprayed! Cast novelties, statuary, colored tiles. Flexible molds. Composition floors. Particulars free. Marbleizing Service, Edwardsville, Illinois.

RICHES In your own business. Let me show you how. Addison, Box 1153, Hot Springs, Ark.

BRONZED Baby shoe mountings, equipment and supplies. We manufacture world's largest assortment of all metal mountings. Wholesale only. Ramy selenium platers \$39.95. Gold and silver plating assemblies low as \$97.50. Write for free copy of electroplating instructions. Tech. Dept., Hollywood Bronze Supply, 1770 N. Vermont Ave., Hollywood 27, California.

RESILVER Mirrors at home. Formula 25c. Ideal Service, Park Ridge 8, Illinois.

UNPAINTED Figurines—Wholesale, retail. Illustrated list free! Oman, 642L Broadway, St. Paul 1, Minnesota.

HOW To set up and run a mirror shop! Resilver mirrors. Make chipped glass nameplates. Electroplating salts and rectifiers. John Sprinkle, V60, Marion, Indiana.

MAKE Rubber stamps, metalize baby shoes, repair dolls, silver mirrors, make plaster novelties. Catalogue of "30 Ideas" free! Universal, Box 1076-A, Peoria, Ill.

CASH For your idea, 280 manufacturers need inventions, patented or unpatented. List free. Invention Bureau, 208M Clinton, Oak Park, Illinois.

MAKE Money making new greaseless doughnuts at home on electric machine. Wholesale to grocers, drug stores, cafes, hamburger shops. Send for free recipes and plans. M. Ray Company, 3605 South 15 Ave., Minneapolis 7, Minnesota.

"SPECIALTY Manufacturing." Big money business. Start on small capital with dependable formulas. Send for free interesting booklet. Howard Robinson, Ph. G., 1300-A South Ohio Street, Sedalia, Mo.

RECAST Old batteries into new. Latest achievements. Battery Laboratories, Minneapolis.

ENVELOPES Addressed accurately, reasonably. Fast service. We have capable addressers in your city. Glenway System, 5713-Y Euclid, Cleveland 3, Ohio.

YOUR Own profitable home business. Preserve live flowers to last forever. New simple discovery. Enormous demand all year round. Tremendous profits! Light fascinating work. Send \$2.00 for working equipment, instructions, and valuable sales plans. Satisfaction guaranteed or money promptly refunded. Alfred Hermansen, 210 Fifth Ave., Suite 1102A, New York 10, N. Y.

I MAKE Big money in the mail-order business. You can do the same at home with copyrighted system. Write me. I'll tell you how. F. Little, R.D. #1, Glenshaw, Penna.

VENDING Machines earn big money! An investment as low as \$10.50 will start you in this fascinating, profitable business that can lead you to the road of success and independence. Routes can be established and operated in either full or spare time with no experience needed. Write for full details and our free catalog illustrating our nut, candy, gum and stamp vendors; also pin ball machines, music boxes, etc. Write immediately to Parkway Machine Corporation, Dept. 7, 623 W. North Avenue, Baltimore 17, Maryland.

READ "Advance"—The voice of mail order. Offers money-making opportunities, sources of supply, personal guidance, etc. Issued monthly. Sample copy 25c. Yearly subscription \$2.00. Advance Publishing Company, 313 East 21st Street, Suite 450, New York 10, N. Y.

A BUSINESS In your own home! Our chemicals, plus free water and cheap "grocery store" materials can bring you over \$500 monthly earnings. Plans and formulas free. Chemica Division, 1269 S. Norton, Los Angeles 6.

A FACTORY In your home garage! Mfg. and sales rights, mechanics' waterless hand cleaner, \$500-\$800 monthly. No special equipment necessary. Formula free. Western Aircraft Mfg., Dept. D, Los Angeles 6, Calif.

START Mailorder bookshop—Everything furnished. 25c brings booklet, samples, exciting ideas. General Publications, Ossining, N. Y.

OPERATE Profitable mail order business. Write Walter Service, 4159-A East 112th, Cleveland 5, Ohio.

COLORGLAZED Concrete pottery made without molds. Patented method. Cemetery products, novelties, tiles. Basement leak-sealing. Money-making projects. Booklet, details free. Men only. National Potteries Company, Grand Rapids, Minnesota.

137 WAYS To make money, in home or office, business of your own. Full particulars free. Elite Co., 220 Grand St., New York 13.

\$25 WEEKLY Working two hours daily. No canvassing. No manufacturing. Lycke, Box 2471, Cleveland 12, Ohio.

BRUSH Plating outfits connect to a battery. No tanks necessary. Good paying business at home plating autoparts, bathroom fixtures, bicycles, reflectors, silvering mirrors. No shop or experience required. Outfits furnished. Free booklet. Gunmetal Co., Ave. H, Decatur, Ill.

COPUBLISH Leading m.o. paper. Latest copy Mail Sale Advertiser and proposition, dime. Vanroy W. Shirk, Lebanon, Penna.

MAILING Postcards selling repeat merchandise is profitable. Everything supplied. Details free. Gordan Publishers, Box 23, Pawtucket, R. I.

MONEYMAKING OPPORTUNITIES

WE Want to buy a product we can sell by mail. Do you have a new or unusual product, or an idea for such a product, that we can sell by mail? If so, this established, reliable firm in Greater Kansas City is ready to talk business with you. Here's your opportunity to make money. Send complete details about your product, or idea, to Dept. A, Special Order Service, Box 164, Kansas City, Kansas. Write today!

BIG Money! Learn watch-clock repairing at home. Free information. Modern Technical Supply, 55-D West 42 St., New York 18.

RAISE Ginseng. Roots bring fortunes. Circular free. Fezler Seed Co., Patchogue, N. Y.

MAKE Flexible arch supports. Profitable business. Tunis System, 1341 Kwis, Puente, Calif.

WANT Notary Public appointment? Official in usually 10 days. Stationers Exchange, Boerne 50, Texas.

BIG Money making lamp shades at home! Full instructions 50c. Balfour, No. 3, 1131 Barclay, Vancouver, B. C.

MAILORDER Know-how. Free literature. Bruce, Box 341-AD, Palo Alto, Calif.

WIN Cash, cars in prize contests! Write for copy filled with current contests, winning hints and tips. Send only 25c. Wright Contest Digest, Dept. 17-A, P.O. Box 2266, St. Louis 9, Missouri.

MAKE Extra dollars! Spare time, home mail business. Facts free. Kanick, 261-B East Abbott, Lansford, Pennsylvania.

UNPAINTED Figurines. Free list. Progress Company, 4033-P Chowne, Minneapolis 10, Minn.

DELIGHTFUL Plans! Australia, South America. Free book "372 Unusual World-wide Businesses." \$800 month reported! Work home (U.S.A.)! Get surprise! Publishers-9E, Carlsbad, Calif.

MAKE Money at home in spare time. Raise Golden Hamsters. Small investment. Literature free. Golden Gate Hamstery, 631-H Richmond Street, El Cerrito, Calif.

WESTERN Advertiser offers many worthwhile mail order opportunities. 6 months subscription 10c. H. Edlund, 577 Kensington, Los Angeles 26, Calif.

EARN Money evenings, copying and duplicating comic cartoons for advertisers. Adservice, Argyle 1, Wisconsin.

HAVE Home candy kitchen! Make for home eating, gifts, profit! Learn professional methods. Sell locally—mail. Etterman, 1991-B1 Lake, Muskegon, Michigan.

START New year right! Make spare money by mail! Big mails! Magazines! 10c. Ideal, B641, Berkeley 1, California.

DOLLARS Three ways with "Kitty-Kat" readi-cut baby shoes. Complete local and mail order plans. Write No-Co-Ro, Oakland 6-K, California.

NEED Extra money? Want your own good paying business? We can help you! Rush name for interesting facts. Hurry! Edison Ransom, 830 South Michigan, Chicago 5, Illinois.

CHURCHES, Organizations, Clubs. \$130.00 free plus 12-card tables. Unique Gift Club Plan, Pine Hill, New Jersey.

MAIL Literature—Run ads, sell merchandise, books, etc. Easy, pleasant, profitable. Everything furnished! Details free. National, Box 88-A, Dorchester 22, Mass.

START Big paying mail order business in own home. Proven methods revealed by experts. Write Mail Business Associates, Inc., 919 State Tower, Syracuse, N. Y.

SENSATIONAL Earnings preparing tax reports. Days, evenings, weekends. Experience unnecessary. Write Auditax, 10775 Q Tabor, Los Angeles 64.

"FORTUNES In Formulas"—900-page book with 10,000 formulas for independent business of your own. A single formula can make your fortune. Order today. \$3.95 postpaid. Circular free. Consolidated Service Bureau, 551-PA So. State, Chicago 5.

MAKE Money to live as you dream to. Send 3c stamp for proof. Hollywood Upholstery Studio, P.O. Box 1544, Oakland, Calif.

NEW Way. Earn \$50 weekly working at home. We show you how. Ability in simple arithmetic essential. Send 25c coin (no stamps) for details. Dollar-a-Month Plan, Box 5236-P, Philadelphia 26, Penna.

EARN Money at home. Little or no capital needed. Free particulars. G. Huthnance, 201 Holbrook, Flint, Mich.

PROFITABLE Mail order business! Operate on "shoestring" from your home. Plans, ideas, moneymaking information 25c. Berg & Garcea, Box 266, San Bruno, Calif.

START Profitable mailorder business at home! "Mail Order World" is packed with ideas, plans, tips. Sample 25c. Romax, 3028 Tracy, Kansas City 3, Missouri.

YOUR Mail order business now ready. A. S. Spencer, Mokena 6, Ill.

EASY Ways to earn extra income are described in Money-Making Hobbies. 132 projects you can make at home and sell anywhere. 160 pages, \$2.00. Popular Mechanics Press, 200-MH East Ontario, Chicago 11, Ill.

WOULD You pay 3%—first \$350 made? Book "505 Odd Successful Enterprises" free! Work home. Expect something odd! Pacific, Oceanside, Calif.

WIN Contest prizes regularly! Others do! 10c brings latest issue "Contest Flyer," other revealing information. Lawrence, 687 Morgan, Camden 4, N. J.

EARN Money at home! Thousands do! "Home Worker Magazine" tells how. Sample, 25c. Sizemore, Box 7, 4917 Kostner, Chicago 30, Ill.

THOUSANDS Articles wholesale. "Supply Source Directory" 10c. Ideal Service, Park Ridge 30, Illinois.

READ Progressive Mailtrade, the magazine that tells how to make money by mail. Dime brings sample and special offer. Progressive Mailtrade, Box 357, Sheboygan, Wisconsin.

DOLLARFUL Ideas for you every month in advance—"Voice of Mail Order." Leads the field in exclusive supply sources. Plans for mail order operation; new products, etc. Details free. Advance Publishing Company, Suite 350, 313 East 21st Street, New York 10.

WIN Contest money. General Contest Bulletin gives hundreds of tips. Lists current contests and rules. Sample 25c. General Contests, 1609 1/2 East 5th, Duluth, Minn.

PUBLISH Your own magazine. Handsome 52 page format, well edited, illustrated. Cost low as \$1.00 month. Brings you prestige, profits. 25c brings sample, details. National, Ord., Nebr.

PRIZE Contest bulletin gives various contests now operating, and valuable hints. 3c stamp. National Contest Bulletin, Box 2685P, Miami, Florida.

FORMULAS, PLANS, ETC.

"WATERLESS Hand cleaner." Make, sell. No machinery. Build profitable business. Formula \$1.00. "Wax-o-Glass" cleans glass; polishes metals. Formula \$1.00. "Wipe-on auto paint" formula \$1.00. Metalizing baby shoes, complete process \$1.00. All four formulas only \$2.00. Satisfaction guaranteed. Ideal Formula Service, Park Ridge 12, Illinois.

GET Fifty valuable trade secrets complete. Only \$1.25. Young Productions, Saint Helens, Oregon.

PRODUCTS Analyzed. Duplicated. Improved. Formulas. Consulting Scientific Company, Swarthmore, Pennsylvania.

FORMULAS Less than penny each. National Service, 1317-P 18th St., Chicago 8.

HOT Tamale, Making for profit. Particulars, Box 384, Altus, Okla.

FREE Formula catalog. Anything analyzed \$20.00. Western Chemical, Salem, Oregon.

10,000 FORMULAS And trade secrets. Free literature. Stillman, 555 Kingston Ave., Brooklyn 3, N. Y.

MILLER'S Modern post-war formulas make products that get the business. Fifty years supplying the best. Literature free! Miller, Manufacturer's Chemist, Tampa 6, Florida.

MAKE—Sell cleaners, soaps, polishes, flavors, cosmetics. No machinery. Formula literature free. Kemico, Park Ridge 16, Illinois.

FORMULAS For nearly everything. Catalog free. Write Creative, Winnetka, Ill.

TESTED Formulas. Interesting descriptive booklet free. Pont, Box 635-PM, Terre Haute, Indiana.

REAL Manufacturing formulas. Lists free. Cummings, Chemist, Gordon Ave., Syracuse 4, N. Y.

PLASTICS

INTERNAL Carvers—Guaranteed fast cutting, high speed, tapered drills with sharp points that make carving easier. 1/16", 3/32"—80c; 1/8"—\$1.00 each postpaid. Send for literature. Bay Sales, 101 Fifth Ave., New York 3, N. Y.

PLASTIC Consulting and engineering. 65 East Rich Street, Columbus 15, Ohio.

PLASTICS Supplies. Free catalog. Terrell's Plastics, 3562 4th Ave., Sacramento, Calif.

NEW Liquid plastic. Clear, colors. Cast without heat. Embed flowers, insects, coins. Sew, drill, carve. Complete kit only \$3.95 postpaid, or send 25c for exciting new home project manual showing how to get started. Castolite, Dept. A101, Woodstock, Illinois.

AMAZING Liquid Plastic kit \$3.25. Embed photographs, keepsakes, coins. Make solid objects. Clear, colors. Beautiful results in half hour. Inexpensive hobby. Send 15 cents for catalogue. Kristalon Plastics, Dept. Z-10, Box 29, Wilmette, Ill.

MAGNIFICENTLY Carved plexiglas wall plaques, 2 1/2" x 4" x 3/4", \$3.39 pair postpaid. Free plastics supplies catalogue. Craft Plastics, Somerville, New Jersey.

EARN Money with plastics. New book, "Money-Making Hobbies," shows you how. 160 pages, \$2.00. Popular Mechanics Press, 200 E. Ontario, Chicago 11, Ill.

LUCITE, Plexiglas. Any size sheets, masked. Square foot (12 x 12) cost, 1/16", 96c; 1/8", \$1.25; 3/16", \$1.52; 1/4", \$1.80. Colors add 10%. Include 10% postage. Almac Plastics, 230 Fifth Ave., New York 1, N. Y.

INTERNAL Carved roses, orchids, swans, goldfish, butterflies, etc. Jewelry and gifts. Crystal Floral Novelty Co., Bound Brook, New Jersey.

PLASTIC, Sheets, rods, tubes, etc. Free list. Plastic Supply Co., 2901 N. Grand Blvd., St. Louis 7, Mo.

WHOLESALE Plastics supply catalog. 10c. Lucite, clear, colored. Metallic acetate, 15 colors. Thick lucite cutoffs, polished blanks for carving. Metal findings, tools, ideas, bargains galore. Quantity prices on casting plastic. Gem-O-Lite, Box 686S, North Hollywood, Calif.

CHEMISTRY

LABORATORY Chemicals, apparatus, books. Catalog 10c. Fleischer's Laboratories, Everett 49, Mass.

NEW. Used catalog 10c, refundable. Atlantic Laboratory Supply, 21 Wenham, Boston JP, Mass.

LIVE Within 800 miles of Chicago? Send 5c for catalog "Everything for the Home Lab." Medal Laboratories, 1521 121st Street, Whiting, Indiana.

USEFUL Laboratory item, catalog of chemicals, laboratory apparatus, kits, 10c. Rex Laboratories, 2849-A Birchwood, Chicago 45, Illinois.

NEW Catalog: Chemistry, mineralogy, biology. 10c. Tracey Laboratories, Evanston, Illinois.

NEW Idea chemical and apparatus outfits for home experimenting. Photo-scales, microscopes, chemicals, biological and laboratory supplies in small quantities. Catalog 15c. Established 1931. John H. Winn, 124A West 23rd Street, New York, N. Y.

CHEMICALS And apparatus for industrial, analytical, and private laboratories. Catalog 15c. Dept. M-50, Biological Supply Co., 1176 Mt. Hope Ave., Rochester, N. Y.

HELP WANTED

LOCAL Farmer for part-time representative to assist field engineer. National Aluminum Sprinkler Irrigation Co., P.O. Box 777, Spokane 3, Wash.

AGENTS WANTED

NEW "Sponge" wall cleaner. Erases dirt like magic. Wallpaper, painted walls, ceilings. Saves redecorating. Lightning seller. Samples sent on trial. Kristee 141, Akron, Ohio.

MORE Money, selling Sunshine's everyday greetings. Little Dutch garden 21, millinery fashion notes, value-packed 48 Sunshine notes, beautiful pastelle suede plus birthdays, sympathy, plastics, children's, gift wrap, imprinted stationery and napkins. Outstanding values, profits. Write today, samples on approval. The Sunshine Art Studios, 115 Fulton St., Dept. PM-1, New York 8, N. Y.

MORE Money—So easy! Sell distinctive new greeting cards, stationery. Fast selling plastic, metallic, 3-dimension, 21-card \$1.00 all-occasion assortments. Profits to 100%. Exclusive gift wraps. Novel "double" cards, animated books, gifts. Bonus. Special offers. Write for free samples exclusive name imprinted decorated stationery and feature all-occasion samples on approval. Elmira Greeting Card Co., 2109, Elmira, New York.

DRESSES, 18c; Coats \$1.00, blouses 35c. Free catalog. Crown, 164-P Monroe Street, New York 2.

300% PROFIT Selling razors. Send 25c for sample. 4-S-Razor, Hutchinson, Kans.

WHERE To buy 800,000 articles and nationally advertised merchandise direct from manufacturers and jobbers. Sent free. "Buy direct and make bigger profits." Glass Pub. Co., Ellwood City 7, Penna.

GREETING Card moneymakers. Birthday, everyday, valentine. Catalog free. Greenport Art Company, Brooklyn 15, New York.

LOOK! New proved Flea-No-Mat rids pets of fleas overnight. Specially treated mattress wanted by all dog owners. Make \$20 day. Sample \$1.50. Sells \$2.95. Write V. P. Garrett Company, Box 1143-P, Dallas, Texas.

\$100.00 FAST—Easy. New office necessity does it. Hudson, 934 Lakeside, Chicago 40.

NEW! Stainless steel, burglar-proof window guard! Sells itself! Millions of eager prospects! Literature, samples: \$1. Artware Corporation, 11110 Ventura Blvd., North Hollywood, California.

BE Renewal headquarters for all magazines. Handle everything at home. Big profits. No experience—no capital needed. Free catalog tells how. Write: McGregor Magazine Agency, Dept. 500A, Mount Morris, Ill.

GET Rich deal! Redybilt mowers—\$25.00. Complete, less motor. Smith Agency-3, Excelsior Springs, Mo.

MAKE \$25.00 Quickly showing Write-well greeting cards, stationery, name labels, "How to make money" booklet free. Samples on approval. Writwell, 4501 Transit Building, Boston.

MEXICAN Feather pictures. Free details. Samples 10c stamps. Sylvia, Apartado 9036, Mexico City.

NYLON Uniforms. Immediate delivery, immediate profits. Sell to doctors, dentists, nurses, waitresses, beauticians, housewives. Free sales kit. Superior Fabrics, Dept. P1, 3936 Market, Philadelphia 4, Penna.

SELL DuPont nylon uniforms. Complete line famous exclusive Hoover styled nylon uniforms for beauty shops, nurses, doctors, waitresses, others. Best quality, splendid values. Exceptional income. Real future. Equipment free. Write fully. Hoover, Dept. B-100, New York 11, N. Y.

DOUBLE Your income—Sell wool and cotton uniforms, badges, initial buckles, belts, etc. Write Hook-Fast, Box 480PM, Roanoke, Va.

FREE Literature—Thousands wholesale supply sources. Money-making business ideas. Wilkin Company, Hillsboro 2, Ohio.

FREE Samples. Big profits showing amazing glow-in-the-dark specialties. House numbers, pictures, plastic novelties, ashtrays, keyholders, religious and nursery objects, etc. Madison Plastics, 303 Fourth Ave., New York 10, N. Y.

MAKE Money calling on friends. Show nationally advertised greeting card assortments. 16-card all occasion assortment only \$1.00. Also birthday, gift wrapping, plastics, imported English napkins, floral stationery, children's books, many more! Up to 50c profit on each assortment. Experience unnecessary. Samples on approval. Write Wallace Brown, 225 Fifth Avenue, Dept. G-4, New York 10.

BIG Money taking orders. Shirts, ties, Sox, pants, jackets, sweaters, shoes, uniforms, etc. Sales equipment free. Experience unnecessary. Nimrod, 4922-BG Lincoln, Chicago.

AMAZING Offer—\$40 is yours for selling only 50 boxes. Also entirely different, new deluxe all-occasion assortment with television card, Little pearls, hankie gift greetings, other surprise items. Feature boxes on approval. Free samples imprinted stationery and rose scented notes. Write today. It costs nothing to try. Cheerful Card Co., 1088, White Plains, N. Y.

BETTER Way to extra money! Sell outstanding new plastic, metallic greeting cards. Gift wrappings, scented stationery. Profits to 100%. Bonus. Request free samples exclusive name imprinted and floral stationery, free catalog and feature all-occasion samples on approval. Special offers. New England Art Publishers, North Abington 201, Mass.

MAKE Money fast. Sell gorgeous, new metal and \$1 plastic greeting card assortments. 100 other sell-on-sight items. 21 all-occasion cards for \$1.00, birthday, Easter, relative cards. Wrappings, scented stationery, gifts. Amazing profits. Bargain offers. Write for samples on approval. Hedenkamp, Dept. PM-3, 361 Broadway, New York.

FREE Samples, and amazing plan, giving you gorgeous dress without penny cost. Rush name today, with dress size. Harford, Dept. B-235, Cincinnati 25, Ohio.

ABSOLUTELY Free! Big package actual sample fabrics and style presentation of dresses, lingerie, hosiery, etc. Take orders. Commissions big. Send no money. Melville Co., Dept. 5275, Cincinnati 3, Ohio.

"NO-FOG" Windshield cloth. Instantly removes blurry mist, frost, sleet, snow. Stops windshield fogging. Samples sent on trial. Kristee 142, Akron, Ohio.

RED Hot office device. Stamps 1500 envelopes hourly. Sells like hotcakes. Big profits. Postway, Gorham 3, Maine.

AGENTS! 100 Brand new products. Confidential bulletin monthly. Publishers, Gardenville 8, N. Y.

BIG Money career. Sell guaranteed Nylon uniforms—white, colors. No investment. Highest commissions. Easy, quick sales to waitresses, beauty shops, hotels, nurses, etc. Complete variety fabrics. Exclusive styles. Free catalog sales kit. Upland Uniform, 255 West 28th Street, Dept. G-3, New York.

FREE Nylons given if Kendex hosiery runs or snags! World's only women's hosiery sold with written guarantee amazing everybody. Mere words could not express unbelievable money-making opportunity. Fantastic earnings become reality. Armstrong earned \$202 in 9 days. Watkins sent 92 orders in one day. Imagine replacing hosiery free regardless of cause—whether use or abuse! Truly sales dynamite for terrific profits. Even if you never sold before, three magic words: "Guaranteed Against Everything" will open doors for you—make women listen and pour money in your pocket. Nationally advertised in Life, Ladies Home Journal, Saturday Evening Post, McCall's and Woman's Home Companion. Awarded Seal of Approval by Good Housekeeping. 75 million readers will see Kendex advertising to help you make quick sales and big money. Complete line from sheerest 15 denier 5 1/2 gauge to heavy 70 denier service. Sizes 8 1/2 to 11 1/2; lengths 28 to 35 inches; latest fashion colors plus white; full fashioned seamed and seamless. No competition because Kendex nylons are not sold in stores. Also complete line men's hosiery actually guaranteed for one full year or replaced free. Nothing like this anywhere. Includes rayon, nylon, lisle, wool, cotton, mixtures etc. All styles, patterns, colors, prices to please everybody. 200,000 pairs constantly in stock for fast delivery. Thousands shipped daily. Over 30 years in business. You need no money or experience. Nothing to pay now or later. Just show free outfits. Write orders. We deliver and collect. Big advance cash plus huge bonus. Earn money spare or full time—exclusively or as side line. No restrictions. Become manager—appoint others to sell for you—earn steady income on their sales. Man or woman, young or old, experienced or beginner, you can make money and friends writing orders. Everything you need is furnished free, including sales books in color, samples of hosiery materials etc. Simply write your name and address on postcard and make money next week with money-making outfits sent free and prepaid. No obligation. Kendex Company, Babylon 43, N. Y.

START Your own business on credit. Always your own boss. 1554 dealers, sold \$5,000 to \$26,500 in 1948; their average \$6,742. We supply stocks, equipment on credit. 200 home necessities. Sales experience not needed to start. Wonderful opportunity to own pleasant, profitable business backed by world-wide industry. Write Rawleigh Co., Dept. A-U-PPM, Freeport, Ill.

DRIVER Agents wanted. Demonstrate Crosley cars. All or spare time. Crosley Motors, 2534-1 Spring Grove, Cincinnati, Ohio.

NO Selling! Sell our business cards by mail. Successful "beginners" plan. Lynn, 5710 Bankfield, Culver City, California.

START The New Year right selling Cell-U-Mop, the finest DuPont cellulose sponge (not rubber) mop on the market! Exclusive patented construction; ideal for every cleaning, waxing purpose in homes, business places, institutions. Quick, easy sales; big profits. Amazing opportunity for full or part-time business of your own. Write today! Cell-U-Mop Co., Dept. PM-1, Freeport, Illinois.

\$1 STARTS You in business. Sell top quality \$1.00 ties. Now only \$7.20 dozen, your profit \$4.80 dozen. Regular \$1.50 up values. Send \$1.00 for introductory offer two ties. Catalog complete line free. Phillip's Neckwear, 20 West 22nd St., Dept. K-39, New York 10.

AGENTS. Sell finest food products direct to homes. Successfully sold for 25 years. Big profits. Powerful combination sale plans make sales easy. Permanent repeat business. Powerful premiums and free door openers for easier sales. Samples furnished. Live territories open to distributors. Mother Hubbard Products Co., 4139 Grand, Dept. M-1, Chicago.

BRAND New! Amazingly different and smart everyday cards. Magic window designs. 2 in 1 metallics. Take easy orders. Pays up to 100% cash profit. Big line of everyday assts. retail 60c up. Personal stationery, coasters, napkins. Free imprint samples. Assortment on approval. Write today. North Star, 31 Glenwood, Dept. D-18, Minneapolis, Minn.

AT Last! Something new and sensational in everyday cards. Make extra money fast! Show gorgeous satin velour metallic cards. Get orders easy. Scented stationery, charmettes, napkins, kiddie cards. 25 other assts. retail 60c to \$1.25. Samples on approval. Puro Co., 2801 Locust, Dept. O40-A, St. Louis 3, Mo.

BIG Profit, wooden product, 39c seller. Cost 9c up. Four samples \$1.00. Samson, Box 31, Dowagiac, Michigan.

BUY Thousands of nationally advertised products direct from manufacturers and distributors. Write for "Buy Direct and Save." Service Publishing, 218-A Investment Bldg., Pittsburgh 22, Penna.

FAST Selling religious article. Big profit. Write: Universal Sales Co., P.O. Box 663, North Attleboro, Mass.

DREAM And reality: Juiciest plum that ever fell into the lap of agents. Daily net earnings \$100. Capital required, \$15. Sample with convincing details, 50c. If you want big money quickly and easily, made in a dignified and legitimate manner, this is your chance. Emmen Tee, Box 612, Hollywood, Ill.

JEWELRY Factory desires salesmen, distributors, jobbers. Pickcraft, 19 Bank Street, Attleboro, Mass.

BIG Bargains for big profits. Over 100 sensational values. Men's used suits \$2, pants 35c, topcoats \$1.25, overcoats \$2, shoes 20c. Experience unnecessary. Free wholesale catalog. Superior, 1250-A Jefferson, Chicago 7.

AGENTS: Stamping names on key protectors. Sample 25c. Stamping outfits, checks, social security and name plates. Hart Mfg. Co., 303 Degraw St., Brooklyn, N. Y.

AMAZING Ketchup dispenser! Pumps ketchup out of bottle. Sells fast to housewives, restaurants, stores. King, 55-P Oleander, West Springfield, Mass.

NEWEST Money-making sensation, miniature authentic replicas, police and firemen's badges also pocket pieces, key chains. Write for descriptive folder. Hook-Fast Specialties, Dept. 20, Box 1425, Providence, R. I.

SELL Big money-maker to men and women. Easy handwork makes fast-selling useful articles. Sunmade Company, Brockton 64, Mass.

SCHOOL Seniors—Earn 40% commission selling classmates America's most beautiful graduation name cards. Largest selection. Outsells all others. Free sample kit. Printcraft, Dept. M, 1425 E. Elm St., Scranton 5, Penna.

SCHOOL Seniors! Your postal will bring our wonder, Kwick-Sell cardalog of popular graduation name cards. Biggest profits! Only firm giving free souvenir chest and card case. Don't miss out! Hurry that postal! Craftcards, Box 235 (L), Pittsburgh 30, Pennsylvania.

LOOK! Make money all year round selling personal initialed individualized belts, buckles, cap badges, tie holders, complete line police and firemen's badges, 2000 emblems to choose. Big profits, whole or part time. Please write today special outfit offer. Hook-Fast Specialties, Box 1425, Dept. 6, Providence, R. I. Established 1926.

SEWING Machine electrification kit. Nationally advertised. Has Good Housekeeping Guaranty Seal. Can be demonstrated and sold in 5 minutes. Make at least \$5 per sale. For complete details write today to Brownell Distributors, Inc., Dept. PM, 308 Canal St., New York 13, N. Y.

FREE Water and our concentrates, make flavors, lotions, shampoos, 125 products, labels, bottles supplied. Qualco, E20030 Russell, Detroit.

MAGIC Cleaner—Laundry soap deal. Hotter than a firecracker. Big profits. Sample free. Bestco, 4642 No. Central, Chicago.

GOLD Lacquered window sign letters. Large sizes penny each. New foils. Absolutely beautiful. Free samples. Atlas, 544 W. 79th, Chicago 20.

EXCELLENT Sideline for printing and advertising salesmen. Decalomania name plates in small quantities. Great demand. Also, make money with our line of automobile initials and sign letters. Free samples. "Ralco" XL-Roxbury, Boston 19, Mass.

PHOTO-Salesmen-agents. Sell beautiful hand-colored plastic enlargements. Collect deposit, we deliver. Profitable sideline. Send card, for free sample kit. Novel Portrait Co., 3343 North Ave., Chicago, Ill.

AGENTS—300% Profit selling genuine gold window letters; stores and offices. Free samples. Metallic Letter Co., 438-B North Clark, Chicago.

CLEAN Up with plastic rayon towels. Powerful quick demonstration. Ink, grease rinse right out. Every home, every business a prospect. Package 6 towels sells \$1.00. Gross \$54.00. Send \$1.00 sample package. Sunbeam Products, 701 Third St. So., St. Petersburg, Florida.

HIGH-GRADE SALESMEN

BURT'S Course in salesmanship is designed to improve your position and salary. Send for valuable information free. Mead Publishing Co., 404 Halliburton Bldg., 1709 W. 8th, Los Angeles 14, Calif.

ADVERTISING Book matches—Cash in on big demand; sell union label matches. Cuts for all businesses and political parties. Free powerhouse selling kit, low prices, protection guaranteed on repeat orders. Cash commissions. Superior Match Co., Dept. M-150, 7530 Greenwood, Chicago.

SELL Ultra-blue stock signs to stores. 1000 slogans, comedy, general, religious. "7x11" cost 6c, sells 35c. Make money. 15 samples ultra-blue signs "7x11" \$1.00 postpaid. Lowy, 8 West Broadway, Dept. 512, New York City 7.

RICH Opportunity for men in their 50's. Healthful, pleasant occupation. No investment needed. 150 of our men made \$500 to \$3,000 in one month; many just beginners. Wallace made \$164 first 2 hours; Crowley made \$224 first day; exceptional earnings. Openings available. Write President, Box 711, Dept. PM, Fort Worth 1, Texas. Canadian address: Box 158, Dept. PM, Terminal "A," Toronto, Ontario.

SALESMEN. Earn \$50.00 weekly, selling only three pairs shoes daily. Commission and bonus. Wide variety for men, women, children. No investment. Experience unnecessary. Free catalog. Tanners Shoes, 559, Boston, Mass.

SELL New automatic floor waxer. Trigger on handle. Hands never touch floors or wax. Retail \$2.95. Profit 125%. Write Smith, Inc., Greenfield 2, Mass.

AMAZING Discovery, Master Glaze, puts brilliant glass-like surface on cars. Free sample, information. Big commissions. Master Glaze, Dept. 686, 7720 Harwood, Milwaukee, Wis.

SELL Automatic fire alarms now. Low cost, big profits. Needed every home, store, farm. Write Harmony Brass Co., Plano 3, Illinois.

SELL Art and commercial calendars. Advertising specialties. Over 1000 good-will items. Diversified line. Highest commissions. Territorial protection. Send \$1.00 refundable deposit for prepaid initial set of samples. Standard Calendar Company, Madison, Illinois.

AMAZING Profits—Repeats sell Lastic Plastic, world's best work gloves. Outwear canvas 10 to 1. Literature free. Modern Company, 12392-D Ohio Street, Detroit 4, Mich.

WHY Not try selling? Men have succeeded selling shoes who believed they could not sell. Free selling outfit puts you in secure business. Consolidated Shoe System, Dept. S-421, Chippewa Falls, Wis.

SALESMEN—Sell America's finest, biggest line of adv. specialties. Sensational sellers to all types of business. Big commissions advanced. Sensational sales plan nets you top earnings. Free outfit. Charms & Cain, 407A South Dearborn, Chicago 5.

SALESMAN. Sell custom made aluminum name plates. Easy to sell. Good profits. Write for particulars. Jackson Aluminum Co., Box 26, Jackson, Ohio.

UNIFORMS Highly styled for nurses, beauticians, waitresses, doctors, housewives. In nylon and other materials. All colors. Highest commissions in industry. Write for details. Uniform Corp. of America, 121 E. 59th St., New York 22, N. Y.

OVER \$500 Weekly average several weeks for Maurice and Ruffo. \$250 weekly common, selling patented tool. Demonstration 2 min. Inexpensive. Prospects everywhere. Exceptional sales proposition. Palcoseel Co., Ltd., Massena PM1, N. Y.

NEW Jobs open in selling! Send name, address for five free issues of Opportunity Magazine's money-making guide, listing hundreds of companies who'll pay you well full or part-time. No experience needed. Opportunity, 28 E. Jackson, Dept. 17, Chicago 4, Ill.

BIG Money taking orders. Shirts, ties, Sox, pants, jackets, sweaters, shoes, uniforms, etc. Sales equipment free. Experience unnecessary. Nimrod, 4922-AN Lincoln, Chicago.

LONG Needed invention. Established company. Every home, factory, store, farm a prospect. Low price, long profit. Exclusive. Fine outfit. No deposit. Information sent airmail. Write: Red Comet, Inc., Dept. 515, Littleton, Colo.

EDUCATIONAL AND INSTRUCTION

"BETTER Memory" will help you win friends and influence people. Write Thomas D. Harrison, 726 N. 15th, Waco, Texas.

USED Correspondence courses and books bought, sold, rented and exchanged. Catalog free. Lee Mountain, Pisgah, Alabama.

PRACTICAL Trigonometry by mail. From actual engineering experience. No textbooks. Individual attention. Details free. Erpenstein, 74 Idora, San Francisco 16.

BOOKKEEPERS—Male or female. Study practical credit management with an experienced credit man. J. Cooke, 116 St. Stephen St., Boston, Massachusetts.

ELECTRICAL Wiring. Learn at home from licensed master and journeymen electricians. Master Electrician Institute, Box 244-B2, Fitchburg, Massachusetts.

BE A disc jockey. Pays big. Easy to learn. Free details. Jockey Jack, Box 5751, Chicago 80m, Illinois.

BECOME A Doctor of Psychology or Metaphysics. Teach secret of contentment, happiness. Win degree of Ps.D. or Ms.D. Solve mental worries. Free book. College of Universal Truth, 5153-C North Clark, Chicago.

LEARN Piano tuning at home. Unlimited income. Sound recordings, tools and instructions furnished. Write Capitol City Tuning School, Department C134, 129 East Michigan, Lansing 16, Michigan.

LEARN Auctioneering now. Term soon. We teach by mail, too. Sample lesson free. Write Nelson Auction School, Renville 184, Minnesota.

LEARN The collection agency business. Highly profitable. Easily mastered. Free folder. Cole Associates, Syracuse 2, N. Y.

PIANO Tuning pays. Learn this profitable profession at home. Our Tonometer and mechanical aids make learning easy. No knowledge music necessary. Diploma granted. Largest and oldest school—52nd year. G.I. approved. Write for booklet. Niles Bryant School, 78 Bryant Bldg., Washington 16, D. C.

BOOKKEEPERS! Increase your earnings! Operate your own simplified "dollar-a-week" bookkeeping and tax service. Full or spare time. Details free. No obligation. Ellis, Box 200, Cedar Grove, N. C.

"HOW To Break and Train Horses"—A book every farmer and horseman should have. It is free; no obligation. Simply address Beery School of Horsemanship, Dept. 1101C, Pleasant Hill, Ohio.

BE A real estate broker through home study or classroom instruction. Write for free book. Approved for veterans. Weaver School of Real Estate, 15 E. Pershing Rd., Box CP-1, Kansas City 8, Missouri.

MAKE Up to \$35-\$45 week as a trained practical nurse! Learn quickly at home. Booklet free. Chicago School of Nursing, Dept. M-1, Chicago.

USED Correspondence courses and educational books, bought, sold, rented, catalog free. Educational Exchange, Summer-ville, Ga.

STUDY For game warden, park, fish, patrol and wildlife conservation service exams. Details free. Write Delmar Institute, C11, Denver, Colo.

NON-Resident courses: High school, college. Earn Triplespeed selfstudy shorthand. Capital City College, Washington 5, D. C.

ABACUS Operator defeats electric calculator operator! Why not you? Mastered ten lessons, \$10; first, including practice abacus, \$2.00. Osborne University, 229 East 45th, San Bernardino, California.

INVESTIGATORS Needed in every town. Hanna, 3911 Tacon, Tampa 9, Florida.

READ With speed! New, amazing method. Save hundreds of hours yearly. Free home test. No obligation. Rush postal. Brownson, 9111 Hoyne, Chicago 20.

AVIATION Work—Engineering and mechanics. Top salaries. Big demand for trained men. Qualify yourself. Free catalog, job lists and full information. Write: Cal-Aero Technical Institute, Dept. C-6, Grand Central Air Terminal, Glendale 1, California.

USED Correspondence courses bought, sold, rented. Literature free. Baker, 5509-B Winthrop, Chicago 40.

SUCCEED At exams. Sensational simple method. Apartado 3246, Caracas, Venezuela.

PHOTOGRAPHIC Mind with Super-memory. Write Thor Books, P-1, Box 1210, Chicago.

INCREASE Your earnings—Learn watch repairing at home. Ten easy lessons. We furnish free watches and all tools. A licensed school. Large percentage of students make up to \$40 a week in spare time while learning. Write today for free information. Illinois School of Watch Repairing, Dept. CPM-1, 2870 Elston Ave., Chicago 18, Ill.

EXPORT! Learn at home from established world trader. Big paying positions. Your own profitable world-wide business by mail order without capital; or travel abroad. Experience unnecessary. Free booklet. Mellinger, 101W, Los Angeles 24, California.

1500 GOVERNMENT Jobs. Start high as \$66.34 week. Men-women. Qualify now for secure positions. Many openings expected soon. Don't delay. Write today for free 40-page book showing jobs, salaries, sample tests. Franklin Institute, Dept. A-24, Rochester, N. Y.

WRITE For pay and pleasure! You can make extra money, have fun, when you take our "earn while you learn" writing courses. We back up our statement with 31,000 satisfied students. Send penny postal today for free details. Comfort Writer's Service, 200 S. 7th St., Dept. PM150, St. Louis 2, Mo.

SHORTHAND In one week. Easy long-hand system. Excellent for secretaries, students. \$1.48. Zinman, 215J West 91, New York 24, New York.

FREE "Check-Chart." Income "booster" plan. Professor Martin, Bonners Ferry, Ida. Mention occupation, plan.

STUTTER? Stammer? Literature sent free. Teurfs Studio, 25 E. Jackson, Chicago 4, Ill.

"HOW To get a job." How to find the work you are best suited for can transform your entire life. Write for details. Bushnell, 25 Union Park, Boston, Mass.

SECRET Investigation. Experience unnecessary. Investigators particulars free. George Wagner, M 125 West 86th, New York.

INVESTIGATOR Training. Robert B. Phillips, Sr., founder. 35 years investigator experience. Formerly U. S. Govt. special agent. For free particulars write the Phillips Secret Service System, 1917-B North Kenneth Ave., Chicago 39, Illinois.

DENTAL Technician's kit. Artificial teeth, plastic, etc. Technician's manual. Grant Laboratory, 219 W. 7th, Los Angeles 14, Calif.

LINGUAPHONE Makes languages easy. At home learn to speak Spanish, Portuguese, Italian, French, German, Russian, by quick, easy Linguaphone Conversational Method. Save time, work, money. Send for free book. State if G.I. Linguaphone Institute, 83 RCA Bldg., New York 20, N. Y.

MEDICAL Laboratory Technicians in great demand. We train you in your own home. Catalogue free. Imperial Technical Institute, Box 973-J, Austin, Texas.

STUDY To be a doctor of psychology or metaphysics. Obtain Ps.D., Ms.D., D.D. or Ph.D. degree. Chartered by state. Write for free book telling how. The Neotarian Fellowship, P.O. Box 148, Los Angeles 53, California.

PLAYS, STORIES, MANUSCRIPTS

FREE—My talk "Column Writing That Pays." Ben Arid, 1141-7th St., Hermosa Beach, Calif.

I WANT New writers to cash checks of \$1 to \$100 offered daily. The easiest way to write for pay. No previous experience necessary. Free details. Saunders M. Cummings, 468-11 Independence Bldg., Colorado Springs, Colo.

BUSINESS SERVICE

PURCHASING Service; most products, material or equipment. State wants, Kelly, BD-9544 Whitcomb, Detroit 27, Michigan.

MIAMI Postmark! Letters 25c. New list of homeowners \$6.00-1000. McDowell, 504 Pacific Building, Miami 32, Florida.

NEW Products. Bulletin 25c. Chaffee, 1611 Chicago Ave., Evanston, Ill.

SPECIAL SERVICES

THREE Letters 20c, postmarked Davenport, Iowa or Buffalo, N. Y. 117 East 11th, Davenport, Iowa.

CIRCULARS Mailed. Envelopes addressed. Choice mailing lists. Many classifications. Smith, Box 6, Mt. Pleasant, Fla.

CUBA—Letters remailed, 25c each. R. Morejon, Box 1291, Havana.

INDEPENDENCE Postmark. Letters 25c each. Patterson, 312 N. Main, Independence, Mo.

ERRANDS And confidentials accomplished New York City. Reasonable. DeLaurent, 239 55th Street, Brooklyn 20, N. Y.

INFORMATION

"HOW To borrow money." Free booklet. Tanner Enterprises, Gainesville, Tex.

CARTOONING, COMMERCIAL ART, SHOWCARD WRITING, SIGN PAINTING

SHOWCARD Writing pays big! Learn rapid, artistic lettering quickly, easily. Our low-cost course shows how. Details free. Sherwood Publishing Co., Irvington 3, N. J.

"HOW To Make Money With Simple Cartoons"—A book everyone who likes to draw should have. It is free; no obligation. Simply address Cartoonists' Exchange, Dept. 91-C, Pleasant Hill, Ohio.

CARTOON Your way to success! Internationally known instructor, Raye Burns, will personally teach you to create salable, original cartoons at home. Course of 26 lessons only \$2.85. Send remittance with order or write for free details and addresses of successful students. Raye Burns School, Box 3583-M, Cleveland 18, Ohio.

CARTOONS Printed. Write School of Cartoons, Box 3291, San Francisco 19, California.

FAMOUS \$75 Lockwood Art Course now only \$6 postpaid. Other smashing art bargains. Catalog 10c. Art Book Shop, Arnold 7-D, Mo.

SIGN Painting taught at home. Test lesson free. Ben Kerns, Box 812-T, Greenville, S. C.

9 ALPHABET 3 Numeral pattern sets and catalog. \$1.00. Sign Letter Distributors, P.O. Box 101, Mineola, N. Y.

CHALK Talks. Laugh producing program. \$1.00. Catalog 10c. Balda The Cartoonist, Oshkosh, Wisconsin.

LEARN Professional lettering. Easy, experience unnecessary. Amazing mechanical process. Complete instructions, 75 alphabets, 250 designs \$1.00. Major-Art System, 3510-A Palmer, Chicago 47.

ADVERTISING AGENCIES, LETTER WRITERS, FOR ADVERTISERS

FREE! 1949 Advertisers Rate and Data Directory. 52 pages! E. H. Brown Advertising Agency, 20 N. Wacker, Chicago 6.

10,000 MAILORDER Prospects read "The W-H Mail Dealer." Write for literature and rate card. W-H Publications, Box 1285-PM, Nashville, Tennessee.

SUCCESSFUL Advertising, only \$2.00, postpaid. Satisfaction guaranteed. William Bennett, 114-35J 116th Street, Ozone Park 16, New York.

MAIL-ORDER—Sales letters, literature, advertising prepared to produce business! Muchnick Co., 150 Nassau, New York 7.

ADVERTISE: 24 Words, 40 newspapers \$3.50. Lists free. Advertising Bureau, 10511-C Springfield, Chicago 43.

CIRCULARS Mailed first class mail 25c per 100. Israel Company, Box 6051-P, Washington 5, D. C.

CANADIAN Mailorder buyers names 1c each, minimum \$1.00; any classification. Untapped mailorder market. Craigie, Box 307AC, New York 19.

AVOID Costly advertising mistakes. Get enlightening Ad-Guide and Ratebook leading newspapers, magazines, mailing lists, 10c. Chicago Advertising Agency, (Established 1900), Chicago 4.

ADVERTISERS! Reach nearly 18,000,000 readers. 25 Sunday national key newspapers, 18 words, \$51.50. "Terrific pullers." 20 popular newspapers, \$10.00. "Free booklet." Special—One inch display 2, 821,198 circulation, \$48.30. Newmark's Advertising Agency, (Established 1893), 217-7th Ave., New York 11.

24 WORDS In 50 weeklies, \$4.96. J. Darnell, 730 Hays, Jackson, Tennessee.

REACH Spanish-speaking mail-order buyers. Great new market for your merchandise. Your classified ad in the Spanish Edition of Popular Mechanics will bring you some nice business from this new field. Rate only 25c per word. Circulation 100,000 copies. Mail a trial ad right now. Popular Mechanics Magazine (Spanish Dept.), 200 E. Ontario Street, Chicago 11, Ill.

ADS Placed in out of town newspapers and magazines. Low rates. Catalogue free. Ideas that pay. Baker Advertising Agency, Successors Ankrum Agency, 189 W. Madison, Chicago 2.

TYPEWRITERS, DUPLICATORS, OFFICE DEVICES

TYPEWRITERS \$17.50; duplicators \$9.75, adds \$12.50. Typewriters, 118 Spruce, Wichita, Kansas.

ABACUS, Loy's. Does work of adding machine and slide rule. \$6.50. Details free. Loy's, 1317 Rhode Island Ave. N.E., Washington 18, D. C.

NEW Selffeeding mimeograph prints postcard to full letter size. Only \$27.50. Factory discount to distributors. Dansen Company, Hopkins, Minnesota.

ADVERTISE. Increase business. "Printomatic" selffeeding "mimeograph" post card duplicator prints, reproduces, thousands anything typewritten, handwritten, \$13.50. Literature. Pittsburgh Typewriter Company, 336-3 Fourth Avenue, Pittsburgh 22, Penna.

RUBBER STAMPS AND OFFICE SUPPLIES

MIMEOGRAPH Paper, 68c ream, samples. Brookman, 56-A West 24th, New York 10.

RUBBER Stamps. Send for catalog. Excello, Box 500, Shreveport, Louisiana.

LINE 20c; 2-35c; 3-50c. Stamp Works, Auburn, Nebraska.

PRINTING OUTFITS AND SUPPLIES

PRESSES, Type, cabinets, supplies. List for stamp. Lincoln Press Company, 220F Hartwell, Fall River, Mass.

PRINTING Presses, type, supplies. Details free. Kelsey Presses, K-11, Meriden, Conn.

HAND Presses, automatics, type, cabinets, cutters, bulletins, 3c. Requirements? Box 918-CS, New York 8.

MAKE Your own rubber printing cuts. Self molding process. Plexirubber, Argyle 1, Wisconsin.

CASH Paid for presses. Printers Exchange, 212 Curtis, Meriden, Conn.

PRINTING Presses, type, supplies. Lists 3c. Turnbaugh Service, Loysville, Penna.

PRINTING, MULTIGRAPHING, MIMEOGRAPHING, GUMMED LABELS

QUALITY Mimeographing, reasonable, prepaid, free sample, prices. Arnold, 1305A Gough, San Francisco 9, Calif.

100 8½ x 11 HAMMERMILL Letterheads and 100 envelopes \$1.85. Herbert Hudson, Centredale, R. I.

SATIN Ribbons printed—For lodges, etc. Samples. C. R. Greene, Tipp City, Ohio.

NEED Printing? Write for samples, prices. Gooch, 202PM, Hernando, Miss.

5000 6¾ ENVELOPES Printed \$2.75 per thousand, price list free. Michel, Box 76F, New York 16.

MIMEOGRAPHING—250 8½ x 11, \$2. Samples, prices, free. Mimeographing, Madison, Tenn.

125 LETTERHEADS 8½ x 11 White bond, 5 lines, \$1.00. Envelopes same. Postpaid. L. & F. Printers, Box 5531-M, Chicago 80, Ill.

SEND 10c Now, for our 48 page 1950 price list—refunded first order. McCalk Press, 1326 South 27th, Omaha, Nebraska.

MIMEOGRAPHING 35c Per hundred. Cut your own stencils. Instructions free. Rush service. McCann, 436 March, Shilington, Penna.

100 ENVELOPES Printed, 2-colors \$1.00. Box 523, Rochester 2, N. Y.

500 8½ x 11 LETTERHEADS \$2.75. Other specials. Universal Printing-Embossing, 203 Avon Avenue, Newark 8, N. J.

250 8½ x 11 WHITE Letterheads with envelopes \$3.00. Webpress, Farmland, Indiana.

BUSINESS Letterheads, envelopes, cards. Samples. Crow, 533 18 St., Huntington 3, West Virginia.

PERSONAL, Business stationery. Free catalog. Spenn, 1728 Mardell, San Antonio, Texas.

200 SINGLE Sheets or 100 folded and 100 envelopes printed, Hammermill bond, \$1.50. John T. Robinson, Printer, Ansonia, Conn.

1,000 EMBOSSED Business cards \$4.00. Geo. Siman, 3538 W. Melrose St., Chicago 18, Ill.

BUY Your printing wholesale. Lowest prices in America. Louis Enterprises, Box 5, Hazel Park, Mich.

FEATHERWEIGHT Business cards, two thousand only \$3.00. Free samples. Havos, 1133 Broadway, New York 10, N. Y.

QUALITY Printing. Lowest prices. Anything in any quantity. Free price list. Albert Wilcox, Nichols, Georgia.

BETTER Printing—Reasonable prices. Send 10c for 1950 catalogue and samples. Refunded first order. Mills & Burnham, No. Abington, Massachusetts.

MIMEOGRAPHING—Reasonable. Any copy. Mailers Service, Box 606-A, Chicago 90, Ill.

1000 BUSINESS Cards \$2.50 prepaid. Samples free. Reliable Print Shop, 905 East Jefferson, Louisville 6, Ky.

MIMEOGRAPHING, Vari-Typing, letter writing. Free price list. Loyal C. Brush, 3303 Paseo, Kansas City 3, Mo.

BETTER Grade printing reasonable. Estimates on anything. Economic Press, Leona, N. J.

MIMEOGRAPHING—Any copy; bargain prices! Topical Emprise, 1527 Highland, Box 42-P, Louisville 4, Ky.

EMBOSSED Business cards, 1000, \$3.45 postpaid. Samples. Spada Enterprises, 10C Lexington, Wethersfield 9, Conn.

QUALITY Printing! Free price list. Nationwide Printing Company, Dept. PM, 2337 Bath Avenue, Brooklyn 14, N. Y.

500 3¼x2¼ FOUR Line gummed stickers 35c; red border 50c. Moritz Printery, Saginaw, Mich.

MIMEOGRAPHING—Letters, pricelists, formulas, instructions. Lowest prices. Lem's Letter Shop, 5710 Stanton, Detroit 8.

PATENT ATTORNEYS

PATENTS, Trademarks; Mexico, Latin America. Particulars free. International Patent Bureau, Mexico D. F., Apartado 1927.

INVENTORS: Learn how to protect your invention. Unless the inventor is familiar with patent matters, he should engage a competent registered patent attorney or agent to represent him. We are registered to practise before the U.S. Patent Office and prepared to serve you in handling your patent matters. "Patent Guide for the Inventor" containing detailed information concerning patent protection and procedure with "Record of Invention" form will be forwarded to you upon request—without obligation. Clarence A. O'Brien & Harvey Jacobson, Registered Patent Attorneys, 01B-A District National Building, Washington, D. C.

INVENTORS—If you consider your invention to be something of importance, take steps to protect it with a United States Patent which gives you the right to exclude others from making, using and selling your invention as claimed. "Patent Protection for Inventors" outlines steps to take to secure patent protection. Mailed promptly without obligation. Victor J. Evans & Co., Merlin M. Evans, Registered Patent Attorney, 531-A Merlin Building, Washington 6, D. C.

INVENTORS—Patent laws encourage the development of inventions. The Rules of Practice of the U. S. Patent Office advises—unless an inventor is familiar with such matters; that he employ a competent registered attorney or registered agent, as the value of patents depends largely upon the skillful preparation of the specifications and claims. Write for further particulars as to patent protection and procedure and "Invention Record" form at once. No obligation. McMorro, Berman & Davidson, Registered Patent Attorneys, 134-S Victor Building, Washington 1, D. C.

PATENTS—Trade marks. Gustave Miller, Registered Patent Attorney, 10-A Warner Building, Washington 4, D. C. Patent Lawyer.

REGISTERED Patent attorney offers services. Sanders, 6430 Evans, Chicago 37, Ill.

HERMAN Lewis Gordon, registered patent attorney. Patent investigations and opinions. Warner Building, Washington, D. C.

PETER Fries, Jr., Registered Patent Attorney. Patents, trademarks, novelty searches, copyrights. 110 East 42nd Street, New York City.

PATENTS. "Proof of Invention" folder mailed without obligation. E. E. Vrooman, Registered Patent Attorney, 507 McKim Building, Washington 5, D. C.

CANADA—Ramsay Company Registered, 273 Bank Street, Ottawa, Canada.

PATENTS—Trade marks. Irving L. McCathran, 315 McLachlen Bldg., Washington 1, D. C. Registered Patent Attorney.

C. A. SNOW & Co.—M-427, Snow Building, Washington 1, D. C. Registered Patent Attorneys. Write for information.

INVENTORS: When you are satisfied that you have invented something of value write me, without obligation, for information as to what steps you should take to secure a patent. Write Patrick D. Beavers (Formerly Randolph & Beavers) Registered Patent Atty., 935 Columbian Bldg., Washington 1, D. C.

INVENTORS: Without obligation, write for information explaining the steps you should take to secure a patent. John N. Randolph, Registered Patent Attorney, 293 Columbian Bldg., Washington 1, D. C.

"INVENTOR'S Guide" free on request. Frank Ledermann, Registered Patent Attorney, 154 Nassau St., New York 7, N. Y.

INVENTORS: Write for free brochure "Evidence of Invention." Labiner, World Building, New York 7.

PATENT Practice before U. S. Patent Office. Validity and infringement investigations and opinions. Booklet and form "Evidence of Conception" forwarded upon request. Lancaster, Allwine & Rommel, Registered Patent Attorneys, Suite 411, 815-15th Street, N.W., Washington 5, D. C.

INVENTORS. For "Record of Invention" form, contact Carl Miller, Registered Patent Attorney, Woolworth Building, New York.

FOR INVENTORS

INVENTORS—Patent laws encourage the development of inventions. The Rules of Practice of the U. S. Patent Office advises—unless an inventor is familiar with such matters; that he employ a competent registered attorney or registered agent, as the value of patents depends largely upon the skillful preparation of the specifications and claims. Write for further particulars as to patent protection and procedure and "Invention Record" form at once. No obligation. McMorro, Berman & Davidson, Registered Patent Attorneys, 134-R Victor Building, Washington 1, D. C.

CASH For your ideas, inventions, patents. A complete marketing and sales service with manufacturers and distributors covering entire country. Free list. Marketing Bureau, 228 N. LaSalle, Chicago.

NEW Products wanted for export. Details 3c. Brokerage, Milbank, S. D.

INVENTORS—This firm is registered to practice before the United States Patent Office and is available to assist you in the preparation and prosecution of your patent application. "Patent Protection for Inventors" booklet containing detailed information and steps to take toward patent protection will be sent upon request. No obligation. Victor J. Evans & Co., 532-A Merlin Building, Washington 6, D. C.

INVENTORS: Learn how to protect your invention. Unless the inventor is familiar with patent matters, he should engage a competent registered patent attorney or agent to represent him. We are registered to practise before the U.S. Patent Office and prepared to serve you in handling your patent matters. "Patent Guide for the Inventor" containing detailed information concerning patent protection and procedure with "Record of Invention" form will be forwarded to you upon request—without obligation. Clarence A. O'Brien & Harvey Jacobson, Registered Patent Attorneys, 91A-K District National Building, Washington, D. C.

FREE Advice. How to obtain a patent and sell your invention. Henry, 2815 Boulevard, Jersey City 6, N. J.

SEARCHES \$5.00. Includes patent copies. Same reliable search as conducted for attorneys. 48 hour service. Free protection forms. Patent Service Institute, 945 Pennsylvania Avenue, Washington 4, D. C.

DEDICATED To more worthwhile inventions; fewer worthless patents. Inquire today. Dept. 324, Inventors-For-Industry Inc., 501, 1947 Broadway, New York 23.

PATENTED. Unpatented inventions promoted. M. Joyce Humphries, 1424 Landtitle, Philadelphia 10, Penna.

INVENTORS-For-Industry. Scientific programme for successful inventing improves quality and quantity of ideas and demonstrates modern sales-ways. Dept. 324, Inventors-For-Industry Inc. 501, 1947 Broadway, New York 23.

INVENTIONS Wanted. Prominent manufacturers and national distributors look to us for new products. You can also benefit by having us assist you with your invention from the idea stage through to the developed product, fully protected. Ask for Booklet "M." Elo Development Co., Chatham Phenix Bldg., Long Island City 1, New York.

PATENT Searches \$5.00. Includes nearest patent copies. 48-hour service. Free protection forms. Patent Research Engineering, 318 Evans Building, Washington 5, D. C.

PATENT Searches \$5.00. Reports airmailed within 4 days. Invention protection forms free. Write Raymond L. Smith, Patent Searcher, 410 Bond Building, Washington 5, D. C.

PATENT Searches \$5.00. Reports airmailed within 4 days. Invention protection forms free. Write Miss Ann Hastings, Patent Searcher, P.O. Box 176, Washington 4, D. C.

INVENTORS—Wait! Compare the selling, development, etc., help offered you by over 50 organizations first before you act. \$2 brings Directory of Inventor Aids. Drawer 1289B, Clearwater, Fla.

COMPLETE Services for inventors. Patent searches including analysis, patent copies. Inventions, patents marketed. Protection forms free. Industrial Patent Reports, Box 1081, Massachusetts Avenue and North Capitol, Washington 13, D. C.

PATENT Owner Representative. Years of experience. Can I help you? Charles A. Scott 773PM Garson Avenue, Rochester 9, N. Y.

INVENTORS: Without obligation, write for information explaining the steps you should take to secure a patent on your invention. John N. Randolph, Registered Patent Attorney, 293 Columbian Bldg., Washington 1, D. C.

CASH For your idea. 280 manufacturers need inventions, patented or unpatented. List free. Invention Bureau, 208M Clinton, Oak Park, Illinois.

INVENTORS: If you have an invention for sale, patented or unpatented, write Institute of American Inventors, Dept. 40A, 1926 Eye St. N.W., Washington 6, D. C.

"INVENTOR'S Guide" free on request. Frank Ledermann, Registered Patent Attorney, 154 Nassau St., New York 7, N. Y.

INVENTORS. For "Record of Invention" form, contact Carl Miller, Registered Patent Attorney, Woolworth Building, New York.

INVENTORS: The usual first step is to have a search of the U. S. Patents conducted, so I can report on patentability. Write, without obligation, Patrick D. Beavers (Formerly Randolph & Beavers), Registered Patent Atty., 936 Columbian Bldg., Washington 1, D. C.

INVENTIONS WANTED

LEVEL-Headed inventors are invited to discuss their plans with Dept. 324, Inventors-For-Industry Inc., 501, 1947 Broadway, New York 23, after obtaining free booklet.

INVENTIONS Promoted. Patented or unpatented. Write Adam Fisher Company, 61 Enright, St. Louis, Mo.

BY Mechanical manufacturer. Advise patent-number. Room 5-D, 2100 Walnut, Philadelphia.

IMAGINEERING: A new name for successful inventing in the world today. If you are inventive-minded, learn more about it. Dept. 324, Inventors-For-Industry Inc., 501, 1947 Broadway, New York 23.

INVENTORS—What have you, patented, patent pending to offer manufacturers? Booklet, information free. Market Contacts, 11106-A2 Longwood, Chicago 43.

FIRE Prevention and equipment inventions needed now. Details free. Continental Research, 1413 Lake, Wilmette, Ill.

HIGHEST Royalties—Cash. Request free Booklet "M." Universal Marketing Co., 354 South Spring St., Los Angeles 13, Calif.

INVENTORS: Hundreds of manufacturers have requested our assistance in locating marketable new products. Complete information, free. Institute of American Inventors, Dept. 40-D, 1926-Eye St. N.W., Washington 6, D. C.

CASH For your idea. 280 manufacturers need inventions, patented or unpatented. List free. Invention Bureau, 208M Clinton, Oak Park, Illinois.

INVENTIONS Wanted. Patented or pending only. Inventors' Exchange-B, Hartford 1, Conn.

PATENTS FOR SALE

PATENT Magnetic hammer. Royalty basis. L. Hertz, R. 3, Farmington, Mo.

FISHING Rod carrier. Fits outside car window. Well engineered, substantial. Carries several rods set up ready for use. Dies for immediate quantity production available. Exclusive national sales rights open. No agents. "Inventor," 109 Sycamore, Pittsburgh 11, Penna.

BEST Offer takes two inventions. Rubber insulator for wires of electric fences, and corner brace for fences. Write James F. Verner, Pocahontas, Iowa.

ONE Man does all work of machine shop crew; get circular. Dysthe, 3136 10th Ave. So., Minneapolis, Minn.

INVENTORS: Test the commercial value of your patented or unpatented inventions, quickly and inexpensively. Write for free information. Institute of American Inventors, Dept. 40-B, 1926-Eye St. N.W., Washington 6, D. C.

MANUFACTURING

MANUFACTURING For particular people. Tool, dies, stampings. Porsberg, Northfield, Ohio.

EXPERIMENTAL And model-work tools, dies. Mfg. Engineers & Machinists since 1896. Baum's Metal Specialties, Kansas City, Mo.

MANUFACTURING: Inventions developed, models, jigs, fixtures. Henry, Engineer, 2815 Boulevard, Jersey City 6, N. J.

FREE Estimates: Models, small lot manufacture, design, metal, plastics, etc. Petty Manufacturing, 5033 Exposition, Los Angeles 16, Calif.

MODELS, Tools, dies, experimental work; large and small lot manufacturing. Van-Ess Specialties Company, 212 W. 14th Street, Covington, Ky.

SMALL, short run, automatic screw machine products up to 5/16" diam. Small stamping. Send sample or drawing. Fisher, 1002 Etowah Ave., Royal Oak, Mich.

WANT Something made? We'll make it. Consultation free. Write Jayemm Company, Burlington, Kentucky.

MODELS — Small lot manufacturing. Metals, plastics, etc. Milburn, Burlington, Kentucky.

MODELS, MODEL SUPPLIES

READY! Our 1950 catalog of ship model kits and fittings; sail, steam, diesel. Send 25c for catalog. Model Shipways Folio, 60, 476 Main St., Fort Lee, N. J.

TINY Power miniature steam engines, locomotives, boilers, fittings, steam tractors. Catalog 25c coin. Chas. Arnold, Plant City, Florida.

BRASS Gears and model supplies for the inventors. Send 10c for catalog. Pierce Model Works, Tinley Park, Ill.

RAILROADERS—50c Gets new Catalog Reference Manual. State O or HO gauge. Walthers, 247 Erie, Milwaukee 2, Wis.

BUILD Historic ship models, complete kits. 39c to \$9. Catalog 10c. Ideal Models, 19 West 18th, New York 11, N. Y.

STEAM Marine engines, boilers, casting kits. Box 326, Evanston, Illinois.

STEAM Locomotives, 1 1/2", 3/4", 1/2", 1/4" scales. Castings, parts, rail, steam fittings! Thorough drawings with instructions. Catalog 35c. Little Engines, Lomita, Calif.

LIONEL Trains catalog 10c. 36 pages illustrated. Hobby Shop, 72 West Washington, Chicago 2, Illinois.

SHIP And yacht model fittings; blueprints. Send 25c for illustrated catalog No. 24—listing hundreds of items. A. J. Fisher, 1002-1 Etowah Ave., Royal Oak, Mich.

SHIP Models and yacht supplies complete. Large 64 page catalogue 30c. Bill Wild's, 510 East 11 St., New York City 9.

MINIATURE Engines, catalogue 25c, listing world's largest selection. Miniature Engine Laboratories, 200 Cement Avenue, Sandusky, Ohio.

HOME CRAFTSMEN

16 NEW Lawn chairs, 22 picnic tables, benches, trellises, etc. All 38 plans, with necessary full size patterns, \$1.00. Mastercraft 13M, 7041 Olcott, Chicago 31, Illinois.

LEATHERCRAFT Supplies, leather and tools, low prices. Send 10c for catalog. Jonas Handicraft Co., (Dept M-1), 32 Frankfort St., New York 7.

PLYWOOD Money-maker! Sells itself. Plan 25c. Box 56-A, Braintree 84, Mass.

HOME Craftsmen, make and sell field tested item. Stamp brings information. Centaur Products, 277 Jennings Road, P.O. Bridgeport 5, Fairfield, Conn.

LAWN Ornaments. Ready cut patterns, full size. 20 assorted \$1.00 postpaid. Lincoln Craft Studio, Farmington, Conn.

8 BEAUTIFUL Full-size whatnot patterns 25c. Joanness, P.O. Box 141-M, Omaha 7, Nebr.

TOYS, Novelties, furniture, garden figures, lawn chairs, etc. 68 popular plans with full size patterns, \$1.00. Mastercraft 11M, 7041 Olcott, Chicago 31, Illinois.

SELL Flying duck windmills. Send \$1.50 for sample. B. Reitz, 13820 Wentworth Ave., Chicago 27, Ill.

DON'T Be a drip, use Brushmaster Wiping Bar. You get professional painting results, stops mess, saves paint, time, money. Fits quarts, gallon cans. 25 cents postpaid, Ralph Rasmussen Co., Pontiac, Illinois.

LEATHER Carving. Fascinating, highly-paid art; age-old secrets now taught for first time in home study course. For hobby, profession or profitable business, write: Baird School of Leather Carving, Box 1367-C, Manitou Springs, Colo.

90 ALL New, full size lawn ornament and novelty patterns, up to 20" high. Only \$1.00. Mastercraft 12M, 7041 Olcott, Chicago 31, Illinois.

80 FULL Sized patterns. Lawn ornaments, toys, novelties \$1.00. Modern Woodcraft, Saginaw, Mich.

50 FULL Size, new 1950 novelty and lawn ornament patterns, up to 20" high, only \$1.00. Pattern Service, Medway 7, Mass.

BALSA, 11" x 11", Laminated. Up to 7' lengths, \$1.00 linear foot. Symington, Union Bay Place, Seattle 5, Wash.

LEATHERCRAFT Bargain list! Francis Byrd, 3406 Montrose Ave., Richmond, Virginia.

OLD Watch movements. \$1.00 each, six assorted \$5.00. Field Bros., 39-B South State Street, Chicago 3.

BANDSAW, Jigsaw owners, let your machine bring extra profits, fun. Free details. Nu-Art, Dept. B, Box 2235, Boston, Mass.

LEATHERCRAFT—Two link belt, bill-fold project, instructions. \$2.29 postpaid, craft catalog. Kale Crafts, 2250 Milwaukee, Chicago 47.

BIG. New, practical, fact-ful plastics book shows how to make swell things at home with new liquid plastic. Embed real flowers, butterflies, shells, photos, to make handsome wall plaques, coasters, paper weights, trays, etc. Cast unusual book ends, candle holders, desk sets, lamp bases. Plastize baby shoes or make profile silhouette plaques of children, dear ones. Also explains proved 6-point success plan for starting your own profitable plastics business. Hundreds successful. Send 25c for "A Success Plan for You." Castolite, Dept. TA101, Woodstock, Ill.

KITCHEN Cabinets. Modern, streamlined. Standard and custom designs. Complete units come partly assembled. Free literature and factory prices. Ellis-Petrik Mfg. Co., 200 McGowan Street, Dallas, Texas.

LEATHERCRAFT, Copper tooling, textile painting. Materials, tools, supplies. Free illustrated catalog. Kit Kraft, 7377 Melrose, Los Angeles 46, California.

SHELLS, Plastics, findings. Low prices. Free catalog. Frances Jones, Box 251, Sarasota, Fla.

CATALOG. Patterns: Plywood novelty furniture, lawn ornaments, silhouettes, weathervanes, letters, numerals. Decals, books, booklets. Hundreds illustrations, 10c. Wo-Met, Ashburn, Georgia.

MAKE Gifts from rare and beautiful Oregon myrtlewood, free price list. Myrtlecraft Studio, Grants Pass, Ore.

WHOLESALE Shellcraft Book 15c. Large shellcraft kit \$1.69 postpaid. Shell-Art Novelty, Dept. PM, 5th and Moore, Philadelphia 48, Penna.

CHINA Marking pencil set \$1. Ace, 1827 E. 21st St., Oakland 6, Calif.

TURN Your workshop into cash. Send time for new catalog describing hundreds of modern, saleable projects. Craftplans, 1321A South Michigan, Chicago 5.

DRESDENCAST Supplies, unpainted figurines. Send for free list. S. T. Farinella, 706 L'Orient, St. Paul, Minnesota.

LUMBER For home craftsmen. Cut to order. Write Forest Products Company, Box 341, Binghamton, New York.

LEATHERCRAFTERS—Complete stock calf skins tanned "hair-on" from unborn calf. Suitable for women's purses, men's wallets, lamp shades, etc. Sells at our tooling leather price. Write, Bay-River Trading Co., 1688 Pomona Ave., San Jose, Calif.

PROTRACTORS, Adjustable arm type, \$6.00 value, only \$1.50 each. Satisfaction or refund. Box 486, Detroit 31, Michigan.

SHELLCRAFT—Free catalogue and instructions. Complete line shells. Smooth beautiful colors. Findings. Rice's Shellcraft, Dept. B, 114 S. Court, Orlando, Fla.

LEATHER, Retail, mail orders, catalog, tools, lacing, supplies. National Handicraft Co., 30 Frankfort St., New York City 7.

LEATHERCRAFTERS: Belt kits, projects, leather, supplies. Free catalog. Art Leather, 411 Joseph Ave., Rochester 5, N.Y.

LEATHERCRAFT, Quality leather, lacing, tools and accessories at bargain prices. Free catalog. Frisco Krafts, Dept. A, Box 3016, Rincon Annex, San Francisco 5, California.

SPECIAL Offer: 80 full size toy, novelty, and lawn ornament patterns only \$1.00 postpaid. Lynds, Box 193D, Medway, Mass.

\$46 FROM Square foot plywood. Jigsaw necessary. Write, Woodarts, C-38, Bridge-water, Mass.

KNOCKDOWN Cedar chests. Lumber and veneers. Free price list. Giles & Kendall Company, Huntsville, Ala.

PROFIT With Larson Leathercraft. Belts, purses, 100 other ideas. Largest supply in U. S. Catalog 10c. Larson, Dept. C, 824 S. Tripp, Chicago 24.

JEWELRY Findings, rhinestones, pearls, sequins, cameos. J & M Novelties, Box 464P, Griffith, Ind.

MAKE IT YOURSELF

STREAMLINED. Built-in kitchen cabinets to fit any kitchen. Illustrated manual describes designing and construction. All for \$1.00. Thombert Company, Newton 10, Iowa.

SAVE 50%-75% Building our Zeolite home water softener. Complete engineered plans \$1.00. Carson Products Company, Room 201, Minneapolis 18, Minn.

BUILD Big two foot balsa glider. Will soar hundreds of feet. Complete parts and plans \$1.00. Grosser, 2854 Fairfield Ave., Bridgeport, Conn.

JUST Off the press—8-page folder illustrating 6 beautiful, popular lamps you can make; for yourself, for Xmas gifts, or to sell others. It's fun, highly profitable; as hobby, or part or full time basis. 8-page folder, 32-page parts catalog, wholesale price list only 25c; refundable first order. Gearon Company, Dept. 400-B1, 27 South Desplaines, Chicago 6, Ill.

BUILD Power cross cut saw sharpener and gummer. With circular saw sharpening attachment. Profitable sideline. Small cost. Scrap materials. Easy plans, illustrations, instructions \$1.00. Satisfaction guaranteed. Charles Lashley, Wellington 5, Ohio.

SIMPLIFIED 4-Way valve to operate single or double acting hydraulic hoists. Plans \$1.00. Post Office Box 297, Libertyville, Illinois.

FREE Handbook, build sawmills, block machines, freezers, tractors, scooters, 250 shop, farm, home machines. Nichols Co., Dept. C-301, Purvis, Miss.

BUILD Your own concrete blockmaker. Easy. Inexpensive. Motor or hand. Make block per minute. Write, C. Lee, Mountain View, Okla.

BENCH Light—Move, raise, lower. Stays placed. Instructions 20 cents. Bradley, Box 237, Springfield, Mass.

GRANDFATHER Clock easily built. Big savings. See ad on page 245.

STEAM Cleaner. Build your own. Plans \$1.50. See our ad on page 268. Connery Mfg. Co., Adrian, North Dakota.

BUILD Your own "tractor." Plans, instructions, Walking, Riding. Send postcard. Free information. Ellsworth Tractor Co., D-1, Camptonville, California.

SOLAR Water heater systems efficient any locality. Standard materials, low cost. Free facts. Solar Water Company, Box 175, Coral Gables, Florida.

"CONCRETE Block Homes." 32 page booklet on how to build. \$1.00. H. C. Lightfoot, Civil Engineer, Richboro 1, Penna.

PLANS AND BLUEPRINTS

BLUEPRINTS, Woodworking, and over hundred other plans. Catalogue 25c. Dealers wanted. Kimo, Box 307J, New York 19.

WATCHES, OLD GOLD, JEWELRY

HIGHEST Prices paid for old gold, silver, platinum, diamonds, watches, gold teeth, spectacles. Cash immediately. Goods returned if offer unsatisfactory. Government licensed. United Smelting Works, (The Old Reliable), 39-B South State, Chicago 3.

HIGHEST Cash prices paid for old gold, diamonds, coins, gold teeth, rings and watches. Satisfaction guaranteed. Argee, Dept. PM1, 2824 S. Cloverdale Ave., Los Angeles, Cal.

"WATCH Tinker kit," instructions, catalogue \$3.95. Bengal Company, Culver City, California.

DIAMOND Like zircons; Alexandrites; rubies; others. Flery sample zircon \$2.00; c.o.d.'s accepted, \$1.00 deposit. Free price list. Imhuxex, Box 232, Dept. PM, White Plains, N. Y.

HIGHEST Cash paid for old, broken jewelry, gold teeth, watches, silverware, diamonds, spectacles, platinum. Free information. Satisfaction guaranteed. Government licensed. Rose Smelting Company, 29-A East Madison, Chicago.

WATCHMAKERS' Journal contains helpful hints on watch repairing. Sample copy 20c. Dean Co., 116-K Nassau St., New York 7, N. Y.

TOBACCO, SMOKERS' SUPPLIES

FREE Literature. Imported briar block bored and fitted with bit—only \$1.00. Carvapipe, 2829-G Dixie, Hamilton, Ohio.

PENCIL-Lighter. Do you smoke, write? Assumulated gold lighter \$1.00 postpaid. Johnny's Craft, Box 229A, Flushing, N. Y.

CIGARETTES—Popular brands \$1.51 per carton postpaid. West of Mississippi add 7c per carton. Min. order 3 cartons. Send check or money order. King Co., Elkton 3, Maryland.

RAZORS, BLADES, SHARPENING

100 RAZOR Blades. \$1.00; 1000, \$6.00. Guaranteed. Specialties, Box 1524, Waterbury, Conn.

FOR THE HOME

GREATEST Home invention since electricity. Illustrated literature free. Robert Poarche, 1034-A N.E. Russet St., Portland 11, Oregon.

QUEEN Pot type range burners wholesale \$24.40. Free literature. Casier Utilities, Saranac Lake, New York.

OF INTEREST TO WOMEN

1000 WAYS To save time, money, labor. Amazing new book "Short-Cuts to Better Housekeeping." 160 pages packed with ideas every housewife will appreciate. Well illustrated. Only 60c postpaid. Popular Mechanics Press, Dept. SC, 200 E. Ontario St., Chicago 11, Illinois.

FOR SALE—MISCELLANEOUS

WHOLESALE Hosiery. Nylons, rayons, cottons, 8c pair. Complete stock list 25c. Sibert Mills, Chattanooga 4, Tenn.

DRESSES 18c; Coats \$1.00; blouses 35c. Free catalog. Crown, 164-PA Monroe Street, New York 2.

FREE Catalog! War surplus clothing bargains. N. Y. Clothing Co., New York 29.

UNIVERSAL Joints 3/4" x 3", undrilled; tool bits 1" x 6"; oil bath air filters; 8-piece combination midget wrench set; \$1.00 each. Cuno oil filters, \$3.95. Army mine detectors, \$49.50. Nylon waterproof tarpaulins 4' x 4', \$1.95; 6' x 7' \$4.95; 7' x 10', \$7.95; 11' x 12', \$14.95; 11' x 18', \$19.95. Prepaid, no c.o.d.'s. United Surplus, 233 Broadway, Oakland, Calif.

USED Vending machines. Largest selection. Satisfaction guaranteed. Vassar, Cleveland 5, Ohio.

WAR Surplus, aircraft items. Shop equipment, machinery and a million other items. Send 10c for 64 page catalog. Atlas Equipment, 229 Southwest Blvd., Kansas City 8, Mo.

WANTED—MISCELLANEOUS

TOY Trolley cars, trains; banks, old toys, miscel. antiques. Fireside, Box 181, Passaic, N. J.

WANTED—Scrap mercury (quicksilver), tantalum, bismuth, tungsten. Metallurgical Products Co., Established 1909, 35th and Moore Sts., Phila. 45, Penna.

QUICKSILVER (Mercury) urgently needed! Immediate payment. Wholesale Terminal, Norwood, Massachusetts.

PERSONAL

PENMANSHIP Corrector! Improves your penmanship in 3 hours. Proof free. Ozment 9, St. Louis, Mo.

RECEIVE Outstanding mail, magazines, samples. Listing 10c. Sibley, Mendon, Mass.

BORROW By mail. Loans \$50.00 to \$300.00 to employed men and women. Easy, quick. Completely private, confidential. No endorsers. Repay in convenient monthly payments. Details free in plain envelope. Write State Finance Co., 210 State Finance Bldg., Dept. D-14K, Des Moines 9, Iowa.

MEXICAN Mailing service. Letters received, forwarded 20c. Postcard 10c. Tiltonson, Apartado 1405, Guadalajara, Jalisco, Mexico.

DETROIT Postmark. Remail your letters 25c ea. Baron, 1785 Seward, Detroit 6, Michigan.

MEN, Women! Enjoy delicious meals. Inexpensive cook books. Free lists. MacSwiggan, 24 Arbella, Salem, Mass.

"DUSFIL." Amazing new home hot air dust filter. Saves money, less housework, safeguards health, washable. \$1.00 brings generous sample kit. Money back guarantee. Micamp Co., 8629 Crispin Drive, Philadelphia 36, Penna.

"HOW Can I find out?" You can! Information discreetly developed. Any matter, person, problem, anywhere. Worldwide. Officially licensed, bonded service. Established 1922. Reasonable. Confidential. William Herman, 170 Broadway, New York.

MISCELLANEOUS

100 MARKETS for handicrafts. Leather, wood, metal, crochet, novelties, etc. Big buyer's bulletin \$1.00. Research, 2409 12th Ave., Los Angeles 16, Calif.

"INTERESTING Mails" — 25c keeps name on mailing lists three months. Bentz, Jr., Desk A/68, Chatawa, Mississippi.

"GOLD" Nuggets. Simulated. Look like the real thing! Approximately 1/4 ounce sealed in cellophane bag. 3 bags for 25c; 15 for \$1.00; 100 for \$5.00. Postpaid. Pacton Enterprises, 3323 Lindell Blvd., St. Louis 3, Mo.

ARTIST, Who can carve or model small ornaments with fine detail according furnished design, can receive current work. Box 451, Leominster, Massachusetts.

1950 AGENTS And mail dealers trade directory. Selling, buying, ideas, sources of supply, offers, tips, etc. \$1 postpaid. Literature free. Savell Sales Company, Masspeth 3, New York.

SPEEDY Triple cake and dough cutter, uniform pieces. Patent Number 48,737. Josephine Henrikson, Climax, Minn.

"PECAN" Candy pralines, ideal gift, \$1.60 dozen, postpaid. Joe Berger, Jackson, Mississippi.

URANIUM Ore detector! Simple! Reliable! \$8.00 postpaid, including six uranium specimens. Manufacturers since 1915, radium apparatus, luminous materials; catalog 10c. Hammer Laboratories, 4034 University, San Diego 5, California.

SQUARE Dance, detailed instructions 30 dances, \$1.00. Patterson, 312 N. Main, Independence, Mo.

ROC-WOOD Handsome hardwood flooring layed with trowel! Sand, varnish. Fire; waterproof. Home, basement, garage, shop. Inexpensive. Roc-Wood, 333 North Michigan Ave., Chicago 1, Illinois.

\$600 BUILDS Cozy home. 4 room concrete block. Step-by-step instructions and blueprint. \$1.00. L. H. Farrow, G83, Box 645, Columbus 16, Ohio.

WORLD'S Most amazing alcohol blow torch, 2400 degrees, self generating, high pressure, no pumping, no matches. Send for literature. Robert Livingston, 1425 Scott St., Williamsport, Penna.

VETERANS! Does Uncle Sam owe you cash or other benefits? Find out easily through Veterans Report, 1025 Vermont Ave. N.W., Washington, D.C. Sample copy 25c.

PAINT—Titanium formula, outside white. Stays white, long lasting and will not peel. \$1.75 per gallon. Pint sample 50c. Pure White Paint Company, 102 North 9th Street, Minneapolis 3, Minnesota.

FREE Information "Choosing a Career," Box 3542, Station-B, Winnipeg, Canada.

TURKISH Bath, inexpensive, collapsible. Simple operation. Comfortable home treatment. Free literature. Gordon Brothers, 337-T East 139 St., New York 51, N. Y.

HEATING Costs reduced 50%! Fires prevented! "Automatic Watchman" easily installed few minutes any furnace or boiler. \$2.00. Free literature and heating hints, Sambekg Mfg., 3259 Clarendon, Cleveland Heights 18, Ohio.

BELTS—Handmade embossed in Mexico. \$1.98. Hobbycraft Center, Las Cruces, New Mexico.

PANNING Gold. Beginners booklet. 36 pages, also catalogue supplies 25c. Old Prospector, B-303, Dutch Flat, Calif.

GEIGER Counters for locating uranium; metal detectors for gold, silver and minerals. Lightweight, low cost, ultra-sensitive. None finer at any price. Free information. Detlectron Company, 5637 Cahuena, Dept. B-1, North Hollywood, Calif.

FOREIGN Employment! Send \$1.00 for directory listing overseas opportunities. R. Carmody, 1805 N. Hampshire N.W., Washington, D. C.

OUTDOOR Toilets, cesspools, septic tanks cleaned, deodorized with amazing new product. Just mix dry powder with water; pour into toilet. Safe, no poisons. Save digging and pumping costs. Postcard brings free details. Burson Laboratories, Dept. P-44, 955 Willard Ct., Chicago 22, Ill.

DUCTS, Pipes, fittings for installing your own heating system. Catalog. Metal Products, Antioch, Illinois.

GEIGER Counters for locating uranium; metal detectors for gold, silver and minerals. Lightweight, low cost, ultra-sensitive. None finer at any price. Free information. Detlectron Company, 5637 Cahuena, North Hollywood, Calif.

LUMINOUS Reflective paints glow day and night in technicolor! New angle money-maker. Assorted color samples 25c. Research, 1842-PM Byron, Chicago 13.

URANIUM Prospecting equipment: Geiger counters \$48.50 to \$70.00. New improved mineralights from \$12.50. Scintilliscopes \$5.95. Prepaid. Guaranteed. Test-specimens free. Western Radiation Laboratory, 1107 West 24th Street, Los Angeles 7, Calif.

YOUR Leather jacket renovated by our craftsmen expertly, reasonably. Request free descriptive circular No. 8. Berlew Mfg. Co., Freeport, N. Y.

GEIGER Counter plans plus prospecting manual \$1.00. Satisfaction or refund. Box 486, Detroit 31, Michigan.

TREASURE, Mineral locators. Goldak now offers treasure locators for \$75.00. Geiger counters reduced to \$95.00. Write the Goldak Co., 1542 West Glenoaks Blvd., Glendale 1, Calif.

VERMONT Maple syrup and sugar. 100% pure, list. H. Marshall, Poultney, Vt.

SAVE Money—Buy everything wholesale. Free information. Orysen, 1147 Sunkist, Waukesha, Wis.

SQUARE Dance instructions. 40 dances, \$1.00. Wesley Rader, 1922 Grant, Denver, Colorado.

"RECEIVE Mail." Moneymaking offers, opportunities, catalogs. Name listed 10c. Ideal Service, Park Ridge 10, Ill.

TREASURE Locators. New electronic lightweight M-Scope mineral and metal finders are now available for immediate shipment. Built for arctic-tropic use. Revolutionizes locating of minerals, gold, silver, metal objects. Unsurpassed efficiency, factory guaranteed. Low prices, time payment plan available. Send for free 16-page illustrated booklet. Fisher Research Laboratory, Inc., Palo Alto, California.

WOODWORKING Power tools — Make them yourself from old auto parts, pipe fittings, scraps. Sanders, drill presses, lathes, saws, etc. Complete details on 40 tools in 96-page book \$1.25. Popular Mechanics Press, (C-43), 200 E. Ontario, Chicago.

70 BIBLE Lessons, 25c. Bulletin, Box 87, Cathedral Station, New York 25.

TATTOOING Outfits, supplies. Illustrated list free. Zeis, 728 Lesley, Rockford, Illinois.

GEIGER Counters for finding uranium ores. Simple operation. Low prices. Interesting literature free. Fisher Research Laboratory, Inc., Palo Alto, California.

TATTOOING Machines, outfits. Free catalogue. Jensen, 120 West 83rd Street, Los Angeles 3.

SOAP Box Racer: Fun to make. Build an exact duplicate of 1946 winner. Clear, easy-to-read blueprints. Simple construction. Order prints #1101. 25c. Popular Mechanics Press, 200 E. Ontario St., Chicago 11, Ill.



BE FAIR TO YOUR HAIR Want better looking hair? Embarrassed by falling dandruff, itching scalp? Get the new VITABRUSH, the electric-automatic brush with built-in brush head motor. . . gives scalp and hair an invigorating "workout" in just 3 minutes. Cleans scalp, stimulates blood supply, distributes the natural oils. Fun to use—relaxing. Write for satisfaction-guaranteed offer—today. Hershey Mfg. Co., 3755 Field Bldg., Chicago 3.

LIFE AFTER DEATH

"Heaven and Its Wonders, and Hell"

by EMANUEL SWEDENBORG, with a brief biography of this famed theologian, philosopher and scientist. 632 page book, treating fully of life hereafter, will be sent for 5c
List of publications free.

The SWEDENBORG FOUNDATION
Room 1618, 51 E. 42nd St., New York 17, N.Y.

Rupture Troubles Ended

Advanced method has healed thousands. No leg straps, no elastic, no plasters. No pressure on hips or spine. Flexo-pad. Entirely different. Endorsed by doctors, mechanics, clerks. Very light. **INEXPENSIVE. GUARANTEED.** Write for information and trial.

SMITH MANUFACTURING COMPANY
EST'D 1893 DEPT. PM PRESTON, ONTARIO

HOW TO BE STRONG

SHORT CUTS TO MOLD MIGHTY MUSCLES

Strong men are not born . . . they are made. Here is your opportunity to learn how to train and build mighty muscles, without a single cent of cost.

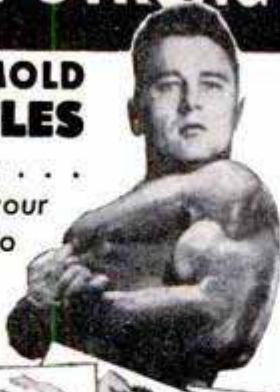

Write Today!

Both FREE



Get this 48 page volume for just mailing and handling costs. PRACTICALLY FREE. "YOU CAN BE STRONG" is crammed full of muscle building instructions, advice, pictures, progressive training chart, questions and answers. All expertly written by men who made the grade.

You also get our newly created "MUSCLE-FINDER." This contains a picture of the anatomy showing every important muscle. You would pay \$1 for this alone. Just turn the dial and "MUSCLE-FINDER" shows you just what you want to know about your anatomy, your important muscles and then you know just what to do . . . to mold a mighty arm, a mighty chest, mighty legs, mighty back, a mighty grip . . . MUSCLE-FINDER points the way to follow advice and instructions. **YOU CAN BE STRONG!** Act at once and get "YOU CAN BE STRONG" and the "MUSCLE-FINDER" practically as a gift. Just enclose 25c to cover mailing and handling costs and receive both by return prepaid mail. These secrets of training and building your body are yours . . . BUT . . . you must act fast because this is a special introductory offer. Send 25c now before you forget.

MOOSEHEAD SALES CO., Dept. 501

366 East 153rd St., New York 55, N. Y.

SAVE UP TO 25% ON QUALITY BALL-BEARING WHEELS!

Bilt-Rite wheels roll smoothly and easily, are semi-pneumatic, ball-bearing, painted red; guaranteed top quality—and you save up to 25%! Compare Bilt-Rite's quality and price—then get your order in today! Dealer inquiries invited.



BILT-RITE BARGAINS on BALL-BEARING WHEELS			
(For 1/2-inch Axles)			
6 x 1.00\$1.30	10 x 1.25\$1.95
8 x 1.251.65	10 x 1.752.15
8 x 1.751.80	10 x 2.002.45
6 x 1.50	\$1.50	
(For 3/8-inch axle)			
6 x 2.00\$3.95	8 x 2.50\$4.45
10 x 2.75	Only \$4.65!	

Bilt-Rite Guarantee
No better wheels are made regardless of price; 10 day return privilege.

If size you need isn't listed, write for Folio A
ORDER TODAY—Send cash, check, or M.O.—Pay postage on arrival.

BILT-RITE WHEEL COMPANY
520 EAST MISSOURI AVE. KANSAS CITY 6, MISSOURI

Get... YOURS FREE!



BOOKLET OF COMPLETE COAST INDUSTRIES PROFIT PLAN



NELS IRWIN
Will help you start your own successful business — at home, spare time or full time

BIG PROFITS

Rich profits are waiting to be tapped in this new field. New MIRACLE finish gives a velvety, luxurious surface to radios, lamps, toys, signs, store displays, figurines, auto dashboards, and hundreds of other items. Make old objects beautiful and salable—make new things worth much more with this soft, rich covering that can be applied to any surface, even if old and worn.

START RIGHT AWAY

Yes, you can learn in a few days to start **MAKING MONEY!** Everything you need is furnished, including fully detailed, illustrated instructions that are complete and easy to understand. Every point is explained, to show you how to start on the road to big money, full or spare time, right in your own home.

EVERYTHING COMPLETE

In addition to full instructions you get a complete set of materials that enables you to start at once. A few cents worth of materials can mean many dollars in return to you—you can earn up to \$5 per hour and more spare or full time. Add to your income from your present job or start a profitable business of your own. Our Business is Booming. Help us fill **HUGE DEMAND.**

ACT NOW

Grasp this opportunity **TODAY!**—Start your own business. It's too good to miss! **SEND NO MONEY!**—fill out the coupon and stick it on a post card or in an envelope and mail today for full details. **FREE** samples of FLOK-KRAFT covered material, and hundreds of useful and profitable **IDEAS**. Do it **NOW!**—be first!

COVERS WOOD, FABRIC, METAL, GLASS, PLASTER, PLASTIC OR ANY SURFACE



LAMPS



CAR TRUNKS



RADIOS



DISPLAY PIECES



TOYS



JEWELRY BOXES



CAR DASHBOARDS



DISPLAY PIECES

FLOK KRAFT USE COUPON FOR FREE SAMPLE
COAST INDUSTRIES Dept. 21
1004 S. Los Angeles St., Los Angeles 15, Calif.

Gentlemen: Please rush me all the details.

NAME _____
STREET _____
CITY _____
STATE _____

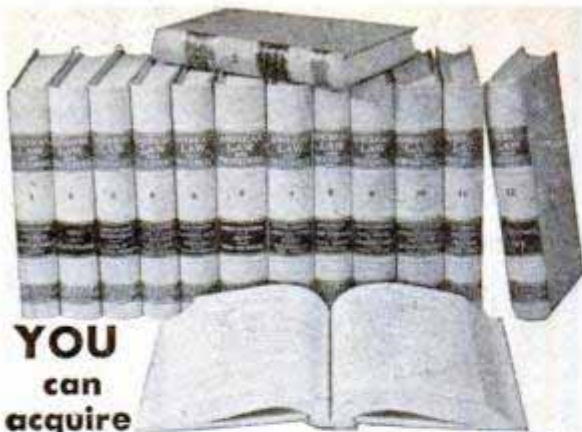

YOU
can
acquire

LAW NIGHTS AT HOME! **L. L. B. DEGREE**

LaSalle's famous Law Library—used as reference in many Law libraries and Law offices—has enabled thousands to master Law surprisingly fast, in spare hours at home, for business and professional advancement.

These 14 remarkable volumes, compiled by leading professors and lawyers, cover the whole basic field of Law in condensed, orderly, simplified manner.

You advance rapidly with this great library, plus special lectures furnished. We guide you step-by-step with personalized Problem Method of instruction . . . you *learn by doing*—handling legal problems—not by memorizing rules.

Send for two FREE 48-page booklets, "Law Training for Leadership," and "Evidence," answering questions about Law and its value to you, and telling how LaSalle Law graduates are winning rapid advancement in business and public life. Mail coupon below. No obligation.

LA SALLE EXTENSION UNIVERSITY A Correspondence Institution

417 S. Dearborn St., Dept. 164-L, Chicago 5, Ill.

Send me your two FREE booklets described above, without obligation.

Name _____ Age _____

Street _____

City, Zone & State _____

SHIP MODELS for Everyone!



AUTHENTIC KITS FOR BOTH NOVICE AND EXPERIENCED BUILDERS
New "Clipper-Bilt" kits at only \$3.95 each have carved balsa hulls, die-cut wood parts, tapered masts, finished fittings and simple plans. Send for your kit today. Select Schooner, Clipper, Barque or all 3. \$3.95 ea. Big catalog describes over 30 beautiful ship models, 600 fittings and several authentic, fascinating gun models. Only 15c. Send for yours at once. **MARINE MODEL CO., Dept. G, Halesite, Long Island, N.Y.**

YOUR OWN PART TIME POPCORN BUSINESS

SMALLEST BIG MONEY-MAKER ON THE MARKET

- IOWA CITY, Operator, "NET \$90. in 1 1/2 days' time"
- OSHKOSH, Operator, "NET \$780. in 4 days' time"

New and Profitable Business. Easy to operate. No intricate parts. No service calls. We ship the machine and the Ready-to-Eat Popcorn. Simply pour in the Popcorn, plug in and you are immediately in business and realizing BIG PROFITS. Be the first Popcorn magnate in your area. WRITE TODAY. Prepoped Corn Shipped Anywhere in U.S.A. in Moisture-Proof Bags.

Look At These
-NET Profits
10 Machines \$37.50
20 Machines \$75.00
100 Machines \$375.00

Delivers HOT Popcorn INSTANTLY
We Supply the Ready-to-Eat Popcorn

A.B.C. POPCORN CO., Write for FREE Particulars
3441 West North Ave., Dept. P-1, CHICAGO 47

NEW AUTO-TURN DIRECTION SIGNAL



Flashes Your Turns Electrically

No more winter window cranking for arm signals. The new **AUTO-TURN DIRECTION SIGNAL** fits any car, flashes parking and tail lights 60-80 times a minute. No interference with regular lights, no extra lights to mount for most late cars. Smoothly operating, featherlight control lever. Works similar to factory installed models. All parts furnished—install it yourself. **SPECIFY MAKE AND YEAR.** For cars earlier than 1942, write for price. **MONEY BACK GUARANTEE.**

Durable, attractive chromium case. Also available in brown. \$10.95, postpaid in U. S. Send check or money order. Postage extra on COD's.

The LESTER Company Box M-1,
1743 North Milwaukee Avenue, Chicago 47, Illinois

500 Pages, 7000 Novelties



10c

Send 10c for mammoth, amazing catalog of 7000 novelties. 1-inch thick, roto picture section, 6-color cover. Carnival, circus, world's fair & science exhibit rolled into one! Includes live animals & pets, scientific supplies, hobbies, funmakers, planes & boats, looms, magic tricks, joke articles, unusual seeds, gadget timesavers, cameras, optical goods, projectors, movies, lucky jewelry, religious novelties, telegraph sets, disguises, musical instruments, stamps, coins, puzzles, fortune tellers, radios, experimental sets, auto & bike accessories, Western wear, telescopes, magnifiers, compasses, banks, smokers' gadgets, artists' supplies, printing sets, engines, motors, shockers, knives, billfolds, fireworks, guns, rifles, sports, money makers, swimming helps. 1000 fascinating books, games, locks, live chameleons, rings, exercisers, curious plants, etc., etc. (DeLuxe Hard Bound Library Edition 25c Postpaid.) Regular paper covered edition 10c. (Stamps accepted.) Sent Air Mail, \$1.00. **JOHNSON SMITH & COMPANY, Dept. 215, DETROIT 7, MICHIGAN**

STAMMERER?

New booklet, "Stammering, and How to Stop It," sent free to any stammerer upon request. Write today. **BENJAMIN N. BOGUE, Dept. 504, Circle Tower, Indianapolis 4, Ind.**



AMAZING NEW PATENT KEE KLASP,

WITH SENSATIONAL FINGER TIP RELEASE
CLEVEREST DEVICE OF THEM ALL. NO MORE LOSS OF KEYS
Remove in a jiffy—without fuss or fumbling

Unique and practical. Precision made of durable, rust-proof, tempered metal. **KEE-KLASP** is particularly ideal for building maintenance men, railroad men, office managers, bank custodians, guards and all others who wish to keep their keys safe. Sells on sight. Write for details. Discounts to Jobbers and Dealers.

EATON ENTERPRISES
Union Sta. Chicago 6, Ill.



ARTISTS MAKE MONEY

Do you like to draw? Send name, address, age and occupation for **FREE ART TEST**, to find out your ability.

ART INSTRUCTION, Inc.
1130 ART INSTRUCTION BLDG., MINNEAPOLIS 15, MINN.

Say You Saw It In POPULAR MECHANICS



FREE!
SAMPLE

That **GLOWS IN THE DARK!**

An Easy Way To MAKE BIG MONEY

Be the first to sell sensational luminous house numbers, light switch plates, wall protectors, cord pulls, novelties, etc. Also luminous pictures, ash trays, keyholders, statues, decals, religious, nursery objects, etc. **THAT GLOW IN THE DARK. SELL ON SIGHT.** Get into this new and growing industry. **ENORMOUS DEMAND . . . NO COMPETITION . . . BIG PROFITS.** Represent a large manufacturer, established over 35 years. **Write at once** for liberal **MONEY-MAKING** offer and **FREE samples** to show you **HOW THEY GLOW IN THE DARK.**
Madison Mills, 303 Fourth Avenue
DEPT. E-4 NEW YORK 10, N. Y.

**LEARN
NEON
TUBE BENDING
AND
NEON SIGN
FABRICATION**



**TRAIN FOR THE TOP JOBS
IN A GROWING INDUSTRY!**

Properly trained men go to the top in America's fast-growing neon sign and fluorescent lighting industries. Here is a field in which earnings of \$2.00 to \$3.00 per hour are commonplace among competent workmen.

Put yourself in line for these top-paying jobs by training at the one school that prepares you for them. Thorough, practical training at G.I.T.I. is conducted by an outstanding staff of instructors with modern professional equipment. To date, not one G.I.T.I. graduate has failed to qualify for or hold a high paying job.

Write today for complete information about our non-technical courses, approved for all G.I. training and excellent for many physically handicapped men. State whether veteran or non-veteran information is desired. No correspondence courses are offered.

**GENERAL INDUSTRIAL
TRAINING INSTITUTE**

DESK M-101

STUEBENVILLE, OHIO

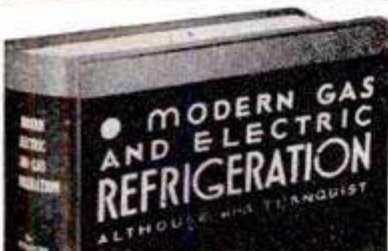

**GET INTO THIS
BIG PAY FIELD**

Over 20 Million
Refrigerators Need
Service and Repairs

**REFRIGERATION
Made Easy!** Biggest Opportunity
in Many Years!

NEW PRINTING — ALMOST 1000 PAGES

408 Pictures—17 Diagrams in Colors Makes All Refrigerator Service Maintenance, Repairs Simple as A. B. C.

Millions of refrigerators need service and repairs. Owners are paying big for competent service which will be needed more and more as these refrigerators get older. Get MODERN GAS AND ELECTRIC REFRIGERATION, the non-technical guide to all types of refrigerators and get your share of this new profit. Get a job or start your own service business. This book will help you make money anywhere. Thousands of copies have been sold. Used by trade schools, manufacturers training programs and U. S. Army, Mail coupon. Send \$5.00 or we will send C.O.D. Money back in 5 days if not satisfied. Act now—this may be the opportunity you have been waiting for.

Mail Coupon

GOODHEART-WILCOX CO.,
1321 S. Michigan Ave.,
Dept. 108, Chicago 16, Ill.

Send Gas and Electric Refrigeration. \$5.00 enclosed. Send C.O.D. (in U. S. or Possessions). I will return book in 5 days if not satisfactory and you will refund my money. If remittance accompanies order we will pay postage charges.

Name _____

Address _____

City _____ State _____

Here's How CREI Prepares You for a
Professional Career with Industry-Recognized
Training in a Minimum of Time

**TELEVISION
RADIO-ELECTRONICS ENGINEERING**

GRADUATES of CREI residence school are preferred by industry because of their training and ability. This recognition is the reason that CREI men quickly find good jobs. With 23 years of practical teaching experience in these highly technical fields, CREI offers an outstanding faculty, modern and complete laboratories, shops and equipment.

New students are accepted twice monthly and each may advance as rapidly as he is capable. The basic course with one specialized course requires an average of 20 months to complete.

CREI is recognized as one of the country's leading technical institutes. Its work is of college level. It prepares the young man for a good job in industry in a minimum of time.



G. I. Approved

CAPITOL RADIO ENGINEERING INSTITUTE
An Accredited Technical Institute Founded in 1927
Mail coupon for Free Catalog

Capitol Radio Engineering Institute, Dept. 1718
16th & Park Road, N.W., Washington 10, D. C.

Please send me your residence school catalog and complete details. (If interested in Home Study check below.)

Name _____

Age _____ If in school, what term? _____

Street _____

City _____ Zone _____ State _____

I am entitled to training under G.I. Bill. Send information on Home Study Courses.



**“GET ON”
Uncle Sam's
PAYROLL**

**START
as high as
\$3,351 Year**

Prepare NOW For
1950 Examinations

**VETERANS GET
SPECIAL PREFERENCE**

Railway Postal Clerks
City Mail Carriers
City Postoffice Clerks
Stenographers-Typists
Liquor Inspectors
Messengers, Etc.

40-Page Book
on Civil Service
FREE.

Mail
Coupon
today—
SURE



COUPON

Name _____

Street _____

City _____ Vet? _____

**FRANKLIN
INSTITUTE**

(Not Government Controlled)

Dept. Z-84
Rochester 4, N. Y.

Rush to me, entirely free of charge, 40-page book with: (1) A full description of U. S. Government jobs; (2) A list of U. S. Government jobs; (3) Tell me how to qualify for a job.



AUTO BOOKS ON APPROVAL



SEND NO MONEY. Just mail the coupon for a complete set of 4 Big, Thick Auto Books. 20th Edition. Over 2700 Pages! Whether you are a mechanic or helper, expert or apprentice, auto owner or driver, take immediate advantage of this **FREE EXAMINATION OFFER.**

MAKE GOOD MONEY NOW HOLD A PERMANENT JOB

America wants its automobiles kept in good repair. Men with "know how" are in demand, at big pay. These books will help you get and hold an important job, or give you a chance to go into business for yourself now or later. Any man who half tries to improve himself can learn auto servicing and repairing by this quick reference method. Use the **JEFFY INDEX** to find easily understood answer to any auto problem. These wonder books prepared by eleven of America's great automobile engineers. Many hundreds of valuable illustrations. Send the coupon **TODAY.**

A year's consulting privileges with our engineers now given with these books without extra charge.

Publishers Since 1898

CAN YOU FIX IT?

These wonder books tell step by step **HOW** to make difficult repairs and adjustments, how to keep a car at maximum efficiency, including latest improvements in car design and operation. Engine troubles and how to correct them well covered.

4 BIG, THICK VOLUMES

Over 2700 pages, 2000 illustrations, wiring diagrams, etc. Beautiful modernistic, washable cloth binding.

AMERICAN TECHNICAL SOCIETY, Dept. A119
Drexel Ave. at 58th St., Chicago 37, Ill.

I would like to examine your 4-Volume Set of Auto Books. I will pay the delivery charges only, but if I choose I may return them express collect. If after 10 days' use I prefer to keep them, I will send you \$2 and pay the balance at the rate of only \$3 a month until \$24.80 has been paid. Include consulting service as offered above.

Name _____

Address _____

City _____ State _____

Please attach letter stating age, occupation, employer's name and address and name and address of at least one business man as reference. Men in service, also please give home address.

Can a Man MY Age Become a HOTEL EXECUTIVE

Even Though He Has No Previous Hotel Experience?

Would you like to step into a well-paid position as Hotel, Club, Restaurant or Inn Manager, Purchasing Agent, Social Director or Assistant Manager? Would you like to look forward happily to the future? The success of Lewis graduates from 18 to 50 **PROVES** you can — though you have no experience in hotel work.



Leland H. Fish, Becomes Manager of Club Though Without Previous Hotel Experience

"For twelve years I had worked at routine jobs. I wanted job security and a position I would enjoy. After reading the Lewis book, 'Your Big Opportunity,' I enrolled. Upon graduating, I secured my first hotel position. Soon I was Manager of a Florida hotel, with a corresponding increase in pay. Now Manager of the Elks' Club in this beautiful city."

Step Into a Well-Paid Hotel Position FREE Book Gives Fascinating Facts

Our **FREE** Book, "Your Big Opportunity," explains how you can qualify for a well-paid position at home, in leisure time: tells how you are registered **FREE** of extra cost in the Lewis National Placement Service. Most important, it shows how you can be a Lewis Certified Employee—certified to "make good" when placed in a position. Mail the coupon **NOW!**

Course Approved for Veterans' Training

LEWIS HOTEL TRAINING SCHOOL
Room SA-324, Washington 7, D. C.

34th SUCCESSFUL YEAR

Send me the Free Book, "Your Big Opportunity," without obligation. I wish to know how to qualify for a well-paid position at home, in my leisure time.

Name _____

Address _____

City _____ Zone _____ State _____

Check here if eligible under G.I. Bill of Rights.

EXPORT PAYS BIG

send for this **FREE BOOK**



High Income-Travel Abroad in WORLD TRADE

Would you like a complete change? Uncrowded field? High income and World Travel opportunities? Your own business capable of unlimited earnings? Or a career as a salaried Export-Import employee or executive, either in the U.S.A. or traveling abroad?

GIGANTIC UNCROWDED INDUSTRY — Go after a share of the enormous profits in an industry in which around \$20 Billion worth of goods will be bought and sold this year by large and small firms and independent men and women traders.

NO PREVIOUS EXPERIENCE REQUIRED — I have had more than 25 years' experience and am actively carrying on a World Trade business right now. Send for my **FREE BOOK** today. Men and women I've started now have their own Export-Import businesses. Others hold salaried positions in this industry of opportunities unlimited.

BUY — SELL WORLD-WIDE WITHOUT CAPITAL — Yes, you can buy and sell at fine profits without investing your own money in the goods. You can start trading by mail order within a few weeks — even operate your business from your own home.

START TODAY — GET FREE BOOK — A special feature of my offer to help you get started fast is a full year's membership (at no extra cost) in I.T.G. which puts you in contact with traders the world over. World Trade Certificate awarded.

Rush coupon today for my illustrated **FREE BOOK**. No obligation. No salesman will call. Air mail reaches us overnight.

B. L. Mellinger, Director, The Mellinger Co.
1418-AA Westwood Blvd., Los Angeles 24, Calif.

MAIL COUPON NOW

The Mellinger Co., Exporters-Importers
1418-AA Westwood Blvd., Los Angeles 24, Calif.

Please send your **FREE BOOK** on World Trade.

Name _____

Address _____

City _____ State _____

NEW for 1950

MIDWEST

Celebrates its 30th YEAR of FACTORY-TO-YOU Selling with a Sensationally NEW 1950 LINE of

TELEVISION

CONSOLES and Complete CHASSIS

New GIANT 16" PICTURE

Here is Television at its finest! . . . brought to you by Midwest, for 30 years a leader in the field of radio and electronics. Immense 151-square-inch screen on new 16" metal-glass tube . . . clear, steady, bright pictures . . . Synchronized sound and picture that a child can tune in perfectly . . . Highest quality FM sound . . . Big 12" Electro-Dynamic Panasonic Speaker. Available in beautiful Television-Radio-Phonograph Consoles, as illustrated, or in complete chassis (not a kit) ready for custom installation in your own cabinet. And you can buy Midwest Television at Low Factory Prices, with Low Down Payment and Long Easy Terms —and on 30 Days Trial! Send for Catalog TODAY!



NEW LOW
Down Payment
Long EASY TERMS



LOW FACTORY TO-YOU PRICE

30 DAYS TRIAL

... also a Magnificent Line of NEW 1950 **MIDWEST RADIOS** featuring the latest Improved FM Circuit and the New 3-SPEED RECORD PLAYER



Powerful new 1950 Series 16 and Series 12 AM-FM Radio in complete chassis. Also beautiful new Console models including the magnificent Symphony Grand Radio-Phonograph with latest FM circuit and new 3-Speed Automatic Record Player.

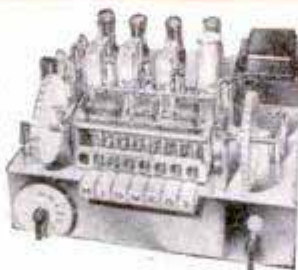

BUY DIRECT FROM THE MIDWEST FACTORY and SAVE!
MIDWEST RADIO & TELEVISION CORP.

Dept. X256, 909 Broadway, Cincinnati 2, Ohio

SEND FOR **FREE** 32-Page Full Color CATALOG



Write in Name and Address (Please Print) on Coupon or 1c Postcard.

MIDWEST RADIO & TELEVISION CORP.
Dept. X256, 909 Broadway, Cincinnati 2, Ohio
Please send me your new FREE 1950 Catalog.

NAME _____
ADDRESS _____
CITY _____ ZONE _____ STATE _____

DIESEL MECHANICS NEEDED BIG PAY . . . GOOD FUTURE



If you have no trade or profession that assures you steady employment and top pay through good times or bad, and regardless of whether you want to be a mechanic, technician, salesman, executive — or have your own profitable shop—you should investigate NOW this opportunity to enter world-famous Bailey Diesel Schools. Prepare yourself, this proven way, for an important place in the fast growing field of Diesel.

Why Gamble With Your Future!

Your future success depends largely on the reputation of the school you attend. Don't take chances! Train at Bailey's—America's foremost school of diesel training. Approved by Missouri State Board of Education. Approved, also, for G. I. Training. Full details FREE. Return coupon below NOW.

MAIL TODAY FOR FREE CATALOG

BAILEY DIESEL SCHOOLS
1656 So. Grand Blvd., St. Louis, Mo.
Please Send Me Your FREE Catalog.

Name

Address

Town State

Veteran Non-Veteran

Resident Training Home Study



LEARN WATCHMAKING and REPAIRING

Have as your goal a
STORE OF YOUR OWN

In California—intensive, practical training unsurpassed anywhere. Award of Graduation, West Coast University, School of Watchmaking. Accredited by United Horological Association of America. Approved for Veterans and Non-veterans. Part-time employment and housing assistance. Our catalog will interest you. Sent upon request. No obligation.

MAIL COUPON
BELOW TODAY!

West Coast University, School of Watchmaking
5145 W. San Fernando Rd., Dept. PM-10
Los Angeles 26, California

Gentlemen: Please send me complete information about your training program.

NAME Age

STREET Zone

CITY State

Veteran Non-veteran

NEW!
Sportsman Jr.
**4-WAY
AIR
PISTOL**
Shoots BB's, slugs, darts & corks
\$3.95
Complete with ammunition

Looks like a Luger, accurate to 25-35 feet Muzzle adapter for different ammunition. Indoor, outdoor use, target practice, small game. Fully guaranteed.

At dealers, or order C.O.D.
SPORTSMAN, JR.
Dept. B
6411 Hollywood Blvd.
Hollywood 28, Calif.

NEW HOT ROD CATALOG!!

Get Yours Now!! A Complete Catalog of SPEED EQUIPMENT & SPECIAL PARTS by such leading manufacturers as Offenhauser, Edelbrock, Winfield, Stewart-Warner & many others.
DON'T MISS THIS MONEY SAVER!! — Only 25¢
DOUGLASS MUFFLER MFG. CO., DEPT. M-1
1916 WEST VALLEY BLVD. ALHAMBRA, CALIF.

FOR THE PLASTIC CARVER

Increase your sales by using our plastic lamp bases to convert your carved plaques into beautiful lamps.

Base is 5" long, 3" wide, 1 1/2" deep with slot on top 1 1/2" by 1/4". Base is ready for use with socket, switch, bulb and 5' cord. All electrical parts (V.A.). Two colors, black or ivory. Send \$1.25 for sample and prices, or \$2.25 for two. P.P. State color. No C.O.D.'s Please.

ARATA, ROBERTS & BROWSE
BOX 576, FAIRLAWN, N. J.

RADIO ENGINEERING

Broadcasting, Television, FM, Servicing, Electronics, Aviation, Marine & Police Radio taught thoroughly. Engineering course equivalent to 3 years' college radio work. Approved Veteran Training. Catalog free.
VALPARAISO TECHNICAL INSTITUTE, Dept. D, Valparaiso, Ind.



LEATHER FLYING HELMET

NO HOOKS, TUBES, OR HOLES

Genuine NAVY aviators flying helmet. Cordovan brown leather. Warm—fleece lined. Brand new! Detachable chin strap. Perfect for cyclists, flyers, farmers, hunters, children and all-around outdoor wear. Best helmet service had. Govt. cost, \$10.00. Sizes small, medium and large. Send check, cash, M.O. C.O.D.'s accepted. Money

back guarantee. **\$1.49** p.p.
GRAND-HAWTHORNE SURPLUS
1439 SE Grand, Dept. PM-120, Portland, Oregon



MAKE MONEY!

RAISE CHIN-CHIN
CHINCHILLA RABBITS!

Pedigreed! Valuable Breeders!
PROFITABLE! EASY! PLEASANT!
Free Illustrated Booklet—WRITE TODAY!
SELLERSVILLE 36, PA.

ROCK HILL RANCH

LOCKSMITHING & Key Making

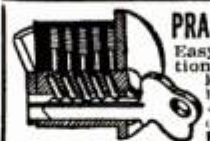

PRACTICAL UP-TO-DATE COURSE—ONLY \$3.95

Easy-to-learn modern information for self-instruction. How to work on locks, de-code, make master-keys, repair, install, service, etc. For every handyman, home owner, carpenter, mechanic, service station operator, fix-it shop, hardware dealer, gunsmith. 53 plain illustrated lessons.
FULL PRICE ONLY \$3.95. SEND NO MONEY.

Just pay postman plus C.O.D. postage. Or send \$3.95 with order, we'll ship postpaid. Satisfaction guaranteed or refund.
NELSON-HALL CO., 1139 S. Wabash Ave., Dept. A-2, Chicago 5, Ill.

DENTIST DRILLS used assorted cleaned and re-metal, plastic. In any chuck. 3 dozen, \$1.50; 6 dozen, \$2.75; Gross, \$4.75. Postage prepaid. Sold on money back guarantee.

KNIGHT DENTAL PRODUCTS

6754 N. Sheridan Road

Chicago 26, Illinois

Say You Saw It in
POPULAR MECHANICS



Thrilling Work COLORING PHOTOS

Fascinating vocation learned at home by those with aptitude. Thrilling pastime. National method brings out life-like colors. Free booklet.

NATIONAL PHOTO COLORING SCHOOL
1315 S. Michigan, Dept. 1351, Chicago 5

EASY TO LEARN

DO YOU WANT MORE MONEY? GET THIS BIG BOOK



PRACTICAL IDEAS—QUICK RESULTS
 Never before such a book of helps for you who wish extra money quick. In this book are formulas, recipes, secrets that have amazed the world. Use these ideas and make many needed money-making products. Experts wrote this book in simple terms, with supply sources for materials, short-cuts and methods for profitable results.

Included FREE! "Knowledge is Power" containing more than 170 sure-fire opportunities to promptly increase income and permanent security.

Lots of profitable businesses have started with a single recipe. Choose from the 162,000 facts and 10,000 formulas such as: — Adhesives, Cosmetics, Beverages, Candy, Ceramics, Cheese, Cleaners, Concrete, Dentifrices, Dyes, Depilatories, Enamels, Flavors, Foods, Gum, Home formulas, Inks, Insecticides, Lacquers, Linoleums, Lubricants, Metals, Mirrors, Oils, Ointments, Paints, Perfumes, Plastics, Polishes, Remedies for Man, Beast & Fowl, Soaps, Solders, Varnishes, etc. 1000's of others to make all sorts of profitable items.

WHEN EXTRA \$\$\$ ARE WANTED

This big book tells what to do and how. No experience needed. You choose from the money-making facts and ideas that are explained in words easily understood. Many fortunes have been made with a single formula. Mail in your order and get started right NOW!



\$3.98 postpaid throughout the world. (C.O.D. plus postage in U. S. only.) Shipped at once.

World-Wide Service — Books on Any Subject

ADAMS BROWN COMPANY, Dept. P110, Boston 67, Mass., U.S.A.

ACCOUNTANT BECOME AN EXPERT

Executive Accountants and C. P. A's earn \$3,000 to \$10,000 a year. Thousands of firms need them. We train you thoroly at home in spare time for C. P. A's examinations or executive accounting positions. Previous experience unnecessary. Personal training under supervision of staff of C. P. A's. Placement counsel and help. Write for free book, "Accountancy, the Profession That Pays."

LASALLE Extension University, 417 So. Dearborn St. A Correspondence Institution Dept. H-288, Chicago 5, Ill.

FEET HURT?
 Get QUICK RELIEF! Dr. Barron's Foot Cushions RELIEVE painful pressure from CALLOUSES, CORNS, SORE HEELS, support WEAK ARCHES, absorb foot shocks. Light, ventilated, spongy. Like Walking On Pillows! Wear in any shoes. Dr. Barron says: "Relieves tired, aching feet from heel to toes." **SEND NO MONEY!** Pay postman \$1.98 for PAIR plus postage (or send \$1.98, we pay postage). State shoe size and if man or woman. **30-DAY TRIAL.** Money back GUARANTEE if no blessed relief! Order NOW!
 ORTHO, INC., 2700 BROADWAY, Dept. 49A, N.Y.C. 25



"I CAN SHOW YOU HOW TO START YOUR OWN BIG PAYING REAL ESTATE BUSINESS"

Learn at home in your spare time WEAVER SCHOOL OF REAL ESTATE

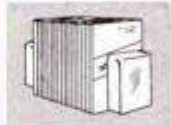

Easy-to-understand printed lesson books



Nationally recognized diploma awarded



Free consultation as long as you want

YOU CAN MAKE BIG MONEY in Real Estate. I can show you how to get started in your own profitable Real Estate business. Since 1936, many hundreds of men and women of all ages have completed my Weaver School of Real Estate course. They are really making good today! Real Estate offers you unlimited opportunity for big money, rapid advancement and lifetime security. I can show you how to get all this quickly. But act now!

STUDY AT HOME in your spare time—or in classes in leading cities. The Weaver School of Real Estate course teaches you everything you need to know to make a high income in Real Estate. And it's easy for you to learn. I send you lessons in easy-to-understand language. You learn quickly and thoroughly. Your lessons are personally graded by an instructor especially assigned to you. If you give me just one hour a week, I can teach you all phases of Real Estate in a very short time.

BE YOUR OWN BOSS. I can help you get started in a business of your own, or help find you a high paying job of your choosing. You may use our free consultation service as long as you need it. Our files are full of letters from graduates who have secured their state licenses and made big profits in their own businesses. They tell me they couldn't have done it without Weaver School of Real Estate training. Real Estate offers you exceptional money-making possibilities and healthful outdoor work. Get started now — fill out and mail the coupon to me today!

FREE BOOK TELLS HOW Approved for Veterans' Training
WEAVER SCHOOL OF REAL ESTATE
 Established in 1936
 15 E. Pershing Rd., Dept. K, Kansas City, Mo.

Mr. Howard S. Weaver: Please send me your big free catalog and show me how I can make money in Real Estate. No obligation, of course.
 Name _____
 Address _____
 City _____ State _____

Say You Saw It in Popular Mechanics

BLISS Electrical Training
 Intensive 32 weeks' residence course in fundamentals of industrial electrical engineering, including radio and electronics. Extensive laboratory, shop work, drafting. Prepares for electrical technician and engineering aides in communications, power, manufacturing, business machines, sales, service. G.I. approved. 57th year. Enter March 6, Sept. 5. Catalog. 7624 TAKOMA AVENUE, WASHINGTON 12, D. C.

NEW BOOKLET TELLS HOW GRAVELY POWER EQUIPMENT
FREE! Solves Upkeep & Gardening Problems
 Give yourself the leisure to really enjoy country living! This big Free Booklet — "POWER versus DRUDGERY" — is chock full of labor-saving ideas — shows how to give your home a lovely setting without long hours, hard work!
MAIL TODAY!
GRAVELY MOTOR PLOW & CULTIVATOR CO.
 BOX 163 DUNBAR, WEST VA.
 NAME _____
 ADDRESS _____
 CITY _____ STATE _____

Learn A Trade NOW! PRACTICAL SHOP TRAINING!

In Our Chicago Shops

- | | |
|---|--|
| <input type="checkbox"/> AUTO MECHANICS | <input type="checkbox"/> WELDING—ARC and GAS |
| <input type="checkbox"/> DIESEL MECHANICS | <input type="checkbox"/> MACHINIST |
| <input type="checkbox"/> REFRIGERATION | <input type="checkbox"/> PIANO TUNING |
| <input type="checkbox"/> BODY-FENDER | |

Above Approved For G. I.'s and Civilians
One of America's Leading Practical Schools
7 Floors of Fully Equipped Shops
Over 48,000 Successful Graduates
Expert Individual Instruction
Learn by Doing—Low Living Expense
Established 1902—Day and Evening Classes

Also the following Home Study Courses

- | | | |
|----------------------------------|--|---------------------------------|
| <input type="checkbox"/> PLASTIC | <input type="checkbox"/> REFRIGERATION | <input type="checkbox"/> DIESEL |
|----------------------------------|--|---------------------------------|

—CALL IN PERSON OR MAIL THIS AD TO—

GREER SHOP TRAINING

(Desk 16) 460 South State St., Chicago 5, Ill.

Please send without obligation free information regarding trade checked above. (Specify whether you are a Veteran or Civilian)

Name _____ Age _____

Address _____

City _____ State _____



PAY RAISING AUTO BOOKS

These famous books will help you on every job—prepare you for a better job—bigger pay—a business of your own. Order today.

Shipped Anywhere Under Money Back Guarantee

DYKE'S Auto Cyclopedia

Leading auto book for 32 years. Now new 21st edition. 1483 pages, 4600 illustrations. Complete instruction in auto mechanics—trouble shooting, testing, adjusting, repairing. Combines practical instruction with basic principles. New edition includes passenger cars, 1948 buses, tractors, diesels, Buick Dynaflow and other new developments. (Book No. 1) \$7.50.

Auto Body-Fender Repair

Completely covers this big, profitable field. Includes all approved methods, tools, equipment, materials, how to do a real professional job, operate a shop successfully. Ideal for mechanics who want to earn more. 325 pages, 232 pictures. (Book No. 2) \$3.50.

materials, how to do a real professional job, operate a shop successfully. Ideal for mechanics who want to earn more. 325 pages, 232 pictures. (Book No. 2) \$3.50.

Auto Service Management

Every detail of profitable auto service station management drawn from hundreds of successful operators. Tells how to start—how to get capital—how to run a service shop or station and make money out of it. Can easily be worth hundreds of dollars to any man who is looking forward to a business of his own or a managerial position. 470 pages, 223 illustrations. (Book No. 3) \$5.00

MONEY BACK IF NOT SATISFIED. In coupon below and mail today.

Goodheart-Willcox Co., Dept. 107
1321 S. Michigan Avenue, Chicago 5

Send books circled below. () C.O.D., I will pay postman plus charges (C.O.D. in U.S. only) () Remittance enclosed. Send postpaid. If not O.K. I will return in 5 days and you will refund purchase price.

1 2 3

Name _____

Address _____

City _____ State _____

NEW EASY RIDE FORD SPRING



For FORD or MERCURY cars up to 1949. Makes car RIDE AMAZINGLY EASY. Saves SEVERE bumps and shocks over obstacles or depressions. Saves REPLACING old springs when weak and flat. EASY TO INSTALL. Simply attach drop forge hooks and tighten to produce NORMAL BOW in old spring, then all springs work together. (No disturbing of shackles)—also steers better. No more front springs bumping or rear of body drooping. Made for both front and rear. PATS. ALLOWED. GET OUR PROOF FROM REPORTS of satisfied users. SATISFACTION OR NO SALE AFTER 30 DAYS TRIAL. Costs less than new spring installed. Adds high value. PRICE \$10.75 each. Live agents wanted. Big demand. To see it — sells it.

WM. GALLOWAY & SONS COMPANY

DEPT. PM

WATERLOO, IOWA



KEEPS BASEMENT PIPES DRY

Just wrap "NO SWEAT" insulation around water pipes and seal with special Vapor Seal Elastic Tape. Pipes will stay dry even in hot, humid weather. Workshop and darkroom stay dry. Tools won't rust. Easy to apply. No fuss. No mess. No sticky tape. No tools required. Neat, clean, attractive installation. Send \$1.00 for enough to protect 20 feet of 1/2" pipe. Full instructions included. We mail postpaid. MONEY BACK if you are not completely satisfied.

ASSOCIATED SPECIALTIES, 10658 Gratiot, Detroit 13, Mich.

AMAZING NEW
WOOD-TURNING TOOLS!
SHARPEN ONCE IN 12-YEARS! (UNDER NORMAL USE)
These remarkable tools tipped with TUNGSTEN CARBIDE will astound you with their performance. They work FREE HAND equally well in wood, plastic or soft metals—and at the same time hold their razor-like edge almost indefinitely. Tests show that they will turn wood or plastic for days and days CONTINUOUSLY without showing any signs of dulling. They are the finest tools available at any price. Beautifully finished 5" blade—flush ground, polished tip—finest brass tube ferrule—9" hardwood handle—over all length 14"—25 tools to 1/2"x30° skew, spear, r. & l. skew, turning and parting. Amazingly Low Prices! Write at once for free literature. **JOHNS MFG. CO., DUNELLEN 8, N. J.**

SUPERETTE DUAL VACUUM AUTO HORNS
ONLY \$8.95 POSTPAID
The voice of authority and commanding warning for safer highway driving. One BLAST and those "Road Hogs" really move over. Installed under the hood or on the front fender. Beautiful lacquer finish. Operates from intake manifold. No tank needed. Only \$8.95 complete with cylinder head bracket, steering column lever, hose, fittings etc.—Send check or money order today. We pay postage. \$1.00 deposit required on all C.O.D. orders.
THE PROTECTORED CO.
Dept. 421, 4033 Windsor Road, Youngstown 7, Ohio

If You're PAST 50



MAKE MONEY! WIN SUITS!

Quick! Easy! No Experience Needed! No Money Needed! No Age Limit!
If you're past 50, here's your golden opportunity to step into BIG MONEY fast! Just take easy orders for handsome, made-to-measure tailoring from friends, neighbors, relatives and co-workers! Earn up to \$15.00 in a day—and get your own bonus suits without paying a penny. Fascinating, profitable work for men over 50! Ask for amazing details now!

EVERYTHING SUPPLIED FREE

You need no experience, no money. Work full or spare time. Your age is actually an asset! Write today for big FREE selling outfit containing over 150 sample fabrics, over 50 full-color style illustrations, complete information for taking orders, and full details of amazing BONUS SUIT Plan! Write today with details about yourself!

J. C. FIELD & SON, INC., DEPT. A-1716
Harrison & Throop Sts., Chicago 7, Ill.

"ROCKET PERFORMANCE" FOR ANY CAR

The revolutionary new VAPOJET is designed on the war developed principle of WATER INJECTION. It offers an ideal, INEXPENSIVE way to gain superior performance from any car. For the owners of new cars with HIGH COMPRESSION engines, VAPOJET gives extra power with low octane gas. Thousands of VAPOJETs are now in use and users report better pick-up, smoother running power and BIG mileage increases on regular gas. Complete, easily installed kit fits all cars, boats and stationary engines and is backed with a 30 day money back GUARANTEE.

Designed to Give

- More Speed
- More Mileage
- More Power

Eliminates carbon & "ping." Reduces wear.

ORDER TODAY

Only
\$9.75

post paid.

Send check or money order and save postage. \$1 deposit on C.O.D. List car, year, and no. of cylinders.



**VAPOJET
MFG. CO.**

11424 Biona Dr., Dept. PM-1
Los Angeles 34, California
AGENTS WANTED

BE A TILE SETTER

LEARN TILE SETTING AT HOME. Ever increasing demand for tile setters. Easy to learn! Big money! Even as a sideline you can make \$75 and up each week. Only \$12.50. Write today for details.

INTERNATIONAL TILE INSTITUTE

P. O. BOX 6961 DEPT. PM1 LOS ANGELES 22, CALIFORNIA



Happy Highways Ahead!

With Popular Mechanics new **MOTORIST'S HANDBOOK**. 160 pages of authoritative advice to keep your car rolling smartly—longer. Brakes, body, spark plugs, battery, starter—every automotive part is covered in this up-to-the-minute manual of year 'round driving pleasure.

Your news dealer has the 60c paper edition. Order the clothbound \$2.00 volume from

POPULAR MECHANICS PRESS

200 E. ONTARIO ST. CHICAGO 11

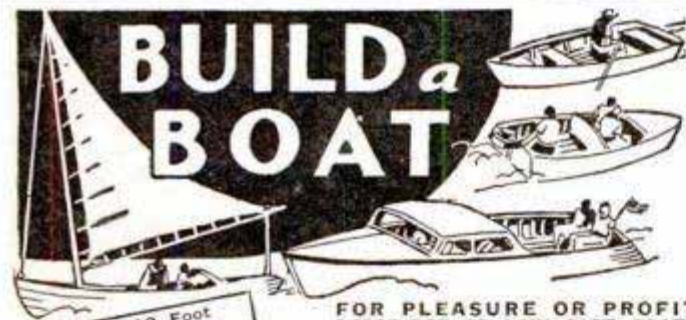

BUILD A BOAT

Row Boat—12 Foot
Dinghy—8 Foot
Dinghy—14 Foot Sailing
Training Ship—6 Foot
Sea Sled—9 Foot
Outboard—12 Foot
Cruiser—18 Foot
Bicycle Boat—Kayak
Row Boat—Sectional
Dinghy—Sailing
Canoe—16 Foot
Sailing—12 Foot
Outboard—Runabout
Pontoon—Ice Yacht

FOR PLEASURE OR PROFIT DESCRIBES 17 LOW COST BOATS

Get this outstanding book and build a boat at home for your own use or to sell at a profit. You can do it. Just the boat you've always wanted—rower, sail or row boat—17 different kinds and sizes.

Order BUILD A BOAT on postal card and pay only \$2.00 plus postage on delivery. Return in 5 days if not pleased and get money back. Or send \$2.00 with order and we'll pay postage. (Outside U. S. \$2.25 with order.) Order today.

POPULAR MECHANICS PRESS
Dept. 598, 200 E. Ontario, Chicago 11

New Advertising Machine



PRINTS and ILLUSTRATES

1¢ Post Cards

FREE Learn how thousands of business men, in every line, are boosting sales in spite of conditions—with 1¢ messages—printed and illustrated in a few minutes on gov't post cards—with amazing new patented **CARDMASTER**. Your "today's" ideas, read by your prospects next morning. Not a toy, but a sturdy advertising machine, built to last for years. Low price, sold direct. Guaranteed for five years. Send name today.

SEND NAME We'll send **FREE** illustrated book of money-making **IDEAS** for your business and complete, unique advertising plans. **RUSH YOUR NAME TODAY.**

CARDMASTER COMPANY
1920 SUNNYSIDE, Dept. 131, CHICAGO 40, ILL.

'PLASTICS'

Fabricating Manual and Catalogue

Work in a fascinating and profitable hobby. Just out—our latest fabricating manual. Tells you how to work with Plastics. Our new Catalogue provides all needed materials: Plexiglas—Lucite—Tenite—Catalin—Acetate—all in sheets, rods, and tubes. Complete line of cements, dyes, accessories and supplies. Send 20c today for 1949 Catalogue and Handbook.

HOUSE OF PLASTICS

8648 Linwood Avenue Dept. PM1 Detroit 6, Michigan

Now! train for BIG PAY in Electrical Field

BUILD YOUR CAREER FOR THE FUTURE — or REFRIGERATION

• BE INDEPENDENT IN YOUR OWN BUSINESS •

HERE you will enjoy the advantages of a thorough practical course of training under guidance of specialized experts, each trained with the scientific developments and the demands of each industry. Both of these courses are geared to the expanding industry so that in the few months it takes, you are a skilled craftsman ready for the **BIG PAY** that trained experts command in **GENERAL ELECTRICITY, APPLIANCE REPAIR, MOTOR REPAIR, and WIRING—Or REFRIGERATION** REPAIR of Hermetically Sealed Refrigeration Units.

BIG MONEY AND SECURITY FOR YOUR FUTURE . . .

NOW is the time to prepare for your future security. Get away from the hard way of earning a living and enjoy the advantages of a trained expert with **BIG PAY** or in **BUSINESS FOR YOURSELF**. There will always be a **BIG OPPORTUNITY** in the **ELECTRICAL FIELD and REFRIGERATION**. Pick either or both and you have a **BIG FUTURE** before you. We are a highly accredited school and you will join with hundreds of other students. We also offer the advantages of **FREE Employment Service**.

For—
Veterans and Non-Veterans

Get the Facts Now MAIL TODAY

Practical Trades Institute, Inc., 25 University Av., S.E., Dept. P-1, MINNEAPOLIS 14, MINN.

— **WONDERFUL OPPORTUNITY** —
• Learn to Become a Trained Expert •

PRACTICAL TRADES INSTITUTE, INC.
25 University Av. S.E., Dept. P-1
MINNEAPOLIS 14, MINN.

Electrical Refrigeration

Without Obligation Mail **FREE** Particulars.

NAME _____

ADDRESS _____

CITY _____ STATE _____

BE YOUR OWN



CARPENTER

PLUMBER

PAINTER

ELECTRICIAN

SAVE Hundreds of Dollars—Make Your Home WORTH More

"Home Guide To Repair, Upkeep and Remodeling" makes it easy to do home repairs, improvements—save up to 90%! Clear directions and diagrams tell materials needed, how to buy and use them. How to repair electric appliances, furnace, refrigerator, gas, plumbing, furniture. How to build garage, divide attic into finished rooms, add wing to house. Plastering, papering, linoleum and tilework, bricklaying, air conditioning, floor repair.

SAVE MONEY ON

Plastering; Papering; Masonry; Repairs of Doors, Windows, Roofs, Basements, Walls, Ceilings, etc.



Same FREE EXAMINATION Offer On—

"50 Things to Make for the Home" — How to make shelves, chairs, cornices, bookcases, tables, trays, fences, shutters, cabinets, etc. Only \$2.95 on easy terms.

FREE 10-DAY EXAMINATION—Coupon will bring you "Home Guide to Repair, Upkeep and Remodeling" to examine FREE—without obligation. Mail it NOW!

McGraw-Hill Book Co., Inc., Dept. PMB-1, 327 West 41st St., New York 18, N. Y.

Send "Home Guide to Repair, Upkeep and Remodeling" for 10-DAY FREE EXAMINATION. If not satisfied, I will return it—pay nothing. Otherwise, I will keep it—send \$1.75 then (plus postage) and \$2 one month later.

SAVE POSTAGE—Check here if enclosing \$3.75 WITH coupon. Then WE prepay postage charges. Money back if you return book.

Name.....

Address.....

City..... State..... PMB-1

CHECK HERE to get "50 Things to Make for the Home" for 10-DAY FREE EXAMINATION.



I CAN TEACH YOU WATCH REPAIRING AT HOME!

Here is a wonderful opportunity to get into this top-pay, easy-to-learn, uncrowded field thru my unique 10-lesson home study course. Watchmakers in big demand. You train under experts—learn to take a watch apart, repair and put it in perfect running order. Get out of the rut—turn spare time into cash—perhaps a business of your own. More jobs than men to fill them. We have students 18 to 65 who have profited by our training. No interference with present job. We furnish all tools, 15-jewel watch and practice movement. A licensed school.

If more interested in clock repairing or jewelry repair and design, check coupon below and mail at once.

MAIL COUPON TODAY

Mr. E. King, President
Illinois School of Watch Repairing
2870 Elston Avenue, Chicago 18, Ill. Dept. PM-1

Send me at once without obligation free literature on

- Watch Repairing Clock Repairing
 Jewelry Repair & Design

Name.....

Address.....

City..... Zone..... State.....

Mystery Auto

STARTS — STOPS ON COMMAND

Whistle at it! Blow on it! Say "Start"—"Stop." Car Responds Instantly

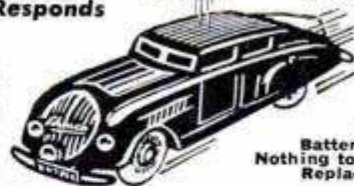

No Batteries Nothing to be Replaced

Amazing, mystifying performance. Fun for young and old. Adjusts to travel straightaway or in any size circle—table top to room size. Whistle at it. Blow on it. Say "start," "stop." Control it as you will without touching except for occasional winding. Back it into an obstruction, car will reverse automatically and go forward. Car is 5 3/4" long. Made entirely of metal. Richly painted. Rubber-tired wheels. Hinged hood opens, showing dummy engine. Nothing to get out of order, will run indefinitely. \$4.75 postpaid. Two for \$9.25. Three for \$13.75. Rush check or M.O. today. Satisfaction guaranteed. \$1.00 deposit for C.O.D.

HOME SHOP PRODUCTS CO., Dept. 11, 4821 Sheridan Rd., Chicago

Grow Royal squabs in only 25 days, they sell for highest prices, poultry tops, large profit. Write today for **FREE TOP** Book good food starter, our prices, easy directions, opportunity success methods of money making breeders in every State. Start now. Our 49th year. RICE FARM, 634 H. St., Melrose, Mass.



HEAT THAT COLD ROOM

Don't shiver in a cold room. You can install this booster fan in warm air furnace pipe yourself, and get forced circulation. Patented cooling feature prevents motor failure common to unventilated fans. Fits pipe sizes from 8" to 12", runs on house current. If your furnace dealer cannot supply you, write for free circular or send check to McLARTY SYSTEMS, Dickman & 26th St., Battle Creek, Mich.

\$10.95

Delivered U.S.A.

Learn REFRIGERATION and AIR CONDITIONING

Prepare yourself for a fine paying job. Get practical training at home—plus 4-full weeks in the ITI Shops. Job placement help. FREE book—write INDUSTRIAL TRAINING INSTITUTE Dept. E-1, 2130 Lawrence Ave., Chicago 25, Ill.

Practical Economical Winter Travel



Call Air SnowCar, plans, engine and propeller—\$495.00. Complete 125 h.p. 4 place factory built jobs—\$1950.00.

CALLAIR, Afton, Wyoming



CARTOONING

HAVE FUN! MAKE MONEY! Cash in on your sense of humor AT HOME—BY MAIL. No experience needed to start. Write today FOR FREE TRIAL LESSON and full particulars. Moon Gag Cartoon School, Dept. D, Fall Creek, Wis.

TWIN-USE

POCKET WATCH & ALARM CLOCK



LOWEST PRICE EVER at \$9.95

Dependable time keeper & APPOINTMENT REMINDER for pocket, table & office use. Loud ring; Luminous hands, numerals & second indicator. Chromed case. Back opens as stand. Easy to set. Regular \$17.50. BUY DIRECT, only \$9.95. We pay tax & del. chgs. or sent C.O.D. 10 DAY

RETURN PRIVILEGE, IMPEXTRA, (PM-3), 551 Fifth Av., New York 17.

"IDEAL" PRECISION RANGE FINDER

ONLY \$2.95 Incl. Tax

Get professional, sharp, clear pictures from your movie or still camera with the beautiful precision built "IDEAL Range-Finder." Easy to use—guarantees perfect focusing. Works the same as \$15.00 models. Highest quality optical system. Three year guarantee with each instrument. At your dealer or send \$3.00 (postpaid) to: FEDERAL INSTRUMENT CORP. 14-02 Broadway, Dept. 13, L.I.C. 6, N. Y.



Don't Envy The PLUMBER-Be One

Make \$15 to \$50 a Day

Every skilled workman will tell you Plumbers have the best of it. WINTER and SUMMER the Plumber is busy at top wages. No skilled Plumber is ever out of a job. Compare his opportunities with any trade. To the man with know how, Plumbing means profit. Investigate Universal Plumbing School. Not a "war born School," but a plumbing school developed and operated by plumbers since 1923.



The Plumber Protects The Health of the Nation

Own Your Own BUSINESS

Have your own business and big profits with little other than training and a kit of tools.

JOURNEYMAN Gets Good Salary

Master Plumbers own their own shop. A Journeyman works for a Master. With this training journey-men can depend on high wages.

G. I. Approved. Established 1923

UNIVERSAL PLUMBING SCHOOL

877 Holmes Street

Kansas City, Mo.

BE A PLUMBER IN JUST 32 WEEKS Learn With Tools—Not Books

No need ever serve an apprenticeship. Don't envy the plumbers big profits—enjoy them. Learn every trick of the trade—Leadwork—Blueprint for plan reading, etc. under Licensed Master Plumbers.

Over 7,000 Successful Plumbers Recommend This School

This system has made more than 7,000 plumbers. Investigate our past performance. If you like to work with tools this is your opportunity. Become a Plumber in America's largest and only school devoted exclusively to plumbing. Write today for FREE information.



SAHARA SUE SAYS

Stop using Harsh Abrasive Soaps, Sahara will Remove Without Water — Paint, Tar, Grease, Grime, Printers' Ink, etc. QUICKLY — EASILY — SAFELY. Contains Lanolin.

Prevents Chapping and Rough Red Hands.

At Your Dealer or Send \$1.00 for two 60c Tubes — Postpaid — Money-Back Guarantee — Agents Wanted SAHARA WATERLESS SOAP CO., Grand Rapids 2, Michigan *

GEIGER COUNTERS

FOR LOCATING URANIUM

and all Radioactive minerals. An OSSCO Geiger counter will indicate deposits of these valuable minerals. Model TX-9 only \$79.00. Write Dept. W for details and prices.

OMAHA SCIENTIFIC SUPPLY CO. 3601 N. 24TH ST. - OMAHA 10, NEBR.



WAR SURPLUS BARGAINS

\$500,000.00 INVENTORY for QUICK LIQUIDATION

Surplus items—hundreds of them for home, shop, factory, farm and outdoor use. New items, used items, reconditioned items—all at tremendous savings—all priced for quick sale.

Page After Page of Values

This big catalog shows page after page of amazing money saving values. Write for your copy today. Send 10c to cover postage, mailing, etc. Write today!

SEND TODAY FOR YOUR COPY **10c**

STARK'S Dept. PM1 509 So. STATE STREET CHICAGO 5, ILLINOIS

EARN MORE MONEY IN ELECTRICITY!

with APPLIED PRACTICAL ELECTRICITY



JUST OFF PRESS

Coyne's new set helps men get ahead in Electricity. 8 great books give you complete A to Z know-how, explained in easy-to-follow language with hundreds of charts, examples, pictures. Covers all branches of electricity including appliance repairing; AC and DC equipment; electrical refrigeration; industrial electronics and much more. Brings you 10,500 electrical facts; 3,400 subjects; hundreds of wiring diagrams, tables, formulae, short-cut methods. Backed by 50 years of Coyne experience in training that has put hundreds of men on the road to top earnings.

Sent on FREE TRIAL

USE SET FREE FOR 7 DAYS!

You have to SEE these books to know how much they'll help you. See them FREE! Just fill out coupon below and mail it in. SEND NO MONEY. Examine the set for 7 days AT OUR RISK!

HANDBOOK OF RESIDENTIAL WIRING FREE FOR PROMPT ACTION



Act promptly and we will include FREE, the valuable new booklet, "Handbook of Residential Wiring Design". If you return the Set at our expense in 7 days, you owe nothing. To keep Set, send either \$23.75 in cash or \$3.00 after 7 days and \$3.00 per month until \$25.50 is paid. Either way, you keep the Residential Wiring Book FREE! Coupon below is just a request to see APPLIED ELECTRICITY Set and to get FREE Wiring Book for doing so. Mail coupon AT ONCE!

FREE TRIAL COUPON—MAIL NOW!

Educational Book Publishing Division, COYNE ELECTRICAL & RADIO SCHOOL, 500 S. Paulina St., Dept. 10-R6, Chicago 12, Ill. YES! Send Coyne's new, 8 volume set, "Applied Practical Electricity" to me, postpaid, for 7 days FREE TRIAL per your offer. Include "Handbook of Residential Wiring" FREE.

Name _____ Age _____
Address _____
Town _____ Zone _____ State _____

SAY YOU SAW IT IN POPULAR MECHANICS

SALESMEN!

WRITE THREE WORDS COLLECT \$9.95

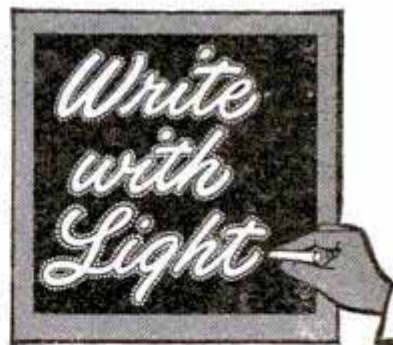

SENSATIONAL NEW ADVERTISING SIGN

YES, MAKE \$9.95 on 10-second demonstration to merchants. Write on glass with amazing magic crayon and presto—a 5-color advertising message takes fire and glows like a brilliant neon sign! Three sales a day and \$29.85 profit is for "lazy" men. Workers can double to triple that amount. FREE SALES KIT. Don't wait. Rush your name and address on a penny postcard for full details and complete sales kit—ALL FREE. Write Today!

MAXILUME CO., 125 W. Hubbard St. DEPT. L-81, CHICAGO 10, ILLINOIS



Perfect Circle

THE MOST HONORED NAME IN PISTON RINGS

Honored by Doctors of Motors, America's expert mechanics, who actively express their piston ring preference by installing millions of Perfect Circles every year.

Honored by America's foremost automotive engineers, who recently acclaimed Perfect Circle Piston Rings as best engineered—4 to 1.

Honored by motor-wise car owners all over America, who in survey after survey have invariably named Perfect Circle their first choice by a wide margin.

Look for this sign (right). It identifies a place where your car will receive expert attention. Your local Doctor of Motors knows your car, knows the value of honest workmanship and reliable parts. He will install a set of Perfect Circle Piston Rings Custom Made for your car to restore power, save gas, stop oil pumping.



Perfect Circle Corporation. Offices: Hagerstown, Indiana and Toronto, Canada. Plants: Hagerstown, Richmond, New Castle, and Tipton, Indiana, and Toronto.

**In an independent survey among automotive engineers—maintenance men, fleet operators and designers of new equipment—Perfect Circle was first choice as the best engineered piston ring—first by more than 4 to 1—and received more votes than ALL other brands combined!*



POPULAR JANUARY 1950 MECHANICS

WRITTEN SO YOU CAN UNDERSTAND IT
VOL. 93 NO. 1

A Half Century of Miracles

This is 1950. We have lived these 50 years amid a tremendous revolution. Look back on this greatest half century of scientific achievement — and look ahead next month as Mr. Kaempfert tells what A. D. 2000 will bring

By **Waldemar Kaempfert**
Science Editor, The New York Times

WHEN MIDNIGHT came on December 31, 1899 and pealing bells and raucous horns ushered in the year 1900, a few paused to wonder what marvels science and invention would produce in the century to come. There never had been a century like the 19th, with its steam engines, its development of electricity, its crude "wireless telegraph," its "horseless carriages," its telephones and telegraphs. What next?

Fifty years have passed, and half the answer can be given. That half eclipses anything of which the wildest writers of scientific fiction or of speculative newspaper articles dreamed in 1900.

The automobile was the doubt and wonder of 1900. The doubt came from the derision that a stalled car always provoked, the wonder from the ingenuity of the contrivance. Benz and Daimler "horseless

carriages" had been running since the eighties in Europe, and by the nineties a few bold Americans, Elwood Haynes, Alexander Winton, Henry Ford and a few others had cars that sputtered and rattled on the roads. Back in 1895 Haynes was told by a Chicago policeman to "get that horseless carriage off the street." About the same time Cortland Field Bishop was arrested for disorderly conduct because he drove an auto through Central Park, New York.

The great contribution of the United States to mechanical road transportation was progressive assembling, which Henry Ford learned from the packing industry and greatly improved. In 1912 it took 14 man-hours to put one Ford car together. The cost was \$8.75. Two years later, the average time for assembling had been reduced to two man-hours, and the cost to \$1.25.

One of the century's most spectacular developments has been the airplane, from the Wright Brothers' craft, below, which stayed aloft 59 seconds in 1903, to today's 600-mile-an-hour Boeing jet bomber, above

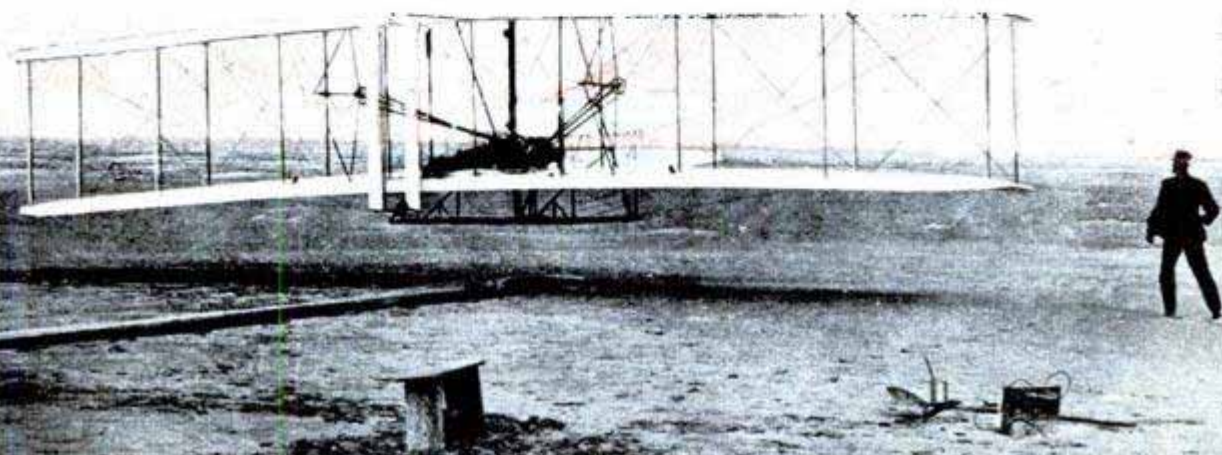

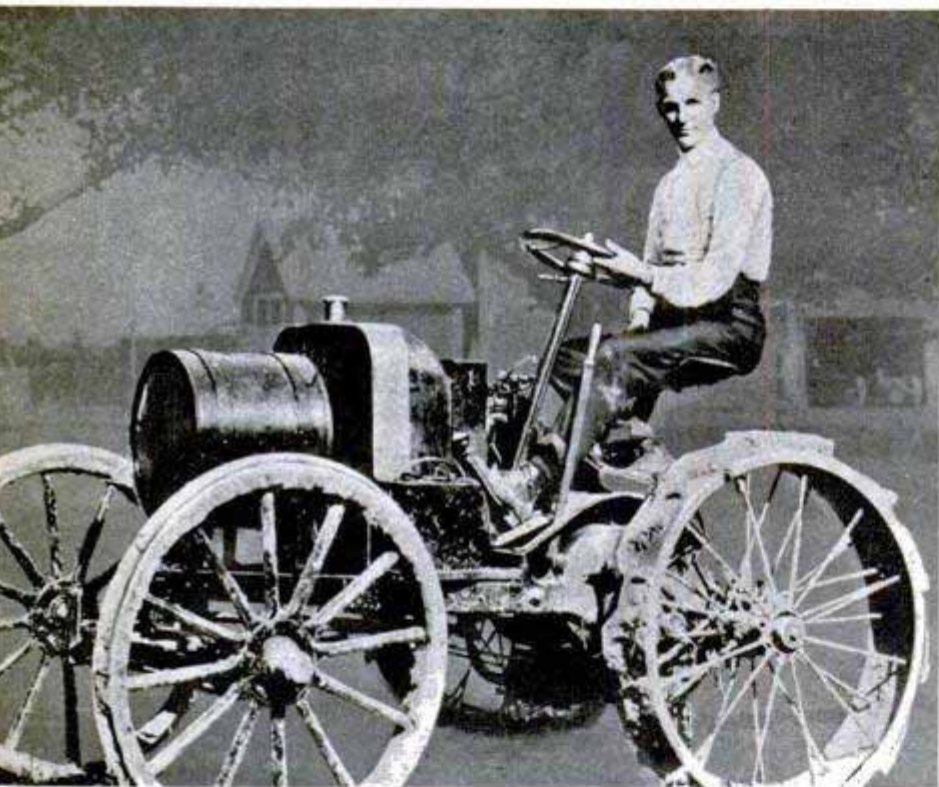

It was Walter Flanders, an Ohio machinist, who really created the Ford system. The machining of a whole cylinder block, boring and reaming the inside, drilling bolt holes, grinding valve seats, planing off the base and head—28 operations in all—took only 45 minutes. The principle revolutionized the production of cars—made it possible for one American out of five to own one.

What really did astonish us in the first decade of the century was the airplane. Inventors of flying machines were still regarded as harmless cranks in 1900. Yet in 1903 the Wright Brothers, two obscure bicycle makers of Dayton, Ohio, announced that they had flown at a speed of 35 miles an hour for almost a minute. Nobody believed them. But the air age had dawned. By the time World War I broke out fighters were making 200 miles an hour. In World War II, 350 and 400 miles an hour were attained. Record-breakers made over 600. Today 300 miles an hour is considered about right for a commercial passenger plane, but some experimental planes have actually traveled beyond the speed of sound—730 miles an hour at sea level. Engineers talk of supersonic speeds of 1000 miles an hour, which means that a man will leave Chicago for London early in the morning and return the same night by the end of this century.

The cry for speed, more speed

Mechanization has radically changed the farmer's life. During the 1900s he has switched from the animal-drawn plow, top, to early tractor made by Ford, left, and eventually to the modern equipment below



One atomic explosion like this could generate enough electric power to supply the United States for months. Though first harnessed in 1945 for destructive use, atomic energy has a limitless peacetime potential

and still more speed came from the military forces of all countries. It was a cry that could not be stilled by the conventional piston engine. After years of research, British Air Commodore Sir Frank Whittle answered it during the last war with jet propulsion. But even jet propulsion will not give us supersonic speeds. So government physicists are turning to rockets with stubby, swept-back wings. Rocket planes have been made and flown for a few minutes. To design them, new principles had to be invoked; for when the speed of sound is reached ordinary machines are hammered and torn apart by the resistant air. Because the rocket engine simply kicks itself along and requires no air from the outside, nobody laughs at the "astronauts" who think of traveling to the Moon and even to Mars.

The new high speeds drive home the importance of mechanical and electrical power in our culture. There were about 27,000,000 horses in 1900, many of them engaged in farm work. Today a horse is not often seen even in rural districts. The all-purpose tractor, the Jeep and motor truck have taken his place, and the stationary gasoline engine saws wood, grinds feed and does most of the chores on a farm.

The farmer has become not only more power minded but more scientifically minded. In 1900 the Abbe Gregor Mendel's laws of heredity were rediscovered after having been embalmed for 41 years in an obscure botanical publication. A science of heredity grew up. It became possible to create plants and animals almost to order. The farmer applied this new knowledge, so that today his cows yield more milk and butter, his steers produce better beef, his wheat stands up in high winds, his hybrid corn yields huge crops. If despite the trend of population from the country to the cities American farms are more than able to feed us, it is because of the development of power-driven agricultural machinery and the application of Mendel's principles of heredity.

Up to 1945 we thought of power in terms of fuel that could be burned in a furnace. In that last year of World War II came the announcement that at a cost of two billion dollars a team of physicists had devised an atomic bomb. By splitting the uranium atom in the manner discovered by two Germans, Hahn and Strassmann, at the end of 1938, some of the enormous energy that bound it together was released with terrifying results over Japan. The energy can

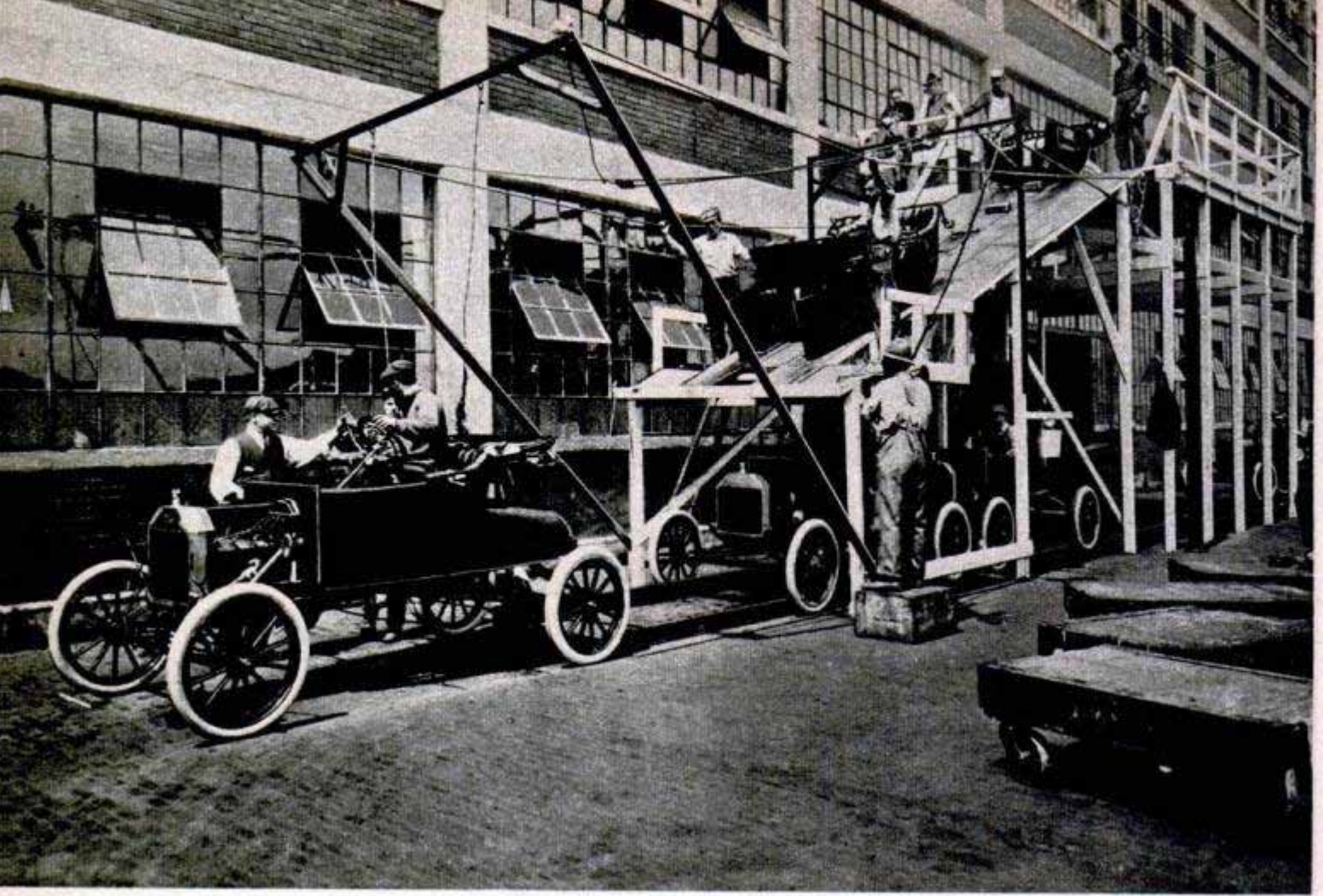

Above, assembly-line techniques like those Ford was using in 1913 sped production to the point where one American in five could buy a car. Below, nylon, introduced in 1938, was the first synthetic fiber



also be tamed for use in a power plant on land or in a ship before the century ends. Not since some savage, who was still a half-ape, found out a million years ago how to make a fire and use it had human ingenuity scored such a technical triumph.

This achievement had been foreshadowed. Soon after the century had opened physicists were telling the world that there was enough energy in a glass of water to drive a liner across the ocean. A young examiner in the Swiss patent office, Albert Einstein, had announced his special theory of relativity in 1905, and from the simple formula given, any high-school boy could calculate how much energy there was in a speck of dirt. The answer ran into staggering figures.

Even before the scientists had proceeded as far as this, they realized that what was happening in the laboratory was also happening in the stars, but on a grander scale. There were the same atoms all through the universe. But in the stars temperatures ran into millions of degrees and pressures into millions of tons. Atoms were being torn apart by these terrific forces and put together again. In the process, matter was transformed into energy and energy into matter. At last it was known why the stars shone.

The lines in the spectrum of the stars

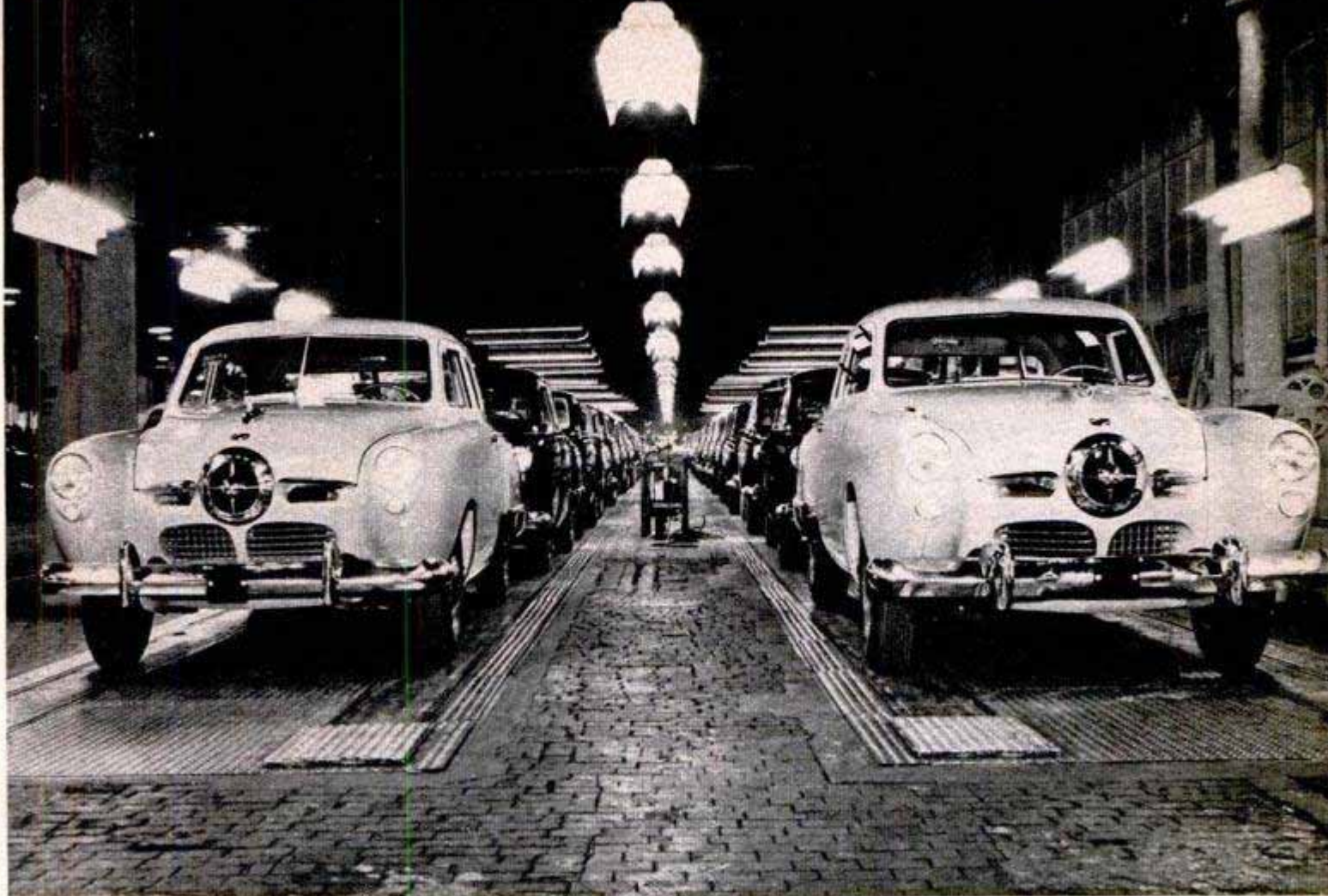

were telling all this, but not until it was known that the atom is a complex of much smaller particles could the message be read. The biggest telescopes in the world—the 100 and 200-inch reflectors of Mount Wilson and Palomar Mountain—were built in the first half of the century, to gather more light that could be broken up into spectral messages.

In the process of battering atomic bits, Ernest Rutherford discovered in 1919 that some elements can be changed into others. Since then microscopic specks of mercury have actually been changed into microscopic specks of gold. So the alchemists were not mad after all. Not only this but entirely new elements were made—elements unknown in nature. Neptunium and plutonium are among them.

After battering atoms of all kinds with the aid of high-speed particles, most of the elements proved to be mixtures of what we call isotopes. For example, there are half a dozen kinds of isotopes of lead, which can be distinguished only by weighing them. There are several hundred of these isotopes. Some of them are radioactive, some of them not. Both kinds are used as "tracers" to find out what happens in the human body when an egg or a piece of beefsteak is digested. The whole theory of

(Continued to page 254)

Above, production lines like this one at Studebaker enable the industry to turn out 140,000 vehicles a week. Below, Westinghouse exhibit showing progress of light from the candle to the incandescent bulb

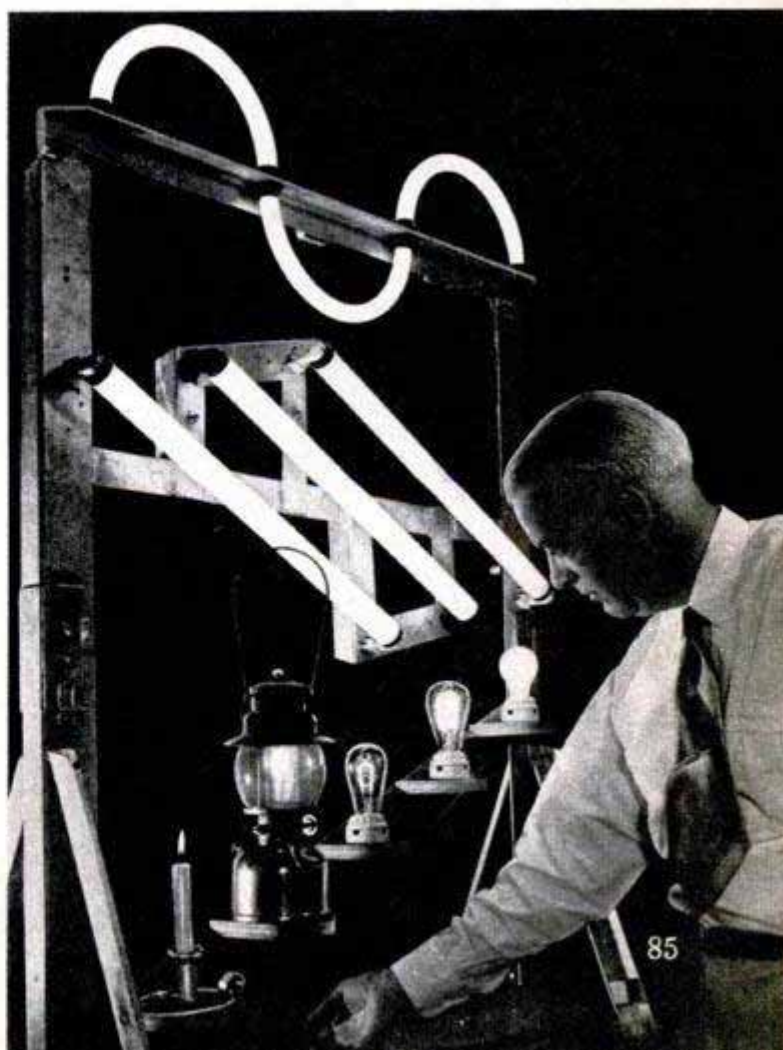

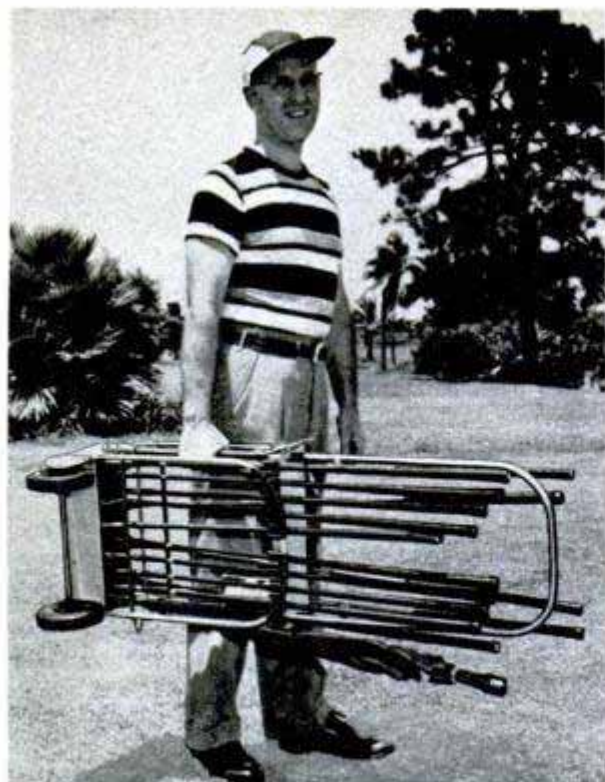

Carry-or-Roll Golf Cart

Golf clubs can either be rolled or carried in a metal cart weighing only 7½ pounds. It is lighter than most bags. Each club is



in a separate rack, head down, and the cart is balanced so that it will even stand upright on the side of a hill. The golf balls feed out from the bottom of a clear plastic tube attached to the cart.



Paper Sorter

Mimeographed or printed sheets are assembled into booklets and inserted into envelopes by a large office machine. The machine also tosses imperfect booklets into the wastebasket and detects misplaced sheets. Vacuum operated, it can stack



19,200 sheets an hour into booklets of eight pages each and prepare them for mailing. The pages are gathered on an assembly line and then slipped into the envelopes.

☛ Egg-case fillers made of foam rubber to cushion hatching eggs during shipment have been developed in England.

Weathertight Sash

Wedged against its frame, a new wooden window seals the cracks on the sides, eliminating the need for weatherstripping except at the head, meeting rail and sill. The double-hung units have no weights, springs or balances to hold them in place. Two levers wedge the sash against the parting stop, holding the window at any desired level. The sash can be slipped out for painting or cleaning.

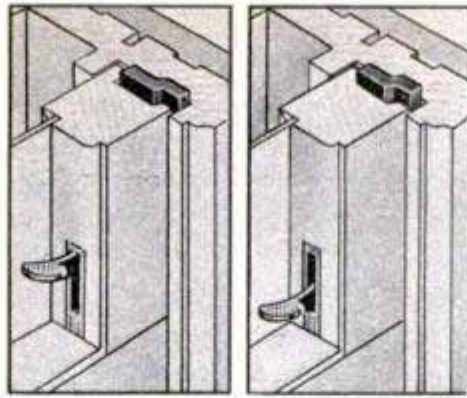

Above, left, when the lever is up the pressure strip pushes sash against frame, sealing all cracks. Above, right, with lever down pressure is off and window can be moved. Right, sash can be removed for cleaning



Modern Peter Piper Picks From Old Car

Pickle picking, a one-time backbreaking chore, now is done with ease from the frames of stripped-down automobiles on Clinton Carter's farm near Mottville, Mich. The pickers work in a sitting position from outriggers extending on either side of the chassis. The machines can be regulated to travel through the field at the rate of $\frac{1}{4}$ mile per hour, steering themselves between the rows.

Film Editor on Hinged Base Folds Into Compact Case

Amateur movie makers can fold all the parts of a film editor into a compact unit when the instrument is mounted on a special base. Made of lightweight metal, the base permits the rewinds, splicer and other parts to be folded into each other, then packed in a carrying case measuring only 16 inches wide, 14 inches high and 15 inches deep. Knurled knobs lock or unlock the parts of the hinged base.

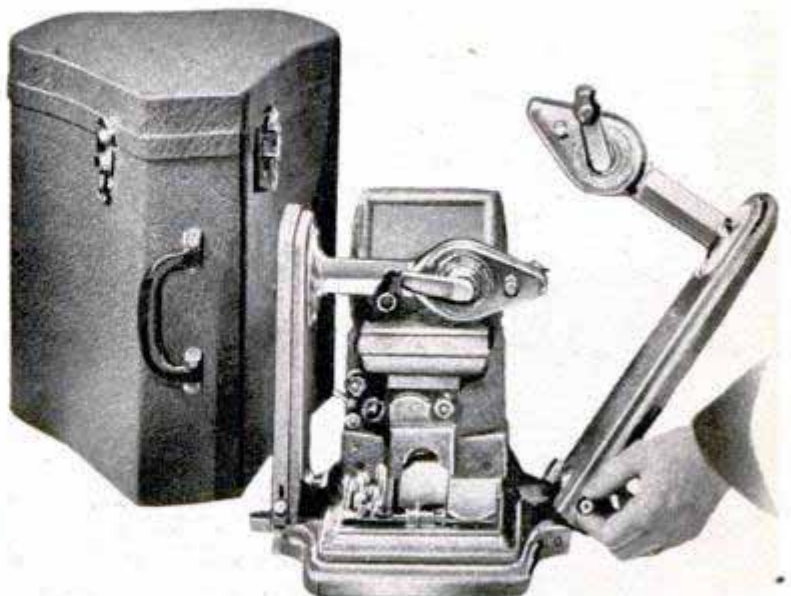

Popular Mechanics provides two sources of further information concerning articles published in each issue: the WHERE-TO-BUY-IT INDEX, starting on page 10, and the WHERE-TO-FIND-IT INDEX, available without charge from Bureau of Information, Popular Mechanics, 200 E. Ontario St., Chicago 11



Airline pilot Heath Proctor peers across the horizon from a DC-6, flying between Los Angeles and Chicago



AN AIRLINE PILOT

By Heath Proctor

Senior pilot of a transcontinental airline and a wartime colonel of the Air Transport Command in India, Heath Proctor discovered the Old Santa Fe Trail from the window of his DC-6. Popular Mechanics sent him by Jeep to explore the old wagon tracks

MAYBE I'm different from other airline pilots, but ever since I was a kid I've liked to look out of windows—house windows, automobile windows, train windows and in recent years cockpit windows.

Late one wintry afternoon on a flight from Chicago to Tucson, Ariz., I was engaged in my window-gazing pastime just west of the Cimarron River in Kansas. We were at a good altitude for observing scenery on a big scale and our DC-6 was purring like a kitten filled with high-octane milk. I had turned the controls over to my copilot and feeling warm and content was





Aerial view of old wagon-trail ruts, in foreground, brought out in sharp relief by snowfall

RIDES THE WAGON TRAIL



looking down at wisps of snow being blown across the wide-open spaces.

In places, the short grass or ruts had caught enough snow to make a rather interesting pattern. Suddenly I sat bolt upright and pressed my head against the cockpit window. That was no haphazard pattern of ruts down there on the prairie. It was a trail, wide in places and narrowing from time to time where the going was apparently rough. This old trail headed majestically into the Southwest toward Wagon Mound, N. Mex., and Santa Fe. I knew I had found the old historic Santa Fe Trail!

I've always been an avid reader of American history and 25 years of chauffeuring planes has given me a bird's-eye view

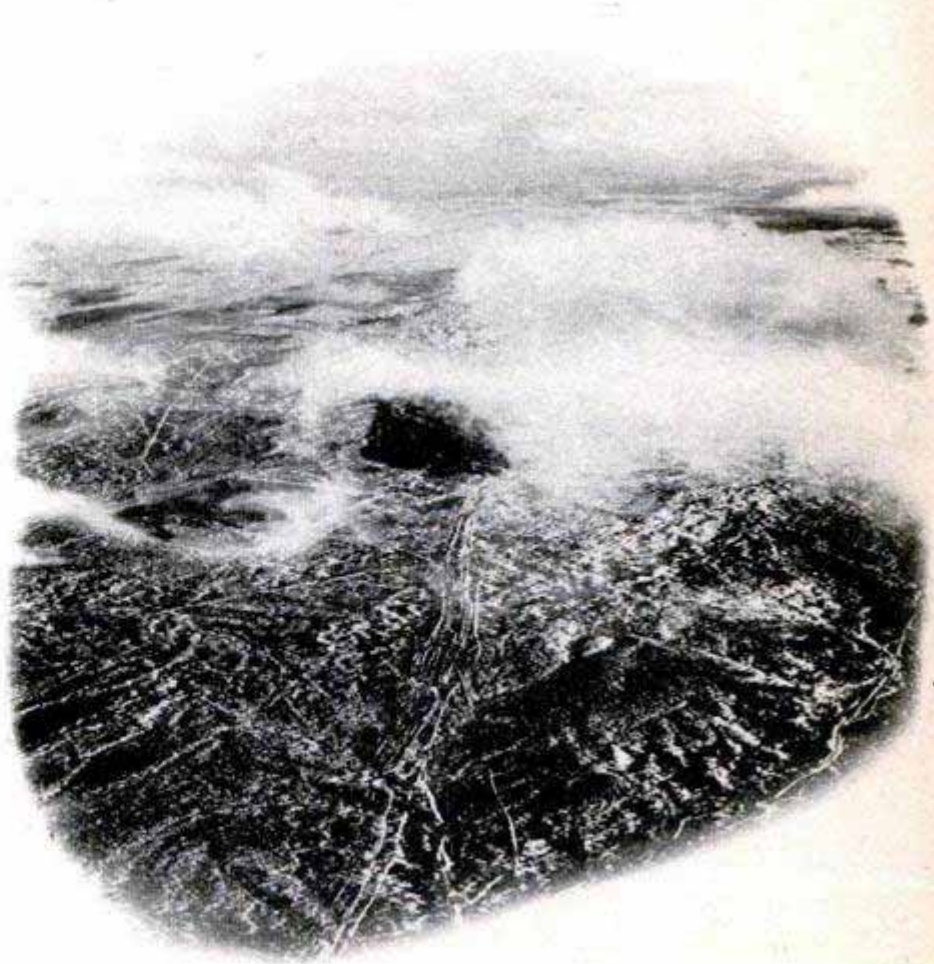

Despite wind and weather, traces of the Santa Fe Trail are still visible across the prairie. It was used until the 1870 s



From a bluff, Proctor points out to Aubrey Cookman of Popular Mechanics a clear marking of the old route

of geography. This has made me appreciate some of those terrific distances traveled by our forefathers on horseback and in ox-drawn wagons. Back in 1935 I found the old Mason and Dixon Line and took a picture of it from the air. This photograph was widely printed because most Americans thought the line existed only in musty history books.

After finding the old Santa Fe Trail I could hardly wait to get to a library and

So many travelers scratched their names on one rock ledge that it has become known as "The Trail Album"

look up some dope on it. It was used principally as a freight route and was well organized. This was in contrast to the old Oregon Trail, which was a "passenger" route traveled by stray groups of families.

The general route of the Santa Fe Trail, via the Arkansas River, was used by the Indians long before white men appeared. Early trappers and explorers followed it, but it wasn't until 1804 that the first pack train freighted the entire distance from the Missouri River to the Mexican settlement of Santa Fe. By 1824 wagons replaced the pack animals and the Santa Fe White Top became the standard vehicle.

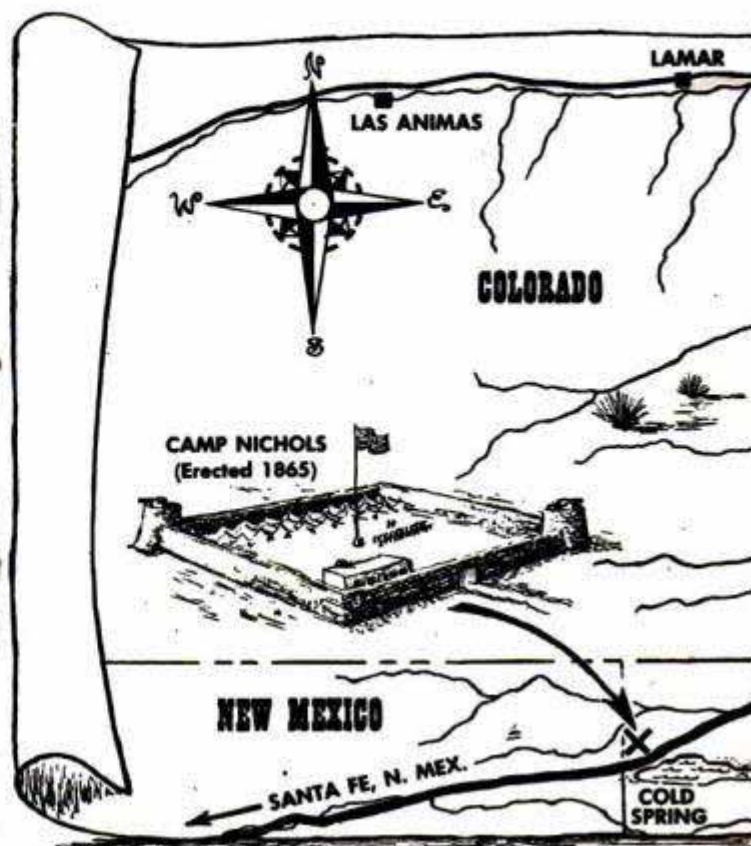



Across Oklahoma, pairs of rutted tracks nearly a foot deep are reminders of the trail's once-heavy traffic

Every time I flew the route between Chicago, Tucson and Los Angeles I would go back among my passengers and point out the marks left by the old wagon trains. And having spotted this bit of history from the air I determined that some day, between flights, I'd come down to the ground and explore the trail on wheels.

Meanwhile, I kept learning more about the trail. Santa Fe back in the early days was part of Mexico and an important city, supplied mostly by the Spanish. As our forefathers expanded westward they naturally entered into competition with the Spanish for the rich Santa Fe market. Over

the trail they sent a flood of low-priced merchandise that entirely supplanted the Spanish or Mexican importations.

The Mexicans retaliated by levying a heavy tax on each wagonload of freight. Yankee ingenuity was put to work and soon the wagon trains took on a new look. They consisted of units made up of three wagons each, a large one followed by two smaller trailers. As they approached the

At Dodge City the Popular Mechanics party followed the Cimarron fork of pioneer freight path westward. Camp Nichols, built by the famous Col. Kit Carson, had a brief life as an Army post to protect travelers

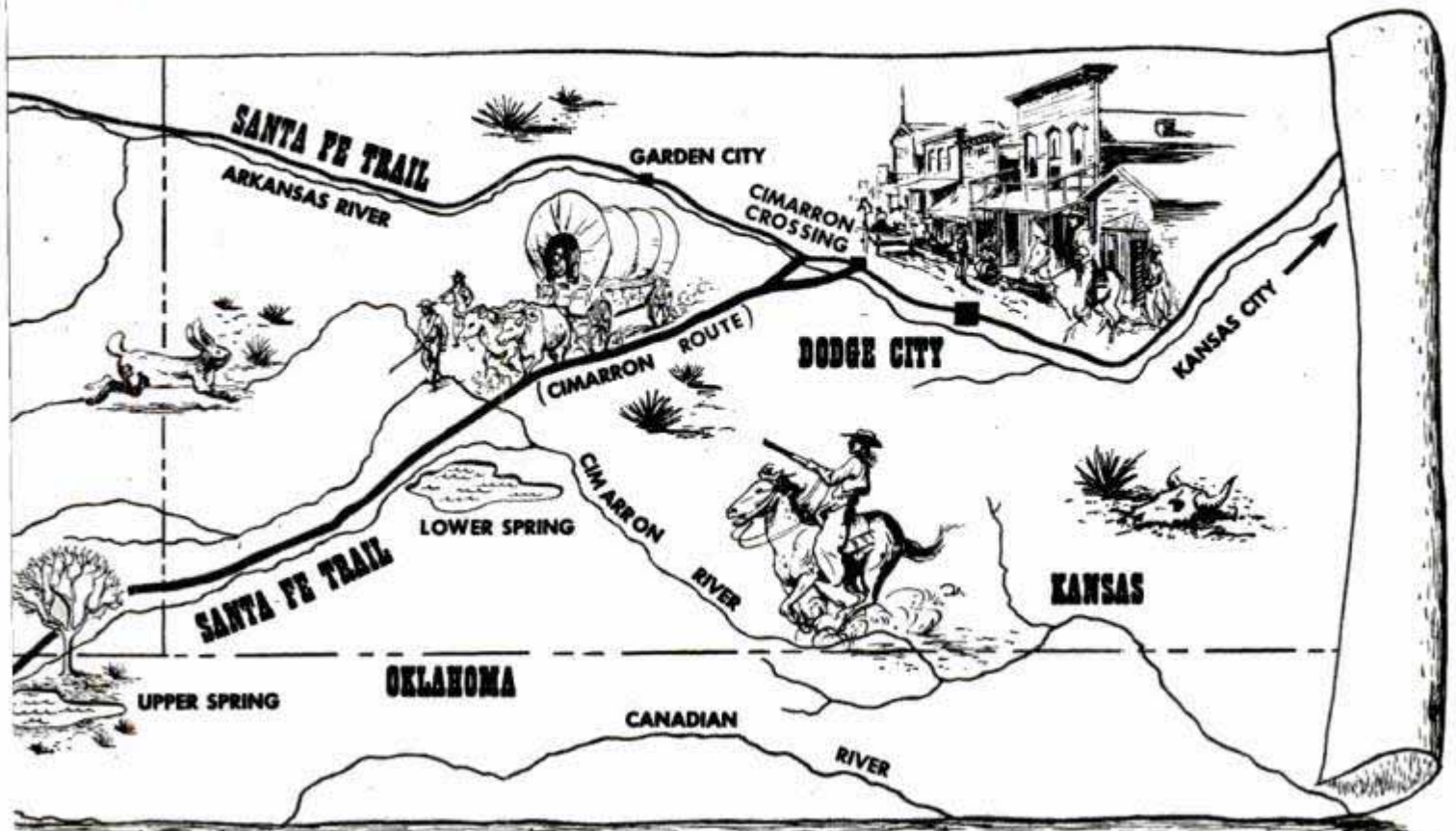



Roy Hardin of the Boot Hill Museum in Dodge City shows Proctor one of a collection of rifles popular in the old West, when a gun was a man's "best friend"



Above, Merritt L. Beeson, son of a Dodge City pioneer, answering questions about an old map of the trail. Below, "Uncle Billy" Baker, county land agent for 25 years, holds a wheel hub found near Boise City



border, where taxes were collected, freight from the two trailers was loaded onto the large "schooner," the trailers were burned and one wagon lumbered and creaked slowly on into Santa Fe.

After the Civil War stagecoach service was established over the trail between Westport (the old name for Kansas City) and Santa Fe. Carrying 11 passengers, 9 inside and 2 in the boot on top of the stage behind the driver, the distance could be made in two weeks of continuous travel. They stopped only to eat and to change horses and drivers. The fare was \$250.

I was amazed at this figure compared with today's airline-passenger fare of \$45 for the same trip! The gap between those figures, and the fact that more people were buried along the wagon trails in one summer than have lost their lives in air accidents during the entire history of commercial flying, are testimonials to the advances made in transportation.

From the air I discovered that most of the trail has been obliterated by plow and weather. From Kansas City to Wagon Bed Spring, Kans., near where the trail reaches the Cimarron River, the ruts are visible only in a few scattered spots. I discovered later that it is almost impossible to find this remnant of the trail on the ground. Actually, it can be seen better from aloft because in places the route seems to have left more of a stain than a trace.

However, from the Cimarron River to Wagon Mound the old route is plainly visible and is a magnificent sight from 20,000 feet. The known camping places, such as Middle Spring, Upper (Flagg) Spring and Cold Spring can be located from a plane. In places the trail is surprisingly wide, with from four to six sets of ruts.

I had begun to doubt if I would ever realize my dream of exploring the trail on the ground when my telephone rang one evening. It was the editor of *Popular Mechanics*. Word had gotten around about my research on the Santa Fe Trail and the editor wanted to know if I would accompany an exploring party along the trail. Would I! Assigned to the story were Aubrey O. Cookman, Jr., an associate editor, Frank Fritz, a photographer, and a Jeep full of gas.

We rode a Santa Fe Railway streamliner to Dodge City, Kans., picked up the Jeep there and started out. The Jeep was a wonderful idea. The man who had marked "rough and rocky" on that part of the map we were to travel had been over it. We followed what is known as the Dry Cimarron Route on the old trail. On it are stretches of rolling prairie where the going is good, but there are others where a Jeep is about the only self-propelled passenger vehicle that could make the grade.

On an expedition such as ours one had better stay right with the tracks, rough or smooth, or he stands a good chance of losing them. We wanted to get right between those ruts and stay there, and we did, but at times we found it necessary to use everything that Jeep had in the way of four-wheel drive and extra-low gear.

The ruts are still deep, generally covered with short prairie grass, but not infrequently bared in rocky land by wind. The pilgrim attempting to follow the route had better carry a compass. In some places it becomes confused with later-day roads or is lost temporarily in heavy growth for a time and has to be relocated by zigzagging back and forth in a general direction of from 20 to 30 degrees south of west.

The first day we were chilled by our inability to locate wagon tracks, visible from the air, along the north bank of the Arkansas, west of Dodge City. The possibility that we might have the same difficulty on the Cimarron Route haunted us, and we lost no time heading out for the unbroken prairies of Cimarron County, Okla., and New Mexico.

The weather didn't cheer us any. It rained and the wind blew, and by the time we reached Boise City, Okla., we felt and looked like three real explorers.

From Boise City we drove north on U. S. Highway 287. We thought that south of the Cimarron River we could identify an area a mile or two wide in which the trail lay. We found the county has erected an historic marker at or near the place where the trail crosses the highway, so we turned west, crossed a parallel railroad and fence line and were out on the open grassland.

Three worried individuals climbed to the summit of the first high knoll to search the country with glasses. Here, if anywhere, was the place we should find our objective. We were not disappointed, for across a creek bottom to the north on a long grassy slope were four parallel tracks reaching away to the west-southwest as far as we could see.

Here were the actual footprints of the great westward migration of American civilization. I truly believe that we, by pure chance, stood then on the exact spot where the illustrator of Gregg's "Commerce of the Prairies" (1844) sketched his picture of a wagon train, four abreast, on the old trail.

This portion of the route was first attempted about 1813 by a party of 30 men using pack animals to carry freight. Failing to find water between the Arkansas and the Cimarron Rivers, they eventually made their way back to the Arkansas after great hardship and continued to Santa Fe over the mountain route.

During the next 10 years, however, buffalo hunters and traders located springs

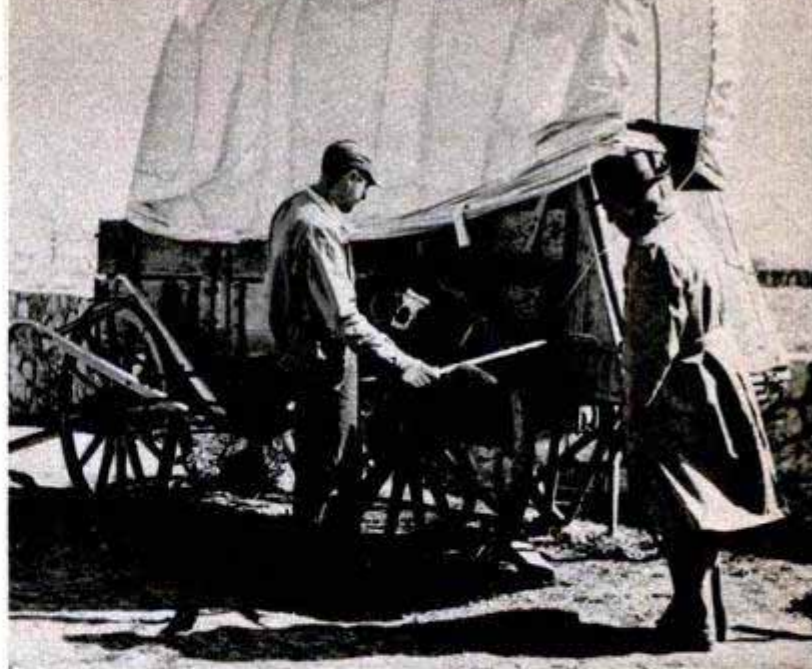

On exhibit at the Dalton Boys' Hideout Museum near Meade, Kans., is an old-time chuck wagon. They served as mobile kitchens of early travel in the West



Above, Buck James displays a rusted bolt from one of the wagon trains that paused to rest on what is now his father's Oklahoma ranch. Below, the Popular Mechanics "pioneers" in camp on the James' ranch





Photo courtesy Beeson Museum, Dodge City, Kans.

Dodge City's main street in 1872. The newly laid tracks of the Santa Fe Railway that was to doom use of the old wagon route are in the foreground. Pioneer Beeson's father owned Long Branch saloon shown at left

and marked a route to Wagon Mound, which became for 40 years the principal freight road to Santa Fe. It wasn't until 1880 that the first train entered that trading center of early New Mexico.

Even the Jeep seemed to pick up pep as we bounced onto the grass-covered road. Hours later the tracks veered sharply to the North, and we could see them on the slope ahead slanting back in again.

A rocky mound came into view in the direction of the detoured tracks, and alongside it a clump of trees. It was "Upper Spring," known locally now as Flagg Spring. Here, in 1828, the first party of freighters to use wagons instead of pack

animals was waylaid by Comanche Indians on its return from Santa Fe.

Upper Spring is peaceful enough now. Boy Scouts have a hut there, and ranchers use the site for rounding up cattle. We took some pictures, searched for relics and moved out again on the trail.

Toward evening we reached Cold Spring. There were two camps here a couple of miles apart. Both sites boast sandstone formations in which trail travelers carved their names and dates of visit. There are literally hundreds of those autographs, of Army officers, buffalo hunters, travelers and trail drivers. The cliffs are a veritable Who's Who of the Santa Fe Trail.

"Miles of nothing" faced the trail explorers during most of their trek across the prairies of Oklahoma





Nearly 80 years later, the same Dodge City street and Santa Fe Railway roadbed shown on the opposite page

We spent the night at Cold Spring, spreading our sleeping rolls in the lee of the Jeep. Our wish to travel the trail of the 49ers had been granted and now we were camping at one of the regular trail camp sites. We had all the atmosphere, except the wagons and the Indians. Before morning we would have been almost willing to put up with a few Indians for the shelter of a wagon or two.

While no one in the party was heard to suggest that tourist camps or hotels might be found preferable to the camp sites on the old trail, the fuel problem did, oddly enough, fit into a schedule of daily travel that made unnecessary any more nights on the lone prairie.

We experienced only one disappointment, and that was that we didn't have time to travel more of that famous old trail. It's there today, but won't be for many more years. The encroachment of civilization on parts of it has been slow, and the wind and weather have been kind to those footprints of the old-timers on the prairie, but it can't be long now.

As I look down now from the heated cockpit of a DC-6 at those deserted tracks winding across the prairie, I'm reminded of a day not many years ago when I chanced to complain of the quality of an Air Force mess in a foreign theater, and was told by the Commanding Officer, "Buddy, you ain't never had it so good."

South of U.S. Highway 287, this boulder-strewn area was a popular camping and watering place on the old trail





Cardboard Umbrella

Sudden showers won't mean wet clothing when you can step into a store or newsstand and buy a cardboard umbrella that you won't mind discarding later because it costs only a quarter. Invented by Charles A. Mueller of Cleveland, the umbrella is called a "Brell." The wire handle is attached on one side so you can stand directly under the center, something you can't do with a rib-type umbrella. When not in use, it folds in half and you carry it under your arm like a newspaper.

Paintbrush Box Has Wringer

Paintbrushes are easily cleaned and stored inside an airtight all-metal box. One compartment of the box has a wringer which removes surplus paint from the brushes. They then are hung on adjustable clips in the other two compartments, which hold solvent or preserving fluids. With the lid in place, the box forms a convenient carrying case.

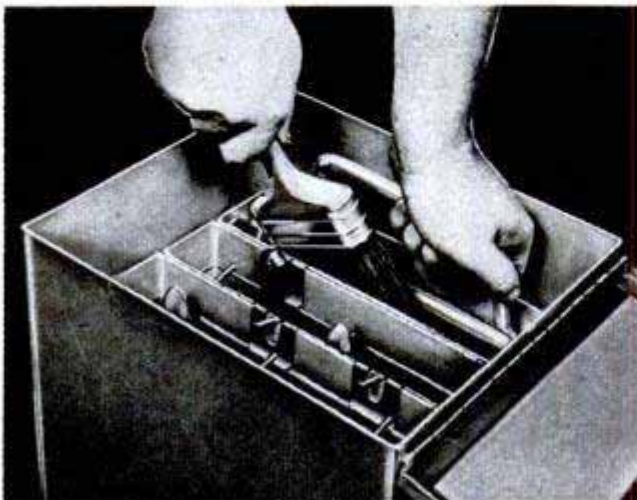

Stand Converts Wrench Into Vise

Plier wrenches, which lock to grip with tremendous pressure, become the jaws of a convenient bench vise when a wrench clamp is used. Mounted on the workbench with one bolt, the clamp provides swiveling as well as pivoting adjustments to hold the work at the desired angle. The wrench can be removed from the clamp quickly for normal use.

Dog in Splints

Yankee, a four-month-old pup, walks and negotiates stairs even though both his left legs are in splints. The dog belongs to Ray Prest of Chicago. Recently the pup fell from a third-floor window, breaking two legs, so his master rigged up the splints to keep him moving until the bones heal.

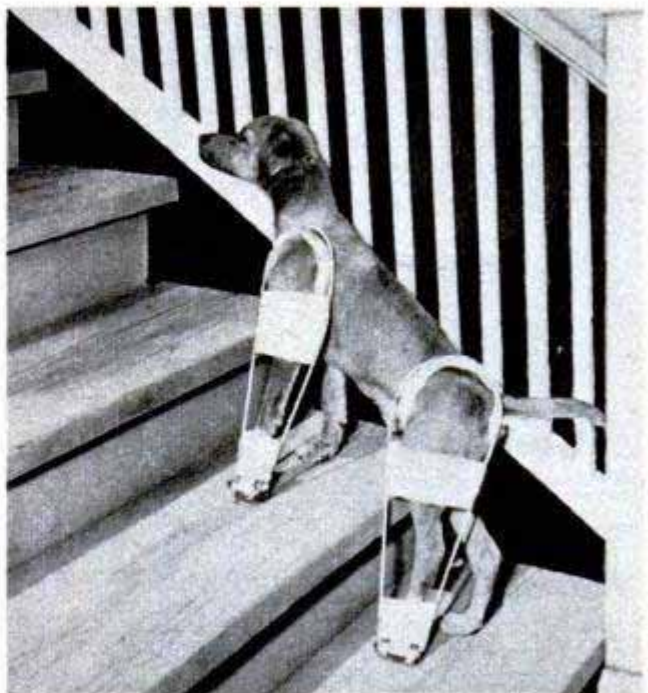

Rainbow on the TV Screen



Above, two stars of black-and-white TV, Kukla and Fran Allison, go into their act in front of an RCA color-television camera during the demonstrations in Washington. Below, these photos of an RCA color receiver in operation give you a sample of what you will see at home when television converts to color

By Richard F. Dempewolff

IN THREE Washington, D. C., hotels last fall, harried television engineers hustled around a collection of ordinary-looking TV sets, tinkering and making adjustments. Seated in rows of chairs before the sets, hordes of newspapermen, radio and FCC executives stirred and chatted noisily. Suddenly, on each screen, light flashed. "Television," someone announced, "brings you a package of rainbows."

A hush fell over the audiences as the video sets came alive with a parade of programs in brilliant full color. Dancers in pastel gowns whirled across multihued set backgrounds. Brilliant yellows, reds and blues of a puppet show leaped from the screens. Some audiences saw a football game; watched the tan pigskin travel back and forth across the white-marked greensward, while red and blue jerseys of the players stood out with such clarity that they seemed almost to have a three-dimensional quality—a phenomenal characteristic of this new miracle. What's more, people look human—even in close-ups.





Above, drawing of RCA projection system, with its three kinescopes. The two dichroic mirrors, center, superimpose the three colors to form a single image

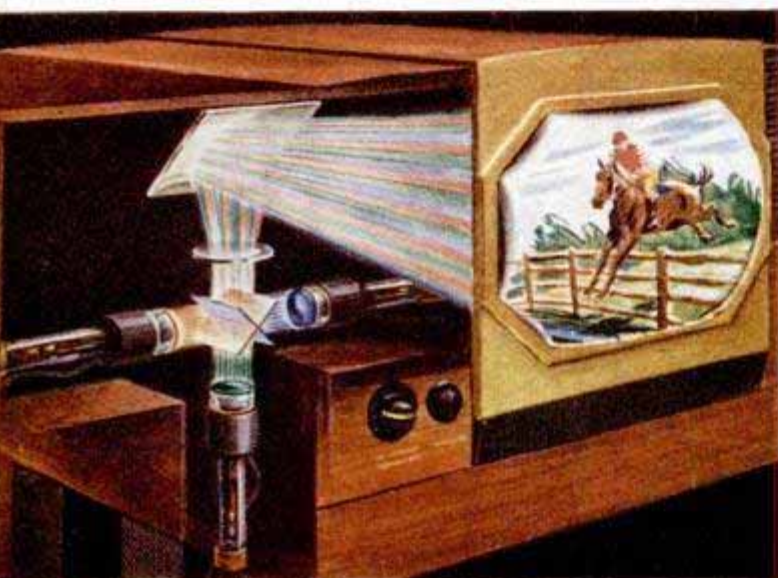

Above, RCA converter changes black-and-white sets into color receivers. Estimated cost: \$145 to \$195



For 10 years, color on the TV screen has been an established fact in the laboratories of several large radio companies, while an eager public drools with anticipation. Its sin was in being born so close on the heels of black-and-white TV which today, comprising some 2,500,000 set owners and 87 stations, represents a staggering investment of millions of public and business dollars. The Gordian knot of the industry has been to produce a system of color that will not make obsolete all the black-and-white equipment now in existence.

Now, three companies—RCA, CBS and Color Television, Inc.—claim they have licked the problem of “compatibility.” The Washington demonstrations before the FCC were aimed at determining which system is most practical.

How do these systems differ and how do they work? Few people, even today, know what makes the picture on their black-and-white video screen. Actually, it is not a solid mass of light and shadow at all, but is made up of a series of lines—like old woodcuts.

In television, the lines are “etched” by a single ray or “flying dot” of light, about the diameter of a pinhead. This ray moves back and forth, progressing downward across the screen of the cathode-ray tube, at a speed so incredible that to the eye it appears like a solid square of light, the size of the screen.

In $\frac{1}{60}$ second it makes a trip of $262\frac{1}{2}$ lines, then repeats it in another $\frac{1}{60}$ second. On the second trip, it covers the spaces between the first lines of light. This is known as “interlacing,” and its purpose is to minimize flicker.

That tiny pin point of light, as it moves along, literally paints the picture on the screen. In the studio, a camera is “scanning” the scene in similar lines, and as light or shadow is picked up by the scanner, it is translated into electrical impulses, which in turn are transmitted and picked up by the receiver in your living room. These impulses make that “flying dot” of light in your own set get brighter or dimmer in just the right places, as it flies along. In black-and-white TV you get a completely new picture of 525 lines every $\frac{1}{30}$ second. Result: wireless movies.

In all color systems, the same flying dot is used—but the electronic geniuses have rigged special devices which make it paint colors instead of just shadows and highlights. CBS’ device is a mechanical color wheel. Newer, but still undergoing development, are the electronic systems about

The RCA receiver at left has direct view instead of projected image. Two dichroic mirrors superimpose the images from three tubes so they are seen as one

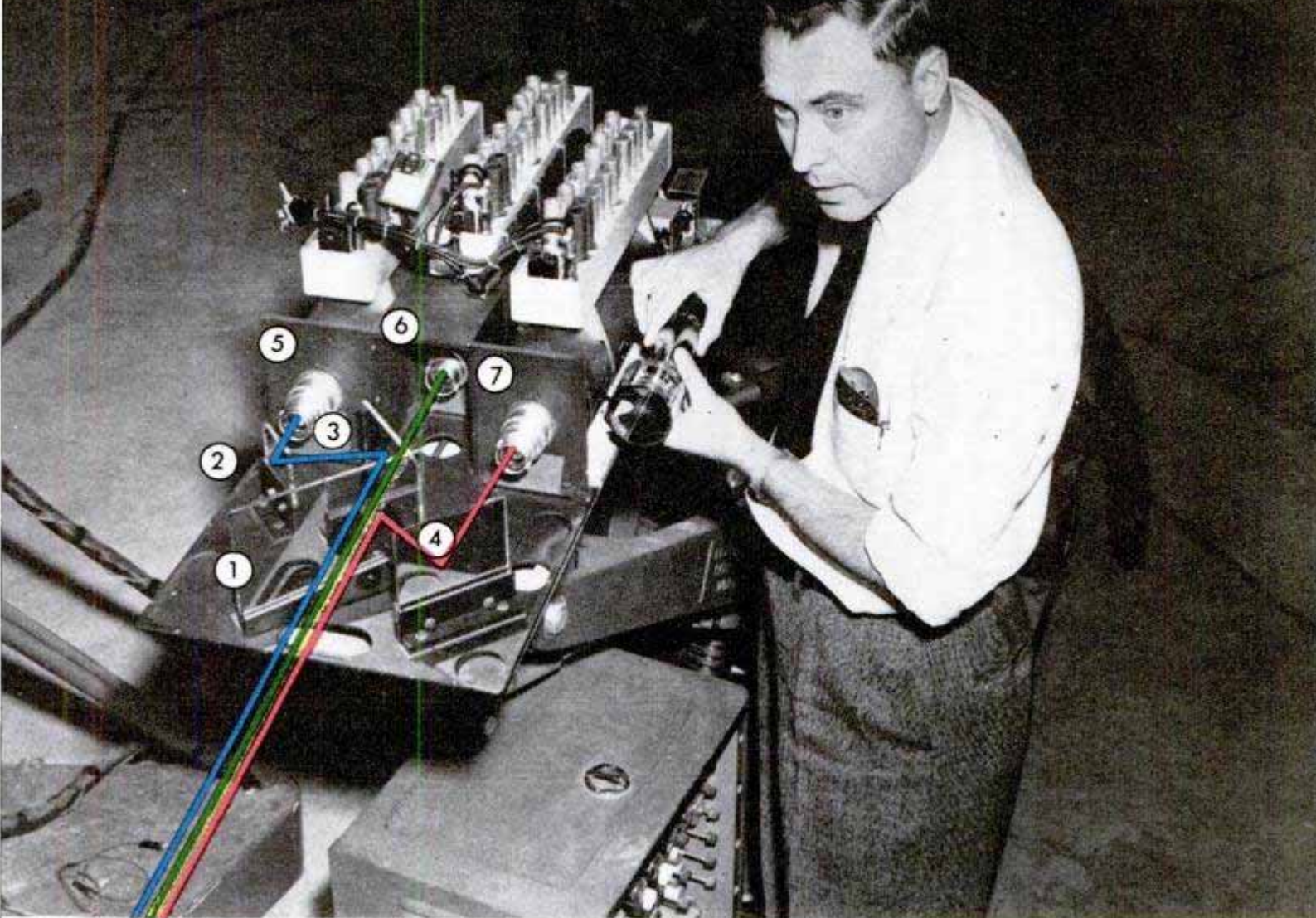

RCA's color camera without cover. Blue rays go through dichroic mirror 1, are reflected by dichroic mirror 3 and regular mirror 2 into lens 5. Red rays bounce off dichroic mirror 1 and regular mirror 4 into lens 7. Green rays pass through both dichroic mirrors, 1 and 3, directly into lens 6 in the center of the camera

which there is much controversy. Let's look at both methods.

Dr. E. W. Engstrom, vice president in charge of research at RCA laboratories, introduced a purely electronic color system which makes the flying-dot "paintbrush" do everything but turn handsprings. Magicians of the system, he explains, are "time multiplex transmission," adapted to television from radio telegraphy, and the complex "electronic sampler." Those are just words; in a minute you'll see what they do.

The camera, developed by a tall, handsome RCA engineer named Dick Webb, has three lenses—one for each of television's three primary colors—green, red and blue. Suppose the camera is focused on the brilliantly colored stage on which Kukla, the puppet, and Ollie, the green dragon, cavort for the TV audience. All those colors pour into the open front of the camera. But suddenly they start bouncing around. A tricky system of dichroic mirrors, which transmit some colors, but reflect others, permits only green to enter the center lens. Red is bounced off one mirror and reflected into the right lens.

Blue bounces off another and is reflected into the lens on the left.

Now, three scanner tubes, one behind each lens, are scanning three pictures of Kukla and Ollie—one showing only the red in the scene; the others only the blue and green.

And here's where the sampler comes in. It actually samples the color intensity picked up by each of those three scanners as it moves along. It samples in sequence—first the green, then the red, then blue, and the speed of its sampling is clear out of this world. Each color is sampled 3,800,000 times a second, for a total of 11,400,000 color samples a second. The green sampler dot, for instance, may be just starting its trip across the first line of the picture field. It samples the picture for green, and exactly nine hundred-millionths of a second later the red is sampled, and so on. Now, in these microscopically split seconds, each color signal is turned into an electrical impulse, which goes out over the time multiplex transmitter—an ingenious device that times and synchronizes the sequence of all those impulses and sends them out as one signal—and is unscrambled and

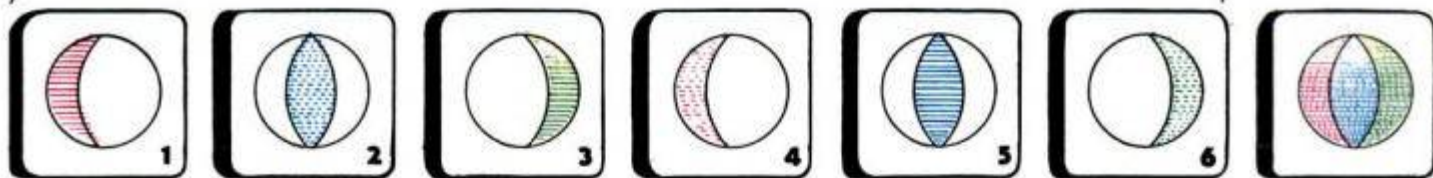

CBS color wheel, left, creates six color fields in $1/24$ second, which to the eye appear as one, right

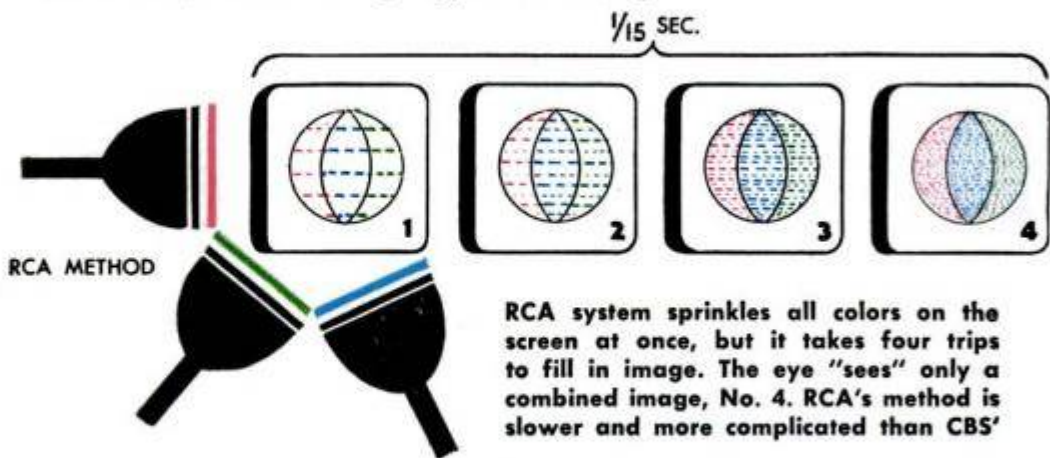

RCA system sprinkles all colors on the screen at once, but it takes four trips to fill in image. The eye "sees" only a combined image, No. 4. RCA's method is slower and more complicated than CBS'

changed back in reverse order on your home receiver. Out come Kukla and Ollie in gorgeous full color.

It's not as simple as that, of course. In the RCA system, the receiving unit contains three kinescopes, each receiving an image from a flying dot painting the picture in its own color. All these dots are flying along at the same relative position as samplers in the studio, and each is splattering the screen with millions of specks of its own specific color, one after another. So each line on the screen is actually made up of a whole string of color specks; green, red, blue, green, red, blue, ad infinitum.

Besides coming back to "interlace" lines, Doctor Engstrom's flying-dot paintbrushes also jog sideways a hair each time the field is covered so that the color specks also "interlace" every $1/60$ second. The result is the biggest mess of color specks you ever saw in your life and so fully is the image "covered" that no human eye in the world can detect a flicker. Even looking close up, the picture seems to be made up of solid masses of color, with just a faint swirling motion like the movement of wind across a wheat field.

Doctor Engstrom points out that with this system, people with current black-and-white sets would be able to get black-and-white reception of the color programs without doing a thing to the sets they own. To receive color, they would have to buy a converter unit.

Actually, black-and-white reception from RCA's color cameras beats anything you're seeing now. Engineers, sweating out the FCC demonstrations at the RCA studios in the cellar of the Wardman Park Hotel in Washington last fall, proved this

to everyone in the audience by accident.

The color demonstrations dragged on too long and the regular scheduled telecast time was creeping up. Black-and-white TV cameras must be warmed up before use, but all the engineers were too busy that day on an important color demonstration to get the black-and-white cameras ready. Finally, the color program ended—simultaneously with starting time for the scheduled network telecast. "There was only one thing to do," explains an RCA engineer. "We turned the color cameras on the black-and-white set, prayed and let fly. Five minutes later phone calls began to come in from points as far as Cleveland. They all said the same thing 'Hey, this is the best definition and brightest reception we've ever had. Why can't we get it this way all the time?'"

What will RCA color cost? Set manufacturers have estimated that converter units to make present black-and-white sets

RCA's two-color receiver is cheaper than the three-tube models, but it can't give true-to-life colors



spew color, would cost from \$145 to \$195 installed. New sets would cost you from \$400 to \$1000, depending on how lavish you want to get.

The only other all-electronic system up before the FCC is one devised by Color Television Incorporated, a West Coast organization that veils its technique in mystery. In many ways, it resembles the RCA system except that the flying dots lay down the color sequences by lines instead of specks. In split seconds, red, green and blue lines of color follow each other down the screen, painting as they go. Since the company has held no public demonstrations, few people know what the pictures look like.

Oldest and most tried color TV system is the one developed by Dr. Peter Goldmark of CBS, an earlier version of which was fully described by *Popular Mechanics* in April 1941. It employs standard black-and-white-transmission apparatus and a single receiving tube. Its secret is a couple of disks with red, green and blue filters. One, with 12 color filters, turns at 720 revolutions a minute in front of a pickup tube in the camera. The other, with six filters (to cut down size) turns at 1440 revolutions a minute in perfect "synch" with the camera disk, in front of the receiving tube on your set. When the red filter is in front of the tube, the red elements of the picture being "shot" appear on the screen. The disk is so timed that, in the split second it takes the flying dot to make one tour of 441 lines down the screen, the wheel has turned to the next color, blue, and the fly-

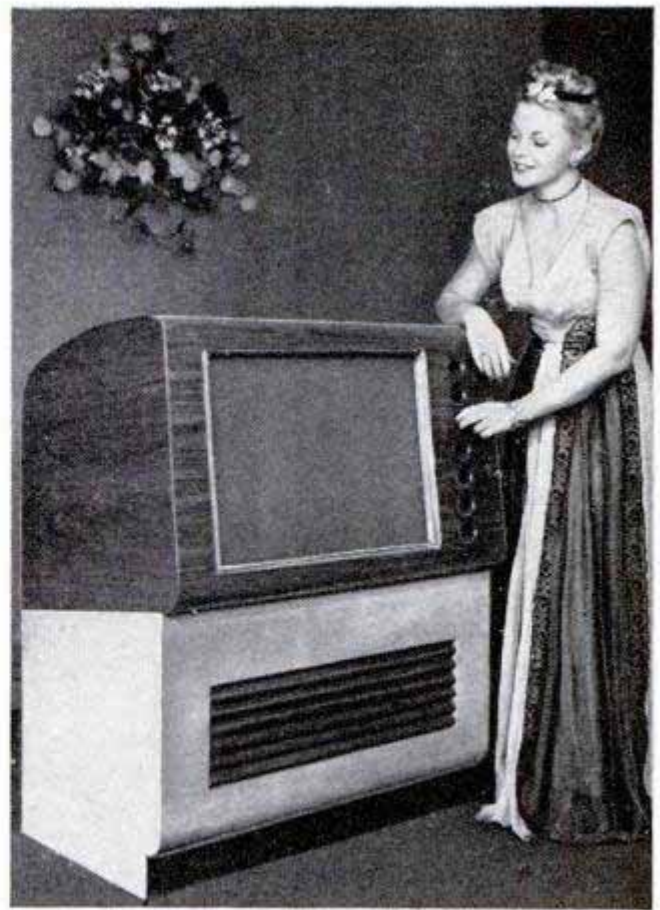

This is a CBS color-television receiver. It uses a projection system to fill its giant 21-inch screen

ing dot paints the blue in the picture on the screen. Then the green dot goes down the screen. Now the red comes back and interlaces. This goes on and on at a rate of 29,160 lines of color per second, or somewhat faster than you can count them. Twenty-four color pictures appear every second.

Actually what is happening is that single-color pictures are being laid down one on top of another at a speed so great that the human eye can't follow them and they merge into one full-color picture. In effect, it is like a three-color printing process.

Because of the rotating disks, the CBS system has become known as mechanical, much to the annoyance of the engineers who point out that the actual transmission of impulses is just as electronic as any other system.

An interesting feature of Columbia's system is the tremendous control achieved by the man at the "color mixer." By turning dials, he can

With the CBS color camera focused on Patty Painter, known as "Miss Color Television," technicians get ready to shoot a scene at the FCC hearings



produce almost any lighting effect desired on the scene being televised. By increasing blue he can make a sunny day gloomy. By adjusting red, scenes shot in the studio can be made to look like outdoors on a sunny day. Auras of blue, red, green, purple can be cast over an orchestra or dance team for "mood" setting.

The brightness of the CBS color pictures is almost uncanny whether the light at the scene of televising is good or bad. To demonstrate this, CBS engineers in Washington televised a girl under full studio lighting. Then they began to douse the lights, one bank at a time, until the light level was too dim to read by. In spite of this, the pretty model gleamed 15 times brighter on the receivers than in the studio.

This odd but handy quirk would be a boon in televising outdoor sports, CBS points out. To prove it, they televised a football game on a rainy day in Washington. The players' jerseys were so bright on the screen that, for all the audience could tell, the sun was shining.

What happens on current black-and-white screens when Columbia color cameras are televising? A shapeless gray mass of shadow appears. Adapter units to make black-and-white reception possible would cost \$20 to \$50 or a handyman can build his own. Converters to make present sets bring in color would cost from \$75 to \$80 and new color sets from \$250 up.

Which brand of color TV will be approved by the FCC, nobody knows at this writing. Most set owners don't care, as long as they get rainbows on their screen. But the value of color TV goes much further than that.

Last year, CBS, in cooperation with Smith, Kline and French, pharmaceutical

manufacturers, demonstrated beyond doubt that its system works and has a terrific potential in science and industry as a teaching medium. At Atlantic City, Denver and Chicago medical conventions, adaptations of CBS equipment, built for the pharmaceutical house, were used to televise surgical operations.

The unique camera, specially designed by CBS for teaching surgery, can be focused so the screen image is actually bigger than what the surgeon sees. Hooked to one end of a six-foot steel arm and balanced at the other end by a metal box containing the scanning equipment, the camera sits high on an upright standard and peers directly down on the patient. Students, instead of craning necks from distant seats in an amphitheater, sit back in easy chairs and see every detail as though they were looking over the surgeon's shoulder.

So graphic were the pictures on the screen, that six members of the audience fainted during an eye operation. No details escaped the color camera. When a surgeon severed the wrong blood vessel, the audience leaned forward tensely, heard him cry, "This never happened to me before," and watched every motion of his swift hands as he called for instruments and quickly sutured the vessel.

The fact is that color television is here. One by one, the problems are being solved. Recently, Dr. Willard Geer of the University of Southern California announced that he had a new receiver that can pick up telecasts transmitted by any of the systems known—including present black-and-white. The heart of the set is a single tube, which shoots out three separate flying dots from three little electron guns in its base. They will paint colors on the screen one after



If you own a black-and-white set and CBS color is authorized by FCC, all you will need to pick up pictures in full color is an adapter like the one this girl is sliding in front of the set. Circular case contains a color wheel. Cost of unit: About \$75

another, all at once or, simply by turning a switch, all the guns will get the same signal and black-and-white will result.

At this writing, the FCC, watchman of the airways, is testing color receivers of CBS, RCA and Color Television, Inc., to be sure the public gets the best system as soon as possible. Whatever the outcome, most experts feel that within two years the chances are good that you'll be watching color on your video screen.

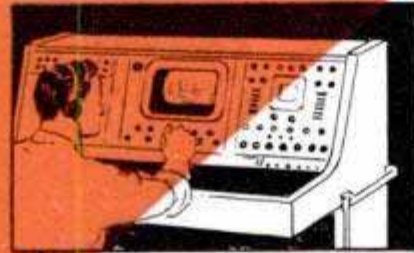
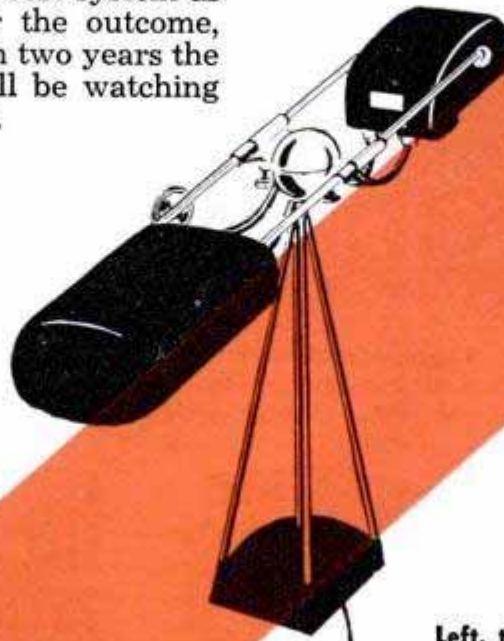

Left, the diagram shows how the CBS color system works. Above, the color camera picks up the image and breaks it down into sequential impulses. An engineer at the control panel feeds these impulses to the transmitter and they are then broadcast, the same as black-and-white, to color receivers. Set shown here has the color adapter in front of it. Of course, color sets can be made with color wheel built in

Already, CBS color TV has proved its value to surgeons all over the country. Right, at St. Luke's Hospital in Chicago, the TV color camera, center, telecasts an operation for study by surgeons who see it on receivers on the other side of town. That's the control panel at the left of photo

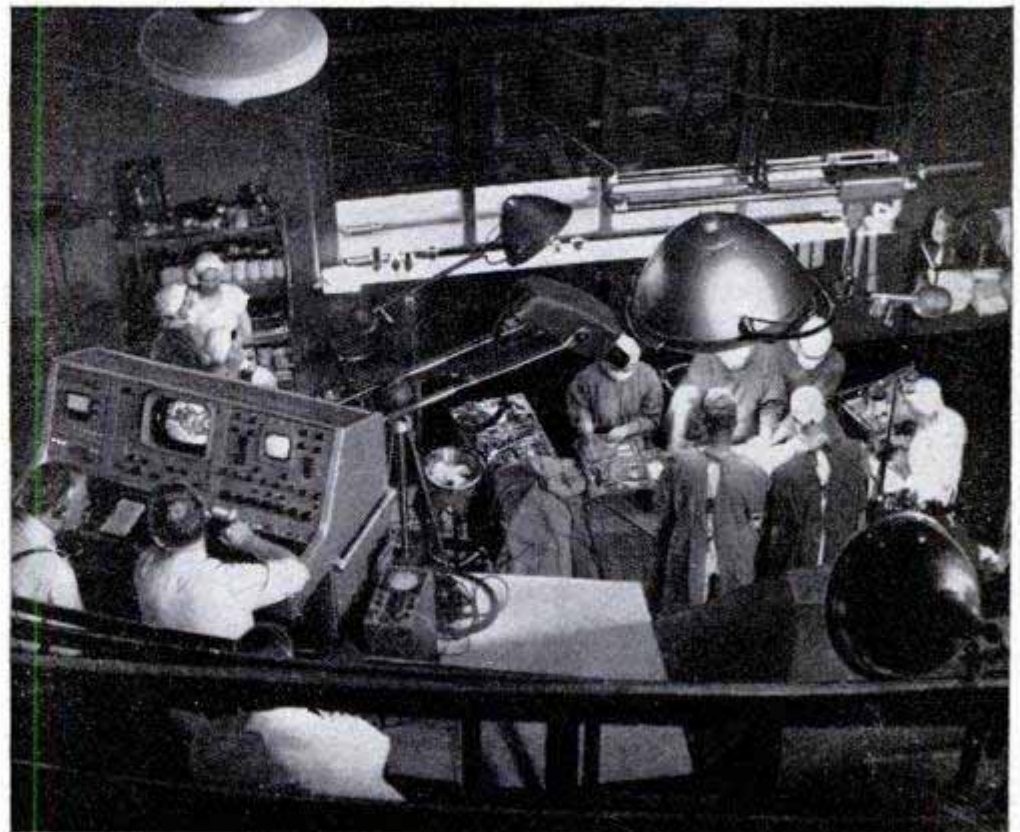

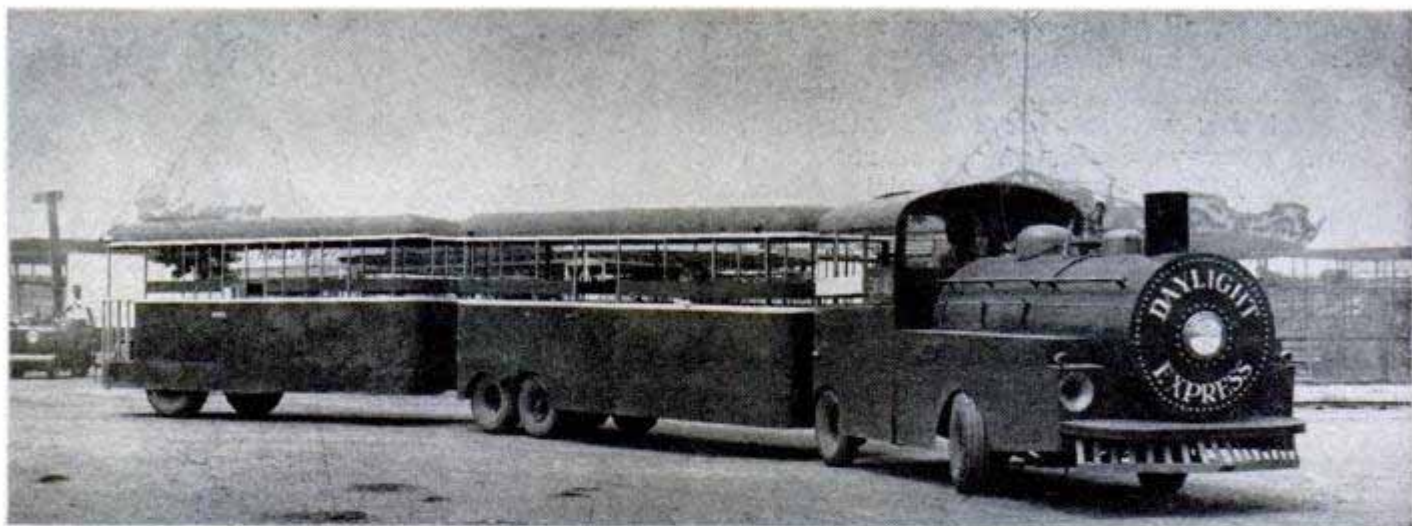

Above, one of the park's two Jeep-engine-powered locomotives. This one is used to tow two trailer cars having aluminum sides and wooden interior seats. Favorite gadget is the automatic mechanism that rings bell

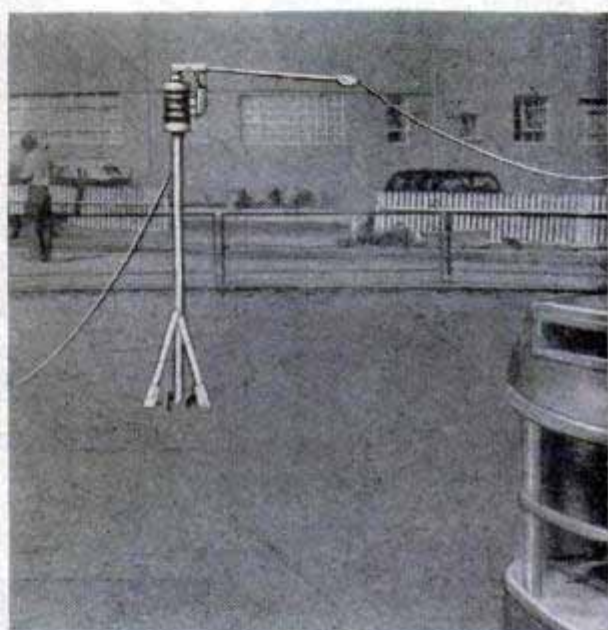
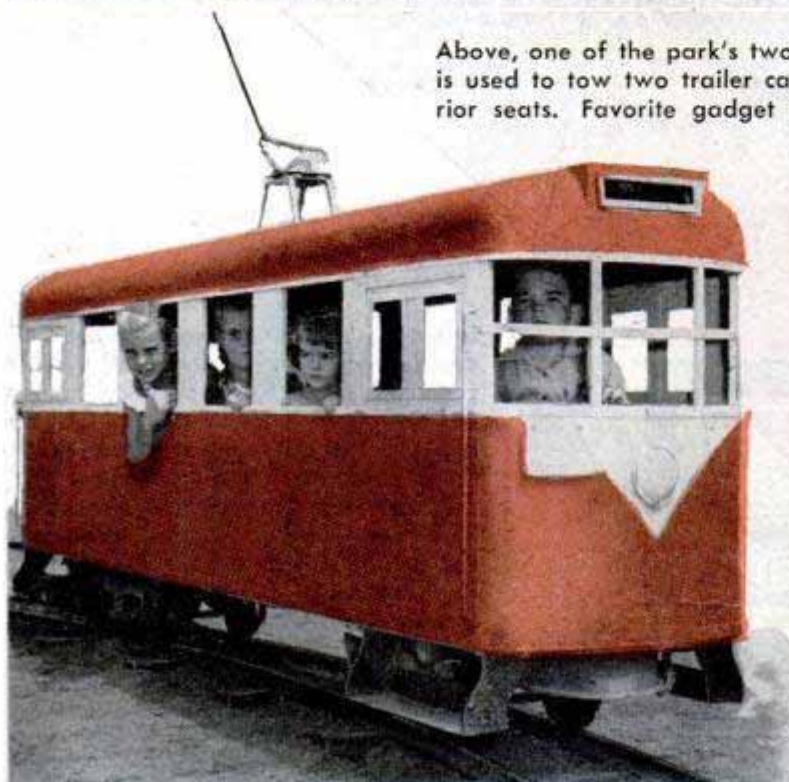

Above, left, happy passengers ride in a miniature trolley car with the child in front "operating" a set of dummy controls. Above, right, current for the trolley's motor comes over a line that extends from a commutator pole in the center of the track

Below, en route to a child's carnival location, one of the fire engines tows a miniature Ferris wheel and the gasoline-driven generator that turns the wheel

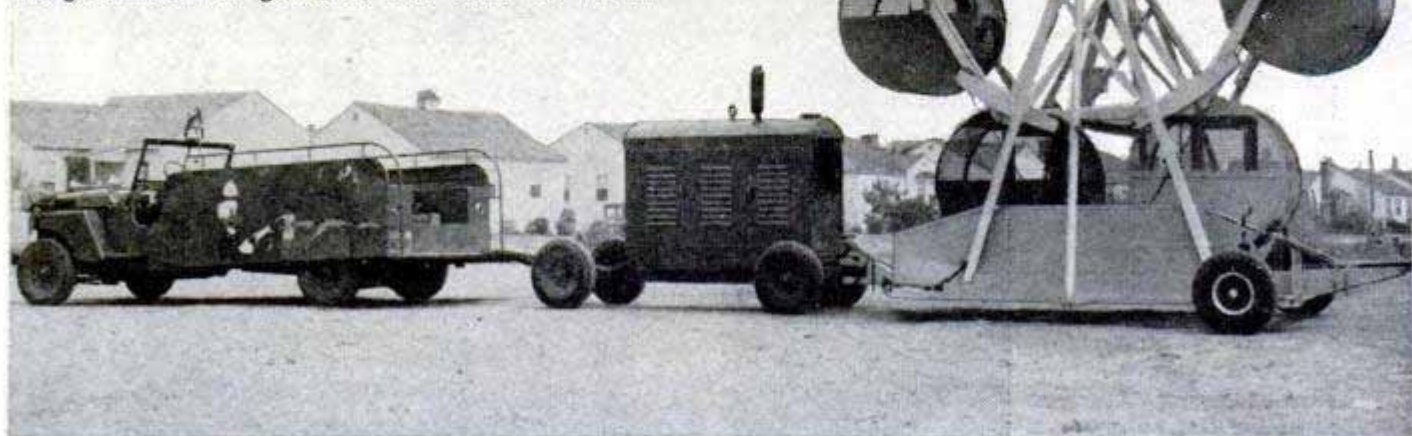

RIDE 'EM KIDS!

Tinkertown might easily be a place dreamed up by some mechanically minded youngster — but it actually exists as an amusement park in Los Angeles. There children can ride a "real" fire engine equipped with red light, bell and siren or a double-deck bus or a miniature trolley car that seats 12 or a toy locomotive and tender powered by a Jeep engine inside. Anybody got a nickel?



↑ Young passengers in the fire engine get all the thrill of going to real fire. They travel over the park on a dirt road graded for climbs and bumps while the red light flashes, the bell rings and siren moans. The engine is made of a standard Army Jeep equipped with small wheels and tires and with fender skirts to improve its looks. It will carry 10

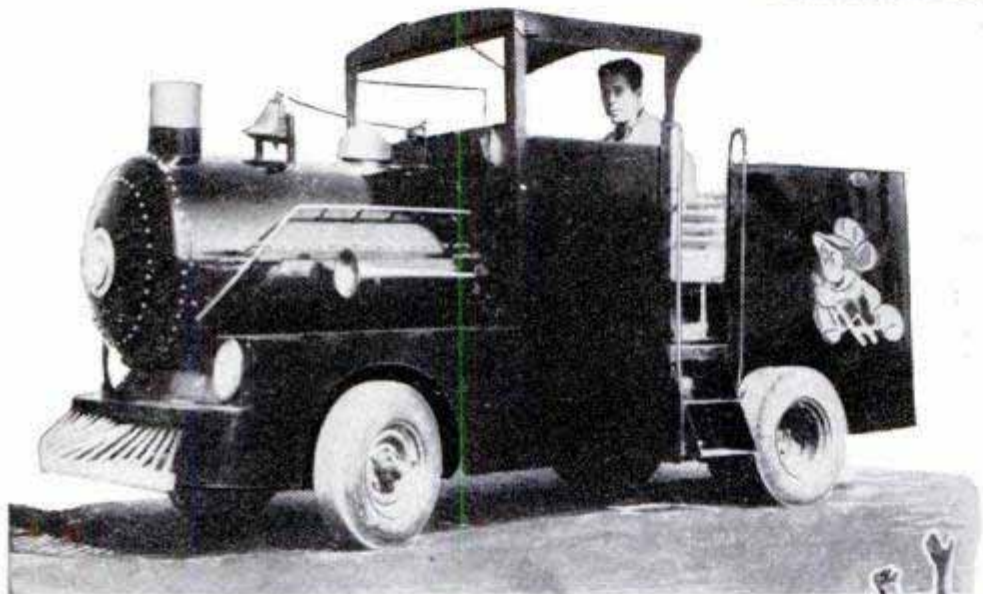

Above, realistic locomotive (despite rubber tires) has a boiler that unhinges allowing mechanics to work on Jeep engine that powers it. Bell is rung by a windshield-wiper mechanism that pulls the bell cord back and forth. Standard Jeep chassis was shortened and narrowed six inches to provide the frame. The locomotive has an air-horn whistle and the body is built of welded-steel sheets. Right, double-deck bus has a sheet-aluminum body and is mounted on chassis of Crosley auto. It will carry about 20 children and driver

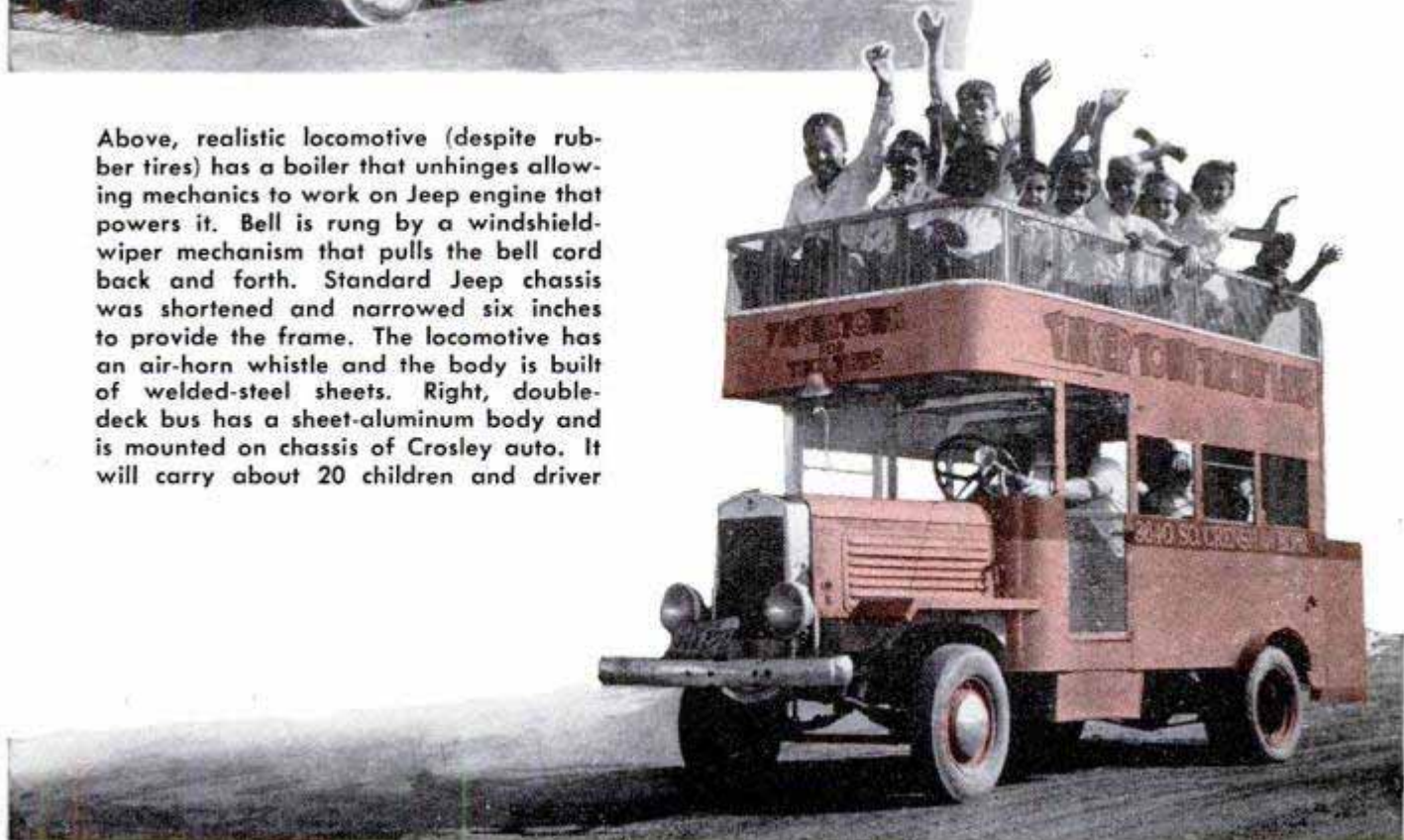



"Gallows" Support Pipe Line

Sinister-looking gallows help absorb the expansion and contraction of 1800 feet of a pipe line that crosses the Red River. The length of the 24-inch-wide pipe changes as much as eight inches between a cool night and a hot day. From points well back from the shore, where the pipe emerges from the ground, it is carried in saddles attached to the crossbars by suspender cables. Turnbuckles in the cables allow the tension on the sides of the saddle to be equalized and the grade between the earth and pipe to be maintained.

Retread Design Stops Tire Skidding

Retreaded with a gridded pattern, automobile and truck tires are said to be so skidproof as to make chains unnecessary even on ice. The grooves between the blocks are only about $\frac{1}{8}$ inch deep. During acceleration and braking, the edges of the blocks dig into the pavement, resulting in faster pickup and stopping. On wet pavement, water is forced to one side by the action of the grooves. An ordinary tire can be retreaded with the new pattern about three times during its useful life.

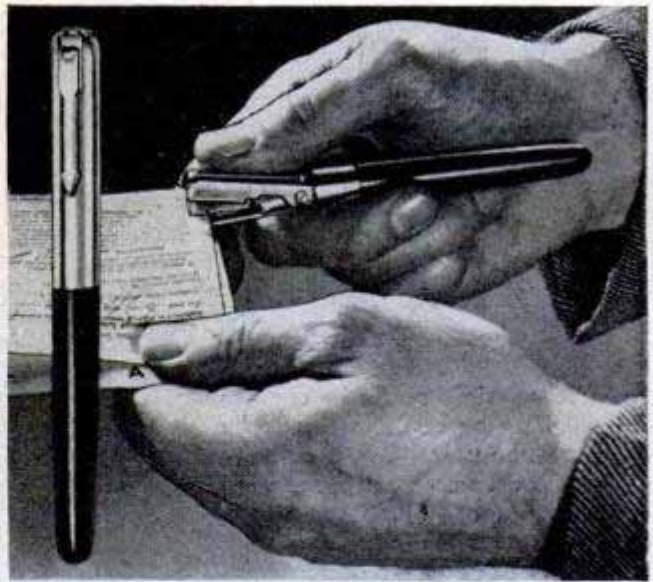
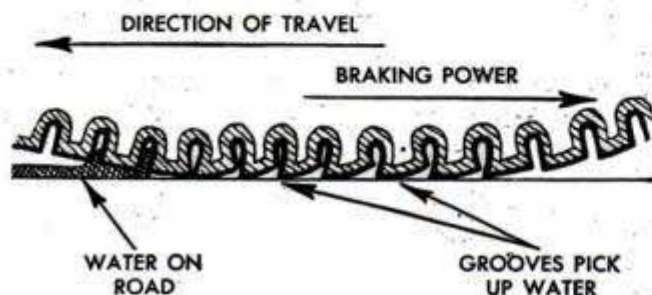

Pen-Size Stapler

Shaped like a fountain pen, a stapler clips to your pocket ready for use wherever and whenever you need it. It weighs only $1\frac{1}{2}$ ounces and holds 100 staples when fully loaded. The staples are a little smaller than standard size, but they will fasten together as many as 12 sheets of paper. The staplers come in five different colors.

Photo Trimmer Guides Let You Cut in Dark

Trimming negatives or enlarging paper in the dark or semidarkness is made foolproof by a pair of adjustable stops that attach to any standard trimming board. By setting one stop for the width and the other for the length, you can cut negative stock down to size in total darkness and each cut will be accurate. The stops swing up out of the way when not in use. The bar on which the stops slide is attached to the cutting board with screws or bolts.

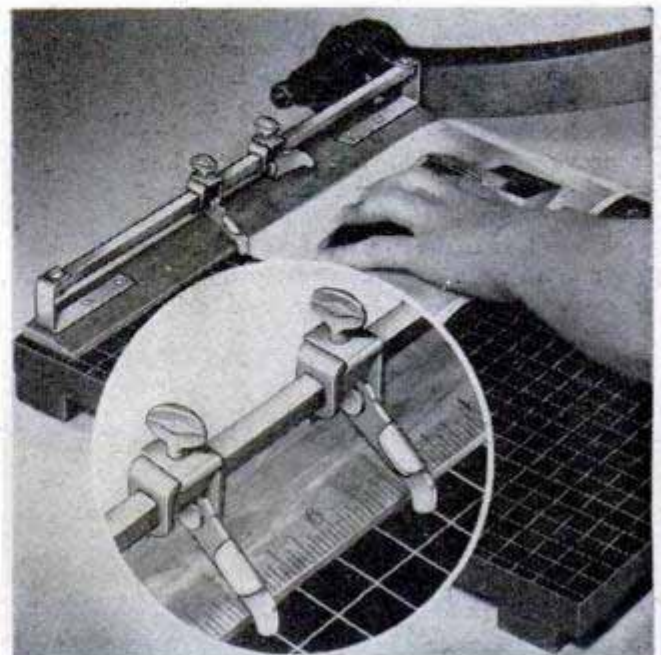

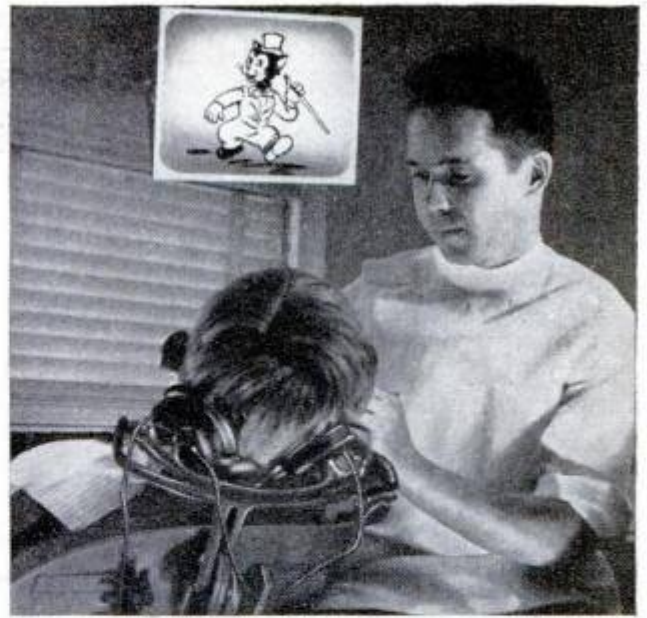
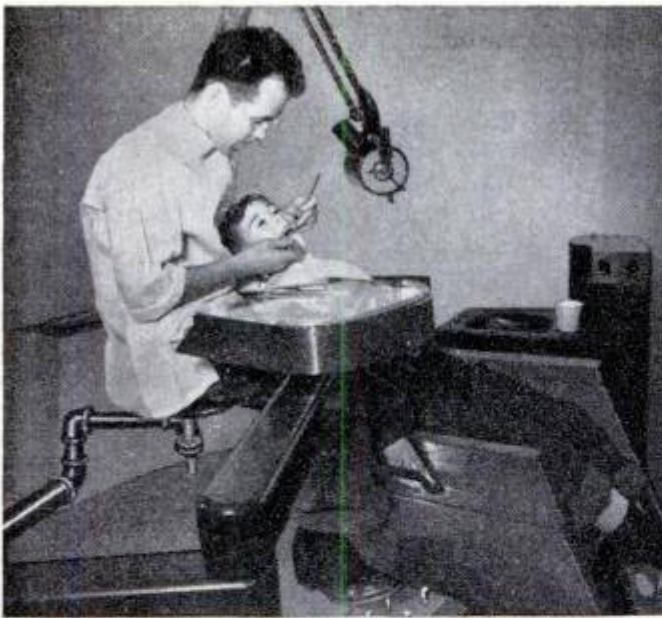

Above, no jitters here. All sinister equipment is hidden in cabinets. Right, patient relaxes while watching movies. Sound is piped into headrest. Below, drill has two tubes, one for water jet and the other for air

Have Fun at the Dentist's

Ten years ago Dr. Richard W. Page of Chappaqua, N. Y., began designing a dentist's office that wouldn't be a chamber of horrors. Today his patients walk into a circular, streamlined room where everything grim, including the drill, is hidden. They relax in a foam-cushioned chair surrounded by attractive cabinets. Hydraulic platforms send patient or dentist up or down at the touch of buttons. Doctor Page can flick a switch and Mickey Mouse will appear on a screen directly in front of the patient. No one but the patient hears the sound track because the speakers are two earphones built into the headrest of the chair. Doctor Page's drill has a pair of tiny pipes which send water or air over the whirling bit. Water cools the bit, thereby cutting pain, and the air jet blows the water

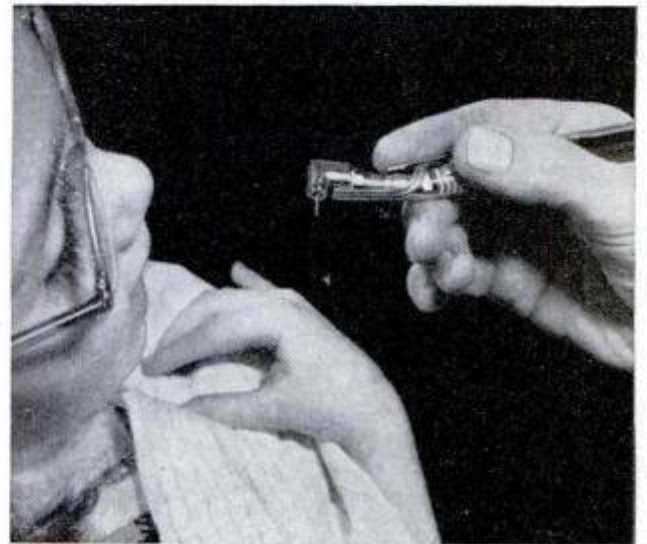

away so the dentist can see what he is doing. The drill is completely concealed in a near-by cabinet when not in use.

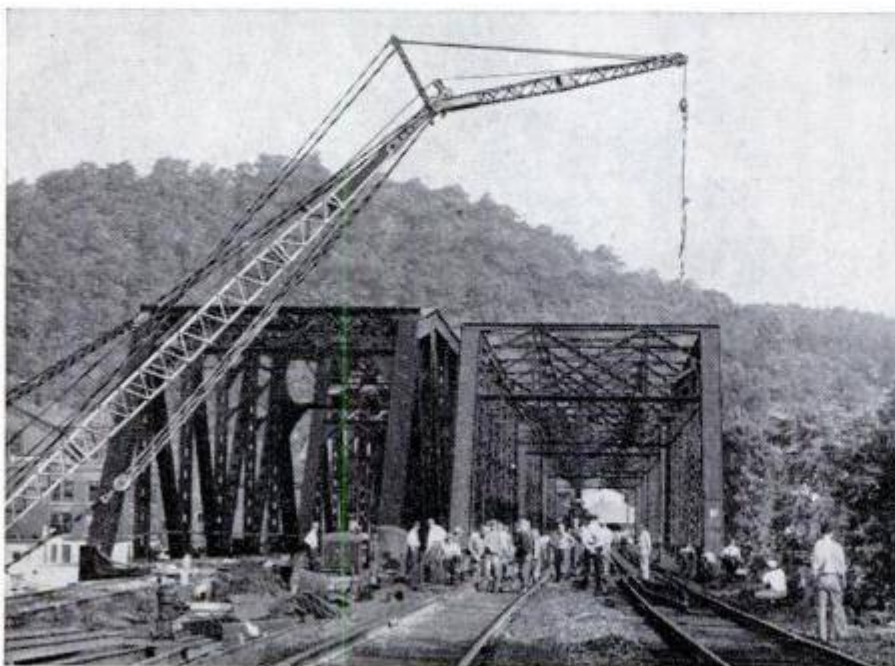

Bridge Shift

Rail traffic was interrupted for only a few hours when a new bridge was installed over the Allegheny River at Warren, Pa. The new and larger bridge was assembled alongside the old span, which continued to carry traffic. When the new structure was assembled, the old bridge was winched to one side and the new one moved into the spot vacated by the old, all in one operation. Pilings supported the old bridge until it could be dismantled.

RED WARNING LIGHTS flashed on the instrument panel and the alarm horn began squawking alongside my ear. Both signals meant the Skyrocket was on fire.

Anything could happen in the next second, for I was 40 feet off the ground and the air-speed needle read 600 miles per hour. I did three things automatically and almost simultaneously.

I began pulling back on the control wheel to gain the altitude I'd need if I had to bail out in the jettisonable nose, and I yanked the handle that operates the fire extin-

guisher system. Then I killed the jet engine.

I hoped that nothing was happening to the ton and a half of explosive rocket fuel 10 feet behind me.

"I've got an indication of fire," I told the Muroc Air Base tower, "and I'm landing down wind, right now!" Muroc replied that the crash wagons were at the landing end of the runway, almost five miles from where I would touch down. They wouldn't be of any help.

Seventy-five seconds later the wheels were on the ground and I was rolling along at 240 miles per hour, faster than I ever want to land an airplane again. Then came

I Fly

Most men begin to slow down at the age of 45. For Gene May the pace gets faster and faster. A graying grandfather, he probably worries about his pilot sons as he routinely pushes his Navy Skyrocket past the sound barrier

May examines yaw meter attached to needle nose, whose sole function is to hold instruments well out in the undisturbed air ahead of the plane



the anticlimax. A malfunction in the warning system was to blame and there was no fire after all.

That false alarm was one of several times that I've been badly frightened since I began testing aircraft at supersonic speeds. Once the engine stalled at 40,000 feet and immediately the plate-glass windshield frosted up so I couldn't see out. It wouldn't take much to put the plane in a dive or a stall and I did some very careful instrument flying in a shallow dive until I got the jet fired up again. As soon as hot air from the engine ducts began blowing across the glass once more the frost cleared away in a

hurry and I could see where I was going.

Another time, at lower altitude, the cockpit temperature jumped to 175 degrees and there was nothing I could do about it. Air resistance alone at high speed can raise the cockpit temperature 135 degrees above normal. Usually the refrigerator unit keeps the temperature down. On this flight the heater valve opened instead of the cooler valve. The heat climbed up close to the boiling point and I handled the controls just as expertly as I could during the eight minutes that it took to get back to Muroc. It was a relief to climb out into the 110-degree summer heat on the ground.

Faster than Sound

By Gene May

Supersonic Test Pilot

Speed gets the headlines, but other performance data is equally important for flight research. Here May checks over a lengthy report after a transonic dash

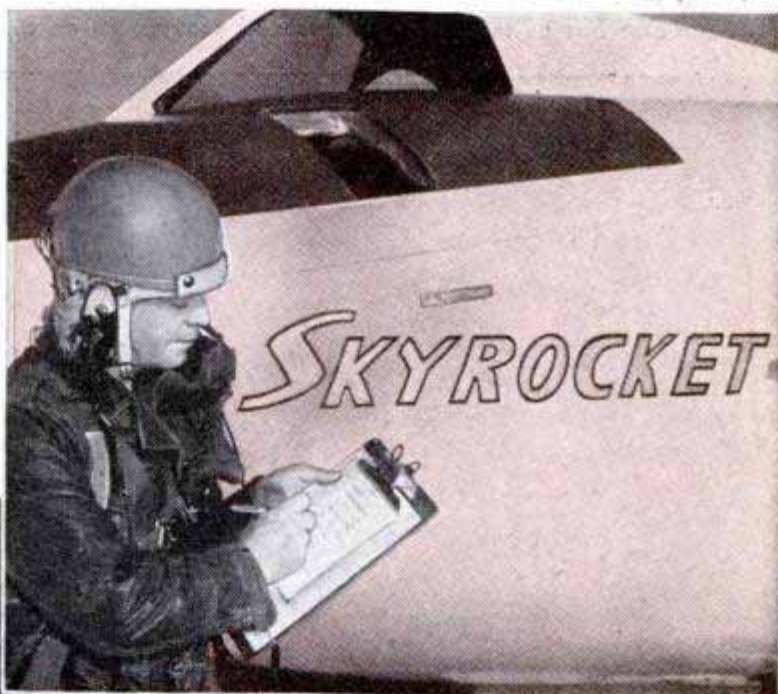

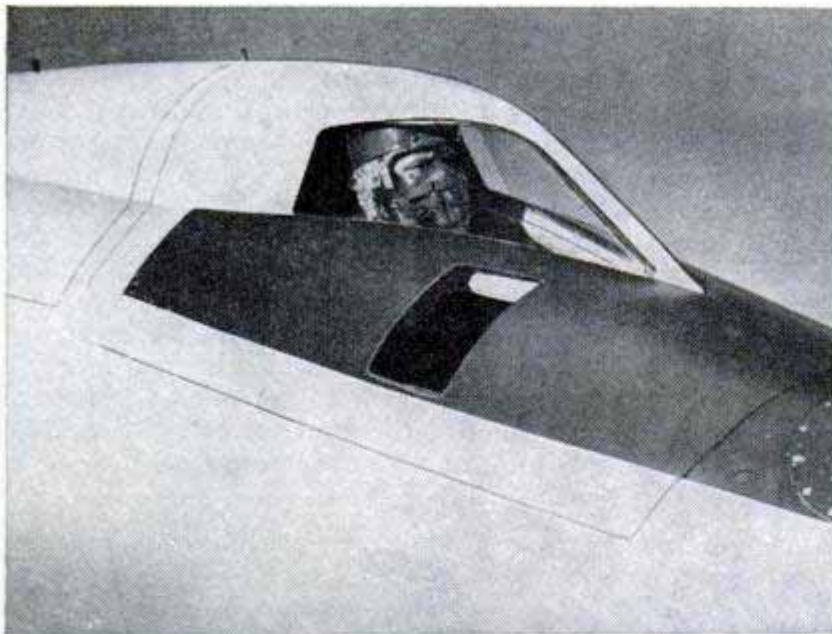

Above, some light for the small, dark instrument panel comes through oblong, plate-glass covered "windows" flanking the cockpit. Below, the Skyrocket has as many instruments and controls as an airliner

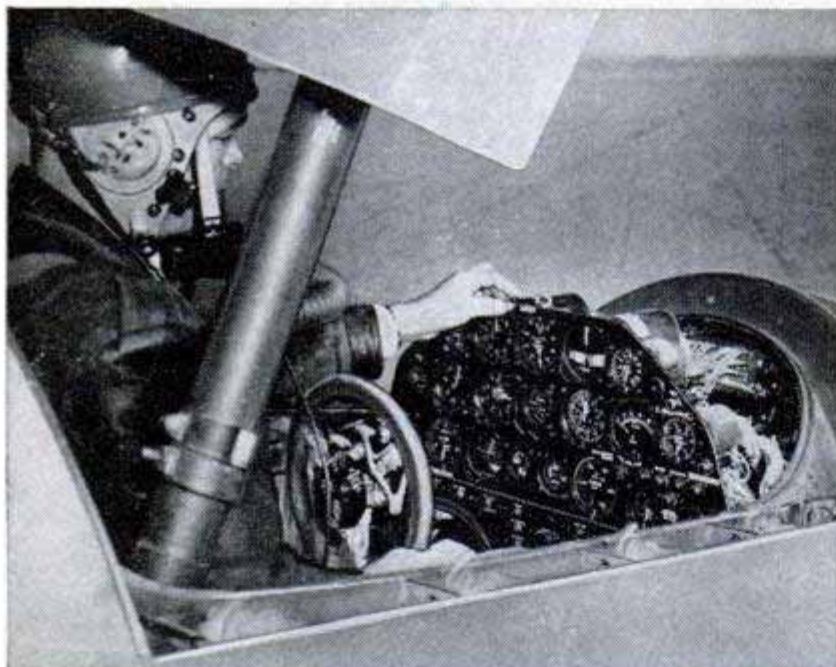

These instances may seem like minor difficulties and yet it's the little things that can bring on disaster when you are flying an experimental airplane at speeds it has never before attained.

So far none of the dire things that are supposed to happen when an aircraft smashes through the "wall" of sound have happened to me. Some planes have flown to pieces in the air when they approached the sound barrier, some have almost shaken themselves to pieces. Some "tuck under" in a dive. I've flown through the speed of sound repeatedly and the Skyrocket does none of these things.

The Skyrocket is Phase Two of a scientific program by the Navy for studying phenomena in the transsonic range. The Douglas El Segundo plant built the swept-

wing plane and its two identical sister ships specially for the job. Phase One was the Skystreak, powered by jet alone, that set a record of 650.8 miles per hour.

The Skyrocket likewise has a jet engine and in addition can blast from four rocket tubes at once to overcome the terrific air resistance that builds up at the speed of sound. This speed varies with the temperature and is 761 miles per hour at standard sea-level temperature, or 663 miles per hour at the —65 degrees or so of 40,000 feet. Speed of sound at any altitude is referred to as a Mach Number of 1.

The Skyrocket weighs almost eight tons loaded and has a wingspan of only 25 feet. It is 45 feet long. Its jet is fueled with aviation gasoline, not kerosene, and the rocket motors burn a combination of liquid oxygen and alcohol water. A hydrogen-peroxide pump, similar to the one in the V-2, pumps the fuel, and all of it can be burned in less than two minutes.

The plane is the fastest in the world at ordinary altitudes. Already it has exceeded its design requirements and I haven't yet flown it at its maximum speed.

Transsonic flight isn't as wild as some people have imagined. The air becomes extremely rough, to be sure. It's like riding a solid-tire truck over bumpy cobblestones.

And the normally sensitive controls become slow and stiff. Instead of flying with finger-tip pressures, I need both hands on the wheel. It takes a long hard push to move the rudder. The cockpit stays about as quiet as usual. I can hear the crash of each rocket motor when I turn it on, then the sound seems to die away.

When you hit the speed of sound it's about like flying through a short stretch of extra turbulence. On the other side, the air smooths out again. Slowing down, you go through the same turbulence once more when your speed and the speed of sound coincide.

With its rockets, the Skyrocket doesn't need to dive to attain its designed speed. The plane accelerates to supersonic speed in level flight or even in a climb. And it

smashes through sound at operational altitudes.

At high altitudes there is no extra sensation of speed but, when I make a run on the deck, just off the ground, the sensation is terrific.

I can catch a glimpse of the Muroc dry lake bed and the parked cars of the observers while I'm turning preparatory to the low-level run. Then, with all four rocket motors blasting, only the horizon in front of me remains clear and visible. It's impossible to focus my eyes on anything long enough to recognize it. Everything near by and at the sides is a blur. The observers and their cars are only a couple of hundred feet away as I go by—but I never see them.

The observers can see me coming but they don't hear me until the Skyrocket is well past them. Then there's a smash of sound and a dwindling roar as the exhaust racket goes by. Ground photographers can't swing their cameras fast enough to get a close-up picture at superspeed and the only good action pictures that have been made of the Skyrocket were taken



Tube extending down at an angle from below the four rocket nozzles is used for jettisoning the remaining rocket-engine liquids before landing

from a distance or when the plane was flying relatively slowly.

It's almost a tradition in aviation that the pilot of a hot airplane has to be in his early twenties. I'm a gray-haired grandfather, so I'm one exception to the rule. Two of my sons are pilots and the third is about ready to start flying. I'm 45 years old and the doctors haven't found a reason yet to restrict me to slow aircraft, say with top

With all four rocket tubes going, the Navy's transsonic-research craft can get off the ground in 2700 feet

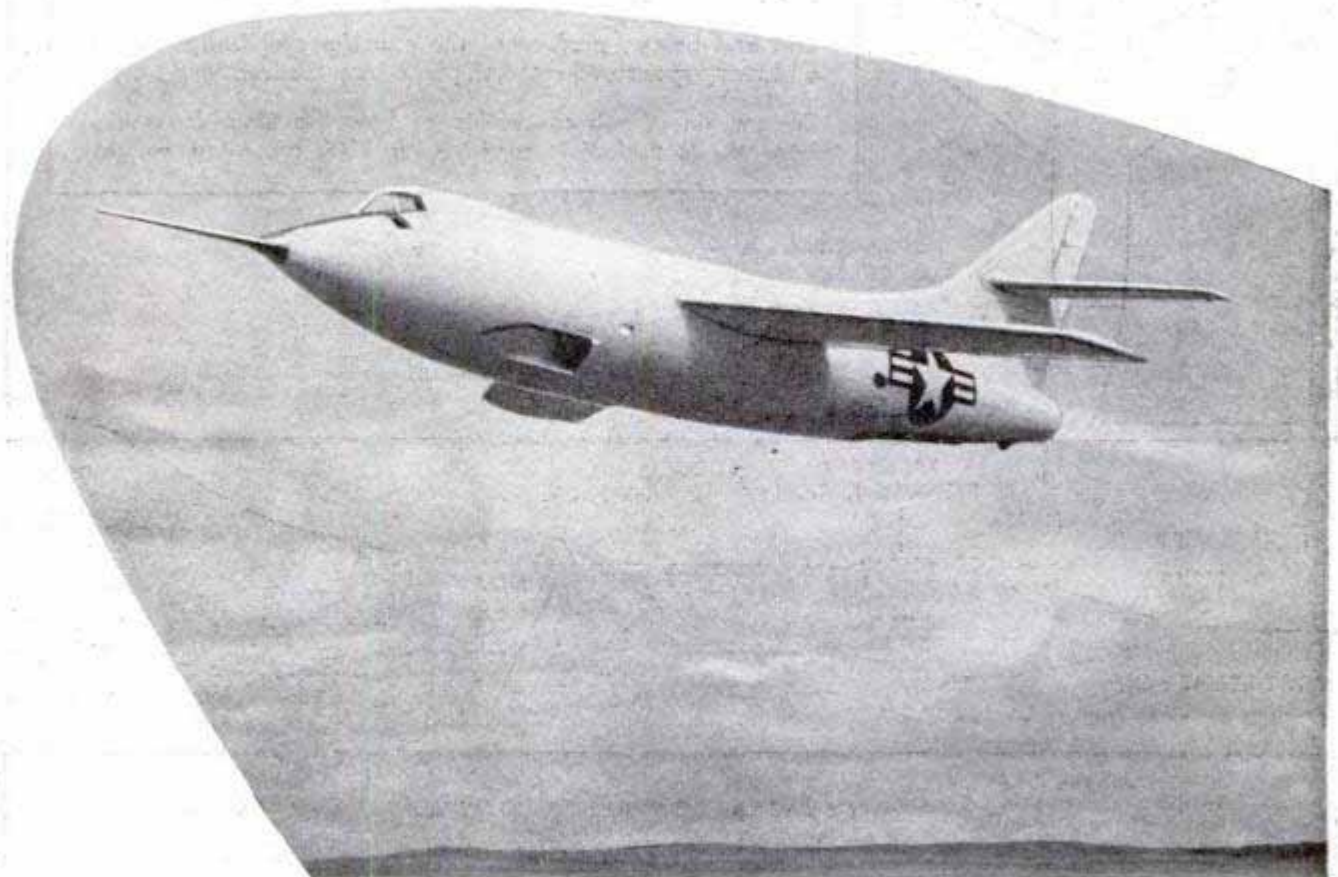

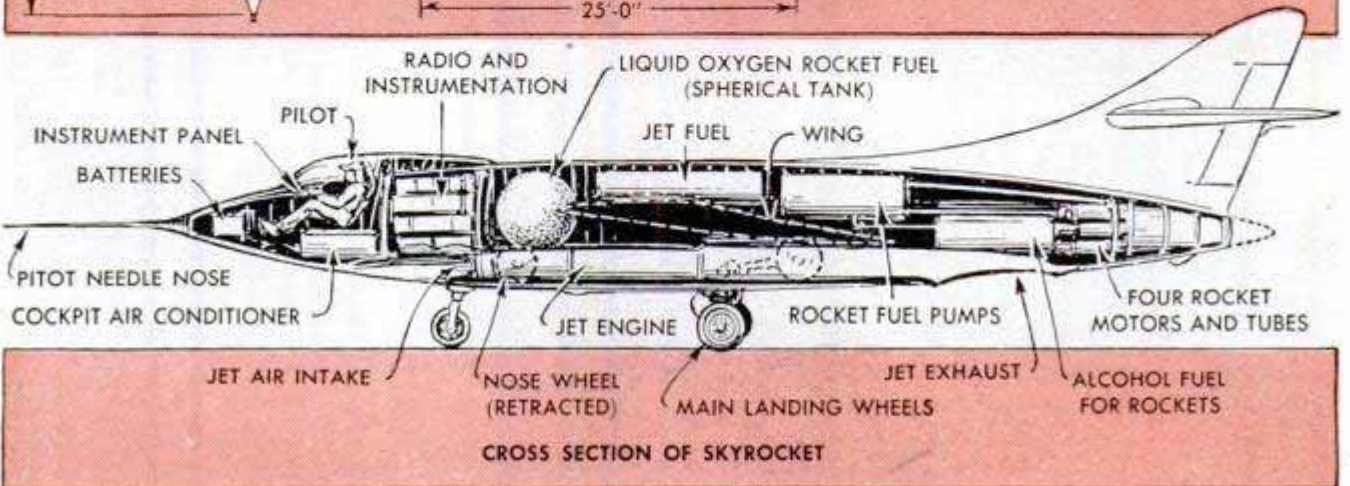
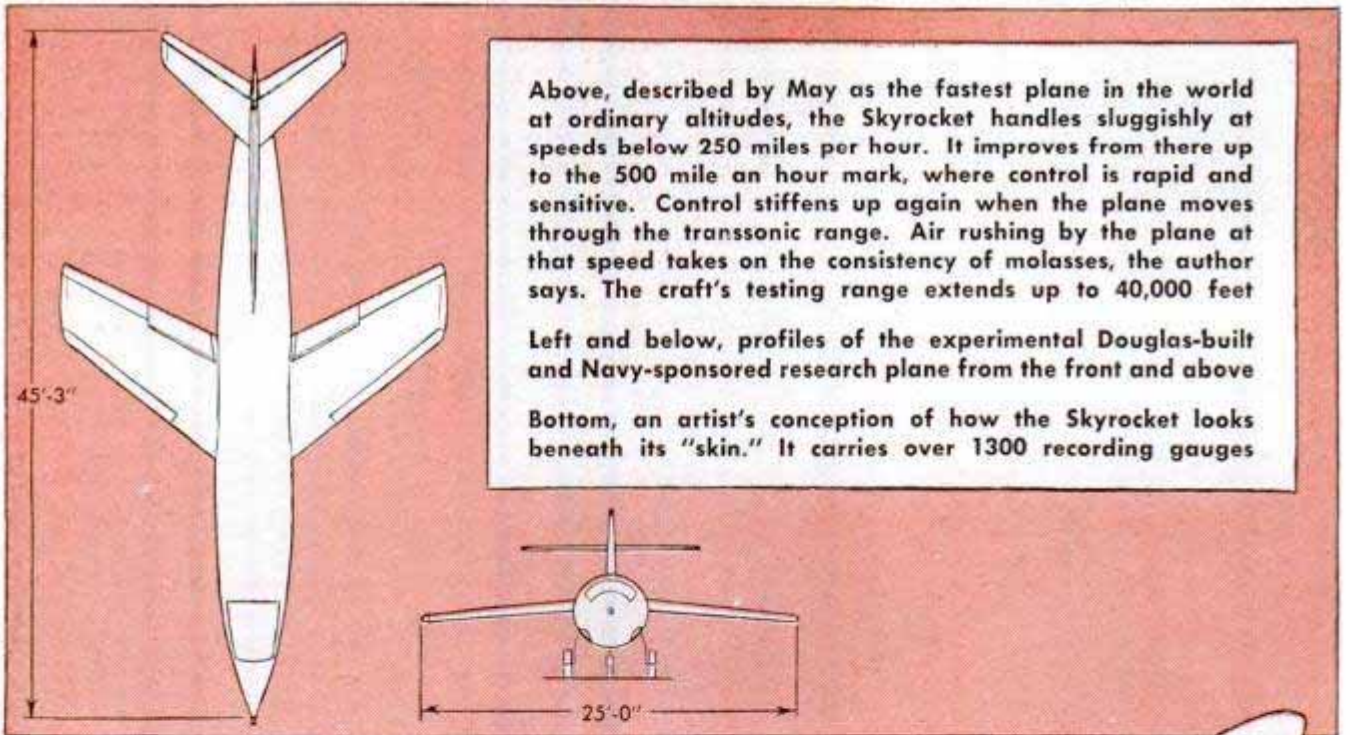
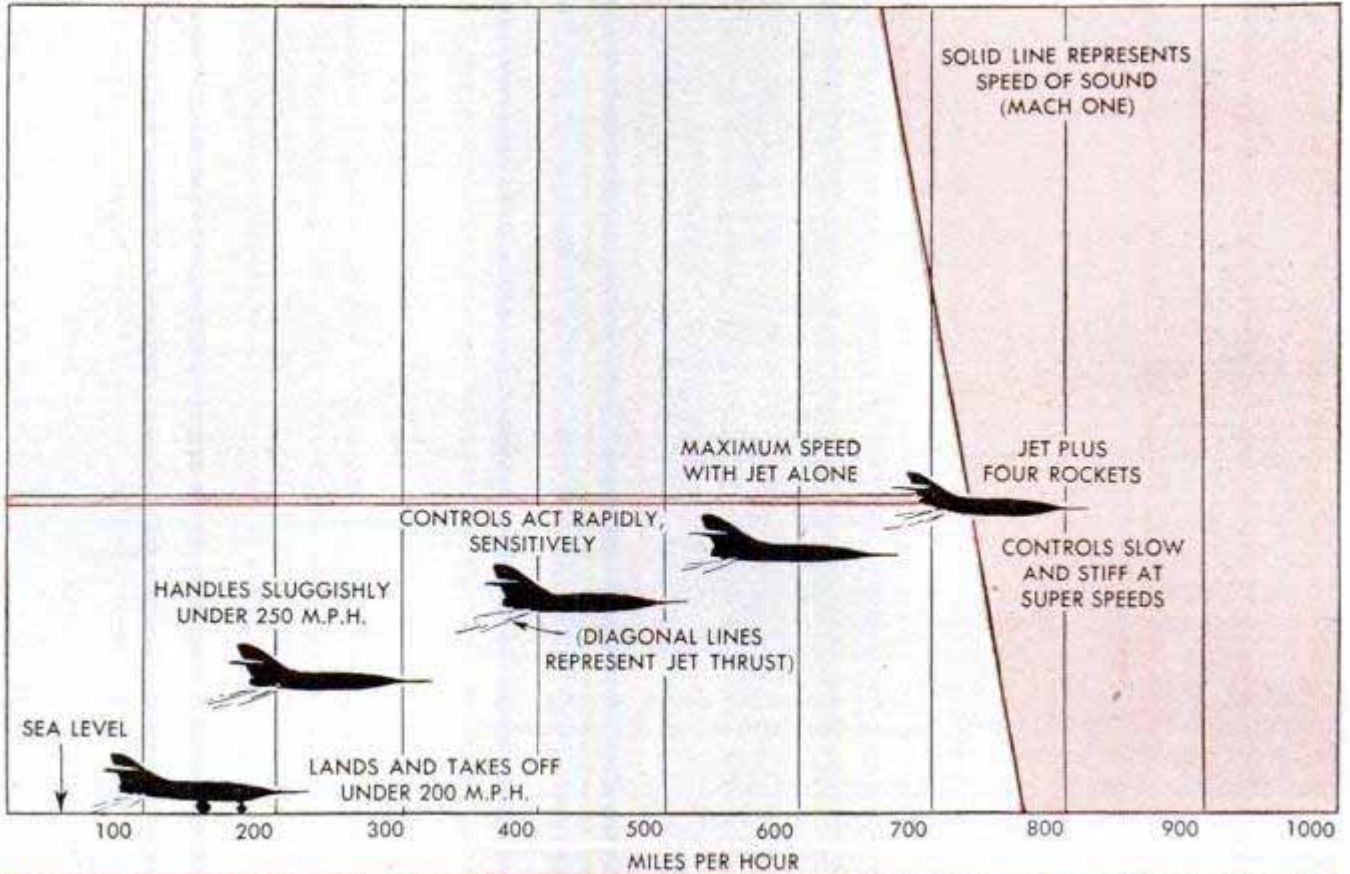

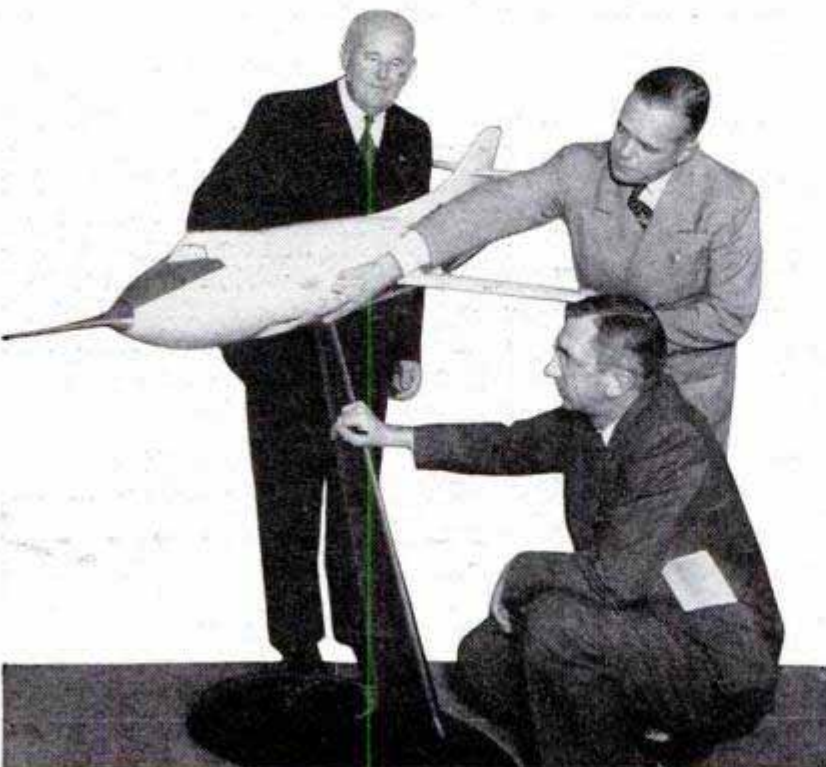
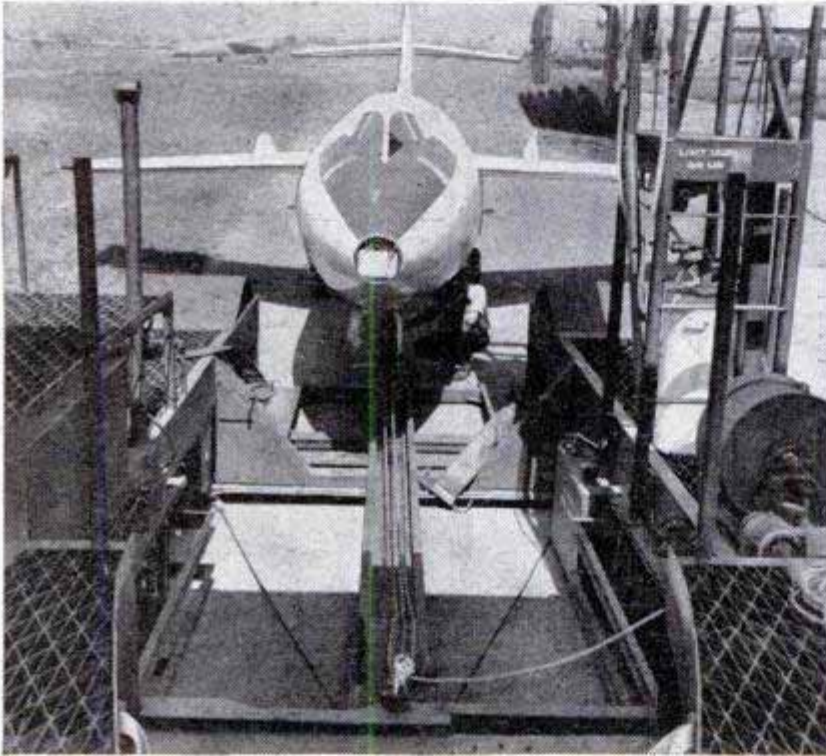

Above and left, going between hangar and runway, the speed-research plane rides on a special trailer. A canopy shields cockpit from the desert sun. Bottom, left to right, T. E. Springer, May and E. H. Heinemann inspect model of Skyrocket. Springer and Heinemann are manager and chief engineer at El Segundo, Calif., plant

speeds ranging from 400 to 500 miles per hour.

A pilot has to be keyed up mentally and physically for supersonic flight, of course, because his life may depend on an instant diagnosis of an unusual condition and an immediate corrective action. He has to think in terms of many miles per minute instead of miles per hour and he flies with his eyes and his mind about 10 miles ahead of the plane.

Actually, top speed is only a small part of the whole Phase Two program. Speed makes the headlines but there are hundreds of other things that are just as important. The way the plane flies and handles at its lowest speeds must be studied with just as much care. The stability and lift of the sweptback wing and tail sections, the stall characteristics at different altitudes, safe take-off and landing speeds, all these must be learned.

With a wing loading of about 90 pounds per square foot, twice that of fast fighter craft, the Skyrocket takes off loaded at 190 miles per hour. It doesn't handle very well at under 250 miles per hour and it normally lands at around

(Continued to page 266)

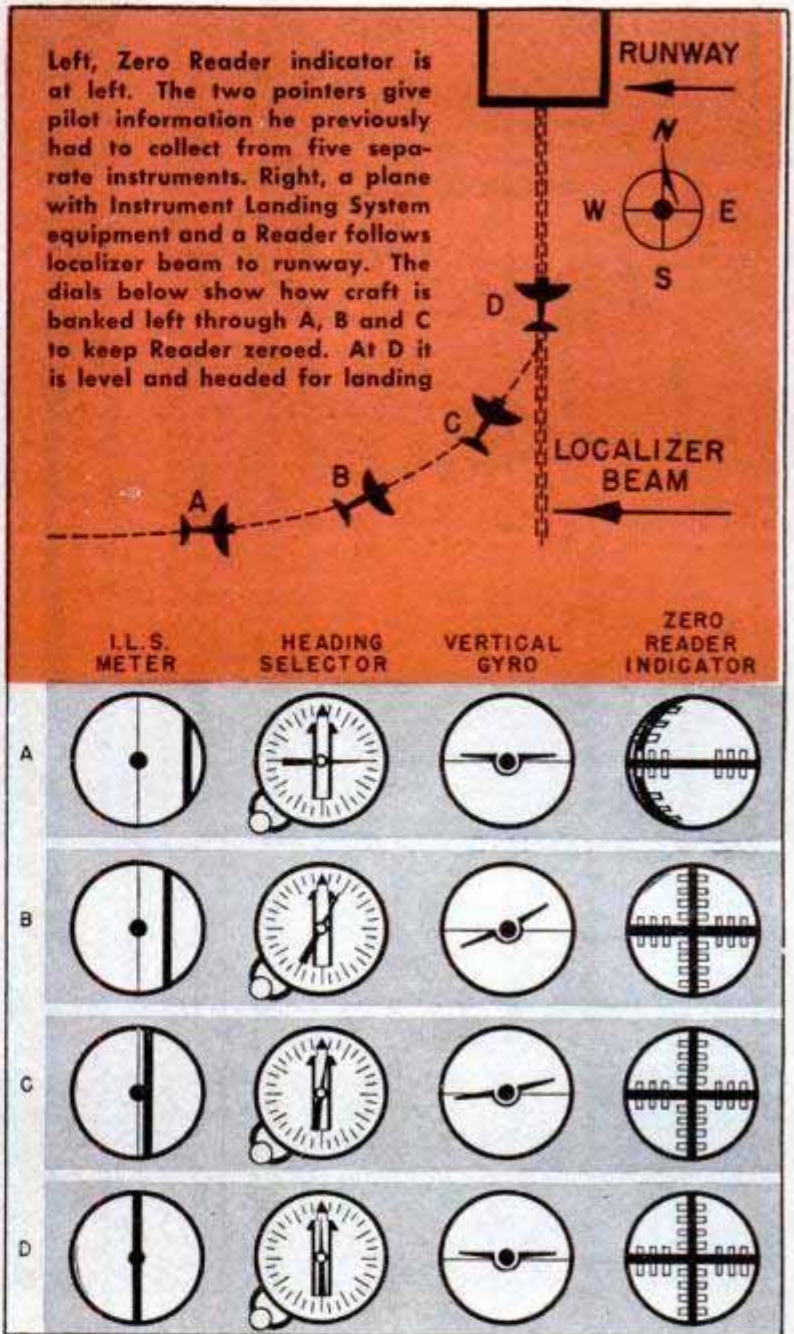

Five-in-One Instrument

Flight information usually supplied pilots by five panel instruments is combined in one called the Sperry Zero Reader. Its two-element indicator tells the airman exactly how to move the controls to steer left or right and to fly up or down. By turning a knob, the pilot can choose whatever compass heading he wants to fly and a thin pointer shows his actual compass heading. The instrument provides coordinated information that permits the human pilot to fly and navigate with a degree of precision and accuracy almost equal to automatic control.

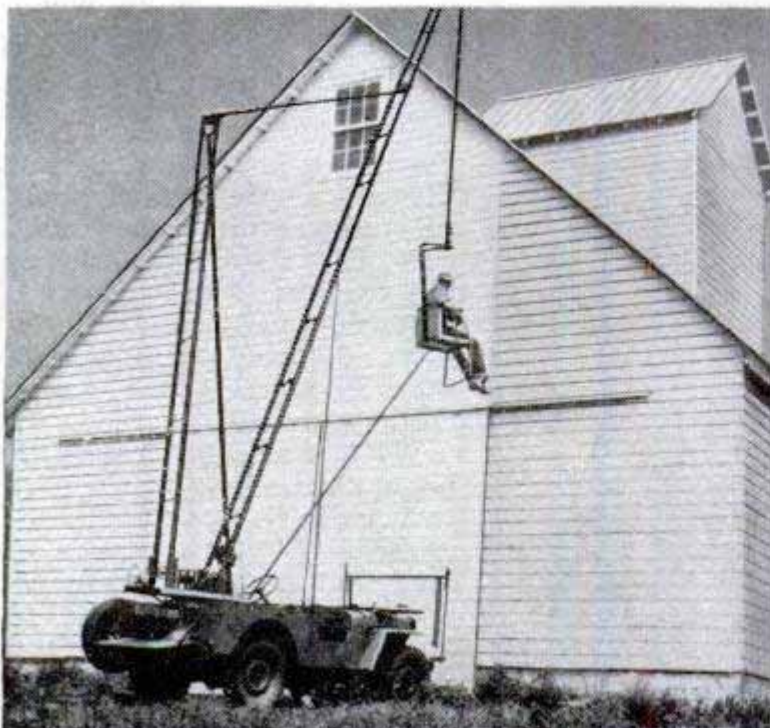

Ladderless Painting

Suspended high in the air, a painter in Lincoln, Ill., sits in a comfortable chair and wields his brush without using ladders or scaffolds. He has developed a telescoping boom which extends to a height of 35 feet. The painter's chair dangles from the boom. The rig is mounted on a Jeep.

Aerial Tree Planting

Department of Agriculture experiments indicate large-scale tree seeding by airplane costs half as much as seeding by hand. For more effective distribution on the ground, the seed was mixed with sawdust and dropped while snow was on the ground. Later snows protect the seed from rodents.



Home Is Where They Park It

When the Priggs of Miami, Fla., go for a ride, they take with them all the comforts of home! Their family car is a neatly arranged "sedan cruiser" that looks like a bus that didn't grow up.

Using a Packard chassis as a base, Paul Prigg designed a rolling home, with sleeping space for two, hot and cold water, closets, dinette and other conveniences. On test trips to New York and Texas, the family had no worries about hotels or motor courts. Although the cruiser is designed to sleep only two adults, the Prigg youngsters are still small enough to fit in comfortably. When they get a little older, Dad Prigg is planning to build a larger model with room for four.

Above, left, with the rest of the family relaxing in the lounge, Mrs. Prigg handles the wheel. For night driving, curtains are drawn behind the driver so interior lights can be turned on. Right, in minutes, the lounge is converted into a bedroom



In the cozy dinette, there is ample space for two adults plus the two youngsters. Below, when Prigg goes fishing, the whole family goes, too, because they take their home along with them



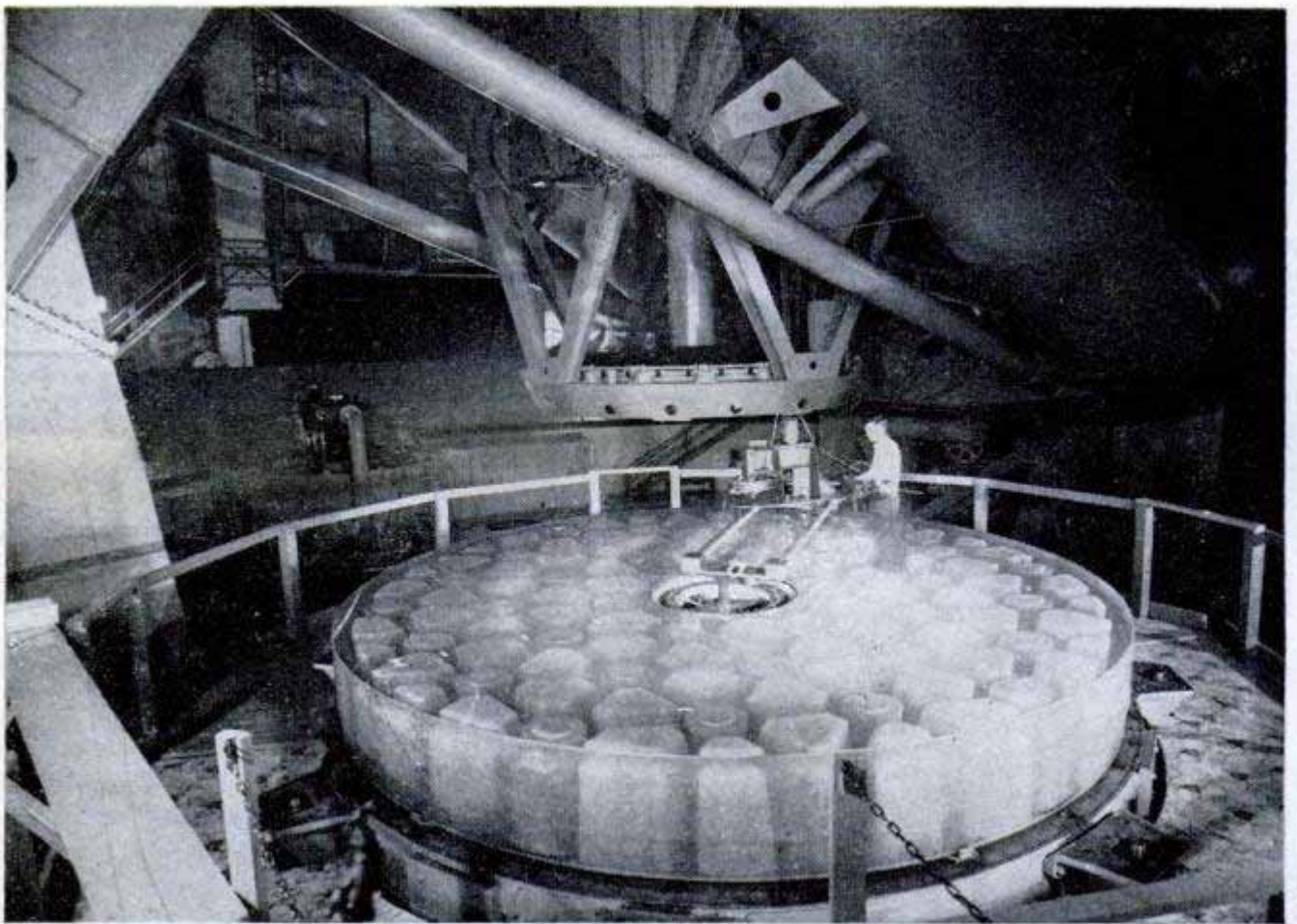

Giant "Eye" Gets Second Test

Tests now being made with the giant 200-inch Hale telescope at Palomar Observatory are expected to reveal that it can photograph stars that are 20 percent fainter than those recorded on its first test plates, now that about $\frac{1}{10}$ ounce of glass has been polished away from its mirror surface.

As little as five or six millionths of an inch of glass were polished away from the

mirror disk, mostly along the outer edge. The polishing job required five months, although no more than seven hours were spent in the actual polishing operation. The balance of the time was consumed in tests, cleaning jobs and arranging the polishing tools. Now recoated with a thin layer of reflective aluminum, the giant mirror is expected to reveal objects more than four million times fainter than are visible to the naked eye.



Drying Agent Protects Tools From Rust and Corrosion

Tools, fishing tackle and other metal objects are protected from rust and corrosion by a perforated canister containing silica gel, an efficient drying agent. One canister absorbs excess moisture from as much as 12 cubic feet of air. When saturated, the silica gel, visible through a window in the center of the canister, turns pink. By placing the unit in a hot oven until the crystals become blue again, you can dehydrate the canister, making it as good as new.

Diethyl ether has been found to be the most effective and convenient means of starting diesel engines in cold weather.

Motorcycle Convertible →

Buzzing around the streets of Munich, Germany, is a strange vehicle that offers most of the comforts of a car and the economy of a motorcycle. August Paul, a mechanic, built it by adding a de luxe sidecar to his motorcycle. It seats two and has a convertible top for protection from the weather. In the sidecar are a steering wheel, gearshift and other controls, so that even a long trip can be made in comfort.

Detergent Makes Rinsing Of Laundry Unnecessary

Housewives can do the family wash in shorter time when they use a new detergent that eliminates all rinse operations. Clothes are ready for the line as soon as they leave the wash water. The dirt, held in constant suspension in the water, floats away when the wash water is removed by the wringer or spin-drier. Another advantage is that the detergent can be used with hard or soft water, quick, thick suds being produced with either. Not only does the no-rinse detergent save time, but it also cuts water consumption, an important point in areas where water is limited at certain times of the year. Whiteness and color-



brightness tests show that the detergent does as thorough a job of cleaning as regular soaps and detergents. It can also be used for washing dishes, windows, floors and other household chores.

Funnel-Shaped Theater Built Like an Airplane Hangar

Like an airplane hangar, a new motion-picture theater in Los Angeles has no interior columns or supports. The rounded roof is supported on laminated wood arches. Located in a residential area where tall, vertical walls are undesirable, the

theater proved to be 25 percent cheaper to build than a conventional theater. The acoustics of the building are excellent because of the sloped ceiling. The theater seats 1800 people and is equipped with a standard-size screen.



WHAT'S NEW *For Your Home*

A four-page "shopping section"
dedicated to modern homemakers



AIR DEODORIZER, shaped like an old wick lamp, can be hung on a wall or placed on a shelf. Deodorizing fluid in the base is noninflammable should anyone try to light the wick of the "lamp"

KITCHEN COUNTER, right, has casters and rolls anywhere you need it. Inside are paper and garbage containers plus storage locker. An inner lid, shown in use below, is handy cutting board



CLOTHESLINE WINDER is worn around your neck like an apron, leaving both hands free to clean the line as it is being payed out or for tying the line on a hook. To wind the line on the reel after use, you just crank as you walk



ICE-CUBE TRAY, at right, frees cubes with finger-tip pressure. You don't even have to take the tray out of the freezing compartment. Cubes are frozen in a latex liner which is placed in an aluminum rack

REEL-TYPE PLUG, below, has storage space for winding excess cord, thus getting it off the floor for neatness and safety. It can be attached to any cord and plugs into any standard wall outlet

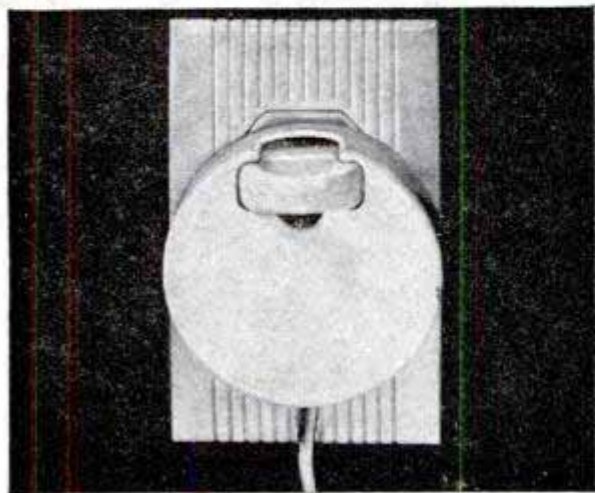

TOY SEWING MACHINE, below, sews well enough to be handy for mother's light stitching, yet it's simple enough to operate to be called child's play

SLACK HANGER, below, attaches to a closet door or wall and holds up to six pairs. Any of the six pairs can be removed without disturbing the others



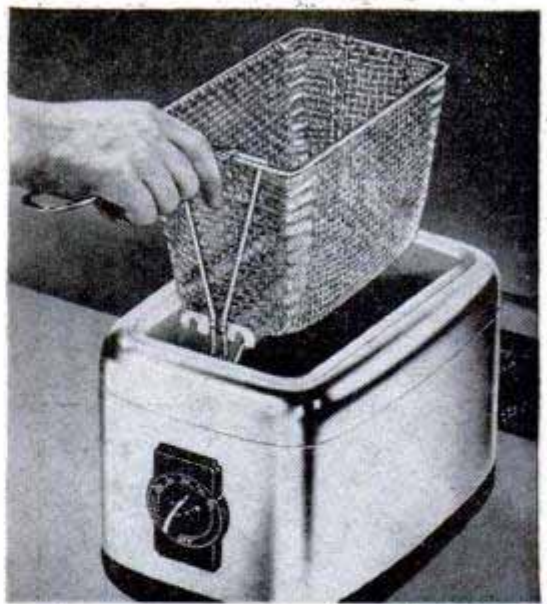

DEEP-FAT FRYER, above, can be set to maintain fat at any desired temperature. A wire frying basket can be locked in raised position for draining. Fryer also pops corn

HOME PASTEURIZER, left, processes any amount of milk from two gallons to two quarts. It is fully automatic in operation, shutting itself off when process is complete

ICE-WATER TAP, lower left, provides cold drinking water without opening door of refrigerator. Cooling coil, tapped to water pipe, hooks onto one of refrigerator shelves

CLOTHES HOOK, below, can be used in a car or home. Arm folds up when not in use

SELF-ACTING LOCK for window, bottom, locks automatically when window is closed

WHAT'S NEW *For Your Home*

Continued from preceding page

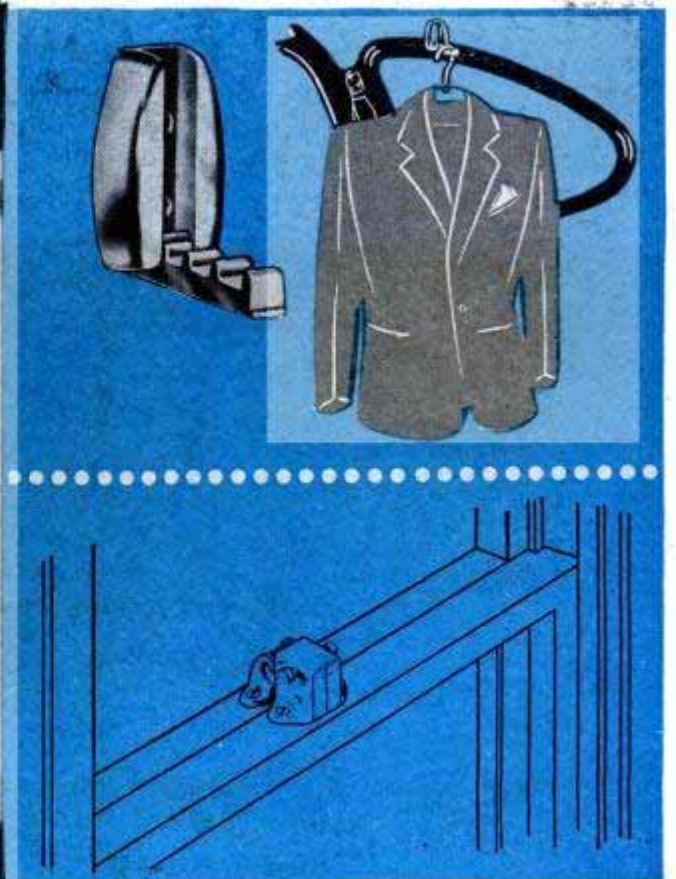

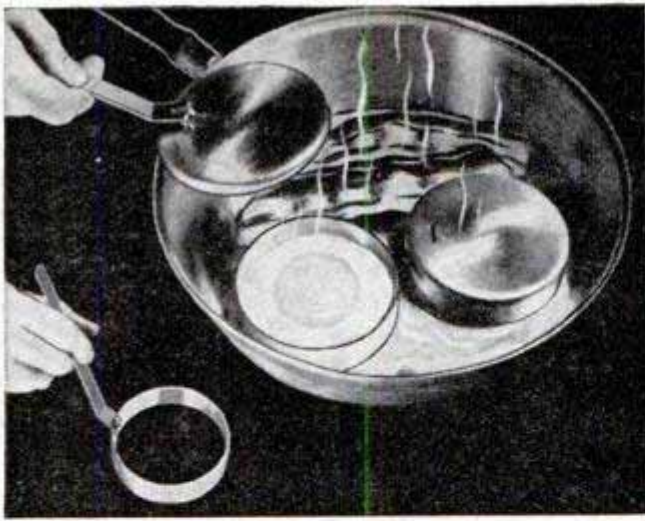

SKILLET RINGS, above, hold eggs in place when frying. Removable handle fits both covers and rings

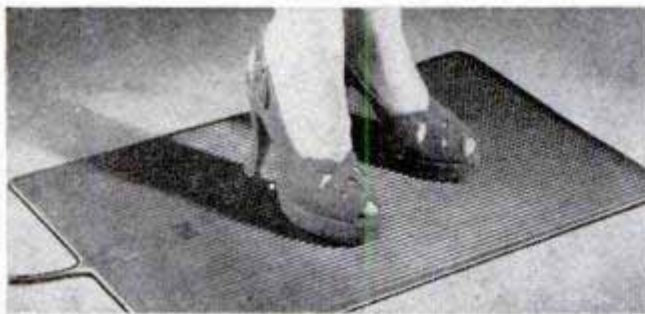

ELECTRIC MAT, above, keeps feet warm when you have to stand on cold floor. Made of rubber, it is safe on damp or wet ground. It plugs into any outlet

INDOOR GARDENS, below, are anchored to the sill by tacks which don't interfere with operation of window. Aluminum frames come in several designs

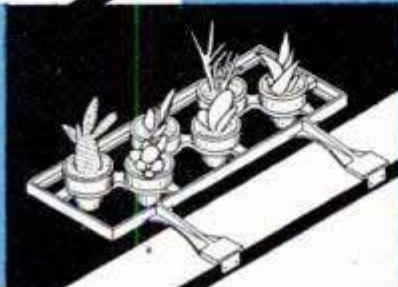
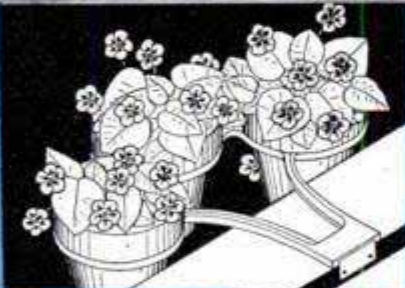
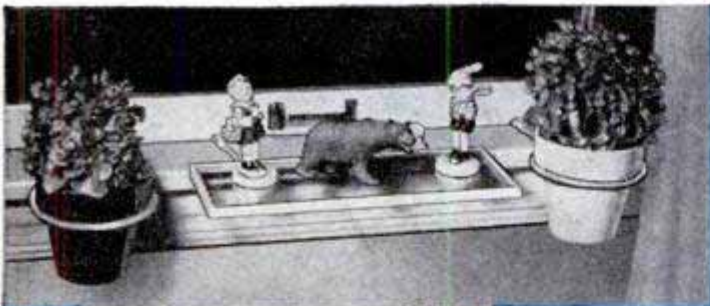

STAY-LEVEL LADDER has adjustable back legs so you can keep it level on stairs or uneven surfaces. The extension parts of the legs are heavy aluminum

TWIN-BLADED KNIFE, below, removes grapefruit segments without squirting! It cuts two segments in one operation without rind or web clinging to them

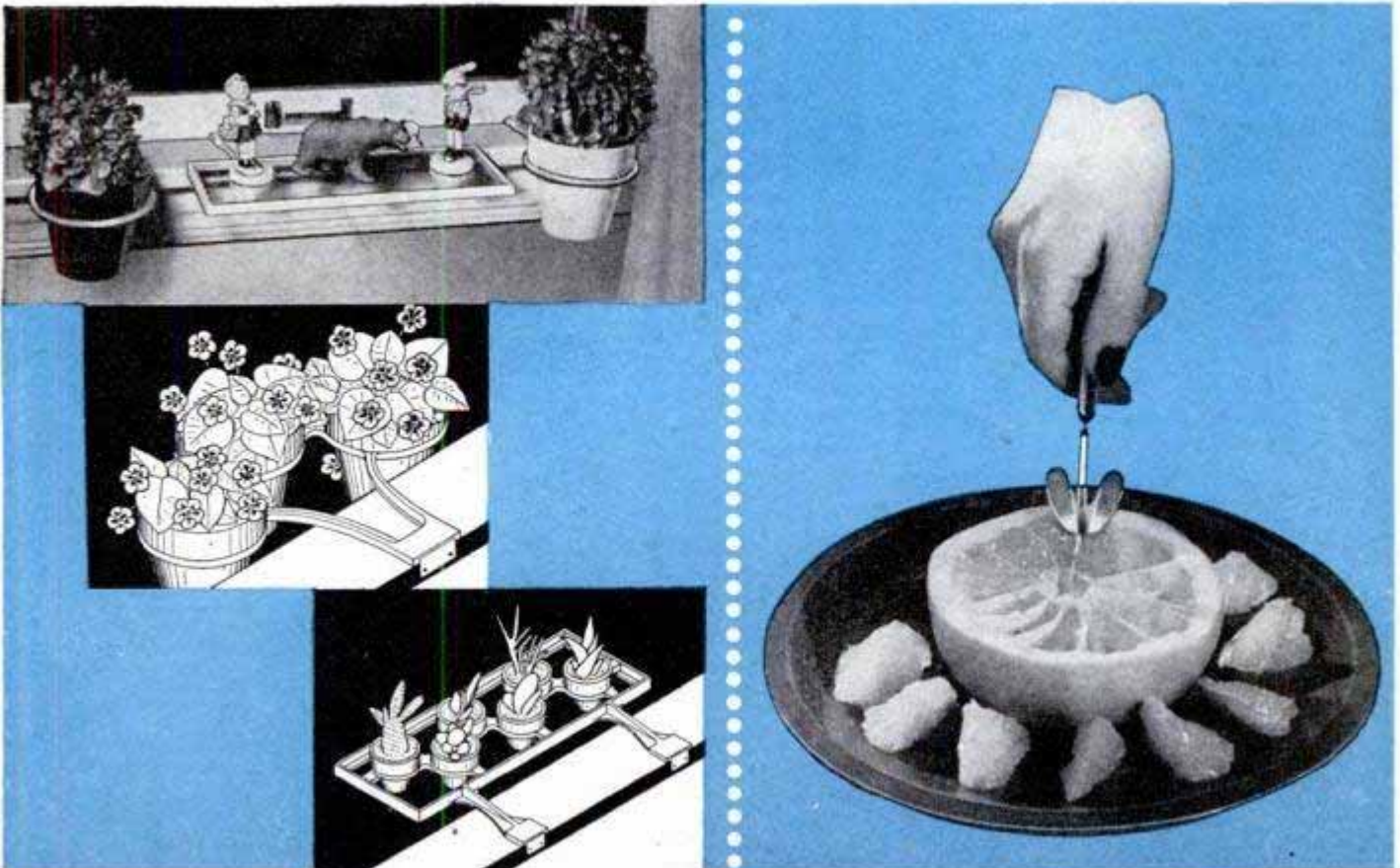



← Sun Cooks Food

Sun rays supply the heat for cooking in a new solar sauce pan. The cooker was developed by French inventor M. Tarcici. The cooking pot hangs in the center of a large dish-shaped reflector which catches and focuses the sun's heat. The reflector follows the sun's movement through an automatic control which also is powered by sunlight.

Satin Tape

Self-sealing tape that looks like glossy satin is designed for both decorative and practical uses. It can be applied as a decoration to packages, used to edge shelving, for framing snapshots in an album and for any purpose where a ribbonlike effect is desired. It is available in 15 colors.

Heating Cord for Blankets

You can convert your regular blankets into the automatic electric variety with a plastic-covered heating cord that has a thermostatic control. Laid out in any pattern between two regular blankets, the cord provides enough heat to keep you warm on sub-zero nights. It consumes less than 75 watts. You can arrange the cord so it merely warms the feet, or just one half of a double bed or all of it, if desired. Fasteners, provided with the 30-foot cord, attach it to the blanket.

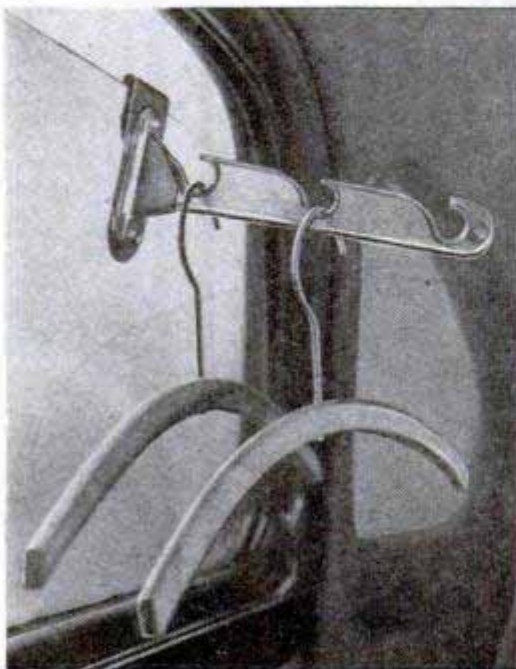

Hanger for Car or Home

For use either in the car or at home, a portable clothes rod holds 45 pounds and up to six hangers. One of the two back plates supplied with the hook slips over a car window to support the clothing. The other is large enough to fit over the top of a door. The hook also can be attached permanently by screwing the larger back plate to any surface. It can be used in a horizontal or vertical position.

Valves in the heart and at the entrance of the main artery, or aorta, to the heart can be replaced by hollow Lucite balls, according to Dr. Charles A. Hufnagel of Harvard Medical School.

"EGG BEATER" ON ICE

HARRIS LEGG, one of the Ice Follies stars, designs and builds his own "death defying" machines for use in his famous jumping act. This season he is thrilling audiences with a double egg-beater sphere which has two sets of steel blades, one turning within the other. As the blades are revolved by a quarter-horsepower electric motor there is an interval of about one fifth of a second when there is an opening in the center of the egg beater exactly 43 inches in diameter. During this split second, Legg must leap through the device—or be caught in the spinning knife edges of the beater. Occasionally he clicks a skate on the edge of a blade and sparks fly, for he is traveling 30 miles an hour. Legg's act depends on

perfect timing and perfect synchronization of the blades. His first jumping machine was a single revolving hoop, then he added another tubular hoop. Last season he used four hoops filled with butane gas and jets which were lighted to make a ball of flame. This created a problem with fire departments in cities where the Ice Follies played and Legg finally substituted steel spikes as a hazard to replace the prohibited flame.

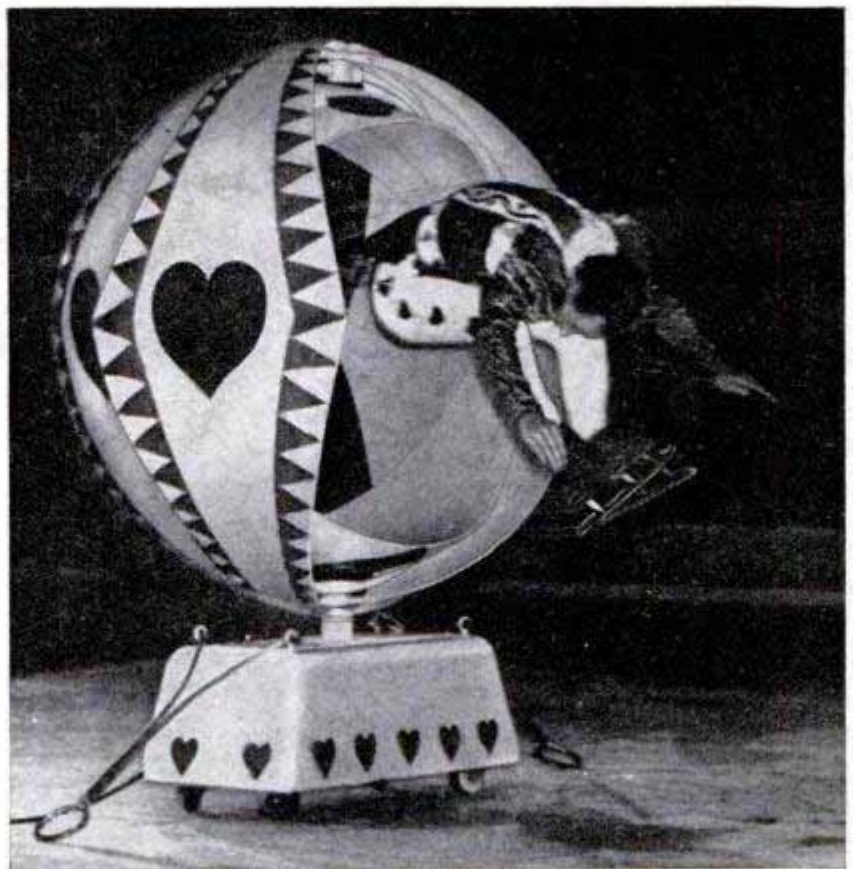

With perfect timing, Harris Legg of the Ice Follies is shown clearing the revolving blades of his "egg beater" which presents a 43-inch opening in the center for about one fifth of a second. Below, details of the beater

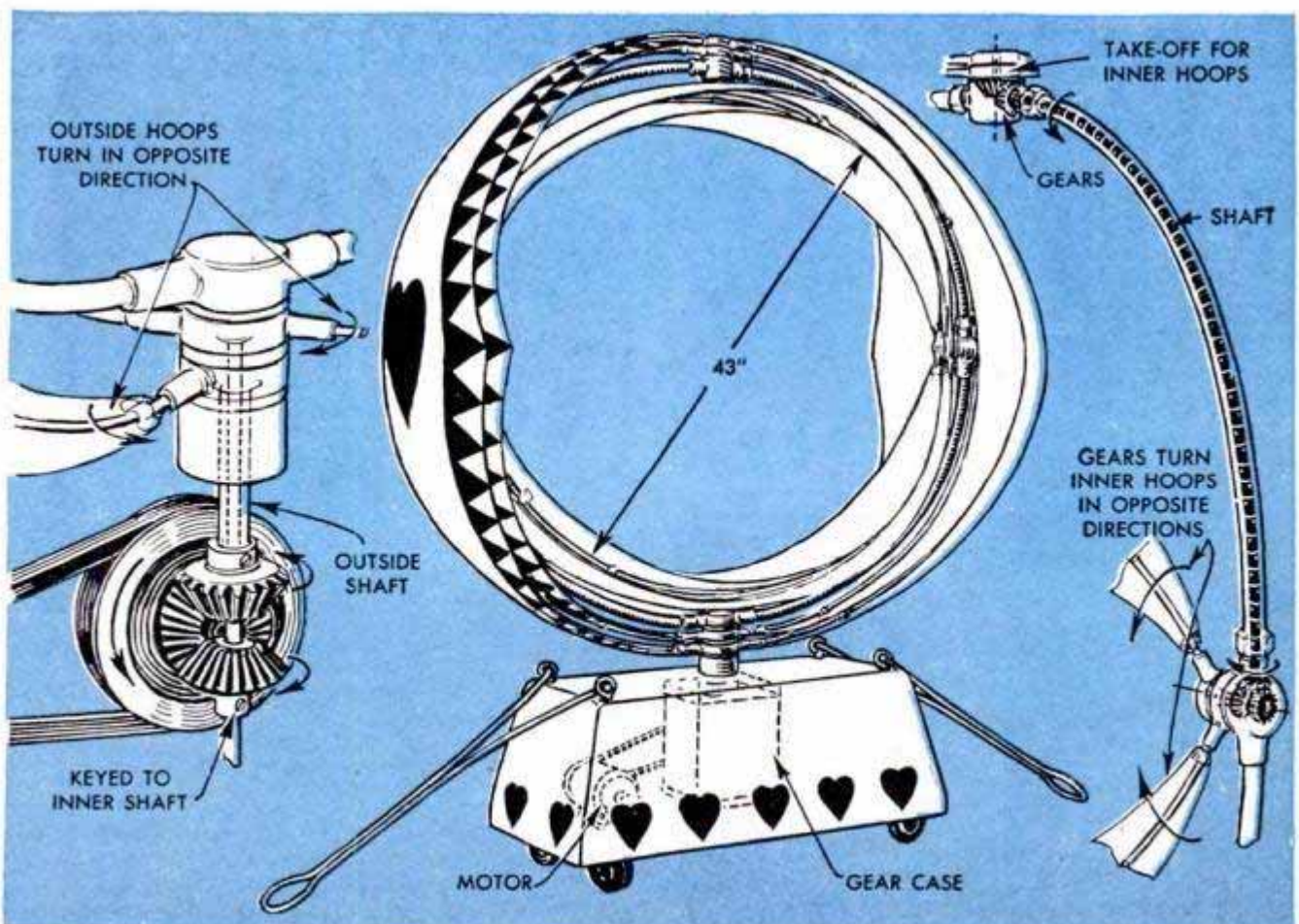

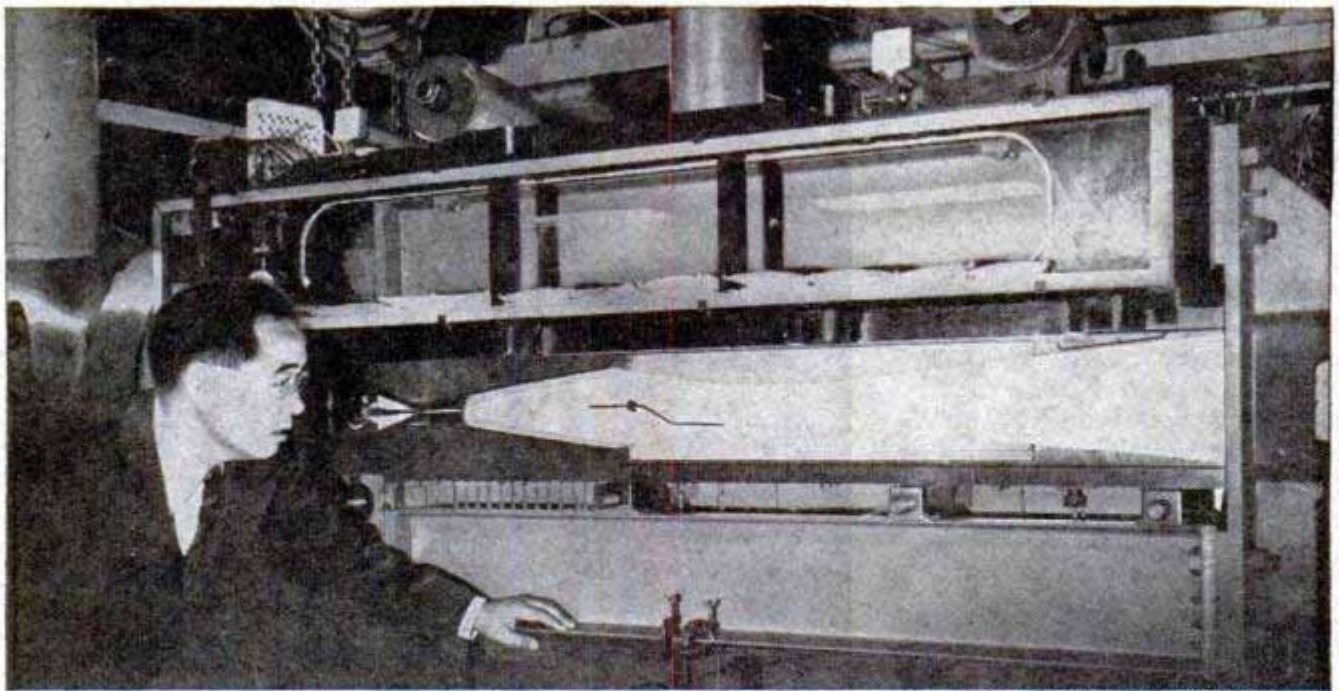

California Institute of Technology photos

Air rushes through Caltech-Army hypersonic tunnel at speed of 7600 miles an hour, making it fastest in the world

CALTECH TUNNEL IS FASTEST IN WORLD

Velocities 10 times the speed of sound, equal to a rocket trip from the United States to Australia in about an hour, are attained in a new hypersonic wind tunnel at the California Institute of Technology.

The tunnel will allow the testing of rocket and missile models at speeds up to 7600 miles per hour, about three Mach numbers faster than the highest rocket speeds reported to date. (A Mach number of one represents a speed equal to the speed of sound, which is approximately 760 miles an hour at sea level.) It can be run continuously for as long as 20 hours.

Air for the hypersonic tunnel is furnished by 15 compressors and is stored in a six-ton reservoir, with steel walls up to 2½ inches thick. Height of the slot in the throat of the tunnel that admits the air to the test section can be varied to obtain the desired Mach number. For a speed of Mach 10, the slot is the approximate thickness of a piece of paper.

Special driers remove moisture from the air to prevent the icing up of model shapes

that are being tested. In the hypersonic tunnel the problem is accentuated by the fact that the sudden expansion of the incoming air drops the temperature in the five-by-five-inch test section to as low as 430 degrees below zero Fahrenheit.

A guided missile designed with the tunnel's aid could take off from San Francisco and arrive at Sydney, Australia, in about an hour. Flight from practically any spot in the United States to Buenos Aires or from New York to London, would take less than an hour.

The highest known rocket speed is 5200 miles an hour, made by a two-stage missile at White Sands, N. Mex., proving ground. It was a Wac Corporal attached to the nose of a German V-2, from which it was fired after the latter reached maximum velocity.

The tunnel, built for the Army Ordnance Department, is being used for obtaining basic information about the design, performance and instrumentation of tunnels for testing rockets and missiles intended to move at hypersonic speeds.

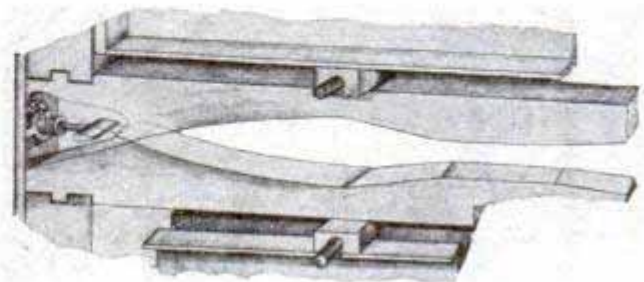
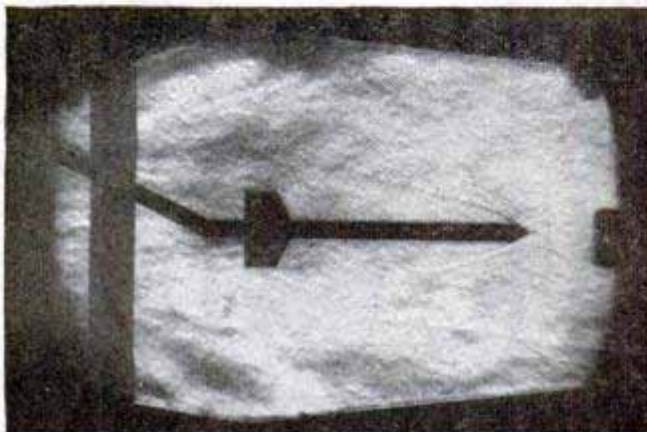

Above, nozzle slit at left of the tunnel throat is .006 inch wide when speed of Mach 10 is reached. Left, Schlieren photo shows shock waves streaming back from nose of rocket model in the test section



Air "Gas Stations" Stretch Plane Range

Almost unlimited ranges are possible for both jet and piston-engine aircraft aided by two new aerial-refueling systems. When perfected they will enable planes of all types and sizes to fly anywhere in the world nonstop. Demonstrating a technique developed in England by Flight Refueling, Ltd., a fighter took on fuel 10 times in the air to set a jet endurance record of more than 12 hours. A hollow probe with an automatic locking device at the tip is fitted to the nose of the receiving plane and a hose with a three-foot-wide cone at the end trails from the tanker craft. The probe is "flown" into the cone when the two planes are flying at about 190 miles an hour. Three toggles in the cone latch over a groove on the probe. A valve operated from the receiver's cockpit opens a valve in the probe at the same time it opens a valve in the cone, permitting the fuel to flow. Each contact took about two minutes and 2500 gallons of fuel were exchanged during the flight. The receiver slows his speed to break contact. A distinguishing feature of the other system, used experimentally by the U. S. Air Force, is that the tanker is primarily responsible for making the con-

Above, left, using British system, up to 300 gallons of fuel a minute are transferred from tanker to receiver. Above, right, probe on nose of receiving plane nears cone trailing from tanker. Below, American technique has telescoping metal tube guided to contact with receiver



U. S. Air Force photo

tact. A telescoping metal boom is positioned by an operator in the tanker's tail. Small airfoils on the boom allow it to be guided up, down or sideways until contact is made with a socket on top of the receiver. The fuel is pressure fed in both British and American systems. A radar beacon in the receiving plane enables the tanker to "home" on it during bad-weather fuel transfers. The U. S. Air Force is also experimenting with another technique that allows three fighters to be refueled simultaneously from a tanker transport.

Duplicate Tape Recordings Made by "Contact Printing"

Borrowing an idea from photography, sound technicians now are making duplicate tape recordings by "contact printing." Recording tape is permanently coated with iron oxide, which forms magnetic patterns

when a recording is made. These patterns in turn can be reproduced on another tape by holding the two in contact with an electromagnet. The method makes it practical to duplicate recordings in large quantities.

Submarine Launches Guided Missile

UNDERWATER craft took on new importance in top military strategy with the launching recently of a 7½ ton radio-controlled flying bomb, the "Loon," from a United States submarine in the Hawaiian Islands. The demonstration was part of a naval "war show" to illustrate how a submarine could enter enemy-held harbors and attack targets 200 miles from the coast. Although fired upon by the anti-aircraft guns of 75 warships, the missile escaped unscathed and finally disappeared over the horizon. Underwater boats are now being designed for seven different war roles.



Intercepting and destroying enemy planes before they can attack ship or shore targets is the job cut out for the Navy's newest guided missile. The Lark is operated by remote automatic control after launching from either shipboard or land. It has a liquid-fuel rocket motor and is aided by a twin-rocket booster assembly that drops away from it shortly after firing

Consolidated-Vultee Aircraft Corp. photo

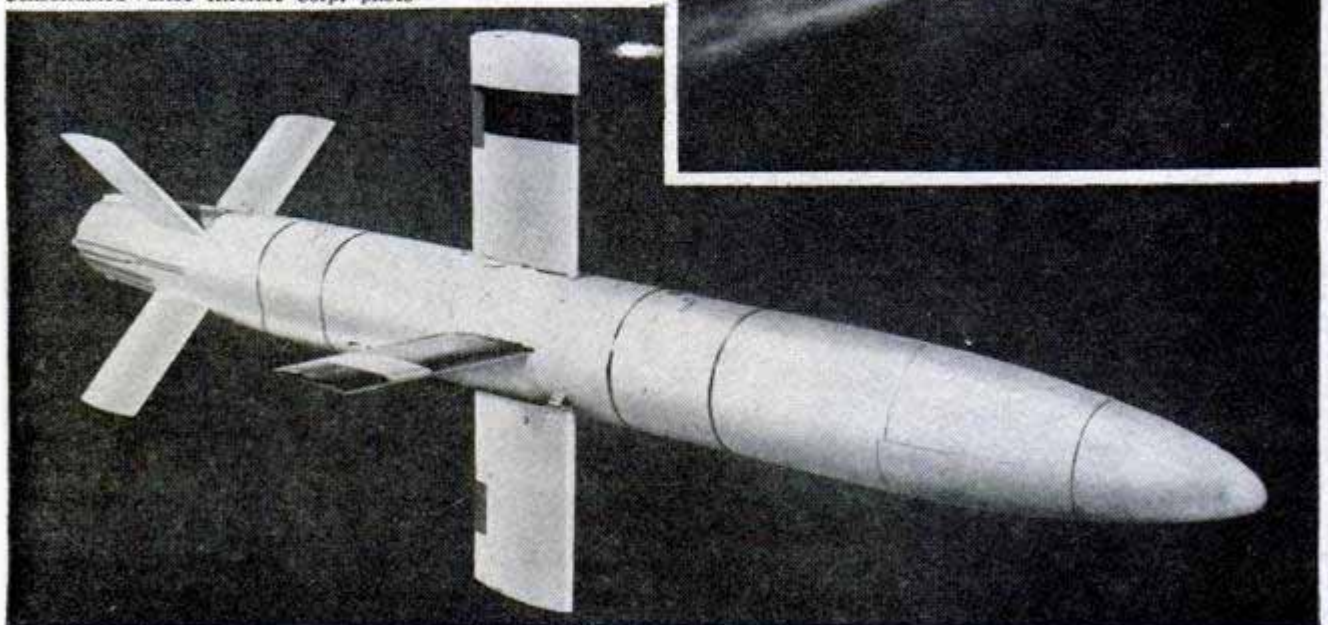
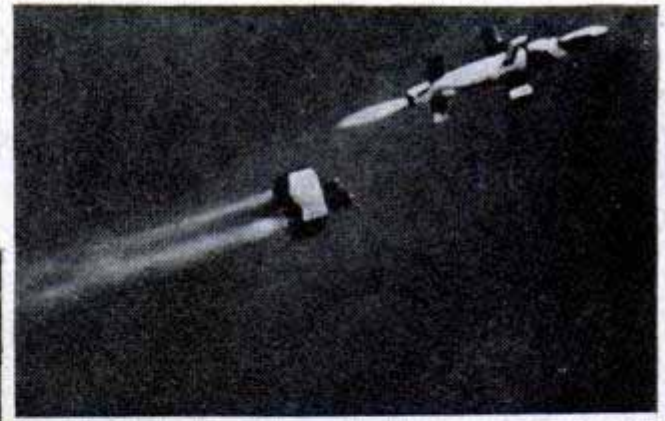

DRY-LAND SUBMARINE SCHOOL

By Gorman McMullen

UP PERISCOPE!" Hovering over their instruments, the men in the conning tower of the submarine suddenly became tense. The underwater craft was in its most dangerous moment: It was abandoning its element of safety, full submersion beyond the sight of hostile craft, by raising its mechanical eye for a quick look for targets.

For critical seconds the periscope's feathery wake formed a telltale finger pointing out the submarine's location to the eyes of enemy ships or aircraft. But the operation couldn't be avoided. The periscope had to be raised above water so crew members could locate the target and send the torpedoes crashing into it.

The number of gray hairs on Navy heads resulting from "sweating out" this moment in combat will never be known. But the Navy believes the scene need never occur again, because recently perfected instruments enable a submarine to locate surface ships while almost completely submerged. These radar and sound-wave instruments—coupled with increased speed, Schnorkel breathing devices and other improvements—have greatly stepped up the deadliness of submarines.

These technical advances created a need for more training in the teamwork that welds a handful of men and a jumble of instruments into one of the deadliest weapons of modern war. The Navy's answer is a three-story dry-land school where—thanks to

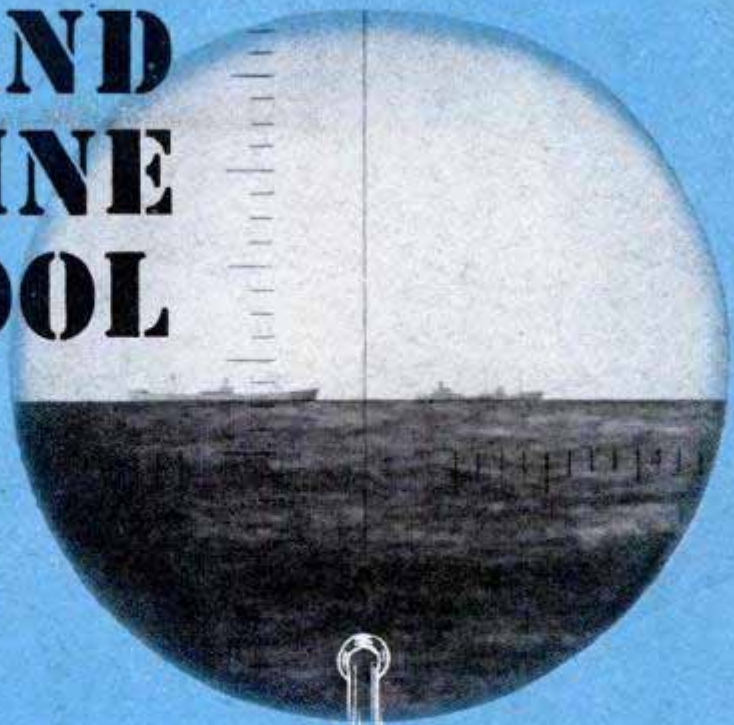

This is the view a submarine commander gets through a periscope as he follows a merchant-ship convoy on the "horizon"

Submarine crewmen in training man the conning-tower controls in the Submarine Attack Teacher at the New London sub school

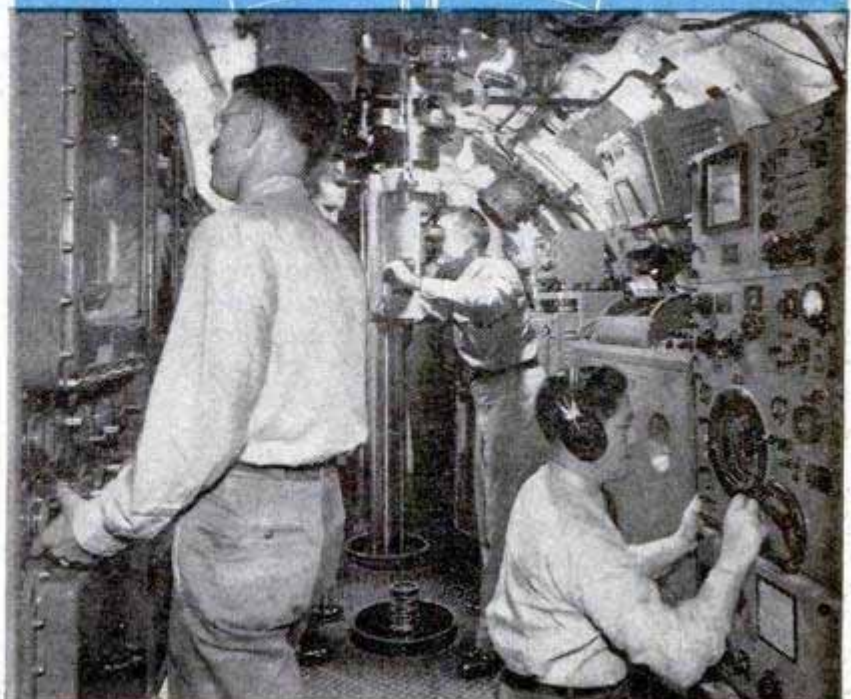

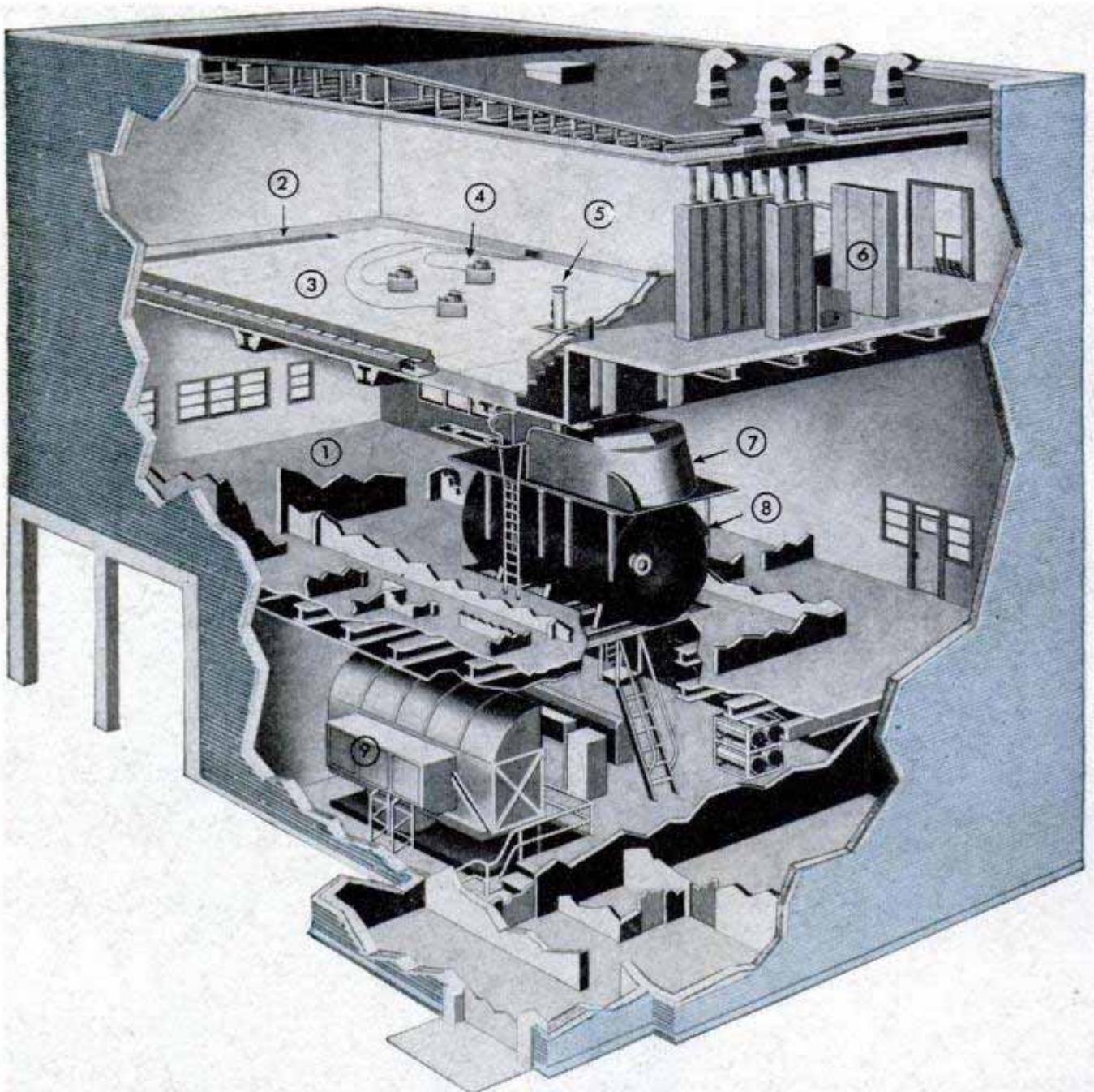

U. S. Navy photos

Cutaway view of the building housing the Submarine Attack Teacher at the New London school. Numbers designate the following: 1. Classroom; 2. Skyboard; 3. Target floor; 4. Model cars; 5. Periscope; 6. Computer rack and panels; 7. Forward bridge; 8. Conning tower, and 9. Submarine diving trainer. With this giant training device, future submarine crews are getting actual practice in underwater duty while on dry land

a network of mechanical brains and other engineering marvels—a submarine crew can synthetically take their craft to sea, submerge and practice with five surface ships any maneuvers which might be carried out afloat. Each man carries out the same duties with the same equipment he would at sea, with only a fraction of the time and expense actual undersea exercises would cost.

The Navy set up the first of these Submarine Attack Teachers in 1948 at New London, Conn. It was designed and built by the Special Devices Center, a branch of the Office of Naval Research, at Port Washington, Long Island. Improved models are now in use at New London and Mare Island, Calif.

Outside, these trainers look like any three-story brick factory. Inside, you see a complete conning tower, a bridge, and diving-control compartment. On the third floor, five model ships maneuver on the floor controlled by a training officer.

In the conning tower on the second floor the captain directs his craft. Move a control and the submarine's instruments, connected to high-speed computing machines, reflect the action as in an actual submarine. Standard hatches lead to the bridge above and the diving-control compartment below. Two periscopes, one operative and one dummy, are flanked by the helmsman's station with instruments and communication lines, radar and sound-wave equipment, torpedo gear, intercommunication

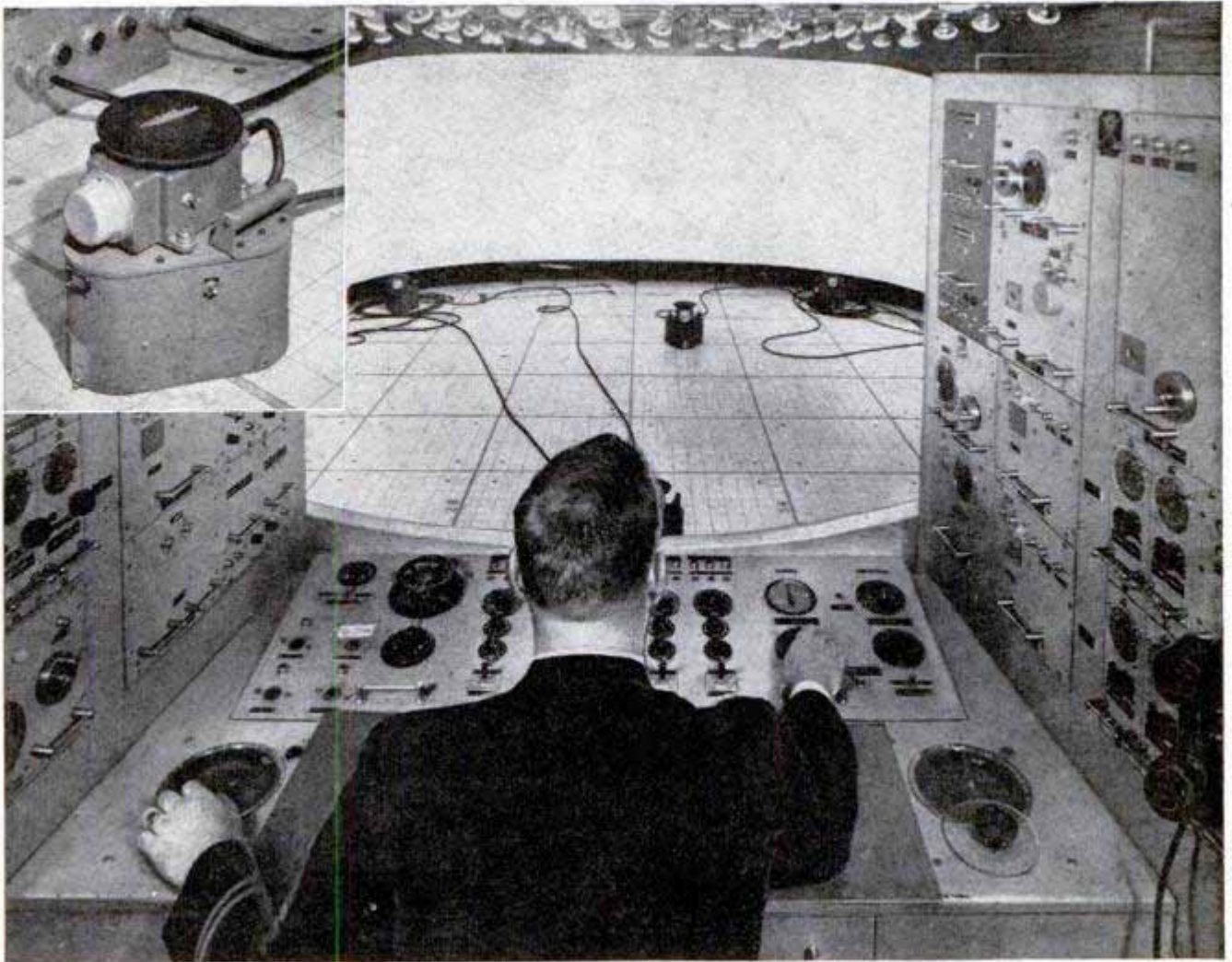

Above, instructor manipulates the target ships from his position at the console. Inset, top left, is a close-up of a model ship on the "crab" which maneuvers for the trainees. Crewmen see this ship through the periscope of the training device. Below, conning station and instructor's post inside the Submarine Attack Teacher

equipment and the intricate array of gadgets which make the eyes of landlubbers bulge.

The instructor checks the actions of officers and men as they maneuver their sub and make their attacks. His panel shows the positions and all statistics about the submarine and target vessels.

When the conning officer looks into his periscope, he views a seascape on which ships are plowing through the waters with bow waves standing out clearly and wakes trailing astern. The seascape is built into the optical system of the periscope, and the "sea" is the third-floor deck of the building. This deck, through which the periscope is raised, drops away gently from the periscope so that distant ships have a hull down appearance. The model ships, built to a scale of 1200 to 1, are mounted on automatically controlled cars which travel at speeds proportionate to the type of ship. The operator of the Trainer determines their course and speed. Since the simulated submarine cannot be moved, the

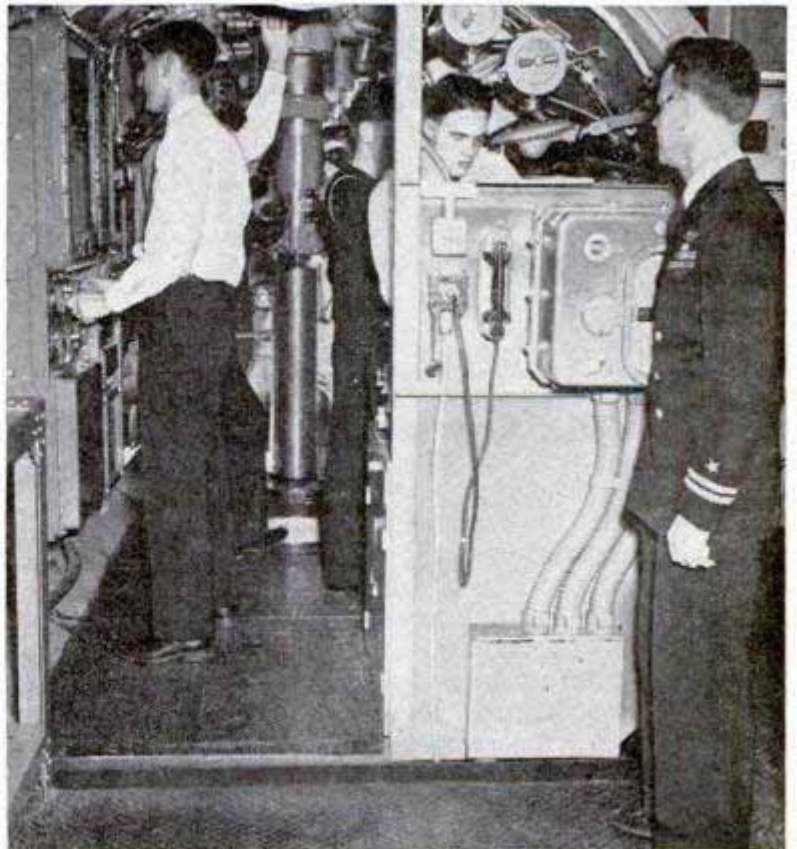

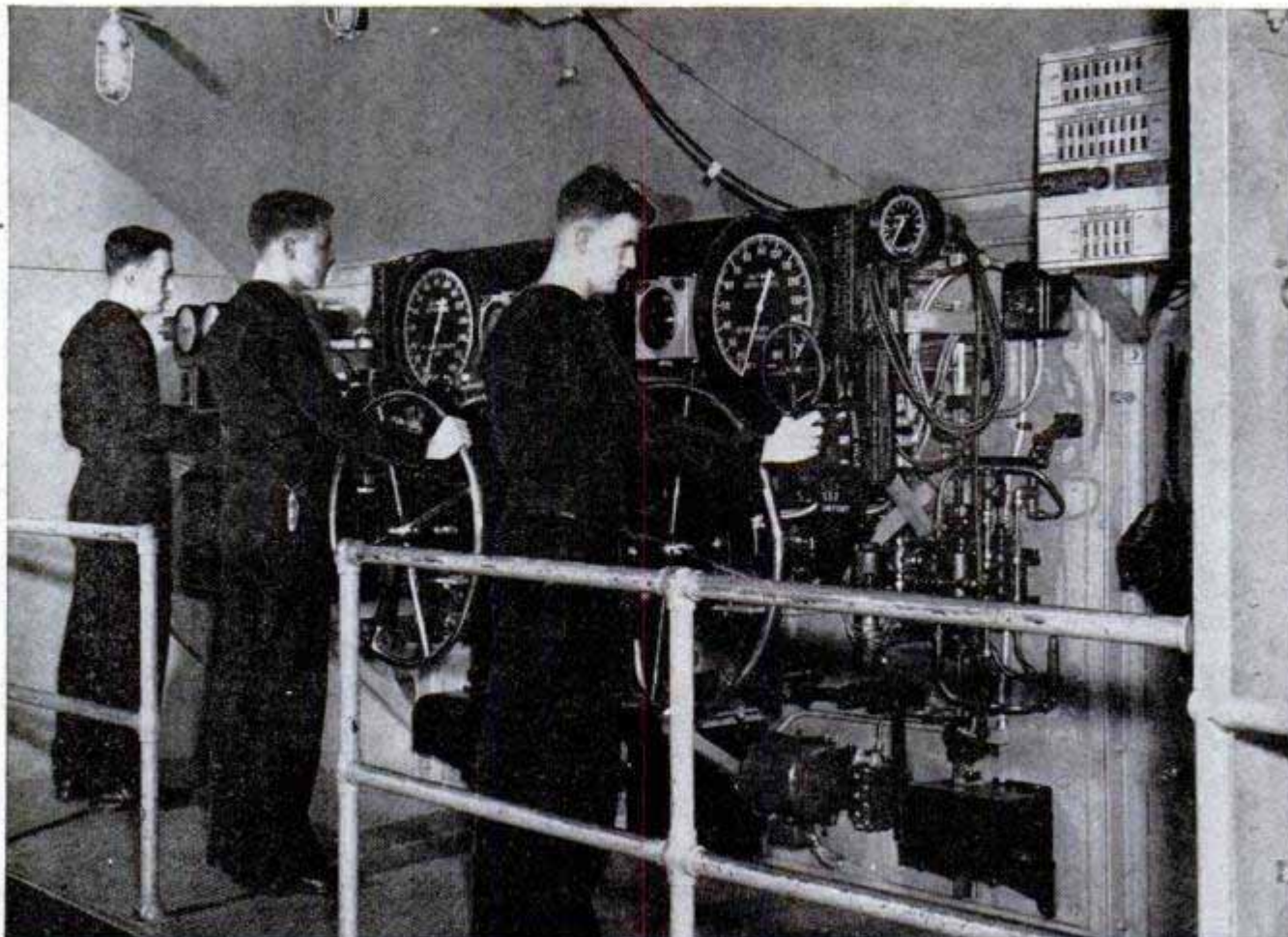

Above, sailors of the underwater fleet practice on the diving trainer. Right, a civilian technician puts together a model ship under a magnifying glass

movement of the model vessels varies to keep the correct distance and bearing from the submarine, depending on its simulated movements. Electric cables attached to the cars run to a computing mechanism, which keeps them traveling correctly. The model ships, which represent merchant vessels, destroyers, cruisers and aircraft carriers, "sail" on a 58 by 35-foot floor, constructed of polished terrazzo slabs. The floor is marked off into grid lines to facilitate computing. The floor provides an optical range of 16,000 yards in one direction, 7000 yards in all others. Radar range is limited to 30,000 yards. Lighting arrangements vary the seascape from bright daylight to night.

Four feet above the model-ship floor stands a battery of computers on the operator's platform, where problems are set up and their solution observed. By the flip of a switch, he makes the submarine react to the characteristics of the older fleet-type submarine or the newer high-speed "guppy" type. The surface vessels can be operated either as targets, or as submarine hunters, to give practice in evasive tactics.

The Diving Trainer, located on the first floor, simulates the control room of a submarine. It affords complete training facilities for diving crews, who operate the controls under directions from the conning



tower. The other operational room contains two standard torpedo-firing panels simulating the torpedo rooms of a submarine.

The Attack Teacher will never replace salt-water practice, but it has proved eminently satisfactory in bringing crews to a high degree of perfection before actually trying out at sea.



Fluorescent-Tube Disposal Device

Fluorescent tubes containing beryllium, a powder classified as a poison hazard, are disposed of safely by a device that breaks the burned-out tubes under water. Developed by the New York Department of Labor, the device consists of a long barrel, an anvil and plunger. The tube is inserted in the barrel, which is then closed by a lid on the top. The opposite end is placed in a bucket of water and the trigger pulled, breaking the fluorescent tube as the plunger crashes it against the anvil. The beryllium dust mixes with the water which is poured down a drain without danger.

Dashboard Pressure Gauge Checks Tires Remotely

Motorists can check the air in their tires without stopping the car by means of a remote-controlled pressure gauge that mounts on the dashboard. By turning a convenient pointer to any of five positions, one for each tire including the spare, the motorist reads the exact air pressure on an adjacent gauge. An additional feature of the device is a warning system that flashes a red light on the panel when the pressure of any tire drops five pounds below safe operating pressure. The lights identify the troublesome tire and provide sufficient warning so the driver can stop his car before any damage is done.



Carton Tongs

Grocery clerks and others who have to handle heavy cardboard cartons and wooden boxes can eliminate back strain with a pair of tongs that permit lifting the cartons with one hand. Grippers of carbon steel hold the box securely but without damage. The upward pull on the handle forces the grippers inward so there is no possibility of slippage.

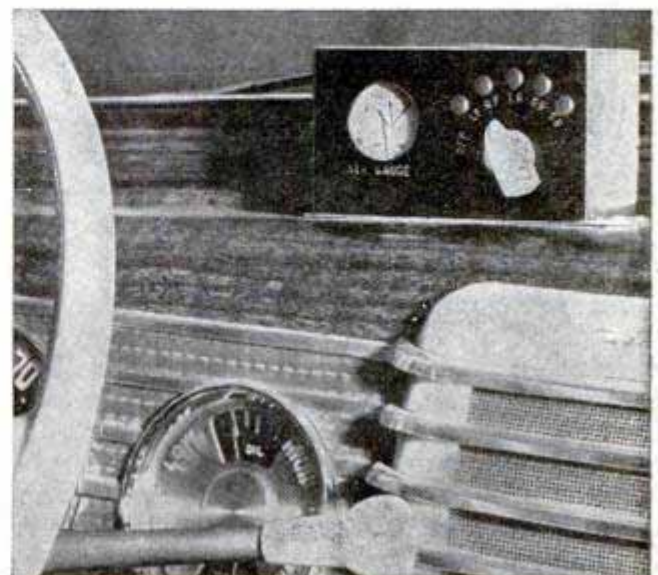

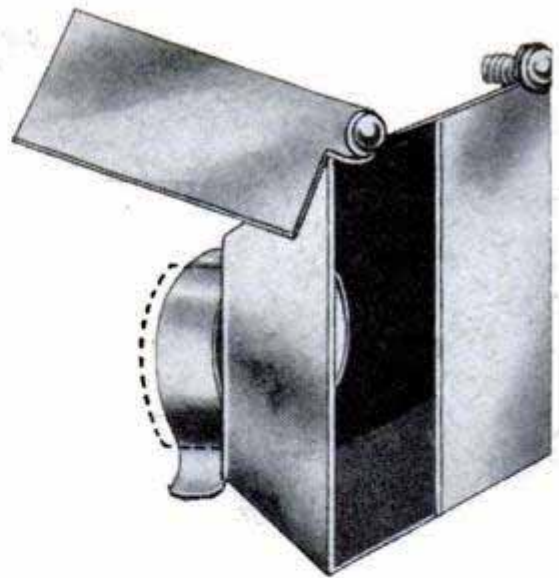

Trick Photo Effects Made With Shutter-Shade

Double exposures are made scientifically for trick photographic effects with a lens shade that has two swinging shutters. With it you can photograph a person "talking" to himself. You simply close one shutter and snap the picture, then pose the subject

on the opposite side and re-expose the film with the first shutter open and the second closed. Many humorous effects can be produced in this manner. The two shutters can be swung open and the holder used as a lens shade, if desired.

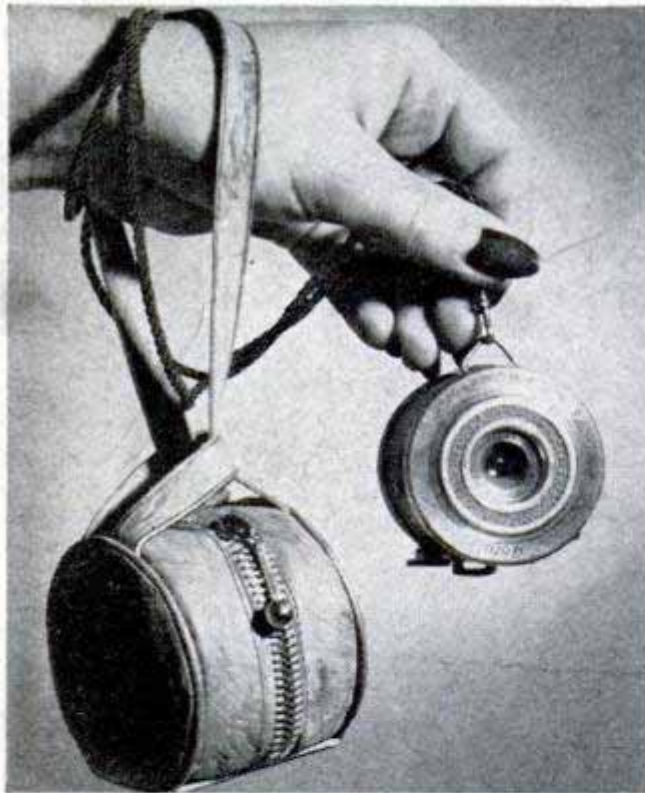

Midget German Camera

Midget cameras make candid shots easy to get and a new midget from Germany is carried in a leather case on the wrist like a tiny handbag, always ready for action. The circular camera has an f:2.8 lens and shutter speeds up to $\frac{1}{200}$ second. The shutter has a built-in flash synchronizer. The 8-mm. film comes in special cartridges that hold 10 exposures.

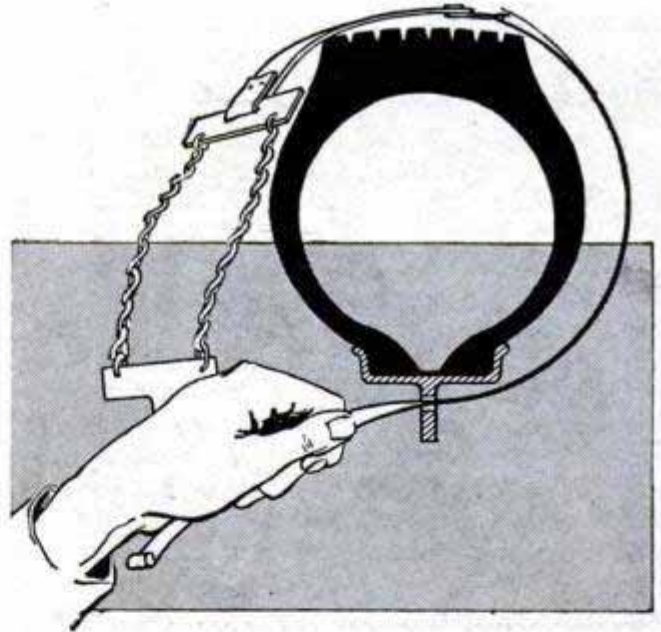

Strap-On Chain Applier

Emergency tire chains, the ones that strap on through the slots in the wheels, go on quickly with the help of an applier that won't drop the strap as it is being pulled around the tire. Wire clips are attached to the end of each strap. The applier, formed of a wide spring-steel band, is pushed through the wheel slot until its hook end comes out over the top of the tire. The wire clip on the strap is then locked in the hook and the applier pulled back through the wheel slot until the chain is in the proper position over the tire. The chain strap is then buckled tight in the normal manner.



Despite the year's loss to rabbits of 15 acres of wheat, the homesteading McClymonds can still smile

Below, J. S. Moore, superintendent of the Minidoka Project, shows two homesteaders their free acreage

Free land—the magic words that helped conquer our frontiers ring out once again. Occasionally, farm land on reclamation projects is available, but homesteading 1950 style is a science, not a gamble

By Rafe Gibbs

EVER CONSIDER homesteading? No, we're not talking to Grandpa, but to you. There's still free land to be had in the United States. It's in limited quantities, and the getting of it requires more than a fast horse to race out and stake your claim. But you do have a good gambling chance at a homestead, providing you can meet certain requirements.

Out in the Northwest, for instance, 75 farm units on federal reclamation projects were made available for homesteading during 1947 and 1948, with more to come. Thirty thousand persons from all over the United States requested applications for a chance at those 75 units. That sounds like tough odds, but additional facts don't make them so tough. Fewer than 4000 applications were returned for land drawings and

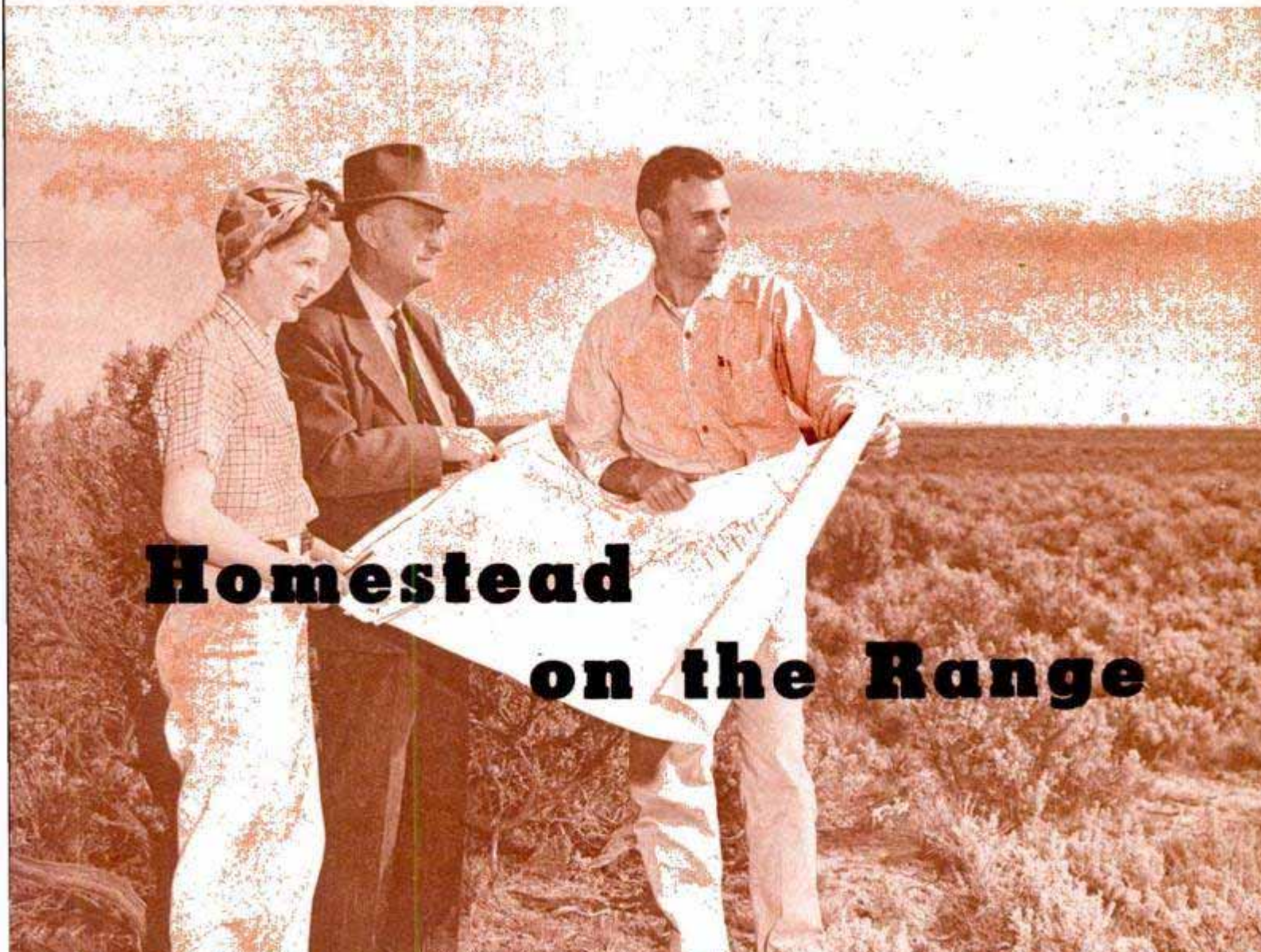

**Homestead
on the Range**



Water from a small reservoir behind a canvas dam is siphoned into the fields by lengths of plastic hose



Farmer adjusts nozzles in the aluminum pipe which carries irrigation water to a field of sweet peas

many of these didn't have a prayer for consideration.

Nothing pains the Bureau of Reclamation more than having a homesteader fail. Qualifications are thoroughly checked before a bureau official says:

"Okay, Mister, that hundred acres over there is yours. Hop to it."

Primarily, the successful applicant must have two years of full-time farm experience, or its equivalent, obtained after the age of 15, and capital assets of \$3000 or the equivalent in such assets as livestock, farm machinery and equipment which would be useful in developing and operating a new irrigated farm. Preference is given to veterans of World War II.

Back in Revolutionary days, to step up enlistments in the Continental Army, a bounty of land was offered, with the acreage depending on rank—1100 acres for a general, 500 for a colonel, 100 for a private. But today an ex-buck private is on an equal basis with an ex-general.

Now, before you start dashing off a letter to the Department of the Interior in Washington, D. C., asking about homestead opportunities, let's take a look at a typical project. The Hunt unit of the Minidoka Project in Southern Idaho is typical—and unusual. It is unusual because a lot of barracks from a Japanese evacuee camp were thrown in free with the land and the settlers have done interesting things with the buildings, but more about that later.

In June 1947, 43 World War II veterans

were awarded Minidoka farms, ranging from 60 to 100 acres.

"It was no land of milk and honey when we moved on it," said cowboy-hatted Eugene Kenner, who used to run cattle over Lava Hot Springs way in Idaho before the war. "Most of the project was covered by sagebrush, with two jack rabbits fighting for shade under each bush. The Japs had grubbed off some of the land for farming, but brush and weeds had snuck back in. Still, the land was ours, and there's something special about land that's free. 'Course we were assessed about \$100 an acre for irrigation-construction charges, but the land itself was free."

To those of you used to dry-land values, \$100 an acre may seem high for irrigation construction, but the figure for the land concerned is reasonable.

"Our first problem was getting homes ready," said Kenner.

And that's where the Japanese evacuee barracks—each 20 by 120 feet—came in. All homesteaders received two barracks, and how they utilized them was their own business. It cost from \$300 to \$600 to get the buildings moved onto the farm sites, but the buildings were worth many times that in lumber alone. Each contained about 15,000 board feet.

You wouldn't recognize some of the old barracks buildings today. With muscle—and money, varying from \$1000 to \$7500—the barracks have become homes of individualistic design.

Earl Mouton, former chief warrant officer in the Navy, for instance, rebuilt a barracks into an H-shaped house, with 20 feet in the center and 40 feet on the ends. What happened to the 20 feet left over? Built that into a garage. Mouton's other building was unscrambled into barns and sheds.

The interior of the Mouton house has been done in knotty pine. There's a friendly fireplace, too.

"I was in the Navy 23 years 7 months and 2 days," said Mouton, "and all the time I wanted a snug harbor of my own. Now, brother, I've got it."

Some of those who came on the project with the minimum of required funds are using the barracks as homes almost as is. But they're roomy!

A homesteader who will have a really different home is Harry Peterson. His barracks house burned down while he was out grubbing sagebrush and he lost everything, including his shirt. He had left the shirt in the house while he worked under the blazing sun. But, before the ashes of his home grew cold, Peterson started picking up rocks off his farm, and now he is building a new house out of them.

"I was one of the extra lucky ones," said ex-cattleman Kenner. "I won a surplus truck on a drawing. My grandfather homesteaded 80 acres over by Rupert, Idaho, in 1906. When he came onto the land all he had was a wagon, a slab of bacon, some flour and beans. But we still have to get in and dig just like Grandpa."

The modern homesteaders are indeed "digging" with the vigor of Grandpa, but they are progressing much faster and their chances of going broke are much less. Here is some more help that the moderns received which Grandpa never knew:

First off, the Minidoka land was carefully



Mr. and Mrs. Marvin York, homesteaders, start work on the foundation of their future home in the West

analyzed by experts before it was allotted for homesteading. Not only did the homesteader know that the land was good, but he knew, before he ever grubbed a bush of sage, what crops would best grow on his particular plot.

Then a GI farm-training program was set up on the Minidoka Project. The homesteaders were taught the latest scientific methods for clearing the land, raising crops and livestock, marketing, financing and keeping books. For attending this school, the veterans received the regular GI subsistence payments. The monthly checks came in mighty nice while waiting for the land to start producing.

Always close at hand was Virgil Cross,

Once a barracks in a Japanese evacuee camp, this building is being converted into a comfortable and attractive home by the homesteaders

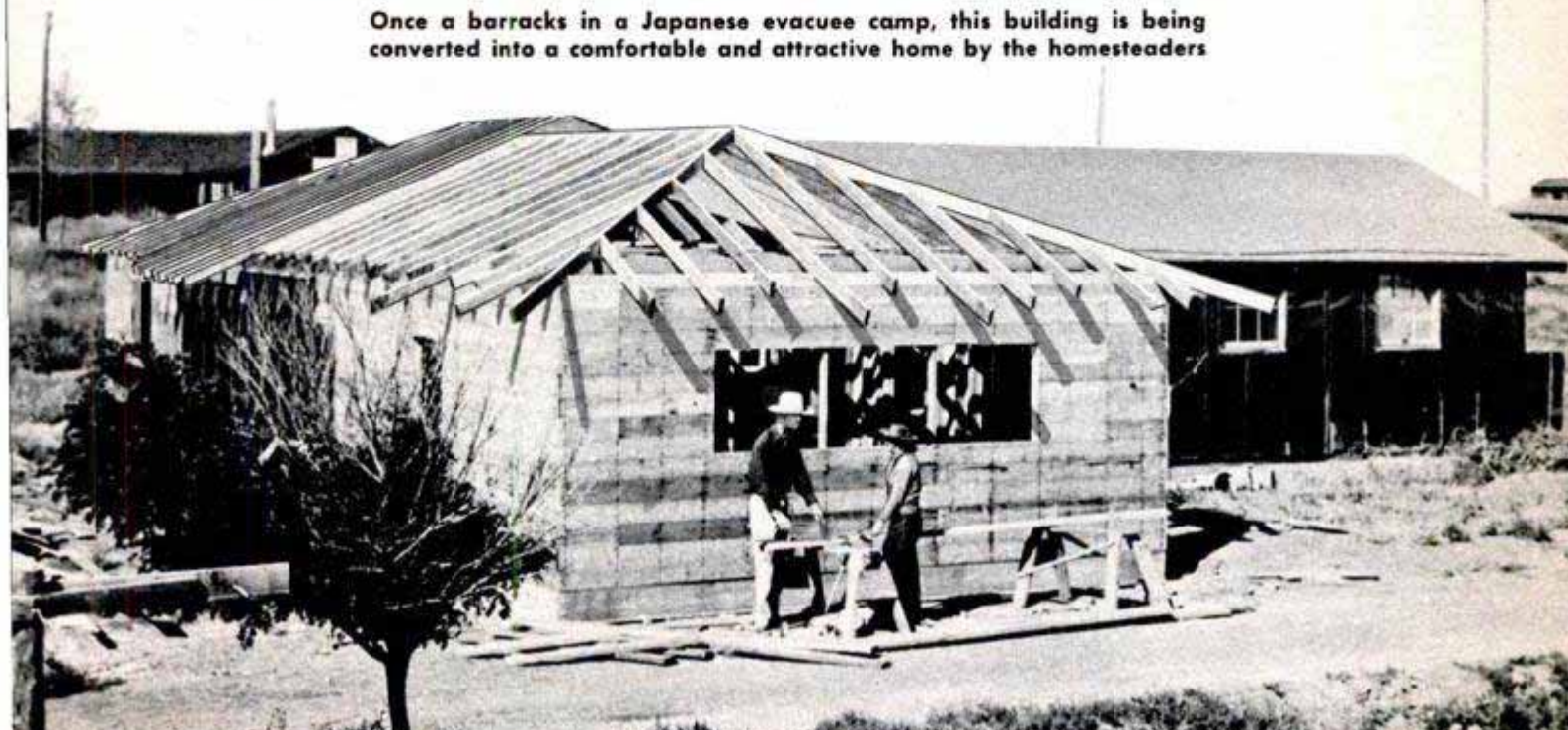



You'd never guess that this modern kitchen was once part of a barracks! Nor is it anything like the huts that were called home by homesteaders of yesteryear

The hardy folk who homesteaded years ago would be amazed at such items as Mrs. Earl Mouton's freezer



University of Idaho county extension agent. Cross continually dropped in to advise the homesteaders on crops adapted to the Minidoka area, on the time for planting, rate of seeding and sources of seed. If a homesteader suggested that he wanted to remodel a barracks into a dairy barn, Cross promptly whipped out a University of Idaho bulletin telling him just how to do it.

The Bureau of Reclamation also had a man on the job to give assistance to the homesteaders. O. V. Chenoweth, land-use specialist, was all over the project, helping lay out and level fields and install irrigation systems. Grandpa sometimes used to have to sight down his land over his thumb. On the Minidoka Project, Chenoweth was there with surveying equipment.

For necessary farm equipment, GI loans averaging \$2000 were extended by a bank at Jerome. The Farm Home Administration also made funds available for long-term loans. Implement companies at Jerome and Twin Falls gave the homesteaders a high priority on tractors.

As a result of all this help, crops—good ones—were produced on the land the first year, 1948. Take Kenner, for instance. He raised 42 acres of Lemhi wheat. Forty bushels to the acre (some farms produced 45). Gem barley went more than 50 bushels to the acre. Perfection peas, 20 sacks to the acre.

The land gave forth generously as expected, but there was the unexpected, too.

"I managed to get 50 acres cleared my first year, and planted it all to wheat," said William McClymonds, veteran from California. "I had a good crop of wheat—and jack rabbits. The rabbits got away with about 15 of the 50 acres of wheat."

Last winter, the homesteaders, with guns and poison bait, were death on rabbits.

McClymonds said he took up his homestead with the minimum of \$3000 in resources, and added:

"A man should really have \$5000."

McClymonds is a hard worker with an all-weather grin. He'll make it. Besides, he has plenty of inspiration — an attractive wife and two equally attractive children.

It used to be that it took the third generation to make good money on new land. On the Minidoka Project, it looks as if the first generation will accomplish that feat.



Less than a year before, this land was just sagebrush. Even without any special preparation with fertilizers, it yielded a good crop of potatoes

Below, a GI homesteader uses the equipment available at the Vocational agricultural School of the Minidoka Project to weld a brace on a scraper



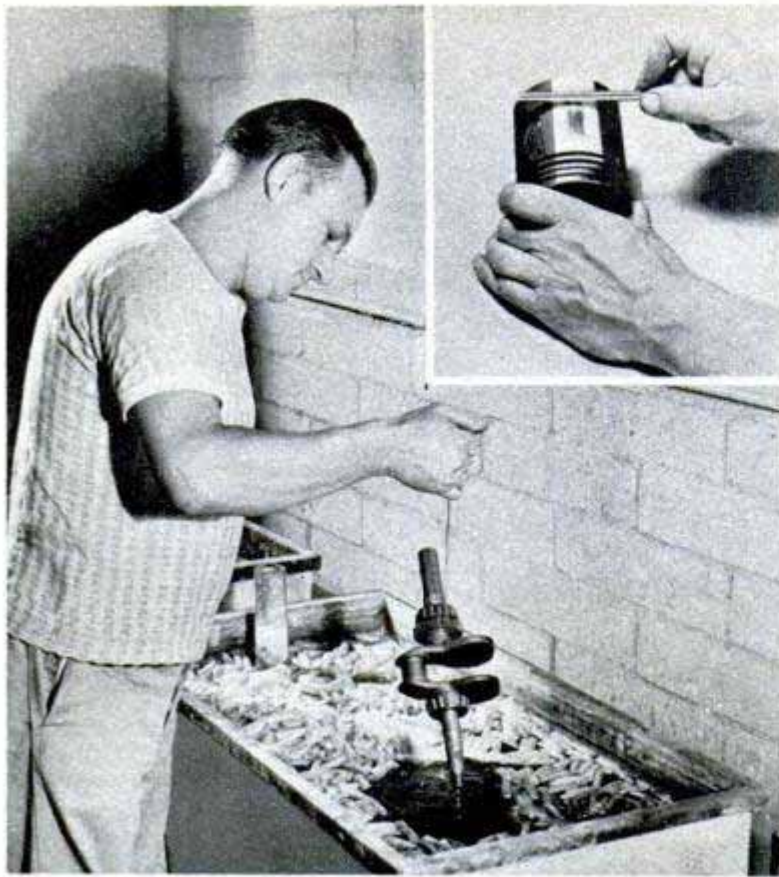

Graphite Coating For Engine Parts

Coating bearings and other friction surfaces of internal-combustion engines with a film of graphite increases life from 3 to 10 times. After a thorough cleaning, the parts are coated by dipping or spraying. The film is stable and unaffected by solvents or weather. In a test of graphite-coated pistons in an automobile engine, no evidence of piston scoring was found even after operation at high oil and water temperatures for 200 hours. Some graphite is absorbed by the pores of the metal to provide a reserve supply that replenishes the film as it is worn away. One treated piston was sandblasted clean on one side to remove all surface graphite, yet, when the area was rubbed by a metal bar, graphite soon worked to the surface to replace the film that had been removed.

Giant Treadmill Tests Locomotives

British locomotives are given test "runs" in an indoor testing station, said to be the most up-to-date in the world. The locomotive is supported on seven pairs of rollers. In treadmill fashion, the engine drives the rollers while technicians, in a sound-proof control room, determine the efficiency of the locomotive by watching a series of dials. One dial shows the speed and others show the amount of pull developed by each wheel. Although the test station doesn't eliminate the standard test runs over the right-of-way, it does permit controlled study of the engine's capabilities under a variety of loads.

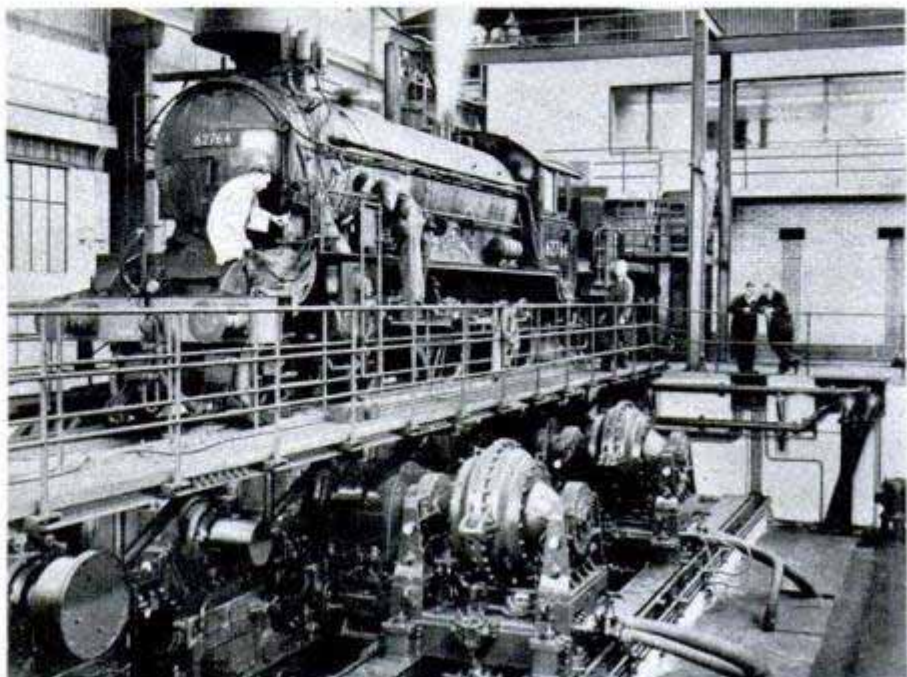
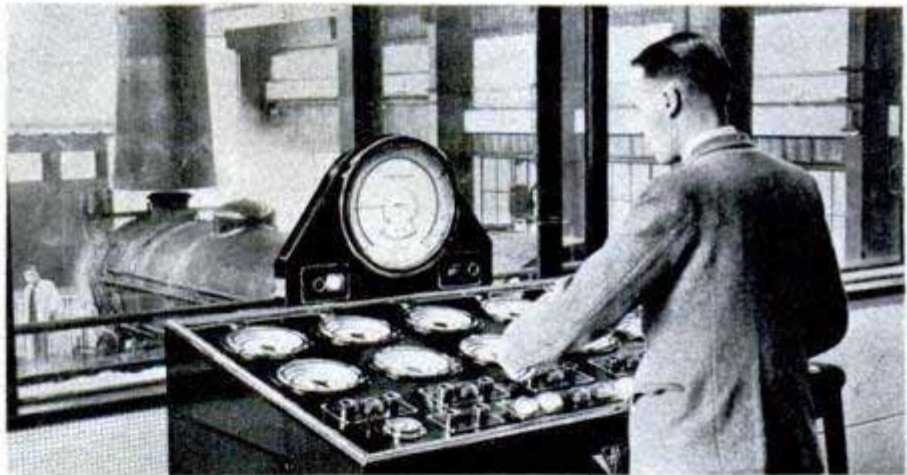

Information not given on articles listed in the index, frequently is contained in the WHERE-TO-FIND-IT INDEX, available at no charge from Bureau of Information, 200 E. Ontario St., Chicago 11

Model Rotary Press Prints Newspapers →

There are model-building hobbyists the world over and one of the more unusual is a German craftsman who built a working model of a giant rotary press similar to those used in the production of large newspapers. The tiny rotary press actually turns out 32-page newspapers with a page size of $1\frac{1}{2}$ by $2\frac{1}{2}$ inches. It took him 10 years to construct the model which is complete even to ladders and guard rails.

Resin Filter Permits Reuse Of Photo Wash Water

Field photo laboratories of the Army Signal Corps are relieved of the problem of finding large water supplies by a purification process that permits wash water to be used over and over again. In a typical field darkroom, about 3000 gallons of water are used in a day, but with the purification process only 10 gallons are necessary. The water, after it has washed the prints, is passed over thousands of tiny particles of synthetic resin which filter out silver and

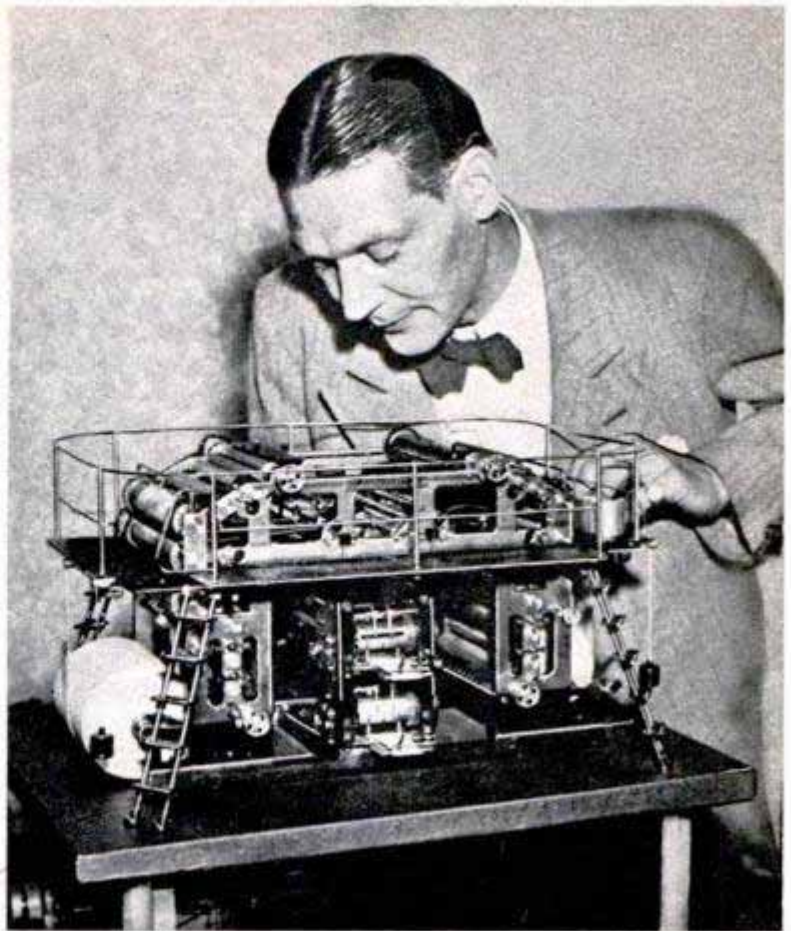

other impurities. The resins are virtually indestructible and are rejuvenated by immersing them in washing soda.

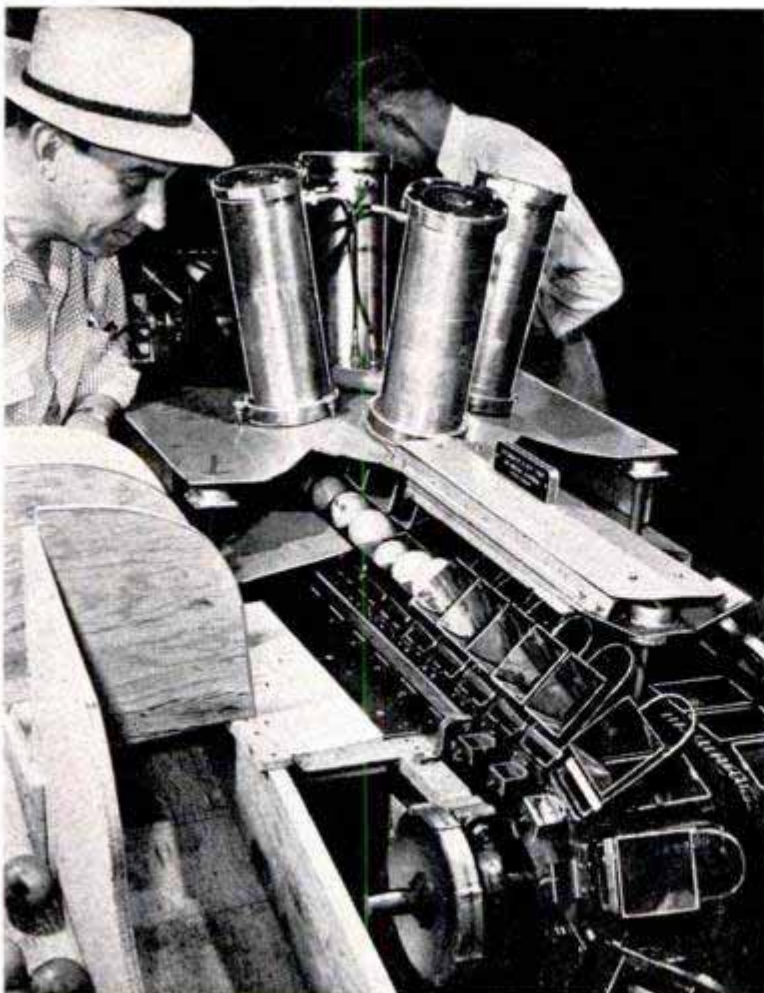

X-Ray Orange Grader Detects Frost Damage

Frost-damaged oranges are automatically detected and rejected by an X-ray grading machine. Such damage is seldom apparent from the outside, so growers must be able to "see inside" the orange to eliminate damaged fruit. Two endless belts carry the oranges in individual cups through the machine. As the fruit enters, it passes in front of a size compensator which presets the X-ray tube for the size of the orange. The orange then passes over the X-ray tube and the frozen areas cast a shadow picture. These pictures are "observed" by four activating chambers which release the orange into one of three exit channels according to grade. About 36,000 oranges can be graded per hour by the machine.

☛ There are 7,555,000 private and publicly owned trucks in the U.S. out of a world total of 15,038,000, according to the Automobile Manufacturers Association.

FOUR-ACRE ROCK GARDEN



A model of the Statue of Liberty stands on a base containing hundreds of radioactive-rock specimens

A lily-pond "moat" protects this spired castle. Now retired, Petersen devotes all his time to his hobby

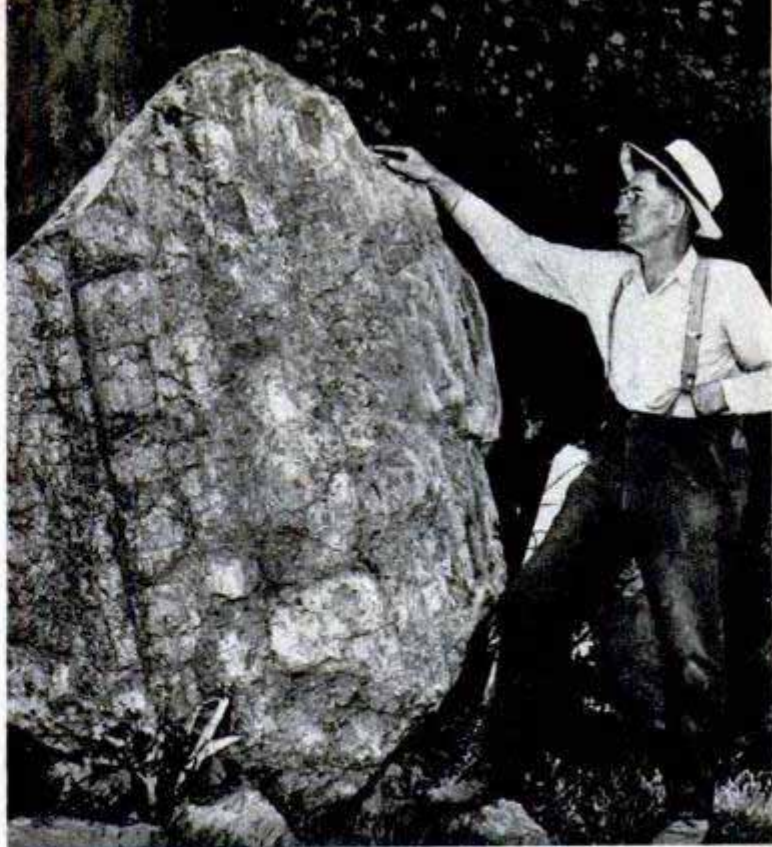

Petersen stands beside a 3½-ton slab of petrified log



Fluorescent minerals, used in this model village, glow eerily under the rays of an ultraviolet lamp

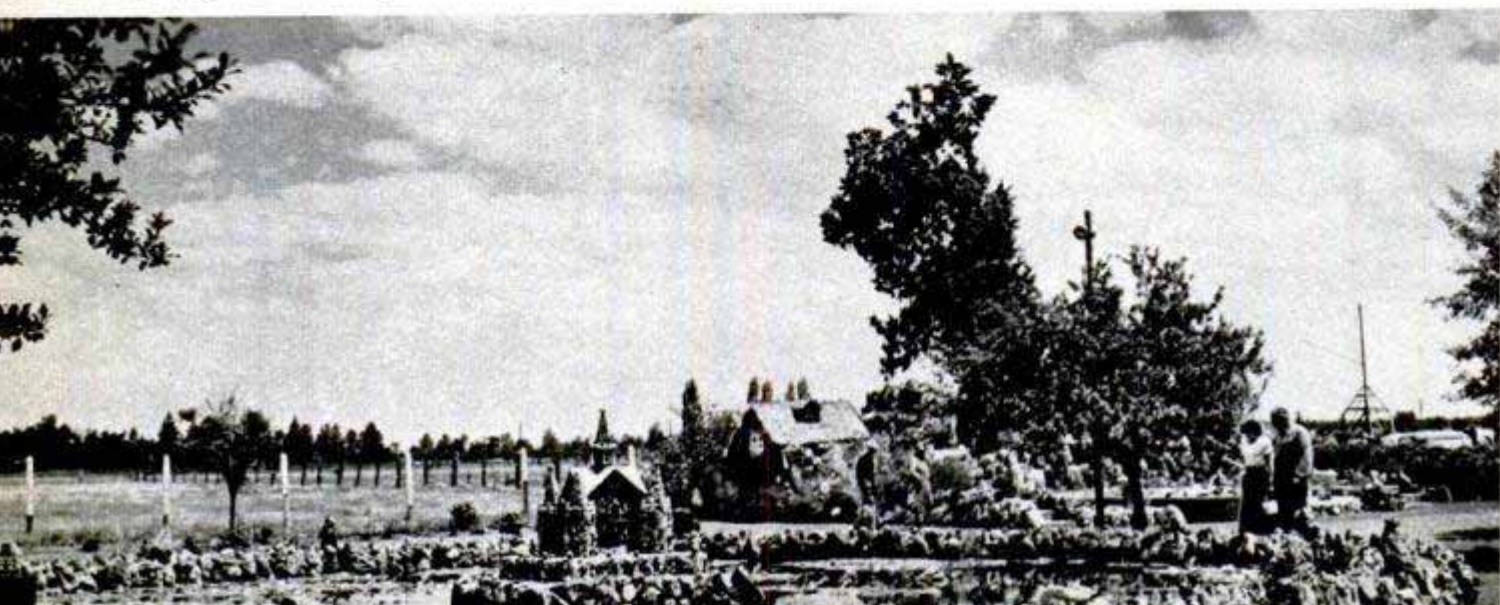



This house is a model of Petersen's family home in Denmark, which he left for a homestead in Oregon in 1905

STUBBORN juniper stumps that spotted the farmyard of Rasmus Petersen near Bend, Ore., were responsible for one of the most unusual geological "museums" in the country. Laboring with little success over the chore of removing the pesky roots, the Oregon amateur geologist decided to put his hobby to work and bury the roots under a rock garden of native stones. That was back in 1935.

Today, the former rancher, now retired,

has landscaped four acres around his home with more than a million pounds of multi-colored-rock specimens that he spotted in the fields and mountains of central Oregon. These specimens range from tiny chips of quartz to a 3½-ton section of petrified Sequoia log. Miniature castles, statues and other architectural designs, all built of rock, make the garden so attractive that 100,000 visitors stroll through it annually, admiring Petersen's handiwork.

All the rock shown in the displays is native to Oregon and was collected by the former rancher as his hobby. Black obsidian is the dark rock visible here

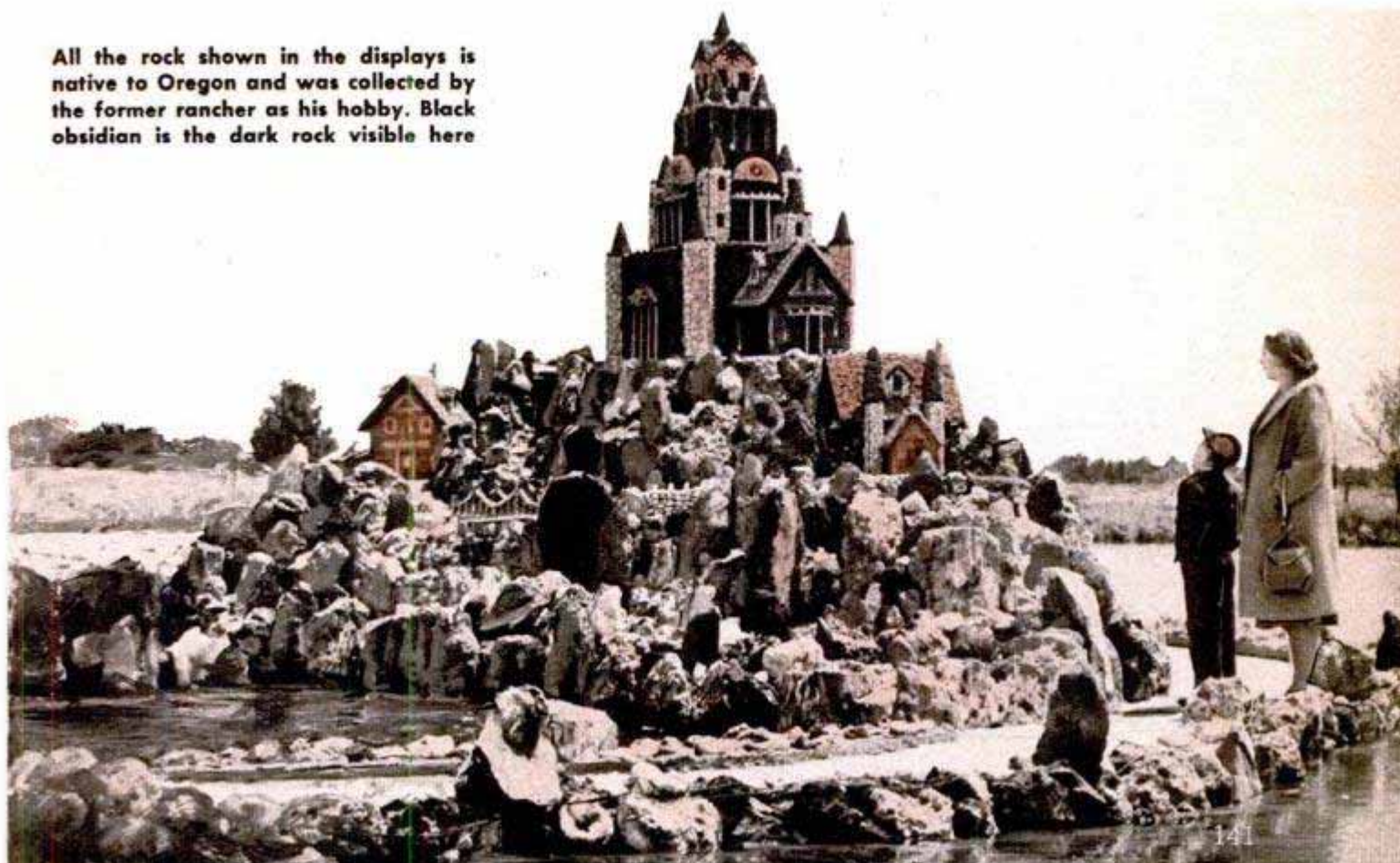



Speed-Light Kit

Photographers can put together their own speed lights with a kit that includes everything necessary for assembling an electronic flash unit. All difficult parts have

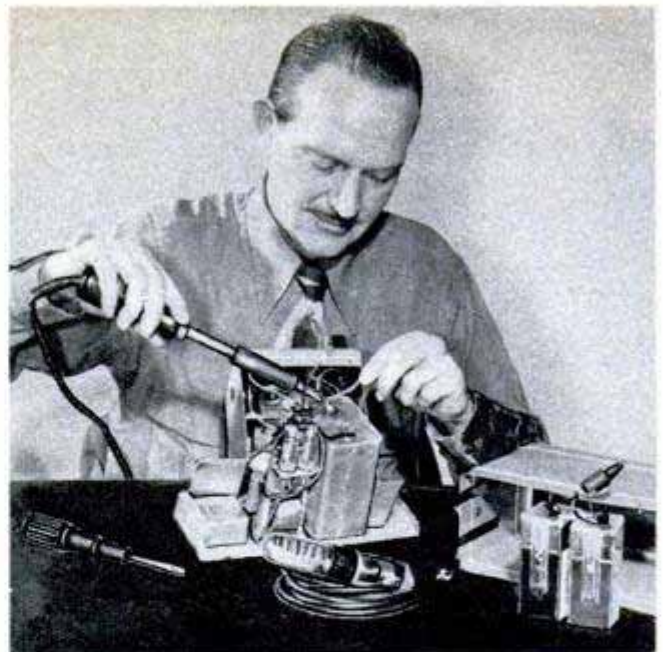

Above, with a screwdriver and soldering iron, you can assemble the kit in an hour. Left, powered by batteries, the speed light provides flash anywhere

been factory-wired. The only tools needed are a screwdriver and soldering iron. Even the solder is included and assembly takes less than an hour. The unit is powered by wet-cell batteries which are wired so they must be disconnected during charging, making it impossible to impress the higher charging voltages on the circuit and thus damage the unit. Space is provided in the case for a second condenser which can be added if more than one light is desired.

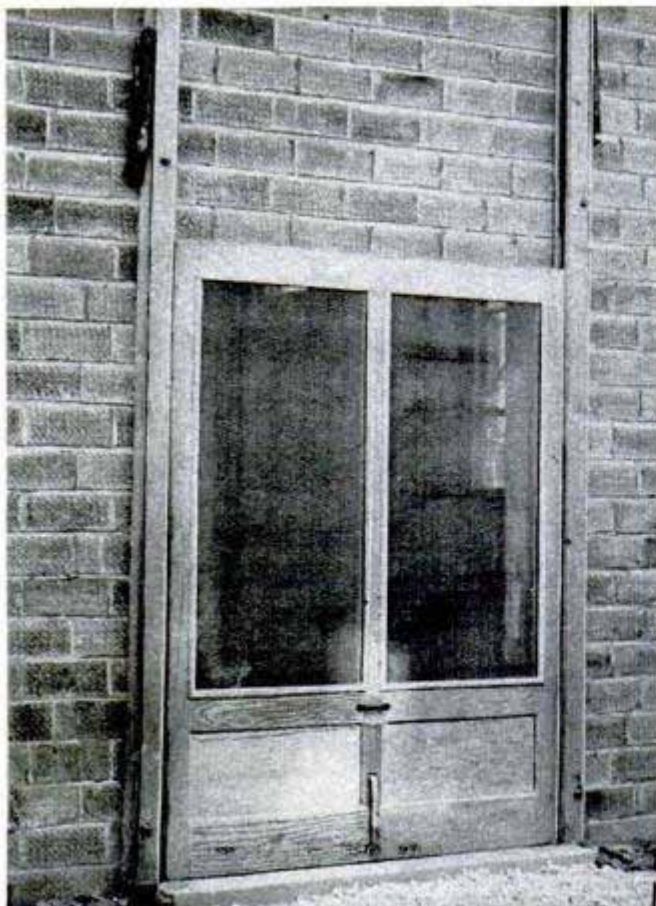

← Overhead Screen Door

Trucks bringing in supplies to a food store can back up to an overhead-type screen door without interfering with its operation. The wide door slides up and down in tracks formed by wooden uprights. Several weights counterbalance the door to make it easier to lift.

Machine Tops Man

Working eight hours, an average man who is in good health can produce only $\frac{1}{4}$ horsepower. The amount of energy produced is equivalent to that obtained from burning a third of a pint of fuel oil. This amount of energy from a diesel engine would transport 396 bags of cement up a 100-foot hill. In terms of fuel, the energy produced by man in eight hours of labor is worth about two cents. However, man has one unique advantage over the machine—an efficient automatic control called a brain. These calculations are from a recent study by F. B. Shoemaker, consulting engineer of General Motors' Detroit Diesel Engine Division.

"Water Wheel" Boosts Voltage

Borrowing the principle of the water wheel, General Electric engineers have developed a voltage multiplier that increases the 1000-volt output of a small generator to 100,000 volts. As a water wheel develops power when its buckets fill with water, the multiplier builds up energy by "filling" 100 capacitors electrically through a sweeping arm with "finger tip" brushes. Discharging the capacitors releases a surge of electricity great enough to leap across a gap between two spheres.

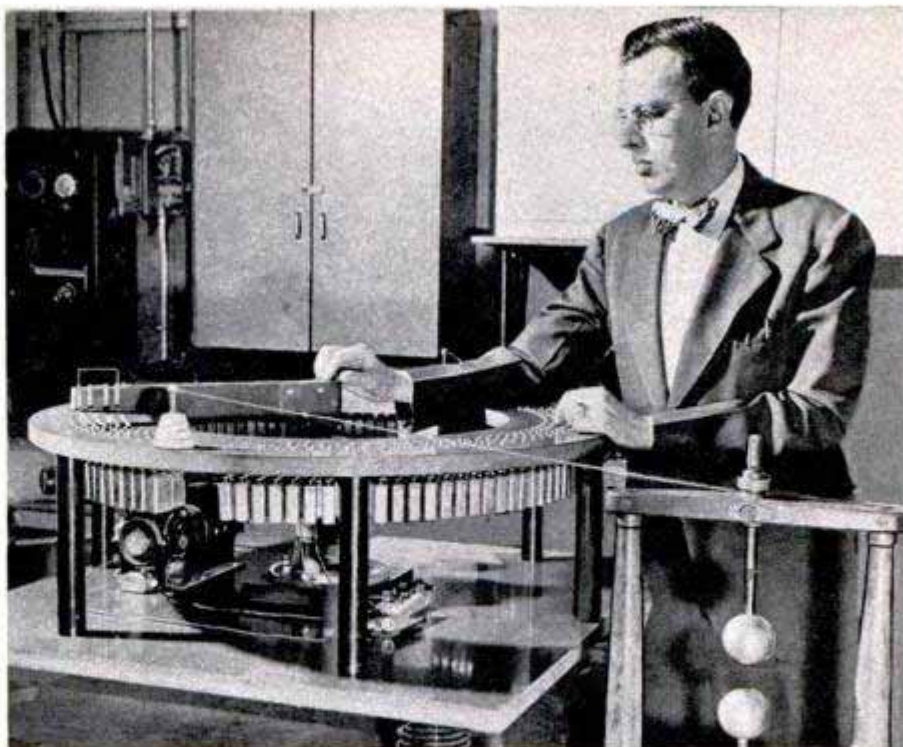

Gas-Turbine Engine Pumps Pipe-Line Gas

Industry is making its first use of the aviation-developed jet engine as a practical source of power. A 2000-horsepower high-temperature gas turbine, built by Westinghouse, is helping to pump natural gas through a 22-inch pipe line connecting Monroe, La., and St. Louis, Mo. Operating on fuel oil, the unit has few moving parts and turns out more power per pound than other industrial power plants.

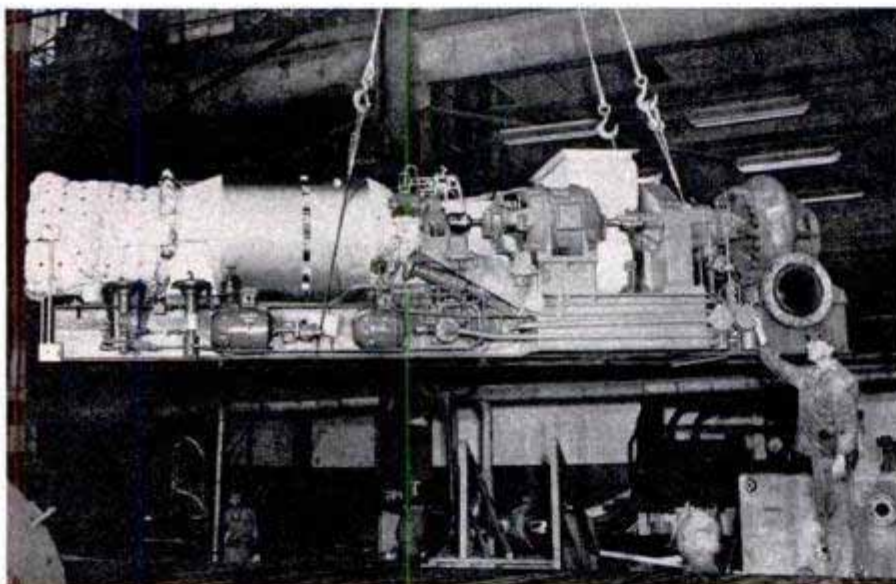

Cycle Salesman Tows His Wares

When Waymon Garner, Milwaukee motorcycle salesman, calls on prospective customers, naturally he goes by motorcycle and, with the help of a tow rig he designed, he takes a sample with him. A cradle, mounted on the rear of his three-wheeler, supports the front wheel of the towed machine. The wheel is locked in the cradle to prevent the towed cycle from bouncing loose when Garner travels over rough roads.



The Dizzy

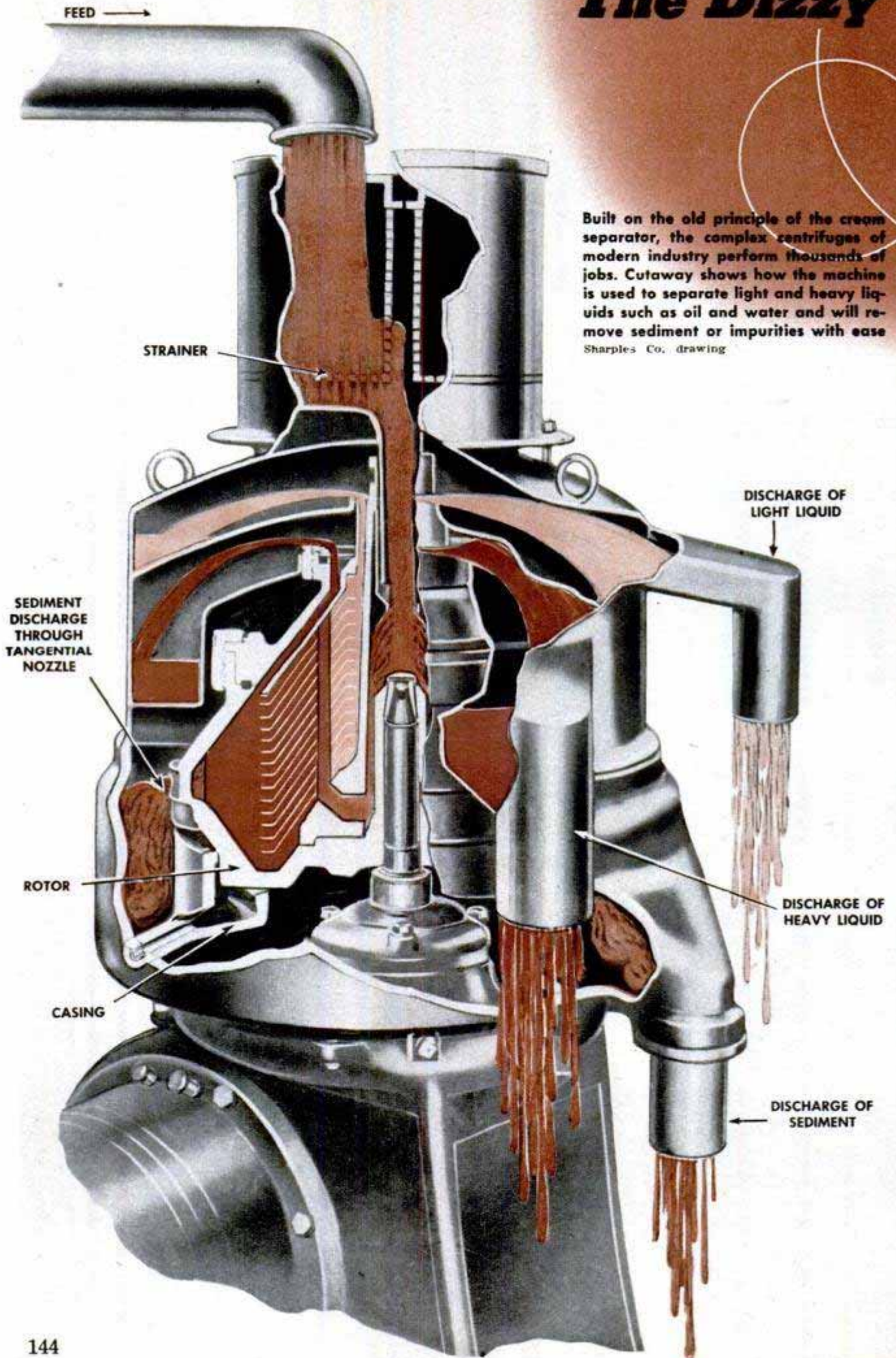

Built on the old principle of the cream separator, the complex centrifuges of modern industry perform thousands of jobs. Cutaway shows how the machine is used to separate light and heavy liquids such as oil and water and will remove sediment or impurities with ease

Sharples Co. drawing

Merry-Go-Round of Industry

By J. D. Ratcliff

BUT FOR centrifugal force, history's greatest fight upset—David vs. Goliath—would have had a different outcome. Little David would have taken a terrific shellacking if centrifugal force hadn't imparted Sunday-punch velocity to the stone from his sling.

Today, centrifugal force is playing a major role in another battle—industry's fight against rising production costs. Applied by the centrifuge—industry's version of the cream separator—it is doing an enormous variety of jobs. It is providing a great variety of better and cheaper consumer goods—automobile finishes, floor waxes, kitchen flavorings—and is playing a heroic role in medical research. The centrifuge is among the most fascinating machines used by modern industry.

In a moment, we'll see more about the centrifuge, but first let's see something about centrifugal force. The most familiar example is provided by whirling a rock on the end of a string. The rock resists changing direction—as it must do constantly to remain on a circular path. It would like to fly off on a tangent. The resultant tension on the string is centrifugal force.

The earth whirling on its axis provides a grand-scale example of the effects of this force. Our globe is 30 miles fatter at the spot where the greatest force is applied: the equator. This same force causes the Mississippi to run uphill! The source of the great river is three miles nearer the center of the earth than its mouth.

An even bigger-scale example is provided by the planets, which are held on their courses by centrifugal force. But for this, the enormous gravitational pulls at work on them would scramble them together like beans in a beanbag.

At the other extreme, centrifugal force acts on some of the tiniest particles in the universe. Atomic bullets are whirled in the cyclotron until they are hurled outward with multimillion-volt pressures.

A striking example of the powers of centrifugal force is provided by racing cars. At high speeds, drivers have no way of knowing whether they have flat tires—tires with

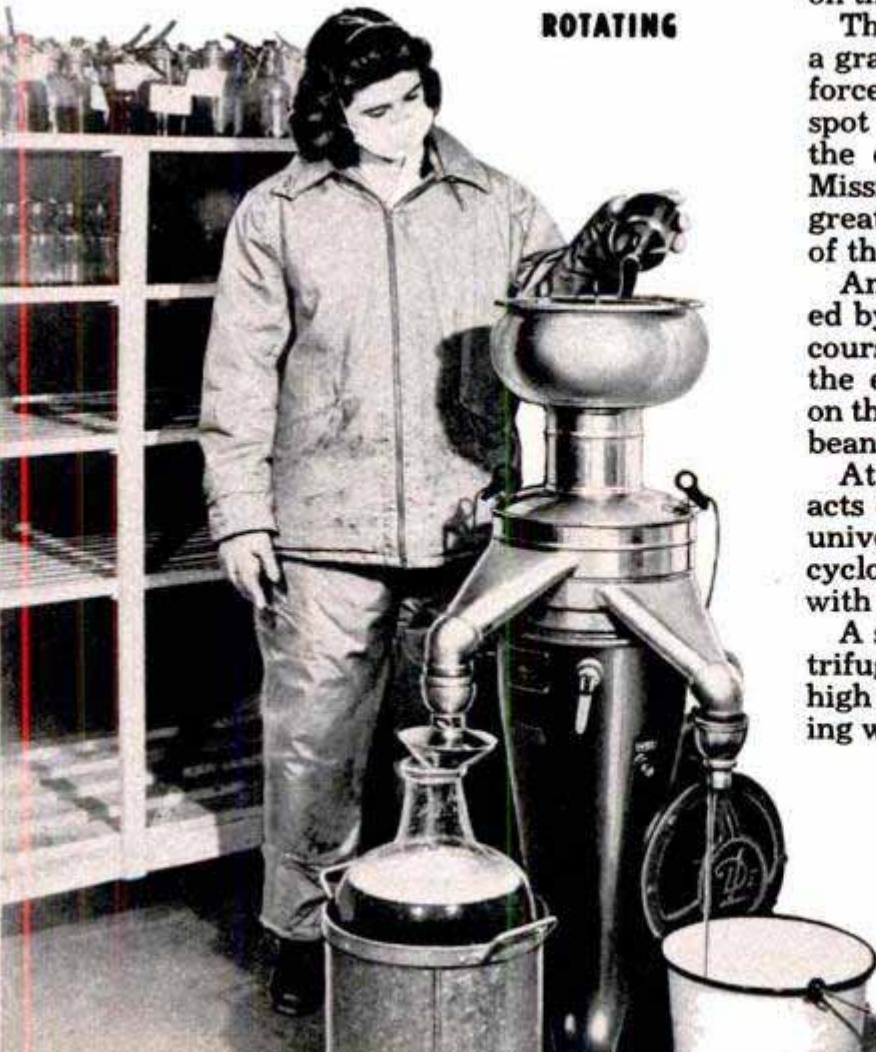
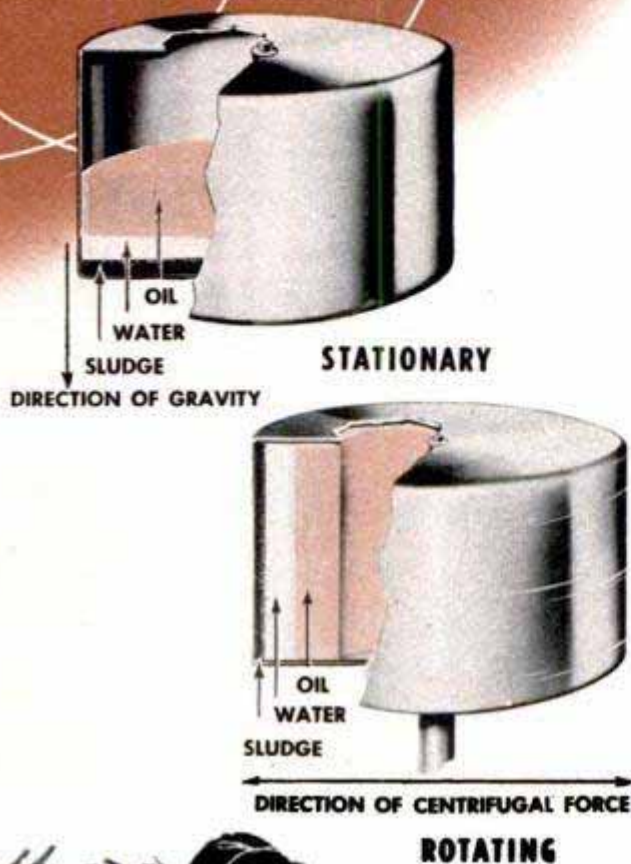

Sketches by Sharples Co.
Photo from De Laval Separator Co.

Centrifuge works like gravity—only it is much faster. When stationary (top), the natural forces form layers of sludge, oil and water. Other sketch shows rotating action. Left, separating plasma in blood

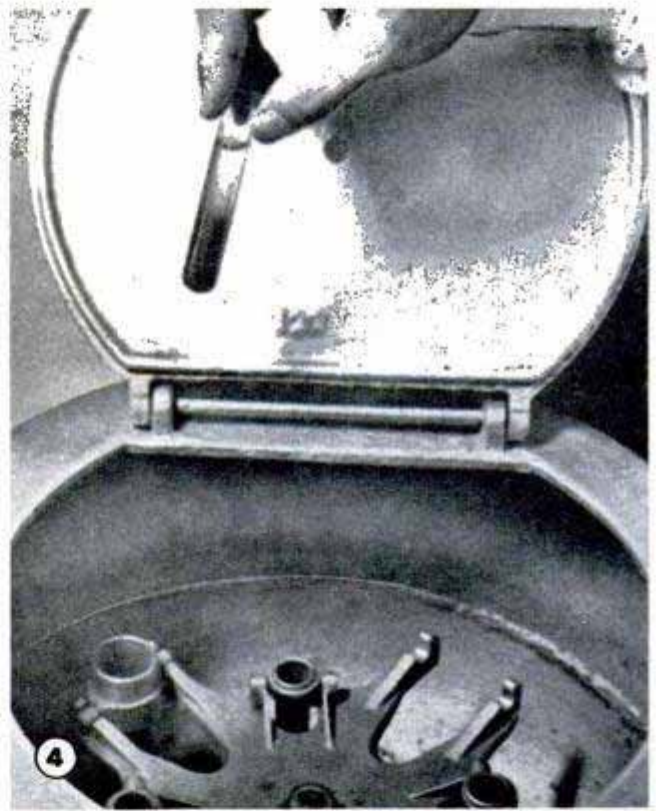
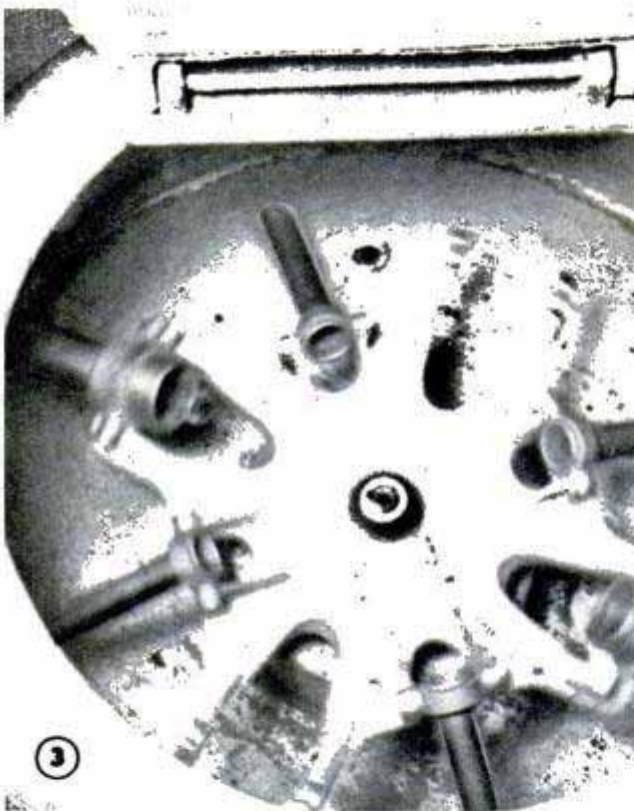
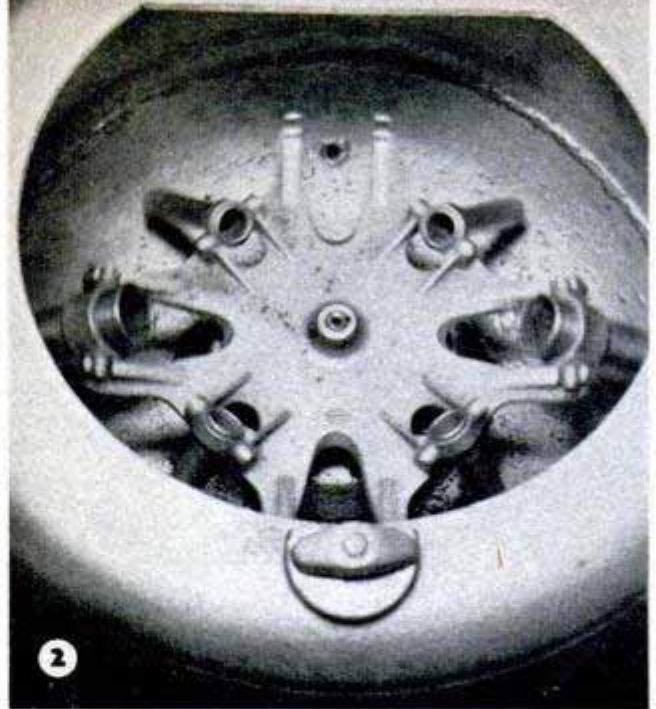

no air in them tend to maintain their shapes until speed drops below 60 miles per hour.

Although centrifugal pull is one of the basic forces of the universe, man made little effort to put it to work for him until the last century. Centrifugal pumps and centrifugal laundry driers were the first applications. The centrifuge in anything approaching its modern form wasn't born until 1875. That year Carl de Laval, Swedish inventor, pondered the problem of separating milk from cream. When whole milk was placed in bowls, it took gravity several hours to do the job—heavier milk settling to the bottom of the bowl, lighter cream rising to the top. But, De Laval, shrewd Swede that he was, reasoned that if whole milk were whirled fast enough, hundreds (even

thousands) of times the force of gravity would be applied. Heavier milk would be thrown to the outer rim of a whirling bowl, and cream would be stratified nearer the center. Spouts could be placed to draw off each one and separations could be achieved in seconds instead of hours. De Laval put his ideas to work, invented the separator.

Applications of De Laval's ideas outside the dairy industry were slow in coming and real mass-scale applications of the centrifuge didn't get under way until 1940. Since then more machines have been built and sold than in all the years that went before.

Today's machines range in size from small laboratory models, little larger than soda-fountain milk-shake mixers, to giant crystal driers which cost \$21,500. The lat-

← Old type of medical centrifuge shows how (1) test tubes of blood are inserted in hinged racks; (2) machine starts spinning; (3) the arms straighten out at 1500 revolutions per minute; (4) after 10 minutes the job is done—corpuscles are separated from the clear lightweight plasma
 Roland Harvey photos

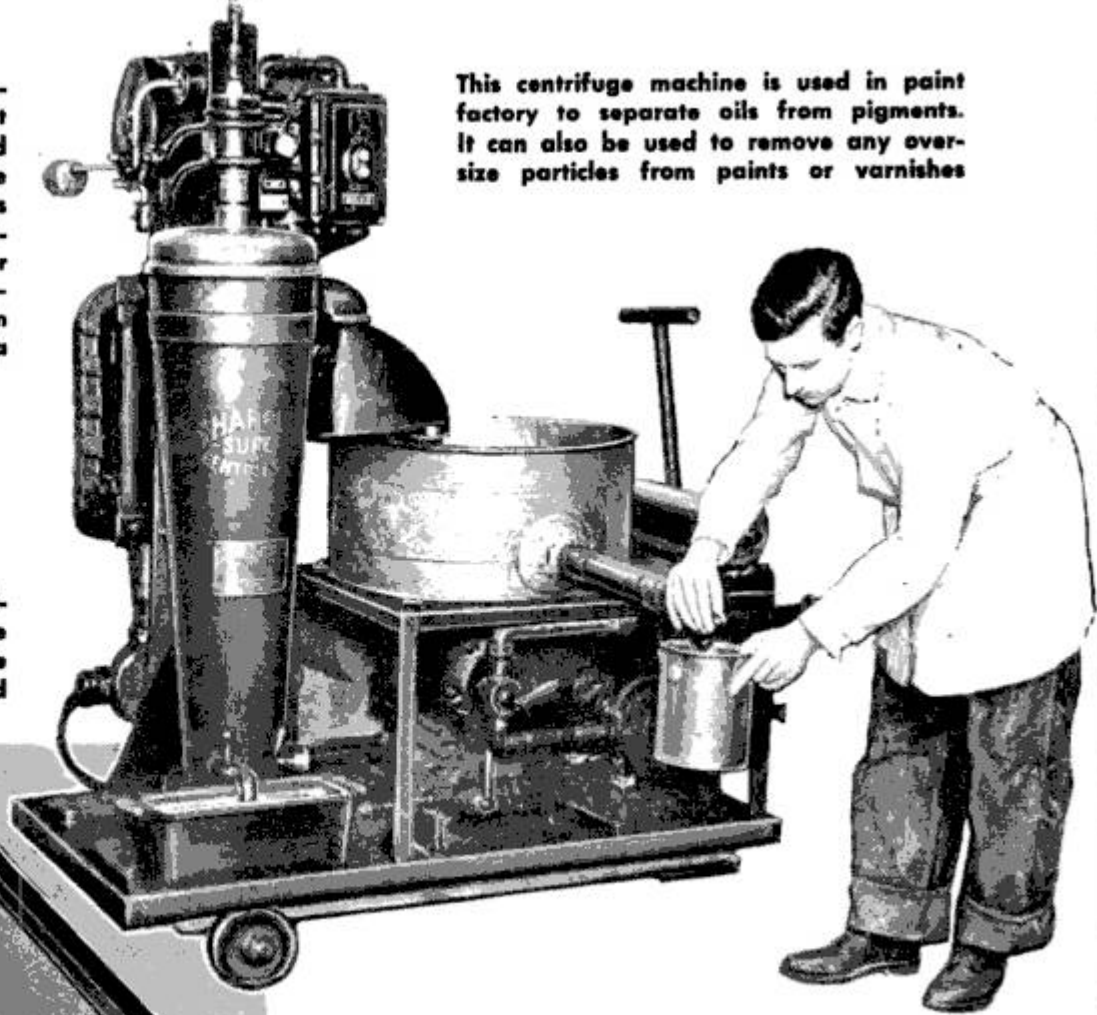

This centrifuge machine is used in paint factory to separate oils from pigments. It can also be used to remove any over-size particles from paints or varnishes

U. S. Air Force uses centrifuge at Wright-Patterson base to whirl pilots around to see how many Gs they can stand

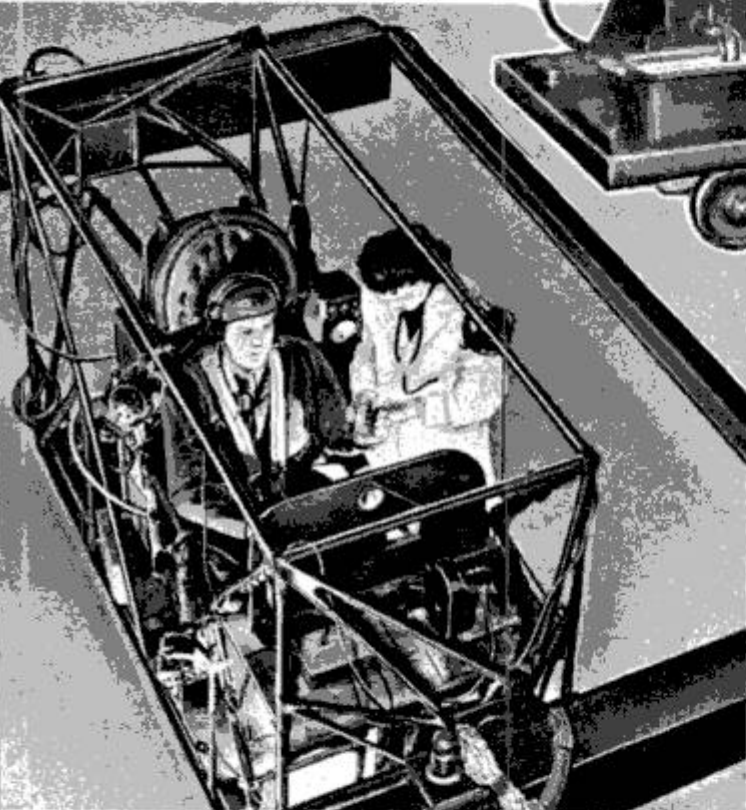

top scientist, who now heads that country's atomic research. Svedberg reasoned that a centrifuge which ran fast enough could apply any desired force and could, therefore, separate liquids which had never been separated before—the "tightest" emulsions, for example. The machine he built had a seven-inch rotor and was powered by an oil turbine. This machine reached a maximum speed of 160,000 revolutions per minute. For comparison, note that an electric fan whirls at about 1750 revolutions per minute; cream separators at about 7000. At the great speed Svedberg achieved, a one-pound weight exerted a force of 600 tons. The rim of the rotor achieved a speed of over 3000 miles an hour!

ter are used to whirl excess moisture from such substances as table salt; are able to handle up to five tons of materials per hour.

Whatever the size, centrifuges are built to finer tolerances than most watches—down to 1/10,000 inch. They have to be, since vibration would be disastrous at ultra speeds. Thus built to run with complete smoothness, centrifuges are among the quietest machines in industry—emitting no more than a faint whine.

Of all centrifuges built to date, the experimental models are the most fascinating. They whirl at stupendous speeds, generate stupendous forces. One of the first of these ultracentrifuges was built at the University of Upsala in Sweden by Dr. The Svedberg, Nobel prize man and Sweden's

For the better part, the far faster machines which followed were little better than tiny tops. The Sharples Corporation of Philadelphia built such a centrifuge which revolved at 1,200,000 revolutions per minute, generating a force 7.6 million times the pull of gravity. At this speed, a one-ounce weight would push outward with a force of 237 tons—the weight of a locomotive.

Even at this speed, the end was not in sight. Recently, Dr. Jesse Wakefield Beams, 49-year-old physicist of the University of Virginia magnetically suspended a tiny rotor in a high vacuum and managed to whirl it at 10 million revolutions per minutes—almost 166,000 revolutions per second! Beams didn't announce that he was seeking such

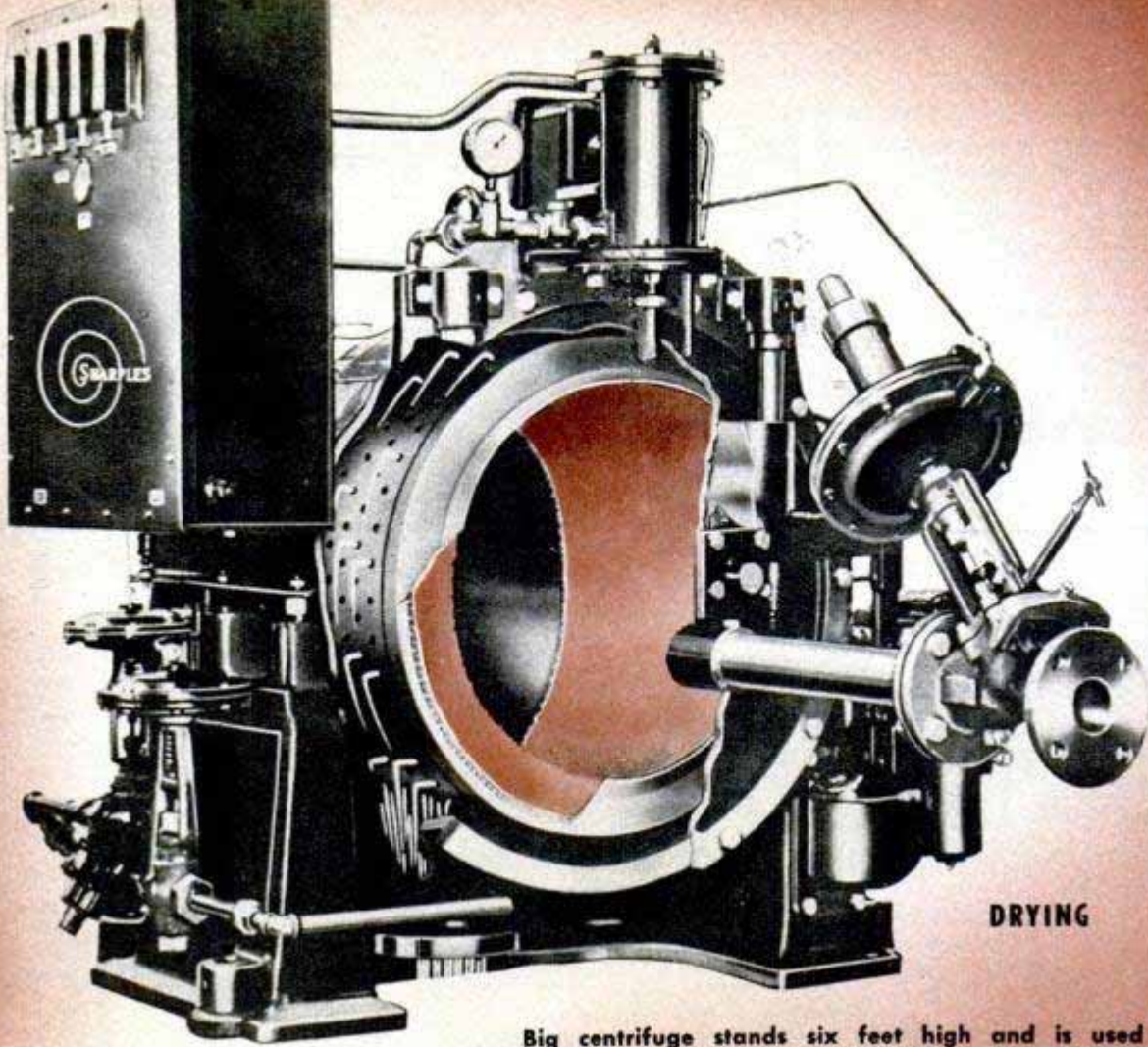

DRYING

Big centrifuge stands six feet high and is used for drying like an automatic washing-machine's "spin dry." Wet crystals (such as soda or salt) are poured into spinning drum and the liquid is squeezed through perforations; knife scrapes drum

Sharples Co. drawings

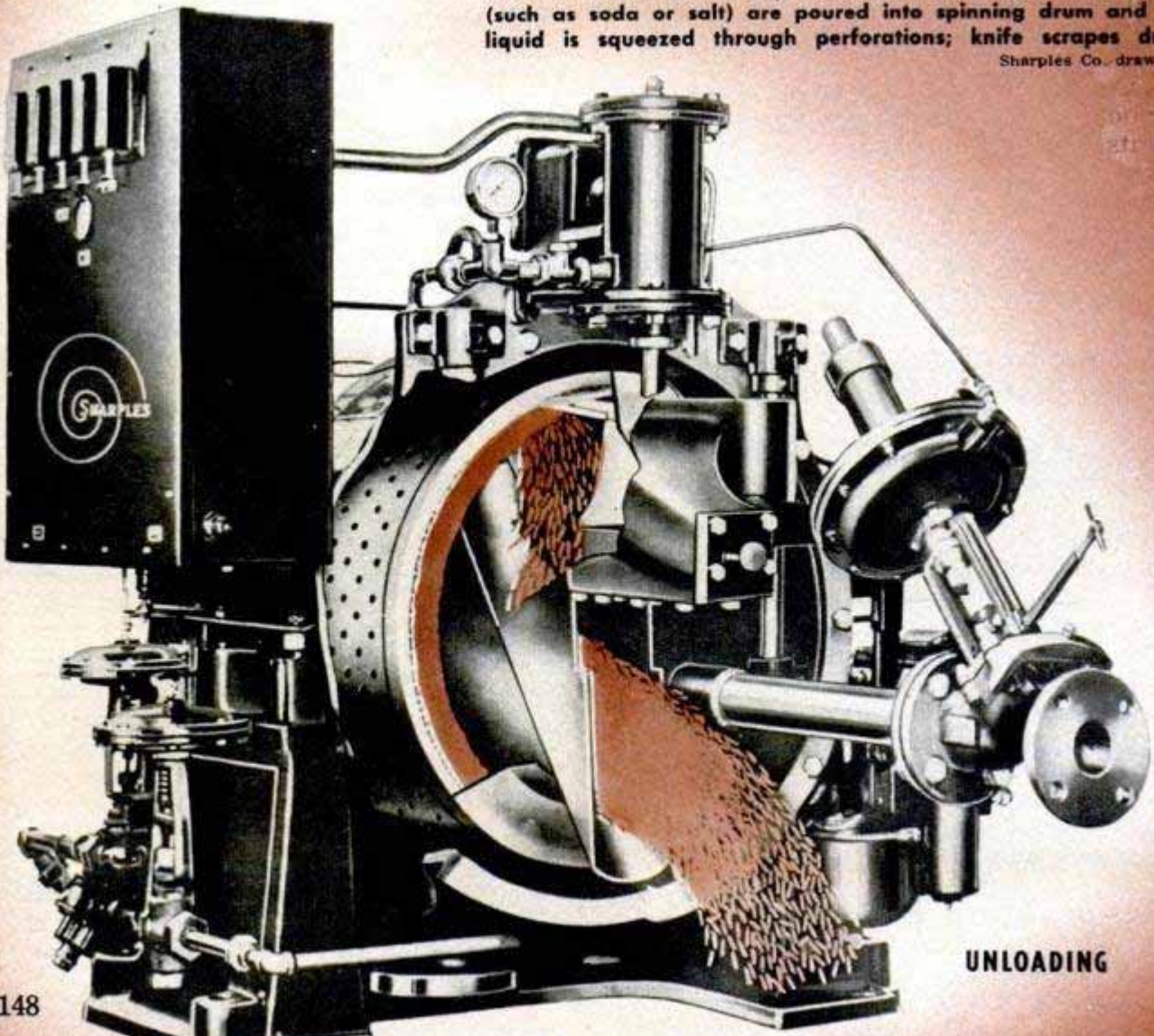

UNLOADING



Dr. Jesse W. Beams and his ultracentrifuge which whirls at 166,000 revolutions per second in a vacuum

super speeds as a means of separating isotopes, yet such an application appears to be feasible. It may one day be possible to separate uranium 235 from slightly heavier uranium 238 by this means, thereby cutting across the processes used at Oak Ridge.

Such speeds are well outside the requirements of industry. For most practical purposes, maximum centrifuge speeds of 50,000 revolutions per minute are sufficient in manufacturing processes. Machines turning at this rate exert forces up to 62,000

Centrifuge reclaims oil used in machining steel. The chips are saved and spun in simple centrifuge

times gravity. The danger of explosion is always present. There are cases where centrifuges have flown apart, metal fragments ripping through walls and partitions like small artillery shells. The danger is greatest with super-speed laboratory machines, which are always protected with armor plate or concrete.

Makers of industrial machines have testing rooms with foot-thick reinforced concrete walls. In these rooms centrifuges are tested to 2½ times maximum working speeds. If they withstand this rigorous testing, the manufacturer assumes they are safe for industry. Hence, commercial centrifuges have only thin shells. The makers reason that if they do explode, a heavier shell would only break and make shrapnel.

Jobs for centrifuges fall into three main classifications: separation of immiscible fluids (such as oil and water); removal of solid particles from a liquid (such as removal of foreign matter which would make a lacquer cloudy); drying operations (such as removal of excess moisture from sugar or salt).

There are cases where centrifuges do all three of these jobs to produce a single product. Take a homely example—a stick of chewing gum. The centrifuge clarifies ink on the wrapper, purifies oil used in rolling the foil covering, removes jungle debris from the chicle, dries the sugar which is dusted on the gum.

(Continued to page 238)

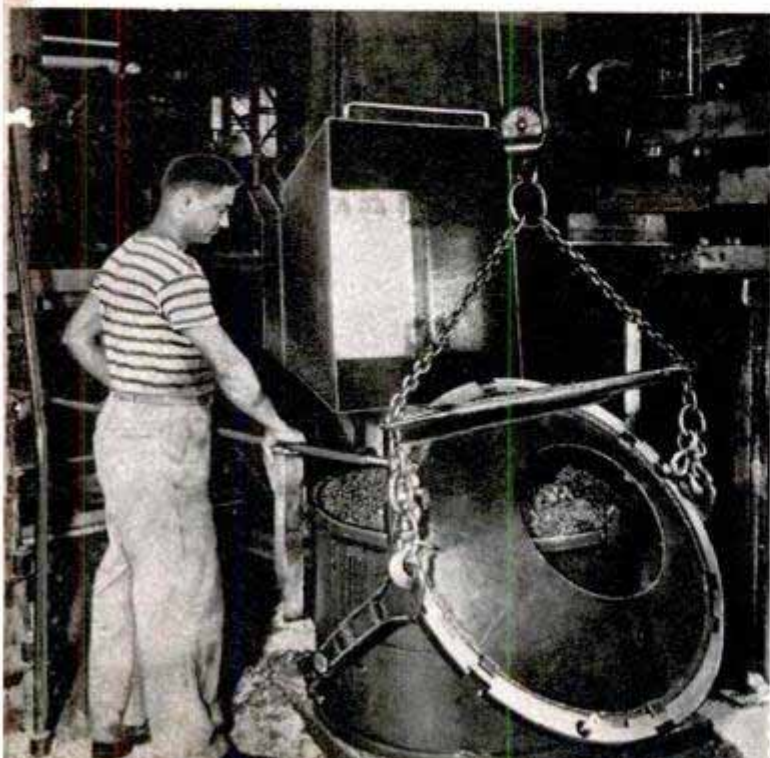

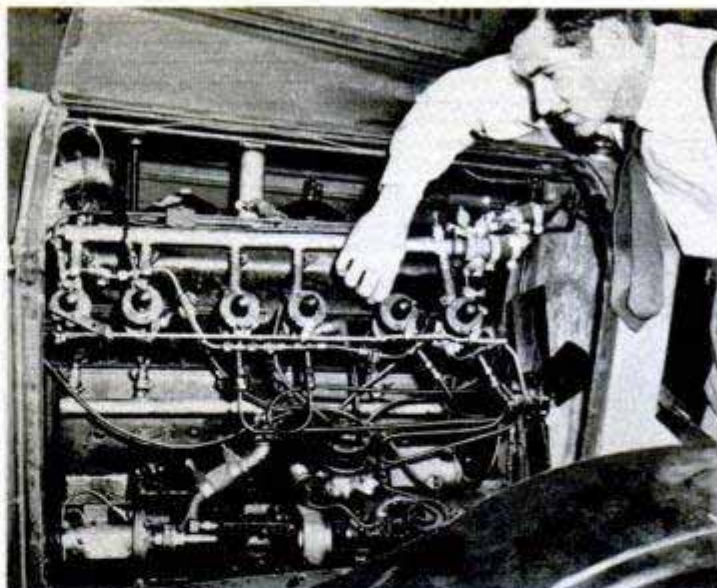
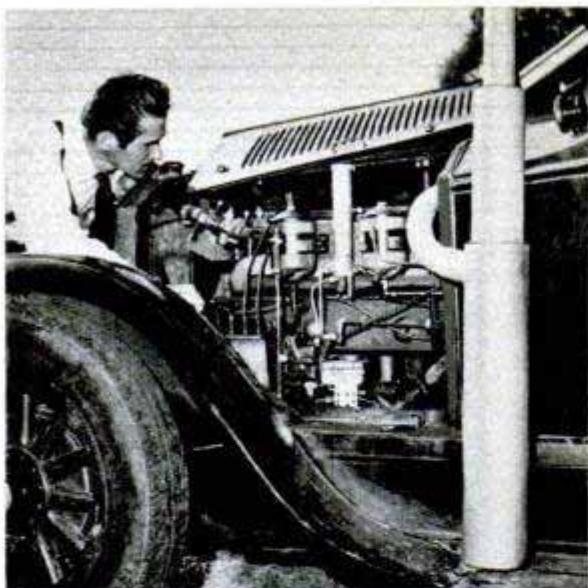

Injection Engine Burns Cheap Oil

Furnace or diesel oil can be used as fuel in a fuel-injection engine built by a Compton, Calif., inventor. The power plant has some of the characteristics of both a gasoline and a diesel engine. Ignition by spark plugs takes place in external, water-cooled combustion chambers, there being no com-

bustion chambers over the pistons. The intake is unthrottled and there is virtually no vacuum at any load, a factor which, the inventor says, reduces oil consumption to almost zero. Compression remains constant at about 200 pounds and acceleration is controlled by regulating the fuel injection. The experimental engine, a rebuilt stock model, is said to deliver 27 miles to a gallon with the cheap fuels.

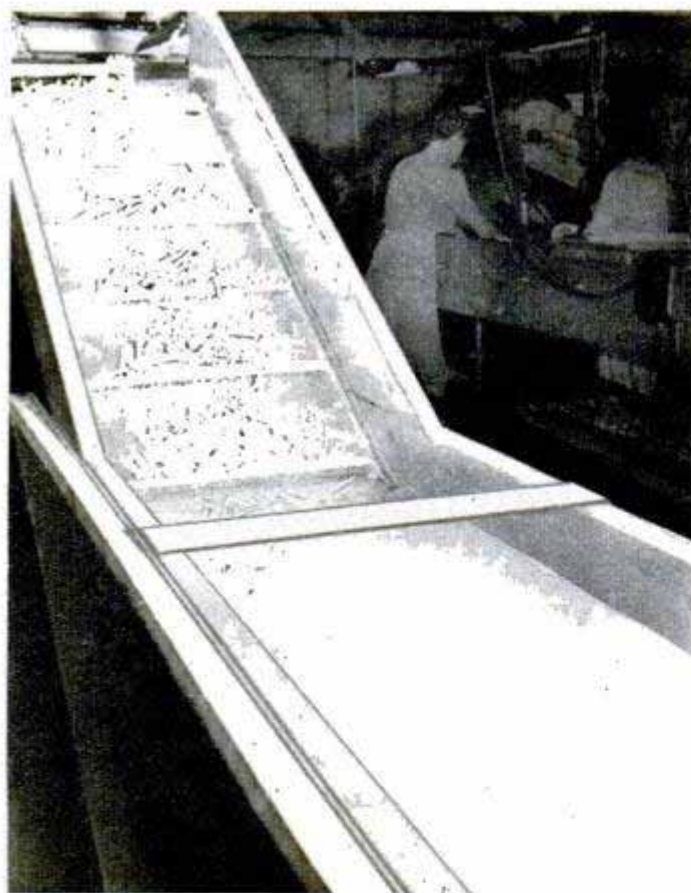

No More KP Duty

Harried husbands who occasionally find themselves peeling potatoes in the kitchen have a new friend in Clyde Miller of Chicago, who plans soon to market spuds ready

for the pot. Miller has developed a solution which preserves peeled spuds for days. In his plant the potatoes are peeled, cut to size for boiling or French frying, treated in the solution and then packaged in transparent bags.

On the Trail of the Bat...

By Tom McHugh

FRED GREELEY and Dr. James Beer of the University of Wisconsin are working on a mystery which may prove more exciting than any Scotland Yard case. They are trying to find where more than one million bats vanish each winter.

Before dawn in subzero weather these men drive off in search of Wisconsin caves on their bat-banding expeditions.

Leaving the car, they plow through snow-covered fields seeking holes, from which thin vapor trails rise, indicating caves below. There the temperature remains about 42 degrees the year 'round.

Bats stream into these caves when cold weather cuts off their food supply of insects. In hibernation they pass the winter,

hanging upside down by their hind feet. In fact, one observer estimates that bats spend five sixths of their lives hanging head downward in the dark.

Inside such caves, Greeley and Beer rapidly pluck the bats from the walls and mark them with numbered aluminum bands. Should the bats be caught again, the zoologists are able to trace their travels.

They found an enormous discrepancy in the summer and winter bat populations. In winter, there are more than one million fewer bats in the caves than in summer. A search of caves in neighboring states failed to find the missing bats. Where did they go?

Naturalists know too little about the habits of the bats to answer this question.

Slithering along in snake fashion, a zoologist emerges from a low-ceiling cave with a bat for banding



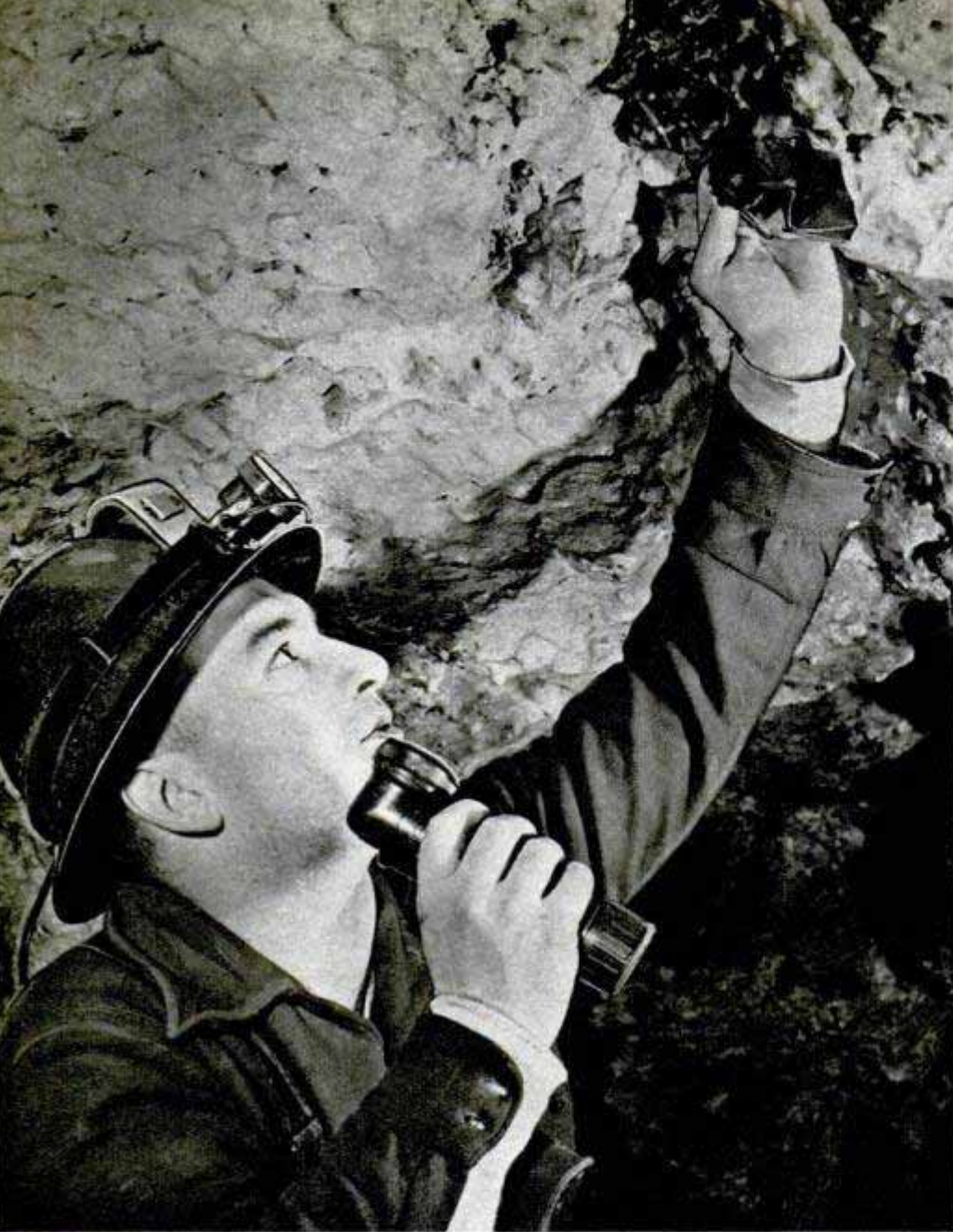

Dr. James Beer picks a bat from a group crowded into a crevice in the cave ceiling. The hibernating mammals awake from their deep sleep when handled. Below, there are more than 50 bats inside this wire cage. Once banded, the bats are released and immediately resume their hibernation



Perhaps they hibernate in unsuspected retreats—retreats other than the large caves where they are normally found. In any case, Greeley and Beer, with 6500 bats banded, stand a good chance of solving this mystery.

But finding the missing bats is not their only problem. Equally baffling is the fact that winter colonies are composed mostly of males; only a few scattered females are ever present.

This is quite the opposite of summer colonies, where as many as 800 females are found together. Such large groups of female bats are referred to as "maternity wards," since it is here that they bear their young.

Zoologists also found that bats have an excellent homing instinct. They will return to the same cave winter after winter. Even if taken far away and released, bats find their way back. Released at sea, they have returned 36 miles to their home roost. Others released as far as 150 miles from their home cave eventually found their way back.

These instances of homing are in themselves quite remarkable. They become even more notable, however, if you consider that bats find their home in the dark with very poor eyesight, using a natural "radar" system known as sonar. The system uses the bats' high-pitched cries which sound, at close range, like the screech of fingernails on a blackboard. Close to the bat's mouth, the sound is about 100 times as intense as normal speech.

They find their home even though it may be no more than a hole in the ground scarcely two feet across. What unusual power of orientation makes this possible?



A band is clipped to the wing of this bat. Thus numbered, the bat can be identified if picked up again

Scientists believe that bats have a well developed kinesthetic sense. They find their cave much the same as we find objects in a dark room in our own home—we subconsciously keep track of our location by means of motions made.

Bats may also use a keen sense of smell. Some of them possess scent glands which emit a strong, musky odor. This odor, together with that from their droppings, could mark the cave.

Another theory is that bats find their way home by using obvious landmarks. This seems unlikely, since bats have poor eyesight and they make long flights only at night.

Since bats are seen only at night, people have formed many weird ideas about them. Bats are supposed to delight in flying into women's hair. Actually, that is one of the last places they would go.

Another misconception is that bats carry bedbugs, lice and numerous other parasites. That may be partly true, but these parasites are quite particular and won't live on humans.

Nor do we have any blood-sucking bats in the U. S. These bats live only in the tropics, where they bite sleeping animals or men, then lap up blood from the wound.

These are some known facts about bats. There are many other facts still unknown. Scientists, like Beer and Greeley who are following the trail of the hibernating bats, will some day solve the mysteries of the winged mammals.

It is easy to see how this animal got its name. It's a long-eared bat



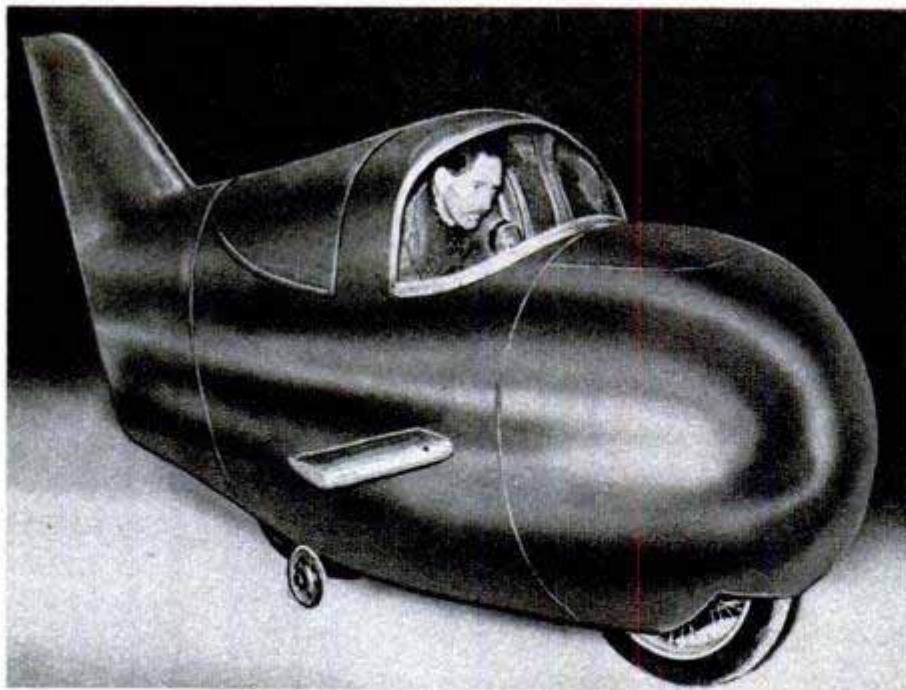

"Flying Egg"

Driver and machine are completely enclosed in the streamlined shell of a racing motorcycle with which Noel Pope, British speedster, hopes to set a new world speed record. Pope, who assisted in the design of the machine, will make his bid for the record in the United States. The machine is a supercharged twin-engine Brough Superior. With it, Pope hopes to exceed 200 miles an hour to break the German-held motorcycle speed record of 174 miles an hour.

Hydraulic Exerciser

Hydraulic resistance does the work of heavy iron weights in a new exercising device. A plunger pushed by the user forces fluid through valves that can be adjusted to supply any desired amount of resistance. It takes less space than a set of weights and is safer since there is no danger of the user dropping it on himself.

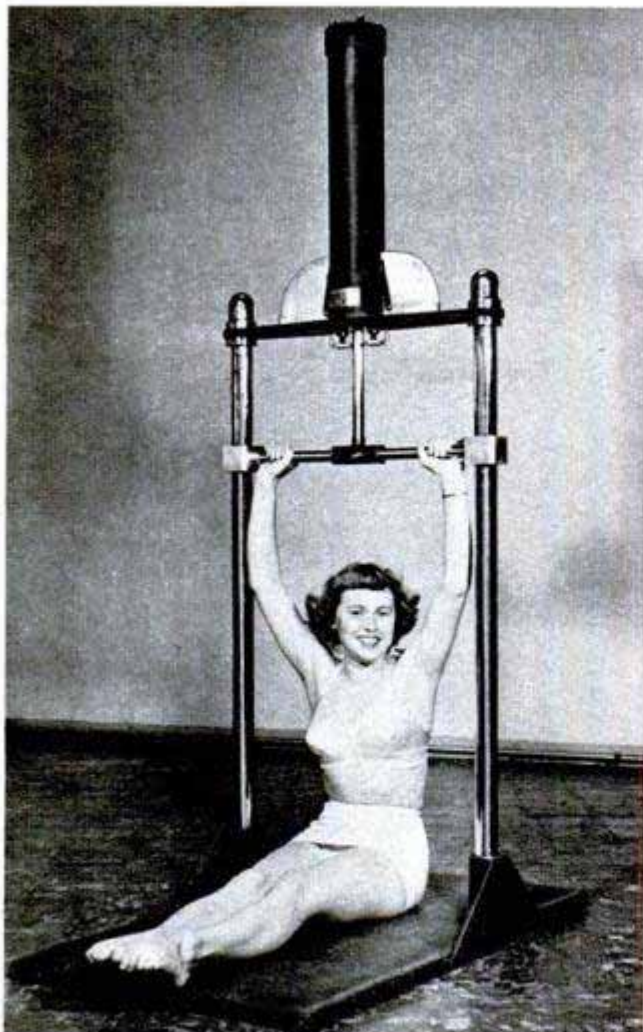

Lamplighter With a 25-Mile "Reach"

By pressing his microphone button seven times in rapid sequence, a flyer 25 miles away can turn on runway lights at an unattended airport. Key to the new safety device is a control box at the field, with a series of radio tubes and two adjustment dials. No extra equipment is needed in the airplane. One of the dials sets the predetermined distance from which the landing lights can be operated and the other establishes the length of time they remain on. If a pilot uses up the light period, all he has to do is press his mike button seven times and the lights flash on again.



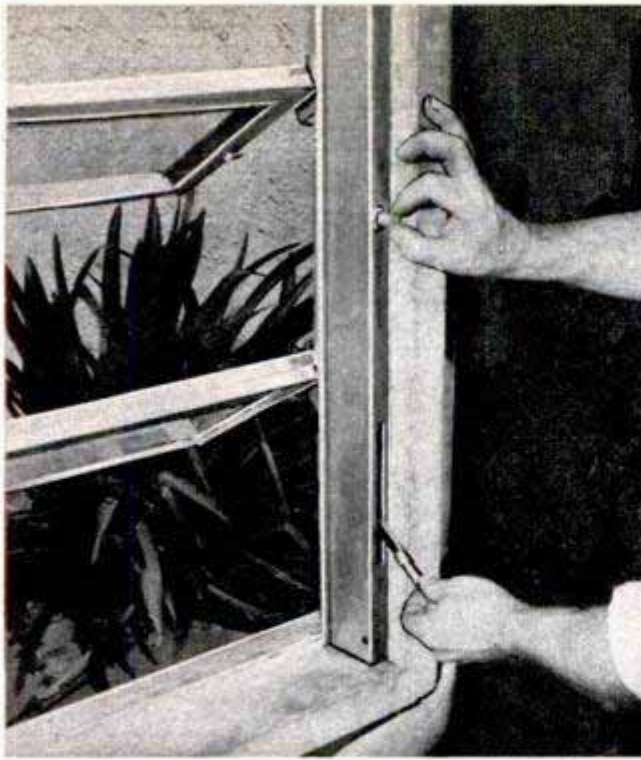

Rain Closes Windows

Homeowners off for a visit now can scoff at sudden storms—the rain itself will close new louver-type windows. As soon as eight ounces of water collect on the top panel, the window automatically swings shut. A wind of six miles an hour or more will

“button up” the house. The antiworry mechanism is a system of springs and balances built into the window frame. By turning a friction screw the homeowner can adjust the window so it will close entirely or only part way. A lever near the bottom of the frame raises all the panels of the window.

Radioactive Trees Test Effectiveness of Chemical

Isotope tracers are making ordinary mesquite trees radioactive in Texas. In an experiment to determine the effectiveness of a chemical designed to kill the hardy mesquite, the trees are checked periodically with a Geiger counter. By means of the tracers, scientists can follow the movement of the deadly chemical. The experiment showed that the preparation does work its way into the roots of the tree, thus assuring its destruction.

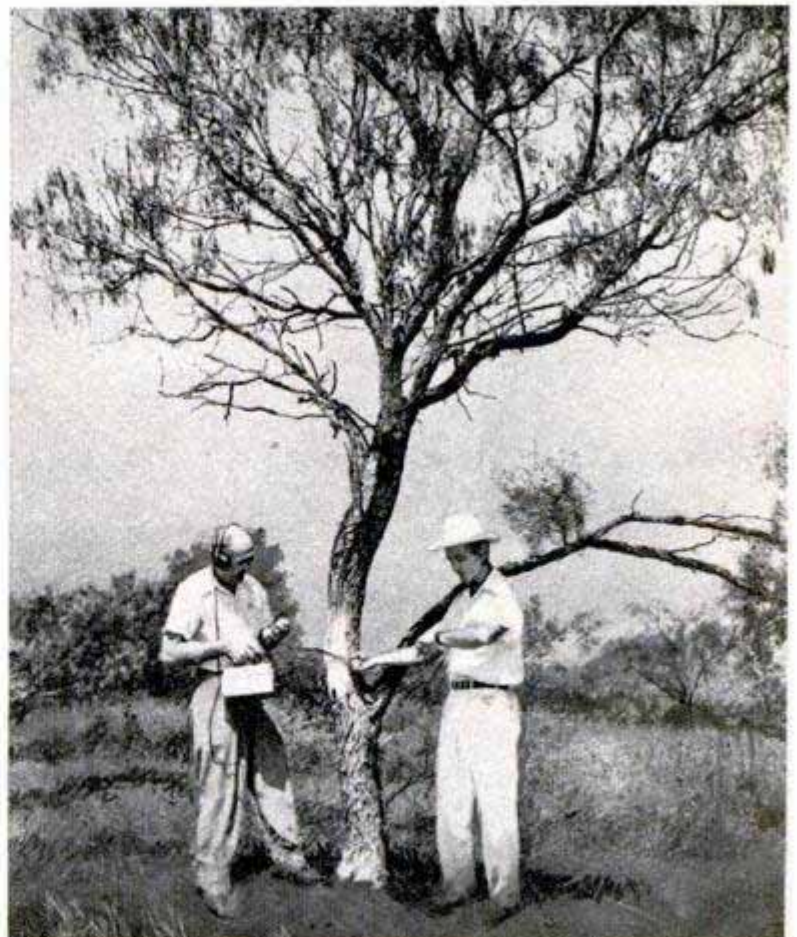

Germ Powder Emits Light

Doctors and scientists of Long Island College of Medicine have developed a new medical powder which emits its own light to kill germs. The powder, called heliogen, gives off ultraviolet rays, shorter than sun-tan rays and more effective in killing germs. In experiments, it was applied to the infected wounds of 22 persons, 20 of whom had failed to respond to sulfa drugs. In every case, the powder stopped the infection.

CAMERA WITH A ROVING EYE

BOTH THE AREA and speed of aerial photo reconnaissance are greatly increased by a new panoramic strip camera. Operating at altitudes as low as 10,000 feet, it produces, on a single negative, sharp pictures which otherwise could be made only at much higher altitudes.

The camera, using a wide-angle lens that is almost ball-shaped, is a development of the Air Force's Air Materiel Command and Boston University's Optical Research Laboratory.

As the exposure is be-

Left, shot from 10,000 feet above Cape Cod, this aerial photo includes: 1. Chatham; 2. Nantucket Sound; 3. Cape Cod Bay; 4. Hyannis airport; 5. Sandy Neck; 6. Barnstable; 7. Route 6; 8. Great Marshes, and 9. A glimpse of Buzzards Bay. Below, camera is mounted so it shoots through opening in the floor of the fuselage



ing made, the camera swings in pendulum fashion at right angles to the line of flight at a speed of nine inches a second. There is no shutter; instead the film is drawn across a narrow slit and the moving image is "wiped" on as the film moves across the slit.

The resulting negative is 18.4 inches long and includes details from horizon to horizon. The distance covered varies with the plane's altitude—at 10,000 feet it is 260 miles, at 30,000 feet it is 450 miles.

Previously, some aerial panoramas were made by rolling the film across the lens of a stationary camera at a rate adjusted to the plane's ground speed. This method produces several types of distortion. Other aerial panoramas are made by piecing together many photos. The new camera takes the panorama in one exposure with virtually no distortion.

Right, this photo of New York includes: 10. Staten Island; 11. Brooklyn; 12. Manhattan Bridge; 13. Brooklyn Bridge; 14. Jersey City; 15. Hoboken; 16. The Empire State Building; 17. Welfare Island; 18. East River; 19. Manhattan; 20. Central Park; 21. The Reservoir; 22. Hudson River, and 23. The Bronx. Below, multiple exposure shows motion (arrow) of camera as the photo is taken

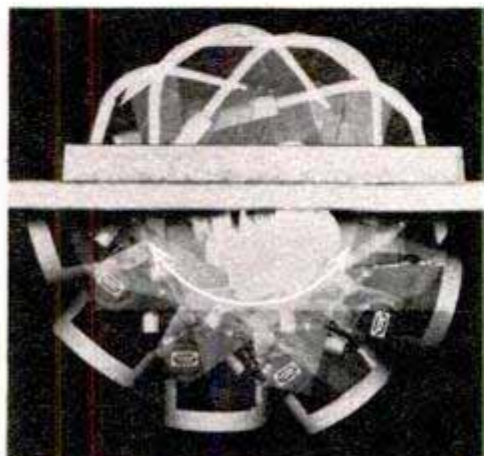
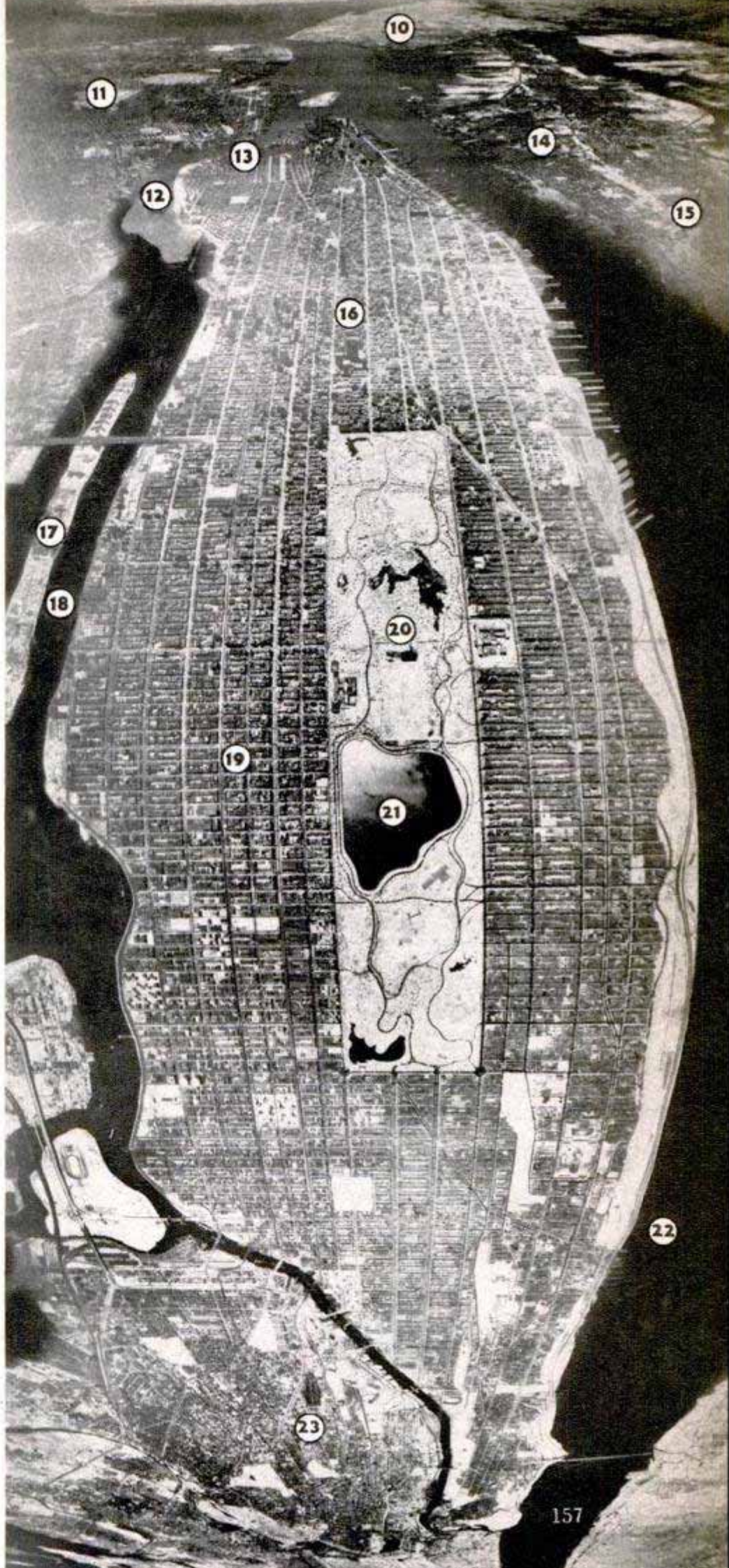



← Hand-Shaped Chair

Displaying the clean, flowing lines of modern design a hand-shaped chair has a frame of walnut glued in sections. The continuous webbing, which supports foam-rubber cushions, is a lacing of plastic-covered wire. One of the student designs shown by the School of Art of the Chicago Art Institute, the chair was made by William Zdeblick.

Radar "Measuring Tape"

Distances between atoms can be measured by radar to an accuracy of $\frac{1}{100}$ of a millionth of an inch. Dr. A. H. Sharbaugh of General Electric says results 1000 times more accurate than is possible with the best optical instruments are achieved by shooting radar waves through the material under study and measuring the power remaining. The new application is expected to reveal valuable data about molecules.

Australian Automobile Has Front-Wheel Drive →

Front-wheel drive is featured on a two-door sedan which may soon be coming off an Australian assembly line if financing plans materialize. The twin-cylinder, four-stroke engine is air cooled with the help of two fans mounted behind the front grille. The wheels are aluminum and the longitudinal frame members are hollow, boxlike castings. Rear coil springs and front transverse springs provide independent suspension for all four wheels. The car is expected to sell for about \$1700.

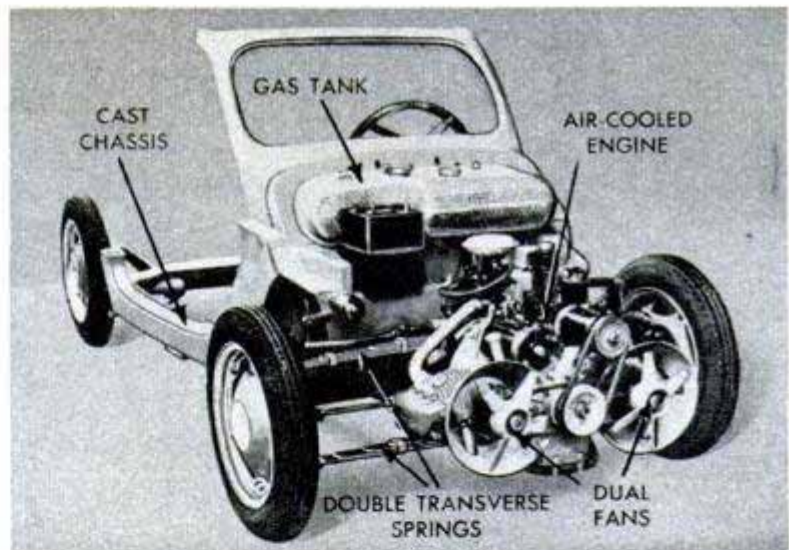

Chemical Kills Hardy Weeds

Noxious grasses which have resisted weed killers now can be eradicated with a new chemical compound. The chemical is called TCA because it is a salt of trichloroacetic acid. It is said to be effective against such damaging weed pests as Johnson, Bermuda and quack grasses, and prickly pear cactus. Soil to which the weed killer is applied becomes sterile, but this condition lasts only a short time. The chemical should not be used on lawns.



Arctic Tires →

Tires made of a new synthetic rubber will bounce instead of shattering at 75 degrees below zero. This rubber was developed by Firestone for arctic operation where equipment has been immobilized by tires, hose, gaskets and belting freezing solid at temperatures of 60 degrees below zero. Tires would take on permanent flat spots when parked and treads would harden and chip. Mileage tests in Texas indicate the rubber will wear satisfactorily under normal highway driving conditions.

Balloon Tests Weather At 99,000-Foot Altitude

Accurate measurements of humidity and temperature at an altitude of 99,000 feet have been made for the first time with an instrument perfected at the University of Chicago. A plastic balloon carries the equipment into the stratosphere to altitudes about twice that at which accurate humidity measurements have been made previously. The new instrument uses a humidity-measuring technique called "dew point hygrometry," an old technique per-

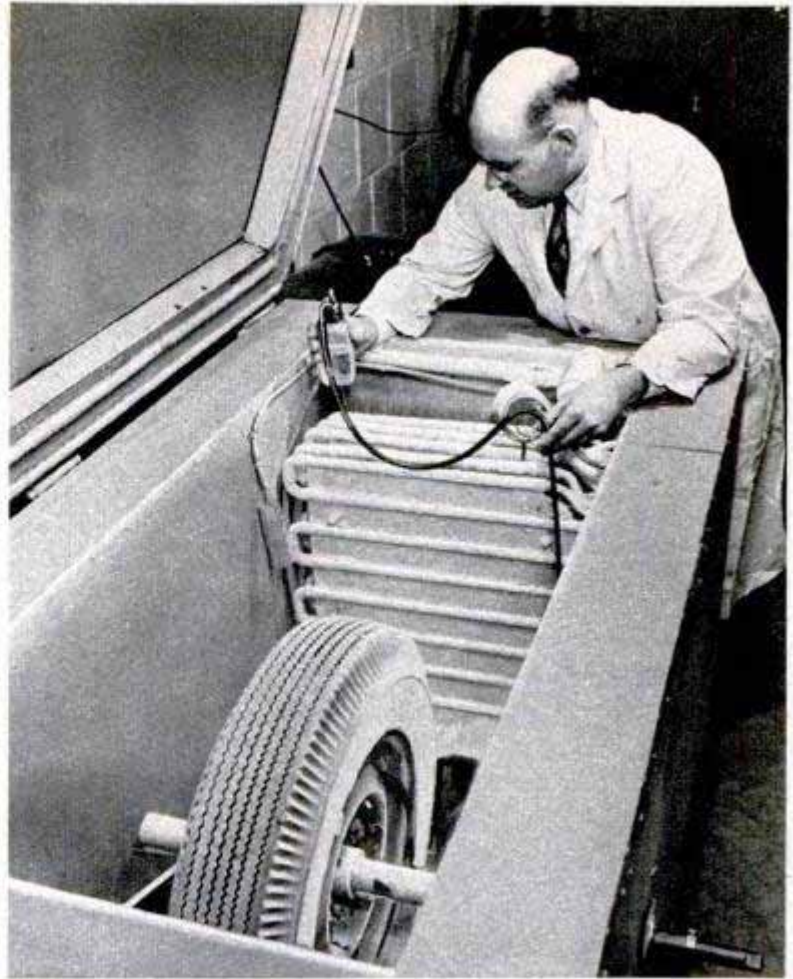

fectured for balloon application by modern electronics. A radio transmitter sends the information back to earth during the flight.

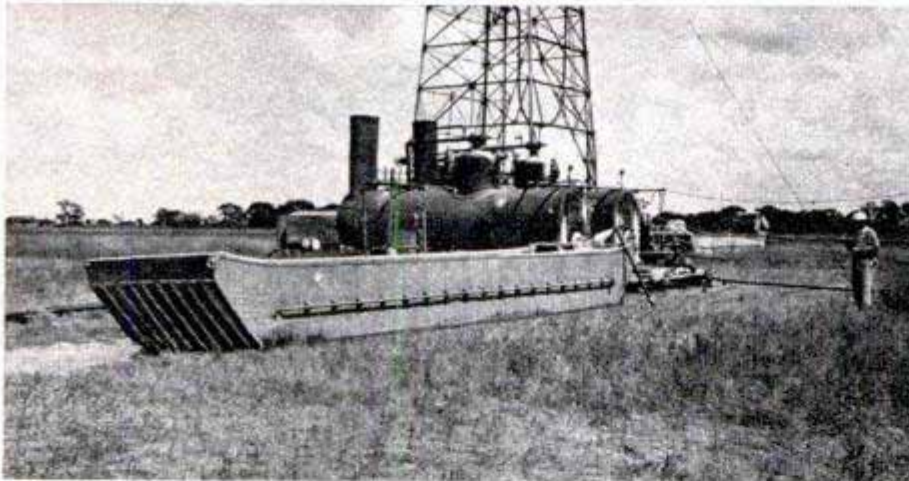

Boats on Dry Land Store Drilling Mud

Surplus boats—the pontoons used by U. S. Engineers—are used by a Texas drilling contractor to hold water in instead of out. He fills the craft with drilling mud, the fluid pumped into oil wells to remove cuttings and cool the bit. The pontoons are towed to the site on a trailer, dragged off and filled with the fluid. When the job is completed they are emptied and again loaded on the trailers, where they serve as storage bins for pipe and drilling equipment.



☞ Widespread use of atomic energy may make it necessary to dispose of radioactive waste products by rocketing them to the moon, says an Australian scientist.



Row of pumps is removing oil from pool hundreds of feet away. Derrick on rails is drilling another well

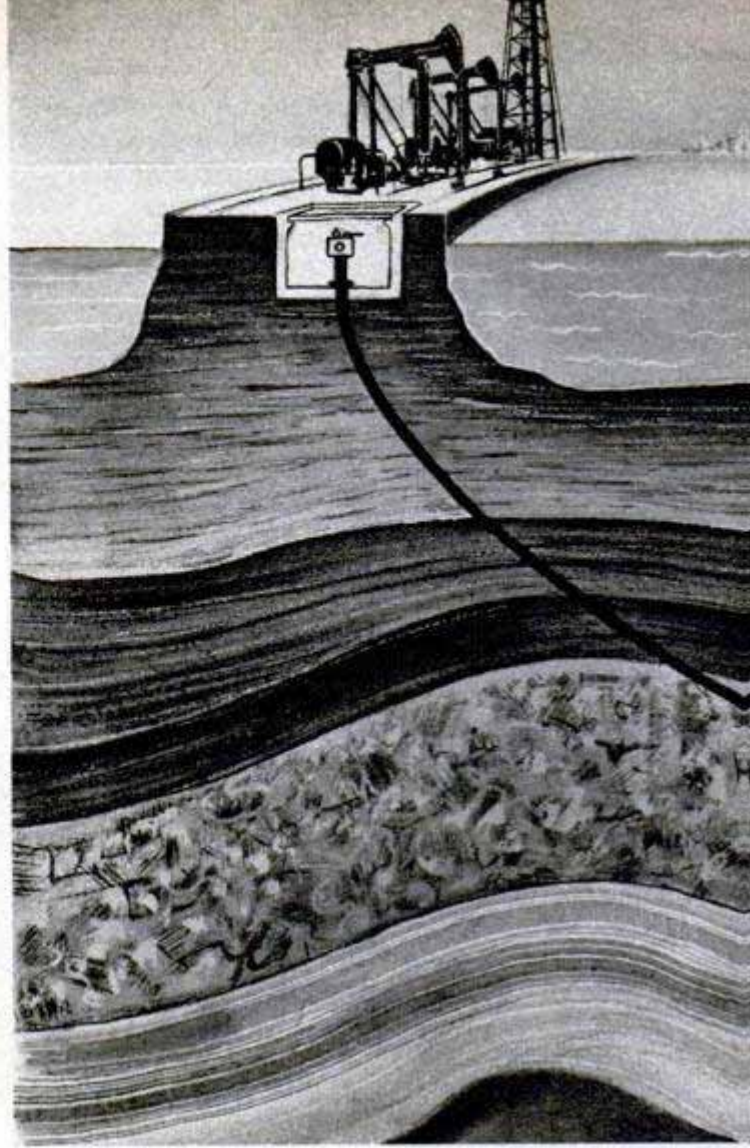

Oil Drillers Throw

Sketch shows free-style pump at bottom of well. Oil pumped into well drives pump, forcing new oil upward

Well below sign pumps oil from under harbor, beyond. Others reach as far as the sky line for oil deposits

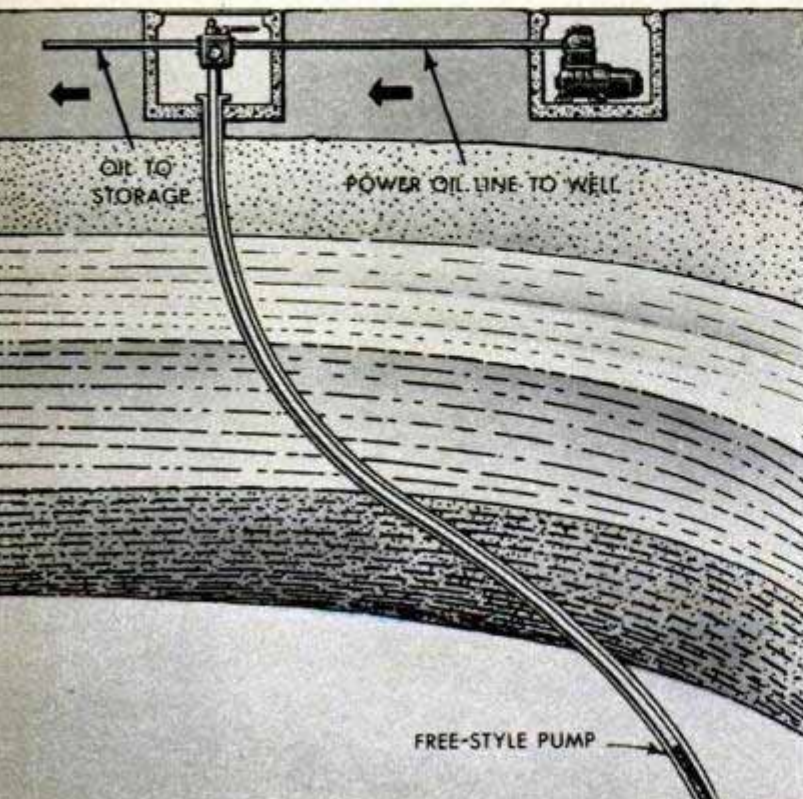

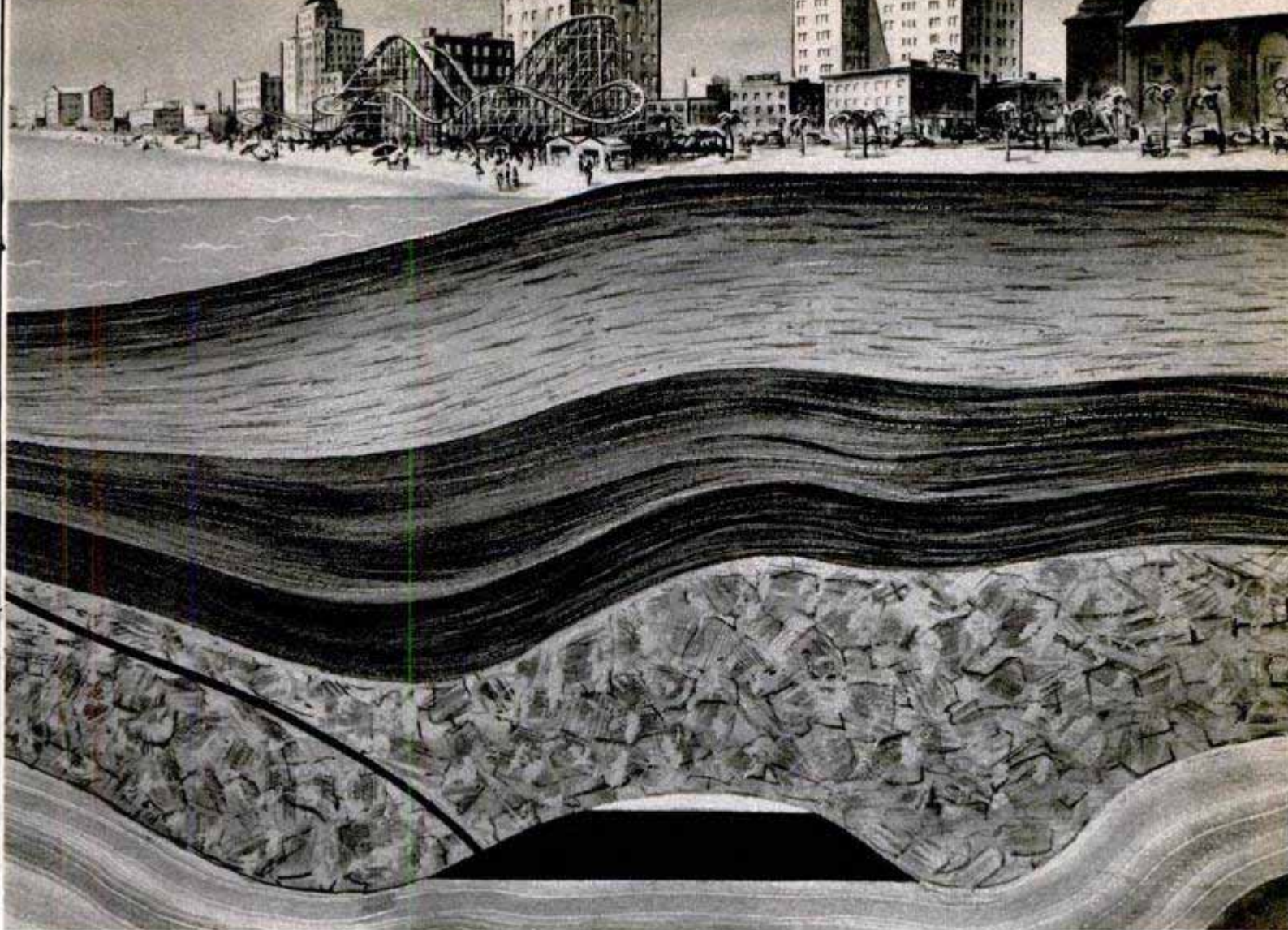

Cutaway drawing shows how oil deposit under city of Long Beach is tapped by well that runs beneath the harbor, eliminating wells and derricks within city

Curves

THE OIL-COMPANY representative and the directional-drilling technician were standing at the edge of the city's industrial district. Near by was a residential area and beyond that they could see a tall building.

"Our community lease extends past that building," the representative was saying. "It's 4800 feet from here, almost a mile away, and oil sands are 5000 feet below the surface. Now, can you drill us a well from here that will tap the formation under that building?"

"Certainly," the technician told him. "That's not very difficult. We'll drill straight down for a couple of hundred feet and then bend the hole due north to miss the other slant wells that are out there. Halfway over we'll whipstock to the northwest and head straight toward the building, meanwhile continuing to go down at an angle of about 45 degrees.

"We can hit the oil zone at an angle or, if you prefer, we'll straighten the hole out

vertically as we reach the target. It will be a real slanted hole but its bottom will be within 10 feet or so of the spot you want."

Oil-field engineers used to complain that no well went straight down. A deep hole might wander several hundred feet from the vertical because of sloping underground formations and the flexibility of drill pipe, or it might describe a giant spiral. In extreme cases, a well might slant off to one side so much that it was finally tunneling parallel with the oil sands.

Today, the engineers not only can control the direction and slope of their holes, they drill crooked holes on purpose. Making oil wells deviate from the vertical has become an exact, scientific process. By means of it, productive formations can now be tapped that otherwise would be inaccessible or too costly to reach.

In the Gulf of Mexico, a dozen deep wells can now be drilled from a single artificial island. The holes radiate out to a dozen

different points in the underlying formation, saving the expense of additional well sites.

Similarly, a group of wells along an ocean beach can be drilled directionally to reach a formation that is thousands of feet offshore. An example of this is Southwest Exploration Company's 200 wells, spaced only 27 feet apart, on a bluff that overlooks the ocean at Huntington Beach, Calif. Each well slants off under the adjacent highway, a rail line and the beach, and taps its individual five-acre parcel of the offshore formation. Some of the wells extend 5000 feet offshore to a depth of 4400 feet.

When a well runs wild and craters or catches fire, it is now possible to drill a new well at a safe distance and slant it underground toward the runaway, capturing its flow and allowing it to be capped.

In mountainous country, an operator now often locates his rig in a convenient valley and drills directionally to reach a pool under a mountain. He saves the expense of building a road up to the top of a peak, hauling up his equipment and then drilling back down again.

In built-up business and residential areas in which drilling is prohibited, it is now usual to place a derrick inconspicuously at one side, if productive sands exist below and if leases are obtained from the property owners.

The present outstanding example of this technique is the new oil field in downtown Long Beach in California. No derricks are visible, but the wells are under the town, nevertheless.

One well taps the sands under an important street intersection, another is half a mile below the basement of a big garage, a third is getting oil from beneath a group of homes. In all, there are more than 150 producing wells that reach in under the city and the adjacent harbor.

All the wells are drilled from an industrial area on the far side of a flood-control channel. Here, in a single line and at 18-foot intervals are concentrated the wells that ordinarily would be spotted over hundreds of acres of ground.

It is, in fact, a portable oil field. The chief lessees mount their drilling derricks on skids or on wheels that roll on railroad tracks. After a well is drilled, the derrick is moved a few feet along its track to the next location. All that remains behind are the well-head equipment and a small pumping unit.

Some of the wellheads are underground in concrete vaults. Aside from the placards on the surface of the ground marking the

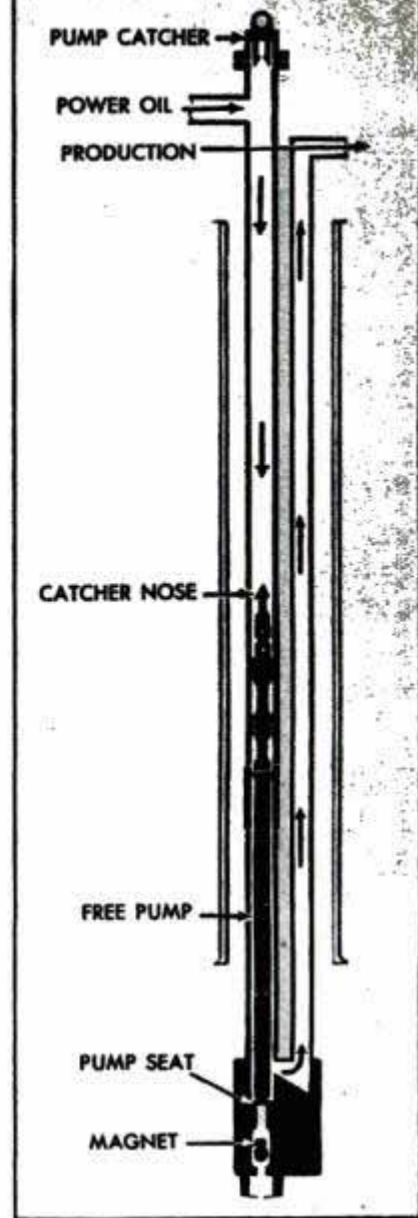

Free pump brings new oil up when the power oil is forced down. The magnet holds the check ball off seat. Below, some types of directional drilling

Avoiding a fault. Hole to the left has shifted, shearing off casing. Holes at the right go under the fault, reach oil at two levels

Several wells from one derrick, where terrain permits only a few drilling sites or for other reasons of economy or necessity.

Reaching under a river or lake where waters are too deep or swift to permit platform or barge drilling from surface.

Extinguishing an oil fire by drilling from a site some distance away and pumping in mud.

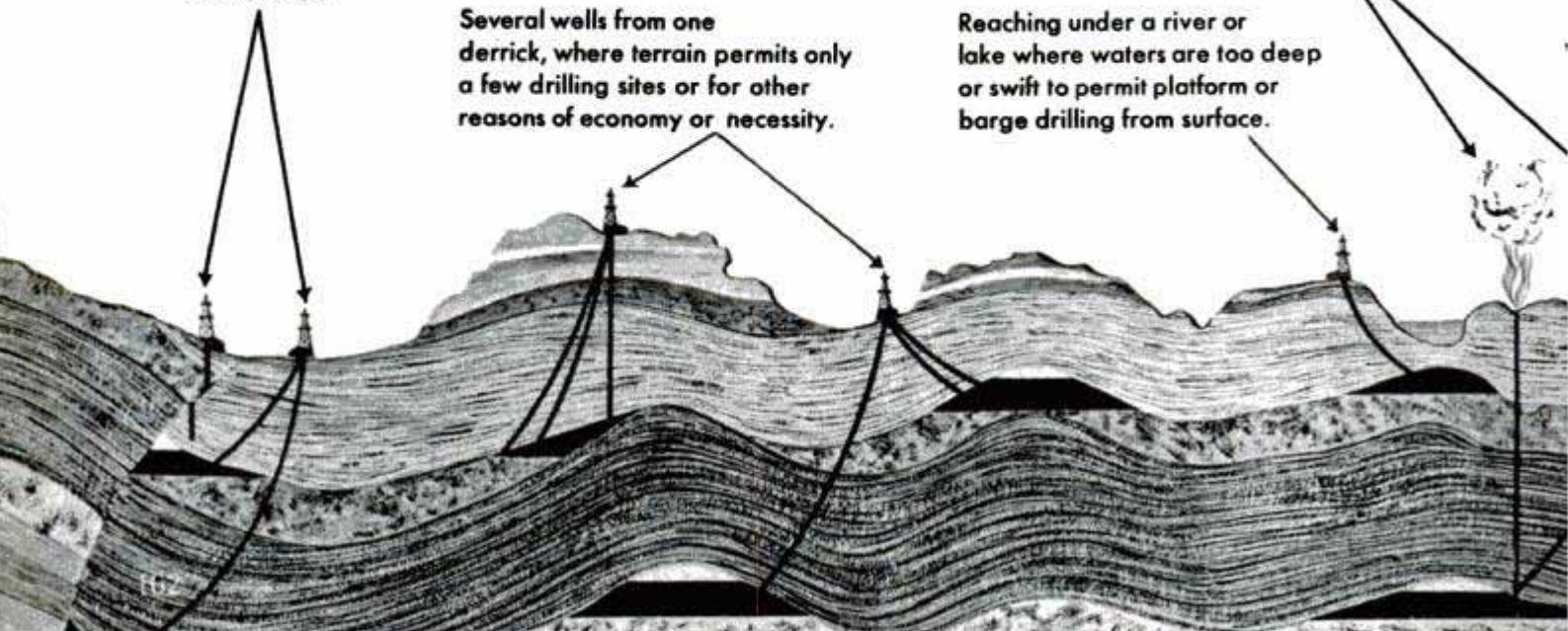

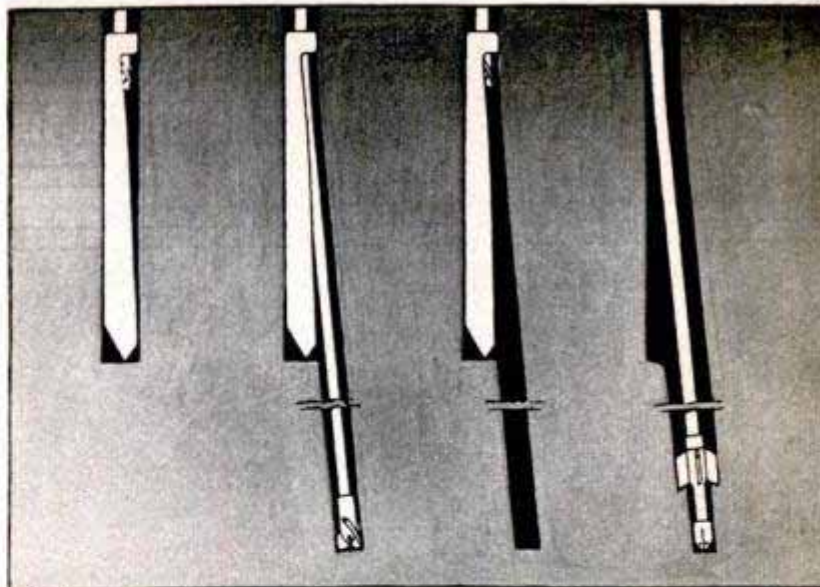
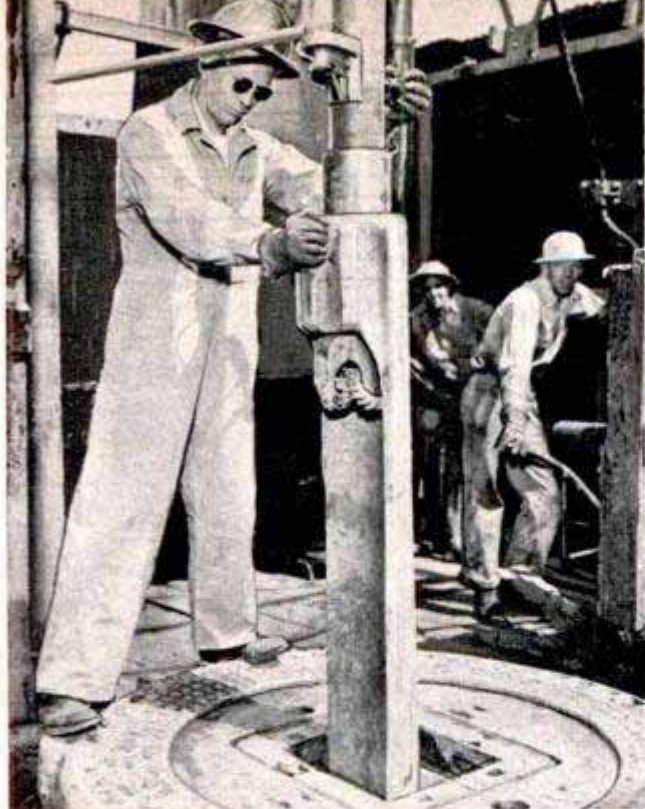

Above, drawings show, from left to right, how the whipstock enters hole and starts drill on slanting course. It is then withdrawn when the drill bit is removed. Finally, drill returns to bore new course

Left, an engineer guides the whipstock into a well

well locations, no one would suspect that he was standing on top of a busy, productive field.

The first tool pushers who attempted to drill directionally placed a few timbers under one side of their rotary tables in order to slant the bit and the drill pipe in the desired direction. That method is still used occasionally. However, modern directional drilling really got its start when a number of precision tools were developed by John Eastman, now head of the Eastman Oil Well Survey Companies that supervise much of the directional drilling in oil fields all over the world.

One of Eastman's devices is the removable whipstock, essentially a long steel

wedge held by a collar just above a small drilling bit. When this combination is lowered into the hole and drilling is resumed, the bit is deflected to one side by the wedge and the hole begins to slant. Instruments are used above ground to line up the whipstock in the desired direction. After a few feet of slant hole have been drilled, the combination is returned to the surface, removed and an ordinary drilling bit is sent down to widen the pilot hole and deepen it.

The driller has other items of equipment beside the whipstock to bend the hole. One is an elbow-jointed tool which is held straight by springs as it is lowered into the well. At the bottom, the elbow joint bends

Drawing from Standard of California Bulletin

Undersea drilling from the shore. Curving holes reach both upper and lower oil formations from same location on the bluff.

Offshore drilling from a platform mounted on pilings. Several holes are often drilled from each platform to produce oil more economically.

Drilling under a city or other occupied place where vertical well site is impracticable. Deeper hole is reaching under the cap of a salt dome, which forms trap for oil.

First two holes reach under city and under salt dome. Hole at right has been redirected to by-pass lost steel bit blocking original hole.

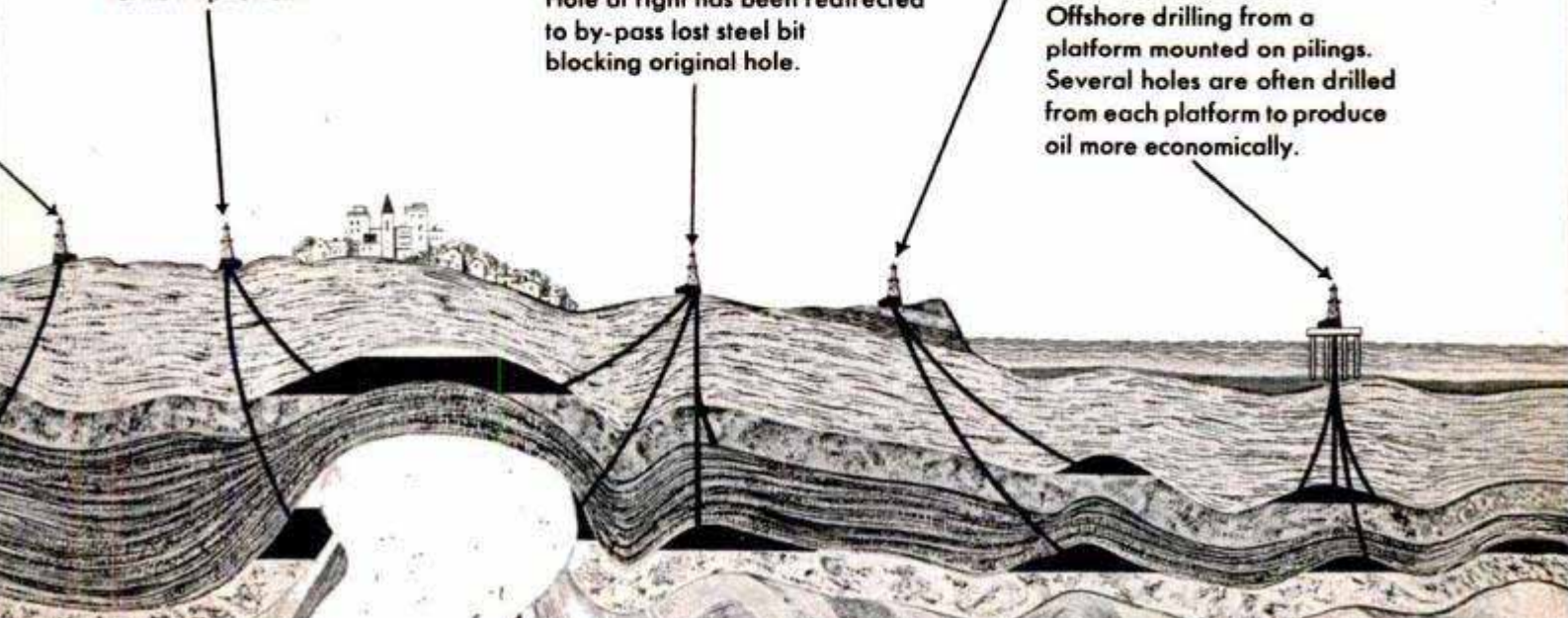



Survey engineers check the time clock on a single-shot survey instrument which, when dropped in hole, records photographically the direction of the bore

Below, these wells, neatly arranged in rows along a highway near Huntington Beach, Calif., were all directionally drilled to tap oil under ocean, left

under drilling pressure and starts off at a slant. Still another curve-thrower is an off-center bit that automatically drills at an angle in sand or other soft formations. Another bit for soft stuff directs a stream of mud to one side through a special jet. Under high pressure, the mud hollows out the bottom at one side and the bit, following the line of least resistance, drills at an angle.

Another of Eastman's developments is the so-called single-shot survey instrument. This is contained in a nonmagnetic tube, about two inches in diameter and as long as 23 feet, that is lowered into the hole. There is a time clock inside the instrument that turns on a small interior lamp when bottom is reached and also operates a camera. The camera photographs the position of a small plumb bob in reference to a compass card. Hauled up to the surface and developed at once, the picture shows the inclination of the hole from the vertical and the direction in which it is headed.

With this information, the drilling crew can continue to put down their hole and guide it in the right direction or, if it is off course, they can tell how much correction they must apply.

There are numerous other directional tools and instruments available now, as well as other techniques, but the general method of drilling remains the same.

In a cluttered field like Long Beach, a directional job has to be carefully laid out on paper before drilling begins. Numerous factors are considered in plotting the course that the well must follow. Taken in account are the horizontal distance from the drilling rig to the target, the vertical depth that must be reached at the target, the safe curves to which the drill pipe may be bent en route and the angle at which the hole

(Continued to page 250)



Model Tram →

After a year's sparetime work, C. W. Lane has completed a tram line in his own back yard. Lane is an Englishman whose hobby is trams — British streetcars. His back-yard model seats 17 children, 10 on the top deck and seven below. A copy of a modern type, it runs on a 330-foot track and is powered by overhead electricity. It has an inside staircase and lights that really work.

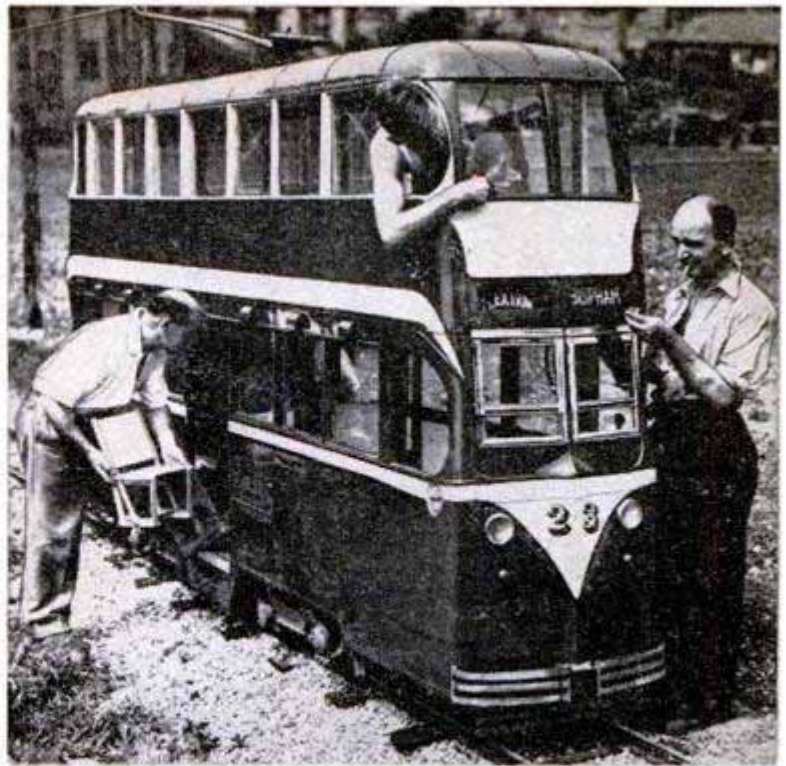

Rust Preventive

One application of a new rust preventive will protect the chrome on automobile bodies up to a year, according to the manufacturer. Previously used by the steel industry to protect metals, the solution now is available for home use. It is a transparent, colorless coating which can be applied to any metal or plated surface to provide protection against rust, corrosion, pitting and

tarnish. It resists weather, heat, cold, grease and grit. The liquid can be applied by brushing, spraying or dipping.



Barrage Balloons Store Grain Crop

Wheat farmers, unable to find storage space for another bumper crop, can solve the problem with surplus barrage balloons that serve as containers. The balloon will hold up to 2000 bushels or, if placed in a pit shaped to the balloon contours, the amount can be increased to 2400 bushels. Grain is dumped in by gravity flow or blown in by pressure.

"No Bounce" Hammer Has Plastic Tips

Hitting 30 percent harder than the ordinary hammer, a plastic-tipped hammer will not bounce or rebound when it strikes. The hollow head is loaded with steel grit that absorbs the rebound, giving a deadweight blow. Designed for use on machined and finished surfaces, setting-up work and soft metals, the hammer has tips of Tenite plastic that can be replaced when worn. Both heavy and light hammers are available equipped with the "no bounce" heads.

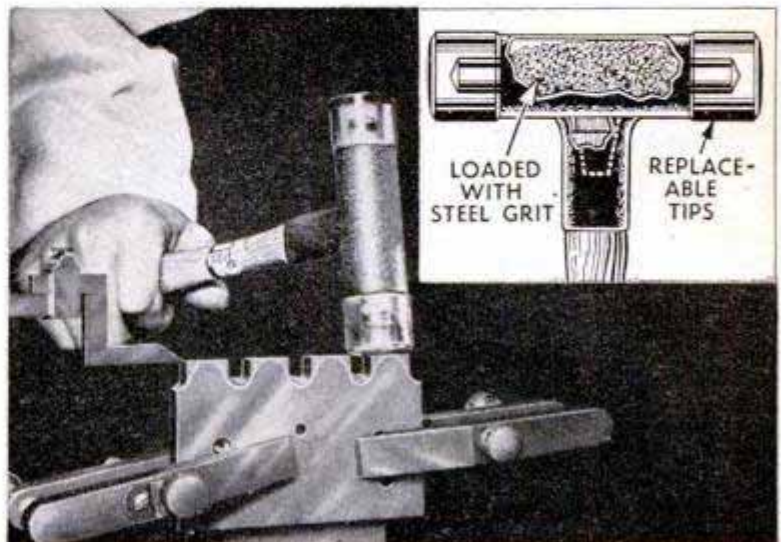

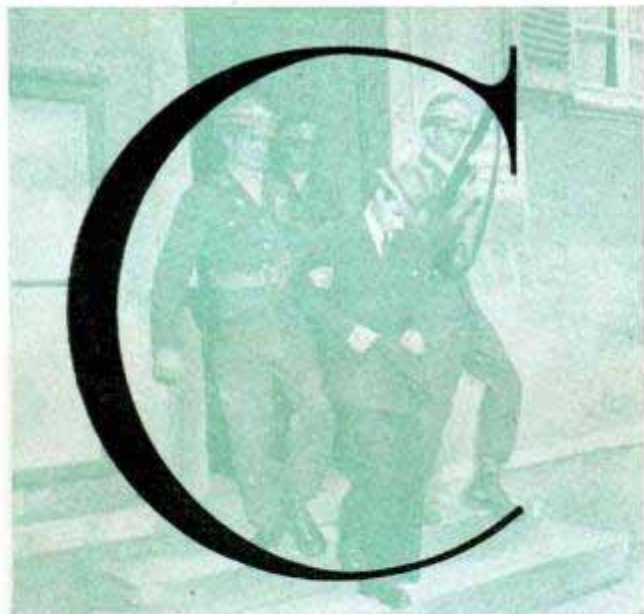

ONE NIGHT some months ago a mysterious dual murder took place in Nuremberg, Germany, within the United States Occupied Zone. An Army Jeep containing six GIs was passing through the downtown area when a shot rang out and killed two of the soldiers.

There wasn't a single clue and no sign of a suspect. An Army crime detective, Capt. Clark Nichols, member of the Criminal Investigation Division at Frankfurt, was consulted and he followed a simple plan.

First of all his ballistic and chemical-analysis equipment was flown to the scene of the crime. Rifles of Army units in the area were collected, tested and marked.

Ballistic studies began when autopsies of both victims showed that a bullet from a .30-caliber carbine had passed through the body of one soldier, killing him instantly. The slug then struck the other victim, who died soon afterward. The 87th rifle tested proved to be the murder weapon and it belonged to an Army private.

When confronted with this scientific evidence, the GI revealed the following facts in a signed confession: Before going on guard duty on the night of the shooting he had been drinking beer. Feeling a bit frisky, he fired three shots at a civilian running up a road. At his final shot an Army Jeep passed through the line of fire.

Thanks to the Army's ultramodern crime-detection methods this case was solved within a week.

Little known to the American public are the letters CID. That's because the Criminal Investigation Division, a segment of the Military Police under the Provost Marshal General, works in absolute secrecy. Its operations are worldwide; headquarters are in Washington, D.C., a training school is maintained at Camp Gordon, Ga., and two scientific crime laboratories are operating in Japan and Germany.



This agency, started early in World War II, uses the newest and most revolutionary crime-solving devices.

Army files overflow with cases solved by the ultramodern science of infrared photography. Very recently in occupied Japan, for instance, somebody was tapping a certain PX cash register of that precious green stuff and not a clue was found. For weeks every employee was secretly watched by day, and no one was seen to open the till. At night the manager was the last one on the job and he was thought to be above reproach. However, since he seemed to be the sole person who could be rifling the register, a trap was set. Army detectives fixed up a camera with an infrared bulb which operated only when the register was opened. One morning a week later the switch was found open. The camera had snapped a fine action shot of the PX manager with his hand in the till!

One of the cleverest soldiers who ever tried to outwit Uncle Sam, delivered mail for a CID detachment. According to CID agents, the man wrote a convincing letter on official CID stationery to a big tobacco company in the United States, pointing out that he, a CID official, had found cigarettes to be of great value in securing the services of informers to help solve Army crimes. In view of this fact, he explained, he was enclosing \$500 from a special fund for which he would expect to receive in the very near future a large quantity of cigarettes. He suggested this plan, he added, because the necessary operations would be delayed considerably if arrangements were made by the usual slow procedure used by the Army purchasing agents.

The company followed the plan, mailing the cigarettes in care of the CID detachment, and welcomed further transactions. Business boomed for the soldier. He found it easy to grab the packages without any of

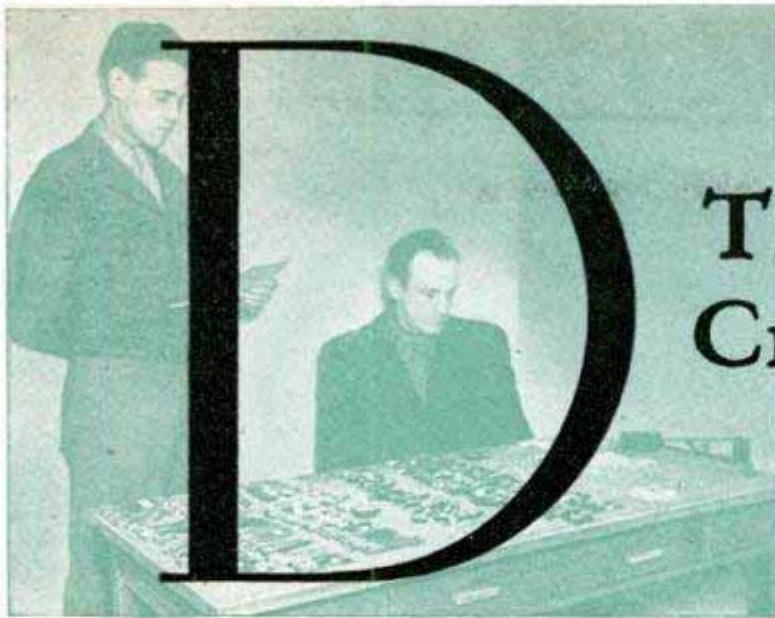

The Army's Crime Bureau

By
Paul Twitchell

his associates seeing them since he received all the mail addressed to the CID detachment. Without bothering to pay customs assessments he peddled the cigarettes for fancy prices and soon had accumulated a couple thousand dollars. The tipoff to CID agents came in two ways: the large money orders he sent home, for which the man could offer no satisfactory explanation, and the fact the natives in his area were getting a large quantity of American cigarettes. When apprehended, he was all set to market penicillin and other drugs on the same illegal basis.

Often Army GIs are of considerable aid to the CID in solving crimes. Some months ago Sgt. Robert E. Bond of a transportation battalion in Berlin helped track down a gang of German tire and tool thieves.

Bond tipped off the CID that he had been approached by a certain German in the

Berlin Ordnance Depot and offered big money to drive a truck out of the depot to a garage in the American sector. The German had observed Bond working at the depot where he regularly picked up supplies for his unit. The German explained that Bond easily could get tires and tools off the official inventory by destroying tally-in and tally-out sheets. These, the German suggested, would be loaded into Bond's truck, driven to a garage in the Lankwitz section, then taken later into the Soviet sector for sale.

When Bond revealed the ingenious plan to CID authorities, he was advised to go right ahead with it. After furnishing secret agents with a description of the truck, the route to be used and the hour of departure, Bond drove out of the depot with the contraband cargo.

Two CID vehicles picked up the trail

Giant board in Tokyo CID laboratory shows all cases under investigation. Note emphasis on solving crimes by chemical analysis, lie detector and identifying types of blood



after a second German had joined Bond to direct him to the rendezvous point. When Bond reached his destination, CID agents were on hand to arrest the buyer and confiscate the truck. Bond also furnished the names of three other conspirators.

Then there's the weird story of a man we'll call Walter Rogers, who got used to the feel of folding money when he was a prosperous New Yorker before he became a draftee. When stationed in Asia some months ago as a member of the occupation forces, he wasn't so well heeled. One day he visited his buddy—call him Bill McElwain—in the hospital with an injury. Bill

had been figuring out possible ways of getting some quick cash and was about to give up when he noticed there was some penicillin lying around loose.

When Walter looked into the matter, a native translator offered him some money for illegal penicillin. The native scratched something on the dirt which looked like 50,000 and Walter returned to the hospital and told Bill he could get 50,000 yen a bottle for the drug. They figured it would be profitable to give 10,000 yen to get control of each bottle at the hospital and the profit on the transaction would net them a walloping 40,000 yen on each vial. This would

amount to over \$2500 at the official exchange rate of 15 yen to the dollar, or almost \$900, if figured at the black-market rate.

With dollar signs dancing in their eyes, the partners made a deal. Walter turned over 30,000 yen to Bill, who delivered to Walter three vials of penicillin. Walter went out to peddle the medicine.

But he got a rude awakening. The figure which the native had scratched in the dirt was not 50,000 after all, but 1500 and Walter walked away not 120,000 yen richer, but 25,500 yen in the red.

The two sad sacks decided the only way they could recoup their losses was to go into the penicillin business in a big way. They enlisted the services of three hospital noncoms as a source of the medicine and soon built up a thriving business. Within six months they had bought money orders at the black market rate of 45 to a dollar and sent home several thousand dollars each. Then the penicillin supply began to wane and one of the insiders at the hospital suggested that they sell morphine.

"Morphine!" said the horrified Walter. "I don't want to handle that stuff! That would mean trouble with the government."

What Walter didn't know was that he was already in trouble with the



CID agent fires suspected weapon into a tube filled with waste, which prevents any marks on bullet except those made by rifling. Below, new light tube gives a clear view of the inner surface of a pistol barrel



government. The hospital commander, finding his stocks of penicillin vanishing mysteriously, called in the CID. They quietly uncovered the black-market ring, some of whose members had already returned to the United States, and rounded up all the guilty parties. Today Walter, Bill and their hospital conspirators are serving terms.

Back in April 1947, the CID uncovered a bizarre tale of occupational gangsterism in Germany in which two AWOL soldiers and a German civilian masqueraded as Army officers and lived on the fat of the land. They meted out severe punishment to other AWOLs while covering up their own illegal activities. They also issued promotion orders for themselves.

Army detectives described the mobsters as: Private Andrew E. Jackson, scarfaced ringleader of the trio; Private Neil Rogers, a reform-school graduate, and Karl Buchheister, a German who spoke English well enough to have been booked the previous winter as an AWOL American soldier.

CID authorities arrested the gang in Mulheim, near Essen. Jackson was cornered in a German civilian's house where he was hiding and posing as an American officer. Rogers was arrested while visiting Buchheister's half-sister. The German was picked up in the local hospital, taking treatment for a minor injury.

As the Army detectives reconstructed the story, the three conspirators first met while confined in the Frankfurt stockade for GI prisoners. They escaped together in the late fall of '46 and for over a year roamed the British and American zones.

The CID picked up their trail the last week in March 1947. A footlocker belonging to an Army lieutenant in Hanau was rifled and in Wurzburg late that month a GI guard was knocked unconscious after he had given the trio highway instructions. His description of his assailants led to their final capture.

While fleeing the U. S. zone, the chiselers were halted by a constabulary patrol near Limburg. They weren't searched properly, according to agents, and promptly

(Continued to page 238)

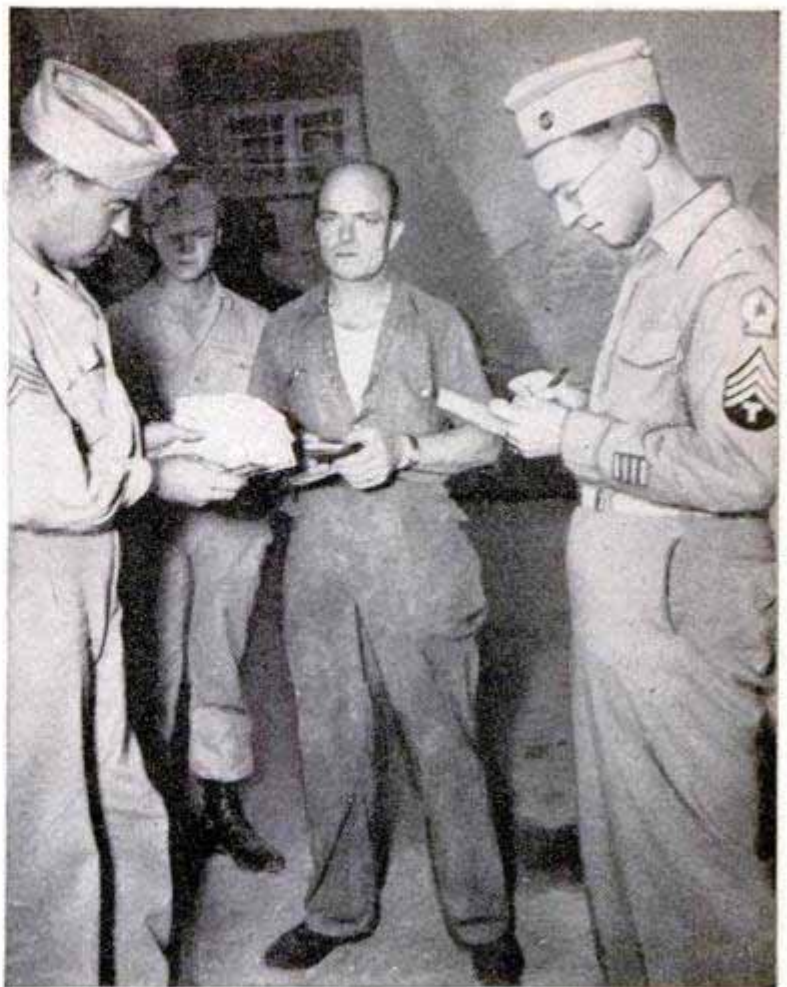

Seized at last, this man gets personal introduction to work of CID. Money the agent is counting came from sale of stolen gas. Below, here's part of the loot uncovered by a 60-man raid in Korea. It includes cigarettes, watches, film, even golf clubs

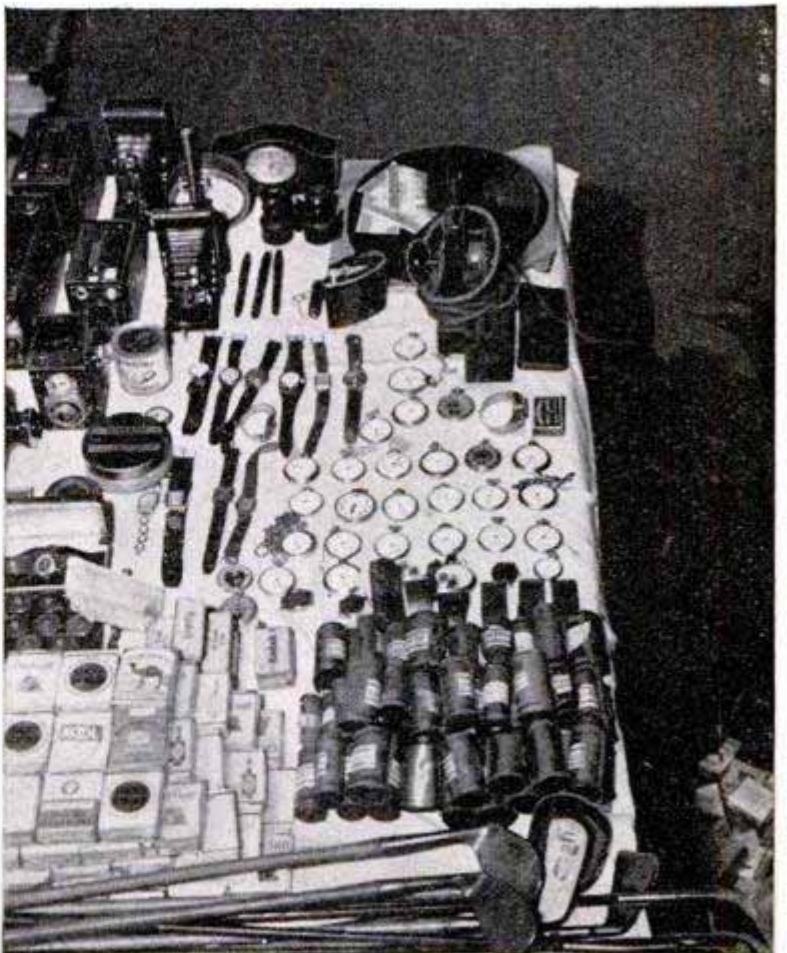



Image appearing on sensitive sheet tells you if the synchronizer is in adjustment. A—Shutter opens too soon; B—Perfect synchronization; C—Shutter is late



Heating With Paint →

ELECTRIC wall surfaces for room heating and warm electric rugs for underfoot are two proposed uses for a new "hot" paint that warms up to a predetermined temperature when connected to an electric outlet. Now, the paint is being used almost exclusively for anti-icing and other heating purposes on aircraft.

Sprayed over bomb-shackle hooks and attached to a source of current, the paint can maintain the metal at a temperature of 100 degrees even though the air temperature is minus 120 degrees, insuring positive release of the bombs. Applied to leading edges, antenna masts, propellers or jet-engine inlet fairings, the material prevents the formation of ice. It is being used to maintain hydraulic cylinders, gearboxes and other aircraft mechanisms at normal operational temperatures.

The paint is a thermosetting electrically conductive plastic material, gray in color, that may be sprayed, silk-screened or applied by other methods to virtually any surface. When applied to a nonconductor, such as cloth or wood, a wide electrode is attached to each end of the unit to insure equal heating or radiation from all parts of the surface. On a metal part, the metal itself may be used as one electrode, the second electrode being an electroplated metallic layer that is applied over the paint, permitting the current to flow through all portions of the paint.

On both conductors and nonconductors the heating area can be electrically insulated by applying, first, a coat of nonconductive insulating plastic material, then the conductive layer, and finally an additional coat of insulating material. The insulator has excellent abrasion resistance and all coatings are moderately flexible, permitting their use in carpets or clothing. The top insulating coat can be colored in any desired hue.

Depending on its application, the paint provides heat at up to 50 percent greater efficiency than do ordinary electrical units. It takes up virtually no space, weighs well under $\frac{1}{10}$ pound per square foot of surface and can be used with either alternating or direct current. When the correct formula is sprayed to the proper thickness, the coat can create and maintain any desired temperature from one degree above the base temperature to as high as 400 degrees.

Worldwide air transportation of military medical patients, the bulk of whom have previously been moved by hospital ships and trains, has been taken over by the Military Air Transport Service.

Quick Test for Synchronizers

Flash guns are checked for synchronization right on the spot and without expensive equipment by a photosensitive sheet that requires no processing. The sensitive material is loaded in a film holder and a picture is taken of a flash bulb being fired by the synchronizer. Because the test sheet retains an image of the burning bulb for a short time, the photographer can see whether the shutter opened at the peak of the flash. No darkroom is required and the sheet can be used repeatedly since the image is retained only temporarily.

Tile With Cutout Center Provides Limitless Patterns

For endless pattern possibilities, a handy rubber floor tile is a square within a square. Measuring 9 by 9 inches, the tile has a 6 by 6-in. square cut out from the center at an angle. This bevel-cut center can be removed and replaced by another insert of a different color. To provide limitless patterns, the tile is available in 14 plain and marbled colors.

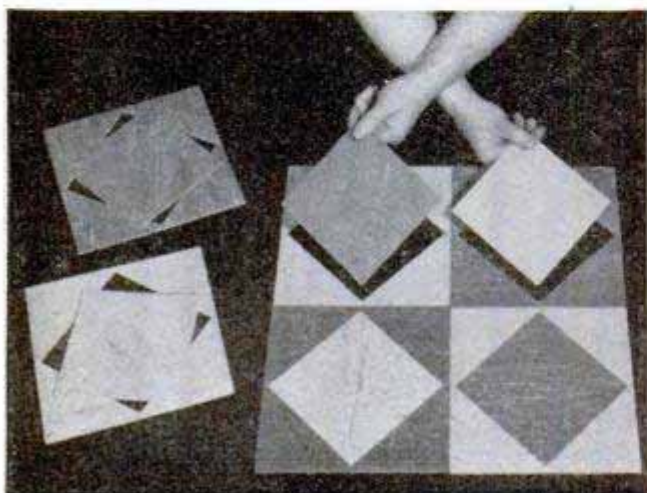



Covered with conductive paint, this panel, used in room-heating tests, keeps a surface temperature of 110 degrees. The paint can also be applied to walls

Below, conductive paint is sprayed on this plastic accessory cover for airplanes. It stops ice formation and keeps working parts at proper temperature



That cold floor is no excuse for staying in bed if you can step on an electric rug, containing a layer of the "hot" paint which is kept warm electrically

Below, the painted square on the bottom of the pail will warm liquids, replacing the immersion heater. Notice the electrodes at each end of painted area

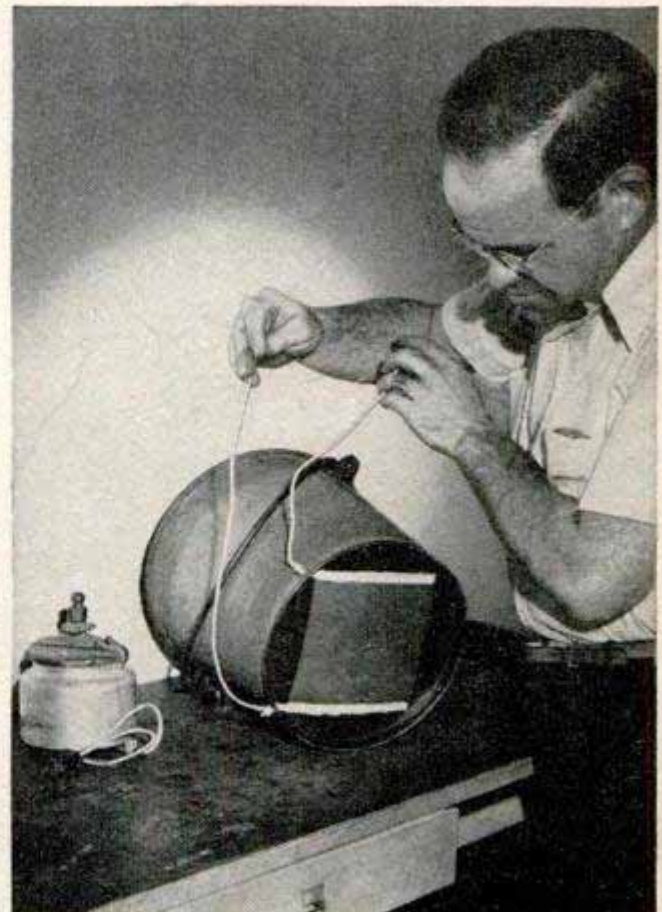

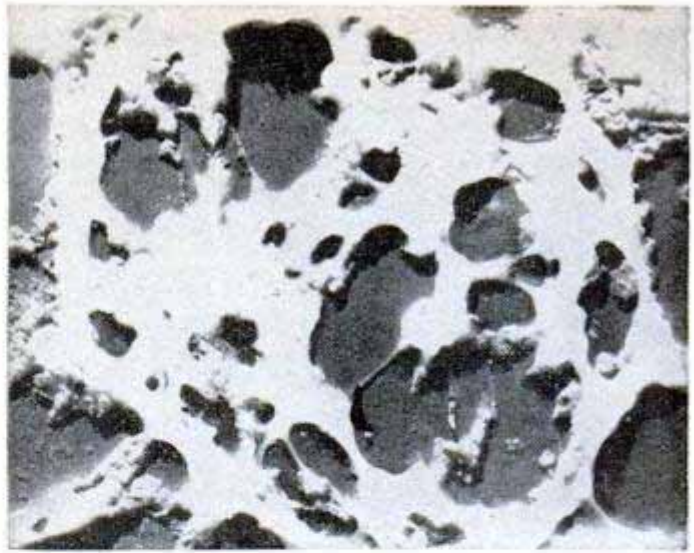
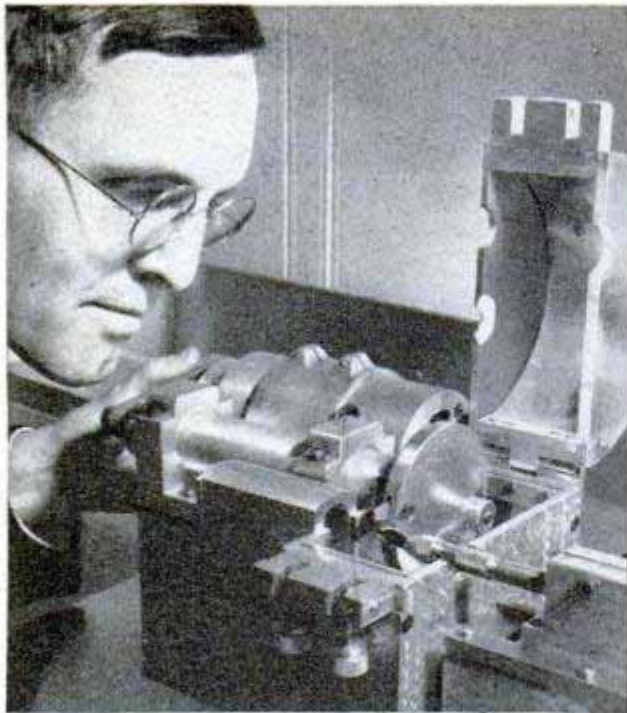

Left, blade of high-speed microtome is on the wheel in center of photo. Above, micrograph of section of frog's eye magnified about 25,000 times. Slice was cut on the expansion cutter, below, and picked up with the brush

Ultrathin Slices For Microscopic Study

Slices so thin that it would require hundreds of them to equal the thickness of a human hair are cut by two new instruments designed to provide scientists with tissue specimens for study under the electron microscope. One instrument, developed at the National Bureau of Standards, uses heat expansion to move the specimen against the knife blade. The specimen, embedded in plastic, is mounted in a hollow brass block that is chilled by the flow of carbon dioxide through it. This cooling contracts the block. When the carbon dioxide is cut off, the block gradually expands as it warms, advancing the specimen slowly against the knife blade. The second instrument, developed at General Electric, is a high-speed microtome that cuts shavings less than two millionths of an inch thick. The blade, mounted in a wheel, does not

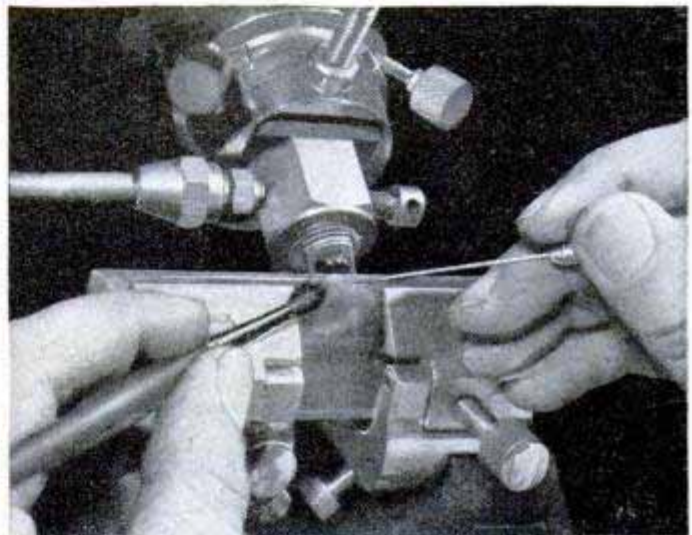

touch the specimen, the cutting being done by a shock wave set up when the wheel is spun at speeds greater than that of sound. The sharpness of the blade is not of primary importance because the high-compression area in front of the blade actually does the cutting.

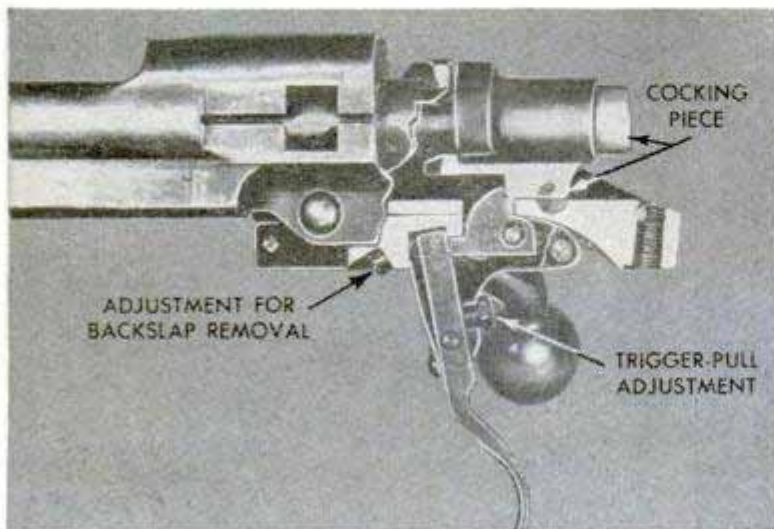

Trigger Conversion Unit For Military Rifles

Military rifles, such as the Enfield and Springfield, are given a crisp, target-rifle trigger release by a conversion unit that is simple to install. The mechanism also converts the Enfield to cock on opening. It provides a short pull that can be adjusted from three to six pounds. No alteration of the receiver is necessary.

☐ When starting a trans-Atlantic run, the Queen Elizabeth carries 1,630,000 gallons of fresh water.



FUNCTIONAL FURNITURE

the **C**raftsman

★ Designed especially to extend our series on furniture construction to include pieces of all-around usefulness, these functional units are attractive and practical when used separately or in combination. Basic pieces are a chest, writing desk and table with combinations worked out as suggested in the sketches. Details on page 181

★ A good reason for the continuing popularity of leather tooling is that you can finish a useful and attractive project in one evening. We've selected a writing case, page 174, as an example

★ A special shop feature, page 224, tells how to build a combination spindle-disk sander of a capacity suitable for pattern and furniture shops

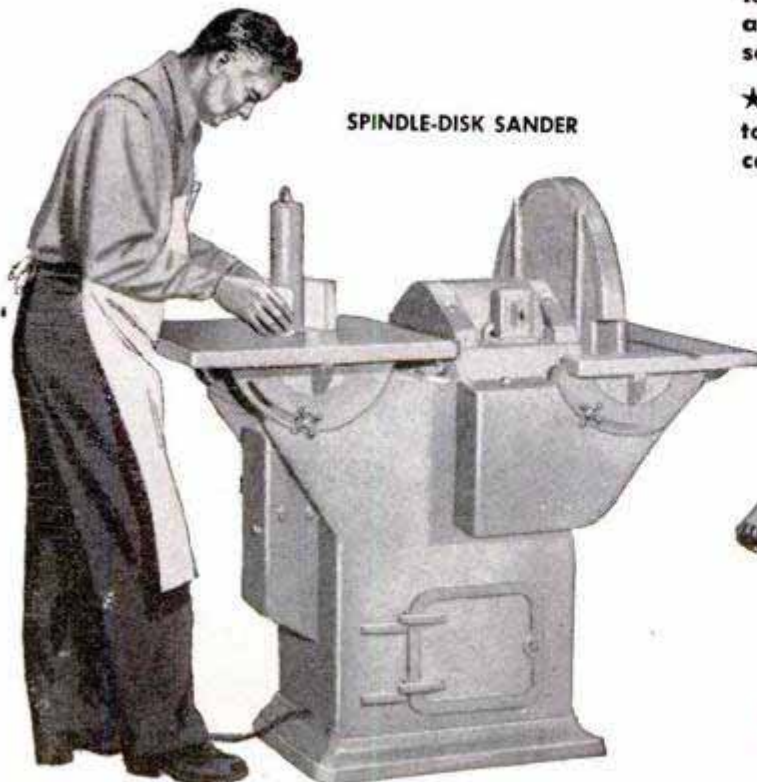

SPINDLE-DISK SANDER



TOOLED-LEATHER WRITING CASE

Tooled-Leather WRITING CASE

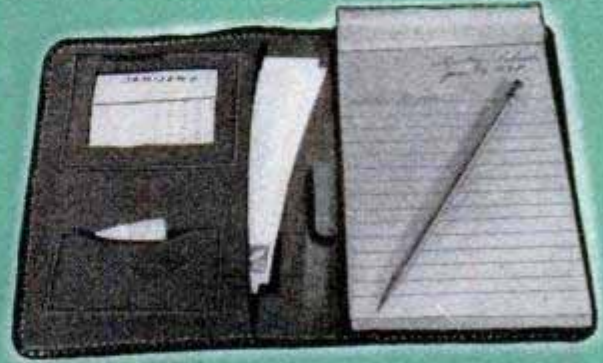
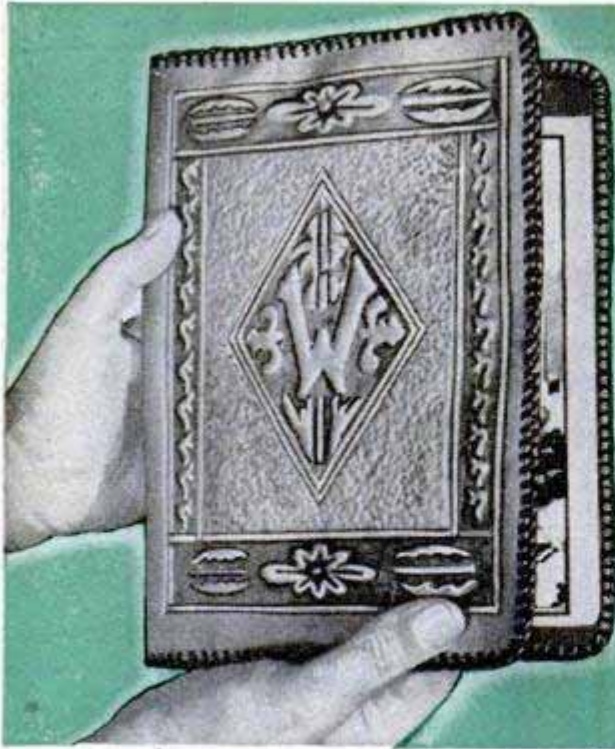

By Elma Waltner

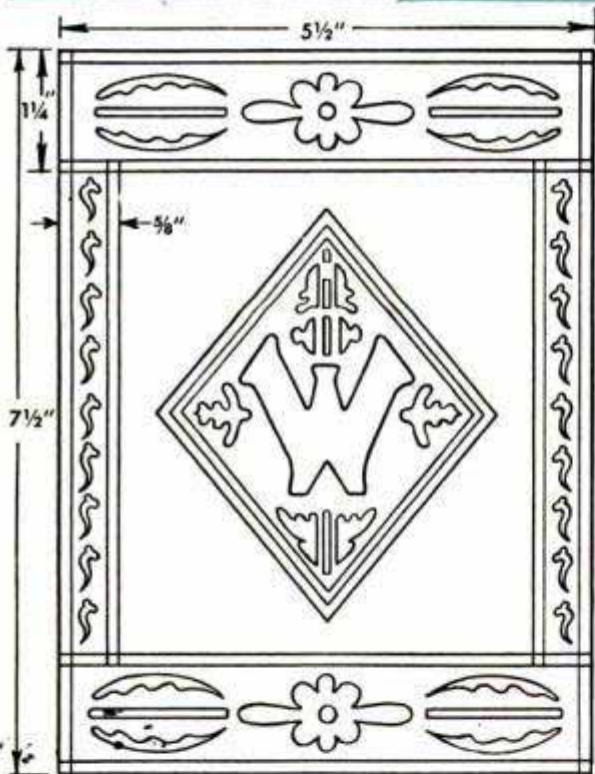

TOOLING DESIGN

A TOOLED-LEATHER writing case makes a handsome and handy accessory, especially for one who travels. This case contains pockets for everything needed, including a calendar. It was tooled in 5-oz. russet steerhide, although other leathers can be used. Steerhide tools nicely and the russet color takes on a rich glossy brown in the tooled areas which contrasts sharply with the lighter natural-colored areas. The case requires a piece of steerhide 9 x 13 in., which, when folded, makes a 6 x 9-in. case with a 1-in.-wide back. Lay out the design suggested at the left, or one of your own choice, on heavy paper, and draw your initial in the center. Almost any initial can be worked in the diamond shape.

Dampen the leather before tracing the pattern onto it. This may be done either on the flesh side or on the grain side, the important point being not to get the leather too wet. Leather that has been dampened too much

Below left, fasten the paper pattern to the leather with cellulose tape and trace the design with a blunt-pointed pencil. Then, deepen the impression in the leather with a tracing tool as in the photo at the right



1



2

will not hold the tooled impression. When dampening the leather on the grain side, it is best to wet the entire piece and not just the area to be tooled. Otherwise, water-marks may result when the leather dries. To trace the pattern, center it on the grain, or face, side of the leather and fasten it with tabs of cellulose tape, Fig. 1. Do not let the adhesive stick to the face side, as it is apt to mark the leather. Instead, bring the tape around to the back or flesh side of the leather. Trace the pattern with a blunt pencil, applying light pressure. This will produce an impression in the dampened leather, which is further deepened by retracing the design directly on the leather with a regular tracing tool, Fig. 2.

Tooling is done on a flat surface, such as a piece of glass. The background of both border and center designs is tooled down to leave the design in relief by rubbing it with the tool. This darkens the leather and makes it glossy, providing a pleasing contrast with the raised portions, Fig. 3. Next, the area surrounding the diamond shape is given a pebbled texture by stippling it with a roundnose tool, Fig. 4. This is done by holding the tool vertically and tapping the leather. If the tooling cannot be completed at one time, it will not harm the work if the leather dries. Simply redampen it when you resume work. Usually, the leather will remain sufficiently pliable for good tooling for several hours.

With the tooling completed, you are ready to add the lining and pockets. Fig. 6 gives the size of the lining and the positions of the various pockets. The lining is cut the same size as the cover of the case and the pockets are sewed to it by machine. Then the lining is machine-stitched to the cover, $\frac{1}{8}$ in. from the edges, using thread of a color which closely matches the leather of the case. The stitching is used to hold the edges of the two materials together while the lacing is applied around the edge to prevent shifting.

Holes for the lacing are punched through both leathers just inside the stitching line,

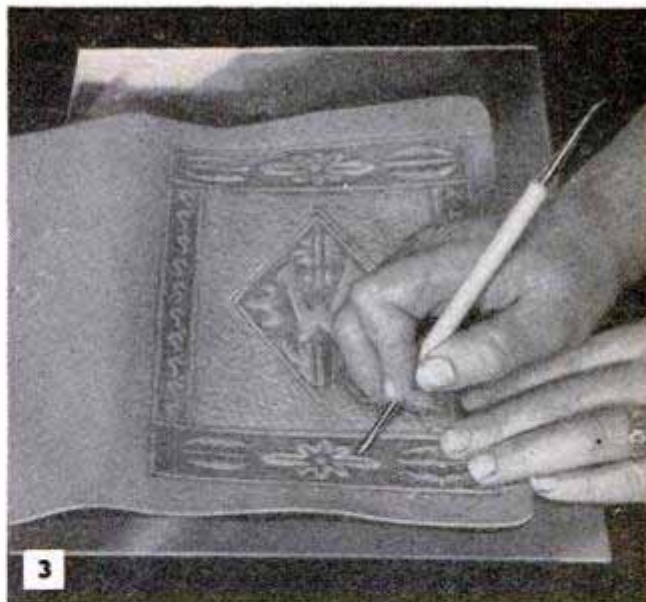

With the leather on a piece of glass, tool down the background areas. This operation darkens the leather

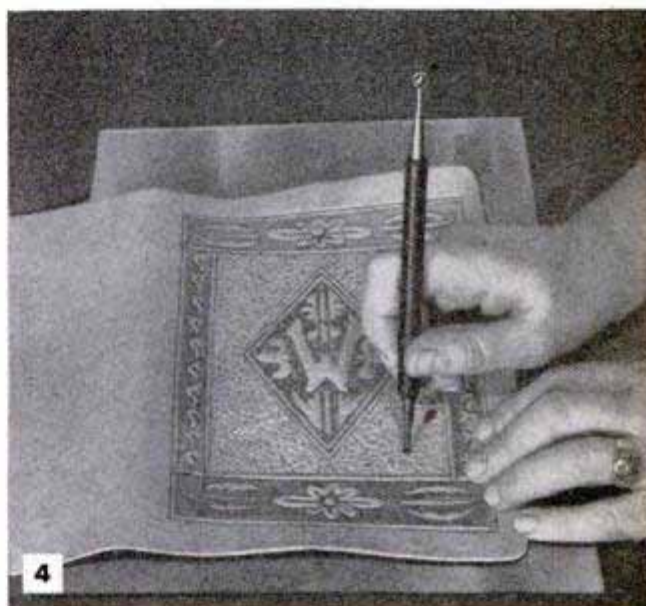

Above, a stipple effect is produced by tapping the leather with a roundnose tool, held vertically. Below, holes for a leather lacing are punched around the edge of the work with a special lacing awl made for the purpose. This is done on a hardwood block

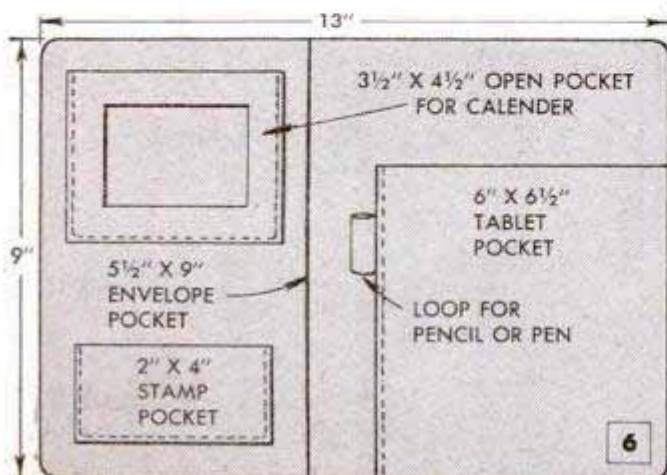

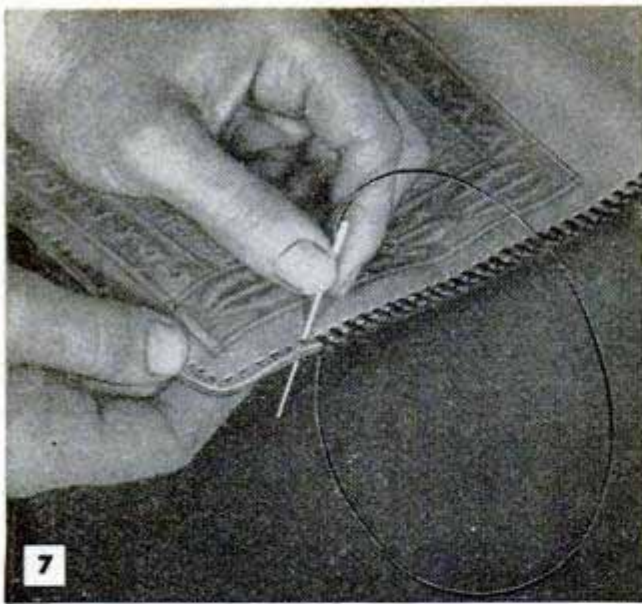

Using a regular lacing needle which has a split end, the lacing is pulled through the slits, front to back

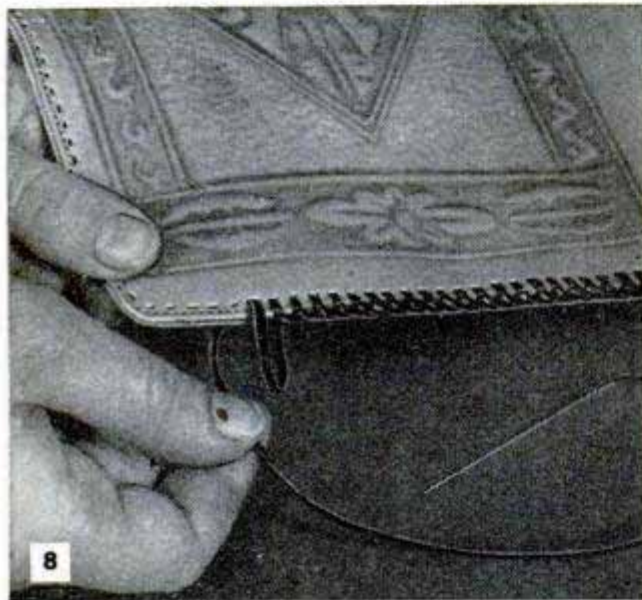

Above, first the lacing is pulled through until a small loop is formed. Then the needle is inserted through the loop, below, keeping the lacing to the left of itself. Finally, the lacing is drawn up tightly to form a knot, lower right. Repeat the steps

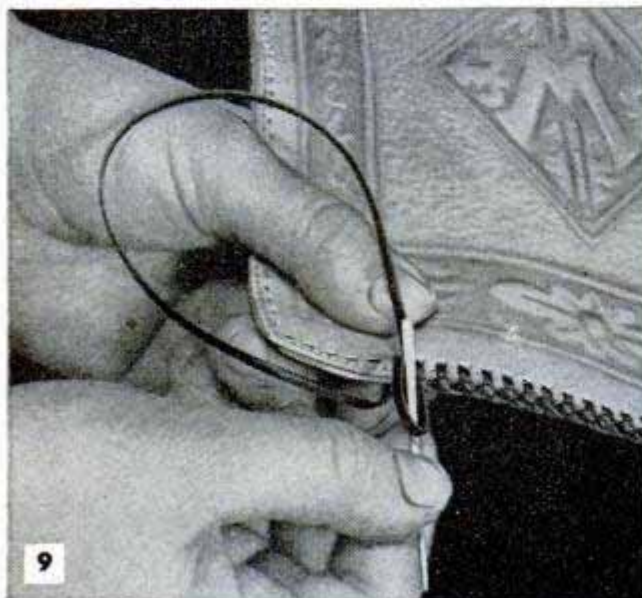

using a special pronged lacing awl to form a series of slits, as in Fig. 5. With the leather positioned on a hardwood block, punch the holes all around the edge. A split lacing needle is needed for threading the lacing through the slits. The skived end of the lacing is inserted in the needle and held in place with a drop of quick-setting cement. Use lengths of $\frac{1}{8}$ -in. lacing about 4 ft. long and begin as follows: Hold the case in the left hand with the tooled side toward you. Start the lacing in the center of the top edge and lace from left to right, inserting the needle from front to back, Fig. 7. Draw it through until only a small loop remains in front, Fig. 8, and then bring the lacing over the edge and through the loop as in Fig. 9. It is important that the lacing passes through the loop to the left of itself, as shown in the photos, and not to the right, otherwise it will not form correctly. Draw the first loop tightly against the edge of the leather and then pull the second loop down tightly to form the knot as in Fig. 10. Continue in this manner, watching that each knot is directly opposite the slit and that the lacing does not slant. Also, take care that the lacing does not twist. Placing the fingers of the left hand under leather and near the knot, as the latter is being drawn taut, will keep the edges of the leather from being stretched and pulled out of shape.

The lacing is joined by skiving the ends of the two pieces to bevel them and then cementing and lapping together. Ends at the start and finish of the lacing are tucked under several of the stitches and fastened with a drop of cement. Now, the completed lacing is placed on the edge of a hardwood block and tapped lightly with a mallet. This flattens the lacing to the approximate thickness of the case and slightly embeds it to keep the knots from shifting. Clean the finished case with saddle soap.

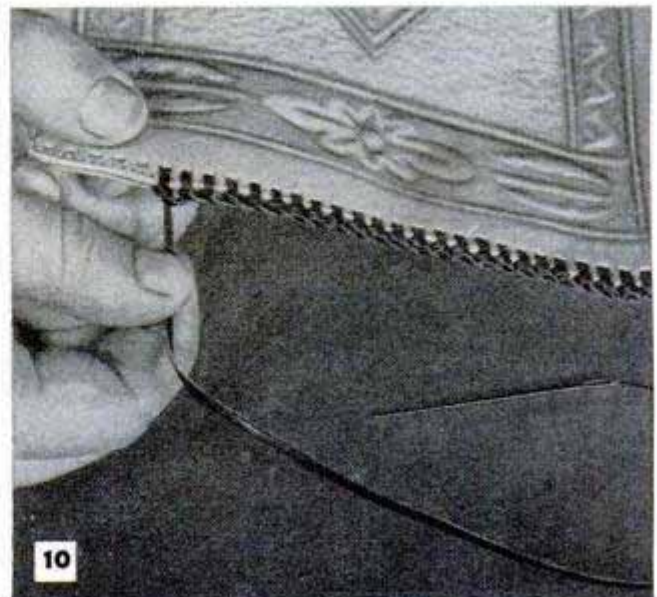

Small Oil Drums Linked Together Double for Large Storage Tank

Heating oil for the home or farm is more economical and convenient to use if it can be stored in sizable quantities and piped directly to the heating unit. However, if the cost of installing a large storage tank is prohibitive, several 55-gal. drums connected with pipe will serve the purpose. Each drum is fitted with a valve so oil can be fed from one drum at a time or all of them simultaneously.

A. M. Wettach, Mt. Pleasant, Iowa.

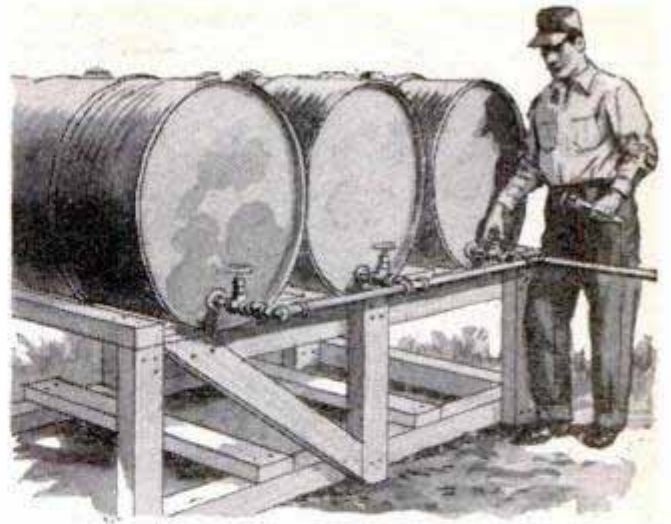

Paper Clip Forms Bookmark



A bookmark that won't fall out of place is had by pressing a paper clip over the page. Slip a folded piece of paper over the page before fastening the clip.

Match-Book Covers Level Furniture

Several match-book covers crisscrossed and closed so they are linked together provide a quick way of supporting a chair or table leg to level the piece of furniture. The stack of covers can be made any thickness and will not work from under the leg as readily as loose pieces of folded paper or cardboard.—Helen Lemberger, Chicago.

Clothespin Belt Holds Washcloths Within Easy Reach

When standing on a stepladder to wash windows or polish woodwork, you can keep both hands free and eliminate bending down to pick up cloths by hanging unused cloths from a clothespin belt. The belt is made by stringing several plastic spring-type clothespins on a length of cord and tying it around the waist.



Underspring Trap Concealed in Top of Stump Outsmarts Suspicious Fox

Here is a secret of experienced fox trappers that takes advantage of the animal's suspicious nature. An open glade including an old, rotten stump and a small tree or sapling about 50 to 70 feet from the stump should be selected as the site for the trap. This is not difficult to locate. Use a long cord to suspend a dead chicken, crow or other bird from a limb of the tree facing

the stump and scatter a few feathers on the ground below the bird. Then, conceal a No. 3 underspring trap in the top of the stump. When a passing fox notices the movement of the dead bird in the breeze he will be suspicious but also extremely curious. After circling the tree and finding nothing wrong, he usually will climb up on something to get a better view of the area. Eventually the fox will locate the stump which is an ideal place for him to view the bird, and when he jumps up on it, he is almost certain to spring the trap. To set the trap, carefully hollow out the top of the stump so there is just enough room for the trap. Wear leather gloves to avoid scent and carry away any excess wood so the fox does not become suspicious of the stump. Conceal the trap drag and chain below the trap, place a piece of clean wax paper over the open jaws of the set trap and crumble rotten wood over the top until the paper is no longer visible. The wax paper prevents the wood covering from sifting down and clogging the trap action.

R. A. Jenkins, St. Louis, Mo.





NO TIME IS WASTED in looking for sewing needles if one is kept with each spool of thread. Just press a short piece of crayon into the hole in the center of the spool and stick the needle into the crayon

TO PROTECT A WINDOW SHADE from damage while top sash is open and also to insure maximum ventilation, install a set of shade brackets a few inches lower than the regular ones. The shade can be mounted on these brackets whenever the upper sash is lowered



WHEN THREADING CURTAINS on a flat or round extension rod the cloth is apt to be torn by snagging on the joints. To prevent this, wrap the joints with cellulose tape so the curtain will slide over them. If the tape is covered by the curtains, the rod can be taped when fully extended and tape left in place

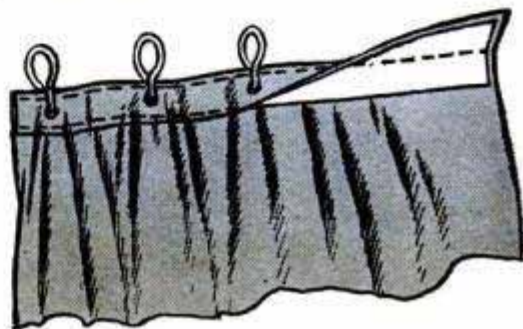

BEFORE INSTALLING RINGS on homemade plastic shower curtains it is a good idea to reinforce the top edge with a strip of adhesive tape. Cloth is folded over the tape and hemmed on the inner edge

RECIPES CLIPPED FROM NEWSPAPERS or magazines are held for easy reference by attaching them temporarily to side of a baking-powder can. Press the lid of the can over the clipping to hold it in place



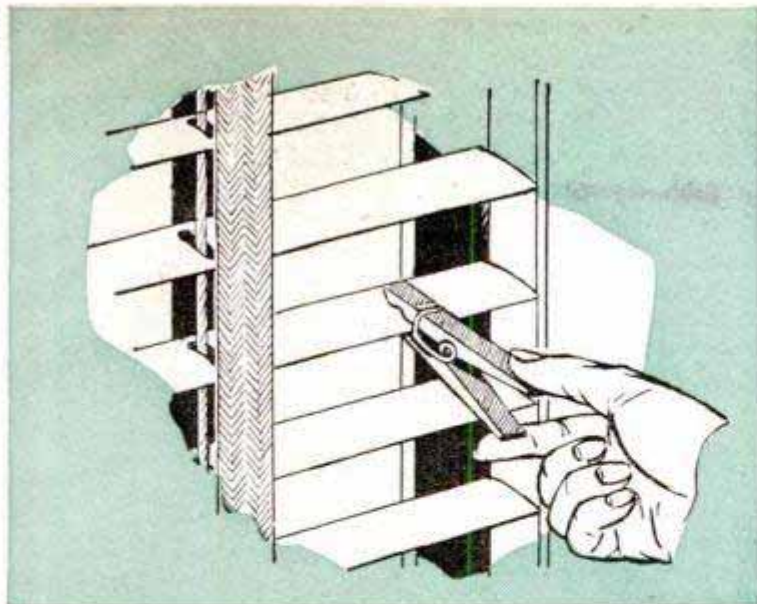

KEEP A SPRING-TYPE CLOTHESPIN handy when you are cleaning Venetian blinds. Then, if the telephone or doorbell rings, clip the pin to the slat being cleaned so you will know where to resume work

PAPER ADHERING TO VARNISH can be removed without damaging the finish by loosening it with olive oil. Apply the olive oil to the paper until it is thoroughly soaked, then pull the paper from the surface

SOLVING HOME PROBLEMS

DON'T WORRY ABOUT WATERING potted plants when you go on vacation. They may be watered for several weeks by placing each one in a large bowl and wedging two inverted quart-size bottles between the pot and bowl. The pot should be raised on blocks, if necessary, so the water barely touches the bottom

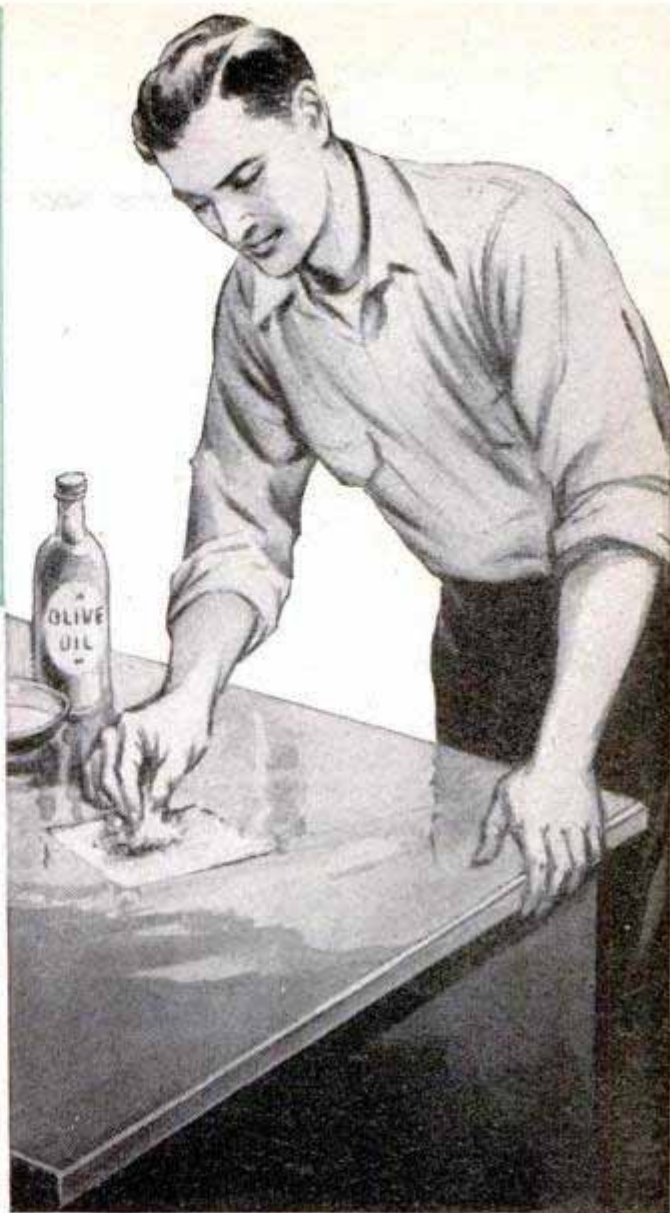

A STRIP OF CLOTH and some glue are the only items necessary to reset a loose picture-frame nail in a plastered wall. Wrap a narrow strip of cloth spirally around shank of the nail and dip it in the glue. Replace the nail in the hole and allow the glue to dry for a day or so before rehung the picture



Basement Windows Kept Cleaner With Concrete Splash Aprons



Finding that his ground-level basement windows were splashed with mud during heavy rains, one homeowner poured a concrete splash apron directly in front of each window. In addition to keeping mud from being splashed onto the glass, the aprons also add to the appearance of the house, as they provide an excellent place for setting flowerpots and boxes during the summer. The apron need not be more than 2 in. thick and can be poured directly on the ground, using a shallow wooden form. A space of $\frac{1}{4}$ in. should be left between the window sill and the apron. This space is filled with tar or asphalt emulsion after the concrete has hardened.

Walter E. Burton, Akron, Ohio.

Whittled Salt and Pepper Shakers Provide Novel Table Decoration

Quickly whittled from blocks of white pine, this rooster and hen are a pair of novel salt and pepper shakers that will be

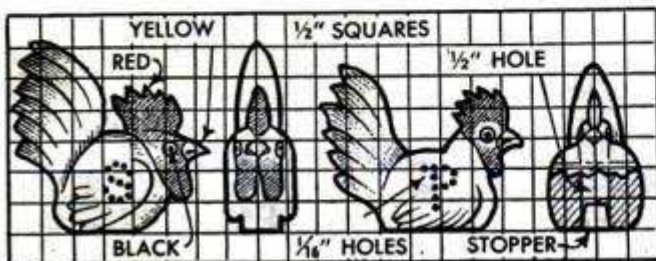

right at home with the breakfast bacon and eggs. The birds are carved as shown in the squared pattern and a $\frac{1}{2}$ -in. hole, 1 in. deep, is drilled into the base of each figure. Then, $\frac{1}{16}$ -in. holes are drilled through one side of both the rooster and the hen to form the letters S and P. Corks are used to plug the $\frac{1}{2}$ -in. holes. On the original set, the heads of the birds were painted red and the beaks and eyes yellow. The bodies were coated with clear shellac and rubbed to a luster.—Wm. P. Kupka, Chelsea, Iowa.

Rattail File Aids Stuffing Toys

When stuffing dolls and toy animals, try using a rattail file to work the stuffing into the limbs. As the teeth of the file have a forward rake, the material will stay in place when the file is withdrawn.—Charles H. Hardy, Los Angeles, Calif.

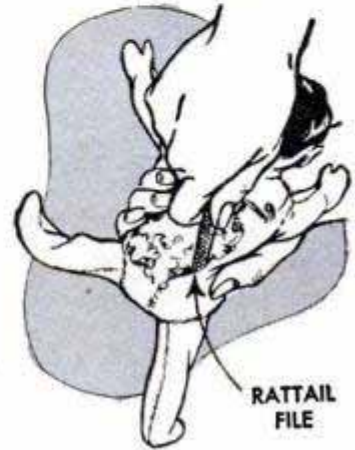

Concrete Laundry Tubs Repaired By Waterproof Crack Filler

If you want a long-lasting repair for cracked concrete laundry tubs, try filling the cracks with a waterproof paste made by mixing white paint or white lead in oil with dry portland cement. First, be sure that the tubs are dry and scrape any loose material from the cracks. Add the cement gradually to the paint, mixing continuously, until the mixture is of the consistency of fresh putty. Then fill the cracks by pressing in a liberal amount of the paste and smoothing off the excess with a heavy stroke of a putty knife. The paste will harden and the tubs will be ready for use within a couple of days. The repair, if made carefully, should last for many years.

E. S. Macgowan, Minneapolis, Minn.

Rubber Bumper for Stepladder

To keep a stepladder from marring interior trim when it is leaned against it, attach a strip of garden hose over the rear edge of the top step. Just slit the hose lengthwise, notch if required, and nail it in place.

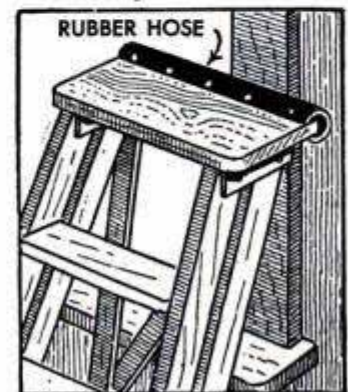

OCCASIONAL FURNITURE

Includes a drop-leaf table, made to order for a combination living-dining room, and a sectional wall ensemble, the units of which can be interchanged to form varied groupings

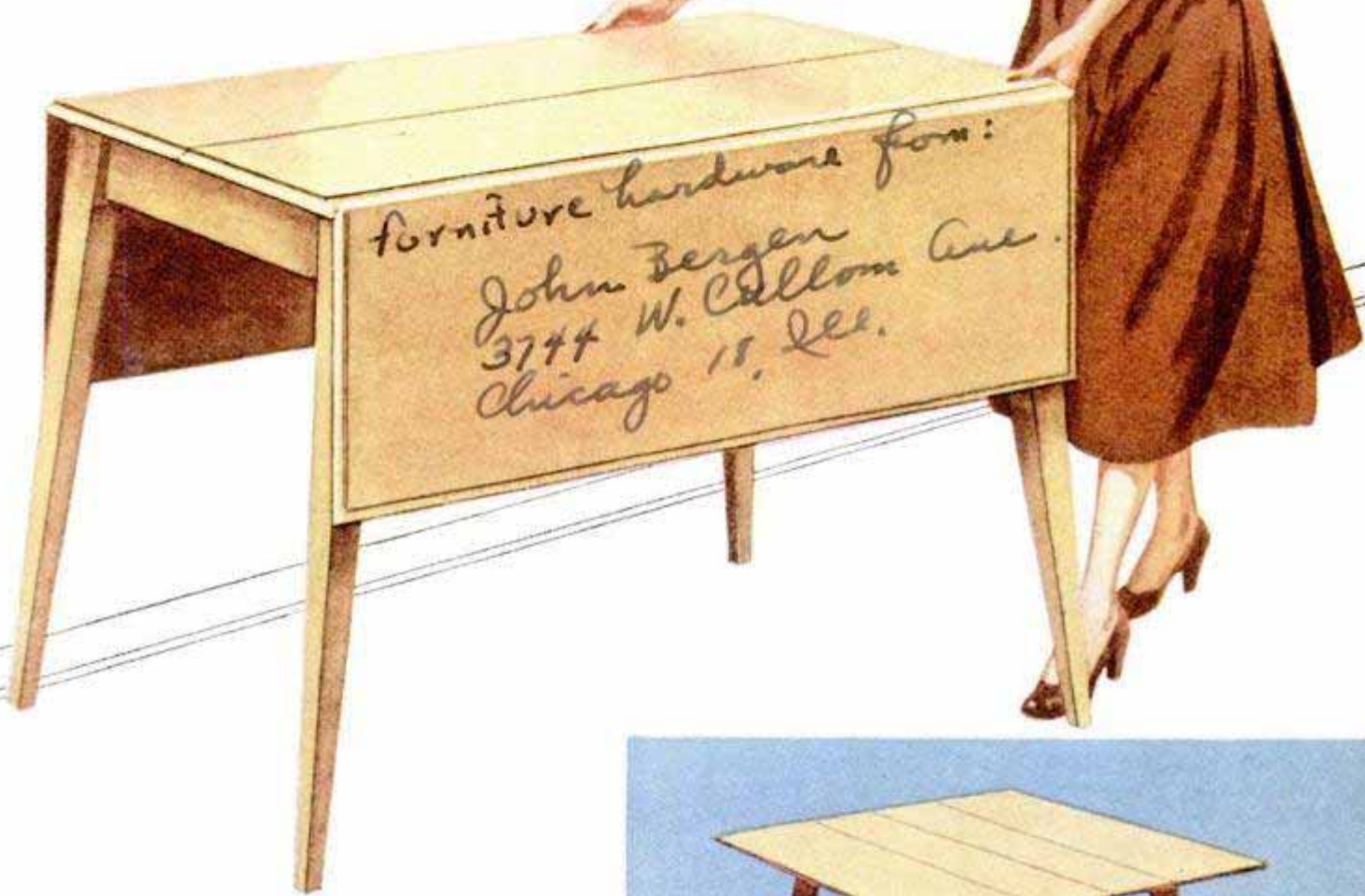

Story by Wayne C. Leckey

DESIGNED as companion pieces to harmonize with the dining and living-room furniture series presented in our issues of September and November 1949, these smart occasional pieces can be used to augment the other pieces or used by themselves in any particular arrangement you desire. The drop-leaf table pictured above is designed especially for a dining alcove where limited space does not permit room for even a dinette set. Such is the case in the latest trend toward eliminating a separate dining room in favor of a combination living-dining room. This table adequately fills the requirement for a piece that takes little space

JANUARY 1950





against the wall when not in use, and yet has big-table capacity when needed. To seat four persons comfortably, the leaves of the table are raised to a horizontal position and the whole top is rotated 90 deg. on a center pivot. In this position, the base of the table supports the drop leaves as shown in Fig. 1. Retractable brackets in each end of the table pull out to support the leaves when the table is fully extended. A lazy-tong mechanism, taking the place of the usual extension slide, extends to permit insertion of two extra leaves, Fig. 2, providing a top surface 40 x 74 in. Suitable dining chairs for the table can be made by following the plans presented in our September 1949 issue, which covers the construction of a complete dining-room suite. Actual construction of the table, detailed in Figs. 12, 13 and 14, will be explained later in the article.

The pieces of the functional wall ensemble pictured above are coordinated in size to fit together in a number of separate sectional arrangements in addition to the complete grouping shown. For example, the secretary, pictured in use at the bottom of

the opposite page, may be combined with an open-end bookcase at each side. Likewise, the three-shelf unit, with doors at the bottom, may be grouped in the same way. An attractive corner grouping is had by flanking the corner bookcase with end bookcases. Still another arrangement is to place the window unit between two end bookcases. These are but a few of the attractive arrangements that are possible with these sectional pieces. If desired, any one of the three basic units, namely, the secretary, three-drawer chest and two-door chest, may be used individually.

The secretary features a pull-out writing shelf which looks like a drawer when closed. The "drawer" front is hinged with special fixtures and lets down to become part of the writing surface. The secretary, like the others, is made primarily from plywood, with solid stock being used for the drawers, base and edging. The same edging, which is characteristic of all the pieces previously presented in our furniture series, also is used here to give a hopper-front effect and at the same time to conceal the laminations of the plywood. Figs. 3 and 4

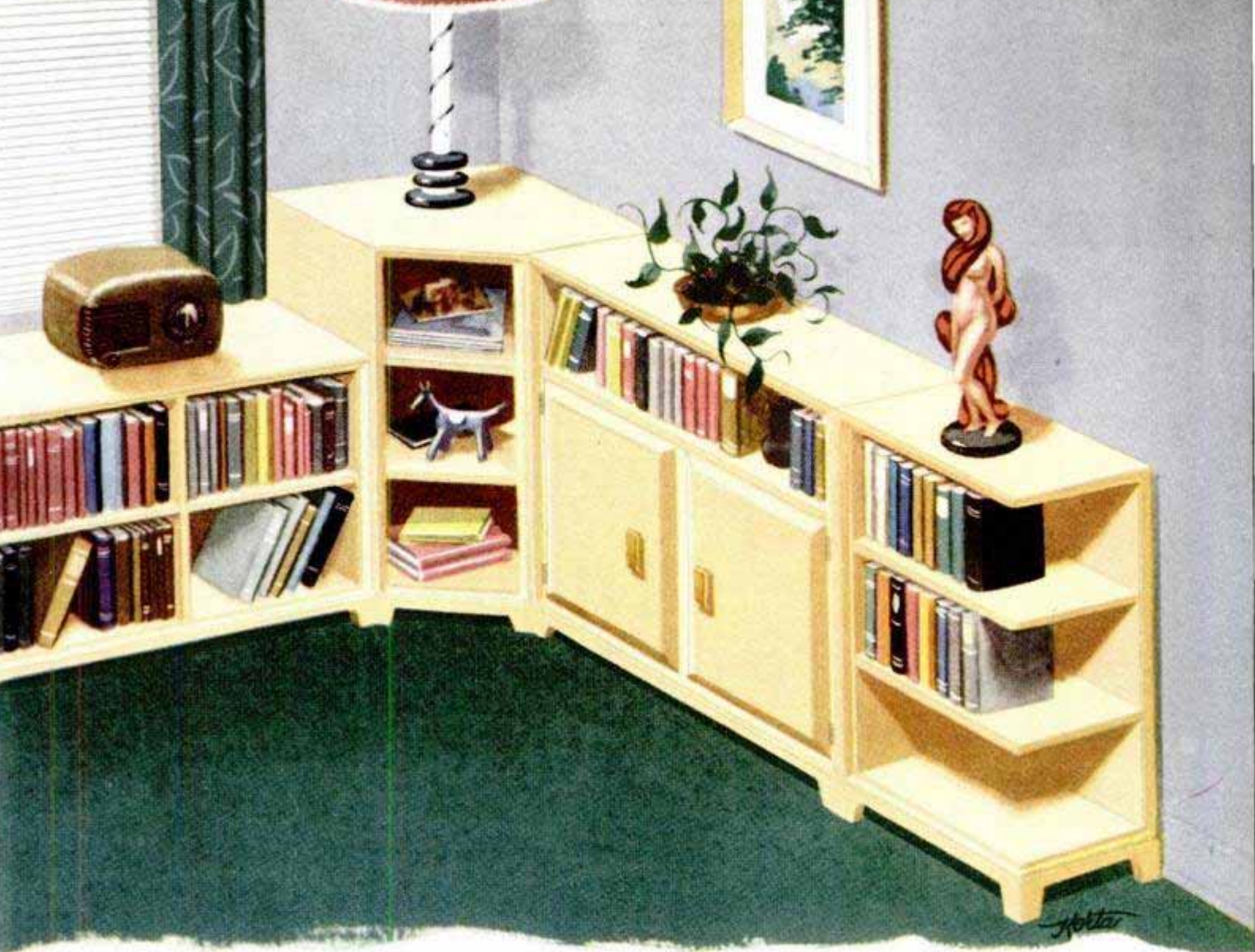

Styled by John Bergen, noted furniture designer

detail the construction of the secretary. In comparing its construction with that of the other pieces you will notice that much of the construction is duplicated. The bases are all the same, as are the drawers and, in most cases, even the manner in which the plywood panels are fitted. The exception is noted in the window, corner and end units which are designed to be flanked by other pieces. Here, the plywood is placed on the inside instead of the outside of the framework. Plywood, $\frac{1}{4}$ in. thick, is used to cover the sides and back of the secretary, while $\frac{3}{4}$ -in. plywood is used for the top.

Make the base assembly first. The members are mitered at all four corners, the rear member having a rabbet cut in the top edge to take the plywood back. A small, $\frac{1}{8}$ -in. cove is run along the top edges of the other pieces, which can be done either before or after gluing and nailing the base together. The hopper edging which frames the front of the



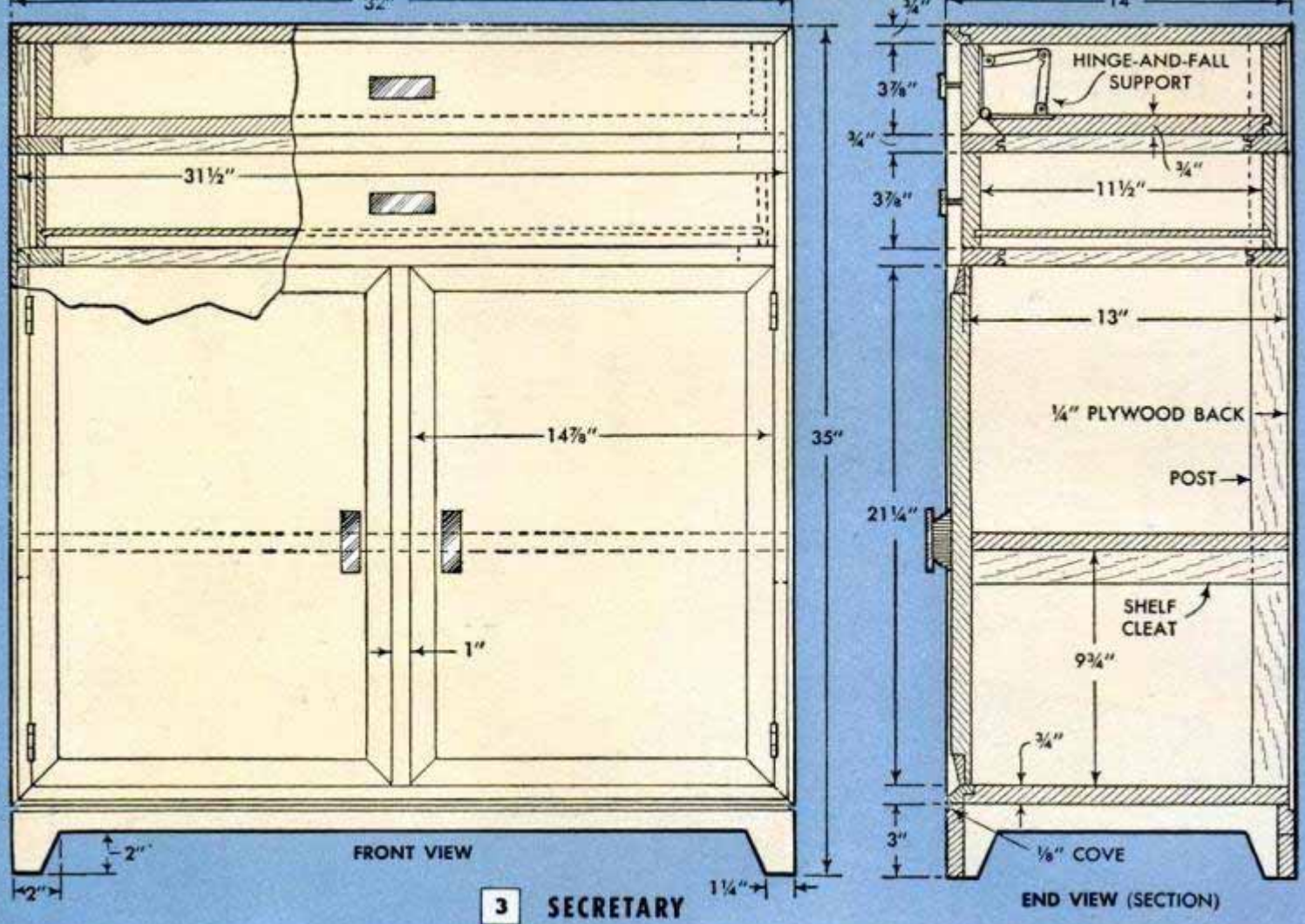

3 SECRETARY

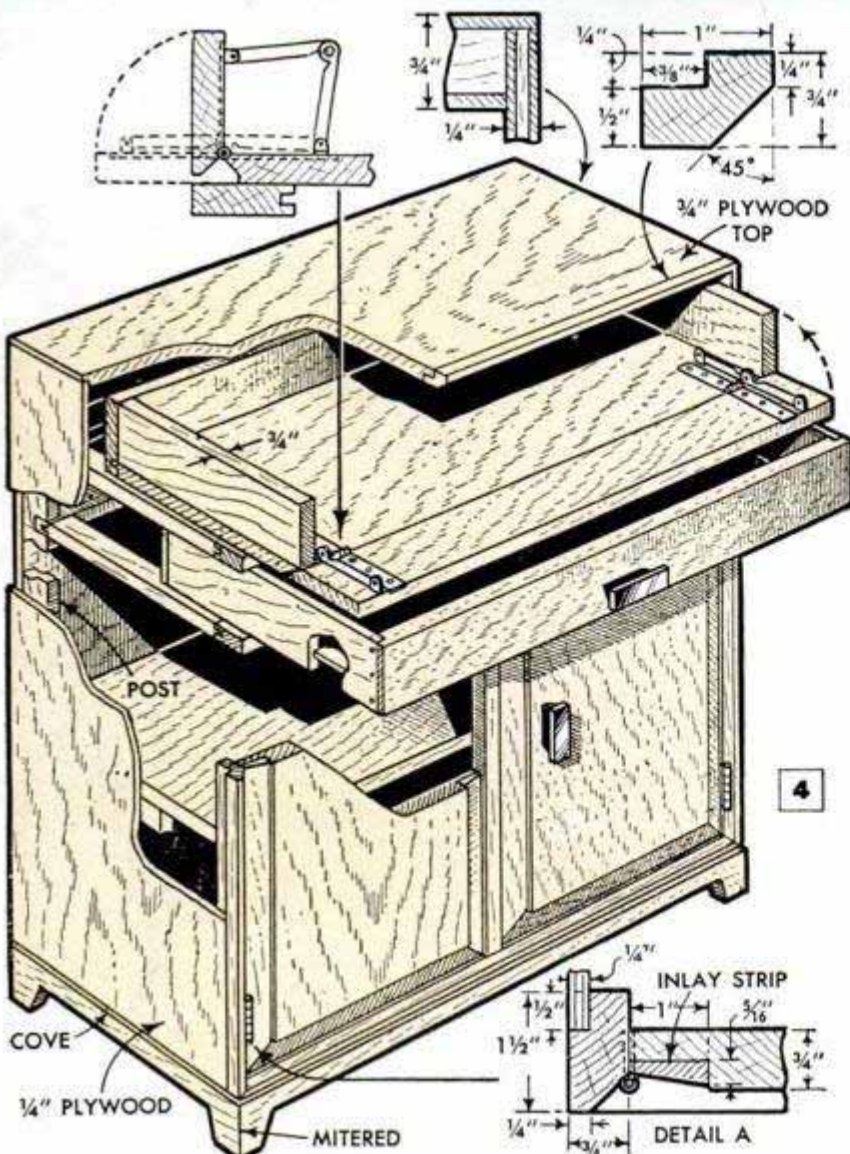

4

cabinet is shaped according to the sectional details included with the cutaway drawing, Fig. 4. The center and bottom shelves can be of plywood, or glued up from solid stock. These should be cut 31½ in. long and the front edge of the bottom shelf rabbeted for the hopper edging. Then the bottom shelf is glued and nailed to the base assembly. The ¾-in. top, including the edging, should have the same over-all measurements as the base. This is rabbeted on all four edges. Note at the ends that the rabbets are cut ¼ in. deep and to the thickness of the top ply of the wood. The top is supported at the rear corners by posts and at the front by the hopper edging. Frames for the drawer and writing shelf are typical open frames, being assembled from ¾ x 1¾-in. stock. Inner edges of the front and rear members are grooved to take tenons formed on the ends of the side members. The frames are fitted into notches cut in the rear posts and supported at the front by nailing into them through the edging rabbet. The ¼-in. side panels overlap the edge of the plywood back

and are cut to fit accurately in the rabbets of the top and in the edging strips. The writing shelf is made similarly to a drawer except that the front is hinged. Note in the sectional detail, Fig. 4, that the bottom edge of the front piece is beveled to match a similar cut made on the front edge of the shelf. A stop should be fitted in the underside of the top to prevent the shelf from being pulled all the way out, and a bullet friction catch installed to hold the drop front closed. Construction of the drawer is apparent from the drawing. Plywood is best for the two doors, but solid stock can be used. In producing the raised-panel effect in plywood, an inlay strip is used to conceal the plies as indicated in detail A, Fig. 4. The door and drawer handles pictured are made up special from $\frac{1}{4}$ -in. brass. Fig. 11 shows how these are soldered together T-shaped and then drilled and tapped for attaching with machine screws. The edges are rounded slightly with a fine file and then the brass is buffed to a high polish. A thin coat of clear lacquer will keep the handles bright.

The three-drawer chest is

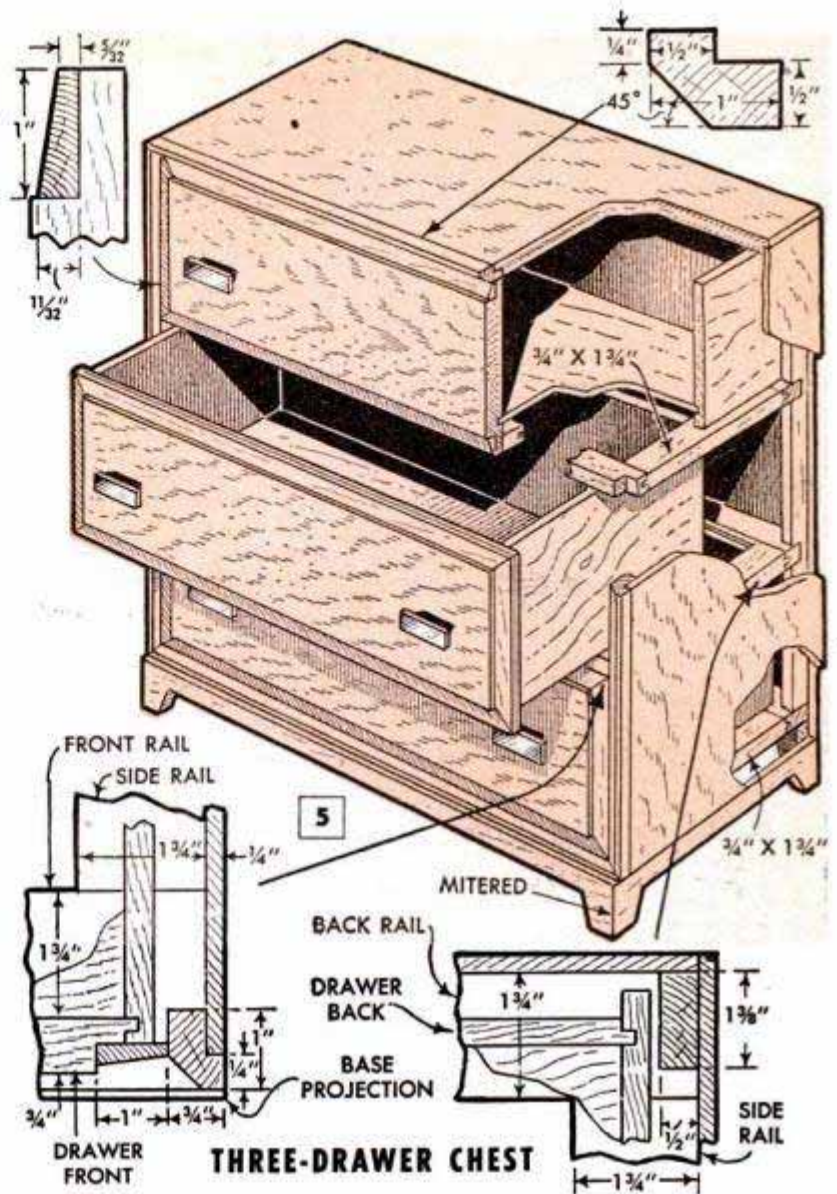

THREE-DRAWER CHEST

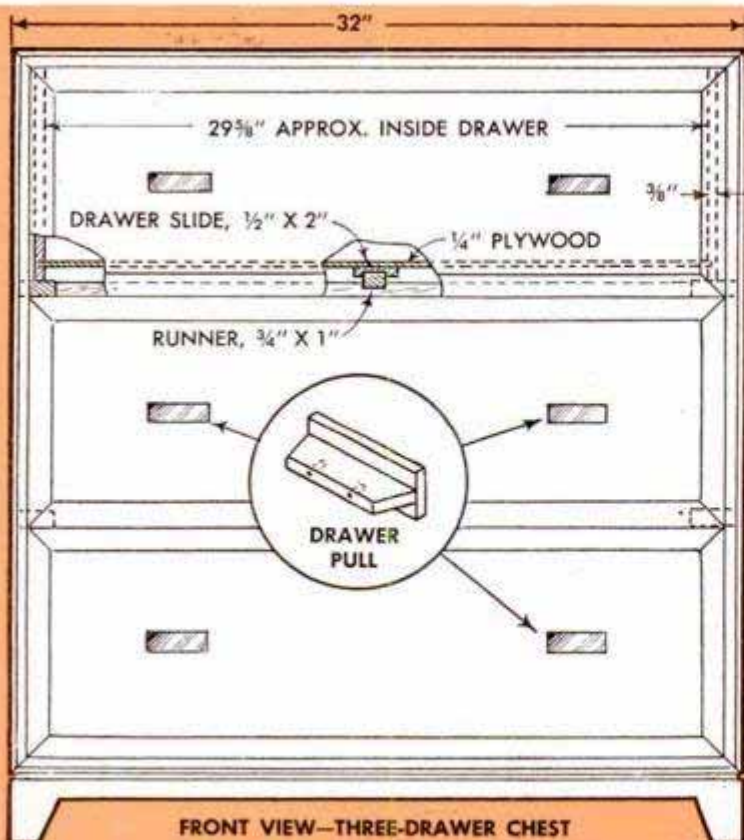

FRONT VIEW—THREE-DRAWER CHEST

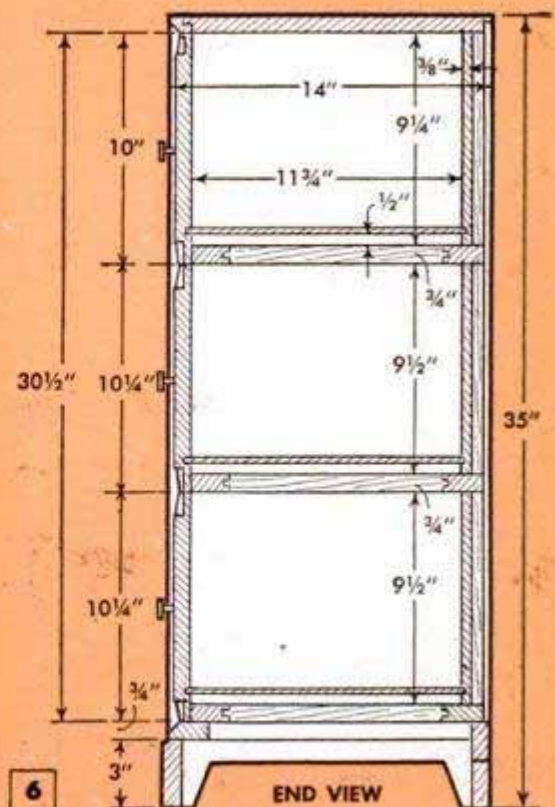

END VIEW

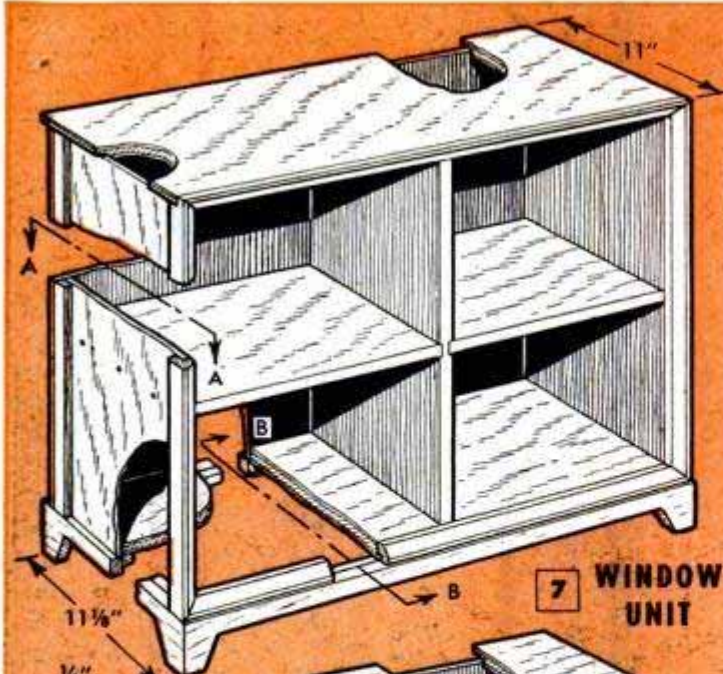

7 WINDOW UNIT

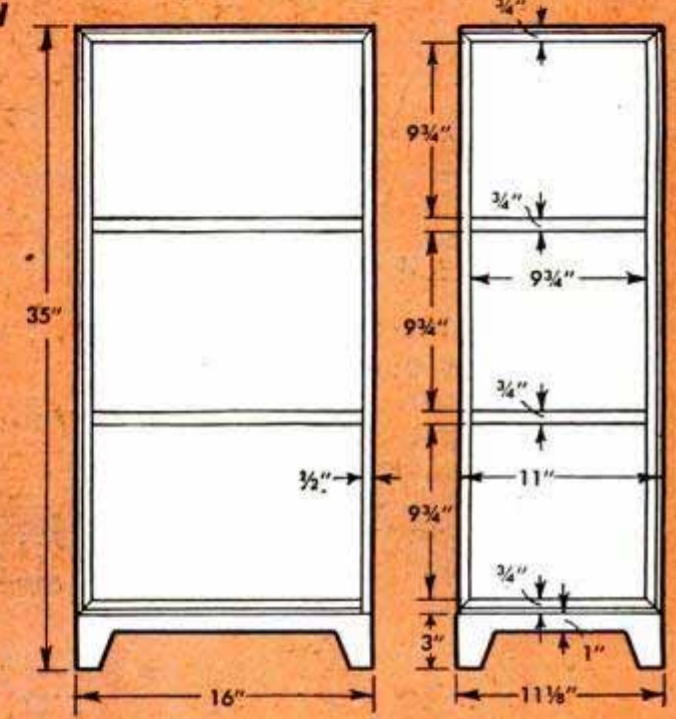
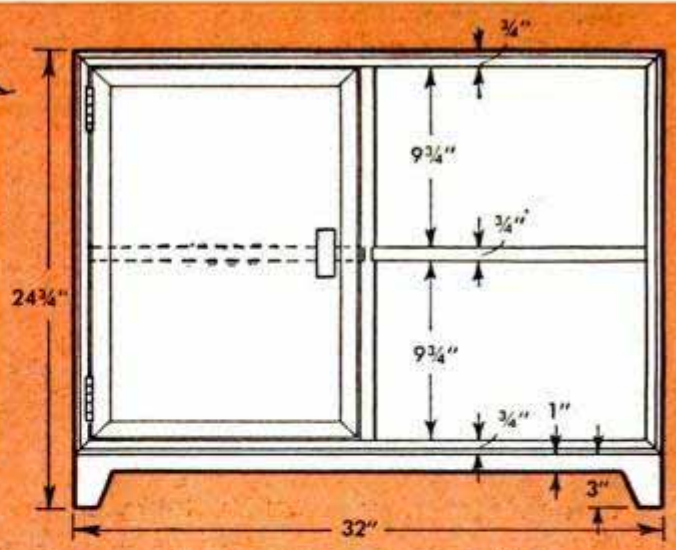

8 END UNIT

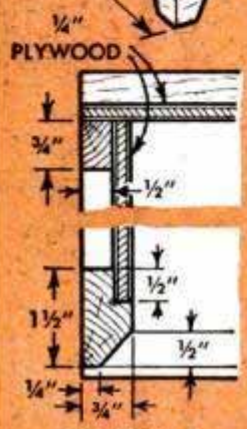

SECTION A-A

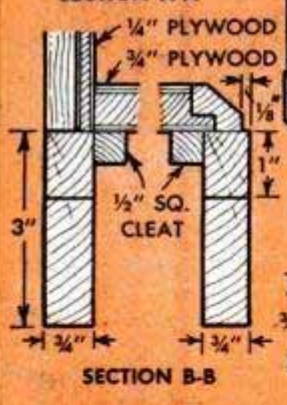

SECTION B-B

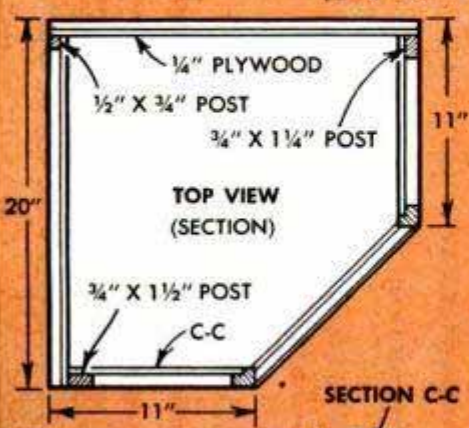

TOP VIEW (SECTION)

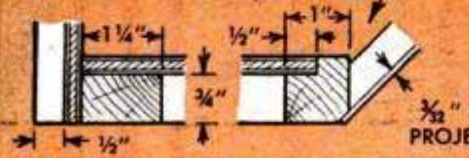

SECTION C-C

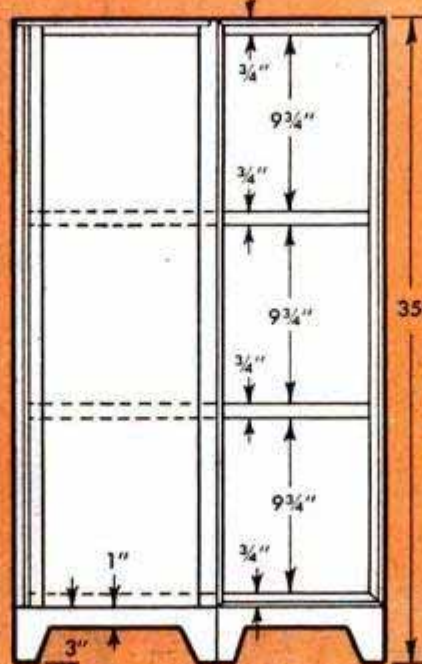

9 CORNER UNIT

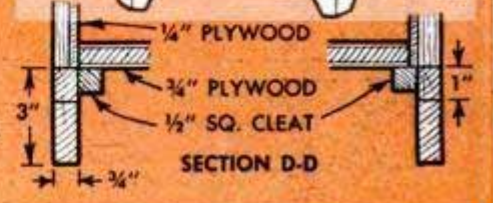
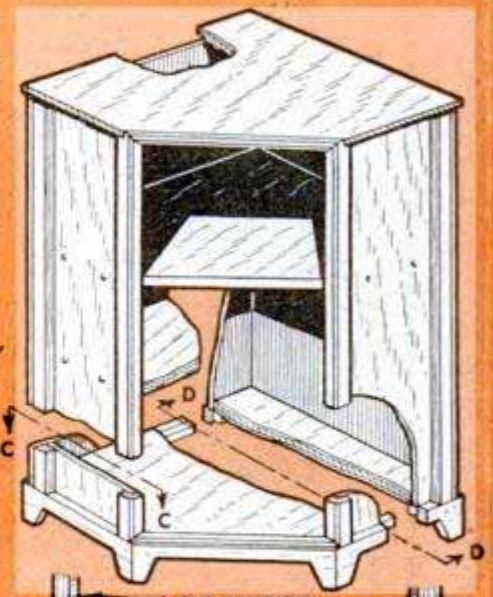

SECTION D-D

basically of the same construction. The cutaway drawing in Fig. 5 and the front and side views in Fig. 6 give the necessary details. Typical chest construction is employed with frames supporting each drawer. Hopper edging is applied as explained before and the drawer fronts are inlaid around the edges. The front view, Fig. 6, details the drawer runners. The strip nailed to the frame engages a wooden channel which is glued and bradded to the bottom of the drawer. This same type of runner is used for the drawer of the secretary. The lower details, Fig. 5, show plan views of the drawer at the front and rear corners.

Window, end and corner units, Figs. 7, 8 and 9, differ basically in construction in that the plywood side panels are placed on the inside of the cabinets instead of the outside. Whether this should be done on the sides of the corner unit depends upon the grouping arrangement. If placed next to the window unit as pictured on page 183,

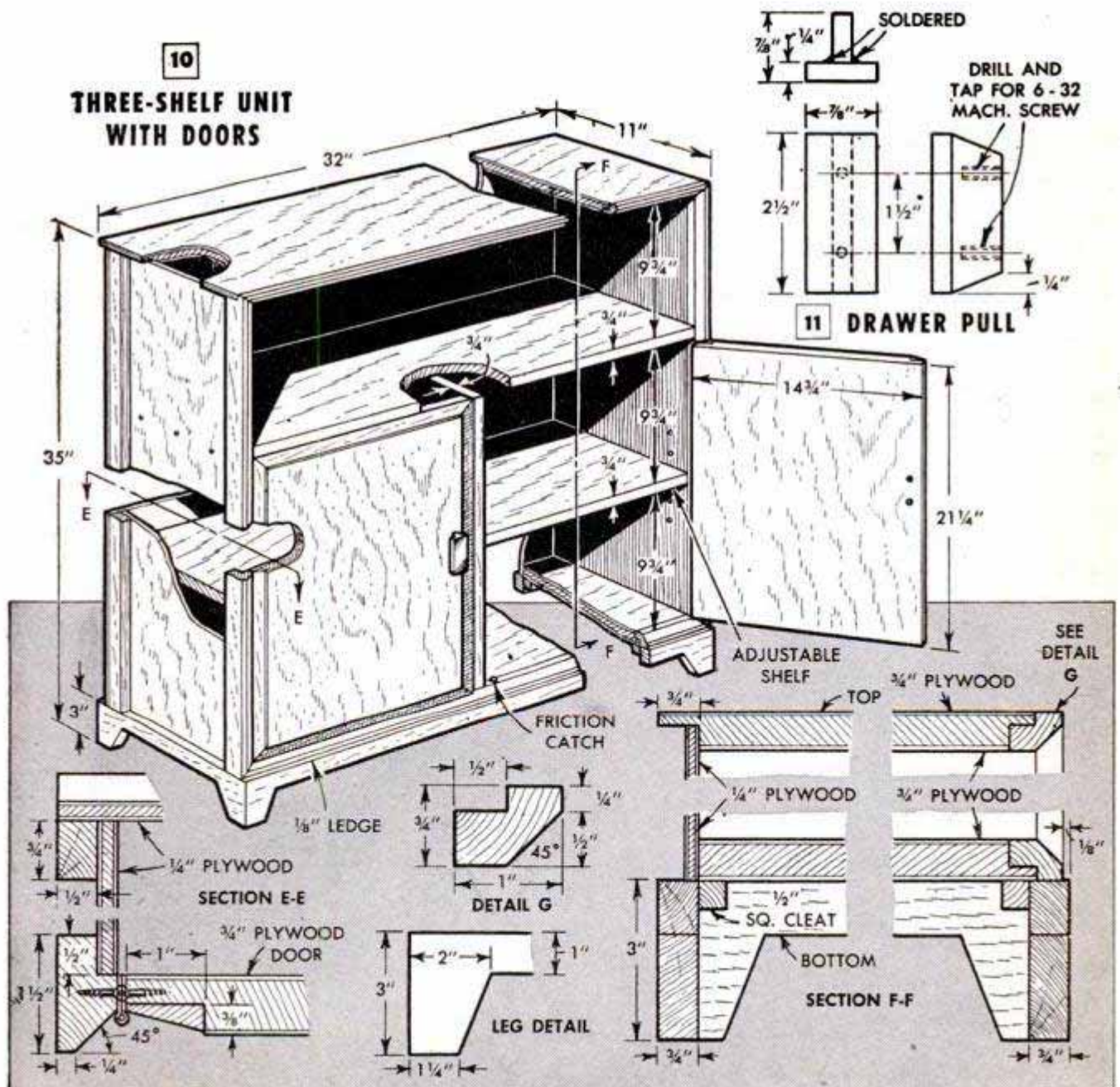
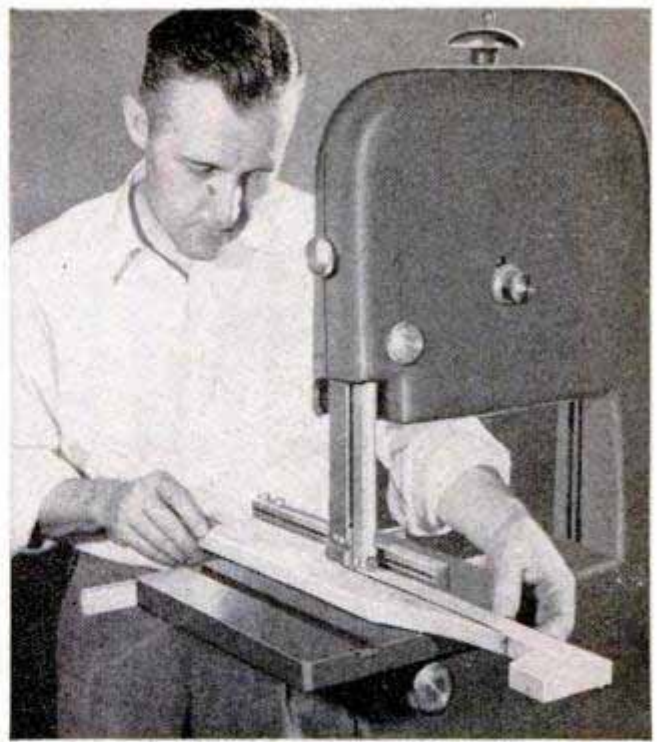

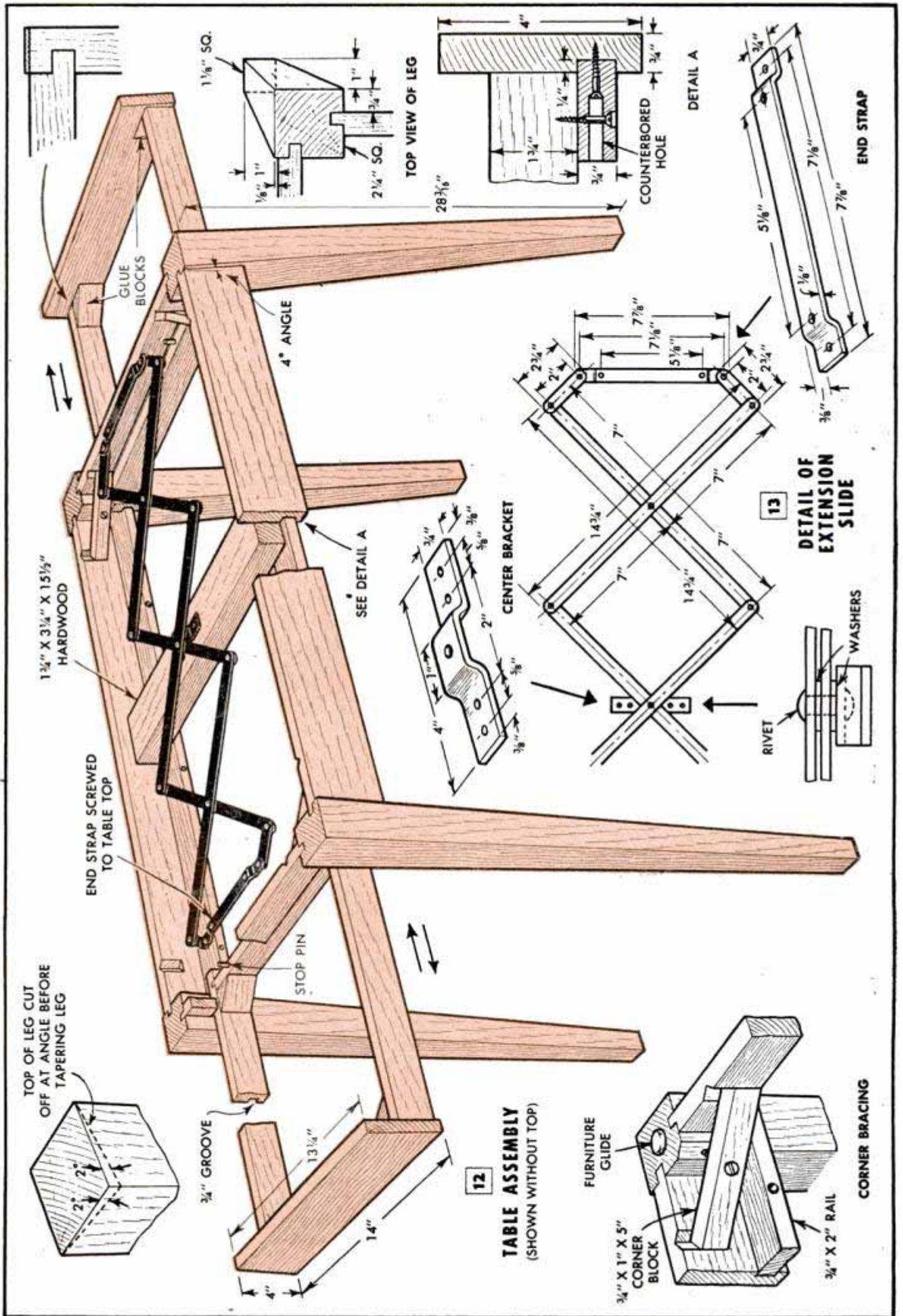

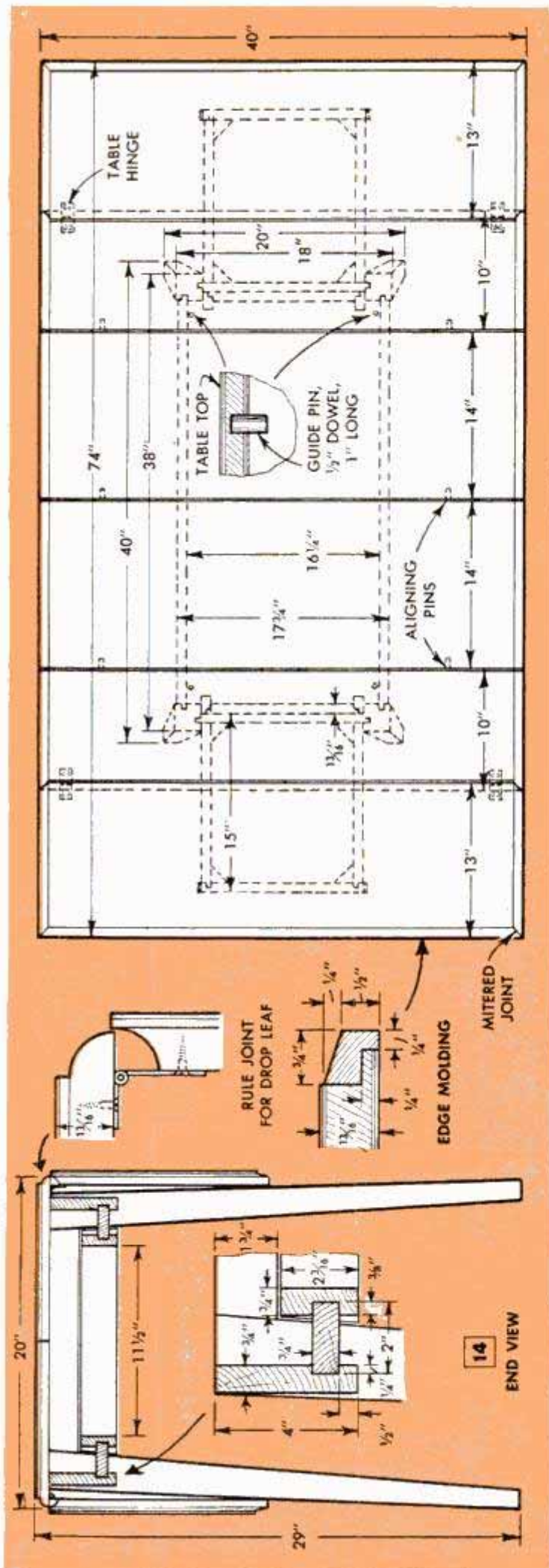

the plywood will have to be applied to the outside. Remember in cutting duplicate parts that the end units will have to be right and left-hand assemblies.

The three-shelf unit, shown fitted with doors in Fig. 10, can be made entirely open, in which case the partition is eliminated and the middle shelf brought out even with the one above it. The sectional details accompanying the cutaway drawing in Fig. 10 show how the 1/4-in.-plywood side panels fit in rabbets cut on the inner edge of the hopper edging.

The drop-leaf table, Figs. 12, 13 and 14, has flared, tapered legs which assume the correct slant by making a compound cut at the top and bottom. This is done before tapering the legs in one of two ways: Either set the miter gauge 2 deg. and tilt the saw table 2 deg., or, support the work horizontally on one corner and make the cut with the gauge set at 2 deg. and the table at 90 degs. Only the adjacent inner faces of each leg are tapered, as indicated in the top-view detail, Fig. 12. The leg tapers from a full 2 1/4-in. square at the top to 1 1/8 in. at the bottom. The two side aprons of the table are angle-cut to match the slant of the legs and the ends are rabbeted to fit open mortises cut in the tapered faces of the legs. Note in detail A that the side aprons are grooved along the lower edge to take strips on which the retractable end brackets slide. Half-width aprons are fitted across the ends of the table and then corner blocks are applied in the manner shown in the corner-bracing detail. Notice that a furniture glide is driven into the top of each leg to make the table top pivot easily. The pull-out brackets are made to slide under the end aprons and are corner-blocked for rigidity. A stop pin is provided at each side.

The lazy-tong extension slide is assembled from flat iron and riveted together as indicated in Fig. 13. This is pivoted to a center bracket which in turn is screwed to a hardwood center member installed between the side aprons. Each end of the extension slide is screwed to the underside of the two top leaves of the table. Fig. 14 shows an end view and a plan view of the table top including the two extra leaves. Outer edges of the plywood top are fitted with a mitered edge molding set in a rabbet, and a rule joint is run on the drop leaves for hinging them with regular drop-leaf hinges. When cutting the rule joints, be sure to allow sufficient clearance between the male and female members so that the joints will not bind after the finish has been applied to the surfaces. Note in the plan view that steel dowel pins forced in blind holes in the underside of the top align and guide the table top when extending it for inserting extra leaves.

Kitchen Knife Fashioned From Hacksaw Blade Handy for Peeling Vegetables and Sawing Bone

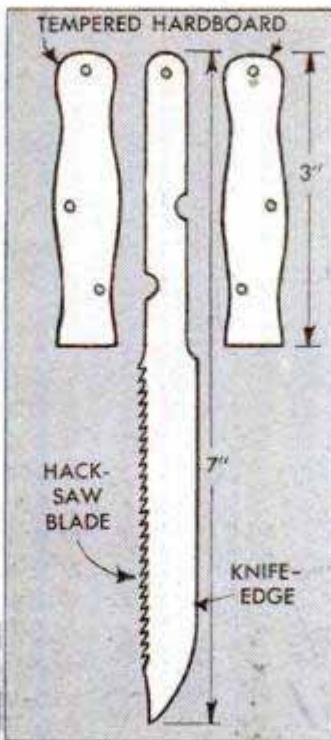

A real timesaver, this kitchen knife has both a keen cutting edge for vegetables or meat and a sharp, saw-tooth edge for bone and gristle. The knife is ground from a hacksaw blade and fitted with a handle of $\frac{1}{4}$ -in. tempered hardboard. A piece of hardboard is cut to fit each side of the blade and registering holes are drilled through both pieces to permit riveting them together. The edges of the hardboard are rounded and the ends of the rivets are ground flush with the handle. Finally, the crack between the handle sections is filled with plastic wood and the handle is shellacked.—J. Harley Hosack, Hartford, Conn.

Dowel Wound With Strip of Sandpaper Provides Efficient Spindle Sander

For removing saw marks and truing the edges of fine fretwork and small curved parts such as shelf brackets and ornamental scrolls, there's nothing quite as handy and efficient as a spindle sander chucked in a drill press. It is easy to make sanding spindles of varying radii by using ordinary dowels of different diameters up to $\frac{1}{2}$ in. Simply cut 6 to 8-in. lengths from the dowel rods, and drive a $1\frac{1}{4}$ -in. brad into one end of each length. Cut off the head of the brad and point the end. Then cut strips 1 in. wide and 8 to 11 in. long from fine emery cloth. Apply glue to the cloth back of each strip, wind it spirally around the dowel, and wind cord over the abrasive strip to hold it tightly in place until the glue sets. To use the spindle, insert the upper end in the drill-press chuck and tighten the jaws lightly. Clamp, or bolt, a square piece of

stock to the drill-press table and lower the spindle until the pointed brad is forced into the wood, then lock the spindle. The brad provides a bearing for the lower end of the sander. For sanding inside fretwork, just lower the sanding spindle within the area which is to be worked.

J. W. Jay, Palmyra, N. Y.

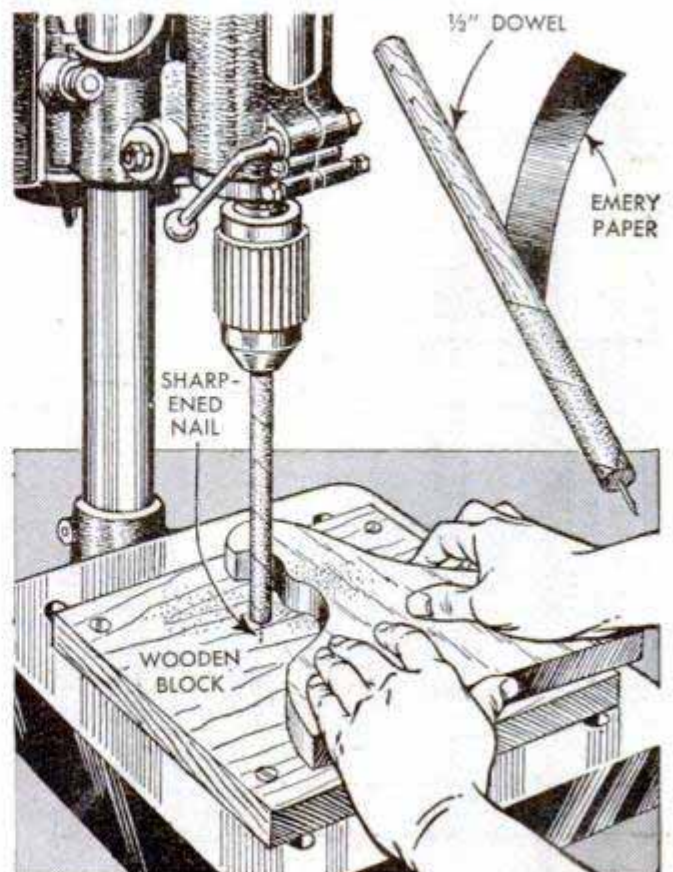

Asphalt Tile Cut in Saw Vise

After experiencing much difficulty in trying to cut asphalt tile to size with a saw, I did a faster and neater job by scoring the tile and breaking it off in a saw vise. After marking the tile, I clamped it in the vise with the edges of the jaws at the line. Then I scored each side of the tile, using the vise jaws as a straightedge, and broke the tile along the scores. Strips as narrow as $\frac{1}{4}$ in. can be cut in this way. If a saw vise is not available, extensions on a bench vise will do.—H. D. Wucher, Livingston, Calif.

Eight-Sided Cupola Improves Garage Roof Lines

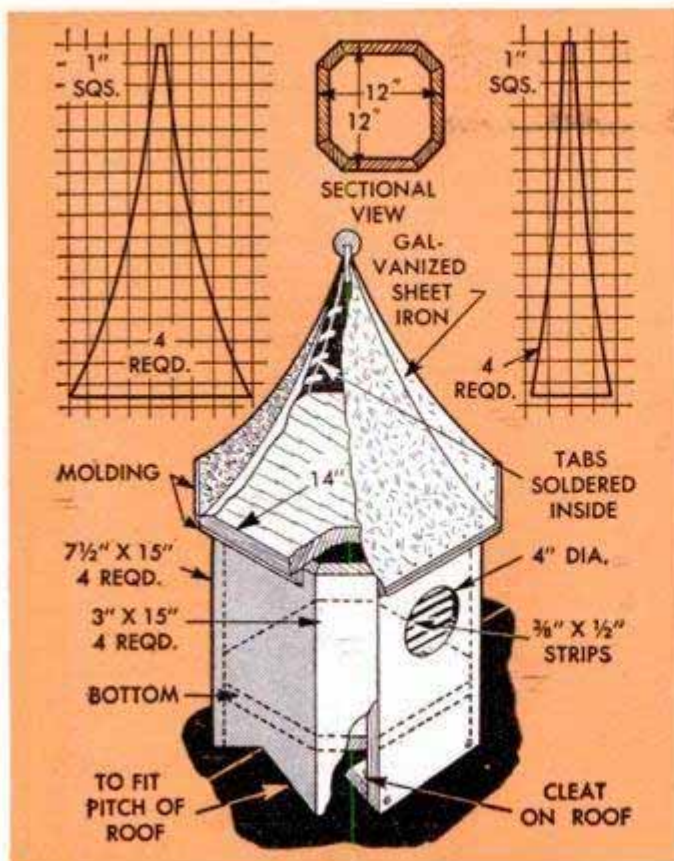

A cupola makes any gable-roofed garage easier to look at, for it "belongs," just as does a chimney on a house. As designed, this one is purely ornamental but, by making an opening in the roof on both sides of the ridge and flashing the joint around the bottom of the cupola when it is installed, it can be made to serve as a ventilator. If used as a ventilator, install two additional louvers. The cupola roof is made of sheet metal in the sloping "turret" type topped by a wooden ball. The crosshatched patterns show how to cut the roof parts and the cutaway view shows how the parts are joined by means of metal tabs sweat-sol-

dered across the joints. In the final assembly, the joints are seam-soldered to make them waterproof. Join the eight sides of the cupola with waterproof glue and clamp nails. Then nail a board over the top and shape it by sawing off the corners so that it overhangs the sides of the cupola 1 in. all around. Attach the roof to the board with small screws and finish with wood molding as shown. Cut the cupola sides to fit the roof pitch and attach to the ridge with cleats. Paint the body of the cupola to match the garage with the louvers in a contrasting color. The ball should be of the same color as the louvers.

Warped Boards Are Forced in Place by Using C-Clamp and Pry Bar

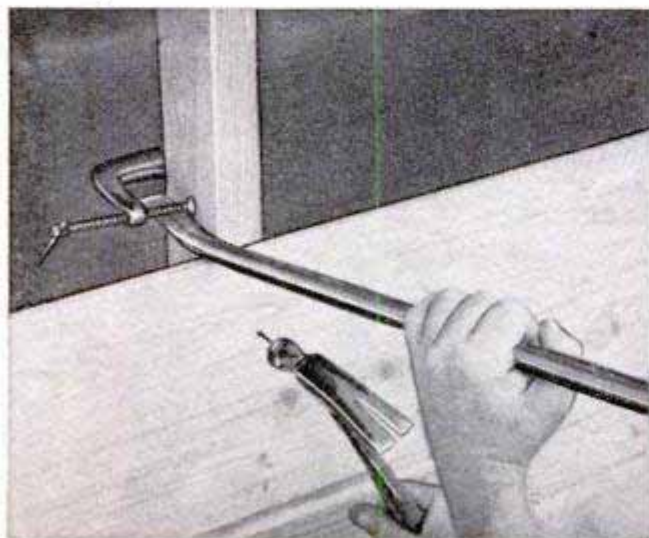

When laying flooring or applying siding or roofing, it is easy to force warped boards in place by using a C-clamp and a pry bar. The clamp is tightened to the opposite side of the stud or joist, as pictured, and the pry bar is hooked under it. The bar is pulled against the edge of the warped board to press the latter tightly against the preceding board, and the pressure is held while the warped board is nailed.

Charles Hedges, Clearwater, Fla.

☐ To prevent nuts from freezing on bolts as a result of rusting, dip the threaded end of the bolt in shellac before turning on the nut. The latter may then be removed at any future time without difficulty.

Home Repairs Pipe Held Securely in Bench Vise To Facilitate Threading



When doing plumbing work in the home, a bench vise frequently is the only method of holding pipe for threading. However, the pipe is likely to slip when the vise is not equipped with pipe jaws. One homeowner solved this problem when threading long lengths of pipe by using a block of wood and a C-clamp to keep the pipe from twisting. The pipe is clamped in the vise near the end to be threaded and supported by the block which is placed near the edge of the bench. Then the free end of the pipe is drawn down and clamped to the far end of the bench with the C-clamp. The block of wood should be about the same height as the vise jaws and positioned as close to the center of the pipe as possible unless, of course, the pipe is longer than the bench.—G. E. Hendrickson, Argyle, Wis.

Pencil Erasers Sheathe Fishhooks

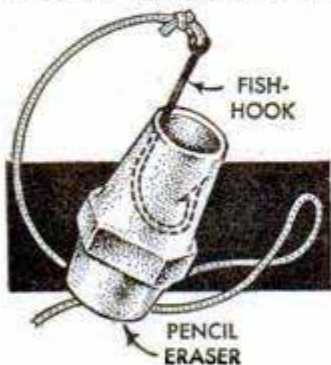

Fishhooks left on the line or carried in a pocket will not cause scratches or tear clothing if they are sheathed with erasers. The erasers are pliable enough to fit several hook sizes.

Safety Pin Locks Lunch Box

If the latches on your lunch box have a tendency to come open, resulting in an occasionally ruined lunch, lock them in the

closed position with safety pins. Just slip the arm of the pin through the lunch-box fastener so it keeps the latch from falling and then close the pin.

Victor H. Lamoy, Upper Jay, N. Y.

Coffee Can Forms Lamp Shade

Just the thing for an overhead shop light, this little shade is improvised from a 1-lb. coffee can and a standard lamp-shade fixture. A hole is cut in the bottom of the can and a fixture is soldered in place on the inside. Then, the shade is screwed onto the socket.

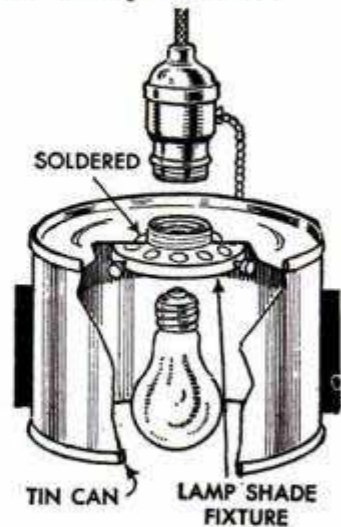

Preventing Ignition-Lock Trouble

The photograph illustrates a common reason for ignition-lock trouble—a heavy ring of keys dangling from the lock while the car is driven thousands of miles. In addition to damaging the lock itself, this practice causes a deep dent in the key which may result in the key failing to work in the car-door lock. It is easier on the ignition lock if you carry the key separately, keeping a spare one on the heavy ring if you like. At least twice a year, blow the dust out of the lock tumblers with compressed air. Then, dip the key in the finest graphite available and work the lubricant on the tumblers. This will insure dependable lock operation.—Ed Packer, Chicago.

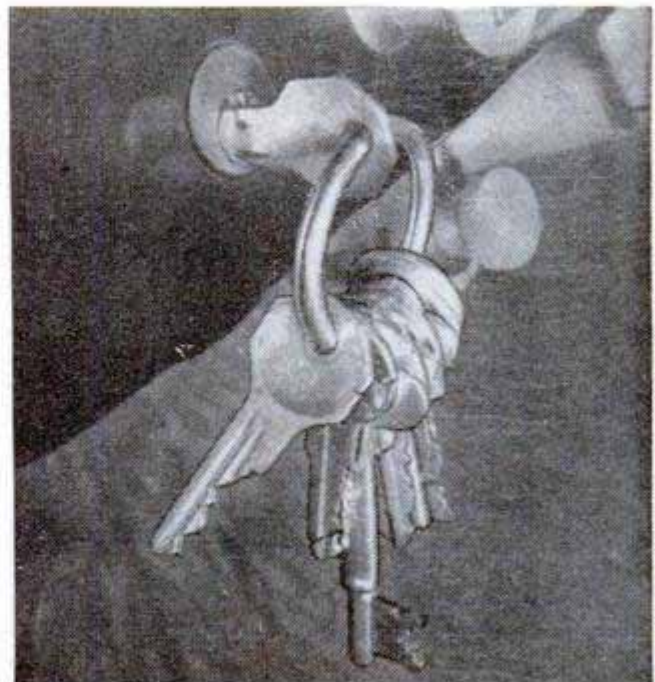

DOUBLE-PENCIL *Lettering*

INDIVIDUALIZED sign and price-tag lettering, in definition almost equal to letterpress printing, can be done by anyone after a few minutes' practice. It's as easy as writing except that you use two pencils held side by side with rubber bands. Study the sample alphabet of outline letters at the bottom of the page and you'll see how it works. Note that most of the horizontal lines coincide while the vertical lines are made double. On some letters it is necessary to tilt the pencils so that only one point touches the paper. After outlining the letters, spaces between the lines can be blacked-in by inking with a small brush.

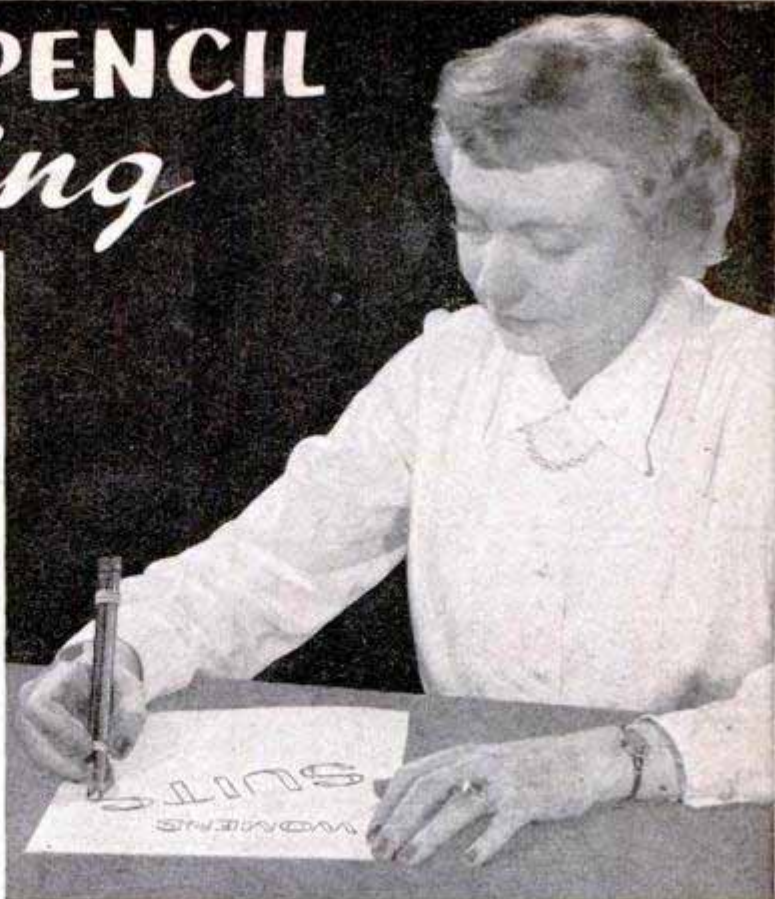

For exceptional neatness, use a ruler to make the vertical lines



Distance between pencil points can be varied to suit the size of letters



Black-in spaces between lines to produce neat, bold-faced lettering

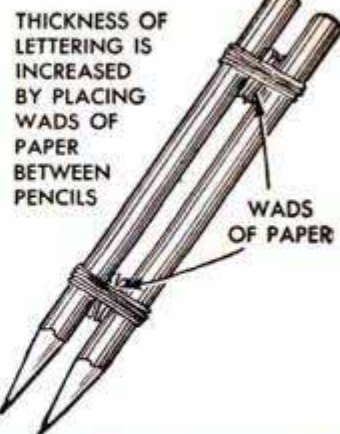

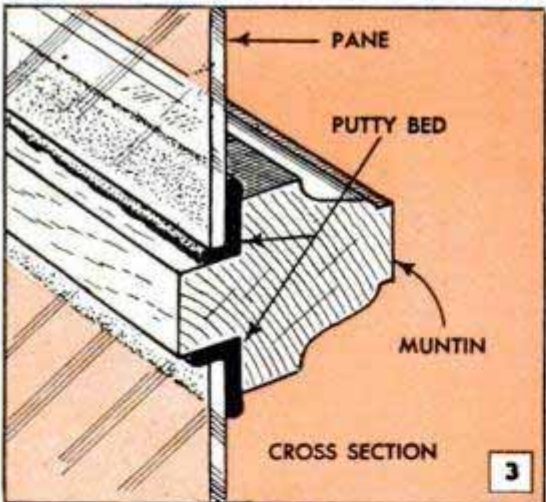
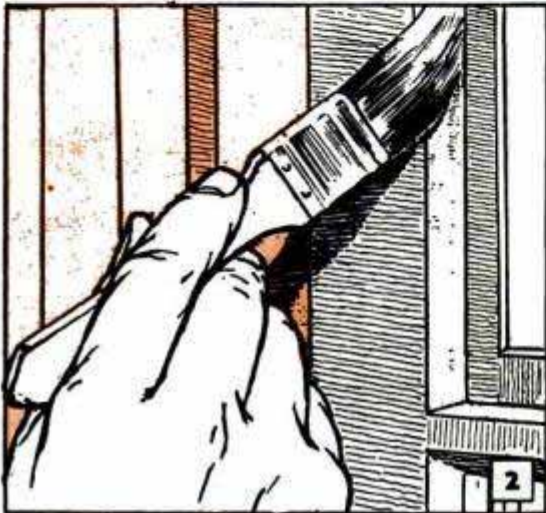
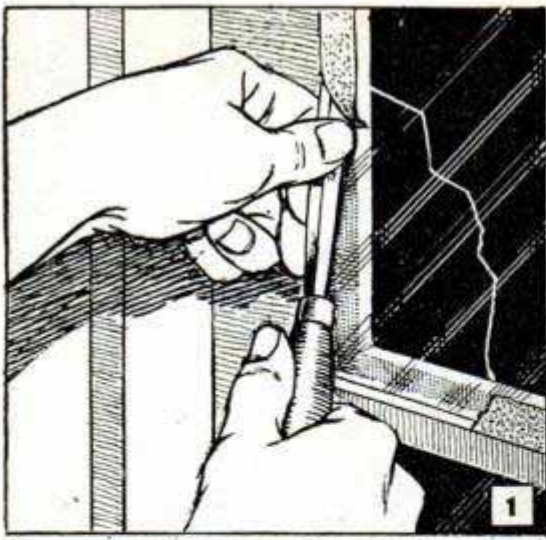

WINDOW

By E. R. Haan

IT'S AN easy matter to repair windows whether they're wood or metal, double-hung or casement, if you can determine what's wrong and apply effective remedies. Also, you can make substantial savings by replacing panes and sash cord yourself and fixing windows that stick or rattle.

Replacing broken panes: Measuring for a new windowpane and getting the repair materials can be done prior to removing the old glass and putty. The new pane should be about $\frac{1}{8}$ in. less over-all than the rabbeted opening in the sash. This allows a margin on each edge of the glass for irregularities and expansion. Precut panes are available in standard sizes at paint and hardware stores, or the dealer will cut the glass to suit. Ordinary window glass comes in two thicknesses—single strength (S.S.) for small panes not over 12 x 16 in. in size, and double strength (D.S.) for larger panes up to 36 x 48 in. The latter is used for all metal sash. There are three grades of window glass—AA, the best; A, intermediate, and B, least perfect. Always be sure to get the AA grade. Besides the glass, you will need glazier's putty. Dealers generally carry separate kinds of putty for wooden or metal sash. For wooden sash you will need No. 1 or No. 2 glazier's points. These are small, triangular pieces of sheet metal which hold the glass in place. Spring-wire clips are used to hold glass in metal sash, one end of each clip fitting in a hole in the sash while the other end bears against the edge of the glass.

The first step in replacing a pane is to remove the old putty. Use a putty knife or a chisel, as in Fig. 1, and be careful not to cut into the sash. Also

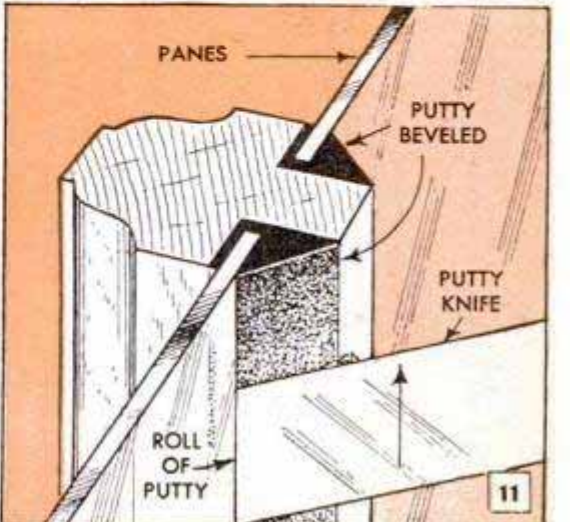
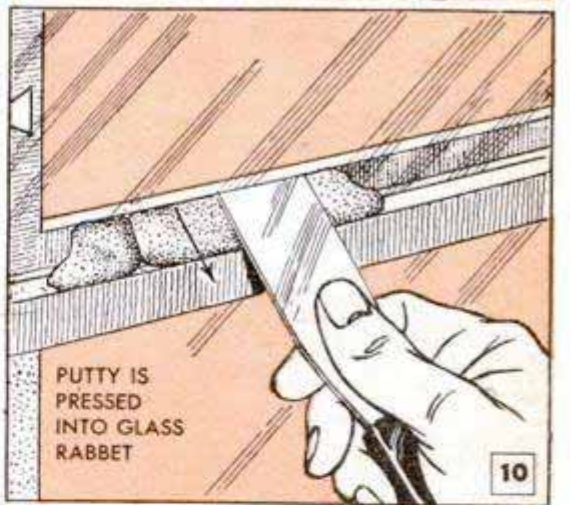
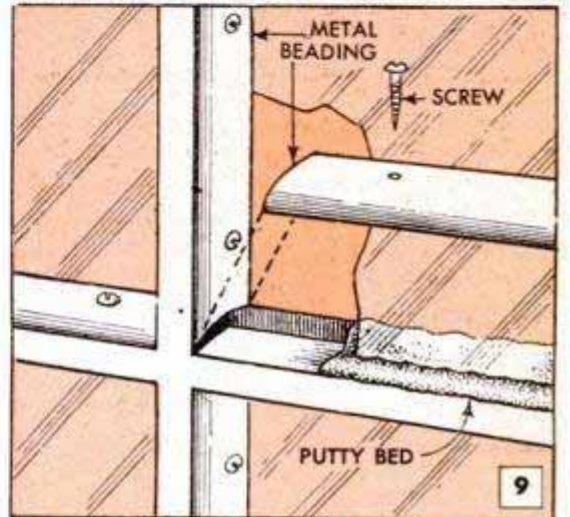
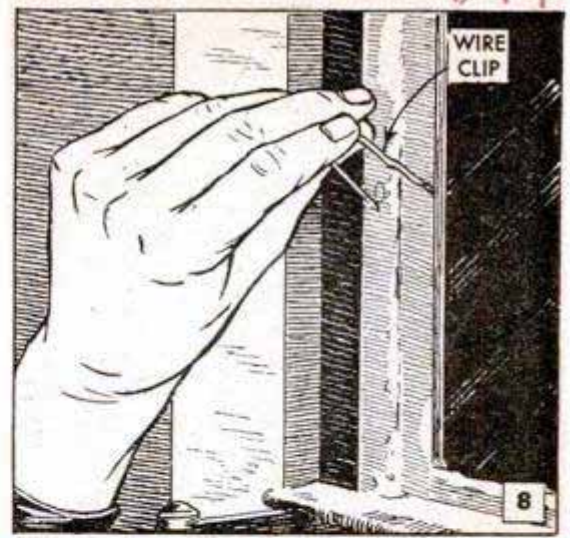

UPKEEP

remove all broken pieces of glass and the old glazier's points or spring-wire clips. On wooden sash the cleaned rabbet is given a thin coat of paint or linseed oil, Fig. 2. After the paint or oil is dry, spread a thin layer of putty in the rabbet to "bed" the glass as in Fig. 3. Press the pane down against it carefully until the putty starts to ooze out. Then, on wooden sash, lay glazier's points on the glass and tap them into the wood with the flat side of a chisel as in Fig. 4. They should be spaced about 4 in. apart. Drive them in just deep enough to hold the glass securely. On most types of metal sash, spring-wire clips are used as in Fig. 8, but some types have metal beading bedded in putty and fastened with screws, as in Fig. 9. In this case, the beading is unscrewed and scraped clean of putty, and then simply relaid in putty and screwed in place again. After applying glazier's points or wire clips to hold panes in place, apply putty to the outside edge of the pane. The putty is pressed into the glass rabbet as shown in Fig. 10 and then beveled with the side of the putty knife, Figs. 7 and 11. After a few days the putty is painted, and the painting is repeated about every two years to prevent weathering. Loose sections of putty should be replaced, as it is important to keep the putty intact and painted. Otherwise, water seepage into the joints of muntins and rails of wooden sash will cause the wood to rot.

Double-hung windows: Both sashes of a double-hung window, Fig. 15, should work easily, yet without excessive play that permits rattling. In raising a stiff lower sash, don't push upward with the palms against the narrow check rail, as in Fig. 5, because this may result in loosening or

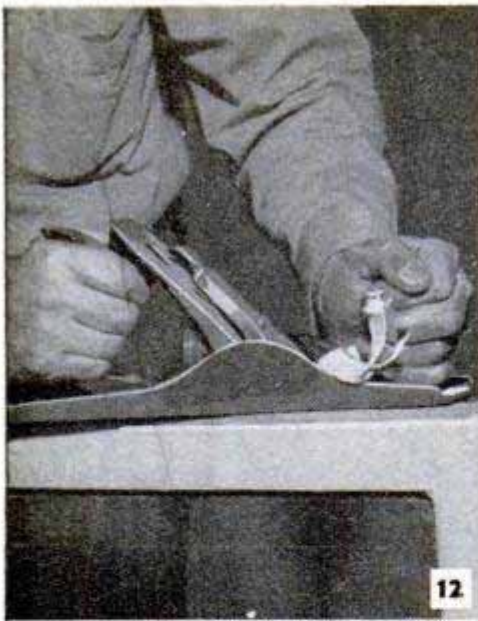

12



13



14

If waxing does not correct sticking sash, it may be necessary to reduce its width by planing. To remove sash, pry off stop bead on one side so sash can be swung outward. Use rag to protect casing as in center photo

breaking the rail. Fig. 6 shows the proper method of pulling on the sash lifts. All average-sized windows should be provided with two sash lifts instead of only one at the center. This permits using both hands to distribute the pull uniformly.

On double-hung windows the most common causes of sticking are swelling of the

wood and sealing of the sash to the stops with paint or varnish. Frequently, sticking due to swelling is cured by applying wax, paraffin or stick graphite in the sash channels, but if the trouble persists the cause must be corrected. Find out if the sash fits too snugly between the stop and parting strips, or fits too tightly between the sides of the frame, or both.

Sometimes it is necessary to remove the sash and reduce its width by planing, as in Fig. 12. A lower sash is removed by first prying off the stop bead on one side, Fig. 13, so the sash can be swung out as in Fig. 14. Next, the sash cord is removed from the groove in the edge of the sash. The knot may have to be pried out, Fig. 16, after which the weight is lowered until the knot rests against the pulley. Then the sash is pulled away from the opposite channel, Fig. 17, to remove the sash cord on this side and let the weight down. Plane off a minimum amount of wood and check for fit after each cut. To remove the upper sash of a double-hung window, the lower sash must be removed first, and then the parting bead between the upper and lower sash is carefully pried out of the groove.

If tightness of a sash is caused by insufficient clearance for the sash between the stop and parting beads, a little dressing with a file or sandpaper held over a block often provides relief. If not, the stop or parting bead may have to be removed and dressed down with file, sandpaper or a block plane. The stop bead that retains the

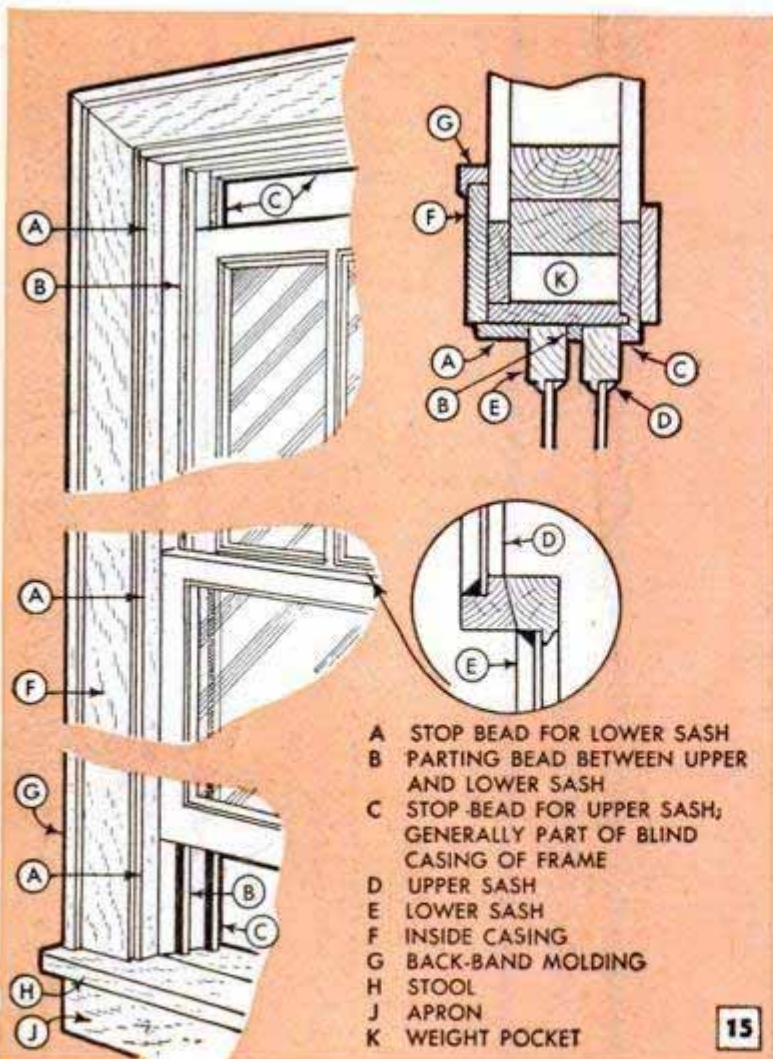

15



16



17



18

When one side of sash is free, remove cord and pull sash from opposite channel. Lower sash weights until knots rest against pulleys. Sticking caused by dried paint around sash can be corrected with point of sharp knife

lower sash can be shifted slightly to provide more clearance. When renailing it, the old nail holes should be avoided.

When sash and frame are stuck together by a film of dried paint, the film is cut by running the sharp point of a knife between the two as shown in Fig. 18. If the paint has run between the sash and frame it may be necessary to remove the sash so that the paint can be scraped or sandpapered. Another cause of tight sash may be that the window frames are thrown out of true by settling of the building. When moderate planing does not remedy the trouble, about the only alternative is to reset the frame so that it is plumb. This is a major undertaking similar to that described under the final paragraph entitled, "Replacing Wooden Sash and Frame."

Hard-to-work casement windows: When it is difficult to open and close wooden casement windows, the swelling of wood is often the cause. As a rule, light planing of each sash is the only sure remedy. Loose hinges, rusted hinges, or hinges out of alignment can make it difficult to open and close casement windows. Sticking also may result if the windows are closed after the sash and frame have been freshly painted. The framework of metal casement windows sometimes is forced out of true by settling of the building, making it almost impossible to open or close the sash. However, the fault may be in the closers which occasionally become hard to operate and require cleaning, oiling or adjusting. These devices usually are easy to remove, as shown in Fig. 19, and some of them are designed to operate without need of oiling. Oil the hinges periodically.

Rattling windows: On a double-hung window, rattling usually can be overcome

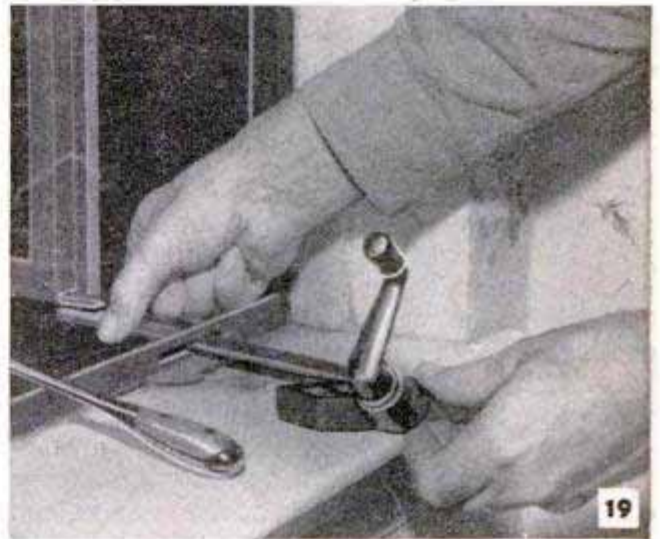

19

Crank-type openers on casement windows are easily removed for adjustment, above. Installing weather stripping in channel corrects rattling sash, below



20



Counterweights may be replaced with spring-type sash balances. These are installed in slots for pulleys, and metal tape is attached to hook on edge of sash

by installation of flat spring-type weather stripping in each sash channel as shown in Fig. 20. Sometimes a pane will rattle in a sash if the putty is loose or does not seal the pane. On wooden casement windows, the openers are often responsible for rattling. If these cannot be adjusted, new non-rattling openers should be installed. Metal casement windows usually have crank-type openers that hold the sash open at any desired angle without tendency to rattle.

Replacing a sash cord: Breakage of a

sash cord in double-hung windows, or stretching of the cord so that the weight comes to rest before the window is open entirely, are other common troubles. Spring-type sash balances of many designs are now used instead of counterweights. The kind shown in Fig. 22 fits in the sash channel, replacing the sash-cord pulley, and can be installed easily as in Fig. 21. When sash cord is to be replaced, remove the sash in the manner previously described. Each sash has two counterweights that raise and lower in weight pockets, detail K of Fig. 15. To tie new sash cord to a weight, the latter must be removed from the pocket through an opening in the frame, Fig. 23. If the sash channels have weather stripping, this is first removed to reach the weight-pocket cover. It is sometimes difficult to locate this cover but careful inspection should show its position. Ends of both cover and opening are beveled to make it fit flush. The cord is replaced with a new one of the same length, making allowance for knots at both ends. Use No. 7 braided sash cord. Tie a knot at one end and then run a length of furnace chain over the pulley and use this to pull the sash cord through. The two are tied together with fine wire as shown in Fig. 23. Cut the broken cord from the weight, and tie the new one to the weight with a bowline knot as shown in Fig. 24. Set the weight in the pocket and insert the other end of the cord into the sash groove. Then replace the sash.

Leaky windows: Stains seen under a window sill often are caused by water driven into the joints during a driving rain-storm. A well-made window frame, such as the one shown in Fig. 25, which is the

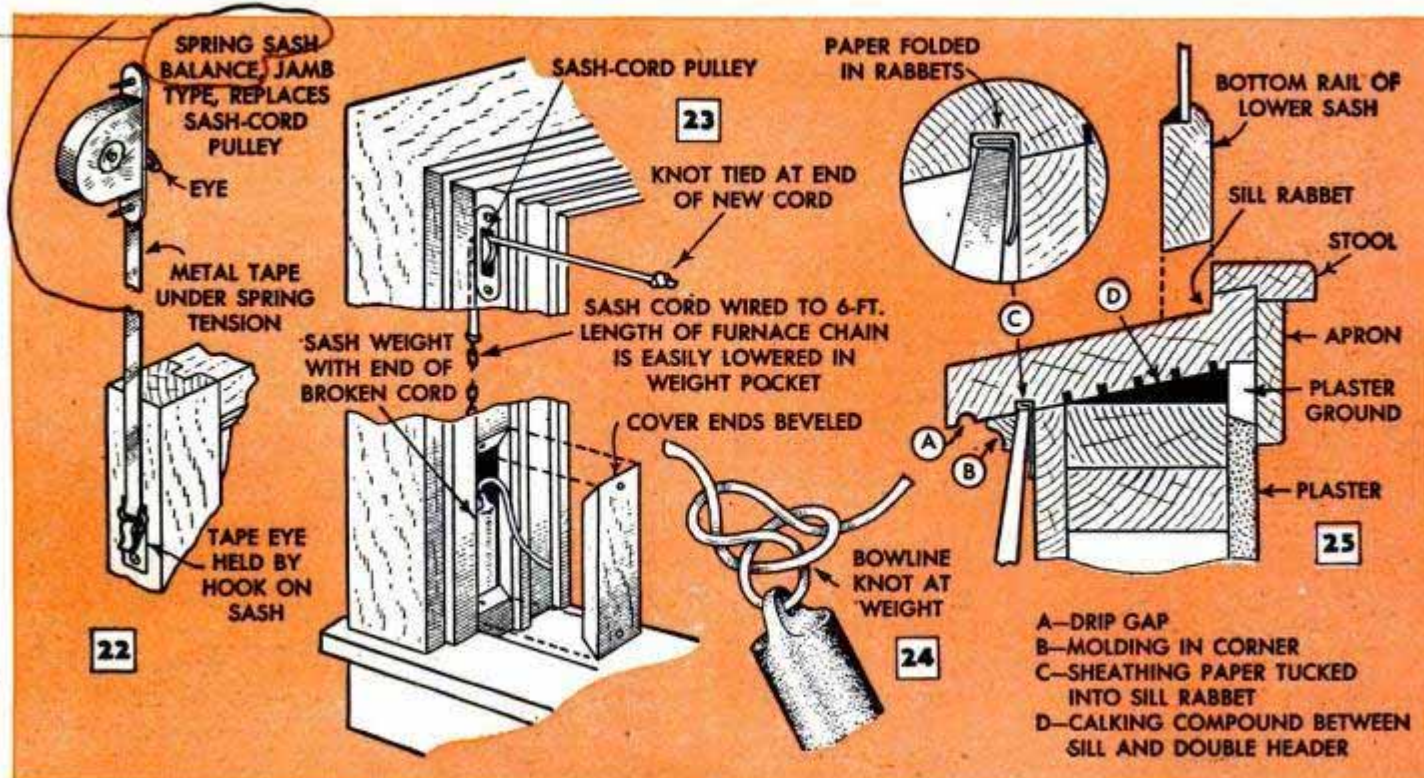

see Thomas; Balance - Sash.

type used on frame construction, has adequate provisions to prevent the entrance of water. These antileak devices include a drip gap A, on the underside of the sill, molding B applied in the corner between the sill and the siding, asphalt sheathing paper tucked into the mortise cut in the underside of the sill to take the siding, as in detail C, and calking compound used generously to fill the space between the sill and the double header under the window as indicated by D. If a window sill has no drip gap, one can be cut by hand with a narrow gouge. This may be held on a block of wood to form an improvised rabbeting plane. A piece of molding, embedded in calking compound, also can be tacked into the corner, as in B, Fig. 25. In brick construction, where wood sills rest on bricks or stone, any space between the two should be calked.

Figs. 26 and 27 show the cross-sectional views of the head and sill of an inferior window frame. Lack of sheet-metal flashing over the drip cap at the head, or a defective flashing, may be the cause of leakage. When installing new flashing, it should be allowed to extend over the edge of the drip cap as shown in the insert. Also, the pieces that comprise the double header in Fig. 26 should have been set on edge for greatest structural strength, instead of laid flat. The latter method is less resistant to sagging. Note also that in this inferior construction the top of the sill is not rabbeted to fit snugly against the bottom rail of the sash. Rabbeting at this point helps prevent the entrance of water in a driving rain. In addition, there is no drip gap on the sill and no molding or calking



Outside joints between window frames and walls are calked to prevent leakage of air and moisture. Calking should be checked annually for tightness

under it. Sometimes, particularly with inswinging casement windows, which are likely to leak under the sash, a drip gap is cut in the lower edge of the sash, as shown in Fig. 28, A. An alternative measure is to provide a length of drip molding on the lower outside edge of the sash, as shown in Fig. 28, B. If molding is used, it is laid in calking compound before being fastened down with screws or nails. All joints between window frames and walls where leakage is possible should be calked, using a gun as shown in Fig. 29. Calking on windows should be checked annually to see if any of it has shrunk or pulled away, in which case it must be renewed.

Replacing wooden sash and frame: When the lower sash of a wooden window starts to decay at the bottom rail, about the only remedy is to replace the entire sash. Remove the old sash and install another one of the same size. When necessary to replace an entire frame and sash, first remove the old sash. Then take off the inside trim which includes the casing, stool and apron. Next, pry off the outside molding under the drip cap at the head, and under the sill. Follow this by removing the outside trim. Then it should be possible to loosen the frame by prying and hammering. A new frame, the same size as the old one, is slipped into place from the outside. Use a level to assure that the frame is perfectly plumb before nailing it in place. Small wooden blocks can be used to support the frame while nailing it. The outside trim is applied next, and then the inside trim.

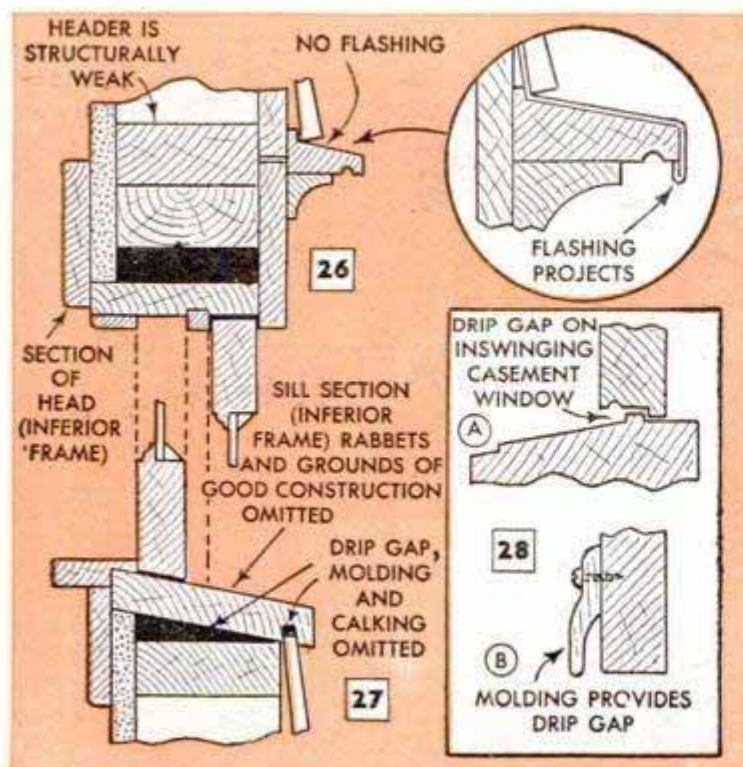

Door Held During Lock Fitting By Sand-Filled Sack

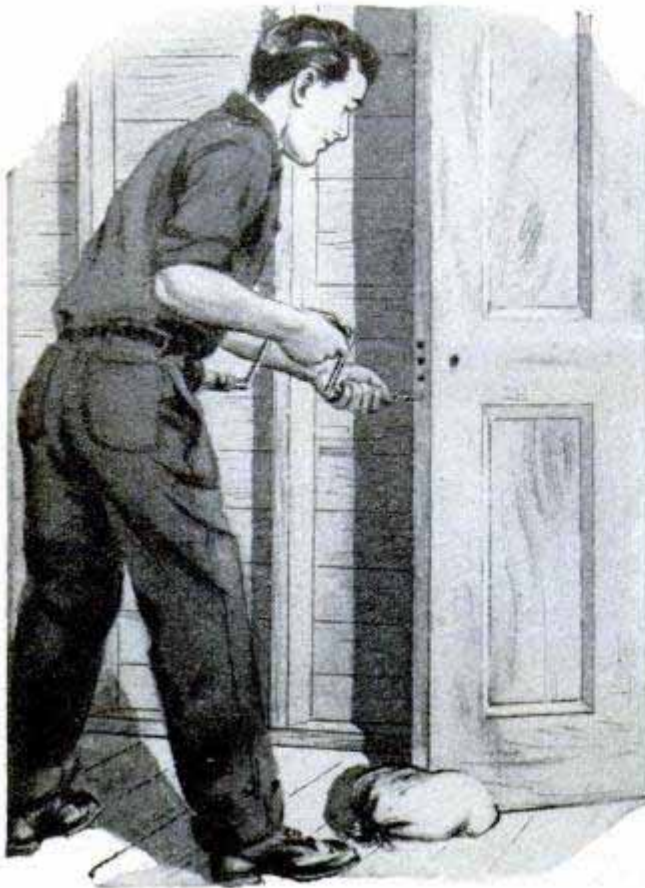

A cloth sack filled with sand or damp soil provides a convenient anchor to hold a new house or garage door steady when cutting the mortise for the lock. Any tightly woven bag, such as a sugar sack, will serve the purpose, and the idea is especially useful where a wooden wedge under the door would mar the finish of a hardwood floor.

Extension Handle on Car Heater Aids Turning Control Knob

If your car is equipped with a gasoline-burning heater located so that the control knob is difficult to reach from the driver's seat, a short extension handle fastened to the knob will facilitate regulating the heat-

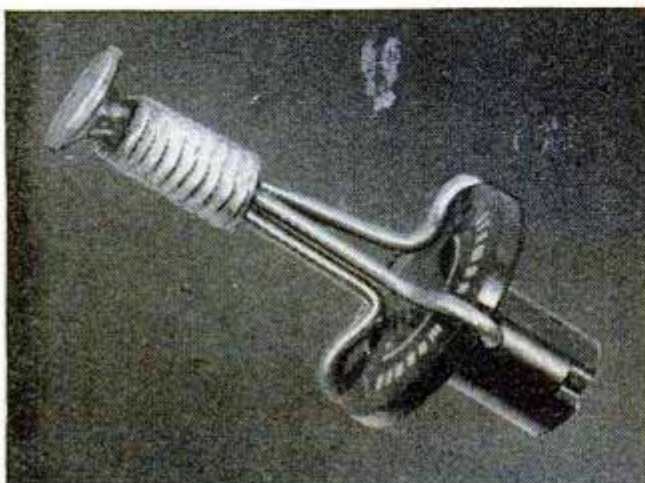

er. The extension can be made quickly from three lengths of heavy wire. Coathanger wire will do nicely. Measure the length of extension required and then cut the wire about 1½ in. longer. After removing the control knob from the heater, file three notches in the edge of the knob, making them about ⅛ in. deep and 120 deg. apart. Bend the ends of the three wires to grip the notches, as shown in the photo, and bind the wires together with heavy, soft copper wire, sweat-soldering it in place. A decorative knob or a plain washer is soldered to the end of the extension to serve as a handle.

Milk Carton Holds Patching Plaster

To save the trouble of cleaning hardened plaster from a pan or pail, mix small amounts of patching plaster in a quart-size milk carton. Cut one side from the carton as shown by the dotted lines in the drawing and discard the container after the job is finished.

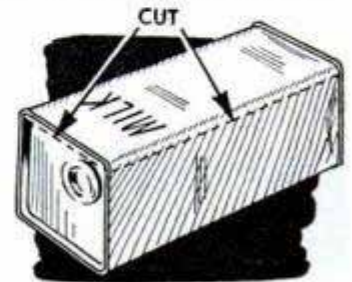

J. Rafalow, Selden, N. Y.

Metal Clips Screwed to Toy Provide Wheel Mounts

Small wheels for toy trucks and trains are easy to assemble and remove if they are mounted with Fahnstock clips. The clips, which are obtainable in most radio-parts stores, are simply screwed to the underside of the toy. Escutcheon pins or nails are inserted through holes in the wheels to provide axles, washers being placed between the wheels and the clips.



R. W. Kainulainen, Spokane, Wash.

Clock Gears Used in Craftwork

Large gears taken from old alarm clocks are useful items for the home craftsman. Grinding or filing the teeth sharp and fitting the gear with a simple handle is a quick way of improvising a tool for serrating paper. The gears also form suitable hole spacers for leatherwork and decorating tools for homemade pottery.

Neal Houlahan, Glenshaw, Pa.

Weighted Toy Clown Swings Precariously on Rail

A flick of the finger starts this funny clown swinging merrily back and forth on his uncertain perch. To make the toy, cut the clown from sheet metal according to the squared pattern and paint it in bright colors. The base, which is a piece of plywood or sheet metal, supports two dowel uprights fastened with screws driven from the underside. A sheet-metal or plywood crossbar is attached between the uprights. If sheet metal is used for the crossbar, drill two holes for the sheet-metal pivot member or, if the bar is of plywood, countersink two depressions for the pivot and drive a small carpet tack in the bottom of each depression to reduce friction. Slot the pivot and the clown, as

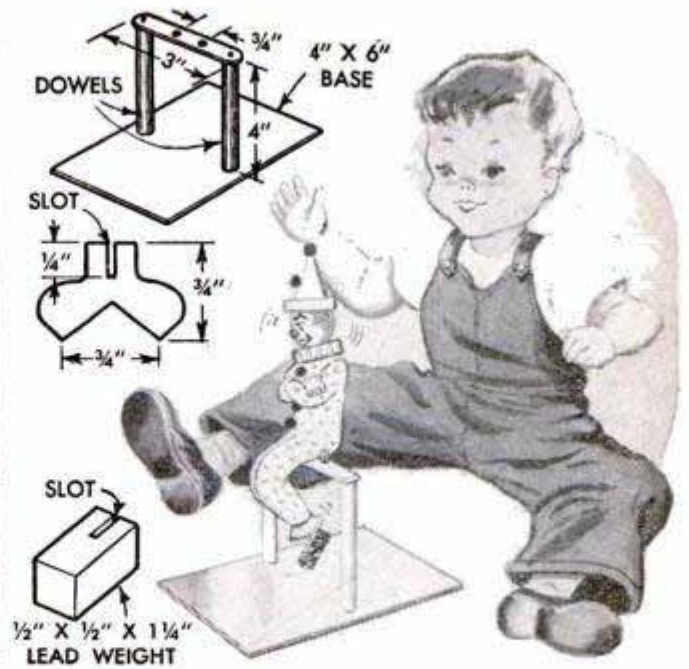
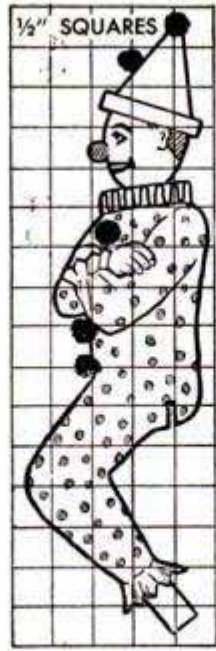

shown, and solder them together. Then, slot a lead weight and squeeze it tightly over the end of the clown's leg.

Rudolph G. Kopp, Milwaukee, Wis.

Wooden Arrow Inserted Through Heart Provides Bewildering Puzzle

It looks impossible but there it is—a solid wooden arrow with both head and tail $2\frac{1}{4}$ in. wide inserted through a 1-in. hole in a heart also cut from solid wood. It's a trick that will keep your friends guessing for some time. The secret is in using basswood which becomes resilient when soaked in water. First, cut out the arrow and heart from $\frac{1}{2}$ to $\frac{3}{8}$ -in. basswood as shown in the detail, making the shaft of the arrow slightly under 1 in. wide. Chamfer the edges of the arrowhead and hole slightly to facilitate pushing the arrow through. Then soak

the arrowhead in water for a few hours or overnight if desired, but no longer, as the basswood will turn black. Squeeze the arrowhead in the jaws of a vise, allowing the tip to extend slightly above the jaws, and by twisting and pressing firmly, work the heart down over the arrowhead. Raise the arrowhead up a little, squeeze in the vise again, and press the heart farther down, repeating the procedure until the arrowhead is completely through the hole in the heart. Do not use a mallet or hammer to force the parts together. Instead, work them together by hand. Soak the arrowhead in water to help it return to its original shape. Whittling rough chamfers along the edges of the heart and arrow will hide any bruises left on the wood. However, be careful not to change the diameter of the hole or the width of the arrowhead and tail. Should the $2\frac{1}{4}$ -in. width be too difficult to push through the 1-in. hole, trimming the arrow to a maximum width of 2 in. will give the desired effect more readily.—H. Simermeyer, New York City.

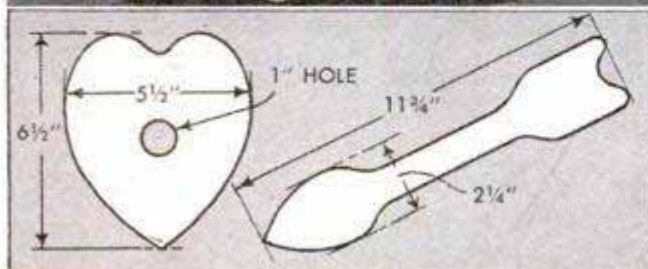

Removing Gum From Shoe Soles

To clean chewing gum from the soles of shoes, first remove as much of the gum as possible with a wad of absorbent cotton soaked in hot water. Then, saturate another cotton wad with turpentine and briskly rub off the remaining gum.

TIRE CARE

By Phil Ruskin

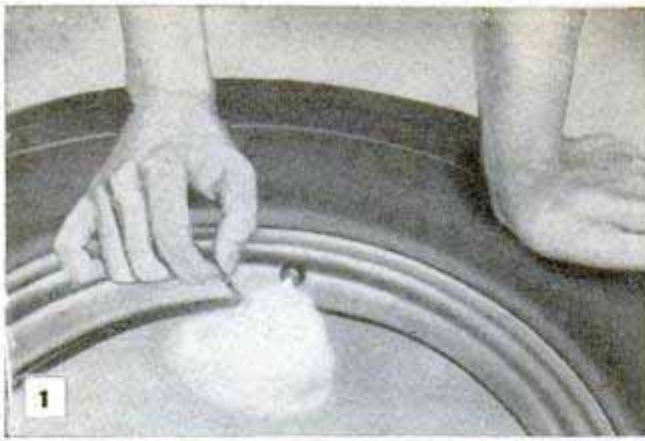

1 First step in removing a tire from the rim is to deflate tube completely by removing the valve core

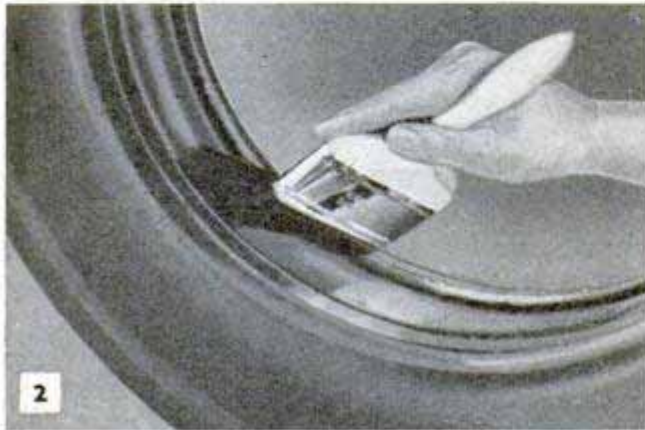

2 Before remounting the tire, coat beads with a vegetable-oil soap. Do not use lubricating oil or grease

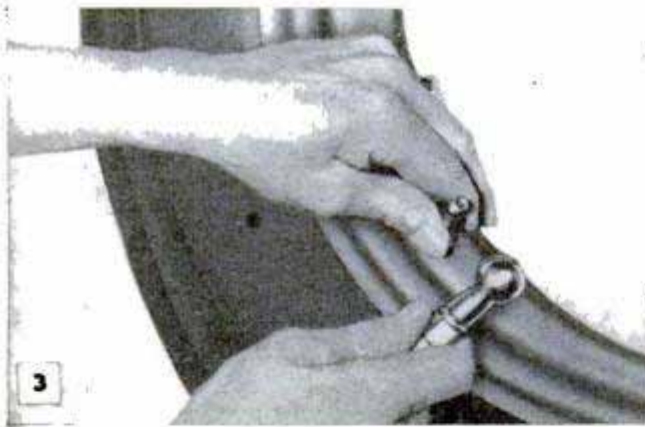

3 After remounting on the rim, inflate the tire to seat the beads tightly against the rim flanges

SUBSTANTIAL savings in yearly car operating costs can result from a careful inspection of your tires at regular intervals. Underinflation, neglect of minor damage and faulty wheel alignment are the common causes of excessive tread wear and early breakdown of casings and tubes. Careful drivers keep a close watch for improper tire inflation and make periodic examinations of the treads to discover embedded glass or nails and to locate and repair cuts, bruises and oil spots before they can do any real damage. The pay-off for these simple precautions comes in greatly increased tire mileage, maximum safety and the minimum of road trouble. Tires should be inflated at regular intervals to the exact pressure recommended by the manufacturer. To prevent slow deflation when on the road or when the car is standing in the garage, keep a careful check on the condition of the valve cores and caps, particularly on older tires. Renew valve cores that show any tendency to leak, and always be sure, after inflating the tires to the correct pressure, that the valve caps are screwed on snugly. Inspect the caps each time they are removed to see that the gaskets are in good condition.

It's no trick at all to dismount and remount a tire on a drop-center rim—if you know how. First of all, deflate the tube as low as possible by pressing on the valve stem with a small screwdriver or other pointed tool. Then deflate completely by removing the valve core, Fig. 1. Loosen the beads on both sides by inserting a tire tool under the edge of the rim and exerting downward pressure to force the bead into the drop center. Coat the casing beads with a vegetable-oil soap (never use lubricating oil) to make removal of the beads over the

TO CHECK TIRE FOR CORRECT INFLATION, NOTE CONTACT OF TREAD WITH ROAD. ALSO NOTE THE RELATIVE AMOUNT OF BULGE OF TIRE SIDEWALLS. USE AIR GAUGE AND INFLATE TIRE TO EXACT PRESSURE RECOMMENDED BY THE CAR MANUFACTURER

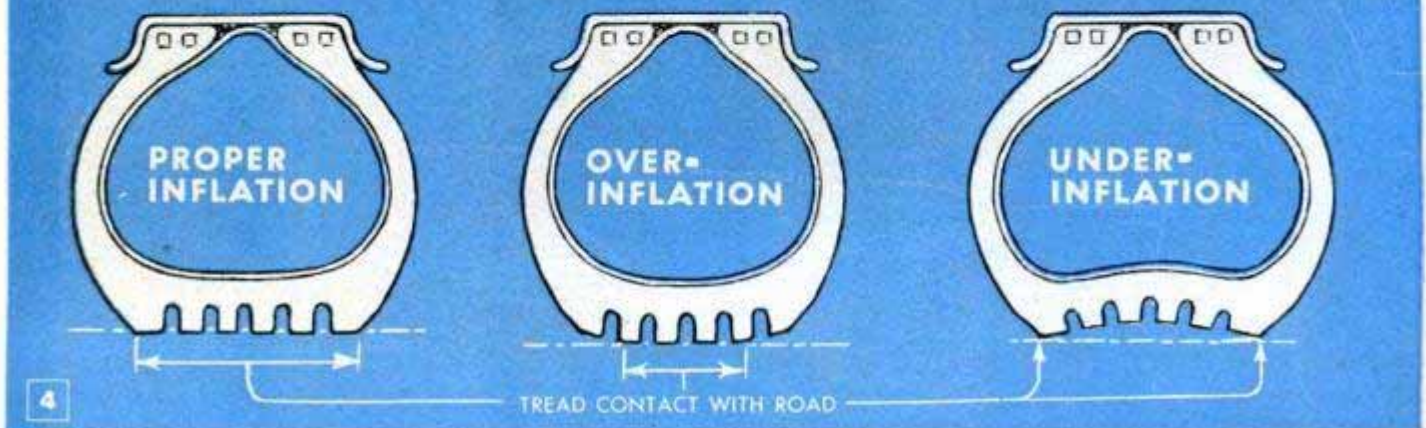

MEANS LONG WEAR

rim flange easier, Fig. 2. Pry one bead over the flange, using two tire tools alternately. At this stage make certain that the valve body has been pressed out of the hole in the rim. Then turn the wheel over and force the other bead off the rim. To remount the casing and tube on the rim, inflate the tube slightly and insert in the casing. Position the tube so that the valve registers with the red dot on the sidewall. Place the casing and tube on the rim and insert the valve body through the hole in the rim. Then force one bead over the rim flange into the drop center. Be careful in this step that the tube is not pinched between the bead and the rim and damaged. Then force the other bead over the rim flange with tools. Inflate the tire slowly to center and seat it on the rim, Fig. 3. When the casing spreads under pressure and both beads seat firmly against the rim flanges, deflate the tube completely, then reinflate to the recommended pressure.

Fig. 4 shows graphically why proper inflation is of the greatest importance. Always test the tire pressure when the tires are cool. As shown in Fig. 4, overinflation causes rapid wear in the center of the tread. It places excessive strain on both casing beads and sidewalls and lessens the ability of the tire to resist cuts and snags and also breaks due to severe impact. An overinflated tire has less resiliency, and restricted tread contact with the road surface means reduced traction and less resistance to skidding. On the other hand, underinflation is the cause of excessive wear on the shoulders of the tread. When the car is driven at moderately high speeds the tires heat up fast and the excessive bending of the sidewalls at the point where the tread meets the road results in ply separation and rapid breakdown of the sidewalls. Figs. 5 and 6 show what happens when a small impact break is neglected.

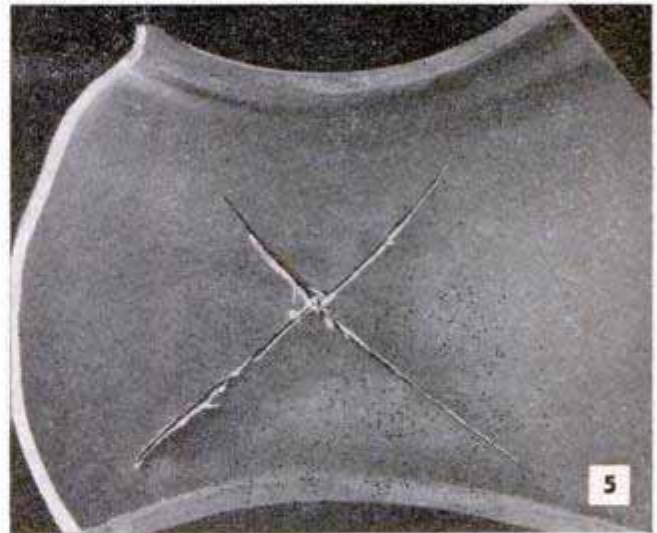

An impact break gradually enlarges to a crisscross pattern. At this stage the tire may "blow" any time



A bad blowout often tears away a portion of tread, exposing cords and making a major repair necessary



Small cuts won't cause immediate tire failure but in time dirt and water will work into the casing and will rot the cords, causing the plies to separate

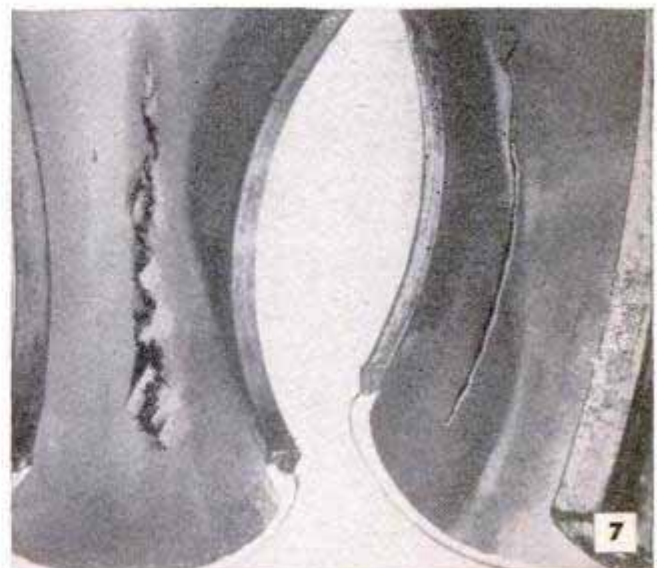

Running with soft tires causes long, irregular breaks in the tread and also in the sidewalls of the casing. Often casings in this condition are not worth repairing



Faulty wheel alignment, worn wheel bearings or a broken spring can result in uneven tread wear

A typical example of excessive wear on the tread shoulders due to underinflation. Note the ridged tread

Too much toe-in or faulty camber adjustment is the usual cause of rapid side wear of the tire tread

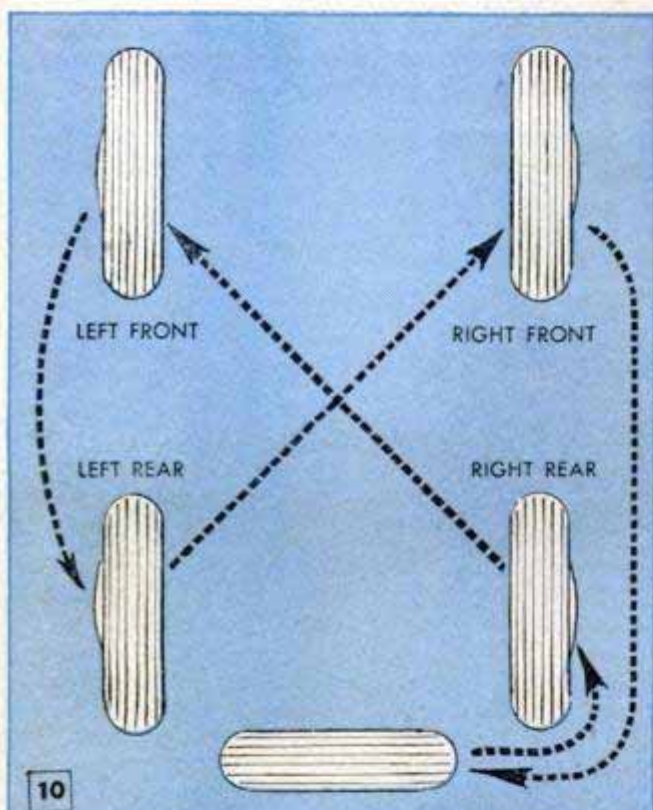

10

TIRES SHOULD BE SWITCHED AT LEAST TWICE A YEAR TO UTILIZE SPARE TIRE AND ALSO TO EVEN UP WEAR BY REVERSING DIRECTION OF ROTATION OF THE TIRES

The break gradually enlarges to the criss-cross form shown in Fig. 5. This pinches the tube, resulting in an eventual break. Air seeps through the break into the cord body, causing a bulge or "blister" to form. Sometimes the entire tread is blown off as in Fig. 6. In Fig. 7 the open casing at the left is a typical example of damage resulting from underinflation. The sidewall break shown at the right in Fig. 7 is another result of running with "soft" tires. Small cuts like that shown in Fig. 8 won't cause immediate tire failure, but in time dirt and water will work into the casing and rot the cords, causing ply separation.

Driving habits have a direct effect on tire mileage. Fast getaways, fast driving on the turns and squealing stops are especially ruinous to tires. Such practices not only grind rubber off the treads, but place severe strains on the entire structure of the casing and tube. The careful driver avoids bumping or scuffing against curbs when parking, driving rapidly over obstructions and driving at high speeds on rough pavement or unsurfaced roads.

The three views in Fig. 9 show what happens to tire treads when the car is driven

TYPICAL WHEEL-ALIGNMENT CHART SHOWING THE VARIOUS SETTINGS

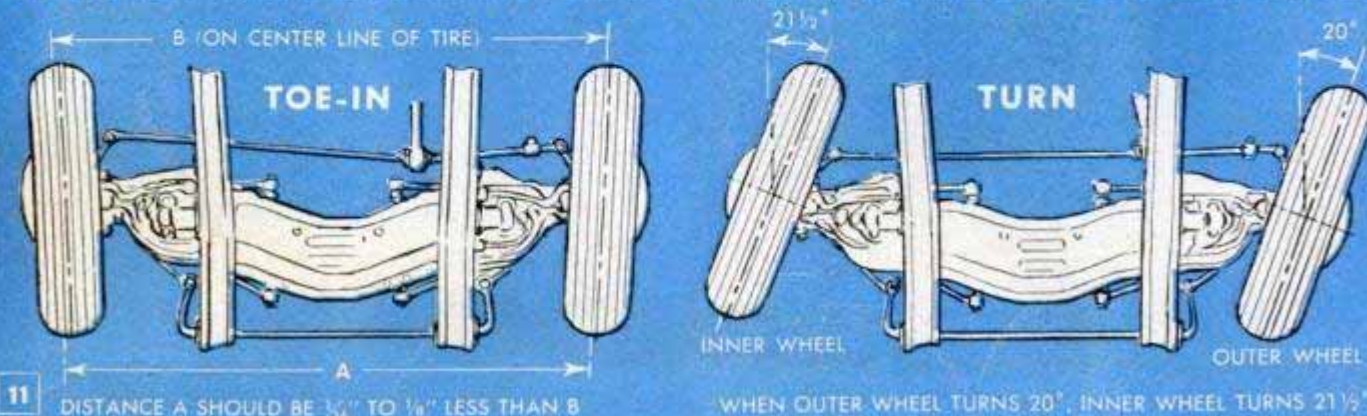

11

with faulty front-wheel adjustment. Worn wheel bearings, a bent axle, too much camber or caster and a broken or weak spring can cause the type of tread wear shown at the left. Wheel misalignment plus underinflation can cause the excessive wear on the shoulders of the tread as pictured in the center view. Faulty alignment plus too much camber is a cause of the excessive side wear on the tread shown in the right-hand view. Wheels should be aligned according to the general recommendations in Fig. 11 and the adjustment checked periodically. Also the tires should be switched regularly on the wheels as in the chart, Fig. 10. The condition of brakes, springs and shock absorbers affects tire wear materially. Brakes that grab on application, or that lock one wheel, will cause rapid tread wear on the tires that are affected. Keep the brakes correctly adjusted and shock absorbers and springs in good condition.

Static and dynamic wheel balance also figure in the mileage you get from your tires. Correct static balance eliminates pounding, Fig. 13, while dynamic balance prevents sidewise wobble, or "snaking," and keeps the wheel rolling in a straight path. Both static and dynamic unbalance are eliminated by the use of wheel weights, Figs. 12 and 14. Wheel balancing is a job for the service shop having equipment made especially for this purpose. After the wheels have been balanced by the use of weights, they should be checked periodically, as normal tire wear may shift the point of balance in time.

Retreading of tires can be recommended as an economical and safe practice when the casing is still in good condition, without any major breaks. If the job is correctly done, using good materials, the usable life of the casing can be extended as much as 50 percent. Minor cuts or breaks in the sidewalls and treads usually can be satisfactorily repaired by vulcanizing before the tire is retreaded. Always install a new tube in a retreaded casing, even though the old tube appears serviceable.

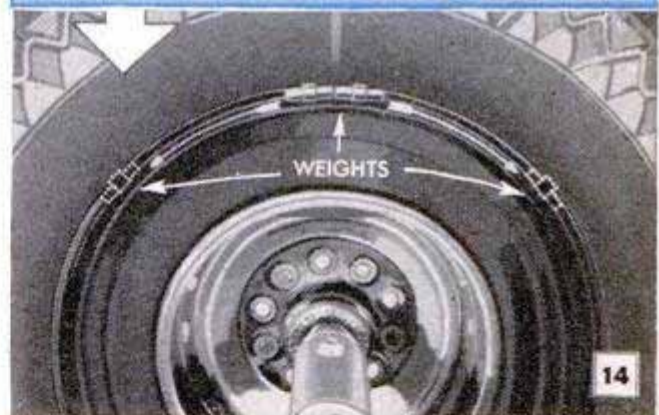
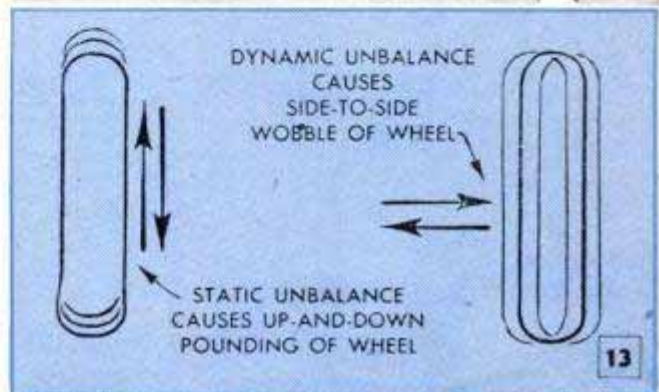
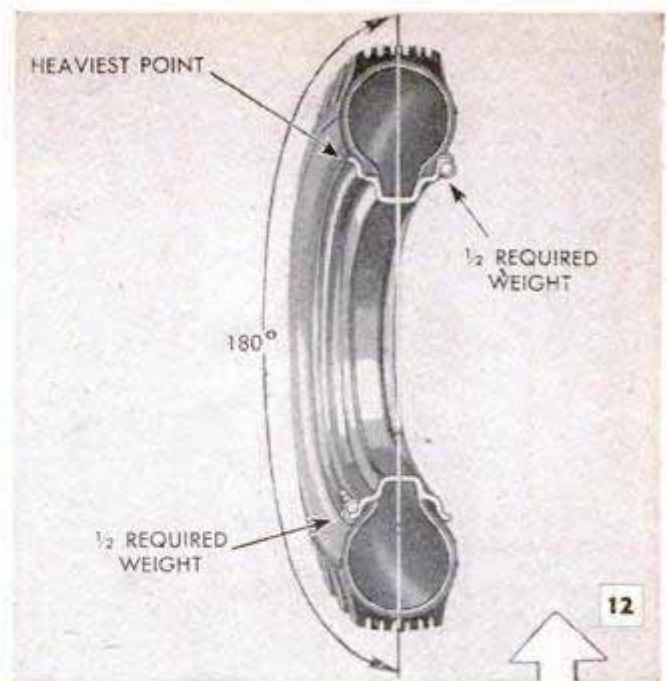

Wheels should be both statically and dynamically balanced to keep them rolling in a straight path and eliminate pounding and wobble, or "snaking"

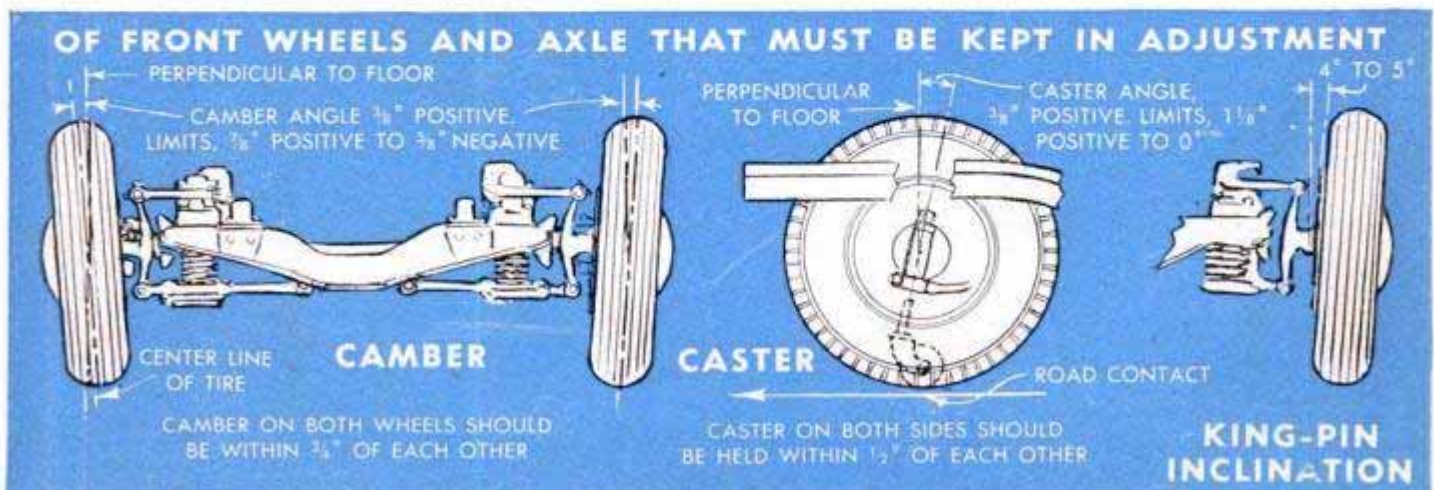

OUTDOOR GYM

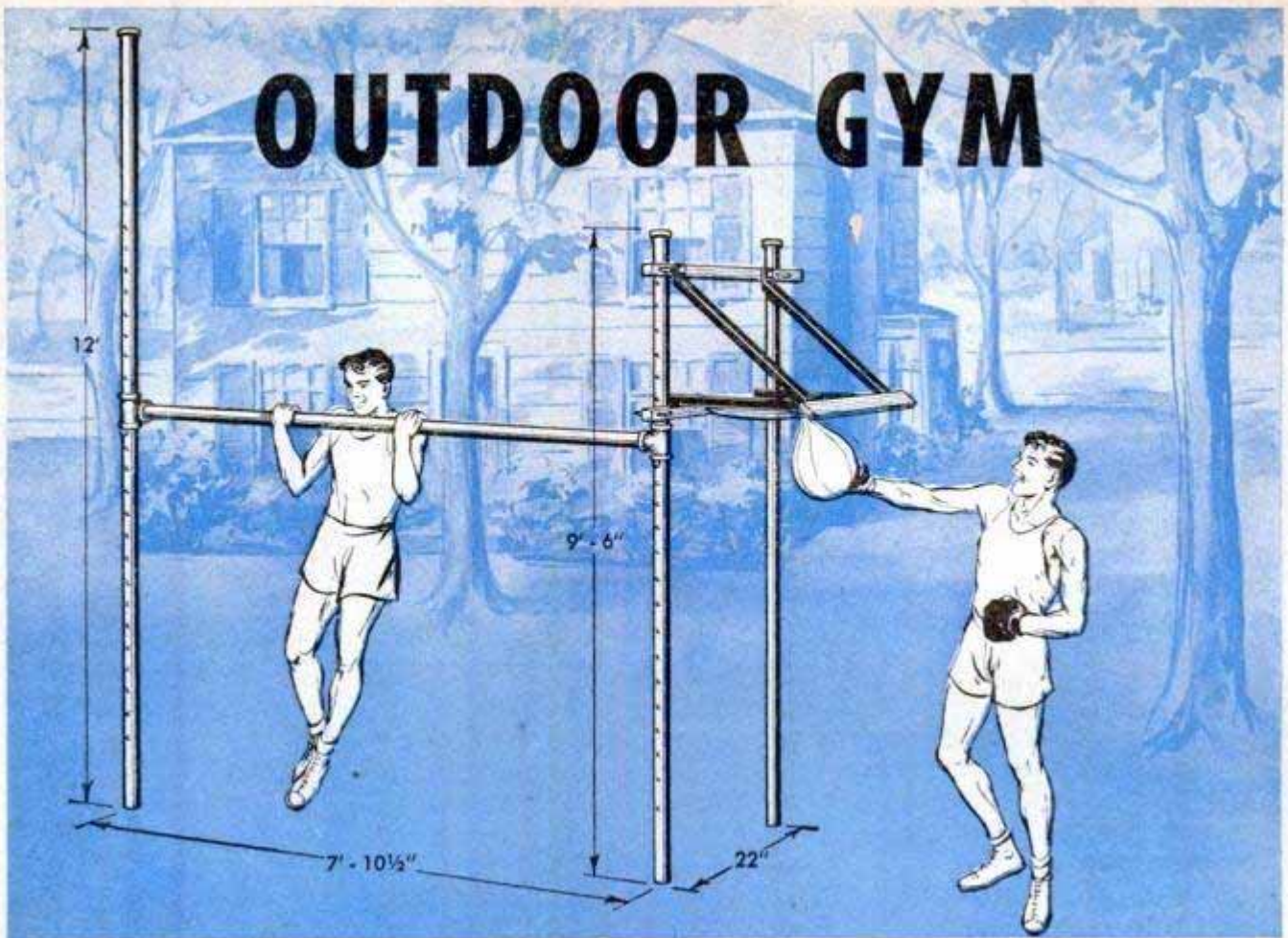

By Thomas Trail

This simple, sturdy outdoor gym can be built in the yard with several pieces of pipe and a few fittings. Both the horizontal exercise bar and the support for the striking-bag platform are adjustable for height. Three uprights of 2-in. pipe, one of them a 12-ft. climbing bar, are anchored in concrete. A series of 1/2-in. holes are drilled in two of the uprights on 3-in. spacings, and each upright is screwed into a coupling on the upper end of the length of pipe which is embedded in concrete. Use 2 1/2-in. pipe tees with reducers on the ends of the 1 1/2-in. exercise bar. The detail at the right shows the assembly of a bolt which supports the bar at each end. The striking-bag frame, which is attached to the uprights with U-bolts, is detailed at the lower right

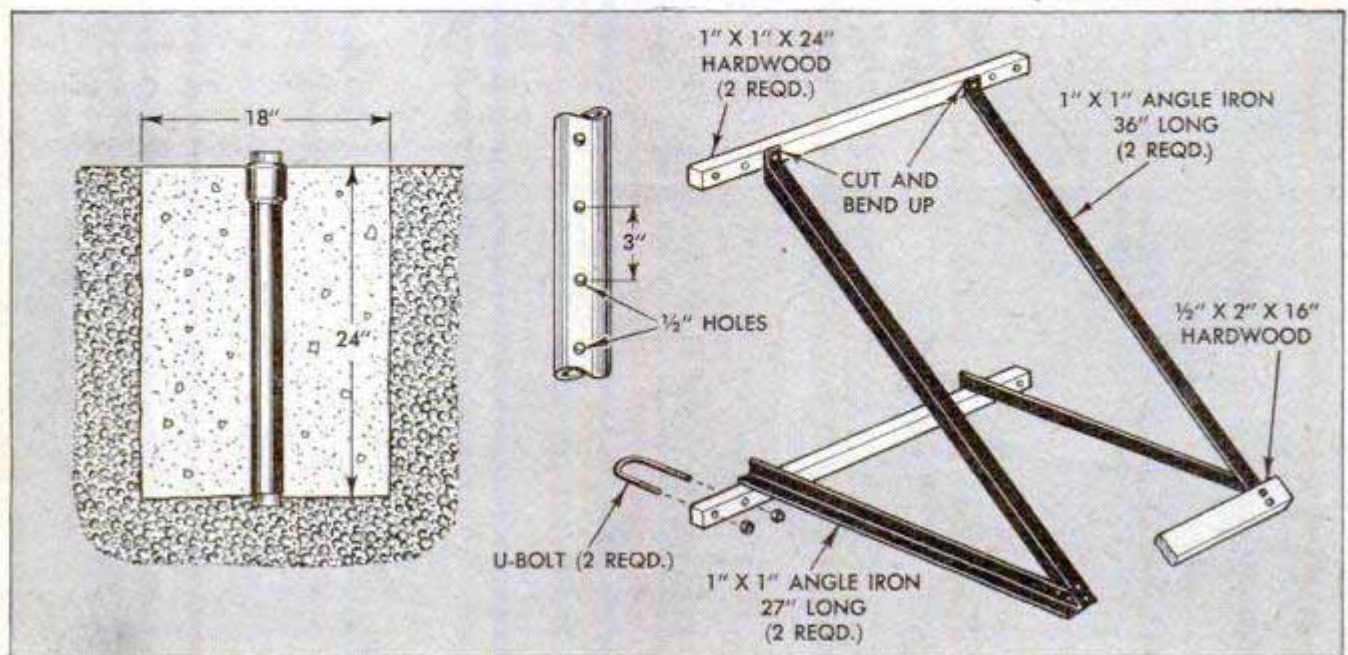
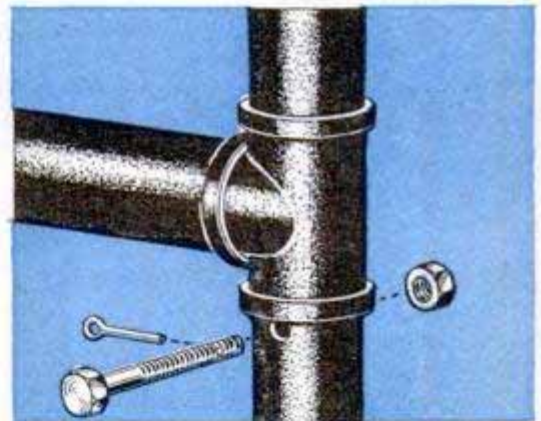

"Crazy Jug" Covered With Baubles Provides Interesting Novelty

Adorned with bits of colored glass, stones, shells and an assortment of trinkets, the "crazy jug" forms an eye-catching ornament for recreation room or patio. In addition, the youngsters will have hours of fun collecting the miscellany used to cover the jug. Most any type of jug or crock will do, and this is completely covered with a 1/2-in. layer of putty. After the decorations have been pressed into the putty, the jug is set in the sun to dry.



Light Socket Taped to C-Clamp Forms Portable Shop Lamp

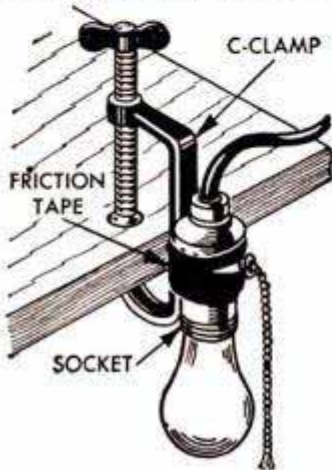

When regular workshop lighting is not bright enough for close work, additional light can be had by taping an extension-cord socket to a C-clamp and fastening the clamp to a convenient spot. Mounting the light in this way also is handy when working on

the car, repairing plumbing or doing other jobs where an extension lamp is necessary.
Herbert E. Fey, New Braunfels, Tex.

Table Listing Spindle Speeds Mounted on Lathe Headstock

For turnings that require critical surface speeds, it is convenient to be able to determine the various spindle speeds of your lathe at a glance. This can be done by stamping the spindle speeds on a metal plate and fastening the plate to the headstock with one of the machine screws used to hold the cover in place.

Dwight Durkee, Jr., Cupertino, Calif.

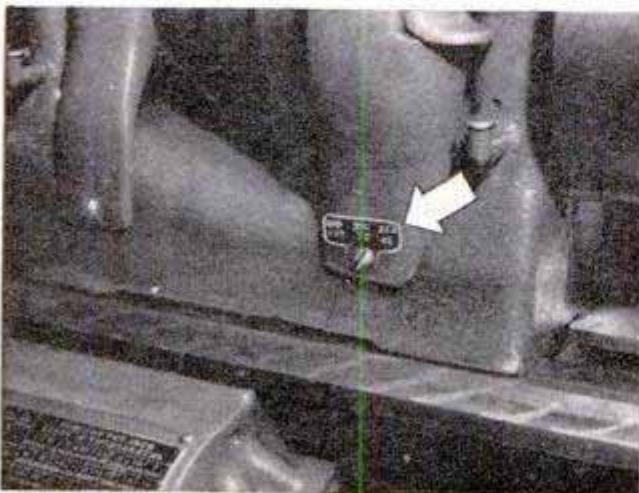

Take Care of Your Camp Ax

To keep a camp ax in the best condition, wipe it dry after using. Then oil the ax lightly and place it in its leather sheath. Stringing a leather thong or shoelace through the belt loop of the sheath will permit hanging the ax from a nail where it is out of the way. Before storing an ax for an extended period of time, always be sure to oil or grease the blade thoroughly and then wrap it in wax paper before placing in the sheath.—Willis O. C. Ellis, Washington C. H., Ohio.

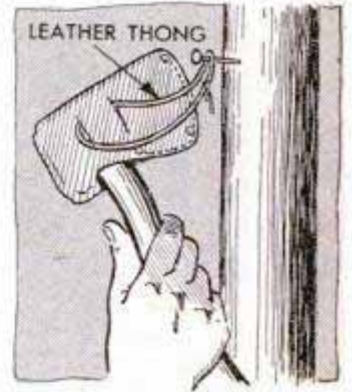

Wood Screw Kept From Loosening

Upsetting the edge of a flat-headed wood screw with a cold chisel is the simplest and one of the most effective ways of locking the screw so that

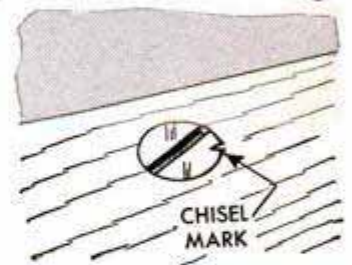

it will not work loose. However, before doing this, remember that some of the wood around the edge of the hole will be torn away if it is necessary to remove the screw.

❑ Instead of using pieces of absorbent cotton to powder the baby, use lamb's-wool powder puffs. They will stay soft no matter how often they are laundered.

"Positive Negatives" for PROJECTION

Negatives from your black-and-white snapshots are copied on positive film, then projected like color transparencies

By Walter E. Burton

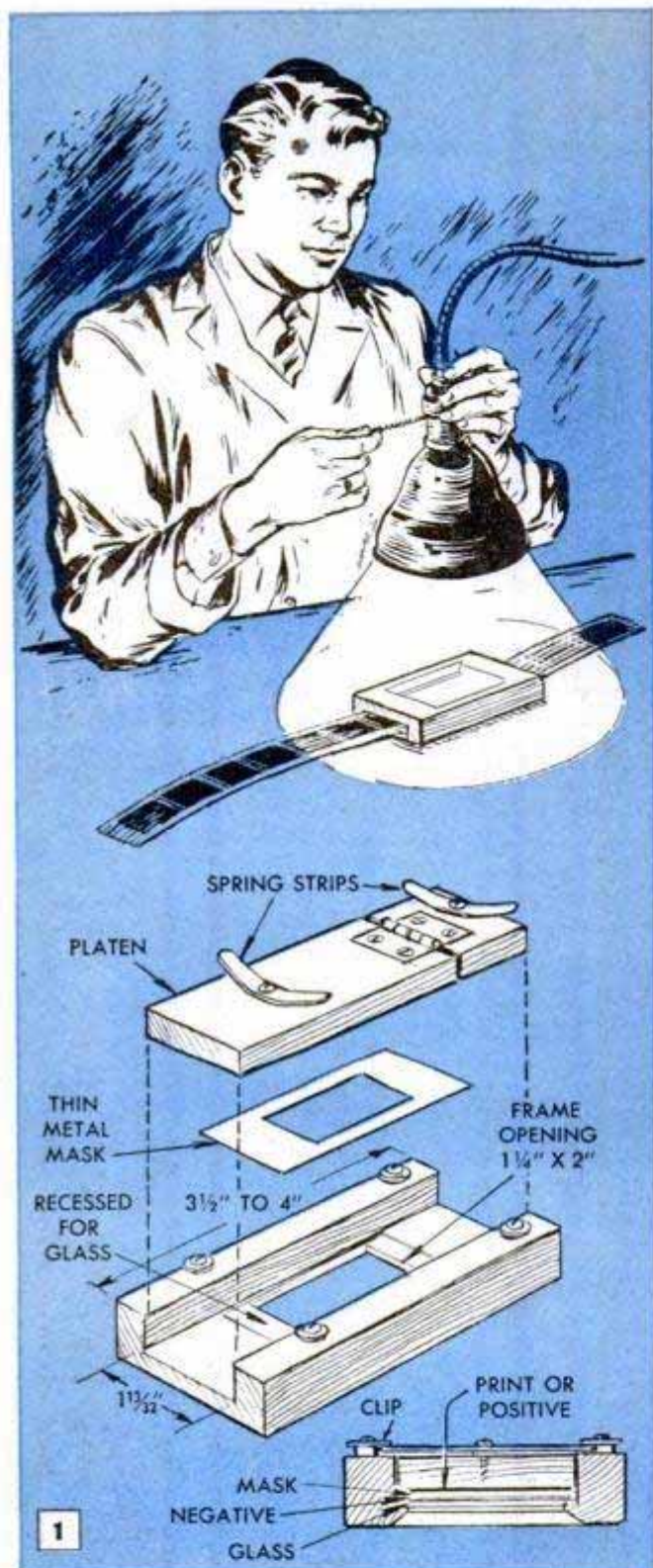

Exposure is the same as in making a print, except positive film is used instead of sensitized paper

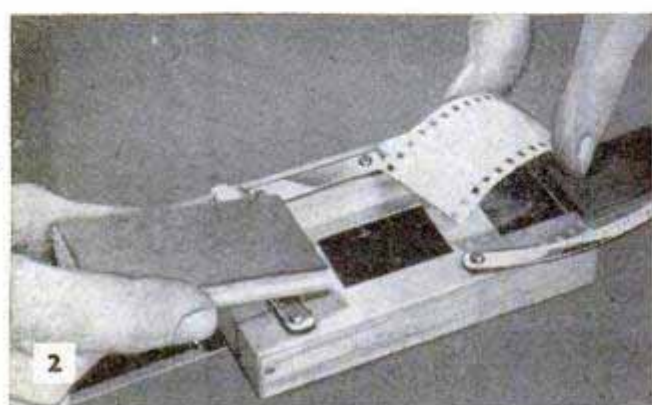

YOU NEED NOT use color film to enjoy the thrill of seeing your snapshots projected on a screen. Black-and-white transparencies often are as satisfactory as colored ones, and generally are superior to plain prints. Negatives from 35-mm. up to the capacity of the slide projector can be made into positive transparencies by contact-printing them on film instead of paper.

Figs. 2 to 6 inclusive picture the steps in making a monochrome black-and-white transparency, using 35-mm. positive film. A printing frame like the one detailed in Fig. 1 is all you need, in addition to the usual developing equipment. The negative strip is inserted between a piece of glass and a metal mask, and the film is held in position by a hinged platen. If there is ample film to permit the end of the strip to be cut on a bias, less difficulty will be had in starting it through the frame. The positive pieces should be about 1/2 in. longer than the length of the frame opening.

Only a brief exposure is required in printing an average negative on positive film. One way to do this is to place the printing frame under a 40 or 60-watt lamp bulb as in Fig. 1, and switch the current on and off as quickly as possible. A few trials will enable you to judge the exposure time accurately. To lengthen the exposure period for better control in developing, move the light source farther away from the printing frame, or use a smaller bulb.

Suitable developer formulas for positive film are published by film manufacturers. However, any developer that is fairly vigorous will do, but a soft-working one should be avoided. When extreme contrast is desired, as in the case of line drawings, use a high-contrast solution such as a "title" developer. If the contrast is still too low, you can make the print on film especially designed for micro-copy work.

The exposed positive film is processed exactly like a paper print. It should be thoroughly fixed and washed for about 1/2 hour in running water. Wipe both surfaces of the film with a moist cellulose

sponge to remove water droplets and hang the film to dry, or lean each one against a glass tumbler. If after drying there are water spots on the back of the film, breathe on it and then wipe the surface with a clean handkerchief. Mount the transparencies between glass in the usual manner. With the picture held right side up, place a positioning dot in the lower left-hand corner, pasting it to the mask before binding. You can make these positioning dots from gummed stock, using a $\frac{1}{4}$ -in. paper punch. The dots serve as a guide in placing the slides upside down in the projector so that when viewed they will always be right side up on the screen. Each slide is inserted with the dot being in the upper right-hand corner.

Prints from negatives that are larger than 35-mm. film can be made on standard 2 x 2-in. lantern-slide plates. These are available in two grades, one for normal negatives and one for contrasty negatives. They are processed like positive film and may be printed either by contact or projection. Positive film is also made in standard sheet sizes. Film is mounted between two thin pieces of glass, whereas lantern slides are faced with only one piece of glass.

When black-and-white transparencies are projected they produce an image rich in detail and have a greater range of tone values than a paper print. With the aid of commercial photo stains and toners, you can further improve the qualities of the slides. Many standard toners will work equally well with both positive film and lantern-slide plates. Sepia tones may be produced on movie film by a sulphide toner, and on lantern-slide plates with a similar toner of slightly different composition. Although such toners can be had commercially in prepared form, formulas for mixing them are given in photo handbooks. The color should match the subject. For example, a summer landscape should be toned sepia while a snow or moonlight scene is best in blue. Toners change the color of the dark portions of the transparency by altering the silver particles, while photo stains alter the high lights by coloring the gelatin coating. By combining the two, slides of more than one color can be produced. Photo stains are a water-soluble dye in which the transparency is immersed for the desired density.

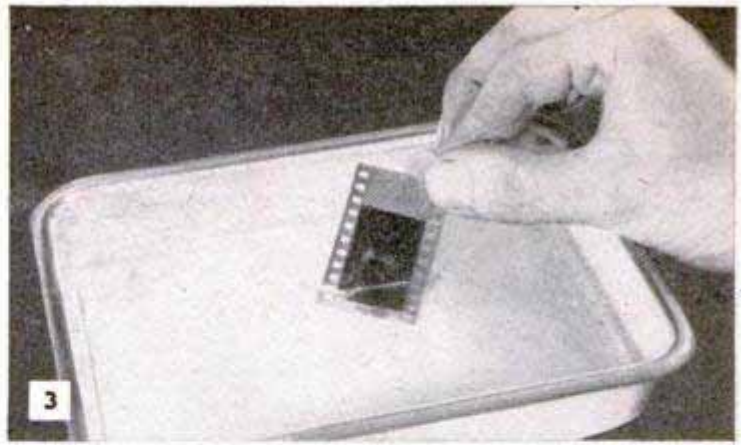

The exposed film is developed in the same manner as in the case of a photoprint, using a fairly vigorous developer



Placing the positive transparency in a ready-cut mask preparatory to mounting it between two 2 x 2-in. cover glasses

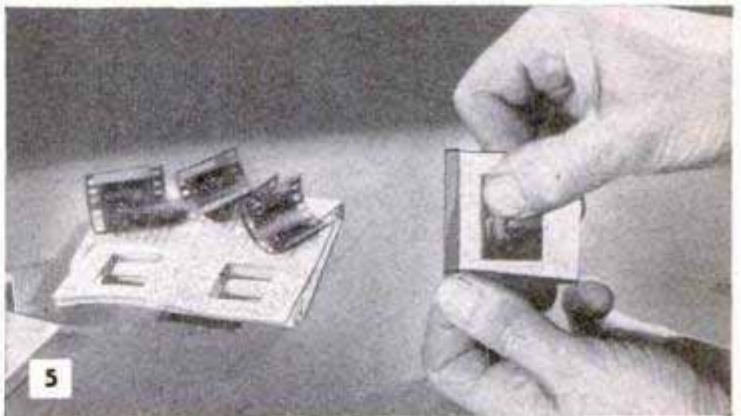

Above, binding the glasses together with gummed paper tape made for the purpose. Below, finished transparencies ready for projection. Dot in lower left-hand corner serves as a guide when inserting slide upside down in the projector



"Flash" Pictures From Photoflood Lamps Permitted by Hand-Held Synchronizer

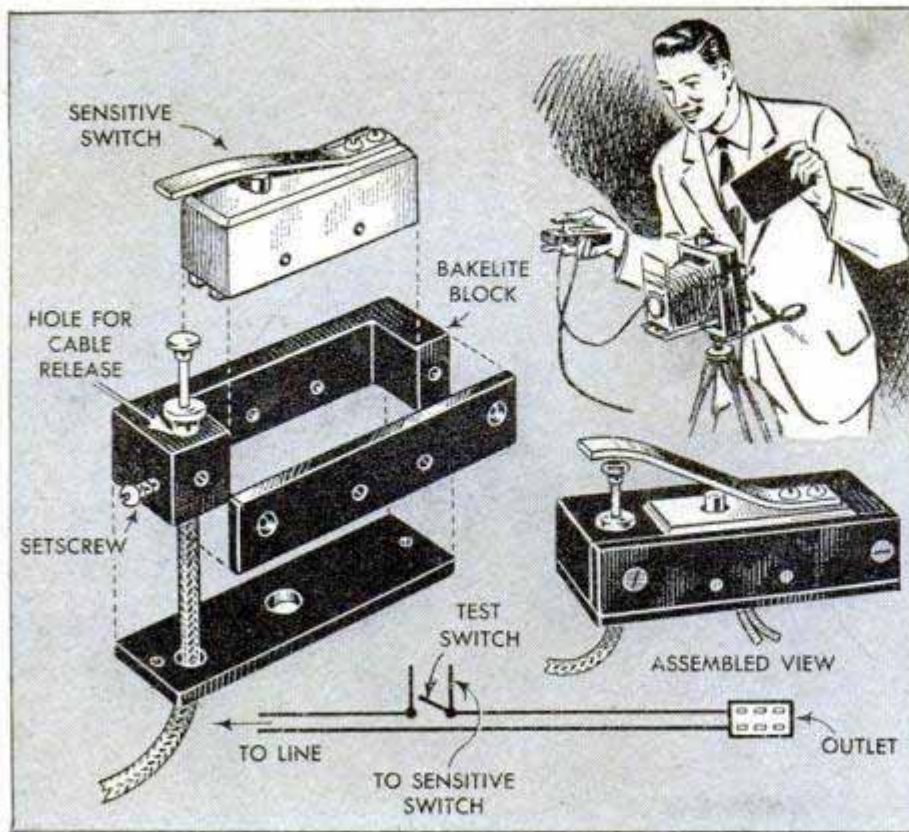

Especially useful when photographing children, this synchronizer for photoflood lamps gives a flash effect by allowing the lights to remain off until the shutter is released. A test switch wired in the circuit permits turning on the lights for focusing without releasing the shutter. The synchronizer consists of a sensitive switch set in a Bakelite housing. The cable release is mounted at one end of the housing so that when the lever of the sensitive switch is depressed the shutter will be released an instant after the switch is closed. Experiment to determine how far the cable-release button should extend above the housing. — Aaron Barnett, Chicago.

Photo Paper Held for Convenient Selection Between Pages of Magazine

When making a number of contact prints, the small sheets of paper can be held for easy selection by inserting them between the pages of a magazine. Using a magazine having a large page size and the type of binding that tends to remain open, slip a sheet of photo paper between the succeeding pages. Then, with the magazine closed, the paper is protected from light and, when needed, the sheets can be grasped more quickly than if kept in a box or an envelope.

Virginia Hanson, Santa Monica, Calif.

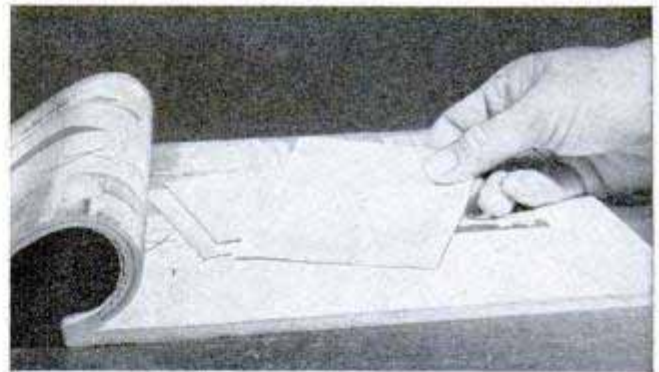

Adding Household Detergent to Final Wash Water Improves Glossy Prints

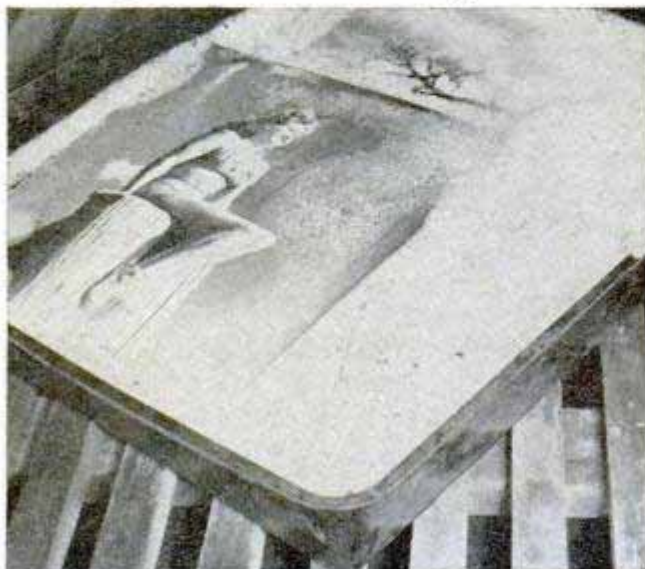

Household washing powder of the soapless-suds type can be used to improve the surface of glossy prints. Add $\frac{1}{2}$ teaspoonful of the detergent to the final wash water before immersing the prints. Washed in this way, the prints will have a minimum of pitting and drying rings when removed from the ferrotype tins.

Carrying Wet News Films

The amateur photographer who is fortunate enough to get an on-the-spot news shot can save precious time by rushing the negative to the newspaper while it is still wet. The negative is simply placed in a jar of cold water and the jar is tightly capped.

David Deutsch, Brooklyn, N. Y.

TRANSPARENCY VIEWER

doubles as retouching stand

EVERY photographer needs this handy accessory for really serious work. It's simply a triangular box made from $\frac{1}{4}$ -in. plywood and fitted with a hinged picture frame containing a diffusing glass. The latter serves as a transparency viewer and also as a negative retouching easel. Fig. 1 shows the unit in use as a viewer and Fig. 2 pictures its convenience as a retouching stand. The left-hand view in Fig. 3 shows how to cut all the parts economically from one piece of plywood. First, join the parts to form the triangular box, Fig. 4, using glue and small brads. Drill four holes in the back panel, three $\frac{3}{4}$ -in. holes for ventilation and one $\frac{3}{8}$ -in. hole for the light cord. Then install a porcelain flush-type socket and a toggle switch, Fig. 5, and wire according to the diagram in Fig. 3. Next, obtain a 5 x 7-in. picture frame and a 5 x 7-in. diffusing glass, available at photo-supply stores, and fasten the glass in the frame with several small brads. Hinge the picture frame to the viewing box as in Fig. 6, using 1-in. butt hinges. Use a 7 $\frac{1}{2}$ -watt, inside-frosted lamp for illumination. This is sufficient for average work. The unit can be made somewhat more stable for negative retouching by driving four rubber-headed tacks into the bottom near the corners. The bottom also can be covered with a piece of $\frac{1}{8}$ -in. felt glued to the bare wood. If desired, the exposed wooden parts can be finished in the natural color of the wood with shellac and varnish, or the wood can be stained to match the finish on the picture frame.—James R. Oswald, Chicago.

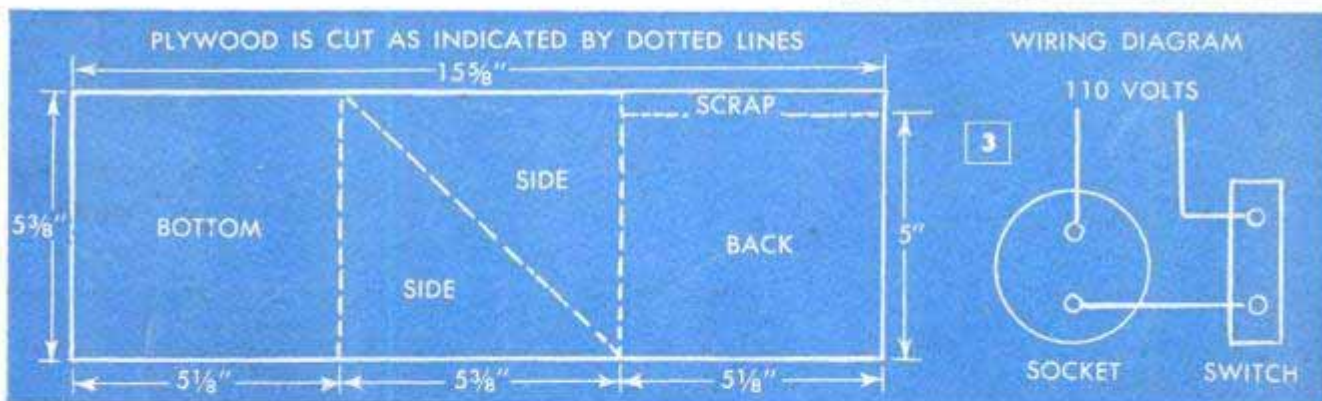
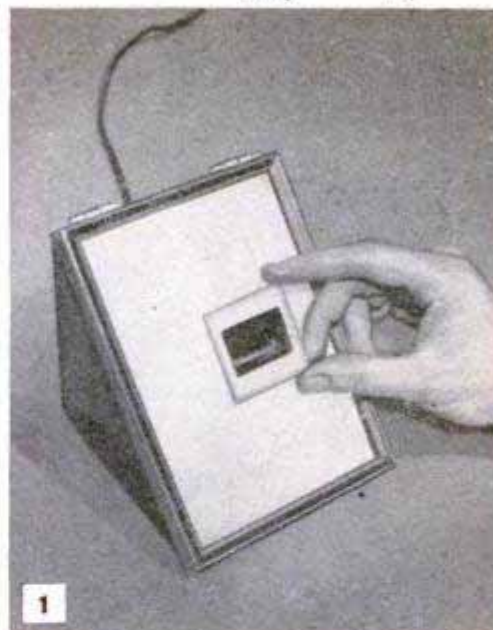

U.I. '51

Handy Photo-Paper Dispenser Has Individual Compartments

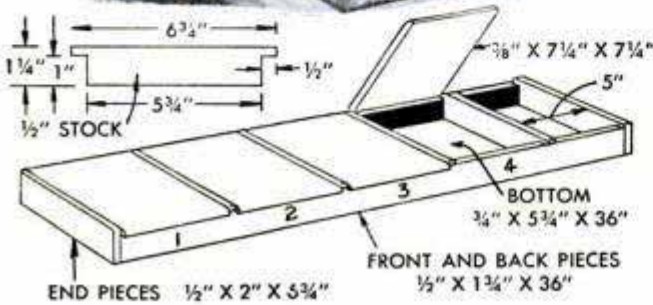
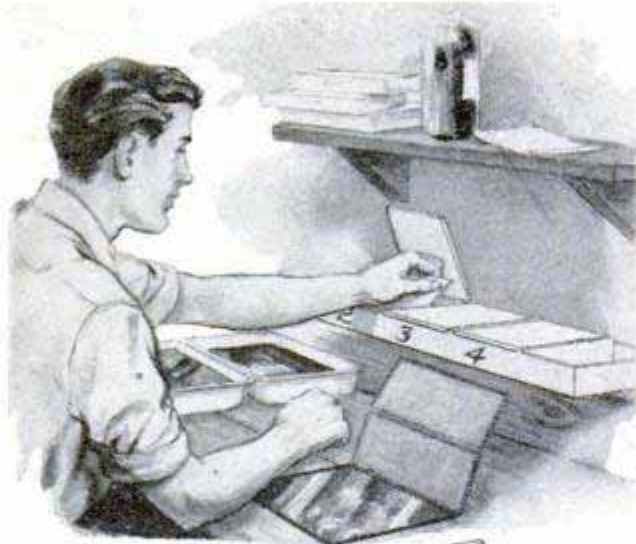

Mounted on a wall with shelf brackets or merely set on the top of a darkroom table, this easily made paper dispenser will hold a large quantity of photo paper of several different grades or sizes. Made to the dimensions given, the dispenser includes four light-tight compartments for paper up to 5 x 7 in. plus a small tray for miscellaneous items. However, the number of compartments and their size can be varied to suit. The covers are hinged at the back with $\frac{1}{2}$ -in. brass butt hinges and they overhang the front of the dispensers $\frac{1}{2}$ in. to provide a finger grip for easy lifting. The inside of the unit is painted flat black and the outside a light color. Numbers to indicate the grade of paper may be painted on the front of each compartment. Be sure that the covers fit closely to prevent light leakage when a bright light is turned on, and store the paper face down in the dispenser.

Dick Hutchinson, El Monte, Calif.

Film Identified on Holder Slide



If you use several types of cut film in your camera, the film in each holder can be identified by writing the type and emulsion speed on the edge of the slide. This strip of

metal, which is usually aluminum, permits writing legibly with a pencil, and it can be erased readily when the film is changed.

Detergent Speeds Drying

Film will dry quickly and with fewer water spots, if it is first soaked in water containing a soapless detergent. Add just enough detergent to make the water sudsy and soak the film for only a minute or so.



Swabbing Insures Clean Negatives

Although water may look perfectly clean, it can leave a fine sediment on negatives, resulting in streaks, blotches and flattening of tones in the prints. To insure that the negatives are clean, use a sponge or a pad of cotton to swab off both sides of each negative while it is held under a stream of running water.

Reducing Dense Areas in Negative With Household Cleansing Powder

A paste consisting of household cleansing powder and alcohol forms an excellent medium for reducing the dense areas of a negative. Using a piece of cotton, rub the paste on the emulsion side of the negative until the denseness is reduced to the desired tone. Then, wash off the negative with alcohol. For working on small areas, wrap the cotton around the end of a matchstick or toothpick. Use alcohol for mixing the paste because, unlike water, it will not soften the emulsion on the negative.



Rep. L.C.B. #141

Sliding Shaper Jig

By Roy Rogers

WHEN running a molding cut across the end grain on wide stock, it is difficult to hold the piece securely against the miter gauge with the hands alone, particularly on a small shaper table. Inaccurate work is likely to result because of the tendency of the stock to creep away from the cutters. This type of work is handled safely and accurately in the special jig detailed in Fig. 1. The jig consists of a base with two endpieces set in grooves and glued and screwed in place. Note that the base also is grooved lengthwise at the center, the width and depth of the groove being determined by the width and thickness of the miter-gauge spline. The miter gauge is

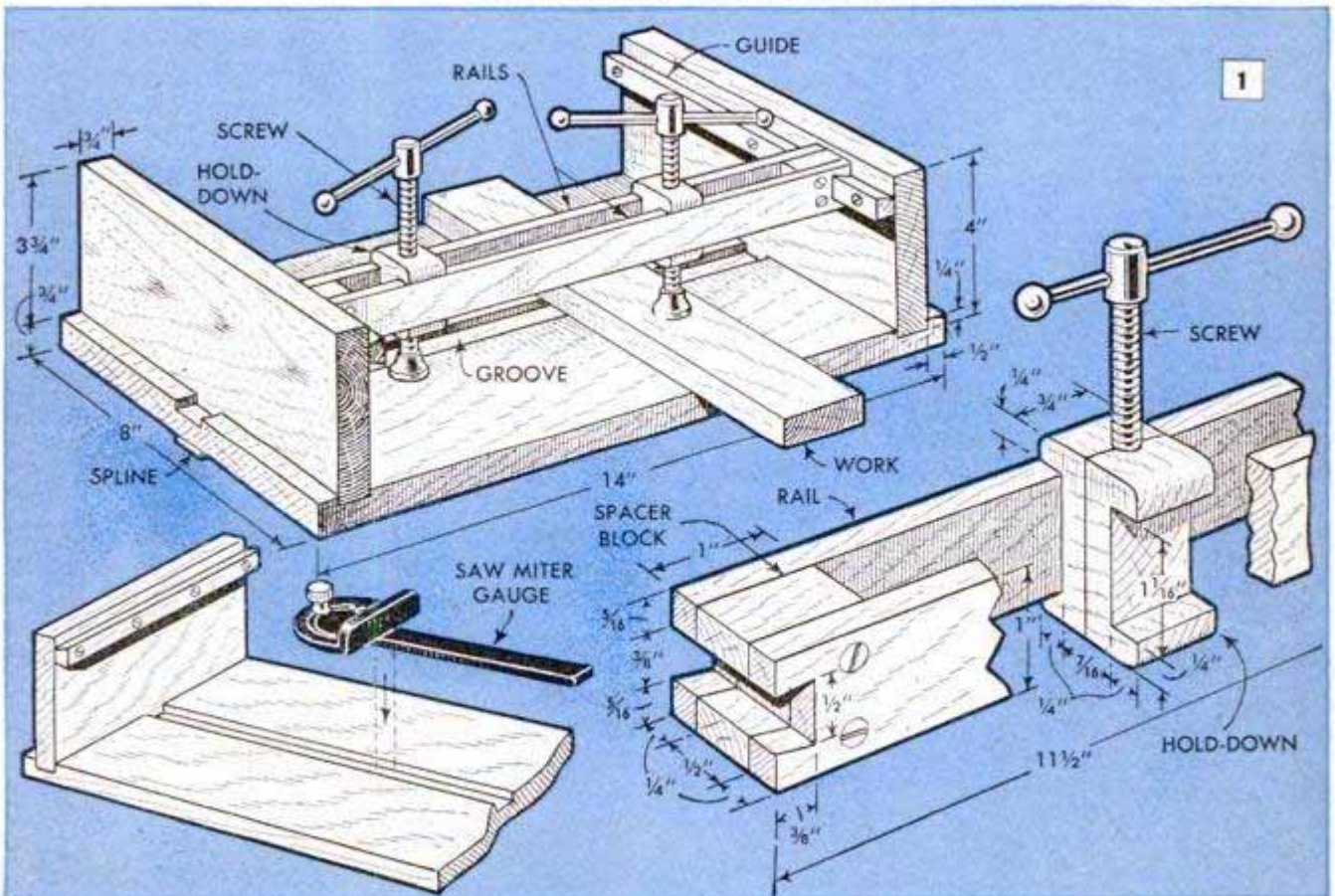
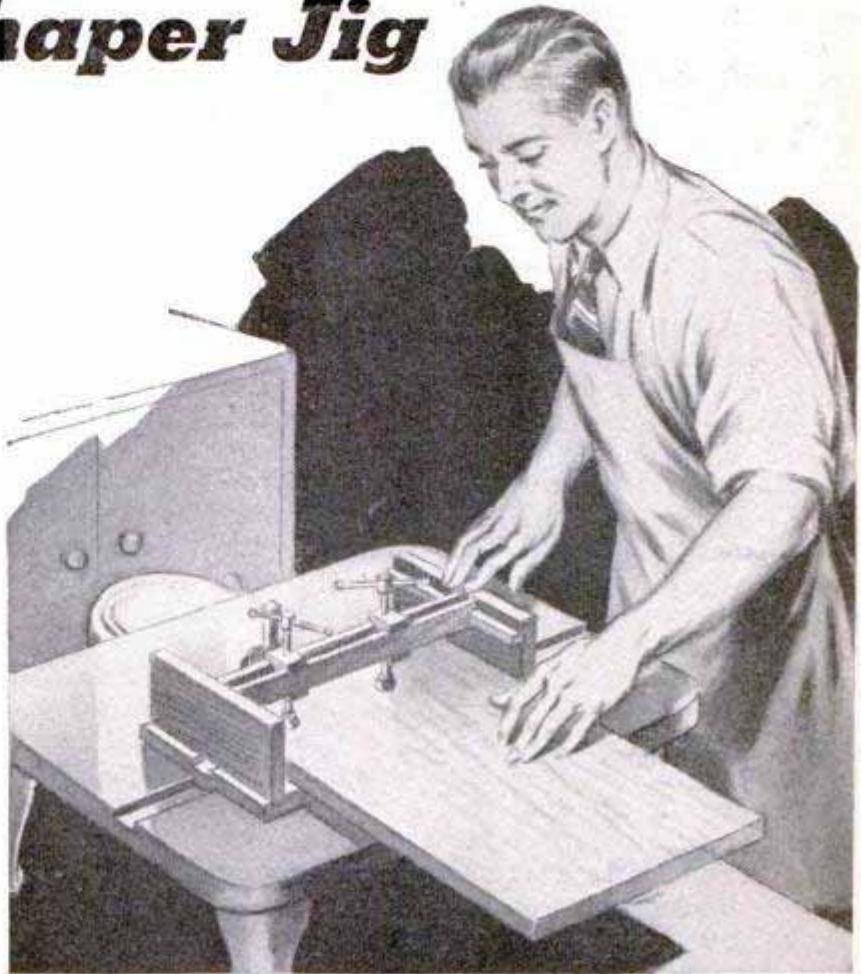

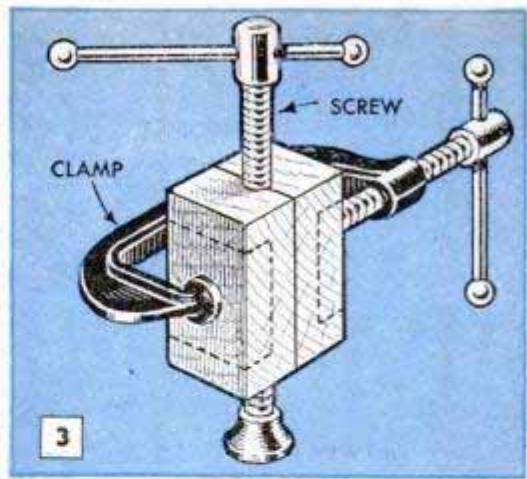
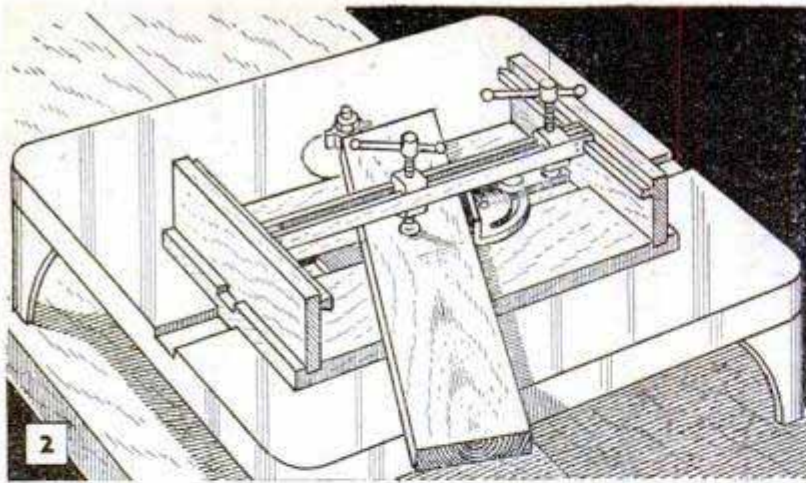

used to guide narrow pieces, as in Fig. 2, where the work is positioned at an angle so that a molding cut can be run across the end. A hardwood spline screwed to the bottom piece, as in Fig. 1, fits in the groove in the shaper table to guide the jig. Care must be taken when fitting this spline to make sure that it is located parallel with the inner edge of the bottom piece and also that it is positioned at right angles to the endpiece. Countersink the screws.

The hold-down screws are taken from old C-clamps. On most types of C-clamps it is only necessary to bend the tabs on the swiveling pad outward and the pad will slip easily off the ball end of the screw. Then the screw can be turned out of the clamp frame. These screws are then made to tap threads in hardwood hold-down blocks by turning them into tapholes drilled in the blocks, Figs. 1 and 3. Determine the size of the taphole required by measuring the diameter of the screw at the bottom of the threads. On certain types of C-clamps the screw can be removed only by cutting away the frame of the clamp. In this case, two blocks must be used to make each hold-down. First clamp the blocks together and drill the taphole. Then clamp the blocks together over the screw as in Fig. 3 and turn the screw back and forth

to form the threads. After the threads are cut in the wood in this manner, glue the blocks together with the screw in place as in Fig. 3. Next, notch the blocks to fit the side members of the sliding bar, as in the lower right-hand detail in Fig. 1. The hold-downs should slide easily when the two bars are assembled with spacer blocks as shown. Cut dovetail notches or grooves in the ends of the assembled unit. Then make dovetail slides from hardwood and screw these to the inner face of the endpieces. The dovetailed ends of the bar fit over these slides as shown in the assembly view in Fig. 1. Check the assembly for free movement along the full length of the dovetail slides. To use the jig, place it in position on the shaper table, locate the stock in line with the shaper cutters with one edge bearing against the rear endpiece and tighten either one or both of the hold-down screws to hold it firmly in position. Slide the jig slowly forward until the work has passed the shaper cutters. Then slide the jig off the table and remove the work before replacing the jig on the table. If the piece requires more than one pass to complete the cut, replace the jig, with the work still in place, on the forward edge of the table and adjust the shaper spindle before running the next cut.

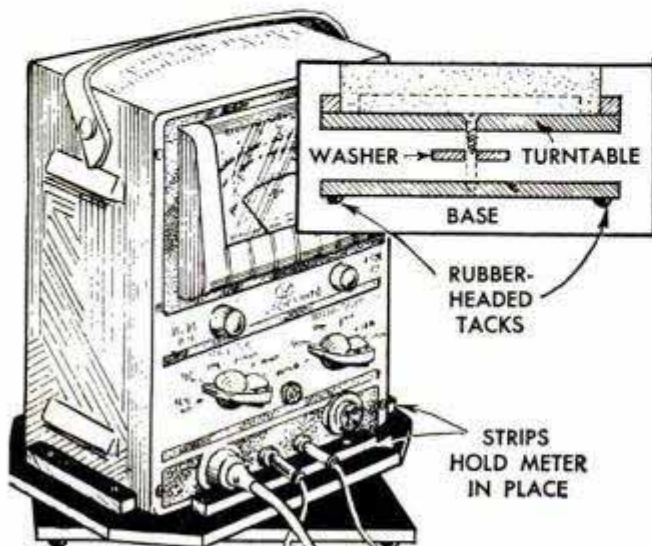

Mounting Test Meter on Turntable Facilitates Reading Dial

When mounted on this easily made turntable, a test meter can be swung so the dial is clearly seen from any position on the workbench. The table rotates on a wooden base from which it is separated by a 2-in.-square plywood "washer." A flat-headed screw driven through the turntable and washer and into the base serves as a pivot.

Robert Hertzberg, Jackson Heights, N. Y.

☐ To salvage a used sheet of carbon paper, hold it over a hot stove for a few minutes. The carbon will melt and flow over the worn areas so the sheet may be reused.

Needing a set of metal-working hammers but finding the cost too high to permit purchasing them, one craftsman economized by turning the half-dozen hammers shown from automobile rear axles. The axle shafts are sawed to convenient lengths, using a power hacksaw if available. The hammers are turned between centers until nearly completed and then they are chucked for finishing the faces to the proper contour. The holes for the handles are bored through the heads, positioning them on the drill-press table by means of a V-block. Two overlapping holes can be drilled to form an oblong hole for a wooden handle, the latter being purchased or reshaped from a broken handle. If steel rod is used for a handle, it should be threaded and the hole in the head tapped so the two parts can be screwed together. The rod may be lightened by boring it out, if desired, and knurled to afford a good gripping surface. If intended only for use on soft metal, the hammers do not have to be heat-treated.

Variety of Hammers for Working Soft Metals Turned Inexpensively From Automobile Axles

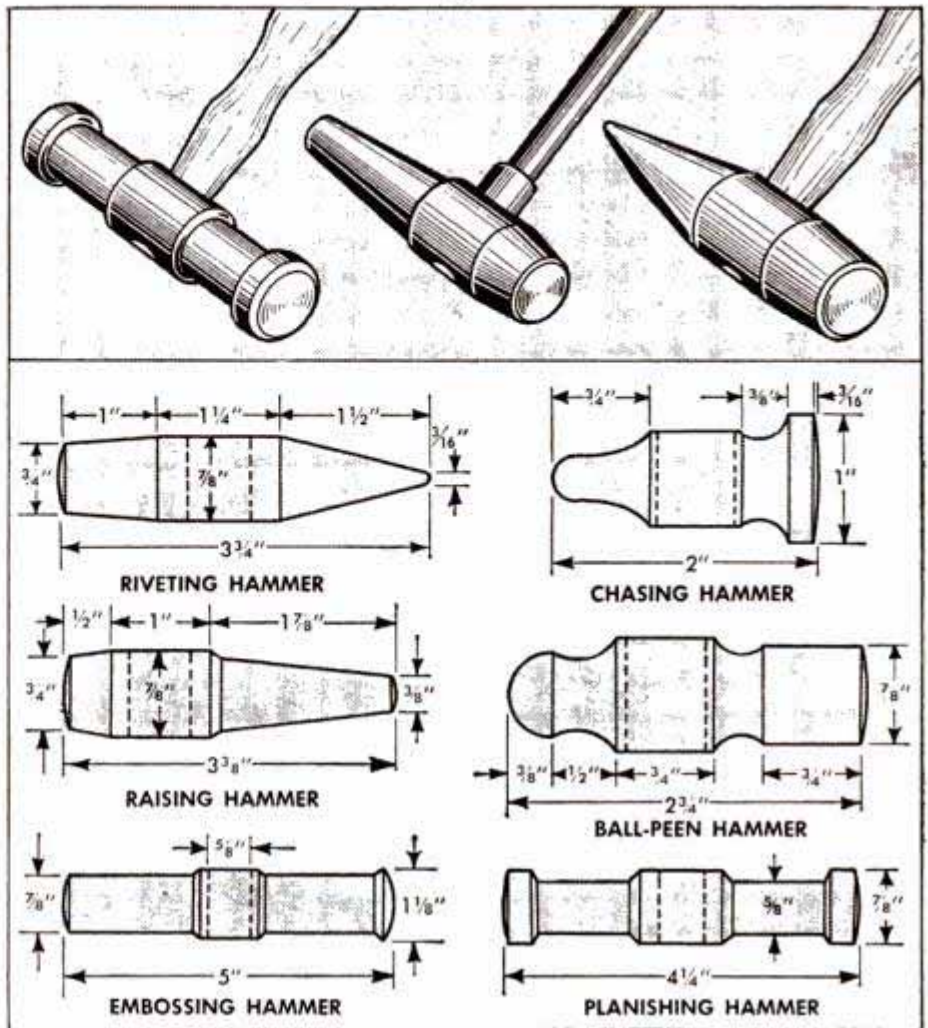

Final polishing is done with emery cloth and oil, and a coating of rust preventive is applied as soon as the hammer is completed.—D. C. Marshall, Manhattan, Kans.

Rats Attracted by Grain Camouflage Drown in Barrel Filled With Water

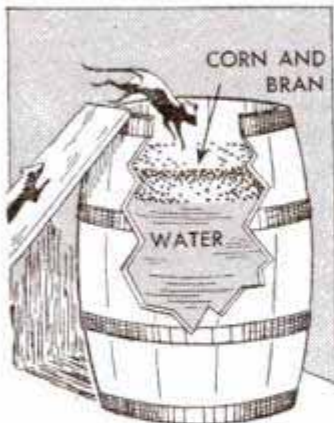

If you have a barn that is infested with rats, this water-filled barrel will get rid of them in a hurry. Using a clean barrel, fill it with bran to about three or four inches from the top. Then sprinkle some corn chop over the bran. Don't fill the barrel with water at this time. Lean a board against the side of the barrel so the rats are able to run up the board and eat the grain in the barrel. Allow the rats to feed on the grain for a week or so until they become familiar with the setup. Then, pour out the bran, replace it with water and pour a 6-in. layer of bran over the

water. Sprinkle corn chop over the layer of bran. The grain should be about the same distance from the top of the barrel as before. The rats, which are accustomed to jumping into the barrel to reach the grain, will continue to do so, except that now they will fall through the bran and be drowned in the water.

Bob Poulson, Los Angeles, Calif.

Storing Artists' Brushes

Before storing artists' brushes for long periods of time, wash them carefully in turpentine or other solvent and then immerse in lard oil for about 20 seconds. Work the oil well into the bristles, squeezing any surplus oil from the brush. Prior to using a brush stored in this way, rinse it thoroughly with turpentine so the lard oil does not retard drying of the paint.

Paul Will, Chicago.

Barrel Canopy Protects Rock Salt

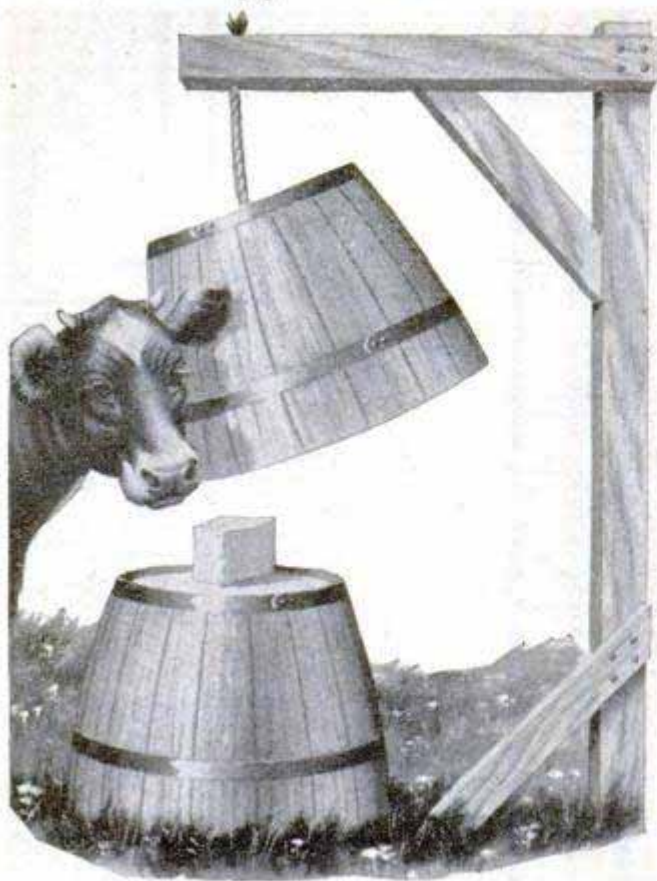

Rock salt kept outdoors for cattle will not be washed away by rain if it is protected with a barrel canopy. The barrel is sawed in two, and one half is placed on the ground to form a table. Then the other half is suspended with rope directly above the table to serve as a canopy. The cattle will nuzzle the canopy out of the way to reach the salt.

Miter-Box Base Prevents Clogging

By mounting his miter box on a subbase bandsawed from $1\frac{1}{16}$ -in. softwood, one carpenter eliminated the tendency of the saw to clog with sawdust and short trimmings from moldings which collect about the rear saw guide at the back of the box. The curved cutout in the subbase is centered so that it is directly below the saw guide as

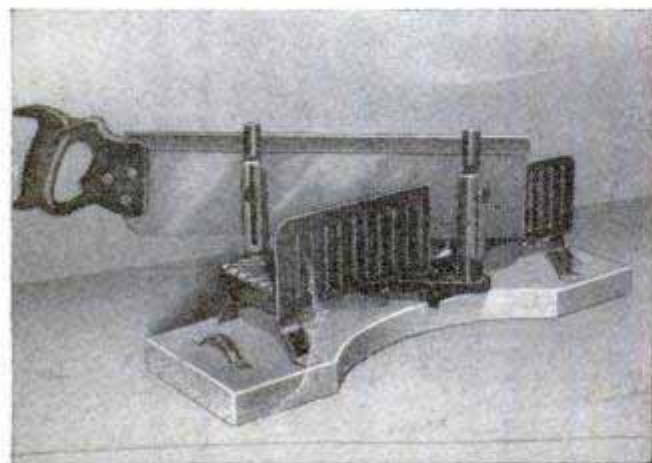

illustrated. The miter box is attached to the base with screws. Two handles screwed to the base facilitate carrying the unit.

Grover Brinkman, Okawville, Ill.

Clock Spring Aids Drawing Arcs

Curves and arcs of a wide variety of sizes can be drawn with the aid of a clock or watch spring. Take the mainspring from an old clock and place it in position on the paper. Then, attain the desired arc by varying the finger pressure along the edges of the spring.



Policarpo R. Bobon, Ilog, P. I.

Rubber-Stamp Rack Is Automatic

Especially handy where a number of different rubber stamps are used frequently, this novel rack automatically returns them to their proper position. The rack is merely a wooden crosspiece mounted on uprights or between two walls in the corner of an office or cashier's cage. Each stamp is hung from the crosspiece with a rubber band and, when needed, it is pulled down, inked and applied to the paper. As soon as the stamp is released, the rubber band pulls it back on the rack.

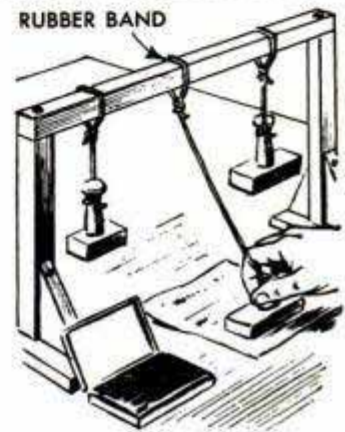

R. Lusignan, Montreal, Que., Can.

Quarter Round Saves Poultry Feed

To keep poultry from wasting feed by billing it out of a straight-sided wooden feeder, nail strips of quarter round to the inner edges of the sides of the feeder. The strips are nailed flat side downward so that they form lips



which make it difficult for the hens to waste the feed. Ordinarily, it is not necessary to attach pieces of quarter round to the ends of the feeder.

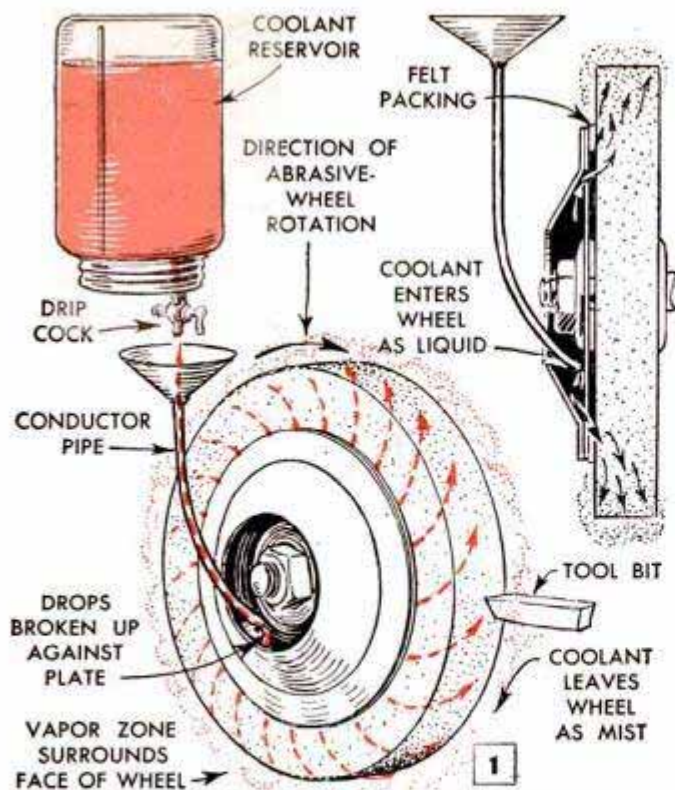

VAPOR-ZONE GRINDING

By Alexander Maxwell

FITTING your bench grinder with a vapor-zone attachment transforms it from a run-of-the-mill shop tool to a highly efficient machine for putting keen, razor-sharp edges on both wood and metalworking tools. Simply by providing a zone of soap-oil vapor which rotates with the grinding wheel, tool-sharpening time is cut in half. As heat is continually dissipated from the cutting edge of the work, the tool remains cool even when heavy cuts are taken. The work can be held firmly with the fingers close to the cutting edge and sharpening completed without quenching in water. The coolant actually reaches the point of contact, burning of the feather edge being minimized as temperatures average 500 deg. cooler than in dry grinding. Danger of altering the work hardness is reduced. In addition, the wheel is washed constantly with less tendency to load, and grinding dust is precipitated in the form of paste.

The vapor-zone attachment operates by restricting the flow of coolant to the point where only an invisible spray emerges from the rim, or face, of the abrasive wheel, Fig. 1. Being light, the vapor is held near the rim by air currents, and whirls around with the wheel until it contacts an object thrust into the air stream. The mist then condenses into droplets, dampening the work but not getting it dripping wet. The most effective coolant, determined by experiment, consists of ½



Distributor-cup form is dished-out, above, and brass is lubricated with graphite grease, below

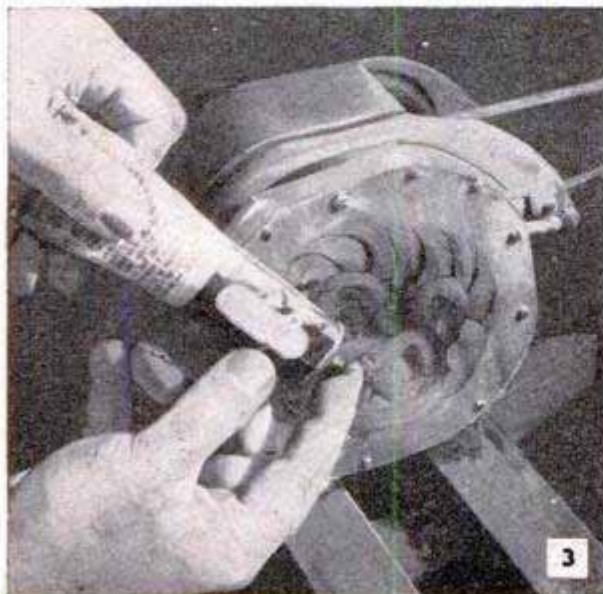

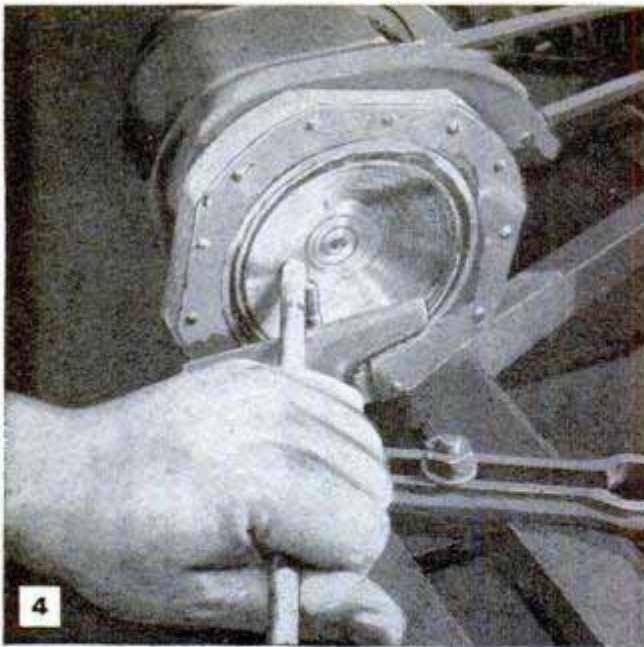

4 Pin clamped to tool rest steadies birch dowel for spinning distributor cup from blank of soft brass

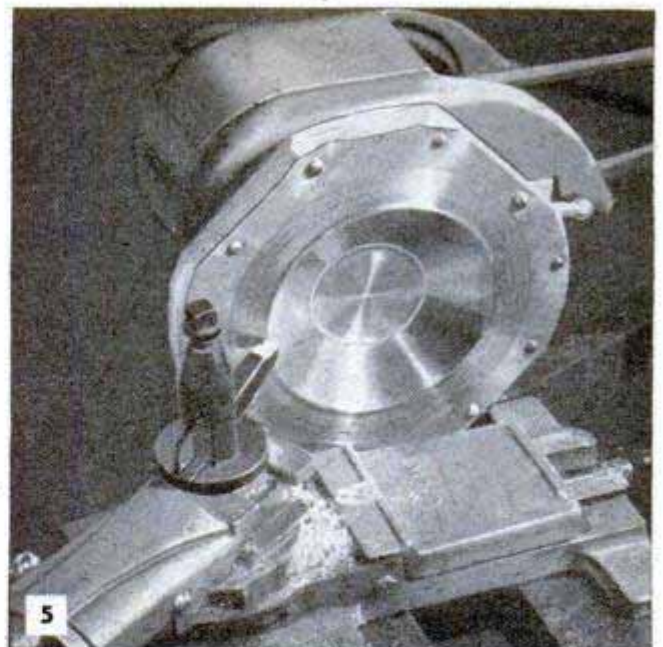

5 Edge of distributor cup is scored on lathe. Then work is unfastened from form and waste cut away

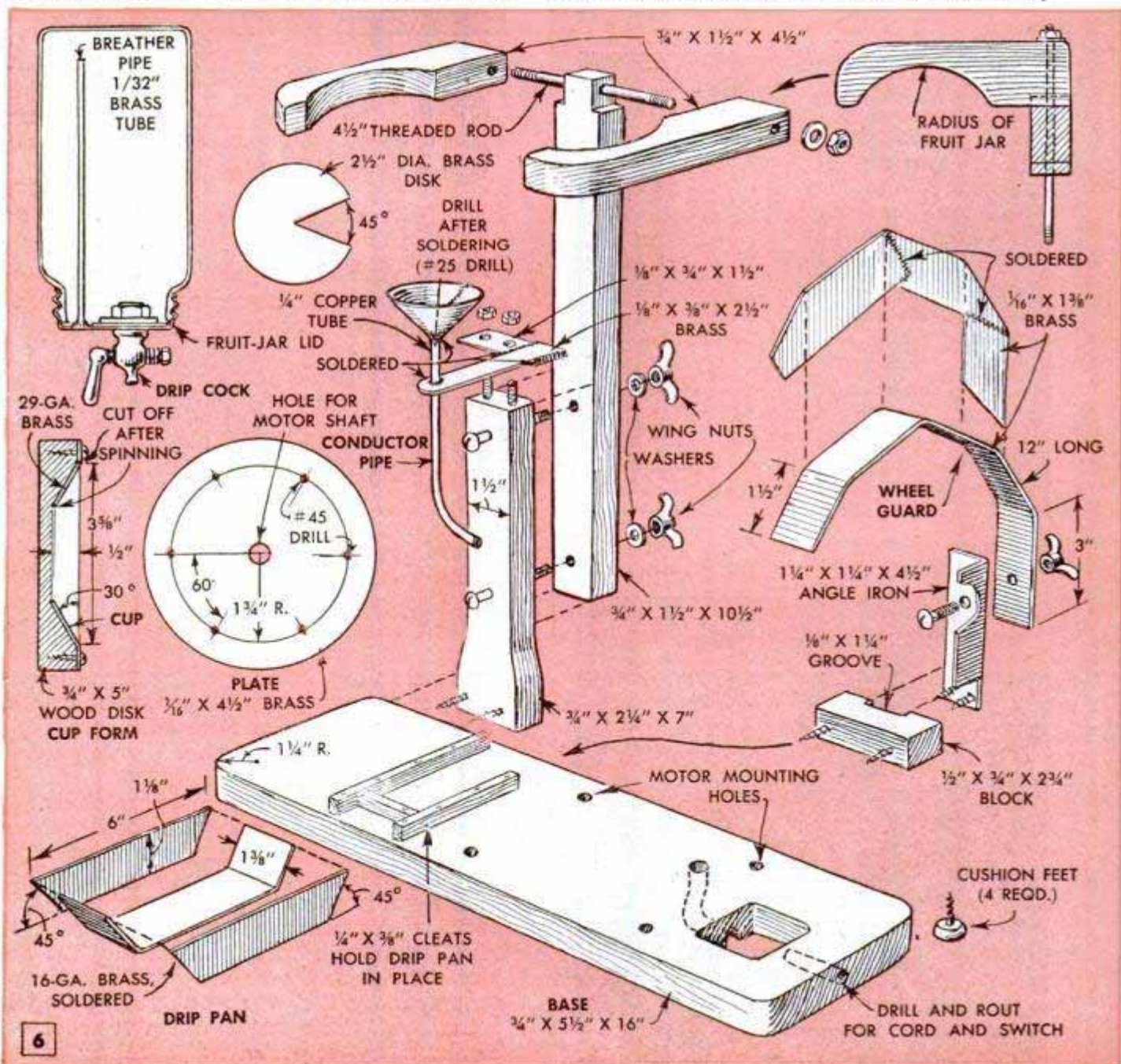



7

Rim of distributor cup is smoothed on emery cloth to assure watertight joint when soldered to brass plate

teaspoonful of soapless laundry powder dissolved in $\frac{1}{2}$ pint of cold water. To this is added as much vegetable cooking oil as will dissolve when stirred (about 6 or 8 drops) and a pinch of borax. A half pint of this coolant will last for an hour or so, cooling much more efficiently than an equal volume of pure water.

Begin construction of the unit by making the cup-shaped distributor disk which is assembled as in Fig. 1. The cup is spun from soft-drawn sheet brass, using a wooden form as shown in Figs. 2 and 6. The brass is screwed securely to the form and smeared with graphite grease, Fig. 3. Spinning is done with a length of $\frac{1}{2}$ -in. birch dowel, using a pin clamped to the tool rest as a fulcrum against which the dowel is held, Fig. 4. Running the lathe at high speed, start from the center of the work and slowly press the dowel downward and outward. Be gentle, as extreme pressure

Metal rod chucked in drill press holds disk against cup to provide pad center and clamp for soldering

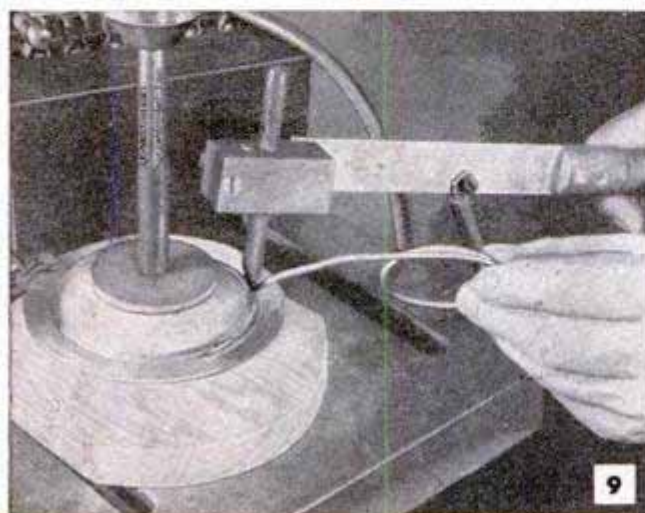

9

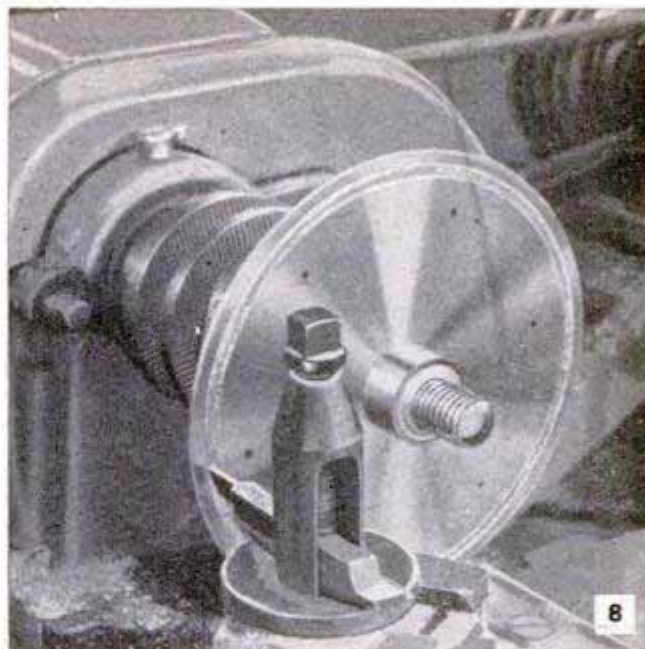

8

After brass plate is cut out and drilled, a groove is turned near edge to receive ring of felt packing

speeds hardening of the brass and may result in a spoiled cup. Continue the stroking action until the metal has "flowed" into the full contour of the form. Then cut away the center section, or bottom, of the cup and carefully score the edge, Fig. 5. Do not cut clear through, because the cup will be damaged when it pulls away. Unfasten the cup from the wooden form and cut along the scored line with tinner's snips. To assure a watertight joint when soldered to a brass plate, the rim of the cup must be lapped smooth on a sheet of fine emery cloth or a lapping plate as in Fig. 7. Cut out and drill the plate, Fig. 6, and true the edge on the lathe. Then turn a groove near the edge for the ring of felt packing, Fig. 8.

The cup and plate must be centered accurately before they are soldered together. This can be done by chucking a pad center in the drill press, using it to center and clamp the parts together. The pad center

Carbon-arc soldering machine speeds work and small fiber brush spreads melted solder for neater joints

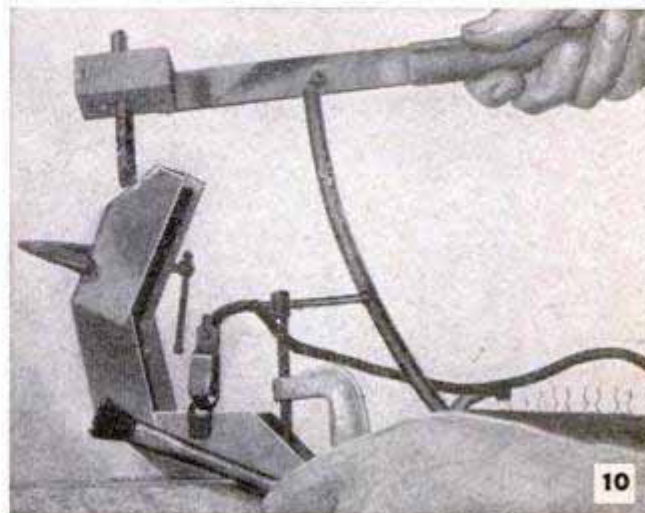

10

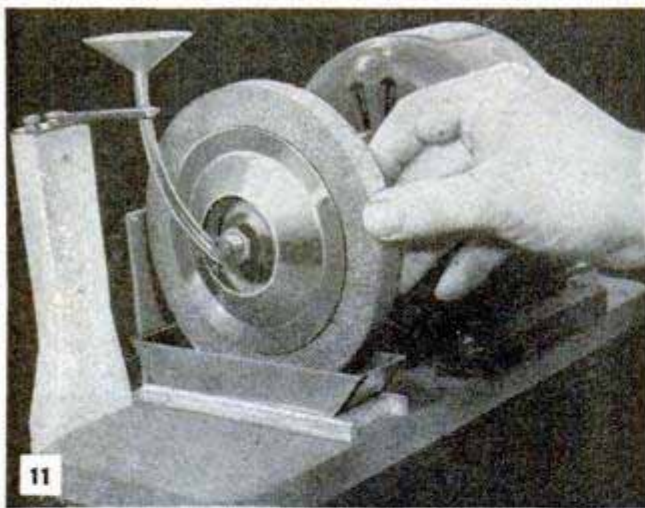

Drip pan fits directly under grinding wheel. End of conductor pipe is positioned close to brass plate

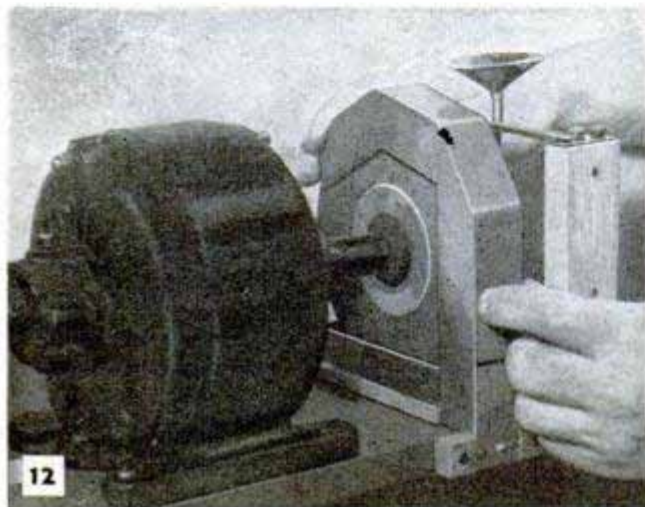

Wheel guard is attached with wing nut, above, and coolant container mounted on wooden clamp, below

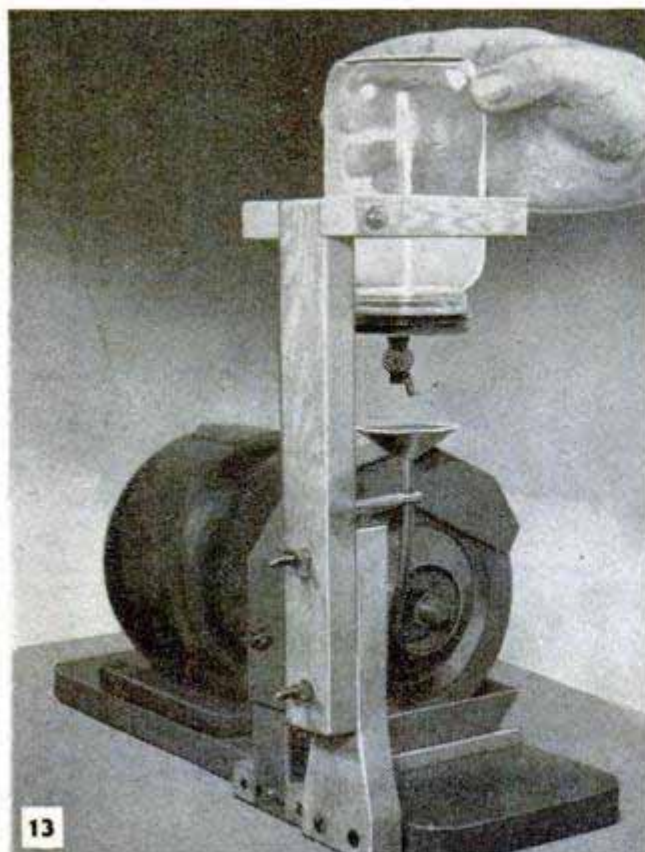

is a length of steel rod with a disk fastened to or merely slipped under the free end. Coat the assembly with flux, tack-solder and then flow a wash of solder completely around the joint, Fig. 9. An inexpensive fiber brush, Fig. 10, may be dipped in flux and used to spread the melted solder, resulting in neater joints. If available, a carbon-arc soldering machine will do the job in a fraction of the time required for ordinary methods.

The base, uprights and jar clamp are made from hardwood as shown in Fig. 6, the radius of the clamping arms being determined by the size of the coolant container. A brass drip pan, held in place with wooden cleats, fits directly beneath the grinding wheel to catch the paste formed by the mixture of grinding dust and coolant. The construction of the conductor pipe is detailed in Fig. 6 and its assembly is illustrated in Figs. 1 and 11. The brass hanger supporting the pipe must be detachable, as it is necessary to remove the conductor pipe each time the grinding wheel is changed. For efficient distribution of the coolant, the end of the pipe must fit as closely to the plate as possible, Fig. 1. However, if a large-diameter retaining washer is used, consider this as part of the plate when checking the pipe length.

The detachable wheel guard, Figs. 6 and 12, must be substantial for maximum safety, so be sure that the soldered joints are strong. After tack-soldering the parts of the guard, flow solder along the joints. A good soldered joint flows all the way through and there should be a continuous fillet of solder along the inside of each joint.

An ordinary glass jar having a screw-type lid will do for the coolant receptacle. The lid is fitted with a drip cock and breather pipe as in Fig. 6, the drip cock being fastened with a stiffening washer and nut. Select a drip cock that turns easily so minute adjustments can be made. It is an excellent idea to keep two or more jars of coolant on hand. Then, as soon as one jar is empty, the cap can be screwed on the full one and the jar mounted in the clamp as in Fig. 13. Note that the clamp should hold the jar high enough so the drip cock can be regulated easily. Protect the completed unit by painting the parts with waterproof lacquer before assembly.

When using the vapor-zone attachment, allow the grinder to run for a few seconds after the coolant has been turned on and hold your finger close to the face of the wheel. Then, when your finger feels cool and droplets form on it, the grinder is ready for use. Experimenting will determine the proper flow of coolant for a particular job. However, one drop per second is about the average rate of flow.

Rough-riding Jeeps obtained from war surplus and being used on farms and in service stations can be made more comfortable by fitting them with foam-rubber seat cushions. Firm-quality foam rubber, 1 in. thick, is looped as shown in the details and mounted on a hardboard base with split brass paper fasteners. Note in the front view of the seat, upper detail, that the loops of rubber run from front to rear. The side view of the back, lower detail, shows how the rubber loops extend across the back and also illustrates how the size of the loops may be varied to form the desired contour. The base is marked off in a series of 2-in. squares and a $\frac{1}{8}$ -in. hole is drilled at each corner of the squares. These holes receive the ends of the brass fasteners which are first inserted through $\frac{1}{16}$ x $\frac{1}{2}$ -in. flat-iron anchor bars. Holes are drilled through the bars to register with the holes in the base and a bar is placed along the bottom of each rubber loop to keep the heads of the fasteners from working through the foam rubber. The

Jeep Seat Cushions of Looped Foam Rubber Absorb Road Shock for Comfortable Ride

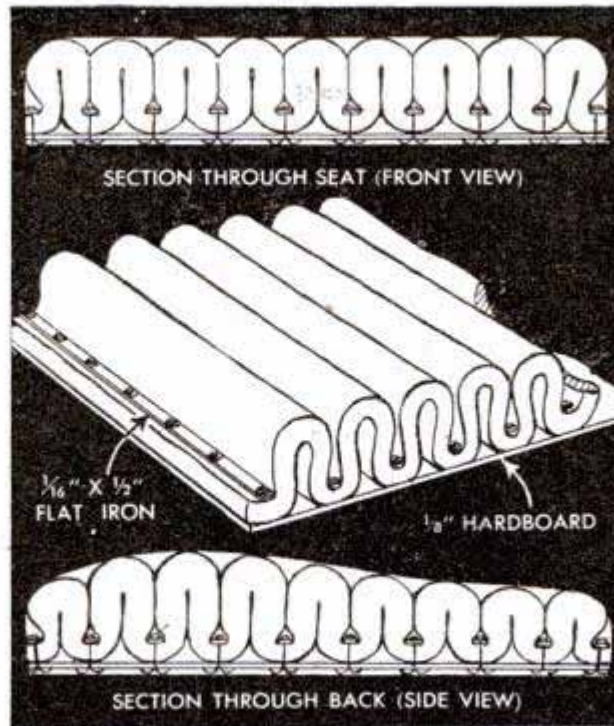

rubber under the anchor bars should be compressed to one half its thickness. The cushions can be covered with fabric, plastic or leatherette, using the original seat covering from the Jeep if it is still in good condition. As this method of padding is simple to employ, it also may be used when building lawn furniture.

Louis H. Keding, La Grange, Ill.

Compound Girder to Support Heavy Load Improvised by Sheathing Beams

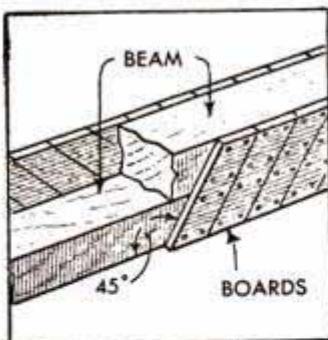

When timbers of sufficient size to support heavy loads are not available, compound girders consisting of two or more beams can be improvised to serve the purpose. The beams are laid

one on top of the other to attain the desired thickness and then sheathed with boards, preferably $1\frac{1}{4}$ in. thick. These boards are spiked at a 45-deg. angle along the sides of the girder, running in an opposite direction on each side. The sheathing counteracts shifting of the beams, and load tests reveal that the sheathing boards will split or the nails pull loose before the beams collapse under excessive loads.

John P. Arnold, Doylestown, Pa.

Nipple Floating on Milk Insures That Pail-Fed Calves Will Drink Slowly

Floating in a pail of milk, this nipple forces a calf to drink slowly in a more natural manner and without wasting the daily ration. The nipple is a 6-in. length of rubber milking-machine tubing forced through a hole drilled in the center of a square piece of $\frac{3}{4}$ -in. board. Be sure that the square piece is cut to the proper size so that it will fit loosely in the pail. A wooden plug is pressed into the lower end of the tubing so that both are flush with the underside of

the board, and a $\frac{3}{16}$ -in. hole is drilled through the plug. The top end of the tubing should be tapered or rounded slightly so that it forms a nipple. — Clyde Zimmerman, Topeka, Kans.

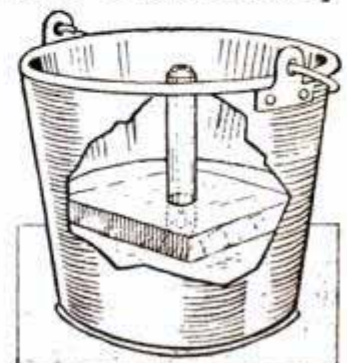

TRACTOR LOW-LOAD PLATFORM

FARMERS and poultrymen who own Ford tractors with hydraulic lifts will find daily use for this handy load platform. The platform is bolted to an underframe made from 3-in. pipe as in the details below. Sleeves in the ends of the tractor lift bars slip onto $\frac{7}{8}$ -in. pins welded into the vertical members of the pipe frame, and the free end of the hydraulic-control bar is pinned to a yoke on the frame. In the raised position the platform is carried about 8 in. above the ground.

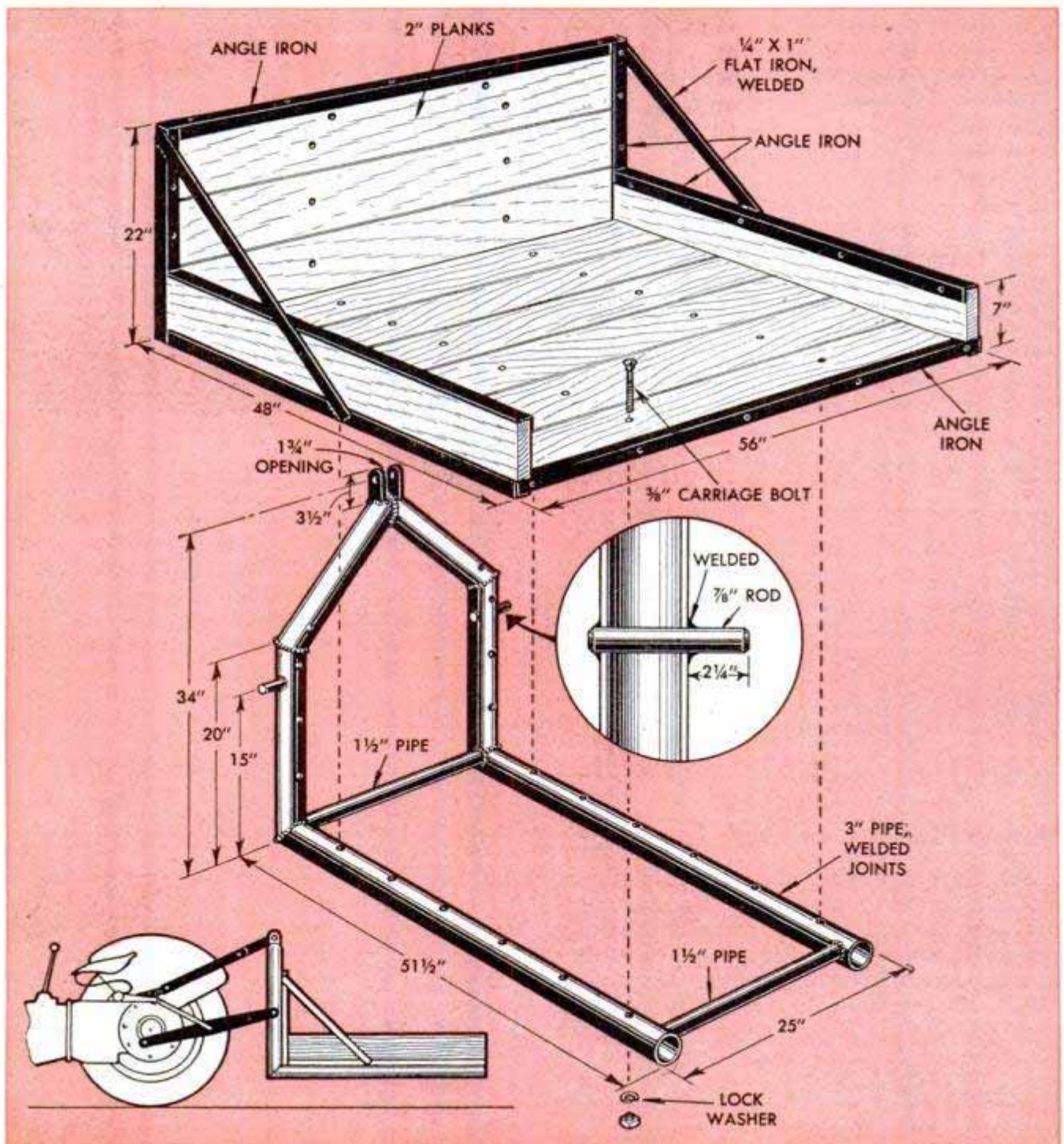
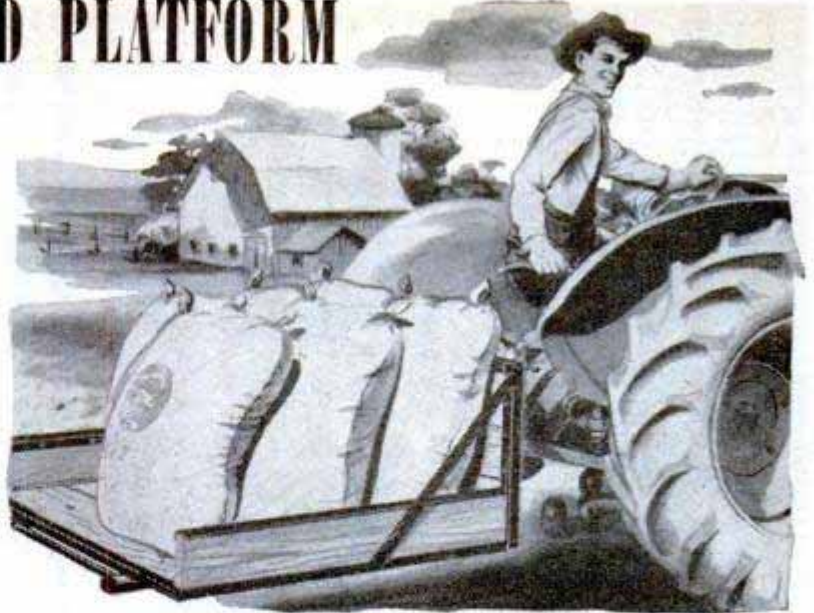

Sheet-Metal Clip on Platform Scale Holds Weighing Slips and Pencil

Weighing slips are prevented from blowing off the platform scale while weighing produce outdoors by one merchant who made a hinged holder of sheet metal to keep both the slips and a pencil handy. The sheet metal is cut and bent as indicated in the sketch and is attached to the wooden beam arm of the scale with two small nails. The free end of the sheet-metal clip is turned back to form a holder for the pencil.

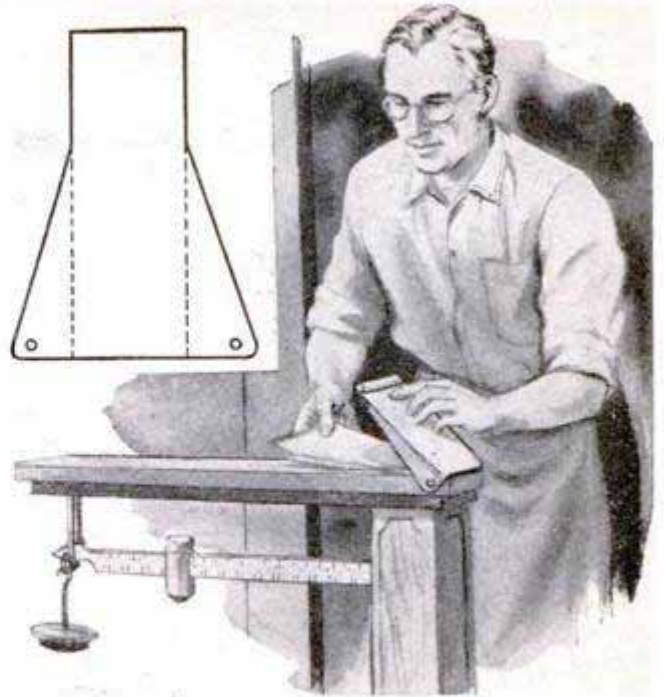

Taper-Measuring Gauge for Lathe Assures Holes of Exact Diameter

With this measuring gauge you can accurately "mike" a tapered hole to an exact diameter. The gauge consists of two movable buttons or studs in a slotted metal channel. The important point in making the gauge is to be sure that each button projects .005 in. above the channel. To check the diameter of a tapered hole turned to the approximate size, the buttons are first set the desired distance apart with a micrometer. Then the gauge is held against the work as in detail A. When the taper is turned to the point where there is no side play between the buttons and the side of the hole as the gauge is moved back and forth, the exact diameter desired is obtained by facing off the end of the work .005 in. To be sure that you remove just .005 in., the gauge is held against the work as in detail B. Then, when a trial cut, part way in from the edge, is deep enough to permit both button and channel to touch the work, the facing cut is completed to produce a hole of exact diameter.

H. Moore, Leeds, England.

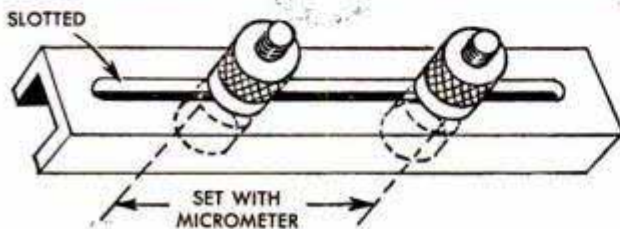
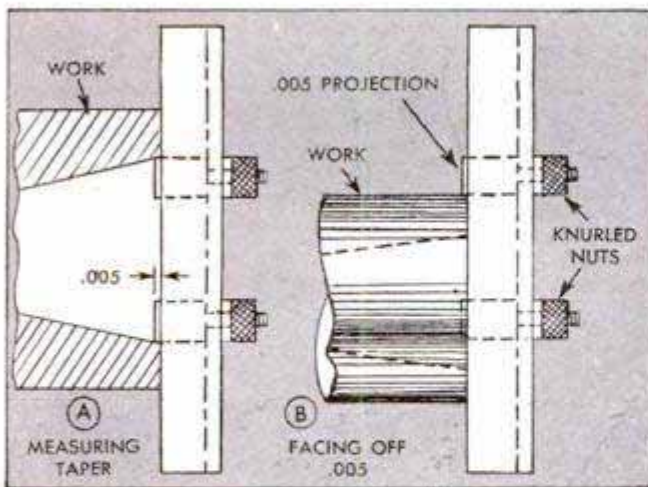

Correct Punching Strengthens Belt

When lacing a belt, maximum strength is maintained if elliptical holes are punched parallel to the length of the belt as shown in the lower detail. Note, by comparing the shaded areas in the two drawings, that if the holes are punched with their length running across the belt considerably more material is removed from the cross section of the belt. The strength and pulling power of the belt is reduced in proportion to the amount of stressed material removed.

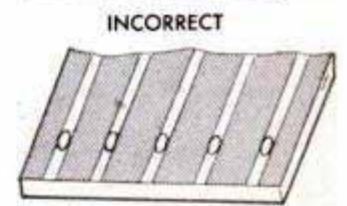
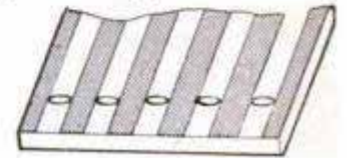

W. F. Schaphorst, Newark, N. J.

Chalk-Line Reel Drilled To Prevent Unwinding

To prevent a mason's chalk-line reel from unwinding when the line is pulled taut and tied, drill a small hole through the reel and pass the line through it as shown in the illustration. When paying out the line, unwind as much as is needed by looping it over the opposite side of the reel and then pull it through the hole.

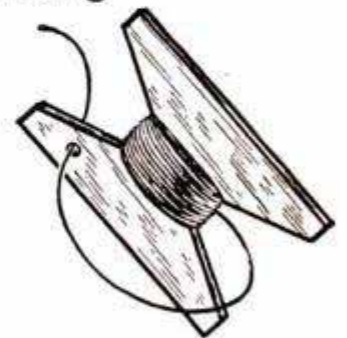

M. S. Hunter, Orangeburg, S. C.

Disk and Spindle **SANDER**

By R. Russell

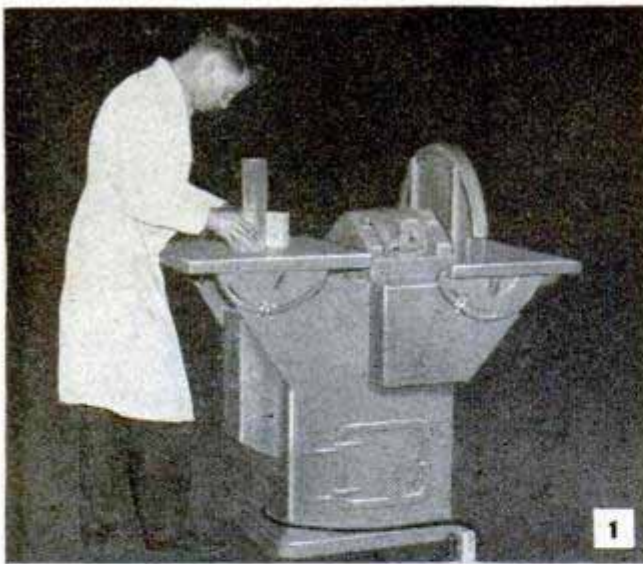

Oscillating spindle sander plus large disk sander combine to form a versatile woodworking machine

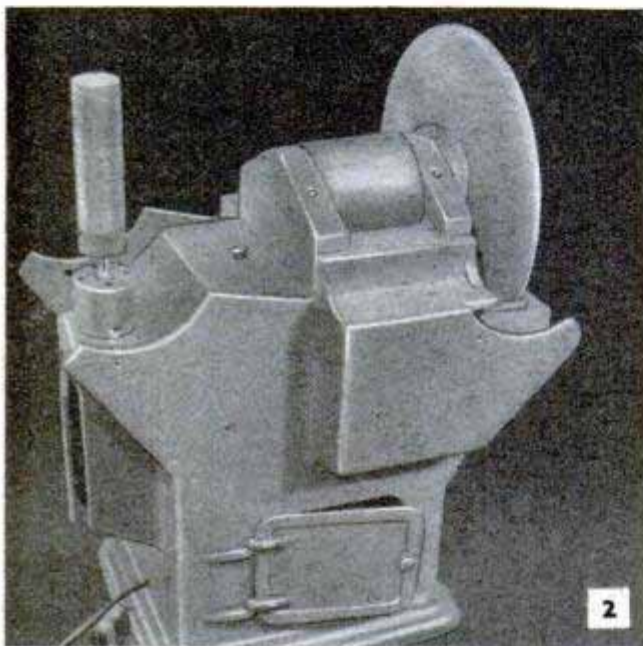

Above, completed machine minus tilting tables. Note service doors for motor and oscillating mechanism. Below, removing dust covers and opening side door give access to both disk and spindle-sander pulleys

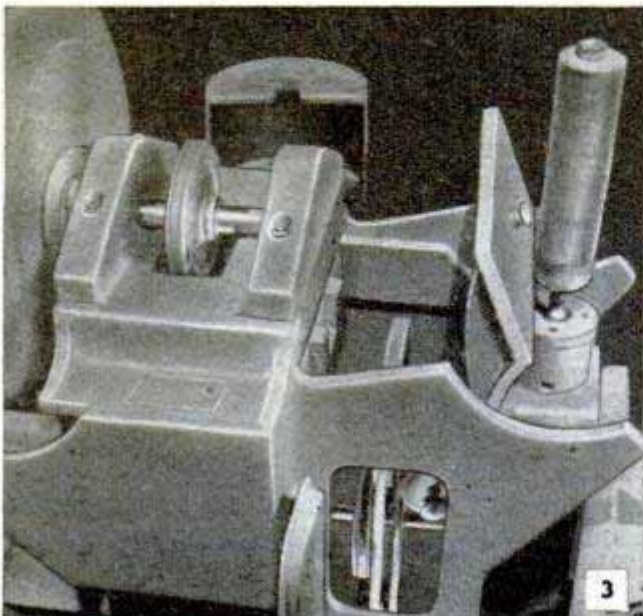

BUILT entirely of plywood, this combination disk and spindle sander provides a sturdy machine for the basement shop or small woodworking shop. The 24-in. disk with its tilting table will handle a wide variety of large work. The spindle sander, pictured in use in Fig. 1, oscillates, and this sander also is equipped with a tilting table. Both sanding units are driven by a 1-hp. double-shaft motor housed in the base of the sander.

Before beginning construction of the sander, it is a good idea to lay out the sectional detail, Fig. 6, full-size on heavy paper. All members are keyed to this detail. Proceed by roughing out the bearing mounts from $\frac{3}{4}$ -in. plywood, 7 ply, making them about 1 in. larger over-all than the finished dimensions, Fig. 4. Note part B is sandwiched between parts A and C to form the front bearing mount and part E is placed between two pieces cut from pattern D to form the rear bearing mount. Mark off the bearing centers and cut holes for the bearings in parts B and E. Standard ball bearings are used and should be a press fit in the holes. Holes 3 in. larger than the bearings are cut in part A and one of the parts D, the other member being left solid. Bearing retainers to fit into the holes in parts A and D are bandsawed from $\frac{3}{4}$ -in. plywood, and a stepped plug is turned to facilitate aligning the bearing mounts for gluing. Only B and C layers of the front bearing mount are glued together at this time. By cutting off the shaft projection from the stepped plug, the latter can now be used to align the sections of the rear bearing mount for gluing. All three layers of this mount are glued and clamped together and allowed to dry.

The two glued sections are placed one on top of the other and aligned with a stepped plug. Then the actual over-all dimensions are laid out from the bearing centers and the work cut to finished size, both front and rear sections being cut simultaneously. The outer layer of the front bearing wall, detail A, is then laid out and sawed separately. Note that the dimension at the base is $1\frac{1}{2}$ in. greater than the widths of the other layers so that a $\frac{3}{4}$ -in. rabbet is formed for the side panels when the three layers are glued together.

After section A has been aligned and glued to section B, the bearing retainers

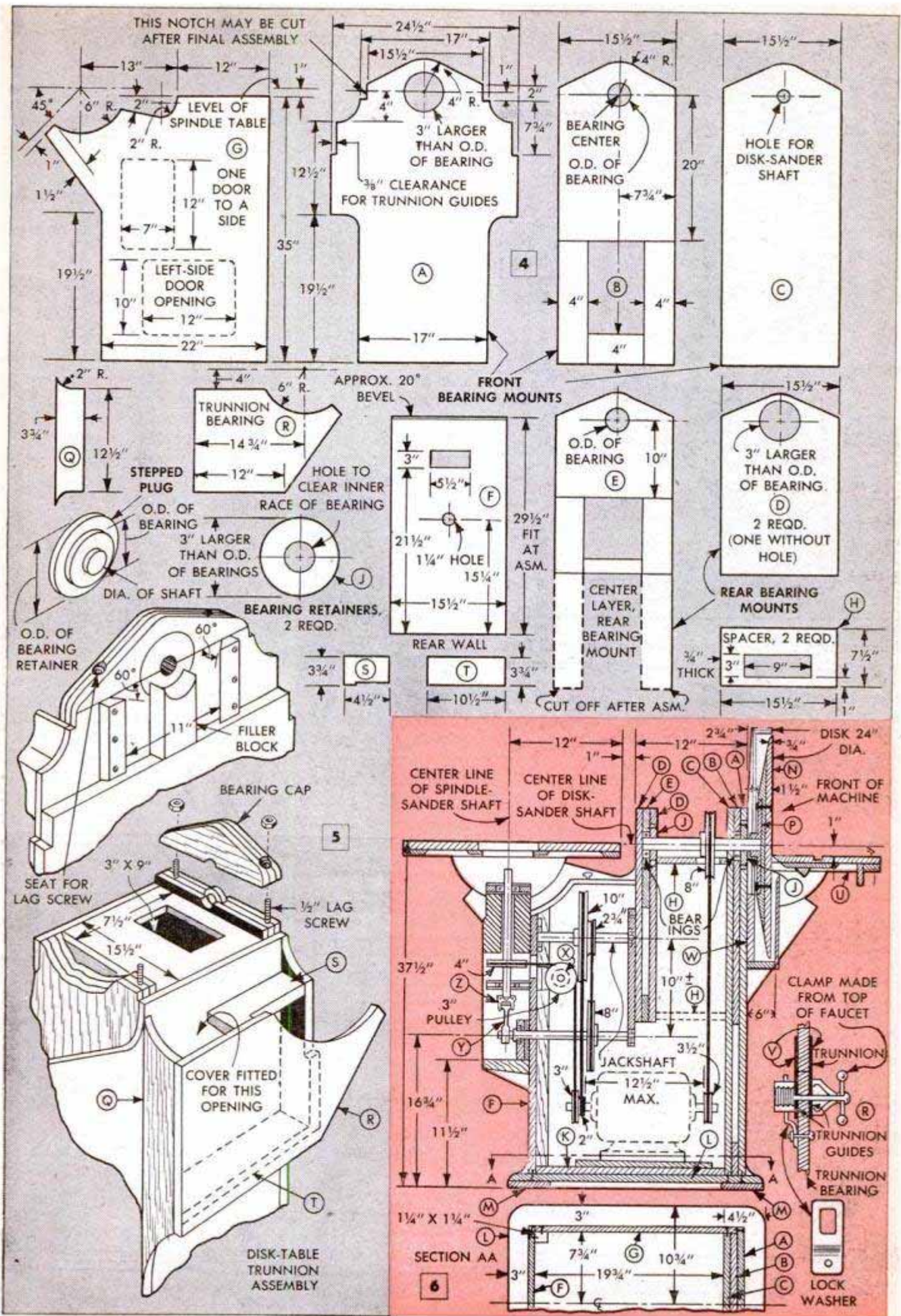



Idler pulleys mounted on detachable rear wall form right-angle drive for the oscillating spindle sander

are screwed to the mounts. Then the top of each bearing mount is drilled for two $\frac{1}{2}$ -in. lag screws and cut off horizontally through the bearing center to form the bearing caps, Fig. 5. The holes in the caps are counter-bored for nuts and, after the lag screws are driven, their heads are cut off and threaded to receive the nuts. Hanger bolts can be used instead of lag screws.

The two side walls, detail G, are cut simultaneously from $\frac{3}{4}$ -in. plywood. The two trunnion bearings, R, the rear wall, F, the spacers, H, and associated parts can also be cut out at this time. As the spacers which fit between the bearing mounts serve to align the bearings, they must be squared accurately. Two of these are cut out, one being installed permanently at the top of the sander and the other being used only temporarily, as shown in Fig. 6. The latter spacer is knocked out after assembly.

The base of the sander consists of two main parts cut from $\frac{3}{4}$ -in. plywood—piece K which is $15\frac{1}{2} \times 19\frac{3}{4}$ in. and piece L which is $21\frac{1}{2} \times 27\frac{1}{4}$ in. When cutting piece K be especially careful to see that the corners are perfectly square, because any irregularity in this piece can throw the entire machine out of alignment. Piece K is screwed and glued to piece L which forms the lower member of the base. Cleats, M, Fig. 6, are cut from 1 x 6-in. stock and attached to the underside of piece L to raise it off the floor.

Two 24-in. disks of $\frac{3}{4}$ -in. plywood are glued together to form the sanding disk, N, Fig. 6. The back side of the disk is turned out to receive a cast-iron faceplate, P, and the disk is faired away from its full thickness at the recess to $\frac{3}{4}$ in. near the outer

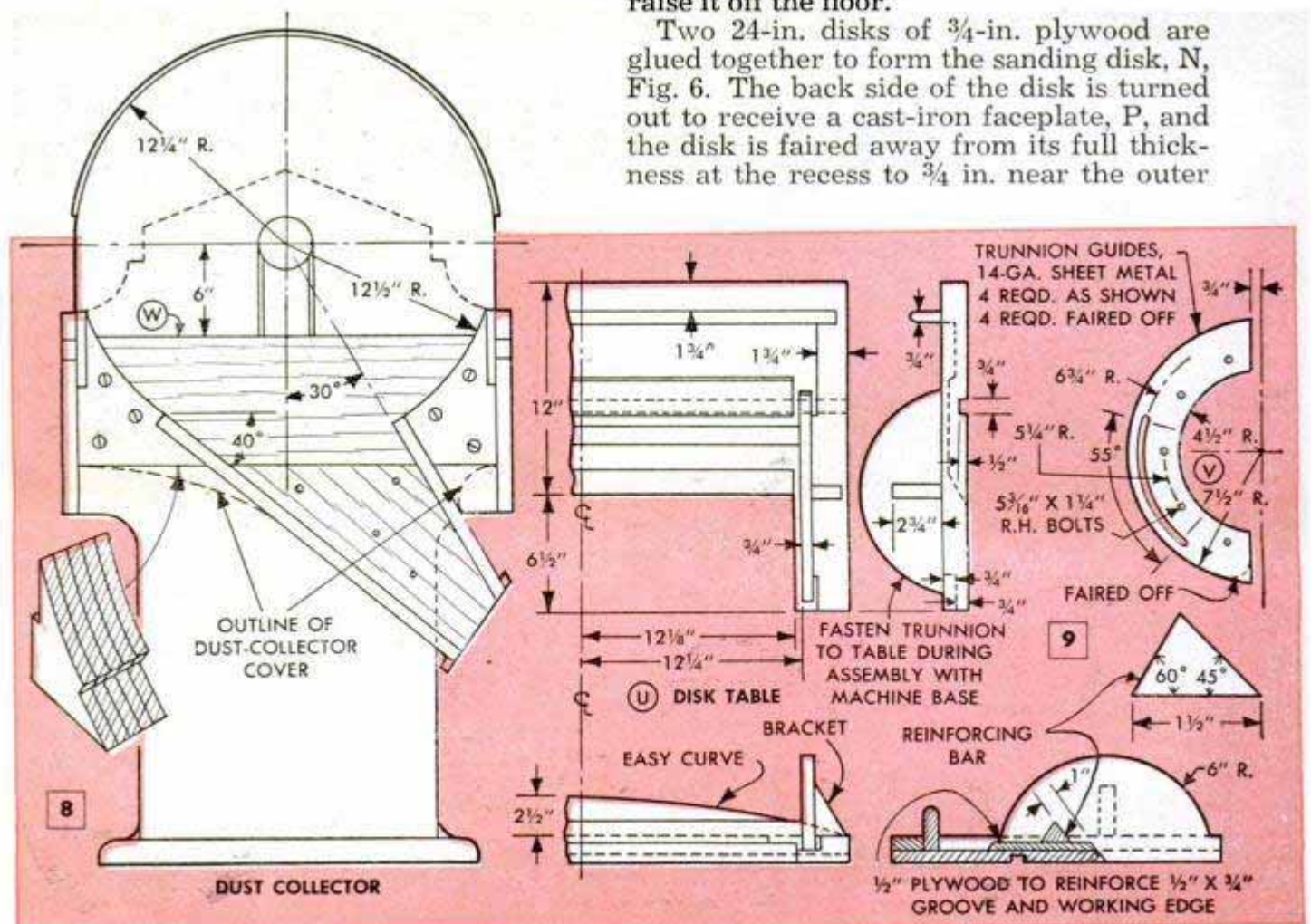

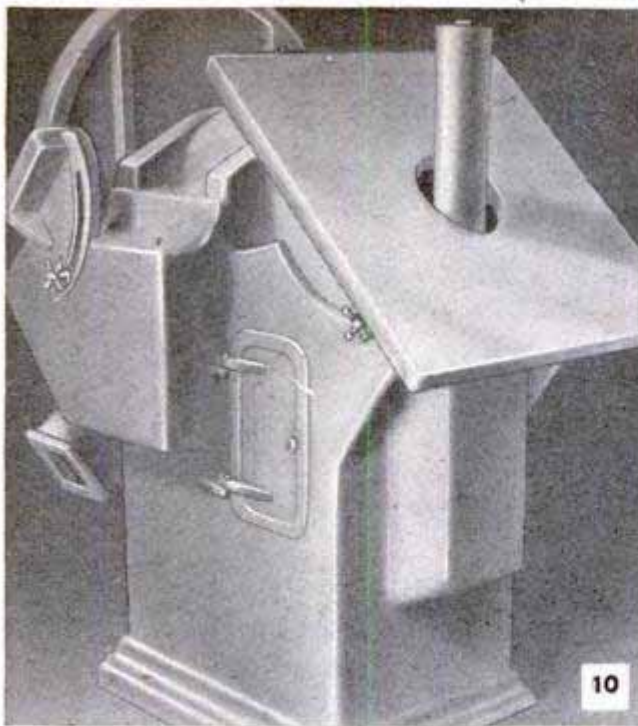

Tables of spindle and disk sanders are shown tilted to maximum angle of 45 deg. Note trunnion clamps

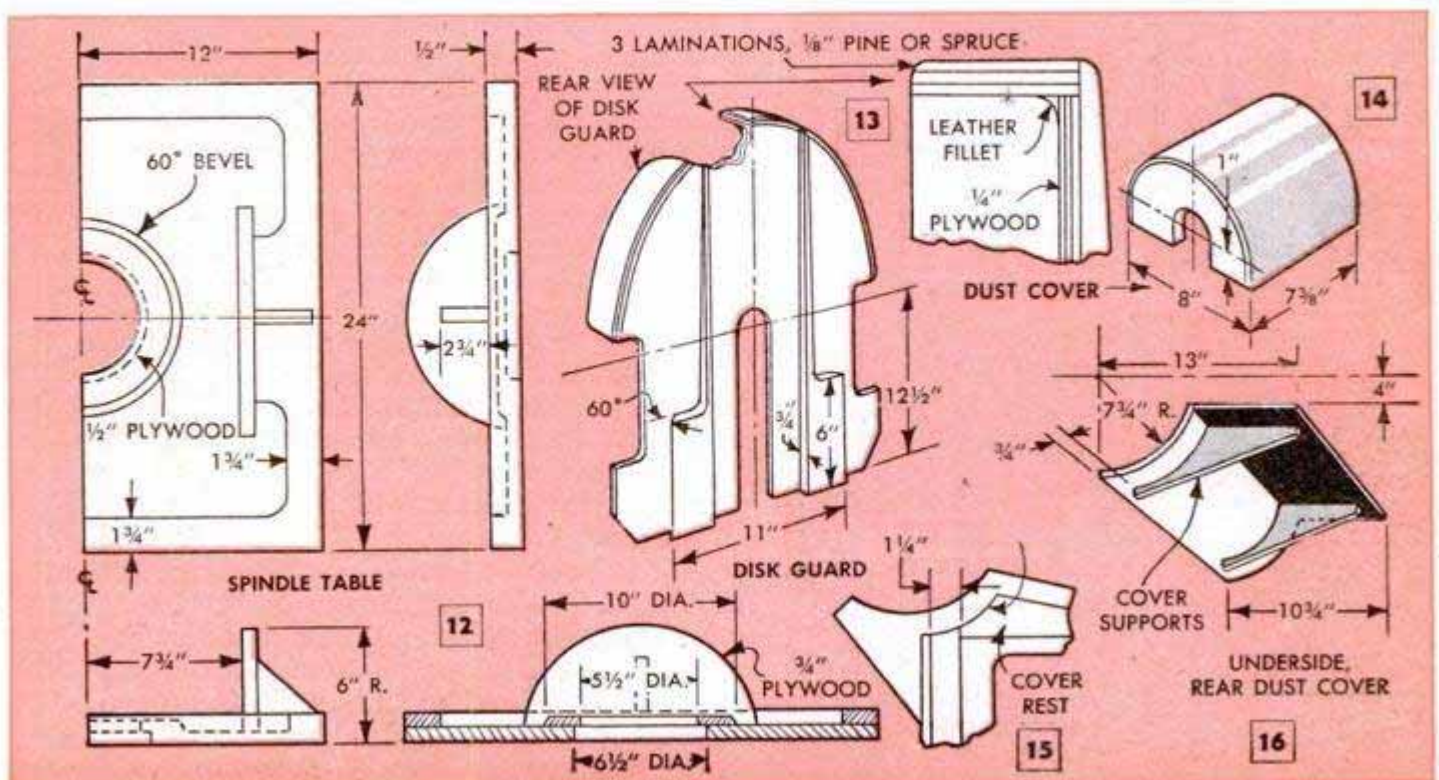

Table of disk sander is grooved for miter gauge and underside is reinforced with plywood and crossbar

edge. The hub of the faceplate is pinned to the shaft and the disk is attached with four elevator bolts in countersunk holes. The shaft size is determined by the bearings.

The machine is now ready for temporary assembly. To do this, fasten the front bearing wall against part K of the base with screws driven up from the underside as in Fig. 6. Install the 1¼-in.-square corner posts and set up the rear wall. Then the spacers, the side walls and the rear bearing wall are installed. When assembled, check the disk-sander shaft for alignment and make any necessary adjustments.

Make the plywood disk table, Fig. 9, detail U, the trunnions and the sheet-metal trunnion guides. Note that the top of the table is grooved for a miter gauge and the underside is fitted with a hardwood reinforcing bar to strengthen the working edge. Fit the trunnion bearings to the temporary assembly, making sure that the 3¾-in. width of parts Q, Fig. 5, is exactly the same as the overhang of the front section of the bearing mount, A, Fig. 4. After tightly drawing up all the joints of the machine, the disk table is fitted by fastening temporary strips on both sides of the trunnion



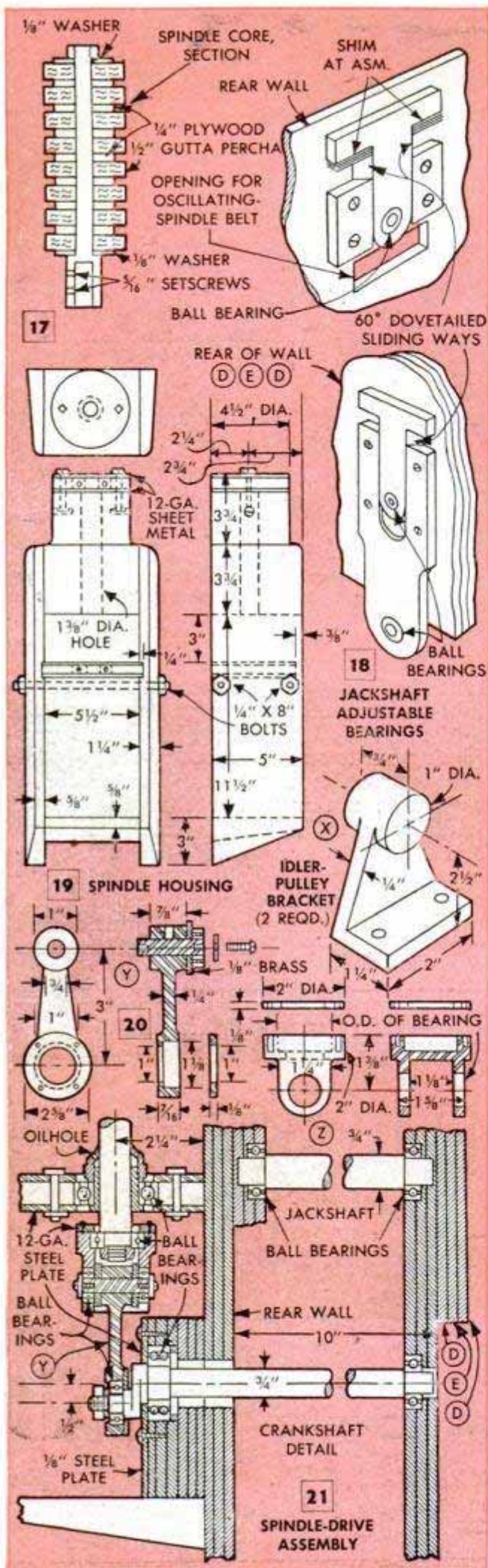

bearings and setting in the trunnions. The table should tilt without rocking but, if rocking does occur, it means that one of the trunnion bearings is out of line.

After the shaft and disk table have been perfectly aligned, the machine is ready for final assembly. Mark all the joint outlines, take the machine apart and then reassemble by gluing and screwing the parts together. However, do not glue the rear wall in place. Attach the sheet-metal guides to the disk-table trunnions and clamp them to the trunnion bearings with clamps made from the tops of faucets, detail R, Fig. 6.

To build the dust-collector chute, Figs. 8 and 11, first attach piece W, a 24 1/2-in. length of 1 x 10, to the front bearing mount between the trunnion bearings, as in Figs. 6 and 8. End blocks for the dust chute are built up in layers from scraps of plywood and bandsawed on a 12 1/2-in. radius. The blocks are fastened to piece W and then top and bottom pieces of the chute are fastened to them. The face side of the chute is covered with 1/4-in. plywood, fastened with screws to permit removal.

The disk guard is made as shown in Fig. 13 and is fitted with beveled mounting brackets to slide between the cleats shown in Fig. 5. Installation of the pulleys, belt and motor, as in Fig. 6, completes the disk-sander portion of the machine.

The spindle table, Figs. 10 and 12, is built similarly to the disk table. Sheet-metal guides and clamps are installed in the same way as for the disk-table trunnion. Fig. 14 shows construction of the disk-shaft dust cover, Fig. 16 construction of the rear dust cover and Fig. 15 the cover rest. Figs. 2 and 3 picture these covers in both the closed and open positions.

The housing for the spindle shaft and bearings shown in Fig. 10 is made of hardwood, as in Figs. 6 and 19, and fitted with an access door pictured in Fig. 2. The bearings are fitted in plywood retainers and held by sheet-metal plates. The spindle thrust-bearing housing and the connecting rod, Figs. 20 and 21, can be of welded steel or cast iron, the diameters being determined by the size of the ball races used. The crankshaft and jackshaft are mounted as shown in Fig. 21, and adjustable bearings for the jackshaft are made as detailed in Fig. 18. The two 3-in. idler pulleys for the right-angle drive, Figs. 6 and 7, are mounted on brackets detailed in Fig. 20.

The spindle drum, Fig. 17, consists of disks of 1/4-in. plywood and 1/2-in. gutta percha, the latter being a sliding fit. These are fastened to a shaft with a nut and washer and the lower end of the shaft is bored to fit over the end of the oscillating drive shaft. The shaft is held in place with two 5/16-in. setscrews.

Radio Electronics

UTILITY TELEVISION TODAY

PRACTICAL applications of television in the home will be featured by many manufacturers in 1950. The table-model TV receiver shown in photo A employs two 6-in. loudspeakers to reproduce the FM sound in a realistic manner. This custom-made TV receiver employs a versatile chassis consisting of three basic units, the power-supply unit, R. F. chassis and deflection yoke assembly.

The manufacturer also makes the separate units and speakers available so that they can be assembled in special installations in any type of cabinet. They may be placed side by side, one above the other, etc., to conform with cabinet or console space. Photo B shows the assembled units without the TV picture tube, as they appear in a conventional cabinet; the separate units are illustrated in photo C. There is a choice of either a 10-in. or 12½-in. tube model. These units are completely wired, pretuned and tested; they are not construction kits. Photo D shows a kitchen television set in gleaming white, made by another manufacturer. It employs a 7-in. tube and is compact enough to fit on a kitchen shelf or cabinet, thus bringing TV right into the homemaker's work center.

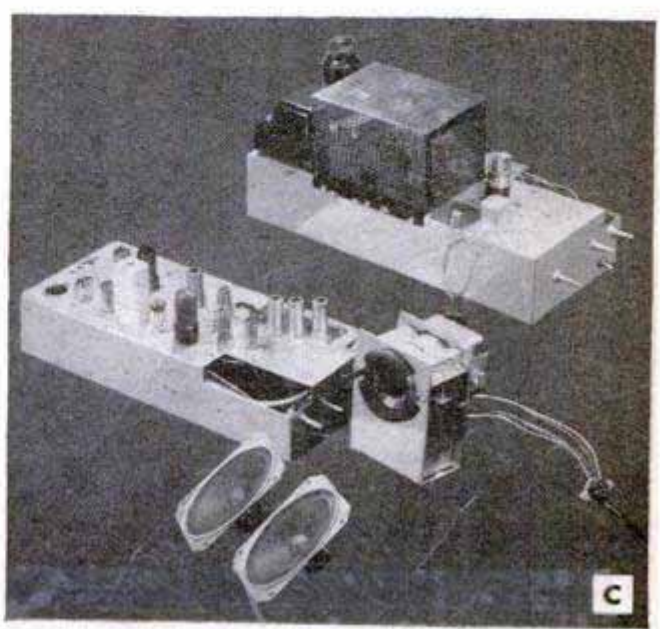
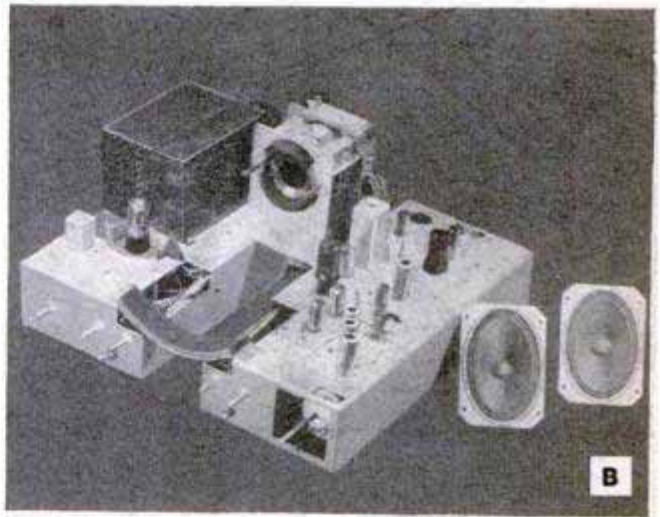
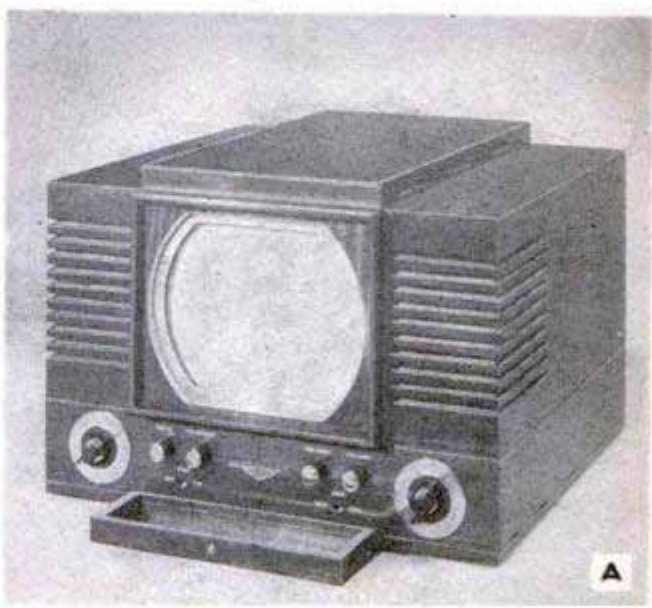

No. 1 PROGRESSIVE ALL-WAVE

DISTANT short-wave stations as well as local broadcast-band programs can be tuned in with good volume and clarity with this specially designed progressive student set. Former progressive student sets have keenly interested beginners because they have made it possible to start out with a simple headphone receiver. Then without wasting parts, they can build a full-fledged, all-electric loudspeaker set at a later date.

This 1950 two-unit series is a little more elaborate than former ones but it is in keeping with the same idea, and it includes the

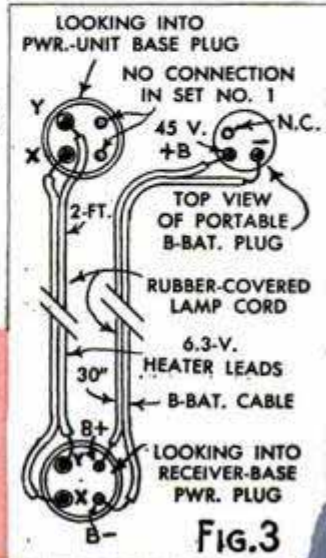
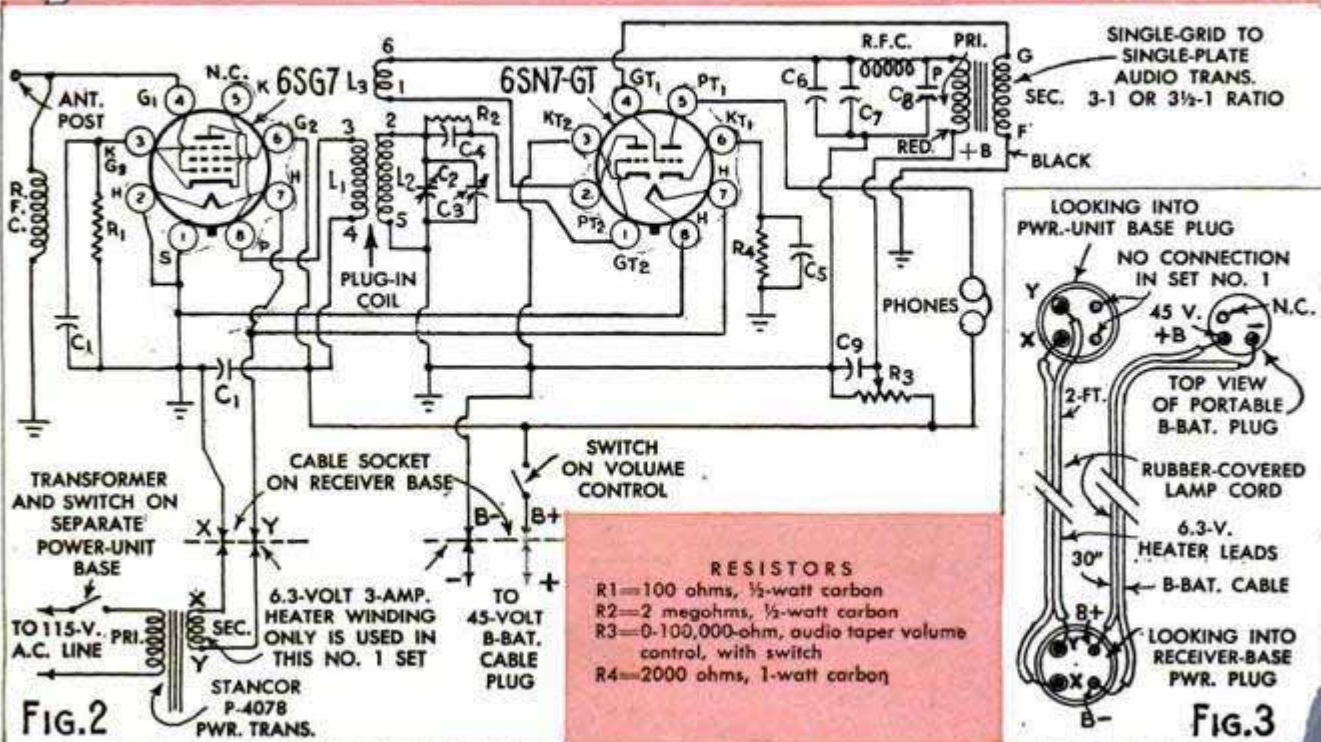
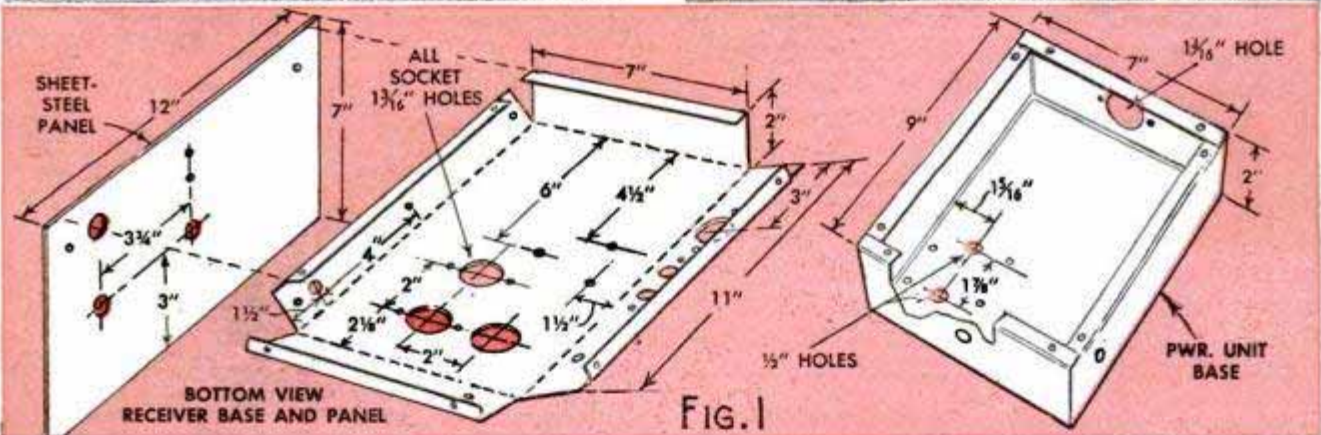
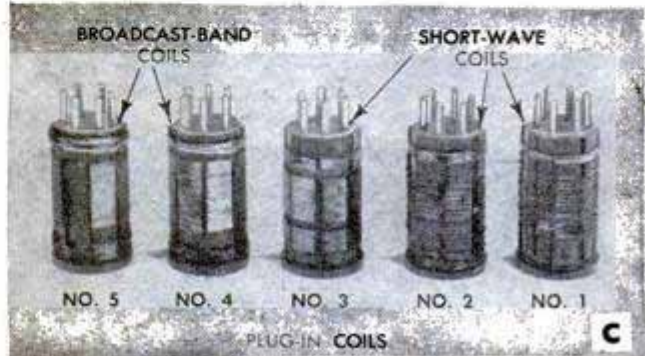
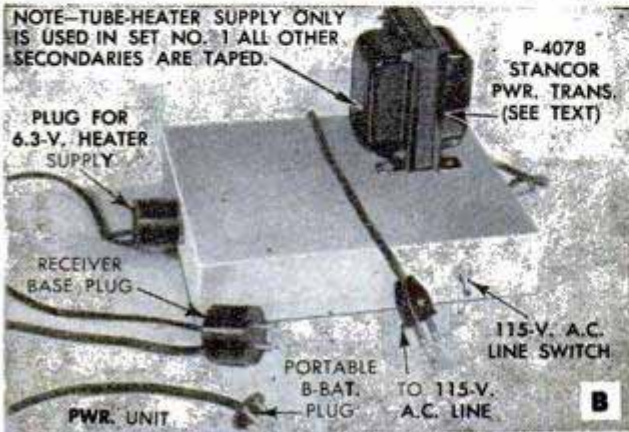
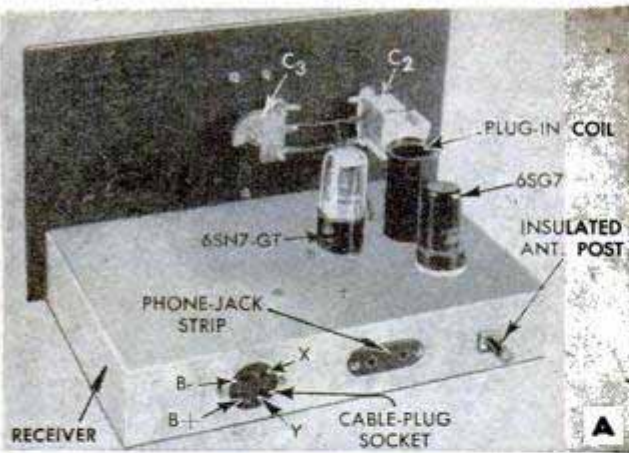

"OVERSEAS DXER" FOR STUDENTS

short-wave bands, and hand-wound coils requested by many builders of previous progressive student sets. The separate power unit plays a very small part in set No. 1 as only the 6.3-volt secondary winding on the power transformer is employed; tape the unused secondary leads carefully. This No. 1 set is complete in itself and should be carefully built and used by the beginner for some time until he is thoroughly familiar with its operation before converting it into the larger all-electric set which will appear in an early issue. Although only two tubes are used in this first set, they provide a radio-frequency stage, a detector, and one audio stage. The R. F. stage furnishes necessary extra sensitivity that will pull in foreign short-wave broadcasting stations with ease.

Photos A and B show the separate receiver and power unit; three of the plug-in coils illustrated in photo C are used to cover the short-wave bands from 1.6 to 15

(Continued to page 234)

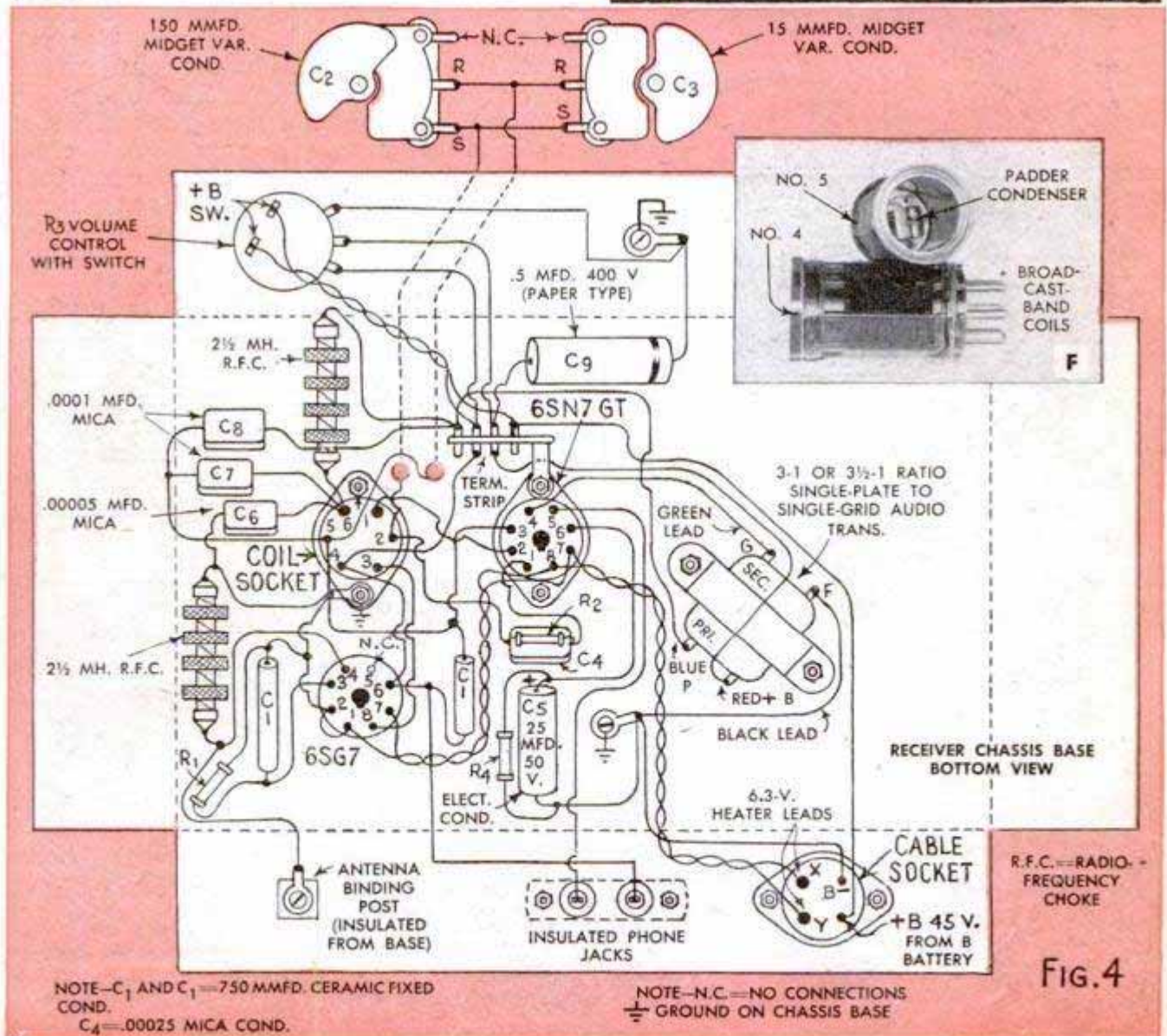
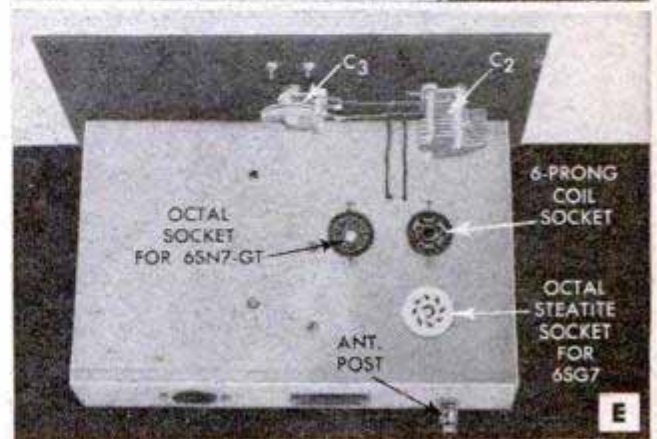

"BLACK" TUBE FOR SHARP-CONTRAST TV PICTURES

By F. L. Brittin

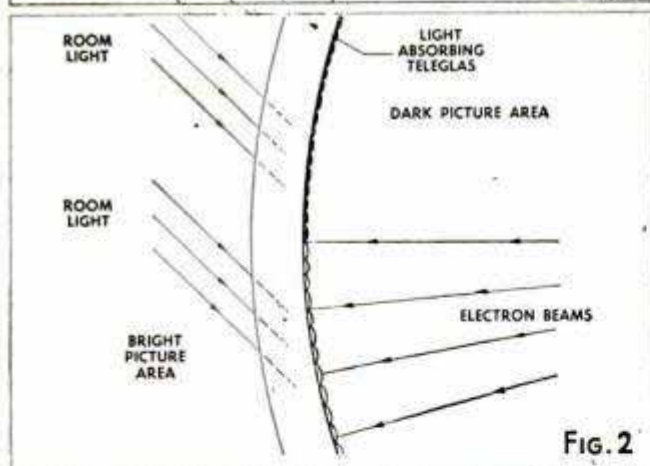
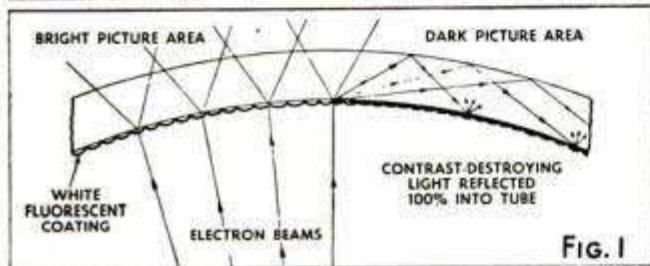

SPECIALLY designed glass known as "Teleglas" is now used in the faces of some metal picture tubes to provide contrast ratios, perfect image reproduction and relieve eyestrain. Developed by the Pittsburgh Glass Company engineers for TV-set manufacturers, it is claimed to make possible the maintenance of an approximate 33 to 1 contrast under widely varying conditions of room light.

A tube faceplate of this glass, held by the young lady in photo A, shows the lines on the dress under the area covered by the glass as compared with other dress areas. It acts as a filter to reduce the detrimental effects of room light, and to minimize halation, or glare.

Eye authorities are in general accord that the main threat of constant television viewing to the eyes comes from concentrating on an overbright image in a darkened room. They claim that the ideal solution is a not overly bright screen which must, however, have sufficient contrast to give a sharp picture in a lighted room. Two identical TV receivers are photographed on the same negative in photo B. The tube at the left has a conventional glass face while that to the right employs the new glass. A cross section of a cathode-ray tube face in Fig. 1 shows that light from the bright picture area striking the exterior tube-face surface at angles greater than 48 degrees is 100 percent reflected over into the dark area. Teleglas reduces the intensity of this unwanted light. The effect of room light on a TV picture is illustrated in Fig. 2. Black areas in the TV picture can be obtained only by an absence of light. Hence, it is essential that external light which might fall on the picture tube be kept to a minimum. The new glass accomplishes this by absorbing unwanted light.

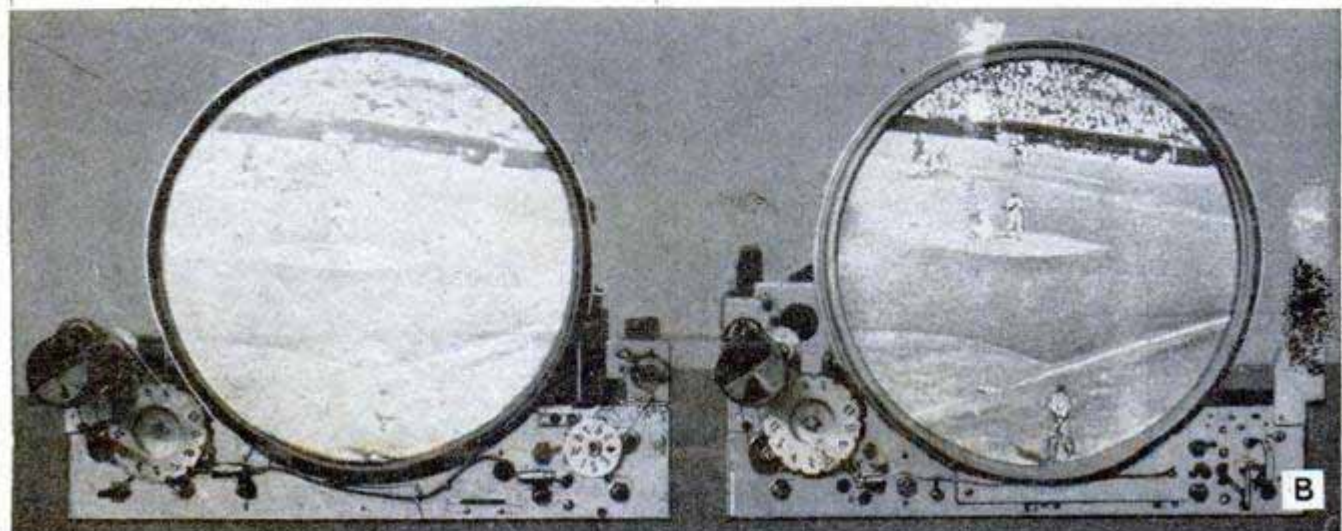

Kodak ABC Photo-Lab Outfit—All the materials and equipment you need to start developing and printing your own pictures. \$7.58.

Kodak Negative Files—Protect individual negatives and negative strips. Index identifies negatives. \$2.25—\$3.25.

Kodak Junior Film Clip—Stainless steel; ideal for smaller sizes of film. Two teeth firmly grip film. \$.23.

Get the most out of
your darkroom—
use *Kodak*
Equipment

With the right Kodak equipment you can have a lot more fun in your darkroom. And you're likely to get better results, too.

Inspect these Kodak darkroom accessories at your dealer's. He can give you many useful tips in choosing the right equipment.

Eastman Kodak Company
Rochester 4, N. Y.

Prices include Federal Tax where applicable

Kodak Darkroom Apron
—Moisture-proof and lightweight. Long waist cord holds towel. Drip cuff at bottom protects shoes. Two sizes, \$2.25 and \$3.



Kodak Washing Assembly—Converts sink into circulating washer. Fresh water enters through hose; hypo-laden water drains through special stopper. \$2.25.



Kodak Utility Footswitch—Keeps both hands free while you're printing, enlarging, or inspecting negatives. \$10.

Kodak Studio Scales—Two-pan type. Weights furnished in avoirdupois or metric system. Mahogany-finish base. \$8.50.

Kodak
TRADE-MARK

Kodak Adjustable Safelight Lamp—Attach it to wall, shelf, or bench. Swing it through nearly a complete circle—it stays in any chosen position. \$7.58.



Kodak Automatic Tray Siphon—Puts fresh water in at top of tray, keeping prints agitated; siphons off chemically laden water. \$5.25.



Kodak Senior Trimmer, No. 5
—Knife automatically returns to cutting position. Hardwood bed marked in 1/2-inch squares. \$12.



**STARRETT
"SATIN CHROME"
MICROMETERS**
Pioneered by Starrett

Satin Chrome Finish eliminates glare, resists rust and stains. Hi-Micro Mirror Finish on anvil and spindle faces—tapered frame—threads hardened and ground from solid—quick-reading figures—every thousandth numbered—many other big features at no extra cost. Furnished in handsome Sycamore case.

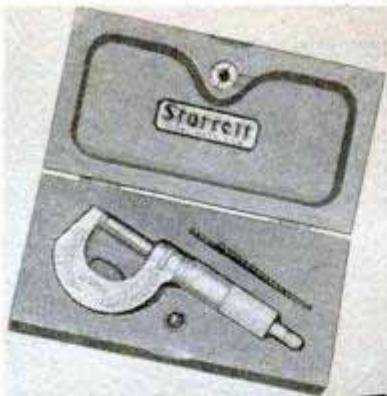

**Own These
Starrett Tools
Make Your
Job Easier**

**STARRETT
COMBINATION SETS**

Eight handy tools in one. Hard precision ground steel blade—easy-reading fine graduations of 8ths, 16ths, 32nds, 64ths—stock and blade seat accurately ground—patented fast-action bolt—built-in level—hardened scribe. A Starrett invention, frequently copied—never equalled.



**STARRETT
STEEL TAPES**

Tough special steel tape ribbon—sharp, bright markings that stand out clear on no-glare black ground—quick-reading figures with foot number marked beside each inch—push-button handle—sturdy case—"Standard for Accuracy"—wide choice of lengths and styles.



SPECIAL OFFER—Only 10¢
50-Page "Tools and Rules" Book
"The Tools and Rules for Precision Measuring" tells how to make accuracy a habit, shows the methods skilled mechanics use. 100 pictures plus reference tables. Send only one dime. Address Dept. AP.



Only 10¢

THE L. S. STARRETT CO. • ATHOL, MASS., U. S. A.

Starrett
REG. U. S. PAT. OFF.

Since 1880... Standard of Precision

Mechanics' Hand Measuring Tools and Precision Instruments
Dial Indicators • Steel Tapes • Hacksaws • Band Saws
and Band Knives • Precision Ground Flat Stock
Buy Through Your Distributor

**No. 1 Progressive All-Wave
"Overseas DXer" for Students**

(Continued from page 231)

megacycles. The remaining two coils cover the standard broadcast band. Complete coil-winding details are given in Fig. 5 and the data chart. Winding the coils will take some time but it is easy to do if you follow

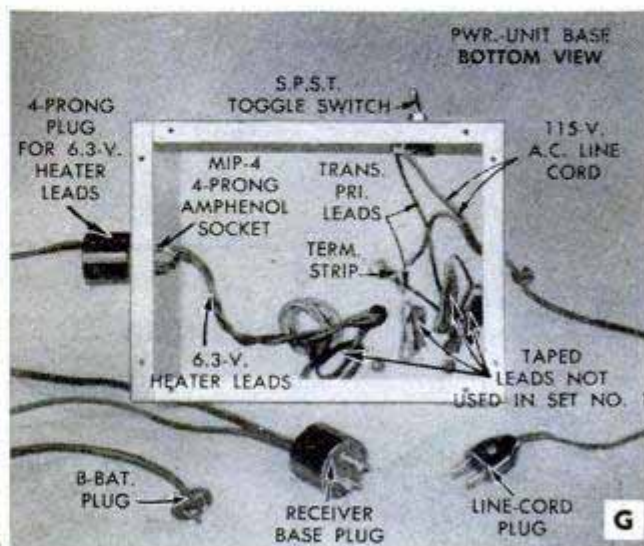

the dimensions and winding data given. As they will be used in both sets, wind them carefully. The coils may require some slight modification to insure smooth operations; coils L1 should be kept as small as possible and still have the detector oscillate. Panel and chassis details are given in Fig. 1; Fig.

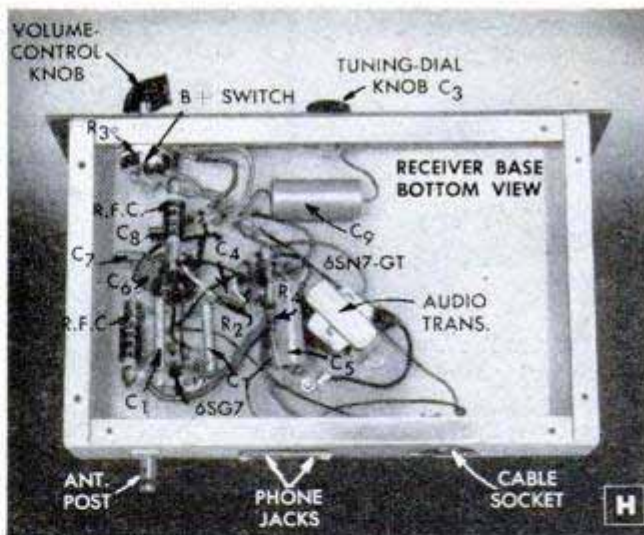

2 is the complete schematic circuit diagram. The cable and plugs are shown pictorially in Fig. 3; the chassis base plugs are made from old 4-prong tube sockets. Note that prong X is on the ground side of the 6.3-volt tube-heater supply; check carefully to make certain that it connects to the X terminal in both chassis cable sockets. When wiring the twisted filament leads in the receiver as shown in pictorial wiring

(Continued to page 236)

A DOUBLE-BARRELED OPPORTUNITY TO

MAKE MONEY!



NEW HOMES



OLD HOMES

**No Schooling —
Steady Work**

Be Your Own Boss!

Another booming year is ahead in the building industry—and here's a double-barreled way for *you* to CASH IN!

Start your own business as a floor surfacing contractor with American Machines—and you will find hundreds of new and old homes are year 'round prospects for your services! No special schooling needed. No long waiting to get going in a business of your own. You can start sanding floors and make money as your own boss *the very first day* your machines arrive! Earnings of \$25 and more a day are not uncommon among men like yourself who have become floormen.

You'll be proud to be a floor surfacing contractor and take your place alongside the plumber, the electrician, the painter and other building craftsmen as an important cog in the construction industry. In new construction you work as a sub-contractor and when resurfacing older homes you will usually operate as a separate businessman.

The investment in floor sanding equipment is small. The overhead is low and you need no elaborate offices, workshop, storeroom or heavy trucking equipment. Many men operate from their own homes and use a regular passenger car to transport their equipment from job to job. Pleasant indoor work... steady the year 'round... prospects everywhere... and *you are your own boss*... a real opportunity for a man with ambition to get ahead and **MAKE MONEY!**

Send for "money-making" booklet entitled "Opportunities in Floor Surfacing"—use coupon and enclose 25c in coin or stamps to cover handling.

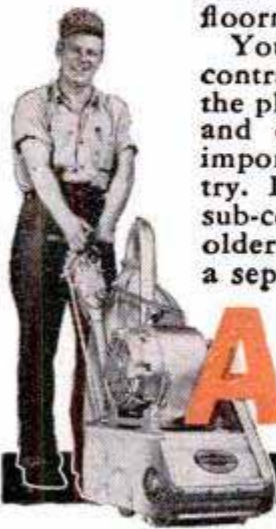

AMERICAN

FLOOR MACHINES

SEND COUPON TODAY! →

The American Floor Surfacing Machine Co., 535 So. St. Clair St., Toledo, Ohio,



Enclosed find 25c in stamps or coin for booklet "Opportunities in Floor Surfacing" telling me how I can start my own floor sanding business.

Name _____

Street _____

City _____ State _____

Announcing the NEW MYERS

FOR
SHALLOW
AND DEEP
WELLS

"HN" series
Ejecto
water system



Sets new standards for pump engineering

Every mechanically minded man will appreciate the advanced engineering of the new Myers "HN" Series Ejecto Water System. You can study its many innovations in a free booklet now available—see for yourself why this latest Myers quality-built system sets new standards for pump performance. Mail coupon today for detailed literature on all Myers Ejecto and Reciprocating Types.



FREE BOOK

THE F. E. MYERS & BRO. CO.
Dept. R-80, Ashland, Ohio
Send free water system booklet:

Name _____
Town _____
County _____ State _____

MAKE YOUR OWN FURNITURE

with Weldwood Plywood
and Easi-Bild Patterns

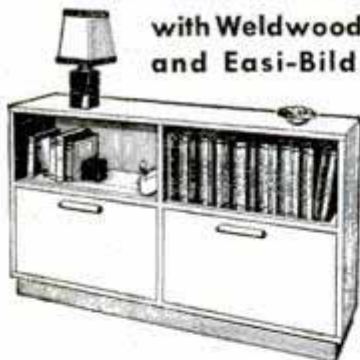

It's easy to save money on furniture when you build it yourself out of Weldwood plywood.

Easi-Bild* Patterns take care of all your designing and planning. At your local lumber dealer you buy the Weldwood and other materials the patterns specify. Then you cut each piece exactly as the pattern indicates, and assemble according to directions. No special tools or skill are needed.

Pattern for the Record and Book Cabinet, shown above, sells for 25¢. The Easi-Bild Pattern Book, illustrating 105 Build-It-Yourself projects, is only 20¢. Send for your copy now, and spend your winter months building home furnishings, toys, lawn furniture, gifts, etc.

*T.M. Easi-Bild Pattern Co.

UNITED STATES
PLYWOOD CORPORATION
Dept. P.M., P.O. Box 215, Pleasantville, N.Y.

COIL WINDING DATA

COIL	L1	L2	L3	
COIL 1	6-turns	10-turns	4-turns	All No. 26 Enam. Wire
COIL 2	8-turns	18-turns S.W. to 1 1/4"	8-turns	No. 26 Enam. Wire
COIL 3	L1 21-turns No. 26	L2 40-turns No. 26	L3 14-turns No. 30	
COIL 4	L1 50-turns	L2 85-turns	L3 40-turns	All No. 30 Enam. Wire
COIL 5	L1 60-turns	L2 100-turns	L3 50-turns	All No. 30 Enam. Wire

NOTE—S.W.—space-wound

In the two high-frequency short-wave coils No. 1 and No. 2, the "grid" winding (L2) is space-wound to the length specified; the "R.F." winding (L1) is wound between the turns of (L2). In the two broadcast-band coils No. 4 and No. 5, (L1) and (L3) are random-wound in order to get the specified number of turns on the standard plug-in coil forms. Coil dope is used on the random winding to hold it in place. In coils Nos. 3, 4 and 5, space L1, L2 and L3 about 1/8" apart. In the short-wave coils Nos. 1 and 2, space L3 1/8" from the combined L1 and L2 coils. Fixed padder condenser across coil L2 inside coil form No. 5 should be a silver-mica type. If 150 mmfd. is not available use a 50 mmfd. and a 100 mmfd. connected in parallel. No padder condenser is necessary in Coil No. 4.

All Coils Close-Wound Unless Otherwise Specified

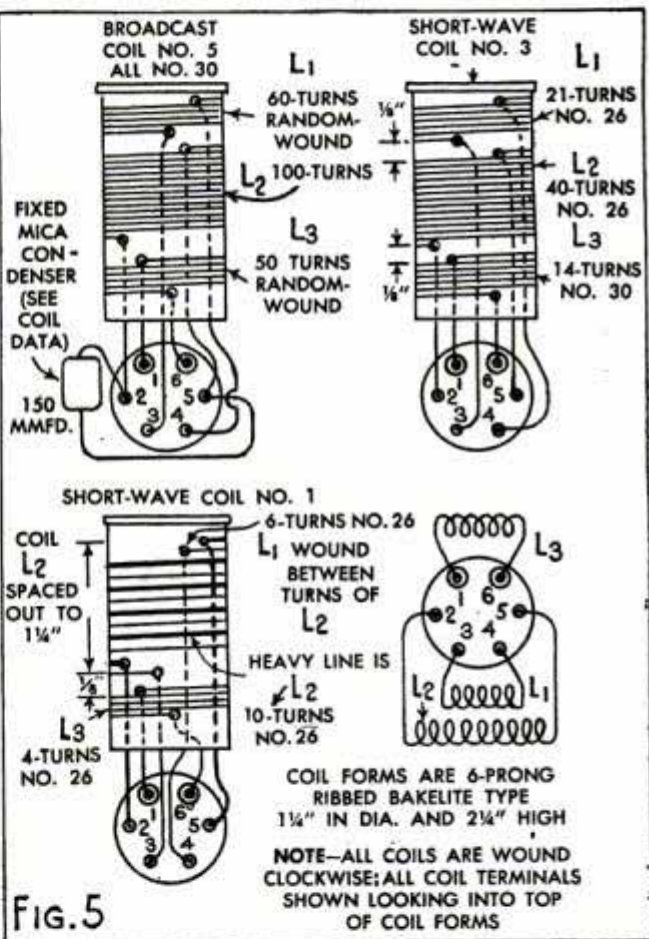

FIG. 5

diagram (see Fig. 4), make sure that the X lead goes to the grounded filament terminal on each tube socket, just as shown in Fig. 2. Underside views of the chassis bases appear in photos G and H. Note taped secondary leads in photo G. The complete operating assembly is illustrated in photo D. Detailed student material list R-885 for this No. 1 two-tube progressive set is available from Popular Mechanics Radio and Electronics department upon receipt of order in the postage.

Handy new **DUNLAP** Utility Drill Kit

OUR OWN TRADE MARK

Drills..Grinds..Sharpens..Sands..Polishes..Bufs!

Free!

SEARS new 1950 Power Tool and Mechanics' Tool Catalogs . . . free! Get yours NOW, at the Hardware Dept. of your nearest SEARS Retail Store!

DUNLAP 26-Piece
1/4-in. Electric Drill Kit
Complete for Only

\$19.50

Cash

DRILL ONLY
\$13.50



Does dozens of jobs... Faster! Easier!



Drill wood, metal, etc.



Sanding or wood working



Polish cars, furniture, etc.

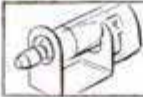

Stand for grinding, etc.

Indispensable! Precision-built! Powerful enough to drive 1/4-in. bits in steel! 1/4-in. 3-jaw chuck. Triple reduction gears; aluminum alloy frame. 110-120-volt. 25 to 60-cycle. AC-DC motor; 6-ft. cord, plug; Underwriters' Labs. approved. 12 in. long. Complete with 10 high speed, 1/16 to 1/4-in. drill bits; 4-in. cloth buffing and 3-in. grinding wheels; 4 3/4-in. rubber sanding disc; 5 1/2-in. sheepskin polishing bonnet; 6 assorted sanding discs; disc template; paint mixer; adapter; drill side-handle; drill stand; in 12 3/4 x 6 1/4 x 6-in. handy steel storage and carrying case.



CRAFTSMAN METAL TURNING LATHE

REG. U.S. PAT. OFF.

Without Motor
\$39.50*
Cash
\$4.00 Down on Easy Terms
\$50.00 with 1/4-H.P. Motor*



* Lathe prices west of Mississippi River . . . slightly higher

America's lowest priced back-gearred, screw-cutting metal turning lathe!

Superb design! Strong, heavy, complete! Ideal for model making, tool room work, turning armatures and scores of small metal turning jobs! 6-in. swing; 12 1/2 in. between centers; 23-7/16-in. bed. 1/2 in. x 20-thread spindle. Removable No. 0 Morse taper centers in headstock and tailstock. 6 speeds: 120 to 1325 R.P.M. Feeds .0024, .0039, .0048 and .0078. With 8 threading gears (cuts threads 8 to 96 per in., right or left hand); two 60° centers; 1/4-in. tool bit; Allen wrench, 1/2-in. lathe dog; 4-in. face plate; 4-step motor- and 3-step machine pulleys; and 3/8 x 36-in. V-belt. Over-all length, 26 3/4 inches.

See these sensational power tools at your nearest Sears, Roebuck Retail Store TODAY!
Sears Easy Terms make it easier to own the tools you need NOW . . . pay while you use them!

CRAFTSMAN and **DUNLAP** Tools by **SEARS, ROEBUCK and CO.**
Famous for fine quality . . . precision performance . . . low price!

The Army's Crime Bureau

(Continued from page 169)

outwitted the patrolmen by pulling hidden revolvers. After tying up their victims, they stole their Jeep, helmets and weapons.

In this Jeep, another Jeep filched from Hochst and a private car stolen from Darmstadt, the party roamed the Mulheim area. They told the local British company commander they were on special assignment to pick up Army AWOLs.

Stamped orders, constabulary helmets and vehicles and the apparent efficiency of the trio persuaded the British to give them a private office, priority telephones, special rations and all the privileges of the garrison. Hardly had they set up "official quarters" when the German, posing as an American corporal, forged himself a promotion to sergeant so he could eat in the sergeants' mess.

Agents said the trio impressed the garrison personnel because they rode constant patrol looking for AWOLs, who incidentally were apprehended in large quantities, and maintained a rigid charge of quarters routine at night!

This clever adventure ended abruptly when two friends of the mobsters were arrested on other charges upon return to Frankfurt. They tipped the military and

the chiseling trio was apprehended and sentenced to imprisonment at hard labor.

Is the CID worth-while, from the American taxpayer's viewpoint? Here's the Army's answer: Each CID agent not only recovers sufficient government property to cover his own yearly pay, retirement and transportation expenses, but he also returns a profit to Uncle Sam of \$2,659.28 per agent. These figures were worked out by the Provost Marshal's office on the basis of \$7,313,933 value of government property recovered in the last fiscal year.

The Dizzy Merry-Go-Round Of Industry

(Continued from page 149)

In many industries, the centrifuge vastly simplifies older production methods. Take, for example, collection of citrus oils—used in flavoring candy, cakes and the extracts on your kitchen shelf. This job was once a peasant industry in Sicily. Peasants would squeeze lemon and orange skins in tubs of water. Oil floated to the surface and was skimmed off. The yield indicates the tediousness of the task: a ton of orange peel yields 2 pounds of oil; a ton of grapefruit rind, ½ pound; a ton of lemon peel, 4 pounds.

(Continued to page 244)

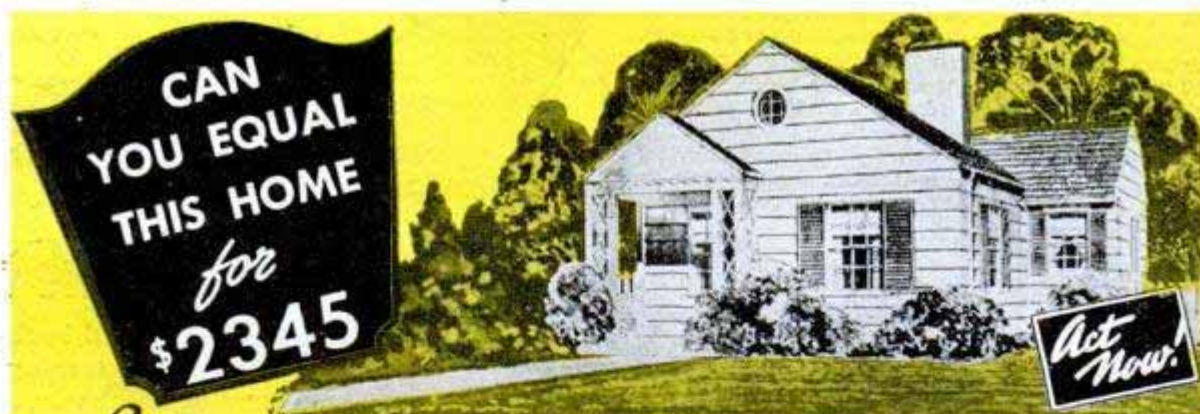

Save 30% to 40% on Your New Home..

Shipped Direct from Our Mill

DON'T pay several hundred dollars more than necessary when you build a home! Buy direct from our mill at our low factory price. We ship you the lumber cut-to-fit, ready to erect. Paint, glass, hardware, nails, etc., all in-

cluded in the price—no extra charges. Plans furnished—also complete building instructions. No wonder our customers write us that we saved them 30% to 40%. Easy terms—monthly payments.



Handsome Big 4-Color CATALOGUE FREE

Pictures wonderful homes in colors at money-saving prices. Designs to suit everyone. Write for your catalogue today.

LEWIS MANUFACTURING CO. 1201 LAFAYETTE AVE., BAY CITY, MICH.



TIME-SAVING TOOLS for SHOP and HOME

The Most Versatile Tool a Man Can Own

MOTO-TOOL

Approx. 25,000 RPM

GRINDS, ROUTS, DRILLS, POLISHES, ETC. Moto-Tools, Kits and Accessories should not be confused with "bargain offers." Compare Dremel Products, feature for feature, with other similar equipment. If ours are not superior in quality, design and performance, we don't want you to buy.

LOOK AT THESE MOTO-TOOL FEATURES

Dynamically balanced armature eliminates vibration • Oilless (oil-sealed) bearings • Patented automatic chuck lock pin • Snap-type sliding switch • Cord protector • Shockproof bakelite housing • Dust-filtered air-cooling system • Weighs 13 oz. • Plugs into any 110-120 V. AC outlet. Backed by over 13 years use in plants of General Electric • Ford • Remington Arms • Nash-Kelvinator • Westinghouse • Douglas Aircraft, etc. . . . plus a money-back Guarantee if not delighted after 5 days' trial.



PRE-WAR PRICES STILL PREVAIL

MOTO-TOOL KIT No. 2, with 23 accessories including high-speed steel cutters and Model 2 Moto-Tool in natural finish hardwood case . . . **\$23.50**
MOTO-TOOL No. 2 with one emery wheel point . . . **\$16.50**



Portable DRILL PRESS

This 12" high, precision drill press is ideal for model making, wood carving, routing, etc. Utilizes No. 2 Moto-Tool.

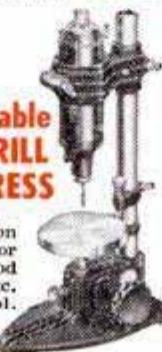

Only **\$9.95** (Less Moto-Tool)

USE COUPON TO ORDER—If your dealer cannot supply you.

DREMEL MFG. CO., Dept. 110-A, Racine, Wis.

FUN FOR BOYS FROM 8 TO 80

DREMEL Electric COPING SAW

CUTS SCROLLS LIKE MAGIC—SANDS AS IT SAWS



BLADE FACES 4 WAYS

SAFE! AS A HANDSAW

JUST GUIDE IT!

Only **\$5.85** with 3 saw blades

FREE PROJECT PLANS

Plans for making six useful, decorative projects packed with each Dremel Electric Coping Saw.

For men who harbor a hobby or do their own repair work . . . for boys who like to make things . . . no other tool will give so much pleasure and satisfaction in the home or workshop for the small amount of money invested as a Dremel Electric Coping Saw. It works in any direction . . . delivers 7,200 strokes per minute . . . so easily, there is no effort . . . so smoothly, work needs no sanding. Saws through 3/4" medium-hard wood at a foot-a-minute speed. Touch-of-the-trigger, foolproof action. Only two moving parts, never needs oiling. Operates on 110-120 v. AC. Thousands and thousands of satisfied users.

MONEY BACK GUARANTEE

If your dealer cannot supply you, use coupon to order direct from factory.

DREMEL MFG. CO., Dept. 110-A, RACINE, WIS.

3 TOOLS IN ONE



Only **\$14.85** POSTPAID

PATENTED

Dremel Electric SANDER POLISHER-MASSAGER



Works Easily in Awkward Places



Sands Flat Surfaces Evenly



Makes Play of Wax Polishing



Soothes Tired Muscles

Say goodbye to hand sanding and polishing! This miracle machine is so easy to handle, a child can use it. Craftsmen and housewives find (1) As a sander, it takes the effort out of sanding walls, woodwork, furniture, workshop projects, etc. Its straight-line, (non-rotary) action will not burn or scratch surfaces. (2) As a polisher, it does a professional job on waxed surfaces of cars, furniture, etc. (3) As a massager, it's ideal for tired or sore muscles.

LOOK AT THESE DREMEL FEATURES

Dremel Sander delivers 14,400 strokes per min., weighs only 2 1/2 lbs. It's foolproof (has only two moving parts . . . never needs oiling). Dremel Sander operates on 110-120 Volt AC. Thousands and thousands of satisfied users prove its value.

SATISFACTION GUARANTEED

Dremel Sander comes complete with 6 sheets assorted grade Garnet Paper for sanding, plus felt pad and sheepskin for polishing. If your dealer cannot supply you, use coupon to order direct from factory. Money back if not delighted after 5 days' trial.

Dremel Mfg. Co., Dept. 110-A, Racine, Wis.

If Your Dealer Cannot Supply You USE THIS HANDY ORDER FORM

DREMEL MFG. CO., Dept. 110-A, Racine, Wisconsin

- Enclosed find \$_____ (check or money order) in full payment for items checked below.
- Enclosed find \$2. Ship items checked below C. O. D. I'll pay postman balance plus postage and fee.
- | | |
|---|--|
| <input type="checkbox"/> Dremel Sander \$14.85 | <input type="checkbox"/> Dremel Coping Saw \$5.85 |
| <input type="checkbox"/> Moto-Tool | <input type="checkbox"/> No. 2 Moto-Tool, \$16.50 |
| <input type="checkbox"/> Kit No. 2, \$23.50 | <input type="checkbox"/> Free Catalog of Dremel Tools |
| <input type="checkbox"/> Drill | |
| <input type="checkbox"/> Press \$9.95 | |

Name _____

Address _____

City _____ Zone _____ State _____

OWN a Nationally Advertised Business

Now, we are appointing dealers in U.S.A., Canada, Mexico and foreign countries . . . in territories still open. If you are capable, co-operative and willing to work to enjoy success, we'll establish you in your own business and arrange easy terms to help you get started. Gross profits up to \$15 and \$20 a day on each of your service men. No experience needed.

Clean Rugs and Upholstery

Duraclean Dealers' businesses are built upon the solid foundation of a national organization with 19 years of Proven Success. Duraclean Service was established to improve cleaning methods for rugs and upholstery . . . to eliminate harsh machine scrubbing . . . to prevent shrinkage from soaking. Instead of floating surface soil down into upholstery and rugs, this amazing process actually removes it!

Protects Against Moths

Here is another year 'round service rendered right in the home, office, or business building — without removing furnishings. Duraproof protects carpets, upholstery, furs, clothing, piano felts and auto interiors from damage by moths or carpet beetles. To our knowledge, Duraproof is the only mothproof service backed by a National Money-Back 4-YEAR WARRANTY.

Voluntary and Repeat Orders

Customers are not merely satisfied—many are enthused with results and tell friends and neighbors. Duraclean is recommended by America's foremost furniture and department stores. Services are NATIONALLY ADVERTISED in Quality Magazines to help create still more demand for you and to explain the superior merits of YOUR modern processes and to develop confidence in your service.

No Overhead Expense

Shop is optional! At the start you may want to render service yourself from your own home, on a part time basis. It's easy to learn. Almost every building in your territory houses a potential customer needing one or both services. Even auto dealers buy your Duraclean Service to revive upholstery in used cars.



Two-Way Profit

You enjoy unusual profits on both materials and labor after paying service men and salesmen. Mr. E. Schalchin reported, "Have on hand 5 orders totaling over \$500, obtained from recommendations of customers." J. Dalton says, "Business previous four weeks was \$1,600."

FREE Booklet

If you are interested in an opportunity like this, fill out the coupon today! A letter and 16 page illustrated booklet will explain everything. We furnish electric machines, advertising matter, store cards, introduction slips, sales portfolios, demonstrators and enough materials to return your TOTAL investment. You can have YOUR OWN business operating within a week after equipment arrives. Mail coupon NOW and discover for yourself. No obligation. Easy Terms!

"OWN a Business" Coupon

Duraclean Co.

0-161 DURACLEAN BLDG.
DEERFIELD, ILLINOIS

With no obligation to me, send booklet and letter giving full details. Tell me how I can OWN a growing business of my own built upon satisfied customers.

Name _____ Age _____

Address _____

City _____ State _____



1/4
PAGE

Better
Homes
and
Gardens

Clinic



for Homemakers

As a service to our readers in solving the hundreds of problems pertaining to a home—inside or out—the editors of *Popular Mechanics* invite you to present your problems to The Clinic Editor for help and advice. Address your questions to The Clinic Editor, *Popular Mechanics Magazine*, 200 East Ontario Street, Chicago 11, Ill.

Water From Copper Pipes Discolors Laundry

Q—We have copper water-supply pipes in our new house and we have found that white laundry left to soak overnight in the water turns a greenish color. What is the cause of this, and the remedy, if any?—P.D., Plainfield, N.J.

A—There are several possible causes of this trouble but we believe the most likely one is that soldering flux accumulated in the pipes when the joints were soldered. The action of the flux at the time of soldering might release copper compounds which would be carried along the pipes by the flow of water through them. These would, of course, dissolve slowly and could very well be the cause of the green discoloration you describe. However, if our interpretation is correct, the trouble should disappear in time, as water flowing through the pipes under pressure will soon wash out the flux deposits.



Roof-Deck Leaks

Q—I have an older style home which has a sheet-metal roof over a sun porch. During hard rains this roof leaks in several places. I have tried roofing cements but without success. Apparently the joints of the tin are soldered. Is there some way I can stop the leaks without putting on a completely new roof?—A.G., Lakewood, Ohio.

A—No doubt rust has eaten through the metal at points where the leaks occur. Whether or not it would pay to attempt a repair of the existing covering would depend on the general condition of the roof. If the metal is corroded over fairly large areas, then we would be doubtful about the value of a repair. Complete renewal of the covering would be advisable in this case. Special canvas is now commonly used as a covering on roof decks. This is much heavier than ordinary canvas and it must be laid in accordance with the manufacturer's instructions for satisfactory results. The old roof covering is removed before laying the canvas, of course. However, if your roof seems to be in fairly good condition and you wish to try repairing it, one suggestion would be to locate the openings in the covering, clean an area 6 to 8 in. square around each opening to the bare metal and

(Continued to page 242)

KING MIDGET

HOME ASSEMBLED MIDGET AUTO



WORLD'S LOWEST PRICED AUTOMOBILE!

80-90 MI. PER GAL.—45-50 MI. PER HR.

Drive this car for as low as 50c per week. Precision built parts direct from factory with beautiful all steel body. Get all the facts on this amazing small auto — send 25c for detailed circular with large picture, 4 view drawings and price of all parts, or send \$1 (refunded first order) for this plus actual assembly book with 42 photos, drawings; blueprints of snow and ice conversions, information on mini-midget racing, etc.

MIDGET MOTORS MFG. CO., ATHENS 1, OHIO

SEND FOR FULL INFORMATION TODAY!

King Midget is the ideal small car for errands, sports use, to and from work, short business or pleasure trips, delivery service or second-car utility for the whole family. Also tops for mini-midget racing. Comfortable — room for husky six footer.

FREE!

NEW RADIO CATALOG

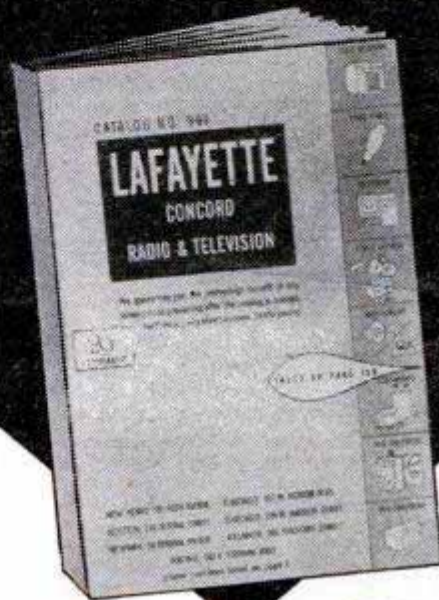

MAKE THIS MASSIVE STERLING SILVER INITIAL RING WITH YOUR OWN INITIALS

No special skills or training needed. With our Ring Kit containing unfinished Sterling Silver ring and 2 or 3 initials, all materials needed and illustrated instructions, you can, in a few hours, make this beautiful heavy Sterling Silver ring for yourself, as a gift to someone special or for sale.

Send check or M.O. today with finger size and initials, or send 3c stamp for finger gauge.

COMPLETE PRICE inc. Fed. Tax \$4.50

AMERICAN JEWELRY MODELS, 62 W. 47th St., New York 17

Hobbyist Catalog

64 pages

WE PAY POSTAGE!

SHIP MODELS . . . TRAINS . . . PLANES
Cars . . . Art Supplies . . . Tools . . .
Projects . . . Games.
U.S.A. and Canada Orders Only.

10¢ write Braun-Craft

1232 ETOWAH, DEPT. PM-6, Royal Oak, Mich.

OTTAWA Buzz Master

7 MODELS—\$99.00 up

Greatest offer made in our 46 years of manufacturing. A model to fit your needs and your pocketbook. Free details.

OTTAWA MFG. CO., 2-027 Brush St., Ottawa, Kans.

No Other Like It!

MAKE YOUR OWN!

WITH **Griffin READYCUT LEATHER PROJECTS**

Over 100 KITS in every kind of Tooling and Carving Leather, accurately cut, all parts included Only Top Grade Leathers used You do the choosing You do the tooling, carving, stamping, the punching and assembling

SEND FOR COMPLETE CATALOG Please send 10c to cover mailing.

SINCE 1924
OUT OF THE WEST, THE HOME OF LEATHER CARVING
Griffin Craft Supplies
5626-A TELEGRAPH AVE.
OAKLAND 9, CALIFORNIA

EVERYTHING FOR THE LEATHER WORKER

Largest, most complete stock of Leathercraft Tools and Accessories in U.S.A.

HIDES AND SKINS of Craft Leathers of every kind if you prefer to cut your own.

COSTS YOU NOTHING • SAVES YOU PLENTY ON RADIOS • TELEVISION • HIGH-FIDELITY PUBLIC ADDRESS • COMPONENTS • TOOLS

Here's everything new in electronics — at your fingertips in this information-packed 164-page catalog, hot off the press. It's free!

The thousands of bargains shown will save you money on every purchase. Rush handy coupon now, or get your copy at any of these Lafayette showrooms:

- CHICAGO: 901 W. Jackson Blvd.
- NEW YORK: 100 Sixth Avenue
- BRONX: 542 E. Fordham Road
- ATLANTA: 265 Peachtree St.
- NEWARK: 24 Central Avenue
- BOSTON: 110 Federal Street



LAFAYETTE RADIO, Dept. LA-50
901 W. Jackson Blvd., Chicago 7
100 Sixth Avenue, New York 13

Please send me FREE Catalog. (This is my first request for this catalog.)

NAME

ADDRESS

CITY ZONE STATE.....

HUNDREDS OF ITEMS AND IDEAS FOR THE WOODWORKER

A board or carload—Top grade kiln dried Mahogany—Walnut—Wh. Hd. Maple—Cherry—Poplar—Aromatic Red Cedar—Red, White and English Brown Oak—Sapell—Andiroba—Balsa Wood. **NEW LOW PRICES.**

HARD TO FIND LUMBER

**BIG NEW NO. 17
CATALOG FOR
WOODWORKERS.
144 PAGES
OF HARD-TO-FIND
SUPPLY ITEMS.**

The finest catalog we ever published. Full of unequaled bargains and useful information.

Greatest Selection of Fine Domestic and Imported Woods

Catalog shows in natural color 32 rare and fancy woods, 43 matched veneer designs, multi-colored bandings, inlays, overlays, 275 scroll patterns to choose from, labor-saving machinery and a section for beginner's instruction.

OVER 100 NEW ITEMS

My stocks are gigantic—bigger than ever before. Really **FAST SERVICE** on your orders. My new catalog includes a "gold mine" of hard-to-find hardware items. Whatever Wood Craftsmen need—I HAVE IT.

**MAIL COUPON TODAY for
GIANT NEW CATALOG #17**

Only 15c Refunded on first order.

Harold F. Hunt, President
CRAFTSMAN WOOD SERVICE CO.
2729 S. Mary St., Dept. A-1, Chicago 8, Ill.

I enclose 15c, to be refunded on my first order. Please send me your big new Catalog No. 17.

NAME _____

ADDRESS _____

TOWN _____

ZONE _____

STATE _____

HERE'S THE ALL-PURPOSE CUTTING TOOL

You've Always Wanted

**NEW
FORSBERG**

**WHIZ
SAW**



7 saws in 1
RIP, CROSSCUT, KEY-
HOLE, COPING, SCROLL,
BAND OR JIG

Precision Made for Precision Work

Every home craftsman will find Whiz-Saw useful for both rough cutting jobs as well as precision work. Light in weight but amazingly sturdy, Whiz-Saw cuts wood, bone, plastic, fibre board, pressed wood, hard rubber, etc. up to 1" in thickness. Whiz-Saw is the only saw made that will make inside cuts without first boring a starting hole. And, when clamped to the Whiz-Saw table, precise band or jig saw work is easy. Send for free booklet.

If your dealer does not carry Whiz-Saw, order direct. Send check or money order payable to The Forsberg Mfg. Co., Bridgeport, Conn., U.S.A.

WHIZ SAW
\$49.00
Table \$18.95

the ideal cutting tool for:

HOBBYISTS
ELECTRICIANS
CARPENTERS
PLUMBERS
SIGN-MAKERS
MAINTENANCE MEN



All-metal Whiz-Saw table may be secured with screws to wood bench or held in vise.

ANOTHER **Forsberg** PRODUCT

Makers of the Famous Whale & Viking Tools

apply a patch by sweat-soldering all four edges of the metal patch to the covering. With good soldering equipment this is quite easy to do, provided the metal is not so badly corroded that it cannot be properly cleaned in preparation for soldering. Clean the soldered joints thoroughly to remove all traces of the soldering flux before repainting.

Removing Decals

Q—I have a number of decorative decals on the kitchen walls. I have been told that these must be removed before the walls are repainted or else they will show through, spoiling the new paint job. Is this right, and, if so, how can I go about removing the decals without damaging the paint or plaster?

C.M., Dallas, Tex.

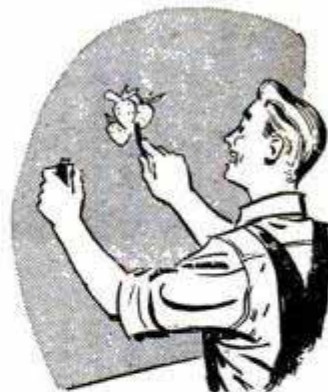

A—The decals should be removed before painting, as the slight irregularities of the raised pattern will show through two or more coats of paint. Also if the decal is loose over even a small portion of its total area, air or moisture may be entrapped while painting over it. This will later cause an unsightly blister. There are two methods of removing decals from a smooth surface such as a painted wall. One way is to cover the decal with a piece of dampened felt (there also is a specially treated felt available for this purpose) and allow it to remain overnight. The felt can be held in place with adhesive tape. At the end of this time the decal should peel off the surface quite easily. A faster method is to coat the decal with lacquer reducer or fingernail-polish remover. Apply either one with a small brush or a wad of cotton and be careful not to get any of the solvent on the painted wall as it softens paint quickly. A few seconds after application of the remover it should be possible to slide the decal off the wall without leaving any trace of discoloration. Wash the walls thoroughly before painting.

Noncoloring Finish

Q—How can I finish light wood in the natural color without changing the appearance of the grain or darkening it? Any clear shellac or varnish finish that I have applied to light-colored woods apparently darkens them for some reason. Isn't there some method of finishing these woods without changing the color so much?—J.D., Birmingham, Ala.



A—Ordinary clear finishes applied to light-colored wood appear to darken it because they change the light-reflecting properties of the surface. Although any finishing material will darken the common light woods to some extent, paste wax rubbed to a dull gloss probably will change the original color the least of any. Of course, to produce a satisfactory finish even on dense woods with wax alone would require several applications and considerable labor. Another base finishing material which colors the wood very little is that known to the trade as sanding sealer. This is a special product and is rarely used alone as a finish. It "builds" rapidly, even on softwoods such as pine, but when sanded lightly to cut the gloss the coating is hardly perceptible. A coat of flat lacquer sprayed over the sealer coat leaves the finished surface as nearly the color of unfinished wood as is possible to achieve with ordinary finishing materials. Of course, it should be remembered that any finished wood surface will darken as it ages. On grainy woods a clear finish will tend to emphasize the characteristic grain pattern.

BRICKCRETE



Local Manufacturing of this Modern Masonry Has High Earning Power

Several hundred territories are being opened up for local Brikcrete manufacture by men of vision and aggressiveness. Brikcrete ties in with today's huge building program. Makes possible better construction at lower cost. Truly better than brick; actually cheaper than lumber. Combines strength, safety, insulation value, colorful beauty that fits today's styling.

Brikcrete is made in locally owned plants, using local materials and local labor. That's why high quality and low price still permit a 100% to 150% mark-up. We supply complete equipment; easy terms if required. Generous co-operation. Exclusive manufacturing privileges in protected territory. Write for information. Brikcrete Associates, Inc. 4679 Division Ave. S Grand Rapids 8, Mich.

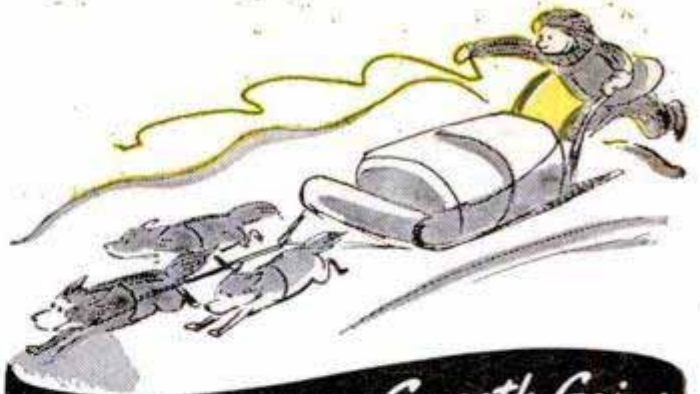

Quick Starting.. Smooth Going

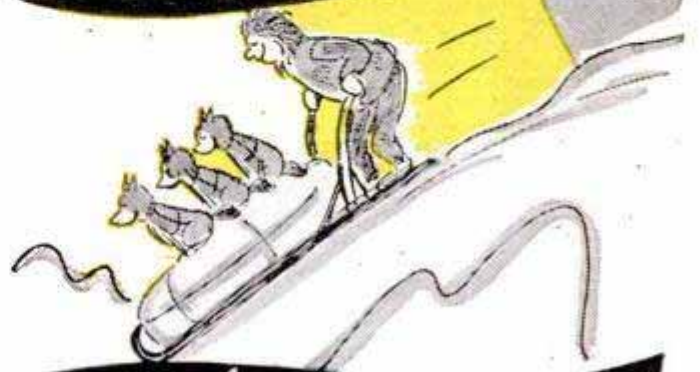

With a CASITE Winter TREATMENT

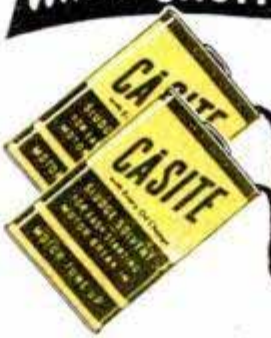

A PINT IN THE CRANKCASE
A PINT THROUGH THE AIR INTAKE

Quick starts everytime, smooth going all the time—that's what you get with a CASITE TREATMENT.

Casite in the crankcase retards congealing of oil . . . lets your motor spin over and go . . . no matter how cold the weather. It cuts dangerous start-up wear, cuts repair bills, too.

Casite through the air intake conditions your car for winter . . . frees sticky valves and rings . . . keeps the engine clean and free-running.

Get a CASITE TREATMENT today—from any garage, service station or car dealer.
THE CASITE CORPORATION • HASTINGS, MICH.
Casite Division, Hastings Ltd., Toronto

QUICK STARTING—SMOOTH GOING or Double-Your-Money-Back

STOP AUTO ACCIDENTS



with new **STOP LIGHT FLASHER!**
MAKES YOUR STOP LIGHT FLASH 115 TIMES A MIN.
FREE OFFER TO YOU! The "Stop-It" warns cars behind—makes your stop light flash on & off, on & off! Completely automatic, acts instantly when you step on foot brake . . . attaches in 5 minutes to any car or truck. Approved by safety engineers, used by Police & Fire depts. Non-rusting, dust, oil, vapor, waterproof. Write NOW for free introductory offer—no obligation. Get this amazing "Stop-It" for your car at no cost to you! Dealers, salesmen wanted.
MACCHI & CO., Dept. MA, 927 Larkin St., San Francisco 9, Calif.

MAKE!
FOLDING
TABLES-
BENCHES-
HORSES-
IN A JIFFY

FOLD-A-WAY CHANNEL STEEL LEGS

Shipped complete, ready to fasten to your top in a minute. Rubber tipped. Used on the job, in homes, workshops, ping pong tables, trailers, camps, boats, churches, lodges, banquet halls.



54.98 Pr.
24" Legs
55.98 Pr.
30" Legs
Postpaid in U.S.A.

THE DIAMOND MFG. COMPANY
1100 ALYAMONT AVENUE SCHENECTADY 7, N. Y.

NOW 1950 MODEL of the famous... HANDEE TOOL OF 1001 USES at new LOW PRICE

It's here—biggest buy of all. First tool of this type and today's finest. The "Cadillac" of small power tools—choice of mechanics and home-crafters everywhere. Make costume jewelry, train and plane models, puppets, tool leather, initial tumblers, internally carve plastics, etc.

A FINE GIFT
Handee with 51 accessories in new steel case

Handee with 7 accessories **\$19.95**



A Whole Tool-shop in one hand. Grinds Drills Engraves Polishes Cuts, Routs Saws, Sands

Here's smooth, controlled power at your fingertips. Handee has 7-bar armature and is perfectly balanced. 25,000 r.p.m. AC or DC. Wt. 12 oz. Order today postpaid on money-back guarantee or write for catalog. Chicago Wheel & Mfg. Co. 1101 W. Monroe St., Dept. PM, Chicago 7, Ill.

with a
Binkley

rota-matic
SANDER

YOU SAVE TIME

DO A BETTER JOB

WITH LESS ENERGY



Yes, once you glide the self-rotating BINKLEY SANDER over any flat, beveled, or rounded wood surface, you'll marvel at the professional results you get. You'll easily produce a smoother, more uniform surface, using far less energy!

AN AMAZINGLY NEW WAY

The BINKLEY "rota-matic" SANDER eliminates all the old "back-breaking" home methods of sanding. For instance, you can sand down a table top in 1/2 to 3/4 the time ordinarily required.

STURDILY BUILT—

WILL LAST FOR YEARS

"rota-matic" sanding disks outwear ordinary sandpaper sheets 20 to 30 times because they rotate, putting each cutting face of the sanding grit to work. This same rotating action makes the disk self-cleaning and even-wearing. Sturdily built of steel—no complicated parts to wear out!

GET YOURS TODAY

Outfit complete with fine, medium, and coarse grit Disks, easily interchangeable. If your dealer can't supply you—don't wait. Send only \$2.50, we'll ship promptly, postage paid. Money back if not satisfied in every way. Write to—

BINKLEY MFG. CO., Desk M-2, Warrentown, Mo.

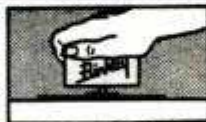

FLAT SURFACE



BEVEL EDGES



ROUND CORNERS

Today, hull refuse from juicing plants goes into enormous presses. A water shower washes out all oils. This wash water feeds into a centrifuge which whirls at 15,000 revolutions per minute. It can handle 2200 gallons of liquid an hour. Oil comes out one spout, waste water out the other.

The centrifuge deserves major credit for making winter driving possible. Remember the day when crankcase oil became so thick that it was often impossible to start engines? Wax, which solidified at low temperatures, was responsible. Centrifuges now remove this wax. Lubricating oil is diluted with naphtha, chilled to a point where wax solidifies. It is whirled out of the oil, and thereafter the oil flows in any weather.

To a great degree, you can thank the centrifuge for the excellent lacquers and varnishes that are on the market today. Some substances are too gummy to be filtered. Hence the problem arises of how to eliminate the impurities. The centrifuge is the answer. It plays a major role in clarifying glues, varnishes, lacquers, floor wax, latex and chicle.

The machine is similarly valuable in the fish-meal industry. Processors of pilchard, sardines, tuna wastes and other fish products want to extract as much valuable oil as possible before they sell fish meal as animal food or fertilizer. The ground fish is mixed with water, run through a centrifuge. Fish meal comes out one spout, water from another, oil from a third.

The centrifuge has hundreds of homely jobs. Take, for example, the one of cleaning grease in doughnut bakeries. Such bakeries use enormous amounts of fat, which represent a major item of expense. Used constantly, the fat soon becomes contaminated with burned particles of dough. Unless it is purified, it goes rancid. Cleaning this fat is a job tailor-made for the centrifuge. Dirty grease goes into the machine. Clean grease comes out one spout, blackened trash out another.

Cutting oils present a similar set of problems. In short time they are contaminated with metal fragments, condensed moisture, dirt and even fungi, which cause skin diseases. Unless they are purified, such oils must be discarded. Centrifuges do such an efficient job of cleaning that oils last almost indefinitely.

In many industries particle size of materials is a matter of supreme importance. This is true of clays to be used in fine china, lampblack which lengthens the life of auto tires, pigment for paints, graphite for pencils. It is particularly important in making inks for ball-point pens, where a slightly oversize particle would clog the minute

(Continued to page 246)

AUTO MECHANICS! BOOST YOUR EARNINGS



AUTO ELECTRICAL SERVICE

made easy!

JUST OFF THE PRESS

Contains technical information

Only **\$2.00**

Over **200 pages**

... packed with latest service methods.

The finest, most completely illustrated full color book on the complete automotive electrical system. Includes full information on the seven basic electrical circuits built by Auto-Lite . . . Starting—Charging—Ignition—Horns—Windshield Wipers—Instruments—Lighting. Plus Trouble Shooting Charts worth many times the price of the book. Gives you the answer every time.

SPECIAL! NO MONEY COUPON

THE ELECTRIC AUTO-LITE COMPANY—Toledo 1, Ohio

Yes, send me your "Maintenance and Operation Manual" by return mail. I will pay the postman when he delivers my copy \$2.00 plus postage. (If \$2.00 is enclosed with this coupon, the book will be sent postpaid.) If after 10 days I am not satisfied I may return the book and my money will be refunded.

NAME _____

ADDRESS _____

STRIPE WITH PAINT
EASY AS USING A PENCIL

PAINTERS' STRIPING TOOL

NOW you can do your own expert striping on furniture, bikes, model planes, bulletins, autos, toys, signs, linoleum, wall board . . . make plain walls look like tile! It's easy to paint straight, curved, circular, even parallel lines with any color. Handiest paint tool in your workshop! Type "M" Master Painters' Striping Tool—complete with tip for 1/16" stripe, \$1.00. Other tools complete with following tips: 1/64", 1/32", 3/64", 5/64", 3/32", 1/8"; \$1.50 ea. Extra tips 75c ea. Entire kit with tool and 7 tips, \$5.00. (C.O.D.'s postage collect.) Dealers write! WENDELL MFG. CO., 4234-B Lincoln Ave., Chicago 18, Ill.

A TOOL... NOT A BRUSH

Dealers Write Today!



\$1.00 POST PAID

WHAM-O SPORTSMAN

HITS LIKE A .22 RIFLE—KILLS RABBITS, SQUIRRELS. For Hunting, Target, Routing Pests.

\$1.00 POST PAID

Dealers Write



HUNTING SLINGSHOT

Powerful, silent, accurate.

Complete with 40 pellets and extra rubber straps. Send \$1.00 today to—

Wham-O Mfg. Co., Box 2P, South Pasadena, Calif. PROFESSIONAL MODEL OF THE NAT'L SLINGSHOT ASSN.

HEAVY DUTY STOCK

BUILD FINE GRANDFATHER CLOCK NOW

The simple sensible Red-i-Kut way as thousands have—SAVE HALF. SHOP TESTED PLANS "SPIRIT OF THE CENTURY" Narrow waist 83" tall or stately "SPIRIT OF AMERICA" straight side model. EASY-TO-FOLLOW photo-pack PLANS tell all—plus BROCHURE of heavy brass weight Westminster, tube chime, movements, dials, solid mahogany case kits. Send \$1.00 today—Both Plans \$1.50 NOW.

KUEMPEL CHIME CLOCK CO., #6 Kuempel Bldg., Minneapolis 16, Minn.

Build your own JET ENGINE!



SEND NO MONEY

Order these plans today

1. JET PROPELLED BICYCLE. Assemble your own. Photo and instructions \$1.00.
2. HOW TO MAKE EXPERIMENTAL JET ENGINES. Seven sheets drawings with information and instructions \$2.95.
3. BOTH OF ABOVE in one order \$3.75. SEND NO MONEY. Order both at once \$3.75 C.O.D. in USA plus c.o.d. postage. Send check or Money Order and we pay postage. Get other information too. Rush Order.

J. HOUSTON MAUPIN, Dept. 55, Tipp City, Ohio

Mortite KEEPS THE COLD OUT

SAVES FUEL AND MONEY

Cordlike and pliable, Mortite is the perfect weather-stripping. Goes on in a jiffy without tools or tacks. Keeps out wind, dust, dirt. Anyone can press it around windows, doors, transoms, baseboards. Weatherstrip a whole window for 29¢—costs even less if you use the larger package. Get Mortite at stores or write for circular. J. W. Mortell Co., 522 Burch St., Kankakee, Ill.



29¢ and \$1.25
Higher west of Rockies and Canada

Make \$3.00 AN HOUR AND MORE

IN FULL OR SPARE TIME! SHARPENING LAWN MOWERS IN YOUR GARAGE or BASEMENT!

READ WHAT THIS CUSTOMER SAYS:

"I am buying a home and my Universal is going to be a tremendous help paying for it." Another Universal owner says, "I have taken in last season more than \$3500.00." Another "During this year I sharpened 602 mowers." Spare time or full time, you, too, can make big money in your own business and be your own boss. No other lawn mower sharpener has the advantages that Universal offers. That's why owners tell glowing success stories in this profitable business. Write today for full details of our proved success plan.



ONLY ON THE UNIVERSAL LAWN MOWER GRINDER

can the inside face and edge of the stationary blade, and all reel blades, be ground to proper clearance

ALL IN ONE SET-UP

WITHOUT REMOVING ANY BLADE FROM THE MOWER Men with 20 and 30 years of experience have tried them all and acclaim the UNIVERSAL Grinder best.

OUR PLAN GIVES ALL THE PROVED SHORT-CUTS TO SUCCESS

SHOWS YOU HOW STEP BY STEP
From the successful experience of hundreds of our customers, we have evolved a basic plan, simple and easy to follow, which leads you to quick success in either spare or full time.

ROGERS MFG. CO. DEPT. M10, LINDSEY, OHIO

SEND THIS COUPON NOW

ROGERS MFG. CO., Dept. M10, Lindsey, Ohio
Please send me full details about the profit possibilities of Lawn Mower Sharpening.

NAME _____
ADDRESS _____
CITY _____ STATE _____

Better, Easier, Quicker GROOVE CUTTING or CABINET-MAKING

with *Warren* DADO SAWING WASHERS

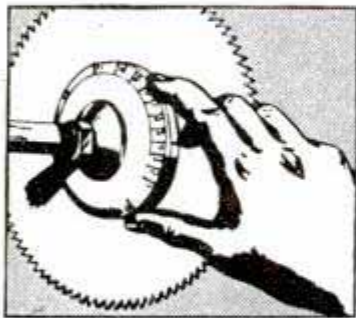

Just dial

DESIRED CUT

Cut accurate, parallel grooves—any width, any angle. Just dial desired width with Micro-matic adjustment. Cuts smooth and clean—no burning or chewing to mar fine wood. Just four simple washers—can be left on blade for straight cuts to strengthen blade. Available in 5 sizes— $\frac{1}{2}$ " , $\frac{3}{4}$ " , $\frac{5}{8}$ " , 1" , $1\frac{1}{8}$ " . See your dealer or send for free booklet. Absolutely guaranteed!

\$4.95
A SET

Dealers, Jobbers, Write for Information!

WARREN DADO SAWING WASHERS CO.

70 Medbury, Dept. 21, Detroit 2, Michigan

Experienced Craftsmen Say:

"YOU CAN'T FINISH WITH A DISC SANDER!"



The disc sander is excellent for roughing, hogging off, removing paint, and for other coarse sanding. But any experienced craftsman will tell you that these same characteristics prohibit its use for finishing, because of swirling, scorching, gouging and other blemishes caused by the disc sander's high speed.

**OSCILLATING MOTION IS THE *only*
MOTION FOR A PERFECT FINISH!**

THE DU-FAST* SANDER AND POLISHER produces quick, easy, perfect finishes at low cost. It requires no special skill or knack. You get an industrial type finish on wood, metal, plastics, plaster and composition materials the first time and every time you use DU-FAST! USE DU-FAST TO REMOVE DISC SWIRLS.

Model BDHU 1 attaches in seconds to either the Home Utility $\frac{1}{4}$ " Electric Drill or the Home Utility 5" Disc Sander-Polisher. (Products of Black & Decker Mfg. Co.) Model SK*1 fits the Skil Home Shop $\frac{1}{4}$ " Electric Drill manufactured by Skilaw, Inc.



DU-FAST SANDER AND POLISHER ATTACHED TO SKIL HOME SHOP $\frac{1}{4}$ " ELECTRIC DRILL



DU-FAST SANDER AND POLISHER ATTACHED TO HOME UTILITY 5" DISC SANDER-POLISHER



DU-FAST SANDER AND POLISHER ATTACHED TO HOME UTILITY $\frac{1}{4}$ " ELECTRIC DRILL

ONLY \$14.95
(Attachment)
(Either Model)

*Pat. Applied For

Manufactured by
DU-FAST, INC.

32 EAST FOURTH STREET, NEW YORK 3, N. Y.

DU-FAST SANDERS ARE AVAILABLE
AT ALL BETTER HARDWARE DEALERS

ball. The centrifuge is the ideal tool to give exact gradations of particle size. The machine whirls out oversize particles of graphite that would make a scratchy pencil, a gritty paint, a rough-textured china.

Still another interesting use is in extraction of lanolin-grease—from sheep's wool. Lanolin, used in creams, soaps and ointments is valuable and wool processors want to recover every ounce possible. The water in which wool is scoured is sent through a centrifuge. Water comes out one spout, lanolin out another, dirt out a third. The machine is valuable in collecting another industrial by-product—yeast from beer. Excess yeast is used to enrich many human and animal foods.

Drying is the third big use of centrifuges. The simplest example is the rotary laundry drier, which spins most of the moisture out of washed clothes. The same principle is used throughout the chemical industry, particularly in the washing and drying of crystals—bicarbonate of soda, copper sulphate, aspirin, borax, table salt and a host of other products. Such machines operate continuously. As soon as moisture is whirled from one batch of material—by a force equal to 900 times the pull of gravity—a knife blade falls into position to scrape crystals from the spinning drum. Once this is discharged, another batch of material flows into the machine.

During the war, the country's two major centrifuge makers, Sharples of Philadelphia and De Laval of New York, were largely occupied by work for the Navy and the Maritime Commission. It was essential for our ships to have top-quality lubricating oils, and such oils weren't always available at various world outposts. Consequently, ships were equipped with their own oil-purifying centrifuges.

Without centrifuges it would have been virtually impossible to process gigantic amounts of blood into life-saving plasma, and blood albumin. The machine played a similarly heroic role in solving one of the most staggering problems ever handed industry—production of penicillin. In the manufacture of this glamorous drug, a solvent absorbs penicillin from liquor in big fermentation tanks where the mold grows. How to separate minute amounts of penicillin from thousands of gallons of valueless liquor? The centrifuge is the answer.

In research work, the centrifuge paved the way for an epochal laboratory achievement—the isolation of a virus. These microbes, which cause such diseases as infantile paralysis, yellow fever, the common cold and measles, are so small that they slip through the porcelain filters which trip up

(Continued to page 248)

SORE MUSCLES?



When muscles are stiff and sore from unusual exercise or strain, use **HEET®**, the liniment that's strong yet does not burn the skin. Wonderful relief from muscular soreness comes as comforting **HEET** quickly starts to penetrate. Just brush it on with the applicator. **HEET** starts at once to ease muscular pain and keeps on working for hours, warms and soothes the painful area.

Thompson BEATS the World on BOATS



Better Built Lower Prices



Light Boat for Auto

Safe Boats With Full Length Spray Rails
Keep passengers perfectly dry—even at high speeds. Catalog also shows two new models of "Take-Along" Boats. Two big factories—save you freight.

CATALOG FREE
Write for your copy. State kind of boat in which you are interested.

THOMPSON BROS. BOAT MFG. CO. (151)
213 Ann St. PESHTIGO, WIS. Write to (either place) 113 Elm St. CORTLAND, N.Y.

New MIRACLE WALL CLEANER

Saves Costly Redecorating!
AMAZING INVENTION. Banishes old-style housecleaning mess and mess. No tags—no sticky "dough"—no red, swollen hands. No more dangerous stepladders. Literally erases dirt like magic from walls, ceilings, window shades, upholstered furniture, etc. *Endadruders!* SAVES REDECORATING!

SAMPLES FOR AGENTS Sample offer sent immediately to all who send name at once. A penny postal will do. **SEND NO MONEY—just your name, KRISTEE CO., 692 Bar Street, AKRON, OHIO.**

\$ AGENTS 300% Profit SIGN LETTERS

For Store Fronts and Office Windows. Anyone can put them on. Free Samples. Liberal Offer to General Agents.
METALLIC LETTER CO., 430 N. Clark, Chicago 10

RUPTURED?

Get Relief This Proven Way

Why try to worry along with trusses that gouge your flesh—press heavily on hips and spine—enlarge opening—fail to hold rupture? You need the Cluthe. No leg-straps or cutting belts. Automatic adjustable pad holds at real opening—follows every body movement with instant increased support in case of strain. Cannot slip whether at work or play. Light. Waterproof. Can be worn in bath. Send for amazing **FREE** book, "Advice To Ruptured," and details of liberal truthful 60-day trial offer. Also endorsements from grateful users in your neighborhood. Write:

CLUTHE SONS, Dept. 31, Bloomfield, New Jersey

Made
\$900
IN SPARE TIME

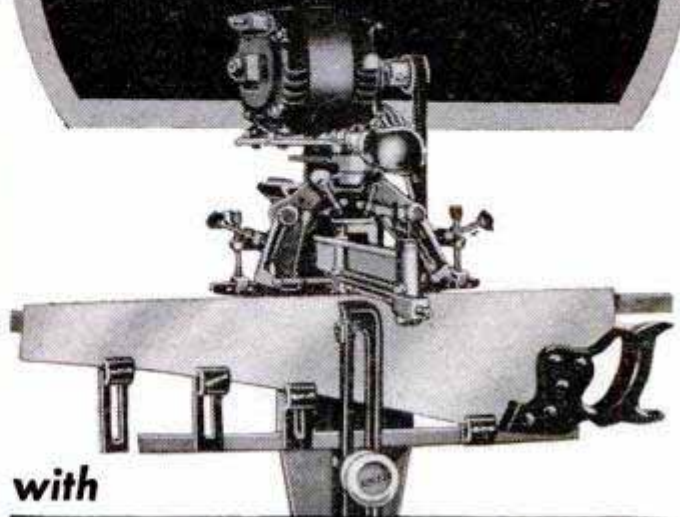

with

FOLEY* automatic SAW FILER

*Trade Mark Reg. U. S. Pat. Off.

"I did very well last year with my Foley equipment, about 950 saws and 240 lawn mowers, in my spare time. About \$900 for me." Leo H. Mix. Len Crego says: "I have done 4 or 5 thousand saws in my spare time in the 4½ years since I got the outfit, and they are all coming back."

Make up to \$2 or \$3 an hour in Spare Time. With the high prices of food, clothing and everything else, just think what you could do with extra money every week! With a Foley Automatic Saw Filer you can file hand, band and circular saws better than the most expert hand filer. "The first saw I sharpened with my Foley Filer came out 100%"—writes Clarence E. Parsons. Every saw you sharpen with the machine accuracy of the Foley Saw Filer is an ad that brings you more customers. Cash business, no canvassing. No eyestrain, no experience needed.

FREE BOOK INDEPENDENCE AFTER 40!

Shows just how you can start at home in spare time in your basement or garage. Just think—with a small investment, no overhead, no stock of goods to carry, you can get right into a cash business—and later on develop into a full-time repair shop. Send coupon today. No salesman will call.



Send Coupon for **FREE BOOK**

FOLEY MFG. CO., 116-O Foley Bldg., Minneapolis 18, Minn.
Send **FREE BOOK**—"Independence After 40."

Name _____

Address _____

**For Your Experimental, Hobby or Model Shop,
Radio or Other Light Production**

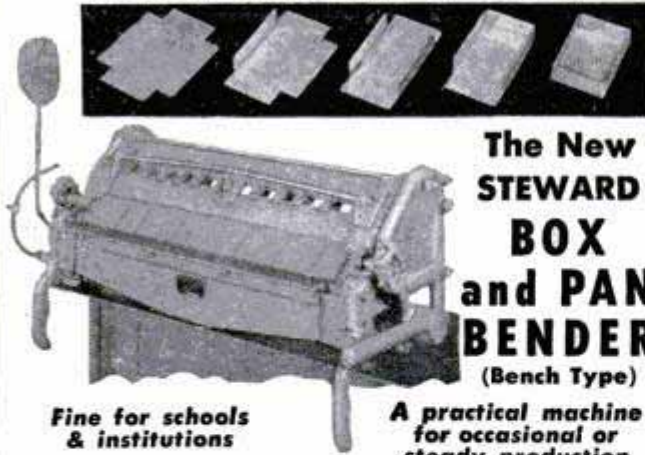

**The New
STEWARD
BOX
and PAN
BENDER**
(Bench Type)

**Fine for schools
& institutions**

**A practical machine
for occasional or
steady production**

This handy machine makes special boxes, pans, trays, angles, channels, radio chassis, etc. from sheet metal up to 20 gauge, 24 inches long. A big feature of this compact but rugged Bender is seven fingers permitting fabrication of boxes bent on four sides . . . made of steel for maximum strength and light weight . . . with adjustments for quick and easy removal.

SPECIFICATIONS: Overall Bending Length 24"; Capacity, 20 gauge mild steel; Height, head open 5 1/2"; Back Gauge Range 1/2" to 9 1/4"; Depth of Fingers 2 1/2"; Net Weight 120 lbs.

STANDARD EQUIPMENT: Full set of seven fingers, 2 of 2"; 2 of 3 1/2"; 1 each of 3", 4", 6"; Gauge table with Gauging Bar and Apron Stop Gauge.

Price complete, ready for use

USED IN THOUSANDS OF SHOPS. SATISFACTION GUARANTEED! Order today, direct
Additional information on other sheet metal fabricating machines upon request on your business stationery.

\$150.00
Freight Prepaid

WARD MACHINERY CO.
560 W. WASHINGTON BLVD. CHICAGO 6, ILL.
Member Chicago Ass'n. of Commerce



**WHOLESALE GUARANTEED
EXCEPTIONALLY GOOD
USED TIRES DIRECT TO YOU**

10% discount on 2 or more tires if you send this ad with order

**TUBE DELIVERED WITH TIRE
AT NO EXTRA COST FOR 15"
AND 16" PASSENGER TIRES**

Safe — Our tires used on school buses and ambulances

**EXCEPTIONALLY GOOD TREAD — NO RECAPS
GUARANTEED FOR 24 MONTHS**

600-16 . . . 6 ply Military—Mud and Snow Tire	\$6.37
550-16 \$5.19	525-18 \$ 6.69
600-16 5.29	550-17 7.99
650-16 5.29	650-15 4.98
700-16 6.29	825-20 15.98
550-15 4.81	900-20 15.98
	1000-20 16.89
	700-15 \$ 5.29
	600-20 9.75
	650-20 9.75
	700-20 10.98
	32-6 (8) 10.49

ALL GOOD TIRES

GUARANTEED FOR 12 MONTHS

550-16 \$3.54	30-5 \$ 7.98	1200-20 \$18.78
600-16 3.59	650-20 7.69	750-24 (36-6) 12.21
650-16 3.89	700-20 (8) 9.29	38-7 (825-24) 13.75
700-16 4.59	700-20 (10) 12.48	1000-22 17.70
550-15 3.79	750-20 (8) 8.19	1100-22 16.89
650-15 3.89	750-20 (10) 9.19	900-24 (40-8) 21.60
700-15 3.98	825-20 11.19	900-16 8.98
550-17 5.69	900-20 11.89	825-15
750-16 8.40	1000-20 12.89	(14 ply) 14.10
600-20 7.98	1100-20 13.89	750-15
		(12 ply) 11.30

GOLD BOND SPECIAL — 750-20 MILITARY TIRES

Will fit 650 x 20	700 x 20 (8 & 10 ply)	34 x 7 (8 & 10 ply)
Special \$10.49	Guaranteed 12 months	
Superior Quality 12.98	Guaranteed 18 months	
Gold Bond Finest 14.98	Guaranteed 24 months	
900 x 16 Special 9.03	900 x 16 extra 11.19	

Send check or money order with this ad

GOLD BOND TIRE CO., Dept. PM 24
512 NORTH 1ST ST., RICHMOND, VA.
"A gold bond written guarantee with every tire"

bacteria, so small that they are invisible under optical microscopes. Up until 1935 only indirect evidence indicated the existence of viruses. That year Dr. W. G. Stanley of the Rockefeller Institute for Medical Research pressed juice from tobacco plants sick with mosaic disease, a disease caused by a virus. He guessed that if he whirled this filtered juice fast enough, virus would be spun to the edge of the centrifuge. Calculations indicated that whirling at the rate of 25,000 revolutions per minute would exert a force on the virus 40,000 times that of gravity. This was enough to promote a separation, opening the way for isolation of absolutely pure virus.

It also opened the way for an attack on other virus diseases—notably yellow fever and influenza. Virus, which is the basis for a vaccine, is grown on the embryos in fertile eggs, since virus requires a diet of live tissue. Bacteria live on such "dead" foods as beef broth, agar and sugar.

Standard laboratory centrifuges are now available for such virus separations. Some ultrafast models whirl fast enough to produce centrifugal force 100,000 times that of gravity. They operate continuously. Fluid pressed from infected chick embryos goes in one end. Virus, in the form of a transparent jelly, comes out one spout, waste fluid out a second.

New uses for the centrifuge are opening up wherever the eye looks. One of the most fascinating of these uses has been on the horizon for some time. It is the separation of solid matter from sewage. At present, this is handled by running raw sewage into vast settling tanks where several days may be required for solid matter to settle out. This practice requires large tracts of land and inevitably depresses real-estate values in surrounding areas.

Tomorrow, this picture may be different. There is no reason why use of centrifuges wouldn't permit disposal plants to be located even in the center of cities. Trunk sewers would feed through centrifuges. A perfectly clear effluent would flow from them. Solid matter might be collected, sterilized and sold as commercial fertilizer. A number of cities are already collecting and selling deposits from settling tanks and centrifuges would enormously simplify this collection of valuable wastes. Such an approach would go a long way toward solving the critical fertilizer shortage the world faces today.

Thus, achievements of the centrifuge bulk larger each day. In many cases, the machine is doing jobs which could not be done by older methods. In others, it is enormously simplifying traditional techniques and cutting costs in the process.

SERRATED JAWS FOR POSITIVE GRIP

SWIVEL JAW



SEYMOUR SMITH
Snap-Lock
PLIER-WRENCH

ALL-NICKEL FINISH

CAPACITY INDICATOR

INSTANT LOCK RELEASE

Only Locking Plier with All These Features

A plier, wrench, clamp; 1000's of uses in garage and home. Heavy pressed steel body, rugged tool steel, replaceable jaws.. 7" size, \$1.75; 10", \$2.25 (10% higher, Denver & West). At dealers everywhere.

SEYMOUR SMITH & SON, Inc.,
900M Main St., Oakville, Conn.
Quality Tools Since 1850

LEARN THE STARS THIS EASY WAY WITH THE **STARSCOPE!**



This new, easy way to observe the stars is fascinating, entertaining and educational. The STARSCOPE registers illuminated images of constellations (through illusion) in their correct positions in the heavens. ("ORION" pictured at left.) Printed Instructions, Battery, and Negative Charts for Viewing over 20 constellations furnished at no additional cost.

Order your STARSCOPE today! **\$3.95** Post Paid

POLARIS D. & M. CO., LINDEN, MO.

REAL ESTATE
BE A BROKER

PAYS BIG! SEND FOR FREE, BIG, ILLUSTRATED CATALOG NOW! No obligation. Graduates report making substantial incomes. Start and run your own business quickly. Men, women of all ages, learn easily. Course covers Sales, Property Management, Appraising, Loans, Mortgages, and related subjects. **STUDY AT HOME** or in our classrooms in big cities. Diploma awarded. G.I. approved. Nationally known. **WEAVER SCHOOL OF REAL ESTATE (Est. 1936)**
15 E. Pershing Road, Dept. PMB, Kansas City, Mo.

FREE BOOK TELLS HOW

BURKS
WATER SYSTEMS
Last Longer



You'll want a BURKS Dual Purpose Super Turbine Water System because of its LIFE-LOK feature. It'll outlast any other water system by many years—give you more water—at lowest cost.

For deep or shallow wells
BURKS Dual System gives you completely automatic service from deep or shallow wells. New folder explains this, also LIFE-LOK feature. Shows why BURKS is best buy. Self Priming—One Moving Part—Dependable Service. Write for literature—prices.

DECATUR PUMP CO., 61 Elk St., DECATUR 70, ILL.

get the world's greatest
RADIO & TELEVISION
CATALOG! FREE

ALLIED'S
196-PAGE GUIDE
TO EVERYTHING
IN RADIO & TV AT
LOWEST PRICES



TELEVISION AND HOME RADIOS



SERVICE SUPPLIES
BUILDERS' SUPPLIES



AMATEUR GEAR



AMPLIFIERS, P.A.
SYSTEMS, RECORDERS

Everything for Experimenters, Builders, Amateurs, Servicemen, Engineers, Soundmen

Save money on every radio need! Get the 196-page 1950 ALLIED Catalog featuring the world's largest stocks of top-quality equipment, at low, money-saving prices! Latest TV releases, home radios and radio-phonos, Amateur equipment, PA systems and High-Fidelity Sound, recorders, test instruments, builders' kits—plus thousands of parts, tubes, tools, books and diagrams. Get more for your money from the World's Largest Radio Supply House. Send today for your FREE copy of the 1950 ALLIED Radio Buying Guide!

ALLIED RADIO ★

ALLIED RADIO CORP.
833 W. Jackson Blvd., Dept. 5-AA-O
Chicago 7, Illinois

FREE CATALOG

Rush FREE 196-Page Catalog

Name.....

Address.....

City..... Zone... State.....

Cushman

MOTOR SCOOTER



**Gets You There
QUICK
AT AMAZING
LOW COST!**

- To Work
- To School
- To Market
- Make Deliveries
- Pleasure

Now, ride anywhere—comfortably, safely—at less than 1/3¢ a mile! Cheaper than shoe-leather! No parking worry. Replaces the second family car.

World's greatest low-cost transportation! Thousands used—getting to and from work, market, school, making deliveries. Standard Model carries extra passenger—delivery models carry 200-lb. load.

POWERFUL ENGINE: Varimatic Drive. Takes steepest hills. Floating drive applies power smoothly. Up to 35 miles an hour.

EASY RIDING: Special springing, long wheel-base, balloon tires.

SAFE: Low center of gravity, heavy brakes. Durable built of finest materials. Flashy new 1950 models now available.

WRITE See your local Cushman dealer for demonstration, or rush card for free folder, photos and low prices. Send for your free copy TODAY! Address Dept. M-1.

75 MILES PER GAL.

DEALER INQUIRIES INVITED

CUSHMAN MOTOR WORKS, Inc
LINCOLN, NEBRASKA U.S.A.



**MAKE BEAUTIFUL
TRAYS,
COASTERS, GIFTS**

of Aluminum, Brass, Copper, Stainless Steel

*Easily! Quickly!
at Low Cost!* For beginners and experienced craftsmen—here's a complete supply of quality metals pre-cut to the size you want . . . and at lowest metal warehouse prices!

ALUMINUM and COPPER CIRCLES. RECTANGULAR SHEETS of Aluminum, Brass, Copper and Stainless Steel. Easy to work, ready to be formed into trays, coasters and hundreds of useful items and gifts.

BRACELET BLANKS of Aluminum, Brass, Copper and Stainless Steel. Perfect for jewelry, ornaments . . . simple to work into attractive handicraft.

FREE BOOKLETS! "Making Aluminum Trays and Coasters", and "Copper Metalcraft" give complete directions for making beautiful metalcraft items easily and quickly. Send for your Free Copy Today!



METAL GOODS CORPORATION

Dept. PM 5239 Brown Ave. St. Louis, Mo.

Oil Drillers Throw Curves

(Continued from page 164)

should pierce the formation. A master map that shows the courses of all the directionally drilled wells in the area is consulted so that the new well can cross safely over or under the ones in its path.

Drill pipe is made of the strongest steel obtainable and yet it is extremely flexible when several thousand feet of it have been connected together. It can be rotated even though it makes several vertical and horizontal changes of direction.

The procedure in drilling a slant hole is to avoid any abrupt angles and to build up a desired curve in a number of small steps. Thus a hole that is to be aimed, for a time, at 60 or 70 degrees from the vertical is normally started as a straight vertical hole. A few hundred feet down, it is whipstocked about four degrees to one side and from then on it is deflected an additional amount every 100 feet until the desired deflection has been obtained. The same whipstocking procedure is used to turn the hole horizontally when needed, as well as for returning it to a vertical path.

Directional drilling imposes no unusual strains on tools or drill pipe. When a slant well has to be pumped to extract its oil, however, wear on the sucker rods that lead from the wellhead down to the pump at the bottom often is excessive. The rods drag and scrape on the metal wall of the well casing. To avoid this, a "free" pump has been developed that has no mechanical connection with the surface.

The pump is something like a double-acting steam pump and is actuated by hydraulic pressure. It is contained in a tube two inches in diameter and seven feet long and is simply dropped down a pipe to the bottom of the well. Then the pipe is flooded with crude oil from the surface, pressure is applied to the oil and the pump begins to operate. The pump returns the "power" crude oil plus as much as 500 barrels of crude oil from the deposit to the surface per day, via a separate pipe. If the pump requires inspection or repairs, it can be returned to the surface by reversing the flow of oil in the two pipes. This forces the pumping unit up to the wellhead.

No matter whether an oil well is drilled straight down into the ground or is slanted off to one side, it sometimes gets into difficulties. The drill pipe may snap or twist off, leaving a few hundred or a few thousand feet of pipe buried in the hole. The walls of the hole may collapse, freezing the pipe so solidly that it can't be rotated or withdrawn.

(Continued to page 252)

Make Garden Masonry for Spare-Time Profits

Millions of homes can use these Ornamental products — urns, vases, flower boxes, bird baths, lawn seats, flagstones, etc. Easily made of sand and cement. Permanently glazed in a range of smart colors. Distinctive — attractive — quick selling.

Eye-Appeal Makes for Cash- and-Carry Sales



Selling prices allow 200% to 300% mark-up on basic costs. Only a small investment needed for supply of molds. Easily set up in shed or garage. Write immediately for catalogue OM and price list.

COLORCRETE INDUSTRIES, INC.
710 Ottawa Ave., Holland, Mich.



Sand Casting — Forging — Heat Treating — Case Hardening BRONZE FOUNDRY



In your own workshop allows you to design and build your own GASOLINE ENGINES, STEAM ENGINES, STATUARY, ART OBJECTS, SPECIAL TOOLS, NEW INVENTIONS, ETC. You can also make forgings and case harden steel. Your shop is not complete without a FOUNDRYETTE. Three sizes are available capable of making bronze castings of 1½, 3 and 6 pounds weight, aluminum, copper, brass, etc., \$22.50, \$29.50, \$42.00 f.o.b. Kansas City. Domestic gas supply and 110 volt AC or DC energy required for operation. Write for circular.

KANSAS CITY SPECIALTIES CO.
Box 6022, Dept. P-12 Kansas City, Mo.

Make your own TUBULAR STEEL CHAIR FOR AS LITTLE AS

\$1.73 COMPLETE!

Make metal chairs, tables, chaise lounge, child's bed, wheelbarrow, many other useful articles for family and friends. Earn money spare time! Use tubular steel, aluminum, iron pipe. Make smooth bends quickly, easily, with HANDY Tube Bender. No other tools needed. Not a toy! HANDY Tube Benders used daily by thousands of plumbers. A guaranteed precision tool! Many uses around the home.

FREE! With Model B4-16 HANDY Tube Bender (for 1" O.D. tubing) we include simple instructions for making tubular chair, table, many other home furnishings. Send check or M.O. for only \$17.70 —

we pay postage. Get your HANDY Tube Bender NOW. Make your own tubular steel furniture. It's easy! It's fun! Save money! Send order to:
HOLSCLAW BROS., Inc.
407 Willow Road
EVANSVILLE 11, INDIANA

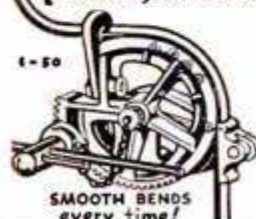

SMOOTH BENDS
every time!

SAY YOU SAW IT IN POPULAR MECHANICS

BUY WISELY for Over-all Value!

Don't "fall" for some over-glamorized gadget or unproved feature. You can depend on an easy-towing, Schult for the all-season comfort of sound engineering... the livability of good design... the years-lasting satisfaction of fine workmanship.



Free..
**"HOW TO BUY A
TRAILER COACH"**

Send today for new booklet. Tells what to look for... how to judge values... protect your investment... and make your dollars go farther.

NEW MODELS ARE BEST VALUES EVER

Write now for free catalogs, and data on 1950 models colored and finished like fine autos. Finest heating plants. Choice of convenient floor plans. Unique features for all-season living and travel.

SCHULT CORP., Dept. 3201, Elkhart, Ind.
In Canada: John Inglis Co., Ltd., Toronto



Say You Saw It in Popular Mechanics

How Constipated People Can Be Kind to Themselves

Thousands of people who suffer from chronic constipation have found an amazingly easy way to be kind to themselves. They don't whip their systems with harsh, painful cathartics. Instead, they turn to Nature's Remedy. For Nature's Remedy, NR tablets, is composed entirely of natural, vegetable laxatives—so gentle, most people take them at night because their sleep is not disturbed, yet regularity is accomplished the next morning.

Try NR at our expense. 25 tablets 25c. Buy a box at any drug store and try it. If you are not completely satisfied, return the box and unused tablets to us. We will refund your money plus postage.

Nature's Remedy
NR-TABLETS-NR

PLAIN OR
CANDY
COATED

EAR NOISES?

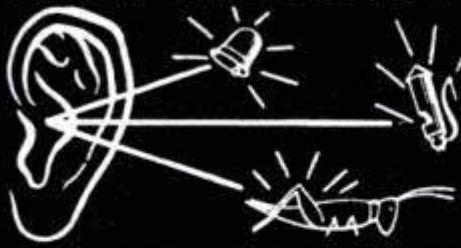

If you suffer from those miserable ear noises and are Hard of Hearing due to catarrh of the head, write us NOW for proof of the good results many people have reported after using our simple home treatment. **NOTHING TO WEAR.** Many past 70 report ear noises relieved and hearing improved. **Send NOW for proof and 30 days trial offer.**

THE ELMO COMPANY
Dept. 475 Davenport, Iowa

NEW 4 in 1 ERA TRAMMEL HEADS

Use on your scale or combination square to make accurate compass, height gage, inside and outside callipers and scriber. Many uses. Every shop needs it. Complete with scriber points, pencil tips, special caliper points. *Satisfaction guaranteed.* At your dealer or direct. Prompt delivery. We pay postage. Order today!

Engineering Research Associates, Inc.
3475 E. Nine Mile Road
Hazel Park Michigan

ONLY \$2.95 POST PAID

WANTED MAN WITH CAR TO RUN STORE ON WHEELS

USE OUR CAPITAL

NO SALES EXPERIENCE NEEDED

The biggest opportunity ever, to quickly establish a money-making, lifetime business, now awaits you as a McNess Dealer. Sell things farmers need and use up. Serve same families year after year. Pleasant work--no bosses--easy to do. We supply capital to work on. Also provide offers--advertising--premiums and trade secrets that bring sales.

First to apply get best trading areas. Don't wait--write us today for McNess proposition. Tell us county and state you want to serve. Ask for free McNess Book.

The McNESS CO., 881 Adams St., Freeport, Ill.

There are a dozen and one things that can happen to a well during drilling and the industry has many ingenious devices for "fishing" out tools and equipment lost or stuck below the surface. A "fishing" expert might be termed a surgeon who makes his diagnosis as far as two or three miles from the seat of the trouble, probes at long range with instruments of extreme delicacy even though they may weigh tons apiece and performs exacting cutting, lancing and measuring jobs without being able to see the "patient."

If the drill pipe twists off underground, he may drop an impression block of soft lead on the end of the pipe, then pull up the block to get a picture of the pipe location in reference to the hole. Once the pipe is located, he can lower a grabhook or a pair of giant tweezers into the hole and fish for the end of the pipe. Sometimes, acid is dumped into a well to eat out the formation and free a stuck drill pipe; sometimes oil is used instead to lubricate the drill pipe and allow it to be pulled free.

When a drill pipe seems irretrievably stuck, it is necessary to learn the exact point at which it binds in order to salvage all the drill pipe above that point. The task seems almost impossible but with a new magnetic detector the point can be determined within a foot or so.

The instrument consists of two powerful electromagnets that are held five feet apart by a rod containing a telescopic joint in its middle. It is lowered down inside the drill pipe to a test depth and the current is turned on, anchoring the two magnets to the drill pipe. Then the drill pipe is stretched by hauling up on it from the surface.

A sensitive device in the telescoping section of the instrument can measure and transmit to the wellhead a stretch of as little as .001 inch between the two magnets. If stretching is registered, the instrument is above the point at which the pipe is stuck; if the pipe doesn't stretch, then the instrument is below that point. After additional test depths have been tried, the instrument unerringly indicates the point at which the pipe is stuck.

One method of retrieving the pipe is to send down a cutting device to the correct depth and cut the pipe free, allowing it to be hauled up. The newest method is to lower a coil of primacord, the military explosive, to the point at which the pipe is stuck, and ignite it electrically. The resulting violent explosion springs the nearest joint in the drill pipe, loosening it and allowing it to be unscrewed from the surface. After that the pipe is hauled up without trouble.

NOW—KEEP EACH ROOM AS WARM OR COOL AS YOU LIKE... Automatically!

Simply replace air valve on radiator with Heat-Timer valve and turn dial to temperature wanted. Heat-Timer acts as an individual thermostat for each room; no changes required in your present controls. Perfect for any one-pipe steam system; pays for itself in fuel savings. Precision made; lasts for years—50,000 satisfied users. At your dealer, or direct—only \$4.95, prepaid; money back instantly if not delighted. Order today for every radiator. Heat-Timer Corp., Dept. E2, 160 Fifth Ave., New York 10.



G. I. DIVERS!

DON'T LET YOUR TRAINING GO TO WASTE. COMMERCIAL DIVERS EARN UP TO \$80 A DAY.

In your spare time you can do odd jobs—clean pools or tanks, retrieve golf balls or outboard motors, locate sunken boats, etc. Very LOW COST complete Gov't surplus EQUIPMENT available—either deep water or shallow water. Catalog 15c on request.

Other marine surplus — sextants, barographs, bells, life preservers, M & T barge units, anchors, etc.

M & E MARINE SUPPLY CO. P. O. BOX 601-Y
CAMDEN, NEW JERSEY

WANT A THRILL?

Expert or beginner, you'll get a thrill without a "kick" shooting America's most amazing guns—the new Crosman Pistol and Rifle powered by CO₂. See them at your Crosman dealers now! Write for literature.

Crosman Arms Co., Inc. • Rochester 7, N. Y.

FALSE TEETH KLUTCH holds them tighter

KLUTCH forms a comfort cushion; holds dental plates so much firmer and snugger that one can eat and talk with greater comfort and security; in many cases almost as well as with natural teeth. Klutch lessens the constant fear of a dropping, rocking, chafing plate. 25c and 50c at druggists... If your druggist hasn't it, don't waste money on substitutes, but send us 10c and we will mail you a generous trial box. © I. P. INC.

KLUTCH CO. Box 5093-A **ELMIRA, N. Y.**

LAWNMOWER SHARPENER OPERATORS

Increase your output... Year 'round business!

NEW BED KNIFE GRINDER sharpens all STRAIGHT EDGE TOOLS

New Ideal Bench Grinder doubles your output of sharpening jobs, speedily grinds straight blade knives. Sharpens all kinds of straight edge tools and ice skates. Write for FREE, fact-filled folder.

THE FATE-ROOT-HEATH COMPANY
Dept. D-3, Plymouth, Ohio

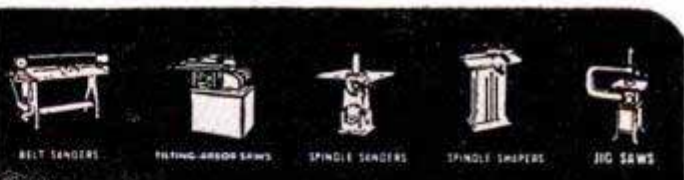

✓ **CUT**
✓ **SHAPE**
✓ **DRILL**
✓ **FINISH**
WOOD • FIBRE
METAL • PLASTICS



High Quality
Low Cost
POWER TOOLS



BOICE-CRANE CO.

943 CENTRAL AVE. • TOLEDO 6, OHIO
Please send free literature on Boice-Crane Power Tools.

NAME _____
STREET _____
CITY _____ STATE _____

Say You Saw It in
POPULAR MECHANICS

FURNITURE MAKING and CABINET WORK

By B. W. PELTON

Complete Step-by-Step Directions for making Every Type of Furniture —Including Built-in Conveniences and Home-remodeling Jobs

Here, in a great new handbook is everything you want to know about furniture making; cabinet work, repair jobs, and remodeling projects. Accurate drawings and practical instructions show you all the tricks of the trade and the real professional methods of repairing, refinishing and reupholstering worn or broken pieces. And there are complete directions for every type of home-remodeling project. Every job is explained in careful detail by a master craftsman who gives you authentic instructions on exactly how to carry out each step in the work—from obtaining the materials to the final finishing operations; staining, varnishing, waxing, etc.

MAIL THIS COUPON

D. VAN NOSTRAND COMPANY, INC. 250 Fourth Avenue, New York 3, N. Y. Examine This **FREE!** Great New Book

Please send me a copy of "Furniture Making and Cabinet Work." Within 10 days I will either return the book, or send you \$2.95, plus postage, as a down payment, and \$2.00 a month for two months until the total price of \$6.95, plus postage, is paid. (If you send entire amount of \$6.95 with this coupon, we will pay postage. Same return privilege and refund guarantee if not completely satisfied.)

SEND NO MONEY NAME _____ ADDRESS _____ CITY _____ ZONE _____ STATE _____
Pop. Mechanics—1-50

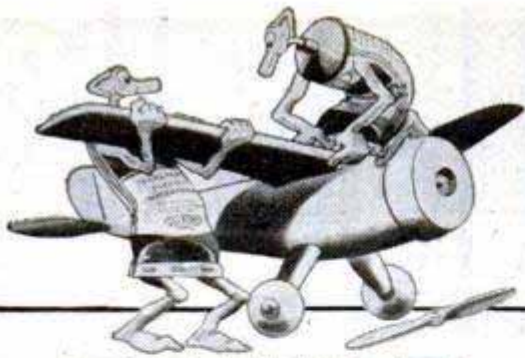

BUILD

STRONGER MODELS

It's transparent, waterproof
flexible and durable.
Get a tube
today.

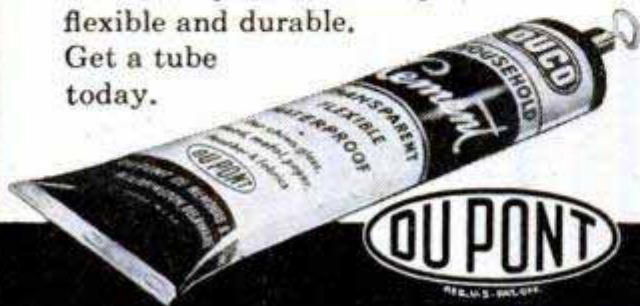

DUCO CEMENT

REG. U. S. PAT. OFF.

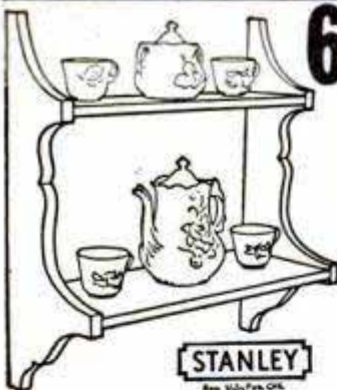

6 EASY WOODWORKING PATTERNS . . . 25¢

Six woodworking patterns for attractive, easy-to-make projects. Actual size. Simple to follow, trace and cut out. Set includes: Wall Shelf (illustrated), Pipe Rack, Phone Holder, Plant Bracket, Novelty Table and Wall Plaque. All six patterns for only 25c, post-paid. Send to Stanley Tools, 110 Elm St., New Britain, Conn.

STANLEY
Reg. U.S. Pat. Off.

THE TOOL BOX OF THE WORLD

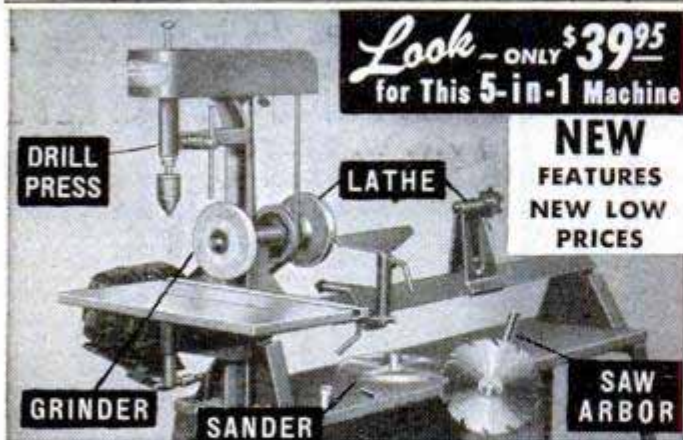

Look - ONLY \$39.95
for This 5-in-1 Machine

NEW
FEATURES
NEW LOW
PRICES

DOES SAME WORK AS \$200 UNITS—precision built, big capacity. Thousands of satisfied owners.

EMRICK SHOP includes all 5 Tools as shown. Has TWO Power Spindles—NOT necessary to move frame for any operation. Only \$39.95 cash, or on Easy Payments. 10-Day FREE Trial. MONEY-BACK Guarantee. FREE literature on New 1950 Features and New LOW Prices. EMRICK, INC., 1909 Clinton, Kalamazoo, Mich.

A Half Century of Miracles

(Continued from page 85)

the way we utilize proteins and fat had to be revised. New sciences of physiology and nutrition are in the making. Some of the radioactive isotopes are already used in the treatment of cancer.

All these developments in atomic physics were the logical result of the discovery of the electron in the closing years of the 19th century. A hydrogen atom, lightest of all atoms, was 1840 times more massive than this electron. Evidently the atom was not the smallest indivisible unit of matter that the chemist had assumed. It was bombarded and bits of it studied.

In 1919 Rutherford inferred from the bits that an atom is like the solar system,



Radio's big impetus came in 1906, with invention of three-electrode vacuum tube by Lee De Forest, above

with a sunlike nucleus around which planetary electrons revolved. This conception has been considerably modified since, but the essential fact that the electron is both a particle of electricity and a particle of matter remains. A flash of lightning is a flash of electrons, a current in a wire, a flow of electrons. For all its dynamos, telephones and telegraphs the 19th century did not know what electricity was. The 20th century does know and defines it in terms of electrons.

Out of this new knowledge of the atom's structure came the branch of electrical engineering called "electronics." Electrons are harnessed in vacuum tubes. There are scores of such tubes, and they have 10,000 uses. They glow in every radio set. They pick up radio waves from a broadcasting station or from the sun and the Milky Way. They are the heart of radar, which makes it possible to detect distant planes in the air,

(Continued to page 256)

1001 DESIGNS for HAND DECORATING



CRAFTSMAN! HOBBYISTS!

Double the value of your craftwork! Get 1001 big, workable designs plus step-by-step directions for stenciling, handpainting, tooling them on leather, wood, metal, fabrics, glassware, plastics! All in one big brand new book "1001 DESIGNS FOR HAND DECORATING."

Includes: Peasant—Primitive—Floral—Borders—Birds—Animals—Oriental—Modern—Native—Monograms—Nursery—Holiday and hundreds more. Plus tips and short cuts for every art and craft! Save time, save work, make more money—a gold mine of ideas! Cloth bound. Only..... **\$2.50** Post send today. Only..... **\$2.50** Paid

COD's accepted. Money Back Guarantee

Homecrafts 799 BROADWAY, Dept. PM1, N. Y. 3, N. Y.

FURNACES FOR HOME AND SHOP



COAL—LP—GAS—OIL. Fittings, pipes and registers. Water heaters, Ranges and floor furnaces. BLOWERS with motors. Get the parts you need and modernize your own heating system. Wholesale & Retail. Lowest prices.

FREE BOOKLET

PEERLESS SALES & SUPPLY
4318 Sheridan Lincoln 6, Nebr.

PISTONS



ALUMINUM ALLOY. For Every Make Engine. Any Year, Odd or Foreign! For auto, "hot rod", racing, truck, tractor, motorcycle, scooter, bike, outboard, marine, compressor, industrial. Send sample or specifications.

JUDSON MFG. CO., 1709 Gillingham, Phila. 24, Pa.

Genuine Snap-on Tools

Available Only Through Snap-on's Direct-To-User Tool Service

WRITE FOR INFORMATION
SNAP-ON TOOLS CORP. • Kenosha, Wisconsin

OTTAWA LOG SAW



World's fastest, self-propelled. 8 H.P. air-cooled motor. Fells trees and cuts 'em up. Powerful for belt jobs. Pays for itself quickly. Always a demand for wood. Nothing like it. Write today for FREE details.

OTTAWA MFG. CO., 2-027 Pine Street, Ottawa, Kansas

HYDRAULIC Power Transmission WITH Infinitely VARIABLE SPEEDS, Clutch and INSTANT REVERSE—OUTPUT TORQUE ADJUSTMENT UP TO 180 inch POUNDS

This positive displacement Hydraulic Torque Converter is the ideal fluid drive with thousands of uses . . . Output Speeds Infinite . . . 0 to 550 R.P.M. . . . in either direction . . . Change Speeds WHILE RUNNING . . . Control and Transmit your power this SMOOTH Oil-Way . . . Will handle 1/2 H.P. to 1 1/2 H.P. Motor, Industrial or Home & Farm Use . . . Cost Government \$300. High Quality Precision Workmanship. Buy this unit to get the most for your money. Case measures 7 1/2" long 7" high 6 1/2" wide. Input & Output Shafts 5/8" dia. Beautiful Red Crackle Finish Case.



Shipping Wght. 25 pounds

Only **\$54.50**

If C.O.D. is requested a 10% Deposit must accompany order and we ship F.O.B. Chicago.

1 1/2"-8 thread Lathe Chuck Adapter, \$3 extra

PREPAID 2 quarts oil included FREE

DIRZIUS MACHINE SHOP "R" 1423-25 So. 52nd Ave., Cicero 50, Ill.

TEN TIMES FASTER THAN HAND SAWING!



Ripping



Crosscutting

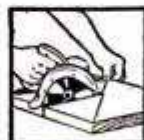
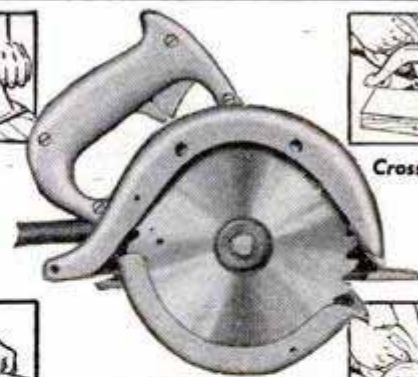

Angle Cutting



Cutting Tile, Transite, Slate

HOME-UTILITY 6" Electric SAW (Cuts to 2" Depth)

\$59.95

Saves You Dollars, Days, in Building, Altering!

Home-Utility 6" Electric Saws speed up general carpentry, home construction and alterations, farm building and maintenance! Saw stair stringers; trim stock size millwork to fit; cut out plywood and wallboard panels; saw lumber to construction length; do hundreds of other jobs!

Built by BLACK & DECKER, world's largest maker of quality electric tools, this perfectly-balanced, close-coupled Saw is easy to handle, easy to follow, safe to use. Powerful universal (AC-DC) motor specially built for power sawing.

See it, try it, at your hardware, electrical or implement dealer. Write today for free "How-To-Do-It" booklet. Gives many helpful hints on saving time, money! Write to: THE BLACK & DECKER MFG. CO., Dept. H1M, Towson 4, Md.

Products of The BLACK & DECKER Mfg., Co.

ELECTRIC HOME-UTILITY TOOLS



1/4" Drills



1/2" Drills



Sander-Polishers



1/4" Drill Kits

CHAMPION V-GLOW PLUGS

for model engines only

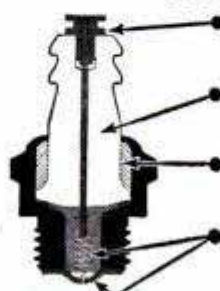

CHAMPION TERMINAL—assures better center electrode seal and provides sturdier electrical connection.

CHAMPION-CERAMIC INSULATORS—proved dependable in millions of Champion Spark Plugs.

CHAMPION SILLMENT SEAL—prevents excessive compression leakage between insulator and shell.

CHAMPION "THERM-O-FLEX" CONSTRUCTION—longer element life, more dependable performance.

Follow recommendations of plug types and fuels approved by engine manufacturer.

CHAMPION SPARK PLUG COMPANY, TOLEDO 1, O.

BRIMMS PLASTI-LINER

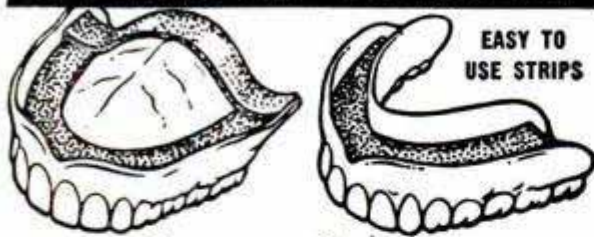

EASY TO
USE STRIPS

One application MAKES FALSE TEETH FIT for the life of your plates

If your plates are loose and slip or hurt... if they rock and cause sore gums... you need Brimms Plasti-Liner. Brimms Plasti-Liner gives instant relief, perfect fit and lasting comfort. Lets you eat anything... talk freely without embarrassment. Ends forever the mess and bother of temporary "stickums" that last a few hours or days.

EASY TO USE... REFITS FALSE TEETH PERMANENTLY

Lay soft Plasti-Liner strip on upper or lower plate. Bite and it molds perfectly. Tasteless, odorless, harmless to you and your plates. It hardens to your plate for lasting fit and comfort. Even on old rubber plates, Plasti-Liner gives good results six months to a year or longer. Removable as per directions. *Guaranteed satisfaction or your money back.*

SEND NO MONEY Order a \$2.25 package to reline both upper and lower plates. Or a \$1.25 package to reline one plate. Pay your postman when he delivers. **Or send money now and save C. O. D. charges.** Generous sample of special plate cleaner included free.

PLASTI-LINER CO., Buffalo 11, N. Y., Dept. 43-N

REMOVE any finish QUICKLY • EASILY

Anyone can do a professional removing job with Wonder-Paste Remover. Applied with a paint brush directly over the surface, Wonder-Paste reduces any finish to a butter-soft sludge that peels off quickly and cleanly.

At Paint and Hardware Stores Everywhere

Write for Leaflet

WONDER-PASTE

Wilson-Imperial Company, 119 Chestnut Street, Newark 5, N. J.



ships at night, meteorites in broad daylight, unseen birds on the wing. They can make the crawling of a fly sound like a cavalcade. They count, sort, tell whether or not a catchup bottle is properly filled, they measure the thickness of paper as it is formed on a machine, they cook dinners, they open and shut doors as we approach and pass on, they create artificial fevers that speed recovery in sickness. The latest calculating machines incorporate as many as 2000 of them and with their aid solve in half an hour problems that would keep a team of mathematicians busy for a month.

A young man named Guglielmo Marconi had been sending messages through space by what was called "wireless" telegraphy

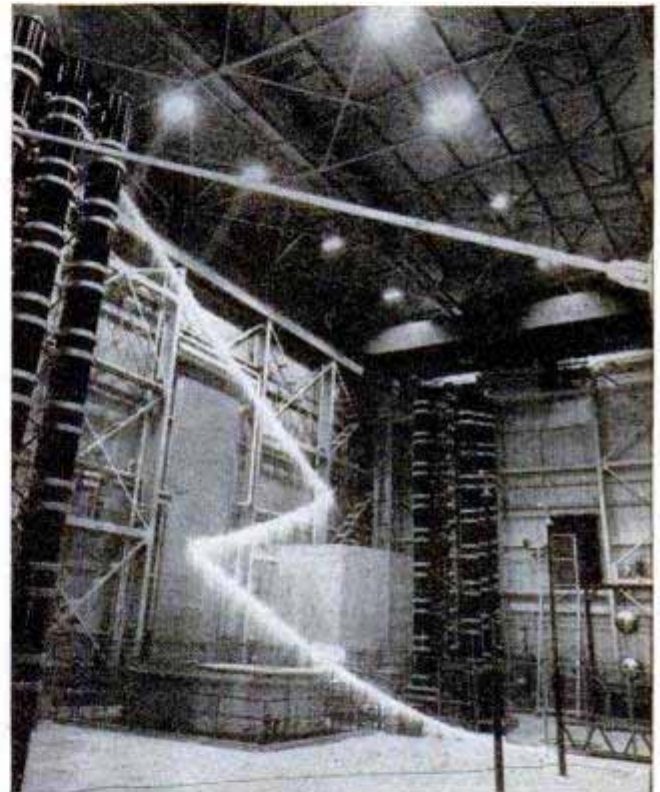

Zigzag flash of 5,000,000 volts of man-made lightning in a laboratory. Following discovery of the electron, 20th century found out what electricity was

GRIP "Hard-to-reach" NUTS THIS EASY WAY

Here's a real time and temper saving wrench that solves the problem of getting at those "hard-to-reach" nuts on radios, electric appliances, automobile bodies, other sheet metal products.

If you've ever fumbled a nut in the tight spots (and who hasn't?), here's your answer. No more unnecessary disassembly of confining parts in working areas either! This wrench slips on your finger and lets you get right at those nuts and bolts with your finger tip. Strong. Sturdy. Flanges adjust for snug fit on any size finger.

For a set of 4 wrenches that fit the 4 most popular hex nut sizes. — 1/4", 5/16", 11/32", 3/8" across the face.

Ask your hardware dealer. If he can't supply you, order direct. Send 39¢ plus 1¢ for postage—coin, check or money order. No. C.O.D.'s, please.



TOUCH 'N' GRIP

FINGER TOOLS

F. E. REDFIELD

31 Colonial Pkwy, Dumont, N.J.

in the closing years of the 19th century, but it was not until 1906, when Lee De Forest invented the three-electrode vacuum tube, that radio came into its own. Now we hear the President's voice in the living room, we telephone across the Atlantic with harnessed electrons.

Electronics can tear you apart and put you together again. When you talk electronically to San Francisco, as you do when you telephone, what happens? Your body stays at your desk, but your mouth goes out over a wire and talks. Why can't you be further disembodied? Why can't your eyes go to San Francisco and see the friend

(Continued to page 258)

PLAN YOUR OWN TELEVISION INSTALLATION and Save Money

Skyrider TV Custom Chassis at New Low Prices



FREE!

New 160 page Catalog. The treasure chest of values in Radio, Television and Electronics for home and workshop. Send for your copy today!

Now, get big picture, direct view Television at Sensational Savings with SKYRIDER TV Custom Chassis . . . made by the manufacturer of "The Radio Man's Radio." Factory wired and tested. Complete with speaker and all tubes, including picture tube. Ready to use. Needs only cabinet or mounting place in wall. Send for Free folder. Features original designs for TV Custom Installations.

"Ideal gift for the entire family"

MODEL	SIZE	PICTURE AREA	PRICE, ONLY
524	10"	61 Sq. In.	\$159.50
521	12½"	92 Sq. In.	\$189.50
520	16"	145 Sq. In.	\$249.50

F.O.B. St. Louis, Missouri • Wire, Write or Phone

Walter Ashe

RADIO CO.

1127 PINE ST.

PHONE CH. 1125

ST. LOUIS 1, MO.

M-SCOPE TREASURE-MINERAL LOCATORS

WRITE FOR FREE, ILLUSTRATED 16-PAGE BOOKLET

M-SCOPE TREASURE-MINERAL LOCATORS. Low priced, unsurpassed efficiency, lightweight models. Factory guaranteed. Immediate shipment. Credit plan available. Write for free 16-page booklet.

GEIGER COUNTERS for finding Uranium ores. Several models, Simple operation. Low priced. Immediate shipment. Interesting free literature.



URANIUM

FISHER RESEARCH LAB., INC., PALO ALTO, CALIF.

GOLD

WRITE FOR YOUR FREE COPY OF THE NEW KRW HYDRAULIC PRESS BOOK



Describes all manner of Production and Shop Work on KRW Hydraulic and Bench Type Presses. Illustrates the new KRW Hand-operated, Electric-operated and Air-operated Hydraulic Presses. 25 to 100-ton capacities.

Write for your copy today.



K. R. WILSON, DEPT. 17, 215 MAIN ST., BUFFALO 3, N. Y.

SET THE PACE WITH THE



Dealer Inquiries Invited

- Cruises at 45 MPH—with faster pickup than car
- 39" high, 71" long overall, wt., 190 lbs.
- 8 HP motorcycle engine
- 50 miles to the gallon
- Automatic clutch
- Internal expanding brakes — handle-grip throttle controls

POWELL MANUFACTURING COMPANY
DEPT. PM150 • COMPTON, CALIF.

ONLY \$247³⁴
AT COMPTON, CALIF.
EXCISE TAX INC.
P-81!

Write for FREE folder and name of nearest dealer

Sensational Bargains: LOWEST PRICES! All Items Guaranteed As Represented

WORKSHOP MOTOR BARGAIN COUNTER

½ H.P. \$19.75

General Electric, Leland, Delco, Westinghouse, Sunbeam, Brown, Brockmeyer and others. Repulsion induction and capacitor induction type motors, alternating current, 60 cycle single phase. Like New. Fully Guaranteed, some shop worn, many brand new, every one a whale of a bargain.



No.	H.P.	Volts	RPM	PRICE
12	1/4	110	1725	\$11.75
13	1/4	110	1725	\$14.75
14	1/2	110	1725	\$19.75
15	1/2	110	3450	\$19.75
16	3/4	110/220	1725	\$32.50
17	1	110/220	1725	\$42.50

Order by number. We have large stock of standard & special motors, all sizes. Write for prices

Write for our BARGAIN FAN & MOTOR Circular and SAVE MONEY • RUSH ORDER TODAY
C. MARSHALL SALES, 3546 W. Fullerton Ave., Dept. P-1, CHICAGO 47, ILL.

THE VAPORITE Automatic HUMIDIFIER for Warm Air Furnaces . . . →

BARGAIN GASOLINE ENGINES

Jacobsen 2 cycle 3/4-1 H. P. Ball Bearing. Less Gas Tank. Shop-worn but never used. FOB. ea. \$27.50

THERMOSTATICALLY controlled water supply puts more moisture in the air. Gives healthier air. Easily installed in bonnet of air furnace. Complete with Thermostat Water Control Valve, Tubing and parts for complete installation. POSTPAID ONLY \$7.50 Prepare Now For Winter



BALL BEARING MANDREL

High speed precision bearings for sawing, grinding, buffing, polishing, etc. 12"x5/8" shaft, threaded 1/2"x20 L.H. with flanges and nut, complete with 2 inch pulley. #100 Mandrel Only \$5.25 postpaid.



BUILD YOUR OWN POWER TOOLS

EASILY, QUICKLY... AT LOW COST

Exclusive GIL-BILT Build-It-Yourself Features

- No machining—build easily with hand tools only
- No blueprint reading—step-by-step pictorial plans, full scale patterns, actual photographs
- Sturdy wood, aluminum, and steel construction
- Capacity and performance of commercial saws selling for \$60 and up

SAVE \$50 OR MORE

GIL-BILT 10-INCH TILTING ARBOR SAW



- 27x28 in. table, 13½ in. capacity in front of blade
- 10 in. blade cuts 3¼ in. deep, tilts full 45 degrees
- Floor model 34" high table always stays level

- New Departure ball bearing arbor, ¾" precision shaft turned down for 5/8" bore blades, alum. housing, shipped ready to run
- Jackscrew and 4½" in. dia. handwheel lowers and raises blade
- Cast aluminum miter gauge and self-aligning rip fence guide

GIL-BILT Metal Parts Kit includes Plans, ball bearing arbor, miter gauge and bar, rip fence guide, dado insert, lock knobs, jack screw mechanism and handwheel, and all other metal parts (less blade)... **\$20.95**
 Same Kit with 10" Combination Blade... **\$24.90**
 Same Kit with 8" Combination Blade... **\$23.90**

GIL-BILT 8-INCH TILTING TABLE SAW

- 21x27 in. table tilts full 45 degrees, 13 in. capacity in front of blade
- 8 in. blade cuts from 0 to 2½ in.
- New Departure ball bearing arbor, 5/8" precision shaft turned down for 1/2" bore blades, alum. housing, ready to run
- Cast aluminum miter gauge and self-align. rip fence guide (same as above)



GIL-BILT Metal Parts Kit includes Plans, Ball Bearing Arbor, Miter Gauge and Bar, Rip Fence Guide, Machined Lock Knobs, Tilt Support Segments, and All Other Metal Parts (less blade)... **\$15.95**
 Same Kit with 8" combination blade... **\$18.90**

GIL-BILT 12-INCH BAND SAW

- Cuts to center of 24 inch circle
- Handles stock up to 6 inch thick
- 18x18 inch table tilts 45 degrees
- Lower wheel and drive pulley runs on sealed New Departure Ball Bearings; Upper wheel runs on two 3/8" bore Oilite Bronze bearings
- Upper wheel tension and tilt mechanism of cast aluminum, completely assembled
- Upper and lower blade guides. Each has ball thrust bearing, self-lub bronze jaws
- Rubber tired wheels. Choice of cast aluminum or make-your-own wood wheels on metal hubs
- Uses standard 78 inch blades up to 3/8 inch wide
- Fully enclosed mechanism for utmost safety

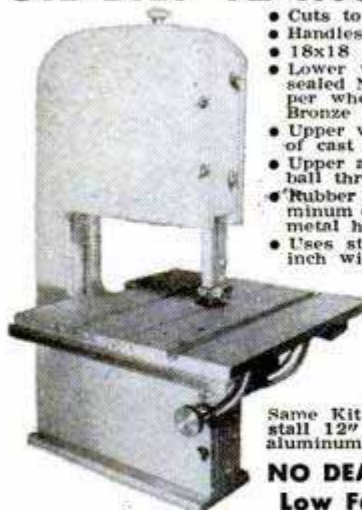

GIL-BILT Metal Parts Kit includes Plans, rubber tires, 1/4 inch blade, hubs for wood wheels, ball bearing spindle, tilt mechanism, guides, table tilt segments and all other metal parts... **\$16.95**
 Same Kit with two machined ready-to-install 12" cast aluminum wheels... **\$20.95**

NO DEALERS — One Low Factory Price

COMPLETE PLANS only \$1.00 EACH

Return in 10 days for full refund if not satisfied. Prices include postage within 600 miles. Over 600 miles add 5%. Send cash, check, or money order for parts kit, or send \$1.00 for Step-by-Step Plans and order kit later less cost of Plans. Plans sent postpaid anywhere in the world.

GILLIOM POWER TOOLS

P. O. Box 1-PA, Lambert Field, St. Louis 21, Missouri

to whom you are talking? This idea, the idea of television, is as old as the telephone. From telegraphy to television directly was too big a leap. First photographs had to be transmitted over wires. Prof. Alfred Korn was the first to do this (1904). In his process, and all other processes that followed, a photograph is scanned line by line with a beam of light. Photoelectric cells (electron tubes) translate the lights and shades in the lines into electric impulses and at the receiving end translate the electric impulses back into lines like the original. The process takes minutes. Television must



Today's television is credited to Vladimir Zworykin, who showed how beam of electrons could be utilized like a luminous brush to paint a picture in light

work in fractions of a second. Not only is there scanning but the lines are broken up into millions of dots, sent out as impulses, then reassembled. It is all so fast that the eye cannot follow the process.

The first man to build a practical television set was a young Scotsman, John Baird. That was in 1925. His mechanical principle is now as obsolete as the high-wheel bicycle. Today's television set must be credited largely to Vladimir Zworykin. He showed how a beam of electrons could be used like a luminous brush to paint a picture in light with flashlike rapidity.

It was Zworykin, too, who did so much to develop the electron microscope, which can magnify theoretically more than a hundred thousand times. An excellent, ordinary

(Continued to page 260)

ARC WELDING

FOR PROFIT OR PLEASURE

60 LBS. OF READY MADE PARTS

Only \$24.95

BUILD YOUR OWN HEAVY DUTY WELDER

SAVE Buy Only NECESSARY PARTS

All parts Ready-Made and easy to assemble. You can do all around welding on steel, cast iron and other metals after only a few hours practice. Illustrated instruction manual included. Sold on 30-Day Money-Back Guarantee!

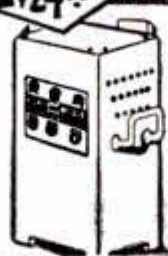

Gives 100% penetration. Welds are stronger than original metal. Operates on 110 or 220 AC.

FREE: Write today for fully illustrated Pamphlet P-1

ATOMIC ARC WELDER CO.
1037 So. 19th St. OMAHA, NEBR.

NEW QUICK-CLAMP 30" BRAKE

Forms angles, flanges, seams. Bends 26 gauge steel. Heavier copper and aluminum. Cam locking. Portable, can be clamped to edge of truck. All steel. Wt. 42 lbs. Express Collect. . . \$24.50 36" size . . . \$29.00



12" BRAKE. Fits in vise to form difficult compound bends, up to 20 gage steel. . . \$12.50 PP.

CUTTER. Cuts 18 gage steel any length and width, \$12.50 PP.
SHEET METAL PLIERS. 2 1/2" wide, \$2.00; 5", \$3.00.
IRON BENDER. Forms hooks, braces, eyelets. Bends 1/4x2, \$10.00

Immediate delivery. Order direct, cash or C.O.D., or send for folder.
WISE BRAKE MFG. CO., P1116 So. 27th St., Omaha 5, Nebr.



5 big-capacity power tools in **1** rugged, precision-built unit

Write for free, 20-page, profusely illustrated book. SHOPSMTIH, Dept. 109-B, 12819 Coit Rd., Cleveland 8, O.

MAGNETS OF ALL TYPES—10c UP
AMAZINGLY POWERFUL!
4 oz. Alnico Magnet, lifts 10 lbs. \$1.10. Our Leader, 15 oz. Magnet, lifts 40 lbs. \$2.50. New alloy—will not weaken! Useful for lifting valuables from tanks, jakes, or rivers easily! 7 small magnets \$1.10 with list of many shop and home uses. Satisfaction guaranteed.
R. EYRICH, 2566 N. 49TH ST., MILWAUKEE 10, WIS.



NOW! FILE YOUR OWN SAWS

Do expert saw filing at home. Precision filing easy without experience. Two simple adjustments. Keeps any hand saw extra sharp and true-cutting. Complete with file. Money back guarantee. Cash with order, prepaid. (COD postage extra.) Order today. \$2.95.

ANOTHER SPEEDCOR TOOL
THE SPEED CORP. PM-1
512 N.E. 73 Ave., Portland 16, Oregon

\$2.95 EACH

SAY YOU SAW IT IN POPULAR MECHANICS

OVERSTOCK SALE

14K GOLD PLATED CHRONOGRAPH WRIST WATCH

Lowest Market Price

\$7.25



Sweep Second Hand; Precision Workmanship; Rugged Shock-resistant case; Radium hands and numerals; Leather strap. It measures distance, speed of cars, planes, horses and other moving objects. It's a time keeper, stop watch, telemeter, tachometer. **ONE YEAR WRITTEN GUARANTEE** and full operating instructions enclosed with each watch. **SEND NO MONEY.** Mail your order today. Pay postman \$7.25 plus 10% Federal tax. Total \$8.00 plus postage. Or send cash (money order or check) with your order and save postage charge.

CHROME CASE \$6.75 plus tax (Total \$7.43)

MARDO SALES CO., Dept. 1705
480 LEXINGTON AVE. NEW YORK 17, N. Y.

THOUSANDS BUILD AT 1/2 THE PRICE

20 MODELS U-MAK-IT BOAT KITS



EASY TO BUILD

5 ROWBOATS

8 TO 14 FT.

Special Models For Fishermen



PRAMS

6 OUTBOARDS

Fast Round or V Bottoms

12 TO 16 FT. Newest Assembly Methods

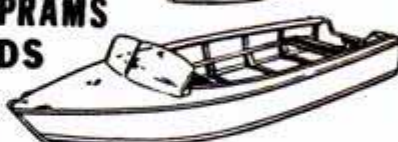

3 INBOARDS & CABIN CRUISERS

For Fishing, Racing or Cruising 16 TO 23 FT. Pre-Assembled Frames

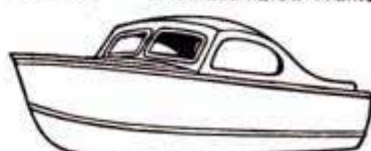

SEND 25c (coin) ORDER YOUR CATALOG TODAY

U-MAK-IT PRODUCTS 703P-WHITTIER ST., New York 59, N. Y.

PISTON TYPE COMPRESSOR



EASY PROFIT IN PAINT SPRAYING

Paints walls, ceilings, screens, furniture and machinery faster, better. All complete as shown less motor. Carry anywhere. Fully guaranteed. Could be used with 1/4 H.P. motor or less. Price \$35.00 less motor F.O.B. Chicago. \$5.00 deposit balance C.O.D. or see your dealer. With motor \$55.00.

IDEAL AUTOMATIC PUMP CO., Dept. P.M. 8
801 W. Washington Blvd. Chicago 7, Ill.

"I Have Earned an Average of \$15.20 AN HOUR"

with Science's New Midget Miracle, the PRESTO Fire Extinguisher

Says William F. Wydallis, Ohio. Many Others "Cleaning Up"—So Can YOU!



W. F. Wydallis



A MAZING new kind of fire extinguisher. Tiny "Presto" (about size of a flashlight!) does job of bulky extinguishers that cost 4 times as much, are 8 times as heavy. Ends fires fast as 2 seconds. Fits in palm of hand. Never corrodes. Guaranteed forever! Sells for only \$3.98!

Show it to owners of homes, cars, boats, farms, etc.—make good income. H. J. Kerr reports \$20 a day. C. Kama, \$1,000 a month. Write for FREE Sales Kit. No obligation. **MERLITE INDUSTRIES, Dept. 51, 201 East 16th St., New York 3, N. Y.** (If you want demonstration sample too, send \$2.50. Money back if you wish.)

Science's New Midget Miracle "PRESTO"

MILL IT ON YOUR LATHE



WITH A

PALMGREN

MILLING ATTACHMENT Convert Lathe in 10 Seconds



Now—you can do milling, slotting, grinding, grooving, squaring shafts, sawing at angles, and many other important operations on your lathe. PALMGREN MILLING ATTACHMENT is a necessary fixture for small shops, schools and emergency work in large plants. Fits South Bend, Atlas, Craftsman, Logan, Sheldon and all other makes. It has graduation for rotary angle adjustments, also graduated feed and adjustment screw. Easily mounted by straddling lathe's regular tool post. Try one—it will quickly pay for itself.

IMMEDIATE DELIVERY

Nos.	Width Jaws	Depth Jaws	Jaws Open	Weight Pounds	Base Opening	Price F.O.B. Factory
150	1 1/2"	1"	1 5/8"	6 1/2	1"	\$18.75
250	2 1/2"	1-7/16"	2 1/2"	11	1 1/4"	24.75
400	4"	1 1/2"	4"	25	2"	39.75

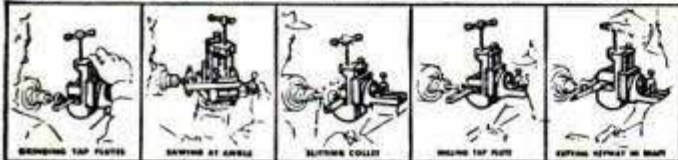

Order from your dealer or jobber. Write for circular No. 354

CHICAGO TOOL AND ENGINEERING CO.

Mfrs. of PALMGREN PRODUCTS for Over 25 Years
8365 South Chicago Avenue Chicago 17, Illinois

GREATEST MOTORCYCLE YET! 1950 HARLEY-DAVIDSON Hydra-Glide

New flashing acceleration shoots you ahead like a rocket, new increased power whisks you over hills like a breeze! Effortless steering, positive stopping, road-hugging stability, amazing riding ease. Write for literature and FREE "Enthusiast" Magazine.



HARLEY-DAVIDSON MOTOR CO., Dept. P, Milwaukee 1, Wis.



PAGE Garden Tractor

PRECISION TRANSMISSION

Catalog sent free.

WRITE TODAY FOR YOURS!



PAGE DOES IT FASTER — EASIER!

WITH WALKING AND RIDING MODELS

New 1950 line with extra features, for spring plowing and dozens of other uses the year 'round! Riding and walking models, 2 to 6 HP. Complete gear drive with reverse, no cheap belts or chains. Large tires—easy to handle—power turn. New reduced factory prices, \$188 to \$428, with cultivator. Get benefits of our 25 years' experience!

FREE CATALOG SHOWS ALL ATTACHMENTS

PAGE DAIRY and FARM EQUIPMENT

1904 S. 81st Street • Milwaukee 14, Wis.

microscope is good only for magnifications of 5000 times, and the best perhaps for 10,000 or 15,000 times. Why can't the optical experts do better? Because when an object is smaller than a wave length of light it is lost, just as a rowboat is lost to view in the trough of two enormous waves. Something finer than a light wave must be used to magnify 30,000 to 50,000, even 100,000 times. That something is the electron. Already viruses have been seen in the electron microscope—something impossible with any combination of glass lenses. In the electron microscope, cancer cells are seen to have tentacles that sink into tissue, which helps to explain why malignant tumors destroy.

After the electron was discovered engineers began to understand what was happening inside an electric lamp. Edison made his filaments of carbon, after having tried metals unsuccessfully. Wonderful as his invention was it depended on the old principle that the hotter an object is the brighter it will glow. Tungsten will glow more brightly than carbon because it will stand more heating. But tungsten crumbles. Dr. W. D. Coolidge felted the particles together so that the metal could be drawn into a wire finer than hair. Thus was the tungsten-filament lamp born. But the bulb blackened, as all lamp bulbs do. Why? Tungsten boiled off the filament. How could boiling be stopped? By pressure. So Irving Langmuir converted the tungsten lamp into a sort of pressure cooker. He put in nitrogen or argon in the lamp under pressure. His gas-filled lamps have illuminated streets for decades.

But this was still the old principle of heating iron white hot to make it give off more light than when it is red hot. Imitate the stars—that was the right way. In the sun electrons are torn from atoms, and the stripped atoms rush about and try to make good their loss, succeeding for a moment and glowing in their excitement, only to be robbed again. The same principle is now applied in what are called gaseous discharge and fluorescent lamps. They glow on every Main Street.

Notice in all these developments of engines, airplanes, electronics and lamps the new command of science and engineering over the environment—over nature. But sometimes the scientist's chief purpose is to give nature a chance. That happens in medicine. No scientific physician imagines that he cures disease. He simply gives nature a chance.

The history of the vitamins is a case in point. As late as 1900 we talked of calories as if we were merely living engines that

(Continued to page 262)

WORLD'S LOWEST PRICED ADDING MACHINE



VEST POCKET SIZE!

Fits vest pocket or purse. Guaranteed Accurate. Operated as easily, and as reliable, as machines costing many times as much. NOT A TOY OR GADGET. Precision made—very durable. Guaranteed for life against defects in construction. Beautiful looking, modernized design. Finished in silver with black numbers and red slides. You positively can't buy a Calculator of equal quality for as little money. ACCEPTED AS THE FINEST LOW PRICED CALCULATOR FOR OVER 35 YEARS! Now completely redesigned and improved. **BETTER THAN EVER BEFORE!** Operates with a flick of your finger. Adds, subtracts, multiplies, divides—counts up to one billion. Pays for itself over and over in mistakes avoided, and time saved.

MAKES IDEAL GIFT
Baby Calculator makes an ideal gift for every Gift occasion. Birthday—Graduation—Christmas—Anniversaries. For men, women, children—teachers, business people, home or shop use. **COMES PACKED READY FOR GIFT WRAPPING.**

TEN DAY TRIAL

Money Back Guarantee
Because we know that our machine is the very best calculator to be obtained at this low price, we make this 10 Day Trial offer on a positive money back guarantee!! Don't buy ANY Calculator without this guarantee! Send only name and address, pay postman \$2.95 plus postage (if cash is sent, we pay postage—you save up to 40c.) (Send full cash if outside U. S.) Money back within 10 days if not delighted.

AGENTS WANTED
CALCULATOR MACHINE CO. (Mfrs.)
DEPT. 222, P. O. Box 248 GLENVIEW, ILL.

Free Trial

Each Baby Calculator enclosed in beautiful rich-looking Leatherette Case — at no extra cost.

ONLY
\$2.95
TOTAL
COST
SEND NO MONEY

USE COUPON

CALCULATOR MACHINE CO., (Mfrs.)
P. O. Box 248, Dept. 222, Glenview, Ill.
Your Calculator is just what I've been looking for. Send one at once (C.O.D.) or (I am enclosing \$2.95).

Name _____
Address _____
City _____ State _____

FOR BIG MEN ONLY!



Write For FREE CATALOG

SIZES 10 to 16 WIDTHS AAA to EEE

We specialize in large sizes only—sizes 10 to 16; widths AAA to EEE. Loafers, Wing Tips, Moccasins, Dress Oxfords, House Slippers, High and Low Work Shoes, Rubbers, Sox. Specially designed for large sizes. Satisfaction guaranteed. Sold by mail only. Write Today for FREE Catalog.

KING-SIZE, Inc., 264, Brockton, Mass.

New MODELS EASIER TO PLAY



Find out about these sensational new Conn Band Instruments. Many wonderful, exclusive features! Today, more than ever, Conns are the "Choice of the Artists." You'll advance faster and take more pride in a genuine Conn—made by the world's largest manufacturer. See your dealer or write us for free literature. Mention instrument. Conn Band Instrument Division, C. G. Conn Ltd., 131 Conn Building, Elkhart, Indiana.

Write FOR FREE FOLDER



HERE'S THE POWER TOOL EXPERTS USE!

IT'S THE FAMOUS
**CASCO
TOOL'N'RACK**

Space-Saving Hard-wood Rack Hangs Up Where You Work



40 PIECES—1001 PRACTICAL USES!

IT'S THE TOOL THAT drills . . . carves . . . sands . . . saws . . . sharpens . . . buffs . . . cuts . . . polishes . . . grinds . . . for WOOD . . . METAL . . . GLASS . . . LEATHER . . . PLASTICS.

THINK OF IT! A master tool that master workmen use. Now, no home job too difficult! This Casco super-speed power tool with Casco's new solid hardwood rack puts workshop perfection at your finger tips . . . Yours to use on a thousand different jobs. Every tool ready for instant use. Precision-built fractional HP motor, AC-DC. Exclusive Casco pencil-grip. Radio static-suppressor! Valuable free 36-page Project Book!

SAVE MONEY! Casco Tool'N'Rack biggest buy yet. It's complete . . . compact . . . convenient. A thrill to own. Get it today!

At Department, Hardware, Auto Supply, Appliance and Jewelry Stores.

AN AMAZING
VALUE
40 pcs. \$17.95
Only

CASCO CASCO PRODUCTS CORP.
BRIDGEPORT 2, CONN.

UNIVERSAL ELECTRIC MOTOR

**110 VOLT 60 CYCLE
CAR SHAVER MOTOR
DYNAMOTOR:**



Here's a truly multi-use motor . . . ideal for meeting a wide variety of practical needs! It can be used as a dynamotor to supply 110 Volt DC (Approx. 15 Watts) from 6 Volt DC—for operating

most types of AC-DC electric shavers or radios from your auto battery, and for many other power uses. Or, it can be converted easily to a 110 Volt 60 cycle motor, approx. 1/25 HP at 3500 RPM—to operate grinders, buffers, polishers, fans, models, etc. Used as a generator it will supply various voltages depending upon speed of rotation; and as a dynamotor, 18 Volt DC input; output 450 Volt 60 MA. DC. Motor is ball bearing construction, 7"x4" size, with 1"x3/16" shaft at one end and 1/2"x3/16" shaft on other end. Instructions furnished.

ORDER #PM-1010 (Postpaid U.S.A.) \$3.50
Motor Converted to 110 Volt 60 cycle: **\$3.95**
ORDER #PM-1110 (Postpaid U.S.A.) \$3.95

6 Volt AC or DC Motor

Ideal for auto heaters, defrosters, fans, models, etc. Used by Gov't. in aircraft. Shaft size: 1/4" x 7/8". **ORDER #PM-610 (Postpaid U.S.A.) \$2.00**



GAS ENGINE GENERATOR: 30 V. DC. See our ad p. 289 Oct. PM for details. #PM-410. F.O.B., Lima. **\$49.50**
DELCO GAS ENGINE GENERATOR: 12 V. DC. Read details in ad p. 289 Oct. PM #PM-510. F.O.B., Lima **\$59.50**
GASOLINE or OIL HEATER UNIT: Forced air. See details our ad p. 298 Nov. PM #PM-910. F.O.B., Lima **\$19.95**

ALL ITEMS ARE GOV'T. SURPLUS! SEND FULL REMITTANCE FOR \$2 to \$3.95 ITEMS * OTHERS: 25% DEPOSIT, BALANCE C.O.D.

FAIR RADIO SALES

132 SOUTH MAIN STREET LIMA, OHIO

Every Electric Drill A PORTABLE SAW

CAN BE USED WITH ONE HAND!
JUST TRY IT! YOU WON'T USE A HAND SAW ANYMORE.
FITS ANY 1/4" ELECTRIC DRILL



"ARCO-SAW" is a rugged precision woodcutting tool with right angle gear drive. (No clumsy direct drive with drill sideways.) Works like high priced Portable Saw. EXCLUSIVE SAFETY YOKE connects drill and saw. ABSOLUTELY SAFE TO USE. All Parts Guaranteed.

Cuts 1 1/8", 2 x 4 BY TURNING OVER

DEALERS: Write for name of nearest wholesaler.

5 DAY MONEY BACK GUARANTEE

"ARCO-SAW" Patent Pending **\$9.95**

ORDER YOURS TODAY at your Dealer or send M.O. or Check for \$9.95 (compl. with 4" "Hycarbon" Blade)

ARROW METAL PRODUCTS CO.

DEPT. A, 140 WEST BROADWAY, N. Y. 13, N. Y.

VENETIAN BLIND KITS

Save as much as

50%

Assemble your own custom-made Venetian Blinds. Complete Kit takes only a few minutes . . . so simple anyone can assemble it.

NO "EXTRAS" TO BUY! You get beautifully finished aluminum slats, all holes drilled, all hardware, screws, tapes and cord, headpiece, tilt, bottom rail, etc. You need only a hammer and screwdriver. Built for a lifetime of service!

Available only by mail from the largest manufacturer of Venetian Blind Kits. Send for complete information today!



-RUSH COUPON NOW!

Flexolite Manufacturing & Supply Co.
Dept. PM-1, 366 Wilson Avenue, Brooklyn 21, N. Y.
Please send complete information on Flexolite Venetian Blind Kits.

NAME _____
ADDRESS _____ CITY _____ STATE _____

had to receive so much fuel in the form of food. Then came the discovery of vitamins, a word coined by Casimir Funk in 1910. Tables might groan with food, yet men might starve for lack of vitamins. Now physicians prescribe vitamins for what are called "deficiency diseases." In other words, nature is given a chance by putting into food what man has taken out of it by his method of processing, cooking and preserving it.

With hormones it is the same story. The name was coined in 1902 by two English physiologists, William M. Bayliss and Ernest H. Starling. Best known of the hormones is insulin, which was first extracted from the pancreas in 1921 by three Canadians, F. C. Banting, C. H. Best and J. B. Collip, and now keeps thousands of diabetics alive. There are a score or so of "ductless glands" in the body, and each of them secretes a hormone. If there is too little of a particular hormone, the results may be dire, as in diabetics. Again the physician administers a hormone to correct a deficiency and thus gives nature a chance to restore a body to health.

The whole trend in medicine is toward chemistry in this first half of the 20th century. Chemotherapy got its real start with Paul Ehrlich, the German pathologist who discovered in 1902 that salvarsan (introduced in 1910) is a cure for syphilis, and who, before that, had chemically dealt with African sleeping sickness and other infections. Now we have the sulfa drugs, the first of which was sulfanilamide, discovered in 1908 by P. Gelmo, and a whole series of "antibiotics," meaning chemical substances which arrest the growth of bacteria and which are derived from molds. The best known of these antibiotics are penicillin, accidentally discovered by Sir Alexander Fleming in 1928, and streptomycin, which came out of researches begun by Prof. S. A. Waksman at Rutgers long before Fleming appeared on the scene. The antibiotics have given the physician a firmer control of infectious diseases than was conceivable in 1900.

Synthetic chemistry as such began in the 19th century. By 1900 there were thousands of synthetic drugs, coal-tar dyes, perfumes and flavors. But clothes were still woven of threads that came from a plant or from an animal's back. Hilaire de Chardonnet had been making what we call rayon since 1891, but rayon was nothing but chemically converted cellulose. The first true synthetic fiber was nylon, introduced in 1938 by the Du Ponts, in accordance with a process devised by the late Wallace Carothers. Later came other real

(Continued from page 264)

FOR FASTER WORK IN HOME OR SHOP...

HOLD-E-ZEE

The Original AUTOMATIC GRIP SCREWDRIVERS



See these popular, high-quality drivers with the exclusive Gripper that holds, starts and sets up screws in unhandy places!

New Models FOR RECESSED HEAD SCREWS  

At Leading Dealers Everywhere
UPSON BROS., INC., ROCHESTER 4, N. Y.

BUILD-ARC WELDER FROM OLD GENERATOR

For Light or Heavy Work. 75-200 amps. No previous experience needed. Complete PLANS and valuable Catalog 35c.

LEJAY MANUFACTURING CO.
1347 LeJay Bldg., Minneapolis 8, Minn.



FREE BOOK

"BENEFITS OF SEAMAN ROTARY TILLAGE"

TELLS HOW SEAMAN ROTARY TILLER produces medium fine or coarse tillage as required... works hard ground and rocky fields.

How it cuts tillage and seeding costs, promotes harder crops, bigger yields... Many other benefits.

Learn about the SEAMAN ROTARY TILLER. Thousands in use. Send for FREE BOOK.

SEAMAN MOTORS INC.
364 N. 25th Street
MILWAUKEE 3, WISCONSIN

CLEANS WINDOWS WITHOUT WATER

NEW CHEMICAL MITT

Sensational! DRY Window Cleaner! Uses no water, no messy liquids. Chemically Treated. Simply glide over windows; leaves glass sparkling clear. No heating water, no heavy buckets to carry. No rags, powders, sponges, cloths. No mess or fuss. No red chapped hands. Dust, dirt, grime, fog disappear like magic. Wonderful for auto windows, windshields!

SAMPLES FOR AGENTS Sample offer sent immediately to all who send name at once. A penny postal will do. SEND NO MONEY—just your name. KRISTEE CO., 691 Bar Street, AKRON, OHIO

OUR GUARANTEE
OUR TIRES must make good or WE WILL

Tube Given With Each Tire
EVERYONE TAKE 10% DISCOUNT ON ALL TIRES

Be Wise—Read this Before You Buy!
OUR EXPERIENCE ASSURES YOU THE BEST BUY IN

GOOD USED TIRES
BUY IN CONFIDENCE
selected POPULAR BRANDS—
positively NOT Re-caps or Re-molds.

5.50-17	5.02	6.70-15	5.75	7.50-16	7.62
6.00-16	5.02	6.70-16	6.75	7.60-15	7.62
6.50-15	5.02	7.00-15	5.30	7.60-16	7.62
6.50-16	5.02	7.00-16	6.30	8.20-15	8.62

GOOD TREAD—NO RE-CAPS. THESE TIRES WILL CARRY YOU TWICE AS FAR!

6.50-20(6)	\$9.22	8.25-20(10)	15.52	11.00-20(12)	\$16.42
7.00-20(8)	10.52	9.00-20(10)	15.52	11.00-22(12)	18.42
7.50-20(8)	10.52	10.00-20(12)	16.22	32x6 (8)	10.02

750-20 MILITARY 8 PLY REGULAR \$9.62—SUPER \$12.92
900-16 MILITARY 8 PLY REGULAR \$8.72—SUPER \$10.92

Thousands of Tires Shipped to Satisfied Customers Throughout United States and Many Distant Points. Send This Ad with Check or Money Order. Dep't 2.

STANDARD 834 N. Broad St., Philadelphia 30, Pa.

deafness

Nearly Cost Me MY JOB!



... until I discovered this New Electronic Way to Hear

Nothing can ruin a man's business chances more surely than loss of hearing. But I stubbornly fought the idea of wearing a hearing aid. I rebelled against that unsightly "button in the ear" and clumsy battery packs.

Then a little book fell into my hands. It told about a new electronic way to hear. And NO BUTTON SHOWS IN THE EAR.

Today I can hear clearly again—even whispers. I can again hold my own with anyone—in business or anywhere else!

If you are hard-of-hearing, send for the valuable FREE book on the new electronic way to hear.

Beltone

MONO-PAC ONE-UNIT HEARING AID

ACCEPTED
GRANTED BY
PHYSICIAN
MEDICAL
SOCIETY

Beltone Hearing Aid Co., Dept. 50PM-1
1450 W. 19th St., Chicago 8, Ill.

Beltone Hearing Aid Co., Dept. 50PM-1
1450 W. 19th St., Chicago 8, Ill.

Please send me FREE booklet on OVERCOMING DEAFNESS with the new electronic way to hear.

Name.....
Address.....
Town.....State.....

SAY YOU SAW IT IN POPULAR MECHANICS

IF IT SLIPS...IF IT CHAFES ...IF IT GRIPES...THEN THROW AWAY THAT TRUSS!



Where other trusses have failed, we have often had our greatest success. The Brooks Appliance actually helps Nature support weakened muscles gently but securely, day and night. It has been ordered or recommended by more than 18,000 doctors. Thousands have written us their thanks for relief from pain and worry—for results beyond their expectations. Sanitary, comfortable, low-priced . . . never sold in stores or by agents, but specially made to fit you. Sent on Trial! Satisfaction guaranteed or money back. Learn what the genuine Brooks may mean to you. Write for Free Booklet and Proof of Results. Ready Now! All correspondence confidential.

Brooks Appliance Co., 161-F State St., Marshall, Mich.

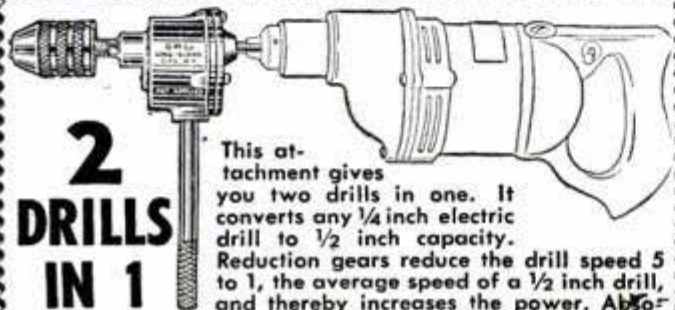

**2
DRILLS
IN 1**

This attachment gives you two drills in one. It converts any 1/4 inch electric drill to 1/2 inch capacity. Reduction gears reduce the drill speed 5 to 1, the average speed of a 1/2 inch drill, and thereby increases the power. Absolutely indispensable for all shop work

and home craftsmen. Satisfaction guaranteed. Order yours now. **\$11.95** post paid

Send check or Money Order with order. Jobbers write for special information. **G. M. CO. MANUFACTURING, INC.** 1308 43rd AVE. LONG ISLAND CITY 1, NEW YORK



**Always KNOW
which way to GO!**

Drive by **HULL AUTOMOBILE COMPASS**

BEACNLITE Illuminated **\$5.95** STREAMLINE Standard **\$3.95**

At your dealer's. Write for literature. **HULL MANUFACTURING CO., P.O. Box 246-D1, Warren, Ohio**

Ball-Bearing **SPEED WHEELS**



JUVENILE WHEELS (No bearing, solid tires)	
4" 40c	6" 65c
5" 45c	8" 75c
(Semi-pneumatic tire, ball bearing)	
8 x 1.25 . . . 1.85	10 x 1.25 . . 2.20
8 x 1.75 . . . 1.95	10 x 1.75 . . 2.30
8 x 2 2.20	10 x 2.00 . . 2.65
12 x 1.75 . . 3.45	
INDUSTRIAL WHEELS	
Lug Base, Semi-Pneumatic tire	
5 x 1.75 . . . 3.65	10 x 2.00 . . 6.10
6 x 2 SW . . . 3.45	10 x 2.75 . . 5.15
6 x 2.00 . . . 4.00	12 x 2.00 . . 6.90
8 x 2.00 . . . 5.20	12 x 3.00 . . 9.20
8 x 2.50 . . . 5.40	16 x 4.00 . 15.15
Smooth Base, Pneumatic tire and tube	
8 x 3.00 . . . 11.00	12 x 4.00 . 12.10
10 x 2.75 . . . 6.80	4.00 x 8 . 13.10
10 x 3.50 . 10.55	14 x 4.50 . 13.40

Dealers, Jobbers, and Manufacturers! Our new prices will interest you.

No c.o.d. orders.

Available Now—CASTERS Write for circulars on all wheels. Prices F.O.B. our plant.

JIM BROWN TOY COMPANY
1093 HOME AVENUE AKRON 10, OHIO

synthetic fibers that have no counterpart in nature.

Synthetic chemistry scored a great military triumph during the war with what chemists call "elastomers," and we of the street "synthetic rubber." Rubber has never been synthesized in the sense that an exact chemical duplicate of natural rubber has been produced. Chemists had been trying since the middle of the last century to make the exact chemical equivalent of natural rubber and never succeeded. In 1931 Father Julius A. Nieuwland of Notre Dame produced an entirely new material which he called chloroprene and from which the Du Ponts made neoprene, the first successful elastomer or substitute for rubber, a substitute which is even better than natural rubber for some purposes.

In a sense both nylon and neoprene are what we now call plastics, all of which are synthetics. Celluloid was probably the first true plastic, and the 19th century used it to make billiard balls, keys for pianos, detachable collars and cuffs and toilet articles. The first of the modern series was bakelite, now Bakelite, which takes its name from its inventor Leo Baekeland.

There are literally hundreds of plastics, out of which we make draperies and combs, steering wheels for automobiles, bathroom ware and material that takes the place of wood and metal. If an architect wanted to get entirely away from wood, brick and stone in building a house he could do so with plastics—if he cared nothing for expense. Plastics are harbingers of the future, portents of a time when nature will be ignored—or controlled if you prefer that way of looking at it—even more effectively than it is today.

Like the revelers of New Year's eve of 1899 we ask "What next?" The full answer must wait for New Year's eve of 1999. Even in the 50 years that have elapsed since 1900 we haven't been able to make the most of what science has discovered and mechanics have invented.

Spray Kills Insects in Planes

Disease-carrying insects and agricultural pests now can be eliminated from overseas transport planes by a flick of the pilot's finger. A new system sprays insecticide into every recess of the plane, preventing such insects as the Hawaiian fruit fly or the oriental peach moth from taking a free ride to the United States. The plane is sprayed once before loading, then given a lighter spray after passengers are aboard to kill any insects which might have flown aboard during loading.



DELTA MILWAUKEE HOMECRAFT®

8" Tilting-Arbor Saw
No. 34-500 **\$6495***
Low down payment, easy terms



Do big-saw jobs at small-saw cost!

Delta® Homecraft 8" Tilting-Arbor Saw

For display men . . .

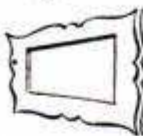

. . . For shipping departments

For sign shops . . .



. . . For cabinet makers

For upholsterers . . .



. . . For hobbyists



There's bigger capacity than ever in this husky new Delta Homecraft bench model with 11 $\frac{5}{8}$ inches of table in front of the blade. Cross-cut and rip stock up to 2 $\frac{1}{4}$ " thick, miter and bevel. The blade tilts 45° to the right. With accessories, you can dado and make mouldings.

This versatile saw is quality-built by the makers of famous Delta-Milwaukee tools. It's sturdy, dependable, accurate. Cast-iron table, milled and precision ground. The arbor runs on lubricated-for-life ball bearings.

See for yourself how you can do big-saw jobs at small-saw cost. Have your local Delta dealer demonstrate the Delta Homecraft 8" Tilting-Arbor Saw today.

Look for the name of your Delta dealer under "Tools" in the classified section of your telephone directory.

POWER TOOL DIVISION
Rockwell
Manufacturing Company
MILWAUKEE 1, WISCONSIN

For everybody who cuts wood!

*Table extension, motor, saw guard and splitter not included. Price subject to change without notice.

HM-75

For Woodworking of PROFESSIONAL QUALITY

POWER KING 12" WOOD LATHE



\$6975*

You can handle all inboard and outboard turning operations quickly and accurately with this rugged, heavy-duty lathe—turn light metals and plastics, too. Has 12" swing—36" between centers—4 speeds, ball bearings, machined ways, new exclusive quick-lock lever for tool support base and tailstock. Precision built by Atlas to industrial quality standards.

POWER KING 4½" JOINTER- PLANER



\$4475*

For factory-smooth fit and finish on your furniture projects install this PK 4½" ball-bearing jointer-planer in your shop. Saves you time and work in planing, rabbeting, tonguing, beveling. Built extra heavy, with grey-iron base and table—precision-ground table surface—tilting fence—3-blade steel cutter head—plus other outstanding features. Atlas quality. See it at your PK dealers or send for catalog.

FREE CATALOG! WRITE
ATLAS PRESS COMPANY

135 N. Pitcher St., Kalamazoo, Mich.



MATCHED PRECISION TOOLS FOR
WOODWORKING AND METALWORKING

I Fly Faster Than Sound

(Continued from page 113)

160 miles per hour. The plane can take off by the jet engine alone, jet and Jato, Jato plus one rocket tube, or one or more rocket tubes. A full rocket take-off is fast. The plane moves ahead as soon as the first rocket tube begins to blast and I cut in the other motors at one-second intervals. The next rocket glues me back firmly against the seat; then the third and fourth motors add their individual thrusts. With all four rocket tubes I can get off the ground in 2700 feet; on ordinary jet alone I need a three-mile run.

An aircraft is no good if its pilot can't control it and so part of Phase Two is to measure the forces that are needed to move the controls at various speeds. In the trans-sonic range, the air flowing past the control surfaces seems to take on the consistency of molasses and it becomes physically impossible to move the controls rapidly. This stiffness is a good thing. The pilot hasn't the strength to maneuver so violently that he builds up dangerous amount of G.

Another part of the program is to learn the things that happen to the structure when the temperature changes from, say, 110 degrees above zero to 65 degrees below zero in the space of a few minutes. This can be the case when I leave Muroc and climb rapidly to 40,000 feet. As one consequence of these studies, the original transparent-plastic windshield of the Skyrocket has been replaced with tempered plate glass. Aside from the possibility that the plastic might get soft or cave in with the heat of high speed, there's a chance of it cracking under excessive changes of temperature by becoming brittle.

To get all this information and more, the Skyrocket carries 625 pounds of special instruments, including a manometer that measures air pressure at 400 points on the wing and tail surfaces and 904 electric strain gauges placed at different points in the structure. Five movie cameras film the readings of special instrument panels during each flight. More than 5000 technical reports on Skystreak and Skyrocket performance have been made to the armed forces and to the aircraft industry and much of this information already has been turned to account in designing the latest production aircraft.

The Skyrocket's whole purpose is to learn what is necessary for safe and practical supersonic flight and in this it has been a success. I don't know how fast we will be going five years from now but there's a chance that I'll be flying even faster aircraft by the time I'm 50.

Atlas gives you the greatest values
in bench-size **PRECISION LATHES**



**"QUICK-CHANGE"
10" LATHE**

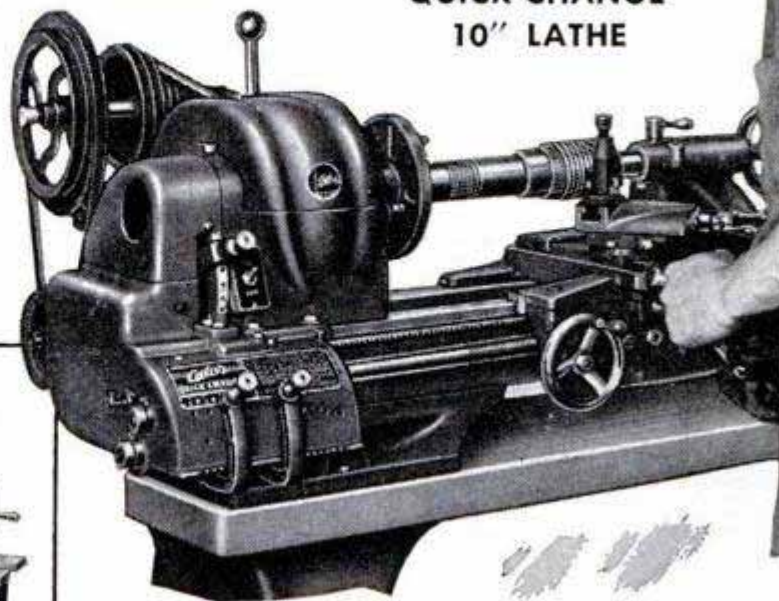

Your metal lathe — whether you need it for commercial work, developing ideas in your home shop, repairing home equipment, or work on special projects — comes to you at much lower cost and with greater performance features when you select an Atlas.

The Atlas has a full 10" swing, gives you a selection of 16 speeds, cuts all standard threads, has precision ground bed, Timken bearings, back gears for extra power, instantly reversible power cross and longitudinal feeds, V-belt drive, "Quick-Change" selection of 54 threads or feeds, plus many other features at only \$272, F.O.B. Kalamazoo, less motor. Standard lathes \$212. 6" lathes \$113.50. Send for latest catalogs — compare the extra-value features.

ATLAS PRESS COMPANY
143 N. PITCHER ST., KALAMAZOO, MICH.



**MATCHED PRECISION TOOLS FOR
WOODWORKING AND METALWORKING**

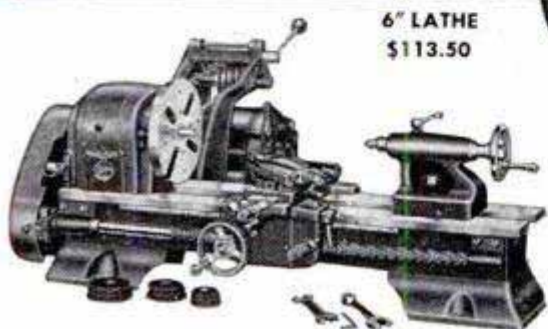

**6" LATHE
\$113.50**



MILLER \$305.00

Atlas 6" lathes, milling machines, and shapers have long proved their precision capabilities.



7" SHAPER \$355.00

FREE CATALOG — Write Today!

ATLAS PRESS COMPANY,
143 N. Pitcher St., Kalamazoo, Mich.

- Please send latest 10" - 6" lathe catalogs.
- Literature on Atlas woodworking tools.

Name _____

Address _____

City, State _____

You'll always value these BIG Atlas woodworking tools



**8"-10"
TILT/ARBOR SAW**

BIG in capacities — for any size job you want to undertake — **BIG** in value — with many unique performance and construction features — and built to industrial quality standards, these are the tools for commercial quality workmanship in your home shop. Use coupon for latest literature.



**10"
Floor
Saw**



24" Jig Saw



6" JOINTER



**Belt and Disc
Sander**



12" Wood Lathe.

FIX IT...



QUICK AS A WINK

Fills cracks and holes in wood, plaster, or almost any material. Savogran Crack Filler sets hard as stone. Savogran Wood Putty is easily tooled; contains real wood. Permanent, non-shrinking. Takes paint beautifully. Repairs furniture, floors, loose rungs, handles, knobs — 1001 uses. Big 1-lb. can only 35c where you buy paints.

For FREE CIRCULAR Write

SAVOGRAN

DEPT. 18, BOSTON 16, MASS.



CRACK FILLER
WOOD PUTTY

SAY YOU SAW IT IN POPULAR MECHANICS

Earns **\$100 a MONTH** in spare time

with **FOLEY LAWN MOWER SHARPENER**



"I did nearly \$100 worth of business in May, sharpening and repairing lawn mowers in my spare time"—says R. D. Fancett. "I figure I made \$100 a month," writes L. R. Michaletz. When you can sharpen 3 or 4 hand mowers an hour with the Foley Lawn Mower Sharpener, at \$1.50 to \$3.00, or 1 or 2 power mowers at \$5.00 to \$8.00 each—just figure out the possibilities for yourself! 99c out of every dollar you take in is profit.

How to Sharpen POWER MOWERS

FREE BOOK "HOW TO SHARPEN POWER MOWERS" shows just how to sharpen any make of power lawn mower with the Foley. Low prices, only \$98.50 to \$139.50—easy payments. Mail coupon today—we'll also send **FREE PLAN** telling how to start your own business without previous experience. No salesman will call.

SEND COUPON TODAY

FOLEY MFG. CO., 107-O Foley Bldg., Minneapolis 18, Minn. Send **FREE BOOK "How to Sharpen Power Mowers,"** and **FREE PLAN** on lawn mower sharpener business.

NAME _____

ADDRESS _____

GET THIS SAFE ELECTRIC JIG SAW

The safe saw for children yet powerful, versatile enough for homeshops. Easily adjustable. Portable. Thousands in use. Plug in any 60 cycle, 110-120 volt AC outlet—and saw! Arm ADJUSTS to permit cutting ANY LENGTH

1/2" wood, 1/2" plywood, thin metal, plastics. Not a "lumber cutter" but for delicate, fine craftsmanship. No belts, gears, wheels.

Use for family projects or making money. The BASIC homeshop tool. Get yours now with **BUILT-IN MOTOR**, 3 blades, cord, plug, \$17.50. At Dealers! If he hasn't, send \$17.50 to factory, we'll ship saw postpaid. See Syncro products, pages 279, 285. (Dealers write!)



SYNGRO

Electric Jigsaw

SYNGRO CORP., DEPT. SH-15, ROCHESTER, MICHIGAN, U.S.A.

SAVE GAS?

FREE TRIAL in your car famous GANE Air-Flow Needle

(Replaces present idle adjustment screw in your carburetor)
New Automotive Discovery—Install them YOURSELF in 5 Minutes
Users report up to 4 EXTRA MILES PER GALLON—comment on SMOOTHER MOTOR, EASIER STARTING, FASTER PICK-UP, BETTER IDLING. (About 1/2 million now in use) However, needles DO NOT show improvement in SOME cars due to type or condition of motor. So try them FIRST for 10 days AT OUR EXPENSE. Check gas mileage and engine performance—if satisfied—send only \$1.50 per needle; (8 cyl. cars take 2) if not satisfied—return them—FAIR ENOUGH? Send card today with name, address, make of car and carburetor—Needles sent Postpaid.
SEND NO MONEY—AMAZING FREE TRIAL OFFER—PAY POSTMAN NOTHING
NATIONAL AUTOMOTIVE RESEARCH CO., 350 W. Washington Blvd., Dept. JA, Venice, Calif.



MONEY BACK GUAR.

7x50 PRISM BINOCULARS
PRECISION OPTICS—BRAND NEW
\$36*
6x50 ACHROMATIC FIELD GLASSES \$16*
*20% Federal Tax
Send for Free Catalog of Binoculars, Telescopes and Microscopes
BROWNSCOPE CO.
Dept. 1M, 24 W. 45th St., New York 19, N. Y.

STEAM CLEANER

100 LBS. STEAM PRESSURE IN 90 SECONDS
BUILD YOUR OWN FROM OUR PLANS—LOW COST—EASY

This type steam cleaner has hundreds of uses in many lines of business. Use it to clean auto motors, radiators, parts, farm machinery, dairy, poultry and hog houses. Thaw frozen radiators, motors, and pipes. Use it to warm up gasoline and Diesel motors in cold weather. Clean floors—heat water, etc. Don't delay, get your plans today! Complete set of plans and instructions **ONLY \$1.50.**
CONNERY MFG. CO., ADRIAN, N. DAKOTA

FLASH Your Turns

ELIMINATE HAND SIGNALLING
ENJOY SAFE — COMFORTABLE WINTER DRIVING WITH THE **SIMPLEX DIRECTIONAL SWITCH**

Here is a safe and comfortable way of signalling your intention to make a left or right turn. Flashes from 60 to 80 times per minute.
Kits furnished with all necessary material for perfect installation. No outside mounting of any kind. . . . uses your present parking and tail lights. Either of our two models fit most cars from 1942 to 1949.

\$8.95 Send check or money order. Postage extra on C.O.D.'s in U.S.
A PRACTICAL GIFT FOR MOTORISTS!
Specify year and make of car. Money back guarantee. Tested and Approved to meet SAE requirements.
DEALERS INQUIRIES INVITED
SIMPLEX SALES COMPANY
1303 W. Jackson Blvd. Dept. A-2, Chicago 7, Illinois

Home Workshop Tools

PRICED TO
EVERY FAMILY PURSE



She'll enjoy your shop and
the money you'll save with
SHOPMASTER
woodworking tools

You can start your home workshop with a Shopmaster Saber Saw, like the one pictured above. The cost is less than \$16.00. With it you can cross cut, rip, and do many other complicated sawing operations.

You can add to your shop at any time. All Shopmaster Tools are independent and designed to do specific work. Independent tools are always ready, and require little adjusting. Just flip the switch and you are ready to go. These uniform precision-built tools can be mounted together and powered with one motor if you wish, or can be independently powered.

There is a size of tool for every shop, so make yours a Shopmaster shop.

SHOPMASTER, INC.

1214 Third St. S., Minneapolis, Minn.

Send me your new full color catalog giving full details on the complete line of SHOPMASTER "Uniform Precision" Tools, and shop layout sheet.

Name

Address

City & State

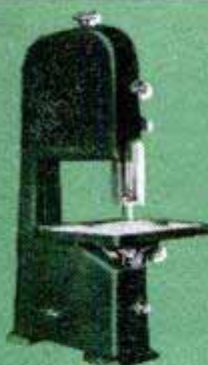

12" Band Saw

\$68.95*

10" Band Saw

\$39.95*



Saber Saw \$15.75*



10" Wood Turning Lathe \$42.50*



12" Drill Press

\$44.95*



7" Tilting Arbor Bench Saw \$39.95*

12" Floor Model Drill Press

\$54.00*



8" Tilting Arbor Bench Saw \$67.50*



8" Tilting Table Bench Saw \$52.50*



6" Jointer \$71.50*

4" Jointer \$39.95*



Spindle Shaper

\$44.50*



Belt and Disc Sander



15" Jig Saw \$24.95*



10" Floor Model Tilting Arbor Saw \$97.50*

*Zone 2, less motor.

5 YEAR WRITTEN GUARANTEE
17 JEWEL CHRONOGRAPH
 2 PUSH BUTTON

ORIGINALLY \$71.50

- Post-War Surplus
- WRISTWATCH
- STOPWATCH
- TELEMETER
- TACHOMETER

Our Price
Now Only

\$21.95
Plus \$2.20 Tax



Precision 4 in 1 Timepiece. Inca-block shock resistant feature. Sweep Second hand. Anti-magnetic. Radium Dial. Stainless steel back. Unbreakable crystal. Perfect for physicians, scientists, technicians, engineers, aviators, photographers, broadcasters, navigators, sportsmen, servicemen, etc. Thousands sold at \$71.50. Order now while they last at this record breaking low price.

5 YEAR WRITTEN GUARANTEE
17-JEWEL WRIST WATCH **\$16.95** PLUS \$1.70 TAX

ORIGINAL PRICE \$59

INCABLOC—SHOCK PROTECTED
 WATER REPELLENT . . .

Sacrificed Because They're POST-War Surplus Luminous dial . . . sweep second hand . . . Super Accurate . . . Imported Swiss precision movement and case. You get these Men's New 5 Year Guaranteed Watches now for a small fraction of the original price. Don't delay! Order now . . . while they last.



TRIAL OFFER! Wear at our risk! Money back in 5 days if not delighted. Send only \$1 down payment with order. Pay balance to postman on arrival plus postage. Or we pay postage if you include full payment plus tax with your order.

FREE! Handsome Expansion Band Included. **ORDER NOW!**
MARYLAND DISTRIBUTORS, Dept. 14
 501 EAST BALTIMORE STREET BALTIMORE 2, MD.

The JIFFY metal CABINET

YOUR ANSWER TO SMALL ITEMS STORAGE at home, office, and shop (IDEAL GIFT, TOO)

So handy to keep nuts, bolts, screws, nails, parts, washers, stamps, hobbyists' needs, etc., at your fingertips.



THIS 32 DRAWER UNIT ONLY \$5.95 POSTPAID

Stop searching, get a 32 or 64 drawer Jiffy to keep those small items that usually get mislaid. Spot welded steel, gray enamel finish, metal drawer guides. Dividers included with aluminum drawers make possible three compartments per drawer. Looks good anywhere. Send check or money order, please—no C. O. D.'s. Prices below. Your money refunded if not satisfied. Dealers write for quantity discount.

SPECIFICATIONS	WITH ALUMINUM DRAWERS	WITH CARDBOARD DRAWERS
32 Drawer Unit 6" Deep 12 3/4" Wide 15 1/4" High	Dividers and Index Cards Included One piece rustproof aluminum drawers for heavy service—good for work bench and industry use.	Suitable for most home uses. Heavy board kraft covered. Metal drawer pulls.
64 Drawer Unit 6" Deep 25 1/2" Wide 15 1/4" High	32 drawer - \$8.95 64 drawer - \$15.95	32 drawer \$5.95 64 drawer \$9.95
Drawer Size 1 1/4" Deep 2 3/4" Wide 6" Long	OHIO ORDERS ADD 3% SALES TAX Marproof Rubber Feet included with all cabinets	
	POSTAGE PAID	POSTAGE PAID

KAYTEE PRODUCTS, Dept. M, Box 588, Canton, O.

ELECTRIC SIREN **Fender Skirts for All Cars**



6 volt. Complete with push button . . . **\$10.95**



Give year, make & model of car when ordering.
 All Metal. Prime finish. Rubber heading prevents rattle.
 Easy to install. **\$12.95 PAIR**

1935-48 FORD V8 & 1939-48 MERCURY

DUAL MUFFLERS
 Increases power. Reduces back pressure. Saves gas. **\$14.95**

MD20N-208—Complete Set
DUALS FOR 1949 FORDS, Set \$19.95

GUTTED MUFFLERS FOR ALL CARS

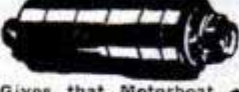

Gives that Motorboat Tone. Universal type to fit all cars, ea. **\$4.95**

Send 25% Cash With All Orders, Balance C.O.D.
 We Can Supply NEW CONVERTIBLE TOPS & REBUILT MOTORS for all Cars. Write for Prices.

JUST OUT! Get the largest Auto Accessory & Parts Catalog in the world. Over fifteen thousand items, including Hollywood Accessories, Hi-Speed Equipment, Rebuilt Engines, all parts & accessories for all cars & trucks. We have that Hard-to-Get-Part! Completely illustrated, Jam packed with bargains. Send 25c.

J. C. WHITNEY & CO.
 1917 ARCHER AVE. CHICAGO 16, ILL.

FREE WORKSHOP CATALOG!

24 pages, chockfull of new workshop tools for beginner and master craftsman. Hundreds of new time-saving, money-saving tools illustrated and described. Write for FREE CATALOG today!
FREE! "How to Start Your Home Workshop" Ordinarily 10c—free if you write now. Gives pointers in planning your home workshop, tells how to save money, what tools to start with, etc.
 A penny postcard will do—WRITE FOR YOUR FREE CATALOGS TODAY
FORSLUND PUMP & MACHINERY CORP.
 1721 MAIN ST. KANSAS CITY, MO.

CRESCENT TOOLS
Give Wings to Work
 ASK YOUR HARDWARE DEALER

SPECIAL OFFER!
LOCK-STITCH SEWING AWL

\$1. Postpaid

Famous, patented lock-stitch sewing awl complete with needles, waxed thread and direction folder. Hundred uses—sewing, repairing leather goods, canvas, belting, harness, saddles, gun cases, awnings, golf bags. Extra needles and thread available. Satisfaction guaranteed or money back. Send currency, check or money order.
 Yates Mfg. Co., 611-H Main St., Lake Geneva, Wisconsin

WET GRINDER For all types of wet grinding carbide tools, glass, ceramics, gem and other stones. Ideal for general tool sharpening. Uses high speed grinding wheels 8" dia., 1" thick. Sealed ball bearings. Built-in water supply. Safety guards serve as splash shields. Underneath belt drive. \$26.50, less wheels and motor. Write for free literature—**VREELAND MFG. CO.**, 2020 S.W. Jefferson, Portland 1, Oregon.

10 SHELF PLANS
 NEW FULL SIZE

New, full size, easily built, beautiful wall shelf plans ready to trace on lumber, cut out and assemble. Corner and wall racks with 1 to 3 shelves. Stores charge about \$75.00 for these shelves. Make money selling them. Finest selection available. **PLUS BONUS** of 48 other novel cut-outs, Dutch Boys, Girls, Toys, etc., etc. **PLUS FREE** latest Handicraft Catalog. Send only \$1 to
JACKSON, Dept. 14
 3933 N. 28th St. Milwaukee 10, Wis.

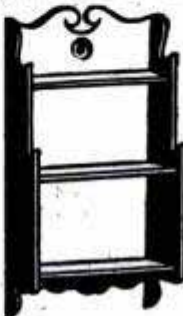



BULL MORTISING KIT

Includes (a) Bull Mortising Adapter made of solid aluminum with double-shield ball bearings and (b) 1/4", 3/8" and 1/2" chisels with corresponding bits. Bull Chisels are made of highest quality steel and are designed specifically for use with 1/4" electric drill or drill press. Kit comes complete as pictured above and guaranteed, only..... **\$23.90**



Just chuck it in your drill—and watch the chips fly!

Now you can mortise on-the-job, now you can rout on-the-spot with the new Bull Mortising Adapter. This amazing new adapter can be attached in either drill or drill press in a matter of seconds, and it gives you a powerful, portable tool that really makes the chips fly!

NOTE: Bull Mortising Adapter and Bull Chisels and Bits are designed specifically for use in any 1/4" electric drill or any drill press; they should not be used with 3/8" or 1/2" electric drills.



BULL MORTISING ADAPTER
Large end chucks into drill or drill press; small end fits any 3/8" shank chisel..... **\$6.95**

ACCESSORIES FOR BULL MORTISING ADAPTER

CHISELS & BITS: Mortising chisels (1/4", 3/8" or 1/2" with bits), each **\$6.00**.
CHISELS ONLY: 1/4", 3/8" or 1/2", without bits, each **\$4.00**.
BITS ONLY: to be used with 1/4", 3/8" or 1/2" chisels, each **\$2.40**.



Chuck it in your drill—and you're a mighty handy guy!

Famous **BULL BUFFER** more than pays for itself the very first time you make your car, floors, boat, woodwork, furniture gleam like new! More than 100,000 home owners are now polishing and sanding the "Bull Buffer" way—the only easy, comfortable way to reach all surfaces, curved or flat. No skill necessary—anyone can polish like a professional or sand like an expert with Bull Buffer. Fits any drill or flexible shaft. **Exclusive swivel action** makes it easy to get to all those "tight places" that other polisher-sanders can't touch. Complete, with sheepskin bonnet and 2 sanding discs, only..... **\$9.95**

ORDER THESE ACCESSORIES FOR YOUR BULL BUFFER

(For use with the Bull Buffer only)

5 3/4" finest quality bark-tan sheepskin bonnet, **\$1.25**.

5 1/4" half-inch pile wool pad with rubberized back. Recommended when cleaning compound is used — will not mat down. **\$1.35**.

5" aluminum oxide production sanding discs (0000-000-00-0-1-212-3), 10c each. #4 open grit, 15c each.

1 1/2" Jacob hex key chuck. When attached to Bull Buffer, gives you angle-head drilling attachment. Increases 1/4" to 1/2" capacity, provides power for heavy drilling in wood or steel. **\$5.00**.

2 1/2" cup wire brush. Easily attached to Bull Buffer head. Removes paint, rust, scale, etc. right now. **\$1.75**.

Adapter B set, for high-speed sanding with Bull Buffer. By running Bull Buffer backwards this set doubles your drill speed. Complete, **\$2.00**.

Who wouldn't be a "handy guy" with these

NEW BULL TOOLS

for electric drill or drill press



NEW! Four different holes with One HOLE SAW!

Now you can cut 1", 1 1/2", 2", 2 1/2" holes with one hole saw—the new Bull Hole Saw that fits any 1/4" electric drill or drill press. Cuts cleanly through any 3/4" stock — wood, plastic, or metal. Complete, with arbor and 4 saws..... **\$4.95**



NEW AUTOMATIC SCREW DRIVER

Now you can get to all those "tight places" and drive screws in seconds where it used to take minutes by hand! The new Bull Driver fits any electric drill, drill press or flexible shaft. Automatically centers on screw groove; automatically disengages when screw is firmly home in wood or metal. Three models — take your choice and order today! Any model **\$4.95**

When ordering, specify model in either standard or Phillips. **MODEL A**—Self-centering model for driving screws up to a No. 14. **MODEL B**—Self-centering model for driving small machine screws. **MODEL C**—Without self-centering hood; long blade reaches those extra-deep counter-sunk jobs.

NEW PORTABLE DRUM SANDER

Uses Standard Sandpaper Sheets!



Now you can get to all those hard-to-reach places with the new Bull Drum Sander — a portable 2" drum sander that fits any electric drill (or drill press). **MOST ECONOMICAL** drum sander on the market because you cut your own strips out of ordinary sandpaper sheets instead of buying costly sanding sleeves! No wedges or screws necessary; new patented feature lets you insert and remove sanding strips at the flick of a finger! Complete..... **\$2.50**



NEW BULL ECONOMY KIT

Use your drill to polish and sand by direct drive with this low-cost kit that includes (a) direct-drive adapter that fits any drill, (b) 5" flexible rubber disc, (c) sheepskin bonnet, (d) 2 sanding discs, all for only..... **\$2.25**

TOMORROW'S TOOLS TODAY

AT YOUR DEALER OR SEND CASH, CHECK OR MONEY ORDER FOR PREPAID SHIPMENT, TO

BERTRAM C. ENGINEERING CO.

Dealers Write Today

3121 MAIN STREET KANSAS CITY, MO.

NEW LOWER PRICES ON CROSLY CARS!

Reductions up to \$105! And the 1950 Crosley cars have hundreds of improvements, many exclusive features such as Hydradisc (airplane type hydraulic) Brakes and Crosley engine with new CIBA (cast iron) Block and 8 to 1 compression ratio. Save with a new Crosley—costs less to buy, less to drive—up to 50 miles on a gallon of regular gasoline.

STATION WAGON
Price reduced \$105. Seats 4, or 2 with 1/4 ton load. All steel.



SEDAN DELUXE
Price reduced \$101. Speedline styling. Rich fabric upholstery. Seats 4, plus luggage.

CONVERTIBLE
Price reduced \$101. 4 passenger. Easy-to-handle top. Big luggage space.



HOTSHOT
Price reduced \$51. A new thrill in motoring. America's own sports car. 2 passenger.

Crosley Trucks, both Panel Delivery and Pick-up have also been reduced—\$83 on each model! Driver agents wanted! Write for details.

CROSLY
a FINE car

You see them everywhere!

IT'S FREE! IT'S NEW!
the 1950 CROSLY CATALOG. Write Crosley Motors, Inc., 2530-HN, Spring Grove Ave., Cincinnati 14, O.

SAY YOU SAW IT IN POPULAR MECHANICS

STOP CHANGING MOTOR OIL!

End this needless waste and expense forever with



RECLAIMO Today's Most Advanced Oil RE-REFINING Filter

Continuously cleans and RE-REFINES motor oil as you drive (by utilizing motor heat)—keeps oil in high grade lubricating quality at all times! Proves conclusively that "Oil Does Not Wear Out Mechanically" as stated by U. S. Bureau of Standards, (Bulletin 86).

"RECLAIMO"

- REMOVES SOLIDS (by filtration)
- REMOVES WATER (by distillation)
- PREVENTS Excess Fuel Dilution
- PREVENTS Acid and Sludge Formation

Stable Viscosity ELIMINATES All Oil Changes
CAR • TRUCK • TRACTOR OWNERS!

FREE 32-PAGE BOOK "OIL FACTS" (with bonus \$1000.00 offer on page 30), gives you the complete "Reclamo" story and details of our extraordinary 90-DAY NO-RISK TRIAL OFFER! Write for your copy TODAY!

NEW ADDED FEATURE!
Gas-Moisture Vapor Injector
Increases Mileage with Smoother Performance



RECLAIMO MFG. CO.

5083 ELSTON AVE., Dept. 20, CHICAGO 30, ILL.

SANDING MADE EASY..

Pat. No. 226581



with the Handy **SandDrum**
ALL-METAL DRUM

\$2.50 with adapter and 6 abrasives

Sold on positive money-back guarantee. Order Today.

EASY, QUICK MOUNTING. No locking key or wrenches needed. No cement, glues or wedges. Patented mounting method saves valuable time. Abrasive tightens while in use. Ideal for use on drill presses, grinder stands, electric drills, motor arbors, etc. Drum is 2" in diameter, 2" long. Adapter and drum head joined with 1/2/20 threads. Economical replacement strips cut from standard sheets.

STAHL SPECIALTY COMPANY

Dept. P 9005 E. 66th Street Kansas City, Mo.

UTILITY TOOL CASE

specially designed for home-and-farm owners, craftsmen, radio and TV repairmen, fishermen, hunters, campers. Adopted by large utility companies for service men. Resists rust. Made of hard vulcanized fibre with reinforced corners, with removable tray and space for electric or large tools. Strong, durable, light! Solid, comfortable plastic handle. Full 8 inches wide; 9 inches high; two sizes:



17 inch (6 compartments) \$6.25 postpaid.

21 inch (8 compartments) \$6.50 postpaid.

NO C.O.D. Moneyback guarantee if returned within 10 days in good condition.

WILLHOUR COMPANY

277 N.J.R.R. Ave., Newark 5, N. J.

INCREASE SAW SHARPENING PROFITS!

Sharpens Saws 5"—30"

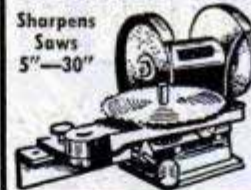

REYNOLDS CIRCULAR SAW GRINDER
Produces top quality results in fraction of time usually necessary for reshaping, jointing, gumming and tooth forming. Any hook or pitch of tooth and depth of cut is quickly adjusted. Both hands are free to control position of saw while grinding. Write now for free circular!

PROVIDENCE SAW & KNIFE COMPANY
305 Eddy St. Providence 3, R. I.



Unbreakable Fire-Safe Amber Hammer Proof Shock Proof

TOOL STEEL PRICED FROM \$c TO \$1.00 EACH

Ask Your Hardware Store for **FULLER'S** Unbreakable Amber Handle SCREW DRIVERS

America's most popular line of moderately-priced screw drivers! Wide range of sizes. **FULLER TOOL COMPANY, Inc.** 911 Fayette St. New York 59 World's largest makers of Amber-Handle Tools

GASOLINE DRIVEN ELECTRIC LIGHT & POWER MODEL PE7SU

115 Volts, single phase, 2500 watt, A.C., 60 cycle. ENGINE: Briggs & Stratton, Air Cooled, 6 1/2 H.P. LELAND GENERATOR. Belt drive with guard, and Duplex Receptacle Mounted. NET WGT.: 310 lbs. GROSS SHIPPING WGT.: 441 lbs. SHIPPING SIZE: 36"x19"x26".

FULLY GUARANTEED

Mrs. List Price \$700.00

OUR PRICE \$295.00

F.O.B. Warehouse

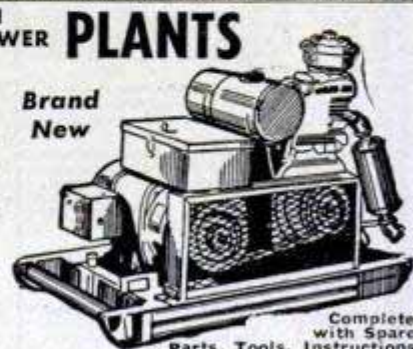

Brand New

Complete with Spare Parts, Tools, Instructions

Ideal for Farms, Cottages, Mills, Garages, Builders, Shops, Homes—will operate deep freeze, oil burner, pumps, saws, compressors, sound & radio systems & general lighting.

MANHATTAN MARINE & ELECTRIC CO., INC.
118 CHAMBERS STREET NEW YORK 7, N. Y.

SHOP by MAIL - SAVE at GROBAN'S - Buy Direct from ad!

LOGAN HEAVY DUTY HYDRAULIC CONTROL



VALVE BRAND NEW control valve with built-in adjustable relief valve, will operate one double-acting hydraulic cylinder or two cylinders as one or a reversible hydraulic motor. Valve handle latches in neutral position. Made of rugged cast aluminum alloy. Open center unloads the pump in neutral position. Throttling control allows operator to regulate the speed of movement of the hydraulic cylinder or motor. Has removable mounting brackets with 4 bolt holes, 3/8" pipe thread connections. Overall dimen.: 12 1/2" H x 8 1/4" D x 8" W. Ship wt. 17 lbs. Govt. Acquisition Cost Over \$100.00. An Excellent Buy. F.O.B. Chicago.

(ITEM #37) **21.95**



HANNA Air Cylinder Brand New

Used for heavy duty industrial applications on shop air lines or with low pressure systems. With 100 lbs. of air pressure, will deliver 1900 lbs. pressure at the ram shaft. All steel construction. Adjustable cushions at both ends of cylinder. Shaft dia. 1 1/2". Foot mounting with clevis on ram shaft, 2 1/2" double-acting stroke; 5" bore, 40 1/2" overall length closed, 7" overall width. 89 1/2 lbs. net wt. Gov't. acq. cost \$101.85.

(ITEM #61) **39.50**
AN EXCELLENT VALUE for F.O.B. Chicago

HALE FIRE and IRRIGATION HIGH VOLUME

Centrifugal Pump

For Fire Protection, Irrigation, De-Watering, Industrial Uses, Farm Uses, Etc. PUMPS RATED 500 GALLONS PER MINUTE AT 275 FT. HEAD PRESSURE

Equipped with 1 1/2" diameter straight splined shaft for direct coupling drive; 4 1/2" threaded suction intake; two 2 1/2" threaded discharge outlets; Hale Pump Co. Model CP volute type; use any 4 or 5 cylinder gas engine direct coupled to pump; dimensions 21" x 24" x 28". Complete with full accessory kit including suction and pressure gauges, priming equipment, and instruction book. Ship. wt. 415 lbs. Gov't. acquisition cost \$425.00.

(ITEM #48) **149.50** F.O.B. Chicago

Hydraulic Control Valve

ITEM #24. Four-way control valve with built-in relief valve, for use with one double action hydraulic cylinder, may be used with 1500 P.S.I. hydraulic system to open and close hydraulic cylinders.



Brand new. Ship wt. 8 lbs. A \$38.00 value. postpaid **7.95**

ITEM #26. Four-way control valve for use with two hydraulic double-action cylinders. Each cylinder may be operated independently of the other or in conjunction with the other. Oil may be locked in any of the cylinders to hold the piston in any required position. Brand new. Ship. wt. 6 lbs. A \$60 value postpaid **10.95**

ITEM #28. A two cylinder double action valve with a unique arrangement, allowing the operator to raise both cylinders simultaneously, to lower them simultaneously or to raise one and lower the other at any predetermined rate and speed. Brand new. Ship. wt. 8 lbs. A \$75.00 value postpaid **14.95**

WAR SURPLUS BARGAINS!

115 Volt-60 Cycle A.C. LIGHT PLANT GENERATOR



(ITEM #67) **59.50** F.O.B. Chicago

IDEAL FOR: Home Lighting, Lodges, Stand-by Electricity, Running All AC Electrical Appliances including: Fans, Motors, Electric Razors, Refrigerators, Incubators, etc.

0-150 Voltmeter with Regulator; 1" diameter shaft with keyway for direct or belt drive, carried in two bearings, one bronze and one ball-thrust bearing, and packed separately to prevent damage to generator or shaft while in transit. Protection for emergencies to operate oil burner, stoker, freezer, water pump, and lights. These units, built to exacting Signal Corps specifications are the answer to your lighting needs. Shipping wt. 60 lbs.

AN OUTSTANDING VALUE **59.50** F.O.B. Chicago

NOW . . . It's Easy to Weld with this handy ARC WELDER

250 AMP. MODEL 252

Designed for many years of trouble-free service. Handles anything from light gauge sheet metal to 1/2" plate

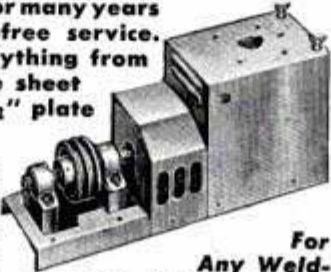

(ITEM #65)

This precision engineered direct current ELECTRIC ARC WELDER is offered at but a fraction of its original value. It can be mounted permanently or easily transported for portable use. Does the job instantly, where and when you need it.

The War Surplus generators for these Arc Welders were built by General Electric, Westinghouse, and Delco-Remy at a cost of over \$300.00. They are light in weight; have oversized lifetime grease-sealed ball bearings; air-cooled commutator; dial type rheostat for easy pinpoint control; high-low range switch; reactor coil for even arc; handles 1/16" to 1/4" rods. Run welder at 2500 R.P.M. from drive pulley or power take-off of tractor, a 7 1/2 H.P. electric motor or a 10 H.P. gas engine. Use two V-belts, or flat belt (on pulley). Continuous welding rating—200 amps.; intermittent rating—250 amps.; 0-30 volts. Now . . . AT A FRACTION OF ITS VALUE. Price includes double V or flat belt pulley and instruction book. Ship. wt. 107 lbs. Only one or two jobs will pay for entire welder. F.O.B. Chicago **99.50**

ACCESSORY KIT including welding helmet, electrode holder, two 10 ft. cables with clamp, and 5 lbs. of assorted welding rods. (ITEM #66) F.O.B. Chicago **10.50**

Remember, Satisfaction is Guaranteed

Logan 4-Way Foot Operated AIR VALVE

Model 6520 BRAND NEW. For double-acting pneumatic devices. Fine for operating air vises, presses, air machinery of many types. Heavy cast construction. Threaded for 1/2" pipe. Dimensions of valve body 8 1/2" L x 5 3/4" W x 7 1/2" H. Net Wt. 28 lbs. Gov't acquisition cost \$42.00. AN OUTSTANDING BUY AT F.O.B. Chicago **15.00**

FREE: NEW '50 CATALOG
Full of unsurpassed surplus values. Welders, Pumps, Hydraulics, Motors, etc. Your copy is waiting for you — Write Today

GROBAN SUPPLY CO. Dept. PM-1
1507 S. MICHIGAN AVE., Chicago 5, Ill.

LOGAN HEAVY DUTY Hydraulic Pump



BRAND NEW . . . for operating hydraulic cylinders and hydraulic motors on tractors, bulldozers, construction machinery, lift trucks, industrial applications, etc. Delivers 8 GPM at 1200 RPM in 1000 P.S.I. using 5 H.P. Has 3/8" pipe thread inlet, 3/8" pipe thread outlet. 3/4" shaft with flat and keyway for direct or pulley drive. Has flange with 4 bolt holes for convenient mounting. Ship. wt. 22 lbs. Overall dimensions: 7" L x 5 1/2" H x 5 1/2" W. A \$105.00 value. FOR ONLY **22.50** F.O.B. Chicago

AIR or OIL HYDRAULICS

Use hydraulics on arbor presses, hydraulic presses, hay lifts, manure loaders, lift trucks—push or pull, tilt or turn, press or squeeze, open or close, lift or lower—and other hydraulic and industrial applications. Use with either air or oil. of finest precision workmanship. BRAND NEW.

ITEM #16—Use these cylinders on farm trucks, bulldozers, hay lifts, manure loaders, etc. Double action, 1 1/2" bore, 27" stroke. (Will lift 1760 lbs. in 2 seconds with Logan Pump.) Wt. 8 lbs. A \$55.00 hydraulic cylinder value for only . . . postpaid **12.95**

ITEM #17—Double action, 2 3/8" bore, 8" stroke. (Will lift 4400 lbs. in one second with Logan Pump.) Will withstand 1500 P.S.I. against wall. Wt. 7 lbs. A \$65.00 value postpaid **14.50**

ITEM #15—Double action, 3" bore, 8 1/2" stroke. All steel hydraulic cylinder, (will lift up to 7000 lbs in 3 seconds with Logan Pump.) Wt. 12 lbs. A \$19.50 \$78.00 value. postpaid **14.50**

ITEM #31. Double action, 3 1/2" bore, 11" stroke. (Will lift 9600 lbs. in 7 seconds using Logan Pump.) Wt. 15 lbs. A \$92.00 value. postpaid **22.50**

ITEM #42—Double action hydraulic cylinder. 4" bore, 18" stroke. Rated lift capacity with 1000 P.S.I. input is 12,560 lbs using Logan Pump. Ship. wt. 30 lbs. AN EXCELLENT VALUE for F.O.B. Chicago **32.50**

HI-PRESSURE FITTINGS for cylinders and valves available at 35c ea. for 3/8" pipe and 50c ea. for 1/2" pipe.

Brand New GENERAL ELECTRIC 8" Sealed Beam SPOTLIGHTS

300 Watts, 110 Volts, A.C.-D.C. Has countless uses for • Homes • Garages • Workshops • Driveways • Outdoor advertising • Displays • Beach lighting • Private air ports • Photography. Wherever you need flood-lighting! Bought by the U. S. Army for signal use. This is the greatest surplus bargain ever offered. Lens, reflector and electrode vacuum sealed in one dustproof, air tight unit. 300 Watts, 110 Volts. Weighs only 2 1/2 lbs. List price \$10.50. **2.75** EA. A TREMENDOUS VALUE for POSTPAID (ITEM #8) 12 or more 2.50 ea. postpaid

Gear Type—All Manganese Bronze Insecticide Pump

For Spraying D.D.T., 2,4-D, Sulphur Compounds, etc. BRAND NEW. Pressures up to 200 lbs. and 14 gallons per minute — at 1200 R.P.M. Will not rust, pit, foul or freeze up. Use rubber hose inlet, 3/8" pipe outlet. Equipped with double mounting bracket. Weight 24 lbs. Dimen. 8"x7"x10". Standard 1" manganese bronze shaft with keyway. U. S. Govt. Acquisition Cost \$62.00. NOW **15.00** F.O.B. Chicago

All Merchandise Brand New - Order Today - Satisfaction Guaranteed!

PLASTIC PAINT

direct to you at a

**BIG
SAVING!**



- White
- Light Green
- Light Gray
- Dark Gray
- Buff
- Ivory
- Brown

\$1.95
GAL.

Use inside or outside for any surface except floors

Freight Prepaid on 12 Gallons



One Coat
PLASTIC ENAMEL

- White
 - Ivory
 - Buff
 - Lt. Gray
- \$2.65**
GAL.

Freight Prepaid on 12 Gallons

RED BARN PAINT \$1.95
• Extra Brite Chrome GAL.

Use 2 gals. from any shipment. If not satisfied return unused portion and we will charge nothing for 2 gals. used and refund all your money. Pint sample, 50c. Send cash with order and THIS ADVERTISEMENT. We will ship direct to you. Sold in 1 gal. and 5 gal. containers.

PLASTIC PAINT CO.

2620 W. North Avenue
Milwaukee 5, Wisconsin

Say You Saw It in
POPULAR MECHANICS

SANDEE

- Mufflers—All Ford, Chev., Ply. \$4.45
- All Buick, Pont., Olds., Chrys.,
- Dodge, Hudson, K.F., Pack., etc. \$5.45
- V-8 and Merc. Duals
- (32-49 incl.)

\$15.95

• TONE

DEALERS WANTED



Beautiful
SANDEE
Fender Skirts
\$9.95

A SANDEE Sportone will outlast two ordinary mufflers and give More Power! More Speed! More Mileage!—plus a tone quality unsurpassed.

Please ship (item): _____ Price _____

Car and Year _____ Name _____

Address _____

SANDEE MUFFLER CO. 5643 Corryne Pl. Culver City, Calif.

LAWN MOWER SHARPENER



lawn mower sharpening
at low cost!

\$4750

less motor.

turn spare time
into dollars

Order direct from
QUAD CITY PRODUCTS
Company, Inc.

Box 42, Rock Island, Ill.

ONE-MAN SAWMILL

LESS THAN
\$225⁰⁰

Easy To Turn Trees Into Money



Makes lumber,
ties, shingles,
crates, lath,
studding,
siding

Belsaw Models

in 10 to 24 foot
sawing lengths.

MECHANICAL FEED, accurate set

works and positive dogs. Use tractor

or old auto engine for low cost power.

Thousands used for commercial sawing.

Pays for itself quickly. Send post card today

for FREE booklet, "How To Make Lumber" and

Catalog of Woodworking Equipment.

BELSAW MACHINERY CO., 811X Field Bldg.

315 Westport Road Kansas City 2, Mo.



HANDY CALCULATOR FOR WOODWORKERS.. ONLY 10c

Just set dial, quickly solves countless problems. Converts linear to board feet, compares workability of various woods, shows bit sizes, nail specifications. Also tool sharpening tips, etc. 6" diameter heavily varnished cardboard. Send 10c to Greenlee Tool Co., 2101 Columbia Av., Rockford, Ill.

Surplus Bargains

SEND
\$10c

JAMMED PACKED WITH BARGAINS
on shop and machinery equipment, hobby
supplies, aircraft parts, etc.

FOR 72 PAGE
CATALOG

ATLAS EQUIP. CO.

Dept. C, 229 S.W. Blvd.

KANSAS CITY, MO.



Print Your Own

Cards, stationery, circulars, tags, labels, photo and movie titles, advertising, etc. Save money. Print for Others. Good Profit; easy rules sent. Raised Printing like Engraving, too. Sold direct from factory only. Write for free catalog of outfits and all details. **KELSEY PRESSES, M-37, Meriden, Conn.**

750 NUTS, \$1
BOLTS, SCREWS

Household assortment—Special by mail offer. All kinds nuts, bolts, washers, rivets—actually almost \$4 worth if bought few at a time. All new. For toys, appliances, tools, furniture, etc. Tremendous quantity. A very unusual bargain. Pin \$1 bill to this for prepaid shipment. Or sent C.O.D. plus postage. Satisfaction or your money back.

Order from the

JOHN'S CO., Dept. C, Girard, Illinois

Record Breakers!



NORTHLANDS

Champions everywhere are setting records on Northland Skis. Northlands lead in design, craftsmanship and offer a wide choice of models to suit every skier. Get in on the fun . . . own a pair of Northlands.

FREE! Northland Ski Manual.
Offer applies in U. S. A. only.

NORTHLAND SKI MFG. CO.

World's Largest Ski Manufacturers

95 MERRIAM PARK • ST. PAUL 4, MINNESOTA

Now CHEAP OIL BURNER
FOR HEATING AND COOKING STOVES - FURNACES
HEAT YOUR HOME, COOK YOUR MEALS
WITH CHEAP FURNACE OIL

NO MORE SHOVELING COAL OR ASHES. Sensational Fuelizer Starter Vaporizing System turns Cheap No. 1 Furnace Oil, also Range, Heater, Tractor Distillate, Kerosene and like oils into oil heat—one of the quickest, hottest fires known. LIFETIME GUARANTEE. \$1.00 Bonus Offer for Testing. We will let you try it in your own stove or furnace for one month. Get yours for introducing. Big profits QUICK. Be first. Send in your name today for details and cash in on the tremendous demand for this Amazing Invention.

NORTHWEST MFG. CO., 634-A Mitchell, S. Dak.

Say You Saw It in Popular Mechanics

Handy Flexible SHAFT

Converts any motor, drill press, electric drill, electric fan (10 inch or larger) into a handy rotary tool

Attach ROTA-SHAFT in a jiffy. Use for grinding, polishing, sharpening, cleaning, engraving, making tools, carving on metal, plastic, wood, glass. Convenient handpiece for easy handling . . . with 1/8 inch Adjustable Chuck. 40-inch overall length. Complete with buff and sanding disc ready to use in a drill press chuck. Order today!

ONLY \$2.95

SEND NO MONEY! Mail your order. Pay postman only \$2.95 plus postage on delivery. Try 10 days—if not delighted, return for money-back. For use on motor, add 35c for Special Coupling and state shaft diameter.

STRADER PRODUCTS CO.
DEPT. M-101
259 Strader Ave. Cincinnati 26, Ohio

OLD FAN MOTOR
VACUUM CLEANER MOTOR



Pack More
Pleasure
Into
Workshop
Hours

EQUIP with

ATKINS "Silver Steel" SAWS



ATKINS No. 400

No finer saw in the world! Balanced blade has teeth fitted for fast, easy cutting. Segment ground for easy clearance. Hardened and tempered for long service between sharpenings. Solid rosewood "Perfection" handle prevents wrist strain. Ship point.

ATKINS MECHANIC-KUT Circular Saws

Razor-keen, fast cutting, extremely accurate. Cut without feathering or slivering. Rip, cut-off or combination. Six to 10-inch diameter. Individually packaged, with one bushing.



ATKINS No. 36 — Nest of Saws

Molded pistol grip Tenite handle. Three hardened and tempered blades — compass, keyhole and nail-cutting. Slotted for 3 cutting angles. Blades quickly interchangeable.



ATKINS No. 37 Compass Saw

Hardened and tempered, 17 x 18 gauge blade. 8 points per inch. New design Tenite utility grip. Similar saw with extra heavy, interchangeable blade is the Atkins No. 38. See also the ATKINS No. 39 Keyhole Saw with Tenite handle.



ASK YOUR HARDWARE DEALER TO SHOW YOU
AN ATKINS WHENEVER YOU NEED A SAW . . .
AND GET QUALITY YOU CAN DEPEND UPON!



E. C. ATKINS AND COMPANY

402 South Illinois Street
Indianapolis 9, Indiana

here's the
VERSA-VISE

the versatile vise for every woodworking need

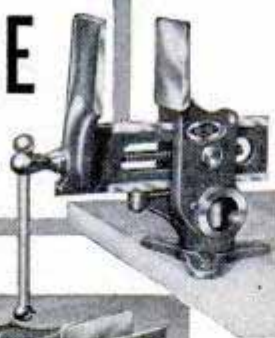

- * Stands Up
- * Lies Flat
- * Turns to the most Convenient Position

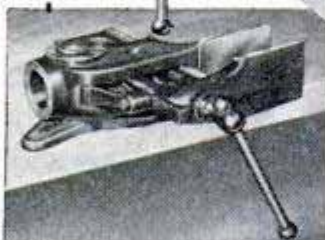

cast semi-steel construction - weighs 16 lbs.

Only \$8.95, f. o. b. Orrville, Ohio. Buy it from your dealer, or send check or money order direct to us for \$8.95 (Ohio customers remit 3% sales tax) and pay the small shipping costs upon delivery. Satisfaction guaranteed or your money back.

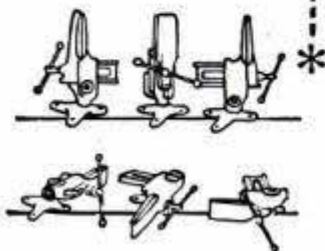

The Will-Burt Co. ORRVILLE, OHIO
Department P

STOP FURNACE LEAKS

Save Fuel Costs

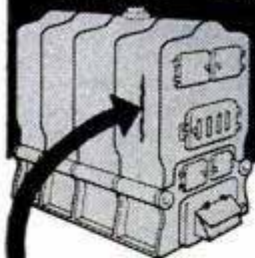

Seal up every heat-wasting crack, opened seam and other leak in your furnace, boiler, tank, radiators and piping tight—as professional repair men do—with Smooth-On No. 1 Iron Cement. Do it yourself—now—and cut this winter's fuel bills. You apply Smooth-On like putty, it hardens like metal, and stays tight, because it expands slightly as it sets. Buy Smooth-On No. 1 in 1 3/4-oz., 7-oz. or 1-lb. size at your hardware store. If they haven't it, write us.

FREE Repair Handbook

40 pages of ingenious, tested, short-cut repairs. Simple directions. 170 illustrations. Write today for YOUR free copy of the Smooth-On Handbook.

SMOOTH-ON MFG. CO., DEPT. 37A,
570 Communipaw Ave., Jersey City 4, N. J.

Do it with
SMOOTH-ON
THE IRON CEMENT OF 1 000 USES

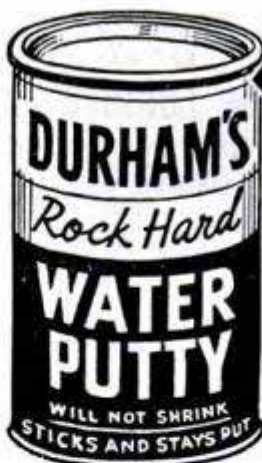

The Modern PLASTIC for Lasting Home Repairs

PERMANENTLY mends cracks or holes in wood, tile, stone or plaster. Sticks and stays put—Does not chip, shrink or fall out. Easy to use. Economical. Mold it, chisel it, polish or paint it. If unobtainable from your lumber, paint or hardware dealer, the big 4-lb. can will be sent you post-paid (in U.S.) for only \$1. Full money-back guarantee, order now.

DONALD DURHAM CO.
Box 804-M, Des Moines, Iowa

NEW GOVT. SURPLUS HOIST and WINCH

Originally made to be used on B-29s for lifting bombs. Mounted on welded steel base, can be attached to truck body or any solid base. Ideal for lifting or moving loads onto trailers, trucks or tractors or for machine shops, garages or warehouses. Capacity 2,000 lbs. Equipped with ratchet for holding load and 18 ft. 3/16" steel cable. Shipping wgt. 50 lbs. FOB, K.C., Mo. Quantity discounts 6 or more.

\$29.95



Send check or M.O. for immediate delivery. No COD's.
AMERICAN AUTO PARTS CO., INC.
1830 LOCUST DEPT. PM9 KANSAS CITY, MO.

DOUBLE ACTION HYDRAULIC ACTUATING CYLINDER

Also pneumatic. Raise, lower, push, pull machinery, garage doors, dump trucks, bulldozer blades, shovels, other uses. Brand new! war surplus! Has attached high pressure swivel connector. Genuine Bendix Aviation part #402685; 4" bore, 18" stroke, 31" long; solid impeller shaft, 1 1/2" diam.; mounting holes, 3/8" I.D. 100-2000 p.s.i.; fittings 3/8"-16 thread. Gov. cost \$200; a top value; powerful, economical. Only \$24.50 Chicago area. Send check or money order. 25% w. C.O.D.'s. Sh. Wgt. 40 lbs. Satisfaction guaranteed. Order today. Quantity buyers, write for spec. discount.
STAHLER DISTRIBUTORS, PM-1, 810 Michigan, Evanston, Ill.



Only \$24.50

SAVE MONEY on Trailer Builders' Supplies! Build, Repair or Modernize! We are the largest and most complete trailer supply house in the States. Get our NEW LARGE 1950 Catalog 10c; blue prints and building instructions 25c.

NATIONAL TRAILER EQUIPMENT CO.
1007 N. Water St. Milwaukee 2, Wisc.



Make Personalized **HOUSE, LAWN MARKERS** For Fun Or Profit



17 new silhouette cutouts (3 shown plus 14 other novel designs) complete alphabet and numbers, ready to trace onto wood. Sawing is easy. Marker with name or address is distinctive personalized gift or addition to your own home. Make markers for fun and to sell. Set of 17 full-size, ready-to-use patterns, alphabet numbers, only \$1.00, postpaid. Money Back Guarantee.

Clip This Ad and Mail With **CRAFTPLANS** Dept. P-153, Chicago 5, Ill.
Dollar Bill or Check TODAY 1321 S. Michigan Ave.

ONAN Portable ELECTRIC PLANTS
FOR CABINS, TRAILERS, CONTRACTORS, BOATS

Light weight, compact, air-cooled engine-driven. Furnish regular city-type A.C. electricity for lights, appliances, radios, etc. Can be carried by hand. Fit trunk of car. Plug-in receptacles on plant. Larger models for farms, homes, businesses beyond highlines. Catalog shows over hundred models. 350 to 55,000 watts.

Gasoline or Diesel Powered
WRITE FOR CATALOG
D. W. ONAN & SONS INC.
5829 Royalston Ave., Minneapolis 5, Minn.



NEW POWER FOR YOUR CAR ENGINE !

BY CONSTANT BALANCE OF LUBRICATING OIL SUPPLY

*Give Your Car this Tonic—
Add Power, Pep and Performance*

MARVEL INVERSE OILER



Here's the famous, low cost, auxiliary lubricating system that meters MARVEL MYSTERY OIL to critical upper cylinder engine parts, precisely in accordance with engine load. The compact INVERSE OILER functions inversely to manifold vacuum, retarding feed *visibly* when throttle is closed or at engine idle, an exclusive MARVEL feature! You can keep ring, piston and valve wear down and performance way UP this winter with the sensational MARVEL INVERSE OILER.

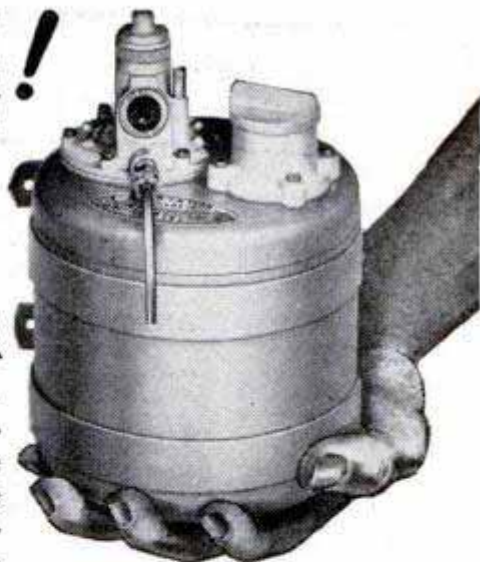

Learn about MARVEL MYSTERY OIL too—the famous oil improving Additive for YOUR motor oil that produces a slow idle, faster engine pick-up and an even, power pull. Thousands of car owners are using it in increased volume this winter for engine protection and to keep starts summer quick in cold weather and in ALL gear greases—it flows at 70° below zero!

WRITE FOR THE FACTS NOW!

The MARVEL INVERSE OILER Is Easily Installed on Most Engines

EMEROL MANUFACTURING COMPANY, INC.
242 West 69th Street (Dept. P. M.), New York 23, N. Y.

PRECISION DIESEL \$2.95

✓ Check These Superior Features

- ✓ DEEZIL is an ultra precision engine as carefully machine tooled as GIANT ARMY engines. Cylinder is honed to .0001 inch. Hand-fitted to its pistons.
- ✓ DEEZIL is the perfect power plant for planes, boats, and race cars. Runs at 7500 R.P.M. Produces 1/7 H.P.
- ✓ DEEZIL is easy to assemble. No ignition headaches. Step-by-step instruction sheet included with kit.

✓ **SEND \$2.95 plus 25c postage today**
WE SHIP IMMEDIATELY

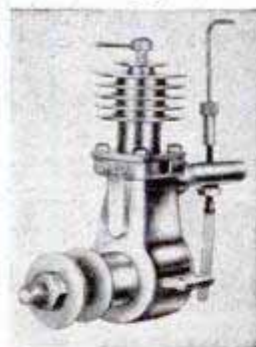

GOTHAM HOBBY CORP., Dept. P, 107 EAST 126th ST., NEW YORK 35, N. Y.

A SURE CURE for Cold Weather Starting... the new SHUR-HETE Motor Water Heater

Install a Shur-Hete unit on your engine—plug it into a 110 volt A.C. outlet and your car will start easily and quickly, even on the coldest mornings. Why? Because the water around the sealed electric element is heated, causing automatic circulation which keeps the entire engine block warm; therefore the oil in the crankcase and around the cylinder walls is always free-flowing.



Easy to install—Any garage mechanic can install a Shur-Hete in a short time. 1/4" connections into head block and into drain plug opening are all that are necessary. Fittings included—nothing else to buy.

Dealerships Open!

JOHANSON MOTOR HEATER CO.
817 W. Webster St. Chicago 14, Ill.

Save Time and Money with Shur-Hete!

Eliminate run-down batteries . . . towing charges . . . needless engine wear . . . and wasted gas.
Uses only 1/3 to 1/2c electric power per hour.
Safe to use with any standard anti-freeze.
Will not overheat engine or burn out.

GUARANTEED!

Shur-Hete Outfits for AUTOS, TRUCKS, TRACTORS only \$13.95

Important: Give make and year of auto, truck or tractor. Shipped parcel post prepaid if remittance is enclosed; otherwise COD with postage added.

For All Autos, Trucks, Tractors
Pat'd and Pat. Pend.

NO MORE Oil Dip-Sticks When You Want to Check Your Oil Level!



Glow Amber
1 Qt. Low
Glow Red
2 Qts. Low



"Oil-Spy"

AN EVER WATCHFUL EYE ON YOUR OIL LEVEL YOUR CHEAPEST INSURANCE AGAINST DAMAGED MOTORS

Measures Oil Level Accurately & Automatically

Now you can know right away when your oil level goes down too low. This inside-the-car-on-the-dash accessory ends for all time the bothersome, time-consuming chore of having to check your oil with a dip-stick. Every car on the road needs one. The Oil-Spy never lets you down. Flashes on an amber light when oil is 1 qt. low, a warning red light when oil falls 2 qts. low. Easily installed in 10 minutes.

Most Valuable Car Accessory Since the Automatic Transmission

Motorists have long wanted it. You read about it in the Nov. '48 issue of Popular Mechanics. Now it's available for every car. Protect the life of your \$300 or more motor. Not only is it useful but it looks very neat on your dash. Stop guessing about oil level. Be sure. Get an Oil-Spy.

ORDER NOW! FITS ALL CARS

Send cash by registered mail only. When ordering C.O.D. send \$2.50. Pay postman balance on arrival. We pay postage when remittance sent with order. State make, model, year of car. Shipped complete with full directions for installation.

\$9.95

YOU MUST BE SATISFIED AFTER 10 DAYS TRIAL OR YOUR MONEY BACK

GARBISCH-EDGINGTON, INC.

465-M-1 Hippodrome Annex Cleveland, Ohio

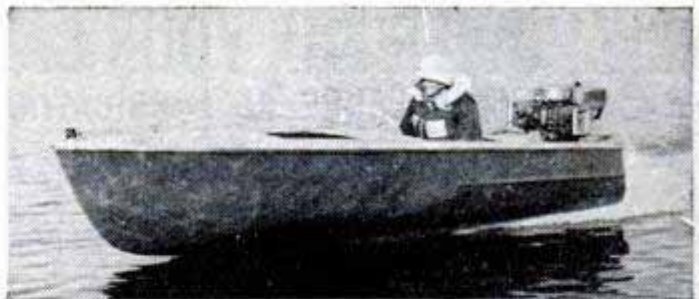

NEW CHAMPIONSHIP RACER

The 14' five-seat Shepard Marathon, designed for the famous New York-Albany race by renowned naval architect, Richard Cole. **BUILD IT YOURSELF** from these accurately scaled factory plans . . . without power tools. Any part may be purchased from the factory's own supply, if desired. **SEND TODAY** for complete plans with parts price list, only **\$2.00**

ORONO BOAT WORKS, WAYZATA, MINN.

HOW TO CUT RAFTERS

New vest pocket book gives lengths, side cuts, plumb cuts, deductions, for all rafters any building from one inch to forty feet wide. Gives numbers to cut on squares. All standard pitches from 1 1/2" to 12 up to 17 1/2 and 12 rise. Any one can frame a roof with this great book. Just open book to your pitch page and there in plain print is your lengths cuts and deductions for any pitched roof. Also gives how to figure elevations. How to figure lumber. How to lay out window and door openings. Written by Harry (Dad) Bleam and it's a dandy. Price only \$2.00 each.

Builders' Topics, Dept. PM, 1512 Market St., Seattle 7, Wash.

SAVE MONEY — BUILD YOUR OWN SPEED LIGHT EQUIPMENT

FOR PROFESSIONAL AND AMATEUR

Easy to follow step-by-step Instructions

Write for FREE list of complete Kits and Components Dept.

CINEX, INC., 165 W. 46th St., N.Y. 19, N.Y.

PM-1

AMAZING NEW ELECTRIC HEATING CABLE

PREVENTS ICE ON ROOFS, DRIVEWAYS ETC.



NOW—protect your roof against ice dams that cause dangerous leakage through walls and ceilings. Guard against frozen walks and driveways that can cause injuries, immobilize your car, isolate you from trains, shopping, schools, etc. Eliminate costly plumbing repairs due to frozen pipes. Heat soil, concrete, liquids, banish all ice worries with the amazing new Brownell Heating Cable—consists of heating element, felt asbestos insulation and protective lead sheath. Absolutely safe, flexible, tough, heats quickly to 165° F, uses little electricity—AC-DC. Comes complete, 60 ft. lengths, ready to plug-in. Full instructions included. **ONLY \$10.95**



SEND NO MONEY!

Prevent costly repair and redecking bills with the new Brownell Electric Heating Cable. Send no money—just the coupon.

Pay postman only \$10.95 plus postage and handling. Full purchase price refunded if returned within 10 days. Send the no-risk coupon NOW!

BROWNELL DISTRIBUTORS, Inc., Dept. HC4
308 Canal St., New York 13, N. Y.

Please rush _____ Brownell Electric Heating Cables. On arrival I will pay postman only \$10.95 ea. plus postage and handling.

I enclose \$10.95 ea. for _____ Cables.

Name _____

Address _____

City, Zone, State _____

Full purchase price refund guaranteed if returned within 10 days.



Reduce RADIO NOISES

SIMPLY PLUG Radio or Appliance cord into Noise Eliminator & plug into wall socket. Enjoy reception FREE from many distracting noises. Send No Money, pay postman \$1 ea. (2 for \$1.75) plus postage or send cash & we'll mail postpaid. Try 5 days, money back if not delighted. **RAND SALES, 688 Lee Street, Dept. A-3, DesPlaines, Ill.**

SAVE \$55.00 ON THE PRICE OF THIS



3/4 H. P.

115 v.
AC-DC motor

4200

R. P. M.

VERSATILE HEAVY DUTY TOOL!

ONLY \$42.50 Direct from mfg.

Get this bargain now! Limited offer from surplus stock. No "catch." Brand new A-1 Spinner. Send check or M.O. today. (No C.O.D.) Money refunded within 10 days if not satisfied.

CALIFORNIANS ADD 3% STATE SALES TAX

HOLT MFG. CO., 272 BADGER AVE., 651 20th STREET,
NEWARK 8, N. J. OAKLAND 12, CALIF.

SAND! MASSAGE! POLISH!

Exclusive
**DOUBLE
ARC
MOTION!**

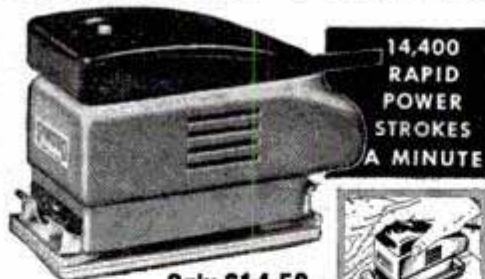

14,400
RAPID
POWER
STROKES
A MINUTE

New

SYNGRO
ELECTRIC

Only \$14.50
**SANDER
POLISHER
MASSAGER**



Amazing new device for light sanding, polishing and body massaging ready! SYNGRO sands, polishes in tight places, corners, around mouldings and on flat, curved or irregular surfaces. Just guide it! Easily adjustable. 60 cycle, 110-120 volt AC. With 10 sheets sandpaper, fabric, lambswool pads, cord, plug. \$14.50 at Dealers! If he hasn't, send \$14.50 to factory, we'll ship Sander postpaid. See other Syncro products pages 268, 285. (Dealers write!)

SYNGRO CORP. DEPT. PH-15
ROCHESTER, MICH., U.S.A.

SURPLUS HIGH SPEED DRILLS MICROMETERS

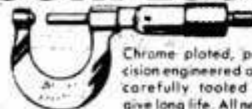

Chrome plated, precision engineered and carefully tooling to give long life. All new.

0-1" capacity . . . each **\$2.25**
1-2" capacity . . . each **3.50**
2-3" capacity . . . each **5.50**
3-4" capacity . . . each **6.50**



All New Drills! Fractional and numbered. Original value \$15.00. Thirty assorted sizes and lengths . . . **\$3.50**

EXPANSION REAMERS



Spiral Flute. Mfd. by Alvard Polk Tool Co. All New, original pack 1/4" 3/8" 7/16" Recommended expansion limit, 006. Original value \$12. Set of 3 . . . **\$4.95**

PNEUMATIC RIVETER & CHIPPING HAMMER

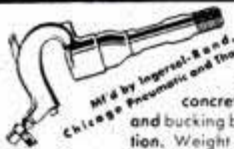

Pistol grip. Ideal for fender, brake lining, concrete breaking work. Like new. Six rivet sets and bucking bar included, making a complete combination. Weight 9 lbs. Each **\$6.95**

SEND 25c FOR ILLUSTRATED CATALOG

AIRBORNE SALES CO., INC. DEPT. PM 1-0
CULVER CITY, CALIF.

STOPS THIEVES AMAZING WAY



**FOR CARS
•
HOMES
•
FARM
BUILDINGS**

A South Dakota manufacturer has discovered an easy way to protect cars, homes, farm buildings from Burglars, sneak and chicken thieves. The manufacturer is so sold on his sensational DEVIL DOG Burglar Alarm that he is willing to let you try it for ten days and will offer you \$1.00 for testing it. New sales plan promises big

money to hustlers. Be first to get your DEVIL DOG Burglar Alarm for introducing in your territory. CASH-IN on the tremendous demand this device will create. Shipped prepaid from factory on ten year guarantee. Rush name and address for details to

NORTHWEST ELECTRIC CO., Dept. 110 A, Pukwana, S. Dak.

Handy Hank says:
"Every man's a handyman with **PLASTIC WOOD**"

Reset loose drawer pulls-

Replaces splintered wood . . .
makes loose screws firm!



Seal drafty cracks-

Fills openings easily . . . dries tight and hard!
Resists weather!

Repair loose tiles-

Holds tiles firm on wall!
Easy!



Also useful in filling cracks in floors, nail and screw holes, repairing broken toys.
Handles like putty . . . hardens into wood!

PLASTIC WOOD

A CELLULOSE FIBRE FILLER

IN CANS
OR TUBES



WEATHER RESISTANT

WE FURNISH ALL MACHINED METAL PARTS, EVERY SCREW, NUT, BOLT, WASHER, AND COMPLETE PLANS FOR THIS...

BIG 10" POWER SAW

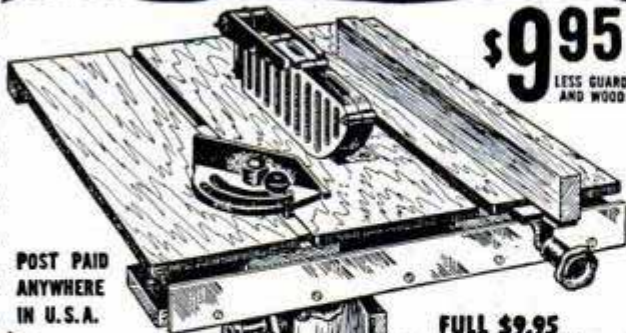

POST PAID ANYWHERE IN U.S.A.

FULL \$9.95 REFUND IF NOT SATISFIED WITHIN 10 DAYS

ASSEMBLE IT YOURSELF WITH SIMPLE HOUSEHOLD TOOLS!

TABLE 24" x 20" • TILTS TO 45° CUTS 0" TO 3/4" DEEP • TAKES 10" BLADE

COMPLETE PLANS (WITHOUT PARTS) 10c

MARCUS • POLLAK DEPT. 44 ROYERSFORD, PA.

New! Lathemaster...

the revolutionary woodturning set every lathe owner needs!



ONLY \$9.95

Now, with LATHEMASTER, you can turn out precision work — even make ornate table legs that match perfectly. And it's easy to use LATHEMASTER — the first really new method of woodturning. Now you can make 12 standard cuts and hundreds of variations with one tool—and 10 times faster, too!

LATHEMASTER takes the guesswork out of woodturning. You can make each cut and each bead just exactly the same. It's a precision tool, beautifully finished. Interchangeable chisel blades are high-carbon shaper steel that holds an edge almost indefinitely. Each blade is ground at both ends, makes 2 standard

cuts. Blades can be quickly inserted, removed, or reversed. Handle is stained hardwood. Shank is chrome-plated steel.

From any angle—including price—there's never been a buy like LATHEMASTER. Order yours today, complete with 6 double-ground blades, shown above, and guaranteed, only.....

\$9.95!

Send Cash, Check or M. O. for Prepaid Shipment

3121 Main Street ALADDIN MFG. CO. Kansas City, Mo. Dealers Write for Information

Save Fingers

with

Industrial Finger Guards



Hundreds of factories save time and injuries and speed production by protecting workers with Industrial Finger Guards. Used for handling rough or sharp articles, for buffing, grinding, sanding, polishing, punch press work and hundreds of other jobs. Protect fingers or thumb, front or back, from cuts, abrasions or blisters. Made of durable leather with elastic web back for snug, cool, comfortable fit. Easy on and off. One size fits all, men or women. Send 10c each for samples or trial order box of 50 at \$4.50 less 10%.

Catalog of Industrial Safety Apparel free on request

INDUSTRIAL GLOVES CO. 1404 Garfield, Danville, Illinois (In Canada: Safety Supply Co., Toronto)

INDUSTRIAL Safety Apparel

Famous Industrial Safeguards Since 1910

GENUINE

DIAMOND SCRIBER!

\$2.00

Postpaid

Writes on glass, metals, plastics. Hex. Aluminum 6". Money back guarantee. Agent inquiries invited.



CLIPPER DIAMOND TOOL CO., INC.

21-B W. 46 ST., N. Y. 19

make your own Gems 29.50 F.O.B.

All necessary lapidary equipment is furnished, including a super-charged diamond blade for sawing, and all wheels for grinding, shaping and polishing; also complete instructions. The complete equipment as shown, less motor and belt, for only \$29.50, f.o.b., Burlington, Wisconsin. Write today for information and literature.

B&I MANUFACTURING CO. Dept. S Burlington, Wis.

ECONOMY TRACTOR

POWERFUL! LIGHTWEIGHT!
Adjustable Tread, High Clearance, 8 H.P. Air Cooled Engine. Automotive Clutch, Differential and Transmission. 15 Attachments.

Write for Catalogue

ENGINEERING PRODUCTS CO., 915-E1, Niagara Ct., Waukesha, Wis.

SHARPEN CIRCULAR SAWS LIKE AN EXPERT

No experience needed. Two simple adjustments. Gets hollow-ground, cross-cut or combination saw blades true and sharp. Fits 6" to 12" blades with 1/2" to 13/16" centers. Includes file and complete instructions. \$6.95 postpaid. (Check or money order) C.O.D.s postage extra. Guaranteed—Money back if not satisfied after 10 day trial. A money maker for fix-it shops. Soon pays for itself. Order today. Free folder.

SURE SHARP MFG. CO., Dept. M-10 P. O. Box 24 Santa Ana, Calif.

BUILD YOUR OWN POWER LAWN MOWER

WHY PAY MORE FOR FACTORY BUILT MOWERS?

WRITE FOR FREE Building Instructions The Rite-Way Mower Attachment Ball Bearing

SAVE MONEY SAVE TIME

Now anyone can save time and effort mowing field or lawn by building their own whirl type power mower. Build according to your own ideas and needs at small cost. Cut close to fences, walks, buildings, etc. Build in short time with parts and instructions we furnish. Requires no special tools.

IT'S FUN TO BUILD

WRITE TODAY FOR FREE INFORMATION T & H MFG. CO., Inc., Dept. MPB-1 811 E. 31, Kan. City 3, Mo.

"Wellworth" Sensational Offer! Reg. \$60.50
WESTINGHOUSE AIR COMPRESSOR

**Model T-1
Brand
New!**

2-CYLINDER PISTON TYPE

Operates with 1/2 H.P. Motor or equivalent gas engine.

Complete outfit consisting of compressor, pressure tank, air gauge, air chuck, 20-ft. hose, pop valve, copper tubing with 4 brass flared fittings for connecting compressor to tank, 4-way cross and 3 nipples. Complete outfit of 7 items..... **ONLY COMPRESSOR SEPARATELY..... \$21.50**

\$32.50
SHIPPING WT. 52 LBS.

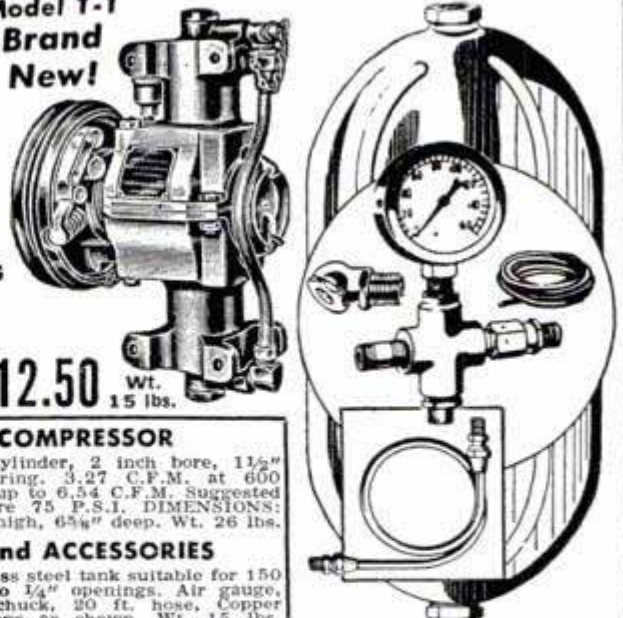

IDEAL for HOME • FARM • FACTORY
Wherever Compressed Air is Needed

For spraying paints, insecticides, etc.; inflating tires, operating air tools and many more uses. Automatic clutch makes it suitable for mounting and operating from trucks, tractors, etc. Instructions furnished. A fortunate purchase from the government enables us to offer you this amazing buy. All brand new equipment. Replacement parts available. This low price is but a fraction of the price of manufacturer and of leading mail order houses.

Equipment less compressor.... **\$12.50** Wt. 15 lbs.

THE COMPRESSOR

Piston Type, 2-cylinder, 2 inch bore, 1 1/2" Stroke Ball Bearing, 3.27 C.F.M. at 600 R.P.M. Capacity up to 6.54 C.F.M. Suggested operating pressure 75 P.S.I. DIMENSIONS: 9" wide, 11 1/2" high, 6 3/4" deep. Wt. 26 lbs.

TANK and ACCESSORIES

12" x 24" stainless steel tank suitable for 150 lb. pressure. Two 1/4" openings. Air gauge, pop valve, air chuck, 20 ft. hose, Copper tubing and fittings as shown. Wt. 15 lbs.

Prices f.o.b. Chicago. Immediate delivery. All items sold on money back guarantee. Send check or money order today. Catalog FREE.

68 PAGE BOOK!

Motor guide, air compressors, home and factory workshop tool catalog. Send 25c to cover postage and handling, deductible from first purchase.

WELLWORTH TRADING CO. 1831 S. State Street
 Dept. D-1, Chicago 16, Ill.

**How To Get MULTIPLE UTILITY
 When You Buy a SMALL GRINDER**

**BUY THE FOREDOM MODEL 100
 FLEXIBLE SHAFT MACHINE**

the choice of tens of thousands because:— Pencil-size handpiece provides positive, sensitive, finger-tip control, works in hard-to-reach places. Your work always well in view. Precision construction and silencer-equipped flexible shaft assures smooth-running performance. Motor not dwarfed to fit the hand, hence more power, longer motor life. Price only \$16.95. Foot rheostat \$4.85 extra.

USE IT TO GRIND, POLISH, DRILL, SAW, SAND, CARVE, MILL, CLEAN, ETCH, ENGRAVE, etc. on all metals, wood, plastics, glass, leather, linoleum, etc.



35" FLEXIBLE SHAFT
\$16.95
 COMPLETE WITH MOTOR

Model 100

BUT THAT'S NOT ALL—

For \$4.95 extra get Foredom's new **DRILL PRESS ATTACHMENT**. Magically and quickly converts machine into a power drill press.

AND FOR ONLY \$3.50 EXTRA there's Foredom's new **B-R-S ATTACHMENT**.

And here's another Amazing

Foredom Product Now turn your old motor, drill press or electric drill into a Flexible Shaft Tool with **FOREDOM PRESTO-FLEX** with **PENCIL SIZE** handpiece. Attached or removed in a jiffy! Gets into tight places. Handy 35" overall length. And—only \$5.95 complete! Precision made. For use on motor, specify motor shaft diameter and add 50c for coupling. (Available for 1/4, 3/16, 3/8, and 1/2" shafts.) No. 50 Accessory Set \$1.50 extra.



MENT. Makes machine serve 3 EXTRA FUNCTIONS—Bench Grinder with angular adjustment. Router with detachable guide for borders, and SHAPER.

Budget your purchase or buy **FOREDOM MULTI-PURPOSE THREESOME** comprising Model 100 Machine, Drill Press Attachment and B-R-S Attachment \$24.95.

NEW ACCESSO-RAK Mount on wall or back of bench and hang up machine. Comes with 40 highly useful accessories, all at your finger tips. Sensational value, only \$4.95.

ORDER TODAY. Send check or money order for items above or sent C.O.D. plus postage. Sold on 10 day money back TRIAL.

Write Today for **FREE CATALOG No. 1125-E**

FOREDOM ELECTRIC CO., Dept. 1125-E, 27 PARK PLACE, NEW YORK 7, N. Y.

FOREDOM — Used by INDUSTRY — Preferred by HOBBYISTS!

**THE BIGGEST
 VALUE
 ON THE MARKET
 DIRECT FACTORY TO YOU**

DYNAMIC ARC-WELDER
Super Charged

DOES WELDING, BRAZING, SOLDERING, CUTTING

This is one of the finest scientifically designed and precision-built genuine heavy duty transformer-welders on the market today! Made by an old established firm. High efficiency, heavy-duty output does work you'd expect from costlier machines. It's **EASY TO OPERATE**. Do expert work in a jiffy by following the simplified instructions furnished. Works on iron, steel, brass, bronze, aluminum or other metals. **OPERATES** from any convenient properly wired 110 VOLT A. C. line. **SAVE TIME AND MONEY . . .** build or repair your own auto, home, farm, or shop equipment and appliances, etc. Make big money doing work for others in spare or full time. **OVER 50,000 SATISFIED USERS** all over the country, hobbyists, maintenance and repair men, farmers, tinsmiths, engineers, home and auto owners. Order today on 10-day trial or send coupon for full details.

\$40.30 VALUE
 Only **\$28.50** F.O.B.

GIFT WORTH \$680 INCLUDED
 For Prompt Action
SEND ORDER TODAY



FREE Full Details SEND TODAY

Please send as checked: Dynamic Welder on 10 day trial. I enclose \$28.50, or \$..... as a deposit. Ship C. O. D. for balance. Details on Dynamic Welder. DEPT. TD-150

Name.....
 Address.....
 City..... State.....

DYNAMIC WELDER CO., Dept. TD-150, 13 E. 23rd St., Chicago 16, Ill.

Make 100% to 150% Profit!

MANUFACTURE BUILDING BLOCKS In Your Own Back Yard



AMAZING GENERAL BLOCK MACHINE
CAPACITY 1000 BLOCKS PER DAY
Only \$199 LESS MOTOR I.O.B. PLANT
SHIPPING WEIGHT 400 Lbs.

Here is an outstanding opportunity for men of vision and small capital. Cinder and concrete blocks are in great demand. Millions used for homes, factories, public buildings. Sell all you produce at 100% to 150% mark-up.

PEAK BUILDING DEMAND!

The General Block Machine is amazingly practical, foolproof. Simple to operate indoors or outdoors. Rugged all steel construction. Vibrator mounted in sealed ball bearings. Produces up to 1,000 blocks per day. Superior 3 Core Type that meets all building code requirements. Can produce 4 x 8 x 16, 8 x 8 x 16, 12 x 8 x 16 blocks. All materials obtainable anywhere. All operating instructions and mixing formulas supplied. Full details FREE without obligation.

HOW TO BUILD YOUR OWN CONCRETE BLOCK HOME
Only 1 Prepaid

Wonderful Book Written & Illustrated by Experts

GENERAL ENGINES CO.

DEPT. P4 • 307 HUNTER ST. • GLOUCESTER, N. J.

Includes floor plans for 6 beautiful, easy to build concrete block bungalows. Shows ways to save money. How to lay blocks, lay out building lines, mix concrete, build steps, porches and concrete floors. Mail coupon at once with \$1.

Name.....
Address.....
City.....Zone...State.....

Pioneers

Leaders

AIR RIFLES BENJAMIN AIR PISTOLS WITH SAFETY LOCK

SEND FOR FREE FOLDER OF LATEST MODELS TODAY
If you want a REAL GUN for PRACTICAL USE inside or outdoors, get a SAFE—CLEAN—ECONOMICAL—BENJAMIN with Adjustable Power and Amazing Accuracy. Use BENJAMIN H-C PELLETS for BEST RESULTS in all rifled models. WRITE AT ONCE.
BENJAMIN AIR RIFLE CO., 812 MARION ST., ST. LOUIS 4, MO.

PRESTO! ANYONE CAN MASTER GLAZE

- LEAVES HARD GLASS-LIKE FINISH
- EASY TO APPLY
- PROTECTS THE SURFACE
- NO SMEAR OR STREAKS AS WITH WAX
- LASTS SIX MONTHS TO A YEAR
- SEALS THE PORES OF THE SURFACE
- WILL NOT FINGER-MARK
- NO OILY FILM AS WITH POLISH
- EASY TO KEEP CLEAN



Car Owners! Meet Master Glaze—the sensationally different luster for new and used cars! Not a wax—not an oil polish—not a paint!—nothing that “smears” over the surface.

MASTER GLAZE is a unique discovery — a creamy liquid — quick and easy to apply! Gives a hard, glass-like surface. Even gasoline cannot dull it! Lasts six months to a year! Amazing luster — beautiful, sparkling clean and brilliant! Doesn't finger-mark—doesn't smear! A match box full glazes an entire car. Seals the pores—protects! NOTHING LIKE IT!

AGENTS

An unusual opportunity! Quick, flashy demonstrator. Big profits. Good territory. Write today!

FREE SAMPLE

Just send your name and address to

MASTER GLAZE CO., 7720-680 W. Harwood Ave., Milwaukee, Wis.

SAVE ALMOST HALF!

PRECISION VERNIER CALIPER

World famous precision, style, workmanship of former Mauser organization of Germany. Made to exacting standards. One-hand operation with positive-action release. Chrome steel throughout, a perfect tool for shop and home. Measures accurately to 1/1000 of an inch and 1/20 mm. Mechanics, tool makers, inspectors, technicians, hobbyists need this excellent instrument. Precise measurements quickly and easily; outside and length, inside, thread, depth measurements. Now, because full scale production is again under way, this beautiful Mauser-type caliper is yours at a price almost half of any comparable tool! Order yours today!

Prepaid with your check or money order.

10 day money back guarantee

ONLY \$15.00

In protective leatherette case.

Dealer inquiries invited.

GLOGAU & CO., INC.

1904 Birchwood Avenue, Chicago 26, Illinois

F.O.B. Chicago, C.O.D.



Start Quickly BIG MONEY ROLLING WITH LIFE CHARGE

MAKE PLEASANT, DIGNIFIED CONTACTS

The MIRACLE Chemical that helps Batteries stay AUTOMATICALLY charged. Adds Months of useful service. Eliminates freezing, overheating and cable corrosion. Revives old Batteries. Saves time and money for user. EAGER BUYERS EVERYWHERE! Fleet owners, garages, service stations and individuals all buy. FOUR EASY SALES A DAY NETS YOU \$144.00 WEEKLY! Advertising and Promotional Material free. Sold on satisfaction guaranteed or money back plan. Send \$1.00 for special sample offer enough for two batteries, or write for free details. GET IN THE BIG MONEY FIELD! DO IT NOW. DON'T DELAY...WRITE TODAY!

BATTERY CHARGE PRODUCTS COMPANY

728 W. Peachtree Street, Dept. M Atlanta, Georgia



LAWN ORNAMENT-NOVELTY PATTERNS

28 Lawn Ornament Patterns, 25c. Other patterns; 15-20" high; Dutch Girl, Dutch Boy, Pirate, Bull Terrier, Mexican Girl, Mexican Boy, Dwarf, Penguin, Flower Girl, 10c each. 25 Novelty Patterns, 30c. All 62 Full Size Patterns, \$1.00 Postpaid. Strother Pattern Service, Dept. BM-8, Box 128, Belington, W. Va.



Only \$19.75 Complete

EXTRA PROFITS! Flocks & Sandblasts

Dual Purpose Spray Gun! Uses only 25 lbs. Air Pressure
• Thousands of uses in Home, Shop, Industry: Makes Auto Interiors Clean & New, Lines drawers, Marproofs lamp bases, Refinishes any object. All in colorful Flock. Etch & Frost windows, glassware, etc. Removes Paint & Rust from Autos, Tools. Guaranteed! Send \$19.75 or write for free information. Flocking supplies!

BLASTO SPRAY GUN MFG.

Dept. PM-1, 7007 Haas Avenue, Los Angeles 47, Calif.

TANK GAUGE

Eliminate old-fashioned measuring sticks, oily hands and smell. The new FIL-THRU combination gauge for users of 55 gal. horizontal oil drums fits standard opening. The accurate, rugged aluminum construction is rainproof, corrosion-proof. Easily installed without tools. Order yours today \$1.95 postpaid. No C.O.D. CHARDON CO., 92 Shepherd St., Rockville Centre, N.Y.



SAY YOU SAW IT IN POPULAR MECHANICS

MODERN LAWN MOWER SHARPENER

FOR LAWN MOWER SHOPS FIX-IT SHOPS

GOLF COURSES • PARKS 101 OTHER JOBS

Sharpens All Reel Type Mowers • Hand, Power or Gang • 10 to 20 Minutes • No Dismantling • No Extra Attachments Needed.

All reel type mowers, from 5-inch edgers to 36-inch power mowers, are quickly sharpened to extreme ends of both left and right twist blades.

Handle, wheels, roller and motor remain in place when sharpening is in process. Bed knife is sharpened in same brackets. Grinding head rides on five ball bearing races. Easy to operate.

Also sharpens chisels, joiner knives, planer blades. Big profit maker. Own your own business. Send Today for FREE Illustrated Bulletin No. 10-C

ORDER NOW
Immediate Delivery

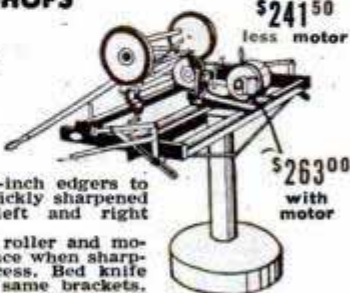

PRICE \$241.50 less motor

\$263.00 with motor

MODERN MFG. CO. 160 N FAIR OAKS AVE PASADENA, CALIFORNIA

Your weight does the work with a "YANKEE" QUICK-RETURN SPIRAL SCREW DRIVER

● Save your wrist: drive and draw screws faster. Just push on a "Yankee" 130A Spiral Driver. Your weight and the spiral turns the screw without blisters or fatigue. Quick-return spring in handle holds the handle after every stroke.

★
Write for the
"YANKEE"
Tool Book
.. FREE ..

"YANKEE" TOOLS
NOW PART OF
STANLEY
THE TOOL BOX
OF THE WORLD

**NORTH BROS.
MFG. CO.**

217 West Lehigh Ave.
Philadelphia 33, Pa.



CAPE COD CHAIRS TRELLISES • ARBORS DUTCH WINDMILLS

Chairs style B-C-A PLANS 50c Ea., all 3 only \$1.00. 12 different Dutch Windmill Detailed PLAN only 75c. Unique 40" high Light-house having copper lantern, ideal for garden or on lake shore of summer home. Large detailed PLAN 75c.
SPECIAL ALL PLANS ABOVE \$3.00 VALUE ONLY \$2.50
SEND 10c for catalogue of many fine projects.
Dept. P12
CRAFTSMAN'S MODEL CO. DELAFIELD, WISCONSIN

BRUSH PLATING OUTFITS

● for re-plating articles in the home and shop. No tanks necessary. Free particulars.

GUNMETAL CO., AVE. M, DECATUR, ILLINOIS

REMEMBER THIS You can't buy a \$20 goldpiece for \$10 So it's dangerous to pay less if you want safe, balanced matched tires. WE REPEAT—Consider your family's Safety, not just PRICE. You see our adv. every month. Buy Now & Take 10%. Positively not recaps. We serve ambulances, fire trucks, school buses, trucks & cars.

GOOD YEAR Firestone Goodrich U. S. ROYAL

& others. Original high tread. Slightly worn. Extra fine traction.

—26 MONTHS GOLDEN RULE GUARANTEE BOND—
Genuine Factory Adjusted "All-Purpose" "AAA" Tires
Read That Top Line Again! You'll Save More than \$

FREE TUBE WITH EACH TIRE	600-16 35.55	650-16 55.85	700-15 55.85	700-15 55.85	475-19 55.85
	600-16(6) 6.66	700-17 9.99	650-15 5.85	525-18 5.85	
	700-16 6.85	750-16 7.95	550-17 7.25	550-16 5.55	

AMERICA'S GREAT LO-PRICE VALUE. 15 Months Guar. Limited Supply

600-16 \$3.65	650-16 \$3.85	700-16 \$4.65	650-15 \$3.95
	700-15 3.95	750-16 5.95	550-17 5.55

LO-PRICE TRUCK TIRES. 15 MONTHS GUARANTEE

32x6(8) \$8.88	750-20(10) \$8.88	1100-20 \$13.95	900-20 \$11.95
32x6(10) 9.99	825-20 11.25	700-20 8.88	1000-20 12.95

SUPERCUSHIONS to fit your wheels; any car. Buy 2 or 4; the Velvet Ride

670-15(600-15) \$6.25	760-15(650-15) \$7.77	670-16(600-16) \$6.66
710-15(650-15) 6.85	820-15(700-15) 7.77	740-16(650-16) 7.77

WE ARE TRUCK-TIRE EXPERTS Matched tires. Truck-owners the world over depend on us to keep their trucks rolling "ON TIME!" at lowest cost. **FACTORY ADJUSTED "ALL-PURPOSE" "AAA" Grade**

26 MONTHS REPLACEMENT GUARANTEE BOND			
600-20 \$9.20	32x6(8) \$11.95	900-20 \$15.85	34x7 \$12.22
650-20 9.99	32x6(10) 13.33	1000-20 16.65	1000-22 17.77
700-20 10.85	825-20 15.95	1100-20 17.77	1100-22 18.88

MILITARY "AAAA" guar. 30 mos. (Supers 14 mos.)
600-16 Super \$6.22 "AAAA" Snow Tread \$7.77
750-16 900-16 750-20
Super \$9.75 Super \$8.60 Super \$8.48
"AAAA" 12.22 "AAAA" 10.90 "AAAA" \$13.00

BLATT GIRARD & LANCASTER AVES., Dept. PM
BLATT BLDG., PHILADELPHIA 31, PA.
Send ck. or money order and this ad. for rush shipment. We won't ship a tire we wouldn't use ourselves. Instant shipment down South, far West and the world over. The name to trust in rubber.

New Values ZEPHYR MODELS Portable Electric Tools

Factory Guarantee
Light Weight
Easy Handling
Compact

Long Life
Low Price
Latest Design

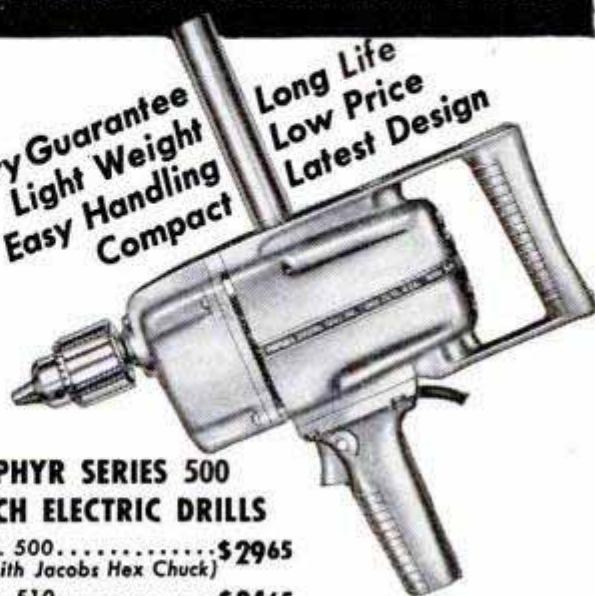

ZEPHYR SERIES 500 1/2-INCH ELECTRIC DRILLS

Model No. 500.....\$2965
(with Jacobs Hex Chuck)
Model No. 510.....\$3465
(with Jacobs Gear Chuck)

Full 1/2-inch drill capacity; removable side handle for close-quarter drilling; weight complete only 9 pounds. U. L. listed.

ZEPHYR SERIES 1950 3/4-INCH ELECTRIC DRILLS

Model No. 1950-H.....\$1795
(with Jacobs Hand-Tite Chuck)
Model No. 1950-G.....\$1995
(with Jacobs Gear Chuck)

Weight complete, only 3 pounds, 2 ounces. The speed, power, and small size make it the ideal power tool; handy to use as source of power for driving drill attachments for disc sanding and polishing, cleaning paint brushes, grinding and sharpening tools, buffing, removing rust and paint with wire wheel brushes, etc. A real money saver around the house, farm and home shop. U. L. listed.

SPRAYMASTER ZEPHYR MODEL SM-25 \$24.95

A complete electric sprayer unit with electric motor, two-cylinder air compressor, pressure equalizer storage tank, 25 to 30 pounds pressure. Sprays paint, enamel, lacquer, insecticides, and mothproofing solutions. Easy to use—no spraying experience necessary for fine job on furniture, cars, radiators, etc. Full instructions with every unit.

See these tools at your dealer, or write direct for full information. Dealer inquiries invited.

GET THIS FREE BOOKLET—16 pages of detail information on Portable's complete line of top-value electric tools, tool kits, and work-saving attachments.



PORTABLE ELECTRIC TOOLS, Inc.
324 W. 83rd Street, Chicago 20, Illinois



THAT ACCURATE TOUCH...

**with the
FINEST
IN STEEL TAPES**

It's easy to be right the first time — it's easy to get "that accurate touch" . . . if your measuring instrument is the Master Streamline. This fine tool simplifies and speeds measuring and cuts down time-wasting errors. Its outstanding features are Streamline's guarantee of better measuring . . . graduations on both sides of blade . . . new lever brake to hold reading . . . direct reading inside measure . . . extra long tip holds blade steady . . . and many others found only in the Master Streamline. See your local hardware dealer or use the coupon.

MASTER

REG. U.S. PAT. OFF.

WOOD AND STEEL TAPE RULES

Master Rule Mfg. Co., Inc. PM-1
201 Main Street, White Plains, N. Y.

I enclose \$2.25 for the 6 ft. Streamline
\$2.50 for the 8 ft. Streamline
Engrave my name (75c extra). Please print clearly:

NAME.....
ADDRESS.....
CITY..... STATE.....

*Save Money—Make Money
with LARSON Leathercraft*

For gifts or for sale—make easy-to-assemble leather items. Complete stock leathers, tools, accessories.

Send ten cents for new catalog of 101 money-making ideas.

J. C. LARSON CO. 824 S. Tripp Ave.
Chicago 24, Illinois

NOW! a complete **TABLE SAW**

for only **\$14.95!**



(Less Motor)

- For CROSS CUT
- RIPPING
- MITER
- GROOVE
- DADO

SPECIFICATIONS

TABLE SIZE..18x20
Total Height..12 1/2"
Size of Saw Blade
Furnished (8" blade
can be used)... 7"
Depth of Cut... 13 1/4"
Saw Arbor Shaft 1 1/2"
Bearings... Oil-Life
Saw Speed.....
4000 r.p.m.
Recommended
Motor Pulley... 5"

UNHEARD-OF VALUE! High-quality table saw that cuts to exact dimensions. Neither blade nor table tilts. All parts except saw blade and mechanical units made of specially-treated hardwood that is guaranteed against defect for one year! Metal parts cadmium-plated to prevent rust. Fence extends full length of table, can be used on either side of blade. Miter gauge graduated for 15°, 30°, 45° cutting. Complete, less motor, only \$14.95! Motors available. Get your order in today!

WE PAY POSTAGE WHEN CASH ACCOMPANIES ORDER

Free! Write today for your new Home Workshop Catalog or "How to Start Your Home Workshop"

FORSLUND PUMP & MACHINERY CORP.

1721 MAIN STREET Dealer Inquiries Invited KANSAS CITY, MO.

ELECTRIFY your SEWING MACHINE



**COMPLETE KIT ONLY
\$12.95** 1 YR. GUARANTEE

Kit comes fully wired . . . installed in a jiffy. Fits all machines. You get these all-new parts:

- Motor & Bracket
- AC-DC 115v 60c
- Pulley & belt
- Multi-speed foot control
- Cord set & block
- Full instructions

FREE . . . reg. \$2.95 chrome SEWLITE given with every kit.

10 DAY FREE TRIAL — ORDER NOW!

Send no money, pay C.O.D. or send money order and we'll pay postage. Please state whether wheel on your machine turns towards you or away from you. Shipping wt. 6 lbs.

Dealer Inquiries Invited

CONTINENTAL SALES CO.

83 GRAHAM AVENUE Dept. PM 50 BROOKLYN 6, N. Y.

DESK MODEL

TELEPHONES

WALL MODEL

\$17.95 for 2 OF EITHER MODEL



Telephones are complete with power, wire, hook-up instructions etc. Any number of telephones can be connected in circuit. Common talking, common ringing. Simple installation, absolutely no technical knowledge required. 25% deposit with order, balance C.O.D. F.O.B. Brooklyn. **FREE: Fine Descriptive Folder.**

Eastern Telephone Co., Dept. PM-6, 320 18th St., Brooklyn 15, N. Y., South B-6161



**CRAFTSMEN! Make Your Own Power Tools
STEEL HOUSING—BALL BEARING**

ROTATING QUILLS

NEW DEPARTURE SELF-LUBRICATING BEARINGS!

- Mount & Put To Work!
- A-51—Plain Spindle..... \$3.75 pp.
 - A-52—1/2x4 1/2 spindle..... \$5.25 pp.
 - A-61—1/2x12 1/2 spindle, housing 2x8 \$7.75 pp.
 - A-62—5/8x12 1/2 spindle, housing 2x8 \$8.25 pp.
 - A-63—3/4x12 1/2 spindle, housing 2 1/4x8 \$9.00 pp.
 - A-71—1x17 1/2 spindle, housing 2 3/4x11 \$16.75 pp.

10,000 r.p.m. 1" BETWEEN WASHER & COLLAR
ASPEGREN PRODUCTS, 1612 (M) Webster Ave., New York 57, N. Y.
Creators: ASPEN DRIVE-ALL Portable Power Unit (illus. Circ. on request)

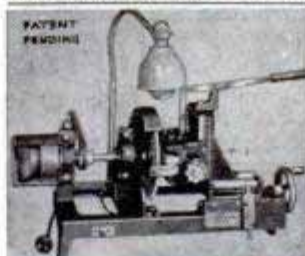

Start a NEW BUSINESS!

or Add to your present Repair Business

SHARPEN DULL PIPE WRENCHES

PIPE TAPS & DIES
"GUM" CIRCULAR SAWS
Write for Information

J. C. MOORE INDUSTRIES

BOX M 276 FREDONIA, PA.

LIQUID MARBLE

**COMPOSITION FLOORS
FLEXIBLE MOLDS**

MOLD Novelties, Statuary, Art Goods in Flexible Plastic Molds; 5c material makes \$1 seller. Make Marbleized floors, Tile Walls. Colorful, glossy, amazing! Easily learned; start in garage or basement. Particulars free. **MARBLEIZING SERVICE, Dept. 10-F, Edwardsville, Ill.**

**Say You Saw It in
POPULAR MECHANICS**

WAR SURPLUS and OTHER ITEMS

Below are just a few of the thousands of items we have in stock at sensationally LOW prices.

- | | | | |
|----------------------|-----------------|-----------------------|---------------------|
| Gas Engines | Grinders | Extension Cords | Gear Head Motors |
| Pumps | Air Compressors | V Pulleys | Electric Hand Saws |
| Air Tanks | Spray Outfits | All size Light Plants | Electric Chain Saws |
| 2 & 4 Wheel Trailers | Bomb Trailers | Generators | Saw Tables |
| | | Fire Pumps | Winches |
| | | Hand Trucks | Arbors |
| | | Electric Drills | Clutches |
| | | | Tires |
| | | | Electric Motors |

Special! Heat Booster

Fits any 8", 9", or 10" furnace pipe. 1500 RPM motor with 6" cord, mounting frame, 7" blade. Motor can be oiled from outside. Easy to install. Silent operation. Warm those rooms with long runs. Stock #583 Regular \$9.95. Your price

\$5.95

A Terrific Buy! GAS ENGINES

Briggs & Stratton NEW in original cartons. MODEL HP LIST Your Price AP 1 1/2 to 2 1/2 \$102 \$49.00 ZXP 5 to 7 \$141 \$69.50 Both models with 2 groove V pulley B size 5 1/2 O.D.

WRITE TODAY. HUNDREDS OF DOLLAR SAVING BARGAINS.

C & H ELECTRIC Co.

434 W. JUNEAU AVE. MILWAUKEE 3, WISCONSIN



SYNCRO

The New
**ALL-PURPOSE
ELECTRIC
HONE
SHARPENER!**

SYNCRO hones sharp hundreds of articles in homes, shops, farms. First and only ALL-PURPOSE hone that m-o-v-e-s electrically! 14,400 rapid, gentle safe strokes a minute! No belts, wheels, gears. 60 cycle, 110-120 volt AC. Both hands free to hold work. Easily adjustable. Ideal birthday, personal gift. With 3 interchangeable Honing Stones, Cord, Plug, \$10.50 at DEALERS. If he hasn't, send \$10.50 direct to us, we'll ship Sharpener post-paid. Satisfaction Guaranteed. See other Syncro products, pages 268, 279, this issue! (Dealers write!)

SYNCRO CORPORATION
DEPT. HH-15, ROCHESTER, MICHIGAN, U. S. A.



RETAIL PRICE \$125.00
FACTORY TO YOU! \$59.95
5 BIG POWER TOOLS in 1

SUPERSHOP is the **PRECISION-BUILT** power tool **WORKSHOP**. Big capacity tilting table saw, vertical and horizontal drill press, 30" lathe, sander, grinder. Lifetime-lubricated **BALL BEARINGS**. Running parts precision-ground. Bearing seats precision-bored. Compare with finest production tools. Buy direct from factory — save \$65.00. Write for **FREE** catalog, full details, trial plan.

SUPERSHOP POWER TOOLS INC.
107 YATES AVE., BELOIT, WIS.

SAY YOU SAW IT IN POPULAR MECHANICS

VICKERS CONSTANT DISPLACEMENT HIGH PRESSURE PUMP. Use it for any type liquid pumping job 375 gal. per hr. at 3750 R.P.M. 1000 pounds pressure per sq. in. Can be used as hydraulic motor O. Acq. \$100.00. **\$8.95** post-paid Brand new directions incl. Wt. 7 lbs.

CHECK AND RELIEF VALVE..... **\$2.50** Post-paid

Send check or Money order. No c.o.d.'s.

GENERAL SALVAGE COMPANY
DEPT. 17, 2922 E. 27th ST. KANSAS CITY, MO.

NEW PACKAGED BOATS 1950 KITS

- ★ 17 NEW MODELS
 - ★ IMPROVED DESIGN—SKIFFS
 - ★ OUTBOARDS — INBOARDS — SAIL BOATS
 - ★ TREDRONIC RACERS — CRUISERS
 - ★ 8 to 16 FT. — EXCLUSIVE FEATURES
- Preassembled frames — Tri-Keel construction — Tredronic bottom — Full length spray rails — Widest beam — Simplified construction — Easy to build.

WORLD'S BEST BOAT BUY!

Send 25c for new 1950 literature, or send \$1.00 for literature, plus booklet "Plywood Boats."

BOAT PATTERNS-BLUE PRINTS

1950 Catalog—over 100 modern designs by famous naval architects. Racing classes, cruisers, inboard, outboard, sail, 6 to 35 ft. Plywood—Steel—Plank. Construction plans, full-size patterns. Send 35c for catalog or \$1.00 for catalog and helpful booklet on "Boat Building."

PLYWOOD CONVERSIONS HARDWARE

—and marine lumber. Stock list 10c List and handbook, "Plywood Hints," 50c (coin). Drives, gears, engines, kits. Catalog 50c (coin). With booklet "Conversion Hints" \$1.00. Send \$1.00 for 250-page Builders' Guide, 15,000 items pictured, priced.

MARINE MART-DEPT. 24-BUFFALO 7, N. Y.

"Have a profitable ARC WELDING business of your own"



Earn \$150⁰⁰ to \$300⁰⁰ extra profit monthly. Buy on easy "PAYS-FOR-ITSELF" terms

"Build Your Own" is shown above.

D.C. or A.C. arc welding is easy with newest HOBART welders. Simplified controls make welding easier, faster, better than ever. You can become expert in almost no time.

Portable welding pays extra profits. Equips you for "on-the-job" welding. Farmers, contractors, factories, builders will keep you mighty busy. They like big savings and willingly pay extra.

Save money "building your own" portable gas drive welder. Heavy duty production welder is used in new Hobart built portables. Instructions show how to build with old auto engine and chassis.

New A.C. welders bring lower costs to shop, farm or factory welding. Hooks to electric power line. Wide welding range. Easier arc to hold helps you turn out more jobs per day and guarantees more profit.

HOBART SCHOOL of welding offers full or brush-up courses on all phases of welding. Learn from experienced instructors, use latest equipment in modern, fire-proof building. Tuition cost is low in this non-profit school. GI approved. Write for catalog.

Use margin for your name and address and mail TODAY to HOBART BROTHERS CO., Box M-10, Troy, Ohio.

HOBART welders

"One of the World's Largest Builders of Arc Welders"

D.C. Shop Welder



D.C. Generator



A.C. Shop Welder



Free!

Vest Pocket Guide. Useful data for all welders.



Just Received!

376 BRAND NEW

INDIAN MOTORCYCLE MOTORS

A real buy in a brand new (in original shipping crate) Model 741 INDIAN twin cylinder motorcycle motor

10-15 horsepower. Complete with a 3 speed transmission, clutch, carburetor and ignition, less generator — ready to install. Will make your old motorcycle perform like new. Ideal for powering TRACTORS, MIDGET CARS, POWER DRIVEN SAWS and TOOLS, TOBOGGAN SLEDS, etc. Foreign orders invited. Act immediately if you want them!

NO DISCOUNT DUE TO LIMITED QUANTITY. Get this bargain now! Limited offer from surplus stock. No "catch." Brand new. Send check or M.O. today, or \$20.00 deposit, bal. C.O.D.

Military Truck Parts Our Specialty

FULTON AUTO EXCHANGE

190 EDGEWOOD AVENUE, N.E., (Dept. P.M.), ATLANTA, GEORGIA



200 lbs. per unit Shipping Weight Crated

\$59.50 each

F.O.B. Atlanta, Ga.

WAR EQUIPMENT MAIL SALE!



WE PAY ALL FREIGHT AND MAIL CHARGES.
 * Power Plants, 110-V., 60-C., 3,000-W. Remote switch electric self-starter. Easily made full automatic. Army's finest plants. Full instructions. Ideal for farmers, sportsmen, contractors. New condition. Fully guaranteed.
 Cost Gov't. \$756. Sale Price—\$345.00



* Industrial Engines. New 1-cyl. Briggs 3.5 heavy duty, air cooled. Excellent for boats, garden tractors, weed sprayers, elevators, pumps, scooters, saws, etc. Complete instructions.
 Cost Gov't. \$130.00. Sale Price—\$75.50



* Same engine with Utility Clutch. \$6.50
 * Winch—3,000 Lb. 12" x 14", 9" high. New steel and bronze drive gears 80-to-1 power ratio. Useful for farmers, truckers, merchants, factories, etc. Used by leading truck lines for loading. Excellent for any hoist boat docks, wagon unloaders, etc. Drive with old car 6-volt starting motor, power take-off, fan pulley, etc. Easily mounted on tractors, trucks, docks, jeeps, etc. Pays for itself.
 Cost Gov't. over \$75.
 Sale Price. \$24.95

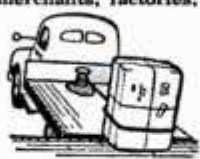

4-STAR SPECIALS

* GUY CABLE AND TURNBUCKLE. 12-ft. flexible steel cable with 14" turnbuckle. 100 uses around farm. Fix sagging gates, barns, guy television antennas. Gov't. cost \$1.10. SALE, 15 for \$4.39

* HYDRAULIC CYLINDERS. 2 1/2" bore, 17" stroke. Excellent for loaders, graders, etc. Gov't. cost \$87.50. SALE, \$11.60

* WELDER. 220-volt, 60-cycle. Genuine Almand. World's finest welder. 0 to 250 amperes. Cable, holder, mask, rods, etc. \$149.50

* CENTRIFUGAL PUMP. Stainless steel shaft. 3/4" outlet. 1 1/2" inlet. Drain cellars, clean cisterns, circulate oil, etc. SALE, \$6.50

* ELECTRONIC EXPERIMENTAL JOB LOT. Tubes, photo cells, thyratrons, resistors, capacitors, relays, switches. Guar. value \$4.99

* BARGAINS IN ELECTRICAL APPLIANCES, MOTORS, HOME WORKSHOP TOOLS, ETC. Write for catalog.

- MANY OTHER BARGAINS SALE**
- A. Utility Clutch, up to 6.5 h.p. \$13.95
 - B. Magneto Rural Telephones 12.40
 - C. Burglar Alarm System 6.99
 - D. Fire Alarm System 9.90
 - E. 2000-watt 110-volt Elements .99
 - F. City Wall or Desk Phones 4.99
 - G. Rotary Gear Pumps 3.95
 - H. Briggs 1.5 h.p. Engine 49.60
 - I. Multi-Speed 110-V. 60-C Motor 8.75

CLOSE OUT on all radio-electronic components: Condensers, resistors, coils, tubes, photo cells, relays, etc. Free Catalog. **INVENTORY CLOSE-OUT SALE!** Finest electrical appliance bargains! Grills, toasters, waffle irons, coffee makers, stoves, irons, etc. Overnight shipment! Send for catalog! Also dozens electronic, hydraulic, mechanical bargains. Order direct from this ad or send card for Free Catalog. **WE PAY ALL FREIGHT AND MAIL CHARGES**

BURDEN SALES COMPANY
 803 "O" ST. LINCOLN, NEBR.

Free Booklet on FLEX-O-SHAFT

illustrating this all-purpose power machine with hand-piece that handles as easily as a pen. Motor with switch, foot-operated rheostat, and 66 accessories at special low price. Write

F. W. STEWART MFG. CORP.
 Dept. A 4311 Ravenswood Ave. Chicago 13, Ill.

BARGAIN OFFER!

ADJUSTABLE ALUMINUM Utili-tray FOR NUTS AND BOLTS

Stop scrambling around for your tools, cutlery, odds and ends. Heavy-gauge, non-rusting, aluminum, four-compartment, adjustable, slide-tray gives you a place for everything!

ALSO IDEAL FOR KITCHEN knives and forks, etc. . . . Makes a good cash drawer . . . End lips fit over side of drawer . . . Lasts a lifetime . . . Will not warp or bend . . . Makes your work easier . . . Ideal Gift . . . Order several at this less-than-half price!

2" depth
 9 1/2" x 12 1/4"
 OPENS UP TO 25"!

SUPPLY LIMITED! ORDER NOW!

OHIO RUSCO, Inc.
 3800 WOODLAND • CLEVELAND, O.

YOU GET ALL THIS FOR ONLY \$1.00 POST-PAID

\$2.39 Value

READY CUT HOMES

Order Now

Homes \$1885.00 and up, freight paid. Orders filled in order received. Save up to \$1000 on modern production method homes. Much more compared with builders' prices. Anyone can assemble. Complete. Plans furnished. Hardware, roof-ting, glass, nails, etc. Send 25c in coin for full color catalogue showing 57 modern low-priced homes and floor plans. Complete low cost building plans ready for filing. Sold separately if desired.

Dept. PM-150
INTERNATIONAL MILL & TIMBER CO.
 Bay City, Mich. **25c**

NEW COLOR CATALOG FOR ONLY 25c

POWER HACKSAW \$47.25

LESS MOTOR
 F. O. B. Benton Harbor

Rugged cast iron construction. Wt. 56 lbs. bronze bearings. Draw cut. Auto. return lift. Auto. shut-off. Vise swivels 45°. Cap. 4" x 4".

Send for full details and name of nearest dealer.

Dept. PM-10
EXCEL MACHINE TOOLS BENTON HARBOR, MICHIGAN

WAR SURPLUS BARGAINS

Substantial Savings on WAR SURPLUS and other MERCHANDISE **OVER 200 TIMELY ITEMS**

FREE CIRCULAR FOR **SIoux FALLS SURPLUS STORE** SIoux FALLS S.D.

\$200 SEXTANT \$7.95

Air Force Surplus—and used. We sell them just like we got them—no operating guarantee—no warranty of any kind. But they are loaded with hundreds of valuable precision parts, optical systems, prisms—good for dozens of other uses. Carrying case included. F.O.B. Houston. Cash with order. Fairchild Model A10A only \$7.95. Model A10 only \$5.95. **AERO PARTS SUP., Dept. PM1, Municipal Airport, Houston 17, Texas**

25 POWER-PRECISION Microscope \$2.79

using 4 precision lenses. **COMPOUND OPTICAL SYSTEM**

A Professional Instrument. Pocket Size. Postpaid

Ideal for:
 • Machinists • Hobbyists • Photographers
 • Engineers • Students • Naturalists

Money-back GUARANTEE—Same Day Shipment

MICROSCOPE & LENS CO. Dept. PM-7, 170 Nassau St., New York 7, N. Y.

Sensationally New HI SPEED COPE-SAW DRILL-BIT

SAWS, CUTS, REAMS—Light metal, wood, plastic, etc. Amazing high speed combination bit and saw fits any electric drill or drill press; takes place of up to 50 in tools. Drills own starting hole to cut, saw, and ream an opening in the center of material. Easy to operate. Ideal for mechanics, electricians, plumbers, hobby workers, many others. **SEND CASH, CHECK OR M.O. ONLY \$3.95**

INTERNATIONAL TWIST DRILL CORP.
 624 WYANDOTTE KANSAS CITY, MO.

Now YOU CAN DRILL SQUARE HOLES

The Budget Square Hole Drill is a simple, economical, nationally used precision tool that will save hours on every woodworking job. Available in 3/8" to 1 1/2" sizes. For use on hand, portable power or drill press operation.



DEALERS WANTED

3/8" and 1/2" sizes only
(Will fit 1/4" drill chuck)

Prices for larger sizes on request.

\$3.50

IDEAL FOR MORTISING

Money Back Guarantee

ORDER DIRECT TODAY. Postpaid when remittance received with order. C.O.D.'s plus charges.

BUDGET MACHINERY & TOOL COMPANY
406 W. Pico Blvd. • Los Angeles 15, Calif.

MARCOT KEY MACHINE

Immediate Delivery



MARCOT No. 8 KEY MACHINE, mounted on Cabinet, less motor. \$ 95.00
Auto Code Book and Depth Keys. 12.50
100 Dz. Popular Key Blanks. 60.00
Set - Key File, Follow-Through Rods, Lock Picks, Bit Key Gauge, Thimble, Plus, Springs. 10.50
"Locksmith Trade Books". 6.75
How to Open Locks without Keys or Picks; Secret of Locksmithing; How to Make Keys by the Impression Method; Master Key Systems.
TOTAL COST \$184.75

A. J. MARCOTTE CO., 1200 N. Kedzie Ave., Dept. PM, Chicago 51, Ill.

Say You Saw It in Popular Mechanics

GEARED TOOLS FOR THIS ATOMIC AGE

.. Are Saving USERS \$s - Energy Making BIG MONEY for AGENTS ..

.. Eifel-Line Super-Tools with the Amazing 4X, EXPANDO-Jaw



The NEW '4X' Jaw
Above Composite Cut shows 2 Positions.
The Exclusive Parallel EXPANSION-Grip has countless new uses.



- A 3-Jaw, 7" Plierenck KIT and
- 8 1/2" PRIME and MASTER KITS with 3 to 8 Jaws, etc.: Universal, Pipe, Wire; for a Million Sizes 0" to 1 3/4", and
- GIANT UNIV. '4X' and PIPE Jaws (Range 1" to 3"):
- Tub'g Ctr., Grip-Clamp, etc. ... 1-Oz. to 1-TON grips!
- Do Thousands of Jobs, Quicker, Better and Easier.
- 8 1/2" Items FIT EIFEL-GEARED Plierencks ... '33 and later. Sold SINGLY or in ANY Combination.



GET the Most Amazing Gripping-tool Facts Ever

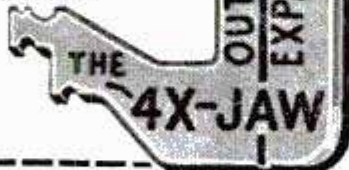

MAIL this COUPON TODAY .. (ON A POSTCARD WILL DO) ..

Print your Address .. Get FREE
1) The 125-Picture MANUAL - M.
2) The 120-Picture CATALOG - C.
.. With OFFER as marked ..
PART-TIME AGENT USER
FULL-TIME DISTRIBUTOR

AMERICAN PLIERENCK CORP'N
4611 N. RAVENSWOOD AVE.,
CHICAGO 40, ILL., DEPT. PM-01



3) Also FREE (in U.S.A.) this 3", 6-Edge, End-and-Angle Screwdriver, etc. ... often more Valuable, Useful than a Pocketknife!



WOODWORKERS CRAFTSMEN ...

here is the GREATEST MASTER MANUAL

I have ever offered

plus

Free

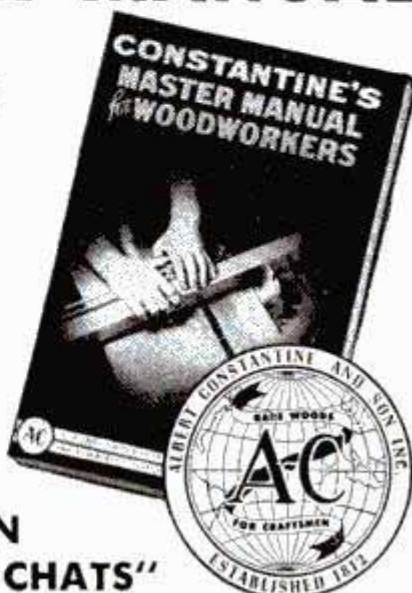

ONE YEAR'S SUBSCRIPTION TO "CHIPS & CHATS"

This is a combination thousands of craftsmen say is hard to beat! My newest, biggest and best Master Manual is chock full of informative, how-to-do-it articles. New sections on power tools, upholstery, picture frame mouldings, etc. Plus ...

GREATEST SOURCE OF SUPPLY FOR HARD-TO-GET MATERIALS

Rare and Fancy Veneers	Plastics and Supplies
Lumber and Plywood	Period Furniture Hardware
Inlays and Borders	Casters and Gliders
Inlay Pictures	Hinges and Locks
Finishing Materials	Musical Movements
Tools, Hand and Power	Bed Hardware
Veneer Press	Moulded Wood Carvings
Instruction Articles	Jewelry Findings

PLUS THESE EXCLUSIVE FEATURES

My Master Manual gives you a Natural Color, Rare Wood Identification Chart featuring 60 different woods (suitable for framing), 8 pages in full color of Inlays and Borders, 7 pages on how to make Inlay Pictures, complete story of Rare Woods, and other interesting and helpful articles. Send for it and I will include "CHIPS & CHATS," an interesting and newsy periodical publication of craftsmen's projects and activities. Also features current bargains in tools, woods, veneers, materials and supplies. This comes free for one year to everyone who sends for my new Master Manual.

ALBERT CONSTANTINE & SON, NEW YORK 54, N. Y.

SEND THIS COUPON TODAY

Albert Constantine and Son, Inc.
791-F East 135th St., New York 54, New York
Enclosed is 25c for a copy of your "MASTER MANUAL" with which I get FREE one Year's subscription to "Chips and Chats."

NAME _____
ADDRESS _____
CITY _____ ZONE _____ STATE _____



**Pearne and Lacy
BUMPER TYPE
HYDRAULIC JACK**

**Ideal For
CARS, TRUCKS, TRACTORS**
Here is the safe, easy, positive method of raising your car, truck or tractor for repairs. Dependable hydraulic action permits 20 inch lift of up to 2500 lbs. with amazing ease. A fingertip release valve gives perfect control when lowering. Sturdy aluminum and steel construction. Weighs only nine pounds. Permanently attached handle. Snap on base. Developed by the leading manufacturer of aircraft jacks.

**\$15.00
VALUE
only
\$9.95
postpaid.**

ORDER TODAY

Pearne and Lacy Machine Co., Inc.
12500 East 23rd Street, Los Angeles 54, Calif.

Ship me _____ Pearne and Lacy Hydraulic Jacks.
(Cash orders postpaid — 25% deposit required on C.O.D. orders.)
Vehicle Make _____ Year _____
Name _____
Address _____ City _____ State _____
DEALERS WANTED: Write for full information.

23 PIECE SOCKET SET

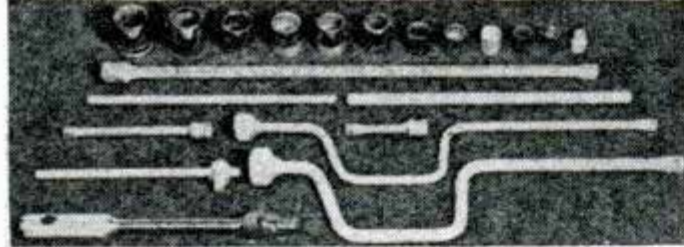

\$20 VALUE PRICE \$9.50

Set consists of 23 pieces. 1/2" and 3/8" drive. All sockets are 12 point & plated, standard makes 1/4" to 1 1/8". Shipping weight 10 pounds. This is what you get.

- | | | |
|-----------------|------------------|---------------------|
| 1—1/4" Socket | 1—13/16" Socket | 1—4" Extension |
| 1—5/16" Socket | 1—7/8" Socket | 1—18" Extension |
| 1—3/8" Socket | 1—15/16" Socket | 1—T-Handle |
| 1—1/2" Socket | 1—1" Socket | 1—1/2" Flex Handle |
| 1—9/16" Socket | 1—1-1/16" Socket | 1—3/8" Speed Handle |
| 1—3/8" Socket | 1—1 1/8" Socket | 1—1/2" Speed Handle |
| 1—11/16" Socket | 2—Bar Handles | |
| 1—3/4" Socket | 1—2" Extension | |



**BLACK & DECKER
HOME UTILITY
1/4 INCH PORTABLE
ELECTRIC DRILL**
7 7/8" LONG
WEIGHS 3 1/4 lbs.

PRICE \$18.95
POSTAGE PAID

Send for **FREE** catalog on home utility power hand tools, products of Black & Decker, electric drills, portable electric saws, etc. The best medium priced electric tools for less. Also many surplus bargains. We pay all postage on power hand tools.

All orders filled promptly, pay by check or money order, electric drills are postpaid—Socket sets F.O.B., Fresno. 25% deposit on C.O.D.'s.

ARMY SURPLUS SALES OF FRESNO
(The Fresno Hardware Co.)

1820 TULARE STREET Dept. 31 FRESNO, CALIF.



DUST-O-VAC FOR ALL MACHINES
For Home Workshops & Industry. **DUST-O-VAC** collects & bags wood & plastic chips, wood & metal dust, wood shavings. *Free Bag.* Attaches to circular saw, planer, band saw, grinder, belt or disc sander, shaper, drill press with shaper or sander attachment, spindle shaper, wood lathe, jig saw, 110 A.C., D.C. Send for mounting instr. for all machines.

\$19.95
Free Ship. east of Miss. West of Miss. add \$1. Check, M.O.

HEAVY CAST ALUMINUM BLOWER — ONLY \$9.75
110V, AC 50-60 cycles, cont. duty motor, deliver app. 100 C.F.M. For workshop, lab, kitchen, cellar, etc. Install yourself. Send for circular.
UNIVERSAL YONKERS CORP., 137 Alexander St., (M1), Yonkers 2, N. Y.

HOME HUMIDIFIER

You can enjoy the healthful benefits of automatic home humidification by equipping your warm air furnace with this self-cleaning, self-flushing humidifier. There is nothing to rust or corrode; copper tank and pans, brass float valve. Very easily installed and requires only one hole in furnace bonnet. Comes complete with saddle, needle valve, tubing, plate rack, and five (5) evaporating plates which provide 316 sq. in. evaporating area. Instruction booklet and bonnet template with each unit. Send check or M.O. now. Additional evaporating plates \$1.70 each.



POST PAID \$16.00

CHARDON CO., 92 Shepherd St., Rockville Centre, N.Y.

New Quick-Acting Lathe Chuck

Cuts down chucking time. The Westcott 3 Jaw Universal Chuck combines the fast operating features of a lever operated chuck with the powerful grip of a pinion chuck. Fits 1 1/2" - 8 thread lathe spindles, 5" dia. Guaranteed to center within .003". You'll say it's best attachment you ever bought or money refunded. Price \$25.75 postpaid. Send for it today.

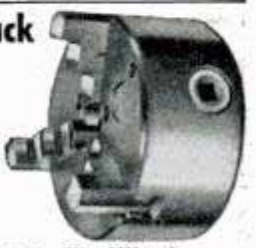

All Types of Chucks Carried in Stock
BALKO, 2303 Devon Ave., Chicago 45, Illinois

**Make Money
SELLING
Eshelman
Kulti-Mowers
and DOING
GARDEN
WORK**



ESHELMAN
FOR BETTER
LAWNS
and GARDENS
also POWER MOWERS
and RIDING TRACTORS
Women can operate it.
Write to Dept. 47
Eshelman Co.
119 Light St., Balto. 2, Md.

New BELT SANDER ONLY \$10.95

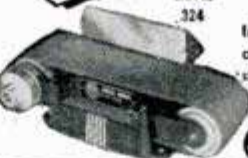

Stationary and Portable

Ideal all-purpose sander for home or shop! Stop-Fence Unit adjusts to 4 positions — tilts to 45°. Sturdy aluminum construction. May be powered by electric motor, drill, lathe, etc.

Send for free circular NOW!
JOHNSON Mfg. Co., Dept. 1B, Lincoln Park 7, R. L.

New 1950 Plastics Supplies Catalog

Just off press. Get details on Plexiglas, Lucite, rods, sheets, tubes, Acetates, cements, dyes, buffs, molding sets, tools, carving kits, everything in plastics. Lowest prices. Price 10c, stamps or coin, with ad for catalog.

Plastics Mfg. & Supply Corp., Dept. PM-1, 4707 Euclid Ave., Cleveland, Ohio

An Outstanding METAL HAND PUNCH
with unusual performance

Needed by every Mechanic in every Shop

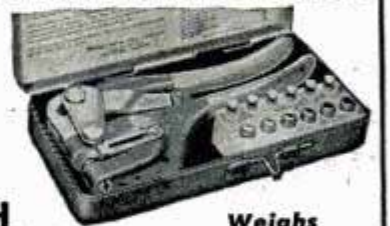

No. 5 Jr. HAND PUNCH
CAPACITY—1/4" THRU 16 Ga. Mild Steel. 3/32" — 1/8" — 5/32" — 3/16" — 7/32" — 1/4" — 9/32"

THROAT DEPTH 2 inches
Weights 2 3/4 lbs.

Punches and Dies Furnished.
ORDER YOURS TODAY!
Write for **FREE** Catalog on other tools.

WHITNEY METAL TOOL CO., Dept. P-1, Rockford, Ill.

DUMORE HOBBY-FLEX

For the hobbyist who wants the best

Flexible-Shaft Tool

Here's the 1/20 HP flexible-shaft tool built to do your shop work. It's not a cut-down or slowed-down industrial model, but a precision-built Dumore Hobby Tool which means more for your money.

EASY TO USE

The Hobby-Flex is ideal for scores of hobby projects — model making to plastic carving — ideal, too, for household odd-jobs. Pen-sized handpiece takes all 1/8" and 3/32" mounted accessories . . . reaches places a hand-grinder can't go . . . lets you see where you're working . . . gives you extra-close, accurate control on fine work. Motor hangs out of way, leaving hands free.

"HOBBY-FLEX INDISPENSABLE"

Hobby-Flex enables you to do all these jobs quickly and easily on wood, glass, metal or plastic . . .

Sanding	Grinding	Drilling	Polishing
Engraving	Sawing	Buffing	Burnishing
Sharpening	Burring	Carving	Shaping

Every shop needs a Hobby-Flex. Order today from your local dealer, or send coupon.

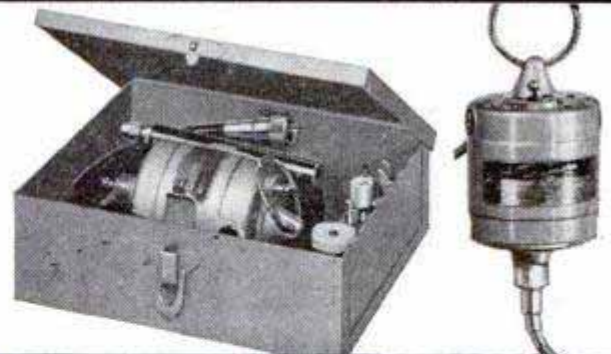

The DUMORE COMPANY

Dept. A-51, Racine, Wisconsin

- Please send me New DUMORE HOBBY CATALOG.
- Send me Hobby-Flex DeLuxe Kit with 10 accessories (as illustrated); \$24.75 enclosed.
- Send me Standard Hobby-Flex Kit; \$19.75 enclosed. (Send check or money order — we'll pay postage. Send 10% and we'll ship C.O.D. plus postage.)

NAME _____
 ADDRESS _____
 CITY _____ ZONE _____ STATE _____

SEND COUPON FOR NEW HOBBY CATALOG *Free!*

DHF-1

Sensational New Electric

① WELDER ② CUTTER!

FOR 110-115 AC or DC • WELD—BRAZE—CUT—SOLDER—HEAT TREAT
 INSTRUCTIONS INCLUDED WAS \$15—NOW ONLY \$12!!

The WELDRITE Combination—tested and proved by countless commercial and amateur users, is now offered direct to you at the amazingly low price of only \$12.00. No Gas—No Gauges—No Spark Lighter needed. Always ready for immediate use—Just plug WELDRITE into 110-115 AC or DC outlet. Uses standard welding and brazing materials. WELDRITE furnished complete with Converter Unit, #1 Single Holder for welding metal to 3/16" thickness, using up to 3/32" rod, and #2 Double Holder with Copper Coated Carbon Electrodes for Brazing, Cutting, Heat Treating, etc. Starting welding

materials and instructions included. Ideal for home workshop. Invaluable for garages, repair shops, farms, etc.

SEND NO MONEY! 10 DAY TRIAL. Order your WELDRITE Electric WELDER-BRAZER-CUTTER C.O.D. today. Pay postman \$12 plus postage charges (wt. 4 lbs.) or send \$12 and we pay postage. Either way, if not satisfied, return WELDRITE in 10 days for refund, less postage charges. **WELDER HOOD** —Approved Arc Welding lens—only \$3.95. Calif. orders add 2 1/2% tax.

BOTH only \$12

① WELDER

② BRAZER-CUTTER

CALIFORNIA TECHNICAL PRODUCTS CO.

Dept. A-1, 448 So. Hill St., Los Angeles 13, Calif.

MAKE ANY CUT WITH THESE NEW WOODSHAPERS for YOUR CIRCLE SAW or DRILL PRESS!

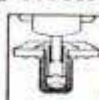

MODEL #60—Originally designed for heavy industrial use, now priced for home workshop. Can be attached directly in chuck of your drill press. Exclusive pilot bearing (see illustration) eliminates side thrust, chatter and vibration—assures smooth cutting action. Blades can't come out—set screws hold them securely. Complete with YOUR CHOICE OF ANY 6 PAIR DOUBLE-GROUND BLADES SHOWN BELOW, only \$12.95.

MODEL #50—Same as Model #60 but without exclusive pilot bearing. Designed for intermittent shaping; over 100 different shapes can be cut. Complete with ANY 6 BLADES OF YOUR CHOICE SHOWN BELOW, only \$8.95.

All Aladdin tools are guaranteed. Postage prepaid with all cash orders. C. O. D. plus postage. GET YOUR ORDER IN TODAY.

ALADDIN C. MFG. CO., INC.

3121 Main Street Kansas City, Missouri
 Dealers Write Today



MODEL SA-10—Heavy-duty, industrial-type shaper of solid steel, now priced in home workshop range. Absolutely safe — blades locked in position with screws all the way through. In ordering, state diameter of shaft. Complete WITH ANY 6 PAIR OF READY-GROUND BLADES SHOWN BELOW, only \$14.95.

ALADDIN WOODSHAPING BLADES

Specify by number the blades you want. Additional blades \$1.50 each, \$3.00 per set.

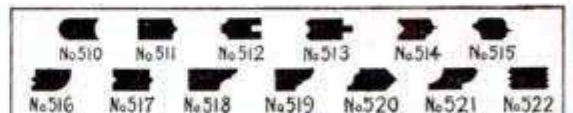

1 cylinder
 5 horsepower
\$496.00



Diesel Power for . . .

- Light Plants —
- Pumping Sets —
- Power Units —

2 cylinder
 10 horsepower
\$797.00

attractive discounts to machinery dealers

attractive discounts to machinery dealers

Crofton Industrial Diesel

CROFTON DIESEL ENGINE CO. SAN DIEGO CALIF.

"Wellworth" BLOWER at Bargain Price

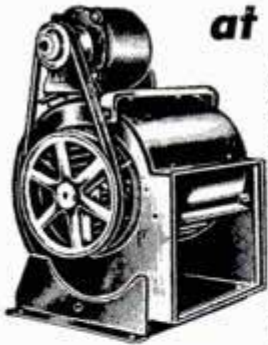

Quiet operating. Double wheel inlet, double width blower. For heating, ventilating, cooling, air washing, exhausting and forced draft.

DIMENSIONS: 10" wheel; outlet 13 1/8" x 11 3/8"; inlet 8 3/4". Height 19", Width 18", Depth 16 1/2". C.F.M. 1/4" S.P. 1600; outlet vel. 1575; motor 1/4 H.P. with overload relay; cord & plug, 110 v. 60 cy. AC. Ship. Wt. 67 lbs. Special price... **\$39.50**

140 CFM "WELLWORTH" BLOWER

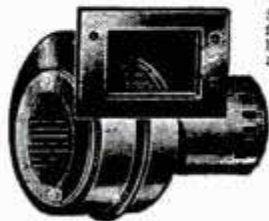

Single-inlet blower that gives top performance on heating, ventilating, exhausting, cooling, drying and similar applications. 5 1/2 x 4" mounting flange with 2 1/2" square discharge. 3 1/2" dia. blower wheel powered by direct-connected 1/15 H.P., 110V., 60C., A.C. motor with conduit box and 20" leads. 7 1/2" wide less flange by 7 1/4" H. x 6 3/4" D. Suited for hundreds of new and replacement uses. Shpg. wt. 6 lbs. **\$16.50**

50 CFM BLOWER
2 1/2" Discharge. **\$8.95**

Sold on money back guarantee. Send check or money order today. Prompt shipment.

68 PAGE BOOK!

Motor guide, air compressors, home and factory workshop tool catalog. Send 25c to cover postage and handling, deductible from first purchase.

WELLWORTH TRADING CO.

1831 S. STATE ST., Dept. D-1 CHICAGO 16, ILL.

HIGH POWER TELESCOPE

60 POWER - ALUMINUM TUBES - OPENS TO 33"

Variable Power Eyepiece Adjustable to 15X, 30X and 60X.

\$4.50 Leather Case Included

5 Sections. 4 Ground & Polished Lenses. Also used as 50X Microscope. Ready to use, only \$4.50 POSTPAID. **BROWSCOPE CO.** Dept. 1M, 24 W. 45th St. NEW YORK 19, N. Y.

WELD
BRAZE, SOLDER, CUT
quickly... easily

The FOUR-WAY
PORTABLE ARC-WELDER

COMPLETE ONLY
10 DAY TRIAL **\$9.95**

YOU'LL BE AMAZED by the work you can do on your first job! Plugs into any convenient properly wired 110 volt A.C. or D.C. line. Follow simple directions and work on iron, steel, bronze, brass, aluminum and other metals. Save money doing own repairs. Make money repairing for others.

Thousands of enthusiastic users among maintenance and repair men, farmers, tinsmiths, engineers, home and auto owners, etc. Pays for itself over and over. Order now on ten-day trial or send for details.

FREE **FOUR-WAY WELDER CO., Dept. PMF-15**
2326 So. Michigan Avenue • Chicago 16, Illinois
Full Details SEND TODAY

FOUR-WAY WELDER CO., 2326 So. Michigan Ave., Chicago 16, Dept. PMF-15. Please send as checked below.
 Four-Way Welder on 10-day trial. I enclose \$9.95, or I enclose \$_____ as a deposit. Ship C.O.D. for balance.
 Illustrated and described details on Four-Way Welder.

NAME _____
ADDRESS _____
CITY _____ STATE _____

BURR HAND SAW FILER

Makes More
PROFITS

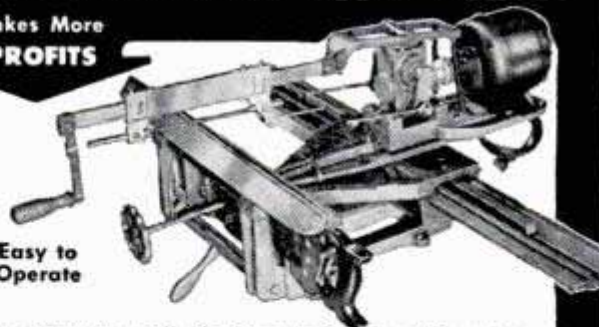

Easy to
Operate

Fast, accurate, will file from both sides. Operator controls file arm. No saw carrier or adjusting screws to fuss with. A money-maker in any shop.

BURR MFG. CO.

8933 VENICE BOULEVARD
LOS ANGELES 34, CALIF.

WRITE
TODAY!

\$4.95 REAL ENGINE VALUE

A miniature gas engine that really operates.

Thousands of Buzz "B" gasoline engines have been sold at twice the price. Now is your chance to buy a real 1/8 H.P. gas engine for only \$4.95. Turns up over 8,000 r.p.m. For Boats, planes, midget cars, etc. Guaranteed and ready to run. Includes Champion spark plug and tank. Send only \$1.00, engine shipped collect for balance, same day.

WRITE FOR FREE CATALOG OR SEND 10c FOR NEW MAMMOTH ILLUSTRATED CATALOG OF THOUSANDS OF HOBBY ITEMS. America's Hobby Center, Inc., Dept. B-10, 156 West 22nd St., N. Y. 11

CARBURETOR TOO RICH MAKES MOTORIST TOO POOR



Car owners who are wasting money and not getting proper gas mileage due to over-rich mixtures will be pleased to learn how to save gasoline by VACU-MATING over-rich mixtures. VACU-MATIC fits all cars, trucks and tractors. It is automatic and operates on the supercharge principle. Easily installed in a few minutes.

SALESMEN WANTED! Big Profits! Send name, address on penny postcard for free particulars and how to get yours for introducing.

VACU-MATIC CO., 7617-1553 W. State St., Wauwatosa, Wis.

BURIED TREASURE. MINERALS AMAZING NEW GOLDAK LOCATORS

SENSATIONAL NEW MODEL!
ONLY 11 pounds weight! One hand operation! Money-Back Guarantee of Superiority. Write for full details.

THE GOLDAK CO.
1542 WEST GLENOAKS BLVD.
GLENDALE 1, CALIFORNIA

World's
largest
maker
of fine
locators.



OPEN

CLOSED

Handy-Cutter
THE TOOL OF A
1,000 USES

Blade exposed
for safe and
rapid cutting.

Blade completely
enclosed for per-
fect pocket safety.

Used as a carton opener, household, hobby or craft knife with only corner of blade exposed, as illustrated above. Or used as safety cutting handle exposing complete edge of blade as shown at right.

The Handy-Cutter you have always wanted, small, compact, easy to carry. All-steel, handsomely nickel plated, holds any single edge razor blade. So safe and convenient you'll want several for your family and friends.

SEND FOR YOURS... NOW!
3 for \$1.00 Post Paid 35c Each

PACIFIC MFG. CO. 3135 EAST FOOTHILL BLVD.
PASADENA 8, CALIFORNIA

FINE TOOLS NEED FINE OIL!



• Lubricates



• Prevents Rust

• Cleans • Polishes

SOLD EVERYWHERE

3-IN-ONE Oil

Handi-Chest

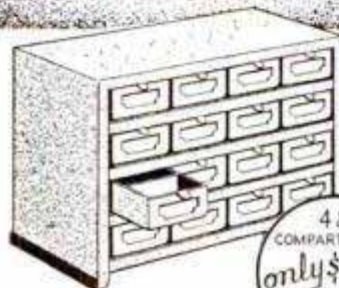

So Handy...

- Home - Office - Shop -
Stamps - Pins - Buttons - Washers
Bolts - Nuts - Nails - Screws -

Ideal Gift!

48
COMPARTMENTS
only \$4.75
CABINET SIZE
6" x 8 1/2" x 12 1/2"

WE PAY POSTAGE

SIZES	DESCRIPTION
32 Drawer 6"-12 3/4"-15 1/4"	★ BEAUTIFUL HAMMERED ENAMEL FINISH
64 Drawer 6"-24 1/2"-15 1/4"	★ REMOVABLE DIVIDERS, INDEX CARDS IN ALUMINUM DRAWERS
Drawer Size (all same) 1 1/4"-2 3/4"-5 3/4"	★ SPOT WELDED STEEL CABINET ★ RUBBER FEET WON'T MAR

PRICES

16 DRAWER-ALUMINUM 4 1/2" BINS.....	\$4.75 (CARDBOARD DRAWERS \$3.75)
32 DRAWER-ALUMINUM 3 1/2" BINS.....	\$8.75 (CARDBOARD DRAWERS \$5.75)
64 DRAWER-ALUMINUM 1 1/2" BINS.....	\$15.75 (CARDBOARD DRAWERS \$9.75)

Satisfaction Guaranteed
WEST OF THE ROCKY MOUNTAINS
AND FOREIGN COUNTRIES ADD 10%
OHIOANS ADD 3% SALES TAX
No C. O. D.'s Please
Send check or money order to:
TIBBITTS MFG. CO.
Dept. J E Alliance, Ohio

BATTERIES! - START

—a factory at home and re-cast junk batteries into new; latest achievement. We supply complete instructions and everything needed. Big Profits!

BATTERY LABORATORIES, Dept. PM, Minneapolis 4, Minn.



Say You Saw It in
POPULAR MECHANICS



NEW! PORTABLE BELT SANDER

Takes Drudgery Out of Sanding!

FOR THE PROFESSIONAL AND HOME CRAFTSMAN. This portable belt sanding attachment handles like a plane. It will do rough, medium or very light sanding with equal facility. Sanding and polishing belts are rapidly and easily changed. Interchangeable pressure plates mean that you get the EXACT PRESSURE REQUIRED. No pressure by the operator is necessary, because of built-in pressure control. Anybody can get professional results!



Complete with 3 pressure pads and 2 sanding belts at a new low price
\$19.95
Order yours now. Send check or M. O. today.

Used with Any Electric Drill or Flexible Shaft!

"BUILT LIKE A TANK"—This precision-built machine is designed for heavy duty work. It is NOT a toy or gimmick! It is built with genuine phosphor bronze and self-lubricating bronze oilite bearings, cast aluminum housing, and ground steel shafts. It will do the job of ANY self-powered belt sander. Weighs 6 lbs. and has 2-inch belt. ADDITIONAL BELTS ALWAYS AVAILABLE.
FITS ALL DRILLS. You cannot overload your drill and you will not be troubled by vibration.
EASY, SIMPLE, EFFICIENT TO USE. Sanding can be done in minutes instead of hours. Good for Wood—Plastics—Metals—Glass—Paint Removal.

GUARANTEED! MONEY BACK IN 10 DAYS IF NOT SATISFIED!

WAR SURPLUS - U.S. SIGNAL CORPS

Genuine EE 8 Portable Telephones
Telephone Wire - Equipment



Big Annual Money-Saving SALE

ONCE AGAIN! BRAND NEW
Field Telephones Available
ea. brand new phone **NOW** only **17⁵⁰**
formerly **21.50** ea.

Amazingly simple to install your own private telephone system with our portable telephones and wire. All you need do is string wire and attach phones to each end and you are ready to ring and talk. Add up to 6 phones on main line for dependable 2-way communication around HOME, FARM, SHOP, CONSTRUCTION PROJECTS, FACTORIES, etc. Powered by standard flashlight batteries. Every phone checked for perfect operation and fully guaranteed.

TELEPHONES LIKE NEW. Each phone thoroughly reconditioned like new.

Ea. phone \$12.95 SPECIAL: 2 for \$24.50

USED, recondit. Exc. Ea. \$9.95 SPECIAL: 2 for \$18.50

Reduced prices on all parts for Field Telephones.
Write for Folder.

PRICES SLASHED ON TELEPHONE WIRE FOR THIS SPECIAL SALE

Prices specially reduced to near wholesale cost.
STOCK UP NOW AND SAVE. ORDER TODAY!

W110B Weather-proof, durable, 2-conductor, stranded 7x.013, reinforced with steel strands for extra tensile strength (3 copper & 4 steel). Many extra uses.

Grade I unused, new, stored in open.

ONE-MILE REELS **SALE SPECIAL \$21.00**
formerly 27.50 MILE

1/2 MILE REELS, formerly 14.25 ea. **SALE SPECIAL \$11.00**
500 FOOT COILS, formerly 3.95..... **SALE SPECIAL \$3.00**
1,000 FOOT COILS, formerly 7.25..... **SALE SPECIAL \$5.75**

Grade II, unused, outer layer wire weathered but when removed inside layers perfect. Usability not impaired.

ONE MILE REELS **SALE SPECIAL \$17.50**
formerly 27.50 mile.

1/2 MILE REELS formerly 14.25..... **SALE SPECIAL \$9.00**

W130 Lightweight Assault wire, 2-conductor
TWO MILE REELS, unused, NEW. (10,500 ft. continuous) wt. only 85 lbs. A Real Special
formerly 57.50 reel. **SALE SPECIAL \$37.50**

BRAND NEW 1/2 MILE REELS. Wt. 16 lbs.
formerly 15.00..... **SALE SPECIAL \$12.95**
1/4 MILE REELS slightly weathered, unused..... **\$4.95**

WRITE FOR FREE FOLDER - MANY OTHER SPECIALS!

All prices FOB Sacramento. No COD. California residents add 3% for sales tax. Small orders sent postage collect plus small handling charge.

SEND CHECK OR MONEY ORDER **LORIS SALES**

P. O. BOX 1896-B

SACRAMENTO, CALIFORNIA

BARRON Drill Press TOOLS

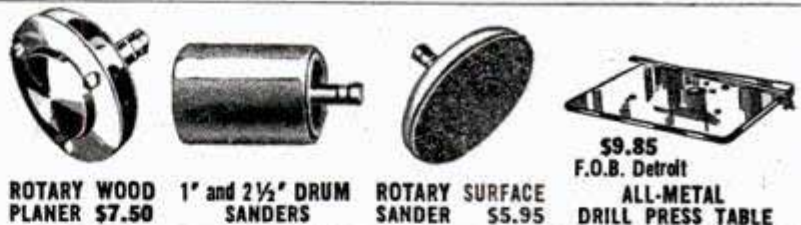

ROTARY WOOD
PLANER \$7.50

1' and 2 1/2' DRUM
SANDERS

ROTARY SURFACE
SANDER \$5.95

\$9.85
F.O.B. Detroit
ALL-METAL
DRILL PRESS TABLE

ALL-METAL
SHAPER FENCE
\$8.25
F.O.B. Detroit



ROUTER &
MORTISING
BITS
\$9.50
per set of six

SHAPER
CUTTERS
\$9.00
including
3 sets Blades



15 ESSENTIAL WORKSHOP OPERATIONS...

You can convert any standard make drill press into your most versatile, useful, low cost workshop tool. Barron Precision Tools now enable you to perform 15 indispensable shop operations—surface—plane woods and plastics—rabbet—tenon—panel—bead—groove—bevel—mortise—route—cut dovetail—sand surfaces and contours—shape—cut moldings—grind and buff. Over 200,000 Barron Tool users. Every tool sold on full 10 day money back guarantee.

See Your Dealer... Or Write Direct

BARRON TOOL COMPANY, INC.
869 Architects Bldg., Detroit 1, Mich.

FREE
Workshop
Guide &
Catalog



SENSATIONAL BARRON SPEED-VISE!

PERMANENT—PORTABLE

Slickest, handiest, most useful all-metal work bench vise. A workshop "must" for—
PLANING • SAWING • DRILLING •
SANDING • FILING • ETC.

Only
\$175
Include 20c
for shipping

Won't mar, mark or dent woods, plastics, metals. No piece too small or too large. 10 Day Money Back Guarantee.
BARRON TOOL CO. • DETROIT 1, MICH.

PARTS FOR MILITARY TRUCKS

4 or 6 Wheel Drive at a SAVINGS—
1/4 ton to 20 ton.

Parts List Available on Most Makes
Military Trucks and Jeep Models
Write stating model of Truck



JEEP TOPS and CURTAINS

Supply Limited (Weatherizing Kit), complete top with back curtain and side curtains with zip-in-doors. 5 windows. Waterproof O. D. color. shipping weight 40 lbs. Never again at such low price
Wonderful value. F.O.B. K.C. **\$49.50**

TRAILER AXLE

Heavy duty trailer axle suitable for many types of trailer construction. Also excellent for building of heavy farm trailers and wagons. It is a 12,000 lb. capacity square type straight trailer axle complete with Timken roller bearings, hubs, and 6 hole 750 x 20 Budd Wheels. Without brakes. Axle is 2 inches square and 69 inches between wheel mounting flanges. Std. width. Write for quantity prices, 6 or more.

With Single Wheels. \$59.50 With Dual Wheels. \$69.50

GAS TANK Utility, 6 qts.—New Surplus. \$2.10
Cylindrical 5 1/2" x 15 1/2", complete....

Brand New **HYDRAULIC JACKS** Walker, 3 ton. Complete, limited supply, ea. **\$9.95**

WINCH CABLE, 1/2", 250 ft...... **\$30.00**

Hundreds of Other Truck & Jeep Parts and Supplies
All prices quoted good 30 days FOB, Kansas City, 25%
Deposit Required on All Orders.

American AUTO PARTS CO
1830 LOCUST — DEPT. PM
KANSAS CITY, MISSOURI.



FLEXEE LIGHT
\$5.25
PRICE INCLUDES
TUBES

Money Back
Guarantee

BUILD FLUORESCENT LAMPS!

Enjoy a most fascinating and profitable hobby assembling fluorescent fixtures. With simple diagrams plus screwdriver and pliers you assemble many types of lamps at a fraction of retail price. Get all the features of expensive lamps: prefabricated heavy steel body with brown crackled finish, wire and wirenuts, ballast, 8-ft. rubber cord and plug, push button starter!

Write for Free Folder describing other models
Flexee Light.....\$5.25 Industrial Fixture \$5.95
Desk Lamp..... 4.95 Bed Lamp.....3.95
Pin-up Lamp.....2.95 All-purpose Strip...3.50
Prices include Fluorescent Tubes
WE PAY POSTAGE—SEND CHECK OR
MONEY ORDER TO:
PURDUE ELECTRIC
SCHILLER PARK, ILLINOIS



750' 2-PLY NYLON 25 lb. T
150' 3-PLY NYLON 85 lb. T
250' 3-PLY NYLON 45 lb. T
300' SINK LINE 30 lb. T
500' 3-PLY Nylon 35 lb. T
500' Linen Line 24 lb. T

BRAIDED NYLON LINE

200' 15 or 20 lb. Test
175' 35 lb. Test
150' 50 lb. Test
125' 75 lb. Test
100' 100 lb. Test
50' 200 lb. Test

110 ft. Nylon Drop Line, 100 lb. Test—50c
Pachner & Koller Liteweight Fly Reel \$1.00
All lines available in longer lengths. Send
Check, Money Order. We pay Postage.

MAC-MILLS, Dept. K-1, Pleasant Valley, New York, N. Y.

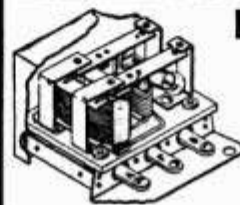

END GENERATOR REGULATOR TROUBLE

REPLACE VOLTAGE REGULATOR
WITH AMAZING NEW WATTAGE REGULATOR
GREATEST ADVANCEMENT IN AUTO
IGNITION SINCE THE SELF-STARTER
DRIVE WITH OR WITHOUT BATTERY
100,000 Mile Money Back Guarantee
For All Popular Cars — \$8.00
State Make and Model of Car

SCIENTIFIC ELECTRIC CO., P.O. Box 2162P1, Sta. H, Cleveland 8, Ohio



DRAINS CELLARS, WASH TRAYS CIRCULATES OIL

Pumps 1800 GPH 300 gal.
30' high, use 1/8 to 1/2 HP **\$6.50**
motor. Will not clog.

Postpaid if cash with order.
(Add 50c for west of the Mississippi.)
Thousands in use since 1936

LABAWCO PUMPS, BELLE MEAD 7, N. J.

BRASS NAME PLATES

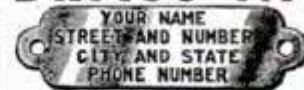

OR KEY TAGS
40c each—3 for \$1.00

Half actual size
QUANTITY PRICE — SAME STAMPING
8 for \$2. - 15 for \$3. - 25 for \$4. - 50 for \$6.

LARGER QUANTITIES ON REQUEST
TAGCO, P. O. Box 203X, Pleasant Valley, N.Y. STAMPING
EQUIPMENT



GERSTNER Tool Chests

Gerstner Tool Chests for savings on good tools—
for safety, too. Free catalog for Machinists and
Toolmakers.

GERSTNER TOOL CHESTS
450 Columbia St. Dayton 7, Ohio

SAY YOU SAW IT IN POPULAR MECHANICS

SURPRISE VALUE
100 Pieces \$1.00
 Grinding Wheels, Cut-off Wheels, Sanding Discs, Mounted Stones, Sharpening and Honing Stones, Rotary Cutting Burs, Abrasive Cartridges, and many other items. Rush check or M. O.

18 ROTARY CUTTERS \$5.85
 \$13.50 Value
 Assorted sizes cutter on 1/8" or 3/32" shank. Will fit all hand grinders. Ideal for cutting wood, metal, or plastic. Brand new.

2 CIRCULAR SAWS \$1.50
 ON 2 MANDRELS — BOTH AT ONE RECORD BREAKING PRICE!
 1" diameter saws on 1/2" Mandrels. For cutting wood, plastic, or soft metals. Order at once! Send Check or Money Order for this big bargain.
4 in. CIRCULAR SAWS, 1/2" arbor holes... 2 for \$1.50
 SCHUPACK SUPPLY CO., 7331 Cottage Grove, Dept. M-1, Chicago 19, Ill.
ILLUSTRATED BARGAIN CATALOG FREE

GARDEN TRACTOR
 2-3-41
 51 H.P. and NEW
 45 H.P. Riding Model Guaranteed
 • 30 ATTACHMENTS • NO BELTS
 • NO CHAINS • POWER TURNING
 • GEAR DRIVEN
 Plow deep furrows. Change attachments in seconds. FREE Instruction Booklet.
 Buy Direct • Special Discount
 Send Passport for Big Free 32-page Catalog
RED-E TRACTOR CO., Richfield, Wisconsin
 50 FOND DU LAC RD., RICHFIELD, WISCONSIN

BUILD 3 Rm. HOUSE FOR \$500
 Long lasting, good looking, insulating. Garages and barns built for as low as \$50.00 with our methods. 100 illustrations and 100 ways to save money and labor. Get this book before you start to build. Guaranteed, \$1.00.
SHEET METAL COTTAGES and other buildings. Several new methods. Illustrated instructions, 50c.
FURNITURE OF COMPOSITION. Cement, sawdust, asbestos, etc., scrap wood, metal, etc. Illus. 50c.
SHOP MACHINES FROM OLD AUTO PARTS: Over 60 described. 50c.
HOME MFG. ENTERPRISE. 50 home shop projects. Illus. 50c.
 Special: All five booklets described above, \$2.00 postpaid.
HOME INDUSTRIES, 1116 So. 27th St., Dept. P1, Omaha 5, Nebr.

WHEELS — WHEELS
 5" Disc Wheel 5/8" Tire 5/16" or 3/8" Sleeve..... 30c ea.
 6" Disc Wheel 5/8" Tire 5/16" or 3/8" sleeve..... 35c ea.
 7" Disc Wheel 3/4" Tire 3/8" sleeve..... 45c ea.
 8" Disc Wheel 1 1/4" Tire 1/2" sleeve..... 70c ea.
 7" Disc Wheel 1" Tire 1/2" ball bearing..... 80c ea.
 8" Disc Wheel 1 1/8" Tire 1/2" ball bearing..... \$1.00 ea.
 8" Disc Wheel 2" semi-pneum. T. 1/2" B.B..... \$1.35 ea.
 10" Disc Wheel 1.75 semi-pneum. T. 1/2" B.B..... \$1.50 ea.
 Above wheel prices include hub cap.
 10" Aluminum Wheel 2 3/4" semi-pneum. T. 1/2" B.B..... 4.50 ea.
 Plus Postage, 20% — C.O.D.'s accepted.
UNITED WHEEL STAMPING CO., PM-1
 2756 W. 115th STREET CHICAGO 43, ILLINOIS

FREE parts catalog
 Build Better Trailers with Safety-Engineered
 ★ Torq-less Axles
 ★ Bull Dog Hitches
 ★ Parking Jacks
 ... Send for your copy TODAY!
HAMMER BLOW TOOL CO.
 Dept. 136, Wausau, Wisconsin

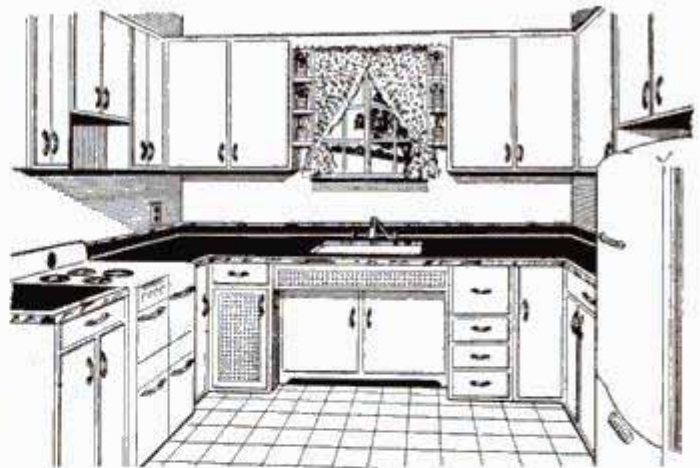

MODERNIZE YOUR OWN KITCHEN EASILY—INEXPENSIVELY
 with EASI-BILD* "Build It Yourself" cabinets

The Easi-Bild Pattern Method takes the mystery out of making modern, professional looking base and wall cabinets. Tells what materials to buy...when and where to use each...specifies the right Casco Glue.
 Includes complete assembly illustrations and step-by-step directions. FULL SIZE CABINET CONSTRUCTION PATTERNS make entire kitchen modernization an easy job!

*Copr. 1949, Easi-Bild Pattern Co.

Follow These Directions. Solve All Your Gluing Problems:

For boats, outdoor furniture, sports equipment —joints that must withstand outdoor exposure —**CASCOPHEN** (Resorcin Resin Glue). The first completely durable glue available to home-craftsmen.

For furniture, toys, heavy-duty home repairs— use **CASCAMITE** (Urea Resin Glue) where you want a light-colored or mold-proof glue line. Use **CASCO** (Casein Glue) for loose-fitting joints, general heavy-duty jobs. Both easily mixed in cold water.

SEND COUPON FOR CABINET PATTERN TO:

Casco Pattern Dept. PM-10
 P. O. Box 215, Pleasantville, N. Y.
 Enclosed is \$.....for material checked below:
 () Kitchen Wall and Base Cabinet, Pattern No. 201—\$1.00.
 () 32-page Pattern Book illustrating 94 pattern projects—20¢.

Name _____
 Address _____
 City _____ Zone _____ State _____

THE BORDEN CO. • CHEMICAL DIVISION
 Makers of Casco Glues

SAVE UP TO 85% IN NEW WAR SURPLUS

We've gone NUTS!!



Just Purchased 100,000 lbs. of the FINEST PRECISION Made ELASTIC & FIBER LOCK NUTS!! All are NEW!!



Here's your chance to "STEAL" Aircraft Quality STOP NUTS at less than the cost of common commercial hex nuts. They're ALL NEW Cad plated Steel and a large quantity are even pre-treated for easier wrenching. ELASTIC or FIBER LOCK SEAL gives a Positive . . . Shake-proof . . . Vibration & Rust Resistant fastener. No lock washer necessary . . . One operation does the job. Just run on the nut. Ideal for use in all types of metal fabrication, assembly, construction etc. . . .

AND LOOK AT THESE PRICES for ELASTIC or FIBER LOCK NUTS

	1,000	10,000	25,000	50,000	100,000	500,000
6-40	\$.25	\$.21	\$.19	\$.17	\$.15	\$.13
802	.31	.28	.25	.23	.21	.19
806						
1002						
1/4-28	.39	.36	.33	.30	.27	.25
5/16-24	.64	.61	.58	.56	.54	.49
3/8-24	.74	.71	.68	.66	.64	.59

Prices shown are per 100 in these quantities. Special discounts on larger quantities.



We also went CRAZY on these!! BEARINGS

Needle, Roller, Recessed, Rod End, Shielded, Unshielded. Made by some of the WORLD'S FINEST MANUFACTURERS OF BEARINGS!! These are the finest Precision Aircraft Bearings, YOURS at a FRACTION of commercial prices.

Description	O.D.	I.D.	Thickness	Price
SHIELDED				
K-3	.7774	.1895	.270	20¢
K-4	.9014	.2495	.335	25¢
K-5	1.250	.3120	.375	35¢
K-6	1.4375	.3745	.469	40¢
K6AR-48	1-3/32	23/64	5/16	30¢
NON-SHIELDED				
3L24BM	7-3/32	4-23/32	1 1/8	7.50
209V	3-11/32	1-3/4	17/32	1.95
NEEDLE				
B-1616P	1-1/4	8"	1"	45¢
465972	1-5/8-1-27/32	9-16	1-1/4-1-1/8	35¢
ROD END (Thread 3/8 x 24)				
RE3M6A	3/16	2"	1/2"	35¢

NOTE: We have 168 other types and sizes of New Bearings in tremendous quantities!!

Ellinwood "44" Here's a Real BUY!! This engine is rated from 4.4 to 5 HP. Has optional power take-off of 1 to 1 from crankshaft or 2 to 1 reduction from camshaft. Makes an ideal auxiliary power plant or can be used to drive pumps, generators, compressors, small boats, etc. Lightweight rugged and contains such fine component parts as Bendix-Timken-Air Moze, etc. **ONLY 69.50**



RIFLESCOPE Finest precision Acromatic optics 5 double element lenses, color corrected, spherical aberration. Dot reticle. Magnification 3 power. Length 9", tube dia. 7/8", objective lens 16", eye lens dia. 25mm. **\$8.95**

6 in 1 HAMMER It Hammers. It pins and has four graduated screw drivers 5 1/2" to 7 7/8" which telescope into handle - A real household aid. **NEW ONLY 89¢**

NEW TARPS - HEAVY CANVAS Mildew & Flame Resistant. Cheap Outside Storage. They are Really Moving at These Prices. **\$3.95** 5' x 7' 16' x 32' **\$39.95** 8 1/2' x 10' **\$8.50** 16' x 22' **\$20.95** Rubberized Linen 7' x 11' NEW **\$5.95** Only 3 lb. light weight yet waterproof ideal for outside car storage.

RUBBER Neoprene Sheet Stock Thickness Approx. Width Price per run yd. #325 .020 1/64" 36" \$1.75 #328 .032 1/32" 22" 1.38 #330 .064 1/16" 36" 2.39 #331 .093 3/32" 36" 3.39 #329 .125 1/8" 46" 4.75 Note: No. 329 is Laminated rubber sheet with cloth center. Flexible & very fine for heavy wear. No. 332 - Grey Neoprene Rubber Floor Mat. Has raised non-skid Diamond pattern with durable cloth backing. Stock size: 36" x 48" x 1/16" thick **\$1.95 ea.**

Pressure Bottle Steel - Tested to 3000 P.S.I. For spray painting, portable welding, etc. All have std. pipe port. H-3 9 1/2" x 3 1/4" dia. . . . \$1.75 H-4 19" x 3 3/4" dia. . . . \$2.75 H-5 - 22 cu. ft. cap. internal vol. 295 cu. in. Shatterproof 20" long x 5" OD \$3.75 H-1 For Diving or Inflating tires, with CO₂ - has dial gauge. 36" hose 2.29

DOUBLE CASTER 2 Needle bearinged 6" Casters joined as a unit on a 7 1/2" x 8" rubber protected steel face plate. The unit is 9" high & will completely swivel. Ball bearings in swivel, entirely enclosed. Bolts furnished. If you have to move heavy machinery or Jigs these are just the thing. **UNIT 789**

Order from this Ad. All sales final. All Prices F.O.B. Los Angeles. Pay by M.O. or Check. P.O.'s Acptd. from D & B firms. 1/2 deposit with C.O.D.'s.

PALLEY SUPPLY CO. DEPT. P.M.I. 6321 SAN FERNANDO RD GLENDALE 1, CALIF. **CATALOG** 92 PAGES-ILLUSTRATED SEND 25¢ TODAY!

Now...A Completely Portable Spray Gun

NO COMPRESSOR HOSE • MOTOR WIRES • PUMP



BECKER Self-Contained SPRAY GUN

Take it Anywhere for

- Painting
- Rust-Proofing
- Varnishing
- Starching
- Humidifying
- Moth-Proofing
- Insecticiding
- Fire-Proofing

Only **\$18.50**

Here is the first completely self-contained and fully portable spray gun . . . needs no wire or hose, no compressor or motor. Take the Becker gun anywhere to do dozens of spray jobs . . . in the house, workshop, garage or garden. Spraying pressure is provided by an inexpensive, easily replaced CO₂ cartridge. One cartridge will spray up to 21 ounces of liquid (depending on viscosity). The Becker Spray Gun comes complete with 3 cartridges. Send only \$18.50 and we ship postpaid. Or, send only \$2 now and pay postman balance plus postage. **MONEY BACK** if not delighted after 5 days' trial. (Extra CO₂ cartridges, 10 for \$1, postpaid.)

SULLIVAN-BECKER CO. • Dept. 110-A • Kenosha, Wis.

AIR TANK and ACCESSORIES

Air receiver, stainless steel, 12 1/2" x 24". 400 lb. test. Ideal for carrying on trucks, autos and wherever compressed air is needed. Equipped with 500 lb. air gauge, tire chuck, 3 ft. highest air hose, air inflation valve with core for retaining pressure in tank, and fittings. Complete outfit **\$6.95** Shipping wt. 20 lbs. Same unit but with 6" x 24" tank **\$5.95**

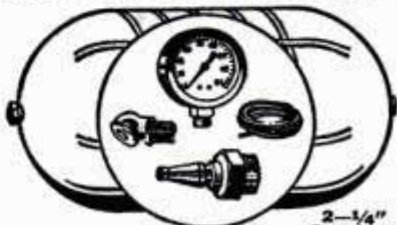

Prices F.O.B. Chicago. Sold on money back guarantee. Send check or money order today. CATALOG FREE. **WELLWORTH TRADING CO.** 1831 S. STATE STREET, DEPT. D-1 CHICAGO 16, ILL.

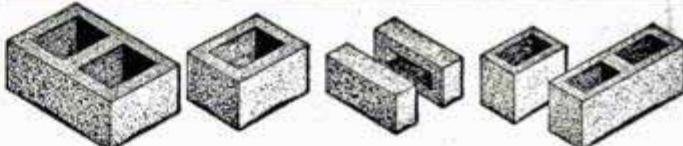

Make Concrete Blocks and Bricks

New superior method makes square, true, easy-to-lay units which will pass any building code. Small investment, high production, big profits. One \$30.00 machine will make four 5"x8"x12" blocks per minute—1000 per day. Pays for itself in a few days. Sell blocks or save 1/5 building cost by making and laying your own.

POST CARD BRINGS FREE FOLDER

Economy Manufacturing Company Dept. P Stone Mountain, Georgia

SAY YOU SAW IT IN POPULAR MECHANICS

ELECTRIC MOTOR BARGAINS!

1/2 HP. \$15.00 1750 RPM **3/4 HP. \$22.00** 1750 RPM
3/4 HP. \$26.00 3450 RPM **1-HP. \$30.00** 1750 RPM
Every Motor Fully Guaranteed
Heavy Duty, Repulsion Induction-Capacitor Types, 110-220 Volts, 60-cycle, Single-phase. Standard Makes (G.E., Wagner, Le-land, Westinghouse, etc.). Rush your order TODAY—large stock of motors in all sizes—1 & 3 phase. 32-v. direct current bargains.



Heavy Duty GRINDER

Priced FACTORY to YOU
For Factories, Garages, etc. Powered by totally enclosed 1/2-horse motor with dust-proof bearings. Built-in heavy duty on & off switch. 8 ft. cord & plug. Comes complete with adjustable shatter-proof eye shields & tool rests. Can be supplied with 1-coarse & 1-fine wheel as pictured; or 1-medium grit wheel & 1-wire scratch wheel for polishing & buffing. For **ONLY \$32.50**
ALL PRICES F.O.B.
ROBERTS ELECTRIC CO., 7232 Madison, Forest Park 4, Ill.

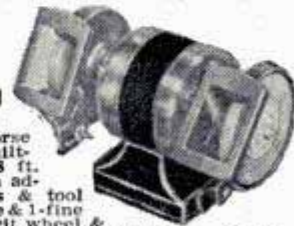

SAVE UP TO 85%

GADGETEERS! HERE ARE THOSE TERRIFIC MIX VALUES

GADGET MIX Especially prepared for the HOBBYIST. Rivets, Spacers, Bolts, Screws, Gears, Etc. A Gold Mine. #106. 5 lbs. \$1.19

BEARING MIX #170A
A PALLEY SPECIAL! Approx. 20 Needles, Ball & Roller Bearings, New & Used - Sizes: 1/2" to 4". Some of these cost Gov't. \$10 a piece. Never such a value. 5 lbs. ONLY \$1.59

HINGE MIX No. 170H. 12 pairs of strap and butt hinges. Sizes: 1" x 1" to 3" x 4" in length to 8" strap. A \$3.00 Value. 2 lbs. for ONLY . . . \$1.09

ABRASIVE AND GRINDING WHEEL MIX 50 Pieces including honing stone, pencil rolls, wheels, Abrasive sheets, etc. A sharp value. #170AG 99c

SPRING MIX #206
Tension, Compression & Tension Springs, assd. sizes. A treasure trove for emergencies. 2 lbs. for ONLY . . . 89c

COMBO-MIX Comb. of all above in one pkg. Special deal. CB-2 \$5.59

SWITCH MIX #SM-1
12 assorted types of Aircraft Switches, including double & single throws, double & single poles & multiples. Voltage ratings from 5 to 20 amps, 125 Volts A.C., 35 amps, 24 Volts D.C. 1001 Uses . . . \$2.95

FILE MIX
Ten Assorted Files of 6", 8", 10", 12" includes 3 Vixens, half rounds, bastards, mills, etc. in seconds and used but in good condition. 1 Vixen alone worth our price for entire mix. #F-1 99c

PULLEY MIX #PM-1
You'll want this one around. 10 micarta and metal pulleys ranging from 1" to 5" with ball and one piece bearings. These are aircraft pulleys, the best made, with 100's of uses. A WONDERFUL BUY . . . \$2.95

COUNTERSINK MIX #16B - Countersink Assortment. Excellent condition. High speed steel. Assortment of ten 100" and 110" with pilot sizes ranging from 3/32" to 3/16" . . . #CM-1 \$2.69

NUT MIX - 3 lbs. Approx. 500 Nuts. Anchor, Lock, Castle, Hex, Elastic Stop Nuts, etc. You'll always have plenty of nuts in the shop. NM-1 \$1.39

SCREW MIX - 5 lbs. incl. 2 1/2 lbs. wood screws & 2 1/2 lbs. machine screws. All sizes. Save dollars and always have plenty of screws on hand . . . \$1.39

REAMER MIX
168 - Reamer Assortment: Special Taper line finish Reamers - High Speed Steel. Slightly used but in excellent condition. Ten assorted sizes ranging from .168 x .165 and .244 x .215 to .425 x .305 and .432 x .403. One alone worth our selling price of ten. For set of ten Reamers. . . . \$4.49

PIANO HINGE
Overall Width Length Price Ea.
1 1/2" (5/8" side) 72" alu. \$1.00
1 1/2" (3/4" side) 53" cad. steel \$0.75

15" WRENCH
Adjustable 4" Jaw opening Drop forged Auto type. Cod. Plated .89c Black 79c

PALLEY SUPPLY COMPANY
6321 SAN FERNANDO RD.
DEPT. P.M.1 GLENDALE 1, CALIF

IN WAR SURPLUS

HEAVY DUTY WINCH

GENUINE U.S. SURPLUS 7 1/2 TON - GAR WOOD
Here's brute power for all lifting operations in shops, garages, foundries, factories - tow-trucks, etc. The Army used these on their "Cletracs". (M-5) Worm gear drive, power driven from 1 1/2" take-off. Cable drum is 15" wide-16" dia, with 6" core. Holds approx. 200 ft. 5/8" cable. Has disengaging clutch & mounting brackets. This winch cost the Gov't many times our price of ONLY \$139.95

No. 100 WINCH HOIST
Thousands of Satisfied Users! Capacity 2500 lbs. with 24 to 1 ratio. Controlled Bronze Worm Gear. Has 19 ft. of 1/2" alloy steel cable with hook and two-speed handle. Ideal for Bays, Factories, Shops, Garages, Tow Trucks, etc. \$21.99

Sperry Aircraft Directional GYRO COMPASS
Precision made for Positive Direction. 360° swing calibrated in 1/10° (6 min). Built in bank indicator, lum. dial. 4 1/2" sq. with 3" dia. face. Vacuum operated. Ideal for autos, planes, boats. Can be used in autos on boats by attaching one tube to intake manifold. Complete with reset and caging knob. . . . ONLY \$449

BATTLE LANTERN - A powerful lamp complete with 2 standard 1 1/2 volt dry cell batteries. \$3.29

AIRCRAFT CABLE
Alloyed steel, rust resistant. 3/16" ea. 18 ft. long, with turnbuckle ends. 99c ea.

OXFORD BRG & TOOL SCRAPERS
Complete set of 4 Tools packed in Grained Wood Case.
Contains 1 ea. 8", 10", 12", 14" half
Three square Scraper. 1-12" Double end Scraper. Made of Finest Tool Steel, SET Forged, Tempered, and Hollow Ground. An Unheard of Price! \$2.49

NEW PRESSURE TANKS
Stainless Steel - Shatterproof and Rustless. Ideal for painting, cooking, spraying, ocean buoy, underwater fishing, or diving.
G-1-12 1/2 x 24 inches - 2100 Cu. In. capacity 29 Cu. Ft. \$4.75
F-1-10 x 18 inches - 1000 Cu. In. capacity 14 Cu. Ft. 4.19
F-2-6 x 45 inches. 1000 Cu. In. capacity 14 Cu. Ft. 3.95
D-2-6 1/2 x 24 in. - 500 Cu. In. Capacity 7 Cu. Ft. Stainless Steel Con. struction. 3.49
D-2- Corrosion resistant steel. - 2.49
A-4-5 1/2 x 15 inches - 280 Cu. In. capacity. 2.25
A-4-5 x 8 inches - 104 Cu. in. capacity. 1.35
No. OR-1 - Oxygen Regulator with 500 lb. gauge will fit all tanks. \$1.39

FIRE EXTINGUISHER
Kiddie Lux CP-2 Type. Built to Gov't Spec. Shatter-proof, heavy case. Fully re-charged, with Horn.
4 lb. 18" x 5" - Wheel Control with horn... 4-TB Type. A \$25.00 Value. #601-B \$14.75
7 1/2 lb. - \$35 Value. #602A 19.25
10 lb. - A \$65.00 Value - # 603 \$25.75
15 lb. - New, Break Disc Type. - A \$75.00 Value. #605-A 29.75
15 lb. Wheel Control Type. #605-B 32.95
15 lb. New, Squeeze Grip Type. - \$85.00 Value. - #605-C \$39.95

from "GADGETEERS" HEAVEN

TWO HEAT SOLDERING IRON

World's Hottest Iron Value!
Two soldering irons in one with button heat control. Push the button. Select 150 or 300 WATT heat for light or heavy work. Complete with tip, bench holder, 5' asbestos cord, U.L. approved, 110V AC. A \$15.00 Value For \$3.95

ELECTRIC SOLDERING IRON 169

16mm MOVIE GUN CAMERA. Has semi-telephoto 1 3/8" (35 mm) lens with yellow filter - 3 shutter speeds for normal (16 frames) semi-slow motion (32 frames) and slow motion (64 frames per second). Uses any standard Eastman film. magazine or Type 'G' AAF magazine. Takes Black & White or Full color pictures. Operates on 24V (dry cell batteries) & require slight conversion for hand use. Diagram furnished. . . . \$2450
Same as above - already converted. \$2995

FILM - Standard, type 'G' magazine - Fits gun camera and many other standard 16mm cameras - Loaded with 50 ft. black and white film - Price includes processing. \$2.25 ea

D.C. GENERATORS
Suitable for adaption to hand welding units, portable and rural lighting, power plant on boats, etc

TYPE	AMPS	VOLTS	PRICE
P1	200	27 1/2	\$17.95
R1	300	30	\$29.75
E5A	50	12	\$14.95

VOLTAGE REGULATOR for use with 24 to 32 volt DC generator. Complete with mounting base . . . \$6.75

D.C. METERS
AMMETERS VOLTMETERS

-30 - 0 - 30	+	0 - 120	0-30 \$3.95
-60 - 0 - 60	+	0 - 240	
-120 - 0 - 120	+	0 - 300	

Your choice 3.95 ea.
COMBINATION VOLTMEETER - AMMETER
30V - 30 AMP \$4.95
30V - 60 AMP
All meters 2" face except D-300 which is 3" face.
SHUNTS - Required for use with D.C. Ammeters 30-60-120-240-300
SOLD ONLY WITH METERS. \$1.00--

NEW ELECTRIC MOTORS
#500 new 1/2 HP - 27 Volt DC 24 Volt AC. This motor can be readily adapted to deliver up to 1/2 HP on 110 Volts AC by the simple method of rearranging armature brush-leads. Free diagram with each order. A Sensational Value \$5.95
#500A - Converted to 110 Volts-AC. Equipped with plug and 3/8" ft. Heavy Duty Cord \$8.49 ea.
#502 - 2 HP - 24 VDC used \$8.95

OXYGEN & ACETYLENE REGULATORS
OXYGEN REGULATOR - Bottle Press. Gauge - 0-3000 PSI. Regulating Press. Gauge - 0-400 PSI
ACETYLENE REGULATOR - Bottle Press. Gauge - 0-500 PSI. Regulating Pressure Gauge - 0-50 PSI.
AIRC & Other Popular Makes to fit All Standard Bottles - ALL NEW!! \$12.95
A Real Buy at \$25.00

PNEUMATIC AND AIR TOOLS
10,000 in various popular makes, sizes, types, Cleco, Aero, Ingersol Rand, Chicago, Pneumatic, Buckeye, etc.

#180 RIVET GUNS
Pistol & Gooseneck Type #180 \$50
SPECIAL VALUE \$8.95 Pistol
AIRC PISTOL
Air Drill or Air Motor with 1 1/4" Jacobs chuck. \$17.95

92 PG. 1949 CATALOG

War Surplus - Tools, Machinery, Raw Materials, Clothing, etc. Illustrated with valuable info., tables, charts & data. Send 25c to cover handling & postage.

NEW HYDRAULIC CYLINDER SPECIAL

Give 20,000 lb. thrust (push pull) using 1500 PSI line pressure as obtained from our hyd. pumps. Or will produce 40,000 lb. thrust with 3,000 lb. line pressure. CAN ALSO BE OPERATED ON LOW PRESSURE AIR SYSTEMS. 4" Bore, 1 1/2" dia. piston shaft, 18" stroke, length 30 1/2". Equipped with ball bearing loaded clevis type mounting and swivel type high pressure steel pipe bracket for easy use. Ideal for road, farm & shop machinery, presses, etc. Cost Gov't \$39.00 \$22.50

We carry the World's Largest Supply of New Hydraulic Equipment featuring over 20,000 Cylinders in 61 Sizes & Types. Can also supply all accessories such as Pumps, Fittings, Valves, Tanks, Hose Fittings. Let us solve your hydraulic problems. Write for information.

BENDIX HYDRAULIC HAND PUMP

Provides an instantaneous source of tremendous power for almost any heavy work. Double action stroke. Delivers 3.0 cu. in. per cycle at 3000 PSI. Max. press. 5000 PSI. Built-in Reservoir cap. 2 1/2 qts. 3/8" pipe outlets. Has Pressure Release Valve. 7 1/2" dia. by 23 3/16" overall ht. Weight 15.2 lbs. A \$40.00 Value for...NEB \$15.95

Vickers Hydraulic Transmission

Self contained, 2 H.P. constant torque at all speeds with variable volume reversible, piston pump (controlled by outside lever) supplying piston hydraulic motor. Automatic pressure, dash pot for smooth control. Power output R.P.M. - 0 to 1/3 input R.P.M. in both directions. Input R.P.M. 1800 continuous 4000 intermittent. Dash pot can be removed for greater R.P.M. Ideal for Lathes, Duplicate Setup on Mills, Conveyors, Small Cars, Drives, Gearing, etc. Includes 2-4" Spline Shafts for input & power take-off - Cost Gov't, approx. \$400. \$127.50

GEAR BOXES VTG-1 - 90°

1:1 bevel gear 1 1/2 to 1 reduction, size 7" x 6". A Lifetime Value. \$3.95
VTG-2 - Inline spur gear 16 to 1 reduction, thru 4 gears. Final take-off 4 1/2" dia. 26 tooth. 3/4" Alum. spur gear. \$6.49
Both above gear boxes have lever control for engaging & disengaging positive clutch. Dust proof housing. Prefabricated bearings. Both can be adapted to Vickers Transmission.

VALUABLE GEAR BARGAINS!

8 to 1 ratio, spindle drive #110 \$2.98
6 to 1 with screw shaft #111 \$4.98
#85 to 1 (can be used for radio, antennae, etc.) . . #112 . . . \$3.95
#G-11 - 10-1 gear ratio \$3.95

ELECTRONIC TRANSMISSION GEAR TRAIN

GT-1 Containing approx. 50 Bronze Spur & Pinion Gears ranging from 3/8" to 4" dia. 5 sets of 7 cluster gears, 2 complete worm & worm gear drive sets, 40 N.D. ball bearings from 1/2" to 1 1/2" dia. watch springs, bushings, posts, face plates, housings - Micro Switches, 2 miniature, controlled clutches, etc. 19 lbs Of Pleasure and profit. A Tremendous Gadget Mine. ONLY \$8.49
Gears in above train are all in multiple size and sequence with identical teeth ratio giving hundreds of ideal gear reduction combinations.

Order from this Ad. All sales final. All Prices F.O.B. Los Angeles, Pac by M.O. or Check. P.O.'s Accepted. from D & B. firms. 1/2 deposit with C.O.D.'s.

THE LARGEST FIRM OF ITS TYPE IN THE WORLD

FOUR PRECISION BALL BEARINGS

Two on spindle, two on drive sleeve. Pre-lubricated and sealed precision type, no oiling required.

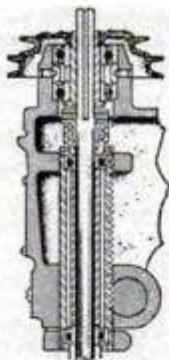

ADJUSTABLE QUILL RETURN SPRING

Retracts quill instantly upon release of feed lever. Tension of spring adjustable.

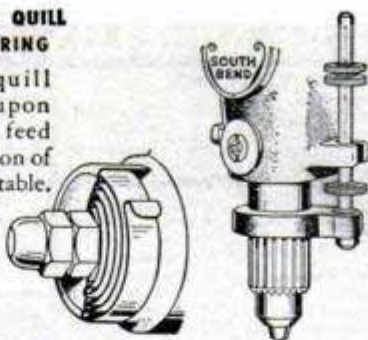

DEPTH GAUGE

Controls feed depth, length of return stroke, or locks spindle in any position. 16th graduations.

BELT TENSION RELEASE

Flip of lever removes tension from belt for easy speed changes. Proper belt tension maintained.



BUILT-IN LIGHT

Provides shielded, shadowless illumination on work area. Independent on-off switch is built-in.

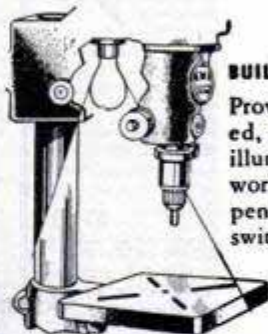

INTERCHANGEABLE SPINDLES

Spindles available to take No. 2 Morse taper shank tools, and for 1/2" straight shank tools, router bits, shaper cutters, etc.



TABLE LOCK

Double-plug binder securely locks table to column. Eliminates misalignment. Column bearing is NOT split.

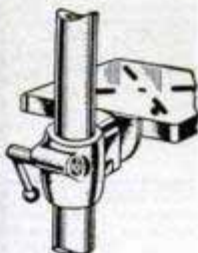

QUILL BEARING ADJUSTMENT

Shoe-type take-up provides feather-touch tension and secure locking. Quill bearing is NOT split.



ONE-PIECE HEAD CASTING

Insures perfect alignment. Double-plug binder locks the head to column. Column bearing is NOT split.



NEW!
SOUTH BEND
14" Drill Press



FREE-FLOATING SPINDLE

Design prevents misalignment, side thrust and whip. Precision splines in spindle and sleeve.

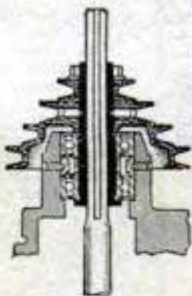

CAPACITIES — SPECIFICATIONS

CAPACITY
Maximum drill size in iron or steel—1/2".
Drills to center of 1 1/4" circle.
CHUCK
Capacity—0 to 3/8"
SPINDLE
Regular drill chuck type supplied.
Travel 4"

CHUCK TO BASE DISTANCE
Bench Model—17"
Floor Model—46 1/2"
SPINDLE SPEEDS
Four—655 to 4530 r.p.m.
TABLE SIZE
10" x 10". Tilts to any angle.

Bench Model **\$129³⁰**
Floor Model **\$144³⁰**

Prices, f.o.b. factory, include drill chuck and 1/3 h.p.; 115 or 230 v., 1 ph., 60 cycle motor and switch.



SOUTH BEND LATHE WORKS

BUILDING BETTER TOOLS SINCE 1906 • 435 EAST MADISON ST., SOUTH BEND 22, INDIANA

Printed by Popular Mechanics Company, Chicago, Ill., U. S. A.

NOW AT MY RISK!
 I want you to read the
WARNER SUCCESS PLAN

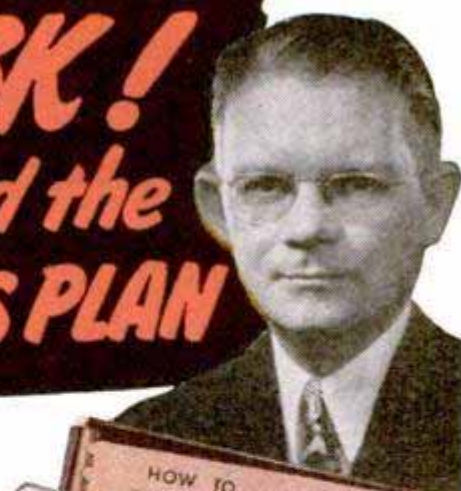

It shows you how to...

METALIZE BABY SHOES AND OTHER KEEPSAKES

- how you can start in spare time with your home as headquarters.
- how to build—step by step—to big profits and personal independence.

This is the famous Warner Success Plan—the Plan for Personal Success in your own fascinating business that many men, married couples credit with freeing them from the limits of a pay check and from the drudgery of a time clock.

It gives the exact step by step instructions for starting a business in spare time—without risking the job or steady pay. It shows with pictures, photographs, and drawings exactly how to Metalize Baby Shoes and other keepsakes. It shows how to get the orders coming in—how to expand—how to get others working for you—how to be SURE of at least twice your present pay before you give up your job for a life of personal independence.

15 Million Prospects

There are 15 MILLION pair of Baby Shoes in the country right now ready to be Metalized. Last year alone, more than THREE MILLION more babies were born.

There's not one of these mothers who doesn't want her baby's first shoes preserved forever. The Business is tremendous . . . and never ending.

The Warner Success Plan shows you how to turn this exciting opportunity into cash. Shows exactly how to prepare the shoes, how to put on them a coating of genuine *gold, silver, or bronze metal* by simple Warner Electroplating process. Shows how to get the business coming in, how to start in spare time, how to pyramid profits. Shows you how the whole family can have fun while building for an independent future. My own Shop here in Chicago does a Big Business by the very secrets I will now unfold to you.

Read The True Facts

Don't say "Yes" now. You must have ALL THE FACTS. Then decide. First, I want you to read the entire Plan—at my risk. After investigating—after discussing it with your family—then and only then do you decide whether to use the plan and make the small investment necessary to start.



\$5.00 An Hour PROFIT

Yes, even in spare time it is possible for a man to finish enough work to pay \$5.00 an hour for his time. Think what this can pyramid into when the family helps.

3c MAY START A FORTUNE

Today I want you to do only one thing. Send the coupon. Let me give you all the facts. Remember, what I send you does not cost you a cent beyond the postage you put on your letter to me. With an opportunity like this, a man who has a serious interest in his future MUST investigate. MAIL the COUPON TODAY and see for yourself why so many families have called the WARNER SUCCESS PLAN a "godsend".



WE SUPPLY ALL MATERIALS

You don't have to go "hunting" when Warner is behind you. We supply all materials, all mounts, chemicals, and metals. And you get the low prices made possible by our big quantity purchases and our own manufacture. You send for just what you need and never have any big investment tied up in stock.

MAKE 12 TIMES YOUR MATERIAL COSTS

Remember, the Warner Process is not a cheap imitation "PAINT" process. It is the genuine METALIZING through real Electroplating. And in spite of being the best, your materials cost so little that your profits are 12 Times your material cost. Then, when mothers order the shoes mounted as book-ends, as pictures, as ash-trays or pen sets, you make the BIG EXTRA PROFITS on the beautiful mounts.

WARNER-ELECTRIC CO.
 1512 Jarvis Avenue
 DEPT. 3-A
 Chicago 26, Illinois

DON'T SEND A PENNY JUST MAIL THIS COUPON TODAY!

Raymond E. Brandell, Mgr., WARNER ELECTRIC CO.
 1512 Jarvis Ave., Dept. 3-A, Chicago 26, Ill.

As long as it doesn't cost me a cent, I am willing to read the facts, investigate, then give you my decision. Send the facts by next mail. Everything you send now is FREE!

NAME _____

ADDRESS _____

CITY _____ Zone _____ STATE _____

Do Scores of Hard Jobs the Quick, Easy Way
COST Less TO BUY--COST Less

Famous **SHAW**

DU-ALL

and

PEPPY-PAL

TRACTORS

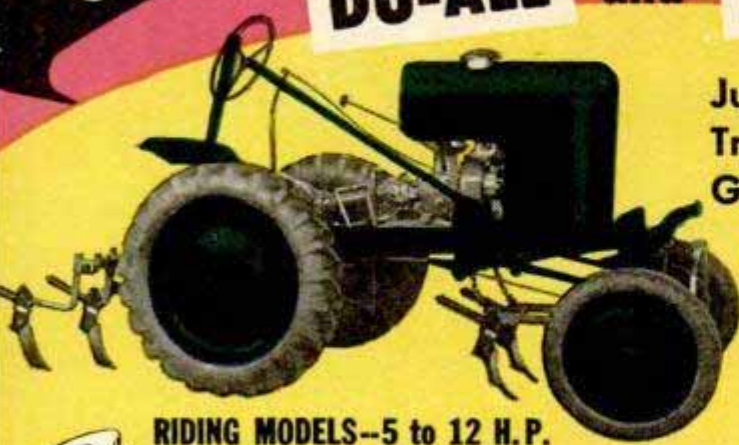

RIDING MODELS--5 to 12 H.P.

Just the Tractors for Gardens, Nurseries, Estates, Poultry Farms, Golf Courses and Cemeteries



WALKING MODELS

EASY TO OPERATE

1½ to 5 H.P.



In Use Throughout the Nation and in Many Foreign Lands... Saving TIME, MONEY and WORK!

Right now is the time to plan ahead... plan to do your work easier, in less time and at less cost this year. Plan to get a famous SHAW Tractor... the machine that does scores of hard jobs the quick, easy, better way! No other investment will pay you better dividends year after year.

TRIED AND PROVED RIGHT! For nearly a half-century SHAW Tractors have proved their value throughout the Nation and in foreign countries. They are built right... to do the job right... with quality materials and expert engineering. Equipped with high-grade air-cooled gasoline or oil engines. You get a full year guarantee against any defect in material or workmanship. They serve faithfully for many years.

LOW-COST DEPENDABLE WORKERS—SHAW Tractors have proved dependable, versatile, low-cost helpers on scores of jobs... ideal workers on small farms, in gardens, truck farms, nurseries, orchards, cemeteries, golf courses, poultry farms and estates. Great for plowing, cultivating, discing, seeding, harvesting, spraying, mowing; operate cutter bars and lawn mowers. Riding tractors with bulldozer also used in foundries and by building contractors for moving sand, dirt, etc. For power on belt jobs... sawing wood, pumping water, grinding feed and running belt machinery. First cost is low and low operating cost will surprise and please you.

EASY TO OPERATE—You'll find a SHAW "Peppy Pal" or "Du-All" Tractor just fitted to your needs... 1½ to 12 H.P. And you'll find that a SHAW will do things a big tractor can't. Easy to operate by elderly persons, boys and girls. Easy to change from one piece of equipment to another. We can supply many attachments at low prices.

GET FULL DETAILS—Get all the facts and you'll get a SHAW! Plan now to do your hard jobs the easy way. Have a SHAW Tractor to do a better job... easier and quicker. It will serve you well... it will give you years of satisfactory, trouble-free, willing service... at amazingly low cost. Many dealers throughout the U. S. sell SHAW Tractors. See them... see their many great, exclusive features. In the meantime, fill out and mail coupon for FREE folders, prices, etc. Get all the SHAW Facts now!



HARROW



RAKE



BULLDOZE and PLOW SNOW

The SHAW Saws Wood, Grinds Feed and Does Many Belt Jobs



PLOW



MOW



CULTIVATE

FILL OUT, CLIP and MAIL COUPON

FREE FOLDERS and PRICES

SHAW MANUFACTURING CO.

4503 Front St., Galesburg, Kans., or 6686 N. 4th St., Columbus,

Send me Free Folders and Prices on SHAW Tractors.

NAME _____

ADDRESS _____