

ANC



POPULAR MECHANICS

MAGAZINE

WE

DEFCT

REG. TRADE MARK, GREAT BRITAIN, NO. 410426



SEE PAGE 88

YOU WON'T GET ANYWHERE UNLESS YOU START



WHEN IT'S AN **Exide** ...YOU **START**

Hunting parties have little respect for the man who's late. When time is so important, even a good excuse is rarely acceptable; a car-starting failure, never... for it can be avoided.

To arrive on time, be sure your car will start. When you buy a battery for your car, buy *starting assurance*. **REMEMBER**, a single starting failure can be far more costly than the little extra you pay for a trustworthy Exide Battery.



1888...DEPENDABLE BATTERIES FOR 61 YEARS...1949 "Exide" Reg. Trade-mark U.S. Pat. Off.

THE ELECTRIC STORAGE BATTERY COMPANY, Philadelphia 32
Exide Batteries of Canada, Limited, Toronto

'50 FORD 50 WAYS NEW!

NEW, NEW, NEW, THROUGH AND THROUGH!



New front seat spring construction gives non-sag support . . . new foam rubber cushion for lasting comfort.



New luxury upholstery and interior trim tastefully selected to harmonize with new '50 Ford body colors.

New, effortless Push-Button Door Handles.



New Rotary Door Latches with spring-loaded nylon-plastic shock absorbers in striker plates.



New bracing scientifically designed for greater strength and low weight. New sealing and insulation at 41 points give new weather-tight snugness and quiet comfort.



★ Dozens of other new body and styling features!

**NEW ENGINEERING
ADVANCEMENTS
MAKE FORD'S
100 h.p. V-8
QUIET AS
A WHISPER!**

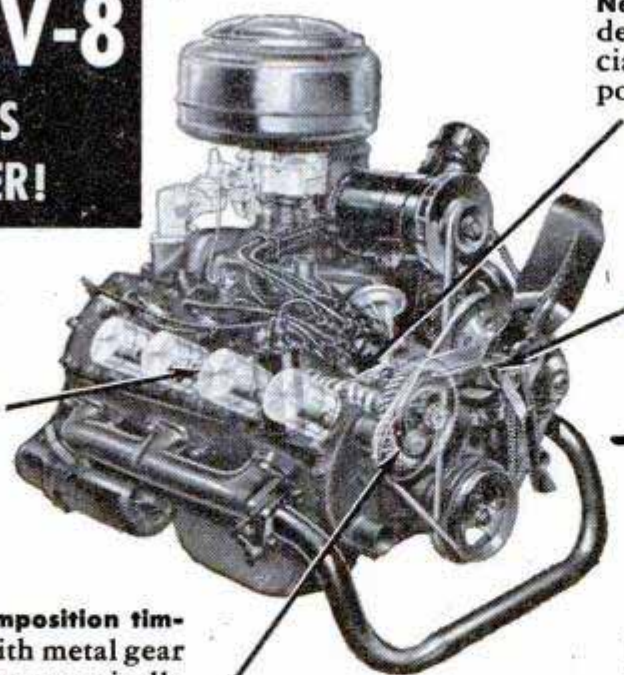

New cast camshaft features newly designed cam contours with special ramp for quiet, even flow of power at all speeds.

New three-blade fan is scientifically designed for increased air flow with minimum noise and power loss. New accessories drive, with two narrow V-belts over 3 pulleys provides quiet, efficient drive for fan, generator, and water pumps.

**Take a GOOD look...
Take a GOOD ride**

**AT YOUR
FORD DEALER'S**

New laminated composition timing gear meshes with metal gear on crankshaft for practically noiseless operation. Gears are wide-faced helical cut for smooth, positive drive.

There's a *Ford* in your future—
with a future built in!

How easy can night driving be?

Get General Electric headlamps and see!

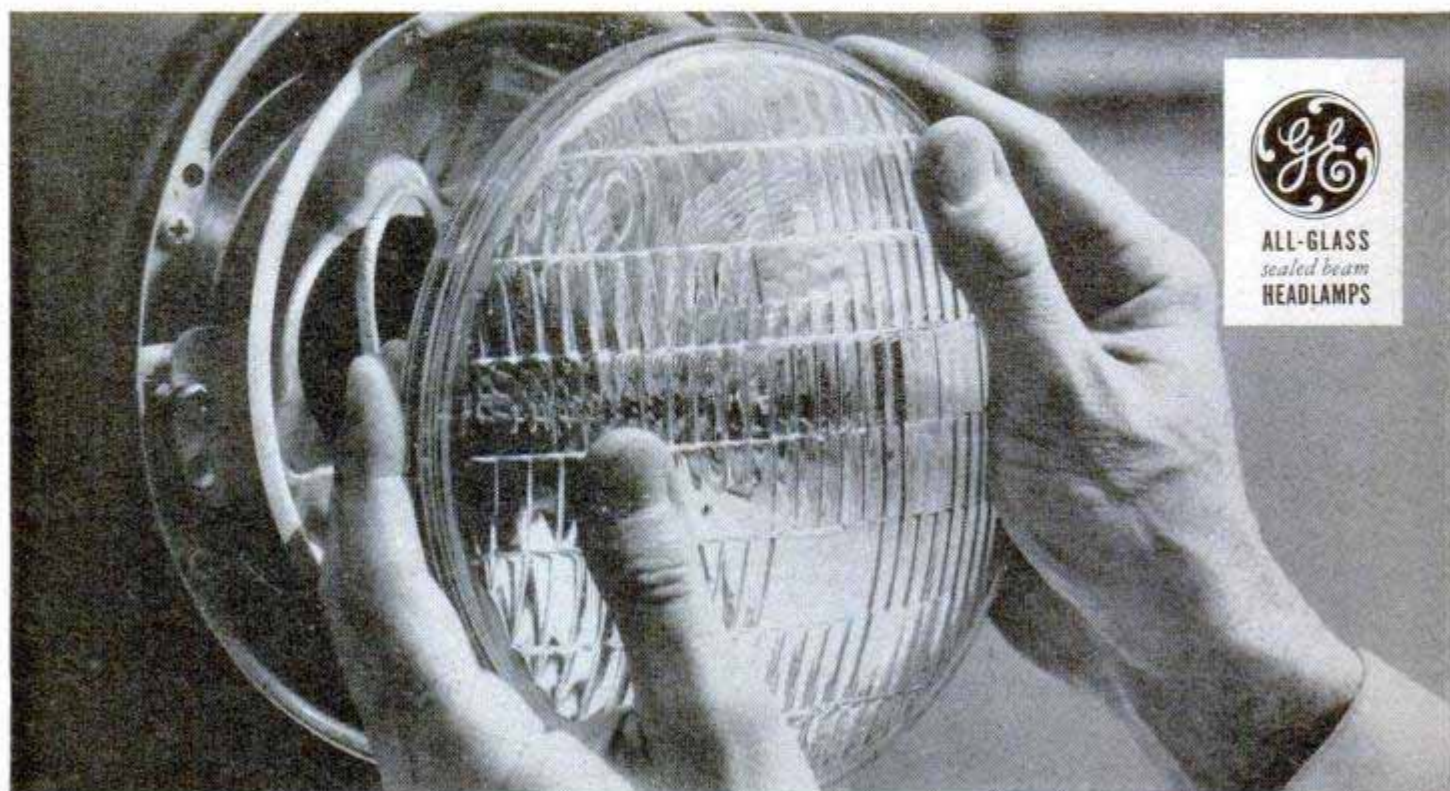

...they do not grow dim!

1. NIGHT DRIVING is easier with General Electric "all-glass" sealed beam headlamps because they average 99% of original light output at end of life. *They do not grow dim!*

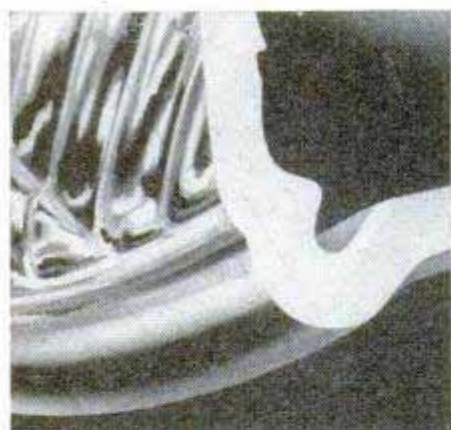

2. DIRT AND MOISTURE can't get in to steal the light—due to the rugged, "all-glass", one-piece construction of G-E sealed beam headlamps.

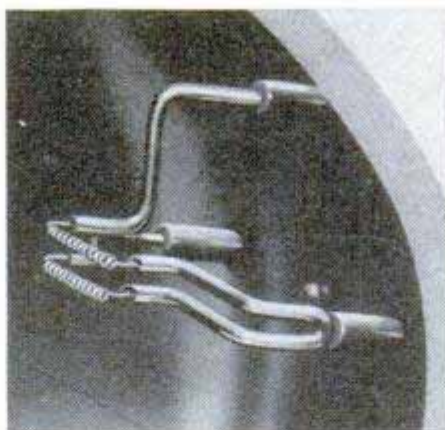

3. FILAMENTS are held in vise-like grip. Won't shake loose on bumpy roads. Give 12% more light on the road for driving, 16% more light for passing.



4. HARD-GLASS LENS is precision-made to throw maximum light on road. Have lights checked when car is serviced—and insist on G-E for replacement!

You can put your confidence in—

GENERAL  **ELECTRIC**

BUILD ONE OF THESE

YOURSELF . . . Save Thousands of Dollars!

Build This 5-Room Concrete Block House for Only

Popular Mechanics Build-It-Yourself Concrete Block House is 26'-8" deep by 32'-8" wide. It has 675 square feet of comfortable living space—living room, two bedrooms, cabinet kitchen, utility room, bath and three closets, concrete block walls, poured concrete floors. Insulated ceiling, hot air heating, gas or oil. Hot air ducts in ceiling, cold air ducts laid under floor. Its total cost was less than \$3650 including all material, heating, plumbing and electrical equipment and outside labor for installing the equipment and plastering all rooms.

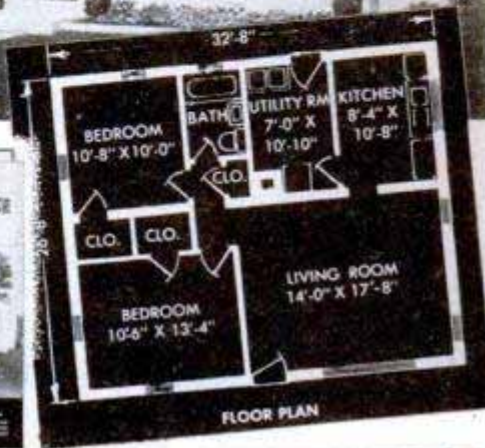

Build This 5 Room 1 1/2 Story Frame House for \$7000



This beautiful, modern home, with breezeway and garage, as pictured, has been built in many locations at an average cost of \$7000 for all materials, equipment and some outside labor. It is 1 1/2 stories with basement, recreation room, living room, kitchen, dining nook, two bedrooms, bath, plenty of closets and space

for 2 additional bedrooms on the second floor. It has an unusually large amount of good, usable living space that can easily be increased to meet the needs of a growing family. The house itself is 35'-9" x 28'-11"; the breezeway is 20'-10" x 8', and the garage is 20'-10" x 12'.

Beat the High Cost of Home Building! Get Book and Plans Now! No Previous Experience Needed!

If you can mix a batch of concrete and saw a board straight you can build either of these Popular Mechanics Build-It-Yourself houses, yourself. Yes Sir! In a few months of spare time you can laugh at the housing shortage and save several thousand dollars while acquiring a home you will be proud to own.

The big, basic idea behind the design of the Build-It-Yourself Houses is ease of construction (so a man could do the job himself with very little assistance) and get the most living at the least cost, considering attractiveness and suitability for any neighborhood. Either is a home anyone can enjoy and be proud to own.

A detailed Build-It-Yourself Book and a set of 10 full-size building blueprint plans are available for each house. Every part of the construction is simplified and thoroughly explained in the Build-It-Yourself Books from the turning

of the first shovel full of earth to the last flick of the paint brush. Every paragraph is written in plain, understandable terms and over half of each book is pictures and diagrams, some in two and four colors, that make every construction detail simple as ABC. The Concrete Block House book also tells how to make your own concrete blocks, how to select and buy a lot and how to build a house of bricks. The Frame House Book includes lumber and mill lists and design variations. Book and set of ten working blueprint plans are all you need to get started and enjoy the thrills of home owning, doing the job yourself and saving thousands of dollars.

If you want to hire a contractor or builder, instead of doing the job yourself, you can still enjoy a tremendous saving by working from the Build-It-Yourself Book and Plans.

ORDER FROM POPULAR MECHANICS PRESS

This mammoth bridge is made entirely of Erector girders. So strong it can support 200-lb. man.

Made of **STEEL** to Build like **REAL**

World's greatest construction toy
Developed at the Gilbert
Hall of Science

ERECTOR®

"Real engineering" nuts and bolts lock Erector parts firmly together.

Other Erector features—curved, straight and giant structural girders. Base plates in 7 sizes and shapes. Electro-magnet. Wheels, radiator, axles and other automotive parts. Total of over 135 different parts.

Dazzling Merry-Go-Round. Whirls round and round. Horses go up and down. Built with No. 10½ Erector and up.

Famous square girder with interlocking edges—built only with Erector.

Powered by famous Gilbert Electric Motor.

Exciting airplane ride. Revolves at dizzy speed. Built with No. 6½ Erector and up.

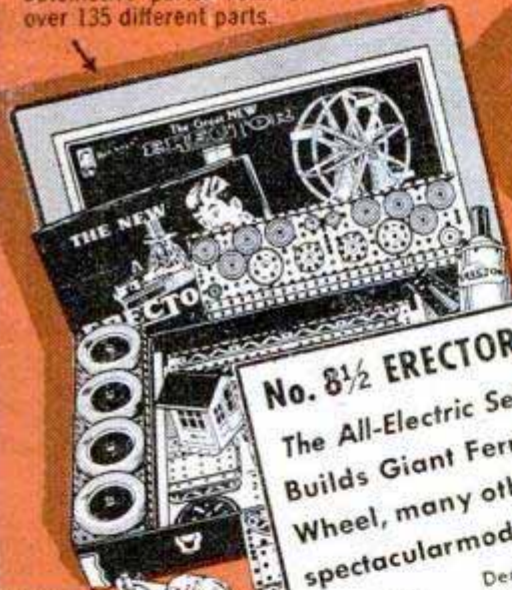

No. 8½ ERECTOR
The All-Electric Set
Builds Giant Ferris
Wheel, many other
spectacular models.
\$19.95
Denver and west
\$20.95

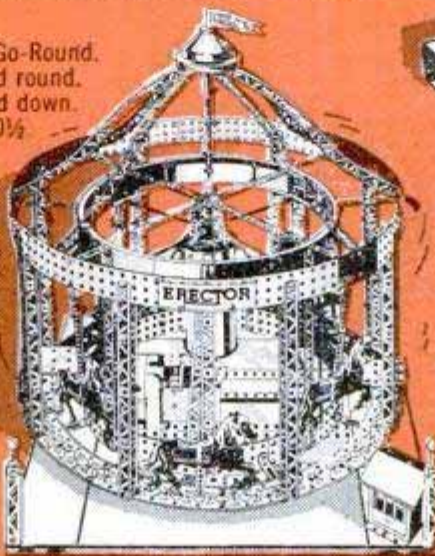

Electric lights. Can be installed to blink or revolve.

Gilbert Electric engine with automobile type gear shift for forward, reverse and stop.

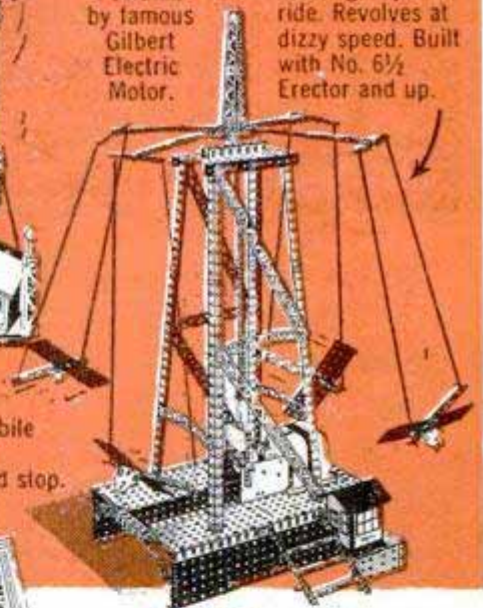

HELLO BOYS! ERECTOR
GIVES YOU MOST OF EVERYTHING!

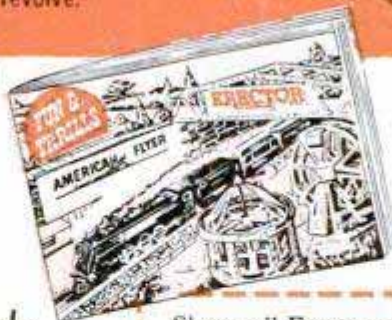

FREE — Big

"Fun and Thrills" book combined with giant American Flyer Train Book. 40 large pages. Over 100 color pictures.

Most fun—most different parts—
most action—most realistic models

Look at these spectacular Erector models. You build them yourself. Piece by piece—with your own hands—you fit gleaming girders, gears and other exciting parts together—see them grow into gigantic engineering marvels. Then hook up the powerful Erector electric engine—with amazing new Flex-O-Matic Drive—and make your models buzz with action. You can build hundreds of realistic models with one Erector set. Tell Dad you want a genuine Erector. Prices start at \$1.75. Denver and west, \$1.85.

125 Erector Awards worth over \$2,000.00. Win an R.C.A. Television Set, movie camera outfit or other big awards for building original Erector models. Mail coupon for details.

Shows all Erectors and tells how to win Television Set or other thrilling Erector Awards. Also contains pictures and descriptions of all American Flyer trains and equipment. Mail coupon today.

Gilbert Hall of Science
117 Erector Square, New Haven, Conn.
RUSH "FUN AND THRILLS" BOOK—FREE

NAME

STREET

CITY

STATE

This One



NEW!

a different name
for your old friends!

PROTO TOOLS

-formerly-

PLOMB TOOLS



Remember,
PROTO is now the name for the
leading brand of mechanics' hand tools.
PROTO tools—formerly Plomb tools—
are manufactured to the same high stand-
ards and are noted for superior design,
special steels, scientific heat treating and
long life. For the finest tools, buy the old-
timers with the new name—PROTO tools.

Write for catalog to

PLOMB TOOL COMPANY

2255K Santa Fe Avenue, Los Angeles 54, Calif.

4983



in this corner.....

THE EDITORS



Calendar Artist

For a man who is happily adjusted to life we nominate Dick Bishop, the artist whose beautiful work is shown beginning on page 97. A writer and photographer set out to discover how he instills such realism and action in his paintings of wild fowl. They found him enjoying life atop a mountain in Vermont. One reason for his easygoing nature, no doubt, is that Bishop is completely adjusted to his work. Never happier than when on a hunting expedition, he tramps the swamps and woods in search of wild fowl. He shoots his beloved birds with an extraordinary slow-motion camera, shown above, that brings them fluttering up to arm's reach. When he grows tired of hunting, he returns to his mountain top and paints the birds, using his movies as a guide.

* * *

Letter to the Editor

Editor's Note: "Hot Rods and Electrons," a featured article in our September issue, was the story of young Tenny Lode, inventive genius now a student at the University of Minnesota. Associate Editor Hicks, who wrote the piece, afterward sent him a copy of our Spanish edition, Mekanica Popular, containing his story. Here is his reply:

"Dear Mr. Hicks:

"The *Mekanica Popular* was a very pleasant surprise and I appreciate it very much. My parents are wondering if, by any chance, your magazine is printed in one of the Scandinavian languages. [Yes, the Danish *Populær Mekanik*.]

"As a result of the story you wrote about me I have some fascinating research work to do. I have been asked to develop a portable lightning generator and a motor utilizing the heat of a fire or glowing coals for

(Continued to page 8)



To the man who wants to enjoy
an ACCOUNTANT'S CAREER



IF you're that man, here's something that will interest you.

Not a magic formula—not a get-rich-quick scheme—but something more substantial, more practical.

Of course, you need something more than just the desire to be an accountant. You've got to pay the price—be willing to study earnestly, thoroughly.

Still, wouldn't it be worth your while to sacrifice some of your leisure in favor of interesting home study—over a comparatively brief period? Always provided that the rewards were good—a salary of \$3,000 to \$10,000?

An accountant's duties are interesting, varied and of real worth to his employers. He has *standing*!

Do you feel that such things aren't for you? Well, don't be too sure. Very possibly they *can* be!

Why not, like so many before you, investigate LaSalle's modern Problem Method of training for an accountancy position?

Just suppose you were permitted to work in a large accounting house under the personal supervision of an expert accountant. Suppose, with his aid, you studied accounting principles and solved problems day by day—easy ones at first—then more difficult ones. If you could do this—and could turn to him for advice as the problems became complex—soon you'd master them all.

That's the training you follow in principle under the LaSalle Problem Method.

You cover accountancy from the basic Principles right up through Accountancy Systems and Income Tax Procedure. Then you add C. P. A. Training and prepare for the C. P. A. examinations.

As you go along, you absorb the principles of Auditing, Cost Accounting, Business Law, Statistical Control, Organization, Management and Finance.

Your progress is as speedy as you care to make it—depending on your own eagerness to learn and the time you spend in study.

Will recognition come? The only answer, as you know, is that success *does* come to the man who is really *trained*. It's possible your employers will notice your improvement in a very few weeks or months. Indeed, many LaSalle graduates have paid for their training—with increased earnings—before they have completed it! For accountants, who are trained in organization and management, are the executives of the future.

Write For This Free Book

For your own good, don't put off investigation of *all* the facts. Write for our free 48-page book, "Accountancy, The Profession That Pays." It'll prove that accountancy offers brilliant futures to those who aren't afraid of serious home study. We'll also include "Ten Years' Promotion in One"—a book which has helped many men. Send us the coupon *now*.

**LASALLE EXTENSION
 CHICAGO 5, ILL.**

Over 2800 Certified
 Public Accountants among
 LaSalle alumni

- Other LaSalle Opportunities**
- Higher Accountancy
 - C.P.A. Coaching
 - Bookkeeping
 - Law: LL.B. Degree
 - Business Management
 - Salesmanship
 - Traffic Management
 - Foremanship
 - Industr'l Management
 - Stenotypy
 (Machine Shorthand)

LASALLE EXTENSION UNIVERSITY
 A CORRESPONDENCE INSTITUTION

417 S. Dearborn St. Dept. 1264-HR Chicago 5, Ill.

I want to be an accountant. Send me without obligation, "Accountancy, the Profession that Pays"—also "Ten Years' Promotion in One."

Name.....Age.....
 Address.....
 City, Zone & State.....



You'll weather winter better with Pyroil.

The special properties found in Pyroil protect your motor from the harsh effects of winter-time driving with low viscosity oils. These oils, although necessary for starting at low temperatures, rob your motor of vital lubrication protection—exposing cylinder walls and piston rings to excessive friction, rust and clogging, due to gummy deposits.

Pyroil, with its quality of adhering to metal surfaces, maintains a constant clinging protective film of oil—eliminating dry starts and reducing friction wear.

Add Pyroil—add miles to your car.

Pyroil for Aircraft Engines

Use Aircraft Pyroil B for lubricating oil, Aircraft Pyroil A for gasoline.

GIVEN! An attractive Pyroil metal savings bank—takes coins up to 50c pieces. **MOTORISTS**, it's yours for the asking—sent postage paid.

Manufactured and Guaranteed by Pyroil Company, 98 Pyroil Bldg., La Crosse, Wisconsin.

Canadian Distributors: Central Purchasing Agencies, Ltd., Toronto, Ontario



PYROIL COMPANY

98 Pyroil Bldg., La Crosse, Wisconsin

I want my car to last and run properly. Please tell me more about Pyroil and how it can accomplish this for me.

Name _____

Address _____

City or Town _____ State _____



(Continued from page 6)

turning the barbecue spit. I have already been paid \$50 as part payment for the work I am doing on the lightning generator.

"One man from Pasadena intends to be in Saint Paul some of these days and will get in touch with me when he comes . . .

"Best wishes to you from my parents and myself.

"Tenny,
1323 Sherburne Ave.,
Saint Paul 4, Minn."

* * *

Letter to the Editor

Gentlemen:

My air-race article published in your August issue seems to have hit the nail on the head regarding the outcome of the Thompson Trophy Race. The planes flown behaved pretty much according to our speculation, with the powerful Corsairs taking the three top places.

Here is a photograph of Cook Cleland's



winning plane. Wing clipping is one of the oldest tricks in the air-racing game, but Cleland, winner of the Thompson Trophy for the second time, was able to go much farther in that direction than his competitors by the use of a clever new device. After cutting a full four feet off each wing tip, he installed large aluminum end plates on the stubs to preserve much of the lifting power which would ordinarily be lost through end spillage of the air flow. At the same time aileron effectiveness was also retained by the same device even though these surfaces were reduced in size.

Another, but unseen, advantage incorporated into the plane was Cleland's ace-in-the-hole. This was the use of concentrated hydrogen peroxide in the water-injection system. Files confiscated at the war's end revealed that the Germans had experimented with H₂O₂ in that manner, gaining an added boost of power as this unstable chemical broke down into oxygen and water. The Thompson champion is the first civilian to put this secret to work in a practical way.

John L. Mackenzie,
9900 Cudell Ave.,
Cleveland, Ohio.

Is High School High enough?

IF YOU were smart enough to finish high school, you already know the answer. A high school diploma is a *must* if you want a decent job at a decent wage. But it's *not* enough if you want more: Real security. Responsible positions. Big rewards.

I. C. S. training is *specialized* training that helps you go farther, *faster*. It supplements your high school education with the practical, working knowledge you need for immediate as well as future advancement. Equally important, it gives you the confidence and self-assurance so characteristic of competent, well-trained, *successful* men.

The courses of these famous schools are designed so you can *learn* while you *earn*. You study in your spare time. At work you prove and apply what you learn.

This system of training is backed up by 58 years of I. C. S. experience. It is success-proved by thousands of students reporting promotions and pay increases. It can mean the difference between "halfway" and "headway" *for you*.

Job competition is getting stiffer every day for high school graduates. Mark and mail the coupon NOW!

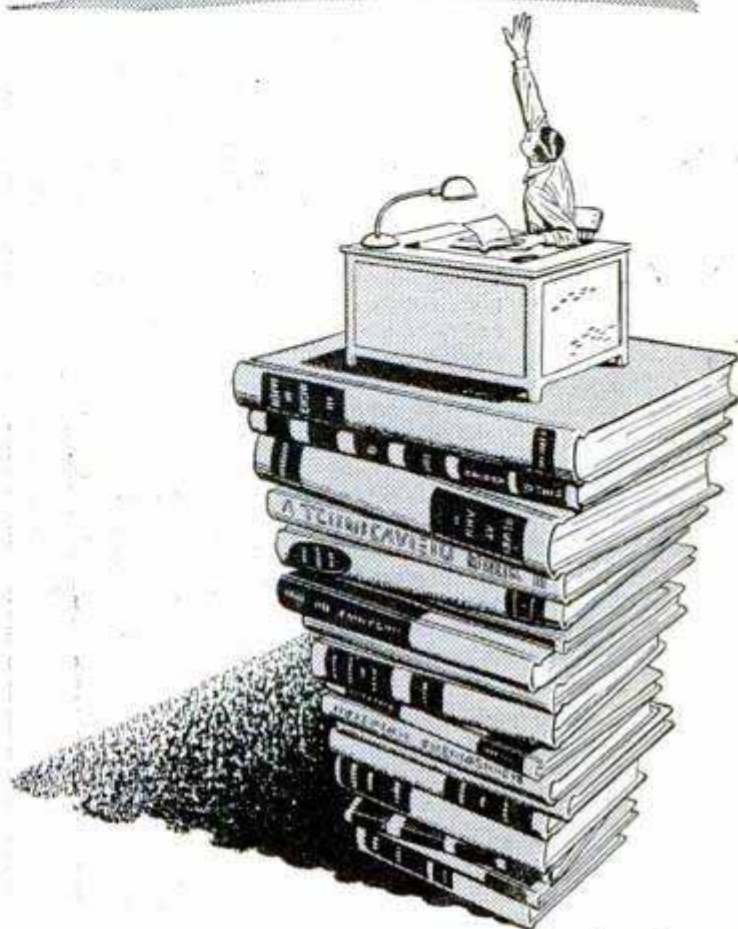

INTERNATIONAL CORRESPONDENCE SCHOOLS

APPROVED
under the
G.I. BILL

BOX 5665-K, SCRANTON 9, PENNA.

Without cost or obligation, please send me full particulars about the course BEFORE which I have marked X:

- | | | | |
|---|---|---|---|
| <p>Business and Academic Courses</p> <ul style="list-style-type: none"> <input type="checkbox"/> Accounting <input type="checkbox"/> Advertising <input type="checkbox"/> App. Psychology <input type="checkbox"/> Bookkeeping <input type="checkbox"/> Business Administration <input type="checkbox"/> Bus. Correspondence <input type="checkbox"/> Bus. Law <input type="checkbox"/> Certified Public Accounting <input type="checkbox"/> Commercial <input type="checkbox"/> Commercial Art <input type="checkbox"/> Cost Accounting <input type="checkbox"/> Federal Tax <input type="checkbox"/> First Year College <input type="checkbox"/> Foremanship <input type="checkbox"/> French <input type="checkbox"/> Good English <input type="checkbox"/> High School <input type="checkbox"/> Higher Mathematics <input type="checkbox"/> Illustration <input type="checkbox"/> Industrial Supervision <input type="checkbox"/> Motor Traffic <input type="checkbox"/> Postal Civil Service <input type="checkbox"/> Retailing <input type="checkbox"/> Retail Bus. Management <input type="checkbox"/> Salesmanship <input type="checkbox"/> Secretarial <input type="checkbox"/> Sign Lettering <input type="checkbox"/> Stenography <input type="checkbox"/> Spanish <input type="checkbox"/> Traffic Management <p>Air Conditioning and Plumbing Courses</p> <ul style="list-style-type: none"> <input type="checkbox"/> Air Conditioning <input type="checkbox"/> Heating <input type="checkbox"/> Plumbing <input type="checkbox"/> Refrigeration <input type="checkbox"/> Steam Fitting | <p>Chemical Courses</p> <ul style="list-style-type: none"> <input type="checkbox"/> Chemical Engineering <input type="checkbox"/> Chemistry, Analytical <input type="checkbox"/> Chemistry, Industrial <input type="checkbox"/> Chemistry, Mfg. Iron & Steel <input type="checkbox"/> Petroleum Refining <input type="checkbox"/> Plastics <input type="checkbox"/> Pulp and Paper Making <p>Civil Engineering, Architectural and Mining Courses</p> <ul style="list-style-type: none"> <input type="checkbox"/> Architecture <input type="checkbox"/> Architectural Drafting <input type="checkbox"/> Building Estimating <input type="checkbox"/> Civil Engineering <input type="checkbox"/> Coal Mining <input type="checkbox"/> Contracting and Building <input type="checkbox"/> Highway Engineering <input type="checkbox"/> Lumber Dealer <input type="checkbox"/> Reading Structural Blueprints <input type="checkbox"/> Sanitary Engineering <input type="checkbox"/> Structural Drafting <input type="checkbox"/> Structural Engineering <input type="checkbox"/> Surveying and Mapping <p>Communications Courses</p> <ul style="list-style-type: none"> <input type="checkbox"/> Electronics <input type="checkbox"/> Prac. FM and Television <input type="checkbox"/> Prac. Telephony <input type="checkbox"/> Radio Operating <input type="checkbox"/> Radio, General <input type="checkbox"/> Radio Servicing <input type="checkbox"/> Telegraph Engineering | <p>Electrical Courses</p> <ul style="list-style-type: none"> <input type="checkbox"/> Electrical Drafting <input type="checkbox"/> Electrical Engineering <input type="checkbox"/> Electric Light and Power <input type="checkbox"/> Lighting Technician <input type="checkbox"/> Practical Electrician <input type="checkbox"/> Power House Electric <input type="checkbox"/> Ship Electrician <p>Internal Combustion Engines Courses</p> <ul style="list-style-type: none"> <input type="checkbox"/> Auto Technician <input type="checkbox"/> Aviation <input type="checkbox"/> Diesel-Electric <input type="checkbox"/> Diesel Engines <input type="checkbox"/> Gas Engines <p>Mechanical Courses</p> <ul style="list-style-type: none"> <input type="checkbox"/> Aeronautical Engineer's, Jr. <input type="checkbox"/> Aircraft Drafting <input type="checkbox"/> Flight Engineer <input type="checkbox"/> Forging <input type="checkbox"/> Foundry Work <input type="checkbox"/> Heat Treatment of Metals <input type="checkbox"/> Industrial Engineering <input type="checkbox"/> Industrial Instrumentation <input type="checkbox"/> Industrial Metallurgy <input type="checkbox"/> Machine Shop <input type="checkbox"/> Machine Shop Inspection <input type="checkbox"/> Mechanical Drafting <input type="checkbox"/> Mechanical Engineering | <ul style="list-style-type: none"> <input type="checkbox"/> Mold-Loft Work <input type="checkbox"/> Patternmaking—Wood, Metal <input type="checkbox"/> Reading Shop Blueprints <input type="checkbox"/> Sheet-Metal Drafting <input type="checkbox"/> Sheet-Metal Worker <input type="checkbox"/> Ship Drafting <input type="checkbox"/> Ship Fitting <input type="checkbox"/> Tool Designing <input type="checkbox"/> Toolmaking <input type="checkbox"/> Welding Engineering <input type="checkbox"/> Welding—Gas and Electric <p>Railroad Courses</p> <ul style="list-style-type: none"> <input type="checkbox"/> Air Brake <input type="checkbox"/> Car Inspector <input type="checkbox"/> Diesel Locomotive <input type="checkbox"/> Locomotive Engineer <input type="checkbox"/> Locomotive Fireman <input type="checkbox"/> Locomotive Machinist <input type="checkbox"/> Railroad Section Foreman <input type="checkbox"/> Steam and Diesel Loco. Eng. <p>Stationary Engineering Courses</p> <ul style="list-style-type: none"> <input type="checkbox"/> Boilermaking <input type="checkbox"/> Combust. Engrg. <input type="checkbox"/> Engine Running <input type="checkbox"/> Marine Engineering <input type="checkbox"/> Power Plant Engr. <input type="checkbox"/> Steam Engineer <p>Textile Courses</p> <ul style="list-style-type: none"> <input type="checkbox"/> Cotton Manufacturing <input type="checkbox"/> Loom Fixing <input type="checkbox"/> Rayon Weaving <input type="checkbox"/> Textile Designing <input type="checkbox"/> Woolen Manufacturing |
|---|---|---|---|

Name _____ Age _____ Home Address _____

City _____ State _____ Working Hours _____ A.M. to _____ P.M.

Present Position _____ Employed by _____

Length of Service _____
in World War II _____

Enrollment under G.I. Bill approved for World War II Veterans. Special tuition rates to members of the Armed Forces.
Canadian residents send coupon to International Correspondence Schools Canadian, Ltd., Montreal, Canada.

4 Keys to SUCCESS IN AVIATION

Through **Embry Riddle** Training

AIRCRAFT & ENGINE MECHANICS

1

We have hundreds of urgent requests for A. & E. Mechanics -- key men in Aviation -- from airlines, oil companies, fixed base operators, etc., both U. S. and Overseas. Training in a C. A. A. approved school is the quickest way to get ahead. Embry-Riddle students learn fast with modern equipment... working on live aircraft in airline-size hangars.



ENGINEERING

2

Embry-Riddle's Design Engineering and Maintenance course offers you eligibility for A. & E. certification plus necessary basic engineering knowledge required to fill positions such as Maintenance Foreman or Field Service, Project or Sales Engineer. If your aim is high, take this course.



A.&E. COMBINED WITH COMMERCIAL

Pilot Mechanics who can test fly the ships they repair... executive pilots able to service their own aircraft -- airmen with dual ability are needed by aviation companies and operators. Embry-Riddle combination training offers you the most in your aviation career.

3



COMMERCIAL PILOTS

Flying holds a real future for Embry-Riddle trained pilots. A quarter-century of experience with 30,000 students... the best instructors, up-to-date aircraft, superb year-round flying weather... qualifications unexcelled anywhere. Instrument and instructor's ratings are also available.

4



Aviation needs you now! Never has there been such opportunity for you in Aviation. Start your career now at Embry-Riddle -- living facilities directly on the Airport. Write today for full information and proof of job opportunities.

LIMITED NUMBER OF VETERANS ACCEPTED

Dean of Enrollments - Dept. 99
Embry-Riddle School of Aviation
Miami 30, Florida

Please Print

NAME _____

ADDRESS _____

City _____

State _____ Age _____

I am interested in...

- A.&E. Mechanic
- Commercial Pilot
- Engineering
- A.&E. Combined with Commercial Pilot
- Flying Mechanic
- Drafting & Design

Check One Veteran Non-Veteran

TRAIN IN MIAMI--AIR CAPITAL OF THE WORLD

WHERE-TO-BUY-IT INDEX

Source of supply appears after items commercially available

AUTOMOTIVE

- Automatic transmission for Ford and Mercury (Borg-Warner Corp., 310 S. Michigan Ave., Chicago 4).....102
- Mechanical "policeman" counts offenses.....127
- Quick oil changes with air pressure (Allen-Sims of Florida, 1415 N.E. 2nd Ave., Miami, Fla.).....155
- Quick-acting car-top carrier (Vulcan Manufacturing Co., Inc., Winona, Minn.).....164
- Roller bearings for leaf springs (Kerklings-Martin, Inc., San Fernando, Calif.).....164
- Baby's travel kit carries Dry Ice (Doerr Products Co., 3304 W. Washington Blvd., Los Angeles 16, Calif.).....164

AVIATION

- Elevator on wheels lifts bomb to plane.....96
- Helicopter flies "no hands".....109
- Parachute plane (Lanier Aircraft Corp., Marlton-Medford Airport, Marlton R. D. 1, N. J.).....123
- Today's French planes.....124
- World's fastest plane.....127
- Fastest drone (Glenn L. Martin Co., Baltimore 3, Md.).....131
- Front-line transport.....142
- Thunderjet fighter gets "radar nose".....142

BOATS

- Radio-guided model to try channel trip.....123
- Quick-change coupling for propeller shaft (Coffing Hoist Co., Danville, Ill.).....130
- Somersault hoist for small boats (Tumbler Dink Hoists, 39-15 Main St., Flushing, N. Y.).....150

FARM

- Wet or dry dust spread by sprayer (Lawrence Aero-Mist Sprayer Co., Greenfield, Mass.).....96
- Weed sprayer for corn fields (Storey Machine Shop, 815 N.W. 72nd St., Miami 38, Fla.).....158
- Japanese plow (Furukawa Farming Machine Co., Tokyo, Japan).....159
- Four tons of chopped hay unloaded in eight minutes (F. B. Recker Co., Hopkinton, Iowa).....171

HOUSE AND HOME

- Wireless tree lights (Magic-Glow Corp., 1706 N. Larrabee St., Chicago 14).....86
- Plastic clips seal tree lights against short circuits (Miller Electric Co., Pawtucket, R. I.).....86
- Tube-type Christmas-tree holder (Republic Stamping and Enameling Co., Canton, Ohio).....86
- Magnetic cabinet latch (Laboratory Equipment Corp., St. Joseph, Mich.).....116
- Chore cart (C. B. Herrick Co., 1935 Euclid Ave., Cleveland 15, Ohio).....126
- Weed-killer applicator (Sherwin-Williams Co., 300 W. Lake St., Chicago 6).....129
- Rubber mat glows in the dark (Flor-Ez Mat Co., 1707 N. Kenmore Ave., Hollywood 27, Calif.).....131
- Volume control for shower (Master Valve Co., Muskegon, Mich.).....140
- Clothesline fastener (Mayfair Hardware, 4748 N. Kenneth Ave., Chicago).....140
- Electric broiler (Mitchell-White Corp., 12 E. 22nd St., New York City).....140
- Baseboard heater (Warren Webster & Co., 1653 Federal St., Camden, N. J.).....140
- Inside-out closet is designed like revolving door (Coast Store and Fixture Co., 4629 Alger, Los Angeles, Calif.).....141
- Divided grate for fireplace (Stainless Foundry & Engineering Co., 5132 N. 35th St., Milwaukee 9, Wis.).....141
- Safety guards keep child from rolling off bed (R. Barbara Blanke Creations, 25 W. 26th St., New York City 10).....141
- Aluminum awning in kit form (C-Thru Aluminum Awning Co., 1100 S. Hope St., Los Angeles 15, Calif.).....141
- Electric dryer (The Taylor Corp., 825 S. Mahoning Ave., Alliance, Ohio).....141
- "Elastic" roofing (Grems Manufacturing Co., 222 Spring St., Klamath Falls, Ore.).....143
- Basement garbage-disposal unit (The Clear Manufacturing Co., 4525 N. 124th St., Butler, Wis.).....158
- Extra room for trailer or small home (Modern Metal Craftsmen, Inc., 3855 N. Miami Ave., Miami 37, Fla.).....165
- Liquid linoleum dressing forms a hard plastic film (Best Home Finishes, 444 The Arcade, Cleveland 14, Ohio).....254

INDUSTRY

- Cutter digs ditches beside rail tracks.....96
- Chemical makes fabrics flame-retardant (E. I. DuPont de Nemours & Co., Inc., Wilmington 98, Del.).....132
- "Cooked" crystals last indefinitely.....143
- Carbon monoxide made harmless.....155
- Diagonal pattern on piston skirts (Perfect Circle Corp., Hagerstown, Ind.).....254

PHOTOGRAPHY

- Complete photo kit for beginners (American Photo Laboratories, 28 N. Loomis St., Chicago 7).....94
- Suitcase projector (Technical Service Inc., 30865 Five Mile Road, Plymouth, Mich.).....94
- Double exposures are impossible with magazine-loaded camera (Phil Kalech Co., 540 N. Michigan Ave., Chicago 11).....95
- Automatic diaphragm control for photoflash photographers (Precision Built Photographic Equipment, 1380 Bush St., San Francisco 9, Calif.).....95
- Between-the-lens shutter has 1/800 second exposure (Eastman Kodak Co., Rochester 4, N. Y.).....95
- Flash gun is tested without taking apart (Conway Camera Co., 34 N. Clark St., Chicago).....95
- Midget projector (Sawyer's, Inc., Box 671, Portland 7, Ore.).....116
- Twin lenses project color in three dimensions (Three Dimension Co., 4555 W. Addison St., Chicago 41).....148

(Continued to page 12)

WHAT Every AUTO MECHANIC Wants to Know

A motor vehicle is a machine of many parts, each part designed and constructed for its own special function. All good mechanics, like good doctors, should know the working theory and operation of each part and understand what causes trouble and how to remedy it.

LET AUDELS AUTO GUIDE SOLVE YOUR PROBLEMS

Every auto mechanic, helper, serviceman and operator can use AUDELS AUTO GUIDE. The information it gives saves time, money and worry. Highly endorsed by all users. It presents the whole subject of auto mechanics from A to Z in plain language and simple terms.

This Big Practical Book gives full information with working diagrams covering the principles, construction, ignition, service and repair of modern cars, trucks and buses.

A complete Guide of 1800 pages, with over 1500 illustrations showing inside views of the working parts, with instructions for service jobs. Diesel engines, Fluid and Hydra-matic drives fully explained.

IT PAYS TO KNOW HOW TO

How to fit pistons—How to locate engine knocks—How to fit connecting rod bearings—How to service main bearings—How to recondition valves—How to time valves—How to adjust fan belts—How to adjust carburetors & chokes—How to rebuild a clutch—How to service automatic transmissions—How to service brakes—How to adjust steering gear—How to cope with ignition troubles—How to service distributors—How to time ignition—How to "tune up" an engine.

INFORMATION IN A HANDY FORM

73 INTERESTING CHAPTERS—Read this partial list of subjects on which practical information is fully given for quick reference under the headings as shown below. Ready Reference Index.

All Parts of an Automobile—Automotive Physics—The Gas Engine—Gas Engine Principles—Multi-Cylinder Engines—Horse Power—Automobile Engines—Stationary Parts—Moving Parts—Pistons—Piston Rings—Connecting Rods—Crank Shafts—Valves—Valve Gear—Cams and Cam Action—Valve Timing—Cooling Systems—Fuel Feed Systems—Dual Fuel Feed—Mixture—Carburetors—Carburetor Service—Automatic Choke—Super-Chargers—Transmissions—Special Transmissions—Fluid and Hydra-matic Drives—Clutches—Universals and Propeller Shafts

A Ready Reference

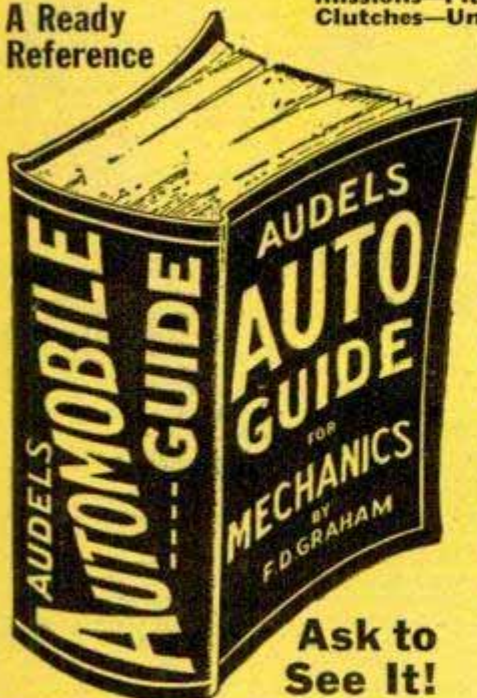

—The Differential—Rear Axles—Rear and Front Suspension—Running Gear—Brakes—Wheel Alignment—Knee Action—Steering Gear—Tires—Lubricants and Lubrication—Automotive Electricity—Ignition Systems—Magneto Ignition—Spark Plugs—Ignition Coils—Distributors—Automatic Spark Control—Ignition Timing—Generators—Starters—Generator and Starter Testing—Lighting Systems—Storage Batteries—Charging and Testing—Diesel Engines and Trouble Shooting.

7 DAYS' FREE TRIAL
TO GET THIS ASSISTANCE FOR YOURSELF SIMPLY FILL IN AND MAIL COUPON TODAY.

\$4 COMPLETE PAY \$1 A MONTH ONLY



Sent on 7 Days Approval

Step up your own skill with the facts and figures of your trade. Audels Mechanics Guides contain Practical Inside Trade Information in a handy form. Fully illustrated and Easy to Understand. Highly Endorsed. Check the book you want for **7 DAYS FREE EXAMINATION**. Send No Money. Nothing to pay postman.

---CUT HERE--- MAIL ORDER

AUDEL, Publishers, 49 W. 23 St., NEW YORK 10, N. Y.

Please send me postpaid for FREE EXAMINATION books marked (x) below. If I decide to keep them I agree to mail \$1 in 7 Days on each book or set ordered and further mail \$1 monthly on each book or set until I have paid price, otherwise I will return them.

- AUTO GUIDE**, 1800 Pages . . . \$4
- DIESEL ENGINE MANUAL, 400 Pages . . . 2
- WELDERS GUIDE, 400 Pages . . . 1
- MACHINISTS Handy Book, 1600 Pages . . . 4
- POWER PLANT ENGINEERS Guide, 1500 Pages. . . 4
- ENGINEERS & FIREMANS EXAMS, 528 Pages. . . 1
- PUMPS, Hydraulics & Air Compressors, 1658 Pgs. . . 4
- MARINE ENGINEERS Handy Book, 1280 Pages . . . 4
- ENGINEERS & Mechanics Guides (8 Book Set). . . 12
- Answers on Practical ENGINEERING, 254 Pages . . . 1
- ELECTRIC WIRING DIAGRAMS, 210 Pages . . . 1
- ELECTRICIANS EXAMINATIONS, 250 Pages. . . 1
- ELECTRICAL DICTIONARY, 9000 Terms . . . 2
- ELECTRIC MOTOR GUIDE, 1000 Pages . . . 4
- HANDY BOOK OF ELECTRICITY, 1440 Pages . . . 4
- ELECTRICAL POWER CALCULATIONS, 425 Pgs. . . 2
- RADIOMANS GUIDE, 914 Pages . . . 4
- ELECTRONIC DEVICES, 216 Pages . . . 2
- ELECTRIC LIBRARY, 7000 Pages (12 Book Set). . . 18
- Vols. I, II, III, IV, V, VI, VII, VIII, IX, X, XI, XII \$1.50 Ea. . . 1
- OIL BURNER GUIDE, 384 Pages . . . 1
- HOUSE HEATING GUIDE, 1000 Pages . . . 4
- CARPENTERS & Builders Guides (4 Book Set). . . 6
- PLUMBERS & Steamfitters Guides (4 Book Set). . . 6
- MASONS & Builders Guides (4 Book Set). . . 6
- BLUE PRINT READING, 416 Pages . . . 2
- PAINTERS & DECORATORS MANUAL, 450 Pgs. . . 2
- GARDENERS & GROWERS Guides (4 Book Set). . . 6
- REFRIGERATION & Air Conditioning, 1280 Pgs. . . 4
- SHEET METAL WORKERS Handy Book, 388 Pgs. . . 1
- SHEET METAL PATTERN LAYOUTS, 1100 Pgs. . . 4
- AIRCRAFT WORKER, 240 Pages . . . 1
- MECHANICAL DRAWING GUIDE, 160 Pages. . . 1
- MECHANICAL DRAWING & DESIGN, 480 Pgs. . . 2
- MATHEMATICS & CALCULATIONS, 700 Pgs.. . . 2
- MECHANICAL Dictionary, 968 Pages . . . 4
- MILLWRIGHTS & Mechanics Guide, 1200 Pgs. . . 4

Name _____
Address _____
Occupation _____
Employed by _____ PM

AUDEL, Publishers, 49 W. 23 St., New York 10, N. Y.

Get... YOURS FREE!

BOOKLET

OF COMPLETE
COAST INDUSTRIES
PROFIT PLAN



NELS IRWIN
Will help you start your
own successful business
—at home, spare time
or full time

BIG PROFITS

Rich profits are waiting to be tapped in this new field. New **MIRACLE** finish gives a velvety, luxurious surface to radios, lamps, toys, signs, store displays, figurines, auto dashboards, and hundreds of other items. Make old objects beautiful and salable—make new things worth much more with this soft, rich covering that can be applied to any surface, even if old and worn.

START RIGHT AWAY

Yes, you can learn in a few days to start **MAKING MONEY!** Everything you need is furnished, including fully detailed, illustrated instructions that are complete and easy to understand. Every point is explained, to show you how to start on the road to big money, full or spare time, right in your own home

EVERYTHING COMPLETE

In addition to full instructions you get a complete set of materials that enables you to start at once. A few cents worth of materials can mean many dollars in return to you—you can earn up to \$5 per hour and more spare or full time. Add to your income from your present job or start a profitable business of your own. Our Business is Booming. Help us fill **HUGE DEMAND.**

ACT NOW

Grasp this opportunity **TODAY!**—Start your own business. It's too good to miss! **SEND NO MONEY!**—fill out the coupon and stick it on a post card or in an envelope and mail today for full details. **FREE** samples of **FLOK-KRAFT** covered material, and hundreds of useful and profitable **IDEAS**. Do it **NOW!**—be first!

**COVERS WOOD, FABRIC, METAL,
GLASS, PLASTER, PLASTIC OR
ANY SURFACE**

USE COUPON FOR FREE SAMPLE

COAST INDUSTRIES Dept. 2-C
1004 S. Los Angeles St., Los Angeles 15, Calif.

Gentlemen: Please rush me all the details.

NAME _____

STREET _____

CITY _____

STATE _____



TOYS



JEWELRY BOXES



CAR DASHBOARDS



DISPLAY PIECES



LAMPS



CAR TRUNKS



RADIOS



(Continued from page 10)

Measuring tape mounts on tripod (Foto-Rule Co., Monrovia, Calif.).....170
 Identification numbers printed on negatives (Champion Photo Supply Co., 327 Main St., Orange 1, N. J.).....170
 Portable lighting kit for movie photographers (Grover Photo Co., 505 1/2 E. Broadway, Glendale, Calif.).....172

SPORTS AND OUTDOOR RECREATION

Tool for angler (W. E. Ketland, 6 King St., Alexandria, Va.)...109
 Heated hunting blind (Porta-Blind Co., 2128 Wealthy St., S.E., Grand Rapids, Mich.).....126
 Back-yard ski tow.....132
 Reversible watch for sportsmen (Jaeger LeCoultre, 580 Fifth Ave., New York City 17).....151
 Telescopic sight has variable power (Bausch & Lomb Optical Co., Rochester 2, N. Y.).....155
 Rubber playgrounds.....159
 Pontoon harness aids swim students.....159

TOOLS

Chuck holds centerless shafts (South Bend Lathe Works, South Bend 22, Ind.).....126
 Guide cuts tap breakage (Tap Guide Mfg. Co., 2520 W. Larpenteur Ave., St. Paul 8, Minn.).....139
 Dowel drill guide (Dowl-It Co., 515 N. Hanover St., Hastings, Mich.).....256
 Reversing switch for single-phase motor (Iron Fireman Mfg. Co., 2838 S.E. 9th Ave., Portland, Ore.).....264

TOYS AND NOVELTIES

Plastic changes to frost (Fry Plastics Co., 7612 S. Vermont, Los Angeles 44, Calif.).....117
 Smoking sign (Rainbow Neon Sign Co., Houston, Tex.).....129
 "Stick ons" for children (Atlantic Plastics, 4732 St. Clair Ave., Cleveland 3, Ohio).....139

MISCELLANEOUS

Moving day for Quonsets.....87
 "Zipper" conveyor belt.....102
 Rocket "diary".....103
 Lightweight chain saw (Mall Tool Co., 7740 South Chicago Ave., Chicago 19).....103
 Automatic dispenser for DDT insecticide (Horton-Noyes Co., Industrial Trust Bldg., Providence, R. I.).....103
 Paintbrush guide (Tru-Trim Products, Hammondsport, N. Y.) 109
 Scientist tries tracing cosmic rays deep underground.....113
 Let-down trailer (Maurice Poirier, 231 N. Orchard Drive, Burbank, Calif.).....113
 Lens increases light intensity (Fairbridge Co., Inc., 945 Main St., Bridgeport 3, Conn.).....116
 Rubber sack in lighter prevents leaks (Reynolds Video Lighter Co., 608 S. Dearborn St., Chicago 5).....116
 Three-inch layer of air blows 1200 miles an hour.....117
 Bubbler also cools bottles (The Ebco Manufacturing Co., West Town at Thomas St., Columbus 8, Ohio).....117
 Passenger car rambles the rails under own power.....122
 Crocodile hunter.....128
 Tree planter (TreeP, Box 183, University Station, Syracuse 10, N. Y.).....130
 "Wrist watch" hearing aid (Acousticon International, 580 Fifth Ave., New York City 19).....131
 Flightless rocket.....139
 Telegraphy practice set works on flashlight cell (Martin Manufacturing Co., 194 Gelston Ave., Brooklyn 9, N. Y.)...143
 Post straightener (The Postratner Co., 112 Irvington St. Annex, New Haven, Conn.).....150
 Plastic shield for glass gauge (Fram's E. Brown Co., 1930 Wilshire Blvd., Los Angeles 5, Calif.).....150
 Ham's TV station is all homemade.....151
 Leash on a reel rewinds itself (Benjamin Reel Products, Inc., 10700-10710 Broadway, Cleveland 5, Ohio).....170
 Combination lamp and easel gives lighted work area (W. D. Rhodes & Co., 7800 W. Gregory St., Chicago).....171
 Trailer goes up or down to match loading dock.....172
 Ash catcher for cigarettes (Smoker-Teer Co., 199 Washington St., Boston, Mass.).....256

Craftsman and Shop Notes Index

AUTOMOTIVE

Don't use inferior brake fluid.....192
 Heating element warms crankcase for fast cold-weather starting.....206
 Removing rusted drain plugs from car radiators.....219
 Hoisting ring for car motor.....219
 Rubber-covered valve stem provides useful garage tool.....228

CHRISTMAS SPECIALS

Glittery Christmas-tree ornaments made from midget photo-flash bulbs.....191
 Buy the right Christmas tree.....193
 Testing Christmas-tree lamps.....212

DRAFTING AND LAYOUT

Scriber heads serve as trammels for improvised beam compass.....216
 Drafting instruments lifted quickly with aid of suction cups.....219
 Adjustable line guide made from old reading glass.....225

FARM

Grids on poultry self-feeders prevent feed waste.....215
 Erosion of fields prevented by concrete dam and spillway.....216
 Low windows in poultry house supply light under roosts.....219
 Lightweight wheelbarrow has aluminum frame.....225

(Continued to page 14)

You Practice COMMUNICATIONS

I Send You Parts To Build This Equipment

As part of my new Communications Course I send you parts to build your own Transmitter. Conduct actual procedure demanded of Broadcast Station Operators, practice many interesting experiments and tests, learn how to put a transmitter on the air.



NEW

You Practice Radio SERVICING

On This Modern Radio You Build With Parts I Send

As part of my Servicing Course, I send you the speaker, tubes, chassis, transformer, loop antenna, EVERYTHING you need to build this modern Radio Receiver that brings in local and distant stations. You use it to conduct many tests and experiments.



BE A RADIO TECHNICIAN

Learn Servicing or Communications

Learn by Practicing in Spare Time with **MANY KITS OF PARTS I SEND**

YOU BUILD this Tester as part of my Servicing Course. It soon helps you **EARN EXTRA MONEY** fixing neighbors' Radios in spare time.



YOU BUILD this Power Pack as part of my new Communications Course. Use it to conduct fascinating experiments with frequency amplifiers and multipliers, buffer stages, etc.



YOU BUILD this Superheterodyne Receiver Circuit and conduct Frequency Modulation experiments and many other tests as part of my Servicing Course.



YOU BUILD this Signal Generator as part of my Servicing Course for more valuable experience. It provides amplitude-modulated signals for many interesting tests and experiments.



VETERANS
GET THIS
TRAINING
WITHOUT COST
UNDER G. I. BILL
MAIL COUPON

YOU BUILD this Wavemeter as part of my new Communications Course. Use it with Oscillator you also build that furnishes basic power to transmitter and determines transmitter frequency.



J. E. SMITH, President National Radio Institute

Want a good-pay job in the fast-growing Radio and Television industries or to be boss of your own money-making Radio and Television shop? I've trained hundreds of men with no previous experience to be Radio technicians. I can do the same for you! Or now, for the first time, enroll in my new practical course in Radio—Television Communications—learn to be a Broadcasting and Communications technician. You learn Radio and Television principles from clear, illustrated lessons. You get practical Radio experience with **MANY KITS OF PARTS I SEND** in my train-at-home method. All equipment yours to keep.

MAKE EXTRA MONEY IN SPARE TIME

As part of my Radio Servicing Course, I send **EXTRA MONEY** booklets, starting the day you enroll. Use your know-how to make \$5, \$10 and more a week **EXTRA MONEY** fixing Radios in spare time while training. The next step is your own Radio shop or a good-pay Radio servicing job. Or, if you prefer, get into Government, Police, Aviation or Marine Radio, Broadcasting, Radio Manufacturing or Public Address Work.

BRIGHT FUTURE IN TELEVISION

Think of the present and future opportunities in the fast-growing Television field. New stations are going on the air every month. . . . Television manufacturers are producing over 100,000 sets a month. It's a fast-growing field and the man who knows Television will be in demand.

GET ACTUAL LESSON AND BOOK FREE

Send now for my special **DOUBLE FREE OFFER**. Get actual lesson on Radio Repairing short-cuts absolutely free. Also get 64-page book, "HOW TO BE A SUCCESS IN RADIO — TELEVISION — ELECTRONICS." See how quickly, easily you can start. J. E. SMITH, President, Dept. 9NP, National Radio Institute, Pioneer Home Study Radio School, Washington 9, D. C.

I TRAINED THESE MEN AT HOME



Good Job in Radio Station
"Am Chief Engineer of Station WORD, in charge of four men. Owe all I know about Radio to NRI."—CLYDE J. BURDETTE, Spartanburg, South Carolina.



Makes Extra Cash in Spare Time
"Earned enough spare time cash to pay for my course by time I graduated. NRI training is tops!"—ALEXANDER KISH, Carteret, New Jersey.



Operates Own Radio Business
"Now have two Radio shops servicing about 200 sets a month. Have largest service establishment in Southeast Missouri."—ARLEY STUDYVIN, DeSoto, Mo.

MY COURSE INCLUDES TELEVISION

Good for Both—FREE

MR. J. E. SMITH, President, Dept. 9NP National Radio Institute, Washington 9, D. C.

Mail me **FREE** Sample Lesson and 64-page book about how to win success in Radio and Television—Electronics. (No salesman will call. Please write plainly.)

Name..... Age.....
Address.....
City..... Zone..... State.....
 Check If Veteran **APPROVED FOR TRAINING UNDER G. I. BILL**



FREE

ALLIED'S NEW 1950 RADIO CATALOG!



SEND FOR THIS
196-PAGE BOOK

Save on Everything in Radio



Get Radio's Leading Buying Guide!

Get everything you need from the world's largest radio supply house—and save money on every purchase! ALLIED's new 196-page 1950 Buying Guide offers widest selections of top quality equipment—ready for speedy, dependable shipment at lowest prices. Have the advantages of expert, friendly service, and guaranteed satisfaction on every purchase. To get more for your radio dollar, send today for your FREE 1950 ALLIED Catalog, the preferred Buying Guide to everything in radio and electronics.

**BUILDERS' KITS
TELEVISION SETS
HI-FIDELITY SOUND
AMATEUR GEAR
THOUSANDS OF PARTS
TUBES, TOOLS, TESTERS
BOOKS & DIAGRAMS**

Everything for
Servicemen, Engineers,
Experimenters, Builders,
Soundmen, Amateurs

ALLIED RADIO

ALLIED RADIO CORP.
833 W. Jackson Blvd., Dept. 5-M-9
Chicago 7, Illinois

Rush FREE 196-Page Catalog

Name.....

Address.....

City..... Zone..... State.....

FREE
CATALOG

(Continued from page 12)

Poultry roosts hinged to wall in sections facilitate cleaning	225
dropping pits	225
Stopper in poultry-fount outlet fitted with wooden handle	228
Cross-bracing supports gatepost	228
Chickens prevented from roosting on poultry-house windows	228

HOUSE AND HOME

Filter for warm-air furnace has steel-wool packing	176
Salt eliminates snow shoveling	176
Drying rack for sweaters	178
Belt hangers made from cardboard	178
Coin aids slipping curtains on rods	178
Clothespin bag held open by hoop	178
Masking tape protects window stops when cleaning blinds	179
Potato peeler used for grating chocolate	179
Oilcloth under needle-point simplifies cleaning problem	179
Finger-pressing wet garments facilitates ironing	180
Garments protected from dust while hanging in closet	199
Lawn roller filled with oil does not rust or freeze	199
Nail driven through floor aids locating wire hole for wall receptacle	200
Cleaning glass drinking straws	206
Don't blame dust on heating system	206

NOVELTIES

Fan bookrack	177
Interlocking wastebasket	181
Gluing paper doilies to solid backing provides novel picture frame	191
Carved plaque for your den	201
Attractive illuminated sign for small shop displays cutout of merchant's specialty	215

OUTDOOR SPORTS

Glove slit for trigger finger	191
Knockdown ice-fishing tipup is conveniently carried	192
Salt-filled sacks permit under-ice muskrat trapping in coldest weather	200
Tree bark serves as compass	202

PHOTOGRAPHY

Lens care	207
Mirror on front of camera puts portrait subject at ease	211
Cushion for photoflood reflector	211

SEWING

Clothespin serves as marking gauge for cutting bias strips	179
Alarm clock holds pincushion	202
Rotating thread kit	203
Ear muffs provide pincushion	212

TOOLS

Scissors jack aids leveling bench	176
Safety box holds power-tool plugs	176
Suction cup chucks copper bowl to spin-polish the inside	180
Upholstering nails driven neatly with aid of rivet set	180
Drills rolled to prevent breaking	199
Protractor on grinder tool rest permits checking work angle	202
Leather punch nibbles holes when making gaskets	202
Clothespin snubs extension cord	206
Prevent mislaying chuck wrench by attaching to drill cord	206
Brace across cupped plywood aids sawing large sheets	212
Lathe pipe centers	213
Clothespin forms pocket clip on carpenter's pencil	216
Collet stop aids in producing accurate repetitive work	216
Portable drill used as power drive	219
Fixtures for faster sawing	226
Old file forms handy extractor for broken bolts and screws	228

MISCELLANEOUS

Suction cup over oil-drum plug prevents water leakage	176
Joining sheet metal without rivets	180
Tapping holes in plastic	180
Hose in frozen hydrant pipe prevents bursting	192
Pulling staples from bulletin board facilitated by tape strips	192
Rope linked with hog ring provides durable door mat	192
Pads on soles prevent slipping	199
Life of straw or chintz scuffs prolonged by adding soles covered with adhesive	200
Measuring fuel oil in storage drum	202
Nails notched for easy breaking	202
Lengthening leather straps	212
Rubber band fastens key to wrist	212
Wall rack for battery hydrometer	212

Radio-Television, Electronics

Electronic secretary (Electronic Secretary Industries, 4528 W. Greenfield Ave., Milwaukee 14, Wis.)	229
Amplifier for 45 r.p.m. record changer in portable case (Crescent Industries, Inc., 4140 W. Belmont Ave., Chicago 41)	230
Modulation monitor for radio hams, police and marine radio-telephone use (Triplet Electrical Instrument Co., Bluffton, Ohio)	232

IMPORTANT NOTICE—It is the intention of this magazine to provide its readers with information regarding the latest developments in the mechanical arts. We take no responsibility as to whether the disclosures contained in our articles are covered by patents and advise readers to investigate this subject before making, using, or selling any of the products, machines, or processes described in order to avoid possible liability for patent infringements.



INVENTORS



Learn how to protect your invention. The U. S. Patent Laws provide that any new and useful art, machine, article of manufacture, or composition of matter, or any new and useful improvement thereof, may be patented if the act of invention is involved. Therefore, every inventor with a valuable invention should take advantage of the Patent Laws and proceed for patent protection in order to safeguard his rights.

A patent gives the inventor the exclusive right to prevent others from making, using, or selling the invention claimed in the patent for a period of seventeen years.

The Patent Laws were enacted for the benefit of the inventor to give him protection for the features of his invention which are patentable. These features must be properly and concisely set forth and claimed in a formal application for patent, in order to comply with the requirements of the Patent Laws. For that reason, unless the inventor is familiar with patent matters, he should engage a competent registered patent attorney or agent to represent him. We are registered to practice before the U. S. Patent Office and are prepared to serve you in the handling of your patent matters.

A specially prepared booklet entitled "Patent Guide for the Inventor", containing detailed information with respect to patent protection and procedure, together with a "Record of Invention" form will be promptly forwarded to you without obligation upon request.

CLARENCE A. O'BRIEN & HARVEY JACOBSON

Registered Patent Attorneys

91-M DISTRICT NATIONAL BUILDING • WASHINGTON 5, D. C.

Patents

Trademarks

Copyrights

CLARENCE A. O'BRIEN & HARVEY JACOBSON
Registered Patent Attorneys

91-M District National Bldg., Washington 5, D. C.

Please send me copy of "Patent Guide for the Inventor" and also "Record of Invention" form. This request does not obligate me.

Name _____

Address _____

City _____ State _____

(Please write or print plainly.)

YOU Need My **PRACTICAL** Training to Make Money in

TELEVISION- RADIO and ELECTRONICS!



I'll Send You
8 BIG KITS of
Radio Parts and Equipment

Learn at
HOME
IN YOUR
SPARE TIME

Now is the Time to Get Into This Fast
Growing Industry—Prepare for a Fine
Paying Job or Your Own Business!

I have trained hundreds of men to become technicians—and I'm ready to do the same for you. Whether your goal is a fine paying job in one of Radio's many branches—or a successful Radio and Television business of your own—you need the kind of training I offer! My training is practical and down to earth. **YOU NEED NO PREVIOUS EXPERIENCE.** I start you with basic fundamentals and give you plenty of practical shop-bench training with many kits of parts I send you. This is the training that sticks with you and makes money for you on the job!

GET PAID FOR SPARE TIME WHILE LEARNING

Soon after you start training I send you my famous **BUSINESS BUILDERS** that show you how to make money in spare time doing interesting Radio jobs. I send you 8 big kits of Radio parts and equipment and help you build step-by-step a powerful 6-tube superhet radio, a 16-range test meter, plus other mighty useful equipment for Radio and Television servicing. You will perform over 175 fascinating experiments while training. You will learn about Television—so that you will be qualified to step into this fast growing, profitable field. I also send you many valuable service manuals, diagrams, and my book telling exactly how to set up your own Television and Radio shop. Clip and mail the coupon below for my two big **FREE** Radio books. I employ no salesmen—and nobody will call on you.

HAVE A BUSINESS OF YOUR OWN

A profitable Radio and Television Service Shop may be started with little capital. I will show you how to get started. At left is pictured one of my graduates, Mr. Merrit C. Sperry, Fairmont, Minn. in his own shop.



Radio and Television Industry Booming

You couldn't pick a better time to get into Radio-Television and Electronics. New Television stations are going off the air to serve every major city—hundreds of new AM and FM Radio broadcasting stations are also on the air. All this creates new and bigger opportunities for the trained man who knows Radio-Television and Electronics

VETERANS

THIS TRAINING AVAILABLE TO YOU UNDER THE G.I. BILL

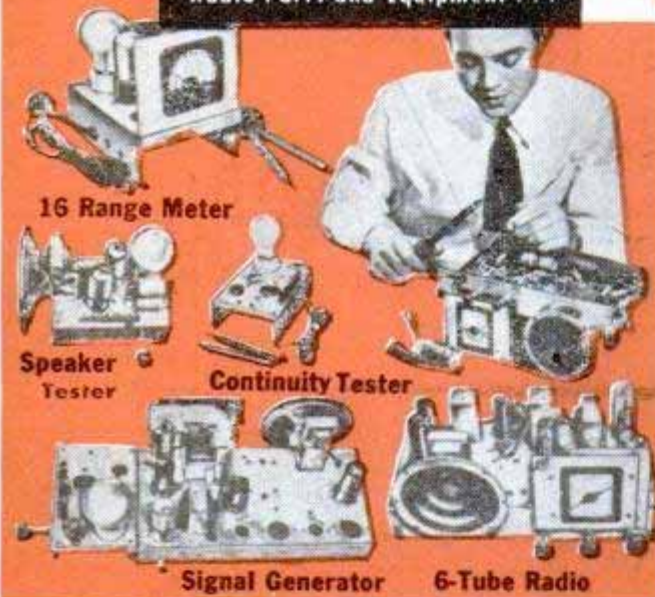

All Kits Are **YOURS TO KEEP**

Each of the hundreds of Radio parts and other items I send my students is theirs "for keeps." You may use this equipment in your Radio and Television service work and save many dollars by not having to buy expensive "ready-made" test equipment.



CALVIN SKINNER of New Orleans, La. tells us he makes \$5 to \$10 in spare time repairing radios. He is now also working with a Television set.



LOREN D. SAUCIER of Coloma, Mich. reports that my training has made it possible for him to repair large numbers of Radio and Television sets.

RUSH COUPON Today!

SPRAYBERRY ACADEMY of RADIO, Dept. 10-D
111 North Canal Street,
Chicago 6, Illinois

Please rush my **FREE** copies of "How To Make Money In Radio-Television and Electronics" and "How To Read Radio Diagrams and Symbols."

Name.....Age.....

Address.....

City.....State.....

() Check here if you are a Veteran

My Training Includes ...
Television, FM (Frequency Modulation), Public Address and High Frequency Applications



These Two Big FREE! Radio Books

Just mail coupon for a **FREE** sample Sprayberry Lesson and my big **FREE** book, "How To Make Money In Radio-Television and Electronics." Learn why my really **practical** training is best of all for you. Discover what's ahead for you in Radio-Television and Electronics. No obligation. Don't delay! Mail the coupon now—and count on me for fast action.

SPRAYBERRY ACADEMY OF RADIO
111 N. CANAL, DEPT. 10-D, CHICAGO 6, ILL.

INVENTORS

Patent laws encourage the development of inventions.

We recommend that an inventor employ a registered Patent Attorney or agent, if the inventor is not familiar with patent matters. This is because the value of a patent depends largely upon the skillful preparation of the specification and claims in the patent application.

The firm of McMorrow, Berman and Davidson is registered to practice before the United States Patent Office. Additionally it engages patent attorneys able to readily understand inventors' disclosures, to advise concerning patentability, and to prepare appropriate specifications and claims.

If an inventor believes he has an invention, a search of the most pertinent prior U. S. patents should be made and a report obtained relative to its patentability. Where such report indicates that the invention appears patentable, in order to secure protection, diligence should be exercised in making application for a patent.

Send for a copy of Patent Booklet entitled "How To Protect Your Invention." This booklet contains information on patent protection and procedure. You will also receive an "Invention Record" blank. This will be promptly forwarded to you upon request—no obligation.

McMORROW, BERMAN & DAVIDSON

Registered Patent Attorneys

PATENTS • TRADE MARKS • COPYRIGHTS

1357 VICTOR BUILDING, WASHINGTON 1, D. C.

McMORROW, BERMAN & DAVIDSON

Registered Patent Attorneys

1357 Victor Building, Washington 1, D. C.

Send me your Patent Booklet, "How To Protect Your Invention", and also "Invention Record" form at once. I understand this request does not obligate me.

Name.....

Address.....

City.....

(WRITE OR PRINT NAME CLEARLY)

Will You Let Me PROVE I Can Make YOU a New Man?

LET ME START SHOWING RESULTS FOR YOU



I COULD fill this whole magazine with enthusiastic reports from OTHERS. But what you want to know is— "What can Atlas do for ME?"

15 MINUTES A DAY

Just give me 15 minutes of your spare time daily. That's all I ask. And even in that short time I'll start giving RESULTS. And it will be the kind of RESULTS that you (and anyone else) can SEE, FEEL, MEASURE with a tape.

FREE BOOK

I myself was once a 97-pound weakling—sickly, half-alive. Then I discovered "Dynamic Tension." And I won the title, "The World's Most Perfectly Developed Man!" "Dynamic Tension" has done so much for other fellows that I simply ask you to let me prove that it can make a New Man of YOU—that it can start new inches of power pushing out your chest—build up your shoulders to champion huskiness—put new, hard, firm muscles on your biceps—make those stomach muscles of your hard ridges!

Why not risk a postage stamp? Send coupon for my 48-page Illustrated FREE BOOK AT ONCE! Address me personally: Charles Atlas, Dept. 8ZY, 115 East 23rd Street, New York 10, N. Y.

CHARLES ATLAS, Dept. 8ZY
115 East 23rd Street, New York 10, N. Y.

I want the proof that your system of "Dynamic Tension" will help make a New Man of me—give me a healthy, husky body and big muscle development. Send me your free book, "Everlasting Health and Strength."

Name _____ Age _____
(Please print or write plainly)

Address _____

City _____ State _____



5 YEAR WRITTEN GUARANTEE
17 JEWEL CHRONOGRAPH
2 PUSH BUTTON

ORIGINALLY \$71.50

● WRISTWATCH
● STOPWATCH
● TELEMETER
● TACHOMETER

Post-War Surplus
Now Only
\$21.95 Plus \$2.20 Tax

Precision 4 in 1 Timepiece. Incublock shock resistant feature. Sweep Second hand. Anti-magnetic. Radium Dial. Stainless steel back. Unbreakable crystal. Perfect for physicians, scientists, technicians, engineers, aviators, photographers, broadcasters, navigators, sportsmen, servicemen, etc. Thousands sold at \$71.50. Order now while they last at this record breaking low price. Send only \$1 down payment with order. Pay balance to post-man on arrival plus postage. Or we pay postage if you include full payment plus tax with your order. Airmail Xmas delivery guaranteed.

FREE! HANDSOME EXPANSION BAND INCLUDED. Money back in 5 days if not delighted. Order now!

MARYLAND DISTRIBUTORS, Dept. 116, 501 E. Baltimore St., Baltimore 2, Md.



LEARN MEAT CUTTING

through actual practice. Profitable Meat Cutting and Self Service Meats taught easily, quickly. LEARN BY DOING at Toledo in just eight short weeks under actual market conditions. For beginners or men with experience. All subjects taught thoroughly and completely. Diploma. Job help. Get store of own. People must eat. School in operation over 25 years. Approved for GI training. Send today for FREE illustrated catalog. No obligation.

NATIONAL SCHOOL OF MEAT CUTTING, Dept. 50-U, Toledo 4, Ohio

REAL ESTATE BE A BROKER

PAYS BIG! SEND FOR FREE, BIG, ILLUSTRATED CATALOG NOW! No obligation. Graduates report making substantial incomes. Start and run your own business quickly. Men, women of all ages, learn easily. Course covers Sales, Property Management, Appraising, Loans, Mortgages, and related subjects. **STUDY AT HOME** or in our classrooms in big cities. Diploma awarded. G.I. approved. Nationally known.

WEAVER SCHOOL OF REAL ESTATE (Est. 1936)
15 E. Pershing Road Dept. PM Kansas City, Mo.

FREE BOOK TELLS HOW

Learn CARTOONING

HAVE FUN! MAKE MONEY! Cash in on your sense of humor at HOME—BY MAIL. No experience needed to start. Write today for FREE TRIAL LESSON and full particulars.

Moon Gag Cartoon School, Dept. E, Fall Creek, Wis.

Learn PHOTOGRAPHY

There's big money in PHOTOGRAPHY—and an action-packed career for you. Our HOME STUDY COURSE—famous throughout the world—is your spare-time **SHORT CUT TO SUCCESS!** Or if you wish . . . **PERSONAL ATTENDANCE TRAINING** at our famous New York Studios is available with subsistence under the G. I. BILL. Our 4th year. Write immediately!

NEW YORK INSTITUTE OF PHOTOGRAPHY
Dept. "49", 10 W. 33 St. New York 1, N. Y.

Learn WOOD PRODUCTION ENGINEERING

VETERANS training is FREE under G. I. BILL.

GET THIS FREE BOOK Today

It tells you how you can learn to become a successful **WOOD PRODUCTION ENGINEER** . . . by the Klok Home Study Correspondence Method . . . or by studying here in Grand Rapids in our Resident School . . . Training in **WOOD PRODUCTION ENGINEERING** offers you great opportunities . . . either to get a top position or to operate your own plant successfully.

The Klok Course teaches you **SKETCHING, ROD-MAKING, DETAILING, STOCK BILLING, TIME STUDY, COST and MANAGEMENT.**

WRITE FOR FREE BOOK TODAY! State preference whether Home Study or Resident course, with name, age, occupation and if veteran.

KLOK INSTITUTE
LOUIS ST., N.W.
GRAND RAPIDS, MICHIGAN

I. C. S. STUDENT JUDGED BEST APPRENTICE IN THE NATION



**Ex-G.I. Took Course in
Electrical Engineering**

I. C. S. Training proves its worth. Recently, Robert M. Hutchison of Evansville, Ind., was picked as "the best electrical apprentice in the nation." He had studied Electrical Engineering with the International Correspondence Schools.

The award was made by the National Electrical Contractors Association. Hundreds of apprentices from every section of the country figured in the competition.

The same training that brought "Bob" Hutchison national recognition is available

"Here's why I consider I. C. S.

Courses exceptional:

- 1 I. C. S. texts are easy to understand; explanations are very clear.
- 2 The student determines his own progress; gets a real sense of achievement.
- 3 Textbooks and lesson material make a valuable set of reference books."

ROBERT M. HUTCHISON

to you. If you want the security and rewards that come with sound, practical training, mark and mail the coupon *today*. Find out what I. C. S. can do for you.

INTERNATIONAL CORRESPONDENCE SCHOOLS

APPROVED
under the
G. I. BILL

BOX 5666-K, SCRANTON 9, PENNA.

Without cost or obligation, please send me full particulars about the course BEFORE which I have marked X:

- | | | | | |
|---|--|---|---|---|
| <p>Air Conditioning and Plumbing Courses</p> <input type="checkbox"/> Air Conditioning
<input type="checkbox"/> Heating
<input type="checkbox"/> Refrigeration
<input type="checkbox"/> Chemical Courses
<input type="checkbox"/> Chemical Engineering
<input type="checkbox"/> Chemistry, Analytical
<input type="checkbox"/> Chemistry, Industrial
<input type="checkbox"/> Chemistry, Mfg. Iron & Steel
<input type="checkbox"/> Petroleum Refining
<input type="checkbox"/> Pulp and Paper Making
<p>Civil Engineering, Architectural and Mining Courses</p> <input type="checkbox"/> Architecture
<input type="checkbox"/> Architectural Drafting
<input type="checkbox"/> Bridge and Building Foreman
<input type="checkbox"/> Building Estimating
<input type="checkbox"/> Civil Engineering
<input type="checkbox"/> Coal Mining
<input type="checkbox"/> Contracting and Building
<input type="checkbox"/> Highway Engineering
<input type="checkbox"/> Lumber Dealer
<input type="checkbox"/> Reading Structural Blueprints
<input type="checkbox"/> Sanitary Engineering
<input type="checkbox"/> Structural Drafting | <p><input type="checkbox"/> Plumbing
 <input type="checkbox"/> Steam Fitting
 <input type="checkbox"/> Communications Courses
 <input type="checkbox"/> Electronics
 <input type="checkbox"/> Practical Telephony
 <input type="checkbox"/> Radio, General
 <input type="checkbox"/> Radio Servicing
 <input type="checkbox"/> Telegraph Engineering
 <p>Electrical Courses</p> <input type="checkbox"/> Electrical Drafting
 <input type="checkbox"/> Electrical Engineering
 <input type="checkbox"/> Electric Light and Power
 <input type="checkbox"/> Lighting Technician
 <input type="checkbox"/> Practical Electrician
 <p>Internal Combustion Engines Courses</p> <input type="checkbox"/> Auto Technician
 <input type="checkbox"/> Diesel-Electric
 <input type="checkbox"/> Diesel Engines
 <input type="checkbox"/> Gas Engines
 <p>Mechanical Courses</p> <input type="checkbox"/> Aeronautical Engineer's, Jr.
 <input type="checkbox"/> Aircraft Drafting
 <input type="checkbox"/> Forging
 <input type="checkbox"/> Heat Treatment of Metals
 <input type="checkbox"/> Industrial Engineering
 <input type="checkbox"/> Industrial Instrumentation </p> | <p><input type="checkbox"/> Structural Engineering
 <input type="checkbox"/> Surveying and Mapping
 <input type="checkbox"/> Mech. Drafting
 <input type="checkbox"/> Mechanical Engineering
 <input type="checkbox"/> Mold-Loft Work
 <input type="checkbox"/> Patternmaking—Wood, Metal
 <input type="checkbox"/> Reading Shop Blueprints
 <input type="checkbox"/> Sheet-Metal Drafting
 <input type="checkbox"/> Sheet-Metal Worker
 <input type="checkbox"/> Ship Drafting
 <input type="checkbox"/> Tool Designing
 <input type="checkbox"/> Welding Engineering
 <input type="checkbox"/> Welding—Gas and Electric
 <p>Railroad Courses</p> <input type="checkbox"/> Air Brake
 <input type="checkbox"/> Diesel Locomotive
 <input type="checkbox"/> Locomotive Engineer
 <input type="checkbox"/> Locomotive Fireman
 <input type="checkbox"/> Locomotive Mechanist
 <input type="checkbox"/> Railroad Section Foreman
 <input type="checkbox"/> Steam-Diesel Loco. Eng.
 <p>Stationary Eng'g Courses</p> <input type="checkbox"/> Boilermaking
 <input type="checkbox"/> Combustion Engineering
 <input type="checkbox"/> Engine Running
 <input type="checkbox"/> Marine Engineering
 <input type="checkbox"/> Power Plant Eng'g </p> | <p><input type="checkbox"/> Mech. Drafting
 <input type="checkbox"/> Cotton Manufacturing
 <input type="checkbox"/> Loom Fixing
 <input type="checkbox"/> Textile Designing
 <input type="checkbox"/> Woolen Manufacturing
 <p>Business and Academic Courses</p> <input type="checkbox"/> Accounting
 <input type="checkbox"/> App. Psychology
 <input type="checkbox"/> Business Administration
 <input type="checkbox"/> Bus. Correspondence
 <input type="checkbox"/> Certified Public Accounting
 <input type="checkbox"/> Commercial
 <input type="checkbox"/> Cost Accounting
 <input type="checkbox"/> Federal Tax
 <input type="checkbox"/> Foremanship
 <input type="checkbox"/> Good English
 <input type="checkbox"/> Higher Mathematics
 <input type="checkbox"/> Industrial Supervision
 <input type="checkbox"/> Motor Traffic
 <input type="checkbox"/> Retailing
 <input type="checkbox"/> Salesmanship
 <input type="checkbox"/> Sign Lettering
 <input type="checkbox"/> Spanish
 <input type="checkbox"/> Traffic Management </p> | <p><input type="checkbox"/> Rayon Weaving
 <input type="checkbox"/> Advertising
 <input type="checkbox"/> Bookkeeping
 <input type="checkbox"/> Bus. Law
 <input type="checkbox"/> Commercial Art
 <input type="checkbox"/> First Year College
 <input type="checkbox"/> French
 <input type="checkbox"/> High School
 <input type="checkbox"/> Illustration
 <input type="checkbox"/> Postal Civil Service
 <input type="checkbox"/> Retail Bus. Management
 <input type="checkbox"/> Secretarial
 <input type="checkbox"/> Stenography </p> |
|---|--|---|---|---|

Name _____ Age _____ Home Address _____

City _____ State _____ Working Hours _____ A.M. to _____ P.M.

Present Position _____ Employed by _____

Length of Service in World War II _____ Enrollment under G.I. Bill approved for World War II Veterans. Special tuition rates to members of the Armed Forces. Canadian residents send coupon to International Correspondence Schools Canadian, Ltd., Montreal, Canada.

INVENTORS

A patent is a valuable right. On the basis of a constitutional provision Congress has established a system under which inventors may secure the exclusive right to prevent the unauthorized use, manufacture and sale of their inventions for periods of seventeen years. The inventor secures this protection by obtaining a patent.

Unless an inventor is thoroughly familiar with such matters, he is advised to employ a competent registered patent attorney or registered patent agent, as the value of patents depends largely upon the skillful preparation of the specification and claims.

This firm is registered to practice before the U. S. Patent Office and is available to assist inventors in the preparation and prosecution of their cases. Detailed information and the preliminary steps to take to obtain patent protection will be furnished upon request.

Form below for mailing convenience

VICTOR J. EVANS & Co. *Merlin M. Evans*
 REGISTERED PATENT ATTORNEY
 430-P MERLIN BUILDING, WASHINGTON 6, D. C.

• • • • •

VICTOR J. EVANS & CO.
 • 430-P Merlin Building, Washington 6, D. C.

• Please send me without obligation a copy of your
 • booklet "Patent Protection For Inventors" together
 • with your convenient "Evidence of Invention" form.

• Name.....

• Address.....

• City and State.....

• • • • •

PATENTS TRADEMARKS COPYRIGHTS

PRINT YOUR OWN POST CARDS



COMPLETE OUTFIT
only
\$7.50

Amazing results in sales, inquiries and contacts... saves time and money... very easy to use GEM STENCIL DUPLICATOR is ideal for Advertising, Announcements, Notices, Labels, Forms, Price Lists—hundreds of uses for every type of business and organization. Comes complete with all supplies, instructions and 60-page Book of Ideas.

FREE TRIAL OFFER: Try it before you buy it! Write and a GEM OUTFIT will be sent you postpaid. After 10 days, send only \$7.50 or return the GEM, no questions asked. The GEM must sell itself; you be the judge.

BOND EQUIPMENT CO. • Dept. 135
 6633 Enright • St. Louis 5, Mo.

SEND NO MONEY • FREE TRIAL OFFER

LEARN TO WRITE



a Good Hand!

FOR BUSINESS AND SOCIAL SUCCESS!
 Easy to improve your handwriting at home quickly with my new instruction books just off the press. Master all the secrets of better penmanship. Simple and easy, fully illustrated, highly endorsed. Begin today. Write for: New Free Book, "How to Become a Good Penman," or check books wanted, \$1.00 each. Business Writing Artistic Writing Card Writing Engrossing Alphabets Bird and Design Flourishing Complete Set \$4.50 Enclose 10c for your name beautifully written and special penpoint for shaded writing.
 S. A. Ziller, President, **TAMBLYN SCHOOL OF PENMANSHIP**
 441 Ridge Bldg. In Business Over 52 Years Kansas City, Mo., U.S.A.

LEARN ADVERTISING ART

Free portfolio "Your Career in Art" gives complete details. Write for combined talent and instruction test to judge your ability and our course.
APPLIED ART STUDIO, 1662 Lincoln Ave., Dept. A, Cleveland 7, Ohio

LAW FREE BOOK



Your FREE copy of "The Law-Trained Man" shows how to gain prestige and greater earnings through Blackstone home law study. All instruction material furnished including 18-volume Law Library written by 65 well-known law authorities. Lawyers, judges among our graduates. LL.B. degree. Low cost; easy terms. Write today.
BLACKSTONE COLLEGE OF LAW 225 N. Michigan Ave. Dept. 59, Chicago 1, Ill.
 A Correspondence Institution Founded in 1890

LEARN WATCHMAKING JEWELRY REPAIRING

Start your training now for a better paying job or your own profitable business. Intensive practical training by experienced craftsman. Write for free catalog. APPROVED FOR VETERANS.

SCIENTIFIC SCHOOL OF WATCHMAKING, DEPT. PM-12
 3923 SAN FERNANDO ROAD GLENDALE 4, CALIFORNIA



NEW

IMPROVED...AMERICANIZED

JUDO

TWO BIG BOOKS FULLY ILLUSTRATED
 1220 SHOW-HOW PHOTOS. 71 LESSONS
 MANY NEW HOLDS

Protect yourself and others. Size and strength mean nothing. Knowledge and skill enable you to master any situation even against biggest bullies or armed thugs. Written and illustrated by one of the world's great Judo experts. Volume 1, basic and advanced holds. Volume 2, very advanced. Each volume \$1.50.

BOTH BOOKS \$2.50 POSTPAID
 OR C.O.D. PLUS POSTAGE
 5-day Money Back Offer. ACT NOW!

Big Combination Offer!
SAVE...

DEPT. M-12
IMPROVED JUDO, INC. P.O. Box 7355, Sta. 1, Los Angeles, Calif.

Prepare in our
Big Training
Shops for these

GREAT OPPORTUNITY FIELDS!



This big fire-proof building is occupied entirely by Coyne.

FIVE BIG FLOORS PACKED WITH MASSIVE EQUIPMENT

Thousands of men and young men have come to our big training shops where we have floor upon floor packed with massive equipment to train with, to prepare for good jobs and real futures in the opportunity fields of Electricity and Radio-Television. For many years, these fields have offered great opportunities to trained men. With new developments, including Electronics and Television, they will continue to grow and offer even greater opportunities. Why be satisfied with a "no future" job? Many "one operation" jobs that exist today will not last. Prepare for a good job with a real future for steady pay and advancement by training NOW in the great training shops of COYNE in Chicago.

NOT "HOME-STUDY" COURSES

Our famous Radio-Television Practical-Technical method gives you practical experience on a massive outlay of equipment. Not by correspondence, but actual shop work plus necessary technical training. You are trained right here in the great Coyne shops that have been training men and young men for over 50 years.

ELECTRICITY RADIO-TELEVISION

INCLUDING INDUSTRIAL ELECTRONICS

Big future in Power Plant Work, Motors, Armature Winding, Home and Factory Wiring, Appliances, Refrigeration, Maintenance, Illumination, etc. Electricians are in demand everywhere—lifetime job service to Coyne graduates. Send for BIG FREE BOOK.

A great field now, even greater growth ahead. Here at COYNE you're trained for Construction, Testing, Trouble-Shooting on Radio, Public Address, Sound Units. Training includes FM, Television Servicing, etc. Many Coyne trained men in good jobs or own well paying Radio-Television businesses of their own.



ELECTRIC REFRIGERATION

This valuable training now included with either course means added opportunities.

G. I. APPROVED

NON-VETERANS who are short of cash can finance most of their tuition and pay in easy monthly payments after graduation. Many earn while learning.

B. W. COOKE, President

COYNE ELECTRICAL AND RADIO SCHOOL

500 So. Paulina St., Dept. 99-72H, Chicago 12, ILL.

LARGEST, OLDEST, BEST EQUIPPED SCHOOL OF ITS KIND IN THE U.S.

Mail Coupon for
Big FREE Book!

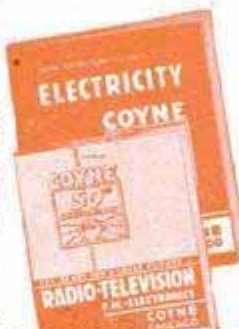

Whether you prefer Electricity, or Radio-Television, train on actual equipment at Coyne. We have a big, fully illustrated book on each course, and we'll send you the one you want, or both if you want to consider both fields, without obligation. Mail coupon—TODAY.

B. W. Cooke, President
COYNE ELECTRICAL AND RADIO SCHOOL
500 S. Paulina St., Dept. 99-72H, Chicago 12, Ill.

Send me the book, checked below and details of your training offer. This does not obligate me and no salesman will call.

ELECTRICITY RADIO-TELEVISION

NAME.....

ADDRESS.....

CITY.....STATE.....

**GET A LOAD
OFF YOUR MIND!**

LEARN MORE — EARN MORE — WORRY LESS!

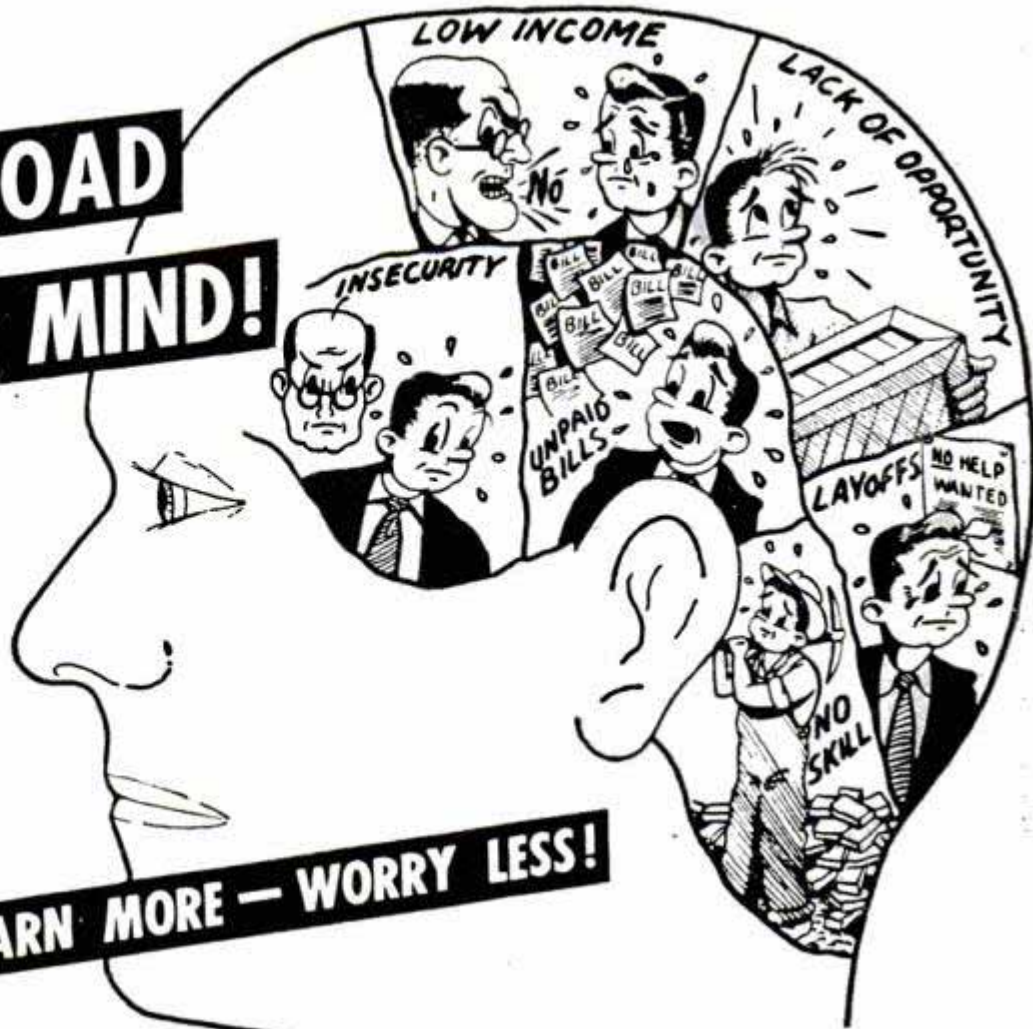

Learn a Trade through C.T.I.!

Worried because of low wages? Bothered by insecurity? Then read these encouraging words from C.T.I. students and graduates! They tell you how technical knowledge—achieved through C.T.I. in a few months of training—has provided a short cut to high income and independence. Listen:

“I enjoy every lesson and am learning more than I ever thought possible by correspondence. I have one man working for me now and I am looking forward to having a bigger and better business soon, thanks to C.T.I.” . . . “Since the news got around that I was a student with C.T.I., I have been offered three jobs paying over \$85.00 a week.” . . . “When I was on my 34th lesson, I quit my job and started a business of my own, and I’m doing fine.” . . . “Thanks to my C.T.I. lessons, I have won the respect of my bosses and the right to hold my head a little higher than

before.” . . . “I have almost finished my course and I give all the credit in the world to C.T.I. home study. I never would have been able to have my own business if it had not been for your training.” . . . “Another valuable benefit that I received from C.T.I. schooling is the habit of learning. Now I feel there is no limit to what I can accomplish in this life.”

Why limit *your* earning potential by lack of training? Better get the facts now—on how you can train for a good future in one of America’s leading industries. Find out all about C.T.I. home study training methods, and about the big C.T.I. residential school in Chicago. *Mail coupon for a big, FREE, illustrated booklet.* Act today!

RESIDENT AND HOME STUDY COURSES

C.T.I. offers full time resident training, as well as home study courses followed by 4 weeks of shop work. Choose the method that best fits your circumstances.

APPROVED TRAINING

C.T.I. is licensed by the State of Illinois, and all of its courses, both residential and home study, are approved by the Illinois Dept. of Public Instruction.

C.T.I. OFFERS PRACTICAL TRAINING IN

- AUTOMOTIVE MECHANICS
- BODY & FENDER REBUILDING
- DIESEL MECHANICS
- REFRIGERATION & AIR CONDITIONING
- ELECTRICITY & ELECTRONICS
- RADIO & TELEVISION
- BUILDING CONSTRUCTION
- MECHANICAL DRAFTING

FILL OUT - CUT OUT - MAIL TODAY

R. C. Anderson, President
COMMERCIAL TRADES INSTITUTE, Dept. E2-12
 1400 W. Greenleaf, Chicago 26, Ill.

Send free illustrated Brochures and other information about the field I have checked below:

- | | |
|---|--|
| <input type="checkbox"/> Automotive Mechanics | <input type="checkbox"/> Electricity & Electronics |
| <input type="checkbox"/> Body & Fender Rebuilding | <input type="checkbox"/> Radio & Television |
| <input type="checkbox"/> Diesel Mechanics | <input type="checkbox"/> Building Construction |
| <input type="checkbox"/> Refrigeration & Air Conditioning | <input type="checkbox"/> Mechanical Drafting |

Name _____ Age _____

Address _____

City _____ State _____

**COMMERCIAL TRADES
 INSTITUTE, Dept. E2-12**
 1400 Greenleaf, Chicago 26



GET INTO

DIESEL-AUTO

MECHANICS *Master All Phases*

JOB LIKE THESE ARE AVAILABLE TO TRAINED MECHANICS. CHOOSE THE FIELD YOU LIKE BEST

Get Complete Training

Diesel Fuel Injection
Automotive Motor Tune-up
Diesel Engine Rebuilding
General Garage Mechanic
Agricultural Implements
Auto Engine Rebuilding
Auto Elec. Service
Public Utilities
Parts Dealers
Bus & Truck Lines
Industrial Maintenance
Contracting & Excavating
Business of Your Own
AND MANY other similar openings.

As a National Schools graduate, you are trained for ALL opportunities in the Diesel & Auto Industries

EARN WHILE YOU LEARN

With our practical Master Shop-Method Home Training, you study at home in your spare time. You receive Spare Time Work Lessons, which show you how to earn while you Learn . . . for extra money and experience. You Learn by DOING.

TOOLS AND EQUIPMENT

To make your training complete, we give you selected mechanic's tools and equipment, illustrated below, including all-metal toolbox — as a regular part of your instruction.

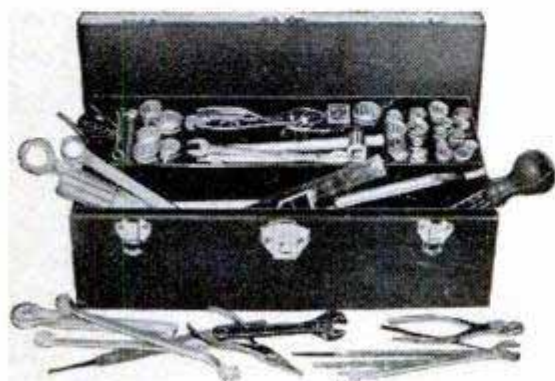

WE GIVE YOU TOOLS OF YOUR TRADE



Shop-Method Home Training by an Established Resident School Prepares you for Many Good Jobs

Opportunity is everywhere for the trained Diesel-Auto Mechanic. Highways throng with cars, busses, trucks, tractors. Garages and Service Stations are kept busy. Factories, ships, farms, railroads, general industry, are dependent upon engine power. Here's a dynamic, fast-growing field that needs trained men who know ALL phases: installation, operation, maintenance and repair. Now—National Schools offers you a practical, all-embracing Diesel-Auto Mechanic's Course, including all of these advantages:

Complete training, covering—Diesels, High Speed and Heavy Duty; Semi-Diesels, Gasoline and Special Fuel Engines AND Allied Mechanics.

- Basic Lesson Texts
- Diesel Installation
- Operation - Maintenance
- Diesel Chart Manual
- Spare Time Lessons
- Engine Service Manuals
- Engine Repair
- Drive Systems
- Diesel Electric Power
- Thermodynamics

TOOLS AND EQUIPMENT

INVESTIGATE

Secure Full Information

NEW, ILLUSTRATED BOOK & SAMPLE LESSON SHOW HOW WE TRAIN YOU . . . SEND FOR THEM TODAY!



NO COST

NO OBLIGATION

APPROVED FOR VETERANS

Check coupon below

NATIONAL SCHOOLS

LOS ANGELES 37, CALIF. • EST. 1905



FIND OUT NOW... MAIL COUPON TODAY

NATIONAL SCHOOLS, DEPT. 12-PMD
4000 South Figueroa Street
Los Angeles 37, California

(Mail in envelope or paste on penny postcard)

Mail me FREE the book, YOUR FUTURE IN DIESEL-AUTO MECHANICS, together with the Sample Lesson. I understand I may keep and use the information with no obligation.

Name _____ Age _____

Address _____

City _____ Zone _____ State _____

Check here if Veteran of World War II



What Strange Powers Did The Ancients Possess?

EVERY important discovery relating to mind power, sound thinking and cause and effect, as applied to self-advancement, was known centuries ago, before the masses could read and write.

Much has been written about the wise men of old. A popular fallacy has it that their secrets of personal power and successful living were lost to the world. Knowledge of nature's laws, accumulated through the ages, is never lost. At times the great truths possessed by the sages were hidden from unscrupulous men in high places, but never destroyed.

Why Were Their Secrets Closely Guarded?

Only recently, as time is measured; not more than twenty generations ago, less than 1/100th of 1% of the earth's people were thought capable of receiving basic knowledge about the laws of life, for it is an elementary truism that knowledge is power and that power cannot be entrusted to the ignorant and the unworthy. Wisdom is not readily attainable by the general public; nor recognized when right within reach. The average person absorbs a multitude of details about things, but goes through life without ever knowing where and how to acquire mastery of the fundamentals of the inner mind—that mysterious silent something which “whispers” to you from within.

Fundamental Laws of Nature

Your habits, accomplishments and weaknesses are the effects of causes. Your thoughts and actions are governed by fundamental laws. Example: The law of compensation is as funda-

mental as the laws of breathing, eating and sleeping. All fixed laws of nature are as fascinating to study as they are vital to understand for success in life.

You can learn to find and follow every basic law of life. You can begin at any time to discover a whole new world of interesting truths. You can start at once to awaken your inner powers of self-understanding and self-advancement. You can learn from one of the world's oldest institutions, first known in America in 1694. Enjoying the high regard of hundreds of leaders, thinkers and teachers, the order is known as the Rosicrucian Brotherhood. Its complete name is the “Ancient and Mystical Order Rosae Crucis,” abbreviated by the initials “AMORC.” The teachings of the Order are not sold, for it is not a commercial organization, nor is it a religious sect. It is a non-profit fraternity, a brotherhood in the true sense.

Not For General Distribution

Sincere men and women, in search of the truth—those who wish to fit in with the ways of the world—are invited to write for a complimentary copy of the sealed booklet, “The Mastery of Life.” It tells how to contact the librarian of the archives of AMORC for this rare knowledge. This booklet is not intended for general distribution; nor is it sent without request. It is therefore suggested that you write for your copy to Scribe M. M. T.

The ROSICRUCIANS
[AMORC]
San Jose California



NOW! Build and Keep
Big Screen Top Quality
Television Receiver at Home
as You Prepare for a
Profitable job in
**TELEVISION
RADIO-ELECTRONICS**

Choice of 10, 12½ or 16 inch picture tube

Now you can get this amazingly practical aid for learning Television at home, to help you get started toward **FASCINATING WORK . . . GOOD MONEY . . . a THRILLING FUTURE**—in a real job, or your own sales and service business. * When you complete our regular home training—described below—you can build and keep a top quality commercial-type Television Re-

ceiver. Standardized chassis is adaptable for a 10, 12½ or 16 inch direct view tube that gives big, bright, sharp, steady pictures. This is an optional training advantage—designed to provide the utmost in practical "learn-by-doing" home training in Television. Mail coupon for complete details. See why you owe it to your "Television Future" to enroll for DeForest's Training, Inc.

Mail Coupon NOW for FREE Information!

See how D. T. I.'s amazingly effective methods help start you toward a **GOOD JOB** or your **OWN BUSINESS** in one of America's most promising fields—including Television, F.M. Radio, Aviation, Train, and Taxi Radio, Broadcast Radio, Industrial Electronics. Get modern lessons . . . plus 16 shipments of Radio-Electronic parts. Work over 300 experiments and projects—including building of (1) commercial-type **OSCILLOSCOPE** for practical

T-V circuit training, (2) double-range R-F **SIGNAL GENERATOR**, (3) jewel-bearing **MULTIMETER**, (4) quality 6-tube **SUPERHET RADIO**. Then build and keep that big new Television Receiver. Here's **EVERYTHING YOU NEED** for real laboratory type training . . . **AT HOME!**

You also build and keep this Professional Type Equipment



Oscilloscope



Multimeter



R-F Signal Generator

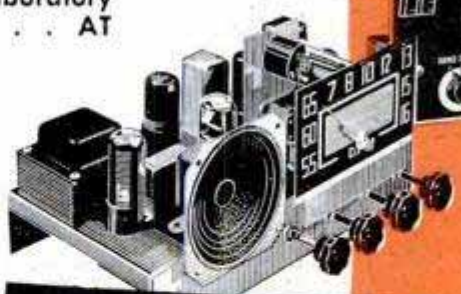

6-Tube Receiver

Modern Chicago Laboratories

* If you prefer, you can get ALL your preparation in our new, Chicago training laboratories . . . one of the finest of its kind. Ample instructors . . . modern equipment. Write for details!

Employment Service

* When you complete your training, our effective Employment Service helps you get started toward a real future in Television—Radio—Electronics.



You also use HOME MOVIES! a D. T. I. Exclusive!

D. T. I. alone includes the modern, visual training aid . . . **MOVIES** . . . to help you learn faster, easier at home. See electrons on the march and other fascinating "hidden action"—a remarkable home training advantage that speeds your progress.

MAIL THIS COUPON NOW!

DeFOREST'S TRAINING, INC.
2533 North Ashland Avenue, Dept. PM-F12
Chicago 14, Illinois

Without obligation, give me complete facts showing how I may make my start in Television-Radio-Electronics.

Name..... Age.....
Street..... Apt.....
City..... Zone..... State.....

De FOREST'S TRAINING, INC.
CHICAGO 14, ILLINOIS
A DE VRY Institution

ME—in a rut? Could be!



YES—you may be in a rut—just getting by—and not fully realizing it.

Every day you stay in that rut you "dig deeper"—make it harder and harder to get out.

So today while you think of it, take stock of yourself—are you getting ahead as fast as you should—are you satisfied to go along in a small job at small pay the rest of your life?

Hundreds of thousands of our students have won promotion and more money—and the prestige and happiness that success brings—perhaps we can help you.

Better investigate—the coupon below is for your convenience. Just check the field of your choice and we'll send you without obligation full information on that field—the requirements and opportunities—plus "Ten Years' Promotion in One"—a book which has helped many men.

Take the first step to get out of that rut—make more money—get a better job.

LASALLE Extension University A Correspondence Institution

417 S. Dearborn St., Dept. 1264-R, Chicago 5, Ill.

If I am in a rut, I don't want to stay in it. Please send me your free 48-page booklet on the field I have marked below and full information about your spare-time training.

- | | |
|---|---|
| <input type="checkbox"/> Higher Accountancy | <input type="checkbox"/> Business Management |
| <input type="checkbox"/> C. P. A. Coaching | <input type="checkbox"/> Traffic Management |
| <input type="checkbox"/> Bookkeeping | <input type="checkbox"/> Foremanship |
| <input type="checkbox"/> Law: LL. B. Degree | <input type="checkbox"/> Industrial Management |
| <input type="checkbox"/> Salesmanship | <input type="checkbox"/> Stenotypy
(Machine Shorthand) |

Name..... Age.....

Address.....

City..... Zone..... State.....

OWN Your Own Business



PATENTED PORTABLE EQUIPMENT

Lifetime Income

Clean and Mothproof rugs and upholstery "in the home" or public buildings. Start full or part time. Gross profits up to \$15 and \$20 a day on EACH of your service men. Easy to learn . . . quickly established.

DURACLEAN cleans by absorption! No scrubbing, soaking or shrinkage. Dirt and grease vanish . . . matted pile rises . . . colors revive. Furnishings used again same day.

DURAPROOF resists moths and carpet beetles. Your service backed by a National Money Back 4 Year Warranty.

We furnish enough material to return your total investment. EASY TERMS. Territories limited. Send for FREE booklet . . . full details.

Duraclean Co. 9-16D Duraclean Bldg. Deerfield, Ill.

WOULD \$400 PER MONTH INTEREST YOU?



It is easily possible to earn \$400 to \$500 a month raising ANGORA RABBITS. No experience required. Wool brings top price. Plenty markets. WRITE TODAY for FREE INFORMATION, PRICES and WHERE to SELL.

WHITE'S RABBITRY
NEWARK 10, OHIO

LEARN AERONAUTICAL ENGINEERING

Aircraft and Engine Mechanics (A & E)

Train at the Flying Wing school—New classes starting soon. Write for illustrated catalog.

Northrop Aeronautical Institute

APPROVED FOR VETERANS DIVISION OF NORTHROP AIRCRAFT, INC.
1527 E. Broadway, Hawthorne, Los Angeles County, California

CORRESPONDENCE COURSES IN RADIO and ELECTRICAL ENGINEERING

Tuition \$25

ELECTRICAL ENGINEERING. Get good grasp of wide electrical field. Modern. Very understandable. Theory made easy.

RADIO ENGINEERING. Extra fine course in radio, public address, photo-electric work. Trains you to be super-service man, real vacuum tube technician. Tuition ONLY \$25, either course. Deferred payment plan. Servicemen needed badly.

FREE LINCOLN ENGINEERING SCHOOL, Box 931-M12, Lincoln, Nebr.

BE A PHOTO-ENGRAVER

We furnish complete equipment and supplies. Learn at home or in our modern, friendly APPROVED school in MISSOURI. Get into this big demand, high profit, high wage field. You can start your own profitable, full time or part time PHOTO-ENGRAVING business right in your own home.

Be independent, be your own boss or pave the way to a high pay job with experience gained in your own shop.

TASOPÉ TRAINING and TASOPÉ EQUIPMENT has enjoyed world wide recognition since 1931. Write for descriptive literature today. No obligation.

THE AURORA SCHOOL OF PHOTO-ENGRAVING, DEPT. 9PM., TASOPÉ BLDG., AURORA, MO.

LEARN LEATHER CARVING

EASILY AT HOME—FOR PROFIT AND FUN

The age-old secrets of the leather-carver's art have been handed down for generations in only a few skilled families. But now the craft is taught by F. O. Baird, nationally-known authority. Mr. Baird supervises every lesson in the complete course. His Carv-A-Plate comes with the course, makes it easy for you to learn to carve beautiful work on belts, handbags, wallets, etc.—for yourself, for gifts, or to sell for BIG PROFITS!

NO ARTISTIC ABILITY NEEDED

The Baird Course shows you how to develop designs, gives you dozens of beautiful patterns to work on. Short cuts, practical tips, how to select leather, etc.—all combined in step-by-step instruction that makes it easy for you to learn this fascinating, highly profitable art.

WRITE NOW FOR COMPLETE INFORMATION

BAIRD School of Leather Carving
Department M-12
MANITOU SPRINGS, COLORADO

NEON SIGN SCHOOL

G. I. APPROVED

Learn Neon. Interesting, clean work, BIG PAY—\$1.50 to \$2.00 an hour to start. Our 12½ week Job-Practice Course gives you practical training in Glass Blowing, Neon Tube Bending, Color Gassing, other branches. No home study. No text books. No mathematics. FREE FOLDER explains. Write today.

ACME NEON INSTITUTE, Dept. QQ-3
330 South Paulina St. Chicago 12, Ill.

LEARN IN 12½ WEEKS



FREE
7-DAY TRIAL!
 Return and Pay Nothing
 If Not Completely Satisfied



Now YOU Can Lick Any AUTO REPAIR JOB!

IN LESS TIME-WITH LESS WORK



See How to Repair—Quickly and Easily—Any Car Built Since 1935! Over 200,000 Service and Repair Facts—More than 2100 "How-to-Do-It" Photos, Drawings, Diagrams! Over 200 "Quick-Check" Tables! 795 Pages of Illustrated Easy, Step-by-Step Instructions!

NO auto repair job is too tough when you've got MoToR's **brand-new** AUTO REPAIR MANUAL! Repair anything from carburetor to rear end—quickly, easily, right! Just look up make, model, and the job in the quick index—and go to it! Clear, ILLUSTRATED instructions lead you through entire operation step by step.

The engineer-editors of MoToR Magazine collected and "broke down" over 150 official factory shop manuals for you, spotted all the vital repair information you need, dove-tailed it all together into ONE handy, easy-to-understand book.

NO OTHER MANUAL LIKE IT!

This BIG book—795 pages, 8½ x 11 inches, sturdily bound—brings you over 200,000 service, repair, adjustment, replacement, tune-up facts on every car built from 1935 thru 1949! More than 2100 cut-away photos, diagrams, drawings show you exactly WHAT to do and HOW to do it! Used by thousands of auto repairmen, Army, Navy, and Technical Schools.

WIN PRESTIGE! EARN MORE MONEY!

MoToR's Manual makes every operation so easy that you'll find yourself tackling jobs you wouldn't think of doing before. And you'll win added prestige and more money in the bargain.

Beginners will find usable helpful guidance on every kind of repair and service job imaginable. Experts will be amazed by the time and labor-saving short cuts they'll discover.

**SEND NO MONEY
 7-DAY FREE EXAMINATION**

Just mail coupon below—without money! When the postman brings book, pay him nothing. First make it show you what it's got! Unless you agree this is the greatest time-saver and work-saver you've ever seen—return book in 7 days and pay nothing. Mail coupon today! Address: MoToR Book Department, Desk 112, 250 West 55th Street, New York 19, N. Y.

Used by
 U. S. Army
 and Navy

**COVERS ANY
 CAR BUILT
 SINCE 1935!**

- American Cord
- Bantam
- Crosley
- Auburn
- De Soto
- Austin
- Dodge
- Buick
- Ford
- Cadillac
- Frazier
- Chevrolet
- Graham
- Chrysler
- Hudson
- Hupmobile
- Kaiser
- Lafayette
- La Salle
- Lincoln
- Lincoln Zephyr
- Mercury
- Nash
- Oldsmobile
- Packard
- Pierce Arrow
- Plymouth
- Pontiac
- Reo
- Studebaker
- Terraplane
- Willlys

ABOVE: Showing operation of Buick Dyna-Flow — and BELOW: How to adjust Ford Clutch. Every moving part is covered in simple words and BIG, CLEAR Pictures.

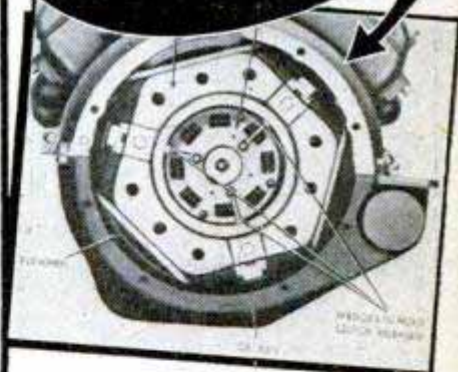

Just 2 of the Many Letters of Praise



"MoToR's Manual paid for itself on the first 2 jobs, and saved me valuable time by eliminating guesswork."
 — W. SCHROP, Ohio.



"Instructions so clear have no trouble learning anything about any car. Now working as mechanic in big plant."
 — SAM ORDONEZ, Cal.

Same FREE Offer on MoToR's TRUCK MANUAL

Covers EVERY job on EVERY truck made from 1936 thru 1946! 1400 pictures, 952 pages, 300,000 facts. All types Gasoline Engines, Truck Diesels, Hesselmans, Fuel Systems, Governors, Lubrication, Ignition, Starters, Clutches, Axles, Brakes, etc.

ALSO covers many buses, tractors, contractor and road building equipment, stationary power machinery. Check box in coupon.



Published by MoToR, The Leading Automotive Business Magazine.

MAIL COUPON NOW FOR 7-DAY FREE TRIAL

MoToR Book Dept., Desk 112, 250 West 55th St., New York 19, N. Y.

Rush to me at once (check box opposite book you want):
 MoToR's NEW AUTO REPAIR MANUAL. If O.K., I will remit \$1 in 7 days (plus 35c delivery charges), \$2 monthly for 2 months and a final payment of 95c one month after that. Otherwise I will return the book postpaid in 7 days. (Foreign price, remit \$8 cash with order.)
 MoToR's TRUCK REPAIR MANUAL. (Described at left.) If O.K., I will remit \$2 in 7 days, and \$2 monthly for 3 months, plus 35c delivery charges with final payment. Otherwise I will return book postpaid in 7 days. (Foreign price, remit \$10 cash with order.)

Print Name..... Age.....

Print Address

City..... State.....

Check box and save 35c delivery charge by enclosing WITH coupon entire payment of \$5.95 for Auto Repair Manual (or \$8 for Truck Repair Manual). Same 7-day return-refund privilege applies.

Do you want

- ➔ ..to go to College?
- ➔ ..or to enter a Profession?
- ➔ ..or get an Office Position?

(Such as Accounting, Architecture, Nursing, Dentistry, Teaching, Social Work, Osteopathy, Beauty Culture, Optometry, Embalming, Chiropody, Law, Medicine, etc.)

To get anywhere, you practically **MUST** finish High School **FIRST**. You can complete our simplified High School Course in **SPARE** time at home, as **FAST** as your time and abilities permit. Equivalent to resident school work—prepares you for college, pre-professional examinations, business, industry. Standard texts furnished. Diploma. Credit for H. S. subjects already completed. Single subjects if desired. Low tuition, easy terms. American School, Chicago, est. 1897—endorsed by educators. Finish your high school education **NOW**. Write **TODAY!**

High School Course at Home

Many Finish in 2 Years

American School, Dept. H945, Drexel Ave. at 58th St., Chicago 37, Ill.

Gentlemen: Send me **FREE** information covering special training in subjects checked below. No obligation on my part.

- | | |
|--|--|
| <input type="checkbox"/> High School Course | <input type="checkbox"/> Diesel Engineering |
| <input type="checkbox"/> Architecture and Building | <input type="checkbox"/> Drafting and Design for Men & Women |
| <input type="checkbox"/> Automotive Engineering | <input type="checkbox"/> Plastics |
| <input type="checkbox"/> Business Management | <input type="checkbox"/> Private Secretary |
| <input type="checkbox"/> Electrical Engineering | <input type="checkbox"/> Mechanical Engineering |
| <input type="checkbox"/> Elec. and Gas Refrigeration | <input type="checkbox"/> Aviation |
| <input type="checkbox"/> Air Conditioning | <input type="checkbox"/> Salesmanship |
| <input type="checkbox"/> Railway Training | <input type="checkbox"/> Radio |
| <input type="checkbox"/> Electronics, Industrial | |

Name.....

Address.....

• YOUR FUTURE • 3 TRADES IN 1 CAREER



WATCHMAKING • JEWELRY- ENGRAVING • STONE SETTING •

Each trade can be a full-time job; together they assure numerous high paying opportunities, or a business of your own. Profit by the *Nationally Recognized Training Methods* of the *Kansas City School of Watchmaking*.

ENROLLMENTS NOW AVAILABLE

Clip and Mail this Coupon Today

KANSAS CITY SCHOOL OF WATCHMAKING
1218 Admiral Blvd.
Kansas City 6, Missouri

Please send me, without obligation, complete information on training in the above courses.

Name.....

Street.....

City..... State.....

Check if Veteran

G. I. Approved

BE A SUPERVISOR

FRANKLIN TECHNICAL INSTITUTE
HELPS YOUNG PEOPLE GET AHEAD



● Specialized technical training opens wide the door to well-paid supervisory jobs in industry. 50,000 young men and women have graduated from this Boston school and found good jobs in engineering and technical fields.

Practical two-year day courses in industrial electricity and electronics, industrial chemistry, mechanical and machine design, structural design and architectural drafting, automotive service and management, electric wiring and maintenance. One-year course in professional photography. Also preparatory and evening classes. Approved for veterans. 42nd year. Write for catalog.

FRANKLIN TECHNICAL INSTITUTE
43 BERKELEY STREET, BOSTON 16, MASS.



ITALIAN ACCORDIONS

Hand Made. Very Best. Buy Direct from Factory Representative at lowest wholesale prices and Save Money. Send Name and Address for **FREE** catalog.

ITALIAN ACCORDION MFG. CO.
7600 Cottage Grove Ave., Dept. PM-12, Chicago 19, Ill.



LEARN MEAT CUTTING At Home — In Spare Time

Get into the vital meat industry. Concise, practical Home Training based on 25 years proven instruction methods used at National's famous resident school. Prepares you for bigger pay as Meat Cutter, Supervisor, market manager or more money in your own store. Go as rapidly as your spare time permits. Diploma. Start **NOW** to turn your spare hours into money. Send for **FREE** bulletin today. No obligation.

NATIONAL SCHOOL OF MEAT CUTTING, INC., Div. U-111, Toledo 4, Ohio

APTITUDE TESTS

discover the kind of work or studies best for your success! You get a personal report—a guide for life—more happiness—more prosperity. For men, women, boys and girls. Write for complete facts.

VOCATIONAL COUNSELING INSTITUTE
956 Maccabees Bldg., Detroit 2, Michigan

MAKE MONEY IN LANDSCAPING

Thorough training by Internationally known Landscape Architect to start your own business, improve your home or advance in this well paid field. Many Opportunities. Approved for Veterans. Send for **FREE** BOOK.



NATIONAL LANDSCAPE INSTITUTE
Dept. P-12, 310 So. Robertson Los Angeles 48, Calif.

RADIO ENGINEERING. Broadcasting, Television, FM, Servicing, Electronics, Aviation, Marine & Police Radio taught thoroughly. Engineering course equivalent to 3 years' college radio work. Approved Veteran Training. Catalog free.
VALPARAISO TECHNICAL INSTITUTE, Dept. D, Valparaiso, Ind.

Say You Saw It in Popular Mechanics



Is this real
or a model?

Get the answer in this picture-packed book on Model Railroading..... only 10c

● Learn about the greatest of all hobbies. Model railroading is the hobby that fascinates hundreds of thousands of men all over the world.

This exciting book tells you that model railroading is simple, is inexpensive, and is constructive. Fully illustrated. Send 10c today for your copy of "Model Railroading for You," written by a well-known authority. The **MODEL RAILROADER, DEPT, 1536, Milwaukee 3, Wis.**

Get
Into

RADIO, TELEVISION and ELECTRONICS Master ALL Phases

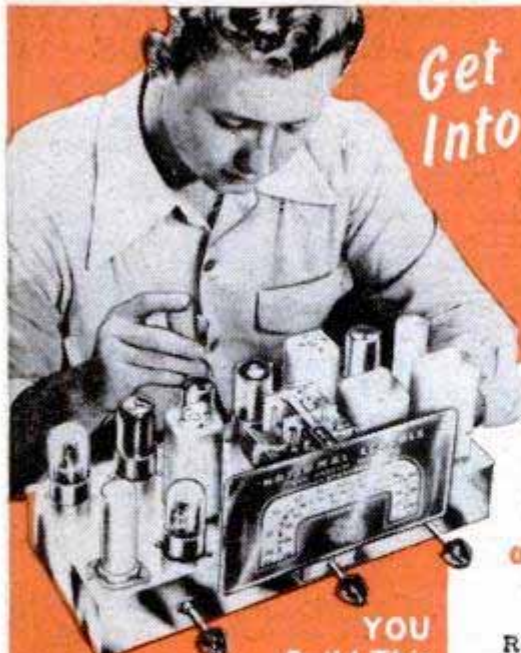

**YOU
Build This
Superheterodyne**

You receive complete standard equipment, including latest type High-Mu Tubes, for building various experimental and test units. You progress step by step until you build a complete Superheterodyne Receiver. It is yours to use and keep.



**YOU RECEIVE THIS
PROFESSIONAL MULTITESTER!**

You will use this professional instrument to locate trouble or make delicate adjustments—at home—on service calls. You will be proud to own this valuable equipment. Complete with test leads.



**SIGNAL
GENERATOR**

You construct the Transatron Signal Generator shown here, demonstrating Transatron Principles in both R.F. and A.F. stages. You study negative type oscillators at firsthand.

AUDIO OSCILLATOR:

An electronic device, which produces audio-frequency signals for modulating R.F. (radio frequency) carrier waves, testing A.F. (audio frequency) amplifiers, speakers, etc.



**T.R.F.
RECEIVER**

You build several T.R.F. Receivers, one of which, a 4-tube set, is shown here. You learn construction, alignment, make receiver tests, and do trouble shooting.

**Get Complete Training. You Receive and Keep All
Equipment, Parts and Lessons. No Extra Charges.**

**GOOD PAY
and Unlimited Opportunities
in JOBS LIKE THESE:**

- Business of Your Own
- Radio Manufacturing, Sales, Service
- Broadcasting Telecasting
- Television Manufacturing, Sales, Service
- Laboratories: Installation, Maintenance of Electronic Equipment, Electrolysis, Call Systems
- Garages: Auto Radio Sales, Service
- Sound Systems and Telephone Companies; Oil Well and Drilling Companies; Engineering Firms
- Theatre Sound Systems Police Radio
- And scores of other good jobs in many related fields

**YOU CONDUCT MANY
EXPERIMENTS LIKE THESE!**

- Checking action of condensers
- Experiments with AF and RF amplifiers.
- Experiments with resonance
- Producing beat frequencies
- Calibrating oscillators
- Experiments with diode, grid-bias, grid-leak and infinite impedance detectors
- Practical experience in receiver trouble shooting
- Application of visual tester in checking parts and circuits
- Experiments with audio oscillators
- Advanced trouble-shooting
- ... and many, many others

**Complete Training by Practical
Resident Trade School, Est. 1905**

The same highly trained faculty, instruction materials and methods used here in our large, modern resident school, are adapted to your training in your own home. Shop Method Home Training has been proved by hundreds of successful graduates.

**Both Resident and Home Study
Courses Offered**

**YOU
LEARN BY
DOING**

You receive special laboratory experiment lessons to show you how to build with your own hands various experimental units such as those shown at left, and how to conduct many tests.

You will find all lessons easy to understand because they are illustrated throughout with clear diagrams and step-by-step examples that you work out yourself. Every piece of the equipment and complete lesson material we send you is yours to keep and enjoy, including the multitester, experimental equipment, all parts of the Superheterodyne, tube manual, radio dictionary, and complete, modern Television texts. All parts are standard equipment.

**Shop Method Home Training . . .
Earn While You Learn**

With our practical resident Shop Method Home Training, you study in your spare time. You receive Spare Time Work Lessons, which show you how to earn while you learn. Service neighbors' radios and TV receivers, appliances, etc., for extra money and experience. Many National students pay all or part of their training with spare time earnings!

**DON'T DELAY! The Radio-Television
Industry needs trained men NOW!**

**APPROVED
FOR
VETERANS!
Check coupon below!**

For quick action,
mail coupon
today and we'll
rush you full in-
formation.

Free!
NEW, ILLUSTRATED
OPPORTUNITY
BOOK AND SAMPLE
LESSON SHOW YOU
HOW WE TRAIN
YOU . . . SEND FOR
THEM TODAY! NO
COST. NO
OBLIGATION.



NATIONAL SCHOOLS

LOS ANGELES 37, CALIF. • EST. 1905



FIND OUT NOW . . . MAIL COUPON TODAY

National Schools, Dept. 12-PM
4000 South Figueroa Street
Los Angeles 37, California

Mail in envelope
or paste on
penny postal.

Send me your FREE book "Your Future in Radio" and the sample lesson of your course. I understand no salesman will call on me.

NAME.....AGE.....

ADDRESS.....

CITY.....ZONE.....STATE.....

Check here if Veteran of World War II

Learn this Profitable Profession



IN 90 DAYS AT HOME

Money-Making Career Open to Men and Women, 18 to 50

Hundreds of men and women between 18 and 50 make \$10 to \$20 in a single day giving scientific Swedish Massage and Hydro-Therapy treatments. There is big demand from doctors, hospitals, sanatoriums and clubs. Graduates earn large full time incomes from these or in private practice in their own offices. Others make good money from home treatments given in spare time. Learn this interesting, money-making profession in your own home, through our home study course. Same instructors as in our nationally known resident school. You can win independence and prepare for future security by qualifying for your Diploma. Course can be completed in 3 to 4 months. Many earn while they learn. Begin your training at once.



Anatomy Charts & Booklet FREE

Enroll now and we will include, at no extra cost, many needed supplies. Fit yourself to help meet growing demand for Scientific Swedish Massage. Send the coupon at once for complete details. Anatomy Charts and 32-Page Illustrated Booklet, FREE, postpaid.

THE COLLEGE OF SWEDISH MASSAGE
Dept. 964R, 41 E. Pearson, Chicago 11, Illinois
Please send me FREE and postpaid, Anatomy Charts, 32-page Booklet and complete details on Home Training.

Name _____ Age _____
Address _____
City _____ State _____

FIND OUT FREE!

HAVE YOU GOT WHAT IT TAKES?

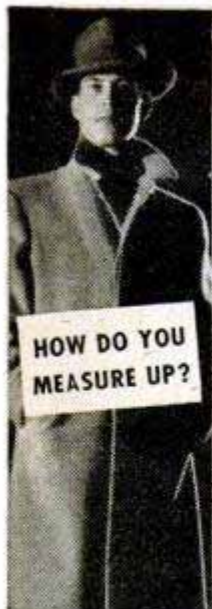

SUCCESS
HOME STUDY
WILL TO WIN
CHARACTER
HEALTH

to be a **FINGER PRINT EXPERT or TRAINED INVESTIGATOR?**
Send for free IAS Qualification Questionnaire. If in our opinion your answers indicate that you "have what it takes," then you will receive absolutely free the famous "Blue Book of Crime" . . . plus full details on how to train at home in Crime Detection and Finger Printing! IAS graduates are key men in over 800 Police Bureaus. See if YOU can train for this exciting, steady, "good pay" work! No obligation. No salesman will call. Write today, stating age.

INSTITUTE OF APPLIED SCIENCE
1920 Sunnyside Ave., Dept. 1359, Chicago 40, Ill.

INSTITUTE OF APPLIED SCIENCE
1920 Sunnyside Ave., Dept. 1359, Chicago 40, Ill. *
Gentlemen: Without obligation or expense on my part, send me your qualification questionnaire. I understand that upon receipt of my answers you will immediately advise me if you think they indicate that I have a chance to succeed in criminal investigation or finger print work. Then I will receive FREE the "Blue Book of Crime," and information on your course and the 800 American Identification Bureaus employing your students or graduates.

Name _____
Address _____ RFD or Zone _____
City _____ State _____ Age _____

Career Training in a Minimum of Time RADIO—ELECTRONICS TELEVISION ENGINEERING

GRADUATES of CREI residence school are preferred by industry because of their training and ability. CREI prepares the young man for a good job in industry in a minimum of time. 22 years practical experience. CREI offers an outstanding faculty, modern laboratories, shops and equipment. New students accepted twice monthly and each may advance as rapidly as he is capable. Basic course with one specialized course requires an average of 20 months to complete.

Approved for Veteran's Training.

• Write for Details and Free Catalog

CAPITOL RADIO

ENGINEERING INSTITUTE

Dept. 1712A, 16th & Park Rd. N.W.

Washington 10, D.C.



STAMMERER?

This new 128-page book, "Stammering, Its Cause and Correction," describing the Bogue Unit Method for scientific correction of stammering and stuttering—successful for 48 years.

Benj. N. Bogue, Dept. 4914, Circle Tower, Indianapolis 4, Ind.

GET THIS FREE BOOK!



RAISE HAMSTERS

The new wonder animals from Syria. Often called Toy Bears. Delightful pets. Everyone wants them. Laboratories need thousands. Clean, odorless. Raise anywhere. A profitable and interesting hobby or business. We furnish breeding stock with manual of instructions.

Write today for free illustrated literature.

GULFHAMSTERY, 1536 BASIL, MOBILE, ALA.

LEARN LANDSCAPING

Profitable, healthful career — absorbing hobby, for men, women. Thorough 45-lesson home-study course takes 8-12 months spare time. Hundreds of successful graduates all over the world. 33rd year. Send for FREE catalog.

American Landscape School, 6569 Grand Ave., Des Moines, Iowa

How to Make Money with Simple Cartoons

A book everyone who likes to draw should have. It is free; no obligation. Simply address

FREE BOOK

CARTOONISTS' EXCHANGE
Dept. 912-D Pleasant Hill, Ohio

STRENGTHEN Your VOICE!

YES—you can now build yourself a powerful speaking and singing voice with this amazing new scientifically sound tested method. Self-training . . . no music or piano required. Results GUARANTEED. Just send your name for the sensational details. FREE chart of your vocal mechanism included! Please state your age.

PERFECT VOICE INSTITUTE, Studio M-2, 1141 S. Wabash Ave., Chicago 5, Ill.

Command Bigger Money! STUDY LAW

STUDY AT HOME for BUSINESS SUCCESS and LARGER PERSONAL EARNINGS. 40 years expert instruction — over 114,000 students enrolled. LL.B. Degree awarded. All text material furnished. Easy payment plan. Send now for FREE BOOK — "Law and Executive Guidance." It explains the course — how you may enroll and the many ways you can profit from Law Study. Write TODAY to:

(GI Approved)

AMERICAN EXTENSION SCHOOL OF LAW
Dept. 21-PM, 646 N. Michigan Ave., Chicago 11, Ill.

BUILDERS

TRADE GUIDES

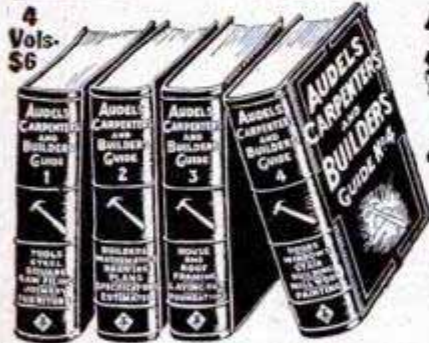

4 Vols. \$6

AUDELS CARPENTERS AND BUILDERS GUIDES—4 VOLS. \$6

\$1 PER MO.

Inside Information for Carpenters, Builders, Joiners, Building Mechanics—all Wood-workers. 1600 pages; 3700 diagrams; flexible; pocket size. Short-cut instructions, new methods, ideas, solutions, plans, systems—money saving suggestions. An easy progressive course for the apprentice. A practical daily helper and Quick Reference for the master worker. A Helping Hand to Easier and Better Work and Better Pay. To get this aid for yourself, simply fill in and mail the FREE COUPON below.

INSIDE TRADE INFORMATION ON:

How to use steel square; How to file and set saws; How to build furniture; How to use mitre box; How to use chalk line; How to use rules; How to make joints; Carpenters' arithmetic; Mensuration problems; Estimating

strength of timbers; How to set girders and sills; How to frame houses and roofs; How to estimate costs; How to build houses, barns, garages, bungalows, etc.; How to read and draw plans; Drawing up specifications; How

to excavate; How to use settings 12, 13 and 17 on the steel square; How to build hoists and scaffolds—skylights; How to build stairs; How to put on interior trim; How to hang doors; How to lath—lay floors; How to paint.

"Auodels Guides worth four times their price—handy too as I carry them in pocket for reference." W. J. Bates, Knoxville, Pa.



4 Vols. \$6

AUDELS PLUMBERS AND STEAMFITTERS GUIDES—4 VOLS. \$6

\$1 PER MO.

A new edition—just out! A practical, illustrated, Reference Library and Study-Course for Master Plumbers, Journeymen and Apprentice Steamfitters, Gas Fitters and Helpers, Sheet Metal Workers, Draughtsmen, Master Builders, Engineers and all Building Trade Students. 1670 pages; 3642 diagrams; flexible; pocket size. Guides explain all the principles, advances and short cuts of the Plumbing and Heating trade. Contains instructions on how to figure and estimate jobs. Use FREE COUPON below to examine, without obligation, this valuable work.

INSIDE TRADE INFORMATION ON:

Air Conditioning. Soldering, tinning. Joint wiping, bending, beating. Pipe—iron—steel, threading. Mathematics, tables, physics. Materials—iron, steel, copper, brass, lead, tin, antimony. Sheet metal—galvanized—plate. Sanita-

tion, syphonage, tanks. Drainage, sewage, purification. Fixtures—bath—kitchen. Pipe fittings, soil pipe, tools. Laying out work. Roughing. Screwed fittings, flanges, joints. Pipe bending, examples. Elbows. Heating, ven-

tilation, refrigeration. Water supply, mains, wells, tanks. Gas-fittings. Underwriters. Sheet metal work, problems, methods, Brazing, heating, lead burning. Welding, various welds, methods. Blacksmithing, forges, tools.

"Auodels Guides are practical, easy to understand, reliable. Cover the field in plain language." W. F. Arminger, Annapolis, Md.

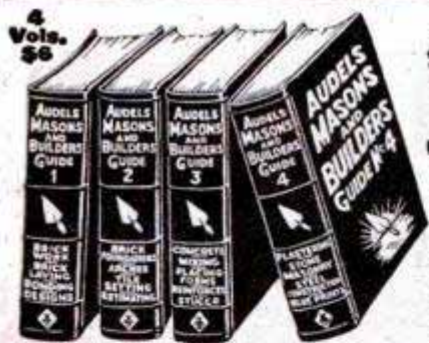

4 Vols. \$6

AUDELS MASONS AND BUILDERS GUIDES—4 VOLS. \$6

\$1 PER MO.

A complete, illustrated trade reference library, for Bricklayers, Cement Workers, Plasterers, Tile Setters and Stone Masons, including a practical outline of Steel Construction. 1100 pages; 2067 diagrams; flexible; pocket size. A practical Trade Assistant explaining modern methods of masonry construction. Easy to understand and apply. A reliable and authentic reference work and study-course for Master Journeyman and Young Mechanic. Use FREE COUPON below and find out for yourself, without obligation, whether this set will benefit you.

INSIDE TRADE INFORMATION ON:

Bricklaying, tools, materials; Brick designs, patterns, bonds; Setting frames and foundations; Mortars, scaffolds, estimating; Mortar and mortar mixing; Tile setting, mosaic, hollow tile; Straight edge test, trow-

eling; How to figure brick work; Safe loads, piers, chimneys; Boiler settings, anchors, fire stops; Labor tables; Concrete, forms; How to figure concrete work; Stucco—on old and new buildings; Plastering—wood lath—metal;

Plasterers agreement; Plastering on various surfaces; Stone masonry; Cutting, finishing, estimating stone; Derricks, rigging; Steel construction; Fire proof; How to read blue prints.

"Auodels Masons Guides are the best books on the subject. Have laid brick 12 years and am able to judge." H. A. Sonnett, Corliss, Pa.



PRACTICAL ELECTRICITY—1 VOL. \$4

Audels Handy Book of Practical Electricity is a simplified Ready Reference and Study Course in one pocket size volume—for Engineers, Professional Electricians and Students. 1040 pages; 2600 diagrams; flexible bound. A reliable authority and handy helper for every electrical worker. Contains important and valuable wiring diagrams, calculations, machine sketches, helps on maintenance and repair. Use this FREE COUPON today and find out, without obligation, how this handy book will help you in your daily work.

Complete in one handy, red leather bound volume



1040 Pages 2600 Diagrams

INSIDE TRADE INFORMATION ON:

Electro-Therapeutics, X-Rays, Shocks, Welding, Brazing, Radio Hook-ups, Motion Pictures, Telephone, Telegraph, Cranes, Bells, Elevators, Pumps, Tools, Ship Drive, Railways, Vehicles, Automobile Electric Systems, Ignition, Generation, Lighting, Plant Management, Power Plans, Armature Winding, Repairing, A. C. Motors and Apparatus, D. C. Motors and Apparatus, Alternator Construction, Dynamos, Wiring, Diagrams, Sign Flashers, Cable Splicing, Power Wiring, Outside Wiring, Switches, Lighting, Rectifiers, Converters, Transformers, Fuses, Circuit Breakers, Rheostats, Electro Plating, Electrolysis, Storage Batteries, Magnetism, Electrical Energy, Conductors, Insulators, Static, Dynamic, Radio Electricity, Applications, Ready Reference and Index Covering the entire field of Modern Electricity.

Learn More and You Will Earn More!

Know your job and you'll never be without one. The skilled man is always in demand. Knowledge is power. Learn your trade thoroughly by easy reading. This coupon is your opportunity for advancement and better pay. You risk nothing in sending for Audels Guides for free examination. Send it NOW!

FREE EXAMINATION COUPON

THEO. AUDEL & CO.

49 W. 23 ST., NEW YORK CITY
Please mail me for free examination the books marked (x) below. If I find them satisfactory, I agree to mail \$1 in 7 days, on each set ordered, and to further mail \$1 monthly on each set until I have paid the purchase price.

- 4 CARPENTERS GUIDES \$6 | 4 PLUMBERS GUIDES \$6
 4 MASONS GUIDES \$6 | 1 ELECTRICIANS HANDY BOOK \$4

NAME.....
ADDRESS.....
OCCUPATION.....
EMPLOYED BY.....PM

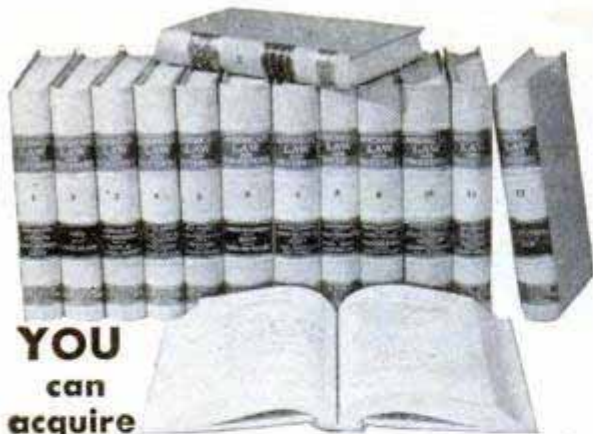

YOU
can
acquire

LAW NIGHTS AT HOME! L. L. B. DEGREE

LaSalle's famous Law Library—used as reference in many Law libraries and Law offices—has enabled thousands to master Law surprisingly fast, in spare hours at home, for business and professional advancement.

These 14 remarkable volumes, compiled by leading professors and lawyers, cover the whole basic field of Law in condensed, orderly, simplified manner.

You advance rapidly with this great library, plus special lectures furnished. We guide you step-by-step with personalized Problem Method of instruction . . . you learn by doing—handling legal problems—not by memorizing rules.

Send for two FREE 48-page booklets, "Law Training for Leadership," and "Evidence," answering questions about Law and its value to you, and telling how LaSalle Law graduates are winning rapid advancement in business and public life. Mail coupon below. No obligation.

LA SALLE EXTENSION UNIVERSITY A Correspondence Institution

417 S. Dearborn St., Dept. 1264-L, Chicago 5, Ill.

Send me your two FREE booklets described above, without obligation.

Name..... Age.....

Street.....

City, Zone & State.....

WATCHMAKING

★ Watch Repairing ★ Jewelry Engraving ★ Jewelry Repairing

Combination men earn top pay. Learn in school fully accredited by Horological Institute of America c/o U.S. Bureau of Standards, Washington, D. C. and United Horological Association of America. Approved for veterans. Receive tools, tuition and subsistence while learning.

Established 1935. Write for FREE booklet



The Baronian School, Inc.

2116 WALNUT ST. (DEPT. C) PHILA. 3, PA.

OPPORTUNITIES AHEAD!
TRAIN FOR A FUTURE IN

DIESEL



• Prepare for the big earning power of Diesel Trained Men. Start learning at home, in spare time. UEI's easy, practical training covers all phases of DIESEL engine operation, fuel systems, auxiliary equipment, repairs and maintenance. Also new Scientific Auto Motor Tune-Up. After home course, you come to Chicago for actual practice in UEI's modern shop under experienced instructors, at UEI's fine, modern school. GET ALL THE FACTS FREE. WRITE TODAY!

DIESEL UTILITIES ENGINEERING INSTITUTE
DIVISION
2521 SHEFFIELD AVENUE Dept. DC-6 CHICAGO 14, ILL.

RUPTURED?

Get Relief This Proven Way

Why try to worry along with trusses that gouge your flesh—press heavily on hips and spine—enlarge opening—fail to hold rupture? You need the Cluthe. No leg-straps or cutting belts. Automatic adjustable pad holds at real opening—follows every body movement with instant increased support in case of strain. Cannot slip whether at work or play. Light. Waterproof. Can be worn in bath. Send for amazing FREE book, "Advice To Ruptured," and details of liberal truthful 60-day trial offer. Also endorsements from grateful users in your neighborhood. Write:

CLUTHE SONS, Dept. 31, Bloomfield, New Jersey

MONEY FOR MEN ALL FREE

THE PLASTEX Industry needs manufacturers on small scale and for big production of Lamp and Clock Stands, Art Goods and Novelties in Plastex and Marble imitation. Experience unnecessary. 1/2c material makes regular 10c store sellers. Rubber moulds furnished for speed production. Small investment brings good returns. Big chain store orders now being placed. Ambitious men have chance for real prosperity. Our Free booklet will interest and benefit you.

PLASTEX INDUSTRIES, Dept. A
3400 Third Ave. New York 56, N. Y.

SHORTHAND in 6 Weeks at Home

Famous Speedwriting system. No signs; no symbols; no machines; uses ABC's. Easy to learn; easy to write and transcribe. Low cost. 100,000 taught by mail. For business and Civil Service. Also typing. 20th year. Write for free booklet to:

Speedwriting

Dept. 1512-9, 55 W. 42 St., New York 18 (R)

NEW! LOW COST! RESPIRATOR

Wear when sanding, grinding, paint spraying, sweeping, dusting, furnace cleaning, etc. Handy as a pair of glasses. Just keep mouth closed and breathe through nose is all you do to operate. Protects against nuisance dusts, lint, coal, cement, grain dust, hay fever pollen. Has 9 sq. in. filter. For EYE protection against paint spray, dusts, gases, fumes, smoke, order our Fog-Proof Rubber GOGGLES \$1.65 p.p. (All prices postpaid in U.S.A.)

JERRY BRYANT, Dept. PM
919 N. Michigan Ave. Chicago 11, Ill.

\$1.00
POST PAID

Become a Doctor of PSYCHOLOGY

Win the degree of Ps.D. Teach the secret of contentment, happiness. Solve mental worries. Experience the revelation of truth. Chartered college. Individual help. Write for FREE book. COLLEGE OF UNIVERSAL TRUTH, 5153-B North Clark St., Chicago.

STOPS FOGGY WINDSHIELDS NEW Chemical Mitt

Amazing Discovery! Autoists wild over new "NO-FOG" Windshield Cleaner. Simply glide over windshield chemically-treated Mitt—at once glass sparkles crystal clear. Cloudy haze, mist, dust, grime disappear like magic. Stops fogging. Sells like wild!

SAMPLES FOR AGENTS Sample offer sent immediately to all who send name at once. A penny postal will do. SEND NO MONEY—just your name.

KRISTEE CO., 689 Bar Street, AKRON, OHIO

\$1.00
POST PAID

Say You Saw It in Popular Mechanics

Learn BAKING At Home

Baking is one of America's high industries in wages. Nearly depression-proof. Thorough basic home course lays sound foundation. If you have aptitude, write for FREE BOOKLET, "Opportunities in Commercial Baking." National Baking School, 1315 Mich. Ave., Dept. 1359, Chicago 5

WHICH OF THESE *Opportunities* INTERESTS *You* MOST?

● Today, choose the job you want—and prepare for it. Or if you are already engaged in the work you like best, start training now for quicker promotion. Acquire the knowledge that will help you to get ahead faster, make more money and have greater security.

American School, founded in 1897 as an educational institution *not for profit*, can help you to reach your goal just as it has helped others during the past fifty-two years. Check the coupon at right, add your name and address and mail it at once. The school will send you details on its training plan and outline of study prepared by specialists. There is no charge, no obligation, so send the coupon immediately.

CHECK, CLIP AND MAIL COUPON NOW

AMERICAN SCHOOL, Dept. G-945, Drexel at 58th, Chicago 37, Ill.

Without obligation, Please send FREE and postpaid, bulletin and details of the Subjects checked:

- | | | |
|--|--|--|
| <input type="checkbox"/> PLASTICS ENGR | <input type="checkbox"/> Accounting | <input type="checkbox"/> Drafting and Design for Men and Women |
| <input type="checkbox"/> Refrigeration | <input type="checkbox"/> Electrical Engr. | <input type="checkbox"/> Radio |
| <input type="checkbox"/> Architecture and Building | <input type="checkbox"/> Electricity-Pract. | <input type="checkbox"/> High School |
| <input type="checkbox"/> Contracting | <input type="checkbox"/> Electronics, Industrial | <input type="checkbox"/> Air Conditioning |
| <input type="checkbox"/> Practical Plumbing | <input type="checkbox"/> Bookkeeping | <input type="checkbox"/> Mechanical Eng. |
| <input type="checkbox"/> Automotive Engr. | <input type="checkbox"/> Private Secretary | <input type="checkbox"/> Shop Management |
| <input type="checkbox"/> Aviation Drafting | <input type="checkbox"/> Diesel Engineering | <input type="checkbox"/> Tool Making |
| <input type="checkbox"/> Aviation | <input type="checkbox"/> Sheet Metal Pattern | <input type="checkbox"/> Better Foremanship |
| <input type="checkbox"/> Business Management | <input type="checkbox"/> Drafting | <input type="checkbox"/> Machine Shop Operations |
| | <input type="checkbox"/> Railway Training | |

Name _____ Occupation _____

Address _____ Age _____

City _____ State _____

AMERICAN SCHOOL

Dept. G-945, Drexel at 58th Street, Chicago 37

TO THOSE WHO THINK LEARNING MUSIC IS HARD

Just strike these notes and you're playing the beginning of the "Merry Widow" Waltz



Look at the diagram. The first note of the music is "D." Following the dotted line to the keyboard you'll find "D" is the white key between the two black keys near the middle of the keyboard. Now read below how you can learn to play any instrument quickly and easily.



EASY AS A-B-C—COSTS JUST A FEW CENTS A DAY!

● Perhaps you think learning music is a tedious grind. It isn't any longer! Long hours of practicing scales and monotonous exercise are over.

You have no excuse for not getting started toward musical good times now! For through an easy method you can now learn to play right at home—without a teacher—for a few cents a day.

Learn to Play by Playing

The lessons come to you by mail from the famous U. S. School of Music . . . complete instructions, clear diagrams, and all the music you need. You learn to play by playing real tunes by note. First you are told how to do a thing. Then a picture shows you how. Then you do it yourself and hear it. Remember, don't confuse our method with any system claiming to teach music "by ear" or by trick methods. We teach you to play only from real notes!

SUCCESS!

Here's what one of our thousands of pupils writes: "I learned more from your course than many of my friends who studied under private teachers have for years. The fact that I've already taken 2 courses and am now enrolling for a third, should speak for itself." F. A. S., Indiana.

Don't delay. Send now for our illustrated Free Booklet and "Print and Picture" Sample which fully explain this remarkable method. So decide which instrument you want to play and mail the coupon today. U. S. School of Music, 712 Brunswick Bldg., New York 10, N. Y. (Successful 51st Year)

FREE PRINT AND PICTURE SAMPLE

U. S. School of Music, 712 Brunswick Bldg., New York 10, N. Y. Please send me Free Booklet and Print and Picture Sample. I would like to play instrument checked below.

- | | | |
|--|--|---|
| <input type="checkbox"/> Piano | <input type="checkbox"/> Saxophone | <input type="checkbox"/> Modern Elementary |
| <input type="checkbox"/> Guitar | <input type="checkbox"/> Trumpet, Cornet | <input type="checkbox"/> Harmony |
| <input type="checkbox"/> Hawaiian Guitar | <input type="checkbox"/> Reed Organ | <input type="checkbox"/> Mandolin |
| <input type="checkbox"/> Violin | <input type="checkbox"/> Tenor Banjo | <input type="checkbox"/> Practical Finger Control |
| <input type="checkbox"/> Piano Accordion | <input type="checkbox"/> Clarinet | <input type="checkbox"/> Have You Instrument? |

Name _____

Address _____

City _____ State _____

Save 2c—Stick Coupon on Penny Postcard

Now! FOREDOM offers 2 NEW ATTACHMENTS

You Get Unexcelled **UTILITY AND VERSATILITY ...**
AT SMALL COST!

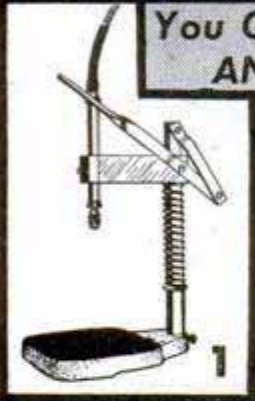

DRILL PRESS ATTACHMENT

1 Now Foredom offers you a **DRILL PRESS ATTACHMENT** for use with Model 100 (see below) and for the many thousands of Foredoms already in use. Handpiece quickly clamps in place and drill press is ready for use, ready to pay for itself over and over again! **PRICED AT A MERE \$4.95.**



B-R-S ATTACHMENT

2 The new Foredom **B-R-S ATTACHMENT** (Bench Stand, Router, Shaper). Speedily clamp handpiece in place and magically you have one unit which serves as a bench grinder with angular adjustment, a router (complete with detachable guide for routing borders) and shaper. Can be used with Model 100 and thousands of Foredoms now in use, providing endless hours of fun and profit. **TRIPLE UTILITY FOR ONLY \$3.50.**

And there's still more - - -

FOREDOM'S NEW MODEL 100 FLEXIBLE SHAFT MACHINE

3 Model 100 Flexible Shaft Machine with all-metal **PENCIL SIZE HANDPIECE** equipped with **CHUCK GUARD** to **PROTECT YOUR FINGERS** and provide **SENSITIVE, POSITIVE, FINGER-TIP CONTROL** for the most delicate tasks. Husky little high-speed universal motor. Foredom's quarter-century reputation for precision workmanship goes with each machine. Other heavier duty models at proportionately reasonable prices. No. 25 Accessory Set (a truly versatile assortment) \$5.50 extra. Also No. 1000 Kit, comprises No. 100 Machine illustrated and set of 12 accessories, all in wooden case for only \$21.50. 6-step Foot Rheostat \$4.85. USE IT to GRIND, POLISH, DRILL, SAW, SAND, CARVE, MILL, CLEAN, ETCH, ENGRAVE, ETC. on all metals, wood, plastics, glass, leather, linoleum, etc.

Foredom's Multi-Purpose **THREESOME** comprising Model 100 Machine, Drill Press attachment and B-R-S attachment. **\$24.95**

And here's another Amazing

Foredom Product FOREDOM PRESTO-FLEX

with **PENCIL-SIZE handpiece**
Quickly Converts Motors or Drills **\$5.95**
into Flexible Shaft Tools



Now turn your old motor, drill press or electric drill into a Flexible Shaft Tool. Simply attach it and presto—a flexible shaft machine! Off again in a jiffy! Pencil-Size handpiece gets into tight places. Handy 35" overall length. And . . . only \$5.95 complete! Precision made. Order NOW. If ordered for use on motor, specify motor shaft diameter and add 50c for coupling (Available for 1/4, 5/16, 3/8, and 1/2" shafts). No. 50 Accessory Set available \$1.50 extra. Order TODAY at your dealer's or use coupon below.

35" FLEXIBLE SHAFT
\$16.95
COMPLETE WITH MOTOR



3.

**OUT OF PAWN
GENUINE DIAMONDS**

SAVE UP TO 50% AND MORE

Unmatched values in genuine blue white diamonds. Each diamond sold with a written iron-clad money back guarantee. All diamonds set in gorgeous new mountings. Send today for beautiful, illustrated catalog showing values from \$10.00 to \$10,000. Over 100,000 satisfied customers have bought Diamonds from Berman's. Our reference—your own bank or any mercantile agency.

BERMAN'S DIAMOND LOAN BANK
DEPT. P — BERMAN BLDG. BALTO. 1, MD.

Send today for
**Illustrated
FREE
Catalog**
NO OBLIGATION

RUPTURE

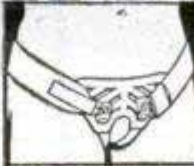

RELIEF...OR YOUR MONEY BACK

A simple . . . sturdy truss support built nature's way by old surgical appliance manufacturer. You risk nothing . . . relief or your money back. Send now for free booklet.

WEB TRUSS CO. Dept. M-84 Hagerstown, Md.

ENGINEERING

Building, Drafting, Etc.

Degree in 27 mos. Approved for G.I. Training. Prepare in Chicago, the Industrial Hub. Earn part living expenses. 45th year. Other shorter courses in Air Conditioning, Refrigeration, Radio, Electricity. Enter Jan., March, July, Sept.

**Chicago
TECH
College**

Write for catalog

S-83 TECH BLDG., 2000 S. MICHIGAN AVE., CHICAGO 16

BARBELLS

FINEST QUALITY \$8.98 up

FREE CATALOG

Send today for big new 4 color fully illustrated free catalog of **BARBELLS, Dumbbells and Health equipment**. Free—world famous \$15.00 Dan Lurie Barbell and Dumbbell training courses with every purchase.

DAN LURIE BARBELL CO.
DEPT. 159L 1729-M11 ROCKAWAY PARKWAY
BROOKLYN 12, N. Y.

Learn REFRIGERATION and AIR CONDITIONING

Prepare yourself for a fine paying job. Get practical training at home—plus 4-full weeks in the ITI Shops. Job placement help. **FREE book—write**

INDUSTRIAL TRAINING INSTITUTE Dept. D-1; 2130 Lawrence Ave., Chicago 25, Ill.

PROFITABLE HOBBIES

Let us show you how extremely easy it is to make beautiful and useful things out of **LIQUID PLASTICS, LIQUID MARBLE, LIQUID IVORY, LIQUID GLASS, CERAMICS, ETC.** . . . as easy as pouring water out of a glass! Make novelties, jewelry, gifts, artware, toys, tools, dies, gadgets, ceramics . . . a million useful things! We supply everything—**MATERIALS, INSTRUCTIONS and BUYERS!** Send only 25c for 1. Big catalog of 300 casting materials, molds and accessories, 2. A beautiful **CAMEO** free (to show you what you can do), and 3. Actual **INSTRUCTIONS** on how to cast and start in the **CASTING BUSINESS!** Send 25c today—this may be the lucky coin that will start the most fascinating and profitable phase of your life! (Catalog only—10c).

PLASTICAST COMPANY (DEPT. C)
4637 N. Kedzie Ave. (Write to P. O. Box 987
Chicago 25, Ill. nearest address) Palo Alto, Calif.

CANADIAN CUSTOMERS, please order directly from: **CANADIAN INDUSTRIAL PLASTICS, LTD.**, 1056 1/2 Pender West, Vancouver, B. C.

— SEND NO MONEY —

FOREDOM ELECTRIC CO., Dept. 1124-E Mail Coupon
27 Park Place, New York 7, N. Y. Now!

Please send me FOREDOMS checked below on 10-day trial

<input type="checkbox"/> Drill Press Attachment (\$4.95)	<input type="checkbox"/> B-R-S Attachment (\$3.50)
<input type="checkbox"/> Presto-Flex Tool (\$5.95)	<input type="checkbox"/> No. 50 Accessory Set (\$1.50)
<input type="checkbox"/> Motor Coupling (50c)	<input type="checkbox"/> No. 25 Accessory Set (\$5.50)
<input type="checkbox"/> Specify motor shaft dia.	<input type="checkbox"/> Foot Rheostat (\$4.85)
<input type="checkbox"/> No. 100 Machine (\$16.95)	<input type="checkbox"/> No. 1000 Kit (\$21.50)
<input type="checkbox"/> Multi-Purpose Threesome (\$24.95)	<input type="checkbox"/> Free Catalog

Send C.O.D. plus postage. I will pay postman.
 I enclose payment. Send postpaid.
(MONEY BACK EITHER WAY IF NOT DELIGHTED)

NAME _____
ADDRESS _____
CITY & ZONE _____ STATE _____

Grow Royal squabs in only 25 days, they sell for highest prices, poultry tops, large profit. Write today for **FREE TOP** Book good food starter, our prices, easy directions, opportunity success methods of money making breeders in every State. Start now. Our 49th year. **RICE FARM, 634 H. St., Melrose, Mass.**

START YOUR OWN BUSINESS!



ELECTRICAL APPLIANCE REPAIRING

SECURITY—INDEPENDENCE WORK SHORT HOURS

There are millions of electrical equipment units in daily use . . . in factories, homes, office buildings and on farms. Skilled electrical technicians are needed to keep this equipment in good running condition.

You can now BE TRAINED to fill this BIG NEED. . . a need that grows day by day because of new electrical inventions for home and factory.

If you are mechanically inclined, can hold and use tools, we can give you the training and time-saving kits that will enable you to . . . Command More Money At Work . . . A Better Paying Job Elsewhere . . . Or A Business Of Your Own!

The ELECTRONIC KIT, a multi-purpose trouble detector, and other valuable Shop Method Training Kits are sent to you! All instruction material is written in simple, easy-to-understand language, chock full of hundreds of detailed photos and drawings.

We show you how to quickly locate the trouble, how to fix it and what to charge. ALSO, how to solicit business and keep business coming to you.

Get Full Facts on how you can get this training at home in your spare time and pay for it out of your earnings while learning!

**IN YOUR OWN
KITCHEN,
BASEMENT,
OR GARAGE**

You don't need elaborate fixtures or expensive equipment to be a successful repairman. Work as many hours as you wish. The Electrical Appliance Technician is his own boss!

**\$5.00-\$6.00
HOUR**

often charged for making ordinary repairs. We show you how to repair refrigerators, vacuum cleaners, washing machines, motors, etc., etc.

**AGE IS NO
BARRIER**

Nor is a minor physical handicap. Work is light, pleasant and PROFITABLE.

EARN WHILE YOU LEARN!



Only had your course a few short weeks and have already made \$800.00. Going to quit my job paying \$250.00 straight salary to operate my own business. — J.D.S., St. Louis, Mo.

I work day times at the shipyard and after 4:00 P.M. I operate from my cellar and garage. I average \$10.00 to \$15.00 clear every day.—Walter Hanby, Brockton, Mass.



SEND COUPON TODAY

WORKING KIT FURNISHED



FREE BOOK

CHRISTY TRADES SCHOOL, DEPT. D-7603
4432 N. Kedzie Ave., Chicago 25, Ill.

Gentlemen:

Please rush me FREE ILLUSTRATED BOOK and full facts about America's fastest growing industry—ELECTRICAL EQUIPMENT SERVICING.

Name _____ Age _____

Address _____

City _____ Zone _____ State _____

INVENTORS

When you are satisfied that you have invented a matter of value—write me, without obligation, for full information as to what steps you should take to secure a Patent.

The usual first step is to have a search of the prior U. S. Patents conducted, so that I can report to you on the question of Patentability.

PATRICK D. BEAVERS

(Formerly RANDOLPH & BEAVERS)

Registered Patent Attorney

934 Columbian Building Washington 1, D. C.

PATRICK D. BEAVERS, Registered Patent Atty.
934 Columbian Bldg., Washington 1, D. C.

Please send me full information on how to secure Patent Protection and Trademark Registration.

Name _____

Street _____

City _____ State _____

INVENTORS

IF YOU WISH TO PROTECT YOUR INVENTION, You should take steps to protect it by a U. S. Patent. Write me for "Record of Invention" form.

CARL MILLER REGISTERED PATENT ATTORNEY

Woolworth Bldg., 35th Floor, Dept. 129A, New York City
Please send me "Record of Invention" form.

NAME _____

ADDRESS _____

BE AN INVESTIGATOR

WORK HOME or TRAVEL. Experience unnecessary.

INVESTIGATOR Particulars FREE. Write to
GEO. M. P. WAGNER, 125 W. 86th St., N. Y.

INVENTORS

Whether an invention is patentable can be substantially determined by a search of the U. S. Patent records. Without obligation, write for information explaining the steps you should take to secure a patent.

JOHN N. RANDOLPH

Registered Patent Attorney

201 Columbian Building, Washington 1, D. C.



PATENTS

AND TRADE MARKS

C. A. SNOW & CO.

REGISTERED PATENT ATTORNEYS

WRITE FOR INFORMATION TO
428 SNOW BUILDING, WASHINGTON 1, D. C.



PATENTS PATENT LAWYER

TRADE MARKS
GUSTAVE MILLER
129-PM WARNER BLDG.
WASHINGTON 4, D. C.

ASSOCIATE EXAMINER
U. S. PATENT OFFICE 1922-1929
Patent Attorney and Advisor
U. S. NAVY DEPT. 1930-1947
REGISTERED PATENT ATTORNEY
Send for Form
"INVENTOR'S RECORD"

INVENTING

—FOR PROFIT! If you have an inventive turn of mind, write for free 28-page booklet explaining how the Institute of American Inventors is helping inventors pre-test the profit possibilities of proposed devices to fill today's unprecedented demand for useful new inventions.

INSTITUTE of AMERICAN INVENTORS

Dept. 4, 1926 Eye St., NW, Washington 6, D. C.

SAY YOU SAW IT IN POPULAR MECHANICS

TRADE MARKS •
COPYRIGHTS •

PATENTS

The Time to Contact
a Patent Attorney is Promptly
After You Have Finished Your Invention

Write for FREE "INVENTOR'S GUIDE" & "Record of Invention"

FRANK LEDERMANN Registered Patent Attorney
154 Nassau St. • 20th Floor • New York 7, N. Y.

HELPFUL BOOKS

Send post card asking for FREE catalog
Popular Mechanics Press, 200 E. Ontario, Dept. 601, Chicago 11

HIGHEST ROYALTIES and CASH

FOR YOUR INVENTIONS

Write for FREE booklet without obligation

UNIVERSAL MARKETING CO.

354 S. SPRING ST. (Suite M)

LOS ANGELES 13, CALIF.

**YOU BUILD THIS
23-TUBE
TELEVISION
RECEIVER**

NOW!

FOR THE FIRST TIME YOU CAN GET
Real Practical HOME TRAINING In

TELEVISION

RADIO AND ELECTRONICS

RTS LEADS THE WAY

WE GIVE YOU

11 BIG

TELEVISION

AND **RADIO KITS**

AT NO EXTRA COST

**YOU WORK AND LEARN
WITH REAL TELEVISION
AND RADIO EQUIPMENT**

RADIO-TELEVISION TRAINING SCHOOL'S master Technicians guide you. Located in the very heart of America's Television, Broadcasting, Radio and Sound Industries, RTS is right "on-the-spot" where new technical improvements are first introduced; is in the best possible position to bring students ACTUAL METHODS and practices developed by the RADIO-TELEVISION industry, leading to real money making opportunities. The 11 BIG KITS RTS gives you enable you to do many practical jobs, build the equipment illustrated; perform more than 100 other fascinating, valuable experiments. These jobs you do give you ACTUAL SHOP experience so vitally necessary to your future success. Thus RTS methods assure you BALANCED TRAINING—Theory PLUS Real Experience.

**OPPORTUNITIES NOW
WIDE OPEN FOR
Properly Trained Men**

Latest reports estimate 400 MILLION new television and radio sets will be built in the next 10 years . . . more than 72 million dollars is being spent RIGHT NOW just for radio repairs ALONE! When you are thoroughly trained by RTS Experts—who have their fingers on the pulse of the Radio-Television industry—a field of unlimited opportunities will open up for you in Your Own Radio-Television Sales & Service Business, F.M., Equipment Manufacturing, Communications and allied fields.

**EARN EXTRA MONEY
while learning at HOME**

Under the RTS amazingly easy, practical home-training plan there is no need for you to quit your present job. You study in SPARE TIME ONLY! RTS Experts show you how

to earn WELCOME EXTRA CASH, even BEFORE FINISHING YOUR TRAINING! In fact, when friends and neighbors know you are studying Radio-Television you may—like many RTS students—actually get MORE REPAIR WORK THAN YOU CAN HANDLE.

**27 YEAR
SUCCESS RECORD**

Backed by over a quarter-century of experience in home training, RTS (formerly Radio Training Association of America) offers practical "Learn-by-doing" methods, assuring you quick step-by-step progress. Begin preparing for your future in Radio-Television now while the time is ripe. If you are at all mechanically inclined—and have a grammar school education, RTS can teach you how to MAKE GOOD in Radio-Television.

GET THE FACTS

Send for FREE BOOK which tells you all about the RTS "time-tested" home-training plan, developed by technicians in the heart of the Radio-Television field. Fill out the coupon now—TODAY! and your FREE BOOK entitled "How To Make Good in Radio-Television" will go out to you AT ONCE. No Obligation. No salesman will call. ACT NOW!

★
**SEND
FOR THIS
30-PAGE
FREE
BOOK!**
★



**YOU BUILD THIS
6-TUBE STANDARD
SUPER HETERODYNE
RADIO SET with
SHORT WAVE
CONVERTER**

**YOU
KEEP ALL
EQUIPMENT
—it's Yours!**

RADIO-TELEVISION TRAINING SCHOOL

5100 SO. VERMONT AVE., LOS ANGELES 37, CALIF., U.S.A.

ESTABLISHED 1922 — 27 YEARS AGO

formerly RADIO TRAINING ASSOCIATION of AMERICA

RADIO-TELEVISION TRAINING SCHOOL, DEPT. 12-PM

5100 South Vermont Avenue, Los Angeles 37, Calif., U.S.A.

Send FREE Illustrated Book showing how I can make good in TELEVISION and Radio through training under the guidance of expert RTS Technicians. No obligation. (No Salesman will call).

NAME _____ AGE _____

ST. & No. _____

CITY _____ ZONE _____

STATE _____

Don't Envy The PLUMBER—Be One

Make \$15 to \$50 a Day

Every skilled workman will tell you Plumbers have the best of it. WINTER and SUMMER the Plumber is busy at top wages. No skilled Plumber is ever out of a job. Compare his opportunities with any trade. To the man with know how, Plumbing means profit. Investigate Universal Plumbing School. Not a "war born School," but a plumbing school developed and operated by plumbers since 1923.



The Plumber Protects The Health of the Nation

Own Your Own BUSINESS

Have your own business and big profits with little other than training and a kit of tools.

JOURNEYMAN Gets Good Salary

Master Plumbers own their own shop. A Journeyman works for a Master. With this training journeymen can depend on high wages.

G. I. Approved. Established 1923

UNIVERSAL PLUMBING SCHOOL

877 Holmes Street

Kansas City, Mo.

BE A PLUMBER IN JUST 32 WEEKS

Learn With Tools—Not Books
No need ever serve an apprenticeship. Don't envy the plumbers big profits—enjoy them. Learn every trick of the trade—Leadwork—Blueprint for plan reading, etc. under Licensed Master Plumbers.

Over 7,000 Successful Plumbers Recommend This School

This system has made more than 7,000 plumbers. Investigate our past performance. If you like to work with tools this is your opportunity. Become a Plumber in America's largest and only school devoted exclusively to plumbing. Write today for FREE information.

G. I. Approved. Established 1923

UNIVERSAL PLUMBING SCHOOL

877 Holmes Street

Kansas City, Mo.

Learn A Trade NOW! PRACTICAL SHOP TRAINING!

In Our Chicago Shops

- | | |
|---|--|
| <input type="checkbox"/> AUTO MECHANICS | <input type="checkbox"/> WELDING—ARC and GAS |
| <input type="checkbox"/> DIESEL MECHANICS | <input type="checkbox"/> MACHINIST |
| <input type="checkbox"/> REFRIGERATION | <input type="checkbox"/> PIANO TUNING |
| <input type="checkbox"/> BODY-FENDER | |

Above Approved For G. I.'s and Civilians
One of America's Leading Practical Schools
7 Floors of Fully Equipped Shops
Over 48,000 Successful Graduates
Expert Individual Instruction
Learn by Doing—Low Living Expense
Established 1902—Day and Evening Classes

Also the following Home Study Courses

- | | | |
|----------------------------------|--|---------------------------------|
| <input type="checkbox"/> PLASTIC | <input type="checkbox"/> REFRIGERATION | <input type="checkbox"/> DIESEL |
|----------------------------------|--|---------------------------------|

—CALL IN PERSON OR MAIL THIS AD TO—

GREER SHOP TRAINING

(Desk 10) 460 South State St., Chicago 5, Ill.

Please send without obligation free information regarding trade checked above. (Specify whether you are a Veteran or Civilian)

Name _____ Age _____

Address _____

City _____ State _____

SHOE REPAIR OFFERS BIG INCOME

LEARN IN 12 WEEKS TIME



You can own your own shop or earn big income as skilled shoe repairman. Growing demand everywhere at top wages for men who know how. We teach you quickly by actually working on shoes and modern machines. School open to all from 18 to 60 years of age. FREE BIG 20 PAGE BOOK explains everything. Send for your copy today. Chicago & Los Angeles schools only approved for Vets.

MODERN SHOE REBUILDING SCHOOL

Established 1927
2937 Belmont Ave., Chicago. 361-12th St., Oakland, Calif.
806 So. Figueroa St., Los Angeles 14, Calif.

BRAND 7 JEWELS!

NEW! 7 JEWELS!

3 Year SERVICE GUARANTEE

- Sweep Second Hand \$5.95
- Radiant Dial
- Chrome Case
- Leather Band
- Shock, Water Resist

\$5.95
P. Paid
Add

80c Tax

Special Order today! Money Back if not satisfied Sorry, no C.O.D.'s.

ELCO PRODUCTS CO., 3805 Broadway, K.C. 2 Mo



Rupture Troubles Ended

Advanced method has healed thousands. No leg straps, no elastic, no plasters. No pressure on hips or spine. Flexo-pad. Entirely different. Endorsed by doctors, mechanics, clerks. Very light. **INEXPENSIVE. GUARANTEED.** Write for information and trial.

SMITH MANUFACTURING COMPANY

EST'D 1893 DEPT. PM PRESTON, ONTARIO

ELECTRICAL TRAINING

Intensive 32 weeks' residence course in fundamentals of industrial electrical engineering, including radio, electronics. Prepares for technician, engineering aides. Approved for veteran training. 57th year. Enter Mar. 6. Catalog.

BLISS ELECTRICAL SCHOOL

7646 TAKOMA AVENUE
WASHINGTON 12, D. C.



HYDROPONICS

BIG FREE Illustrated Book



Fascinating Hobby! • Profitable Business!

You can grow vegetables, flowers or rare plants WITHOUT SOIL (Hydroponics) every day of the year. Learn the fast, clean, pleasant way to grow any plant indoors or out. No experience needed. Realize BIG RETURNS from a limited space. Amazing opportunity for real profits. Send postcard today for free picture book showing how others from every state are succeeding in this wide open field. Don't delay! Act now!

GILBERT & COMPANY, 846-X WEST IVY STREET, SAN DIEGO 1, CALIFORNIA

SAY YOU SAW IT IN POPULAR MECHANICS

Be an INVESTIGATOR

JAMES S. BOLAN, FORMER POLICE COMMISSIONER OF NEW YORK CITY offers MEN & WOMEN an attractive opportunity to prepare for a future in *Investigation & Criminology* by comprehensive Home Study Course. Free placement service assists graduates to obtain jobs. APPROVED UNDER G. I. BILL OF RIGHTS.

Write for Free Booklet PM.

THE BOLAN ACADEMY, INC.
EMPIRE STATE BLDG., NEW YORK 1, N. Y.



**I MADE
\$14 PER DAY**
While still learning!

T. E. H.—WEST VIRGINIA



**I MADE
\$800 IN 3 MONTHS**
While taking your course!

F. V.—NEW YORK

Get into the

ELECTRIC APPLIANCE REPAIR & SERVICE BUSINESS

SPARE OR FULL TIME. Want a good-paying business—a job in a fast-growing industry? Learn electrical appliance repair and service. I will teach you this interesting, good-paying business. The **EASY** step-by-step home study method, taught by PTS, prepares you **NOW** to reap lush profits to be made in this unlimited field. Have **YOUR OWN BUSINESS**—spare or full time—prepare for one of the many openings for trained men.

ACT NOW. Millions of new appliances in homes—millions of new homes being wired for electricity assures hundreds of customers in nearly every neighborhood.

EASY TO LEARN. Men of all ages, yes, even the man of 69 can get into this ever expanding field—a business well suited to men who like to use their hands—a **REAL OPPORTUNITY** for the practical man who is not happy in his present job. Get started **NOW**—send for **FREE BOOK** giving all details.



OPEN YOUR OWN SHOP

As soon as you enroll, I send you my New Book "How To Open Your Own Business" at no extra cost. PTS training is more than a home study course in electric appliance repair and service. It gives you the "know how" on the operation of your shop from a business standpoint: What to charge, how to get customers. Everything possible is done to start you on the road to success.

EARN WHILE YOU LEARN. You can actually start earning before your course is finished. I send you your first lesson showing you easy jobs that can be done in your **SPARE TIME AT HOME**. Remember, one good repair job will pay for the cost of your course. **NO BIG OVER-HEAD** needed. Start in your garage, basement, attic or spare room. When you are ready to expand, I will give you the benefit of my advice and experience.

WE TEACH YOU:

How to repair:
Washing Machines, Vacuum Cleaners, Ranges (gas and electric), Auto electricity, Irons, Motors, Garbage Disposal Units, Fluorescent Lights, Electric Shavers, Refrigeration, House Wiring.

**AT HOME IN YOUR
SPARE TIME OR FULL TIME**

**I SEND
YOU A
BIG KIT
of TOOLS
at No
Extra
Cost**



H. T. ARMSTRONG

**HERE'S MY
PLAN FOR
YOUR
SUCCESS**

Big Book
Containing
All The
Details of My Plan
For Your Success.

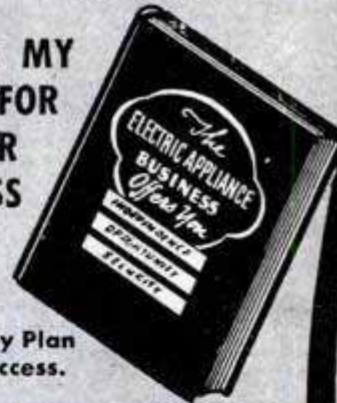

**SEND FOR
THIS
FREE BOOK**

MAIL THIS COUPON TODAY

**H. T. ARMSTRONG
PACIFIC TRAINING SCHOOLS**

7219 So. Broadway, Dept. P-912, Los Angeles 3, Calif.
Dear Sirs: Please send me, without obligation, your free booklet and complete details.

Name _____

Address _____

City _____ Zone _____ State _____



SAVE YOUR TROPHY

MOUNT your own Hunting Trophies

SPORTSMEN

Save and MOUNT your WILD-GAME
Be Your Own Taxidermist!

Hunters, anglers, nature-lovers, you will be **AMAZED** to learn and know the pleasures of Taxidermy. Your home-museum of beautiful **TROPHIES** will delight you and your family and friends.

LEARN AT HOME BY MAIL

We can teach you with fine success. More than **450,000** students have learned from this reliable school, **EASILY AND QUICKLY**. Here is the greatest **HOBBY** you ever dreamed of.

Mount Ducks, Quail, Deer, Fish

Save these beautiful trophies. **TAN** skins and furs. Decorate your **HOME AND DEN**. Become widely known and **FAMOUS** as a Taxidermist.

MEN AND BOYS Double your interest in hunting and outdoor-life. Have a magnificent hobby that will **enthrall** you all your **lifetime**. **WRITE TODAY**.

Ask for FREE BOOK

MAIL THE COUPON—TODAY

Tells how **YOU** can learn Taxidermy at home, 48 pages, 100 pictures of wild-game. A wonderful book, strange, unique. You never saw the like before. This book is **PRICELESS** to hunters, trappers and nature-lovers. **ABSOLUTELY FREE** if you **WRITE AT ONCE**, this minute! Use the **COUPON** or a **POSTAL** will do.

PLEASE STATE YOUR AGE.

FREE BOOK

Northwestern School of Taxidermy,
2512 Elwood Bldg., Omaha 2, Neb.

Send me your free illustrated book, "How to Mount Game." Also tell me how I may learn this fascinating art easily and quickly by mail. No obligation. State your age.

Name _____ Age _____
Address _____



Be Sure To Send for Free Book Now!

WHAM-O SPORTSMAN

HITS LIKE A .22 RIFLE —
KILLS RABBITS, SQUIRRELS.
For Hunting, Target,
Routing Pests.

\$1.00 postpaid



HUNTING SLINGSHOT

Powerful, silent, accurate.

Complete with 40 pellets and extra rubber straps. Send \$1.00 today to—

Wham-O Mfg. Co., Box 2P, South Pasadena, Calif.
PROFESSIONAL MODEL OF THE NAT'L SLINGSHOT ASSN.

Dealers Write
HEAVY DUTY STOCK

Learn ACCOUNTING BOOKKEEPING

This nationally renowned school has demand for graduates in good salary positions thru Nationwide recognition and placement service. Write Department PMD today for Big 32 page Success Book to be sent to you **FREE**



Hills BUSINESS UNIVERSITY AND EXTENSION SCHOOL
619 W. MAIN ST. OKLAHOMA CITY 2, OKLAHOMA

HOMESITES \$300 LOW TERMS

In California's loveliest Garden Spot, on scenic shores of beautiful Morro Bay. Enjoy future independence with excellent soil, soft water, wonderful fishing, hunting, boating, bathing, etc. Grow fruits, vegetables, poultry. Perfect temperate climate. Congenial community. Finest investment. Free literature.

RICHARD S. OTTO

DEPT. M SAN LUIS OBISPO, CALIFORNIA

make MONEY CASTING AT HOME



Make your own rubber molds quickly, cheaply with **X.L. RUBBER**. Cast thousands of perfect figurines, book ends, plaques, ornaments, ash trays, etc. **GREAT PROFITS!**

Write for NEW Catalog.
X.L. Rubber, Pts. \$2.00; Qts. \$3.50; Gallons \$8.95; Models and enough rubber for 3 molds \$1.30 postpaid.

PLASTIC ARTS STUDIO 3403 S. MADISON ST., Muncie Ind.

LEARN MOVIE PROJECTION THEATRE MANAGEMENT

The Motion Picture Theatre Business offers big opportunities for trained men. Get into a fascinating field with a promising future. Train at home in spare time. Free Catalog. Established 20 years.

THEATRE SCHOOL, 370 Washington St., Elmira, New York

CARPENTRY BRICKLAYING

APPROVED FOR VETERAN TRAINING • FREE CATALOG

PENNSYLVANIA INSTITUTE SCHOOL OF TRADES
30th & MARKET STS. PHILA. 4, PENNA.



MAKE MONEY!
RAISE CHIN-CHIN CHINCHILLA RABBITS
Pedigreed! Valuable Breeders!
PROFITABLE! EASY! PLEASANT!
Free illustrated Booklet—WRITE TODAY!
ROCK HILL RANCH SELLERSVILLE 36, PA.



CLEANS WINDOWS WITHOUT WATER

NEW CHEMICAL MITT
Sensational! DRY Window Cleaner! Uses no water, no messy liquids. Chemically Treated. Simply glide over windows; leaves glass sparkling clear. No heating water, no heavy buckets to carry. No rags, powders, sponges, chamois. No mess or muss. No red chapped hands. Dust, dirt, grime, fog disappear like magic. Wonderful for auto windows, windshields!

SAMPLES FOR AGENTS Sample offer sent immediately to all who send name at once. A penny postal will do. **SEND NO MONEY—just your name.** KRISTEE CO., 690 Bar Street, AKRON, OHIO.



AMAZING NEW MAGIC CATALOG

350 pages of mystifying, easy-to-do tricks and illusions. 600 illustrations. Send \$1.00 now for catalog, credited on your first \$5.00 purchase.

NATIONAL MAGIC CO.
119 S. State St. Dept. M-12 Chicago 3, Ill.

I'll Give You 30 DAYS TRIAL

To Test This Magnificent New 1950

MIDWEST TELEVISION

Console Right In Your Own Home



A. G. Hoffman
President

You are the sole judge of the performance of Midwest Television. You must be satisfied or it is **NO SALE!** Your decision will not be influenced by high-pressure salesmanship but by what your eyes and ears, see and hear.



EASY TERMS

READ WHAT THESE FOLKS SAY about MIDWEST TELEVISION



"I Am Amazed At The Clearness of The Picture"
Bayonne, N.J.—I am more than satisfied with my new Midwest "Constellation" Television Receiver. I really am amazed at the clearness of the picture, the fine reception, and the general attractiveness of the set. Midwest Television is everything you said it was, plus a whole lot more.
Charles Maraza
661 Avenue "E"

"My Midwest Television and Radio Are The Best I've Seen"
Wilkesburg, Pa.—Recently I bought a Midwest Television Receiver Chassis to supplement my Midwest Series 16 AM-FM Radio and I am well pleased with both. In my estimation, my Midwest Television and Radio are the best I've seen. Please let me know if I can secure one of your large console cabinets to hold my complete outfit.
David M. King
751 Ross Avenue

"My Midwest Is Worth Far More Than I Paid For It"
Utica, N.Y.—I am writing you this letter because I feel that the wonderful Midwest Symphony Grand radio-phonograph which I purchased from you several months ago deserves a few words of praise. In my estimation, my Midwest is worth far more than I paid for it. Its performance on all bands is really amazing and its tone is with out equal.
Matthew J. Banash
1410 Francis St.



GIANT NEW 16-inch PICTURE

Now In Our 30th Year Of **FACTORY-TO-YOU Selling**



MIDWEST Offers

FACTORY-TO-YOU, A Line of Beautiful Consoles and Complete Chassis TELEVISION MODELS

Here is Television at its finest! Brought to you by Midwest, the world's largest and oldest exclusive Factory-To-You radio and Television manufacturer. Giant new 16-inch Picture Tube receivers with 151 square inches of image . . . clear, steady, bright pictures . . . perfectly synchronized picture and sound that even a child can tune . . . new long distance FM sound circuit . . . big 12" Dynamic Panasonic Speaker. Available in beautiful consoles or complete chassis (not a kit) for custom installation in your own cabinet. Low Factory Prices, Long Easy Terms, and Liberal 30 Days Money-Back Trial. Send for **FREE 32-Page, 4-Color Catalog.**

Send TODAY FOR
LOW FACTORY PRICES

Write For **FREE 32-Page, 4-Color Catalog** or Paste This Convenient Coupon on 1c Post Card

Midwest Radio & Television Corp.
Dept. X255, 909 Broadway, Cincinnati 2, Ohio
Please send me your new **FREE 1950 Midwest Catalog**

Name _____
Address _____
City _____ Zone _____ State _____

... also a Magnificent Line of **NEW 1950 RADIOS** featuring the New Long Distance FM Circuit and New 3-SPEED PHONOGRAPH

MIDWEST RADIO & TELEVISION CORP

Dept. X255 909 Broadway Cincinnati 2, Ohio

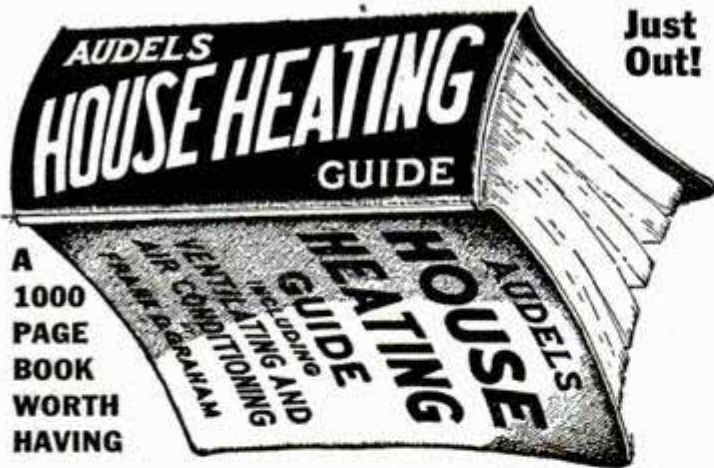

Just Out!

A 1000 PAGE BOOK WORTH HAVING

For Heating, Ventilating and Air Conditioning Engineers, Plumbers, Maintenance Men, Contractors, Building Superintendents and Mechanics seeking practical, authentic information on Heating, Ventilating, Air Conditioning. 1000 Pages—910 Illustrations—57 Chapters explaining the working principles of all Modern House Heating, Ventilation and Air Conditioning systems. Fully illustrated and indexed. This up to date book of reference gives answers to 1001 questions on Heating, Ventilating, Air Conditioning & Radiant Heating.

\$4 COMPLETE • PAY ONLY \$1 A MONTH

To get this assistance for yourself, fill in and

MAIL ORDER

AUDEL, Publishers, 49 W. 23rd St., New York 10, N. Y. MAIL AUDEL'S HOUSE HEATING GUIDE for free examination. If O. K. I will send you \$1 in 7 days; then remit \$1 monthly until price of \$4 is paid. —Otherwise, I will return it.

Name _____
 Address _____
 Occupation _____
 Employed by _____ PM

Can a Man MY Age Become a HOTEL EXECUTIVE

Even Though He Has No Previous Hotel Experience?

Would you like to step into a well-paid position as Hotel, Club, Restaurant or Inn Manager, Purchasing Agent, Social Director or Assistant Manager? Would you like to look forward happily to the future? The success of Lewis graduates from 18 to 50 PROVES you can — though you have no experience in hotel work.



Harry E. Roorbach, Veteran, Wins Success as Hotel Executive

"While I was in the hospital awaiting discharge from the U.S. Navy, I enrolled for Lewis Training. Shortly after I had completed the course, the Lewis National Placement Service informed me of an opening near my home.

"At present, I am Night Manager in the largest hotel in Rochester. I owe my success to the Lewis course."

Step Into a Well-Paid Hotel Position FREE Book Gives Fascinating Facts

Our FREE Book, "Your Big Opportunity," explains how you can qualify for a well-paid position at home, in leisure time; tells how you are registered FREE of extra cost in the Lewis National Placement Service. Most important, it shows how you can be a Lewis Certified Employee—certified to "make good" when placed in a position. Mail the coupon NOW!

Course Approved for Veterans' Training

LEWIS HOTEL TRAINING SCHOOL
 Room PX-324, Washington 7, D. C.

34 th **SUCCESSFUL**
 YEAR

Send me the Free Book, "Your Big Opportunity," without obligation. I wish to know how to qualify for a well-paid position at home, in my leisure time.

Name _____

Address _____

City _____ Zone _____ State _____

Check here if eligible under G.I. Bill of Rights.

STUDY AT HOME

With An Educational Institution

Men with specialized training win higher positions, insure larger earnings, and are bigger successes in business and public life. Opportunities NOW greater than ever before. Send for our Catalog.

ARTS and SCIENCES

Courses in Philosophy; Education; Letters; Public Health; Medical Jurisprudence; Psychology; Sociology; Physics; Chemistry; Geology; Political Science; Theology; Business and Commerce; Accounting; Mathematics; Statistics; Agriculture.

ENGINEERING

Courses in Electrical, Civil Mechanical, Drafting, Architectural, Steam, Aeronautical, Radio, Structural, Mining, Industrial, Petroleum, Marine, Chemical, Diesel, Automobile, Refrigeration, and Air Conditioning Engineering.

LAW

Complete Professional Law Course includes 18 Hornbook Series college grade textbooks. Courses also in Commercial Law, Patent Law and Medical Jurisprudence.

McKinley-Roosevelt Incorporated, 4610-K, Sheridan Rd., Chicago 40, Ill.

"LEARN-BY-DOING"

ELECTRICITY

PRACTICAL TRAINING NOT "HOME STUDY"

NATION'S LARGEST EXCLUSIVE ELECTRICAL SCHOOL

G.I. APPROVED Get actual experience in great shops of M.T.I. Learn all phases Practical Electricity; Housewiring, Motors, Const., Maintenance, etc. Living arrangements, Part-time jobs, etc. A post card brings the story.

MICHIGAN TECHNICAL INSTITUTE, Dept. PM-12
 2281 W. Fort St., Detroit 16, Michigan

SUCCEED IN THE POULTRY BUSINESS!

Poultry is providing many trained men and women with a good, comfortable living, either part or full time. For 28 years our Home Study Course has been helping thousands obtain training and "know how" that means extra income from the start. Don't delay — Write today for prospectus describing courses, methods, service, opportunities.

NATIONAL POULTRY INSTITUTE
 DEPT. 50 ADAMS CENTER, N. Y.

Learn ACCOUNTING BOOKKEEPING

This nationally renowned school has demand for graduates in good salary positions thru nationwide recognition and placement service. Write Department PME today for Big 32 page Success Book to be sent to you **FREE**

Hills **BUSINESS UNIVERSITY AND EXTENSION SCHOOL**
 619 W. MAIN ST. OKLAHOMA CITY 2, OKLAHOMA

SPEED & POWER HANDBOOK

BUILD FAST STOCK CARS!
COVERS FORDS to CADILLACS

Build California Roadsters! Hollywood Sport Cars! 150 MPH Rods! Breathtaking Methods — Authentic — Direct from California!

SAVE MANY DOLLARS

Build your own Dual Manifolds! Superchargers! Hot Cams! Water Injectors! Hi-Compression Heads! Mileage Devices! Get up to ten more miles per gallon! Get racing speed, lightning acceleration, dynamic power increases from any make passenger automobile! Get construction drawings! Tuning techniques! Speed tricks! Economy secrets! Ingenious formulas! Including "Racing Frames" — "Reciprocating Masses" — "Jet Engines" — "Braking Characteristics" — "Dynamometers" — Dual Pipes, Gears, Fuels, Manifolds, Porting, Relieving, Lowering! Balancing. Including complete Racing Equipment Catalogues!

Includes "CALIFORNIA AUTOMOBILE CUSTOMIZING" — Glossy photographs! Diagrams! Newest Ideas! Conversions! Re-Styling all makes! Streamlining! Chopping! Channeling! Customizing!

50 CHAPTER LIBRARY EDITION—complete—\$1.98 Postpaid.

NEWHOUSE AUTOMOTIVE INDUSTRIES
 5805-B4 EAST BEVERLY BLVD. LOS ANGELES 22, CALIF.

\$350 IN A SINGLE
WEEK

GROSS

IN
MY OWN
BUSINESS

FREE BOOK! MAIL COUPON

VON SCHRADER MFG. CO.
41R Pl., Racine, Wisconsin

Send at once (no obligation) your FREE booklet containing information about your Electric Upholstery Cleaner and how I can own my own permanent, profitable business.

Name _____

Address _____

City _____ Zone _____ State _____

Some Make More, Some Less . . .
Start This Business for **YOUR OWN**

George Held earned \$350 in one week
with

ELECTRIC UPHOLSTERY CLEANER

• Here's YOUR chance to start a money-making, year-round business of your own and make the success you've dreamed about. R. O. Donnelly took in \$40 in seven hours. O. W. Ware landed a \$750 hotel job and made a fine profit. J. S. Corbit grossed \$279.50 his first month. P. D. Ash cleaned 23 auto seats at \$5 each in one week. And so it goes. Homes, hotels, offices, clubs, all places where furniture is used, offer you big profit possibilities. Auto seats and interiors, also.

NO SHOP OR OFFICE NECESSARY

You clean furniture on customers' premises. No hauling costs. No high rents. Supplies are in-

expensive and you operate, at low cost, from your home. What you take in is mostly profit. Surely YOU will want to investigate an opportunity like that — right away. Own your own business. Be your own boss. If you are ambitious, honest and courteous, we will help you to start and succeed.

FULL INFORMATION FREE MAIL COUPON TODAY

Send the coupon or write for Furniture Cleaner Booklet. It tells all about this electric cleaner—how to start YOUR business—how to make a profitable success. Don't delay. It's your BIG opportunity.



MAIL COUPON TO

VON SCHRADER MFG. CO., 41R PL., RACINE, WIS.

draw me!

COPY THIS GIRL AND TRY FOR A

FREE \$240 ART COURSE

5 PRIZES 5 Complete Art Courses, including
Drawing Outfits! Each Course Valued at \$240

Opportunity of a lifetime, if you dream of being a commercial artist, designer, or illustrator! An easy-to-try way to win FREE art training!

Whether you win or not our instructors will send you their comments on your work, if your drawing shows promise! Trained illustrators and artists now making big money. Find out now if YOU have profitable art talent. Start your drawing now. Mail it today.



ART INSTRUCTION, INC., Dept. 12139C
500 South 4th Street, Minneapolis 15, Minnesota

Please enter my attached drawing in your January drawing contest. (PLEASE PRINT)

Name _____ Age _____

Address _____ Phone _____

City _____ Zone _____ County _____

State _____ Occupation _____

RULES: You must be amateur. Our students not eligible. Make copy of girl 5 ins. high. Pencil or pen only. Omit lettering. All drawings must be received by Jan. 31, 1950. None returned. Winners notified. If desired, send stamped, self-addressed envelope for list of winners.

BETTER JOBS BETTER PAY FOR SKILLED MEN!

QUICK TRAINING BOOKS SHIPPED for Examination

SEND NO MONEY! Prepare for a better job at bigger pay by sending the coupon NOW for any set of easy-to-understand self-training text books. These great books, prepared by long experienced experts, can help you to acquire the "know how" that wins promotions and puts more money in your pocket. Any set of books sent for 10 days examination.

AUTOMOBILE ENGINEERING

4 Big, Thick Books

20th Edition, Over 2700 Pages



These wonder books tell how—step by step—to make the repairs and adjustments that keep any make of car at maximum operating efficiency. More than 2000 illustrations, wiring diagrams, data sheets, etc. Total price only \$24.80. Low monthly payments. Sent on trial.

BUILDING, ESTIMATING and CONTRACTING

Up-to-Date Edition

9 Volumes — 4000 Pages

These 9 practical books can help you to make more money by becoming foreman, superintendent, or running your own business. Drawing plans, estimating, masonry, carpentry, building, remodeling, heating, painting and many other subjects included. 2750 illustrations. Total price only \$34.80. Low monthly payments. Sent on 10 days' trial.



APPLIED ELECTRICITY

INCLUDING RADIO AND REFRIGERATION

New 19th Edition

8 Books — 3700 Pages

NEW, up-to-date edition contains many new subjects in detail, including blueprint reading, electronics, F.M. radio, fluorescent lighting and other modern electrical topics as well as full range of standard practices. 2700 illustrations.

134 tables. Total price only \$34.80. Low monthly payments. Sent on trial.

Publishers since 1898

(A year's consulting privileges with our engineers (now given with these books at no extra charge.)

AMERICAN TECHNICAL SOCIETY

Dept. X919 Drexel at 58th St. Chicago 37, Ill.

CLIP AND MAIL COUPON TODAY

AMERICAN TECHNICAL SOCIETY, Dept. X919

Drexel at 58th Street, Chicago 37, Ill.

Send for 10 days' free use, the following set of books:

I will pay the delivery charges only, and if fully satisfied, will send you \$2.00 in 10 days and then \$3.00 a month until the total price of \$_____ is paid. If I return the books in 10 days I will owe you nothing. You are to include a Year's Consulting Privileges with your engineers without extra charge.

Name _____

Address _____

City _____ State _____

Please attach letter stating age, occupation and name and address of employer, and at least one business man's name and address as reference. Men in service also please give home address.

EST. 1914

BUY DIAMONDS at WHOLESALE PRICES

Save UP TO 50%

Learn how to benefit from Loan Foreclosures and Estate Liquidations. All Diamonds reset in new mountings. Your bank is our reference.

WRITE For FREE CATALOG

CITIZENS Diamond Brokers
Dept. C • 195 Mitchell St. • Atlanta, Ga.

Learn Upholstering

A money-making business or fascinating hobby. Practical home training. You get materials to make and upholster a fine Ottoman with your first lesson. Professional upholsterer's tools available. Write today for free, illustrated booklet. State whether interested for career or hobby.

WEST COAST UNIVERSITY, Extension Dept. PM-129
1601 S. Western Ave. Los Angeles 6, Calif.

Bar Bells

Buy Direct From Factory **\$8.95** up

Write for free booklet and price list

INDEPENDENT IRON WORKS
2416 East 23rd Street, Dept. B
Los Angeles 11, Calif.

Learn to Write

at Home in spare time

Write for FREE BOOK, "How to Become an Expert Penman," showing what others learned by my Simplified Method. You can greatly improve your writing, or become an Expert Penman. For Full Details without cost or obligation check or state Courses interested in: Business Writing Ornamental Writing Bird, Eagle, and Swan Flourishing. Send 10c for Special Penpoint, your name and a flourished bird written on a card.

Box 25K, CHILLICOTHE, MO.

YOU CAN BE AN All Around HE-MAN All 5 famous courses by George F. Jowett, world's greatest body builder in 1 complete muscle building volume (valued at \$5 each) now only 10c. Packed with How-to-Do-it pictures. 1. How to Mold a Mighty Arm. 2. Mighty Chest. 3. Mighty Back. 4. Mighty Grip. 5. Mighty Legs. Free strong men photo book. Quick results or money back! Send 10c.name.address.age.

JOWETT INSTITUTE, Dept. PM-912, 230 Fifth Avenue, New York City

BIG FREE CATALOG

of WAR SURPLUS OPTICAL BARGAINS

Build Your Own RIFLESCOPE, BINOCULARS, TELESCOPES, ETC.
We Furnish Optics and Instructions

- LENSES, PRISMS & RETICLES
- EYEPIECES and OBJECTIVES

Send \$1.00 for Stock #2-H 10-Piece Lens Kit and Big Instruction Booklet.

We Have Numerous Types of Assembled Optical Instruments Including BINOCULARS and RIFLESCOPES.

CHECK OUR BARGAINS . . . Request CATALOG H

EDMUND SALVAGE COMPANY
BARRINGTON, NEW JERSEY

Start Your Career in 6 to 36 Months With Our Unique Step-by-Step Training

Each course unit at the Milwaukee School of Engineering is complete in itself. All courses begin with practical training in the school's complete laboratories—and prepare you for specific occupational objectives or advanced training. More than 1,500 students now enrolled from 48 states and 18 overseas countries. Faculty of 85 specialists, 35,000 former students in industry all over the world.

MILWAUKEE SCHOOL OF ENGINEERING



Founded in 1903
by Oscar Werwath

Courses Available at Vocational, Technical and Professional Level

- | | | |
|---|---|--|
| <p>SERVICE
6 to 12 months</p> <ul style="list-style-type: none"> • Electricity • Welding • Refrigeration • Heating | <p>TECHNICIAN
1 to 2 years</p> <ul style="list-style-type: none"> • Electrotechnics (Power) • Radio and Television • Electronics • Refrigeration, Heating and Air Conditioning | <p>PROFESSIONAL
3 years</p> <ul style="list-style-type: none"> • Electrical Engineering • Bachelor of Science Degree • Major in Electronics or Power |
|---|---|--|



Terms Start January, April, July, September



FREE ... New 48-Page
PICTORIAL BULLETIN

Send Coupon Today

MILWAUKEE SCHOOL OF ENGINEERING

Dept. PM-1249, N. Broadway and E. State, Milwaukee, Wis.

Without obligation send me free bulletin, "Your Career," and more details on course in

Name _____ Age _____

Address _____

City _____ State _____

EARN \$5 an HOUR—ON THE SIDE

WHILE LEARNING WATCH & CLOCK REPAIRING AT HOME

WITH OUR NEW 15 ITEM SELF TRAINING KIT

Containing: AMERICAN JEWELER WATCH MOVEMENT for practicing; PROFESSIONAL TOOLS: Loupe; 6 Watch Screw Drivers; Clock Screw Driver; Tweezers; Clock Tweezers; Material Tray; Case Opener & Knife; Movement Gauge; plus COMPLETE ILLUSTRATED COURSE IN MODERN WATCH & CLOCK REPAIRING incl. use of tools and materials. Complete; easy to understand. (U.S.O.D., plus charges!)

\$14.95 PAID

POST MONEY BACK GUARANTEE. All-inclusive instructive Tool Catalog with about 600 illustrations & descriptions FREE with KIT or send \$.50 credited to 1st order.

MODERN TECHNICAL SUPPLY CO.

Dept. 12MMC, 55 W. 42nd St. New York 18, N. Y.

RIEDEL WORK GLOVES

"The Right Glove for Every Job"

Riegel Textile Corp.

342 Madison Ave. New York 17, N. Y.

NEW! ADVERTISING MACHINE

PRINTS & ILLUSTRATES PENNY POST CARDS

Easy to boost sales with Cardmaster. Thousands are doing it. Not a toy but a sturdy Advertising Machine Guaranteed 5 years. Get money-making facts today. Act now!

FREE

An Illustrated Book of New Plans, Business Getting Ideas for your own business. Get it.

CARDMASTER, 1920 Sunnyside, Dept. 1312, Chicago 40

Say You Saw It in Popular Mechanics

Big money in spare time! Learn at home Time pianos in 30 days

No musical knowledge needed. Piano tuners in great demand everywhere. Train under experts. Learn with phonograph recordings in 30 days. We furnish recordings, instruction books and professional tools (including record player if needed). We show you how to line up part or full time work for big earnings. Send for FREE literature today.

CAPITOL CITY TUNING SCHOOL

Dept. 1234, 129 E. Michigan Ave., Lansing 16, Mich.



Start As High As \$3,351 YEAR

MEN - WOMEN

FRANKLIN INSTITUTE

- Postoffice Clerks-Carriers
- Railway Postal Clerks
- Stenographers
- Accountants
- Statistical Clerks
- Typists
- Liquor Inspectors
- Many Other 1950 Jobs

(Not Government Controlled)

Dept. Y83

Rochester 4, N. Y.

Gentlemen: Rush to me, FREE of charge, list of U. S. Government big pay jobs. Send FREE 40-page book describing salaries, vacations, hours, work, etc. Tell me how to qualify for one of these jobs.

Veterans Get Preference
MAIL COUPON TODAY SURE

Name _____

Address _____ Vet? _____

ENGINEERING DEGREE IN 27 MONTHS

Big Demand for Graduates

Aeronautical, Chemical, Civil, Electrical, Mechanical and Radio Engineering (including Television)

Hundreds of young men are earning engineering degrees in this recognized institution each year—continuous operation. New terms start quarterly. Many students earn a major part of their college expenses in this large industrial center.

Low tuition. Competent instruction. Thorough intense practical program. Modern laboratory facilities including new physics lab. and modernized wind tunnel. Individualized instruction emphasized.

Approved for Veterans. Engineering preparatory courses. Students from 48 states and 21 foreign countries. Enter December, March, June or September. Send coupon for free catalog and full information. Enroll now.

SEND COUPON TODAY

INDIANA TECHNICAL COLLEGE

5129 E. Washington Boulevard
Fort Wayne 2, Indiana

Please send me free information on B.S. Engineering Degree in 27 months as checked.

Aeronautical, Chemical, Civil, Electrical,
 Mechanical, Radio-Television.

Name _____

Address _____

BIG PAY JOBS for men who qualify in DIESEL



ASSURE YOUR FUTURE. Steady, high-pay jobs await men qualified in Diesel, Tractor, and Heavy Equipment. Are you qualified for job and advancement opportunities in this fast-growing field? You can qualify!

COMPLETE DIESEL COURSE NOW AVAILABLE. If you are ambitious and want to get ahead in this big money field, you'll want to know about the complete Diesel home training course now offered by Interstate Training Service. Covers all phases of operation, repair, service. Easy to master in spare time. No interference with present job. Up-to-the-minute. Regularly revised to cover new developments. We invite comparison of material offered. Free placement advisory service.

YOU OWE IT TO YOURSELF to investigate Interstate Training Service Diesel Training. Thousands agree it has helped them to better jobs... better pay. It can do the same for you!

SEND FOR FREE BOOK TODAY!

INTERSTATE TRAINING SERVICE, Portland 13, Ore.
Please see that I receive FREE 24-page book,
"Getting Ahead in Diesel." (K-3)

NAME _____ AGE _____

ADDRESS _____

CITY _____ ZONE _____ STATE _____

TRAIN NOW FOR AN AVIATION CAREER IN SUNNY SOUTHERN CALIFORNIA

MAXIMUM TRAINING IN MINIMUM TIME

Specializing in AERONAUTICAL ENGINEERING and MASTER AVIATION MECHANICS since 1929 America's Finest Aeronautical Institute . 7000 successful graduates. **MAKE MORE MONEY MAIL COUPON TODAY APPROVED FOR VETERANS.**

Board and Room now available.

Without obligation, send free catalogue with full information.

NAME _____ AGE _____ PM-12

ADDRESS _____

CITY _____ ZONE _____ STATE _____

CAL-AERO TECHNICAL INSTITUTE
GRAND CENTRAL AIR TERMINAL • GLENDALE 1, CALIFORNIA

WANTED MAN WITH CAR

NO TIME LIKE NOW TO GET IN McNESS BUSINESS

It's no trick to make good money when you use your car as a McNess "Store on Wheels." Farmers buy everything they can from McNess Men because McNess Products are tops in quality, represent extra values. Attractive business-getting prizes and premiums; also money-saving deals to customers make selling McNess daily necessities a snap.



WE SUPPLY CAPITAL—START NOW!

There's no better work anywhere. Pays well, permanent, need no experience to start, and we supply capital to help you get started quick. You begin making money first day. Write at once for McNess Dealer Book. It's FREE. Tells all—no obligation. (15)

THE McNESS CO., 818 Adams St., Freeport, Ill.

PISTONS

ALUMINUM ALLOY. For Every Make Engine, Any Year, Odd or Foreign! For auto, "hot rod", racing, truck, tractor, motorcycle, scooter, bike, outboard, marine, compressor, industrial. Send sample or specifications.

JUDSON MFG. CO., 1709 Gillingham, Phila. 24, Pa.

Hobbyist Catalog

WE PAY POSTAGE!

SHIP MODELS . . . TRAINS . . . PLANES
Cars . . . Art Supplies . . . Tools . . .
Projects . . . Games.
U.S.A. and Canada Orders Only.

10¢ write *Braun-Craft*
1232 ETOWAH, DEPT. PM-5, Royal Oak, Mich.

MAGIC TRICKS

IT'S FUN TO DO MAGIC!

BE POPULAR! AMAZE-MYSTIFY-ENTERTAIN!
FOR 30 YEARS DOUGLAS HAS SATISFIED CUSTOMERS ALL OVER THE WORLD. NOW YOU CAN ENJOY THIS FASCINATING HOBBY. ONLY 25¢ BRINGS OUR CATALOG. 500 TRICKS—CONTAINING BRAND NEW TRICKS FOR POCKET, PARLOR, STAGE.

JOIN IN THE FUN . . . SEND 25¢ TODAY

DOUGLAS MAGICLAND, DEPT K, DALLAS, TEXAS

SAY YOU SAW IT IN POPULAR MECHANICS

WATCH REPAIRING

Be A Master Watchmaker

Large earnings with no dull seasons and a steady secure future are yours as a Master Watchmaker! The famous Sweazey System teaches you how . . . expertly, quickly, successfully . . . at home or in our modern school.

FREE BOOK

Write today for your free copy of "Master Watchmakers Wanted." Tells about big opportunities in Watch Repairing, Gem Setting and Engraving.

CHICAGO SCHOOL OF WATCHMAKING

Famous Since 1908
DEPT. 1129 — 1608 N. MILWAUKEE AVE., CHICAGO 47

**WARMEST WINTER FRIEND
A MAN'S FACE EVER HAD!**



**GENUINE U.S. NAVY
FACE MASK**

**50¢ FOR EVERY
OUTDOORSMAN!**

- Hunters! Anglers!
- Skiers! Fliers!
- Boatmen! Cyclists!
- Campers! Scouts!
- Farmers! Laborers!
- Outdoor Mechanics!
- Telephone Linemen!
- Lumberjacks!
- Railroad Workers!
- Construction Men!
- Winter Sport Fans!

Protects face, ears, chin against rain, snow, sleet, hail, sand, dust! Made of warm, double-thick white-lined blue wool cloth. Also in O.D. rubberized cloth at 75c. For men and women alike! Fits any size! Send cash, stamps, check or money order. **Money-back guarantee!**

**WINTER PROTEXION COMPANY
Dept. A Box 387, Baltimore, Md.**

**MICRO-VOX
THE WIRELESS "MIKE"**

**Broadcasts Over Any
Radio Within 50 Feet!**

Here's a fascinating complete miniature transmitting system that will delight everyone! Round table discussions . . . Baby listener . . . Practical jokes and dozens of other uses that will astonish one and all! Complete with tube, batteries, tuner and built-in high-fidelity microphone. Clear, life-like tone. Easy to operate!

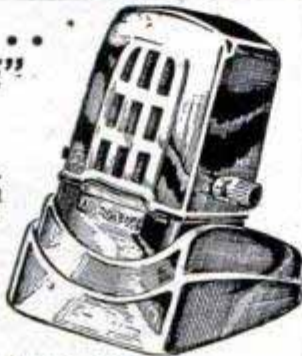

**SAVE MONEY! Send Check or M.O. \$6.95 COMPLETE
We Pay Postage. C.O.D. Plus Postage.**

TRUSOUND, INC. (Dept. PM-12) 630 W. Randolph St. Chicago 6, Ill.

REMEMBER THIS You can't buy a \$20 goldpiece for \$10 So it's dangerous to pay less if you want safe, balanced matched tires. WE REPEAT—Consider your family's safety, not just PRICE. You see our adv. every month. Buy Now & Save 10%. Positively not recaps. We serve ambulances, fire trucks, school buses, trucks & cars.

**GOOD YEAR Firestone
Goodrich U. S. ROYAL**

& others. Original high tread. Slightly worn. Extra fine traction.

FREE TUBE WITH EACH TIRE —26 MONTHS GOLDEN RULE GUARANTEE BOND—Genuine Factory Adjusted "All-Purpose" "AAA" Tires Read That Top Line Again! You'll Save More than \$

600-16	\$5.55	650-16	\$5.85	700-15	\$5.85	475-19	\$5.85
600-16(6)	6.66	700-17	9.99	650-15	5.85	525-18	5.85
700-16	6.85	750-16	7.95	550-17	7.25	550-16	5.55

AMERICA'S GREAT LO-PRICE VALUE. 15 Months Guar. Limited Supply

600-16	\$3.65	650-16	\$3.85	700-16	\$4.65	650-15	\$3.95
		700-15	3.95	750-16	5.95	550-17	5.55

LO-PRICE TRUCK TIRES. 15 MONTHS GUARANTEE

32x6(8)	\$8.88	750-20(10)	\$8.88	1100-20	\$13.95	900-20	11.95
32x6(10)	9.99	825-20	11.25	700-20	8.88	1000-20	12.95

SUPERCUSHIONS to fit your wheels; any car. Buy 2 or 4; the Velvet Ride

670-15(600-15)	\$6.25	760-15(650-15)	\$7.77	670-16(600-16)	\$6.66
710-15(650-15)	6.85	820-15(700-15)	7.77	760-16(650-16)	7.77

WE ARE TRUCK-TIRE EXPERTS Matched tires. The world over depend on us to keep their trucks rolling "ON TIME" at lowest cost. **FACTORY ADJUSTED "ALL-PURPOSE" "AAA" Grade**

GOLDEN RULE 26 MONTHS REPLACEMENT GUARANTEE BOND

600-20	\$9.20	32x6(8)	\$11.95	900-20	\$15.55	134x7	\$12.22
650-20	9.99	32x6(10)	13.33	1000-20	16.65	1000-22	17.77
700-20	10.85	825-20	15.95	1100-20	17.77	1100-22	18.88

MILITARY "AAAA" guar. 30 mos. (Supers 14 mos.)

600-16 Super	\$6.22	"AAAA" Snow Tread	\$7.77
750-16 Super	59.75	900-16 Super	58.60
"AAAA"	12.22	"AAAA"	10.90
		"AAAA"	\$13.00

**BLATT GIRARD & LANCASTER AVES., Dept. PM
BLATT BLDG., PHILADELPHIA 31, PA.**

Send ck. or money order and this ad. for rush shipment. We won't ship a tire we wouldn't use ourselves. Instant shipment down South, far West and the world over. The name to trust in rubber.

**Get into BUSINESS
for Yourself!**

**METALIZING
BABY SHOES
AT HOME IN
SPARE TIME**



Get facts about amazing money-making *Warner Success Plan* that shows you every easy step in completely charted path to personal independence—with your home as your headquarters . . . This proved and tested Plan is working like magic. It's backed by an old, reliable company . . . And we send it to you on a No-Risk Trial Money Back Guarantee.

QUICK CASH WAITING
Demand for METALIZED Baby Shoes and other keepsakes is growing bigger daily. Our Tested Plan Shows How to Do the Work, How to Bring in the Business, How to Make as much as \$5 an Hour. Spare or full time, big steady profits are waiting for you. Send penny postcard or mail coupon for FREE Facts. Act! Time is precious.

FREE offer of COMPLETE MONEY MAKING PLAN • SEND NO MONEY Just Mail COUPON

**Ray Brandell, Mgr., Warner Electric Co.,
1512 JARVIS AVE., DEPT. 312, CHICAGO 26, ILL.**

Please rush complete details about your No-Risk Trial Money Back Plan for Metalizing Baby Shoes. Everything you send is FREE and costs me nothing—now or ever.

NAME _____
ADDRESS _____
CITY _____ ZONE _____ STATE _____



**U.S.
GOVERNMENT
JOBS**



**Start
AS HIGH AS \$3,351.00 YEAR**

Many 1950 Examinations Expected. Prepare NOW!

Veterans Get Special Preference! 40-Page Civil Service Book —FREE

Mail Coupon Today—SURE

**Franklin Institute
Dept. Y84
Rochester 4, N. Y.**

(Not Government Controlled)

Gentlemen: Rush to me, FREE of charge, list of U. S. government big pay jobs. Send FREE 40-page book describing salaries, vacations, hours, work, etc. Tell me how to qualify for one of these jobs.

Name _____

Address _____ Vet? _____

BUDGET-SAVING HAIR CLIPPER



Cuts and Trims Hair

Shaves Arms and Legs

Removes Hair Under Arms

ONLY
\$9.95
AT YOUR
DEALERS

THE VERSATILE

Cadet^(R)

ELECTRIC HAIR CLIPPER

Put the practical "Cadet" Electric Hair Clipper to work . . . saves time and money for the whole family! You'll find this strong, yet inexpensive electric hair clipper mighty handy for removing superfluous hair, too. Has special design blade for clean, close cutting. Operates on 110 V., 60 cycle A.C. Fully approved by Underwriters' Laboratories. Only \$9.95 at barber and beauty shops, and drug, department, hardware and electric appliance stores. If your dealer cannot supply you, order direct from factory. Send check or money order. Money back if not delighted after 5-day trial.

ELECTRO TOOL CORPORATION

DEPT. 529-M • RACINE, WISCONSIN

"PRACTICAL CERAMICS"

by Mildred G. Bell
AT LAST!

A book on ceramics and pottery making that really tells you what you want to know.

ILLUSTRATED LESSONS ON:

- How to make ceramic jewelry—flowers
- How to use Underglaze, overglaze, engobes
- How to do Sgraffito
- How to apply and fire Lace
- How to cast in molds
- How to set up the kiln and fire

Over 90 Illustrations — Many Original Designs — An Instruction Book for the Hobbyist — A Marvelous Guide for the Teacher.

SEND CHECK OR MONEY ORDER **\$1.95** postpaid

BELL CERAMICS INC.

21 MIDLAND AVENUE, MONTCLAIR, NEW JERSEY
Send for FREE Illustrated Catalog of Patterns, Supplies and Molds

Learn WATCH REPAIRING

Earn while AT HOME you Learn

Learn this fascinating and profitable trade in your spare time at Home through our Correspondence Department. Each individual student receives individual attention! Post-Graduate course at resident school optional for correspondence students.

OUR MOTTO: Not how quickly, OR how thoroughly we can train you.

AT OUR RESIDENT SCHOOL

APPROVED FOR G. I. TRAINING

Our school is set up on an individual basis where every student receives individual attention from our competent instructors in a home-like and cheerful atmosphere.

JOHN VAN PUFFELEN, Director

Write TODAY FOR FREE INFORMATION American Institute of Specialized Watch Repair
270-276 East Bldg., Grand Rapids 6, Michigan



FEET HURT?

Get QUICK RELIEF! Dr. Barron's Foot Cushions RELIEVE painful pressure from CALLOUSES, CORNS, SORE HEELS, support WEAK ARCHES, absorb foot shocks. Light, ventilated, spongy. Like Walking On Pillows! Wear in any shoes. Dr. Barron says: "Relieves tired, aching feet from heel to toes." SEND NO MONEY! Pay postman \$1.98 for PAIR, plus postage (or send \$1.98, we pay postage). State shoe size and if man or woman. 30-DAY TRIAL. Money back GUARANTEE if no blessed relief! Order NOW! ORTHO, INC., 2700 BROADWAY, Dept. 499, N.Y.C. 25

Toilet Paper Filters Oil Better . . . at Fraction of Cost

An ordinary roll of toilet paper makes an ideal element for any oil filter. Laboratory tests prove it cleans oil faster and better than popular makes of filter elements. With a simple set of adapter plates you can start using toilet paper . . . instead of expensive replacement elements . . . in your present oil filter. Easy to install yourself. For proof and descriptive literature, send name, address, make of car or truck and brand of filter.

RETLIF OIL FILTER CORPORATION

1237 No. Highland

Los Angeles, Calif.

TRI-STATE COLLEGE

B. S. DEGREE IN 27 MONTHS

66th Year.
World-Wide Enrollment

ENGINEERING—Courses in Civil, Elec., Mech., Chem., Aeronautical and Radio, Television. Also Bus. Admin., Acc't. and Sec. Science. Visitors welcome. See beautiful campus, well equipped laboratories. Graduates successful. Enter Jan., March, June, Sept. Write for Catalog. 4129 College Avenue, Angola, Indiana.

For CHRISTMAS AMAZING NEW KEY-LIGHT INVENTION!



Throws a powerful beam of light. Helps find the key-hole, lost articles in car, home, theatre, etc. Case made of genuine leather and is a beauty. Send \$1.00 today. Double Your Money Back on Request. Agents wanted.

NORTHWEST MFG. CO.
Dept. KL-1 Mitchell, S. D.



MAKE THIS

MASSIVE STERLING SILVER INITIAL RING WITH YOUR OWN INITIALS

No special skills or training needed. With our Ring Kit containing unfinished Sterling Silver ring and 2 or 3 initials, all materials needed and illustrated instructions, you can, in a few hours, make this beautiful heavy Sterling Silver ring for yourself, as a gift to someone special or for sale.

Send check or M.O. today with finger size and initials, or send 3c stamp for finger gauge.

AMERICAN JEWELRY MODELS, 62 W. 47th St., New York 17

SAY YOU SAW IT IN POPULAR MECHANICS

MAKE THIS SUIT YOURS NEW PLAN



EARN CASH SHOWING TO FRIENDS!

Write at once if you want this fine made-to-measure suit! You can get it by taking a few orders from friends, and earn up to \$10, \$12 in a day. Your bonus suit helps you take more orders with latest style, made-to-measure guaranteed suits at amazingly low prices. Also complete line of Ladies' Tailored Suits. No experience, no money needed. Write TODAY for FREE SAMPLES—telling about yourself—age, etc. No obligation!

PIONEER TAILORING CO. Congress and Throop Streets, Dept. Z-1116, Chicago 7, Ill.

BE A GOVERNMENT LICENSED AIRPLANE AND ENGINE MECHANIC
Train Now at **LINCOLN**

EARN BIG PAY IN AVIATION

Start your aviation career by enrolling in our **MASTER AVIATION MECHANICS**, CAA Approved 1 Year Course, a complete course in both airplanes and airplane engines. Our **REFRESHER AIRPLANE & ENGINE MECHANICS COURSE** is designed for veterans or others with aviation mechanics experience. Either course is available to veterans under the G.I. Bill of Rights. Write today for complete information.

LINCOLN AVIATION INSTITUTE
 UNION AIR TERMINAL DEPT. P-12 LINCOLN, NEBRASKA

Learn **CARPENTRY BRICK LAYING**

Big money in the Building Trades. Learn now while opportunities are greatest. Train in our completely equipped shops under expert instructors, or by Home Study. Vets attending school entitled to G.I. Benefits. Write for FREE catalog.
MIDWEST SCHOOL OF BUILDING TRADES, Dept. PM-12
 411 N. Center St. Bloomington, Ill.

RAILROAD TELEGRAPHY

Prepare quickly for top pay railroad job. Starting pay approx. \$265.00 monthly. 5-Day Week. Paid vacations. Free travel passes. Go anywhere. Railroads need men constantly. FREE particulars.
AMERICAN SCHOOL RAILROAD TELEGRAPHY
 201 PHIPPS BLDG. WENATCHEE, WASH.

ANALYZE HANDWRITING

NEW, uncrowded, fascinating field. Gratifying earnings reported by graduates in Employment, Credit, Social Service, Police and Entertainment fields. Others have developed profitable private practice, full or spare time, as Personal and vocational Counselors. Send for 3,000-word **TEST LESSON** and **PROOF** book FREE. Write today!
I.G.A.S., Inc., 303 Wilhoit Bldg., Springfield 4, Mo.

Learn **THE SCIENCE OF SALESMANSHIP**

This nationally renowned school has demand for graduates in good salary positions thru Nationwide recognition and placement service. Write Department PMF today for Big 32 page Success Book to be sent to you **FREE**

Hills BUSINESS UNIVERSITY AND EXTENSION SCHOOL
 619 W. MAIN ST. OKLAHOMA CITY 2, OKLAHOMA

Chronograph Wrist Watch 7 JEWEL GOLD PLATE

\$12.98

Sweep Second Hand; Precision Workmanship; Rugged Shock-resistant case; Radium hands and numerals; Leather strap. It measures distance, speed of cars, planes, horses and other moving objects. It's a time keeper, stop watch, telemeter, tachometer. **ONE YEAR WRITTEN GUARANTEE** and full operating instructions enclosed with each watch. **SEND NO MONEY.** Mail your order today. Pay postman \$12.98 plus 10% Federal tax. Total \$14.28 plus postage. Or send cash (money order or check) with your order and save postage charge.

MARDO SALES CO., Dept. 1704-G
 480 LEXINGTON AVE. NEW YORK 17, N. Y.

EARN MORE IN DRAFTING



Steady Employment
 •
 More Opportunities for Promotion
 •

"Here I am at work making good money as a draftsman. I'm glad I sent the coupon to Chicago Tech for that Free Trial Lesson and found out how easy it is to learn Drafting in spare time at home. Today I feel secure in my job because the draftsman's work comes first on any new project. And, in addition, draftsmen can't be replaced with machines. What's more, I feel I'm slated for promotion and more pay, because I see so many draftsmen advancing to high-pay jobs."

LEARN IN SPARE TIME—AT HOME!
 (or at the College in Chicago)

A few hours of pleasant home study every week—that's all. No interference with your present job. All the tools you need; drawing outfit included. With Chicago Tech's help, you train yourself step by step. This tested method—developed over 45 years of C.T.C. progress—prepares men quickly for good positions in industry.



FREE INFORMATION—SEND COUPON
 To prove to you how easy it is to learn Drafting at home by the Chicago Tech method, we will send you this **FREE TRIAL LESSON**. No charge for this lesson, now or later. Fill out and mail coupon, or send post card today.

CHICAGO TECHNICAL COLLEGE

S-212 Tech Bldg., 2000 S. Michigan Ave., Chicago 16, Illinois
 Mail me **FREE** Lesson with information about big opportunities in **DRAFTING**.

Name _____ Age _____
 Address _____
 City _____ Zone _____ State _____

SAY YOU SAW IT IN POPULAR MECHANICS

DO YOU WANT MORE MONEY?
GET THIS BIG BOOK

PRACTICAL IDEAS — QUICK RESULTS
 Never before such a book of helps for you who wish extra money quick. In this book are formulas, recipes, secrets that have amazed the world. Use these ideas and make many needed money-making products. Experts wrote this book in simple terms with supply sources for materials, short-cuts and methods for profitable results.

Included FREE! "Knowledge is Power" containing more than 170 sure-fire opportunities to promptly increase your earnings and your security.

Lots of profitable businesses have started with a single recipe. Choose from the 162,000 facts and 10,000 formulas such as:—Adhesives, Cosmetics, Beverages, Candy, Ceramics, Cheese, Cleaners, Concrete, Dentifrices, Dyes, Depilatories, Enamels, Flavors, Foods, Gum, Home formulas, Inks, Insecticides, Lacquers, Linoleums, Lubricants, Metals, Mirrors, Oils, Ointments, Paints, Perfumes, Plastics, Polishes, Remedies for Man, Beast & Fowl, Soaps, Solders, Varnishes, etc. 1000's of others to make all sorts of profitable items.

WHEN EXTRA \$ \$ \$ ARE WANTED
 This big book tells what to do and how. No experience needed. You work from the money-making facts and ideas that are explained in words easily understood. Many fortunes have been made with a single formula. Mail in your order and get started right NOW!

\$3.98 postpaid throughout the world. (C.O.D. plus postage in U. S. only.) Shipped at once.
 World-Wide Service — Books on Any Subject

ADAMS BROWN COMPANY, Dept. P129, Boston 67, Mass, U.S.A.

10,000 IDEAS SECRETS FORMULAS
 924 BIG PAGES ILLUSTRATED

POSTPAID \$3.98 ANYWHERE IN THE WORLD

Lots of DIESEL



IN THE
PACIFIC NORTHWEST

Yes, DIESEL is BIG business in Oregon, Washington, and adjoining states where industries and populations are growing so incredibly fast.

DIESEL IS THE KING OF POWER . . . on our railroads, highways, waterways and in our industries.



L. L. ADCOX,
President

MEN WHO ARE equipped with the thorough training they get at the ADCOX SCHOOL, are prepared for a splendid future in the great Northwest. A fine place to live and enjoy life.

**I PRODUCE
DIESEL MEN
IN 3
SHORT MONTHS**

NEWEST FACILITIES AND EQUIPMENT, Advanced Instruction Methods by highly paid, Expert Instructors, combined with my 40 YEARS of trade school experience, enable me to turn out **REAL DIESEL ENGINE TROUBLE SHOOTERS.** When you receive your Adcox Diploma you are ready to begin your career in Diesel.

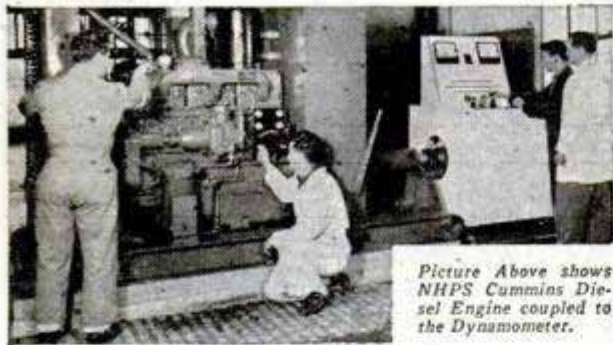

Picture Above shows NHPS Cummins Diesel Engine coupled to the Dynamometer.

YOU LEARN ENGINE CONSTRUCTION FROM THE GROUND UP. Special laboratory for Injection, Fuel Pumps, Nozzles and Governors. Trouble Shooting under full Dynamometer Load (as shown in picture).

This kind of training puts ADCOX out in front!

CLASSES LIMITED — Latest type equipment (no obsolete engines), Skilled Instructors — combine to insure best possible training. You learn Diesel **RIGHT**, and you learn it **FAST** . . . in this Nationally Famous School!

DIESEL SCHOOL CATALOG FREE
APPROVED FOR VETERANS

L. L. ADCOX, President
ADCOX SCHOOL
237 N. E. Broadway, Portland 12, Oregon
Without obligation, send FREE Catalog No. PM

Name _____
Address _____
Town _____ State _____
If World War II Veteran, Check Here



An Outstanding METAL HAND PUNCH with unusual performance

Needed by every Mechanic in every Shop



No. 5 Jr. HAND PUNCH

CAPACITY—1/4" THRU 16 Ga. Mild Steel. 3/32" — 1/8" — 5/32" — 3/16" — 7/32" — 1/4" — 9/32" — Punches and Dies Furnished.

THROAT DEPTH 2 inches
Weighs 2 3/4 lbs.

IDEAL XMAS GIFT

only \$8.75

ORDER YOURS TODAY!

Write for FREE Catalog on other tools.

WHITNEY METAL TOOL CO., Dept. P-12, Rockford, Ill.

Postpaid in U.S.A.

Reduce RADIO NOISES



SIMPLY PLUG Radio or Appliance cord

into Noise Eliminator & plug into wall socket. Enjoy reception FREE from many distracting noises. Send No Money, pay postman \$1 ea. (2 for \$1.75) plus postage or send cash & we'll mail postpaid. Try 5 days, money back if not delighted. **RAND SALES, 688 Lee Street, Dept. A-2, Des Plaines, Ill.**

CARBURETOR TOO RICH MAKES MOTORIST TOO POOR



Car owners who are wasting money and not getting proper gas mileage due to over-rich mixtures will be pleased to learn how to save gasoline by **VACU-MATING** over-rich mixtures. **VACU-MATIC** fits all cars, trucks and tractors. It is automatic and operates on the supercharge principle. Easily installed in a few minutes.

SALESMEN WANTED! Big Profits! Send name, address on penny postcard for free particulars and how to get yours for introducing.

VACU-MATIC CO., 7617-1547 W. State St., Wauwatosa, Wis.

BAKE YOUR OWN FINISHES IN YOUR SHOP



Real Industrial baked finishes now possible for small consumers and home workshops. Quality paints at factory prices. Write for free color charts, information and prices TODAY. **M & S INDUSTRIAL PAINT CO., 549 W. Washington Street, Chicago 6, Ill.**

LEARN WATCH REPAIRING



AT HOME. By our modern and original system of instruction you can learn every part of the **WATCH REPAIRING TRADE AT HOME.** Prepare yourself for a well-paying position or start in business after completing our course of instruction. Good watch repairers are in demand and generally earn very good salaries. For particulars apply to the **Wisconsin School of Watch Repairing 759 North Milwaukee St., Milwaukee 2, Wis.**

BE A TILE SETTER

LEARN TILE SETTING AT HOME. Ever increasing demand for tile setters. Easy to learn! Big money! Even as a sideline you can make \$75 and up each week. Only \$12.50. Write today for details.

INTERNATIONAL TILE INSTITUTE
P. O. BOX 6961 DEPT. PM12 LOS ANGELES 22, CALIFORNIA

SAY YOU SAW IT IN POPULAR MECHANICS

FENDER SKIRTS \$9.95 PER PAIR

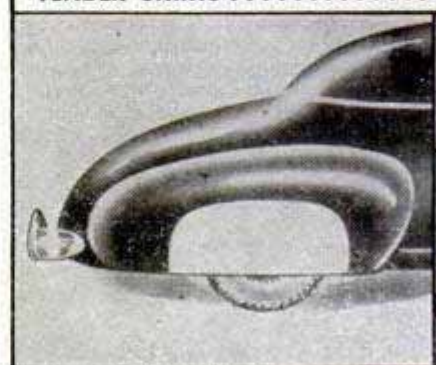

For 95% of all cars. Beautify your car . . . bring out the flowing lines designed in it. Sparkling beauty you'll like. Constructed of heavy gauge body steel, finished in prime. Perfect fit. Prompt delivery.

An Ideal Christmas Gift
SANDEE MUFFLER CO.
5643 Corryne Place
Culver City, Calif.
Gentlemen: Please send me one set of Sandee Fender Skirts to fit my _____ (year and make of car).
 Check or M.O. for \$9.95 enclosed. No C.O.D.s at this low price, please.

WAR SURPLUS AND OTHER BARGAINS

FANCY BRIAR PIPES
We have been awarded 100,000 fancy briar pipes by Quartermaster Corps. Assorted shapes and sizes. All popular makes. Buy now for Christmas Gifts..... Set of 7. **\$3.50**

MICROMETERS

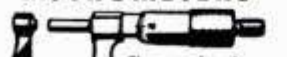

Chrome plated, precision engineered and carefully tool to give long life. All new.
0-1" capacity . . . each **\$2.25**
1-2" capacity . . . each **3.50**
2-3" capacity . . . each **5.50**
3-4" capacity . . . each **6.50**

EXPANSION REAMERS



Spiral Flute. Mfd. by Alvard Park Tool Co. All New, original pack. 1/4"-3/8"-7/16" Recommended expansion limit, .006". Original value \$12. Set of 3 **\$4.95**

MICROSWITCH



Type Z-2"x1"x 1/4". Used open or closed. For automatic contacting-light, sound, model train systems, chimes, etc. New . . . 5 for **\$2.**
Aluminum Spring Actuator to fit above Microswitch . . . 5 for **\$2.**



HIGH SPEED DRILL BITS
ALL NEW! Fractional and numbered. Original value \$15. 30 assorted sizes and lengths **\$3.50**

Send check, money order or cash. 25% Deposit required on C. O. D. orders.
All prices F. O. B. Culver City, Calif.

SEND 25c FOR ILLUSTRATED CATALOG

AIRBORNE SALES CO., INC. DEPT. PM 12-9 CULVER CITY, CALIF.



WAR SURPLUS BARGAINS

\$500,000.00 INVENTORY for QUICK LIQUIDATION
Surplus items—hundreds of them for home, shop, factory, farm and outdoor use. New items, used items, reconditioned items—all at tremendous savings—all priced for quick sale.

Page After Page of Values
This big catalog shows page after page of amazing money saving values. Write for your copy today. Send 10c to cover postage, mailing, etc. Write today!

SEND TODAY FOR YOUR COPY **10c**

STARK'S Dept. 509 So. STATE STREET CHICAGO 5, ILLINOIS

SHIP MODELS for Everyone!

AUTHENTIC KITS FOR BOTH NOVICE AND EXPERIENCED BUILDERS
New "Clipper-Bit" Kits at only \$3.95 each have carved balsa hulls, die-cut wood parts, tapered masts, finished fittings and simple plans. Send for your kit today. Select Schooner, Clipper, Barque or all 3. \$3.95 ea.
Big catalog describes over 30 beautiful ship models, 600 fittings and several authentic, fascinating gun models. Only 35c. Send for yours at once, MARINE MODEL CO., Dept. G, Halesite, Long Island, N.Y.



Earn BIG PAY while Learning

VETERANS CAN EARN UP TO \$290.00 per month while training

Learn By Doing in Our **BIG ALLIED SHOPS**

- MACHINIST TRADE.
- DRAFTING—ALL BRANCHES.
- TOOL, DIE MAKING & DESIGNING.
- TOOL ENGINEERING.
- PRODUCT ILLUSTRATION & DESIGN.

• **BIG DEMAND FOR TRAINED MEN**

FREE Employment Service After Graduation

ALLIED SCHOOL OF MECHANICAL TRADES, Inc.
1338-1340-1342 So. Michigan Avenue
4212 Allied Building, Chicago 5, Ill.

Write for **FREE Catalog**
A 1c Postcard will do.

Put your future in your own hands

BE AN ARTIST

Here's the Amazing Way We Teach You Step-by-Step to Draw At Home in Spare Time

Draw for money. Prepare yourself now for a fascinating, pleasant and profitable Art career. **COMMERCIAL ART, DESIGNING, CARTOONING**—all in one complete home study course. No previous art experience necessary. We teach you step-by-step and prepare you for good art jobs in advertising, newspaper and magazine publishing, department stores, printers, engravers, or in art studios, etc. You can become your own boss. For 35 years our graduates have been "making good"—**WHY NOT YOU?**



Trained Artists Are Capable of Earning \$65-\$80 and MORE a WEEK

Write for **FREE BOOK**, "Art for Pleasure & Profit"—tells about our course, instruction service, material furnished, what our graduates say, and commercial opportunities for you. **TWO ART OUT-FITS** and other features included with training.

VETERANS! Course G.I. Approved

FREE BOOK gives details!

WASHINGTON SCHOOL OF ART, Studio 1212R
1115—15th St., N.W., Washington 5, D.C.

Please send me full information and your Free Book, "Art for Pleasure and Profit." (Please print.)

Name _____ AGE _____
Street _____
City _____ Zone _____ State _____

Photography

for **PLEASURE or PROFIT**

Learn at home. Spare time. Practical basic training. Long-established school. Many have earned while learning. Send coupon below for free booklet, "Opportunities in Modern Photography" and full particulars.

AMERICAN SCHOOL OF PHOTOGRAPHY
1315 Michigan Avenue Dept. 1359 Chicago 5, Illinois
Send booklet, "Opportunities in Modern Photography," full particulars and requirements. No salesman will call.

Name _____ Age _____
Address _____
City _____ Zone _____ State _____

America's Famous PAY

RAISING BOOKS

Step up in your job. Prepare for a better job—bigger pay. Do as thousands of others have done—get the extra money you want with the help of these famous books. This can easily be the golden opportunity you have waited for. Order today. Money back if not satisfied.

DYKE'S AUTO ENCYCLOPEDIA (1)

Complete instruction in auto mechanics with special emphasis on trouble shooting, testing, adjusting and repairing. New edition includes passenger car specifications, 1948 trucks, buses, tractors, diesels, Buick Dynaflo and other new developments. 1483 pages. 4600 illustrations. . . . \$7.50

AUTO BODY AND FENDER REPAIRS (2)

Covers the entire field including tools, equipment, approved methods and materials. Shows how to do a real professional job and make money keeping cars new-looking in business for yourself or on a good pay job. 325 pages. 232 illustrations. . . . \$3.50

AUTO SERVICE MANAGEMENT (3)

New book gives every detail of profitable auto service management. Shows how to get a business started—how to raise capital—how to operate and make money. Only book on the subject and recommended for all men who want to advance to managerial positions. 470 pages. 223 illustrations. \$5.00

GAS AND ELECTRIC REFRIGERATION (4)

Covers repairs, adjustments, replacements and overhauling every type of domestic, commercial and industrial equipment. 17 working diagrams in 6 to 8 colors. Most complete and widely used book on the subject. 928 pages. 408 illustrations. . . . \$5.00

DYKE'S CARBURETOR BOOK (5)

Use it to become a specialist in auto engine tune up. Covers carburetion, ignition, fuel pumps, valves, etc. 233 pages. 549 illustrations. . . . \$3.50

VOCATIONAL MATHEMATICS. SHOP ARITHMETIC (6)

Demonstrates 700 practical problems in all arithmetic branches. 137 pages. 294 illustrations. . . . \$1.25

SHOP GEOMETRY ALGEBRA, TRIGONOMETRY (7)

Exceptionally fine instruction for bench layout men, machinists and others. 165 pages. 300 diagrams. . . . \$1.50

AIR CONDITIONING (8)

Get your start in this big industry with this authoritative book. Covers entire field. 450 pages. 108 illustrations. \$4.00

HOUSE WIRING (9)

Sixth edition. A complete manual of electrical house wiring featuring instruction based on National Electric Code. 350 pages. 600 illustrations. \$3.00

POWER WIRING—A. C. (10)

The recognized and simplified authority on wiring for all types of A.C. Motors, generators, switchboards, etc. 460 pages. 600 illustrations. \$4.00

POWER WIRING—D. C. (11)

Companion volume to A. C. Power Wiring. Covers entire D. C. field. 497 pages. 533 illustrations. . . . \$4.00

SHEET METAL LAYOUT (12)

Latest in practical shop procedure. For the beginner and the experienced men. 143 problem drawings. . . . \$3.50

MODERN WELDING PRACTICE (13)

The very latest information on all types of welding presented in easy-to-read, non-technical style. 400 pages. 277 illustrations. . . . \$4.00

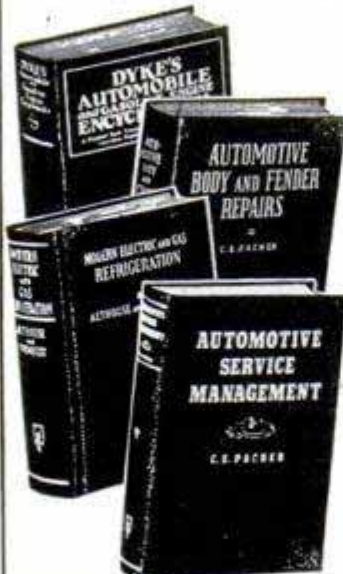

PLUMBING AND PIPE FITTING (14)

Contains 43 layout job sheets with instruction guide to materials, tools and proper procedure. 63 illustrations and diagrams. . . . \$2.50

BAILEY'S HANDBOOK (15)

Universal questions and answers for stationary, marine, diesel engineers and firemen. Use it to prepare for passing any grade license. . . . \$2.00

STORAGE BATTERY PRACTICE (16)

Explains best practices in battery work. 277 pages. 258 illustrations. . . . \$2.50

ELECTRICAL TROUBLE SHOOTING (17)

Most complete and informative book on automobile and airplane electrical work. Answers 600 vital questions. 600 pages. . . . \$5.00

DIESEL HANDBOOK (18)

The world's standard book on modern diesel engine practice. 720 pages. Illustrated. \$5.00

AIRPLANE DRAWING (19)

An introduction to the study of the structures of modern airplanes through mechanical drawing. 25 lessons. 54 drawing plates. . . . \$1.50

AIRCRAFT SHEET METAL WORKERS MANUAL (20)

Practical and helpful book for mechanics and students. 130 pages. 80 illustrations. \$2.50

AIRPLANE WELDING (21)

Thoroughly covers metal airplane materials and construction with welding. 420 pages. 193 illustrations. . . . \$3.50

AIRCRAFT FLIGHT INSTRUCTOR (22)

The book that will teach you to fly. 350 pages. 129 illustrations. . . . \$2.50

MECHANICAL DRAWING (23)

A book of mechanical drawing achievement inventories and an effective method of study. 45 full page forms and plates. . . . \$1.50

SHEET METAL DIE DESIGN (24)

A job sheet manual covering all types of sheet metal dies. 8 1/2 x 11 inches. Illustrated. . . . \$1.50

ELECTRONIC TELEVISION (25)

The first book on TV with the picture tube. For technical men, experimenters, students and engineers. Illustrated. . . . \$2.50

Famous BAILEY TECHNICAL SCHOOLS

OFFER THE FOLLOWING COURSES:

COMMERCIAL ELECTRICITY
PRACTICAL DIESEL ENGINEERING

Your future success depends largely on the reputation of the school you attend. Don't take chances! Train at America's foremost school of mechanical specialization. Bailey is recognized and approved by industry. Bailey graduates get the top pay jobs! Send for FREE Catalog. State name of course in which you are interested. G. I. Approved.

BAILEY TECHNICAL SCHOOLS

1656 S. Grand Blvd., St. Louis 4, Mo.

LOCKSMITHING & Key Making

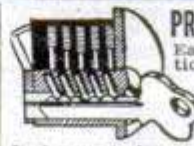

PRACTICAL UP-TO-DATE COURSE—ONLY \$3.95

Easy-to-learn modern information for self-instruction. How to work on locks, de-code, make master-keys, repair, install, service, etc. For every handyman, home owner, carpenter, mechanic, service station operator, fix-it shop, hardware dealer, locksmith. 53 plain illustrated lessons. FULL PRICE ONLY \$3.95. SEND NO MONEY. We'll ship postpaid. Satisfaction guaranteed or refund.

Just pay postman plus C.O.D. postage. Or send \$3.95 with order. NELSON-HALL CO., 1139 S. Wabash Ave., Dept. M-2, Chicago 5, Ill.

MAKE MONEY Learn Refrigeration Be An Expert—

HERE IS AN OPPORTUNITY for a splendid future. Learn Servicing and Installation for all types of Refrigeration. If you are ambitious and mechanically inclined learn how this school can help you.

PRACTICAL TRADES INSTITUTE, Inc. WRITE 25 University Ave. S.E., Dept. P-12, Minneapolis 14, Minn. TODAY

MIRACLE RANGE - FINDER VALUE

Get professional, sharp, clear pictures from your movie or still camera with the beautiful precision built "IDEAL Range-Finder." Easy to use—guarantees perfect focusing. Works the same as \$15.00 models. Highest quality system.

only \$2.95 incl. tax



Three year guarantee with each instrument. At your dealer or send \$3.00 (post paid) to:

FEDERAL INSTRUMENT CORP. 14-02 BROADWAY DEPT. 24 L.I.C. 6, N. Y.

DENTIST DRILLS used assorted cleaned and re-cut. Can be used on wood, metal, plastic. In any chuck. 3 dozen, \$1.50; 6 dozen, \$2.75; Gross, \$4.75. Postage prepaid. Sold on money back guarantee.

KNIGHT DENTAL PRODUCTS
6754 N. Sheridan Road Chicago 26, Illinois

BE AN AUTO MACHINIST



Draw Top Pay • No Job Worries

Earn more money in auto mechanics—Specialize! New FREE booklet tells how to prepare for good jobs with high pay and job security. Our modern equipment and practical instructions make it easy to learn—get experience in

ENGINE REBUILDING or GENERAL AUTO MECHANICS

Job Placement Service FREE

Practical Shop Training Learn to operate the very latest shop machinery. Friendly instructors take a real interest in preparing you for a good job.

VETERANS American is a G.I. approved school.

WRITE TODAY FOR FREE BOOKLET

AMERICAN TRADE SCHOOL 2411 McGee Kansas City, Mo.



MAIL COUPON NOW

Mail to GOODHEART-WILCOX CO., INC., Dept. 104 1321 South Michigan Avenue, Chicago 5 Send at once, books indicated below. (Draw circle around number of book wanted). If not OK I will return in 5 days and you will refund my money.

Remittance for \$_____ enclosed. Send postpaid.
 Send COD (In U. S. only) I will pay postman.

1 2 3 4 5 6 7 8 9 10 11 12 13 14 15
16 17 18 19 20 21 22 23 24 25

Name _____
Address _____
City _____ Zone _____ State _____

**WORLD'S
BEST
WANT AD
MEDIUM**

CLASSIFIED Advertisements



Advertisements in this section 75 cents per word, each insertion, minimum 10 words, payable in advance
To be inserted under proper classification, copy must be in our office the 22nd of the
second month preceding date of issue
F. W. Johnson, Manager, Classified Advertising
Popular Mechanics Magazine, 200 East Ontario Street, Chicago 11, Illinois

1114

**CLASSIFIED
ADVERTISEMENTS**

1114

**OPPORTUNITIES
FOR YOU**

AUTOMOBILES, MIDGET CARS

CALIFORNIA Custom accessories—Ideal Christmas gifts. Buy direct and save. Push button door conversions, speed equipment, chrome motor accessories, solid hood sides, grille panels, lowering kits, fender skirts, dual pipes. Revised 1949 catalog, 32 illustrated pages, new low prices; 25c. Eastern Auto Supply, 3319-A South Grand, Los Angeles 7, California.

FORD Owners Handbook. Service information all 1932-1949 models \$1.50—Model "A" Handbook \$1.00—Model "T" Handbook \$1.50—Motor's Automobile Repair Manual \$7.00—Chevrolet car, truck book 1930-1940 \$3.50—Outboard Handbook \$3.50—all postpaid. Clymer, Dept. 11A, 1268 S. Alvarado, Los Angeles 6, Calif.

DIRECT From California—The very latest in speed equipment for all makes of passenger automobiles! All of the nations leading racing accessory manufacturers represented in one catalogue! See and compare brands, specifications, costs! We ship all over the world. Wholesale, retail. Picture catalogues, speed, power, and mileage information 50c complete. Newhouse Automotive Industries, 5805-B7 East Beverly, Los Angeles 22.

"WATER Injection." Also speed, power, economy methods! Free descriptive, illustrated, information. Neher Industries, La Verne, California.

SPEED And custom equipment. Hollywood mufflers, duals, singles, large chrome echo cans, heads, manifolds, cams, fender skirts and other hi-speed and custom equipment. Also pictures and information on customizing cars and souping up engines economically. All in one handbook. Send \$1.00 for the handbook and receive full credit for it on your first \$5.00 order. Jack Hubbard, Dept. PM-1, 9440 Mackenzie Rd., St. Louis 23, Mo.

"SPEED And Mileage" Manual—140 illustrations, drawings, charts, photographs! Guaranteed finest, most authoritative book! Easy, inexpensive ways to build speed equipment. California hot rods. Beautiful custom cars, 200 h.p. road, track conversions. Superchargers. Dual manifolds. Racing heads. Twin mufflers. Water injectors. Economizers! Get super speed, mileage, acceleration; top racing performance from any car! Complete instructions with working diagrams on fast engines! Speed tuning! Restyling! "Customizing!" Gas saving! Racing tricks! Cams! Fuels! Balancing! Porting! Ratios! Frames! "Offys"! Learn 100 ways to save gas! Reveals stock car speed secrets. California speed shop methods. Custom styling information. Streamlining. Lowering. Sport changes. Hollywood roadster plans. Speed conversions! Covers all cars. Complete Manual plus Hot Rod Handbook plus Equipment Catalog; all three only \$1.98. Almqvist Engineering, Milford 42, Pennsylvania.

"HOLLYWOOD" Mufflers — Beautiful deejone rumble! "Straight-thru" design increases efficiency, speed, acceleration, mileage! Singles. All cars \$4.85. Finest V-8 duals \$15.90. Satisfaction guaranteed. Speed equipment catalog 25c. Almqvist Engineering, Milford 42, Pennsylvania.

1949 SUPERIGNITIONER. Starting, pep, mileage. \$4.50. EG Mfg., Elmsford, N. Y.

AUTOMOTIVE Trouble shooting. 500 questions and answers. \$1.00 postpaid. Charles Nelson, 2908 Washington Ave., Santa Monica, California.

"SPEED Equipment" bargains—California mufflers \$4.50, V-8 duals \$15.90, chrome carburetor stacks 98c, dual manifolds \$9.95, chrome echo cans \$1.65, racing camshafts \$29.95 exchange, hi-compression heads \$19.75. All popular brands! Illustrated catalog 25c. (Dealers wanted). Almqvist Automotive Engineering, Milford 42, Pennsylvania.

"AUTO Owners"—Something new. Free details. E. Medved, Yukon, Penna.

CLYMER'S Steam Traction Engine and Threshing Machine Book \$2.50—No. 5 Scrapbook Antique Cars \$2.00—Steam Automobile Scrapbook \$2.00—Motor History of America Book \$3.00—Life of Henry Ford \$3.00—All postpaid. Clymer, Dept. 11A, 1268 S. Alvarado, Los Angeles 6, Calif.

LARGEST Selection America's foremost custom and speed equipment, Hollywood mufflers; lowering kits, skirts, chromed accessories; racing heads \$39.95. Dual manifolds \$24.95. New illustrated catalog 25c. Von Esser's, 3307 W. Irving Park, Chicago 18, Ill.

LIFE Of Ted Horn, American Automobile Racing Champion \$2.00—Hot Rod Pictorial \$1.50—How to Build Racing Automobile \$2.00—Indianapolis Race History Book since 1909, 360 large pages, 1100 illustrations \$3.50—Power and Speed \$2.50—Postpaid. Clymer, Dept. 11A, 1268 S. Alvarado, Los Angeles 6, Calif.

HOT Rod speed equipment, Smithy's mufflers. Send 25c for illustrated catalogue. Chrome V-8 velocity stacks 99c. Buick type power tube rings (6) \$1.99 per set. Chrome flamingo (like on Packard) \$3.99 each. Super goose horn \$3.99. Bobbing birds (sticks on glass) 39c each. Send money order or money, mailed postpaid U.S.A. Honest Charley Speed Shop, 2204 McCallie Ave., Chattanooga, Tenn.

NEW Catalog every American car. 120 photographs, specifications, all G-M, Ford, Chrysler and independents including Del Mar, Playboy, Gregory, Tucker, Davis, Keller. Compare all cars in one book. \$2.00 postpaid. Clymer, Dept. 11A, 1268 S. Alvarado, Los Angeles 6, Calif.

HOT Rod—The only monthly magazine about building roadsters, streamliners, etc. Sample copy 25c, \$3.00 yearly. Hot Rod, 548 S. San Vicente, Los Angeles 48, Calif. Dept. PM.

SEE Our ad under motorscooters for midget car bargains. Midget Motors Directory, Athens, Ohio.

AUTOMOBILE Racing book, fifth edition, well-illustrated. Building bodies, frames, engines, Ford conversions. Plans. Roadsters. Indianapolis cars. \$1.00 postpaid. Popular Mechanics Press, 200 E. Ontario St., Chicago 11, Ill.

1949 INDIANAPOLIS Race Yearbook. Just out. Complete information, articles, photographs. Postpaid \$1.50. Clymer, Dept. 11A, 1268 S. Alvarado, Los Angeles 6, Calif.

DUALTONE'S New muffler—The "California 99;" now ready in singles or duals. Superior in every way, yet no increase in price! Dealers inquiries invited. Catalogue 20c. Dualtone Mufflers, 2636 C India Street, San Diego 1, California.

PICTORIAL Grand Prix Racing. 48 action photographs European cars and drivers. New book, late records and pictures. Postpaid, \$1.00. Clymer, Dept. 11A, 1268 S. Alvarado, Los Angeles 6, Calif.

CALIFORNIA Bill's Chevrolet and Ford speed, power, mileage manuals. See ad page 75.

"SPEED And Power" Handbook — 50 chapter library edition! Breathtaking methods. Authentic. Direct from California! Covers Fords to Cadillacs, all makes! Build your own dual manifolds! Superchargers! Hot cams! Water injectors! Hi-compression heads! Mileage devices! Save many dollars! Get racing speed, lightning acceleration, dynamic power increases from any make automobile! Build fast stock cars! California roadsters! 160 M.P.H. rods! Get construction drawings! Tuning techniques! Speed tricks! Economy secrets! Ingenious formulas! Including "racing frames," "reciprocating masses," "jet engines," "braking characteristics," "dynamometers." Also dual pipes, gears, fuels, porting, relieving, lowering, balancing! Includes speed equipment catalogues! Also "California Automobile Customizing," glossy photographs! Diagrams! Very newest ideas! Conversions! Re-styling all makes! Streamlining! Chopping! Channeling! Customizing! Complete \$1.98 postpaid. Newhouse Automotive Industries, 5805-B2 East Beverly, Los Angeles 22.

NEW '49 Chevrolet test book just out \$1.50—New '49 Kaiser Vagabond test report. Information good and bad all K-F cars. Travelogue. Complete mechanical information. 300 owners' letters, comments. Postpaid \$1.50. Clymer, Dept. 11A, 1268 S. Alvarado, Los Angeles 6, Calif.

CUSTOM-RETYLING. Super handbook. Brand new! 200 graphic photographs, sketches, Medley cutaways. Thousands ideas! Guaranteed: Biggest, best buyable. \$2 postpaid, including catalog. Post Publications, Box 723-KE, Arcadia, California.

AUTOMOBILE Racing, sixth edition. 100 illustrations. Drawings, building instructions Ford-60 midget, California roadster, Offenhauser racer. World's record 158.5 m.p.h. car. \$2.00 postpaid; \$2.40 c.o.d. Popular Mechanics Press, 200 E. Ontario St., Chicago 11, Ill.

1949-1950 CATALOG All new British cars. Complete specifications, manufacturers address, comparison charts, prices. Just out. Postpaid, \$2.00. Clymer, Dept. 11A, 1268 S. Alvarado, Los Angeles 6, Calif.

RACING Car equipment for all cars, engines, racing heads, manifolds, carburetors, mufflers, etc. Speed instructions and literature \$1.00—refunded first order. Lee Motorcraft Co., 1412-D Great Northern Bldg., Chicago 4, Ill.

WE Sell direct to customers over 200 speed equipment parts manufactured by us. Ford A-B-V8-6-4- (Ferguson), Studebaker Champion, Chevrolets and Willys. Cylinder heads, dual intake manifolds, lynite flywheels, oversize valves, compound springs, camshafts and other supplies. Complete engines ready for race for cars, boats and midgets. \$1.00 to cover illustrated literature and price sheet. R & R Mfg. Co., Robert M. Roof, Box 546, Anderson, Indiana.

USE Toilet paper for oil filter cartridges. See ad on page 48.

NEW Sensational seat cover. Mono. 6545 Santa Monica Blvd., Hollywood, California.

FROM Speedway to roadway! Track-proved hi-speed heads and manifolds now available for your passenger car! No special tools needed! Increase horsepower 25%! Astounding getaway! Free illustrated catalog. Speedsport, 6215AA Diversey, Chicago 39.

AUTO SUPPLIES AND EQUIPMENT

"ANTI-SWAY Bar" for rear end of Ford's and Mercury's 1932 to 1942. Eliminates road sway at high speeds or in cross winds. Prevents body and fenders rubbing on tires in turns when long spring shackles are installed. Complete kit with instructions for easy installation only \$7.95. Many other high quality items including "Belond" racing exhaust headers for all Ford's and Mercury's, complete exhaust systems, Mello-Tone single and dual mufflers, chrome extensions, shackles, skirts, etc. Send 25c in coin for our fully illustrated catalog now and be on our mailing list for new items in the future. Discounts to the auto trade. Southern California Muffler Co., 11142 Washington Place, Culver City, California.

BATTERY Chargers—5 amp. selenium rectifier. Can be used for electroplating. \$6.95 postpaid. Regency Sales, 5316 S. Justine, Chicago 9, Illinois.

BURGLAR Alarms! For auto or home. Automatic! Electrical! \$4.95. Details free. Write! Grand, 2506-52nd, Kenosha, Wisconsin.

FAULKNER & Associates Manufacturers, 1151 So. Broadway, Los Angeles 15, Calif. Introducing sensational, tested, proven "Ringin." World's only chemical product that reseals rings, valves; removes glaze, carbon. More power, mileage, quicker starting, reduced oil consumption. Money back guarantee. Retail \$1.95 quart, double investment. Sample case—12 quarts wholesale \$12.00 freight prepaid, U.S.A. Trial quart can \$2.00 postpaid, send check or money order. Territories available.

TILLOTSON Carburetors, parts, manuals. Free list. Agencies available. 600 LaPrairie, Ferndale 20, Mich.

WELDING Bodies, blocks, repairing frames, fenders pays good profits. Easy with Hobart welders. Free catalog. Terms. Write Hobartweld, Box M-1292, Troy, Ohio.

NEW Miracle chrome protector. Free information. Turke Industries, Hinsdale 5, Illinois.

"SMITHYS Mufflers." Send for list. Bucks Auto Parts, 1296H, Merced 12, California.

CONVERTIBLE Top covers. Tailored. Snap-on. \$19.50. Vassar, Cleveland 5, Ohio.

TIRES: We are overstocked. Will sacrifice all size truck and passenger tires while they last. Write Field Tire Company, Downingtown 3, Penna.

TRACTION-Tracks gets cars out of snow. Free literature. Belanger's, 51-5 Talcott Ave., Rockville, Conn.

INFRARED Auto engine warmer. Automatic, new! Literature free! Engineering Development, Box 37M Station "C," Lincoln, Nebraska.

NEW Spark plugs \$25.00 per hundred! Mfg'd. by national concern. Not surplus junk, but late issue. Assortment covers all modern cars. 200 for \$45.00; 300 for \$60.00. 1/2 deposit. Lew Leibe, Hawthorne, California.

"**AIRFLOW** Needles." Save gasoline! Free trial! If satisfactory, \$1.50. Specify car, carburetor. Neher Industries, La Verne, California.

FOR Speed, m.-per-gal., and long wear use in Crosley engines the new patent hydraulic pistons. Complete set, rings, pins, etc., \$38. W. Smiley Adams, Inc., Haverford, Penna.

AUTOMATIC Glove compartment light, adds convenience and beauty to any car. Install without drilling. \$1.25. Tor, 1927 N. Kedzie, Chicago 47.

"**LEKTRON**" Coil booster saves gas! Quick winter starting for cars, trucks, tractors. Easily installed. \$2.00. Guaranteed. Electronic Industries, Cleveland 11, Ohio.

MOTORISTS Save gasoline by Vacuumating overrich mixtures. Fits all cars. For free particulars write Vacuumatic, Dept. 1548, Wauwatosa, Wis.

DOUBLESEAL Closes gaps under overhead doors. Stops drafts. Edwards Industries, Dept. 101, 4268 Shenandoah Ave., St. Louis 10, Mo.

INITIALS For your car. Send 50c for 6. Stilwell, Empress Bldg., Decatur 64, Ill.

AUTOMOTIVE Surplus tool specials! Pullers, wrenches, socket sets, reamers. Other bargains. Nationally advertised merchandise. Send dime for catalogue. Glenco Supply, 7521 Myrtle Avenue, Glendale 27, N. Y.

AUTO And truck parts. New and used. Lowest prices. Complete stock. Prompt replies. Babbitt Auto Parts, 2833 Chicago Ave., Chicago 22, Ill.

NEW And used guaranteed parts for civilian and army cars and trucks. Largest stock in America. Mail orders. Pioneer Auto Wrecking Co., 734 W. 13th Ave., Denver, Colorado.

AUTO Parts. Buy direct. Get dealers' prices. Represent us in your territory. Write requirements. Specify car make. Mechanics Auto Parts, Factory Warehouse, 3807-PM N. Ashland, Chicago 13.

BUICK Parts—Enjoy new-car pep and power in your old Buick. Same day service from world's largest stock of new (not rebuilt) Buick parts and engines. Ship anywhere. Write today. Robertson Buick Co., 1001 S. Wabash Ave., Chicago 5, Ill.

CHEVROLET Parts. Scarce motor, body, sheet metal parts. Grossman Chevrolet, Minneapolis, Minnesota.

BRUSH Plating outfits connect to a battery. No tanks or shop required. Free particulars. Gunmetal Co., Avenue J, Decatur, Illinois.

VAPOJET Gives car jet performance. Saves gas. See page 69.

AUTO TRAILERS

TRAIL Hut converts box trailer or pickup into folding camper sleeping four. Plans \$1.00, guaranteed. Trail Hut, 600 Sixteenth Street, Oakland 12, California.

TRAILER Coaches. Save money. Buying? Building? Sound engineering construction, chassis, bodies, furnishings. Travel, dwelling, trailer plans. \$1.50 postpaid. Popular Mechanics Press, 200 E. Ontario St., Chicago 11, Ill.

TRAILER Plans circulars illustrated, 8 types 10c. Craftsmann Books, Box 1153, Milwaukee 1, Wis.

BUILD Your own trailer! Save money! Have every feature you want! Plans for house, sport, camp and utility trailers. Catalog describing 9 models 10c. 15c in Canada and overseas. Jim Dandy, Box 125-A, Wausau, Wisconsin.

MOTORCYCLES, BICYCLES, MOTORSCOOTERS AND SUPPLIES

BICYCLE Supplies wholesale, retail. List 10c. Universal, 4713 Virginia, St. Louis, Mo.

MODERN Motorcycle Mechanics Manual, latest edition 600 pages, 275 illustrations, covers all British and American motorcycles. \$4.00 postpaid. Nicholson Bros., Saskatoon, Canada.

WHEELS! Build wagons, scooters, mowers, trailers, wheelbarrows, grocery carts. 4" to 16". Free list. T & H Mfg. Co., Inc., Dept. CPA-12, 811 East 31st, Kansas City, Mo.

FLASHLIGHT Size rechargeable batteries. Write! Kimley, 103 Highland, Williamsville 21, N. Y.

MOTORCYCLE Parts and VL parts. Motorcycles, 5425 S. Ashland, Chicago.

WHIZZER Bike-motor \$25; Cushman motor-scooter \$15; Midget Racer \$40; Shaw bicycle motor \$15; Harley-Davidson motorcycle \$15; Smith motor-wheel \$25; Good motorscooter (twist grip) \$22.50. Rush 25c for new catalog #15 listing many other amazing bargains in motorscooters, used motors, midget cars, parts, wheels, etc. Gail, 538 Erie, Toledo, Ohio.

KNEEACTION Motorbike \$15; Midget car (steel frame) \$25; Moto-Scout \$15; Whizzer motorbike with all attachments \$25; Indian motorcycle \$30. Other motorscooters \$8 up, motors \$3 up. Send 25c for new catalog #943 listing many other sensational bargains in used motors, motorscooters, motorcycles, parts, etc. Associated, Box 1764-CS, Toledo, Ohio.

MIDGET Car \$5, motorbike conversions \$5, brand new Regal motorscooters \$37.50 less motors, Indian motorcycle \$25, midget car \$20, Custer motorscooter \$25, all complete. Gasoline engines \$2 up. Super-cycles, Cushman's, Salsburys. Plenty new motorscooters, midget cars, homebuilders parts, automatic clutches, transmissions, engines, tires, etc. at factory prices. Special sale! Four balloon tires for \$3. Over 5500 tires in stock. Mailorder only. Send 25c for big war-bargain catalogue just out listing these and hundreds of other bargains. (35c by first class mail.) Midget Motors Directory, Athens, Ohio.

RECONDITIONED Motorcycles and motors. Chromium accessories. Complete stock Indian parts. Expert rebuilding. Fast service. Indian Motorcycle Sales, Kansas City 1, Mo.

MOTORCYCLE Accessories, apparel. Large illustrated catalog 25c. Limex, Dept. M, Bellerose 6, N. Y.

MOTORCYCLE Journal—Worldwide coverage. Illustrated. Year's subscription \$1.00, Sample 15c. Motorcycle News, 5424-A Sawyer, Chicago 25.

TIRES And industrial wheels, suitable for scooters, wheelbarrows, farm equipment, etc. All sizes. Bicycles and accessories. Send dime for list. Cycle Transport Company, 1241 So. Michigan Ave., Chicago 5, Illinois.

AVIATION

ICEBOAT Engine, war surplus, complete with magneto, carburetor, electric starter, generator, motor mount, and 7 1/2-foot propeller, excellent running condition, ready to go! Small Jacobs aircooled airplane radial type, very light weight for power, ideal for your iceboat, air-drive boat, airplane or citrus anti-frost wind generator, special \$168.00. Estimated original cost \$4000.00. Hurry! They won't last long! Payment with order. Gaare Supply, Box 1377, Vernon, Texas.

RAM Jets—Be a contributor to our nation's ram jet know-how. Send post card for free information. Decker Engine Works, Plasterco, Va.

SNOW Sleighs and air boats—Build your own for \$350. Propellers, plans, skis, engines. Literature 20c. Banks-Maxwell, Box 3301E, Ft. Worth.

NATIONAL Air Race Sketch Book. 84 pages illustrations, 90 drawings, 51 charts, 14 winner plane plans. Covers all national races 1929, 1948 inclusive. Completely new, just out. Postpaid \$2.00. Clymer, Dept. 11A, 1268 S. Alvarado, Los Angeles 6, Calif.

PROPELLERS, wood or metal, pusher or tractor, for air driven snow or ice sleds and boats. Low price airplane type wood propellers. Models for aircraft or automobile engines. Send us your requirements. Souvenir propellers. Literature 10c. Senenich Corporation, Dept. M, Lancaster, Penna.

LIGHTPLANE Manuals, blueprints. Circular illustrating designs, motors 20c. Craftsmann Books, Box 1153, Milwaukee 1, Wis.

JET Engine \$3.00; plans \$1.00; literature 10c. M.E.W., 387 University, St. Paul, Minn.

PROPELLERS—2-3 Blade for sleds, air-drive boats. Catalog. Standard Aero Craft, Box 387, Ft. Worth, Texas.

BATTERIES, GENERATORS

EDISON Nickel batteries, 37 to 600 ampere. Also kits with Edison plates; make your own. Interesting literature. Hawley Smith Co., Croton Falls 1, New York.

ELECTRICAL SUPPLIES

ELECTRIC Pencil—Writes, engraves all metals. 110 volt model \$2.95; 6 volt model \$1.25. Reb Industries, 265-DY, Elmhurst, Illinois.

BUY Lamp parts wholesale—Parts you need for building, repairing, or assembling. Save money on large or small orders. New catalog for 10c. Gearon Company, Dept. 300-B12, 27 South Desplaines, Chicago 6, Ill.

LAMPS—Build own originals, parts wholesale, any amounts. Catalogue 10c. Brown Lamp Co., Box 501 Wellston, St. Louis 12, Mo.

FREE Catalog—Motors, generators, welders made from surplus aircraft generators, water softeners, and many other bargains. LeJay Company, Minneapolis, Minnesota.

WATTHOUR Meters, reconditioned, calibrated, guaranteed. Write for bulletin. Maspenock Electric, Starr Lane, Jamaica Plain, Mass.

BUILD Your own electric motors from scrap automotive generators—complete illustrated instructions for all makes. Only \$1.00. Autopower, 920 Theresa, St. Louis 3, Mo.

SILICON Transformer lamination cut to order; magnet wire, insulation. Morton Electrical Service, Maywood, Ill.

LEARN Electrical appliance repair. House wiring, motors, washers, cleaners, refrigerators, lamps, auto ignition, etc., complete illustrated course. Tools furnished. Free booklet. Pacific School, 7219 South Broadway, Los Angeles 3.

ELECTRIC Pencil: engraves all metals \$1.25. Beyer Mfg., 10511-H Springfield, Chicago 43.

NEW G.E. motors 1/2 horsepower \$12.50, other bargains. Free literature. Plenge, 9 Stuyvesant Oval, New York 9, New York.

WELDING, SOLDERING, PLATING

WELDING Training pays. Learn quickly at best equipped school in U. S. Non-profit. G. I. approved. Free catalog. Write Hobartweld, Box M-1295, Troy, Ohio.

WELDER! New portable Champion Special transformer welder; 110/120 volts a.c. develops to 75 amps.; 9 heat stages. Welds, brazes, solders, cuts all metals. Easy to use. Simple instructions. Special flame weld torch free. Splendid for shop, farm, home repairs. Saves hundreds of dollars yearly. Only \$27.50. Also heavier models. 10 day free trial. Magic Welder Co., 239 MP Canal St., New York, N. Y.

"BUILD-UR-OWN" Welder and a.c. power plant. Welding—plus power for tools, lights, motors—anywhere. Save \$350 using Hobart generator and your engine. Free instruction book. Terms. Write Hobartweld, Box M-1293, Troy, Ohio.

ACETYLENE Welding outfits new \$45.00, used \$25.00; arcwelders \$46.50. Eagle Welding, Dept. PM, 5085 Broadway, Chicago 40, Ill.

200 AMPERE Welding generators. Free literature. Lewis Short, Burrton, Kansas.

WELDERS, 110 V. Welds 1/2". \$29.50. Morris, 1850A State, Schenectady 4, N. Y.

RECTIFIERS 0-4 V.D.C. \$9.50. 0-8 V.D.C. \$12.50. 0-12 V.D.C. \$18.50. All 0-100 amps. Starkweather, Ottawa, Kansas.

WELDERS For all requirements. Easy terms. Free catalog. Write Hobartweld, Box M-1294, Troy, Ohio.

LOWEST Prices on a.c. welders. New. Holgeron's Service, Canton, Kans.

RADIATOR Repairing books, supplies, equipment, gasoline torch. Write, Curfman Co., Maryville, Mo.

BUY Direct from factory. Welding and cutting equipment. All makes of equipment repaired. Established 1913. Box 331, Hamilton, Ohio.

ELECTROPLATING Salts and rectifiers. Mirror resilvering and chipped glass nameplate supplies. John Sprinkle, V55, Marion, Indiana.

RADIATOR Repairing, cleaning, recording. How to equip small shop at low cost. Supply sources, trade secrets, instructions. Now only \$3.50 postpaid: Radiator Service, McBain, Mich.

ELECTROPLATING Units — Complete. \$2.00 and up. Free literature. Regency Sales, Dept. M, 5316 S. Justine, Chicago 9, Illinois.

TRICKS Of metal treating are explained in "Welding, Brazing and Soldering," an excellent instruction manual at only \$2.00. Popular Mechanics Press, 200-WB E. Ontario, Chicago 11, Ill.

MACHINERY, TOOLS, SUPPLIES

4 POUND Mixture machine screws and nuts \$1.00. Foner, 2826 Penn, Pittsburgh 22, Penna.

WAR Surplus in small tools for machine shop. Send 15c for bulletin. Travers Tool Co., Dept. P, 5 Court Square, Long Island City 1, N. Y.

ACME Rotary wheel dresser. A high grade, ball bearing dresser for truing and shaping grinding wheels. Send for free information. Max Manufacturing Company, 138 Stockton Avenue, San Jose 11, California.

WELDERS For all requirements. Easy terms. Free catalog. Write Hobartweld, Box M-1297, Troy, Ohio.

LITTLE Giant drilling machines. Drills steel, etc. 1/2" capacity chuck. Inexpensive. Particulars. Hamco, 2301 Hill, Alexandria, Louisiana.

BALL Bearing saw and dado arbors. 1/2, 3/8, 3/4 in. shaft, 9" housing, rugged, true, guaranteed, \$8.00 postpaid. Hawthorne Tool Co., Otsego 1, Mich.

MECHANICS Tool chests, \$16, catalog. Montgomery, 53 Park Place, New York 7.

10" **BANDSAW** \$14.95! World's lowest priced! Modern. Self-lubricating bearings. Investigate! Free illustrated literature. Accro., 4610-E Alaska, Saint Louis 11, Missouri.

AMAZING Diamond tool dresser with new type clamp guide for bench grinders. Trues and dresses accurately in one operation. Nothing like it. Only \$3.75 complete with diamond. Send check or money order to Rademacher, 10322 Balfour, Detroit, Mich.

TUNGSTEN-Carbide pencil point graving tool, \$1.50 postpaid. Hiett's, 4102 Fifth Ave., Chicago 24, Ill.

ELECTRIC Tools. Big discount. New, guaranteed. Catalog 10c. Betco, 619 North Broadway, Oklahoma City, Oklahoma.

"8-IN-1" Tool kit \$1 postpaid. Flat, ball-peen hammer, nut and ice cracker, bottle opener, leather punch, awl, medium and tiny screw drivers. Unscrews for separate uses. Arthur Lee, 16 Court St., Brooklyn, N. Y.

BAND Saw for home workshop and hobbyists. Special \$14.95. Factory to you. Cir. free. American Band Saw Co., 147 E. Lake St., Minneapolis, Minn.

CONCRETE Block machines. Standard sizes. \$39.50 machines average 400 daily. Free catalog. Concrete Machine Company, 5129 South Compton, St. Louis 11, Mo.

CHUCKS, Independent, universal; threaded 1 1/2"-8, 1"-8, 1"-10, 1"-12, or with adapter recess. Other chucks to 16" diameter. Write for quotation and free literature. No obligation. Westcott Chuck Co., 3600 Walnut, Oneida, N. Y.

HOME Lathe owners — Build your own attachments. Send for picture, sample of work and list of blueprints. Cut gears, ratchets, etc. Make neat screws easy way. The Home Shop, 415 Raymond Ave., Glendale 1, Calif.

POWER Tools, equipment wholesale prices. Free bulletin. Homecrafters Cooperative, Grand Rapids 6, Michigan.

BOATS, OUTBOARD MOTORS

BOAT Plans: Over 300 designs easy-to-build outboards, sailboats, runabouts, cruisers, etc. Get free catalog now. Motor Boating, 572C Madison Avenue, New York 22, N. Y.

TWENTY Plywood boat plans \$1.00. Catalog of boatbuilding plans 10c. The Rudder, 15 Murray Street, New York 7.

SAVE 50%—Assemble your own boat. Famous Schneider speedsters, rowboats, sailboats, hunting skiffs, in easy to assemble kits. Also boat plans and templates. Illustrated literature 25c. Schneider Boats, 1913 W. Vliet, Milwaukee 5, Wis.

KNOCK-DOWN Boat kits. Outboards, inboards, sails, hydroplanes. Easy to assemble. Minimum cost. Catalog with specifications, prices, 25c. Brooks Boat Company, Carrollton 11, Michigan.

KAYAK Blueprints, deluxe models—Catalogue 10c. Viking Canoes, Merrick, N. Y.

CONVERSION Parts for all engines, marine manifolds, transmissions changed to high-speed reverse, propellers, shafts, couplings, etc. Money back guarantee. Conversion Parts Co., 278 Adams Street, Boston 22, Mass., U.S.A.

P38 BELLY Tanks, steel, 10 foot, unused. \$9.95. Free picture. Anzio Boat Co., 1625 "T," Merced, Calif.

OUTBOARD Motor parts, new; used. Save money, write for price quotation. Cylinders rebored, new pistons, all makes. Outboard Motor Mart, Inc., 309 Atlantic Avenue, Boston 10, Mass.

BUILD Marine motors, Ford or Jeep. Federal Marine Motors, 9011 Cottage Grove, Chicago 19, Ill.

SAVE 2/3 Cost. Build your own boat with our ready cut parts by the Welch system. No experience necessary. Rowboats to cruisers. Illustrated catalogue 25c. Midwest Boat Company, Menomonee Falls, Wisconsin.

OUTBOARD Motors—Used bargains, \$45 up, free list. Used parts, most models, save money! Boat and motor equipment and accessories. Big catalog, send dime. Crandall-Hicks, 911 Commonwealth, Boston, Mass.

NEW, Used, rebuilt marine motors. Marine conversions, fittings. Free catalog. Stokes Marine Supply, Dept. 24, Coldwater, Michigan.

MARINE Conversions for Ford and Jeep engines. Catalog 10c. Lehman Manufacturing Company, Department D, Newark 2, New Jersey.

STEERING Wheels, windshield brackets, from \$6.95. Modern fittings at lowest prices. Complete pre-cut plywood boats. Bargains galore. Folder 10c. Marine, Box 681, Mendota, Minnesota.

ENGINES, MOTORS, DYNAMOS

WELDERS For all requirements. Easy terms. Free catalog. Write Hobartweld, Box M-1296, Troy, Ohio.

WINDING Data, listing 225 motors, single and three phase. \$1.00. Motor Data Co., Box 7631, Kansas City 3, Mo.

SEE Our iced advertisement under Aviation. Gaare Supply, Box 1377, Vernon, Texas.

WELDING Generator, 150 ampere \$47.50. Motors, 1/2 horse \$15; 1 horse \$30. Water pumps \$12.50. Butler, 1885 Milwaukee, Chicago 47.

MAKE Your own 5 h.p. gas engine. Machine your own castings. Prints and instructions. Free literature. Keenest Motors, Antioch, Illinois.

ATHLETIC EQUIPMENT, BODY BUILDING COURSES

CHIN With one hand! 10c. Sports Centre (PM), 204 East 81, New York 28, N. Y.

BARBELLS, Dumbbells. Inquiries invited. Miller Barbells, Scarborough Bluffs, Ontario, Canada.

DEADLY Judo—Fiercest fighting technique. Trick knockouts. (Over 200 illustrated pictures.) Expert instructions; three volumes. Complete \$2.25. Variety House, Box 46-B Wall Station, New York 5.

BARBELLS, Exercise equipment. Courses. Free booklet. Good Barbell Co., Reading, Penna.

SPORTING GOODS, GUNS, FISHING TACKLE, ARCHERY, TRAPPING

AN Ideal Christmas gift for the fly fisherman—Fly-tying sets and tools for either the professional or amateur. Try our famous line of fly-tying vises and gadgets. New beginner's vise with instruction sheet \$1.00. Send 10c for catalog. D. H. Thompson, 335 Walnut Avenue, Elgin, Illinois.

NEW—Ideal for Xmas! One-hand, slide-blade pocket knife and nail file set. Both top quality items, packaged in beautiful gift box. Keen cutting, highest carbon steel knife blade and triple-cut nail file. Both slide out with slight thumb pressure to any one of 4 safe-locking positions. Handles lustrous colored plastic. Both for only \$2.00 postpaid. From your dealer or Gits Molding Corp., Dept. 26, 4600 Huron, Chicago 44. Money back guarantee.

GUNS! 2000 Modern, antique. Illustrated catalog 50c. Martin Retting, W. Hurley 20, N. Y.

SPORTING Goods; guns. Send for big money-saving catalog. Enclose 10c. Woodland Sports, Woodland Hills 2, Calif.

FISH Cleaning holder. Cast aluminum with stainless steel prongs, \$1.50 postpaid U. S. Wonderful Christmas gift for fishermen. Dealers inquiries invited. Sylvan Assembling Works, Manitowoc, R. #2, Wis.

RIFLEMEN—Build your own custom rifle case. Packaged kit only \$12.50! Beautiful results. Literature. Western Sierra Co., Lone Pine 15, Calif.

PISTOLS, Revolvers, firearms, ammunition. List 25c. Frank Farish, Vicksburg, Miss.

GUN Cabinets, gun racks, literature free. H. Schiefelbein, Berlin, Wis.

CHRISTMAS Special—New, genuine, marine combat knives, commando knives, machetes. \$1.55 each, postpaid, no C.O.D.'s. Catalogue 10c. Mail-Mart, 512 Sommers Building, San Diego 1, Calif.

FISHERMEN—Make your own sinkers with our molds. Free illustrated booklet. Reading Instrument Co., Box 78, Reading, Penna.

LEARN Gunsmithing! Details, copy "Guns and Gunsmithing" 25c. Gunsmith, Palatine, Illinois.

190 **PROFUSELY** Illustrated pages antique and modern pistol, sword, etc. values, 50c. Robert Abels, A860 Lexington Ave., New York 21.

BOWS, Arrows. Quality archery equipment. Popular prices. Catalog 10c. Illustrated archery instruction book 50c. Archery, 617-K So. State, Chicago 5.

5000 **BARGAINS**. Firearms, binoculars, war relics. Catalog 40c. Smith Firearms, Runnemeade, New Jersey.

SHOTGUNS, Rifles, revolvers, over 500 modern, obsolete. Also cartridges, list 10c coin. Ed Howe, 52 Main, Coopers Mills, Maine.

TAXIDERMISTRY

"MODERN Taxidermist Magazine," Greenfield Center, N. Y. Devoted exclusively to taxidermy. Two sample copies 25c.

MICROSCOPES, TELESCOPES, MICROSCOPES, MAGNIFIERS

SAVE 50% On new binoculars! The ideal gift! Free catalog. Write today! Bushnell Importers, 43-M12 East Green, Pasadena 1, California.

MICROSCOPE Wanted. Binocular research type. Zeiss preferred. Leiter, 1301 Westbury, Philadelphia 31, Penna.

WAR Surplus bargains. Binoculars, telescopes, sextants, millions of lenses, prisms, reticles, eyepieces, objectives, etc. Request free "Catalog CH." Send \$1.00 for Stock CH—10-piece lens kit and big instruction booklet. Edmund Salvage Co., Barrington, N. J.

16X MAGNIFIER: Exceptional power, beautifully mounted. Factory closeout \$1.00. Optical Assembly Co., Celina, Ohio.

POWERFUL Astronomical telescope, equatorial mounting, two eyepieces, \$16.50. Bunn Optical Laboratories, 4213 Gifford Avenue, Cleveland 9, Ohio.

LENSES: One 1 1/2" prism, \$1.00; 2 condensers \$1.00; 2 objectives \$1.00; 2 magnifiers \$1.00; 2 reducers \$1.00. Optical Assembly Co., Celina, Ohio.

POWERFUL Astronomical telescopes easily made. Perfect lenses and instructions; 100X \$3.00, 100X and 200X \$4.00, 100X, 200X and 400X \$6.00. Clear vision, full power guaranteed. Instructions alone 10c. Suffolk Science Service, Box 208, Manorville, N. Y.

BINOCULARS, Telescopes, watches, guns. Buy, sell, trade. Schweer's, Donnellson, Iowa.

REFLECTING Telescopes, 60X, completely assembled \$25.00. Guaranteed observatory clearness. Free information. Skyscope, 475 Fifth Avenue, New York 17.

ASTRONOMICAL Telescopes, binoculars, microscopes; bought, sold, repaired. Books. Lists 10c. Rasmussen-Reece, Amsterdam, N. Y.

TELESCOPES, Binoculars, microscopes, big bargain catalog free. Brownscope Company, 24 West 45th Street, New York.

DOGS, PETS, BIRDS, RABBITS

RAISE Guinea pigs. Make extra money. Booklet free. Taylor, Box 426A, Hapeville, Georgia.

RAISE Rabbits. Four pound fryers in eight weeks. Ready market for meat, fur, wool. Illustrated book, describing leading breeds, housing, breeding, feeding, marketing. By America's largest rabbit association 10c. American Association, 12 AR&CBA Building, Pittsburgh 17, Penna.

MAKE Money raising Angoras. Circular free. Vaughn's Rabbitry, Otley, Iowa.

GIVE A gift that lives! Million laughs, hours of fun. Hohl's Hamsters. Literature free. Ideas for markets 10c. Hohl's Hamster display plan \$1.00. Box 695, Newark, Ohio.

PUPPIES, A. K. C., boxers, English bulls, Scotties, toy and medium fox terriers, cocker spaniels, police, Boston, Terriers, collies, English shepherds, spitz, dachshunds, Beagles, chows, Pekingese, Pomeranians, wire hair fox terriers, most any kind. Ann's Kennels, Paw Paw, Ill.

HAMSTERS—Finest pedigreed breeding stock. Free illustrated literature. Prompt service. Mount Clemens Hamstery, 94 Church, Mount Clemens, Mich.

SAINT Bernards, Boxers, Schwarzwald, Hof Kennels, 5136 Cascade Road, Grand Rapids 6, Mich.

RAISE Hamsters for profit. Pets, breeders, virgins, high grade stock. Stamp for prices. Goulding's Hamstery, 1037 Elm, Manchester, N. H.

BEAUTIFUL Pure white pedigreed police puppies. Ansonia Kennels, Mose, North Dakota.

HAMSTERS For Christmas. Wonderful pets. Selected breeders or pets \$2.50 pair, \$3.75 trio. Free literature. Valley Hamstery, 734 North Milam, San Benito, Texas.

RAISE Rabbits and other small stock commercially. Amazing new facts. Read Small Stock Achievements, sample 10c, \$1.00 a year. Sequoia Publishers, Orski, Calif.

REAP The golden harvest with Golden Hamsters. Literature free. Pat's Hamster Farm, Waterford 3, N. J.

GIVE Hamsters. Christmas pets \$1.00, pairs \$3.75. Pam's Hamstery, 3010 10th Ave., No., St. Petersburg, Fla.

GOLDEN Syrian hamsters, selected breeders and pets. Free information on how to raise these clean, inexpensive to raise, animals for pets and profit. The E. K. Farm, Route 1, Box 56A, Arlington Heights, Illinois.

RAISE Mink. Amazingly profitable. Free booklet gives inside "Secrets." Mølgard, Brigham, Utah.

\$1.00 FOR Booklet "Canary, Its Care, Breeding and Training," and three copies cage-bird magazine. American Canary, 2899PM N. Hausted, Chicago 14, Ill.

GOLDEN Hamster pets. Wonderful Xmas gifts. Clean, odorless. No digestive troubles. Easily raised. Profitable hobby. Write, Pyle Hamstery, Okmulgee, Okla.

\$3000 YEARLY Raising Angora rabbits. We buy your output. Contract particulars free. Kise's Enterprises, St. Paul 8, Minn.

BEAUTIFUL Great Danes—Loving companion, guard. Sidney Baucom, Salt Lake City, Utah.

MAKE Money! Raise Chinchilla rabbits. Experience unnecessary. Valuable breeders. Extra profit from laboratories, furs, delicious meat. Pleasant hobby. Write today! Rockhill Ranch, Sellersville 15, Penna.

MINK Raising information free. Complete. Lake Superior Mink Farm, Superior, EEL, Wisconsin.

\$400 MONTHLY Raising Angora rabbits. No experience required. Details free. White's Rabbitry, Newark, Ohio.

MAKE Extra cash. Raise Giant Chinchilla rabbits. Waters Rabbit Farm, Glennville, Ga.

GRINSTEAD'S Famous Angoras! Giant Chinchillas! World's most profitable rabbits. Finest pedigree, heavy-producing, prize-winners. Literature free. Grinsteads, Edwardsville, Illinois.

SPORTSMEN: 200 Pointers, setters, straight cooners, combination hunters, rabbit and fox hounds. Reasonable. List free. Ramsey Creek Kennels, Ramsey, Ill.

\$300 MONTHLY Raising Angoras for our market. Particulars free. Wilson, Stanton, Calif.

INCREASE Your income by raising domestic rabbits. Small space needed. Ready market for delicious meat, fur and wool. Largest magazine in the industry tells you how. \$1.50 per year. Sample 15 cents. No stamps. Small Stock Magazine, Lamoni 20, Iowa.

SEE Gulf Hamstery ad on page 30. Shows picture of Hamster.

PLANTS, SEEDS, NURSERY AND GARDEN SUPPLIES

WE Sell on the installment plan. Best varieties peach and apple trees, low as 12c; grapevines 4c; shrubs 13c; evergreens 15c. Berries and plants. Catalog free. Benton County Nursery, Box 542, Rogers, Arkansas.

FARMS, FARM LANDS, REAL ESTATE

STROUT'S Golden anniversary farm catalog—Just out! Over 2800 outstanding bargains. Coast-to-coast. Mailed free. Write today. Strout Realty, 7 So. Dearborn St., Chicago 3, Ill.

FARMS, Farms, farms! Ask for catalog. Kingwell Agency, Corvallis, Oregon.

BIG Free winter catalog! Farm and country real estate bargains, good pictures, many states, easy terms, many equipped, crops included. For special service, state requirements, desired location. United Farm Agency, 1408-PM Consumers Bldg., Chicago 4, Ill.

FLORIDA—Hunting, fishing, fruit growing. 5 acres. \$245.00. \$10.00 down, \$10.00 month. G. B. Potterfield, Union Building, Charleston, W. Va.

\$3.75 PER Acre Missouri-Oklahoma land: total reduced price. Large, small tracts; cash, payments. Warranty title. Free list, maps. Frederick Calvert, (owner), Winter Haven, Florida.

HOMESITES \$300—Convenient payments. California's finest garden section. On Morro Bay's scenic shores. Wonderful fishing, hunting, boating, bathing. Fertile soil, softest water, temperate climate, congenial community. Free literature. Richard Otto, Department M, San Luis Obispo, California.

SOLD For taxes. Calif., Oregon, Washington timber, grazing, ranch and mining lands. 25c to \$3 acre min. bid. 10c (coin) brings circulars, photos, maps. Pacific Lands, Box 2350-PM, Hollywood, Calif.

FARMS, Ranches, lodges, resorts. Big selection, Milwaukee Road territory, Washington, Idaho, Montana, Dakotas, Minnesota, Iowa, Missouri, Michigan, Wisconsin, Illinois, Indiana. Free colorful descriptive folders, price lists. L. H. Robbins, 738J Union Station, Chicago 6, Ill.

GOOD Farms—Ranches. Washington, Minnesota, Montana, Idaho, Oregon, North Dakota. Dependable crops, favorable climate. Write for literature, lists describing typical farm opportunities. Specify which state. J. W. Haw, 119 Northern Pacific Railway, St. Paul 1, Minn.

\$5.00 MONTHLY Buys 40 acres. Near town; price \$200.00. Free list. Box 425-P, Carthage, Mo.

FLORIDA Campsites—\$75.00 at \$5.00 monthly buys nice, high dry lot in Lake County (world's best bass fishing) near Ocala National Forest. St. Johns River, beautiful lakes, pavement, electricity. Folder free. Howard Vernor, DeLand, Florida.

FLORIDA Homes, groves, farms, business opportunities. H. L. Chambers, Realtor, Wauchula, Florida.

POULTRY, FARM SUPPLIES

EARN \$4 to \$12 hourly. Chick sexing, turkey sexing, culling and caponizing. G. I. approved. Pilch's School, Box S-10, Thompsonville, Connecticut.

RAISE Chickens of tomorrow with Pilch's famous chicks from old hen breeders. They live, grow fast, produce wonderfully. 20,000 Pullorum clean breeders—Reds, Rocks, Crosses, Sex-Links, White Rocks, Hamps, baby and started chicks. Write Pilch's, Box C-6, Thompsonville, Conn.

FARMERS! Increase roadside sales with new streamline design market stand, 8' x 16'. Easy to build. Plans \$1.00. Welker, 6111 W. 76 St., Los Angeles 45, Calif.

RAISE Turkeys the new way. Write for free information explaining how to make up to \$3000 in your own backyard. Address—National Turkey Institute, Dept. 3, Columbus, Kansas.

KNOW How to raise poultry for profit. Read Northeastern Poultryman. Every issue packed with helpful hints and practical suggestions. Latest articles on breeding, feeding and management. Subscribe now. 1 year 65c. 2 years one dollar. Foreign subscriptions \$1.00 a year. Northeastern Poultryman, Dept. P.M., 376 Boylston St., Boston 16, Mass.

PROFITABLE OCCUPATIONS

GOOD Money in weaving. Weave rugs at home for neighbors on \$49.50 Union loom. 30,000 doing it. Booklet free. Union Looms, 79 Post St., Boonville, N. Y.

LOCKSMITHING Secrets! Key fitting, lock repairing, opening. Prices, sources. Illustrated book \$1.00. Wechsler, 7 West 36, New York City.

FREE Book "How to Make Money With Home Workshop" describes amazing methods used by hundreds of successful craftsmen. Tells what to make, how to sell workshop output spare time. Write at once for details. Remember it's free! Craftsman, 115A Worth St., New York City.

NO Work. No cost. Fabulous money paid for dwarfed trees grown in your room. Complete instructions \$1.00. American, Box, Wagner Station, Los Angeles 47, Calif.

RUSH \$1.00 For your copy "How to Make Money With Hobbies." Enjoy your hobby and make money. Willis Book Shop, 1401 Whitelock Street, Baltimore 17, Md.

FOREIGN Employment. Construction men, building trades mechanics, helpers, office men. Good workers needed for oil projects, mining, pipe lines, dams, power plants, roadways, shipping, etc. Transportation and quarters furnished; high wages. Listings of firms actively working and hiring on projects in South America, Arabia, Asia, Africa, Alaska, Central America, etc. Send \$1.00 for foreign construction compendium and application forms. Foreign Service Bureau, Dept. P.M.13 (Employment), P.O. Box 295, Metuchen, New Jersey.

FREE List on request. "500 Profitable Occupations." Tanner Enterprises, Incorporated. Gainesville 1, Texas.

LEARN Professional candy making. Profitable home occupation. Details 10c. Pate, Kissimmee, Florida.

DELIGHTFUL Plans! Australia, South America. Free book "372 Unusual Worldwide Businesses." \$800 month reported! Work home (U.S.A.)! Get surprise! Publishers, 8W, Carlsbad, Calif.

TIMELY WAR SURPLUS SPECIAL!

Be Prepared For Freezing Weather To Come With This COMPLETE

WINTERIZATION EQUIPMENT KIT
for ALL CARS & TRUCKS
and all other gasoline and diesel engines

Guarantees Instant Starting, day or night in snow, sleet and icy cold. Maintains warm engine temperature even when engine is not operating. Keeps battery warm and charged.



THE KIT CONSISTS OF:

1. A complete engine and battery heater that circulates warm water in the engine block and radiator even when engine is idle.
2. A self-contained fuel tank.
3. A special battery heater.
4. A hand operated primer pump that forces extra charge of gas into the cylinders when starting.
5. A 180° Thermostat Control.
6. Radiator and louvre covers.
7. Complete instruction booklet.

The Perfection Superflex Engine Heater is a device for warming the water in the block and radiator system of a gasoline or diesel engine even when the engine is shut down. The heater is a small safe gasoline burner placed near the motor block. Fuel is gravity fed from the main fuel tank or special fuel tank furnished in the kit. A small flue creates the needed draft. Fuel supply is controlled by a shut-off valve and float chamber which maintains constant fuel level in the heater. Every gasoline and diesel engine made can be protected from cold weather with this kit. It can also be used to winterize all marine, stationary and mobile engines.

This Entire Engine and Battery System complete at lowest price ever offered.
Shipping wt. 158 lbs. Gov't. acquisition Cost over \$70.00

16.50
F.O.B. Chicago

GROBAN SUPPLY CO. Dept. PM-12
1507 S. MICHIGAN AVE., Chicago 5, Ill.

WRITE FOR OUR NEW 1950 44 PAGE CATALOG—IT'S FREE!



Ideal Christmas Gifts

ONLY \$7.89

Includes Tax, Postage and Insurance

\$7.89 is all you pay — no other charges.

ONE YEAR FULL GUARANTEE

GUARANTEED

GENUINE SWISS SPORTS WATCH

Made by the world's finest craftsmen—rugged shock-resistant case—sweep second hand—measures speed of moving cars, airplanes, horses and other moving objects—choice of black or white dial face—stock limited.

Send Money Order or Check today to

AMERICAN TRADING POST

DEPT. PM, 512 NORTH 1st STREET, RICHMOND, VA.
An HONEST Value at the LOWEST Price

We can't



STOP THE PRESSES!

There's so much demand for the practical "how-to-do-it" books published by Popular Mechanics Press! The big fall list contains one or more fascinating and profitable books for every one of the family.

4 NEW BOOKS

4 ANNUALS



Money-Making Hobbies. Shows 132 ways to earn extra income! Hundreds of useful and beautiful things to make. 160 pages. On Sale Now! 60c.



Shop Notes. 1950 edition of an old favorite for men who use tools. A manual of time and labor-saving hints. 240 pages. \$1.00. On Sale Now!



Short Cuts to Better Housekeeping. No other book like this! 1000 ways to save your time, labor and money. 160 pages. 60c. On Sale Sept. 15.



What to Make. Vol. 11 of this famous series of best projects from Popular Mechanics' Craft articles. 240 pages. \$1.00. On Sale Sept. 15.



Christmas Handbook. Gifts you can make, decoration ideas, how to make Xmas cards, hints for entertaining, etc. 144 pages. 60c. On Sale Oct. 1.



Home Kinks. Popular Mechanics annual collection of short cuts to home repairs and maintenance jobs. 112 pages. 35c. On Sale Oct. 15.



Planning Your Home Workshop. Sam Brown reveals secrets of getting the most out of your workshop. 128 pages. 60c. On Sale Oct. 15.



Useful Ideas. Another famous PM annual with helpful hints for homemakers, gardeners, mechanics, sportsmen, motorists. 112 pages. 35c. On Sale Nov. 15.

Get these helpful books at your favorite newsstand. If not available, write—

POPULAR MECHANICS PRESS
200 East Ontario Street
Chicago 11, Illinois

SAY YOU SAW IT IN POPULAR MECHANICS

ALL BRAND NEW

GROBAN'S WAR SURPLUS SPECIALS!

SATISFACTION GUARANTEED

LOGAN HEAVY DUTY OIL

Hydraulic Control Valve



BRAND NEW control valve with built-in adjustable relief valve, will operate one double-acting hydraulic cylinder or two cylinders as one or a reversible hydraulic motor. Valve handle latches in neutral position. Made of rugged cast aluminum alloy. Open center unloads the pump in neutral position. Throttling control allows operator to regulate the speed of movement of the hydraulic cylinder or motor. Has removable mounting brackets with 4 bolt holes. 3/8" pipe thread connections. Overall dimen.: 1 1/2" H x 8 1/2" D x 8 1/2" W. Ship. wt. 17 lbs. Gov't. Acquisition Cost over \$100.00. An Excellent Buy. **F.O.B. Chicago 21.95**

(ITEM #37)

LOGAN HEAVY DUTY OIL

Hydraulic Pump

BRAND NEW . . . for operating hydraulic cylinders and hydraulic motors on tractors, bulldozers, construction machinery, lift trucks, industrial applications, etc. Delivers 8 G.P.M. at 1200 R.P.M. at 1000 P.S.I. rating. H.P. Has 1 1/2" pipe thread inlet, 3/4" pipe thread outlet. 3/4" shaft with flat and keyway for direct or pulley drive. Has flange with 4 bolt holes for convenient mounting. Ship. wt. 22 lbs. Overall dimen.: 7" L x 5 1/2" H x 5 1/2" W. A \$105.00 value. **FOR ONLY 22.50**

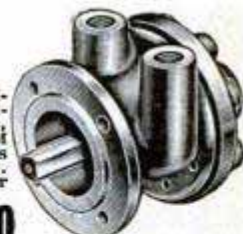

22.50
F.O.B. Chicago

(Item #29)

AIR or OIL HYDRAULICS



Use hydraulics on arbor presses, hydraulic presses, hay lifts, manure loaders, lift trucks—push or pull, tilt or turn, press or squeeze, open or close, lift or lower—and other hydraulic and industrial applications. Use with either air or oil . . . of finest precision workmanship. **BRAND NEW.**

ITEM #16—Use these cylinders on farm trucks, bulldozers, hay lifts, manure loaders, etc. Double action, 1 1/2" bore, 27" stroke. (Will lift 1760 lbs. in 2 seconds with Logan Pump.) Wt. 8 lbs. A \$55.00 hydraulic cylinder value for only . . . **postpaid 12.95**

ITEM #17—Double action, 2 3/8" bore, 8" stroke. (Will lift 4400 lbs. in one second with Logan Pump.) Will withstand 1500 P.S.I. against wall. Wt. 7 lbs. A \$65.00 value . . . **postpaid 14.50**

ITEM #15—Double action, 3" bore, 8 1/2" stroke. All steel hydraulic cylinder will lift up to 12,000 lbs. (7000 lbs. in 3 seconds with Logan Pump). Complete with fittings. Wt. 12 lbs. A \$78.00 value **postpaid 19.50**

ITEM #31 Double action, 3 1/2" bore, 11" stroke. (Will lift 9600 lbs. in 7 seconds using Logan Pump.) Complete with fittings. Wt. 15 lbs. A \$92.00 value . . . **postpaid 22.50**

ITEM #42—Double action hydraulic cylinder, 4" bore, 18" stroke. Rated lift capacity with 1000 P.S.I. input is 12,560 lbs. Logan Pump. Ship. wt. 30 lbs. AN EXCELLENT VALUE for **32.50**

HIGH PRESSURE FITTINGS for cylinders and valves available at 35c ea. for 3/8" pipe and 50c ea. for 1/2" pipe.

LOGAN 4-Way Foot Operated

AIR VALVE

Model 6520



BRAND NEW. For double-acting pneumatic devices. Fine for operating air valves, presses, air machinery of many types. Heavy cast construction. Threaded for 1/2" pipe. Dimensions of valve body 8 1/2" L x 5 3/4" W x 7 1/2" H. Net Wt. 28 lbs. Gov't acquisition cost \$42.00. AN OUTSTANDING BUY AT . . . **15.00**

(ITEM #59)

F.O.B. Chicago

Self-Priming

ELECTRIC PUMP

APPLICATIONS: oil burners, aquariums, fluid metering, fuel pump, tool post grinder, coolant pump, pressure lubricating pump, general industrial, etc.



Compact — BRAND NEW

MOTOR MFD. BY BLACK & DECKER: double ball bearing, series wound, continuous duty, 1/30 H.P. electric motor, rated 12,000 R.P.M. Transformer included for use on 110 V AC current. Also applicable for 24-32 V DC.

PUMP MFD. BY WELDON TOOL CO. with standard 1/4" tubing ports; rated 2 G.P.H.; remove pump and use motor as high speed grinder.

OVERALL DIMENSIONS: 7 3/4" long x 3 1/4" wide x 3 1/4" high. Approx. wt. 3 lbs. \$51.00 value. (ITEM #1) . . . **12.95**

postpaid

NOW . . . It's Easy to Weld with this handy

ARC WELDER

250 AMP. MODEL 252

Designed for many years of trouble-free service. Handles anything from light gauge sheet metal to 1/2" plate

(ITEM #65)

This precision-engineered direct current ELECTRIC ARC WELDER is offered at but a fraction of its original value. It can be mounted permanently or easily transported for portable use. Does the job instantly, where and when you need it. The War Surplus generators for these Arc Welders were built by General Electric, Westinghouse, and Delco-Remy at a cost of over \$300.00. They are light in weight; have oversized lifetime grease-sealed ball bearings; air-cooled commutator; dial type rheostat for easy pinpoint control; high-low range switch; reactor coil for even arc; handles 1/16 to 3/16" rods. Run welder at 2500 R.P.M. from drive pulley or power take-off of tractor, a 7 1/2" H.P. electric motor or a 10 H.P. gas engine. Use one or two V-belts, or flat belt (on pulley). Continuous welding rating—200 amps.; intermittent rating—250 amps.; 0-40 volts. Now . . . AT A FRACTION OF ITS VALUE. Price includes double V or flat belt pulley and instruction book. Ship. wt. 95 lbs. Only one or two jobs will pay for entire welder. **99.50**

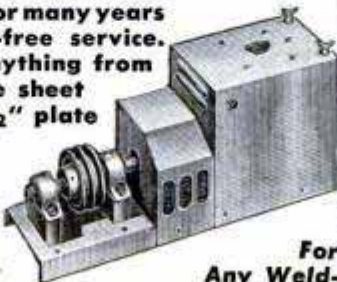

For Any Welding Job, Light or Heavy

ACCESSORY KIT including welding helmet, electrode holder, two 10 ft. cables with clamp, and 5 lbs. of assorted welding rods. **10.50** (ITEM #66) F.O.B. Chicago Remember, Satisfaction is Guaranteed

115 Volt—60 Cycle A.C. LIGHT PLANT GENERATOR



IDEAL FOR: Home Lighting, Hunting Lodges, Stand-by Electricity, Running All AC Electrical Appliances including: Fans, Motors, Electric Razors, Refrigerators, Incubators, etc.

750 Watts at 1800 RPM using 1 1/2 HP gasoline engine. SUPPLIED WITH V-BELT PULLEY DRIVE, 0-150 Voltmeter with Regulator, 1" diameter shaft with keyway, carried in two bearings, one bronze and one ball-thrust bearing, and packed separately to prevent damage to generator or shaft while in transit.

Protection for emergencies to operate oil burner, stoker, freezer, water pump, and lights. These units, built to exacting Signal Corps specifications, are the answer to your lighting needs. Shipping wt. 60 lbs. **59.50**

F.O.B. Chicago

FREE CATALOG!

Write for free copy of our new 1950 44-page catalog including Hydraulic Manual featuring diagrams, photographs and instructions. Catalog lists excellent war surplus values: pumps, valves, hydraulics, lights, motors, etc.

ORDER DIRECT FROM AD
Send payment or purchase order today
SATISFACTION GUARANTEED

HANNA

Air Cylinder

Brand New

Used for heavy duty industrial applications on shop air lines or with low pressure systems. With 100 lbs. of air pressure, will deliver 1900 lbs. pressure at the ram shaft. All steel construction. Adjustable cushions at both ends of cylinder. Shaft dia. 1 1/2". Foot mounting with clevis on ram shaft. 26 1/2" double-acting stroke; 5" bore, 40 1/2" overall length closed, 7" overall width. 89 1/2 lbs. net wt. Gov't. acq. cost \$101.85. (ITEM #61)

AN EXCELLENT VALUE for 39.50
F.O.B. Chicago



G-1 Stainless Tank

Use these tanks on compressors, for tire inflators, pulsation chambers, seats, buoys, hydraulic reservoirs, fluid and milk containers, fuel containers, etc. Tough, light, 450 lbs. P.S.I. Aviators Breathing Oxygen bottles, type G1, 2100 cu. in. (approx. 9 gallons) int. vol., 2" x 12", 1/4" threaded openings at ea. end. Wt. 19 lbs. .051" thick. **4.95** (ITEM #63)

F.O.B. Chicago

Gear Type—All Manganese Bronze Insecticide Pump

For Spraying D.D.T., 2,4-D, Sulphur Compounds, etc.

BRAND NEW. Pressures up to 200 lbs. and 14 gallons per minute — at 1200 R.P.M. Will not rust, pit, foul or freeze up. Use rubber hose inlet. 3/4" pipe outlet. Equipped with double mounting bracket. Weight 24 lbs. Dimen. 8" x 7" x 10". Standard 1" manganese bronze shaft with keyway. U. S. Gov't. Acquisition Cost \$62.00. NOW **15.00** FREE—complete instructions and performance data with each pump. (ITEM #50) F.O.B. Chicago



Hydraulic Control Valve

ITEM #24. Four-way control valve with built-in relief valve, for use with one double action hydraulic cylinder, may be used with 1500 P.S.I. hydraulic system to open and close hydraulic cylinders. Brand new. Ship. wt. 8 lbs. A \$38.00 value. **postpaid 7.95**



ITEM #26. Four-way control valve for use with two hydraulic double-action cylinders. Each cylinder may be operated independently of the other or in conjunction with the other. Oil may be locked in any of the cylinders to hold the piston at any required position. Brand new. Ship. wt. **10.95**

ITEM #28. A two cylinder double action valve with a unique arrangement, allowing the operator to raise both cylinders simultaneously, to lower them simultaneously or to raise one and lower the other at any predetermined rate and speed. Brand new. Ship. wt. 8 lbs. A \$75.00 value **postpaid 14.95**

GROBAN SUPPLY CO., 1507 SOUTH MICHIGAN AVE. Chicago 5, Ill. Dept. PM-12

Modernizing? Remodeling? Use..
CHROMTRIM
"Trim-it-Yourself"
METAL MOULDINGS

You'll find hundreds of uses for this handy metal trim around your home. Kitchen, bathroom, stairs or attic can be streamlined in a jiffy. Chromtrim comes in convenient 6' lengths, 8 shapes, all ready to tack on.

Chromtrim is easy to cut — Economical to use — Bends simply to any shape.

Send 10¢ for "Trim Ideas"—16 pages brimming with Chromtrim projects, ideas, and directions for use.

R. D. Werner Co., 295 Fifth Ave., N. Y. 16
 Enclosed is 10¢ for CHROMTRIM "Trim Ideas" booklet PM-12
 Name _____
 Address _____
 City _____ Zone _____ State _____

R. D. WERNER CO., INC.
 295 Fifth Avenue, New York 16, N. Y.

Performance that excels • Stamina that endures
DOUGLASS Steel-Pack MUFFLERS
 FOR ALL MAKES AND MODELS

Rugged construction. Steel tubing. Straight-thru-design. Solid tube with steel packing. "Throbbing Deep Tone." Complete for Easy Installation

32-40 FORD V-8	\$5.95	29-49 CHEVROLET	\$5.96
41-49 FORD V-8	6.85	31-41 PLYMOUTH	5.96
39-49 MERCURY	6.85	42-49 PLYMOUTH	6.85
35-48 FORD & MERCURY DUAL SETS			\$23.00
49 FORD & MERCURY DUAL SETS			25.00

Specify Year and model • Satisfaction Guaranteed
 Enclose Full Amount With Order All Equipment F.O.B.
1949 COMPLETE RACING EQUIPMENT CATALOG 25c
DOUGLASS MUFFLER MANUFACTURING COMPANY
 1914 W. VALLEY BLVD., Dept. M-12, ALHAMBRA, CALIF.

BE STRONG USE BARBELLS

95 POUND SET
 Only \$10.80
 Extra Plates 10c pound

We have been selling the finest barbell equipment since 1928. We operate our own foundry and sell direct to you at a very low profit. No other company can match our low prices.

Send for our **FREE** Barbell Catalog.

BUR BARBELL CO.
 LYNDHURST 24
 NEW JERSEY

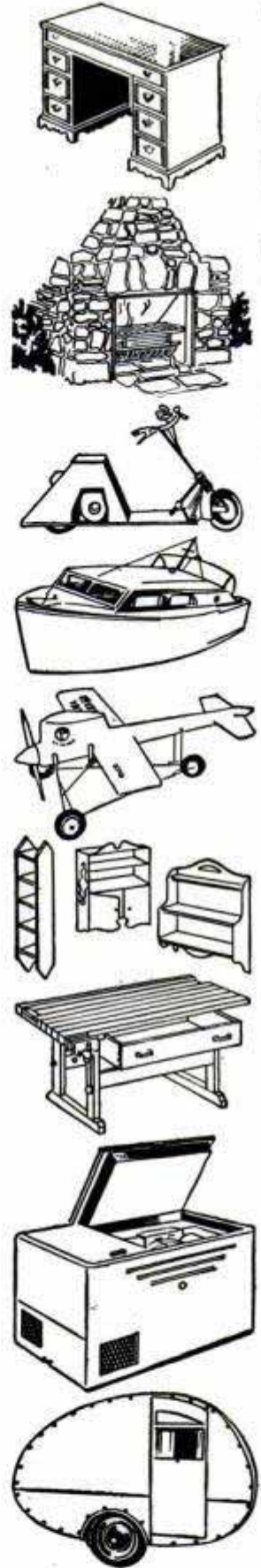

YOU CAN MAKE THESE WITH POPULAR MECHANICS PLANS AND BLUEPRINTS

- 501—Colonial Grandfather's Clock. 25c
- 507-508—Doll-House, 5-Rooms, Open staircase, fireplace... 50c
- 526—Queen Anne Coffee Table: True replica of antique... 25c
- 528—Duncan Phyfe Console Table: 30 in. high... 25c
- 529—Lawn Chair: Southern style... 25c
- 593—Three Attractive Corner Shelves: Scroll-sawed... 25c
- 596—Three Hanging Type Shelves: Hold books, china, etc... 25c
- 661—Rocking Horse: Scroll-sawed from plywood... 25c
- 707—12 Ft. Rowboat: Flat-bottom, four seats... 25c
- 795—Two Handsome Cedar Chests... 25c
- 811-812—16 Ft. Canoe: Canadian type, cedar planking... 50c
- 813-814—Pops Outboard Racer: 10 ft. long, stepped bottom... 50c
- 828-835—Sovereign of the Seas: English warship model... \$2.00
- Sovereign of the Seas: Instruction Book... \$1.00
- 836—12 In. Bandsaw: Uses plywood, cuts two in. stock... 25c
- 839—Melrose Corner Cabinet: Old Colonial design... 25c
- 846-848—Governor Winthrop Desk: True copy of original... 75c
- 896-897—Three Easily Made Workbenches—Simplified construction... 50c
- 906-909—Midget Auto: 58 in. wheelbase, 1/2 to 3/4 h.p... \$1.00
- 910—Circular Saw Table: Hardwood, 24" x 36", Stationary... 25c
- 917—Outdoor Fireplaces: Several simple but practical... 25c
- 920-922—Lawn and Garden Furniture: Swings, arbors, tree seat... 75c
- 923—Indoor Fireplaces: Standard sizes... 25c
- 926-927—Venetian Blinds: Three different styles... 50c
- 930—Hooked Rug Frame—Quilting Frame... 25c
- 933—Cape Cod Cupboard: 4 ft. wide, 5 ft. 8 in. high... 25c
- 935—Knee-Hole Desk: 40 in. long, 30 in. high, 31 1/2 in. wide... 25c
- 936—Modern Coffee Table: 24 in. long, 15 in. wide... 25c
- 952—Child's Crib in Maple... 25c
- 958—Colonial Corner Cupboard: 6 ft. 8 in. high... 25c
- 961—Hanging China Cabinet: 38 in. long, 40 in. high... 25c
- 969—Combined Chest and Writing Desk: 35 1/4 in. high... 25c
- 970—Modern Clothes Chest: of Plywood... 25c
- 977—Bookcase in Chippenwick Style: 47 in. high, 10 in. PR... 25c
- 978—Lawn Chair on Wheels: Lightweight, easy to wheel... 25c
- 981—Colonial Wall Shelf: 30 in. high, 19 in. wide... 25c
- 984—Duncan-Phyfe Drop-Leaf Table: Reproduction of historic piece... 25c
- 986-987—Utility Trailers: Built of old auto parts... 50c
- 989-990—Speedy Motor Scooter: Gas engine, 40 to 60 miles on gal. of gas... 50c
- 991—Gun Cabinet: Handy cabinet includes rack for rifles... 25c
- 993—Twin-Deck Beds: 6 ft. 4 in. long, 31 1/2 ft. wide... 25c
- 1106-1112—SEACRAFT—25 FT. CABIN CRUISER: Adaptable as sport fisher, express cruiser, or utility boat. Cruises at 15 knots with marine engine or converted auto engine. Cabin sleeps four. Galley has freshwater tank, sink, and cook stove. Set of seven large-sized blueprints scaled 1 in. per ft. plus 40-page two-color illustrated booklet, only... \$10.00
- 1012—Fireplace Fittings: Andirons, log rack, etc... 25c
- 1080-1081—Banta: 12 Ft. Plywood Runabout: Vee-Bottom, 3-passenger... 50c
- 1086—Black Forest Corner Shelf: Scroll-sawed... 25c
- 1089-1090—Home-Constructed Freezing Unit: reaches 30 degree temp... 50c
- 1091-1096—17 ft. trailer, 7 ft. wide. Steel chassis... \$1.50
- 1102-1105—Midget Trailer: "Tear-drop" body. Sleeping quarters for two... \$1.00
- 1113-1114—Gold Rush of '47: The A.M.A. Open Class B Record Holder Plane Model... \$1.00

FILL OUT AND MAIL THIS COUPON NOW

POPULAR MECHANICS CO.
 200 E. Ontario St., Chicago 11

Please send the following plans _____

I am enclosing \$ _____

Name _____

Address _____

Got an Idea? An Inventive Mind? . . .
Want to Cash In on It? . . .

THEN GET
CLOTH
BINDING
\$2.50

MONEY from IDEAS

MONEY FROM IDEAS by Myron P. Laughlin, is a down to earth, informative and useful book for every man with an active, inventive mind, who believes he has ideas that can be patented. Get this book to determine what inventions are needed for today's market, and how to go about inventing them; how to get a patent, protect it, sell it and make money out of it. 144 pages, well illustrated, indexed, and contains an appendix of patent forms, most valuable for the sale, assignment or licensing of patents.

Vital, Informative and Practical Help!

Inventions and How They Are Patented—What Inventions Can Do For You—The Growth of an Idea—Let Others Experience Guide You—An Invention, How It Was Developed—An Invention, How It Was Protected—An Invention, How It Paid Its Way in the World—How to Make Money From Inventions—Invention is a Business—Specialization—Sources of Information, A Where-to-Find-It Index—Records of Progress—Development Work—Starting a Business—Selling Patent Rights—Selecting a Patent Attorney—Patent Forms—Form of Assignment and Royalty Agreement—Form of License—Helpful Books.

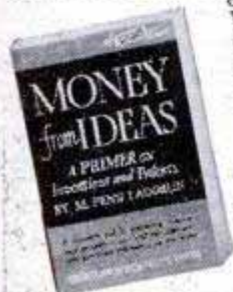

Order from
POPULAR MECHANICS PRESS

"SEA CRAFT" BLUEPRINTS READY NOW!

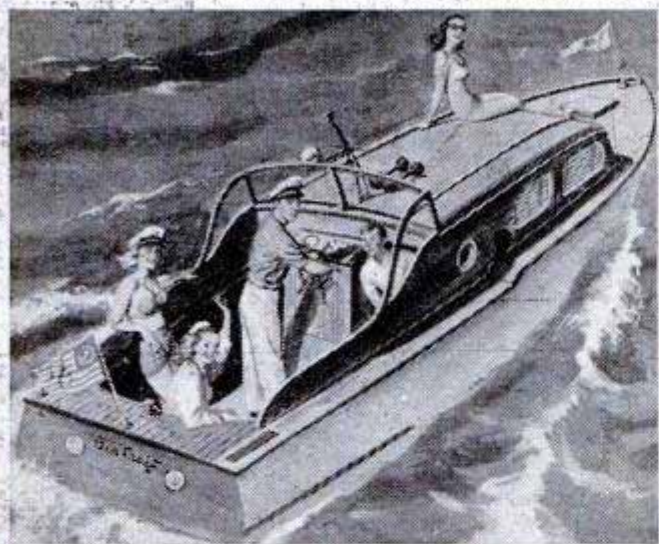

Build this luxurious cabin cruiser yourself and save money. What a beauty it is! A 25-foot boat readily adaptable as a sport fisher, express cruiser, or utility boat. Cruises effortlessly at 15 knots with a marine engine or converted auto motor. Its spacious cabin sleeps four and has a galley complete with fresh-water tank, sink, and cook stove. Has open cockpit large enough for fishing, lounging, etc. During war the Coast Guard used "Sea Craft" for ship-to-shore travel. Order today your complete set of seven large-size blueprints scaled 1 inch to the foot. These, plus a 40-page two-color illustrated booklet giving step-by-step instructions, only \$10.00.

POPULAR MECHANICS PRESS
200 EAST ONTARIO ST. CHICAGO 11, ILL.

Like ACTION?



Get NORTHLANDS

For speed, easy control and true running, buy internationally famous Northland Skis. Northlands offer latest designs, fine craftsmanship and a wide choice of models to completely satisfy every skier. Own Northlands, give Northlands. (Northlands make fine Christmas gifts.)

FREE! Northland Ski Manual. (Offer applies in U.S.A. only)

NORTHLAND SKI MFG. CO.

World's Largest Ski Manufacturer's
95 MERRIAM PARK • ST. PAUL 4, MINNESOTA

DIRECTION SIGNAL

Flashes Your Turns
Automatically



No more winter window cranking for arm signals. The new AUTO-TURN DIRECTION SIGNAL fits any car. Flashes parking and tail lights 60-80 times a minute. No interference with regular lights, no extra lights to mount for most late cars. Works similar to factory-installed models. All parts furnished—install it yourself. SPECIFY MAKE AND YEAR. For cars earlier than 1942, write for price. MONEY BACK GUARANTEE.

\$10.95 Postpaid in U. S. Send check or money order. Postage extra on C. O. D.'s.

The LESTER Company

BOX M-12
1743 N. MILWAUKEE AVE.,
CHICAGO 47, ILLINOIS

FULLY GUARANTEED TIRES COST LESS

Nationally famous FIRESTONE, GOODRICH, U.S. ROYAL, GOODYEAR, and other makes. Trucking Fleets, Busses, Hospitals and Schools buy from PYRAMID with confidence. Every tire selected and inspected for your safety.



NEW TREAD SNOW TIRES

Hundreds of Sharp, Heavy Cleats that grip and bite into snow, ice, and mud. NO CHAINS NEEDED.

600x16	8.95	670x15	9.95
650x16	9.95	710x15	10.45
650x15	9.95	760x15	10.95
700x15	10.95	820x15	11.95

Regular Treads—Tube Given FREE with Every Tire—10% Disc. to Vets

550x16	3.48	700x15	3.69	700x20	8.98	34x7 (10)	9.48
600x16	3.48	700x16	4.98	32x6 (8)	8.98	825x20	11.45
650x16	3.59	750x16	6.48	32x6 (10)	10.89	900x20	11.60
650x15	3.59	600x20	7.68	750x20 (8)	8.09	1000x20	12.59

Regular Treads—AAA	6.19	700x16	6.19	700x20	10.89	34x7 (10)	12.98
600x16	5.19	750x16	7.59	32x6 (8)	10.69	825x20	14.68
650x16	5.19	600x16 (6)	6.45	32x6 (10)	12.48	900x20	14.98
650x15	5.09	650x16 (6)	6.95	750x20 (8)	10.68	1000x20	15.98
700x15	5.29	900x16	8.89	1100x20	13.98	1000x22	17.59



MILITARY "ALL-PURPOSE" TREADS

900x16	8.65	750x20	8.95	1100x20	16.95
900x20	13.95	1000x20	14.95	1400x20	22.95

600x16 MILITARY "NEW TREAD" TIRES 7.95

750x20 MILITARY "NEW TREAD" TIRES 19.45

Largest stock of used tires in the East. Thousands of satisfied customers. Tires shipped to all parts of the world. Mail orders given personal attention. SEND MONEY ORDER OR CHECK WITH ORDER.

PYRAMID TIRE CO.

1333-35 North 5th St.
Dept. M, Phila. 22, Pa.



When Screws Won't Stay TIGHT, Use SMOOTH-ON

Apply Smooth-On No. 1 Iron Cement to screw threads and into the screw hole. Insert and tighten up the screw. It will take hold and, when set, will STAY TIGHT, for Smooth-On expands slightly as it hardens, wedging the screw in place. This is only one small use for this general-purpose iron cement. With it you can stop leaks and seal cracks in cast metal parts, tighten loose knobs, casters, tool and utensil handles, make many auto repairs. Buy it in 1 3/4-oz., 7-oz., 1-lb. or larger size at your hardware store. If they haven't Smooth-On, write us.

FREE 40-page Repair Handbook

Many original uses for Smooth-On around the house, on the car, etc. Simple directions. 170 illustrations. Send postcard for YOUR free copy.

SMOOTH-ON MFG. CO., Dept. 37

570 Communipaw Ave., Jersey City 4, N. J.

Do it with

SMOOTH-ON

THE IRON CEMENT OF 1000 USES



Learn A Trade NOW! PRACTICAL SHOP TRAINING!

In Our Chicago Shops

- | | |
|---|--|
| <input type="checkbox"/> AUTO MECHANICS | <input type="checkbox"/> WELDING—ARC and GAS |
| <input type="checkbox"/> DIESEL MECHANICS | <input type="checkbox"/> MACHINIST |
| <input type="checkbox"/> REFRIGERATION | <input type="checkbox"/> PIANO TUNING |
| <input type="checkbox"/> BODY-FENDER | |

Above Approved For G. I.'s and Civilians
One of America's Leading Practical Schools
7 Floors of Fully Equipped Shops
Over 48,000 Successful Graduates
Expert Individual Instruction
Learn by Doing—Low Living Expense
Established 1902—Day and Evening Classes

Also the following Home Study Courses

- | | | |
|----------------------------------|--|---------------------------------|
| <input type="checkbox"/> PLASTIC | <input type="checkbox"/> REFRIGERATION | <input type="checkbox"/> DIESEL |
|----------------------------------|--|---------------------------------|

—CALL IN PERSON OR MAIL THIS AD TO—

GREER SHOP TRAINING

(Desk 16) 460 South State St., Chicago 5, Ill.

Please send without obligation free information regarding trade checked above. (Specify whether you are a Veteran or Civilian)

Name _____ Age _____

Address _____

City _____ State _____

SENSATIONAL NEW Complete With Engine

Midget RACER McCoy "19"

READY TO RUN

Brand New! Enjoy speed, action, thrills and fun with the classiest miniature racer you ever saw. Complete with famous engine with double ball bearings, gas tank and transmission gears all installed and ready to run. Heavy die cast aluminum body, 9 1/2 inches long. Turned wheels. Heavy duty rubber tires. Racing bridle included. Weighs 3 pounds.

The Perfect Xmas Gift



Only \$17.25 postpaid.

Engine equipped with glow plug for battery-less operation. Guarantee certificate packed with each racer. RUSH ORDER. Specify finish wanted—iridescent red or polished aluminum body. Only \$17.25 postpaid. If COD send \$5 deposit with order. Outside U.S. \$18.00 postpaid, remittance with order. Order today. You can't beat this for fun.

HOME SHOP PRODUCTS CO.

DEPT. 519, 4821 SHERIDAN ROAD, CHICAGO 40, ILL.

WHEELS - WHEELS

5" Disc Wheel 5/8" Tire 5/16" or 3/8" Sleeve	30c ea.
6" Disc Wheel 5/8" Tire 5/16" or 3/8" sleeve	35c ea.
7" Disc Wheel 3/4" Tire 3/4" sleeve	45c ea.
8" Disc Wheel 1 1/2" Tire 1 1/2" sleeve	70c ea.
7" Disc Wheel 1" Tire 1 1/2" ball bearing	80c ea.
8" Disc Wheel 1 1/4" Tire 1 1/2" ball bearing	\$1.00 ea.
8" Disc Wheel 2" semi-pneum. T. 1 1/2" S.B.	\$1.35 ea.
10" Disc Wheel 1.75 semi-pneum. T. 1 1/2" S.B.	\$1.50 ea.
Above wheel prices include hub cap.	
10" Aluminum Wheel 2 3/4" semi-pneum. T. 1 1/2" S.B.	4.50 ea.
Plus Postage, 20% - C.O.D.'s accepted.	

UNITED WHEEL STAMPING CO., PM-12

2756 W. 115th STREET CHICAGO 43, ILLINOIS

Practical Economical Winter Travel



CallAir SnowCar, plans, engine and propeller—\$495.00. Complete 125 h.p. 4 place factory built jobs—\$1950.00.

CALLAIR, Afton, Wyoming

AGENTS 300% Profit SIGN LETTERS

For Store Fronts and Office Windows. Anyone can put them on. Free Samples. Liberal Offer to General Agents.

METALLIC LETTER CO., 430 N. Clark, Chicago 10



HANDICAST

trade mark

A hollow, non-sinkable, six-ounce, durable plastic "spinning" ring for casting and trolling hand fishing lines. Long tangle-free casts averaging 150 feet with a two ounce weight are easily made. Patent applied for.

Send \$2.25 for HANDICAST, postpaid and guaranteed, to:

THE HANDICAST COMPANY

Main P. O. Box 5254 Cleveland 1, Ohio
(Dealer Inquiries Invited)

SAY YOU SAW IT IN POPULAR MECHANICS

Get This Now! SPRAY PAINTING



New Book Makes Money Saves Money

NEW EDITION FOR 1950

Features Home Auto Spray Painting—Home Workshop and Craft Jobs! A Book for the Professional and Home Owner

Get this new and bigger spray painting book to help you on the job or for better, time-saving paint work around the home and car, and beautiful painting and finishing of home workshop jobs, with the small, inexpensive sprayers now available. Thoroughly practical—covers every phase of spray painting technique. Tells what paint or other finish to use, how to mix colors, how to make perfect jobs, easy, quick. New edition has over 180 pages. Cloth binding, illustrated. Send \$2.00 for postpaid delivery or we will send C.O.D. Money back if not satisfied in five days.

FREDERICK J. DRAKE & CO.

117 GREEN BAY ROAD DEPT. 19 WILMETTE, ILL.

NEW TORPEDO DIRECTOR \$3.25



Shipped Express Charges Collect

This instrument was used to direct the launching of torpedoes from aircraft. It is brand new and comes packed in a nicely finished plywood box.

Instrument contains an achromat lens diameter 37 mms., and focal length 80 mms. in a threaded mount. The reflector plate is optically flat glass in the shape of an ellipse 45 mms. wide and 65 mms. long. Has a 28 volt light bulb in a white surfaced reflector housing and a glass reticle with the aiming pattern engraved on it.

Government Surplus Bargains!

New Inclinometer

An Aircraft instrument that registers the incline from level to 30 degrees up or down. It will work out nicely in cars or trucks as well as aircraft and sail planes. This instrument is completely self contained and there are no electrical connections to be made. Price only \$2.95 Post Paid in U.S.A.

NEW WIRE BARGAIN \$2.00

485 feet Brand New Telephone Wire. 3 conductor braided insulated copper and steel telephone wire. It is of copper for conductivity and steel for strength. Worth at least .03c per foot, yet due to an exceptional buy we can now offer it at less than .01c per foot. (Shipped Express, Charges Collect.)

NEW VICTOR D-12 COMPASS

NOW \$9.50



This compass has a 7" luminous dial and is mounted in oil. It is pin compensating and has 3 metal legs for mounting. It is similar to the type D-4 and will work out equally well in boats or aircraft. New in original government cartons complete with pins. (Shipped Express, Charges Collect.)

NOTE: Mich. residents add 3% Sales Tax

New - 12 Volt 50 Amp Generator (Less Pulley)

This generator is excellent for truck or bus use. It will also make a fine power supply for your radio shack or nice light welder. Brand new in original boxes. — \$7.95 each. (Shipped Express Collect.)

New Oxygen Tanks

These tanks are approximately 44" long by 6" in diameter. They will stand up to 400 lbs. pressure, and have an outlet on either end threaded with standard 1/4" pipe thread. A real buy at only \$1.50 (Shipped Express Charges Collect.)

N. Silverstine Company
6532 E. McNichols Road
Detroit - 12 - Michigan

How to Make Your FORD or CHEVROLET FAST!

NEW! FORD HOTROD MANUAL

128 pages tell you how to make your Ford fast! Covers Ford V-8, Mercury, Model A & B, Ford 6, Zephyr! How to install hydraulic brakes on any Ford, channel jobs, coupe, sedan and roadster info. How to install V-8 or Merc engine in Model A chassis. Actual information, not generalized ideas!

THESE ARE THE WORLD'S FINEST SPEED MANUALS! YOUR SATISFACTION GUARANTEED OR MONEY BACK!

NEW! CHEVROLET SPEED MANUAL

How to build fast coupes, sedans, roadsters and boats. Covers 1937 thru 1949 models. Supercharging, camshafts, dual and triple carburetion, all data necessary for hopping-up your Chevrolet. Specific info, with all details covered. 90 terrific pages.

POST-PAID \$2.00 each — BOTH BOOKS \$3.50 Parts price sheets enclosed. Dealer inquiries invited.

CALIFORNIA BILL

Box 1, Dept. PM-12
EAGLE ROCK STA. LOS ANGELES 41, CALIF.



Dealer Inquiries Invited

SET THE PACE WITH THE

- Cruises at 45 MPH—with faster pickup than car
- 39" high, 71" long overall, wt., 190 lbs.
- 8 HP motorcycle engine
- 50 miles to the gallon
- Automatic clutch
- Internal expanding brakes — handle-grip throttle controls

POWELL MANUFACTURING COMPANY
DEPT. PM1249 • COMPTON, CALIF.

Powell
P-81!

ONLY \$247³⁴
AT COMPTON, CALIF.
EXCISE TAX INC.

Write for FREE folder and name of nearest dealer

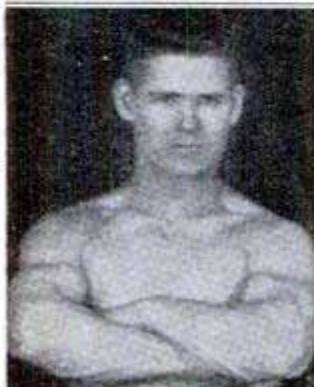

COMPLETE ARM, CHEST AND BACK MUSCLE BUILDING COURSE AND APPARATUS for only \$2. Post-paid

Great Strength easily obtained by following my instructions and using my exercises 10 minutes mornings and at night. Noticeable results guaranteed in 7 days, send \$2 for complete illustrated course of instructions and a set of 3 exercising apparatus. Light, Medium and Heavy. Satisfaction guaranteed or money refunded.

J. A. DRYER
Box 5527-P Chicago 80, Ill.

HELPFUL BOOKS

Send post card asking for FREE catalog
Popular Mechanics Press, 200 E. Ontario, Dept. 601, Chicago 11

FREE!! HOW TO MAKE BIG MONEY

METALIZING BABY SHOES AND OTHER PRECIOUS KEEPSAKES AT HOME

FREE FACTS SHOW HOW TO MAKE \$5 PER HOUR, UP TO \$25 — \$50 PER DAY. START EARNING AT ONCE. YOUR OWN BIG PAY BUSINESS STARTED AT HOME ON A SHOESTRING. DON'T PASS THIS UP. WRITE FOR FREE DETAILS TODAY!

KIKTAVI CO.
2111 W. MANCHESTER, LOS ANGELES 47, DEPT. PM-12

270 MILES FOR \$1.68

Drive the smart Crosley Sedan, the brand new car that costs less to buy and drive than a high upkeep used car. Hundreds of improvements including Hydradisc (airplane type hydraulic) Brakes and Crosley engine with new CIBA (cast iron block). Seats 4, operates for about 1/2 as much as other cars. Here's a typical owner's report:

Troy Lee Woody, Logan, W. Va., on a 270 mile trip averaged 44 miles per gallon of gasoline. Trip cost only \$1.68—about the price of a phone call.

For free literature on all 6 money-saving models, write name and address on margin of this ad, tear off and mail to Crosley Motors, Inc., 2530-HMSpring Grove Ave., Cincinnati 14, Ohio.

CROSELY
A FINE CAR

You see them everywhere!



PEARL FINISHING
BIG MONEY RIGHT AT HOME
FREE Facts show how to earn up to \$25 to \$50 per day AT HOME. Be First! Gleaming Pearl Finish for BABY SHOES in Pink, Blue, Ivory—plus hundreds of items of leather, plaster, metal, etc. WRITE TODAY!
PEARL-KOTE CO., 2111 W. Manchester, Los Angeles 47, Dept. 22

30 POWER SUPER SCOPES!



Extends to 36 inches. Precision and Polished Lenses. A scientific instrument. Ideal for Studying Stars, Plane Spotting, etc. Satisfaction Guaranteed or Money Refunded. Send Check or Money Order to

\$2.95
Post Paid

CRITERION CO., Dept. PM4

438 Asylum St. Hartford 3, Conn.



Happy Highways Ahead!

With Popular Mechanics new **MOTORIST'S HANDBOOK**. 160 pages of authoritative advice to keep your car rolling smartly—longer. Brakes, body, spark plugs, battery, starter—every automotive part is covered in this up-to-the-minute manual of year 'round driving pleasure.

Your news dealer has the 60c paper edition. Order the clothbound \$2.00 volume from

POPULAR MECHANICS PRESS

200 E. ONTARIO ST. CHICAGO 11



BUILD A BOAT

- Row Boat—12 Foot
- Dinghy—8 Foot
- Dinghy—14 Foot Sailing
- Training Ship—6 Foot
- Sea Stead—9 Foot
- Outboard—12 Foot
- Cruiser—18 Foot
- Bicycle Boat—Kayak
- Row Boat—Sectional
- Row Boat—Sailing
- Dinghy—16 Foot
- Canoe—12 Foot
- Sailing—12 Foot
- Outboard—17 Foot
- Outboard—Runabout
- Pontoons Ice Yacht

FOR PLEASURE OR PROFIT DESCRIBES 17 LOW COST BOATS Get this outstanding book and build a boat at home for your own use or to sell at a profit. You can do it. Just the boat you've always wanted—power, sail or row boat—17 different kinds and sizes.

Order **BUILD A BOAT** on postal card and pay only \$1.50 plus postage on delivery. Return in 5 days if not pleased and get money back. Or send \$1.50 with order and we'll pay postage. (Outside U. S. \$1.70 with order.) Order today.

POPULAR MECHANICS PRESS
Dept. 998, 200 E. Ontario, Chicago 11

PAY RAISING—EXTRA MONEY BOOKS

Use these books to prepare for a better job—bigger pay—to start a profitable spare time or full time business of your own, improve your home, or start a hobby. Popular Mechanics specializes in supplying outstanding self-help books on many subjects. Send for our FREE catalog.

- Outdoor Sports Manual
- Hunters, Fishermen, Trappers, Campers, Archers, Boatmen, here is your book! . . . \$2.00
- Shop Notes Library
- 5 Vols. — 1950, 49, 48, 47, 44 (No Dup. Mat.) . . . \$3.48
- Shop Notes—1950 . . . \$1.00
- Painting, Furniture Finishing and Repairing . . . \$1.50
- Rewinding and Servicing Electric Motors (No. 75) . . . \$2.50
- Photo Handbook
- An entirely new and different book from our Popular Photo Guide. It's a complete guide to better pictures and dark-room technique, and features dozens of handy gadgets you can make yourself. . . . \$2.00
- Motor's Truck Repair Manual
- Mechanics, Truck Specialists, Service Stations, Fleet Owners! Here is your book! Covers every job on every truck made since 1936 — 1400 pictures, 952 Pages . . . \$8.00
- Garden Book
- Build own trellises, lawn furniture, fireplaces, ornaments, etc. . . . \$1.25
- Diving, Cutting and Welding in Underwater Salvage Operations. Only book of its kind . . . \$2.00
- Picture Framing
- Modern methods for making and painting picture frames. Fully illustrated. . . . \$2.75
- Television Servicing — The basic book for the practical radio man. Covers circuits, instruments and trouble shooting. Price . . . \$4.00
- Bee Keeping for Profit and Pleasure. Bees pay big profit. \$2.00
- 210 Deluxe Small Homes \$1.00
- Into the Freezer and Out
- A complete handbook on the home freezing of foods \$2.50
- Concrete Handbook
- New book on using concrete around home, garden, farm . . . \$1.50
- Leather Art by Baird
- Leathercraft is a wonderful hobby whether for pleasure or for pay. Get this beautifully illustrated, clearly detailed book at once. Tells you each step and furnishes actual designs . . . \$3.00
- Welding, Brazing and Soldering
- How to build own equipment and how to use it effectively . . . \$1.25
- Modern Refrigeration
- Electric, Gas. Be service expert . . . \$5.00
- Dyke's Auto Ency. (includes Diesels, airplane engines). New 20th Ed. World's greatest book for mechanics . . . \$7.50
- Household Mechanics
- The "fix-it" book to end all "fix-it" books. Covers electric appliances, painting, carpentry, etc. . . . \$2.98
- Oil Burner Handbook . . . \$2.50
- Build Your Own Boat
- Describes 17 popular boats—rowboats, sailboats, plywood outboard, etc. 192 pgs. \$1.50
- House Wiring (No. 89) . . . \$2.50
- Turn Scrap Into Money
- Convert old auto generators into motors, welders, etc. . . . \$1.00
- Popular Mechanics Farm Manual
- Packed with practical ideas and usable information that can easily be worth hundreds of dollars to every farm family and to homeowners everywhere. Send for free descriptive folder giving complete contents! . . . \$3.00
- Woodworking for Everybody . . . \$2.75
- Sheet Metal Work . . . \$3.00
- Tool and Saw Sharpening (No. 92) . . . \$2.50
- Forging Practice . . . \$1.50
- Action Toys (No. 66)
- Plans for 21 easy-to-make toys . . . \$2.50
- Foundry Work . . . \$2.25
- Pattern Making
- Wood, metal . . . \$2.25
- Forty Power Tools
- Build own saw, drill, lathe, sander, etc., from scraps—save money . . . \$1.50
- Carpentry
- The Young Craftsman
- Over 450 things boys can make . . . \$1.50
- Five Acres and Independence
- How to make money on small farm . . . \$2.50
- Your Home and How to Build It Yourself. Step-by-step construction of the famous POPULAR MECHANICS house. Wonderfully illustrated. \$3.00
- Drake's Householders Cyclopaedia
- This is the time to save money on those necessary home repair jobs—Repairing, Remodeling, Carpentry, Painting, Decorating. Plumbing, Heating, Electric Wiring and Appliance Repairs, Furniture Repairs — This new book covers them all . . . \$5.00
- Motorist's Handbook
- Popular Mechanics scores again. A 160 page guide to automotive happiness . . . \$2.00
- Modern Fruit Production. Best book on the subject. Everything you need to know about the orchard. Price . . . \$5.00
- What to Make for Children
- Junior tough on toys? Build him playthings that will last. . . . \$2.00
- LeJay Manual of Homemade Electric Equipment. How to construct 50 items that are scarce and valuable. . . . \$1.50
- How to Estimate for the Building Trades: Material and labor costs for masonry, plumbing, electricity, carpentry, heating, hardware, painting, etc. 629 pages . . . \$2.50
- Rabbits for Food and Fur \$2.50
- Tool Making . . . \$4.00
- Tool Design . . . \$4.50
- Plumbing Installation & Repair . . . \$2.00
- Ropp's Calculator
- Figuring made easy . . . 75c
- Slide Rule Simplified . . . \$2.75
- Drake's Refrigeration Service Manual . . . \$2.00
- Primer for Home Builders
- All the information you need to know in building a house . . . \$2.50
- How to Read Aircraft Blueprints . . . \$4.40
- America's Best Low Cost Homes
- 125 popular practical designs . . . \$1.00
- Toys You Can Make of Wood . . . \$2.50
- A.B.C. of Poultry Raising \$2.50
- Ice Cream for Small Plants
- Some technical formulas for ice cream, ices and frozen desserts on a commercial scale . . . \$2.50
- Furniture Joinery . . . \$2.00
- Essentials of Upholstery . . . \$3.25
- Radio Physics Course
- A thorough training in radio fundamentals . . . \$5.00
- Lessons in Ornamental Penmanship. You can easily learn to write beautifully. Delight and amaze your friends with the skill you can acquire by using this book—Only . . . \$1.50



MAIL THIS COUPON TODAY

Check the books you want, write your name and address below, and mail this advertisement with money order or check. Outside U. S. A. include 15% additional for shipping charges.

Books selected will be mailed promptly on our "money back if you're not entirely satisfied" guarantee.

Name _____
Address _____
City _____ State _____

Mail to **POPULAR MECHANICS PRESS**
DEPT. 700 — 200 EAST ONTARIO ST., CHICAGO 11, ILL.



200 AMP. MOBILE JEEP ARC WELDING UNIT



FOR ONLY \$345

68 COMPONENT PARTS COMPLETE
(Includes Spare Parts)

Power Tool Attachment

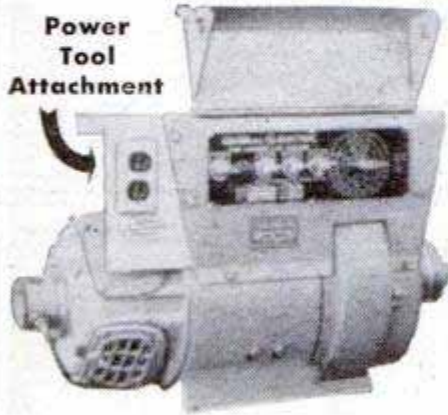

Elsewhere You Would Pay \$795
(or more with spare parts)
YOU CAN SAVE OVER \$400

This General Electric 200 Amp. Generator, Series WD 3200, was built to sell for \$795 complete. The manufacturer, under government contract, built more units than the contract called for. We took them off his hands brand-new at less than cost. Now you can get them for an unheard of saving of over \$400. Built to rigid government specifications, and engineered for welding shop use.

IMPORTANT FACTS ON UNIT
Shipping weight complete 675 lbs. Capable of welding 1/4" rod continuously. AC-DC power tool outlet. Maximum amperage—285. Complete—ready for use—nothing else to buy. Adaptable to civilian or military jeep, farm tractor, any gasoline engine. We'll mount unit for \$20.

90 DAY NEW GUARANTEE
Complete Portable Unit \$845

Regular \$795 G-E welding unit mounted on reconditioned jeep. Would cost over \$1900 for new jeep and this unit. Such a bargain will never be equalled!

ACT NOW!

Limited Supply. Orders filled as they come in. Hurry, and be sure of getting yours.

Will demonstrate on request if within reasonable distance.

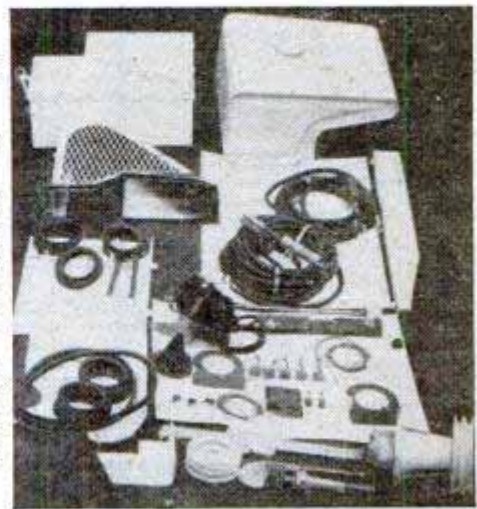

EASY TERMS Pay 25% down, balance sight draft F.O.B. Cleveland.

ORDER NOW and SAVE MONEY!

WELDERS SUPPLY CO.

(Authorized GE Dealer)

4409 LORAIN AVE.

CLEVELAND, OHIO

DEPT. PM-12

SANDEE CHROME SILENTIP



\$2.95 EACH

FOR QUIETER PERFORMANCE

An exhaust tailpipe extension that is actually a small muffler. Chrome plated. Will make a sport muffler or dual set quieter and still give straight thru performance.

SANDEE MUFFLER CO., 5643 Corryne Pl., Culver City, Calif.



\$10.95

Delivered U.S.A.

HEAT THAT COLD ROOM

Don't shiver in a cold room. You can install this booster fan in warm air furnace pipe yourself, and get forced circulation. Patented cooling feature prevents motor failure common to unventilated fans. Fits pipe sizes from 8" to 12", runs on house current. If your furnace dealer cannot supply you, write for free circular or send check to McLARTY SYSTEMS, Dickman & 26th St., Battle Creek, Mich.

SAVE MONEY — BUILD YOUR OWN SPEED LIGHT EQUIPMENT

FOR PROFESSIONAL AND AMATEUR

Easy to follow step-by-step instructions

Write for FREE list of complete Kits and Components Dept.

CINEX, INC., 165 W. 46th St., N.Y. 19, N.Y. PM-12

NEW! BIG FIELD



FOR PROFIT AND PLEASURE COPPER TOOLING & ETCHING

EARN BIG MONEY — SPARE OR FULL TIME

No experience needed—start at once. BIG MONEY waiting in COPPER ART field. Plaques, Bowls, Trays, Gifts, Souvenirs of all kinds. Start on the road to success NOW! Here is an opportunity to get started in your own Big Paying Business—FREE DETAILS don't wait—WRITE NOW!

Hollywood Copper Art Studios

4257 Beverly Blvd., Dept. PM-12, Los Angeles 4, Calif.

Say You Saw It in
POPULAR MECHANICS

EXPORT PAYS BIG



FREE BOOK

World Trade firm offers men and women plan for big pay positions or unlimited-profit businesses of their own in Export-Import Mail-order World-wide without capital, from home, or travel abroad. Write today for Free Book. State if veteran Airmail reaches us over night The Mellinger Co 1418-I Westwood, Los Angeles 24, Calif

Mystery Auto

STARTS — STOPS ON COMMAND

Whistle at it! Blow on it! Say "Start"—"Stop." Car Responds Instantly

Amazing, mystifying performance. Fun for young and old. Adjusts to travel straightaway or in any size circle—table top to room size. Whistle at it. Blow on it. Say "start." "stop." Control it as you will without touching except for occasional winding. Back it into an obstruction, car will reverse automatically and go forward. Car is 5 3/4" long. Made entirely of metal. Richly painted. Rubber-tired wheels. Hinged hood opens, showing dummy engine. Nothing to get out of order, will run indefinitely. Makes a sensational Xmas gift. \$4.75 postpaid. Two for \$9.25. Three for \$13.75. Rush check or M.O. today. Satisfaction guaranteed. \$1.00 deposit for C.O.D. HOME SHOP PRODUCTS CO., Dept. 19, 4821 Sheridan Rd., Chicago



No Batteries
Nothing to be Replaced

Make Use of
**POPULAR
MECHANICS
BOOKS**

STREAMLINED HELP



**BETTER JOBS
HOBBIES
AND PASTIMES
HOME AND FARM
WORKSHOPS
HOME REPAIRS-
IMPROVEMENTS**

THE INEXPENSIVE PRACTICAL BOOKS WITH A MILLION READERS!

Want help on your job—extra knowledge that brings extra pay? Want to save money on home repairs? Want practical information to better enjoy hobbies and home and farm workshop projects? Then get a Popular Mechanics Book. These easy-to-use books, written in plain, everyday how-to-do-it English, and extravagant with pictures, plans, diagrams, etc., will give you the practical help you need. Full library size, cloth bound book unless otherwise described. Rush order on coupon today. Money back if not satisfied.



FORTY POWER TOOLS YOU CAN MAKE

Have your own powered workshop at low cost. Tells how to make forty different machines such as lathes, drill press, jig saw, band saw, circular saw, sanders, from pipe fittings, old auto parts, wood, etc. New 1948 edition. \$1.50

POPULAR MECHANICS PHOTO HANDBOOK

An entirely new and different book from our popular Photo Guide. It's a complete guide to better pictures and darkroom technique, and features dozens of handy gadgets you can make yourself. \$2.00

BUILD A BOAT FOR PLEASURE OR PROFIT

How to build 17 low-cost boats at home—power, sail or row boat. Prepared especially for the home builder with limited tools, no experience and little money to spend. Plans, diagrams and illustrations. \$1.50

WHAT TO MAKE FOR CHILDREN

A Popular Mechanics book for Dad, Mother and the whole family. Shows how to make toys, dolls, doll houses, slides, see-saws, rocking horses, furniture. 175 projects to make from discarded or inexpensive materials. \$2.00

THE GARDEN BOOK

How to build your own trellises, fences, lawn furniture, outdoor fireplace, attractive ornaments and other things for your yard and garden. Beautify your grounds—enjoy attractive equipment—at low cost. \$1.25.

OUTDOOR SPORTS MANUAL

220 helpful articles and hints for fishermen, hunters, campers, trappers, archers and boatmen. If you love the outdoors, double your enjoyment with the help of this new book. Contains 334 illustrations. \$2.00

WHAT TO MAKE. 10 Volumes



The famous annual craftsman's guide. Shows what to make and how to make hundreds of things in spare time for fun or profit. Novelties, gifts, toys, games, furniture, etc. Cloth bound and filled with instructive pictures. Single volumes, each \$1.75. Save money on 10 volume set, complete, only \$15.00.

POPULAR MECHANICS SHOP NOTES

New 1949 volume. Latest in series of practical and helpful year books for every man who uses tools. Contains 240 pages and 750 illustrations. This book will make money for you and make your job easier. Soil-proof paper cover. \$1.00

POPULAR MECHANICS MOTORIST'S HANDBOOK

For every man who drives a car and wants to do his own servicing and simple repairs. A money-maker for the professional auto repairman. Hundreds of ideas, helps, and kinks you can use every day. \$2.00.

CONCRETE HANDBOOK

How to do all types of concrete work and make ornamental things of cement—walks, driveways, foundations, steps, vases, benches, etc. Ideal book for home owner, handyman and construction men. \$1.50

WELDING, BRAZING AND SOLDERING

How to construct welding equipment and use it effectively—small arc welder, spot welder, arc torch. Best approved methods, tricks and kinks to use in soldering, brazing, heat treating iron and steel. \$1.25



YOUR HOME and HOW TO BUILD IT YOURSELF

Step by step instruction by which any one with ordinary knowledge of use of hand tools can build a five-room house complete. Every detail is shown in pictures with amazing

clarity. Will save hundreds of dollars building any house. Spiral bound. \$3.00. Complete set regular builders plans \$12.50. Book and plans \$14.00.

FARM MANUAL

Hundreds of articles on making farm implements and equipment, maintaining the home, farm workshop, live stock and poultry, many farm hints and kinks. A book for every member of every farm family. 284 pages. Hundreds of illustrations. \$3.00



THE BOY MECHANIC

One of the most popular and best known Popular Mechanics publications. Describes hundreds of things for boys to do and make. Develops natural talents and industry. Crammed with how-to-do-it illustrations. The perfect gift for every boy. \$2.00

PAINTING, FURNITURE FINISHING AND REPAIRING

A book for craftsmen, home owners, shop workers and furniture repairmen and finishers. Covers repairs and finishing, restoring antiques, spray and brush painting of all kinds. An all 'round book for everyone. \$1.50

USE THIS HANDY COUPON • Mail Today

POPULAR MECHANICS PRESS, Dept. 128, 200 E. Ontario St., Chicago 11

Send Popular Mechanics books checked. I will pay postman, plus charges (U.S.A. only). Remittance enclosed—send fully prepaid. I will return books in five days for return of money if not satisfactory. Outside U.S.A. please add 15% for postage and wrapping.

Forty Power Tools . . . \$1.50	What to Make (Children) . . . \$ 2.00	Boy Mechanic \$ 2.00
Painting, Finishing, etc. 1.50	Garden Book 1.25	Concrete Handbook . . . 1.50
Motorist's Handbook . . . 2.00	What to Make (1 Vol.) 1.75	Welding, Brazing 1.25
Photo Handbook 2.00	10 Volumes 15.00	Your Home 3.00
Build a Boat 1.50	Shop Notes 1.00	Book with Plans 14.00
Sports Manual 2.00		Farm Manual 3.00

Name _____

Address _____

City _____

State _____

Check
for
FREE
Cata-
log

FURNITURE for YOUR BEDROOM

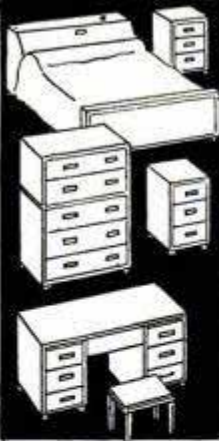

SAVE MONEY, be the envy of your neighbors by making this beautiful bedroom suite yourself! Only a power saw and jointer are needed to turn out this smart suite, featuring bed with storage space, three-piece vanity with cosmetic compartment and makeup mirror, Mr. and Mrs. dresser, and twin night stands with drawers. Letters demanding detailed plans poured in after this furniture was pictured in Popular Mechanics Magazine. Now the 4 plans are ready—easy-to-follow scale drawings—and they're yours for only \$2.00! Send for a complete set today.

POPULAR MECHANICS PRESS
200 EAST ONTARIO STREET, CHICAGO 11, ILL.

Build Your Own Motorized Workshop

This Famous Book Shows How to DO IT!



Easy-to-Make 40 Different Power Machines

Make them yourself—lathes, drill presses, sanding machines, shaper, circular, band and scroll saws and other power tools—from wood, pipe, and discarded parts that cost little or nothing. Get the new edition of "Forty Power Tools You Can Make" even though you have the older edition. This new book has 20 new tools. Make yourself up-to-date, efficient power machines that will save you hundreds of dollars. Send \$1.50 with order and save high C. O. D. charges. Your money back if not satisfied.

POPULAR MECHANICS PRESS, 200 E. Ontario St., Chicago 11, Ill.

POPULAR MECHANICS

Christmas Handbook

144 PAGES
CLOTH
\$2.00

A Wonderful Collection of Ideas, Gifts, Decorations, Toys—You Can Make!

Popular Mechanics new Christmas Handbook is certain to fill a long felt Christmas-time need in thousands of American homes, and to be cherished as a practical, useful gift. There are articles on entertaining and decorations for Christmas-time hostesses—and how-to-do-it instructions for the making of beautiful greeting cards and gifts of all kinds.

Partial Contents

How to Select a Xmas Tree, Exterior and Interior Lighting, Rotating Xmas Trees, How to Make Your Own Greeting Cards, Helpful Hints on Home Decoration, Tips for the Holiday Hostess, How to Make Gifts for All Ages, The Story of Christmas, Christmas in Other Lands, Centerpieces, etc., Gift Wrappings, Christmas Games, How to Make Candles, Xmas-Tree Ornaments.



Order From

POPULAR MECHANICS PRESS

200 East Ontario Street Chicago 11, Illinois

DECEMBER 1949

AUTO MECHANICS! BOOST YOUR EARNINGS

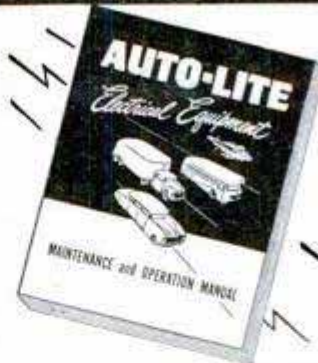

AUTO ELECTRICAL SERVICE

made easy!

JUST OFF THE PRESS

Contains technical information

Only \$2.00
Over 200 pages
... packed with latest service methods.

The finest, most completely illustrated full color book on the complete automotive electrical system. Includes full information on the seven basic electrical circuits built by Auto-Lite . . . Starting—Charging—Ignition—Horns—Windshield Wipers—Instruments—Lighting. Plus Trouble Shooting Charts worth many times the price of the book. Gives you the answer every time.

SPECIAL! NO MONEY COUPON

THE ELECTRIC AUTO-LITE COMPANY—Toledo 1, Ohio

Yes, send me your "Maintenance and Operation Manual" by return mail. I will pay the postman when he delivers my copy \$2.00 plus postage. (If \$2.00 is enclosed with this coupon, the book will be sent postpaid.) If after 10 days I am not satisfied I may return the book and my money will be refunded.

NAME _____

ADDRESS _____

SALESMEN!

10-Second Demonstration

Nets You

\$9.95



Yes—Storekeepers now "Write with Light"—wipe off and write new sign—all in 10 seconds. Fastest seller in years. 10-second demonstration pays you \$9.95 cash in advance. Orders pour in HAND-OVER-FIST. Get started in your territory while "LITE WRITER" is brand new and hot as a pistol.

Litewriter "MAGIC CRAYON" MAKES SIGNS THAT GLOW LIKE BRILLIANT NEON!

Merchants everywhere—in small town and big city—all stare with amazement at this newest of all Fluorescent Sensations! They write on glass with "MAGIC CRAYON"—and Presto!—before their very eyes—there's a 5-color Advertising Message that glows like a brilliant Neon Sign!

FREE! Complete Sales Kit. Send name on penny postcard NOW for Big FREE Sales Kit and Free offer of Sample Demonstrator. No cost now or ever. Rush postcard now.

MAXILUME CO., 125 W. Hubbard St.
DEPT. L-812 CHICAGO 10, ILLINOIS

What a
gift for
Christmas!

Prince Albert

America's Largest-Selling
SMOKING TOBACCO

★ To bring a smile to the face of any pipe smoker on your Christmas list — or to any man who likes to roll his own cigarettes — give Prince Albert! Choice, crimp cut tobacco — mild and full-flavored! And the big one-pound tin comes gift-packed in a colorful Christmas package — with a "built-in" gift card right on top!

R. J. Reynolds Tobacco Co., Winston-Salem, N. C.



THE NATIONAL JOY SMOKE



POPULAR DECEMBER 1949 MECHANICS

WRITTEN SO YOU CAN UNDERSTAND IT
VOL. 92 NO. 6

The New Breed of Sports Cars

SPORTS-CAR enthusiasts who have preferred European automobiles because they could find no domestic makes that satisfy them are beginning to build cars for themselves.

Scores of owners have spent from \$2500 to \$20,000 each to build the kind of cars they desire. One manufacturer of race cars, in answer to the demand, has tooled up for limited production of a sports car of his own design.

What is a sports car, anyway?

It's a car, the enthusiasts tell you, that has outstanding speed, steering and roadability characteristics. It's a car that's a pleasure to drive. It's useful around town, safe on the highway, and also is suitable for competition in the special road races that presently are coming back in popularity.

The trouble with American stock cars, a sports-car driver complains, is that they are miniature busses designed for a soft ride and for easy parking by a

By Thomas E. Stimson, Jr.



Rear-engine sports car has European lines and is powered by a Buick engine; without windshield, the car stands 39 inches tall. Engine in car below is placed at exact center of gravity. The rear-compartment deck is raised by hydraulic cylinder to reach engine or the fuel tank



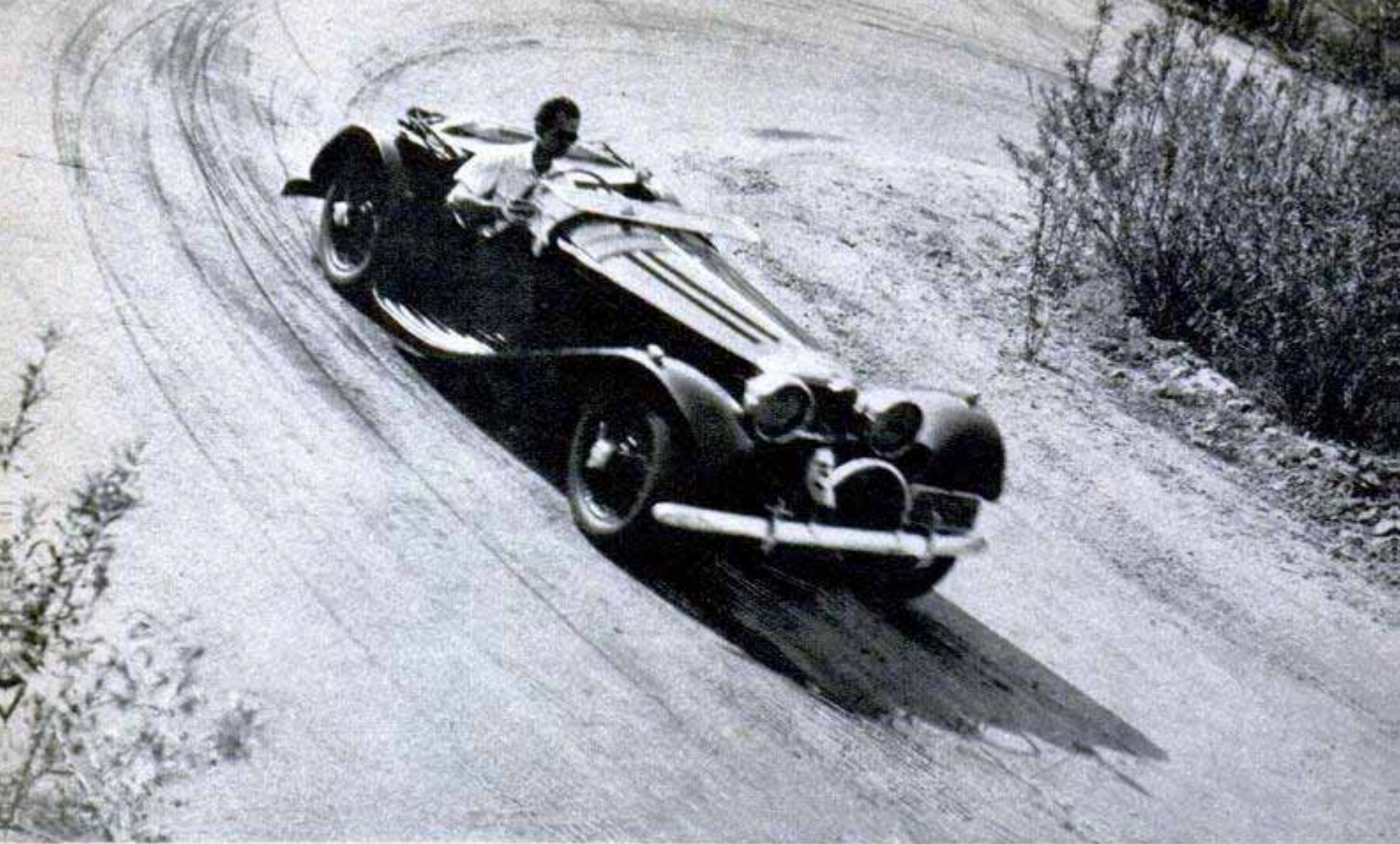

A low-slung British Jaguar rounds a sharp curve on a paved mountain road in a California sports-car race

weak woman. They have high centers of gravity and most of the weight is suspended between the front wheels. They have extreme steering ratios. As a result, they are safe only at moderate speeds and they can't turn a corner unless they are braked almost to a crawl. Many European sports cars of less than half the horsepower can walk away from them in traffic or on a mountain road.

Much of this is true, of course, because

stock-car designers have had to sacrifice some things to provide other qualities that the majority of buyers desire. Until now the demand for high-performance sports cars has been satisfied by importations from abroad. England, France, Italy and Germany all have produced low-slung, lightweight cars that fall into this category. The Jaguar, with an engine the same size as the standard Chevrolet, has been clocked across a flying mile at 132.6 miles per hour.

Chassis of Edwards sports car shows tubing used as frame which serves as auxiliary 13-gallon gas tank

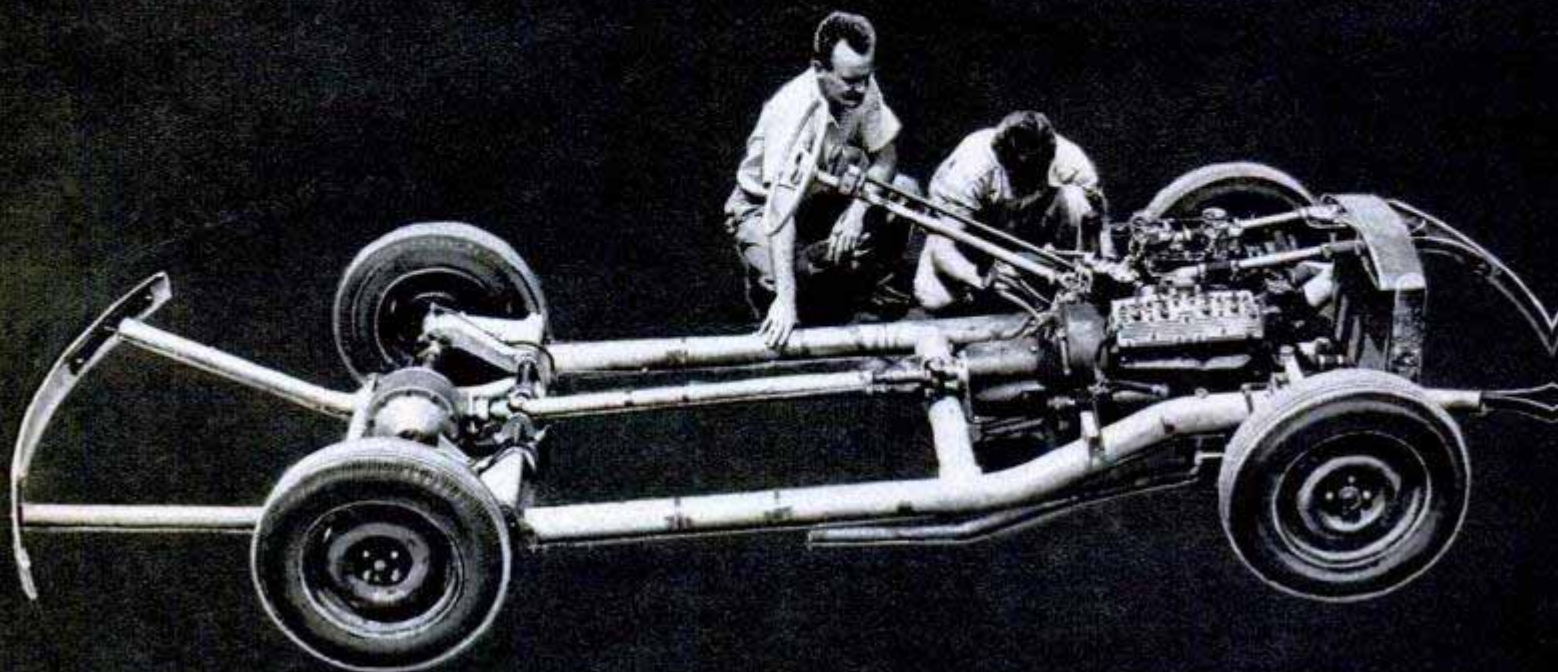

The Talbots, the M.G.s, Alfa Romeos and BMWs, among others, have outstanding roadability. Many of them have supercharged engines. In one 1000-mile road race in Europe, the winning car, powered by a specially tuned supercharged engine that was mounted in a closed streamlined body, won at an average speed of 108.9 miles per hour.

Of all the foreign cars the little M.G. roadster, of which there are hundreds in the United States, has done the most to revive interest in sports cars in this country. Owners of the cars form clubs and engage in hill climbs and in races over rough roads that are full of obstacles. Full-fledged road races are usually community events and are conducted with the permission of town and state officials because it is necessary to close off and barricade the approaches to roads that are being used as the course.

One of the biggest road races held in the United States since the war attracted nearly 50,000 people. The race was held at Watkins Glen, N. Y., and consisted of eight laps around a 6.5-mile course that was especially selected to include all types of road surfaces from concrete to dirt, sharp corners, steep hills, bridges and all the other ordinary hazards of cross-country touring. Thirty-five cars competed and the race was won by an Alfa Romeo sedanette that averaged 63 miles per hour, having been timed at 103 miles per hour on one straightaway. A redesigned and rebuilt Buick took second place and all the other winners were foreign cars.

Possibly the toughest road race of all time was held last year, not in Europe or in the United States but in South America. One hundred and thirty-six drivers, mostly in stock cars, started from Buenos Aires and raced north to Caracas, Venezuela.

Then, after a long boat trip to Lima, Peru, the cars that were still in the competition raced down part of the west coast and back over the Andes to their starting point. The total distance was 11,800 miles, very little of which was on pavement or improved roads. The winners split prize money of \$100,000 between them.

The American hot rods have been called sports cars and some of them do approach that classification. Most of them, however, are designed primarily for racing wide open against time on a straight and level course. Usually their engines are highly stressed and are tuned for peak efficiency at maximum revolutions per minute. They are inefficient at ordinary road speeds. Too, most of the hot rods steer and corner very poorly by sports-car standards. In competition with true sports cars, the hot rods usually turn over or spin off the course if the driver is heavy footed; if he drives more conservatively, he falls way behind the leaders.



Quarter-scale model of the Edwards car provides full-scale body measurements for the engineers. This model shows top removed and rear seats concealed for use as a sporty low-slung roadster

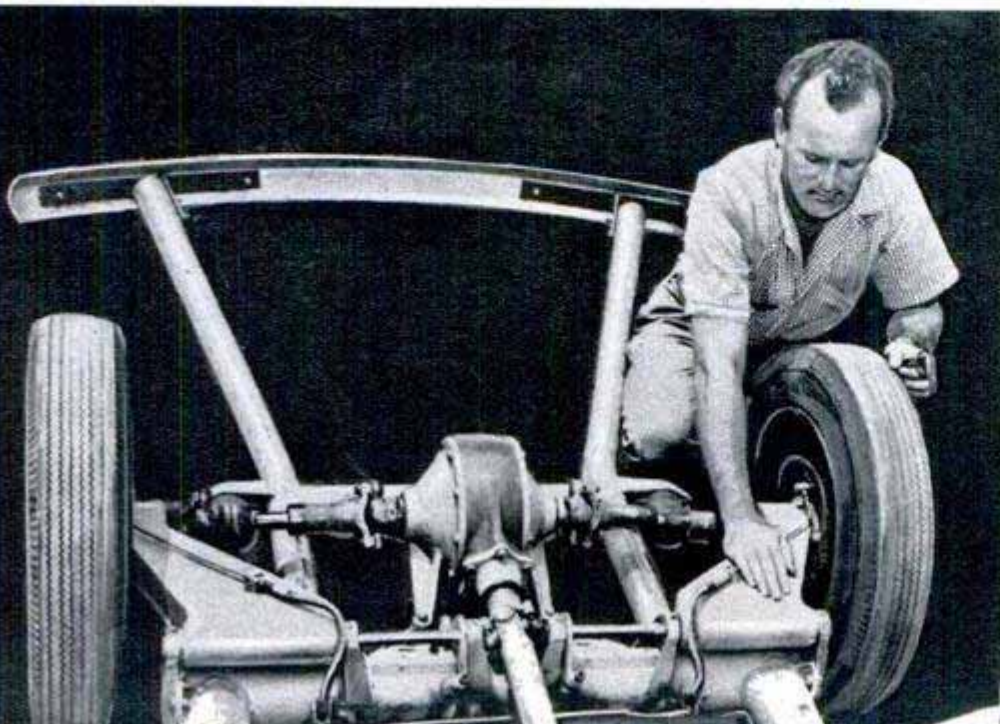

Left, trailing-arm suspension system and torsion-bar springs of the Edwards car are shown. Differential is fixed solidly to frame to reduce unsprung weight of this carefully built auto

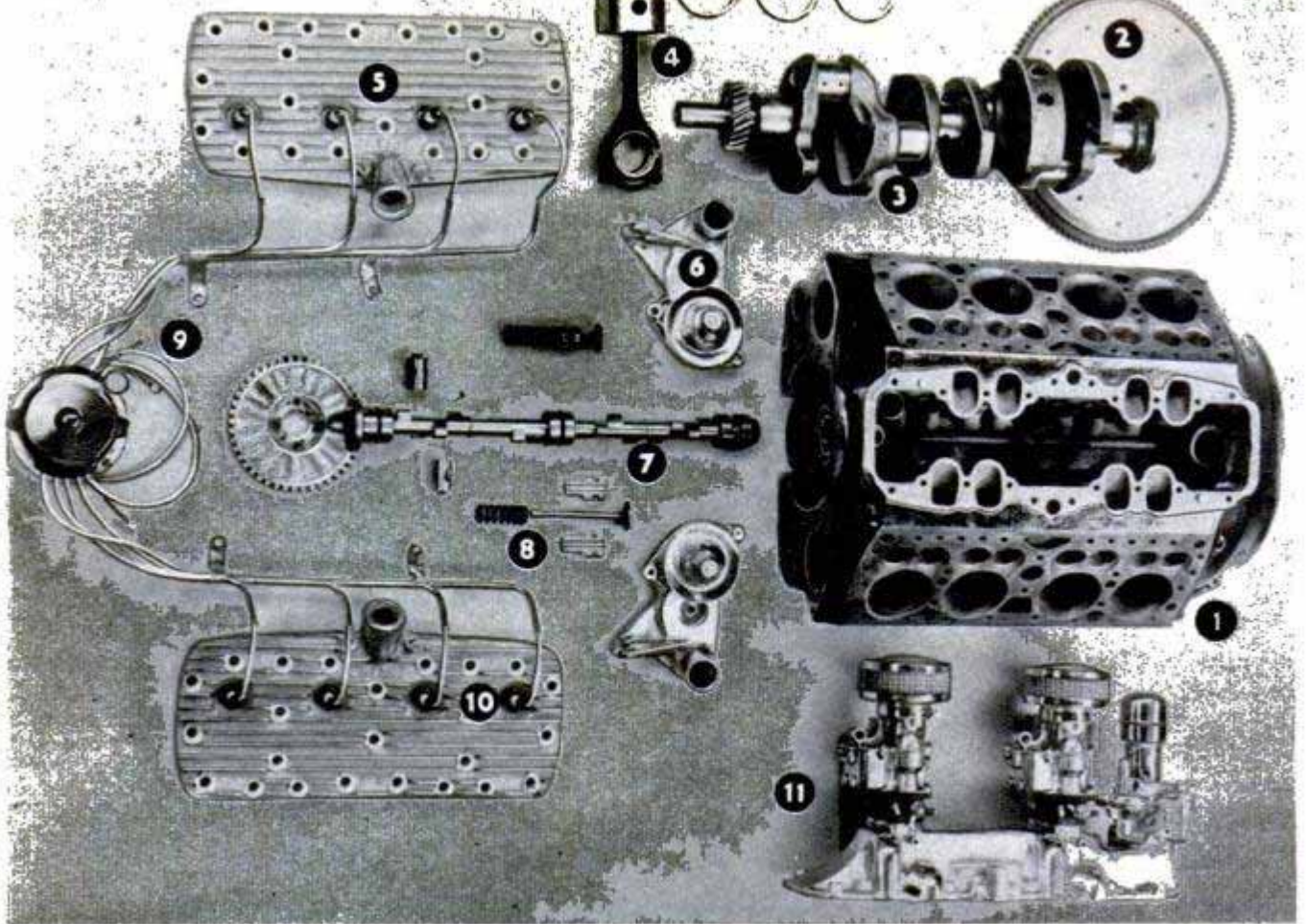

This shows what happens when an 85-hp. stock Ford V-8 is reworked to deliver up to 190 hp. 1—Block is ported and relieved to permit easier flow of fuel and gases. 2—Lightweight flywheel. 3—Counterbalanced crankshaft. 4—Matched connecting rods and pistons with special bearing inserts. 5—Custom-built heads with a compression ratio of up to 11 to 1. 6—Chromed water pumps (for looks). 7—High-grind camshaft. 8—Adjustable tappets with oversize valves and guides. 9—Special racing ignition system provides hot spark at all r.p.m. 10—Racing spark plugs. 11—Special intake manifold to which are attached twin carburetors, the fuel pump and a fuel strainer

What the American sports-car designers are achieving is a new idea in automobiles. They are combining the sure-footedness of the typical European car with the roomier body and good seating capacity of American cars. Most of the American-built sports cars are roadsters or convertible coupes, the convertibles having a hard or soft top that may be completely removed. A short wheelbase of 100 inches or a little more is preferred even though the body itself is much longer. The motor must have plenty of power. Steering and suspension are especially important and the car must be stable at all times.

Much of this development centers in southern California. One typical roadster, built by Paul Omohundro, has practically a stock Mercury chassis that is powered by a Cadillac engine and that supports a special body of sweeping lines. Another car, designed and built by Norman E. Timbs, automotive engineer, is a rear-engine roadster that is powered by a Buick engine mounted exactly at the center of gravity, behind the driving compartment. The chassis consists of welded aircraft tubing. The aluminum body was made up on a wooden pattern and was welded together.

It is hinged in the center and the rear section is raised by a hydraulic cylinder to allow access to the engine. Steering, brakes and other equipment are standard Mercury parts. The car has a 117-inch wheelbase and is 17½ feet long over-all. Top of the windshield is 47 inches off the ground. Heavier than most sports cars, it weighs 2500 pounds and has an estimated top speed of about 120 miles per hour.

One of the best known sports cars is in limited production by Kurtis-Kraft, Inc., of Los Angeles. Designed for ease of maneuverability, comfort, safety and high speed, it incorporates many of the ideas of Frank Kurtis, head of the company and well known as a designer and builder of midget and Indianapolis race cars.

The car is a low-slung roadster on a 100-inch wheelbase and is 169 inches over-all. It stands 51 inches high. Power plants of from 80 to 160 horsepower are available at the buyer's option and the top speed is dependent on the power plant. The side frames extend to the outside of the car and become part of a full wrap-around bumper assembly. All fenders and body panels, with the exception of the doors, are made

(Continued to page 248)



Top, German engineer rebuilt a Volkswagen for racing. It has four carburetors and a top speed of 80 m.p.h.

Just below the Volkswagen is a speedster composed of a reworked Mercury chassis and a powerful Cadillac engine

Third from top is Kurtis sports car which can do 100 m.p.h. with a small engine. Designer Kurtis is at the wheel

Left, Kurtis demonstrates telescoping steering-wheel column that allows driver to move wheel to desired position



WIRELESS TREE LIGHTS eliminate all fire hazards due to faulty insulation on Christmas-tree light strings. The ultraviolet-ray lighting set decorates the tree with ornaments that glow without wires or heat. The ornaments, of various shapes and colors, are made of plastic that becomes fluorescent when struck by rays from an ultraviolet bulb at the base of the tree. Because there is no wiring to limit placement of the "lights," a more balanced decoration is possible. The ultraviolet bulb is mounted in a hooded fixture that can be used throughout the year with a standard fluorescent tube to provide illumination over the sink or desk. The new system cuts down the cost of lighting, too, because the bulb consumes only 15 watts.

TUB-TYPE HOLDER (below, left) supports a Christmas tree in 12 quarts of water. The original water supply in the tub will last through the holiday season without replenishing. The holder measures 15 inches in diameter at the base and is seven inches high. Three setscrews bite into the tree trunk to hold it in place. According to the U.S. Forest Service, a tree is less flammable if it is cut off diagonally and then placed in water reaching above the cut surface.



PLASTIC CLIPS (below) permanently attached to new Christmas-tree lamp sockets seal out tinsel and other decorations that might cause short circuits. No metal is exposed anywhere on the socket. The clips also serve as clamps to hold the sockets to the tree. The lights are available with either incandescent or fluorescent bulbs.

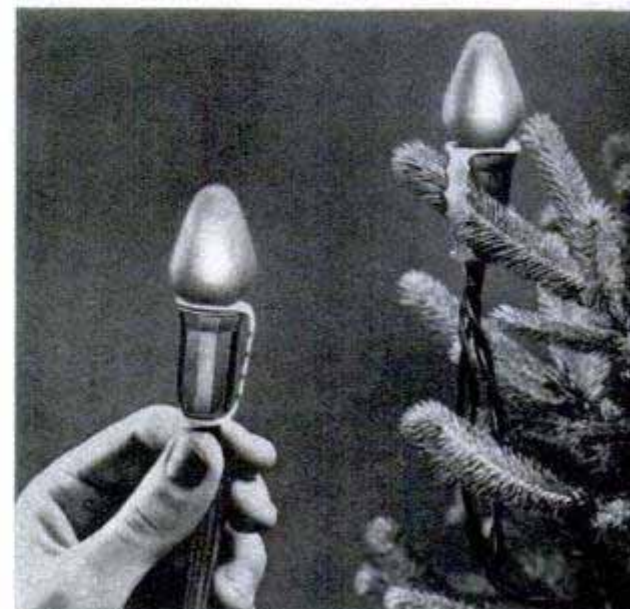

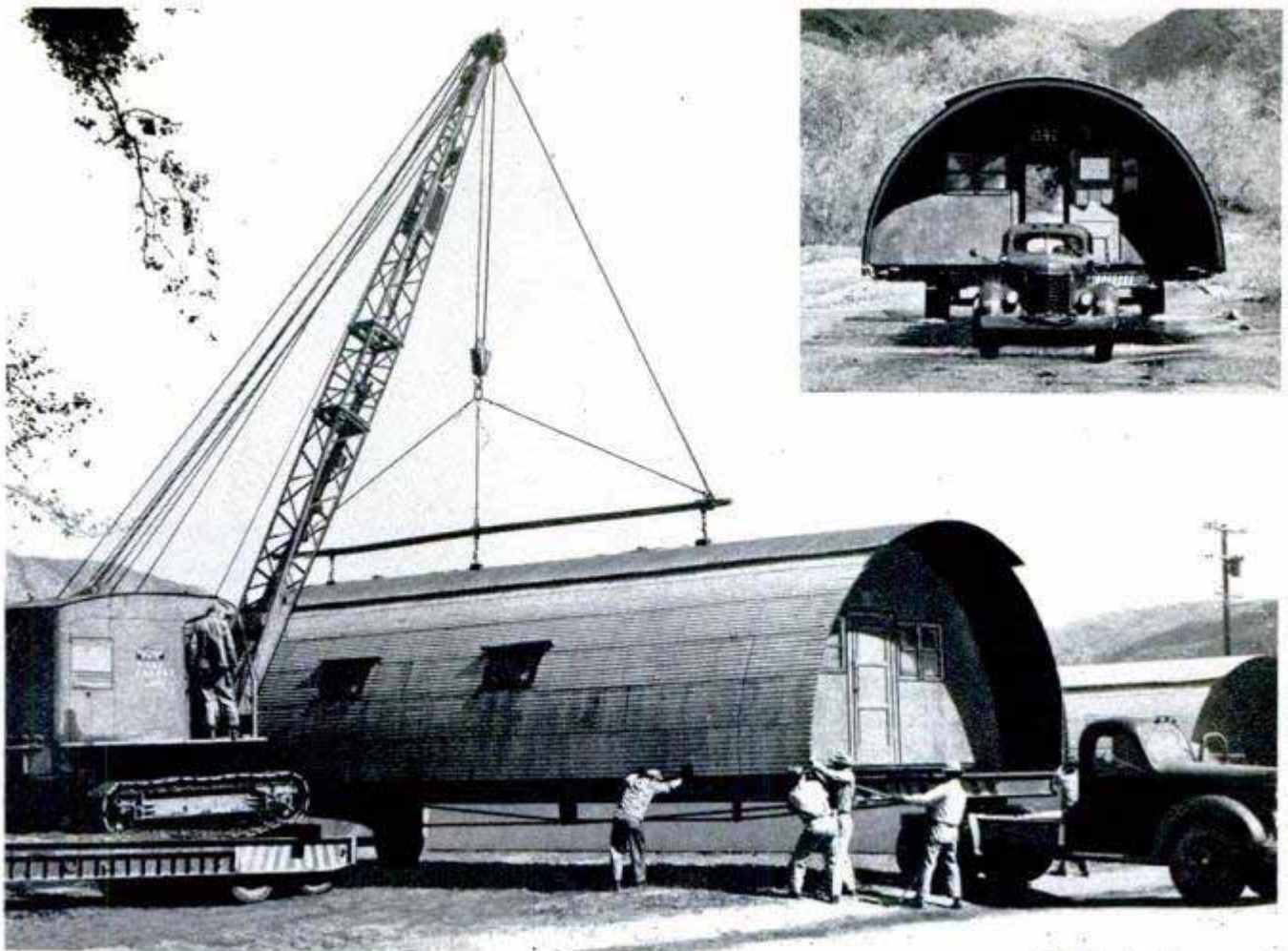

U.S. Marine Corps photos

Using a crane with a spreader bar, Marines and civilian workers hoist a Quonset onto the special trailer. Inset, the truck, trailer and 13,000-pound hut even had to ford shallow river beds during the trip. Below, the trailer is more than 55 feet long and 12 feet wide. Small trucks warned motorists of "house on wheels"



Moving Day for Quonsets

Marines, faced with the problem of moving Quonset huts 22 miles to a new site, solved it with typical ingenuity—they built a trailer big enough to carry a complete building. After hoisting a hut aboard the trailer with a crane, they towed it down the highway to Camp Joseph H. Pendleton at Oceanside, Calif., and dropped it on its new site. The estimated cost of moving each

hut was \$75. The old method of moving a hut by disassembling and reassembling cost \$576. The trailer, built in eight days, measured 55½ feet long by more than 12 feet in width. It supported the 10,000-pound huts with ease.

By measuring sediment layers, which accumulate at a rate of about ¼ inch per 1000 years, scientists have estimated that the Atlantic Ocean is half a billion years old.

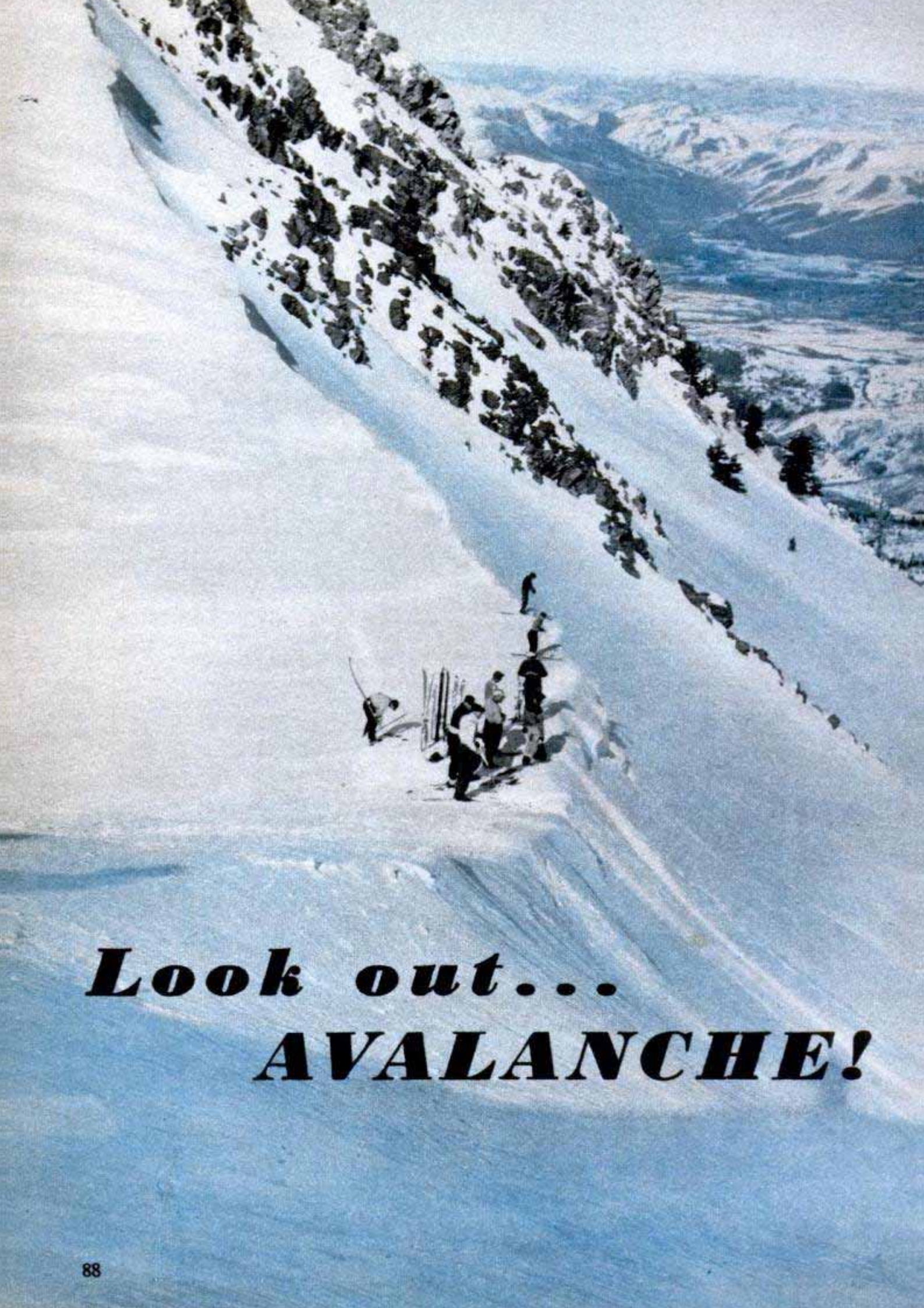

Look out...
AVALANCHE!

← Party of skiers prepares for three-mile downhill run from the summit of Mt. Ogden, Utah. Such high, steep, open slopes as this make avalanches more frequent in the West than on the New England slopes



U.S. Forest Rangers check potential slide areas very carefully, marking them if the danger warrants. This ranger is carrying signs up the slope for posting

IT WAS TYPICAL avalanche weather—successive storms followed by prolonged cold. The fresh snow had not yet settled and the surface was extremely unstable. All of which meant that skiing at this particular winter resort in the Rockies had to be restricted to certain slopes that were known to be safe.

“What about Blank Creek Run?” Bill Smith and Joe Anderson, two good skiers, asked the instructor.

“Have to test it first.”

Four men on hickories—two skiers, an instructor and a ski patrolman—climbed a ridge to the head of Blank Creek Run.

“I’ll make a quick test,” said the instructor. “Wait until I’m off the slope.”

He skied swiftly into the danger zone, turned sharply and headed back. But Bill and Joe failed to follow orders. They, too,

zoomed onto the slope. Silent as death itself, it gave way under the weight of the three men. A great river of snow began to race down the canyon.

“Look out—avalanche!” shouted the instructor and barely regained the safety of the ridge. Bill skied straight across the hazardous slope and reached the other side. But Joe made a mistake that cost him his life. He tried to outrun the avalanche by schussing straight down. The express-train speed of the slide caught him, carried him over a cliff and buried him 15 feet deep. He died of suffocation before rescue crews arrived.

With 5,000,000 Americans addicted to winter sports, research on avalanches in the United States has become important. The U. S. Forest Service, with supervision over 90 percent of the skiing areas in the



U.S. Forest Service photos

The hard work of shoveling and a big repair bill were enough to teach this pair a lesson. Next time, they won't park their car in a "closed area." A slide has completely buried the car



Ordinarily on duty towing skiers on Mt. Hood, the Sno-Motor (see cover) is ready when an avalanche strikes to speed rescuers wherever they are needed



Above, with this portable radio, the rescue party calls for more supplies and help. Below, avalanches can be set off harmlessly with a charge of tetrytol

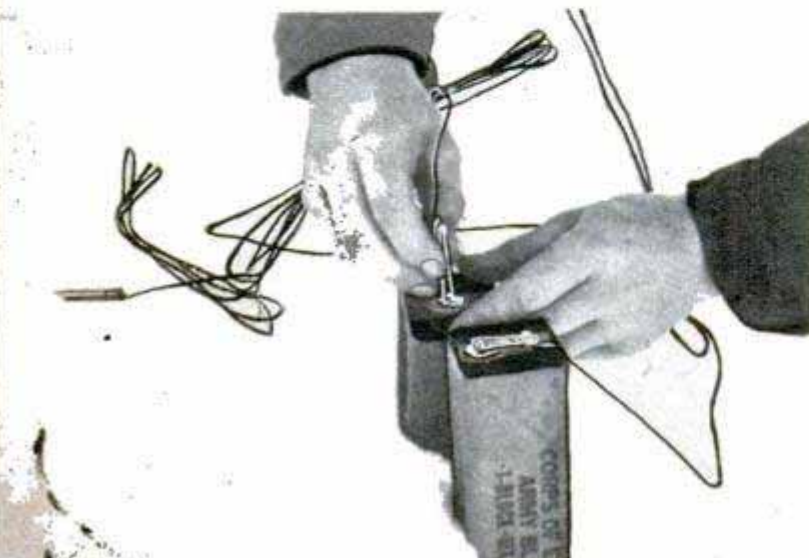

western states, has just completed a 10-year study of this powerful, complex force of nature.

In charge of the project have been Montgomery M. Atwater, snow ranger at Alta, Utah, and F. C. Koziol, supervisor of the Wasatch National Forest. They have written a 96-page monograph for the Forest Service, "The Alta Avalanche Studies."

Alta's excellent skiing slopes were chosen as a "laboratory" not because they are more dangerous but because this was the first true alpine ski area to be developed in the United States and because detailed records of snowslides have been kept in this section for the last 75 years.

Avalanche forecasting is not yet an exact science — the hour, location and violence cannot be pin-pointed. But the green-uniformed rangers of the U. S. Forest Service, using research done at Alta, can warn you when to stay out of areas of probable slides.

Exactly the same conditions of terrain and climate that produce the finest skiing also produce avalanches. As a general rule, the greater potential danger exists on the steep, high-altitude, open slopes of the West rather than on the gentler, wooded slopes of New England and Eastern Canada.

Avalanche terrain depends upon grade, shape and surface of the land. Grade is most important. Unless the slope is 25 degrees or steeper, there is little danger of avalanches. Next comes shape. Convex slopes are more dangerous than concave because snow settling on a bulging surface is under tension. Third is surface. Areas where the ground is rough, boulder-strewn or covered with brush will hold the snow pack better than a relatively smooth or grass-covered slope. Tree cover is important also. Recent studies by Swiss researchers have shown that reforestation is a good way of reducing snowslides.

It is a mistake, however, to gamble entirely upon trees. They are virtually use-

less against certain types of avalanches. For example, a light, dry powder snow will flow like water or sand around tree trunks. Two of the most devastating slides at Alta in recent years originated in forested areas.

Size also is a factor in snow avalanches. A wide slide descending a short slope does less damage than a narrow slide on a long slope. It's the difference in momentum between a milk truck nudging into your car at two miles per hour and a "hot rod" smacking it at 60.

Contrary to general opinion, avalanche hazards do not exist straight through the winter from the first flurries of snow in November to the last lingering patches in April. Danger from avalanches is like that from tornadoes—greatest at different times of the year and in different locations. Trained observers watch for telltale signs of avalanches and take measures to combat them.

A major storm is the principle direct cause of an avalanche. This is just another way of stating the basic formula worked out by Atwater and Koziol: "Sufficient snow in a favorable location."

Ten factors are weighed in the forecasting of avalanche hazards: (1) Old snow depth; (2) old snow surface; (3) new snow depth; (4) new snow type; (5) new snow weight; (6) rate of accumulation; (7) wind force; (8) wind direction; (9) temperature developments, and (10) snow settlement.

Of this list, new snow depth, rate of accumulation and wind direction are the most important factors in "triggering" an avalanche. A snow ranger, however, must take all factors into consideration and make a decision based upon field tests, observation and experience. He can't shut down an area just because there is a little snow moving, nor can he afford to take chances with public safety.



Swiss avalanche expert shows ranger how to test the snow's resistance to penetration by a ram instrument. This is an important factor in avalanche prediction

Below, two members of the National Ski Patrol at Mt. Hood use a toboggan to transport this injured skier





Slides can be started "on order" by snow rangers who ski swiftly to the center and then cut back to safety

Avalanche forecasting is a continuous process. During a storm, a snow ranger must keep a mental "box score" of all the factors involved and do a considerable amount of field testing. One who knows his business will not be caught by surprise. He can never forget, however, that he must establish a two-hour "safety margin" before the growing hazard becomes a possible man-killer. It takes about that long to shut down the lifts and clear skiers off the slopes.

In a well-chosen, properly planned winter sports area, the avalanche hazards can be controlled by closing off dangerous slopes, trails and highways until the dan-

ger no longer exists or by triggering avalanches at times chosen by man rather than by the fickle gods of the mountains.

An experienced ski mountaineer can trigger a slope by skiing out on it and zipping back to safety. The Swiss, for many years, have used explosives. Comprehensive experiments along this line have been tried at Alta and elsewhere in the West. One of the best explosives for this type of work is tetrytol, developed in World War II, which is affected neither by cold nor dampness. In Colorado, the 168th Field Artillery Battalion has assisted in the research by firing 105-mm. howitzers into the eight-foot snowdrifts of Hoop Creek Basin.

Loudspeakers outside ranger's cabin are used to broadcast slide warnings



The Forest Service recognizes four types of avalanches:

(1) **Dry-snow avalanches**—composed of loose, newly fallen snow. Where a long, wide slide path exists, this type of slide is highly dangerous. It is sometimes accompanied by a destructive air blast—the slide traveling above as well as on the ground. Danger to the skier lies as much in suffocation from "snow dust" as in physical violence.

(2) **Wet-snow avalanches**—slides of this



Only experienced skiers under supervision of an instructor or Forest Ranger should investigate snow ledges like this one. Below, diagram illustrates avalanche described in text which resulted in death for one skier

type are heavier and comparatively slower moving. A skier can generally get out of their way. Their greatest threat is to buildings and stationary objects.

(3) Slab avalanches—these are the most dangerous of all. Snow slab or wind slab has a characteristic dull, chalky, nonreflecting surface, but is generally concealed under fallen snow. Release of a slab avalanche is sudden, violent and extensive. The whole slope starts moving at once. A skier caught in a slab avalanche is knocked off his feet and pounded by grinding, rough-edged blocks. The outcome is purely a matter of luck—usually bad.

(4) Combination avalanches—any one of the three types described above can and often does occur in combination with any or all of the others.

(Continued to page 258)

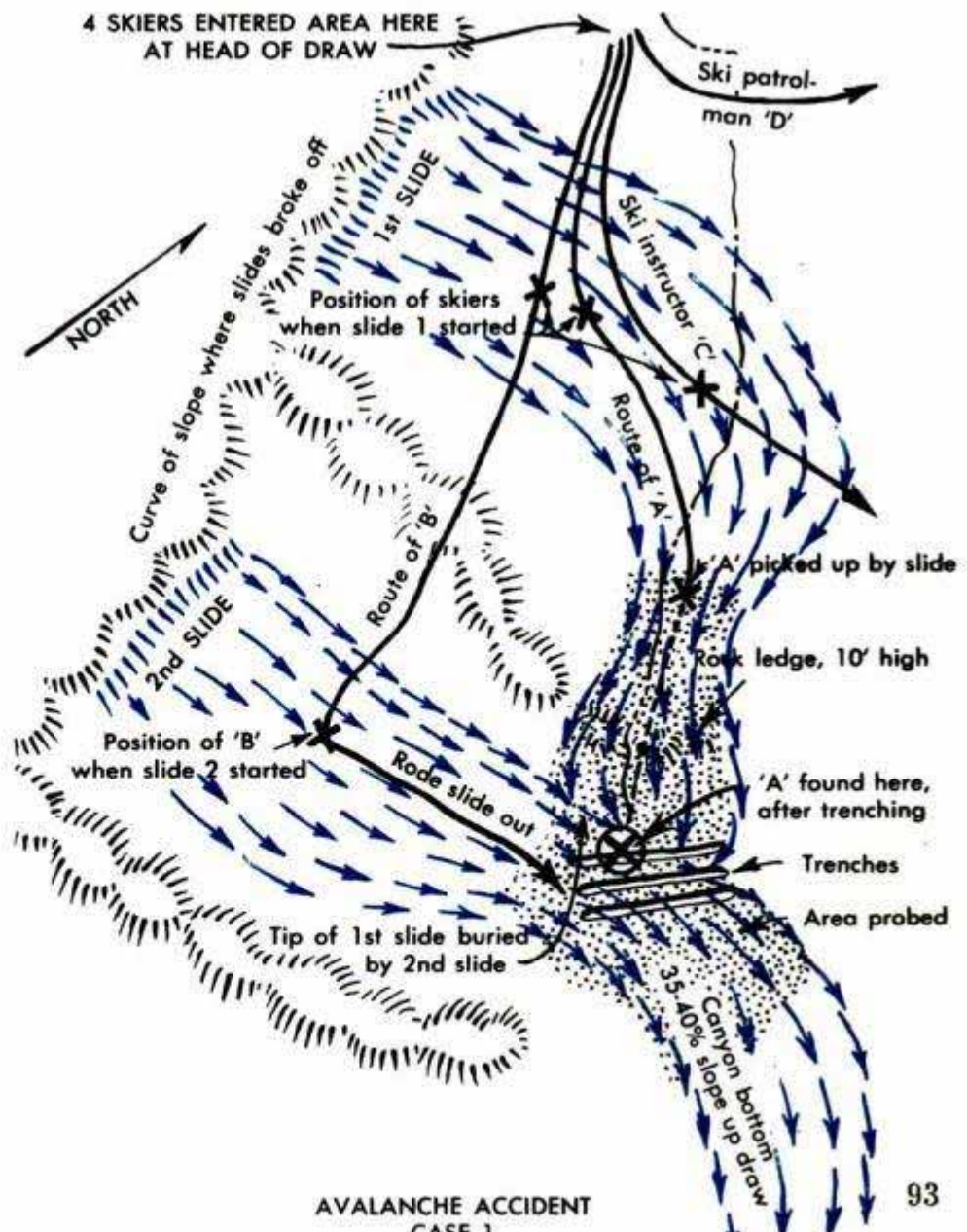



No operator is needed with the suitcase projector shown in use above. Continuous film rewinds itself as it is shown. Right, an inside view showing the film magazine

Suitcase Projector

Weighing only 40 pounds, a suitcase projector provides everything necessary for showing a movie, either silent or sound. Projector, screen, film magazine, amplifier and speaker are compactly arranged inside the carrying case. When in use, the screen is pulled forward and the picture projected on it from the rear. No operator is necessary as the film runs continuously once the machine is started, the magazine rewinding the film as it is shown.

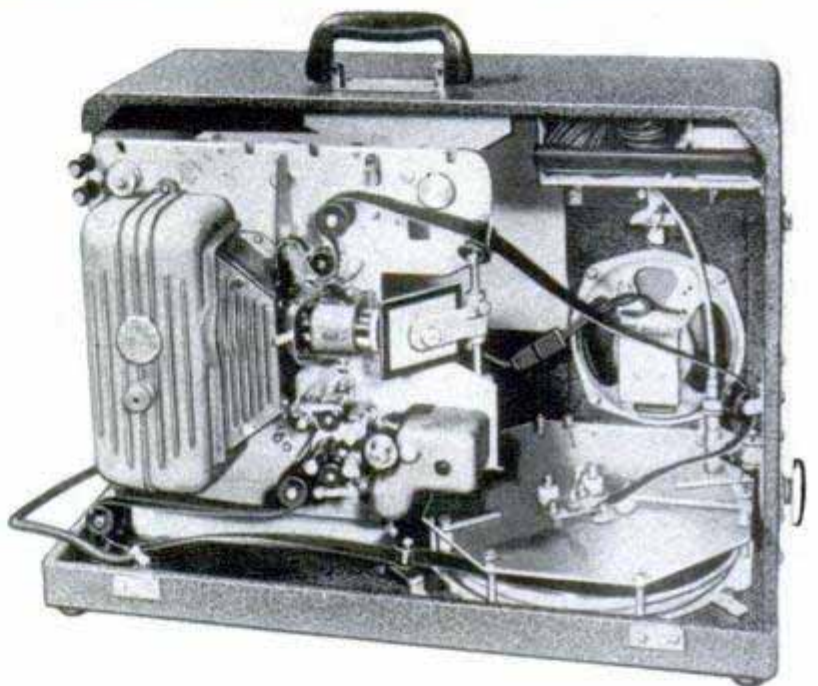

Complete Photo Kit For Beginners

Complete in one package, a beginner's photographic kit provides the young hobbyist with all the equipment necessary to do everything from taking the picture to enlarging the negative. The camera furnished with the kit has a fixed-focus lens and a shutter speed of $\frac{1}{125}$ second to stop action. Masks are provided with the enlarger. Developing trays, a roll-film tank, graduate, safelight bulb, clips, chemicals and an instruction book are also furnished.



Flash Gun Is Tested Without Taking Apart

Photographers who use midget flash bulbs can test the circuit without removing the reflector assembly by means of a testing unit with a bayonet base. The unit is simply pressed into the socket like a flash bulb. It is especially convenient when testing several extension flashes because it eliminates removing the reflectors, a time-consuming but necessary chore when the conventional screw-type test unit is used.

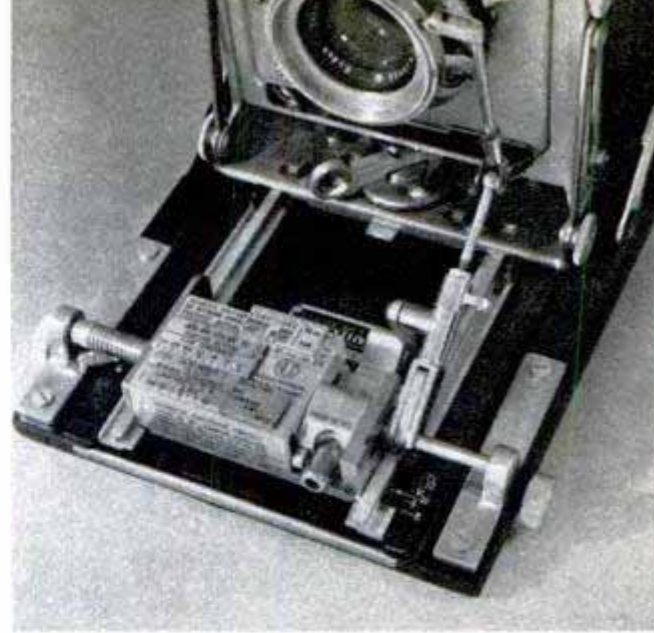

Automatic Diaphragm Control For Photoflash Photographers

Photoflash photographers don't have to bother about diaphragm settings when they have an exposure control coupled to their camera. The control device, designed for use on press cameras, automatically adjusts the diaphragm as the camera is focused. Several scales on the control are preset to match prevailing conditions. These include film speed, shutter speed, flash bulb and reflector types and the conditions of the surroundings. Once these have been set into the control, the photographer merely focuses and shoots, the diaphragm aperture being set by a mechanical linkage. The control does not interfere with normal operation of the camera.

Between-the-Lens Shutter As Fast as 1/800 Second Exposure

Exposures as brief as $\frac{1}{800}$ second are made possible by a between-the-lens shutter that opens and closes in a manner completely different from previous models. Instead of moving in and out with a reciprocating motion, as conventional shutter blades do, the blades of the new shutter pivot and rotate through a partial circle to open and close in one continuous movement, eliminating the slight pause present in the reciprocating type when the movement changes from outward to inward. Featured on the Kodak Tourist, the shutter is said to be the fastest of its type in the world.

Double Exposures Are Impossible With Magazine-Loaded Camera

Just about foolproof in operation, a new miniature camera has a film transport that winds the film as the shutter is cocked for the next shot, thus preventing double exposures. The 14-exposure film magazine used in the camera requires no threading. You just drop it in the camera, replace the side plate and wind the film. The combination shutter-cocking and film-winding process enables the photographer to take 14 pictures in less than 30 seconds.



Wet or Dry Dust Spread By Sprayer

Power sprayers can be used for wet or dry dusting when a hopper attachment is added. Developed by the Aero-Mist Sprayer Company for use with their sprayers, the attachment does not interfere with normal use of the sprayer and is easily attached or detached. The hopper holds two cubic feet of dust and has a positive feed control that regulates flow from 2 to 10 pounds a minute.

Elevator on Wheels Lifts Bomb to Plane

Designed for the Air Force, a mobile lift elevates a 50,000-pound bomb 12½ feet into the air, high enough to fit it into the bay of a large bomber. Operated hydraulically, the lift is mounted on a wheeled carriage which can be used to move the bomb. In order to fit the bomb exactly into the opening, the elevator can roll it 360 degrees in either direction, shift it four inches to either side, 10 inches fore and aft or tilt it six degrees up and down.

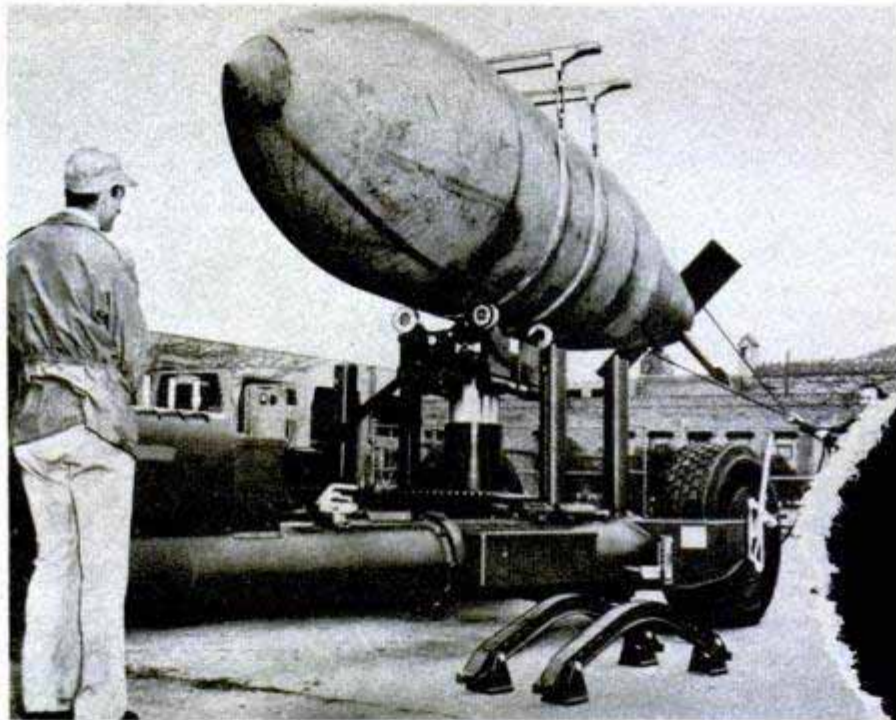

Cutter Digs Ditches Beside Rail Tracks

Powered by compressed air, a versatile machine for railroads clears track-sides of weeds and brush and then digs an 18-inch drainage ditch outside the rails. The channels are needed to carry off water during heavy rains. In winter, the machine clears the track of snow. It can dig a maximum of five miles of ditches per hour.

Hens with white lobes lay white eggs, those with brown lobes lay brown eggs.





Copyright by Brown & Bigelow

CALENDARS WITH WINGS

By Clifford B. Hicks

ANY SPORTSMAN who has squatted patiently in a duck blind, waiting for that first flight of mallards to shower down from the early morning skies will put his stamp of approval on the paintings of Richard E. Bishop.

No armchair artist, Dick Bishop paints game birds as you see them over the barrel of a gun. His work somehow rekindles in your mind some half-forgotten incident of bygone hunting days—the wary old pintail that planed down just after you'd bagged your limit or the flock of greenheads that swooped in from nowhere to land not 20 feet from your blind.

Bishop is considered by sportsmen, naturalists and artists alike to be one of America's foremost painters of wild fowl. Millions of people throughout the world see his work on the Bishop calendars each year.

Artist's dramatic painting at top is printed on the annual Bishop calendar by the high-speed press at right. Many people have a collection of calendars



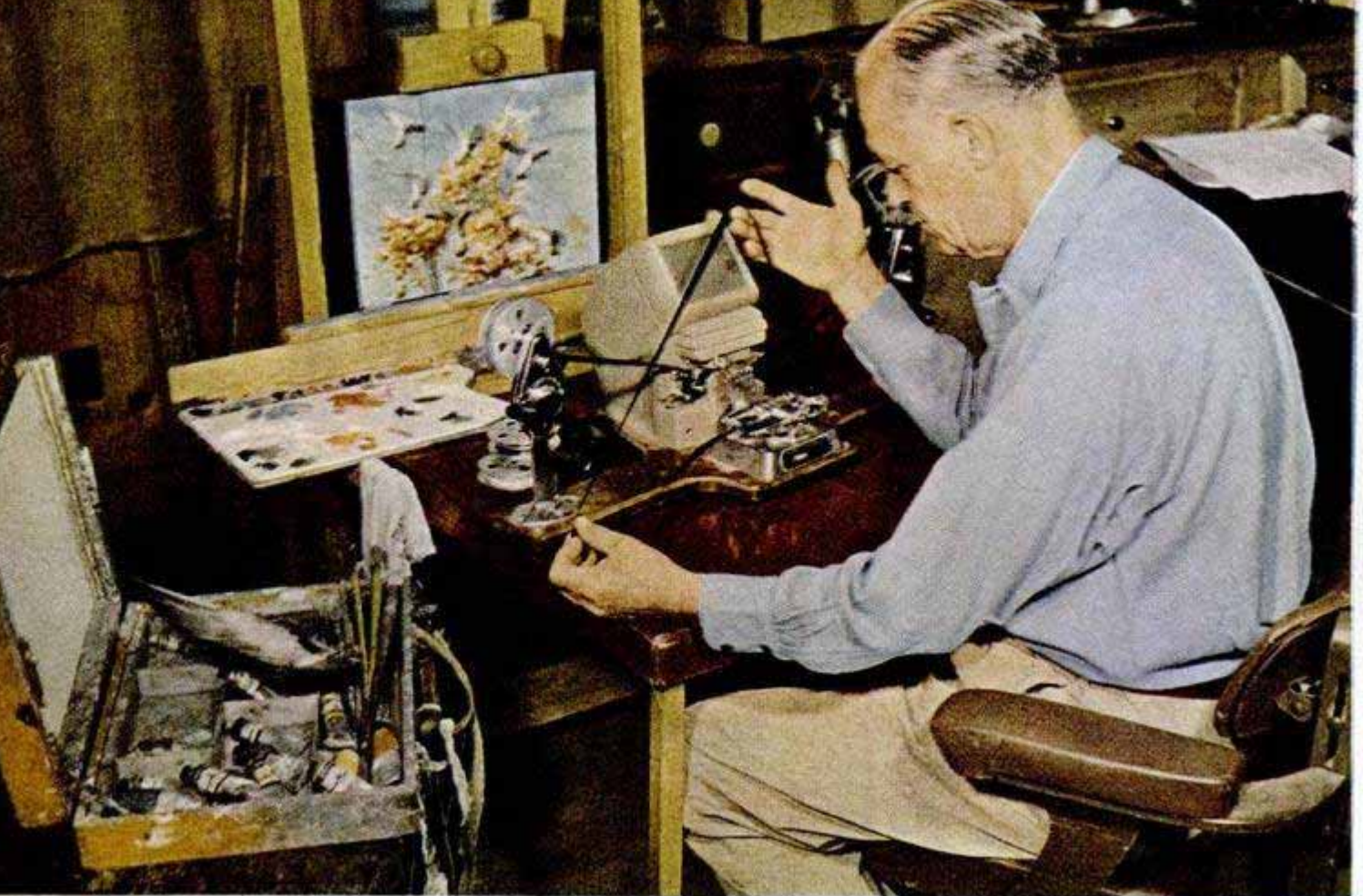

After Bishop has made a preliminary sketch, he runs through film file to find a similar movie sequence. Snipping out about three feet of the film, he runs it through a projector time after time to study the birds' action

The artist is able to impart a flawless realism to his work because he has spent a lifetime studying the flight of game birds. He has taken thousands of feet of slow-motion pictures showing wild fowl in all stages of flight. By studying these films, Bishop has discovered how a bird flies, how it lands and how it keeps its balance. Bishop's friends say they wouldn't be at all

surprised to see the artist himself hovering high in the air over his mountain-top studio some day.

Discharged from the Army back in 1919, Bishop returned to his old job as engineer and salesman for a rolling mill. He returned, too, to the lakes and marshes, to the woodcock cover which he had tramped and hunted all his life. One day engineer Bishop picked up an old sheet of copper and decided to try etching on it one of the game birds he loves. That started his career as artist Bishop. He had never taken any art training, but somehow, with a phonograph needle, wax and acid, he transferred to the copper the feeling of motion and majesty he saw over the barrel of his gun. A print of this etching won a prize in a Philadelphia print exhibit.

In an effort to broaden his field, he began studying art at night school. Soon he was painting flights of Canadian geese against

Artist is an authority on bird wings. His collection includes all types from an eagle to a humming bird. Such study produces fine realism in his paintings

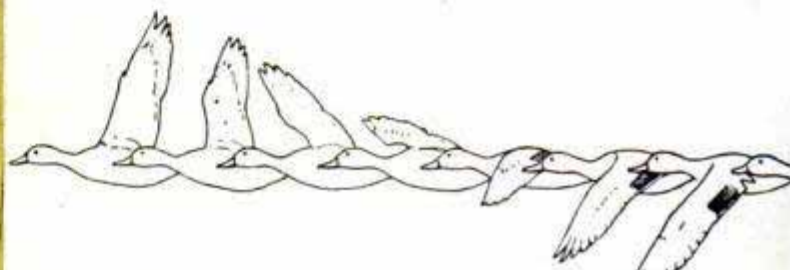



After Bishop has made a preliminary sketch, he runs through film file to find a similar movie sequence. Snipping out about three feet of the film, he runs it through a projector time after time to study the birds' action

The artist is able to impart a flawless realism to his work because he has spent a lifetime studying the flight of game birds. He has taken thousands of feet of slow-motion pictures showing wild fowl in all stages of flight. By studying these films, Bishop has discovered how a bird flies, how it lands and how it keeps its balance. Bishop's friends say they wouldn't be at all

surprised to see the artist himself hovering high in the air over his mountain-top studio some day.

Discharged from the Army back in 1919, Bishop returned to his old job as engineer and salesman for a rolling mill. He returned, too, to the lakes and marshes, to the woodcock cover which he had tramped and hunted all his life. One day engineer Bishop picked up an old sheet of copper and decided to try etching on it one of the game birds he loves. That started his career as artist Bishop. He had never taken any art training, but somehow, with a phonograph needle, wax and acid, he transferred to the copper the feeling of motion and majesty he saw over the barrel of his gun. A print of this etching won a prize in a Philadelphia print exhibit.

In an effort to broaden his field, he began studying art at night school. Soon he was painting flights of Canadian geese against

Artist is an authority on bird wings. His collection includes all types from an eagle to a humming bird. Such study produces fine realism in his paintings

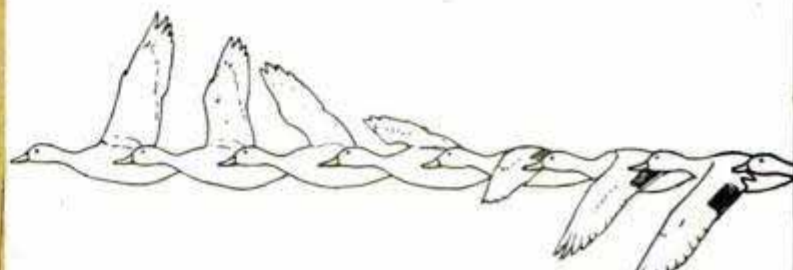



Copyright by Brown & Bigelow

CALENDARS WITH WINGS

By Clifford B. Hicks

ANY SPORTSMAN who has squatted patiently in a duck blind, waiting for that first flight of mallards to shower down from the early morning skies will put his stamp of approval on the paintings of Richard E. Bishop.

No armchair artist, Dick Bishop paints game birds as you see them over the barrel of a gun. His work somehow rekindles in your mind some half-forgotten incident of bygone hunting days—the wary old pintail that planed down just after you'd bagged your limit or the flock of greenheads that swooped in from nowhere to land not 20 feet from your blind.

Bishop is considered by sportsmen, naturalists and artists alike to be one of America's foremost painters of wild fowl. Millions of people throughout the world see his work on the Bishop calendars each year.

Artist's dramatic painting at top is printed on the annual Bishop calendar by the high-speed press at right. Many people have a collection of calendars





Wet or Dry Dust Spread By Sprayer

Power sprayers can be used for wet or dry dusting when a hopper attachment is added. Developed by the Aero-Mist Sprayer Company for use with their sprayers, the attachment does not interfere with normal use of the sprayer and is easily attached or detached. The hopper holds two cubic feet of dust and has a positive feed control that regulates flow from 2 to 10 pounds a minute.

Elevator on Wheels Lifts Bomb to Plane

Designed for the Air Force, a mobile lift elevates a 50,000-pound bomb 12½ feet into the air, high enough to fit it into the bay of a large bomber. Operated hydraulically, the lift is mounted on a wheeled carriage which can be used to move the bomb. In order to fit the bomb exactly into the opening, the elevator can roll it 360 degrees in either direction, shift it four inches to either side, 10 inches fore and aft or tilt it six degrees up and down.

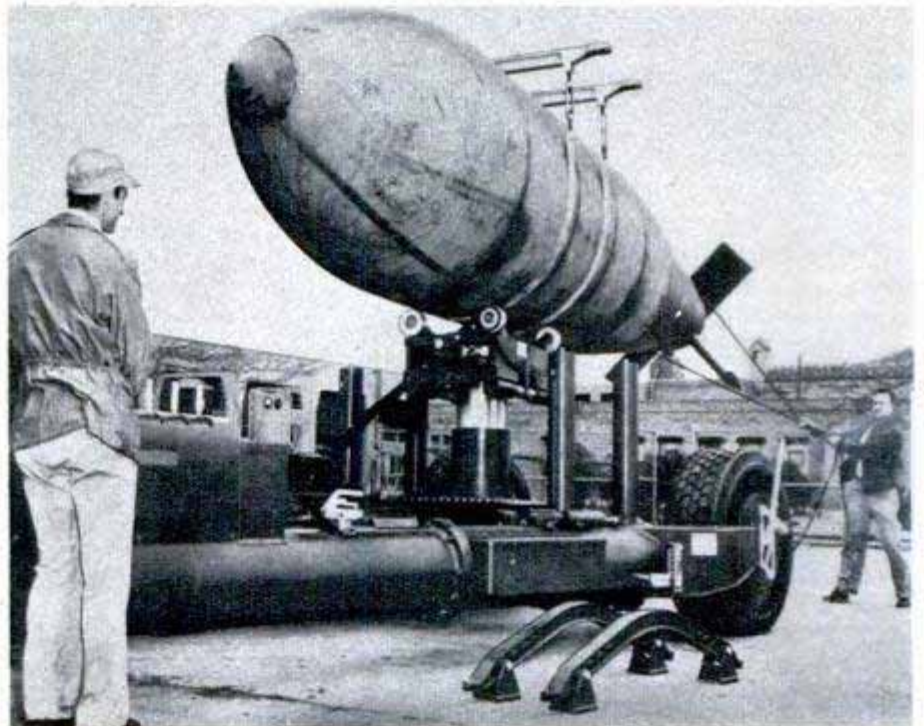

Cutter Digs Ditches Beside Rail Tracks

Powered by compressed air, a versatile machine for railroads clears track-sides of weeds and brush and then digs an 18-inch drainage ditch outside the rails. The channels are needed to carry off water during heavy rains. In winter, the machine clears the track of snow. It can dig a maximum of five miles of ditches per hour.

☞ Hens with white ear lobes lay white eggs, those with brown lobes lay brown eggs.



Flash Gun Is Tested Without Taking Apart

Photographers who use midget flash bulbs can test the circuit without removing the reflector assembly by means of a testing unit with a bayonet base. The unit is simply pressed into the socket like a flash bulb. It is especially convenient when testing several extension flashes because it eliminates removing the reflectors, a time-consuming but necessary chore when the conventional screw-type test unit is used.

Between-the-Lens Shutter Has 1/800 Second Exposure

Exposures as brief as $\frac{1}{800}$ second are made by a between-the-lens shutter that opens and closes in a manner completely different from previous models. Instead of moving in and out with a reciprocating motion, as conventional shutter blades do, the blades of the new shutter pivot and rotate through a partial circle to open and close in one continuous movement, eliminating the slight pause present in the reciprocating type when the movement changes from outward to inward. Featured on the Kodak Tourist, the shutter is said to be the fastest of its type in the world.

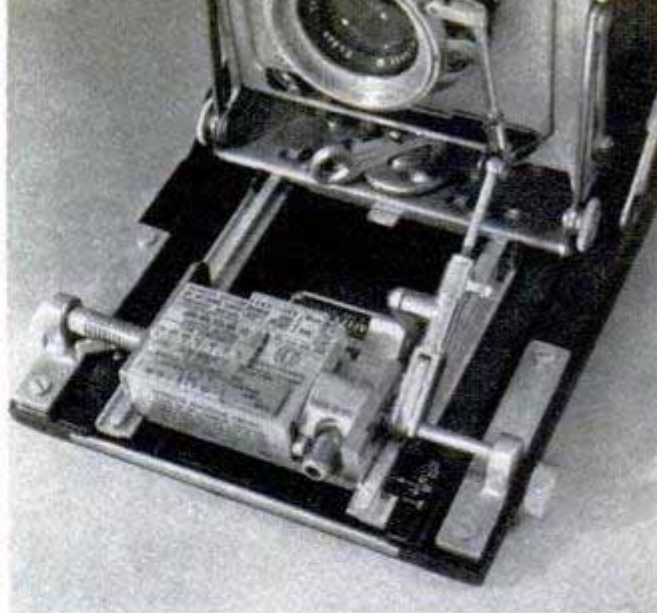

Automatic Diaphragm Control For Photoflash Photographers

Photoflash photographers don't have to bother about diaphragm settings when they have an exposure control coupled to their camera. The control device, designed for use on press cameras, automatically adjusts the diaphragm as the camera is focused. Several scales on the control are preset to match prevailing conditions. These include film speed, shutter speed, flash bulb and reflector types and the conditions of the surroundings. Once these have been set into the control, the photographer merely focuses and shoots, the diaphragm aperture being set by a mechanical linkage. The control does not interfere with normal operation of the camera.

Double Exposures Are Impossible With Magazine-Loaded Camera

Just about foolproof in operation, a new miniature camera has a film transport that winds the film as the shutter is cocked for the next shot, thus preventing double exposures. The 14-exposure film magazine used in the camera requires no threading. You just drop it in the camera, replace the side plate and wind the film. The combination shutter-cocking and film-winding process enables the photographer to take 14 pictures in less than 30 seconds.





the dark skies, mallards and pintails rocking and sideslipping in for a landing. About this time, too, he began taking black-and-white movies at 128 frames per second and analyzing the film to find out what happens to each feather during a wingbeat.

It wasn't long until the tail began wagging the dog. In 1933, at the height of the depression, he abruptly dropped his sales and engineering work and became a full-time artist. It was a wise decision, both for Bishop and for sportsmen.

Bishop's calendars, published by Brown & Bigelow of St. Paul, have become the chief means of broadcasting the beauty of his paintings. They adorn the walls of 250 different types of business establishments from coal yards to night clubs. Each year six of the artist's paintings are reproduced on the Bishop calendar, treasured by sportsmen everywhere.

The artist first makes small pencil sketches to work out the approximate scenes he wishes to depict. Then, working very fast, he paints from 8 to 12 of the scenes in oil. He says he "roughs them in" but most sportsmen would be happy to frame and hang these "roughs."

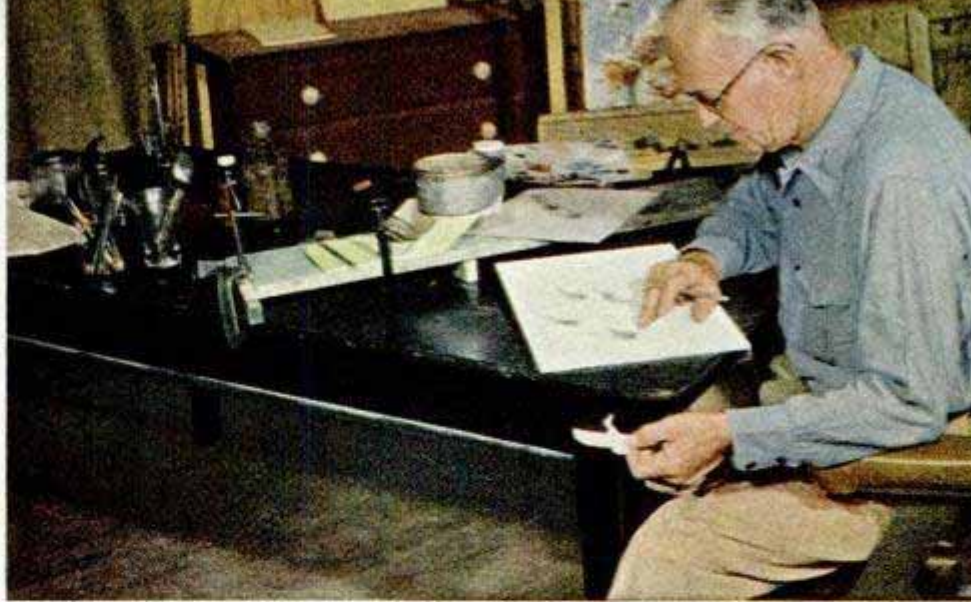
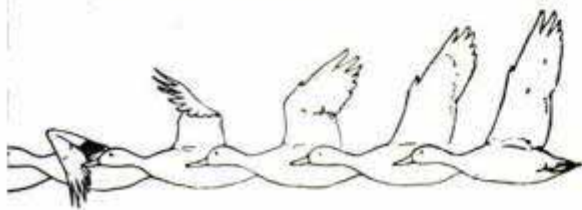

First step in painting is to lay out pattern of birds with cutouts

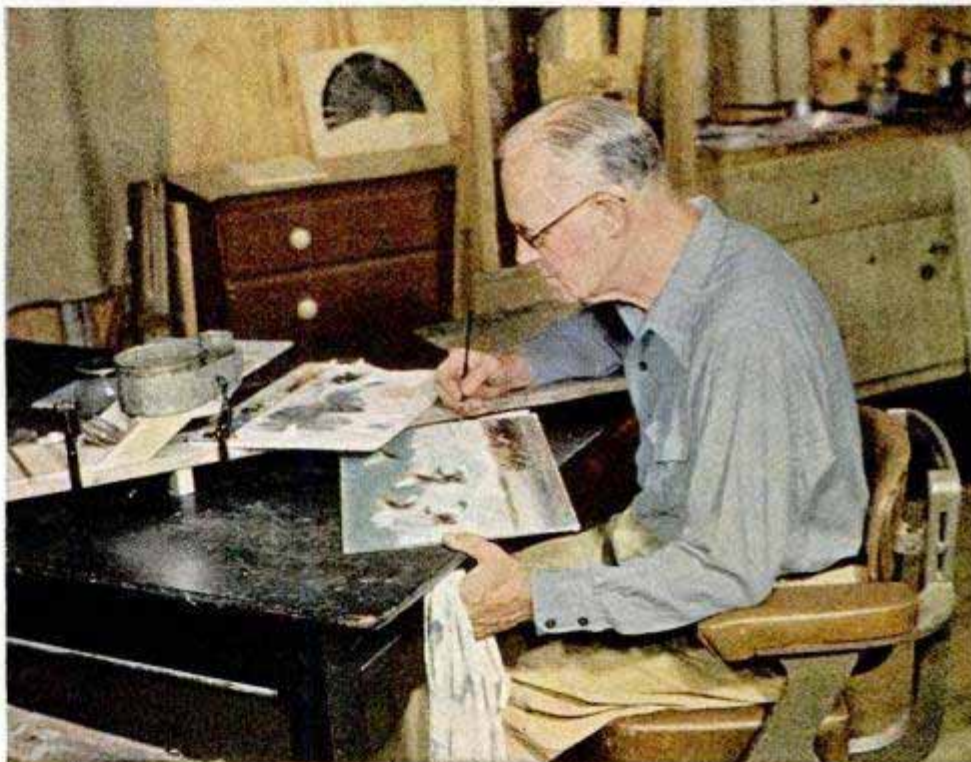

Next, Bishop fashions what he calls a "rough" to serve as a guide. Actually, most sportsmen would consider it beautiful enough to hang. Below, to get detail for final painting he studies wings of a shoveler

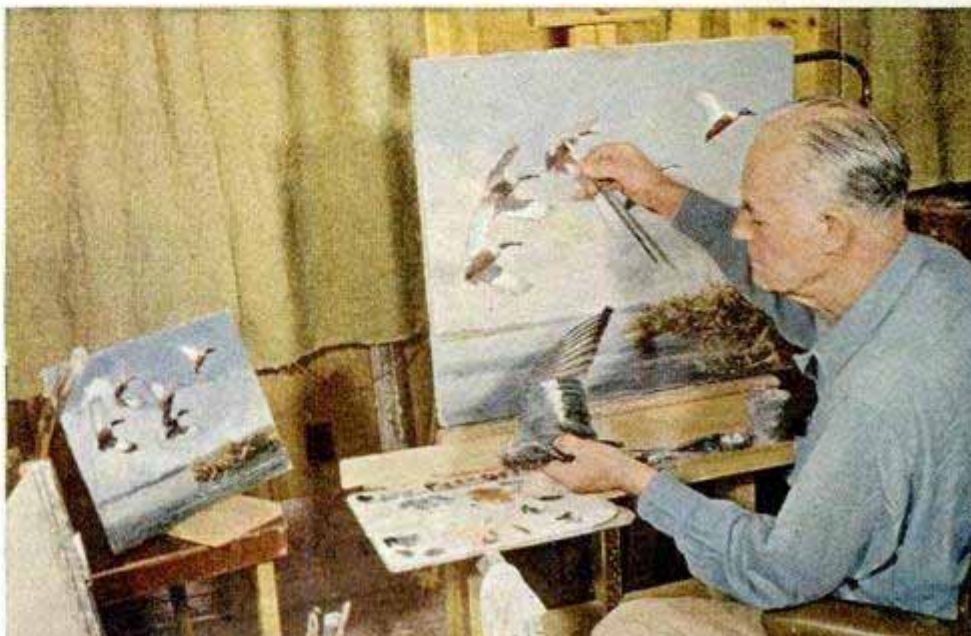

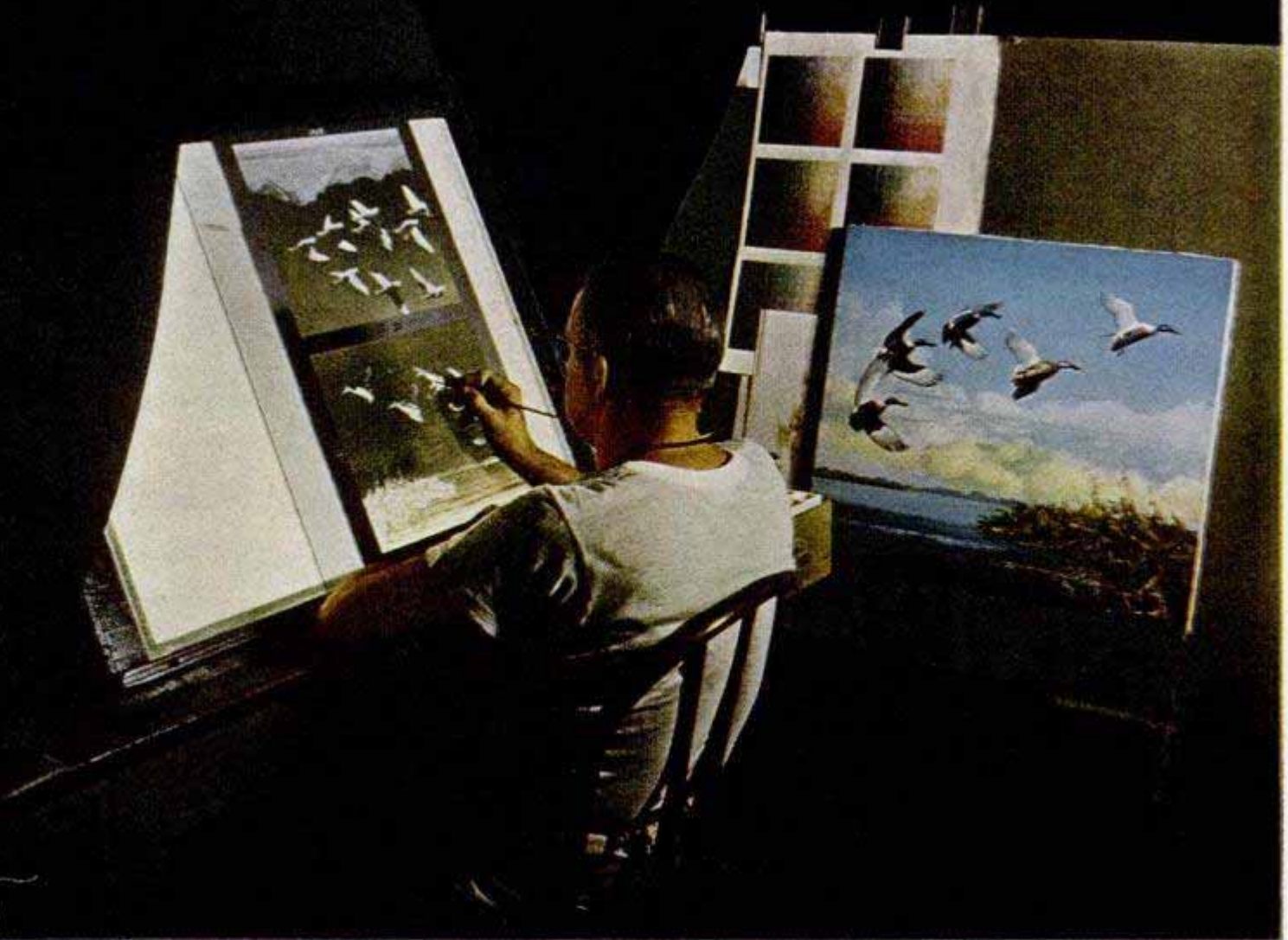

In printing painting, it is photographed into color-separation negatives. Here artist retouches negatives. He compares painting and color chart with them. Below, Bishop's fireplace tiles each show different bird



These preliminary paintings, each showing a different type of bird, are sent to Brown & Bigelow, where a committee chooses six of them for final execution. Then with a

deft brush and the knowledge that has come from many years of wild-fowling and study, Bishop covers the canvas with birds so real that you can hear the rush of their pinions and the slap of their feet as they plane in for a landing.

It is during this phase of his work that Bishop uses his extraordinary motion pictures. The artist has traveled throughout the North American continent, Great Britain and the Pacific islands to photograph wild fowl in their natural surroundings, an undertaking that requires much more skill than firing a shotgun at a rising redleg. This month he is leaving on a trip to Africa to photograph the birds of that continent.

Bishop's 16-mm. camera originally was designed to analyze machinery or sports in

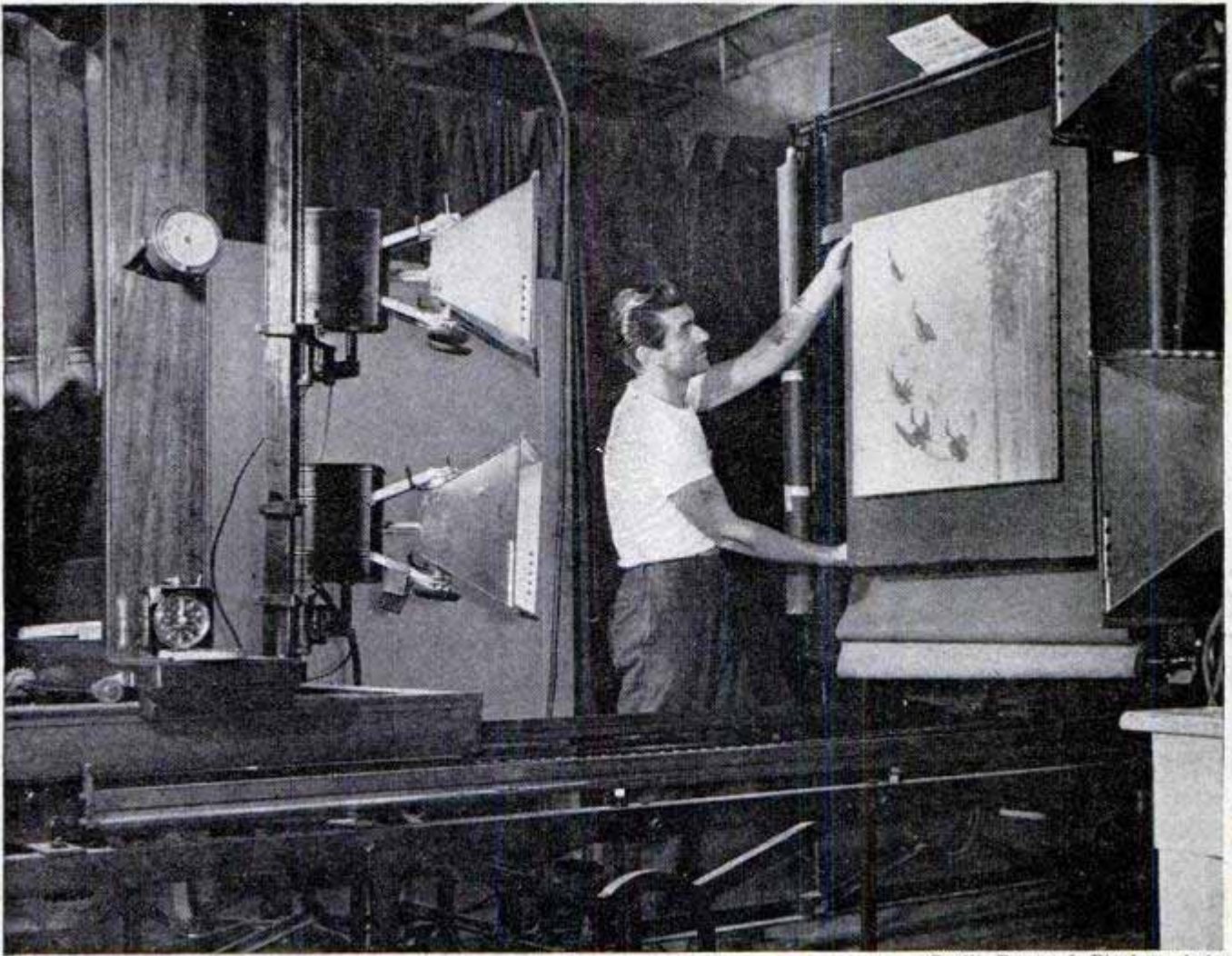

Credit—Brown & Bigelow photos

slow motion. He uses a six-inch lens with an f:2.7 aperture. Years ago he told a friend—a mechanical and mathematical genius—what he wanted in the way of a range finder. The friend came back with a superb attachment that will focus from infinity to 10 feet in an instant by the movement of a trigger on the camera gunstock. The movies are taken on color film at $\frac{1}{250}$ second, with 128 exposures per second. When they are projected, the birds move at only one eighth their actual speed. And the lens brings them fluttering up to your lap.

In the field, Bishop virtually thinks like a duck. He anticipates their movements and knows where they are apt to fly next. But the focal depth of his lens is only about 18 inches, so a large percentage of his motion pictures are out of focus. He edits his films, throwing out an estimated 80 percent of the footage. He has exposed at least eight miles of movie film in 25 years.

When an approved calendar sketch is returned to Bishop, he runs through his film file and finds a flight of birds which duplicates the action he wishes to depict in the final painting. He then snips out about three feet of the chosen sequence, splices the ends together and mounts the film in his projector. When he turns on the

(Continued to page 238)

This camera separates the colors in the painting, taking one negative for each of printing-ink colors

Complete six-sheet calendar is assembled in mounting machine, which binds it with strip of tin across top



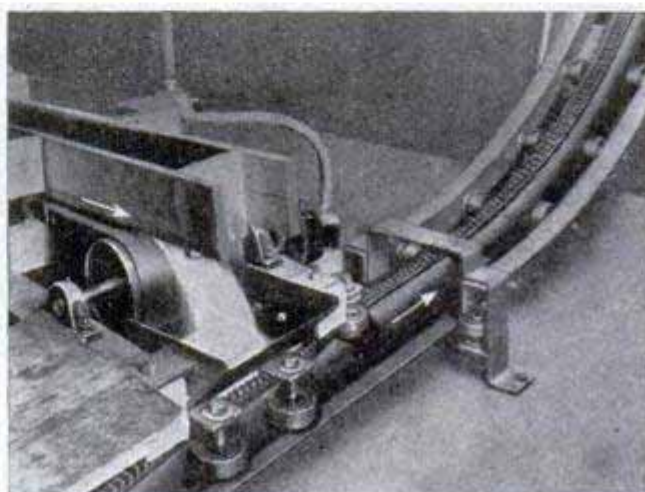
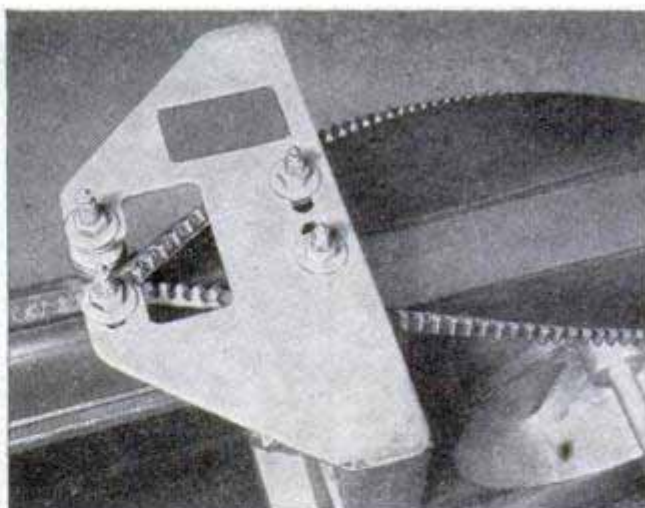
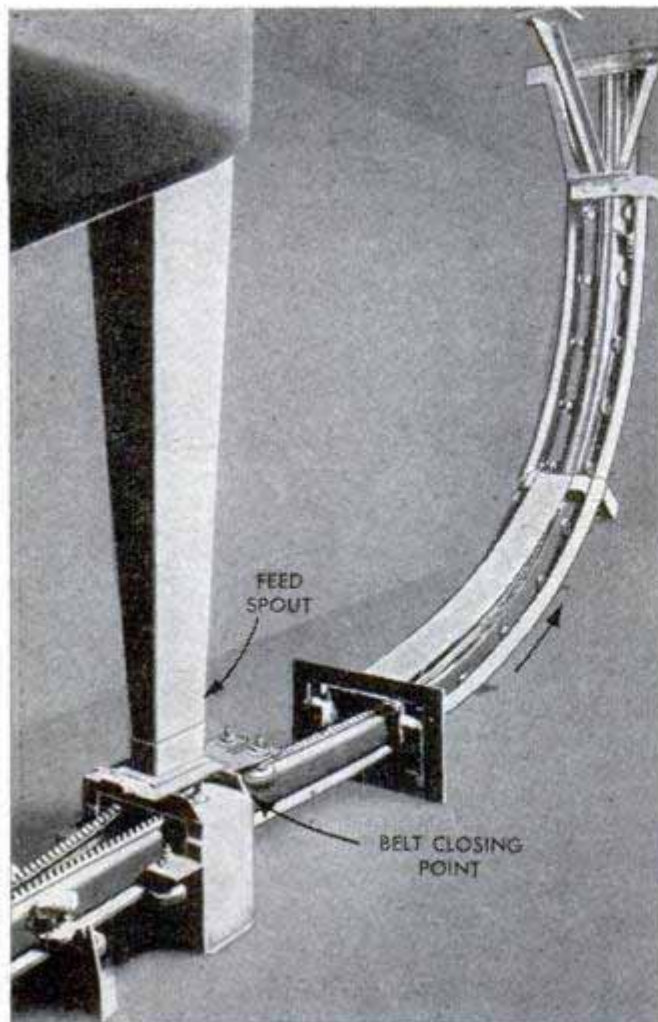

Left, materials drop into open top of belt just before zipper teeth are closed. Top, right, ball-bearing rollers unlock teeth to discharge load. Lower, right, flat conveyor belt can be set up to feed zipper belt

"Zipper" Conveyor Belt

Rubber teeth on a new conveyor belt mesh like a zipper, sealing the belt into a tube that can travel up, down or around curves. The belt is designed to handle breakable materials gently and without contamination. It is being used to move

seed corn, almonds, fragile ceramic pellets and dehydrated potatoes. The open belt approaches a feed spout where the material is dropped inside. Rollers then lock the teeth together and the belt moves along a track. At the unloading point, rollers force the teeth apart and the belt is drawn over a pulley to discharge the load.

Automatic Transmission for Ford and Mercury

Clutch pedals will be missing from Fords and Mercurys equipped with a new automatic transmission which is expected to be in production early next summer. This transmission, developed by Borg-Warner Corp., in cooperation with Ford, will feature gasoline economy. Officials of the Ford Company report that in tests the new transmission gives better gasoline mileage than cars fitted with the old conventional transmissions. The shift embodies a hydraulic torque converter and an automatically shifted three-speed planetary gearbox. The latter is so arranged that the engine transmits power in all gear ratios. Automatic changeover from intermediate to top gear is effected anywhere from 15 to 60 miles an hour. The changeover depends on the amount of throttle used. The trans-

mission selector on the steering column has four positions for driving conditions and a fifth position for the parking brake. Neutral is in the center with driving range and low-gear positions to the right; parking and reverse are to the left. As in other automatic selectors, the shift to low gear or reverse is done manually; all other driving is done with the selector in driving-range position and the shifting is fully automatic. According to reports, the optional transmission will be priced at "not over \$150."

☞ Creaking joints are not a sign of old age, says an Oregon doctor, whose experiments show that such factors as temperature, humidity and even thunderstorms affect the frequency with which the bones in his fingers cracked when twisted.

Lightweight Chain Saw →

Weighing only 11 pounds, an electric chain saw can be equipped with an extension pole so that you can cut 12-inch branches high in a tree while standing safely on the ground. By taking two cuts, you can fell, buck and limb trees up to 24 inches in diameter. Its lightness makes possible one-hand operation from a ladder or scaffolding. Operating on 115 volts, a.c. or d.c., the saw plugs into any standard household outlet or, for field work, it can be powered by a portable generator.

Rocket "Diary"

Guided missiles now carry a magnetic metal tape "diary" in an armored cylinder when they penetrate the atmosphere miles above the earth. Data on air pressure, speed, temperature and many other factors are recorded on the tape which is 150 feet long and six inches wide. The recorded section is fed into a cylinder, armored to withstand the shock of crashing to earth when the missile's flight ends. After recovery, the tape is played back through a transcriber and the information plotted on charts. Developed by the Armour Research Foundation of the Illinois Institute of Technology, the new method may replace the automatic radio signals now used. The present system involving radio signals requires elaborate



air and ground equipment, and difficulties are often encountered in both transmission and reception.

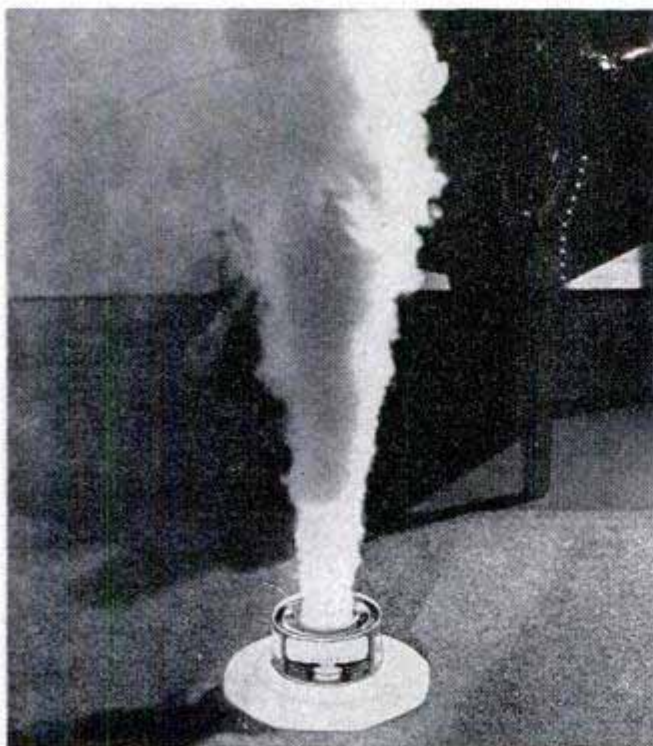

Automatic Dispenser For DDT Insecticide

Smoke is used as a carrier for DDT in a new indoor insecticide packaged in a can that dispenses the spray automatically. According to the manufacturer, the smoke-borne DDT not only kills flying insects, but it continues to kill bugs for several weeks after the treatment because of the invisible layer of DDT that remains on all exposed surfaces. When a release tab on the can is pulled, the DDT-carrying smoke issues from the can and circulates through the room, getting into hard-to-reach places. The smoke will not soil or tarnish anything and, after airing, the room retains no odor.

☞ Hot was the word for the temperature at Azizia, Libya, North Africa, on Sept. 13, 1922, when the thermometer read 136 degrees, a world's record, according to the U. S. Weather Bureau.



Young lady whispering to Mrs. Santa, who tends to her knitting, shows the relative size of this huge display

SANTA CLAUS LIVES IN

By **Richard F. Dempewolff**

SANTA CLAUS' workshop is not at the North Pole as you've been led to believe. It's in Pittsburgh.

There, in two big factories covering 150,000 square feet the floors are chock full of startling realistic mechanical creations. Eight-foot Santas sit in monstrous chairs, heaving with deep-bellied laughter. Some roll their twinkling eyes at passers-by, others slap their big thighs in good-humored mirth. Near by Mrs. Santa rocks back and forth knitting a sweater she's been working on for 15 years.

Mechanical gnomes poke their Disneyish faces from every nook, some playing tunes on fiddles, others hammering at forges or working at planing tables. There are reindeer that move and talk, fairies and elves hovering on gossamer wings. There are Santas riding in jiggling jalopies, Santas in sleighs full of toys, Santas being bathed by dwarf attendants. There are rocking Santas, laughing Santas, talking Santas.

But that's not all. Here in this craftsman's



Elysium from time to time you might find complete, full-scale houses under construction, full-size diesel engines, a monstrous electric razor capable of shaving Paul Bunyan, or even Paul Bunyan himself, 23 feet high in sitting position, with eyes that turn and lips that move as he speaks.

On the other end of the scale are models to delight the most exacting model builder. A table-top model of an entire steel mill, for instance, in which tiny machinery takes the miniature billet, rolls it, drops it in a furnace, stamps it out in forms, lifts them by diminutive crane, runs them through baths and produces one-inch railroad-car wheels. Or perhaps you'd be more fascinated by the pocket-size working model of a four-ton lathe.

Over this dazzling array of craftsmanship hangs an aura of busy excitement. There's a medley of singing saws, whirring motors and the tinkle of music boxes being tested—punctuated by the steady tattoo of hammers. With Christmas coming on, the demand for Santa Clauses is tremendous.

Department stores want mechanical Christmas displays for windows and toy departments. Industry wants models and eye-catching behemoths for conventions and fairs.

So, today, the inventors, artists and master mechanics in Pittsburgh's streamlined version of Santa's North Pole factory—the Gardner Displays Co., which began in 1918 as a little sign-painting shop and has grown into one of the biggest display outfits in the country—are busier than ever satisfying demands.

The St. Nicks and their whimsical entourage of dwarfish folk were introduced to the Gardner line about 10 years ago by Karl Roth. Roth, until his recent death, was a busy, gnomish fellow himself. He gave the mechanical Santas every realistic quirk his fertile mind could conjure. Their



Rocking Santa gets his whiskers curled in preparation for the holidays

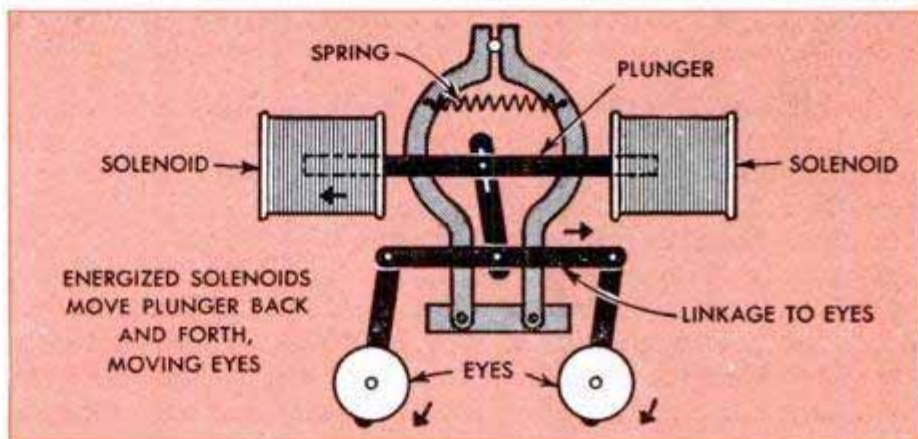

PITTSBURGH

Above, solenoids and linkage control eye movements. Below, when these Santas and gnomes are dressed up for Christmas, you won't see the "works" visible here



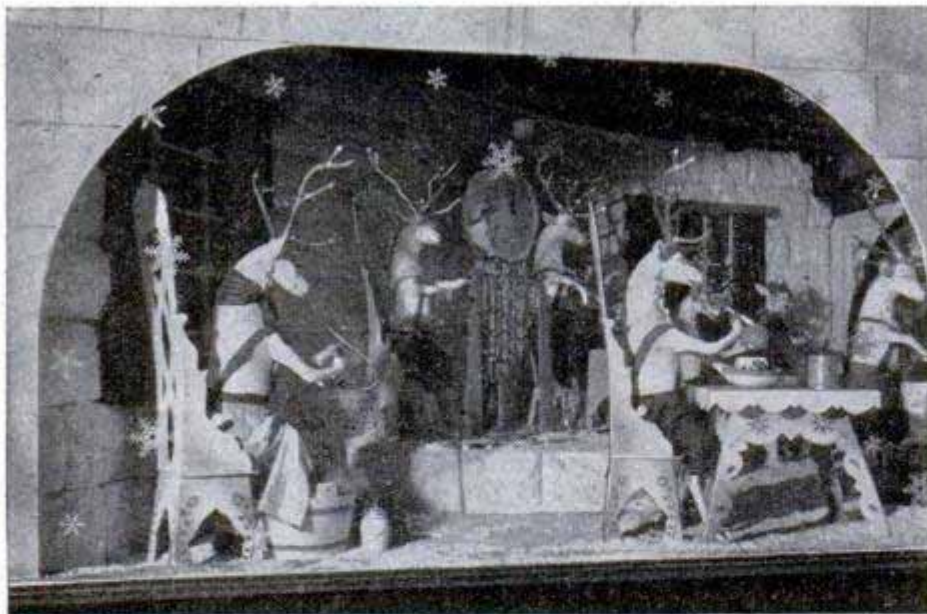

In this display, the reindeer at left has a cold and sprays his nose with an atomizer. The one at the table helps himself to a big Christmas dinner

bellies shake when they laugh; their shoulders heave; they tap their feet. Today there are 36 big laughing Santas in existence, plus 250 others that perform a variety of stunts. Each is handmade and the biggest ones rent for \$500 a season. At that, there aren't nearly enough to go around. Stores lucky enough to rent them continually get requests from parents to hold them over. One store got so many such requests that it had to keep Santa laughing clear through January.

Since the first Santa, Karl Roth's principles have been applied to other kinds of

Gardner robots. Reactions are always terrific, for the incredible realism of these creatures is enough to stand your hair on end. Recently, one of the men from the Gardner executive offices was walking through the shops and happened to see a realistic figure being set up for an elaborate display. He felt the fellow's foam-rubber countenance, whereupon the figure raised its hand, opened its mouth and snapped, "Take your hands off me. What d'ya think you're doin', Bub?"

The genius behind the vocal chords of the Santas and other Gardner robots is Bill Hill, an electronics wizard. "All our talking and moving figures have a spinal column," he explains. "This carries the wiring and relays which synchronize the lip action with the voice."

The mouths of Gardner talking dummies don't just bob up and down rhythmically. They go by syllables. The skeleton framework of the head is made in two pieces. The lower jaw, hinged under the skull, is an entirely separate piece that raises or lowers just like a human jaw, held shut by a spring. It is drawn downward by an

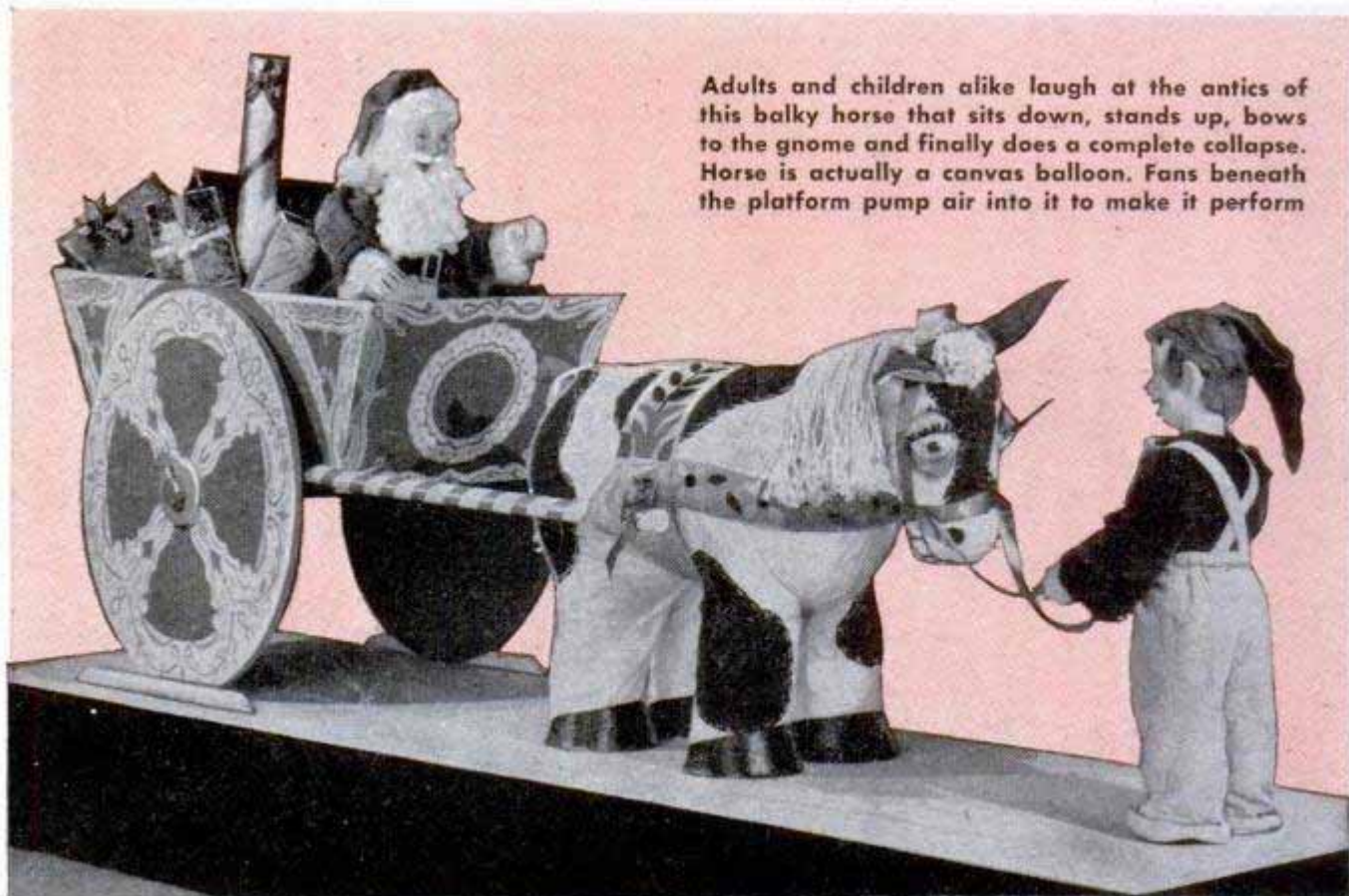

Adults and children alike laugh at the antics of this balky horse that sits down, stands up, bows to the gnome and finally does a complete collapse. Horse is actually a canvas balloon. Fans beneath the platform pump air into it to make it perform

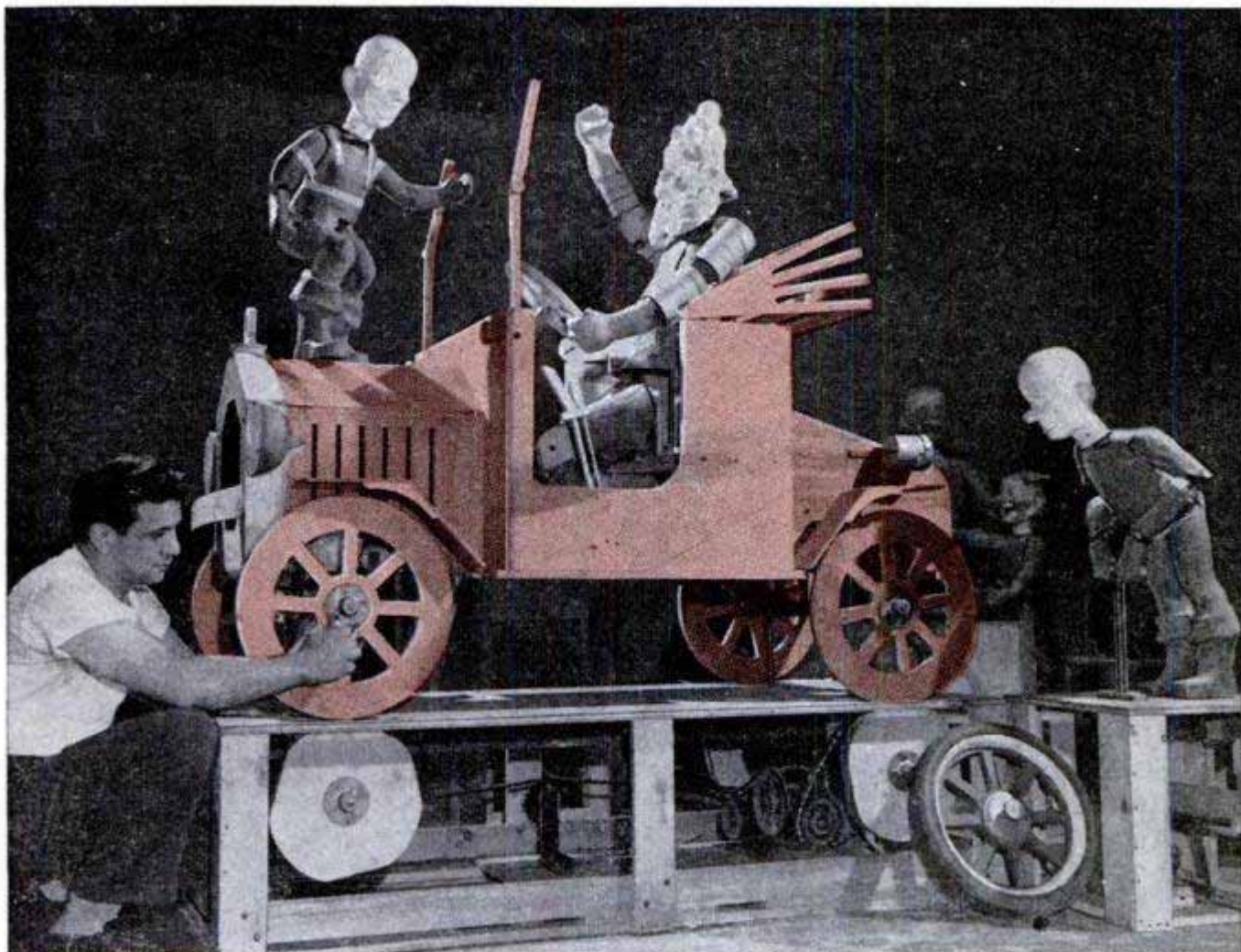

The "Jalopy" is the latest Gardner creation. Santa and gnomes put on an act as it bounces over the "highway"

Not all Gardner displays are for Christmas. This is a "weather bird" that talks, giving weather reports

Working in Santa's workshop, this animated gnome is busy night and day, planing away on a piece of wood

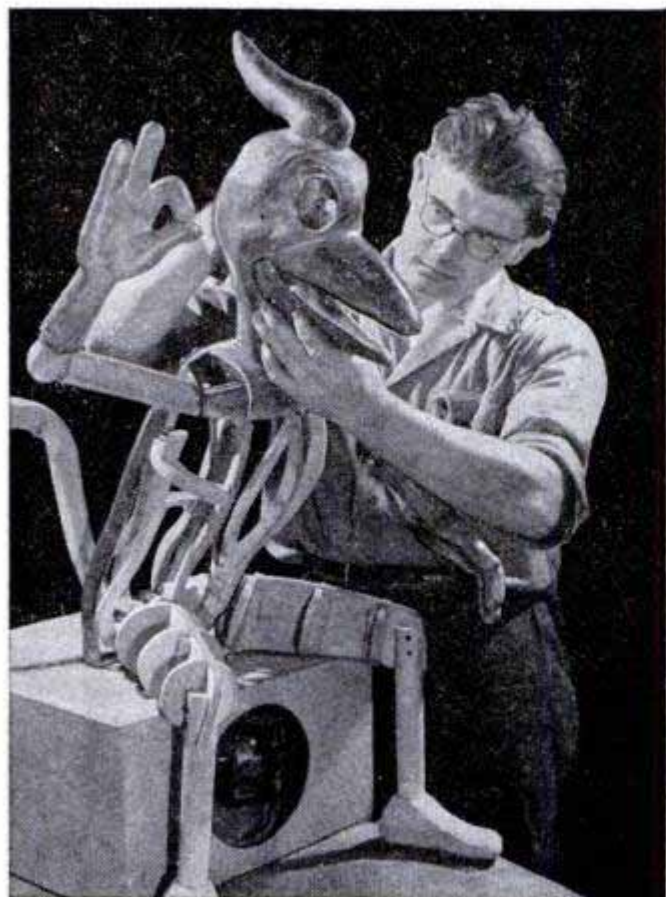



Truly a Paul Bunyan of displays, a 23-foot model of the huge woodsman talks and moves. That's a real girl between his feet

Below, assembling the mighty Bunyan at the Chicago Railroad Fair. It took two men to put the fist of the figure in place



electromagnet which, in turn, is controlled electronically by sound impulse. Somewhere in the figure—usually in the chest—is a loud-speaker, from which the voice is broadcast. Thus, a hidden operator with a mike can answer questions asked by anyone in the audience. Current goes from the operator's mike through an amplifier, which furnishes power to operate the lips. The longer the syllable, the more power. And the more power, the longer the reaction on the electromagnet, which holds the jaw down until the syllable subsides. To heighten the realism, the skeleton framework of the giant's head is covered with foam-rubber skin and features.

Movement of the creatures is controlled either automatically by eccentric cams, or manually by push button. "We make them stand up and sit down," says Hill. "Their eyes roll by electromagnet operating on a hinged crossbar like the eyes of a 'sleeping baby doll'; their hands can move to saw a fiddle, raise in a gesture, hammer pegs, or shake yours—all by simple arrangement of motors, cams, shafts and gears."

A 12-foot "Alice in Dairyland," made especially for the Wisconsin Centennial, stood up from a chair, greeted visitors as they entered, then sat again. At the Chicago Railroad Fair, there was Genial Joe, the nine-foot railroad engineer, who answered questions about railroading all day long.

Gardner craftsmen will tell you that nothing is impossible. Hanging above the desk of Jim Seibel, whose job it is to figure out how to design and build many of the weird requests that come in, is a quote that says: "It's a significant coincidence that the word American ends in 'I Can.'" Seibel believes it, too.

Recently, a client wanted a series of animated dioramas that would be seen one at a time—like a shifting scene. Seibel and Hill went them one better by having the three-dimensional dioramas fade into each other. How? A Chinese mirror, transparent glass when you look through it at one angle, a mirror at another. Half the dioramas were set up on a moving belt on a platform. The others went on a second platform belt in front of,

(Continued to page 266)



Helicopter Flies "No Hands"

Another aviation "first" was made recently by Stanley Hiller, Jr., when he flew as a flight observer on the first pilotless cross-country flight to be made by helicopter. With an empty cockpit, the helicopter

flew 25 miles over San Francisco Bay at an altitude of 3800 feet. The flight was made possible by a control system developed by Hiller to stabilize the performance of helicopters. The machine in which the historic flight was made is a Hiller-360, a product of United Helicopters, Inc.

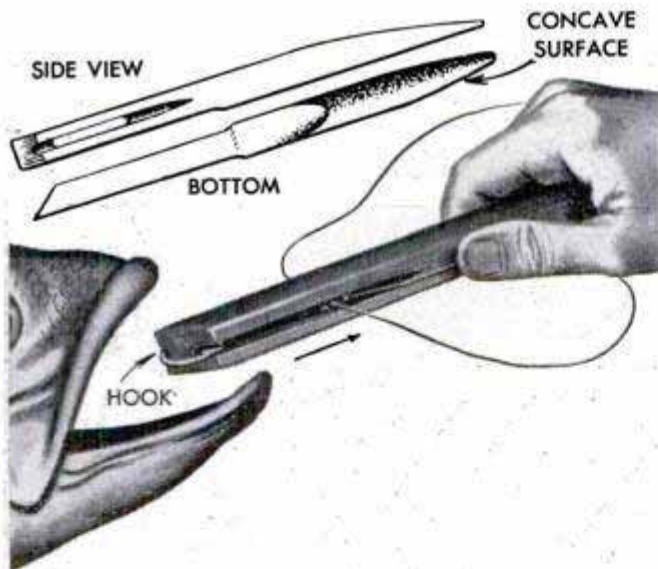

Tool for the Angler

Scaling, removing hooks and picking fish from a gill net are just a few of the jobs accomplished by a versatile tool for anglers. Made of plastic, the tool can't damage lines, nets or hooks. When a hook is deeply embedded, the angler loops the line through a slot and pushes the tool down the fish's mouth. When the hook is forced out, the barb seats in a groove while the tool is pulled back out. The pointed end of the tool can be wedged into a gill net to free the fish, or used as an aid in splicing rope.

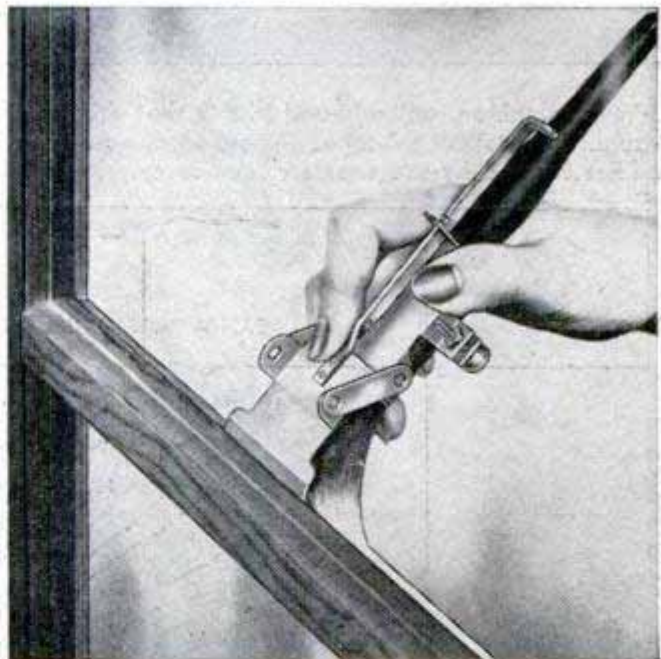

Paintbrush Guide

You can paint window sash without smearing the glass with a guide which clamps to the brush. A blade on the guide slides along the edge of the glass, protecting it from the paint. When the brush is to be used for ordinary painting, the guide slides back out of the way. It fits any 1½-inch brush and is also useful for painting trim or molding.

The Case of the Vanishing Sardine



Above, plankton, animals and plants that drift with the current are caught in nets like this one. Below, sardines spawn in the two huge eddies formed by the counterclockwise current off California's coast

IT REQUIRES no Sherlock Holmes or J. Edgar Hoover to figure out what happened to the passenger pigeon, the buffalo or the trumpeter swan. These creatures, which once existed in large numbers in the United States, were slaughtered by men and guns.

But down in the mysterious depths of the sea it is much more difficult to explain why certain finny species suddenly disappear.

For example, the sardine. It might not be a major calamity if you never ate another sardine sandwich. Tuna or salmon might do just as well. But thousands of fishermen all over the world depend for their livelihood on catching these little fish with greenish-gray back and silvery undersides.

In recent years, off the coasts of Portugal, India, Japan and California, where 40,000 persons have depended upon the sardine for a living, the total catch has dwindled from a high of 800,000 tons to a mere 150,000 annually. This has meant a yearly

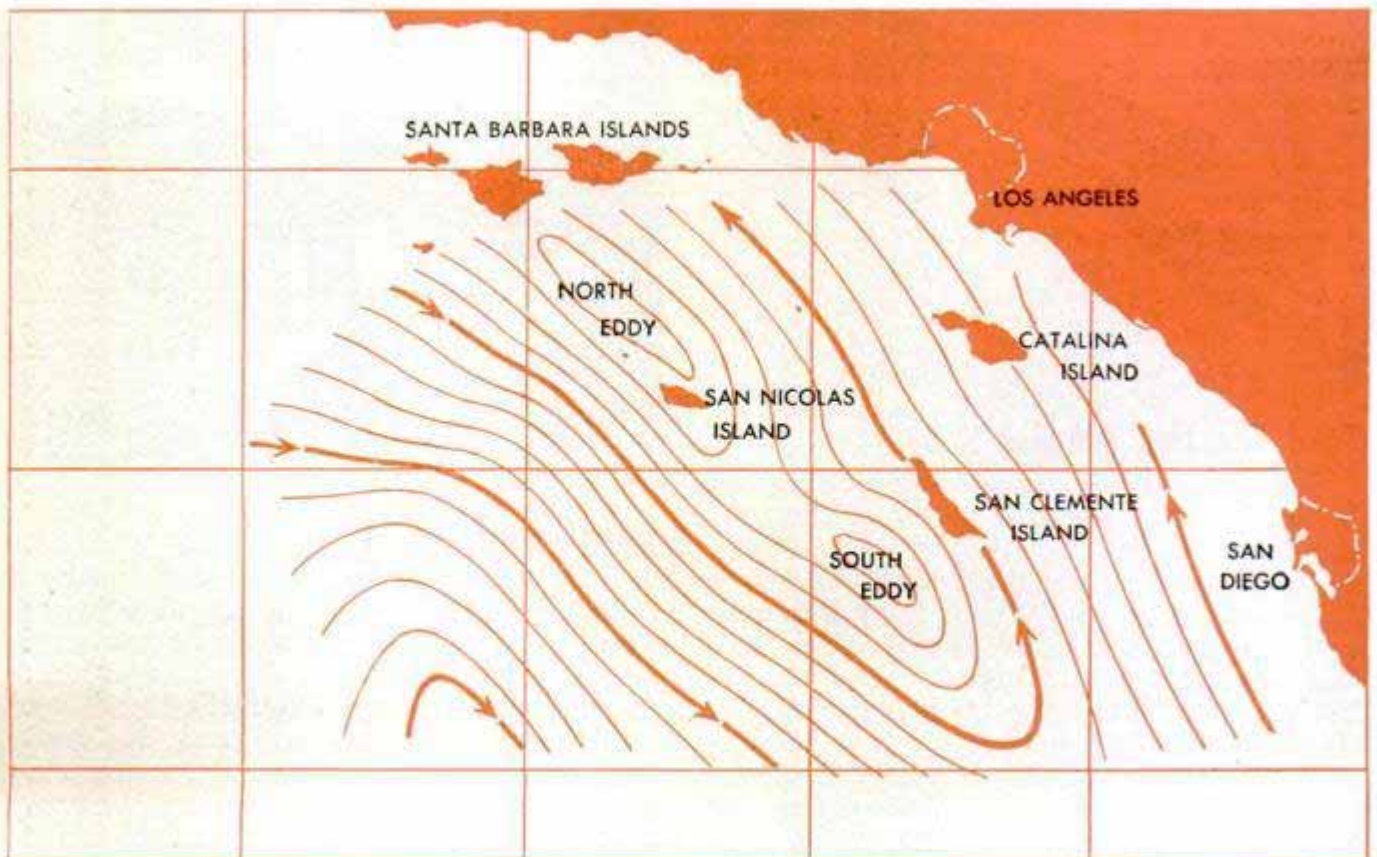

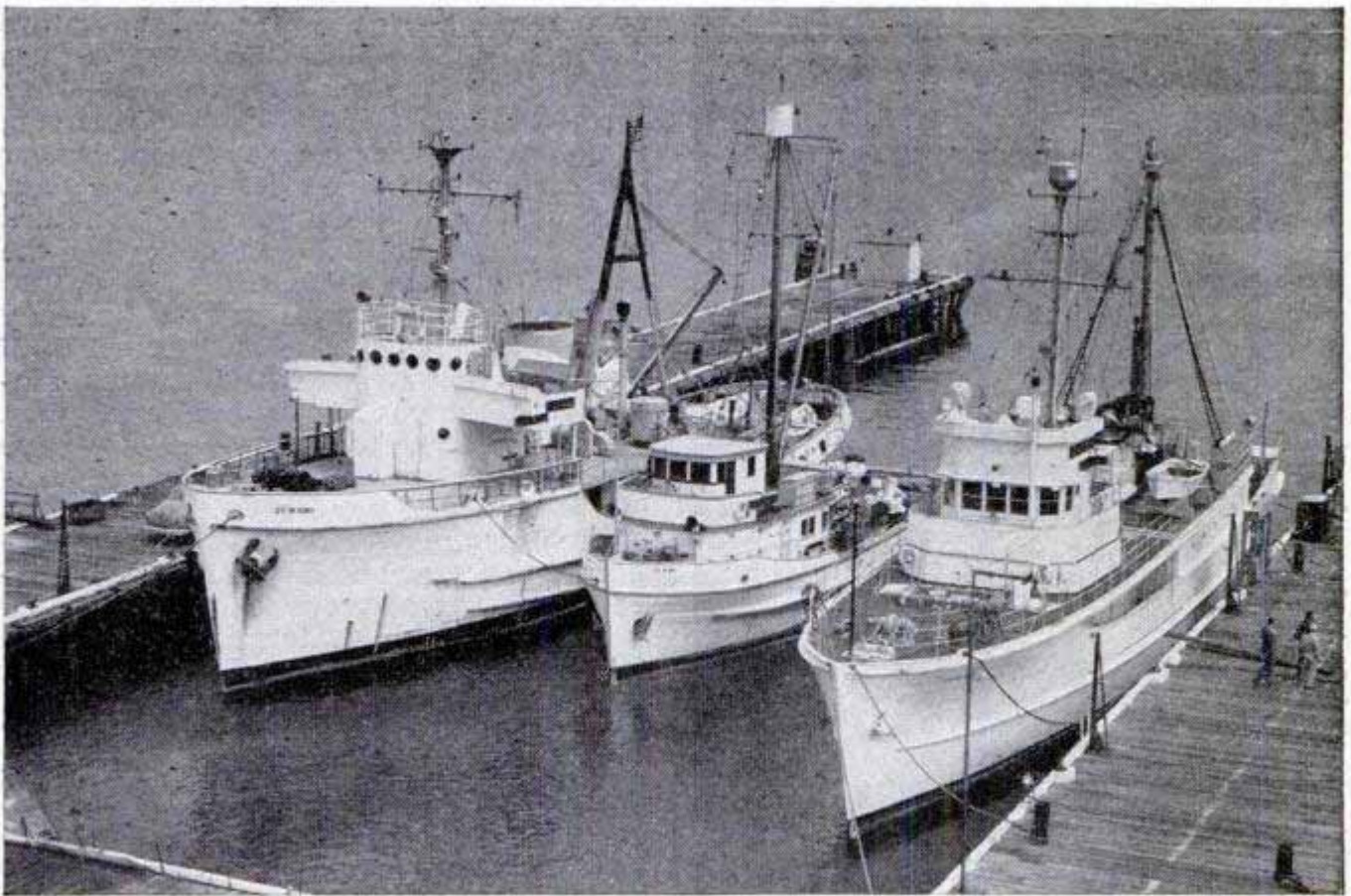

These vessels are part of the fleet that sails under the Scripps flag trying to solve the sardine mystery

loss of \$30,000,000 to California's sardine fishermen alone.

That's why three years ago they called upon the University of California to set up a Marine-Life Research Program.

In effect, they said:

"We want you to put your best fish detectives on this case and find out what's happening to the vanishing sardine."

To finance the program, the California legislature appropriated \$700,000. In addition, a special tax of 50 cents a ton was slapped on all sardines netted off the California coast. Collaborating with the University of California in what has been described as "the greatest fishing expedition in history" are the California Division of Fish and Game, the U. S. Fish and Wildlife Service, the U. S. Navy and the California Academy of Sciences.

At the Scripps Institution of the university, a 110-man team has been gathered to investigate the sardine problem. It includes learned biologists, chemists, physicists, meteorologists; highly

skilled cartographers, laboratory assistants, marine technicians; and seagoing crews for the "floating laboratories" that sail the Pacific to solve the mystery of the disappearing sardine.

In charge of the project is Dr. Roger Revelle, a tall, cigar-smoking scientist who was a commander in the Navy's Hydrographic Office during the war. His colleagues jokingly call him "The Admiral."

An artist works on a topographic chart of the canyons in the ocean floor

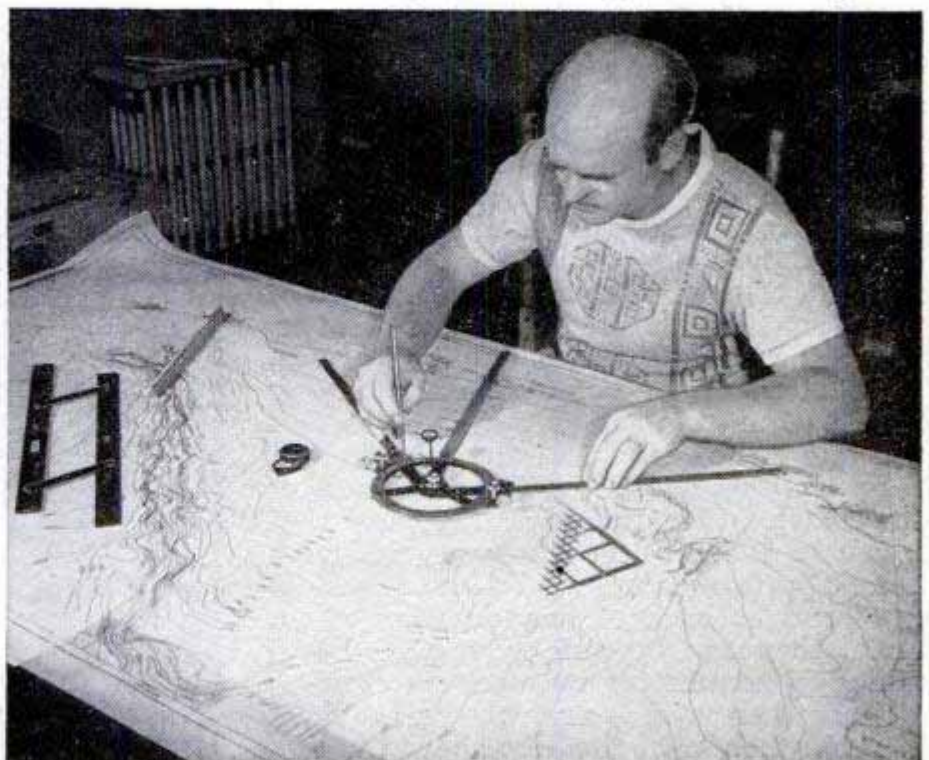

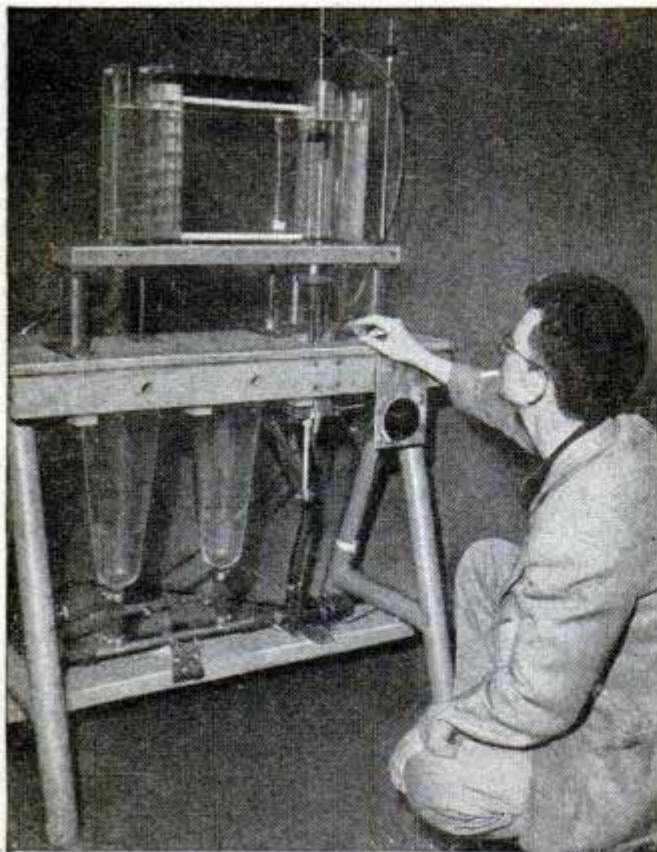

This device, the elutriator, sorts the animals and plants brought up as samples from the ocean depths

His sardine-hunting "fleet" consists of six ships. Four belong to the Scripps Institution, two others to cooperating agencies.

These six ships are now investigating the 670,000 square miles of ocean that lie in a 400-mile belt between the Columbia River and Cedros Islands of Lower California.

Assigned to regular patrol duties are the *Horizon*, *Crest* and the *Black Douglas*. Every month each of these ships covers one third of the total area, stopping at "stations" 40 miles apart to take samples of sea water and sea life down to depths of 3000 feet. This means that each ship must be at sea at least 15 days a month. When storms brew and the little ships bob about like corks, it's rugged duty for the 17-man crews and the scientists aboard.

Scientists and technicians at the Scripps Institution investigate weather and currents, analyze sea water, study the tiny animal and vegetable life in the sea, as well as the commercial fish and larger sea animals. In addition, the Fish and Wildlife Service, at its laboratory on Point Loma, is studying the spawning habits of the sardines and the fate of the young, newly hatched fish.

So well equipped are the six vessels of the Marine-Life Research Program that much of the routine laboratory analyses can be performed at sea. When the results are brought back to headquarters at La Jolla, they can be quickly analyzed and added to existing information.

Fishermen over several years have evolved their own theories about the dis-

appearance of the sardines. "Temperature changes in the water killed 'em," argues one old salt. "Lack of plankton—they starved to death," says another, referring to the microscopic plants and animals near the surface on which the sardines feed. "Sea lions gobbled 'em up," decides a third man. "They migrated to other parts of the Pacific," declares a fourth.

The scientists themselves won't be ready to say what happened to the sardines until they've completed several more years of investigating all possible factors.

Like good detectives, however, they have some hunches, based upon experience. One of the hottest of these is that the currents of the ocean may be responsible for carrying sardine eggs and larvae away from favorable spawning grounds.

Contour maps of waters off the southern California coast indicate the existence of two huge eddies near Catalina Island which are thought to be vast sardine "nurseries." These eddies, caused by the southward-bound California current, are 60 miles wide and 200 miles long, with huge counter-clockwise movements. They change in size and location during different seasons, but tend to remain in the same general area.

In these giant whirls, plankton grow in profusion. And during the spring of the year mature sardines go there to spawn and raise their young. The baby sardines feed on the plankton and grow into adults. When currents shift and the eddies are reduced in size, the immature sardines may

(Continued to page 258)

A Scripps scientist determines the number and type of phytoplankton on a slide containing a sea sample





Let-Down Trailer

Loading a new automobile trailer is easy—a hydraulic cylinder drops the bed to the ground for wheeling heavy loads aboard. Pumping the cylinder by hand then raises the bed to its normal riding position. The wheels of the trailer are independently sprung on double-action shock absorbers, a system that is said to give a smooth, non-sway ride when the trailer is empty or loaded. Both the suspension and the hydraulic mechanisms are adaptable to horse and house trailers as well as utility trailers.

Left, double-action shock absorbers eliminate springs on the let-down trailer. Above, pump lifts trailer bed after it has been lowered to the ground for easy loading, below

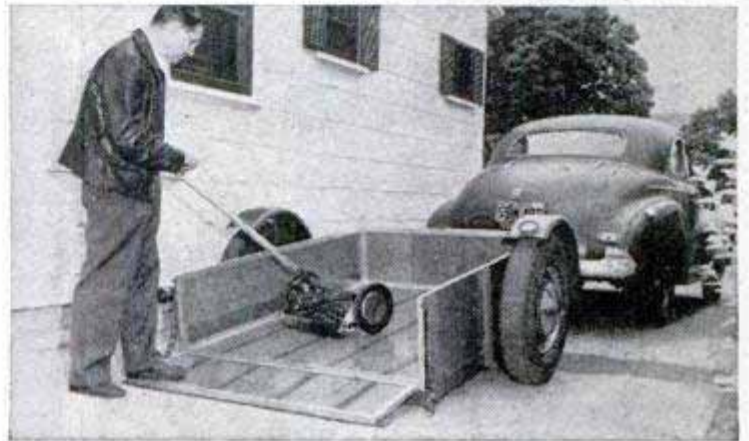

Scientist Tries Tracing Cosmic Rays Deep Underground

Science is going deep underground in an effort to learn more about cosmic rays. Lowell M. Bollinger of Cornell University

is using complex equipment of his own design in an effort to trace cosmic rays that penetrate deep into the earth. He

hopes to determine how much of the cosmic radiation that bombards the earth can penetrate to great depths without losing most of its energy through collision with earth molecules. The site of his experiments is the deepest salt mine in the United States near Ithaca, N. Y. His equipment includes a cylinder which is surrounded by 48 Geiger counters.

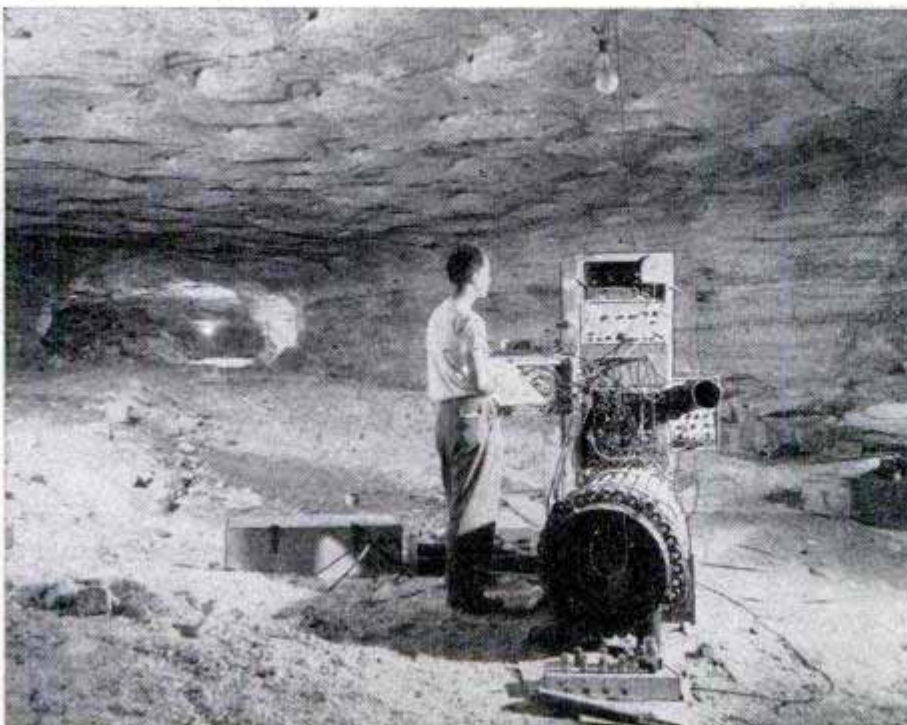

☐ On Feb. 5 and 7, 1892, the mercury dropped to 90 degrees below zero at Verkhoyansk, Siberia, to set the world's cold-weather mark that has never been broken.

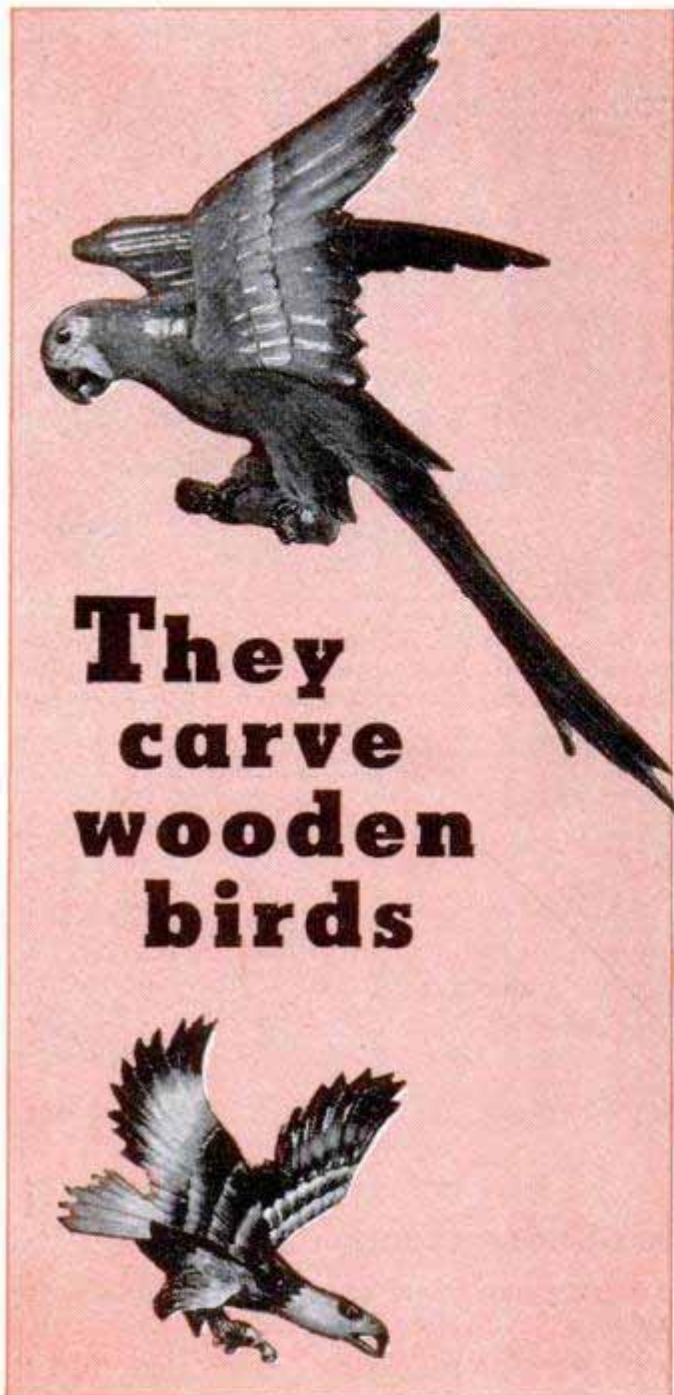

They carve wooden birds

By Lyn Harrington

TWO TORONTO craftsmen, Marian Morton and F. H. Little, have converted a hobby into a business—making lapel pins or bird brooches. Both ardent ornithologists, they reproduce in Carolina gumwood the birds they study in native habitats.

Their bird brooches are neither conventional nor stylized in any way—except that they are flat on one side where the pin is attached. While they work in mass production, there is nothing hasty or indifferent about their work. Their finished pins bring about \$10 apiece.

A board $\frac{7}{8}$ -inch thick is rubber-stamped with the designs most in demand and the figures are cut out with a power jigsaw. Usually the blanks are turned over to carvers to rough out either in the shop or in their own homes. Three quarters carved,

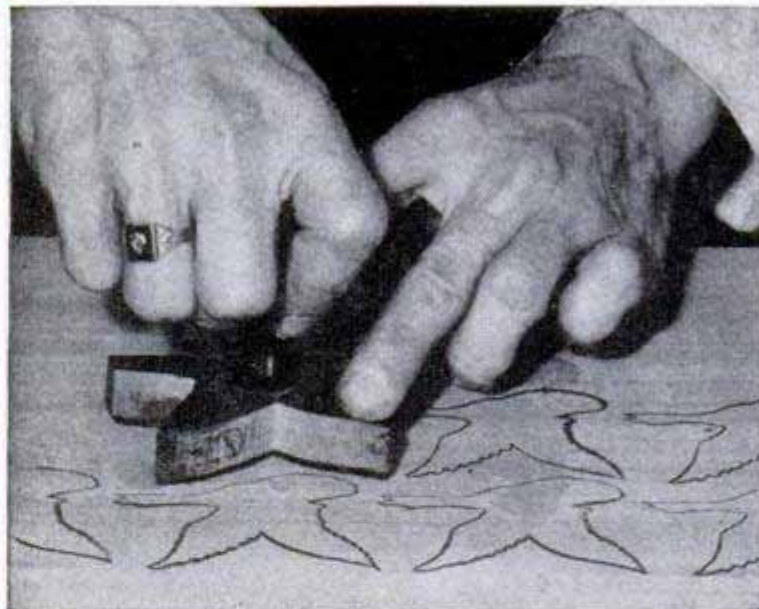

Craftsmen rubber-stamp the most popular designs on a piece of Carolina gumwood. Below, they are roughed out with a jigsaw, then turned over to carvers

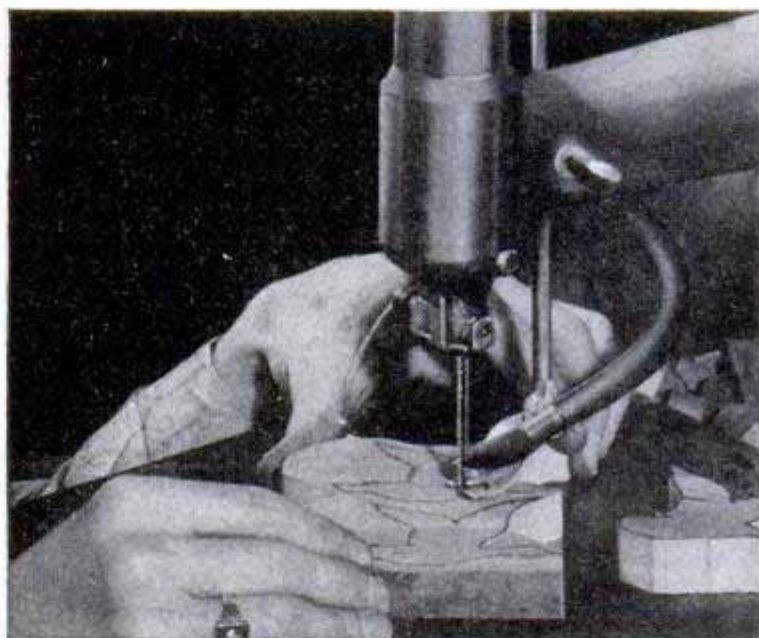

Photos by Richard Harrington

they are returned for the final finishing, which usually is done by Little.

While each part of the operation requires care, beaks are the trickiest part of the carving. Usually feet are not carved in wood, but are made from wire to give a more realistic effect.

Keen eyes and a steady hand are needed for painting the birds in their true-to-life colors. Few birds require less than 20 different colors, and for the cock pheasant some 50 are needed.

Favorites with customers at summer resorts are the white-winged sea gulls. Ducks, geese and the American eagle are the tourist's choices.

The Toronto craftsmen have found both satisfaction and profit in building their hobby into a business.



As many as 25 different chisels are used in finishing the carving. Below, after a pin has been attached to the back, each bird is painted. Most birds require 20 different colors and the cock pheasant about 50





Lighter "Exhales" to Prevent Leaks

Inside a new cigarette lighter is a rubber sack which prevents the fuel from leaking as a result of changes in the air pressure. Frequently, lighters and fountain pens leak during airplane flights, or when they are suddenly carried from a cold to a warm room. The rubber sack inside the new lighter compensates for the sudden expansion of air by expelling air from the fuel chamber. Made of transparent Lucite, the lighter has a visible fuel supply.

Lens Increases Light Intensity

Concentrating the light rays of an electric-lamp bulb, a small glass lens produces a bright area with about twice the light intensity of the unaided bulb. Designed to direct the light where it is needed, the lens is said to double the light without creating any bothersome shadows. Two wire clips on the lens snap over the bulb to hold it in any desired position.

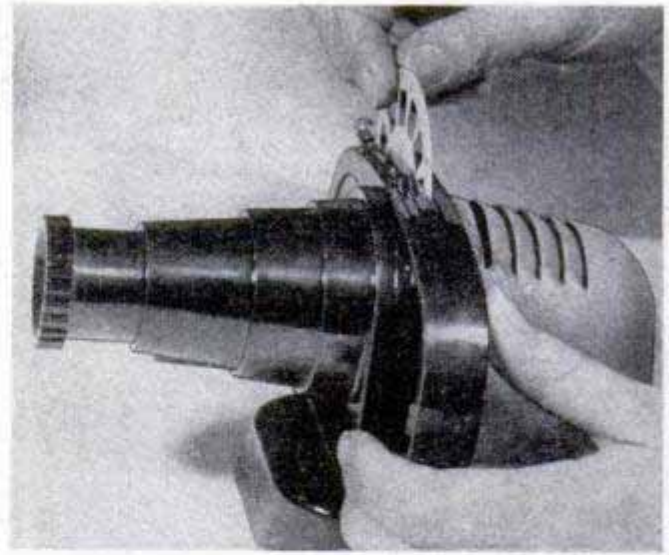
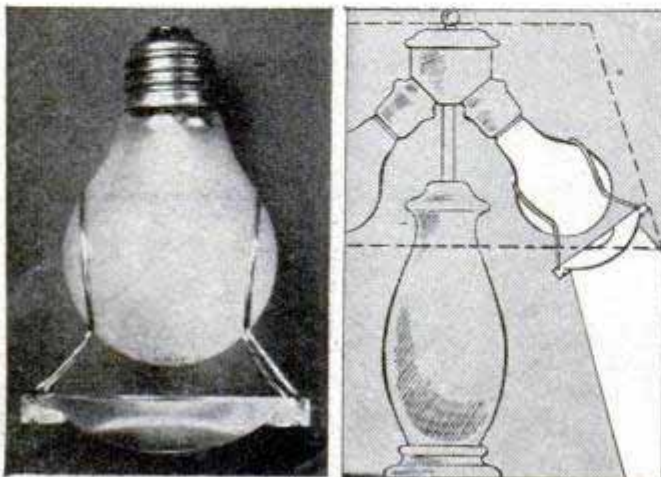

Midget Projector

Both grownups and youngsters can have fun with a small projector that projects specially mounted Kodachrome pictures. The projected picture from a throw of six feet is 11 by 12 inches and focusing is controlled by a knurled ring on the projection lens. A heat-absorbing shield envelops the 30-watt lamp and promotes air circulation. The pictures are mounted seven to a disk for inserting in the machine and are kicked forward with a trigger mechanism. The inexpensive disks include travel scenes throughout the world, Christmas and fairy stories and many other subjects. Kodachromes are mounted for three-dimensional use with a stereoscopic viewer also made by the same manufacturer. This 115-volt unit will operate on a.c. or d.c.

Magnetic Cabinet Latch

Magnetism is used as the holding power in a new cabinet latch. The latch consists of a small but powerful magnet which is screwed to the cabinet shelf. A special steel plate is attached to the door just opposite the magnet. When the door is closed, the magnet holds the plate firmly. The small magnet is said to last a lifetime without losing its power.

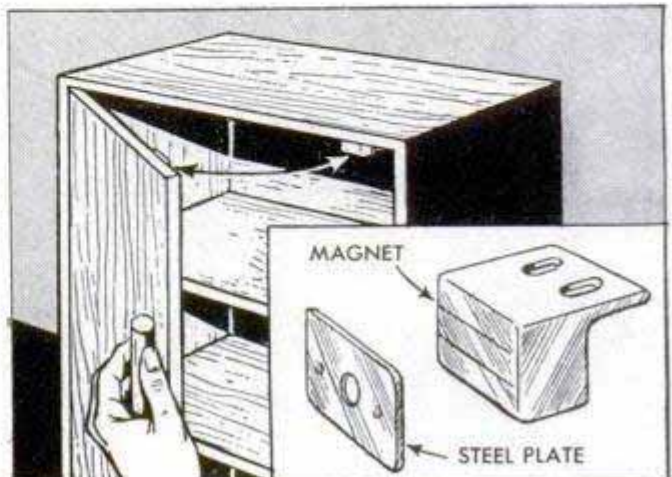

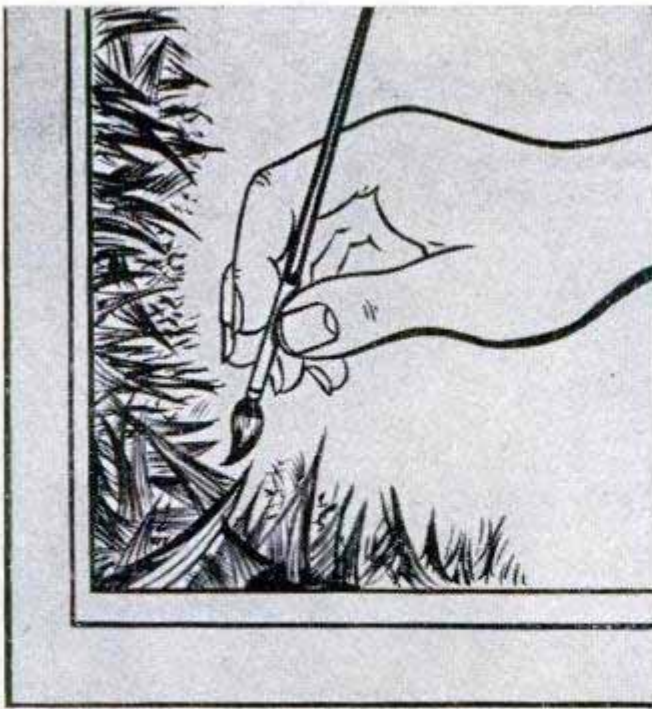

Plastic Changes to Frost

For Christmas decoration, frostlike crystal patterns can be formed with a new plastic liquid. Made in nine colors and clear, it can be brushed, dipped or sprayed on metals, glass, ceramics or plastic. It can be rubbed off with a cloth dipped in acetone or lacquer thinner, or scraped off with a razor blade.



Bubbler Also Cools Bottles

You can have your choice of cold water or bottled beverages with a new cooler that has a separate compartment capable of cooling as many as 28 small bottles. A hinged door on the beverage compartment can be locked if desired. Temperatures in the compartment are adjustable within a range of 36 to 46 degrees.

Three-Inch Layer of Wind Blows 1200 Miles an Hour

Air pours at a 1200-mile-an-hour rate from a three-inch jet built by Curtiss-Wright for basic research in air-flow phenomena. So strong that not even a hand can be thrust into it, the jet creates a roar so loud that near-by workers have to wear ear stoppers and headphones. Pressure tubes hooked to the nozzle lead to an instrument panel which records the air speed.

More than half the weight of a typical plant is drawn from the air.

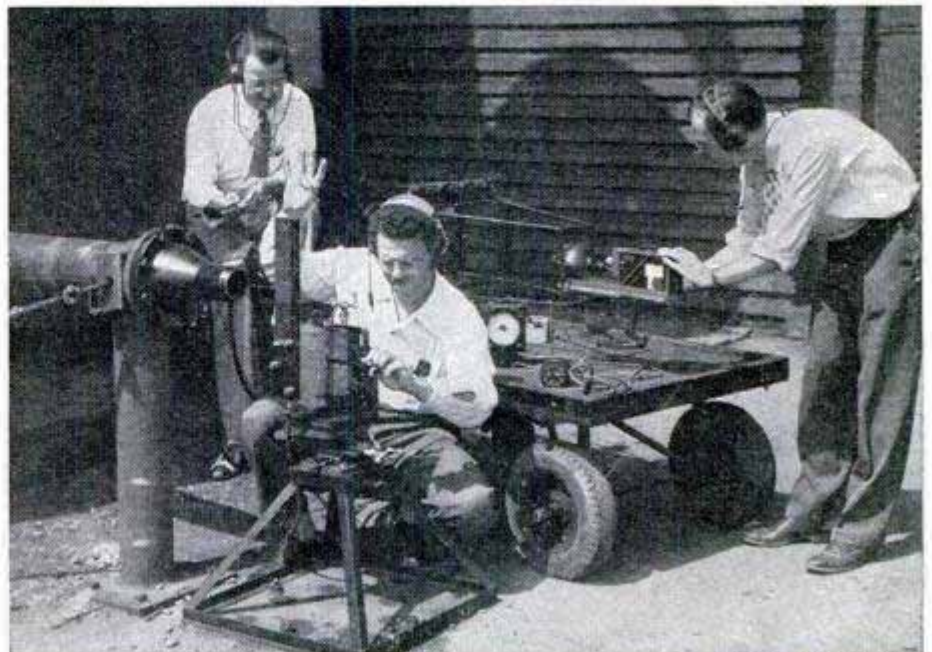

Curtiss-Wright photo



Nightmare to smugglers is this trim Border Patrol craft roaring out into the harbor with a well-armed crew. Below, patrol officers check crew of small Caribbean ship, looking for stowaways or "extra" men who come along to jump ship in any American port





If patrolmen on this plane see a suspicious-looking boat nearing Florida waters, they can spread an alarm by radio and a patrol boat will be dispatched in a hurry to search the vessel. Florida is today the favorite target of organized alien smuggling



SALTWATER BORDER PATROL

By Verne O. Williams

THOUSANDS of aliens from Europe and Asia are trying to gain illegal entrance to the United States — the promised land. Barred because of war crimes and other blots on their record, or unwilling to await their turn on the immigrant quotas, they try to slip across the borders by plane, boat or subterfuge.

Opposing this flood is a mere handful of inspectors in the Border Patrol, the tough right arm of the Immigration and Naturalization Service. Their grimdest problem is the heartless alien smuggler, often capable of murdering his human cargo to avoid capture.

The watch on the Mexican border deals with the largest number of illegal entries, but these are largely migrant agricultural workers. Ports all around the coasts must be watched for stowaways and crew deserters. But the favorite target of organ-

ized alien smuggling today is Florida, explains the 6th district immigration director, W. F. Miller.

A few minutes by air from Miami lies the island republic of Cuba, host today to more than 300,000 aliens of every nationality, all waiting for a chance to duck over to the States. They are in Cuba on visitors' permits and not allowed to work. Many see their funds diminishing and become desperate.

Recruiters for the smugglers, passing the word stealthily among the international colonies in Havana, line up groups, extracting half the fare of \$500 to \$2000 in advance. Their destination if by small boat will likely be a secluded harbor in the Florida Keys, or if by plane, an isolated inland air strip.

Defense operations of the Border Patrol in a sector extending from the North Carolina border south around Key West and up to the Apalachicola River are directed by radio from Miami headquarters. By plane, fast cruiser, swamp-gliding "airboats," and patrol cars, radio-directed inspectors can converge on a smuggler.

Obviously, the 58 harassed border patrolmen strung out along this 2371 miles of sea frontier cannot watch every harbor and inland airfield. The key to their success, says chief inspector Frank Hornyak, is that every man on the Border Patrol works



Nerve center of the Border Patrol is at Miami where raids by plane, boat and car are synchronized by two-way communication setup



Jeep tows the Patrol's airboat (note propeller) into the Everglades as far as possible. The boat skims over the "river of grass" area (below) at 40 m.p.h. and it can jump over small logs and low brush



at making hundreds of friends in strategic spots who will act as the eyes and ears of the service. These range from millionaires with beach homes to coastal fishermen, from dock laborers to airport managers. The system works.

Relaxing on the porch of her ocean-front home on glamorous Miami Beach, a sleepy society matron idly watched the dappled pattern of moonlight on the surf. Just as she was about to retire she suddenly realized a part of the pattern had unmistakably taken the form of a boat. Showing no lights on its dark hull or spars, it was slowly edging toward the beach.

She went to her telephone, and a few seconds later two Border Patrolmen walked down to the beach. After hearing an anchor splash, one patrol inspector doffed most of his clothing and swam quietly out to the mysterious vessel.

As he gripped its gunwale he overheard a discussion in foreign accents. The subject concerned the best way to enter the Miami harbor without getting caught. When the hum of speedboat motors reached the occupants of the anchored vessel across the dark water half an hour later, they became alarmed and prepared to weigh anchor. But they were rudely interrupted by a dripping figure that suddenly emerged from the sea over the stern.

"You're under arrest by the U. S. Border Patrol!" said the figure, who might have been a man from Mars for the nerve-shattering effect he had on the five astounded aliens. He made them turn on the vessel's running lights and a Border Patrol speedboat, called by the inspector on shore, quickly came alongside. Another attempt to penetrate the border watch had failed.

The smashing last year of the biggest air-smuggling operation in border history came about after a tip by a forewarned airport manager. When he saw the face of an Oriental fleetingly in the cabin

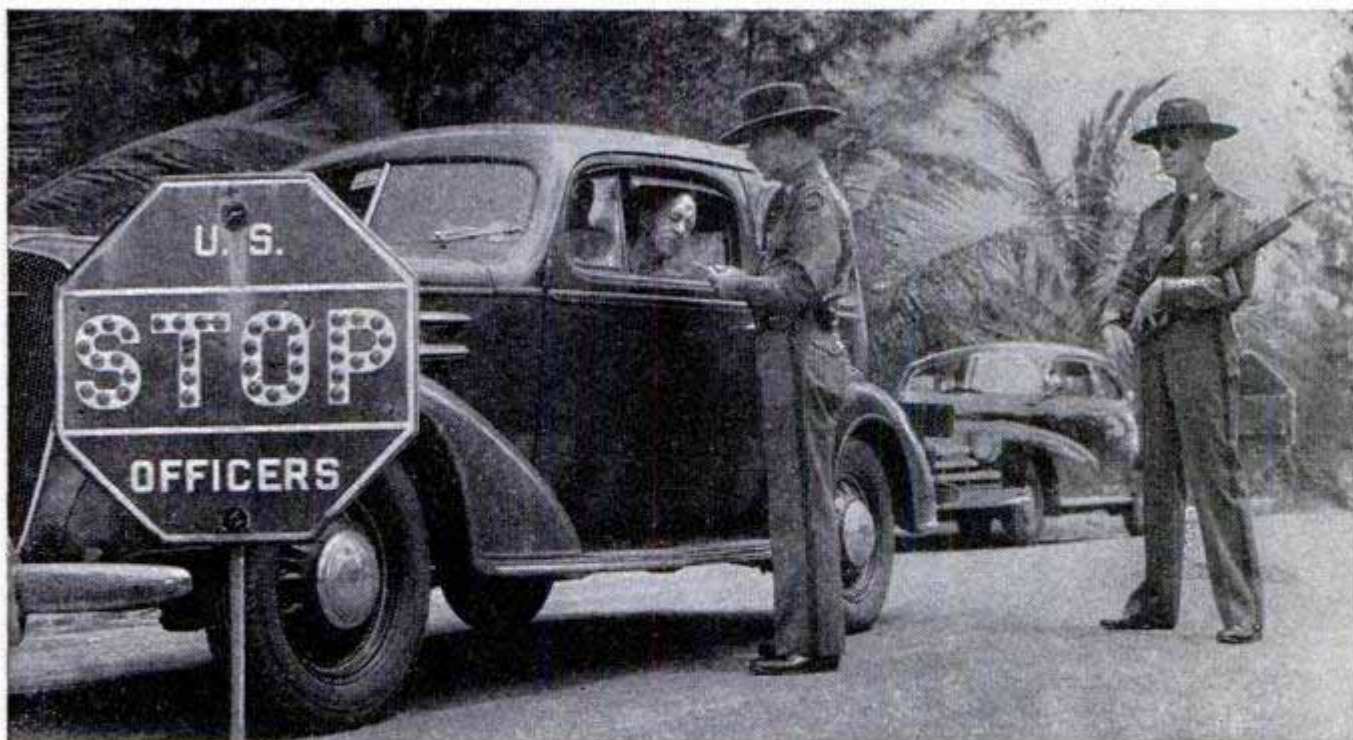

Road blocks are strategically placed so that smugglers' cars will come upon them too late to turn around

of a red Cessna that stopped for gas at his Fernandina, Fla., air strip, J. L. Haverstick gave its number to the Border Patrol.

The break was not accidental. Miami headquarters had wind of the aerial activities, and every man had been out warning airport personnel. The smuggling ring had put 34 aliens, including 25 Chinese, in the States by flying from a Cuban field to a point in the South for refueling and thence north to New York. But the tip-off trip was the last. The plane was watched, and the pilot, on his return to Miami, confessed.

These cases were colorful and dramatic, but behind them goes on a routine which is responsible for the unpublicized majority of apprehensions. Bus and railroad stations are watched, and in a large port like Miami one inspector daily checks the bookings of the city and county jails.

For instance, one warm summer night in the Florida Keys two border men riding car patrol were turning in and out of boat landings when they came on a parked roadster containing a romancing couple. Politely dimming their lights, the border men drove away. But as he slapped at the mosquitoes that had poured in through the windows during the brief pause, one inspector began to think.

It was a very calm night and consequently alive with mosquitoes from the mangrove pools. How could that couple stand them? His partner agreed with his suspicions and they quietly returned with lights out. This time the couple was unhappily fighting mosquitoes.

The border men sat out the mosquito siege themselves for what proved hours. Finally, boat motors thrummed across the

little bay. The lookout roadster blinked its lights three times. And a little later a surprised gang of smugglers found themselves caught with their cargo of aliens.

In one case, fishermen in the labyrinth of the Ten Thousand Islands region spotted 10 Chinese nearly dead from thirst on a tiny mangrove islet. Ever so often the skeletons of other unluckier groups are discovered along these uninhabited shores where the saw-grass wilderness of the Florida Everglades meets the sea.

To find out if landed aliens could possibly "walk out" of the Glades, chief inspector Hornyak and partner M. A. Black, carefully equipped, set out on foot to attempt to cross Cape Sable, a feasible route. They struggled across crocodile-infested creeks, through snake-filled mangrove jungles, used up all their drinking water in the intense heat, and finally emerged many hours behind schedule. Their experiences convinced them the Glades would be a deathtrap for unequipped aliens.

Several years later Seminole Indians reported seeing the tracks of white men deep in the Glades. Employing an Army weasel, a tracked amphibious vehicle, Hornyak and R. C. Barron traced the tracks of three shoeless walkers for miles, watching them grow faltering and erratic, until they disappeared in a dense hammock. Hornyak feels certain they were aliens.

Nevertheless, the Border Patrol uses plane and swamp-gliding airboats to watch this region. Despite the perils and high fees demanded by postwar smugglers, the men know thousands more unwanted aliens await any chance to slip through the border watch.

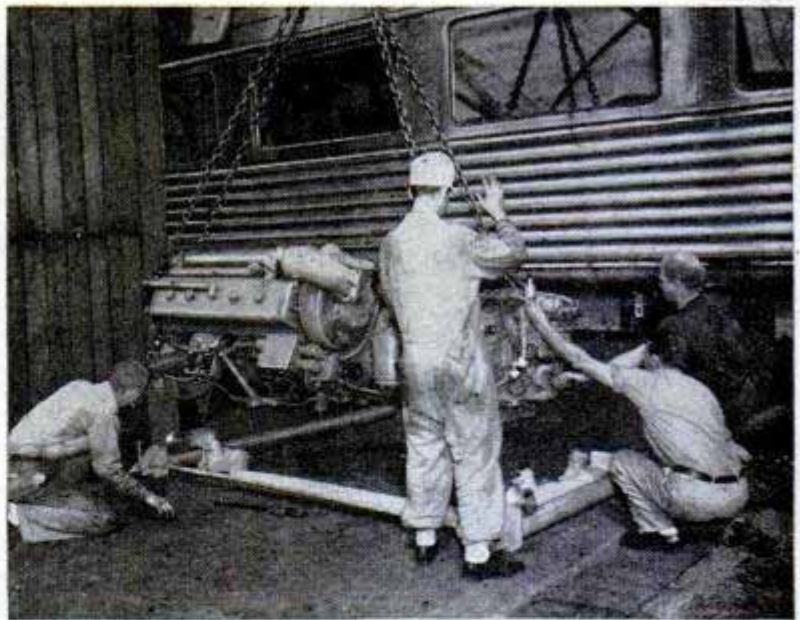

There's a small engineer's compartment in vestibule at each end of the car. Power is transmitted through a torque converter up to 57 miles an hour, when transmission automatically locks into direct drive. Right, engine can be replaced with new one within an hour

Passenger Car Rambles the Rails Under Own Power

Don't be surprised if you see a lonely passenger car cruising the rails at 80 miles an hour without a locomotive in sight. It will be the self-propelled rail car, recently built by the Budd Company, which has two 275-horsepower diesel engines slung between the trucks. The cars can be operated alone, or several of them can be coupled together to form a complete train. Like a trolley, the car has engineer's controls at both ends, and one engineman can operate any number of cars. Biggest advantage of the car is that none of the passenger space is taken up by the engines or controls.



Car seats 90 passengers with no revenue space occupied by the engines. Two other models have fewer seats but mail and baggage compartments

Note engine cooling system in the blister atop car. All other equipment is built into space between trucks, which lowers center of gravity

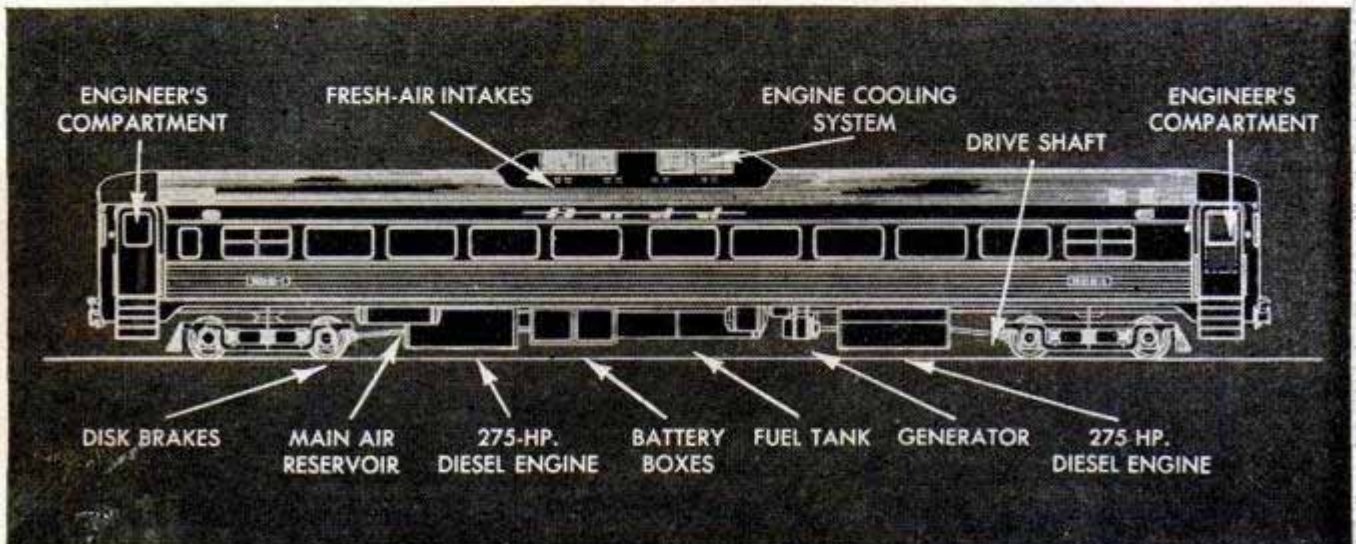

Parachute Plane

Landing approaches at angles greater than 40 degrees are possible with the Lanier Paraplane, which acts as its own parachute in case of engine failure. It takes off or lands within 200 feet, flies from 30 to 120 miles an hour and can't spin. Key to its parachutelike performance is a gull-shaped wing that forms a trough, or air cell, around the two-place cabin. The wing's shape is controlled from the cockpit, where levers operate scoops and slots to give varied effects of air brake, flap and lift control. Though 20 feet long and the same distance across the wing tips, the wings can be folded for storage in an area 8 by 20 feet, the size of an ordinary garage. The plane is powered by a 90-horsepower engine.

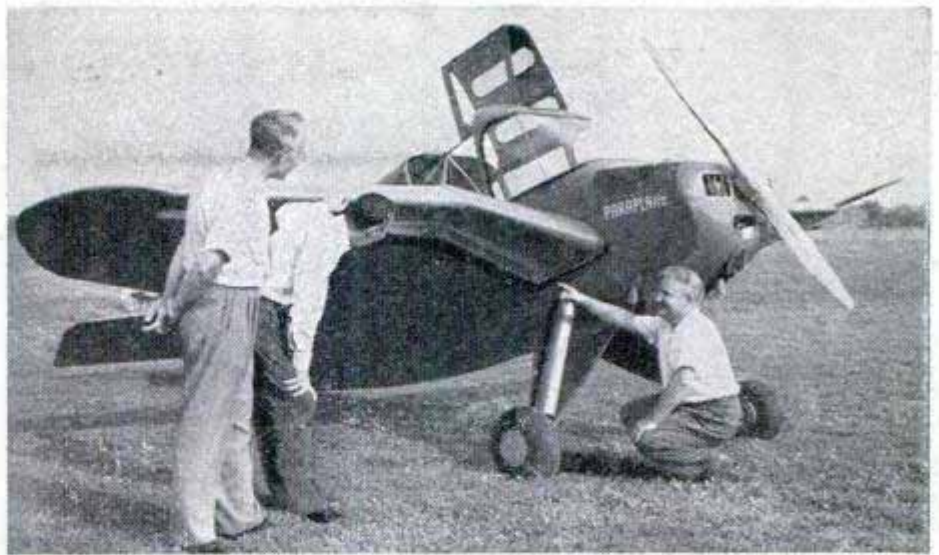

Radio-Guided Model To Try Channel Trip

There'll be no one aboard a new yacht when it makes an attempt to cross the heavy seas of the English Channel soon. The yacht is a model, six feet long, complete with lifeboats, anchor and smokestack. Designed and built by H. W. Eastaugh of England, the craft is guided by remote radio control. During the cross-channel try it will be operated from a boat which can cruise as far as three miles from the model and still maintain effective control. The yacht's top speed is six knots.

Information not listed on articles in the index, starting on page 10, frequently is listed in the WHERE-TO-FIND-IT index, which is available without charge from Bureau of Information, Popular Mechanics Magazine, 200 E. Ontario St., Chicago 11



Intended for high-altitude reconnaissance and photography, the SE 1010 cruises at 325 m.p.h.

For armament the SO 6020, a long-range jet fighter, carries four machine guns or six cannons

French Air Information Service photos

TODAY'S FRENCH PLANES



UNUSUAL shapes dominate new French aircraft design. One of the oddest is Rene LeDuc's spear-nosed 010 ramjet, which has already exceeded 560 miles an hour, using only half power. The 010 is essentially a flying stovepipe, powered by five burners, with fuel comprising one third of its three-ton weight. Another strange looking craft at the Paris Air Show was the stubby NC-1070, a carrier-based torpedo plane. Built short for shipboard operation, its two jet-engine nacelles are almost as long as the 33-foot fuselage. Fourga's turbojet glider, with a V-tail and a tiny, 80-pound power unit mounted on its back, takes off on its own and flies 160 miles an hour at 10,000 feet. Known as the CM8 R 13, it has a 35,000-foot ceiling and a 150-mile range.

First experimented with as a "piggyback" model, Rene LeDuc's 010 ramjet may fly well beyond speed of sound at 50,000 feet





One of the country's few new helicopter designs is the twin-rotor SE 3000. A production version will carry four passengers or freight

With a British Rolls Royce Nene jet engine, Dassault's 450 Ouragan ranks among France's fastest interceptor types



Antisubmarine defense will be one of the ship-based NC 1070's roles

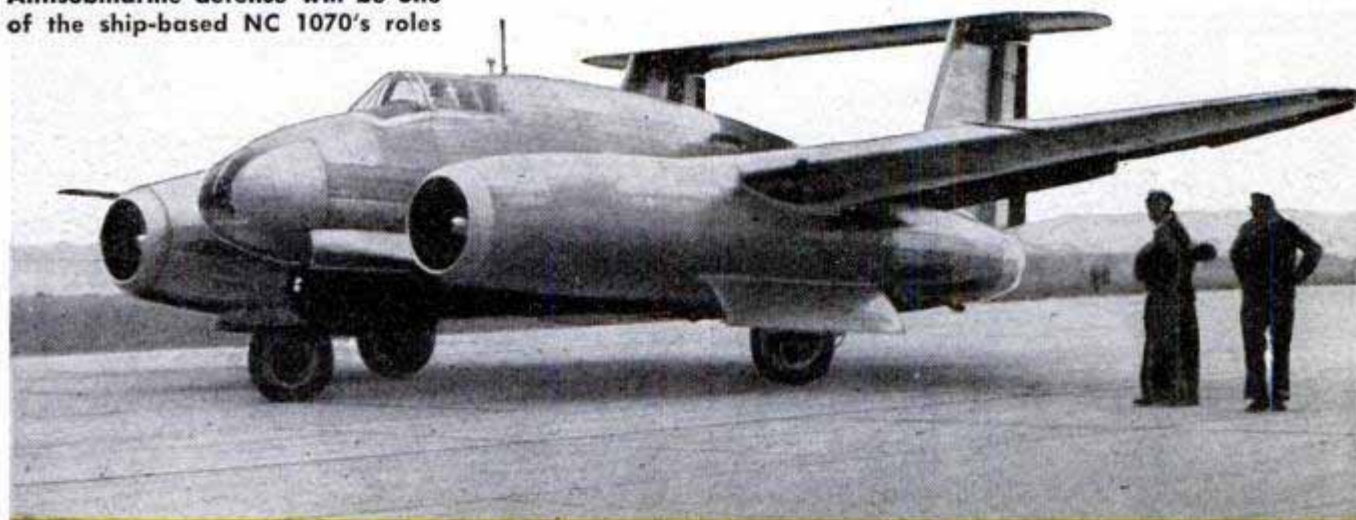

Developed for European sky routes, the piston-powered SO 30P Bretagne carries 37





Chore Cart

Household chores are made easier by a lightweight cart that totes anything from the weekly wash to trash barrels and groceries. Designed like a hand cart, the lit-

tle buggy has two wheels on a welded frame. A shelf pivots down at just the right height to hold a laundry basket. When the cart is to be used for carrying larger items, the shelf can be tilted up along the frame where it is out of the way.



Heated Hunting Blind

For hunters who like comfort with their sport, a portable blind folds into a package 12 inches in diameter and 5½ inches thick. It can be carried in an accessory wood case which converts into a seat and will accommodate a small stove and a lunch kit. The blind is covered with weather-resistant fabric, has a 12-foot circumference and is 46 inches high.

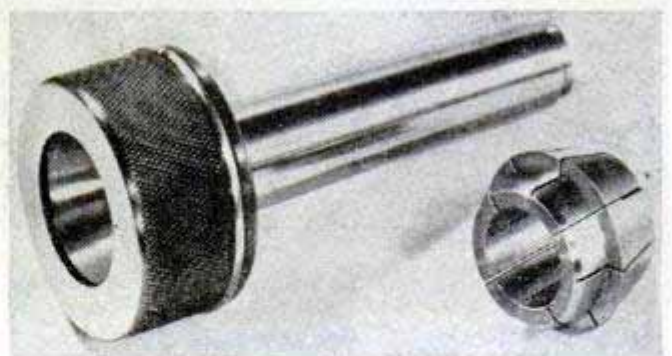
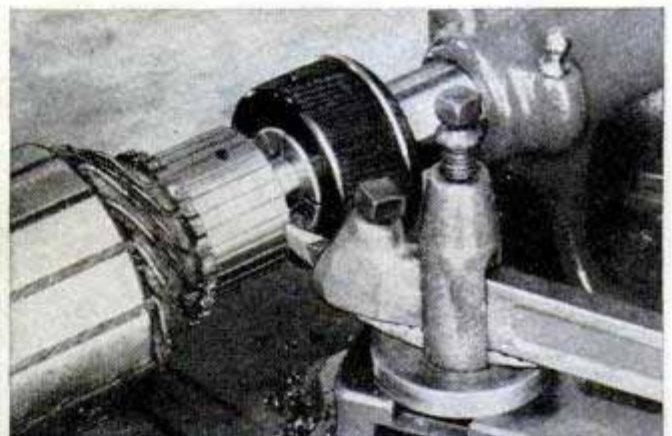

Chuck Holds Centerless Shafts

Centerless shafts such as those in many automobile starters and generators are held concentrically in a lathe by an adjustable chuck. Any shaft ¼ to one inch in diameter can be accurately centered with the chuck. The attachment can be used in the lathe headstock to hold and drive the work or adjusted in the tailstock for an accurate running fit.

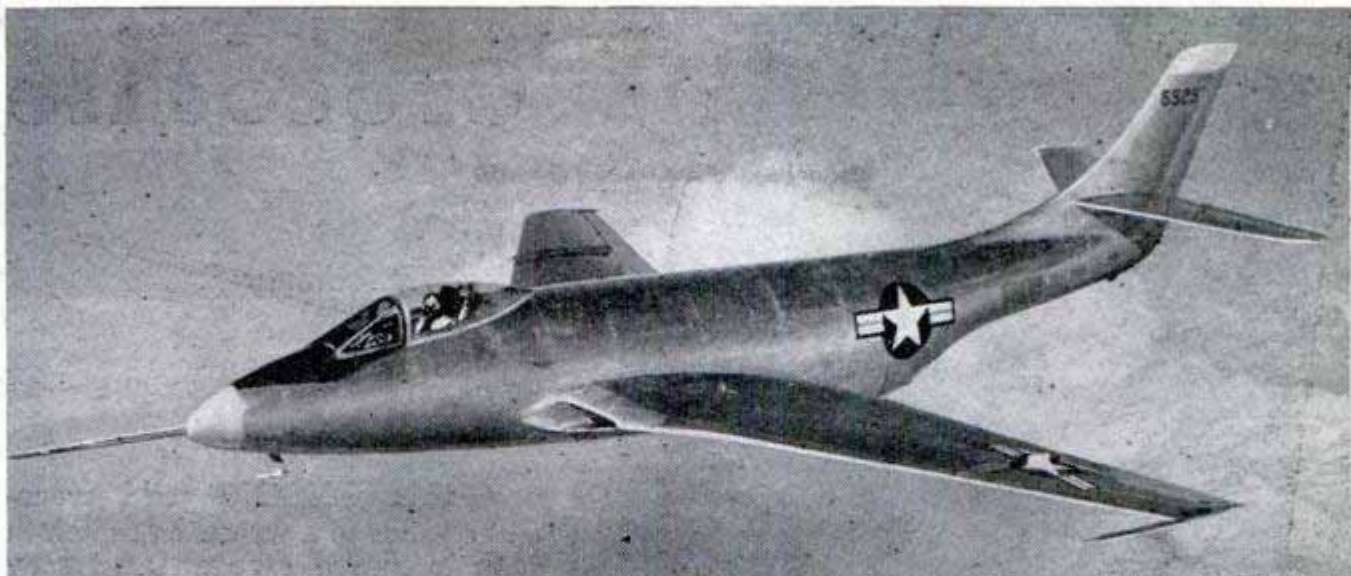

McDonnell Aircraft photos

World's Fastest Plane?

Attempts to exceed the world air-speed record of 670.981 miles an hour with the McDonnell XF-88 Voodoo are expected soon. They will probably be made at the Muroc, Calif., flight test center, where a North American F-86 Sabre set the present mark in 1948. Powered by two turbojet engines, the shark-bellied Voodoo is capable of operating deep in enemy territory. It is about 55 feet long, 15 feet high and has swept-back wings spanning 40 feet. Its cabin is fitted with a power-operated canopy. The Air Force has not yet released performance figures on the XF-88.

Air for the Voodoo's twin turbojets comes in through ducts at the wing roots. The exhaust escapes from an opening below the level of the tail behind the trailing edge of the wing



Mechanical "Policeman" Counts Speed Offenses

Car owners who let friends and employees drive their cars can check up on speeding offenses by means of an automatic recorder that counts the number of times the car exceeds a preset speed limit. The recorder is connected to the speedometer cable and a numbered ring, visible through a small window, clocks the offenses. The car owner can set the recorder to operate at any desired speed.

❑ Fish can be frozen in solid ice for long periods and still survive if they are thawed out gradually.

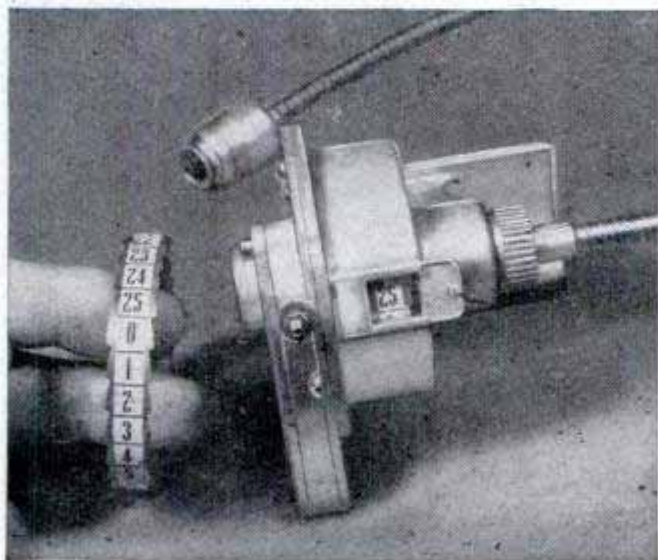

Crocodile

By
Robert Faherty

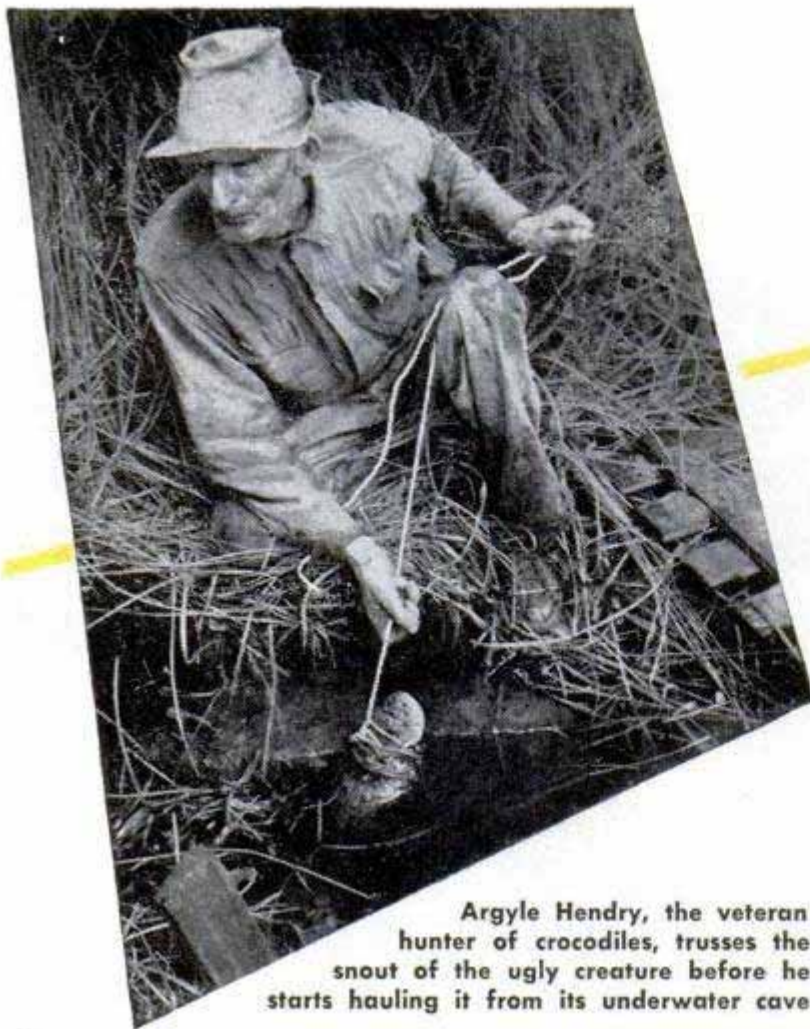

Argyle Hendry, the veteran hunter of crocodiles, trusses the snout of the ugly creature before he starts hauling it from its underwater cave

CHALLENGING wild crocodiles to a wrestling match in their native swampland may sound like sudden death to most people, but to Argyle Hendry, a Florida hunter, it's a way to make a living.

This lean, grizzled veteran of south Florida wilds brings the jaw-snapping creatures back alive and sells them to reptile farms for as much as \$100 each. His weapons are a spear, some rope, a gaff hook and a basket of tricks. He carries a rifle and shotgun, but they're strictly emergency weapons and he rarely uses them.

From his small boat, Hendry spots the croc as it lies on the bottom of the lagoon. Moving up silently, Hendry hurls his spear

As his helper jabs into the cave with a gaff hook, Hendry waits for the croc to break for freedom. The gate prevents its escape



Hunter

with a tremendous thrust, impaling the animal. If he's lucky, Hendry can hang on as the crocodile twists and leaps, trying to shake itself free. But, as often as not, the powerful brute breaks free and escapes to its underwater cave to nurse its wound.

The next step calls for tricks that Hendry has learned through the years. First, he barricades the cave and jabs into the constricted opening with his gaff hook. Sometimes, the croc, annoyed by the jabs, makes a break for freedom. Then Hendry deftly rings the slender snout with a rope noose and, with his assistant, hauls the thrashing reptile ashore where its powerful tail is tied securely with rope.

Other times, the croc refuses to come out and Hendry has to tempt it to the surface with imitations of the mating call. These deep-throated sounds are something like that of a half-grown swine: "Rooonk, rooonk, oonk, roooooonk."

Once caught, the crocodile is lashed to a pole and brought to civilization where it spends its life basking in the sun, returning the wide-eyed stares of Florida's tourists.

An unwilling subject, the crocodile "poses" for a picture on the dock at Key Largo after the battle

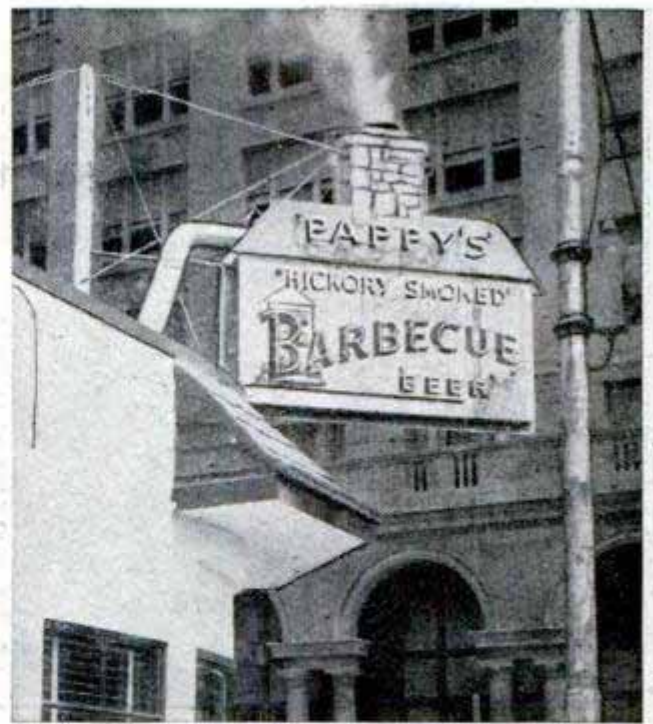

Smoking Sign

"Hickory Smoked Barbecue," read the signs outside a chain of restaurants in Houston, Tex., and passers-by can see and smell the smoke as it rolls from the signboards. Atop the sign is a chimney connected by galvanized pipe with the barbecue pit inside the building. Smoke flowing up through the pipe passes through the chimney and gives an attractive hazy appearance to the neon lights on the display.

Weed-Killer Applicator

Weed-killing solutions are sprayed on lawns by a plastic applicator that requires no pumping or air pressure. The nozzle-like applicator is screwed on the top of a gallon jug containing the solution. When the jug is tilted downward, the solution flows through the nozzle in an even spray.

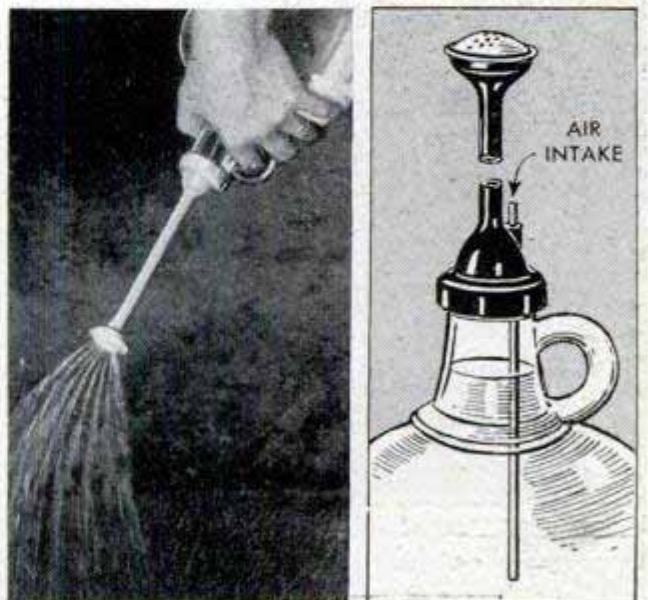



Left, the two rear wheels of the planter pack the soil around the roots of the seedlings. Above, all the operator has to do is drop seedlings into the trench. Below, close-up shows how the trench is cut

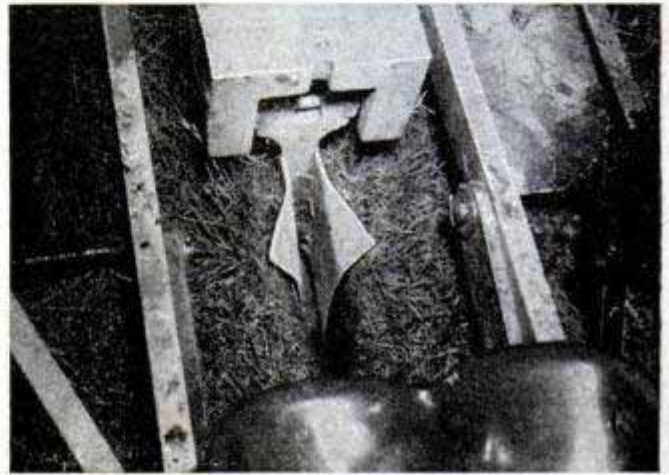

Tree Planter

Reforestation is a quick job with a planting machine that plants up to 10,000 seedlings a day. The planter, pulled by a tractor, slips along on steel runners equipped with keels which prevent them from sliding to the side on hills. A coultter makes a slit in the soil and a plow follows to make a furrow. The operator sits behind a tree box that holds 1000 to 2000 seedlings. He drops the trees into the furrow and two heavy wheels pack the soil around them.

Quick-Change Coupling for Propeller Shaft of Boat

Propeller-shaft connections are made in a few minutes when a new coupling is used. The coupling, designed for attaching the propeller-shaft flange to the propeller shaft of an inboard motorboat, will lock securely

any type of hub, wheel or other connection to a shaft. A self-locking nut eliminates cotter-pinning. Two keys fit into milled keyways and are threaded on the top to match the thread of the hub, which is split to take the keys. For motorboat use, the keyway is not cut through to the shaft end, thus preventing the propeller from backing off when the motor is reversed. The principal feature of the coupling is the speed with which it can be assembled and disassembled, the two operations being completed in a total time of less than 10 minutes.

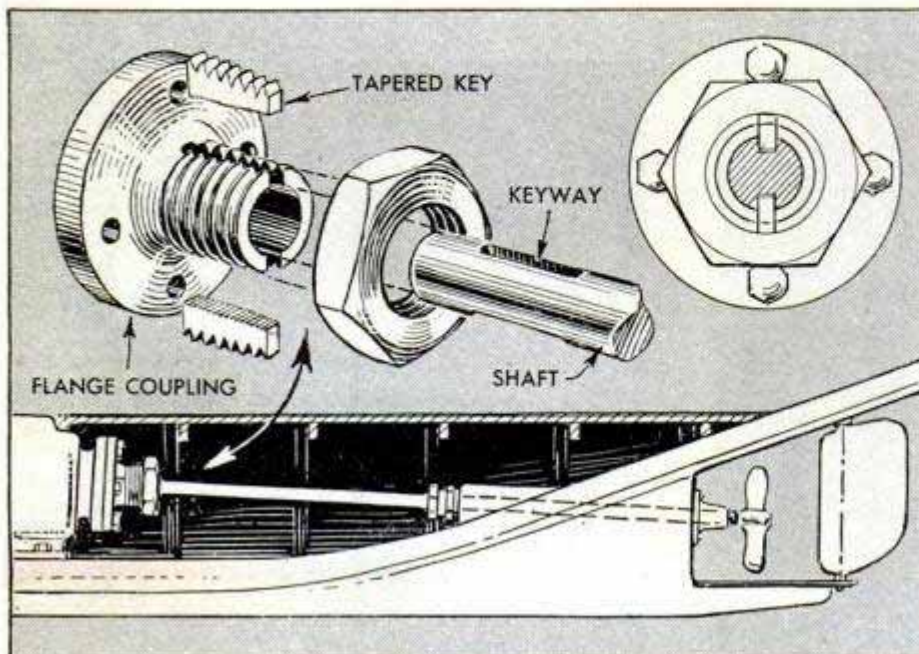

Ⓞ About 12½ billion kilowatt hours of electricity are used each year in the United States in the production of 1¼ billion pounds of aluminum.

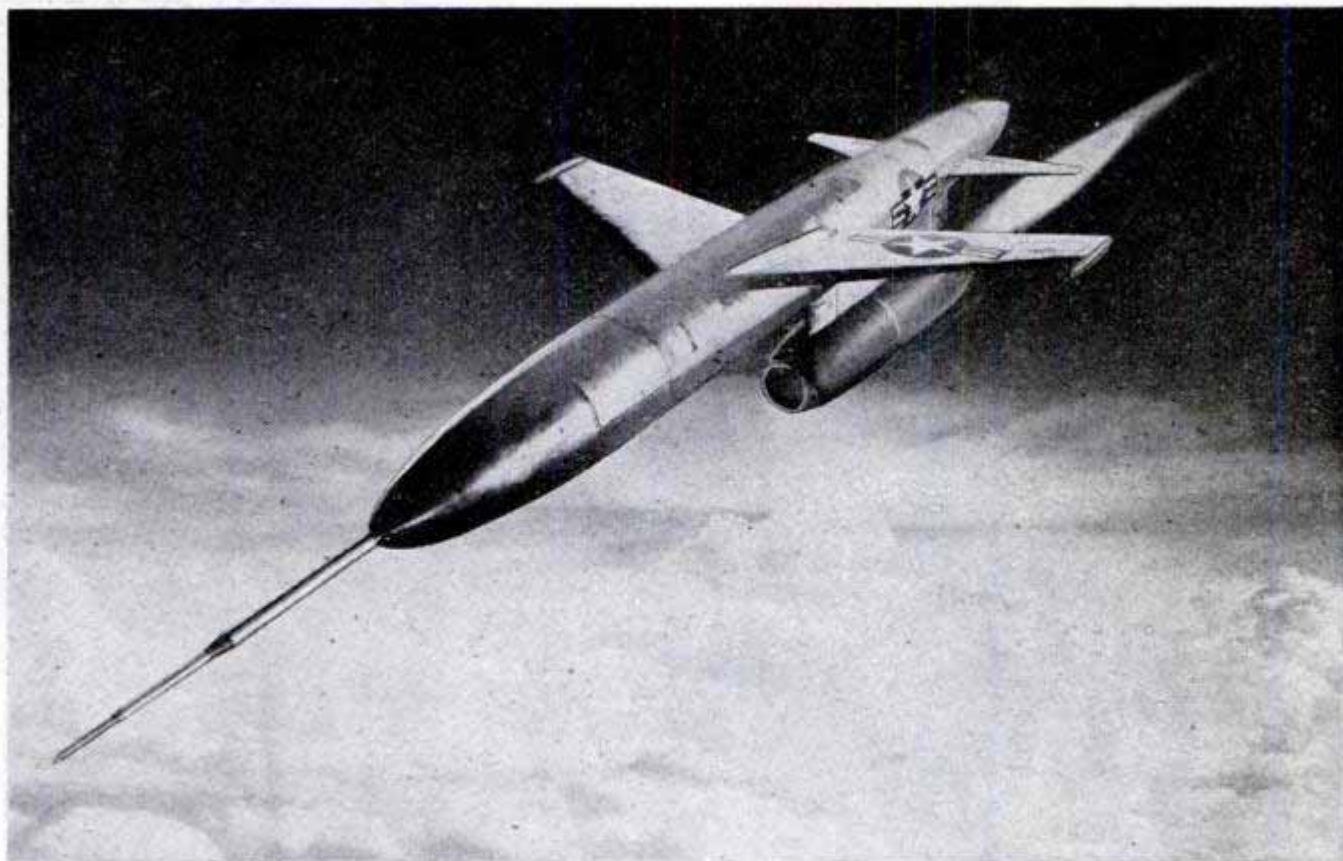

Fastest Drone

Maneuvers of the faster fighter airplanes will be simulated by a remotely controlled ramjet target drone being built for the U. S. Navy. The lowest speed at which the KDM-1 can operate is faster than that of any "live" target now being used in anti-

aircraft training. Developed by the Glenn L. Martin Company, the new drone will be launched from twin-engine aircraft preset for a prescribed course or radio controlled in flight. When its fuel supply is exhausted, the drone zooms up, a parachute opens and it drops into the ocean. The drone may be recovered and repaired for further use.

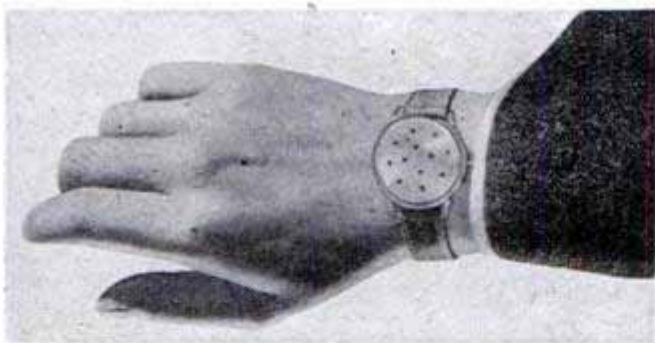

"Wrist Watch" Hearing Aid

As inconspicuous as a watch, a small hearing aid straps to the wrist. The aid is more convenient to use than most types because the wearer need not turn his body toward the speaker to pick up conversation. An almost imperceptible turn of the wrist catches sound coming from any direction. The cord for the hearing aid runs up the speaker's arm under his sleeve.

☐ Samples of air collected by V-2 rockets 42 miles above the earth are the same in chemical make-up as air at ground level, according to scientists at the University of Durham.

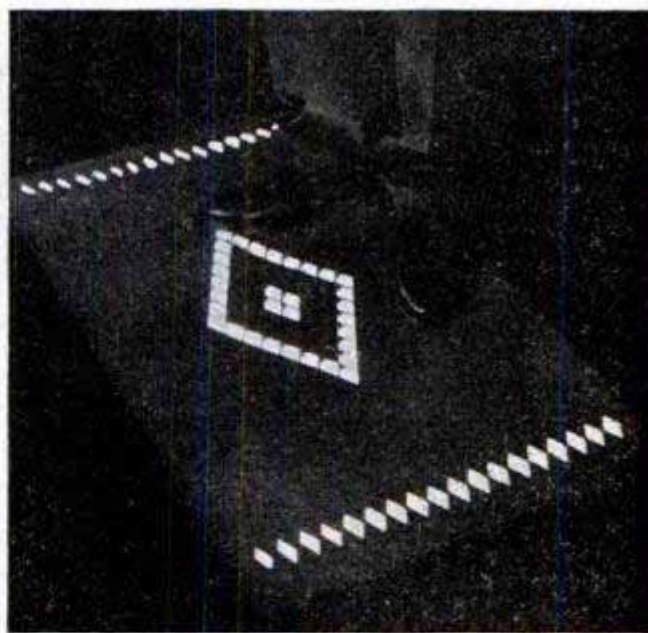

Rubber Mat Glows in Dark

Dark stair landings are made less dangerous by a rubber mat that glows in the dark. Treated with a fluorescent solution, the mat outlines the landing to prevent missteps. It is washable and will not chip or crack under ordinary usage.



Back-Yard Ski Tow

Three skiers can ride up a 200-foot slope simultaneously on a backyard tow built by Dr. H. B. Minnich of Lititz, Pa. Powered by a $3\frac{1}{2}$ horsepower garden tractor, total equipment cost of the tow was less than \$50. The tractor is at the top of a hill, attached to a framework supporting belts and pulleys that transfer power to the car wheel on which the tow rope runs. At the bottom of the incline, the rope passes through a pulley anchored to an upright with block and tackle.



Chemical Makes Cotton and Rayon Fabrics Flame-Retardant

Cotton and rayon fabrics can be made flame-retardant with a chemical which does not change the appearance or feel of the materials, according to DuPont chemists who developed the process. Dry cleaning, home laundering and weathering do not affect the flame resistance. An inorganic chemical, it reacts chemically with

the cellulosic molecule of fibers rather than merely coating the fiber surface. A flame held to the treated materials will char the fabric at the point of contact, but the flame does not spread. The process of applying the chemical, called Erifon, is so exacting that it can be used only in textile-finishing mills, the chemists say.

Eight million people squeezed into the multistoried metropolis of New York down their astronomical daily fare of fresh milk and oranges and artichokes, burn their colossal quotas of coal and kilowatts with little thought of the miracle that restocks their island daily despite blizzard and transportation tangle and the perennial menace of strikes

By Arthur M. York

NO LESS arresting than New York's sky line is its life line.

The story behind the fact that eight million people sit down to dinner daily and each gets a share from the hundreds of carloads of food served up for the meal is one that speaks both for the industry of the city's myriad food handlers and for the abiding faith of the diners. Part of the low rumble and throbbing of the city is that of

food coursing in along its main arteries to keep its citizens alive. Tugboats toot as they scurry about the harbor, delivering barge-loads of food. Every midnight there's a honking traffic snarl on narrow Washington Street, where hundreds of trucks jockey to deliver or pick up food within a few hours, so that Mrs. New Yorker will find fresh produce at her neighborhood store come morning.

Apartment buildings tremble in the night as meat, milk or poultry trains grind through a tunnel beneath the city. They are on their way to a small crowded freight yard where land values are so high that possible methods of building skyscrapers above the yards have been considered.

New York has attracted its eight million people because it has everything—everything, that is, except life's necessities.

All food and fuel, the very life blood of the city, must be imported. The 1400 carloads of perishable foods consumed each day come an average distance of 1500 miles.

The 90,000 tons of coal and the 15,000,000

City With a Fragile Life Line

Complicating the problem of supplying New York is the fact that its heart, Manhattan, is a crowded island



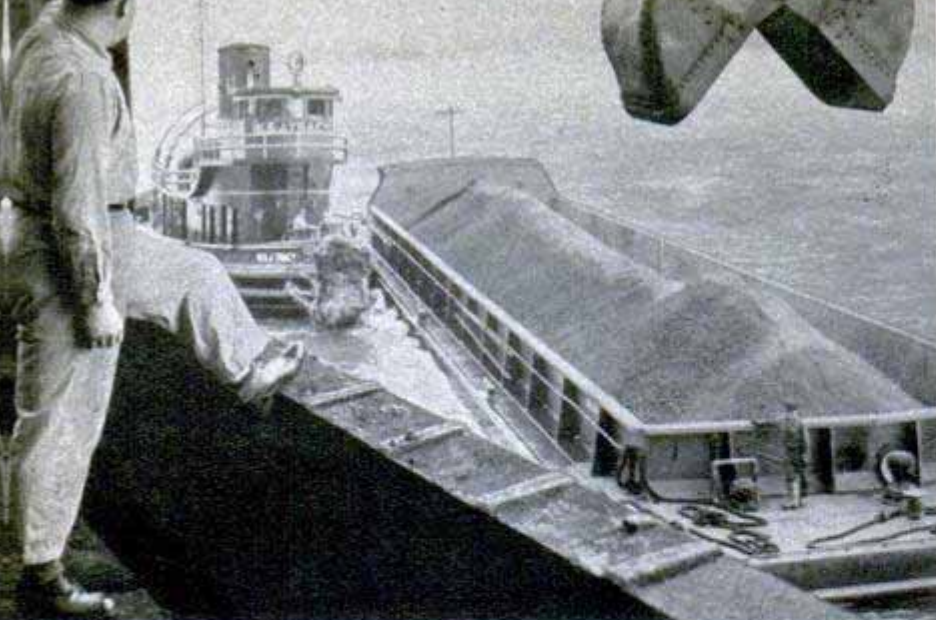

Coal barge being nosed into a Brooklyn pierhead. The city's network of power plants alone use 15,000 tons of coal daily



Above, perishable foods are a big part of traffic at the New York Central's freight yards. Below, double-decked piers with truck access to both levels are included in water-front plans

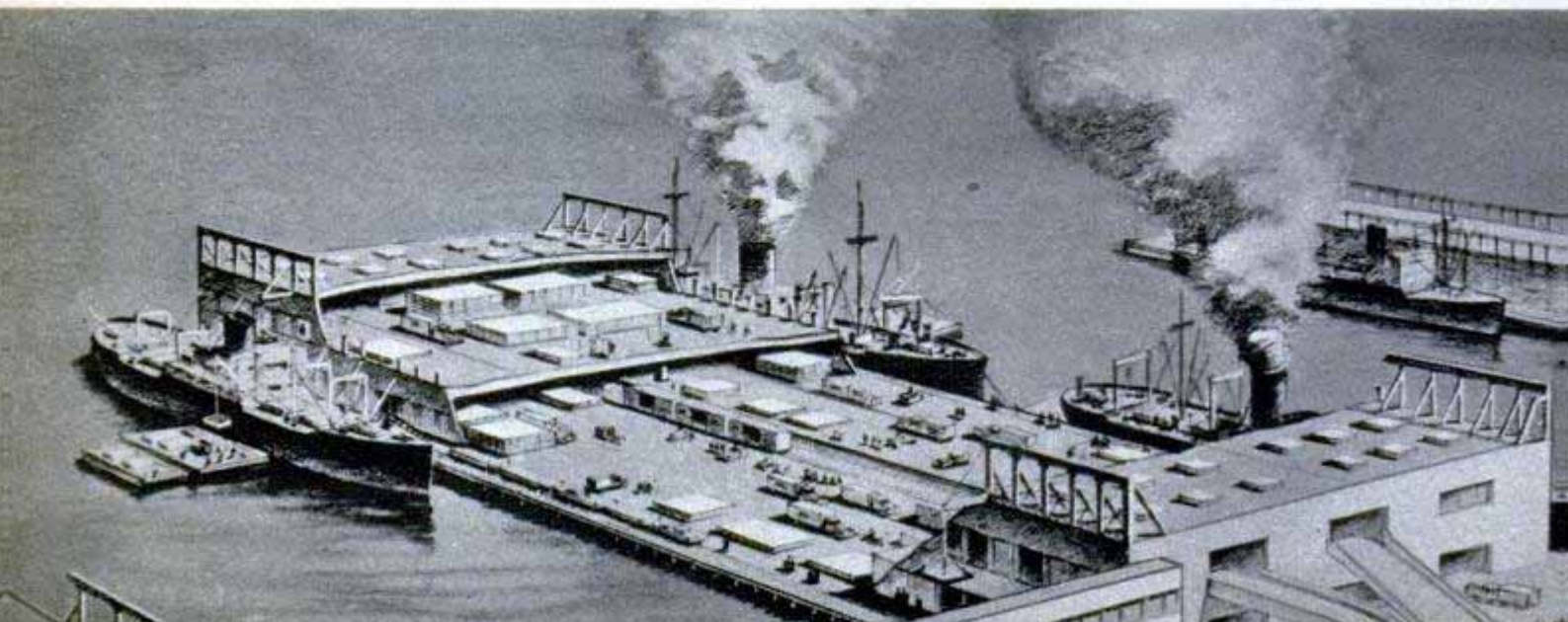

gallons of fuel oil burned daily in New York mean not only heat. They are also power and light. And electric power from fuel-burning steam plants is required for subways, trains, elevators, air conditioning and refrigeration.

Without imported fuel, nothing would move—practically nothing would happen along the city's steel and concrete canyons.

In addition to the 1400 carloads of perishable foods eaten daily in New York, about an equal amount of canned and packaged foods are consumed. Thus, about 2800 carloads, or roughly 28 trainloads, of food must be brought into the city every 24 hours. That's at the rate of a carload every 16 seconds, around the clock.

If these big figures defy comprehension, here are a few simplified illustrations:

Take an average eight-room house and fill it with eggs. Fill every available space, including the cellar and the attic. That's about 320,000 eggs, enough to keep New Yorkers satisfied for one hour.

These eight million people toss off 30 gallons of milk per second and two dozen 1000-pound beef critters wouldn't last 10 minutes. They eat 2½ carloads of fruit and vegetables every hour.

The fact that the borough of Manhattan, the heart of the city, is an island complicates the problem of supplying New York. It explains why this ultramodern metropolis, serviced by planes, electric trains and trailer trucks, leans heavily on the lowly tugboat.

All of the coal and most of the food comes from the west and must cross the Hudson River. Available

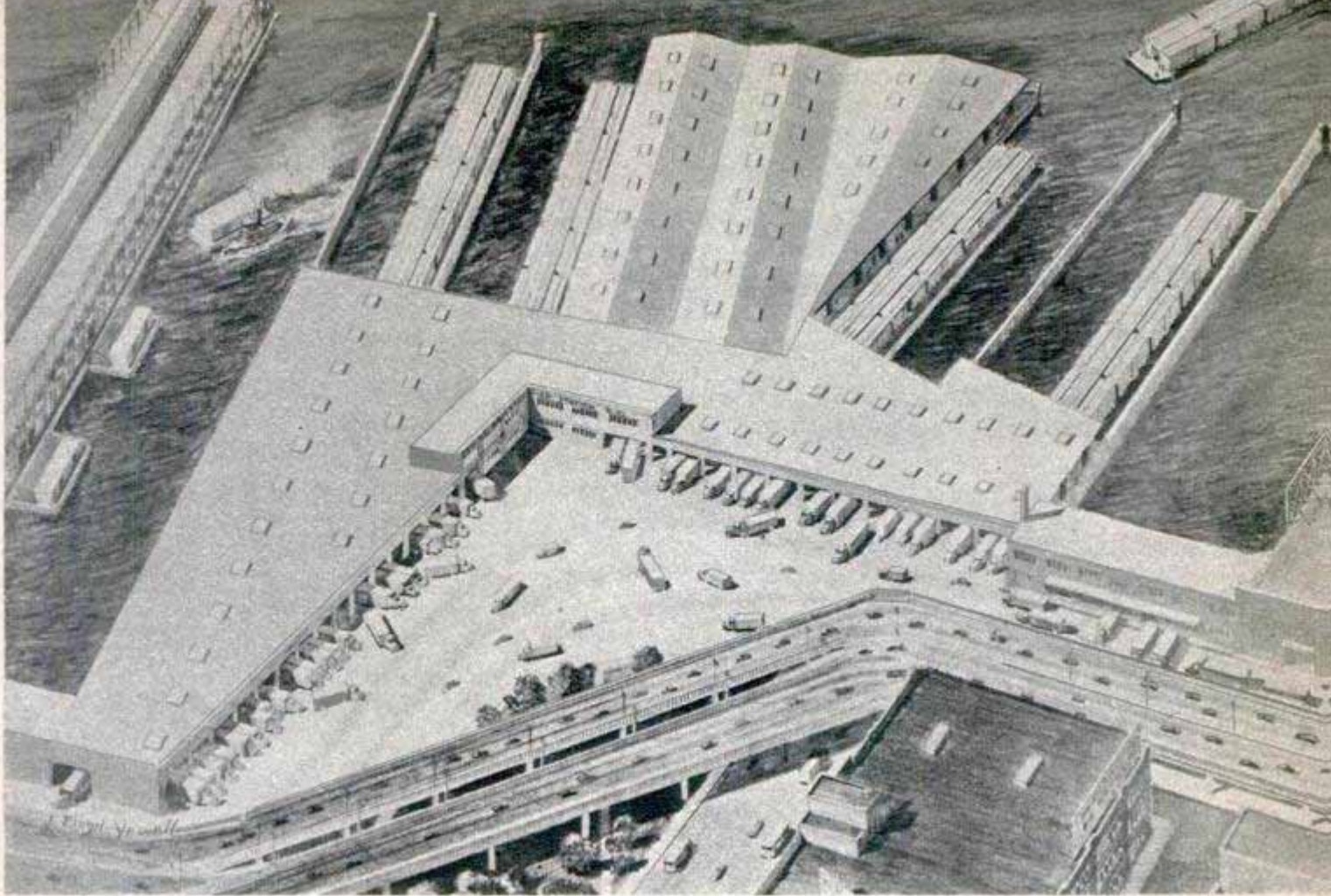

Berthing space for eight car floats is proposed for station along Hudson River, at 23rd Street, in Manhattan

train tunnels are barely sufficient to accommodate passenger and mail trains. Coal is unloaded into barges in New Jersey and towed across the river by tugs to docks in Manhattan, Brooklyn and Queens. About two thirds of the perishable foods come by the same route.

Fuel oil is delivered almost entirely by tanker ships from the Gulf of Mexico. These ships, as well as those bringing in tropical foods, require the help of tugboats to jockey them into position at the docks.

Thus, the 400 tugboats in New York har-

bor constitute a vital link in the life line.

Trucks also play a big part. Produce trucks roll in from farming areas in New York and New Jersey, with 60 percent of the city's fresh fruits and vegetables. And today, tank trucks are giving overworked rail lines into the city a lift by toting in 65 percent of the 5,000,000 quarts of milk New Yorkers thirst for daily.

Trucks also shuttle most foods from railheads and dockside to markets and corner grocery stores throughout the city, and deliver coal and fuel oil to homes.

Sliding tank, with a fraction of city's five-million-quarts-a-day milk quota, from flatcar to truck trailer

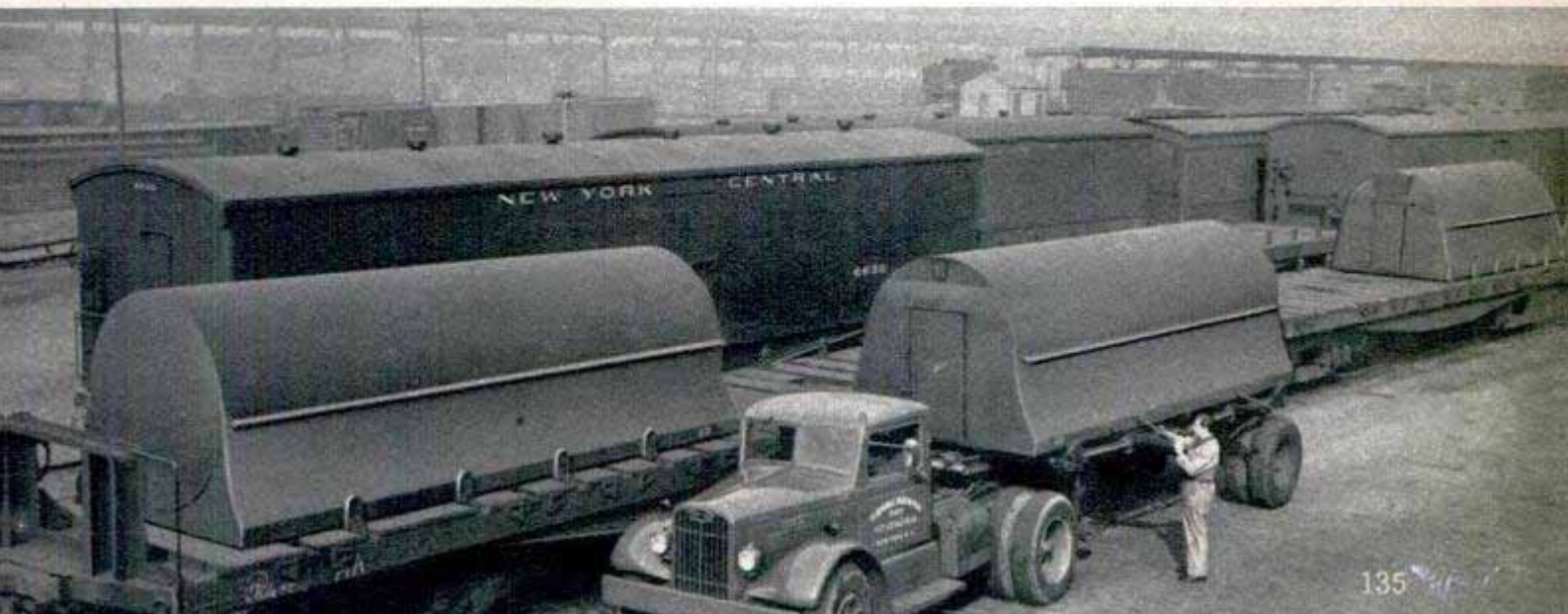

With these many complicated and interdependent lines of food and fuel delivery, interlacing the city like a blood system, it seems almost miraculous that it goes on day after day, on and on, without somewhere breaking down. Nothing, it seems, can stop it. One would think that a transportation strike or a heavy snow would quickly snarl the tight schedule, leave store shelves and coalbins bare and make thousands go hungry and cold.

But not so. New York has faced every kind of hunger threat—tugboat strike, rail strike, truck strike, blizzard—and rode serenely through with no more than slight inconvenience.

Perhaps the answer is in the city's diversification of food deliveries. If one mode of transport is stopped, the others tend to take up the slack. Also, the city carries a considerable backlog of food in pantries, stores, warehouses and cold-storage plants.

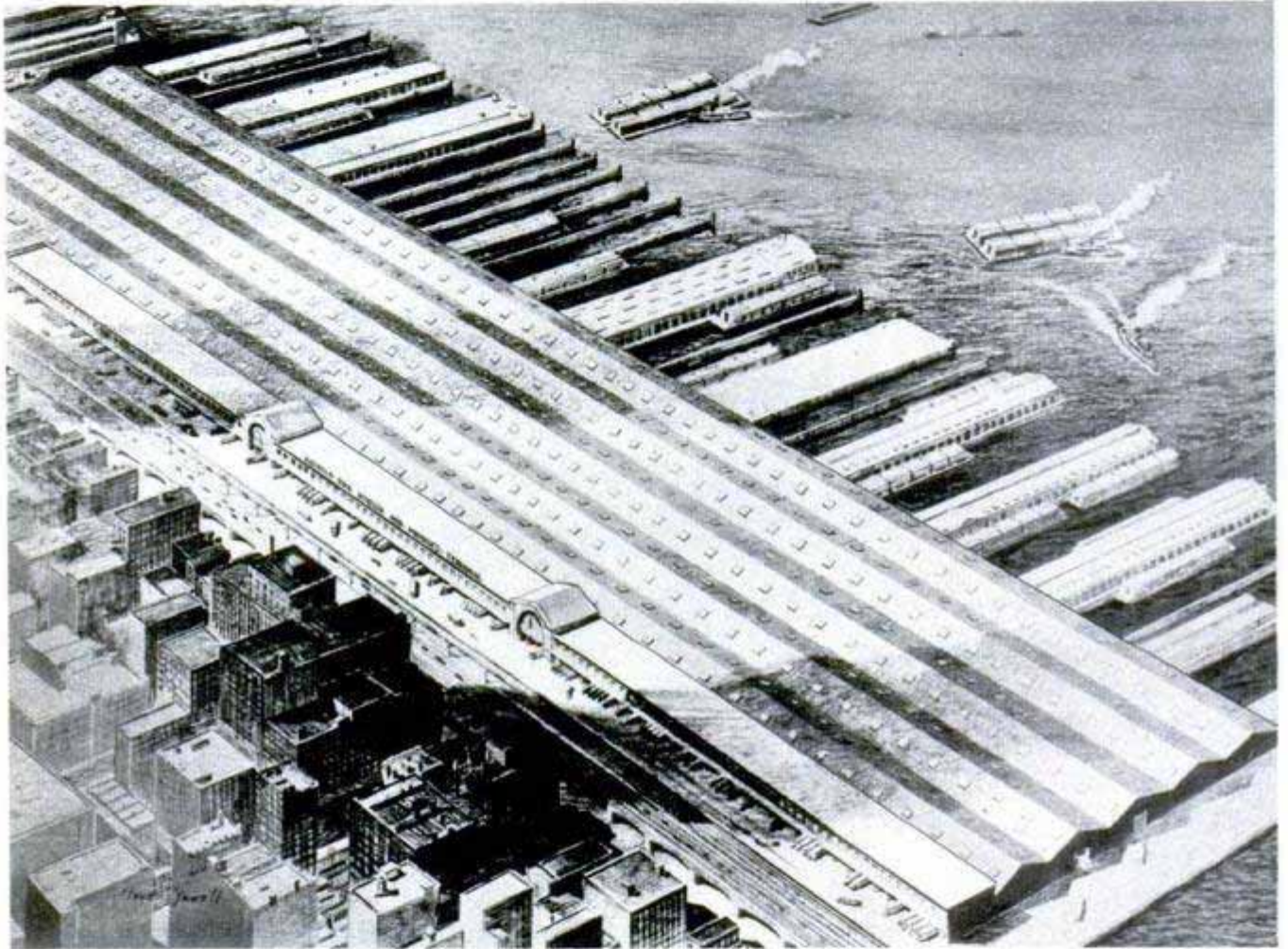

Approximately 1,200,000 tons of fresh fruit and vegetables will be distributed yearly to New Yorkers from world's largest produce terminal, to be built on Hudson River. Diagram below shows arrangement of facilities

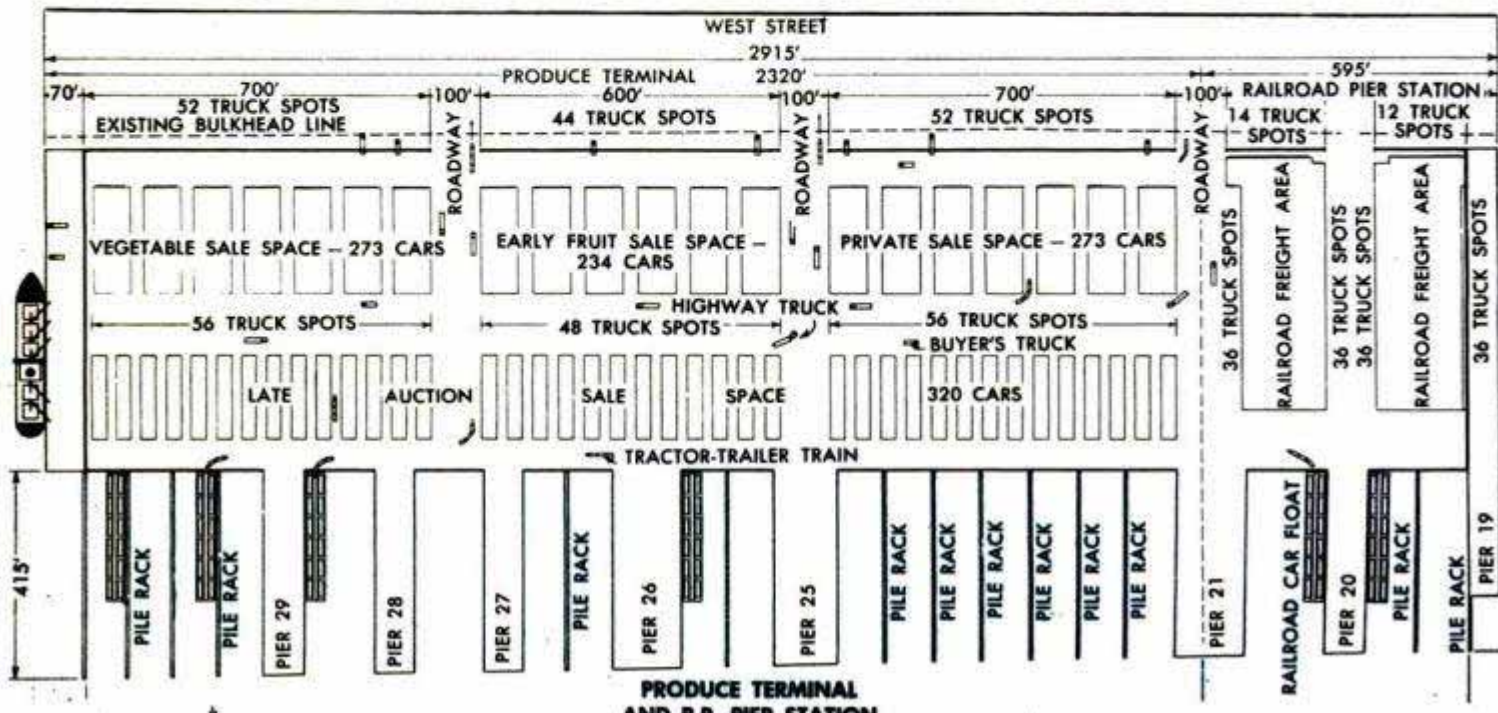

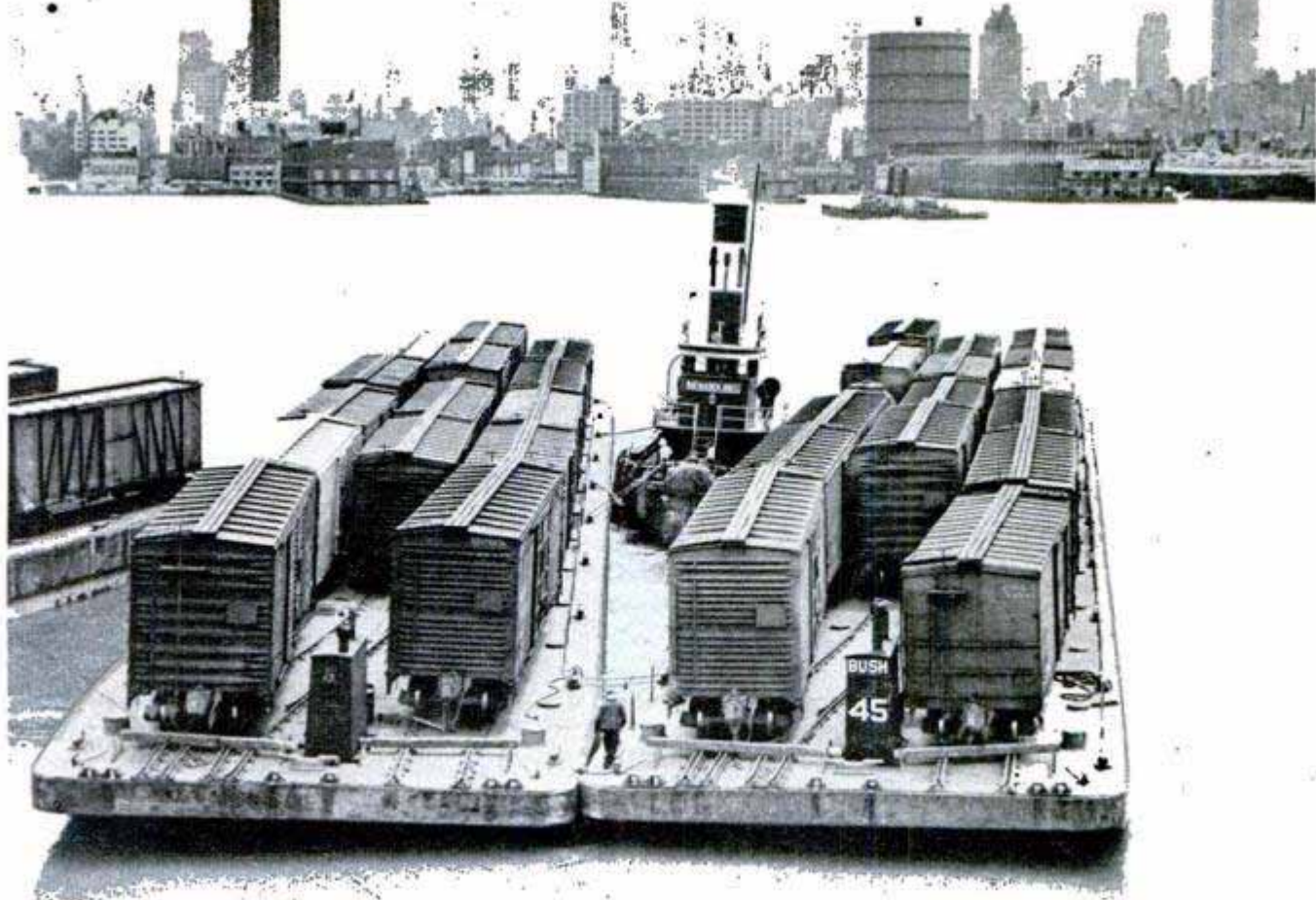

The railroad strike of May, 1946, was hailed at the time as a greater threat than coal, tugboat and steel strikes combined. However, when the strike ended after a 10-day duration, the city had not yet used up its food backlog. Meanwhile, the city police and market departments had made arrangements to mobilize 5000 trucks to bring in 15,500 tons of fresh produce a day from farms within a radius of 100 miles of the city. Over 100,000 trucks in the state could have been pressed into service if necessary.

The tugboat strike of September, 1946, also worried the city momentarily. But the strikers continued to carry essential supplies. Even if they had not, it would have been possible to shuttle food supplies across the Hudson by truck.

A truck tie-up could be the greatest blow of all. No other form of transport can substitute for the trucks that deliver food to stores or fuel to homes.

Witness the September, 1946, strike of truck drivers. Within a week, chain-store shelves were bare. These stores closed their doors until the strike ended, weeks later. However, the strike involved only chain-store food deliveries. Police escorted non-striking truckers as they made deliveries to independent grocers. New York's eight million eaters were slightly inconvenienced, but suffered no hardship.

The biggest snowstorm in the city's history—the 26-inch fall in December, 1947—made hardly a dent in the city's supply of essentials. Milk was in short supply for a few days, due to stalled tank trucks. And

All of the coal and most of the food for Manhattan must cross the Hudson River, keeping a fleet of 400 tugboats busy pushing barge traffic. Below, shifting canned goods to trucks for distribution to stores



home fuel deliveries were hampered for a day or two, until side streets were cleared of snow. But snow-removal crews gave priority to the movement of essential commodities and New Yorkers went on eating.

Neither man nor nature has been able to brew a catastrophe sufficient to throttle the big city's throbbing life line.

In fact, city officials are more concerned over the gradual stifling effects of time. Every increase in population (it has mounted half a million in the last 10 years) places

an added strain on already overworked dock facilities, produce markets, traffic lanes and freight yards.

New York's food-supply system is becoming both more precarious and more expensive. Dock facilities are limited and crowded and trucks backing up to them block street traffic.

By an inefficient but unavoidable system, a large portion of produce brought across the river on car floats is trucked to the Washington Street market, to be unloaded, auctioned and loaded onto other trucks. As



Above, new construction is expected to eliminate two thirds of the trucking in and out of the congested Washington Street Market. Below, a 26-inch snow in 1947 hampered but didn't halt New York's supply of essentials

a result, the market area in rush hours often contains three times as many vehicles as it can conveniently handle. The congestion spells delays, overtime expense for handlers and truckers and added expense to the food consumer.

The city is studying means of cutting and mounting cost of food deliveries. According to one plan, \$7,225,000 could be saved in vessel delays each year by building new piers and widening and improving the ones that already exist.

Construction of a new fruit and produce terminal—the world's largest—is also being considered. Because of high real-estate costs in the area, it is proposed to construct this terminal entirely over water, extending for 12 blocks along the water front. Under a single 32-acre roof, over 1000 carloads of produce (about half a million separate packages) can be unloaded from car floats, displayed, sorted, sold and delivered to 434 buyers' truck berths within a few hours.

This project would relieve traffic congestion on water-front streets and eliminate two thirds of the trucking in and out of the overburdened Washington Street market area. It would reduce by nine million dollars the annual cost of the city's fruit and vegetable deliveries. And it would remove a cause for concern, about which the average bustling New Yorker has never a second's thought anyway.



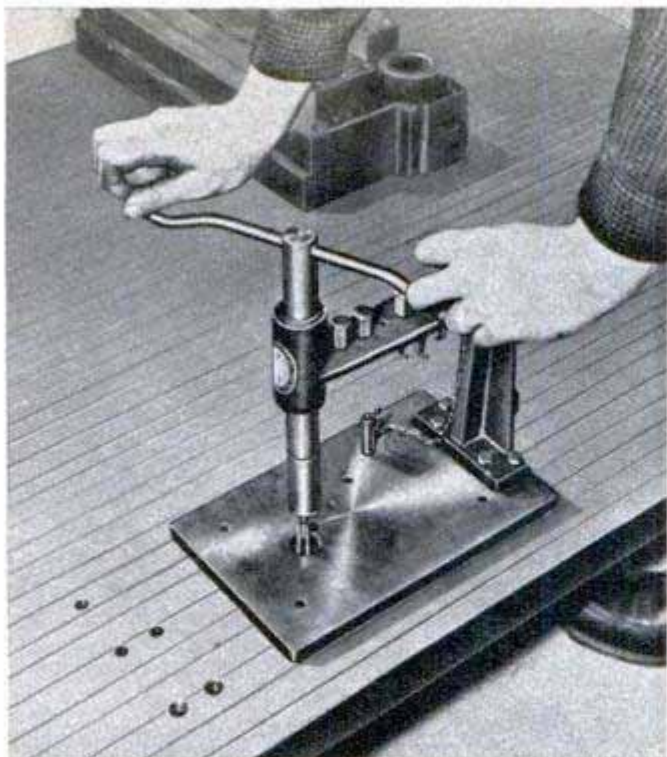

Guide Cuts Tap Breakage

Tap breakage is virtually eliminated by a portable guide that keeps the tap running straight in the hole. Suitable for lathe and hand tapping, the guide comes equipped with seven adapters for all normal requirements. If desired, the spindle can be removed and used alone as a tap extension for hard-to-reach jobs. The complete unit weighs about 32 pounds.

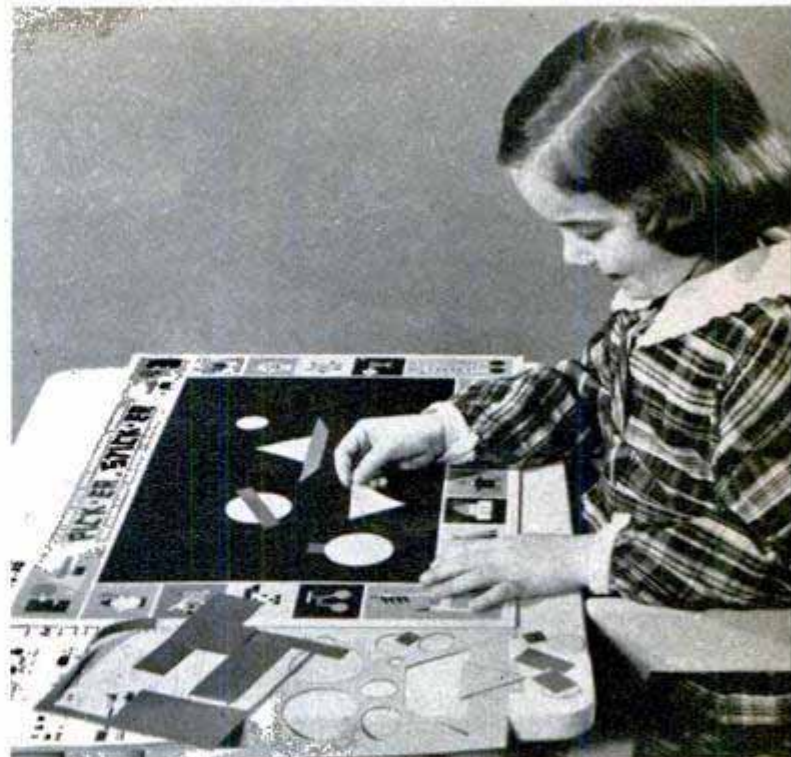

"Stick Ons" for Children

Colored cutout designs for childrens' play are made from flexible Vinylite plastic that sticks to polished surfaces or a special game board. They are pressed in place with the fingers and no glue or paste is needed. The shiny, nontearing designs are easily removed and can be reused indefinitely. All parts of the set can be cleaned with a damp cloth.

FLIGHTLESS ROCKET is not really a rocket at all, except in appearance. It's a wooden scale model that, like the extinct dodo, never leaves the ground. Built by General Electric engineers as part of their research program for the Army, the model furnishes data for use in designing rockets that will zoom skyward

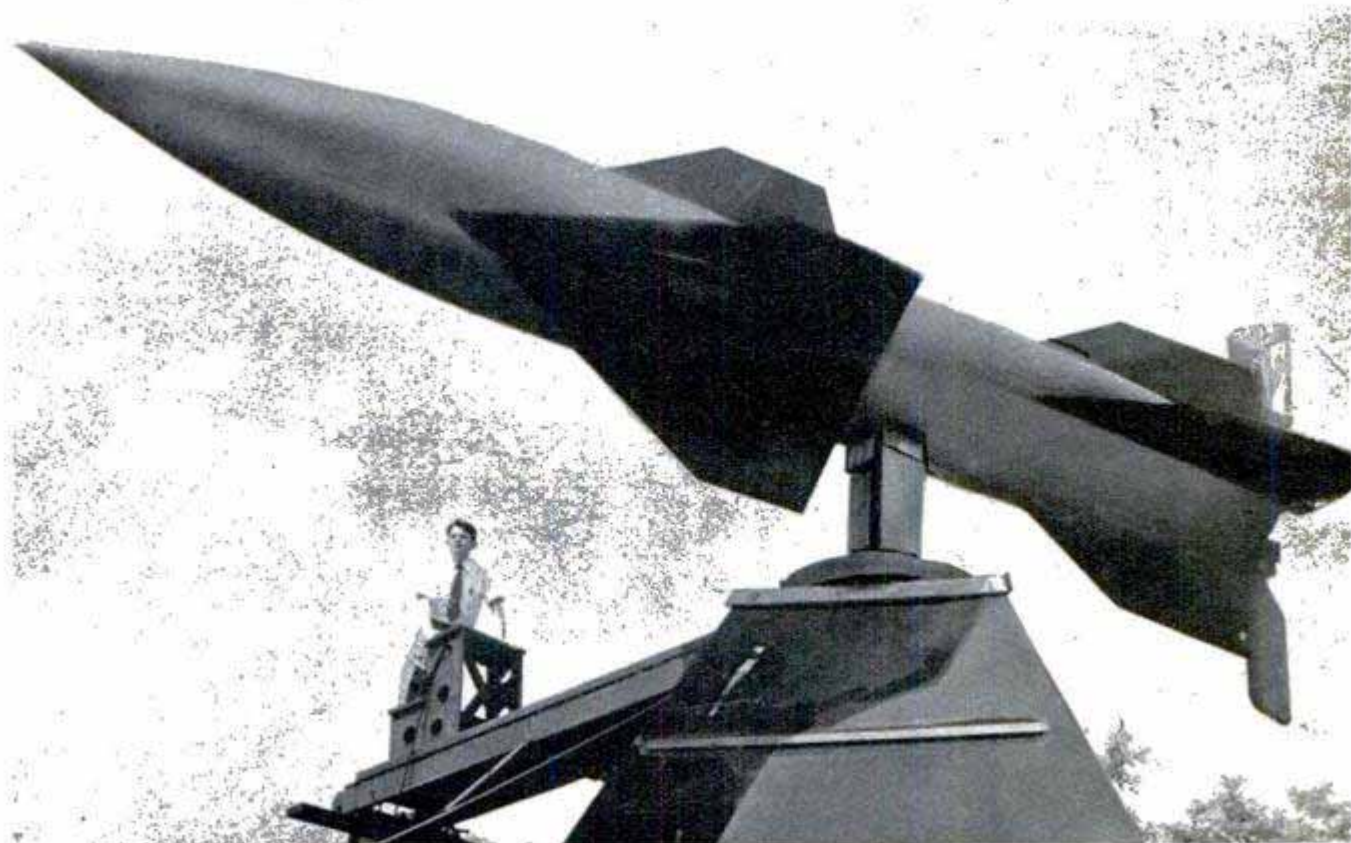

WHAT'S NEW *For Your Home*

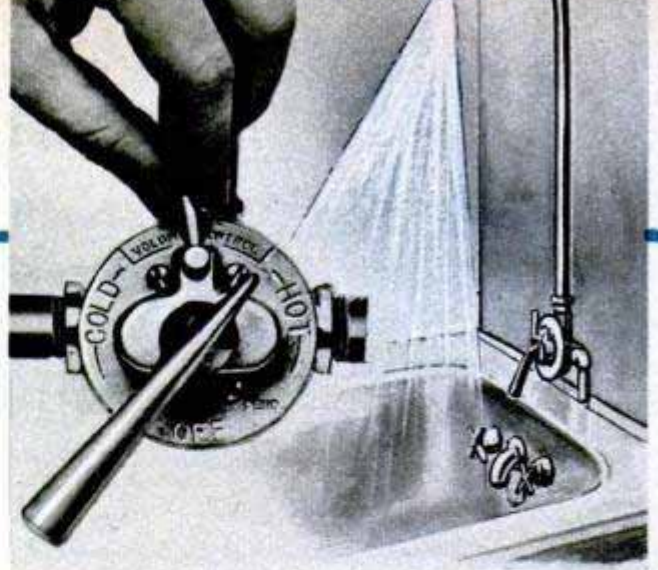

VOLUME CONTROL on shower-mixing valve lets you adjust temperature and flow separately. Full flow or trickle, the water temperature remains the same



ELECTRIC BROILER holds meat upright in a steel grill. With it, you can broil food right on the table



CLOTHESLINE FASTENER eliminates knots and can't slip. The heavier the load, the tighter the grip

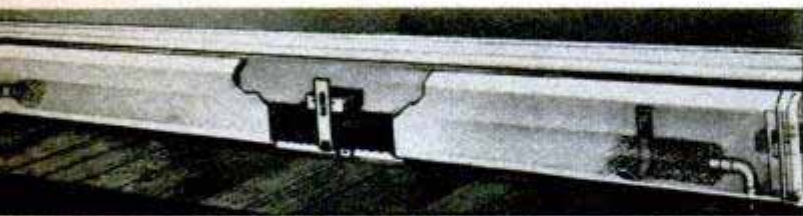

BASEBOARD HEATER, below, can be installed in existing homes right over the present baseboard

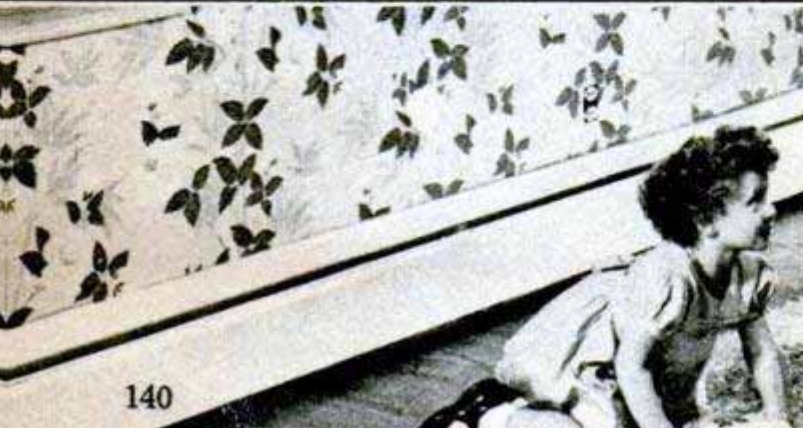



INSIDE-OUT CLOSET is designed like a section of a revolving door. The entire outer wall swings inside, bringing the clothes rack into the room for convenient selection of clothing. Built as a unit, it can be installed in a standard clothes closet or, if desired, set against a wall as a separate piece of furniture



DIVIDED GRATE for fireplace swings up, uncovering the center of the hearth for quick cleaning

SAFETY GUARDS, below, coated with Tenite plastic, clamp to bed so sleeping child can't roll off



ALUMINUM AWNING comes in kit form. Sketch, left, shows how louvers keep sun out, let light in

ELECTRIC DRIER has built-in warm-air breeze; makes its own "sunshine" by ultraviolet lamp

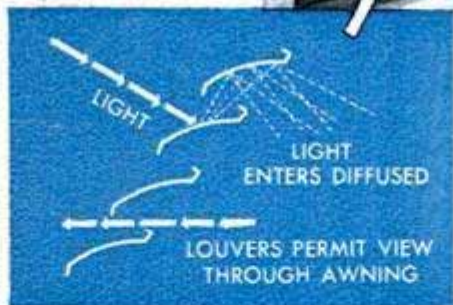

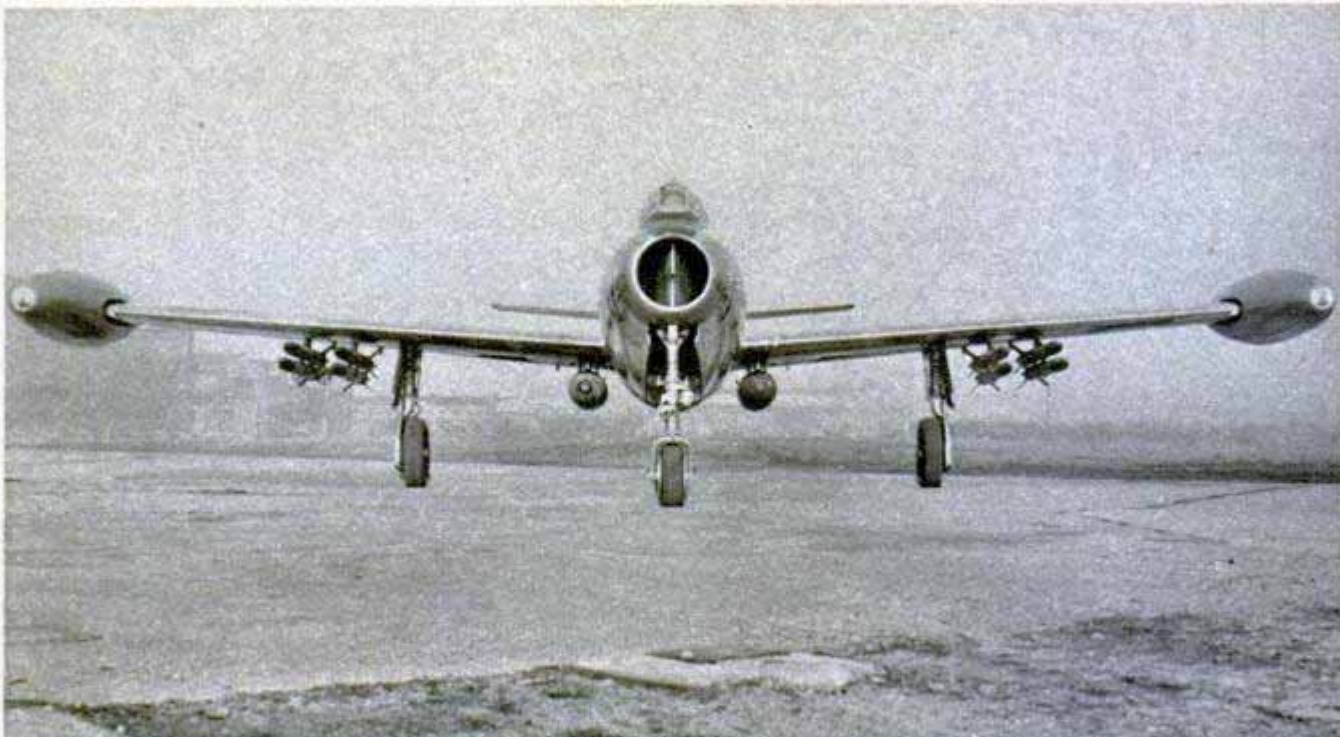

Republic Aviation Corp. photos

Above, a rocket-and-bomb-laden F-84, before nose air intake was plugged. Below, the plane after nose "operation," with new flush side inlet ducts



Thunderjet Fighter Gets "Radar Nose"

To improve its ability to detect enemy bombers, the F-84 Thunderjet's "breathing" nose has been experimentally replaced by radar equipment. Air for the engine will enter through flush side inlet ducts. The change has increased the plane's rate of climb. A new version of the F-84, already in production, will have a 50 percent greater range and 5000 foot greater ceiling than the model now used by the Air Force. The nose section was lengthened to allow the pilot more room.

Front-Line Transport For U.S. Air Force

Something new — air lift from staging areas to the front line — will be supplied by the Northrop Raider C-125 assault transport. Full-span flaps and high wing lift permit the three-engine cargo plane to operate from dirt runways. A rear ramp door allows trucks to be driven directly aboard. The U. S. Air Force is getting 13 for assault transport use and 10 for arctic rescue work. The Raider requires only a two-man crew for routine



operation, is 65 feet long, has an 87-foot wingspan and carries a five-ton pay load. It has a rugged, fixed landing gear with long-travel shock struts to soften rough terrain landings.

"Elastic" Roofing →

Asphalt roofs last years longer when coated with a metallic compound that protects the asphalt from the weather and, at the same time, increases the waterproofing and insulating qualities of the roof. Not to be confused with liquid aluminum asphalt paints, the new material is completely mineral hydrocarbon plus pure aluminum paste. It is non-oxidizing and will not lose its toughness, elasticity, reflectivity or adhesion. The material is so elastic it can be stretched like rubber. Prepared in liquid form, it is applied by spray, brush or mop. The solvent evaporates, leaving a bright, uniform foil film bonded to the cured asphalt surface.



"Cooked" Crystals Last Indefinitely

Quartz crystals, used by radio stations to keep their broadcasts on an assigned frequency, can now be made virtually everlasting with a process discovered by Army Signal Corps scientists. The crystals are superheated to about 900 degrees and then gradually cooled. Ordinary crystals deteriorate and fail to keep the broadcast signal on the cor-



rect frequency. This aging characteristic is eliminated by the new crystals, which will hold a desired frequency indefinitely.

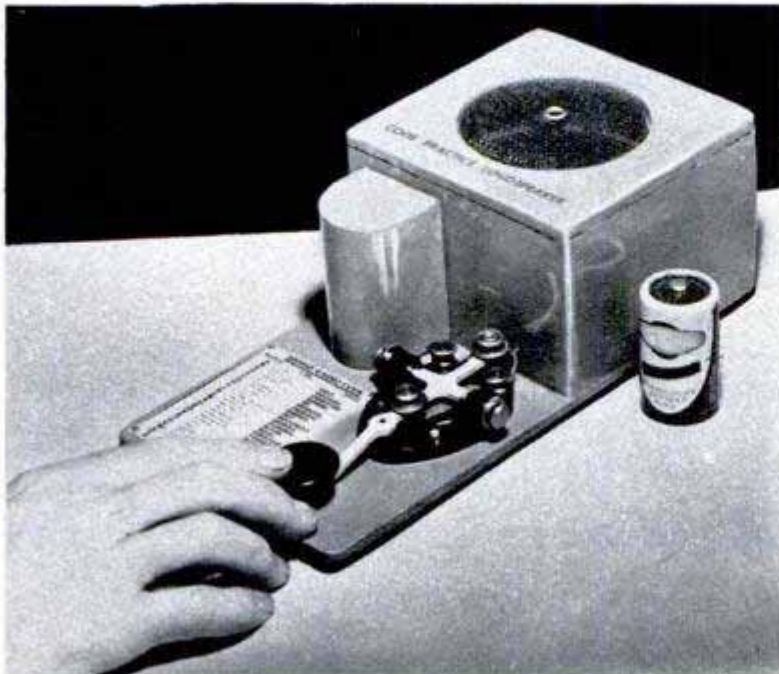

Telegraphy Practice Set Works on Flashlight Cell

Only a small flashlight cell is needed to power a new telegraphic code-practice set that uses no vacuum tubes. It has a four-inch speaker and for long-distance operation external terminals are included. Six sets can operate on one line. The unit produces a tone and volume comparable to professional sets.

Information not listed on articles in the index, starting on page 10, frequently is listed in the WHERE-TO-FIND-IT INDEX, available from Bureau of Information, 200 E. Ontario St., Chicago

Belt Line to the Sugar Bowl

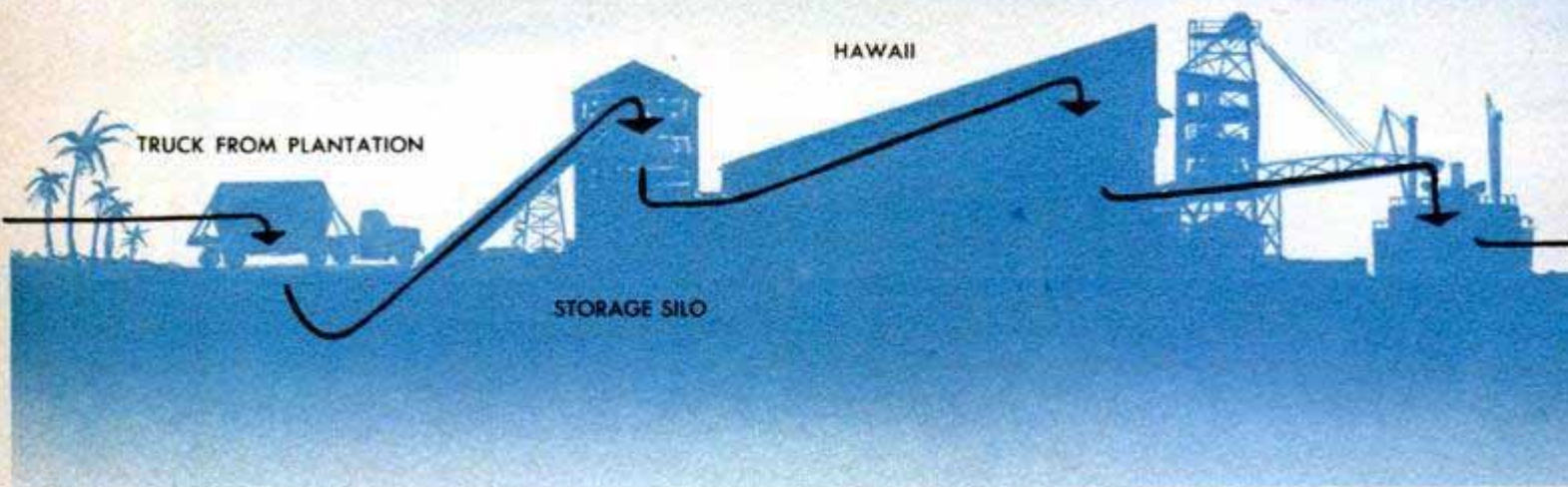

MILES of endless belts and scores of giant silos may soon replace the lines of sweating stevedores, balancing heavy bags of sugar on their shoulders, as the annual crop of sweetness makes its way to American refineries.

Hawaiian growers have solved the problem of bulk-handling raw sugar and, at

present, about half of the islands' million-ton crop is shipped to California refineries in bulk. With the Hawaiian-California installation as a pattern, sugar men all over the world may soon use belt lines to "pour" raw sweet into the world's sugar bowls.

Costly and frequently scarce jute sugar bags will be unnecessary; handling costs

Clamshell bucket at Crockett, Calif., bites into the raw sugar before dropping it into center discharge tube



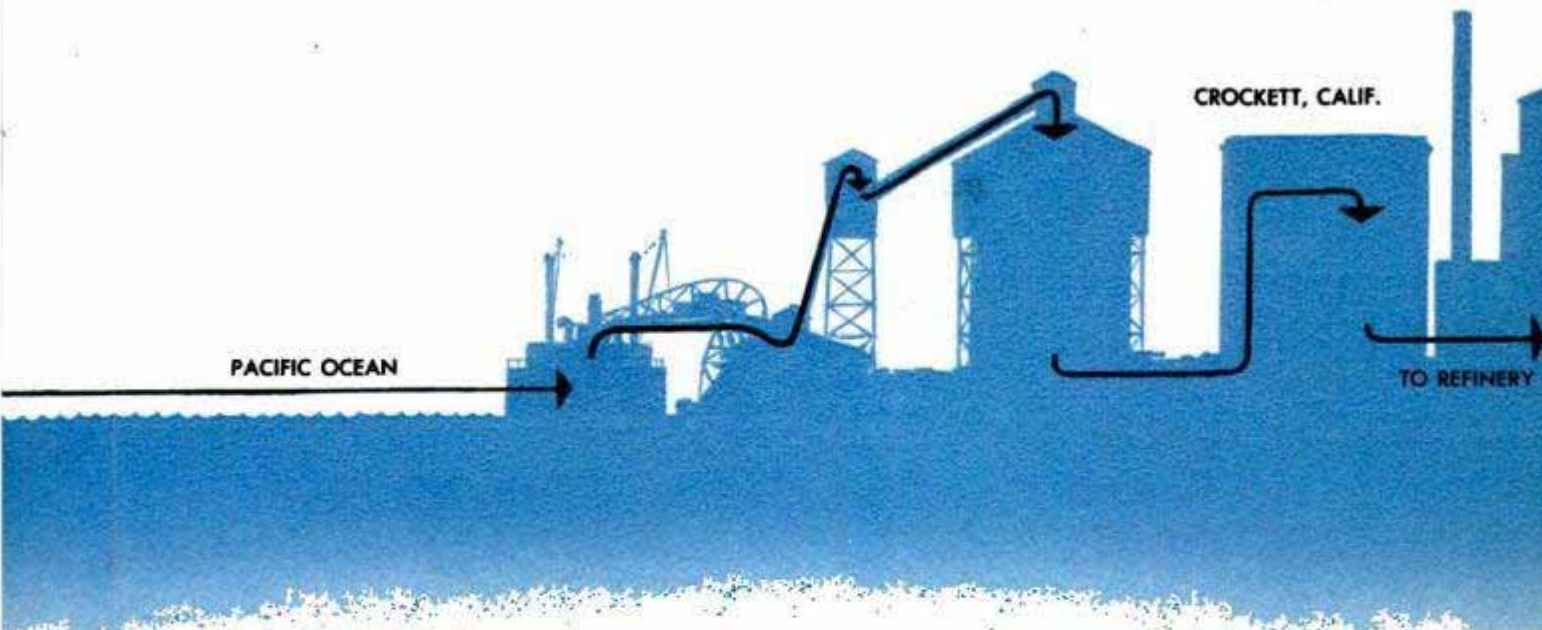

PACIFIC OCEAN

CROCKETT, CALIF.

TO REFINERY

The diagram shows a silhouette of a sugar processing facility. An arrow labeled 'PACIFIC OCEAN' points to a ship at a dock. A curved arrow shows the path of sugar from the ship, up a gantry, and into a large storage silo. Another arrow shows the sugar being transported from the silo to a building labeled 'TO REFINERY'.

will be reduced; turn-around time of ships will be cut and there will be better use of cargo space, when the promising Hawaiian techniques are universally adopted.

Cement, grain and other loose products have long been carried on and off ships by belts and blowers, but special problems connected with raw sugar, principally its stickiness and tendency to pack under pressure, have made ordinary bulk methods unfeasible. When the war began in 1939, the sugar men, faced with the threat of an end to jute-bag shipments from India, decided to work on the problem with all their energies.

The Hawaiian industry was the first. By 1942, a 30,000-ton-capacity bulk sugar storage plant had been erected at the port of Kahului on the Island of Maui, within sight of cold-eyed young marines practicing beach-storming operations which soon were to be followed by victories over the Japanese on the Pacific Islands.

Simultaneously, preparations were made at Crockett, Calif., to unload and store the raw sugar. Two steel gantries were erected at the dock and equipped with continuous-chain bucket elevators, which could be lowered into the steamer holds to remove the sugar.

The first shipment from Hawaii was made in June, 1942, and the method proved entirely practical. Further expansion to other Hawaiian ports was postponed until 1947, due to material shortages.

The Maui operation accounts for about 15 percent of the Hawaiian crop. Next facilities were started two years ago at Hilo, on the "big" Island of Hawaii, where another 30 percent of the crop is grown, and the Crockett facilities were enlarged.

Thirty thousand tons of sugar can be stored at Maui and 40,000 tons at Hilo. The former is a large wooden structure, while at Hilo there are four steel silos, 76 feet in

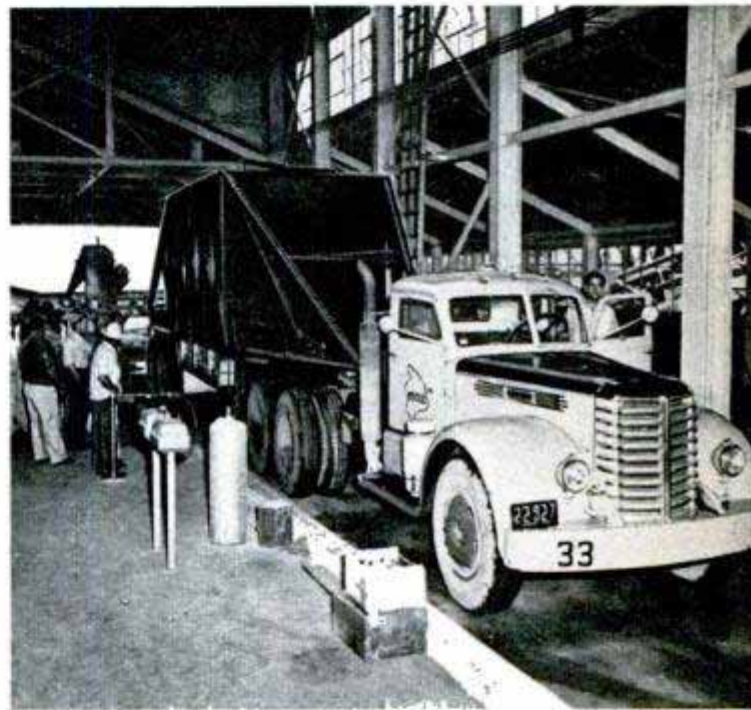

Trailer, filled with 20 tons of raw sugar, has its load weighed on a scale before dumping it at Hilo bulk plant. Below, the glistening raw sugar pours from trailer into the receiving pit on way to silo

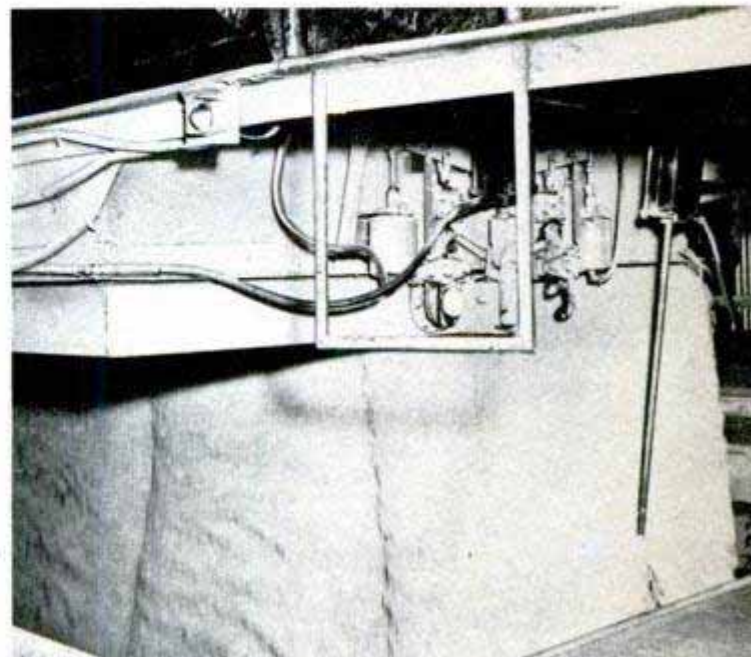

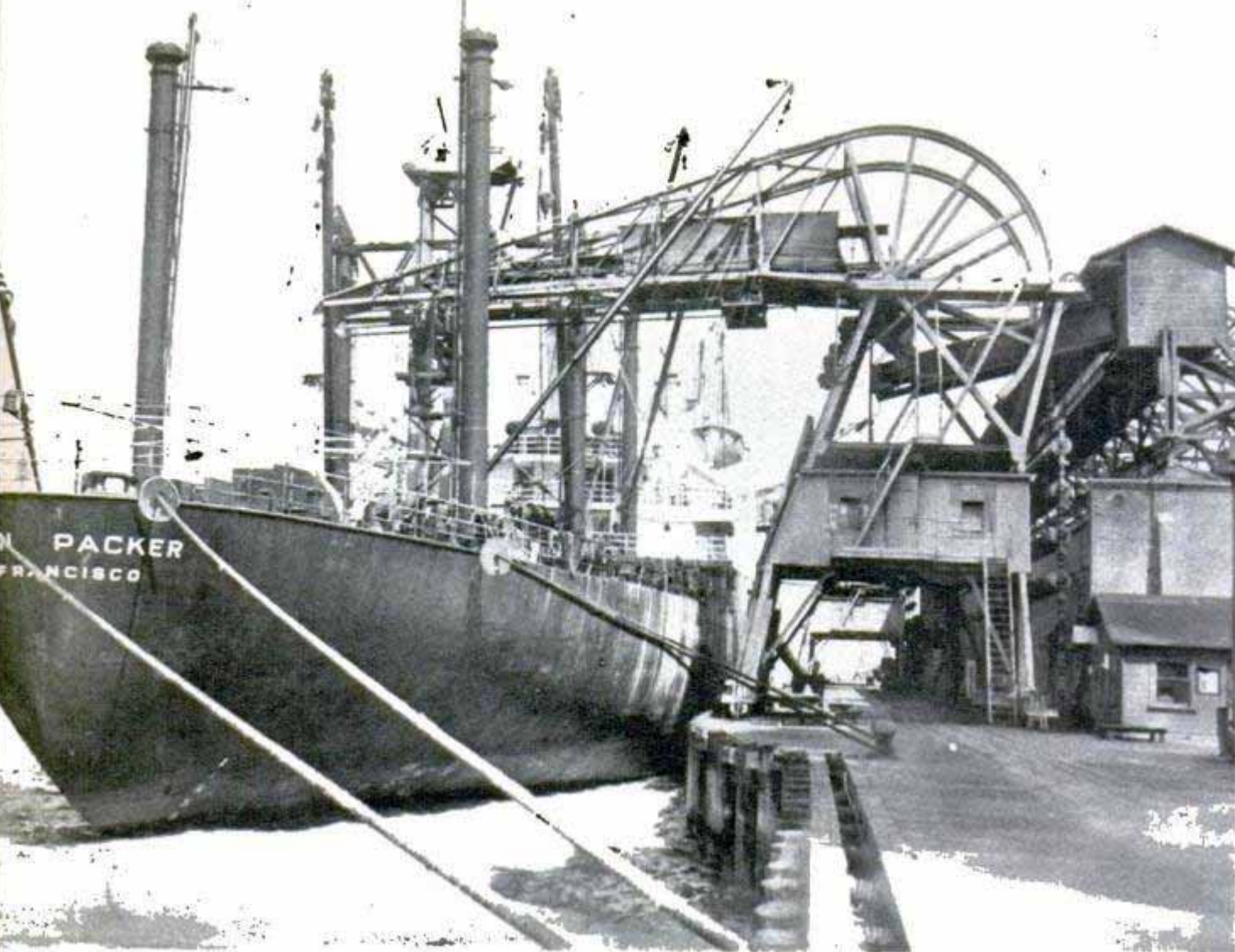

Bulk sugar by the shipload is unloaded mechanically from this C-3 cargo vessel alongside the Crockett dock

height and 80 feet in diameter. Later, at Nawiliwili on the Island of Kauai and Honolulu, Oahu, construction will follow the Hilo design.

Sugar is dumped by rail cars or trucks directly on long conveyor belts, which carry the sugar to the top of the silos, where it

pours, like a waterfall, into the bins below. Covering the silos is a superstructure that houses moving cranes, from which are suspended the clamshell buckets used to discharge the sugar. These pick up the sugar in the silos and drop it down a sectional discharge tube that extends up

through the center of each silo. At the bases are conveyors which carry it to the steamers. The discharge tubes are made up of six-foot lengths of steel pipe, six feet in diameter, which are added section by section as the sugar builds up in the silos. As sugar is removed, tubes are similarly taken down, section by section.

A device known as a Sinden trimmer "shoots" the sugar to all sections of the steamers' holds.

Like a shimmering waterfall, the raw sugar cascades from a conveyor belt into an 80-foot silo at the Hilo storage plant

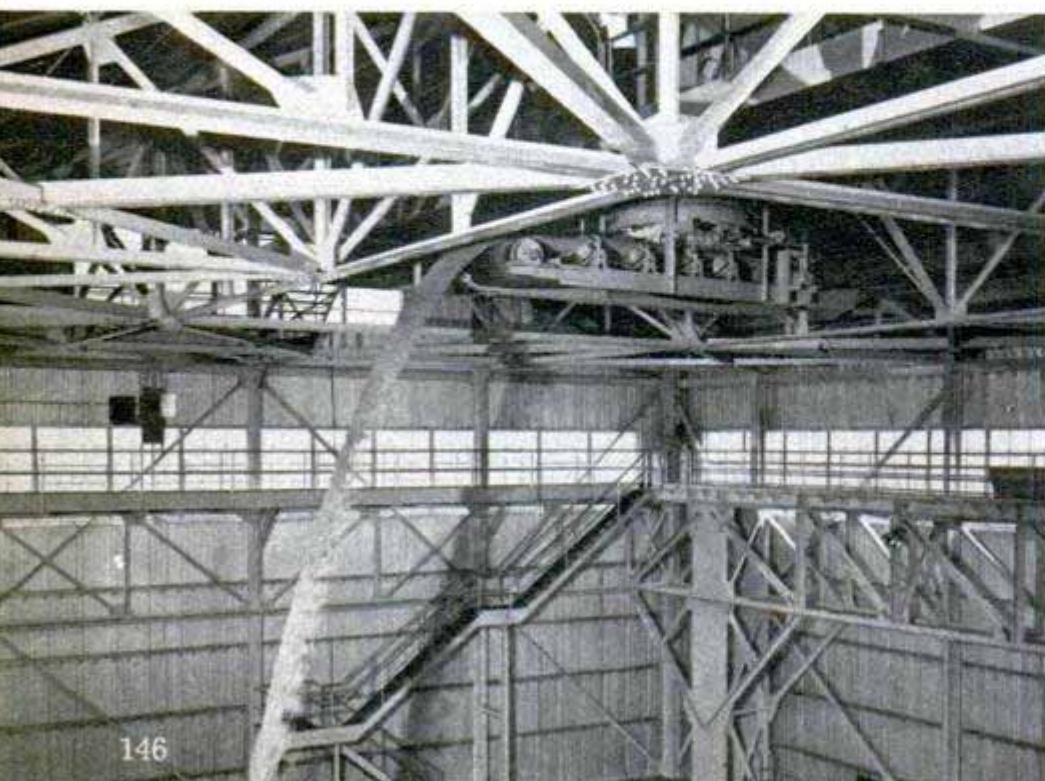



These are the storage silos at Crockett, Calif. Note the ramps inside which conveyor belts move the sugar

The two unloading gantries at the dock are arranged to travel the full length of the vessels so that sugar can be removed from any hatch. The Crockett plant, which is a cooperative owned by the Hawaiian plantations under the name California and Hawaiian Sugar Refining Corporation, has nine storage silos to hold the sugar until it can be refined. The total capacity is 90,000 tons.

The C-3 cargo vessels now used to haul raw sugar from Hawaii to Crockett have not required any extensive alterations or additions. Solid wooden sheathing is used to keep the sugar away from the hull. Average bulk cargo is 7000 tons, and 10 ships have so far been equipped for the work.

When completed, the

Flowing uphill, the raw sugar is carried to the silos. Hopper at rear is the pit into which the trailer dumps its big load

Hawaiian and California units will have cost about \$9,000,000, borne proportionately by the Hawaiian plantations. For more than a half century, these sugar-growing farms have improved methods of production until today they are among the most progressive farm enterprises on earth.



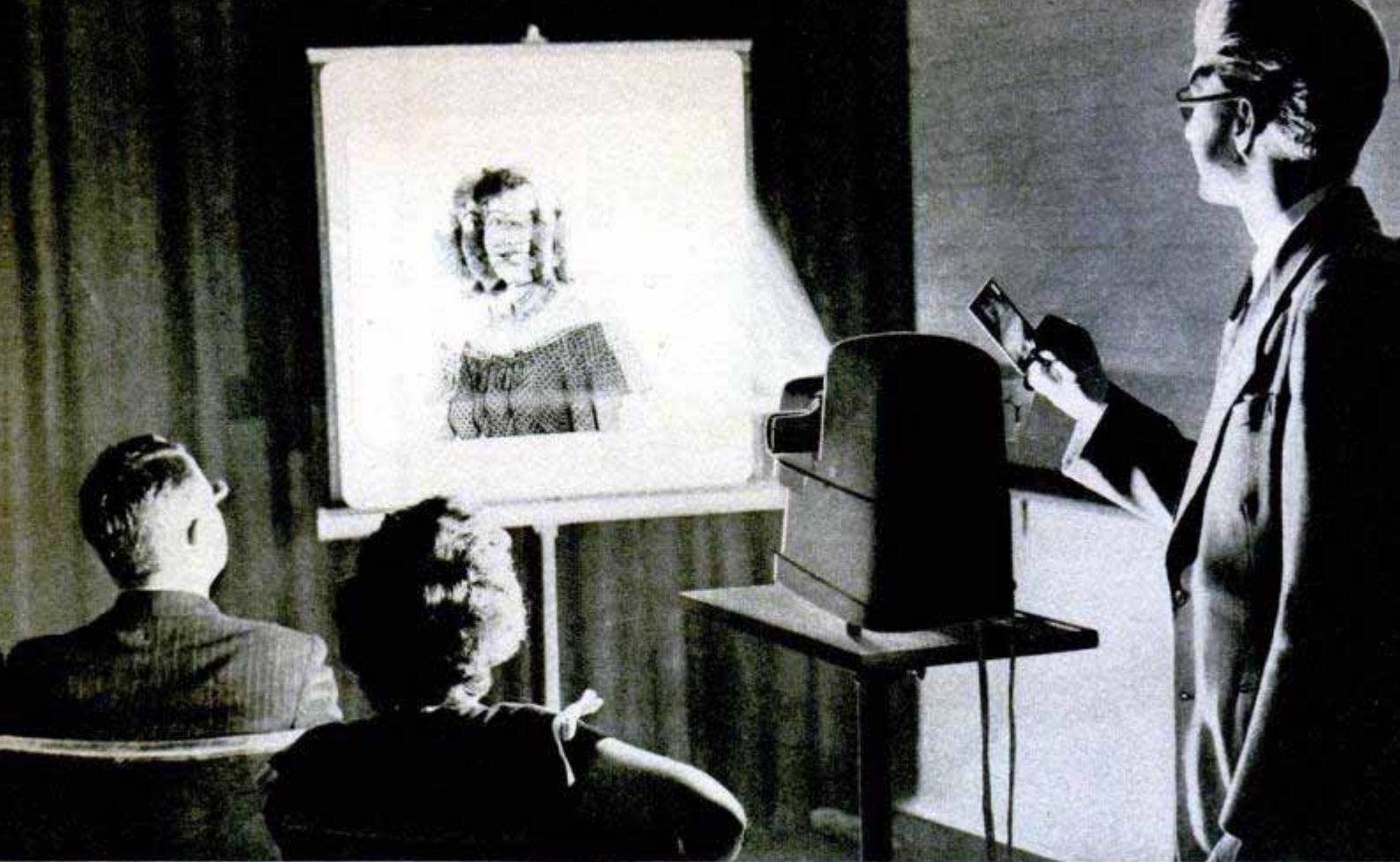

Above, not much larger than a regular projector, the stereo model shows slides in three dimensions. Below, drawing shows optical system and position of twin images. Two colors are used here to separate images for clarity. Actually, both images would be in full, natural color. Notice the Polaroid screen and spectacles

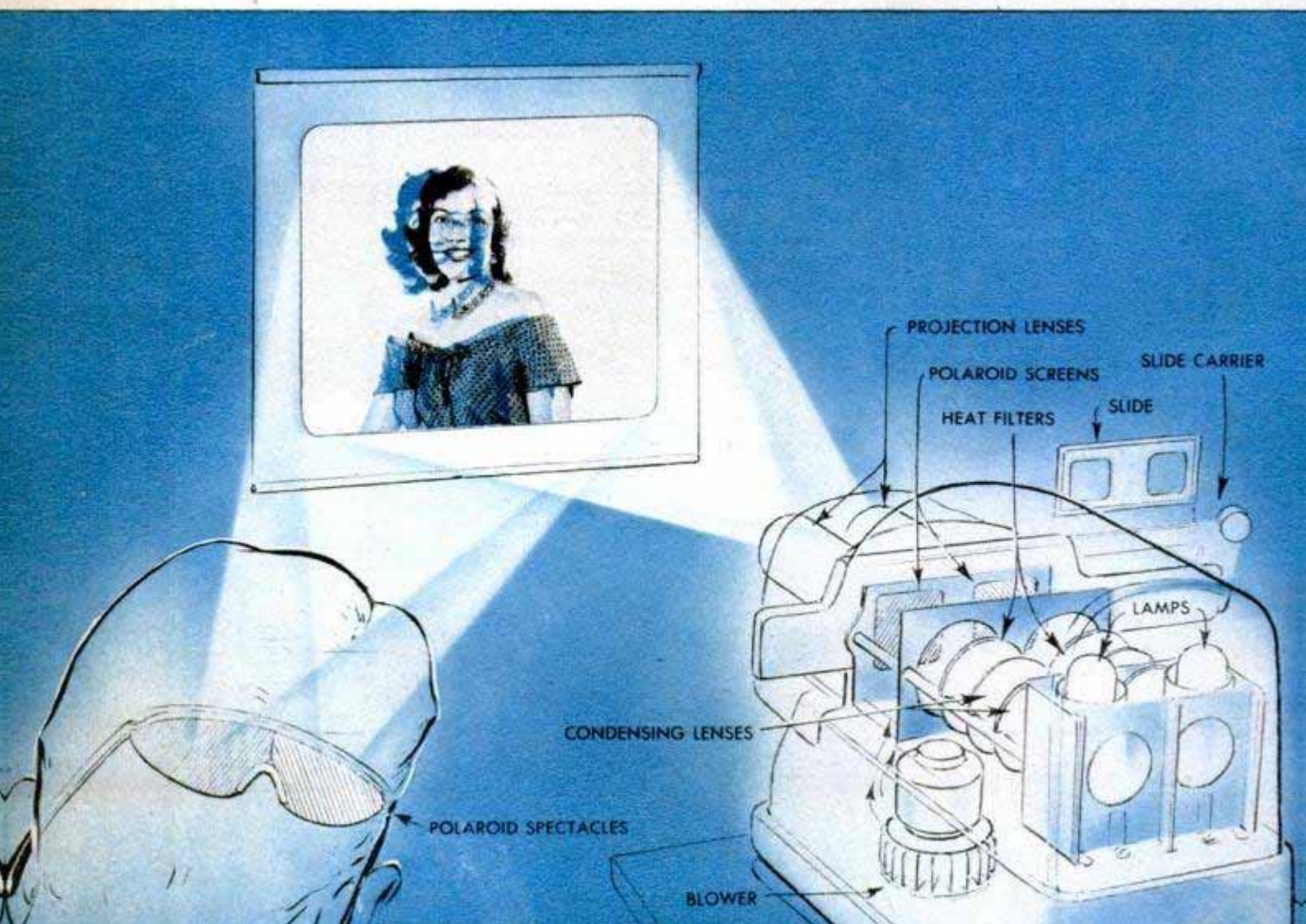

TWIN LENSES PROJECT COLOR IN THREE DIMENSIONS

YOUR SCREEN becomes a "picture window" through which you see color slides in three dimensional realism when you show stereo transparencies with a twin-lens projector. The projected picture seems to step right off the screen and hang in mid-air with such naturalness that you're sure you are seeing the subject itself and not its picture!

The projector takes Stereo Realist slides, 2 by 2-inch stereo slides and the proposed American Standard slides without adjustment. It has two complete optical systems with matched f:3.5 fully corrected projection lenses. Secret of the three-dimensional effect is a pair of polarizing filters on the projector and matching polarized lenses on the spectacles worn by the viewers. Unlike old-fashioned three-dimensional projection systems, there are no colors added to the slides. No red and blue tints separate the two images. Polarization does the trick without changing the natural colors of your transparencies.

The special screen used is not beaded, but has a flat surface essential for three-dimensional effects.

The polarized spectacles permit the right eye to see only the image projected by the right lens and the left eye, the left-lens image. Lightweight, the spectacles are designed so they can be worn comfortably over regular glasses.

Without the spectacles, you see two images on the screen. Slightly out of register, they present a blurred view. But when you put on the glasses, the two images become one—a natural, just-like-the-original view that brings the wonders of nature indoors for you and your friends to enjoy time and time again.

DECEMBER 1949

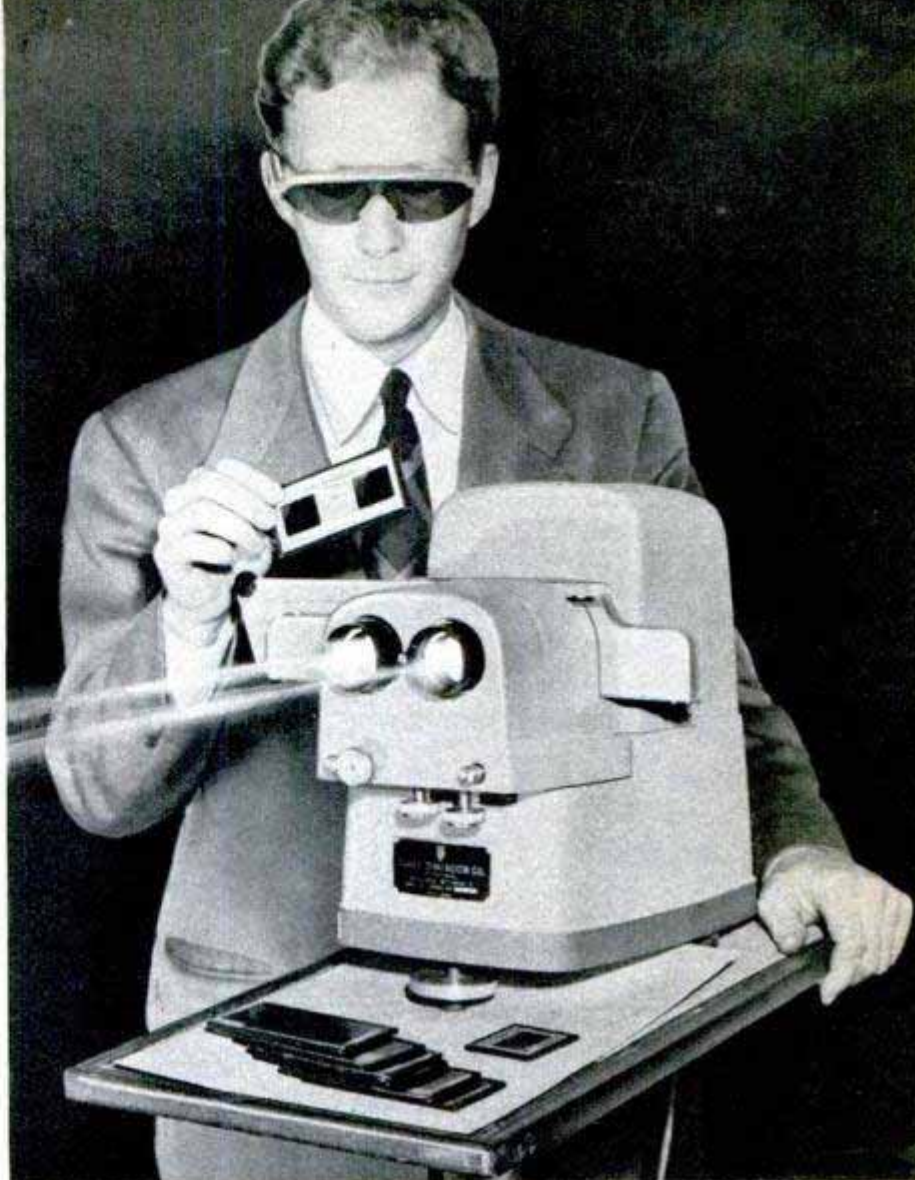

Front view of the projector shows its twin lenses. It can be used to show single slides by turning off one projection lamp

Below, three-dimensional color slides, taken on a stereo camera like this one, provide a new thrill when shown by projection

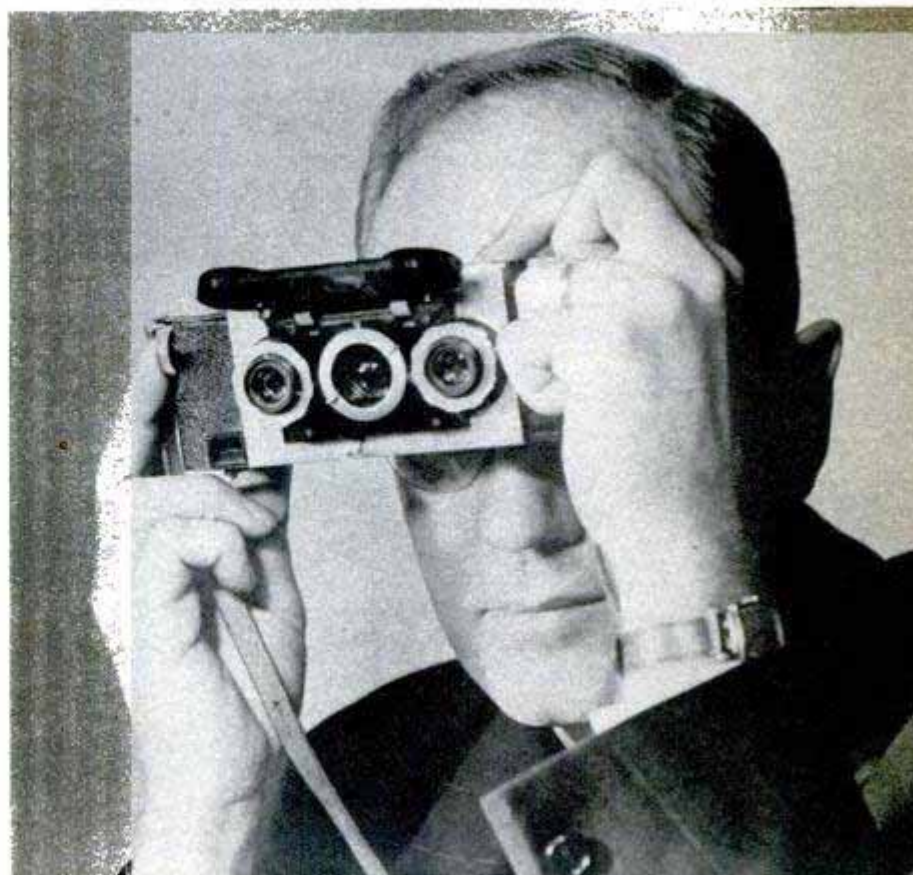



Post Straightener

Bent posts which are embedded in concrete are quickly straightened by a hydraulic tool. Designed for straightening parking-meter posts, the straightener does its job while the post is still in the concrete. A collar is fastened to the post and a hydraulic jack pumped a few times to apply pressure to the bend. The posts can be straightened whether they are bent toward the curb or sidewalk.



Plastic Shield for Glass Gauge

Liquid-level glass gauges are protected against accidental breakage by a plastic shield which also protects the operator against the escaping liquid and shattered glass should the gauge blow up from internal pressures. Designed for use on tanks or other vessels containing light oils, corrosives or poisonous substances, the Tenite plastic shield has three vent tubes on one side to divert the spray of escaping material away from the operator. Loose-fitting caps cover these vents to prevent foreign matter from entering, yet fit loosely enough so as not to interfere with the escape of spray should the inner gauge break.

Hoist Somersaults Small Boat to Deck of Larger Craft

Even a cumbersome dinghy can be hauled aboard a sail or motor boat with a new end over end, into the larger craft. Two hoist. The hoist tumbles the small boat, straps are fastened to the dinghy. The boat-

man then pulls on a hoisting line, lifting the bow of the dinghy over until the boat slides, bottom up, onto the boat deck. During the dinghy's somersault, the water automatically is bailed out.

Straps are fastened to stern of the dinghy. When the line to the bow is pulled, the dinghy tumbles aboard



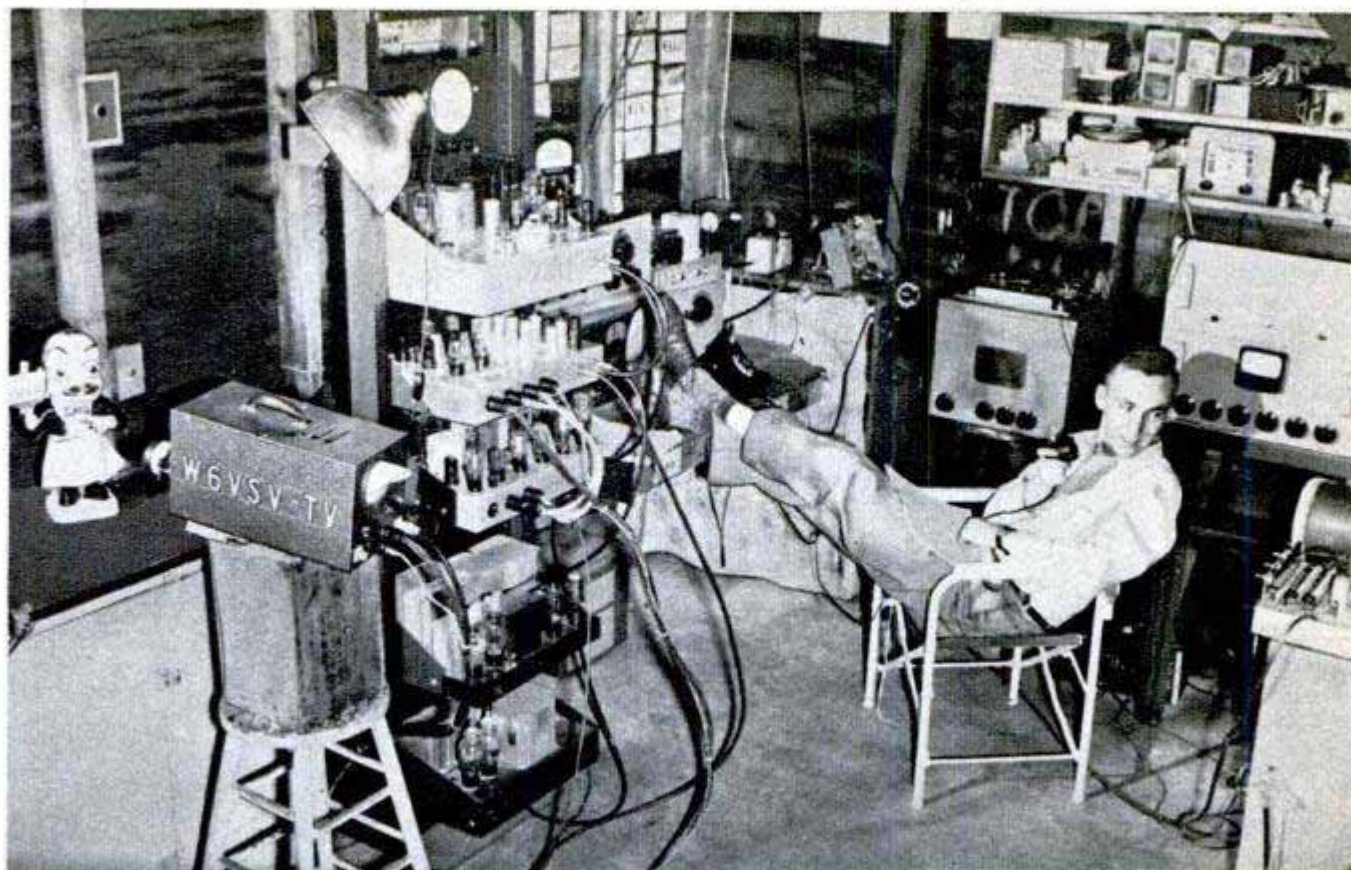

Above, Melvin monitors the image as he transmits his call letters, carried by "Rudy the Waiter," seen in front of camera. Left, picking up a program from his living room



Ham's TV Station Is All Homemade

In less than one month, a California radio hobbyist built himself a television station, complete with camera; that he now uses to broadcast amateur programs almost every night. The hobbyist, 23-year-old Bob Melvin, took over the family garage for his equipment. Members of his family serve as actors.

Sportsman's Wrist Watch Flips Over to Protect the Crystal

Sportsmen can wear a reversible wrist watch during the most strenuous games without danger of cracking the crystal or damaging the movement. When worn with the face out, the watch looks no different from any fine model. However, when there's danger of cracking the crystal in work or in play, the wearer simply swings the watch upside down so that the

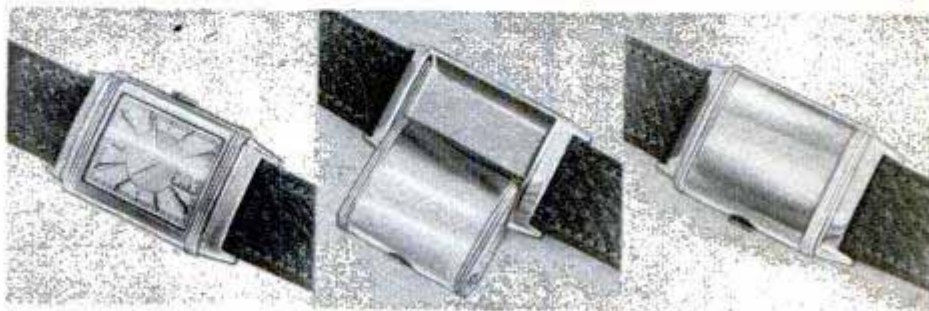

steel back is up and the crystal is protected in the face-down position. Initials can be engraved on the back, if desired.



Four mechanical wizards puzzle over the problem of how to manufacture a new part for an air cleaner. Below, atomizer tool "liquefies" metal, then sprays it on worn parts to make them as good as new



SHORT-CUT

By C. G. Wallis

*Director, Westinghouse Headquarters
Manufacturing Engineering Dept.*

DID YOU ever hear of "painting" with molten steel? Or cutting brass with a rubber wheel?

A trip through the Westinghouse Electric Corporation's Manufacturing Engineering Department at East Pittsburgh, Pa., would show you these and hundreds of other production short-cuts that have brought the department the nickname of the "know how laboratory."

Many of these production techniques are original, some have been learned from others, but all add up to a quicker or more accurate way of meeting production problems that arise in Westinghouse plants.

The know-how laboratory was established in 1939 to help solve all kinds of how-to-do-it problems. To date, the lab has cooperated with engineers of Westinghouse operating divisions to turn out more than 1000 improved techniques for producing everything from electric appliances to giant generators.

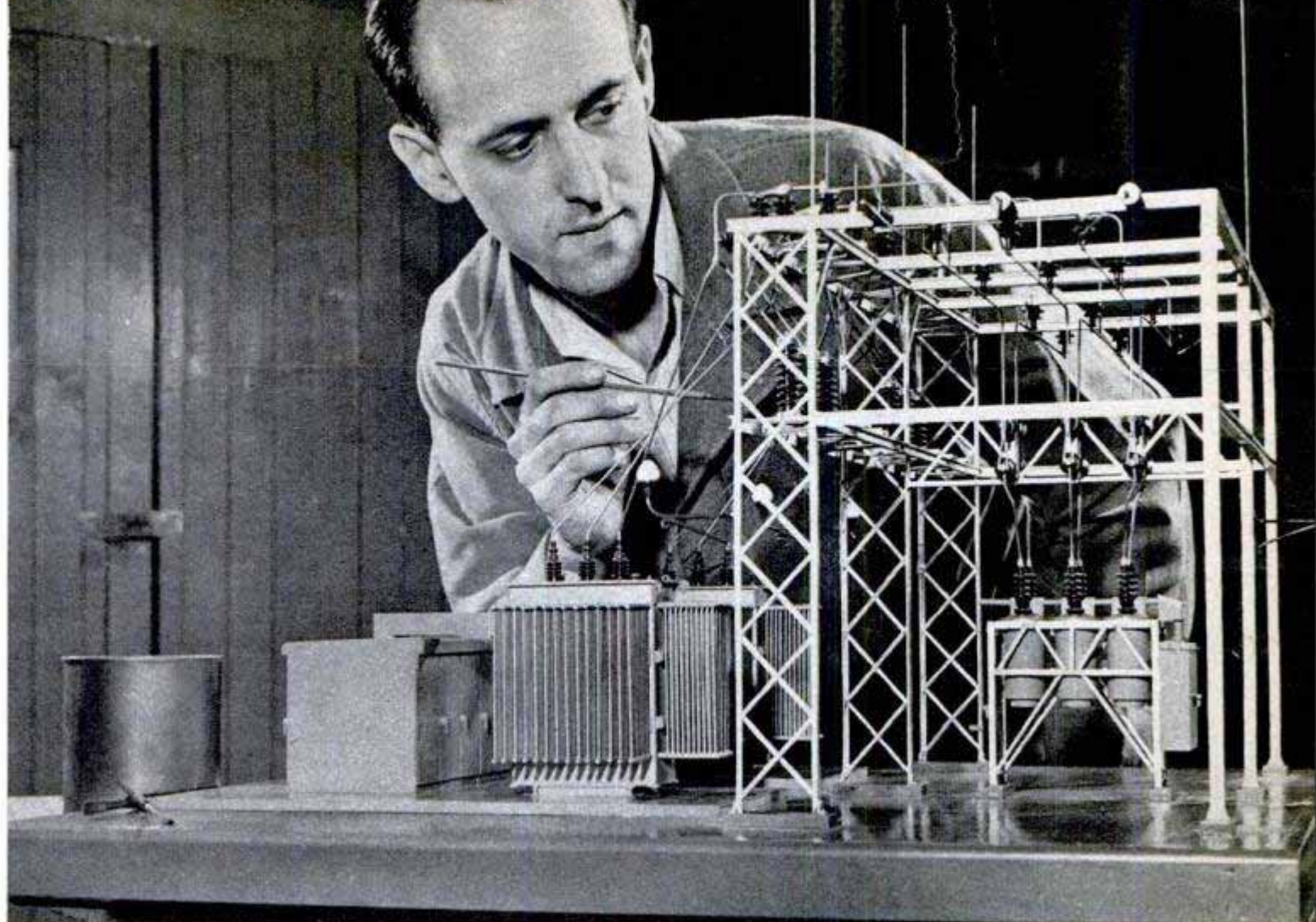

Westinghouse photos

ENGINEERS

Expert modelmaker touches up a power substation which will be used in planning an efficient plant layout. Below, a disk made of rubber and abrasive makes a clean, fast cut through a bar of steel

The constant aim of the lab is to boost production and to lower costs. Some of the methods used are fascinating in their simplicity. For instance, the simple technique of putting a notch in the cutting edge of a standard twist drill permits it to operate up to 10 times as fast as an unnotched drill—veritable “bullet speed” drilling. This means greater production of drilled parts.

A staff of 50 engineers and technicians have combined ingenuity and persistence to come up with such valuable new discoveries as “painting” with molten metal. Many Westinghouse plants felt the need for some method of repairing worn parts of expensive equipment.

The know-how engineers helped turn the trick by using a new tool developed by an atomizer concern. This tool, which “liquefies” rods of metal and then sprays the metal like paint, now is used to recoat with steel such items as worn or damaged bearings or screw threads. When refinished, these parts are again as good as new.

Many of the techniques not only save time and material, but frequently bring about an improved product. Although the method of cutting metals with abrasive



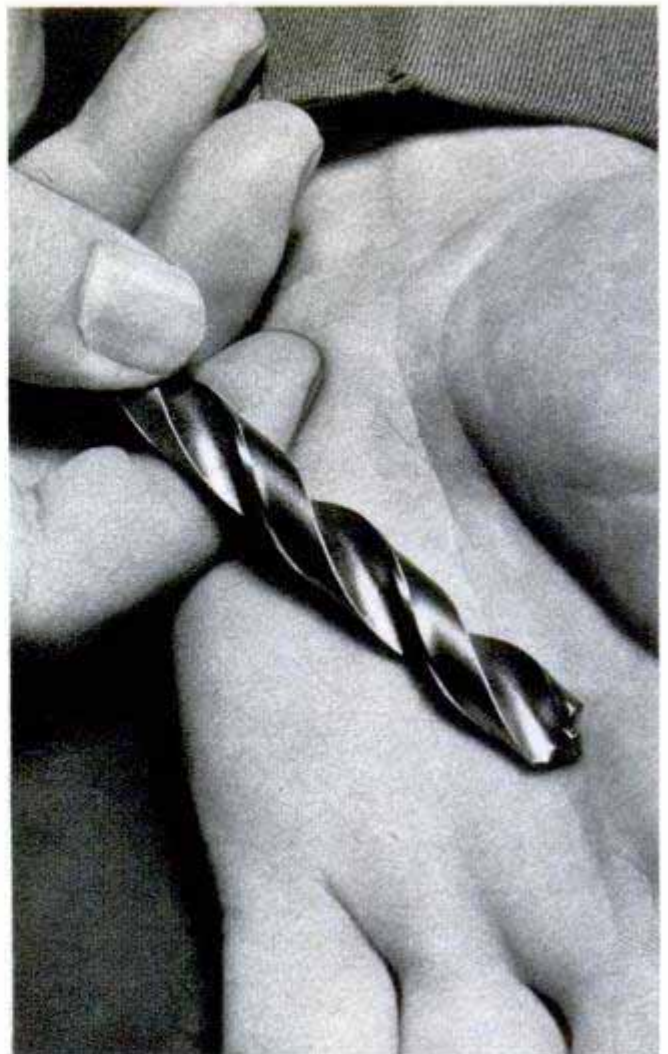

Bullet-speed drilling works 10 times faster than ordinary methods. All that's necessary is to notch the drill

rubber disks that resemble giant typewriter erasers has been used in other industries, the lab has adapted the idea to production-line needs.

These disks, whirling at speeds up to 3500 revolutions per minute, depend on friction alone to cut brass, copper, steel and other metals. Not only do they cut the metal faster, but they also leave a much cleaner cut than saws.

Another of the new techniques makes it possible to weld long steel I-beams in one fifth the time of former methods. Moisture-proofing of rotating parts of locomotive motors now is being done in the lab in just three hours' time. It used to take two days.

Cast-iron "logs" weighing 1000 pounds are whittled into millions of iron chips in a lathe used for testing lathe cutting tools. After this Bunyan-sized job is finished, the cutting tools are examined under a microscope for wear.

A special power press which can exert 300 tons pressure "squeezes" intricate parts from solid blocks of copper. The parts which formerly required 12 separate operations are now made in one.

Models, too, are used to help lower manufacturing costs and speed the flow of finished electrical products to industrial and home consumers. The same "flow of

work" theories employed in scientifically planned kitchens are employed by engineers who build models. With these "toy factories" they can plan the location of machine tools and production lines to obtain the most efficient flow of work.

Plants based on this planning already have been built in Mexico and similar know-how is now being prepared to help other countries make electrical equipment to raise their standards of living.

The lab also serves as a training ground for showing young manufacturing engineers how industrial know-how, both for domestic use and for export, is manufactured "on order" in much the same way other divisions of Westinghouse manufacture giant electric generators, motors or transformers.

Besides testing new equipment, developing new techniques and gathering information for export, the lab serves as a clearing house for new developments in the various Westinghouse plants, aids in setting up new manufacturing processes and develops many new products of its own.

Such products include paint with a glass-smooth finish for spraying on electric appliances, an oilless washing-machine bearing and a collapsible metal container for factory handling of large machine parts.

Telescopic Sight Has Variable Power

Marksmen can "move" right up on the target with a variable-power telescopic rifle sight that can be changed from 2½ to 4 power by turning a knurled ring near the eyepiece. Changing the power doesn't alter the focus or eye distance. Windage and elevation adjustments are made in the mount instead of in the telescope so the sight can be attached to the gun without changing previous corrections. The reticle is permanently centered in the optical system, thereby eliminating image deterioration that often results when the position of the reticle is changed.

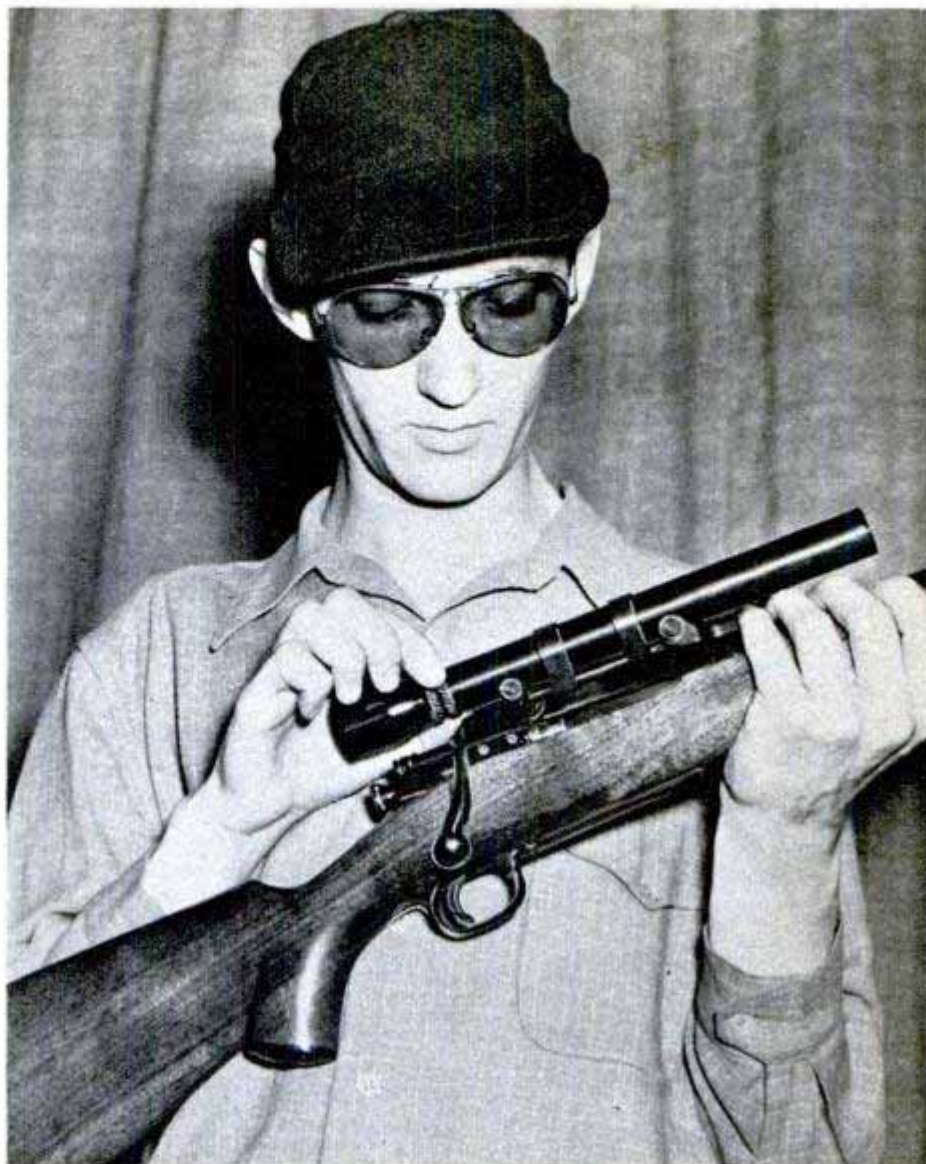

Carbon Monoxide Made Harmless

Carbon-monoxide poisoning can be prevented by a chemical, containing silver permanganate, which neutralizes the dangerous gas. The silver-permanganate powder is coated on granules of various metallic oxides to provide relatively large surface areas for exposure to the gas. These

coated granules could be placed in the ventilating systems of garages, mines, submarines, aircraft and tunnels to rid large volumes of air of the lethal gas.

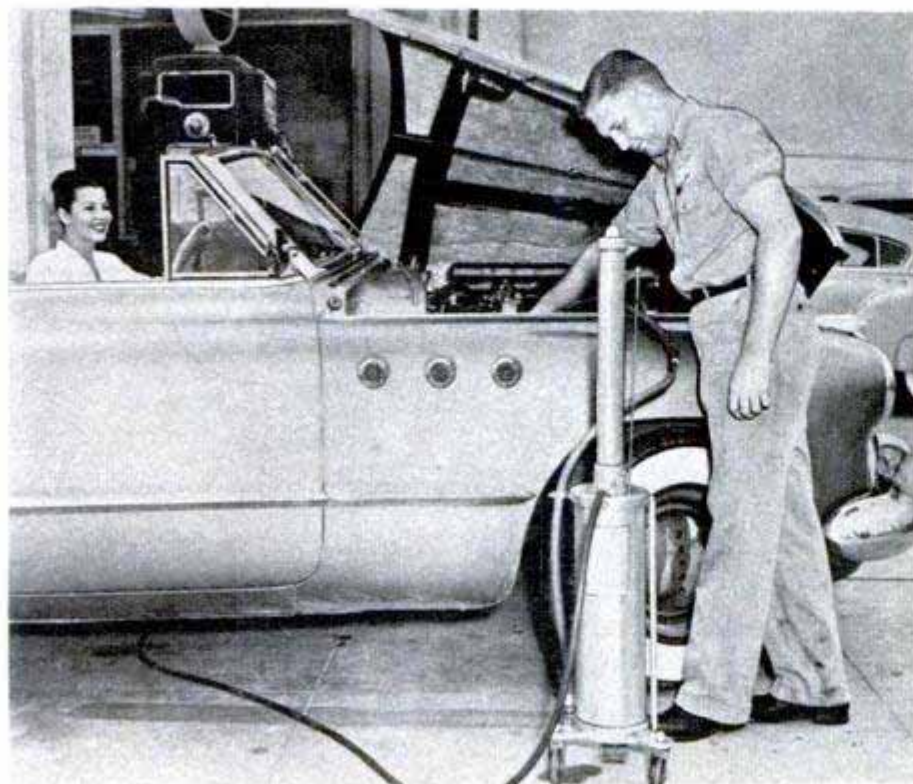

Quick Oil Changes With Air Pressure

Service stations can drain the dirty oil from your engine in two minutes with an air-pressure-operated changer, making it possible to change your oil while you are getting gas. The device is automatic and shuts itself off when the crankcase is empty. An ejector tube is inserted in the dipstick or filler-tube opening and air pressure does the rest. The drain plug on the crankcase is not touched and pits or lifts are unnecessary. The unit is coupled to the station's air hose and wheeled alongside the car.



TV IS AT HOME ON THE ROAD

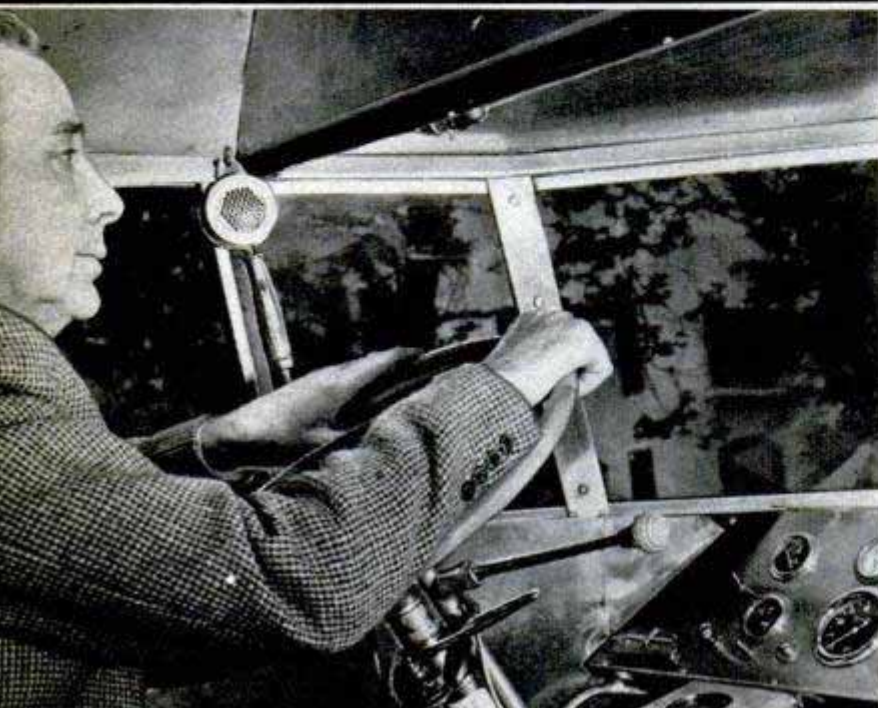

A TELEVISION SET, a broadcast receiver and an amateur 10-meter radio station which can work hams all the way from Australia to South Africa are part of the equipment of a "motor home" built by J. Roy Hunt, Hollywood motion-picture cameraman.

Eighteen feet long, Hunt's mobile home is powered by a stock Ford engine mounted in the rear, with air scoops to provide a flow of cool air through the radiator. Opposite the driving compartment is a galley that includes a butane stove, a sink with hot and cold water and a refrigerator. Groceries, pans and dishes are stored in cupboards. A compartment behind the driver's seat contains washstand, shower head, toilet, electric razor and medicine chest. The double door to the compartment provides wardrobe space inside and a full-length mirror outside.

The main living space, finished in

Top, the home on wheels has a sleek aluminum skin on a streamlined body. The TV antenna pulls in pictures whenever Hunt cruises into a broadcast radius. Left, mike for ham radio hangs near driver

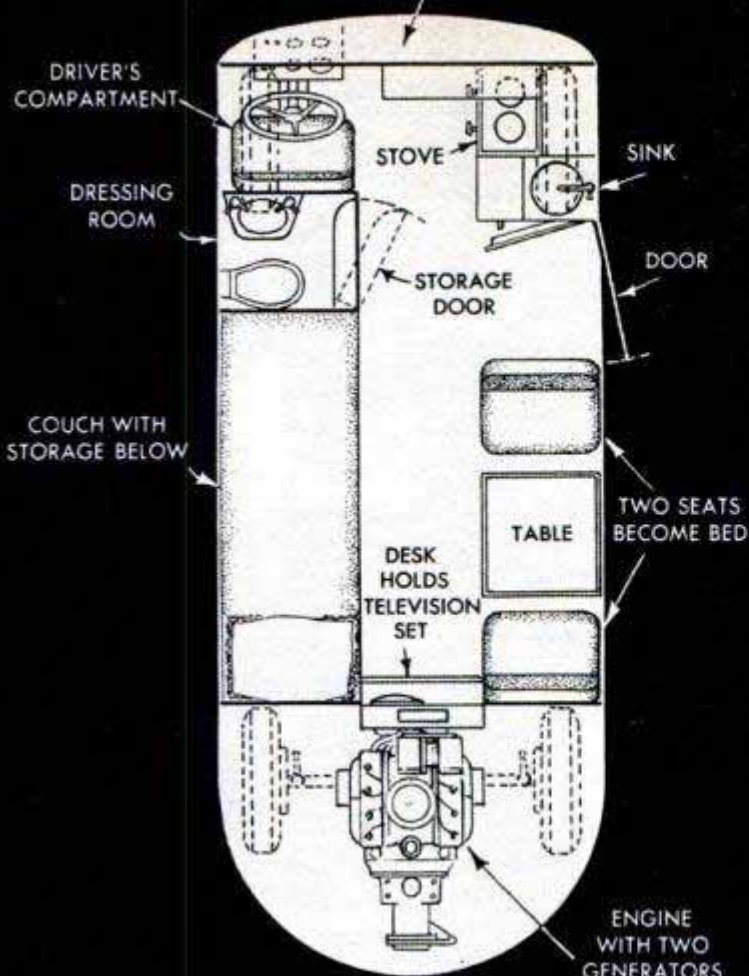

mahogany and birch, contains a couch that doubles as a bed, and a table with two cushioned seats that convert into a bed when the table is removed. A combination service table, writing desk and make-up kit may be lowered from the rear wall. The television set occupies a niche on the table.

Hunt spent about \$10,000 and two years of work in building the house car, after making cardboard mock-ups of most of its parts. The chassis is built up of 1½-inch square chrome tubing and the exterior skin is aluminum. All structural parts are welded or riveted.

Electric power for the radio equipment and the numerous interior lights and exhaust fans is provided by batteries connected to auxiliary generators on the engine and also by a small electric-light plant mounted in the front of the car. Hot water is heated either by engine exhaust or by a special butane burner. Twenty gallons of cold water and 18 gallons of hot water are carried in tanks above the driving compartment.

Ready for the road, the car weighs 4630 pounds. It is equipped with oversize tires, safety tubes and a truck-type transmission. It handles equally well in traffic and on twisting mountain grades.

Drawing shows space-saving arrangement inside the mobile home. Top, right, Ford engine is mounted above the rear axle and cooled by air scoops. Center, living compartment features television set, couch, table and chairs. Right, galley has hot and cold water, refrigerator, stove and cabinets

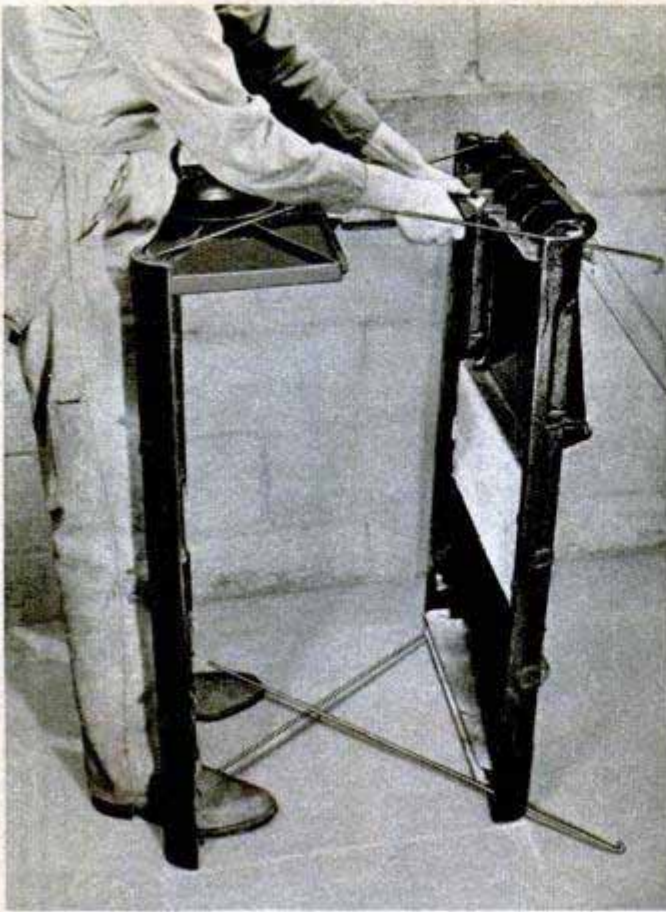

Basement Garbage Incinerator

Homeowners can build their own garbage incinerator with a kit containing all the parts except firebrick and other materials that can be purchased locally. Metal parts in the kit form a frame to which firebrick, flue pipe and damper are attached.

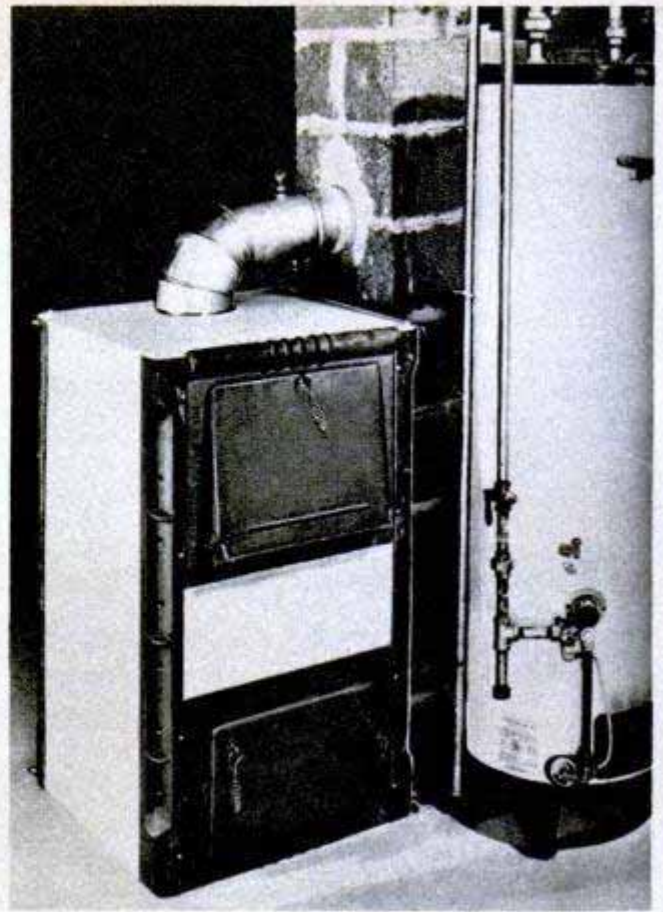

The incinerator is connected with the furnace smoke pipe. Refuse placed in the incinerator burns from the top down, acting as its own fuel. Four jets of air from the corners of the unit aid combustion. So little ash remains that it need be removed only once in every three or four months, according to the manufacturer.



Weed Sprayer for Corn Fields

Riding high on stilts, a spraying machine kills weeds in corn fields up until the time the corn reaches maturity. The sprayer has a clearance of eight feet and straddles two rows of corn as it moves down the field at a speed of about four miles an hour. A

40-foot boom extends out from the machine at right angles to its direction of travel. Spraying tips hang down between the rows to spray weeds between 10 rows of corn. The machine has four-wheel drive with knee action in the front wheels. It was designed and built in this country for use in Venezuela.

Pontoon Harness → Aids Swim Students

Pontoons bridged by a tubular-steel frame support a harness in which children and grownups can learn to swim. The harness hangs on adjustable chains. Invented by a Duisberg, Germany, swimming teacher, it supports the beginner while he is learning to use his arms and legs properly.

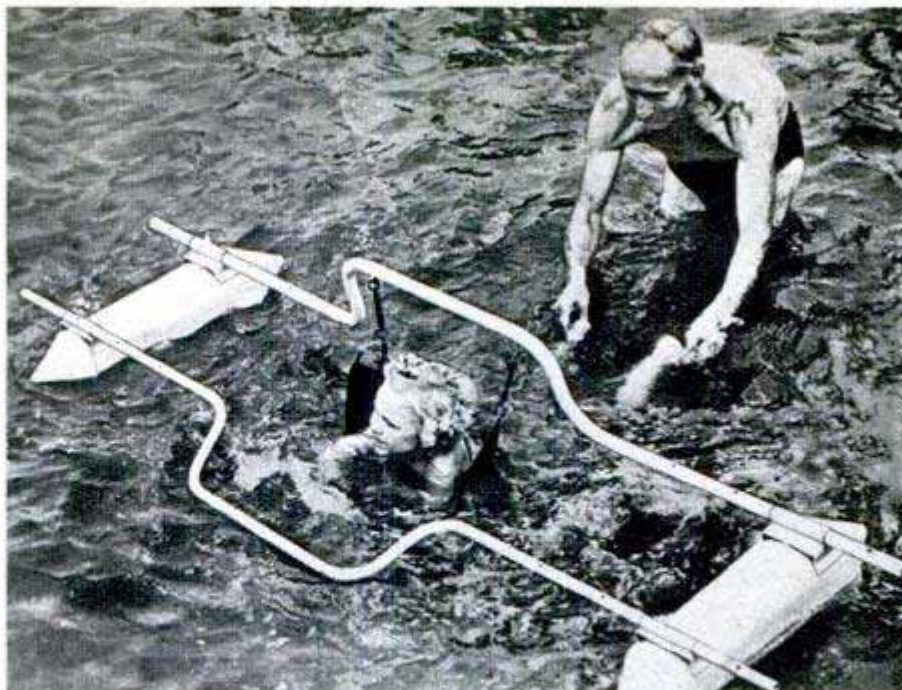

Rubber Playgrounds

Falling on a new playground will almost be fun—its surface is rubberized to prevent skinned knees and make shoe leather wear longer. At Akron, Ohio, a test installation has shown its effectiveness. For the new surface, ground rubber replaces crushed slag in the

asphalt mixture. There are no abrasive particles on the surface and, although Johnny won't bounce when he falls, at least he won't rip the skin off his knees.

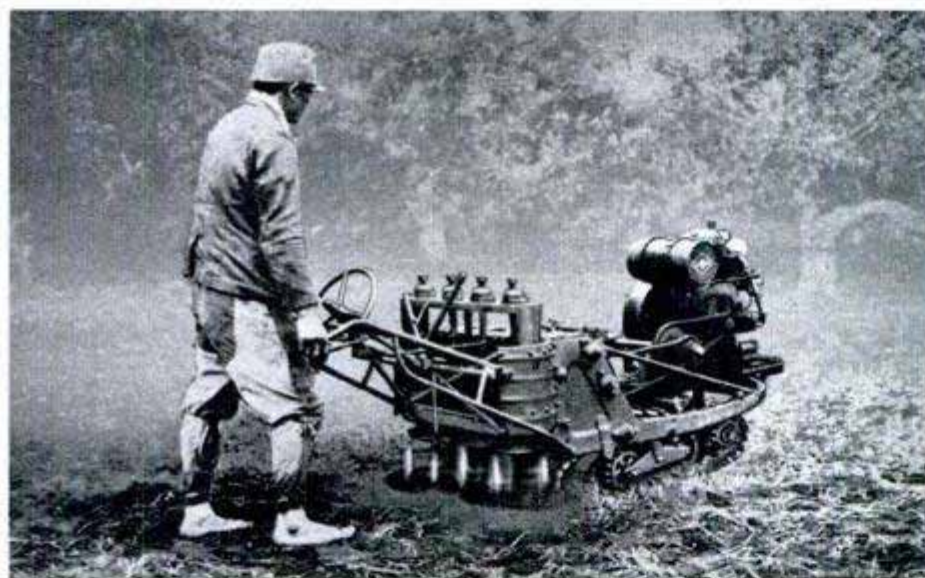

Japanese Plow

Four claws rotate horizontally on a Japanese plow, breaking up the soil to a depth of seven inches. Powered by a small air-cooled engine of 2½ to 4 horsepower, the plow is expected to relieve some of the equipment shortage on Japanese farms. The machine moves at a speed of about one mile an hour and plows a strip 30 inches in width.

☐ Scheduled airlines in the U. S. are expected to fly a total of 6,500,000,000 passenger miles this year, nearly 500,000,000 more than in 1947, which was the record year.

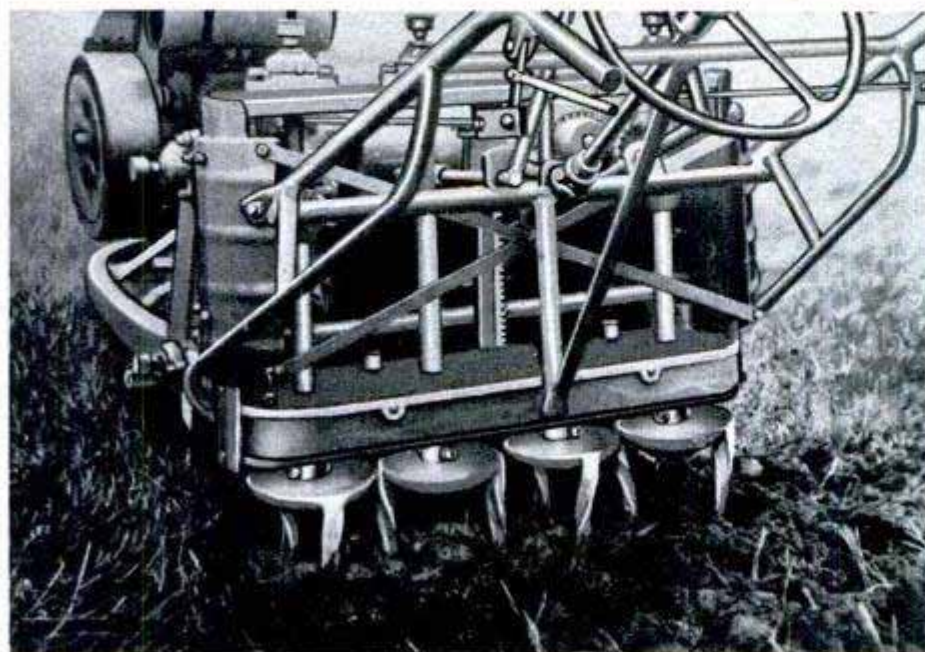

Sources of available products described in this issue are listed in the WHERE-TO-BUY-IT INDEX, pages 10, 12 and 14. Sources of further information on other articles are listed in the WHERE-TO-FIND-IT INDEX, which is available without charge from Bureau of Information, Popular Mechanics Magazine, 200 East Ontario Street, Chicago 11, Illinois

LISTEN to the falling stars!

Have you ever heard a cosmic wolf whistle? It's music to the ears of the meteor hunters, listening in by radio as a castaway in space streaks toward earth in its suicide plunge

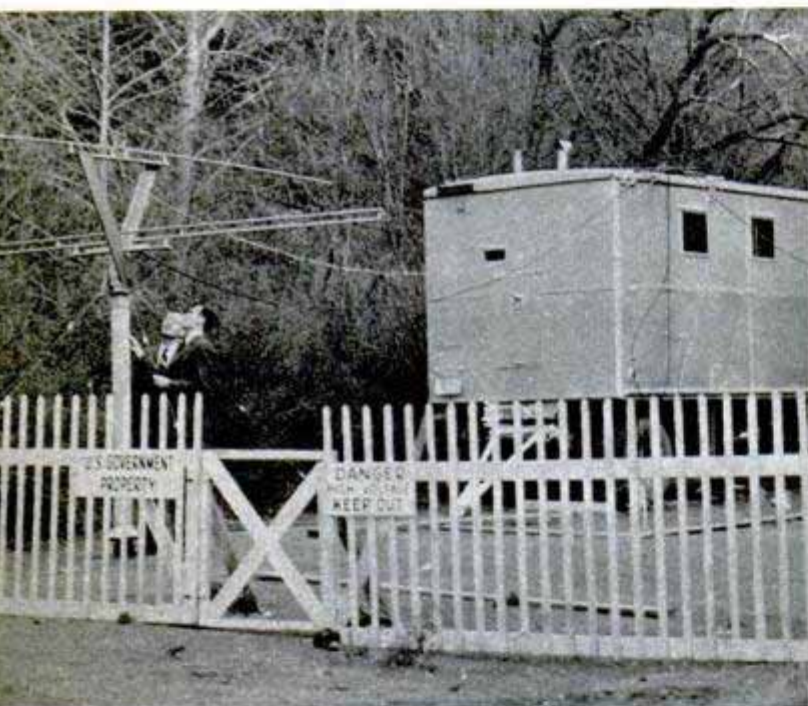

"Radio camera" is located in mountain bowl to eliminate direct signals from distant transmitter. Two antennas pick up "sounds of the stars." Below, mechanical pen records information on meteors picked up by the radio



EVERYONE has seen falling stars but how many people have heard them? Half a dozen individuals, at least. These are the scientists who are participating in radio-meteor studies conducted for the Navy by Stanford University.

In a mountain valley near that school you climb into a trailer loaded with radio gear and put on a pair of earphones. All you can hear is a faint hum and then, suddenly, there's a shrill whistle. It starts high and comes down the scale, a drawn-out note of descending pitch.

"That's a meteor," the technician at the receiver tells you. "Sounds like a cosmic wolf whistle, doesn't it? Judging by the tone and duration, it was about the size of a pea and was traveling 37 miles per second. It slowed down as it encountered the resistance of the upper atmosphere and it burned up 50 or 60 miles overhead."

In the next few minutes you listen to a dozen more of the eerie whistling sounds, some loud and some weak, as additional meteors plunge into the atmosphere and are consumed by friction. None of them would have been bright enough to have been seen by eye, but each was faithfully recorded by the equipment in the trailer.

Practically speaking, the equipment comprises a radio camera 100 times more sensitive than the human eye and possibly 10,000 times more sensitive than an astronomical camera. Devised by Professors Oswald G. Villard and Lawrence E. Manning, the camera consists of a radio transmitter and a receiver, spaced six miles apart. The receiver is placed in the bowl of a mountain valley to reduce the strength of the direct signal.

100 MILES

75 MILES

50 MILES

No more powerful than the average amateur outfit, the transmitter beams a narrow and continuous high-frequency wave toward the sky. The receiver picks up some of the direct signal plus any reflections that return to it from overhead. Ordinarily, these signals are recorded as wavy lines on the paper tape of a recorder.

When a meteor strikes the atmosphere and glows from the heat of friction it leaves a trail of ionized gas. This trail behaves as a reflecting surface that bounces back to earth some of the energy from the radio camera's transmitter. The reflected wave suffers a Doppler shift in frequency that can be translated into velocity. The direction finders used with the radio camera show the meteor's path or orbit. The duration and amplitude of the reflected wave are indications of the meteor's size. The "after signal" reflection that continues to be picked up from the ionized path after the meteor has dissipated provides a way of measuring the force and direction of upper-air winds.

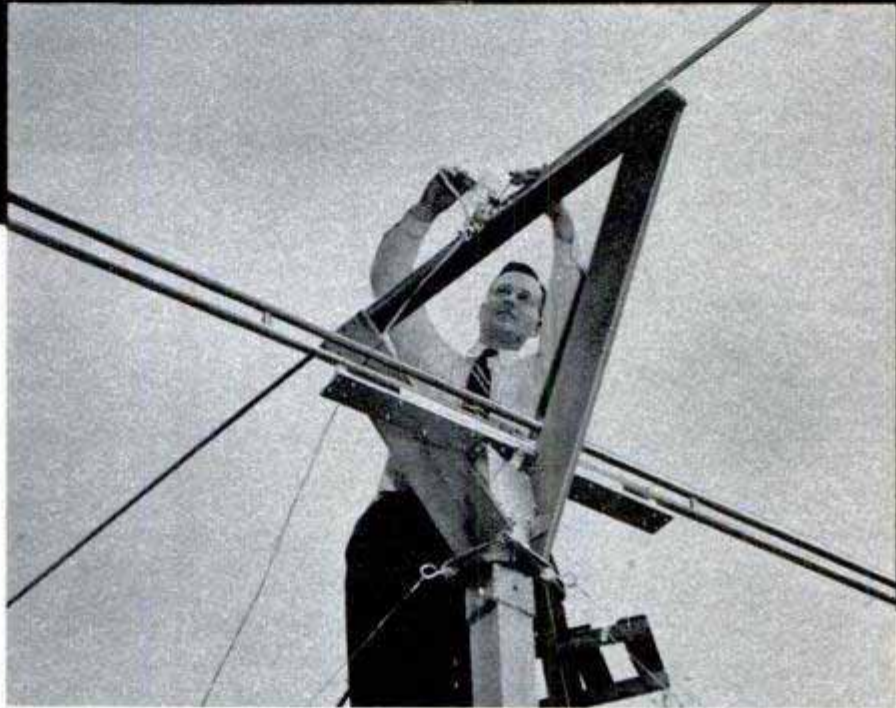

Drawing shows how meteors, falling into the earth's atmosphere, leave ionized trails which bounce radio signals back to earth. Above are shown the directional antennas which can be aimed to pick up reflected signals

Radio-coordinated cameras also record the meteors. At dusk, roof and sides of trailer are slid back along track to open the skies to the cameras. Eighteen miles away other cameras will take matching pictures





Here's a photo of a falling meteor. Camera with shutter rotating at 600 r.p.m. records trail as a broken line

While Stanford is keeping watch on meteors, Harvard College Observatory is making comparable studies with pairs of astronomical cameras that employ synchronized rotating shutters. English scientists are using radar to study meteors. Other research programs likewise are aimed at learning more about these bits of cosmic "driftwood."

The reason for this sudden interest is that future rockets will be traveling through the thin upper reaches of the atmosphere. Wind conditions and other phenomena have an effect on any rocket's course. Meteors are a handy means by which these conditions can be studied. That's why the Navy's Bureau of Ordnance is sponsoring both the Stanford research and the Harvard Meteor Expedition that has been operating near Las Cruces, N. Mex.

Almost all meteors are burned up by friction, but a few reach the earth and yield valuable information

It is estimated that a gravel truckload of meteoritic material is collected by earth's gravity every day. Most of it consists of minute particles but even the smallest of these move at tremendous speed. The so-called shower meteors may be traveling as fast as 133,000 miles per hour while the very slowest move at a 43,000-mile-per-hour pace. Traveling at top speed, a bit of material no larger than a pea generates about as much energy as a big locomotive.

Only rarely is a meteor large enough to plunge through the ionosphere and the lower atmosphere and land on the earth's surface. These meteorites may be smaller than a man's fist or they may measure three feet or more in diameter. Possibly once in 1,000 or 10,000 years a great meteorite strikes the earth. Of these, one of the largest was the million-ton-plus nickel-iron mass that created the 4100-foot-wide Meteor Crater in what is now Arizona. Small meteorites and fragments of the larger ones have told scientists a great deal about the composition of the solar system and about the interior of our own earth.

Harvard is concentrating principally on obtaining pairs of matched photographs of the larger meteors, from which very precise information can be obtained.

An expedition in the New Mexican desert has erected two stations 18 miles apart, each equipped with three cameras attached to astronomical mounts that turn in a direction opposite to the earth's rotation. These permit pin-point time exposures of the stars. Each camera has a rotating shutter that turns at a speed up to 600 revolutions per minute. Thus, in a time exposure, the images of the stars will be sharp and clear and the trail of any visible meteor will be recorded as a straight or curved line, broken into short segments by the shutter action. Knowing the shutter speed, the speed of the meteor can be calculated at any point.

Each of the three cameras at one station is pointed toward a different portion of the sky and each is paired off with a twin camera at the other station. The fields of each pair are aimed to coincide at an altitude of

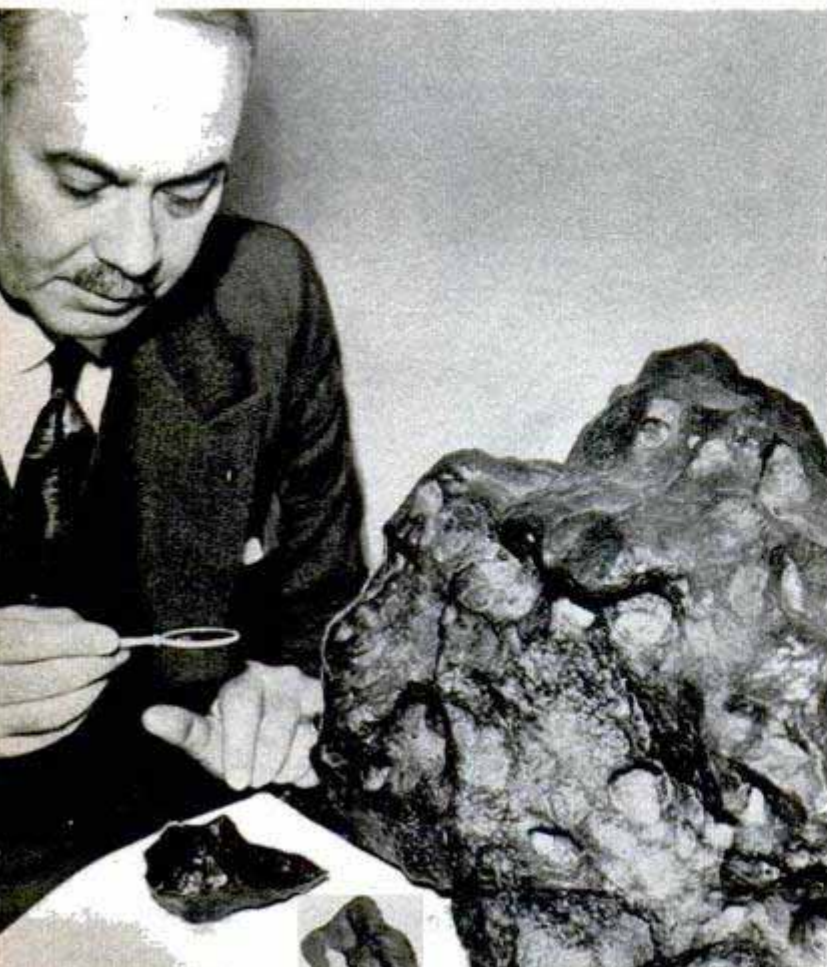

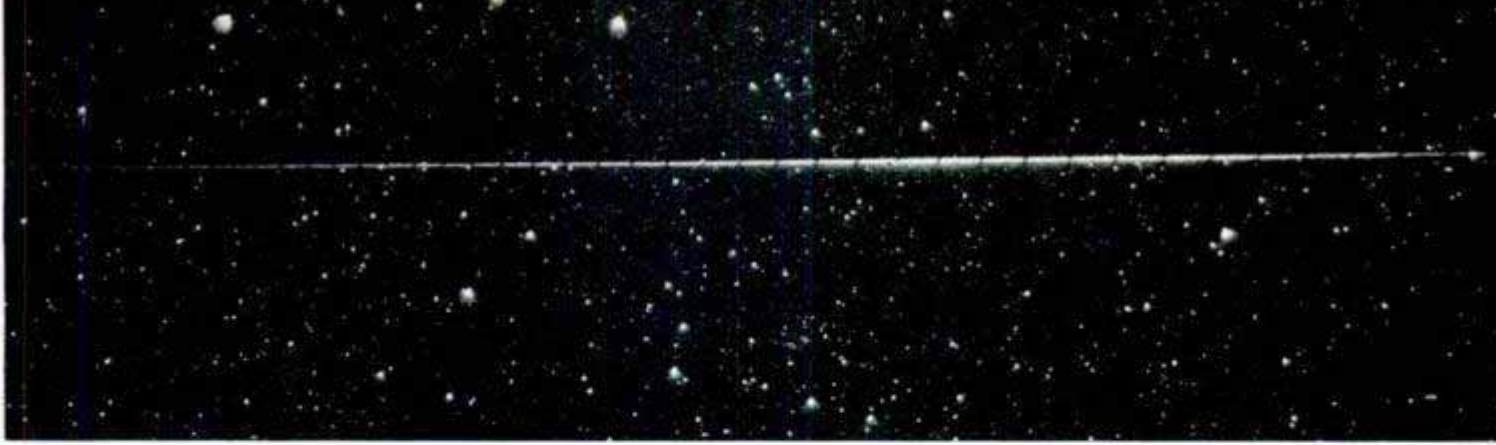

Rotating shutter causes breaks in photo of meteor trail. Measurement of breaks shows deceleration of meteor

70 kilometers and the shutters of each pair are synchronized by radio.

By studying photographs made simultaneously by twin cameras, it is possible to calculate almost to the yard the altitude at which a particular meteor heated up brightly enough to be photographed, and the lower altitude at which it disappeared. Deceleration of a meteor can be determined by studying the length of the segments that make up its trail, and this leads to information about the density of the ionosphere and the stratosphere.

With luck an observer may see possibly 10 meteors in an hour but only an occasional meteor is brilliant enough to leave an image on a photographic plate. Robert E. McCrosky and the other young meteor hunters at Las Cruces spend night after night on watch, camera shutters whirling, without getting a satisfactory picture. One good set of pictures per week is average.

To speed up the program, the expedition is being equipped with a pair of new spe-

cially designed super-Schmidt telescopes to which molded curved photographic films will be attached. Each Schmidt will have a 52-degree field and will pick up many meteors that are not bright enough to be photographed by the present equipment. Later, a similar station 80 miles north of Edmonton, Alta., will be similarly equipped. Meanwhile, additional meteor research is being performed at Harvard Observatory itself under Dr. Fred L. Whipple, director of the Harvard program.

From the military standpoint the research on meteors is expected to make it possible to aim rockets more precisely and yield new information on ballistics.

More than that, it should contribute new information to other fields. The upper-air tides that have previously been called a theoretical enigma now are proving to be very real. Studies of meteor pictures confirm the theory that in the northern hemisphere the density of the atmosphere 50

(Continued to page 252)

Thousands of years ago a giant meteorite smashed into earth at what is now Arizona, digging hole 570 ft. deep



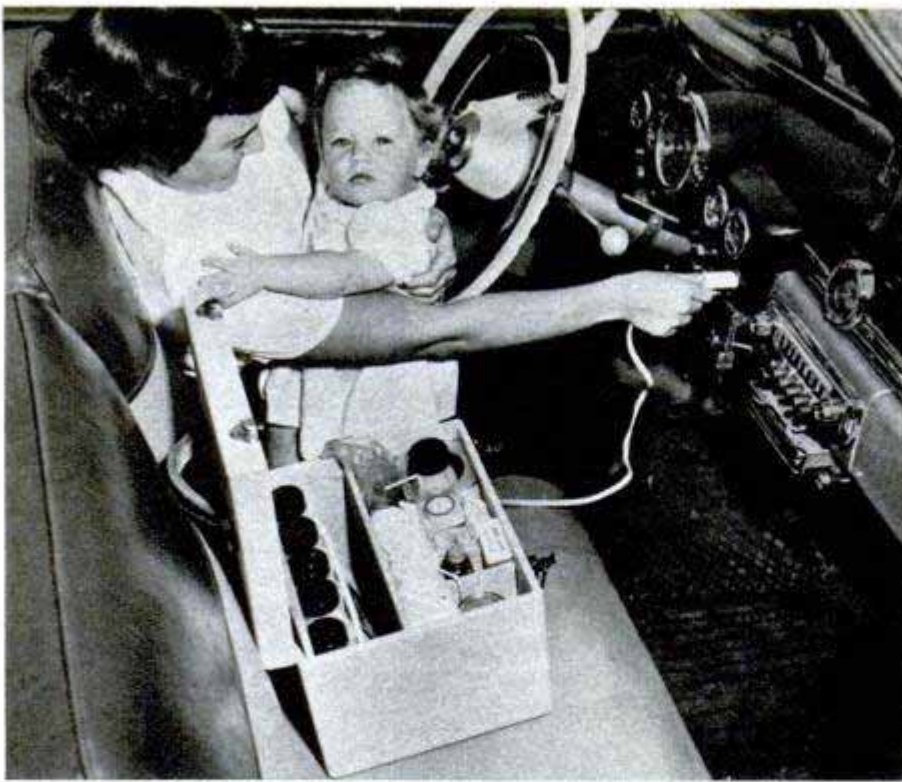

Baby's Travel Kit Carries Dry Ice

Everything that baby needs on a long automobile trip is carried in a travel kit that has a built-in bottle warmer. The cord for the dry-type bottle warmer plugs into the cigarette-lighter socket. An insulated section in the easy-to-carry box keeps six filled bottles cool with Dry Ice. Space is also provided for an ample supply of food cans, powder, soap, medicine, diapers and other essentials for baby's comfort and health. The box is covered with a washable material and has a convenient handle.

Roller Bearings for Leaf Springs

Squeaking springs are eliminated by neoprene pads in the center of which are inserted metal rollers to reduce metal-to-metal friction. The pads are placed between the spring leaves near the ends and the rollers produce noiseless flexing. A screwdriver, wedged between the leaves, opens the spring enough to allow insertion of the pads. According to the manufacturer, the pads make spring lubrication unnecessary.

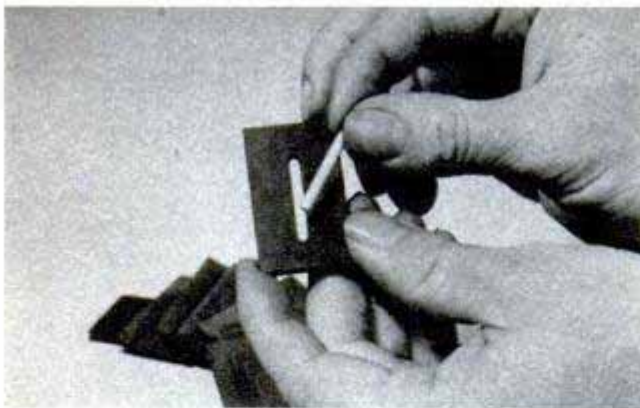

Quick-Acting Car-Top Carrier

It takes only a few seconds to attach or remove a new car-top carrier that is tightened or loosened by means of a convenient wing nut. The carrier, of tubular construction, telescopes as the nut is turned, tightening rubber-covered metal claws against the rain troughs. No metal touches the car finish and there are no fabric straps to stretch and loosen their grip on the rain troughs. Twin suction cups rest on the crown of the roof where the strength is greatest. The adjustable load trays can be locked in any position on the crossbar to accommodate loads of various widths.



EXTRA ROOM FOR TRAILER OR SMALL HOME



Sturdy and hygienic, this back-yard playhouse can be taken down easily; requires almost no maintenance

If you live in a trailer or small home, you can add an extra room with a prefabricated kit that goes up without nuts, bolts or nails. Clips hold the interchangeable panels together, permitting the room to be taken down and moved, if desired. Wide louvers provide light and air with protection against rain. Also available in the same design are small playhouses, suitable for "outdoor" eating and recreation.

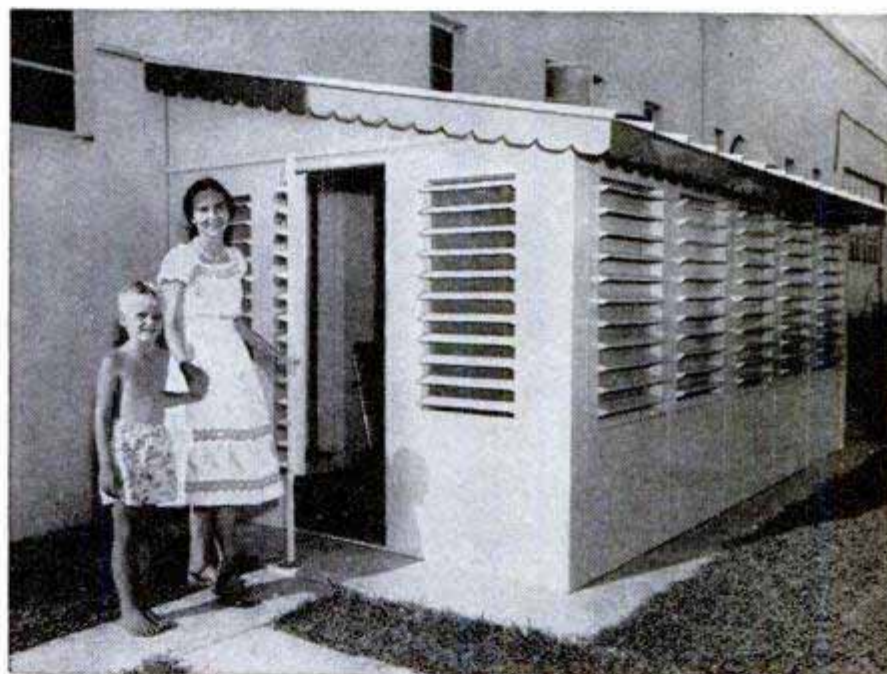

Above, shown here alongside a building, this all-metal room is designed to be attached to a trailer, providing an extra living room for the trailerites. The prefabricated kits come in models to fit various trailers

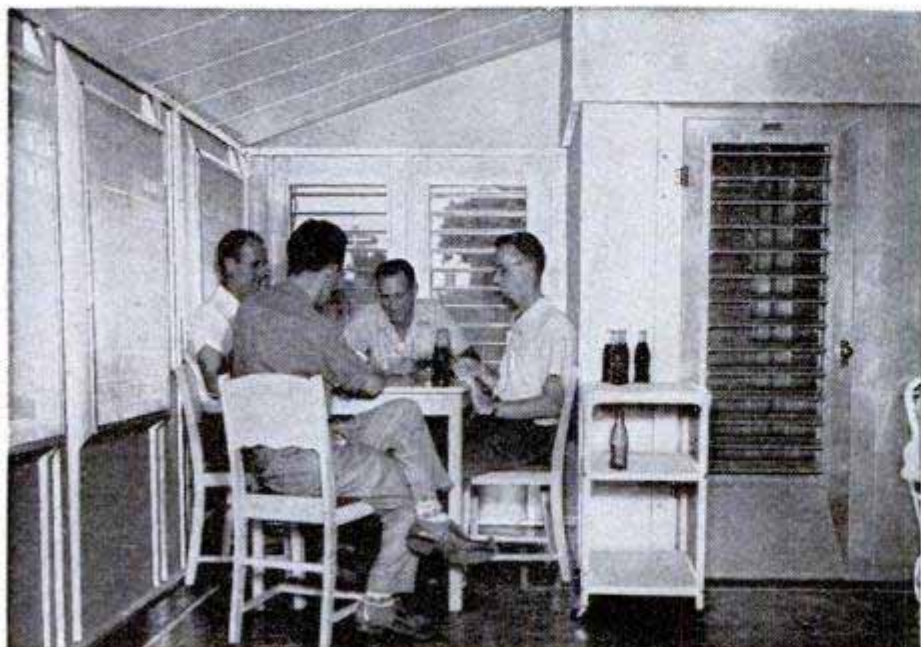

Left, light and airy, the room is a fine place for the weekly card game with the neighbors. Even the screens are aluminum, as is everything but the floor

SOFAR – the navy's lost and found

When a plane crashes, it drops a bomb into water. Sound from the bomb tells shore stations where wreck is located

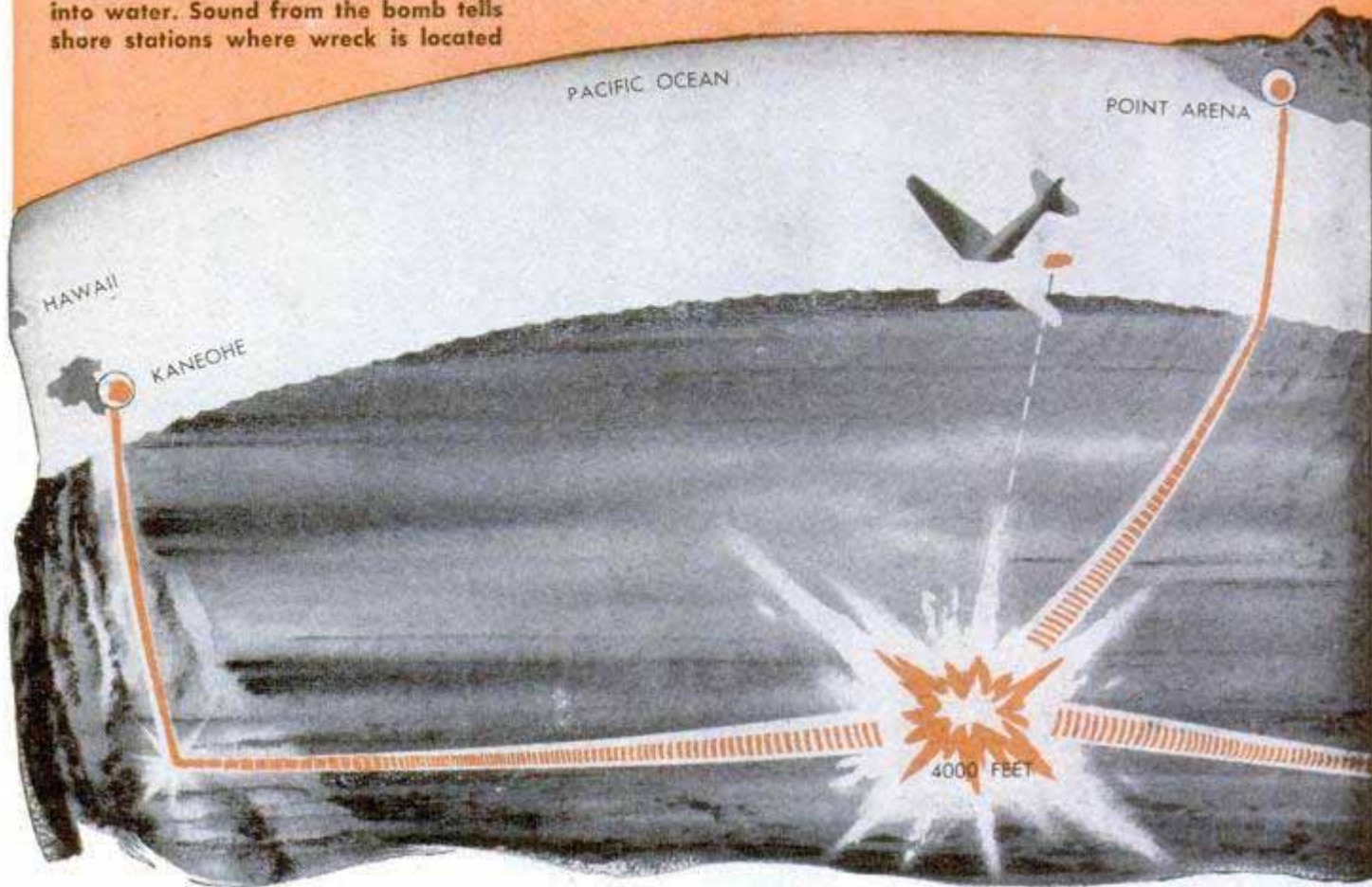

By Andrew Hamilton

THE NAVY is making it harder and harder these days for plane and ship voyagers to get lost at sea. In fact, the saga of Eddie Rickenbacker and his companions who drifted for days in a rubber life raft may seldom happen again.

The reason? SOFAR.

An abbreviation for Sound Fixing And Ranging, the name SOFAR describes a new underwater sound system that will plot the position of downed planes and wrecked vessels 2500 miles at sea within a mile of the point of accident. A rescue plane will be winging help within an hour. Without SOFAR, it would be necessary to search thousands of square miles of ocean.

SOFAR covers much greater distances than LORAN or radio direction finders and its accuracy is comparable to that of first-rate celestial navigation.

Under exhaustive tests by the Navy since first announced in 1946, the Pacific SOFAR network has now been set up and is expected to be in full operation next year. Stations are located at Kaneohe Bay in the Hawaiian Islands and at Point Arena and Point Sur along the California coast.

The principle of SOFAR is a simple one. When a ship or plane is in trouble and requires help, a small, underwater bomb is dropped into the sea. It sinks and explodes several thousand feet down—sending out sound waves in all directions at the rate of about one mile per second. It is like ripples from a rock tossed into a pool. These sound waves are picked up minutes later by monitoring stations and by means of special SOFAR charts, the distressed vessel or aircraft is located.

SOFAR is a by-product of wartime submarine-detection studies carried on for the Navy's Bureau of Ships by Dr. Maurice Ewing, then director of research in physics for the Woods Hole Oceanographic Institution and now professor of geology at Columbia University.

Professor Ewing's studies demonstrated that, as a result of an amazing "speaking tube" effect in the ocean, sound travels great distances at depths between 1500 and 6000 feet. In general, the depth of the sound channel becomes shallower the farther north or south of the equator you go.

In 1943, during tests conducted under

agent

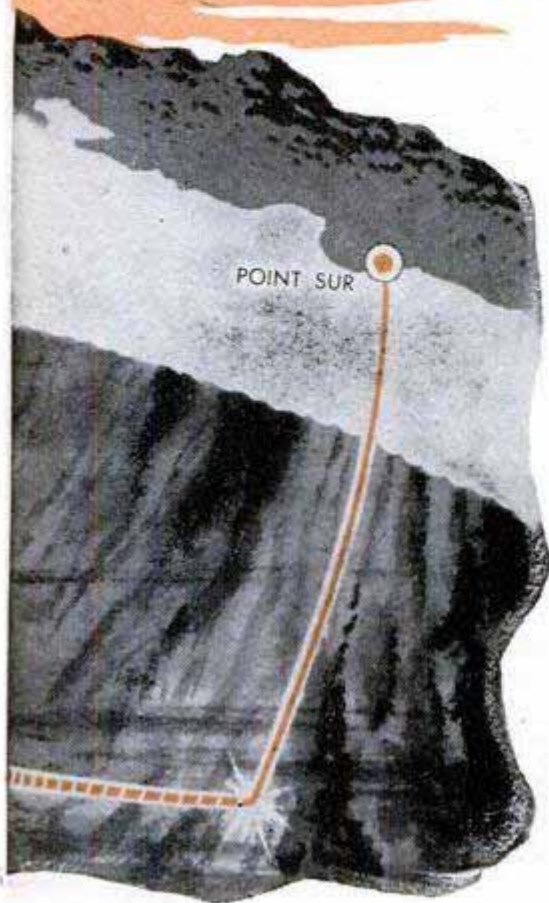

Above, officer plots wreck location using data from SOFAR recorders

Ewing's supervision in the Bahamas, sound was heard 100 to 300 miles away when bombs were exploded at 600 feet. But when the depth was increased to 4000 feet, the sound was detected as far away as Dakar, North Africa, 3100 miles. Previous to this research, no man-made underwater sound had been heard more than a fraction of this distance.

Beneath the surface of the sea, sound does strange things. For example, at the point of explosion the noise will last not more than one second. But 2000 miles away it can be heard for as long as 24 seconds. The signal at the receiving hydrophones sounds like a kettledrum building up to a sharp, grand finale — after which it ceases abruptly.

This building-up process is caused by the fact that sound travels by multiple paths back and forth across the sound

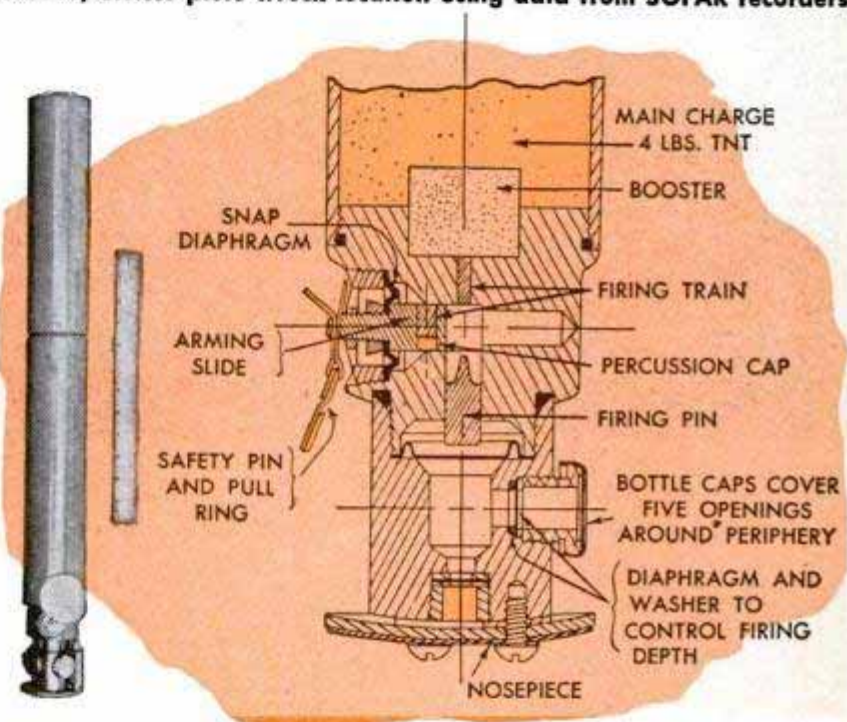

Above, diagram of firing-pin end of SOFAR bottle-cap bomb. Left, a photograph of the bomb alongside a foot ruler. Below, automatic receiver that sounds an alarm and records the signal on tape and wire



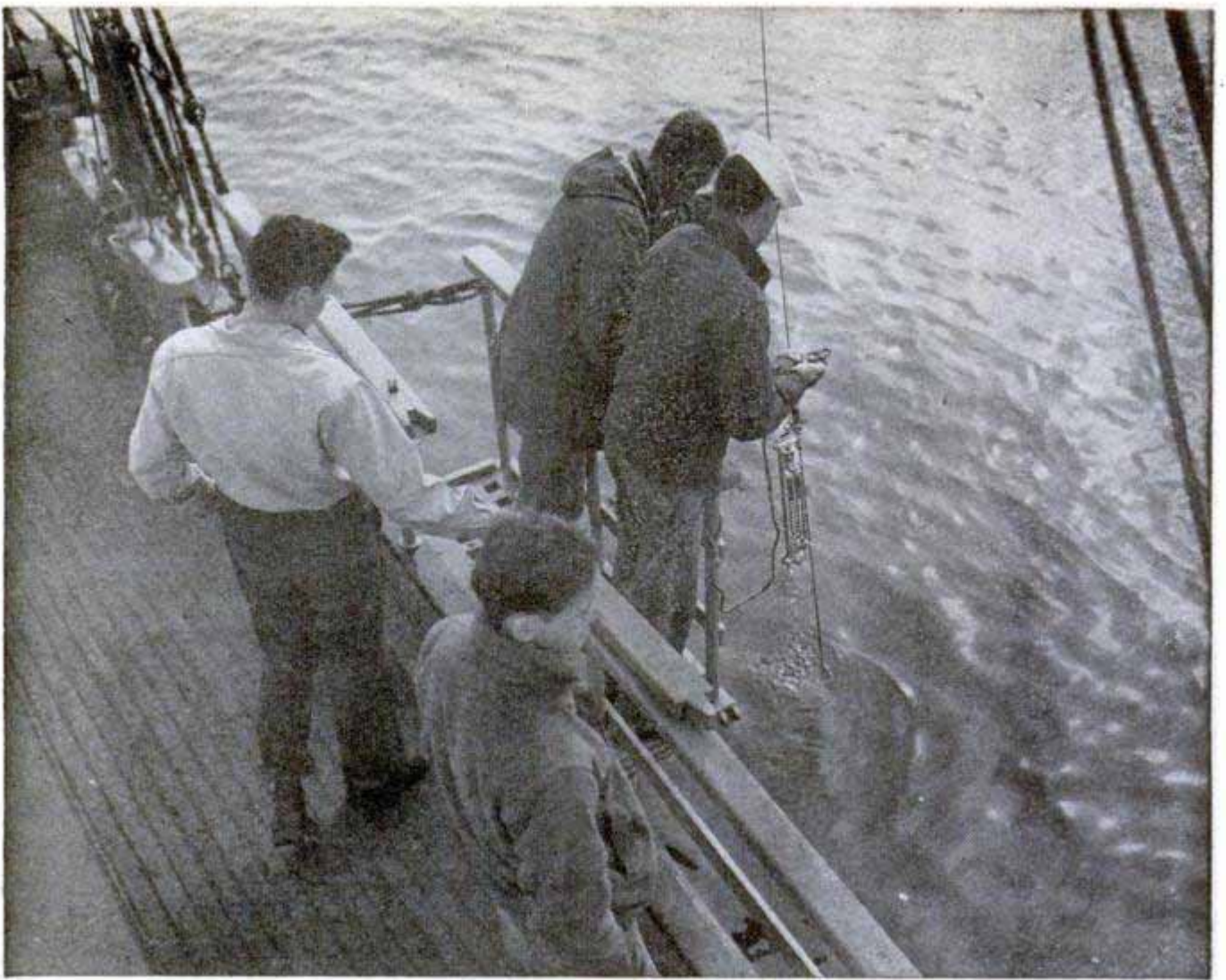

Pulling in a sample of water from the deep. Scientists took hundreds of such samples in developing SOFAR

channel while the finale travels directly but slower. The sharp, concluding finale makes time measurements possible to within $\frac{1}{100}$ second.

The "speaking tube" zone through which sound travels great distances in water is created by the joint action of temperature and pressure. As sound waves approach the top or bottom of the sound channel, they are bent back toward the center. Sound originating above the zone is absorbed by reflection from the surface and by bubbles due to waves. Sound below the zone is absorbed by the ocean bottom.

Changes in speed of sound in water result from changes in water temperature and pressure. Hence, sound travels faster near the surface where water is warmer and also near the bottom where pressure is greater. For this reason, the speed of sound is slowest in the middle of the speaking-tube zone and fastest when bent away from top and bottom.

The possibilities of using these discoveries in an air-sea rescue system were readily apparent. During the latter stages of World War II, the Navy's Bureau of Ships and the Woods Hole Oceanographic Institution began the development of a

SOFAR locating system. After the war, the Bureau of Ordnance and the Naval Electronics Laboratory were drawn into the picture—especially in the designing of an underwater bomb (or signal as the Navy prefers to call it).

The problem was to build a signal bomb that would be light in weight, easy to store in a ship or plane and foolproof in operation. There would be times when it might have to be set off by passengers who wouldn't know a firing pin from a fin, a percussion cap from a piston.

It was decided to take the Navy's Mk. 15 practice depth charge and redesign it for use as a SOFAR signal bomb. Many models were blueprinted and several built. Finally, an engineer at the Naval Ordnance Laboratory came up with a unique idea—the "bottle cap" design, which has now been adopted as the SOFAR bomb. It is a small bomb, approximately 28 inches long, 3 inches in diameter, weighing 13 pounds and holding four pounds of T.N.T.

The name comes from ordinary crimped metal caps (like those used on soft-drink bottles) which cover five openings around one end of the bomb. There is a sixth opening in the bottom which is not capped.

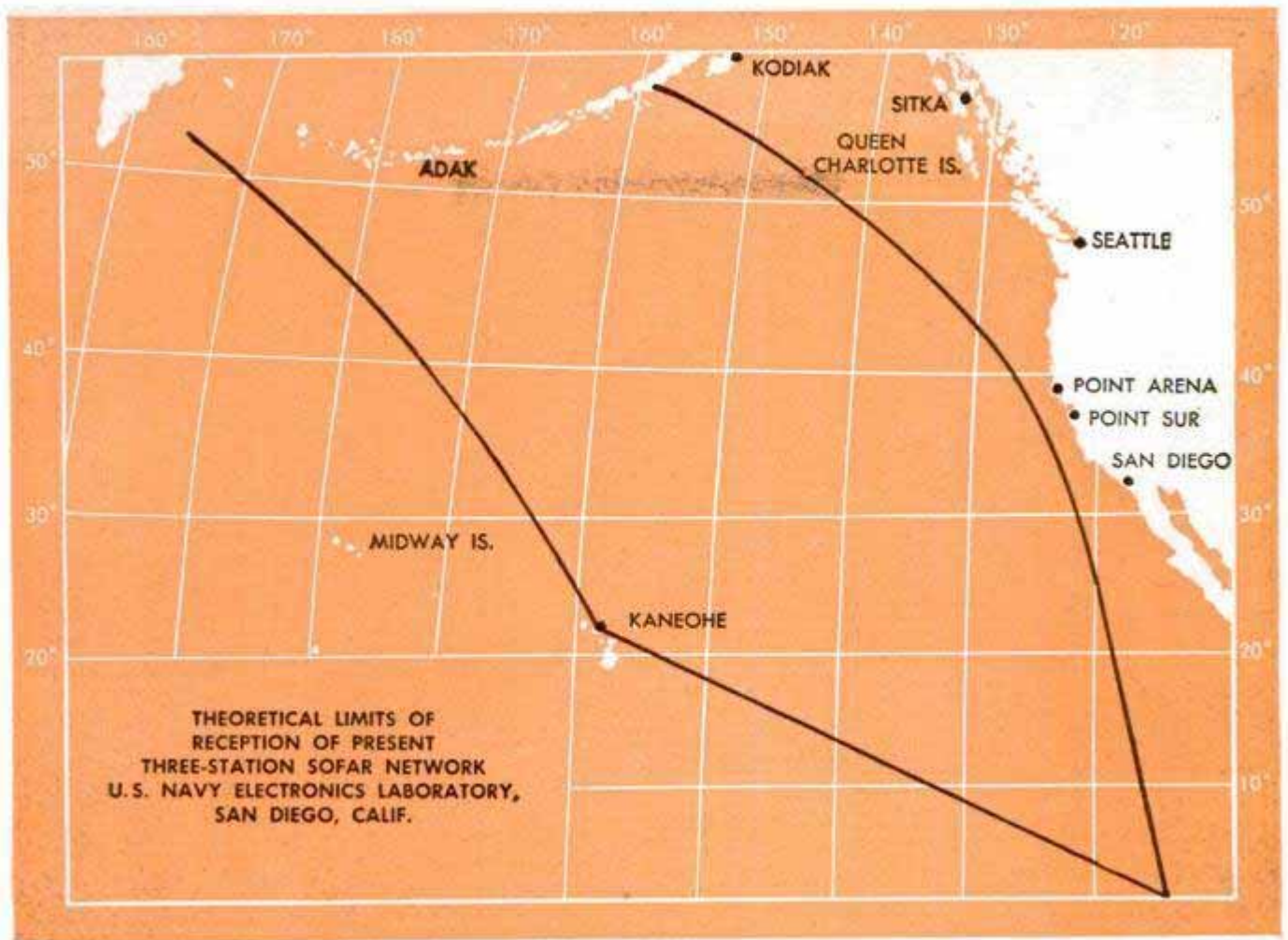

When a downed pilot takes to his rubber life raft, he consults a small chart which comes with the bomb and determines the correct exploding depth according to latitude. With an ordinary bottle opener, he wrenches off the corresponding bottle cap. The five openings around the side of the bomb are for explosions at 1500, 2000, 2500, 3000 and 3500 feet. The hole at the end is for 4000 feet. Thus, the bomb will automatically fire at that depth if for some reason one of the other caps is not removed.

As the bomb sinks through the water, pressure is built up on a thin metal diaphragm exposed by the removal of the cap. At the

(Continued to page 246)

Above, ships and planes in area outlined on map will have a good chance of being spotted by the present SOFAR network

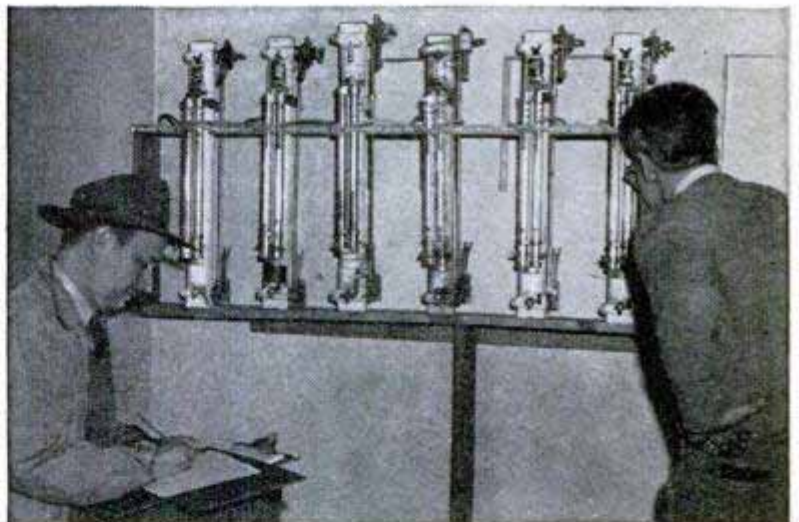

Above, analyzing water samples collected in Nansen bottles. Below, this is how the SOFAR signal looks when picked up on the tape by the receiver. Note the sharp peak and abrupt drop

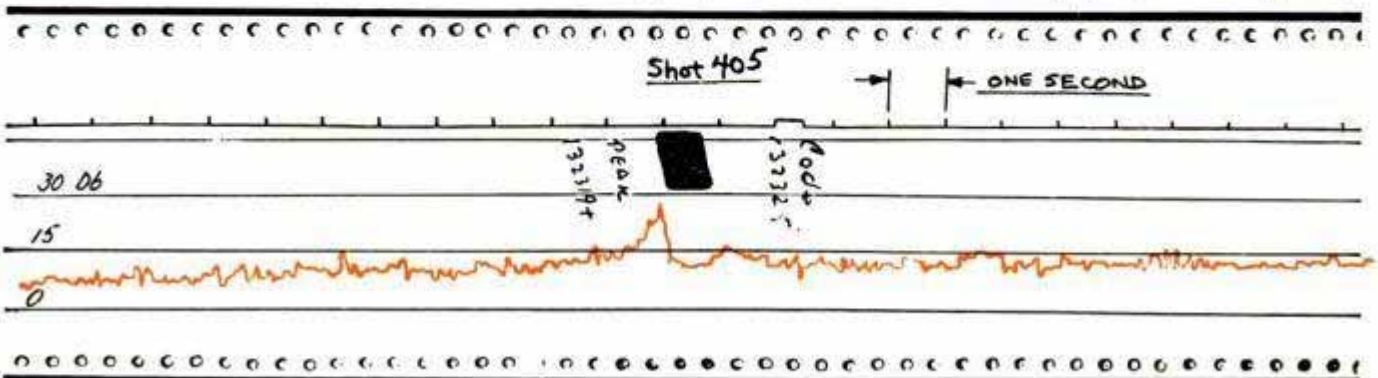

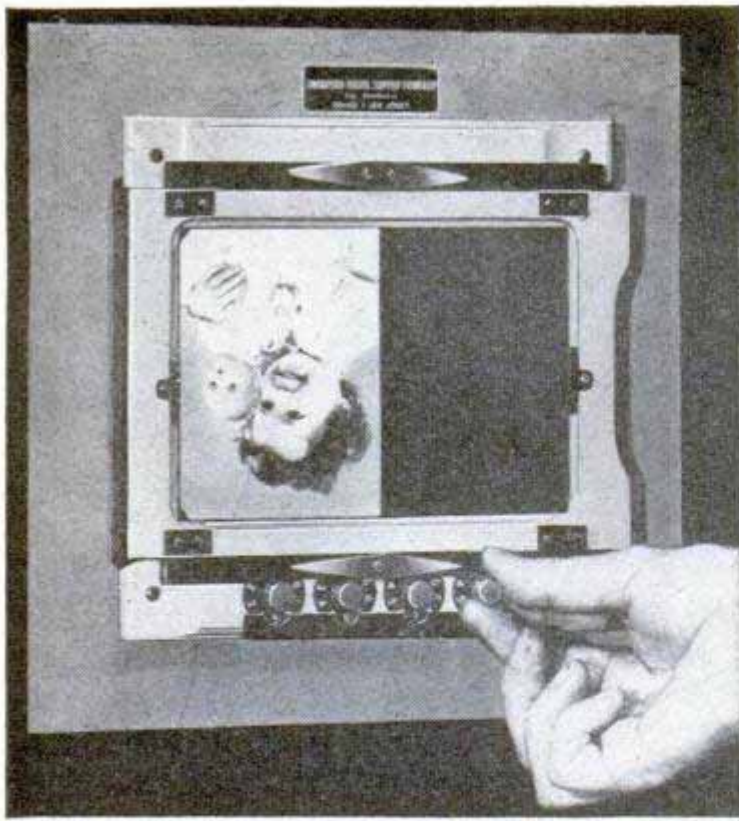

Identification Numbers Printed on Negatives

Negatives can be marked with identification numbers automatically during exposure to prevent errors in filing and print-

ing. Marking is done by a special camera back that fits any 8 by 10 or 5 by 7 studio or view camera. Dials on the back can be set to any number up to 9999. When the negative is exposed, the key number is printed on the margin of the negative.

Measuring Tape Mounts on Tripod

Mounted between the tripod head and the camera, a steel rule provides a quick and accurate means of measuring distances when making extreme close-up photographs with supplementary lenses. On the side of the case which contains the rule is etched a table giving conversion data for various supplementary lenses. By measuring the distance between the lens and subject and then referring to the table, the photog-

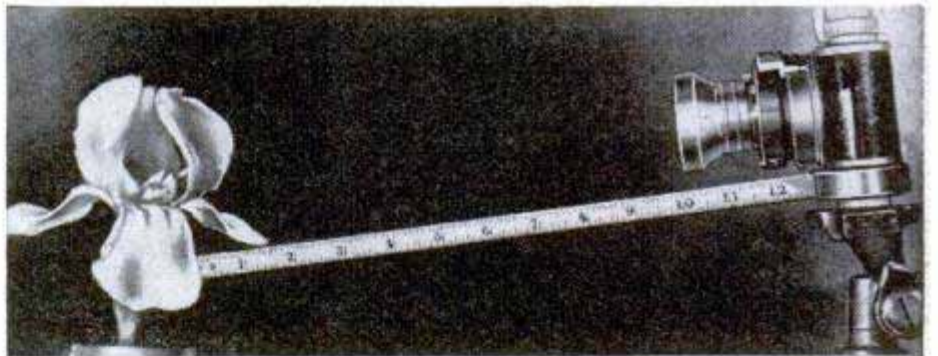

rapher learns where to set the camera focusing scale to be sure of sharp negatives. One side of the case has a screw that fits the tripod socket of the camera and the other side has a socket for the tripod.



Leash on a Reel Rewinds Itself

Dogs that have to be tied up are given considerable freedom by a leash on a self-winding reel. An 18-foot leash has a tension of slightly over one pound, not enough to hamper the dog's movements. The reel takes up or pays out the leash as the pet moves around.

Combination Lamp and Easel Gives Lighted Work Area

Drawings or photographs that require retouching are held at a convenient angle by a combination lamp and easel which provides a well-lighted working space. Practical for those who read in bed, the 10 by 12-inch easel surface holds a book or magazine upright and the adjustable shade insures adequate lighting without glare from the pages. The easel can be locked in any position from horizontal to almost vertical.

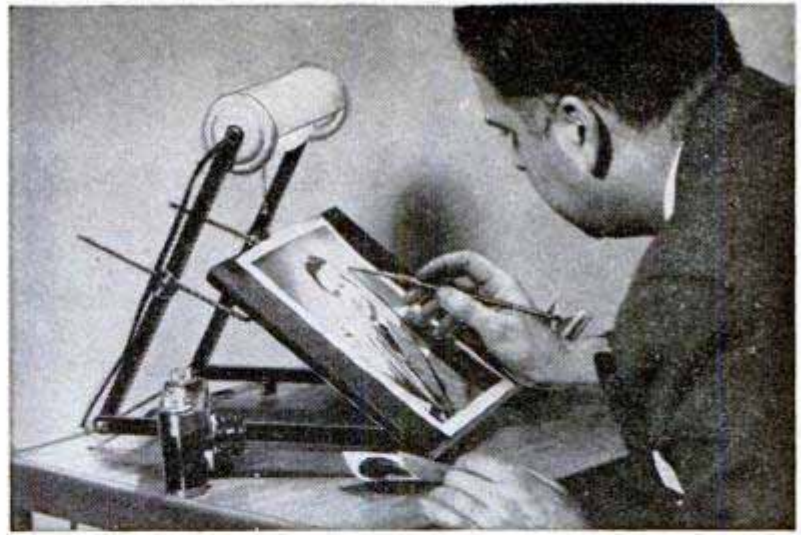

Four Tons of Chopped Hay Unloaded in Eight Minutes

Four tons of chopped hay can be unloaded in three to eight minutes by a self-unloading wagon box that is powered by a $\frac{1}{2}$ -horsepower electric motor. A speed

reducer gears the motor down to provide tremendous power at low speeds. The power unit is placed on the ground beside the tail gate of the wagon and power is

transmitted to the cable take-up shaft by a telescoping drive shaft. Two cables pull a false tail gate to the rear of the wagon, spilling the load. A third cable returns the tail gate to the front end of the wagon box in six seconds when unloading is completed. Any number of wagons can be used with one power unit. The telescoping drive shaft makes uncoupling easy.



Left, false tail gate shoves a load of green field grass out of the truck while workers load it into a silo. Below, the tail gate is pulled to rear by cables connected to an electric motor

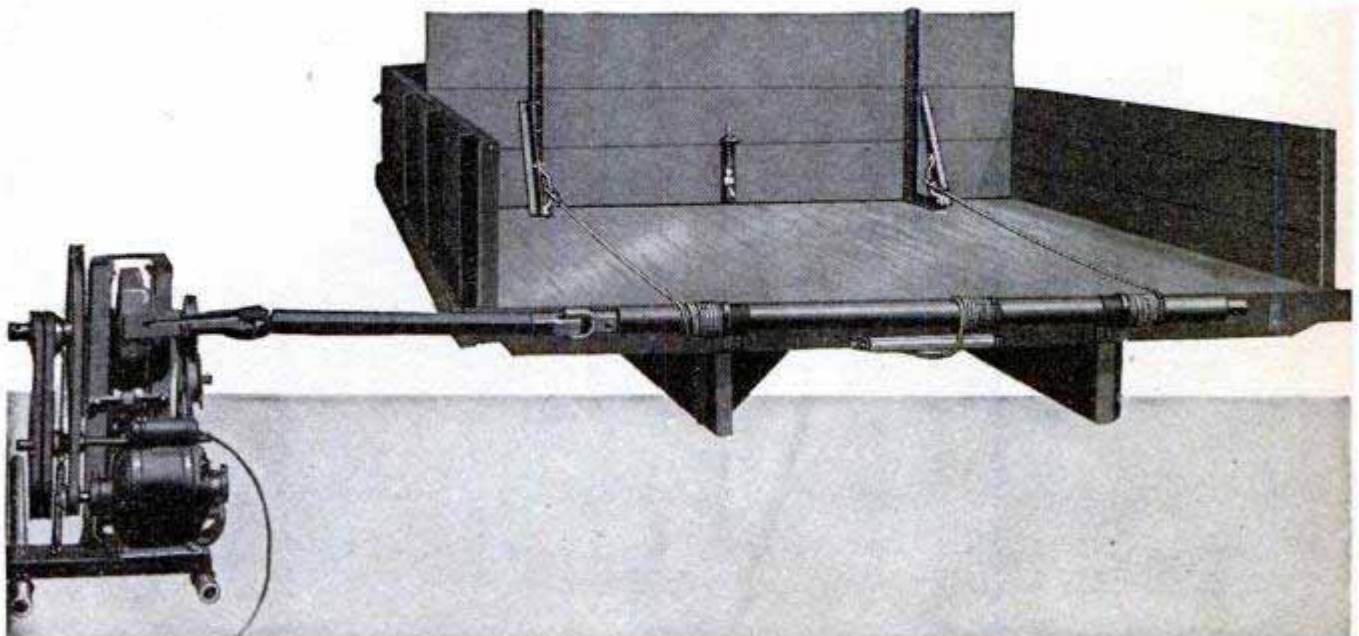

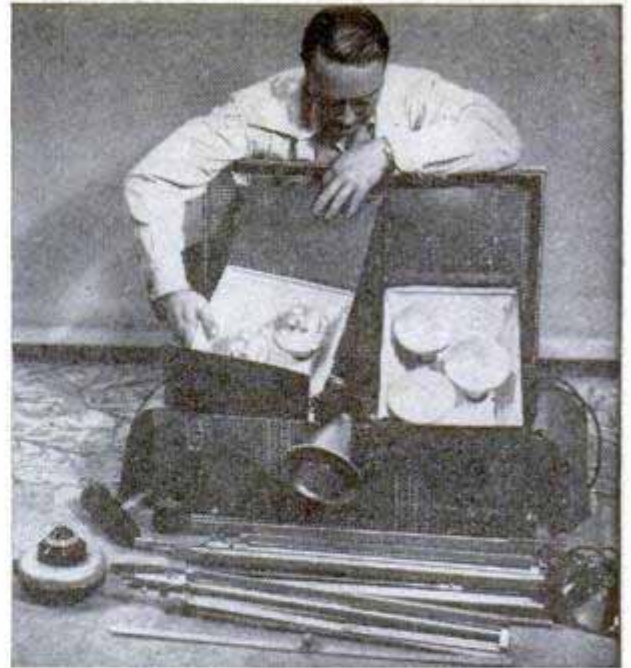

Portable Lighting Kit for Movie Photographers

Designed to pack in one suitcase, a complete lighting set allows the amateur to take brilliant indoor movies wherever ordinary house current is available. When used with a special step-up transformer, the lights provide as much illumination as a dozen No. 12 photoflood lamps. With the

transformer, the lights can be used on a 15-ampere circuit without danger of blowing the fuse. Two floodlights, each containing three lamps, one boom light and a clamp-on spotlight are included. Collapsible standards and an automatic reel with a capacity of 15 feet of cord are also included.

Trailer Goes Up or Down to Match Loading Dock

Loading and unloading big trailers are speeded by a hydraulic wheel-suspension system that enables the operator to raise or lower the trailer bed to match the height of the loading dock. If desired, the trailer can be lowered all the way to the ground.

Similar to the retractable landing gear of an airplane, the suspension system is hydraulically operated. A pump, driven by a small gasoline engine, powers the system. Each wheel can be adjusted separately through a distance of 53 inches.

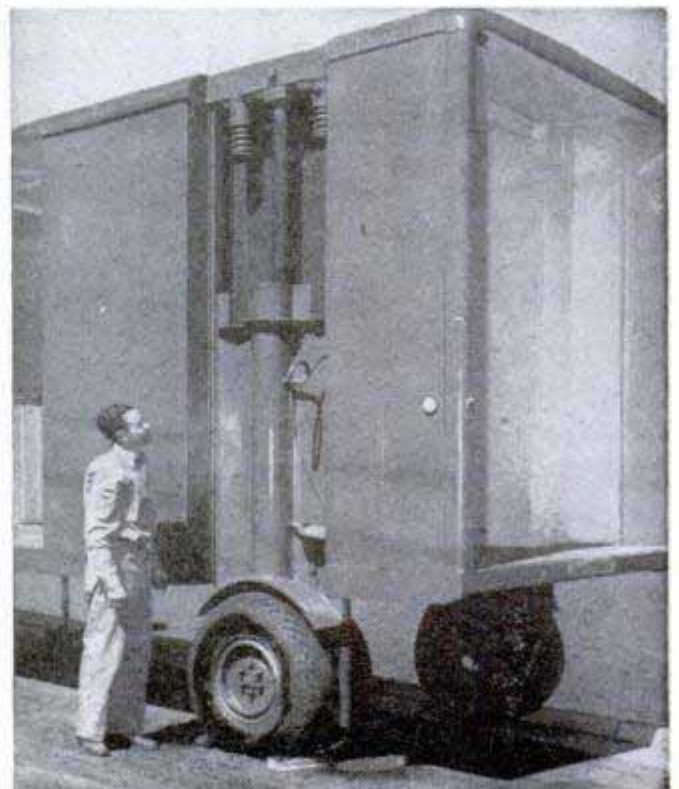
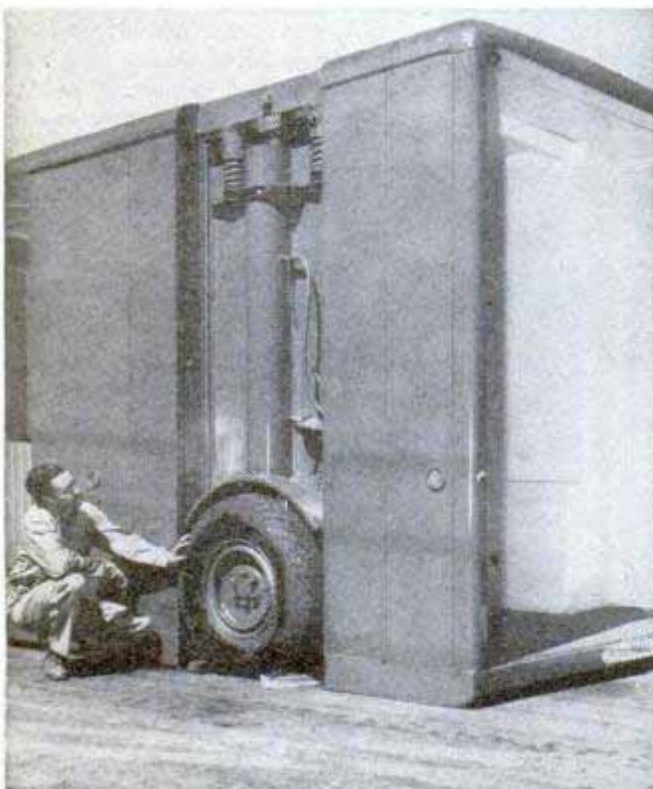

The CRAFTSMAN

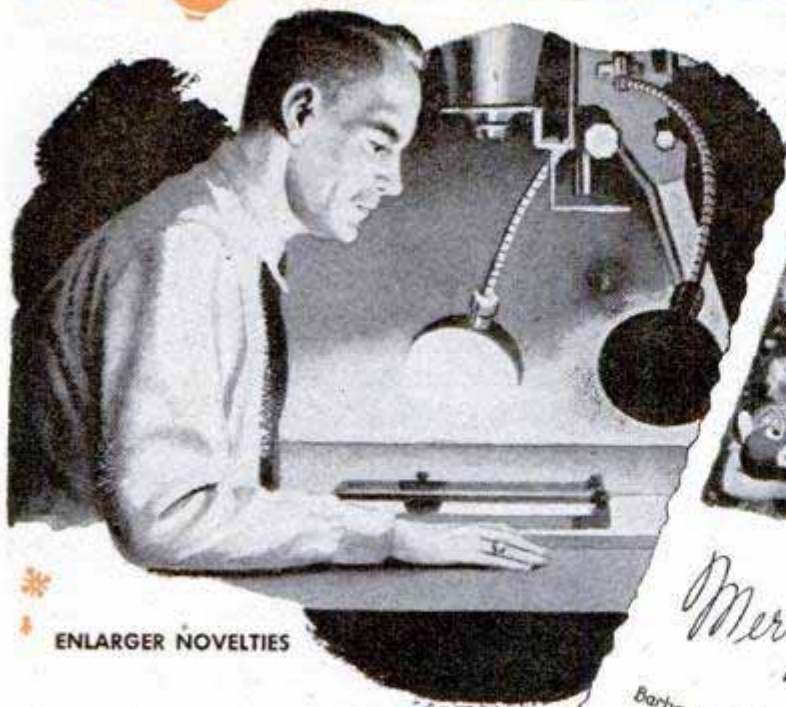

ENLARGER NOVELTIES



Merry Christmas
The SMITHS

Barbara • Josephine • Richard • Frederic

Using your photo enlarger to make personalized greeting cards is a way of saying "Merry Christmas" with a spirit and meaning appreciated by friends everywhere. Procedure is fully described on page 208. This month the home-repair series covers the care and servicing of house doors—how to correct sagging doors, how to adjust locks and hinges, and so on, page 194. Two shop stories of interest to craftsmen are motorizing and modernizing an old treadle-type sewing machine, page 174, and building a lathe milling fixture, page 220. Special-interest feature of the milling fixture is that the machine work is done on the lathe on which fixture is to be used

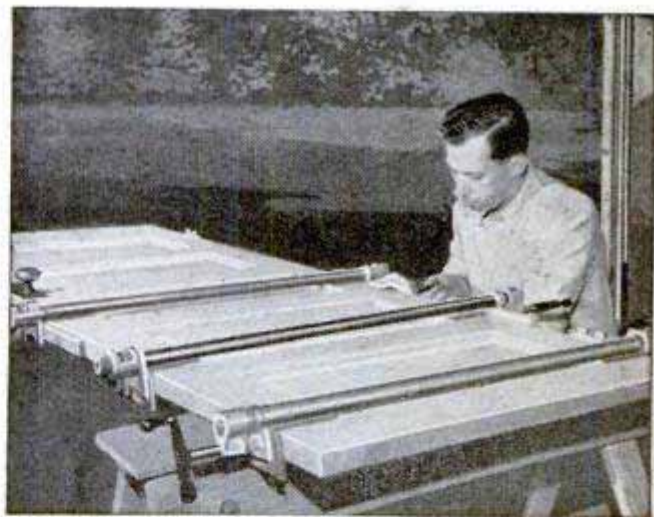

DOOR REPAIR

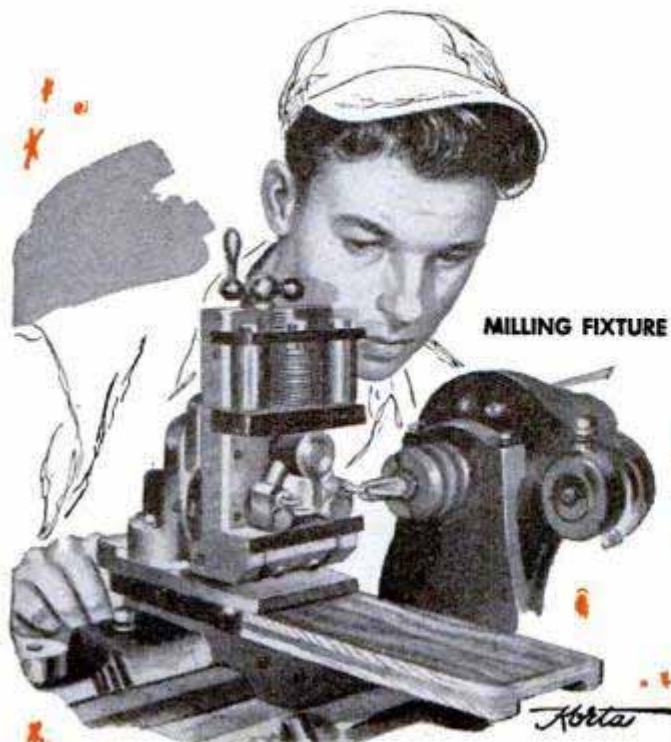

MILLING FIXTURE

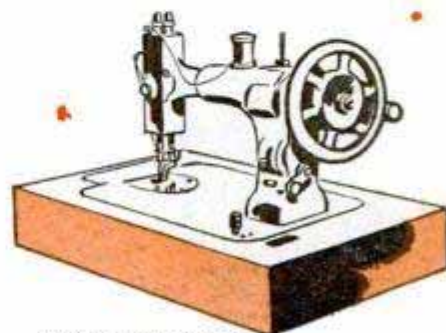

MODERNIZE YOUR SEWING MACHINE



OLD TO NEW



By J. W. Roche and M. C. Anderson

USING conversion kits now available, you can electrify that old treadle sewing machine and then make it over into a modern portable type by fitting the sewing head into an attractive cabinet. Almost any old sewing-machine head that is still in serviceable condition will do.

First remove the head from the cabinet and determine the over-all size of the mounting board, or base, to which the head is hinged. On some old machines the mounting board is in two parts. In this case, a new mounting board will have to be fitted. If it is necessary to make this part, use oak or birch plywood so that it can be finished attractively. Next, by measuring the sewing head, determine the required depth of the cabinet base, or bed frame, Fig. 1. This is given as 3½ in., which is average, but you may have to change this dimension. Then measure the sewing head for over-all height, length and width. These dimensions, plus an allowance for clearance all around, will give you the inside dimensions of the cabinet hood.

Figs. 2, 3 and 4 show the cabinet base partly completed and the machine mounting board being fitted. As detailed in Fig. 1, an offset is formed all around the inside of the base on which the mounting board rests when the head is in position. If you have the necessary equipment,

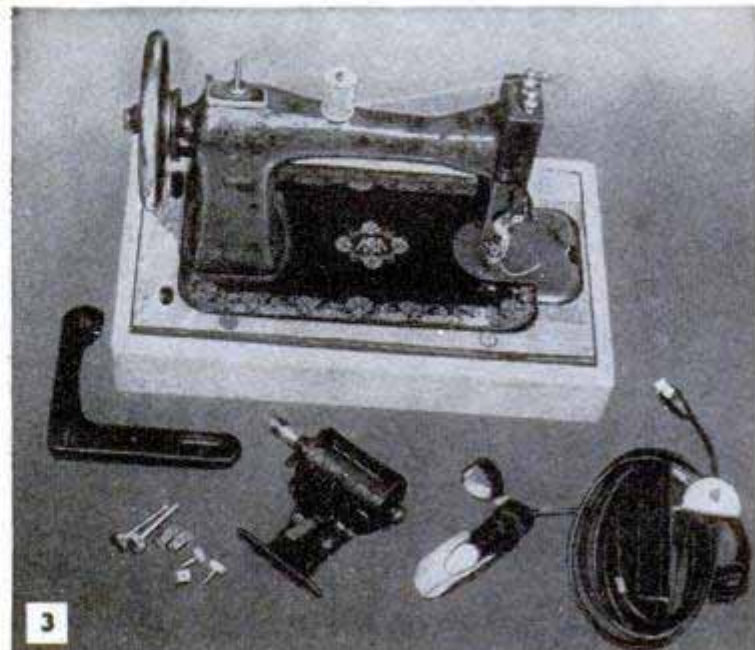
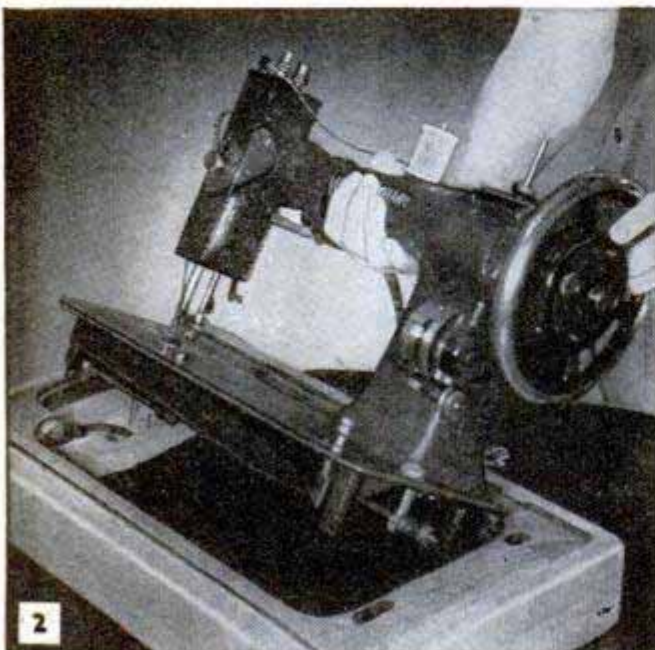
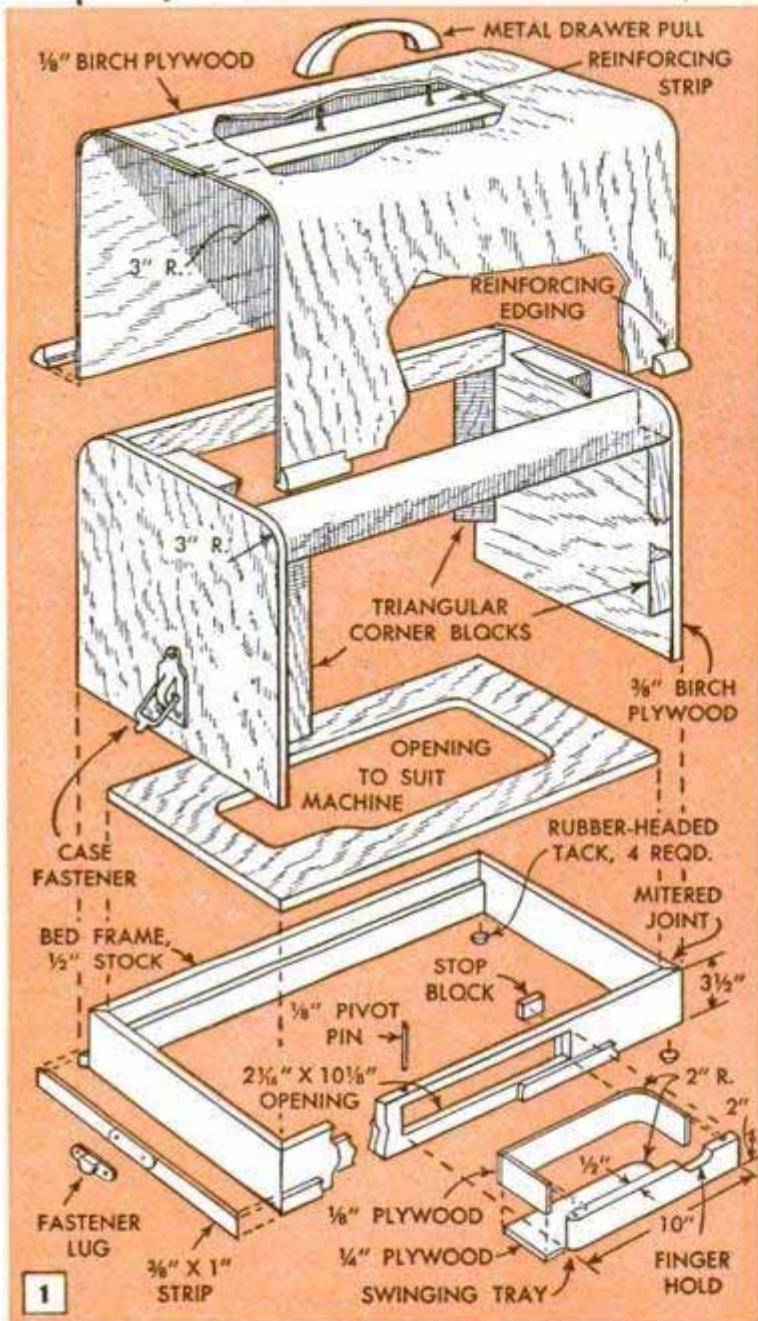

Sewing-Machine Conversion

the extra pieces which form the offset can be omitted and the upper edges of the sides and ends rabbeted instead. The swing-out tray is optional. On some types of sewing heads it is not possible to install the tray unless the base is made deeper so that the tray will clear when closed. The endpieces of the cabinet hood are cut from $\frac{3}{8}$ -in. plywood with a 3-in. radius at the upper corners. If desired, the hood can be made with a fully rounded top instead of the flat top detailed. The end panels are glued and bradded to the spreaders. Triangular corner blocks are glued flush with the edges of the endpieces at the top and sides. Then the plywood covering is dampened at the points where it will take the bends and is bradded and glued in place. After the glue is dry, set the heads of the brads below the surface and fill the holes with a wood filler. Install a reinforcing strip of hardwood under the point where the carrying handle will be attached, as in the upper detail, Fig. 1. Attach the handle with screws driven up from the underside of the hood through the reinforcing strip.

Now, make a trial fit of the hood as in Fig. 5. It should fit over the bed frame without binding. This determined, glue rabbeted strips to the bottom edges of the hood to protect the edges of the thin plywood. These strips match the $\frac{3}{8}$ x 1-in. strips glued to the outside of the bed frame,

as in the lower detail, Fig. 1. Varnish all exposed parts in the natural color of the wood. If birch or other close-grained hardwood is used, no stain or filler will be necessary. Instructions supplied with the motor kit, Fig. 3, will indicate clearly how to install and operate the unit. Have the kit on hand before building the hood so you can make allowance for hood clearance.

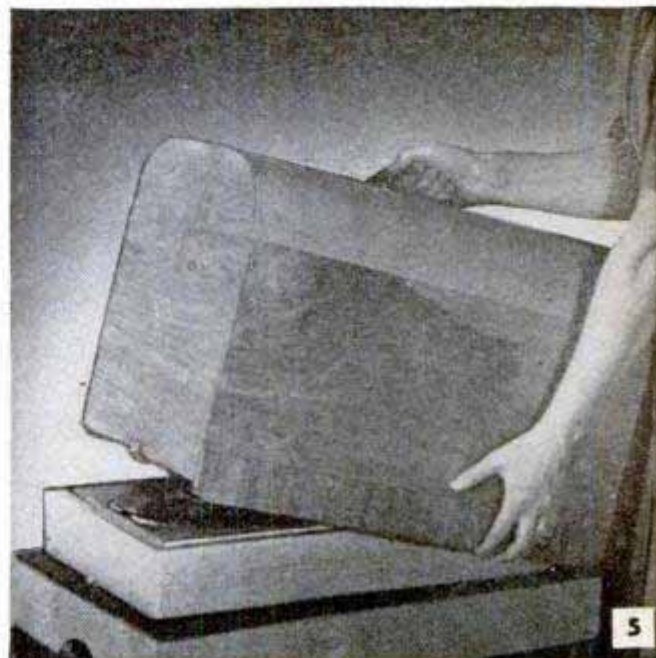
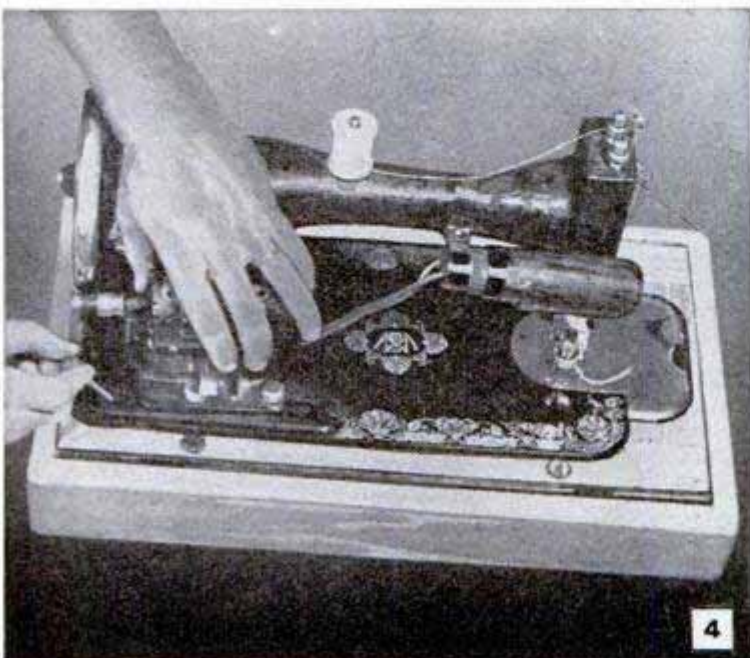

Scissors Jack Aids Leveling Bench

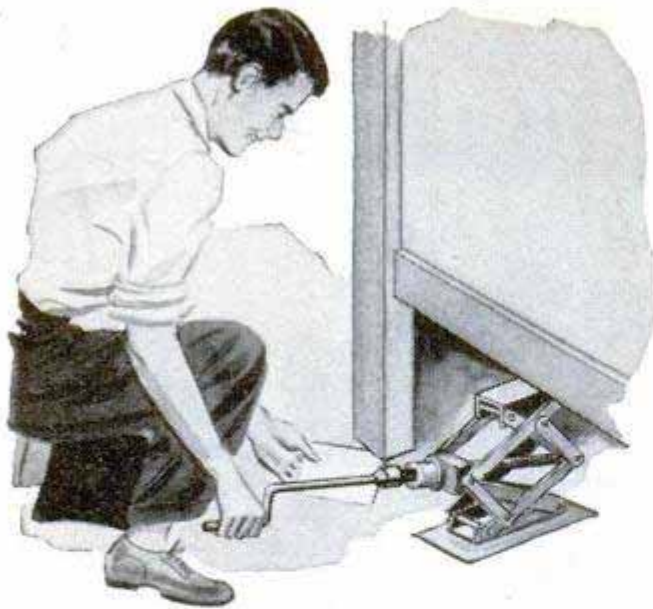

Little effort is required to level a heavy lathe stand or workbench if the legs of the table are raised with a scissors-type car jack. The jack is slipped under a side or end rail near the leg to be shimmed.

Robert Hertzberg, Jackson Heights, N.Y.

Filter for Warm-Air Furnace Has Steel-Wool Packing

Instead of buying a new filter for my warm-air furnace periodically, I made an inexpensive one which can be cleaned easily and will last indefinitely. It consists of a wooden frame 2 in. deep, having the same over-all dimensions as the original filter. A wooden partition nailed across the frame divides the filter into two sections to sim-

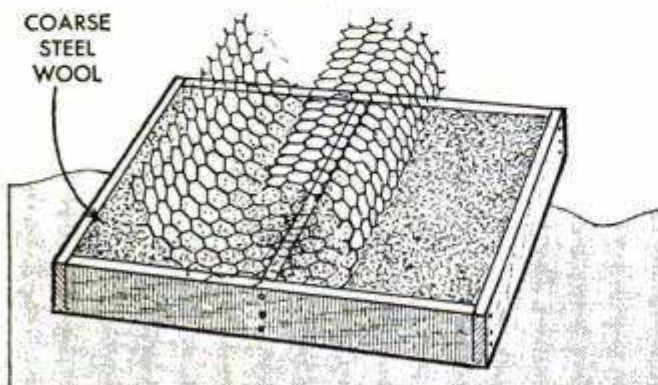
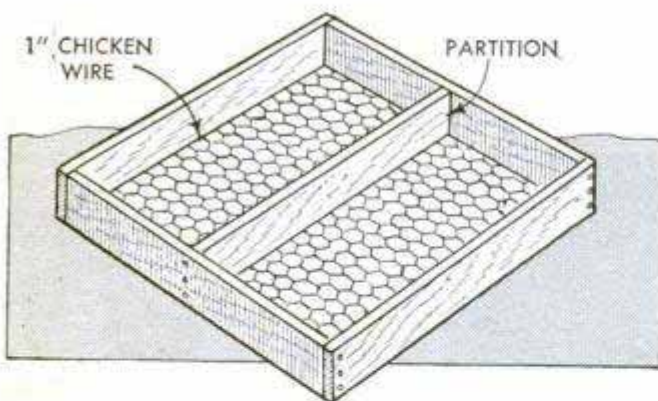

ply cleaning. Each section is packed with one pound of coarse steel wool which is held in place by tacking 1-in.-mesh poultry wire over both sides of the frame. To clean the filter, simply remove the steel wool and wash it in kerosene, allowing it to dry before replacing. The efficiency of the filter can be increased by sprinkling a small amount of lightweight motor oil over the steel wool.—R. Boettinger, Englewood, N.J.

Suction Cup Over Oil-Drum Plug Prevents Water Leakage

Water seeping into outdoor fuel-oil drums can be prevented by fitting the suction cup from a drain plunger over the vent pipe. This will keep water from entering between the threads of the bung and the filler plug. The cup is located on the pipe so it fits snugly against the drum when the plug is screwed into the bung. A little gasket cement applied around the neck of the suction cup will stop water from seeping in around the vent pipe.

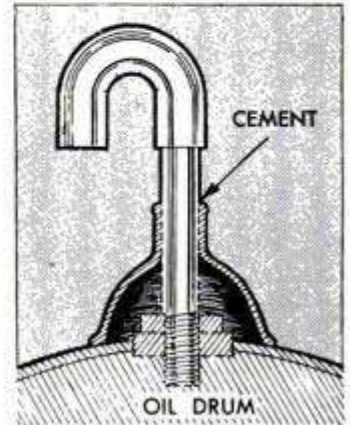

Glenn R. Uhlmann, Bremerton, Wash.

Safety Box Holds Power-Tool Plugs

To keep inquisitive children from turning on his power tools, one home craftsman inserts the extension-cord plugs in a padlocked safety box. The latter is a small wooden box fastened to the wall near the receptacle. Slots in the bottom of the box admit the cords, and the size of the plugs prevents them from being pulled through the slots. Box is mounted near wall outlet.

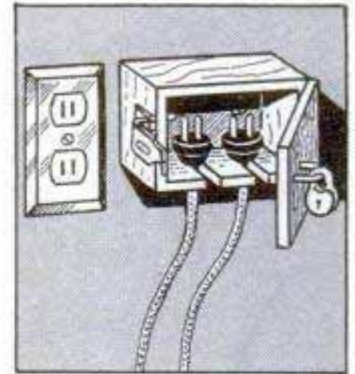

Sidney Abbot, San Francisco, Calif.

Salt Eliminates Snow Shoveling

Try sprinkling salt over your walks and driveway as soon as it begins to snow. The salt will melt the snow as it falls and save you the work of shoveling.

Hubert H. Wehner, Saginaw, Mich.

☛ Pork fat will render more quickly if it is first run through a food chopper.

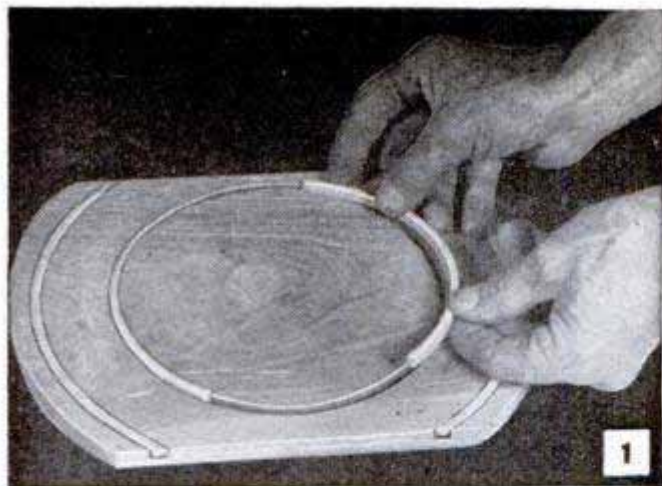

FAN BOOKRACK

GOOD DESIGN, usefulness and ease of construction — these features are the measure of a wood novelty such as this fan bookrack. The fan design is relieved by means of wide V-cuts which expose a contrasting inlay simulating the fan lacings. Begin by making the piece shown in detail C at the right. This piece is $\frac{1}{2}$ in. thick, 9 in. wide and 12 in. long and the ends are bandsawed on an 8-in. radius. Lathe-turn grooves in the piece and inlay with a contrasting wood as in Fig. 1. Then cut on the dotted lines, detail C, and make the fixture shown in detail B. Now, grind straight molding cutters to the wide V-shape required and set up to shape the endpieces on the circular saw as in Fig. 2. After running the shaping cuts, rabbet the straight edges of the endpieces to take the bottom and back of the rack. These parts are of $\frac{3}{8}$ -in. stock. Finish all parts in the natural color before assembling. Finally, fit the simulated fan loop at the lower corners of the endpieces. See detail A and also Fig. 3. These parts should be made from the same contrasting wood as the lacing inlays and are finished in the natural color.

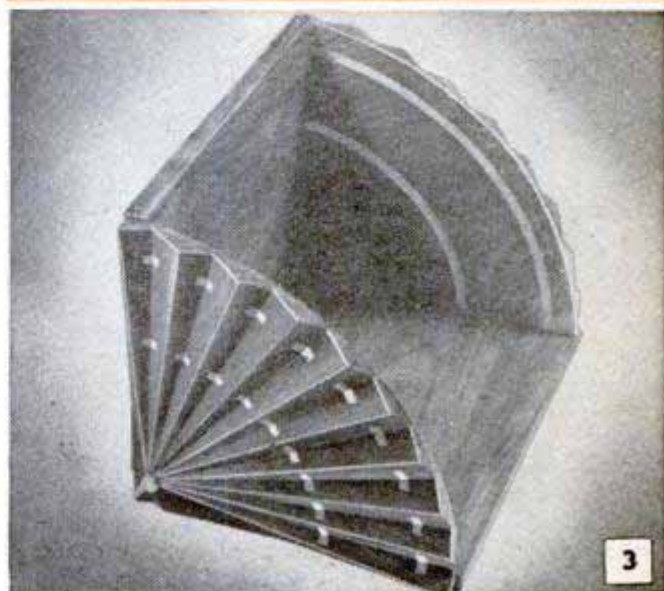
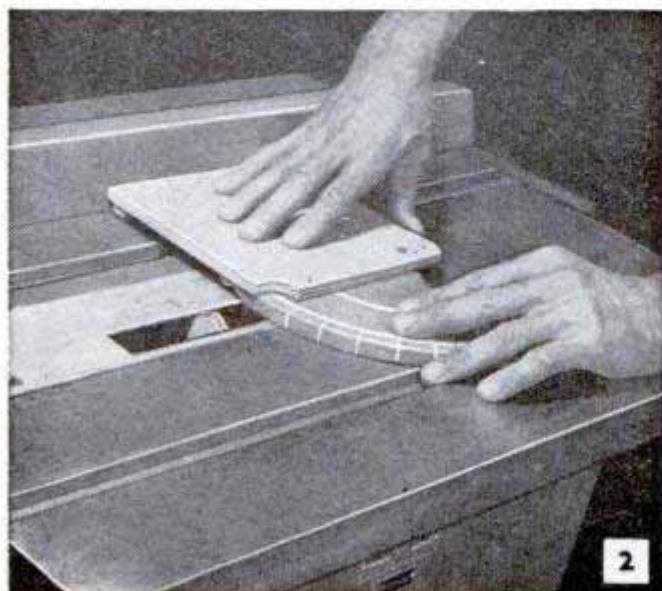
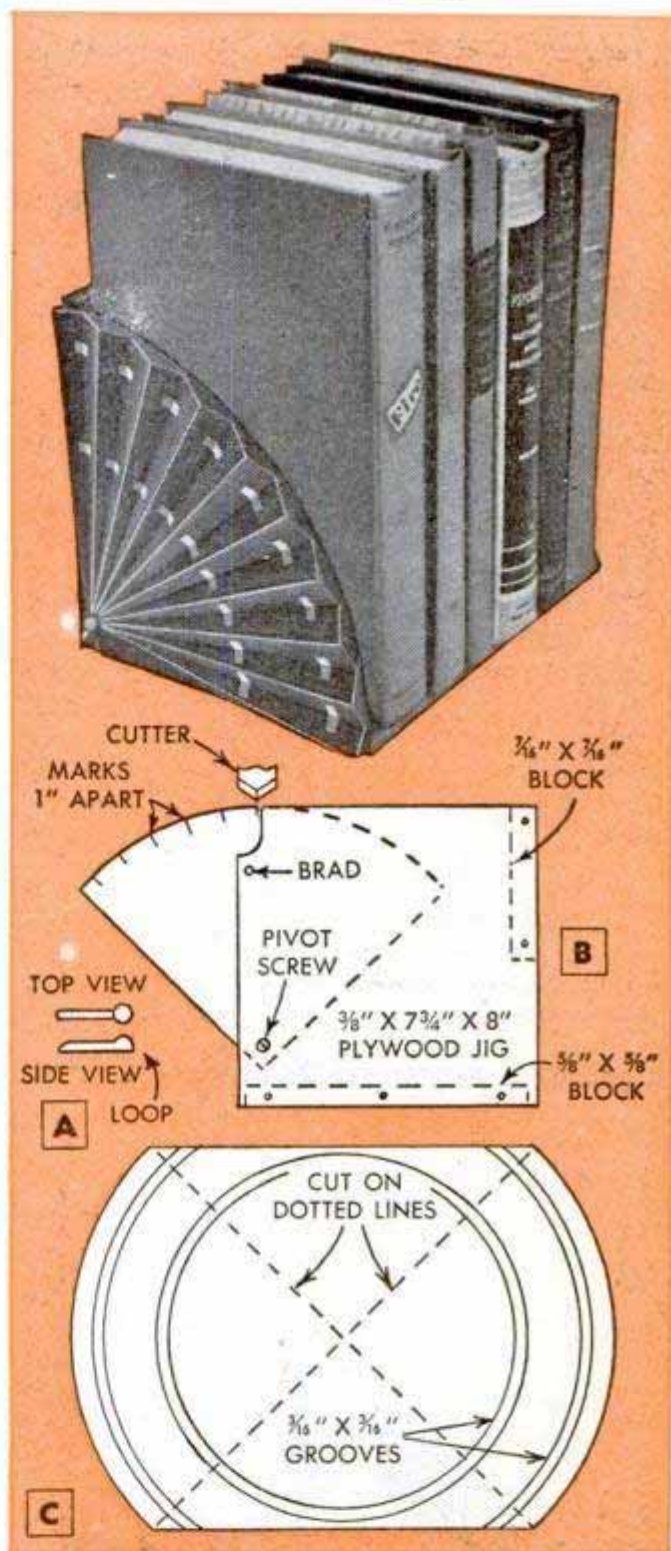

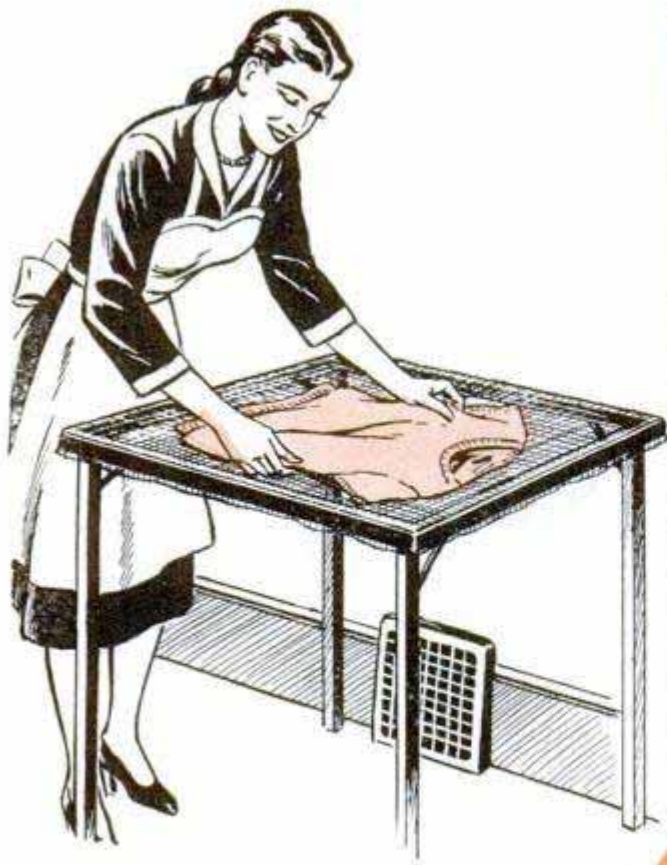

FOR DRYING SWEATERS, mittens and other soft, hard-to-dry garments, cut the top off an old card table. Cover the frame with plastic screen stretched tightly and tacked

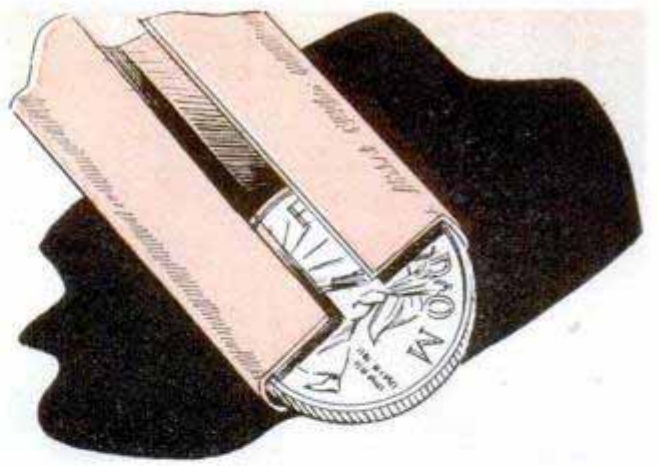

OPEN-MESH CURTAINS slip easily over sections of flat, telescoping rods when you wedge a coin into the end of the larger rod section. The contour of that portion of the coin which projects prevents snagging of the soft, open-mesh material

SOLVING
HOME
PROBLEMS

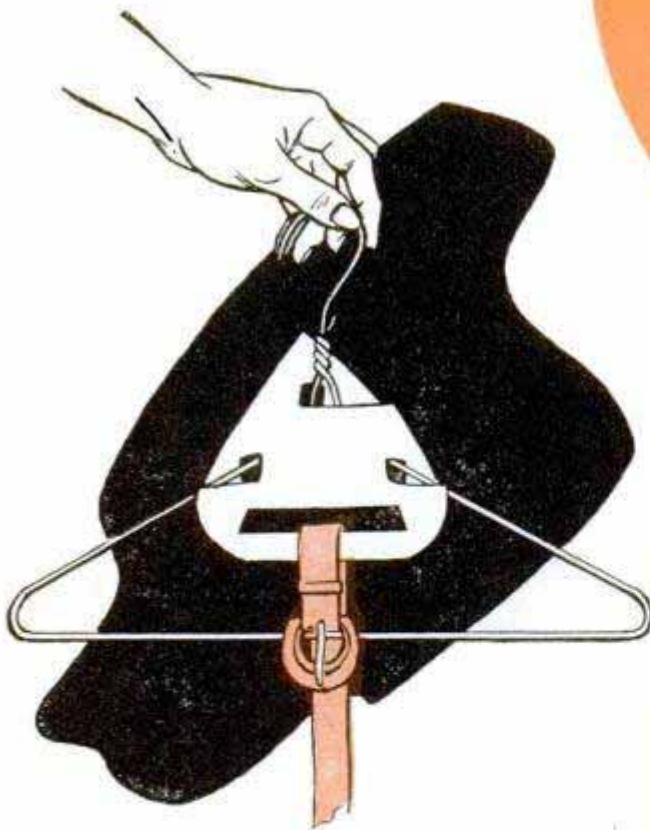

SIMPLE BELT HANGERS are made from cardboard to fit over a wire clothes hanger for storing matching belt with a suit or skirt. Note that square openings are cut in the cardboard and slits are made from bottom corners of the openings to the edges

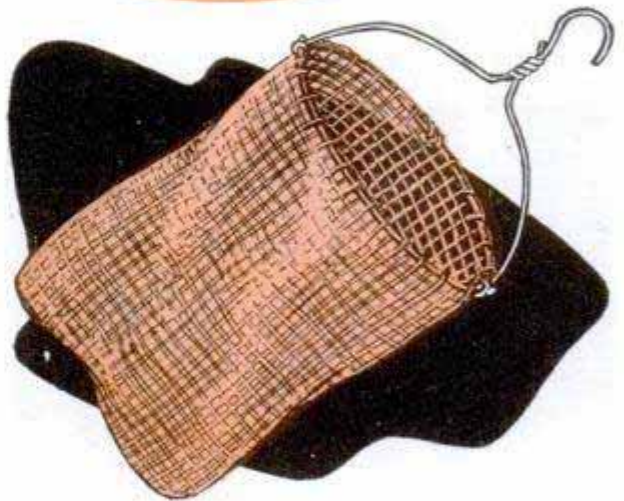

THIS CLOTHESPIN BAG is especially handy because the top is held open by a hoop made from a wire clothes hanger. Use another hanger to make the hook bail for supporting the bag on the clothesline. Sew an onion sack to the hoop and there you are

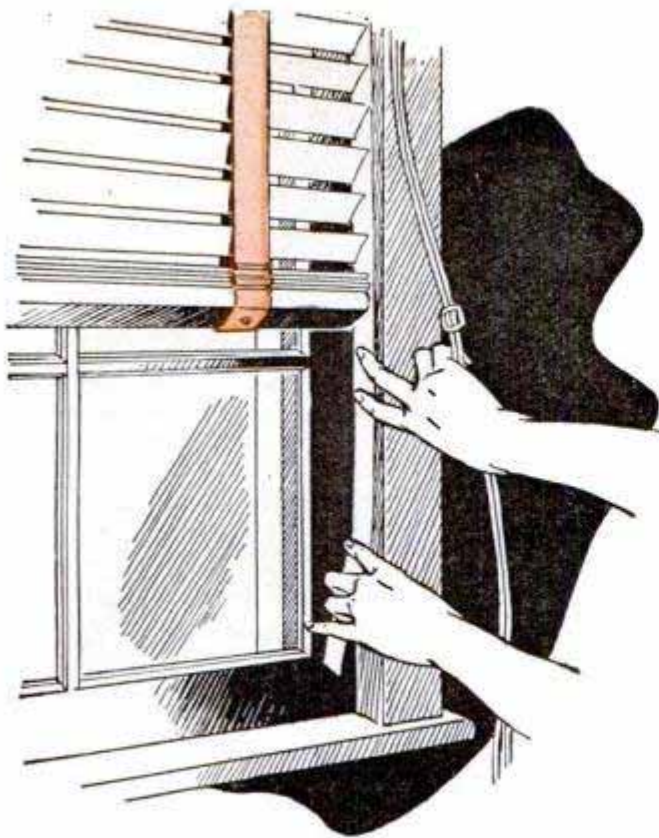

WINDOW STOPS won't get nicked, scratched or soiled when cleaning Venetian-blind slats if you protect them with painter's masking tape. This is placed over face of the stop as shown. The same pieces of tape are stripped off and reused a number of times for this purpose before discarding



WHEN UPHOLSTERING chair seats or footstools with needle-point it's a good idea to place a piece of oilcloth under the floral design. Then, when sponging the design to clean and brighten it, the oilcloth will protect the padding underneath from absorbing moisture. Size of the oilcloth is determined by the size of the design



GRATING CHOCOLATE uniformly fine so it melts quickly without scorching is done in a jiffy with an ordinary potato peeler. By varying the angle at which the peeler is held, the size of the chocolate particles can be made large or small as desired

AN ORDINARY WOODEN CLOTHESPIN makes a good marking gauge for cutting strips on the bias from heavy fabrics. Mark one leg of the clothespin as shown below to give the width of the bias strip which is required. Then slip the clothespin over the edge of the cloth and slide it along the edge as the cutting progresses

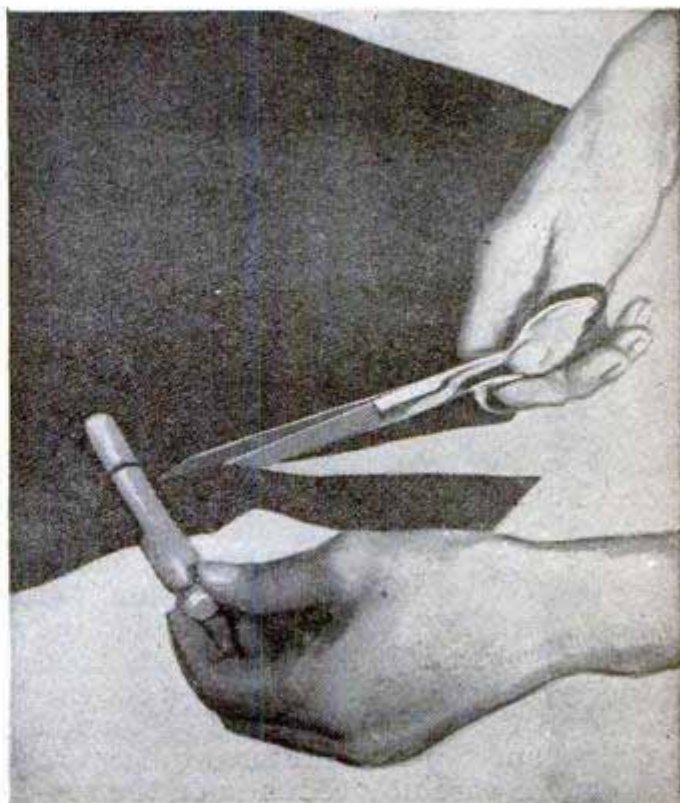

Finger-Pressing Wet Garments Facilitates Ironing



Instead of hanging dresses, blouses and similar garments out to dry, wrap them in a turkish towel to absorb excess water and then hang them on a clothes hanger. Press the garments evenly and firmly on the front and back with the fingers, fasten all buttons and close all the zippers. Then hang the garment in a suitable place to dry and finger-press again while it is still slightly damp. When the garment is dry, it will require very little ironing.

Helen Lemberger, Chicago.

Suction Cup Chucks Copper Bowl To Spin-Polish the Inside

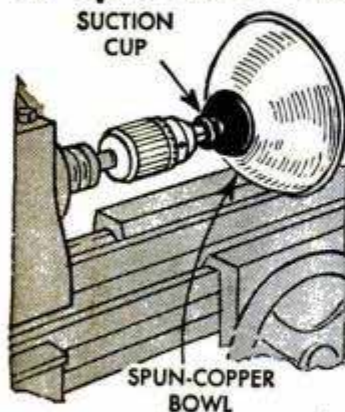

With the aid of a suction cup, a tarnished spun-copper bowl can be easily mounted in a metal-turning lathe to facilitate polishing the inside. A nut embedded in the cup is turned tightly on the threaded end of a length of 1/2-in. rod which, in turn, is chucked in the lathe drill chuck. If the suction cup used is the type having a machine screw embedded in the rubber, the end of the rod is drilled and tapped to receive the screw. The bowl is carefully centered on the suc-

tion cup to avoid vibration and, with the lathe running at moderate speed, the inside of the bowl is quickly polished with steel wool or abrasive cloth. The suction cup will not mar the highly-polished outer surface of the bowl, and a firm grip can be assured by coating the edge of the cup with glycerin or soap.

Alfred D. Beavin, Fair Haven, Vt.

Joining Sheet Metal Without Rivets

Pieces of light-weight sheet metal can be joined tightly without riveting or soldering. First drill a 1/8-in. hole through one of the pieces and remove the burr with a file. Then make a registering hole in the other piece of sheet metal by driving the pointed end of a center punch through it.

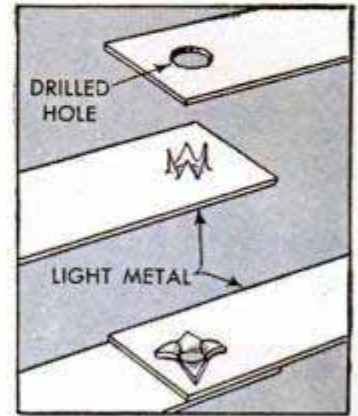

The jagged burr formed around the punched hole is passed through the hole in the first piece, and then the prongs are hammered over the edges of the hole.

Herbert E. Fey, New Braunfels, Tex.

Tapping Holes in Plastic

By using the threads of a proper-sized screw as a tap, holes in plastic parts can be threaded quickly. Drill the holes slightly undersize and heat the threaded portion of the screw with a soldering iron or over an open flame. Then turn the screw into the hole to cut the threads in the plastic.—Harold Pallatz, Brooklyn, N. Y.

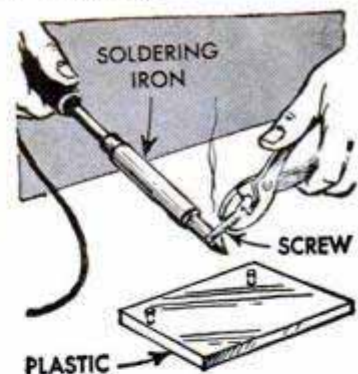

Upholstering Nails Driven Neatly With Aid of Rivet Set

The problem of driving upholstering nails without damaging the heads can be solved by using a large rivet set. The nails are driven part way with a hammer and finished with the set.





By
Benj. Nielsen

Interlocking WASTEBASKET

Painted in traditional red or black and decorated in gold, this intriguing Chinese wastebasket, with its interlocking corners, makes you wonder how it fits together. It consists of 18 slats, 5/16 in. thick, 14 of which are made 3 in. wide and four 1 1/2 in., all being notched as indicated in the half patterns shown. Note that 10 of the 3-in. slats are beveled on both edges, whereas the others are beveled on just one edge. The basket is built up by fitting a plywood bottom into grooves run on the inside of three of the bottom slats. When all slats are interlocked, the two top half slats are held with brads.

*Furniture you
can build*

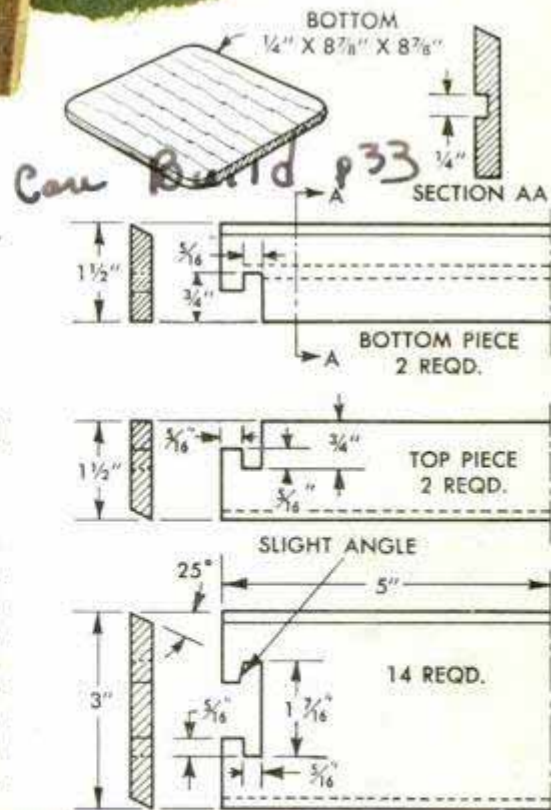

STACK-SAWING LOCKING CORNERS



HOW BOTTOM IS FITTED



INTERLOCKING THE CORNERS





No need to be apprehensive about tackling the upholstering—simplified method makes it easy. Cushions are upholstered on separate frames and then screwed in place right in the chair. New sagless-type springs topped with pocketed coil units provide deep oversize cushions for real lounging comfort. Stock materials used



Your Living-Room

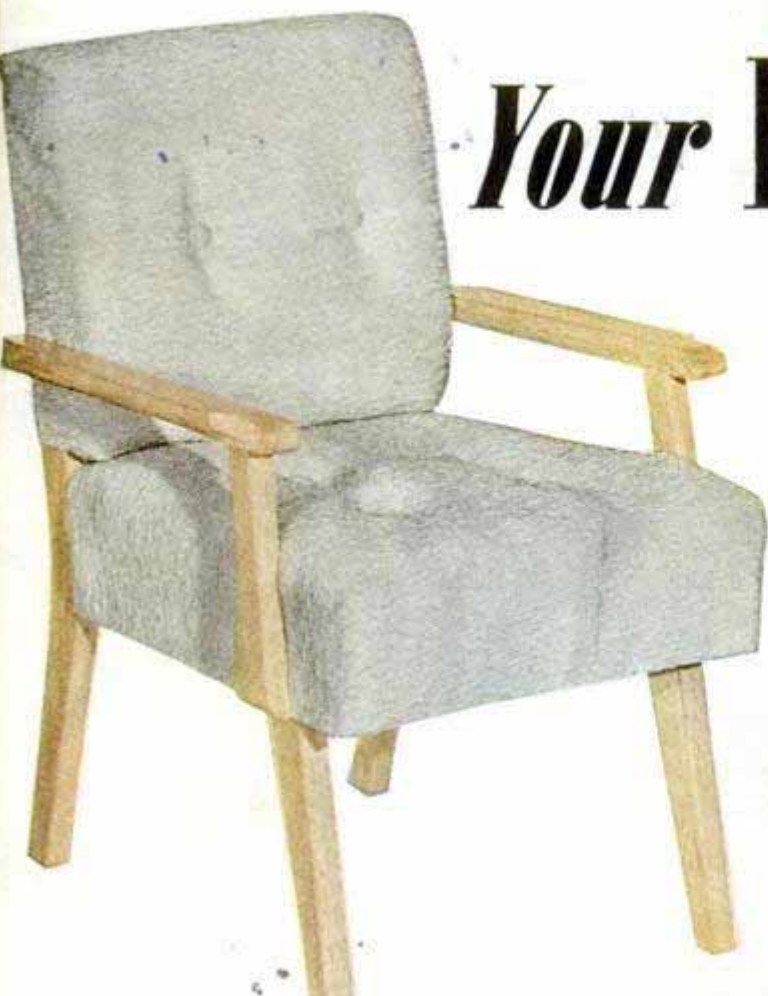



Furniture

Furniture hardware from:

Styled by John Bergen, noted furniture designer

3744 W. Cullom Ave. - Chgo 18, Ill.

PO Box 8, Glenbeulah, Ill.
Story by W.C.

Part II

Wayne C. Leckey

WITH THE cabinet pieces of the group completed as described last month in Part I, you can begin the sectional sofa and chairs. Normally, conventional upholstering that requires tying springs and sewing welt seams is a job for the experienced worker, but here, through the use of sagless-type springs and "box" cushions, the work is simplified to the point where an amateur can do a first-class job. The upholstered pieces of the group include a three-piece sectional sofa, an easy chair and a hostess chair, the latter being made with either wooden or padded arms. The two photos at the bottom of page 182 show how

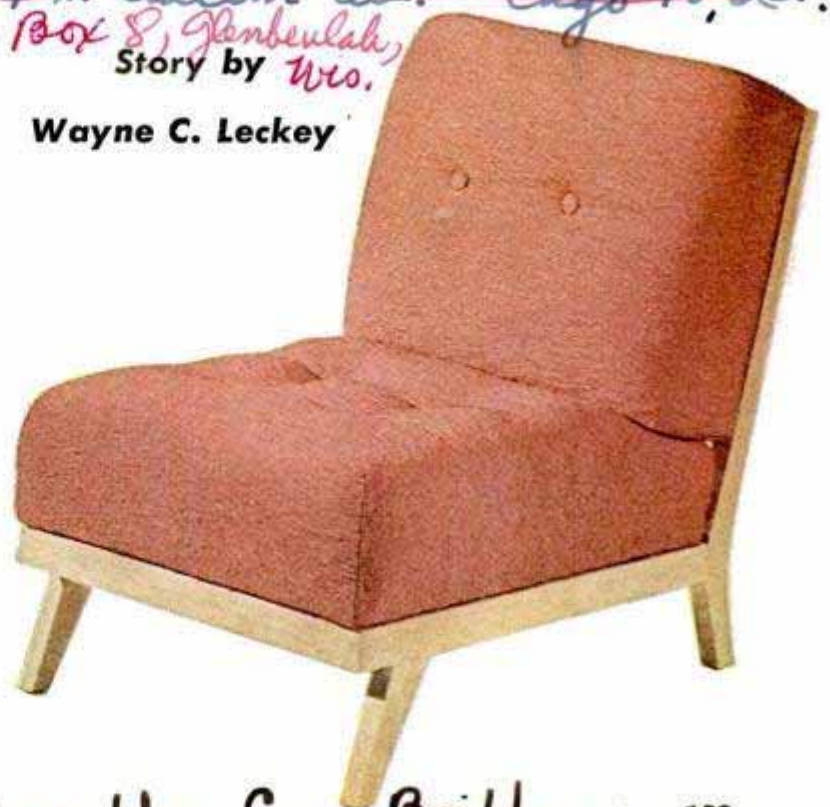



Here's how units of the sectional sofa can be used in conjunction with a living-room fireplace and cocktail table. End units of the sofa are placed together and the center unit is used opposite as a separate chair

the hostess chair will look in each case. Basically, the easy chair, shown at the top of the same page, is a duplicate of the sectional units, except that it is fitted with two arms. Seat and back cushions of each unit are built-up on separate frames which are then screwed to the chair frame. In the case of the hostess chair, the upholstering method differs in that the seat and back are sprung and padded right on the chair.

The sectional sofa is highly functional and can be arranged in a number of ways. Its individual units may be grouped around a corner table as pictured in Part I, or they may be used side by side and flanked with a pair of end tables as shown on the preceding page. Still another suggested arrangement is given in the photo above. Here, the two end units having the arms are placed together and the center unit is used as an individual chair. In addition to the upholstered pieces, Part II covers the construction of two distinctive lamps.

Frames for the sectional sofa, easy chair and the hostess chair are detailed in Figs. 18 to 22 inclusive. The original pieces were made of solid oak to match the rest of the furniture. Parts of the frames not exposed can be made of any scrap hardwood. Both end units of the sofa are made as pictured

in Fig. 19, one being built with a right and the other with a left-hand arm. The center unit of the sofa, and the easy chair, are exact duplicates of the others, the center unit, of course, having no arms. Construction of the hostess chair, Fig. 21, is basically the same, differing primarily in size and the addition of a tacking rail across the back. As previously mentioned, this chair can be fitted with either wooden or padded arms. In both cases, the arms are made up separately and doweled through the holes in the fabric and into the frame after the upholstering has been completed. Then screws are driven into each arm from the inside. Fig. 18 details the framework for the padded arms and Fig. 17 shows them being trial-fitted, registering holes being made for the dowels. Note that the seat corner joints of all the frames are glued and doweled and then drawn up rigidly with lag screws. The front legs of the frames are half-lapped into the side rails, glued and screwed. The arms on the easy chair and the end units of the sectional sofa are screwed permanently to the frames before upholstering. Holes for the screws are counterbored through the width of the arms. When the frames are completed, all exposed surfaces of the chairs are sanded and finished as desired. The rear

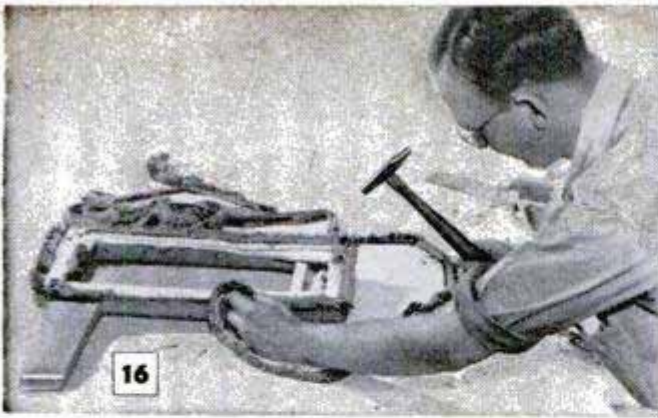

16

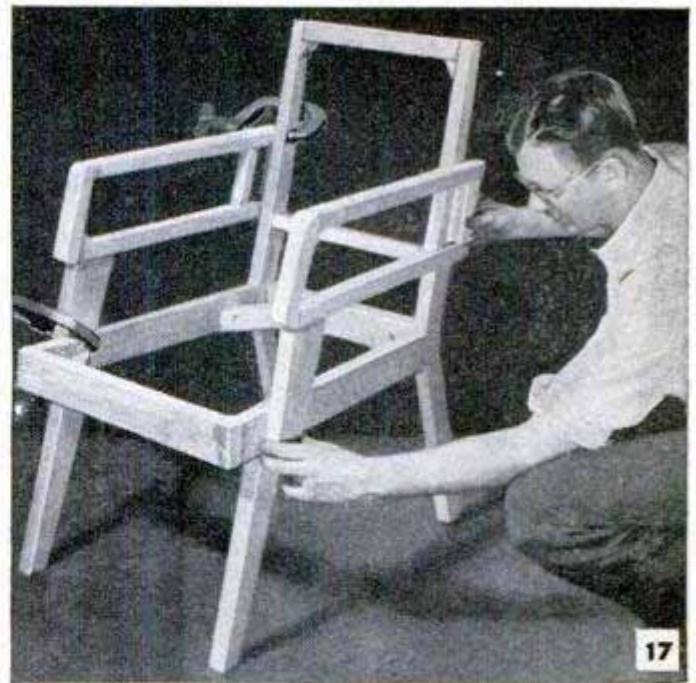

17

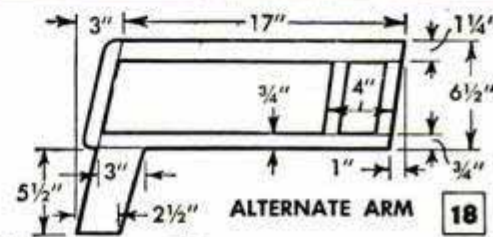
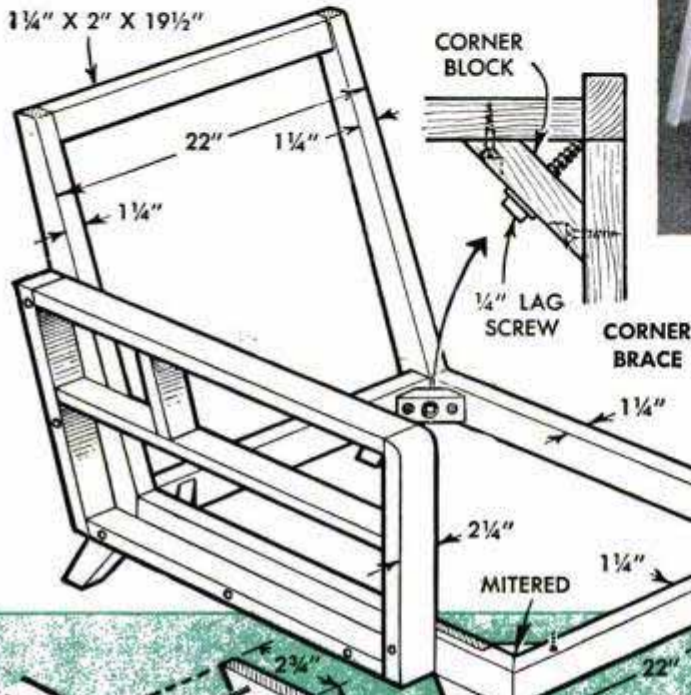

18

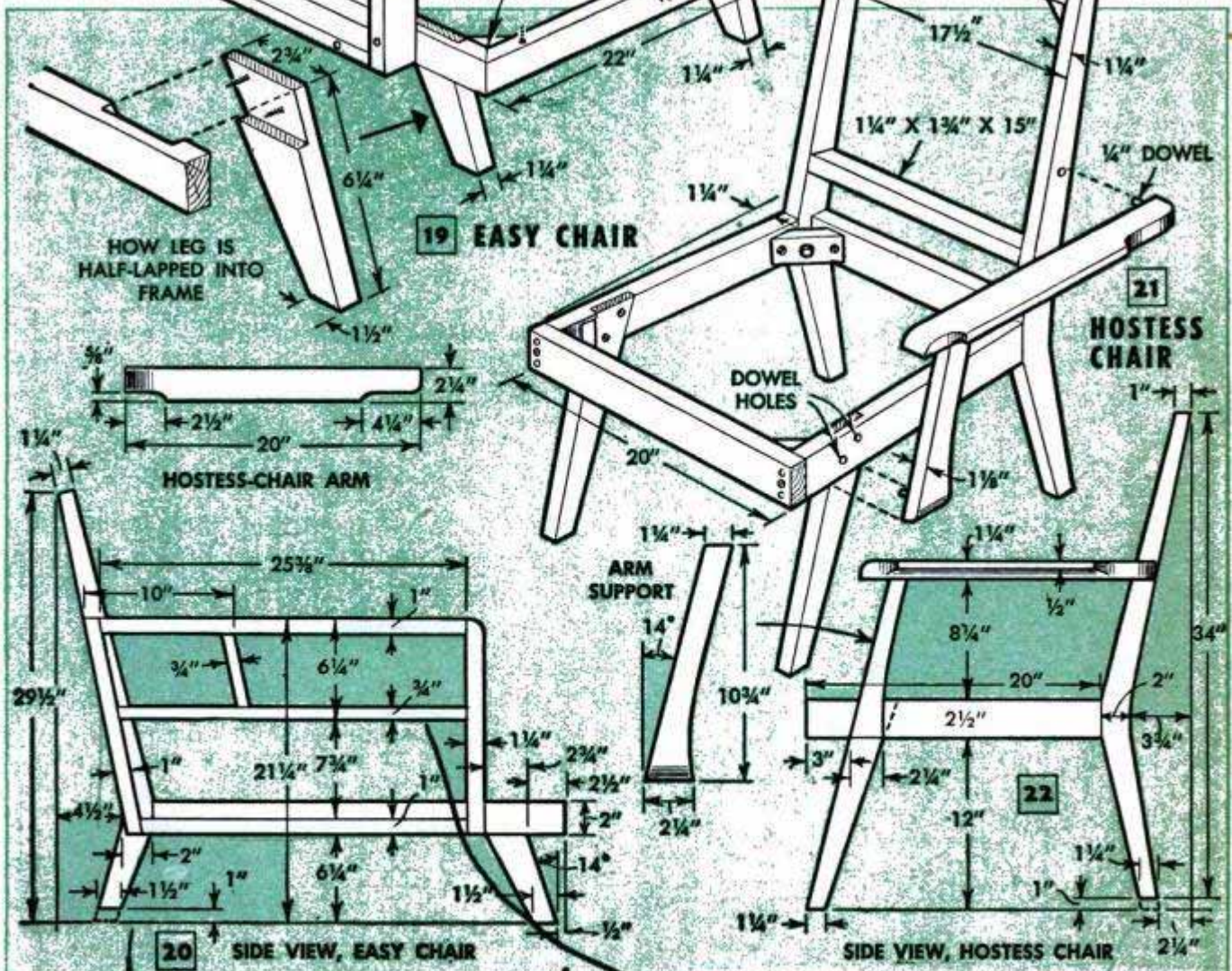

19 EASY CHAIR

21 HOSTESS CHAIR

HOSTESS-CHAIR ARM

20 SIDE VIEW, EASY CHAIR

22 SIDE VIEW, HOSTESS CHAIR

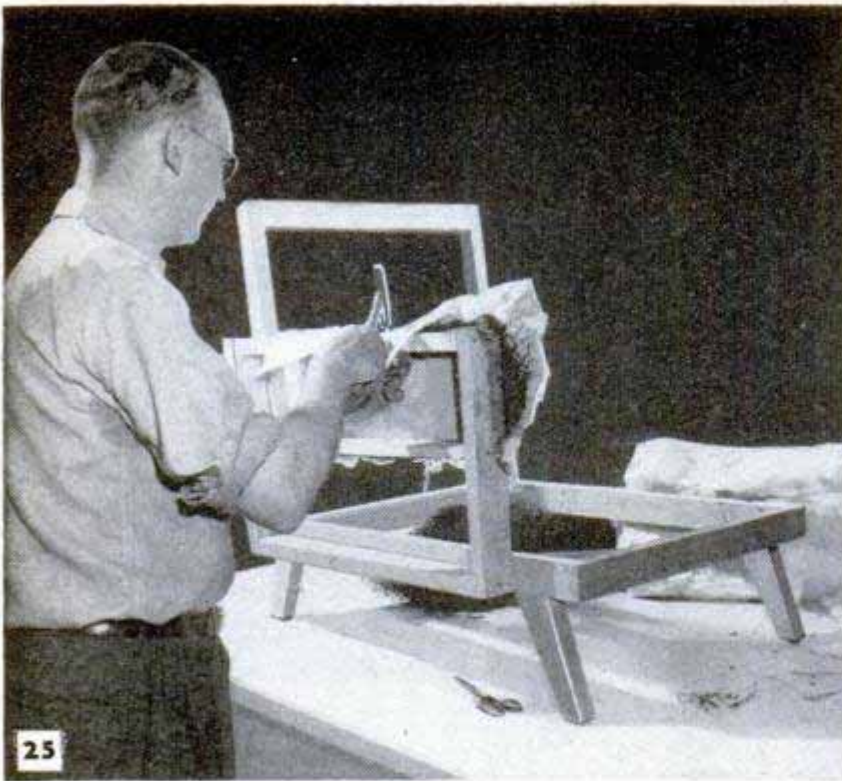

25

Above, this operation shows the padded arm of one of the sofa units being covered with muslin. Below, pocketed coil springs sold in strip form are sewed together to make up the required-size marshall unit



26

Below, the marshall unit is placed on top of the spring unit to which it is sewed around the four sides. Below, right, moss or tow filling is placed over marshall unit and then two layers of cotton

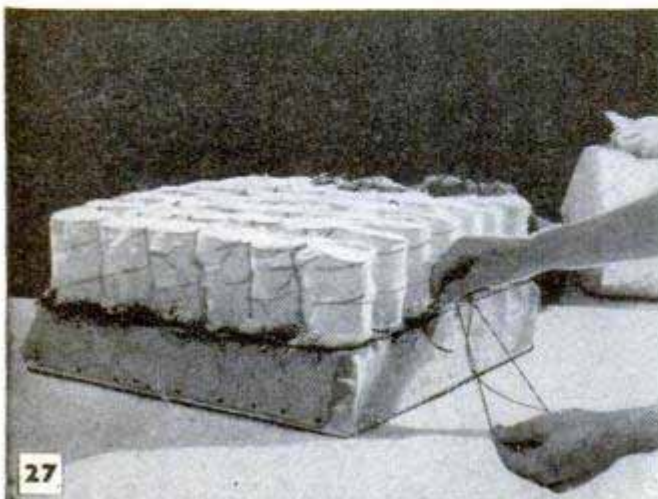

27

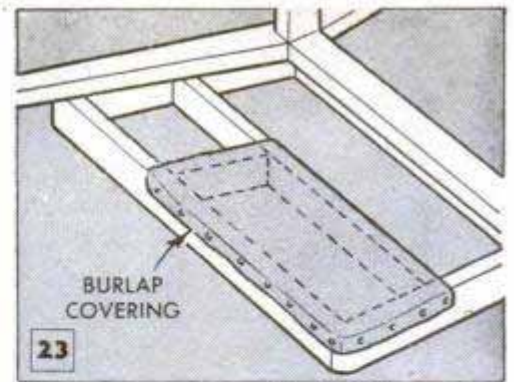

23

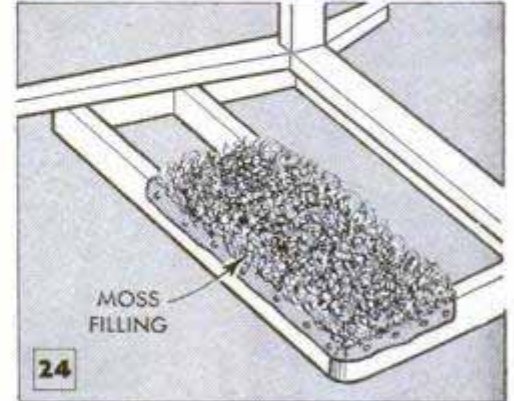

24

legs of the chairs can be cut off now to give the correct slant or after the units have been upholstered and tested.

Upholstering of the sofa units and the easy chair is done exactly alike. First, the arms are covered on the inside with burlap as in Fig. 23. Next, the burlap is padded with moss or tow filling which is held in place with long stitches through the burlap, Fig. 24, and then a layer of cotton placed over the filling is covered with muslin which is pulled firmly and tacked to the arm, Fig. 25. Edging material called "brush" is applied to the inside and outside edges of the arms. The details in Fig. 31 show how this is done. On the inside, the brush is tacked to the face of the arm on three sides so that it overhangs the padding. On the outside, the material is tacked to the edge of the arm on all four sides so it stands upright. The space around the edge of the arm between the brush trim is covered as follows. A piece of stiff cardboard long enough to reach around three sides of the



28

arm is padded with cotton and covered with fabric. Gimp nails are used to tack the strip in place, driving them along each edge and then concealing the heads by pulling the fabric up over them. This leaves the outside of the arm which is covered similarly with a cardboard panel, tacking it in the same manner as just described.

Cushions for the seat and back of the sofa and easy chair are built-up separately on flat hardwood frames, half-lapped at the corners, Fig. 32. The frames are made the same size as the over-all size of the chair frames. The seat frames require five, 8-ga. sagless-type springs, 26 in. long, while the back frames take five, 12-ga. springs 16½ in. long. The springs are anchored to the front and rear edges of the frame with special clips made for the purpose. These are first nailed to the wood and then crimped over the spring wire before renailing. Note that the ends of the springs are bent back to prevent them from slipping out of the clips. In all installations, it is

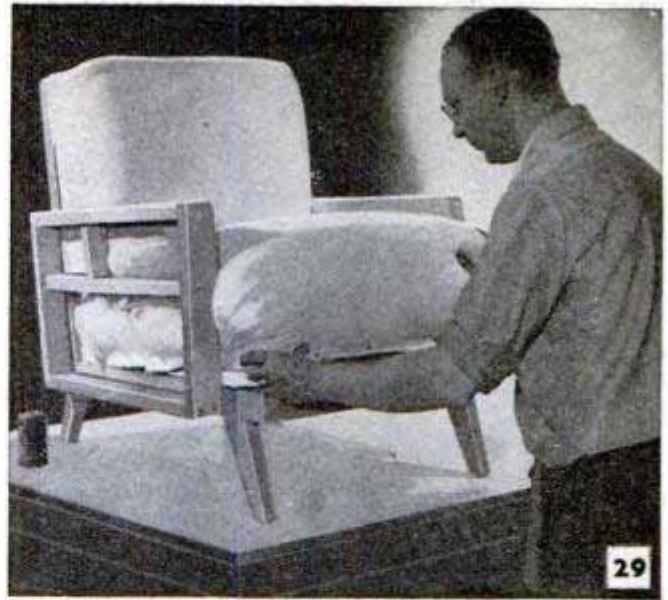

Above, here the seat and back cushions of the easy chair are being tested for satisfactory fit prior to covering with fabric. Screws hold cushions in place

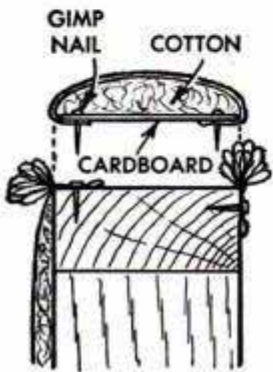

CARDBOARD

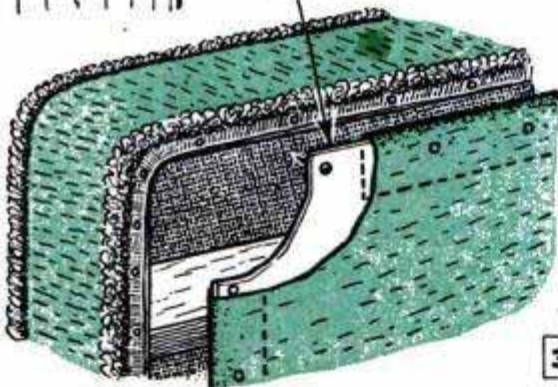

31

METHOD OF ATTACHING FABRIC TO SIDE OF CHAIR

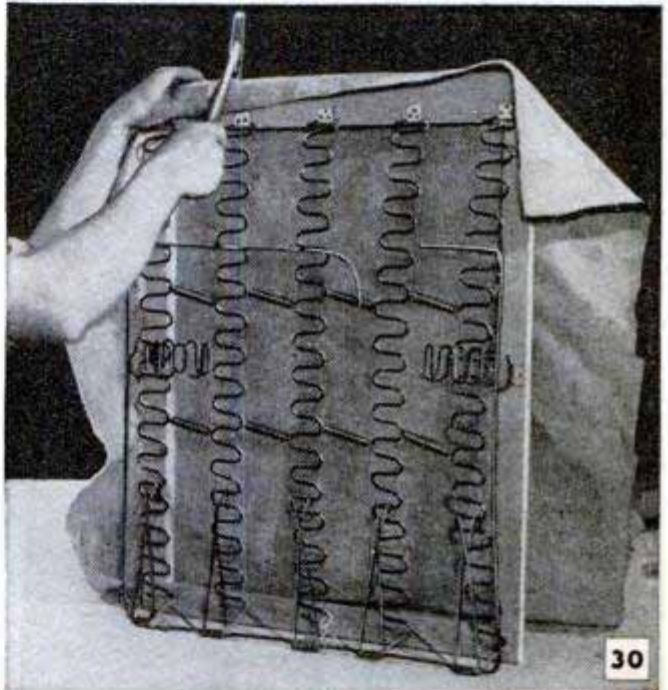

30

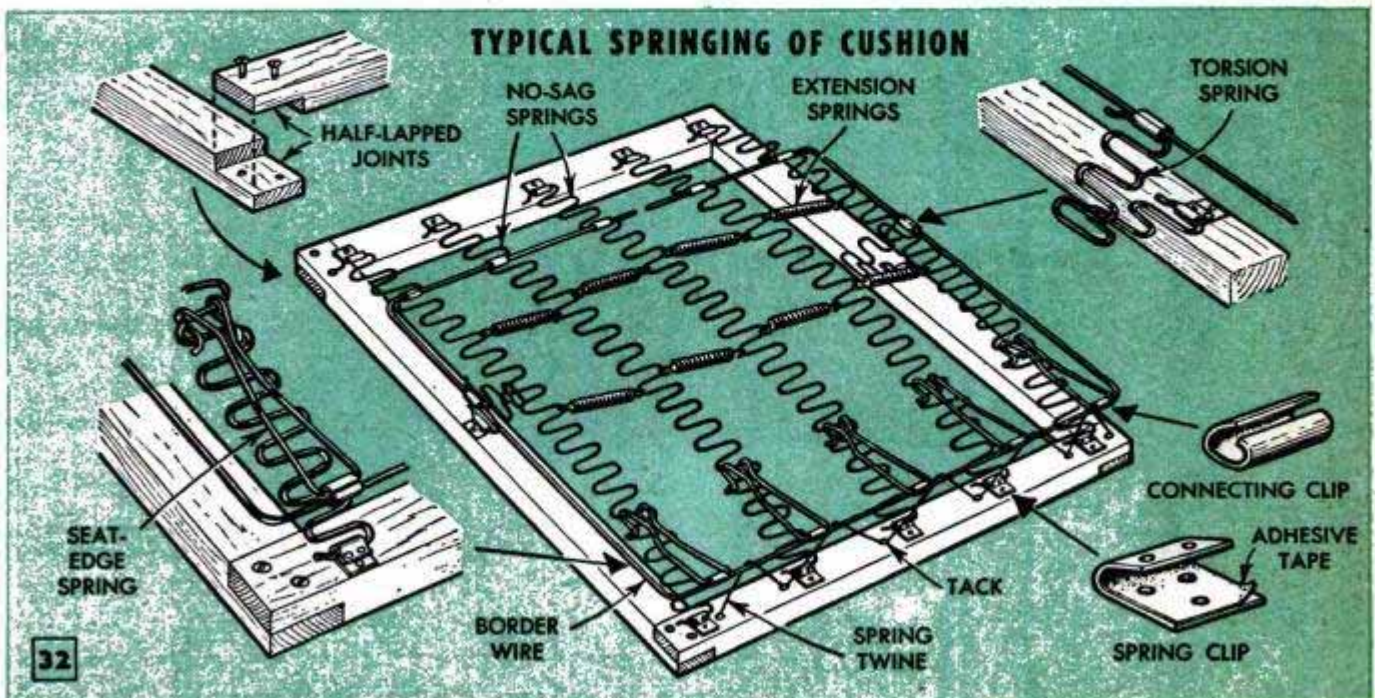

32



33

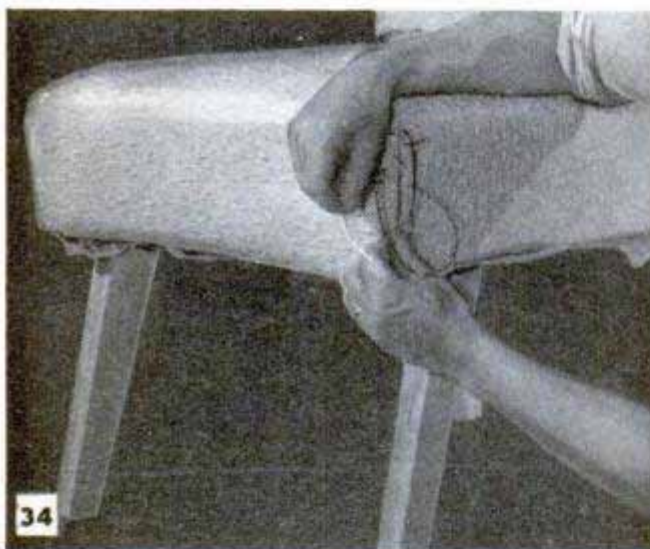

34

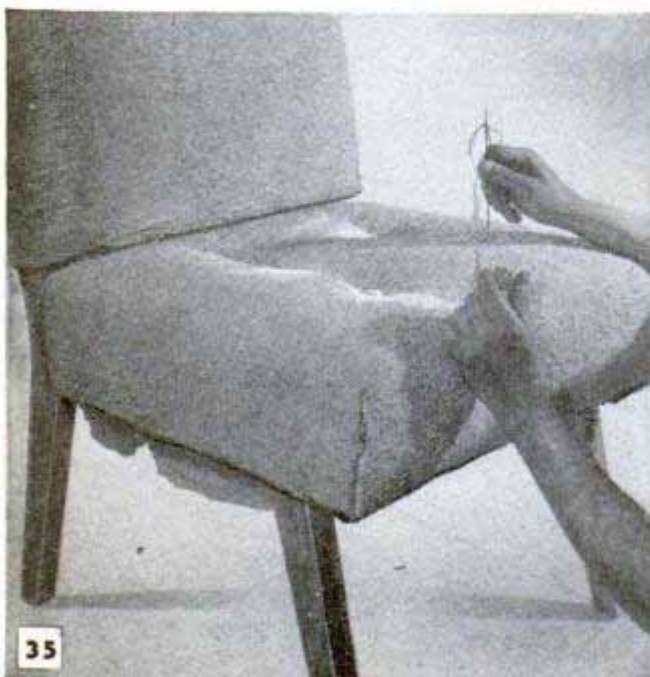

35

recommended that the direction of the bent ends be alternated. If the bent end of the first spring points to the right, the bent end of the next spring should point to the left. This permits the connecting extension springs to be applied in a straight line. The springs are applied bowed and are cross-tied with eight extension springs. Edge springs are hooked into the sagless springs across the front and these serve to support an 8-ga. border wire which forms the box shape of the spring unit. The border wire is attached to the edge springs with special clips which are crimped over the two parts. This type of clip also is used to fasten the rear edge of the border wire to the sagless springs. At each side, a torsion spring is used to support the border wire, clips being applied as before to anchor it to the wire and the wooden frame. You'll note that the border wire does not extend to the rear of the frame but stops about 8 in. or so from it. This is done to allow room for the back cushion to fit neatly into the seat cushion. Finally, the border wire across the front edge is pulled down under tension with regular spring twine and tacked securely to the wooden frame. The back cushions are sprung in exactly the same manner, the front edge of the seat becoming the top edge of the back.

The next step is to cover the spring unit with burlap as shown in Fig. 30. This is simply pulled firmly over the border wire and tacked to the edges of the frame. Now, the spring unit is covered with a marshall unit which is made up of a number of individual coil springs encased in cloth pockets. These are purchased in strips and you merely build-up the unit to the required size by sewing them together as in Fig. 26. The seat requires a unit seven coils wide and nine coils deep, while the back takes seven wide and five deep. The completed unit is sewed to the spring unit, using a curved upholsterer's needle and sewing around the border wire and the base of each individual coil spring, Fig. 27. Next, moss or tow filling is placed on top of the marshall unit and then two layers of cotton, Fig. 28. This is followed by covering the cotton with muslin, pulling it down smoothly and tacking it to the underside of the wooden frame. Fig. 29 shows checking the cushions for fit after the muslin covering has been finished. Box corners are formed at the front corners of the seat and at the top corners of the back cushion by hand-stitching the fabric covering as shown in Fig. 34. The cushions are held in place in the chair with flat-headed screws. In the case of the seat, the screws are driven up from below in counterbored holes in the rails. The back cushion is held with four screws which are driven through holes in the back of the chair frame and capped with

regular wooden screw plugs or short lengths of dowel rod. The back cushion differs from the seat in one respect. With the underside of the frame exposed, the back must be fitted with a fabric-covered cardboard panel before fastening the cushion to the chair frame.

The **hostess chair** is upholstered in the same general manner, except that the springing is done right on the chair frame as indicated in Fig. 37. Five, 9-ga. sagless springs, 20½ in. long are required for the seat and five, 12-ga. springs, 14½ in. long are needed for the back cushion. Also, 10 additional seat edge springs are required as these are installed at both front and back, Fig. 37. The fabric covering is brought down over the rails of the seat and tacked to the underside. The back is covered similarly, Fig. 33. The rear of the back is enclosed with a fabric-covered panel in the same manner as previously described, nailing it with gimp nails and then pulling the material up over the heads. If padded arms are to be used on the chair, brush edging is applied around the outside edge of the arms, Fig. 16, and a cardboard panel is used on the outside.

Tufting the seat and back cushions gives them a professional touch. Four buttons are placed in the seat cushions of all the pieces and two in the back cushions. Plain wooden buttons made for this purpose are covered with scraps of fabric and then stitched through to the springs, Fig. 35. The tufts are made by pulling down on the buttons and tying the sewing twine securely to the sagless springs, Fig. 36. Finally, cambric dust covers are tacked to the underside of each seat cushion.

The **lamps** are detailed in Figs. 38 and 39. The table lamp features four 6-in.-sq. ceramic tiles framed in a box-shaped base. These can be purchased in any large department store and, as the exact size of the tile varies somewhat, buy them first and build the base around them. The sectional view shows how the wooden members are grooved for the tiles which are installed as the assembly progresses. Corners of the base are mitered and holes are provided for a 30-in. length of ½-in. threaded pipe. The exposed portion of the pipe is covered with ½-in. brass tubing as indicated. Then, with a standard cap and canopy attached to the top, a locknut concealed in the base of the lamp ties the assembly together.

The wooden column of the floor lamp, Fig. 38, is made up of two separate pieces to provide a center hole for the lamp-cord pipe. A ¼ x ½-in. groove is run lengthwise in each piece and then the two are glued and clamped together before tapering. Assembly of the top portion of the standard is shown in the detail above Fig.



Upholstery of the hostess chair differs from the others in that springs are fastened directly to the chair frame, instead of a separate frame. Also, seat edge springs are placed across both front and back as indicated below. Fabric is brought down over rails and tacked to underside

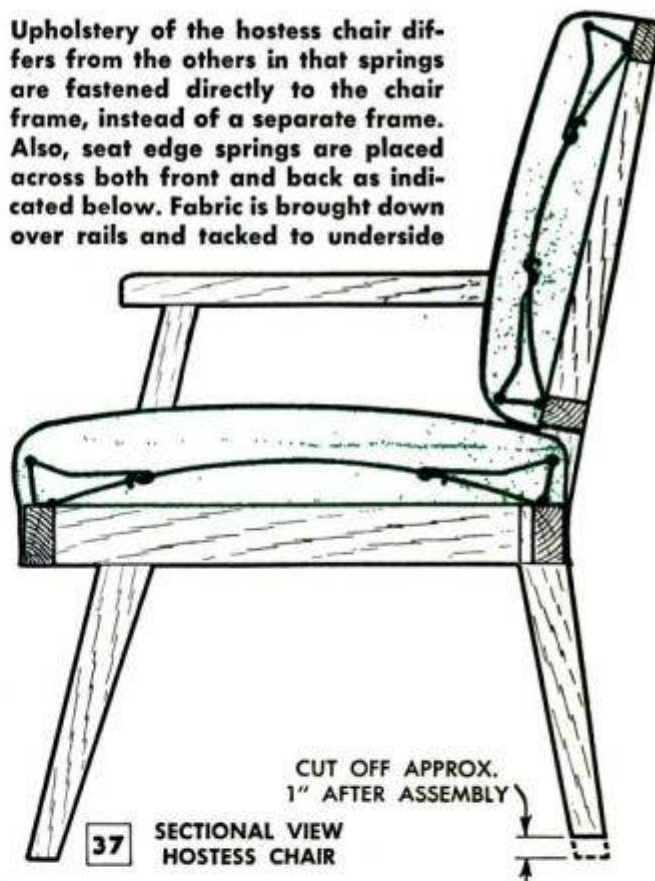

38. The brass fixture at the top of the wooden column is not a stock item but is made up specially from lengths of brass tubing soldered together.

The fixture is designed to take a standard mogul-type socket which is screwed to the upper end of the ½-in. pipe. A hole is provided in the side of the fixture to accommodate the socket turn button and the top ring

is fitted with three thumbscrews to support a standard 10-in. glass bowl. The base of the lamp consists of four 1 3/4-in.-thick pieces planed to 3/4 in. at the edge and mitered at each corner. These are glued together and then a flat surface is planed at the apex of the four pieces to receive a 3/4 x 2 5/16-in.-sq. block. Then a 1/2-in. hole is bored through the center and the hole is counterbored on the underside of the base to take a nut and washer. A small tapered leg is glued and screwed to each corner of the base and then the lamp column is tightened securely to the base by means of the nut in the bottom.

Plans detailing the entire living-room set are available for those who prefer to work from larger drawings.

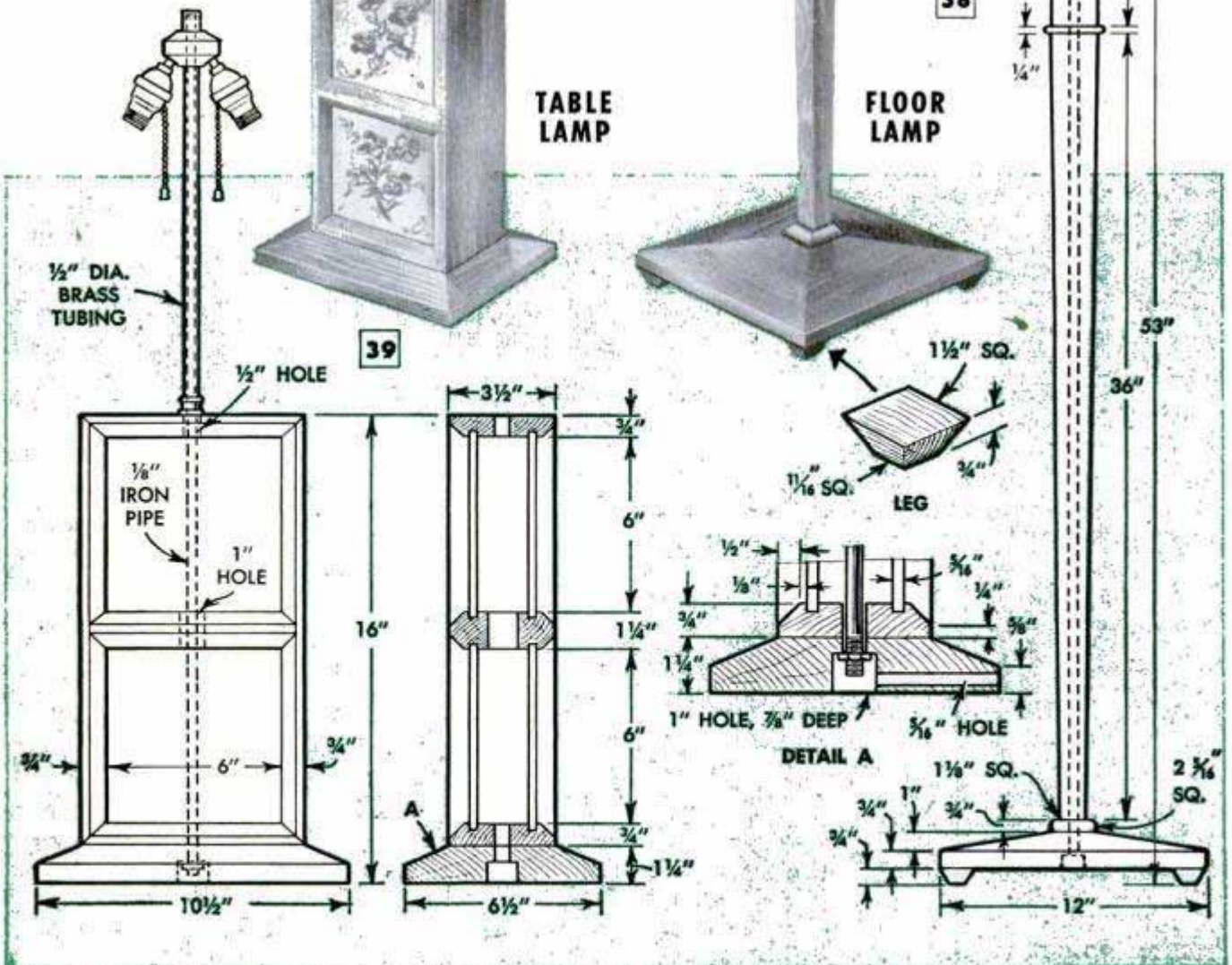
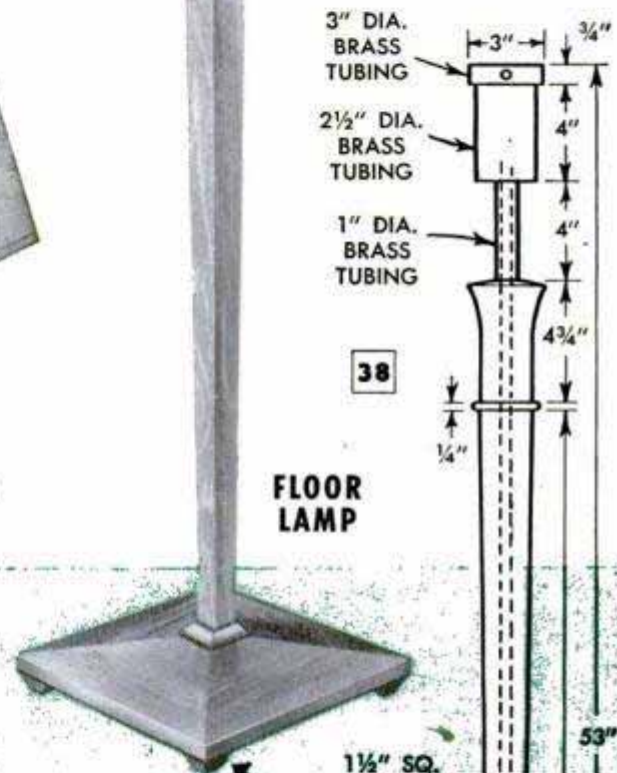
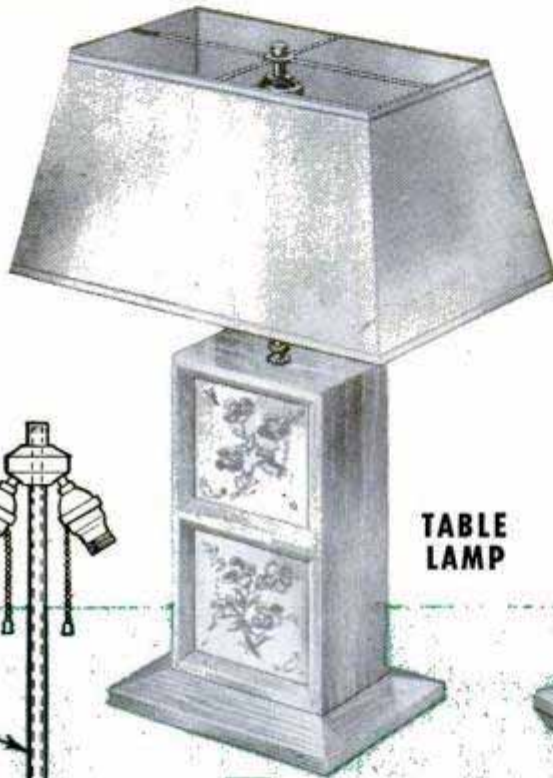
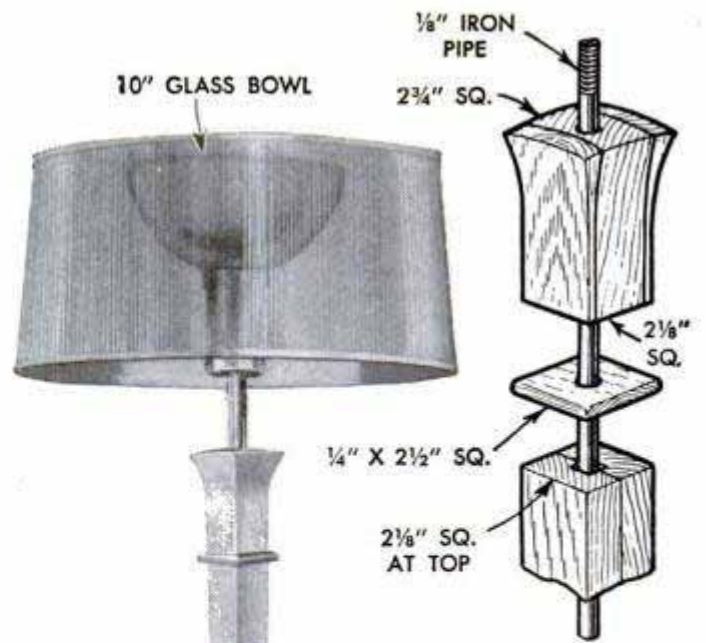

Gluing Paper Doilies to Solid Backing Provides Novel Picture Frame

Gluing a stack of paper doilies to a rigid backing and jigsawing around the design results in an attractive embossed picture frame. Hardwood, plywood or heavy, rigid cardboard will provide a suitable backing. First, shake the loose punchings from the doilies and stack six to eight of them together so the designs are in exact register. Then, coat the backing with glue, set the stack of doilies in the glue and flow glue liberally over the doilies. A casein glue is excellent for this purpose and, if used, about 50 percent more water than normal should be added so the glue will penetrate the paper readily. Allow the glue to soak into the paper for a few minutes and carefully press a dry rag over the surface to absorb the excess glue. After the glue has set for 24 hours, jigsaw the picture frame, following the outline of the doily. Rabbet the back of the frame to permit mounting the picture, using a router or chisel and making the rabbet $\frac{1}{8}$ in. deep and from $\frac{1}{4}$ to $\frac{1}{2}$ in. wide. If desired, the backing can be painted before gluing so the color will show through the perforations in the doilies, or the completed frame can be painted to suit. In the latter case, the paint should be thinned



considerably so it will not fill the perforations in the doilies and destroy the embossed appearance. If the proper design of doily is used, as many as four frames of diminishing sizes can be jigsawed from one gluing operation.

Edward J. Hobert, Hempstead, N. Y.

Glittery Christmas-Tree Ornaments Made From Midget Photoflash Bulbs



Inexpensive Christmas-tree ornaments that sparkle in the light of the colored bulbs can be made quickly from bayonet-type photoflash lamps. Remove the prongs and contact and fit the base of the lamp with a hanger bent from a paper clip. Then coat the bulb with mucilage or rubber cement and sprinkle it liberally with silver or gold-colored metallics, commonly called flitter and used by show-card painters. After the adhesive dries, shake off the excess metallics.—Jeanne Stasack, Chicago.

Glove Slit for Trigger Finger

In cold weather, a quick shot with rifle or shotgun is impossible if it is necessary to remove a bulky hunting glove before firing. One experienced hunter slits the underside of the index finger of his glove. In this way, he can slip his trigger finger out of the hole for a quick shot without taking off the glove.

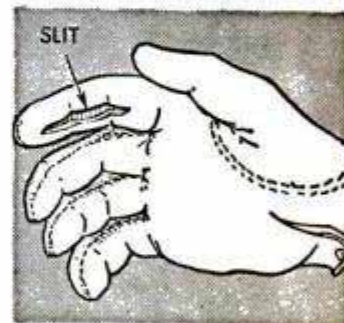

Immediately sponging with turpentine will remove fresh paint spots from a rug.

Knockdown Ice-Fishing Tipup Is Conveniently Carried

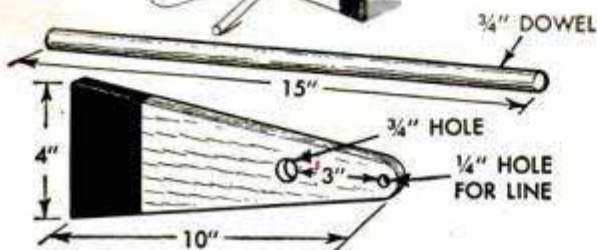

Made quickly from plywood and $\frac{3}{4}$ -in. dowel, a dozen or more of these ice-fishing tipups can be carried in a compact bundle or in a sack. The tapered flag is drilled at the lower end to permit tying the fishline and a hole for the dowel is drilled about 3 in. from this point. The dowel should be a fairly snug fit in the hole, but loose enough to permit pulling it out readily when taking the tipup apart for packing. The upper end of the flag, which rests on the ice when the line is set, is painted red so it can be seen easily.

Pulling Staples From Bulletin Board Facilitated by Tape Strips



When stapling a notice to a bulletin board, drive the staples through a cloth-tape border. In this way, all the staples can be removed quickly simply by pulling the end of the tape. Drive the staples across the tape so the latter will not be torn loose leaving the staples intact. If it is desired to draw special attention to a bulletin, use a brightly colored tape to frame it. This

method can also be used with thumbtacks instead of staples.

Andrew Vena, Philadelphia, Pa.

Hose in Frozen Hydrant Pipe Prevents Bursting

If an outdoor water hydrant cannot be protected from freezing, a plugged length of rubber tubing placed inside the vertical pipe will keep the latter from bursting. Cut the tubing to the longest length possible and plug both ends tightly. Then slip the tubing in the pipe where it will take up the expansion of the water as it freezes.

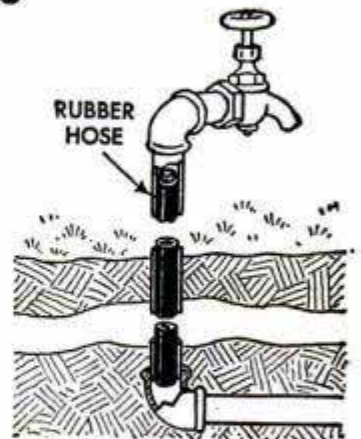

Edward H. Stutz, Cleveland, Ohio.

Don't Use Inferior Brake Fluid

There are few sensations as frightening as pushing the brake pedal of your car down to the floor and finding that nothing happens. The cause is likely to be an inferior grade of hydraulic-brake fluid containing a low-boiling solvent. Whenever your brakes are used frequently, particularly in hot weather, the temperature of the fluid is likely to be raised to the boiling point of some solvents, forming vapor pockets in the hydraulic-brake lines. The result is that the brakes don't work, and the car won't stop until the fluid is allowed to cool. To play safe, be sure that the brake system in your car is filled with a fluid meeting the specifications of the Society of Automotive Engineers, or one as good as the fluid recommended by the car manufacturer. The SAE has adopted specifications for both an all-purpose, heavy-duty brake fluid and a moderate-duty fluid.

Rope Linked With Hog Rings Provides Durable Door Mat

Forming lengths of rope into series of loops and binding them together with steel hog rings results in a durable, lightweight door mat. It can be made any desired size.—R. E. Wade, Three Rivers, Mich.

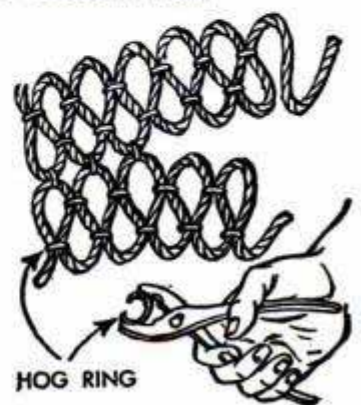

BUY THE RIGHT CHRISTMAS TREE

By Edward L. Throm

IN THE NORTH WOODS country on both sides of the Canadian-American border, axes are ringing and saws are singing all through November and early December. The woodsmen cut more carefully than usual, and do not lop off branches, for they are working on the annual supply of millions of evergreens needed for the celebration of Christmas.

Loaded on huge logging trucks, the trees are rushed to the nearest loading point, and then are transported either by large motor trucks or by rail to wholesale and retail markets.

But not all of the evergreens marketed for Christmas trees are ideal for the purpose. Some dry out quickly, shedding their needles faster than the children can eat the first batch of Christmas candy. And, because of their dryness, such trees present a dangerous fire hazard. Others will never make satisfactory Christmas trees because their shape does not conform to our ideas of a beautiful tree.

The Douglas fir is the ideal evergreen for Christmas-tree purposes. You can tell it by its soft, flat needles, and the buds at the ends of the branches which cause the needles to bend aside gracefully. The form of the Douglas fir is usually a long pyramid, uniformly shaped on all sides.

One of the least desirable Christmas trees is the spruce, which looks quite like the Douglas fir. You can identify it by the sharpness of its needles, and the ease with which they break off when handled. Beware of hemlock, too, which also sheds its needles rapidly. Look for two white lines on the under side of the hemlock's needle-like leaves.

Pines would make good Christmas trees except for their habit of growing informally in all directions. Rarely do they assume the pleasing contours we have come to desire in a holiday tree.

Red cedars are not often seen on the market, but make colorful Christmas trees when they can be obtained. Their scalelike foliage is very tiny, and they produce berries instead of cones.

Select your Christmas tree for its shape rather than its size. You'll find that it will attract far more attention than a larger tree

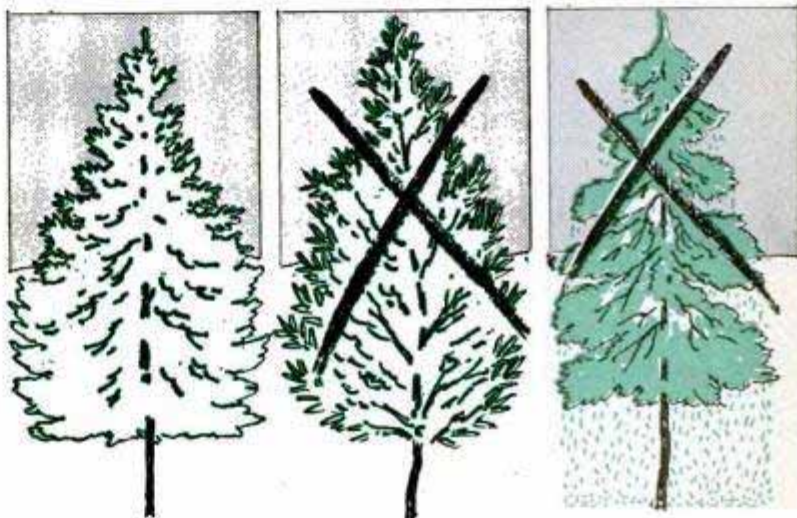

Douglas Fir

Spruce

Hemlock

having unpleasing proportions. It is best to have selected the place where the tree is to be set up beforehand, so that a tree of appropriate size may be chosen.

Don't buy a tree that's too large for the number of ornaments you have or can afford to add to your supply. A sparsely trimmed tree can be an eyesore, while a smaller tree, tastefully decorated, can be a thing of great beauty. On the other hand, trees can be overloaded with ornaments.

When you get the tree home, keep it in water or moist sand until it is time to set it up for decorating. If it is at all possible, set your Christmas tree in a small watertight tub or some other type of stand which will make it possible for you to water the tree from time to time. By doing this you will be guaranteed a fresh, green tree all through the holidays. Watering the tree will also lessen the danger of fire from a short circuit in the tree-light system or a spark from an electric toy near the tree, as a green tree will not catch fire readily.

KEEPING DOORS

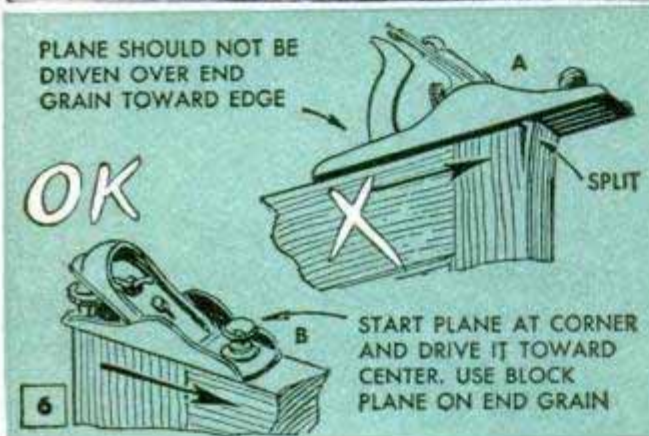
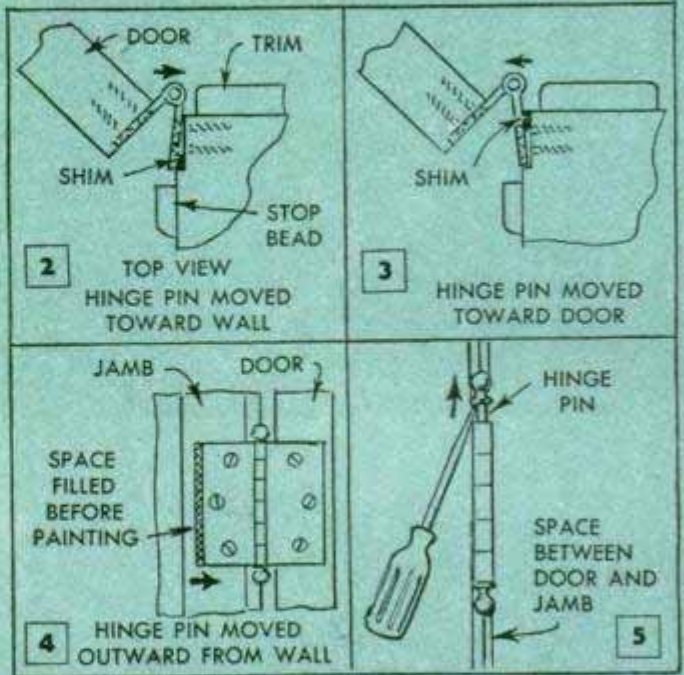
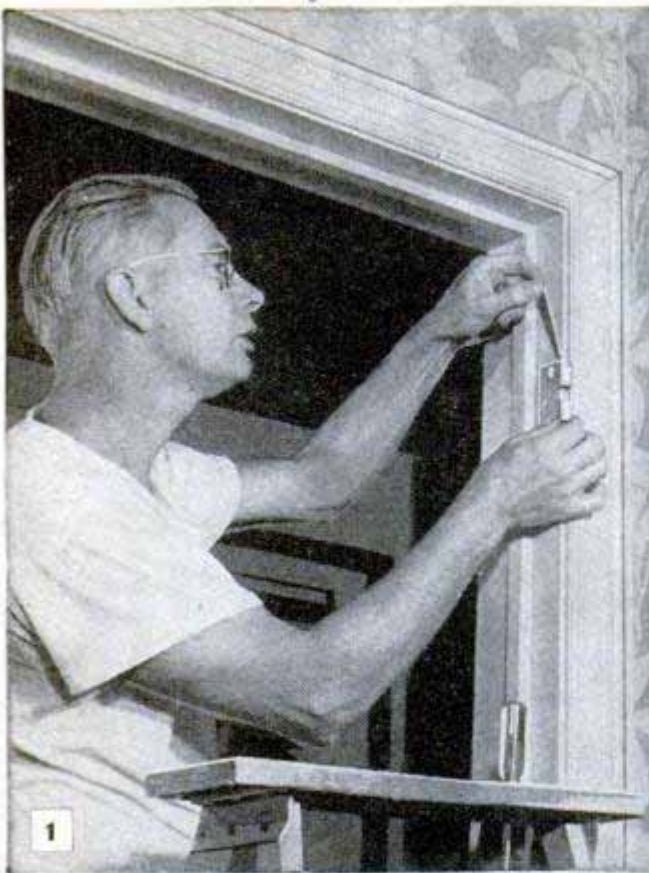

By E. R. Haan

DOORS that stick, rattle or fail to open and close properly are easily repaired and adjusted by the average homeowner without any outside help. No special tools are required to do a workmanlike job. In addition to the normal wear to which house doors are subjected, shrinking and warping of wood and settling of the building contribute to the causes of common door troubles. When properly hung, a house door should have a uniform clearance between its edges and the frame of about $\frac{1}{16}$ in. If this is not the case, it should be possible at least to insert a sheet of paper between the door and the jamb and draw it along from corner to corner unrestricted except by the latch and hinges. There also should be $\frac{1}{16}$ -in. clearance between the hinged edge of the door and the stop. When halfway open, the door should not tend to swing open or shut, nor should it bind at any point within the normal swing. Usually

such troubles are caused by the hinge pins not being in vertical alignment. The hinge screws should be tight and the door should not rattle when fully closed. The latch plate must register with the striker plate so that both the latch bolt and the dead bolt engage the openings in the striker plate when the door is closed.

Sticking doors: Very often the cause of a sticking door can be remedied without planing either edge. First, check to see that the hinges are tight. Stand in front of the door edge and, with a hand on each knob, try moving the door toward and away from the hinges. If the hinges move, tighten the screws. If the screw holes are enlarged, drive in longer and larger screws. If the trouble does not show up in loose hinges, it is possible that the doorframe may have been forced out of square by settling of the house. Often it is possible to readjust the door by placing folded paper shims under the hinge leaves as in Figs. 1 to 3 inclusive. By positioning the shims under the front or rear edge of the hinge leaves, the pins are shifted toward the right or left as indicated by the arrows in Figs. 2 and 3. When using these methods, be sure that the space between the door and the frame is as uniform as possible after tightening the screws. If the hinges move as the door is closed, thinner shims will have to be used. When it is necessary to move the hinge pins out and away from either the stop or the wall in order to get them in alignment, the hinge may have to be reset on the jamb as in Fig. 4.

AT THEIR BEST

How to make those minor repairs and adjustments that help keep house doors in first-class working condition—simple jobs that any homeowner can do in spare time with only a few common household tools

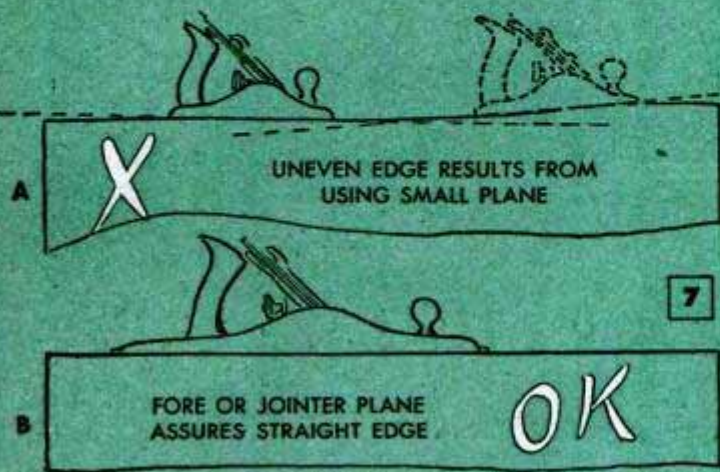

Planing door edges: When tightening of hinge screws or shifting of the hinges does not free a door that sticks, then the removal of wood from the edge of the door with a file or plane will be necessary. If the door sticks at the top or bottom try a coarse file first. If planing is necessary to remove more wood, use a block plane or a smooth plane on the end grain. When planing the ends of the stiles (vertical members of the frame of the door) always stroke the plane from the edge of the door toward the center, Fig. 6,B, to avoid splitting off the corners of the stiles, Fig. 6,A. When the door sticks along the latch edge, or if it cannot be closed, remove it from the frame so that the hinge edge can be planed. To do this, push a wedge under the door near the latch edge and remove the hinge pins, Fig. 5. If the door has three hinges, remove the lower and center pins first, then the upper one, after which the door can be lifted from the frame. Next, remove the hinge leaves from the door and support it rigidly on edge against a workbench as in Fig. 9, or make a door jack as in Figs. 8 and 10. Measure the exact width of the doorframe at several points from bottom to top. Transfer these measurements to the door and mark a gauge line along the hinge edge, allowing $\frac{1}{16}$ in. for clearance. Plane off the waste to the gauge line and deepen the hinge mortises, or gains, so that the hinge leaves will again be flush with the surface of the wood when screwed back in position as in Fig. 11,A. Rehang the door by simply reversing the procedure used in

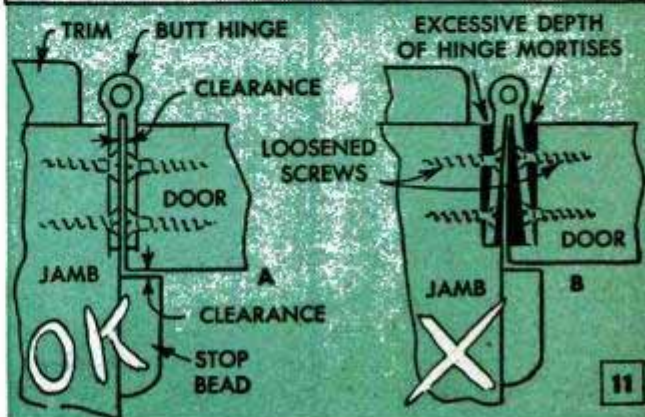
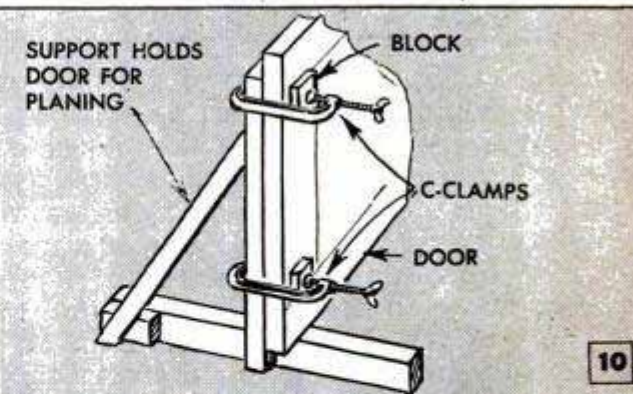
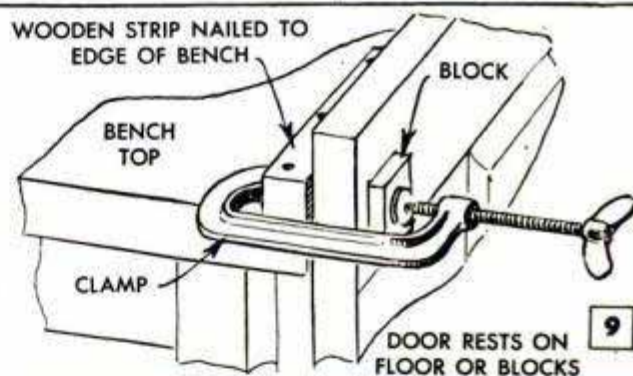

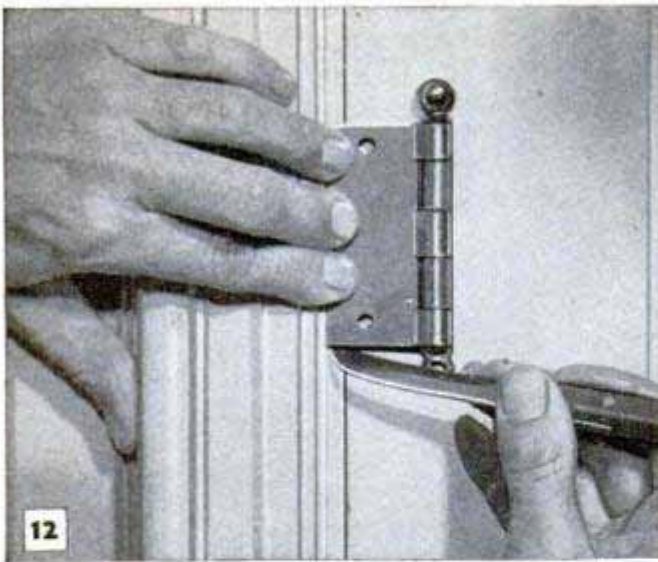

running the chisel edge in from the side. This must be done with care to avoid cutting too deep and splitting the wood beyond the sides of the mortise. Center hinges are necessary on heavy doors and also are used on light doors to prevent warping. The size of the individual hinge required is largely determined by the size of the door. For standard doors $1\frac{3}{8}$ in. thick, $3\frac{1}{2}$ -in. butt hinges generally are used. For doors over 36 in. wide and 2 in. or more in thickness, 5-in. butt hinges are fitted. When repositioning hinges or installing them on new doors, avoid locating the hinge pins too close to the frame. This may cause the edge of the door to strike the stop. To as-

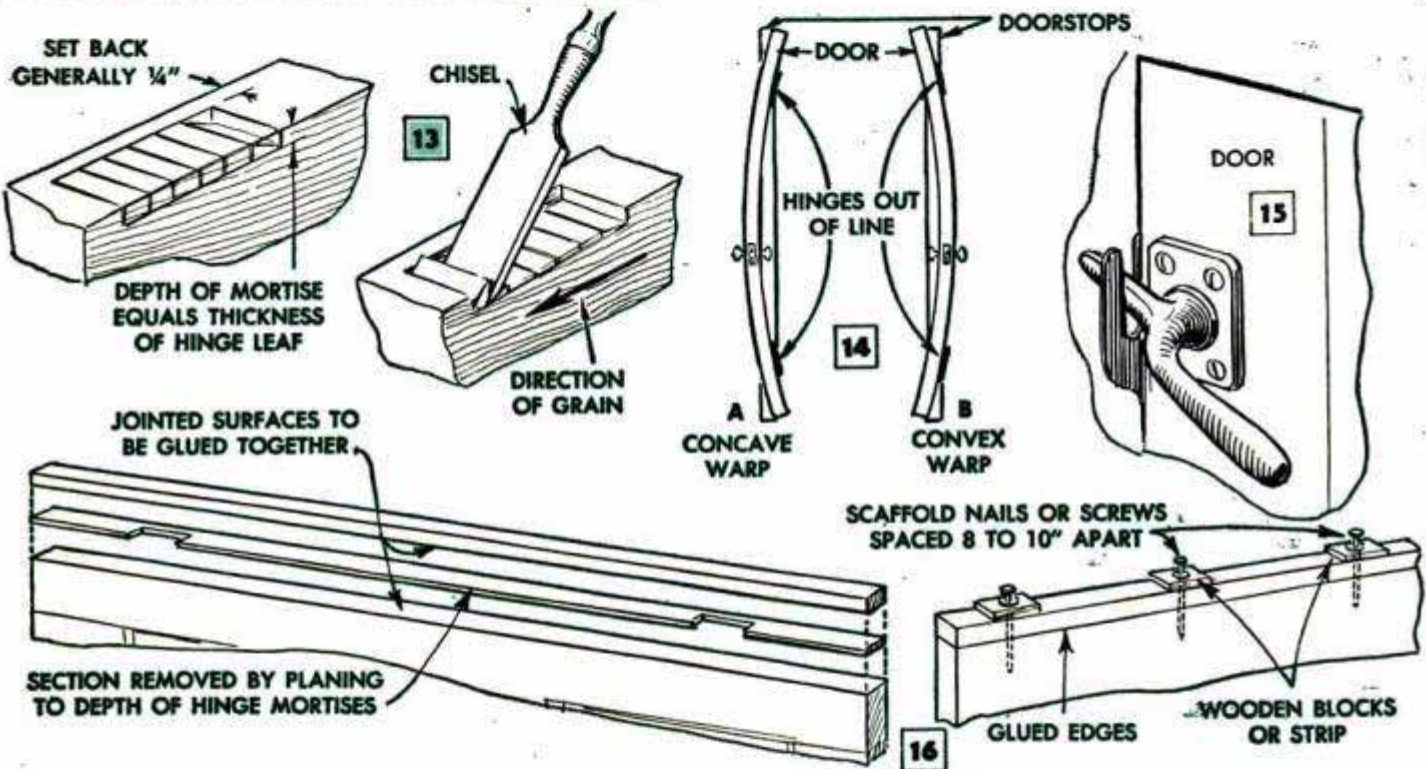

removing it. Spread a drop of light oil on each hinge pin before inserting it in the hinge eyes. When planing the edges of doors in the manner described, always use a fore plane or jointer plane to assure a straight edge as in Fig. 7,B. Use of a jack plane or smooth plane may result in an uneven, wavy edge as in Fig. 7,A, due to the short length of the plane bottom. Always set the plane blade to cut a very thin shaving. This will produce a smooth cut and will avoid removal of too much wood.

Hinge details: When hinge mortises are too deep, the edge of the door will press so tightly against the jamb when closed that the hinge screws are gradually pulled loose as in Fig. 11,B. This condition can be corrected by inserting cardboard shims under the hinge leaves. Hinges also may be loosened if the mortises in the jamb are slanted. When deepening or truing hinge mortises, make successive cuts with a chisel as in Fig. 13, and then pare out the waste by

sure free and noiseless operation, door hinges should be cleaned and oiled at regular intervals.

Warped doors: Doors that warp, Fig. 14, not only are difficult to open and close, but they cannot be satisfactorily weatherstripped or locked securely because of misalignment of the hinges and latch. Doors made from woods not thoroughly seasoned are more likely to warp excessively, especially if the thickness of the stiles and rails is $1\frac{3}{8}$ in. or less. A common remedy for either convex or concave warping is the installation of a third hinge midway between the other two. Care is taken to see that the pin of the middle hinge is in line with the other hinge pins. To install the middle hinge, mark the door and jamb as in Fig. 12. Then remove the door, cut the mortises and install the hinge leaves. When rehanging the door it will be necessary to apply pressure to the center to force the hinge eyes in line so that the pin can be

inserted. Sometimes only the stile on the latch edge of the door is warped, the other being comparatively straight. This problem is somewhat more difficult to solve, but it generally is possible to reverse an inside door and effect a satisfactory repair. The hinges and latch are transposed from one side to the other and the old hinge and latch mortises are concealed with filler blocks and plugs. These are sanded flush so that they will be concealed when the door is refinished. If paint or enamel is used, the repair will not be discernible.

Outside doors which are directly exposed to weathering and also to warm, moist air on one side and cold, dry air on

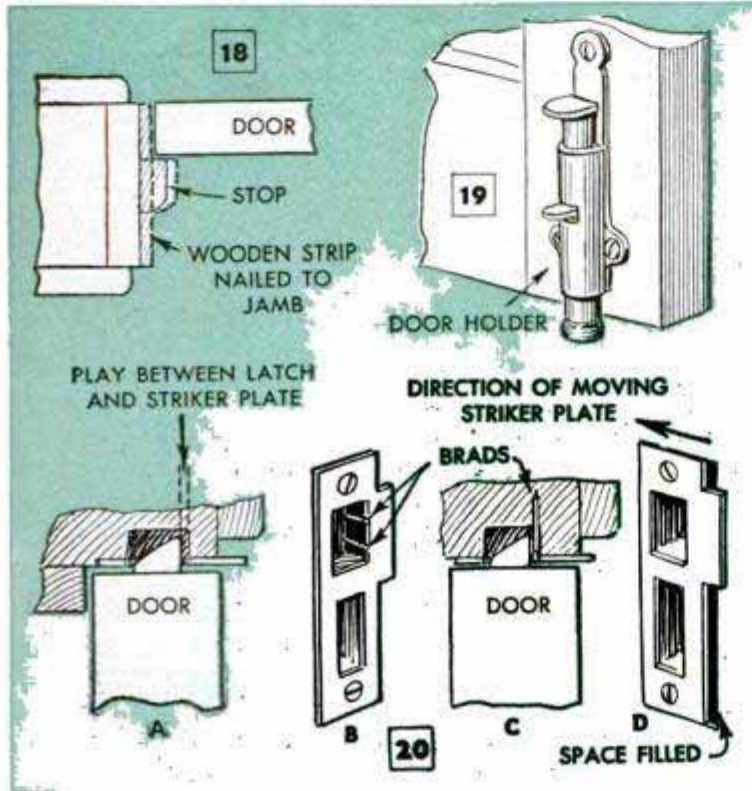
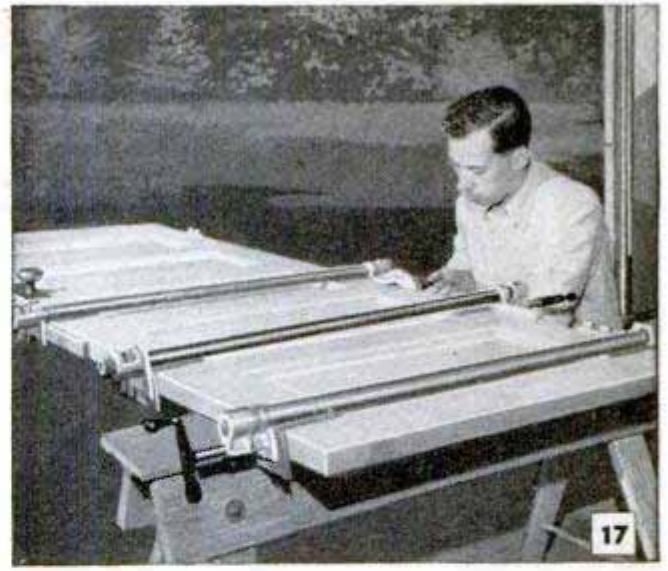

door as in Fig. 16. Remove the door, support it vertically with the door jack as in Fig. 10 and remove the hinge leaves. Then plane down the stile to the bottom of the hinge mortises, taking special care to joint the edges square. Then rip a strip from the same kind and grade of wood as that in the door and somewhat thicker than required to build the door out to the needed width. Spread waterproof glue on one face of the strip and also on the edge of the door stile. Then clamp the strip to the door edge with at least four bar clamps. If bar clamps are not available, scaffold nails or screws driven through small blocks and through the strip into the door stile at regular intervals will hold the edging in place until the glue sets. Remove the nails, or screws, after the glue is dry and fill the holes with putty. Plane the door to the required width, mortise the hinge leaves and rehang.

Another method of making a narrow door fit a distorted frame is detailed in Fig. 18. In this case, a thin strip of wood is nailed or screwed to the jamb on the latch side of the frame, and the stop and striker plate are replaced. If the stop is of the type not readily removable, then a narrow filler strip only as wide as the thickness of the door is used.

Regluing doors: Doors which are unprotected on the top and bottom edges with paint or varnish absorb considerable moisture during the summer months when the humidity is high. Changes in the wood due to swelling and shrinking eventually will break the bond of the glue in the joints, causing them to open. Filling the cracks will do little good as alternating changes in the dimensions of the parts will quickly break the crack filler loose. The only effective and permanent remedy for a door in this condition is to remove it from the frame and reglue the joints with waterproof glue. To do this, place the door on sawhorses and carefully pry the joints open with a narrow chisel or screwdriver.

the other, will warp if they are not well protected with an unbroken film of paint or varnish at all times. This protection should include both sides and all edges. Especially susceptible to damage by exposure are those doors which open onto porch decks, high terraces or patios. To keep such doors tightly closed and prevent warping it's often advisable to install extra latches of the type shown in Fig. 15.

Doors that are too narrow: When settling of a house causes a doorframe to spread, sag or become distorted in any way, or when the door itself shrinks excessively because of the use of unseasoned wood, there may be too great a gap between it and the jamb to permit the latch bolt to engage the striker plate. For a temporary repair, thick cardboard shims or thin strips of plywood can be inserted under the hinges. A better and more permanent remedy for this particular condition is to glue a strip of wood to the hinge edge of the

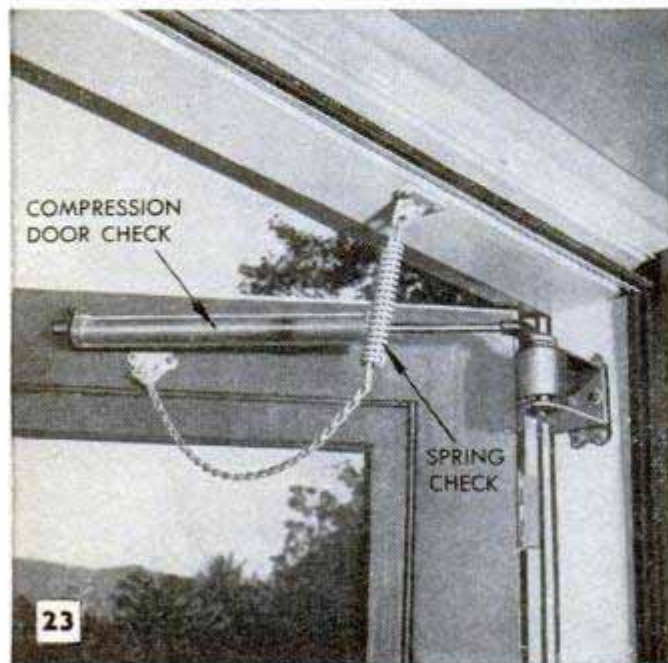
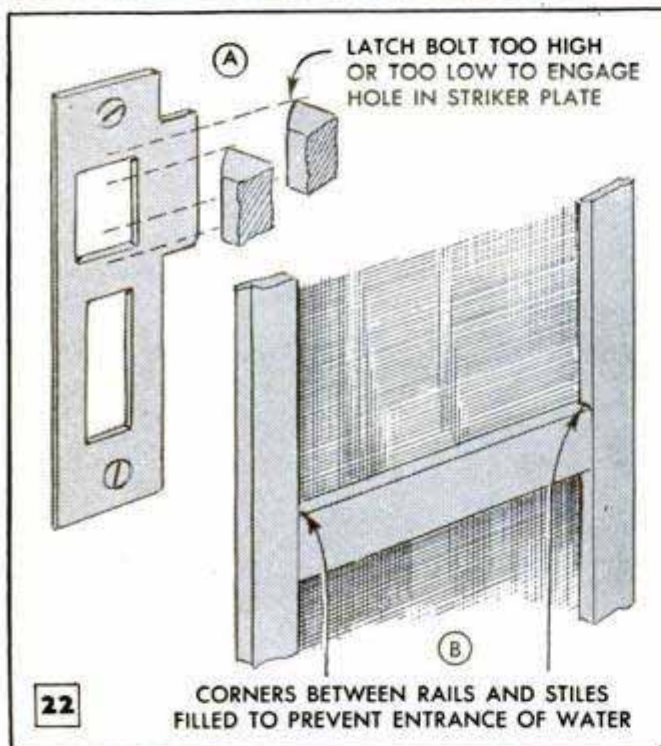
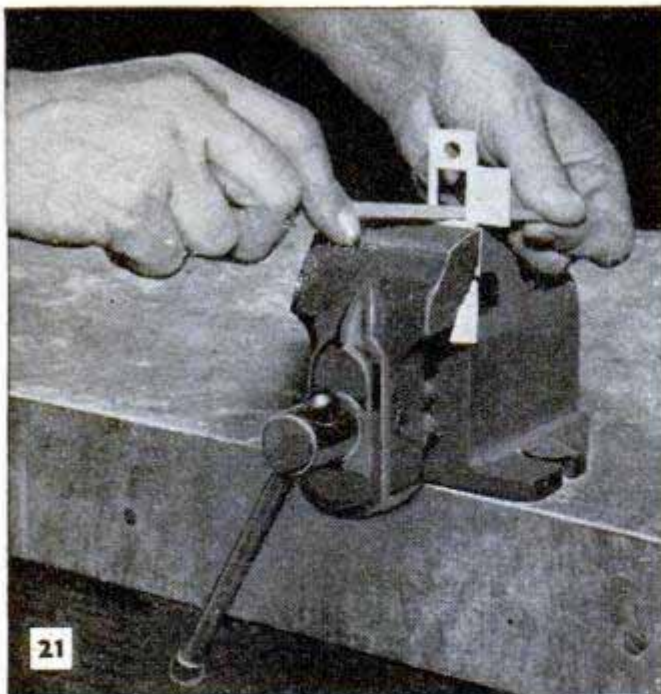

Spread glue liberally in the opened joints and immediately draw the parts together with bar clamps as in Fig. 17. Wipe off all excess glue with a damp cloth. Be sure that the glue is thoroughly dry before releasing the clamps. Then refinish the door and rehang.

Doors that rattle: One of the most common annoyances is a door that rattles. This can be caused by a draft of air and is especially troublesome if the latch bolt fits the striker plate loosely as in Fig. 20,A. Often, an effective temporary repair is made by driving one or two small brads into the wood under the striker plate so that the top ends will be flush with the surface of the plate as shown in details B and C of Fig. 20. This gives the same effect as moving the plate. Cut the heads off the brads if necessary and, if they still are too large, dress them lightly with a small file so that the latch bolt will slip into place when the door is fully closed. The permanent repair, of course, is to move the striker plate as in Fig. 20,D, or move the doorstop. Moving the striker plate generally is best as the stop may be splintered or the finish damaged in the process of moving it. In moving the striker plate, it will be necessary to pare the sides of the offset mortise to allow room for the latch bolt and dead bolt to slip home when the door is closed. If an open door slams hard as the result of a sudden draft from an open window, it may be extensively damaged. In some cases hinges and joints are loosened or broken. To guard against possible damage and, at the same time, to hold the door securely open, install a foot-operated holder like the one shown in Fig. 19.

Bolt does not enter striker plate: Another door defect caused by settling of the building is that the latch bolt does not enter the opening in the striker plate, but rides on the plate above or below the opening as in Fig. 22,A. Sometimes the opening in the striker plate can be enlarged sufficiently with a file as in Fig. 21 but, when the bolt misses by more than $\frac{1}{16}$ in., it is better to move the plate. First, determine the exact path of the bolt by closing the door until the latch bolt touches the projection of the striker plate. Mark the point at which the upper edge of the bolt contacts the plate, then remove the latter and mark the path of the bolt across the width. With this mark as an index, it is easy to determine where to locate the plate. Enlarge the plate mortise accordingly and install the plate in the new position. When moving the striker plate up or down in this manner, it sometimes happens that one of the striker-plate screws will enter the mortise made for the latch bolt or dead bolt. Should this happen, drill a hole in the bottom of the mortise

and glue in a short length of 1/2-in. dowel to serve as an anchor for the screw.

Thresholds: When thresholds under outside doors become worn or splintered they should be renewed. After removing the door and stops, it's easy to pry up the old threshold and install a new one. Thresholds are available in standard widths and after cutting to length they should be painted or varnished on the underside before installation. Hardwood thresholds are preferable to those of softwood. Space between the door and the threshold should be sealed tightly when the door is closed to prevent entrance of cold air and water. An interlocking weather strip consisting of a saddle screwed to the threshold, and a metal strip screwed to the bottom of the door, will prevent air and water leaks. Usually the metal saddle is set in calking compound.

Screen doors and combination doors: The combination screen-and-storm door is exposed to severe weathering and should be adequately protected with paint or spar varnish. When repainting this type of door and also screen doors, work the paint down into any tiny openings or cracks between the rails and stiles, Fig. 22,B. All doors having plywood panels, such as garage doors, should be painted regularly to prevent the panels from loosening or warping. On combination doors fitted with one or more plywood panels, be sure that open cracks at the joints are closed with paint or filler to keep out moisture and prevent damage. To correct sagging screen doors and combination doors use adjustable braces made especially for this purpose. Braces of the same type, but larger and heavier, are available for use on garage doors. Constant slamming of screen and combination doors under tension of a coil spring is not only annoying but damaging to the door. Also, there is always the danger that sudden gusts of wind will swing a combination door violently against the house and split the hinge stile. A spring check of the type shown in Fig. 23 will prevent this damage. Some homeowners use both spring and compression checks on the same door as indicated in the photograph.

Pads on Soles Prevent Slipping



When you have to walk on streets or sidewalks covered with ice, you can reduce the possibility of slipping by sticking two or three heavy bunion pads to the sole of each shoe. Wipe the soles clean with lukewarm water and dry thoroughly before applying the pads.



Garments Protected From Dust While Hanging in Closet

Paper bags in which garments are returned from the dry cleaner can be put to good use as dust protectors for garments hanging in a closet. Slit open one side of the bag with a knife to simplify placing it over the garment and, when it is in place, fasten the side with paper clips.

Lawn Roller Filled With Oil Does Not Rust or Freeze

To keep the inside of a lawn roller from rusting, fill it with used crankcase oil instead of water. Thus, the roller does not have to be emptied during the winter, as the oil, of course, will not freeze.

Drills Rolled to Prevent Breaking

The slightest bend in a small twist drill is likely to cause poor work and may eventually result in a broken drill. These bends can be straightened and the life of the drill prolonged by rolling

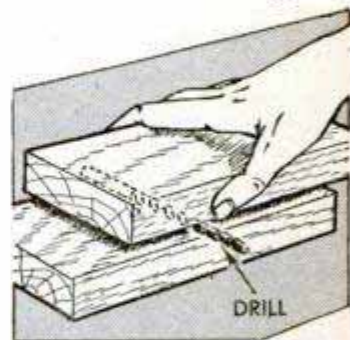

it between two hardwood blocks. The faces of the blocks are sanded smooth and, with the drill laid crosswise between them, the top block is moved back and forth to roll the drill. Straighten small drills in this manner at regular intervals.

A. H. Waychoff, Phoenix, Ariz.

Life of Straw or Chintz Scuffs Prolonged By Adding Soles Covered With Adhesive



Longer service can be had from light-soled straw or chintz scuffs by adding an extra sole consisting of cork or felt padding covered with moleskin adhesive and heavy adhesive tape. Trace patterns for the moleskin and adhesive tape directly from the scuffs and make the patterns for the padding $\frac{1}{4}$ in. smaller all the way around. Cut the padding from felt or $\frac{1}{16}$ -in. sheet cork and fasten to the scuffs with cellulose tape as shown. Then, cut out the moleskin and press it over the cork. Finally, cut the outer soles from chiropodist's heavy adhesive tape and press them carefully over the moleskin.

Nail Driven Through Floor Aids Locating Wire Hole for Wall Receptacle

When bringing up wires from the basement to install a new wall receptacle on the first floor of a house, locating the hole to be drilled through the wall plate is simplified by driving a nail through the floor from above to serve as a guide. Using a long, thin nail, drive it through a crack between the floor boards as near to the base molding as possible and directly opposite the location of the wall receptacle. The

nail should not be driven completely into the flooring so it can be pulled without difficulty when the job has been completed. By checking the distance from the nail to the position of the hole upstairs and then measuring from the spot where the nail projects through the underside of the floor, it is a simple matter to determine the exact spot where the wire hole should be drilled.

P. R. Wilson, Brooklin, Ont., Can.

Salt-Filled Sacks Permit Under-Ice Muskrat Trapping in Coldest Weather

During zero weather when thick ice covers the backwaters of streams and marshes, it isn't necessary to give up muskrat trapping. The secret of successful under-ice trapping is in keeping holes in the ice open even in the coldest weather so the muskrats will come up to breathe. This can be

done with a salt brick of the type used for livestock. Break up the brick and place about a dozen small pieces in a cloth sack, using one sack for each set to be made. Select the locations for the sets near a muskrat house if possible and, for each one, chop a small hole in the ice where the water is not more than $1\frac{1}{2}$ to 2 ft. deep. Reach down into the hole and pull together a mound of water weeds so that the top of the mound is 4 to 6 in. below the underside of the ice. Bury the salt sack about 3 in. deep in the mound, directly beneath the hole and conceal a No. $1\frac{1}{2}$ underspring trap on top of the mound. The trap chain should be fastened to a stake which is pushed into the mud of the stream bed. The hole is covered with brush to protect it from the wind and cold, and the slowly dissolving salt rises to keep the hole from freezing over. Muskrats in the vicinity are sure to see the open holes and, when climbing the mounds, will be caught in the traps. Many minks also have been taken with this method.—R. A. Jenkins, St. Louis, Mo.

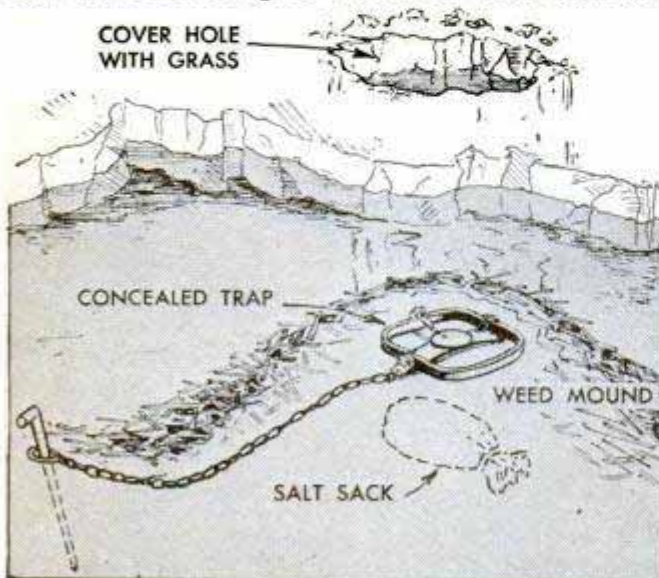

CARVED PLAQUE for your den

By Hi Sibley

A PLAQUE like the one detailed below is a simple relief carving at its best. In wood carving of this type, the background is recessed with sharp hand tools, leaving a profile of the subject in relief. This is then rounded with short, paring cuts to form contours and shapes which are characteristic of the subject selected. Use clear white pine, or oak, and cut the piece to the size given in Fig. 1. Trace the outline on the wood, being careful to get it centered. Recess the background as in Fig. 3, removing the wood from the shaded area to the depth given with a wide carver's gouge, Fig. 2. Now, note sections A-A to D-D inclusive in Fig. 1. Begin with paring cuts and work in the rounded contours with skew knife, veining tool and small gouge. Relieve eyes, nose and ears with the veining tool and narrow gouge. Avoid long, single cuts which may go too deep and alter the contour lines of detailed parts. When the carving is complete, leave the wood unfinished. Hang the plaque on the wall at eye level with a $\frac{3}{8}$ -in. rope attached in the manner shown.

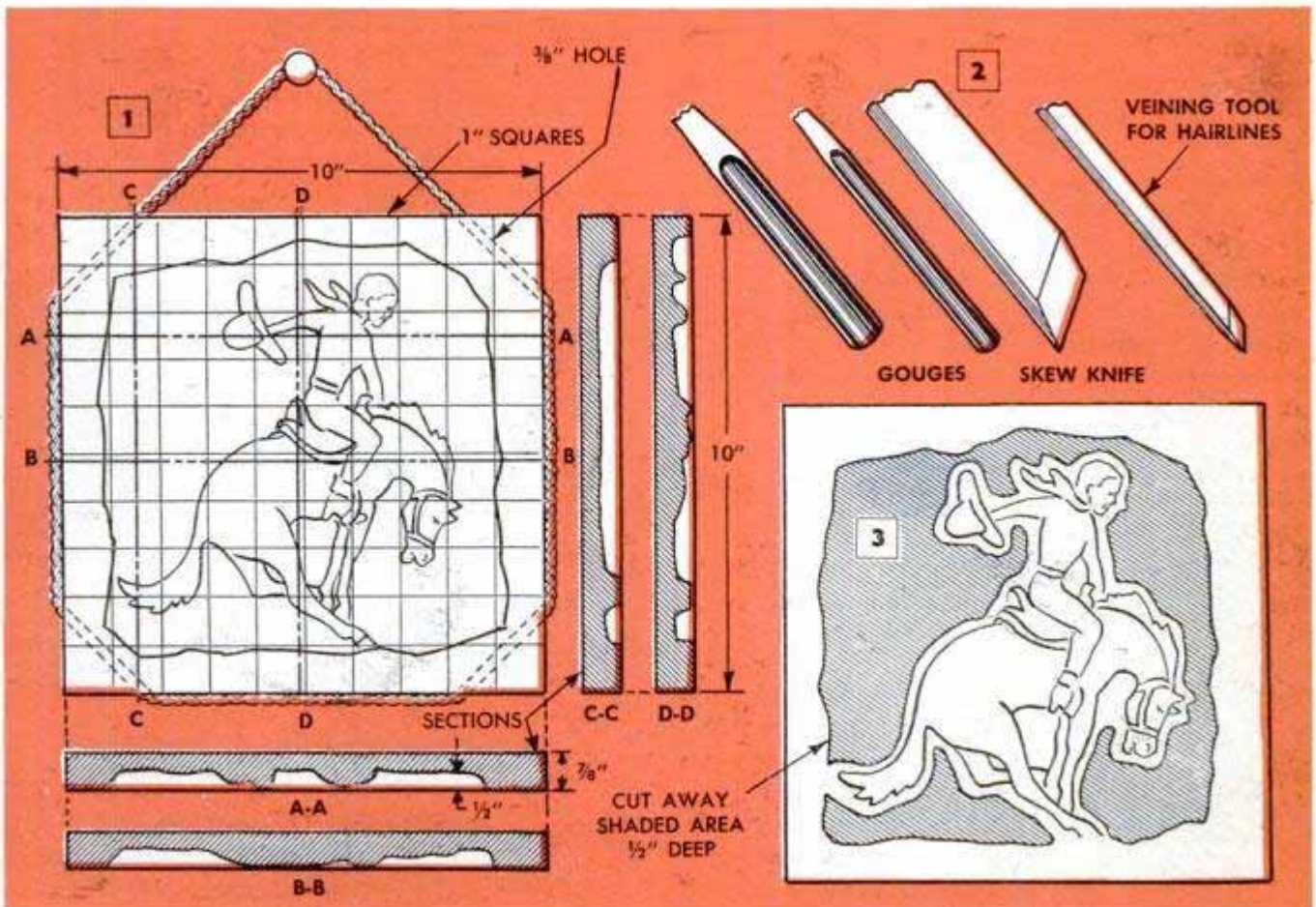

Protractor on Grinder Tool Rest Permits Checking Work Angle

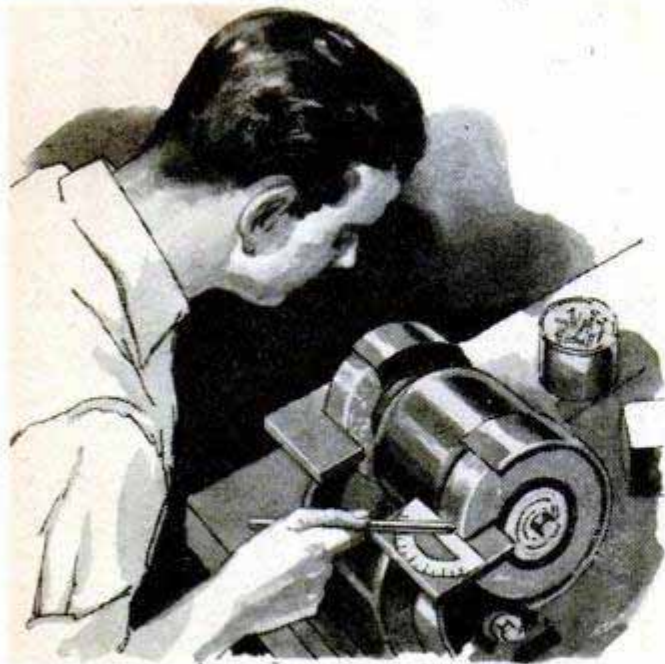

When using a bench grinder for chamfering or pointing the ends of rod stock, the angle of the work can be checked at a glance by means of an inexpensive protractor cemented to the tool rest of the grinder. The protractor should be located so that its base line is at right angles to the surface of the grinding wheel.

Measuring Fuel Oil in Storage Drum

A record of fuel-oil consumption can be kept easily if an accurately graduated measuring stick is used to gauge the amount of oil in the drum. The following table is for a 55-gal. drum, the graduations being painted on the stick starting at the lower end and working upward.

5 gal.....	3 $\frac{1}{8}$ in.	30 gal.....	11 $\frac{1}{2}$ in.
10 gal.....	5 $\frac{1}{8}$ in.	35 gal.....	13 $\frac{1}{16}$ in.
15 gal.....	6 $\frac{7}{8}$ in.	40 gal.....	14 $\frac{1}{16}$ in.
20 gal.....	8 $\frac{3}{8}$ in.	45 gal.....	16 $\frac{3}{8}$ in.
25 gal.....	10 in.	50 gal.....	18 $\frac{3}{8}$ in.

Edwin J. Rebman, Spokane, Wash.

Nails Notched for Easy Breaking

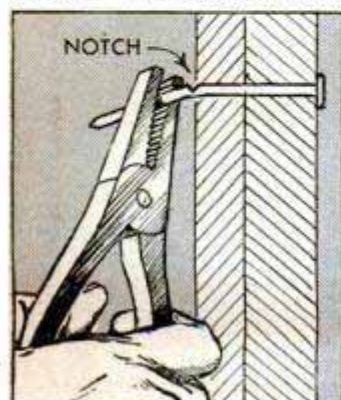

If long nails must be driven through thin pieces of wood, the protruding ends can be broken off easily if they are notched prior to driving. The thickness of the work is marked on the nail and a notch is filed

where the tip projects from the work. If the holes are to be filled for a finished job, the nail should be notched to break off slightly below the surface.

Alarm Clock Holds Pincushion

For a pincushion that can be carried conveniently and stood on end wherever it is needed, just insert an ordinary cushion in a discarded alarm-clock case. Remove the face and mechanism from the clock and place the pincushion inside,

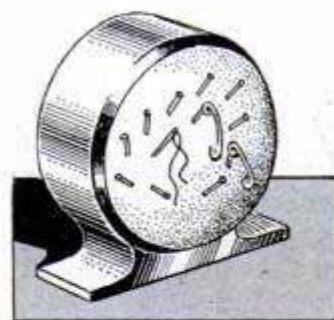

backing it with paper or cotton, if necessary, to hold it flush with the rim of the case.—Paul Criton, Kayville, Sask., Can.

Tree Bark Serves as Compass

Should you be lost in the woods on a day when the sun cannot be seen, just look at the trees to find your bearing. Stand in a spot where the woods are equally dense all around and look closely in all directions. You will notice that the woods appear darker in one direction, which is south. This is due to the fact that the bark is thicker and darker on the north side.

Leather Punch Nibbles Holes When Making Gaskets

To cut holes in leather or rubber when making gaskets, try using a leather punch to nibble around the portion of the material to be removed. A guide line can be followed closely with the punch, and the result is a neat, accurate job even on irregular contours.

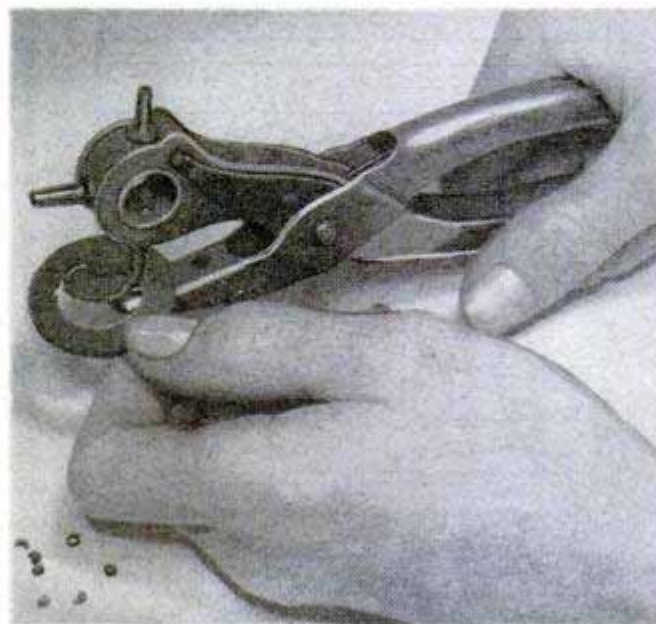

Rotating THREAD KIT

By Elma Waltner

WITH YOUR thread stored in transparent compartments which rotate with a touch of the finger, this novel sewing accessory makes it easy to spot the right color in a jiffy. The five thread compartments resemble a poker-chip rack and are made of $\frac{1}{8}$ -in. heat-forming plastic, such as Plexiglas or Lucite. Each one requires a piece $2\frac{3}{4}$ in. wide and 3 in. long. The protective paper covering is removed from the plastic and the pieces are placed in a kitchen oven at 250 deg. F. Heating makes the plastic pliable so that it can be formed into slotted cylinders by wrapping it around a wooden stick. Handle the plastic with cotton gloves to protect the hands and also to avoid finger marks in the softened material. The spool holders are cemented to a $\frac{1}{4}$ -in. plastic base that is laid out as in Fig. 1 and carefully cut to shape. A hole is drilled through the center of this piece for a screw on which it rotates. Except for the loop at the top of the handle, which also is made of plastic, the rest of the holder is made from scraps of choice hardwood. The base is turned according to the sectional view in Fig. 1 and is drilled in the center to take a flat-headed wood screw long enough to pass through the plastic and up into a $\frac{3}{4}$ -in. "dowel" handle. The screw is backed off slightly to permit the thread compartments to rotate freely. If desired, a thin washer may be placed between the wooden base and the plastic.

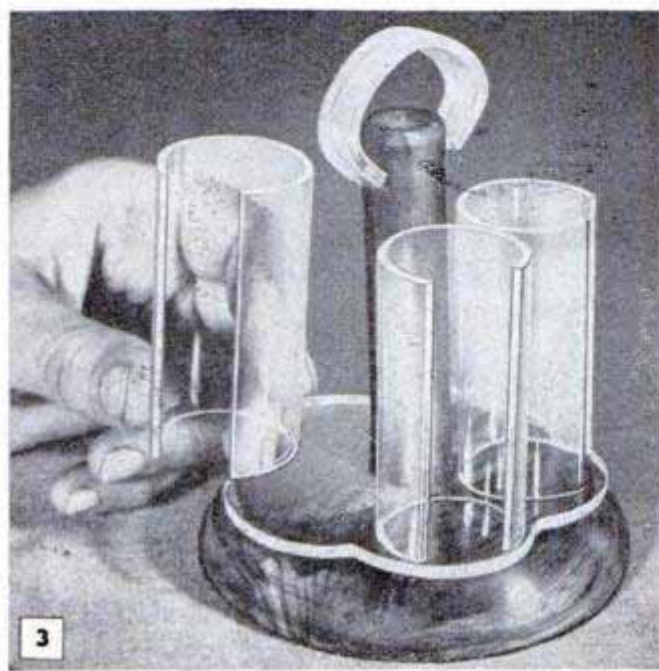
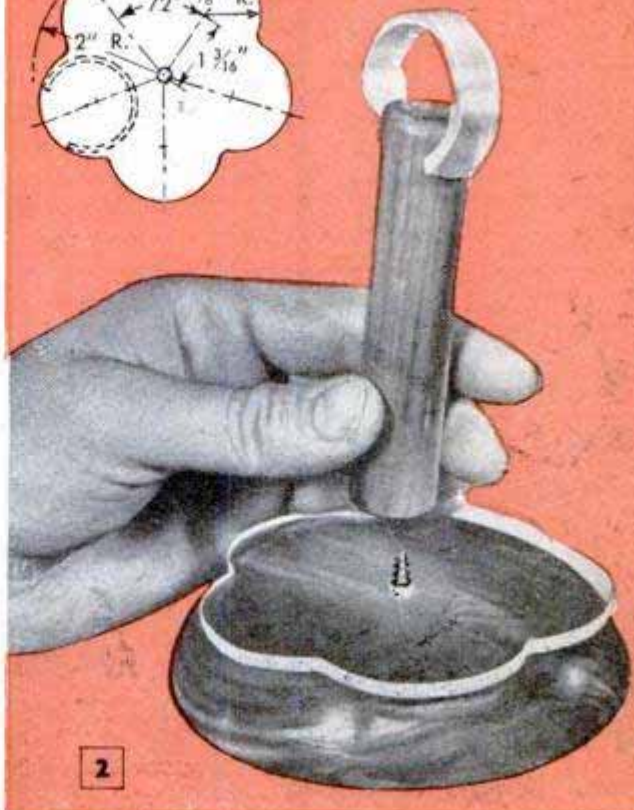
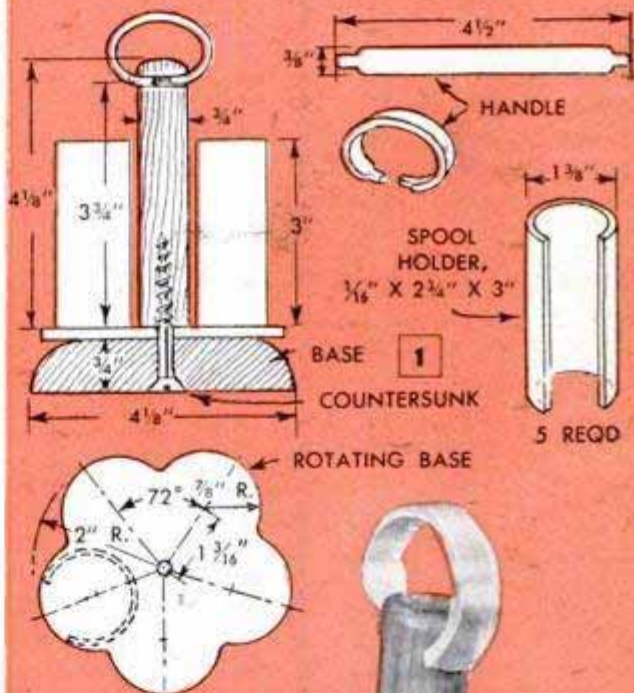

*Toy Trucks
Toys you can
make*

CHRISTMAS

Two dandy toy trucks you'll surely want to have ready for Billy Christmas morning. Both work like real thing

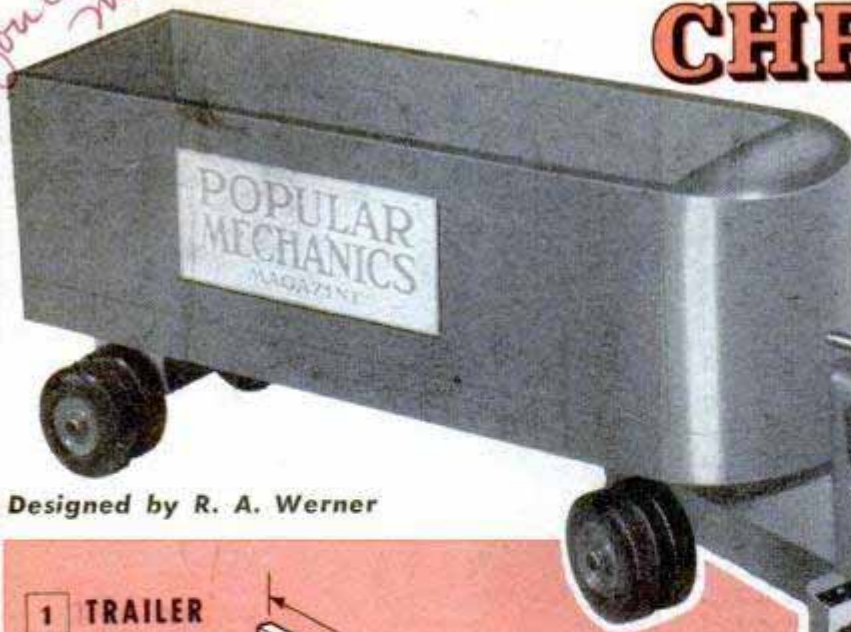

Designed by R. A. Werner

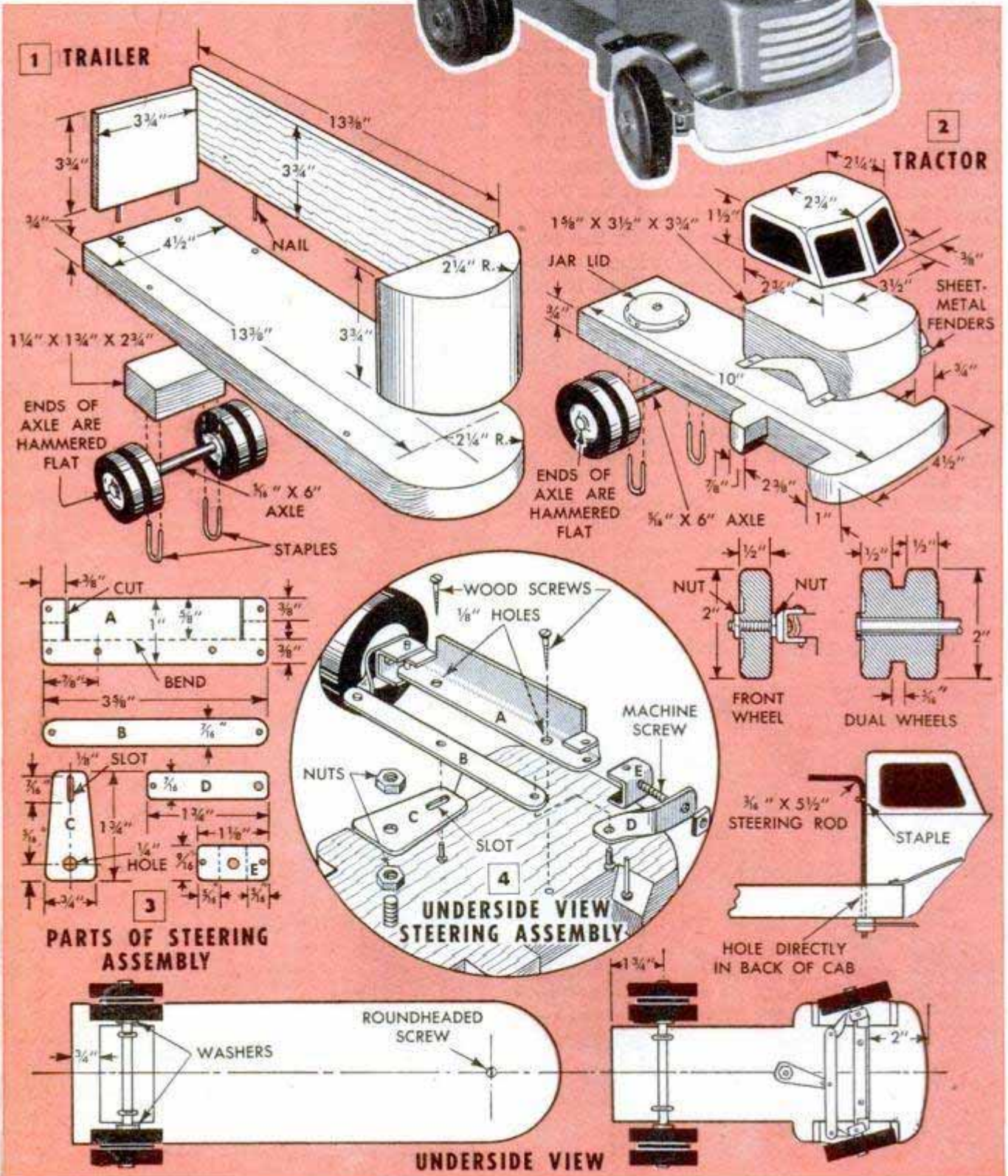

TOYS

ONLY
Book
for
Boys

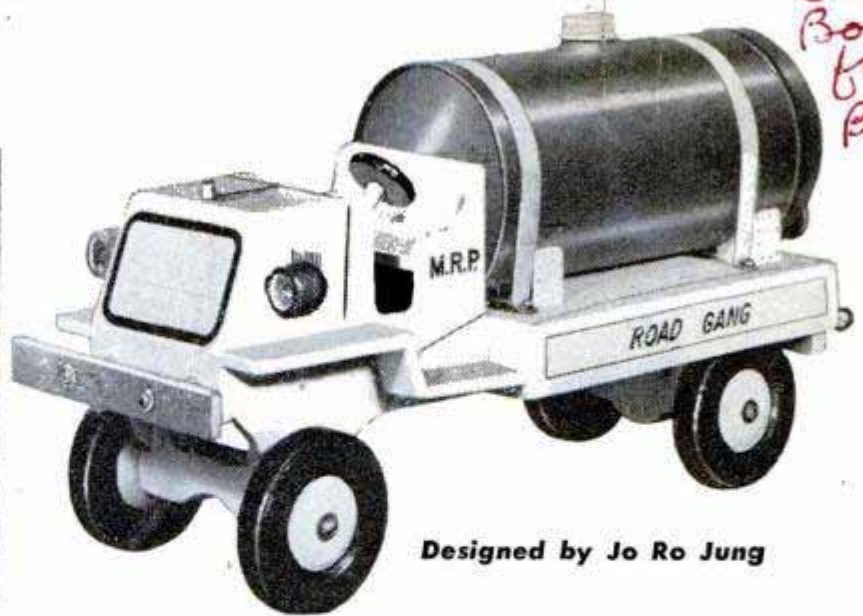

Designed by Jo Ro Jung

The trailer truck, detailed in Figs. 1 to 4 inclusive, actually steers like its prototype. The body of the trailer has removable sides and endgate, and couples to the tractor by means of a screw-and-jar-lid hitch. Fig. 3 shows the parts required for the steering gear, which are keyed with the assembly view, Fig. 4, to show where they go. Steering is done by an L-shaped rod located at the rear of the tractor cab and is connected to the steering gear by a slotted linkage. The wheels are lathe-turned from hardwood and the dual ones are peened on

$\frac{5}{16}$ -in. axles which are held with staples. Axles for the front wheels are machine screws, locked in place with nuts.

The sprinkler truck, while not steerable, actually sprinkles water. Assembly of the truck itself is apparent from the drawing in Fig. 5. The tank can be any suitable tin can such as a tall orange-juice can. The cover is soldered shut and a filler cap, taken from a 1-gal. turpentine can, is added. The valve for the sprinkler was taken from a discarded Bunsen burner. Punch a tiny hole in the filler cap to aid the flow of water.

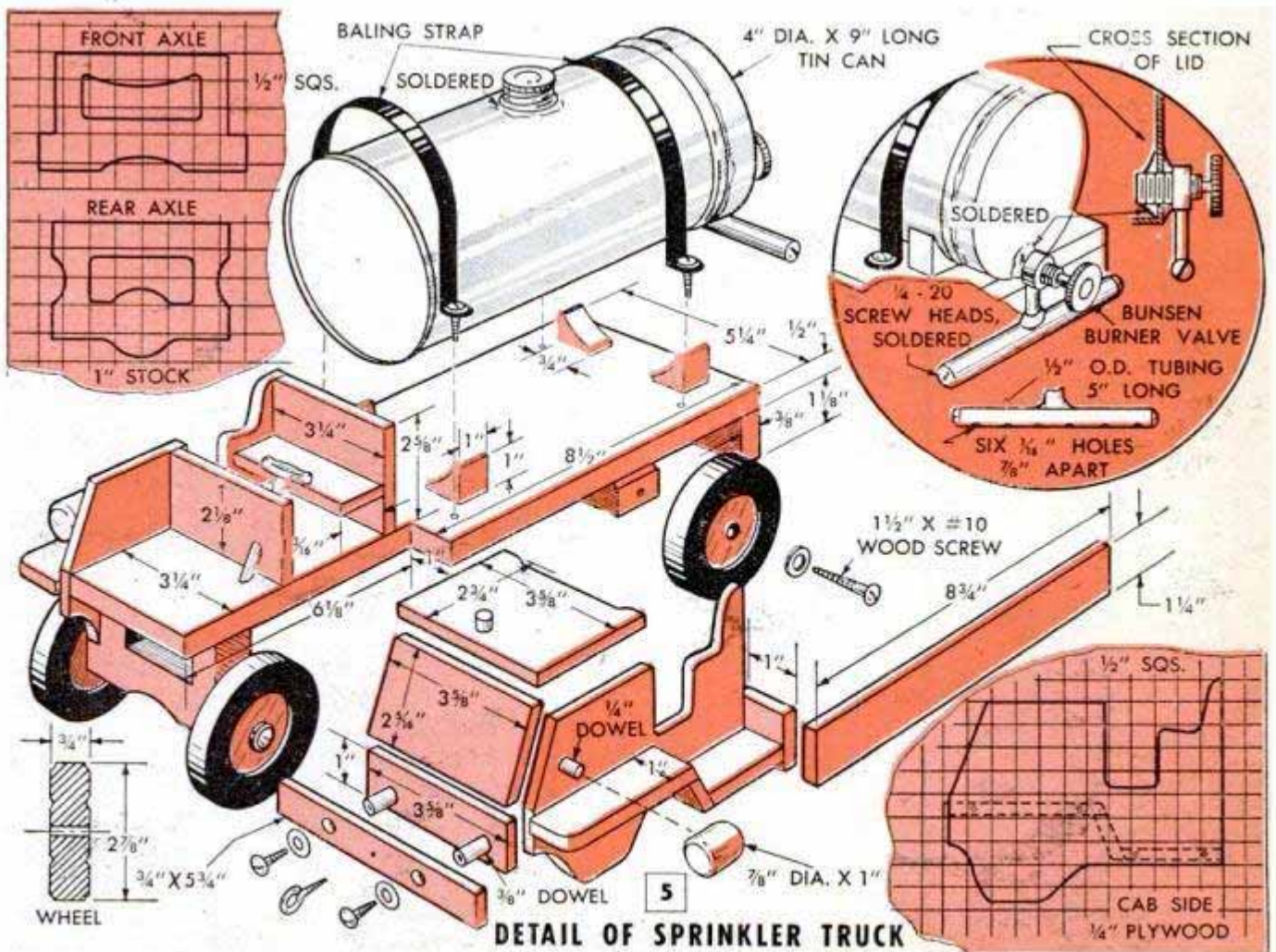

Heating Element Warms Crankcase For Fast Cold Weather Starting

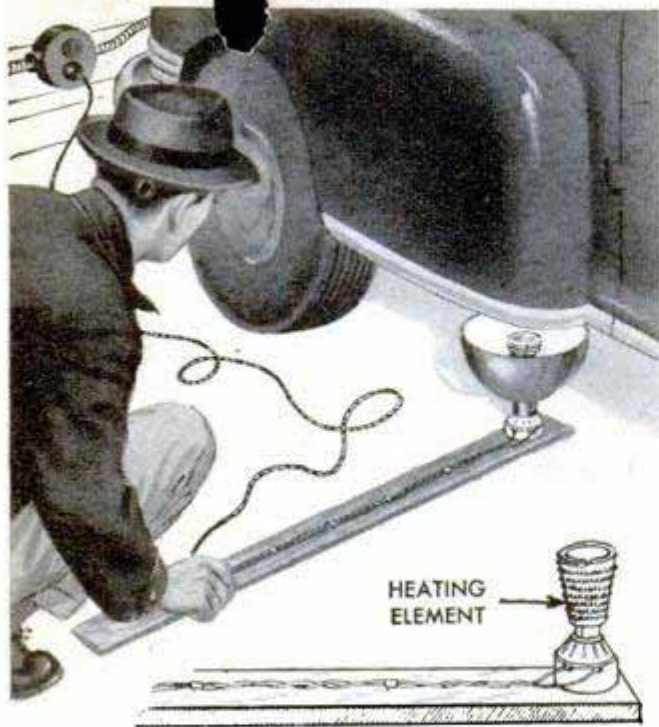

Even though a car is kept in an unheated garage, it will start quickly in the coldest weather if it is preheated with an electric heating element. The heating element is turned into a lamp socket mounted at the end of a 4-ft. length of board and an extension cord, wired to the socket, is plugged into a wall receptacle in the garage. A 10-in. photoflood reflector is used to direct the heat upward. Using the board as a handle, the heating unit is pushed directly under the crankcase and left in that position for 10 minutes or more. If you drive the car to work in the morning, it is a good idea to turn on the preheater before breakfast. Then, by the time you are ready to leave, the congealed oil in the crankcase will have been loosened enough to permit starting the car without delay. Before using the heater, take reasonable precautions to prevent the possibility of fire. Be sure there is not an excess of grease or oil on the crankcase where it will be too close to the heating element.

Cleaning Glass Drinking Straws



Ordinary pipe cleaners are just the thing for cleaning the inside of glass or plastic drinking straws, teapot spouts and similar surfaces which are difficult to clean thoroughly. The pipe cleaners should be

worked into both ends of the straws, after which the latter are simply rinsed in clear water and allowed to dry.

Clothespin Snubs Extension Cord

The extension-cord plug from a portable power saw or electric drill will not pull loose from a wall receptacle if it is snubbed with a spring-type clothespin. The pin is taken apart and one half screwed to the wall beneath the receptacle. Then, the pin is reassembled and the extension cord is clamped between the arms.—Georges Normandin, Shawinigan Falls, Que., Can.

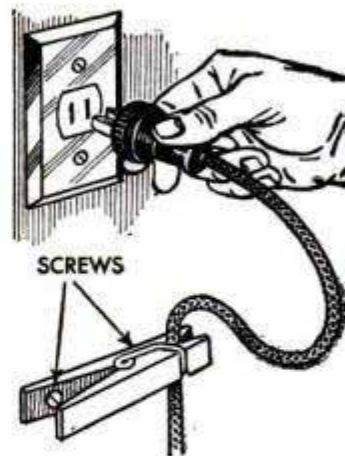

Don't Blame Dust on Heating System

According to the National Warm Air Heating and Air Conditioning Association, your heating system is not responsible for dust in the home. Some of the dust filters through cracks around the interior trim and is brought in when people enter the house. However, most of the dust comes from textiles used in the home. It is possible to achieve efficient dust control with the warm-air winter air-conditioning system which filters the air before it is heated. Modern heating-system filters are capable of cleansing indoor air of about 85 percent of all airborne dust, dirt, lint and pollen.

Prevent Mislaying Chuck Wrench By Attaching to Drill Cord

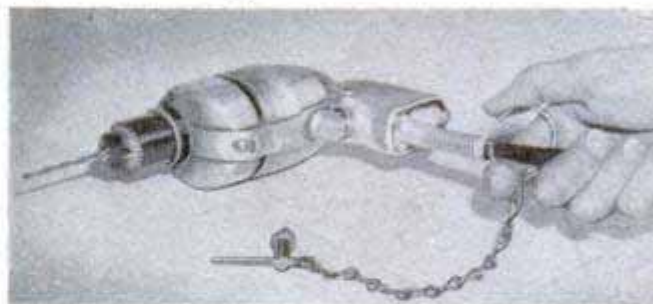

Mislaying the chuck wrench for a portable electric drill can be prevented by clipping the wrench to the extension cord before storing the drill. Attach the wrench to a ring taken from a loose-leaf binder, using a short length of lightweight chain, and snap the ring around the cord. When using the drill, fasten the ring around a belt loop or buttonhole so the wrench will not be lost.—Evan Wright, Topeka, Kans.

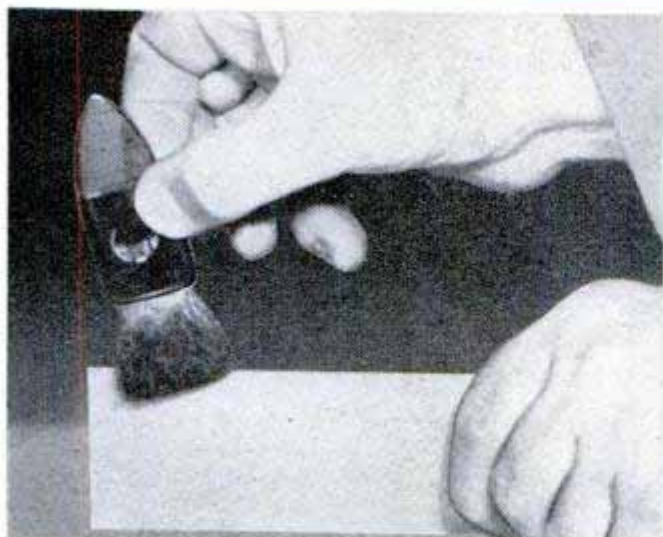

Before using a camel's-hair lens brush, clean it by brushing back and forth across the edge of a piece of cardboard as shown. This will remove dust and grit



After cleaning a lens with the brush, breathe gently on the glass, then dry it with tissue sold for this purpose. Use a light, circular movement of the tissue

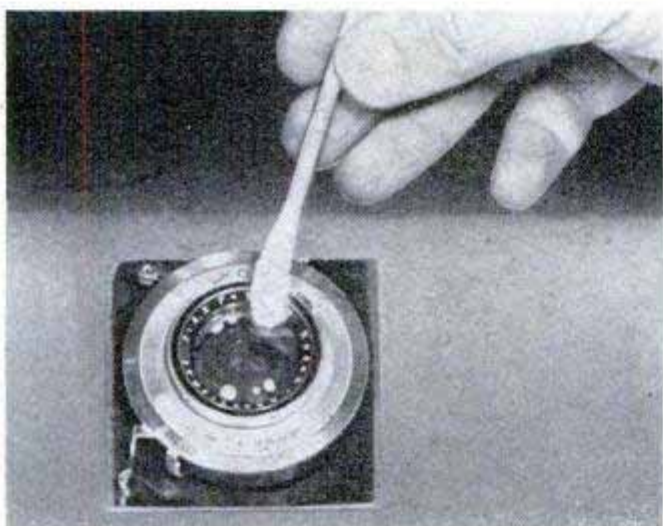

Apply liquid lens cleaners sparingly, using a piece of cotton wrapped on the end of a nail stick. Use only the special cleaners made for this purpose

A small box with a locking lid is good protection for a lens assortment. Cover the lenses with soft padding such as that supplied with projection lamps

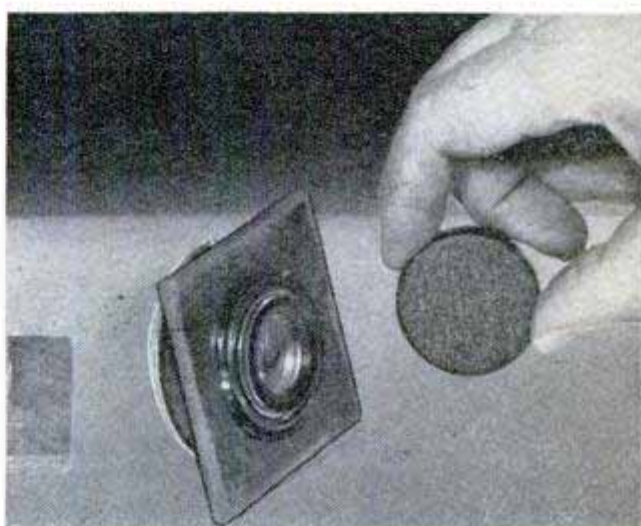

Cover lenses while not in use to protect them from dust and moisture. When not in camera, provide removable lens units with front and back covers

Lenses that are to be stored, carried in coat pocket or in camera carrying case should be protected by means of a chamois bag having a drawstring



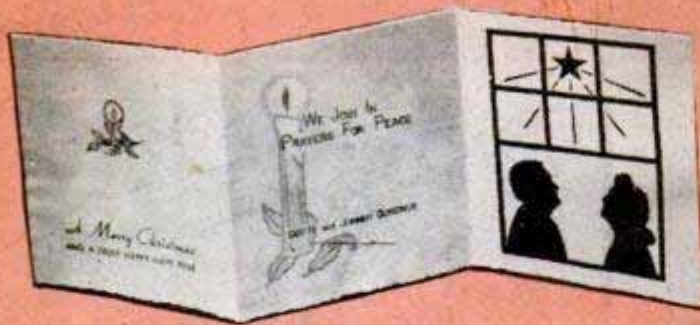

1



2

ANNOUNCEMENTS



BOOK MATCHES

CHRISTMAS CARDS

ENLARGER DOUBLES AS COPY

By Perry S. Graffam

THERE'S more to be had from an enlarger than just blowups. In many cases, this versatile darkroom accessory can be equipped at little cost to function as an efficient copying camera. All you need are just three items, a camera adapter back to slide between the bellows and lamp house of your enlarger, a pair of copying lamps and a homemade mirror attachment for viewing the ground glass and focusing, Fig. 8. The camera adapter back must be one that is made to fit your particular enlarger and you should buy two cut-film holders to fit it. The enlarger shown in Fig. 4 is a 4 x 5-in. Omega and takes the same type holder as that supplied with a Graphic camera. The copying lamps are made from a pair of gooseneck desk lamps. The ones that are fitted with C-clamps are the easiest to convert. Fig. 6 shows how the clamping brackets are altered by sawing on the dotted lines. The lamps are attached to the sides of the enlarger by fastening the brackets with small machine or thumbscrews. Being flexible, the lamps can be left permanently attached to the enlarger

and swung out of the way. If the lamps are connected to a common plug, fit them with a plug that can be distinguished readily from the one on the enlarger. No. 1 photo-floods or regular enlarger bulbs can be used in the lamps. The latter are less brilliant and permit more latitude in making exposures.

The periscope viewer which rests on top of the adapter back can be made of wood, metal or cardboard. The sides of the original were of wood and the top and nose-piece of cardboard. As the size of the viewer must be made to fit the head of the particular enlarger, no dimensions are given. A piece of mirror is mounted in the viewer at a 30-deg. angle, as shown in Fig. 5, and the inside of the viewer is painted dull black to eliminate light reflections. The ground glass on the adapter back is marked off in 1-in. squares. Rule the lines on the glossy side of the glass, using a draftsman's ruling pen and India ink.

The viewer and adapter back are placed in the enlarger by removing either the lamp house or the condenser lenses. The lenses were removed from the enlarger pictured in Fig. 7. Three thumbscrews



METER DIAL



INDICATOR MARKERS

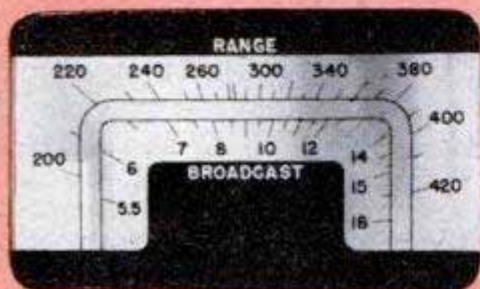

AIRCRAFT RADIO DIAL

COMMERCIAL COPY

3

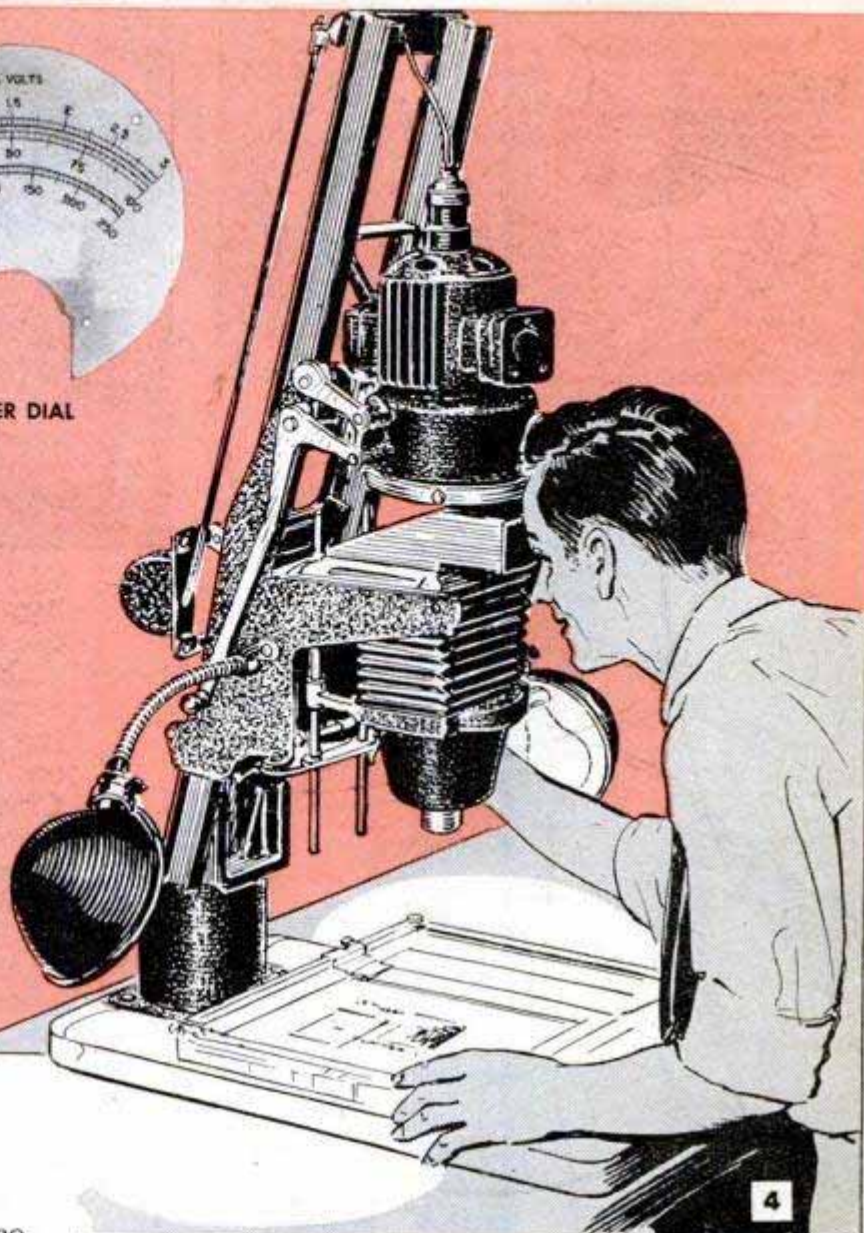

CAMERA

usually hold the lenses in place. The adapter back is placed over the open end of the bellows and the viewer goes on top of the adapter. The enlarger is now set up to make copy negatives.

To make a copy negative, place the material to be copied on the enlarger easel. With the lens aperture opened all the way, peer into the viewer and focus the copy sharply on the ground glass, bringing it to the desired size. With this done, slip a loaded film holder in the adapter. Now you are ready to make the exposure, much the same as you would with a camera. Set the aperture of the enlarger lens at its smallest opening, pull the slide from the film holder and turn on the copying lamps. Several test negatives usually will have to be made to obtain the correct exposure the first time. If super-XX film is used and the lens opening is set at f:32, an exposure of from five to seven seconds is suggested. From here on, the

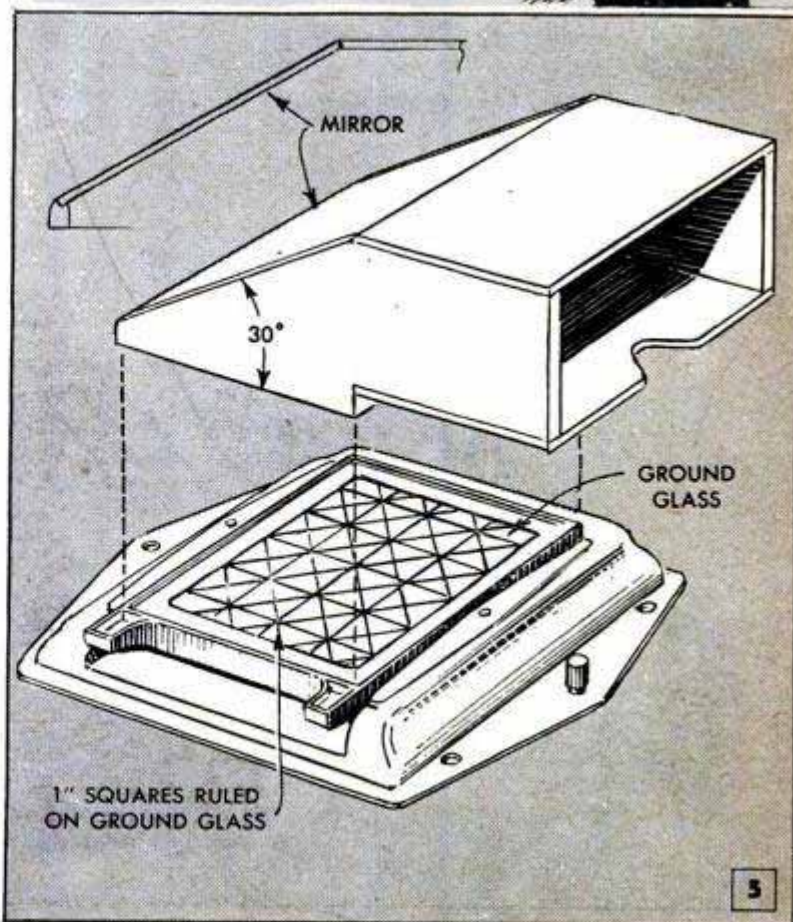

3

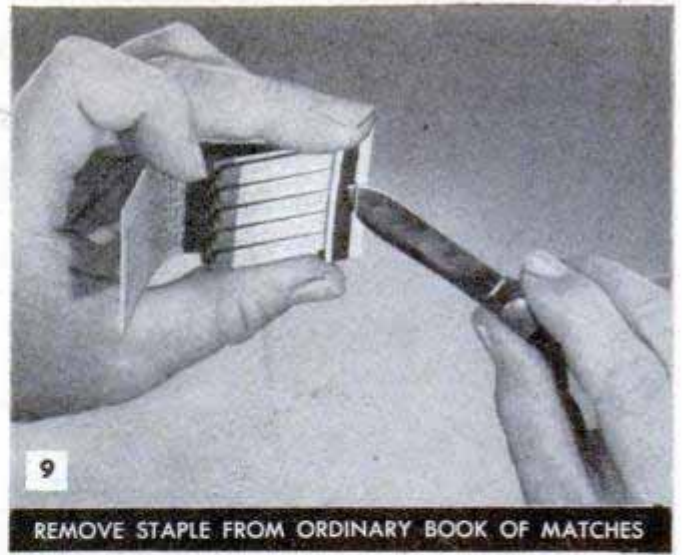
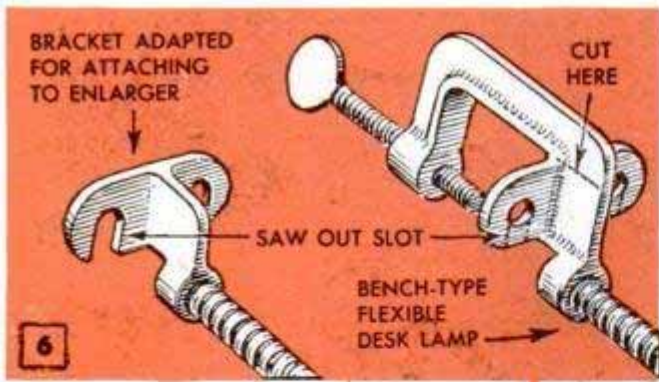

REMOVE STAPLE FROM ORDINARY BOOK OF MATCHES

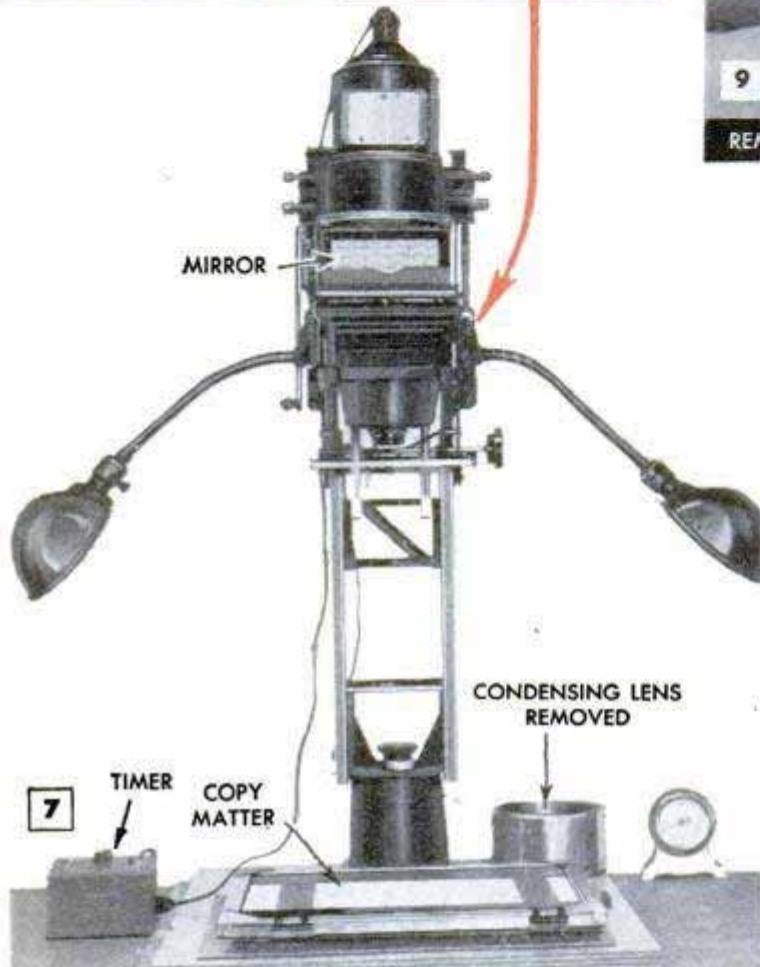

negative is processed and printed in the usual manner.

Examples of what you can do with your enlarger when set up for copying work are shown in Figs. 1, 2 and 3. These include birthday and Christmas cards, birth announcements, personalized match-book covers and numerous types of commercial copy, which can be produced by copying photos and drawings from magazines, actual retouched photographs, etc. In fact, there's little that cannot be copied, the only limitation being the area your enlarger will cover. The Christmas card pictured in Fig. 1 was made with three negatives. The printed verse was copied from an old Christmas card and the third negative was made by shooting a couple silhouetted against a sheet brightly lighted from behind. A print was made of

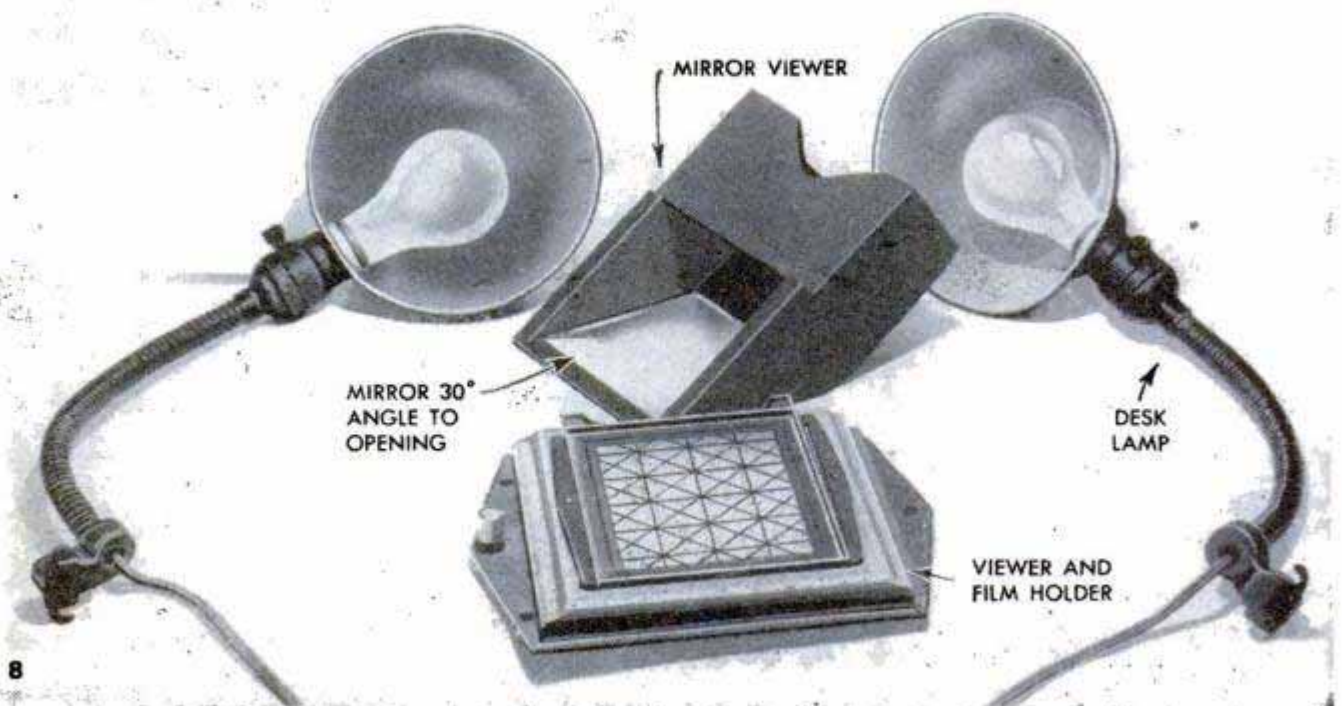



10 TAKE OUT MATCHES AND DISCARD COVERING

the third negative, and the images cut out and pasted on a drawing of a window and star. This composite print was then placed on the enlarging easel and copied. The complete card was printed at one time by taping the negatives in position in a contact printer. Finally, the candles were hand-colored. The second card pictured in Fig. 2 also was made from a composite, the card featuring on the cover how the scene pictured on the inside was made.

Personalized match-book covers are fun to make. First a copy negative is made from the photo or sketch you plan to use and then it is printed or enlarged on double-weight paper slightly larger than the finished size of the cover. After this, each personalized cover is applied to commercial book matches by simply pulling out the staple, Fig. 9, removing the matches, Fig. 10, and then replacing them in the new

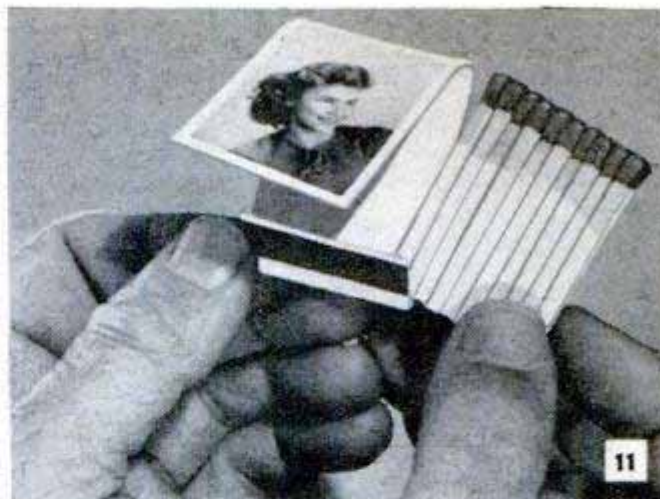

11 PLACE MATCHES IN NEW COVER MADE OF PHOTO PAPER



12 FASTEN MATCHES TO NEW COVER WITH STAPLE

cover, Fig. 11, and finally restapling as in Fig. 12. A prepared striking-surface liquid can be purchased for coating the new covers and a simple jig can be improvised to facilitate applying the solution neatly.

Mirror Mounted on Front of Camera Puts Portrait Subject at Ease

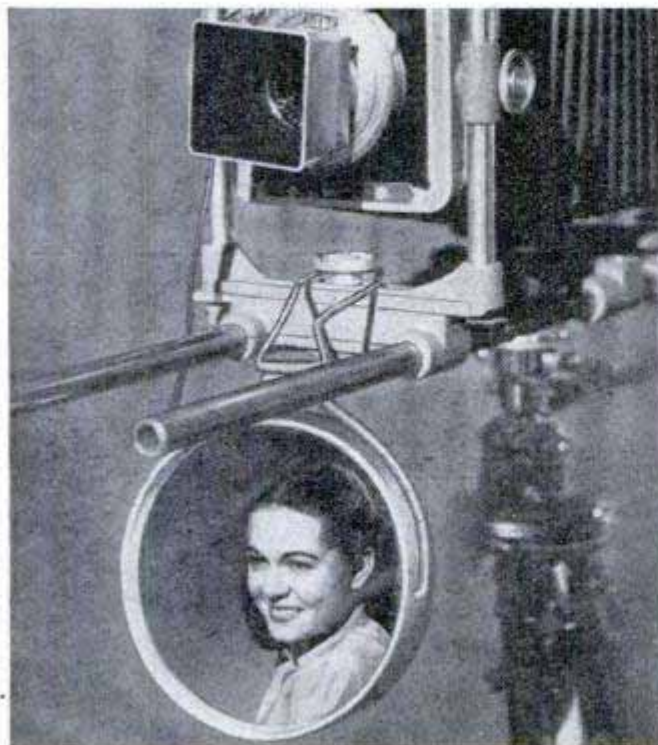

Especially helpful when taking portraits of women, a mirror mounted on the front of the camera will give the subject more confidence and is handy for last-minute primping. Just hang a shaving mirror as shown in the photo so the subject can see for herself how she looks before the camera.—Virginia Hanson, Santa Monica, Calif.

Cushion for Photoflood Reflector

To protect the filaments of photoflood bulbs, slip a rubber ignition-cable nipple over the top section of the light stand. This cushions the shock if the top section accidentally drops into the lower one.



*out of
Business
3/51
Pacific
Elemental*

Brace Across Cupped Plywood Aids Sawing Large Sheets



Two blocks nailed to one side of a 2 x 4 provide a convenient holder for sawing plywood that will keep the work from flexing and vibrating. The blocks are spaced slightly closer together than the width of the plywood sheet. The latter is bowed and wedged between the blocks as shown in the illustration, the resiliency of the material holding it in place.

G. E. Hendrickson, Argyle, Wis.

Lengthening Leather Straps

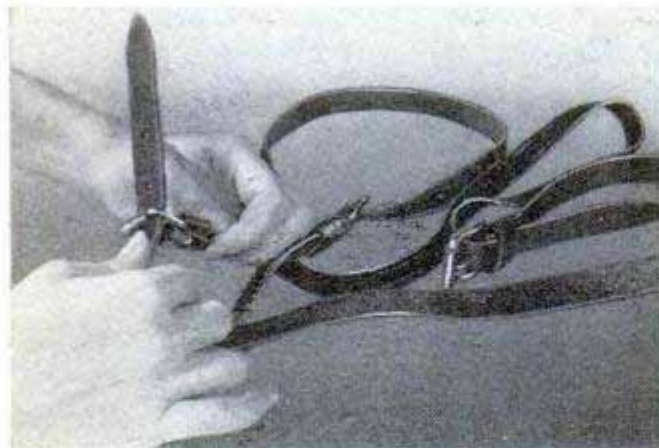

Long leather straps often needed for lashing trunks and luggage in place, can be made by merely buckling together several short straps to obtain the desired length.

Ear Muffs Provide Pincushion

A pair of spring-type ear muffs slipped over the shoulder serves as a handy pincushion that can be carried right along with you while sewing. The pincushion is

out of the way but always within easy reach of either hand.

Benj. Nielsen, Aurora, Neb.

Testing Christmas-Tree Lamps

If a toy-train transformer is available when arranging the Christmas-tree lights, you'll find it a handy aid in testing the individual lamps. Fasten battery clamps to the wires of a lamp socket cut from a discarded string and attach the clamps to the low-voltage terminals of the transformer. With the first lamp in the socket, gradually advance the rheostat until the proper brilliance is reached. Then use this position for testing the remaining lamps.—H. Leeper, Canton, Ohio.

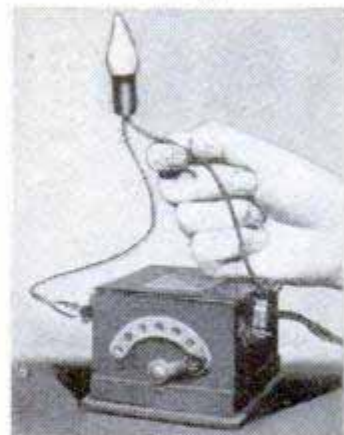

Wall Rack for Battery Hydrometer

Though it is convenient to store a battery hydrometer by hanging it on a wall, acid dripping from the spout is likely to damage clothing and equipment. This wooden wall rack collects the drops of acid in a glass dish or jar placed directly under the spout of the hydrometer. The wood is protected with an acid-resistant coating of melted wax.—H. Zave, Chicago.

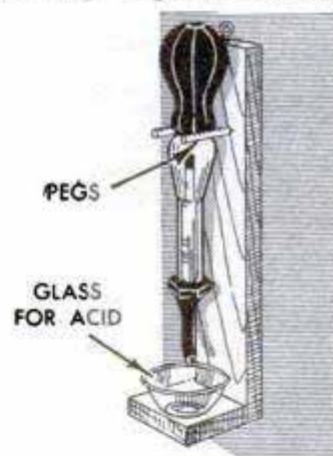

Rubber Band Fastens Key to Wrist

When coming home late at night or with your arms full of bundles from a shopping trip, you can save the trouble of searching for the door key if you previously fasten it to your wrist with a rubber band. At a convenient time, slip the rubber band through the hole in the key and insert your hand through the loops.



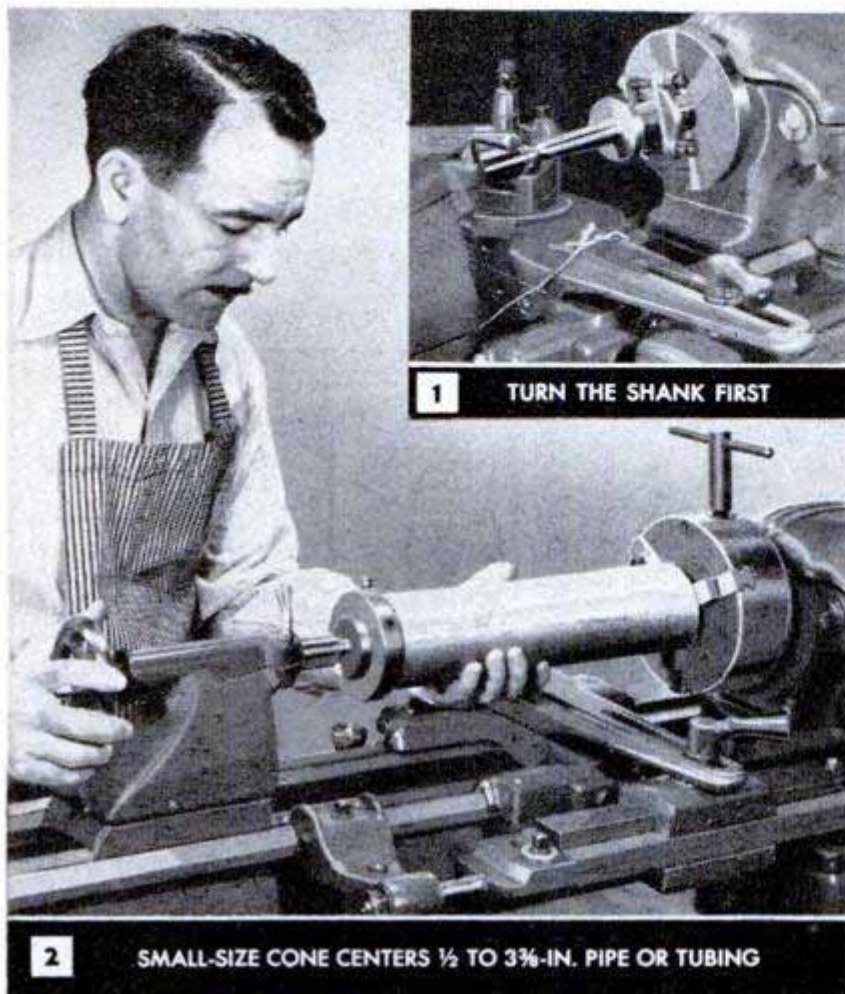

LATHE PIPE CENTERS

By Sam Brown

SMALL job shops and individual craftsmen having only infrequent use for pipe centers can save both money and setup time by making one or a pair to handle those occasional jobs requiring the turning and threading of tubing or pipe in the lathe. The individual center consists of two parts, Fig. 3, a shank and a cone. Stock for the shank is faced to the net length and center-drilled. Then the shank is mounted between centers and the taper turned as in Fig. 1. Fig. 3 gives the specifications for a No. 2 Morse taper but this can be turned to a No. 1 or No. 3 Morse taper as required by the lathe spindle which the center is to fit. Complete the shank as in Fig. 3,

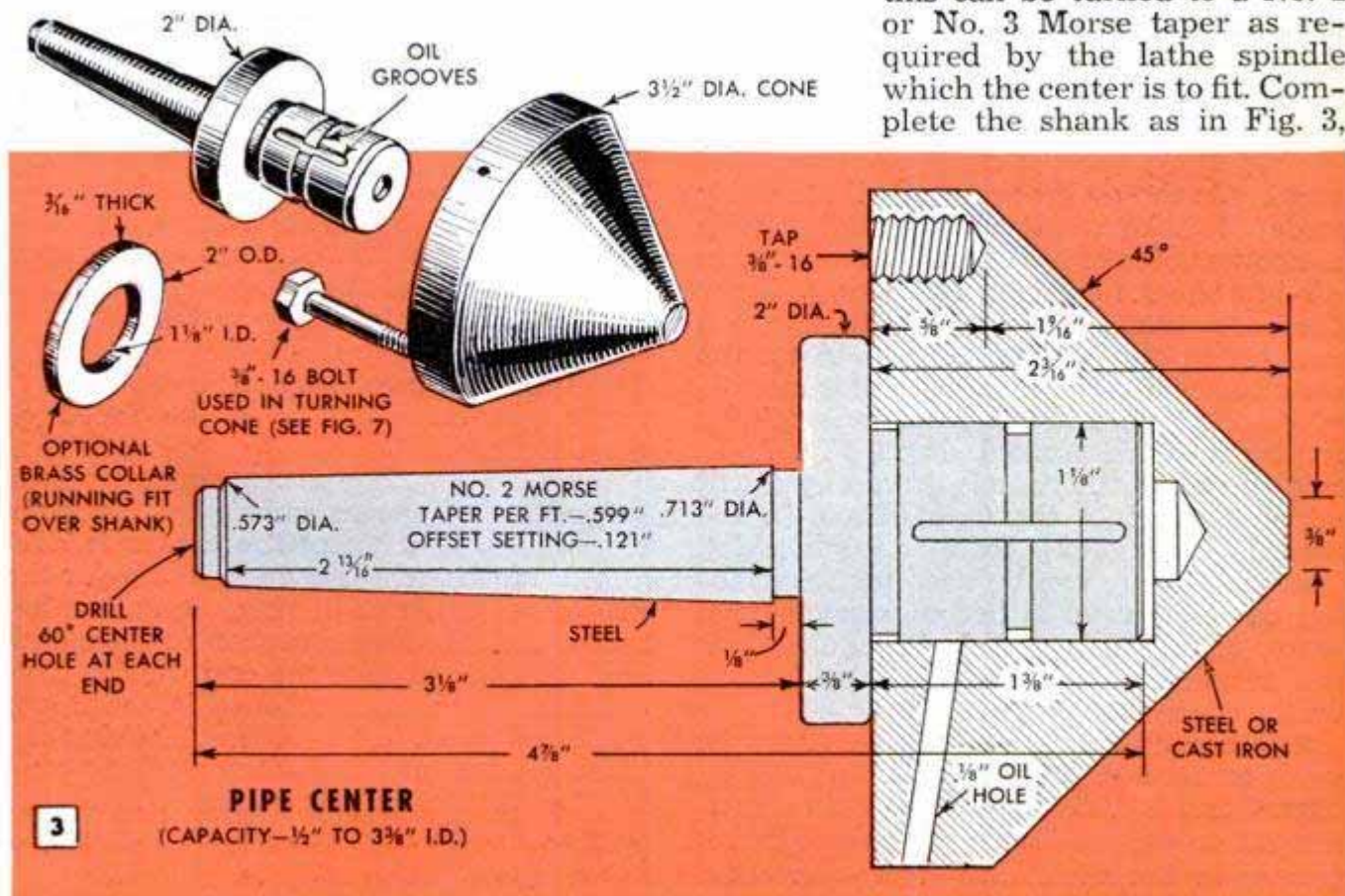

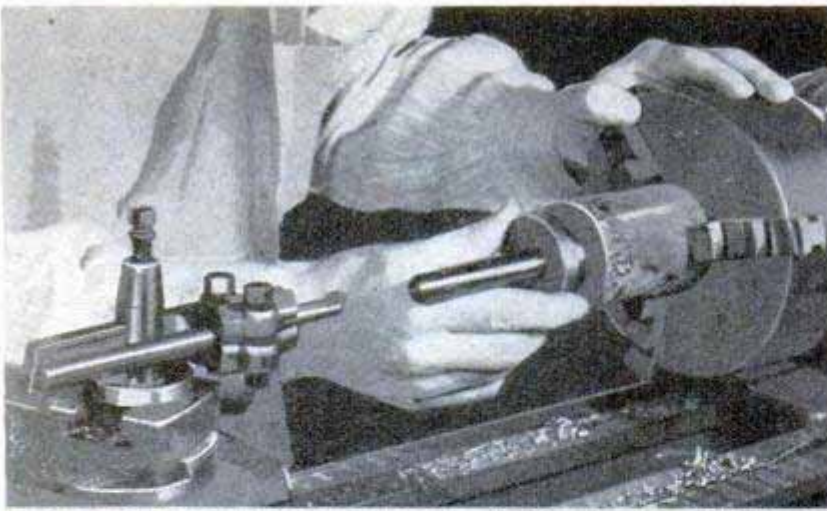

4 CONES AND OTHER FITTINGS ARE BORED TO TAKE SHANK

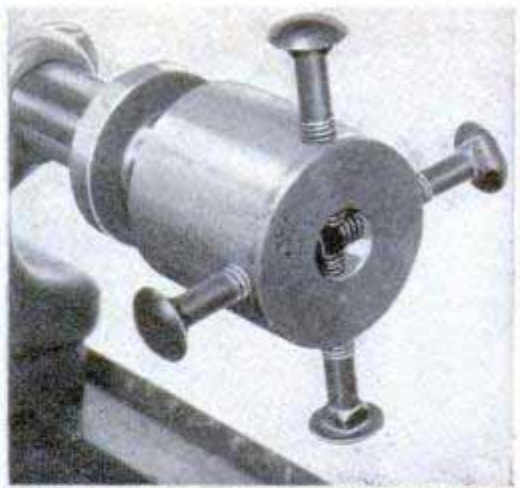

5 EXPANDING PIPE CENTER

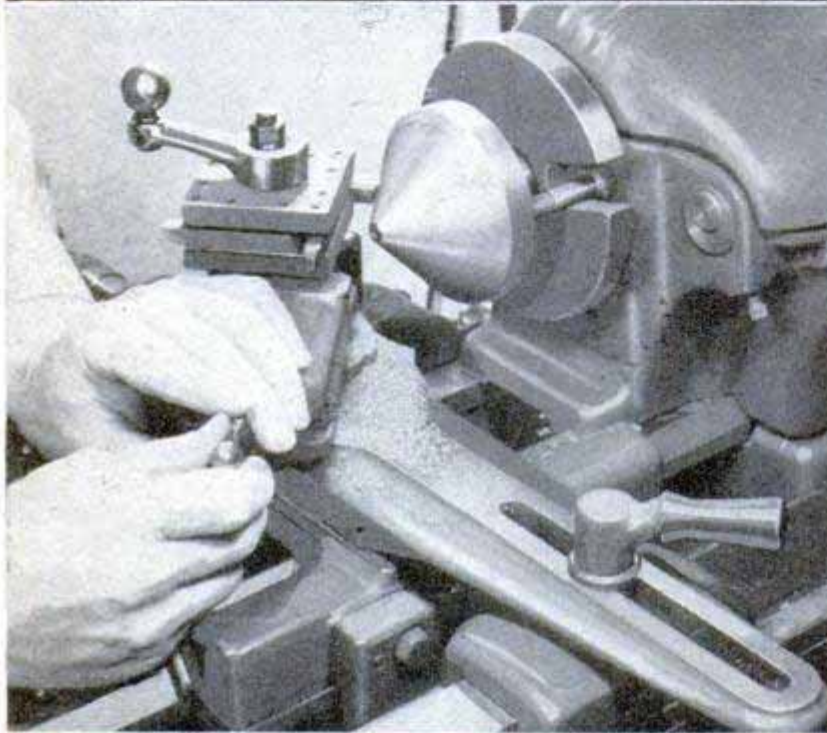

7 BOLT IN SLOT OF FACEPLATE ROTATES CONE WHEN TURNING TAPER

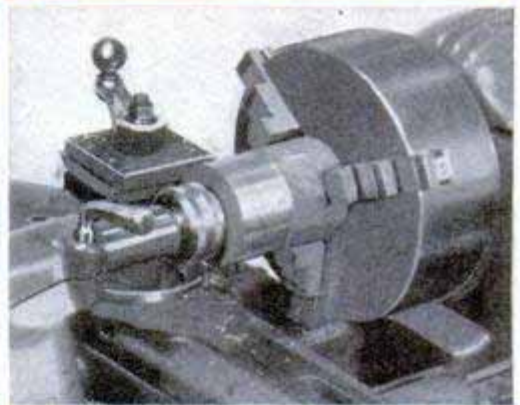
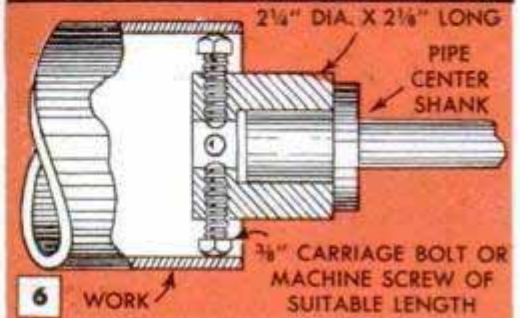

8 BALL-BEARING CENTER IS USED WHEN TURNING DOWN SMALL WORK

turning in the oil grooves and oil reservoir as detailed. Break, or chamfer, all corners as shown. Stock for the cone is mounted in a 3-jaw chuck for facing and boring. Check the bore diameter frequently to assure a running fit on the shank, Fig. 4. After the cone has been faced and bored, it is mounted on the shank in the headstock spindle for turning the conical shape, Fig. 7. In this operation the cone is driven by a bolt which turns into the tapped hole in the cone, Fig. 3, and engages the faceplate slot. The same setup can be used for resurfacing the cone after it becomes scored and worn. If the work is likely to require their use, larger cones can be made up for use on the same shank.

Another useful fitting for pipe and tube work in the lathe is the expanding center, Figs. 5 and 6. This unit is bored to a running fit on the pipe-center shank so that it rotates in the same manner as the cone.

The bolts, equally spaced around the circumference of the unit, are turned in sufficiently to allow the center to be slipped inside the end of the tube, or pipe, as in Fig. 6. Then, by backing out the bolts, the tubing can be centered and held securely. This type of center is especially adapted to use on work which must be faced or threaded in the lathe.

Work done with pipe centers normally is turned at slow speeds and for this the plain, sleeve-type bearing of the center is adequate. However, some operators favor the use of an antifriction ring, or collar, between the shouldered section of the shank and the cone to take the end thrust. This optional part is dimensioned in the upper left-hand detail in Fig. 3. Small tubing can be supported on a ball-bearing lathe center, Fig. 8. This is a standard lathe accessory and ordinarily is used for supporting heavy work.

A real attention-getter for most any small store, but especially suitable for a gift or toy-shop, this illuminated sign displays a brightly lighted cutout of the merchant's specialty. It's just the thing to attract evening shoppers during the holiday season. The lower portion of the sign, or lamp house, is made like a box, using solid stock or waterproof plywood for the ends, bottom and top. The sides are sheets of $\frac{1}{8}$ -in. hardboard. The name to be illuminated is jigsawed in both sides of the box and any remaining surface on the hardboard may be decorated with a painted monogram or design. The sides are backed with panels of frosted glass held in place with strips of quarter round at the bottom and a rabbeted molding along the top edge. Two lamp sockets mounted on the

bottom of the box are wired to a switch inside the store. Parallel slots cut in the top of the box permit illuminating both sides of the cutout. The latter can be a simple design jigsawed from plywood or a more elaborate one carved in relief from solid stock. A plywood canopy fitted with a ridge cap of galvanized sheet metal is supported by four $\frac{1}{2}$ -in. iron rods. The latter are set in blind holes, drilled at the corners of the

Attractive Illuminated Sign for Small Shop Displays Cutout of Merchant's Specialty

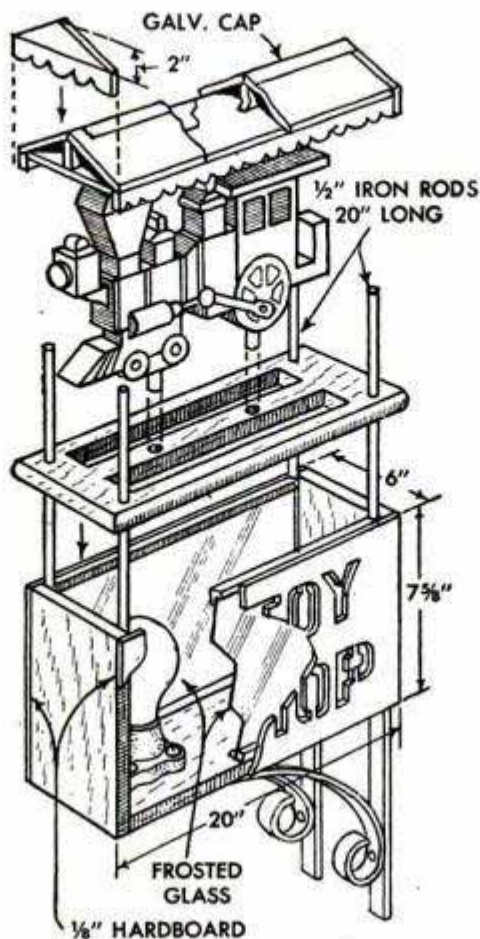

bottom of the box, and project through holes in the top. To facilitate renewing the light bulbs inside the sign, do not attach the slotted top permanently to the lamp house. In this way, the entire upper portion of the sign can be lifted off. Paint the sign to suit, using a reflecting paint on the inside of the box, and mount it on the side of the building with appropriate metal brackets.—Hi Sibley, Nuevo, Calif.

Grids on Poultry Self-Feeders Prevent Feed Waste

Poultrymen troubled by undue feed waste when flocks are put on range or are started on new rations, can profitably equip self-feeders with special grids which permit the chickens to reach the feed easily but prevent them from billing it out of the hoppers. The grids consist of wooden frames fitted with equally spaced crossbars of heavy wire, or dowels, and hinged to the top edges of the hopper. The frames close against a horizontal strip nailed between the ends of the hopper. Hooks or latches are provided to keep the grids closed.

☛ To keep paint from clogging the bristles of a new paintbrush, dip the brush in linseed oil before using.

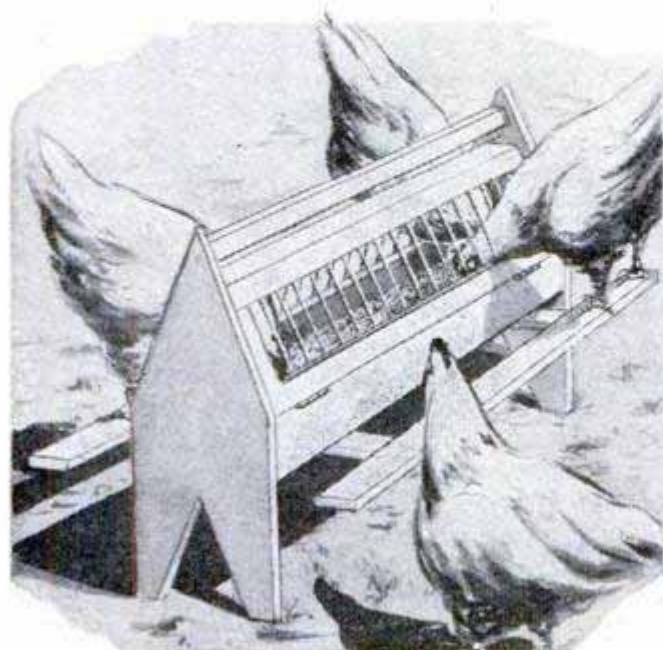

Scriber Heads Serve as Trammels For Improved Beam Compass

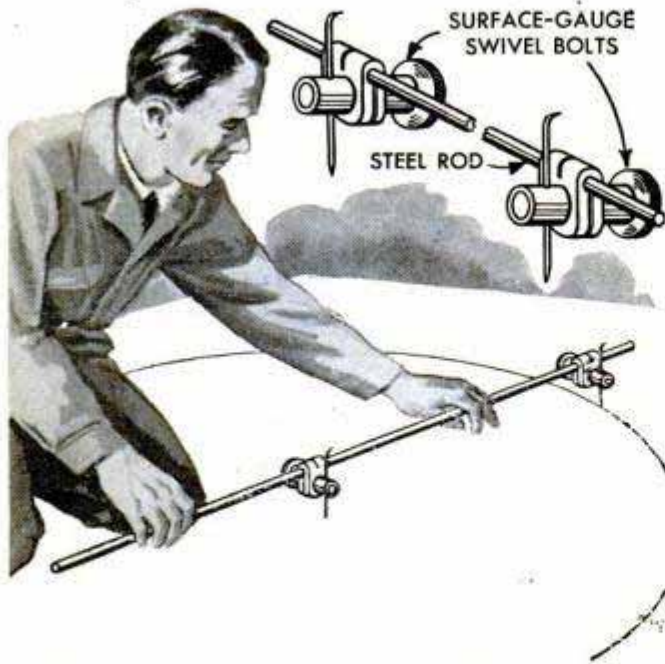

Having only occasional need for a large beam compass, one layout man quickly improvises a serviceable compass by using the scriber heads from two surface gauges as trammels. These are slipped onto a polished steel rod of the correct diameter and length. The heads are adjusted on the rod to strike the radius desired and the scribers are turned with the straight points down and locked in place with the swivel screws, or bolts. In cases where a pencil mark is required, a small-diameter pencil of the type supplied with bridge score tallies can be sanded down to fit the scriber hole in one of the heads.

Charles W. Adams, Waterloo, Ont., Can.

Erosion of Planted Fields Prevented By Concrete Dam and Spillway

On many farms, surface water from a heavy rainfall is brought down from higher levels through sloping, cultivated fields on grassed waterways. These usually lead to some natural drainage point, such as a stream or roadway. However, unless the flow can spread and drain away slowly at the point where it leaves the grassed

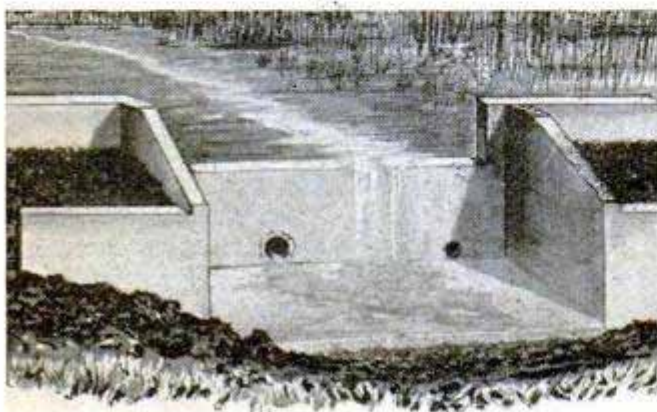

W.T.M. Concrete

waterway, it may form a deep ditch through which tons of valuable topsoil will be carried away during a single downpour. One farmer, confronted with this problem, built a concrete spillway with wide wings to contain the flow and spread it over a wide area. Thus the backwaters drain away slowly over the spillway. Tile lines, opening into the bottom of the spillway, extend back into the field to drain away the water remaining after the level falls below the top of the spillway.

Clothespin Forms Pocket Clip On Carpenter's Pencil

This handy pocket clip made from half of a spring-type clothespin keeps a carpenter's pencil from falling out of a shirt or overalls' pocket everytime the worker bends over. The side of the pencil is notched to receive one arm of the spring, and the clothespin is fitted to the other side of the pencil. The large plastic clothespins are excellent for this purpose.

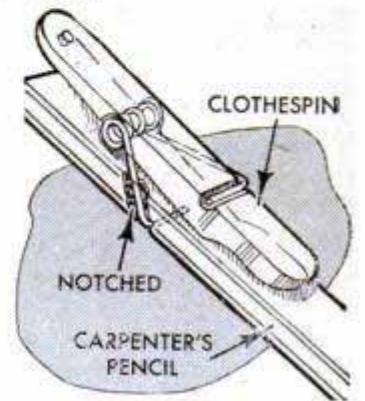

Rae Prickett, Moffat, Colo.

Collet Stop Aids in Producing Accurate Repetitive Work

Faced with the problem of holding uniformly close tolerances on work done in a second-operation lathe setup, one machinist devised this novel stop for use with a draw-in collet chuck. It will prove useful in any repetitive work where dimensions must be accurately held from a shoulder. The detail and also the sectional view of the stop in place on the collet are more or less self-explanatory. Of course, the stop must be made from mild steel to fit the collet being used, hence no dimensions are given. The diameter of the undercut recess in the back of the stop is such that the stop will slip over the end of the collet when it is drawn in. Then, when the collet is released to the normal open position, the stop will be held in place.—Geo. Austin, Syracuse, N. Y.

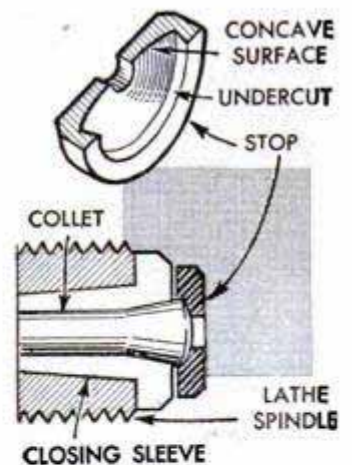

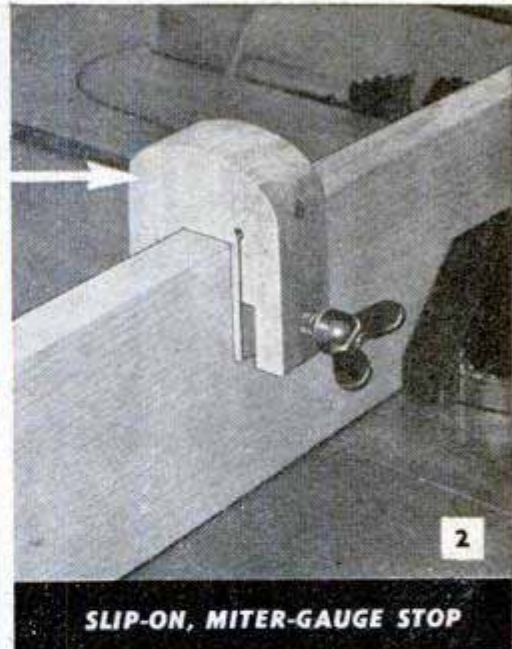
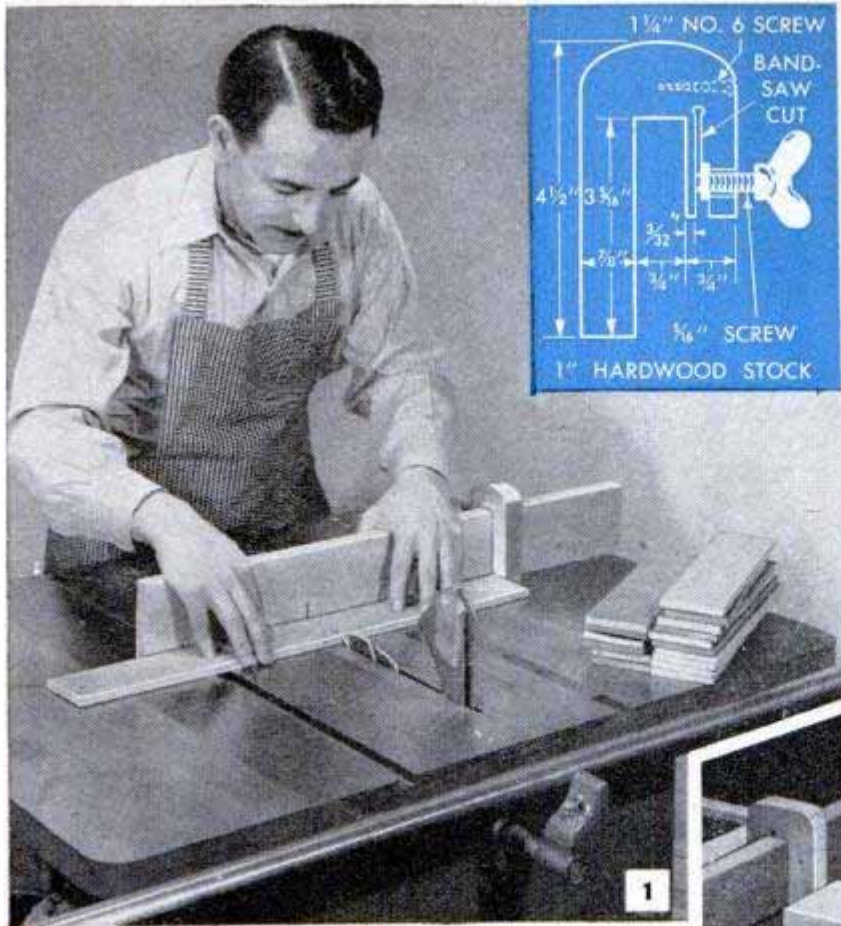

SLIP-ON, MITER-GAUGE STOP



SLIP-ON, RIP-FENCE STOP

QUICK-SET STOPS for your bench saw

HERE ARE several easily made adjustable stops that can save a lot of time when you're doing duplicate cutoff work on a bench saw. As an example, take the miter-gauge stop which is used on a wooden facing attached to the miter gauge as in Figs. 1 and 2. Set it for the first cut with a rule and you can run any number of pieces all exactly the same length without having to bother with blocks and clamps. The construction is shown in the detail. The wing screw is turned through a nut and bears against a thin section of wood to hold the stop in place. A wood screw at the top guards against splitting. The clamping arm, Fig. 2, should be short enough to work over the top of the miter gauge. A companion piece is the slip-on, ripping-fence stop in Fig. 3. This unit does not require clamping. Merely cut it to a light, wedge-fit over the fence. The side toward the saw should be exactly 1 in. wide so that the scale on the ripping-fence guide bar can be used. The reading will be minus the 1-in. thickness of the stop, of course. Some operators prefer a built-in sliding stop, Figs. 4 and 5.

The unit in Fig. 4 consists of a wooden miter-gauge facing slotted and grooved to permit movement of a sliding stop. The head of the bolt holding the stop should be



REVERSIBLE SLIDING STOP FOR MITER GAUGE

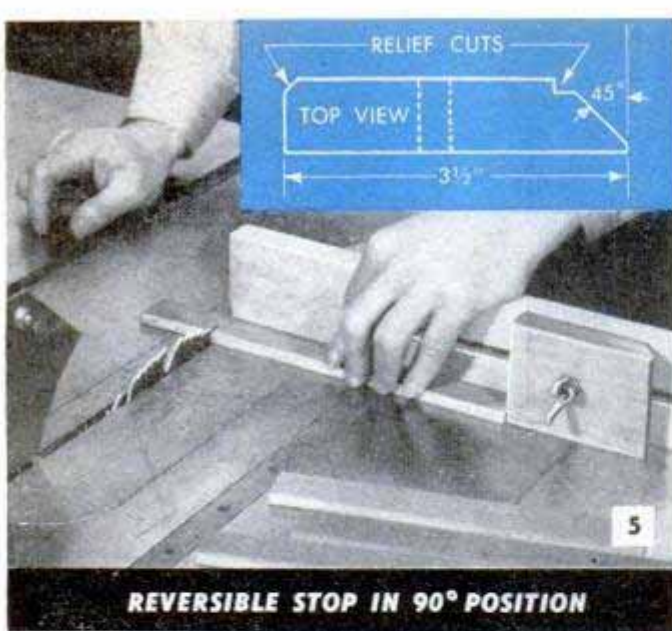

REVERSIBLE STOP IN 90° POSITION

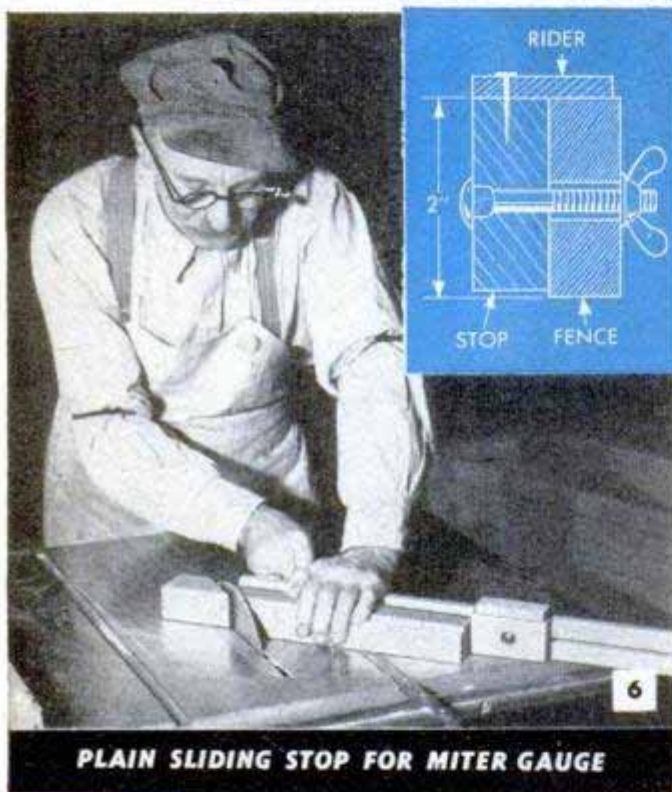

PLAIN SLIDING STOP FOR MITER GAUGE

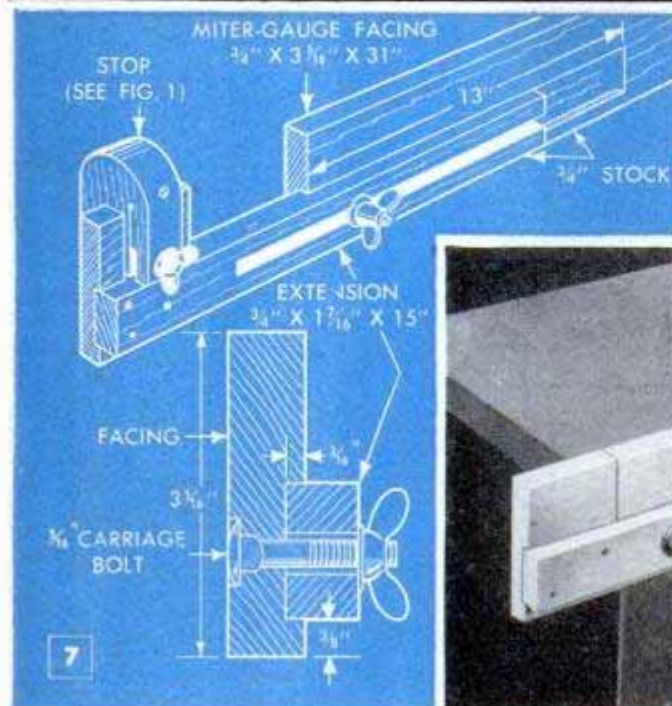

recessed deep enough to slide behind the miter gauge without binding. One end of the stop is cut square and the other at a 45-deg. angle. Either end can be used by simply reversing the block. The plain sliding stop, Fig. 6, is preferred by some operators, although it will not work behind the miter gauge. The projecting end of the facing strip is slotted through to permit the stop bolt to slide as in the detail, Fig. 6. Note that the miter-gauge facing is cut off flush with the saw blade. This is done to permit maximum travel of the stop block to the left for handling longer than average work. The extension stop, Figs. 7 and 8, incorporates all the features needed for cutoff work. The extension feature permits the handling of long pieces without sacrificing support on either side of the blade and, at the same time, the unit is sufficiently small to be handled on the average saw table without being unwieldy. The slip-on stop is the same as that detailed in Fig. 1. Fig. 7 details the construction and shows the shallow stopped groove run in on the back side of the facing to take the slotted extension arm. When the extension arm is not required, it fits neatly in the groove at the outer end of the facing as in Fig. 8. When making this stop unit, be sure to rip the facing wide enough so that the stop block will clear the top of the miter gauge. Clearance of the block is necessary when handling work of varying lengths as settings can be made anywhere from the blade to the end of the facing strip, or to the end of the extension piece.

Note in Fig. 5 that all the stop blocks described are relieved on the inside corners. This is necessary to provide clearance for splintered or burred ends on the work. When making duplicate cuts with a stop, be sure that sawdust does not accumulate in front of the facing strip, as this may be the cause of inaccurate settings. The end of the stop bearing on the surface of the saw table should be beveled about 5 deg. to give adequate clearance. Use hardwood for both the facing strips and the stops.

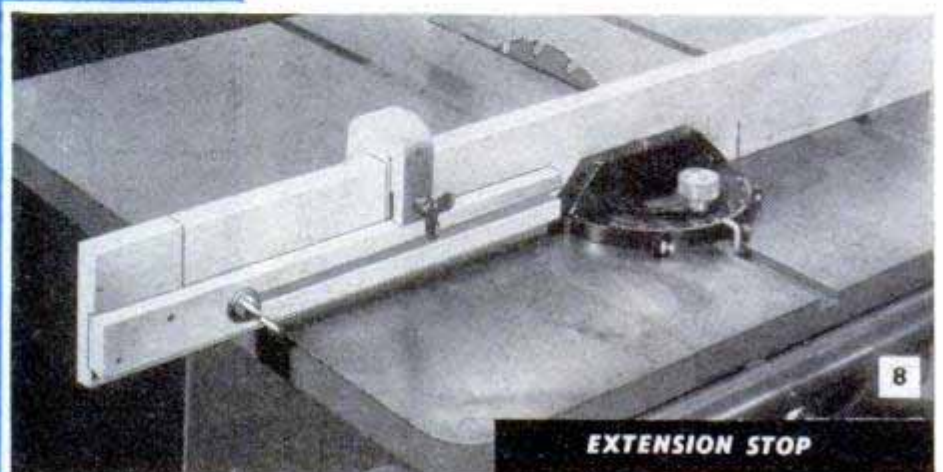

EXTENSION STOP

Portable Drill Used as Power Drive

Lacking an idle motor and jackshaft to drive his grindstone at the correct speed, one farmer used a portable electric drill as the slow-speed power source. He mounted the grindstone fixture on a bracket attached to a convenient post in the farm workshop. Then he mounted a small V-pulley on a $\frac{1}{2}$ -in. bolt and ground the threads off the end of the bolt to give the drill chuck a good grip. In the setup pictured, the bolt is passed through a $\frac{1}{2}$ -in. hole drilled through a short piece of hardwood which is nailed to one side of the post to serve as a bearing. The drill chuck is then tightened on the bolt and the drill is supported in a horizontal position by clamping the D-handle to an L-shaped wooden bracket. A V-belt transmits power.

A. M. Wettach, Mt. Pleasant, Iowa.



Drafting Instruments Lifted Quickly With Aid of Suction Cups



Draftsmen will find triangles and curves more easy to handle if they use small suction cups to lift them from the paper. This is especially handy when inking as the instrument

can be lifted directly upward, thus eliminating the danger of smearing the ink.

Richard Hanscom, Elmhurst, Ill.

Low Windows in Poultry House Supply Light Under Roosts

Installing ordinary two-light basement windows in the rear wall of a poultry house will allow light to enter the back of the house and under the roosts. Not only is this convenient when working in the poultry house, but the hens will face the windows, scratching the litter more evenly over the floor instead of only toward the back wall.

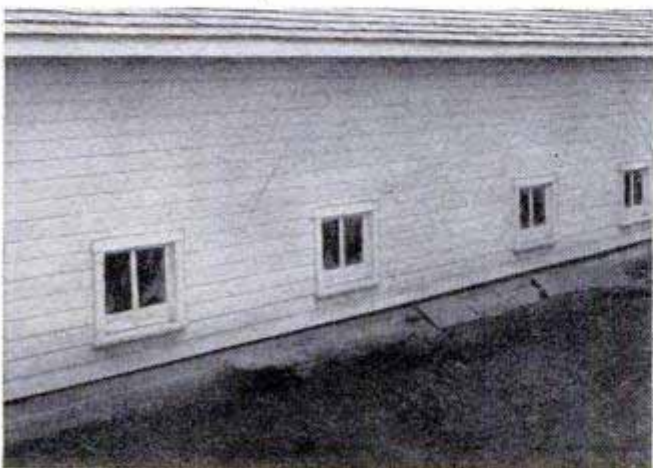

Removing Rusted Drain Plugs From Car Radiators

When frozen by rust, radiator drain plugs of the type used on some cars are practically impossible to remove. One mechanic solved the problem by drilling a $\frac{1}{4}$ -in. hole through the square shank of the plug. Then, he simply inserted a $\frac{1}{4}$ -in. pin punch in the hole and turned out the plug with comparative ease.

W. H. McClay, Pasadena, Calif.

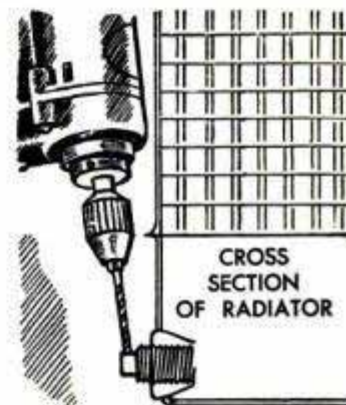

Hoisting Ring for Car Motor

To eliminate the use of chains when lifting a car motor from the frame, one garage mechanic made a simple hoisting ring which screws onto the threaded end of the crankshaft, replacing the fan pulley. The hoisting ring is made by sawing off the large end of a connecting rod and welding a nut in the end of the rod. The nut, of course, must be threaded to fit the crankshaft.

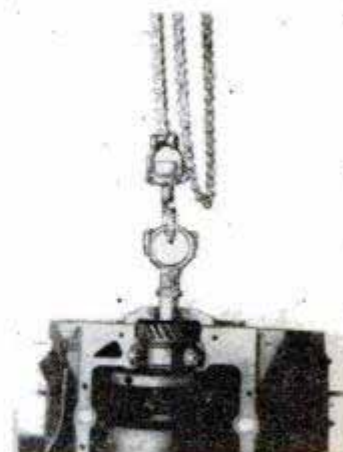

LATHE MILLING FIXTURE has compound-angle setting

By Everett W. Holt

TWO FEATURES of this milling fixture recommend it to machinists and manual-training departments doing specialized work and also to modelmakers with widely diversified problems in machining small parts. The fixture can be made completely on the lathe on which it is to be used and it has a provision for compound-angle settings, a particularly valuable feature where the shop lathe must be made to serve as a milling machine. The only additional lathe accessories necessary in the construction of the fixture are a stub arbor on which to mount a slitting saw, an end mill and a pair of small angle plates. Dimensions in the detailed drawings have been worked out to fit a lathe of 9-in. swing but, of course, these can be altered to make a fixture suitable for use on larger lathes.

As detailed in Figs. 1 and 2, the fixture is

designed to straddle the compound rest. The sliding jaw has a quick-release device which permits adjustment to any position up to a 3-in. opening. The first step is to face off the sides of the compound parallel with the dovetail groove on the underside. The compound is removed from the lathe and, with a rod placed in the dovetail groove, the compound is clamped to a faceplate, Fig. 3. Accurate locating of the compound on the faceplate is accomplished by setting each end of the rod to the cutting bit. This assures perfect parallelism. As the milling vise locates from the end of the compound, machining the sides of the compound in this way is optional. However, this operation provides additional bearing surfaces to carry the load when making heavy cuts. Also, the end of the compound must check parallel to the faceplate when the

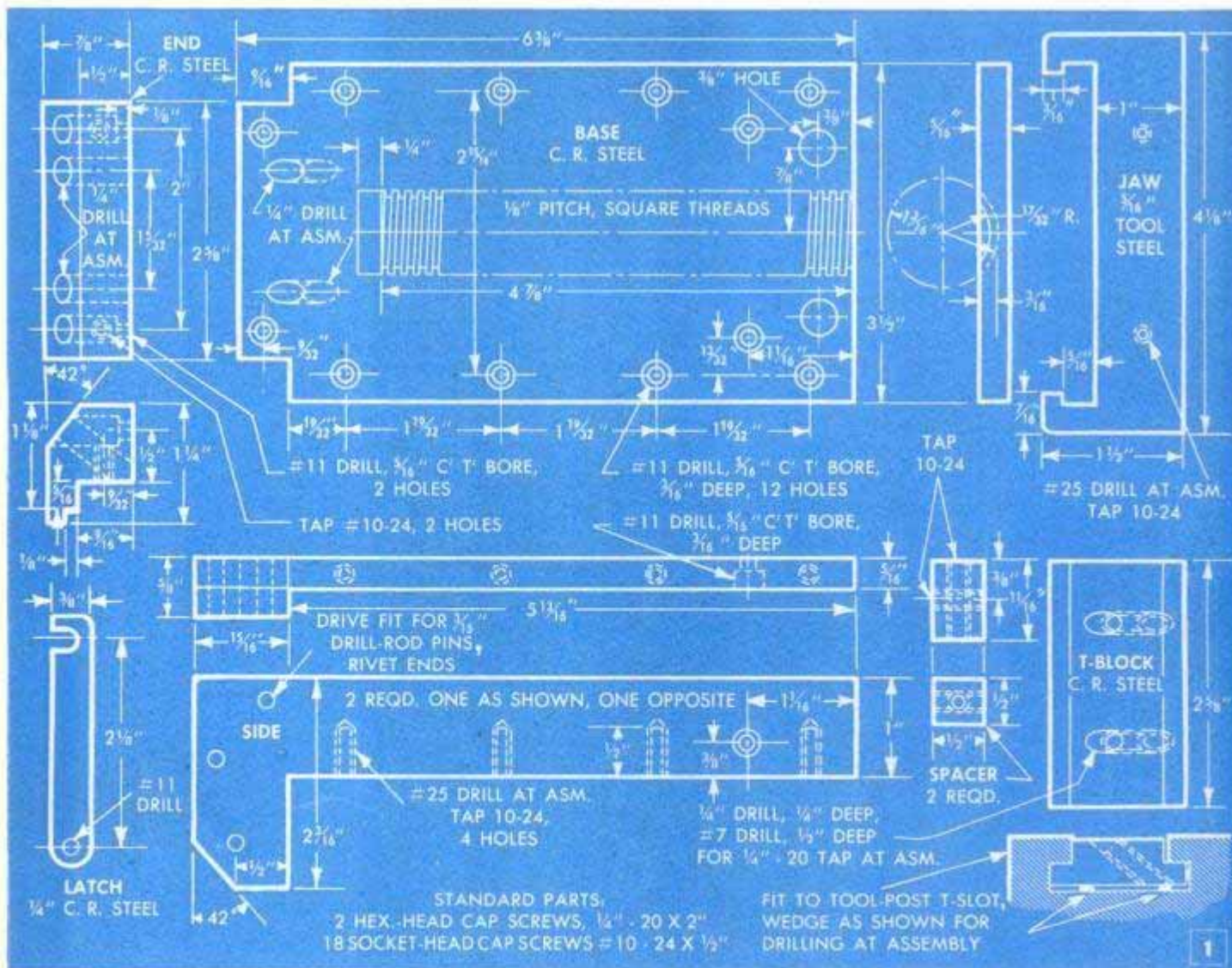

compound base is set at 90 degrees. The lathe setup for cutting the side plates, Fig. 1, is shown in Fig. 4. Note the support under the outboard end of the plate to prevent chatter. When running this support up to the surface of the plate, be careful not to spring the end upward. The endpiece, which supports the fixed jaw, is faced to size in a four-jaw chuck and is then clamped to an angle plate mounted on the cross slide for milling the bottom profile with an end mill. Drilling and counterboring for the jaw screws is done in this same setup before milling the 42-deg. bevel, Fig. 1.

For convenience in checking fit, the adjusting screw for the sliding jaw should be finished and threaded before cutting the threads in the vise base

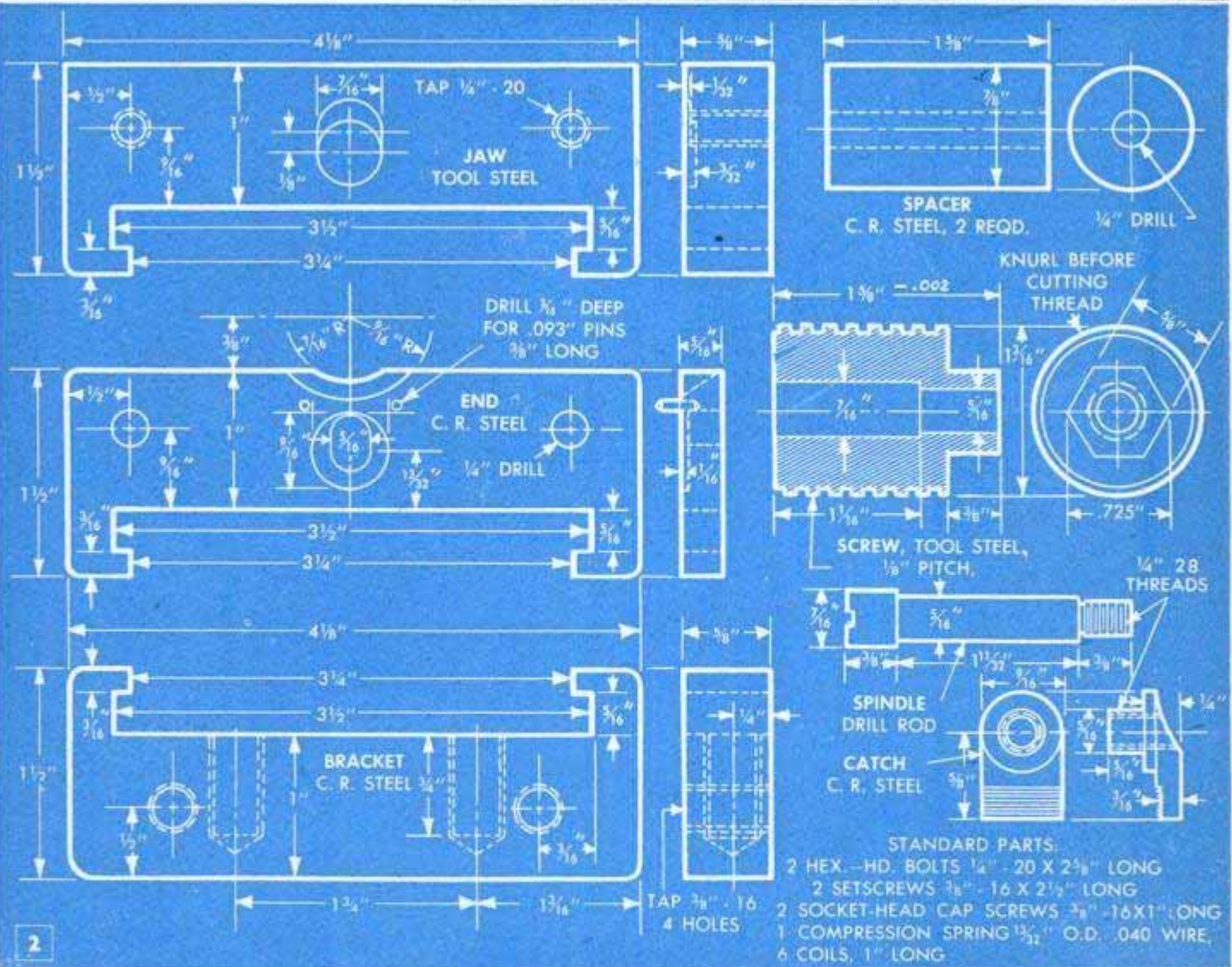

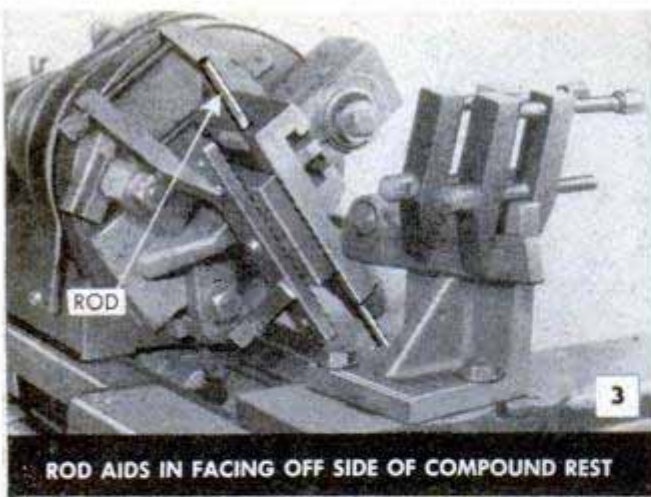

ROD AIDS IN FACING OFF SIDE OF COMPOUND REST

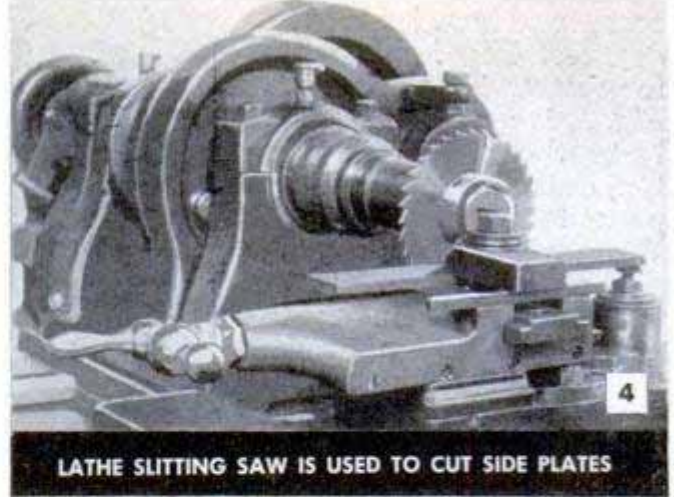

LATHE SLITTING SAW IS USED TO CUT SIDE PLATES

plate. Note that the screw is knurled before threading, Fig. 2. The setup for threading the base plate is shown in Fig. 7. The threading tool operates in much the same manner as a boring bar with a fly cutter. The bar is $\frac{7}{8}$ in. in dia. and 16 in. long and the threading tool is mounted in a hole drilled transversely through the bar about midway of the length. The tool is adjusted by means of a setscrew. After the half thread has been cut in the plate, check the fit of the screw through the full length of

the thread. Now, finish the balance of the parts detailed in Fig. 2. The parts of the sliding jaw, left-hand details in Fig. 2, are slotted and undercut by mounting the pieces in the four-jaw chuck. After turning, the arcs in the undercuts are filed flat. When all parts have been made and holes drilled and tapped where indicated, note carefully the upper left-hand and center left-hand details in Fig. 2. Dotted lines in the end view show the depths of the $\frac{7}{16}$ -in. offset recess in the jaw, while the end and

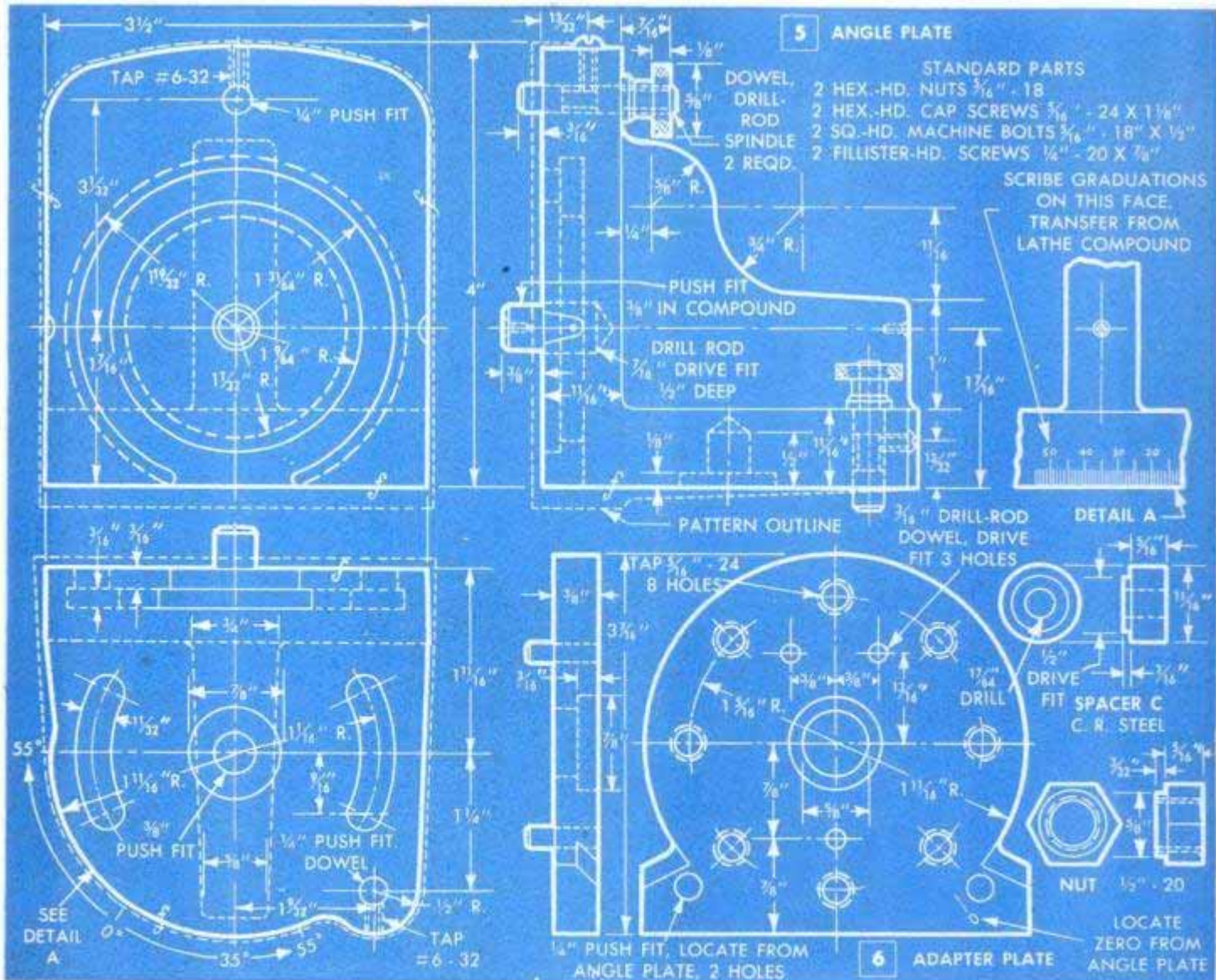

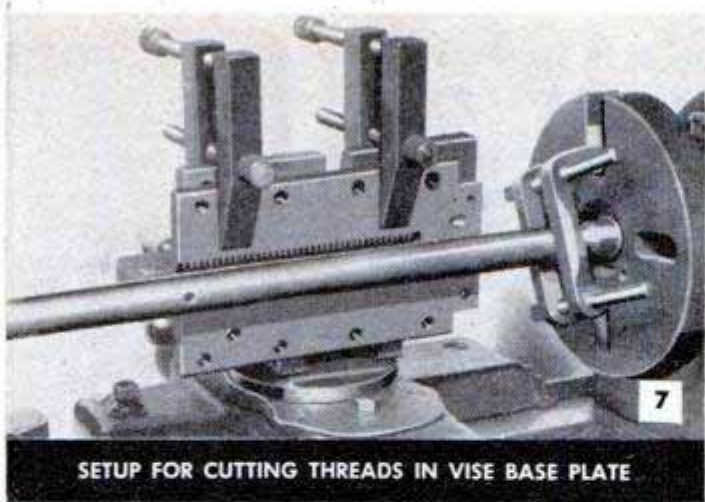

SETUP FOR CUTTING THREADS IN VISE BASE PLATE

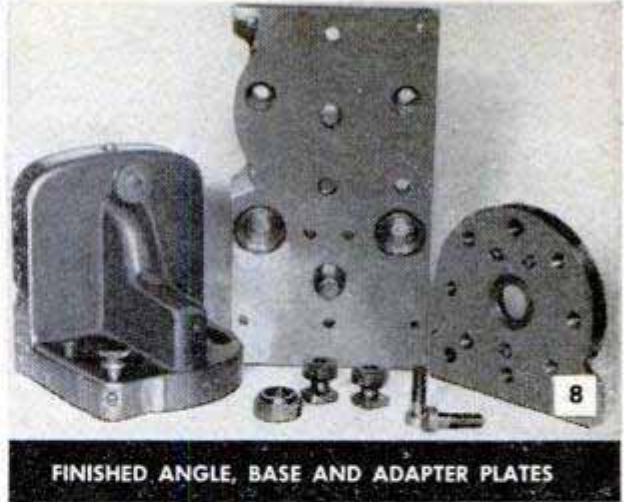

FINISHED ANGLE, BASE AND ADAPTER PLATES

flat views of the endpiece show the finger-slot radii and the $\frac{1}{16}$ -in. depth of the $\frac{9}{16}$ -in. recess. After drilling, the $\frac{7}{16}$ -in. hole in the endpiece is elongated to a slot, one edge of which touches the edge of the recess. In assembly, a spring fits over the body of the spindle to hold the head of the spindle in the deeper recess in the jaw. The catch, Fig. 2, seats in the recess in the endpiece and in this position holds the adjusting screw in positive engagement with the half threads in the base plate. When the catch is lifted

out of the recess, the movement allows the head of the spindle to slip out of the deeper recess in the jaw. This disengages the screw from the half threads in the base plate, leaving the jaw free to slide up or down. The position of this catch is shown clearly in Figs. 10 and 11.

The next parts to be made are the angle plate, Fig. 5, and the special base plate, Fig. 9. The purpose of the latter part is to extend the rearward travel of the vise beyond the normal cross-feed limits of the compound. If the travel of the compound is sufficient to serve your purpose, the base plate can be omitted and the angle plate, Fig. 5, can be made to fit the compound seat on the lathe carriage. With the base plate, the travel of the vise is sufficient for a 6-in. cut, Fig. 10. Note in Fig. 5 that the angle plate is shown in three views and the adapter plate, Fig. 6, in two views. The finished parts are shown in Fig. 8 along with the special base

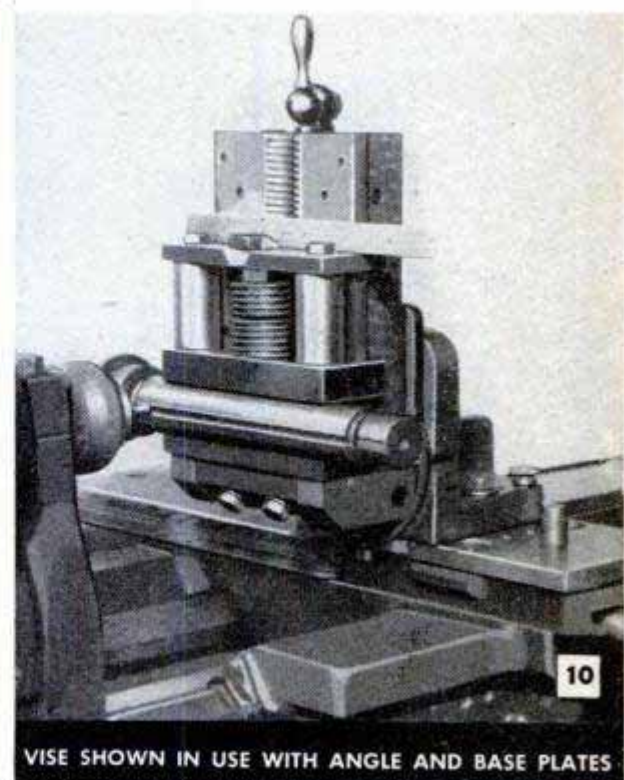
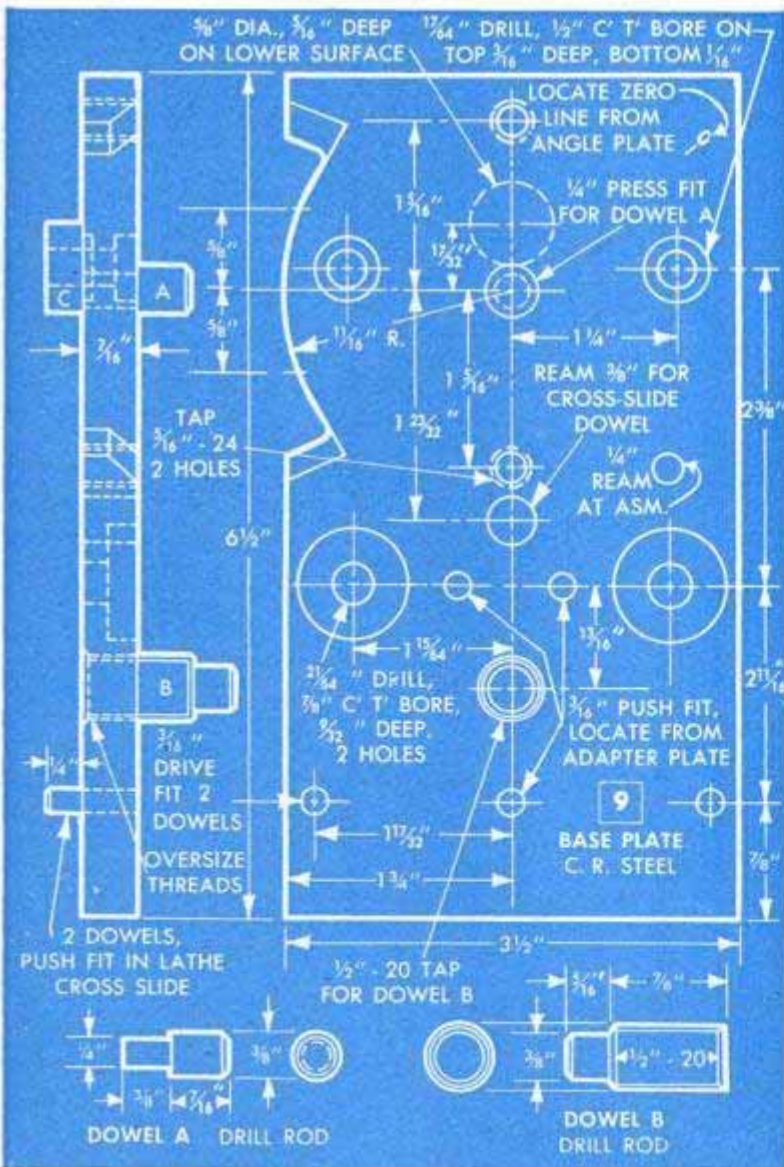

VISE SHOWN IN USE WITH ANGLE AND BASE PLATES

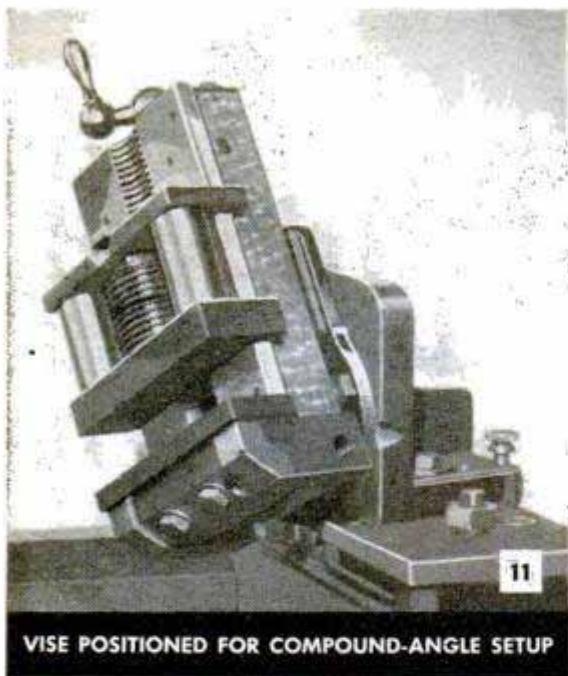

11 VISE POSITIONED FOR COMPOUND-ANGLE SETUP

plate. The angle plate and the adapter plate, Figs. 5 and 6, are castings made from special patterns, the pattern outlines being shown by dotted lines outside of the profile in the three views of the angle plate. Make the angle-plate pattern from three pieces of white pine joined with screws countersunk below the surface. Fill the screw holes and fillet all angles and corners with wood putty or beeswax. Sand the pattern smooth and finish with two coats of shellac. Be sure to make the proper shrinkage and draft allowances for gray iron on patterns for both the angle and adapter plates. Note especially in Fig. 5 that the rib, or web, of the angle plate is made high enough to provide a center for turning the circular T-slot in the vertical face. The curved slots in the base of the angle plate are made by drilling the end holes full size, then connecting with a series of smaller holes drilled along each arc. The waste is removed with a chisel and the arcs

are filed flat to the scribed radius lines. All faces of the angle plate marked with the symbol "f" are finished either by filing or grinding to dimension. The graduations on the base of the angle plate are scribed from the compound with the two parts clamped together. The push-fit dowel in the base of the angle plate locates the work square with the cutter in two positions and the dowel in the vertical face, or leg, locates the vise jaws parallel to the cross slide by engaging a hole drilled in the bottom of the compound.

The plate detailed in Fig. 12 is used to support work not adapted for gripping in the vise. The plate attaches at the top with the screws used with the detachable end bracket and is fastened at the bottom with the special clamp detailed at the lower left in Fig. 12. It pays to make the small, piloted counterbores which must be used on certain parts of the vise. Examples are the counterbores for dowels A and B in Fig. 9 and dowel A in Fig. 12. The counterbores are of the interchangeable pilot type and can be made from drill rod as in the lower right-hand details in Fig. 12. Drill the body of the counterbore longitudinally for the pilot, then saw two slots at right angles across one end. File away the waste at an angle between the slots to form cutting edges. Then heat the counterbore to a cherry red and quench in water. Hone the cutting edges with a fine oilstone, heat the shank until the cutting end turns to a straw color and quench again.

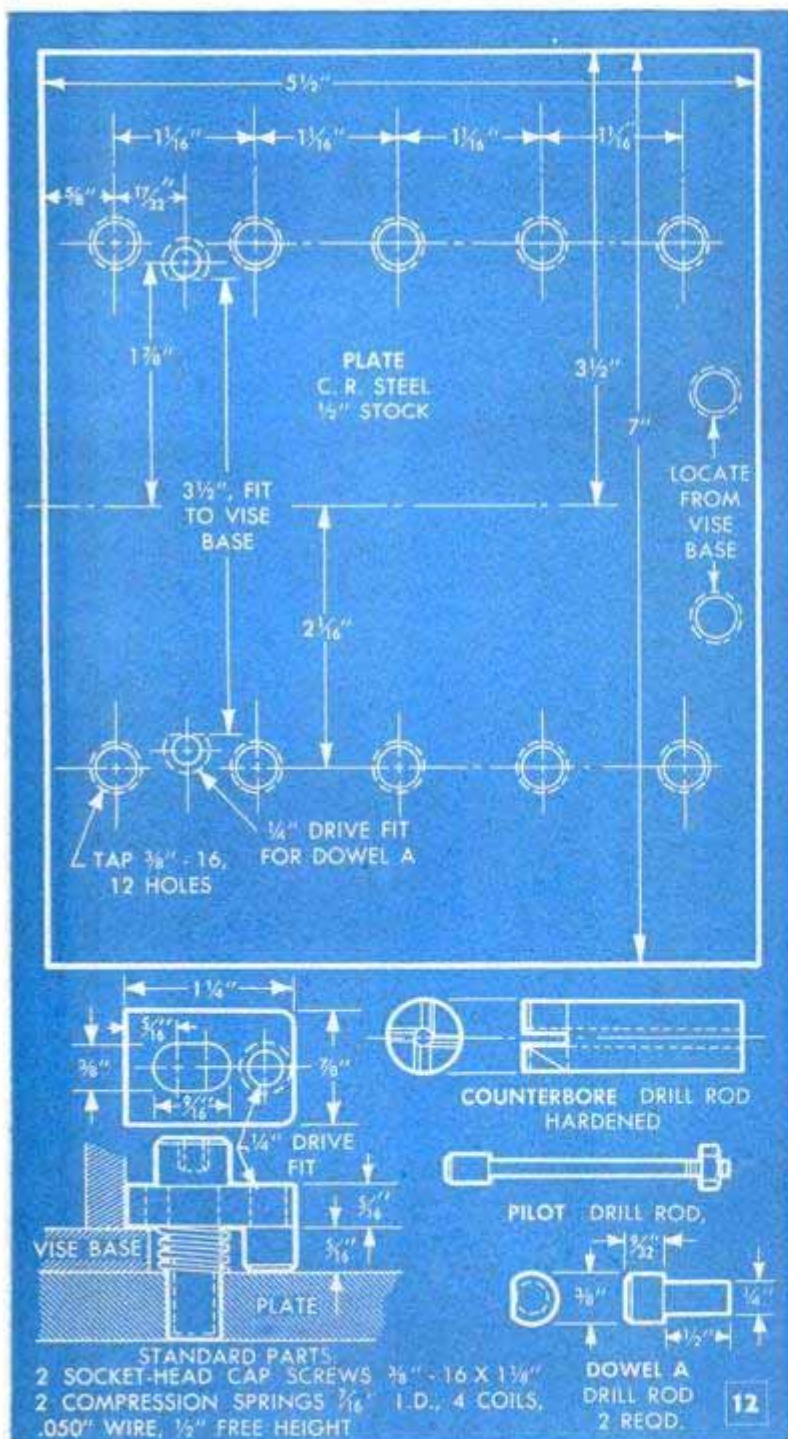

Lightweight Wheelbarrow Has Aluminum Frame

Utilizing his portable welding outfit, one farmer made a lightweight wheelbarrow from aluminum tubing. A strong, rigid frame of truss-type construction is formed by cross-bracing the tubing. A wooden platform is bolted to the upper longitudinal members and also to the front members of the wheel yoke, bolt holes being drilled through the tubing. Note from the photograph that each side of the wheel yoke is made up of three lengths of tubing joined at the axle bearing. Each leg consists of two lengths of tubing, additional rigidity being gained by welding the leg members to the length of tubing

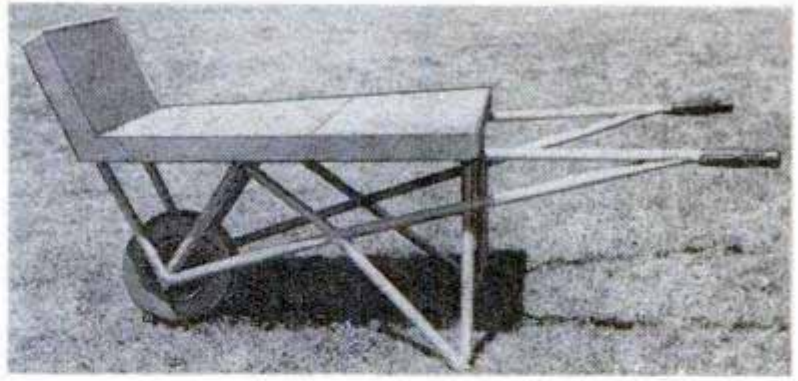

which runs from the wheel to the outer end of the handle. The handles are fitted with rubber bicycle handgrips and the wheel is equipped with a pneumatic tire.

Kenneth R. Imig, Watseka, Ill.

Adjustable Line Guide for Draftsmen Made From Old Reading Glass

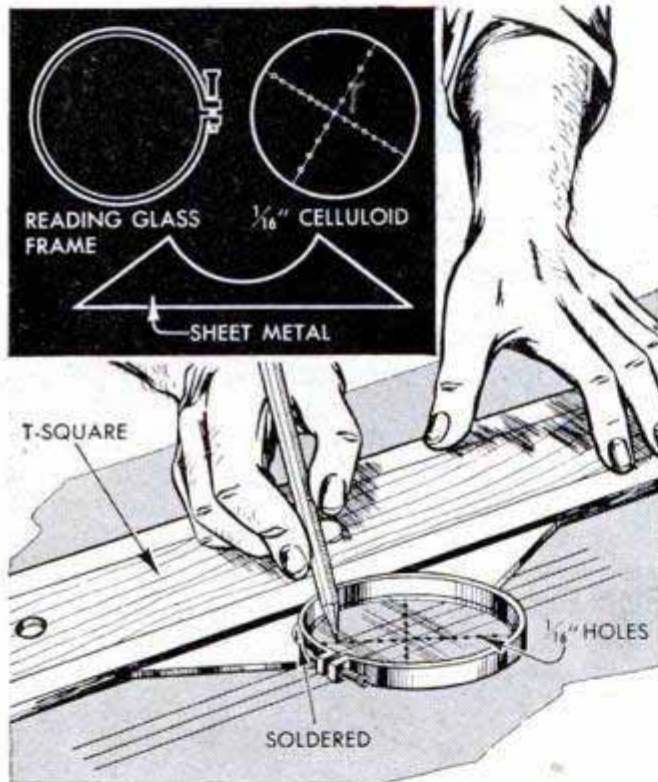

Here's an adjustable ruling guide that can be made inexpensively from a discarded reading glass, a piece of celluloid and a strip of sheet metal. The handle and lens are removed from the reading glass and the lens is replaced with a celluloid disk. Two rows of holes to take the point of a pencil are drilled in the disk at right angles to each other, the spacing of the holes in one row being different. For example, holes can be $\frac{1}{8}$ in. apart in one row and $\frac{1}{4}$ in. apart in the other. Before the celluloid is fitted in place, the rim of the reading glass is cut off and filed down to within $\frac{1}{32}$ in. of the lens groove to bring the disk nearly flush with the bottom. A sheet-metal straight-edge, cut to fit the diameter of the rim, is soldered to the latter. A bicycle-spoke socket is used as a setscrew to clamp the rim around the disk. In use, variation in the spacing of the lines is had by merely loosening the setscrew and rotating the celluloid disk slightly.

Julius Marsh, Riverside, Ill.

Poultry Roosts Hinged to Wall in Sections Facilitate Cleaning Dropping Pits

To shorten the job of cleaning his poultry houses, one poultryman made the roosts in hinged sections so they could be raised to give easy access to the dropping pits. The sections consist of frames made from 2 x 4s covered with 1 x 2-in.-mesh welded wire. The frames are hinged to the back wall of the dropping pits and hooks are provided in the ceiling joists to hold the sections in the raised position. Individual roosts are nailed across the top of the frames over the wire mesh.



❑ A defective spark plug can result in wasting 10 percent of the gasoline burned.

FIXTURES FOR FASTER SAWING

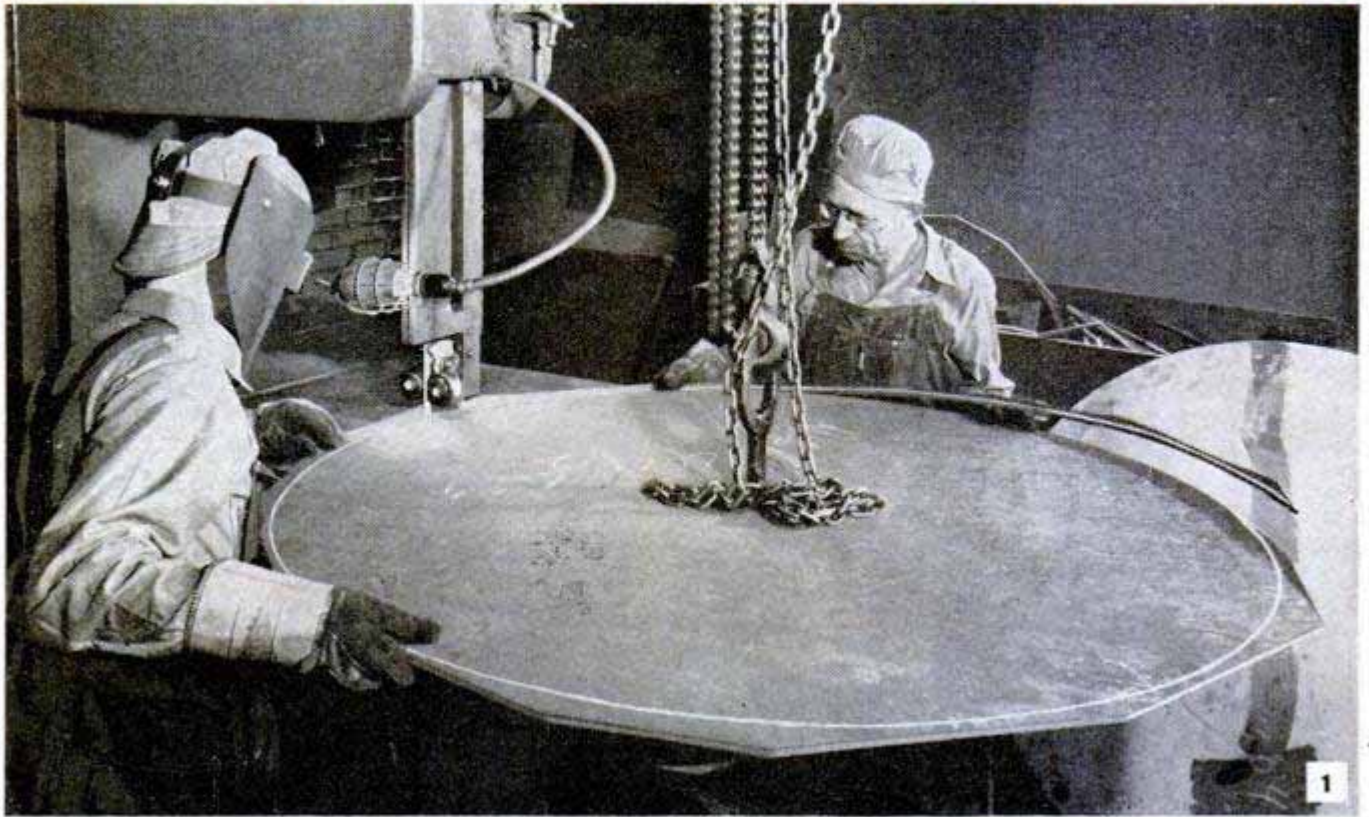

By Alexander Maxwell

PROBLEMS of cutting duplicate parts of sheet metal and other materials in small custom shops are easily solved by friction sawing. Simple jigs and fixtures can be made to handle special work even though there are only a few parts of any one kind or size. A good example of the type of work that comes into the custom shop is that pictured in Fig. 1. Here, a heavy disk nearly 4 ft. in diameter is being cut from a rough-trimmed blank of stainless steel by friction sawing. First the circle is laid out and marked on the blank and a hole is drilled through at the center for a heavy eyebolt. Then the work is supported at the side of the machine, in position for sawing, by means of a chain hoist. Where the work is of such a nature that the cutting must be done without relying entirely on the ability of the operator to follow a line under difficult conditions, use of the special circle-cutting jig detailed in Fig. 2 is advisable. To support a large disk, this jig must be of welded construction with all parts sufficiently heavy to prevent springing. The pivoting unit is supported on a T-beam bolted to the saw frame. Note that a series of holes is drilled in the legs of the beam so that the unit can be moved along the length of the beam as the radius of the work requires. Bolster pads are welded to the supporting frame directly under the pivot pin, and the work is supported on a small block of hardwood or a ball-thrust bearing, which

rests on the bolster. When the setup is complete and the work is in position, the pivot pin is lowered to the surface of the work by means of the handle. Light pressure on the handle will force the hardened point of the pin into the work sufficiently to hold it in position while the circular cut is made, Fig. 2. After the cut is started, the disk may tend to tip because of the greater weight of metal at the outer edge of the work. To avoid the necessity of having to hold down a heavy disk, some operators place a C-clamp on the supporting frame under the outer edge of the disk. The edge of the disk rides on the clamp which can be seen in position in Fig. 3.

Building a jig for cutting segments of a circle is equally simple. Fig. 5 details a good one and Fig. 4 shows an example of the work. A T-shaped radius bar swinging from a pivot pin, Fig. 5, carries the work blank to the saw. Two locating pins on the radius bar are inserted in jig-drilled pilot holes in each blank to eliminate the possibility of slippage, or error in the radius of the curved cut. Make sure that the pivot pin, Figs. 2 and 5, is on a line with the saw blade. On a short radius, it is best to use a narrow blade to provide ample clearance between the back of the blade and the outside edge of the saw cut. If the blade binds even slightly, it will leave a rough edge on the work and also may be damaged by heating.

Where the radius of the work varies on the single piece, as on a cam, operators use the jig shown in Figs. 6 and 7. Here, the

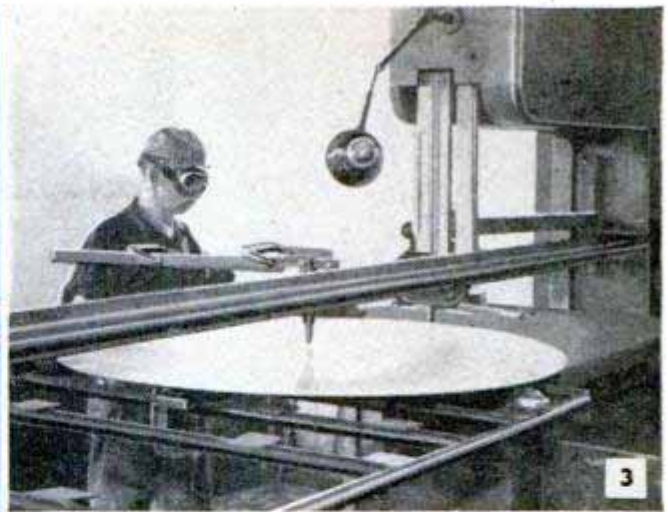
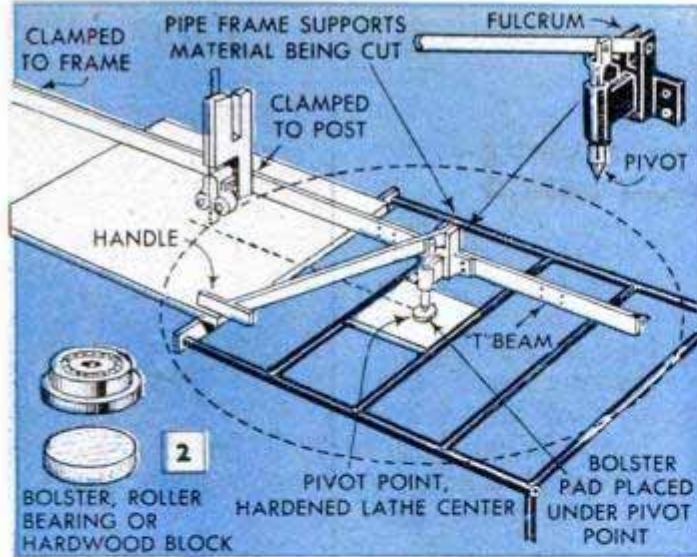

Perfect circles can be friction-sawed from heavy sheet metals with setup employing centering jig

work is guided by hand in sawing to the layout line and cutting pressure is maintained by means of a weight working against a hand-held feed dog, Fig. 7. This arrangement enables a skillful operator to produce extremely accurate work and at the same time relieves him of the tiresome job of maintaining cutting pressure by hand. The edges of the rough cam are V-notched at regular intervals and a guide lever is made up to suit the work as in Fig. 7. The crossbar on the end of the lever engages the keyway in the cam as in Fig. 6. This gives the operator control of the direction of cut. The feed dog, which is held in the right hand as in Fig. 6, engages the notches cut in the edge of the rough cam and the pull of the weight on the dog applies sufficient pressure to the work to keep the saw blade engaged. As the cut progresses, the operator shifts the dog from one notch to the next until the cut has been completed. On the job illustrated in Fig. 6 it will be necessary to stop the feed and the machine at one or two points along the length of the cut and shift the guide lever to avoid having it interfere with the progress of the cut. With this arrangement, it is possible to cut a variety of curved shapes from metal sheets and plates.



Above, special jig for cutting circle segments of varying radii. Below, detail of segment-cutting jig

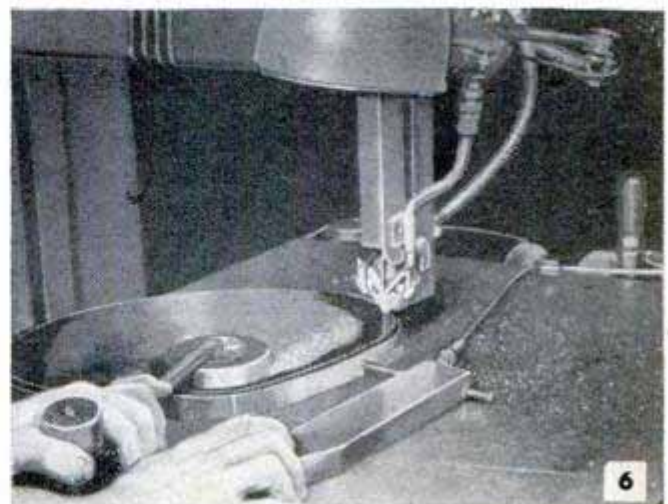
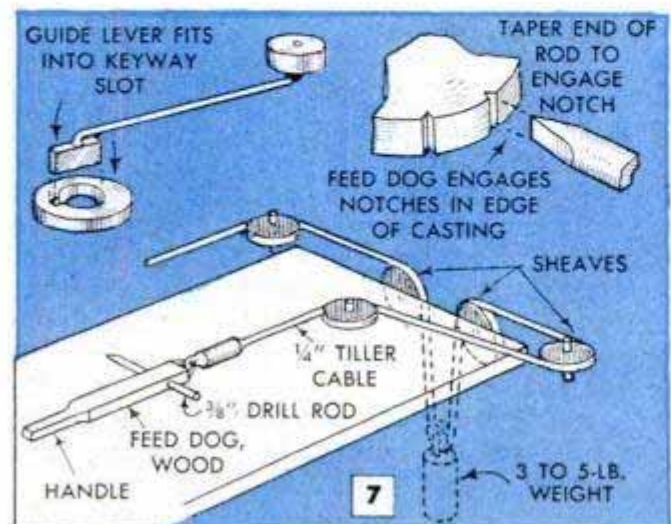
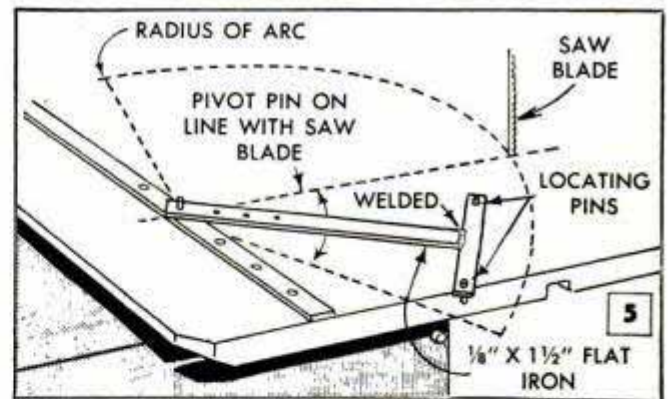

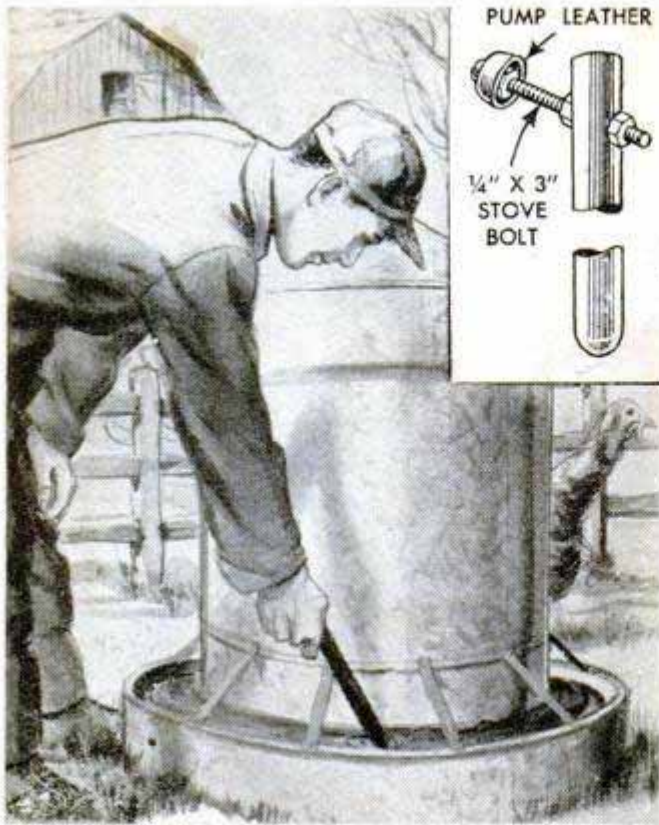

Stopper in Poultry-Fount Outlet Fitted With Wooden Handle

When refilling large poultry founts, one turkey rancher uses a novel stopper on a wooden handle to plug the fountain outlet. In this way, he does not have to plunge his hands into the icy water to stop the hole. A piece of broomstick, about 10 in. long, forms the handle and this is drilled at an angle near one end to take a 3-in. bolt. A pump leather or rubber stopper large enough to close the hole in the fount is fastened at the head of the bolt. Then the bolt is passed through the handle and tightened in place with a nut on each side of the broomstick.—A. E. Holden, Angola, Ind.

Cross-Bracing Supports Gatepost



As most gateposts are braced in line with the gate to support the weight of the latter while it is closed, they have a tendency to sag when a heavy gate is swung open. This can be corrected by mounting a sturdy diagonal brace to each side of the hinge post as shown in the drawing. The braces should be located so the gate can be opened fully. However, when they are used, the gate cannot be swung back flush with the fence.

W. R. Black, Contact, Nev.

Chickens Prevented From Roosting On Poultry-House Windows

Chickens are kept from roosting on poultry-house windows of the ventilating type if strips of hardware cloth are used to form sloping screens over the tops of the windows. When covered with a screen in this way, the sash can be left open for ventilation. Bending the screens down at the ends prevents entrance of preying animals.



Rubber-Covered Valve Stem Provides Useful Garage Tool

Cutting the valve from an old inner tube provides a handy tool for deflating tires and removing valve cores for replacement. Leave the rubber around the stem intact and screw a notched-type valve cap to the end. The rubber serves as a convenient handle and the tool is not as likely to get lost as a lone cap. Lyle Brands, Falconer, N. Y.

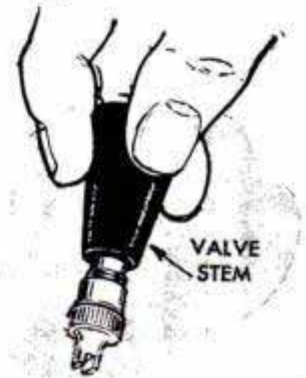

Old File Forms Handy Extractor For Broken Bolts and Screws

By means of an extractor made from an old three-cornered file, bolts and screws can be removed easily even though their heads have been broken off. First, grind the blade of the file to sharpen the corners and tip. Then, slip a nut over the file tang and braze it to the top of the blade. A short length of 1/2-in. pipe is then brazed to the nut to form a handle. To use, drill a hole in the center of the part to be removed. Place the tip of the extractor blade in the hole and tap the handle so the corners of the blade grip the metal. Finally, clamp a wrench over the nut and turn the extractor to back-out the broken part.

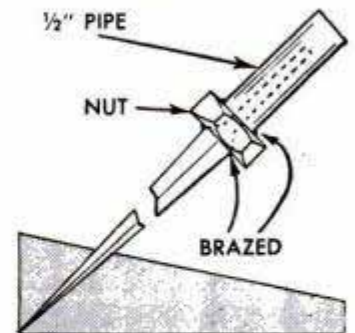

R. E. Dow, Conway, Ark.

Electronic Secretary

MANY important telephone calls go unanswered in offices every day. This would not happen if you had an electronic secretary on the job. Briefly, this is what would take place if you called an office equipped with one of the Zimmerman electronic secretaries illustrated. A voice at the other end would answer something like this: "Yes, this is the Soapy Box Top Company. You are listening to a recorded message. Mr. Smith is out right now but if you wish to leave a message you have exactly 30 seconds to do so." Then you give your name, leave a message, telephone number or order, and hang up. When Mr. Smith returns to his desk he simply flips a switch, and this robot electronic secretary repeats the message.

The inventor, Mr. Joseph Zimmerman, is shown with one of his early models in photo A. Photos B and C are external and interior views of the present compact unit now being manufactured. The device operates entirely without wired connections to any telephone equipment. It consists of a standard wire recorder and record player, a small desk box on which the telephone is placed, a weighted "lifting box" to put on the receiver hook in place of the receiver, and a series of sensitive relays and automatic switches. For operation, you merely take the receiver off the hook and replace it with the lifting box. This holds the receiver buttons down and, when the phone rings, the vibrations are picked up and amplified with vacuum tubes to a point where they operate a sensitive relay. This relay in turn operates others, the lifting box goes into action, starts the automatic turntable and gives the caller the prerecorded message. When the message runs out, the wire recorder takes over for the reply. At the end of 30 seconds, the "canned" message cuts in again with a warning: "Your time is up. If you need more, please call this number again. Thank you."

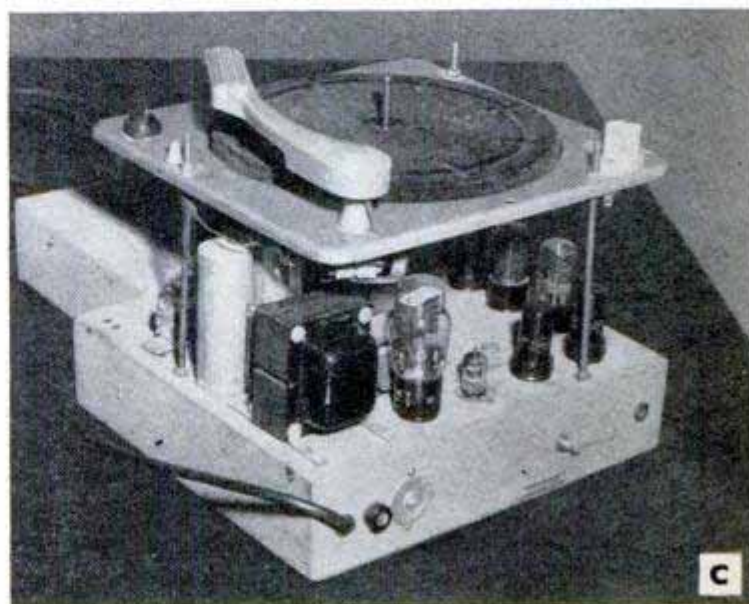

AMPLIFIER FOR 45 R.P.M. RECORD

By Joseph Vanella

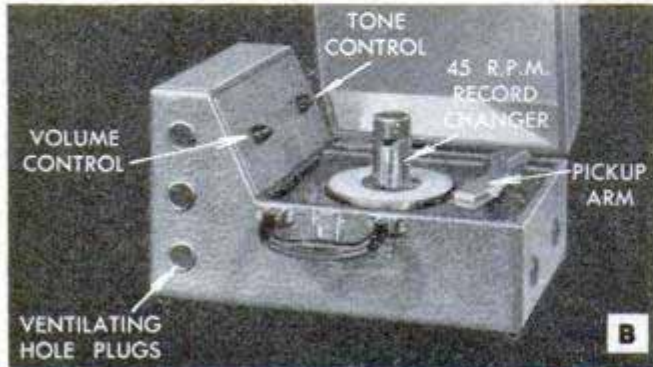

PERHAPS the most interesting recent event in the field of recorded music was the introduction of the 45 R.P.M. record changer and the colorful RCA 7-in. plastic disks especially designed for it in seven shades according to music types. These small records play up to $5\frac{1}{2}$ minutes, which is equal to the longest playing time of the conventional 12-in. disk.

The unit plays from eight to ten records at one loading and provides 50 minutes of music without attention, or a full hour and 40 minutes with one turnover of the records. Students and experimenters can purchase the record-changer mechanism, developed by RCA and built by licensed manufacturers, from radio-parts houses for about \$15. The changer unit is easily connected to a

portable amplifier or the audio stages of a receiver. The base plate of the Crescent Industries model C6-A1 as illustrated in this article is only $7\frac{1}{8}$ x $10\frac{1}{8}$ in. The over-all height is

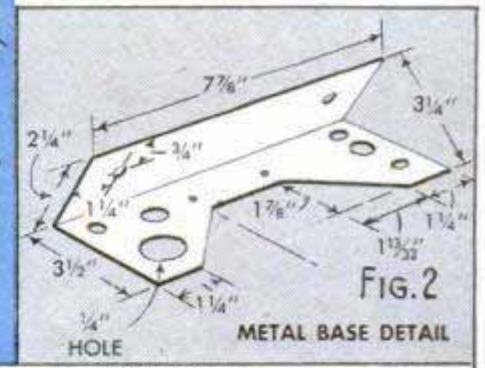
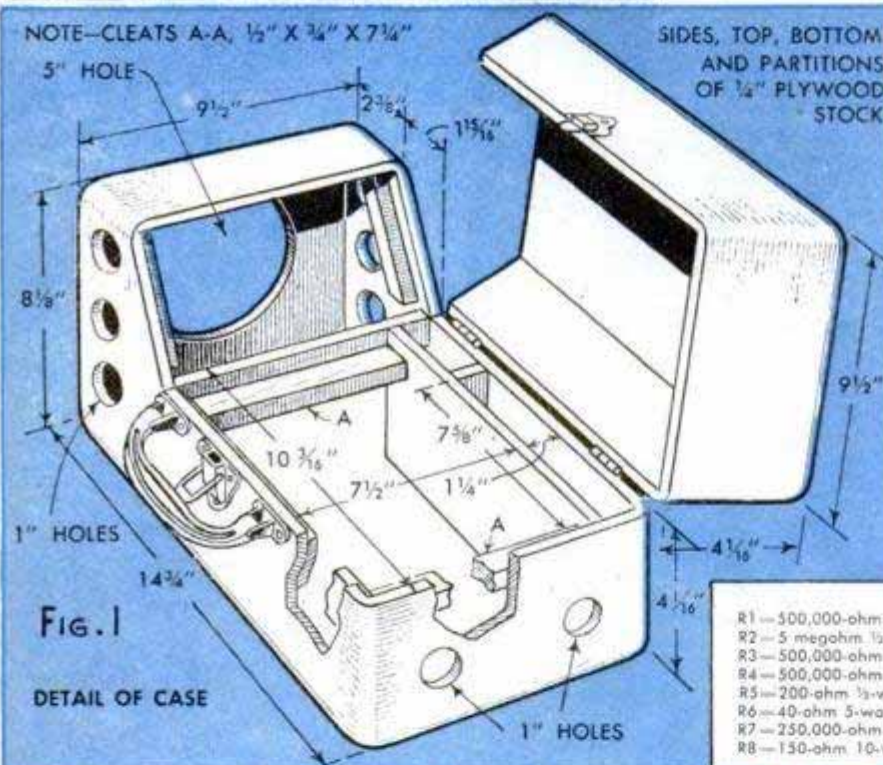

- RESISTORS**
- R1—500,000-ohm midget volume control, audio taper, with s.p.s.t. switch
 - R2—5 megohm $\frac{1}{2}$ -watt carbon
 - R3—500,000-ohm midget tone control, audio taper, with s.p.s.t. switch
 - R4—500,000-ohm $\frac{1}{2}$ -watt carbon
 - R5—200-ohm $\frac{1}{2}$ -watt carbon
 - R6—40-ohm 5-watt wire-wound, or carbon
 - R7—250,000-ohm $\frac{1}{2}$ -watt carbon
 - R8—150-ohm 10-watt wire-wound type

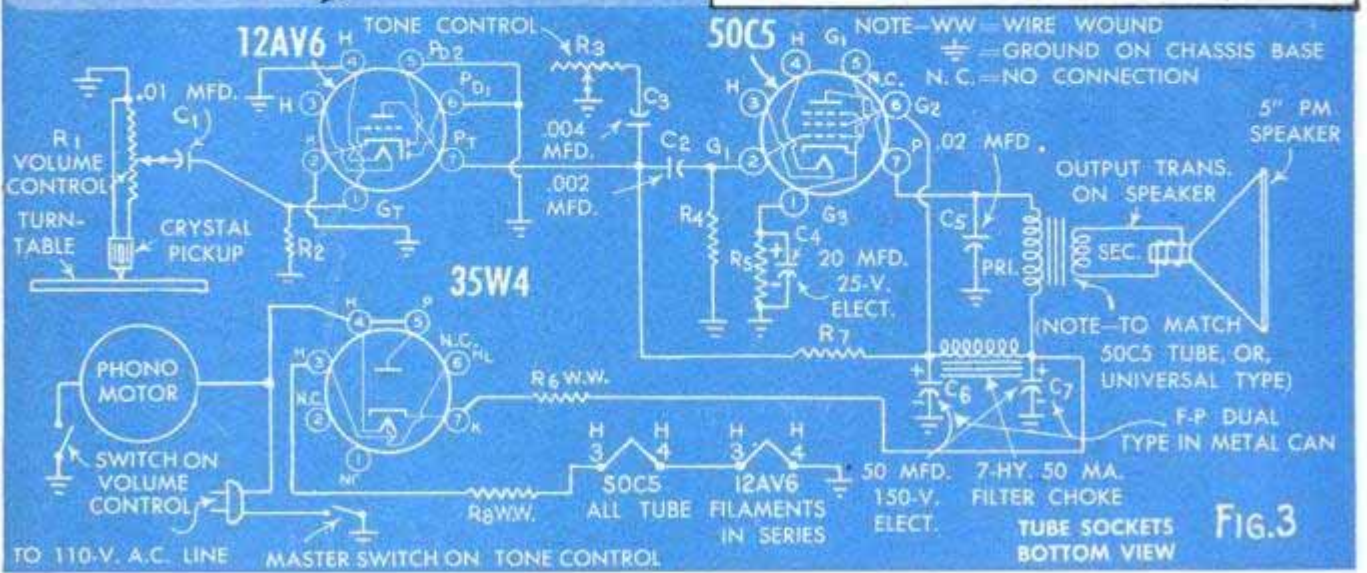

CHANGER IN PORTABLE CASE

6 $\frac{3}{4}$ in. The drop mechanism of the changer is contained in a 1 $\frac{1}{2}$ -in.-dia. spindle and no posts or clamps are used to grip the records. Cutaway drawings, Figs. 5 and 6, show this mechanism, which is claimed to be trouble-free. The records are changed quietly and the fast change cycle lasts only about two seconds.

Owing to its compact design, it is ideal for portable use in a cabinet of the type shown in photos A and B. This also houses the special highly efficient, midget audio amplifier to be described. The cabinet may be built of plywood and covered with imitation leather, as detailed in Fig. 1, or installed in a similar commercial cabinet. The record

(Continued to page 234)



C

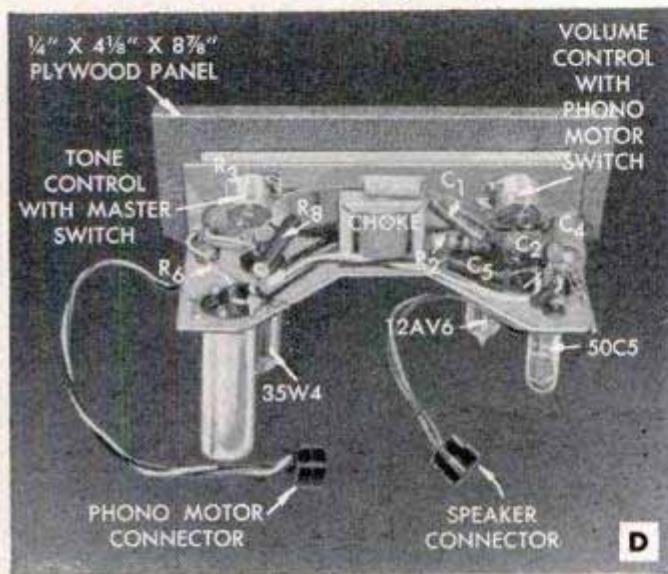

D

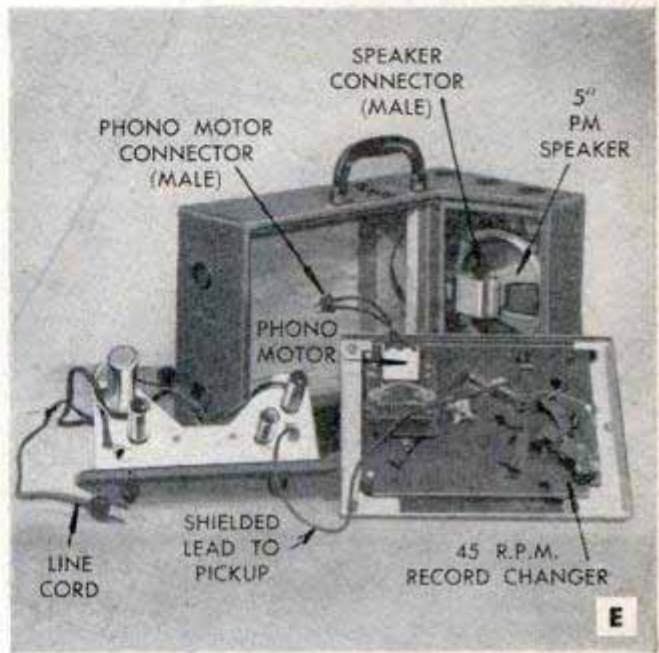

E

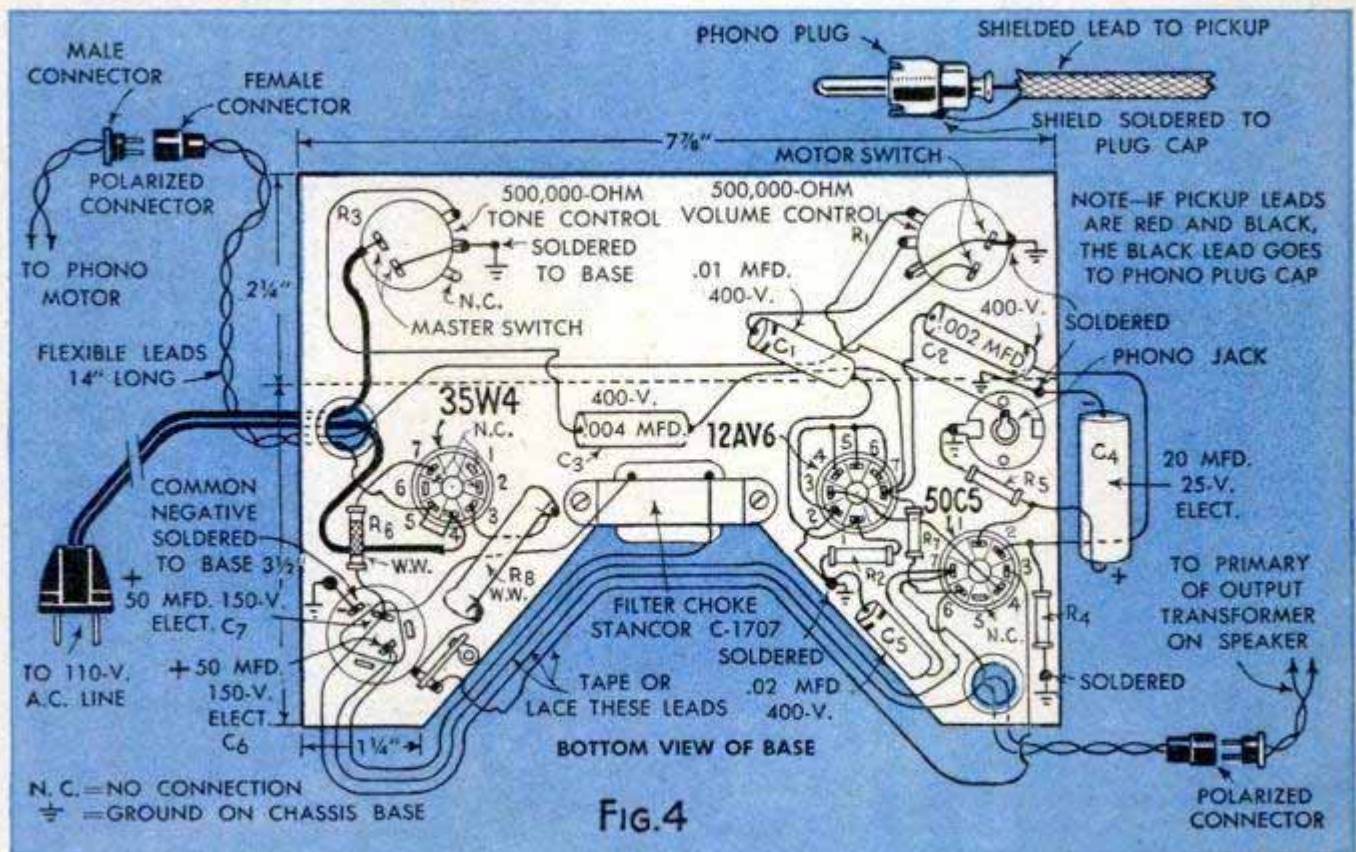

FIG. 4

Modulation Monitor for Radio Hams, Police and Marine Radiophone Use

EVERY operator of a radiotelephone appreciates the importance of checking modulation in order to obtain maximum efficiency from the transmitter, and to avoid causing unnecessary interference. There are several methods for doing this but usually they are not as efficient as they should be. The Triplett 3296 modulation monitor illustrated is of special interest to the discriminating radio amateur as it will continuously monitor the carrier level, percentage of modulation, modulation peaks and also provide for monitoring of the audio component by means of headphones.

The peak indicator may be preset for any percent of modulation from 20-120, and will provide instantaneous flash when the predetermined modulation level is reached. A rear view of the chassis is shown in photo A; the circuit diagram appears in Fig. 1. The unit is housed in a metal case; the overall dimensions are 8 x 9 x 15½ in. Referring to the front view, photo B, the left-hand meter keeps a constant check on the level of the transmitted carrier. This is accomplished by coupling a small amount of the R.F. voltage from the transmitter to the tuned input coil, rectifying this R.F. voltage by the first 6H6 diode tube, and passing this through the d.c. milliammeter. A switch is employed to permit reading of either the positive or negative side of the carrier. Since the input circuit is tuned to the transmitter frequency, any change is noted by a decrease in the carrier-level-meter reading.

To measure the percentage of modulation, two separate indicators and circuits are used. One indicator is the right-hand meter which measures the actual percentage of modulation. The other modulation indicator is the light located near the top center of the panel. When the large center knob is set for the desired percentage modulation, the lamp will light when that percentage of modulation is reached in the transmitter, thus permitting control of the transmitter to maintain any desired percentage of modulation. This is done by taking the output of the first 6H6 and passing through a 6SJ7 amplifier. The output of the 6SJ7 is impressed on the grid of a 2050 Thyatron tube which operates as a relay to trigger the flash lamp, giving instantaneous flashes without lag. Audio monitoring of the signal is also obtained in the 6SJ7 amplifier output.

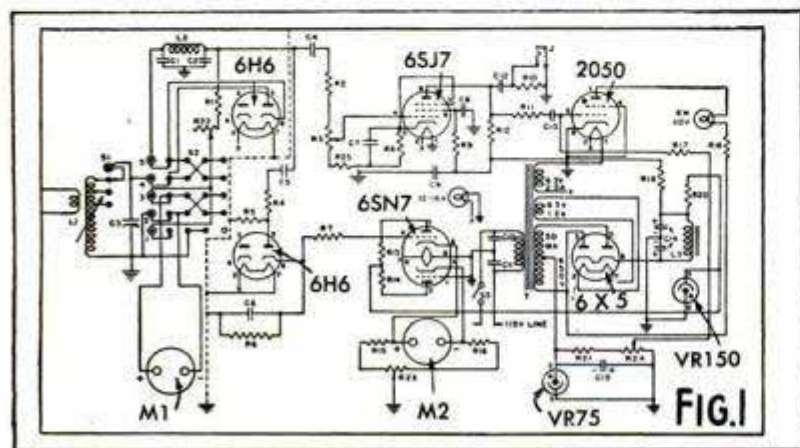
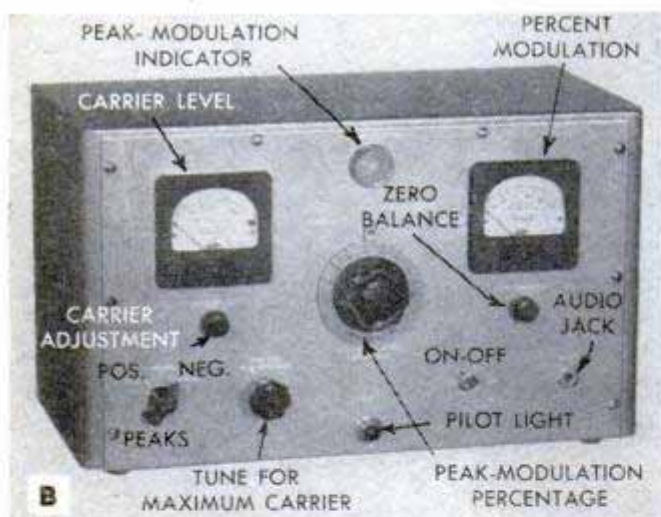
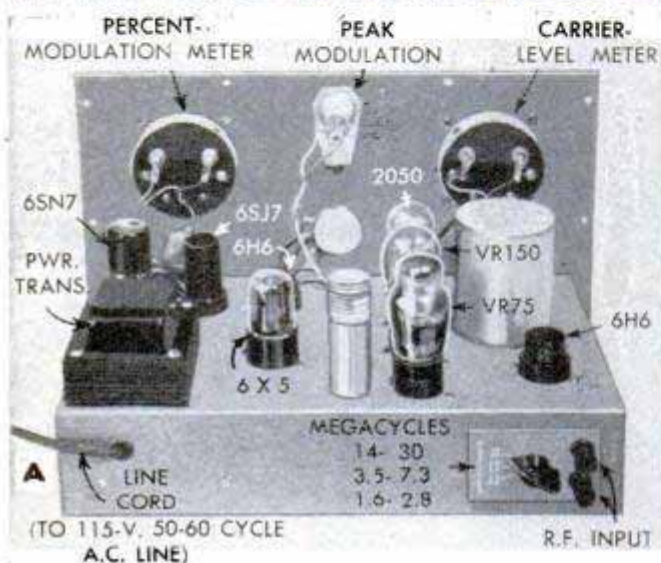



Kodak Duaflex Camera—Three stops: $f/8$, $f/11$, $f/16$. Double-exposure prevention. \$19.85. With fixed-focus Kodet Lens, \$12.75. Flashholder, \$3.33.



Kodak Flash Bantam $f/4.5$ Camera—Fast $f/4.5$ Lumenized lens. $1/200$ shutter synchronized for "flash." Automatic film stop. \$49.50. Flashholder, \$11.08.



Kodak Tourist $f/4.5$ Camera
New $1/800$ shutter, \$95. With $f/4.5$ lens, $1/200$ shutter, \$71. With $f/6.3$ lens, \$47.50; $f/8.8$ lens, \$38.50; Kodet Lens, \$24.50. Flashholder, \$11.08.

*More than ever,
a Kodak Camera
is the "wanted" gift*

... Because nowadays even the simplest Kodak cameras make beautiful full-color pictures as well as black-and-white. At your Kodak dealer's...

Eastman Kodak Company,
Rochester 4, N. Y.



Kodak Reflex II Camera—Kodak Ektalite Field Lens boosts image brightness $2\frac{1}{2}$ times. $F/3.5$ Lumenized lenses, $1/300$ shutter, film stop. Negatives, $2\frac{1}{4} \times 2\frac{1}{4}$. With case, \$155. Flashholder, \$11.08.

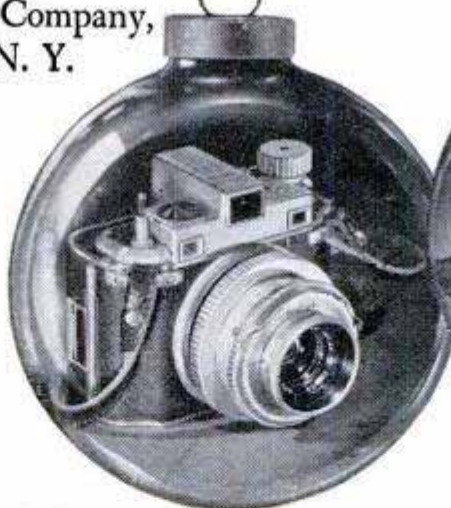

Kodak Medalist II Camera
Finest lens in the $2\frac{1}{4} \times 3\frac{1}{4}$ field—Kodak Ektar $f/3.5$. $1/400$ shutter, coupled range finder, automatic film stop, depth-of-field scale. \$312.50. Flashholder, \$11.08.



Kodak 35 Camera with Range Finder—For miniature Kodachrome photography. $1/200$ shutter, automatic film advance. \$86.75. Flashholder, \$11.08.

**Prices include
Federal Tax**

Kodak
TRADE-MARK

Amplifier for 45 R.P.M. Record Changer in Portable Case

(Continued from page 231)

changer requires only a 3½-in. space above the base plate and 3¼ in. below. The cabinet shown is designed to house the amplifier on a metal chassis supported on the back of the plywood control panel. This chassis base is detailed in Fig. 2. The cutout section allows clearance for the 5-in. PM

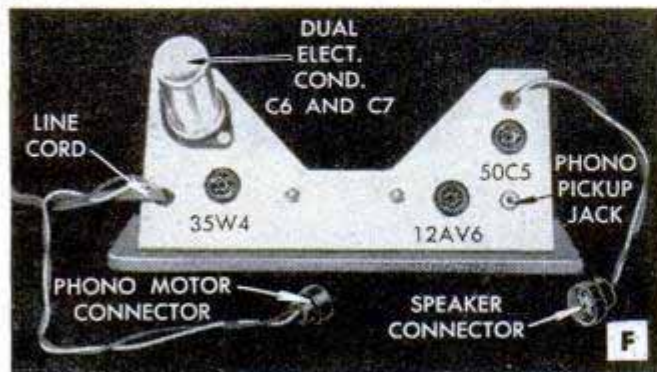

loudspeaker. Good ventilation is provided for by means of ventilating hole plugs and these should not be omitted. These plugs have a fine wire screen inset in a ring with spring flanges, and are to be found in radio-parts catalogues. The loudspeaker hole also should be backed with wire screen to protect the speaker cone.

Before starting construction of the amplifier or portable case, it is a good idea to study the various diagrams and photos carefully. Photo A shows the completed unit in the case ready for carrying; in photo B, the lid is raised to show the controls. The lid is conveniently detachable as indicated in photo C; this photo also illustrates the method of stacking the records.

The schematic circuit diagram for the amplifier appears in Fig. 3, and a pictorial wiring diagram is shown in Fig. 4. This pictorial diagram is a detailed underside view of the amplifier chassis shown in photo D, and the chassis base has been flattened out to show each part clearly. Top views of this base appear in photos E and F. A polarized connector is employed to connect the record-changer motor to the line supply; a similar plug and socket connects the output of the audio amplifier to the primary of the output transformer which is mounted on the speaker. With this arrangement, it is a simple matter to remove the amplifier chassis and the record changer from the case without having to unsolder any connections. A type 12AV6 duodiode miniature tube is used in the input stage of the amplifier, and a new type 50C5 miniature pentode tube is employed

(Continued to page 236)

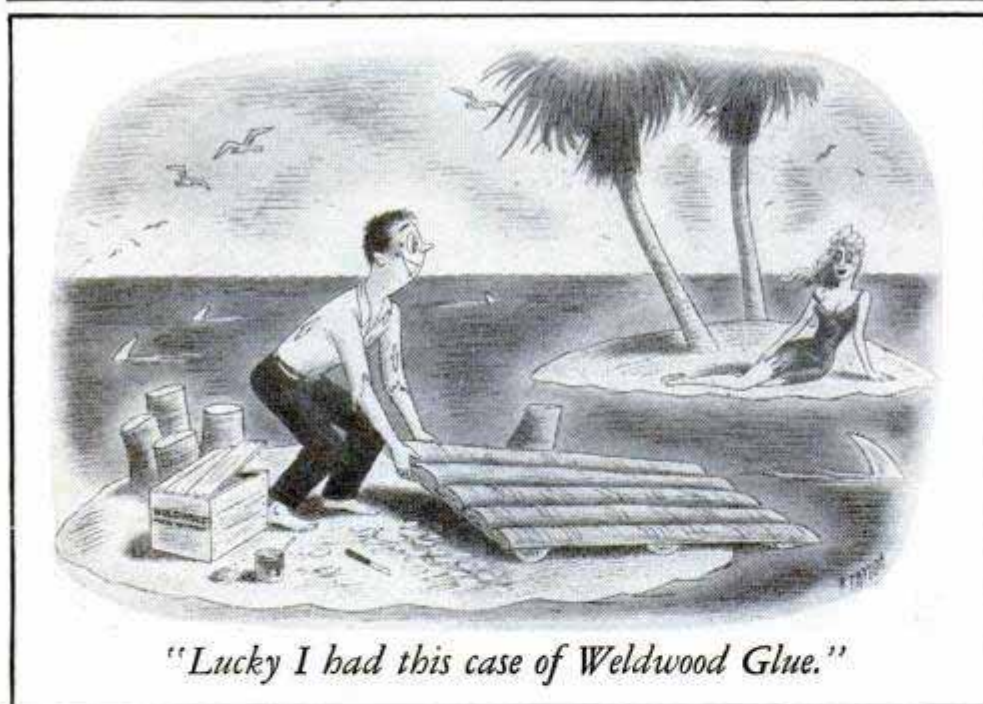

Remember Weldwood Glue when you need dependable wood-to-wood bonds. Quick and easy to mix with cold water . . . tremendously strong . . . stain-free . . . rot-proof . . . and permanent. At paint, hardware, variety stores and lumber yards. 15¢, 35¢, 65¢, 95¢ and larger sizes.

WELDWOOD PLASTIC RESIN GLUE
United States Plywood Corporation, New York 18, N. Y.

ALSO HANDY FOR WOOD HOBBYISTS!



Firzite

— to give you smooth finishes on fir plywood and other soft woods.

A pre-finishing material that seals the wood pores . . . tames the wild grain . . . virtually eliminates checking and grain raising. An excellent base for stain, paint or enamel. White or clear. White Firzite provides an easy, low-cost way to achieve "blond," "bleached" or "wiped" finishes.



Satinlac

— to preserve the beauty of all woods.

An inexpensive coating for the proper finishing of Weldwood Hardwood Plywood and similar woods. Clear. No brush marks. Brings out all the natural beauty of wood. Does not yellow or darken with age.

FIRZITE and SATINLAC are available from paint, hardware and lumber dealers. Write for leaflet No. 1 on finishing plywood.

Your Choice

WITH SHOPMASTER A \$100 SHOPMASTER BUDGET SHOP to a \$600 DE LUXE SHOP



DRILL PRESS

SABER SAW

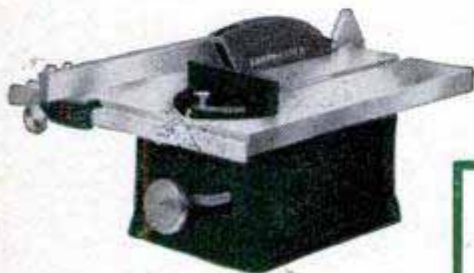

7" TILTING ARBOR SAW



1

SHOPMASTER
COMBINATION
BUDGET SHOP

These Three
Independent Tools
Approximately

\$100
PLUS MOTORS

37 DIFFERENT OPERATIONS are possible with this Shopmaster Budget Shop. It only takes 2 ft. by 3 ft. of space. Other tools may be substituted to fit your needs, or you can BUILD this Budget Shop to a DeLuxe Shop.

Send this coupon for your free copy of SHOPMASTER'S Shop Layouts, full color catalog and price list.

Today

52 operations possible with this SHOPMASTER Standard Shop. Five tools for flexibility and for all types of work.

2

SHOPMASTER
COMBINATION
STANDARD SHOP



4" JOINTER



10" LATHE

- Saber Saw
- 10" Lathe
- 4" Jointer
- Drill Press
- 7" Tilting Arbor Saw

This compact shop will fit in a small space and only costs approximately

\$180
plus motors

3

SHOPMASTER
DELUXE SHOP

Nine tools for every type of work, a complete shop. Truly a DeLuxe Woodworking Shop.

- 6" Jointer
- 12" Drill Press
- Saber Saw
- 10" Lathe
- 15" Jig Saw
- 12" Band Saw
- Spindle Shaper
- 8" Tilting Arbor Saw
- Belt and Disc Sander

All with stands and priced just under

\$600
plus motors

SHOPMASTER, INC.
1214 SOUTH THIRD ST.
MINNEAPOLIS 15, MINNESOTA



SHOPMASTER INC.
MINNEAPOLIS, MINN.

See your SHOPMASTER Dealer

Please send me the literature listed.

NAME _____

ADDRESS _____

CITY _____ ZONE _____ STATE _____



YES, if you're not getting anywhere with hints that you'd like somebody to give you one of these handsome kits of Nicholson X.F. Swiss Pattern Round Handle Needle Files for Christmas, don't wait—give yourself the treat.

"X.F.," meaning "Extra Fine," is the mark of the very highest achievement of the file-maker's art. In a beautiful orange-and-blue plastic box with bottom stand are twelve fascinating file shapes (no two alike) applicable to most every possible use in model building, clock repairing, small die making, delicate instrument fabrication, etc. They're the pride of the hobbyist and precision craftsman, and come in over-all 4", 5½" and 6¼" lengths; in cuts Nos. 0, 2, 4 and 6. At good hardware stores.

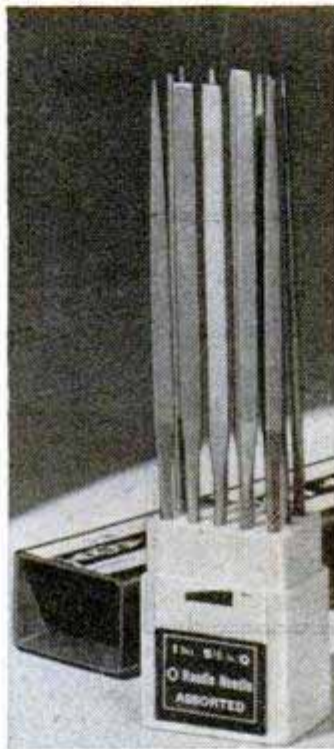

ROTARY FILES and BURS, too, are tops for trueness, sharpness and long-lasting quality when bearing the Nicholson trade-mark. Made of high-speed steel, with files hand-cut and burs machine-ground from solid. Favorite assortments are: **ROTAKIT No. 40**—5 files and 5 burs with ¼" shank; and **ROTASET No. 88** (illustrated)—18 burs with ⅜" shank.



NICHOLSON FILE CO.
22 Acorn Street
Providence 1, R. I.
(In Canada, Port Hope, Ont.)



NICHOLSON
FILES FOR EVERY PURPOSE

in the output. The rectifier is a miniature 35W4 half-wave type. Wire the circuit carefully and check your wiring with both circuit diagrams. Use rosin-core wire solder and No. 18 or 20 hookup wire with push-back insulation. This excellent little amplifier includes volume and tone controls, and the output is sufficient for a large room. These midget controls include the s.p.s.t. switches; the master switch is on the tone

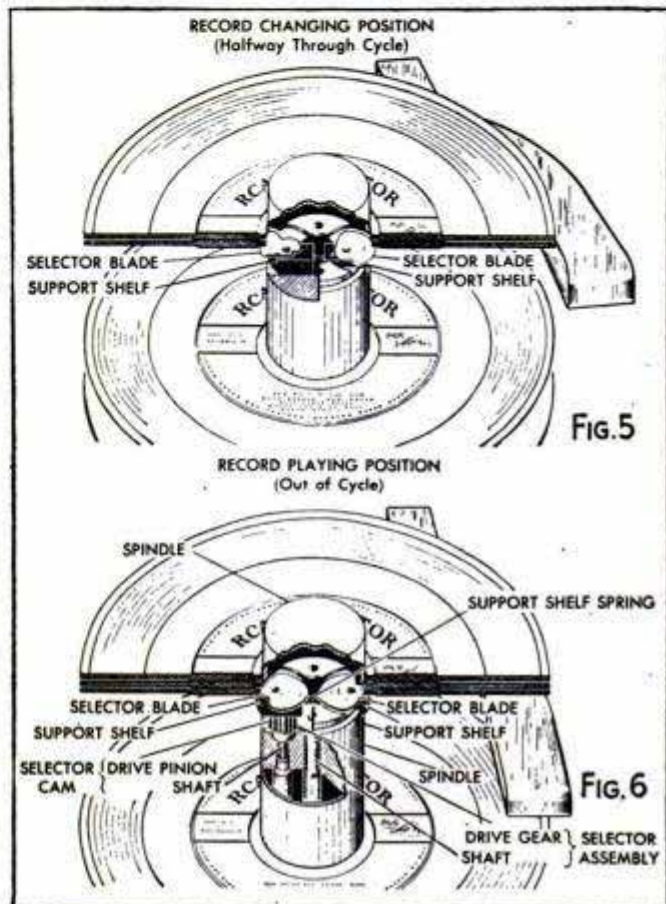

control. When operating the unit, this switch is turned on first to permit the amplifier to warm up. When the tubes have warmed up, turn on the volume control which also closes the motor switch. The volume control can then be advanced to the desired volume.

When stacking the records over the center post for automatic operation, place the desired selections upward, the last record to be played on top. Turn on the volume control and motor-drive switch; then push the "start-reject" knob on the changer plate to "start" and let go. The mechanism will then automatically play in sequence one side of each record stacked on the separator shelves. To reject a record being played push the "start-reject" knob to "reject." At conclusion of playing, and as the last record is being repeated, lift the tone arm and place it on the rest and turn off the motor switch. Detailed student material list R-384 is available from Popular Mechanics Radio and Electronics department upon receipt of ordinary letter postage.

PLYMOUTH the car that likes to be compared in big little details too!



Counterbalanced luggage lid lifts at finger touch, can't fall on your head

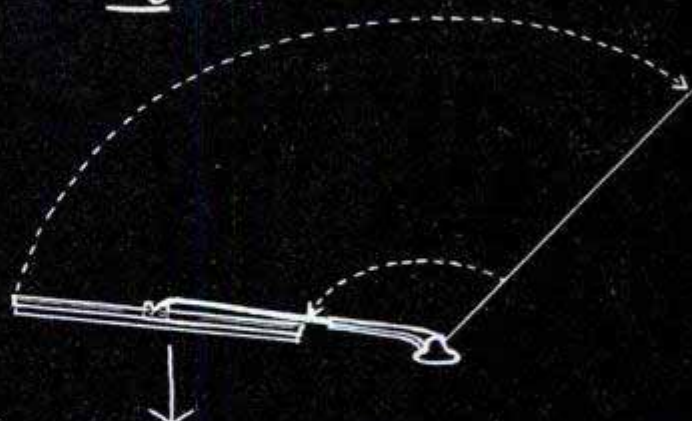

New wipers clean 61% more windshield area

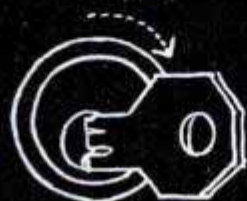

Just turn ignition key - engine starts

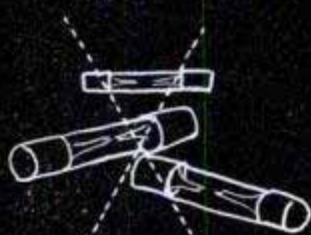

Circuit breaker protects against "shorts" no more fuses to replace

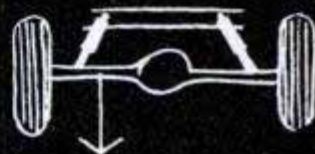

New diagonal mounting of rear shock absorbers softens ride both sideways and up & down



PLYMOUTH Division of CHRYSLER CORPORATION - Detroit 31, Michigan

Your nearby Plymouth dealer will be glad to point out the features of the new Plymouth and arrange a ride.

Tremendous trifles! Door locks that protect children riding in back. A special holder that keeps the jack from rattling while stored in the luggage compartment. A fuel filter in the gas tank that prevents clogging of the fuel line. Dozens of other thoughtful little features in your new Plymouth!

They're those big little details of engineering that overlay the solid value underneath.

They're proof, too, of the same

consideration for you that has gone into the major parts. Into the gliding softness of Plymouth's famous Air Pillow Ride. Into the greatly increased vision provided by the beautiful new body design. Into the lively power of 7 to 1 compression ratio. Into many advantages exclusive with Plymouth in the low-priced field.

But you be the judge! Visit your nearby Plymouth dealer. Compare all features of "all three." Drive Plymouth—and let the ride decide!

SELF-CONTROL STARTS HERE

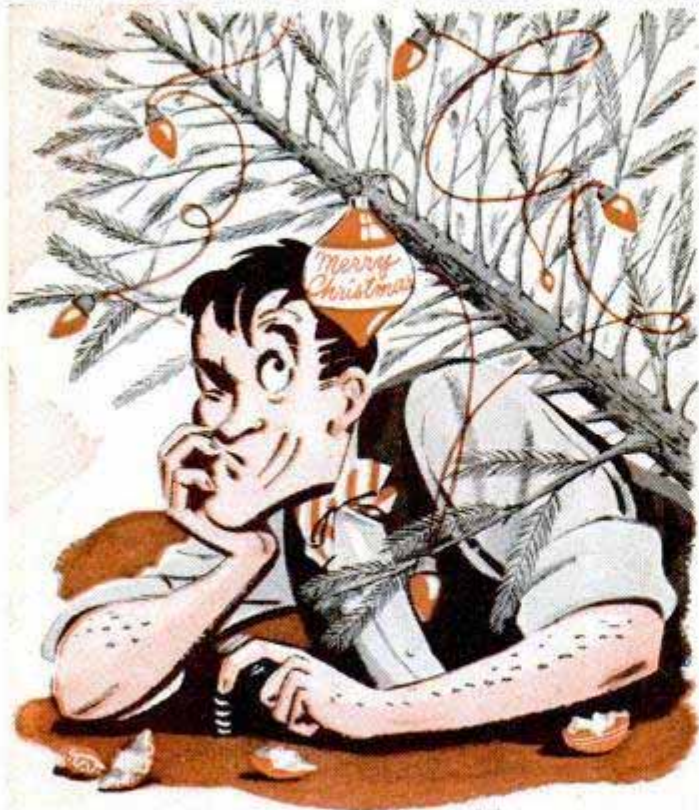

and to restore
ENGINE PERFORMANCE

OIL-CONTROL STARTS HERE

TO STOP OIL-PUMPING, REPLACE WORN
CONNECTING ROD BEARINGS

It's like being by-passed by Santa Claus when your car engine pumps oil and *performance goes up in smoke!* Check for worn connecting rod and main bearings, first cause of oil-pumping. To restore power, pep, economy—replace with Federal-Mogul Oil-Control Bearings.

*They're engineered
for the job!*

FEDERAL-MOGUL SERVICE

(Division of Federal-Mogul Corporation)
DETROIT 13, MICHIGAN



CONTROL OIL-PUMPING
WHERE IT STARTS—REPLACE WITH

FEDERAL-MOGUL

OIL CONTROL BEARINGS

1899 • FIFTY YEARS OF CONTINUOUS BEARING EXPERIENCE • 1949

Calendars With Wings

(Continued from page 101)

projector, the film loop runs through again and again while he watches the action. After he has studied the movement hundreds of times, he knows exactly what happens to each bird at any given moment, and can stop that bird in flight on the canvas. He knows wild fowl so well he can change a mallard on the film to a pintail on his easel.

It is this feeling of motion, derived from his movies, which makes Bishop's art work come alive. Gazing at a Bishop painting, you can feel the marsh wind on your cheek, see the lift of the wings, the splash of water and the power of the bird.

The artist has spent weeks in the field with Edgar M. Queeny, famous sportsman, photographing wild fowl. The men frequently compare their sequences. They know now exactly how a bird flies.

Many of the sequences prove beyond doubt that all surface-feeding ducks fly straight up and out of the water. Sportsmen and bird authorities have been misled for centuries into believing that ducks leap into the air and then start their flight. Actually, the duck carefully unfolds its wings, lays them on the water and then with a mighty downthrust drives itself straight up and clear of the surface. Then, so fast the eye can't see the movement, the bird makes a recovery stroke, thrusts down again, this time on the air, and becomes completely airborne.

Not so the sea and diving ducks. Like overweight planes, these birds must run rapidly along the surface, flapping their wings until finally they build up enough speed to become airborne.

Performing the same function as the rudder and stabilizer of an airplane, the bird's tail helps determine the direction of flight. Bishop says the tail is made of 16 to 20 short flight feathers embedded in a base which contains more than 1000 tiny muscles to control them.

He claims that his movies prove ducks and geese can perform any stunt accomplished by an aviator. He has pictures of ducks flying backward, upside down, standing still in the air like a helicopter and looping the loop. One picture shows a baldpate coming in for a landing when suddenly it encounters a reverse air current and tumbles into the water with a tremendous and embarrassing splash.

Mallards, when they are frightened during a getaway, speed their wingbeat up to 10 or 12 times a second, but throttle down to 8 when cruising. Through Bishop's

(Continued to page 244)

Take the Thrill-road to Good times!

RIDE A NEW 1950

HARLEY-DAVIDSON

HYDRA-GLIDE



RIDE THE "CHAMP"!

You've got a *new* thrill coming! A touch of the throttle and you're off like a comet! Hills melt away like magic! Rough roads fly beneath you with hardly a quiver of the handlebars. Steering is feather light. Braking is smooth and sure. Day-long riding leaves you fresh and ready for more fun as you take in exciting races, hillclimbs, delightful gypsy tours and club events. Easy payment terms bring you this finest Harley-Davidson of all time. See your Harley-Davidson dealer today. Mail the coupon now!

HARLEY-DAVIDSON MOTOR CO., Dept. P, Milwaukee 1, Wisconsin

Send for *free* copy of ENTHUSIAST Magazine filled with motorcycle action pictures and stories; also literature on new 1950 models.

Name.....

Address.....

City..... State.....

DEALERS: Valuable franchises available for the full line of famous Big Twins and 125 Model. Your opportunity to line up with the greatest name in motorcycles. Write or wire today.

MILLERS FALLS TOOLS

for a Merry Christmas



Square



Bit Brace



Smooth Plane



Hack Saw Frame



Carving Tool Set



Screw Driver Set



Automatic Drill



Spiral Screw Driver

Hand Drill



Block Plane



Torpedo Level



You'll surprise and delight any man or boy when you give him Millers Falls Tools — practical, handsome and appreciated gifts. Offered in Christmas boxes, they're all essential, dependable tools for shop or home. Best of all, their price is modest, their quality the very highest. See them in your hardware dealer's special Christmas display.

Millers Falls Co., Greenfield, Mass.

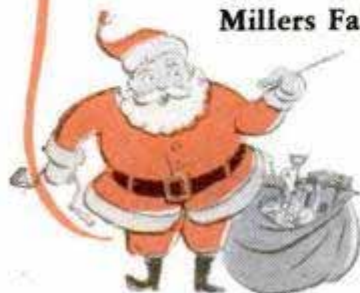

A lifetime gift for every man

Clinic



for Homemakers

As a service to our readers in solving the hundreds of problems pertaining to a home—inside or out—the editors of *Popular Mechanics* invite you to present your problems to The Clinic Editor for help and advice. Address your questions to The Clinic Editor, *Popular Mechanics Magazine*, 200 East Ontario Street, Chicago 11, Ill.

Leveling Cracked Plaster

Q—The plaster on walls and ceilings of two rooms in my home is quite badly cracked and uneven in places as a result of the plaster being raised on one side of the larger cracks. I cannot paper over the walls or ceilings because of the poor condition of the surface. What do you think is best to do, re-plaster, or try leveling the old plaster? How does one level plaster in this condition?

C. A., Coffeyville, Kans.

A—Of course, replastering both walls and ceilings is the best and surest repair. You do not state what kind of lath is under the plaster or whether the building is old or comparatively new. The question, however, is whether it would pay to expend the hand labor necessary to level the ridged and broken plaster. In any case, all loose plaster must be removed and the areas patch-plastered. A portable electric disk sander could be used to level the ridges, but this would be a dusty, disagreeable job. The principal objection to this procedure is that in some cases it will be necessary to reduce the thickness of the plaster to such an extent that it may break up, or the brown coat will be exposed over a considerable area. If the offsets at the cracks are only slight (1/16 in. or less), then it is practical to level the ridges by hand-sanding with medium-grit sandpaper. Brush out all the loose material and fill the cracks with a crack filler made especially for this purpose. Then size walls and ceilings before hanging wallpaper.

Wall Condensation

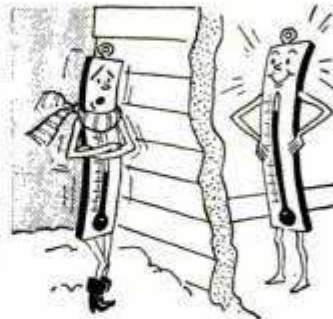

Q—Will you explain wall condensation and how it became a serious problem in ordinary house construction? What is the cause, that is, what actually happens between the inner and outer walls, and how does one prevent it, if that is possible? W.F., Indianapolis, Ind.

A—Space does not permit an extended discussion of this problem, but perhaps a basic cause of wall condensation can be outlined briefly. Because of what is known as vapor pressure, air containing moisture escapes through the walls and ceilings of the house when the outside temperature is lower than that inside the building. At the same time, heat loss through an uninsulated wall tends to prevent a lowering of the temperature within the wall to the condensation point. For this reason,

(Continued to page 242)

More Americans buy **CRAFTSMAN** Power Tools than any other brand! To be **FIRST** . . . they've **GOT** to be good!

Let these 3 handy tools **PROVE** to you that **CRAFTSMAN** gives you **MORE** for your money!

CRAFTSMAN Deluxe Rotary Electric Tool

It's actually a whole shop-full of tools-in-one!

GRINDS SHARPENS DRILLS SAWS	CUTS CARVES ENGRAVES ETCHES	ROUTS SANDS POLISHES BUFFS	BRUSHES CLEANS and many other uses!
--	--	---	--

Amazingly useful for hobbyists, industrial shop-work, etc.! A perfect Christmas gift! Powerful, 18,000 R.P.M. motor for 110-120-volt, 25-60 cycle, A.C.-D.C. 1000-volt tested! Entire tool Underwriters' Labs. approved! Front ball bearing; self-aligning rear bronze bearing. Built-in condenser reduces radio static. On-off switch; removable pistol grip. Accurate chuck and 2 collet inserts, 3/32 and 1/8-in. capacity. 5 1/2-ft. rubber-covered cord; plug. Tool 7 in. long. 52-pc. set (mounted wheels, saws, cutters, drills, polishing wheels, etc.), in sturdy case.



52-PC. SET
COMPLETE IN CASE
ONLY **\$18.50**
\$2.00 Down **Cash**

For
**WOOD, METALS,
GLASS, PLASTICS,
LEATHER, ETC.**



ONLY
\$10.95

Complete with 10
sanding sheets and
polishing pads

CRAFTSMAN Electric Sander-Polisher

Hundreds of uses! No tiresome rubbing or pressing!



Polish cars easily!



No pressing needed!



Adjustable stroke!

Handy; easy to use! Weight of tool does work! A finishing sander only, for polishing cars, furniture, woodwork, silverware, even shoes! Sands furniture, walls, woodwork, shop projects. Wonderful for body massage, too! Heavy duty magnetic power unit. 14,400 strokes per minute. Die-cast housing; bakelite handle. Size, 5 1/2 x 2 3/4 x 4 1/2-in. For 110-120-volt, 60 cycle A. C. only. With 8-ft. cord; plug; 10 sanding sheets; lambswool and velour polishing pads.

CRAFTSMAN Magnetic Jig Saw

No motor or belt needed! Sturdy...not a toy!

A perfect gift for any man or boy . . . for hobby-minded women and girls, too! Not a toy, but a rugged, well-made power tool. Makes hundreds of things—such as models, puzzles, small furniture, picture frames, etc. Just plug it in—and saw! No motor to buy! No belt . . . no gears . . . no oiling! Power unit is enclosed in base. Use anywhere—even on kitchen table.

Blade gives super-smooth cut that needs no sanding. Short-stroke action makes saw so safe even small boys and girls may use it. Sturdy metal construction. Off-on switch. Rubber feet. 8 1/2 x 8-in. table; 10 1/2-in. high. Three 5-in. pin-end blades, 5 1/2-ft. cord, plug and instructions. For 110-120-volt, 60-cycle A. C. only. Underwriters' Labs. approved.

Look at its cutting capacity!

Wood up to 1/2-inch thick;
Plastics up to 3/8-inch thick;
Aluminum up to 3/32-inch thick;
Brass up to 1/16-inch thick;
Zinc up to 1/16-inch thick.

It's easy and inexpensive to make hundreds of useful things!



Furniture



Book Ends



ONLY **\$12.50**

Cuts to
Center
of
22-inch
circle

Jana
Name
Pins

See these **CRAFTSMAN** super-value Power Tools at your nearest Sears, Roebuck Retail Store **TODAY!**

CRAFTSMAN Hand and Power Tools by **SEARS, ROEBUCK and CO.**
Famous for fine quality . . . precision performance . . . low price!

Gifts for every purse and person

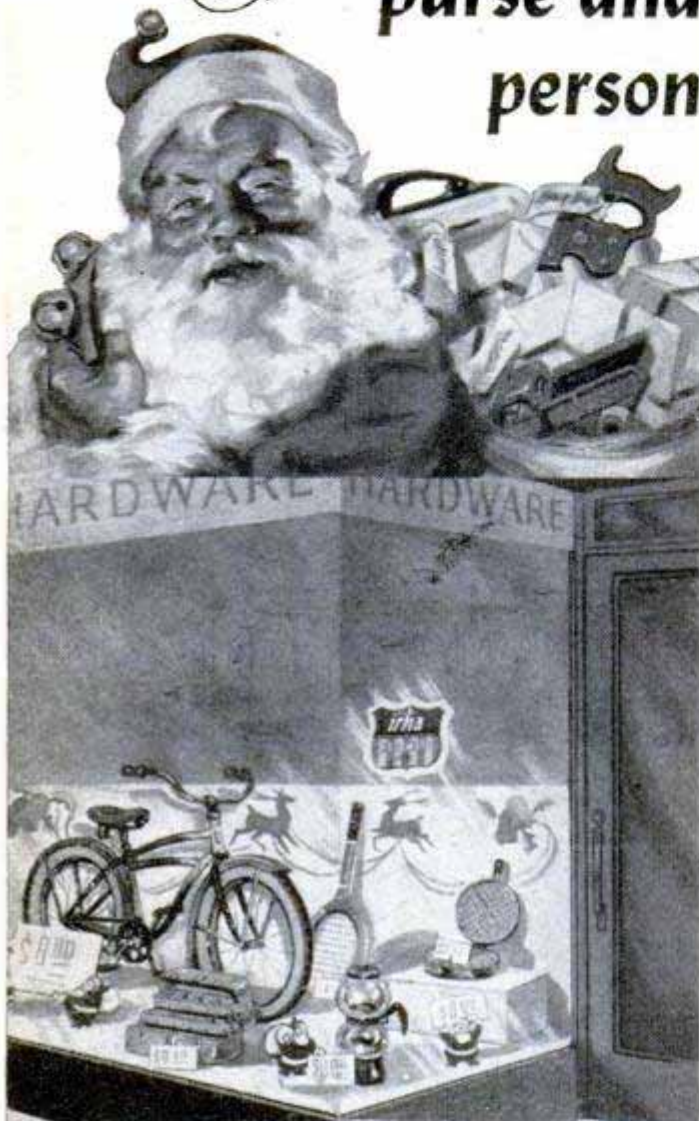

★ Wise Old Saint Nick knows *by long experience* just where to find the finest . . . Whether it's tools or sports equipment for Dad, an electric mixer, waffle iron or coffee maker for Mom, skates for Sister Jane or a bicycle for Brother Bob, Santa knows the *irha* emblem is a trustworthy guide.

Santa Claus has established a branch at your home town hardware store. There you'll find useful gifts for every member of the family—gifts that will out-live Christmas; gifts to be treasured for years.

And whether your holiday budget be small or large, your friendly hardwareman, with gifts for every purse and every person, will help you make this year's giving reflect the true spirit of Christmas.



This is the red, white and blue emblem of Personal Service displayed in stores of thousands of independent hardware retailers. It is a symbol of friendly service in keeping your needs supplied.

© 1948, 1949

NATIONAL RETAIL HARDWARE ASSOCIATION

such walls remain comparatively dry. Some years ago, when house walls were insulated with sawdust and other fine materials, the insulating properties of these materials greatly retarded, but did not entirely prevent, the passage of heated, moisture-laden air through the walls and ceilings. This slowing up of the process of air and heat transfer usually resulted in a gradual lowering of the temperature within the walls to a point where the water vapor in the air condensed, generally on the inner surface of the sheathing boards. At this point, the beads of moisture formed frost if the temperature was sufficiently low, or penetrated the sheathing and siding to the paint film if the temperature at the inner surface of the boards was above the point where frost would be formed or condensation take place. This penetration of moisture through the boards from the back is a cause of peeling paint, rotted framing and a general condition of dampness throughout the whole structure. Manufacturers of insulating materials in various forms have developed vapor barriers which are installed along with the insulation in the form of moisture-resistant covers, or "envelopes," for the insulating material itself, and also in separate sheet forms which are tacked over the studding under the plaster. These barriers are fully effective only if they are installed in accordance with the manufacturer's instructions. In houses with insulation in walls and ceilings but without vapor seals, reducing the humidity in the house will lessen the possibility of trouble that is caused by condensation.

Hanging Storm Sash

Q—My home is quite old and the window frames have deteriorated along with the rest of the structure. My storm windows do not fit as tightly as I believe they should. How can I obtain a tight seal between the storm sash and the frame?

R.F., Green Bay, Wis.



A—Although there are several materials that can be used for this purpose, one of the simplest ways to seal the sash is to glue or tack strips of $\frac{1}{8}$ x $\frac{3}{4}$ -in. felt to the inside edge of the sash frame all around and also across the bottom rail. If the surface of the sill is irregular or the window frame is out of square, it may be necessary to use two thicknesses of felt across the bottom. Plane the top of each sash to a bevel of about 5 deg. to prevent water running down between the sash and the frame. Installation of the felt strips probably will prevent use of the sash hangers. It is better when sealing the sash in the manner described to use turn buttons as fasteners. After placing the storm sash, screw the turn buttons up tightly.

Open Shutter Joints

Q—I have stationary ornamental shutters of the paneled type. Recently the shutter frames have either shrunk or expanded (I don't know which) and have exposed an unpainted strip along the sides of each panel. How can I prevent this? J.A., Reading, Pa.

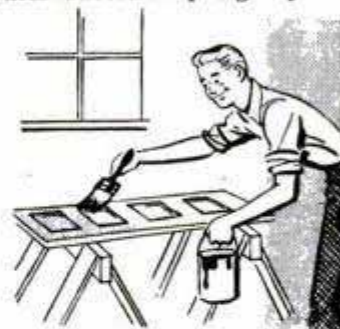

A—When this occurs it's a fairly reliable indication that the moisture content of the wood in the shutters was unduly high at the time of installation and painting. There is no immediate remedy in the sense that the tendency of wood to alternately shrink and swell can be entirely prevented or corrected. However, removing the shutters and storing them for a time in a dry place before repainting and rehanging will probably help to minimize the trouble. If the joints have opened, it might pay to pry them apart and reglue the joints with a waterproof glue. This would have to be done carefully to avoid marring or splintering the wood. Be sure that the glue is dry before repainting.

a practical gift for a merrier Christmas...

Home Craftsmen . . . Radio Men . . . Meter Men
 Carburetor Repair . . . Sewing Machine
 and Business Machine maintenance . . . and
 all home appliance repair men will find
 this set well suited for their work.

Snap-on's
MIDGET
TOOL SET
 Built for Professional Mechanics



X115-TMB
 Midget Sized
 Socket Set
 1/4" drive

HERE'S WHAT YOU GET:

- | | |
|---|-------------------------------|
| Midget Ratchet | Sliding Bar |
| 4" Extension Bar | Midget Gripping Plier |
| 6 Hex. Sockets,
3/16", 1/4", 5/16",
3/8", 7/16", 1/2" | Screw Driver |
| 3 Square Sockets
1/4", 5/16", 3/8" | Screw Starter |
| | Chrome-plated flock-lined box |

The man who gets this set of Midget Snap-on tools will say that they are the finest he ever owned for doing tiny, tricky jobs on small equipment. No more fumbling with oversized tools that can slip and break delicate parts.

Connecting drives, socket openings and ratchet parts are precision machined.

This smart set comes in a handsome chrome-plated metal box with beautiful red flock lining. All wrenches and sockets are chrome-plated.

\$14⁸⁵

Add local Sales Tax

Mail This Coupon Today!

SNAP-ON TOOLS CORP., 8062-K 28th Avenue, Kenosha, Wisconsin
 Please send me the Midget Tool Set in time for Christmas. I enclose Check, Money Order for \$14.85 plus local sales tax.

Name.....
 Address.....
 City..... State.....



GENUINE
Snap-on Tools

can be bought only from
 Snap-on branch sales
 offices and field represent-
 atives or Direct-by-Mail.

HOLIDAY

every day!

Enjoy that real Holiday feeling every day with HOLIDAY—the aromatic High Grade pipe mixture —at a popular price. Only 15 cents!

Also in vacuum pounds

TO MAKE NEW FRIENDS—FOR HOLIDAY

Here's a Sensational PIPE OFFER!

Cool-smoking aluminum pipe with genuine imported briar bowl!

Only **50¢ plus** inside paper wrapper from 12 tins of Holiday Pipe Tobacco.

Offer limited to U.S.A.
Expires February 28, 1950

Send to Holiday, Dept. PM-3, Richmond, Virginia

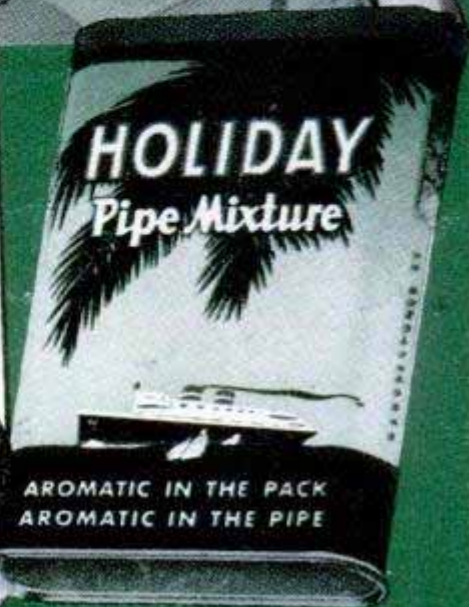

AN ADVENTURE IN GOOD SMOKING

amazing pictures, these rapid beats look almost leisurely. He has contributed parts of his films to Ducks Unlimited, the conservation organization, for use in raising funds to preserve the birds he paints.

Bishop also has made a detailed study of the physiology of wild fowl, with emphasis on the wing structure. He'll tell you, for example, how a bird "zippers up" its feathers. Each feather is composed of hundreds of parallel barbs. Projecting from these barbs are hundreds of tiny, invisible barbules which interlock with those on adjacent barbs. And the barbules in turn have microscopic, hooklike barbicels that branch out to seize adjoining barbules like grappels. These millions of barbicels provide a tight grip to bind together the parts of the feather.

Now, if you ruffle a feather the wrong way, you'll break the hold of these millions of barbicels. Smooth it back the right way and Nature will zipper up the wing again as the barbicels grapple each other.

All of this knowledge, absorbed in a lifetime of bird study, somehow is built into each painting as Bishop deftly covers the canvas. When you see a baldpate rising over the marsh grasses in one of Bishop's paintings, you see it over the barrel of a gun. It's your duck, the one you bagged last fall or the one that scudded over the

treetops just out of range during your last day in the field.

Bishop sends these finished paintings to Brown & Bigelow where they are photographed and then printed on large-size calendars. His work also has been reproduced in two books and he has illustrated *Prairie Wings*, a book written by Queeny, his fellow sportsman.

But painting wild fowl is just a small part of Bishop's work. It has become a challenge to him to depict his beloved birds in as many different media as possible.

He fires etchings on glassware and smoking accessories. He makes the molds for beautiful fireplace tiles, each of them showing a different bird in a different stage of flight. He hand-prints his birds on fine linens. Dinner plates become decorative pieces when etched with his colorful wild fowl. He also molds beautiful jewelry pieces and silver buttons to carry out his themes.

Craftily placed in all the paintings and etchings are lures that coax the sportsman back to the marsh. The hunter likely will find himself reflecting that the chuckling and gabbling of mallards as they dive for acorns that have fallen to the bottom of some shallow, flooded timber are far more appealing sounds than the conversation of business associates or even of friends.

Manufacturing Opportunities in Concrete Products Industry

The great building industry is your profitable market for masonry products. Low investment... high returns... wide-open opportunity to establish a lifetime business. The biggest building years in the nation's history are just beginning. New construction, involving billions of dollars, means huge demands for block, drain tile, and other masonry products which YOU can manufacture locally, from local materials with local labor for local consumption. Remember, MASONRY products mesh with today's demands.

Use our modern machines and equipment to insure the finest quality products at pared-to-the-bone manufacturing costs. Sold direct. Backed by 40 years of manufacturing. Write for catalog. Gives prices and full information.

CONCRETE EQUIPMENT CO.
512 Ottawa Ave., Holland, Mich.



**WAKE UP
YOUR
Scalp**
WITH THE NEW
ELECTRIC-AUTOMATIC
Vitabrush

BE FAIR TO YOUR HAIR Want better looking hair? Embarrassed by falling dandruff, itching scalp? Get the new VITABRUSH, the electric-automatic brush with built-in brush head motor... gives scalp and hair an invigorating "workout" in just 3 minutes. Cleans scalp, stimulates blood supply, distributes the natural oils. Fun to use—relaxing. Write for satisfaction-guaranteed offer—today. Hershey Mfg. Co., 3735 Field Bldg., Chicago 3.

**EARN BIG MONEY
AND BE YOUR OWN BOSS**
Sharpening Lawn Mowers

**Build a Business of Your Own With
A UNIVERSAL GRINDER**

In your own garage or basement, and earn \$25.00 a day or more. Mr. Hardy writes, "I am doing a fine business with the UNIVERSAL GRINDER. One customer sends another. I spent 40c for a newspaper ad and have done nearly \$500.00 worth of business." Mr. Helmeck of Canada writes, "We sharpened 750 mowers last year and are 1050 on this year's run. The Universal surely makes customers." Mr. Barton of California says, "The mower business, with the Universal Grinder, has been a gold mine these last two years."

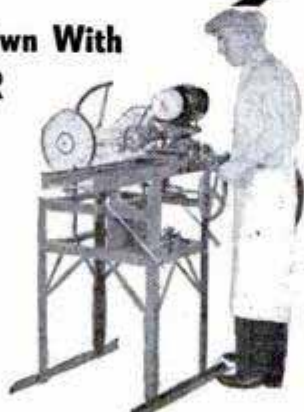

Only on the UNIVERSAL GRINDER can the inside face and edge of the stationary blade, as well as the reel blades, be ground to proper clearance ALL IN ONE SET-UP without removing any blade from the mower.

WRITE FOR FREE FOLDER TODAY!

ROGERS MFG. CO., Dept. M-129, Lindsey, Ohio



Handyman, hobbyist, skilled craftsman or apprentice—give him a gift he'll prize and use, a gift that keeps on giving pleasure and profit... dependable, accurate STARRETT TOOLS.

There's a tool for every purse.



Steel Tape No. 510
Popular 50' length



Combination Set No. 9
Eight Handy Tools In One



1" Micrometer No. 230
"Satin Chrome" Finish plus
12 other big features



The Starrett Book For Student
Machinists. Only \$1.00 per copy



Hack Saw Frame No. 153
Pistol Grip—Adjustable Frame



Toolmaker's Hammer No. 815
With Built-In Magnifying Glass



Dial Indicator Gage No. 1010
Vest Pocket Size—Plastic Case



Kit of Tools No. 902
Basic Measuring Equipment

**SEE YOUR DISTRIBUTOR
FOR 3000 GIFT IDEAS**

Your Starrett Tool Distributor will gladly show you these and more than 3000 other gift-worthy items in the complete Starrett line. Or write for Starrett New Tools Booklet "AP".

THE L. S. STARRETT CO., ATHOL, MASSACHUSETTS, U. S. A.

TRADE MARK
Starrett

REG. U. S. PAT. OFF.

Since 1880... Standard of Precision

MECHANICS' HAND MEASURING TOOLS AND PRECISION
INSTRUMENTS • DIAL INDICATORS • STEEL TAPES • HACKSAWS
BAND SAWS AND BAND KNIVES • PRECISION GROUND FLAT STOCK

Buy Through Your Distributor

SOFAR—The Navy's Lost and Found Agent

(Continued from page 169)

designated depth, it ruptures the small diaphragm, releases a firing mechanism and explodes the bomb.

SOFAR signal bombs are now being manufactured by the Thomas A. Edison Co., West Orange, N. J.

At the same time that the bomb was being developed, work was also under way on setting up the SOFAR monitoring stations. To determine the characteristics of the ocean—and especially the salinity, pressure and temperature in the speaking-tube zone—Navy and civilian scientists spent months aboard seagoing laboratories in the Pacific. They ran deep-sea power winches and lowered Nansen bottles to collect samples of sea water. They plotted depth and position by means of echo sounders and signals sent by SHORAN stations on land.

Another purpose of these long, seagoing experiments was to determine the best locations for the underwater hydrophones which pick up the bomb's explosion. These hydrophones, usually three in number, are encased in a pyramid-shaped, perforated metal cage. They are connected by submarine cable to the monitoring equipment

ashore. For best reception they are located in the center of the sound channel and strategically placed so that undersea ridges or submarine canyons will not interfere. Duplicate hydrophones and cable installations are made at each station so that service may be continued in the event of failure of one of the units.

Originally, for example, it was decided to put one of the monitoring stations at Monterey, Calif. But a deep and twisting submarine canyon just offshore made it impossible to find a suitable location for the hydrophones. So the station was moved south to Point Sur. In the Hawaiian Islands, Hilo also was considered a possible SOFAR monitoring location. But steep and rocky offshore conditions ruled it out also.

Once the three stations were located, there followed a long period of testing and checking on the performance of equipment. Some unusual sea sounds were picked up—schools of whales cruising by, near-by explosions on shore and even the rumble of volcanic activity in the Hawaiian Islands. Ways to lock out the unwanted sound had to be devised.

Here's how the monitoring stations work:

Three stacks of automatic monitoring equipment are on duty day and night. When a SOFAR signal starts coming in,

(Continued to page 248)

WOW! ANOTHER BULLSEYE FOR BESSIE!

LOOK AT THAT GAL GO!! WHOEVER SAID SHOOTIN' WAS A MAN'S GAME HADN'T SEEN THE DAISY TARGETTE!

IT'S MY TURN NEXT! THEN YOU'LL SEE SOME REAL FANCY SHOOTIN', PARDNER!

I GET A TURN TOO! POP SAYS THE DAISY TARGETTE IS TOPS FOR SAFETY!

ZING!

Also TARGETEER AIR PISTOL OUTFIT \$2.98

No. 118

Original Daisy fun gun outfit! Blued steel pistol accurate to 12 feet. Safe. Adjustable sight. 400 rounds "tiny B-B" ammunition, paper targets, 2 steel "birdie" targets. Carton is target backstop. ALL. \$2.98.

No. 320

DAISY Targette®

TABLE TARGET PISTOL SET

COMPLETE \$4.95

No. 320

NEW GIFT IDEA READY!

SAFE FUN FOR FOLKS 8 TO 80!

For "smart" giving—adult guest entertaining—living-room target practice—get the amazing new Daisy TARGETTE SET with SILVERY CHROME-PLATED AIR PISTOL, 10" long, adjustable sight, safe, accurate to 12 feet; RED PLASTIC TABLE-TOP SHOOTING GALLERY, slotted to "park" pistol; 7 IVORY-WHITE SPINNER TARGETS; 800 ROUNDS "tiny B-B" ammunition in 2 metal cans held in Gallery "legs." Quality-built to last. Only \$4.95 at hardware, sports goods, department stores!

IF DEALER IS SOLD OUT send \$5 for Targette Set, \$3 for Targeteer Outfit. We'll ship postpaid anywhere in Continental U.S.A. Satisfaction Guaranteed.

THE GIRLS DIDN'T WANT TO PLAY CARDS AND THE FELLAS WOULDN'T DANCE, SO I GOT OUT THE DAISY TARGETTE SET!

THEN YOU'D BETTER SLIP DOWN TO THE CORNER FOR SOME SANDWICHES 'CAUSE THEY'LL STAY LATE!

GOSH! THEY HAVEN'T HAD SO MUCH FUN AROUND HERE SINCE I WAS A PUP!

Prices higher Canada, Rockies, West

DAISY MANUFACTURING CO., DEPT N-9, PLYMOUTH, MICHIGAN, U. S. A.

KING MIDGET

HOME ASSEMBLED MIDGET AUTO



WORLD'S LOWEST PRICED AUTOMOBILE!

80-90 MI. PER GAL.—45-50 MI. PER HR.
Drive this car for as low as 50c per week. Precision built parts direct from factory with beautiful all steel body. Get all the facts on this amazing small auto—send 25c for detailed circular with large picture, 4 view drawings and price of all parts, or send \$1 (refunded first order) for this plus actual assembly book with 42 photos, drawings; blueprints of snow and ice conversions, etc.

MIDGET MOTORS MFG. CO., ATHENS 1, OHIO

SEND FOR FULL INFORMATION TODAY!

King Midget is the ideal small car for errands, sports use, to and from work, short business or pleasure trips, delivery service or second-car utility for the whole family. Comfortable—room for husky six footer.

A 10-Ton Press at Low Cost

Pressing, separating, bending, and straightening jobs in your shop are easy with this press. Ten-ton capacity provides ample pressure. Adjustable table takes work up to 18 inches wide and 11½ inches high. Send for free bulletin showing press and wide variety of accessories.

UT-10A Press f.o.b. factory \$36.00



DAKE ENGINE COMPANY

624 Seventh Street, Grand Haven, Michigan



NOW! FILE YOUR OWN SAWS

Do expert saw filing at home. Precision filing easy without experience. Two simple adjustments. Keeps any hand saw extra sharp and true-cutting. Complete with file. Money back guarantee. Cash with order, prepaid. (COD postage extra.) Order today. \$2.95.

SPEEDCOR PRODUCTS, PM-12
512 N.E. 73 Ave., Portland 16, Oregon

\$2.95 EACH

FINE TOOLS NEED FINE OIL!



• Lubricates



• Prevents Rust

• Cleans • Polishes

SOLD EVERYWHERE

3-IN-ONE Oil

Lasting Christmas Gifts

ZEPHYR MODELS

Quality Electric Tools

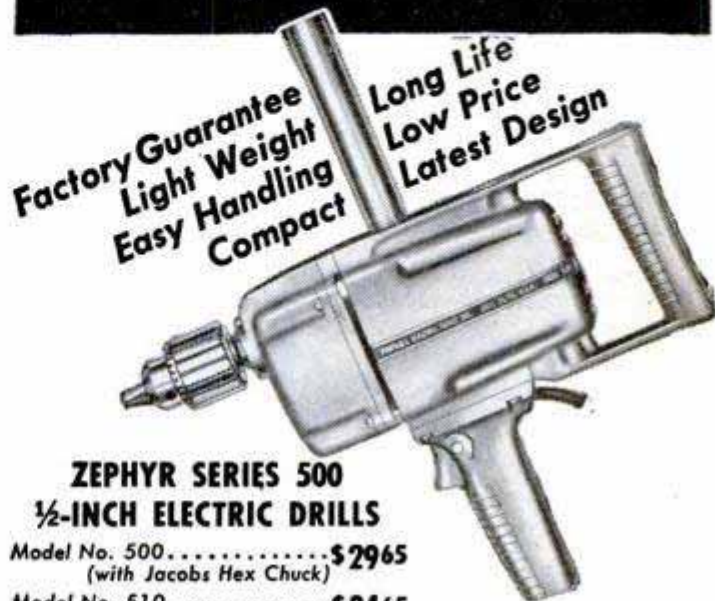

ZEPHYR SERIES 500 ½-INCH ELECTRIC DRILLS

Model No. 500.....\$2965

(with Jacobs Hex Chuck)

Model No. 510.....\$3465

(with Jacobs Gear Chuck)

Full ½-inch drill capacity; removable side handle for close-quarter drilling; weight complete only 9 pounds. U. L. listed.

ZEPHYR SERIES 1950 ¼-INCH ELECTRIC DRILLS

Model No. 1950-H.....\$1795

(with Jacobs Hand-Tite Chuck)

Model No. 1950-G.....\$1995

(with Jacobs Gear Chuck)

Weight complete, only 3 pounds, 2 ounces. The speed, power, and small size make it the ideal power tool; handy to use as source of power for driving drill attachments for disc sanding and polishing, cleaning paint brushes, grinding and sharpening tools, buffing, removing rust and paint with wire wheel brushes, etc. A real money saver around the house, farm and home shop. U. L. listed.

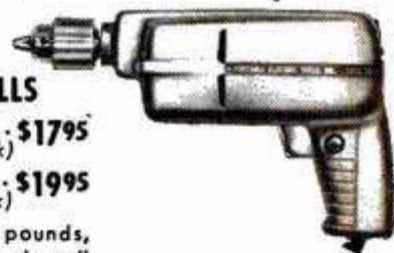

SPRAYMASTER ZEPHYR MODEL SM-25 \$24.95

A complete electric sprayer unit with electric motor, two-cylinder air compressor, pressure equalizer storage tank, 25 to 30 pounds pressure. Sprays paint, enamel, lacquer, insecticides, and mothproofing solutions. Easy to use—no spraying experience necessary for fine job on furniture, cars, radiators, etc. Full instructions with every unit.



See these tools at your dealer, or write direct for full information. Dealer inquiries invited.

Canadian Offices:
664 LaGauchetiere St., West, Montreal 3
1900 McKay Road, North Vancouver
GET THIS FREE BOOKLET



PORTABLE ELECTRIC TOOLS, Inc.
324 W. 83rd St., Chicago 20, Ill.



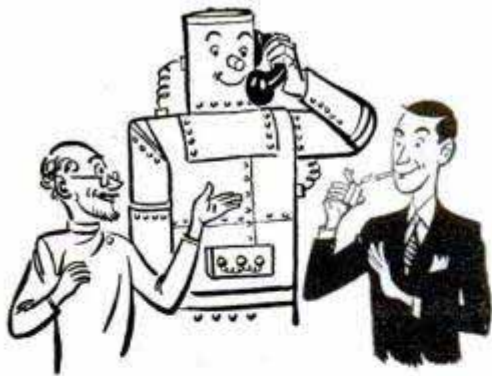

**That's nothing!
My REGENS is completely
automatic, too!**

- Single motion lights and closes
- "Slide-out" tank lights pipe, too
- Windproof "weather-guard" design
- Easy-filling removable tank
- Precision made of solid brass
- Guaranteed for one full year

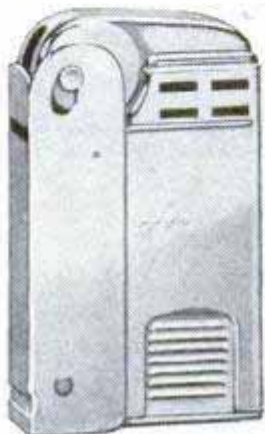

STILL THE BEST LIGHTER BUY

In nickel, chrome, enamel, **\$1.50 to \$5.00**
etched or rhodium finish



For best results with any lighter use
Regens Yellow Flints, Regens Lighter Fluid
AT BETTER JEWELRY, DRUG, TOBACCO AND DEPT. STORES

Regens Lighter Corporation
2 East 46th Street, New York 17

**THRILLING MODEL KITS!
Wonderful Christmas Gifts**



Beechcraft
Bonanza

Planes—trains—ships!
Wonderful realism, accurate details! Thrilling scale models to decorate home or office, display on mantel, desk, or in collector's groups. Assemble models yourself, or give as gifts to friends who like to construct things. All parts ready-shaped

for easy assembly. Wide range of subjects, including newest ships, planes, and historic trains. See them at your Toy or Hobby Dealer.

StromBecker

Send for free circular describing all models
STROMBECK-BECKER MFG. CO., Dept. PM-12, Moline, Illinois

things begin to happen. An alarm bell starts ringing to attract the attention of the operator. The wavy line on the two recording paper tapes begins to veer up at a jagged angle. A magnetic wire recorder captures the sound of the signal so that it may be re-recorded if necessary.

As soon as the kettledrum signal reaches its finale, the monitoring unit reverts to normal. The operator at the station tears off the tape and measures the point of highest rise with a hairline slide rule to get the exact time of arrival. This information is radioed to a control center.

Upon receipt of the information from the three monitoring stations, the control center gets a "fix" from special SOFAR charts and a table of probable time lapses. By quick, rule-of-the-thumb figuring, the control-center navigation officer can determine the location of the crippled ship or plane within 10 miles. A rescue plane is dispatched immediately. After a more careful check is made, the navigation officer radios a correction to the rescue plane which should be accurate within one mile.

The Pacific continues to be explored by Navy scientists with a view toward extending the SOFAR network in the future. Monitoring stations may be set up at Midway Island and other locations. And when the northeast Pacific is blanketed, SOFAR may be set up in other areas crisscrossed by heavy sea and air traffic.

The New Breed of Sports Cars

(Continued from page 84)

of Fiberglas, lighter and far more resistant to damage than metal.

The car has independent front suspension with semielliptic springs in the rear. One unique feature is the telescopic steering column that has four inches of travel and may be pushed or pulled to a position that is comfortable to the driver. The car is equipped with a convertible top and has removable Plexiglas side windows. It weighs 2300 pounds.

After exhaustive testing of the chassis in traffic and over rough mountain and desert roads, production of the first dozen units was started several months ago. Price is in the \$4000 range. The car may be purchased in knocked-down kit form at about half the assembled price. No special tools or skills are needed for putting it together and the car can be assembled ready for the road with about three weeks of work.

What some engineers rate high among sports cars, here or abroad, is a custom job completed late this summer by Dietz & Lesovsky, Culver City race-car builders,
(Continued to page 250)

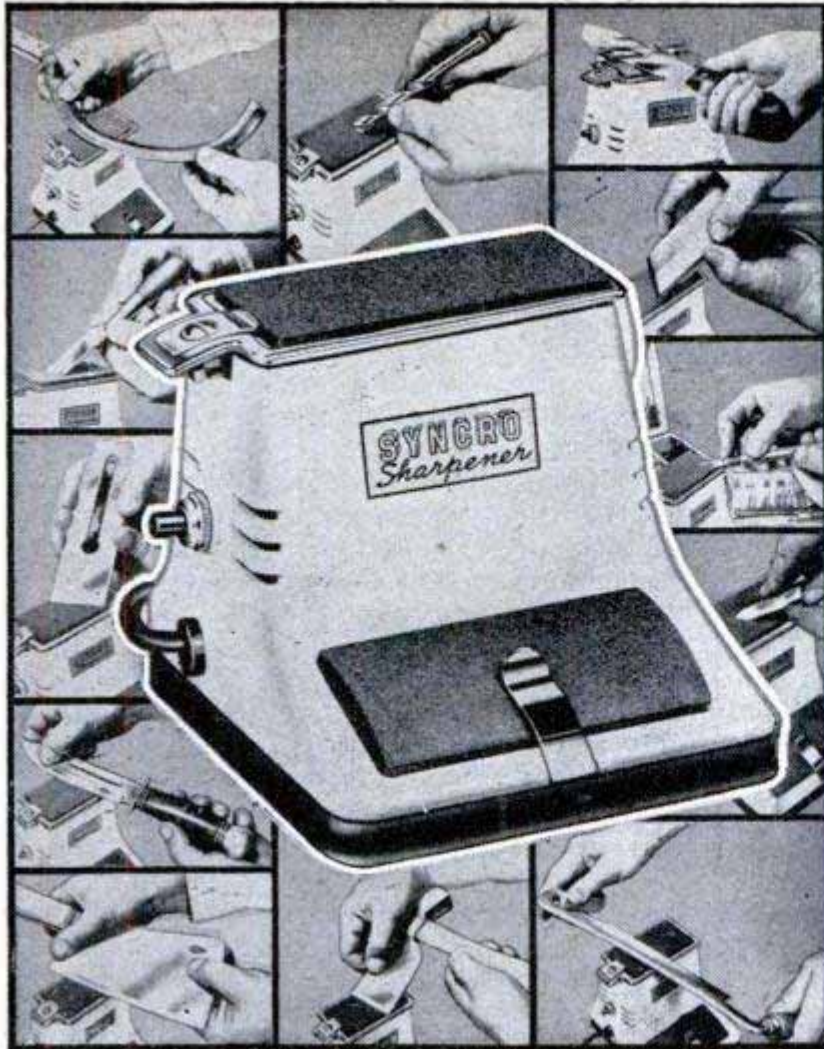

Hones all these sharp — hundreds more!

SAFE ELECTRIC JIG SAW "FAMILY" PROJECT TOOL!

Here's a "Gift" tool that's safe for even small children yet powerful enough to be the most versatile tool in adult workshops! Thousands used by schools, homecraftsmen, hospitals, institutions, etc. Portable. No belts, gears or wheels. Operates on 60 cycle, 110-120 volt AC. Arm adjusts to permit cutting any length $\frac{1}{2}$ " wood, $\frac{1}{4}$ " plywood, thin metal and plastic. Not a "lumber cutter" but for delicate, fine craftsmanship. Perfect for family projects or making money. Made and GUARANTEED by the largest company of its kind. Built-in Motor. Complete

\$17.50

NEW and BETTER Electric SANDER-POLISHER-MASSAGER The Perfect Gift!

You'll love this handy, beautiful, light-weight SYNCRO Electric SANDER-POLISHER! Also gives gentle body massage! 14,400 exclusive "Double Arc" strokes a minute makes sanding or polishing a pleasure instead of a chore! Just guide it. For light sanding, finishing, refinishing, redecorating. Perfect for polishing shoes, furniture, autos, etc. Give or get SYNCRO. 60 cycle, 110-120 Volt AC. Comes with 9 sheets Aluminum Oxide sandpaper, felt and virgin lambswool pads. 8 ft. cord, plug, only

\$14.50



NEW ELECTRICAL GIFT IDEAS for KITCHEN and WORKSHOP!

NEW and ONLY ALL-PURPOSE Electrical HONE SHARPENER

The Gift any woman or man will really appreciate! This beautiful new SYNCRO sharpens *not just knives* but hundreds of other articles safely, quickly—by HONING the edge. "Honing" helps preserve edges. 14,400 gentle, rapid HONING strokes a minute! NOTHING ELSE like SYNCRO! No belts, gears or wheels. 60 cycle, 110-120 volt AC. Insist on genuine SYNCRO—the only electric ALL-PURPOSE HONE Sharpener! Comes with 3 Honing Stones, cord, plug, switch, only

\$10.50



Adjustable Arm
Permits Cutting
ANY Length
Material

NOW
ONLY

\$17.50

COMPLETE with
BUILT-IN MOTOR

COMPLETE
with Plug, cord,
3 blades

YOU CAN DO IT BETTER WITH

SYNCRO

QUALITY PRODUCTS

HOW TO GET YOUR SYNCRO:

Because SYNCRO HONE SHARPENERS and SANDER-POLISHERS are so new, dealers may not yet have their stock. If dealer hasn't, order your SYNCRO Sharpener, Sander-Polisher-Massager and Saw direct. Send full amount, we'll ship prepaid! Remember—don't be satisfied with anything but a genuine SYNCRO!

SYNCRO CORP., Dept. H-129, ROCHESTER, MICHIGAN
World's Largest Makers of Safe Electric Jig Saws

Give **STANLEY** ...the tools you'd like to get

IN CHESTS



Stanley No. 908, 23 tools and chest. Fine selection of tools for the woodworking hobbyist.

INDIVIDUALLY



Stanley No. 51 1/2 Nail Hammer. "Right hand" of hobbyists and home handymen.



Stanley No. 4 Bench Plane. Choice of 9 out of 10 woodworkers.

IN SETS

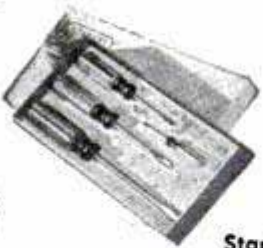

Stanley No. 2000A Screw Driver Set. Four handy screw drivers. Stanley No. 750A Chisel Set. Three popular size socket chisels.

SEND... NOW!

Stanley Tools, 1129 Elm St., New Britain, Conn. (In Canada: Send to Stanley Tool Co. of Canada, Ltd., Roxton Pond, Quebec.)

Please send me Series A () and Series B () of the new Early American project plans. I enclose 25¢ for each set.

Name.....
Street.....
City..... State.....

Make any man or boy happy... give him Stanley Tools. Designed for expert craftsmen but priced for everyone. Sold in chests, in sets and individually. Give Stanley Tools... a worthwhile gift.

NEW STANLEY PROJECT PLANS

Early American Designs—easy to follow. Two packets with 15 designs in each, 25¢ per packet, postpaid.

THE TOOL BOX OF THE WORLD



Reg. U.S. Pat. Off.

HARDWARE • HAND TOOLS
ELECTRIC TOOLS • STEEL STRAPPING

for Sterling Edwards of Beverly Hills. Of trim modern design, the car is a high-performance, general-purpose convertible coupe. It is intended also for competition in road races and sports-car events, and when stripped for racing has a top speed in the neighborhood of 120 miles per hour.

In city traffic, the Edwards car is simply a small automobile of outstanding lines. From its appearance, no one would guess that it can outclimb many motorcycles on steep motorcycle hill-climb courses or that its stability is so great that it can be maneuvered violently at 80 miles per hour in perfect safety. In tests it has been accelerated so rapidly from a standing start that it leaves rubber behind for a full city block. In second gear it hits 75 miles per hour. It floats across chuckholes and washboard roads that would hammer most cars to pieces. The rear end squats when the brakes are applied, bringing the car to a stop, under control, in considerably less than average distance.

These sound like fantastic claims and they are, judged by ordinary standards. They were proved, however, by 3000 miles of test driving of the bare chassis before the body was installed. Edwards, several race-car drivers and engineers all had a hand in testing the car on race tracks, hill climbs and in traffic and on winding mountain roads.

The car has a 100-inch wheelbase, is 13 feet 8 inches over-all and stands 53 1/2 inches tall. It weighs less than a ton. There is room for four people and the car is equipped with a demountable "hard" leather top. The engine is a 60-horsepower Ford V-8 rebuilt with Eddie Meyer racing parts to produce 120 horsepower. The radiator is of special design.

The frame is in the form of a closed "H" and consists of electrically welded 4-inch chrome moly seamless aircraft tubing, joined and baffled so that the frame may be used as an auxiliary fuel tank of 13 gallons capacity. The car's regular fuel tank holds 25 gallons.

The front suspension, employing coil springs, uses stock parts modified in design to improve the stability. The steering ratio is 8 to 1, permitting quick maneuvering with only a partial turn of the steering wheel. The rear wheels are independently suspended on trailing arms and are fitted with torsion-bar springs. The design is a modification and improvement on an older European suspension principle. To help reduce the unsprung weight, the differential is fixed to the frame and each rear axle is provided with its own universal joint.

(Continued to page 252)

NOW

UNLIMITED RANGE

For Your SHOP PROJECTS



6" Jointer-Planer

10" Tilt Arbor Floor Saw

8" and 10" Tilt Arbor Table Saws

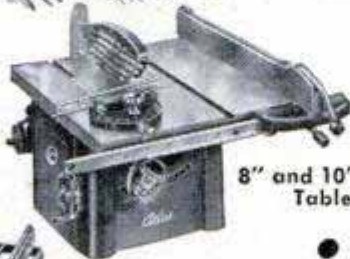

with **BIG Capacity** **Atlas QUALITY TOOLS**

There's always a way for a clever man to beat the high cost of furniture, and home repairs and improvements — if he has the tools to do it. These new big-capacity Atlas tools are built to help you get real dividends from your shop work this year. They pay for themselves on just a few jobs.

They have the capacity for any project you want to undertake, whether it's a big expanding dining table, oversize bed, or a remodeling job. They are made with the precision manufacturing standards of metal-working tools. They are ruggedly built to last a lifetime, with many exclusive features.

You've never seen tools like these before. Send the coupon below for latest illustrated literature.

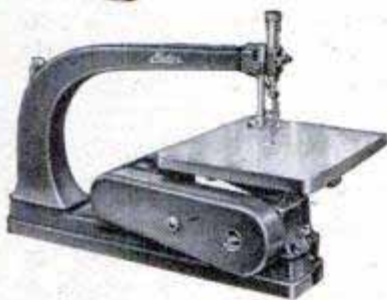

24" Jig Saw

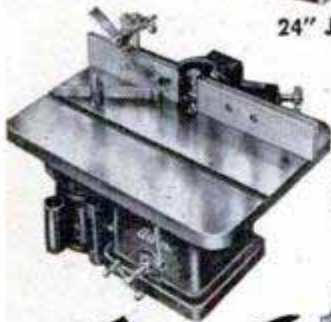

Wood Shaper



12" Wood Lathe



Drill Presses



Belt and Disc Sander

FREE

ATLAS PRESS COMPANY,
1243 N. Pitcher St., Kalamazoo, Mich.

Please send catalogs on Atlas 8" and 10" saws 6" Jointer-Planer 24" Jig Saw Wood Shaper 12" Lathe Drill Presses Belt and Disc Sander.

Name _____

Address _____

City, State _____

ATLAS PRESS COMPANY

1243 N. Pitcher St. • Kalamazoo, Mich.



MATCHED PRECISION TOOLS FOR WOODWORKING AND METALWORKING

STOP**GOO**

MILANO

LOCKMOUNT

a more enjoyable pipe
for **4** good reasons

1. **LOCKMOUNT**
guarantees
tight fit
2. **LIFETIME
HESSON GUARD**
stops goo
3. **PERMANENT
CORK SEAL**
keeps shank
clean, dry
4. Sweet-
smoking
**IMPORTED
BRIAR**



W D C
MILANO
LOCKMOUNT
\$150

Milano Standard
Mount \$1

Variety of shapes

WM. DEMUTH & CO., INC., 5th AVE., NEW YORK 22

Edwards and Norman Timbs, the design engineer, spent several months in study and research before construction started. A complete set of chassis drawings was made so that each part of the car could be reviewed ahead of time. Several separate 1/4-scale clay models of proposed bodies were built up and modified before arriving at the final appearance of the car. At one time, four different shapes of fenders were all on the same model to permit selection of the best. From the final clay sculpture an identical model was built of wood and the full-scale body measurements were taken from the wooden model. From these measurements, a full-size body mock-up was built, from which the body builders obtained their dimensions and to which they fitted each aluminum body panel. Including all the experimental and test work, the cost of the car is close to \$20,000. Several additional cars from the same plans may be built later.

Listen to the Falling Stars

(Continued from page 163)

miles or so above the earth increases in summer and decreases in winter. This seems to be associated with the seasonal warming and cooling of the ground. Day-to-day changes in ground temperatures have no effect on upper-air density, nor are storm fronts responsible for changes in density. On the whole, the extreme upper atmosphere appears to be very patchy or even cloudlike in texture.

From studies of shower meteors a great deal more may be learned about comets. Shower meteors appear to be the debris from a comet's tail and they may provide clues that indicate just what a comet is, where it came from and why it disintegrates.

From radio research on meteors it is hoped to learn more about freak conditions that sometimes vastly extend the range of short-wave transmitters or cause interference between widely separated stations. The ion columns or clouds that are caused by the passage of a meteor may be involved in this phenomenon.

Another question, still to be answered, is why the ionization produced by a large meteor appears to hang on stubbornly instead of disappearing quickly. There is a chance that these ion columns may be a source of cosmic-ray bursts. There is a chance, too, that the research will yield concrete information about "contra terrain" matter, the theoretical atom in which the negative charges are clustered in the nucleus and the positive charges are outside, just the opposite of the accepted atomic state.

The NEWEST in Tree Stands:



YULE KING
TREE STAND

This shiny stand with aluminum water container is easily assembled with its snap-in legs—no nuts or bolts required, does not tip.

Post paid anywhere in the USA
for only **\$2.50**

Supply is limited, send your order today. Immediate delivery.

YULE KING SALES CO., BOX 566, MERRILL, WISCONSIN

**ALL NEW
FOR 1950**

★ **PACKAGED BOAT KITS**
★ **MOLDED BOATS**
★ **PATTERNS · PLANS**

PACKAGED BOATS — EASY TO BUILD

7 NEW TREDRONIC RACERS. 17 sensationally new models, skiffs, outboards, runabouts, racing boats. 8' to 16', all new designs. Increased performance, simplified assembly. World's best boat buy. Send 25c for 1950 literature. Literature & booklet "Plywood Boats" \$1.00.

INDUSTRIAL MOLDED HULLS

Made by Industrial Shipping Co., Ltd., Halifax, Canada. Save time, save money, build your boat this sensationally new way from one piece, seamless hulls or complete kits (8-18 ft.). Send 25c for literature.

NEW PLANS & PATTERNS FOR 1950

Over 100 modern designs by famous naval architects. Racing classes, cruisers, inboard, outboard, sail. 6 to 35 ft. Construction plans, full size patterns. Send 35c for catalog or \$1.00 for catalog and helpful booklet on Boat Building.

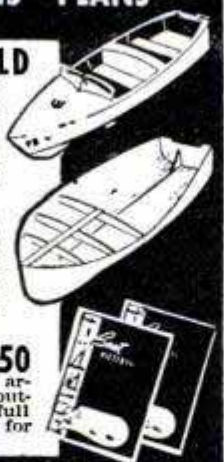

MARINE MART, 1700 NIAGARA ST., DEPT. 24, BUFFALO, N. Y.

IDEAL CHRISTMAS GIFT!

Genuine "STANDARD" **STEEL CASTING ROD**

Regular \$5.95 Rod
A special at \$2.95 this summer. Now at still greater savings! Very special—Postpaid... **\$1.95**
Plus 2% Sales Tax

ONLY A LIMITED QUANTITY to sell at this amazing price! Listen! Cork grip, offset aluminum handle, stainless steel eyes, copper bound! 4-5 ft. length. A magnificent rod—simple, flexible action. A gift you'll be proud to give or get! Send Check or Money Order today to get in on this special.

STANDARD EQUIPMENT CO., Dept. PM-12, Cedar Rapids, Iowa
"Selling Quality for 35 Years"

BRASS NAME PLATES OR KEY TAGS

YOUR NAME
STREET AND NUMBER
CITY AND STATE
PHONE NUMBER

40c each—3 for \$1.00

Half actual size
QUANTITY PRICE — SAME STAMPING
8 for \$2. - 15 for \$3. - 25 for \$4. - 50 for \$6.
LARGER QUANTITIES ON REQUEST
TAGCO, BOX 38X, WINGDALE, N. Y. STAMPING EQUIPMENT

More Local Plants Needed to Supply Growing Demand

More local plants are badly needed to make Dunbrik-Dunstone — America's finest masonry. Smart — modern — colorful. Yet costs less than lumber. Millions used annually for homes, stores, factories, public buildings, etc.



Write for portfolio "Blueprints for Profit"

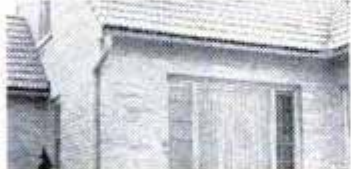

With Dunbrik-Dunstone you can ride the tide of the biggest building cycle in history. Local plant — local materials — local labor. Equipment costs moderate. Liberal sponsor co-operation. 100%—150% mark-up on basic costs. Outstanding manufacturing opportunity for men of vision and responsibility. Write at once.

DUNBRIK-DUNSTONE

W. E. DUNN MFG. CO.
600 W. 24th St., Holland, Mich.

**SANTA SAYS:
"A WONDERFUL HOBBY
WORKSHOP GIFT!"**

Just dial ANY WIDTH CUT ON YOUR SAW

**WITH
Warren
DADO SAWING WASHERS**

Cut clean, accurate, parallel grooves—12 widths, any angle. No chatter, burning, chewing—or sanding! No more blade vibration—no screws to fuss with—just four balanced washers. Simply dial desired width with Micro-matic adjustment. Can be left on blade for straight cuts. Available in 5 sizes—1/2", 3/4", 5/8", 1", 1 1/8". A perfect gift for woodworkers. See your dealer or write—

\$4.95 SET

WARREN WASHERS CO.
Dept. 32 • 70 Medbury • Detroit 2, Mich.

SAY YOU SAW IT IN POPULAR MECHANICS



JUST WHAT I WANTED

A **NORTON**
abrasives®

**SHARPENING
STONE**



You can please any man who works with tools by giving him a **CRYSTOLON®** Combination Sharpening Stone. Has a coarse side for fast sharpening and a fine side for keen finishing—and it's oil-filled. A useful long-lasting gift. Comes in 4 to 8 inch sizes, priced as low as \$1.10. Get one at your hardware store today. Be sure it's a **CRYSTOLON** stone.

➔ Send 10c for instructive booklet "HOW TO SHARPEN"—Address Dept. PM-12



BEHR-MANNING

TROY, N.Y.

Also Mfrs. of Abrasive Paper and Cloth



If you like fine tools

... then you'll certainly like to work with the new **GREENLEE** Socket Chisels. Perfectly balanced... handsome, transparent green plastic handles... fine bevel-edged **GREENLEE** blades, so long the choice of true craftsmen. Ask your hardware dealer about them.



SPECIAL OFFER... WOODWORKING CALCULATOR... 10¢. Quick solutions to countless problems... converting linear to board feet, nail and bit sizes, etc. Send 10c to Greenlee Tool Co., 2112 Columbia Ave., Rockford, Ill.

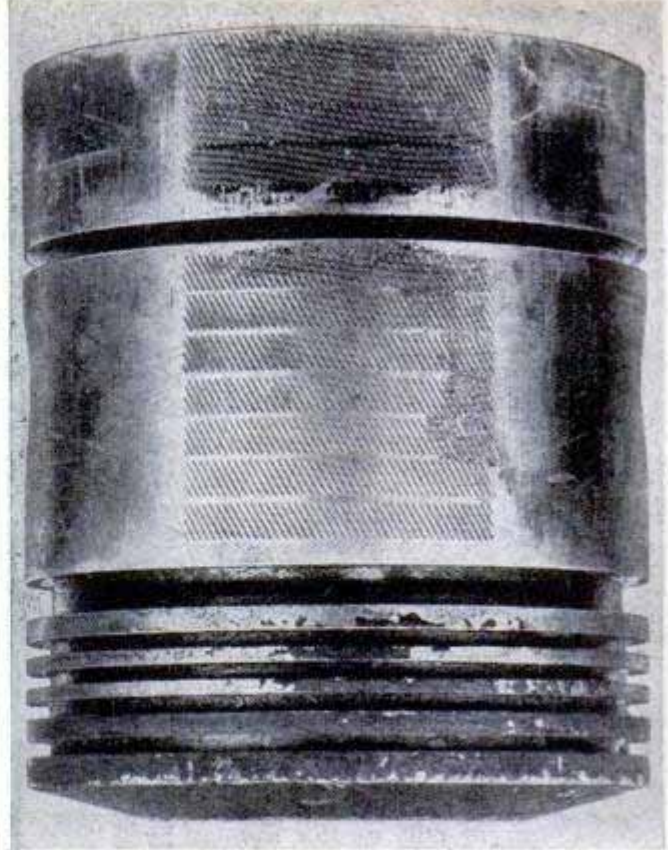

Diagonal Pattern On Piston Skirts

Pistons can be fitted in cylinders with one half the clearance customarily allowed if the bearing surfaces are scored with a diagonal pattern. This means a tighter fit and, therefore, more efficient engine performance. Research has shown that an interrupted surface, such as the diagonal pattern, has a greater load-carrying capacity than a smooth surface and also has great resistance to scuffing and scoring. The pattern is pressed into the piston skirt by machine. As the grooves are pressed, the metal bulges slightly between the lines, thus increasing the piston diameter without the use of expanders. One piston, removed from a bus after 109,000 miles of cross-country operation under hilly conditions, showed almost no difference in top and bottom diameters and no scoring on the bearing surfaces with the diagonal pattern.

Liquid Linoleum Dressing Forms a Hard Plastic Film

Easily applied with a brush, a liquid linoleum dressing forms a hard plastic film said to be 80 percent as hard as glass. It protects kitchen cabinets from unsightly stains and can be wiped clean with a damp cloth. The dressing can also be applied on table tops, coffee tables or any surface where varnish can be used. Two coats are claimed to protect the surface for two years.

Do a Better Job WITH ONE OF THESE EMPIRE LEVELS

Smallest, most handy and accurate level made. "Cigar-shaped" — no sharp corners to tear pocket. Aluminum stock. Only 3 oz. wgt. 9" long. Has Level, Plumb, 45° Vials.
No. 26..... \$2.00



ALUMINUM LEVEL — No. 151

Cast and Machined, a Beautiful Tool, with Patented, Removable Level and Vial.
With 2 Plumb, 2 Levels, 2 — 45° Vials. 18"..... \$6.40
24"..... \$6.80 28"..... \$7.80

Order EMPIRE LEVELS from your local dealer.
Write direct for literature.

EMPIRE LEVEL MFG. CO.

BOX 97, DEPT. P-255 MILWAUKEE 13, WISCONSIN

Command Bigger Money! STUDY LAW

STUDY AT HOME for BUSINESS SUCCESS and LARGER PERSONAL EARNINGS. 40 years expert instruction — over 114,000 students enrolled. LL.B. Degree awarded. All text material furnished. Easy payment plan. Send now for FREE BOOK — "Law and Executive Guidance." It explains the course — how you may enroll and the many ways you can profit from Law Study. Write TODAY to:

(GI Approved)

AMERICAN EXTENSION SCHOOL OF LAW

Dept. 21-PM, 646 N. Michigan Ave., Chicago 11, Ill.

HANDY POCKET SIZE PLANE

DOES WORK OF BIG ONE

Precision made. Easy to grip as big one. 3 1/4" x 1 1/4" face. Can't be beat for fitting and finishing. Pat. extension handle. A "must have" for hobbyists etc. Blade guaranteed to hold edge. Cash with order, ppd. COD postage extra. Order today! \$1.95.



SPEEDCOR PRODUCTS

512-P N. E. 73rd Ave. Portland 16, Ore

PAINTERS' STRIPING TOOL

NEW, IMPROVED

Modern — streamlined — fits the hand like a fountain pen! Easy to use as a pencil. Draws parallel lines — straight, curve or circular. Does expert job on autos, furniture, toys, bikes, model planes, signs, bulletins, linoleum. (Makes wall board look like tile.) Every painter and craftsman needs one! Type "M" MASTER Painters' Striping Tool complete with tip for 1/16" stripe. \$1.00. Other tools complete with following tips: 1/64", 1/32", 3/64", 5/64", 3/32", 1/4", \$1.50 ea. Extra tips 75c ea. Entire kit with tool and 7 tips — \$5.00. (COD's postage collect.) Paint dealers, write!

EASY AS
USING A
PENCIL!

\$1.00
POST
PAID



WENDELL MFG. CO.

4234-B Lincoln Ave., Chicago 18, Illinois

Lafayette

RADIO ELECTRO NEWS

★ 29th YEAR SERVING AND SAVING YOU MONEY

NEW YORK: 100 Sixth Avenue and 542 E. Fordham Road

CHICAGO: 901 W. Jackson Blvd. BOSTON: 110 Federal St.

NEWARK: 24 Central Avenue. ATLANTA: 265 Peachtree St.



REPOGLE DRAFTING MACHINE

New device cuts actual drafting time by one-third! Makes sharp, accurate drawings up to 16x22". Combination 90° angle; calibrated scale moves at any angle to any point on the masonite board. Includes 17 1/2 x 23 1/2 x 1/4" board, steel arms, fitting and rubber feet.

18N15092P—Shpg. Wt. 8 lbs..... **6.63**

ELECTRIC MOTOR KIT & BOOK

Fascinating story of electricity told pictorially in full color, 32-page book. Permanent metal binding and hard covers. 33 precision-made parts and wire to assemble electric motor that really runs on flashlight battery.



32N2445P—Less Batteries..... **2.95**

20N20622P—Battery (2 required)..... Each **6 1/2¢**



WIRELESS MICROPHONE

Enjoy hours of real fun and entertainment. Talk through your radio speaker with this battery-powered microphone. No wires necessary. Broadcasts between 1000 and 1700 KC. Supplied complete with one flashlight cell and "Minimax B" batteries, and 1L4 tube. Attractive lightweight plastic case. 6 1/4 x 5 1/2 x 5". Ready for immediate use.

32N22620P—Shpg. Wt. 3 lbs..... **4.64**

FREE! 164 PAGE BARGAIN CATALOG BIG, NEW 1950 EDITION JUST OUT

Packed solid with outstanding values of the latest in RADIO — TELEVISION and ELECTRONICS. Smart servicemen throughout the nation look to Lafayette for savings up to 40% on thousands of parts, test equipment, ham gear, tools, tubes, record playing equipment and accessories. Here's one complete money-saving source for all your radio and TV needs. Don't delay...paste the coupon on a penny postcard and mail it now!



LAFAYETTE RADIO, Dept. 119
901 W. Jackson Blvd., Chicago 7
100 Sixth Avenue, New York 13

MAIL THIS
FOR FREE CATALOG
AND TO ORDER

- Check here for FREE Catalog. (Please don't check if already on our mail list.)
- Please fill my order for items checked above for which I enclose \$..... in postal note, money order or check. I will remit few cents postage when order is received.

NAME.....
ADDRESS.....
CITY..... ZONE..... STATE.....

SAY YOU SAW IT IN POPULAR MECHANICS

at the
flip of this
switch



1/2 h.p., single phase, 115v.

this motor
REVERSES *instantly*

Now available at a popular price—a single phase motor that reverses *instantly* at the flip of a switch. Starts in either direction. Idles to a stop or stops immediately by applying switch. The newly invented Iron Fireman *Reverswitch* built into this motor gives it the versatility of a three-phase motor.

Note these quality features: *Shielded Ball Bearings*, permanently lubricated; *Totally Enclosed* to keep out dirt; *Overload Protection*, automatic reset; *Capacitor Start*, high starting torque.

You can do things with this motor that you could never do before on such applications, as lathes, conveyors, hoists, dumb waiters, garage doors, etc. Complete, ready to plug in—\$39.50 express prepaid. If not at your dealer, order direct. Write for free literature. Iron Fireman Manufacturing Co., 2838 S.E. 9th Avenue, Portland 2, Oregon.



IRON FIREMAN
Reversing
MOTOR

THAT ACCURATE TOUCH...

with the
FINEST
IN STEEL TAPES



It's easy to be right the first time — it's easy to get "that accurate touch" . . . if your measuring instrument is the Master Streamline. This fine tool simplifies and speeds measuring and cuts down time-wasting errors. Its outstanding features are Streamline's guarantee of better measuring . . . graduations on both sides of blade . . . new lever brake to hold reading . . . direct reading inside measure . . . extra long tip holds blade steady . . . and many others found only in the Master Streamline. See your local hardware dealer or use the coupon.

MASTER

REG. U.S. PAT. OFF.

WOOD AND STEEL TAPE RULES

Master Rule Mfg. Co., Inc. PM-12
201 Main Street, White Plains, N. Y.

I enclose \$2.25 for the 6 ft. Streamline
\$2.50 for the 8 ft. Streamline
Engrave my name (75c extra). Please print clearly:

NAME.....
ADDRESS.....
CITY..... STATE.....

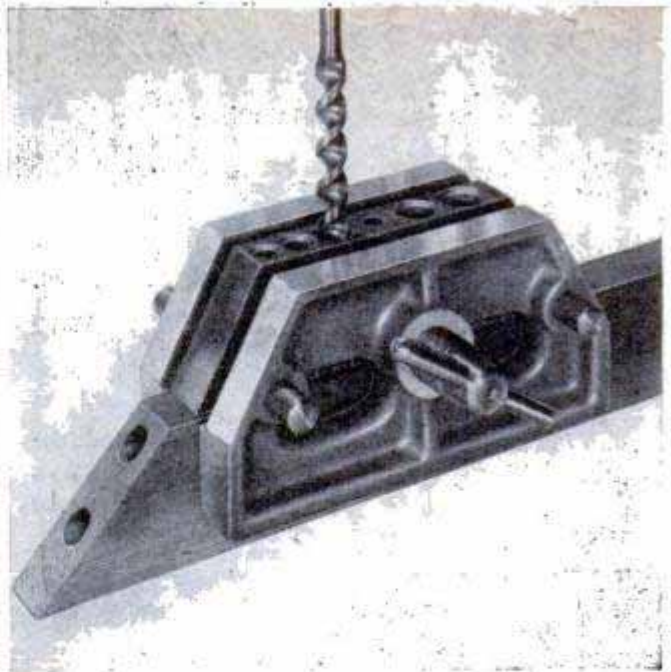

Dowel Drill Guide

Woodworkers can accurately center dowel holes with a new drill guide that holds the material like a vise. When the workpiece is clamped in the tool, the guide holes for the drill are automatically centered over the work. The jaws will clamp on work up to two inches in thickness. The guide accommodates five sizes of drills.

Ash Catcher for Cigarettes

Sparks and ashes won't fly around in the strongest wind when the cigarette is smoked inside a briar sleeve that fits on the end of a cigarette holder. For those who must smoke while in bed, it eliminates the danger of fire because the hot end of the cigarette cannot touch the bedclothes. Motorists who smoke while driving are protected against flying sparks which often burn holes in clothing and upholstery.



Mortite

KEEPS THE COLD OUT

SAVES FUEL AND MONEY

Cordlike and pliable, Mortite is the perfect weatherstripping. Goes on in a jiffy without tools or tacks. Keeps out wind, dust, dirt. Anyone can press it around windows, doors, transoms, baseboards. Weatherstrip a whole window for 29¢—costs even less if you use the larger package. Get Mortite at stores or write for circular. J. W. Mortell Co., 522 Burch St., Kankakee, Ill.



Sand Casting — Forging — Heat Treating — Case Hardening BRONZE FOUNDRY



In your own workshop allows you to design and build your own GASOLINE ENGINES, STEAM ENGINES, STATUARY, ART OBJECTS, SPECIAL TOOLS, NEW INVENTIONS, ETC. You can also make forgings and case harden steel. Your shop is not complete without a FOUNDRYETTE. Three sizes are available capable of making bronze castings of 1½, 3 and 6 pounds weight, aluminum, copper, brass, etc., \$22.50, \$29.50, \$42.00 f.o.b. Kansas City. Domestic gas supply and 110 volt AC or DC energy required for operation. Write for circular.

KANSAS CITY SPECIALTIES CO.
Box 6022, Dept. P-11 Kansas City, Mo.

FREE TO HOME PLANNERS



"Little Blue Booklet" of 29 popular plans sent FREE to acquaint you with our MONEY SAVING home planning service which includes 1200 Tested Designs; beautifully illustrated plan books; work- ing drawings; material lists; specifications—all at LOW COST. Write today for FREE BLUE BOOKLET and complete information. America's pioneer residential plan service.

Small Homes Plan Book — 68 beautiful designs.
Budget Homes Plan Book — 78 economy plans for 1 and 2 story homes.

\$100

L. F. GARLINGHOUSE CO., Inc., Box PM-3, Topeka, Kans.

Plastic Coasters and Tiles

EMBED REAL FLOWERS in NEW Magic PLASTIC

Now, create many unusual things like the distinctive pansy coaster shown—made by embedding real pansies in Castolite—the "magic" liquid plastic that "pours cold like honey . . . sets at room temperature like glass." Comes crystal-clear or may be dyed for brilliant color effects. Embed other flowers, too, also coins, medals, stamps, butterflies. Cast gorgeous bookends, art objects, figurines for gifts or to sell. New pleasure, fine profits are possible. No special artistic ability required.

EMBED YOUR PHOTOS

Preserve your treasured photos in Castolite. Make beautiful medallions like the one shown, unusual photo-lampshades, lamp bases, distinctive paperweights with embedded photos. Sell your photos in unique plastic mounts. Use only home utensils. Follow simple step-by-step method. Write for free literature showing how to get started. Write today.

THE CASTOLITE CO. DEPT. P-1 WOODSTOCK, ILL.

FREE

get it now—

ALLIED'S NEW 1950 RADIO CATALOG!

196 PAGES OF BIG VALUES

EVERYTHING IN RADIO AT LOWEST PRICES



TELEVISION AND HOME RADIOS



SERVICE SUPPLIES BUILDERS' SUPPLIES



AMATEUR GEAR



AMPLIFIERS, P.A. SYSTEMS, RECORDERS

Send for Radio's Leading Buying Guide

Save money on every radio need! Get the new 196-page 1950 ALLIED Catalog, preferred and used by everyone in radio. See the world's largest stocks of top-quality equipment, all at low, money-saving prices! Latest TV releases, home radios and radio-phonos, Amateur equipment, PA systems and High-Fidelity Sound, recorders, test instruments, builders' kits—plus thousands of parts, tubes, tools, books and diagrams. Have all the advantages of quick delivery, complete selections, big savings and expert personal help from the World's Largest Radio Supply House. Send today for your FREE copy of the 1950 ALLIED Radio Buying Guide!

ALLIED RADIO

ALLIED RADIO CORP.
833 W. Jackson Blvd., Dept. 5-MM-9
Chicago 7, Illinois

FREE CATALOG

Rush FREE 1950 ALLIED Catalog

Name

Address

City.....Zone.....State.....

Look Out . . . Avalanche!

(Continued from page 93)

If a skier is buried in an avalanche, prompt organized rescue operations are the only hope of getting him out alive. There are records of persons who have lived for as long as 72 hours while buried. Ordinarily, however, they are killed instantly by crushing, or die within a short period because of exposure, shock or suffocation.

Avalanche rescue operations are divided into two phases. The first rescue party, consisting of not less than three persons, preferably 10, sets out immediately under the supervision of an experienced mountaineer. Working at maximum speed, they make a rapid search of the slide in an attempt to locate the victim quickly.

The second party, equipped for extended rescue operations with probes, shovels, toboggans, flashlights, etc., starts within 30 to 60 minutes. It includes every able-bodied person in the vicinity and takes over from the first party if hasty action is unsuccessful. In an avalanche rescue, hope is never abandoned until the victim is found.

In recent years the Swiss have developed a successful method of using trained German shepherd dogs to locate persons buried in avalanches. These animals are able to sniff out skiers buried 12 feet deep in a fraction of the time that would be required by probing.

Most avalanche accidents occur through carelessness or ignorance. But the powerful, death-dealing avalanche can be defeated if individual winter sportsmen will cooperate with the Forest Service.

"The only good avalanche," say Atwater and Koziol, "is one that has already happened—harmlessly."

The Case of the Vanishing Sardine

(Continued from page 112)

be carried away to less favorable waters where they die.

Scientists can't foresee any way of controlling these currents, but they can detect favorable and unfavorable patterns and thus may be able to advise the fishing industry whether or not to expect a good or bad year.

In addition to sardines, many other kinds of fish and fish eggs are caught on the scientific angling trips. Before the work began, some 650 piscatorial species were known to exist in California waters. By the end of the project, several years hence, it is predicted that the total number will run above 1000.

(Continued to page 260)

Alan Ladd says—*Say*

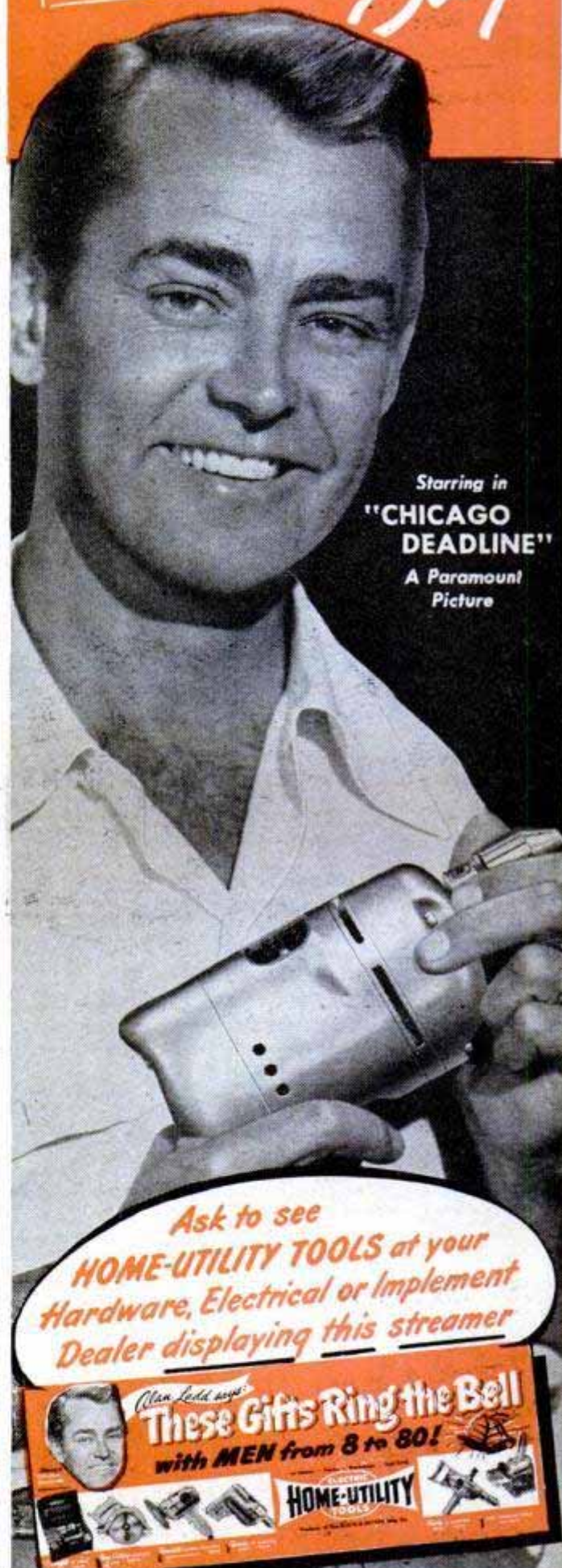

Starring in
"CHICAGO DEADLINE"
A Paramount Picture

Ask to see
HOME-UTILITY TOOLS at your
Hardware, Electrical or Implement
Dealer displaying this streamer

Alan Ladd says
These Gifts Ring the Bell
with MEN from 8 to 80!

HOME-UTILITY TOOLS

Merry Christmas with Home-Utility Tools!

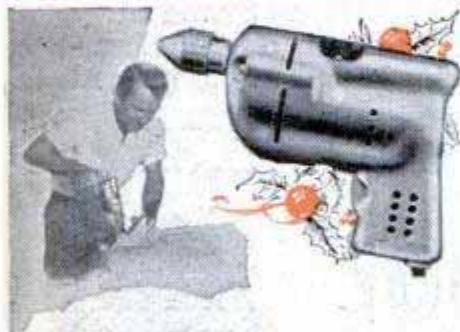

DRILLS HOLES IN A JIFFY! Ideal "all-around" tool for drilling, sanding, polishing, cleaning. Drilling capacity to $\frac{1}{4}$ " in steel, $\frac{1}{2}$ " in hardwood. Compact, light. Shaped to fit the hand. Famous "Pistol Grip and Trigger Switch".

H-U $\frac{1}{4}$ " ELECTRIC DRILL \$18.95



BEATS HAND SAWING 10 TO 1! Cuts to full 2" depth. Rips, crosscuts, drives many blades and discs. Easy to handle and easy to follow. Unmatched quality at this price. Hundreds of uses.

H-U 6" ELECTRIC SAW \$59.95

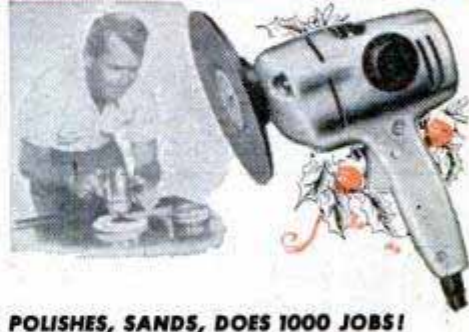

POLISHES, SANDS, DOES 1000 JOBS! One low price gives you this versatile tool complete with 3 sanding discs, lambswool polishing bonnet, backing pad, can of useful Home-Utility Electric Wax! Convert it into a speedy drill with $\frac{1}{4}$ " Jacobs Chuck (\$3.45 extra).

H-U 5" SANDER-POLISHER \$29.95



A BIGGER DRILL FOR BIGGER JOBS! Gives you extra capacity for portable drilling — $\frac{1}{2}$ " diam. in steel, $\frac{3}{8}$ " diam. in hardwood. Hole Saws available up to 3" diam. Makes powerful bench drill press when mounted in HOME-UTILITY Bench Stand (\$17.45).

H-U $\frac{1}{2}$ " ELECTRIC DRILL \$35.95



HANDY DRILL KIT PACKED WITH USES!

One price gives you H-U $\frac{1}{4}$ " Drill; horizontal stand; 13

high-speed twist drills; grinding, buffing and wire brushing attachments — all in a sturdy metal carrying kit.

H-U $\frac{1}{4}$ " ELECTRIC DRILL KIT \$39.95



REVOLUTIONARY SANDING ATTACHMENT! Ideal for sanding picture molding, hobby parts, sharpening edged tools, etc. Fits H-U Sander-Polisher or H-U $\frac{1}{4}$ " Drill. Attaches to horizontal stand (\$3.35 extra). Gives you sanding table, metal plate, mitre gage, 3 discs, disc cement.

H-U DISC SANDING TABLE \$8.25

YOU CAN DO THOUSANDS OF JOBS LIKE THESE WITH HOME-UTILITY TOOLS



DRILL IN ALL MATERIALS



WAXING FURNITURE



REMOVING OLD PAINT



DRILLING OUT BROKEN BOLTS



INSTALLING HARDWARE



SHARPENING EDGED TOOLS



TRIMMING MILL-WORK



SAWING STAIR STRINGERS

FOR HOMES • FARMS • SHOPS • TOOL KITS

ELECTRIC HOME-UTILITY TOOLS

Products of The BLACK & DECKER Mfg. Co.

Send for this new, useful
HOW-TO-DO-IT Booklet—FREE!



HOME-UTILITY ELECTRIC TOOLS
The Black & Decker Mfg. Co.,
Dept. H12M, Towson 4, Md.

Gentlemen: Please send me your free booklet on speeding up odd jobs.

NAME.....
ADDRESS.....
CITY..... ZONE..... STATE.....

Among the rare species caught recently is the famous ribbonfish, a long snakelike creature, often mistaken by landlubbers for a "sea serpent." The eggs of this fish, about the size of a grain of rice, were caught in the fine-meshed sardine nets.

Another oddity is the rare medusafish which lives in the internal cavity of the medusa or jellyfish—like a baby kangaroo in its mother's pouch—where it is protected from larger fish that dare not approach the jellyfish and its stinging nettles.

In the shops of the Scripps Institution, many new kinds of equipment have been devised for the scientific fishermen by the special-developments division. Among

them are a shallow-water camera that uses stroboscopic light, a plankton net, enclosed in a steel tube, which can pulled through the water at 15 knots, many times faster than any previous net. Another unusual development is a tiny maximum-depth meter which is inserted in fish to record the greatest depths they reach.

One of the most valuable tools in the sardine project—and one which may have tremendous commercial possibilities—is sonar. This device, developed by the Navy for detecting submarines, is a kind of underwater radar using sound waves instead of electrical impulses.

(Continued to page 264)

The Ideal Christmas Gift

DREMEL *Electric* MOTO-TOOL

The "Pocket Size Machine Shop"

Grinds, Routs, Drills, Carves, Engraves, Cleans, Polishes, Finishes

APPROX. 27,000 R.P.M.

MOTO-TOOL KIT NO. 2 With 23 Accessories (High-Speed Steel Cutters, Grinding Wheels, Polishing Accessories) \$23.50

MOTO-TOOL NO. 2 with one emery wheel point \$16.50

Great for Hobbyists

Saves Time and Labor

10 REASONS WHY MOTO-TOOL IS A BETTER BUY

Here's what you get in a Dremel No. 2 Moto-Tool: Oil-less, sealed bearings

- Patented automatic chuck lock pin
- Oversize armature shaft, hardened, ground, polished
- Shockproof, bakelite housing
- Dust filtered air cooling system
- Dynamically balanced armature (for vibrationless operation)
- Exclusive hanger hook
- Sturdy 110-120 Volt AC-DC motor
- Weight only 13 oz.
- Cutters in Kit No. 2 are made of high speed steel (not common high carbon steel) for longer life, faster cutting.

Portable DRILL PRESS

Add all-around versatility to your Moto-Tool with this 12" high drill press. Just the thing for creating costume jewelry, model making, carving, routing, drilling, etc. Utilizes No. 2 Moto-Tool, which can be raised, lowered or swung in any direction. Weighs 3½ lbs.

Only \$9.95
(Less Moto-Tool)



Moto-Tools, Kits and Accessories should not be confused with "bargain offers." We invite you to compare Dremel Products feature for feature with other similar equipment. If you are not fully convinced ours are far superior in quality, design and performance, we don't want you to buy.

WIDELY USED IN INDUSTRY —Moto-Tool is a precision-built electric tool, backed by over 13 years of industrial use in such plants as: GENERAL ELECTRIC • FORD • REMINGTON ARMS • NASH-KELVINATOR • WESTINGHOUSE • DOUGLAS AIRCRAFT, etc.

PRE-WAR PRICES STILL PREVAIL

MOTO-TOOL KIT NO. 2 with 23 accessories including high-speed steel cutters and Model 2 Moto-Tool in natural finish hardwood case..... \$23.50

MOTO-TOOL NO. 2 with one emery wheel point..... \$16.50

WHERE TO BUY —Buy Moto-Tool from your dealer. If he cannot supply you, send check or M. O. for items desired and we will ship postpaid. Or, send only \$2 now and pay postman balance plus postage on delivery. **MONEY-BACK** if not delighted after 5 days' trial. Catalog of Dremel Tools **FREE**.

DREMEL MFG. CO., Dept. T119-M, Racine, Wis.

BIG VALUE!



MODEL NO. 1
MOTO-TOOL KIT
Only \$17.50

Moto-Tool Kit No. 1 contains the lighter Model No. 1 Moto-Tool and 34 practical accessories: steel cutters, grinding wheels, etc. in an attractive, lacquer-finish wood case. It's the biggest bargain \$17.50 in the field.....

MOTO-TOOL NO. 1 with one emery wheel point... \$9.85

A Gift the Whole Family Can Use
THREE TOOLS IN ONE



Patented

Only
\$14.85
 POSTPAID



Son, you'll have to wait to sand your boat until I polish some furniture.

A Dremel Sander sure takes the work out of sanding.

DREMEL *Electric* **SANDER**
 Popular Labor Saver for the
HOME and SHOP



MAKES PLAY OF WAX POLISHING



SOOTHES TIRED MUSCLES BY MASSAGE

FUN FOR BOYS FROM 8 TO 80
DREMEL *Electric* **COPING SAW**
 CUTS SCROLLS LIKE MAGIC—SANDS AS IT SAWS

BLADE FACES 4 WAYS

SAFE! AS A HANDSAW

JUST GUIDE IT!

Only **\$5.85**
 with 3 saw blades

For men who harbor a hobby or do their own repair work . . . for boys who like to make things . . . no other tool will give as much pleasure and satisfaction in the home or workshop for the small amount of money invested as a Dremel Electric Coping Saw. It works in any direction . . . delivers 7,200 strokes per minute . . . so easily, there is no effort . . . so smoothly, work needs no sanding. Makes child's play of tricky scroll designs . . . saws through 3/4" medium hard wood at a foot-a-minute speed. Touch-of-the-trigger, foolproof action. Saw has only two moving parts . . . never needs oiling. Operates on AC current. Thousands and thousands of satisfied users.

WHERE TO BUY IT—Buy Dremel Electric Coping Saw from your dealer. If he cannot supply you, use the coupon to order direct from factory. We ship postpaid if you send check or money order in full. Or, send \$2 now and pay postman balance plus postage, on delivery. Money back if not delighted after 5 days' trial.

DREMEL MFG. CO. • Dept. 5119-M • Racine, Wis.



Plan for making six useful decorative projects packed with each Dremel Electric Coping Saw.

The popular Dremel Electric Sander is more than a sander . . . it's also a polisher and massager. This miracle machine is so easy to handle, a child can use it. It delivers 14,400 strokes per minute. (1) As a sander, it gets into tight corners, takes the effort out of sanding walls, woodwork, furniture, workshop projects, etc. Its straightline (non-rotary) action will not burn or scratch surfaces. (2) As a polisher, it does a professional job on waxed surfaces of cars, furniture, refrigerator cabinets, etc. (3) As a massager, it's ideal for tired or sore muscles of the back, legs or arms. Users testify it is more effective than machines made expressly for this purpose.

LOOK AT THESE DREMEL FEATURES

Dremel Electric Sander does all the work . . . you merely guide it. It weighs only 2 1/2 lbs.; it's foolproof (has only two moving parts . . . never needs oiling). Quick-change clamps firmly hold abrasives and pads. Dremel Sander is sturdily built to give long, trouble-free service. Operates on 110-120 Volt, 60 Cycle, AC. Thousands and thousands of satisfied users prove its outstanding value.

WHERE TO BUY IT — Dremel Electric Sander comes complete with 6 sheets assorted grade Garnet Paper for sanding, plus felt pad and sheepskin for polishing. Buy it from your dealer. If he cannot supply you, use coupon below to order direct from factory. We ship postpaid if you send check or money order in full. Or, send \$2 now and pay postman balance plus postage, on delivery. Money back if not delighted after 5 days' trial.

**If Your Dealer Cannot Supply You
 USE THIS HANDY COUPON ORDER FORM**

DREMEL MFG. CO. • Dept. 5119-M • Racine, Wisconsin

- Enclosed find \$_____ (Check or M. O.) in full payment for items checked below. Ship postpaid at once.
- Enclosed find \$2.00 in part payment for items checked below. I agree to pay postman balance plus postage, on delivery.
- Dremel Electric Sander \$14.85 Dremel Electric Coping Saw \$5.85
- Free catalog of Dremel Electric Tools.

Name _____
 Address _____
 City _____ Zone _____ State _____

ONLY \$199.50 FOR A COMPLETE POWER WORKSHOP



Your complete power workshop in just 18" x 60" floor space. With ½-hp. ball-bearing motor illustrated, \$199.50.



FOR less than \$200—and with eight square feet of floor space—you can have a power shop second to none in capacity, accuracy and flexibility. It's SHOPSMITH—five heavy-duty, extra-feature tools in one unit so beautifully engineered, so ingeniously designed that you can convert from tool to tool in less than 60 seconds.

NEVER BEFORE SUCH AMAZING CAPACITY

Imagine a circular saw that cuts to center of 8' plywood panels . . . a lathe that takes work up to 15 inches in diameter . . . a drill press that mortises doors and panels as easily as it drills miniature parts . . . a disc sander that squares, miters and

finishes with "try square" accuracy. You get these, and more, with SHOPSMITH.

OUTPERFORMS SINGLE-PURPOSE TOOLS

Compare SHOPSMITH with any combination of single tools at any price. Compare it for accuracy, capacity, all-round utility. You'll see why the thousands of men who own SHOPSMITH praise it so enthusiastically. On display at any Montgomery Ward store and at leading hardware or department stores. SHOPSMITH, complete with attachments, costs \$169.50. With heavy-duty ½-hp. ball-bearing motor, \$199.50.

5 RUGGED POWER TOOLS IN 1

1 EIGHT-INCH CIRCULAR SAW

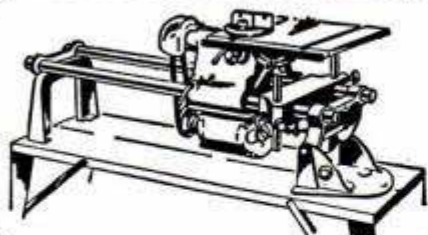

Effective table width up to 56". Maximum depth of cut, 2 1/4". Machined tilting table, ribbed for extra strength. Precision-tooled rip fence and miter gauge. Unique micro-adjustment permits extremely accurate ripping.

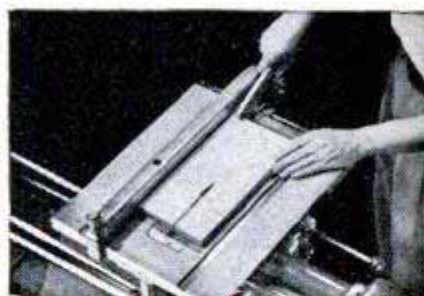

2 TWELVE-INCH DISC SANDER

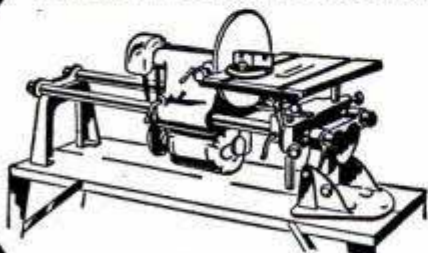

Cast-aluminum disc easy to attach and remove. Extra-large, adjustable table measures 14 1/2" x 17". Miter gauge and rip fence can be used for accurate squaring and jointing. Has features found in no other disc sander.



3 HORIZONTAL DRILL PRESS

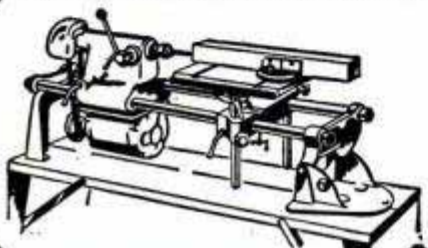

Extremely useful operation possible only with SHOPSMITH. 4" quill feed, automatic stops. Permits large, heavy pieces to be drilled or mortised quickly and accurately. Eliminates need for jigs. Length of work limited only by size of room.

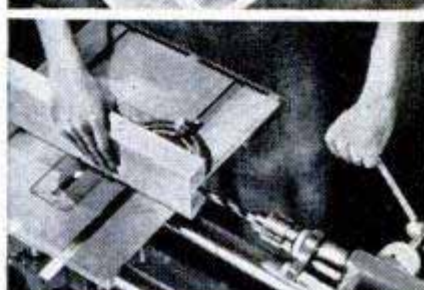

4 VERTICAL DRILL PRESS

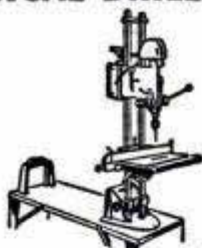

SHOPSMITH drills to the center of a 15" circle, has a maximum clearance table to chuck of 27". Jacobs key chuck takes drills from 5/64" to 1/2" diameter. Rugged, six-spline spindle with 4" feed. Variable speeds 875 to 3500 rpm.

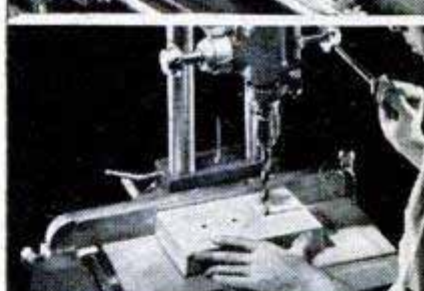

5 THIRTY-THREE-INCH WOOD LATHE

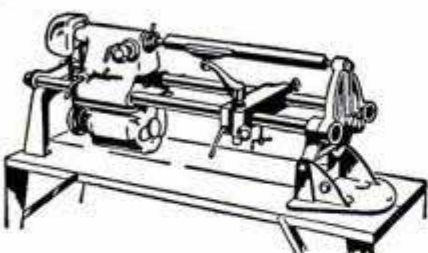

With a 15" swing, SHOPSMITH has greater capacity than most other heavy-duty lathes. Distance between centers, 33". Swivel-arm tool rest always slides parallel to ways—no need for constant adjusting. Has 4" quill feed. Quickly adaptable for oversized faceplate work.

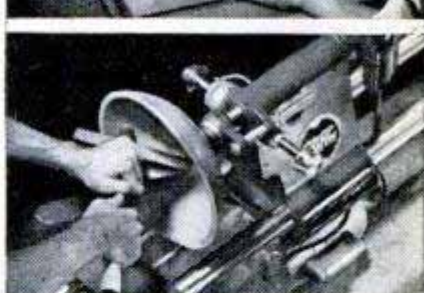

AND THAT'S NOT ALL! WE'VE MORE TO TELL YOU, BUT NO MORE SPACE TO TELL IT HERE. IT'S ALL COVERED IN AN ATTRACTIVE, ILLUSTRATED BOOKLET. WRITE FOR YOUR FREE COPY TODAY!

Address SHOPSMITH, Dept. 105-B,
at factory nearest you.
12819 Coit Rd., Cleveland 8, Ohio, OR
417 Montgomery St., San Francisco, Calif.

I'm interested in SHOPSMITH. Please send me a free copy of the descriptive booklet. And tell me where I can see SHOPSMITH demonstrated.

Name _____

Address _____

City _____ State _____

BUILD ELECTRIC CLOCKS ...of your own design...



with

Klockit ... for Profit!

TRADE MARK

Ideal for
BUILT-IN
clocks...



Kitchens



Movement 3"x4½"x2" deep

POWERFUL GUARANTEED MOVEMENT FOR 3" TO 36" DIAL CLOCKS

BUILD ELECTRIC CLOCKS for homes, offices, dens or club rooms in natural woods, plastics, metal or other materials. Make modern and novelty clocks for profit!

QUIET LIFETIME ELECTRIC MOVEMENT is shielded against moisture and dust. Has sweep second hand shaft... self starting... not a toy! Highest quality precision construction resists wear indefinitely. **NEVER NEEDS OILING!** Guaranteed for one full year.

QUICK EASY MOUNTING. Just drill centerpost hole and mount with four screws. Operates in any position. Ideal for behind wall mounting. Full instructions with every kit.

Make clocks for Christmas gifts... Take orders for special built-in clocks! Sample Klockit includes 110 volt 60 cycle rear set movement, hour, minute and sweep second hands for 8" dial clock (hands may be clipped for smaller dials), 12 dial markers and full instructions. Immediate shipment. Specify kit desired.

Offices



Dens



Club
Rooms



and
Novelty
clocks
of all
kinds



Order your KLOCKIT today.

KK1 ... for up to 1/8" thick dial face material.
KK4 ... for up to 3/8" thick dial face material.
KK5 ... for up to 1" thick dial face material.
Larger or special hands, and other Klockits for alternating current 24 volt to 220 volt, 50 or 60 cycle available. Write for prices and quantity discounts.

Sample Klockit

\$6.95

net postpaid in U.S.A. Send check or money order.

© 1949 All Rights Reserved

Klockit Division of

HART-FARGO INDUSTRIES, INC.

405 South Wabasha • St. Paul 7, Minnesota

At present, sardine fishing is restricted to the dark of the moon because schools can only be detected at a distance of 100 yards by the phosphorescence of their scales. By means of sonar echoes, however, it might become possible to discover schools of sardines 1000 yards away. Nets could then be lowered in the daytime as well as at night.

During the war, University of California scientists working for the Navy found that they got mysterious sonar echoes in the daytime from depths of 500 to 1000 feet. They called the layer the "deep scattering layer."

At night, the layer rose to the surface and became more diffuse. Later it was determined that the sound was reflected back to the sonar ship by marine animals. Studies are now being made to find out if these animals are tiny plankton, larger fish or even giant squid which may compete with the sardines for food. Investigations of this mystery of the deep were explained in a feature article entitled "Deep-Sea Mystery Story," which appeared in the September 1949 issue of *Popular Mechanics*.

With these scientists working on the problem, using skills and equipment that would make Sherlock Holmes envious, we may someday know the solution to the case of the vanishing sardine!

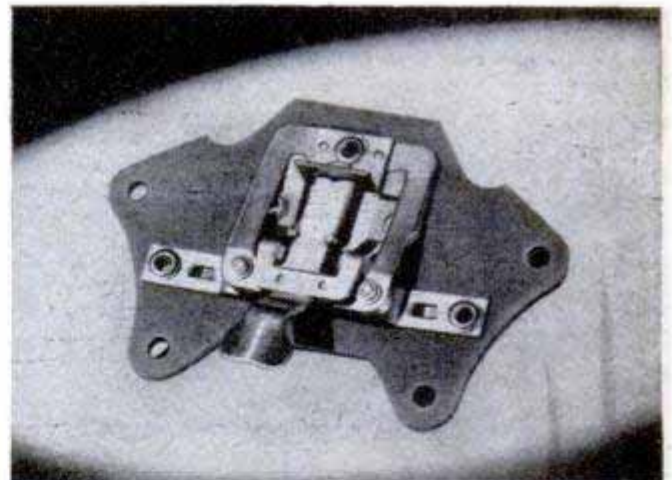

Reversing Switch For Single-Phase Motor

Single-phase electric motors now can be reversed instantly with a simple switch that replaces the starting switch and is held in place by the same mounting screws. Its action is mechanical, being similar to conventional starting switches except that it has two contacts instead of one. The contact which is closed determines the polarity of the auxiliary winding field and the direction of rotation. An external control switch directs passage of the current through the internal reversing switch.

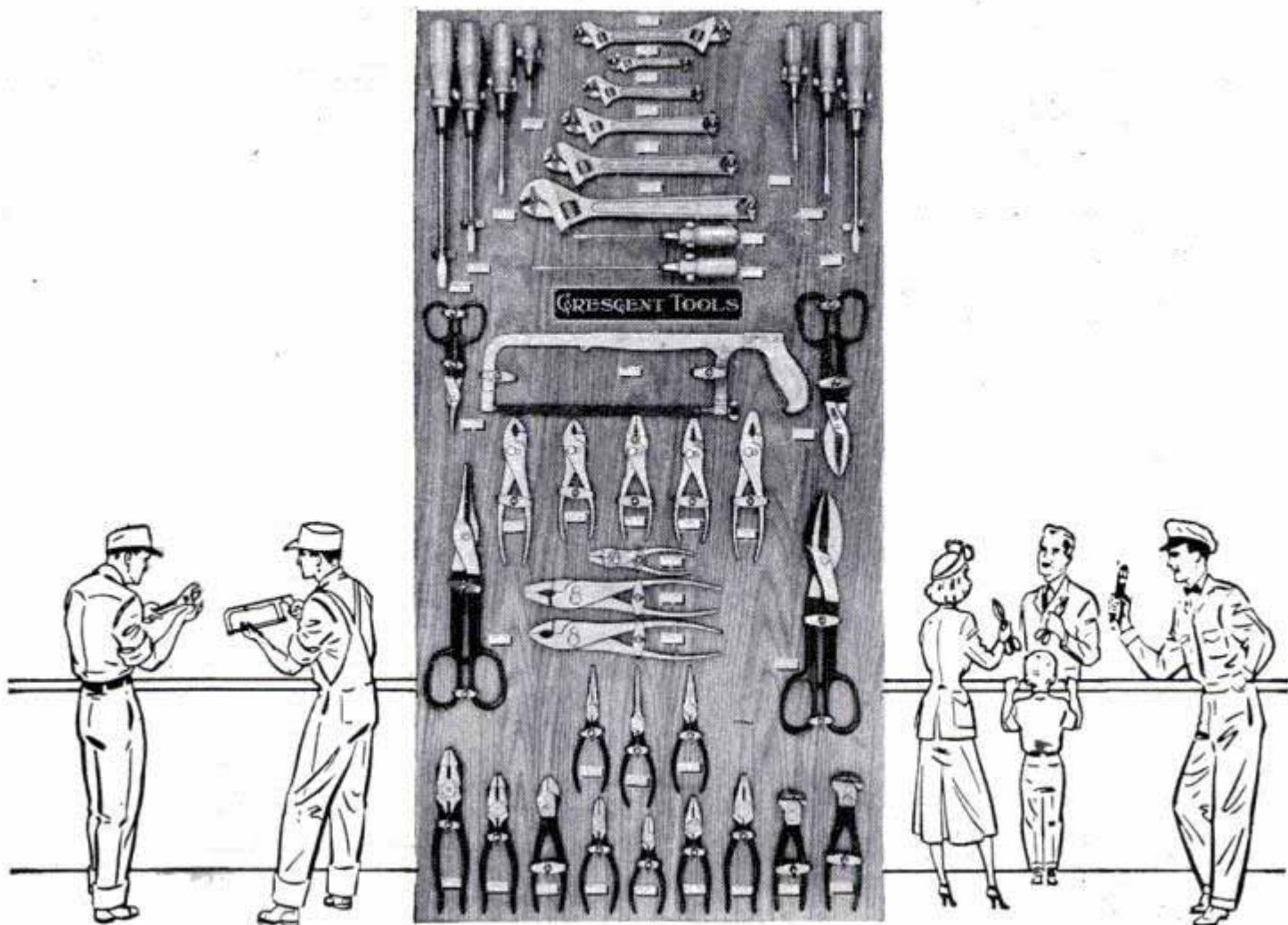

BUY TOOLS WITH CONFIDENCE WHERE YOU SEE THIS DISPLAY

Crescent not only manufactures Hand Tools of Good Design and Outstanding Performance, but Crescent Dealers make it easy for you to select and purchase them.

About 30,000 Hardware Dealers throughout the country stock Crescent Tools. Almost 3,000 of these dealers

display them on Tool Panels, like the one illustrated above, which make it easy for the purchaser to select the size and type best suited to his needs.

When you need Hand Tools and if you want the best for your dollar, go to your Hardware Dealer and ask for the "Crescent" or "Crestology" Brand.

**EVERYBODY
RECOGNIZES
QUALITY**

by this Trade-mark

CRESCENT TOOLS



"Crescent" is our trade-mark, registered in the United States and abroad, for wrenches and other tools. Sold by leading distributors and retailers everywhere and made only by
CRESCENT TOOL COMPANY, JAMESTOWN, NEW YORK

FREE PLAN

Tells How to Start
Your Own Business

FILING SAWS

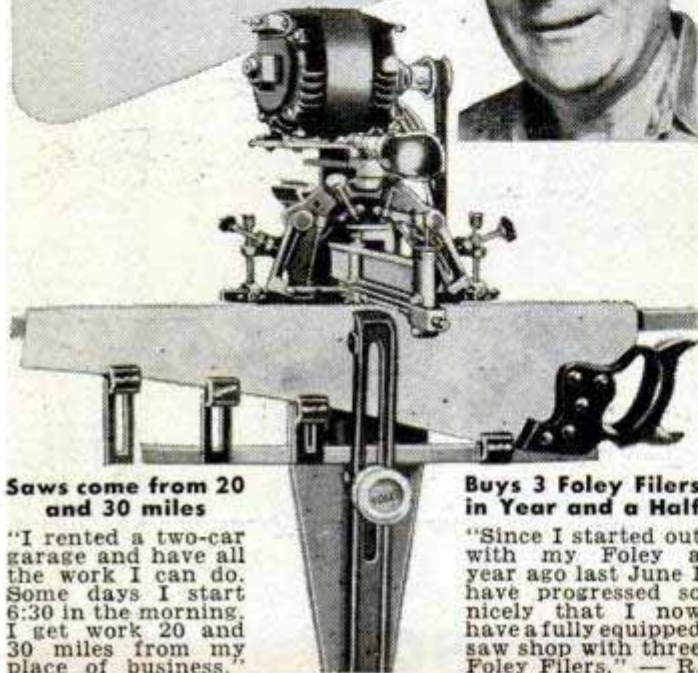

Saws come from 20
and 30 miles

"I rented a two-car garage and have all the work I can do. Some days I start 6:30 in the morning. I get work 20 and 30 miles from my place of business."
—Charles H. Smith.

Buys 3 Foley Filers
in Year and a Half

"Since I started out with my Foley a year ago last June I have progressed so nicely that I now have a fully equipped saw shop with three Foley Filers."
—R. W. Persinke.

FOLEY FILED SAWS BRING NEW CUSTOMERS

Here is a steady repeat CASH business you can start in your own basement or garage in your spare time. Every saw you sharpen with the machine accuracy of the Foley Saw Filer is an ad that brings you more customers. S. M. Hollingshead wrote to us: "I am doing very well with my Foley Filer, and I am glad I invested in your machinery. It is very satisfactory and works very well in the small community in which I live."

You can file all hand saws, also band and cross-cut circular saws on the Foley Saw Filer. The adjustments are simple — there is no eyestrain — and you can start right away to turn out perfect cutting saws. "The first saw I sharpened with my Foley Filer came out 100%. I think it is a marvel of perfection."
—writes Clarence E. Parsons.

FREE BOOK Shows How to Start

"INDEPENDENCE AFTER 40" explains how you can get business from hardware stores, home owners, farmers, carpenters, schools, mills, factories, etc. Just think — with a modest investment, no overhead, no stock of goods to carry, you can start right in on a cash business that will help pay the rent, buy groceries, or a new car. Start now—you can get IMMEDIATE DELIVERY on a Foley Saw Filer.



Send For **FREE BOOK**

FOLEY MFG. CO., 1216-9 Foley Bldg.
Minneapolis 18, Minn.

Send me free book "INDEPENDENCE AFTER 40!"

Name _____

Address _____

Santa Claus Lives in Pittsburgh

(Continued from page 108)

and beneath, the first. A viewing frame, set at the top platform level, held the Chinese mirror at an inward slant. It acted as a window for the upper dioramas and reflected those below. Hence, as different dioramas were moved into position, they overlapped the one already in the frame until the latter was moved away on its belt. "Of course," Seibel points out, "the mirror reflected the bottom ones in reverse, so it took some careful figuring. Now we can truthfully say that we can even build things backwards."

Nobody knows when the firm branched from sign painting to more elaborate displays, but Chicago's Century of Progress (1933-34) saw them well represented. Today, you can hardly visit a fair without seeing something from the shop. Literally thousands of animated displays have come from its lathes and bandsaws. Two of its full-scale houses, complete with furnishings and appliances, toured the country for the FHA in five freight cars. Sixty-seven Gardner creations adorned the New York World's Fair, including an elaborate thing designed by Salvatore Dali, called the "Dream of Venus." It consisted of a huge water tank, in which swam fish, live mermaids with rubber tails and a rubber piano.

During the war, the busy shops turned out full-size airplane training mockups for the Army. There were pilot-training cockpits for instrument practice, cutaway machine guns and a full-size ditching mockup of a B-17 bomber, which slid down a track into a Florida lagoon hundreds of times. Full crews were aboard. At first it took them 10 minutes to escape; later they did it in 40 seconds.

As soon as the war ended, Gardner got back into its old stride, turning out impossible displays for anyone. An order came in not long ago for a full-scale diesel engine with three freight cars and a caboose. Seibel was told to deliver in 10 days. Gardner has never missed a deadline, and Jim had no intention of spoiling the record. "We started building that thing without plans," he says. "Just laid out a framework and went to work with wallboard, wire, plaster and aluminum sheeting."

By the time the plans were ready, the train was half finished. Rails and ties were carved out of wood—in perspective. Homosote was used to represent the gravel between the ties. "We made that one with time to spare," Seibel recalls. "The headlight glared, its horn blew and I hear it attracted a lot of attention."

(Continued to page 268)

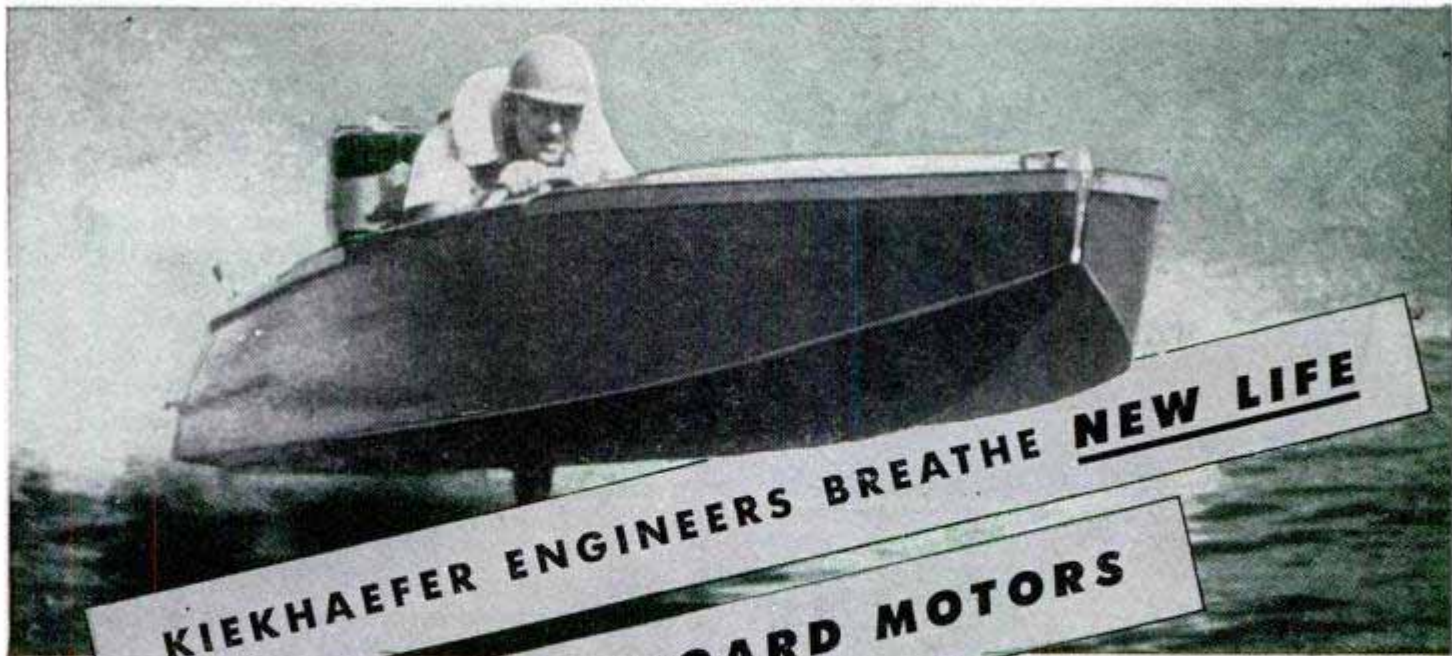

KIEKHAEFER ENGINEERS BREATHE NEW LIFE

INTO BIG OUTBOARD MOTORS

Even More Performance per horsepower! Now More Performance per pound of weight!THE SENSATIONAL NEW 1950

KIEKHAEFER

MERCURY

25 H.P. Thunderbolt

IT'S AN ALTERNATE FIRING "4". THE FIRST 4 CYLINDER-IN-LINE 2 CYCLE OUTBOARD ENGINE, THE ULTIMATE IN SMOOTH STEADY POWER!



The unrelenting determination of Kiekhaefer engineers . . . the years of research in laboratory . . . the thousands of hours testing in salt and fresh water . . . the torture of thousands of hours gruelling dynamometer destruction tests are climaxed by the introduction of the new 25 H.P. Mercury Thunderbolt.

Not just a new model, but a new type of outboard, the Thunderbolt brings to boating lovers the performance and precision of finest automotive and aircraft engines. Its four cylinder-in-line two cycle construction produce a power impulse every 90° of crankshaft rotation. It's a package of caged lightning . . . powerful as a grizzly . . . yet gentle as a kitten. Its synchronized spark and throttle insure smoothness over the entire speed range and flashing "hold onto your hat" acceleration. It's light weight . . . and it's "Full Jeweled"! Anti-friction bearings on the crankshaft, driveshaft and propeller shaft . . . forged steel connecting rods with roller bearings on the crank pins and wrist pins give all moving parts an "Anti-friction Ride", and its low oil to gasoline ratio and perfected fuel distribution mean longer spark plug life.

Drive a Mercury Thunderbolt and you'll never be satisfied with anything else in a high performance outboard motor. Get the full story of this revolutionary new outboard by writing direct to

**PROVED FULL JWELED POWER*
THE BIG ENGINEERING DIFFERENCE**

*First in Mercury, In Every Mercury,
Only in Mercury*

*Ball and Roller Bearings Throughout



KIEKHAEFER CORPORATION, DEPT. P. M.
660 South Hickory Street
Fond du Lac, Wisconsin, U.S.A.



with a **Binkley** *rota-matic* SANDER

YOU SAVE TIME

DO A BETTER JOB

WITH LESS ENERGY



Yes, once you glide the self-rotating BINKLEY SANDER over any flat, beveled, or rounded wood surface, you'll marvel at the professional results you get. You'll easily produce a smoother, more uniform surface, using far less energy!

AN AMAZINGLY NEW WAY

The BINKLEY "rota-matic" SANDER eliminates all the old "back-breaking" home methods of sanding. For instance, you can sand down a table top in $\frac{1}{2}$ to $\frac{3}{4}$ the time ordinarily required.

STURDILY BUILT—

WILL LAST FOR YEARS

"rota-matic" sanding disks outwear ordinary sandpaper sheets 20 to 30 times because they rotate, putting each cutting face of the sanding grit to work. This same rotating action makes the disk self-cleaning and even-wearing. Sturdily built of steel—no complicated parts to wear out!

GET YOURS TODAY

Outfit complete with fine, medium, and coarse grit Disks, easily interchangeable. If your dealer can't supply you—don't wait. Send only \$2.50, we'll ship promptly, postage paid. Money back if not satisfied in every way. Write to—

BINKLEY MFG. CO., Desk M-1, Warrenton, Mo.



FLAT SURFACE



BEVEL EDGES



ROUND CORNERS

Seibel is always dreaming up odd materials to achieve the effects he wants. Arms and legs on many big figures are made with steel rods, jointed and levered if the parts are to move, then capped with papier-mache for contour. But papier-mache is expensive, so today you'll see huge cartons of cardboard rolls, like the kind they roll oilcloth around, sitting in the Gardner warehouse. They're stronger and cheaper.

Wigs give Seibel a bad time. They're expensive and it's tough getting just the right quality. For a ventriloquist unit, he walked the streets for days, prowling through furrier shops. Finally, he saw what he wanted—a gorgeous piece of Persian lamb, just the right shade. Before the eyes of horrified furriers, he slashed off what he wanted, paid \$40 for the skin, threw the scraps back on the counter and walked out of the shop. "It was just right," he said. "We made our own wigs."

The 12-foot "Alice in Dairyland" required \$350 worth of hair, bought from an Italian wigmaker. "We had it waved and set," he says, "but by the time Alice got to the fair, that hair was so heavy it drooped straight as a poker. We had to do it over continually."

Perhaps the toughest job that ever hit the Gardner workshop was one that came in this year. A railroad company wanted a figure of Paul Bunyan 23 feet high; he was to move his hands, turn his head, roll his eyes and talk like a he-man. All last summer that monster of a figure sat on display at the Chicago Railroad Fair, doing all the things it was supposed to do.

Under ordinary procedure, Seibel would draw a rough sketch and turn it over to the art department for detailed plans of each part. On Bunyan, there just wasn't time. Seibel went out and got reams of wrapping paper, spread it out on the floor and went to work with a big crayon, drawing a full-scale sketch of what he needed. Then he stuck the paper together with tape and hung it from the highest rafter. It was 23 feet high. Bunyan progressed like all masterpieces—bit by bit. They tried nails for his mustache, but gave that up when they rusted. Wire brushes retarded movement of his mouth when he talked. Finally, they just painted on the whiskers.

The massive head was built along standard Santa Claus lines, with wire caging formed over the skeleton. The head was then modeled in clay, a plaster-cast mold made from it, and then cast in papier-mache. Over this was pulled a skin of foam rubber $\frac{1}{8}$ -inch thick.

The eyes had to be sealed to prevent rain from getting in and gumming up the works.

(Continued to page 270)

NOW... FILL CIGARETTE LIGHTERS... NEW SENSATIONAL WAY!



WITH PATENTED FLUID CONTROL DISPENSER! FIRST IMPROVEMENT IN LIGHTER HISTORY!

Twist - It's Open
Squeeze Container-Fill Lighter
Twist Back - It's Closed

- NO CAP TO REPLACE. NO TOP TO PUNCTURE.
- NO EVAPORATION OR SPILLING.
- NO OVERFLOW WHEN FILLING LIGHTERS.
- USES LAST DROP OF FLUID WITHOUT TILTING.

THIS FLUID IS THE FINEST EVER MADE. It is DOUBLE DISTILLED, with THOLITE added, to give you a CLEANER, BRIGHTER flame.



When original container is empty... "QUICK AS A WINK"... transfer original dispenser to another 8 oz. container of FC Lighter Fluid

INTRODUCTORY OFFER: One large 8 oz. Container with FLUID CONTROL Dispenser attached and two 8 oz. refills.

Get this half year supply of Lighter Fluid with Dispenser for only \$1.00

MAIL COUPON TODAY!

FLUID CONTROL CORP., 2430 S. Ashland Ave., Chicago 8, Ill.

Enclosed find \$1.00 for three 8 oz. Containers of FC Lighter Fluid with Dispenser. Postage and handling charges included.

Name _____

Address _____

City _____ Zone _____ State _____

MAN'S BEST LAXATIVE

Grows in Fields
and Forests



10 HERBS IN
TINY TABLET

Folks who need help in keeping regular should look to herbs and roots—for the help provided by Nature.

10 such herbs and roots, scientifically compounded, are found in Nature's Remedy, NR Tablets. Countless thousands of folks have found an NR at night the best way to assure regularity in the morning. So gentle—no griping. It is wonderful—leaves you feeling refreshed, invigorated.

Try NR at our expense. 25 tablets 25c. Buy a box at any drug store and try it. If you are not completely satisfied, return the box and unused tablets to us. We will refund your money plus postage.

PLAIN OR CANDY COATED

Nature's Remedy
NR-TABLETS-NR

The GIFT that Keeps on GIVING Year after Year

HULL
AUTOMOBILE
COMPASSES

At your dealer's.
Write for circular.

Beaconlite
Illuminated.
\$5.95.
Streamline
standard.
\$3.95.



HULL MANUFACTURING CO., P. O. Box 246-D12, Warren, Ohio

KEEP YOUR TOOLS SHARP!

The revolving Oilstone Tool Dresser offers an oilstone with a continuous motion. The accepted method of putting a keen edge on a sharp cutting edge is to oilstone it. Round carving tools and gouges, the most difficult tools to oilstone by hand, can be rolled back and forth over the revolving oilstone and sharpened as easily as a flat tool. Write for circular.



CLAUSING MANUFACTURING CO.
235 RICHMOND AVE. OTTUMWA - IOWA

*Prices
Reduced!*

On limited quantity of all new SOUTH BEND high speed steel drill sets. Jobber lengths with straight shanks IN INDEXED STEEL CASES.

Shipped postpaid anywhere in U.S.A.

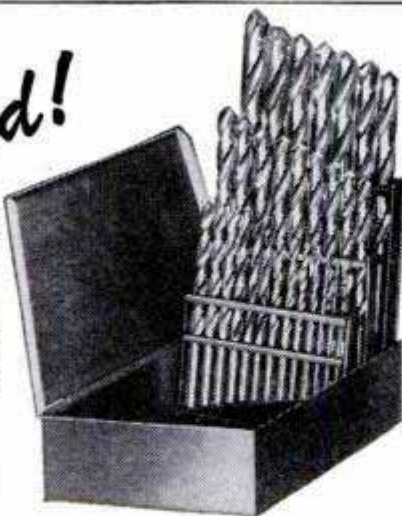

Cat. No.	Description	Old-Price	New
6129	Set of 29 drills, 1/16" to 1/2" by 64ths	\$28.25	\$21.75
6113	Set of 13 drills, 1/16" to 1/4" by 64ths	5.75	4.43
6121	Set of 21 drills, 1/16" to 3/8" by 64ths	14.25	10.97
6115	Set of 15 drills, 1/16" to 1/2" by 32nds	15.50	11.93
6260	Set of 60 number drills, Nos. 1 thru 60	22.00	16.94
6326	Set of 26 letter drills, A thru Z	25.25	19.44

SOUTH BEND LATHE WORKS

Building Better Tools Since 1906

455 E. MADISON ST., SOUTH BEND 22, INDIANA

DECEMBER 1949

Give the World's Most Useful Hand Tool!



New
WISE-GRIP
WRENCH

LOCKS to work
with Ton Grip



"He'll" be thrilled to receive this marvelous new VISE-GRIP! Most useful tool he can own! Gives his hand More Than TON Gripping Power! Does difficult jobs like magic! Powerful LOCKED grip turns stubborn nuts, studs, screws with worn slots . . . pulls headless nails . . . holds smallest parts for grinding, filing, sawing . . . does repair jobs usually impossible outside a well equipped machine shop!

New Involute Jaw Curve holds all shapes—nuts, rounds, irregular shapes, with unbelievable ease. Knurled Jaw Tips prevent slipping. Has Thin Nose, Super Wire-Cutter. Fine alloy steel. Specially hardened. Nickel plated finish.

WITH Cutter	No. 7W—7-in.	\$2.25
	No. 10W—10-in.	2.50
WITHOUT Cutter	No. 7C—7-in.	1.85
	No. 10C—10-in.	2.25

Also world famous original model:

No. 7—7-in.	1.65
No. 10—10-in.	1.95

If not at your dealers,
order direct.

Postage paid if money
accompanies order.



Dept. M12

DeWitt, Nebr.

SAY YOU SAW IT IN POPULAR MECHANICS

Own a Super Powered **SPEED BOAT**

Your choice

\$3.95
Postpaid



SEA GULL • Outboard Racer
MODEL L3 16 INCHES



SPORTSTER • Inboard Motor
MODEL L1 17 INCHES



RUNABOUT • Inboard Motor
MODEL L2 15 INCHES

All Boats have Beautifully Grained Mahogany Finished Wood Hulls, High-Gloss Enameled Steel Decks, and are powered with Precision Built Spring Type Motors. Your Choice for \$3.95 or All 3 Boats for \$10.

Attention Model Boat Builders



YOU CAN BUY THE
MOTORS ONLY,
INBOARD \$1.00
OR
OUTBOARD \$1.00

STRATO-ROCKET

Rocket goes up to 400 feet in the Air... Makes Parachute Landing. Complete with Launching Rod, 2 Rockets, Parachute Kit \$1.00

Gift Wrapped and Mailed Postpaid any Place in U. S. or Canada. Enclose Check or Money Order and Print Name and address plainly.

DEALERS INVITED

All orders shipped same day prepaid
● **NY-CAL Company, Encinitas, California**

So the plastic shop blew nine-inch plastic bubbles and sealed them into the rubber. Another, smaller set, fitted inside them. These were the actual eyes, attached to the hinged crossarm that turned them back and forth.

Fourteen waterproofed double blankets made Paul Bunyan's shirt, with balsa-wood buttons the size of pie plates. Two tarpaulins, 30 by 60 feet each, were just enough for the pants. Two hanks of horse-hair made his wig. His hands, six feet long, and his nine-foot boots, were made of papier-mache, from plaster casts. Coat after coat of varnish went over these exposed parts until they were thoroughly waterproofed. Miles of wiring hooked up a pair of pick-up microphones at audience-head height—down near Bunyan's feet—to the hidden operator's booth, where questions from the audience were heard and answered. As in the talking Santas, the operator could answer the questions. The sound impulses traveled up under Bunyan's shirt to a pair of auditorium speakers capable of sending his voice booming for three miles, and at each syllable, his gigantic mouth would open and close in proper "synch." His hands and arms, hinged and belted in true anatomical fashion, raised and lowered under power from several electric motors, activated by buttons in the operator's booth. His monstrous head swung from side to side, and so did his eyes.

Seibel, Hill and the huge collection of imaginative craftsmen at Gardner are back in the Santa Claus business right now. They've built a new unit this year—"the Jalopy." It's a half-scale lizzie with Santa driving, gnomes scattered around pumping tires, throwing gimmicks in the engine and raising Cain in general. The simple plywood affair has fenders hung on springs. Everything on it is loose, including the wheels. Through slots in its platform, the wheels contact big eccentric cams which are turned by electric drive. These send the jalopy into the biggest cavort you ever saw. Fenders flop, things heave, the gnomes dance around like little devils and Santa sits cheerily smiling and waving his free arm at all and sundry. A dozen of them have come off the assembly line so far. It's not a big display, but it's effective and a lot of kids will get a bang out of it.

"There was a big one I'm glad we didn't get," says Jim Seibel. "A large department store wanted a Statue of Liberty, almost full scale. It was to sit on their marquee and stretch up 10 stories in the air. They gave up the idea." Then he gets a far-away look in his eye. "We could have done it, of course—it would have been a whopper."

O.D. WOOL SHIRTS
13 to 15
244

PANTS
28 to 32
266

Used, reg. re-issue, perfect condition 100% wool serge. Cleaned & pressed by Q.M. Corp. Add 12c ea. post.

GEN. NYLON 50 FT
59¢

PARACHUTE CORD
3/16" dia. White or khaki. 550 lb ten strength. For clotheslines, venetian blind and drapery cords and other uses. Add 4c post.

50% WOOL HOSE
39¢

NEW. Medium weight, rugged and warm. Post 3c.

CUSHION SOLES
49¢

NEW. 63% wool, double sole. These are known as the desert sox. Khaki and white. Add 4c postage per pr.

WAR SURPLUS BARGAINS

AND OTHER ORDER FROM THIS AD PLEASE

WATCH CAPS
77¢

NEW Navy watch caps. Color, blue 100% pure wool knit. Please add 5c postage each.

all wool WRISTLETS
13¢ 8 PAIR \$1.00

NEW 100% O.D. wool knit. Ideal for glove and mitt inserts, wristlet replacements, etc. Worth 75c per pair. Add 3c postage per pair.

12.99

B-15 Style FLIGHT JACKET

NEW. Renders greatest warmth per oz. of weight. Mountain cloth outside, pile lined body and sleeves. Genuine mouton collar, 4 pockets—2 outside, 2 inside. Wool knit cuffs and waistband. Add 27c postage.

BRAND NEW KHAKI SHIRTS-PANTS
14 to 17
25.9

28 to 42
333

Genuine 82 chino khaki suntan material. Pants with cuffs. Add 11c post. per garment.

NAVY T-SHIRTS
59¢

WHITE

NEW. Combed yarn, full cut, small, medium, and large. 5c postage.

SIZZLING SPECIALS

ARMY STYLE 688 COMBAT BOOTS

NEW. For sportsmen and outdoor wear. 10" high. Reversed uppers, full oak leather sole, with composition outer sole. Add 27c post.

6 TO 12

DUST MASKS
33¢

New \$1.50 value. Ideal for millers, farmers, paint and insecticide spraying. Add 6c postage for each.

NAVY SUN GLASSES
66¢

Navy issue. Ground & polished lenses, plastic frame, wire center. \$4.00 value. Add 6c post.

AVIATORS
1.33

24K Style GOLD PLATED RIMS

Large size 52mm lenses. Shuts out max. violet & infra red ray. Pearl sweatband. Comp. with handsome case. Add 7c post.

GREATEST WATCH VALUE IN U.S.A.

17 JEWEL Military Style WRIST WATCH

19.95 PLUS 10% FED. TAX

BRAND NEW GEN. INCABLOC WATERPROOF SHOCKPROOF

Non-magnetic, radium dial, sweep second hand. St. steel case. Complete with leather strap. Guaranteed Swiss 17 Jewel movement. A truly remarkable value. Add 15c post.

WAR SURPLUS CIRCULAR

SEND FOR FREE

Over 200 War Surplus and other outstanding bargains.

SIoux FALLS SURPLUS STORE

113 NO. PHILLIPS SIoux FALLS, S. DAK.

OUR BETTER QUALITY.....2.55

Hand Operated HYDRAULIC ARBOR PRESSES

K. R. WILSON

215 MAIN ST., BUFFALO 3, N. Y., U.S.A.

WRITE FOR YOUR FREE COPY OF THE NEW KRW HYDRAULIC PRESS BOOK



Describes all manner of Production and Shop Work on KRW Hydraulic and Bench Type Presses. Illustrates the new KRW Hand-operated, Electric-operated and Air-operated Hydraulic Presses. 25 to 100-ton capacities.

Write for your copy today.

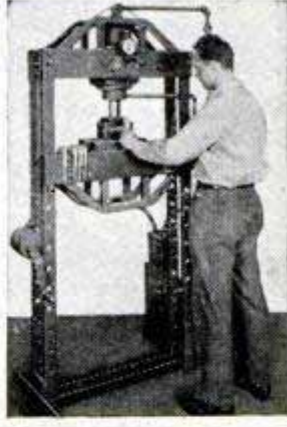

K. R. WILSON, DEPT. 17, 215 MAIN ST., BUFFALO 3, N. Y.

"Wellworth" 1/4" REDUCING VALVE & GAUGE

Oil resistant, pressure 0-to-200 lb. Reduced pressure 0-to-75 lb.; 3 outlets 1/4". **\$5.75**

1/30 H. P. MOTOR

12 volt D. C. motor. 2450 R.P.M. 2.0 amps. 1/4" shaft. Size overall 3" x 4". Weight 3 lbs. USE AS 6 VOLT GENERATOR. ea. **\$2.75**

QUANTITY PRICES
4 for \$7.50—24 for \$36.00—100 for \$135.00

AUTOMATIC PRESSURE SWITCH WITH UNLOADER

Double pole, with 2 way release valve. Set at 125 to 150 lbs. pressure. Wt. 4 lbs. Only **\$10.25**

Same without unloader. **\$7.50**

Switch—20 to 40 lb. adjustable to 80 lbs. For air or water. **\$5.50**

"Wellworth" AIR COMPRESSOR

Piston type, size 2x1 3/4. head in valves, bronze bearings, splash lubrication. "V" Belt drive. Intake muffler and cleaner. Capacity 2.8 c.f.m. at 100 lbs. continuous pressure or 150 lbs. intermittent, with 1/2 hp motor. Can be used with 1/4 hp or 1/2 hp at lower speed. Weight 14 lbs. Operating instructions furnished. **PRICE ONLY... \$17.50**

Price F.O.B. Chicago. Sold on money back guarantee. Send check or money order today. Prompt shipment. Catalog free.

WELLWORTH TRADING CO. 1831 S. STATE ST., Dept. D-12 CHICAGO 16, ILL.

GREATEST

25
piece set only
\$14.95

**POWER TOOL VALUE
EVER OFFERED!**

*Dear Mom—
We'd like this
wonderful gift for Xmas—
Dad + Junior*



Famous
CASCO
ELECTR-O-TOOL
KIT IN
NEW PLASTIC
CHEST

Casco's ELECTR-O-TOOL kit is the most complete, practical power-workshop any craftsman or hobbyist can own. Has ALL the accessories you need to drill, cut, etch, carve, grind, buff, polish, sand engrave, saw, clean and sharpen—metal, wood, glass, leather, plastic and fibre. 1001 year-round money-saving uses. Operates on AC and DC current. Fully GUARANTEED. Now on sale at Department, Hardware, Appliance, Auto Accessory and Jewelry stores.



CASCO Products Corp.
Bridgeport 2, Conn.

**Extra
HEAT**

where and when
you need it!



Portable heat-makers that really make cold rooms comfortable. Just plug into electric outlet. Completely automatic, with trouble-free thermostatic control. Made of cast iron just like a stationary radiator. Will last a lifetime. Gives steady heat just where you need it! And only when you need it! Clean, odorless. Three sizes, AC or DC, \$57 to \$78 FOB factory. It will pay for itself in comfort, safety and convenience. Learn the whole story of this efficient heater—use the coupon below.

Listed  by
Underwriters' Laboratories, Inc.

Ideal for:

- Bedrooms • Rumpus Rooms •
- Bathrooms • Camps and Offices
- Nurseries • Sick Rooms •
- Work Shops • Sun Porches

BURNHAM Portable ELECTRIC STEAM RADIATOR

Burnham Corporation, Electric Radiator Div.
Irvington, N. Y. Dept. PM129

Please send folder telling more about the Burnham
Portable Electric Steam Radiator.

Name _____
Address _____
City _____ State _____



**HERE'S EVERYTHING YOU NEED
TO LEARN THE MATCHLESS ART
OF LEATHER CARVING—AT HOME**

Now carve your own beautiful bags, bill-folds, belts, moccasins, key cases—anything from leather—at one-tenth the cost. We supply everything: patterns, tools, leathers, fittings, instruction books for craftsmen. Turn hobby into a business. Send \$1 for big set patterns, or

Send Only 25c for New Catalog #102

BURTONS LTD. 1755 1/2 GLENDALE BLVD.
LOS ANGELES 26, CALIF., DEPT. E2

NEW GOVT. SURPLUS HOIST and WINCH

Originally made to be used on B-29s for lifting bombs. Mounted on welded steel base, can be attached to truck body or any solid base. Ideal for lifting or moving loads onto trailers, trucks or tractors or for machine shops, garages or warehouses. Capacity 2,000 lbs. Equipped with ratchet for holding load and 18 ft. 3/16" steel cable. Shipping weight 50 lbs. F.C.C., Kansas City, Mo.

\$29.95



Send check or M.O. for immediate delivery. No COD's

AMERICAN AUTO PARTS CO., INC.
1830 LOCUST DEPT. PM9 KANSAS CITY, MO.



BUILD FINE GRANDFATHER CLOCK NOW

The simple sensible Red-i-Kut way as thousands have—SAVE HALF. SHOP TESTED PLANS "SPIRIT OF THE CENTURY" Narrow waist 83" tall or stately "SPIRIT OF AMERICA" straight side model. EASY-TO-FOLLOW photo-pack PLANS tell all—plus BROCHURE of heavy brass weight Westminster, tube chime, movements, dials, solid mahogany case kits. Send \$1.00 today—Both Plans \$1.50 NOW. KUEMPEL CHIME CLOCK CO., #6 Kuempel Bldg., Minneapolis 16, Minn.



New Automotive Discovery—replaces present idle adjustment screws in carburetor. OVER A MILLION NOW IN USE.

Famous GANE "Air-flow" NEEDLE

Users report up to 25% MORE MILEAGE, EASIER WINTER STARTING, FASTER PICK-UP, PERFECT IDLING. Fits all cars—install in 5 minutes, \$1.50 each (8 cyl. cars take 2) SEND NO MONEY, just mail card with name, address, make of car and carburetor. Needles sent postpaid with illustrated data for FREE TRIAL IN YOUR CAR. MAIL CARD NOW!

NATIONAL AUTOMOTIVE RESEARCH CO.
BOX 3097-J12, LOS ANGELES 54, CALIFORNIA

**SAVE GAS!
FREE TRIAL
IN YOUR
CAR!**

LUMINESCENT PRODUCTS

- LIGHT REFLECTING CRYSTALS
- COLORED GLASS CRYSTALS
- LUMINOUS POWDERED PIGMENTS

COMBINATION TRIAL
ORDER & LISTING
\$1.00 POSTPAID

ORDER
TODAY

GLOWELL COMPANY
475 FIFTH AVE • DEPT. MP • NEW YORK 17, N. Y.

Say You Saw It in Popular Mechanics



**WILL
you Wear this Suit!**

**Be My Local Agent
UP TO \$12. IN A DAY**

How would you like to wear a fine made-to-measure suit without paying one cent? You can get it by taking a few orders from friends. Do this—get your bonus suit—and also earn up to \$12 a day without house-to-house canvassing! Represent my big, old established company. I need ambitious men in every town, and this is your chance.

Experience Not Necessary

SAMPLES FREE. I send you absolutely free gorgeous, valuable big, demonstration equipment containing actual samples of fabrics. Demonstrate these samples for me and take orders. Show great tailoring values. Save money for friends. Make money for yourself. Write! SEND NO MONEY! For quick action, tell us about yourself—age, etc. Get demonstration equipment FREE and opportunity to get your own made-to-measure suit WITHOUT one penny cost. **H. J. COLLIN, PROGRESS TAILORING COMPANY, Dept. 2-216, 500 South Throop Street, Chicago 7, Illinois**

The Ideal Gift for the Home Owner

NO COMPRESSOR
HOSE • MOTOR
WIRES • PUMP

BECKER Self-Contained SPRAY GUN

Take it Anywhere for

- Painting
- Rust-Proofing
- Varnishing
- Starching
- Humidifying
- Moth-Proofing
- Insecticiding
- Fire-Proofing



Only
\$18.50

Here is the first completely self-contained and fully portable spray gun . . . needs no wire or hose, no compressor or motor. Take the Becker gun anywhere to do dozens of spray jobs . . . in the house, workshop, garage or garden. Spraying pressure is provided by an inexpensive, easily replaced CO2 cartridge. One cartridge will spray up to 21 ounces of liquid (depending on viscosity). The Becker Spray Gun comes complete with 3 cartridges. Send only \$18.50 and we ship postpaid. Or, send only \$2 now and pay postman balance plus postage. **MONEY BACK** if not delighted after 5 days' trial. (Extra CO2 cartridges, 10 for \$1, postpaid.)

SULLIVAN-BECKER CO. • Dept. 119-M • Kenosha, Wis.

500 Pages, 7000 Novelties



Send 10c for mammoth, amazing catalog of 7000 novelties. 1-inch thick, roto picture section, 6-color cover. Carnival, circus, world's fair & science exhibit rolled into one! Includes live animals & pets, scientific supplies, hobbies, funmakers, planes & boats, looms, magic tricks, joke articles, unusual seeds, gadget timesavers, cameras, optical goods, projectors, movies, lucky jewelry, religious novelties, telegraph sets, disguises, musical instruments, stamps, coins, puzzles, fortune tellers, radios, experimental sets, auto & bike accessories, Western wear, telescopes, magnifiers, compasses, banks, smokers' gadgets, artists' supplies, printing sets, engines, motors, shockers, knives, billfolds, fireworks, guns, rifles, sports, money-makers, swimming helps, 1000 fascinating books, games, locks, live chameleons, rings, exercisers, curious plants, etc., etc., etc. (DeLuxe Hard Bound Library Edition 25c Postpaid.) Regular paper covered edition 10c. (Stamps accepted.) Sent Air Mail, \$1.00. **JOHNSON SMITH & COMPANY, Dept. 178, DETROIT 7, MICHIGAN**

10c

SPEDEX TRACTOR OWNERS!!

Now! For your Model "C"—Power Reverse (Pat. Pending) and Quick Hitch Conversion Kits (for draw bar machines). Buy him one for a practical Xmas! Get both for only \$23.95; or separately: Reverse Kit \$19.95, Conversion Kit \$4.95. Easily put on from simplified instructions! Shipped Prepaid, Check or Money Order with order. 90-day material warranty. When ordering, specify center-to-center distance between holes on draw bar. Many other attachment bargains!! Write for further information and prices.

SPEDEX SALES CO., Est. 1945—T. R. Woodruff, Prop.
315 Main St. Dept. QRS Madison, New Jersey

FULLSIZE, CUT-TO-SHAPE BOAT PATTERNS

and specifications. Designed by Naval Architect. Cruisers, runabouts, sloop, outboards, sailing canoe, etc. Low prices. Send 25c (coin) for illustrated catalog. **SPECIAL: Send \$1.00 for "HOW TO BUILD BOATS" book, postpaid. PolyWog Houseboat Plans, \$10. Marine Catalog \$1. Cleveland Boat Dept. 666, Cleveland 13, Ohio**

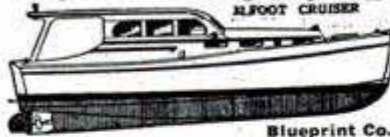

Say You Saw It in Popular Mechanics

SPEEDSITE

New REAR
SIGHT
for SHOTGUNS



Thrill to clean hits—High scores! Amaze yourself with overnight accuracy! Used, endorsed by experts. Guaranteed to increase accuracy or money back! To order send name, address, describe your gun and barrel. When Speedsite arrives pay postman \$5.95 plus charges or send **M O** Fits Singles, Pumps and Automatics.

SPEEDSITE SALES, Dept. M
P.O. Box 83, Grand Rapids, Mich

\$5.95
PPD



Jon-E Hand Warmer shown open in position to ignite or extinguish. Perforated cap fits over lower case when in use.

JON-É HAND WARMER

Keeps Hands Warm in Coldest Weather!

Don't suffer cold hands, stiff fingers this winter. Get yourself a Jon-E Hand Warmer. Merely fill Jon-E Hand Warmer with "stove and lamp" or "white" gasoline or naphtha, ignite the exclusive flameless heating element, and your Jon-E Hand Warmer will give off comforting heat for more than 20 hours on one filling. Carried in pocket or mittens, it can't burn or set fire to clothing. Made of heavy copper, beautifully chromium plated, every Jon-E Hand Warmer is fully guaranteed.

Only \$3.50 at department, sporting goods or hardware stores. If unable to obtain, send coupon today!

ORDER FORM

Aladdin Laboratories, Inc.
Department (P-12) Minneapolis, Minnesota

For the enclosed \$, please send me
Jon-E Hand Warmers, postpaid. Price \$3.50 each.

Name

Address

City Zone State

SANDEE

- Mufflers—All Ford, Chev., Ply. \$4.45
- All Buick, Pont., Olds., Chrys.,
Dodge, Hudson, K.F., Pack., etc. \$5.45
- V-8 and Merc. Duals
(32-49 incl.)
\$15.95



DURABILITY

**SPORTONE
MUFFLERS**
(Pats. Pend.)

Beautiful
SANDEE
Fender Skirts
\$16.95

A SANDEE Sportone will outlast two ordinary mufflers and give More Power! More Speed! More Mileage!—plus a tone quality unsurpassed.

Please ship (item): _____ Price _____
Car and Year _____ Name _____
Address _____

SANDEE MUFFLER CO. 5643 Corryne Pl. Culver City, Calif.

GRIPSO The new 5-in-1

WITH EXCLUSIVE FINGER TIP RELEASE

WISE PLIERS



Gripso unlocks instantly from any position with one finger. Saves time, saves knuckles from being bruised by handles leaping apart. Places complete control of tool in one hand.

Most useful hand tool you'll ever own! Pliers, hand vise, clamp, nut wrench and pipe wrench all in one! New Gripso does the work of a whole kit of tools around home, auto, workshop. Special curved lower jaw works against flat upper jaw to assure 3-point contact, giving positive grip in all directions. Cannot slip. Adjusting screw has both right and left hand threads, permits double-quick adjustment for ratchet or plier action. You adjust lock and release ALL WITH ONE HAND. High grade steel, 8" long, 13 oz. Black satin finish \$2.75, copper finish \$3.25, postpaid. A practical gift every man will enjoy. Send check or money order today.

H. R. Basford Co., 235 15th St., Dept. PM.
San Francisco, Calif.

Please send me:

_____ (quantity) black satin Gripso's at \$2.75 each.
_____ (quantity) copper finish Gripso's at \$3.25 each.

Enclosed is \$ _____ check money order.

Name (print) _____

Address _____

City _____ Zone _____ State _____



FREE

New Christmas Catalog of Mossberg Firearms

An easy way to solve your gift problems — and to decide what you, yourself, would like. Complete array of rifles, shotguns, telescopic sights and spotting scope — all at Mossberg rock-bottom prices — and all available at your dealer's.

Use the coupon at once to give yourself ample time to decide.

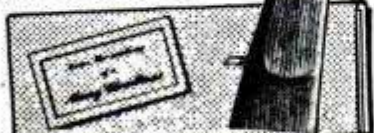

O. F. MOSSBERG & SONS, Inc., New Haven 5, Conn.

Sirs: Rush me your New Christmas Catalog of Mossberg Firearms available at my dealer's.
96512

NAME

STREET

CITY STATE

(Zone)

SANDING MADE EASY..

Pat. No. 2265681



with the Handy SanDrum

ALL-METAL DRUM

\$2.50 with adapter and 6 abrasives

Sold on positive money-back guarantee. Order Today.

EASY, QUICK MOUNTING. No locking key or wrenches needed. No cement, glues or wedges. Patented mounting method saves valuable time. Abrasive tightens while in use. Ideal for use on drill presses, grinder stands, electric drills, motor arbors, etc. Drum is 2" in diameter, 2" long. Adapter and drum head joined with 1/2-20 threads. Economical replacement strips cut from standard sheets.

STAHL SPECIALTY COMPANY

Dept. P 9005 E. 66th Street Kansas City, Mo.

SPECIAL OFFER!

LOCK-STITCH SEWING AWL

\$1. Postpaid

Famous, patented lock-stitch sewing awl complete with needles, waxed thread and direction folder. Hundred uses — sewing, repairing leather goods, canvas, belting, harness, saddles, gun cases, awnings, golf bags. Extra needles and thread available. Satisfaction guaranteed or money back. Send currency, check or money order. Yates Mfg. Co., 611-H Main St., Lake Geneva, Wisconsin

U-MAK-IT BOAT KITS EASY TO BUILD

- 5 ROWBOATS 8 TO 14 FT.
- 6 OUTBOARDS 12 TO 16 FT.
- 3 INBOARDS 16 TO 23 FT.
- & CABIN CRUISER



SEND 25c (coin) ORDER YOUR CATALOGS TODAY
U-MAK-IT PRODUCTS 703P-WHITTIER ST.
New York 59, N. Y.

DESK MODEL



TELEPHONES

\$17.95 for 2 OF EITHER MODEL

Telephones are complete with power, wire, hook-up instructions etc. Any number of telephones can be connected in circuit. Common talking, common ringing. Simple installation, absolutely no technical knowledge required. 25% deposit with order, balance C.O.D., F.O.B. Brooklyn.

WALL MODEL



FREE: Fine Descriptive Folder.

Eastern Telephone Co., Dept. PM-5, 320 18th St., Brooklyn 15, N. Y., South 8-6161

Save Fingers

with

Steel-Grip Finger Guards



INDUSTRIAL Safety Apparel

Famous Industrial Safeguards Since 1910

Hundreds of factories save time and injuries and speed production by protecting workers with Steel-Grip Finger Guards. Used for handling rough or sharp articles, for buffing, grinding, sanding, polishing, punch press work and hundreds of other jobs. Protect fingers or thumb, front or back, from cuts, abrasions or blisters. Made of durable leather with elastic web back for snug, cool, comfortable fit. Easy on and off. One size fits all, men or women. Send 10c each for samples or trial order box of 50 at \$4.50 less 10%.

Catalog of Steel-Grip Safety Apparel free on request

INDUSTRIAL GLOVES CO.

1406 Garfield, Danville, Illinois
(In Canada: Safety Supply Co., Toronto)

\$200 CELESTIAL NAVIGATION SEXTANT \$7.95

★ ★ GENUINE AIR FORCE SURPLUS! WHAT A BUY!

NEVER BEFORE AT A PRICE LIKE THIS—MAYBE NEVER AGAIN
PRECISION CONSTRUCTION THROUGHOUT

Here is a masterpiece in fine precision engineering that was used by the AAF for globe wide navigation of bombers. Estimated original cost was around \$200.00—and now as surplus it brings a wonderful opportunity to boatmen, airmen, experimenters, inventors and other mechanically inclined hobbyists to delve into the mysteries of celestial navigation at a price anyone can afford—actually less than 4% of original cost. Because we have only 3000 of them, it's first come—first served. Only by fast action now, will you avoid possible disappointment—and we reserve the right to return your check if your order arrives after our stock is depleted.

Case Included
With Each
Sextant



USE ON AIR, SEA or LAND

For the boatman or student of navigation the Sextant or Octant is used to determine their position on the earth's surface by means of astronomical observations of the stars, planets, etc. In the air or on the sea the navigator uses it to set his course—to accurately steer for any given point. Never before at anywhere near this price could you secure so fine a precision instrument. And it is of tremendous value to experimenters, inventors and others for the many valuable parts that make up the complete assembly.

HUNDREDS of VALUABLE PARTS

In the illustrations shown at the right you gain an idea of the hundreds of parts that are included. It's a veritable treasure-trove of fine lenses, prisms and other optical systems, gears, rheostats, relay, switches, timer, flash battery motor, V/R counter, bubble chamber, worm drives, solenoid, lights and light system, optical eye-piece, battery case, filters, controls, etc., not to mention a great array of fine small screws, pins, nuts, washers, springs, etc. These parts and sub-assemblies may be adapted to hundreds of other uses. The optical equipments alone are worth many times the price we are now asking for the complete outfit.

DON'T MISS THIS BARGAIN VALUE! ACT NOW

These Sextants are used. We are selling them just as we received them. Some show use more than others. They have all seen actual service in the AAF. We have not checked or "collimated" them—no operational warranty is given—that is why they are being offered at this low price. There are only 3000 to sell—and they are offered strictly subject to prior sale. They won't last long at this low price.

TWO MODELS TO SELECT FROM

FAIRCHILD A10-A

Automatic timing Sextant. Includes battery case and holder, plus fine mahogany colored hardwood case, 9 1/2 x 9 x 5 1/2 ins. Case alone is worth this price. Each as illustrated

\$7.95

FAIRCHILD A10

Same as model A10-A but without automatic timing system. Carrying case and battery holder included. Each only

\$5.95

We will ship prepaid if you include 70c to cover postage and handling. Shp. wgt. 10 Lbs.

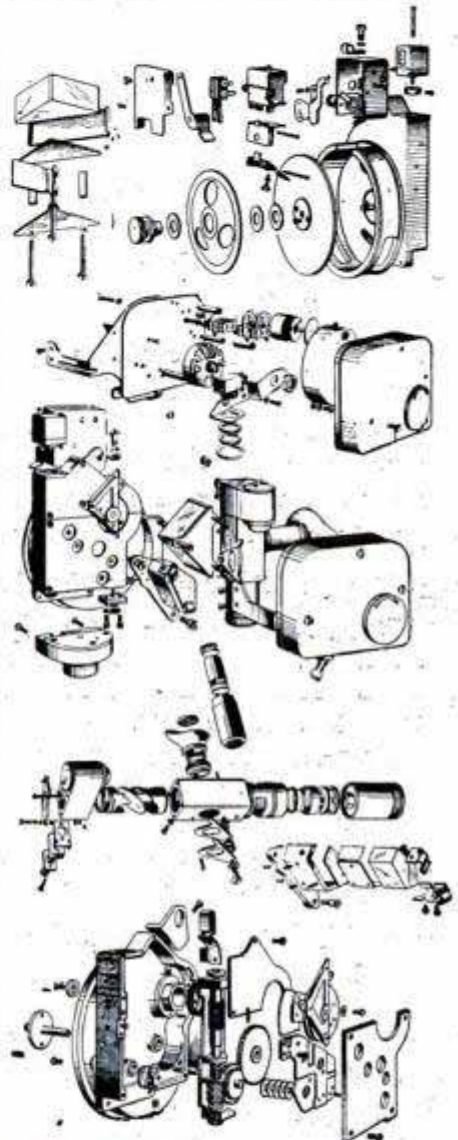

BRAND NEW FAIRCHILD A10 SEXTANTS

These are brand new surplus—all perfect—every one guaranteed in good operating condition. System includes 2 power Galilean telescope and light system. During this great sale you can buy this famous precision instrument at a bare fraction of actual replacement cost. Remember, they are all new surplus and fully guaranteed.

EACH ONLY

\$20.00

\$60 FIRE EXTINGUISHER \$14.95



For homes, factories, shops, etc. Fine air pressure type surplus fire extinguisher, with 1 gallon carbon tetrachloride, ready for use. Underwriters approved. Tested for 400 lbs. pressure, operates at 100 lbs. pressure. Outfit includes tank, gauge, hose, nozzle, hand pump and hanging bracket. To operate open valve—air pressure in tank throws stream considerable distance. Easily refilled. Measures approx. 6 in. diameter, 24 in. high. By express only, not mailable. Shp. wgt. 35 lbs. A wonderful value. NOW ONLY

\$14.95

\$50 AAF MAGNETIC COMPASS \$5.95

A war surplus bargain of unusual value. May be used on airplanes, boats, autos, etc. Made by Pioneer. Panel mounting type with 3 1/4 inch mounting face (mount on panel or hang). With luminous card and numerals. Easily compensated with a screw driver. Will ship prepaid for 50c extra. Never again at only.....

\$5.95

\$100 BREATHING OXYGEN SET \$7.95

Brand new surplus
★
Ready to use
★
Portable

with Automatic
"Demand" Type
Valve



A find for airmen, mountaineers, firemen, paint shop workers and others who on occasion demand extra oxygen. This popular "demand" type oxygen outfit requires no technical knowledge for use—just breathe into the mask provided and the regulator automatically delivers such oxygen as you demand. Set consists of D2 type shatter-proof steel bottle 6 x 24 inches; demand type regulator AN6022-1; 0-500 lb. oxygen gauge and type A10 demand oxygen mask with hose. Net weight 7 lbs. Condition, NEW war surplus. Shipping weight 10 Lbs.

OXYGEN FILLED
Complete as described above with oxygen loaded tank. By express only—not mailable. Each complete.....

\$9.95

LESS OXYGEN
Complete outfit as described but with empty tank. Can be shipped parcel post. Each complete.....

\$7.95

Refiller hose, orifice and valve for charging tank with oxygen. Set only
Six foot flexible extension hose, with fittings.....

\$2.00

\$2.00

ALL F. O. B. HOUSTON
SEND CHECK
OR MONEY-ORDER

AERO PARTS SUPPLY

Dept. PM12, Municipal Airport
HOUSTON 17, TEXAS



DO EVERY JOB
*better-faster-
 cheaper-*
 WITH
COMPRESSED AIR

Paint Buildings, boats, tractors, trucks; refinish furniture and fenders; inflate tires; grease and lubricate motors, engines, implements. Destroy weeds. Rid livestock, poultry and pens of pests with portable air power.

Free Literature explains relative advantages of 4-cylinder **PRESSURE QUEEN** and single-cylinder **PRESSURE PRINCESS** spray painting outfits. Tells how to save material, time and money by using the proper outfit at the right price.

*It Is Yours For The Asking
 Write Today*

THE CAMPBELL-HAUSFELD CO.
 1046 RAILROAD AVE. HARRISON, O.

**BOYS! Have fun
 with CHEMCRAFT!**



FREE-

This exciting new book



Send today for new, FREE Chemcraft Chemistry book—"The Wonders of Chemistry". Shows how to amaze friends and family with chemical magic. Describes many fascinating home experiments like making perfume, windshield cleaner, soap, etc. Loads of fun, thrills, excitement and adventure await boys who start now to obtain knowledge of Chemistry. Act now! Send for FREE Chemcraft Chemistry book—TODAY!

REG U S PAT OFF

CHEMCRAFT
 Now — with Safe Atomic Energy



Sold in the best stores all over the country. Address below for your FREE copy of "THE WONDERS OF CHEMISTRY."

THE PORTER CHEMICAL COMPANY
 63 Prospect Avenue • Hagerstown, Md.

**AMES
 UNIVERSAL DIAL
 INDICATOR SETS**

New Gov't. Surplus

Dial indicator — face 2 1/4", graduated in 1/1000ths. Dial reading-0-50-0; spindle travel — 1/4"; can be used on stationary or revolving parts on lathes, milling machines, drill presses, etc., and for automotive work. Comes complete with dial gage, hole attachment, bar with upright, clamp sliding swivel, dial holding rod and 3 contact points — with case shown.

Reg. Sold
\$23.00

**NOW
 \$15.00**

VETERAN TOOL AND SUPPLY CO.
 88 BAXTER STREET NEW YORK 13, N. Y.

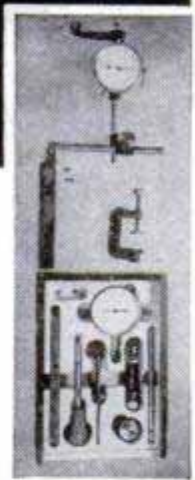

BARGAIN!

NEW HIGH SPEED ROTARY FILES

Set of 5 Assorted	\$ 2.00
" " 10 "	3.75
" " 20 "	7.25
" " 30 "	10.00

1/4" shank



WE BUY SURPLUS TOOLS

SID TOOL CO., 183 Grand St., N. Y., N. Y.

GENUINE DIAMOND SCRIBER!

Writes on glass, metals, plastics. Hex. Aluminum 6". Money back guarantee. Agent inquiries invited.

\$2.00
 Postpaid

CLIPPER DIAMOND TOOL CO., INC. 21-B W. 46 ST., N. Y. 19

Write today for Complete details

GEIGER COUNTERS

FOR PROSPECTING RADIOACTIVE MINERALS

OMAHA SCIENTIFIC SUPPLY CO.
 Dept. V, 3601 N. 24th St., Omaha 10, Nebr.

CODE-SENDING-RECEIVING-SPEED

Learn to send and receive Radio Code with greater speed. Stop nervous tension. Have confidence. Be proficient. Same system used by radiotelegraph specialists. Thousands of operators needed. Rush name for FREE book.

CANDLER SYSTEM CO.
 Dept. 5-0, Box 928, Denver 1, Colo., U. S. A.

ARC WELDING
 FOR PROFIT OR PLEASURE

60 LBS. OF READY MADE PARTS *Only \$24.95*

BUILD YOUR OWN HEAVY DUTY WELDER **SAVE**
 Buy Only NECESSARY PARTS

All parts Ready-Made and easy to assemble. You can do all around welding on steel, cast iron and other metals after only a few hours practice. Illustrated instruction manual included. Sold on 30-Day Money-Back Guarantee!

FREE: Write today for fully illustrated Pamphlet P-12

ATOMIC ARC WELDER CO.
 1037 So. 19th St. OMAHA, NEBR.

Gives 100% penetration. Welds are stronger than original metal. Operates on 110 or 220 AC.



DELTA
MILWAUKEE **Homecraft**

**8" Tilting-Arbor Saw
No. 34-500**

Cuts stock up to
2 1/4" thick. Ball-
bearing arbor.

\$64⁹⁵

without motor, saw
guard, or extension

Build Happiness

Give Delta[®] Homecraft Power Tools

Make this a Christmas to be remembered — with Delta Homecraft gifts for yourself or someone else

There's the happiness that comes with owning and using the finest tools and there's the satisfaction of saving time and money on home repair jobs.

Delta Homecraft Power Tools are quality tools—rugged, safe, and dependable — with built-in accuracy. They're designed specifically for home-shop use, so the prices are low, and you can buy them on easy terms.

See the full selection of Delta Homecraft Power Tools and accessories at your nearest dealer.

Send us coupon below for his name and address, free shop-planning book and catalog.

POWER TOOL DIVISION



Rockwell

Manufacturing Company
MILWAUKEE 1, WISCONSIN

Prices subject to change without notice.

FREE BOOK

"How to Start Your Home Workshop"

Page after page of ideas, tips, and pictures to help you in planning. Send coupon for your copy.



Tear out coupon and mail today

Power Tool Division
ROCKWELL MANUFACTURING CO.
680N E. Vienna Ave., Milwaukee 1, Wis.
Send me free shop-planning book, catalog and list of Delta Homecraft dealers.

Name.....
Address.....
City.....(.....) State.....

HM-73



**10"
Band Saw,
No. 28-110**
\$39⁹⁵
without motor
or lamp
attachment



**16"
Scroll Saw,
No. 40-110**
\$31⁹⁵
without motor,
belt, or lamp
attachment



**11"
Drill Press,
No. 11-120**
\$43⁹⁵
without
motor



AT WAREHOUSE-TO-YOU PRICES
 Now ... from one convenient and economical source you can get these high quality metals for your needs, pre-cut to your specifications.

ALUMINUM, BRASS, COPPER, STAINLESS STEEL in RECTANGULAR SHEETS
 Easy to work, adaptable to hundreds of uses such as lamp shades, serving trays, wall brackets, etc. Ideal for modern silhouette cut-outs.

CIRCLES of ALUMINUM and COPPER
 Perfect for shaping and forming into useful items, and for perforated design work.

Write for price lists and complete information

FREE BOOKLETS tell how YOU can use these metals—easily and quickly. Write for your free copies today.



METAL GOODS CORPORATION

Dept. P M 5239 Brown Ave. St. Louis 15, Mo.

GOLD BOND
 BUY AT WHOLESALE

WHOLESALE GUARANTEED EXCEPTIONALLY GOOD USED TIRES DIRECT TO YOU
 10% discount on 2 or more tires if you send this ad with order
TUBE DELIVERED WITH TIRE AT NO EXTRA COST FOR 15" AND 16" PASSENGER TIRES

Safe — Our tires used on school buses and ambulances
EXCEPTIONALLY GOOD TREAD — NO RECAPS
 GUARANTEED FOR 24 MONTHS

600-16 . . . 6 ply Military—Mud and Snow Tire \$6.37			
550-16 \$5.19	525-18 \$ 6.89	700-15 \$ 5.29	
600-16 5.29	550-17 7.99	600-20 9.75	
650-16 5.29	650-15 4.98	650-20 9.75	
700-16 6.29	825-20 15.98	700-20 10.98	
550-15 4.81	900-20 15.98	32-6 (8) 10.49	
	1000-20 16.89		

ALL GOOD TIRES GUARANTEED FOR 12 MONTHS

550-16 \$3.54	30-5 \$ 7.98	1200-20 \$18.78
600-16 3.59	650-20 7.69	750-24 (36-6) 12.21
650-16 3.89	700-20 (8) 9.29	38-7 (825-24) 13.75
700-16 4.59	700-20 (10) 12.48	1000-22 17.70
550-15 3.79	750-20 (8) 8.19	1100-22 16.89
650-15 3.89	750-20 (10) 9.19	900-24 (40-8) 21.60
700-15 3.98	825-20 11.19	900-16 8.98
550-17 5.69	900-20 11.89	825-15
750-16 8.40	1000-20 12.89	(14 ply) 14.10
600-20 7.98	1100-20 13.89	750-15
		(12 ply) 11.30

GOLD BOND SPECIAL — 750-20 MILITARY TIRES
 Will fit 650 x 20 700 x 20 (8 & 10 ply) 34 x 7 (8 & 10 ply)

Special \$10.49	Guaranteed 12 months
Superior Quality 12.98	Guaranteed 18 months
Gold Bond Finest 14.98	Guaranteed 24 months
900 x 16 Special 9.03	900 x 16 extra 11.19

Send check or money order with this ad
GOLD BOND TIRE CO., Dept. PM 24
 512 NORTH 1ST ST., RICHMOND, VA.
 "A gold bond written guarantee with every tire"

SORE MUSCLES?



BODY ACHES?

When muscles are stiff and sore from unusual exercise or strain, use **HEET®**, the liniment that's strong yet does not burn the skin. Wonderful relief from muscular soreness comes as comforting **HEET** quickly starts to penetrate. Just brush it on with the applicator. **HEET** starts at once to ease muscular pain and keeps on working for hours, warms and soothes the painful area.

Binoculars for X'mas! Order Now. Quantity Discounts.

SAVE UP TO 50% BINOCULARS DIRECT From IMPORTER
 Use 10 Days At Our Risk!
 IF YOU CAN FIND ANY BETTER AT ANY PRICE ... ALL YOUR MONEY WILL BE GLADLY REFUNDED.
 GERMAN ENGINEERED. BRAND NEW. DELUXE LEATHER CASE INCLUDED. Each instrument precision built to rigid military specifications. Buy direct at lowest unheard of prices! Free Catalog. Many other models. Largest stock in the West. ORDER TODAY! Send check or Money Order: \$2.00 deposit on COD's. Add 20% Tax, Postage included. (Add \$8.50 for Coated Optics) FREE BOOK "How To Select Binoculars"
BUSHNELL IMPORTERS Dept. M12, 43 E. Green, Pasadena 1, Calif.

Who Ever Heard of POWER TOOLS

Only \$800 Each?
 Own a power workshop. Have fun. Make money. Get heavy-duty Emrick Lathe, Drill Press, Circular Saw, Grinder, Sander — all in ONE machine. Use 1/4 to 1/2 H.P. motor. Equals in performance equipment costing \$200 or more. Direct factory price \$39.95 complete. Send \$18.00 (balance c.o.d.) for 10-day FREE TRIAL. Money-back guarantee. Our fifty-first year. Write today for FREE Catalog.
EMRICK, INC., 1889 Clinton, Kalamazoo, Mich.

5-in-1 MACHINE

REAL ESTATE BE A BROKER

PAYS BIG! SEND FOR FREE, BIG, ILLUSTRATED CATALOG NOW! No obligation. Graduates report making substantial incomes. Start and run your own business quickly. Men, women of all ages, learn easily. Course covers Sales, Property Management, Appraising, Loans, Mortgages, and related subjects. **STUDY AT HOME** or in our classrooms in big cities. Diploma awarded. G.I. approved. Nationally known.
WEAVER SCHOOL OF REAL ESTATE (Est. 1936)
 15 E. Pershing Road, Dept. PMB, Kansas City, Mo.

FREE BOOK TELLS HOW

SHARPEN SKATES!

NEW ICE SKATE GRINDER
 grinds all makes and types of ice skates!

Here's a speedy way to make extra money all winter! Sharpen ice skates of any type on the new Ideal Model 50 Bench Grinder, with skate grinder attachment. It's the finest—and FASTEST—method. Write TODAY for free folder with complete money-making facts!

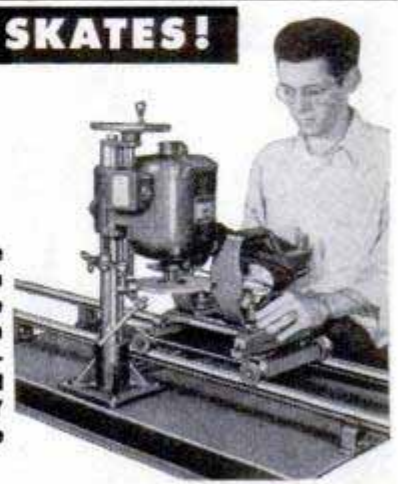

THE FATE-ROOT-HEATH CO., Dept. D-3, Plymouth, O.

FILE SAWS FOR PROFIT!

NEW BeMaCo Rapid Saw Filer opens the door to extra income. Easy to operate. Fast, efficient power filer. Priced right! Does a beautiful job. Operator has complete control.

BeMaCo Rapid Saw Set—Finest Automatic Saw Set on the market. Manufactured exclusively by Beaver Mfg. Co. Sets 400 teeth a minute. No tooth breakage. For hand saws or band saws. Start earning now.



Write for details today!

BEAVER MFG. CO.

802-H South Isis Avenue • Inglewood, California

DELCO FAN MOTORS BOOSTER FANS FOR HEATING or COOLING

Get immediate heating or cooling with this easy to install booster fan that really moves the air. Heavy duty Delco Motor, sturdy and quiet, assures excellent performance and long life. Has a 7 $\frac{3}{4}$ " D.—6 blade fan. Operates on 110 V. 50-60 Cycle A.C. current at a speed of 1500 R.P.M. Has horseshoe steel base with triple rubber mounts. A real buy. Money back guarantee. Shipping weight 6 lbs. **\$4.75** No. 9989, only

Send check or money order plus postage
SEND FOR FREE CATALOG

G & E EQUIPMENT SUPPLY COMPANY
1390 WEST FULTON STREET CHICAGO 7, ILLINOIS

Your car...

... can be seriously damaged by a leaky radiator. Don't take chances—take care! Use Warner Liquid Solder... it's non-metallic, deposits tiny fibers to repair leaks anywhere in the cooling system. Fast, sure and easy to use—just shake . . . pour . . . and fret no more.



Warner
A FAMOUS NAME
IN AUTOMOBILE HISTORY

In Two Sizes, at Service Stations, Accessories Stores, Car Dealers, Auto Repair Shops

How to give QUICK REST to tired eyes

MAKE THIS SIMPLE TEST TODAY



EYES OVERWORKED? Put two drops of gentle, safe Murine in each eye. Then feel that refreshing, soothing sensation that comes instantly. You get—



QUICK RELIEF from the discomfort of tired eyes. Murine's seven important ingredients are scientifically blended to cleanse and refresh overworked, tired eyes. Use Murine morning and night and whenever your eyes tell you to.

MURINE FOR YOUR EYES



IDEA FOR CHRISTMAS Give A Super-Safe SHERIDAN

The
"SILVER
STREAK"

Only
\$19.95
RETAIL

The Only Pneumatic Rifle
With an Automatic Safety

Here's a quick-handling, easy-operating, trouble-free pneumatic rifle you'll be proud to own. "Silver Streak's" quality, accuracy, controlled power and shooting economy make it the best buy on the market. Ideal for target or small game shooting, it pays for itself in low-cost ammunition (\$2.15 per 500 rounds)!

See the "SILVER STREAK" at Your Dealer's!

Ask your dealer to show you this dependable addition to the famous Sheridan line. If he cannot supply you, mail check or money order direct. Money refunded if not satisfied upon inspection.

Dealers! Wholesalers! Write for our new discounts.

SHERIDAN PRODUCTS INC.
Dept. 159-M • RACINE, WISCONSIN

Flex-O-Shaft

HANDLES LIKE
A PEN*

\$35.00



FLEX-O-SHAFT is an improved all-purpose machine for homes, schools, shops, or factories. The slender, light-weight aluminum hand piece is ideal for grinding, drilling, sawing, buffing, scoring, etching, polishing, and scores of other uses. There is no bulky, throbbing, pulling motor in your hand. The light-weight motor can hang on the wall, or can be set down on working table. Speed is controlled by foot-operated rheostat, leaving hands free. This precision ball-bearing tool is as easily guided as a pen, speeding up operation because of ease in handling. It is a wonderful, compact, power house for making all kinds of objects. This unit consisting of Flex-O-Shaft with 6-ft. cord, 1/16 H.P. Motor, Rheostat with cord and plug, all for \$35.00. Write today!

FLEX-O-SHAFT
and complete
Tool Kit with
66 accessories
ONLY

\$50.00

F. W. STEWART MFG. CORP.
Dept. A, 4311 Ravenswood Ave.
Chicago 13, Ill.

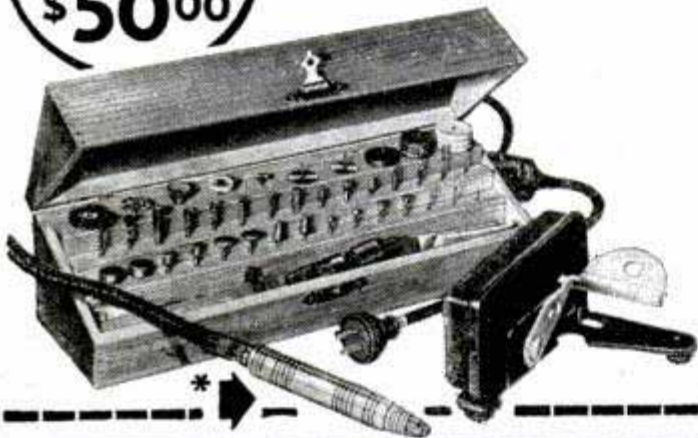

K-R-O KILLS RATS

• K-R-O BIS-KITS are ready-made, easy to use; containing *fortified red squill*, they're safer around livestock, pets, and poultry. K-R-O POWDER is 100% *fortified red squill*; economical to use in badly infested areas when mixed with natural baits. BIS-KITS, 35c and \$1.00; POWDER, 75c at drug, seed, and feed stores. Money-back guarantee. *The K-R-O Company, Springfield, Ohio.*

BUILD YOUR POWER TOOLS

WITH POLY BALL BEARING ARBORS
HEAVY DUTY GRINDER Model D-12
Pictured
ONLY \$18.25
Ship. wt. 13 pounds



POLY BALL BEARING ARBORS
C4-1/2x12 1/2 spindle, housing 2x8, \$7.95 pp.
C5-5/8x12 1/2 spindle, housing 2x8, \$8.45 pp.
C6-3/4x12 1/2 spindle, housing 2 1/4x8, \$9.45 pp.
D8-1x17 1/2 spindle, housing 2 3/8x11, \$18.75 pp.

FREE!
Write for
POLY illustrated
literature.

SHAPER ARBORS—Free literature on request.
POLY PRODUCTS, 2032-A E. Walnut, Pasadena 8, Calif.

make your own Gems 29.50 F.O.B.

All necessary lapidary equipment is furnished, including a super-charged diamond blade for sawing, and all wheels for grinding, shaping and polishing; also complete instructions. The complete equipment as shown, less motor and belt, for only \$29.50, f.o.b., Burlington, Wisconsin. Write today for information and literature.

B&I MANUFACTURING CO.
Dept. S Burlington, Wis.



SHARPEN ALL TYPES OF CIRCULAR SAWS

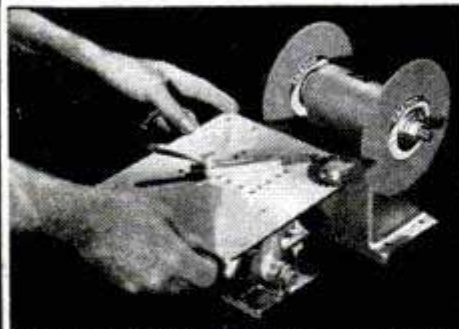

ALSO MANY CARBIDE TIP TOOLS AND CUTTERS

This all-purpose sharpening fixture is the only one of its kind. Easiest, simplest, fastest sharpening method available and sharpens 95% of all saws used. Assures cleaner cuts. Save money and make money by sharpening tools, cutters and saws for yourself and others. Unlimited uses. Precision built at surprisingly low prices. Send check or money order . . . money-back guarantee . . . nothing to lose . . . shipped prepaid.

MODEL 135 (illustrated above) only \$29.95 for 1 1/2" to 12" diameter saws and cutters. Table tilts either side almost to 80°.
MODEL 160 only \$49.50 for 1 1/2" to 16" diameter saws and cutters. Table tilts either side over 30°.
MODEL 280 only \$11.95 for 7" to 8" diameter saws.
MODEL 100 only \$14.95 for 7" to 10" diameter saws.
MODEL 120 only \$16.95 for 7" to 12" diameter saws.
MODEL 130 only \$23.50 for 2" to 12" diameter saws.

Grinder stand and grinding wheels not included in price of fixture.
Dust Proof Ball Bearing Grinding Wheel Stand with 30" "V" Belt \$14.95 (illustrated above)
2 grinding wheels \$5.00 extra.

TREYCO PRODUCTS

264 HARTFORD AVENUE Dept. PM-11 BUFFALO 17, N. Y.

MAKE YOUR OWN! WITH

Griffin READYCUT LEATHER PROJECTS

Over 100 KITS in every kind of Tooling and Carving Leather, accurately cut, all parts included. Only Top Grade Leathers used. You do the choosing. You do the tooling, carving, stamping, the punching and assembling.



SEND FOR
COMPLETE CATALOG
Please send
10c to cover
mailing.

EVERYTHING FOR THE LEATHER WORKER

Largest, most complete stock of *Leathercraft Tools and Accessories* in U.S.A.

HIDES AND
SKINS of Craft
Leathers of every
kind if you prefer
to cut your own.

SINCE 1924
OUT OF THE WEST, THE HOME OF LEATHER CARVING
Griffin Craft Supplies
5626-A TELEGRAPH AVE.
OAKLAND 9, CALIFORNIA

"Wellworth" Sensational Offer! Reg. \$60.50
WESTINGHOUSE AIR COMPRESSOR

**Model T-1
 Brand
 New!**

2-CYLINDER PISTON TYPE

Operates with 1/2 H.P. Motor or equivalent gas engine.

Complete outfit consisting of compressor, pressure tank, air gauge, air chuck, 20-ft. hose, pop valve, copper tubing with 4 brass flared fittings for connecting compressor to tank, 4-way cross and 3 nipples. Complete outfit of 7 items..... **ONLY COMPRESSOR SEPARATELY..... \$21.50**

\$29.95
 SHIPPING WT. 40 LBS.

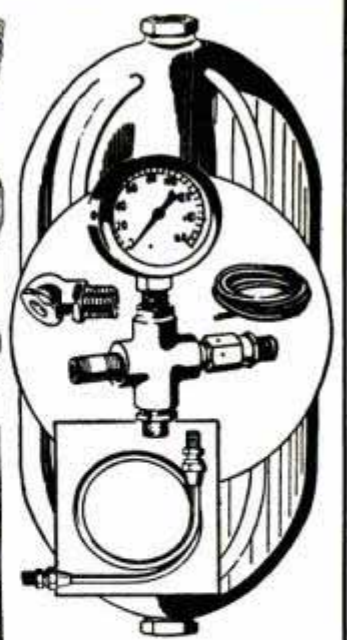
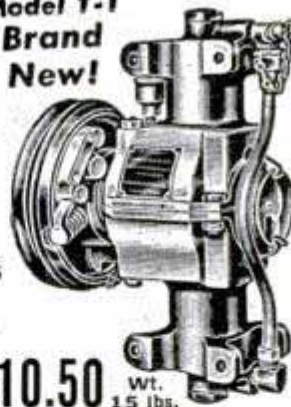

Equipment less compressor.... **\$10.50** wt. 15 lbs.

THE COMPRESSOR

Piston Type, 2-cylinder, 2 inch bore, 1 1/2" Stroke Ball Bearing. 3.27 C.F.M. at 600 R.P.M. Capacity up to 6.54 C.F.M. Suggested operating pressure 75 P.S.I. DIMENSIONS: 9" wide, 11 3/8" high, 6 3/8" deep. Wt. 26 lbs.

TANK and ACCESSORIES

6" x 24" stainless steel tank suitable for 150 lb. pressure. Two 1/4" openings. Air gauge, pop valve, air chuck, 20 ft. hose, Copper tubing and fittings as shown. Wt. 15 lbs.

IDEAL for HOME • FARM • FACTORY
Wherever Compressed Air is Needed

For spraying paints, insecticides, etc.; inflating tires, operating air tools and many more uses. Automatic clutch makes it suitable for mounting and operating from trucks, tractors, etc. Instructions furnished. A fortunate purchase from the government enables us to offer you this amazing buy. All brand new equipment. Replacement parts available. This low price is but a fraction of the price of manufacturer and of leading mail order houses.

Prices f.o.b. Chicago. Sold on money back guarantee. Send check or money order today. Prompt shipment. Catalog free.

WELLWORTH TRADING CO., 1831 S. State St., Dept. D-12, CHICAGO 16, Ill.

WITH MOLLY YOU CAN FASTEN ANYTHING
 and do it quickly, neatly and safely, MOLLY will hold fixtures securely to floors, ceilings or any hollow wall construction... Simple to install, all you need is a screw driver. Sold by leading hardware and lumber dealers everywhere.

FIRST... DRILL HOLE SAME SIZE AS THE MOLLY... THEN INSERT MOLLY

USE A SCREW DRIVER TO TURN SCREW

NOW MOLLY IS FULLY INSTALLED

NO SPECIAL TOOLS NEEDED!

WRITE FOR FREE DESCRIPTIVE FOLDER

NEXT... REMOVE THE SCREW

WHERE SCREWS WON'T HOLD... USE MOLLY'S

NOW... PLACE FIXTURE IN POSITION. RETURN SCREW AND TIGHTEN.

MOLLY SCREW ANCHORS

MOLLY CORPORATION 522 COURT ST. READING, PA.

PRECISION DIESEL \$2.95

Check These Superior Features

- DEEZIL is an ultra precision engine as carefully machine tooled as GIANT ARMY engines. Cylinder is honed to .0001 inch. Hand-fitted to its pistons.
- DEEZIL is the perfect power plant for planes, boats, and race cars. Runs at 7500 R.P.M. Produces 1/7 H.P.
- DEEZIL is easy to assemble. No ignition headaches. Step-by-step instruction sheet included with kit.

SEND \$2.95 plus 25c postage today WE SHIP IMMEDIATELY

GOTHAM HOBBY CORP., Dept. P, 107 EAST 126th ST., NEW YORK 35, N. Y.

OUR 212th ADVERTISEMENT

M-SCOPE TREASURE-MINERAL LOCATORS

WRITE FOR FREE, ILLUSTRATED 16-PAGE BOOKLET

M-SCOPE TREASURE-MINERAL LOCATORS. Low priced, unsurpassed efficiency, lightweight models. Factory guaranteed. Immediate shipment. Credit plan available. Write for free 16-page booklet.

GEIGER COUNTERS for finding Uranium ores. Several models, Simple operation. Low priced. Immediate shipment. Interesting free literature.

URANIUM FISHER RESEARCH LAB., INC., PALO ALTO, CALIF. GOLD

MASTER HOBBY ARBOR TOOL KIT AT THE GIVE-AWAY PRICE \$5.95

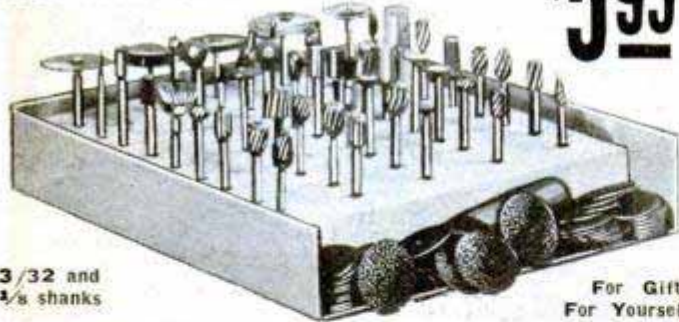

3/32 and
3/8 shanks

For Gifts
For Yourself

A 50c FOUNTAIN PEN FREE WITH ORDER. The best gift you can give to the hobby worker. We give you saws, drills, routers, carvers, emery disks, polishing compound, reamers, borers, shapers, stone points, grinding points. About 150 pieces that we went out and priced in other stores for over \$20.00 for half of what we sell for \$5.95. In addition to the above we include a dozen saws and a 60c mandrel. After receiving set, if you don't think it is worth what we say, send it back. Your money refunded.



BURGESS ELECTRIC SPRAYER (Complete)

Just plug it in and spray.
24 oz. capacity. Fast, economical for paint, varnish, oils, insecticides, etc.

\$12.95

25 ASSORTED SAWS

Some slightly off color, but all perfect and new. 2 mandrels included worth 60c each. Total value \$15.00. All this for only **\$1.95**

Get our 100 page catalog. Send 25c, your money refunded with first order.

All above items shipped P.P. Prepaid. Send check, Money Order or C.O.D. to Dept. P.M.

GENERAL AIRE CO.

447 W. NORRIS ST. • Dept. PM • PHILA. 22, PA.



1-minute angle set-ups!
Tilt it for the angle and lock it. You're set up for any operation, machine or bench. Two sizes, 2" and 2 3/4" jaws, with or without swivel base. Write for Vise

Folder and "Yankee" Tool Book.

YANKEE TOOLS NOW PART OF



THE TOOL BOX OF THE WORLD
NORTH BROS. MFG. CO.
Philadelphia 33, Pa.

HYDRAULIC Power Transmission WITH Infinitely VARIABLE SPEEDS, Clutch and INSTANT REVERSE—OUTPUT TORQUE ADJUSTMENT UP TO 180 inch POUNDS

This positive displacement Hydraulic Torque Converter is the ideal fluid drive with thousands of uses. . . . Output Speeds Infinite 0 to 550 R.P.M. . . . in either direction. . . . Change Speeds WHILE RUNNING. . . . Control and Transmit your power this SMOOTH Oil-Way. . . . Will handle 1/4 H.P. to 1 1/2 H.P. Motor. Industrial or Home & Farm Use. . . . Cost Government \$300. High Quality Precision Workmanship. Buy this unit to get the most for your money. Case measures 7 1/2" long 7" high 6 1/2" wide. Input & Output Shafts 5/8" dia. Beautiful Red Crackle Finish Case.

FINGER TIP CONTROL

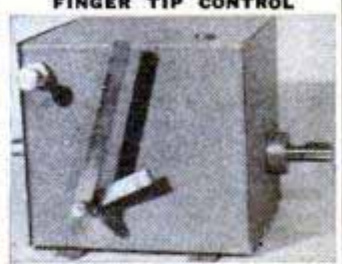

Shipping Wght. 25 pounds

Only **\$54.50**

If C.O.D. is requested a 10% Deposit must accompany order and we ship F.O.B. Chicago.

1 1/2"-8 thread Lathe Chuck Adapter, \$3 extra

PREPAID
2 quarts oil included FREE

DIRZIUS MACHINE SHOP "Q" 1423-25 So. 52nd Ave., Cicero 50, Ill.

FOAM RUBBER

For Experimenters, Home Craftsmen, Hobbyists

LOWEST PRICES—SAVE 50%
16 x 16 x 1 1/2" . . . ea. \$1.25
16 x 22 x 1 1/2" . . . ea. 1.55
18 x 24 x 2" . . . ea. 2.00
24 x 24 x 2" . . . ea. 2.75

AUTO SEAT TOPPER PADS
Place on seat cushion and cover with your seat cover.
24" x 60" x 1 1/2" ea. \$5.00
24" x 60" x 2 1/4" ea. 7.50

Use for furniture cushion fillers, mattresses, Mattress pads, cushions. Foam Rubber is available in any size or thickness. Send For Free Price List. Immediate delivery. No C.O.D.'s.

RIOR RUBBER COMPANY, Dept. P-12
50 East 22nd St. Chicago 16, Ill.

MONEY
BACK
GUAR.



7x50 PRISM BINOCULARS

PRECISION OPTICS—BRAND NEW

\$36*

6x50 ACHROMATIC
FIELD GLASSES
\$16*

*20% Federal Tax

Send for Free
Catalog of Binoculars,
Telescopes and Microscopes

BROWNSCOPE CO.

Dept. 12M, 24 W. 45th St.,
New York 19, N. Y.

New BELT SANDER ONLY \$10.95

MODEL
324

Stationary and Portable



Ideal all-purpose sander for home or shop! Stop-Fence Unit adjusts to 4 positions—tilts to 45°. Sturdy aluminum construction. May be powered by electric motor, drill, lathe, etc.

Send for free circular NOW!

JOHNSON Mfg. Co., Dept. 1A, Lincoln Park 7, R. L.

SAVE UP TO 25% ON QUALITY BALL-BEARING WHEELS!

Bilt-Rite wheels roll smoothly and easily, are semi-pneumatic, ball-bearing, painted red; guaranteed top quality—and you save up to 25%! Compare Bilt-Rite's quality and price—then get your order in today! Dealer inquiries invited.

BILT-RITE BARGAINS on BALL-BEARING WHEELS

(For 1/2-inch Axles)
6 x 1.00 \$1.30 10 x 1.25 \$1.95
8 x 1.25 1.65 10 x 1.75 2.15
8 x 1.75 1.80 10 x 2.00 2.45
6 x 1.50 \$1.50
(For 3/8-inch axle)
6 x 2.00 \$3.95 8 x 2.50 \$4.45
10 x 2.75 Only \$4.65!



Bilt-Rite Guarantee

No better wheels are made regardless of price; 10 day return privilege.

If size you need isn't listed, write for Folio A
ORDER TODAY—Send cash, check, or M.O.—Pay postage on arrival.

BILT-RITE WHEEL COMPANY
520 EAST MISSOURI AVE. KANSAS CITY 6, MISSOURI

WORLD'S LOWEST PRICED ADDING MACHINE

VEST POCKET SIZE
IDEAL XMAS GIFT!

FREE TRIAL
ONLY \$2.95
TOTAL COST
SEND NO MONEY

Fits vest pocket or purse. Guaranteed accurate. Operated as easily, and as reliable, as machines costing many times as much. Not a toy. Precision made, very durable—guaranteed for life against defects in construction. You positively can't buy a calculator of equal quality for as little money. **ACCEPTED AS THE FINEST LOW PRICED CALCULATOR FOR OVER 35 YEARS!** Operates with a flick of your finger. Adds, subtracts, multiplies, divides—counts up to one billion. Pays for itself over and over in mistakes avoided, and time saved.

MAKES IDEAL GIFT
Sold on a positive money back guarantee. Send only \$2.95. Calculator sent postpaid, or send name and address and pay postman \$2.95 plus postage. **MONEY BACK IN 10 DAYS IF NOT DELIGHTED!** (If outside U. S., send \$3.50.)

AGENTS WANTED
CALCULATOR MACHINE CO., (Mfrs.)
Dept. 221, P.O. Box 248, Glenview, Illinois

Each Baby Calculator in Beautiful, rich-looking Leatherette case—at no extra cost.



TODAY'S BIGGEST PREFAB BOAT BUY

Build a better boat than you can buy! Save up to 55%. See **OZARKA's Model 12-A**—a trim, top-quality 12-footer with laminated rib construction, all oak frame, for years of boating pleasure with motors up to 16 H.P. A cinch to assemble, a joy to own. Send 10c for descriptive literature. **OZARKA, INC.**
6129 Borden Street, Woodstock, Ill.

\$39.50
AND UP!



HEAVY CAST ALUMINUM BLOWER, NOW ONLY \$9.75

SINGLE EXHAUST BLOWER, DELIVERS APP. 100 CFM. For workshops, labs, kitchens, refrigeration, air conditioning. Ready to install yourself with any household tools. 110V AC 50-60 cycles cont. duty motor.

DOUBLE EXHAUST BLOWER—with 2 housings on extended shaft motor. Now only \$15.

Also LARGE 275CFM BLOWERS. DUST-O-VAC—Picks up & bags shavings and dust from all machines, for home workshops & industry, only \$19.95.

FREE Literature. Send check, M.O. All shipments F.O.B. Yonkers, N. Y. Pay postman delivery charges.

UNIVERSAL YONKERS CORP., (M12) 137 Alexander St., Yonkers 2, N.Y.

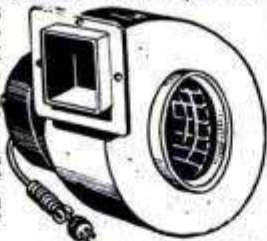

BURR HAND SAW FILER

Makes More PROFITS

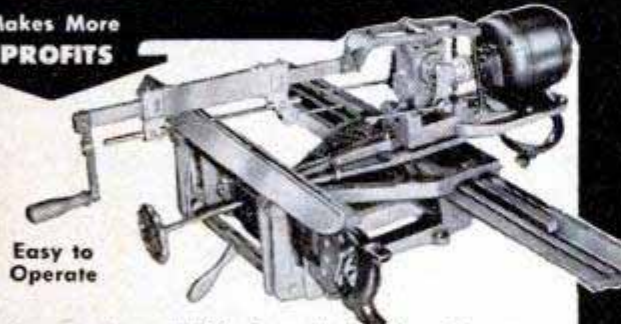

Easy to Operate

Fast, accurate, will file from both sides. Operator controls file arm. No saw carrier or adjusting screws to fuss with. A money-maker in any shop.

BURR MFG. CO.

8933 VENICE BOULEVARD
LOS ANGELES 34, CALIF.

WRITE TODAY!



Quick Starting... Smooth Going



With a CASITE Winter TREATMENT

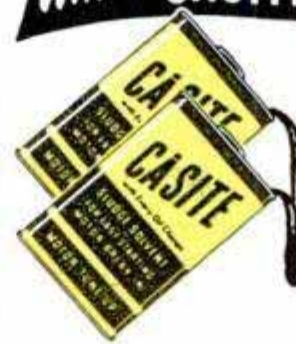

A PINT IN THE CRANKCASE

A PINT THROUGH
THE AIR INTAKE



Quick starts everytime, smooth going all the time—that's what you get with a CASITE TREATMENT.

Casite in the crankcase retards congealing of oil . . . lets your motor spin over and go . . . no matter how cold the weather. It cuts dangerous start-up wear, cuts repair bills, too.

Casite through the air intake conditions your car for winter . . . frees sticky valves and rings . . . keeps the engine clean and free-running.

Get a CASITE TREATMENT today—from any garage, service station or car dealer.

THE CASITE CORPORATION • HASTINGS, MICH.

Casite Division, Hastings Ltd., Toronto

QUICK STARTING—SMOOTH GOING
or Double-Your-Money-Back

The JIFFY metal CABINET

YOUR ANSWER TO SMALL ITEMS STORAGE
at home, office, and shop
(IDEAL GIFT, TOO)

So handy to keep nuts, bolts, screws, nails, parts, washers, stamps, hobbyists' needs, etc., at your fingertips.



THIS 32 DRAWER UNIT ONLY \$5.95 POSTPAID

Stop searching, get a 32 or 64 drawer Jiffy to keep those small items that usually get mislaid. Spot welded steel, gray enamel finish, metal drawer guides. Dividers included with aluminum drawers make possible three compartments per drawer. Looks good anywhere. Send check or money order, please—no C. O. D.'s. Prices below. Your money refunded if not satisfied. Dealers write for quantity discount.

SPECIFICATIONS	WITH ALUMINUM DRAWERS	WITH CARDBOARD DRAWERS
32 Drawer Unit 6" Deep 12 3/4" Wide 15 1/4" High	Dividers and Index Cards Included One piece rustproof aluminum drawers for heavy service—good for work bench and industry use.	Suitable for most home uses. Heavy board kraft covered. Metal drawer pulls.
64 Drawer Unit 6" Deep 25 1/2" Wide 15 1/4" High	32 drawer - \$8.95 64 drawer - \$15.95 OHIO ORDERS ADD 3% SALES TAX Marproof Rubber Feet included with all cabinets	32 drawer \$5.95 64 drawer \$9.95 POSTAGE PAID
Drawer Size 1 1/4" Deep 2 3/4" Wide 6" Long	POSTAGE PAID	POSTAGE PAID

KAYTEE PRODUCTS, Dept. M, Box 588, Canton, O.

Sharpens 1,000 MOWERS per Season

in spare time with the **FOLEY**



LAWN MOWER SHARPENER

"I have sharpened over 10,000 mowers in my Foley Lawn Mower Sharpener in the last 10 years—only repairs needed were new belts."—Charles H. Smith, From Ralph Rand—"The first month's business paid for my machine." The Foley sharpens all sizes and types of mowers in 15 or 20 minutes (with handles on). Prices run from \$1.50 to \$2.00 for hand mowers, and \$5.00 to \$8.00 for power mowers. This is the way to make money!

Prices \$98.50 to \$139.50

EASY PAYMENTS—Put a new 1950 model Foley Lawn Mower Sharpener in your shop that will handle all hand and power mowers. 99¢ out of each dollar you take in is profit. **FREE PLAN** shows how to start—mail coupon today!

Send for FREE PLAN

FOLEY MFG. CO., 1207-9 Foley Bldg., Minneapolis 18, Minn.
Send FREE PLAN on the Foley Lawn Mower Sharpening business.

Name _____
Address _____

BRIMMS PLASTI-LINER

One application MAKES FALSE TEETH FIT for the life of your plates

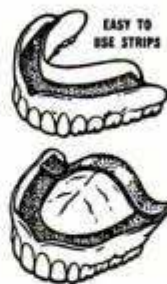

If your plates slip or hurt, rock and cause sore gums... you need Brimms Plasti-Liner. Easy to use. Gives instant comfort. Hardens to plates permanently. Lets you eat anything, talk freely without embarrassment. Even on old rubber plates gives good results six months to a year or longer. Ends forever mess and bother of temporary stickums. Tasteless, odorless, harmless to you and your plates. Removable as per directions. *Guaranteed satisfaction or your money back.*

SEND NO MONEY... pay postman when he delivers. Or send money now and save C. O. D. charges. Send \$2.25 for package to reline both plates or \$1.25 to reline one plate. Generous sample of special cleaner included free.

PLASTI-LINER CO., Buffalo 11, N. Y., Dept. 43-M



SAHARA WATERLESS HAND SOAP

Removes without water - Paint, Tar, Grease, Printer's Ink, Linoleum Paste, most Chemical Stains, etc.

At Your Dealer or Send \$1.00 for two 60c Tubes, Postpaid—Money-Back Guarantee—Agents Wanted

* SAHARA WATERLESS SOAP CO. GRAND RAPIDS 2, MICHIGAN *

OTTAWA Buzz Master

7 MODELS—\$99.00 up
Greatest offer made in our 46 years of manufacturing. A model to fit your needs and your pocketbook. Free details.
OTTAWA MFG. CO., 2-927 Brush St., Ottawa, Kans.



No Other Like It!

Say You Saw It in Popular Mechanics

Pioneers AIR RIFLES BENJAMIN AIR PISTOLS Leaders WITH SAFETY LOCK

SEND FOR FREE FOLDER OF LATEST MODELS TODAY
If you want a REAL GUN for PRACTICAL USE inside or outdoors, get a SAFE—CLEAN—ECONOMICAL—BENJAMIN with Adjustable Power and Amazing Accuracy. Use BENJAMIN H-C PELLETS for BEST RESULTS in all rifled models. WRITE AT ONCE.
BENJAMIN AIR RIFLE CO., 812 MARION ST., ST. LOUIS 4, MO.

NOW—KEEP EACH ROOM AS WARM OR COOL AS YOU LIKE... Automatically!

Simply replace air valve on radiator with Heat-Timer valve and turn dial to temperature wanted. Heat-Timer acts as an individual thermostat for each room; no changes required in your present controls. Perfect for any one-pipe steam system; pays for itself in fuel savings. Precision made; lasts for years—50,000 satisfied users. At your dealer, or direct—only \$4.95, prepaid; money back instantly if not delighted. Order today for every radiator. Heat-Timer Corp., Dept. E1, 160 Fifth Ave., New York 10.



Witte
Now Offers You
Small Diesels
up to 34 HP

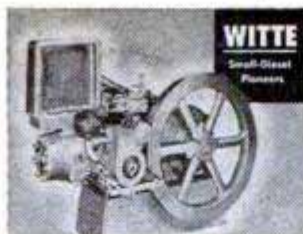

Witte Diesel Power Unit Model DLRC

Two new Witte Diesel Power Units have been added to the Witte line . . . enabling you to put reliable, low-cost Witte power to work on all jobs that demand up to 34 HP.

Series DL delivers a maximum of 21.4 hp at 600 rpm . . . Series DO a maximum of 34.3 hp at 475 rpm. They're single-cylinder, horizontal, full diesels, equipped with gasoline starters. Each is available with radiator or tank cooling, clutch or stub-shaft mounting.

These new Witte Power Units give you the same advantages as the widely-accepted smaller units in the Witte line—low fuel cost . . . a minimum of simple maintenance . . . long, trouble-free life.

Write today for more information and complete specifications on these new Witte Diesels.



WITTE ENGINE WORKS
 DEPT. C-12, KANSAS CITY 3, MO., U.S.A.
 Division of Oil Well Supply Company
 Witte Dieselelectric Plants and Diesel Power Units

UNITED STATES STEEL

A MAN'S BEST FRIEND IS HIS POCKET KNIFE



"CAMPER"—
 Compact kit
 of tools. Many
 other styles
 at your
 dealer's.

CAMILLUS
has the edge!

No. 99
 About \$2. Closed 3 3/4"

CAMILLUS CUTLERY COMPANY, CAMILLUS, N. Y.

NEW SAW EASY HANDLING BIG POWER

New American Portable Electric Saw saves time, labor and money in production work. Not a hobby tool. One hand operation. Cuts any angle. 8" blade. Write . . . give occupation.

AMERICAN
 FLOOR SURFACING MACHINE COMPANY
 535 So. St. Clair St. Toledo 3, Ohio

CARTWRIGHT'S

Patented

TRU-CUT TIN SNIPS

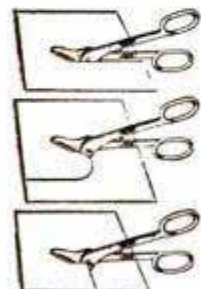

Prompt Delivery



\$4.95 Postpaid on cash orders

CHECK THESE 10 TRU-CUT FEATURES

- 1—Cuts perfect circle, right or left.
- 2—Cuts square points, either right or left.
- 3—Hands always above metal.
- 4—Fits the hand, well balanced, light weight.
- 5—Forward Stop prevents pinched fingers.
- 6—Guaranteed against mechanical defects.
- 7—Special "Cup Tension Washer" retains tight fit.
- 8—Faster, truer, easier cutting.
- 9—Stays sharp longer.
- 10—Will cut up to 18 gauge sheet metal.

Send cash, check or money order. \$1.00 deposit on C.O.D.'s. Satisfaction guaranteed.

IF DEALER CAN'T SUPPLY, ORDER DIRECT FROM US

J. CARTWRIGHT & SON
 MALAGA, Dept. P.M., CALIF.

When you use pliers...

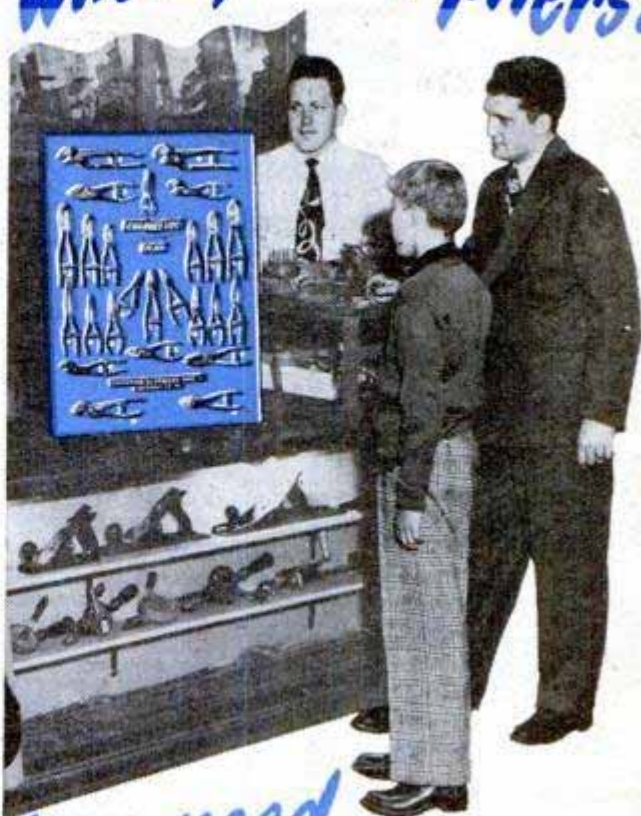

You need CHANNELLOCK

There are lots of "fussy fix-it" jobs around the house that Dad, Mom or the kids can easily do when Channellock pliers are handy. No matter what—electrical, automotive, plumbing, battery, or anything mechanical—you need Channellock pliers.



Send for Catalog C-14 today.

Channellock's patented tongue and groove joint gives you these "plus" features: Greater Strength, Longer Wearing, Self-Cleaning, Closely-spaced Adjustments, Visible Adjustment, No Wear on Joint Bolt.

CHAMPION DEARMENT TOOL CO.
 MEADVILLE, PA.



Only **CHAMPION DEARMENT MAKES**

CHAN NEL LOCK

TRADE MARK REG.

U. S. PATENT OFFICE

**SAVE TIME!
AND WORK!**

**MAKE EXTRA!
MONEY!**



**EASY TO
OPERATE**

**SHAW
"DU-ALL"**
and "PEPPY PAL"
GARDEN TRACTORS

PLOW



HARROW



CULTIVATE



MOW

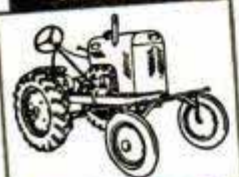

RIDE

AW-2

**SHAW
MFG. CO.**

These sturdy walking and riding tractors ideal for dozens of uses around the farm, orchard, garden, golf course, estate and poultry farm.

DO DOZENS OF JOBS

Shaw Du-All or Peppy-Pal tractors do many jobs quickly and easily. Plow, cultivate, harrow, mow, disk, bulldoze, spray, grind, haul and saw wood. New uses discovered every day.

BUILT FOR RUGGED WORK

Sturdy, extra-strength construction means low upkeep, long life. Patented tool control allows quick shift for crooked rows. Attachments easy to change with improved "Jifty Hitch."

CHEAP TO OPERATE

Operates on a few cents an hour. Soon pays for itself in time and labor-saving plus low initial and operating costs.

LOW FACTORY PRICES

Buy direct or through your dealer! Almost anyone who has a garden can afford a Shaw Du-All or Peppy-Pal. Full year's guarantee.

RIDING TRACTORS

Four models, from 5 to 12 1/4 H. P., 58 in. wheelbase, 36 in. wide, 24 in. plant clearance. Hand or electric starter. Improved steering device, brakes enclosed in differential housing shaft. Standard hitch for trailers and wagons. Plow, harrow, cultivator, cutter bar, snow plow, bulldozer available.

PROMPT SHIPMENT No waiting — order now for immediate delivery.

FREE: Illustrated folders giving complete details and price lists. Write today:

4512 Front St., GALESBURG, KAN.
668-G North 4th St., COLUMBUS, O.

HEY FELLOWS! LOOK! Pre-War Engine Back on the Market

STEAM ENGINES

REAL WORKING MODELS!

Built in a precision machine tool factory from finest quality materials. Years of pleasure — interesting and instructive.

- 40-lb. pressure tested boiler. Operates up to 1 hour on filling.
- Double action two-cycle piston.
- Counter-balanced machined crankshaft.
- Safety pop-off valve.
- Real steam whistle.
- Pulley power take-off on fly-wheel.
- Finest quality tested electrical cord and heating element. AC or DC current.

\$495

Fully guaranteed. Truly a quality working model, precision built of high tensile-cold rolled steel.

STEAM ENGINE INDUSTRIES
1320 Farnam St. Omaha, Nebr.
Enclosed find remittance for \$4.95. Check Money Order

Send complete Steam Engine as described above, complete with warranty. Postage paid.

Name _____
Address _____
City _____

**MAIL
COUPON
TODAY!**

FASTEST PLANER in the WORLD
at this Low Price ... **\$195.00**

BELSAW Multi-Duty Planer



● LARGER CAPACITY ● FASTER OUTPUT ● KNIFE SHARPENING ATTACHMENT

BELSAW MACHINERY CO 8-1010 Field Bldg., 315 Westport Rd., Kansas City, Mo.

Speed up production! Increase your profits! BELSAW power self-feeds at 24 feet per minute... The lowest-priced surfacer that will handle 12x6 in. stock. Planes green or dry sawed lumber into smooth, worked forms. Three high-speed steel knives make 42 cuts per inch. Multi-duty BELSAW takes inexpensive attachments for all planing mill operations — Jointing, Rabbeting, Grooving, Matching. BELSAW is the **only 12 in. planer providing attachments for jointing and grinding its own knives.** Start planning NOW for BIGGER VALUE and BETTER PERFORMANCE, with BELSAW. Write for FREE specifications, illustrations and low prices.

NEW QUICK-CLAMP 30" BRAKE

Forms angles, flanges, seams. Bends 26 gage steel. Heavier copper and aluminum. Cam locking. Portable, can be clamped to edge of truck. All steel. Wt. 42 lbs. Express Collect. ... \$24.50
36" size \$29.00



12" BRAKE. Fits in vise to form difficult compound bends, up to 20 gage steel. ... \$12.50 PP.
CUTTER. Cuts 18 gage steel any length and width, \$12.50 PP.
SHEET METAL PLIERS. 2 1/2" wide, \$2.00; 5", \$3.00.
PLASTIC BAR BENDER, 1/4x8 capacity, \$1.00
IRON BENDER. Forms hooks, braces, eyelets. Bends 1/4x2, \$10.00
Immediate delivery. Order direct, cash or C.O.D., or send for folder.

VISE BRAKE MFG. CO., P1116 So. 27th St., Omaha 5, Nebr.

**BURIED TREASURE, MINERALS
AMAZING NEW GOLDAK LOCATORS**

SENSATIONAL NEW MODEL!
ONLY 11 pounds weight! One hand operation! Money-Back Guarantee of Superiority. Write for full details.



THE GOLDAK CO.
1542 WEST GLENOAKS BLVD.
GLENDALE 1, CALIFORNIA

World's largest maker of fine locators.

WOODWORKERS ... Get this
CONSTANTINE MASTER MANUAL

Got the Most Fun From Your Hobby Indispensable to woodworkers. Newest, biggest edition, more pages, more color, helpful how-to-do-it articles, pre-war and new items, more bargains. Send 25c today and we will include **FREE! FULL YRS. SUBSCRIPTION** to Chips and Chats, published bi-monthly. Keeps you up-to-date on everything in woodworking, offers big money-saving bargains. Send now.



ALBERT CONSTANTINE & SON, Inc.
791-E East 135th Street, New York 54, N. Y.

FIBRE ARMS AND LEGS!

Light, correctly fitted, strong and comfortable. Natural appearance. Braces for all deformities. Scientific design. Fair Terms.

BUCHSTEIN-MEDCALF

223 S. 6th St., Minneapolis, Minn.

SAY YOU SAW IT IN POPULAR MECHANICS



**ONAN Portable
ELECTRIC PLANTS**

**FOR CABINS, TRAILERS,
CONTRACTORS, BOATS**

Light weight, compact, air-cooled engine-driven. Furnish regular city-type A.C. electricity for lights, appliances, radios, etc. Can be carried by hand. Fit trunk of car. Plug-in receptacles on plant. Larger models for farms, homes, businesses beyond highlines. Catalog shows over hundred models. 350 to 55,000 watts.



Gasoline or Diesel Powered

WRITE FOR CATALOG

D. W. ONAN & SONS INC.
5828 Royalston Ave., Minneapolis 5, Minn.

MAGNETIC TOOL HOLDER

Guaranteed Permanent



Saves VALUABLE TIME and MONEY!

ZIP! YOUR TOOLS OFF OR ON WAS \$2.45

Now Only \$1.95
POST PAID No C.O.D.

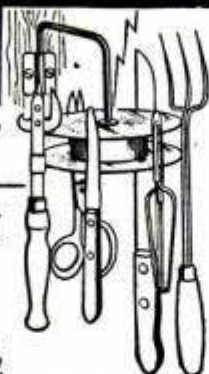

Will Never Weaken

KEEP YOUR MOST-USED TOOLS AT YOUR FINGER TIPS!

Works like magic. Just TOUCH the tool to the holder, the powerful Alnico magnet holds it there until needed again. Holds steel tools & utensils of all shapes; keeps them cleaner—sharper. Holder rotates for easy accessibility. See P. M. Nov. issue pg. 266.

TRIAL OFFER—Send \$1.95 for your HOLDER. If you don't agree that it's worth every penny paid, return it for FULL REFUND. Dealers wanted.

RONALD EYRICH, 2566 N. 49th St., Milwaukee 10, Wis.
(Manufacturer of Permanent Magnets)



CAPE COD CHAIRS TRELLISES • ARBORS DUTCH WINDMILLS

Chairs style B-C-A PLANS 50c Ea., all 3 only \$1.00. 12 different trellis designs PLAN of all 12 only 50c. Authentic 40" high Dutch Windmill Detailed PLAN only 75c. Unique 40" high Light-house having copper lantern, ideal for garden or on lake shore of summer home. Large detailed PLAN 75c.

SPECIAL ALL PLANS ABOVE \$3.00 VALUE ONLY \$2.50

SEND 10c for catalogue of many fine projects.

Dept. P11

CRAFTSMAN'S MODEL CO. DELAFIELD, WISCONSIN



OWN A Printing Business

Cards, Tickets, Stationery, etc. Good profit in spare time. **PRINT YOUR OWN** greeting cards, movie titles, church work, etc. Save money. Easy rules supplied. Raised printing like engraving too. Have home shop. Sold direct from factory only. Pays for itself in short time. Write for free catalog of outfits, and all details. **KELSEY PRESSES, 0-37, MERIDEN, CONNECTICUT**

SAY YOU SAW IT IN POPULAR MECHANICS

SAVE MONEY! YOU CAN INSTALL AMERICAN EAGLE PRE-SET GAP SPARK PLUGS! SAVE GAS... WITH A HOTTER, MULTIPLE SPARK!



American Eagle RADIAL CATHODE Spark Plugs give off a 'halo' of fire instead of the single lane spark produced by conventional plugs. Tops for oil burning engines! Tops for fuel savings!

All American Eagle spark plugs are precision set at the factory for all makes and models of cars and require no special tools to install. They're stronger, made of the finest material available and are warranted to last longer.

See Popular Mechanics—Oct. Issue—pg. 270

Price: 85c each—79c in sets of 6 or more (U.S. Only)

If your dealer cannot supply you order direct! State YEAR—MAKE—MODEL OF YOUR CAR—Send full amount and we ship prepaid.

DEALERS: WRITE FOR INFORMATION & PRICE LISTS

AMERICAN EAGLE SPARK PLUG CO.
3211 CADILLAC TOWER • DETROIT 26, MICH.

THE BULL BUFFER

PAT. PEND.

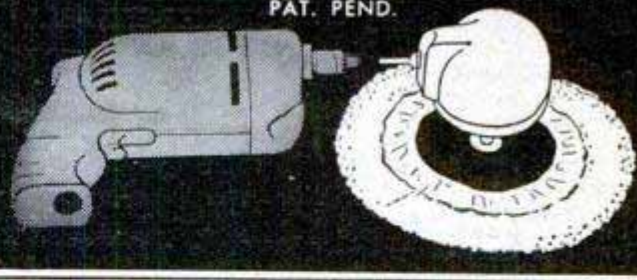

\$9.95 Famous angle-head polisher-sander complete with sheep-skin bonnet and 2 sanding discs. Fits the chuck of any 1/4 inch electric drill. A heavy-duty, rugged tool you'll use to make your car, floors, woodwork, furniture gleam like new! It's America's First Choice—more than 100,000 in daily use. Order today!

Order These Accessories for Your Bull Buffer

(For use with Bull Buffer only)

- 534" finest quality bark tan sheep-skin bonnet, \$1.25
- 5" aluminum oxide production sanding discs (0000-00-0-1-2 1/2-3), \$.10 each. #4 open grit, \$.15 each.
- 1/2" Jacobs Hex key chuck. When attached to the Bull Buffer, gives you angle-head drilling attachment. Increases 1/4" drill to 1/2" capacity, provides power for heavy drilling in wood or steel. \$5.00
- 2 1/2" cup wire brush. Easily attached to Bull Buffer angle-head. Removes paint, rust, scale, etc. right now! \$1.75

NEW! JUST CHUCK IT IN YOUR DRILL— AND WATCH THE CHIPS FLY!

Now you can mortise on-the-job, now you can rout on-the-spot with the new Bull Mortising Adapter!



This amazing new adapter can be attached in either drill or drill press in a matter of seconds, and it gives you a powerful, portable tool that really makes the chips fly!

NOTE: Bull Mortising Adapter is designed specifically for use in any 1/4" electric drill or any drill press; it should not be used with 3/8" or 1/2" electric drills.

BULL MORTISING KIT

Includes Bull Mortising Adapter and 1/4", 3/8", and 1/2" chisels with corresponding bits. Complete, guaranteed, **\$23.90** only.

MORTISING ADAPTER ONLY

Fits only 1/4" electric drill or drill press; also fits any standard mortising bit and chisel. **\$6.95**

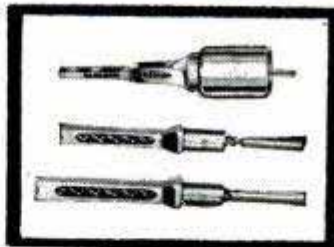

NEW PORTABLE DRUM SANDER

Uses Standard Sandpaper Sheets!

Now you can get to all those hard-to-reach places with the new Bull Drum Sander—a portable 2" drum sander that fits any electric drill (or drill press.) **MOST ECONOMIC!** drum sander on the market because you cut your own strips out of ordinary sandpaper sheets instead of buying costly sanding sleeves! No wedges or screws necessary; new patented feature lets you insert and remove sanding strips at the flick of a finger. Complete, with 6 sanding strips, **\$2.50**

At All Leading Hardware and Department Stores or Order Direct For prepaid shipment, send cash, check or M.O. to

BERTRAM B. ENGINEERING COMPANY
3121 MAIN STREET Dealers Write Today KANSAS CITY, MO.

NEW AUTOMATIC SCREW DRIVER!

Now you can get to all those "tight places" and drive screws in seconds where it used to take minutes by hand! The new Bull Driver fits any electric drill, drill press or flexible shaft. Automatically centers on screw groove; automatically disengages when screw is firmly home in wood or metal. Three models—take your choice and order today! Any model, **\$4.95**. When ordering, specify model in either standard or Phillips. **MODEL A**—Self-centering model for driving screws up to #14. **MODEL B**—Self-centering model for driving small machine screws. **MODEL C**—Without self-centering model; long blade reaches those extra-deep countersunk jobs.



3 BUYS FOR A MERRY XMAS!

BULL BUFFER — POLISHER-SANDER

Polish and sand expertly with your electric drill! **BULL BUFFER** more than pays for itself the very first time you make your car, boat, floors and wood-work gleam like new! With exclusive gear reduction unit, 2 sanding disks and sheepskin bonnet. Complete Home Kit—only

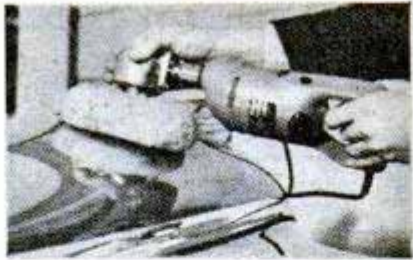

\$9.95

1/4" ELECTRIC DRILL

(Complete with Chuck)

A real buy! Speedy and powerful for driving **BULL BUFFER** (above), drill attachments for disc sanding and polishing, grinding and sharpening tools, portable saw attachment (below) etc. Terrific value—only



\$10.95



PORTABLE SAW ATTACHMENT

Converts any 1/4" drill into a portable saw with 1 1/8" cutting capacity!

A welcome addition to any tool shop! Now you can have a real portable saw for only

\$9.95

ALL SHIPPED F.O.B. NEW YORK CITY—ENCLOSE CHECK OR MONEY ORDER. NO C.O.D. 10-DAY MONEY-BACK GUARANTEE.

HERMAN MACHINE & TOOL CO. 714 Third Ave., New York City

GIGANTIC XMAS SAVINGS

New Precision Bilt MICROMETERS

Nationally known makes. Gives a lifetime of accurate service.

1" Central	\$3.50	5" Reed	\$7.25
1" Central, Tubular (also ideal for tubing)	\$3.75	6" Central	\$7.50
1" Slocumb	\$4.25	7" Slocumb	\$9.00
2" Central	\$4.95	9" St. James	\$10.00
5" Central	\$7.00	11" St. James	\$11.00

NEW SURPLUS



FIRE EXTINGUISHERS

1 gal. capacity fully charged, ready to use. Carbon-tetrachloride is non-conductor; stored pressure type shoots 40 foot stream; height 23", diameter 5". Ideal for home, garage, workshop, etc. Lists approx. \$65.00. Our price

\$14.95

BARGAINS IN BENCH LEGS

Make your own workshop bench with steel bench legs. Heavy gauge, drilled for use. Used, good condition.



Heavy Duty:		Light Weight:	
Wide High	Pair	Wide High	Pair
28 1/2" x 28"	\$4.95	28 1/2" x 28 1/2"	\$2.50
28 1/2" x 31 1/2"	\$5.50	34 1/2" x 28 1/2"	\$3.50
34 1/2" x 33 1/2"	\$7.50	28 1/2" x 34"	\$4.50
Cross Brace: 5 ft.	\$1.25	8 ft.	\$1.75
		10 ft.	\$2.00

Special Offer "Husky" 37 Piece SOCKET SET

New, 1/2" Drive, 14-Hex sockets 7/16—1 1/8, 4 sq. sockets 1/2"—1 1/16", Sliding T ratchet, 15" Flex. hdl., 8" Cross-bar, 11 piece Midge and Socket Set, Adapter, 2 extensions. Regular list, \$55.53. Our special price

\$21.95

Prices F.O.B., Kansas City, Mo. No C.O.D.'s.

Send 10c for New 64 page Jam-packed Catalog

ATLAS EQUIPMENT CO. 229 S.W. Blvd. Dept. P.M. 11 Kansas City, Mo.

U-Build-it **Little Sport**
\$299.00
BUY AS YOU BUILD
BE DOLLAR WISE — EASY DOES IT

Goes together like a child's construction set. All High strength tubular steel prefab sections, with aluminum or steel exteriors. Kit includes all complete knock down sections parts, windows, running gear, tires & hitch. Can be picked up at factory or shipped Via Frt. Standard sizes available 12' 16' 20' 24' 28' 32' body lengths. Caravan or Conventional style. Send 10c for Catalog & further information. (A single source for complete parts & equipment)

U-BUILD-IT-TRAILER

P. O. Box 611 Transportation Specialties, Inc. 917 Fremont St. Elkhart, Indiana

POWER HACKSAW \$47.25

LESS MOTOR
F. O. B. Benton Harbor

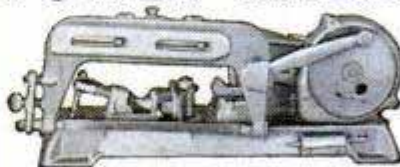

• Rugged cast iron construction. Wt. 56 lbs. bronze bearings. Draw cut. Auto. return lift. Auto. shut-off. Vise swivels 45°. Cap. 4" x 4".

Send for full details and name of nearest dealer.

EXCEL MACHINE TOOLS BENTON HARBOR, MICHIGAN Dept. PM-129

"ZERO-ZIP" 7.50

Replace your oil drain plug with our Thermal Heater and forget about cold weather starting—leave in year around if desired. Keeps oil warm for instant starting in zero weather. For 110 V. A.C.—fits most cars. Specify make & model. Complete kit includes 15 ft. ext. cord.



PRODUCT ENGINEERING COMPANY, Box No. 1781, Tulsa, Okla.

MARCOT KEY MACHINE

Immediate Delivery



MARCOT No. 8 KEY MACHINE, mounted on Cabinet, less motor, \$ 95.00
 Auto Code Book and Depth Keys. 12.50
100 Dr. Popular Key Blanks 60.00
 Set — Key File, Follow-Through Rods, Lock Picks, Bit Key Gauge, Thimble, Pins, Springs. 10.50
 "Locksmith Trade Books": 6.75
 How to Open Locks without Keys or Picks: Secret of Locksmithing; How to Make Keys with the Impression Method; Master Key Systems.
TOTAL COST \$184.75

A. J. MARCOTTE CO., 1200 N. Kedzie Ave., Dept. PM, Chicago 51, Ill.



ONLY **\$8.95** POSTPAID

Compares with \$25 to \$100 Air Horns

SUPERETTE DUAL VACUUM AUTO HORNS

The voice of authority and commanding warning for safer highway driving. One BLAST and those "Road Hogs" really move over. Installed under the hood or on the front fender. Beautiful lacquer finish. Operates from intake manifold. No tank needed. Only \$8.95 complete with cylinder head bracket, steering column lever, hose, fittings etc.—Send check or money order today. We pay postage. \$1.00 deposit required on all C.O.D. orders.

THE PROTECTUROC CO. Dept. 403, 4033 Windsor Road, Youngstown 7, Ohio

BRUSH PLATING OUTFITS

• for re-plating articles in the home and shop. No tanks necessary. Free particulars. **GUNMETAL CO., AVE. M, DECATUR, ILLINOIS**

SAY YOU SAW IT IN POPULAR MECHANICS

RETAIL PRICE \$125.00



FACTORY TO YOU! \$59.95
5 BIG POWER TOOLS in 1

SUPERSHOP is the **PRECISION-BUILT** power tool **WORKSHOP**. Big capacity tilting table saw, vertical and horizontal drill press, 30" lathe, sander, grinder. Lifetime-lubricated **BALL BEARINGS**. Running parts precision-ground. Bearing seats precision-bored. Compare with finest production tools. Buy direct from factory — save \$65.00. Write for **FREE** catalog, full details, trial plan.

SUPERSHOP POWER TOOLS INC. 106 YATES AVE., BELLOIT, WIS.

Now YOU CAN DRILL SQUARE HOLES

The Budget Square Hole Drill is a simple, economical, nationally used precision tool that will save hours on every woodworking job. Available in 3/8" to 1 1/2" sizes. For use on hand, portable power or drill press operation.



DEALERS WANTED

3/8" and 1/2" sizes only: \$3.50
(Will fit 1/4" drill chuck)

Prices for larger sizes on request. Money Back Guarantee

ORDER DIRECT TODAY. Postpaid when remittance received with order. C.O.D.'s plus charges.

BUDGET MACHINERY & TOOL COMPANY
406 W. Pico. Blvd. • Los Angeles 15, Calif.

FORMING WITHOUT DIES

with DI-ACRO BENDER

Many small parts can be rapidly formed without dies, to accuracy of .001" with DI-ACRO "Die-Less Duplicating" Machines—Benders, Brakes, Shears, Rod Parters, Notchers, Punches. Save die expense and time delay. For experimental work, samples, models, etc., as well as regular production runs. Write for "Die-Less Duplicating" circular.



O'NEIL-IRWIN MFG. CO. 341 8th AVE. LAKE CITY, MINN.

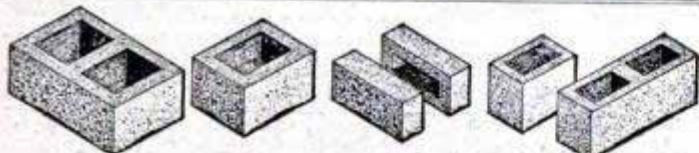

Make Concrete Blocks and Bricks

New superior method makes square, true, easy-to-lay units which will pass any building code. Small investment, high production, big profits. One \$30.00 machine will make four 5"x8"x12" blocks per minute—1000 per day. Pays for itself in a few days. Sell blocks or save 2/3 building cost by making and laying your own.

POST CARD BRINGS FREE FOLDER

Economy Manufacturing Company
Dept. P Stone Mountain, Georgia

TORP JR. Model Airplane Engine

AMERICA'S FASTEST GROWING HOBBY
AN IDEAL GIFT FOR YOUR YOUNGSTER

Come on, get acquainted with model flying. You'll have fun... if you equip your plane with K & B's Torp Jr. This little engine has everything and is designed for all types of flying, Free Flight, U-Control, Stunt, Speed and Scale... readily adaptable for model race cars and boats. Torp Jr., really easy to operate, yet outperforms any engine in its class.

INFANT Also available The Infant .020. World's Smallest Production made Glo. Ignition Engine. This engine, now world famous, is interchangeable with the Torp Jr. Complete with Glo Plug and fuel tank only \$4.95



Fully Guaranteed Glo Plug Ignition .035 Cu. In. Displacement Turns 15,000 RPM Weights only 1-1/16 oz. Easy to Start Famous K & B Quality Thoroughly tested in factory and field.

See your model dealer today or for dealer information write to
K & B MANUFACTURING CO. 6901 S. Eastern Ave. Bell Gardens, Calif.

Be Independent! Have your own business!

\$150 to \$300 extra profit monthly for you with Simplified arc welding



NEW "Pays-for-itself" terms

... puts you in business with but little cash outlay

Equip NOW to go after those BIG PAY jobs!

In spare or full time... on shop or field work... you make more money with HOBART Arc Welders. Mail coupon below and find out why.

A. C. Transformer Type arc welders

Made in all sizes for shop work. Used on 220-volt power lines. Knocks out welding jobs in a jiffy at lowest costs. Same as used by large manufacturing plants on production.

A. C. - A. C. combination welder and power

With this portable gasoline engine driven unit, you can handle the profitable outside jobs. Do A. C. welding... operate lights, motors, appliances, tools... meet emergencies for electric power anywhere, day or night. A real money maker. Nothing like it on the market. D. C. Welders with Auxiliary A. C. or D. C. power also available.

Yes! You can "Build-Your-Own"

Save \$\$\$\$ with a Hobart Generator complete except for motor. Made for D. C. or A. C. Welding. Hook up to your electric motor, power shaft or gas engine. Hobart shows you how to build portable gas drive unit.

Become an expert! HOBART trains you

Complete or partial courses in welding are taught by experienced instructors in fully equipped, modern Hobart Trade School. For details write HOBART BROTHERS CO., Box M-129, Troy, Ohio.



Motor Driven D. C. Welder



Generator Only to "Build-Your-Own"



A. C. Transformer Welder



Hobart Trade School

HOBART WELDERS

"One of the world's largest builders of arc welders"

HOBART BROTHERS CO., BOX M-129, TROY, OHIO

Please send more information on Hobart Arc Welders, checked. Also send Welder's Guide FREE!

- Motor Driven D. C. Welder
 "Build-Your-Own" Generator
 A. C. Welder or A. C. Power Plant
 Gas Engine Driven Welders
 Hobart School of Welding

My work is _____

Name _____

Address _____

DEAF?

HEAR BETTER Or Pay Nothing

Why pay \$150 to \$200 for a hearing aid when the new Zenith "Miniature" at only \$75.00 is guaranteed to give you all the power and performance you need if your hearing can be helped by a hearing aid.

The Zenith "Miniature" is as new and advanced as Zenith's Radio, FM, and Television Sets—world famous for top quality. Tiny, jewel-like, beautiful—weighs only 6 1/2 oz. with batteries. Needs no "fitting." Comes ready to wear. Let a trial of this new, sensationallly-priced Zenith prove it can save you real money two ways—on original cost and on upkeep expense. Surprisingly economical. Here's Zenith's amazing guarantee: If any \$200 hearing aid outperforms Zenith in both efficiency and economy, your money back—under our 10-Day Return Privilege. Dealers in all principal cities. For Authorized Zenith Hearing Aid Dealer in your locality consult your classified telephone book; or write for complete coast-to-coast dealer list. Don't live in a world of silence when it is now possible for the hard of hearing to even hear a whisper. For free descriptive literature, address:

Zenith Radio Corporation, Hearing Aid Division
Dept. 1291, 5801 West Dickens Avenue
Chicago 39, Illinois

Makers of World Famous Zenith Radio, FM and Television Sets

HUNDREDS OF ITEMS AND IDEAS FOR THE WOODWORKER

A board or carload—Top grade kiln dried Mahogany—Walnut—Wh. Hd. Maple—Cherry—Poplar—Aromatic Red Cedar—Red, White and English Brown Oak—Sapelli—Andiroba—Balsa Wood. **NEW LOW PRICES.**

HARD TO FIND LUMBER

**BIG NEW NO. 17
CATALOG FOR
WOODWORKERS.
144 PAGES
OF HARD-TO-FIND
SUPPLY ITEMS.**

The finest catalog we ever published. Full of unequalled bargains and useful information.

Greatest Selection of Fine Domestic and Imported Woods
Catalog shows in natural color 32 rare and fancy woods. 43 matched veneer designs, multi-colored bandings, inlays, overlays. 275 scroll patterns to choose from, labor-saving machinery and a section for beginner's instruction.

OVER 100 NEW ITEMS

My stocks are gigantic—bigger than ever before. Really **FAST SERVICE** on your orders. My new catalog includes a "gold mine" of hard-to-find hardware items. Whatever Wood Craftsmen need—I HAVE IT.

**MAIL COUPON TODAY for
GIANT NEW CATALOG #17**

Only 15c Refunded on first order.

Harold F. Hunt, President
CRAFTSMAN WOOD SERVICE CO.
2729 S. Mary St., Dept. A-12, Chicago 8, Ill.

I enclose 15c, to be refunded on my first order. Please send me your big new Catalog No. 17.

NAME _____
ADDRESS _____
TOWN _____ ZONE _____ STATE _____

Every Electric Drill A PORTABLE SAW



**JUST TRY IT! YOU WON'T
USE A HAND SAW ANYMORE.
FITS ANY 1/4" ELECTRIC DRILL**

"ARCO-SAW" is a rugged precision tool with right angle gear drive. (No clumsy direct drive with drill sideways.) Works like high priced Portable Saw. **EXCLUSIVE SAFETY YOKE** connects drill and saw, **ABSOLUTELY SAFE TO USE.** All Parts Guaranteed.

**Cuts 1 1/8", 2 x 4 BY
TURNING OVER**

"ARCO-SAW"

\$9.95

Patent Pending

DEALERS: Write for name of nearest wholesaler.

5 DAY MONEY BACK GUARANTEE

ORDER YOURS TODAY at your Dealer or send M.O. or Check for \$9.95 (compl. with 4" "Hycarbon" Blade)

ARROW METAL PRODUCTS CO.

DEPT. A, 140 WEST BROADWAY, N. Y. 13, N. Y.

Say You Saw It in POPULAR MECHANICS

AIR COMPRESSORS

Lowest-Ever Closeout Price!

Brand New Reg. \$60.50

WESTINGHOUSE 1850
Model T-1 Complete F O B Pgh.

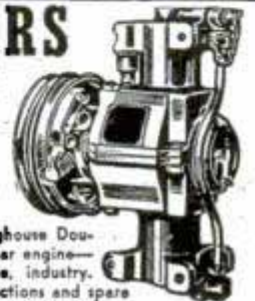

Surplus Special at an amazing low price. Westinghouse Double-piston type, 6.54 volume. Mounts on truck or car engine—or operate with 1/2 HP motor. For farm, home, industry. Verified government acquisition cost of \$48. Instructions and spare parts kit included. Send check or money order. Weight 26 lbs.

Descriptive Literature on Request

NATIONAL STORES 200 Smithfield St., Dept. 21
PITTSBURGH, PENNA.

**\$14.00 UNIVERSAL PRECISION
LATHE CHUCK ONLY.....\$2.95**

2 inches with hardened steel jaws, perfectly balanced for trueness, made by nationally known chuck manufacturers. Every craftsman, machine shop, should own one at this unusually low price. Send check or money order to **HAR-MUR • 2349 W. Devon Ave. • Chicago 45, Ill.**

Make Personalized HOUSE, LAWN MARKERS For Fun Or Profit



17 new silhouette cutouts (3 shown plus 14 other novel designs) complete alphabet and numbers, ready to trace onto wood. Sawing is easy. Marker with name or address is distinctive personalized

gift or addition to your own home. Make markers for fun and to sell. Set of 17 full-size, ready-to-use patterns, alphabet numbers, only \$1.00, postpaid. Money Back Guarantee.

Clip This Ad and Mail With **CRAFTPLANS** Dept. P-151, Chicago 5, Ill.
Dollar Bill or Check TODAY 1321 S. Michigan Ave.

MAKE UP TO \$5.00 AN HOUR IN YOUR OWN BIG-PROFIT BUSINESS!

National Organization teaches, helps, supplies everything—for establishing Rug, Upholstery, etc. Cleaning Business. Do work in customers' homes, buildings—new, easy way. Only a few dollars needed to start. Big, year-around demand everywhere. Write for FREE details! **AMERICLEAN CO., INC.**; 211 North 7th St.; Dept. G-25; St. Louis 1, Mo.

A GOOD XMAS GIFT FOR MEN 8 pc BOX & OPEN END WRENCHES

Sizes 13/64 to 7/16

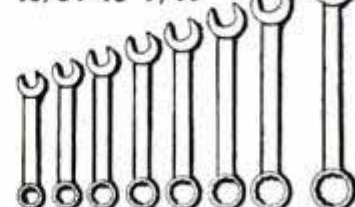

in Plastic Roll Kit
Guaranteed Retail \$3.00

PER SET
SEE YOUR DEALER
Sample (Salesman's)
\$1.50

PER SET Postpaid
Dist. and Exporters
Write for spec. low price catalog free.

STEPHENS TOOL WORKS

BOX 306 LATIJ. STA.

LOS ANGELES 43, CALIF.

NEW-SURPLUS LIGHT PLANTS

BUY and SAVE at C & H ELECTRIC

Here are NEW Army Light Plants and Generators at a fraction of the actual value and list price. Prepare for any emergency. BUY TODAY at these amazingly low prices. Write for FREE circular on WAR SURPLUS and OTHER ITEMS all at bargain prices.

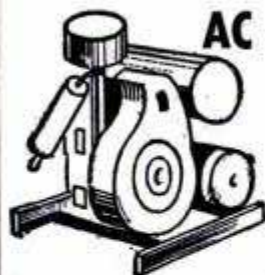

AC ARMY LIGHT PLANTS

300 WATT, 110-220 volt AC, 60 cycle light plant powered by 1 HP gas engine, direct drive. Mounted base weight 40#. New Stock #409..... **\$89.50**
500 WATT, 110 volt AC, 60 cycle. Onan direct connected. Stock #414. New..... **\$139.50**
750 to 1000 WATT, AC 110 volt, 60 cycle, direct drive, air-cooled, Briggs & Stratton Model AP, Eicor generator, Radio filter, self exciter, volt meter & regulator, rope start, 110 lbs., 20" long, 17" wide, 18 1/2" deep. Stock #573 New. Your price..... **\$149.50**

NEW 1500 WATT, 110 & 220 volt, 60 cycle, AC plant with Briggs & Stratton directly coupled to a Master generator. Stock #352. New..... **\$209.50**

2500 WATT, 110 volt AC, 60 cycle with Briggs & Stratton Model Z and Leland generator. Stock #317. Used but like new..... **\$265.00** New..... **\$295.00**
 Add \$10.00 for tools and spare parts.

5000 WATT, 110 volt AC, 60 cycle with automatic remote control. Powered by 4 cyl. Jeep gas engine. Used but like new. Stock #318..... **\$495.00**

7500 WATT, 110 volt AC, 60 cycle powered by a VE 4 Waukesha 4 cyl. gas engine, Continental or Hollinsworth generator. Remote control starting. Complete with switchboard. Used but like new. Stock #347..... **\$595.00**
 Add \$65.00 for transformer to make this plant 3 phase 220 volt.

10,000 WATT, 110-220 volt AC, 60 cycle. Remote control. Powered by a Jeep 4 cyl. gas engine. Used but like new. Stock #319..... **\$800.00**

New job original crate only...... **\$1100.00**

25,000 WATT, 220 volt AC, 3 phase. Used, like new and guaranteed. Stock #415..... **\$2150.00**

50 KW or 62 1/4 KVD Cummins diesel generator, 240 volt, 3 phase, 60 cycle, AC, 1200 RPM, 150 amps. Rating 50%, continuous excitor; 110 volts Cummins diesel engine, water cooled exhaust, complete with operating panel starting. All automatic controls plus 3 point suspension. Rubber mount. Full set of diesel major operating parts. Was used as standby. 200 appx. running hrs. Appx. 6400 lbs. GUARANTEED Like New. Price \$7400.00. Stock **\$4400.00** #572. Save \$3000.00. Your price.....

SPECIAL! AC ARMY GENERATORS

300 WATT, 12 volt DC, 2000 RPM. Heavy duty with current cut out relay. High and low switch. 30 amp. meter. Can be bought less shaft and base to be used directly mounted to a Briggs & Stratton 1 HP engine. Tapered shaft engine required. Stock #323. **\$7.00** NEW only.....
Complete with shaft, base, and bearing. Stock #324..... **\$15.95**
300 WATT, 110-220 volt AC, generator. Mfg. by Electric Specialties Co. Weighs 20 lbs. Stock #416. NEW only..... **\$29.50**



750 to 1000 WATT, 110 volt, 60 cycle, Eicor, ball bearing, with volt meter & rheostat, radio filter, self exciter. Generator fastens for direct drive to model AP & BP Briggs & Stratton tapered shaft. Price **\$69.50** With AP engine assemble yourself, add..... **\$59.50**

1500 WATT, 110-220 volt, 60 cycle, 1800 RPM, Master ball bearing to fasten on ZEP Briggs & Stratton engine. Stock #525. New..... **\$109.50** direct drive..... **\$145.00**

2500 to 3000 WATT, Leland generator, 110 volt, 60 cycle, self exciter, radio filter, junction box for plug in. Stock #321..... **\$99.50**

3000 WATT, Delco, 110 volt DC. Plug in, ball bearing 2800 RPM. List price \$343.00. Used but like new **\$300.00** Stock #321.....

7500 WATT, 110 volt AC with complete panel board and remote control...... **\$300.00**

BRIGGS & STRATTON GAS ENGINES

Briggs & Stratton NEW in original cartons

Model	HP	Shaft	List	Your price
AP	1 3/4 to 2 1/2	3/4"	\$102	\$49.00
ZP	5 to 7	1"	\$141	\$74.50

Buy TODAY—These BARGAINS just can't last. Inquiries invited on Diesel generators from 5 KW to 150 KW NEW or REBUILT.

ALL ITEMS GUARANTEED AS REPRESENTED **C & H ELECTRIC Co.**
 434 W. JUNEAU AVE.
 MILWAUKEE 3, WISCONSIN

All prices F.O.B. Milwaukee, 25% deposit required on all C.O.D. orders. No C.O.D.'s under \$10.00. Use stock number when ordering. Many other bargain items not listed—write for our free circulars.



for All Autos, Trucks, Tractors
 Pat'd and Pat. Pend.

A SURE CURE for Cold Weather Starting... the new SHUR-HETE Motor Water Heater

Install a Shur-Hete unit on your engine—plug it into a 110 volt A.C. outlet and your car will start easily and quickly, even on the coldest mornings. Why? Because the water around the sealed electric element is heated, causing automatic circulation which keeps the entire engine block warm; therefore the oil in the crankcase and around the cylinder walls is always free-flowing.

Easy to install—Any garage mechanic can install a Shur-Hete in a short time. 1/4" connections into head block and into drain plug opening are all that are necessary. Fittings included—nothing else to buy.

Dealerships Open!
JOHANSON MOTOR HEATER CO.
 817 W. Webster St. Chicago 14, Ill.



Save Time and Money with Shur-Hete!

Eliminate run-down batteries... towing charges... needless engine wear... and wasted gas.
 Uses only 1/3 to 1/2c electric power per hour.
 Safe to use with any standard anti-freeze.
 Will not overheat engine or burn out.

GUARANTEED!
Shur-Hete Outfits for AUTOS, TRUCKS, TRACTORS
 only \$13.95

Important: Give make and year of auto, truck or tractor. Shipped parcel post prepaid if remittance is enclosed; otherwise COD with postage added.

QUALITY

Dynasaw*

Satisfaction
 Guaranteed or Money Back

- Cuts curves like a band saw
- cuts metal like a hack saw
- cuts scrolls like a jig saw
- cuts straight or angular like a bench saw
- cuts to center of 48" circle
- cuts 1/4" steel—brass—aluminum
- 10" x 10" precision ground grey iron table tilts to 45°



Write for free catalogue on DYNASAW and other MP tools.

\$18.95
 F. O. B.
 ROYERSFORD, PA.

* MARCUS-POLLAK, DEPT. 1, ROYERSFORD, PA.

SUPER 100 PIECE SOCKET TOOL SET

S
O
C
K
E
T
S

T
O
O
L
S

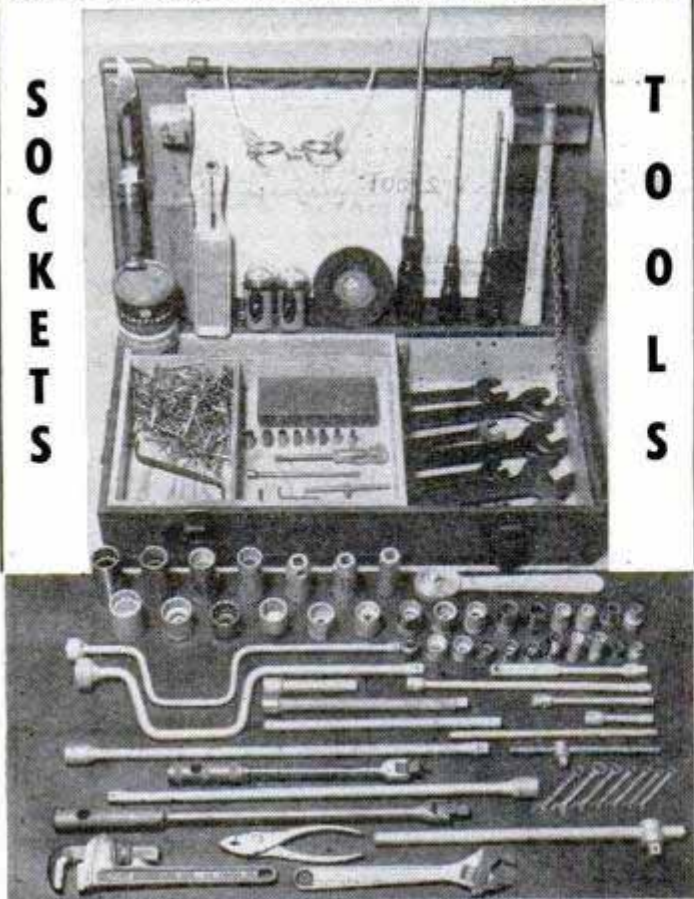

\$85.00 VALUE for ONLY \$34.25

Our purchase of over 200,000 wrenches as unused U. S. Airforce surplus makes this low price possible. All tools are NEW, all sockets are 12 point and plated. They are well-known popular standard makes such as Plomb, Snap-On, etc. Set consists of over 100 tools and a husky tool chest that will last you a lifetime. This is what you get:

- | | | |
|---|--|---|
| <p>1/2" DRIVE SOCKETS & ACCESSORIES</p> <p>7 Deep Sockets—3/4" to 1 1/4"</p> <p>1-7/16" Socket</p> <p>1-1/2" Socket</p> <p>1-9/16" Socket</p> <p>1-5/8" Socket</p> <p>1-11/16" Socket</p> <p>1-3/4" Socket</p> <p>1-Adapter 1/2" to 3/4" drive</p> <p>1-13/16" Socket</p> <p>1-7/8" Socket</p> <p>1-15/16" Socket</p> <p>1-1" Socket</p> <p>1-1 1/16" Socket</p> <p>1-1 1/8" Socket</p> <p>1-1 3/16" Socket</p> <p>1-1 1/4" Socket</p> <p>1-Ratchet Handle</p> <p>1-Speed Handle</p> <p>1-18" Flex Handle</p> <p>1-10" Flex Handle</p> <p>1-T-Handle</p> <p>1-Bar Handle</p> <p>1-18" Extension</p> <p>1-10" Extension</p> | <p>1-4" Extension</p> <p>1-10" Pipe Wrench</p> <p>1-10" Adjustable Wrench</p> <p>1 Pair Pliers</p> <p>1 Chrome Hunting Knife</p> <p>1 Plastic Mallet</p> <p>8 Box Open-End Wrenches for Carburetors, Ignitions, and Radios.</p> <p>1000 Cotter Keys, 25 sizes</p> <p>1 Cotter Key Puller</p> <p>3/8" DRIVE SOCKETS & ACCESSORIES</p> <p>1-1/4" Socket</p> <p>1-5/16" Socket</p> <p>1-3/8" D-socket</p> <p>1-7/16" D-socket</p> <p>1-1/2" D-Socket</p> <p>1-1 1/2" Socket</p> <p>1-9/16" Socket</p> <p>1-9/16" D-Socket</p> <p>1-5/8" Socket</p> <p>1-11/16" Socket</p> <p>1-3/4" Socket</p> | <p>1-Speed Handle</p> <p>1-Flex Handle</p> <p>1-T-Handle</p> <p>1-Bar Handle</p> <p>1-10" Extension</p> <p>1-4" Extension</p> <p>1-2" Extension</p> <p>1/4" DRIVE SOCKETS & ACCESSORIES</p> <p>The 1/4" drive is a 12-piece set with steel box.</p> <p>1-10" Screw Driver</p> <p>1-Cabinet Screw Driver</p> <p>1-Cross Point Screw Driver</p> <p>2 Cans plastic water proof glue</p> <p>1-File Card & brush</p> <p>1-Pair safety goggles</p> <p>2-One-cell trouble lights</p> <p>1-Large roll friction tape</p> <p>4-Allen wrenches</p> <p>10 End wrenches—7/16" to 1 1/2"</p> |
|---|--|---|

Send for free catalog on home utility power hand tools, electric drills, portable electric saws, etc. The best medium-priced electric tools for less. We pay all postage on power hand tools.

All orders are filled the day they arrive. Pay by check or money order, 25% dep. on C.O.D.'s. Price is F.O.B. Fresno. All items listed are new. **DEPT. 312**

ARMY SURPLUS SALES OF FRESNO

1820 TULARE STREET FRESNO, CALIFORNIA

FRESNO HARDWARE COMPANY

HIGH POWER TELESCOPE

60 POWER - ALUMINUM TUBES - OPENS TO 33"

Variable Power Eyepiece Adjustable to 15X, 30X and 60X.

\$4.50



5 Sections. 4 Ground & Polished Lenses. Also used as 50X Microscope. Ready to use, only \$4.50 POSTPAID. **BROWSCOPE CO.** Dept. 12M, 24 W. 45th St. NEW YORK 19, N. Y.

LAWN MOWER SHARPENER



lawn mower sharpening at low cost!

\$4750

less motor.

turn spare time into dollars

Order direct from **QUAD CITY PRODUCTS Company, Inc.** Box 42, Rock Island, Ill.

140 CFM "WELLWORTH" BLOWER



Single-inlet blower that gives top performance on heating, ventilating, exhausting, cooling, drying and similar applications. 5 1/8 x 4" mounting flange with 3 1/2" square discharge. 3 1/2" dia. blower wheel powered by direct-connected 1/15 H.P., 110V., 60C., A.C. motor with conduit box and 20" leads. 7 1/2" wide less flange by 7 1/4" H. x 6 3/4" D. Suited for hundreds of new and replacement uses. Shpg. wt. 6 lbs.

\$16.50

50 CFM BLOWER, 2 1/2" discharge \$8.95

PRICES F.O.B. CHICAGO. Sold on money back guarantee. Send check or money order today. Prompt shipment, Catalog free.

WELLWORTH TRADING CO.

1831 S. STATE ST., Dept. D-12, CHICAGO 16, ILL.

SET and JOINT CIRCULAR SAWS

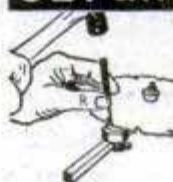

Joint and set circular saws in a jiffy. New tool combines both jointer and set in one precision instrument. Simple—accurate—anyone can get blades round and true. For blades 6 to 12 inches in diameter. Complete with file and hard steel anvil. Money-back guarantee. Both tools just \$4.95. Send for free illustrated folder.



SURE-SHARP MFG. CO., Dept. MS-129, P. O. Box 24, Santa Ana, Calif.

DRAINS CELLARS, WASH TRAYS CIRCULATES OIL



Pumps 1800 GPH 300 gal. 30' high, use 1/8 to 1/2 HP motor. Will not clog. **\$6.50**

Postpaid if cash with order. (Add 50c for west of the Mississippi.)

Thousands in use since 1936

LABAWCO PUMPS, BELLE MEAD 7, N. J.

SAVE MONEY on TRAILER BUILDERS' SUPPLIES! BUILD, REPAIR or MODERNIZE! We are the largest and most complete trailer supply house in the States. Get our New Large 1949 Catalog 10c; blue prints and building instructions 25c.



National Trailer Equipment Co., 1007 N. Water St., Milwaukee 2, Wisc.

SURPLUS BARGAINS

LINEMAN'S TOOL & SAFETY BELT

Brand new web type belts in the original package.

ONLY \$3.95

POLE AND TREE CLIMBERS

Without straps Used, good

ONLY \$1.50 Per Pair



Send 10c for our Jam-packed Catalog!

Enclose full amount with order.

All Equipment F.O.B.

C & H SALES COMPANY

2176 M-12 E. COLORADO ST

PASADENA 8, CALIF.

TOOL BARGAIN OUTFIT



THE MASTER KIT \$50 VALUE
fits all hand grinders for CUTTING, SHAPING, GRINDING, POLISHING Wood, Metal or Plastic **\$9.75** Post Paid in U.S.A.

- Over 300 Tools & Items in sturdy container
- 1 High Speed Steel Rotary File
 - 3 Grinding Wheels 1 to 3" dia.
 - 12 Mounted Stones 1/4" to 1/2" shanks
 - 9 Rotary Cutters 1/8 & 3/32 shanks
 - 30 Miniature Cutters 3/32 Shank
 - 10 Cut off Discs and Grinding Wheels
 - 1 Drum Sander 1/8" Shank
 - 15 Abrasive Bands for Drum Sander
 - 15 Leather and Felt Polishing Wheels 1/2 to 1" in diameter
 - 15 Felt Polishing Cyls. with Mandrel
 - 25 Abra. Sanding Discs 1 1/2 to 2" dia.
 - 3 Rubber Wheels 7/8" diameter
 - 2 Speed Drills 3/32 Shank
 - 2 Mandrels 1/8 and 3/32" Shanks
 - 3 Rotary Bristle Brushes
 - 1 Rotary Wire Wheel Brush
 - 1 1" Circular Saw, 1/4" Mandrel
 - 2 Rubber Cylinders, 3/32" Mandrels
 - 1 Muslin Polishing Buff, 3 to 4" dia.
 - 150 other items—all new & valuable

SCHUPACK SUPPLY CO., 7331 Cottage Grove, Dept. M-11, Chicago 19, Ill.
BARGAIN CATALOG FREE ON REQUEST

ITS EASY — ITS FUN — ITS PROFITABLE!
MYSTERIOUS DEVICE WELDS BRAZES SOLDERS & CUTS
ANYONE CAN OPERATE



This newly invented **FOUR-WAY PORTABLE ELECTRIC WELDER** will do brazing, soldering, welding and cutting on brass, bronze, iron, steel, cast iron and other metals. It's easy to use, **WORKS INSTANTLY** off any properly wired 110 VOLT A.C. OR D.C. LINE. Does a thousand and one professional type repair jobs. **SAVES TIME AND MONEY** on auto, home appliance, farm and shop repairs. Ideal for maintenance men, farmers, repair shops, engineers, tinsmiths, home and auto owners, bicycle and fix-it shops. **10 DAY TRIAL OFFER**. COMES COMPLETE WITH ALL SUPPLIES READY TO OPERATE including instructions. **FULLY GUARANTEED**. Order today for 10 DAY TRIAL or write for FREE particulars.
FOUR-WAY WELDER CO. Dept. 129-PMF
2326 S. Michigan Ave., Chicago 16, Ill.

LATHE CUTTER BIT GRINDING GAUGE
For checking clearance and rake angles.
50¢ postpaid
SOUTH BEND LATHE WORKS
455H E. MADISON ST., SOUTH BEND 22, IND.

How to get BETTER FINISHES



Do Like Professionals. Use **"TACK CLOTH"** Before you **PAINT** or **VARNISH**. If you paint, varnish or lacquer woodwork, furniture, etc. at home, **"TACK CLOTH"** is the professional's secret of a slick, smooth, glistening finish every time. Used by all large industrial finishers. Just wipe over surface and remove every trace of lint, dust, sand, or dirt. No more 4 \$1 specks, spots or rough places to mar your finish. To introduce to Home Users, send only \$1 for 4 large 18" x 36" **"TACK CLOTHS."**
BAUGHN CHEMICAL PRODUCTS CO.
7025 N. Ravenswood, Dept. 212, Chicago 26, Ill.

SEALED POWER PISTON RINGS

Best in New Cars! Best in Old Cars!
Sealed Power Corporation, Muskegon, Michigan

SAY YOU SAW IT IN POPULAR MECHANICS

Now CHEAP OIL BURNER

FOR HEATING AND COOKING STOVES - FURNACES
HEAT YOUR HOME, COOK YOUR MEALS
WITH CHEAP FURNACE OIL

NO MORE SHOVELING COAL OR ASHES. Sensational Fuelizer Starter Vaporizing System turns Cheap No. 1 Furnace Oil, also Range, Heater, Tractor Distillate, Kerosene and like oils into oil heat—one of the quickest, hottest fires known. **LIFETIME GUARANTEE. \$1.00 Bonus Offer for Testing.** We will let you try it in your own stove or furnace for one month. Get yours for introducing. Big profits **QUICK**. Be first. Send in your name today for details and cash in on the tremendous demand for this Amazing Invention.
NORTHWEST MFG. CO., 634-P Mitchell, S. Dak.



POWER KING #3001

The Lowest-Priced Ball-Bearing Tilt/Arbor Saw

Yes, now you can get real "production" on your shop projects — at low cost! — zip through your saw work in a tenth the time... make important savings on shelves, cupboards, cabinets, furniture, home repairs, and remodeling!

The Power King #3001 — built by Atlas — has many features of high-priced saws: tilt/arbor (table *always* flat), cuts 2 1/4" deep, sealed ball bearings, precision-ground grey-iron table (16" x 25 1/2" with two low-cost extensions), full length double-locking rip fence. You can't beat its value—see it today!

Price F.O.B. Kalamazoo includes blade, motor rail, belt, pulley, mitre gauge, fence, splitter, guard — less motor. Extensions \$3.50 each. **\$39.50**



PK 4 1/2" Jointer-Planer For "Factory-Smooth" Finishes

Your projects can have the smartness of professional furniture with this Power King 4 1/2" Ball Bearing Jointer-Planer in your shop. Saves you time and work in planing, rabbeting, tonguing, beveling. It's built extra heavy, with grey-iron base and table — precision-ground table surface — tilting fence — 3-blade steel cutter head — plus other outstanding features. A good companion tool for your circular saw and a real value at only..... **\$44.75**

F.O.B. Kalamazoo

NEW FREE CATALOG

Name _____
Address _____
City, State _____

ATLAS PRESS CO.
1235 N. Pitcher St., Kalamazoo, Mich.

MATCHED PRECISION TOOLS FOR WOODWORKING AND METALWORKING

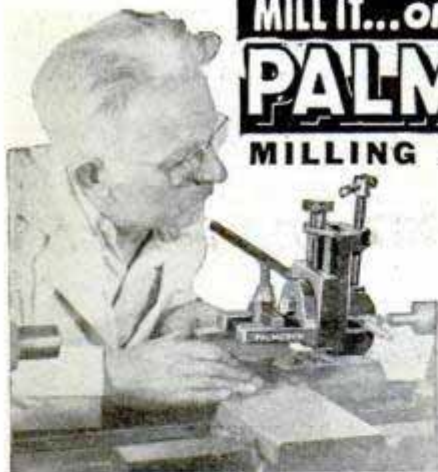

MILL IT... ON YOUR LATHE!
PALMGREN
MILLING ATTACHMENT

3 SIZES
 No. 250 Illustrated

2 1/2" JAW Only

CONVERT LATHE IN 10 SECONDS

Now you can Mill, Slot, Grind, Groove, Square Shafts, Saw at Angles, Recess and many other important jobs. **SAVE TIME and MONEY!** Why send work out or use costly methods when a PALMGREN MILLING ATTACHMENT will solve your problem.

Precision built, it has accurate graduations for rotary angle adjustments, also graduated vertical feed screw. Fits South Bend, Atlas, Craftsman, Logan, Sheldon and all other lathes. Thousands now in use in small and large machine shops, repair shops, railroads, schools, home work shops, etc. **ORDER SIZE NEEDED TODAY!**—it will quickly pay for itself.

IMMEDIATE DELIVERY

Nos.	Width Jaws	Depth Jaws	Jaws Open	Weight Pounds	Fits Tool Post	Price F.O.B. Factory
150	1 1/2"	1"	1 3/8"	6 1/2	1" Dia.	\$18.75
250	2 1/2"	1-7/16"	2 1/2"	11	1 1/4" Dia.	24.75
400	4"	1 1/2"	4"	25	2" Dia.	39.75

Order From Your Dealer or Jobber: Write for Circular No. 353
 Mfrs. of PALMGREN PRODUCTS Since 1915

CHICAGO TOOL and ENGINEERING CO.

8365 South Chicago Ave. Chicago 17, Ill.

JUST A FEW OPERATIONS YOU CAN DO ON YOUR LATHE!



PARTS FOR MILITARY TRUCKS

4 or 6 Wheel Drive at a SAVINGS—
 1/4 ton to 20 ton.

Parts List Available on Most Military Trucks and Jeep Models



JEEP TOPS and CURTAINS

Supply Limited. (Weatherizing Kit), complete top with back curtain and side curtains with zip-in-doors. 5 windows. Waterproof O. D. color, shipping weight 40 lbs. Never again at such low price
\$49.50
 Wonderful value. F.O.B. K.C.

TRAILER AXLE



Heavy duty trailer axle suitable for many types of trailer construction. Also excellent for building of heavy farm trailers and wagons. It is a 12,000 lb. capacity square type straight trailer axle complete with Timken roller bearings, hubs, and 6 hole 750 x 20 Budd Wheels. Without brakes. Axle is 2 inches square and 69 inches between wheel mounting flanges. Std. width. **AN EXCELLENT BUY.**

With Single Wheels. \$59.50 With Dual Wheels. \$69.50

Save \$30.00 On JEEP Spare Parts KIT

Originally packed for Amphibious Jeeps. Also adaptable for all military and some civilian jeeps. Contains 29 major items. Offered at our low price of... **\$8.95**

WINCH CABLE, 1/2", 250 ft. \$30.00

Hundreds of Other Truck & Jeep Parts and Supplies
 All prices quoted good 30 days FOB, Kansas City, 25% Deposit Required on All Orders.

American AUTO PARTS CO.

1830 LOCUST — DEPT. PM
 KANSAS CITY, MISSOURI.



FLASH Your Turns



ELIMINATE HAND SIGNALLING
ENJOY SAFE — COMFORTABLE WINTER DRIVING WITH THE SIMPLEX DIRECTIONAL SWITCH

Here is a safe and comfortable way of signalling your intention to make a left or right turn. Flashes from 60 to 80 times per minute.

Kits furnished with all necessary material for perfect installation. No outside mounting of any kind. Uses your present parking and tail lights. Either of our two models fit most cars from 1942 to 1949.



\$8.95
 Post-paid in U.S.

Send check or money order.
 Postage extra on C.O.D.'s

A PRACTICAL CHRISTMAS GIFT FOR MOTORISTS!

Specify year and make of car. Money back guarantee. Tested and Approved to meet SAE requirements.

DEALERS INQUIRIES INVITED

SIMPLEX SALES COMPANY

1303 W. Jackson Blvd.
 Dept. B-1, Chicago 7, Illinois

LIQUID MARBLE

COMPOSITION FLOORS FLEXIBLE MOLDS

Mold, Brush, Trowel, Spray It! Mold Novelties, Statuary, Art Goods in Flexible Plastic Molds; 5c material makes \$1 seller. Make Marbleized floors, Tile Walls. Colorful, glossy, amazing! Easily learned; start in garage or basement. Particulars free. **MARBLEIZING SERVICE, Dept. 10-F, Edwardsville, Ill.**

MANUFACTURE BLOCKS

Only \$199

Easy to start your own profitable business. General high speed, low cost Concrete Vibrator Block Machine produces 1000 blocks in 8-hour day. All sizes and shapes. Complete details FREE. Mail \$1 for wonderful book, "How to Build Your Own Concrete Block Home."



GENERAL ENGINES CO.
 (EASTERN DIVISION) DEPT. P3, DREXEL BLDG., PHILA. 6, PA.



GERSTNER Tool Chests

built to rigid standards, please the most exacting Machinist and toolmaker. Free Catalog.

GERSTNER TOOL CHESTS

449 Columbia St. Dayton 7, Ohio

ELECTRIC SHEAR SHARPENER

Over 65,000 Sold—It Must Be Good!



Genuine Carborundum wheel ideal for shop or home use. Send remittance with order and shipment will be made at once, prepaid to your door, complete with electrical goods catalogue.

Motor driven

\$9.75
 complete with vise

WILLIAM MARVY COMPANY
 477 St. Peter Street St. Paul 2, Minn.

New 1950 Plastics Supplies Catalog

Just off press: Get details on Plexiglas, Lucite, rods, sheets, tubes, Acetates, cements, dyes, buffs, molding sets, tools, carving kits, everything in plastics. Lowest prices. Price 10c, stamps or coin, with ad for catalog.

Plastics Mfg. & Supply Corp., Dept. PM-12, 4707 Euclid Ave., Cleveland, Ohio

Now YOUR DRILLPRESS CAN DO LATHE WORK

THE AMAZING, NEW TURNBUG

Here's a precision-built attachment for any drillpress that enables you to do precision turning in metal or wood! Quickly set up and quickly taken down. Fits any drillpress table. Capacity, 4" swing. Ideal for amateur or experienced craftsman, garages or small shops. Price post-paid, only \$29.50. Satisfaction guaranteed. Order today from

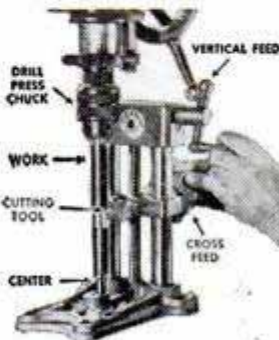

BALFRE GEAR & MFG. CO.
 4711 W. LAKE ST., CHICAGO, ILL.

WRITE TODAY FOR FREE FOLDER

Phonograph Scratch Eliminator

Consists of 2 condensers and powdered iron core choke connected in a filter network. Same as used in most jukeboxes to improve low note response and eliminate scratch. Connects instantly between pickup and amplifier. A super bargain at.....

\$2.00

HEAT GUN

Streamlined pistol grip heat gun. Vivid red housing. 20 cubic feet per minute blast of hot air at 160° Fahrenheit. Ordinary blowers have small fan motors, but this has a lifetime-lubricated AC-DC motor of the rugged vacuum cleaner type, that produces a hurricane of either hot or cold air. Blow out dirt or dust from radio chassis. Dry out ignition systems. Heat carburetors. Quick-dry paint. Thaw out radiators or water pipes, etc. Warning:—Keep this away from your wife. She will use it to dry her hair because it will do it in half the time of her ordinary hair dryer, to say nothing of her using it to dry stockings or clothing, or to roast the refrigerator instantly. Only **\$12.95**. Satisfaction guaranteed or money refunded if returned prepaid within 5 days.



SENSATIONAL VALUE IN AC-DC POCKET TESTER

This analyzer, featuring a sensitive repulsion type meter housed in a bakelite case, represents the culmination of 15 years achievement in the instrument field by a large company specializing in electronic test equipment.



Specifications of the AC-DC Model
 Volt-Ohm-Milliammeter:
 AC Volts—
 0-25, 50, 125, 250
 DC Volts—
 0-25, 50, 125, 250
 Milliamperes AC—0 to 50
 DC Milliamperes—
 0 to 50
 Ohms Full Scale—
 100,000
 Ohms Center Scale—
 2400
 Capacity—
 .05 to 15 Mfd.
 Total Price, prepaid anywhere in the USA — **\$7.00**. Similar DC Meter, lacking the AC operated ranges of above, **\$5.50** prepaid.

POWER RHEOSTATS

Exceptionally rugged. Trouble-free design. Withstand severe overloading to many times nominal wattage rating without burning or smoking. Ideal for electroplaters, model railroads, etc. 3 sizes available—50, 60 and 200 ohms. Regular price \$5.20. **YOUR COST \$1.00.**

SENSATIONAL, FASCINATING, MYSTERIOUS SELSYNS. Brand new Selsyns made by G.E. Company. Two or more connected together work perfectly on 110 V AC. Any rotation of the shaft of one Selsyn and all others connected to it will rotate exactly as many degrees in the same direction, following unerringly as if the units were connected together by shafting instead of wire. This is true whether you twist the shaft of the master unit a fraction of a revolution or many revolutions. Useful for indicating direction of weather vanes, rotating directional antennas, or controlling innumerable operations from a distance. Complete with diagram and instructions. Per Matched pair **\$4.95**.



HOME WORKSHOP AT BARGAIN PRICE

Accurate and precise 2 speed guaranteed hobby lathe, the essential machine for the home workshop. Sturdy enough for light production work or factory standby service. Supplied with 56' of belting for connecting to any available electric motor or power take-off. Also included in this unbelievable offer are such accessories as a 1/2" drill chuck with specially hardened tool steel jaws, a 4" electric furnace high speed grinding wheel, a cotton baling wheel and a large supply of buffing compound, and a 4" steel wire scratch brush. Your cost **\$6.00**. Sole export agent. Distributor inquiries invited.

DELUXE SUPERHET AC-DC RADIO KIT

World's Only Radio with These Features

Extra high quality radio in kit form with complete instructions. Features 2 iron core I.F. transformers, a 2 gang condenser, and polystyrene insulated edgewise wound antenna loop. Tubes include 12AT6, 12BA6, 12BE6, 50B5 & 35W4. Receives broadcast band from 550 to 1700 KC. Kit form **\$8.75** or 2 for **\$17.00**. Assembled, Wired and tested **\$12.95** or 2 for **\$25.00**.

BUFFALO RADIO SUPPLY, 219-221 Genesee St., Dept. PM, BUFFALO 3, N. Y.

1 cylinder
5 horsepower
\$496.00

attractive discounts
to machinery dealers

Diesel Power for

- Light Plants —
- Pumping Sets —
- Power Units —

Crofton industrial Diesel

CROFTON DIESEL ENGINE CO. SAN DIEGO CALIF.

2 cylinder
10 horsepower
\$797.00

attractive discounts
to machinery dealers

SANDER and 1/4" Powerhouse DRILL

HEAVY DUTY SANDER for ROUGH or FINISH WORK

SANDS FLOORS OR ANY TYPE OF WOODWORK... EVEN IN HARD-TO-GET-AT PLACES...

'SAN-DAL' Sander Fits Any 1/4" Drill

Nothing to get out of order: has only 2 moving parts, requires no oiling. For use with sandpaper (WET or DRY) or any type polishing cloth—both easily attached. Lightweight, sturdy construction—any woman can handle it. Ideal for home and shop. Sanding plate: 3 1/2" x 7". Sander and polisher can be bought separately for \$12.95.

BOTH FOR 21.90
(26.90 VALUE)
SAVE 5.00

DEALER INQUIRIES INVITED

POWERHOUSE DRILL outperforms most drills selling for \$20.00 or more. 17 to 1 steel gear ratio maintains power without danger of overloading. Drills holes up to 1/4" in steel . . . 1/2" in wood. Underwriters approved. Factory guaranteed. Powerhouse drill can be bought separately for \$13.95.

G. E. BENNETT STORES
723 Granby St. (Dept. M) Norfolk 10, Va.

MAKE ANY CUT WITH THESE NEW WOODSHAPERS for YOUR CIRCLE SAW or DRILL PRESS!

MODEL #60—Originally designed for heavy industrial use, now priced for home workshop. Can be attached directly in chuck of your drill press. Exclusive pilot bearing (see illustration) eliminates side thrust, chatter and vibration—assures smooth cutting action. Blades can't come out—set screws hold them securely. Complete, with **YOUR CHOICE OF ANY 6 PAIR DOUBLE-GROUND BLADES SHOWN BELOW**, only **\$12.95**.

MODEL #50—Same as Model #60 but without exclusive pilot bearing. Designed for intermittent shaping; over 100 different shapes can be cut. Complete, with **ANY 6 BLADES OF YOUR CHOICE SHOWN BELOW**, only **\$8.95**.

All Aladdin tools are guaranteed. Postage prepaid with all cash orders. C. O. D. postage. **GET YOUR ORDER IN TODAY.**

ALADDIN B. MFG. CO., INC.
3121 Main Street Kansas City, Missouri
Dealers Write Today

For Your Circle Saw

through. In ordering, state diameter of shaft. Complete with **ANY 6 PAIR OF READY-GROUND BLADES SHOWN BELOW**, only **\$14.95**.

ALADDIN WOODSHAPING BLADES
Specify by number the blades you want. Additional blades **\$1.50** each, **\$3.00** per set.

MODEL SA-10—Heavy-duty, industrial-type shaper of solid steel, now priced in home workshop range. Absolutely safe—blades locked in position with screws all the way through. In ordering, state diameter of shaft. Complete with **ANY 6 PAIR OF READY-GROUND BLADES SHOWN BELOW**, only **\$14.95**.



◆ Gear-Train Motor

Ball bearing, low inertia reversible type. Can be used to operate small displays, models, etc. Operates from 12 volt AC with use of condenser. Normally operates 26 volt 400 cycle. Motor 588 RPM; Low speed gear 14 RPM. Extra large gear for 7/8 RPM \$1.00 extra. Order #PM-4119 complete motor, gear-train, condenser, & instructions—Postpaid U.S.A. \$2.00

TRANSFORMER for above—110 volt input; output 12 volt. #PM-5119—Postpaid U.S.A. \$2.00

6 VOLT AC or DC MOTOR

Ideal for auto heaters, defrosters, fans, models, etc. Used by Gov't. in aircraft. Shaft size: 1/4"x7/8" Order #PM-6119—Postpaid U.S.A. \$2.00



CAR SHAVER MOTOR

Use your electric shaver in your car! Dynamotor will supply 110 volt 10 watt current from 6 volt DC—will operate most types of AC-DC shavers. Used by Gov't. to supply voltage for radio equipment. #PM-2119—P.P. U.S.A. \$3.00

20 Watt MOTOR GENERATOR — Permanent magnet field. Will supply 24 volts 1.8 amps and 480 volts .04 amps DC at approx. 3500 RPM. Shaft size: 3/8"x1". Motor size: 3"x4"x7 1/2". Can also be used as a motor on 12-24 VDC input. Order #PM-7119—Postpaid U.S.A. \$3.00

P1 GENERATOR — Aircraft type, supplies 24 volt DC 200 amps. Ideal for building your own welder. Shipping wt. approx. 65 lbs. Order #PM-8119—

Brand NEW \$30.00 USED \$22.50 F.O.B., Lima

◆ HEATER UNIT — Gasoline or oil forced air heater used to pre-heat tank engines. Easily adapted to other uses. Operates from 24 VDC source. Has electric igniter, thermostat control, forced air blower, auto-pulse electric fuel pump. Removed from unused Gov't. vehicles. Cost Gov't. many times this low price. Shipping wt. approx. 65 lbs. #PM-9119 \$19.95 F.O.B., Lima

SEND FULL REMITTANCE ON \$2 AND \$3 ITEMS OTHER ITEMS 25% DEPOSIT AND BALANCE C.O.D.

FAIR RADIO SALES

132 SOUTH MAIN ST. LIMA, OHIO

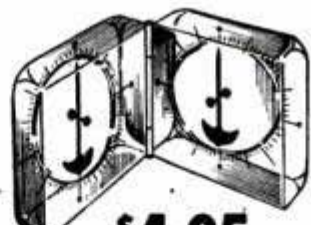

3-Directional FOLDING PRECISION LEVEL

\$4.95

Instant reading plumb and level made of clear moulded transparent lucite. Folds up into a small 3" x 3" x 3/4" box that carries in pocket. Levels vertically and horizontally in both planes at one reading. Can be used above, below, or on the side of any object or surface. Easy to read from every direction, place or position. Pinpoint accuracy. Lightweight. Sturdy. Durable. Bright . . . easily read figures with black indicator. Send for free folder.

Single Unit measures one direction only \$2.95

DON BERRY, INC • P. O. Box 24, Capitol Hill Station • Denver, Colorado

OIL FACTS!!

Tells the TRUTH about lubricating oils; written by an insider. 32 pages, 25c; worth as many dollars! I DO NOT SELL OIL!

REMANCO, 5083 Elston Ave., Dept. 18, Chicago 30, Ill.

HANDY SEWING AWL

Patented lock-stitch awl, complete with 2 needles and reel of waxed thread at this special price! Satisfaction guaranteed, or money back. HUNDREDS OF USES—sewing and repairing leather goods, tents, belting, awnings, saddles, sporting goods and others. Complete instructions. Send currency, check or money order. Postpaid. \$1

RADEN SALES COMPANY Dept. M, Box 5601, Dallas, Tex.

LAWN ORNAMENT-NOVELTY PATTERNS

28 Lawn Ornament Patterns, 25c. Other patterns: 15-20" high; Dutch Girl, Dutch Boy, Pirate, Bull Terrier, Mexican Girl, Mexican Boy, Dwarf, Penguin, Flower Girl, 10c each. 25 Novelty Patterns, 30c. All 62 Full Size Patterns, \$1.00 Postpaid. Strother Pattern Service, Dept. BK-8, Box 128, Belington, W. Va.

BUILD YOUR OWN POWER LAWN MOWER

WHY PAY MORE FOR FACTORY BUILT MOWERS?

WRITE FOR FREE Building Instructions The Rite-Way Mower Attachment Ball Bearing

SAVE MONEY SAVE TIME Now anyone can save time and effort mowing field or lawn by building their own whirl type power mower. Build according to your own ideas and needs at small cost. Cut close to fences, walks, buildings, etc. Build in short time with parts and instructions we furnish. Requires no special tools.

IT'S FUN TO BUILD

WRITE TODAY FOR FREE INFORMATION T & H MFG. CO., Inc., Dept. MPA-12 811 E. 31, Kan. City 3, Mo.

GENERATOR REGULATOR BATTERY END TROUBLE

REPLACE VOLTAGE REGULATOR WITH AMAZING NEW WATTAGE REGULATOR GREATEST ADVANCEMENT IN AUTO IGNITION SINCE THE SELF-STARTER DRIVE WITH OR WITHOUT BATTERY 100,000 Mile Money Back Guarantee For All Popular Cars — \$8.00 State Make and Model of Car SCIENTIFIC ELECTRIC CO., P.O. Box 2162P1, Sta. H, Cleveland 8, Ohio

Say You Saw It in POPULAR MECHANICS

WONDER PASTE Paint Remover The modern, easy way to strip paint, varnish, enamel, etc. At paint and Hardware stores. WILSON-IMPERIAL CO., 119 Chestnut St., Newark 5, N. J.

The Chief WORK BENCH

Built to Last a Lifetime!

With Bottom Shelf and 18" Sq. Drawer. 2"x6", Solid Plank, Grooved and Dovetailed Top and 1"x8" Back Rail, Shellacked to a Smooth, Satiny Finish.

MOHAWK LUMBER CO. Dept. 33 14525 W. Chicago Blvd. Detroit 27, Mich. Enclosed Check Money Order for \$ Ship CHIEF WORK BENCHES at Quantity \$16.95 each, F.O.B. Detroit, Mich. Send C.O.D., \$5 Deposit Enclosed.

NAME ADDRESS CITY STATE

A CHRISTMAS PRESENT HE'D APPRECIATE

\$16.95 F.O.B. DETROIT

Send Check or Money Order, or Will Ship C. O. D. (\$5 Deposit)

ELECTRIC SIREN



6 volt. Complete with push button... **\$10.95**

Fender Skirts for All Cars



Give year, make & model of car when ordering. All Metal. Prime finish. Rubber beading prevents rattle. Easy to install. **PAIR... \$12.95**

DeLuxe Fender Fins

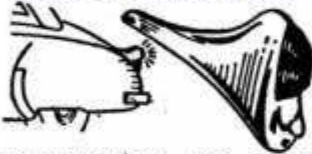

For 1949 Chev., Ford, Pontiac Chrome plated with Red reflector lens. Contoured to fit rear fender perfectly. Streamlines — adds dashing beauty. Interiors large enough to allow for socket and light. **PAIR... \$12.95**

GUTTED MUFFLERS



Gives that Motorboat Tone. Universal type to fit all cars, ea... **\$4.95**

Illuminated Swan

Chrome body, transparent, unbreakable, lucite wings which illuminate. With bulb and wire. Height 8". Length 6 1/2". Choice of blue, amber and red **\$4.95 EA.**

We Can Supply NEW CONVERTIBLE TOPS & REBUILT MOTORS for all Cars. Write for Prices.

Send 25% Cash With All Orders, Balance C.O.D.

J. C. WHITNEY & CO.

1917 ARCHER AVE.

CHICAGO 16, ILL.

MORE NEW CARS AND TRUCKS ARE EQUIPPED WITH

AC SPARK PLUGS

THAN WITH ANY OTHER MAKE.

ACE TOOLS



Be permanently toolled-up for every operation on your Metal Cutting Lathe.

No. 8-A Ace Tool Set for 9" and 10" Swing Lathes—fits shank size 3/8" x 3/4". Includes Turning, Cutting-off, Boring, Knurling and Threading Tools with high speed cutters, blades and wrenches. 8 complete tools in fitted steel case—nothing else to buy. See your local dealer or order direct.

ARMSTRONG BROS. TOOL CO. \$24.25
5268 W. Armstrong Ave., Chicago 30, Ill.

Handi-Chest

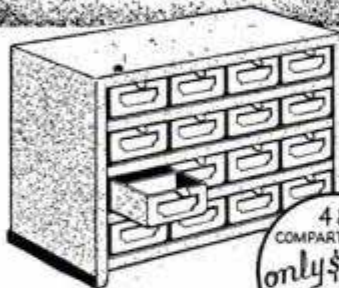

So Handy...

—Home—Office—Shop—
Stamps—Pins—Buttons—Washers
Bolts—Nuts—Nails—Screws—

Ideal Gift!

48 COMPARTMENTS
only \$4.80
CABINET SIZE
6"-8 1/2"-12 3/8"

PRICES

16 Drawer - Aluminum 48 line... (cardboard drawers \$1.00)	\$4.80
32 Drawer - Aluminum 90 line... (cardboard drawers \$1.00)	\$8.80
64 Drawer - Aluminum 192 line... (cardboard drawers \$2.00)	\$15.80

Satisfaction Guaranteed

Charges add 3% Sales Tax
No C. O. D.'s Please
Send check or money order to
TIBBITS MFG. CO.
Dept. 12 F Alliance, Ohio

SIZES	DESCRIPTION
32 Drawer 6"-12 3/4"-15 1/4"	★ Baked enamel cabinet ★ Rubber Feet won't mar
64 Drawer 6"-24 1/2"-15 1/4"	★ Spot welded steel cabinet
Drawer Size (all same) 1 1/4"-2 3/4"-5 3/4"	★ Removable dividers, index cards in aluminum drawers.

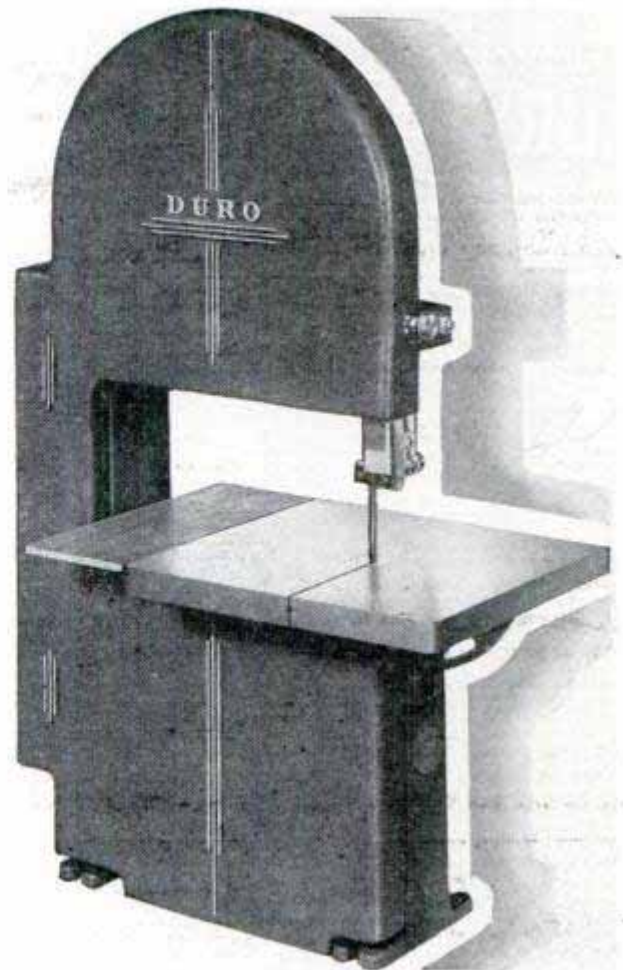

New DURO saw with High-priced features at lowest cost!

Sleek, rugged and streamlined, this new DURO 10" Band Saw is even better than it looks! It offers a host of features and advantages you'd expect to find only on models selling for many dollars more! Check these big DURO features:

BALL BEARING BLADE GUIDES—Patented, exclusive with Duro, these ball bearing blade guides above and below the table reduce friction heat and wear, keep the blade running truer, smoother.

HEAVY CAST IRON FRAME gives extra rigidity, vibrationless operation, increased accuracy.

CAST ONE PIECE WHEEL GUARD unlocks with one knob, exposing top and bottom wheels for quick blade changing. No tools necessary.

OTHER ADVANTAGES include rubber-tired disc wheels on needle type bearings, double trunnion table supports, separate tension knobs for blade adjustment, heavy cast iron table with extension tilts to 45°—and many others.

DURO 10" BAND SAW only \$49.95 less motor

See this new saw and others in the complete 1950 DURO Power Tool line at your dealers. Or, write for full details and specifications today.

DURO METAL PRODUCTS CO.
2685 N. Kildare Ave., Chicago 39, Ill.

Gentlemen:
I am interested in your new low cost 10" Band Saw. Please rush me full details and specifications on it plus the brochure showing the complete 1950 line of DURO Power Tools.

Name _____
Address _____
City _____ Zone _____ State _____

THE BIGGEST SURPLUS BARGAINS IN YEARS

ELECTRIC MOTOR 1/2 H. P. 27 V.D.C. R. P. M. 4000 No. 750. For Intermittent or Continuous Duty 5/8" SHAFT. VARIABLE SPEED MOTOR CAN BE ADAPTED, TO 110V.A.C. or R.E.A. line by simple arranging armature brush leads. UNUSED. Instructions \$5.50 incl.

ELECTRIC MOTOR 1/2 H.P. 24 Volt D.C. R.P.M. 2500 Amp. 22 #HCA24. Gov't. cost \$75.00. BRAND NEW... \$3.50

ELECTRIC MOTOR 1/4 H.P. 28 Volt D.C. R.P.M. 4000 #2832 with simple instructions to convert to 28-32 Volt A.C. Gov't. cost \$82.84. Brand New... \$3.50

ECLIPSE MOTOR & GEAR UNIT. Brand new. This is a 24 V. D.C. motor with built in planetary and bevel gear reduction. Has 1- horizontal and 1- vertical take off shaft. Overall gear ratio to motor is 40-1 can be adapted for 2-1 or 20-1 ratio. Unit can be operated from 32 D.C. Farm light plant. Ideal as OVERHEAD GARAGE DOOR OPERATOR. DRIVE FOR SMALL HOIST WELL PUMP JACK. LAWN MOWER DRIVE, DRIVE FOR POST DRILL, \$12.50 etc. Wt. 23 lbs. Gov't. cost \$221.00. Only... (Instructions incl.)



WEAVERS HYDRAULIC HAND PUMP — BRAND NEW. For hydraulic jacks, presses, hoist, etc. For operating hydraulic cylinders, to pump oil or hydraulic fluid under pressure. Has built in check valve, and is capable of delivering 1000 lbs. pressure. Wt. 10 1/2 lbs. A \$50.00 value. Instructions incl. \$8.50

VICKERS CONSTANT DISPLACEMENT HIGH PRESSURE PUMP. Use it for any type liquid pumping job 375 gal. per hr. at 3750 R.P.M. 1000 pounds pressure per sq. in. Can be used as hydraulic motor 0. Acq. \$100.00. \$8.95 post-Brand new directions incl. Wt. 7 lbs.



HYDRAULIC CHECK & RELIEF VALVE \$2.50 Post-paid

VICKERS UNLOADING VALVE. Brand New—By passes full amount output of the pump while the cylinder is not in operation. Takes starting load off of electric motor driving the pump. Price. \$4.95 post-paid

BRAND NEW HYDRAULIC CONTROL VALVE. This is a TWO CYLINDER DOUBLE ACTION VALVE with unique arrangement allowing the operator to raise both cylinders simultaneously, to lower them simultaneously or to raise one and lower the other at any predetermined rate and speed. A \$75.00 value. \$8.95 Post-paid

ADEL PRECISION VALVE BRAND NEW. This is for a double end cylinder control or for two single cylinders that are to work in opposition to each other. When pressure is applied on one line, it will open opposite check valve so that pressure in that line can be relieved. No. 10335. Now only \$4.95 Post-paid

BRAND NEW HYDRAULIC CONTROL VALVES. Four way control for use with two hydraulic double action cylinders. Each cylinder may be operated, independently of the other or in conjunction with the other. Oil may be locked in any of the cylinders to hold the piston at any required position. Brand New \$60.00 \$8.95 postpaid value. Only



THOMPSON BOOSTER PUMP. Use them for Homes, Farms, Ranch, and Shop. Motor driven centrifugal pump will empty 50 gal. drum of water in approx. 20 min. Runs on 24V. D.C. A.C. New. \$7.50

LUBE PUMP. BRAND NEW. Precision Gear Impeller Pump. Pumps liquids up to 3 gal. per minute. Pressure up to 200 lbs. per sq. in. St'd 1/2" Threaded and keyed shaft. Instructions incl. Wt. 4 lbs. Price. \$3.95 plus postage

D.C. GENERATOR. Brand new. For farm—Home—Ranch. Delivers 430 Volts D.C. at 3450 R.P.M. Ball bearing supported. Fan cooled armature. Self lubricating bearing. Drive it off farm tractor gas engine, etc. #211220-A. Wt. 21-lbs. \$5.50 Now only

SENSATIONAL FASCINATING MYSTERIOUS SELSYN. Two or more connected together can be adapted for 110 V. A.C. For weather vanes rotating directional antennas or controlling distance operations. Diagram and instructions incl. Wt. 3 1/2 lbs. Price. \$3.50 add 10% for postage

VALUABLE GEARS BARGAINS SPEED REDUCER 10-1 or 5-1 ratio, 90 degree angle. Shaft Driven 1 1/2" spline Shaft with 3 mounting holes 5/16". Gears held in forged and machined aluminum housing with two needle bearings, one bronze bearing, and three high speed shielded bearings. Sealed self lubricating chamber. \$3.50 Price

NEW PUROLATOR GASOLINE FILTER. Aircraft type. Today's advanced gasoline Re-refining filter for all cars, Trucks, Tractors and all Motor Boats. Cleans and refines gasoline as you drive. Removes solids, water and prevents sludge formation. Install at home in a few minutes. STOP GASOLINE WASTE AND EXPENSE. Instructions incl. Permanent, needs no replacements. Ea. \$4.95



NEW CUNO OIL FILTER, aircraft type #507. Filters oil without cartridge replacements. For autos, trucks and tractors. Install at home in a few minutes. STOP CHANGING MOTOR OIL. Instructions \$4.95 Post-incl. Ea.

Send check or Money order. No c.o.d.'s. Prices f.o.b. K.C. except when marked postpaid.

GENERAL SALVAGE COMPANY
Dept. 17, 2922 E. 27th St. Kansas City, Mo.

ASSEMBLE IT YOURSELF — SAVE \$2



Novel—Easy-to-Build—Authentic TOWN PUMP LAMP KIT

This lamp will make an interesting and unique addition to any bedroom, den, playroom, bar, office, etc. An interesting and educational item for children. A wonderful present for craftsmen, hobbyists and shut-ins. Any one can assemble it. No special equipment needed.

HERE IS WHAT YOU GET FOR ONLY

Complete kit including socket and cord, plus full easy-to-follow instructions. (Add your own lamp shade.) **\$2** pre-paid

SATISFACTION FULLY GUARANTEED

Attractively Gift Boxed for Gift Giving — Order Several Today! Sorry No C.O.D.'s

WOODCRAFT PRODUCTS 107 BELLEPLAINE AVE., PARK RIDGE, ILLINOIS

D.C. ARC WELDER

OVER \$300 VALUE AT LESS THAN 1/3

200 Amperes Continuous Duty. Up to 250 amps. intermittent duty. Easily mounted on your tractor. Welding range from 0-up by dial type control. 1-yr. guarantee with money back 10-day trial period. Write for FREE literature. OR send 35c for PLAN "Build Your Welder from Aircraft Generator" literature included.



LEJAY MFG., 847 LeJay Bldg., Minneapolis 8, Minn.

NEWEST OTTAWA LOG SAW

SELF-PROPELLED — MOVES ANYWHERE ON OWN POWER

World's fastest Log Saw. Powerful 6 H-P air-cooled motor. Attachments for sawing down trees, buzzing limbs, post hole digging and pulley for belt jobs. Big demand for wood, pulp, posts. Make big money sawing wood this easy way. Low factory-to-user prices. Nothing like it. FREE details. OTTAWA MFG. CO., 7-927 Pine St., Ottawa, Kansas



Start a NEW BUSINESS!
or Add to your present Repair Business
SHARPEN DULL PIPE WRENCHES
PIPE TAPS & DIES
"GUM" CIRCULAR SAWS
Write for Information
J. C. MOORE INDUSTRIES
BOX M 276 FREDONIA, PA.

MAGNETS OF ALL TYPES—10c UP
AMAZINGLY POWERFUL!
4 oz. Alnico Magnet, lifts 10 lbs.
1.10. Our Leader, 15 oz. Magnet, lifts 40 lbs. \$2.50. New alloy—will not weaken! Useful for lifting valuables from tanks, lakes, or rivers easily! 7 small magnets \$1.10 with list of many shop and home uses. Satisfaction guaranteed.
R. EYRICH, 2566 N. 49TH ST., MILWAUKEE 10, WIS.

SAY YOU SAW IT IN POPULAR MECHANICS

MINIATURE ENGINES

The World's Most Fascinating Hobby

Send 25 cents (refunded with first \$1.00 purchase) for my illustrated catalogue of the WORLD'S LARGEST SELECTION of model engine castings and drawings—Models of every type and for every purpose including steam, gasoline, traction and live steam 1/4", 1/2", 3/4" & 1" scale locomotives.

WAYNE MILLER
200 CEMENT AVENUE SANDUSKY, OHIO



NOW 1950 MODEL of the famous... **HANDEE** TOOL OF 1001 USES at new **LOW PRICE**

It's here—biggest buy of all. First tool of this type and today's finest. The "Cadillac" of small power tools—choice of mechanics and home-crafters everywhere. Make costume jewelry, train and plane models, puppets, tool leather, initial tumblers, internally carve plastics, etc.

A FINE GIFT
Handee with 51 accessories in new steel case.....

Handee with 7 accessories **\$19.95**

Here's smooth controlled power at your fingertips. Handee has 7-bar armature and is perfectly balanced. 25,000 R.P.M. AC or DC. Wt. 12 oz. Order today postpaid on money-back guarantee or write for catalog.

CHICAGO WHEEL & MFG. CO.
1101 W. Monroe St. Dept. PM Chicago 7, Ill.

NEW LOW PRICE
24.95

A Whole Tool-shop in one hand. Grinds Drills Engraves Polishes Cuts, Routs Saws, Sands

NEW ERA TRAMMEL HEADS

Use on your scale or combination square to make accurate compass, height gage, inside and outside calipers and scriber. Many uses. Every shop needs it. Complete with scriber points, pencil tips, special caliper points. Satisfaction guaranteed. At your dealer or direct. Prompt delivery. We pay postage. Order today!

Engineering Research Associates, Inc.
3475 E. Nine Mile Road
Hazel Park Michigan

ONLY \$2.95 POST PAID

"EVEREADY"
THE FLASHLIGHT BATTERY WITH "NINE LIVES"
Recovers Power Between Uses—
Bounces Back for Extra Life!

BUILD YOUR OWN TILTING ARBOR SAW!
Exclusive GIL-BILT Build-It-Yourself Features

- No machining—build easily with hand tools only
- No blueprint reading—step-by-step pictorial plans, full scale patterns, actual photographs
- Sturdy wood, aluminum, and steel construction
- Capacity and performance of commercial saws selling for \$60 and up

SAVE \$50 OR MORE

GIL-BILT 10-INCH TILTING ARBOR SAW

- 27x28 in. table, 13 1/2 in. capacity in front of blade
- 10 in. blade cuts 3/4 in. deep, tilts full 45 degrees
- Floor model 34" high, table always stays level
- New Departure ball bearing arbor, 3/4" precision shaft turned down for 5/8" bore blades, alum. housing, shipped ready to run
- Jackscrew and 4 1/2 in. dia. handwheel lowers and raises blade
- Cast aluminum miter gauge and self-aligning rip fence guide

GIL-BILT Metal Parts Kit includes Plans, ball bearing arbor, miter gauge and bar, rip fence guide, dado insert, lock knobs, jack screw mechanism and handwheel, and all other metal parts (less blade)..... **\$20.95**
Same Kit with 10" Combination Blade **\$24.90**
Same Kit with 8" Combination Blade **\$23.90**

GIL-BILT 12-INCH BAND SAW

- Cuts to center of 24 inch circle
- Handles stock up to 6 inches thick
- 18x18 inch table tilts 45 degrees
- Lower wheel and drive pulley runs on sealed New Departure Ball Bearings; Upper wheel runs on two 3/8" bore Oilite Bronze bearings.
- Upper wheel tension and tilt mechanism of cast aluminum, completely assembled.
- Upper and lower blade guides. Each has ball thrust bearing, self-lub bronze jaws
- Rubber tired wheels. Choice of cast aluminum or make-your-own wood wheels on metal hubs.
- Uses standard 78 inch blades up to 3/8 in. wide.
- Fully enclosed mechanism for utmost safety.

GIL-BILT Metal Parts Kit includes Plans, rubber tires, 1/4 inch blade, hubs for wood wheels, ball bearing spindle, tilt mechanism, guides, table tilt segments and all other metal parts..... **\$16.95**
Same Kit with two machined ready-to-install 12" cast aluminum wheels..... **\$20.95**

GIL-BILT CAPACITOR MOTORS

- Sealed precision ball bearings
- Remote control switch for safe operation
- Double shaft. Tough cast alum. frame
- Overload protector prevents burn-outs

1/2 H.P., 1725 R.P.M..... **\$27.95**
1/2 H.P., 3450 R.P.M..... **29.95**
1/2 H.P., 1725 R.P.M..... **22.95**

Return in 10 days for full refund if not satisfied.
(Prices include postage within 600 miles. Over 600 add 5%)
Also available—Plans and Parts Kit for 8" Tilt/Table saw. Order Plans at \$1.00 each—sent postpaid anywhere in the world or write for FREE descriptive catalog.

GILLIOM POWER TOOLS P. O. Box 1-PN, Lambert Field St. Louis 21, Missouri

BARRON Drill Press TOOLS

ROTARY WOOD PLANER \$7.50 **1" and 2 1/2" DRUM SANDERS** **ROTARY SURFACE SANDER \$5.95** **\$9.85 F.O.B. Detroit ALL-METAL DRILL PRESS TABLE**

ALL-METAL SHAPER FENCE \$8.25 F.O.B. Detroit

ROUTER & MORTISING BITS \$9.50 per set of six

SHAPER CUTTERS \$9.00 including 3 sets Blades

15 ESSENTIAL WORKSHOP OPERATIONS...

You can convert any standard make drill press into your most versatile, useful, low cost workshop tool. Barron Precision Tools now enable you to perform 15 indispensable shop operations—surface-plane woods and plastics—rabbet—tenon—panel—bead—groove—bevel—mortise—route—cut dovetail—sand surfaces and contours—shape—cut moldings—grind and buff. Over 200,000 Barron Tool users. Every tool sold on full 10 day money back guarantee.

See Your Dealer... Or Write Direct

BARRON TOOL COMPANY, INC.
569 Architects Bldg., Detroit 1, Mich.

FREE Workshop Guide & Catalog

Sensational Bargains: LOWEST PRICES! All Items Guaranteed As Represented

WORKSHOP MOTOR BARGAIN COUNTER

No.	H.P.	Volts	RPM	PRICE
12	1/4	110	1725	\$11.75
13	1/4	110	1725	\$14.75
14	1/2	110	1725	\$19.75
15	1/2	110	3450	\$19.75
16	3/4	110/220	1725	\$32.50
17	1	110/220	1725	\$42.50

General Electric, Leland, Delco, Westinghouse, Sunbeam, Brown, Brockmeyer and others. Repulsion induction and capacitor induction type motors, alternating current, 60 cycle single phase. Like New, Fully Guaranteed, some shop worn, many brand new, every one a whale of a bargain.

Order by number. We have large stock of standard & special motors, all sizes. Write for prices

Write for our **BARGAIN FAN & MOTOR Circular** and **SAVE MONEY**

C. MARSHALL SALES, 3546 W. Fullerton Ave., Dept. P-12, CHICAGO 47, ILL.

THE VAPORITE Automatic HUMIDIFIER for Warm Air Furnaces...

BARGAIN GASOLINE ENGINES

Jacobsen 2 cycle 3/4-1 H.P. Ball Bearing. Less Gas Tank. Shop-worn but never used. FOB. ea. \$22.50

BALL BEARING MANDREL

High speed precision bearings for sawing, grinding, buffing, polishing, etc. 12"x5/8" shaft, threaded 1/2"x20 L.H. with flanges and nut, complete with 2 inch pulley. \$100 Mandrel Only \$4.95 FOB Chicago

RUSH ORDER TODAY

2 DRILLS IN 1



This attachment gives you two drills in one.

It converts any 1/4 inch electric drill to 1/2 inch capacity. Reduction gears reduce the drill speed 5 to 1, the average speed of a 1/2 inch drill, and thereby increases the power. Absolutely indispensable for all shop work and home craftsmen. Satisfaction guaranteed. Order yours now.....

\$11.95
post paid

Send check or Money Order with order. Jobbers write for special information.

G. M. CO. MANUFACTURING, INC.
1308 43rd Ave.
Long Island City 1, New York.

AUTOMATIC COMPRESSOR UNIT

BEST BUY OF THE YEAR!
A PRACTICAL XMAS GIFT

1/2 H.P. heavy duty capacitor motor. AC 110/220 volt, 60 cycle, 2x1 3/4 inch piston type compressor, splash feed lubrication, 12x24 inch tank, automatic pressure switch, CFM 2.8 at 100 lb. pressure, or 150 lbs. pressure for intermittent duty. Check valve, safety valve, air regulator with gauge and filter, 20 ft. air hose with air chuck for inflating tires. V belt drive. Mounted on 2 wheels, ball bearing, with 2"x10" pneumatic tires. Portable, with handle. Shipping wt. 90 lbs.



SPECIAL PRICE **\$89.50**
SOLD ONLY DIRECT TO USER

PRICES F.O.B. CHICAGO. Sold on money back guarantee. Send check or money order today. Prompt shipment. Catalog free.

WELLWORTH TRADING CO.

1831 S. STATE ST. Dept. D-12 CHICAGO 16, ILL.

ELECTRIC MOTOR BARGAINS!



1/2 HP. \$15.00 3/4 HP. \$22.00
1750 RPM 1750 RPM
3/4 HP. \$26.00 1-HP. \$30.00
3450 RPM 1750 RPM

Every Motor Fully Guaranteed

Heavy Duty, Repulsion Induction-Capacitor Types, 110-220 Volts, 60-cycle, Single-phase. Standard Makes (G.E., Wagner, Le-land, Westinghouse, etc.). Rush your order TODAY—large stock of motors in all sizes—single and three phase. 32-volt direct current bargains. All prices F.O.B.

ROBERTS ELECTRIC CO., 7232 Madison, Forest Park 3, Ill.

Electric Steam Engine

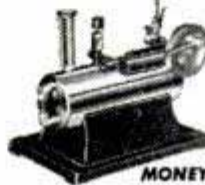

Was \$14.95

Now \$7.95

POST PAID

MONEY BACK GUARANTEE

Develops 1/20 H.P. Approx. 3200 RPM. 9" long, 6" wide, 9" high. Equip. with automatic safety valve, throttle valve, water level gauge, pulley attach, electric cord. Boiler of nickel plated steel.

Order Today. Send check or money order.

ALLEN'S HOBBIES 333 W. 4th Street, Los Angeles 13, Calif.



KNU-LOK PLIERS

No. 450. Quick acting toggle clamps... Holds anything together. For Gluing, Drilling, etc. 2 1/2 inch reach, 8 inch overall. Used but excellent.

75c each

Every shop needs several of these
SPECIAL SIX FOR ONLY \$4.25

STANDARD IMPROVED

DRILL CHUCK

No. 1. O to 1/2 inch. New. In original factory package. Complete with No. 2 M. T. arbor and key. \$12.00 Value. Only.....

\$5.65



TORQUE WRENCHES

KENT MOORE. 3/4 drive, 25#, for Chevrolet Service Depts. New..... **\$1.85**
DURO. 1/2" drive, 100#. No. 8099 1/2. Shockproof Plastic Handle. In green enameled case. New..... **\$5.85**
STUREVANT. 25#. 3/4's drive. Finest Steel. Floating Handle. \$17.50 Value. New..... **\$2.45**

DEVILBISS ENGINE CLEANER GDZ-510. Complete with hose. For cleaning motors, engines, etc. New. Only..... **\$6.95**

AIR TOOLS

Chicago Air Drill, Pistol Grip, 1/4" Jacobs Chuck..... **\$16.50**
Cleveland Air Hammer, No. 16, Pistol Grip..... **6.45**
Cleveland Air Hammer, E3, Pistol Grip..... **6.85**
Chicago Air Hammer, 3X, Pistol Grip..... **6.95**
Cleveland Air Hammer, E5, Pistol Grip. Cap. 1/4" Rivet.... **12.45**
Rivet set retaining Springs, Used 60c... New 75c
Air Tools Used But Guaranteed Operating Condition.

RIGID SCREW EXTRACTOR SETS For screws 1/4" to 1/2" inclusive. Drills, drill guides, extractors & turnuts. 21 pieces and case. New. \$12.00 Value..... **\$6.95**

SOCKET SET "Truth" 1/2" drive 18 piece. Large metal box, sliding tee, speeder, ratchet, two extensions, 13 twelve pt. sockets, 7/16 to 1 1/4" chrome plated. (New)..... **\$12.95**

Prepaid if Cash Accompanies Order. All C.O.D.'s Plus Postage
MAIN SUPPLY, Dept. B, 521 Main St., Kansas City, Mo.



Free Sample!

Big profits showing amazing **GLOW-IN-THE-DARK SPECIALTIES**, House numbers, pictures, plastic novelties, religious and nursery objects, etc. Large manufacturer. Enormous demand. Sell on sight. Write at once for **FREE SAMPLES**.

MADISON MILLS, Dept. D-4
303 Fourth Ave. NEW YORK 10, N. Y.



MACHINE SHOP EQUIPMENT

The 1949 edition of the famous Center Tool Co. Catalog is now ready! Every workshop owner should have a copy. 240 pages full of illustrations, descriptions, and prices of the latest tools made by best known manufacturers in U. S. You pay the cost of printing—50c. We refund your 50c with your first order of \$10.00 or more. Prompt delivery on most tools. Send check or money order today!

CENTER TOOL CO.

153 Centre Street, Dept. C, New York 13

HELPFUL BOOKS

Send post card asking for **FREE catalog**

Popular Mechanics Press, 200 E. Ontario, Dept. 601, Chicago 11

\$4.95

REAL ENGINE VALUE

A miniature gas engine that really operates.

Thousands of Buzz "B" gasoline engines have been sold at twice the price. Now is your chance to buy a real 1/6 H.P. gas engine for only \$4.95. Turns up over 8,000 r.p.m. For boats, planes, midget cars, etc. Guaranteed and ready to run. Includes Champion spark plug and tank. Send only \$1.00, engine shipped collect for balance, same day.



WRITE FOR FREE CATALOG OR
SEND 10c FOR NEW MAMMOTH ILLUSTRATED
CATALOG OF THOUSANDS OF HOBBY ITEMS.

America's Hobby Center, Inc., Dept. B-129, 156 West 22nd St., N. Y. 11

New DUMORE HOBBY TOOL

More power . . . more capacity
... More value for your money!

DRILL
GRIND
SAW
BUFF
POLISH
BURR
ETCH
SAND
SHARPEN
CARVE
ROUT
ETC.



DeLux Hobby Tool

Comparative Torque
In Ounce-Inches At
15,000 R. P. M.

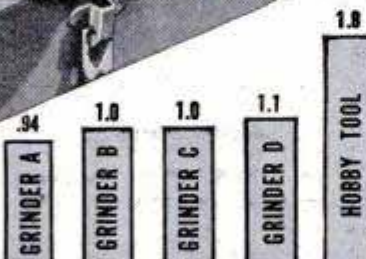

Here's the light-weight, popularly-priced handgrinder that really has "guts" (see graph)... handles all 1/8" and 3/32" mounted accessories... gives you all the smooth trouble-free performance you've come to expect from Dumore. You'll be proud to work with... proud to own the Hobby Tool!

- Full 1/40 h.p. Dumore Motor... 28,000 r.p.m.
- Highest maximum power.
- Most power on continuous duty.
- Handsome styling... a beauty!
- Push-button tool lock... no wrenches.
- Handy, fast thumb switch.
- "No-tire" shape fits your hand.
- 1/8" and 3/32" chuck capacity.

Hundreds of uses in your shop and around the house. See it at your hardware dealer, or mail coupon today.

The DUMORE COMPANY

Dept. M-51, Racine, Wis.

- Please send complete information on the NEW Hobby-Tool Handgrinder.
 - Send me DeLux Hobby Tool with 50 accessories (as illustrated); \$23.50 enclosed.
 - Send me Standard Hobby Tool with 2 accessories; \$16.50 enclosed. (All shipping charges C.O.D.)
- NAME.....
ADDRESS.....
CITY..... ZONE..... STATE.....
DHT-1

CUT COUPON AND MAIL TODAY

NEW 1950 QUALITY All Cast-Iron Construction

12" x 16" Precision Ground
Cast Iron Table

EXTENSIONS AVAILABLE
THE TILT ARBOR
SAW IS A COMPLETE UNIT

There are no loose pieces
to mount behind the machine.

MONEY
BACK
IF NOT
SATISFIED

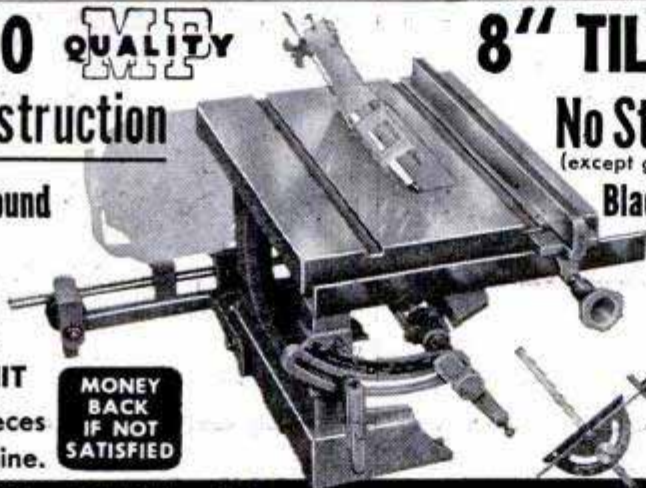

8" TILT ARBOR SAW

No Stampings • No Die Casting
(except guard)

Blade tilts to 50°—Table stays level

\$29.95 Less Motor
COMPLETE AS SHOWN

SHIPPING WT. 80 LBS. • F.O.B. ROYERSFORD
MACHINE #2024B with
double shielded lubricated
for life ball bearings. \$32.95

WRITE FOR FREE CATALOGUE

MARCUS-POLLAK, DEPT. 45

ROYERSFORD, PA.

Industrial Transformer Type DYNAMIC Super Charged ARC WELDER

OVER 50,000 SATISFIED USERS!

IDEAL FOR AUTO HOME APPLIANCE AND FARM IMPLEMENT REPAIRS

WORKS ON IRON, STEEL and other metals. Does work you'd expect from a larger costlier machine. Portable, easily carried. OPERATES from any properly wired 110 Volt Line. Also available for 220 volt current at slight additional cost.

IT WELDS • BRAZES • SOLDERS • CUTS!

ONLY \$28.50 COMPLETE

EASY TO OPERATE TRANSFORMER TYPE WELDER. If inexperienced you can learn to do professional work by following the SIMPLIFIED WELDING and OPERATING INSTRUCTIONS FURNISHED—comes complete ready to operate with helmet, rods, cable, instructions. SAVE TIME and MONEY—Do your own welding. Just a few repair jobs will pay for this machine. A practical and profitable machine tool for any workshop. Make money doing repair work for others. Write today for full particulars.

DYNAMIC WELDER CO., Dept. TD-129, 15 E. 23rd St., Chicago 16, Ill.



SPECIAL GIFT OFFER! ARC TORCH WORTH \$6.80 YOURS at NO EXTRA COST!

TWIN CARBON TORCH (illustrated) for use with DYNAMIC is unsurpassed for brazing, soldering, pre-heating and cutting iron, steel, brass, bronze and other metals. With it you greatly increase profitable uses of your welder. Does work of oxy-acetylene torch. Comes complete with instructions, carbons and cables. For LIMITED TIME ONLY we are giving a

Twin Carbon Electric Arc Torch worth \$6.80 with every DYNAMIC WELDER. Act now to get this valuable premium at the single low price of welder alone.



Mail Coupon FOR FREE FACTS

10-DAY TRIAL OFFER

DYNAMIC WELDER CO., Dept. TD-129, 15 E. 23rd St., Chicago 16, Ill. Send me FREE details of your ELECTRIC Arc Torch Gift Offer and Dynamic Welder 10-Day TRIAL OFFER.

NAME.....
ADDRESS.....
CITY..... ZONE..... STATE.....

Only \$1.25 POSTPAID



PROTECT walls and plaster from open doors with the NEW Recoil DOOR BUMPER AND HOLDER

It's the latest in door stops... The recoil bumper cushions the shock as door swings back against the wall. Protects both door and wall. The self-engaging holder keeps door open. Built to last a lifetime. Order Today... Only \$1.25 p.p.d. Send check or money order



MAXIMOFF RESEARCH 6921 1/2 Van Nuys Blvd., Van Nuys, California

MONEY BACK GUARANTEE

WAR EQUIPMENT MAIL SALE!

WE PAY ALL FREIGHT AND MAIL CHARGES.



★ Power Plants. 110-V. 60-C. 3,000-W. Remote switch electric self-starter. Easily made full automatic. Army's finest plants. Full instructions. Ideal for farmers, sportsmen, contractors. New condition. Fully guaranteed.
Cost Gov't. \$756.....Sale Price—\$345.00



★ Industrial Engines. New 1-cyl. Briggs 3.5 heavy duty, air cooled. Excellent for boats, garden tractors, weed sprayers, elevators, pumps, scooters, saws, etc. Complete instructions.
Cost Gov't. \$130.00.....Sale Price—\$75.50
★ Same engine with Utility Clutch..... 86.50



★ Winch—3,000 Lb. 12" x 14", 9" high. New steel and bronze drive gears 80-to-1 power ratio. Useful for farmers, truckers, merchants, factories, etc. Used by leading truck lines for loading. Excellent for any hoist boat docks, wagon unloaders, etc. Drive with old car 6-volt starting motor, power take-off, fan pulley, etc. Easily mounted on tractors, trucks, docks, jeeps, etc. Pays for itself.
Cost Gov't. over \$75.
Sale Price.....\$24.95

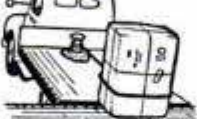

★ Welding Generators. 275-400 Amp. Brand new. Genuine G.E. units. Ready to operate. Complete with pulley, heat control rheostat, etc. Build and repair your own machinery. Do professional work for pay. Drive with tractor, old auto engine, or electric motor. Hundreds uses. Complete with instructions on "How To Weld."
.....Sale Price, \$ 89.90
★ Same unit with helmet, rods, holder, cables, etc.....\$104.50



★ Pressure Air Unit and Sprayer. Portable wheeled Briggs-N 1 1/2 hp. engine driven unit. Bendix 2-cylinder compressor. Gauge, regulator, valves, hose—complete. Excellent for painting, weed or insect spraying, tire pumping, cleaning and greasing equipment, etc. Hundreds uses—our most popular item. Guar.
Cost Gov't. \$259.....Sale Price—\$99.50

MANY OTHER BARGAINS SALE

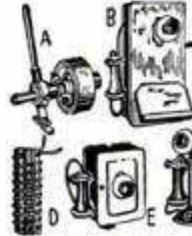

- | | |
|-----------------------------------|---------|
| A. Utility Clutch, up to 6.5 h.p. | \$13.95 |
| B. Magneto Rural Telephones | 12.40 |
| C. Burglar Alarm System | 6.99 |
| Fire Alarm System | 9.90 |
| D. 2000-watt 110-volt Elements | .99 |
| E. City Wall or Desk Phones | 4.99 |
| F. Rotary Gear Pumps | 3.95 |
| G. Briggs 1.5 h.p. Engine | 49.60 |
| H. Multi-Speed 110-V, 60-C Motor | 8.75 |

→ CLOSE OUT on all radio-electronic components: Condensers, resistors, coils, tubes, photo cells, relays, etc. Free Catalog.

→ CHRISTMAS SALE! Finest electrical appliance bargains! Make ideal gifts. Grills, toasters, waffle irons, coffee makers, stoves, irons, etc. Overnight shipment! Send for catalog!

Also dozens electronic, hydraulic, mechanical bargains. Send Card for Free Catalog. We Pay All Freight and Mail Charges.

FREE CATALOG

BURDEN SALES COMPANY

802 "O" ST.

LINCOLN, NEBR.

PISTON TYPE COMPRESSOR



EASY PROFIT IN PAINT SPRAYING

Paints walls, ceilings, screens, furniture and machinery faster, better. All complete as shown less motor. Carry anywhere. Fully guaranteed. Could be used with 1/4 H.P. motor or less. Price \$35.00 less motor F.O.B. Chicago. \$5.00 deposit balance C.O.D. or see your dealer. With motor \$55.00.

IDEAL AUTOMATIC PUMP CO., Dept. P.M. 8
801 W. Washington Blvd. Chicago 7, Ill.

STOPS LEAKS PERMANENTLY

Cut your fixture replacement, water and fuel bills with Economy Renewable Seats. Make economical, permanent repairs quickly and easily with the Junior Kit (illus.). Repair bathroom, kitchen and laundry fixtures. Everything you need included in steel box. This is a natural for the "Fixit" shops—get extra income from making permanent repairs on your customers' faucets.

Senior Master Kit also available—repairs faucets and valves up to 1" pipe. Write for illustrated circular and prices.

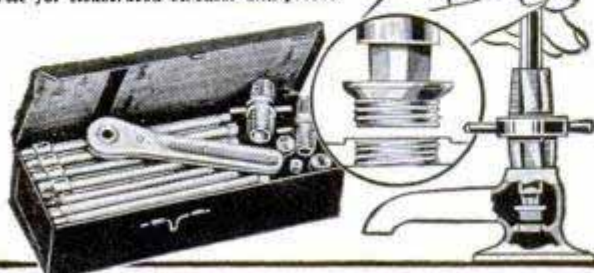

ECONOMY VALVE SEAT CO.
3122 N. California Ave. Chicago 18, Ill.

\$9.95 converts your 1/4" drill into a POWERFUL, PORTABLE SAW!

NEW BULL ARROW SAW offers you these new engineering features:

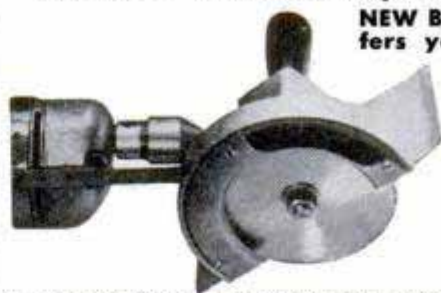

- Angle Gear Drive—ONE HAND operation!
- Exclusive Safety-Yoke
- Light, aluminum casting; self-lubricating bearings
- Precision gear box gives you FULL POWER for sawing.
- Fits any 1/4" electric drill. Depth of cut: 1 1/8"

THE SOONER YOU ORDER, THE SOONER YOU CAN THROW AWAY THAT OLD HAND SAW!

Only \$9.95, complete; send cash, check or M.O. for prepaid shipment

BERTRAM ENGINEERING CO.
3121 MAIN ST. KANSAS CITY, MO.

\$\$ IDEAL XMAS GIFT \$\$ Flocks & Sandblasts



Dual Purpose Spray Gun! Uses only 25 lbs. Air Pressure
● Thousands of uses in Home, Shop, Industry: Makes Auto Interiors Clean & New, Lines drawers, Marproofs lamp bases, Refinishes any object. All in colorful Flock. Etch & Frost windows, glassware, etc. Removes Paint & Rust from Autos, Tools. Guaranteed! Send \$19.75 or write for free information. Flocking supplies!

BLASTO SPRAY GUN MFG.
Dept. PM-12, 7007 Haas Ave., Los Angeles 47, Calif.

NONE BETTER! SUPER DRILL GRINDER



Sharpens round shank drills from 3/32" to 1/2" in diameter, up to 6" long. Grinds old drills like new in 4 different point angles, using hand or power grinding wheels. Money-back guarantee.

Price only \$2.95

At Dealers or Postpaid

CRANDALL MFG. CO. 1512 W. Slauson, Dept. FA-45, Los Angeles 44, Calif.

Build your own JET ENGINE!



Order these plans today

1. JET PROPELLED BICYCLE. Assemble your own. Photo and instructions \$1.00.
2. HOW TO MAKE EXPERIMENTAL JET ENGINES. Seven sheets drawings with information and instructions \$2.95.
3. BOTH OF ABOVE in one order \$3.75. SEND NO MONEY. Order both at once \$3.75 C.O.D. in USA plus e.o.d. postage. Send check or Money Order and we pay postage. Get other information too. Rush Order.

J. HOUSTON MAUPIN, Dept. 55, Tipp City, Ohio

DOUBLE ACTION HYDRAULIC ACTUATING CYLINDER



Also pneumatic. Raise, lower, push, pull machinery, garage doors, dump trucks, bulldozer blades, shovels, other uses. Brand new; war surplus; Has attached high pressure swivel connector. Genuine Bendix Aviation part #402685; 4" bore, 18" stroke, 31" long; solid impeller shaft, 1 1/8" diam.; mounting holes, 5/8" I.D. 100-2000 p.s.i.; fittings 3/4"-16 thread. Gov. cost \$200; a top value; powerful, economical. Only \$24.50 Chicago area. Send check or money order, 25% w. C.O.D.'s. Sh. Wgt. 40 lbs. Satisfaction guaranteed. Order today. Quantity buyers, write for spec. discount.
STAHLER DISTRIBUTORS, PM-12, 810 Michigan, Evanston, Ill.

Only \$24.50

Say You Saw It in POPULAR MECHANICS

Save! MANUFACTURER'S SURPLUS



OVER \$3.00 WORTH OF USEFUL SCREWS, BOLTS, WASH- 2 1/2 lb. box \$1.00
ERS, RIVETS, NUTS, ETC. 1/2 only
POST PAID ANYWHERE IN U.S.A.
10 lbs. \$3.25 25 lbs. \$7.50
Send Cash, Check or Money Order.
A really practical assortment for every workshop, hobbyist, or maintenance service men. Satisfaction fully guaranteed. Order today from
ILLINOIS SCREW & NUT COMPANY, Dept. B
3435 Fullerton Chicago 47, Illinois

SAVE UP TO 85%

IN WAR SURPLUS from "GADGETEERS" HEAVEN

92 PG. 1949 CATALOG
War Surplus - Tools, Machinery, Raw Materials, Clothing, etc. Illustrated with valuable info., tables, charts & data. Send 25c to cover handling & postage.

NAVY ARCTIC Jacket



COST GOVT. APPROX \$80.00

Foul Weather Ahead, Mates! Be ready - with this **EXTRA HEAVY LEATHER JACKET**. Fully lined with heavy **SHEEP-SKIN** pelt. Fur collar has storm tabs. Two patch pockets, adjustable waist, zipper closure, knit cuffs. Sizes 36 thru 44... In Excellent Condition. **Now 24.50**

MACKINAW



Here's a real outdoor, rough weather garment. Heavy Poplin cover - water repellent, wool blanket lined, thigh length. Sleeve flap adjustment. Full belt, 2 roomy pockets. Just right for the outdoor man, truck & tractor driver, hunter, farmer, etc. Sizes 34 thru 38... **\$7.95**

FLYING SUIT or Blue Bunny SUIT



For hunting, winter sports, skiing or "bundling". As coveralls for cold outdoor, or farm work, 100% woven wool with extra flannel inner lining for double warmth & utility. Wiring so fine, flexible it does not interfere with movement. Can be used with or without heating or can be plugged into car, tractor, or truck battery. Sizes 36 thru 44. **\$3.49**

16 POCKET VEST



Sturdy, Yet Light Wt. Satin Lined with Tie Straps, 14 Outside Pockets, Plus Knife, gun, or Tool, Leather Holder, 2 large 11" x 8" Pockets. Inside, Wonderful Hunting, Fishing, or Mechanic. A Steel **\$2.49**

HUNTING KNIFE #107



6" chrome vanadium blade, handle, leather grip. In leather sheath. **\$5.98 - Value for ONLY \$1.89**

(Like Above) 5 in. polished blade **\$1.69**
With Parkerized black Finish **\$1.49**

BOLO KNIFE



10" x 2" Parkerized blade. 5" Gripp'd Handle. Weight 1 1/2 lbs. ... Ideal for Hunting, Clearing Brush or Trails. With Case **\$1.19 ea.**

Hand COMPASSES



#151 - MARCHING - Lensite, with Luminous Dial... **\$1.59**
#152 - MATCHBOX - both Jewel & liquid floating dial **39c**
#153 - NEW!!! JEWEL Watch Pocket Compass **1.59**
#154 - WRIST STRAP Compass... **69c**

Loose Leaf BINDER



3 metal post. Cylindrical locking heavy duty 3/16" fabricated hinged cover. End identification window. Ideal for price books, salesmen catalogues, photo albums, students, publications, Reference books, etc. Will hold 500 sheets, 8" x 11". **59c ea.**

50 Page Binder Band Fillers for **25c Extra.**

STATIONERY & PEN KIT



Contains Air Mail Stationery 25 envelopes & Fountain Pen with 14K Gold Plated point. A VALUE!! **33c**

PALLEY SUPPLY CO
6321 SAN FERNANDO RD.
DEPT. PM12 GLENDALE 1, CALIF

NYLON PARACHUTES



Make your own Dresses, Lingerie-Blouses and Uniforms. - from this fashionable Genuine Nylon. Each chute contains enough Nylon. (Approx. 50 sq. yds.) for a year's supply of underclothes. **ONLY \$14.95**

CHRISTMAS WATCH BARGAINS



7 Jewel - sweep sec. hand, metal face, Radium Dial & Numbers # SW-1 **\$7.95**

15 Jewel - Waterproof. Radium dial & hands, sweep sec. hand, stainless steel screw back. A terrific Buy at **\$12.95**

17 Jewel - AUTOMATIC WINDING-SHOCKPROOF-WATERPROOF-SWISS WATCH. Sweep sec. hand, stainless steel screw back, radium dial & hands. Body movements keep it properly wound. # AW-1 **\$23.95**

Chronograph



17 Jewel - One of the finest made anywhere. Cased in Switzerland. Sweep sec. hand, stop & re-set buttons. Measures distance, airspeed, groundspeed, taces. Ideal for the sportsman. **\$21.95**
Special at # CH-1

Navigators WATCH



AN 5740 - NEW! Made for AAF by Hamilton. Has 24 hour and a 60 second dial - 21 Jewel movement. Black face & white numerals. Sweep sec. hand. Stainless steel case. Pocket size. No. NW-1 **ONLY \$39.95**

Paint Sprayer



Lightweight Portable Home Spray Unit. Sprays any type paint, lacquer, enamel, etc. Complete unit contains gun, hose, piston type compressor & 110 V. AC-DC motor. Just press the trigger and paint. **\$14.95**

FOAM RUBBER



Molded & pre-shaped. Can be cut to fit your Chair seat, Boat, Auto, Truck or Trailer Seats. Ideal for all Sports Events.
25" x 62" x 1 1/2" **\$6.45**
25" x 65" x 2" **\$8.45**
25" x 65" x 1 1/2" **\$7.45**

FOAM RUBBER ADHESIVE - Specially prepared to cement all types of foam rubber. per qt. **\$1.55**

Genuine LEATHERETTE



To cover Chairs - Nooks - Auto Seats, etc.

SPECIAL! 54" Ivory Leatherette \$1.29 (per run yd.)

WIDTH - COLORS - PRICE (per run yd.)

36" Grey, Brown, Black	\$1.19
36" Lt. Green, Dark Green, Blue	1.65
54" Red, Grey, Lt. Blue, Yellow	1.89

NAVIGATORS LAMP



A handy light for desk, work bench, chart table, engine room, etc. Can be used on 6-12-24-110 V by changing bulb. 3 ft. shaft has 4 joints to adjust position... **ONLY \$2.95**

FIELD TELEPHONE



A private phone or intercom system - Easy to operate. Reception up to 20 miles. Uses 2 standard flashlight batteries. Several phones can be used on same line. Set contains generator for ringing. Leather carrying case & phone. **7.95 PER UNIT**

COMPLETE SYSTEM OF two generators & two phones. 15.50

CLAMP-ON ANYWHERE LAMP With adjustable ball and socket swivel head, rubber covered cord and wall plug.



Wonderful for Indoor Photography. Floodlights. Baby Spot or Large Spot Personal Bed Reading. Workbench. Garage, etc. Lamp Alone **99c**

Highly Polished 9" diameter Parabolic Reflector or 5" diameter Spot Reflector at **Only 85c ea.**

ARMY SKI GLASSES



Genuine Polaroid
Paratroops & Ski Troops used them for Eye protection from Snow, Sun & Wind. Fine grade, form fit leather frames fur lined. Adj. elastic band. Ideal for Mountains, Beach, Driving, etc. **29c**

PROTECT YOUR EYES!!

Genuine ARMY AIR FORCES SUNGLASSES



HERE'S THE REAL McCOY!
ARMY AIR FORCE & base. Precision Polished & Ground. Glare-Free lens with leather case to be attached to belt. Gold plated adjustable frame. Pearlloid sweat bar & pads. **Only \$3.95**

SAVE A LIFE! IT MAY BE YOUR OWN!

KLEER-VUE NIGHT DRIVING GLASSES



With 57mm yellow amber, 6 base lenses. Optically. Precision Ground and Polished! Your doctor will recommend these. Not a Cheap "Process" Lense. Reduces headlight glare & Sharpens "object focus" during night driving.

In Men's size or Ladies Harlequin style. ND-1 **\$16 VALUE \$4.59**
SAME GLASSES but clip-on. \$3.59

Fit-over style without temple bars **\$3.59**

Aviators (AN-6530) Windproof & Dustproof GENUINE GOGGLES



Rubber or chamois covered frame. Clear Amber or Green GROUND LENSES are interchangeable. Adjustable nose bar. Ideal for Flying, motorcycling, etc. **1.69**

GO-1 - NEW!!



One piece Type Shatterproof. polaroid lens - Sponge Rubber frame. **U.S. NAVY Only 59c EACH**

MAKE YOUR OWN XMAS GIFTS with these PLASTIC KITS



Kit #1 contains 2 lbs. plexiglass & Lucite sheet in various shapes, 1 oz. bottle of clearset cement, and 5 bottles of colors in Orchid, Red, Yellow, Peach, etc. Also a Plastic Handbook of uses & instructions. This set easily worth \$5.50. Our Price **\$2.19**

Kit #2 contains 1 1/2 lbs. of plastic sheet, a 1-oz. bottle of clearset cement, and the Plastic Handbook. A \$2.50 Value for **ONLY 99c**

Plexiglass & Nascolite clear plastic shts.

NASCOLITE - Full sheets app. 1/8" x 37 1/2" x 49 1/2", app. 10 1/2 lbs. each **\$12.50**

PLEXIGLASS - Full Sheet
5/16" x 36" x 24" ... Per Sheet... **\$13.00**
5/16" x 36" x 48" ... Per Sheet... **\$25.00**

Fabricators write in for our special quantity prices, all above are new & marked. Also inquire about other large stocks of Plastics.

New Stewart-Warner Heater.



Compact Car-like Gasoline fired heater with motor, fan blower - Automatic Thermo Switch, Copper element, glow type spark plug - Manufactured by Stewart-Warner. 24 V. D.C. - Can operate on 6 Volt Battery. Ideal for Auto, Boats, Light Aircraft, Etc. SW 2 A Steal at... **ONLY \$6.95**

B-15 Style JACKET



That "HOT" JACKET You'll be proud to Wear! Water repellent, wind resistant, Nile Green combed Gov't. Zeelan sanforized Poplin. Full sturdy zippered front with 100% wool pile lined sleeves & body. Two slash pockets & large Mouton Fur Collar. Ribbed cuffs and bottom. Sizes: 36 to 46
Boy's sizes: 6 to 18
\$10.95 \$8.95

D-1 AIR CORPS JACKET



Genuine All Leather Flying Jacket. Fleece lined body & sleeves. Has full zipper and two slash pockets. Completely reconditioned & cleaned.

A warm rugged jacket for Hunter, Farmer, etc. Sizes: Small, Med, Large. A real Gov't. Surplus Value **8.95 ea.**

FLIGHT COVERALLS - Made especially for the NAVY of tan BYRD cloth. Strong, durable, yet light. Has 2 large breast pockets. One sleeve pencil pocket and 4 large zippered leg pockets. Full zippered front and tailored waist. Sizes: Small, Med., Large. A re-issue in Splendid condition. **4.95**

Air Corp. NYLON COVERALLS. Light wt. 8 pockets. Full zipper front. Sizes: Small, med., large. No. 480-A **6.95**

NATIONALLY FAMOUS DICKIE Matched Shirts & Pants As Advertized in LIFE



You'll feel dressed right for the job in Dickie's matched work shirts and pants. Made in 3 sleeve and 3 tail lengths for every collar size. Dickie gives you Wear-N-Forget seams, Easy-Alter Outlet, & choice of Army Tan or Silver Grey color. All fully sanforized. To order pants give waist size & leg lgh. **PANTS... \$3.69**

For shirts give collar size and sleeve length. **SHIRTS... 3.49**

FLYING HELMET



All New! Winter type with fleece or chamois lining. Has ear puffs & chin cup. Ideal for pilots, cycle - drivers, sportsmen, etc. **\$1.95**

NEW! All leather, chamois lined with chin cup. For winter or summer. 1.59

AIR CORP CAP



All leather, sheepskin lined for cold weather. Turn down flap for ear protection. Leather bound long visor. Small, Med., & Large. **\$2.98**

MITTENS - Sheepskin lined, leather outer cover, for outdoor or winter work. Small, Medium, and Large. **\$2.69 PR**

HORSEHIDE Flight Jacket



Smart & stylish. Top grade Horsehide with furry Mouton collar. Has 3 roomy pockets & zipper slash pockets. Knitted wrist & waist band. Fully lined, body & sleeves, with blanket stitched Rayon-tex. Flannel inner lining. Full length zipper closure. Cordovan Brown. Sizes thru 46... **\$22.50**

Order from this Ad. All sales final. All Prices F.O.B. Los Angeles. Pay by M.O. or Check. P.O.'s Accepted. From D & B. firms. 1/2 deposit with C.O.D.'s.

LARGEST FIRM OF ITS TYPE IN THE WORLD

TOP 3

FOR
YOUR
SHOP

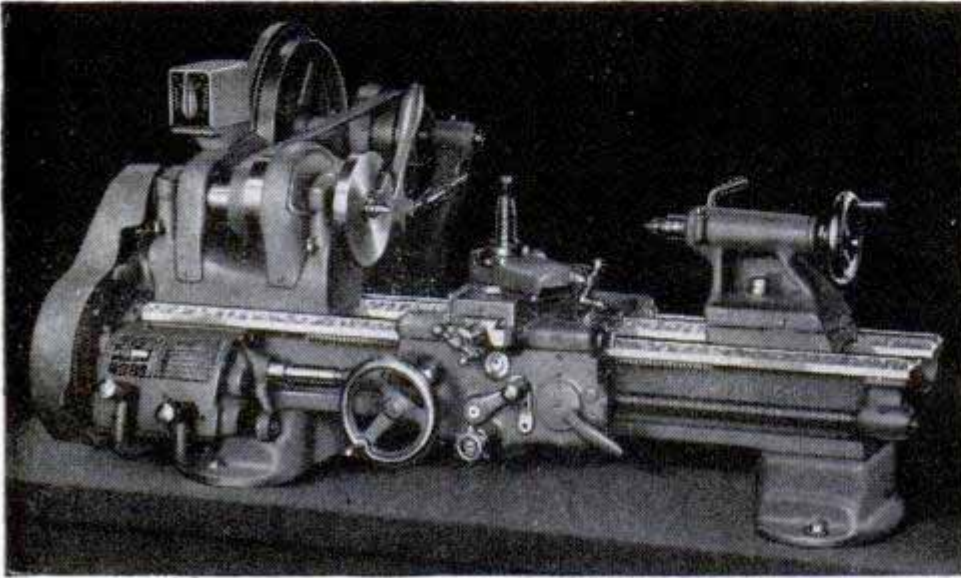

9" MODEL A BENCH LATHE

★

These South Bend machine tools make a perfect combination for any shop. They are quality-built throughout to give you greater accuracy and long, dependable service. You'll find them very easy to operate and adaptable to wide varieties of work. This combination will enable you to turn out work of the highest quality in your own shop.

South Bend machine tools are the *top buys* every time—you get more for your money.

Write today for literature.

*All prices f.o.b. factory

3-ft. bed length with 12-speed horizontal drive, 1/2 h. p. motor and switch.
Time Payments: \$85.45 down, **\$340.45***
\$22.52 for 12 months.
(Other models as low as \$160.00)

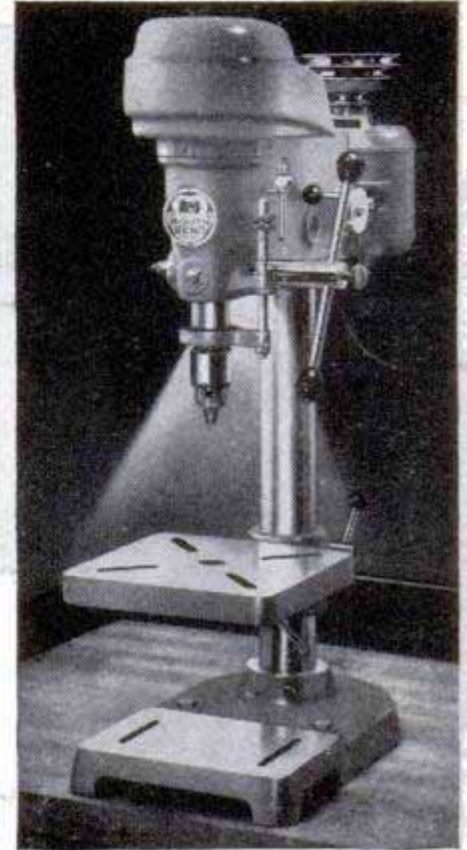
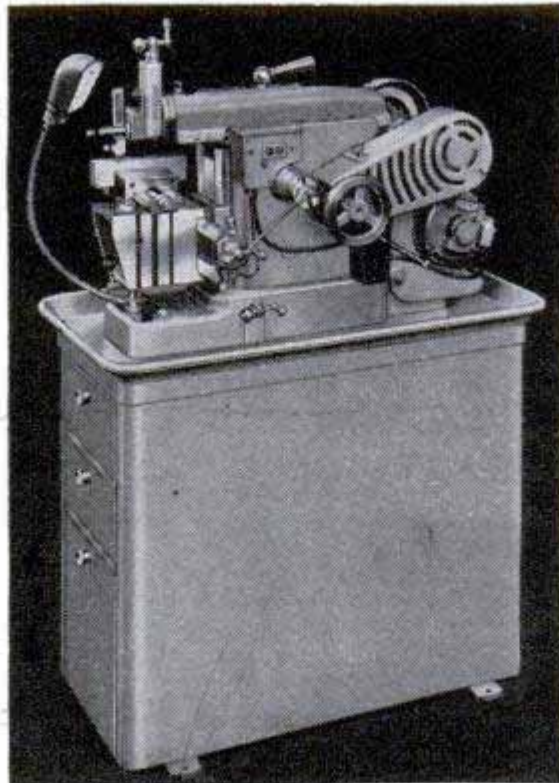

14" DRILL PRESS

Bench model with chuck, built-in light, 1/3 h. p. motor, and switches.

Time Payments: \$33.30 down, **\$129.30***
\$8.48 for 12 mos.
(Floor model also available)

★ ★

7" BENCH SHAPER

Price includes vise, light, switches and drive unit with 1/3 h. p. motor.

Time Payments: \$114.30 down, **\$456.30***
\$30.21 for 12 mos.
(Steel stand \$125 extra)



SOUTH BEND LATHE WORKS

BUILDING BETTER TOOLS SINCE 1906 • 455 EAST MADISON STREET, SOUTH BEND 22, INDIANA

Printed by Popular Mechanics Company, Chicago, Ill., U. S. A.

POPULAR MECHANICS

These Major Racing Events of 1949

WERE WON WITH ENGINES EQUIPPED WITH

DEPENDABLE

CHAMPION

SPARK PLUGS

100-MILE NATIONAL AAA CHAMPIONSHIP AUTOMOBILE RACES



Arlington Downs, Texas
Milwaukee, Wisc.
Trenton, N. J.
Milwaukee (200 miles)

DuQuoin, Ill.
Syracuse, N. Y.
Detroit, Mich.
Springfield, Ill.

UNLIMITED CLASS SPEEDBOATS



Gold Cup
Silver Cup
Harmsworth
Gull Lake
Detroit
Memorial

President's Cup
U. S. Speed
Record Run
Detroit River
Marathon

OUTBOARD MOTORBOATS



National Outboard Regatta
15 out of 17 first places
Albany to New York Marathon
Portland, Oregon Marathon

OTHER AUTO RACING CLASSICS



Pike's Peak Climb
Mille Miglia (1000-mile Italian road race)
Belgian Grand Prix
Holland Grand Prix
LeMans, France 24-hour road race
National Midget Car Championship, DuQuoin, Ill.

THESE ARE BUT A FEW OF LITERALLY HUNDREDS AND HUNDREDS OF VICTORIES ACHIEVED BY CHAMPION EQUIPPED ENGINES THIS YEAR IN NEARLY EVERY TYPE AND CLASSIFICATION OF RACING! THE CHAMPIONSHIP PERFORMANCE OF DEPENDABLE CHAMPION SPARK PLUGS IS A MATTER OF RECORD, UNEQUALLED BY ANY OTHER SPARK PLUG!

CHAMPION SPARK PLUG COMPANY, TOLEDO 1, OHIO



Follow the Experts — Use the Spark Plugs Champions Use!

Listen to the CHAMPION ROLL CALL . . . Harry Wismer's fast sportscast every Friday night, over the ABC network

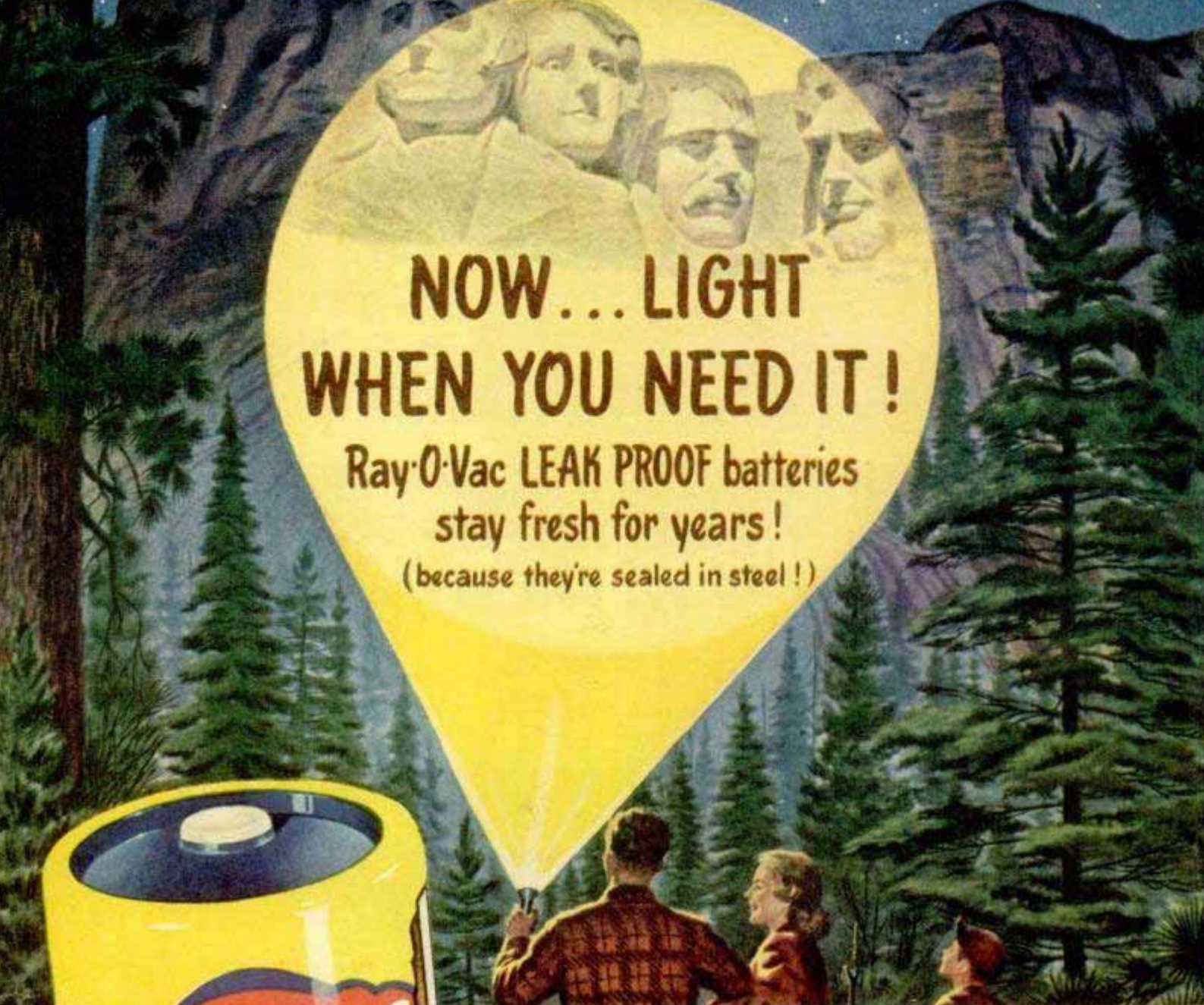

**NOW... LIGHT
WHEN YOU NEED IT!**

**Ray-O-Vac LEAK PROOF batteries
stay fresh for years!**

(because they're sealed in steel!)



© 1949 BY RAY-O-VAC COMPANY, MADISON, WIS. RAY-O-VAC, CANADA LTD., WINNIPEG, MAN.

See how much more you get

in these truly modern batteries. Each Ray-O-Vac Leak Proof starts with a powerful, well made battery. Then . . .

1. Steel bottom is added.
2. And a steel top.
3. Next—Multi-ply insulation. Nine layers of protection against corrosion.
4. Last—a steel jacket. This completes an air-tight seal, to stop corrosion and keep the battery fresh and powerful. Only Ray-O-Vac builds batteries with all four of these safeguards.

GUARANTEE on every Ray-O-Vac Leak Proof: "If your flashlight is damaged by corrosion, leakage or swelling of this battery, send it to us with the batteries and we will give you **FREE** a new, comparable flashlight with batteries."

Ask for Ray-O-Vac Leak Proof's

Buy Spares... they stay fresh