

ANC



# POPULAR MECHANICS MAGAZINE

WRITTEN SO YOU CAN UNDERSTAND IT

REG'D. TRADE MARK GREAT BRITAIN No. 410428

REG. U.S. PAT. OFF.

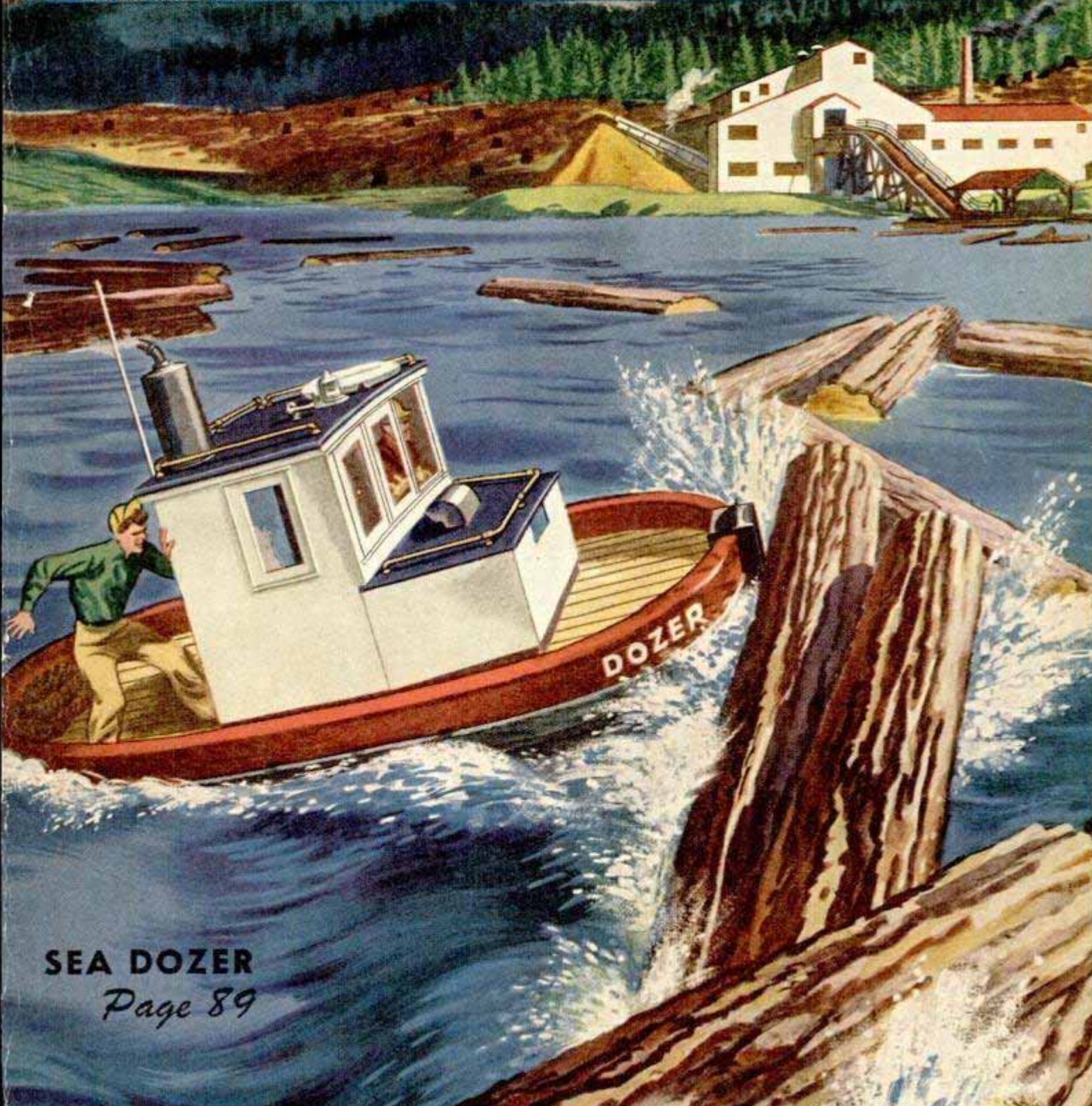

**SEA DOZER**  
*Page 89*

Ready for **WINTER ?**

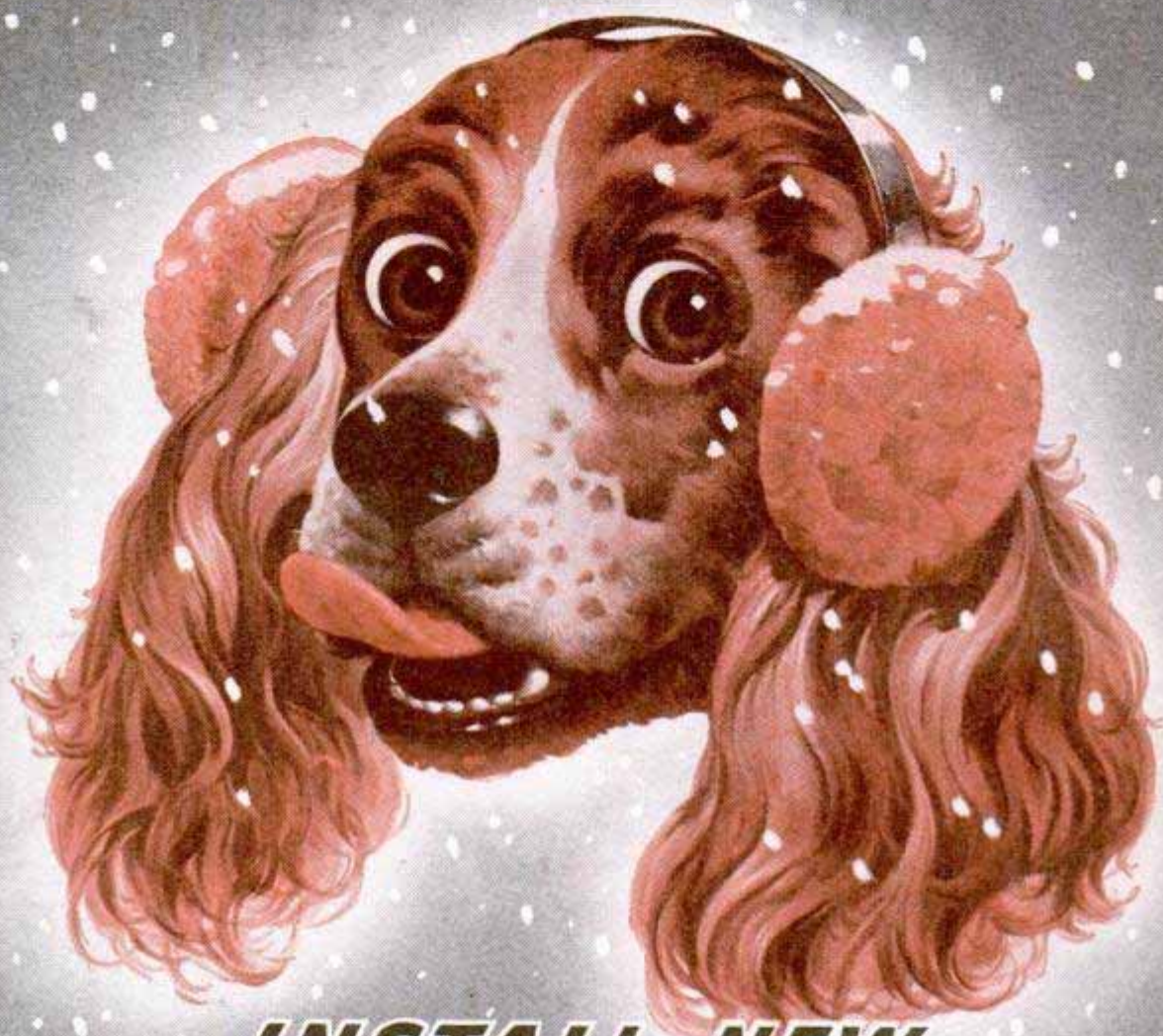

*INSTALL NEW*

**CHAMPION**

**SPARK PLUGS**

# Can you answer these 6 questions about the 3 leading low-priced cars?



..Which car has the highest compression ratio for greater engine performance and economy?



..Which car has the famous Air Pillow Ride for your greater comfort?



..Which car has Safety-Rim Wheels for your added protection in the event of a tire blowout?



..Which car has Automatic Ignition-Key Starting for your greater convenience?

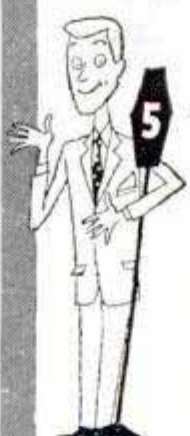

..Which car has Floating Power for smoother engine performance and longer car life?



..Which car has Automatic Electric Choke for quicker warm-up, more economical use of gas?

## You said it!

THE ANSWERS ARE ALL THE SAME—

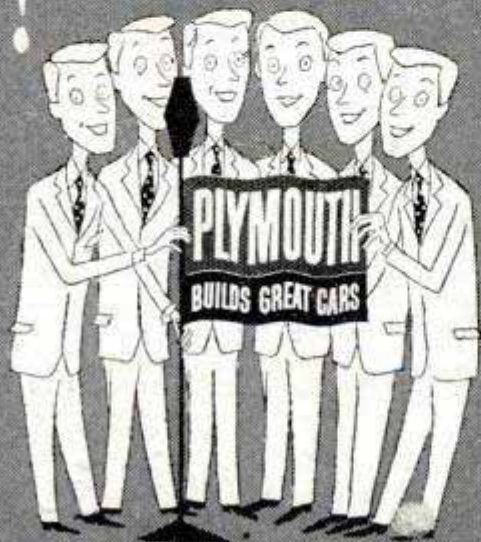

# PLYMOUTH

the car that likes to be compared

This One



1DEP-9ZC-UYQ5

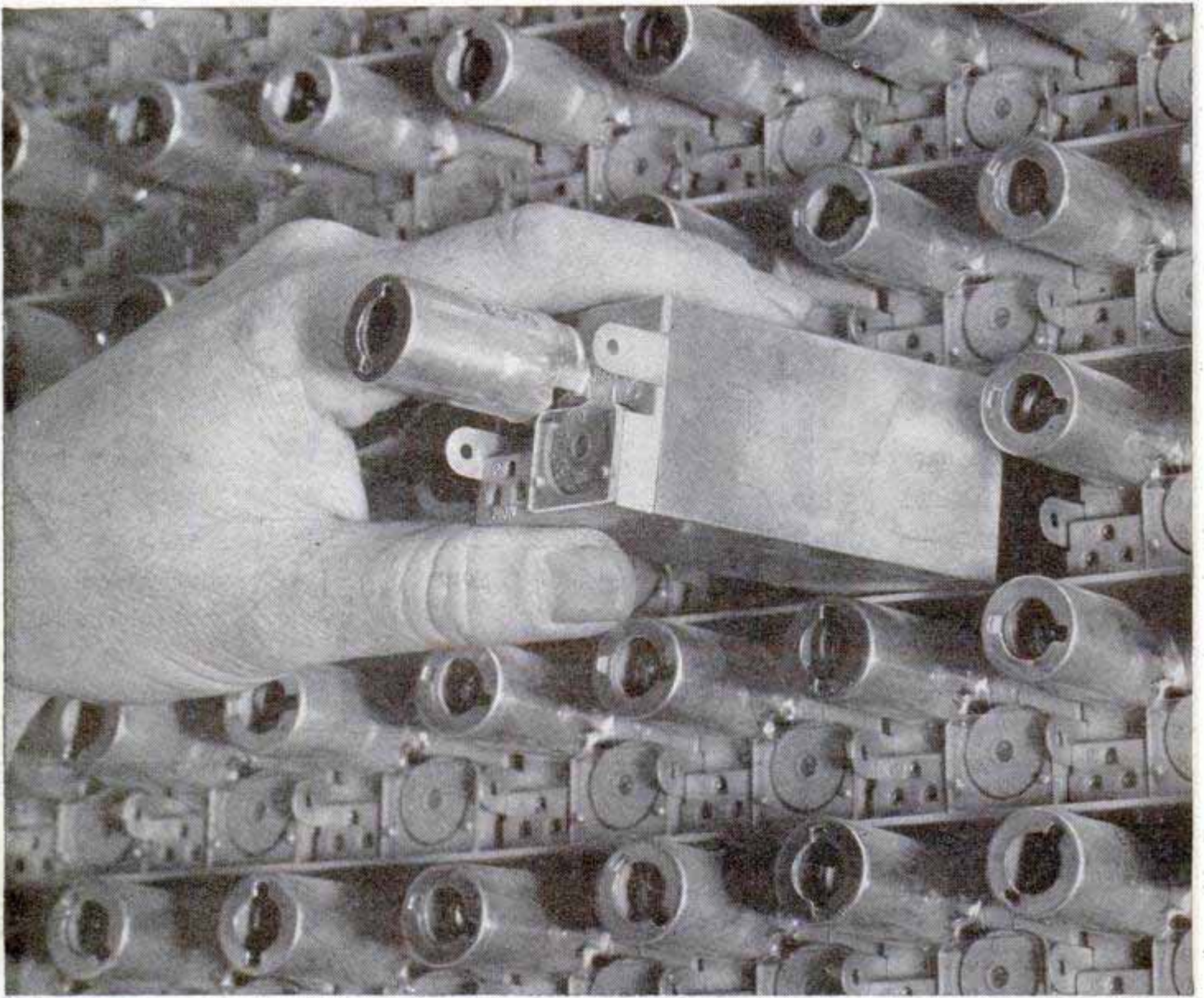

**ANOTHER SCORE IN THE**

## *battle of the inches*

It takes many costly buildings to house your telephone system. Every inch saved helps keep down the cost of telephone service. So at Bell Telephone Laboratories engineers work constantly to squeeze the *size* out of telephone equipment.

In the picture a new voice frequency amplifier is being slipped into position. Featuring a Western Electric miniature vacuum tube, tiny permalloy transformers, and special assembly techniques, it is scarcely larger than a single vacuum tube used to be. Yet it is able to boost a voice by 35 decibels. Mounted in a

bay only two feet wide and 11½ feet high, 600 of the new amplifiers do work which once required a *room* full of equipment.

This kind of size reduction throughout the System means that more parts can be housed in a given space. Telephone buildings and other installations keep on giving more service for their size — and keep down costs.

The new amplifiers, which will soon be used by the thousands throughout the Bell System to keep telephone voices up to strength, are but one example of this important phase of Laboratories' work.

**BELL TELEPHONE LABORATORIES** *Exploring and Inventing, Devising and Perfecting, for Continued Improvements and Economies in Telephone Service*







**ALL-GLASS**  
sealed beam  
**HEADLAMPS**



## Why this headlamp does not grow dim

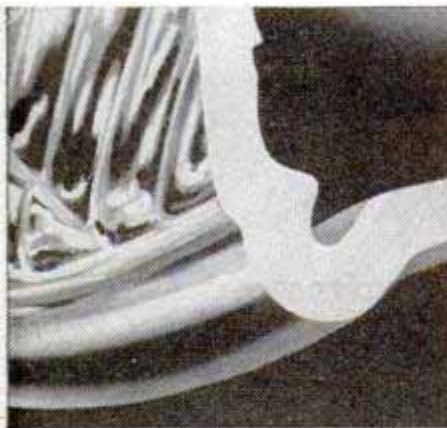

**1. DIRT AND MOISTURE** can't get in to steal the light, because the General Electric headlamp is a one-piece "all-glass" unit. Lens is shock-resistant hard glass, precision-made to throw maximum light on road.

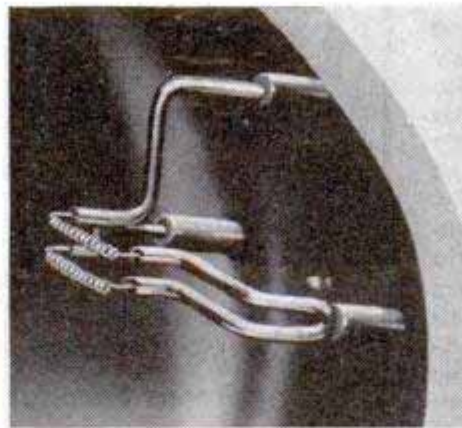

**2. RUGGED FILAMENTS** give 12% more light on the road for driving, 16% more light for passing. Clamped in a vise-like grip, they won't shake loose. And the reflector stays mirror-bright for life.

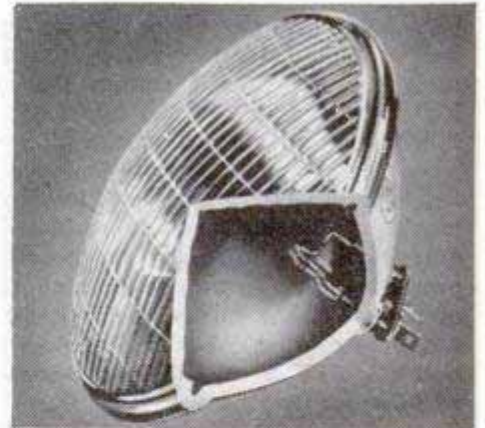

**3. ONE-PIECE CONSTRUCTION** means G-E headlamps average 99% of original brightness at end of life . . . *do not grow dim!* Have lights checked when car is serviced. Get G-E lamps for replacement.

*You can put your confidence in—*

**GENERAL**  **ELECTRIC**

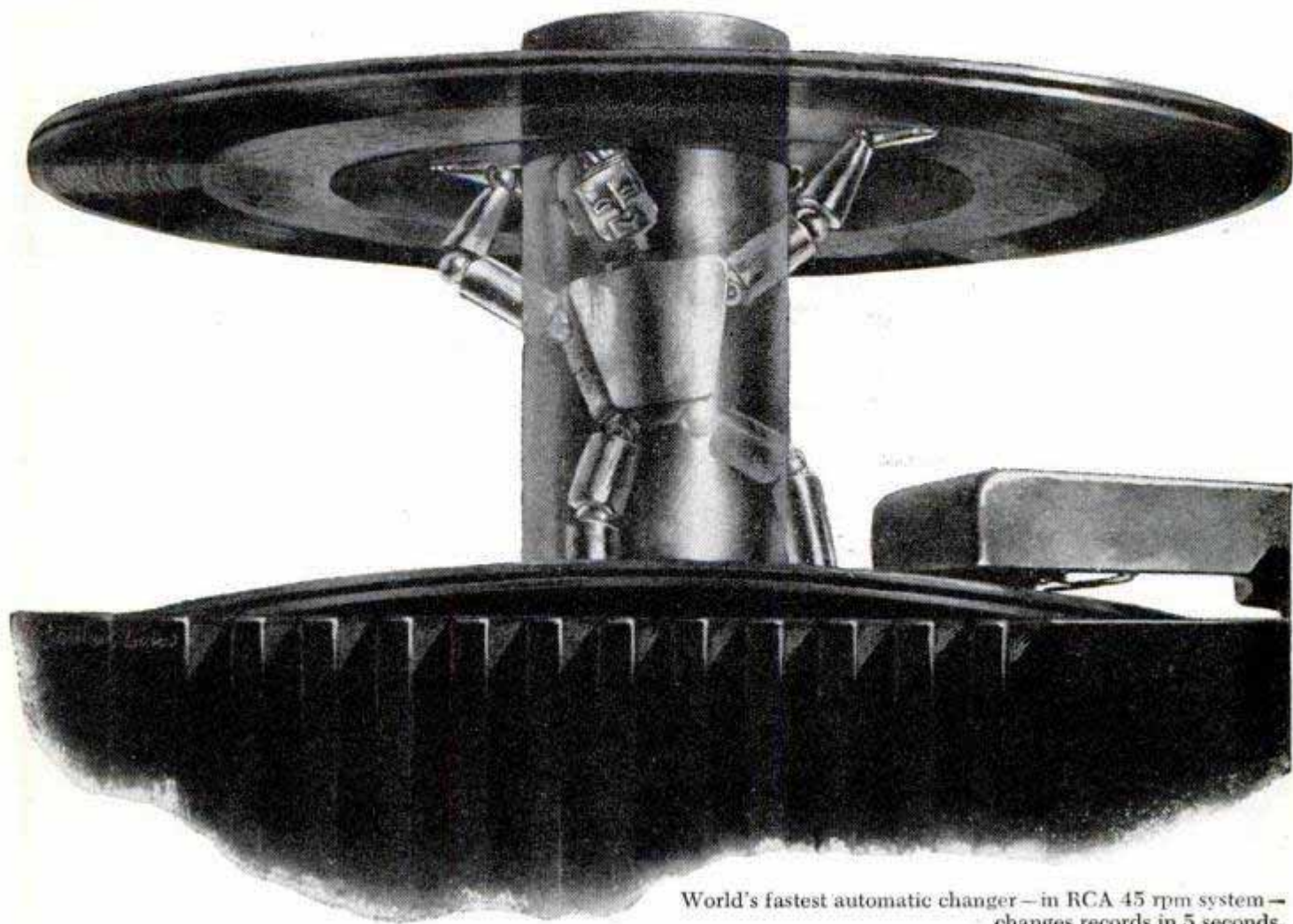

World's fastest automatic changer—in RCA 45 rpm system—changes records in 5 seconds.

## *Quick change artist*

Hundreds of thousands are now enjoying RCA's thrilling new way of playing records . . . they marvel at its wonderful tone, its compactness . . . and the speed with which it changes records.

Prolonged research is behind this achievement, research which sought—for the first time in 70 years of phonograph history—a record and automatic player designed for each other.

Revolutionary is its record-changing principle, with mechanism *inside* the central spindle post

on which records are so easily stacked. Result: a *simplified* machine, that changes records in 5 seconds.

Remarkable, too, are the new records—only 6 $\frac{1}{8}$  inches in diameter—yet giving as much playing time as conventional 12-inch records. Unbreakable, these compact vinyl plastic discs use only the distortion-free “quality zone” . . . for unbelievable beauty of tone.

Value of the *research* behind RCA's 45 rpm system—which was started eleven years ago at

RCA Laboratories—is seen in the instant acceptance, by the public, of this better way of playing records. Music lovers may now have *both* the 45 rpm system, and the conventional “78.”

\* \* \*

*Development of an entirely new record-playing principle is just one of hundreds of ways in which RCA research works for you. This continued leadership in science and engineering adds value beyond price to any product of RCA, or RCA Victor.*



**RADIO CORPORATION of AMERICA**

*World Leader in Radio — First in Television*

**It's 2-SPEED  
you need!**



Imagine the fun of pulling away from pals on upgrades . . . and of gliding along on level stretches while others churn their legs!



Shift gears as in a car

Like the gear shift on a car, the New Departure "Speed Changer" offers *low speed* for quicker getaway, easier pedaling on hills, better control in traffic; *high speed* for making time on level stretches.

Be first in your neighborhood to sport this wonderful "Speed Changer"! Fits right into the New Departure Coaster Brake on your bike. Ask your dealer about it now!

On your new bike insist on America's favorite

## New Departure COASTER BRAKES



**FREE!** Have fun mystifying your friends! Guess their ages, read their minds! Send a postcard for Magic Packet P6. Address:

**NEW DEPARTURE • DIVISION OF GENERAL MOTORS  
BRISTOL, CONNECTICUT**

1869

in this corner.....

## THE EDITORS



THERE'S a new infant in our family. *Populær Mekanik*, Scandinavian counterpart of *Popular Mechanics*, was born in Copenhagen, Denmark, in September of this year and is now being distributed throughout the Scandinavian countries. It is directed by Jorgen Grusgaard and Jorgen Norredam of the Danish capital. This is our third foreign-language edition. *Mecanique Populaire* began publication in Paris, France, shortly after the close of the war and this French edition now circulates throughout most of continental Europe and Canada. A Spanish-language edition, *Mecanica Popular*, is printed in our own Chicago plant and distributed throughout the Latin American countries and Spain. All these editions are direct translations of *Popular Mechanics*, and their sale, now approaching 300,000, is evidence of the vast interest in American scientific and mechanical developments on every continent. It is our hope and belief that these editions are playing a vital part in extending American influence and prestige.



\* \* \*

### Letter to the Editor

Gentlemen:

There has been considerable interest out here in your article of how to build a Geiger counter (Feb. 1949). Especially, people are building and using the counters in the rich ore regions of Idaho.

A funny thing happened there. Some modern prospector had the clever idea of going to the state capitol at Boise, Idaho, and running his Geiger counter up and down the shelves of ore samples which have been on display there for years. When his counter went by one piece of ore, it clicked at full speed. But no one in the museum could tell the excited man what part of the state that particular sample came from. There was no record or placard on the piece of ore and no one could remember who brought it in. Since then

(Continued to page 8)



**"What's he got  
that I haven't got?"**

LOOK at the successful men you know. "What have they got" that you haven't?

Very little, probably. In most ways these men are no brighter or naturally more capable than average. Many of them probably have no more formal education or better natural aptitudes than you.

But that little extra they have is important. They have the special knowledge and ability for which business is glad to pay well—they know the what, why and how of business. They have also the confidence and aggressiveness which come from knowing that they know and can apply their knowledge.

You may add that extra—may get that same profitable knowledge and ability—that same confidence and aggressiveness—if you are willing to pay the price in earnest, necessary study. For LaSalle has spent over 40 years developing, testing and proving, with over a million student members, spare-time success training in certain specialized business fields. What scores of thousands of men and women—many just like you—have done, you should be able to do.

You need not leave your home or interrupt your job; you need pay comparatively little money. But you must be ambitious and willing to study seriously. And soon after you start training, the results will begin to show up in your own confidence and in your work. For what you learn at home tonight is so practical that often you can apply it on the job tomorrow.

How much do you want success—more money, a promotion or a new job, prestige and responsibility? If you really want it, you will use this coupon to find out what LaSalle training can do for you. It costs only a postage stamp, but a coupon like it has been the starting point to real success for scores of thousands—and can be for you.



**LASALLE EXTENSION UNIVERSITY**  
**A Correspondence Institution**

Dept. 1164-R • 417 S. Dearborn • Chicago 5, Ill.

I want to know how LaSalle can help me win success in the field I have checked below. Please send me your free 48-page booklet about that field and your success training in it—plus "Ten Years' Promotion in One," a book which has helped many men.

- Higher Accountancy
- C.P.A. Coaching
- Bookkeeping
- Law: LL.B. Degree
- Business Management
- Salesmanship
- Traffic Management
- Foremanship
- Industr'l Management
- Stenotypy (Machine Shorthand)

Name.....Age.....

Address.....

City, Zone and State.....

**LASALLE EXTENSION UNIVERSITY**  
**A Correspondence Institution**

{ Dept. 1164-R, 417 So. Dearborn St. }  
{ Chicago 5, Ill. }

# WHAT GOES ON INSIDE YOUR CAR?

Smooth, comfortable, carefree driving comes from "within." That's where Pyroil works for you. You can depend on Pyroil to clean your motor and keep it clean because it removes harmful carbon and sludge deposits. You can depend on Pyroil to maintain piston and cylinder surface lubrication, preventing dry friction wear and corrosion.

Next time you stop for gas or oil—add Pyroil—add more smooth miles to your car.

## Pyroil for Aircraft Engines

Use Aircraft Pyroil B for lubricating oil, Aircraft Pyroil A for gasoline.

## Ideal Christmas Gift

Surprise him with a practical gift that will be enjoyed for months—a twin quart Christmas wrapped package of Pyroil—one quart for the gasoline—one quart for the lubricating oil. Included in each package (without extra cost) are two useful auto accessories—a windshield scraper and a rubber key case—extra gifts he will appreciate.

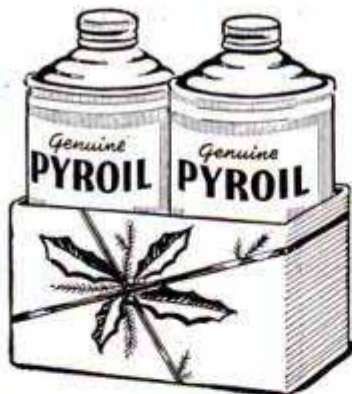

2 Extra Gifts  
At No Extra Cost

## SPECIAL GET ACQUAINTED OFFER

This unusual gift—2 quarts of Pyroil and 2 extra gift items only \$3.25 postage prepaid anywhere in the U.S. You not only give a gift—but improved car motor performance that will thrill him. Mail your order today. It's a great way to remember all your friends who drive. Send remittance with order to save C.O.D. charges, we will have a local dealer fill your order or we will fill direct.

## PYROIL COMPANY

97 Pyroil Bldg. La Crosse, Wisconsin

(Continued from page 6)

prospectors have been feverishly building counters and are combing the whole state for the origin of that ore sample. There has been such a demand for the special tubes used in Geiger counters that the Raytheon jobber in far away Portland, Ore., has been swamped with orders.

Thomas E. Riley,  
233 Kellogg Park,  
Portland 2, Ore.

\* \* \*



## Thanks, Inspector!

After reading our "how to build" story of the Concrete Block House last May and June, a subscriber in Ann Arbor, Mich., decided to build it, bought our set of plans and showed them to the city building inspector. We blush with pride over the next letter from Ann Arbor: "I would like to tell you that the Inspector said he had never seen such a detailed set of plans in all of his years in his position, and that he only wished that everyone had as complete information as you have given. We are very pleased with the whole setup."

\* \* \*

## Letter to the Editor

Dear Sir:

I read with interest the article about the Journal Publishing Co., Portland, Ore., in the June issue. On page 138 you have an illustration of a typesetting machine being lowered by a specially designed carriage. The caption (says) it is one of the Linotype machines. It so happens that the machine in the picture is an Intertype... To a printer there is a difference... like showing a picture of a Ford and calling it a Chevrolet.

L. V. Nesbit,  
2231 Ward St.,  
Berkeley, Calif.

Mr. Nesbit has a printer's sharp eye.

\* \* \*

☐ For those who are left unsatisfied by the ordinary paper match, there is now a perfumed match whose fragrance lingers on.

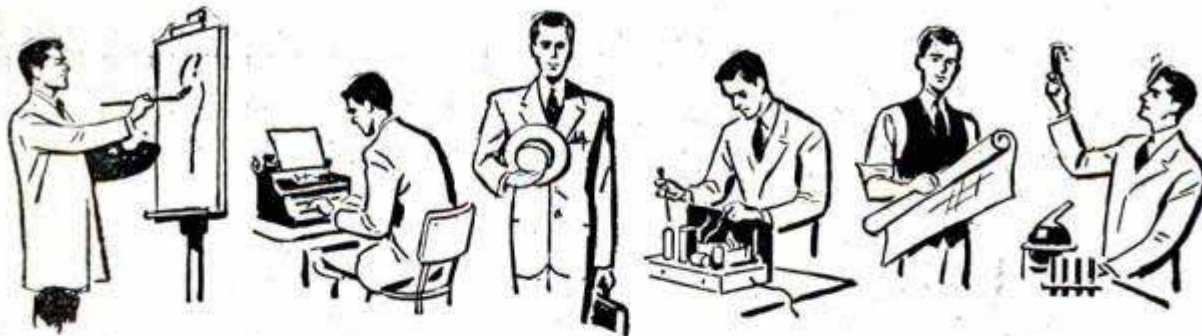

## CASH IN on your HIDDEN TALENTS

Locked in your mind may be the germ of a valuable idea . . . an undeveloped aptitude . . . a hidden talent. And the key that can help unlock those capabilities of yours is *training*—sound, practical, down-to-earth training!

Helping men and women bring out the best that's in them has been the job of I. C. S. for more than 57 years. In every field of industry, you'll find leaders whose skills were developed through study with I. C. S.

They are the ones who sensed a latent ability within themselves — *and who proceeded to do something about it.* While others (equally gifted, perhaps) plodded along in routine jobs, they mastered I. C. S. Courses . . . qualified themselves for rich rewards.

You can develop your hidden talents the same way they did. Start *today* and be ready for tomorrow's opportunities. Here's the coupon to mail:

### INTERNATIONAL CORRESPONDENCE SCHOOLS

APPROVED  
under the  
G.I. BILL

BOX 5663-K, SCRANTON 9, PENNA.

Without cost or obligation, please send me full particulars about the course BEFORE which I have marked X: —

- |  |  |   |  |
|--|--|---|--|
| <p><b>Air Conditioning and Plumbing Courses</b></p> <p><input type="checkbox"/> Air Conditioning      <input type="checkbox"/> Plumbing</p> <p><input type="checkbox"/> Heating                      <input type="checkbox"/> Steam Fitting</p> <p><input type="checkbox"/> Refrigeration</p> <p><b>Chemical Courses</b></p> <p><input type="checkbox"/> Chemical Engineering</p> <p><input type="checkbox"/> Chemistry, Analytical</p> <p><input type="checkbox"/> Chemistry, Industrial</p> <p><input type="checkbox"/> Chemistry, Mfg. Iron &amp; Steel</p> <p><input type="checkbox"/> Petroleum Refining      <input type="checkbox"/> Plastics</p> <p><input type="checkbox"/> Pulp and Paper Making</p> <p><b>Civil Engineering, Architectural and Mining Courses</b></p> <p><input type="checkbox"/> Architecture</p> <p><input type="checkbox"/> Architectural Drafting</p> <p><input type="checkbox"/> Bridge and Building Foreman</p> <p><input type="checkbox"/> Building Estimating</p> <p><input type="checkbox"/> Civil Engineering</p> <p><input type="checkbox"/> Coal Mining</p> <p><input type="checkbox"/> Contracting and Building</p> <p><input type="checkbox"/> Highway Engineering</p> <p><input type="checkbox"/> Lumber Dealer</p> <p><input type="checkbox"/> Reading Structural Blueprints</p> <p><input type="checkbox"/> Sanitary Engineering</p> <p><input type="checkbox"/> Structural Drafting</p> | <p><input type="checkbox"/> Structural Engineering</p> <p><input type="checkbox"/> Surveying and Mapping</p> <p><b>Communications Courses</b></p> <p><input type="checkbox"/> Electronics</p> <p><input type="checkbox"/> Practical Telephony</p> <p><input type="checkbox"/> Radio, General      <input type="checkbox"/> Radio Operating</p> <p><input type="checkbox"/> Radio Servicing      <input type="checkbox"/> Television</p> <p><input type="checkbox"/> Telegraph Engineering</p> <p><b>Electrical Courses</b></p> <p><input type="checkbox"/> Electrical Drafting</p> <p><input type="checkbox"/> Electrical Engineering</p> <p><input type="checkbox"/> Electric Light and Power</p> <p><input type="checkbox"/> Lighting Technician</p> <p><input type="checkbox"/> Practical Electrician</p> <p><b>Internal Combustion Engines Courses</b></p> <p><input type="checkbox"/> Auto Technician      <input type="checkbox"/> Aviation</p> <p><input type="checkbox"/> Diesel-Electric</p> <p><input type="checkbox"/> Diesel Engines      <input type="checkbox"/> Gas Engines</p> <p><b>Mechanical Courses</b></p> <p><input type="checkbox"/> Aeronautical Engineer's, Jr.</p> <p><input type="checkbox"/> Aircraft Drafting      <input type="checkbox"/> Flight Engineer</p> <p><input type="checkbox"/> Forging      <input type="checkbox"/> Foundry Work</p> <p><input type="checkbox"/> Heat Treatment of Metals</p> <p><input type="checkbox"/> Industrial Engineering</p> <p><input type="checkbox"/> Industrial Instrumentation</p> | <p><input type="checkbox"/> Industrial Metallurgy</p> <p><input type="checkbox"/> Machine Shop      <input type="checkbox"/> Mech. Drafting</p> <p><input type="checkbox"/> Mechanical Engineering</p> <p><input type="checkbox"/> Mold-Loft Work</p> <p><input type="checkbox"/> Patterning—Wood, Metal</p> <p><input type="checkbox"/> Reading Shop Blueprints</p> <p><input type="checkbox"/> Sheet-Metal Drafting</p> <p><input type="checkbox"/> Sheet-Metal Worker</p> <p><input type="checkbox"/> Ship Drafting      <input type="checkbox"/> Ship Fitting</p> <p><input type="checkbox"/> Tool Designing      <input type="checkbox"/> Toolmaking</p> <p><input type="checkbox"/> Welding Engineering</p> <p><input type="checkbox"/> Welding—Gas and Electric</p> <p><b>Railroad Courses</b></p> <p><input type="checkbox"/> Air Brake      <input type="checkbox"/> Car Inspector</p> <p><input type="checkbox"/> Diesel Locomotive</p> <p><input type="checkbox"/> Locomotive Engineer</p> <p><input type="checkbox"/> Locomotive Fireman</p> <p><input type="checkbox"/> Locomotive Machinist</p> <p><input type="checkbox"/> Railroad Section Foreman</p> <p><input type="checkbox"/> Steam-Diesel Loco. Eng.</p> <p><b>Stationary Eng'g Courses</b></p> <p><input type="checkbox"/> Boilermaking</p> <p><input type="checkbox"/> Combustion Engineering</p> <p><input type="checkbox"/> Engine Running</p> <p><input type="checkbox"/> Marine Engineering</p> <p><input type="checkbox"/> Power Plant Eng'g      <input type="checkbox"/> Steam Engr.</p> | <p><b>Textile Courses</b></p> <p><input type="checkbox"/> Cotton Manufacturing</p> <p><input type="checkbox"/> Loom Fixing      <input type="checkbox"/> Rayon Weaving</p> <p><input type="checkbox"/> Textile Designing</p> <p><input type="checkbox"/> Woolen Manufacturing</p> <p><b>Business and Academic Courses</b></p> <p><input type="checkbox"/> Accounting      <input type="checkbox"/> Advertising</p> <p><input type="checkbox"/> App. Psychology      <input type="checkbox"/> Bookkeeping</p> <p><input type="checkbox"/> Business Administration</p> <p><input type="checkbox"/> Bus. Correspondence      <input type="checkbox"/> Bus. Law</p> <p><input type="checkbox"/> Certified Public Accounting</p> <p><input type="checkbox"/> Commercial      <input type="checkbox"/> Commercial Art</p> <p><input type="checkbox"/> Cost Accounting</p> <p><input type="checkbox"/> Federal Tax      <input type="checkbox"/> First Year College</p> <p><input type="checkbox"/> Foremanship      <input type="checkbox"/> French</p> <p><input type="checkbox"/> Good English      <input type="checkbox"/> High School</p> <p><input type="checkbox"/> Higher Mathematics      <input type="checkbox"/> Illustration</p> <p><input type="checkbox"/> Industrial Supervision</p> <p><input type="checkbox"/> Motor Traffic      <input type="checkbox"/> Postal Civil Service</p> <p><input type="checkbox"/> Retailing      <input type="checkbox"/> Retail Bus. Management</p> <p><input type="checkbox"/> Salesmanship      <input type="checkbox"/> Secretarial</p> <p><input type="checkbox"/> Sign Lettering</p> <p><input type="checkbox"/> Spanish      <input type="checkbox"/> Stenography</p> <p><input type="checkbox"/> Traffic Management</p> |
|--|--|---|--|

Name \_\_\_\_\_ Age \_\_\_\_\_ Home Address \_\_\_\_\_

City \_\_\_\_\_ State \_\_\_\_\_ Working Hours \_\_\_\_\_ A.M. to \_\_\_\_\_ P.M.

Present Position \_\_\_\_\_ Employed by \_\_\_\_\_

Length of Service in World War II \_\_\_\_\_ Enrollment under G.I. Bill approved for World War II Veterans. Special tuition rates to members of the Armed Forces. Canadian residents send coupon to International Correspondence Schools Canadian, Ltd., Montreal, Canada.

# 4 Keys to SUCCESS IN AVIATION

Through Embry-Riddle Training



## AIRCRAFT & ENGINE MECHANICS

1

We have hundreds of urgent requests for A. & E. Mechanics -- key men in Aviation -- from airlines, oil companies, fixed base operators, etc., both U. S. and Overseas. Training in a C. A. A. approved school is the quickest way to get ahead. Embry-Riddle students learn fast with modern equipment... working on live aircraft in airline-size hangars.



## ENGINEERING

2

Embry-Riddle's Design Engineering and Maintenance course offers you eligibility for A. & E. certification plus necessary basic engineering knowledge required to fill positions such as Maintenance Foreman or Field Service, Project or Sales Engineer. If your aim is high, take this course.



## A.&E.

## COMBINED WITH COMMERCIAL

3

Pilot Mechanics who can test fly the ships they repair... executive pilots able to service their own aircraft -- airmen with dual ability are needed by aviation companies and operators. Embry-Riddle combination training offers you the most in your aviation career.



## COMMERCIAL PILOTS

4

Flying holds a real future for Embry-Riddle trained pilots. A quarter-century of experience with 30,000 students... the best instructors, up-to-date aircraft, superb year-round flying weather... qualifications unexcelled anywhere. Instrument and instructor's ratings are also available.



**Aviation needs you now! Never has there been such opportunity for you in Aviation. Start your career now at Embry-Riddle -- living facilities directly on the Airport. Write today for full information and proof of job opportunities.**

### LIMITED NUMBER OF VETERANS ACCEPTED

Dean of Enrollments - Dept. 99  
Embry-Riddle School of Aviation  
Miami 30, Florida

Please Print

NAME \_\_\_\_\_

ADDRESS \_\_\_\_\_

City \_\_\_\_\_

State \_\_\_\_\_ Age \_\_\_\_\_

I am interested in...

- A. & E. Mechanic
- Commercial Pilot
- Engineering
- A. & E. Combined with Commercial Pilot
- Flying Mechanic
- Drafting & Design

Check One  Veteran  Non-Veteran

**TRAIN IN MIAMI--AIR CAPITAL OF THE WORLD**

## WHERE-TO-BUY-IT INDEX

Source of supply appears after items commercially available

### AUTOMOTIVE

- Auxiliary auto weighs 475 pounds (International Motor Products, Glendale, Calif., c/o R. Stanley Griffin)..... 94
- Oil stick with spring gives true reading (St. Anne Industries, St. Anne, Ill.)..... 94
- Angle attachment for valve grinder (Waterbury Tool Division, Vickers Inc., Waterbury 91, Mass.)..... 103
- Wood panels mount on car body to add station-wagon look (Michael R. Senucci, 25100 Station Wagon Homes, 165 Clifton Place, Brooklyn 5, N. Y.)..... 104
- Chrysler station wagon (Chrysler Corp., Detroit, Mich.)..... 109
- Engine heater (Locomotive Testing Station, British Railways, Rugby, England)..... 112
- German automobiles..... 121
- Rollers simulate bumpy road to detect rattles in car (Western Tool & Engineering Co., 7720-28 Male Ave., Los Angeles 1, Calif.)..... 131
- Adjustable clothes rack for auto mounts on window molding (E. D. Clingman, 251 Houseman Bldg., Grand Rapids 2, Mich.)..... 153
- Car "road tested" on dynamometer (Clayton Manufacturing Co., Ellis Lane & Valley Blvd., El Monte, Calif.)..... 159
- Back-up guard stops car (Peter Fasolino, 11 Pratt St., Buffalo, N. Y. and Alfonso Fasolino, 62 N. Park Ave., Buffalo, N. Y.)..... 164
- Single-seater auto has one-horsepower engine..... 164

### AVIATION

- Trainer for flight engineers (Spartan School of Aeronautics, Municipal Airport, Tulsa, Okla.)..... 119
- Three-jet plane (Glenn L. Martin Co., Baltimore 3, Md.)..... 120
- Ball-out rehearsal..... 122
- Jet-engine starter (Dodge Bros., Corp., 7900 Jos. Campau Ave., Detroit, Mich.)..... 150
- Jet fighter "lines" without leaving ground (Grumman Aircraft Engineering Corp., Bethpage, L. I., N. Y.)..... 179
- Spray-on paint remover for camouflage enamels..... 264

### BOATS

- Lift clamp for outboard motor allows shaft to swing into boat (Rite-Way Lift Company, Berwyn, Ill.)..... 113
- Swedish speedboat..... 124
- Glass-fiber dinghy (Sid Hall, Sausalito, Calif.)..... 174
- Army cargo launch is assembled from three sections (Edo Corporation, College Point, N. Y.)..... 175
- Amphibian cycle makes sea voyage..... 179
- Plastic-coated starter for outboard motors (Wilson Products Company, 740 E. 106th St., Chicago 28)..... 262

### FARM

- Bug killers more potent yet safer to use than DDT (General Aniline and Film Corporation, 230 Park Ave., New York City)..... 95
- Preincubated eggs can be cooled before shipment..... 103
- Calves dehorned by soldering iron (General Electric Company, 1 River Road, Schenectady 5, N. Y.)..... 124
- Farm hands bale hay in air-conditioned comfort..... 140
- Cables carry mail from road to farm..... 147
- Dual wheels and single tires add stability to tractor (International Harvester Co., 180 N. Michigan Ave., Chicago 1)..... 158
- Horn-shaped trap snares plant bugs..... 159
- Biological warfare kills insects..... 164
- Electric-fence clip (Community Industries Assn., George Tractor Division, 811 S. Hamilton St., Sullivan, Ill.)..... 272

### HOUSE AND HOME

- Versatile yard cart (Rocklin Manufacturing Company, Grand Avenue at Jennings Street, Sioux City 7, Iowa)..... 102
- No-kneel waxer (Lou-Bar Products, 938 Pico Blvd., Santa Monica, Calif.)..... 120
- German-made scissors do almost everything..... 130
- Electric "housemaid" even shines shoes..... 146
- Room-size humidifier attaches to register (Laufenberg, Inc., 2229 S. Kinnickinnic Ave., Milwaukee 7, Wis.)..... 147
- Sewing machine sews on buttons (Necchi Sewing Machine Sales Company, 1151 Broadway, New York City 1)..... 173
- "Sound" opens garage doors (Vendo Company, 7400 E. 12th St., Kansas City 3, Mo.)..... 174
- Mower de luxe even has radio..... 174
- Illuminated initials of homeowner (H. H. West Products, 1421 N. Sierra Bonita, Pasadena 7, Calif.)..... 272

### INDUSTRY

- Metal-sealed heater is explosionproof (Electromode Corporation, 45 Crouch St., Rochester 3, N. Y.)..... 94
- Nylon fur..... 103
- Cemented carpet wears longer (Pioneer Carpet Mills Corporation, Paterson, N. J.)..... 104
- Computer with a memory..... 112
- Lightweight metal joist (C. D. Contracting Co., 2051 McKee Ave., S.W. Grand Rapids, Mich.)..... 146
- Shatter-resistant glasses (American Optical Co., Southbridge, Mass.)..... 151
- Truck dumper (Norris Grain Co., St. Marys, Kans.)..... 151
- Plastic coating on steel tubing resists corrosion (Jones & Laughlin Steel Corp., Jones & Laughlin Bldg., Pittsburgh 30, Pa.)..... 169
- Telephone-wire guards (Tennessee Eastman Corp., Kingsport, Tenn.)..... 169
- Frozen eggs in the shell..... 173
- Progress of oil in pipe line marked by radioactive tracer..... 174

### MEDICAL

- Wonder drug can now be produced synthetically (Parke, Davis & Co., Foot of Joseph Campau Avenue, Detroit, Mich.)..... 139
- "Hearing aid" radio weighs 5 1/2 ounces (Acousticraft Corp., 2144 S. Kedzie Ave., Chicago 23)..... 139
- High-altitude test chamber used to cure whooping cough..... 140
- Radioactivity locates brain tumors..... 270

(Continued to page 14)

# WHAT Every AUTO MECHANIC Wants to Know

A motor vehicle is a machine of many parts, each part designed and constructed for its own special function. All good mechanics, like good doctors, should know the working theory and operation of each part and understand what causes trouble and how to remedy it.

## LET AUDELS AUTO GUIDE SOLVE YOUR PROBLEMS

Every auto mechanic, helper, serviceman and operator can use AUDELS AUTO GUIDE. The information it gives saves time, money and worry. Highly endorsed by all users. It presents the whole subject of auto mechanics from A to Z in plain language and simple terms.

This Big Practical Book gives full information with working diagrams covering the principles, construction, ignition, service and repair of modern cars, trucks and buses.

A complete Guide of 1800 pages, with over 1500 illustrations showing inside views of the working parts, with instructions for service jobs. Diesel engines, Fluid and Hydra-matic drives fully explained.

### IT PAYS TO KNOW HOW TO

How to fit pistons—How to locate engine knocks—How to fit connecting rod bearings—How to service main bearings—How to recondition valves—How to time valves—How to adjust fan belts—How to adjust carburetors & chokes—How to rebuild a clutch—How to service automatic transmissions—How to service brakes—How to adjust steering gear—How to cope with ignition troubles—How to service distributors—How to time ignition—How to "tune up" an engine.

### INFORMATION IN A HANDY FORM

73 INTERESTING CHAPTERS—Read this partial list of subjects on which practical information is fully given for quick reference under the headings as shown below. Ready Reference Index.

All Parts of an Automobile—Automotive Physics—The Gas Engine—Gas Engine Principles—Multi-Cylinder Engines—Horse Power—Automobile Engines—Stationary Parts—Moving Parts—Pistons—Piston Rings—Connecting Rods—Crank Shafts—Valves—Valve Gear—Cams and Cam Action—Valve Timing—Cooling Systems—Fuel Feed Systems—Dual Fuel Feed—Mixture—Carburetors—Carburetor Service—Automatic Choke—Super-Chargers—Transmissions—Special Transmissions—Fluid and Hydra-matic Drives—Clutches—Universals and Propeller Shafts

A Ready Reference

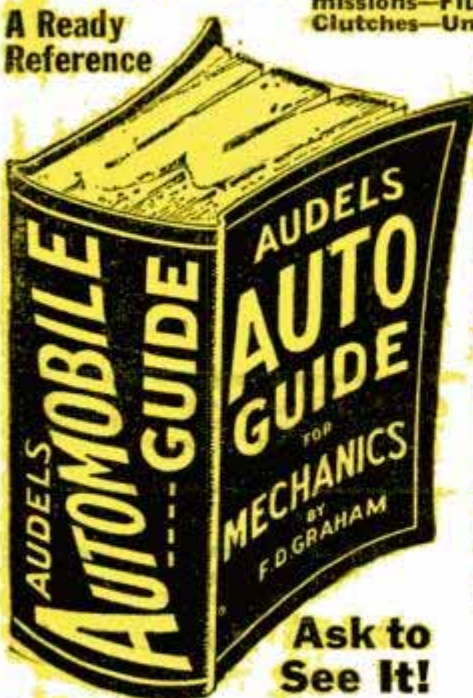

—The Differential—Rear Axles—Rear and Front Suspension—Running Gear—Brakes—Wheel Alignment—Knee Action—Steering Gear—Tires—Lubricants and Lubrication—Automotive Electricity—Ignition Systems—Magneto Ignition—Spark Plugs—Ignition Coils—Distributors—Automatic Spark Control—Ignition Timing—Generators—Starters—Generator and Starter Testing—Lighting Systems—Storage Batteries—Charging and Testing—Diesel Engines and Trouble Shooting.

**7 DAYS' FREE TRIAL**  
TO GET THIS ASSISTANCE FOR YOURSELF SIMPLY FILL IN AND MAIL COUPON TODAY.

**\$4 COMPLETE PAY \$1 A ONLY 1 MO.**



### Sent on 7 Days Approval

Step up your own skill with the facts and figures of your trade. Audels Mechanics Guides contain Practical Inside Trade Information in a handy form. Fully illustrated and Easy to Understand. Highly Endorsed. Check the book you want for 7 DAYS FREE EXAMINATION. Send No Money. Nothing to pay postman.

## ---CUT HERE--- MAIL ORDER

AUDEL, Publishers, 49 W. 23 St., NEW YORK 10, N. Y.

Please send me postpaid for FREE EXAMINATION books marked (X) below, if I decide to keep them I agree to mail \$1 in 7 Days on each book or set ordered and further mail \$1 monthly on each book or set until I have paid price, otherwise I will return them.

- AUTO GUIDE, 1800 Pages . . . \$4**
- DIESEL ENGINE MANUAL, 400 Pages . . . 2
- WELDERS GUIDE, 400 Pages . . . 1
- MACHINISTS Handy Book, 1600 Pages . . . 4
- POWER PLANT ENGINEERS Guide, 1500 Pages. . . 4
- ENGINEERS & FIREMANS EXAMS, 528 Pages. . . 1
- PUMPS, Hydraulics & Air Compressors, 1658 Pgs. . . 4
- MARINE ENGINEERS Handy Book, 1280 Pages . . . 4
- ENGINEERS & Mechanics Guides (8 Book Set). . . 12
- Answers on Practical ENGINEERING, 254 Pages . . . 1
- ELECTRIC WIRING DIAGRAMS, 210 Pages . . . 1
- ELECTRICIANS EXAMINATIONS, 250 Pages. . . 1
- ELECTRICAL DICTIONARY, 9000 Terms . . . 2
- ELECTRIC MOTOR GUIDE, 1000 Pages . . . 4
- HANDY BOOK OF ELECTRICITY, 1440 Pages . . . 4
- ELECTRICAL POWER CALCULATIONS, 425 Pgs. . . 2
- RADIOMANS GUIDE, 914 Pages . . . 4
- ELECTRONIC DEVICES, 216 Pages . . . 2
- ELECTRIC LIBRARY, 7000 Pages (12 Book Set). . . 18
- Vols. I, II, III, IV, V, VI, VII, VIII, IX, X, XI, XII \$1.50 Ea. . . 1
- OIL BURNER GUIDE, 384 Pages . . . 1
- HOUSE HEATING GUIDE, 1000 Pages . . . 4
- CARPENTERS & Builders Guides (4 Book Set). . . 6
- PLUMBERS & Steamfitters Guides (4 Book Set). . . 6
- MASONS & Builders Guides (4 Book Set). . . 6
- BLUE PRINT READING, 416 Pages . . . 2
- PAINTERS & DECORATORS MANUAL, 450 Pgs. . . 2
- GARDENERS & GROWERS Guides (4 Book Set). . . 6
- REFRIGERATION & Air Conditioning, 1280 Pgs. . . 4
- SHEET METAL WORKERS Handy Book, 388 Pgs. . . 1
- SHEET METAL PATTERN LAYOUTS, 1100 Pgs. . . 4
- AIRCRAFT WORKER, 240 Pages . . . 1
- MECHANICAL DRAWING GUIDE, 160 Pages. . . 1
- MECHANICAL DRAWING & DESIGN, 480 Pgs. . . 2
- MATHEMATICS & CALCULATIONS, 700 Pgs.. . . 2
- MECHANICAL Dictionary, 968 Pages . . . 4
- MILLWRIGHTS & Mechanics Guide, 1200 Pgs. . . 4

Name \_\_\_\_\_  
Address \_\_\_\_\_  
Occupation \_\_\_\_\_  
Employed by \_\_\_\_\_

AUDEL, Publishers, 49 W. 23 St., New York 10, N. Y.

I Will  
Show You  
How to

# Learn RADIO

## You Build This Modern Superheterodyne Receiver

As part of my Course, I send you the Speaker, Tubes, Chassis, Transformer, Loop Antenna—EVERYTHING you need to build this modern, powerful Radio Receiver. You also get parts to build many other real Radio circuits like those pictured here. Mail coupon for complete information.

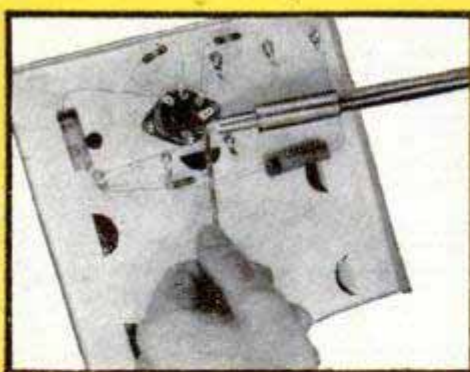
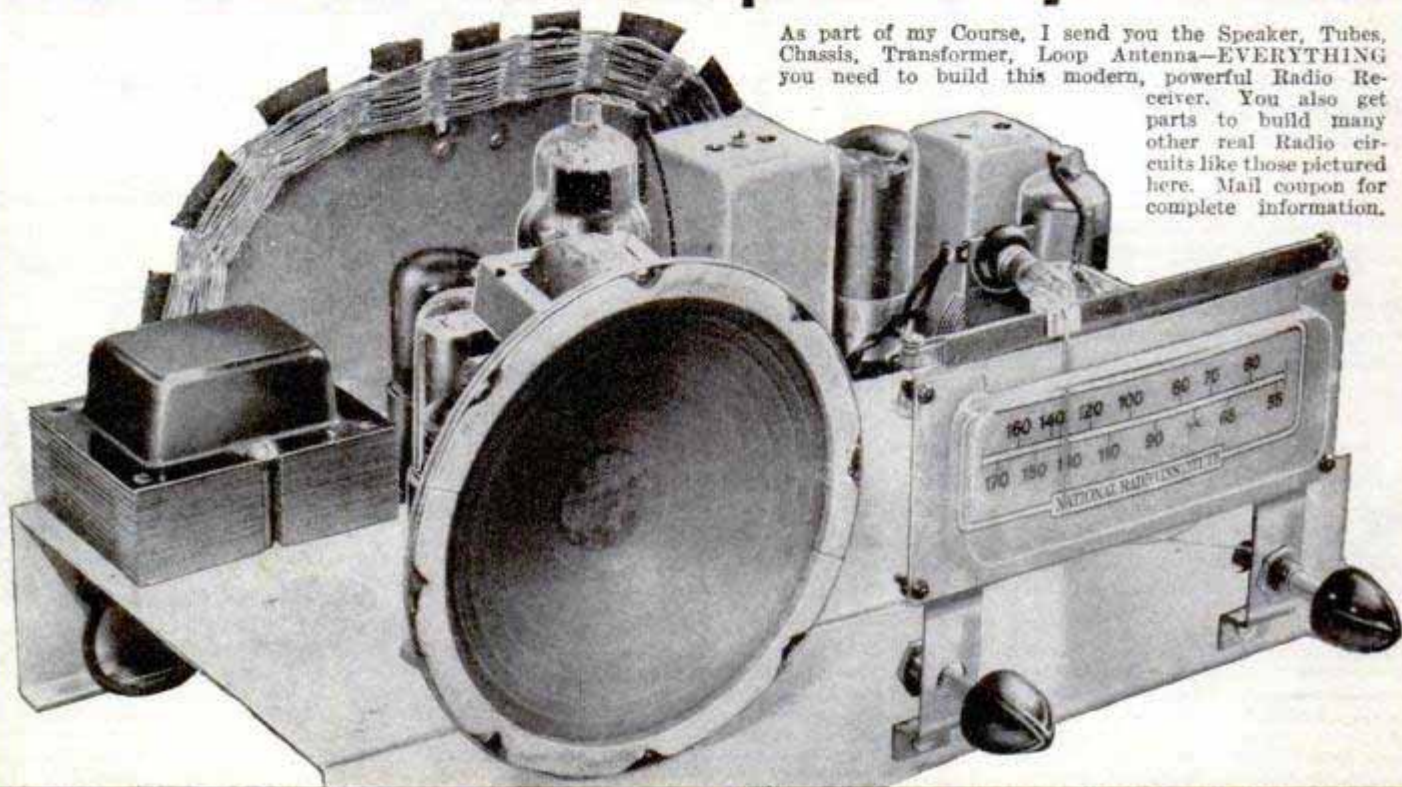

**YOU PRACTICE** Radio soldering with Soldering Equipment and Radio Parts I send you. Get practical experience mounting and connecting parts.

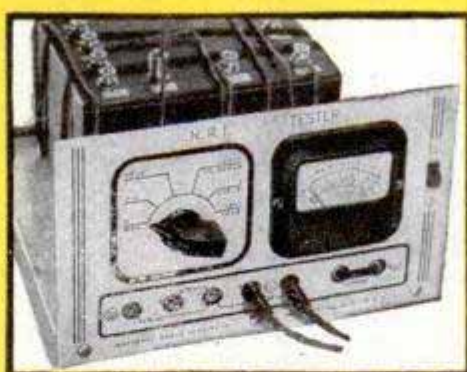

**YOU BUILD** this Tester with parts N. R. I. sends early in course. Soon helps you fix neighbors' Radios and **EARN EXTRA MONEY** in spare time.

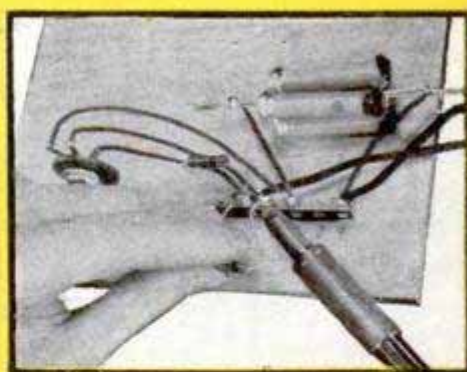

**YOU TEST** Radio Circuits like this built with parts I send. Build special circuits; learn how to locate and repair circuit defects.

## READ WHAT MEN I TRAINED AT HOME ARE DOING, EARNING



"Today I am considered an expert Radio and Television Technician. I have 4 employees working for me. Radio repair business has doubled."—**PAUL G. MILLER**, Toledo, Ohio.

"Since I finished my N.R.I. Course, have been busy on Radio repairing and installing Television. Believe Television is the coming business."—**VINCENT MARCHESANI**, Philadelphia, Pa.



"Four years ago, I was a book-keeper with a hand-to-mouth salary. Now I am a Radio Engineer with key station of the ABC network."—**NORMAN H. WARD**, Ridgefield Park, New Jersey.

"My first job was operator with KDLR, obtained for me by your Graduate Service Dept. Am now Chief Engineer, Police Radio Station WQOX."—**T. S. NORTON**, Hamilton, Ohio.



"Am doing Radio Servicing full time. Have my own shop and am making more money now than I ever did before. Owe this to N.R.I."—**CURTIS STAETH**, Fort Madison, Iowa.

"When I was only half way through the N.R.I. course, I was making an average of \$5 to \$8 a week fixing Radios in my spare time."—**E. J. STREITENBERGER**, New Boston, Ohio.



# by Practicing in Spare Time

I Send You  
Big Kits  
of Radio Parts



## KNOW RADIO & TELEVISION Train at Home-Win Success

Want a good pay job in the fast growing RADIO-TELEVISION Industry? Want a money-making Radio-Television shop of your own? Here's your opportunity. I've trained hundreds of men to be successful Technicians . . . MEN WITH NO PREVIOUS EXPERIENCE. My tested and proved train-at-home method makes learning easy. Learn Radio-Television principles from illustrated lessons. Get practical experience building, testing, with MANY KITS OF PARTS I send. All equipment yours to keep.

### MAKE EXTRA MONEY IN SPARE TIME

The day you enroll, I start sending SPECIAL BOOKLETS that show you how to make \$5, \$10 a week or more EXTRA MONEY fixing neighbors' Radios in spare time while learning. From here, it's a short step to your own shop or a good pay Radio-Television servicing job. Or be a licensed Radio-Television Operator or Technician.

### TELEVISION OFFERS BRIGHT FUTURE

The number of Radio stations has nearly tripled in the last few years—and within three years, experts predict there will be 1000 Television stations on the air. Then add developments in FM, Two Way Radio, Police, Marine, Aviation, Microwave Relay Radio! Think what this means! New jobs, more jobs, good pay for qualified men. The man who prepares now will reap rich rewards!

*Good for Both—FREE*

MR. J. E. SMITH, Pres., Dept. 9MP  
National Radio Institute, Washington 9, D. C.

Mail me Sample Lesson and 64-page Book about How to Win Success in Radio-Television—both FREE. (No salesman will call. Please write plainly.)

NAME.....AGE.....  
ADDRESS.....  
CITY.....ZONE.....STATE.....  
 Check if Veteran  
Approved Under G. I. Bill

## VETERANS

GET THIS  
TRAINING  
WITHOUT COST  
UNDER G. I. BILL  
MAIL COUPON

### MAIL COUPON FOR BOOKS FREE

Act now! Send for my FREE DOUBLE OFFER. Coupon entitles you to actual lesson, "GETTING ACQUAINTED WITH RECEIVER SERVICING." It shows you that learning at home is easy, practical. You also get my 64-page book, "HOW TO BE A SUCCESS IN RADIO-TELEVISION." It tells what my graduates are doing and earning, how quickly you can be on your way to good pay, success, a bright future. Send coupon in envelope or paste on penny postal. J. E. SMITH, President, Dept 9MP, National Radio Institute, Pioneer Home Study Radio School, Washington 9, D. C.

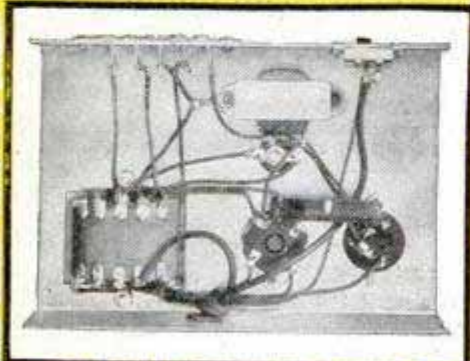
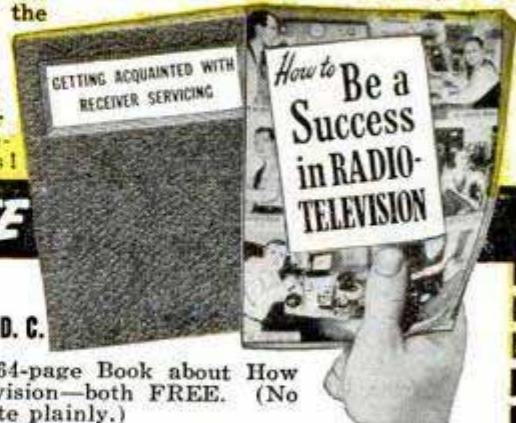

**YOU BUILD** Vacuum Tube Power Pack; make changes which give you experience with packs of many kinds. Learn how to correct Power Pack troubles.

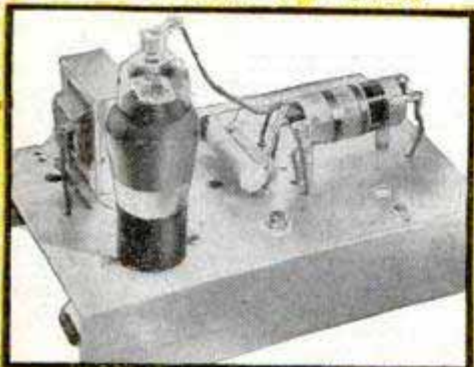

**YOU BUILD** this A. M. Signal Generator for more valuable experience. It provides amplitude-modulated signals for many tests and experiments.

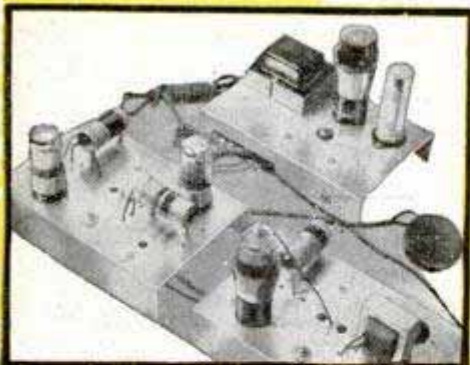

**YOU PRACTICE FM** (Frequency Modulation) experiments, get more experience with this Superheterodyne Receiver Circuit you build with parts I send.

## SAMPLE LESSON

# FREE

Gives hints on Receiver servicing, locating defects, repair of Loudspeaker, I. F. Transformer, Gang Turner, Condenser, etc. Mail coupon.

**FIND OUT ABOUT THIS  
TESTED WAY  
TO BETTER PAY**

# FREE ALLIED'S NEW 1950 RADIO CATALOG! Save on Everything in Radio



SEND FOR THIS  
196-PAGE BOOK



## Get Radio's Leading Buying Guide!

Get everything you need from the world's largest radio supply house—and save money on every purchase! ALLIED's new 196-page 1950 Buying Guide offers widest selections of top quality equipment—ready for speedy, dependable shipment at lowest prices. Have the advantages of expert, friendly service, and guaranteed satisfaction on every purchase. To get more for your radio dollar, send today for your FREE 1950 ALLIED Catalog, the preferred Buying Guide to everything in radio and electronics.

**BUILDERS' KITS  
TELEVISION SETS  
HI-FIDELITY SOUND  
AMATEUR GEAR  
THOUSANDS OF PARTS  
TUBES, TOOLS, TESTERS  
BOOKS & DIAGRAMS**

Everything for  
Servicemen, Engineers,  
Experimenters, Builders,  
Soundmen, Amateurs

## ALLIED RADIO

ALLIED RADIO CORP.  
833 W. Jackson Blvd., Dept. 5-L-9  
Chicago 7, Illinois

Rush FREE 196-Page Catalog

Name.....

Address.....

City.....Zone.....State.....



### PHOTOGRAPHY

Enlarging camera copies movie film (Federal Manufacturing & Engineering Corp., Brooklyn 5, N. Y.)..... 95  
Movie camera has built-in exposure meter (Arcap Manufacturing Company, 7916 Beverly Blvd., Los Angeles 36, Calif.) 130  
Range finder for movie camera (Wilson Department Store, Inc., 366-370 Fulton St., Brooklyn 1, N. Y.).....151

### TOOLS

Lathe attachment for drill press (Balfre Gear & Mfg. Co., 4711 W. Lake St., Chicago 44)..... 124  
Powered saw gummer (Belsaw Machinery Co., 315 Westport Road, Kansas City 2, Mo.)..... 131  
Multiple drill fits saw table (O. E. Hadwiger, 715 W. Abriendo Ave., Pueblo, Colo.)..... 159  
Ring locks sanding disk in place (Waterborg Machine Co., 2830 Rapids Drive, Racine, Wis.)..... 164  
Electric abrasive finisher weighs only three pounds (Craft Hollow Industries, Wallingford, Pa.)..... 164  
Stapling hammer has a whiplike driving action (Stapling Engineers, Inc., 1739 Cornelia Ave., Chicago 13)..... 179  
Magnetic tool holder (Ronald Eyrich, 2566 N. 49th St., Milwaukee, Wis.)..... 266

### TOYS AND NOVELTIES

"Car-Bus" carries kids on simulated ride..... 165  
Yard merry-go-round powered by riders (Taylor Wyman Co., Westminster, S. C.)..... 165  
Sculptor of chessmen (Al Dritzner, Port Washington, L.I., N. Y.)..... 166  
Cattle car for toy train loads and unloads itself (Lionel Corporation, 15 E. 26th St., New York City)..... 169

### TRANSPORTATION

Underground bridges are shell for subway..... 125  
Train-ticket vendor..... 139  
Automatic transmission for motor bicycles (Powermatic, Inc., 310 N. Howard St., Akron, Ohio)..... 147  
Motorcycle taxical (Geier-Werke, Ernst Upmeyer & Sohne, Fernruf Nr. 387, Lengerich i. Westf., Germany)..... 150  
Adapter unit gives bike two-speed transmission (New Department, Div. of General Motors, Bristol, Conn.)..... 158  
Rail car's three heating systems maintain even temperatures (Bob Wood, Minneapolis-Honeywell Regulator Co., 2954 4th Ave., South, Minneapolis 8, Minn.)..... 258

### MISCELLANEOUS

Commands spoken into mike operate model railway (DeVault Electronics, Route 1, Box 255-A, Walnut Creek, Calif.)..... 95  
Motor for wheelchair operates on battery (American Wheel Chair Co., Inc., 55 E. Washington St., Chicago 2)..... 102  
Lighter-fluid can has built-in pump (Fluid Control Corporation, 2430 S. Ashland Ave., Chicago)..... 104  
Baby trailer (Central Truck Lines, Inc., 1000 Jackson St., Tampa 2, Fla.)..... 109  
Refining unit cleans oil for reuse (Automatic Oil Refiners, Orchard Park, N. Y.)..... 113  
Magazine holder (A. P. Cary, Cary Products Company, 934 N. Lancaster Ave., Dallas 8, Tex.)..... 119  
Hand warmer heats without flame (Aladdin Laboratories, Inc., 420 S. 6th, Minneapolis, Minn.)..... 131  
Heat aids plant killers..... 139  
Winter resort for geese..... 148  
Cross-country tour on plastic skates..... 150  
Liquids "fingerprinted" (Lane-Wells Co., Instrument Division, 717 N. Lake St., Pasadena, Calif.)..... 168  
Pocket fan (Arran Electrical Manufacturing Co., 54 Hans Place, London S.W. 1, England)..... 169  
Counterfeit-money detector (Ruth Devices Corporation, 11 Broadway, New York City 4)..... 173  
Mechanical sculpturing..... 175  
Skiers ride in trailer behind snow tractor (Tucker Sno-Cat Corp., Medford, Ore.)..... 180  
Radioactive materials show how food moves up tree..... 180  
Fog machine aids science..... 268  
Automatic laundry for small parts (L & R Manufacturing Co., 577 Elm St., Arlington, N. J.)..... 270

## Craftsman and Shop Notes Index

### AUTOMOTIVE

Hole stops crack in car window..... 185  
Tire traction on slippery pavement gained with asphalt shingle..... 188  
Switch flashes car stop light without applying brakes..... 188  
Guard over garden-hose nozzle prevents marring car finish..... 209  
Correcting trouble in shifting gears by tightening bearing retainer..... 224  
Paper clips fastened to dashboard hold delivery sheets and maps..... 231

### FARM

Water level maintained in range trough by float-controlled valve..... 222  
Skids under platform of self-feeder permit easy transport..... 223  
Yoke "weans" self-sucking cow..... 224  
Narrow-tread feed cart saves time in dairy barns..... 225  
Inexpensive forge for farm shop utilizes old vacuum cleaner..... 225  
Sloping sides on feeding bunks permit cattle to reach feed more easily..... 236

### HOUSE AND HOME

Truss rod supports floor to eliminate post in basement recreation room..... 184  
Razor blade and clothespin open machine-made buttonholes..... 186  
Trousers hangers tightened with strips of cloth..... 186

(Continued to page 24)





# INVENTORS



Learn how to protect your invention. The U. S. Patent Laws provide that any new and useful art, machine, article of manufacture, or composition of matter, or any new and useful improvement thereof, may be patented if the act of invention is involved. Therefore, every inventor with a valuable invention should take advantage of the Patent Laws and proceed for patent protection in order to safeguard his rights.

A patent gives the inventor the exclusive right to prevent others from making, using, or selling the invention claimed in the patent for a period of seventeen years.

The Patent Laws were enacted for the benefit of the inventor to give him protection for the features of his invention which are patentable. These features must be properly and concisely set forth and claimed in a formal application for patent, in order to comply with the requirements of the Patent Laws. For that reason, unless the inventor is familiar with patent matters, he should engage a competent registered patent attorney or agent to represent him. We are registered to practice before the U. S. Patent Office and are prepared to serve you in the handling of your patent matters.

A specially prepared booklet entitled "Patent Guide for the Inventor", containing detailed information with respect to patent protection and procedure, together with a "Record of Invention" form will be promptly forwarded to you without obligation upon request.

## CLARENCE A. O'BRIEN & HARVEY JACOBSON

*Registered Patent Attorneys*

91-L DISTRICT NATIONAL BUILDING • WASHINGTON 5, D. C.

*Patents*

*Trademarks*

*Copyrights*

CLARENCE A. O'BRIEN & HARVEY JACOBSON  
Registered Patent Attorneys

91-L District National Bldg., Washington 5, D. C.  
Please send me copy of "Patent Guide for the Inventor" and also  
"Record of Invention" form. This request does not obligate me.

Name \_\_\_\_\_

Address \_\_\_\_\_

City \_\_\_\_\_ State \_\_\_\_\_  
(Please write or print plainly.)

**YOU** Need My PRACTICAL Training to Make Money in

# TELEVISION- RADIO and ELECTRONICS!



*I'll Send You*  
**8 BIG KITS of**  
Radio Parts and Equipment



I have trained hundreds of men to become technicians—and I'm ready to do the same for you. Whether your goal is a fine paying job in one of Radio's many branches—or a successful Radio and Television business of your own—you need the kind of training I offer! My training is practical and down to earth. **YOU NEED NO PREVIOUS EXPERIENCE.** I start you with basic fundamentals and give you plenty of practical shop-bench training with many kits of parts I send you. This is the training that sticks with you and makes money for you on the job!

Soon after you start training I send you my famous **BUSINESS BUILDERS** that show you how to make money in spare time doing interesting Radio jobs. I send you 8 big kits of Radio parts and equipment and help you build step-by-step a powerful 6-tube superhet radio, a 16-range test meter, plus other mighty useful equipment for Radio and Television servicing. You will perform over 175 fascinating experiments while training. You will learn about Television—so that you will be qualified to step into this fast growing, profitable field. I also send you many valuable service manuals, diagrams, and my book telling exactly how to set up your own Television and Radio shop. Clip and mail the coupon below for my two big **FREE** Radio books. I employ no salesmen—and nobody will call on you



A profitable Radio and Television Service Shop may be started with little capital. I will show you how to get started. At left is pictured one of my graduates, Mr. Merrit C. Sperry, Fairmont, Minn. in his own shop.

Each of the hundreds of Radio parts and other items I send my students is theirs "for keeps." You may use this equipment in your Radio and Television service work and save many dollars by not having to buy expensive "ready-made" test equipment.



of New Orleans, La. tells us he makes \$5 to \$10 in spare time repairing radios. He is now also working with a Television set.



of Coloma, Mich. reports that my training has made it possible for him to repair large numbers of Radio and Television sets.

You couldn't pick a better time to get into Radio-Television and Electronics. New Television stations are going off the air to serve every major city—hundreds of new AM and FM Radio broadcasting stations are also on the air. All this creates new and bigger opportunities for the trained man who knows Radio-Television and Electronics

**THIS TRAINING AVAILABLE TO YOU UNDER THE G.I. BILL**

**SPRAYBERRY ACADEMY of RADIO, Dept. 10-C**  
111 North Canal Street,  
Chicago 6, Illinois

Please rush my **FREE** copies of "How To Make Money In Radio-Television and Electronics" and "How To Read Radio Diagrams and Symbols."

Name.....Age.....  
Address.....  
City.....State.....  
( ) Check here if you are a Veteran

**My Training Includes ...**  
**Television, FM (Frequency Modulation), Public Address and High Frequency Applications**



Just mail coupon for a **FREE** sample Sprayberry Lesson and my big **FREE** book, "How To Make Money In Radio-Television and Electronics." Learn why my really practical training is best of all for you. Discover what's ahead for you in Radio-Television and Electronics. No obligation. Don't delay! Mail the coupon now—and count on me for fast action.

**SPRAYBERRY ACADEMY OF RADIO**  
111 N. CANAL, DEPT. 10-C, CHICAGO 6, ILL.

# INVENTORS

Patent laws encourage the development of inventions.

We recommend that an inventor employ a registered Patent Attorney or agent, if the inventor is not familiar with patent matters. This is because the value of a patent depends largely upon the skillful preparation of the specification and claims in the patent application.

The firm of McMorrow, Berman and Davidson is registered to practice before the United States Patent Office. Additionally it engages patent attorneys able to readily understand inventors' disclosures, to advise concerning patentability, and to prepare appropriate specifications and claims.

If an inventor believes he has an invention, a search of the most pertinent prior U. S. patents should be made and a report obtained relative to its patentability. Where such report indicates that the invention appears patentable, in order to secure protection, diligence should be exercised in making application for a patent.

Send for a copy of Patent Booklet entitled "How To Protect Your Invention." This booklet contains information on patent protection and procedure. You will also receive an "Invention Record" blank. This will be promptly forwarded to you upon request—no obligation.

## McMORROW, BERMAN & DAVIDSON

*Registered Patent Attorneys*

PATENTS • TRADE MARKS • COPYRIGHTS

1356 VICTOR BUILDING, WASHINGTON 1, D. C.

### McMORROW, BERMAN & DAVIDSON

*Registered Patent Attorneys*

1356 Victor Building, Washington 1, D. C.

Send me your Patent Booklet, "How To Protect Your Invention", and also "Invention Record" form at once. I understand this request does not obligate me.

Name.....

Address.....

City.....

(WRITE OR PRINT NAME CLEARLY)

# How to Make YOUR Body Bring You FAME

Instead of SHAME!

Will You Let Me Prove I Can Make You a New Man?

I KNOW what it means to have a body that people pity! I was once a skinny 97-lb. weakling—such a poor specimen that I was constantly self-conscious, embarrassed. But later I discovered the secret that turned me into the holder of the title, "The World's Most Perfectly Developed Man." I'd like to prove that the same system can make a NEW MAN of YOU!

*Charles Atlas*

This is an actual snapshot taken at the beach.

## 7 DAY TRIAL OFFER

I don't say I can do all this for you in 7 days. But I DO want to prove I can show you enough results in even THAT short time to convince you that my system of "Dynamic Tension" will give you the kind of body you have always longed to have!

Do you want powerful shoulders—a fine, deep chest—biceps like iron—arms and legs rippling with strength—a stomach ridged with sinewy muscle—a build to be proud of? Then let me prove that "Dynamic Tension" is what you need.

**FREE BOOK** It costs only a stamp—or a postcard—to mail coupon below. I'll send my new, free book, "Everlasting Health and Strength." It tells about my "Dynamic Tension" method; shows, from actual photos, how I have developed my pupils—explains about my 7 DAY TRIAL OFFER. Charles Atlas, Dept. 8Z, 115 East 23rd St., New York, N. Y.

**CHARLES ATLAS, Dept. 8Z, 115 East 23rd Street, New York, N. Y.**

I want the proof that "DYNAMIC TENSION" will help make a new man of me—give me a healthy, husky body and big muscle development. Send me your free book, "Everlasting Health and Strength."

Name \_\_\_\_\_ Age \_\_\_\_\_  
 (Please print or write plainly)  
 Address \_\_\_\_\_  
 City \_\_\_\_\_ State \_\_\_\_\_

Mail Coupon Now for FREE Book



Now YOU Can **STOP** Faucet Drip

It's Easy—Quick—with

**NEW O'Malley**

## All-Purpose FAMILY FAUCET REPAIR SET

Complete Drip-Stopper and Nu-Seater tools and parts to (1) stop faucet drip, and (2) renew worn-out faucets... Come mounted on card, with washers and simple, illustrated directions in attached envelope.

ASK YOUR DEALER for the O'MALLEY All-Purpose "Family" Set. Only \$2.95. Keep all faucets like new. If no dealer remit direct. Sent postpaid in U. S. A. (No C. O. D.'s please). Also available at stores: Single-purpose O'MALLEY No. 3 Drip Stopper Set... or \$1 sent postpaid. Free illustrated folder

**EDW. O'MALLEY VALVE CO.**  
 1069 East 76th Street • Chicago 19, Illinois

Jobbers, Dealers, Write

**Learn ACCOUNTING BOOKKEEPING**

This nationally renowned school has demand for graduates in good salary positions thru nationwide recognition and placement service. Write Department PMA today for Big 32 page Success Book to be sent to you **FREE**

**Hills BUSINESS UNIVERSITY AND EXTENSION SCHOOL**  
 619 W. MAIN ST. OKLAHOMA CITY 2, OKLAHOMA

**Learn PHOTOGRAPHY**

There's big money in PHOTOGRAPHY—and an action-packed career for you. Our HOME STUDY COURSE—famous throughout the world—is your spare-time SHORT CUT TO SUCCESS! Or if you wish... PERSONAL ATTENDANCE TRAINING at our famous New York Studios is available with subsistence under the G. I. BILL. Our 40th year. Write immediately!

**NEW YORK INSTITUTE OF PHOTOGRAPHY**  
 Dept. "49", 10 W. 33 St., New York 1, N. Y.

**MAKE MONEY!**

**RAISE CHIN-CHIN CHINCHILLA RABBITS**  
 Pedigreed! Valuable Breeders!  
**PROFITABLE! EASY! PLEASANT!**  
 Free Illustrated Booklet—WRITE TODAY!  
**WILLOW BROOK FARM, SELLERSVILLE 36, PA.**

**Learn WOOD PRODUCTION ENGINEERING**

VETERANS training is FREE under G. I. BILL.

GET THIS FREE BOOK Today

It tells you how you can learn to become a successful WOOD PRODUCTION ENGINEER... by the Klok Home Study Correspondence Method... or by studying here in Grand Rapids in our Resident School... Training in WOOD PRODUCTION ENGINEERING offers you great opportunities... either to get a top position or to operate your own plant successfully.

The Klok Course teaches you SKETCHING, ROD-MAKING, DETAILING, STOCK BILLING, TIME STUDY, COST and MANAGEMENT.

WRITE FOR FREE BOOK TODAY! State preference whether Home Study or Resident course, with name, age, occupation and if veteran.

**KLOK INSTITUTE**  
 LOUIS ST., N.W.  
 GRAND RAPIDS, MICHIGAN



# "Why, he knows all about me!"

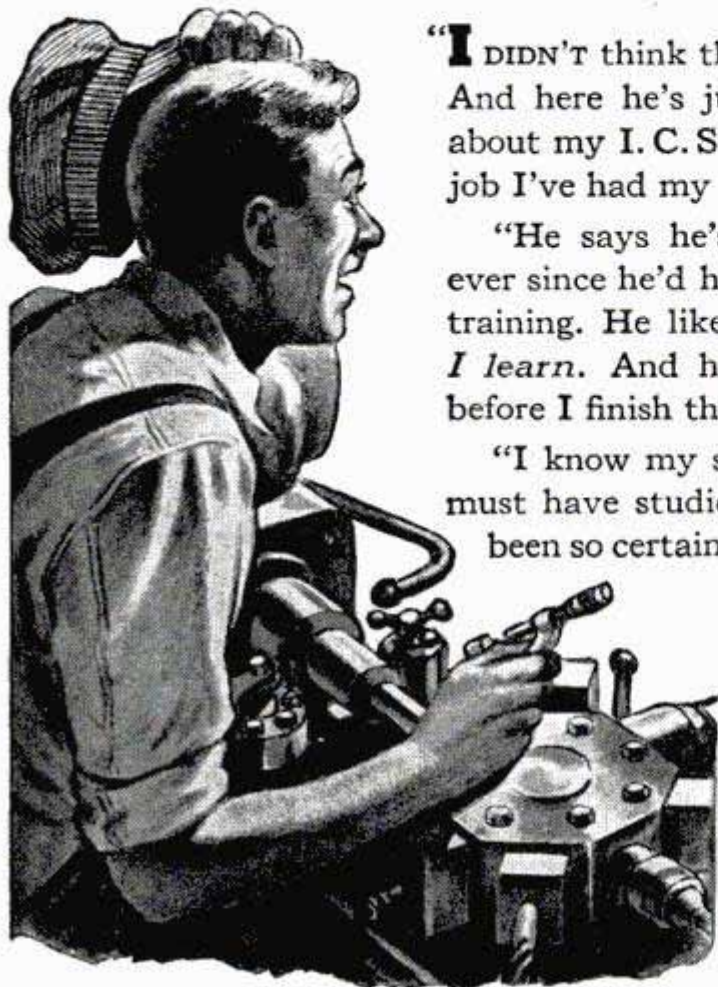

"I DIDN'T think the boss knew my name. And here he's just stopped by to talk about my I. C. S. Course and the bigger job I've had my eye on.

"He says he's had *his eye on me* ever since he'd heard I was getting that training. He likes the idea of my applying what I learn as *I learn*. And he says there'll be good news for me even before I finish the course.

"I know my studies showed in my work. But I guess he must have studied with I. C. S. himself or he couldn't have been so certain about just where I was getting my training."

Quite possibly the boss *is* an I. C. S. graduate. Thousands of employers are. Whether he is or isn't, however, he knows about your studies. I. C. S. regularly reports student progress to superiors. Letters of employer appreciation for this service are a regular part of our mail. So are student and graduate letters telling us of advancements—600 a month on an average. There *must* be a connection. Mail the coupon for full information.

## INTERNATIONAL CORRESPONDENCE SCHOOLS

APPROVED  
under the  
G.I. BILL

BOX 5664-K, SCRANTON 9, PENNA.

Without cost or obligation, please send me full particulars about the course BEFORE which I have marked X:

- |   |  |  |  |
|---|--|--|--|
| <p><b>Air Conditioning and Plumbing Courses</b></p> <p><input type="checkbox"/> Air Conditioning<br/><input type="checkbox"/> Heating<br/><input type="checkbox"/> Refrigeration<br/><input type="checkbox"/> Plumbing<br/><input type="checkbox"/> Steam Fitting</p> <p><b>Chemical Courses</b></p> <p><input type="checkbox"/> Chemical Engineering<br/><input type="checkbox"/> Chemistry, Analytical<br/><input type="checkbox"/> Chemistry, Industrial<br/><input type="checkbox"/> Chemistry, Mfg. Iron &amp; Steel<br/><input type="checkbox"/> Petroleum Refining<br/><input type="checkbox"/> Plastics<br/><input type="checkbox"/> Pulp and Paper Making</p> <p><b>Civil Engineering, Architectural and Mining Courses</b></p> <p><input type="checkbox"/> Architecture<br/><input type="checkbox"/> Architectural Drafting<br/><input type="checkbox"/> Bridge and Building Foreman<br/><input type="checkbox"/> Building Estimating<br/><input type="checkbox"/> Civil Engineering<br/><input type="checkbox"/> Coal Mining<br/><input type="checkbox"/> Contracting and Building<br/><input type="checkbox"/> Highway Engineering<br/><input type="checkbox"/> Lumber Dealer<br/><input type="checkbox"/> Reading Structural Blueprints<br/><input type="checkbox"/> Sanitary Engineering<br/><input type="checkbox"/> Structural Drafting</p> | <p><input type="checkbox"/> Structural Engineering<br/><input type="checkbox"/> Surveying and Mapping</p> <p><b>Communications Courses</b></p> <p><input type="checkbox"/> Electronics<br/><input type="checkbox"/> Practical Telephony<br/><input type="checkbox"/> Radio, General<br/><input type="checkbox"/> Radio Operating<br/><input type="checkbox"/> Radio Servicing<br/><input type="checkbox"/> Television<br/><input type="checkbox"/> Telegraph Engineering</p> <p><b>Electrical Courses</b></p> <p><input type="checkbox"/> Electrical Drafting<br/><input type="checkbox"/> Electrical Engineering<br/><input type="checkbox"/> Electric Light and Power<br/><input type="checkbox"/> Lighting Technician<br/><input type="checkbox"/> Practical Electrician</p> <p><b>Internal Combustion Engines Courses</b></p> <p><input type="checkbox"/> Auto Technician<br/><input type="checkbox"/> Diesel-Electric<br/><input type="checkbox"/> Diesel Engines<br/><input type="checkbox"/> Aviation<br/><input type="checkbox"/> Gas Engines</p> <p><b>Mechanical Courses</b></p> <p><input type="checkbox"/> Aeronautical Engineer's, Jr.<br/><input type="checkbox"/> Aircraft Drafting<br/><input type="checkbox"/> Flight Engineer<br/><input type="checkbox"/> Forging<br/><input type="checkbox"/> Foundry Work<br/><input type="checkbox"/> Heat Treatment of Metals<br/><input type="checkbox"/> Industrial Engineering<br/><input type="checkbox"/> Industrial Instrumentation</p> | <p><input type="checkbox"/> Industrial Metallurgy<br/><input type="checkbox"/> Machine Shop<br/><input type="checkbox"/> Mechanical Engineering<br/><input type="checkbox"/> Mold-Loft Work<br/><input type="checkbox"/> Patternmaking—Wood, Metal<br/><input type="checkbox"/> Reading Shop Blueprints<br/><input type="checkbox"/> Sheet-Metal Drafting<br/><input type="checkbox"/> Sheet-Metal Worker<br/><input type="checkbox"/> Ship Drafting<br/><input type="checkbox"/> Tool Designing<br/><input type="checkbox"/> Toolmaking<br/><input type="checkbox"/> Welding Engineering<br/><input type="checkbox"/> Welding—Gas and Electric</p> <p><b>Railroad Courses</b></p> <p><input type="checkbox"/> Air Brake<br/><input type="checkbox"/> Diesel Locomotive<br/><input type="checkbox"/> Locomotive Engineer<br/><input type="checkbox"/> Locomotive Fireman<br/><input type="checkbox"/> Locomotive Machinist<br/><input type="checkbox"/> Railroad Section Foreman<br/><input type="checkbox"/> Steam-Diesel Loco. Eng.</p> <p><b>Stationary Eng'g Courses</b></p> <p><input type="checkbox"/> Boilermaking<br/><input type="checkbox"/> Combustion Engineering<br/><input type="checkbox"/> Engine Running<br/><input type="checkbox"/> Marine Engineering<br/><input type="checkbox"/> Power Plant Eng'g</p> | <p><input type="checkbox"/> Mech. Drafting<br/><input type="checkbox"/> Ship Fitting<br/><input type="checkbox"/> Ship Fitting<br/><input type="checkbox"/> Toolmaking<br/><input type="checkbox"/> Car Inspector<br/><input type="checkbox"/> Steam Engr.</p> <p><b>Textile Courses</b></p> <p><input type="checkbox"/> Cotton Manufacturing<br/><input type="checkbox"/> Loom Fixing<br/><input type="checkbox"/> Textile Designing<br/><input type="checkbox"/> Rayon Weaving<br/><input type="checkbox"/> Woolen Manufacturing</p> <p><b>Business and Academic Courses</b></p> <p><input type="checkbox"/> Accounting<br/><input type="checkbox"/> App. Psychology<br/><input type="checkbox"/> Business Administration<br/><input type="checkbox"/> Bus. Correspondence<br/><input type="checkbox"/> Certified Public Accounting<br/><input type="checkbox"/> Commercial<br/><input type="checkbox"/> Cost Accounting<br/><input type="checkbox"/> Federal Tax<br/><input type="checkbox"/> Foremanship<br/><input type="checkbox"/> Good English<br/><input type="checkbox"/> Higher Mathematics<br/><input type="checkbox"/> Industrial Supervision<br/><input type="checkbox"/> Motor Traffic<br/><input type="checkbox"/> Retailing<br/><input type="checkbox"/> Salesmanship<br/><input type="checkbox"/> Sign Lettering<br/><input type="checkbox"/> Spanish<br/><input type="checkbox"/> Traffic Management</p> <p><input type="checkbox"/> Advertising<br/><input type="checkbox"/> Bookkeeping<br/><input type="checkbox"/> Business Administration<br/><input type="checkbox"/> Bus. Law<br/><input type="checkbox"/> Commercial Art<br/><input type="checkbox"/> Commercial Art<br/><input type="checkbox"/> First Year College<br/><input type="checkbox"/> French<br/><input type="checkbox"/> High School<br/><input type="checkbox"/> Illustration<br/><input type="checkbox"/> Postal Civil Service<br/><input type="checkbox"/> Retail Bus. Management<br/><input type="checkbox"/> Secretarial<br/><input type="checkbox"/> Stenography</p> |
|---|--|--|--|

Name \_\_\_\_\_ Age \_\_\_\_\_ Home Address \_\_\_\_\_

City \_\_\_\_\_ State \_\_\_\_\_ Working Hours \_\_\_\_\_ A.M. to \_\_\_\_\_ P.M.

Present Position \_\_\_\_\_ Employed by \_\_\_\_\_

Length of Service in World War II \_\_\_\_\_ Enrollment under G.I. Bill approved for World War II Veterans. Special tuition rates to members of the Armed Forces. Canadian residents send coupon to International Correspondence Schools Canadian, Ltd., Montreal, Canada.

# INVENTORS-PATENTS

Unless an inventor is thoroughly familiar with such matters, he is advised to employ a competent registered patent attorney or agent as the value of patents depends largely upon the skillful preparation of the specification and claims.

For his guidance, the following are the usual preliminary steps which the inventor takes toward patent protection.

The "Evidence of Invention" form mentioned below is offered as a convenience to the inventor in making his disclosure of invention.

The inventor should date and sign his disclosure and have it witnessed by two or more persons who are capable of understanding his invention. The disclosure should then be mailed to the registered patent attorney or agent whom he selects to assist him. The disclosure should be accompanied by a letter authorizing the patent attorney or agent to conduct a preliminary search among previously granted U. S. patents for similar types of invention. The patent attorney or agent then prepares a report of the probable patentability of the invention and recommends the further course the inventor should take, provided the report indicates possible patentability.

This firm is registered to practice before the U. S. Patent Office and is available to assist inventors in the preparation and prosecution of their cases. The coupon below is suggested as a convenience to the inventor in starting action on his invention.

**VICTOR J. EVANS & Co.** *Merlin M. Evans*  
REGISTERED PATENT ATTORNEY

430-M MERLIN BUILDING, WASHINGTON 6, D. C.

• • • • •

• VICTOR J. EVANS & CO. •  
• 430-M Merlin Building, Washington 6, D.C. •

• Please send me without obligation a copy of your •  
• booklet "Patent Protection For Inventors" together •  
• with your convenient "Evidence of Invention" form. •

• Name..... •

• Address..... •

• City and State..... •

• • • • •

PATENTS      TRADEMARKS      COPYRIGHTS

## WANTED MAN WITH CAR



### No Time Like Now to Get In McNess Business

It's no trick to make good money when you use your car as a McNess "Store on Wheels." Farmers buy everything they can from McNess Men because McNess Products are tops in quality, represent extra values. Attractive business-getting prizes and premiums; also money-saving deals to customers make selling McNess daily necessities a snap.

### We Supply Capital—Start Now!

There's no better work anywhere. Pays well, permanent, need no experience to start, and we supply capital to help you get started quick. You begin making money first day. Write at once for McNess Dealer Book. It's FREE. Tells all—no obligation. (1)

THE McNESS CO., 817 Adams St., Freeport, Ill.

Use Your  
CAR  
to Raise  
Your  
PAY

## SUCCEED IN THE POULTRY BUSINESS!



Poultry is providing many trained men and women with a good, comfortable living, either part or full time. For 28 years our Home Study Course has been helping thousands obtain training and "know how" that means extra income from the start. Don't delay — Write today for prospectus describing courses, methods, service, opportunities.

NATIONAL POULTRY INSTITUTE

DEPT. 50

ADAMS CENTER, N. Y.

## LAW FREE BOOK



Your FREE copy of "The Law-Trained Man" shows how to gain prestige and greater earnings through Blackstone home law study. All instruction material furnished including 18-volume Law Library written by 65 well-known law authorities. Lawyers, judges among our graduates. LL.B. degree. Low cost; easy terms. Write today.

BLACKSTONE COLLEGE OF LAW 225 N. Michigan Ave. Dept. 58, Chicago 1, Ill.  
A Correspondence Institution Founded in 1890

## REAL ESTATE BE A BROKER

**PAYS BIG! SEND FOR FREE, BIG, ILLUSTRATED CATALOG NOW!** No obligation. Graduates report making substantial incomes. Start and run your own business quickly. Men, women of all ages, learn easily. Course covers Sales, Property Management, Appraising, Loans, Mortgages, and related subjects. **STUDY AT HOME** or in our classrooms in big cities. Diploma awarded. G.I. approved. Nationally known.

WEAVER SCHOOL OF REAL ESTATE (Est. 1936)  
15 E. Pershing Road Dept. PM-11 Kansas City, Mo.

FREE BOOK TELLS HOW

## IS YOUR JOB DEPRESSION PROOF?

Can you lose employment because of depression, business failure or old age? Learn watchmaking, the mechanical profession called "depression-proof for trained men" by impartial national authorities. Old age brings increased respect rather than insecurity. Study veteran training approved courses in watch and clock repair, jewelry engraving, chronograph repair at the world's largest, best-equipped watchmaking school.

SEND FOR FREE 116-PAGE INFORMATION PACKET

WESTERN PENNSYLVANIA  
HOROLOGICAL INSTITUTE  
WORLD'S LARGEST WATCHMAKING SCHOOL



DESK 40, 808 RIDGE AVE., PITTSBURGH 12, PA.

# THESE MEN ARE GETTING PRACTICAL TRAINING IN **ELECTRICITY**

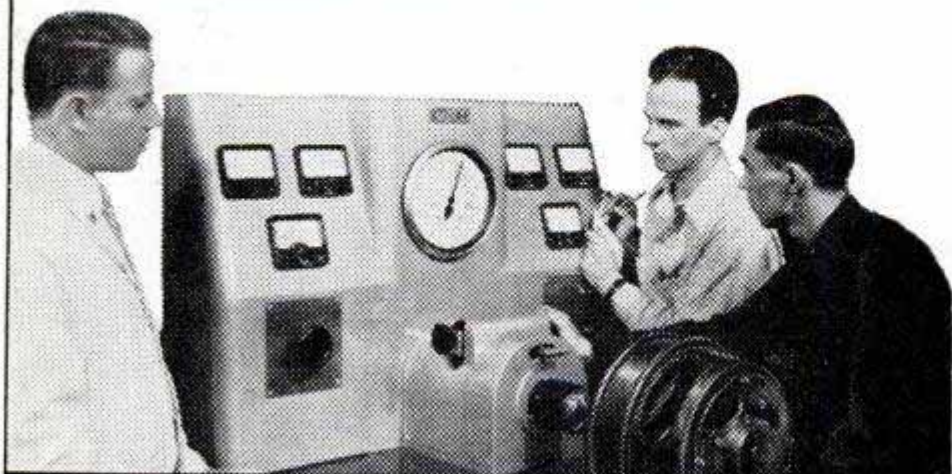

*On Real:*

**A.C. and D.C. MOTORS  
GENERATORS  
SWITCHBOARDS  
CONTROLLERS  
WIRING JOBS  
APPLIANCES  
ELECTRONIC UNITS**

*(Shown at left—Instructor demonstrating latest type of Test Unit for checking the efficiency of a Motor.)*

# AND **RADIO-TELEVISION**

*On Real:*

**TELEVISION SETS  
RADIO RECEIVERS  
F.M. (Frequency Modulation)  
RECORD CHANGERS  
AUTO RADIOS  
AIRPLANE RADIOS  
PUBLIC ADDRESS Systems**

*(Right—Instructor explaining operation of 20-inch Cathode Ray tube used in Dumont Television Set.)*

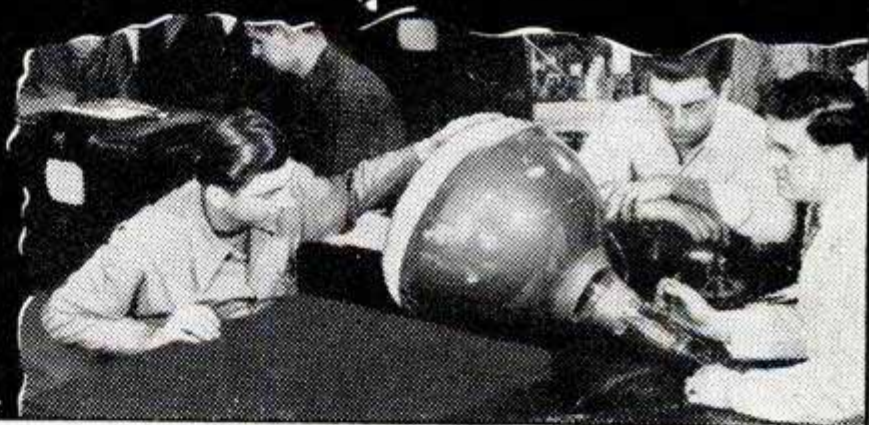

## Just Like YOU Can Get in the Great SHOPS of COYNE

Prepare NOW for a real future the quick, practical way. Come to the Great Shops of COYNE in Chicago. Largest and best equipped school of its kind—now celebrating our 50th Anniversary. GI approved. Finance plan for non-veterans. **Mail coupon.**

**NOT "HOME-STUDY" COURSES!** At Coyne you learn on real, full-size equipment. Trained instructors show you how, then you do typical jobs yourself. We don't teach by mail.

**CLIP COUPON NOW** for big new illustrated Coyne book on either **ELECTRICITY** or **RADIO-TELEVISION** or both. No obligation; no salesman will call. Get the facts now!

**COYNE** **ELECTRICAL & RADIO SCHOOL**  
500 S. Paulina St., Dept. 89-72H  
Chicago 12, Ill.

B. W. COOKE, Pres.

**Mail Coupon for**

**FREE BOOKS!**



B. W. COOKE, President  
COYNE ELECTRICAL &  
RADIO SCHOOL, Dept. 89-72H  
500 S. Paulina St., Chicago 12, Ill.

Send **FREE**, the book checked below, and details of your training offer. This does not obligate me and **no salesman will call.**

**ELECTRICITY**       **RADIO-TELEVISION**

NAME .....

ADDRESS.....

CITY.....STATE.....



# C. T. I. BRINGS SHOP PROVED TRAINING INTO YOUR HOME!



## LEARN A WELL-PAID TRADE THIS PRACTICAL WAY!

The methods used in teaching you a trade through C.T.I. Home Study have been thoroughly tested in C.T.I.'s modern shops in Chicago. These *shop-proved* principles save you a great deal of time, insure intensive yet complete technical training, and provide a wonderful foundation on which to build a successful future.

The superiority of C.T.I. training is emphasized repeatedly by C.T.I. graduates, thousands of whom earn good income or own a business of their own. You'll gain confidence from these inspiring messages: "I am earning from \$75 to \$95 a week, and have established a fine reputation for doing good work. I thank C.T.I. for helping me learn a trade." . . . "Your training makes me feel I am somebody. In the near future I will open my own shop." . . . "I am working in a shop on a 50-50 basis. Yesterday the owner turned over the entire shop to me, with instructions to run it as I see fit. He said that although I was just out of school, I knew what I was doing." . . .

"I have done a lot of things in my life, but the smartest and biggest step toward success was taking a C.T.I. course." . . . "I now make twice as much as I did before. The extra money sure takes care of those bills I used to worry about." . . .

Why delay *your* training? A complete course of study is waiting for you at C.T.I.—and we'll bring it to your home! Choose your field from the opportunities listed in the coupon below, fill out, and mail today!

### C.T.I. TRAINING IS G. I. APPROVED

All C.T.I. courses, both residential and home study, are fully approved by the Veterans Administration—which means that eligible veterans will have their tuition paid by the government. Remember, there's a time limit on when training must begin, so act now!

**NON-VETERANS**—We'd like to tell you about our Easy-Payment Finance Plan and Pay-After-Graduation Plan. Write for information.

#### C.T.I. OFFERS PRACTICAL TRAINING IN

- AUTOMOTIVE MECHANICS
- BODY & FENDER REBUILDING
- DIESEL MECHANICS
- REFRIGERATION & AIR CONDITIONING
- ELECTRICITY & ELECTRONICS
- RADIO & TELEVISION
- BUILDING CONSTRUCTION
- MECHANICAL DRAFTING

#### FILL OUT - CUT OUT - MAIL TODAY

Mr. R. C. Anderson, President  
COMMERCIAL TRADES INSTITUTE, Dept. E2-11  
1400 W. Greenleaf, Chicago 26, Ill.

Send free illustrated Brochures and other information about the field I have checked below:

- Veteran     Non-Veteran
- |   |  |
|---|--|
| <input type="checkbox"/> Automotive Mechanics             | <input type="checkbox"/> Electricity & Electronics |
| <input type="checkbox"/> Body & Fender Rebuilding         | <input type="checkbox"/> Radio & Television        |
| <input type="checkbox"/> Diesel Mechanics                 | <input type="checkbox"/> Building Construction     |
| <input type="checkbox"/> Refrigeration & Air Conditioning | <input type="checkbox"/> Mechanical Drafting       |

Name \_\_\_\_\_ Age \_\_\_\_\_

Address \_\_\_\_\_

City \_\_\_\_\_ State \_\_\_\_\_

**COMMERCIAL TRADES INSTITUTE, Dept. E2-11**  
1400 Greenleaf Chicago 26





GET INTO

# DIESEL-AUTO MECHANICS

Master All Phases

**JOB LIKE THESE ARE AVAILABLE TO TRAINED MECHANICS. CHOOSE THE FIELD YOU LIKE BEST**

### Get Complete Training

- Diesel Fuel Injection
- Automotive Motor Tune-up
- Diesel Engine Rebuilding
- General Garage Mechanic
- Agricultural Implements
- Auto Engine Rebuilding
- Auto Elec. Service
- Public Utilities
- Parts Dealers
- Bus & Truck Lines
- Industrial Maintenance
- Contracting & Excavating
- Business of Your Own
- AND MANY other similar openings.

As a National Schools graduate, you are trained for ALL opportunities in the Diesel & Auto Industries

### EARN WHILE YOU LEARN

With our practical Master Shop-Method Home Training, you study at home in your spare time. You receive Spare Time Work Lessons, which show you how to earn while you Learn . . . for extra money and experience. You Learn by DOING.

### TOOLS AND EQUIPMENT

To make your training complete, we give you selected mechanic's tools and equipment, illustrated below, including all-metal toolbox—as a regular part of your instruction.



**WE GIVE YOU TOOLS OF YOUR TRADE**



### Shop-Method Home Training by an Established Resident School Prepares you for Many Good Jobs

Opportunity is everywhere for the trained Diesel-Auto Mechanic. Highways throng with cars, busses, trucks, tractors. Garages and Service Stations are kept busy. Factories, ships, farms, railroads, general industry, are dependent upon engine power. Here's a dynamic, fast-growing field that needs trained men who know ALL phases: installation, operation, maintenance and repair. Now—National Schools offers you a practical, all-embracing Diesel-Auto Mechanic's Course, including all of these advantages:

### Complete training, covering—Diesels, High Speed and Heavy Duty; Semi-Diesels, Gasoline and Special Fuel Engines AND Allied Mechanics.

- Basic Lesson Texts
- Diesel Installation
- Operation - Maintenance
- Diesel Chart Manual
- Spare Time Lessons
- Engine Service Manuals
- Engine Repair
- Drive Systems
- Diesel Electric Power
- Thermodynamics

### TOOLS AND EQUIPMENT

#### INVESTIGATE

Secure Full Information

**NEW, ILLUSTRATED BOOK & SAMPLE LESSON SHOW HOW WE TRAIN YOU . . . SEND FOR THEM TODAY!**



NO COST

NO OBLIGATION

APPROVED FOR VETERANS

Check coupon below

## NATIONAL SCHOOLS

LOS ANGELES 37, CALIF. • EST. 1905



### FIND OUT NOW...MAIL COUPON TODAY

NATIONAL SCHOOLS, DEPT. 11-PMO  
4000 South Figueroa Street  
Los Angeles 37, California

(Mail in envelope or paste on penny postcard)

Mail me FREE the book, YOUR FUTURE IN DIESEL-AUTO MECHANICS, together with the Sample Lesson. I understand I may keep and use the information with no obligation.

Name \_\_\_\_\_ Age \_\_\_\_\_

Address \_\_\_\_\_

City \_\_\_\_\_ Zone \_\_\_\_\_ State \_\_\_\_\_

Check here if Veteran of World War II



## Start As High as \$3,351 a Year Get Ready Now for Coming Examinations in Your Section

**Veterans Get Preference**

### Railway Postal Clerks

Railway Postal Clerks get \$2,750 the first year regular, being paid on the first and fifteenth of each month. (\$114.60 each pay day.) Their pay is automatically increased yearly to \$3,850. Advance may be had to Chief Clerk at \$5,850 a year. (\$243.75 each pay day.)

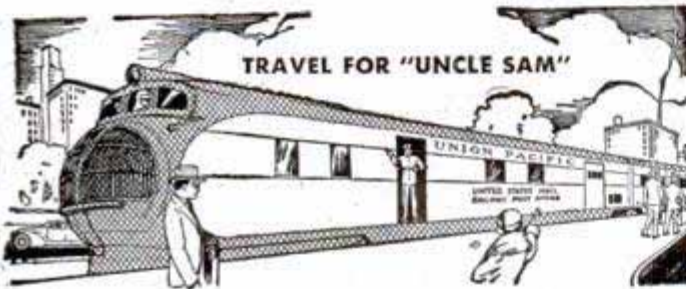

### 3 Days On—3 Days Off—Full Pay

Railway Postal Clerks on long runs usually work 3 days and have 3 days off duty or in the same proportion. During this off duty their pay continues just as though they were working. They travel on a pass when on business. When they grow old, they are retired with a pension.

### City Mail Carriers, Post Office Clerks

Clerks and Carriers now get \$2,500 the first year on regular and automatically increase \$100 a year to \$3,550. Open to men-women 18 to 50.

## GOVERNMENT CLERK



### Many Other Positions

Many other positions are obtainable. Rural Carriers—Stenographers—Typists—Assistant Statistical Clerks—Customs Inspectors—Office Machine Operators—etc. Those wishing these positions should qualify at once.

### Get Free List of Positions

Fill out the following coupon. Tear it off and mail it today—NOW, at once.

This investment can help you to get a big-paid government job.

**FRANKLIN INSTITUTE, Dept. X-83, Rochester 4, N. Y.**

(Not Government Controlled)

Rush to me, entirely free of charge (1) a full description of U. S. Government Jobs; (2) Free copy of illustrated 40-page book, "How To Get A U. S. Government Job"; (3) List of U. S. Government Jobs; (4) Tell me what to do to qualify for one of these jobs.

Name \_\_\_\_\_

Address \_\_\_\_\_ Vet? \_\_\_\_\_

Use This Coupon Before You Mislaid It. Write or Print Plainly.

(Continued from page 14)

Bathroom door latch can be opened in emergency.....	186
Steps of ladder made slip-proof.....	186
Potting the top of a pineapple.....	186
Handy window mask for painting sash.....	187
Colander keeps frying grease from splattering.....	187
Suspending wire coat hangers from door.....	187
Spring-type clothespins used when dyeing clothes.....	187
Tags tied to heating-system valves give emergency information.....	202
Old dress serves as pattern.....	202
Taping cord to vacuum cleaner prevents loose connections.....	203
Fan placed on electric range dries hair quickly.....	209
Sidewalk snowplow of sheet metal mounted on lawn mower.....	214

### NOVELTIES

Jewelry box turned from dark hardwood is ornamented with tooled gold rose.....	184
Twin pin-up lamps in plastic.....	189
Miniature plant stands.....	199
Black-walnut book ends in ultramodern design.....	202
Frying pans form lighting fixture for high cabin ceiling.....	203
Coconut-shell baskets.....	215

### OFFICE, SHOP AND STORE

Shadowgraph utilizes sheet of glass to produce interesting designs.....	198
Portable filing cabinet.....	200
Automatic straightedge utilizes odds and ends.....	223
Horseshoe magnet used as anchor simplifies marking metal price tags.....	231
Typing gummed labels in quantity.....	231

### OUTDOOR RECREATION

Simple formula for waterproofing outdoor blankets and woolen clothing.....	184
Hand brakes mounted on sides of toboggan permit both speed and directional control.....	185
Clock spring set under trap pan stops tripping by small animals.....	188

### PAINT AND PAINTING

Removing paint from fabric.....	188
Warming varnish aids spreading.....	203
Increasing efficiency of spray gun powered with vacuum cleaner.....	209
Cover eliminates capping paints.....	224

### PHOTOGRAPHY

Dual-purpose hot plate.....	216
Filing cabinet utilizes cigar boxes for holding classified negatives.....	217
Shadowless table-top shots.....	217
Drop outlets on flash-gun extensions prevent pulling cords in front of lens.....	218
Proper diaphragm opening indicated by handy table taped to camera.....	218
Photo outlined with luminous paint brightens youngster's sleeping room.....	218
Sanding new wooden photo tongs insures undamaged prints.....	218
Lamp dries ferrotyped prints without curling.....	219
Paper cut-film separators hold chemicals for weighing on balance.....	219
Viewer aids color-slide projection.....	219
Heating pad under developer tray controls solution temperature.....	220
Salt softens contrasty picture.....	220
Flash bulbs fired simultaneously by contact-ignition method.....	220
Correcting off-color transparency for improved projection.....	220
Tape stuck to glass funnel permits steady flow.....	220
Corks floating in washing tray keep prints from sticking.....	220

### TOOLS

Wall rack for hacksaw blades.....	198
Phonograph needle held in pencil provides plastic scriber.....	203
Improvised modelmaker's clamp.....	214
Tractor exhaust preheats blowtorch.....	224
Novel spring-brass tweezers retrieve small parts.....	224
Removing broken bolts or studs.....	231

### MISCELLANEOUS

String gloves protect nylons.....	185
Beam recharges luminous ring painted around flashlight lens.....	188
Length of twine removes cork from inside of bottle.....	203
Cork sheathes blade point.....	214
Gluing model airplanes simplified.....	214
Glass container for toothbrush.....	214
Self-tilting kerosene drum rests on auto springs.....	231

## Radio-Television, Electronics

Special-purpose antennas (American Phenolic Corp., 1830 S. 54th Ave., Chicago 50).....	237
Indoor a.c.-d.c. amplifier for hard-of-hearing persons.....	238
Radio and electronics today (Automatic record changer, Webster-Chicago Corp., 5610 Bloomingdale Ave., Chicago 39; wave traps and line filter, Meissner Mfg. Co., Mt. Carmel, Ill.; radio built into table lamp, Allied Radio Corp., 833 W. Jackson Blvd., Chicago 7; clock radio, General Electric Company, Schenectady, N. Y.; TV pay-as-you-see meter, Crosley Radio Division of Avco Mfg. Corp., Cincinnati, Ohio).....	240

**IMPORTANT NOTICE**—It is the intention of this magazine to provide its readers with information regarding the latest developments in the mechanical arts. We take no responsibility as to whether the disclosures contained in our articles are covered by patents and advise readers to investigate this subject before making, using, or selling any of the products, machines, or processes described in order to avoid possible liability for patent infringements.



**NOW!** Build and Keep  
Big Screen Top Quality  
Television Receiver at Home  
as You Prepare for a  
Profitable job in  
**TELEVISION  
RADIO-ELECTRONICS**

**Choice of 10, 12½ or 16 inch picture tube**

Now you can get this amazingly practical aid for learning Television at home, to help you get started toward **FASCINATING WORK . . . GOOD MONEY . . . a THRILLING FUTURE**—in a real job, or your own sales and service business. \* When you complete our regular home training—described below—you can build and keep a top quality commercial-type Television Re-

ceiver. Standardized chassis is adaptable for a 10, 12½ or 16 inch direct view tube that gives big, bright, sharp, steady pictures. This is an optional training advantage—designed to provide the utmost in practical “learn-by-doing” home training in Television. Mail coupon for complete details. See why you owe it to your “Television Future” to enroll for DeForest’s Training, Inc.

**Mail Coupon NOW for FREE Information!**

See how D. T. I.’s amazingly effective methods help start you toward a **GOOD JOB** or your **OWN BUSINESS** in one of America’s most promising fields—including Television, F.M. Radio, Aviation, Train, and Taxi Radio, Broadcast Radio, Industrial Electronics. Get modern lessons . . . plus 16 shipments of Radio-Electronic parts. Work over 300 experiments and projects—including building of (1) commercial-type **OSCILLOSCOPE** for practical

T-V circuit training, (2) double-range R-F **SIGNAL GENERATOR**, (3) jewel-bearing **MULTIMETER**, (4) quality 6-tube **SUPERHET RADIO**. Then build and keep that big new Television Receiver. Here’s **EVERYTHING YOU NEED** for real laboratory type training . . . **AT HOME!**

*You also build and keep this Professional Type Equipment*



**Modern Chicago Laboratories**

\* If you prefer, you can get **ALL** your preparation in our new, Chicago training laboratories . . . one of the finest of its kind. Ample instructors . . . modern equipment. Write for details!

**Employment Service**

\* When you complete your training, our effective Employment Service helps you get started toward a real future in Television—Radio—Electronics.



**You also use HOME MOVIES! a D. T. I. Exclusive!**

D. T. I. alone includes the modern, visual training aid . . . **MOVIES . . .** to help you learn faster, easier at home. See electrons on the march and other fascinating “hidden action”—a remarkable home training advantage that speeds your progress.

**MAIL THIS COUPON NOW!**

**DeFOREST’S TRAINING, INC.**  
2533 North Ashland Avenue, Dept. PM-F11  
Chicago 14, Illinois

Without obligation, give me complete facts showing how I may make my start in Television-Radio-Electronics.

Name..... Age.....  
Street..... Apt.....  
City..... Zone..... State.....

**De FOREST’S TRAINING, INC.**  
CHICAGO 14, ILLINOIS  
A DE VRY Institution



# BEYOND EARTH

## What Strange Cosmic Power Influences Humans ?

BY WHAT RIGHT does man presume that he is the chosen being of the universe and that the earth alone shapes his existence? In the infinite spaces above, tenanted by vast and magnificent worlds, are Cosmic forces which influence the life of every mortal. As iron filings respond to the attraction of a magnet, so too, your acts are the result of an impelling influence upon your will. Just as the unseen Cosmic rays give the earth form and substance, so too, from the infinite reaches, an invisible subtle energy affects the thought processes of every human. Life itself bows to this strange universal force—why, then, should YOU not understand and COMMAND IT? You are like a pendulum either to be swung forward to happiness and the fulfillment of your dreams, or backward into discouragement and disillusionment. Why remain poised in a state of anxiety, uncertainty, and anticipation? Learn to draw to yourself these Cosmic forces which will give your mind the creative impetus that will assure the end in life you seek.

### For You — A Gift Copy of the Sealed Book

Not for the curious nor the skeptical, but for the modern man and woman the Rosicrucians, a progressive movement of thinking persons, offer a free, Sealed Book, telling how you may acquire the truth about these phenomenal Cosmic powers little understood today and which make for freedom and attainment in life. THIS IS THE DAY AND AGE OF MASTERY. Throw off the age-old custom of—"let life be as it may"—and learn to *create it as you wish it.*

**The ROSICRUCIANS**  
(AMORC)  
SAN JOSE, CALIFORNIA

#### USE THIS GIFT COUPON

Scribe M. C. J. The Rosicrucians (AMORC)  
Rosicrucian Park, San Jose, California.

Please send me without obligation the free, Sealed Book, which tells how I may obtain the unusual facts about the Cosmic forces which affect my life.

NAME.....

ADDRESS.....

CITY..... STATE.....

✦ *The Rosicrucians are NOT a Religious Organization* ✦

Worth Big Money To: Mechanics, Handymen, Garagemen, Farmers, Repair Men, Service Station Operators, Taxi Owners.

# NOW ANY Auto Repair Job IS A "Cinch" for YOU!



MoToR's BRAND-NEW 1949 Edition AUTO REPAIR MANUAL is Showing Thousands of Men How to Handle ANY Job on ANY Car—Faster and Easier! Now Let It Go to Work For You!

WITH MoToR's amazing brand-new AUTO REPAIR MANUAL you can whiz through ANY job—in LESS time, and with LESS work! Just look up make, model, and job—and go to it! With this easy-to-follow book, any job—from radiator to rear end—becomes a pushover for you!

**"EVERYTHING You Need to Know about EVERY Make and Model Car Since 1935!"**

MoToR's Manual brings you the complete "dope" from over 150 Official Factory Shop Manuals, boiled down in simple easy-to-read and understand words and 2100 big clear pictures. Over 200,000 service, repair, tune-up facts on all standard makes and models built from 1935 thru 1949! 35,000 essential dimensions and specifications. 795 big 8½ x 11-inch pages. Used by the U. S. Army and Navy technical schools! No wonder thousands of auto repairmen call it their auto "Bible"!

**Win Prestige! Earn More Money!**

MoToR's Manual makes every operation so easy that you'll find yourself tackling jobs you wouldn't think of doing before. And you'll win added prestige and more money in the bargain.

Beginners will find usable, helpful guidance on every kind of repair and service job imaginable. Experts will be amazed by time and labor-saving short cuts they'll discover.

Used by  
U. S. Army  
and Navy

COVERS ANY  
CAR BUILT  
SINCE 1935!

- Auburn
- Austin
- Buick
- Cadillac
- Chevrolet
- Chrysler
- Ford
- Frazer
- Graham
- Hudson
- Hupmobile
- Kaiser
- Lafayette
- La Salle
- Lincoln
- Mercury
- Nash
- Oldsmobile
- Packard
- Pierce
- Arrow
- Plymouth
- Pontiac
- Reo
- Studebaker
- Terraplane
- Willlys
- Cord
- Crosley
- De Soto
- Dodge
- Ford
- Frazer
- Graham
- Hudson
- Hupmobile
- Kaiser
- Lafayette
- La Salle
- Lincoln
- Mercury
- Nash
- Oldsmobile
- Packard
- Pierce
- Arrow
- Plymouth
- Pontiac
- Reo
- Studebaker
- Terraplane
- Willlys

ABOVE: Showing operation of Buick Dyna-Flow — and BELOW: How to adjust Ford Clutch. Every moving part is covered in simple words and BIG, CLEAR Pictures.

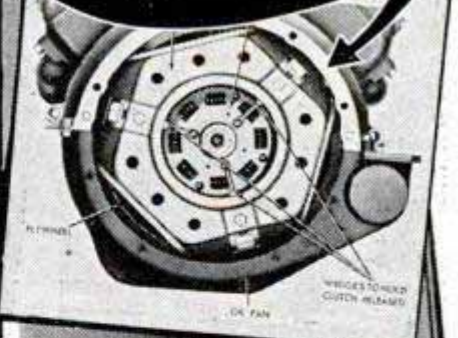

"MoToR's Manual paid for itself on the first 2 jobs and saved me valuable time eliminating guess-work." — W. SCHROF, Ohio



"I have done jobs with this Manual that I would not attempt without it." — C. L. VANERSTROM, Hazel Park, Mich.



"A boy can easily follow its instructions." — CURTIS AUBERRY, Murfreesboro, Tenn.

**Same FREE Offer on MoToR's TRUCK MANUAL**

Covers EVERY job on EVERY truck made from 1936 thru 1946! 1400 pictures, 952 pages, 300,000 facts. All types Gasoline Engines, Truck Diesels, Hesselmanns, Fuel Systems, Governors, Lubrication, Ignition, Starters, Clutches, Axles, Brakes, etc., etc.

ALSO covers many buses, tractors, contractor and road building equipment, stationary power machinery. Check box in coupon.

**FREE TRIAL**

**SEND NO MONEY**

Find out for yourself—without risking a cent—how this book pays for itself the first few times you use it. Mail the coupon without money. Try it out—FREE—for 7 days. Then if not convinced it's the greatest time-saver and work-saver you ever saw, return the book and pay nothing. MoToR Book Dept., Desk 111, 250 W. 55 Street, New York 19, N. Y.

Published by MoToR, The Leading Automotive Business Magazine



**MAIL COUPON NOW FOR 7-DAY FREE TRIAL**

**MoToR BOOK DEPT.**  
Desk 111, 250 W. 55th St., New York 19, N. Y.

Rush to me at once (check box opposite book you want):

MoToR's New AUTO REPAIR MANUAL. If O.K., I will remit \$1 in 7 days (plus 35c delivery charges), \$2 monthly for 2 months and a final payment of 95c one month after that. Otherwise I will return the book postpaid in 7 days. (Foreign price, remit \$8 cash with order.)

MoToR's TRUCK REPAIR MANUAL. (Described at left.) If O.K., I will remit \$2 in 7 days, and \$2 monthly for 3 months, plus 35c delivery charges with final payment. Otherwise I will return the book postpaid in 7 days. (Foreign price, remit \$10 cash with order.)

Print Name ..... Age .....

Print Address .....

City ..... State .....

Check box and save 35c delivery charge by enclosing WITH coupon entire payment of \$5.95 for Auto Repair Manual (or \$8 for Truck Repair Manual). Same 7-day return-refund privilege applies.



# \$250,000 FOR THIS!

## 2100 Other Inventions Badly Needed—Big Cash Waiting for Your Little Ideas

IT'S OFTEN the *simplest* ideas that make the *most* money! The Kiddie Kar brought its inventor a cool MILLION dollars. A 70-year-old grandmother made \$350,000 on an improved overall buckle. The paper clip, the hair-pin, the rubber pencil tip all made fortunes for the people who "dreamed" them up.

You can cash in, too — *if you concentrate on the inventions that are really needed!*

### The EASY Way to Get Started

Don't waste time and brain-work on something nobody wants! Find out WHAT to invent. A valuable book by Raymond F. Yates, noted science editor and inventor, lists and describes over 2100 PRACTICAL, money-making ideas that are crying aloud to be invented!

These 2100 ideas are the things *most needed* and *surest to make money*. They are listed under 34 different headings for quick reference: Electrical Radio, Automotive, Agricultural, Building, Household, Clothing, Toys, Time-savers, etc.

This book ALSO tells how to think inventively; how to PROTECT your ideas; how to develop an invention STEP-BY-STEP, etc.

## FREE EXAMINATION OFFER SEND NO MONEY

Wouldn't you like a slice of the \$280,000,000 that American inventors get each year in royalties? Get started now! You don't risk a penny. Simply mail coupon below **WITHOUT MONEY** — and get "2100 Needed Inventions," by Raymond F. Yates, for 5 days' FREE TRIAL. If, even in that short time, you are not convinced that this book can help you make money — just return it and owe nothing. Otherwise, send only \$2.50 plus few cents postage, as payment in full.

Any one of the 2100 ideas in this book can bring *somebody* a fortune. Maybe it can be YOU! Mail coupon at once! Wilfred Funk, Inc., Dept. T4911, 227 East 44th Street, New York 17, N. Y.

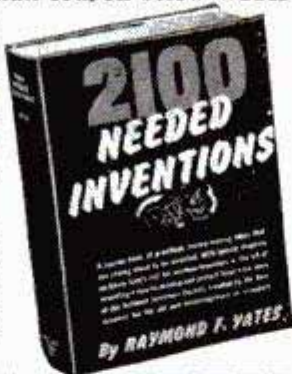

### FREE 5-DAY EXAMINATION

**WILFRED FUNK, Inc.**  
Publishers, Dept. T4911  
227 East 44 Street, New York 17, N. Y.

Please send me 2100 NEEDED INVENTIONS, for FREE EXAMINATION. If I keep the book I will send you \$2.50 plus few cents postage. Otherwise I will return it within 5 days, without further obligation.

Name \_\_\_\_\_

Address \_\_\_\_\_

City \_\_\_\_\_ Zone No. \_\_\_\_\_  
(if any) State \_\_\_\_\_

Check here if enclosing 2.50 WITH this coupon, and we will pay all postage charges. Same 5-day return privilege, for full refund, applies. *Canadian Orders—25c extra for carrying charges. (Only U.S. funds accepted.)*

# Command Bigger Money! STUDY LAW

STUDY AT HOME for BUSINESS SUCCESS and LARGER PERSONAL EARNINGS. 40 years expert instruction — over 114,000 students enrolled. LL.B. Degree awarded. All text material furnished. Easy payment plan. Send now for FREE BOOK — "Law and Executive Guidance." It explains the course — how you may enroll and the many ways you can profit from Law Study, Write TODAY to:

(GI Approved)

AMERICAN EXTENSION SCHOOL OF LAW  
Dept. 20-PM, 646 N. Michigan Ave., Chicago 11, Ill.

## FALSE TEETH KLUTCH holds them tighter

KLUTCH forms a comfort cushion; holds dental plates so much firmer and snugger that one can eat and talk with greater comfort and security; in many cases almost *as well as with natural teeth*. Klutch lessens the constant fear of a dropping, rocking, chafing plate. 25c and 50c at druggists. . . . If your druggist hasn't it, *don't waste money on substitutes*, but send us 10c and we will mail you a generous trial box. © I. P. INC.

KLUTCH CO. Box 4993-K ELMIRA, N. Y.

## SHORTHAND in 6 Weeks at Home

Famous Speedwriting system. No signs; no symbols; no machines; uses ABC's. Easy to learn; easy to write and transcribe. Low cost, 100,000 taught by mail. For business and Civil Service. Also typist. 26th year. Write for free booklet to:

## Speedwriting

Dept. 1511-9, 55 W. 42 St., New York 18

STATEMENT OF THE OWNERSHIP, MANAGEMENT, CIRCULATION, ETC., REQUIRED BY THE ACT OF CONGRESS OF AUGUST 24, 1912, AS AMENDED BY THE ACTS OF MARCH 3, 1933, AND JULY 2, 1946, OF POPULAR MECHANICS MAGAZINE, published monthly at Chicago, Illinois, for October 1, 1949.

State of Illinois, County of Cook, ss.  
Before me, a Notary Public in and for the State and county aforesaid, personally appeared H. H. Windsor, Jr., who, having been duly sworn according to law, deposes and says that he is the Editor of the Popular Mechanics Magazine, and that the following is, to the best of his knowledge and belief, a true statement of the ownership, management (and if a daily, weekly, semiweekly or triweekly newspaper, the circulation), etc., of the aforesaid publication for the date shown in the above caption, required by the Act of August 24, 1912, as amended by the acts of March 3, 1933, and July 2, 1946 (section of Postal Laws and Regulations), printed on the reverse of this form, to wit: First. That the names and addresses of the publisher, editor, managing editor, and business managers are: Publisher, Popular Mechanics Company, 200 E. Ontario St., Chicago, Ill.; Editor, H. H. Windsor, Jr., 200 E. Ontario St., Chicago, Ill.; Managing Editor, R. M. Grant, 200 E. Ontario St., Chicago, Ill.; Business Manager, W. H. Petridge, 200 E. Ontario St., Chicago, Ill. Second. That the owner is: (if owned by a corporation, its name and address must be stated and also immediately thereunder the names and addresses of stockholders owning or holding one percent or more of total amount of stock. If not owned by a corporation, the names and addresses of the individual owners must be given. If owned by a firm, company, or other unincorporated concern, its name and address, as well as those of each individual member, must be given.) Popular Mechanics Company, 200 E. Ontario St., Chicago, Ill., H. H. Windsor, Jr., 200 E. Ontario St., Chicago, Ill., H. H. Windsor, Jr., Trustee for H. H. Windsor III and Wm. T. Windsor, 200 E. Ontario St., Chicago, Ill. Third. That the known bondholders, mortgagees, and other security holders owning or holding 1 percent or more of total amount of bonds, mortgages, or other securities are: (if there are none, so state.) The Equitable Life Assurance Society of the United States, 29 S. LaSalle St., Chicago, Ill. Fourth. That the two paragraphs next above, giving the names of the owners, stockholders, and security holders, if any, contain not only the list of stockholders and security holders as they appear upon the books of the company but also, in cases where the stockholder or security holder appears upon the books of the company as trustee or in any other fiduciary relation, the name of the person or corporation for whom such trustee is acting, is given; also that the said two paragraphs contain statements embracing affiant's full knowledge and belief as to the circumstances and conditions under which stockholders and security holders who do not appear upon the books of the company as trustees hold stock and securities in a capacity other than that of a bona fide owner; and this affiant has no reason to believe that any other person, association, or corporation has any interest direct or indirect in the said stock, bonds, or other securities than as so stated by him. Fifth. That the average number of copies of each issue of this publication sold or distributed, through the mails or otherwise, to paid subscribers during the twelve months preceding the date shown above is (not daily publication). (This information is required from daily, weekly, semiweekly, and triweekly newspapers only.) H. H. Windsor, Jr., Editor. Sworn to and subscribed before me this 14th day of September, 1949, Vera L. Freehill, Notary Public. (My commission expires July 17, 1950.)

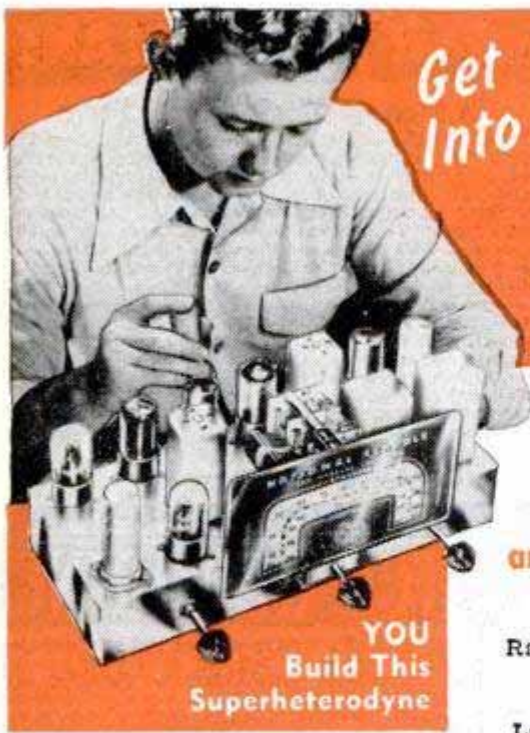

Get  
Into

# RADIO, TELEVISION and ELECTRONICS

## Master ALL Phases

**YOU  
Build This  
Superheterodyne**

You receive complete standard equipment, including latest type High-Mu Tubes, for building various experimental and test units. You progress step by step until you build a complete Superheterodyne Receiver. It is yours to use and keep.



### YOU RECEIVE THIS PROFESSIONAL MULTITESTER!

You will use this professional instrument to locate trouble or make delicate adjustments—at home—on service calls. You will be proud to own this valuable equipment. Complete with test leads.



### SIGNAL GENERATOR

You construct the Transatron Signal Generator shown here, demonstrating Transatron Principles in both R.F. and A.F. stages. You study negative type oscillators at firsthand.

### AUDIO OSCILLATOR:

An electronic device, which produces audio-frequency signals for modulating R.F. (radio frequency) carrier waves, testing A.F. (audio frequency) amplifiers, speakers, etc.



### T.R.F. RECEIVER

You build several T.R.F. Receivers, one of which, a 4-tube set, is shown here. You learn construction, alignment, make receiver tests, and do trouble shooting.

**Get Complete Training. You Receive and Keep All Equipment, Parts and Lessons. No Extra Charges.**

### GOOD PAY and Unlimited Opportunities in JOBS LIKE THESE:

Business of Your Own  
Radio Manufacturing, Sales, Service  
Broadcasting Telecasting  
Television Manufacturing,  
Sales, Service  
Laboratories: Installation, Maintenance of Electronic Equipment, Electrolysis, Call Systems  
Garages: Auto Radio Sales, Service  
Sound Systems and Telephone Companies; Oil Well and Drilling Companies; Engineering Firms  
Theatre Sound Systems Police Radio  
**And scores of other good jobs  
in many related fields**

### YOU CONDUCT MANY EXPERIMENTS LIKE THESE!

Checking action of condensers  
Experiments with AF and RF amplifiers.  
Experiments with resonance  
Producing beat frequencies  
Calibrating oscillators  
Experiments with diode, grid-bias, grid-leak and infinite impedance detectors  
Practical experience in receiver trouble shooting  
Application of visual tester in checking parts and circuits  
Experiments with audio oscillators  
Advanced trouble-shooting  
... and many, many others

### Complete Training by Practical Resident Trade School, Est. 1905

The same highly trained faculty, instruction materials and methods used here in our large, modern resident school, are adapted to your training in your own home. Shop Method Home Training has been proved by hundreds of successful graduates.

**Both Resident and Home Study  
Courses Offered**

### YOU LEARN BY DOING

You receive special laboratory experiment lessons to show you how to build with your own hands various experimental units such as those shown at left, and how to conduct many tests.

You will find all lessons easy to understand because they are illustrated throughout with clear diagrams and step-by-step examples that you work out yourself. Every piece of the equipment and complete lesson material we send you is yours to keep and enjoy, including the multitester, experimental equipment, all parts of the Superheterodyne, tube manual, radio dictionary, and complete, modern Television texts. All parts are standard equipment.

### Shop Method Home Training . . . Earn While You Learn

With our practical resident Shop Method Home Training, you study in your spare time. You receive Spare Time Work Lessons, which show you how to earn while you learn. Service neighbors' radios and TV receivers, appliances, etc., for extra money and experience. Many National students pay all or part of their training with spare time earnings!

### DON'T DELAY! The Radio-Television Industry needs trained men NOW!

**APPROVED  
FOR  
VETERANS!**  
Check coupon below!

For quick action,  
mail coupon  
today and we'll  
rush you full in-  
formation.

**Free!**

**NEW, ILLUSTRATED  
OPPORTUNITY  
BOOK AND SAMPLE  
LESSON SHOW YOU  
HOW WE TRAIN  
YOU . . . SEND FOR  
THEM TODAY! NO  
COST. NO  
OBLIGATION.**



## NATIONAL SCHOOLS

LOS ANGELES 37, CALIF. • EST. 1905

**FIND OUT NOW . . . MAIL COUPON TODAY**

National Schools, Dept. 11-PM  
4000 South Figueroa Street  
Los Angeles 37, California

Send me your FREE book "Your Future in Radio" and the sample lesson of your course. I understand no salesman will call on me.

NAME..... AGE.....

ADDRESS.....

CITY.....ZONE.....STATE.....

Check here if Veteran of World War II

Mail in envelope  
or paste on  
penny postal.

# 9 BIG BUILDING BOOKS

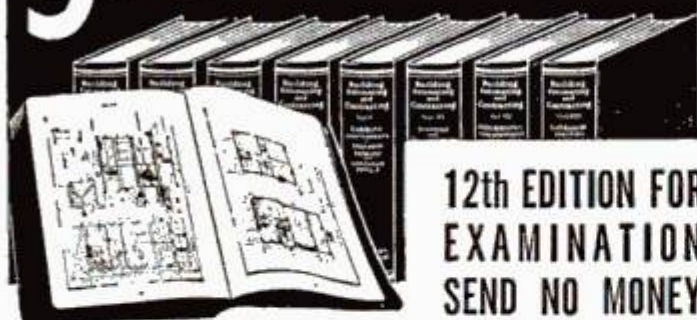

**12th EDITION FOR EXAMINATION SEND NO MONEY**

Learn to draw plans, estimate, be a live-wire builder, do remodeling, contracting. These 9 practical, profusely illustrated books cover subjects that will help you to get more work and make more money. Masonry, concrete forms, carpentry, steel square, roof framing, construction, plumbing, heating, painting, decorating and many other subjects. More than 4000 pages — 2750 illustrations.

## BETTER JOBS — BETTER PAY UP-TO-DATE EDITION

A nationwide building boom is in full swing and trained men are needed. Big opportunities are always for MEN WHO KNOW HOW. These books supply quick, easily understood training and handy, permanent reference information that helps solve building problems.

These books are the most up-to-date and complete we have ever published on these many subjects.

### Coupon Brings Nine Big Books for Examination

**AMERICAN TECHNICAL SOCIETY—Publishers since 1898**  
Dept. G819 Drexel at 58th Street Chicago 37, Ill.

You may ship me the Up-to-Date edition of your nine big books, "Building, Estimating and Contracting," without any obligation to buy. I will pay the delivery charges only, and if fully satisfied in ten days, I will send you \$2.00, and after that only \$3.00 a month, until the total price of only \$34.80 is paid. I am not obligated in any way unless I keep the books.

Name \_\_\_\_\_

Address \_\_\_\_\_

City \_\_\_\_\_ State \_\_\_\_\_

Please attach a letter stating your age, occupation, employer's name and address, and name and address of at least one business man as a reference. Men in service, also please give home address.



**HIGH PAY • SECURITY**  
When You

## LEARN A TRADE

Get ready for a well-paid, lifetime job or a business of your own in one of these FIVE ESSENTIAL TRADES. Complete training under expert instructors with practical experience prepares you to step into a good paying job with a future and security.

**ELECTRICITY:** Basic electricity, Residential and Industrial Wiring and Appliance Repair.

**PLUMBING:** Every phase — pipe cutting and threading to complete installations, blue print reading.

**AUTOMOTIVE & TRACTOR:** Engine overhaul, Transmissions, Carburetion, Generator-Ignition Systems, Tune Up.

**DRAFTING:** College level training in general Machine and Architectural Drafting

**SHOE REPAIRING:** Complete practical training includes reconditioning and rebuilding.

Approved for Veteran's Training



## NATIONAL TRADE SCHOOL

2610 Grand • Kansas City 8, Mo.

Without obligation to me please send full information on the course checked.

.....Automotive and Tractor Technician .. Drafting

.....Plumbing .....Electricity .....Shoe Repairing

Name..... Age.....

Address.....

City..... State.....

Veteran?.....

# 500 make-it-yourself PLANS

In Handy 6"x9" Book Form

These 10 NEW project books are packed with from 28 to 60 different plans in each. Get more pleasure and profit out of your hobby—easy step-by-step instructions, complete bills of materials, hundreds of show-how photos and working drawings. Every project practical and successfully made: 1—Christmas Decorations, Cards (96 pp, 50 items). 2—Doll Houses and Furniture (80 pp, 40 items). 3—Toys and Games for Juniors (88 pp, 45 items). 4—Toys & Games for Wee Folk (96 pp, 60 items). 5—Leather Projects (88 pp, 30 items). 6—Projects in Metal (96 pp, 44 items). 7—Small Metal Novelties (88 pp, 37 items). 8—Garden Furniture (96 pp, 60 items). 9—Fences, Gates, Trellises (96 pp, 57 items). 10—Bird Houses (64 pp, 28 items) . . . Specify titles when ordering and send money with order; we pay the postage and will ship promptly.

**\$1** Only PER BOOK POST PAID

**THE HOME WORKSHOP LIBRARY**

814 No. Michigan Ave., Chicago 11, Illinois

# LEARN WATCH REPAIRING



**AT HOME.** By our modern and original system of instruction you can learn every part of the WATCH REPAIRING TRADE AT HOME. Prepare yourself for a well-paying position or start in business after completing our course of instruction. Good watch repairers are in demand and generally earn very good salaries. For particulars apply to the Wisconsin School of Watch Repairing 759 North Milwaukee St., Milwaukee 2, Wis.

# HYDROPONICS

24 Page FREE Illustrated Book

Grow out-of-season vegetables, rare flowers or house plants by hydroponics WITHOUT SOIL. Start a fascinating hobby or profitable business in your home. No experience needed for top results. Small space gets BIG RETURNS. Easy, clean, pleasant way to grow any plant indoors or out every day in the year. Fast growth, increased yields, unlimited PROFIT OPPORTUNITIES. Send postcard today for free illustrated book showing how others from every state are succeeding in this wide open field.

CHARLES C. GILBERT & CO., 824 W. IVY STREET, SAN DIEGO 1, CALIF.

# LEARN TO WRITE a Good Hand!

**FOR BUSINESS AND SOCIAL SUCCESS!**  
Easy to improve your handwriting at home quickly with my new instruction books just off the press. Master all the secrets of better penmanship. Simple and easy, fully illustrated, highly endorsed. Begin today. Write for:  New Free Book, "How to Become a Good Penman," or check books wanted, \$1.00 each.  Business Writing  Artistic Writing  Card Writing  Engrossing Alphabets  Bird and Design Flourishing  Complete Set \$4.50  Enclose 10c for your name beautifully written and special penpoint for shaded writing.

S. A. Ziller, President, TAMBLYN SCHOOL OF PENMANSHIP 441 Ridge Bldg. In Business Over 52 Years Kansas City, Mo., U.S.A.

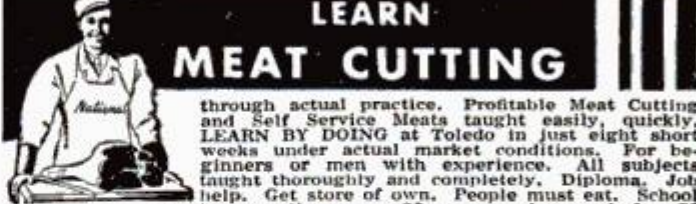

# LEARN MEAT CUTTING

through actual practice. Profitable Meat Cutting and Self Service Meats taught easily, quickly. LEARN BY DOING at Toledo in just eight short weeks under actual market conditions. For beginners or men with experience. All subjects taught thoroughly and completely. Diploma. Job help. Get store of own. People must eat. School in operation over 25 years. Approved for GI training. Send today for FREE illustrated catalog. No obligation. NATIONAL SCHOOL OF MEAT CUTTING, Dept. 50-T, Toledo 4, Ohio

SAY YOU SAW IT IN POPULAR MECHANICS

## Be an INVESTIGATOR

JAMES S. BOLAN, FORMER POLICE COMMISSIONER OF NEW YORK CITY offers MEN & WOMEN an attractive opportunity to prepare for a future in Investigation & Criminology by comprehensive Home Study Course. Free placement service assists graduates to obtain jobs. APPROVED UNDER G. I. BILL OF RIGHTS. Write for Free Booklet PM.

### THE BOLAN ACADEMY, INC.

EMPIRE STATE BLDG., NEW YORK 1, N. Y.



**YOU BUILD THIS  
23-TUBE  
TELEVISION  
RECEIVER**

**NOW!**

FOR THE FIRST TIME YOU CAN GET  
Real Practical HOME TRAINING In

# TELEVISION

## RADIO AND ELECTRONICS

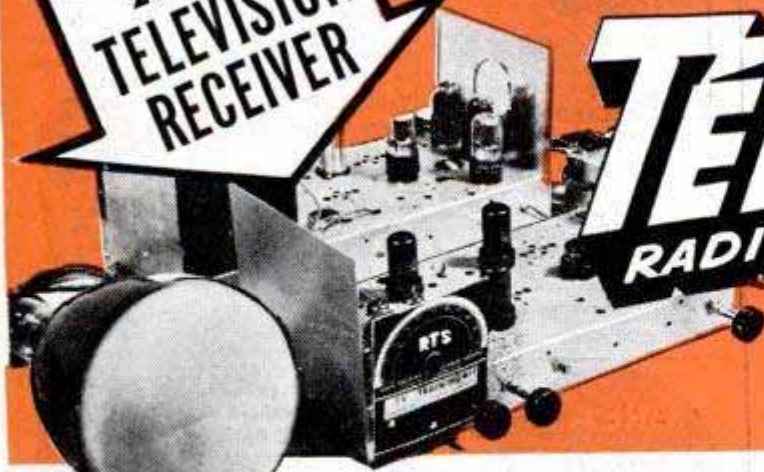

**YOU WORK AND LEARN  
WITH REAL TELEVISION  
AND RADIO EQUIPMENT**

RADIO-TELEVISION TRAINING SCHOOL'S master Technicians guide you. Located in the very heart of America's Television, Broadcasting, Radio and Sound Industries, RTS is right "on-the-spot" where new technical improvements are first introduced; is in the best possible position to bring students ACTUAL METHODS and practices developed by the RADIO-TELEVISION industry, leading to real money making opportunities. The 11 BIG KITS RTS gives you enable you to do many practical jobs, build the equipment illustrated; perform more than 100 other fascinating, valuable experiments. These jobs you do give you ACTUAL SHOP experience so vitally necessary to your future success. Thus RTS methods assure you BALANCED TRAINING—Theory PLUS Real Experience.

**OPPORTUNITIES NOW  
WIDE OPEN FOR  
Properly Trained Men**

Latest reports estimate 400 MILLION new television and radio sets will be built in the next 10 years . . . more than 72 million dollars is being spent RIGHT NOW just for radio repairs ALONE! When you are thoroughly trained by RTS Experts—who have their fingers on the pulse of the Radio-Television industry—a field of unlimited opportunities will open up for you in Your Own Radio-Television Sales & Service Business, F.M., Equipment Manufacturing, Communications and allied fields.

**EARN EXTRA MONEY  
while learning at HOME**

Under the RTS amazingly easy, practical home-training plan there is no need for you to quit your present job. You study in SPARE TIME ONLY! RTS Experts show you how

to earn WELCOME EXTRA CASH, even BEFORE FINISHING YOUR TRAINING! In fact, when friends and neighbors know you are studying Radio-Television you may—like many RTS students—actually get MORE REPAIR WORK THAN YOU CAN HANDLE.

**27 YEAR  
SUCCESS RECORD**

Backed by over a quarter-century of experience in home training, RTS (formerly Radio Training Association of America) offers practical "Learn-by-doing" methods, assuring you quick step-by-step progress. Begin preparing for your future in Radio-Television now while the time is ripe. If you are at all mechanically inclined—and have a grammar school education, RTS can teach you how to MAKE GOOD in Radio-Television.

**GET THE FACTS**

Send for FREE BOOK which tells you all about the RTS "time-tested" home-training plan, developed by technicians in the heart of the Radio-Television field. Fill out the coupon now—TODAY! and your FREE BOOK entitled "How To Make Good in Radio-Television" will go out to you AT ONCE. No Obligation. No salesman will call. ACT NOW!

**RTS LEADS THE WAY**

WE GIVE YOU

**11 BIG  
TELEVISION  
AND RADIO KITS  
AT NO EXTRA COST**

**YOU BUILD THIS  
6-TUBE STANDARD  
SUPER HETERODYNE  
RADIO SET with  
SHORT WAVE  
CONVERTER**

**YOU  
KEEP ALL  
EQUIPMENT  
—it's Yours!**

★  
**SEND  
FOR THIS  
30-PAGE  
FREE  
BOOK**  
★



**RADIO-TELEVISION TRAINING SCHOOL**  
5100 SO. VERMONT AVE., LOS ANGELES 37, CALIF., U.S.A.  
ESTABLISHED 1922 — 27 YEARS AGO  
formerly RADIO TRAINING ASSOCIATION of AMERICA

**RADIO-TELEVISION TRAINING SCHOOL, DEPT. 11-PM**  
5100 South Vermont Avenue, Los Angeles 37, Calif., U.S.A.

Send FREE Illustrated Book showing how I can make good in TELEVISION and Radio through training under the guidance of expert RTS Technicians. No obligation. (No Salesman will call).

NAME \_\_\_\_\_ AGE \_\_\_\_\_  
ST. & No. \_\_\_\_\_  
CITY \_\_\_\_\_ ZONE \_\_\_\_\_  
STATE \_\_\_\_\_

# This is How You Can Become a RADIO-TELEVISION TECHNICIAN



**Prepare Here  
for a career  
in America's  
fastest  
growing  
industry**



**T**RAIN NOW for opportunities in television—the field which business leaders predict will be among the top ten industries by 1951. You can become a Radio-Television Technician in only 18 months of continuous study at this non-profit, well-equipped Technical Institute and College.

**Choose the Course  
That Interests You Most**

#### SERVICE

**6 to 12 months**

- Electricity
- Welding
- Refrigeration
- Heating

#### TECHNICIAN

**12 to 24 months**

- Radio and Television
- Electronics
- Electrotechnics (Power)
- Welding
- Refrigeration, Heating, Air Conditioning

#### PROFESSIONAL

**36 months**

- Electrical Engineering —B.S. Degree; Major in Electronics or Power

## Equip Yourself for Specific Positions...

in receiver and transmitting testing, servicing, sales, supervision, and production. Your technician's course can also be credited toward a B.S. degree in Electrical Engineering.

Practical, military or academic training will be evaluated for advanced credit.

Faculty of 85 specialists. Over 1500 currently enrolled. 35,000 former students.

Write for new  
48-page Pictorial  
Bulletin . . .  
"Your Career"

Terms Begin Jan., April, July, Oct.

**MILWAUKEE  
SCHOOL of ENGINEERING**  
Founded 1903 by Oscar Werwath

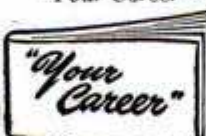

MILWAUKEE SCHOOL OF ENGINEERING  
Dept. PM-1149, N. Broadway & E. State, Milwaukee, Wis.

Without obligation send free bulletin "Your Career" and more details on course in \_\_\_\_\_

NAME \_\_\_\_\_ AGE \_\_\_\_\_

ADDRESS \_\_\_\_\_

CITY \_\_\_\_\_ ZONE \_\_\_\_\_ STATE \_\_\_\_\_

Check if World War II Veteran

## BE AN AUTO MACHINIST



**Draw Top Pay • No Job Worries**

Earn more money in auto mechanics—Specialize! New FREE booklet tells how to prepare for good jobs with high pay and job security. Our modern equipment and practical instructions make it easy to learn—get experience in

**ENGINE REBUILDING or  
GENERAL AUTO MECHANICS**

Job  
Placement  
Service  
FREE

**Practical Shop Training**  
Learn to operate the very latest shop machinery. Friendly instructors take a real interest in preparing you for a good job.

**VETERANS**  
American is a G I approved school

**PLANNING  
YOUR FUTURE IN  
AUTO MECHANICS**

**WRITE TODAY FOR  
FREE BOOKLET**

**AMERICAN TRADE SCHOOL**  
2411 McGee Kansas City, Mo.



**GREAT  
PROFITS**  
MAKE YOUR OWN  
RUBBER  
MOLDS

**X.L. RUBBER MOLDS**

will realize you great profits quickly!

**WRITE FOR NEW FREE CATALOG**

YOU can EASILY learn to cast thousands of perfect plaques, book ends, figurines, ash trays, etc. IT'S EASY, FUN, PROFITABLE! X.L. Rubber, Pts. \$2.00; Qts. \$3.50; Gallons \$8.95; Models and enough rubber for 3 molds \$1.30 postpaid.



SEND  
FOR  
FREE  
FACTS

**PLASTIC ARTS STUDIO** 3403 S. Madison St., Muncie, Ind.

Is Your Life  
Crowned  
With Success?

## LEXIPOWER



**WE THINK IN WORDS. THOUGHT IS POWER.**

Let this New Science show you how to WIN WITH WORDS—financially, socially, culturally. Develop a MASTERFUL VOCABULARY. Influence others. Improve your personality, manifest your latent ability. You are judged and rated by every sentence you utter. Start using the POWER of LEXIPOWER after the first Lesson. Write NOW for FREE details about LEXIPOWER. Dime-a-Day LESSON CLUB.

**LEXIPOWER LESSON CLUB**

517-J W. Deming Place

Chicago 14, Illinois

## STAMMERER?

This new 128-page book, "Stammering, Its Cause and Correction," describing the Bogue Unit Method for scientific correction of stammering and stuttering—successful for 48 years.

Benj. N. Bogue, Dept. 4914, Circle Tower, Indianapolis 4, Ind.

GET THIS  
FREE  
BOOK!

**"How to Make Money with  
Simple Cartoons"**

A book everyone who likes to draw should have. It is free; no obligation. Simply address

**FREE BOOK**

**CARTOONISTS' EXCHANGE**  
Dept. 911-F Pleasant Hill, Ohio

SAY YOU SAW IT IN POPULAR MECHANICS

## SHOE REPAIR OFFERS BIG INCOME LEARN IN 12 WEEKS TIME



You can own your own shop or earn big income as skilled shoe repairman. Growing demand everywhere at top wages for men who know how. We teach you quickly by actually working on shoes and modern machines. School open to all from 18 to 60 years of age. FREE BIG 20 PAGE BOOK explains everything. Send for your copy today. Chicago & Los Angeles schools only approved for Vets.

**MODERN SHOE REBUILDING SCHOOL**

Established 1927 Dept. PM  
2937 Belmont Ave., Chicago. 361-12th St., Oakland, Calif.  
806 So. Figueroa St., Los Angeles 14, Calif.

**FREE**  
7-DAY TRIAL

JUST MAIL COUPON  
Pay Nothing to  
Postman

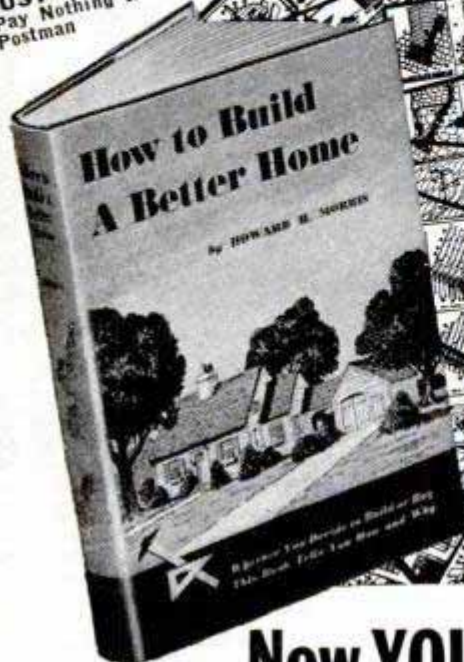

See the  
Numbers

Just  
Follow the  
Numbers and  
**YOUR HOME**  
is Built!

30 Easy Steps!

Now YOU-TOO Can Lick

Secrets That Produce Fine Homes—Completely  
Revealed in This Great Easy-Reference Book!

**How to Start** • Deciding Upon Ownership  
• How to Select Service • How to Finance  
• Building Lot • How to Plan • Fill Out  
Documents • Obtain Good Construction  
• How to Prevent Termites • Decay • Cor-  
rosion • How to Lay Out Building, Excavate,  
Grade • Monolithic Concrete Construction  
• Masonry • Footings • How to  
Build Piers, Foundation Walls • Basement  
• How to Waterproof • Build Chimneys,  
Fireplaces • How to Select Woods • House  
Framing Methods, Details • Finish Carpen-  
try, Millwork • How to Insulate • Sheet-  
Metal Work, Roofing, Stucco, Lath, Plaster  
• How to Paint, Finish • Tile Work, Elec-  
trical Work, Plumbing, Heating • List of  
Publications for Home Builder (Most are free  
or cost few cents) • Stock Plans • Taxes,  
Insurance, Interest, Maintenance, Assess-  
ments • How to Choose Bank, Real Estate  
Dealer, Contractor • Locating House on Lot,  
Tax Searches, Comparative Costs, Design  
• Prefabricated Houses? Bungalows, List of  
Usual Mistakes • Architectural Don'ts, 300  
additional paragraphs important information.

**QUICK REFERENCE INDEX TO SPECIAL  
PAGE SIZE ILLUSTRATIONS**  
(HUNDREDS OF ILLUSTRATIONS)

Footings—foundation walls—basements •  
Garage floor, footings, etc.—septic tank—  
grease trap—basement window • Concrete  
porches, steps, automobile runways, drive-  
ways, walks • Brick steps, terraces •  
Brick, tile, stone wall details—flagstone,  
stepping stone walks • Masonry dwellings  
—brick veneer walls • Chimney, fireplace  
details • Balloon framing details (mini-  
mum-shrinkage type), (box sill type) • Roof  
framing details • Basement columns, gir-  
ders—framing openings—bridging • Miscel-  
laneous details • Watertables—exterior  
sidewalls, siding, shingles—cornices—porch  
columns • Double-hung wood window  
details • Door frame details—points for mill-  
work—stock doors, windows—sash details •  
Paneling—stairwork—baseboard details •  
Termite shields • Flashing details • Gut-  
ters, leaders (downspouts) • Roofing details.  
One Simple Fact May Repay HUNDRED  
Times Small Cost. A Book You Will Refer  
to for Years!

**READ WHAT GREAT BUILDING AUTHOR-  
ITIES AND OTHERS SAY ABOUT THIS  
AMAZING BOOK (NAMES ON REQUEST)**

Excerpts from typical letters of praise:  
"... the best book on the subject" ...  
"valuable information." ... excellent ref-  
erence book." ... clear and compact ...  
complete, unbiased information." ... "you  
are to be congratulated."

## ANY Home Building Job!

"How to Build a Better Home" Is Showing Tens of Thousands How to Handle  
Any Construction Job—Faster, Easier! Now Let It Build Your House for YOU!

**H**ERE'S how to "knock over" every con-  
struction job—including "tough nuts".  
Thousands are letting "How to Build a Bet-  
ter Home" tackle toughest building, re-  
modeling, alteration problems—in LESS  
TIME, with less work, more fun than ever!

### Everything You Need to Know

All diagrams—only book of its kind—8  
years in making! Worth \$50! Answer to  
prayers!

The WORKS—how to plan, construct, super-  
vise—simply, clearly explained. Jam-packed  
with everything you need. Your insurance  
against warped floors, smoking chimneys,  
sagging insulation, decay.

Now let these hundreds architect's diagrams,  
instructions, facts go to work for YOU!  
Tackle anything—footing, roof, small bun-  
galow, two-family house, light frame  
construction, solid brick—quickly, easily, right!  
Just look up job in index; then let diagrams  
show you number by number, step by step,  
how to put homes together!

### WHY PAY RENT?

If you are leery of 'cheap' building, shoddy  
work, poor design—if fed-up dreaming, get  
started! Prove it yourself, free.

Why pay landlord? Get more, better rooms,  
for less than rent! Why wait, hope, never  
know? Get started now. Be ready for "rainy  
days." Remember, how you swore you  
would own your own home. With this book  
you can. Your security! Rent to others, add  
another floor, apartment, get extra income  
to pay off taxes, interest, mortgage!

### SAVE THOUSANDS OF DOLLARS

Whether you spend \$2,000 or \$20,000—  
use architect or stock plans—in Maine,  
Calif., or Florida—let this book help you.  
Get "in the know," talk building language.  
Be respected, admired, proud. Here is hap-  
piness, a place of your own! The way to  
lick housing shortage.

Employ uneducated labor—show them how  
—save THOUSANDS. Try it YOURSELF  
FREE. How can you lose? Start small, build  
UP. Get home, free and clear. Pay loan  
back in small sums like rent, yet get twice  
as much room! Aluminum windows, radiant  
heating, air conditioning, garbage disposals.  
Build part now, rest later, pay as you go!

### How To Build—from Plans to Paint

See for yourself. One page can be worth  
fortune. No "boloney". We have files and  
files of letters to prove. You can do own  
plans in evenings. WHERE TO BEGIN? Just  
a quick glance at contents will show you.  
Those who bought write they have never  
seen such a book for any price, anywhere!

### HUNDREDS Construction Details

Every type home discussed in FULL. Read  
what fraction of enthusiastic purchasers  
have to say. See how they bless day they  
sent coupon for free examination. See how  
they came back with orders for friends,  
relatives—business associates. Read, study,  
every word in this "ad"—FOR WE TELL  
YOU THE TRUTH, and we back up these  
little printed words with this no-risk offer:

### SEND NO MONEY Examine it—7 Days FREE!

Don't spend cent. Just mail coupon. See  
hundreds of step-by-step diagrams, large  
8 1/2" x 11" size. See how to supervise or  
build YOURSELF—even if you know nothing  
NOW! Then, if you are THRILLED, send  
only \$2.98 (plus shipping charges). If not  
thrilled, return book, and pay nothing! This  
is your chance. Awake! Mail FREE EXAMI-  
NATION COUPON NOW, to the Westport  
Publishing Company, Dept. PM11, West-  
port, Conn.

### FREE Examination Coupon—Mail Now

The Westport Publishing Company

"Books of Merit", Dept. PM-11, Westport, Conn.

Send "How to Build a Better Home." After  
7 days I either return and owe nothing, or  
keep it and send \$2.98 (plus shipping charges).

Name \_\_\_\_\_ Age \_\_\_\_\_  
(please print)

Address \_\_\_\_\_

City & Zone \_\_\_\_\_ State \_\_\_\_\_

Save shipping charges. Enclose \$2.98 (check or  
money order) WITH coupon. WE then pay ship-  
ping. If not thrilled, return and we refund  
\$2.98 by AIR MAIL! Foreign Orders \$3.50 Cash  
with order.

Deluxe library binding \$4.98.

# YOU ARE IN DEMAND IF YOU CAN DRAW!



If you like to sketch, write for **FREE TALENT TEST**. Splendid opportunities for *trained* artists. Find out if you have talent worth developing.



**ART INSTRUCTION, INC.**  
Dept. 11139C • Minneapolis 15, Minnesota

Send me your **FREE** Talent Test.

Name \_\_\_\_\_ Age \_\_\_\_\_  
 Address \_\_\_\_\_  
 City \_\_\_\_\_ Zone \_\_\_\_\_  
 County \_\_\_\_\_ State \_\_\_\_\_  
 Occupation \_\_\_\_\_ Phone \_\_\_\_\_

# EARN MORE

\$\$\$



## SEND FOR THIS **FREE** BOOK NOW!

• Increase your earning power. Become *thoroughly* trained in a well-paid profession. Without obligation, find out about the opportunities in Electrical, Mechanical, Plastics, Civil, Mining and other engineering fields. Our *free* 118-page handbook, lists details of home study courses, compiled by world authorities. See for yourself how you can soon earn more dollars. Write today, to: Canadian Institute of Science and Technology, Ltd., 487 Century Building, 412, 5th Street, N.W., Washington, D. C.

Special discounts for Servicemen  
**MAIL THIS COUPON NOW**

Canadian Institute of Science & Technology, Ltd.,  
487 Century Building, 412, 5th Street, N.W.,  
Washington, D. C.

Please forward free of cost or obligation of any kind your 118-page handbook "Engineering Opportunities."

Name \_\_\_\_\_ Age \_\_\_\_\_  
 Address \_\_\_\_\_

CANADIAN ENQUIRIES: 263 Adelaide St. W, Toronto

IT COST ME MONEY  
TO FORGET!

...This Doesn't Happen  
If You Use *Memindex*



**MEMINDEX**—the famous memory method and personal systematizer—is credited by thousands of successful persons with speeding their rise to the top. Memindex keeps all data on handy, cleverly indexed and dated cards—today's always visible. Fine leather **POCKET CASE** organizes your daily memos—handsome **DESK UNIT** keeps permanent records for you. No transcribing. Worth 1000 times its small cost to salesmen, business and professional men, hobbyists and social leaders. Outfits \$5.75 and up.



IDEAL  
XMAS  
GIFT

**FREE** Dated Cards for balance of 1949 with your 1950 Memindex. Write for folders describing complete line of reminder specialties.

**WILSON MEMINDEX CO.**

Dept. L-9  
149 Carter St. Rochester 5, N. Y.

NATION'S  
LARGEST  
EXCLUSIVE  
ELECTRICAL  
SCHOOL

"LEARN-BY-DOING"  
**ELECTRICITY**

PRACTICAL TRAINING  
NOT "HOME STUDY"

**G.I. APPROVED** Get actual experience in great shops of M.T.I. Learn all phases Practical Electricity; Housewiring, Motors, Const., Maintenance, etc. Living arrangements, Part-time jobs, etc.

A post card brings the story,  
**MICHIGAN TECHNICAL INSTITUTE**, Dept. PM-11  
2281 W. Fort St., Detroit 16, Michigan

## STOPS FOGGY WINDSHIELDS NEW Chemical Mitt



**Amazing Discovery!** Autoists wild over new "NO-FOG" Windshield Cleaner. Simply glide over windshield chemically-treated Mitt—at once glass sparkles crystal clear. Cloudy haze, mist, dust, grime disappear like magic. Stops fogging. *Sell like wild!*

**SAMPLES FOR AGENTS** Sample offer sent immediately to all who send name at once. A penny postal will do. **SEND NO MONEY**—just your name.  
**KRISTEE CO., 687 Bar Street, AKRON, OHIO**

## Learn ACCOUNTING BOOKKEEPING

This nationally renowned school has demand for graduates in good salary positions thru nationwide recognition and placement service. Write Department PMB today for Big 32 page Success Book to be sent to you. **FREE**



*Hills* **BUSINESS UNIVERSITY AND  
EXTENSION SCHOOL**  
619 W. MAIN ST. OKLAHOMA CITY 2, OKLAHOMA

**NEW!**

**FOR PROFIT & PLEASURE**

**IN COPPER TOOLING  
AND ETCHING**

**No Experience Needed**

**DO  
IT  
AT  
HOME**



At last a way to get in on the **Big Money** made every day in Copper Art. You make plaques—Bowls—Trays—Gifts—Souvenirs of all kinds.

Art talent not necessary. Our **New Method** makes it easy to learn. **Big Markets** waiting. Anyone can learn quickly—you start making money right from the start. Don't miss this opportunity to cash in at once on this big-paying easy to operate business. Be your own boss. **SEND NO MONEY**—Act Now to get all the free details—just send your name on a penny postcard today—**Do it Now!** Write Today—Money-Back Guarantee.

**HOLLYWOOD COPPER ART STUDIOS**, Dept. PM-11  
4257 BEVERLY BLVD., LOS ANGELES 4, CALIF.

# WHICH OF THESE *Opportunities* INTERESTS *You* MOST?

Accounting  
Air Conditioning  
Architecture & Building  
Automotive Engineering  
Aviation—Practical  
Aviation Drafting & Design  
Better Foremanship  
Bookkeeping  
Business Management

Contracting  
Diesel Engineering  
Drafting & Design  
Electrical Engineering  
Electricity—Practical  
Electronics, Industrial  
High School Courses  
Machine Shop Operations  
Mechanical Engineering

Plastics Engineering  
Plumbing—Practical  
Private Secretary  
Radio Operating & Servicing  
Railway Training  
Refrigeration  
Sheet Metal Pattern Drafting  
Shop Management  
Tool Making

## THINK! LOOK FORWARD!

Business is making big, new plans

Men and Women are preparing for the future

### WHAT ARE YOU DOING ABOUT YOUR TOMORROWS?

● *Today*, choose the job you want—and prepare for it. Or if you are already engaged in the work you like best, start training *now* for quicker promotion. Acquire the knowledge that will help you to get ahead faster, make more money and have greater security.

Invest part of your spare time in more rapid progress. Start training now, in spare time in your own home. Be ready to grasp your opportunity and step out ahead of those who lack the ability you have attained.

American School, founded in 1897 as an educational institution *not for profit*, can help you to reach your goal just as it has helped others during the past fifty-two years. Give serious thought to the list above. Pick one or more subjects that interest you. Then check the coupon at right, add your name and address and mail it at once. The school will send you details on its training plan and outline of study prepared by specialists. There is no charge, no obligation, so send the coupon immediately.

**PRACTICAL, EFFECTIVE HOME - STUDY TRAINING SINCE 1897**

### Take This First Easy Step

## CHECK, CLIP AND MAIL COUPON NOW

AMERICAN SCHOOL, Dept. G845, Drexel at 58th, Chicago 37, Ill.  
*Without obligation. Please send FREE and postpaid, bulletin and details of the Subject checked.*

- |  |  |  |
|--|--|--|
| <input type="checkbox"/> PLASTICS ENG'R            | <input type="checkbox"/> Accounting            | <input type="checkbox"/> Drafting and Design for Men and Women |
| <input type="checkbox"/> Refrigeration             | <input type="checkbox"/> Electrical Engr.      | <input type="checkbox"/> Radio                                 |
| <input type="checkbox"/> Architecture and Building | <input type="checkbox"/> Electricity-Pract.    | <input type="checkbox"/> High School                           |
| <input type="checkbox"/> Contracting               | <input type="checkbox"/> Electronics, Industr. | <input type="checkbox"/> Air Conditioning                      |
| <input type="checkbox"/> Practical Plumbing        | <input type="checkbox"/> Bookkeeping           | <input type="checkbox"/> Mechanical Eng.                       |
| <input type="checkbox"/> Automotive Engineering    | <input type="checkbox"/> Private Secretary     | <input type="checkbox"/> Shop Management                       |
| <input type="checkbox"/> Aviation Drafting         | <input type="checkbox"/> Diesel Engineering    | <input type="checkbox"/> Tool Making                           |
| <input type="checkbox"/> Aviation                  | <input type="checkbox"/> Sheet Metal           | <input type="checkbox"/> Better Foremanship                    |
| <input type="checkbox"/> Business Mgmt             | <input type="checkbox"/> Pattern Drafting      | <input type="checkbox"/> Machine Shop Operations               |
| <input type="checkbox"/> Railway Training          |  |  |

Name..... Occupation.....

Address..... Age.....

City..... State.....

### AMERICAN SCHOOL

Dept. G845, Drexel at 58th Street, Chicago 37

# INVENTORS

When you are satisfied that you have invented a matter of value—write me, without obligation, for full information as to what steps you should take to secure a Patent.

The usual first step is to have a search of the prior U. S. Patents conducted, so that I can report to you on the question of Patentability.

## PATRICK D. BEAVERS

(Formerly RANDOLPH & BEAVERS)

Registered Patent Attorney

934 Columbian Building Washington 1, D. C.

**PATRICK D. BEAVERS, Registered Patent Atty.**  
934 Columbian Bldg., Washington 1, D. C.

Please send me full information on how to secure Patent Protection and Trademark Registration.

Name \_\_\_\_\_

Street \_\_\_\_\_

City \_\_\_\_\_ State \_\_\_\_\_

# INVENTORS

IF YOU WISH TO PROTECT YOUR INVENTION, You should take steps to protect it by a U. S. Patent. Write me for "Record of Invention" form.

## CARL MILLER REGISTERED PATENT ATTORNEY

Woolworth Bldg., 35th Floor, Dept. 119A, New York City  
Please send me "Record of Invention" form.

NAME \_\_\_\_\_

ADDRESS \_\_\_\_\_

# BE A DETECTIVE

WORK HOME or TRAVEL. Experience unnecessary.  
DETECTIVE Particulars FREE. Write to  
GEO. P. M. WAGNER, 125 W. 86th St., N. Y.



# PATENTS

## AND TRADE MARKS

### C. A. SNOW & CO.

REGISTERED PATENT ATTORNEYS

WRITE FOR INFORMATION TO  
428 SNOW BUILDING, WASHINGTON 1, D. C.



TRADE MARKS •  
COPYRIGHTS •

# PATENTS

The Time to Contact  
a Patent Attorney is Promptly  
After You Have Finished Your Invention

Write for FREE "INVENTOR'S GUIDE" & "Record of Invention"

**FRANK LEDERMANN** Registered Patent Attorney  
154 Nassau St. • 20th Floor • New York 7, N. Y.

# PATENTS PATENT LAWYER

TRADE MARKS

**GUSTAVE MILLER**  
119-PM WARNER BLDG.  
WASHINGTON 4, D. C.

ASSOCIATE EXAMINER  
U. S. PATENT OFFICE 1922-1929  
Patent Attorney and Advisor  
U. S. NAVY DEPT. 1930-1947  
REGISTERED PATENT ATTORNEY  
Send for Form  
"INVENTOR'S RECORD"

# INVENTING

—FOR **PROFIT!** If you have an inventive turn of mind, write for free 28-page booklet explaining how the Institute of American Inventors is helping inventors pre-test the profit possibilities of proposed devices to fill today's unprecedented demand for useful new inventions.

**INSTITUTE of AMERICAN INVENTORS**  
Dept. 4, 1926 Eye St., NW, Washington 6, D. C.

# BE A NOTARY PUBLIC

Old legal-supply house, 22 cities, helps you get appointment by governor if you qualify, equips you fully. Pay after appointment (2 payments \$12.50 each). Respected public office. You certify legal papers, use official seal made with your name, collect your fees. Easy, Inquire—

**STATIONERS EXCHANGE BOERNE 41, TEXAS**

SAY YOU SAW IT IN POPULAR MECHANICS

# INVENTORS

Whether an invention is patentable can be substantially determined by a search of the U. S. Patent records. Without obligation, write for information explaining the steps you should take to secure a patent.

## JOHN N. RANDOLPH

Registered Patent Attorney  
201 Columbian Building, Washington 1, D. C.

# HIGHEST ROYALTIES and CASH

# FOR YOUR INVENTIONS

Write for FREE booklet without obligation

## UNIVERSAL MARKETING CO.

354 S. SPRING ST. (Suite M)

LOS ANGELES 13, CALIF.

# BUILDERS

## TRADE GUIDES



### AUDELS CARPENTERS AND BUILDERS GUIDES—4 VOLS. \$6

Inside Information for Carpenters, Builders, Joiners, Building Mechanics—all Woodworkers. 1600 pages; 3700 diagrams; flexible; pocket size. Short-cut instructions, new methods, ideas, solutions, plans, systems—money saving suggestions. An easy progressive course for the apprentice. A practical daily helper and Quick Reference for the master worker. A Helping Hand to Easier and Better Work and Better Pay. To get this aid for yourself, simply fill in and mail the FREE COUPON below.

**INSIDE TRADE INFORMATION ON:**

How to use steel square; How to file and set saws; How to build furniture; How to use mitre box; How to use chalk line; How to use rules; How to make joints; Carpenters' arithmetic; Mensuration problems; Estimating strength of timbers; How to set girders and sills; How to frame houses and roofs; How to estimate costs; How to build houses, barns, garages, bungalows, etc.; How to read and draw plans; Drawing up specifications; How to excavate; How to use settings 12, 13 and 17 on the steel square; How to build hoists and scaffolds—skylights; How to build stairs; How to put on interior trim; How to hang doors; How to lath—lay floors; How to paint.

"Auodels Guides worth four times their price—handy too as I carry them in pocket for reference." W. J. Bates, Knoxville, Pa.



### AUDELS PLUMBERS AND STEAMFITTERS GUIDES—4 VOLS. \$6

A new edition—just out! A practical, illustrated, Reference Library and Study-Course for Master Plumbers, Journeymen and Apprentice Steamfitters, Gas Fitters and Helpers, Sheet Metal Workers, Draughtsmen, Master Builders, Engineers and all Building Trade Students. 1670 pages; 3642 diagrams; flexible; pocket size. Guides explain all the principles, advances and short cuts of the Plumbing and Heating trade. Contains instructions on how to figure and estimate jobs. Use FREE COUPON below to examine, without obligation, this valuable work.

**INSIDE TRADE INFORMATION ON:**

Air Conditioning. Soldering, tinning. Joint wiping, bending, beating. Pipe—iron—steel, threading. Mathematics, tables, physics. Materials—iron, steel, copper, brass, lead, tin, antimony. Sheet metal—galvanized—plate. Sanitation, syphonage, tanks. Drainage, sewage, purification. Fixtures—bath—kitchen. Pipe fittings, soil pipe, tools. Laying out work. Roughing. Screwed fittings, flanges, joints. Pipe bending, examples. Elbows. Heating, ventilation, refrigeration. Water supply, mains, wells, tanks. Gas-fittings. Underwriters. Sheet metal work, problems, methods, Brazing, heating, lead burning. Welding, various welds, methods. Blacksmithing, forges, tools.

"Auodels Guides are practical, easy to understand, reliable. Cover the field in plain language." W. F. Arminger, Annapolis, Md.



### AUDELS MASONS AND BUILDERS GUIDES—4 VOLS. \$6

A complete, illustrated trade reference library, for Bricklayers, Cement Workers, Plasterers, Tile Setters and Stone Masons, including a practical outline of Steel Construction. 1100 pages; 2067 diagrams; flexible; pocket size. A practical Trade Assistant explaining modern methods of masonry construction. Easy to understand and apply. A reliable and authentic reference work and study-course for Master Journeyman and Young Mechanic. Use FREE COUPON below and find out for yourself, without obligation, whether this set will benefit you.

**INSIDE TRADE INFORMATION ON:**

Bricklaying, tools, materials; Brick designs, patterns, bonds; Setting frames and foundations; Mortars, scaffolds, estimating; Mortars and mortar mixing; Tile setting, mosaic, hollow tile; Straight edge test, troweling; How to figure brick work; Safe loads, piers, chimneys; Boiler settings, anchors, fire stops; Labor tables; Concrete, forms; How to figure concrete work; Stucco—on old and new buildings; Plastering—wood lath—metal; Plasterers agreement; Plastering on various surfaces; Stone masonry; Cutting, finishing, estimating stone; Derricks, rigging; Steel construction; Fire proof; How to read blue prints.

"Auodels Masons Guides are the best books on the subject. Have laid brick 12 years and am ablet to judge." H. A. Sonnett, Corliss, Pa.

### PRACTICAL ELECTRICITY—1 VOL. \$4

Audels Handy Book of Practical Electricity is a simplified Ready Reference and Study Course in one pocket size volume—for Engineers, Professional Electricians and Students. 1040 pages; 2600 diagrams; flexible bound. A reliable authority and handy helper for every electrical worker. Contains important and valuable wiring diagrams, calculations, machine sketches, helps on maintenance and repair. Use this FREE COUPON today and find out, without obligation, how this handy book will help you in your daily work.



**INSIDE TRADE INFORMATION ON:**

Electro-Therapeutics, X-Rays, Shocks, Welding, Brazing, Radio Hook-ups, Motion Pictures, Telephone, Telegraph, Cranes, Bells, Elevators, Pumps, Tools, Ship Drive, Railways, Vehicles, Automobile Electric Systems, Ignition, Generation, Lighting, Plant Management, Power Plans, Armature Winding, Repairing, A. C. Motors and Apparatus, D. C. Motors and Apparatus, Alternator Construction, Dynamos, Wiring, Diagrams, Sign Flashers, Cable Splicing, Power Wiring, Outside Wiring, Switches, Lighting, Rectifiers, Converters, Transformers, Fuses, Circuit Breakers, Rheostats, Electro Plating, Electrolysis, Storage Batteries, Magnetism, Electrical Energy, Conductors, Insulators, Static, Dynamic, Radio Electricity, Applications, Ready Reference and Index Covering the entire field of Modern Electricity.

### Learn More and You Will Earn More!

Know your job and you'll never be without one. The skilled man is always in demand. Knowledge is power. Learn your trade thoroughly by easy reading. This coupon is your opportunity for advancement and better pay. You risk nothing in sending for Audels Guides for free examination. Send it NOW!

**FREE EXAMINATION COUPON**

**THEO. AUDEL & CO.**  
49 W. 23 ST., NEW YORK CITY

Please mail me for free examination the books marked (x) below. If I find them satisfactory, I agree to mail \$1 in 7 days, on each set ordered, and to further mail \$1 monthly on each set until I have paid the purchase price.

4 CARPENTERS GUIDES \$6     4 PLUMBERS GUIDES \$6

4 MASONS GUIDES \$6     1 ELECTRICIANS HANDY BOOK \$4

NAME.....

ADDRESS.....

OCCUPATION.....

EMPLOYED BY.....PM



Put your future  
in your own hands

# BE AN ARTIST

Here's the Amazing  
Way We Teach You  
Step-by-Step to Draw  
At Home in Spare Time

Draw for money. Prepare yourself now for a fascinating, pleasant and profitable Art career. COMMERCIAL ART, DESIGNING, CARTOONING—all in one complete home study course. No previous art experience necessary. We teach you step-by-step and prepare you for good art jobs in advertising, television, newspaper and magazine publishing, department stores, printers, engravers, or in art studios, etc. You can become your own boss. For 35 years our graduates have been "making good"—WHY NOT YOU?



Trained Artists Are Capable of Earning  
**\$65-\$80 and MORE a WEEK**

Write for FREE BOOK, "Art for Pleasure & Profit"—tells about our course, instruction service, material furnished, what our graduates say, and commercial opportunities for you. TWO ART OUTFITS and other features included with training. Low cost—only \$5 monthly.

VETERANS! Course G.I. Approved

FREE BOOK gives details!

WASHINGTON SCHOOL OF ART, Studio 1211R  
1115—15th St., N.W., Washington 5, D.C.

Please send me full information and your Free Book, "Art for Pleasure and Profit." (Please print name, etc.)

Name \_\_\_\_\_ AGE \_\_\_\_\_

Street \_\_\_\_\_

City \_\_\_\_\_ Zone \_\_\_\_\_ State \_\_\_\_\_



TRAIN NOW FOR AN  
**AVIATION CAREER**  
IN SUNNY SOUTHERN CALIFORNIA

MAXIMUM TRAINING IN MINIMUM TIME

Specializing in AERONAUTICAL ENGINEERING and MASTER AVIATION MECHANICS since 1929 America's Finest Aeronautical Institute . 7000 successful graduates. MAKE MORE MONEY MAIL COUPON TODAY APPROVED FOR VETERANS. Board and Room now available.

Without obligation, send free catalogue with full information.

NAME \_\_\_\_\_ AGE \_\_\_\_\_ PM-11

ADDRESS \_\_\_\_\_

CITY \_\_\_\_\_ ZONE \_\_\_\_\_ STATE \_\_\_\_\_

**CAL-AERO TECHNICAL INSTITUTE**  
GRAND CENTRAL AIR TERMINAL • GLENDALE 1, CALIFORNIA



## Famous BAILEY TECHNICAL SCHOOLS

OFFER THE FOLLOWING COURSES:

COMMERCIAL ELECTRICITY  
PRACTICAL DIESEL ENGINEERING

Your future success depends largely on the reputation of the school you attend. Don't take chances! Train at America's foremost school of mechanical specialization. Bailey is recognized and approved by industry. Bailey graduates get the top pay jobs! Send for FREE Catalog. State name of course in which you are interested. G. I. Approved.

**BAILEY TECHNICAL SCHOOLS**

1656 S. Grand Blvd., St. Louis 4, Mo.

**EXTRA MONEY—LOADS of FUN!**  
MAKING TRUE-TO-LIFE MASKS

As a hobby or business you'll enjoy this fascinating art. Friends—relatives—acquaintances—they're all potential customers. Inexpensive to make, no special skill required. Cash in now in fun or money. Be first in your community. Send \$1.00 for complete instructions and sketches on how to make true-in-detail LIFE MASKS. Offer expires soon—so order now.

KEARNEY & CLARK  
Box 1308 Akron 9, Ohio

**MEN'S WRIST WATCH**  
IDEAL XMAS GIFT  
Only \$5.95

... with gleaming, stainless steel Expansion Band. Amazing value—1 year guarantee. Jeweled, smart chrome case, radium dial—hands sweep second hand; shock resistant. Wear with pride or give as a gift. Send \$5.95, plus 10% Federal Tax, postpaid. Or order C.O.D. plus postage. Satisfaction guaranteed.

**MUDIAL WATCH HOUSE**  
330 S. Wells St., Dept. AA, Chicago 6, Ill.

LEATHER or STAINLESS STEEL EXPANSION FREE OF EXTRA COST



**RAISE HAMSTERS**

The new wonder animals from Syria. Often called Toy Bears. Delightful pets. Everyone wants them. Laboratories need thousands. Clean, odorless. Raise anywhere. A profitable and interesting hobby or business. We furnish breeding stock with manual of instructions.

Write today for free illustrated literature.

**GULFHAMSTERY, 1536 BASIL, MOBILE, ALA.**

**LEARN MOVIE PROJECTION THEATRE MANAGEMENT**

The Motion Picture Theatre Business offers big opportunities for trained men. Get into a fascinating field with a promising future. Train at home in spare time. Free Catalog. Established 20 years.

**THEATRE SCHOOL, 370 Washington St., Elmira, New York**

**TRAIN TO BE A TOP-NOTCH DENTAL TECHNICIAN**

**FOR A BRIGHTER FUTURE**

Study at a modern, well-equipped school under skilled, professional teachers. Approved for Veterans.

**KERPEL SCHOOL OF DENTAL TECHNOLOGY—309 S. BROAD ST. PHILADELPHIA 7, PA. — KI 5-6760**





# IF I Send YOU THIS FINE SUIT-

Will You Wear It and Show It to Friends?

Amazing plan! No money needed! I want an ambitious, alert man in your town to get this splendid made-to-measure suit by taking a few orders from friends. Show it—talk about it—use this suit to help you take more orders and earn up to \$10.00 in a day. My sensational plan can bring you good money—easy!

**No Experience Needed—No House-to-House Canvassing**  
Experience not necessary. Amazing low price mean big income for you without house-to-house canvassing, and amazing chance to get your own suit as a BONUS without paying one cent.

### Send for FREE Cloth Samples!

I supply complete, elaborate demonstrating samples to you FREE, and tested, sure-fire selling plans. This is your chance. Don't let anyone get ahead of you. Start at once. Your income may begin first day. Send no money—now or ever. Write today for complete equipment and surprising BONUS SUIT OFFER. For quick action, tell us about yourself—age, etc.

John Grant, STONE-FIELD Corp.

532 S. Throop Street,  
Dept. Y-816, Chicago 7, Ill.



## Beat the Depression.....

LEARN PROFESSIONAL LOCKSMITHING AT HOME

ONLY GOV'T APPROVED SCHOOL IN NATION

There is a Reason Why - Inquire

NAT'L LOCKSMITHING SCHOOL

1021 VALENCIA SAN FRANCISCO 10, CALIF.

## Learn Upholstering

A money-making business or fascinating hobby. Practical home training.

You get materials to make and upholster a fine Ottoman with your

first lesson. Professional upholsterer's tools available. Write today for free, illustrated booklet. State whether interested for career or hobby.

WEST COAST UNIVERSITY, Extension Dept. PM-119  
1601 S. Western Ave. Los Angeles 6, Calif.

YOU CAN BE AN **All Around HE-MAN** 10c

All 5 famous courses by George F. Jowett, world's greatest body builder in 1 complete muscle building volume (valued at \$5 each) now only 10c. Packed with How-to-Do-it pictures. 1. How to Mold a Mighty Arm. 2. Mighty Chest. 3. Mighty Back. 4. Mighty Grip. 5. Mighty Legs. Free strong men photo book. Quick results or money back! Send 10c, name, address, age.

JOWETT INSTITUTE, Dept. PM-911, 230 Fifth Avenue, New York City

SAY YOU SAW IT IN POPULAR MECHANICS

## PROFITABLE HOBBIES



Let us show you how extremely easy it is to make beautiful and useful things out of LIQUID PLASTICS, LIQUID MARBLE, LIQUID IVORY, LIQUID GLASS, CERAMICS, ETC. . . as easy as pouring water out of a glass! Make novelties, jewelry, gifts, artware, toys, tools, dies, gadgets, ceramics . . . a million useful things! We supply everything—MATERIALS, INSTRUCTIONS and BUYERS! Send only 25c for 1. Big catalog of 300 casting materials, molds and accessories. 2. A beautiful CAMEO free (to show you what you can do), and 3. Actual INSTRUCTIONS on how to cast and start in the CASTING BUSINESS! Send 25c today—this may be the lucky coin that will start the most fascinating and profitable phase of your life! (Catalog only—10c).

PLASTICAST COMPANY (DEPT. C)

4637 N. Kedzie Ave.  
Chicago 25, Ill.

(Write to nearest address)

P. O. Box 987  
Palo Alto, Calif.

CANADIAN CUSTOMERS, please order directly from: CANADIAN INDUSTRIAL PLASTICS, LTD., 1056 1/2 Pender West, Vancouver, B. C.

## FREE! MY PLAN FOR YOUR SUCCESS

Learn ELECTRICAL APPLIANCE REPAIR and SERVICING



### SPARE OR FULL TIME

Want a good-paying business—a job in a fast-growing industry? Learn electrical appliance repair and service. I will teach you this interesting, good-paying business. The EASY step-by-step home study method, taught by PTS, prepares you NOW to reap lush profits to be made in this unlimited field. Have YOUR OWN BUSINESS—spare or full time—prepare for one of the many openings for trained men.

### ACT NOW

Millions of new appliances in homes—millions of new homes being wired for electricity assures hundreds of customers in nearly every neighborhood.

### EASY TO LEARN!

Men of all ages, yes, even the man of 60 can get into this ever expanding field—a business well suited to men who like to use their hands—a REAL OPPORTUNITY for the practical man who is not happy in his present job. Get started NOW—send for FREE BOOK giving all details.

### OPEN YOUR OWN SHOP

PTS training is more than a home study course in electric appliance repair and service. It gives you the know-how on the operation of your shop from a business standpoint—what to charge—how to get customers. Everything possible is done to assist you to start on the road to your success.

### EARN WHILE YOU LEARN

You can actually start earning before your course is finished. I send you your first lesson showing you easy jobs that can be done in your SPARE TIME AT HOME. Remember, one good repair job will pay for the cost of your course. NO BIG OVERHEAD needed. Start in your garage, basement, attic or spare room. When you are ready to expand, I will give you the benefit of my advice and experience.

**Yours!** AT NO EXTRA COST  
Big kit of tools and ELECTRICAL APPLIANCE TESTER

**Free!**  
Big book containing all of the details of my plan for your success.  
**WRITE NOW!**

### YOU LEARN TO REPAIR

Vacuum cleaners, Washing machines, Lamps, Motors, Irons, Ranges (gas and electric), Auto electricity, Garbage disposal units, Fluorescent lights, Electric shavers, Refrigeration, House Wiring.

USE THIS COUPON

PACIFIC TRAINING SCHOOL — Dept. P911  
7217 So. Broadway, Los Angeles 3, Calif.

Please send me your FREE BOOK.

NAME \_\_\_\_\_ AGE \_\_\_\_\_  
ADDRESS \_\_\_\_\_ ZONE \_\_\_\_\_  
CITY \_\_\_\_\_ STATE \_\_\_\_\_

FINANCING

PROFITS

POLICIES

TAXES

COSTS

AUDITS

BECOME AN EXPERT

# ACCOUNTANT

Choice of Bookkeeping—Advanced Accounting or CPA Coaching—No experience necessary!

The demand for skilled accountants—men who really know their business—is increasing. National and State legislation is requiring of business much more in the way of Auditing, Cost Accounting, Business Law, Organization, Management, Finance. Men who prove their qualifications in this important field are promoted to responsible executive positions.

**Free Book—"Accountancy, the Profession that Pays"**

Knowledge of bookkeeping unnecessary. We train you from ground up, or according to your individual needs. Low cost; easy terms.

Send for free 48 page book describing the LaSalle accountancy training, and the opportunities in this highly profitable field.

## LASALLE EXTENSION UNIVERSITY A CORRESPONDENCE INSTITUTION

417 South Dearborn Street  
Dept. 1164-HR Chicago 5

Please send me information on the training checked below, also "Accountancy, the Profession that Pays"—all without obligation.

- Accounting  
 CPA Coaching  
 Expert Bookkeeping

FREE



Name.....Age.....

Address.....

City.....Zone.....State.....

## ENGINEERING DEGREE IN 27 MONTHS

### Big Demand for Graduates

Aeronautical, Chemical, Civil, Electrical, Mechanical and Radio Engineering (including Television)

Hundreds of young men are earning engineering degrees in this recognized institution each year—continuous operation. New terms start quarterly. Many students earn a major part of their college expenses in this large industrial center.

Low tuition. Competent instruction. Thorough intense practical program. Modern laboratory facilities including new physics lab. and modernized wind tunnel. Individualized instruction emphasized.

Approved for Veterans. Engineering preparatory courses. Students from 48 states and 21 foreign countries. Enter December, March, June or September. Send coupon for free catalog and full information. Enroll now.

SEND COUPON TODAY

## INDIANA TECHNICAL COLLEGE

5119 E. Washington Boulevard  
Fort Wayne 2, Indiana

Please send me free information on B.S. Engineering Degree in 27 months as checked.

- Aeronautical,  Chemical,  Civil,  Electrical,  
 Mechanical,  Radio-Television.

Name.....

Address.....



# BE A LOCKSMITH

Learn Locksmithing and Keyfitting from experts in your spare time at home. Uncrowded field! No layoffs, no slow seasons. AGE OR PHYSICAL HANDICAP is no disadvantage. Year round steady income in this permanent, respected career. Full or part time. Practical, easy lessons show how to make money even while learning! ALL MATERIALS AND SPECIAL TOOLS SUPPLIED.

write DEPT. P3

Locksmithing Institute, Inc.

55 Park Ave. Rutherford, New Jersey

## SHIP MODELS for Everyone!

AUTHENTIC KITS FOR BOTH NOVICE AND EXPERIENCED BUILDERS

New "Clippers-Bits" kits at only \$3.95 each have carved balsa hulls, die-cut wood parts, tapered masts, finished fittings and simple plans. Send for your kit today. Select Schooner, Clipper, Barque or all 3. \$3.95 ea.

Big catalog describes over 30 beautiful ship models, 600 fittings and several authentic, fascinating gun models. Only 35c. Send for yours at once. MARINE MODEL CO., Dept. G, Halesite, Long Island, N.Y.



## NEW! LOW COST! RESPIRATOR

Wear when sanding, grinding, paint spraying, sweeping, dusting, furnace cleaning, etc. Handy as a pair of glasses. Just keep mouth closed and breathe through nose is all you do to operate. Protects against nuisance dusts, lint, coal, cement, grain dust, hay fever pollen. Has 9 sq. in. filter. For EYE protection against paint spray, dusts, gases, fumes, smoke, order our Fog-Proof Rubber GOGGLES \$1.65 p.p. (All prices postpaid in U.S.A.)

JERRY BRYANT, Dept. PM  
919 N. Michigan Ave. Chicago 11, Ill.



Order Today \$1.00 POST PAID

## WOULD \$400 PER MONTH INTEREST YOU?



It is easily possible to earn \$400 to \$500 a month raising ANGORA RABBITS. No experience required. Wool brings top price. Plenty markets. WRITE TODAY for FREE INFORMATION, PRICES and WHERE to SELL.

WHITE'S RABBITRY  
NEWARK 10, OHIO

WE'LL PAY YOU \$1000. for 3 gallons of "WORN OUT" motor oil from your own auto, truck or tractor engine. Details, page 30 in our FREE BOOK—"Oil Facts."

RECLAIMO MFG. CO., 5083 Elston Ave., Dept. 16, Chicago 30, Ill.

## EASY TO LEARN CODE

Learn or increase speed with an Instructograph—the Radio-Telegraph Code Teacher that takes the place of an operator-instructor and enables anyone to master code without further assistance. Available tapes from beginners alphabet to typical messages on all subjects. Speed range 5 to 40 WPM. Always ready—no GRM. Thousands have "acquired the code" with the Instructograph System. Write today for convenient rental and purchase plans.

INSTRUCTOGRAPH COMPANY

4701-V Sheridan Road, Chicago 40, Illinois



SAY YOU SAW IT IN POPULAR MECHANICS

## WATCHMAKING

★ Watch Repairing ★ Jewelry Engraving ★ Jewelry Repairing

Combination men earn top pay. Learn in school fully accredited by Horological Institute of America c/o U.S. Bureau of Standards, Washington, D. C. and United Horological Association of America. Approved for veterans. Receive tools, tuition and subsistence while learning.

Established 1935. Write for FREE booklet



The Baronian School, Inc.

2116 WALNUT ST. (DEPT. C) PHILA. 3, PA.

# THOUSANDS NOW PLAY

## who never thought they could!



**After Ten Months Plays in Band**

I had no idea I would accomplish so much musically. After only ten months I was playing in bands. I now am employed in a music store as an instructor. This I owe to your marvelously simple lessons.

\*R. C., Paterson, New Jersey



**Wouldn't Take \$1000 for Course**

The lessons are so simple that anyone can understand them. I have learned to play by note in a little more than a month. I wouldn't take a thousand dollars for my course.

\*S. E. A., Kansas City, Mo.



**Shares Course With Sister**

The teaching is so interesting and the pieces so beautiful I couldn't ask for anything better. I recommend your course highly. My sister shares it with me and feels the same way.

\*D. E. G., Wausau, Wisc.



**Lots of Fun**

The progress I have made is thrilling. I'm on Lesson Seven and tossing off "Little Buttercup" like a maestro. The course is easy and what is most important—lots of fun.

\*B. B., Jr., Hartford, Connecticut



**Plays After 2 Months**

I hesitated before sending for your course because of an earlier experience I had with a course by ear from another company. I am playing pieces now I never dreamed I would play after only two months.

\*E. T., Prichard, Ala.

\*Actual pupils' names on request. Pictures by professional models.

## You, too, can play any instrument By this EASY A-B-C Method

**Y**OU think it's difficult to learn music? That's what thousands of others have thought! Just like you, they long to play some instrument—the piano, violin, guitar, saxophone or other favorites. But they denied themselves the pleasure—because they thought it took months and years of tedious study to learn.

### Learn in Spare Time at Home

And then they made an amazing discovery! They learned about a wonderful way to learn music at home—without a private teacher—without tedious study—and in a surprisingly short time. They wrote to the U. S. School of Music for the facts about this remarkable short-cut method. And the facts opened their eyes! They were amazed to find how easy it was to learn.

The result? Over 850,000 men and women have studied music at home this simple, A-B-C way. Now, all over the world, enthusiastic music-lovers are enjoying the thrilling satisfaction of creating their own music. They have found the key to good time, popularity and profit.

### Costs Only Few Cents a Day

And that's what you can do, right now. Get the proof that you, too, can learn to play your favorite instrument—quickly, easily, in spare

time at home for only a few cents a day. Never mind if you have no musical knowledge, training or talent. Just read the fascinating booklet and Print and Picture sample that fully explain all about the famous U. S. School method. Instruments supplied when needed, cash or credit. If interested tear out the coupon now, before you turn the page. U. S. School of Music, 711 Brunswick Bldg., New York 10, N. Y. (51st year)

**FREE!**

Print and Picture Sample



### NOTICE

Please don't confuse our method with any systems claiming to teach "without music" or "by ear." We teach you easily and quickly to play real music, any music by standard notes—not by any trick or number system.

**U. S. SCHOOL OF MUSIC.**  
711 Brunswick Bldg., New York 10, N. Y.

I am interested in music study, particularly in the instrument checked below. Please send me your free illustrated booklet "How to Learn Music at Home," and your free Print and Picture Sample. (Instrument supplied when needed, cash or credit.)

Piano	Saxophone	Clarinet	Practical
Guitar	Trumpet, Cornet	Trombone	Finger
Hawaiian	Reed Organ	Flute	Control
Guitar	Tenor Banjo	Modern	Piccolo
Violin	Ukulele	Elementary	Mandolin
Piano Accordion		Harmony	

Mr. \_\_\_\_\_ Have you \_\_\_\_\_  
Mrs. \_\_\_\_\_ Instrument? \_\_\_\_\_  
Miss \_\_\_\_\_ (Please print)

Address \_\_\_\_\_

City \_\_\_\_\_ State \_\_\_\_\_

NOTE: If you are under 16 years of age, parent must sign coupon.

SAVE 2c — STICK COUPON ON PENNY POSTCARD



# AUTO BOOKS ON APPROVAL



**SEND NO MONEY.** Just mail the coupon for a complete set of 4 Big, Thick Auto Books. 20th Edition. Over 2700 Pages! Whether you are a mechanic or helper, expert or apprentice, auto owner or driver, take immediate advantage of this **FREE EXAMINATION OFFER.**

### MAKE GOOD MONEY NOW HOLD A PERMANENT JOB

America wants its automobiles kept in good repair. Men with "know how" are in demand, at big pay. These books will help you get and hold an important job, or give you a chance to go into business for yourself now or later. Any man who half tries to improve himself can learn auto servicing and repairing by this quick reference method. Use the **JIFFY INDEX** to find easily understood answer to any auto problem. These wonder books prepared by eleven of America's great automobile engineers. Many hundreds of valuable illustrations. Send the coupon **TODAY.**

**A year's consulting privileges with our engineers now given with these books without extra charge.**

*Publishers Since 1898*

### CAN YOU FIX IT?

These wonder books tell step by step **HOW** to make difficult repairs and adjustments, how to keep a car at maximum efficiency, including latest improvements in car design and operation. Engine troubles and how to correct them well covered.

### 4 BIG, THICK VOLUMES

Over 2700 pages, 2000 illustrations, wiring diagrams, etc. Beautiful modernistic, washable cloth binding.

**AMERICAN TECHNICAL SOCIETY, Dept. AB19**  
Drexel Ave. at 58th St., Chicago 37, Ill.

I would like to examine your 4-Volume Set of Auto Books. I will pay the delivery charges only, but if I choose I may return them express collect. If after 10 days' use I prefer to keep them, I will send you \$2 and pay the balance at the rate of only \$3 a month until \$24.80 has been paid. Include consulting service as offered above.

Name \_\_\_\_\_  
Address \_\_\_\_\_

City \_\_\_\_\_ State \_\_\_\_\_  
Please attach letter stating age, occupation, employer's name and address and name and address of at least one business man as reference. Men in service, also please give home address.

## Learn this Profitable Profession



**IN 90 DAYS AT HOME**

## Money-Making Career Open to Men and Women, 18 to 50

Hundreds of men and women between 18 and 50 make \$10 to \$20 in a single day giving scientific Swedish Massage and Hydro-Therapy treatments. There is big demand from doctors, hospitals, sanatoriums and clubs. Graduates earn large full time incomes from these or in private practice in their own offices. Others make good money from home treatments given in spare time. Learn this interesting, money-making profession in your own home, through our home study course. Same instructors as in our nationally known resident school. You can win independence and prepare for future security by qualifying for your Diploma. Course can be completed in 3 to 4 months. Many earn while they learn. Begin your training at once.



### Anatomy Charts & Booklet FREE

Enroll now and we will include, at no extra cost, many needed supplies. Fit yourself to help meet growing demand for Scientific Swedish Massage. Send the coupon at once for complete details. Anatomy Charts and 32-Page Illustrated Booklet, **FREE**, postpaid.

**THE COLLEGE OF SWEDISH MASSAGE**  
Dept. 964P, 41 E. Pearson, Chicago 11, Illinois

Please send me **FREE** and postpaid, Anatomy Charts, 32-page Booklet and complete details on Home Training.

Name \_\_\_\_\_ Age \_\_\_\_\_  
Address \_\_\_\_\_  
City \_\_\_\_\_ State \_\_\_\_\_

## Career Training in a Minimum of Time RADIO—ELECTRONICS TELEVISION ENGINEERING

**GRADUATES** of CREI residence school are preferred by industry because of their *training and ability.* CREI prepares the young man for a good job in industry in a minimum of time. 22 years practical experience. CREI offers an outstanding faculty, modern laboratories, shops and equipment. New students accepted twice monthly and each may advance as rapidly as he is capable. Basic course with one specialized course requires an average of 20 months to complete.

*Approved for Veteran's Training.*

• **Write for Details and Free Catalog**



**CAPITOL RADIO ENGINEERING INSTITUTE**  
Dept. 1711A, 16th & Park Rd. N.W.  
Washington 10, D.C.



## ENGINEERING

**Building, Drafting, Etc.**

Degree in 27 mos. Approved for G.I. Training. Prepare in Chicago, the Industrial Hub. Earn part living expenses. 45th year. Other shorter courses in Air Conditioning, Refrigeration, Radio, Electricity. Enter Jan., March, July, Sept.

*Write for catalog*

**P-83 TECH BLDG., 2000 S. MICHIGAN AVE., CHICAGO 16**

## LEARN ADVERTISING ART

Free portfolio "Your Career in Art" gives complete details. Write for combined talent and instruction test to judge your ability and our course.

**APPLIED ART STUDIO, 1662 Lincoln Ave., Dept. A, Cleveland 7, Ohio**

## DE LUXE SHEFFIELD CHRONOGRAPH WRIST WATCH



Has everything—plus new low price. It's a timekeeper, stop watch, measures speed of planes, cars, horses, etc. Sweep second hand, chrome case, unbreakable crystal. Swiss movement. Sold to \$29.95. Send cash, check, or C.O.D.

**9<sup>75</sup>**

**WAYNE SALES COMPANY**  
423 American Ave., Long Beach 12, Calif.

**LIMIT ONE** Guaranteed by mfg. for **FULL YEAR**

## EARN HIGH SCHOOL DIPLOMA AT HOME

Guided study permits you to complete High School education in shortest possible time. Modern methods make it interesting, easier. Prepare for better jobs, pre-professional, college entrance exams. Recognition for H.S. credits already earned. Books supplied. Low tuition, easy terms. Write for Free Information.

**HOME STUDY INSTITUTE**  
209 VINE AVENUE DEPT. PM-11 PARK RIDGE, ILL.

## OWN a Business.



Clean and Mothproof rugs and upholstery "in the home." Patented equipment. No shop needed. Duraclean dealer's gross profits up to \$20 a day on **EACH** serviceman. These Nationally Advertised services create repeat customers. Easy to learn. Quickly established. Easy terms. Send today for **FREE** Booklet—Full details.

**DURACLEAN CO., 9-16N DURACLEAN BLDG. DEERFIELD, ILL.**

## AIR-CONDITIONING REFRIGERATION

**BIG PAY TRADE** Mastered by Mail

### HOME STUDY COURSE

Teaches Air Conditioning and Refrigeration . . . the field of the future with a future. Get in now on the ground floor. Restaurants, taverns, stores, theaters, etc., all need and are installing air conditioning. Maintenance men will be needed for Big Pay Jobs. Learn at Home in your spare time. Four week practical training period in the great modern shops of ACRI in Baltimore included in course. For details—Write—

**ACRI, 110 N. Paca St., Baltimore 1, Md.**

# There's a BIG Future for YOU in AERONAUTICAL ENGINEERING — with NORTHROP Training



Aeronautical Engineering offers a wide choice of interesting duties. Here two engineers install a guided missile model in the Northrop Aircraft, Inc. wind tunnel.



Wing-top classroom—an example of how engineering instruction at Northrop comes vividly to life in the midst of this famous aircraft research and production center.

You can ride to success on wings of the great *Air Age*. Aviation is progressing at "super-sonic" speed. Things to come defy your imagination. Stretching ahead of you can be a lifetime career of fascinating work and rich rewards—in *Aeronautical Engineering*. Many types of creative duties call for men with *imagination* and *originality*. Many practical kinds of work call for men who like *action* and the use of *skill*.

Northrop training in *Aeronautical Engineering* has won choice jobs for graduates. Many of even the more recent Northrop graduates are in such important work as design, research, testing, stress analysis, aerodynamics and power plant engineering. They have drawn top pay brackets for starting jobs...have moved up fast to even better jobs.

Learn all about your big opportunities in Aviation. Get full details on Northrop's 2-year *Aeronautical Engineering Course*. You can begin your training soon—classes start every 8 weeks.

## SEND COUPON FOR CATALOG NOW



**NORTHROP AERONAUTICAL INSTITUTE**  
1527 East Broadway, Hawthorne, Los Angeles County, Calif.

Please send information on opportunities in *Aeronautical Engineering*, your catalog, and starting dates of classes. I am interested in:

Aeronautical Engineering       Aircraft & Engine Mechanics

Name \_\_\_\_\_ Age \_\_\_\_\_

Address \_\_\_\_\_

City \_\_\_\_\_ Zone \_\_\_\_\_ State \_\_\_\_\_

Check one:  Veteran       Non-Veteran

### APPROVED FOR VETERANS

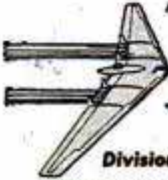

## Northrop Aeronautical Institute

Division of Northrop Aircraft, Inc. ★ James L. McKinley, Managing Director

1527 EAST BROADWAY, HAWTHORNE, LOS ANGELES COUNTY, CALIF.

# Watchmakers MAKE MONEY!

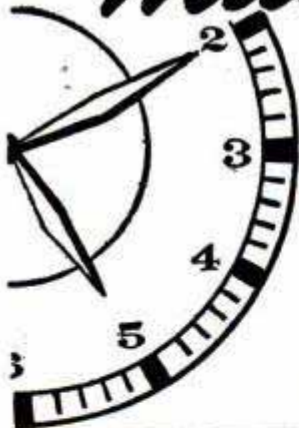

Large earnings with no dull seasons, professional dignity, a steady secure future are yours as a Master Watchmaker! You can

choose a fine job or go into your own business. The famous Sweazey System teaches you... expertly, quickly, successfully.

### SEND FOR FREE BOOK NOW →

Since 1908, Chicago School of Watchmaking graduates have been in constant demand. Write today for your free copy of our new illustrated book about the big opportunities in watch repairing, gem setting and engraving.

**CHICAGO SCHOOL OF WATCHMAKING, 1608 Milwaukee Avenue, Chicago 47, Illinois, Dept. 1119**

Please send your new book, "Master Watchmakers Wanted" without cost or obligation.

- I am interested in attending residence school.  
 I am interested in home study.  
 I am a veteran.       I am a non-veteran.

NAME \_\_\_\_\_

ADDRESS \_\_\_\_\_

CITY \_\_\_\_\_ ZONE \_\_\_\_\_ STATE \_\_\_\_\_

# TRAVEL - for 'UNCLE SAM'

## ARE YOU JOB-SATISFIED? GET A U. S. GOVERNMENT JOB Many Positions to Be Filled

Railway Mail Clerks — Postoffice Clerks — Mail Carriers — Stenographers — Typists, Statistical Clerks — Liquor Inspector, etc. 40 page Civil Service Book — FREE.

**MEN — WOMEN**

**Veterans Get Preference**

Mail Coupon immediately—today sure.

Although not government controlled, this can be your first step toward a secure Civil Service Career.

As high as \$3,351.00  
**FIRST YEAR**



### COUPON

**FRANKLIN INST., Dept. X-84, Rochester 4, N. Y.**

Gentlemen: Rush to me without charge, 40 page book with list of U. S. Government big paid positions. Advise me also regarding salaries, hours, work, vacations, etc. Tell me how to qualify for a position.

Name.....

Address..... Vet?.....

# Do you want

- ..to go to College?
- ..or to enter a Profession?
- ..or get an Office Position?

(Such as Accounting, Architecture, Nursing, Dentistry, Teaching, Social Work, Osteopathy, Beauty Culture, Optometry, Embalming, Chiropody, Law, Medicine, etc.)

To get anywhere, you practically **MUST** finish High School **FIRST**. You can complete our simplified High School Course in **SPARE** time at home, as **FAST** as your time and abilities permit. Equivalent to resident school work—prepares you for college, pre-professional examinations, business, industry. Standard texts furnished. Diploma. Credit for H. S. subjects already completed. Single subjects if desired. Low tuition, easy terms. American School, Chicago, est. 1897—endorsed by educators. Finish your high school education **NOW**. Write **TODAY!**

## High School Course at Home

Many Finish in 2 Years

American School, Dept. H845, Drexel Ave. at 58th St., Chicago 37, Ill.

Gentlemen: Send me **FREE** information covering special training in subjects checked below. No obligation on my part.

- |  |  |
|--|--|
| <input type="checkbox"/> High School Course          | <input type="checkbox"/> Diesel Engineering                  |
| <input type="checkbox"/> Architecture and Building   | <input type="checkbox"/> Drafting and Design for Men & Women |
| <input type="checkbox"/> Automotive Engineering      | <input type="checkbox"/> Plastics                            |
| <input type="checkbox"/> Business Management         | <input type="checkbox"/> Private Secretary                   |
| <input type="checkbox"/> Electrical Engineering      | <input type="checkbox"/> Mechanical Engineering              |
| <input type="checkbox"/> Elec. and Gas Refrigeration | <input type="checkbox"/> Aviation                            |
| <input type="checkbox"/> Air Conditioning            | <input type="checkbox"/> Salesmanship                        |
| <input type="checkbox"/> Railway Training            | <input type="checkbox"/> Radio                               |
| <input type="checkbox"/> Electronics, Industrial     |  |

Name.....

Address.....

## EARN MORE MONEY IN ELECTRICITY!

with APPLIED PRACTICAL ELECTRICITY



Coyne's new set helps men get ahead in Electricity. 8 great books give you complete A to Z know-how, explained in easy-to-follow language with hundreds of charts, examples, pictures. Covers all branches of electricity including appliance repairing; AC and DC equipment; electrical refrigeration; industrial electronics and much more. Brings you 10,500 electrical facts; 3,400 subjects; hundreds of wiring diagrams, tables, formulae, short-cut methods. Backed by 50 years of Coyne experience in training that has put hundreds of men on the road to top earnings.

Sent on **FREE TRIAL**

### USE SET FREE FOR 7 DAYS!

You have to **SEE** these books to know how much they'll help you. See them **FREE!** Just fill out coupon below and mail it in. **SEND NO MONEY.** Examine the set for 7 days **AT OUR RISK!**

### HANDBOOK OF RESIDENTIAL WIRING FREE FOR PROMPT ACTION



Act promptly and we will include **FREE**, the valuable new booklet, "Handbook of Residential Wiring Design". If you return the Set at our expense in 7 days, you owe nothing. To keep Set, send either \$23.75 in cash or \$3.00 after 7 days and \$3.00 per month until \$25.50 is paid. **Either way, you keep the Residential Wiring Book FREE!** Coupon below is just a request to see **APPLIED ELECTRICITY** Set and to get **FREE** Wiring Book for doing so. Mail coupon **AT ONCE!**

### FREE TRIAL COUPON—MAIL NOW!

Educational Book Publishing Division,  
**COYNE ELECTRICAL & RADIO SCHOOL,**  
 500 S. Paulina St., Dept. 89-R6, Chicago 12, Ill.  
 YES! Send Coyne's new, 8 volume set, "Applied Practical Electricity" to me, postpaid, for 7 days **FREE TRIAL** per your offer. Include "Handbook of Residential Wiring" **FREE.**

Name..... Age.....  
 Address.....  
 Town..... Zone..... State.....

NEEDLESS TO PAY MORE RISKY TO PAY LESS



**VETS — GARAGES**  
 Service Stations

Take 10% **DISCOUNT**  
 ON 1 TO 100 TIRES.

**OUR GUARANTEE**  
 OUR TIRES must make good or WE WILL  
 If You Want **SAFE TIRES**

Be Wise—See Us Before You Buy  
 Our Experience Insures Your Safety

You get what we advertise

**USED TIRES — ORIGINAL TREAD**

**BUY IN CONFIDENCE** safe dependable  
 selected **POPULAR BRANDS**—Guaranteed  
 to give **A-1 SERVICE.** These tires are  
 absolutely **NOT** Re-caps or Re-molds.

**REMEMBER:** Tube **SENT** with **EVERY** tire regardless of **PRICE**  
 or **GRADE**

**SELECTED FOR TOUGHEST JOBS** Not just good... **THE BEST**  
 These are genuine Values! One Trial will **CONVINCE YOU**

TOPS IN VALUE		TOPS IN SAFETY	
600-16 ... \$5.02	650-16 ... \$4.72	700-16 ... \$6.02	
650-15 ... 4.72	700-15 ... 5.02	750-16 ... 7.62	

World's Best Truck Tire Values		Top Service Minimum Prices	
6.00-20(6) \$9.22	8.25-20(10) 15.52	11.00-20(12) \$16.42	
6.50-20(8) 9.22	9.00-20(10) 15.52	11.00-22(12) 18.42	
7.00-20(8) 10.52		32x6 (8) 10.02	
7.50-20(8) 10.52	10.00-20(12) 16.22	32x6 (10) 12.82	

750-20 **MILITARY 8 PLY REGULAR \$9.62—SUPER \$12.92**  
 900-16 **MILITARY 8 PLY REGULAR \$8.72—SUPER \$10.92**

ONE QUALITY THE BEST AVAILABLE

**HERE'S MAXIMUM QUALITY IN THESE O.K. SAFE TIRES**

600-16 ... \$3.42	650-16 ... \$3.62	700-16 ... \$4.42
650-15 ... 3.62	700-15 ... 3.72	750-16 ... 5.62

Thousands of Tires Shipped to Satisfied Customers Throughout United States and Many Distant Points. Please Note: We've made Thousands of Friends by Giving a Tube with Passenger and Truck Tires. **MAIL ORDERS** given Personal Attention—Send This Ad with Check or Money Order. Dept. 2

**STANDARD** 834 N. Broad St., Philadelphia 30, Pa.

Imported **CHRONOGRAPH** with 2 push buttons

**WRIST WATCH \$6.90**

Plus 69c Fed. Tax  
**1 Year Written Guarantee and Instructions**

**GIVEN STAINLESS STEEL EXPANSION BAND**

"Wonder" Watch. Used to time autos, airplanes, horse races, athletic events.

- Tachometer • Telemeter • Hands & Nos. Glow in Dark • Unbreakable Crystal • Large Red Sweep Hand • Tells Time • Measures Speed & Distance • Stop Watch • Precision Made

**SENT ON APPROVAL.** Deposit \$6.90 plus tax and postage with postman or send money order, save postage. (Same money back privilege.)



7-Day Money Back Guarantee

**THE JEWELBOX, Dept. GD, 1674 Broadway, N.Y. 19, N.Y.**

# CARPENTRY BRICKLAYING

APPROVED FOR VETERAN TRAINING • **FREE CATALOG**

**PENNSYLVANIA INSTITUTE SCHOOL OF TRADES**  
 30th & MARKET STS. PHILA. 4, PENNA.

## APTITUDE TESTS

discover the kind of work or studies best for your success! You get a personal report—a guide for life—more happiness—more prosperity. For men, women, boys and girls. Write for complete facts.

**VOCATIONAL COUNSELING INSTITUTE**  
 956 Macabees Bldg., Detroit 2, Michigan

## Learn THE SCIENCE OF SALESMANSHIP

This nationally renowned school has demand for graduates in good salary positions thru Nationwide recognition and placement service. Write Department PMC today for Big 32 **FREE** page Success Book to be sent to you



**Hills BUSINESS UNIVERSITY AND EXTENSION SCHOOL**  
 619 W. MAIN ST. OKLAHOMA CITY 2, OKLAHOMA

**SAY YOU SAW IT IN POPULAR MECHANICS**

## Learn BAKING At Home

Baking is one of America's high industries in wages. Nearly depression-proof. Thorough basic home course lays sound foundation. If you have aptitude, write for **FREE BOOKLET**, "Opportunities in Commercial Baking." National Baking School, 1315 Mich. Ave., Dept. 1358, Chicago 5



# BARGAINS!

Save \$100 or more on famous Hohner accordions, latest models, Demonstrators. Guaranteed like new. Hurry! Write today for list, as supply is limited. Easy terms. Free "Self-Teacher" course with each accordion.



## Genuine Hohner harmonicas



Brand new—at cut prices!  
"Old Standby" \$1.95.  
"Marine Band" \$2.35  
Chromatics at \$10.95,  
\$13.95, \$18.95

Free picture-method instructor.

Send check or money order to

**JORGENSEN BROS.** Racine 4, Wisconsin



## FREE TO HOME PLANNERS

"Little Blue Booklet" of 29 popular plans sent FREE to acquaint you with our MONEY SAVING home planning service which includes 1200 Tested Designs; beautifully illustrated plan books; working drawings; material lists; specifications—all at LOW COST. Write today for FREE BLUE BOOKLET and complete information. America's pioneer residential plan service.  
Small Homes Plan Book — 68 beautiful designs.  
Budget Homes Plan Book — 78 economy plans for 1 and 2 story homes.

**\$100**  
BOTH BOOKS FOR

**L. F. GARLINGHOUSE CO., Inc.,** Box PM-2, Topeka, Kans.

## EARN \$5 an HOUR—ON THE SIDE

WHILE LEARNING WATCH & CLOCK REPAIRING AT HOME

WITH OUR NEW 15 ITEM SELF TRAINING KIT  
Containing: AMERICAN JEWELLED WATCH MOVEMENT for practicing; PROFESSIONAL TOOLS: Loupe; 6 Watch Screw Drivers; Clock Screw Driver; Tweezers; Clock Tweezers; Material Tray; Case Opener & Knife; Movement Gauge; plus COMPLETE ILLUSTRATED COURSE IN MODERN WATCH & CLOCK REPAIRING incl. use of tools and materials. Complete: easy to understand. (If C.O.D., plus charges) **\$14.95 POST MONEY BACK GUARANTEE.** All-inclusive Instructive Tool Catalog with about 600 illustrations & descriptions FREE with KIT or send \$3.50 credited to 1st order.  
**MODERN TECHNICAL SUPPLY CO.**  
Dept. 11MMC, 55 W. 42nd St. New York 18, N. Y.

## How to Make Money with Simple Cartoons



A book everyone who likes to draw should have. It is free; no obligation. Simply address

**FREE BOOK**

**CARTOONISTS' EXCHANGE**

Dept. 911-D Pleasant Hill, Ohio



## 6 POWER PRISM

**VEST-POCKET IN SIZE**

**BINOCULARS COATED OPTICS!**

Dynamic in power and range. At 1100 yards has sharp, clear field of 370 feet! Made under military supervision. Moisture-proofed... Dust proofed! All metal construction. Individual eye focussing. Adjustable for all eye widths! A compact, durable, all purpose prism binocular. NOT a field glass. **Coated optics means entire optic system is coated!** Economy priced at fraction of what similar glasses sell at retail! Complete with leather case and straps only \$19.50 plus 20% Fed. tax. Cash orders sent postpaid. On C.O.D.'s include \$2 deposit. **Guaranteed.** Try 20 days at our risk. **United Products Co., 7941 S. Halsted, Dept. ARF-1408, Chicago 20.** Reference Dun & Bradstreet.

# EARN MORE IN DRAFTING



Steady Employment  
•  
More Opportunities for Promotion

"Here I am at work making good money as a draftsman. I'm glad I sent the coupon to Chicago Tech for that Free Trial Lesson and found out how easy it is to learn Drafting in spare time at home. Today I feel secure in my job because the draftsman's work comes first on any new project. And, in addition, draftsmen can't be replaced with machines. What's more, I feel I'm slated for promotion and more pay, because I see so many draftsmen advancing to high-pay jobs."

## LEARN IN SPARE TIME—AT HOME!

(or at the College in Chicago)

A few hours of pleasant home study every week—that's all. No interference with your present job. All the tools you need; drawing outfit included. With Chicago Tech's help, you train yourself step by step. This tested method—developed over 45 years of C.T.C. progress—prepares men quickly for good positions in industry.



## FREE INFORMATION—SEND COUPON

To prove to you how easy it is to learn Drafting at home by the Chicago Tech method, we will send you this FREE TRIAL LESSON. No charge for this lesson, now or later. Fill out and mail coupon, or send post card today.

## CHICAGO TECHNICAL COLLEGE

P-212 Tech Bldg., 2000 S. Michigan Ave., Chicago 16, Illinois  
Mail me FREE Lesson with information about big opportunities in DRAFTING.

Name \_\_\_\_\_ Age \_\_\_\_\_  
Address \_\_\_\_\_  
City \_\_\_\_\_ Zone \_\_\_\_\_ State \_\_\_\_\_

## SAW YOU SAW IT IN POPULAR MECHANICS

## 10,000 HELPS TO BE YOUR OWN BOSS, IN THIS BIG BOOK!



**PRACTICAL IDEAS—QUICK RESULTS**  
Never before such a book of helps for you who wish extra money quick. In this book are formulas, recipes, secrets that have amazed the world. Use these ideas and make many needed money-making products. Experts wrote this book in simple terms, with supply sources for materials, shortcuts and methods for profitable results.

Included "Knowledge is Power" containing more than 170 sure-fire opportunities to promptly increase income and permanent security.

**FREE!** Lots of profitable businesses have started with a single recipe. Choose from the 162,000 facts and 10,000 formulas such as: — Adhesives, Cosmetics, Beverages, Candy, Ceramics, Cheese, Cleaners, Concrete, Dentifrices, Dyes, Depilatories, Enamels, Flavors, Foods, Gum, Home formulas, Inks, Insecticides, Lacquers, Linoleums, Lubricants, Metals, Mirrors, Oils, Ointments, Paints, Perfumes, Plastics, Polishes, Remedies for Man, Beast & Fowl, Soaps, Solders, Varnishes, etc. 1000's of others to make all sorts of profitable items.

**WHEN EXTRA \$\$\$ ARE NEEDED**  
This big book tells what to do and how. No experience needed. You choose from the money-making facts and ideas that are explained in words easily understood. Many fortunes have been made with a single formula. Mail in your order and get started right NOW!

POSTPAID  
**\$3.98**  
ANYWHERE IN THE WORLD

\$3.98 postpaid throughout the world. (C.O.D. plus postage in U. S. only.) Shipped at once.  
**World-Wide Service — Books on Any Subject**  
**ADAMS BROWN COMPANY, Dept. P119, Boston 67, Mass., U.S.A.**



YOU  
can  
acquire

## LAW NIGHTS AT HOME! L. L. B. DEGREE

LaSalle's famous Law Library—used as reference in many Law libraries and Law offices—has enabled thousands to master Law surprisingly fast, in spare hours at home, for business and professional advancement.

These 14 remarkable volumes, compiled by leading professors and lawyers, cover the whole basic field of Law in condensed, orderly, simplified manner.

You advance rapidly with this great library, plus special lectures furnished. We guide you step-by-step with personalized Problem Method of instruction . . . you learn by doing—handling legal problems—not by memorizing rules.

Send for two FREE 48-page booklets, "Law Training for Leadership," and "Evidence," answering questions about Law and its value to you, and telling how LaSalle Law graduates are winning rapid advancement in business and public life. Mail coupon below. No obligation.

### LA SALLE EXTENSION UNIVERSITY

A Correspondence Institution

417 S. Dearborn St. Dept. 1164-L Chicago 5, ILL.

Send me your two FREE booklets described above; without obligation.

Name \_\_\_\_\_ Age \_\_\_\_\_

Street \_\_\_\_\_

City, Zone & State \_\_\_\_\_

## BIG PAY JOBS for men who qualify in DIESEL



**ASSURE YOUR FUTURE.** Steady, high-pay jobs await men qualified in Diesel, Tractor, and Heavy Equipment. Are you qualified for job and advancement opportunities in this fast-growing field? You can qualify?

**COMPLETE DIESEL COURSE NOW AVAILABLE.** If you are ambitious and want to get ahead in this big money field, you'll want to know about the complete Diesel home training course now offered by Interstate Training Service. Covers all phases of operation, repair, service. Easy to master in spare time. No interference with present job. Up-to-the-minute. Regularly revised to cover new developments. We invite comparison of material offered. Free placement advisory service.

**YOU OWE IT TO YOURSELF** to investigate Interstate Training Service Diesel Training. Thousands agree it has helped them to better jobs... better pay. It can do the same for you!

**SEND FOR FREE BOOK TODAY!**

INTERSTATE TRAINING SERVICE, Portland 13, Ore.  
Please see that I receive FREE 24-page book,  
"Getting Ahead In Diesel." (K-3)

NAME \_\_\_\_\_ AGE \_\_\_\_\_  
ADDRESS \_\_\_\_\_  
CITY \_\_\_\_\_ ZONE \_\_\_\_\_ STATE \_\_\_\_\_

# K-R-O KILLS RATS

• K-R-O BIS-KITS are ready-made, easy to use; containing *fortified red squill*, they're safer around livestock, pets, and poultry. K-R-O POWDER is 100% *fortified red squill*; economical to use in badly infested areas when mixed with natural baits. BIS-KITS, 35c and \$1.00; POWDER, 75c at drug, seed, and feed stores. Money-back guarantee. The K-R-O Company, Springfield, Ohio.

*Learn to Write at Home in spare time*

Write for FREE BOOK, "How to Become an Expert Penman," which shows how others have learned by taking my Courses at home in spare moments. You, too, can greatly improve your penmanship, or become an Expert Penman. Check or state Courses interested in:  Business Writing  Ornamental Writing  Bird, Eagle and Swan Flourishing. Send 10c for Special Penpoint and your name with a flourished bird written on a card.

**WRITE TODAY**

Box 25K, CHILLICOTHE, MO.

## MEN! OVER 40?

READ "THE MALE HORMONE"

DeKruif's great book—for new enjoyment of living! Send \$1 bill with name and address.

VITA PUBLISHING CO., Dept. PM  
1189 1/2 No. Western Ave., Hollywood 27, Calif.

was \$2.50  
NOW  
\$1.00  
POSTPAID

## ELECTRICAL TRAINING

Intensive 32 weeks' residence course in fundamentals of industrial electrical engineering, including radio, electronics. Prepares for technician, engineering aides. Approved for veteran training. 57th year. Enter Mar. 6. Catalog.

**BLISS ELECTRICAL SCHOOL**  
7644 TAKOMA AVENUE  
WASHINGTON 12, D. C.



**OUT OF PAWN  
GENUINE DIAMONDS**

**SAVE UP TO 50% AND MORE**

Unmatched values in genuine blue white diamonds. Each diamond sold with a written iron-clad money back guarantee. All diamonds set in gorgeous new mountings. Send today for beautiful, illustrated catalog showing values from \$10.00 to \$10,000. Over 100,000 satisfied customers have bought Diamonds from Berman's. Our reference—your own bank or any mercantile agency.

**BERMAN'S DIAMOND LOAN BANK**  
DEPT. P — BERMAN BLDG. BALTO. 1, MD.

Approx. 1/2 Ct. \$95 Incl. Tax \$200 VALUE

Send today for **FREE Catalog**  
NO OBLIGATION



**\$350** IN A SINGLE WEEK **GROSS**



IN MY OWN BUSINESS

Some Make More, Some Less...  
Start This Business for **YOUR OWN**

George Held earned \$350 in one week with

### ELECTRIC UPHOLSTERY CLEANER

● Here's YOUR chance to start a money-making, year-'round business of your own and make the success you've dreamed about. R. O. Donnley took in \$40 in seven hours. O. W. Ware landed a \$750 hotel job and made a fine profit. J. S. Corbit grossed \$279.50 his first month. P. D. Ash cleaned 23 auto seats at \$5 each in one week. And so it goes. Homes, hotels, offices, clubs, all places where furniture is used, offer you big profit possibilities. Auto seats and interiors, also.

#### NO SHOP OR OFFICE NECESSARY

You clean furniture on customers' premises. No hauling costs. No high rents. Supplies are in-

expensive and you operate, at low cost, from your home. What you take in is mostly profit. Surely YOU will want to investigate an opportunity like that — right away. Own your own business. Be your own boss. If you are ambitious, honest and courteous, we will help you to start and succeed.

#### FULL INFORMATION FREE MAIL COUPON TODAY

Send the coupon or write for Furniture Cleaner Booklet. It tells all about this electric cleaner—how to start YOUR business—how to make a profitable success. Don't delay. It's your BIG opportunity.



### FREE BOOK! MAIL COUPON

VON SCHRADER MFG. CO.

41N Pl., Racine, Wisconsin

Send at once (no obligation) your FREE booklet containing information about your Electric Upholstery Cleaner and how I can own my own permanent, profitable business.

Name \_\_\_\_\_

Address \_\_\_\_\_

City \_\_\_\_\_ Zone \_\_\_\_\_ State \_\_\_\_\_

MAIL COUPON TO

VON SCHRADER MFG. CO., 41N PL. RACINE, WIS.

### BE A PHOTO-ENGRAVER

We furnish complete equipment and supplies. Learn at home or in our modern, friendly APPROVED school in MISSOURI. Get into this big demand, high profit, high wage field. You can start your own profitable, full time or part time PHOTO-ENGRAVING business right in your own home.

THE AURORA SCHOOL OF PHOTO-ENGRAVING, DEPT. 9PM., TASOPÉ BLDG., AURORA, MO.

Be independent, be your own boss or pave the way to a high pay job with experience gained in your own shop.

TASOPÉ TRAINING and TASOPÉ EQUIPMENT has enjoyed world wide recognition since 1931. Write for descriptive literature today. No obligation.

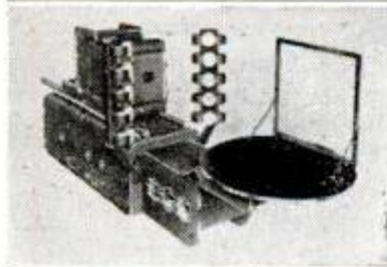

## LEARN MEAT CUTTING EASILY - QUICKLY At Home - In Spare Time



The steady, dependable trade of Meat Cutting taught easily, quickly by improved HOME METHOD. National School, established over 25 years, has organized its famous "Learn By Doing" Classroom, Cutting room and Retail Market training system into sound, practical HOME STUDY form.

Now, by the miracle of this EXTENSION TRAINING you can prepare in Your Spare Time At Home, for a better job, bigger responsibilities or success and security in a store of your own. Remember, PEOPLE MUST EAT!

Buying, cutting, percentage, pricing, advertising, selling—a complete meat education. For beginner or men with ex-

perience. Thousands of successful graduates. Send coupon for FREE Bulletin NOW!

#### MAIL THIS COUPON TODAY FOR FREE BULLETIN

National School of Meat Cutting Div. U-110, Toledo 4, Ohio

Send me your FREE Bulletin on Meat Cutting and Meat Merchandising. No obligation. No Salesman will call.

Name \_\_\_\_\_

Street \_\_\_\_\_

City \_\_\_\_\_ State \_\_\_\_\_

# NOW EASY TO START A Big Business ON A SMALL INVESTMENT



## WARNER SUCCESS PLAN Gives exact instructions showing you

- How to start in spare time
- How to use home as headquarters
- How to bring in the business
- How to do real METALIZING in genuine GOLD, SILVER, or BRONZE, by the easy Warner Method
- How to start without risking your job
- How to pyramid your profits
- How to be sure of steady, big income.

Don't turn this page until you've given serious thought to your future. In the uncertain years ahead, the men who own their businesses are the ones who will be happiest. A small start now easily can lead you to complete independence, freedom from time clocks, freedom from fear of lay-offs, freedom from the limits of a pay check.

Now, while you can do it without risk—now is the time to investigate the exceptional opportunity offered you by the Warner Success Plan. Looking into the market, checking up on the possibilities for big sales and big profits will not cost you anything. Isn't this the time to lay the foundation for a future of complete independence—a life of happiness—a steady, dependable income?

## METALIZING BABY SHOES AND OTHER KEEPSAKES

offers an exciting new opportunity to men or couples who want personal independence

If you'd like the feeling of being boss instead of being bossed—the Baby Shoe business is made to order for you. Just think of the appeal. A mother's love for her child—her desire to preserve forever the tiny shoes in which her baby took its first toddling steps. No wonder orders come easy and fast. No wonder profits are big. Then think of the Future. Fifteen Million babies in the last five years—three million last year—millions more next year. As long as babies are born, this business will prosper—in good times or bad. Think of the fun. Every job is different, interesting. And when you deliver a job and collect the money, you get a tremendous glow of satisfaction out of the mother's happy exclamations over your work. There's not another business I know of that offers you such big rewards in cash, in security, in a future, in independence that can be started on such a shoestring. You'll be glad you saw this ad—IF YOU SEND THE FREE COUPON.



## READ THE ENTIRE PLAN

### 7 DAYS AT MY RISK

#### DON'T SEND A PENNY NOW — Just Send Your Name

This is one of the most fascinating businesses you can imagine. There are 15 MILLION pair of baby shoes waiting right now to be METALIZED. The opportunities are unlimited. The future is very big. And it's a business in which the whole family can have fun helping. A perfect business for man and wife to start—or for two partners. And I want you to read the whole Plan at my risk. Don't spend a cent unless you go ahead.

I want every serious minded man to let me show what I've done in our own shops here in Chicago—reveal the exact facts about the profits to be made and the way to make them. I don't want you to spend a cent for supplies until you've studied the facts, talked them over with the family, and satisfied yourself that this is the ONE BIG OPPURTUNITY FOR YOU. That's why I allow you to read all trade secrets contained in the Warner Success Plan at My Risk. If you don't go ahead, you don't pay a cent.

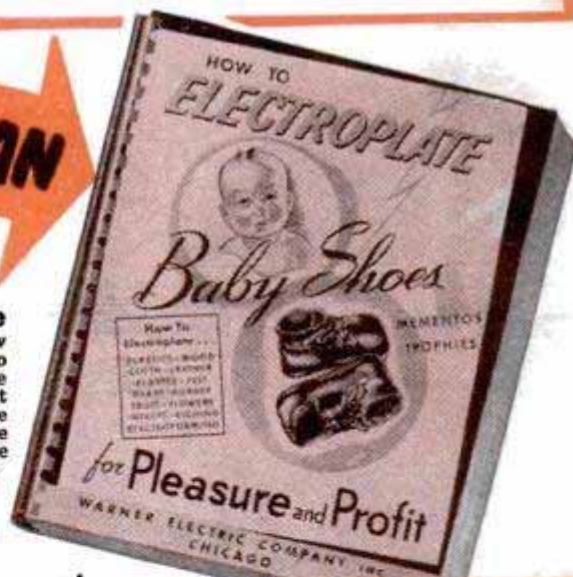

### ALL FACTS FREE! MAIL!

Raymond E. Brandell, Mgr., Warner Electric Co.,  
1512 Jarvis Ave., Dept. 311, Chicago 26, Ill.

As long as it doesn't cost me a cent, I am willing to read the facts, investigate, then give you my decision. Send the facts by next mail. Everything you send now is FREE!

NAME \_\_\_\_\_  
ADDRESS \_\_\_\_\_  
CITY \_\_\_\_\_ Zone \_\_\_\_\_ STATE \_\_\_\_\_



### \$5.00 AN HOUR

Yes, it's possible for one man to turn out enough work to make \$5.00 an hour for his time. Think of how that pyramids when a partner or the whole family works.

#### Old Established Firm Backs You Up

The Warner Electric Company just celebrated its 26th year of success. You get a *Real Start* when you "join up with Warner"—you get real *Guidance to Success*.

**Warner Electric Co., Dept. 311**  
1512 Jarvis Ave., CHICAGO 26, ILL.

### WE SUPPLY EVERYTHING

You don't have to go "hunting" when Warner is behind you. We supply all materials, all mounts, chemicals, and metals. And you get the low prices made possible by our big quantity purchases and our own manufacture. You send for just what you need—and never have any big investment tied up in stock.



# CLASSIFIED Advertisements



Advertisements in this section 75 cents per word, each insertion, minimum 10 words, payable in advance To be inserted under proper classification, copy must be in our office the 22nd of the second month preceding date of issue

F. W. Johnson, Manager, Classified Advertising  
Popular Mechanics Magazine, 200 East Ontario Street, Chicago 11, Illinois

## 1195 CLASSIFIED ADVERTISEMENTS

## 1195 OPPORTUNITIES FOR YOU

### AUTOMOBILES, MIDGET CARS

"SPEED And Mileage" Manual! 140 illustrations! (Guaranteed most authoritative and complete book of its kind!) Easily obtain racing performance—up to 50% greater speed, power, mileage from any car! Complete instructions on building inexpensive speed equipment! Fast sports cars! "California Hot Rods!" 155 m.p.h. conversions! Superchargers! Dual manifolds! Twin mufflers! "Water Injectors!" Heads! Economizers! All about fast engines, speed tuning, restyling, "customizing," gas saving, "racing tricks," cams, fuels, ratios, "stock car speed secrets!" Latest California speed shop methods! "Custom styling information!" Streamlining! Sport changes! Lowering! Working diagrams! "Hollywood roadster plans!" Speed conversions! Drawings! Charts! Photographs! All cars! "Complete Manual" (plus) "Hot Rod Handbook" and equipment catalog. All three \$1.98. Alquist Engineering, Milford 32, Pennsylvania.

NEW Catalog '49-'50 British cars. Complete specifications, address each manufacturer; comparison charts. Descriptions in English, French, German, Spanish. Beautiful photos all makes British cars including latest AC, Allard, Alvis, Armstrong-Siddeley, Aston-Martin, Hillman Minx, H.R.G., Humber, Invicta, Jaguar, Jensen, Jowett, Lanchester, Lagonda, Lea-Francis, Lloyd, M.G., Morgan, Morris, Riley, Rolls Royce, Rover, Singer, Standard, Sunbeam-Talbot, Triumph, Vauxhall and Wolseley. The finest book ever published on British cars! Postpaid \$2.00. Clymer, Dept. 11A, 1268 S. Alvarado, Los Angeles 6, Calif.

LARGEST Selection of America's foremost custom and racing equipment. Dual and single mufflers, heads \$39.95, dual manifolds \$24.95, skirts \$12.95. All cars, California chrome motor accessories. New Fall illustrated catalog 25c. Von Essers, 3307 W. Irving Park, Chicago 18, Illinois.

FORD Owners' Handbook. Service information all 1932-1949 Models \$1.50—Model "A" Handbook \$1.00—Model "T" Handbook \$1.50—Motor's Automobile Repair Manual \$7.00—Chevrolet Car, Truck Book 1930-1940 \$3.50—Outboard Handbook \$3.50—All postpaid. Clymer, Dept. 11A, 1268 S. Alvarado, Los Angeles 6, California.

"SPEED & Power" Handbook—50 chapter library edition! Breathing methods—authentic—direct from California! Covers Fords to Cadillacs—all makes! Build your own dual manifolds! Superchargers! Hot Cams! Water injectors! Hi-compression heads! Mileage devices! Save many dollars! Get up to ten extra miles per gallon! Get racing speed, lightning acceleration, dynamic power increases from any make automobile! Build fast stock cars! California roadsters! 160 MPH rods! Get construction drawings! Tuning techniques! Speed tricks! Economy secrets! Ingenious formulas! Including "Racing Frames," "Reciprocating Masses," "Jet Engines," "Braking Characteristics," "Dynamometers." Also dual pipes, gears, fuels, porting, relieving, lowering, balancing! Including complete Racing Equipment Catalogues! Also "California Automobile Customizing," glossy photographs! Diagrams! Very newest ideas! Conversions! Re-styling all makes! Streamlining! Chopping! Channeling! Customizing! Complete \$1.98 postpaid. Newhouse Automotive Industries, 5805-B2 East Beverly, Los Angeles 22.

BONNEVILLE National Speed Trials photographs, details, story, compiled by California hotrod expert. Action photos, details of timing methods, records, engines used by winners! Foreign cars, streamliners, roadsters, track jobs, competition coupes, and many others. Chock full of pictures, both action and stills. Comparisons of speeds attained by expensive foreign jobs and homemade U. S. hotrods. Sent postpaid for \$1.00. California Bill, Box L-1C, Eagle Rock, Los Angeles 41, Calif.

DUALTONE'S New muffler—The "California 99;" now ready in singles or duals. Superior in every way, yet no increase in price! Dealers inquiries invited. Catalogue 20c. Dualtone Mufflers, 2636 C India Street, San Diego 1, California.

NEW '49 Chevrolet test book just out \$1.50—New '49 Kaiser Vagabond test report. Information good and bad all K-F cars. Travelogue. Complete mechanical information. 300 owners' letters, comments. Postpaid \$1.50. Clymer, Dept. 11A, 1268 S. Alvarado, Los Angeles 6, Calif.

CALIFORNIA Custom accessory headquarters. Buy direct from original designers and save. Solid hood sides, grille panels, lowering kits, fender skirts, dual pipes, chrome motor accessories, speed equipment, push button door conversions. Revised 1949 catalog, 32 illustrated pages, new low prices—25c. Eastern Auto Supply, 3319-A South Grand, Los Angeles 7, Calif.

FORD Owners and mechanics, we supply several simple replacement parts making Ford and Mercury brakes free floating, super powerful with soft pedal; eliminating squeal, chatter and groan—\$4.25-\$6.90. All models, 1928-1948. Easily installed by yourself. Write for details. Super Brake-Floater Company, 4022 West Lake Street, Chicago 24, Illinois.

LIFE Of Ted Horn, American Automobile Racing Champion \$2.00—Hot Rod Pictorial \$1.50—How to Build Racing Automobile \$2.00—Indianapolis Race History Book since 1909, 360 large pages, 1100 illustrations \$3.50—Power and Speed \$2.50—Postpaid. Clymer, Dept. 11A, 1268 S. Alvarado, Los Angeles 6, Calif.

MAKE Your Model "A" do 100 m.p.h. Lightning acceleration, breath-taking top speed. Complete details, photographs. \$1 postpaid. Four Barrell, Box L-1C, Eagle Rock, Los Angeles 41, Calif.

JUST Out! Get the largest auto accessory and parts catalog in the world. Over fifteen thousand items, including Hollywood accessories, hi-speed equipment, rebuilt engines; all parts and accessories for all cars and trucks. New, used and rebuilt! We have that hard-to-get-part! Completely illustrated, jam-packed with bargains. Send 25c. J. C. Whitney & Co., 1919 Archer Ave., Chicago 16, Ill.

INSTALL V-8 engine in your Model A for extreme acceleration, more top speed, smoother performance. Complete details, photographs. \$1 postpaid. A-V-8, Box L-1C, Eagle Rock, Los Angeles 41, Calif.

CLYMER'S Steam Traction Engine & Threshing Machine Book \$2.50—No. 5 Scrapbook Antique Cars \$2.00—Steam Automobile Scrapbook \$2.00—Motor History of America Book \$3.00—Life of Henry Ford \$3.00—All postpaid. Clymer, Dept. 11A, 1268 S. Alvarado, Los Angeles 6, Calif.

MAKE Your Ford fast! Complete details, photographs. How to construct 120 m.p.h. Hotrod. \$1 postpaid. California Bill, Box L-1C, Eagle Rock, Los Angeles 41, Calif.

AIRFORCE Sensitive altimeters. Registers changes of 10' height of mountains, depth of canyons. \$12.50. Half deposit. Government cost \$175. Fresno Alrmotive, Chandler Field, Fresno, Calif.

"VAPO-STEAMATIC" Water injector. Easily built! Finest automatic "Moist-Humidity" system! Engineering triumph—Tremendously increases horsepower! Eliminates ping, carbon, overheating! Reduces wear—Lengthens engine life! Copyrighted "Water Injection Handbook"—with working drawings covering automobiles, motorcycles, airplanes, tractors! Includes plans, speed equipment catalogues, diagrams, instructions—\$1.00 complete. Newhouse Automotive Industries, 5805-B1 East Beverly, Los Angeles 22.

NEW Catalog every American car. 120 photographs, specifications. All G-M, Ford, Chrysler, and independents including Del Mar, Playboy, Gregory, Tucker, Davis, Keller. Compare all cars in one book. \$2.00 postpaid. Clymer, Dept. 11A, 1268 S. Alvarado, Los Angeles 6, Calif.

"SPEED Equipment" bargains. California mufflers \$4.50, V-8 duals \$15.90, chrome carburetor stacks 98c, dual manifolds \$9.95, chrome echo cans \$1.65, racing camshafts \$29.95 exchange, hi-compression heads \$45.00. All popular brands! Illustrated catalog 25c. Alquist Automotive Engineering, Milford 32, Pennsylvania.

"200 WAYS To Save Gas"—Increase efficiency, speed, power, life of your automobile! "Illustrated Manual" \$1.98. Alquist Engineering, Milford 4A, Penna.

"HOLLYWOOD" Mufflers. Beautiful deetone rumble! "Straight-thru" design increases efficiency, speed, acceleration, mileage! Singles, all cars \$4.85. Finest V-8 duals \$15.90. (Satisfaction guaranteed.) Speed equipment catalog 25c. Alquist Engineering, Milford 4A, Penna.

1949 INDIANAPOLIS Race Yearbook. Just out. Complete information, articles, photographs. Postpaid \$1.50. Clymer, Dept. 11A, 1268 S. Alvarado, Los Angeles 6, Calif.

"WATER Injection." Free descriptive, illustrated information. Nehr Industries, La Verne, California.

CUSTOM-RETYLING. Super handbook. Brand new! 200 graphic photographs, sketches, Medley cutaways. Thousands ideas! Guaranteed! Biggest, best buyable. \$2 postpaid, including catalog. Post Publications, Box 723-KE, Arcadia, California.

RUSTED-OUT Bodies, doors, fenders repaired without welding, soldering. Professional results. Write, Gibes, 2134 Hadson, Chicago 22.

RACING Car equipment for all cars, engines, racing heads, manifolds, carburetors, mufflers, etc. Speed instructions and literature \$1.00—refunded first order. Lee Motorcraft Co., 1412-D Great Northern Bldg., Chicago 4, Ill.

WE Sell direct to customers over 200 speed equipment parts manufactured by us. Ford A-B-V8-6-4- (Ferguson), Studebaker Champion, Chevrolets and Willys. Cylinder heads, dual intake manifolds, lynite flywheels, oversize valves, compound springs, camshafts and other supplies. Complete engines ready for race for cars, boats and midgets. \$1.00 to cover illustrated literature and price sheet. R & R Mfg. Co., Robert M. Roof, Box 546, Anderson, Indiana.

NEW Sensational seat cover. Mono. 6545 Santa Monica Blvd., Hollywood, California.

FROM Speedway to roadway! Track-proved hi-speed heads and manifolds now available for your passenger car! No special tools needed! Increase horsepower 25%! Astounding getaway! Free illustrated catalog. Speedsport, 6215AA Diversey, Chicago 39.

#### AUTO SUPPLIES AND EQUIPMENT

**POWER** And speed equipment for all cars and boats. Increase your power and economy with our equipment. Cams, flywheels, heads, manifolds and all hot rod accessories. Send for price list. Schiefer's Automotive, 4192 30th St., San Diego 4, Calif.

**INITIALS** For your car. Send 50c for 6. Stilwell, Empress Bldg., Decatur 64, Ill.

**AMAZING!** Eliminate an expensive operation. Remove sideswipes from your car with our "all purpose" scientifically treated solvent cloth. Send 50c. Victory Miracle, 1302 N. Alta Vista Blvd., Los Angeles 46, Calif.

**CONVERTIBLE** Top covers. Tailored. Snap-On. \$19.50. Vassar, Cleveland 5, Ohio.

**AUTOMOTIVE** Surplus tool specials! Pullers, wrenches, socket sets, reamers. Other bargains. Nationally advertised merchandise. Send dime for catalogue. Glenco Supply, 7521 Myrtle Avenue, Glendale 27, N. Y.

**"SMITHYS** Mufflers." Send for list. Bucks Auto Parts, 1296H, Merced 13, Calif.

**CHRISTMAS** Present trouble? Auto bells, the newest warning signal. \$8.95. Free details. Bermuda Auto Bells, D-26, 16 Concord St., West Hartford 7, Conn.

**SAVINGS** To 50% on generators, starters, voltage regulators, 6-32 volts, distributors, armatures, magnetos, carburetors, fuel pumps, windshield wipers, radiators. "Old models in stock." Write your needs. Prompt reply to all inquiries. State Ignition, 2521 Indiana, Chicago 16.

**WELDING** Pays good profits. Bodies, blocks, frames, fenders—easy with Hobart Welders. Low cost. Easy terms. Free catalog. Write Hobartweld, Box M-1192, Troy, Ohio.

**SENSATIONAL.** Tested, proven Ringin. Worlds only chemical product reseats rings, valves; removes glaze, carbon. More power, mileage, reduced oil consumption. Money back guarantee. Territories available. Sample case—12 quarts, wholesale \$12.00. Double investment. Retail \$20.00 quart. Send check or money order. Manufactured by Faulkner & Assoc., 1151 So. Broadway, Los Angeles, Calif.

**BATTERY** Chargers—5 amp. selenium rectifier. Can be used for electroplating. \$6.95 postpaid. Regency Sales, 5316 So. Justine, Chicago 9, Ill.

**OVERDRIVE!** Does your car have overdrive? Write for free money-saving information. Hill, 5227D Parker, Chicago, Ill.

**VAPOR** Injector, \$8.00. Cools engine, improves operating efficiency. Injection automatically controlled by Bernoulli lift, integrated with engine work load and radiator water temperature. Send make and year of car or truck. 10 days trial, refund. Tenco, Box 5528, Washington 16, D. C.

**VAPORJET** Gives car jet performance. Saves gas. See page 85.

**"HOT Rod"** Handbook (plus) "California Speed Manual" and "Racing Equipment" Catalog—All three only \$2.00. Speed Publications, Drawer 716, Port Jervis 4A, New York.

**GOVERNMENT** Surplus. Low voltage circuit tester in steel box. Cost \$202.00. Our price \$27.50. Will test batteries, starters, generators, voltage regulators, grounds, short circuits. Wilt Electrical Company, 7829 S. Racine Ave., Chicago 20, Ill.

**MOTORISTS** Save gasoline by Vacuumating overrich mixtures. Fits all cars. For free particulars write Vacuumatic, Dept. 1544, Wauwatosa, Wis.

**SERVICE** Stations, garages, and agents—sell nationally advertised Plexiglas windows for cars, trucks, buses and boats. Aberdeen Auto Parts, Box 283-D, Aberdeen, Maryland.

**AUTO** And truck parts. New and used. Lowest prices. Complete stock. Prompt replies. Babbitt Auto Parts, 2833 Chicago Ave., Chicago 22, Ill.

**NEW** Grilles for all cars. Wagner Grille Co., Route 2, Bernville, Penna.

**"ANTI-SWAY Bar"** for rear end of Ford's and Mercury's 1935 to 1941. Eliminates road sway at high speeds or in cross winds. Prevents body and fenders rubbing on tires in turns when long spring shackles are installed. Complete kit with instructions for easy installation only \$7.95. Many other high quality items including "Belond" racing exhaust heaters for all Ford's and Mercury's, complete exhaust systems, Mello-Tone single and dual mufflers, chrome extensions, shackles, skirts, etc. Send 25c in coin for our fully illustrated catalog now and be on our mailing list for new items in the future. Discounts to the auto trade. Southern California Muffler Co., 11142 Washington Place, Culver City, California.

**MASTER** Cylinders: Bronze sleeved for lifetime dependable service—\$10.00 complete. Specify make, model of car. E & M, 1157 Felipe, El Monte, Calif.

**SAVE** Gasoline! Quick starting! "Air-flow needles," \$1.50. Free trial! Specify car, carburetor. Neher Industries, La Verne, California.

**NEW** And used guaranteed parts for civilian and army cars and trucks. Largest stock in America. Mail orders. Pioneer Auto Wrecking Co., 734 W. 13th Ave., Denver, Colorado.

**LACHAPELLES** Motor and motor fuel treatment (patented), stops ping, gives more miles per gallon, more miles per motor. 100,000 miles treatment. \$3.00 postpaid. Ferns Products, 8120 Walnut Dr., Los Angeles 1, Calif.

**"LEKTRON"** Atomic coil booster saves gas! Instant starting, smoother power. Easily installed. \$2.00. Money-back guarantee. Specify car. Electronic Industries, Cleveland 11, Ohio.

**PISTONS,** American, foreign and racing. Catalog 10c. Merryman Co., Lawndale, Calif.

**SPEEDOMETERS**—Any make completely rebuilt. Including parts, labor \$4.95 ppd. Unconditional new factory guarantee. Mail your defective speedometers to: Western Speedometer Rebuilders, 10452 Magnolia Blvd., No. Hollywood, Calif.

**AUTO** Parts. Buy direct. Get dealers' prices. Represent us in your territory. Write requirements. Specify car make. Mechanics Auto Parts, Factory Warehouse, 3807-PM N. Ashland, Chicago 13.

**BUICK** Parts—Enjoy new-car pep and power in your old Buick. Same day service from world's largest stock of new (not rebuilt) Buick parts and engines. Ship anywhere. Write today. Robertson Buick Co., 1001 S. Wabash Ave., Chicago 5, Ill.

**CHEVROLET** Parts. Scarce motor, body, sheet metal parts. Grossman Chevrolet, Minneapolis, Minnesota.

**HARD-TO-GET** Auto body parts. We supply. Miller Auto Parts Service, 192 N. Clark Street, Chicago.

**BRUSH** Plating outfits connect to a battery. No tanks or shop required. Free particulars. Gunmetal Co., Avenue J, Decatur, Illinois.

#### AUTO TRAILERS

**TRAILER** Plans circulars illustrated, 8 types 10c. Craftsmann Books, Box 1153, Milwaukee 1, Wis.

**TRAILER** Plans—House, utility, boat, etc. Axles, chassis, hitches, windows, etc. Catalog with booklet, "Trailer Hints," \$1.00. Catalog only, 50c. Marine Mart, Buffalo 7-B, N. Y.

**CONVERT** Box trailer or pick-up to folding camper sleeping four. Plans \$1.00, guaranteed. Trail Hut, 600 Sixteenth Street, Oakland 12, Calif.

**BUILD** Your own trailer! Save money! Have every feature you want! Plans for house, sport, camp and utility trailers. Catalog describing 9 models 10c. 15c in Canada and overseas. Jim Dandy, Box 125-A, Wausau, Wisconsin.

#### MOTORCYCLES, BICYCLES, MOTORSCOOTERS AND SUPPLIES

**WHEELS!** Build wagons, scooters, mowers, trailers, wheelbarrows, grocery carts, 4" to 16". Free list. T & H Mfg. Co., Inc., Dept. CPA-11, 811 East 31st, Kansas City, Mo.

**MOTORCYCLE** Accessories, apparel. Large illustrated catalog 25c. Limex, Dept. M, Bellerose 6, N. Y.

**MOTORCYCLE** Parts bought and sold. "Motorcycles," 5205 South Honore, Chicago.

**BICYCLE** Supplies, wholesale, retail. List 10c. Universal, 4713 Virginia, St. Louis, Mo.

**MOTORCYCLE** Pistons and parts, new. Used. Harley, Indian, Henderson, Super-X. List 10c. Ballak, 811 N. 9th, St. Louis 1, Missouri.

**WHIZZER** Bike-motor \$25; Cushman motor-scooter \$15; Midget Racer \$40; Shaw bicycle motor \$15; Harley-Davidson motorcycle \$15; Smith motor-wheel \$25; Good motorscooter (twist grip) \$22.50. Rush 25c for new catalog #15 listing many other amazing bargains in motorscooters, used motors, midget cars, parts, wheels, etc. Gail, 538 Erie, Toledo, Ohio.

**HARLEY** Davidson 125—New outstanding lightweight motorcycle, 100 miles to gal. Floor models, absolutely new \$325. Also new 1949 Harley Overheads at special discount. Harley parts, accessories, big stock new and used, 24 hour service on mail orders. Used 45" motors with gen. and carb. \$50. New Harley generators \$30. Used generators, need few repairs \$5. Cylinders rebored and pistons fitted. Special prices on used pistons, all models. Chrome work done promptly at low cost. Complete shop for all overhauls and rebuilding motorcycle engines. Give us a try. Harley Davidson Motorcycle Co., 2115 Olive, St. Louis, Mo.

**KNEEACTION** Motorbike \$15; Midget car (steel frame) \$25; Moto-Scoot \$15; Whizzer motorbike with all attachments \$25; Indian motorcycle \$30. Other motorscooters \$8 up, motors \$3 up. Send 25c for new catalog #943 listing many other sensational bargains in used motors, motorscooters, motorcycles, parts, etc. Associated, Box 1764-CS, Toledo, Ohio.

**MIDGET** Car \$5, motorbike conversions \$5, brand new Regal motorscooters \$37.50 less motors, Indian motorcycle \$25, midget car \$20, Custer motorscooter \$25, all complete. Gasoline engines \$2 up, Super-cycles, Cushman's, Salsburys. Plenty new motorscooters, midget cars, homebuilders parts, automatic clutches, transmissions, engines, tires, etc. at factory prices. Special sale! Four balloon tires for \$3. Over 5500 tires in stock. Mailorder only. Send 25c for big war-bargain catalogue just out listing these and hundreds of other bargains. (35c by first class mail.) Midget Motors Directory, Athens, Ohio.

**MOTORCYCLE** Journal—Worldwide coverage. Illustrated. Year's subscription \$1.00. Sample 15c. Motorcycle News, 5424-A Sawyer, Chicago 25.

**TIRES** And industrial wheels, suitable for scooters, wheelbarrows, farm equipment, etc. All sizes. Bicycles and accessories. Send dime for list. Cycle Transport Company, 1241 So. Michigan Ave., Chicago 5, Illinois.

**HARLEY-DAVIDSON** Parts, accessories, batteries, and tires. 24 hour service. Authorized factory dealer. Philadelphia Harley-Davidson Company, 857 North Broad Street, Philadelphia 23, Penna.

**MOTORSCOOTERS,** New design, 6 big features. Literature 10c. Rollaway Motors, Lancaster, N. H.

**RECONDITIONED** Motorcycles and motors. Chromium accessories. Complete stock Indian parts. Expert rebuilding. Fast service. Indian Motorcycle Sales, Kansas City 1, Mo.

#### AVIATION

**MENASCO** Engines new. Inverted 4 air-cooled. 125 hp. For snow sleds, shallow boats. \$225. Airforce sensitive altimeters \$12.50. Half deposit. Fresno Airmotive, Chandler Field, Fresno, Calif.

**LIGHTPLANE** Manuals, blueprints. Circular illustrating designs, motors 20c. Craftsmann Books, Box 1153, Milwaukee 1, Wis.

**JET** Engine \$3.00; plans \$1.00; literature 10c. M.E.W., 387 University, St. Paul, Minn.

**PROPELLERS,** Plans, skis, engines, for snow sleds, air boats. Literature 10c. Banks-Maxwell, Box 3301E, Ft. Worth.

**PROPELLERS**—2-3 Blade for sleds, air-drive boats. Catalog. Standard Aero Craft, Box 387, Ft. Worth, Texas.

#### BATTERIES, GENERATORS

**GENUINE** Edison batteries. Fifteen year life. Unconditionally guaranteed. Free literature. See-Jay Company, 3522 Webster Avenue, New York 66, N. Y.

**EIGHTEEN** New 13-volt, 33 amp. generators with voltage regulators, \$10.00 each, make offer for lot. Samuel J Crawford, Tower Bldg., Santa Monica, Calif.

**EDISON** Non-acid lifetime storage batteries for home lighting, motors, industrial uses, radios, etc. Free interesting literature. Hawley Smith Co., Croton Falls 1, N. Y.

## ELECTRICAL SUPPLIES

**BUILD** Your own electric motors from scrap automotive generators—complete illustrated instructions for all makes. Only \$1.00. Autopower, 920 Theresa, St. Louis 3, Mo.

**BUY** Lamp parts wholesale—Parts you need for building, repairing, or assembling. Save money on large or small orders. New catalog for 10c. Gearon Company, Dept. 300-B11, 27 South Desplains, Chicago 6, Ill.

**FREE** Gift with sewing machine electrification kit. Easily installed. \$17.50 complete. Steelman, 232 South 4 Ave., Mount Vernon, N. Y.

**SILICON** Transformer lamination cut to order; magnet wire, insulation. Morton Electrical Service, Maywood, Ill.

**LEARN** Electrical appliance repair. House wiring, motors, washers, cleaners, refrigerators, lamps, auto ignition, etc., complete illustrated course. Tools furnished. Free booklet. Pacific School, 7219 South Broadway, Los Angeles 3.

**LAMPS**—Build own originals, parts wholesale, any amounts. Catalogue 10c. Brown Lamp Co., Box 501 Wellston, St. Louis 12, Mo.

**ELECTRONIC** Door lock! Sensational! Invisible! Positive protection! Inexpensive! Tremendous profits! Free details! Aimesworth, 17544 Raymer, Northridge, Calif.

**THERMOSTATS**. War surplus. New heavy duty line voltage. Adjustable temperature range. Ideal for controlling furnaces, unit heaters, electric heaters, auto heaters, etc. \$3.95 each. Paul Ilg Supply Co., 6200 Touhy, Chicago 31, Ill.

**ELECTRIC** Pencil: engraves all metals \$1.25. Beyer Mfg., 10511-H Springfield, Chicago 43.

**OIL** Lamps—Electrify them in 1/2 minute. Catalog all lamp parts and instructions 10c. Gyro Lamps, 5402P Clark, Chicago 40.

**NEW** G.E. motors 1/2 horsepower \$13.50, other bargains. Free literature. Plenge, 9 Stuyvesant Oval, New York 9, New York.

**WATT-HOUR** Meters. Reconditioned, guaranteed. Ideal for cabins, trailers, shops. \$2.95. T. Price, 310-14th, Raymond, Wash.

## WELDING, SOLDERING, PLATING

**WELDERS** From aircraft generators. Proven plans \$1.00. Electroweld Company, 16 South Second Avenue, Walla Walla, Washington.

**LOWEST** Prices on a.c. welders. New. Holgerson's Service, Canton, Kans.

**WELDERS** For all requirements. Free catalog. Write Hobartweid, Box M-1194, Troy, Ohio.

**"BANTAM-CHAMP"** Welder starts you in profitable welding business. Pay only \$16 monthly. Write for information on this new, low-cost 200 amp. welder and free "Guide to Better Welds." Hobartweid, Box M-1193, Troy, Ohio.

**WELDING**—A profitable trade. Learn quickly at best equipped school in U. S. Low cost. G.I. approved. Free catalog. Write Hobartweid, Box M-1195, Troy, Ohio.

**ACETYLENE** Welding outfits new \$45.00, used \$25.00; Arcwelders \$46.50. Eagle Welding, Dept. PM, 5085 Broadway, Chicago 40, Ill.

**ELECTROPLATING** Units—Complete \$2.00 and up. Free literature. Regency Sales, 5316 S. Justine, Chicago 9, Illinois. Dept. M.

**RADIATOR** Repairing books, supplies, equipment, gasoline torch. Write, Curfman Co., Maryville, Mo.

**WELDERS** 110V. Welds 1/2" steel, \$29.50. Morris Welding Service, 1850A State, Schenectady 4, N. Y.

**BUY** Direct from factory. Welding and cutting equipment. All makes of equipment repaired. Established 1913. Box 331, Hamilton, Ohio.

**RECTIFIERS** 0-4 V.D.C. \$9.50, 0-8 V.D.C. \$12.50, 0-12 V.D.C. \$18.50. All 0-100 amps. Starkweather, Ottawa, Kansas.

**ELECTROPLATING** Salts and rectifiers. Mirror resilvering and chipped glass nameplate supplies. John Sprinkle, V55, Marion, Indiana.

**RADIATOR** Repairing, cleaning, recoring. How to equip small shop at low cost. Supply sources, trade secrets, instructions. Now only \$3.50 postpaid. Radiator Service, McBain, Mich.

## MACHINERY, TOOLS, SUPPLIES

**BRAND** New lathes with chuck and grinding attachment. While they last \$12.50 each. Acme Sales, Box 208, Lorain, Ohio.

**CONCRETE** Block machines. Standard sizes. \$39.50 machines average 400 daily. Free catalog. Concrete Machine Company, 5129 South Compton, St. Louis 11, Mo.

**ROTARY** Hole cutters for wood, plastic or soft metal. Holes 1"-5". Postpaid 98c. H. L. Boggess, Liberty, Mo.

**YOUR** Shop needs our machines. Lathes, drills, millers, shapers. Accurate, low prices, immediate delivery. Money back guarantee. Conversion Parts Co., 278 Adams Street, Boston 22, Mass. U.S.A.

**"BUILD-UR-OWN"** Welder—A.C. power combination. Portable—Welding plus a.c. power anywhere. Your engine plus Hobart generator saves \$350. Free instruction book. Write Hobartweid, Box M-1196, Troy, Ohio.

**MACHINE** Tools for wood and metal. We specialize in small machinery. Sorry no hand tools. Tell us your needs, we will quote. Kandier, Kalamazoo 14, Michigan.

**ELECTRIC** Tools. Big discount. New, guaranteed. Catalog 10c. Box 1161, Oklahoma City, Oklahoma.

**CARGO** Snow sleds—Tow with snow tractor. Symington's, Union Bay Place, Seattle 5, Wash.

**YOUR** 10" Lathe will swing 18" with a center raiser. Full information. Production Machine Tool, 629 E. Pearl, Cincinnati, Ohio.

**BAND** Saw for home workshop & hobbyists. Special \$14.95; factory to you; cfr. free. American Band Saw Co., 147 E. Lake St., Minneapolis, Minn.

**MOTORS**. 1/2 HP, 1750 r.p.m., \$16.50; 1/3 hp., \$9.00. 3/4 hp., 3450 r.p.m., \$26.00. Free literature. Robert, 7232 Madison, Forest Park 3, Ill.

**CHUCKS**, Independent, universal; threaded 1 1/2"-8, 1"-8, 1"-10, 1"-12, or with adapter recess. Other chucks to 16" diameter. Write for quotation and free literature. No obligation. Westcott Chuck Co., 3600 Walnut, Oneida, N. Y.

**HOBBY** Vise precision built, semi-steel, 2" jaw, 3 1/2" opening \$1.25, cash with order. Box 759, Lodi, Calif.

**AUTOMATIC** Toolmaker's, mechanic's punch. New design. Retail \$1.50. Distributors wanted. Lakelin Products Co., 2316 Rugby Road, Dayton 6, Ohio.

**HOME** Lathe owners—Build your own attachments. Send for picture, sample of work and list of blueprints. Cut gears, ratchets, etc. Make neat screws easy way. The Home Shop, 415 Raymond Ave., Glendale 1, Calif.

**WHOLESALE** Prices—Power tools! Save 30% on standard, heavy-duty, guaranteed bandsaw, circle saw, jointer, sander, etc. Opportunity of a lifetime to completely "power-ize" your home or farm workshop at wholesale prices. Act fast! Send postcard for free information. Western-Standard Co., Dept. M, 3005 Hennepin Ave., Minneapolis 8, Minnesota.

**CONCRETE** Mixers—New low prices, \$49.00 up. Write for literature and price sheet. Muller Machinery Company, Inc., Dept. PM, Metuchen, New Jersey.

**BALL** Bearings 1/4 list price. Free list. Burgess, Box 168, Ferguson, Mo.

**WINCHES** For contractors, farmers and shops. 1/4 and 3/4 ton; electric steel; bargains. For literature and prices write, Gold Foundry & Machine Works, 1622 South Osage, Independence, Missouri.

**POWER** Tools, equipment wholesale prices. Free bulletin. Homecrafters Cooperative, Grand Rapids 6, Michigan.

## BOATS, OUTBOARD MOTORS

**FOR** Sale—Used and rebuilt outboard boats, many different sizes. Write for bargain list. Dunphy Boat Corp., 332 Broad St., Oshkosh, Wisconsin.

**P38** BELLY Tanks, steel, 10 foot, unused. \$9.95. Free picture. Anzio Boat Co., 1625 "T," Merced, Calif.

**OUTBOARD** Motor parts, new; used. Save money, write for price quotation. Cylinders rebored, new pistons, all makes. Outboard Motor Mart, Inc., 309 Atlantic Avenue, Boston 10, Mass.

**FIRE** Extinguishers. Carbon dioxide. Permanent installation remote control. \$17.50. Menasco Engines. New inverted 4 aircooled. 125 hp. For airdrive boats, sleds, \$225. Half deposit. Fresno Airmotive, Chandler Field, Fresno, Calif.

**SUPPLIES** For fabric covered canoes and boats. Clear nitrate dope \$3.00 per gal. 42" fabric, \$2.00 lineal yard. Thomas Flying Service, Oak Hill, West Virginia.

**MARINE** Specialties and motor conversions catalog. Sixty pages of struts, finishes, hardware, plexiglas windshield kits, electric tachometers, inboard and outboard air cooled motors, etc. Immediate delivery. Catalog with booklet, "Conversion Hints," \$1.00. Catalog only, 50c. Marine Mart, Buffalo 7-B, N. Y.

**SAVE** 50%—Assemble your own boat. Famous Schneider speedsters, rowboats, sailboats, hunting skiffs, now in kit form. The hard work is done. You do the easy assembling. Illustrated literature 25c. Schneider Boats, Dept. P, 1913 W. Vliet, Milwaukee 5, Wis.

**PACKAGED** Lumber—Marine plywood, seasoned oak and cedar, sized, selected. Send \$1.00 for booklet, "Plywood Boats," with quotation form and literature. Forms and literature, 25c. Marine Mart, Buffalo 7-B, N. Y.

**CONVERT** Fords and Jeep to 100% marine engines with Osco's world famous Convo-Kits. Deluxe catalogue 25c (coin). Oscomotors, 2020B Orleans, Philadelphia 34, Penna.

**KNOCK-DOWN** Boat kits. Outboards, inboards, sail, hydroplaners. Easy to assemble, minimum cost. Catalog with specifications, prices, 25c. Brooks Boat Company, Carrollton P10, Michigan.

**BOAT** Builders' guide—250 pages, 15,000 items pictured, priced, deliverable. Send \$1.00. Marine Mart, Buffalo 7-B, N. Y.

**SAVE** 1/3 To 1/2 on all our marine conversions. For example: Complete V8 Ford kit for only \$89.50. Illustrations free. Complete catalog beautifully illustrated—25c. Arthur Gershel, 650 Sunrise Highway, Rockville Centre, N. Y.

**BUILD** Marine motors, Ford or Jeep. Federal Marine Motors, 9011 Cottage Grove, Chicago 19, Ill.

**SAVE** 2/3 Cost. Build your own boat with our ready cut parts by the Welch system. No experience necessary. Rowboats to cruisers. Illustrated catalog 25c. Midwest Boat Company, Menomonee Falls, Wisconsin.

**OUTBOARD** Motors—Used bargains, \$45 up, free list. Used parts, most models, save money! Boat and motor equipment and accessories. Big catalog, send dime. Crandall-Hicks, 911 Commonwealth, Boston, Mass.

**NEW**, Used, rebuilt marine motors. Marine conversions, fittings. Free catalog. Stokes Marine Supply, Dept. 24, Coldwater, Michigan.

**MARINE** Conversions for Ford and Jeep engines. Catalog 10c. Lehman Manufacturing Company, Department D, Newark 2, New Jersey.

**STEERING** Wheels, windshield brackets, from \$6.95. Modern fittings at lowest prices. Complete pre-cut plywood boats. Bargains galore. Folder 10c. Marine, Box 681, Mendota, Minnesota.

## ENGINES, MOTORS, DYNAMOS

**ELECTRICIANS**: Service manuals on transformers, welders, chargers, portable tools, automatic washers, etc. Guaranteed. Illustrated. \$1.00 copy. Send for literature. E. A. Western, Box 1902, Phoenix, Arizona.

**G.E. Motor**, 1/3 hp. \$12.25, 1/4 hp. \$11.80, 1/2 r.p.m. Rich Mfg. Co., 2401 San Jacinto, Houston, Texas.

**WELDING** Generator, 150 ampere \$47.50. Motors 1/2 horse \$15, 1 horse \$30. Water pumps \$12.50. Butler, 1885 Milwaukee, Chicago 47.

**"BUILD-UR-OWN"** Welder. Hobart generator plus auto engine saves \$350. Free instruction book. Write Hobartweid, Box M-1197, Troy, Ohio.

**WINDING** Data, listing 225 motors, single and three phase, \$1.00. Motor Data Co., Box 7631, Kansas City 3, Mo.

## ATHLETIC EQUIPMENT, BODY BUILDING COURSES

**BARBELLS**, Dumbbells. Inquiries invited. Miller Barbells, Scarborough Bluffs, Ontario, Canada.

**6** BODY Building courses, four barbell, two dumbbell, in 53-page muscle building book with six illustrated wall charts, \$1. Paramount, 2420 E. 23rd, Los Angeles 11, Calif.

**BARBELLS**, 95 Pound set. \$11.50. Develop your body. Jackson Barbells, Springfield 4, N. J.

**DEADLY Judo**—Fiercest fighting technique. Trick knockouts. (Over 200 illustrated pictures.) Expert instructions; three volumes. Complete \$2.25. Variety House, Box 46-B Wall Station, New York 5.

**BARBELLS**, Exercise equipment. Courses. Free booklet. Good Barbell Co., Reading, Penna.

### SPORTING GOODS, GUNS, FISHING TACKLE, ARCHERY, TRAPPING

**NEW** Riflescopes, mounts, and shooting accessories, latest models, lowest prices. New catalog 10c. Discounts to dealers. Acme, 389 Champion, Battle Creek, Mich.

**FOOTBALL Shoes**. Make your own with Bur-Kleets, rubber stick-on cleated soles and heels. Send \$1.10 to Bur-Kleets, 361 Davis Road, Mansfield, Ohio.

**SNOOPERSCOPE Tube**. Permits nighttime vision. Tube and complete instructions \$14.95. Limited quantities. Filters 15c. Voltmeter, oscillator kit \$2.95. Precise, 942 Kings Highway, Brooklyn 23, New York.

**BRAND New Pistols** 22 Cal. Short, Long, Longrifle. Blue or bright finish. Sample \$5.00, doz. \$48.00. Acme Sales, Box 208, Lorain, Ohio.

SEND 10c for list 100 used guns. Frayseth's, Willmar, Minn.

**LEARN Gunsmithing!** Details, copy "Guns and Gunsmithing" 25c. Gunsmith, Palatine, Illinois.

"**CROW Hunting**," complete book and multi-tone crow call. \$1. Toad, Lamar Missouri.

**MARINE Combat knives**, 7-inch parkerized blade, leather sheath, \$1.50. Commando knives, machetes, etc. Catalogue 10c. Gordon's, 512 Sommer Bldg., San Diego 1, Calif.

**AAA Sport Centre**, Bayonne 13, N. J. Sports catalog 10c. \$3.00 hunting knife, \$2.00 postpaid in U. S. No c.o.d. Gift with knife.

**LAMINATED Stocks**—Beautiful, warp-proof, inexpensive; blanks, semi-finished, finished. Target blanks any dimensions. Literature. Banks-Maxwell, Box 3301E, Ft. Worth.

**FISHERMEN**—Make your own sinkers with our molds. Free illustrated booklet. Reading Instrument Co., Box 78, Reading, Penna.

**ALL Sizes fishermen's sinker molds**. Illustrations, Schiercke, 5 Fullerton, Albany, New York.

**AMMUNITION Prices slashed**. American and foreign loads below retail. Dime for list. Central Sports, Delphos, Ohio.

**190 PROFUSELY Illustrated pages** antique and modern pistol, sword, etc. values. 50c. Robert Abels, A860 Lexington Ave., New York 21.

**MOLDS For fishermen's sinkers, squids, and jigs**. Sweet's Molds, Tonawanda, N. Y.

**BOWS, Arrows**. Quality archery equipment. Popular prices. Catalog 10c. Illustrated archery instruction book 50c. Archery, 617-K So. State, Chicago 5.

**5000 BARGAINS**. Firearms, binoculars, war relics. Catalog 40c. Smith Firearms, Runnemede, New Jersey.

**SHOTGUNS**. Rifles, revolvers, over 500 modern, obsolete. Also cartridges, list 10c coin. Ed Howe, 52 Main, Coopers Mills, Maine.

### TAXIDERMY

"**MODERN Taxidermist Magazine**," Greenfield Center, N. Y. Devoted exclusively to taxidermy. Two sample copies 25c.

### BINOCULARS, TELESCOPES, MICROSCOPES, MAGNIFIERS

**TELESCOPIC Discoveries**. "Life on Mars," "Saturn Has Rings," "Last Ice Age." Free circular S-1. Donald Cyr, 1412 Palm Terrace, Pasadena 6, California.

**SAVE 50%** on new binoculars—The ideal Gift! Free catalog and booklet, "How to Select Binoculars." Write today! Bushnell Importers, 43-M11 East Green, Pasadena 1, California.

**16X MAGNIFIER**: Exceptional power, beautifully mounted. Factory closeout \$1.00. Optical Assembly Co., Celina, Ohio.

**POWERFUL Astronomical telescope**, equatorial mounting, two eyepieces, \$16.50. Bium Optical Laboratories, 4213 Gifford Avenue, Cleveland 9, Ohio.

**LENSES**: One 1½" prism, \$1.00; 2 condensers \$1.00; 2 objectives \$1.00; 2 magnifiers \$1.00; 2 reducers \$1.00. Optical Assembly Co., Celina, Ohio.

**FREE Catalogue!** Thousand war surplus optical bargains. Lenses, prisms, telescopes, binoculars, etc. H. Jaegers, 93-08-95th Avenue, Ozone Park 16, New York.

**POWERFUL Astronomical telescopes** easily made. Perfect lenses and instructions; 100X \$3.00, 100X and 200X \$4.00, 100X, 200X and 400X \$6.00. Clear vision, full power guaranteed. Instructions alone 10c. Suffolk Science Service, Box 208, Man-orville, N. Y.

**BINOCULARS**, Telescopes, watches, guns. Buy, sell, trade. Schweer's, Donnellson, Iowa.

**REFLECTING Telescopes**, 60X, completely assembled \$25.00. Guaranteed observatory clearness. Free information. Skyscope, 475 Fifth Avenue, New York 17.

**ASTRONOMICAL Telescopes**, binoculars, microscopes; bought, sold, repaired. Books. Lists 10c. Rasmussen-Reece, Amsterdam, N. Y.

**TELESCOPES**, Binoculars, microscopes, big bargain catalog free. Brownscope Company, 24 West 45th Street, New York.

### DOGS, PETS, BIRDS, RABBITS

**AMAZING Profits raising Chinchillas**. Real fun too. No experience necessary. Make money year round. Catalog, details free. The Chinchilla Ranch, Inc., 208 N. Franklin St., Port Washington, Wis.

**GOLDEN Syrian hamsters**, selected breeders and pets. Free information on how to raise these clean, inexpensive to raise, animals for pets and profit. The E. K. Farm, Route 1, Box 56A, Arlington Heights, Illinois.

**RAISE Mink**. Amazingly profitable. Free booklet gives inside "Secrets." Molgard, Brigham, Utah.

**GENUINE South American Chinchillas**. Raise them for fun and profit. No odors, complete instruction. Send for feeding chart \$2.00. Chinchilla Exchange, 10740 Wilshire Blvd., Los Angeles 24, Calif.

**\$1.00 FOR Booklet "Canary, Its Care, Breeding and Training"**, and three copies cage-bird magazine. American Canary, 2839PM N. Halsted, Chicago 14, Ill.

**GOLDEN Hamster pets**. Wonderful Xmas gifts. Clean, odorless. No digestive troubles. Easily raised. Profitable hobby. Write, Pyle Hamstery, Okmulgee, Okla.

**\$3000 YEARLY Raising Angora rabbits**. We buy your output. Contract particulars free. Kise's Enterprises, St. Paul 8, Minn.

**GIVE A gift that lives!** Million laughs, hours of fun. Ideal pets. Literature free. Ideas for markets 10c. Hohl's Hamster Display Plan \$1.00. Box 695, Newark, Ohio.

**67 VARIETIES**; Pigeons, peafowls, pheasants. Catalogue 10c. Houck's, Tiffin 3, Ohio.

**TROPICAL Fish**, complete instructions, 63 illustrations. Send 10c (coin). Hobby Publications, 14416½ Ventura, Sherman Oaks, Calif.

**HAMSTERS**, Finest pedigreed breeding stock. These hardy, odorless animals can be raised anywhere. Send for free, illustrated literature. Mount Clemens Hamstery, Mount Clemens, Mich.

**BEAUTIFUL Pure white pedigreed police pups**. Ansonia Kennels, Mose, N. Dak.

**BEAUTIFUL Great Danes**—Loving companion, guard. Sidney Baucom, Salt Lake City, Utah.

**SEE Gulf Hamstery ad on page 38**. Shows picture of Hamster.

**GOLDEN Hamsters**. Clean odorless pets, male \$2.00. Pair \$5.00. Pet pen \$3.00. Photo free. Pet Hamstery, Rt. 3, Box 390, Dayton, Ohio.

**MAKE Money!** Raise Chinchilla rabbits. Experience unnecessary. Valuable breeders. Extra profit from laboratories, furs, delicious meat. Pleasant hobby. Write today! Rockhill Ranch, Sellersville 15, Penna.

**MINK Raising** amazingly profitable. Free folder gives inside "secrets" on feed; care. Lawrence Molgard, Brigham City 12, Utah.

**HAMSTER Raising** is profitable; information. Pem's Hamstery, 3010-10th Ave. No., St. Petersburg, Fla.

**MINK Raising information free**. Complete. Lake Superior Mink Farm, Superior, Eel, Wisconsin.

**HAMSTERS**: Choice quality breeders and pets. \$2.50 pair; \$3.75 trio. Free literature. Valley Hamstery, 734 North Milam, San Benito, Texas.

**\$400 MONTHLY Raising Angora rabbits**. No experience required. Details free. White's Rabbitry, Newark, Ohio.

**MAKE Extra cash**. Raise Giant Chinchilla rabbits. Waters Rabbit Farm, Glennville, Ga.

**GRINSTEAD'S Famous Angoras!** Giant Chinchillas! World's most profitable rabbits. Finest pedigree, heavy-producing, prize-winners. Literature free. Grinsteads, Edwardsville, Illinois.

**RAISE Rabbits**. Four pound fryers in eight weeks. Ready market for meat, fur, wool. Illustrated book, describing leading breeds, housing, breeding, feeding, marketing. By America's largest rabbit association. 10 cents. American Association 12, AR & CBA Building, Pittsburgh 17, Pennsylvania.

**SPORTSMEN**: 200 Pointers, setters, straight cooners, combination hunters, rabbit and fox hounds. Reasonable. List free. Ramsey Creek Kennels, Ramsey, Ill.

**\$300 MONTHLY Raising Angoras for our market**. Particulars free. Wilson, Stanton, Calif.

**INCREASE Your income** by raising domestic rabbits. Small space needed. Ready market for delicious meat, fur and wool. Largest magazine in the industry tells you how. \$1.50 per year. Sample 15 cents. No stamps. Small Stock Magazine, Lamoni 20, Iowa.

### PLANTS, SEEDS, NURSERY AND GARDEN SUPPLIES

**WE Sell on the installment plan**. Best varieties peach and apple trees, low as 12c; grapevines 4c; shrubs 13c; evergreens 15c. Berries and plants. Catalog free. Benton County Nursery, Box 542, Rogers, Arkansas.

**CHRISTMAS Presents**—Twelve big gladiolus bulbs, all colors delivered \$1.50. Glad Haven, Sebastopol, Calif.

### FARMS, FARM LANDS, REAL ESTATE

**FARMS, Ranches, lodges, resorts**. Big selection, Milwaukee Road territory, Washington, Idaho, Montana, Dakotas, Minnesota, Iowa, Missouri, Michigan, Wisconsin, Illinois, Indiana. Free colorful descriptive folders, price lists. L. H. Robins, 738J Union Station, Chicago 6, Ill.

**NEW Free winter catalog!** Farm and country real estate bargains, good pictures, many states, easy terms, many equipped, crops included. For special service, state requirements, desired location. United Farm Agency, 1408-PM Consumers Bldg., Chicago 4, Ill.

**FARMS—Homes**; 124-page catalog, 2790 bargains, 35 states. Mailed free. Strout Realty, 255-P 4th Ave., New York 10, N. Y.

**WEST'S New time and money saving catalog**, over 1000 farm and business bargains. Free. West's Farm Agency, CK-4, Pittsburgh 17, Penna.

**FLORIDA Homes, groves, farms, business opportunities**. H. L. Chambers, Realtor, Wauchula, Florida.

**RAYBURN'S Ozark guide**, Eureka Springs, Arkansas. Homeseekers; tourists magazine. Year, \$1.50.

**\$5.00 MONTHLY Buys 40 acres**. Near town; price \$200.00. Free list. Box 425-P, Carthage, Mo.

**FLORIDA Campsites**—\$75.00 at \$5.00 monthly buys nice, high dry lot in Lake County (world's best bass fishing) near Ocala National Forest. St. Johns River, beautiful lakes, pavement, electricity. Folder free. Howard Vernor, DeLand, Florida.

**GOVERNMENT Lands \$2.00 acre up**. Information all states twenty-five cents. National Tax Service, 901-A Majestic Bldg., Detroit.

**GOOD Farms—Ranches**. Washington, Minnesota, Montana, Idaho, Oregon, North Dakota. Dependable crops, favorable climate. Write for literature, lists describing typical farm opportunities. Specify which state. J. W. Haw, 119 Northern Pacific Railway, St. Paul 1, Minn.

**SOLD For taxes**. Calif., Oregon, Washington timber, grazing, ranch and mining lands. 25c to \$3 acre min. bid. 10c (coin) brings circulars, photos, maps. Pacific Lands, Box 2350-PM, Hollywood, Calif.

## POULTRY, FARM SUPPLIES

**RAISE Turkeys** the new way. Write for free information explaining how to make up to \$3000 in your own backyard. Address—National Turkey Institute, Dept. 3, Columbus, Kansas.

**RAISE Fryers** new easy way. One man home plan earns \$3000 yearly. Circular free. Poultryman's Institute, 1046 So. Olive, Los Angeles 15, Calif.

**EARN \$4 To \$12 hourly.** Chick sexing, culling and caponizing. G.I. approved. Pilch's School, Box PM, Thompsonville, Connecticut.

**GROW Chicken** of tomorrow today with chicks from Pilch's Famous Old Hen Breeders. You too will like Pilch's chicks because so many other people do. 14,000 Pullorum Clean Breeders. Reds, Rocks, Crosses, Sex-Links, White Rocks, Hamps, Started Pulletts, Started Chicks, Capons. Write for valuable '49 calendar. Pilch's Chicks, Box M, Thompsonville, Conn.

**KNOW How** to raise poultry for profit. Read Northeastern Poultryman. Every issue packed with helpful hints and practical suggestions. Latest articles on breeding, feeding and management. Subscribe now. 1 year 65c. 2 years one dollar. Foreign subscriptions \$1.00 a year. Northeastern Poultryman, Dept. P.M., 376 Boylston St., Boston 16, Mass.

## PROFITABLE OCCUPATIONS

**REFRIGERATION** And air conditioning. Complete, illustrated course. Free booklet. Mechanics School, 7219 South Broadway, Los Angeles 3.

**MEN—Women.** "Everybody likes candy." Learn to make professionally. Our 39th year. Ragsdale Candies, D6, East Orange, New Jersey.

**NO Work.** No cost. Fabulous money paid for Dwarf trees, grown in your room. Details for stamp. American Box, Wagner Station, Los Angeles 47, California.

**FOREIGN Employment.** Construction men, building trades mechanics, helpers, office men. Good workers needed for oil projects, mining, pipe lines, dams, power plants, roadways, shipping, etc. Transportation and quarters furnished; high wages. Listings of firms actively working and hiring on projects in South America, Arabia, Asia, Africa, Alaska, Central America, etc. Send \$1.00 for foreign construction compendium and application forms. Foreign Service Bureau, Dept. P.M.12 (Employment), P.O. Box 295, Metuchen, New Jersey.

**"WATERLESS Hand Cleaner."** (Oil base.) Make, sell. No machinery. Build profitable business. Complete formula \$1.00. Ideal Service, Park Ridge 15, Ill.

**WOULD You pay 3%—First \$350 made?** Book "505 Odd, Successful Enterprises" free! Work home. Expect something odd! Pacific, Oceanside, Calif.

**WORLD Wide Construction News Bulletin—\$1.00** brings complete report on projects and contractors for construction men. Pacific, Alaska, Persia, Latin America, India, etc. Global Reports, P. O. Box 883-DX, Hollywood 28, Calif.

**LOCKSMITHING Secrets!** Key fitting, lock repairing, opening; prices. Sources. Illustrated book \$1.00. Wechsler, 7 West 36, New York City.

**FREE Book "372 Unusual Worldwide Businesses!"** South America, New Zealand! Work delightful, "different" plans home (U.S.A.). Publishers 8M, Carlsbad, Calif.

**BIG Money—Learn watch repairing** through home study. Ten easy lessons. We furnish free watches and all tools. A licensed school. Write today for free information. Illinois School of Watch Repairing, Dept. C.P.M., 2870 Elston Ave., Chicago 18, Illinois.

**KEEP Domesticated earthworms** and they will keep you. Valuable booklet 10c. Midwest Earthworm Farms, Box 999, Wichita, Kansas.

**\$400 MONTHLY** Raising Angora rabbits. No experience required. Details free. White's Rabbitry, Newark, Ohio.

**PROFITABLE Sparetime.** Easy-made attractive Christmas items. Complete manufacturing instructions, selling suggestions. Community concession. \$5.00 refundable. C-B Products, P.O. Box 164, San Diego 4, California.

**MUSHROOMS** Grown, boxes, barrels. Instructions 50c. Spawn \$1.00. Manureless process \$2.00. Gordons, 553 William, Winnipeg, Manitoba.

**HOLIDAY Flower, novelty making.** Wonderful home business pays excellent profits. Literature free. Velva Artcrafts, 324-M East 14, New York 3, N. Y.

**MAKE Flexible molds!** Cast plaques, novelties, bookends! Free sample! H. Tooker, Hamilton 9, Ohio.

**WANTED.** Be exclusive agent in the plant where you work, for the jet pipe the pipe smokers are looking for. P. Desjardins & Son, Webster St., Fall River, Mass.

**OUTDOOR Work** for extra income. Information free. Morris, 328-A Parkway NE, Atlanta 5, Georgia.

**RAISE Ginseng roots,** markets guarantee you \$10 pound, seeds for fall planting. Cir. free. Pezler Seed Co., Patchogue, N. Y.

**CHENILLE Machines** and materials for manufacturing bedspreads, rugs, etc. Sims Textiles, Dalton, Georgia.

**"HOW To Raise Worms for Bait."** Booklet, 25c coin. Ross, 749-A Rincon, El Sobrante, California.

**"FROG-RAISING"**—New book explains everything! Marlboro-A, Box 7002, New Orleans 19, Louisiana.

**INTERESTED** in Latin American and foreign employment? \$1.00 brings copy-righted "Foreign Service Directory" with complete listing of firms in oil, mining, aviation, construction, steamship, manufacturers, importers and exporters with hot tips for immediate application. Published since 1944. Global Reports, P.O. Box 883-P, Hollywood 28, Calif.

**FOREIGN Employment?** Latest bulletin, overseas directory and application forms: \$1.00. (C.O.D. \$1.32.) Foreign Service Institute, P.O.B. 3934, Miami, Fla.

**\$46 FROM** Square foot plywood; jigsaw necessary. Write, Woodarts, P-38, Bridgewater, Mass.

**OWN** And operate mirror shop! Supplies for silvering mirrors, making chipped glass nameplates and electroplating. John Sprinkle, V50, Marion, Indiana.

**RAISE Fishworms.** Easy, profitable. Send 25c in coin for complete instructions. Huffman Worm Ranch, Rives Junction, Mich.

**TYPISTS,** Profitable business at home. Complete copyrighted information 50c. Rosdahl Industries, 72-A W. Washington St., Chicago 2, Ill.

**MAKE Greaseless doughnuts** at home. New amazing electric machine. You'll coin money selling to grocers, drug stores, cafes, hamburger stands. Low cost will surprise you. Experience unnecessary. Send for free recipes and plans. Morgan Ray Co., 3605 South 15th Ave., Minneapolis 7, Minn.

**WANTED—Purchasing agents.** No money or experience required. Write Dept. C, Purchasing Manager, 2719 Lawrence, Chicago, Ill.

**ALASKA—The Last Frontier** offers unlimited opportunities. \$1 brings government map and directory listing firms in fishing, construction, mining, aviation, fish and game rules, homestead data. Alaska Opportunist, Box 883-M, Hollywood 28, Calif.

**YOU Can make real money** raising Golden Hamsters. New tiny animal. Easily raised at home. Write for details. Hudson Hamstery, Newfoundland 1, N. J.

**BE The Popular Mechanics** representative in your neighborhood and earn big profits in your spare time. Write Popular Mechanics Magazine, Room 408M, 200 E. Ontario St., Chicago, Ill.

**\$40.00 WEEKLY** Made growing mushrooms, fresh, dried. Dominion patent 331583. Free spawn. North American, 169P Yonge, Toronto, Canada.

## BOOKS, PERIODICALS, PICTURES, POSTCARDS

**BOOKS—Government surplus.** Textbooks, including International Correspondence School's Home Study Pamphlets. One half million volumes. Bargain prices. Free catalog. Long's College Book Co., Dept. PM, Columbus 1, Ohio.

**BOOKS, Out-of-Print,** hard-to-find. Free catalogue. Banker Book Co., Dept. R, Sherman Oaks, Calif.

**FICTION Lovers.** Send five books and one dollar, we return five others plus a bonus book. Address, Book Haven, 70 Wolcott Terr., Newark 8, N. J.

**CARTOON Magazine,** full of knockout jokes, gags, cartoons. Laughs galore. Sample copy 15c. K. O. Harris, Box 550, Palm Springs, California.

**SAVE 25% To 85%!** New books. Unusual values. Write for free catalogues. Book Readers Circle, Box M, 80 East 11th Street, New York 3.

**SEE Chicago!** 25 colored view cards, \$1.00. Ed Solarek, 1118 N. State, Chicago.

**READ How To Be The Smart Woman.** An outstanding book of suggestions on cultivating poise, personality, charm and individuality. \$1.50. Liza's Gift Shop, New Market, Virginia.

**POCKET Novels,** swap fifteen, one dollar. Youmans, Box 118, Lima, Ohio.

**BOOKFINDERS!** (Scarce, out-of-print, unusual books). Quickly supplied. Send wants! Clifton, Box 1377-PM, Beverly Hills, Calif.

**NATIONAL Geographic Magazines** 1888-1949. Any issue, Box 327-PM, Periodical Service, Swarthmore, Penna.

**SELF-EXPLAINING Bible;** Illustrated circular free. Box 446-P, Minneapolis, Minn.

**BOOKHUNTERS!** All subjects. Send wants! Jaher Book Service, 620-P East 178 Street, New York 57.

## GAMES, TOYS, NOVELTIES

**KITE Fans!** Roll-O-Kite—Looks like giant spool. Spins as it flies. Sensational performance. 50c. Roll-O-Kite, 737 So. Westlake Ave., Los Angeles 5, Calif.

**FREE Toy catalog** showing wonderful buys on metal fire engines, farm wagons with horses. Stanley Toys, Oconto, Wis.

**NEW Ball** in disc game, thrilling, exciting. Send now for Christmas \$2.95. Luther Creasy, Catawissa, Penna.

**NEW Way** to entertain. Write Thor Books, PG-11, Box 1210, Chicago.

**NEW Strato-rocket** parachute toy. Goes up 400 ft. Thrilling! Sensational! What a toy! Xmas special \$1.00 postpaid. Ny-Cal Company, Encinitas, Calif.

**WORLD'S Largest kite.** Only \$20. Lifts light person. War surplus. Free literature. Great-Northern Mart, No. Adams, Mass.

## MAGIC TRICKS, PUZZLES, JOKER NOVELTIES

**500 TRICKS** You can do! Send 25c for Douglas famous catalog, best in magic at lowest prices. Unequaled service to magicians for 30 years. Douglas Magicland, Dept. 1, Dallas, Texas.

**GUARANTEED Magic tricks!** Catalogs, 10c. Newton Magical Company, Bonham, Texas.

**VENTRILOQUIST Dummies.** Catalogue 10c. Be a ventriloquist. Free particulars. state age. Maher, Box 36-M119, Kensington Station, Detroit 24, Michigan.

**FOUR Professional tricks,** including recent magician's convention prize winner. Worth over \$1.25. With our catalog, 25c. Steiner's, 316-M East 61, New York.

**SECRET Invisible ink.** Only 25c. Novelties, 208 W. Glendale Road, Webster Groves, Missouri.

**200 ELBTRIC Stunts,** 110 volts, \$1. Kutting Sons, Los Altos 2, Calif.

**DOUBLETALK,** Laughs galore, terrific! \$1.00 postpaid. Lukas, 1604, Ft. Lauderdale, Florida.

**SEND For "special magic offer."** "Ma-rean" Magic Shop, Hopewell, Virginia.

**JOIN Magicians' fraternity!** Sample trick magazine and details, 25c. International Magicians, Mt. Morris, Illinois.

**400-PAGE Catalogue** of 2000 tricks, pocket, parlor, stage. World's finest magic. Send \$1.00 for catalogue (refundable first \$5.00 order). Kanter's, M-1311 Walnut, Philadelphia 7.

**MAGIC Tricks, puzzles, books, cards,** punch boards. Catalog 10c. Specialty, Box 671, St. Louis 1, Mo.

**500 TRICKS** Catalog and book "84 Card Tricks," both only 50c. Robbins Co., 152-P West 42nd Street, New York.

**LEARN Magic,** ventriloquism, mind-reading. Write for particulars. Quackenbus, Big Flats, N. Y.

**WORLD'S Largest professional magic shop,** keeps you in touch with latest tricks. To receive mailings, send 50c for new catalog. Holden's, M220 West 42nd St., New York.

**16 CARD Tricks** and catalog 25c. Sterling Magic, Royal Oak, Mich.

**BE A magician.** Large professional magic catalog of latest tricks, 35c. Ireland, C-109 North Dearborn, Chicago 2.

**PROFESSIONAL Catalog.** 124 pages, 25c. Williams, 900 Plymouth, Ellwood City, Penna.

**VENTRILOQUISM Taught.** 3c stamp bring particulars. Smith, 801 Bigelow, Peoria 5, Ill.

## STAMP COLLECTING

**FREE**—Famous Americans set, Flag set, National Parks set, and Presidential set to \$5.00. A total of 90 stamps free to customers for our unsurpassed U.S. and foreign selections. Send 3c for 15 of the above stamps and full particulars. Triboro Stamp Co., 145 Nassau St., Dept. 111, New York.

**100 DIFFERENT** Foreign stamps 10c to applicants for my quality foreign approvals. Karr Ross, Dept. A2, Box 3266, Washington 10, D. C.

**10 ASSORTED U. S. Commemorative** 15c. Five U. S. Air Mail 15c. 10 Famous Americans 25c. All for 50c. Ideal Stamp, Box 179-K, Park Ridge, Illinois.

**ONE Dollar special.** 1000 stamps, over 700 major varieties. Satisfaction guaranteed. F. S. Parsons, Box #3246, San Francisco 19, Calif.

**SENSATIONAL!** Set each Honduras, Martinique, Guadeloupe, Guiana, also \$2,000,000.00 stamp, Brunei, over 100 different others. Everything 10c with approvals. Whitehead, 315P So. 5th Ave., Canton, Ill.

**GIBRALTAR Packet free**—Nice collection Gibraltar, New Zealand Centennial, British Uganda, French Colonials, early British Colonial, West Indies, South American, war stamps plus Philatopic Monthly Magazine. All for 5c postage. Empire Stamp Company, Dept. PM, Toronto 5, Ontario.

**FREE!** Canadian sets, royal visit, George VI, George V, coronation, jubilee, others, to approval applicants. Ensign, Box 118-M, South Orange, N. J.

**\$1-\$2-\$5 UNITED States**, commemoratives, airmail, high values in large collection United States stamps only 5c to applicants United States approvals. Metropolitan, 140B Nassau, New York 7.

**UNITED States stamps** nearly 100 years old, Roosevelt set, others, 40c value—only 5c to applicants United States approvals. Wakonda, 140G Nassau, New York 7.

**100 DIFFERENT** selected Swiss stamps sent registered, remit trustfully \$1.00 to Kobler, Postmaster Neufeldstrasse 141, Berne, Switzerland.

**200 MIXED** Worldwide pictorials, commemoratives every packet 10c. Sibley, Mendon, Mass.

**EXCHANGE** Stamps universe. Particulars free. "Exchangers," Bry 126, Seine, France.

**1875 WURTEMBERG** Set free! Approvals. Colonial, Box 326A, Passaic, N. J.

**100 DIFFERENT** 3c with approvals. Bailey, 317 Boylston, Daytona Beach, Fla.

**ABSOLUTELY Free**—Gilbert Ellice, Cook Islands, Tonga, Seychelles, Ascensions—free to approval applicants. Viking, 130-Z Clinton St., Brooklyn, N. Y.

**SMOKY Mountain** and Centenary Sheets with our 56 page completely illustrated United States catalogue 25c. Colonial Stamp, Saugerties 2, N. Y.

**INTERESTING Packet**—10c with approvals. L. F. Chick, 436 No. Main, Brewer, Maine.

**STAMP** Cleaning service, details. Thos. Carrod, 141-03-70 Ave., Flushing, N. Y.

**100 DIFFERENT** Stamps free with approvals at 60% discount. Martinsen, Box 115D, Washington Bridge Station, New York City 33.

**ILLUSTRATED** Album with spaces for 2000 stamps, plus stamps cataloging over \$1; hinges, gauge, 10c with approvals. Moublow, 740 Hegney, Bronx 56.

**FAMOUS** Americans (35) \$1.00 to approval applicants. Suburban Stamp Sales, St. Louis 14, Mo.

**250 MIXED** Stamps 10c with approvals. Robert Howell, 209 Maple Ave., Lansdowne, Penna.

**EXCHANGE** Duplicates—Send 100 different stamps and one unused airmail stamp. Receive 100 different in return. Swappers, Box 102, Rochelle Park, N. J.

**FREE "StampFinder."** Tells instantly country to which any stamp belongs. 36 pages profusely illustrated. Approvals. Garcelon, Calais 17, Maine.

**EACH** 25 Different. U. S., Switzerland, Netherlands, Denmark, Canada. All 10c. Approvals included. Alatelo, Maynard, Massachusetts.

**FREE U. S. \$1 Franklin** to approval applicants. Litten, 318 North 5th Avenue, Maywood, Illinois.

**OUR Penny** approvals are famous the country over. Try 'em. Roscoe Stamp, 1321 Roscoe, Chicago 13.

**FIFTY** Canadian and Newfoundland, 10c. Approvals. Reede, 696 Gerrard, Toronto.

**GIFT.** Roosevelts, Greece, complete mint set to approval applicants. Deane Stamps, Box 87, Miami 35, Florida.

**PACKETS** 10c each. Send for free list. Karr Ross, Dept. A4, Box 3266, Washington 10, D. C.

**SURPRISE** Premium. Approval applicants. Vast, 519 N.W. 38 St., Miami, Fla.

**BARGAINS!** All different. 2000 worldwide, \$8.00; 1000 worldwide or 500 Hungary, \$3.00; 100 New Zealand, \$2.00; 100 Bohemia, \$1.00. Kwongchong, Don Street, Invercargill, New Zealand.

**150 WORLDWIDE** 5c With approvals. Free lists. Klondike, Harrisburg, Illinois.

**PENNY** Approvals that satisfy. Neil Gronberg, Box 5441-P, Philadelphia 43, Penna.

**FREE!** Rare Polish Roosevelt set complete. Economical, quality approvals included. Reedell, Greensburg, Penna.

**200 WORLDWIDE**, 27c Postage. Pacific, P.O. Box 5704, Los Angeles, Calif.

**307 ALL** Different free. Commemoratives, triangles, bicolored beauties, high values. Strange countries. New varieties galore. Free to approval buyers. Garcelon, Box 500, Calais, Maine.

**MIXTURES.** Worldwide. 1,500. \$1.00. Missions Outlet. Reverend Marshall, Paterson 1, New Jersey.

**FAMOUS** Approvals. Free premium your choice. Berthal, 2219 H St., Bellingham, Wash.

**25 SIAM** Plus Albania error 10c. Approvals, pricelists. Charles Chase, 1026 Walker Avenue, Oakland 10, California.

**GERMANY** Collection. 100 different only 10c with foreign approvals. Modern Stampco, Box 12P, Wakefield Station, N. Y.

**HAVE** Fun, add thousands of stamps to your collection at 1c each. Write for my Economy 1c Approvals. Joseph Goldman, Lynbrook, N. Y.

**PENNY** Approvals with something special. Sturgeon, 2112 Dodson, Ft. Smith, Arkansas.

**50 DIFFERENT**, United States block, Russia Airmails packet, package hinges, 10c. Approvals. Greenwood, 263 Meridian, Miami Beach, Fla.

**NEW** Premium plan, free U. S. with U. S. approval purchases. Warriner, 7139, Apex Station, Washington, D. C.

**ISRAEL** #1-3 Free. Approvals accompany. Art's, 801 B Street S.E., Washington 3, D. C.

**LIBERIAN** Triangulars, 10c with approvals. Vargo Stamps, 6044 South Fairfield, Chicago 29, Illinois.

**SENSATIONAL!** Capejuby, Brunel, Perak, Honduras, Paraguay, Nigeria, and over 100 different others. Everything 10c with approvals. D. O'Keefe, 7517 Merrill Ave., Chicago 49, Ill.

**BANZAI!** Mammoth Jap bargain offer! \$250.00 in genuine Japanese banknotes issued for Philippine invasion and valuable collection 50 different Japanese stamps cataloging nearly \$2.00. All for only 10c. Approvals. Garcelon, Calais 102, Maine.

**250—YES—250** Stamps, postmarks, meters, seals 25c. Gus Hoffman, Wickenburg, Arizona.

**\$1.00, \$2.00, \$5.00 U. S. Free.** Approval applicants. Flamingo, Box 4038, Miami 38, Florida.

**100 STAMPS**, Album, watermark detector, hinges, gauge; 25c. Northeast, Box 6618, Kansas City, Mo.

**1000 DIFFERENT** And 17 Mint Hitler to approval buyers. Bacon, 8221 Page, St. Louis 14, Missouri.

**DA VINCI**, Ghandi, Roosevelt, and twelve other historical stamps free to approval applicants. Stampchest, Box 164M, Teaneck, N. J.

**FREE!** 10 Large mint pictorials! Request approvals. Phipps, 910 20th, Santa Monica, Calif.

**TEN** Sets, including Chinese inflation, South American midgets, San Marino airmails, Ceylon, Siam, etc., 10c to approval applicants. Walker's, 321 Willow, Mayfield, Kentucky.

**SAN** Marino—Collection of 30 diff. mint stamps, including sets. Only 10c with approvals. Trans-Globe Stamp Co., P.O. Box 958, Newark 2, N. J.

**FREE!** Five different Australian to approval applicants. Hoyt, 1576 N. Cove, Toledo 6, Ohio.

**115 DIFFERENT** Hitlers, Roosevelt, Liberia Vatican, etc., 25c. Buckley, 208 Ludlow Bldg., Dayton 2, Ohio.

**WHOLESALE**—Dealers list. 3c postage. Whitlow, 3535 Clarendon, Dallas 11, Texas.

**GIANT** United States catalog! Complete: 128 pages, 1,000 pictures! Only 25c (deductible). Harrisco, 202 Transit Bldg., Boston 17, Mass.

**STAMP** Catalog profusely illustrated. 3c. Century, Box 418, Beverly Hills, California.

**QUALITY** Stamps, Prospect Place, Bristol, Conn. 10 triangle stamps 10c. Free list.

**GERMANY**, "Nazi Army Issue;" ships, planes, rockets, (13) free to approval customers. William Deems, Ravenswood, West Virginia.

**FREE U. S. price** catalogue for stamps, albums, supplies. Stone, 618 Washington, Dorchester 24, Mass.

**WORLDWIDE** Stamps. All different. 200-25c; 500-50c; 1000-\$1.25; 2000-\$3.00; 5000-\$15.00. Beacon Sales, Northboro 2, Mass.

**CHARMS**—Churchill, Hitler, airmail, Roosevelt, Mussolini, Stalin, free with approvals. Granada, 4891 Southwest Fifth Street, Miami 44, Florida.

**APPROVALS**—U. S., foreign, 1c up. Turbyfill, 513 West 29th, Norfolk, Va.

**FREE** Stamp catalog! New, different. Saves you money on stamps, albums, packets, supplies. Ewing-Stamps, 109 North Dearborn, Chicago 2, Ill.

**UNITED-STATES** Commemorative collection. 37 different unused. Columbians to 1943 issues only. Price \$1. Request approvals. "Stamps," 987, Albany 4, New York.

**AMAZING "Queer Countries"** packet—Free with approvals! Saxon, Walden, N. Y.

**25 DIFF.** 19th Century given to approval applicants. Rossom, 218 West 59th St., Chicago 21, Ill.

**SUPERB** Approvals, net prices. Stamps 1/3 to 1/2 catalog. P. G. Beals, 170A Tremont St., Boston, Mass.

**EIGHT** Bicolored French colonies free. Approval applicants. Everglades, 279 Northwest 57th St., Miami, Florida.

**WORLD—500** Diff. 50c, 1000-\$1.00, 75 Canada 25c. Approvals, lists. Victoria Stamp Company, London 4, Canada.

**KINGS** Ransom, Nigeria, Gold Coast, sets are in our packet of 20 different from 20 countries, 3c to approvers. Allmendinger, 709 Dover, Philadelphia 31, Penna.

**100 DIFFERENT** United States commemoratives, including valuable publications. Originally \$3.00. Special. Price \$1.00. Guaranteed. Supply limited. 11423 76th Avenue, Edmonton, Alberta, Canada.

**HUGE** Roosevelt Bolivian music set free to approval applicants. Stone's Stamps, Dept. D, P.O. Box 604, Coral Gables 34, Florida.

**THOUSANDS** Of beautiful stamps 1c each. Why pay more when you can get the best for less. Write today for trial selection. Thrifty Stamp Service, Box 147, Beaumont, California.

**200 BRITISH** Empire stamps! Norfolk, Tokelau Islands, Grahamland, Pakistan, Nepal, big stamp of murdered Mahatma Gandhi; many others. Stamps cataloging up to 20c each! Only 10c! Kenmore Stamps, Arlington 74-A8, Mass.

**FREE.** Absolutely free. \$22.50 catalogue value in better grade stamps, including airmails, pictorials, commemoratives. Also free. International albums and Scott catalogues. Free hinges. Free mystery sets to \$1.00 value. Free \$5.00 Presidential. All free to approval applicants buying under colossal Raymax plan. Raymax, 123-Z William St., New York City 7.

**200 DIFFERENT** Including Abyssinia, Seychelles, Perak, many others only 10c with approvals. Richtmyer, 2901 22 South, Seattle 44, Wash.

**FINE** Approvals. Fast, personal service. What countries do you prefer? I'll send their stamps. Skinner, 438 Locust, Long Beach 12, Calif.

**AROUND** The world—30 different countries; Basutoland, Nyassaland, Tangier, Cyprus, St. Helena. 10c with approvals. Excello Stamps, P.O. Box #95, Hackensack, N. J.

**FLAG** Stamp free, if you request my U. S. approvals. Wenigman, 1933 Patterson, Chicago.

**MINT** Dahomey set free to approval applicants. Stanfield, Rogersville, Tennessee.



PROFUSELY Illustrated U. S. catalogue 10c. Miller Stamp Company, Malden 48, Massachusetts.

MINT Black Harding 10c. Approvals sent. Louis Merrill, 1623 5th, Portsmouth, Ohio.

GOYA Nude (2) 5c. Approvals, Han-nay's, 310 Quail, Albany 3, N. Y.

SENSATIONAL! \$1.00 Packet, 10c! Approvals. Atlas, 3210-M Republic, Racine, Wisconsin.

TOPS! Our book "How To Collect Stamps." Send for your free copy today! Littleton Stamp Co., Littleton 37, N. H.

750 FRANCE And colonies stamps 10c. Littleton Stamp Co., Littleton 25, N. H.

50,000 STAMP Grabbags 25c each. Anderson, 630 Bingham, Reading, Penna.

AROUND The globe—100 pictorials from 100 different countries 25c with approvals. Fields, 1939 E. 85, Cleveland 6, Ohio.

SELECTED U. S. mint Roosevelt and Flag sets. Both only \$1.00. Approvals. Quinn, 570, Madison 1, Wisconsin.

EXOTIC Collection—Fezzan Ghadames, Togoland, Cameroons, Andorra, Reunion, Miquelon, Algeria, Somalis, Guadeloupe, Gulana. Natives, maps, ships, idols, snakes, rhinoceros, others 5c. Imperial Stamps, Tampa, Florida.

118 WORTHWHILE Stamps, including Chinese hunger stamps, strange countries, pictorials aplenty. Only 10c with surprise-packed approvals. Atlas Stamps, 4220 West 16th, Little Rock 22, Arkansas.

FREE! Volcano pictorial! Madagascar! Burmese! Nigeria! Approvals. Keating, 637-P Bergen, Jersey City, New Jersey.

MAGNIFIER, Big stamp magazine; first U. S. commemorative; plus unused \$5000 Foreign Legion, diamond, giant, and other worthwhile stamps. Everything free to approval buyers. Capital Stamp Company, Little Rock 2, Arkansas.

10,000 PENNY Approvals waiting for you. Many from exotic countries, pictorials, airmails, new issues. Tilbury, Box 862, Newark 1, N. J.

\$5.00 CATALOG Price for 10c! (1) Big collection 112 all different stamps from Africa, South America, South Sea Islands, (2) Four desirable unused U. S. cataloging 40c. (3) Fine packet 25 British Colonies; Burma, Solomon Islands, etc. (4) U. S. \$5.00 high value. Everything (all four items) only 10c with approvals. Crystal, Littleton 41, New Hampshire.

TOP Stamps for middle collectors at bottom prices. Free premiums. Approvals. Moore, Box 623, Oildale, Calif.

BARGAINS! 2000 Foreign stamps \$1.00, 5000 \$2.00, 2000 U. S. \$1.00, 5000 \$2.00. Post-All, 930-F Street, Washington 300, D. C.

DESIRABLE Mounted collection—U. S., Cuba, Philippines. All different. Including airmails! Commemoratives! High-values! Only 10c to "Gold Nugget" approval applicants. Kessel's, Folsom, California.

YOU'LL Like our American and British Colonial approvals. Write now. Chesapeake Stamps, 748 Overbrook, Baltimore 12, Maryland.

50 DIFF. France, only 5c to new approval applicants. Bert Sotka, Box 146M, Jackson Heights, N. Y.

100 ASSORTED U. S. old and new. 25c. Weatherby, Medina, Ohio.

ZEPPELIN, Roosevelt, Columbian, Hitler airmail, etc., sent for 10c. Approvals included. Thirdeco, 101 3rd Ave., Newark, New Jersey.

ILLUSTRATED Stamp magazine, 26 weeks 25c. Stamp Journal, Kalamazoo, Michigan.

FREE "Round the World" packet to approval applicants. Lange, Box 21, Hub Station, New York 55.

300 DIFFERENT Given free with approvals. Postage 3c. Windsor Stamps, 1435 East 67th Place, Chicago 37.

FREE—Illustrated catalog! Kenmore Stamps, Arlington 74-C7, Mass.

FREE! Powerful magnifying glass—to approval applicants; also big bargain lists. Jamestown Stamp Co., Dept. 207, Jamestown, New York.

GENUINE "Goya Nude" set (catalogs 55c) 15c. Approvals. Royal Stamp Company, Tamaqua, Penna.

543 BARGAIN Offers, free! Kenmore Stamps, Arlington 74-D3, Mass.

200 DIFFERENT Stamps 10c with approvals. 500 mixed United States 25c. Carlton's, Tujunga, Calif.

66 DIFFERENT Stamps, including U. S. battleships 6c. Worldwide approvals. Telle-Arts, Devon, Conn.

TRAINS! Trains! Trains! 12 train stamps and packet of 100 different stamps for 10c with approvals. Reich Stamp Company, 4647 Kenmore, Dept. M20, Chicago 40, Illinois.

DEALERS—Wholesale list. Postage 3c. Frank, 5031 Queensberry, Baltimore 15, Md.

OLD Scarce U. S. seconds on approval. Slightly defective, bargain prices, Hershfield, Clintonhill Station, Newark 8, N. J.

25 ALL Different stamps 10c. Tunis, Wakeman Ave., Newark 4, New Jersey.

POUND Stamps containing thousands \$1.00. Longacre Shop, 108 West 42nd, New York 18.

ZOWIE-E! A barrel of fun for only a dime. 500 United States stamps—absolutely unpicked and unsorted—just as received from church missions. Many varieties, including large commemoratives, airmails, high denominations up to \$5.00! Stamp-dom's biggest package of fun—and you might find something really valuable! Price only 10c to serious approval service applicants. Money back if not delighted. Illustrated bargain lists with each order. Mystic Stamp Company, Dept. 80, Camden, New York.

1c EACH And less! Thousands of bargains! Cole, 43-A Rinewalt, Buffalo 21, New York.

YOU Need these! All six for 10c! To introduce our exceptional approval service, we'll send you: 1. Pocket stock book, 2. Watermark detector, 3. Stamp tongs, 4. Perforation gauge, 5. Book for duplicates, 6. Package of stamp hinges. All only 10c to approval applicants. Free! Big list other bargains. Jamestown Stamp Co., Dept. K, Jamestown, New York.

FREE! United States commemorative price list. Historical Stamp Co., 1280 Ocean Ave., Brooklyn 30, N. Y.

50 DIFFERENT U. S. 10c. No approvals. Pricelist free. Seidenberg, Cassopolis, Mich.

PENNY Approvals by country. M. H. Hoerning, 15, Farmington, Ark.

AIRMAIL Packet—Worldwide. Big bargain. With approvals 5c. A. Wirth, Nor-wichtown, Conn.

CASH For your duplicates! Particulars free. Goliath, Bethlehem 7, N. H.

FREE! Illustrated United States catalog. Low prices! Americo, Bristol, Conn.

WOW! \$10.00 Worth of fun 10c! What a treasure hunt! Big package 500 foreign stamps, including airmails, pictorials and others from the world over; stamps worth up to 25c each. This offer sent for 10c to approval applicants only. Jamestown Stamp Co., Dept. 22, Jamestown, New York.

UNITED States approvals complete coverage, fine quality, attractive prices. Seminole Stamps, Box 1138-P, Coral Gables, Florida.

"MAN Size" United States approvals! Illustrated catalog! Sullivan, Endicott Arcade, St. Paul 1, Minn.

U. S. Price list. Send postage. State Stamp Service, 1225 Park Building, Pittsburgh 22, Penna.

200 DIFFERENT Including Roosevelt triangle, 5c to approval applicants. M. Avalon Stamp Company, Springfield, Mass.

FREE! Crystal-mount samples! Har-risco, 202 Transit Bldg., Boston.

FREE U. S. price list, postage 3c. Mark Hanna, 335 5th Ave., Pittsburgh 22, Penna.

WORLD'S Largest stamp (7½"x14 inches). A real curiosity! Retail for 50c, only 3c to approval applicants. Tatham Stamp Co., Springfield 30, Mass.

STAMP Collections wanted. Complete collections, duplicate lots, surplus stock, mint and used. Prefer trade for printing or other items, buy outright if priced right. What have you, what's wanted? Vanroy Shirk, Lebanon, Penna.

FREE! 100 Worldwide different stamps to approval buyers. Big U.S. and illustrated bargain lists sent with approvals. Bookman, Maplewood, N. J.

#### COINS, TOKENS, CURRENCY

1878-S UNCIRCULATED Dollar, \$3.00. Coin subscription 50c. Willard, 5719 Kenmore, Chicago 40.

INDIAN Penny with catalog, 10c. (Refundable.) Brunk Coins, 3530-N Osceola, Chicago 34, Illinois.

1852 VATICAN Stamped covers \$1.50 each. 1863 Vicksburg wallpaper newspaper \$2.50. 105 South 15, Omaha.

SCARCE 1922D Lincoln cent 15c. Reynolds Coin Shop, Flint 3, Michigan.

OLD Money wanted. Do you know that coin collectors pay up to \$100.00 for certain U. S. cents? And high premiums for all rare coins? We buy all kinds. Send 4c for large coin folder. May mean much profit to you. Numismatic Co., Dept. 20, Fort Worth, Texas.

U. S. Coins bought. Illustrated folder 10c. Hutchinson's, 3463 "I" Street, Philadelphia 34, Penna.

20 DIFF. Coins, 50c. Free lists. Approvals upon application. Bishop, Box 2201, Kansas City, Mo.

MONEY For you—We pay \$2 to \$500 each for hundreds of U. S. and foreign coins. You may have valuable coins. Better be sure. Send 20 cents for illustrated 4x6 Coin Value Book. Guaranteed buying and selling prices. Coin Exchange, (7) Le Roy, N. Y.

GENUINE Roman coins 2000 years old large size \$1.00 or two small \$1.00. One hundred different foreign coins \$3.00. Chelsea, 40 W. 18, New York 11.

FREE Foreign coin and banknote with giant bargain list 10c. 4 new Whitman folding albums \$1.00. 1949 coins for sale. Olson, 5800 Lake, Chicago 44.

35 DIFFERENT Coins, \$1.00. 100 different bills, \$1.00. Oddehon, Box 482, St. Louis, Mo.

BARGAINS! Rare collection contains United States Large Cent over 90 years old, Flying Eagle Cent, White Indian Cent, 1881 Cent, 1909V.D.B. Cent, 1912-D Cent, 2c piece, 3c Silver, 3c Nickel, Half Dime, Shield Nickel, 1863 Nickel, Jackson Cent, Liberty Seated Dime, Civil War Cent, Confederate Bill, Broken Bank Bill, Foreign Coin, Foreign Bill, Ancient Roman Coin over 1500 years old and our complete buying and selling catalogue, all for \$3.00. Catalogue alone 25c. 20 different dates Indian Cents \$1.00. Colonial Coin over 160 years old \$1.00. Colonial Bill \$1.00. Or everything \$5.00. Worthy Coin Corporation, 294 Washington (D-201), Boston, Mass.

IRISH Set 8 animal coins \$3.95. 100 different foreign coins \$3.95. Giant guide-book \$1.50, handbook 75c, catalogue 15c. Bebebe Coin Company, 1180 East 63rd, Chicago 37, Illinois.

FREE! Foreign coin, banknote and coin collectors illustrated catalog to approval service applicants. Send 3c postage. Tatham Coinco, Springfield 30, Mass.

16 PAGE Coin bargain list and Mexican 10 peso bill, all for dime. Coin Shop, 31 North Clark, Chicago 2, Illinois.

UNCIRCULATED Foreign coin and banknote with huge price list 10c. Tousseau Coins, 109 Mathilda Avenue, Sunnyvale, California.

COINS Wanted: Itemized list 20c. Elsholz, Box 9014-M, Pittsburgh 24, Penna.

GET Profit and pleasure in collecting old coins. Send 10c for 56 page illustrated coin catalog. You'll be delighted with it. Send for it now. B. Max Mehl, 370 Mehl Bldg., Fort Worth, Texas. Largest rare coin establishment in U. S. Established 49 years.

COINS Wanted, will pay up to \$2000 for certain coins, send 25c for catalogue. Burton's, 111 So. Third, Columbus, Ohio.

COMMEMORATIVE \$½. Oregon, Texas, Kentucky, Cleveland, Long Island. \$2.00 ea. Illustrated catalogue 25c. Norman Shultz, Salt Lake 9, Utah.

#### ANTIQUES, RELICS, INDIAN GOODS, CURIOS

10 ANCIENT Indian arrowheads \$1.00. Tomahawk \$1.00. List free. Lear's, Kirby, Arkansas.

#### PRECIOUS STONES, MINERALS

GEMS—Save money, buy direct. Zircons and other semi-precious stones. Catalog 10c. J. Lavering, 1140 Adams, Redwood City, California.

RUBY Synthetic 5mm. diamond cut first quality. Send \$1.00—includes tax and mailing. Wertheimer, Box 1283, Grand Central Sta., New York 17, N. Y.

ZIRCONS, Loose. Genuine Siam imports. Pure white. Special: 3 genuine zircons, from ½ kts. to 1½ kts., \$6.00 tax included. We can supply zircons in all sizes and mountings of all types. Send order or write for details today. B. Lowe, Holland Bldg., Dept. PM, St. Louis, Mo.

GEMSTONES, Mineral specimens. Every variety. Lowest prices. Postcard brings free list. Plummer's, 2177C Bacon, San Diego 7, California.



RENT 16MM. sound films, 50c reel. Large selection; free catalog. Film Service, 128 Chestnut, Roselle Park, N. J.

FILMS And equipment exchanged or bought for cash. Sound, silent. Bargains. Lists free. Frank Lane, Little Bldg., Boston, Mass.

8-16MM. Silent-sound films. Complete rental library. All latest subjects. Free catalogue, (sample film 10c). Garden Film, 317 West 50th, New York 19.

MOTION Picture technique at home. Big money. Special registration for veterans. Free catalog. Motion Picture Institute, Birmingham 4, Mich.

FREE Movies. Thousands of subjects. Interesting. Entertaining. Fascinating. New directory—only 50c. International Cine Society, Dept. 102-M, 1300 Taylor N.W., Washington 11, D. C.

BASS Says: 39 years of leadership guarantees satisfaction. Finest cine equipment, 8mm., 16mm., and 35mm., silent and sound. Write the old "Horse Trader." Satisfaction or your money back always! Bass Camera Company, Dept. A, 179 W. Madison St., Chicago 2.

LEARN Movie projection, management. Free catalog. Theatre Institute, Elmira, N. Y.

I BUY, Exchange, swap movies. What have you? What do you want? Lowest exchange rates in world. Catalogue \$1.00. Refundable. Harvey Iris, Box 539, Brockton, Mass.

### MUSIC AND MUSICAL INSTRUMENTS

HILLBILLY, Polka records—Late, old 29c. Guaranteed. Catalog 3c. F-L, Box 19-L, New York 35, N. Y.

POEMS Considered for musical setting. Send poem for immediate examination and useful rhyming dictionary. Richard Brothers, 24 Woods Building, Chicago.

POEMS Wanted. Percentage basis collaboration. Terry Tune Master, 709½ PM North Broadway, Oklahoma City 2.

SONGWRITERS—600 Top recording artists who plug new songs. List 50c. "Songs," 931-A White Street, Dubuque, Iowa.

SONGWRITERS Publishers printing service. Stuckmann Music Press, 4737 Broadway, Chicago 40.

POEMS Wanted for professional development. Songs copyrighted. Send poems. Harmonist, Box 68, Weston, Ontario, Can.

PHONOGRAPH Records 15c. Catalogue. Paramount, TA-313 East Market, Wilkes-Barre, Penna.

LOCAL Salesman. Musical knowledge. Box 367, Decatur, Ill.

VOICE "Effortless control!" 15 lessons \$10.00. Cer-Studio, 14356A Jersey Ave., Norwalk, Calif.

SONGWRITERS! Outstanding, ethical offer. Hibbeier, C5, 2157 N. Avers, Chicago 47.

MUSIC Arranged, songs printed. Frank Wildt, Music Publisher, Lancaster, Penna.

YOUR Poems set to music, recorded. Free booklet, attractive offer. Write. Songland, 331-C West 46th, New York.

SONGWRITERS—Publication collaboration. Newart Publishers, G.P.O. Box 1226, Syracuse, N. Y.

WRITE Songs. Big money and reputation. Write for information. J. Gordon Pub. Co., 201 N. Hoyle Ave., Chicago.

SONGWRITERS Attention! The amazing demand for phonograph records, accelerated by countless juke-boxes, warrants your immediate investigation. We are offering new writers the rare opportunity of having celebrated "hit" composer furnish music on reduced percentage basis for any likely poems received this month. Phonograph records are outselling piano copies 5 to 1. Recola Records, Hollywood 28, Calif.

POEMS Wanted for musical setting. Send poems for free examination. Five Star Music Masters, 630 Beacon Bldg., Boston, Mass.

POEMS Wanted to be set to music. Free examination. Send poems. McNeil, Master of Music, 510-PM S. Alexandria, Los Angeles, California.

### RADIOS, SUPPLIES, INSTRUCTION

MAKE Loudest crystal radio. Instructions, loudest crystal, catalog 25c. Amorose, Route Four, Richmond, Virginia.

BUILDING Radios? Diagrams furnished 25c each. Questions, problems promptly answered 5c each. Include stamped envelope. Gurtner, 17218 Barlow, Detroit,

FIX Any radio. Amazing new instrument locates radio troubles double quick. Simple instructions show you how. Thousands now in use. Free—write today for 28-page illustrated technical manual, "The Inside Story." Feiler Engineering Company, Dept. 11PM9, 945 George St., Chicago, Illinois.

MAKE Simple, tubeless, batteryless, distance-getting crystal radios. Crystal and illustrated instructions 25c postpaid. Allen, 427-P, Clinton, Missouri.

BEST Distance record crystal circuit, crystal, catwhiskers, "Radiobuilder," catalog—all 25c. Laboratories, 578-C, San Carlos, California.

CRYSTAL Set plans, 3 for 25c. Watkins, 3 Woodlawn Ave., Baltimore 28, Md.

TELEVISION Schematic diagrams for ten different sets \$1.00 postpaid. Melpro Co., P.O. Box 40-PM, Bay Ridge Station, Brooklyn 20, N. Y.

HEADPHONES. Guaranteed U. S. Signal Corps used headsets with adjustable leather headbands and black Bakelite earphones. Special now \$1.99. Allen Radio, Dept. HPM, Clinton, Missouri.

BUILD Modern console type radio cabinet with sliding free-panel, doors of natural wood. Simple, easy-to-read blueprints. Order number 1100. 25c. Popular Mechanics Press, 200 E. Ontario, Chicago 11, Ill.

### BUSINESS OPPORTUNITIES

CONVERT Hand mowers to power mowers. Do it now, this winter. Sell the Handy-Dandy conversion kits. Easily installed on 16 to 20" mower. Use any small gasoline or electric motor. Quick delivery. Kits purchased with or without engines. Also new Garden Cultivator. Cultivates 3" deep. Attachments available; weed cutter, lawn mower, and snow plow. Retail \$124.50 with cultivator 1 hp. engine. Snow plow only \$11.95. Discount to dealers. LeClaire Manufacturing Company, LeClaire, P.M. 11, LeClaire, Iowa.

START Your own business on credit. Always your own boss. 1554 dealers, sold \$5,000 to \$26,500 in 1948; their average \$6,742. We supply stocks, equipment on credit. 200 home necessities. Sales experience not needed to start. Wonderful opportunity to own pleasant, profitable business backed by world-wide industry. Write Rawleigh Co., Dept. K-U-PPM, Freeport, Illinois.

BE Independent, be secure, have your own profitable business—earn \$10.00 and more a day making beautiful, fast-selling lamps at home. No equipment needed. Illustrated course teaches you quickly. Course, parts catalog, wholesale price list, only \$2.00. Gearon Company, Dept. 200-B11, 27 South Desplaines, Chicago 6, Ill.

"HOW To build your own mail order business." 10,000-word handbook; starts you right. Sent postpaid 25c. Satisfaction guaranteed. Excelsior Service, 1330 January, St. Louis 10, Mo.

BE Independent—Operate America's lowest price penny vending machine. Big profits. Immediate shipments. Write for bulletin and prices. Fielding Mfg. Co., Desk 119, Jackson, Mich.

START Home manufacturing business making cleaning compounds, soaps, insecticides, cosmetics, polishes, food flavors. No machinery. Literature free. Kemix, Park Ridge, Ill.

FOR An extremely profitable lifetime business, operate a Collection Agency-Credit Bureau. Easily learned. Free folder. Cole & Associates, Syracuse 2, N. Y.

TRADE Magazines—Current copies. Business, professions, agriculture, automotive, aviation, sports, hobbies; all fields. Price-list free. Commercial Engraving Publishing Co., 34C North Ritter, Indianapolis 19, Indiana.

"MAKING Money at Home." 68 pages, 63 projects, fully illustrated. What to do, how to do it, where and how to sell it. \$1.00 postpaid; 5-day return privilege. Earl B. Shields, Publisher, 107-P West Wacker Drive, Chicago 1.

"INDUSTRIAL Hand Cleaner!" (Without ammonia—Kerosene!) Sample \$1 refunded on first order concentrate. Free manufacturing; distributing plans. "Rythmo-C-Ex," Kingsport, Tennessee.

WHERE To buy 800,000 articles wholesale. Details free. Schibani, Box 1576-M, Birmingham 1, Alabama.

LEARN Electrical appliance repair. House wiring, motors, washers, cleaners, refrigerators, lamps, auto ignition, etc., complete illustrated course. Tools furnished. Free booklet. Pacific School, 7219

AUTOMATIC Saw setter used with Foley filer. Stadick Manufacturing Co., New Ulm, Minn.

MAIL Order offers increased income, independence, unlimited possibilities; free literature. Manhattan House, 126 Lexington, New York 16.

REFRIGERATION And air conditioning. Complete, illustrated course. Free booklet. Mechanics School, 7219 South Broadway, Los Angeles 3.

SELL By mail. Good deal with nice profits. Home City Services, Box 1062-PM, Springfield, Mass.

AMAZING Marble-glazed cement pottery, Hollywood style, without moulds. Benches, fountains, stucco-rock walls, garden ornaments; chemically colored. Dime brings sample, pictures. Hollywood Cementcraft, 8527-R Wonderland, Hollywood 46, California.

BETTER Mailorder business. I received 200 orders from first small ad. Demand growing daily. Get details. Grant Lovell, 2166 South Shore, Erie 21, Penna.

"WATERLESS Hand cleaner." Make, sell. No machinery. Build profitable business. Formula \$1.00. "Wax-o-Glass" cleans glass; polishes metals. Formula \$1.00. "Wipe-on auto paint" formula \$1.00. Metallizing baby shoes, complete process \$1.00. All four formulas only \$3.00. Satisfaction guaranteed. Ideal Formula Service, Park Ridge 11, Illinois.

QUICK Money! "Repairing car batteries!" At home! Easy too! Batterymen, Grand Junction, Colorado.

WOULD You pay 3%—first \$350 made? Book "505 Odd, Successful Enterprises" free! Work home. Expect something odd! Pacific, Oceanide, Calif.

HOW To sell by mail. Free literature plus gift subscription offer. Shaw, Box 438, Coconut Grove, Fla.

BRONZED Baby shoes mountings; metals, onyx, plastics, hardening solution. Wholesale, Box 2095, Wichita, Kansas.

MILLION Articles wholesale. "Supply Source Directory" 25c. Publisher's, Box 1302-P11, Detroit 31.

MAKE Perfume. Learn profitable mail-order business free. International, 6347 Parnell-PM-11, Chicago 21, Illinois.

MAKE Perfumes at home. Very simple. Free details. Tropical, Box 5652, Chicago.

ANNOUNCING: Complete simplified shoe repair course, big demand, in depression proof trade, \$7.95 complete, information free. Shoe Service System, Conway, New Hampshire.

"LIFETIME Repeat orders!" Sell our business cards by mail. \$5.85 "Starter" plan. Lynn, 5710 Bankfield, Culver City, California.

40% COMMISSION On fast-selling item. Every shopper a prospect. Send \$1.00 for sample. E. L. Edwards Company, 5333 Georgia Ave., Washington, D. C.

UNUSUAL Information. Lowest prices! Locksmithing secrets illustrated! Lock opening, repairing, etc., \$1.00. Prospecting. 10,000 formulas, trade secrets. Mail-order. Others. Free details. National, 378-P Hooper Street, Brooklyn 11, New York.

MADE \$24,500 Using formulas from Schemer magazine. Box 775M, Alliance Ohio. Year \$1.00. Three samples 25c.

IMPORT-EXPORT Agency opportunities, unlimited profits, hundreds of overseas connections seeking representatives in U. S. List \$1. Stout, 1116P, Caesar, Pasadena 10, California.

OWN A printing business. Good profit printing cards, stationery, etc., in spare time. Easy rules furnished. Have home shop. Write for details. Kelsey Corp., Meriden 24, Conn.

MANUFACTURERS Getting rich with new post-war products, all lines. You can easily make them at big profit from guaranteed, chemist-developed formulas and analyses. Literature free! Miller, Analytical Chemist, Tampa 6, Florida.

START Home mailorder business. Details—Gedgard, Box 798-J, New York 1, N. Y.

START Profitable mail order business, particulars free. Dawson Service, 1308P, The Dalles, Oregon.

AMBITIOUS? Postcard brings description of practical book showing how to get the job, promotion, you want. House of Cason, 6411 Hollywood Blvd., Hollywood 28, Calif.



USE Your home as magazine subscription station. Represent all magazines. Liberal commissions. Supplies furnished. Big Christmas gift business now. Catalog, full details, free. McGregor Magazine Agency, Dept. 509B, Mount Morris, Ill.

WANTED Unused U. S. postage stamps, small discount. Advance Stamp Co., 24 East 23rd St., New York.

GET "How To Sell by Mail and Win." Literature free. Lexington Mail Service, 5538 Lexington, Chicago 44, Ill.

EXTRA Money. No selling; operate vendors. Amazing profits, details free. Silver King, Suite B, 623 Diversey, Chicago 14.

UNPAINTED Bookends, plaques, statues, figurines. List. Haverty Products, 1219 8th Ave., Altoona, Penna.

LIQUID Marble—Colorful, glossy! Molded, brushed, sprayed! Cast novelties, statuary, colored tiles. Flexible molds. Composition floors. Particulars free. Marbleizing Service, Edwardsville, Illinois.

RICHES In your own business. Let me show you how. Addison, Box 1153, Hot Springs, Ark.

BRONZED Baby shoe mountings, equipment and supplies. We manufacture world's largest assortment of all metal mountings. Wholesale only. Ramyr selenium platers \$39.95. Gold and silver plating assemblies low as \$97.50. Write for free copy of electroplating instructions. Tech. Dept., Hollywood Bronze Supply, 1770 N. Vermont Ave., Hollywood 27, California.

RESILVER Mirrors at home. Formula 25c. Ideal Service, Park Ridge 8, Illinois.

UNPAINTED Figurines. Free list. Progress Company, 4033-P Chowen, Minneapolis 10, Minnesota.

HOW To set up and run a mirror shop! Resilver mirrors. Make chipped glass nameplates. Electroplating salts and rectifiers. John Sprinkle, V60, Marion, Indiana.

MAKE Money spare or full time, casting metal toys and novelties. Big wholesale and chain store demand for cast metal autos, soldiers, ashtrays, banks, etc. keeps manufacturers busy. Production moulds furnished for up to 100 and more castings per hour. No experience or special place necessary. "Cash-in" on holiday orders now being placed. Write for full information and illustrations of patterns needed. Metal Cast Products Co., Dept. A, 1696 Boston Road, New York 60, N. Y.

LEARN Piano tuning, repairing at home. Tremendous field! Piano parts, tools furnished. Established 1935. Empire School of Piano Tuning, 606-B East University Ave., Champaign, Illinois.

LEARN Sewing machine repairing at home. Install our wholesale motor kits. Make \$125 to \$300 in a week. Free particulars. Taylor Service Co., Hamilton PM, Ohio.

UNPAINTED Figurines—Wholesale, retail. Illustrated list free! Oman, 642L Broadway, St. Paul 1, Minnesota.

CO-PUBLISH And advertise in The Central Mail Advertiser. Sample copy 10c. Low rates. Large circulation. Bagby Printing Co., Georgetown, Ohio.

BIG Money! Made in lettershop operation! Easy pleasant work. Free details! Woods Letter Service, Bedford, Penna.

MAKE Rubber stamps, metalize baby shoes, repair dolls, silver mirrors, make plaster novelties. Catalogue of "30 ideas" free! Universal, Box 1076-A, Peoria, Ill.

SELL Jewelry by mail. Everything furnished ready to go. Orders filled; small capital. Tremendous possibilities! Jomay, Box 1224-A, Toledo 3, Ohio.

CASH For your idea, 280 manufacturers need inventions, patented or unpatented. List free. Invention Bureau, 208M Clinton, Oak Park, Illinois.

MAKE Money making new greaseless doughnuts at home on electric machine. Wholesale to grocers, drug stores, cafes, hamburger shops. Send for free recipes and plans. M. Ray Company, 3605 South 15 Ave., Minneapolis 7, Minnesota.

"SPECIALTY Manufacturing." Big money business. Start on small capital with dependable formulas. Send for free interesting booklet. Howard Robinson, Ph. G., 1300-A South Ohio Street, Sedalia, Mo.

MAILING Postcards selling repeat merchandise is profitable. Everything supplied. Details free. Gordan Publishers, Box 23, Pawtucket, R. I.

HOME Business making statuettes, plaques, artificial marble, rubber molds. Metallizing baby shoes. Silvering mirrors. Formulas, Felder free. Creative, 236-L Winnetka, Illinois.

RECAST Old batteries into new. Latest achievements. Battery Laboratories, Minneapolis.

ENVELOPES Addressed accurately, reasonably. Fast service. We have capable addressers in your city. Glenway System, 5713-Y Euclid, Cleveland 3, Ohio.

VENDING Machines earn big money! An investment as low as \$10.50 will start you in this fascinating, profitable business that can lead you to the road of success and independence. Routes can be established and operated in either full or spare time with no experience needed. Write for full details and our free catalog illustrating our nut, candy, gum and stamp vendors; also pin ball machines, music boxes, etc. Write immediately to Parkway Machine Corporation, Dept. 7, 623 W. North Avenue, Baltimore 17, Maryland.

YOUR Own profitable home business. Preserve live flowers to last forever. New simple discovery. Enormous demand all year 'round. Tremendous profits! Light fascinating work. Send \$2.00 for working equipment, instructions, and valuable sales plans. Satisfaction guaranteed or money promptly refunded. Alfred Hermansen, 210 Fifth Ave., Suite 1102A, New York 10, N. Y.

I MAKE Big money in the mail-order business. You can do the same at home with copyrighted system. Write me. I'll tell you how. F. Little, R.D. #1, Glenshaw, Penna.

POPCORN Equipment, potato chip outfits. Long Eakins Company, 4960 Hi Street, Springfield 99, Ohio.

READ "Advance"—The voice of mail order. Offers money-making opportunities, sources of supply, personal guidance, etc. Issued monthly. Sample copy 25c. Yearly subscription \$2.00. Advance Publishing Company, 313 East 21st Street, Suite 450, New York 10, N. Y.

A BUSINESS In your own home! Our chemicals, plus free water and cheap "grocery store" materials can bring you over \$500 monthly earnings. Plans and formulas free. Chemica Division, 1269 S. Norton, Los Angeles 6.

A FACTORY In your home garage! Mfg. and sales rights, mechanics' waterless hand cleaner. \$500-\$800 monthly. No special equipment necessary. Formula free. Western Aircraft Mfg., Dept. D, Los Angeles 6, Calif.

START Mailorder bookshop—Everything furnished. 25c brings booklet, samples, exciting ideas. General Publications, Ossining, N. Y.

OPERATE Profitable mail order business. Write Walter Service, 4159-A East 112th, Cleveland 5, Ohio.

COLORGLAZED Concrete pottery made without molds. Patented method. Cemetery products, novelties, tiles. Basement leak-sealing. Money-making projects. Booklet, details free. Men only. National Potteries Company, Grand Rapids, Minnesota.

\$25 WEEKLY Working two hours daily. No canvassing. No manufacturing. Lycke, Box 2471, Cleveland 12, Ohio.

137 WAYS To make money, in home or office, business of your own. Full particulars free. Elite Co., 220 Grand St., New York 13.

BRUSH Plating outfits connect to a battery. No tanks necessary. Good paying business at home plating autoparts, bathroom fixtures, bicycles, reflectors, silvering mirrors. No shop or experience required. Outfits furnished. Free booklet. Gunmetal Co., Ave. H, Decatur, Ill.

COPUBLISH Leading m.o. paper. Latest copy Mail Sale Advertiser and proposition, dime. Vanroy W. Shirk, Lebanon, Penna.

### MONEYMAKING OPPORTUNITIES

ASSEMBLE And sell electric bed warmers. 400% profit. Altozeo Co., 7811 Guthrie, Cleveland 2, Ohio.

WESTERN Advertiser offers many worthwhile mail order opportunities. 6 months subscription 10c. H. Edlund, 577 Kensington, Los Angeles 26, Calif.

MAKE Money sharpening and gumming cross cut saws. One man and two woman types. Also all circular saws. Build machine yourself at small cost. Plans, illustrations, instructions \$1.00. Satisfaction guaranteed. Charles Lashley, Wellington 2, Ohio.

WANT Notary Public appointment? Official in usually 10 days. Stationers Exchange, Boerne 50, Texas.

"DEPRESSION Insurance!" Complete plan and sample \$1, refunded first order. Information free. "Pru-A-Ex," Kingsport, Tennessee.

SELL Cameras, typewriters, watches, shavers, Kodak, Revere, Bulova, Royal, Schick. 25-40% commissions. Diamond Company, 17 East 42 Street, New York 17, N. Y.

CHURCHES, Organizations. Earn \$100.00 free plus 24 card tables, free delivery. Box 392, Clementon, New Jersey.

WIN Cash, cars in prize contests! Write for copy filled with current contests, winning hints and tips. Send only 25c. Wright Contest Digest, Dept. 17-M, P.O. Box 2266, St. Louis 9, Missouri.

FREE Book "372 Unusual Worldwide Businesses." Successful! Australia, South America, Work home (U.S.A.)! Delightful plans. Get surprise! Publishers-8L, Carlsbad, Calif.

MAKE Money at home in spare time. Raise Golden Hamsters. Small investment. Literature free. Golden Gate Hamstery, 631-H Richmond Street, El Cerrito, Calif.

GET Dollars in your mail. Your orders filled free! Write. Siwaslian, 4317-C Gleane Street, Elmhurst, N. Y.

CONVERT Burnt out light bulbs into fire extinguishers. Every home a prospect at your own price. Full instructions \$1.00. Details free. Fred A. Lewis, Box 104-A Kensington Station, Brooklyn, New York.

UNIQUE, Unusual items. Flexible plan. Local; mail. Profit 100%, 300%. Details, imprinted weather forecaster 10c. Refundable. Central, Simpson 1, Kansas.

WOULD You pay 3%—first \$350 made? Book "505 Odd Successful Enterprises" free! Work home. Expect something odd! Pacific, Oceanside, Calif.

EARN Money evenings, copying and duplicating comic cartoons for advertisers. Adservice, Argyle 1, Wisconsin.

HELICOPTER. 14" Rotors, rubber motor, \$3.00 dozen, \$1.00 two samples. Helio-toy, R. 8, Dallas 11.

EARN Money—Learn shellcraft. Fascinating, profitable. Send one dollar for model material and instructions. C. W. Spence, Box 311, Seaside Heights, N. J.

\$50 WEEKLY While learning watch repairing. See ad page 45.

NEW, Highly profitable, easily sold packaged button assortments. More than doubles your money. Write Capital Findings, 475-P Fifth Ave., New York 17.

YOUR Mail order business now ready. A. S. Spencer, Mokena 6, Ill.

15 MINUTES Masters advertising and sign lettering, complete system; sign painters' secrets; cartooning book; all three, \$1. Free circular. Abenterprises, Box 875-M, Peoria, Illinois.

PROFITS and fun with your pen. Sensational raised letter engraving. Gold, silver or copper. Engrave Christmas cards, stationery, invitations. Simple as writing. Amaze your friends and make money. Free sample! Specialties Clearing, 5520 Ethel Ave., Van Nuys, Calif.

WIN Contest prizes regularly! Others do! 10c brings latest issue "Contest Flier," other revealing information. Lawrence, 687 Morgan, Camden 4, N. J.

MAKE Extra dollars! Full, spare time, home mail business. Start small, grow. Easy, pleasant. Facts free. Kanick, 261-A East Abbott, Lansford, Penna.

EARN Money at home! Thousands do! "Home Worker Magazine" tells how. Sample, 25c. Sizemore, Box 7, 4917 Kostner, Chicago 30, Ill.

SCHOOL Seniors—Sell classmates America's most beautiful graduation name cards. Largest selection, 40% commission. Outsell all others. Free sample kit. Printcraft, Dept. M, 1425 E. Elm St., Scranton 5, Penna.

MAKE Money at home as renewal headquarters for all magazines. Big profit in Christmas gift sales. Liberal commissions. Supplies furnished. Catalog free. Write McGregor Magazine Agency, Dept. 509C, Mount Morris, Ill.

THOUSANDS Articles wholesale. "Supply Source Directory" 10c. Ideal Service, Park Ridge 30, Illinois.

READ Progressive Mailtrade, the magazine that tells how to make money by mail. Dime brings sample and special offer. Progressive Mailtrade, Box 357, Sheboygan, Wisconsin.

PROFIT With Larson Leathercraft. Belts, purses, 100 other ideas. Largest supply in U. S. Catalog 10c. Larson, Dept. C, 824 S. Tripp, Chicago 24.



**FREE Nylons** given if Kendex hosiery runs or snags! World's only women's hosiery sold with written guarantee amazing everybody. Mere words could not express unbelievable money-making opportunity. Fantastic earnings become reality. Armstrong earned \$202 in 9 days. Watkins sent 92 orders in one day. Imagine replacing hosiery free regardless of cause—whether use or abuse! Truly sales dynamite for terrific profits. Even if you never sold before, three magic words: "Guaranteed Against Everything" will open doors for you—make women listen and pour money in your pocket. Nationally advertised in Life, Ladies Home Journal, Saturday Evening Post, McCall's and Woman's Home Companion. Awarded Seal of Approval by Good Housekeeping. 75 million readers will see Kendex advertising to help you make quick sales and big money. Complete line from sheerest 15 denier 51 gauge to heavy 70 denier service. Sizes 8½ to 11½; lengths 28 to 35 inches; latest fashion colors plus white; full fashioned seamed and seamless. No competition because Kendex nylons are not sold in stores. Also complete line men's hosiery actually guaranteed for one full year or replaced free. Nothing like this anywhere. Includes rayon, nylon, lisle, wool, cotton, mixtures etc. All styles, patterns, colors, prices to please everybody. 200,000 pairs constantly in stock for fast delivery. Thousands shipped daily. Over 30 years in business. You need no money or experience. Nothing to pay now or later. Just show free outfits. Write orders. We deliver and collect. Big advance cash plus huge bonus. Earn money spare or full time—exclusively or as side line. No restrictions. Become manager—appoint others to sell for you—earn steady income on their sales. Man or woman, young or old, experienced or beginner, you can make money and friends writing orders. Everything you need is furnished free, including sales books in color, samples of hosiery materials etc. Simply write your name and address on postcard and make money next week with money-making outfits sent free and prepaid. No obligation. Kendex Company, Babylon 23, N. Y.

**AGENTS!** 100 Brand new products. Confidential bulletin monthly. Publishers, Gardenville 8, N. Y.

**NEWEST** Money-making sensation, miniature authentic replicas, police and firemen's badges also pocket pieces, key chains. Write for descriptive folder. Hook-Fast Specialties, Dept. 20, Box 1425, Providence, R. I.

**UP TO \$50.00** in a week and tailored suit for yourself without paying one cent. Write for plan. Progress Tailoring Co., Dept. Y-217, Congress & Throop, Chicago 7, Ill.

**LOOK!** Make money all year round selling personal initialed individualized belts, buckles, cap badges, tie holders, complete line police and firemen's badges, 2000 emblems to choose. Big profits, whole or part time. Please write today special outfit offer. Hook-Fast Specialties, Box 1425, Dept. 6, Providence, R. I. Established 1926.

**PROFITABLE** Business selling creme, waxes, polishes. Samples \$1.00 postpaid. Refundable. Valtex Company, Rochester 20, New York.

**SELL "NuSilver Plating Liquid."** Cloth applied. Renews silverware like new. Silverplated brass, copper. NuSilver, 508-PM11A New York St., Aurora, Illinois.

**NEW Items!** Fast sellers! Big profit! Large selection including billfolds, musical instrument novelties, household utensils. Perfect gift items for men, women, children. Write for free illustrated catalog. Ermo, Dept. M, 507 5th Ave., New York 17, N. Y.

**SELL** New stock signs to all kinds businesses. Set of eight sell for \$1. Sample set only 50¢ postpaid. Al Hawkins Co., Sioux City 7, Iowa.

**SELL** Christmas displays to stores, offices. Big profit. Al Peterson Associates, Box 822, Providence 1, R. I.

**AGENTS.** Sell finest food products direct to homes. Successfully sold for 25 years. Big profits. Powerful combination sale plans make sales easy. Permanent repeat business. Samples furnished. Live territories open to distributors. Mother Hubbard Products Co., 4139 Grand, Dept. P.M., Chicago.

**CHRISTMAS** And everyday greeting card bargains. 4154g Fifth Street, Philadelphia 40.

**SMASH Market!** Gas mower (Clinton)—\$84.50. Delivered. Electric—\$49.50. Act quick! Modern Products-3, North Kansas City, Mo.

**WORK** Garments and embroidered uniforms, wool or cotton. Thousands of prospects. Outfit furnished. Dodson Sales, Box 480C, Roanoke, Virginia.

**WONDER** Metal (putty). Fill holes, leaks and cracks in all metal articles. Fireproof. Applied with fingers. Hardens like iron. Repaired articles can be used at once. Cooking utensils, hot water heaters. Boilers. Tanks. Radiators. Pipes. Salesmen's large size 25c. Home Chemical Co., 143 West Florence, Los Angeles, Calif.

**SELL** New clothing. Lowest prices. Operate from home, auto, store. Enormous profits. Big catalog free. National Mail Order, 1219-A So. Jefferson, Chicago 7, Illinois.

**MANUFACTURE** Foam cleaner at home. Gallon costs 5¢—sells for \$1.69. Full details with ½ gallon size 25c. Kohne, 506 West 45th, Chicago 9.

**BIG Money—Fast!** Sell plastic tablecloths (from \$3.50 doz.), drapes, aprons, over 300 other items. Cash advanced daily. Lowest factory prices, highest quality plastics! Huge selling kit free! The Dur-Ver Co., 2781-G Atlantic Ave., Brooklyn 7, N. Y.

**MEXICAN** Feather pictures Christmas novelty. \$1.00 (stamps) brings \$2.00 worth samples, details. Refunded if unsatisfied. Aztec Art-P, Apartado 762, Mexico City.

**BIG Money** selling tooth powder. J. Walker, 633 Plymouth Ct., Dept. 1, Chicago 5, Ill.

**AMAZING** New Sahara Waterless Hand Soap. Sell to jobbers, stores, factories. Exclusive territory. Sahara Waterless Soap Co., Grand Rapids, Michigan.

**SELL** Big money-maker to men and women. Easy handwork makes fast-selling useful articles. Sunmade Company, Brockton 64, Mass.

**BE** Renewal headquarters for all magazines. Big profit in Christmas gift sales now. No experience, no capital needed. Free catalog tells how. Write: McGreggor Magazine Agency, Dept. 509A, Mount Morris, Illinois.

**SCHOOL Seniors—**Earn 40% commission selling classmates America's most beautiful graduation name cards. Largest selection. Outsells all others. Free sample kit. Printcraft, Dept. M, 1425 E. Elm St., Scranton 5, Penna.

**SCHOOL Seniors!** Your postal will bring our wonder, Kwick-Sell cardalog of popular graduation name cards. Biggest profits! Only firm giving free souvenir chest and card case. Don't miss out! Hurry that postal! Craftcards, Box 235 (L), Pittsburgh 30, Pennsylvania.

**BIG Money** taking orders: Shirts, ties, socks, pants, jackets, sweaters, shoes, uniforms, etc. Sales equipment free. Experience unnecessary. Nimrod, 4922-BG Lincoln, Chicago.

**1949 CHRISTMAS** Card catalog now ready! Earn more money! Be a wholesale jobber! A large selection of box assortments, imprint lines, religious, personalized cards and Christmas novelties. Three sample boxes, retailing for \$2.60, only \$1.00 postpaid. Catalog free! Elfko, 440 North Wells, Chicago 10.

**HOTTEST** 39c Item on the market. Write National Sales & Service, Greenville, Penna.

**FREE** Samples. Big profits showing amazing Glow-in-the-Dark specialties. House numbers, pictures, plastic novelties, religious and nursery objects, etc. Large manufacturer. Madison Plastics, 303 Fourth Ave., New York 10, N. Y.

**SEWING** Machine electrification kit. Nationally advertised. Has Good Housekeeping Guaranty Seal. Can be demonstrated and sold in 5 minutes. Make at least \$5 per sale. For complete details write today to Brownell Distributors, Inc., Dept. PM, 308 Canal St., New York 13, N. Y.

**FREE** Water and our concentrates, make flavors, lotions, shampoos, 125 products, labels, bottles supplied. Qualco, E20030 Russell, Detroit.

**MAGIC** Cleaner—Laundry soap deal. Hotter than a firecracker. Big profits. Sample free. Bestco, 4642 No. Central, Chicago.

**PHOTO-Salesmen-agents.** Sell beautiful hand-colored plastic enlargements. Collect deposit, we deliver. Profitable sideline. Send card, for free sample kit. Novel Portrait Co., 3343 North Ave., Chicago, Ill.

**GOLD** Lacquered window sign letters. Large sizes penny each. New foils. Absolutely beautiful. Free samples. Atlas, 544 W. 79th, Chicago 20.

**AGENTS—300% Profit** selling genuine gold window letters; stores and offices. Free samples. Metallic Letter Co., 438-B North Clark, Chicago.

**EXCELLENT** Sideline for printing and advertising salesmen. Decalomania name plates in small quantities. Great demand. Also, make money with our line of automobile initials and sign letters. Free samples. "Ralco" XL-Roxbury, Boston 19, Mass.

### HIGH-GRADE SALESMEN

**SALESMEN:** Take orders for Laminite signs. No electricity yet glow like neon. Creating sensation: Big advance comm. No investment. Laminite, 1544 Cortland, Chicago 22.

**ADVERTISING** Book matches—Cash in on big demand; sell union label matches. Cuts for all businesses and political parties. Free powerhouse selling kit, low prices, protection guaranteed on repeat orders. Cash commissions. Superior Match Co., Dept. M-119, 7530 Greenwood, Chicago.

**SELL** Calendars now. Be the first in your district. Good sideline or full time. Every business wants them. Few calendar salesmen are on the road now which means more sales for you. Fleming Calendar Co., 6539 Cottage Grove, Chicago 37.

**SELL** Ultra-blue stock signs to stores. 1000 slogans, comedy, general, religious. "7x11" cost 6c, sells 35c. Make money. 15 samples ultra-blue signs "7x11" \$1.00 postpaid. Lowy, 8 West Broadway, Dept. 500, New York City 7.

**BIG Money** selling business cards. Torris, 1541 Fillmore, Gary, Indiana.

**MEMOLITE—**Always a light, pencil, and memo pad. Beautiful plastic base and shade. Sell one or more to everyone shown. The perfect gift. Big profits. Rush \$2.50 for sample and full details. Money-back guarantee. Bolman Industries, 4027 Indiana, Kansas City 4, Mo.

**COMMISSION** Plus bonuses of television set, new Ford car, etc.; selling metal awnings. 36 inch size \$11.50 retail. We make all sizes. H. C. Bridges, Decatur, Alabama.

**SELL** Scots guard automatic fire alarms. Retailers for only \$3.95. Write for details. Royal Scot, Box 96, Waterbury, Conn.

**UNIFORMS** Highly styled for nurses, beauticians, waitresses, doctors, housewives. In nylon and other materials. All colors. Highest commissions in industry. Write for details. Uniform Corp. of America, 121 E. 59th St., New York 22, N. Y.

**MANAGERS,** Representatives for Cinderella fashions. Write Mr. Huff, Regional Manager, 129 Joralemon St., Brooklyn, N. Y.

**AGENTS.** Dealers and distributors. Here's the money making item you've been looking for. Acclaimed by users throughout the country. Every housewife, storeowner and janitor a prospective customer. Many states still open (including main cities). Write today. Speed Waxer Company, Dept. PM-5, 4451 Elston Ave., Chicago 30, Ill.

**MAKE** Big money selling automatic door seals. Proven device stops under-door drafts. Every home a prospect. Bern-El Co., 4719 W. Washington Blvd., Los Angeles, Calif. Dept. C11.

**SCREAMIN' Meanies!** Balloons that fly and scream. Hottest item. 70¢ dozen—7.20 gross. Ellswood's Balloon Headquarters, Pueblo, Colorado.

**NEW Jobs** open in selling! Send name, address for five free issues of Opportunity Magazine's money-making guide. Listing hundreds of companies who'll pay you well, full or part-time. No experience needed. Opportunity, 28 E. Jackson, Dept. 17, Chicago 4, Ill.

**JEWELRY** Factory desires salesmen, distributors, jobbers. Pickcraft, 180 North Main, Attleboro, Mass.

**BIG Money** taking orders. Shirts, ties, socks, pants, jackets, sweaters, shoes, uniforms, etc. Sales equipment free. Experience unnecessary. Nimrod, 4922-AN Lincoln, Chicago.

### PLAYS, STORIES, MANUSCRIPTS

**I WANT** New writers to cash checks of \$1 to \$100 offered daily. The easiest way to write for pay. No previous experience necessary. Free details. Saunders M. Cummings, 468-11 Independence Bldg., Colorado Springs, Colo.

## EDUCATIONAL AND INSTRUCTION

**STOP Being a nobody.** You'll never be successful unless you learn to speak correctly in your everyday speech. Complete course, also includes "How to Become a Brilliant Conversationalist." New Right-and-Wrong method makes it easy. One of the famous Dollar-a-Lesson courses. 5 lessons complete. Get started. Send \$1.00 for first lesson. Cincinnati Educational Institute, Dept. K2, Box 1825, Cincinnati 1, Ohio.

**YOUR Own successful business**—Expense unnecessary. Big profits waiting—make 1001 items for sale—do profitable business with manufacturers. Help fill huge demand. New Miracle Finish makes old items beautiful—new items worth much more. It is easy. Cash in now on big Christmas orders. Write now—free samples and booklet containing powerful money-making plan. Coast, 1004H S. Los Angeles St., Los Angeles 15.

**MAKE Up to \$35-\$45 week** as a trained practical nurse! Learn quickly at home. Booklet free. Chicago School of Nursing, Dept. M-11, Chicago.

**"HOW To Break and Train Horses"**—A book every farmer and horseman should have. It is free: no obligation. Simply address Beery School of Horsemanship, Dept. 11011, Pleasant Hill, Ohio.

**HOME Bible course.** Simple, helpful, instructive. Total cost \$4.00 includes textbooks, stationery, examinations, certificate. \$1.00 starts you, or simply request prospectus. The Bible Study School, 378 Van Houten Street, Paterson 1, N. J.

**INEXPENSIVE Manual teaches air conditioning.** Write Don Nelson, Warner Robins, Georgia.

**STAMMERING Corrected.** Booklet gives full information. Write: William Dennison, 543-A Jarvis St., Toronto, Ont.

**NEW Book reveals spectacular method** for correct answers from slide rule—50c. Roger Kennedy, 538 S. Clark, Chicago.

**EXPORT!** Learn at home from established world trader. Big paying positions. Your own profitable world-wide business by mail order without capital; or travel abroad. Experience unnecessary. Free booklet. Mellinger, 111W, Los Angeles 24, California.

**BE A real estate broker** through home study or classroom instruction. Write for free book. Approved for veterans. Weaver School of Real Estate, 15 E. Pershing Rd., Box CP-11, Kansas City 8, Missouri.

**BECOME A Doctor of Psychology or Metaphysics.** Teach secret of contentment, happiness. Win degree of Ps.D. or Ms.D. Solve mental worries. Free book. College of Universal Truth, 5153-G North Clark, Chicago.

**SECRET Investigation.** Experience unnecessary. Investigators particulars free. George Wagner, M 125 West 86th, New York.

**YOU Can be president of your own credit-collection business.** Many who answered our ads now have their names on office doors. Be independent, be secure in a lifetime business of your own. Franklin Credit, Roanoke 7, Va.

**U.S. Gov't. jobs?** Start high as \$3,351.00 year. Men; women. Qualify now for secure positions. Free 40-page book, sample tests. Write: Franklin Institute, Dept. Y-24, Rochester, N. Y.

**AIR Conditioning, refrigeration, heating, ventilating and heat pump engineering classes are forming now.** Write for free booklet. Detroit Air Conditioning Institute, Dept. B, 4125 Grand River, Detroit, Michigan.

**INVESTIGATOR Training.** Robert B. Phillips, Sr., founder. 35 years investigator experience. Formerly U. S. Govt. special agent. For free particulars write the Phillips Secret Service System, 1917-B North Kenneth Ave., Chicago 39, Illinois.

**MOTION** And time study correspondence course. Time Analyst, 407 S. Bedford, Evansville, Indiana.

**DENTAL Technician's kit.** Artificial teeth, plastic, etc. Technician's manual. Grant Laboratory, 219 W. 7th, Los Angeles 14, Calif.

**LINGUAPHONE Makes languages easy.** At home learn to speak Spanish, Portuguese, Italian, French, German, Russian, by quick, easy Linguaphone Conversational Method. Save time, work, money. Send for free book. State if G.I. Linguaphone Institute, 83 RCA Bldg., New York 20, N. Y.

**PHOTOGRAPHIC Mind with Super-memory.** Write Thor Books, P-11, Box 1210, Chicago.

**VOICE—Strengthen, train your voice** this tested, scientific way. Self-instruction course; no music or piano required. Silent exercises develop your voice power. Results guaranteed! Sensational details free. State age. Perfect Voice Institute, 1141 Wabash, Dept. 2L-2, Chicago 5.

**LEARN Professional lettering.** Design stationery, advertising. Easy, no experience. Amazing mechanical process. Complete instructions. 75 alphabets. 250 designs \$1.00. Major-Art, 3510-X Palmer, Chicago 47.

**SPANISH? It's easy** with "Speed-O-Way," \$7.95 complete. Free folder. Speed-O-Way, 116, Box 2301, Houston 1, Texas.

**SCIENCE Of memory simplified.** "The Art of Memory Development" free. Memorology Studio, 2016-P Sunnyside Ave., Chicago 25, Illinois.

**USED Correspondence courses bought, sold, rented.** Literature free. Baker, 5509-B Winthrop, Chicago 40.

**MEDICAL Laboratory Technicians** in great demand. We train you in your own home. Catalogue free. Imperial Technical Institute, Box 973-J, Austin, Texas.

**PIANO Tuning pays.** Learn this profitable profession at home. Our Tonometer and mechanical aids make learning easy. No knowledge music necessary. Diploma granted. Largest and oldest school—51st year. G.I. approved. Write for booklet. Niles Bryant School, 78 Bryant Bldg., Washington 16, D. C.

**HOME Study course, drugless therapy.** Free literature. Institute of Drugless Therapy, Tama, Iowa.

**BOOKKEEPERS! Increase your earnings!** Operate your own simplified "Dollar-A-Week" bookkeeping and tax service. Full or spare time. Details free. No obligation. Ellis, Box 200, Cedar Grove, North Carolina.

**USED Correspondence courses and books bought, sold, rented and exchanged.** Catalog free. Lee Mountain, Pisgah, Alabama.

## BUSINESS SERVICE

**PURCHASING Service;** most products, material or equipment. State wants. Kelly, BB-9544 Whitcomb, Detroit 27, Michigan.

**REMAIL Your letters from Lincoln or Omaha, Nebraska.** 25c each. Bouges, 3648 Folsom, Lincoln, Nebraska.

**WE Receive, remail letters** \$2.00 monthly or 25 each. "Samson," 7425 Henri-Julien, Montreal 10, Canada.

**INCORPORATION Charters and services** as Delaware resident agent, Delaware laws, free details. Tax Research Bureau, Inc., 223 Delaware Trust Building, Wilmington 28, Delaware.

## SPECIAL SERVICES

**QUESTIONS Pertaining to construction answered.** Send question and dollar to Box 412, Fontana, Calif.

**SALESMANAGER Desires profitable items** for distribution. Lovik, P. O. 3657, San Francisco, California.

**INVENTORS Engineering Service.** I can help you with design, development and marketing problems. A. G. Hupp, Design Engineer, 4915 West Vollmer, Milwaukee, Wisconsin.

**NEW York postmark!** General mail service. MRS Sales, 126 Lexington Avenue, New York 16.

**PERSONAL—Business information.** Re-mailing. Personal Counseling, Box 1411, St. Petersburg, Fla.

**LETTER Remailed 25c (coin).** Moran, 117 East 11, Davenport, Iowa.

## CARTOONING, COMMERCIAL ART, SHOWCARD WRITING, SIGN PAINTING

**CARTOON Your way to success!** Internationally known instructor, Raye Burns, will personally teach you to create salable, original cartoons at home. Course of 26 lessons only \$2.85. Send remittance with order or write for free details and addresses of successful students. Raye Burns School, Box 3583-M, Cleveland 18, Ohio.

**"HOW To Make Money With Simple Cartoons"**—A book everyone who likes to draw should have. It is free; no obligation. Simply address Cartoonists' Exchange, Dept. 911-C, Pleasant Hill, Ohio.

**LEARN Sho-card writing.** Hollywood Sho-Card School, Box 710, Alhambra, Calif.

**SIGN Painting taught at home.** Test lesson free. Ben Kerns, Box 812-T, Greenville, S. C.

**INTERESTED in cartooning? Write Cartoons D2, Box 3291, San Francisco 19, Calif.**

**SIGN Painting—Quick, easy method,** \$2 complete. J. F. Blackwell, Upper Marlboro, Maryland.

**CARTOONS Drawn to your gags** \$1. Cartoonscribe, 232 Grant St., Cincinnati, Ohio.

**9 ALPHABET 3 Numeral pattern sets** and catalog, \$1.00. Sign Letter Distributors, P. O. Box 101, Mineola, N. Y.

**CHALK Talks.** Laugh producing program, \$1.00. Catalog 10c. Balda The Cartoonist, Oshkosh, Wisconsin.

## ADVERTISING AGENCIES, LETTER WRITERS, FOR ADVERTISERS

**ADVERTISING Copy, layouts, folders, circulars, sales letters created for you.** Expert, inexpensive. Dinads, 94 Yesler, Seattle 4, Washington.

**PUZZLED About your advertising failures?** Read Successful Advertising. Only \$2.00, postpaid. Satisfaction guaranteed. William Bennett, 114-35H 116th Street, Ozone Park 16, New York.

**ADVERTISE: 24 Words, 40 newspapers \$3.50.** Lists free. Advertising Bureau, 10511-C Springfield, Chicago 43.

**MAILORDER Buyers names 1c each.** Minimum \$1.00. Ideal Name Service, Park Ridge, Ill.

**FREE! 1949 Advertisers Rate and Data Directory.** 52 pages! E. H. Brown Advertising Agency, 20 N. Wacker, Chicago 6.

**MAILING Lists;** \$5.00-1000 up. Write Dixie Service, King, N. C.

**AVOID Costly advertising mistakes.** Get enlightening Ad-Guide and Ratebook leading newspapers, magazines, mailing lists, 10c. Chicago Advertising Agency, (Established 1900), Chicago 4.

**ADVERTISERS! Reach nearly 18,000,000 readers.** 25 Sunday national key newspapers, 18 words, \$51.50. "Terrific pullers." 20 popular newspapers, \$10.00. "Free booklet." Special—One inch display 2.-821,198 circulation, \$48.30. Newmark's Advertising Agency, (Established 1893), 217-7th Ave., New York 11.

**24 WORDS In 50 weeklies, \$4.96.** J. Darnell, 730 Hays, Jackson, Tennessee.

**ADS Placed in out of town newspapers** and magazines. Low rates. Catalogue free. Ideas that pay. Baker Advertising Agency, Successors Ankrum Agency, 189 W. Madison, Chicago 2.

## TYPEWRITERS, DUPLICATORS, OFFICE DEVICES

**TYPEWRITERS \$17.50;** Duplicators \$9.75; adders \$12.50; burglar alarms \$2.95. Meier's, 118 Spruce, Wichita, Kansas.

**ADDRESSING Machine.** Expensive performance, but lowest cost. Circular free. Elcraft, Box 8184E, Portland 7, Oregon.

**JIFFY Mailer—Stamps 1500 envelopes hourly.** \$1.95. Folder, Postway, Gorham, Maine.

**RECONDITIONED Typewriters, printing devices.** Write Dixie Service, King, N. C.

**ADVERTISE.** Increase business. "Printomatic" selffeeding "mimeograph" post card duplicator prints, reproduces, thousands anything typewritten, handwritten, \$13.50. Literature. Pittsburgh Typewriter Company, 336-3 Fourth Avenue, Pittsburgh 22, Penna.

## RUBBER STAMPS AND OFFICE SUPPLIES

**RUBBER Stamps.** Send for catalog. Excello, Box 500, Shreveport, Louisiana.

**LINE 20c; 2-35c; 3-50c.** Stamp Works, Auburn, Nebraska.

## PRINTING OUTFITS AND SUPPLIES

**PRINT Your own cards, stationery, circulars, advertising.** Save money. Simple rules. Print for others, nice profit. Raised printing like engraving too. Have home shop. Details free. Kelsey Presses, L-11, Meriden, Conn.

**CASH Paid for presses.** Printers Exchange, 212 Curtis, Meriden, Conn.

**PHOTO-OFFSET Plates for Multilith and Davidson.** American Graphic, 1041 Eighteenth Avenue, Newark 6, N. J.

**MAKE Your own rubber printing cuts.** Self molding process. Plexirubber, Argyle 1, Wisconsin.



HOBBY Printers, make new press; productive, inexpensive; details free. Roberts, Box 184, Walpole, Mass.

PRESSES, Type, cabinets, supplies. List for stamp. Lincoln Press Company, 220D Hartwell, Fall River, Mass.

PRESSES, Type, supplies. Catalog 10c. Printers Supply, 211, Springfield, Missouri.

USED Type, printing presses, type cabinets, etc. cheap. Visit our store. Edward Van Dillen, Inc., 74 Beekman St., New York 7, N. Y.

PRINTING Presses, type, supplies. Lists 3c. Turnbaugh Service, Loysville, Penna.

### PRINTING, MULTIGRAPHING, MIMEOGRAPHING, GUMMED LABELS

NEED Printing? Write for samples, prices. Gooch, 202PM, Hernando, Miss.

PRINTING. Fast service. Amazingly low prices. Price list. Merchants Press, Taylor, Texas.

MIMEOGRAPHING By expert, reasonable, prepaid, free sample, prices. Arnold, 1305p Gough, San Francisco 9, Calif.

50 8 1/2 x 11 HAMMERMILL Letterheads with envelopes \$1.00. Benneville Printing, Box 1931, Pittsburgh 30, Penna.

EMBOSSSED Business cards, 1000, \$3.45 postpaid. Samples. Spada Enterprises, 10C Lexington, Wethersfield 9, Conn.

100 SHEETS 5 1/2 x 8 1/2, 100 Envelopes \$1.50 postpaid. Barber Press, RR2, Marion, Ohio.

1000 EMBOSSSED Business cards \$2.75, samples. Avery, 112-B So. Elizabeth, Wichita 12, Kansas.

125 HAMMERMILL Letterheads 8 1/2 x 11 \$1.00 postpaid. Envelopes, cards same. Odom, Box 9345, Tampa, Florida.

GLO-BRITE Letterheads "increase" business. Beautiful combination colors. Samples free. Rienzi Press, 24 North 7th Street, Newark 7, New Jersey.

BUSINESS, Personal stationery. State requirements. Samples, pricelists free. How Printing Company, 721-23 Eunice, Webster Groves 19, Missouri.

100 8 1/2 x 11 HAMMERMILL Letterheads and 100 envelopes \$1.85. Herbert Hudson, Centredale, R. I.

MIMEOGRAPHING Specialists. Finer impressions. Reasonable. Mailers Service, Box 606-F, Chicago 90, Ill.

BUSINESS, Personal stationery, cards, samples. Dawson Print, 1308F, The Dalles, Oregon.

FINE Printing. Fast. Postpaid. Samples, list. Makovec, Tarpon Springs, Florida.

150 8 1/2 x 5 1/2 LETTERHEADS, 100 Envelopes \$2.00. R. Cook, (Dept. 2119) 730 West Gift, Peoria 5, Illinois.

BUY Your printing wholesale. Lowest prices in America. Louis Enterprises, Box 5, Hazel Park, Mich.

MIMEOGRAPHING. 1000 \$4.50. Free samples and prices. Lowellty, 7 Bagley, Lowell, Mass.

MIMEOGRAPHING, 250 8 1/2 x 11, \$2. Samples, prices, free. Mimeographing, Madison, Tennessee.

1000 BUSINESS Cards \$2.50. Prepaid samples free. Reliable Print Shop, 905 E. Jefferson, Louisville 6, Ky.

PREPARE Your own illustrated copy for inexpensive photo offset printing. No cuts necessary. Folder free. Pengad Offset, Bayonne 4, New Jersey.

QUALITY Printing! Free price list. Nationwide Printing Company, Dept. PM, 2337 Bath Avenue, Brooklyn 14, N. Y.

1000 ENVELOPES Printed. Five lines. 6 3/4 size, white wove. \$5.00 prepaid. Hatch Press, Meriden 1, Connecticut.

PRINTING? Lowest prices. Samples free. Churchill, Box 194A, West Medway, Massachusetts.

BUSINESS Cards, \$2.25 thousand; 5 lines. 3 x 6 circulars 150 words limit, 5000 \$7.50. Wilson Printing, Montezuma, Indiana.

BETTER Grade printing reasonable. Estimates on anything. Economic Press, Leonia, N. J.

BUSINESS, Personal stationery. State requirements. Samples. Mero Products, 100 Morrison, Punksatuney, Penna.

SUPERIOR Mimeographing - Bargain prices! Topical Emprise, 1527 Highland, Box 42 M, Louisville 4, Kentucky.

QUALITY Printing. We specialize in publications, newspapers, tabloids. Send copy for estimate. Bagby Printing Co., Georgetown, Ohio.

100 ENVELOPES Printed, 2-colors \$1.00. Box 523, Rochester 2, N. Y.

SEND 10c Now, for our 48 page 1949 price list—refunded first order. McCall Press, 1326 South 27th, Omaha, Nebraska.

500 3/4 x 2 1/4 FOUR Line gummed stickers 35c; red border 50c. Moritz Printery, Saginaw, Mich.

MIMEOGRAPHING—Letters, pricelists, formulas, instructions. Lowest prices. Lem's Letter Shop, 5710 Stanton, Detroit 8.

### PATENT ATTORNEYS

INVENTORS—Patent laws encourage the development of inventions. The Rules of Practice of the U. S. Patent Office advises—unless an inventor is familiar with such matters; that he employ a competent registered attorney or registered agent, as the value of patents depends largely upon the skillful preparation of the specifications and claims. Write for further particulars as to patent protection and procedure and "Invention Record" form at once. No obligation. McMorro, Berman & Davidson, Registered Patent Attorneys, 134-L Victor Building, Washington 1, D. C.

PATENTS—If you have a valuable invention, the usual procedure is to authorize a preliminary search through appropriate classes of U. S. patents. This firm is registered to practice before the Patent Office, is available to make such a search and report to you concerning the probable patentability of your invention. Booklet and convenient "Evidence of Invention" form sent upon request. Victor J. Evans & Co., 431-M Merlin Building, Washington 6, D. C.

PATENTS—Trade marks. Gustave Miller, Registered Patent Attorney, 119-A Warner Building, Washington 4, D. C. Patent Lawyer.

PATENTS. Trade marks. Sanders, 6430 Evans, Chicago 37. (Registered U. S. Patent Office.)

INVENTORS: Learn how to protect your invention. Unless the inventor is familiar with patent matters, he should engage a competent registered patent attorney or agent to represent him. We are registered to practise before the U.S. Patent Office and prepared to serve you in handling your patent matters. "Patent Guide for the Inventor" containing detailed information concerning patent protection and procedure with "Record of Invention" form will be forwarded to you upon request—without obligation. Clarence A. O'Brien & Harvey Jacobson, Registered Patent Attorneys, 91B-K District National Building, Washington, D. C.

PETER Fries, Jr., Registered Patent Attorney. Patents, trademarks, novelty searches, copyrights. 110 East 42nd Street, New York City.

PATENTS. "Proof of Invention" folder mailed without obligation. E. E. Vrooman, Registered Patent Attorney, 507 McKim Building, Washington 5, D. C.

CANADA—Ramsay Company Registered, 273 Bank Street, Ottawa, Canada.

PATENTS—Trade marks. Irving L. McCathran, 315 McLachlen Bldg., Washington 1, D. C. Registered Patent Attorney.

C. A. SNOW & Co.—M-427, Snow Building, Washington 1, D. C. Registered Patent Attorneys. Write for information.

INVENTORS: When you are satisfied that you have invented something of value write me, without obligation, for information as to what steps you should take to secure a patent. Write Patrick D. Beavers (Formerly Randolph & Beavers) Registered Patent Atty., 935 Columbian Bldg., Washington 1, D. C.

INVENTORS: Without obligation, write for information explaining the steps you should take to secure a patent. John N. Randolph, Registered Patent Attorney, 203 Columbian Bldg., Washington 1, D. C.

"INVENTOR'S Guide" free on request. Frank Ledermann, Registered Patent Attorney, 154 Nassau St., New York 7, N. Y.

INVENTORS: Write for free brochure "Evidence of Invention." Labiner, World Building, New York 7.

PATENT Practice before U. S. Patent Office. Validity and infringement investigations and opinions. Booklet and form "Evidence of Conception" forwarded upon request. Lancaster, Allwine & Rommel, Registered Patent Attorneys, Suite 411, 815-15th Street, N.W., Washington 5, D. C.

INVENTORS. For "Record of Invention" form, contact Carl Miller, Registered Patent Attorney, Woolworth Building, New York.

### FOR INVENTORS

INVENTORS—If you have a valuable invention, the usual procedure is to authorize a preliminary search through appropriate classes of U. S. patents. This firm is registered to practice before the Patent Office, is available to make such a search and report to you concerning the probable patentability of your invention. Booklet and convenient "Evidence of Invention" form sent upon request. Victor J. Evans & Co., 432-M Merlin Building, Washington 6, D. C.

INVENTORS—Patent laws encourage the development of inventions. The Rules of Practice of the U. S. Patent Office advises—unless an inventor is familiar with such matters; that he employ a competent registered attorney or registered agent, as the value of patents depends largely upon the skillful preparation of the specifications and claims. Write for further particulars as to patent protection and procedure and "Invention Record" form at once. No obligation. McMorro, Berman & Davidson, Registered Patent Attorneys, 134-K Victor Building, Washington 1, D. C.

DRAFTING—Send sketch for estimate. Rankin, P.O. Box 4753 N. Sta., Memphis 7, Tenn.

SEARCHES \$5.00. Includes patent copies. Same reliable search that we conduct for patent attorneys. Free protection forms. 48 hour service. Patent Service Institute, 945-A Pennsylvania Avenue, Washington 4, D. C.

COMPLETE Services for inventors. Patent searches including analysis, patent copies. Inventions, patents marketed. Protection forms free. Industrial Patent Reports, Box 1081, Massachusetts Avenue and North Capitol, Washington 13, D. C.

SELL Your idea for \$\$\$ to manufacturers now making similar articles. Individual list 25 topnotch firms personally selected per your needs—\$1.00. Lovejoy, 525—40th, Richmond 1, California.

THE Right letter sells your idea. To get strong sales letter send \$2, details. Beauxarts, 545 Fifth Avenue, New York 17, N. Y.

INVENTORS—Subscribe to "The Visioneer." A monthly bulletin for inventors, listing names and addresses of firms requesting new products. Send 25c sample copy, \$1.00 three months, \$3.00 per year. Write Visioneer, Inc., 206 Security Bldg., West Bend, Wis.

CASH For your ideas, inventions, patents. Complete marketing and sales service with manufacturers and distributors covering entire country. Free list. Marketing Bureau, 228 N. LaSalle, Chicago.

INVENTORS: We print pending applications for patent ready for distribution to manufacturers. Write for free sample copy. Acme Printing Co., Inc., 708 13th Street N.W., Washington 5, D. C.

INVENTORS: Learn how to protect your invention. Unless the inventor is familiar with patent matters, he should engage a competent registered patent attorney or agent to represent him. We are registered to practise before the U.S. Patent Office and prepared to serve you in handling your patent matters. "Patent Guide for the Inventor" containing detailed information concerning patent protection and procedure with "Record of Invention" form will be forwarded to you upon request—without obligation. Clarence A. O'Brien & Harvey Jacobson, Registered Patent Attorneys, 91A-K District National Building, Washington, D. C.

INVENTORS Having inventions for sale, patented or unpatented. Write, Schriber, Nashville, Illinois.

PATENT Searches \$5.00. Reports airmailed within 4 days. Invention protection forms free. Write Miss Ann Hastings, Patent Searcher, P. O. Box 176, Washington 4, D. C.

INVENTIONS Promoted. Details free. Or send \$2 for great book—"Dollars In Inventions." Adam Fisher Co., 61 Enright, St. Louis 8, Mo. (Est. 1911).

PATENT Searches \$5.00. Reports airmailed within 4 days. Invention protection forms free. Write Raymond L. Smith, Patent Searcher, 410 Bond Building, Washington 5, D. C.

PATENT Owner Representative. Years of experience. Can I help you? Charles A. Scott 773PM Garson Avenue, Rochester 9, N. Y.

PATENT Search \$5.00. Confidential. Reliable. Individual service. Prompt report. P. Davis-Carrington, Box 7530, Washington 4, D. C.

PATENT Searches \$5.00. Includes nearest patent copies. 48-hour service. Free protection forms. Patent Research Engineering, 318 Evans Building, Washington 5, D. C.

SEE Our ad under "Models" in which we tell you the story of our activities for many years. The Gent Machine Co., 443 Green Rd., South Euclid 21, Ohio.

INVENTORS: Without obligation, write for information explaining the steps you should take to secure a patent on your invention. John N. Randolph, Registered Patent Attorney, 202 Columbian Bldg., Washington 1, D. C.

CASH For your idea. 280 manufacturers need inventions, patented or unpatented. List free. Invention Bureau, 208M Clinton, Oak Park, Illinois.

INVENTORS: If you have an invention for sale, patented or unpatented, write Institute of American Inventors, Dept. 40A, 1926 Eye St. N.W., Washington 6, D. C.

"INVENTOR'S Guide" free on request. Frank Ledermann, Registered Patent Attorney, 154 Nassau St., New York 7, N. Y.

INVENTORS: The usual first step is to have a search of the U. S. Patents conducted, so I can report on patentability. Write, without obligation, Patrick D. Beavers (Formerly Randolph & Beavers), Registered Patent Atty., 936 Columbian Bldg., Washington 1, D. C.

INVENTORS. For "Record of Invention" form, contact Carl Miller, Registered Patent Attorney, Woolworth Building, New York.

### INVENTIONS WANTED

INVENTORS—What have you, patented, patent pending to offer manufacturers? Booklet, information free. Market Contacts, 11106-A2 Longwood, Chicago 43.

INVENTIONS—Charges from royalties only. Inventors Manufacturers Associates, 5 Beekman Street, New York.

HIGHEST Royalties—Cash. Request free Booklet "M." Universal Marketing Co., 354 South Spring St., Los Angeles 13, Calif.

INVENTORS: Hundreds of manufacturers have requested our assistance in locating marketable new products. Complete information, free. Institute of American Inventors, Dept. 40-D, 1926-Eye St. N.W., Washington 6, D. C.

CASH For your idea. 280 manufacturers need inventions, patented or unpatented. List free. Invention Bureau, 208M Clinton, Oak Park, Illinois.

INVENTIONS Wanted. Patented or pending only. Inventors' Exchange-B, Hartford 1, Conn.

### PATENTS FOR SALE

PATENT Pending. Automatic illuminated keyholder. 726 Superior St., Oak Park, Ill.

PATENT #2474936—Royalty basis, novel freezing molds, various uses. Robert E. Elliott, 85 Gates Avenue, Valley Stream, New York.

INVENTORS: Test the commercial value of your patented or unpatented inventions, quickly and inexpensively. Write for free information. Institute of American Inventors, Dept. 40-B, 1926-Eye St. N.W., Washington 6, D. C.

### MANUFACTURING

EXPERIMENTAL And model-work tools, dies. Mfg. Engineers & Machinists since 1896. Baum's Metal Specialties, Kansas City, Mo.

MODELS, Tools, dies, experimental work; large and small lot manufacturing. Van-Ess Specialties Company, 212 W. 14th Street, Covington, Ky.

PRECISION-MADE Models, tools, dies, manufacturing. Reasonable prices. Swanberg Tool Works, 5124 North Kildare Avenue, Chicago 30, Illinois.

ENGINEERING And machine shop. Commercial Machinery Co., P.O. Box 1403, Milwaukee 1, Wis.

SMALL, short run, automatic screw machine products up to 5/16" diam. Small stamping. Send sample or drawing. Fisher, 1002 Etowah Ave., Royal Oak, Mich.

PRODUCTION Wanted large or small lots in brass, bronze, aluminum, iron. Complete facilities—Engineering, pattern shop, foundries, machine shop, sales. Enardo, Tulsa 1, Okla.

WANT Something made? We'll make it. Consultation free. Write Jayemm Company, Burlington, Kentucky.

MODELS—Small lot manufacturing. Metals, plastics, etc. Milburn, Burlington, Kentucky.

### MODELS, MODEL SUPPLIES

POWER Models. Unusual steam, gasoline and traction engines. Metals, tools, accessories. New catalog 35c. Chas. Cole, Ventura, Calif.

RAILROADERS—50c Gets new Catalog Reference Manual. State O or HO gauge. Walthers, 247 Erie, Milwaukee 2, Wis.

HO Plastic kits; station, church, house, school, stores, barn; two for \$1. Johnson, 366 Freeman, Long Beach 14, Calif.

TOY Boat motors, inboard and outboard, for boats to 24", with propeller assembly. \$1.00 postpaid. Ny-Cal Company, Encinitas, Calif.

STEAM Marine engines, 2 cylinder V-type precision machined. Bronze construction, with built in speed control. Free literature. Model Marine Engine Wks., Box 326, Evanston, Ill.

READY! Our 1950 catalog of shipmodel kits and fittings; sail, steam, diesel. Send 25c for catalog. Model Shipways Folio, 476 Main St., Fort Lee 60, N. J.

STEAM Locomotives, 1 1/2", 3/4", 1/2", 1/4" scales. Castings, parts, rail, steam fittings! Thorough drawings with instructions. Catalog 35c. Little Engines, Lomita, Calif.

LIONEL Trains catalog 10c. 36 pages illustrated. Hobby Shop, 72 West Washington, Chicago 2, Illinois.

BUILD Historic ship models, complete kits, 39c to \$9.00. Catalog 10c. Ideal Models, 19 West 18, New York 11, N. Y.

SHIP And yacht model fittings; blueprints. Send 25c for illustrated catalog No. 24—listing hundreds of items. A. J. Fisher, 1002-1 Etowah Ave., Royal Oak, Mich.

SHIP Models and yacht supplies complete. Large 64 page catalogue 30c. Bill Wild's, 510 East 11 St., New York City 9.

INVENTIONS Developed: The specialists are at your service who can develop auto accessories, gasoline engines, automatic cigarette-making machines; weighing, vending and automatic photograph machines; electric scales; turbines; air, electric and steam motors and other intricate devices. We can handle your development drawings, experimental work, patterns, models, special tools, dies, stampings, castings, plating, forging and spinning. Can make any metal novelty. Complete organization for developing and manufacturing. Advice backed by 50 years' experience. Send drawings or samples. The Gent Machine Company, 445 Green Road, South Euclid, 21, Ohio.

### HOME CRAFTSMEN

MUSIC Box kit: Ready for assembly and decoration. Swiss musical movement, instructions included, \$3.95 postpaid. Catalogue of over 30 crafts 25c. Refundable. Hobby Crafts, 1701 Macombs Road, New York 53.

MAKE Jewelry your hobby. Free catalog. Allen Lapidary Equipment Co., 3632 W. Slauson, Los Angeles 43, Calif.

LEATHERCRAFT Supplies, leathers and tools, low prices. Send 10c for catalogue. Jonas Handicraft, 32B Frankfort St., New York 7.

LEATHERCRAFT. Monthly price list guarantees best prices. Catalog free upon request. Tandy Leather Company, Dept. PM-119, P.O. Box 397, Tulsa 1, Oklahoma.

CELLULOID—Beautiful selection. Motives, opaques, onyx, pearls. Used by ring makers everywhere. One pound assortment. Pieces approximately 30 sq. in. each. Price \$1.00. Please add 10c postage. Craft Service, 337 University Avenue, Rochester 7, New York.

WHOLESALE Shellcraft Book 15c. Large shellcraft kit \$1.69 postpaid. Shell-Art Novelty, Dept. PM, 5th and Moore, Philadelphia 48, Penna.

WORKING Model spinning wheel. Complete blueprints and instructions \$1.00. Williams Woodcraft, 6408 31st Ave., Kenosha, Wis.

SHELLS, Plastics, findings. Lowest prices. Free catalog. Frances Jones, Box 251, Sarasota, Fla.

MONEY Making shell-kit, \$2.95 plus 20c postage. Make shell jewelry and novelties. Leinen Crafts, 2308 Raynor, Joliet, Ill.

LUMBER For home craftsmen. Cut to order. Write Forest Products Company, Box 341, Binghamton, New York.

MAKE Your own "Hercules" belts! Complete kit includes finest calfskin links, tongue and metal buckle. Simple instructions enclosed. Send \$1.00, we ship prepaid. Arokraft, Dept. M, 32 W. Randolph, Chicago 1.

"KLONDIKE" Jewelry findings—bracelets, pins, earrings, chains, rings, stones, clips and other jewelry parts. Easy to assemble. Sample pound \$2.00, five pounds \$7.50. Imported cut stones. For rings, jewelry, novelties, etc. All shapes, colors, sizes. Sample 100 stones assorted \$1.50 lot. Thousand lots, \$5.00. Imported beads, all colors, sizes, sample pound \$1.00; five-pound lots, \$4.00. Prepaid only. Merchandise Distributing, Dept. 1PM, 19 E. 16th Street, New York 3.

TOYS, Novelties, furniture, cutouts, lawn chairs, etc. 68 popular plans with full size patterns, \$1.00. Mastercraft 11M1, 7041 Olcott, Chicago 31, Illinois.

DARRA-JAMES Power tools pay off! Save money; have fun in your own home workshop. Free illustrated folder: Dept. M, Toolcraft Corp., Waterbury, Conn.

LEATHERCRAFT, Copper tooling, textile painting. Materials, tools, supplies. Free illustrated catalog. Kit Kraft, Dept. AC11, 7377 Meirose, Los Angeles 46, Calif.

OZARK Wood samples. Eleven useful identified varieties. Prepaid \$1.25, check or cash to Davis Lumber, Cabool, Mo.

LEATHERCRAFTERS—Complete stock calf skins tanned "hair-on" from unborn calf. Suitable for women's purses, men's wallets, lamp shades, etc. Sells at our tooling leather price. Write, Bay-River Trading Co., 1688 Pomona Ave., San Jose, Calif.

50 FULL Size, new 1950 novelty and lawn ornament patterns, up to 20" high, only \$1.00. Pattern Service, Medway 7, Mass.

90 ALL New, full size lawn ornament and novelty patterns, up to 20" high. Only \$1.00. Mastercraft 11M2, 7041 Olcott, Chicago 31, Illinois.

PROTRACTORS, Adjustable arm type. \$6.00 value, only \$1.50 each. Satisfaction or refund. Box 486, Detroit 31, Michigan.

MAKE Smoking pipes, briar blocks and stems. Send for circular. Michelson & Sternberg, 23 West 47th Street, New York 19.

GLASY-Cast, the liquid plastic that works the quick and easy way. Cold-set. 15 to 30 minutes for finished product. Free samples and instructions. Make embeddings, novelties, plastic frames, machine parts, etc., for real profits. Two lbs. for \$2.95. Elasto-Mold: Flexible production molds made in 20 minutes. Also finest quality rubber latex. Wholesale prices. Plastic Service, 294 Washington St., Dept. P-1, Boston 3, Mass.

KITCHEN Cabinets. Modern, streamlined. Standard and custom designs. Complete units come partly assembled. Free literature and factory prices. Ellis-Petrik Mfg. Co., 204 Mc.Gowan Street, Dallas, Texas.

SHELLCRAFT—Free catalogue and instructions. Complete line shells. Smooth beautiful colors. Findings. Rice's Shellcraft, Dept. B, 114 S. Court, Orlando, Fla.

16 NEW Lawn chairs, 22 tables, benches, trellises, etc. All 38 plans, with full size patterns, \$1.00. Mastercraft 11M3, 7041 Olcott, Chicago 31, Illinois.

LEATHERCRAFTERS Instruction Manual published by U. S. Government postpaid for 15c with our price lists covering everything you need. Cardinal Leathers, 177 William, New York 7, New York.

80 FULL-SIZED Patterns, toys, novelties, lawn ornaments \$1.00. Modern Woodcraft, Saginaw, Mich.

PLYWOOD Money-maker! Sells itself. Plan 25c. Box 56-A, Baintree 84, Mass.

LIFE Masks, more personal than any photograph! Profit possibilities unlimited! Cost only few cents to make. Complete instructions \$1.00. Komar Company, M-11, LaPorte, Indiana.

NEW Sparkling flitter makes surface like sparkling jewels. 10 colors. Envelopes 10c. DeMallie, 128 Marion Street, Rochester, N. Y.

CRAFT Supplies—Leather, metal, plywood, plastics, tools. Free catalog. Kale Crafts, 2250 Milwaukee, Chicago 47.

SWISS Music movements, finest make, assorted tunes, \$1.90 direct imports. Helaxe Company, 233 West 72 Street, New York.

MAKE Beautiful lamps from wood. Lovely gifts. 10 plans dollar. Childers Woodcraft, Dublin, Texas.

**SHELLCRAFT.** Make jewelry at home for pleasure and profit. Instructions free. \$2 brings shells and material to make 6-pair brooches and earrings. Shell Company, Chamber Commerce Bldg., Dept. PM-11, Miami 32, Florida.

**SELL** Your handicrafts. Market list—\$1.00. Craftsmanship, Box 160, Wall Street Station, New York.

**TILE** Your own bathroom, kitchen, any room with colorful, guaranteed, amazing "Styron" wall tile. Save 30% at our prices. Save on labor costs. Simplified instructions. Free literature. U. S. Tile Co., 30PM West Washington, Chicago.

**MAKE** Your own clamps. Fixtures for any length. Billstrom, Inc., Rockford, Ill.

**LEATHER.** Retail, mail orders, catalog, tools, lacing, supplies. National Handicraft Co., 30 Frankfort St., New York City 7.

**LAWN** Ornaments. Ready cut patterns, full size. 20 assorted \$1.00 postpaid. Lincoln Craft Studio, Farmington, Conn.

**8 BEAUTIFUL** Full-size whatnot patterns only 25c. Joannes, P.O. Box 141-M, Omaha 7, Nebr.

**LEATHERCRAFTERS:** Belt kits, projects, leather, supplies. Free catalog. Art Leather, 411 Joseph Ave., Rochester 5, N.Y.

**LEATHERCRAFT.** Quality leather, lacing, tools and accessories at bargain prices. Free catalog. Frisco Krafts, Dept. A, Box 3016, Rincon Annex, San Francisco 5, California.

**LEATHERCRAFT** Bargain list! Francis Byrd, 3406 Montrose Ave., Richmond, Virginia.

**LEATHERCRAFTERS!** Free catalog! Leathers, tools, supplies. Rosenblum Leather, 518 N. 8th, Sheboygan, Wisconsin.

**SPECIAL Offer:** 80 full size toy, novelty, and lawn ornament patterns only \$1.00 postpaid. Lynds, Box 193D, Medway, Mass.

**CRAFT** Catalog free. "Artcraft's Little Giant." 6500 items covering several crafts. "Tops in our field." Artcraft Leather, Dept. PM, 271 12th St., Oakland 7, Calif.

**\$46 FROM** Square foot plywood. Jigsaw necessary. Write, Woodarts, C-38, Bridgewater, Mass.

**KNOCKDOWN** Cedar chests. Lumber and veneers. Free price list. Giles & Kendall Company, Huntsville, Ala.

**PROFIT** With Larson Leathercraft. Belts, purses, 100 other ideas. Largest supply in U. S. Catalog 10c. Larson, Dept. C, 824 S. Tripp, Chicago 24.

**JEWELRY** Findings, rhinestones, pearls, sequins, cameos. J & M Novelties, Box 464P, Griffith, Ind.

**MAKE** Your own jewelry! All types of findings, metal and plastic; cameos, beads, shell kits, illustrated catalog. 20c. Hobby Art, P.O.B. 276, Dept. 7, New York 18, N. Y.

### MAKE IT YOURSELF

**JUST** Off the press—8-page folder illustrating 6 beautiful, popular lamps you can make; for yourself, for Xmas gifts, or to sell others. It's fun, highly profitable; as hobby, or part or full time basis. 8-page folder, 32-page parts catalog, wholesale price list only 25c; refundable first order. Gearon Company, Dept. 400-B11, 27 South Desplaines, Chicago 6, Ill.

**EASY** Simple way to build your own modern furniture. Write for free details. Fabbrola Products, 110 West 84th St., New York, N. Y.

**AIR** Purifier. Build your own. Electrically operated, designed for home construction. Plans \$1.00. Ozone Kits, Box 1573, Cincinnati 1, Ohio.

**INEXPENSIVE** Electrolytic rectifier. A.C. to D.C. Electroplate at home. Charge batteries. Directions \$1.00. Boone Consultants, 1181 Wilshire Court A, Cincinnati 30, Ohio.

**GRANDFATHER** Clock easily built. Big savings. See ad on page 276.

**BUILD** Block, brick, tile machine, sell 15 items; good profit. Build low cost home. Two blocks per minute; simple, inexpensive. Write, U-Build-It, P.O. Box 7026, Tampa 3, Fla.

**BUILD** Your own "tractor." Plans, walking, riding. Send postcard. Free information. Ellsworth Tractor Co., D-1, Camptonville, California.

**SOLAR** Water heater systems efficient any locality. Standard materials, low cost. Free facts. Solar Water Company, Box 175, Coral Gables, Florida.

**HOME** Freezer and cool room plans and price list \$1.00. Farm Freezer Equipment Company, Route 7, Box 1038, Vancouver, Washington.

**"CONCRETE** Block Homes," 32 page booklet on how to build. \$1.00. H. C. Lightfoot, Civil Engineer, Richboro 1, Penna.

### WATCHES, OLD GOLD, JEWELRY

**WATCHMAKERS'** Journal contains helpful hints on watch repairing. Sample copy 20c. Dean Co., 116-K Nassau St., New York 7, N. Y.

**WATCHMAKERS** Tools, Supplies. Sold; bought. Catalogue! Bengal Company, Culver City, Calif.

**HIGHEST** Prices paid for old gold, silver, platinum, diamonds, watches, gold teeth, Spectacles. Cash immediately. Goods returned if offer unsatisfactory. Government licensed. United Smelting Works, (The Old Reliable), 39-B South State, Chicago 3.

**JEWELRY** Making. Illustrated catalog 20c. George Sassen, 35 Maiden Lane, New York City 7.

**WATCHMAKERS!** Beginners! Watches; movements; descriptive list. Box 1874, Chicago 90, Illinois.

**EXPERT.** Guaranteed watch repairing; all type watches. Chronographs our specialty. Send your trial order. Estimate submitted before proceeding. Miller's, 749 Broadway, New York, New York.

**HIGHEST** Cash for old, broken jewelry, gold teeth, watches, silverware, diamonds, spectacles. Free information. Satisfaction guaranteed. Government licensed. Rose Smelting Company, 29-A East Madison, Chicago.

### TOBACCO, SMOKERS' SUPPLIES

**CIGARETTES:** Popular brands, \$1.51 postpaid within 600 miles, \$1.53 beyond 600 miles. Min. order 5 cartons. Fresh stock. Same day service. Send check or money order to: National Tobacco Co. Inc., Elkton, Maryland. Dept. EOS.

**FREE** Literature. Making pipes for pleasure and profit. Carvapipe, 2829-G Dixie, Hamilton, Ohio.

**PERSONALIZED** Cigars. Names on gold bands of quality cigars, box of 50—\$5.00. Eugene Phillips, 243 18 St., Elmira, N. Y.

**CIGARETTES** — Popular brands \$1.51 per carton postpaid. West of Mississippi add 7c per carton. Min. order 3 cartons. Send check or money order. King Co., Elkton 3, Maryland.

### FOR THE HOME

**DISTINCTIVE** Gifts, free catalogue. Sl. Friend, 218-14 67th Avenue, Bayside, N. Y.

**NEW** Invention — A-Jus-T-O Paint-Can Handle. Fits quarts, pints, ½ pints, ¼ pints. Prevents accidents. Every home needs one. 25c postpaid. Doty, Box 448, Port Richmond, Staten Island 2, N. Y.

### FOR SALE—MISCELLANEOUS

**1950 EDITION** "Dollar-Maker Tips." \$2.00 postpaid. Literature free. Savell Sales Company, Maspeth 1, N. Y.

**FREE** Catalog! War surplus clothing. Men's, women's. Amazing bargains. N. Y. Clothing Co., New York 29.

**SURPLUS** Tents, tarpaulins, outdoor clothing, camping, paints; free catalogue. Morsan, 10-19E 50th Ave., Long Island City 1, N. Y.

**USED** Vending machines. Largest selection. Satisfaction guaranteed. Vassar, Cleveland 5, Ohio.

**WAR** Surplus, aircraft items. Shop equipment, machinery and a million other items. Send 10c for 64 page catalog. Atlas Equipment, 229 Southwest Blvd., Kansas City 8, Mo.

**OVERSTOCK!** J-M Sales purchase manufacturer's overstock of brand new \$15.00 paint sprayers. Sensational bargain at gigantic savings. Applies enamels, lacquers, varnishes, etc. No accessory equipment needed. Just plug in and squeeze trigger for super results. Complete \$9.85 postpaid. Cash or C.O.D. Dept. PM1, J-M Sales Company, 1465 Broadway, New York, N. Y.

**ONE** Ounce Alaska gold 35 dollars. Money order. The Goldminer, Box 362, Fairbanks, Alaska.

**HOSIERY,** Sheets, print cloths, etc.! Wholesalers write for prices. Spartan Hosiery Company, Spartanburg, S. C.

### WANTED—MISCELLANEOUS

**WANTED**—Literature and inquiries from exporting companies or buyers in Miami, Florida. Prefer articles that can be airmailed. José Armando Ferraro, Apartado 1323, Caracas, Venezuela.

**SWAP,** Buy, Sell anything. Free lists. Swappers' Guide, Box 415, Evansville, Ind.

**QUICK** SILVER (Mercury) urgently needed! Immediate payment. Wholesale Terminal, Norwood, Massachusetts.

### PERSONAL

**BORROW** By mail. Loans \$50.00 to \$300.00 to employed men and women. Easy, quick. Completely private, confidential. No endorsers. Repay in convenient monthly payments. Details free in plain envelope. Write State Finance Co., 210 State Finance Bldg., Dept. B-14K, Des Moines 9, Iowa.

**UNWANTED** Neckties exchanged, 5c each. Minimum, ten. Nick Carter, 210 So. Flower, Los Angeles 12, Calif.

**STUTTERING** Or stammering corrected at home. Amazingly successful method. Send for free literature showing how you, too, may overcome stuttering at home. The Athenium, PM-11, 1714 Chestnut, St. Louis 3, Mo.

**LETTERS** Written, business or personal, also job applications, reports, speeches, re-writing. Low rates. Osborn, 600 West 113th, New York 25.

**"1,000 ITEMS** Free," latest edition, plus 500 big mails (you count 'em), \$1.00. Particulars with supermails. 25c. Dealership. Wright Publications, 2270-N Hubbard, Memphis 8, Tenn.

**MEXICAN** Mailing. Letters received, forwarded 20c. Photographic postcards 10c. Tillotson, Apartado 1405, Guadalajara, Jalisco, Mexico.

**MIAMI** Postmark! Letters 25c each. McDowell, 504 Pacific Building, Miami 32, Florida.

**HAIR** Falling? Write Elson, 137 Lewis Street, Phillipsburg, N. J.

**MAIL** From outstanding companies. Name listed 10c. Sibley, Mendon, Mass.

**MEXICAN** Law. General practice attorney, 1203 Arizona Street, El Paso, Texas.

**"HOW** Can I find out?" You can! Information discreetly developed. Any matter, person, problem, anywhere. Worldwide. Officially licensed, bonded service. Established 1922. Reasonable. Confidential. William Herman, 170 Broadway, New York.

### MISCELLANEOUS

**ATTENTION** Home weavers—Maysville carpet warp and rug filler—all colors available; immediate delivery. Kay Craft Co., Olyphant, Penna.

**"WALLETS"** Embossed handmade in Mexico. Worth \$10.00 in the States \$2.98 postpaid. Hobbycraft Center, Las Cruces, New Mexico.

**CHRISTMAS** Gift item for children. Giant pencil-shaped plastic case containing 12 name-imprinted pencils. \$1.50 p.p. Print name wanted. ABC Monogram, 3937-K Fullerton, Chicago 47.

**"INTERESTING** Mails"—25c keeps name on mailing lists three months. Bentz, Jr., Desk-A/37, Chatawa, Mississippi.

**BRASS** Identification name plates or key checks, stamped with your name and address 25c. (please print). Alfred G. Hanson, 1014 Campbell Ave., Willmar, Minn.

**PERFUME** Bottles. For samples send 25c for packing and postage. Tropical, Box 5652, Chicago.

**FRESH** California dates, all varieties, wholesale and retail. Gift packs our specialty. Sedwell's, 2802 South La Cienega Blvd., Los Angeles 34, California.

**YOUR** Leather jacket renovated by our craftsmen expertly, reasonably. Request free descriptive circular No. 8. Berlew Mfg. Co., Freeport, N. Y.

**AIRFOAM** Rubber: 1"x16"x18", \$1.95; 4"x21"x22", \$3.95; 1"x24"x60", \$9.95; 4½"x27"x75", \$32.50; 6"x24"x38", \$9.95; auto seat pads, \$7.95. Other sizes cut or fabricated to order. Write for prices. All shipments prepaid. In California add 3% sales tax. United Foam Rubber, Dept. C, 233 Broadway, Oakland, California.

WOULD You like to know how these classified ads pull? Tell me what you have to advertise and I'll send you some "Amazing Proof." F. W. Johnson, Classified Adv. Mgr., Popular Mechanics Magazine, 200 E. Ontario St., Chicago 11, Ill.

REPAIR Pewter tea sets, candelabras, etc. with soldering iron and our low temperature solder. A generous size bar and instructions 50c. The Metal Repair Shop, 781 Selby Ave., St. Paul 4, Minn.

GENUINE Buckskin jackets. Soft—Durable—Beautiful. Only \$29.50. A \$55.00 value. Write for free Buckskin catalogue. Berman Bros. Fur Co., Dept. P, Minneapolis, Minn. Established 1899.

SAMPLE Print for house or utility building mailed free. Large prints \$2.00. Arthur Gales Company, Racine, Wis.

YOUR Name imprinted in gold on 13 good pencils 50c. 6—30c. Pencil Printers, Box 1163, Hutchinson, Kansas.

CHRISTMAS Cards postpaid—35 for 75c or 60 for \$1.00. Distinctive double folders with envelopes. Hix Craft, Box 473, Hartford 1, Conn.

PATENT Pending. Steel shelf. Wall or corner. Novel. Very decorative. Sample \$1.50. Samples of other copyrighted articles later. Not sold in stores. Unique Holders, 3134 Chase St., Toledo 11, Ohio.

10 LATEST Novelty cards 10c. 12 jokers' tricks 25c. Comic Xmas or everyday cards, 3 for 25c. Free catalog with each order. Laramie Sales, 4800 S. Laramie Ave., Chicago 38, Ill.

4-COLOR Mechanical pencil, latest on market, ideal for students, artists, engineers, businessmen, etc. Easy, instant use; only \$2.98 postpaid. Trans-Light Co., 505 5th Avenue, New York 17, N. Y.

WRITE Your name in gold, silver, copper on Christmas cards, stationery. Golden rays process. Looks like expensive engraving. Simple to do. Can make extra money writing for friends. Complete \$1.00 postpaid. Satisfaction guaranteed. West Coast Co., 1204 Russ Bldg., San Francisco 4, Calif.

USED Dresses 18c; men's overcoats \$1.00; skirts 50c. Free catalog. Crown, 164-PM Monroe St., New York 2.

BUILD Your own Geiger Counter. Save money! Write for free parts list and diagram. Woodwid Industries, 5217-AX Hollywood Blvd., Hollywood 27, Calif.

PANNING Gold. Beginners booklet. 36 pages, also catalogue supplies 25c. Old Prospector, B301, Dutch Flat, Calif.

INFORMATION. Any subject. The Roxbys, 747 S. New Hampshire, Los Angeles 5.

GEIGER Counter plans plus prospecting manual \$1.00. Satisfaction or refund. Box 486, Detroit 31, Michigan.

INEXPENSIVE Home turkish bath, lightweight, collapsible. Information free. Gordon Brothers, 656 Grand Street, Brooklyn 11, New York.

WHAT Every boy in America wants. Old time sling shot 50c. Maison Courcier, Box 313, Mandeville, La.

TREASURE, Mineral locators. Goldak now offers treasure locators for \$75.00. Geiger counters reduced to \$95.00. Write the Goldak Co., 1542 West Glenoaks Blvd., Glendale 1, Calif.

SUNSHINE Toy and Novelty Catalog. Send for your free copy. Chuck full of amazing, fascinating gift items. Sunshine Sales, Dept. P-R2, Loudonville, Ohio.

MEN! Large size shoes, large size socks! We specialize in large sizes 10 to 16, widths AAA-EEE. Dress, sport, work shoes. Guaranteed. Write for free catalog. King-Size, Inc., 197, Brockton, Mass.

URANIUM Prospector's handbook \$1. Details free. Craft Publications, 601 S. Vermont, Los Angeles 5, Calif.

GEIGER Counters \$48.50 and \$70, complete. Prepaid. Guaranteed uranium spinthariscopes (scintilliscopes) with samples \$6. Western Radiation Laboratory, 1107 West 24th Street, Los Angeles 7, Calif.

VERMONT Maple syrup and sugar. 100% pure, list. H. Marshall, Poultney, Vt.

SAVE Money—Buy everything wholesale. Free information. Orysen, 1147 Sunkist, Waukesha, Wis.

SQUARE Dance instructions. 40 dances. \$1.00. Wesley Rader, 1922 Grant, Denver, Colorado.

DO You need money? Raise your own capital! Simple, easy, sure method. Details free. Fenninger, 4219 Berkeley, Chicago 15.

START Mailorder business. Get details concerning beginners booklet guide. Wayne Berger, Baltic, Ohio.

"RECEIVE Mail." Moneymaking offers, opportunities, catalogs. Name listed 10c. Ideal Service, Park Ridge 10, Ill.

GEIGER Counters. Uranium quickly located with new, super-sensitive, 5 lb. detector. Sensational low price. The Detector Company, 5637 Cahuenga, North Hollywood, California.

TREASURE Locators. New electronic lightweight M-Scope mineral and metal finders are now available for immediate shipment. Built for arctic-tropic use. Revolutionizes locating of minerals, gold, silver, metal objects. Unsurpassed efficiency, factory guaranteed. Low prices, time payment plan available. Send for free 16-page illustrated booklet. Fisher Research Laboratory, Inc., Palo Alto, California.

NECKTIES Exchanged! Mail us six you're tired of. Pronto you receive six different cleaned ties. Pay postman \$1. Tie Exchange, 3, Watertown, S. D.

70 BIBLE Lessons, 25c. Bulletin, Box 87, Cathedral Station, New York 25.

TATTOOING Outfits, supplies. Illustrated list free. Zeis, 728 Lesley, Rockford, Illinois.

SQUARE Dance instructions. Calls, 25 sets, \$1.00. Rayburne, Eureka Springs, Arkansas.

GEIGER Counters for finding uranium ores. Simple operation. Low prices. Interesting literature free. Fisher Research Laboratory, Inc., Palo Alto, California.

TATTOOING Machines, outfits. Free catalogue. Jensen, 120 West 83rd Street, Los Angeles 3.

MAKE Your own tractor, saw mill, home freezer, and scores of other farm devices. Amazing new book. "Popular Mechanics Farm Manual." 284 Pages packed with hundreds of illustrated plans and farm workshop ideas. Descriptive circular free. Popular Mechanics Press, Room 603, 200 East Ontario Street, Chicago 11, Illinois.



Earn **BIG PAY** while Learning

VETERANS CAN EARN UP TO \$290.00 per month while training

- Learn By Doing in Our **BIG ALLIED SHOPS**
- MACHINIST TRADE.
  - TOOL, DIE MAKING & DESIGNING.
  - TOOL ENGINEERING.
  - DRAFTING—ALL BRANCHES.
  - PRODUCT ILLUSTRATION & DESIGN.

• BIG DEMAND FOR TRAINED MEN

Accredited by The American Society of Tool Engineers. Endorsed by Leaders of Industry throughout U.S.A.

FREE Employment Service After Graduation

**ALLIED SCHOOL OF MECHANICAL TRADES, Inc.**

1338-1340-1342 So. Michigan Avenue  
4211 Allied Building, Chicago 5, Ill.

Write for FREE Catalog  
A 1c Postcard will do.

BE STRONG USE **BARBELLS**

**95 POUND SET**  
Only \$10.80

Extra Plates 10c pound

We have been selling the finest barbell equipment since 1928. We operate our own foundry and sell direct to you at a very low profit. No other company can match our low prices.



Send for our **FREE** Barbell Catalog.

**BUR BARBELL CO.**  
LYNDHURST 23  
NEW JERSEY

# CHEMISTRY

LEARN AT HOME... Chemical knowledge is essential for thousands of good jobs in industry, business, science. IPC enables you to master practical chemistry. It's the ONLY home study chemistry course which enables you to learn by performing actual experiments—using chemicals and apparatus supplied with the course—in addition to your IPC textbook studies. Compares with recognized college courses in General Chemistry. Write today for free descriptive booklet.

**INSTITUTE OF PRACTICAL CHEMISTRY**  
3 PROSPECT AVENUE, HAGERSTOWN, MD.

## TRI-STATE COLLEGE

**B. S. DEGREE IN 27 MONTHS**

66th Year.  
World-Wide Enrollment

ENGINEERING—Courses in Civil, Elec., Mech., Chem., Aeronautical and Radio, Television. Also Bus. Admin., Acc't. and Sec. Science. Visitors welcome. See beautiful campus, well equipped laboratories. Graduates successful. Enter Jan., March, June, Sept. Write for Catalog, 4119 College Avenue, Angola, Indiana.

SAY YOU SAW IT IN POPULAR MECHANICS

### NIGHT AUTO SAFETY KIT

Sensational new safety units that SPARKLE BRILLIANTLY IN REFLECTED LIGHT; actually "protect your rear" while driving or parked at night. A "must" for every auto, truck, tractor, etc. Kit consists of 2 Silver units for front of car and 2 Red for rear. Can be permanently attached easily and quickly to bumper, body or windows. SPARKLITE is cut from SCOTCHLITE, the magic material used during World War II. Send only \$1.00, postpaid. No C.O.D.'s please. Satisfaction guaranteed.



**SPARKLITE SALES CO.** Dept. A-11  
Box 29, Overland Dr. St. Louis 14, Mo.

# WHY FEAR HEART FAILURE?

## How to strengthen your HEART MUSCLES!

When Bernarr Macfadden jumped out of a plane 3000 feet up, the entire medical world was astonished and bewildered. How could the heart of a man 81 years old withstand two super-normal shocks deadly dangerous to an ordinary individual of advanced age... first the cruel and savage jerk when the parachute opens suddenly—and second, the painful jolt of landing on the ground with the force of leaping from a two story building.

Bernarr Macfadden's heart had been trained by a system of his own. The heart is just a muscle and like any other muscles can be strengthened.

Bernarr Macfadden has prepared a digest of his writings with illustrated instructions which can be applied at home. We publish a book on **STRENGTHENING YOUR HEART AND ARTERIES**. The book and Bernarr Macfadden's writings and instructions are furnished in connection with a special individual letter of instructions after studying answers to your questionnaire, provided you will temporarily deposit (to show serious intent) a \$10.00 contribution with the Foundation, a non-profit organization, for educational work. Your deposit will be refunded promptly in case you are not satisfied and benefitted within 30 days.

The **BERNARR MACFADDEN FOUNDATION, Inc.**

Bernarr Macfadden Foundation, Inc.

535 Fifth Ave., New York 17, N.Y (Dept. PM-11)

Gentlemen: Please send me the book, **YOUR HEART AND ARTERIES** and Bernarr Macfadden's digest and writings on **STRENGTHENING THE HEART** as a text for study. I am to get a complete letter with instructions after submitting my answers to the questionnaire which you furnish. I enclose a \$10.00 contribution for the Foundation's educational activities. I agree to give careful consideration to instructions. Money will be refunded within 30 days if dissatisfied—if I return the book and digest.

Name \_\_\_\_\_

Street & No. \_\_\_\_\_

City or Town \_\_\_\_\_ Zone \_\_\_\_\_ State \_\_\_\_\_

# Don't Envy The PLUMBER—Be One

## Make \$15 to \$50 a Day

Every skilled workman will tell you Plumbers have the best of it. WINTER and SUMMER the Plumber is busy at top wages. No skilled Plumber is ever out of a job. Compare his opportunities with any trade. To the man with know how, Plumbing means profit. Investigate Universal Plumbing School. Not a "war born School," but a plumbing school developed and operated by plumbers since 1923.



### Own Your Own BUSINESS

Have your own business and big profits with little other than training and a kit of tools.

### JOURNEYMAN Gets Good Salary

Master Plumbers own their own shop. A Journeyman works for a Master. With this training journeymen can depend on high wages.

G. I. Approved. Established 1923

### UNIVERSAL PLUMBING SCHOOL

877 Holmes Street

Kansas City, Mo.

### BE A PLUMBER IN JUST 32 WEEKS

Learn With Tools—Not Books  
No need ever serve an apprenticeship. Don't envy the plumbers big profits—enjoy them. Learn every trick of the trade—Leadwork—Blueprint for plan reading, etc. under Licensed Master Plumbers.

### Over 7,000 Successful Plumbers Recommend This School

This system has made more than 7,000 plumbers. Investigate our past performance. If you like to work with tools this is your opportunity. Become a Plumber in America's largest and only school devoted exclusively to plumbing. Write today for FREE information.

# Learn A Trade NOW! PRACTICAL SHOP TRAINING!

### In Our Chicago Shops

- |   |  |
|---|--|
| <input type="checkbox"/> AUTO MECHANICS   | <input type="checkbox"/> WELDING—ARC and GAS |
| <input type="checkbox"/> DIESEL MECHANICS | <input type="checkbox"/> MACHINIST           |
| <input type="checkbox"/> REFRIGERATION    | <input type="checkbox"/> PIANO TUNING        |
| <input type="checkbox"/> BODY-FENDER      |  |

Above Approved For G. I.'s and Civilians  
One of America's Leading Practical Schools  
7 Floors of Fully Equipped Shops  
Over 48,000 Successful Graduates  
Expert Individual Instruction  
Learn by Doing—Low Living Expense  
Established 1902—Day and Evening Classes

### Also the following Home Study Courses

- |                                  |  |                                 |
|----------------------------------|--|---------------------------------|
| <input type="checkbox"/> PLASTIC | <input type="checkbox"/> REFRIGERATION | <input type="checkbox"/> DIESEL |
|----------------------------------|--|---------------------------------|

—CALL IN PERSON OR MAIL THIS AD TO—

## GREER SHOP TRAINING

(Desk 10) 460 South State St., Chicago 5, Ill.

Please send without obligation free information regarding trade checked above. (Specify whether you are a Veteran  or Civilian )

Name \_\_\_\_\_ Age \_\_\_\_\_  
Address \_\_\_\_\_  
City \_\_\_\_\_ State \_\_\_\_\_

### A WELCOME GIFT—FROZEN ROOF DRAINS?



**NO-FREEZE** protects your home. It eliminates one of winter's most exasperating problems.

**NO-FREEZE** guards against the hazards of frozen drain pipes, bursting leaders and hanging icicles. Danger of damage to interior walls and ceilings from ice clogged drains is eliminated.

**NO-FREEZE** is a sturdy, easily installed brass container with chemicals which dissolve in freezing weather to melt ice and snow. Non-injurious to metals, woods, roofs, or shrubs. One filling normally lasts all winter.

**\$7.00**

Postpaid

Money Back Guarantee

For **NO-FREEZE** Unit with container of chemicals. Refills for subsequent years 75c each—3 for \$2.00.

West of Miss. add 25c postage for unit and 10c each refill. No C.O.D.'s please. Write for details.

**CHESTERBROOKE CO., Rockaway 4, N. J.**

# ELECTRICIANS' SCHOOL

HOUSE AND COMMERCIAL WIRING • MOTOR REPAIR AND REWINDING • ELECTRIC REFRIGERATION

Approved for Veterans Training

## PENNSYLVANIA INSTITUTE SCHOOL OF ELECTRICITY

42nd and SPRUCE STS.

PHILADELPHIA 4, PENNA.

# FREE BARGAIN CATALOG of BOOKS

25,000 books of all publishers listed in our 55th Annual Bargain Catalog of 256 pages. Old-time favorites—latest "best sellers." Reference, Fiction, Juvenile, History, Scientific, etc. Supplying schools, colleges, libraries and thousands of individual customers. Send postcard today for our new 1950 catalog, "Bargains in Books."

**THE BOOK SUPPLY COMPANY, DEPT. 131**  
564-566 West Monroe St. Chicago 6, Ill.

# EXPORT PAYS BIG

World Trade firm offers men and women plan for big pay positions or unlimited-profit businesses of their own in Export-Import Mail order World-wide without capital, from home, or travel abroad. Write today for Free Book State if veteran. Airmail reaches us over night. **The Mellinger Co 1422 KB Westwood, Los Angeles 24, Calif.**

# RAILROAD TELEGRAPHY

Prepare quickly for top pay railroad job. Starting pay approx. \$265.00 monthly, 5-Day Week. Paid vacations. Free travel passes. Go anywhere. Railroads need men constantly. FREE particulars.

**AMERICAN SCHOOL RAILROAD TELEGRAPHY**  
101 PHIPPS BLDG. WENATCHEE, WASH.

SAY YOU SAW IT IN POPULAR MECHANICS

## SURPLUS BARGAINS

### LINEMAN'S TOOL & SAFETY BELT

Brand new web type belts in the original package. **ONLY \$3 95**

### POLE AND TREE CLIMBERS

Without straps **ONLY \$1.50**  
Used, good Per Pair



Send 10c for our Jam-packed Catalog!

Enclose full amount with order. All Equipment F.O.B.

### C & H SALES COMPANY

2176 M-11 E. COLORADO ST. PASADENA 8, CALIF.

Plastic Coasters  
and Tiles

## EMBED REAL FLOWERS in NEW Magic PLASTIC

Now, create many unusual things like the distinctive pansy coaster shown—made by embedding real pansies in Castolite—the "magic" liquid plastic that "pours cold like honey" . . . sets at room temperature like glass. Comes crystal-clear or may be dyed for brilliant color effects. Embed other flowers, too, also coins, medals, stamps, butterflies. Cast gorgeous bookends, art objects, figurines for gifts or to sell. New pleasure, fine profits are possible. No special artistic ability required.

### EMBED YOUR PHOTOS

Preserve your treasured photos in Castolite. Make beautiful medallions like the one shown, unusual photo-lampshades, lamp bases, distinctive paperweights with embedded photos. Sell your photos in unique plastic mounts. Use only home utensils. Follow simple step-by-step method. Write for free literature showing how to get started. Write today.

THE CASTOLITE CO. DEPT. M-1  
WOODSTOCK, ILL.

## PRINCE ALBERT

★ THE NATIONAL JOY SMOKE ★

Performance that excels • Stamina that endures

### DOUGLASS Steel-Pack MUFFLERS

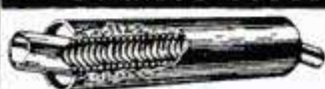

FOR ALL MAKES  
AND MODELS

Rugged construction. Steel tubing. Straight-thru-design. Solid tube with steel packing.

"Thrbbing Deep Tone." Complete for Easy Installation

32-40 FORD V-8 ..... \$5.95 29-49 CHEVROLET ..... \$5.96

41-49 FORD V-8 ..... 6.85 31-41 PLYMOUTH ..... 5.96

39-49 MERCURY ..... 6.85 42-49 PLYMOUTH ..... 6.85

35-48 FORD & MERCURY DUAL SETS ..... \$23.00

49 FORD & MERCURY DUAL SETS ..... 25.00

Specify Year and model • Satisfaction Guaranteed

Enclose Full Amount With Order

All Equipment F.O.B.

1949 COMPLETE RACING EQUIPMENT CATALOG 25c

### DOUGLASS MUFFLER MANUFACTURING COMPANY

1914 W. VALLEY BLVD., Dept. M-11, ALHAMBRA, CALIF.



### ITALIAN ACCORDIONS

Hand Made. Very Best. Buy Direct from Factory Representative at lowest wholesale prices and Save Money. Send Name and Address for FREE catalog.

ITALIAN ACCORDION MFG. CO.

7600 Cottage Grove Ave., Dept. PM-11, Chicago 19, Ill.

SAY YOU SAW IT IN POPULAR MECHANICS

## MAKE YOUR OWN!

WITH

### Griffin READYCUT LEATHER PROJECTS

Over 100 KITS in every kind of Tooling and Carving Leather, accurately cut, all parts included Only Top Grade Leathers used You do the choosing. You do the tooling, carving, stamping, the punching and assembling



SEND FOR  
COMPLETE CATALOG  
Please send  
10c to cover  
mailing.

SINCE 1924

OUT OF THE WEST, THE HOME OF LEATHER CARVING

Griffin Craft Supplies

5626-A TELEGRAPH AVE.  
OAKLAND 9, CALIFORNIA

### EVERYTHING FOR THE LEATHER WORKER

Largest, most complete stock  
of Leathercraft Tools and Acces-  
sories in U.S.A.



HIDES AND  
SKINS OF Craft  
Leathers of every  
kind if you prefer  
to cut your own.

## Now! FOREDOM offers 2 NEW ATTACHMENTS

You Get Unexcelled UTILITY  
AND VERSATILITY...  
AT SMALL COST!

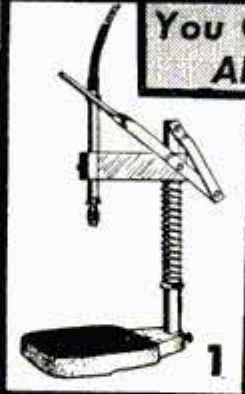

### DRILL PRESS ATTACHMENT

1 New Foredom offers you a DRILL PRESS ATTACHMENT for use with Model 100 (see below) and for the many thousands of Foredoms already in use. Handpiece quickly clamps in place and drill press is ready for use, ready to pay for itself over and over again! PRICED AT A MERE \$4.95.

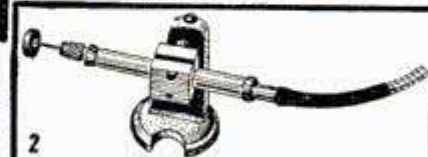

### B-R-S ATTACHMENT

2 The new Foredom

B-R-S ATTACHMENT (Bench Stand, Router, Shaper). Speedily clamp handpiece in place and magically you have one unit which serves as a bench grinder with angular adjustment, a router (complete with detachable guide for routing borders) and shaper. Can be used with Model 100 and thousands of Foredoms now in use, providing endless hours of fun and profit. TRIPLE UTILITY FOR ONLY \$3.50.

And there's still more - - -

### FOREDOM'S NEW MODEL 100 FLEXIBLE SHAFT MACHINE

3 Model 100 Flexible Shaft Machine with all-metal PENCIL SIZE HANDPIECE equipped with CHUCK GUARD to PROTECT YOUR FINGERS and provide SENSITIVE, POSITIVE, FINGER-TIP CONTROL for the most delicate tasks. Husky little high-speed universal motor. Foredom's quarter-century reputation for precision workmanship goes with each machine. Other heavier duty models at proportionately reasonable prices. No. 25 Accessory Set (a truly versatile assortment) \$5.50 extra. Also No. 1000 Kit, comprises No. 100 Machine illustrated and set of 12 accessories, all in wooden case for only \$21.50. 8-step Foot Rheostat \$4.85. USE IT TO GRIND, POLISH, DRILL, SAW, SAND, CARVE, MILL, CLEAN, ETCH, ENGRAVE, ETC. on all metals, wood, plastics, glass, leather, linoleum, etc.

Foredom's Multi-Purpose THREESOME comprising Model 100 Machine, Drill Press attachment and B-R-S attachment..... \$24.95

And here's another Amazing

### Foredom Product FOREDOM PRESTO-FLEX

with PENCIL-SIZE handpiece  
Quickly Converts Motors or Drills \$5.95  
into Flexible Shaft Tools



Now turn your old motor, drill press or electric drill into a Flexible Shaft Tool. Simply attach it and presto—a flexible shaft machine! Off again in a jiffy! Pencil-Size handpiece gets into tight places. Handy 35" overall length. And - - - only \$5.95 complete! Precision made. Order NOW. If ordered for use on motor, specify motor shaft diameter and add 50c for coupling (Available for 1/4, 5/16, 3/8, and 1/2" shafts). No. 50 Accessory Set available \$1.50 extra. Order TODAY at your dealer's or use coupon below.

— SEND NO MONEY —

FOREDOM ELECTRIC CO., Dept. 1123-E Mail Coupon  
27 Park Place, New York 7, N. Y. Now!

Please send me FOREDOMS checked below on 10-day trial

- |  |  |
|--|--|
| <input type="checkbox"/> Drill Press Attachment (\$4.95)               | <input type="checkbox"/> B-R-S Attachment (\$3.50)     |
| <input type="checkbox"/> Presto-Flex Tool (\$5.95)                     | <input type="checkbox"/> No. 50 Accessory Set (\$1.50) |
| <input type="checkbox"/> Motor Coupling (50c)                          | <input type="checkbox"/> No. 25 Accessory Set (\$5.50) |
| <input type="checkbox"/> Specify motor shaft dia.                      | <input type="checkbox"/> Foot Rheostat (\$4.85)        |
| <input type="checkbox"/> No. 100 Machine (\$16.95)                     | <input type="checkbox"/> No. 1000 Kit (\$21.50)        |
| <input type="checkbox"/> Multi-Purpose Threesome (\$24.95)             | <input type="checkbox"/> Free Catalog                  |
| <input type="checkbox"/> Send C.O.D. plus postage. I will pay postman. |  |
| <input type="checkbox"/> I enclose payment. Send postpaid.             |  |
- (MONEY BACK EITHER WAY IF NOT DELIGHTED)

NAME \_\_\_\_\_

ADDRESS \_\_\_\_\_

CITY & ZONE \_\_\_\_\_

STATE \_\_\_\_\_

## STRENGTHEN Your VOICE!

YES—you can now build yourself a powerful speaking and singing voice with this amazing new scientifically sound tested method. Self-training . . . no music or piano required. Results GUARANTEED. Just send your name for the sensational details. FREE chart of your vocal mechanism included! Please state your age.

PERFECT VOICE INSTITUTE, Studio L-2, 1141 S. Wabash Ave., Chicago 5, Ill.

# NOW! Build Your Future On



## DIESEL Opportunities

LOOK around you. See the way tractors, trucks, buses, railroads, ships, power plants and equipment of many kinds are "going Diesel." Every day new opportunities are opening—in industrial and farming communities—for trained men who can install, maintain, operate and repair Diesel engines. Plan now to build your future in this growing field.

### Diesel Knowledge is Earning Power

Now, you can begin learning DIESEL in spare time at home. UEI practical training teaches you, step by step, how Diesel engines operate, how fuel systems work, repairs, accessories and auxiliary equipment; a world of Diesel "know how." Also new Scientific Motor Tune-Up covering auto ignition systems, generators, tune-up procedure, etc. Includes actual practice on Diesel equipment in our shop under expert guidance. For 22 years UEI training methods have helped mechanically inclined men better themselves.

### NOW IT'S UP TO YOU!

Coupon below brings you all the facts without cost or obligation. Get going today! MAIL COUPON NOW

**UTILITIES ENGINEERING INSTITUTE**  
Diesel Division  
2521 Sheffield Ave.  
Dept. DC-5,  
Chicago 14, Ill.

Founded  
1927



Send  
Coupon  
for  
**FREE  
FACTS**

**UTILITIES ENGINEERING INSTITUTE, Diesel Division**  
2521 Sheffield Ave., Dept. DC-5, Chicago 14, Ill.

Please send me Free Facts about Diesel opportunities and training.

NAME \_\_\_\_\_ Age \_\_\_\_\_

ADDRESS \_\_\_\_\_

CITY \_\_\_\_\_ Zone or County \_\_\_\_\_ STATE \_\_\_\_\_

Check here for special information if you are under 17.

## Can a Man MY Age Become a HOTEL EXECUTIVE

### Even Though He Has No Previous Hotel Experience?

Would you like to step into a well-paid position as Hotel, Club, Restaurant or Inn Manager, Purchasing Agent, Social Director or Assistant Manager? Would you like to look forward happily to the future? The success of Lewis graduates from 18 to 50 PROVES you can—though you have no experience in hotel work.

**Clyde B. Corley, Veteran, Without Previous Hotel Experience, Wins Ass't. Manager's Position**

"After my release from the Air Force, I enrolled for Lewis Training. Now Assistant Manager of this Club, my position is fascinating as well as lucrative. The people with whom I am associated are of the finest calibre. My salary is more than \$400. a month, and I've been in this work less than a year! All thanks to Lewis Training."



### Step Into a Well-Paid Hotel Position FREE Book Gives Fascinating Facts

Our FREE Book, "Your Big Opportunity," explains how you can qualify for a well-paid position at home, in leisure time; tells how you are registered FREE of extra cost in the Lewis National Placement Service. Most important, it shows how you can be a Lewis Certified Employee—certified to "make good" when placed in a position. Mail the coupon NOW!

#### Course Approved for Veterans' Training

**LEWIS HOTEL TRAINING SCHOOL**  
Room PS-324, Washington 7, D. C.

**34<sup>th</sup> SUCCESSFUL YEAR**

Send me the Free Book, "Your Big Opportunity," without obligation. I wish to know how to qualify for a well-paid position at home, in my leisure time.

Name \_\_\_\_\_

Address \_\_\_\_\_

City \_\_\_\_\_ Zone \_\_\_\_\_ State \_\_\_\_\_

Check here if eligible under G.I. Bill of Rights.

# BIG FREE CATALOG

## of WAR SURPLUS OPTICAL BARGAINS

Build Your Own RIFLESCOPE, BINOCULARS, TELESCOPES, ETC.  
We Furnish Optics and Instructions

- LENSES, PRISMS & RETICLES
- EYEPIECES and OBJECTIVES

Send \$1.00 for Stock #2-H  
10-Piece Lens Kit and Big  
Instruction Booklet.

We Have Numerous Types of Assembled Optical Instruments Including BINOCULARS and RIFLESCOPES.  
CHECK OUR BARGAINS . . . Request CATALOG H

**EDMUND SALVAGE COMPANY**  
BARRINGTON, NEW JERSEY

## RUPTURE-EASER

A strong, form fitting, washable support. Back lacing adjustable. Snaps up in front. Adjustable leg strap. Soft, flat groin pad. No steel or leather bands. Unexcelled for comfort. Also used as after operation support. For men, women and children. Mail orders give measure around the lowest part of the abdomen. Specify right or left side or double. We prepay postage except on C.O.D.'s.



Right or left  
Side \$3.95  
Double 4.95

308 East 12th Dept. PM-119 Kansas City 6, Mo.

## NEW! ADVERTISING MACHINE

PRINTS & ILLUSTRATES FREE PENNY POST CARDS

Easy to boost sales with Cardmaster. Thousands are doing it. Not a toy but a sturdy Advertising Machine Guaranteed 5 years. Get money-making facts today. Act now!



CARDMASTER, 1920 Sunnyside, Dept. 1311, Chicago 40

## ANALYZE Handwriting

Try it FREE, use it — to understand yourself and others in business and social life—more clearly than you ever thought possible. Many use their knowledge of handwriting to make more money full or part time. Simply send your name today for FREE ILLUSTRATED lesson. No obligation. Must be over 21.

INTERNATIONAL GRAPHO ANALYSIS SOCIETY, INC.,  
203 Wilhoit Building Springfield 4, Mo.



## THE PERFECT GIFT

- SWISS PRECISION MOVEMENT \$5.95 Plus 10% Fed. Tax
- STAINLESS STEEL
- SWEEP SECOND HAND WOMAN'S MODEL \$6.95 Plus 10% Fed. Tax
- RADIUM DIAL
- GIFT BOX

Send only \$1.00 with order. Pay balance plus postage on arrival. We pay postage if you enclose payment in full with your order.

**GUARANTEED JEWELRY CO.**  
1348 C Morrison Avenue, New York 59, N. Y.

Wheels  
Wheels



Wheels  
Wheels

5" Disc Wheel	5 1/2" Tire	5/16" or 3/8" Sleeve	30c ea.
6" " "	5 3/4" " "	5/16" or 3/8" Sleeve	35c ea.
7" " "	1 1/2" " "	1 1/2" Sleeve	45c ea.
8" " "	1 1/2" " "	1 1/2" ball bearing	70c ea.
7" " "	1 1/2" " "	1 1/2" ball bearing	80c ea.
8" " "	1 1/2" " "	1 1/2" ball bearing	\$1.00 ea.
8" " "	2" " "	semi-pneum. T. 1/2" B.B.	\$1.35 ea.
10" " "	1.75 " "	1/2" B.B.	\$1.50 ea.

Above wheel prices includes hub cap.  
10" Aluminum Wheel 2 3/4" semi-pneum. T. 1/2" B.B. \$4.50 ea.  
Plus Postage, 20%. C.O.D.'s accepted.

UNITED WHEEL STAMPING CO.  
2756 W. 115th STREET PM-11 CHICAGO 43, ILLINOIS



FAST PUSH-BUTTON POWER CAR!

**ALL ELECTRIC REMOTE CONTROL  
1951 AUTO SENSATION!**

- Driven By Powerful Remote Control
- Powered with Electric Mini-Motor
- Latest All Electric Marvel
- Balloon-type Rubber Tires



Imagine only **\$3.49** COMPLETE!

Push The Button!  
**IT STARTS! REVERSES! STOPS! STEERS!**

The greatest new electrical toy since the electric trains. REMOTE CAR is a thrillingly realistic scale model, made of colorful shining plastic. It runs and steers by remote control—no wind-up or friction motor, but an ALL-ELECTRIC PRECISION-MADE MOTOR, powered by 2 long lasting flashlight batteries. Push the magic rheostat button, and you really make things happen. Here's real action to fascinate every child, and daddy too. RUSH YOUR ORDER TODAY! SEND NO MONEY! Remit with order and we pay postage, or C.O.D. plus postage.

NOVELTY MART · 59 East 8th Street, Dept. 416 New York 3, N.Y.

**PEARL**  
FINISHING OFFERS YOU  
**BIG MONEY**

RIGHT AT HOME

AMAZING NEW PEARL FINISH can be instantly applied to any article—leather—wood—plastic—glass—metal, etc.

BABY SHOES preserved for life in beautiful Baby Pink, Blue, and Ivory thrill mothers and bring immediate sales.

Nothing else like it! Costume jewelry, buttons, earrings, treasured mementos, etc., etc., take on new splendor and beauty at once.

TREMENDOUS DEMAND—Help us fill it—Fantastic profits await those who act NOW. Be First! Scoop the market. Never before has such an opportunity been offered. Never before such Big Profits made so quickly.

DON'T PASS THIS UP—It costs Absolutely Nothing to get the FREE FACTS that show you the EASY WAY to QUICK, BIG MONEY overnight. Mail Coupon TODAY!

PEARL-KOTE CO. Dept. 21  
2111 W. Manchester Ave., Los Angeles 47, Calif.  
Okay! RUSH me FREE FACTS at once.  
Name \_\_\_\_\_  
Address \_\_\_\_\_  
City \_\_\_\_\_ Zone \_\_\_\_\_ State \_\_\_\_\_

**NEW BATHROOM DEODORIZER**



Secret chemical invention automatically banishes unpleasant odors in bathroom, kitchen, anywhere. Gives off refreshing fragrance. Just hang on wall. No liquids, sprays, or wicks. Needs no attention. Beautifully designed!

SAMPLES for AGENTS Sample offer sent immediately to all who send name at once. Hurry—postcard will do. SEND NO MONEY—just your name.  
KRISTEE CO., 688 Bar St., Akron, Ohio

**ARTISTS MAKE MONEY**

Do you like to draw? Send name, address, age and occupation for FREE ART TEST, to find out your ability.

ART INSTRUCTION, Inc.

11139 ART INSTRUCTION BLDG., MINNEAPOLIS 15, MINN.

SAY YOU SAW IT IN POPULAR MECHANICS

**NO FROZEN PIPES**  
TRADE MARK

WRAP ON CABLE INSULATES WATER PIPES IN THE COLDEST WEATHER

Simple, low cost protection against frozen pipes. Insures running water in coldest weather. Wrap "No Frozen Pipes" cable around your water pipe, plug in and you're all set!

- B-12 CABLE 30 WATTS 2-5 FEET OF PIPE..... \$2.80
- M-26 CABLE 60 WATTS 5-12 FEET OF PIPE..... \$3.80
- THERMOSTAT WITH PILOT LIGHT..... \$4.50

Immediate Delivery. Order Direct, Cash or C.O.D. or Send for Folder

**MONEY-BACK GUARANTEE**

Tens of thousands in use all over this country, Canada and Alaska. Your money refunded if not satisfactory.

**ASSOCIATED SPECIALTIES, INC.**

10658 GRATIOT AVE., DETROIT 13, MICHIGAN

Dealers and Salesmen Wanted

**SALESMEN!**

10-Second  
Demonstration  
Nets You  
**\$9.95**



Yes—Storekeepers now "Write with Light"—wipe off and write new sign—all in 10 seconds. Fastest seller in years. 10-second demonstration pays you \$9.95 cash in advance. Orders pour in HAND-OVER-FIST. Get started in your territory while "LITEWRITER" is brand new and hot as a pistol.

**Litewriter "MAGIC CRAYON" MAKES SIGNS THAT GLOW LIKE BRILLIANT NEON!**

Merchants everywhere—in small town and big city—all stare with amazement at this newest of all Fluorescent Sensations! They write on glass with "MAGIC CRAYON"—and Presto!—before their very eyes—there's a 5-color Advertising Message that glows like a brilliant Neon Sign!

FREE! Complete Sales Kit. Send name on penny postcard NOW for Big FREE Sales Kit and Free offer of Sample Demonstrator. No cost now or ever. Rush postcard now.

**MAXILUME CO., 125 W. Hubbard St. DEPT. L-811 CHICAGO 10, ILLINOIS**

# The Steady Pay Profession Good Times or Bad!

## SCIENTIFIC CRIME DETECTION

FOLLOW  
THIS MAN  
Operator  
No. 38



### It Is Easy to Learn!

I will teach you this fascinating science during your spare time at home. It pays to be an expert in Finger Printing, Firearms Identification, Police Photography and Criminal Investigation. I have trained hundreds of men and women now successfully serving in identification bureaus throughout America. You, too, may quickly prepare yourself to become a well-paid valued officer of the law, often sharing in the generous rewards offered for wanted criminals.

**FREE! OVER 800**

### "BLUE BOOK OF CRIME"

This book is full of exciting information on scientific crimedetection. It will show how you can get started in a grand career. Now, at amazingly low cost. Clip coupon now... Mail it today.

of all Identification Bureaus in the U. S. employ students and graduates of I. A. S. A majority of these men are heads of Bureaus. Many of them knew nothing about crime detection before training with me. Now they have steady jobs, good salaries and a fine future. Write today for full particulars and free book. Give age.

### INSTITUTE OF APPLIED SCIENCE

1920 Sunnyside Ave., Dept. 1358, Chicago 40, Ill.

**INSTITUTE OF APPLIED SCIENCE**  
1920 Sunnyside Ave., Dept. 1358, Chicago 40  
Gentlemen: Without any obligation on my part, send me the "Blue Book of Crime," and complete list of Identification Bureaus employing your students or graduates, together with your low prices and Easy Terms Offer. (Literature will be sent ONLY to persons stating their age.)

Name..... Age.....  
Address.....  
RFD or Zone..... State.....

SAY YOU SAW IT IN POPULAR MECHANICS

## ELECTRIFY your SEWING MACHINE

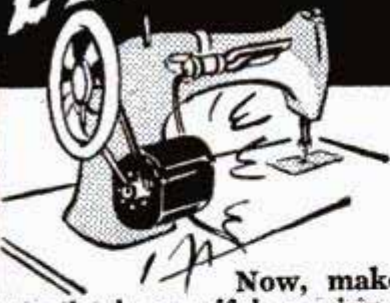

Now, make mother's or wife's sewing a pleasure. Easy to install. Fits all machines.

- Motor & Bracket
- 7 Speed Foot Control
- AC-DC 60c. 115 v.
- Cord Set
- Pulley & Belt
- Complete Instructions

### 10 DAY FREE TRIAL AT OUR RISK

SEND NO MONEY, pay postman plus C.O.D., or enclose money order and we will pay postage. MONEY BACK after ten days if not completely satisfied. Shipping Wt. 6 lbs. State whether wheel on your machine turns towards or away from you.

### 2-TONE LUGGAGE CARRYING CASE

Specify base width, length and make of your machine.  
Wt. 11 lbs.

**\$9.95**



KIT COMPLETE WITH SEWLITE (as illustrated) \$12.95

### CONTINENTAL SALES CO.

Dept. PM5, 83 Graham Ave., Brooklyn 6, N.Y.

# PAY RAISING—EXTRA MONEY BOOKS

Use these books to prepare for a better job—bigger pay—to start a profitable spare time or full time business of your own, improve your home, or start a hobby. Popular Mechanics specializes in supplying outstanding self-help books on many subjects. Send for our FREE catalog.

- Outdoor Sports Manual  
Hunters, Fishermen, Trappers, Campers, Archers, Boatmen, here is your book!.....\$2.00
- Shop Notes Library  
5 Vols. — 1950, 49, 48, 47, 44 (No Dup. Mat.).....\$3.48
- Shop Notes—1950.....\$1.00
- Painting, Furniture Finishing and Repairing.....\$1.50
- Rewinding and Servicing Electric Motors (No. 75).....25c
- Photo Handbook  
An entirely new and different book from our Popular Photo Guide. It's a complete guide to better pictures and dark-room technique, and features dozens of handy gadgets you can make yourself.....\$2.00
- Motor's Truck Repair Manual  
Mechanics, Truck Specialists, Service Stations, Fleet Owners! Here is your book! Covers every job on every truck made since 1936 — 1400 pictures, 952 Pages.....\$8.00
- Garden Book  
Build own trellises, lawn furniture, Areplaces, ornaments, etc.....\$1.25
- Diving, Cutting and Welding in Underwater Salvage Operations. Only book of its kind.....\$2.00
- Picture Framing  
Modern methods for making and painting picture frames. Fully illustrated.....\$2.75
- Modern Illustration  
A practical art course covering all branches of commercial drawing, painting and methods of reproduction.....\$3.00
- 210 Deluxe Small Homes \$1.00  
Into the Freezer and Out  
A complete handbook on the home freezing of foods \$2.50
- Concrete Handbook  
New book on using concrete around home, garden, farm.....\$1.50
- Leather Art by Baird  
Leathercraft is a wonderful hobby whether for pleasure or for pay. Get this beautifully illustrated, clearly detailed book at once. Tells you each step and furnishes actual designs.....\$3.00
- This Way Up  
The successful philosophy of practical business men \$2.00
- Welding, Brazing and Soldering  
How to build own equipment and how to use it effectively.....\$1.25
- Modern Refrigeration  
Electric, Gas. Be service expert.....\$5.00
- Dyke's Auto Ency. (includes Diesels, airplane engines). New 20th Ed. World's greatest book for mechanics.....\$7.50
- Household Mechanics  
The "fix-it" book to end all "fix-it" books. Covers electric appliances, painting, carpentry, etc.....\$2.98
- Oil Burner Handbook.....\$2.50
- Build Your Own Boat  
Describes 17 popular boats—rowboats, sailboats, plywood outboard, etc. 192 pgs. \$1.50
- House Wiring (No. 89).....25c
- Turn Scrap Into Money  
Convert old auto generators into motors, welders, etc.....\$1.00
- Popular Mechanics Farm Manual  
Packed with practical ideas and usable information that can easily be worth hundreds of dollars to every farm family and to homeowners everywhere. Send for free descriptive folder giving complete contents!.....\$3.00
- Woodworking for Every body.....\$2.75
- Sheet Metal Work.....\$3.00
- Tool and Saw Sharpening (No. 92).....25c
- Forging Practice.....\$1.50
- Action Toys (No. 66)  
Plans for 21 easy-to-make toys.....25c
- Foundry Work.....\$2.25
- Pattern Making  
Wood, metal.....\$2.25
- Forty Power Tools  
Build own saw, drill, lathe, sander, etc., from scraps—save money.....\$1.50
- Carpentry.....\$2.50
- The Young Craftsman.....\$1.50  
Over 450 things boys can make.....\$1.50
- Five Acres and Independence  
How to make money on small farm.....\$2.50
- Your Home and How to Build It Yourself. Step-by-step construction of the famous POPULAR MECHANICS house. Wonderfully illustrated \$3.00
- Drake's Householders Cyclopaedia  
This is the time to save money on those necessary home repair jobs—Repairing, Remodeling, Carpentry, Painting, Decorating, Plumbing, Heating, Electric Wiring and Appliance Repairs, Furniture Repairs — This new book covers them all.....\$5.00
- Motorist's Handbook  
Popular Mechanics scores again. A 160 page guide to automotive happiness.....\$2.00
- Knots, Ties and Splices  
For everyone who uses rope.....\$1.25
- What to Make for Children  
Junior tough on toys? Build him playthings that will last.....\$2.00
- LeJay Manual of Homemade Electric Equipment. How to construct 50 items that are scarce and valuable.....\$1.50
- How to Estimate for the Building Trades: Material and labor costs for masonry, plumbing, electricity, carpentry, heating, hardware, painting, etc. 629 pages.....\$5.50
- Rabbits for Food and Fur \$2.50
- Tool Making.....\$4.00
- Tool Design.....\$4.50
- Plumbing Installation & Repair.....\$2.00
- Ropp's Calculator  
Figuring made easy.....75c
- Slide Rule Simplified.....\$2.75
- Drake's Refrigeration Service Manual.....\$2.00
- Primer for Home Builders  
All the information you need to know in building a house.....\$2.50
- How to Read Aircraft Blueprints \$4.40
- America's Best Low Cost Homes  
125 popular practical designs.....\$1.00
- Toys You Can Make of Wood.....\$2.50
- A.B.C. of Poultry Raising \$2.50
- Ice Cream for Small Plants  
Some technical formulas for ice cream, ices and frozen desserts on a commercial scale.....\$2.50
- Furniture Joinery.....\$2.00
- Essentials of Upholstery.....\$3.25
- Radio Physics Course  
A thorough training in radio fundamentals.....\$5.00
- Lessons in Ornamental Penmanship. You can easily learn to write beautifully. Delight and amaze your friends with the skill you can acquire by using this book—Only.....\$1.50



## MAIL THIS COUPON TODAY

Check the books you want, write your name and address below, and mail this advertisement with money order or check. Outside U. S. A. include 15% additional for shipping charges.  
Books selected will be mailed promptly on our "money back if you're not entirely satisfied" guarantee.

Name.....  
Address.....  
City..... State.....

Mail to **POPULAR MECHANICS PRESS**  
DEPT. 700 — 200 EAST ONTARIO ST., CHICAGO 11, ILL.  
**POPULAR MECHANICS**



# WILL YOU WEAR *this* SUIT Without Paying 1¢-

BE MY LOCAL AGENT UP TO \$12.00 IN A DAY!

How would you like to wear a fine made-to-measure suit without paying one cent? You can get it by taking a few orders from friends. Do this—get your bonus suit—and also earn up to \$12 in a day without house-to-house canvassing! Represent my big, old established company. I need ambitious men in every town, and this is your chance.

**Experience Not Necessary**

**SAMPLES FREE.** I send you absolutely free gorgeous, valuable big, demonstration equipment containing actual samples of fabrics. Demonstrate these samples for me and take orders. Show great tailoring values. Save money for friends. Make money for yourself. Write! **SEND NO MONEY!** For quick action, tell us about yourself—age, etc. Get demonstration equipment FREE and opportunity to get your own made-to-measure suit WITHOUT one penny cost. **H. J. COLLIN, PROGRESS TAILORING COMPANY, Dept. Y-216, 500 SOUTH THROOP STREET • CHICAGO 7, ILLINOIS**



## LOW PRICED TIRE LUG at a FRACTION OF THE PRICE OF TIRE CHAINS

Gets you out of snow, ice and mud. Made of live rubber—noiseless—nothing to rattle.

Easy to put on and take off. Just slip web-strap through slot in wheel and tighten buckle. Set of 4, postpaid. **\$3.95**

**Emergency Tire Lug Sales Co.**

195 W. 9-MILE RD. DETROIT 20, MICH.

## HOMESITES \$300 LOW TERMS

In California's loveliest Garden Spot, on scenic shores of beautiful Morro Bay. Enjoy future independence with excellent soil, soft water, wonderful fishing, hunting, boating, bathing, etc. Grow fruits, vegetables, poultry. Perfect temperate climate. Congenial community. Finest investment. Free literature.

**RICHARD S. OTTO**

DEPT. M SAN LUIS OBISPO, CALIFORNIA

## LOCKSMITHING & Key Making



**PRACTICAL UP-TO-DATE COURSE—ONLY \$3.95**

Easy-to-learn modern information for self-instruction. How to work on locks, de-code, make master-keys, repair, install, service, etc. For every handyman, home owner, carpenter, mechanic, service station operator, fix-it shop, hardware dealer, gunsmith. 53 plain illustrated lessons. **FULL PRICE ONLY \$3.95. SEND NO MONEY.**

Just pay postman plus C.O.D. postage. Or send \$3.95 with order, we'll ship postpaid. Satisfaction guaranteed or refund.

**NELSON-HALL CO., 1139 S. Wabash Ave., Dept. L-2, Chicago 5, Ill.**

MANUFACTURER'S

## SURPLUS



PAY ONLY **4.95**

PERFECT XMAS GIFT FOR YOUNG & OLD ALIKE. RETAILS FOR \$15 AND MORE. This fine microscope is created by the world famous optical craftsman of Rochester, N. Y. Especially designed for use in labs & schools and for scientific study in the home. Precision built with special lens construction. Each microscope comes complete with slides.

**SPECIFICATIONS**

- Magnifications of 60, 90, 150
- All-metal body, 8 ins. high
- Adjustable tilt stand
- Automatic turret with lock
- Rack & gear adjustments
- Chrome & black crinkle finish

Money back guarantee

AVOID THE XMAS RUSH — ORDER NOW! Send check or money order please.

**NAT LEHRER** Dept. PM, 73 CANAL STREET NEW YORK, NEW YORK



# START YOUR OWN BUSINESS, FULL OR PART TIME

Don't work for "small wages." Get in on the Big Money by learning Electrical Appliance Repairing NOW in your spare time. Learn it the simple, easy way by working with your hands building, testing, checking. We supply you with valuable Kits that will give you that all-important "know how."

More men are needed immediately. Millions of refrigerators, motors, washing machines, irons, vacuum cleaners, house wiring need fixing. This demand must be met! Rush name today for **FREE ILLUSTRATED BOOK** and special form for paying us later from cash earnings!

**CHRISTY TRADE SCHOOL**  
4432 N. Kedzie Avenue Dept. D-7503 Chicago 25, Ill.

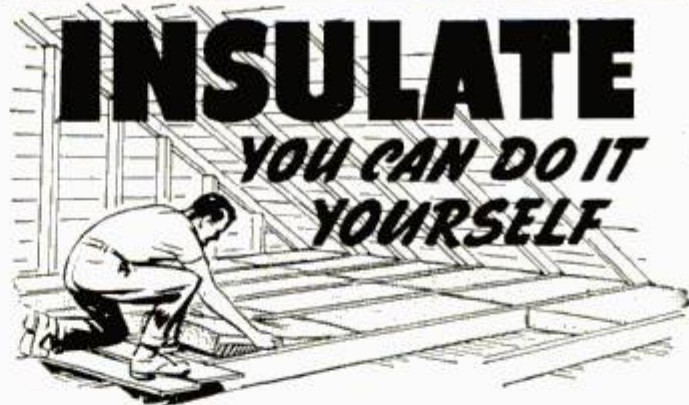

**YES, you can insulate your home easily, quickly, and at low cost with Gold Bond Rock Wool Insulation.** Light, easy-to-handle batts slide right in between attic floor joists or between rafters. Fireproof! Keeps homes warmer in winter, cooler in summer; pays for itself in fuel savings. For full benefits order "full-thick" Gold Bond Rock Wool Batts from your local Gold Bond Lumber and Building Supply Dealer today!

FREE BOOK OF SUGGESTIONS

**NATIONAL GYPSUM COMPANY,**  
Dept. E-7, Buffalo 2, New York

Gentlemen: Send free copy of new Book-let, "Live Better for less!" showing full details on the benefits of insulation.

Name .....

Street .....

City ..... State .....

(Please print name and address)

**GOLD BOND**  
  
**WHOLESALE GUARANTEED EXCEPTIONALLY GOOD USED TIRES DIRECT TO YOU**  
 10% discount on 2 or more tires if you send this ad with order  
**TUBE DELIVERED WITH TIRE AT NO EXTRA COST FOR 15" AND 16" PASSENGER TIRES**

Safe — Our tires used on school buses and ambulances  
**EXCEPTIONALLY GOOD TREAD — NO RECAPS**  
 GUARANTEED FOR 24 MONTHS

600-16 . . . 6 ply Military—Mud and Snow Tire . . . . .	\$6.37		
550-16 . . . . . \$5.19	525-18 . . . . . \$ 6.69	700-15 . . . . . \$ 5.29	
600-16 . . . . . 5.29	550-17 . . . . . 7.99	600-20 . . . . . 9.75	
650-16 . . . . . 5.29	650-15 . . . . . 4.98	650-20 . . . . . 9.75	
700-16 . . . . . 6.29	825-20 . . . . . 15.98	700-20 . . . . . 10.98	
550-15 . . . . . 4.81	900-20 . . . . . 15.98	32-6 (8) . . . . . 10.49	
	1000-20 . . . . . 16.89		

**ALL GOOD TIRES**  
 GUARANTEED FOR 12 MONTHS

550-16 . . . . . \$3.54	30-5 . . . . . \$ 7.98	1200-20 . . . . . \$18.78
600-16 . . . . . 3.59	650-20 . . . . . 7.69	750-24 (36-6) 12.21
650-16 . . . . . 3.89	700-20 (8) . . . . . 9.29	38-7 (825-24) 13.75
700-16 . . . . . 4.59	700-20 (10) . . . . . 12.48	1000-22 . . . . . 17.70
550-15 . . . . . 3.79	750-20 (8) . . . . . 8.19	1100-22 . . . . . 16.89
650-15 . . . . . 3.89	750-20 (10) . . . . . 9.19	900-24 (40-8) 21.60
700-15 . . . . . 3.98	825-20 . . . . . 11.19	900-16 . . . . . 8.98
550-17 . . . . . 5.69	900-20 . . . . . 11.89	(14 ply) . . . . . 14.10
750-16 . . . . . 8.40	1000-20 . . . . . 12.89	750-15 . . . . .
600-20 . . . . . 7.98	1100-20 . . . . . 13.89	(12 ply) . . . . . 11.30

**GOLD BOND SPECIAL — 750-20 MILITARY TIRES**  
 Will fit 650 x 20 700 x 20 (8 & 10 ply) 34 x 7 (8 & 10 ply)

Special . . . . . \$10.49	Guaranteed 12 months
Superior Quality . . . . . 12.98	Guaranteed 18 months
Gold Bond Finest . . . . . 14.98	Guaranteed 24 months
900 x 16 Special . . . . . 9.03	900 x 16 extra . . . . . 11.19

Send check or money order with this ad  
**GOLD BOND TIRE CO., Dept. PM 24**  
 512 NORTH 1ST ST., RICHMOND, VA.  
 "A gold bond written guarantee with every tire"

**CORRESPONDENCE COURSES IN**  
**RADIO and ELECTRICAL ENGINEERING**  
 Tuition \$25

**ELECTRICAL ENGINEERING.** Get good grasp of wide electrical field. Modern. Very understandable. Theory made easy.  
**RADIO ENGINEERING.** Extra fine course in radio, public address, photo-electric work. Trains you to be super-service man, real vacuum tube technician. Tuition ONLY \$25, either course. Deferred payment plan. Servicemen needed badly.  
**FREE** Write for free copies of school catalogs, student magazines, etc.  
**LINCOLN ENGINEERING SCHOOL, Box 931-M11, Lincoln, Nebr.**

**SANDEE**

Mufflers—All Ford, Chev., Ply. . . . . \$4.45  
 All Buick, Pont., Olds., Chrys.,  
 Dodge, Hudson, K.F., Pack., etc. . . . . \$5.45  
 V-8 and Merc. Duals  
 (32-49 incl.)  
**\$15.95**

**SPORTONE MUFFLERS**  
 (Pats. Pend.)

**DURABILITY**

Beautiful SANDEE Fender Skirts \$16.95

DEALERS WANTED

A SANDEE Sportone will outlast two ordinary mufflers and give More Power! More Speed! More Mileage!—plus a tone quality unsurpassed.

Please ship (item): \_\_\_\_\_ Price \_\_\_\_\_  
 Car and Year \_\_\_\_\_ Name \_\_\_\_\_  
 Address \_\_\_\_\_  
**SANDEE MUFFLER CO. 5643 Corryne Pl. Culver City, Calif.**

**SPEED & MILEAGE MANUAL**  
 140 Illustrations



EASILY GET THRILLING ACCELERATION—AMAZING MILEAGE — RACING PERFORMANCE FROM ANY AUTOMOBILE!

Famous New Book shows simplified Soup-up Methods—Speed Tuning—Economy Secrets—Customizing Plans—Latest Track Proven Methods for all cars! Tells how to build your own **SPEED EQUIPMENT! FAST SPORT CARS! "HOTRODS!" 155 MPH ROAD & TRACK CONVERSIONS!** Complete Instructions on building inexpensive Superchargers! Dual Manifolds! "Water Injectors!" Hi-Speed Heads! Twin Mufflers! Economizers! All about—Fast Engines, Gas Saving, Restyling, "Cam Secrets," Multiple Carburetion, Fuels, Porting, Ratios, Frames, "Oxy's!" **BRAND NEW METHODS, Plans, Formulas, "Racing Tricks!" "STOCK CAR SPEED SECRETS!"** Also latest **"HOLLYWOOD CUSTOM STYLING!"** Streamlining! Sport Changes! Lowering! Speed Conversions! Including—California Roadster Plans! Racer Diagrams! Working Drawings! Performance Charts! Graphs! Beautiful Photographs! Etc!

**COMPLETE MANUAL (plus) "California Hot Rod Handbook" and Equipment Catalog—**  
**ALL THREE \$1.98** Post-paid

**ALMQUIST AUTOMOTIVE ENGINEERING, Milford 33, Pa.**

**Learn CARPENTRY BRICK LAYING**

Big money in the Building Trades. Learn now while opportunities are greatest. Train in our completely equipped shops under expert instructors, or by Home Study. Vets attending school entitled to G.I. Benefits. Write for FREE catalog.

**MIDWEST SCHOOL OF BUILDING TRADES, Dept. PM-11**  
 411 N. Center St. Bloomington, Ill.

**MAKE BIG MONEY LEARN TO REBUILD SEALED REFRIGERATION UNITS**  
 LEARN NOW—WE TEACH YOU HOW

MILLIONS of Sealed Units will need rebuilding. Factories usual charge is \$80 to \$100 per unit. We offer a Post-Graduate Course (16 weeks) to graduates of school, or those with few years service experience. **START YOUR OWN BUSINESS.**

**PRACTICAL TRADES INSTITUTE, Inc.** WRITE TODAY  
 25 University Ave., S.E., Dept. P-11, Minneapolis 14, Minn.

**HOT RUNNING WATER!**



Attaches easily, quickly to any standard faucet. Regulates temp. by turning faucet. Operates AC or DC. Comes with 8-ft. rubber cable and plug. Our DELUX heater has delighted many thousands of users. Send \$3.95 cash, check, or M.O. We will ship prepaid or, if you wish, we will ship C.O.D.—you pay postman \$3.95 plus few cents postage. Order 3 for \$10—save \$1.85.

**METROPOLITAN ELECTRONICS CO.**  
 Dept. 114, 106 Fifth Ave., N.Y. 11, N.Y.

Now Only \$3.95

Holes for AIR FLOW



New Automotive Discovery—replaces present idle adjustment screws in carburetor. **OVER A MILLION NOW IN USE.**

**Famous GANE "Air-flow" NEEDLE**

Users report up to 25% MORE MILEAGE, EASIER WINTER STARTING, FASTER PICKUP, PERFECT IDLING. Fits all cars—install in 5 minutes. \$1.50 each (8 cyl. cars take 2) SEND NO MONEY, just mail card with name, address, make of car and carburetor. Needles sent postpaid with illustrated data for FREE TRIAL IN YOUR CAR. MAIL CARD NOW!

**NATIONAL AUTOMOTIVE RESEARCH CO.**  
 BOX 3097-JK, LOS ANGELES 54, CALIFORNIA

**SAVE GAS! FREE TRIAL IN YOUR CAR!**

**SAVE on ALUMINUM LADDERS**



Lowest price in America! Finest quality genuine aluminum step ladders, extension ladders and industrial ladders. Lightweight. Stronger. Lasts years longer. Direct from Mfg'r. Write for literature and FREE TRIAL OFFER; no obligation.

**MORTON METAL PRODUCTS CO.**  
 DEPT. M  
 3517 Gratiot St. St. Louis 3, Mo.

New pat. safety features

**HANDICAST**  
 trade mark



A hollow, non-sinkable, six-ounce, durable plastic "spinning" ring for casting and trolling hand fishing lines. Long tangle-free casts averaging 150 feet with a two ounce weight are easily made. Patent applied for.

Send **\$2.25** for HANDICAST, post-paid and guaranteed, to:  
**THE HANDICAST COMPANY**  
 Main P. O. Box 5254 Cleveland 1, Ohio  
 (Dealer Inquiries Invited)

**NEW for 1950**

# MIDWEST

Celebrates its 30th YEAR of FACTORY-TO-YOU Selling with a Sensationally NEW 1950 LINE of

# TELEVISION

CONSOLES and Complete CHASSIS

**New GIANT 16" PICTURE**

Here is Television at its finest! . . . brought to you by Midwest, for 30 years a leader in the field of radio and electronics. Immense 151-square-inch screen on new 16" metal-glass tube . . . clear, steady, bright pictures . . . Synchronized sound and picture that a child can tune in perfectly . . . Highest quality FM sound . . . Big 12" Electro-Dynamic Panasonic Speaker. Available in beautiful Television-Radio-Phonograph Consoles, as illustrated, or in complete chassis (not a kit) ready for custom installation in your own cabinet. And you can buy Midwest Television at Low Factory Prices, with Low Down Payment and Long Easy Terms — and on 30 Days Trial! Send for Catalog TODAY!



**NEW LOW**  
Down Payment  
Long EASY TERMS

**30 DAYS TRIAL**



LOW FACTORY TO-YOU PRICE

... also a Magnificent Line of NEW 1950 **MIDWEST RADIOS** featuring the latest Improved FM Circuit and the New 3-SPEED RECORD PLAYER

Powerful new 1950 Series 16 and Series 12 AM-FM Radio in complete chassis. Also beautiful new Console models including the magnificent Symphony Grand Radio-Phonograph with latest FM circuit and new 3-Speed Automatic Record Player.

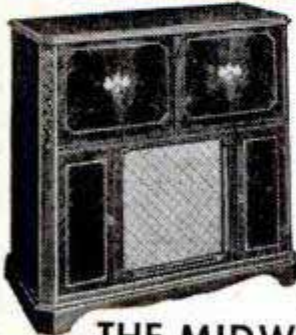
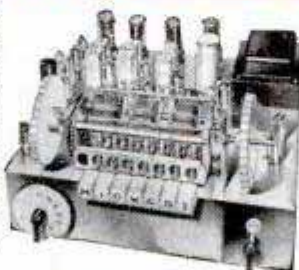

BUY DIRECT FROM THE MIDWEST FACTORY and **SAVE!**

**MIDWEST RADIO & TELEVISION CORP.**

Dept. X254, 909 Broadway, Cincinnati 2, Ohio

SEND FOR **FREE** 32-Page Full Color CATALOG



Write in Name and Address (Please Print) on Coupon or 1c Postcard.  
MIDWEST RADIO & TELEVISION CORP.  
Dept. X254, 909 Broadway, Cincinnati 2, Ohio  
Please send me your new FREE 1950 Catalog.

NAME \_\_\_\_\_  
ADDRESS \_\_\_\_\_  
CITY \_\_\_\_\_ ZONE \_\_\_\_\_ STATE \_\_\_\_\_

# TODAY'S "GOLD MINE" A REAL BONANZA!

## SENSATIONAL INVENTION Proved All-time Best Seller!

Ends cleaning drudgery forever! This amazing Artmoore invention Fully Patented, scrubs, sweeps, mops, washes walls, waxes floors! No stooping or kneeling! Wrings automatically. Hands never touch water. Hundreds of thousands sold until war cut off materials. **NOW BACK AGAIN and Selling Faster Than Ever.** Former distributors ordering again in one, two and three gross lots. New dealers and distributors clamoring for rush orders. **Hurry! GET THE FACTS ABOUT THE BIGGEST MONEY MAKER OF THE YEAR.**

## Exclusive Territory to Responsible Distributors and Crew Managers

Nothing so sensational in years! Guthmuller sold 21 in a single order. Boehme, took 20 orders from 17 customers. McIntyre cleared \$800 in one month. Many others producing top earnings of their lives. A chance for **DISTRIBUTORS and CREW MEN** to make similar sensational returns in **EXCLUSIVE and PROTECTED** territories. Mail coupon today!

**A. L. MOORE, Pres., ARTMOORE COMPANY**  
Dept. 411, 1319 N. 3rd St., Milwaukee 12, Wis.



National Advertising supports you

GOOD HOUSE-KEEPING  
BETTER HOMES & GARDENS  
FARM JOURNAL  
POPULAR MECHANICS

Mail this for **FREE** Information

Rush full particulars about the New Art Cleaner, and details of your exclusive territory Offer for Distributors and Crew Men. No cost or obligation in getting the facts. No franchise is sold.

**A. L. MOORE, Pres.,  
ARTMOORE CO., Dept. 411,  
1319 N. 3rd St., Milwaukee 12, Wis.**

Name \_\_\_\_\_  
Address \_\_\_\_\_  
City \_\_\_\_\_ Zone \_\_\_\_\_ State \_\_\_\_\_

## A Vital New Book for Radio Men! TELEVISION Servicing

Get This Much Needed Book Now and Keep Up-to-Date ☆ Helps You Earn More

Television Servicing by Manly is for the professional radio man. It starts where the radioman's knowledge and experience with AM sound receivers stops and provides simplified instruction, easy to follow, on all service operations. If you are in radio work get this timely book now. Protect your job and your future with **TELEVISION SERVICING**—the complete TV service manual. Covers alignment and other adjustments, replacements, test setups and connections, and trouble shooting with test patterns and oscilloscope traces. Includes instructions for using sweep and marker generators, oscilloscopes, and electronic voltmeters in such work. Over 400 pages. 302 illustrations. (Book No. 1) \$4.00.



### Other Drake Books for Radio and TV Men

**Cyclopedia of Radio and Electronics**  
A complete, easy to understand, reference-instruction book. Standard radio, high frequency and UHF, public address and sound, television, phototubes, industrial electronic tubes, and applications. 764 pages, 900 illustrations, tables and graphs, all especially prepared for this book. (Book No. 2) \$6.00.

**Electrical and Radio Dictionary**  
More than 3800 definitions of the technical words and terms used in all branches of radio, including aviation, navigation and industrial control, photo-electricity, photocell applications, sound pictures, public address systems, television, telephotography, electricity and magnetism. 300 pages, 550 illustrations. (Book No. 3) \$3.00.

## MAIL COUPON NOW

**FREDERICK J. DRAKE & CO., Dept. 18**  
117 Green Bay Road, Wilmette, Ill.

Send me the books checked below. If not satisfied I will return them in 5 days and money will be refunded.

1 \_\_\_\_\_ 2 \_\_\_\_\_ 3 \_\_\_\_\_ (Circle Numbers Wanted)  
 Check or Money Order enclosed \$ \_\_\_\_\_ Send books postpaid.  
 Send C.O.D. plus postage.

Name \_\_\_\_\_

Address \_\_\_\_\_

City \_\_\_\_\_ State \_\_\_\_\_

Drake's Books are Sold by Leading Booksellers

# A BIG BOOK BUY!

For Every Home Craftsman

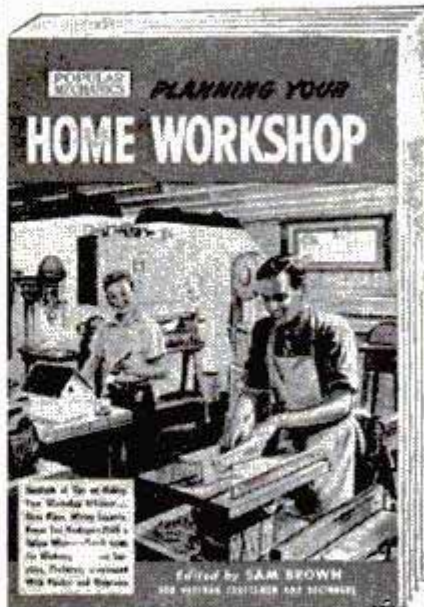

- FLOOR PLANS
- POWER TOOLS
- HAND TOOLS
- MOTOR HINTS
- SHOP LIGHTS
- WORK BENCHES
- TOOL CABINETS

## PLANNING YOUR HOME WORKSHOP

Edited by **SAM BROWN**

Only Sam Brown and Popular Mechanics could give you such a book as "Planning Your Home Workshop," for these are magic names in the world of craftsmanship. Brown is a recognized authority and author of many articles and books on home workshops, advisor to power tool manufacturers and a man who has worked with every type of power tool, with all kinds of materials, and has a world-wide reputation for excellence in fine craftsmanship.

Planning Your Home Workshop is a "must" for the beginner and the experienced home shop worker, for no other book gives such complete information on shop layout and maintenance.

### Your Shop — Layout — Equipment and Practical Shop Maintenance

This book shows how to set up a shop on a limited budget, how to avoid costly mistakes by buying the right tools, where to get the tools you need and want, what size and type to select, the basic "big-six" power tools, what hand tools to buy, floor plans and layouts to suit available space and facilities, the best use of electric motors, shop furniture you can build, hobbies for the home workshop, a selection of projects, and many other subjects. It contains 128 pages with more than 250 photos and 100 detailed scale drawings, many in colored line.

**POPULAR MECHANICS PRESS** 200 EAST ONTARIO STREET  
CHICAGO 11, ILLINOIS

Gentlemen: I enclose \$2.50. Please send me my copy of *Planning Your Home Workshop* in sturdy cloth binding.

(Name) \_\_\_\_\_

(Address) \_\_\_\_\_

(City) \_\_\_\_\_ (Zone) \_\_\_\_\_ (State) \_\_\_\_\_

GIVE A GIFT YOU'D LIKE TO RECEIVE

# Alvacord Electric Blanket \$9.95

MAKER ONLY POSTPAID

**Controlled Warmth . . . Complete Safety**

Now you can afford electric blanket comfort on every bed in the house. With Alvacord, you actually make your own . . . using blankets you already have. 30" long Alvacord is the same type of waterproof heating unit employed in most expensive electric blankets . . . uses less power than a 75-watt bulb . . . plugs into any AC outlet. Built-in safety-stat positively prevents overheating. Adjustable to 12 different heats.

**MONEY BACK GUARANTEE . . .** If local dealers do not have Alvacord, order direct. Send \$9.95 (check or m.o.) and we will ship postpaid complete with 12 "Stay-Put" Fasteners to hold Alvacord in place. Or, send \$2 now, pay postman balance plus postage. Money-back if not delighted after 5-day trial.

Uniform heating for both sides of double bed.

ONLY ALVACORD GIVES YOU ANY HEAT PATTERN YOU NEED.

Foot warmer for two with no body heat.

**ALVA T. SMITH COMPANY**  
DEPT. 139-L \* 161 W. WIS. AVE.  
MILWAUKEE 3, WIS.

Grow Royal squabs in only 25 days, they sell for highest prices, poultry tops, large profit. Write today for **FREE TOP** Book good food starter, our prices, easy directions, opportunity success methods of money making breeders in every State. Start now. Our 49th year. **RICE FARM, 634 H. St., Melrose, Mass.**

**HIGH POWER TELESCOPE**  
60 POWER - ALUMINUM TUBES - OPENS TO 33"

Variable Power Eyepiece Adjustable to 15X, 30X and 60X.

**\$4.50** Leather Case Included

5 Sections. 4 Ground & Polished Lenses. Also used as 50X Microscope. Ready to use, only \$4.50 POSTPAID.

**BROWSCOPE CO. Dept. 11M, 24 W. 45th St. NEW YORK 19, N. Y.**

**RADIO ENGINEERING**, Broadcasting, Television, FM, Servicing, Electronics, Aviation, Marine & Police Radio taught thoroughly. Engineering course equivalent to 3 years' college radio work. Approved Veteran Training. Catalog free.

**VALPARAISO TECHNICAL INSTITUTE, Dept. D, Valparaiso, Ind.**

**"PLASTICS"**  
**Fabricating Manual and Catalogue**

Work in a fascinating and profitable hobby. Just out—our latest fabricating manual. Tells you how to work with Plastics. Our new Catalogue provides all needed materials: Plexiglas — Lucite — Tenite — Catalin — Acetate — all in sheets, rods, and tubes. Complete line of cements, dyes, accessories and supplies. Send 20c today for 1949 Catalogue and Handbook.

**HOUSE OF PLASTICS**  
8648 Linwood Avenue Dept. PM11 Detroit 6, Michigan

Drive a **FORD** and **Feel the DIFFERENCE!**

**HELPFUL BOOKS**

Send post card asking for **FREE catalog**  
Popular Mechanics Press, 200 E. Ontario, Dept. 601, Chicago 11

**Giffy ELECTRIC HEATER**

**HOT WATER IN FIVE MINUTES**

For baby's bath, your washing, shaving and many other uses in the home, camping, business or on the farm.

**One Year Guarantee**  
See your local Dealer or order direct . . .

**AMBORY CORPORATION**  
Dept. MP-6 Hazel Park, Michigan

**Get... YOURS FREE!**

**AMAZING NEW Miracle Finish**  
MEANS \$\$\$ TO YOU

**BOOKLET OF COMPLETE COAST INDUSTRIES PROFIT PLAN**

**Coast Industries**

**NELS IRWIN**  
Will help you start your own successful business — at home, spare time or full time

**BIG PROFITS**

Rich profits are waiting to be tapped in this new field. New **MIRACLE** finish gives a velvety, luxurious surface to radios, lamps, toys, signs, store displays, figurines, auto dashboards, and hundreds of other items. Make old objects beautiful and salable—make new things worth much more with this soft, rich covering that can be applied to any surface, even if old and worn.

**START RIGHT AWAY**  
Yes, you can learn in a few days to start **MAKING MONEY!** Everything you need is furnished, including fully detailed, illustrated instructions that are complete and easy to understand. Every point is explained, to show you how to start on the road to big money, full or spare time, right in your own home.

**EVERYTHING COMPLETE**  
In addition to full instructions you get a complete set of materials that enables you to start at once. A few cents worth of materials can mean many dollars in return to you—you can earn up to \$5 per hour and more spare or full time. Add to your income from your present job or start a profitable business of your own. Our Business is Booming. Help us fill **HUGE DEMAND.**

**ACT NOW**  
Grasp this opportunity **TODAY!**—Start your own business. It's too good to miss! **SEND NO MONEY!**—fill out the coupon and stick it on a post card or in an envelope and mail today for full details. **FREE** samples of **FLOK-KRAFT** covered material, and hundreds of useful and profitable **IDEAS** Do it **NOW!**—be first!

**COVERS WOOD, FABRIC, METAL, GLASS, PLASTER, PLASTIC OR ANY SURFACE**

**TOYS**  
**JEWELRY BOXES**  
**CAR DASHBOARDS**  
**DISPLAY PIECES**

**LAMPS**  
**CAR TRUNKS**  
**RADIOS**

**FLOK KRAFT**

**USE COUPON FOR FREE SAMPLE**  
**COAST INDUSTRIES** Dept. 2-B  
1004 S. Los Angeles St., Los Angeles 15, Calif.

Gentlemen: Please rush me all the details.

**NAME** \_\_\_\_\_

**STREET** \_\_\_\_\_

**CITY** \_\_\_\_\_

**STATE** \_\_\_\_\_

# Build This 5-Room Concrete Block House Yourself - Complete for less than \$3650

**Popular Mechanics  
Home of the Year**

Has All These Features

- ★ Five Finished Rooms plus Bath and Three Closets
- ★ Concrete Block Walls—Poured Concrete Floors—Vapor-Sealed
- ★ Walls Stuccoed Outside—Fully Plastered Inside
- ★ Complete Heating and Plumbing Equipment and Electric Wiring
- ★ Modern Cabinet Kitchen
- ★ Insulated Ceiling

Build-It-Yourself Book and Set of Building Plans, Only \$12.50



## Beat the High Cost of Home Owning! No Experience Needed! Follow Book and Plans! Save Thousands of Dollars!

If you can mix a batch of concrete following simple instructions, and saw a board straight you can build this new Popular Mechanics concrete block house yourself. Yes Sir! In a few months of spare time you can laugh at the housing shortage and save several thousand dollars while acquiring a home you will be proud to own.

Like Popular Mechanics' famous Build-It-Yourself frame house introduced in 1947, a new BUILD-IT-YOURSELF BOOK for this five room Concrete Block House is now ready, along with a full size set of building blueprint plans. The book covers every construction detail and the plans are so simplified, so easy to follow, that you need have no experience to do a fine workman-like job. On the other hand, if you want to hire a contractor or an ordinary builder, have him follow these plans and still enjoy a tremendous saving. Read further about this fine permanent type house. See how easy you can build it and own it yourself. Order book and plans on coupon below.

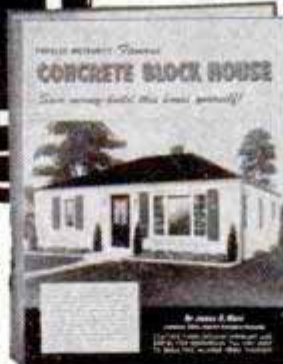
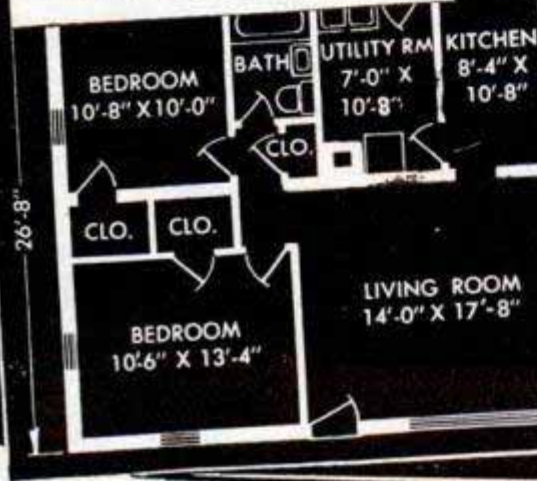

## Start Planning Now!

**It's Easier Than You Think  
to Own Your Home**

### IDEAL FOR FAMILY OF FOUR

Popular Mechanics Build-It-Yourself Concrete Block House is 26'-8" deep by 32'-8" wide. It has 675 square feet of comfortable living space — living room, two bed rooms, cabinet kitchen, utility room, bath and three closets. Built in a Chicago suburb, a relatively high price region, in a high price year, its total cost was less than \$3650.00 including all material, heating, plumbing and electrical equipment and outside labor for installing the equipment and plastering all rooms. In many localities it can be built for even less and additional savings can be made by using less expensive bath and kitchen equipment.

### LONG LIFE MATERIALS — EASY UPKEEP

Construction is concrete throughout —poured concrete floors and concrete block walls—both vapor sealed for insulation—construction that requires no special skill. Walls are furred-out and plastered inside, stuccoed outside. Ceiling is insulated. Only a very minimum of carpentry is required—

simple shingled hip roof, door frames and trim, which almost anyone can do. Interior doors are new flush type. Hot air heating plant may be gas, oil or coal-fired. Hot air ducts terminate in ceiling, cold air ducts are tile laid under the floor.

### EASY TO BUILD — EASY TO OWN

Every part of the construction is simplified and thoroughly explained in the BUILD-IT-YOURSELF Book, from the turning of the first shovel full of earth to the last flick of the paint brush. It is written in plain, understandable terms and packed with pictures and diagrams that make every construction detail simple as ABC. The book also tells how to make your own concrete blocks, how to select and buy a lot and how to build a house of bricks. Book and set of ten working blueprint plans are all you need to get started and enjoy the thrills of home owning, doing the job yourself and saving money too. Book, \$2.00. Set of plans, \$12.00. See coupon for special money-saving offer when both are ordered together.

### USE THIS COUPON TO GET BUILD-IT-YOURSELF BOOK AND PLANS

Popular Mechanics Press, Dept. 600  
200 East Ontario Street, Chicago 11

Send postpaid, the items checked. Remittance for \$\_\_\_\_\_enclosed.

- Build-It-Yourself Concrete Block House Book \$ 2.00
- Set of 10 Builders Blueprint Plans . . . . . 12.00
- Book and Plans ordered together (Save \$1.50) . . . . . 12.50
- Extra sets of plans—each . . . . . 5.00

Name \_\_\_\_\_

Address \_\_\_\_\_

City \_\_\_\_\_ Zone \_\_\_\_\_ State \_\_\_\_\_



# PISTONS



**ALUMINUM ALLOY.** For Every Make Engine. Any Year, Odd or Foreign! For auto, "hot rod", racing, truck, tractor, motorcycle, scooter, bike, outboard, marine, compressor, industrial. Send sample or specifications.

**JUDSON MFG. CO., 1709 Gillingham, Phila. 24, Pa.**

## LEARN WATCHMAKING JEWELRY REPAIRING

Start your training now for a better paying job or your own profitable business. Intensive practical training by experienced craftsman. Write for free catalog. APPROVED FOR VETERANS.

**SCIENTIFIC SCHOOL OF WATCHMAKING, DEPT. PM-11**  
3923 SAN FERNANDO ROAD GLENDALE 4, CALIFORNIA

# WAR SURPLUS BARGAINS

Substantial Savings on WAR SURPLUS and other MERCHANDISE OVER 200 TIMELY ITEMS

**FREE CIRCULAR** **SIoux FALLS SURPLUS STORE** **SIoux FALLS S.D.**

## FIX ANYTHING ELECTRICAL!

Insure against hard times with amazing new electrical appliance repair method. Even beginners can fix electrical appliances double quick. At sensational low price, you get training course and new simplified electrical tester. Send postal card for details. No obligation.

**FEILER ENGINEERING CO., Dept. IIPM9, 945 George St., Chicago 14, Ill.**

# HELPFUL BOOKS

Send post card asking for FREE catalog

Popular Mechanics Press, 200 E. Ontario, Dept. 601, Chicago 11



## 40 NEW EDITION Power Tools YOU CAN MAKE

**TURN WOOD, SCRAP AND WASTE INTO PRACTICAL POWER SHOP TOOLS**

Don't limit your workshop fun to use of hand tools. Get the new edition of "Forty Power Tools You Can Make" with many new tools, and make your own power machines. Step up your fun and production. Do a better job with power tools. Make them yourself from wood and old discarded materials at small cost.

This book gives every detail in plain language you can understand and follow. Hundreds of pictures and plans show every step to follow. Mail coupon with \$1.50 today. Even though you have the old edition get this new book with 20 new tools. Money back if not satisfied.

# 40 Power Tools

You Can Make at Little or No Cost

Some of the 40 Tools You Can Make

- |                                |                           |
|--------------------------------|---------------------------|
| Table Saw with Tilting Arbor   | Wood Lathe                |
| Saw Sander Unit                | Power Hack Saw            |
| Drill Press from pipe fittings | Double Duty Sander        |
| Bending Brake                  | Jig Saws                  |
| Thickness Planer               | Band Saws                 |
|                                | 40 Different Tools in All |

POPULAR MECHANICS PRESS, Dept. 4000  
200 E. Ontario St., Chicago 11

Send the new edition of "Forty Power Tools You Can Make."

Remittance for \$1.50 enclosed.

Name \_\_\_\_\_

Address \_\_\_\_\_

City \_\_\_\_\_ Zone \_\_\_\_\_ State \_\_\_\_\_

# PLASTICS

EVERYTHING YOU NEED UNDER ONE ROOF!

**SPEEDEE-BUFF**  
A liquid hand compound—contains abrasives.  
4 oz. . . . \$0.60 1 pt. . . . \$1.75

**PL-1 PLEXIGLAS—LUCITE CEMENT** Apply with brush, eye dropper or hypodermic needle. 30-second action. Permanent bond, no discoloration.  
2 oz. . . . \$0.35  
1 pt. . . . 1.50  
1 gal. . . . 5.10

**INTERNAL PLASTICS CARVING DRILLS** Special precision, machine made, tapered drills ground to perfect points, sharp cutting edges.  
**DIAMETER EACH DOZEN**  
1/16" . . . . \$0.95 \$10.45  
3/32" . . . . .95 10.45  
1/8" . . . . . 1.00 11.00

**CUTTERS** Selected small cutters, precision made for detailed carving.  
**SHANK EACH DOZEN**  
3/32" Round, Plain \$0.30 \$3.00  
3/32" Flame . . . . .60 6.00

**HANDEE TOOL**  
Our best recommendation for a carving tool. 25,000 rpm—Easy to handle, built to withstand carving usage. Complete with 7 accessories (not drills) \$20.50

**CRYST-L-CRAZE**  
Newest decorative coating. Easily applied by brush. Gives beautiful crystallized pattern—White or colors—to plastics, glass, copper and ceramics. Tops for "Jack Frost" Christmas decorations.  
2 oz. . . . . \$0.45  
1 pt. . . . . 1.75  
1 qt. . . . . 3.10  
1 gal. . . . . 10.90

**JEWELRY FINDINGS**  
**EAR WIRE** Dozen \$0.35 Gross \$3.75  
**PIN BACK** Safety catch—with holes or prongs. Size 3/4" and 1". Dozen \$0.35 Gross 3.75

**BEAUTY PIN**  
Dozen . . . . \$0.12  
Gross . . . . 1.05

**FOUNTAIN PEN, FUNNEL-SWIVEL** (For Desk Set) Funnel-Swivel Pen Each \$0.60 Dozen 6.00

**SCREW EYE** Dozen \$0.30 Gross 3.10

**Pen** Each \$0.55 Dozen 5.50

**CLARO-CAST**  
A clear liquid casting plastic for imbedding insects, flowers, coins, etc. Tops for casting novelties.  
1 pt. . . . . \$1.95  
1 qt. . . . \$3.75 1 gal. . . \$16.00  
Instruction book—\$0.20

**PLIA-FLEX**  
A flexible liquid, air-dry mold material. Ideal for plastic molds. Price, 4 oz. \$ .75; pt. \$1.95; qt. \$3.60; gal. \$8.50.

**DYE** Deep, rich colors blend beautifully, dropper cap. Red, Old Rose, Fuchsia, Yellow, Green, Blue, Orchid, Black, Brown, Fluorescent Red. 1 oz. 30c; 4 oz. \$1.00; pt. \$2.75; gal. \$8.75.

**BACKING MATERIAL FOR CARVED PIECES**  
Jet black and solid or translucent white, Plexiglas or Lucite 1/16" thick.  
3" x 6" . . . . .each \$0.22  
12" x 12" . . . . .each 1.69

**FILL-IN POWDER**  
Fills cavity before coloring. Seals cavity before backing. 2 oz. . . \$0.50 8 oz. . . \$1.75  
"Internal Carving in Plastics" Complete course of instructions by an expert, H. A. Zosack. Only \$1.50

**PRACTICE BLOCKS**—Plexiglas and Lucite. Special price—\$1.00 lb.  
5 lb. . . \$4.75 10 lb. . . \$9.00

**PROJECT BLOCKS**  
Lucite and Plexiglas, polished 2 sides only.  
**THICKNESS SIZE PRICE**  
3/8" 1" x 1" \$0.08  
1/2" 2" x 2" .26  
1" 1" x 1" .14  
1 1/2" 1 1/2" x 1 1/2" .45  
2" 2" x 2" .80  
3" 3" x 3" 2.15

**METALLIC ACETATE**  
Colors: gold, silver, red, blue, green, fuchsia, lime  
aquamarine, chartreuse, iris, orchid, black, rose, pink, pink, purple, white, bronze, ice blue, multi-color

Newest thing in plastics craft material. Make costume jewelry, flowers, book covers, etc. Sheets 10" x 25" . . . . \$0.85 20" x 50" . . . . \$3.00

**FOR PLASTICS "KNOW-HOW..."** Latest book by Cherry. Recommended for all-round "how-to-do-it." . . . . \$1.50

**PLASTIC JEWEL BOX**  
Size 3 1/2" x 3 3/4" x 1 1/4". Modern style jewelry boxes add richness, charm to any merchandise. Each . . \$0.15 Dozen . . \$1.50



**COMPLETE CATALOG FREE!** A catalog of plastics supplies for the hobbyist. Everything in plastics under one roof—at prices you can afford. GET YOURS NOW!

**TO ORDER,** send check or money order. Add 15% of order to cover postage. (Any postage overpayment will be refunded.) Send 25¢ deposit with C.O.D. orders.

**FRY PLASTICS CO.—Dept. 711**  
7612 So. Vermont—Los Angeles 44, Calif.

# FREE!! HOW TO MAKE BIG MONEY

**METALIZING BABY SHOES AND OTHER PRECIOUS KEEPSAKES AT HOME**

FREE FACTS SHOW HOW TO MAKE \$5 PER HOUR, UP TO \$25—\$50 PER DAY. START EARNING AT ONCE. YOUR OWN BIG PAY BUSINESS STARTED AT HOME ON A SHOESTRING. DON'T PASS THIS UP. WRITE FOR FREE DETAILS TODAY!

KIKTAVI CO.

2111 W. MANCHESTER, LOS ANGELES 47, DEPT. PM-11

## COMPLETE LOCKSMITH SHOP *only*

**ALL NEW MERCHANDISE! \$99.00**  
POPULAR STANDARD EQUIPMENT

**START YOUR SHOP NOW!** At Home, Garage, Basement, or rent a small store, or add a key department to your present business.

- |   |   |
|---|---|
| 1 Precision key machine complete with three cutters | 3 Locksmith instruction books             |
| 1 Heavy plywood key display board with 100 hooks    | 1 Automotive lock manual                  |
| 1000 Popular key blanks and cut keys                | 1 Assortment of pins and springs          |
|   | 1 Assortment of disc tumblers and springs |
|   | 1 Misc. set of locksmith tools            |

**ALL FOR ONLY \$99.00 — EASILY WORTH \$130.00!**  
Slightly higher out of U.S.A. 25% deposit on C.O.D. orders. Start making money at once! Order your outfit today! Complete satisfaction guaranteed. Write for FREE Catalog today!

REPAIR SHOP SERVICE • Box 264X • Skokie, Ill.

## MAKE MONEY IN LANDSCAPING

Thorough training by Internationally known Landscape Architect to start your own business, improve your home or advance in this well paid field. Many Opportunities. Approved for Veterans. Send for FREE BOOK.



**NATIONAL LANDSCAPE INSTITUTE**  
Dept. P-11, 310 So. Robertson Los Angeles 36, Calif.

## WIRING MADE EASY!

At last—A Great New Handbook that Shows You How to Plan, Install and Repair Every Type of House Wiring

### PRACTICAL RESIDENTIAL WIRING

By JOHN F. NOWAK

Here it is, a practical, authoritative book on house wiring, which you can use to do complete electrical jobs—from the smallest repairs to the wiring of an entire home. It begins by showing you how to draw electrical diagrams, and proceeds, step by step, through every type of present-day installation. The National Electrical Code is clearly applied to every operation, insuring that everything you do fulfills Code requirements.

Throughout this great handbook each job is explained in plain English and illustrated by hundreds of hands-at-work photographs. See for yourself how completely this book covers every detail of planning, installation, repair, and maintenance. Mail the coupon now for a FREE 10-day examination of this complete, brand-new handbook.

#### MAIL THIS COUPON

D. Van Nostrand Company, Inc. EXAMINE THIS BOOK FREE!  
250 Fourth Avenue, New York 3, N. Y.

Please send me "Practical Residential Wiring" on approval. Within 10 days I will either return the book without obligation or send you \$1.95, plus a few cents postage, and \$2.00 per month for 2 months thereafter. (If you send the entire amount of \$5.95 with this coupon, we will pay the postage. Same return privilege and refund guarantee.)

SEND NO MONEY

Name \_\_\_\_\_  
Address \_\_\_\_\_  
City \_\_\_\_\_ Zone \_\_\_\_\_ State \_\_\_\_\_

PM 11-49

## MICRO-VOX . . . . THE WIRELESS "MIKE"

Broadcasts Over Any Radio Within 50 Feet!

Here's a fascinating complete miniature transmitting system that will delight everyone! Round table discussions . . . Baby listener . . . Practical jokes and dozens of other uses that will astonish one and all! Complete with tube, batteries, tuner and built-in high-fidelity microphone. Clear, life-like tone. Easy to operate!

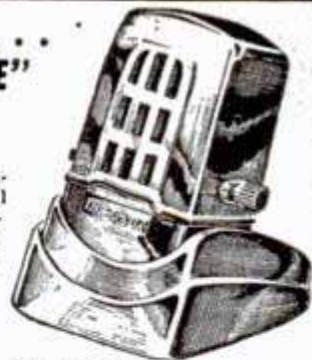

SAVE MONEY! Send Check or M.O. \$6.95 COMPLETE  
We Pay Postage. C.O.D. Plus Postage.

TRUSOUND, INC. (Dept. PM-11) 630 W. Randolph St. Chicago 6, Ill.

## Announcing the King Oscillator Razor

The moving blade feature is the only device which automatically 'Shears Off' your beard with a smooth, square, even cut at the skin line. No more ingrown hairs. No more raw, chafed, scraped skin. Real shaving comfort. Less than 1/2¢ per shave.

RAZOR SALES CO.  
LIVINGSTON, N. J.  
Agents Wanted  
Satisfaction Guaranteed



98¢  
POST PAID

EVERYTHING YOU NEED FOR

## INTERNAL CARVING of PLASTICS

Plastic hobbyists, attention. Here under one roof you can get everything you need for carving plastics. Plexiglas plaques, cubes, and other shapes—cut to sizes you want, and expertly polished on all sides—various shaped blanks for shellcraft and engraving, tools, drills, dyes, filler, etc. Lowest prices. Rush 10¢ today for brochure.

Get 6 page brochure packed with pictures, prices of complete line, including ready-to-carve gift items. SEND TODAY FOR YOUR COPY! Only 10¢

D. W. COPE—Plastics 7401-M Marillac Drive, St. Louis 21, Mo.



## AMAZING NEW MAGIC CATALOG

350 pages of mystifying, easy-to-do tricks and illusions. 600 illustrations. Send \$1.00 now for catalog, credited on your first \$5.00 purchase.

NATIONAL MAGIC CO.

119 S. State St. Dept. M-11 Chicago 3, Ill.

## PLAIN TALK HEARD 1000 FT. AWAY!

Amazing new LOW COST INTERCOM PHONE carries natural voice clearly up to 1000 ft. away. Great time saver. Fun too! Talk room to room, basement to attic, house to barn, etc. Super Fone is ideal for home, store, shop, etc. Plug in on regular 110v. current, AC or DC. No battery needed. Place call boxes anywhere. Complete 2 station outfit as shown, wired ready for use, only \$29.95. Extra stations \$9.95 each. Send only \$1 with order, pay balance C.O.D. plus postal charges. Or remit in full for PREPAID shipment. Satisfaction or Money Back. Agents Write. SUPER MFG. CORP., Dept. M-11, Chicago 24, Ill.



## TURN SPARE TIME INTO PROFIT

with our RUB-ER-SPRA. Make Genuine Rubber Molds that cost ONLY A FEW CENTS EACH and then cast thousands of FAST SELLING NOVELTIES. Make Money Fast . . . Send 25¢ for catalog. KEN-DOR STUDIO, 949 George St., Dept. P-11, Lake Geneva, Wisc.



## MASTER MIND!

Learn Short-Cut Mathematics

Juggle figures, do baffling number tricks. Make people gasp at your marvelous lightning-quick mind. Multiply 4 figures by 4 figures without using old-fashioned multiplication! Big cloth-bound volume; fully illustrated course. Includes worked-out problems, answers, etc. Sensational bargain, only \$1.49, postpaid—or COD plus postage. Satisfaction guaranteed or refund. Order this amazing "Short-Cut Mathematics" today!

NELSON-HALL CO., 1139 S. Wabash Ave. \$1.49  
Dept. 2L-2 Chicago 5, Ill. Complete

# How to get Finishes like PROFESSIONAL DECORATORS



Use "TACK CLOTH" Before You Paint or Varnish and get a **PERFECT FINISH EVERY TIME!**

You've admired the beautiful results Professional and Industrial Finishers always get. Now you can get this same "professional finish" when you paint, varnish or lacquer wood-work or furniture at home. Just do like Professionals do—always use "TACK CLOTH" before you paint. This removes every trace of lint, dust or sand, so the finish never shows a sign of a speck, or spot. Saves hours of pre-cleaning time, too! Get "TACK CLOTH" today. To introduce to home users send only 81 for 4 large 18" x 36" cloths. Same as those supplied by millions to industrial finishers. Just send name and \$1.

**BAUGHN CHEMICAL PRODUCTS CO.**  
7025 N. Ravenswood Ave. Dept. 211  
Chicago 26, Ill.

**4 FOR ONLY \$1**  
LARGE SIZE  
18" x 36"  
4 cloths should last Several Months

## WHAM-O SPORTSMAN

HITS LIKE A .22 RIFLE — KILLS RABBITS, SQUIRRELS. For Hunting, Target, Roving Pests.

**\$1.00** postpaid

Dealers Write



HUNTING SLINGSHOT

Powerful, silent, accurate.

Complete with 40 pellets and extra rubber straps. Send \$1.00 today to—

Wham-O Mfg. Co., Box 12N, South Pasadena, Calif.  
PROFESSIONAL MODEL OF THE NAT'L SLINGSHOT ASSN.

## CARTOONING

HAVE FUN! MAKE MONEY! Cash in on your sense of humor AT HOME—BY MAIL. No experience needed to start. Write today FOR FREE TRIAL LESSON and full particulars. Moon Gag Cartoon School, Dept. D, Fall Creek, Wis.



## MAGIC ICE CARPETS

No More Stalling on Icy Streets

No more pushing, tugging, rocking. Just slip Magic Ice Carpets in tracks of rear wheels and roll away! 4 layers of woven steel wire give positive traction. Galvanized. Won't harm tires. Size 28"x5 1/2". Wonderful Xmas Gift. Order for yourself, too. **\$1.25** Per pair, only.

Add 15c for postage

Wonderful Xmas Gift THE PECKS, 930-P E. 50th St., Chicago 15, Ill.

## RUPTURE RELIEF

Advanced method. No leg straps, no elastic, no steel. Entirely different. Guaranteed. Write:

SMITH MANUFACTURING COMPANY  
DEPT. PM PRESTON, ONT., CAN.

## HELPFUL BOOKS

Send post card asking for FREE catalog

Popular Mechanics Press, 200 E. Ontario, Dept. 601, Chicago 11



gets you there F-A-S-T

75 miles per gal.

CUSHMAN MOTOR WORKS LINCOLN, NEBR.

## WONDERFUL GIFT!

Quick! Convenient! Handy for going to and from work, running errands, making deliveries, etc. A wonderful Christmas gift! Safe! Dependable! Economical! Costs less than 1/3¢ per mile to own, operate, maintain. See your dealer or write Dept. PM-11 for facts.

## Play GUITAR in 10 DAYS

OR GET YOUR MONEY BACK!



Let Ed Sale, top radio guitarist, teach you to play with his famous diagram-photo system. Book contains 53 photos, 45 diagrams showing exactly how to place your fingers. Gives you 110 popular songs, words and music—along with complete, easy to learn instructions. Imagine your joy when you find after only two weeks you are playing beautiful music! Amaze your friends! Be the life of the party! SEND NO MONEY. Pay Postman \$1.95 Plus Postage. INSTRUMENTS SUPPLIED on cash or credit, ask for Price List and Credit Plan. ED SALE, Dept. 6, Point Pleasant, New Jersey.

# America's Famous PAY RAISING BOOKS

Step up in your job. Prepare for a better job—bigger pay. Do as thousands of others have done—get the extra money you want with the help of these famous books. This can easily be the golden opportunity you have waited for. Order today. Money back if not satisfied.

**DYKE'S AUTO ENCYCLOPEDIA (1)**  
Complete instruction in auto mechanics with special emphasis on trouble shooting, testing, adjusting and repairing. New edition includes passenger car specifications, 1948 trucks, buses, tractors, diesels, Buick Dynaflo and other new developments. 1483 pages, 4800 illustrations... **\$7.50**

**AUTO BODY AND FENDER REPAIRS (2)**  
Covers the entire field including tools, equipment, approved methods and materials. Shows how to do a real professional job and make money keeping cars new-looking in business for yourself or on a good pay job. 325 pages, 232 illustrations... **\$3.50**

**AUTO SERVICE MANAGEMENT (3)**  
New book gives every detail of profitable auto service management. Shows how to get a business started—how to raise capital—how to operate and make money. Only book on the subject and recommended for all men who want to advance to managerial positions. 470 pages, 223 illustrations... **\$5.00**

**GAS AND ELECTRIC REFRIGERATION (4)**  
Covers repairs, adjustments, replacements and overhauling every type of domestic, commercial and industrial equipment. 17 working diagrams in 6 to 8 colors. Most complete and widely used book on the subject. 928 pages, 408 illustrations... **\$5.00**

**DYKE'S CARBURETOR BOOK (5)**  
Use it to become a specialist in auto engine tune up. Covers carburetion, ignition, fuel pumps, valves, etc. 233 pages, 549 illustrations... **\$3.50**

**VOCATIONAL MATHEMATICS. SHOP ARITHMETIC (6)**  
Demonstrates 700 practical problems in all arithmetic branches. 137 pages, 204 illustrations... **\$1.25**

**SHOP GEOMETRY, ALGEBRA, TRIGONOMETRY (7)**  
Exceptionally fine instruction for bench layout men, machinists and others. 165 pages, 300 diagrams... **\$1.50**

**AIR CONDITIONING (8)**  
Get your start in this big industry with this authoritative book. Covers entire field. 450 pages, 108 illustrations... **\$4.00**

**HOUSE WIRING (9)**  
Sixth edition. A complete manual of electrical house wiring featuring instruction based on National Electric Code. 350 pages, 600 illustrations... **\$3.00**

**POWER WIRING—A. C. (10)**  
The recognized and simplified authority on wiring for all types of A.C. Motors, generators, switchboards, etc. 460 pages, 600 illustrations... **\$4.00**

**POWER WIRING—D. C. (11)**  
Companion volume to A. C. Power Wiring. Covers entire D. C. field. 497 pages, 533 illustrations... **\$4.00**

**SHEET METAL LAYOUT (12)**  
Latest in practical shop procedure. For the beginner and the experienced men. 143 problem drawings... **\$3.50**

**MODERN WELDING PRACTICE (13)**  
The very latest information on all types of welding presented in easy-to-read, non-technical style. 400 pages, 277 illustrations... **\$4.00**

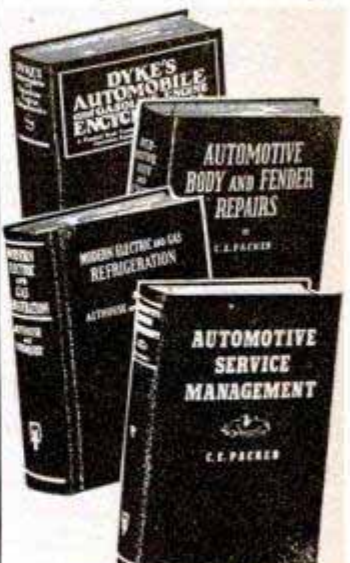

**PLUMBING AND PIPE FITTING (14)**  
Contains 45 layout job sheets with instruction guide to materials, tools and proper procedure. 63 illustrations and diagrams... **\$2.50**

**BAILEY'S HANDBOOK (15)**  
Universal questions and answers for stationary, marine, diesel engineers and firemen. Use it to prepare for passing any grade license... **\$2.00**

**STORAGE BATTERY PRACTICE (16)**  
Explains best practices in battery work. 277 pages, 258 illustrations... **\$2.50**

**ELECTRICAL TROUBLE SHOOTING (17)**  
Most complete and informative book on automobile and airplane electrical work. Answers 600 vital questions, 600 pages... **\$5.00**

**DIESEL HANDBOOK (18)**  
The world's standard book on modern diesel engine practice. 720 pages, illustrated... **\$5.00**

**AIRPLANE DRAWING (19)**  
An introduction to the study of the structures of modern airplanes through mechanical drawing. 25 lessons, 54 drawing plates... **\$1.50**

**AIRCRAFT SHEET METAL WORKERS MANUAL (20)**  
Practical and helpful book for mechanics and students. 130 pages, 80 illustrations... **\$2.50**

**AIRPLANE WELDING (21)**  
Thoroughly covers metal airplane materials and construction with welding. 420 pages, 193 illustrations... **\$3.50**

**AIRCRAFT FLIGHT INSTRUCTOR (22)**  
The book that will teach you to fly. 350 pages, 129 illustrations... **\$2.50**

**MECHANICAL DRAWING (23)**  
A book of mechanical drawing achievement inventories and an effective method of study. 45 full page forms and plates... **\$1.50**

**SHEET METAL DIE DESIGN (24)**  
A job sheet manual covering all types of sheet metal dies. 8 1/2 x 11 inches, illustrated... **\$1.50**

**ELECTRONIC TELEVISION (25)**  
The first book on TV with the picture tube. For technical men, experimenters, students and engineers. Illustrated... **\$2.50**

## MAIL COUPON NOW

Mail to GOODHEART-WILCOX CO., INC., Dept. 102  
1321 South Michigan Avenue, Chicago 5

Send at once, books indicated below. (Draw circle around number of book wanted). If not OK I will return in 5 days and you will refund my money.

Remittance for \$\_\_\_\_\_ enclosed. Send postpaid.

Send COD (In U. S. only) I will pay postman.

1 2 3 4 5 6 7 8 9 10 11 12 13 14 15  
16 17 18 19 20 21 22 23 24 25

Name \_\_\_\_\_

Address \_\_\_\_\_

City \_\_\_\_\_ Zone \_\_\_\_\_ State \_\_\_\_\_

For Christmas—the latest addition to our line of HUDSON Miniatures'

"Old Timer" AUTO KITS



The  
1903  
RAMBLER

6 1/2" long, \$2.50

### Forerunner of the Nash auto

The authentic detail and colorful appearance of Hudson Miniatures' "Old Timer" autos enhance dens, offices and club and game rooms. These 3/4" scale models are extremely easy to assemble. No carving or tedious fitting of parts required. Kits are prefabricated and all parts are die-cut to proper length or made of cast plastic. The other six models available are: 1904 Oldsmobile, 6" long, \$1.95; 1903 Model "A" Ford, 6 1/2" long, \$2.50; 1910 Model "T" Ford, 8" long, \$2.50; 1911 Maxwell, 7 1/2" long, \$2.50; 1909 Model "T" Ford, 8" long, \$2.95; 1909 Stanley Steamer, 8" long, \$2.95.

Sorry, no C. O. D.'s. Please include 25c for postage and handling.

## SCRANTON HOBBY CENTER

315 Adams Ave., Dept. 14, Scranton 10, Penna.

## PRINT YOUR OWN POST CARDS

COMPLETE OUTFIT  
only  
**\$7.50**

Amazing results in sales, inquiries and contacts . . . saves time and money . . . very easy to use GEM STENCIL DUPLICATOR is ideal for Advertising, Announcements, Notices, Labels, Forms, Price Lists—hundreds of uses for every type of business and organization. Comes complete with all supplies, instructions and 60-page Book of Ideas.

**FREE TRIAL OFFER:** Try it before you buy it! Write and a GEM OUTFIT will be sent you postpaid. After 10 days, send only \$7.50 or return the GEM, no questions asked. The GEM must sell itself; you be the judge.

**BOND EQUIPMENT CO. • Dept. 135**  
6633 Enright • St. Louis 5, Mo.

SEND NO MONEY • FREE TRIAL OFFER

MONEY  
BACK  
GUAR.

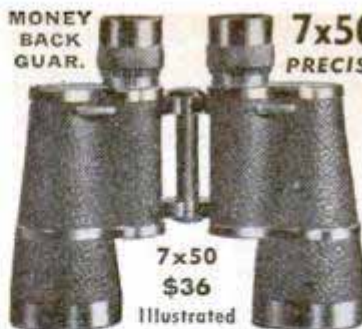

**7x50 PRISM BINOCULARS**

PRECISION OPTICS—BRAND NEW

**\$36\***

6x50 ACHROMATIC  
FIELD GLASSES  
**\$16\***

\*20% Federal Tax

Send for Free  
Catalog of Binoculars,  
Telescopes and Microscopes

**BROWNSCOPE CO.**

Dept. 11M, 24 W. 45th St.,  
New York 19, N. Y.



**BARGAIN BAR BELLS!**

**895**

UP

BUILD your chest, arms, neck, shoulders, thighs as Nature intended! Have a magnificent new body in Less Than 3 Months,—Only 5 Minutes a Day! 4 Million Men, Coast to Coast, 8 to 80, are doing this—YOU CAN, TOO! Get details about Paramount Bar Bells and System—finest on the market—at Factory-Price Savings up to 30%. Send NOW for your "Power-Thru-Paramount" Self-Check Health Chart. Just say—"Send Chart." It's FREE! Write TODAY!!

INDEPENDENT IRON WORKS, Dept. B  
2416 E. 23rd St. Los Angeles 11, Calif.

## HELPFUL BOOKS

Send post card asking for FREE catalog

Popular Mechanics Press, 200 E. Ontario, Dept. 601, Chicago 11

## POPULAR MECHANICS

# Christmas Handbook

144 PAGES  
CLOTH  
\$2.00

**A Wonderful Collection of Ideas, Gifts, Decorations, Toys—You Can Make!**

Popular Mechanics new Christmas Handbook is certain to fill a long felt Christmas-time need in thousands of American homes, and to be cherished as a practical, useful gift. There are articles on entertaining and decorations for Christmas-time hostesses—and how-to-do-it instructions for the making of beautiful greeting cards and gifts of all kinds.

### Partial Contents

How to Select a Xmas Tree, Exterior and Interior Lighting, Rotating Xmas Trees, How to Make Your Own Greeting Cards, Helpful Hints on Home Decoration, Tips for the Holiday Hostess, How to Make Gifts for All Ages, The Story of Christmas, Christmas in Other Lands, Centerpieces, etc., Gift Wrappings, Christmas Games, How to Make Candles, Xmas-Tree Ornaments.



Order From

**POPULAR MECHANICS PRESS**

200 East Ontario Street Chicago 11, Illinois

## How to Make Your FORD or CHEVROLET FAST!

### NEW! FORD HOTROD MANUAL

128 pages tell you how to make your Ford fast! Covers Ford V-8, Mercury, Model A & B, Ford 6, Zephyr! How to install hydraulic brakes on any Ford, channel jobs, coupe, sedan and roadster info. How to install V-8 or Merc engine on Model A chassis. Actual information and illustrations—not generalized ideas!

THE WORLD'S FINEST SPEED MANUALS!  
SATISFACTION GUARANTEED OR MONEY BACK!

### NEW! CHEVROLET SPEED MANUAL

How to build fast coupes, sedans, roadsters and boats. Covers 1937 thru 1949 models. Supercharging, camshafts, dual and triple carburetion, all data necessary for hopping-up your Chevrolet. Specific info, with all details Fully illustrated. 90 terrific pages.

SENT POSTPAID \$2.00 each ☆ 2 BOOKS \$3.50

**CALIFORNIA BILL**

Box L, Dept. PM-11  
EAGLE ROCK STA. LOS ANGELES 41, CALIF.

# SURPLUS SALE 1000's OF REAL BARGAINS

## PNEUMATIC TOOLS

### AIR GRINDERS

Aro, Model 22 L.C.S., 1/4" Collet, 17,000 RPM, ea.....\$11.45  
 Thor, Bantam, 14,000 RPM, 1/4" Collet Chuck, ea..... 10.85  
 Ingersoll Rand Multivane, Size 00, 1/4" Collet Chuck, ea.... 10.85  
 10 Mounted Stones, assorted, 1/4" Shank, for above, New.... 3.85  
 10 Rotary Files, 1/4" Shanks, Good Assortment of Shapes,  
 Includes Files Listing from \$1.35 to \$4.50. Some new,  
 all good, set..... 6.75

### AIR SCREWDRIVERS

Chicago Pneumatic Powervane, No. 301, non-reversible, ea.....\$13.75  
 Thor, Size 218RY, Reversible, Pistol Grip, ea..... 28.50  
 Phillips and Straight bits for above, ea..... .20

### PNEUMATIC HAMMERS

Cleveland, No. 16, Pistol Grip, ea.....\$ 6.45  
 Cleveland, E2, Pistol Grip..... 6.75  
 Chicago, 3X, Pistol Grip..... 6.95  
 Thor, 3S, Pistol Grip..... 11.95  
 Rivet set retaining springs, Used 60, New..... 75c

### AIR DRILLS

Chicago, Pistol Grip, 1/4" Jacobs Chuck.....\$16.50  
 Chicago, Pistol Grip, 5/16 Jacobs Chuck..... 17.25  
 Chicago, Pistol Grip, 3/8" Jacobs Chuck..... 19.25  
 Thor, Straight Grip, 1/4" Jacobs Chuck..... 11.95  
 Thor, 90 degree, Size 210S for threaded  
 shank drills..... 18.75



All Pneumatic Tools Used But Tested and Guaranteed.

### SOCKET SET

Truth, 1/2" drive 18 pc., large metal box, sliding tee, speeder, ratchet, two extensions, 13 twelve pt. sockets, 7/16 to 1 1/4 chrome plated.

(NEW) .....\$12.95

### HAND VISE

1 1/2 Milled Steel jaws and handle. Sold by mail order houses at \$1.95.

Only ..... 79c

FREE CATALOGUE—Write for It!

(Shipments Prepaid If Cash Accompanies Order, Otherwise C.O.D. Plus Postage, Minimum Order \$1.00)  
**MAIN SUPPLY STORE, Dept. B, 521 Main Street, Kansas City 6, Missouri**



### RIVET SETS

(B) Flush Set, Face 1 1/4 Dia. Length 3" (Pictured) ea. .... .65  
 (C) Long Flush, Face 1 1/4, Length 6", ea..... .85  
 (D) Swivel Flush, Face 1 1/4 Length 4", ea.....\$1.25  
 MBH 3/32, 1/8, 5/32, 3/16, ea. .... .35  
 R.H. 5/32, 3/16, ea..... .40  
 F.H. 1/8, 5/32, ea..... .40  
 Some New—All Good

### TORQUE WRENCHES



Kent Moore 3/8 drive, 25 pound, for Chevrolet Service Depts.....\$1.85  
 Duro, 1/2" drive, 100 lbs. No. 8099 1/2. Shockproof Plastic Handle, In Green Enameled Case .....\$5.85  
**Special Offer, One Duro and One Kent Moore, both for..... 6.95**  
 (All Torque Wrenches New)

**CHUCK KEYS, No's. 1 & 7, 30c, No's. 2 & 30, 35c, No. 3, 45c**

**STARRETT TOOL MAKERS DIVIDERS 3", \$1.00, 4", \$1.25, 6" \$1.50.**

Starrett 'Wiggler' No. 828.....85c  
 (All Above Items New)

### SLOCUMB "MIKES"

Plain (Used but Good)  
 4 to 5", \$5.00, 12 to 13", \$9.50  
 13 to 14" \$10.00, 15 to 16", \$11.50,  
 16 to 17", \$12.00.

Sensational New Electric

# ① WELDER ② CUTTER!

FOR 110-115 AC or DC • WELD—BRAZE—CUT—SOLDER—HEAT TREAT INSTRUCTIONS INCLUDED WAS \$15—NOW ONLY \$12!!

The WELDRITE Combination—tested and proved by countless commercial and amateur users, is now offered direct to you at the amazingly low price of only \$12.00. No Gas—No Gauges—No Spark Lighter needed. Always ready for immediate use—Just plug WELDRITE into 110-115 AC or DC outlet. Uses standard welding and brazing materials. WELDRITE furnished complete with Converter Unit, #1 Single Holder for welding metal to 3/16" thickness, using up to 3/32" rod, and #2 Double Holder with Copper Coated Carbon Electrodes for Brazing, Cutting, Heat Treating, etc. Starting welding

materials and instructions included.

Ideal for home workshop. Invaluable for garages, repair shops, farms, etc. **SEND NO MONEY! 10 DAY TRIAL.** Order your WELDRITE Electric WELDER-BRAZER-CUTTER C.O.D. today. Pay postman \$12 plus postage charges (wt. 4 lbs.) or send \$12 and we pay postage. Either way, if not satisfied, return WELDRITE in 10 days for refund, less postage charges. **WELDER HOOD—Approved Arc Welding lens—only \$3.95.** Calif. orders add 2 1/2% tax.

BOTH only \$12



CALIFORNIA TECHNICAL PRODUCTS CO.

Dept. A-11, 448 So. Hill St., Los Angeles 13, Calif.



## Is this real or a model?

Get the answer in this picture-packed book on Model Railroading ..... only 10c

Learn about the greatest of all hobbies. Model railroading is the hobby that fascinates hundreds of thousands of men all over the world.

This exciting book tells you that model railroading is simple, is inexpensive, and is constructive. Fully illustrated. Send 10c today for your copy of "Model Railroading for You," written by a well-known authority. The MODEL RAILROADER, DEPT. 1535, Milwaukee 3, Wis.



NO WIRES! TALK! SING! GAGS!

## MICRO-VOX Home BROADCAST Station

Amazing! Portable! Complete miniature broadcast outfit. Same principle as big stations. Any radio within 50 feet receives clear, life-like voice or music. No wire connections to radio. Easy to operate. Self-contained. Watch-like precision. Hundreds of Uses—Sing, Play, Sound Effects, Shows, Records, Inter-Com, Public Address System, Baby Listener, etc. **SEND NO MONEY!** \$6.95 C.O.D. plus postage, or remit \$7 and we pay postage. Money-Back Guarantee... 24 hour trial.

• Studio Quality Mike  
 • 45 V. "B" Battery  
 • 1 1/2 V. "A" Battery  
 • TUNER • SWITCH  
 • TUBE

ALL THE FAMILY LISTENS ON YOUR RADIO

\$6.95 Ready to Use

Write: NATIONAL ELECTRONICS

DEPT. 48 622 KINZIE, CHICAGO

UP TO 50 FT.! CLEAR! LIFE-LIKE!



# WhiskER®

THE ELECTRIC SHAVER THAT'S  
SOLD BY BARBERS



ONLY  
**\$12.95**  
RETAIL

Now! Smooth, Close Shaves . . . For the Man Who  
Shaves Once a DAY — or, Once a WEEK

Barbers know a good shave when they see one. That's why they recommend and sell WhiskER. WhiskER whisks away any length beard, clean as a whistle, without pulling or stalling. It uses a time-tested hair clipping principle, with an extremely, close-shaving blade. Operates quietly on 110 v, 60 cycle AC; no radio interference. The next time you visit your barber or beautician, ask to see the WhiskER. If he does not have WhiskER, he can order it for you on a 5 day trial.

MADE BY WELL KNOWN MANUFACTURER OF  
QUALITY BARBER AND BEAUTY TOOLS

. . . that's your guarantee of a precision product and long, satisfactory performance. Ladies: Buy WhiskERs at your favorite beauty shop for gifts or for personal depilatory use.

**ELECTRO TOOL CORPORATION**  
DEPT. W529-L RACINE, WISCONSIN

# Photography

for



**PLEASURE or PROFIT**

Learn at home. Spare time. Practical basic training. Long-established school. Many have earned while learning. Send coupon below for free booklet, "Opportunities in Modern Photography" and full particulars.

**AMERICAN SCHOOL OF PHOTOGRAPHY**

1315 Michigan Avenue Dept. 1358 Chicago 5, Illinois  
Send booklet, "Opportunities in Modern Photography," full particulars and requirements. No salesman will call.

Name \_\_\_\_\_ Age \_\_\_\_\_  
Address \_\_\_\_\_  
City \_\_\_\_\_ Zone \_\_\_\_\_ State \_\_\_\_\_

**REMEMBER THIS** You can't Buy a \$20 Goldpiece for \$10. So It's Dangerous to Pay Less—if You want safe, balanced, matched tires. **WE REPEAT**—Consider your family's safety—not just price! You see our adv. every month. Buy now & take 10%. Positively not recaps. Buy 1 or 100.

We serve ambulances, fire trucks, school busses & pass. cars  
**GOODYEAR** Goodrich, Firestone, U. S. & Others, Original High Tread, Slightly Worn, —26 MONTHS GOLDEN RULE GUARANTEE BOND—Genuine Factory Adjusted "All-Purpose" "AAA" Tires  
Read That Top Line Again! You'll Save More than \$

600-16	\$5.50	650-16	\$5.50	700-15	\$5.45
600-16(6)	6.50	650-16(6)	6.50	700-15	5.25
700-16	6.50	750-16	7.77	800-17	7.00
710-15	5.95	475-19	6.00	525-18	6.65

**WE ARE TRUCK-TIRE EXPERTS** Matched tires. Truck-owners the world over depend on us to keep their trucks rolling ON TIME at lowest cost. **FACTORY ADJUSTED** "All-Purpose" "AAA" Grade

<b>GOLDEN RULE 26 MONTHS REPLACEMENT GUARANTEE BOND</b>					
600-20	\$9.20	32x6(8)	\$11.75	900-20	\$15.95
650-20	9.20	32x6(10)	12.95	1000-20	16.95
700-20	10.52	825-20	15.95	1100-20	17.50

<b>600-16 MILITARY GUAR. 15 MOS. \$5.55</b>					
<b>DELUXE SNOW-TREAD \$7.50 GUAR. 30 MOS.</b>					
<b>MILITARY'S TOP GRADE GUAR. 30 MONTHS—(SUPERS 14 MONTHS)</b>					
750-16	\$9.75	Super	\$8.60	750-20	\$ 8.95
Top Grade	12.75	Top Grade	10.90	Top Grade	13.00

**BLATT** GIRARD & LANCASTER AVE., Dept. PM BLATT BLDG., PHILADELPHIA 31, PA.  
Send ck. or money order and this ad. for rush shipment. We won't ship a tire we wouldn't use ourselves. Instant shipment down south, far west and the world over. The name to trust in rubber.

Write today for Complete details

# GEIGER COUNTERS

FOR PROSPECTING RADIOACTIVE MINERALS

**OMAHA SCIENTIFIC SUPPLY CO.**  
Dept. U, 3601 N. 24th St., Omaha 10, Nebr.

## New 1950 Plastics Supplies Catalog

Just off press. Get details on Plexiglas, Lucite, rods, sheets, tubes, Acetates, cements, dyes, buffs, molding sets, tools, carving kits, everything in plastics. Lowest prices. Price 10c, stamps or coin, with ad for catalog.

Plastics Mfg. & Supply Corp., Dept. PM-11, 4707 Euclid Ave., Cleveland, Ohio

AMAZING NEW

## WOOD-TURNING TOOLS

SHARPEN ONCE IN 12-YEARS! (UNDER NORMAL USE)

These remarkable tools tipped with TUNGSTEN CARBIDE will astound you with their performance. They work FREE HAND equally well in wood, plastic or soft metals—and at the same time hold their razor-like edge almost indefinitely. Tests show that they will turn wood or plastic for days and days CONTINUOUSLY without showing any signs of dulling. They are the finest tools available at any price. Beautifully finished 5" blade—flush ground, polished tip—finest brass tube ferrule—9" hardwood handle—over all length 14"—10 tools to choose from: round and square nose from 1/4" to 1/2"—1/8" cut off; and 1/2"x30° skew. Amazingly Low Prices! Write at once for free literature. **JOHNS MFG. CO., DUNELLEN 6, N. J.**

**Learn REFRIGERATION and AIR CONDITIONING**

Prepare yourself for a fine paying job. Get practical training at home—plus 4-full weeks in the ITI Shops. Job placement help. FREE book—write

**INDUSTRIAL TRAINING INSTITUTE** Dept. C-1, 2130 Lawrence Ave., Chicago 25, Ill.

SAY YOU SAW IT IN POPULAR MECHANICS

## AMAZING CALENDAR WATCH

Tells minute, hour & day of month

Most intelligent watch we ever saw; a triumph of Swiss craftsmanship! Gives exact minute and hour; then tells what day of the month it is. So good, that a printed 1-year guarantee is included. Glow-at-night dial; timed and tested movement; leather strap. In presentation box.

**SEND NO MONEY—10 DAY TRIAL**

Pay postman \$9.95, plus tax and COD postage (or send check for \$10.94 and we pay postage). Wear 10 days; return if not delighted.

**Swiss Watch Distributors**  
Dept. M-11, Sandy Springs, Ga.

**ONLY \$9.95** plus 95c tax



# Learn by Mail to Mount Birds

Animals, Game-Heads, Fish, Pets, to Tan Skins

**Men, Boys!** Be a **Taxidermist**. Learn at home in spare time. Easily, quickly learned. **Grand Fun**. A wonderful, profitable hobby, for expert hunters, also for amateurs, even young boys. Mount wild-game, although wild-game is not necessary. Use common, domestic specimens, squirrels, pigeons, even frogs. This famous, reliable school in business more than 35 years. **More than 300,000 delighted students**. Think of that!

## Hunters Save Your Trophies — Have a Home-museum Be a Taxidermy Artist

You will be **THRILLED** and **DELIGHTED**. You learn **QUICKLY**, easily **AT HOME**. Your friends will be amazed. Hunters from near and far will bring their **TROPHIES** to be mounted. You can earn fine **profits** in **spare time**. Many students earn \$60 to \$100 a month, in season. **Rush the coupon today**, and learn all about wonderful taxidermy. **DO IT NOW!**

Save your own hunting trophies. Have a lifelong hobby. Have a home museum that you are proud of, and that makes you popular and well-known far and wide. **BOYS**, wild-game is **not** necessary. Use common specimens, squirrels, pigeons, owls, domestic birds and animals. **It's wonderful**. Inquire today. **Kill fewer game-birds. Double your fun and pleasure.**

## Fun — Fascination — Profit

And so easily learned in spare time. Wild-game is growing scarcer. Help preserve it. Shoot only a **FEW** fine ducks and other game-birds. **MOUNT THEM** for home and den, and have **MORE FUN** and **PLEASURE** than killing the legal limit every day. **Help preserve the wild-game.**

Remember you learn to mount expertly, **birds, animals, game-heads, fish, pets, to tan skins and furs**. Investigate! You will be delighted. Send for **free book today**. "Eat your trophies and have them too."

**THE N. W. SCHOOL OF TAXIDERM, 2511 Elwood Bldg., Omaha 8, Nebr.**

## FREE BOOK!

Yes **FREE**, 44 pages, with 100 unique pictures of taxidermy work. No other book in the world like this. It will amaze and thrill you. **Ask today for your free copy. State your AGE.**

## Send the Coupon!

Write name plainly in coupon or margin, or a **post card** will do. **Rush** your request, as **free books** may be exhausted quickly. **Decide now**. Don't wait a moment. **State your age.**

## FREE BOOK

Northwestern School of Taxidermy, 2511 Elwood Bldg., Omaha, Neb. Send me your free illustrated book, "How to Mount Game". Also tell me how I may learn this fascinating art easily and quickly by mail. No obligation. State your age.

Name \_\_\_\_\_ Age \_\_\_\_\_  
Address \_\_\_\_\_

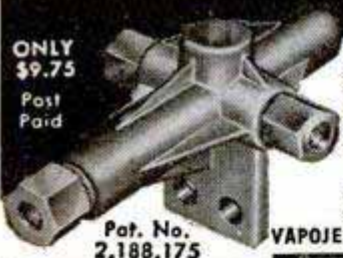

ONLY \$9.75 Post Paid

## JET PERFORMANCE FOR YOUR CAR WITH VAPOJET

This aircraft developed water-oil vapor injector is designed to give faster pick-up, smoother running power, and tends to eliminate carbon, vapor lock and overheating. Users of the new Vapojet report up to 25% more mileage per gallon of regular gas. Complete, easily installed kit fits all car, tractor, boat or stationary engines. **Agents Wanted.**

**MONEY BACK SATISFACTION GUARANTEE**  
(If returned within 30 days)  
Order today. Only \$9.75 ppd. Send check or money order & save postage. \$1 deposit on C.O.D.

**VAPOJET MFG. CO., 11424 Biona Dr., Dept. PM-11, Los Angeles 34, Calif.**

**MAIL COUPON TODAY**  
Rush me \_\_\_\_\_ Vapo-Jet Kits including carburetor adaptor, copper tubing, fittings, etc. and illustrated instructions. Enclosed is my check or money order for \$ \_\_\_\_\_  
Name \_\_\_\_\_  
Car \_\_\_\_\_ No. of cyl. \_\_\_\_\_ Year \_\_\_\_\_  
Street \_\_\_\_\_  
City \_\_\_\_\_ State \_\_\_\_\_

## LOCKSMITHING & KEYMAKING

**PRACTICAL HOME TRAINING OUTFIT INCLUDES EVERYTHING NECESSARY TO GET STARTED IN YOUR OWN BUSINESS**  
Excellent full or part time earning opportunities. Professional outfit includes supplies, tools, key cutting machine. Get practical training from Master Locksmiths on house locks, auto locks, padlocks, etc. Learn to cut keys by code, master locks, change combinations, quickly, identify key blanks, many profitable "tricks of the trade." Booklet of information **FREE**. Write today. **UNITED SUPPLY & SERVICE, 3327 Madison St., Dept. PM-11, Chicago, Illinois.**

**SAY YOU SAW IT IN POPULAR MECHANICS**

## FULLSIZE, CUT-TO-SHAPE BOAT PATTERNS

and specifications. Designed by Naval Architect. Cruisers, runabouts, sloops, outboards, sailing canoe, etc. Low prices. Send 25c (coin) for illustrated catalog. **SPECIAL: Send \$1.00 for "HOW TO BUILD BOATS" book, postpaid. PolyWog Houseboat Plans, \$10. Marine Catalog \$1. Cleveland Boat Blueprint Co., Dept. 666, Cleveland 13, Ohio**

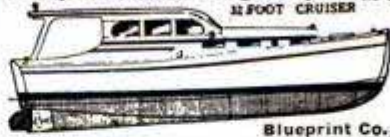

# PLAN YOUR OWN TELEVISION INSTALLATION and Save Money

**Skurider TV Custom Chassis at New Low Prices**

**FREE!**  
New 160 page Catalog. The treasure chest of values in Radio, Television and Electronics for home and workshop. Send for your copy today!

Now, get big picture, direct view Television at Sensational Savings with SKY-RIDER TV Custom Chassis . . . made by the manufacturer of "The Radio Man's Radio." Factory wired and tested. Complete with speaker and all tubes, including picture tube. Ready to use. Needs only cabinet or mounting place in wall. Send for **Free folder**. Features original designs for TV Custom Installations.

*Ideal Xmas gift for entire family!*

MODEL	SIZE	PICTURE AREA	PRICE, ONLY
524	10"	61 Sq. in.	\$159.50
521	12½"	92 Sq. in.	\$189.50
520	16"	145 Sq. in.	\$249.50

F.O.B. St. Louis, Missouri • Wire, Write or Phone



**Walter Ashe RADIO CO.**  
1125 PINE ST. PHONE CH. 1125 ST. LOUIS 1, MO.

# Learn A Trade NOW! PRACTICAL SHOP TRAINING!

## In Our Chicago Shops

- |   |  |
|---|--|
| <input type="checkbox"/> AUTO MECHANICS   | <input type="checkbox"/> WELDING—ARC and GAS |
| <input type="checkbox"/> DIESEL MECHANICS | <input type="checkbox"/> MACHINIST           |
| <input type="checkbox"/> REFRIGERATION    | <input type="checkbox"/> PIANO TUNING        |
| <input type="checkbox"/> BODY-FENDER      |  |

Above Approved For G. I.'s and Civilians  
One of America's Leading Practical Schools  
7 Floors of Fully Equipped Shops  
Over 48,000 Successful Graduates  
Expert Individual Instruction  
Learn by Doing—Low Living Expense  
Established 1902—Day and Evening Classes

## Also the following Home Study Courses

- |                                  |  |                                 |
|----------------------------------|--|---------------------------------|
| <input type="checkbox"/> PLASTIC | <input type="checkbox"/> REFRIGERATION | <input type="checkbox"/> DIESEL |
|----------------------------------|--|---------------------------------|

—CALL IN PERSON OR MAIL THIS AD TO—

## GREER SHOP TRAINING

(Desk 16) 460 South State St., Chicago 5, Ill.

Please send without obligation free information regarding trade checked above. (Specify whether you are a Veteran  or Civilian )

Name \_\_\_\_\_ Age \_\_\_\_\_  
Address \_\_\_\_\_  
City \_\_\_\_\_ State \_\_\_\_\_

## LEATHERCRAFT COPPER TOOLING TEXTILE PAINTING

Make your spare time PROFITABLE. Send today for FREE illustrated catalog showing everything you need. KIT KRAFT, 7377 Melrose Ave., Dept. AD-11, Los Angeles 46, Calif.

## Perfect LASTING FIT for Your FALSE TEETH WITH ONLY ONE APPLICATION or it costs you nothing!

PERMA-FIT is the amazing new plastic reliner that gives you permanent fit and denture comfort. If your plates are loose, ill-fitting, cause sore gums — use one-application PERMA-FIT, and say goodbye forever to bothersome, short-lasting powders or pastes. You simply lay this soft plastic strip on your upper or lower plate . . . bite . . . and PERMA-FIT conforms to the exact shape of your gums. Easily removed according to directions. Safe, same material as your denture.



**Eat Everything, Laugh and Talk Freely!**  
Delighted users everywhere express their gratitude. Remember, one-application PERMA-FIT carries bonafide money back guarantee. Only \$1.00 for either upper or lower plate.

SEND NO MONEY! Just pay postman C. O. D. plus postage, or send \$1.00 and save postage

PERMA-FIT COMPANY, 63 E. Adams St., Chicago 3, Ill., Dept. 11L

# STUDY AT HOME

With An Educational Institution

Men with specialized training win higher positions, insure larger earnings, and are bigger successes in business and public life. Opportunities NOW greater than ever before. Send for our Catalog.

## ARTS and SCIENCES

Courses in Philosophy; Education; Letters; Public Health; Medical Jurisprudence; Psychology; Sociology; Physics; Chemistry; Geology; Political Science; Theology; Business and Commerce; Accounting; Mathematics; Statistics; Agriculture.

## ENGINEERING

Courses in Electrical, Civil Mechanical, Drafting, Architectural, Steam, Aeronautical, Radio, Structural, Mining, Industrial, Petroleum, Marine, Chemical, Diesel, Automobile, Refrigeration, and Air Conditioning Engineering.

## LAW

Complete Professional Law Course includes 18 Hornbook Series college grade textbooks. Courses also in Commercial Law, Patent Law and Medical Jurisprudence.

McKinley-Roosevelt Incorporated, 4610-K, Sheridan Rd., Chicago 40, Ill.

DESK MODEL	<b>TELEPHONES</b>	WALL MODEL
	<b>\$17.95 for 2</b> OF EITHER MODEL	
Telephones are complete with power, wire, hook-up instructions etc. Any number of telephones can be connected in circuit. Common talking, common ringing. Simple installation, absolutely no technical knowledge required. 25% deposit with order, balance C.O.D., F.O.B. Brooklyn.		
FREE! Fine Descriptive Folder.		
Eastern Telephone Co., Dept. PM-4, 320 18th St., Brooklyn 15, N. Y., South 8-6161		

## MECHANICAL DRAFTING LAYOUT AND DESIGN

Many opportunities exist for well trained men in this field. For a few cents a day you can study at home in your spare time. Thorough, practical work assignments in blueprint form. Small student body assures "personal instruction" to each student. Course includes necessary drawing board mathematics. Quality instruments and everything supplied. Standard industrial practices taught by State-approved instructor. Pay-as-you-learn. Get the Colonial story first. Write for Free Catalog today. Please state your age.

APPROVED BY STATE OF NEW JERSEY  
COLONIAL SCHOOL OF MECHANICAL DRAFTING  
MORRIS PLAINS, NEW JERSEY



## BARBELLS

FINEST QUALITY.....\$8.98 up

FREE CATALOG

Send today for big new 4 color fully illustrated free catalog of BARBELLS, Dumbbells and Health equipment. Free—world famous \$15.00 Dan Lurie Barbell and Dumbbell training courses with every purchase.

DAN LURIE BARBELL CO.

Dept. 159L, 1729-M11 Rockaway Parkway, Brooklyn 12, N.Y.

SAY YOU SAW IT IN POPULAR MECHANICS

## FLASH Your Turns



### THE SIMPLEX DIRECTIONAL SWITCH

Kits furnished with all necessary material for a perfect installation. No outside mounting of any kind. We make use of your present parking and tail lights.

SHIPMENTS ARE MADE FROM STOCK  
Eliminate hand signaling. A safe and comfortable way of signaling your intention of making a right or left turn. Flashes from 60-80 times per minute. Either of our two models will fit most cars from 1942 to 1949.

Specify year and make of car. Money back guarantee. Tested and Approved to meet SAE requirements.

DEALERS INQUIRIES INVITED

**\$8.95**

Send check or money order. Postage extra on C.O.D.'s

Post-Paid in U.S.

SIMPLEX SALES COMPANY

Dept. A, 1303 W. Jackson Blvd. Chicago 7, Illinois



**FREE-10 DAY TRIAL**

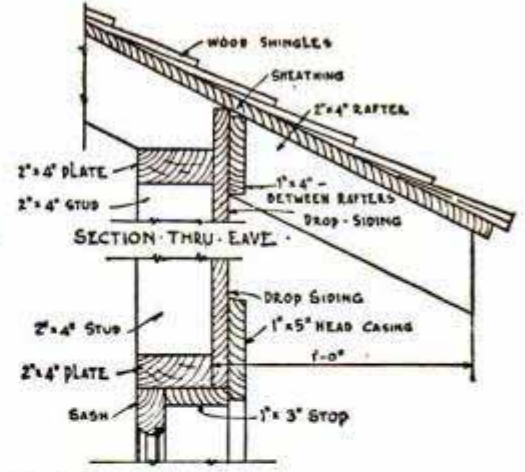
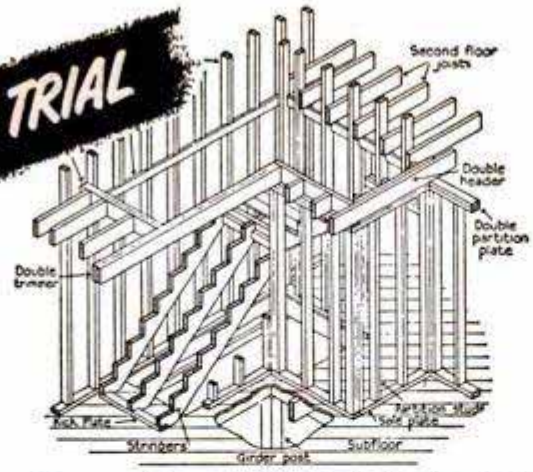

# NOW—Get the INSIDE TRADE FACTS on HOUSE CONSTRUCTION DETAILS

Save Money and Time — Get Better Construction — with these Professional Methods

Here, at last, is an exact working guide on every detail of house construction from foundation to finish. Tells you dimensions, materials, processes, step-by-step working methods. Hundreds of scale drawings and photographs make every step easy to follow. Can be used for alterations in a set of stock plans, for making additions or changes in a building, or for complete con-

struction of a dwelling. Conforms with modern practice and building regulations in all parts of the country. A book you will refer to for years! The professional guidance you get on even a single house construction detail can *repay you a hundred times the small cost* of this wonderful volume! Send for free-examination copy today. Mail coupon below.

## Every Step in House Construction Explained and Illustrated:

- Excavations • Footings and drainage • Foundation forms • Sills • Girders • Joists • Sub-flooring • Exterior wall framing • Interior wall framing • Ceiling joists • Gable roof • Hip roof • Gambrel roof • Dormers • Siding and shingling • Cornices • Porches • Exterior walls of wood • Exterior walls of brick • Interior walls finished in plaster, in plywood • Wall panels • Mouldings for interior trim • Stair construction • Windows • Sash details • Window framing details • Doors and door trim • Hardware used in dwellings • Closets, shelves, built-in equipment • Breakfast alcove • Sewing room • Flooring • Chimneys and fireplaces • Mantels and seats • Outdoor fireplaces • Scaffolds • Garages • Electric wiring • Insulation • Arches and gates • Lattice porch, lattice trellis • Garden benches, tables • Swings and other garden furniture • Picket fences • Log cabins, camps, cottages • Barns • Feeders and nests • Rabbit hutch • Septic tank • Painting and finishing • Heating systems • Air conditioning systems • Prefabricated houses • Useful information for home builders including architectural styles and data on modern building materials.

**313 PAGES, SIZE 8½ x 11. FULLY INDEXED. 1500 ILLUSTRATIONS**

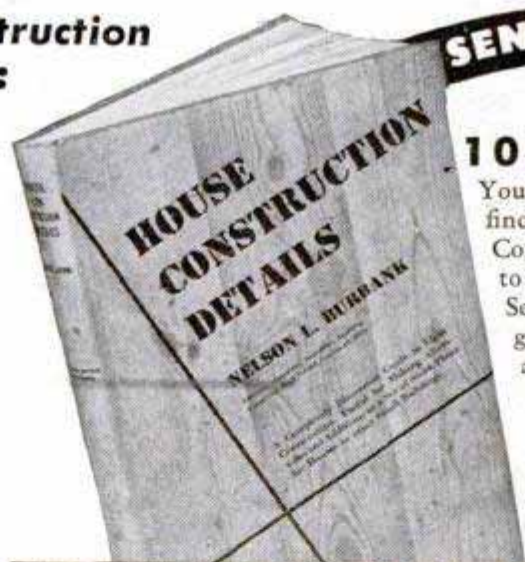

**SEND NO MONEY!**

### Examine 10 DAYS FREE

You don't risk a penny to find out how valuable "House Construction Details" can be to you. Just mail coupon. See for yourself how you get clear, professional guidance on every building detail. Then either send only \$4.50 (plus postage) in full payment, or return the book and owe nothing. Mail free-examination coupon NOW.

## MAIL THIS COUPON

**Simmons-Boardman Publishing Corp.** Pop. Mech. 11-49  
 30 Church Street, New York 7, N. Y.  
 Send me for 10 DAYS' FREE EXAMINATION, "House Construction Details." I will either return it in 10 days and owe nothing, or send only \$4.50 (plus shipping charges) in full payment.  
 Name.....  
 Address.....  
 City & State ..  
 **SAVE!** Send \$4.50 with this coupon and we will pay postage. Same return and refund privilege.

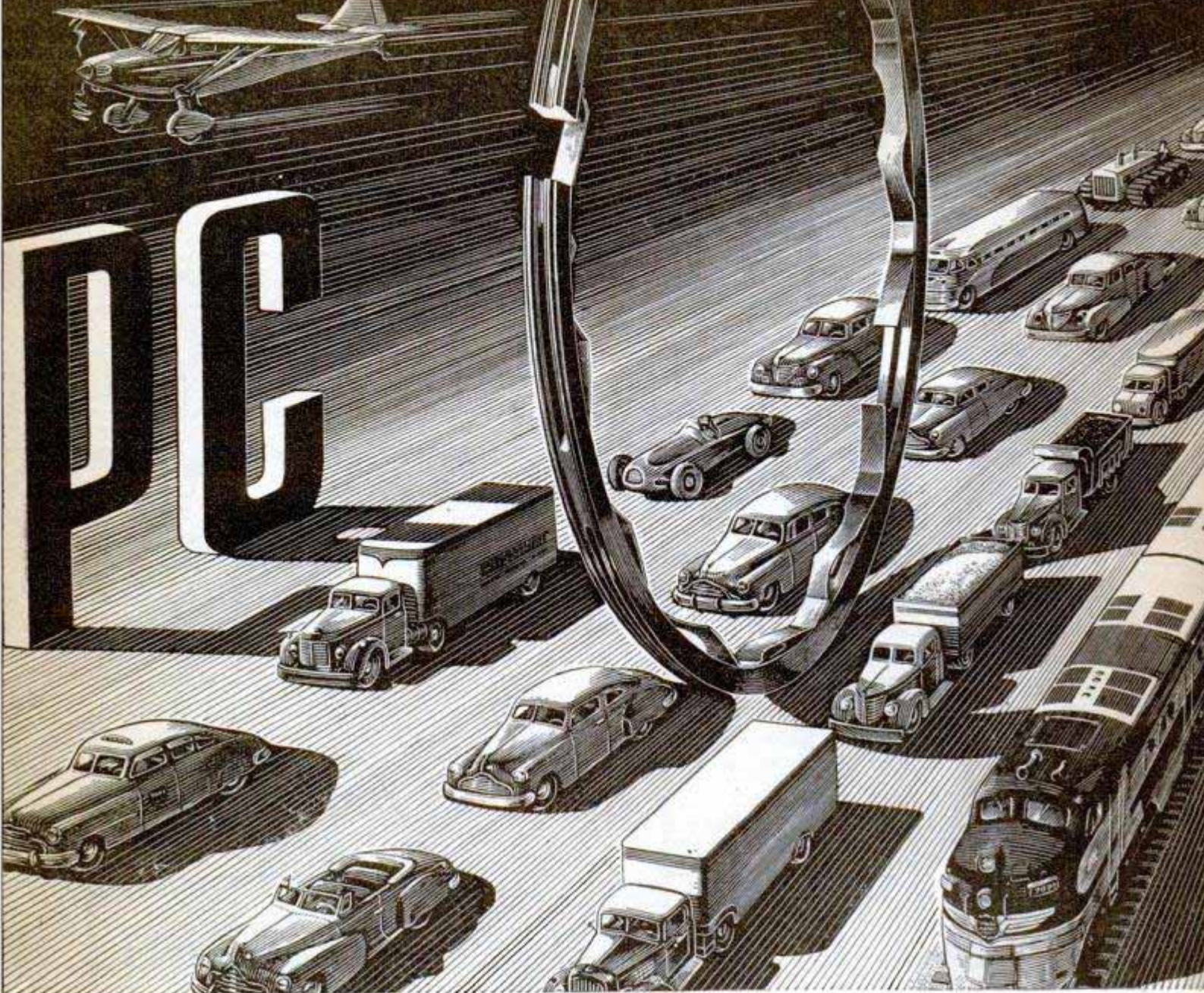

# Perfect Circle THE MOST HONORED NAME IN PISTON RINGS

**Honored by** America's foremost automotive engineers, who recently acclaimed Perfect Circle Piston Rings as best engineered—4 to 1\*

**Honored by** Doctors of Motors, America's expert mechanics, who actively express their piston ring preference by installing millions of Perfect Circles every year.

**Honored by** motor-wise car owners all over America, who in survey after survey have invariably named Perfect Circle their first choice by a wide margin.

**Look for this sign (right).** It identifies a place where your car will receive expert attention. Your local Doctor of Motors knows your car, knows the value of honest workmanship and reliable parts. He will install a set of Perfect Circle Piston Rings Custom Made for your car to restore power, save gas, stop oil pumping.

*Perfect Circle Corporation. Offices: Hagerstown, Indiana and Toronto, Canada. Plants: Hagerstown, Richmond, New Castle, and Tipton, Indiana, and Toronto.*

\*In an independent survey among automotive engineers—maintenance men, fleet operators and designers of new equipment—Perfect Circle was first choice as the best engineered piston ring—first by more than 4 to 1—and received more votes than ALL other brands combined!

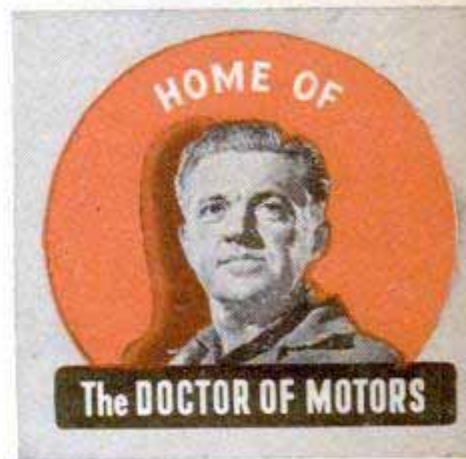

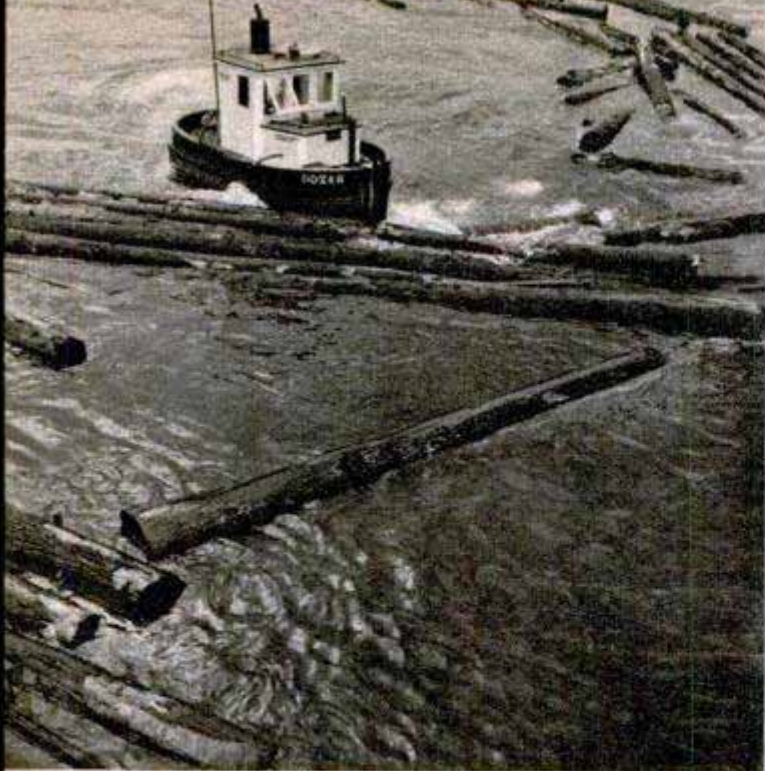

# POPULAR NOVEMBER 1949 MECHANICS

WRITTEN SO YOU CAN UNDERSTAND IT  
VOL. 92 NO. 5

*By Ewart Thomas*

**S**HORTY HILT rides a tubby little boat instead of a horse. He works on the water instead of on the range and he herds logs instead of cattle.

Yet, if Shorty wore spurs he'd be a typical cowboy. His job is almost exactly the same as handling cows on a western ranch.

With the squat, powerful little Dozer under him, he charges around the end of a log raft at Port Angeles on Puget Sound and cuts out the logs that he wants, then

## *Logging "cowboys" ride the sea dozer*

Above, Sea Dozer slams into tangled jackpot. Below, cribs and rafts make a fascinating pattern from the air

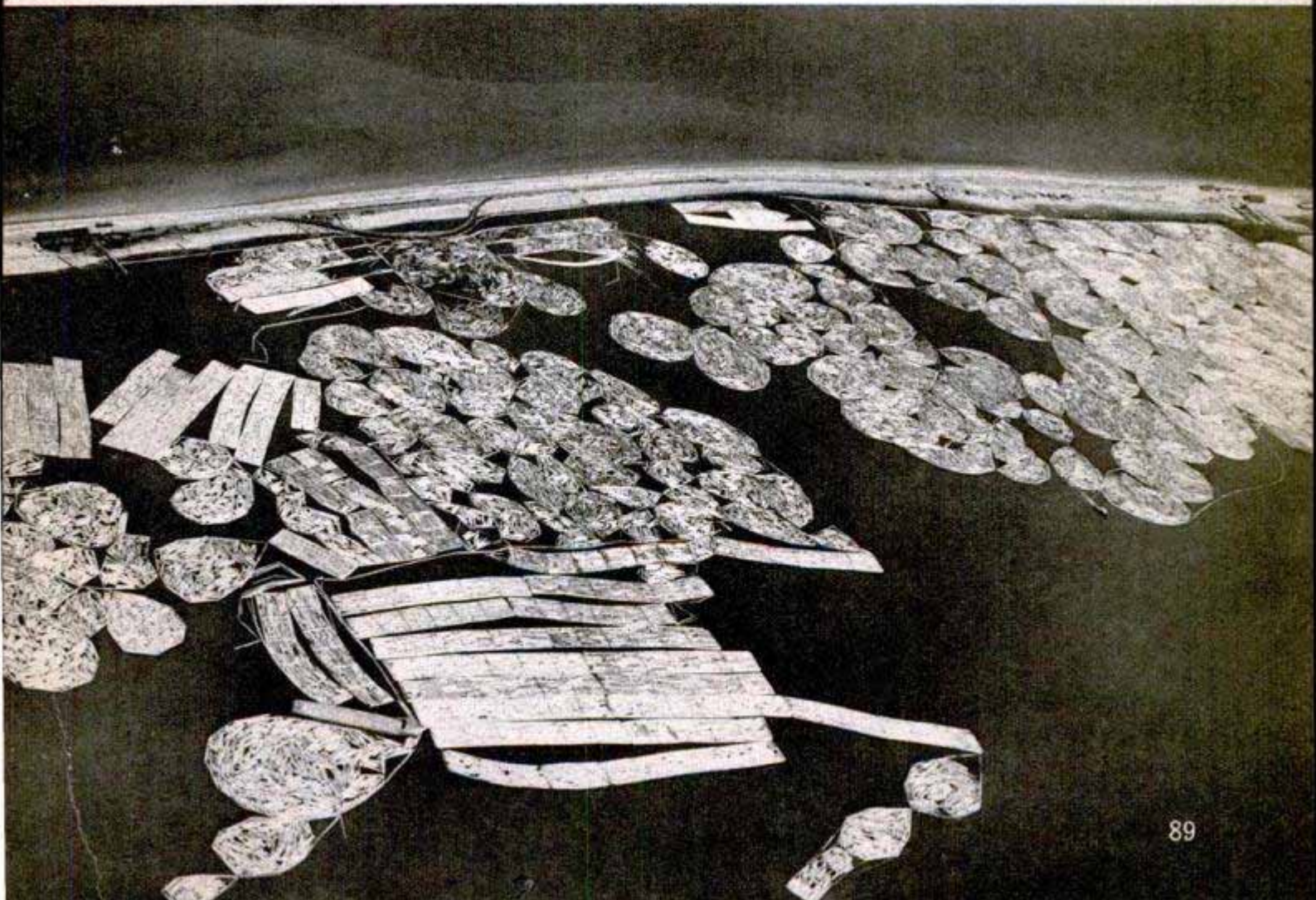

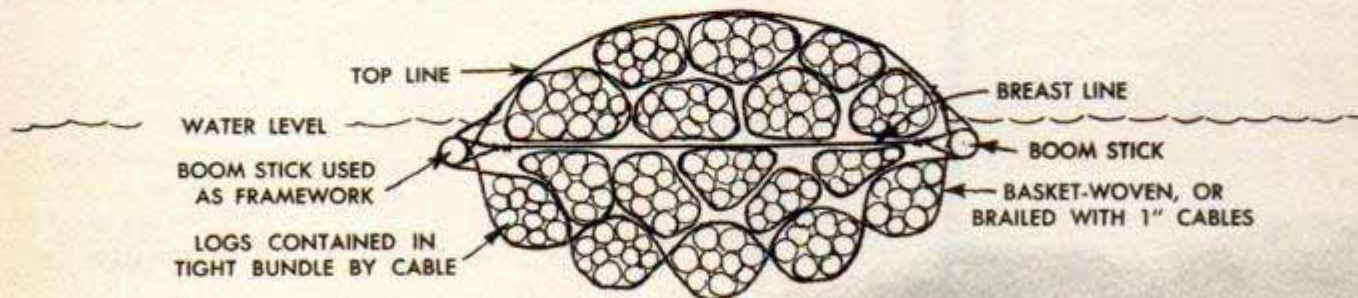

Here's the way a crib is built: Top, left, lowest logs are bound with cables. Top, right, crane lifts logs from truck to crib. Diagram shows cross section of crib. Above, a crib 260 feet long begins its journey

shoulders them to one side. He storms after a few logs that are drifting away and pushes them back into line. Spinning around so fast that his stern ships water, he slams into a tangled jackpot of logs and separates them into an orderly array of floating pieces.

No ordinary boat could take this punishment and the Dozer is one of the most extraordinary ever built. Only 16 feet long, it has been called the sturdiest and most powerful craft for its size ever built.

Its fir keel is 14 by 18 inches in cross section. Its ribs are 5 by 5, on 12-inch centers. The stem is a piece of 10 by 14-inch gumwood, additionally armored by a 14-inch steel I-beam in front. The planking consists of 2-inch fir that is topped by a ½-

inch layer of ironwood and further protected by an exterior skin of half-oval corrugated steel.

The boat's heavy-duty 140-horsepower marine engine turns an oversize 26-inch propeller that has a 22-inch pitch. When the six-ton Dozer rams a 12-ton log, it's the log that gives way.

The Dozer was built when Crown Zellerbach Corporation wanted an improved "seadozer" that could do the same work in the water that a bulldozer does in the woods. Specifically, the company wanted a craft that could safely break up the deep rafts that are delivered to its newsprint paper mill at Port Angeles.

In the past, the rafts were broken up by crews of calk-booted boom men who were



Sea Dozer is as agile as a cow pony, rounding up stray logs or maneuvering in close quarters between them

in constant danger of being plunged from a rolling log and caught or crushed under water. Today, the Dozer performs the hazardous work safely and easily and the men have other tasks.

For its Port Angeles mill, Crown Zellerbach gets most of its pulp logs from scientifically managed forests at the northwest tip of the Olympic Peninsula. The logs are hauled down to Neah Bay, near Cape Flattery, on huge logging trucks that roll their 50 or 60 tons of cargo over specially graded private roads.

At Neah Bay, the trucks are driven out over a causeway to a crib dock where an overhead crane picks up an entire load of logs and deposits it in a "crib" or deep raft. The skeleton of the crib consists of huge logs, called crib sticks, that are chained end

to end to form the exterior shape of the raft. The first loads of logs that are deposited inside the crib sticks are woven together with one-inch steel cables. Tied together this way, they serve as the underwater hull for the succeeding loads of logs that are laid on top of them. When ready for its tow to Port Angeles, the completed crib is 260 feet long, draws 20 feet of water, and may stand 25 feet above water. One of the deep rafts may contain 1500 separate logs that will total more than ½ million board feet. The top loads are tied down and are secured to the crib sticks with additional lengths of cable.

A deep raft, properly built, can withstand fairly heavy seas; it needs to, for Juan de Fuca Strait is seldom like a millpond. Shipping of all sizes takes a beating when



Above, left, hook on bow plate prevents the Dozer from riding over a log. Above, oversize propeller takes constant beating

winter storms swoop down from Alaska. Yet only two of the last 56 Crown Zellerbach cribs have suffered storm damage during the 46-mile tow to Port Angeles. This is in spite of the fact that the weather sometimes gets so bad that the causeway at Neah Bay is repeatedly swept by green seas. At times like these, the logging truck drivers wait on shore until a lull occurs, then they race out to the crib dock and discharge their loads. Sometimes, however, they can't get out to the dock until the rocks that the waves have left on the roadway have been heaved aside.

After a crib reaches Port Angeles, its cables are loosened and connected to overhead lines that are then hauled free by a donkey engine on shore. In theory, all the logs in the raft should spread out over the water immediately, one log deep. This never happens. Some of the logs in the pile are

Left, branding logs with hammer prevents "rustling." Below, logs exposed to water too long are stacked in a huge pile

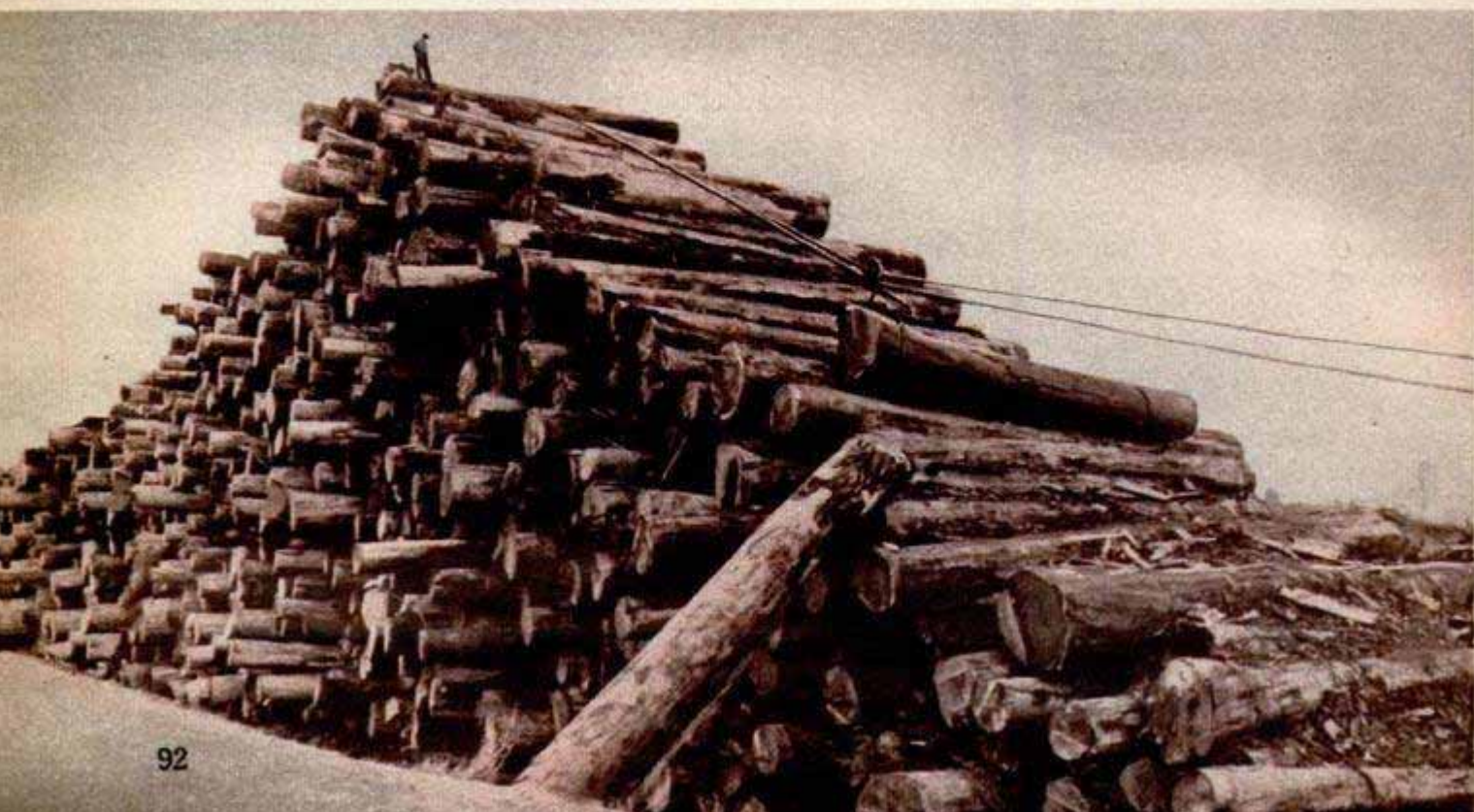

rolled sideways when others move above them. Some are upended as the raft begins to spread. Many scrambled bunches or jackpots result.

Busting these jackpots is the job for which the Dozer was built. But even the Dozer can't do it by brute strength alone. Shorty Hilt, in the wheelhouse, uses a dozen tricks to cajole the key logs into freeing themselves from the tangles.

The I-beam stem is sharp enough to prevent a log from slipping when the Dozer pushes against it and the result is that Shorty can plough right into a log and then twist the wheel around and move the boat sideways or at an angle to withdraw the log from the jackpot. Held against the stem, the log moves with the boat. An ordinary boat can push a log only when moving straight ahead but Shorty can nudge a log with either bow or with the side of his boat with little fear of damaging the hull.

One way of getting a log out of a jam is to roll it out, and Hilt does this by putting the stem in contact with the log and then turning and rolling the boat at the same time. Caught by the corrugations of the hull, the log is literally spun out of the pile.

The bottom of the armored stem projects outward in the form of a hook that catches under a log and prevents the boat from riding up onto it when pushing straight ahead. That was its original purpose, but it has other uses as well. Shorty has learned that the hook is as good as a crane for boosting up the free end of a partly submerged log and getting it loosened from the pile. Rubbing up against the log, he puts the Dozer's nose down by jockeying the throttle and the reverse gear. This gets the hook

(Continued to page 254)

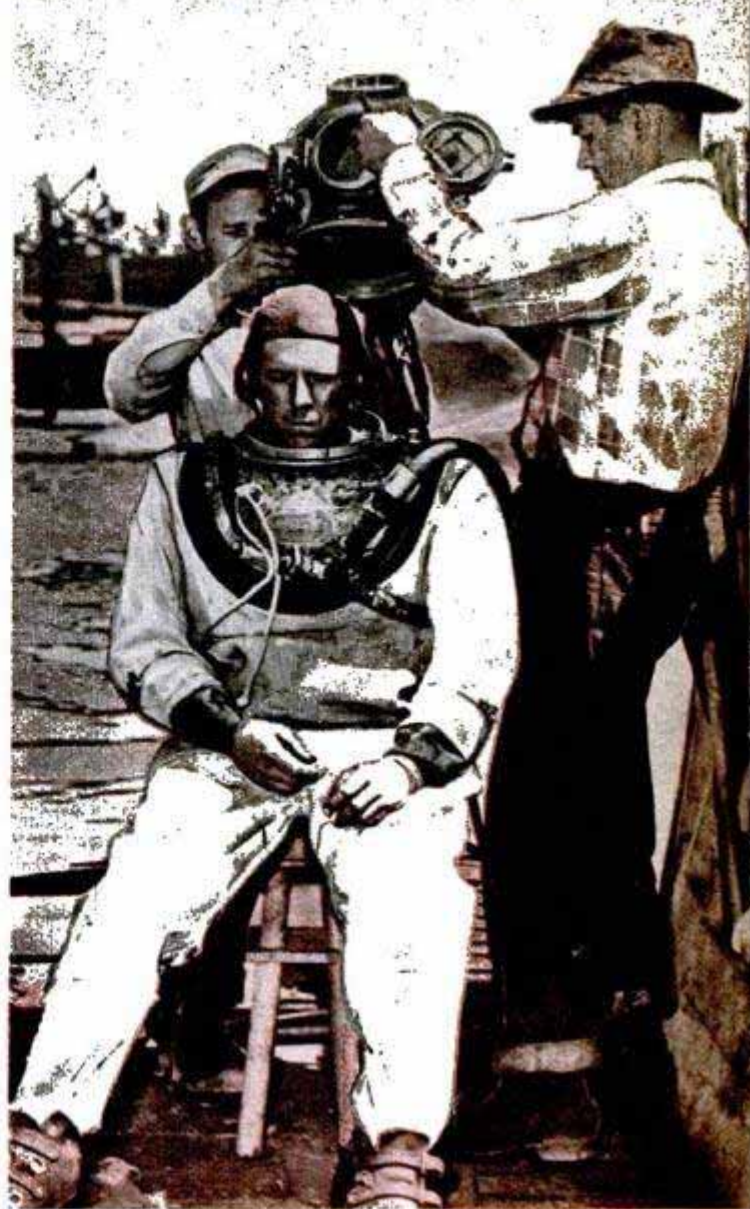

Log diver prepares for a trip to the bottom in search of logs so water-soaked they sink instead of float

Diver uses the smaller barge in the foreground. In the background is the grappling barge, which has snagged two logs on the bottom and hauled them up

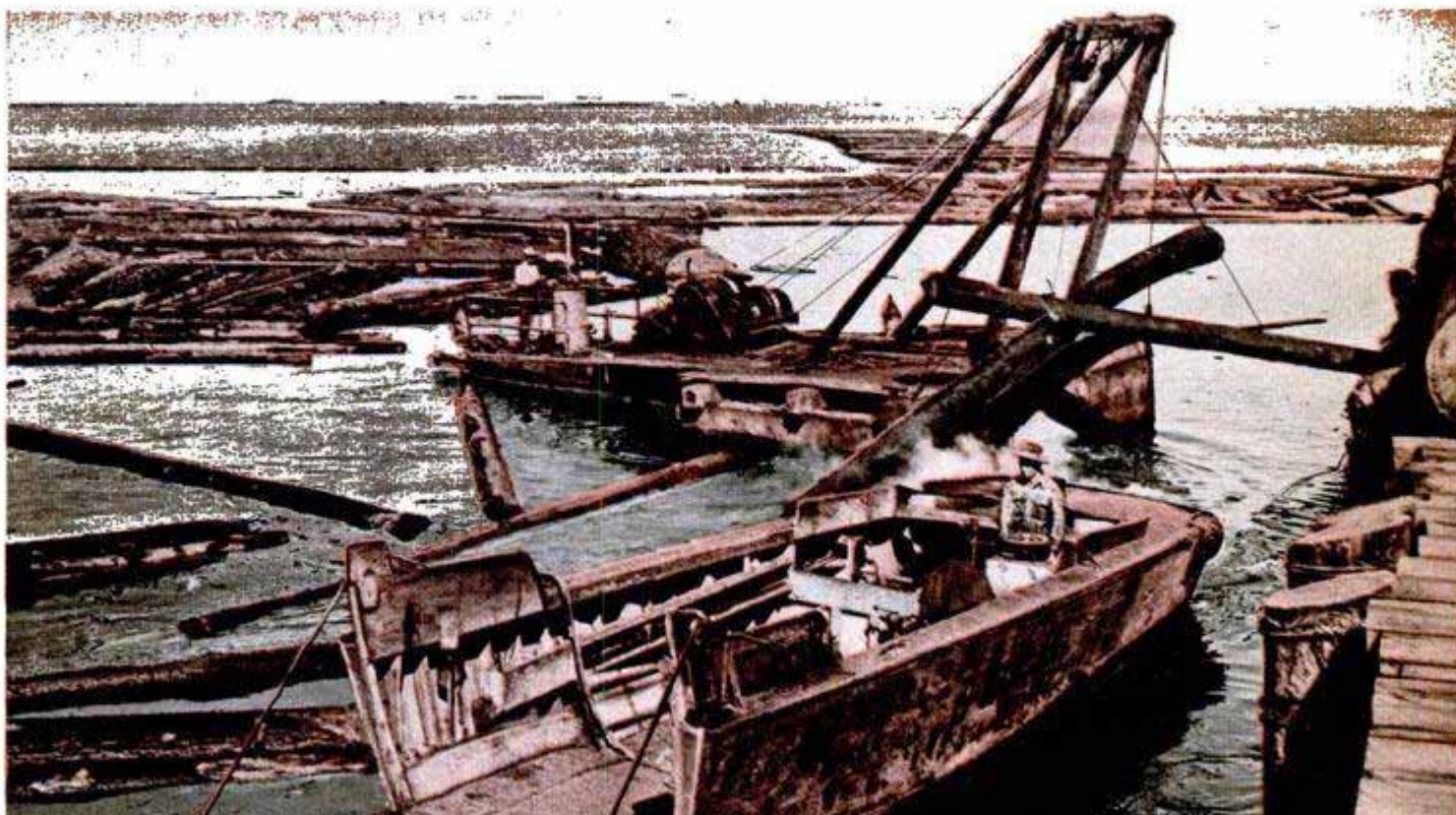



## Auxiliary Auto Weighs 475 Pounds

You'll be able to drive up to 240 miles on three gallons of gasoline in a tiny automobile designed as an auxiliary vehicle for the American family. The car, called the Imp, has a 7½-horsepower rear engine, weighs only 475 pounds and is expected to sell for about \$500. The fully automatic transmission eliminates the need for a clutch pedal and gearshift. Luggage space is in front of the seat.

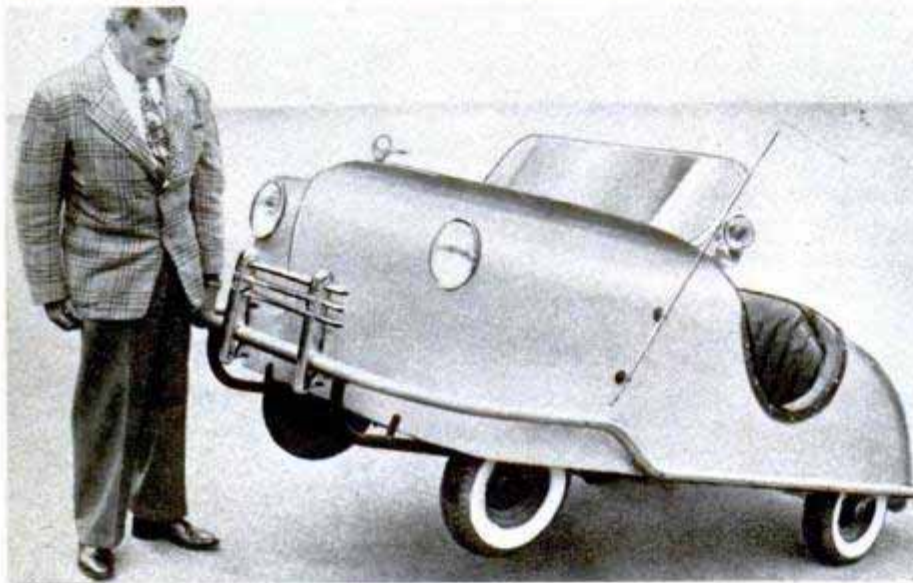

## Oil Stick With Spring Gives True Reading

Accurate oil readings are assured by a new dip stick made in several models to fit different makes of cars. The stick, actuated by a spring mechanism, must be pushed all the way to the bottom before it can be pulled out. Thus the driver, while seated in his car, can be sure that the attendant has checked the oil supply accurately.

## Metal-Sealed Heater Is Explosionproof

Electric heaters with elements that are completely sealed in metal are designed especially for warming dangerous areas that contain gasoline, naphtha, natural gas and dry-cleaning solvents. Because the wires are completely encased, the heater is said to be explosionproof. The nickel-chromium wire is insulated and sheathed in seamless metal tubing, then embedded in a one-piece aluminum casting. The casting has fins which conduct the heat at a low operating temperature. The heater is designed for gasoline bulk stations, dry-cleaning establishments and other buildings where an open heating unit

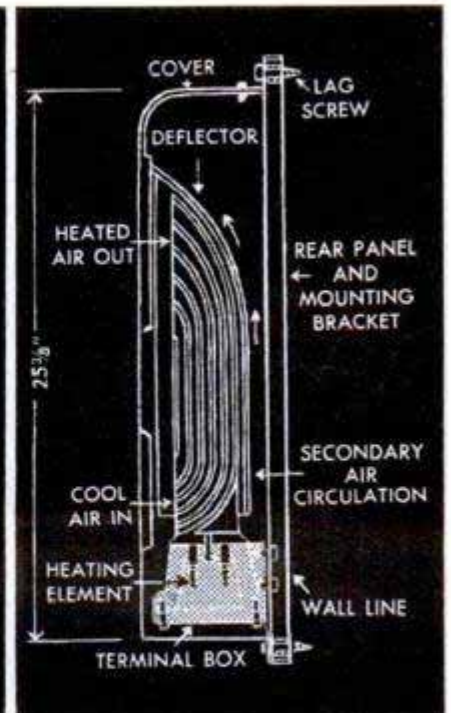

would be dangerous. It is available in three models with ratings of 2000, 4000 and 6000 watts.



## Enlarging Camera Copies Movie Film

Favorite frames of your home-movie reels can be made into wallet-size snapshots with the help of an enlarging camera that is used under normal room illumination. The camera and its built-in illumination unit are mounted on a convenient stand. The camera takes 127 film and has a fixed-focus lens. With a viewing device that is part of the unit, you select the frame you wish to copy, then press a shutter-release button and the job is done. The film is processed as usual to produce standard prints or, if desired, jumbo enlargements.

## Bug Killers More Potent Yet Safer To Use Than DDT

Five times as potent as DDT, two new insecticides are only one third as toxic to animals, thus providing farmers with a safer method of pest control. The two insecticides, BNB and BNP, are not yet on the market, but field tests have shown they will kill pests that DDT does not, such as the Mexican bean beetle. Although expected to be about five



times as expensive as DDT, the new chemicals will be no more costly to use because of their greater potency.

## Commands Spoken Into Mike Operate Model Railway

"Start!" says Ray DeVault into a little microphone, and his model train begins chugging down the track. "Go back!" he

says, and the model immediately shifts into reverse. DeVault, who lives in Walnut Creek, Calif., designed the voice control in



a Marine radar shop on Guam. The control is attached to the remote-control unit that is a part of almost every electric engine these days. The number of words the operator speaks determines what the engine will do. The voice is picked up by a microphone and operates a relay, which is timed to trip not more than once per word, regardless of the speed of pronunciation. DeVault now is manufacturing the control for other fans.

☐ Potatoes can be graded for baking, boiling or frying by measuring their specific gravity, according to experiments at Colorado A. & M. College.



In emergencies, the Army's ham station, K4USA, can operate in the field with this portable transmitter

# ARMY HAMS to the RESCUE

By **Richard F. Dempewolff**

**T**HIS is K4USA — King Four Uncle Sugar Able — calling CQ, CQ, CQ. Come in for a rag chew."

The man at the radio transmitter, beaming the general "seek you" signal familiar to anyone who has ever fanned the ham frequencies on the short-wave sector of his radio dial, may be a top-ranking military officer these days. Reason?

Uncle Sam's military establishment is a "ham." In fact, it's a whole network of hams known as MARS, the Military Amateur Radio System. Established less than a year ago, the net already comprises some 1000 military and organized reserve radio hams throughout the United States, Panama and Hawaii. Other overseas outposts have just been set up in Labrador, Newfoundland and Turkey. Soon MARS may reach out to encompass most of the country's 75,000 licensed civilian amateur radio operators, who fill their designated channels with enthusiastic chatter 24 hours a day.

Some folks (and there are some) who think of hams as slightly daft hermits who spend every waking moment in an attic corner diddling with dials on a plumber's nightmare of homemade radio equipment might wonder why the Army would want to join the act.

Chaplain St. Onge and his radio were key links in communications during the Greenland icecap rescue





**Forced down on the Greenland icecap, the men in this C-47 were picked up with the help of Chaplain St. Onge and the Army ham net. Note snow dugout that sheltered the crewmen**

The military doesn't wonder at all. It's no newcomer to the ham bands. Major Rawleigh Ralls, Chief MARS, Air Force, and Captain E. L. Nielsen, Chief MARS, Army, explain it simply: "Before the war, the AARS (Army Amateur Radio System), a blueprint for the present MARS, proved the value of hams beyond all question. In every theater of war, amateurs formed a hard core of military radio personnel. Hams became the instructors at Army radio schools, the research engineers who helped develop radar, the small manufacturers who adapted, perfected and built much of the efficient modern field radio equipment that contributed toward the winning of World War II."

The military thinks it would be nice to have such a backlog of skilled radio talent again. Then, there's another and even more important use for a good ham net-

**It was a jato-equipped C-47 with landing gear like the one shown here that rescued the stranded flyers**

work in peacetime. It has to do with the very nature of a ham.

There's nothing in FCC regulations that says a ham must do anything besides "bat the breeze" with brother hams in China, Afghanistan or Bemidji in order to keep his license. But, when floods hit Texas last year, amateurs with portable transmitters and put-put generators rushed to the stricken area. Where telephone and telegraph lines were wiped out, they set up emergency communications, aiding the Red Cross and other rescue services to maintain contact with scattered rescue teams and the outside world, sending messages to relatives of survivors and dead. In earthquakes, tornadoes, big forest fires and explosions, amateur radio operators always come running with their home-grown apparatus to help out.

It was to organize and coordinate this



vast potential of emergency communication that the Army and Air Force last November quietly hoisted two spidery, signal-squirting antennas to the roof of the Pentagon Building and went to work.

MARS is controlled from two stations, operating on a wide range of frequencies. Eventually, the net will use lightweight teleprinters, facsimile machines and a host of other modern time-saving devices.

K4USA is the Army's central ham shack atop the Pentagon. The Air Force sends its chatter from K4AF in an adjoining part of the building. Net control stations are set up at Army posts and airfields in each of the six Army areas in the United States. These stations, in turn, provide the link with control stations on the state level—to which local members report.

How does the network operate when disaster hits? Suppose there's a gigantic munitions explosion in a New Bedford, Mass., plant. The telephone exchange is reduced to rubble, telegraph lines are down, local radio stations are demolished. For blocks around, buildings are piles of broken masonry. Dead and injured lie along the streets.

But there's a MARS ham in the suburbs, whose 100-watter sits safe and sound on a table on the sunporch. He has seen and heard the explosion. A quick visit with local police and Red Cross workers gives him an appraisal of the situation. There's a dire communication emergency. The ham reports into the net.

W2USA is the MARS control station for the First Army area in New York. Our ham sends a QRR signal there. QRR is practically synonymous with the old SOS.

From W2USA, Capt. Richard Speer has the message relayed to the Pentagon. A check with Red Cross National Headquarters verifies the communications emer-

gency and the help of MARS is requested. The network is in business officially.

Now, something else happens. All MARS stations have two sets of call letters. When K4USA is just "rag chewing," it is simply K4USA. But, when it's working the net as official MARS, it switches to regular Army frequencies and becomes WAR. Likewise, K4AF becomes AIR. Member stations with private "W" call letters change their "W" to "A" or "AF."

So, using calls WAR and AIR, the Army and Air Force control shacks in the Pentagon go out over the MARS channels, alerting all hams in the New Bedford area: "QRR, QRR, QRR—attention all MARS members. This is the MARS headquarters station. Stand by on this frequency for instructions."

The rest is routine. Hams in New Bedford are ordered out to the disaster area with portable rigs; others monitor the frequencies from their home sets and relay messages. The Red Cross needs ambulances quickly. In a few minutes, a roving MARS member on the scene has made the request, which is relayed to Washington. Military commanders in the Pentagon authorize 50 ambulances sent out from nearby military establishments. That order goes out over WAR and AIR to Massachusetts Army posts and airfields on the network. A few minutes later, the ambulances are rolling.

Meanwhile, the local MARS members in New Bedford are busy messaging back and forth between separated rescue parties, helping coordinate operations. After all necessary equipment, doctors and other aids have been ordered, MARS hams then go to work relaying personal messages to

Future Army hams practice code at Fort McPherson's radio school, attended by regulars and reservists





Last winter, during "Operation Snowbound," plowing and rescue operations were directed by Army ham radio

relatives of casualties and survivors. It is all done quickly and efficiently.

MARS already has had a chance to show its stuff. Last December, a C-47 with seven men on board crash landed on Greenland's bleak icecap. Air Rescue Service planes scouted the wreck, saw the survivors waving their arms, but couldn't land due to rugged ice and snow conditions. They needed special equipment—and quickly.

At his tiny amateur radio station—VO6AN—in Goose Bay, Labrador, Army Chaplain Alexis St. Onge, an incurable ham and now a MARS member, talked with the returning rescue party and learned their plight.

VO6AN was on the air a moment later

with a QRR. In a short time, K4USA was coming through in good shape. The contact was maintained and became the main line of communication between the Air Rescue party and Washington throughout the dramatic rescue.

Over the hookup, Air Rescue men described the tough conditions. Washington experts quickly radioed from the Pentagon to Army posts in widely separated parts of the country to procure the special equipment that would be needed. They ordered it flown to Greenland immediately.

Hours later, a big plane took off from an airfield in Greenville, S. C., with a glider in tow. The glider had a special tow hook that would not only release it for a landing



Left, acting governor of Wyoming, Arthur G. Crane, directs snow rescue work on an Army network. Below, sergeant prepares a tape at K4USA for code-practice broadcast

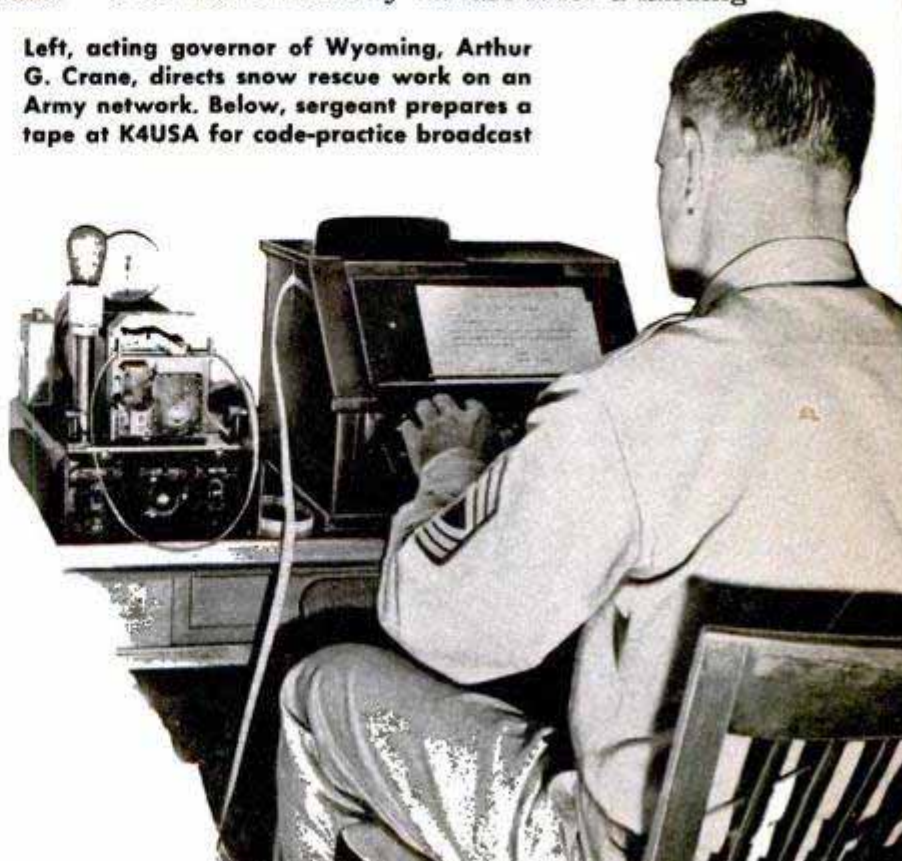

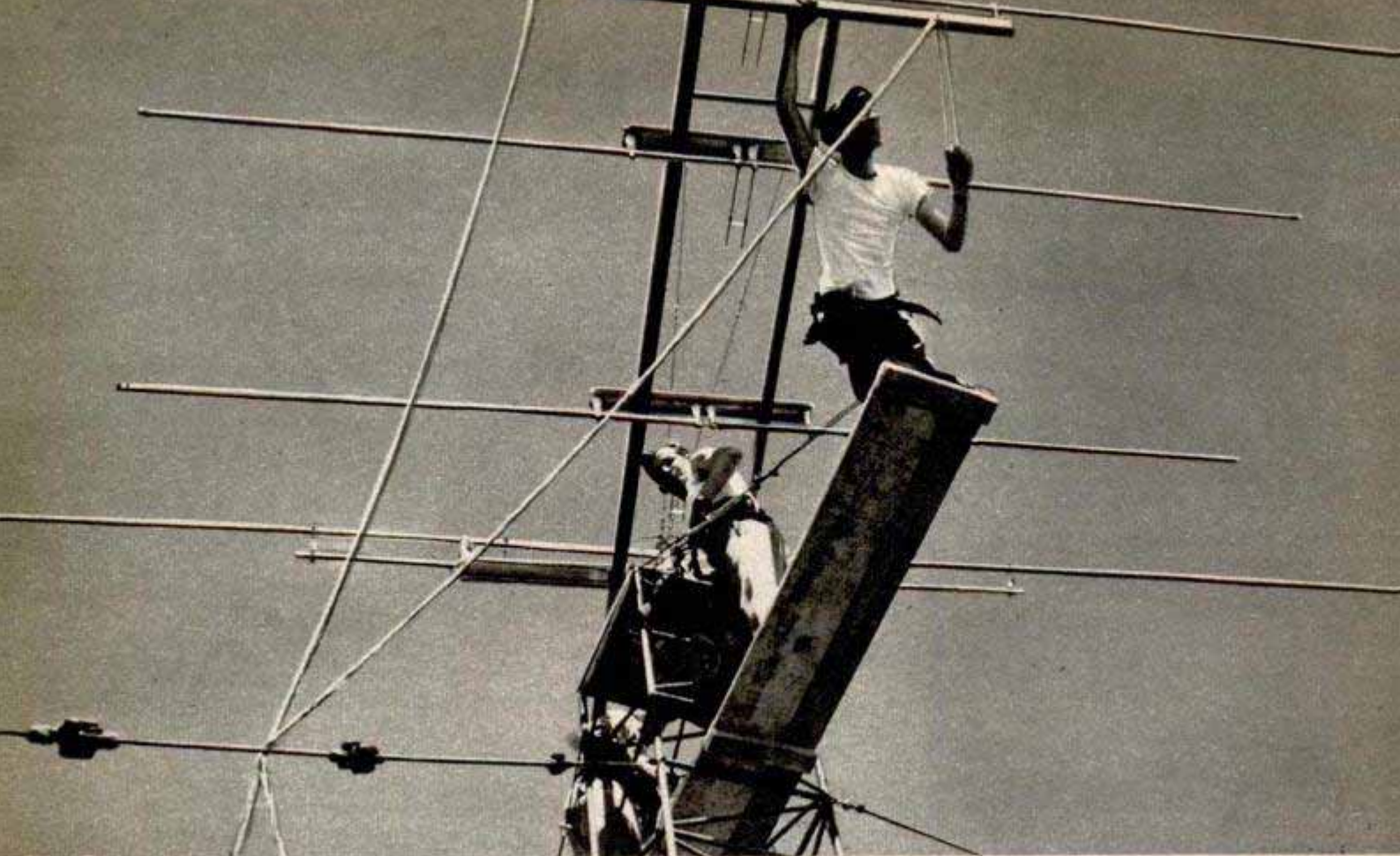

Atop the Pentagon Building, Air Force personnel erect an antenna for broadcasts beamed by MARS station K4AF

while the tow plane continued to fly, but would also catch a dropped line from the tow plane. Thus, it could be dragged aloft again after picking up its cargo of survivors.

At Wright-Patterson field in Dayton, mechanics hurriedly prepared another plane, a C-47 with combination wheel-ski landing gear and jato units—just in case the glider missed. It, too, thundered toward the icecap.

The whole world knows the outcome. The glider cracked up on landing. A Fortress went in after it and ditto. But the C-47 made it in safely, picked up the survivors of all three crashes and took off easily with its jet assist.

The point is that without a good through line of communication it might have been weeks before proper equipment



Radio is almost an obsession with hams. This Army officer didn't let a stay in the hospital interfere with his fun. He took his ham set with him



was brought to the scene and the frozen survivors rescued.

MARS hams don't just bat the breeze all the time between disasters. There's plenty of official duty. Members must report into the net at specified times for MARS news and instructions. Semiofficial messages—Father's Day greetings from soldiers and sailors overseas, family death messages, minor orders — pour from K4AF and K4USA at a rate of about 50 a day. The boys engage in DXing and traffic handling in simulated emergencies. Every night from the Pentagon shacks, operators send Morse code practice tests, starting at 5 words per minute and working up to 35. The day of the brass pounder is not yet over and all MARS members must report for these lessons in order to develop what's known as a "sweet fist."

For a time, Pentagon operators had to pound out the monotonous tests themselves. Even Sgt. Paul Allyn, K4USA's operator, whose fist is sweet enough so that he can send 50 words a minute in good shape, got bored with the routine. Now, he has a Boehme keyer to do the job for him. This is simply a circuit-breaker activated by punched tape. The tape ends can be pasted together, forming a circle of perforated paper. Thus, the same message will go 'round and 'round through the keyer while Allyn simply adjusts the speed to anything from five to 150 words a minute. It takes a pretty hot ham, however, to transcribe anything over 50.

Whether MARS is working on an official

(Continued to page 246)

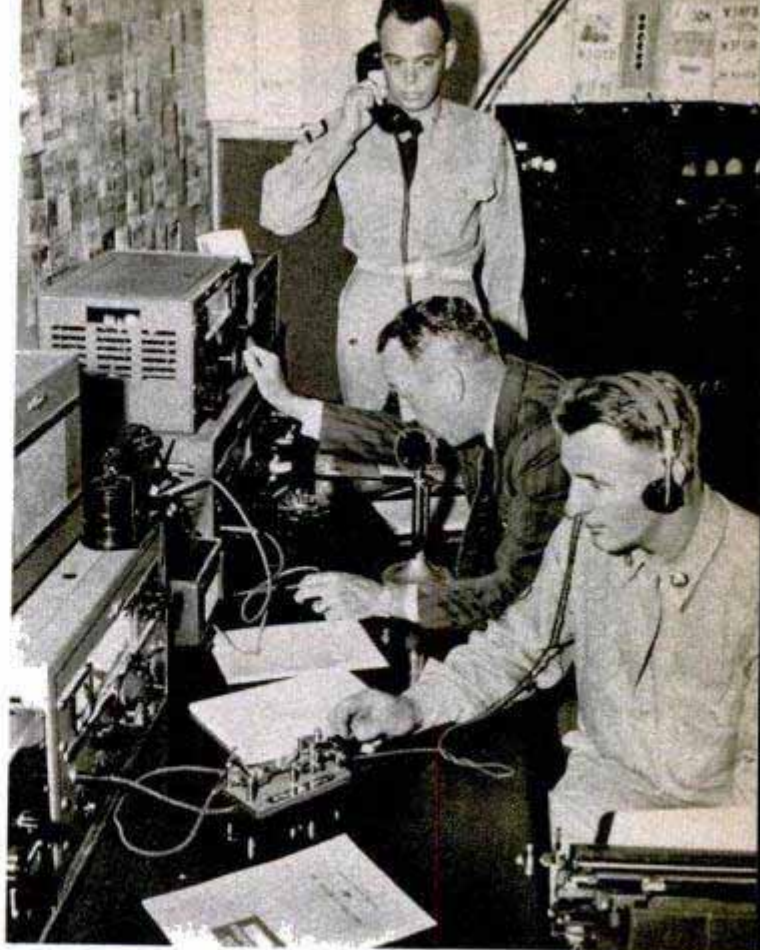

Inside the Army's ham shack atop the Pentagon Building in Washington. From here, net-control station, K4USA, broadcasts to MARS members around world

Army areas, numbered on map, have MARS headquarters. Radio net, maintained by areas, is shown by straight lines on the map, one set for K4USA, the other for K4AF. Also shown is system of relaying word of plane crash to Washington, which orders out rescue teams from the nearest land and air bases

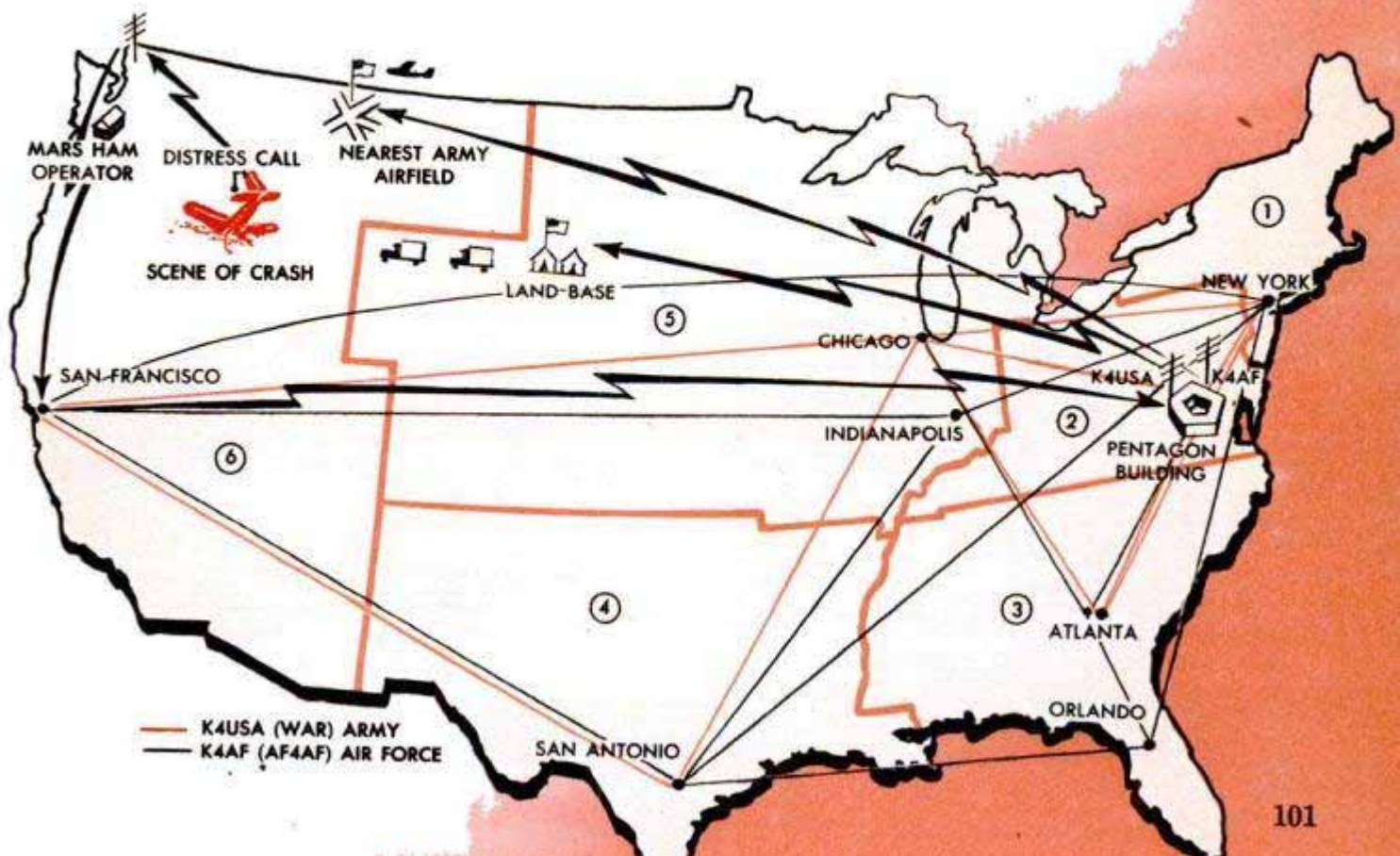



## Versatile Yard Cart

Lawn chores are made easier by a versatile vehicle with interchangeable parts. The basic unit consists of a tubular framework mounted on a wheel and two legs.

With a metal basket attached, the vehicle becomes a wheelbarrow. A revolving reel handles garden hose. A tray fits the vehicle to make it a steady serving cart, or a broiler can be installed to convert it into a rolling grill for the back yard.



## Motor for Wheel Chair Operates on Battery

Wheel chairs are made self-propelled by a new electric motor and battery unit. The attachment fits any folding tubular chair of standard design. It is fastened behind the chair and delivers power through two small wheels, belt-driven from the electric motor. A steering lever fits the front wheels of the chair. Atop the steering handle is a button which starts and stops the motor. Provided with the unit is a portable battery charger that plugs into any electric socket.

Information not listed on articles in the index, starting on page 10, frequently is listed in the WHERE-TO-FIND-IT INDEX, available without charge from Bureau of Information, 200 East Ontario Street, Chicago 11, Illinois



## Nylon Fur

Two Canadian scientists have developed a nylon fur which, according to tests, is warmer than the caribou skins the Eskimos wear. Assigned by the the government to produce a synthetic fur for Canadian soldiers and airmen in the far north, the young chemical engineers developed the first suits of nylon in little more than a year. Men who tested the synthetic furs in 50-below weather for several days had only one criticism — the nylon fur might be too warm. It is mothproof, fire-resistant, washable with soap and water and long-wearing. When Eskimos first saw the synthetic material, they wouldn't believe it was anything but natural fur. So far, the scientists have duplicated only caribou and wolverine furs, but they say it's only an-

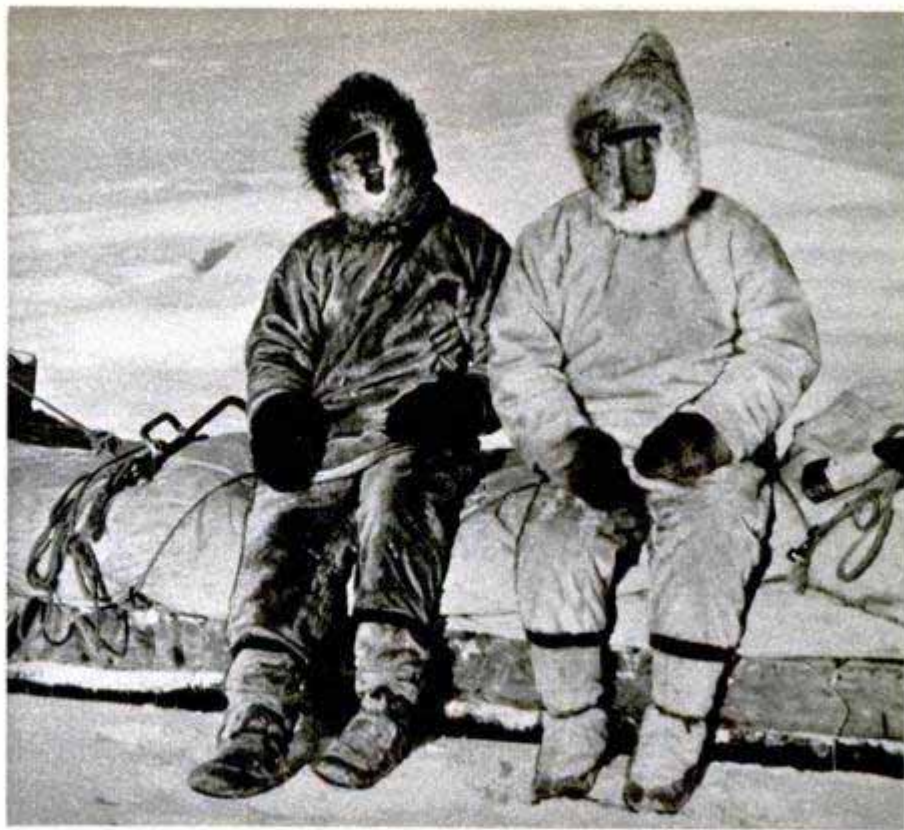

other step to imitating furs such as muskrat, beaver and mink. The method may produce a new Canadian industry.

## Preincubated Eggs Can Be Cooled Before Shipment

Poultry breeders now can start the hatching of an egg, interrupt the process for several days and then finish the incubation without damage to the chick, according to scientists of the Department of Agriculture. This makes it possible to candle the eggs after the preincubation, eliminate

the infertile ones and guarantee that the eggs will be almost 100 percent fertile. The eggs are preincubated for 16 to 18 hours at 100 degrees. They then are cooled to about 50 degrees, candled and shipped. When they reach the hatchery or poultry grower, the incubation is resumed.

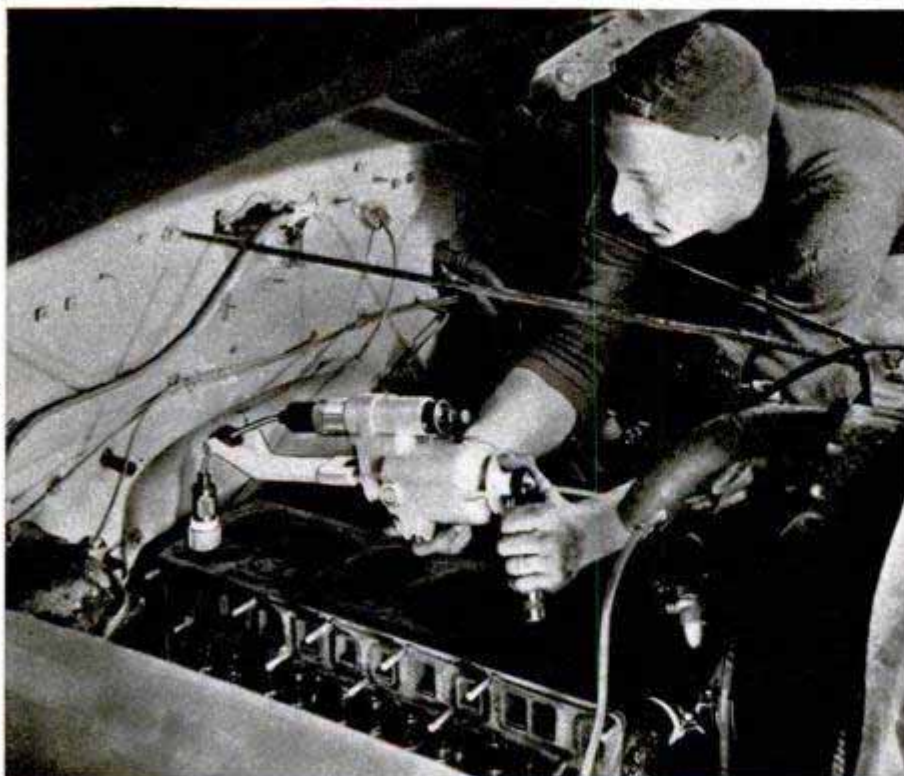

## Angle Attachment For Valve Grinder

Hard-to-reach valve seats on new models of cars and trucks can be reconditioned quickly with an angle attachment for power grinders. The flexible drive shaft runs through a rigid-aluminum bracket, enabling the tool to work under cowl overhang. Two steel pins guide the attachment accurately into position on the grinder and one screw locks it securely.

Over 100,000 school busses carry the 5,416,000 students in the U. S. who depend on these vehicles for transportation.

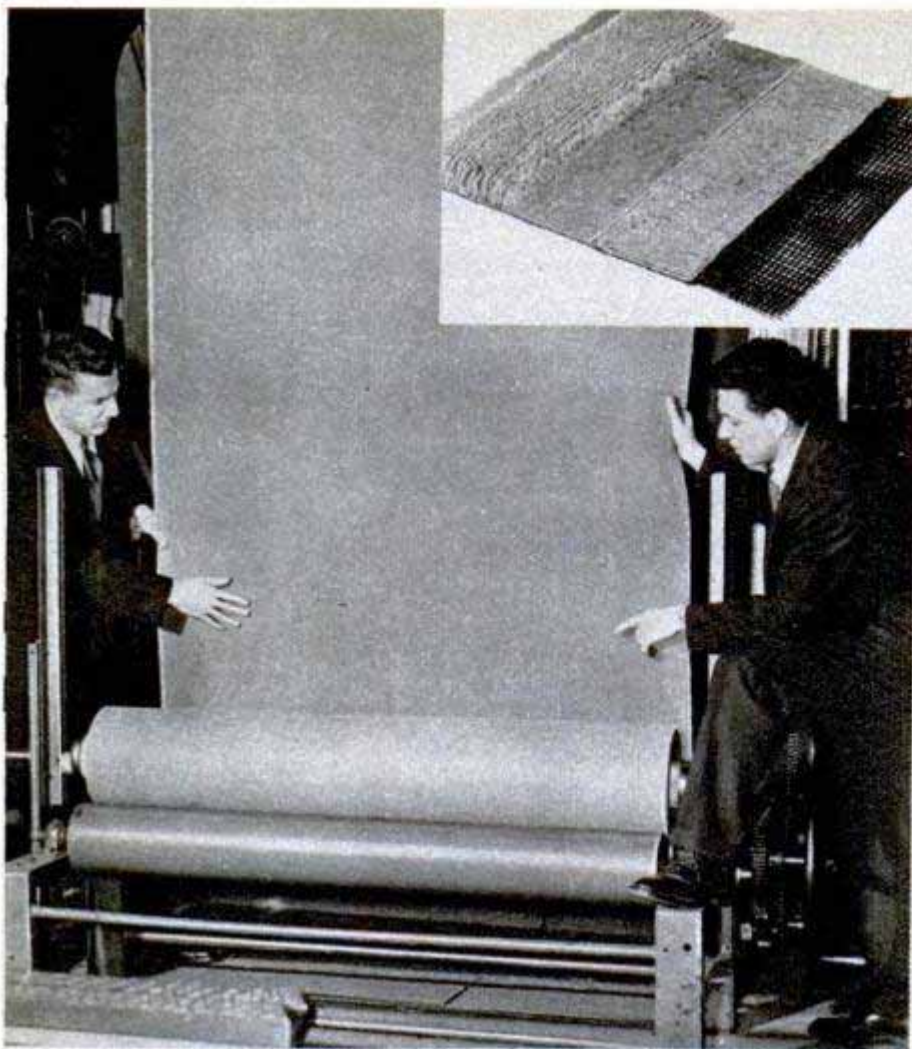

## Cemented Carpet Wears Longer

Weaving is eliminated in a radically new carpet in which the wool tufts are cemented to a heavy cloth backing. Use of the adhesive, specially developed by the United States Rubber Company, makes it wear over 50 percent longer than a conventional floor covering of the same pile height and thickness. The adhesive is tough but flexible, giving the carpet the same feel and handling qualities as the woven type. It is ravelproof and frayproof, and can be cut in any direction for fitting and repairing.

Section of new carpeting, which has tufts cemented to a heavy cloth backing. Inset, a cutaway showing carpet's construction. Starting at right, open fabric is cemented to burlap and wool pile placed on second layer of adhesive. Oven "curing" follows

## Lighter-Fluid Can Has Built-In Pump

Cigarette lighters are filled without spillage from a can with a tiny pump that prevents evaporation and has no cap to replace. When the nozzle is swung around over the edge of the can, a valve inside the pump opens, allowing fluid to flow steadily as the sides of the can are squeezed. Flow stops instantly when the pressure is released. To seal the can, you simply swing the nozzle around, closing the valve.



## Wood Panels Mount on Car Body To Add the Station-Wagon Look

Standard automobile bodies can be given the luxurious look of a station wagon with a wood covering that attaches to the sides of the body with metal screws. Frames of the covering are hardwood and the panels are mahogany, varnished to protect them from the weather. The conversion kit comes complete with simple mounting instructions so the owner can make his own installation.



**P**ERMANENTLY "perky," a new plastic lace provides a ribbon of color around everything in the home from the kitchen window to the housewife's hat. Just looking at the delicate lace, called Lacelon, suggests a thousand and one ways to use it. The featherweight material won't wilt when it's wet and can be washed with one swipe of a damp cloth. It won't run or unravel, can be cut at any point and stitched by hand or machine. Florists have welcomed the lace because it will remain crisp despite moisture or cold. Used on a hat, Lacelon can be shaped into ruffles, bows or swirls that will retain their shape if worn in the heat of the sun or sudden showers. Need a new lamp shade? Just sew bright ruffles of Lacelon on the top and bottom edges of the old one. Instead of buying new curtains, tack a ruffle of the colorful lace around the kitchen window. The rainbow material is available in three and five-inch widths. The homeowner has his choice of 10 colors that will appeal to the entire family including the children. For a bow in daughter's hair, just twist the lace into the proper shape. If baby has no hair, stick the bow in place with a bit of cellulose tape. Junior probably won't stand for this for more than a few seconds—but you may have time enough to snap a photograph.

↓ Delicate yet colorful, Lacelon retains its crispness indefinitely, can be cleaned with damp cloth



Minnesota Mining & Manufacturing Co. photos

↑ Housewives can make colorful frames for kitchen windows with the plastic lace. No curtains to wash!

## Plastics Spin a Rainbow Indoors





† Florists have been quick to adopt Lacelon because it retains its shape despite moisture and cold. Arrangements such as these can be made in advance, then placed in cooler. Fabric laces would wilt under such conditions

↓ There's no trick to sewing the perky lace—just run it through the machine as you would any material. Stay inside the scalloped edge, which might tear out



† To make filmy ruffles the housewife sews straight down the lace, just inside the delicate swirled edge. Then the ribbon is ruffled up along the thread and tacked to the window or sewed to last year's hat

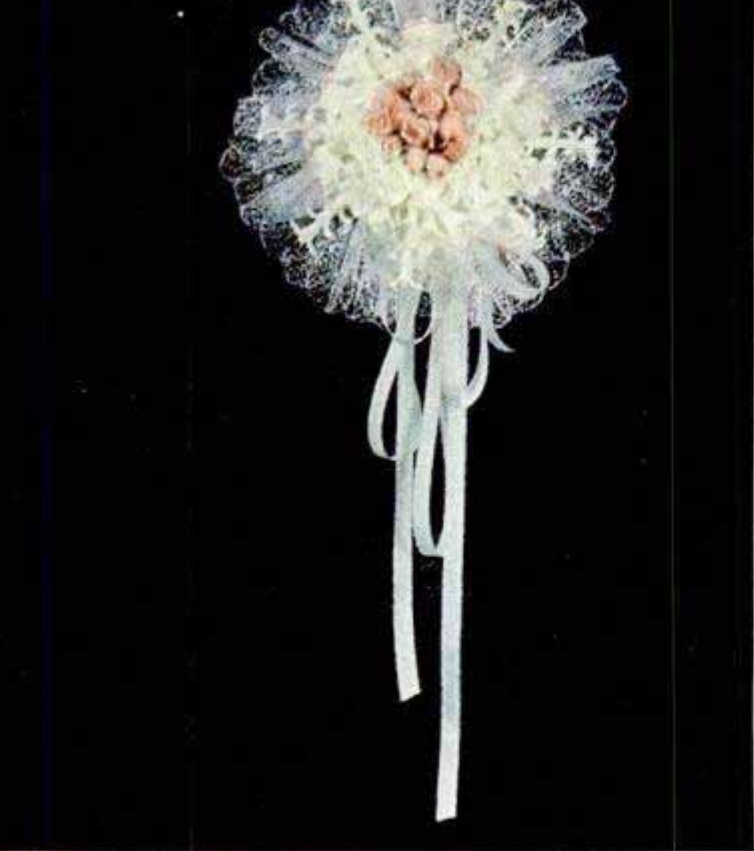

↑ Plastic forms a crisp halo for an arrangement of roses

Above, right, an old lamp shade becomes a new one with ruffles of color on it

Right, wrapping gifts is an art made easier by a material which is bound to look good

↓ Strips of various colors sewed together make delicate doilies that can be wiped clean





↑ Milady has a new hat—only it's the old one with a perky halo of lace. The original trimming is removed and a ruffle of Lacelon sewed around the hat. Artificial flowers can be combined with lace if desired



← Anyone can make imaginative gift wrappings with the new material. Large bows and lace "flowers" are made by gathering the material as desired, then holding it in place on the package with cellulose tape

↓ Using the crisp material in unusual places puts spots of color in the kitchen. Here a "new look" is achieved by trimming the shelf edges of a whatnot with runners of lace. The plastic is flame resistant



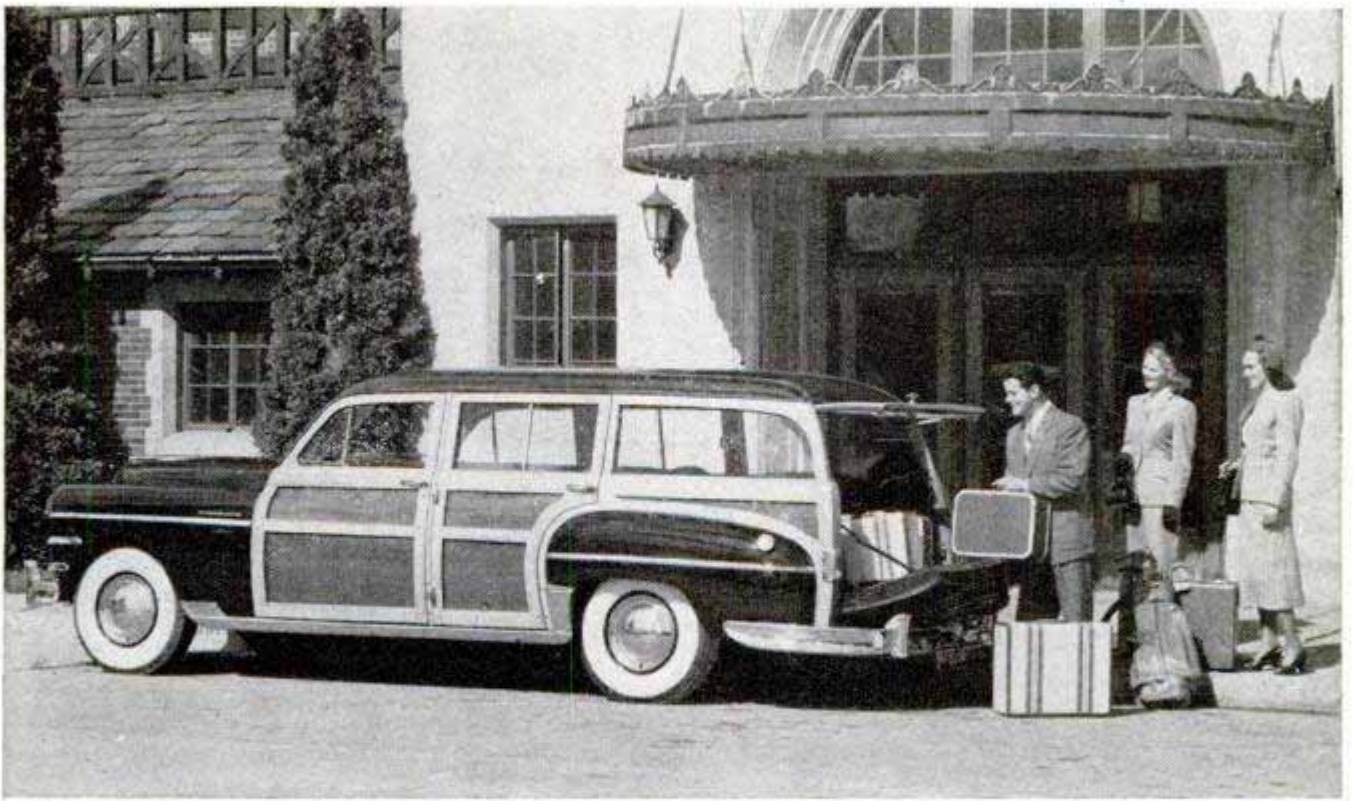

## Chrysler Station Wagon

Chrysler's first station wagon since 1941 is a nine-passenger Royal model powered by the six-cylinder Chrysler Spitfire engine. The car has three full-width seats and two of them can be removed to provide a loading space 10 feet long. The spare tire is mounted in a special compartment in the

tail gate and can be unlocked and removed without lowering the gate. Stoplight and license combination are a part of the tire-compartment cover. The station wagon has white-ash trim fitted onto steel body panels with a mahogany finish. Interior upholstery is a leatherlike plastic resembling alligator hide and can be cleaned with soap and water.

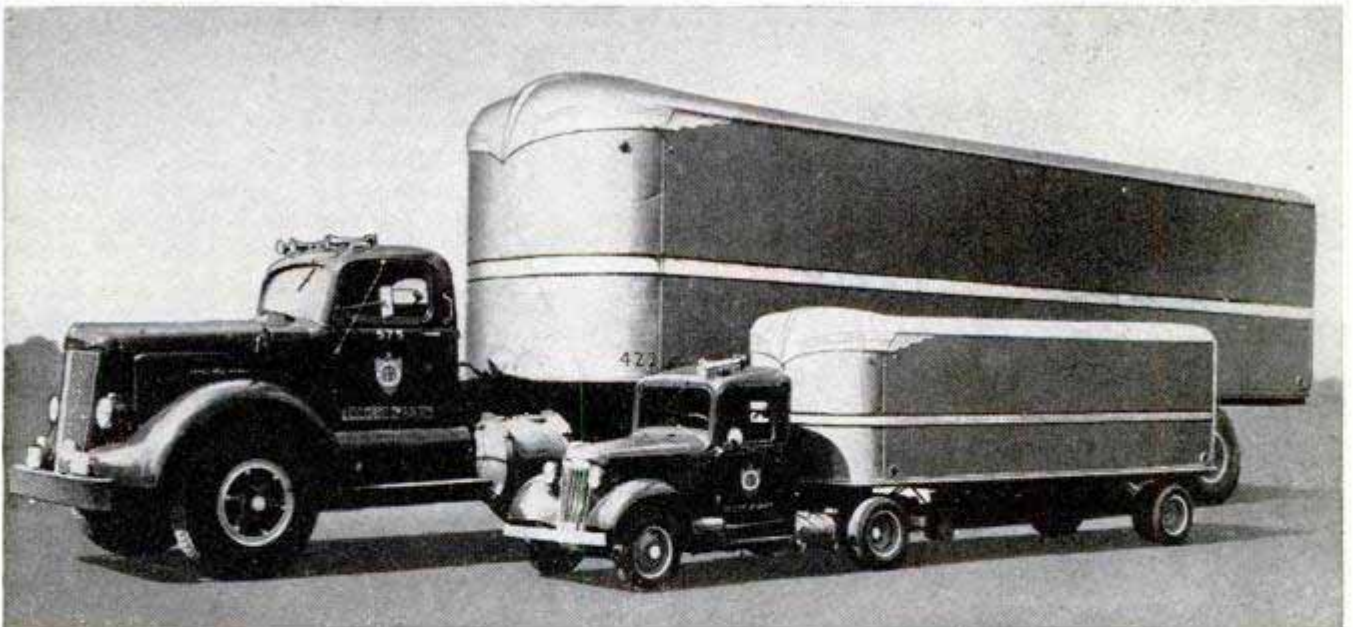

## Baby Trailer

Employees of a truck line in Tampa, Fla., recently spent five months and \$7000 to build a miniature semitrailer that looks exactly like its prototype except for size. The baby truck including trailer is 14 feet long and 4 feet wide. Weighing 1310 pounds, it has a Crosley Cobra engine that

pushes it along at speeds up to 50 miles per hour. The midget truck is making a tour of the cities served by the company. It is driven on short hauls, but on long trips it is carried by one of its big brothers.

☐ Disposable oxygen masks, made of paper, Pliofilm and plastic, have been developed by the U. S. Air Force.



## WHAT'S NEW *For Your Home*

**CLOTHESLINE PROP** adjusts in length like a telescope. One twist of a locking device clamps the two sections together securely at any position. Rubber tips on both ends keep the aluminum prop from slipping or toppling in the wind. It can be adjusted from 4½ to 8 feet

**WASHABLE LAMP SHADE** quickly slips off its base of translucent parchment to be cleaned in warm water and suds. The parchment base serves as a shade while the rayon cover dries. Elastic in the fabric shade assures a neat, trim fit



**NEEDLE THREADER** for sewing machines ends eyestrain for the seamstress. Just a couple of turns of the handwheel and the threading is done. It works on any machine

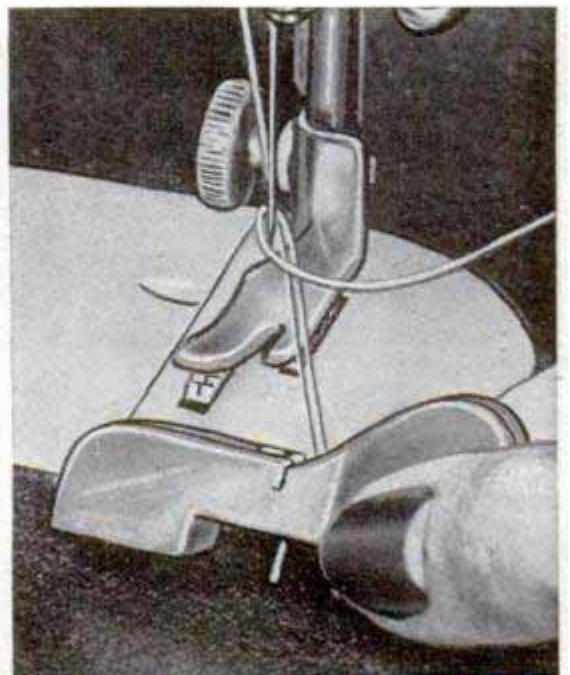





**PASTRY ROLLER**, left, is a modern version of the centuries-old rolling pin. Entirely of plastic, it has eight nonsticking rollers to speed pie-making and its multiple action eliminates lumps and waves



**COFFEE-BOWL HOLDER**, above, does two jobs at one time. It holds the glass top of a coffee maker securely and has a recessed base to catch drippings



**SELF-EMPTYING HAMPER**, above, fits on any door or wall and empties itself when a catch is released. It is made with an open weave for ventilation

**PORTABLE BABY BED**, below, is so light you can carry it and the baby at the same time. The tubular-aluminum frame folds to suitcase size for carrying. Net sides provide ventilation and let baby look around



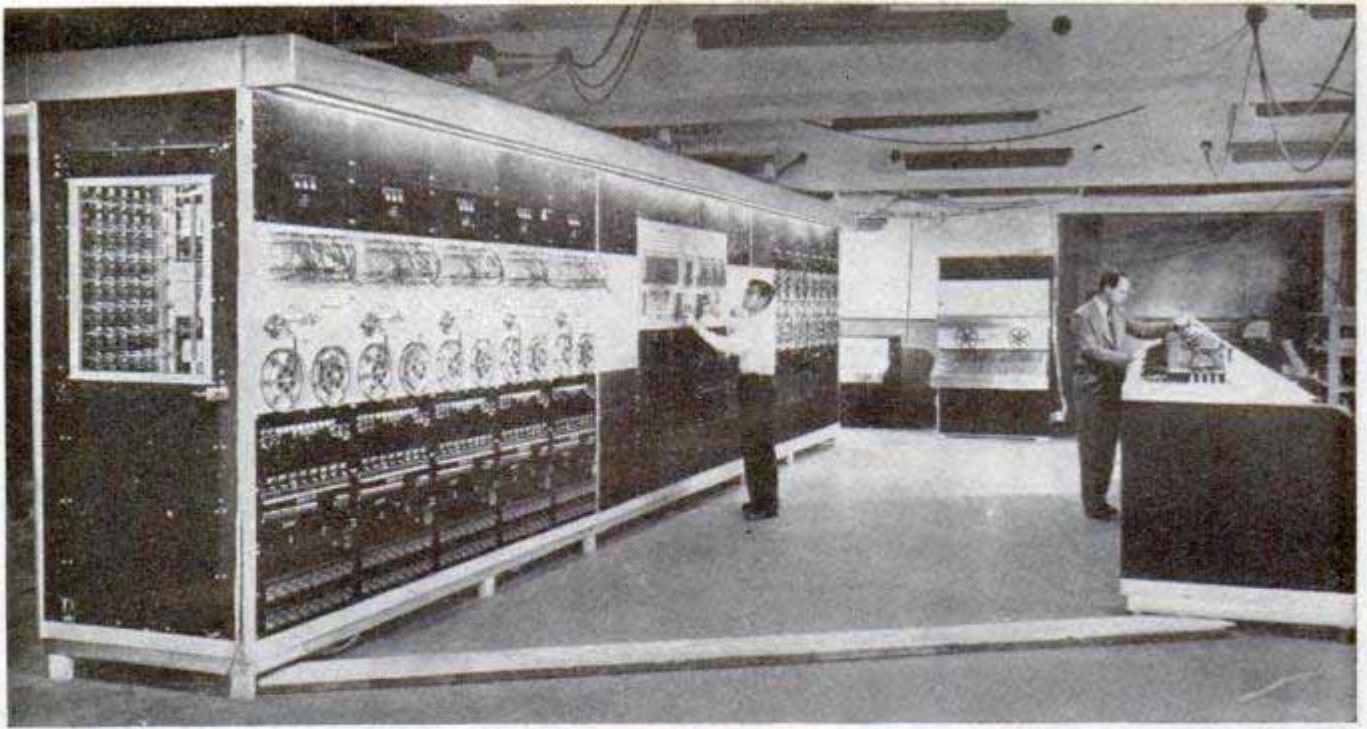

Mathematical marvel, the Mark III, answers problems on magnetic tape. Tape then is fed into typewriters which write solution. Right, information is given to coding box

### Computer's Memory System Stores 64,000 Numbers

In just about  $\frac{1}{1000}$  second a new computer can multiply two 16-digit numbers; it can add the numbers in one third that time. The computer, the Mark III at Harvard University, has a memory system capable of storing up 64,000 digits for later use. The system consists of nine drums. Difficult mathematical problems are fed on magnetic tape into one drum, which in turn "commands" the machine to solve the problems by using the numbers in the eight storage drums. All information and numbers for the computer are represented by small magnetic spots on the whirling drums. Because the answers are

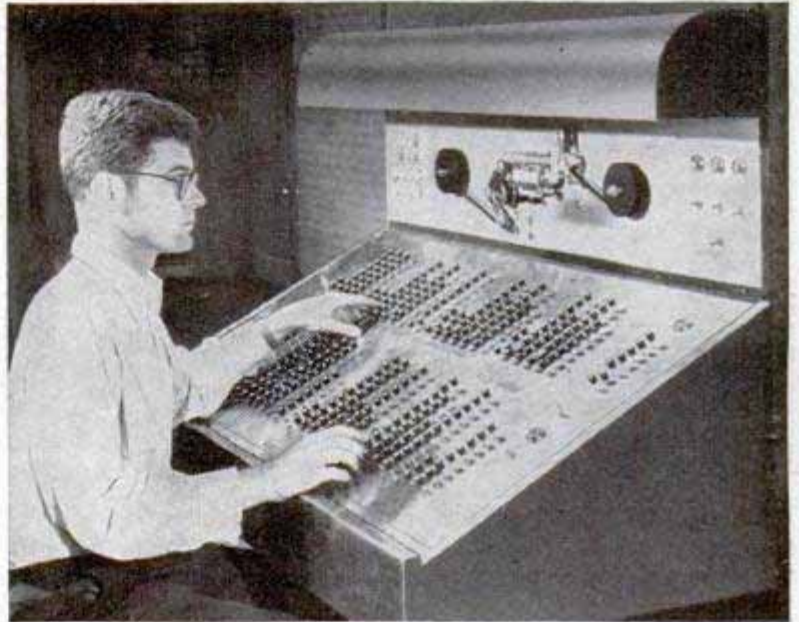

computed faster than typewriters can print them, they are recorded on magnetic tape which then is fed to a battery of typewriters at a slower speed. The computer is 30 feet long and weighs almost 10 tons.

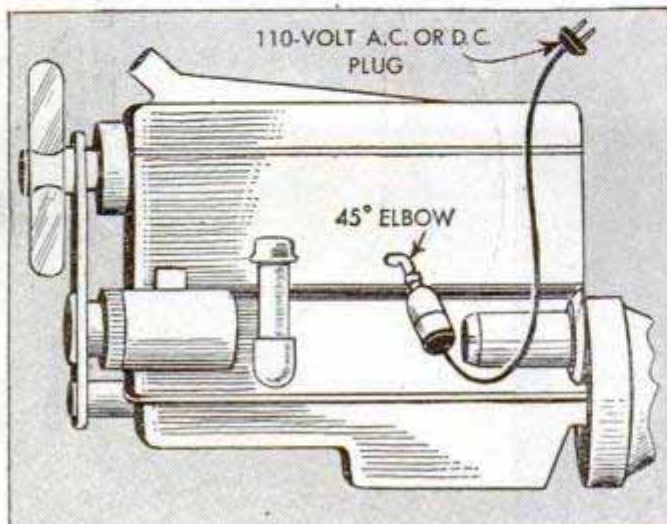

### Engine Heater

Easy starting of a car during cold weather is assured by a water heater, installed on the engine, which can be plugged into any convenient electric outlet. A pipe elbow is installed in the drain hole of the engine block, and the heater screwed to the elbow. When the cord is plugged in, the water inside the heater is warmed to a certain temperature, discharged into the engine block, and more water drawn into the heater.

Using a new type engine, a twin-jet British Gloster Meteor climbed to 40,000 feet in four minutes.

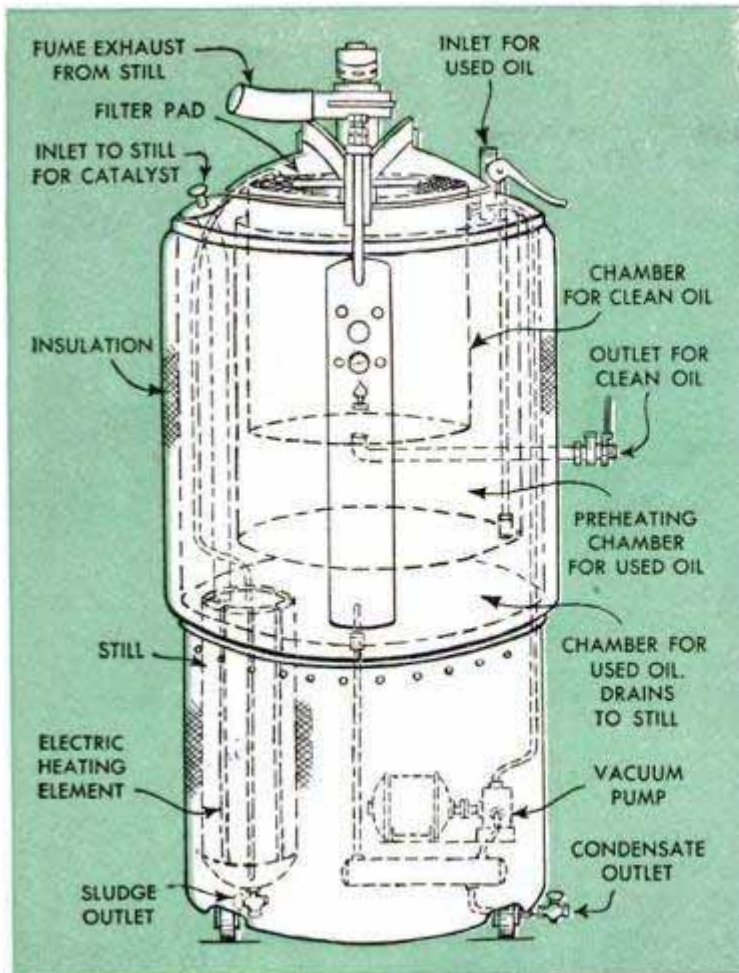

*Refer to: The Hilliard Corp.  
102 W 4th St., Elmira, N.Y.*

## Miniature Refinery Cleans Motor Oil for Reuse

Based on the theory that oil does not wear out, an oil-refining machine uses a catalytic process with high temperatures and sub-atmospheric pressures together with filtration to prepare used oil for reuse. The complete refining unit removes all carbon, acids, metal particles, water and dirt.

According to the maker, the machine turns out lubricating oils equal or superior in all characteristics to the original qualities of the oils. It operates on 110 or 220-volt current, weighs 300 pounds and has a daily capacity of 75 gallons, handling 3½ gallons of used oil at a time.

## Lift Clamp for Outboard Motor Allows Shaft to Swing Into Boat

Shear-pin repairs are carried out quickly when the outboard motor has a lifting device that permits swinging the shaft into the boat while the weight of the motor is still supported on the transom. The clamplike lift comes in two sizes to fit all types of outboards. The motor is tipped to a horizontal position so that the shaft can be swung into the boat easily.

Some 43½ million motor vehicles are now in use in the U. S., according to a recent estimate of the Automobile Manufacturers Association.

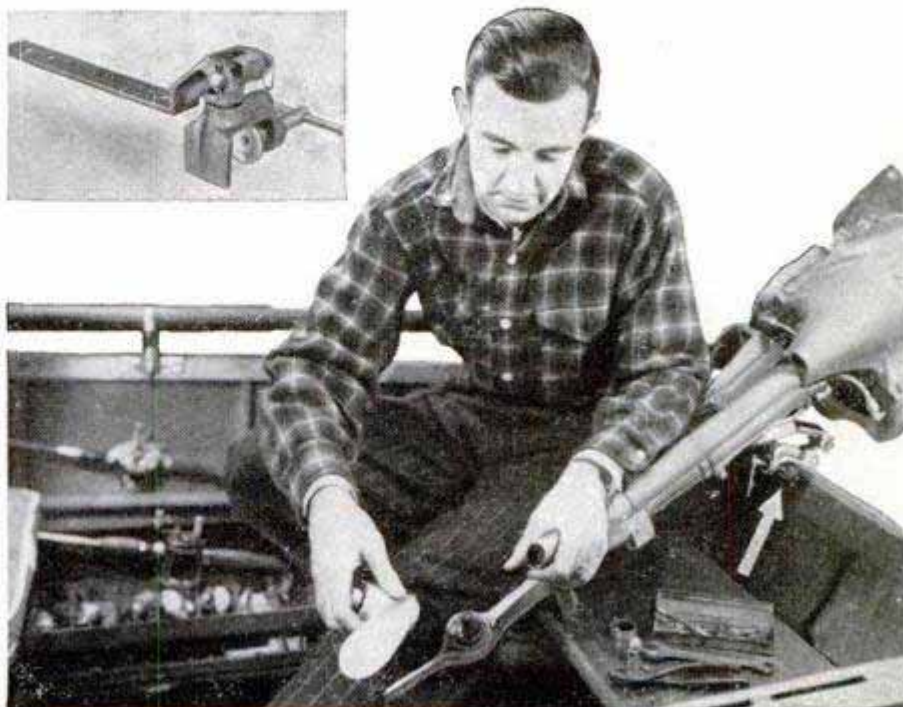

# Stoves That

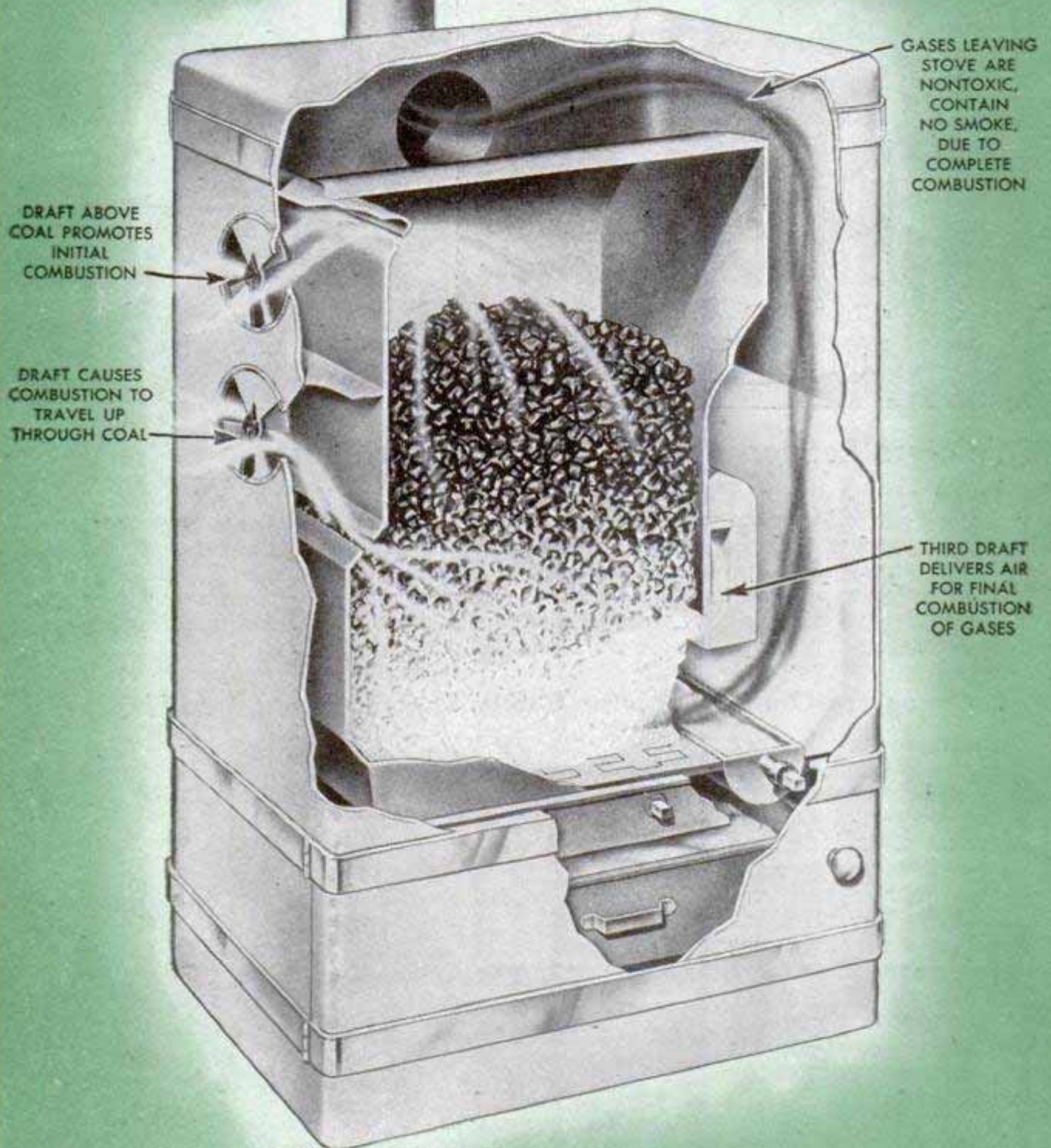

This smoke-eating stove achieves almost complete combustion by burning both solids and gases through a unique draft arrangement. Users of stoves of this type report a big saving in coal, and long intervals (from 12 to 24 hours) between stokings

# Eat Their Own Smoke

By Harland Manchester

**T**HE CONVENTIONAL domestic stove or furnace is a highly efficient device for carrying fuel up the chimney and sprinkling it on the neighbor's wash. In most stoves, fresh fuel on top of the fire liberates gases before it starts to burn, forming soot and tars which foul up the flue and escape into the outside air. That plume of smoke coming from the chimney may look pretty on Christmas cards but, to an engineer, it is a sign that fuel is being wasted. If combustion were complete, there would be no visible smoke.

In some 2700 houses in the Midwest and South last winter there was no indication to the passing traveler that the folks were home. The familiar smoke plume was gone. A new type of coal stove, representing the first radical improvement in space-heaters since Ben Franklin's famous invention, had eliminated the smoke nuisance in 2000 houses, and was also cutting fuel bills and greatly extending the intervals between

stokings. In 700 other houses, a soft-coal burning hot-air furnace, also designed for smokeless combustion, was achieving similar results.

The smokeless stove was invented in the laboratories of the Battelle Memorial Institute of Columbus, Ohio, one of the oldest and largest nonprofit industrial-research organizations in the United States. The furnace was developed by Prof. Julian R. Fellows of the University of Illinois. One of Battelle's most important clients is the bituminous-coal industry, whose frank aim in life is to sell more bituminous coal. Back in 1940, Bituminous Coal Research, Inc., the industry's research group, took a hard look at the census figures. They found that 47 percent of the country's homes were heated by some kind of stove, and that soft coal was by far the most important fuel used for this purpose. At the same time, the uncontrolled burning of this major fuel was being widely condemned as a cause of

Prof. Julian R. Fellows demonstrates his smokeless furnace in lobby of hotel to prove absence of flue gas

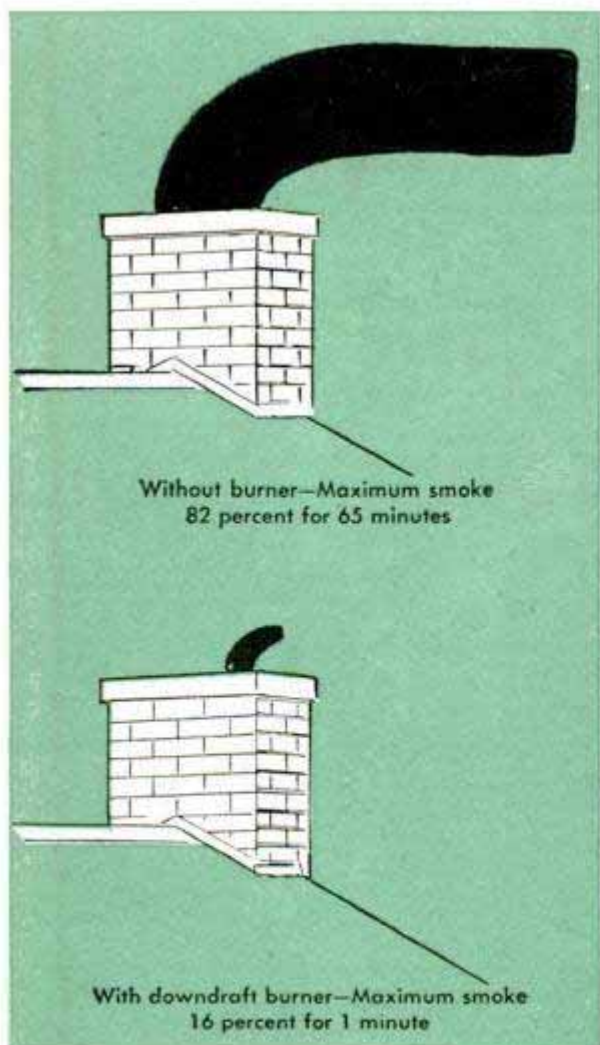

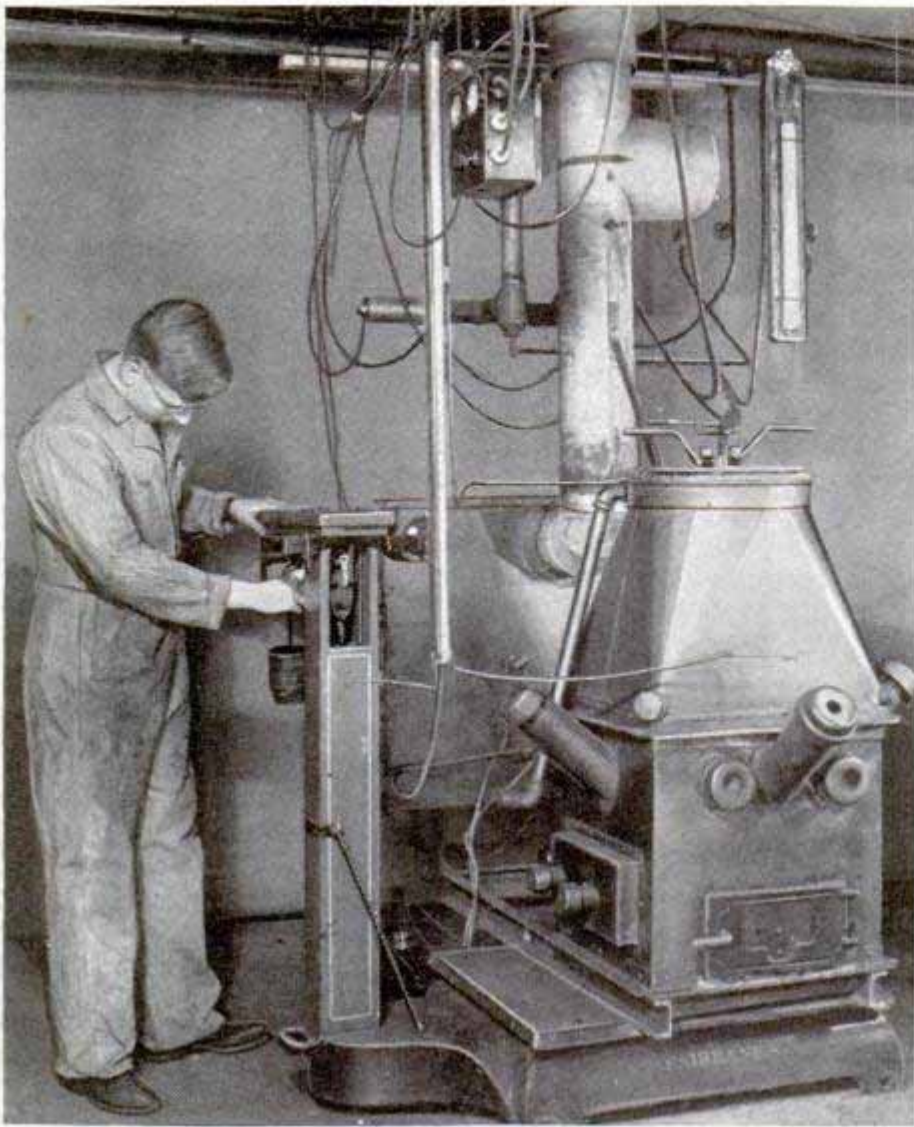

Laboratory model of coal heater with smoke meter and test apparatus for studying combustion. Scale shows weight loss during burning. Thermocouples test temperatures in different parts of firebox and water samplers collect gas samples. Photoelectric cells measure density of smoke

air pollution—a field in which it also holds first place. Big industries can cleanse their furnace exhausts by installing in their stacks electrical precipitators or other devices which are much too expensive for

complete combustion by burning the volatile gases that were wasted up the flue, substantial fuel economy would result.

The bare statement of these goals was sufficient to interest stove makers, who sell

home stoves and furnaces. In many cities and towns, homeowners are not allowed to burn the cheap bituminous fuel because of the smoke nuisance. Obviously, if a nonsmoking space-heater could be devised, soft coal would be in a better competitive position with other fuels.

This was the assignment handed to Bertrand A. Landry, Battelle's supervisor of fuels research, and Ralph A. Sherman, well-known fuels expert and assistant director of Battelle, in the fall of 1940. It was found that a number of other possible improvements were intimately connected with this goal. For instance, one reason why the ordinary coal stove produces so much smoke is the need for frequent firings—often every three or four hours. When you shovel in coal you raise a lot of dust, produce a glut of unburned gases, and suddenly thicken and blacken the smoke plume. So they chalked up "longer interval between firings." It was also obvious that if you obtained more

## SMOKELESS HEATERS

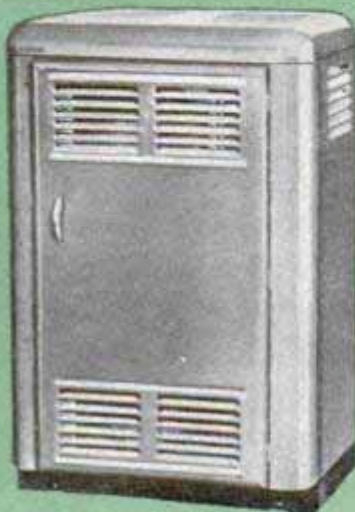

FULL-SIZE CIRCULATOR TYPE



RADIANT TYPE



SMALL-SIZE RADIANT TYPE

several hundred thousand coal-burning space-heaters every year. Twenty-seven manufacturers joined in financing the program, and work in the Battelle fuels laboratory slipped into high gear. Many existing stoves were exhaustively tested. They were mounted on scales with flexible connections to observe the rate of weight loss during burning; temperatures in various parts of the firebox were taken by means of thermocouples; the behavior of air currents was recorded; gas samples were obtained by means of water-cooled samplers, and the density of smoke in the flue was measured by photoelectric cells.

It soon became apparent that two steps were necessary for the complete combustion of coal—one for burning the solids and the other for burning the gases liberated by heat. Most conventional coal stoves are based upon the notion that burning fuel is a single, indivisible problem, with the result that black smoke consisting largely of a tar fog rolls up the chimney.

Several experimental stoves were designed and tested at Battelle, resulting finally in the "BCR smokeless stove" now in use. This engineering feat was about as complicated as designing a new internal-combustion engine, but the behavior of the new stove may be described simply somewhat as follows: (1) There is an air intake at one side of the fuel bed and an exit on the other side, both above the grate, and this cross-flow of air causes combustion of the solid fuel, after distillation, so that the hot gases do not pass through the "green fuel" above. (2) An air intake near the top of the fuel bed causes ignition to advance upward, against the downward flow of air, which at the same time carries the distillation products diagonally downward to the exit. (3) A secondary air intake, located near the outlet to the flue, mixes air thoroughly with the hot, combustible gases and burns them before they can escape.

Most of the engineering development necessary to transform the Battelle laboratory results into practical commercial designs has been done by development en-

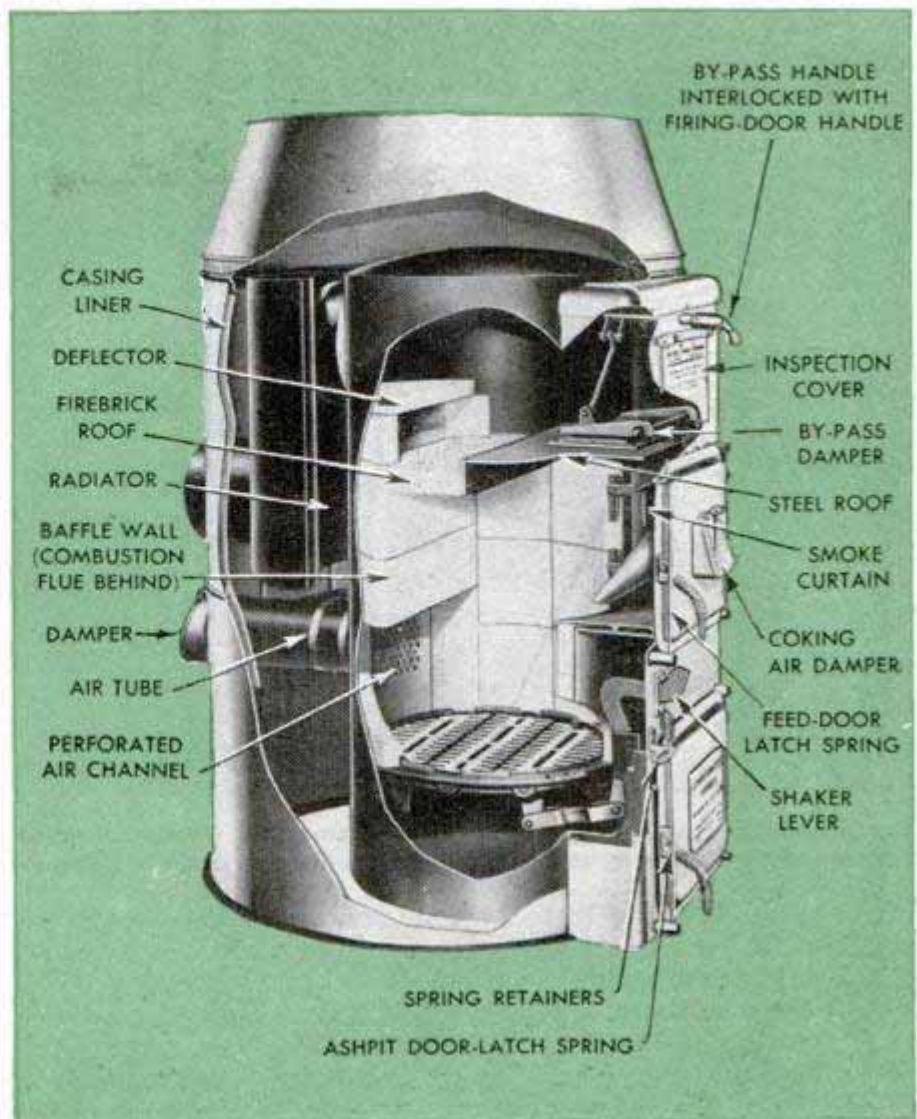

The Lennox smokeless furnace is production example of a down-draft unit

gineers of Bituminous Coal Research, Inc., who have worked in cooperation with several stove manufacturers.

After the stove was completed, it was supplied to many selected householders in Chicago, Indianapolis, Cincinnati and Pittsburgh, and supervised tests were conducted for three years under actual operating conditions. Bituminous coal in a size about 1½ by 2 inches was recommended. Users found that no smoke came from their chimneys except immediately after firing, and many reported a fuel saving of 12.5 percent or better. Many users were enthusiastic because they could throttle the stove down and leave their homes for 24 hours without worrying about freezing pipes.

Two of the participating manufacturing firms are now making the new stove. The Oakland Foundry Company of Belleville, Ill., is turning out two models. One is a circulating-type heater with an attractive enameled jacket which has an output rating of 40,000 B.T.U. per hour—suitable for a small house—and sells for \$110, about the price of a comparable conventional stove. While it is designed for firing with 50 to 55 pounds of coal once every 12 hours, it can

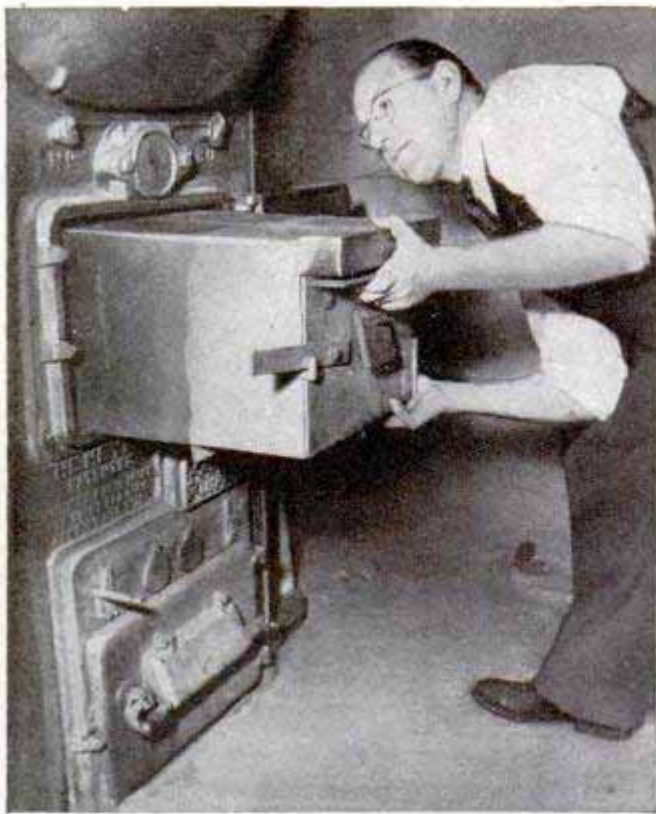

**Experimental Fellows model of down-draft smokeless burner installed in firing door of ordinary furnace**



**Woodomat warm-air furnace will heat eight rooms and one filling of the fuel magazine will last 12 hours**

often be made to go 18 to 24 hours on one stoking. It can be banked for 72 hours. Oakland's other model is a small, cabin-type heater without a jacket which has a B.T.U. rating of 25,000 and sells for around \$60. The King Stove and Range Company of Sheffield, Ala., also is making two models, a plain cast-iron utility heater with a 40,000-B.T.U. output, intended for low-income homes, and an attractive circulating (jacketed) heater of the same capacity. An ingenious control actuated by stack temperature is provided with all types to prevent excessive burning rates, thus saving fuel and protecting the heaters.

These manufacturers sell through retailers, not directly to the buying public. Coal people estimate that 200,000 to 400,000 will be sold in the next five years. For the next few seasons, they will be sold only in a few localities where close watch on their durability can be maintained. Irreproachable performance seems already achieved, but minor changes may be needed to insure long life.

Next on the schedule came a smokeless hot-air furnace, built according to the same principles. Twelve were built last winter. Five were installed in houses and seven are being tested in various laboratories preparatory to large-scale manufacture. One was placed in the cellar of J. Frank Byrne, a physicist on the Battelle staff, to the great satisfaction of Mr. Byrne, his wife and his neighbors. He fires the furnace once a day, he reports, burns two thirds as much coal as with a conventional furnace,

there is almost no visible smoke from the chimney, and his wife has less trouble keeping the house clean. When he opens the feed door for firing, an inner door opens directly to the flue passage so that fumes in the magazine cannot escape into the house through the open door. The institute is also adapting the smoke-eating principle to residential boilers.

The BCR stoves and furnaces were built primarily to enable users to burn cheap bituminous coal without creating a smoke nuisance, and bid fair to fulfill the original purpose of extending the market for soft coal, but any kind of coal can be used in them, with similar advantages in fuel economy and long intervals between firings. BCR's smoke-killing campaign is not limited to home heaters. It has perfected a method of injecting air or steam into the fireboxes of coal-steam power plants to create turbulence and eliminate smoke. Thousands of these overfire jets are now in use.

While the BCR heater was the first of its type to appear, there is no monopoly on the principle of a secondary air feed to burn up the gases which cause smoke. Prof. Julian R. Fellows of the Home-Heating Research Laboratories of the University of Illinois has developed a smokeless furnace which he has demonstrated with no smoke-stack in hotel lobbies without being ejected. Professor Fellows has turned his patent rights over to the university, and seven manufacturers hold licenses. One of them,

(Continued to page 266)



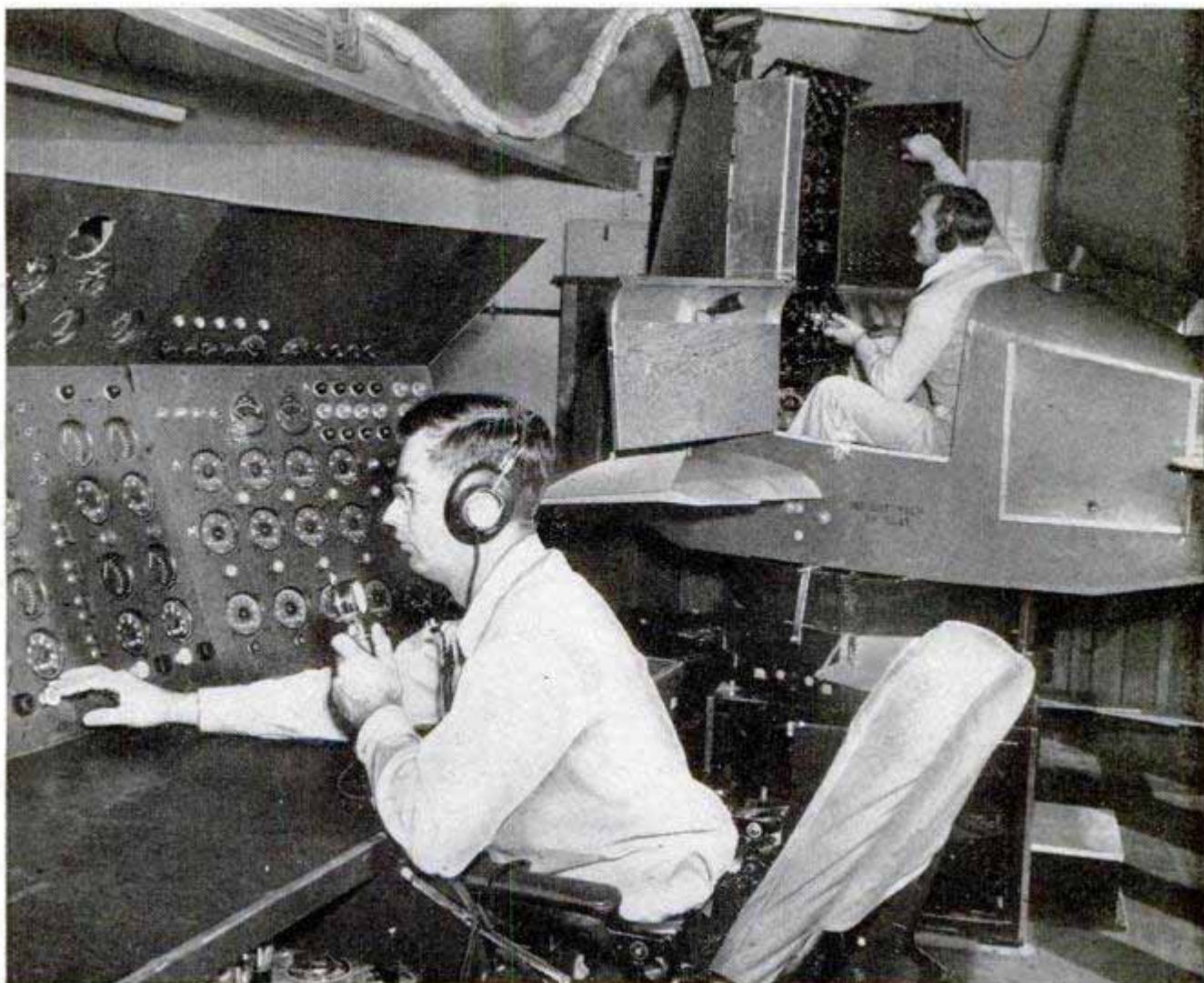

## Trainer for Flight Engineers

All the problems facing flight engineers on big airplanes are simulated in a new ground trainer developed at the Spartan School of Aeronautics in Tulsa, Okla. It is a pilot trainer that has been enlarged to accommodate a control pedestal with from 20 to 22 handles and knobs, an instrument panel with 40 to 50 instruments and additional unit controls. An instructor at a

near-by panel "flies" the trainer, setting up operational problems for the student to solve. The trainee responds by raising or lowering power settings, manipulating the fuel system and controlling the propellers, mixture, cowl flaps and many other units as he would in the air. The government now permits half the 25 hours necessary for the practical portion of flight-engineer certification to be taken in the ground trainer instead of in flight.



## Magazine Holder

Following how-to-build-it plans in a magazine is made easier by a convenient metal stand that holds the magazine open to any page at the correct angle for comfortable reading. Strong enough to support any book from a typist's notebook to a large reference book, the rack makes typing faster and more accurate. When not in use, the stand requires little storage space as it folds almost flat.

Information not listed on articles in the index, starting on page 10, frequently is listed in the WHERE-TO-FIND-IT INDEX, which is available without charge from Bureau of Information, Popular Mechanics, 200 East Ontario St., Chicago 11



Glenn L. Martin Co. photos

## Triple-Jet Attack Plane

Ground support will be the mission of the U. S. Air Force's first three-jet plane, the Martin XB-51. It is 80 feet long and both the wings and horizontal tail surfaces

sweep back at a 35-degree angle. Two engines are on pylons beneath the cockpit and the third is near the tail. Only two men, a pilot and a navigator-radio operator, are required to fly it. The landing gear is of the tandem or bicycle type.



## Four Spigots on Applicator Spread Wax on Floor

There's no need to stoop or kneel to wax floors when a new applicator is used. The waxer consists of a lamb's-wool spreader and an aluminum tank with four rubber valves. The housewife pours liquid self-polishing wax into the container and replaces the cap. When she lowers the handle so the four valves are pressed against the floor, wax flows out in four equal puddles. She raises the handle to the normal working position and spreads the wax with the lamb's wool. Wax that is not used may be left in the container as long as desired.

## German Automobiles

Berlin's first automobile show since the war showed an American influence in the design of several of the new cars. The Hansa 1500 two-door sedan, built by the Borgward factory in Bremen, has the straight lines of a fenderless postwar American car. It has a maximum speed of about 75 miles an hour and gasoline consumption of 27 miles a gallon. Other cars in the show which attracted considerable attention were the Volkswagen (including a two-color convertible) and Ford's Taunus. The latter is powered by a 34-horsepower engine, has a maximum speed of 65 miles per hour and travels 32 miles on a gallon of gasoline. The show marked the 50th anniversary of the Automobile Club of Germany and more than 80 companies participated.

**Top, a Volkswagen convertible was a hit at Berlin auto show. Right, Hansa design shows American influence. Below, Ford's Taunus has 34-hp. engine**

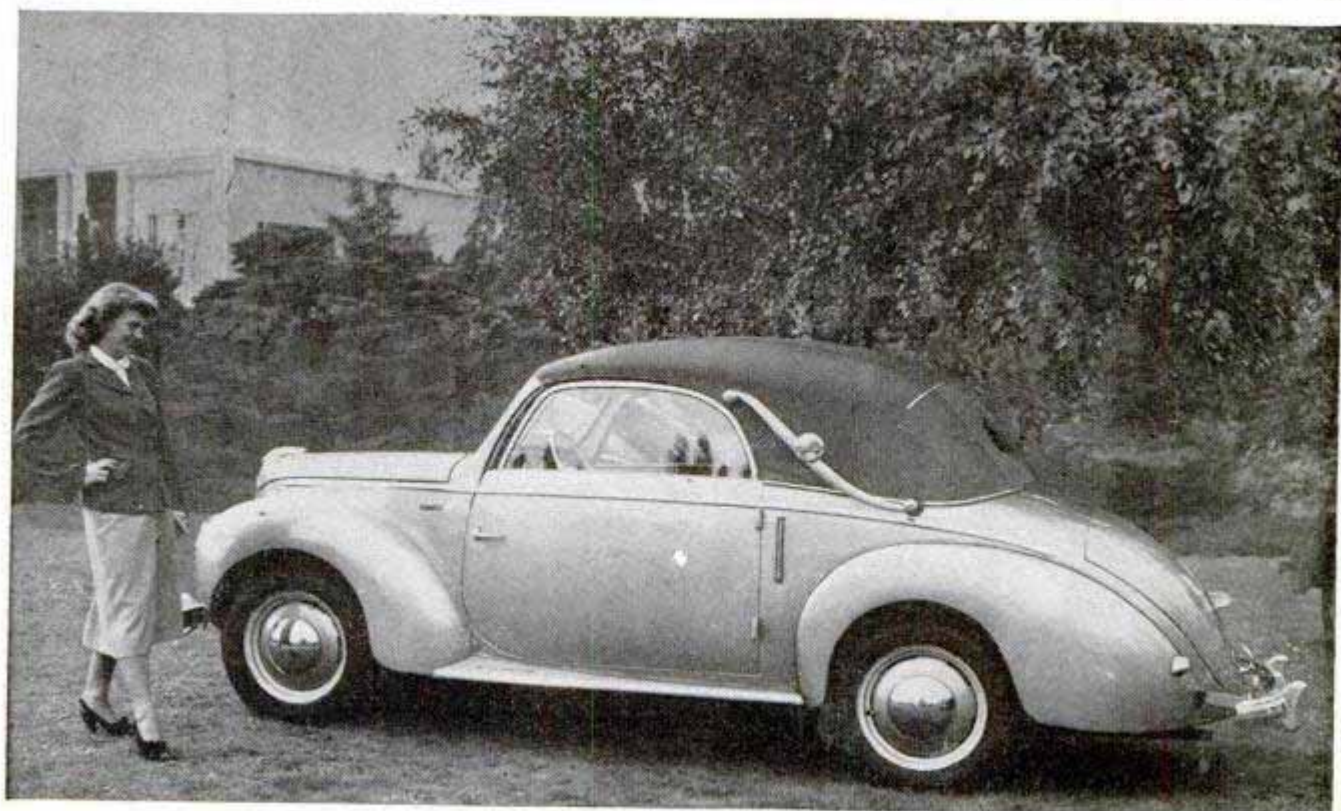
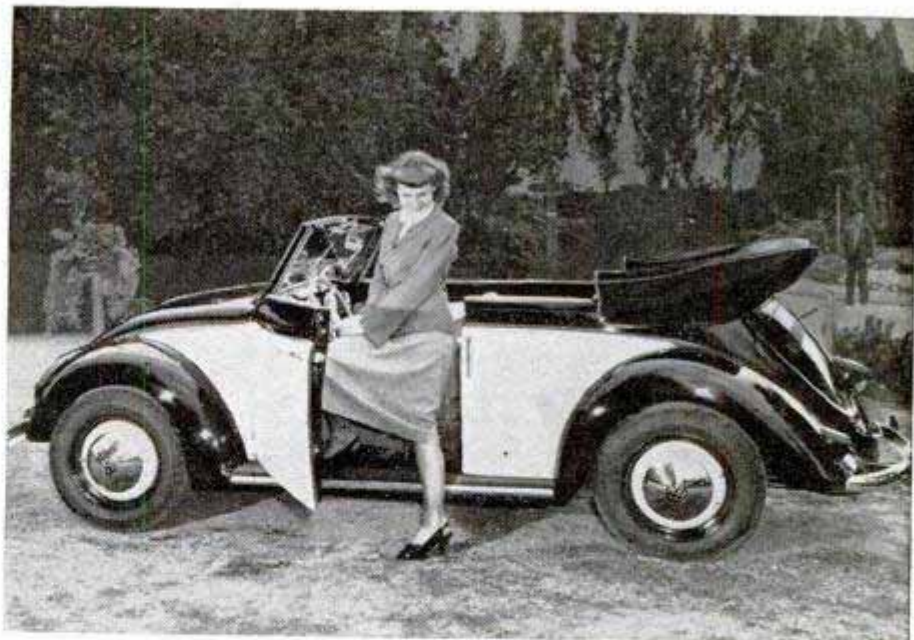

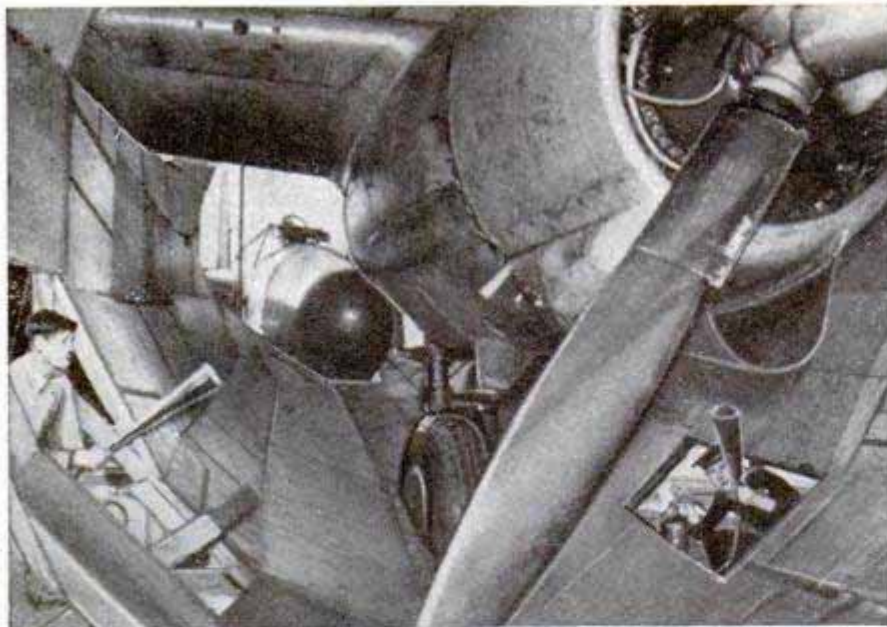

Wind tunnel surrounds the engine of a Marauder. It guides the propeller blast back across the plane from which students practice 'chute jumps

WHEN THE WAR was over, the men who had chalked up a record five million parachute jumps from troop carriers and crippled planes became the only experienced experts on jumping technique. After all, they were alive.

"Roll the plane on its back and drop out," claimed one school. They forgot the long list of men who had tried it and lost an arm, leg or a life to the whipping tail surfaces that clipped them on the way past. "Stand up in the cockpit, pop the 'chute and float home," another group advocated, ignoring cases like that of the Navy pilot who tried it when his

# Bail-Out Rehearsal

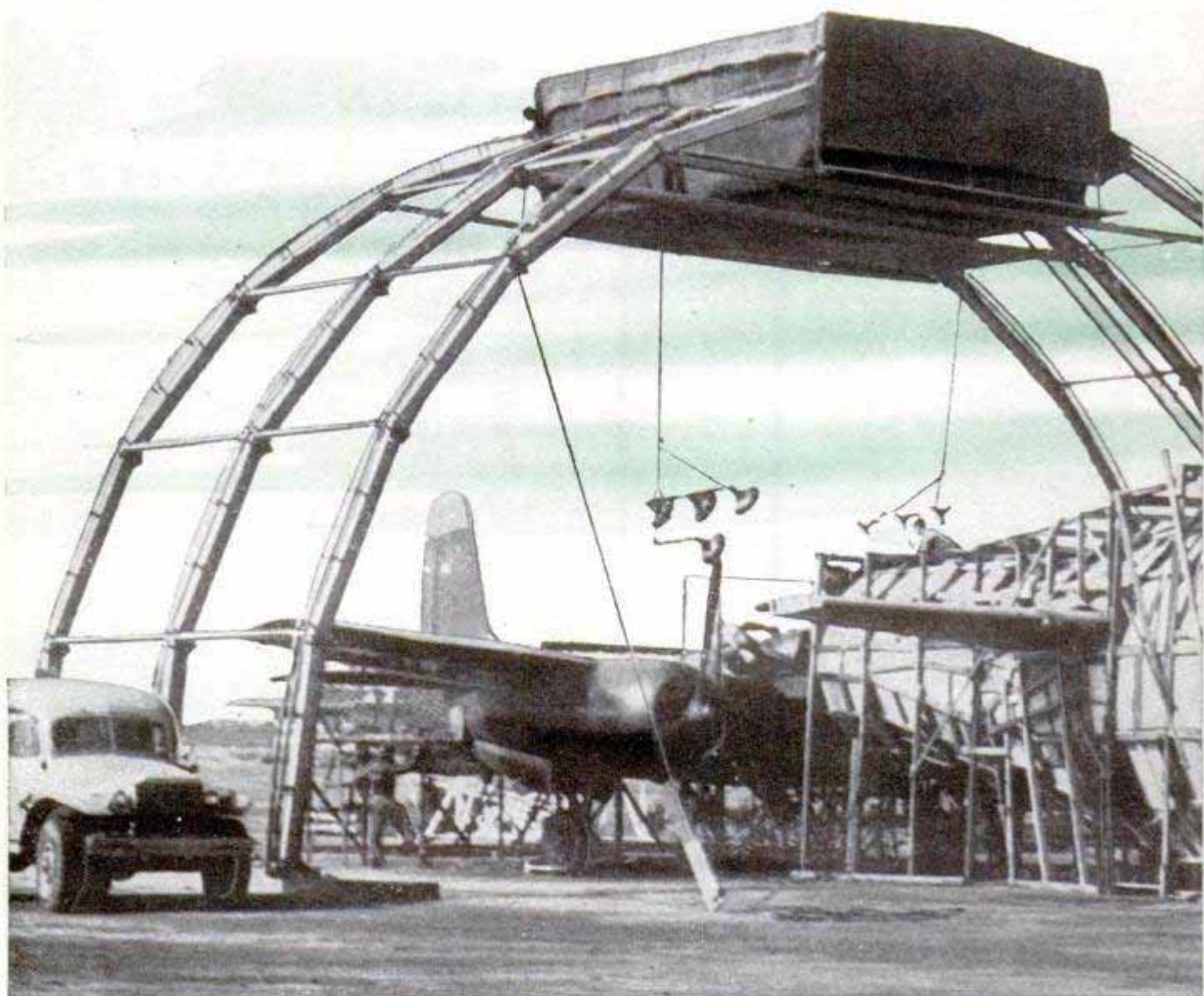

engine conked. His shroud lines snagged the rudder and he rode to his grave with the plane.

Recently, officials at the Bureau of Medicine and Surgery and the Fleet Marine Force at Cherry Point, Md., decided to solve the problem of snarled 'chutes and clipped appendages. What was the best way to leap from a crippled plane?

To find out, they rigged up a plane with heavy rope nets over each wing, stretching from nose to tail. Above this was built a section of hangar framework from which they suspended a camera booth and floodlights. To simulate a normal slip-stream blast of 140 miles per hour, the Marines built a plywood wind tunnel around the engine nacelle of another plane. This unit was aimed in the direction of the test plane to give "jumpers" the windy effect of actual flight. The blast from a third plane's propeller cools the engine confined in the wind tunnel.

Some 250 Marine pilots dressed in full regalia made

(Continued to page 264)



Student tumbles from an older-type plane in a practice dive. With head down, slip stream will carry him over the wing and under tail assembly

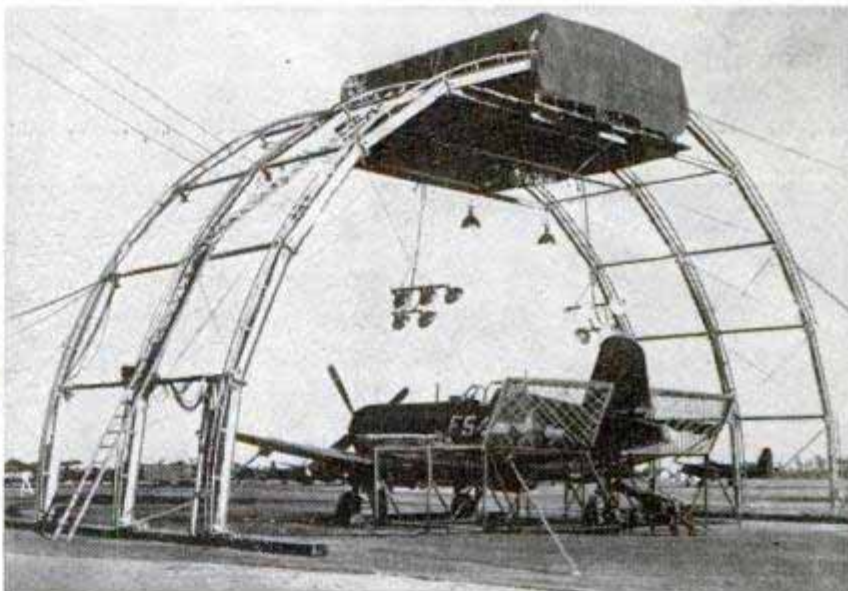

Instructors photograph the practice jumps from housing above the plane. Pictures reveal mistakes which could take pilot's life in a real jump

Three planes are used in the setup. At far left is the bail-out plane with rope nets to catch the students. Plane in wind tunnel produces a slip stream of 140 miles an hour. Propeller blast from plane at right cools the engine of the second plane, which otherwise might catch fire





## Swedish Speedboat

Like old-time river boats, a new Swedish speedboat uses a paddlewheel as a means of propulsion. The wheel, made of special

steel to withstand high speed, revolves inside a housing at the stern and throws up a high spray of water as the craft churns across the surface. Powered by a Ford motor, the boat hits a speed of 50 knots.

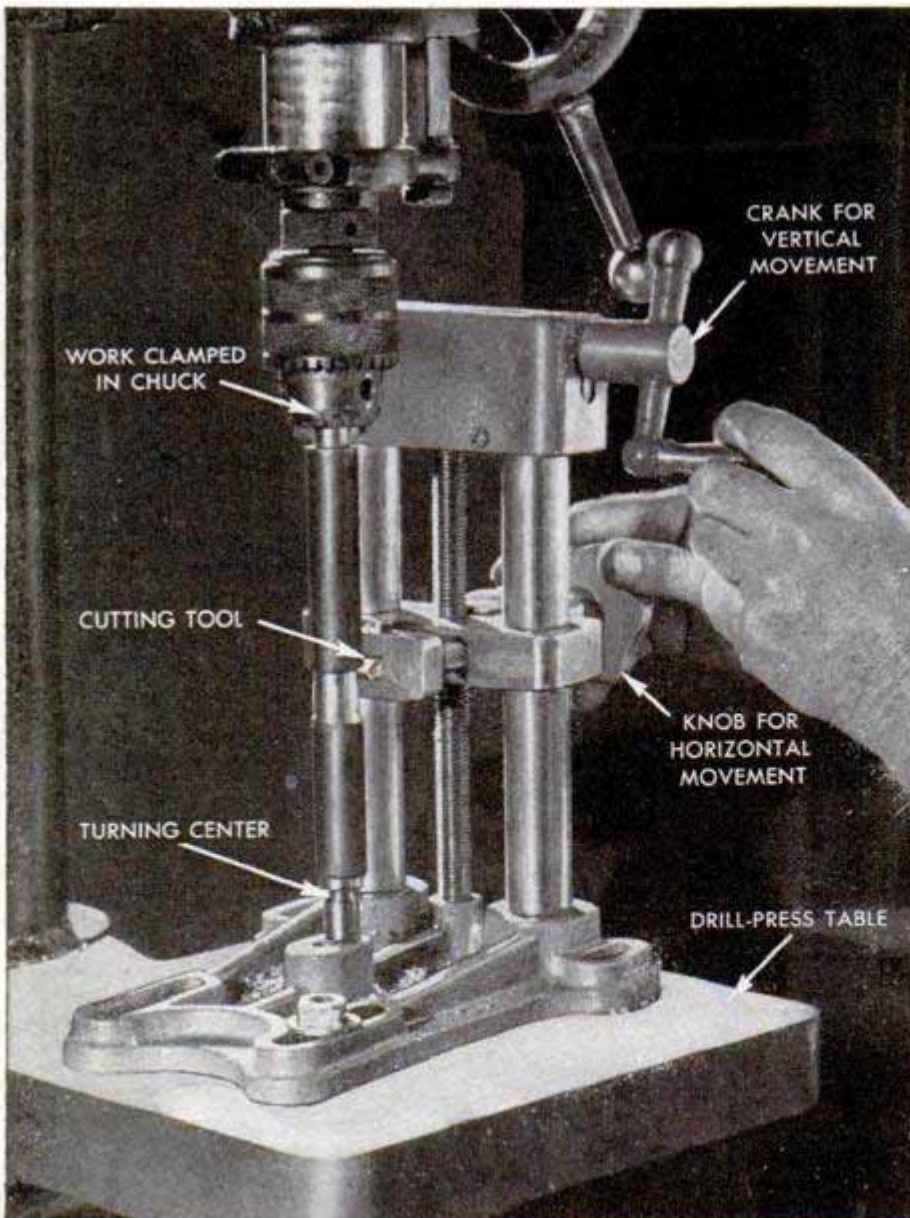

## Attachment for Drill Press Converts It to Lathe

With a new attachment, an ordinary drill press can be converted into a metal-turning lathe. The attachment bolts to the drill table. Clamped in the drill-press chuck, the work is lowered over a center point on the attachment. The cutting tool is clamped in a holder, which is adjusted by two handles, one for vertical and the other for horizontal movement. As the work spins, the cutting tool is moved against it. Work up to four inches in diameter can be turned with the attachment.

## Calves Dehorned By Soldering Iron

Calves are dehorned before the horn breaks through the tissue by searing the horn-producing cells with an electric soldering iron. A hollowed-out tip is used so that it can be placed over the bump where the horn would normally develop.

## Underground Bridges Are Shell for Subway

TRAFFIC on Toronto's main north-south thoroughfare will run smoothly with a minimum of interruption while Canada's first rapid-transit subway is being built beneath it. The project is expected to take four years to complete and will cost approximately \$30,000,000.

New construction techniques are being used, since the city of close to a million population is built largely on clay and sand, close to sea level. Steel pilings are being driven for 30 or 40 feet into the sidewalks, close to buildings, to form a reinforced concrete retaining wall and to act as supports for underground truss bridges spanning the street.

One block at a time is to be closed off and traffic rerouted while the spans are put in position. The steel-truss bridges will also carry conduits for public utilities such as gas and water mains, electric, telephone and cable lines.

Excavating will start after the spans are in place and concrete tunnels built for the subway tracks. Sand will be put in as a filler between the street level and the top of the subway, and the street surface paved to carry only busses and automobiles.

Using 10-car trains, the 4.6-mile-long subway will cut present surface-car travel time from one end of the line to the other from 45 minutes to 15 minutes. Twelve bridges will have to be built over cross streets where subway stations are located, and there will be 31 ventilating shafts to provide air at the rate of 50,000 cubic feet per minute.

Top, during initial stage of Toronto subway work, steel pilings are driven 30 or 40 feet into the sidewalks. All utilities are underground. During the next stage, center steel pilings will support pavement and house utilities, except main sewer, which has now been relocated along the sides. Bottom, on completion of concrete subway tunnel, inside the steel girders, only motor traffic will use the street level

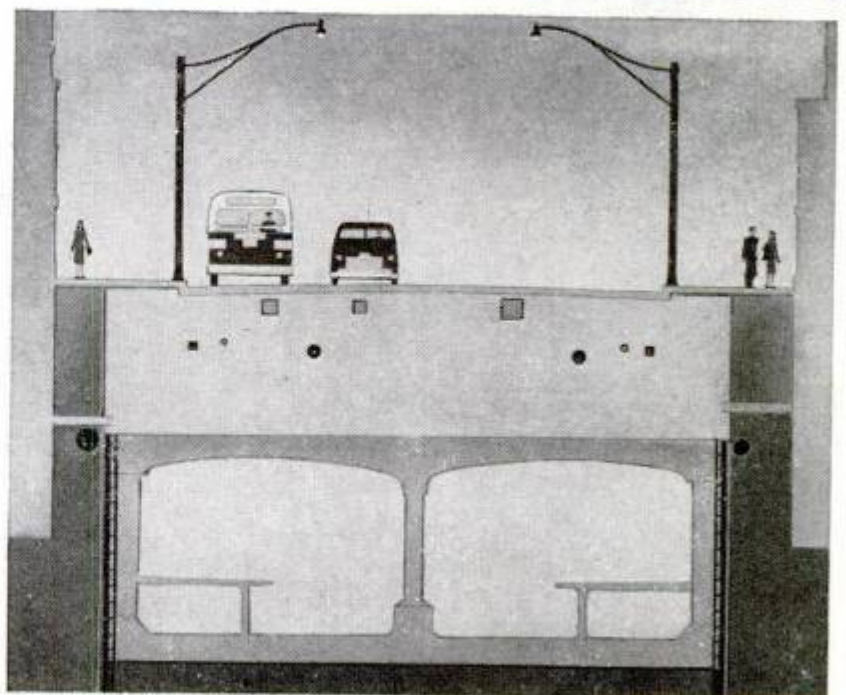
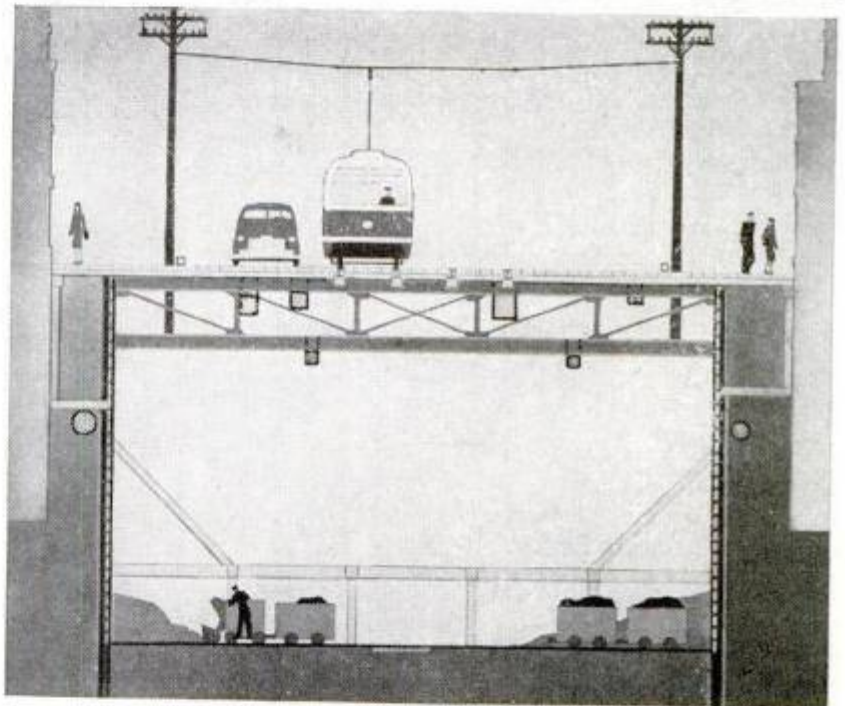
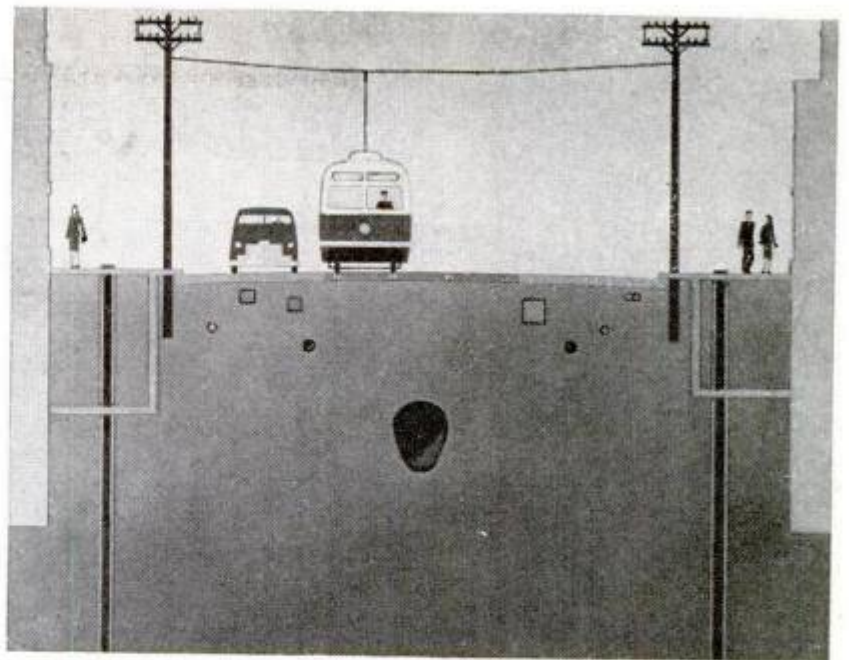

# Modern Noah

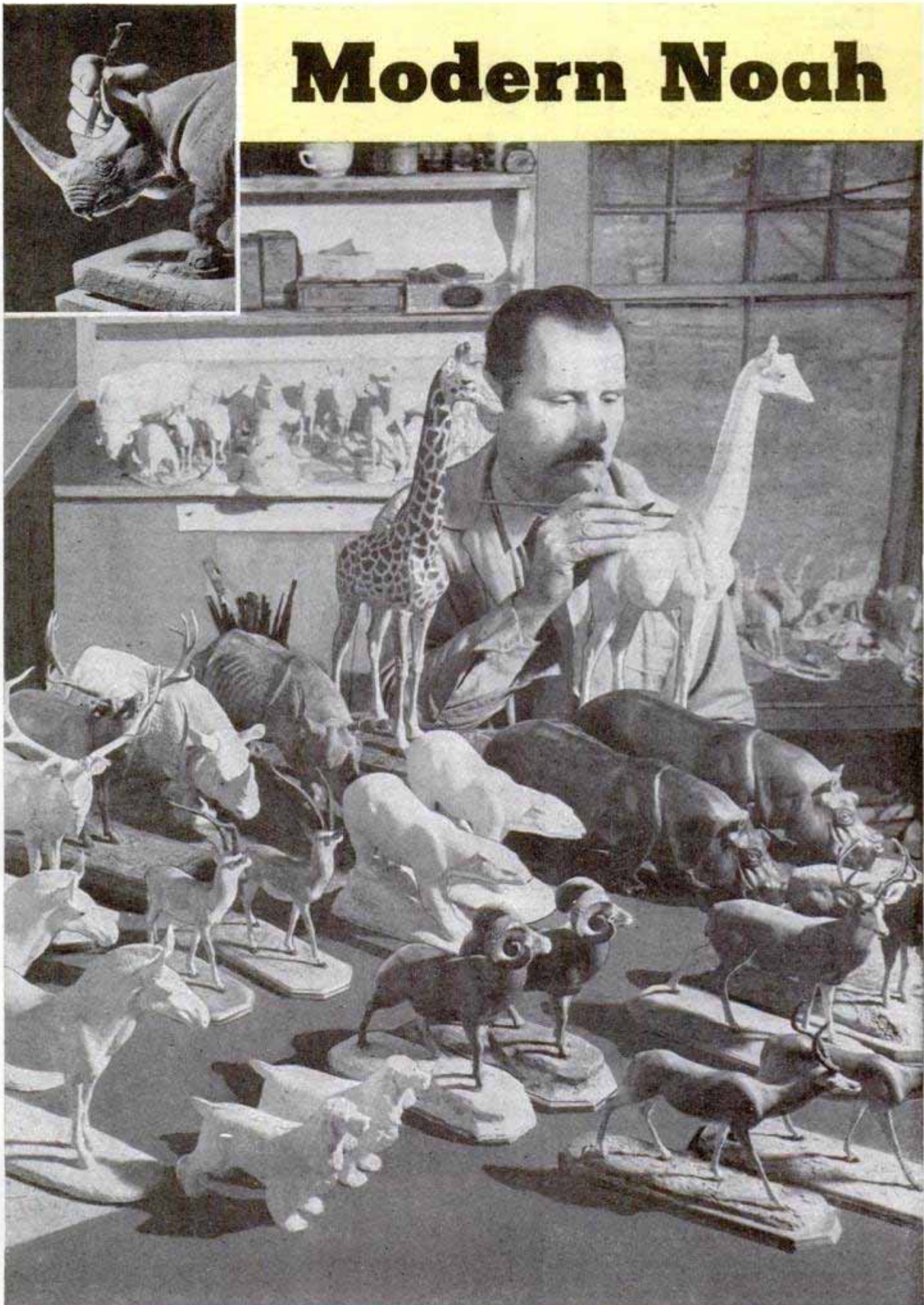

Louis Paul Jonas, only modern rival for Noah, is shown working among his candidates for his private ark. He first makes a clay model such as the detailed piece for a rhinoceros shown in the upper left corner



# Peoples an Ark

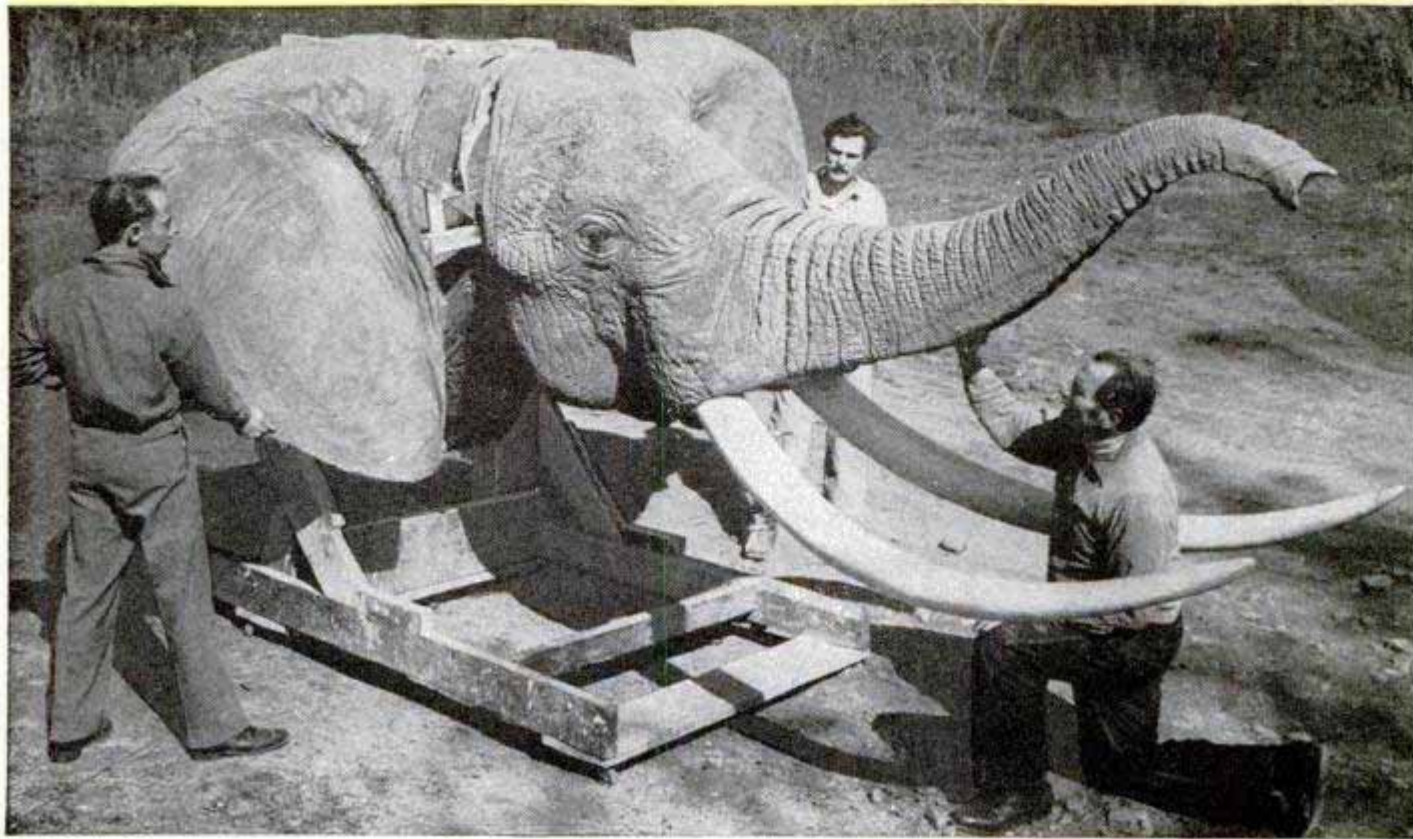

By Alfred Eris

**T**HERE'S no telling what you may run into prowling around some of those upstate New York barns—like the one belonging to Louis Paul Jonas. Open the barn doors and you may find yourself face-to-face with a life-size elephant head complete with menacing tusks.

Instead of ordinary cows, the Jonas barn is full of such creatures as the cheetah, bongo, dikdik, takin, babirusa and the koala. Their presence is explained when you learn that Jonas, one of America's well-known sculptors, has taken over a barn on the Churchtown-Hollowville Road in New York where he is turning out his amazingly life-like animals for museums, schools and collectors. One of the world's foremost miniature-animal sculptors, Jonas has been at work for years on his favorite project: making a perfect  $\frac{1}{10}$ -scale model of every mammal in the world. There are about 250 distinct species and he has done close to half, all realistically painted. Jonas does not believe in mass-production methods.

This is the elephant head that startles visitors to the barn where Jonas works. Both ears are detachable for transport

Below, the sculptor puts a finishing touch to one life-size elephant eye. The artificial hide is almost perfect replica



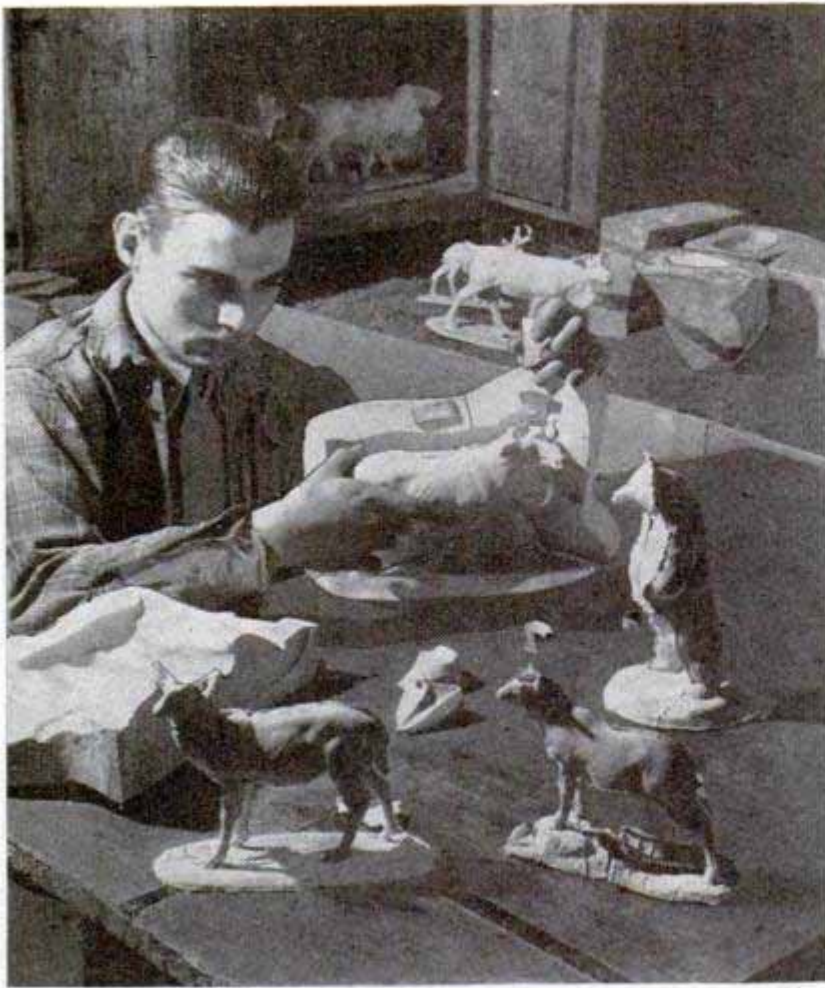

Cast from plaster molds, the models are made of a rubbery substance and then painted realistically. They stand rough handling. Below, a workroom window frames silhouettes—all are 1/10 scale

He says that no two tigers are striped exactly alike and in Jonas' collection you will not find any two miniature animals identical. He feels that this conforms with Nature's subtle variations.

Jonas was born in Hungary. He arrived in the U. S. when he was 14 to join four older brothers, all taxidermists, in Denver. A few years later, he was apprenticed to Carl Akeley at the American Museum of Natural History where he learned his art. Since those days Jonas has done habitat groups for museums all over the country. He uses his own composition for his miniatures, a rubbery combination of latex and a plastic binder. His miniatures can be handled roughly, are lightweight and more permanent than plaster castings. The sculptor has complete files on every known animal, its measurements, weight and other details. He has thousands of paintings and photos of animals. From his library data alone, he can mold an accurate miniature of any animal in the world.

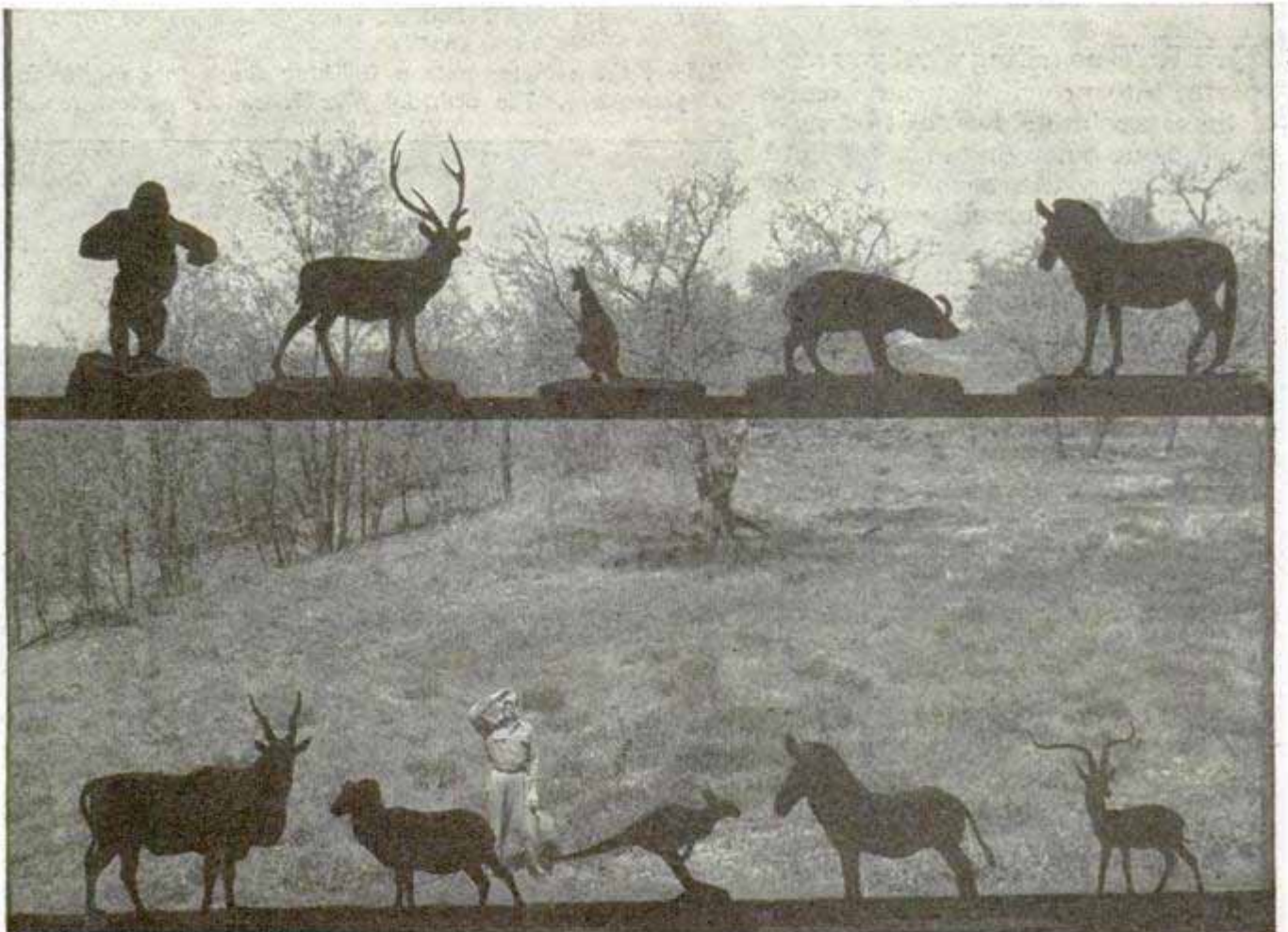

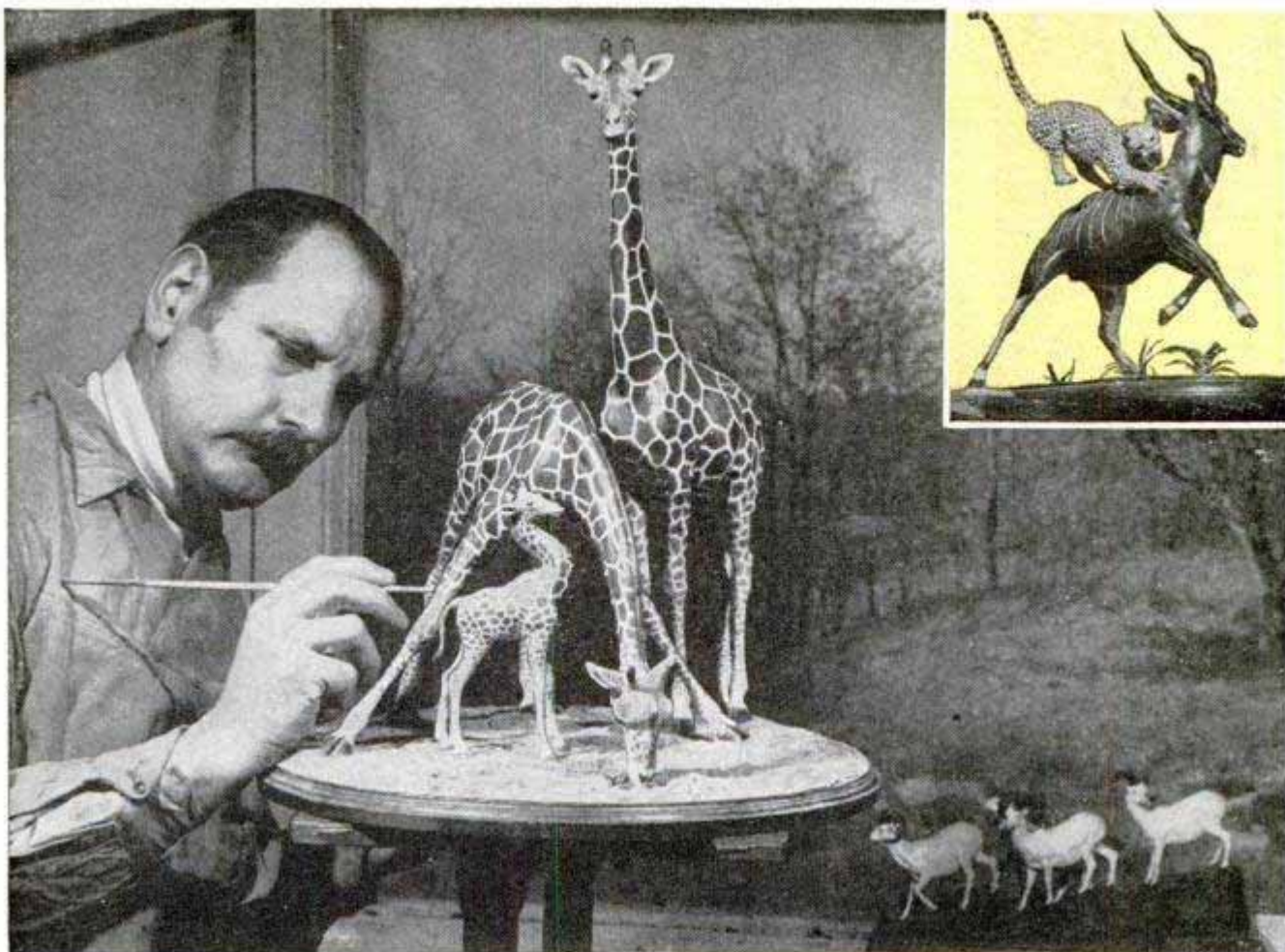

If this carefully painted giraffe family were magnified it would fool its own cousins. One of the animals is spreading its feet to drink at a water hole. Inset shows a leopard attacking a bongo and only one foot of the leopard is attached to prey. Below, African mammals will occupy one corner of the growing Jonas' ark



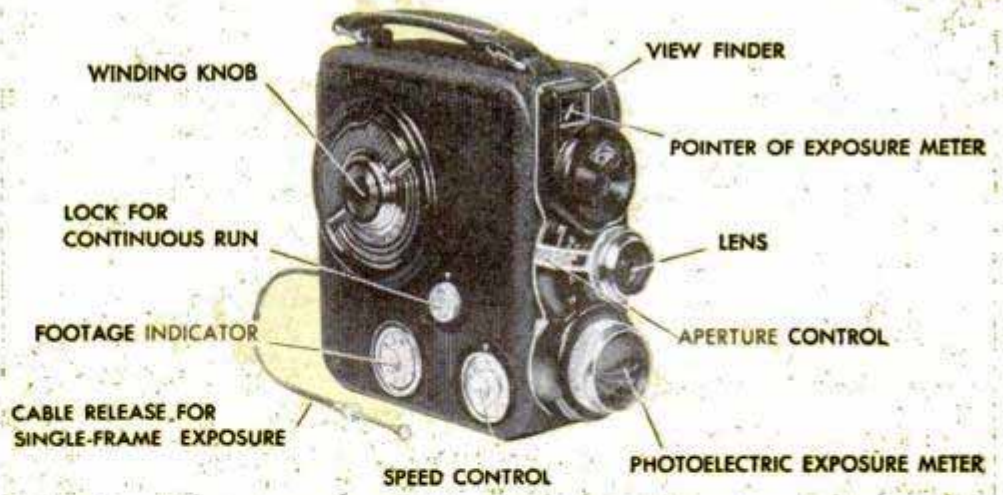

## Movie Camera Has Built-In Exposure Meter

Determining correct exposure is an automatic operation with a new 8-mm. movie camera that has a built-in photoelectric exposure meter. The pointer of the meter is located in the view finder and is coupled to the aperture control. By moving the aperture control until the meter pointer is

centered in the view finder, the photographer automatically sets the diaphragm opening for the correct exposure. The exposure meter is also coupled to the shutter speed control and automatically adjusts for any speed from 8 to 32 frames a second. The camera has an f:1.9 coated lens.

## German-Made Scissors Are a Tool of Many Uses

There's almost nothing a pair of German-made scissors can't do. Like any scissors, they will cut paper and cloth, but, in addition,

they drive nails and screws, cut glass and wire, tighten small nuts, make button-holes and can be used as a tiny pipe wrench.

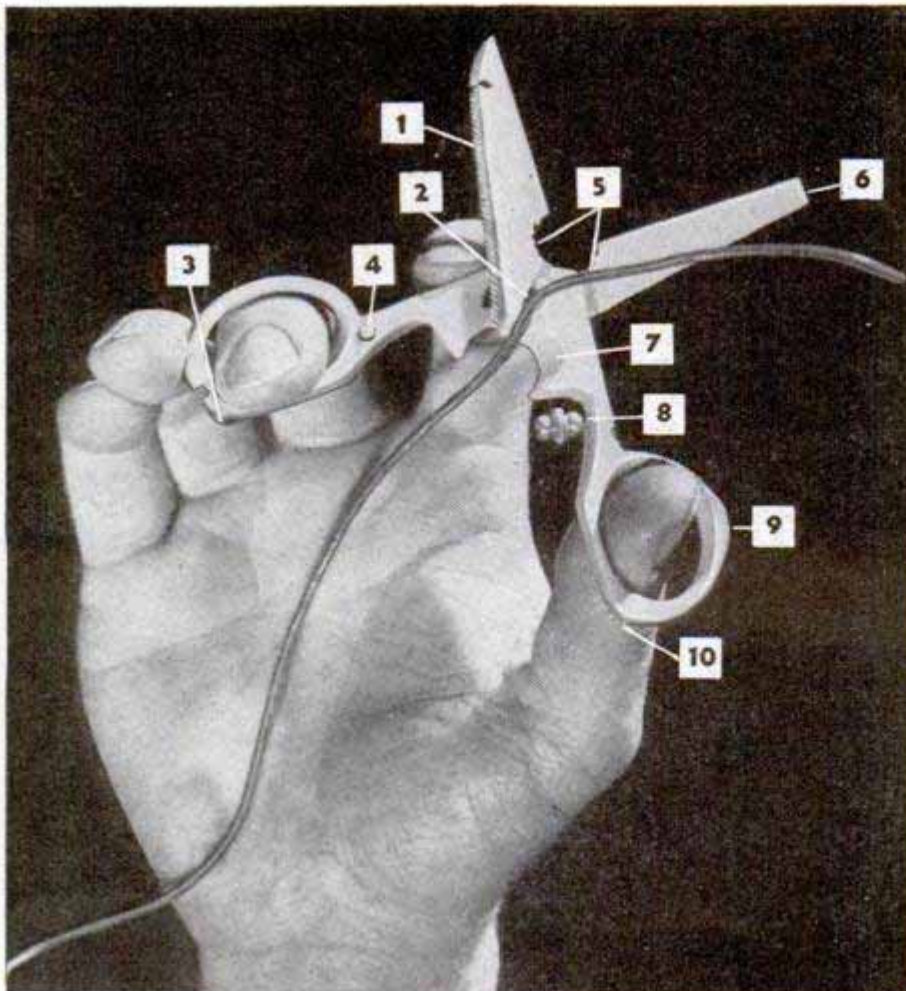

The blades come apart, allowing one blade to be used as a paring knife and nail file. A perforating wheel on one handle scores paper for accurate tearing. Etched on the back side of one blade is a ruler and, as an added attraction, there's a small glass lens in the handle inside which are scenic views of Germany.

Numbers on the picture at left show some of the extra features of these multi-purpose scissors. 1—nail file. 2—wire snips. 3—glass cutter. 4—lens. 5—wrench jaws. 6—screwdriver. 7—cigar cutter. 8—buttonhole adjuster. 9—hammer. 10—paper perforator. Naturally, scissors can be used for cutting paper as well

Rescuing more than 5000 persons from danger last year was only one of the Coast Guard's many activities. The group also operates the International Ice Patrol and enforces the Migratory Bird Act.



### Pocket-Size Hand Warmer

Your hands won't get cold no matter how low the thermometer drops when you carry a personal hand warmer, which looks like an oversize cigarette lighter. The miniature stove burns benzine or white gasoline, but there is no flame, just a faint glow. With the perforated cover in place, the warmer can be carried in the pocket or held in the hand. One filling lasts from 24 to 36 hours, depending on the fuel used. Ideal for winter sportsmen, the warmer can also be used instead of a hot-water bottle in the sick room. There's no danger of setting clothing or bedding afire, according to the manufacturer.



### Powered Saw Gummer

Circular-saw blades are kept in top-notch operating condition by a power grinder that evens up the teeth to make the blade perfectly round and shapes the back of the teeth to balance the saw and eliminate "galloping." After these two operations, known as jointing and gumming, all the operator has to do is touch up the points of the teeth with a hand file. The motor that powers the wheel is built right into the machine, which handles all types of circular blades from 8 to 48 inches in diameter. Weighing only 77 pounds, the machine is portable and is quickly mounted on the edge of a workbench.

### Rollers Simulate Bumpy Road to Detect Rattles in Car

Rattles and squeaks in automobiles can be quickly detected by a mechanic in the garage with the aid of a pair of rollers that simulate road conditions. The mechanic mounts the car's two rear wheels on the two rollers and blocks the front wheels to prevent forward movement. The rollers, which are concave to prevent sideslip, vibrate the entire car when it is in gear.



# MEXICO CITY IS SINKING

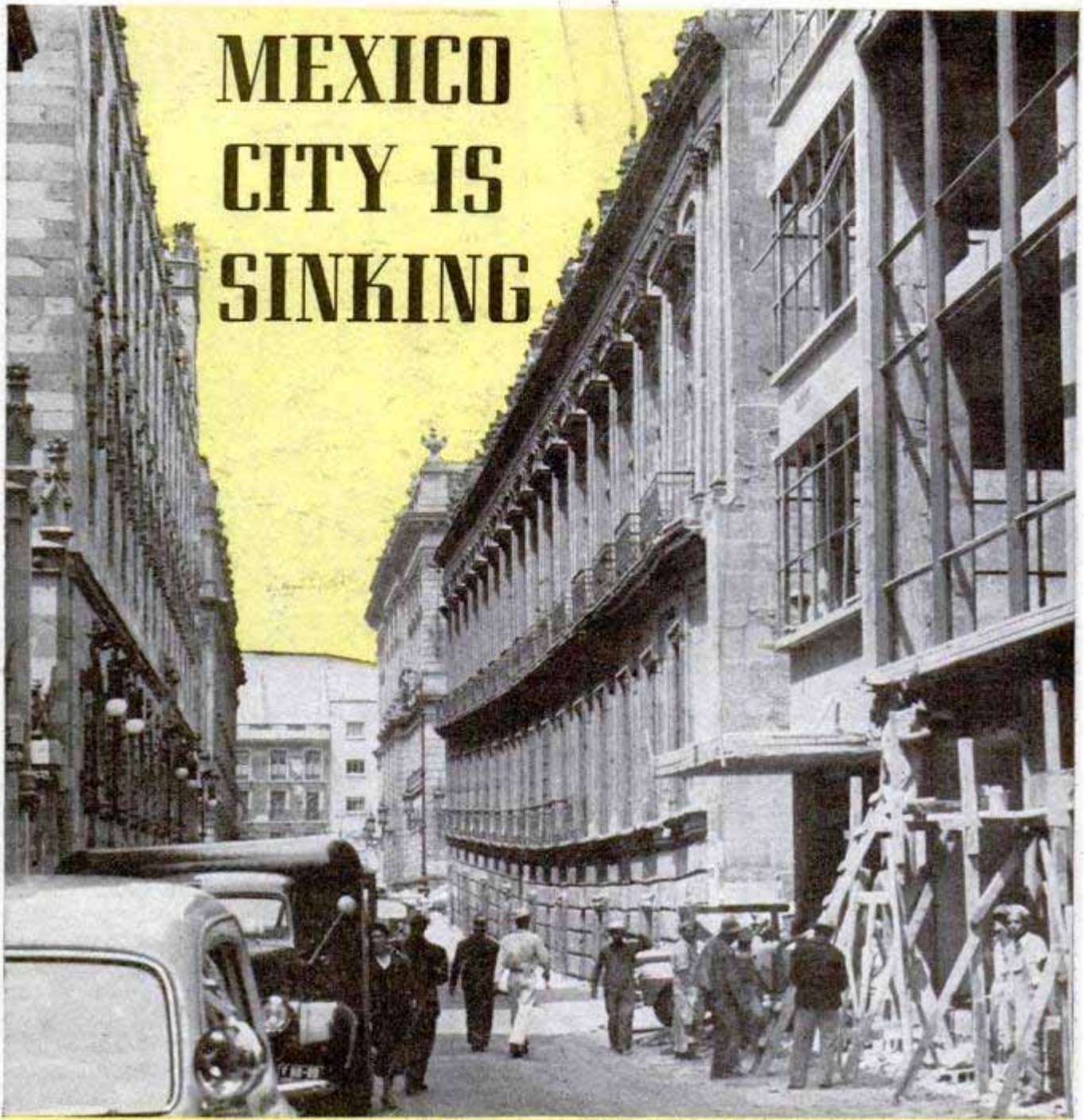

Jose A. Cuevas, a Mexican engineer, builds skyscrapers that float. Hearing of his ingenious schemes to defeat nature in a city that tilts and sags on its soft crust, Popular Mechanics sent Thomas E. Stimson, Jr., to the Mexican capital to tell his story



VOLCANIC-ASH PARTICLES IN WATER FORM JELLYLIKE SUBSTANCE (MANY TIMES MAGNIFIED)

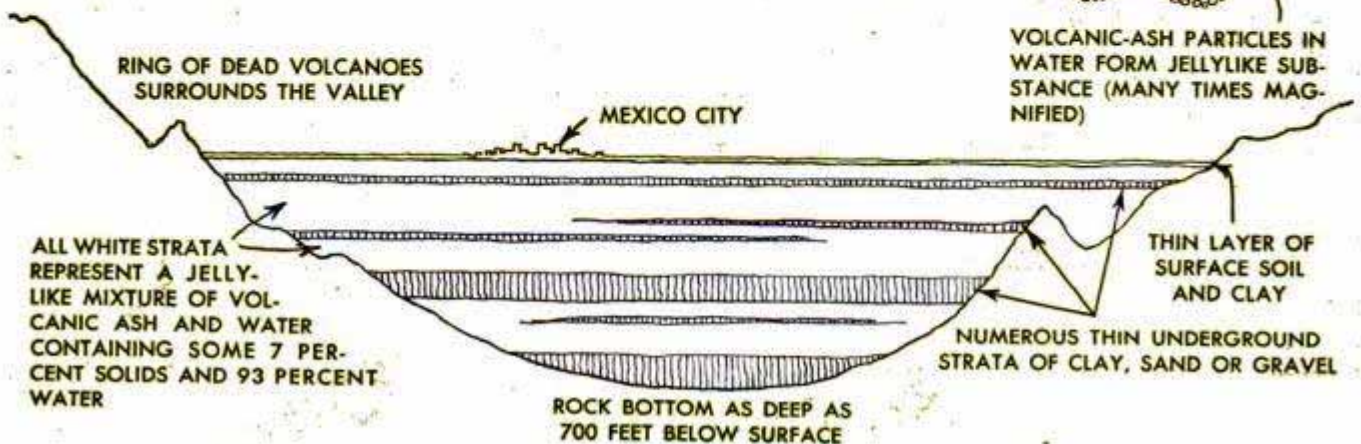



Threatened by unstable jellylike subsoil are these modern buildings comprising downtown Mexico City

By Thomas E. Stimson, Jr.

**I**N MEXICO CITY, a man who digs a 40-foot pit big enough for a building foundation is apt to find after a few weeks that his pit is only 35 feet deep. The earth swells upward when the weight of the overburden is removed.

In Mexico City, too, an engineer who builds a 10-story structure may find within a few years that his building has settled a couple of feet into the earth and has tilted badly to one side. Adjacent structures, meanwhile, will have developed noticeable cracks because of the sinking of their heavy neighbor.

The world-famous Palace of Fine Arts has sunk some 12 feet since it was built on top of a concrete slab early in the century. The ancient Loreto church has tipped a good three feet from the vertical, as a unit. Some old structures half a block or more in length present a wavelike appearance today because of uneven settlement. Even a guest in one of the new hotels may walk up or down hill en route to his room.

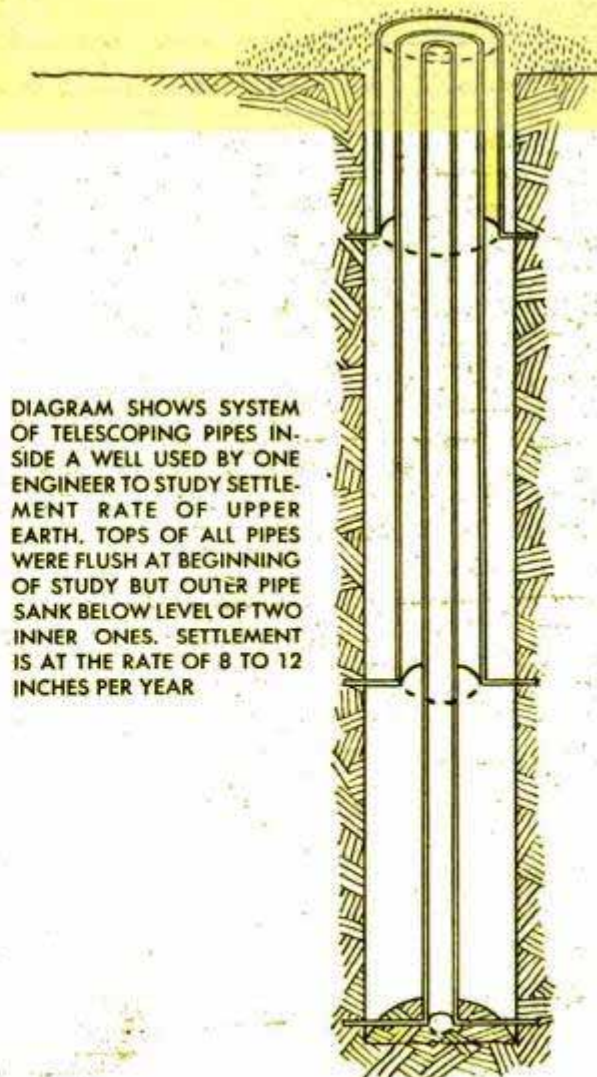

DIAGRAM SHOWS SYSTEM OF TELESCOPING PIPES INSIDE A WELL USED BY ONE ENGINEER TO STUDY SETTLEMENT RATE OF UPPER EARTH. TOPS OF ALL PIPES WERE FLUSH AT BEGINNING OF STUDY BUT OUTER PIPE SANK BELOW LEVEL OF TWO INNER ONES. SETTLEMENT IS AT THE RATE OF 8 TO 12 INCHES PER YEAR



**This 300-year-old church has tilted three feet from the vertical due to uneven settlement of the soft soil**

These odd situations are due to the fact that Mexico City virtually floats on the top of a semifluid subterranean lake. The metropolis rests on a thin layer of soil below which there are hundreds of feet of a unique colloidal-like suspension of water and volcanic ash. This jellied substance is called "jaboncillo" after the Spanish word for soaplike because of its slippery quality. At some depths, the jaboncillo consists of 93 percent water and only 7 percent ash, the ash being formed into a spongelike structure that contains the water. At different underground levels in the jaboncillo are some 20 stiffer, but fairly thin layers of clay, sand, or gravel, all saturated with water.

Any heavy structure that is built on top of this material is bound to sink. The early Aztecs learned to support their stone buildings on small wooden piles that were driven into the ground and the Spanish adopted the same practice after they conquered the Aztec capital. By driving clusters of foundation piles they were able to erect structures three or four stories tall in reasonable safety.

Taller buildings were utterly impractical until engineers discovered they could "anchor" them to relatively firm beds of sand

or clay 100 or 150 feet below the surface. They drove down piles, one on top of the other, until a firm underground stratum was reached. On groups of such deep underground stilts, they could then erect a 10 or 15-story building. Even foundations like these, however, are subject to some sinking and tilting. In a few cases, tremendous jacks have been installed in the basements to help keep the buildings in plumb.

The very newest buildings are being designed on a new principle that avoids all the difficulties encountered in the past. They are built to float in the soil like ships at sea. Their weight is precisely the same as the weight of the material that was excavated to make room for their subsurface structure. Being no heavier than the soil that they replace, they cannot sink. Nor can they disturb the plumb of neighboring structures.

This new idea was originated by Jose A. Cuevas, noted Mexican civil engineer, who first utilized it in the construction of the National Lottery Building, the recently finished headquarters of the government's lottery organization.

In the last decade, Cuevas has developed a number of new principles in foundation engineering, based on his observations of





These three sketches show conditions that baffle Mexican engineers. Above, soil under long buildings sinks most in the center due to weight of the structure—in area between X and Y



If central portion of sagging building (A-B) is removed, the two ends must be supported to prevent their collapse. The sinking of the subsoil will continue because of heavy weight

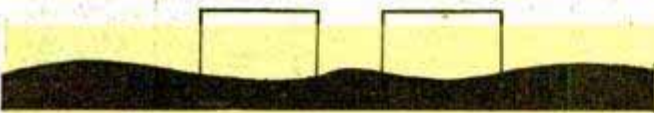

If a wider section of the building is removed (X-Y) the earth will rise between the two ends and each will return to a vertical position. This is due to the spongelike soil far below



Temporary bracings in window niches of this cracked building help to save it from ruin. The trouble was caused by the erection of a larger building next door which caused a local settlement in the earth—a frequent happening



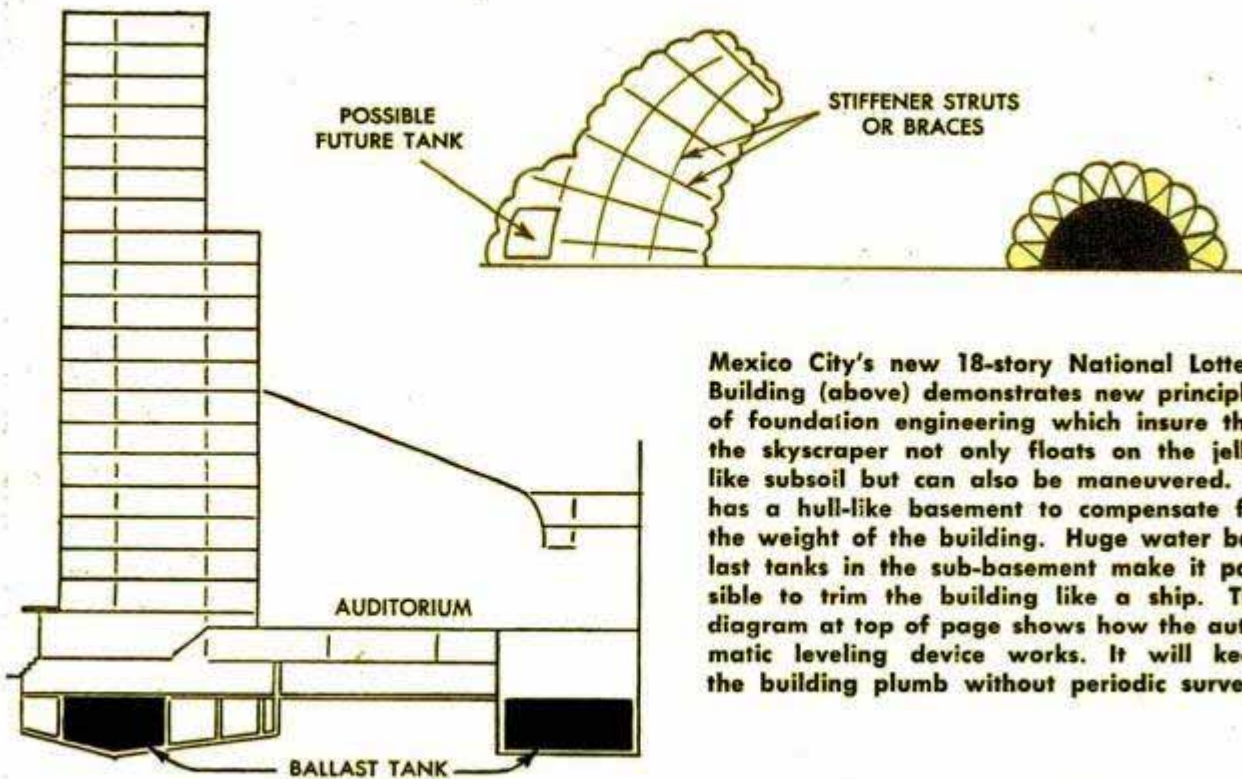
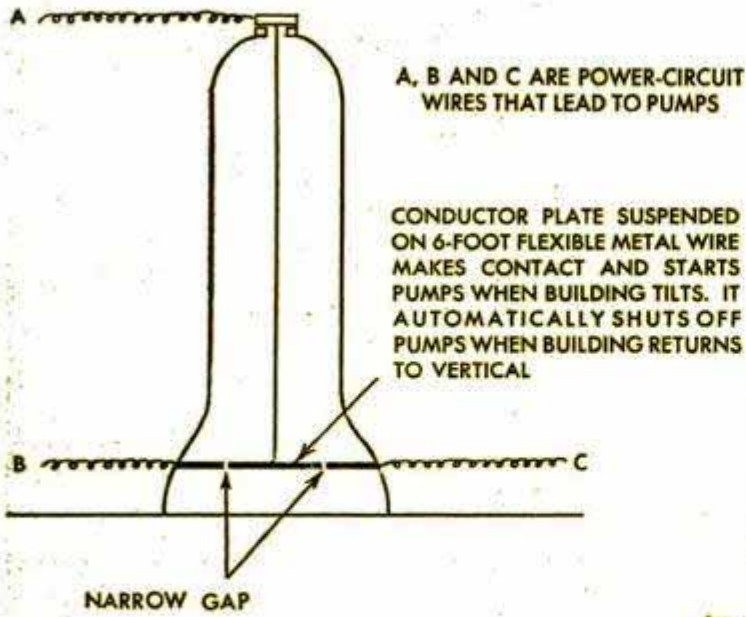

Mexico City's new 18-story National Lottery Building (above) demonstrates new principles of foundation engineering which insure that the skyscraper not only floats on the jelly-like subsoil but can also be maneuvered. It has a hull-like basement to compensate for the weight of the building. Huge water ballast tanks in the sub-basement make it possible to trim the building like a ship. The diagram at top of page shows how the automatic leveling device works. It will keep the building plumb without periodic surveys

the acute conditions in Mexico City. His ideas are now universally accepted and have influenced the design of heavy structures that have been built on top of marshy or unstable soils in various parts of the world.

One of his innovations in designing the National Lottery Building was to provide three huge water ballast tanks in its sub-basement so that the building could be trimmed back to the vertical again in case it ever tilts.

The result is that this skyscraper not only floats but it can be maneuvered. Before the building's elevator was installed, Cuevas hung a long plumb line in the empty shaft, with its bob almost scraping the ground floor. Then he pulled the switch that pumped water into the ballast tank in the building's north wing. Next morning, the plumb bob showed that the building was six inches out of line, tilted toward the north. That day he reversed the flow of water, emptying the north tank and filling the tank in the southern wing. Next day the plumb line showed that the building had passed through the vertical and was now tilted six inches to the south.

By emptying all tanks Cuevas has raised the building  $\frac{1}{2}$  inch above its normal level in 24 hours and by flooding all tanks he has sunk the edifice  $\frac{3}{4}$  inch below its prescribed elevation within a couple of days. Gas, water and sewer lines, of course, have flexible connections.

This year Manuel Arizmendi, the building's chief engineer, is installing an automatic leveling device that will keep the building in plumb at all times without



Rafael Reynoso y M., PM representative in Mexico and Thomas E. Stimson check ballast tank in building

Jose Cuevas, below left, noted civil engineer, poses with model of National Lottery Building he designed

Small motors and pumps in sub-basement of Lottery building are used to fill or empty the ballast tanks

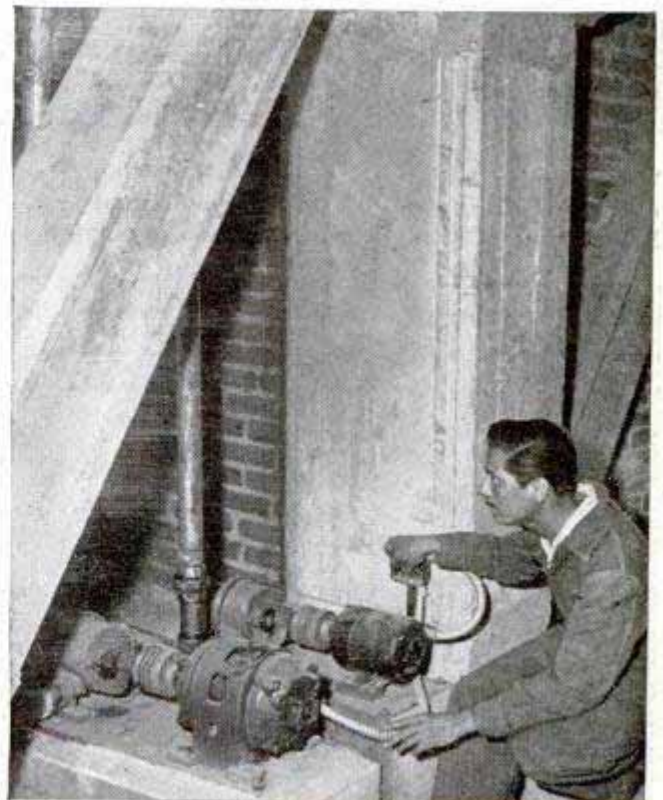

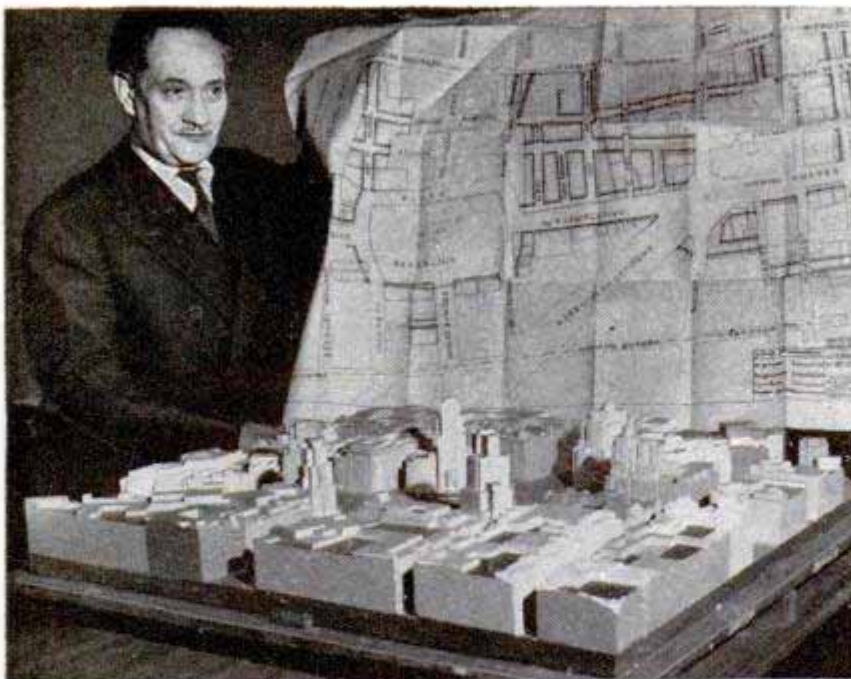

Jose Cuevas, engineer who pioneered new ideas on foundations, shows model of proposed reconstruction of downtown Mexico City

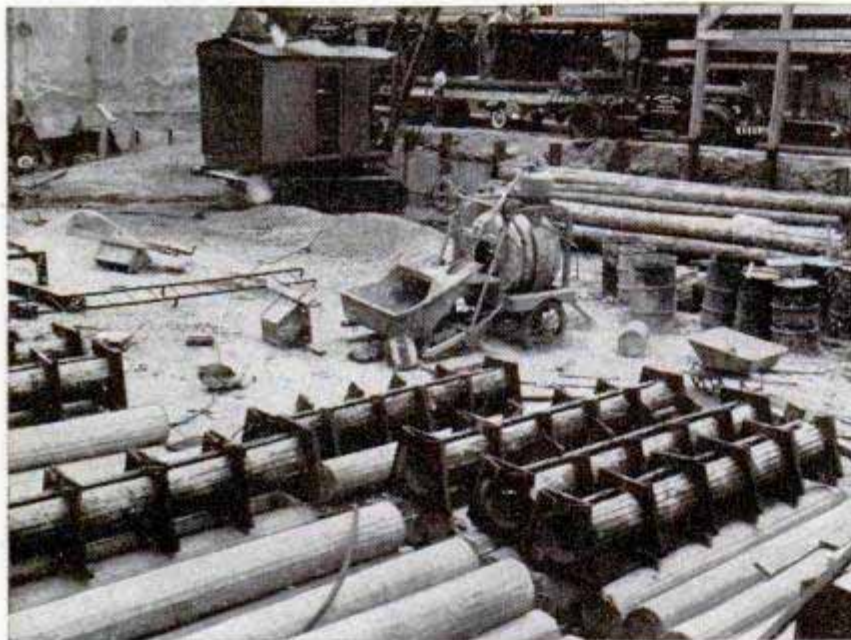

Wooden piles (background) and reinforced concrete piles will anchor a new building to one of firm layers of sand or clay beneath city. Below, some of Mexico's modern buildings along the Avenida Juarez



periodic surveys. The device consists of an electrified plumb line and bob that will swing toward one or three partially circular contacts if the building tilts. When the bob touches one of the contacts, an electrical circuit is completed that starts the pumps that bring the building back into line. When the building is plumb again the bob breaks contact, stopping the pumps.

"As designed, the National Lottery Building was to weigh 16,500 metric tons plus 1500 tons of temporary ballast, equal to the weight of planned future additions," Cuevas says. "Thus the building has a total displacement of 18,000 metric tons. The same weight of material was excavated to receive its hull, which extends some 40 feet below ground level.

"Actually the building is supported on two separate hulls, one under the main portion of the edifice and one under the stage of the auditorium. The tops of the two hulls are connected by bridge members that also serve as part of the building's structure."

Because the authorities were dubious about his daring and unprecedented plan for a floating building, Cuevas modified the construction of the first hull and then, after the skeptics were convinced, built the second hull according to his original plans.

An excavation for the first hull was made and its concrete floor, walls and rigid interstructure were poured in place. Then it was loaded with pressed concrete blocks as ballast to an amount equal to the weight of the building that it was to support. Measurements that were made over periods of time showed that the hull truly did float; that is, it did not sink under the great weight of its ballast. Later, when the building was under construction, ballast was removed day by day to compensate for the growing weight of the structure.

When the first hull-like

(Continued to page 260)

## "Hearing Aid" Radio Weighs 5½ Ounces

Smaller than two packs of cigarettes, a personal radio that fits in your shirt pocket or clips to your belt provides private listening as you walk, work or play. Built like a hearing aid, the two-tube set is battery operated and you listen through a lightweight headphone. The radio weighs only 5½ ounces, complete with batteries. It has a range up to 100 miles. Two models are available. One has the radio and battery pack built into one case. The other has a separate battery case with the radio mounted on a wristband.



## Wonder Drug Can Now Be Produced Synthetically

One of nature's wonder drugs, chloromycetin, can now be made artificially from readily available raw materials, thus making possible an all-out attack against such diseases as typhus, typhoid fever, Rocky Mountain spotted fever and virus pneu-

monia. This is the first time any of the wonder drugs, such as penicillin and streptomycin, has been produced synthetically at a cost low enough to be practical. Chloromycetin combats diseases caused by Rickettsia, organisms of sub-bacterial size.



## Train-Ticket Vendor

Setting a destination selector knob and dropping the required coins in a slot gets the passenger a ticket on the Long Island Railroad. Fare rates to all stations are posted on the "automaticket," which vends only one-way passage. The ticket comes out one slot and the change from another.

## Heat Aids Plant Killers

Temperature has a great effect on the ability of 2,4-D to kill plants, according to Dr. Sally Kelly of Vassar College. In experiments, the chemical compound was sprayed on three test plants at three temperatures, 41, 59 and 77 degrees F. At 77 degrees the results were prompt, but at the two lower temperatures there was a decided lag before any change in the plants. When plants that were sprayed at lower temperatures were moved into a 77-degree room, they immediately started to die.

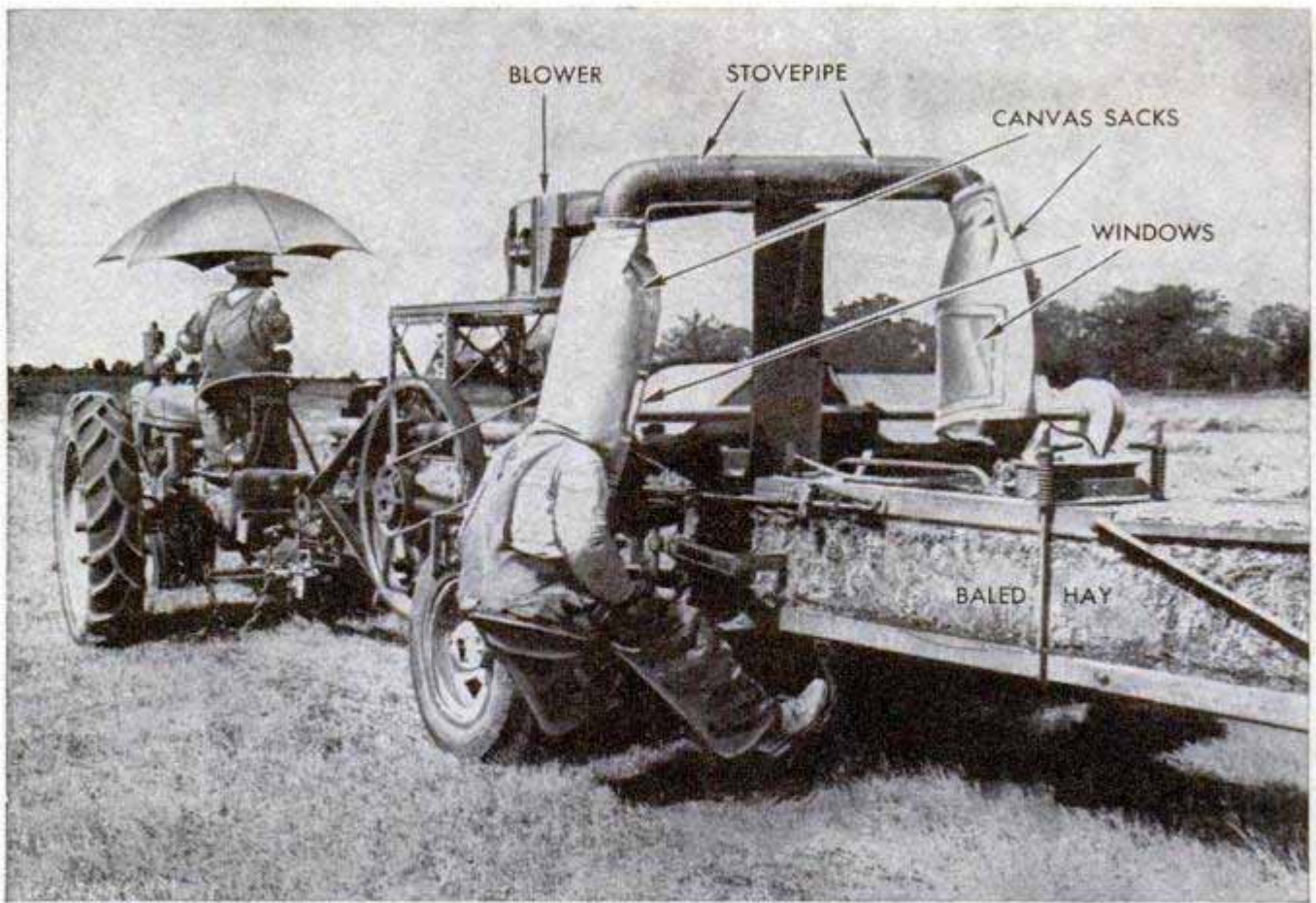

## Farm Hands Bale Hay in Air-Conditioned Comfort

Farm hands work in air-conditioned "offices" when operating the hay baler at Walser Hahn's farm near Jefferson City, Mo. Built by Hahn's son, Herbert, the air-conditioner consists of a blower, several lengths of stovepipe and two canvas sacks.

The workers place their heads inside the sacks, which have large windows in the front, and breathe fresh air blown back from the front end of the baler, minus the straw and dust that float in the air at the rear end of the machine.

## High-Altitude Test Chamber Used to Cure Whooping Cough

Built to permit high-altitude tests on airplane pilots at ground level, the mobile decompression chamber is used in England in an effort to cure children suffering from whooping cough. Pressure is reduced until

it equals that at 12,000 feet altitude. Final results of the experiments are not yet known, but in Paris similar treatment has cut recovery time from weeks to a few days in many cases.

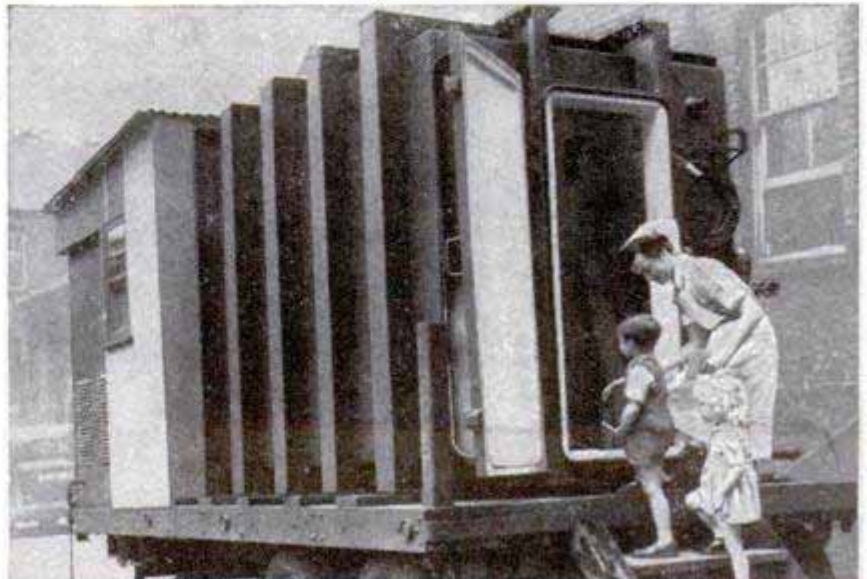

# Industry's lifesaving sleuths



Bethlehem Steel Co. photo

Hunting potential "killers," the industrial hygienist, left, checks radiation of a weld-testing X-ray unit

By John L. Kent

**E**VERY DAY scores of lives are saved by men who neither rush into fire-swept buildings nor plunge into the roaring surf. Neither do they peer into microscopes and hunt disease bacteria. Yet, they spy upon things that endanger the health of the people they protect.

Here's how one "health detective" saves lives in a Pennsylvania foundry.

Quietly approaching a workman grinding rough spots from a casting, the "detective" opens a suitcaselike instrument box and takes out a long bottle, half-filled with a clear liquid. The bottle has a hose connected to a small electric motor in the box. Plugging an electric cord into a nearby outlet, he flips the switch and holds the bottle close to the workman's face.

A few moments later, the visitor leaves with the glass bottle in hand. The workman pauses momentarily to acknowledge a goodbye hardly heard above the noise of the grinder and again bends over his work.

"Oh, him," the workman replies when

you step up and ask about this pantomime. "He's finding out how bad the air is . . . you know, how much dust there is. He checks my place every week or so."

The visitor is an industrial hygienist, an engineer whose job is to save the health and possibly the lives of men and women in that foundry.

Invisible but injurious gases are spotted by this health "detective" who patrols a factory work area

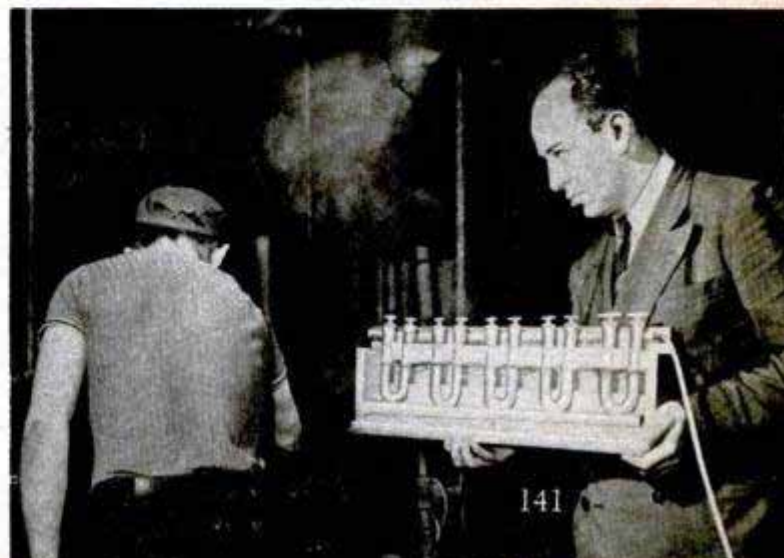

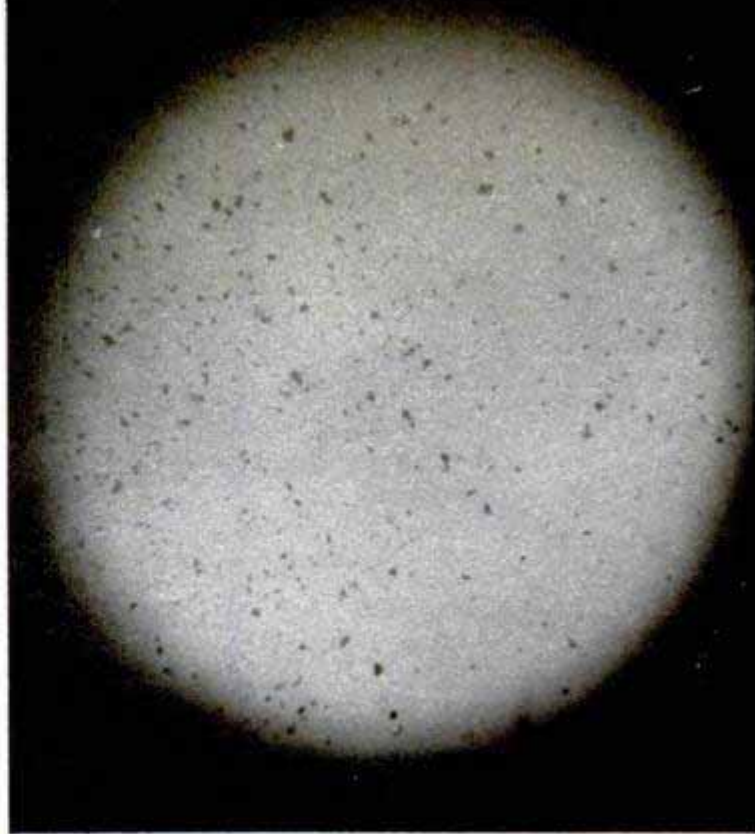

Left, a hygienist counts dust particles with the help of a microprojector. Magnified 100 times, the image is projected on an 8 by 10-inch screen for accurate counting. Right, the dust particles as seen on the screen

The bottle held by the engineer is an impinger, constructed so that any dirt in the air is caught in the alcohol in the bottle. Samples for dust counting are taken from the alcohol in the laboratory.

Dust concentrations are harmful and play an important part in respiratory diseases such as tuberculosis, silicosis and pneumonia.

Our high standard of living depends on the high level of production of our factories. Yet, the many diseases and sicknesses and even deaths resulting from work

**Safeguarding the workers' health, this ventilating system on the factory roof removes contaminated air**

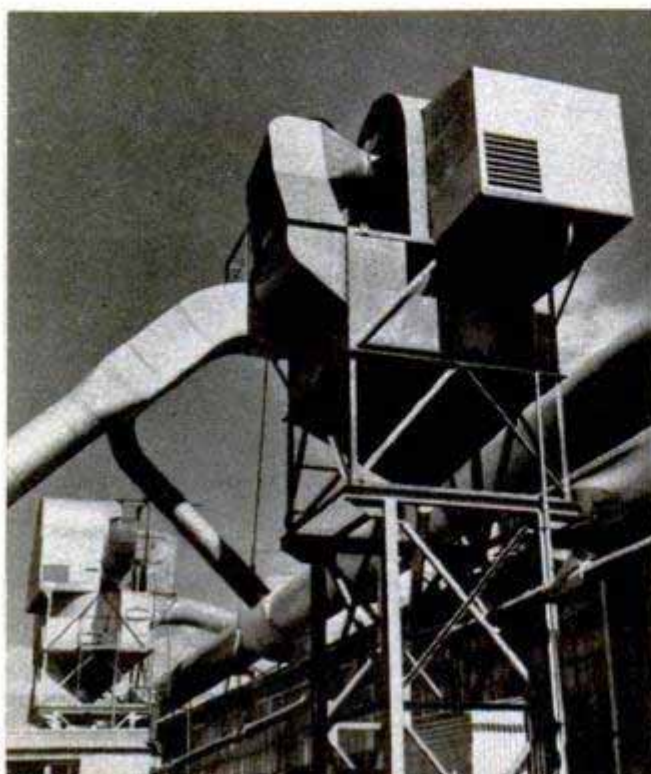

in factories show that our industrial environment is not one intended for man. Man is a sensitive animal. His eyes, ears, nose, throat, lungs and skin are easily damaged.

The industrial hygienist's job is to find what is bad for the workman and either eliminate it or prevent harm from it. A great number of industrial firms now employ full-time industrial hygienists and safety engineers. Many have separate divisions concerned solely with workers' health on the job.

Industrial-hygiene activities are no longer limited to large firms with thousands of employees. All businessmen are finding that it pays and in some cases government agencies have stepped in to safeguard the health of workers. Whereas, a few years ago, only a few organizations, such as the U. S. Public Health Service, the U. S. Bureau of Mines and a sprinkling of states were interested in this field, today there are industrial-hygiene bureaus in every state, and in large cities and counties.

In the modern plant, the employee has back of him a fully organized effort in this direction. There are industrial-hygiene engineers, laboratory chemists, safety engineers, physicians and trained nurses.

Safety appliances are in good working order and working conditions are hygienic. The employee wears a respirator to protect his lungs and goggles to protect his eyes. On some jobs, he's equipped with rubber gloves. Often, he works in an air-conditioned enclosure to counteract heat, smoke or irritating fumes. To get rid of



objectionable dusts and gases, exhaust ventilating systems are used. Measures are also taken to protect him from radiation such as that of X-ray apparatus which may be used, for example, to check on the effectiveness of welding.

To do this, the industrial hygienist has fences erected to keep workers away from ray areas, makes the operators of X-ray equipment wear film badges which indicate the amount of radiation to which they are exposed, and periodically uses an X-ray meter.

The Bethlehem Steel Company, a pioneer in the industrial hygiene field, is spending \$1,500,000 a year on its industrial medical program to protect the health of its 143,000 employees. An experienced industrial-hygiene engineer is in charge.

Its laboratory is equipped to collect and analyze quantitatively a wide variety of solids and gases in the atmosphere in extremely small amounts and in dilutions as low as a millionth of a gram per cubic foot of air.

Usually, collected dust is analyzed chemically to determine its content of contaminants. However, under some conditions, an actual count of the number of particles of dust is required.

To make such a count, a sample of liquid containing the collected dust particles is allowed to settle in a glass cell which is placed under a microscope. Definite areas are blocked out and the number of dust particles in several of these areas is counted. To count the particles easily, the image on the stage of the microscope is thrown onto a large screen by means of a microprojector.

Colorimetric methods are also extensively used in the laboratory. The actual amount of a certain colored

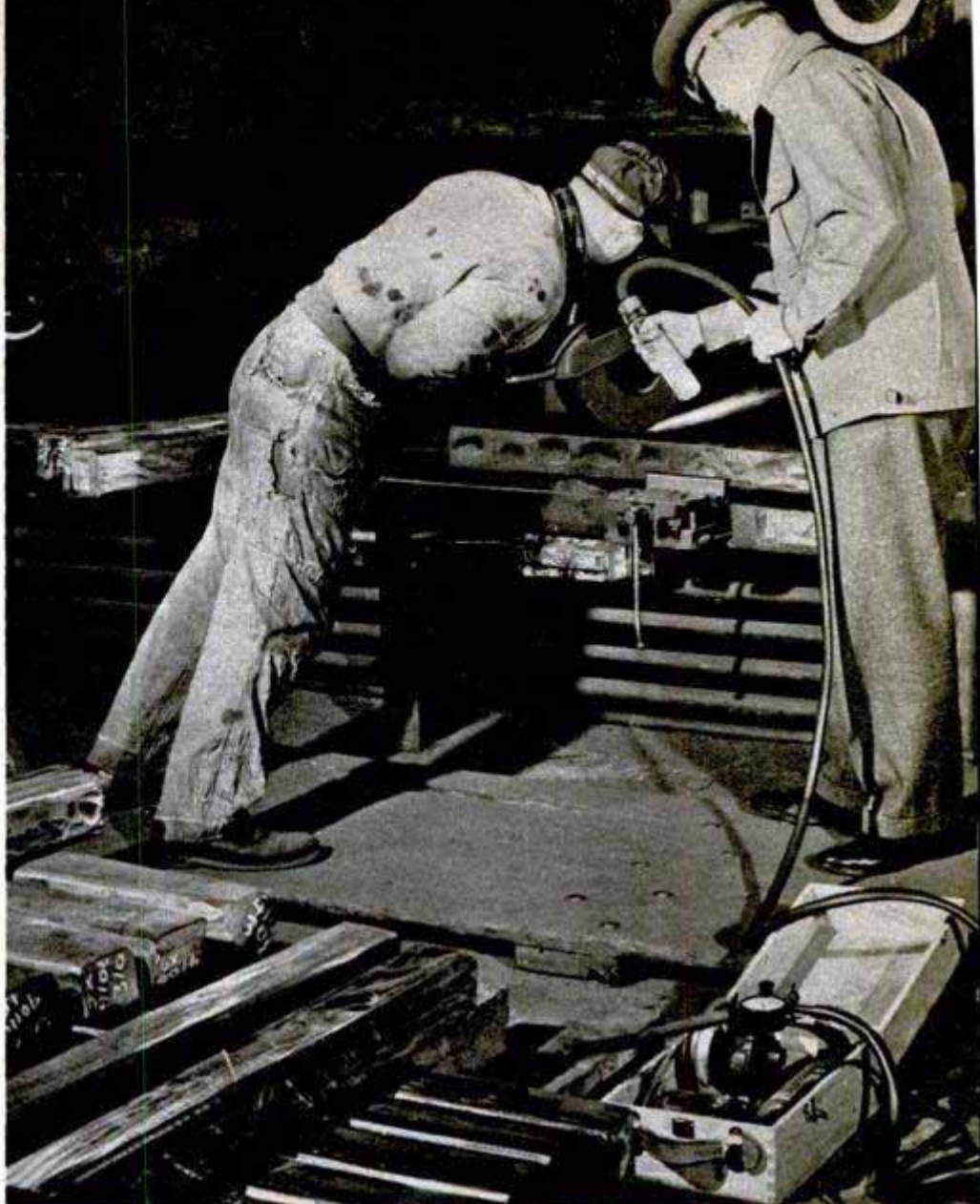

Above, a health sleuth collects an air sample alongside a swing-frame grinder. Caught in a vial of alcohol, the dust in the air is measured on the microprojector. Below, a counter measures atomic radiations of an isotope stringer that is being withdrawn from the pile at Oak Ridge



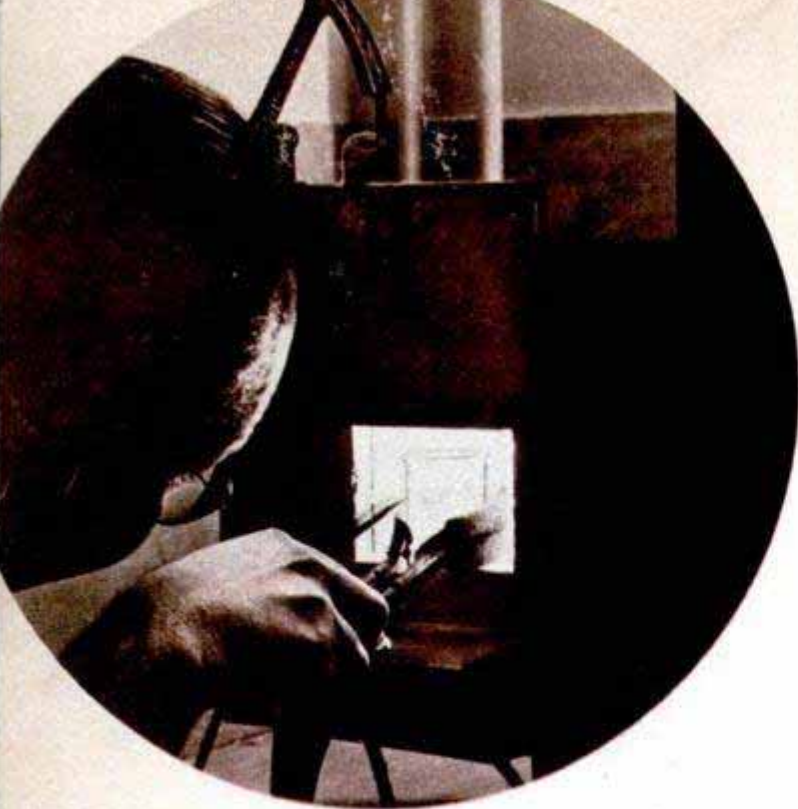

Above, urinalysis provides advance warning of lead poisoning. Sample is removed from furnace before it is checked for lead content. Below, fractionating column determines composition of unknown solutions

chemical compound contained in a solution may be quickly and accurately determined by comparing it with a similar solution of known concentration.

Such comparisons are frequently carried out by visual observation, but in many cases a spectrophotometer is used. In this instrument a photoelectric cell, far more sensitive to color variations than the human eye, is used to make the comparisons.

The possibility of lead poisoning is investigated by urinalysis. Subjected to intense heat in a muffle furnace, all organic matter in the sample is burned away, leaving only the ash. A solution of the ash is drawn into a vial which is inserted into the spectrophotometer. The percentage of light transmitted through the solution shows how much lead has been absorbed by the workman.

A particularly handy instrument is a fractionating column, used to determine the percentage of each component of an unknown solution. The components are separated by being boiled off at their respective boiling points.

Another device is the refractometer. It determines the refractive index of liquids and solids and also offers a means of determining their concentration. The index measures the ability of a substance to bend light. This helps to identify the unknown substance. The refractometer is often used in conjunction with the fractionating column.

The latest reports of the U. S. Public Health Service and State health departments describe studies of the familiar types of occupational hazards such as exposure to lead and silica in potteries, fumes and dusts in foundries, and solvents in degreasing operations and in dry-cleaning establishments. Others tell of exposure to excessive temperatures and humidities, continuous vibration and poor lighting.

Dermatitis is a skin infection common among machinists and metalworkers who handle cutting oils used in cooling and lubricating cutting tools. On the West Coast a number of fruit sorters recently developed what was promptly dubbed "left arm dermatitis." It was the result of handling fruit which had been washed in a new type of fungicide. In the packing sheds, fruit is processed by passing it through a wash tank for removal of dirt and spray residue. The fungicide, used to control mold on fruit while it is in storage, was dissolved in the rinse water.

Most of the dermatitis originated on the worker's left arm because in guiding the wet fruit as it rolled along the sorting table the worker drew it to one side in the curve of his arm.

Last summer, a workman in a Cleveland

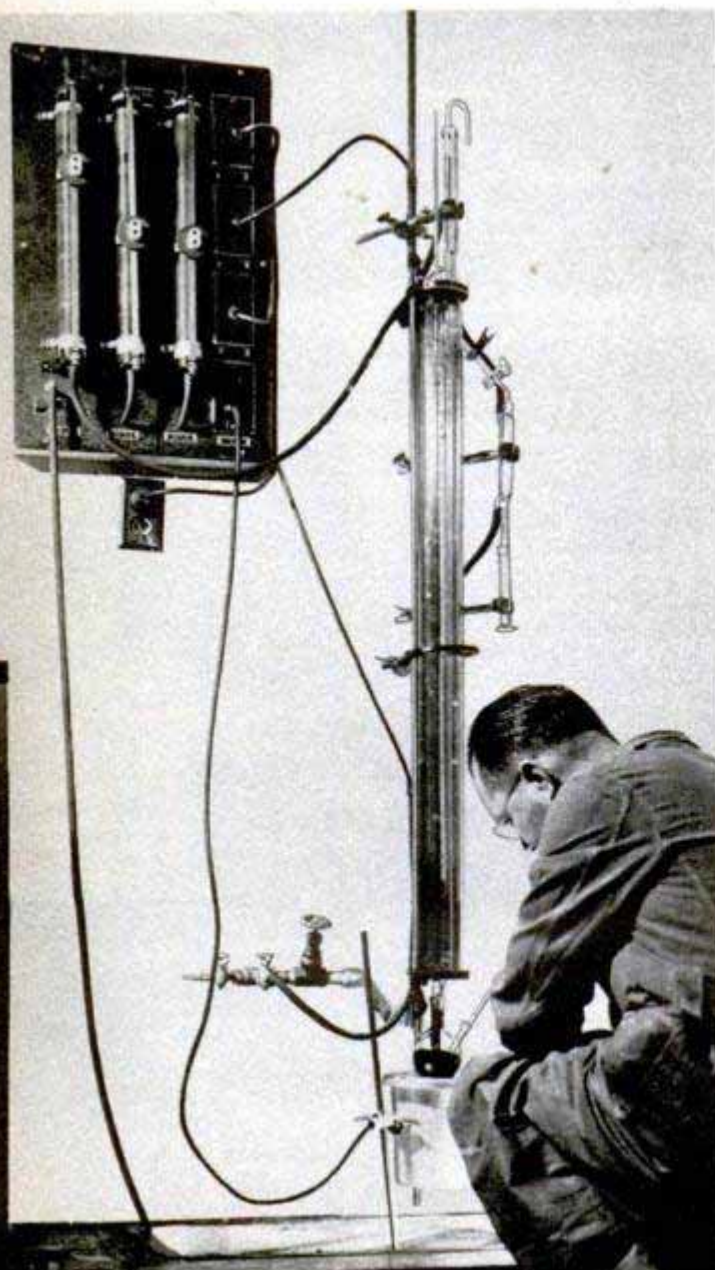

paint-manufacturing plant refused to wear a respirator provided by the company. Apparently perfectly healthy, he suddenly became ill and died within a few days. As a result, the Cleveland Department of Public Health and Welfare made a study of the industry. Of the 51 paint plants in the city, 35 were found to be using lead carbonate or leaded zinc in appreciable quantities.

The city's public health engineers concluded that while lead poisoning is not widespread in the paint industry now, it is still a potential health hazard.

The U. S. Public Health Service recently completed a study of the health hazards in the use of sodium fluoride at open-hearth furnaces. The chemical, introduced into the manufacture of steel during World War II, preserves the fluid state of molten metal, allowing for the escape of trapped gases which otherwise cause blowholes in the ingots. Workmen complained bitterly about its use. However, after a careful study made at four Republic Steel Corporation plants in Ohio, the Public Health Service concluded that while the addition of the sodium fluoride caused more smoke and fumes, it did not constitute a significant health hazard.

Government reports also reveal efforts at minimizing newly developed hazards. Although several people have died as a result of exposure to radioactivity in the course of atomic-energy research, no deaths have been reported in the industrial handling of isotopes and other radioactive substances.

To prevent injury and deaths from this newest industrial servant, the Atomic Energy Commission and the National Military Establishment are engaged in a continuous study aimed at devising better indicating and protection methods.

At one time, the health and safety of the employee was of little concern to industrial firms. If a man got sick, he was laid off and a healthy man hired. But, industry found that this was a shortsighted approach.

Says J. J. Bloomfield, Assistant Chief of the Division of Industrial Hygiene, U. S. Public Health Service:

"On the over-all scene, there is a keener appreciation of the importance of the worker's health. The preservation and maintenance of industrial health has various implications. To management, it means greater profits and new outlets. To the worker, it means employment. To the consumer, it means new luxuries—television and other modern inventions."

But, these developments often bring new hazards and it takes a bit of detective work to uncover the health menace before it strikes. This is the increasingly important job of the industrial hygienist.

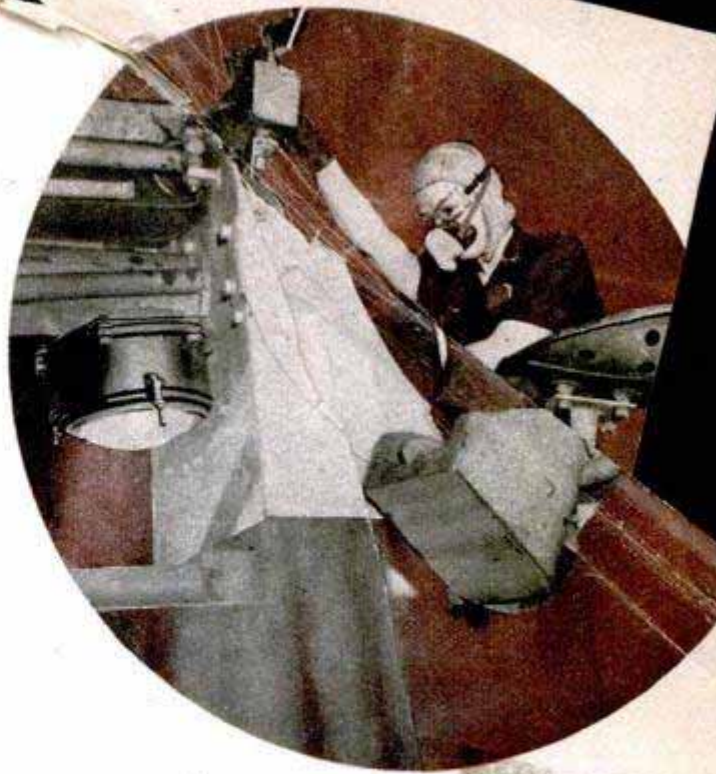

Above, woman operator of sandblaster wears goggles and respirator to protect her health. Below, factory hygienist is measuring the noise made by a chipping hammer to be sure it does not exceed safety limit.

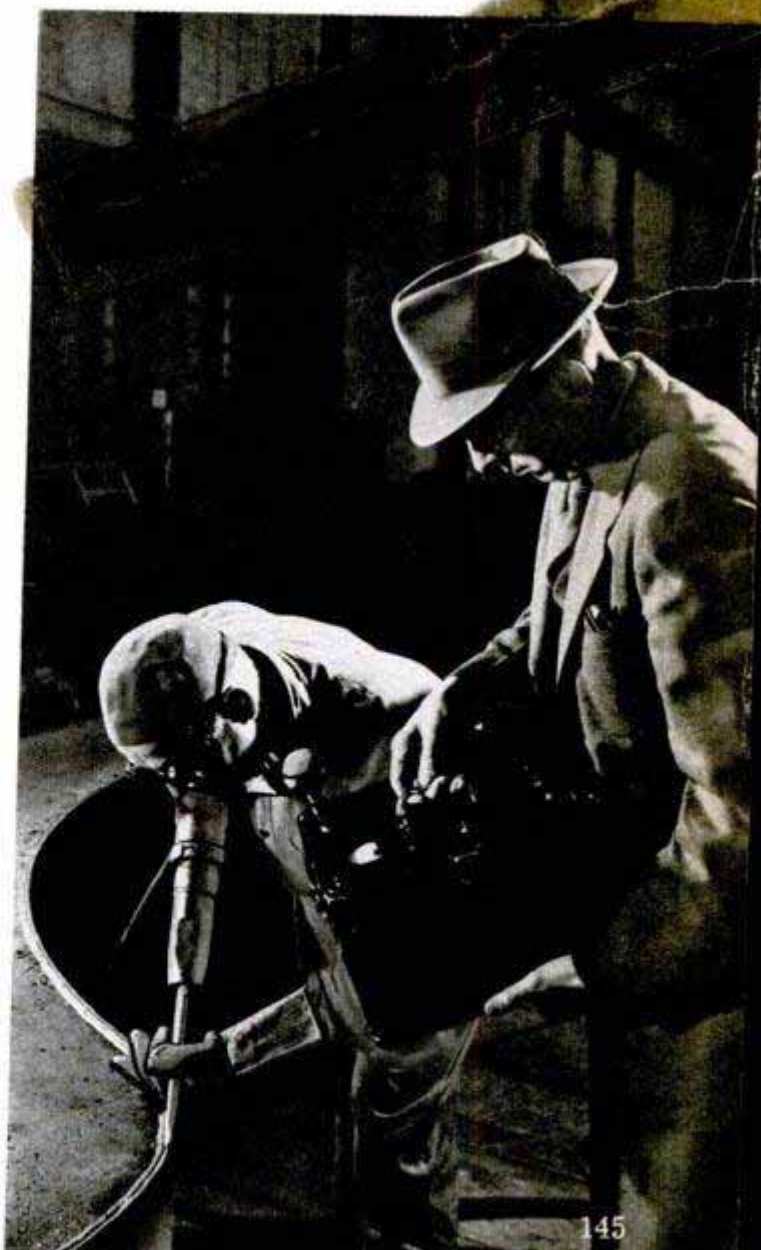



## Electric "Housemaid" Even Shines Shoes

British housewives now have an electric "housemaid" that cleans shoes, scours pans, peels potatoes, grinds meat and coffee, beats eggs and sharpens knives. A variety of polishing and scraping heads comes with

the machine. Because a traditional duty of the housewife in England is shining her husband's shoes every week, the electric machine is becoming very popular in that country.

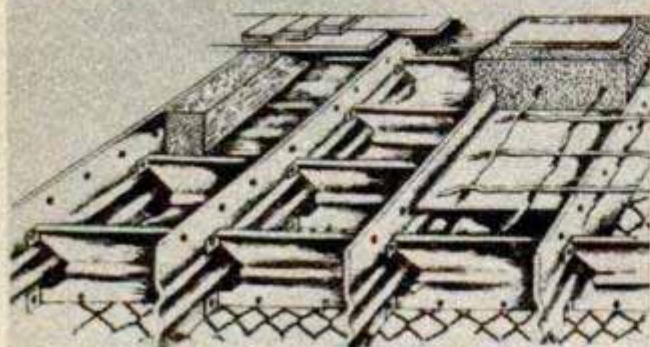
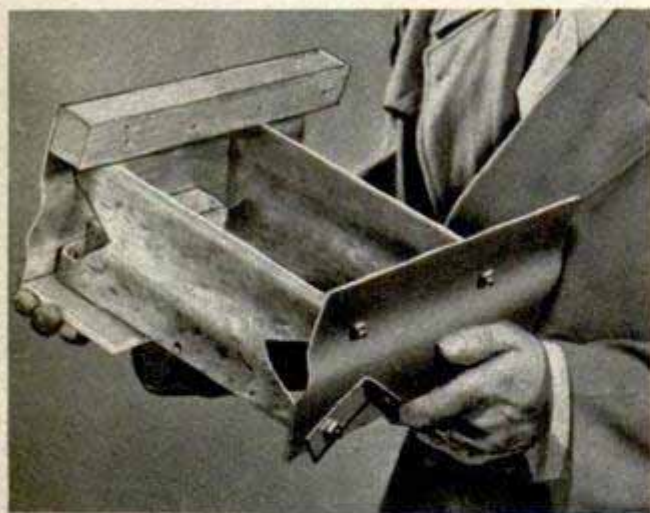

## Lightweight Metal Joist

Floor joists of aluminum would provide a rigid, nonwarping support for floors and ceilings that can be mass-produced, according to the inventor, Dudley C. Pierce of Grand Rapids, Mich. Not yet in production, the joists have provision for nailing wood floors to one side and attaching metal lath to the other side for plastering. If desired, the floor can be made of concrete or any other standard floor material. One important advantage of the prefabricated joist is that it would eliminate the waste space in commercial buildings where a false ceiling is usually suspended from the joists. With the metal joist, ceilings could be mounted directly on the supporting members.

Sources of available products described in this issue are indexed on pages 10, 14 and 24. Sources of further information on other articles are listed in the WHERE-TO-FIND-IT INDEX, which is available without charge from our Bureau of Information, 200 East Ontario Street, Chicago 11, Ill.

## Cables Carry Mail From Road to Farm

Farmers now can sit inside their homes, press a push button and their mail will zip up from the road in a cylinder that rolls along a pair of cables. The trolley mailbox, invented by N. E. Leatherman of Pueblo, Colo., is designed for farm homes situated some distance from mail routes. A motor inside the box picks up current from the cables and powers the wheels. The car will travel  $\frac{1}{2}$  mile or more.

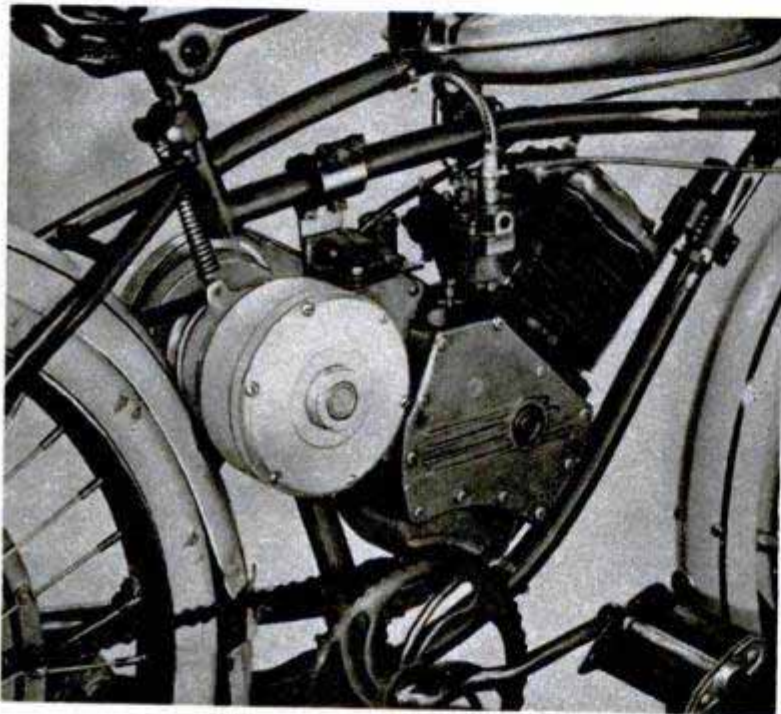

## Automatic Transmission For Motor Bicycles

Motor bicycles, garden tractors and power mowers can now have a fully automatic transmission that can be installed in 10 minutes. It has no fluid coupling or hydraulic system; instead, power is transmitted through a centrifugal clutch. As the motor speed increases, the clutch gradually engages and power flows to the rear wheel. When the motor is idling, the clutch automatically throws the transmission out of gear. In low gear, the transmission has a gear ratio of 1.7 to 1 and in high gear, direct drive is used. On bicycles, the transmission eliminates belt slippage and makes it unnecessary to pedal to help the motor.

## Room-Size Humidifier Attaches to Register

Individual humidifiers that slip over the top of a hot-air register allow you to control the humidity in each room. Consisting of an aluminum tank and a curved steel hood, the humidifier also directs the hot air out into the room, thus reducing the streaks and smudges often deposited on walls above registers. The tanks are easily filled from the side and one filling lasts about eight hours.

Scientists at Armour Research Foundation have developed a synthetic substitute for African and East Indian palm oil, a vital ingredient in making hot-dip tinplate.



# Winter Resort for Geese

*Photos by Hugo H. Schroder*

**T**HOUSANDS of wild geese, most of them from Canada, converge each October on the farm of Lockhart Gaddy near Ansonville, N. C. There they spend a leisurely winter under the protection of a man they have come to regard as a personal friend.

Back in the early '30s Gaddy built a three-acre artificial pond on his farm. In 1934 nine wild geese swooped down to investigate the pond and remained for the winter. Making friends with these first birds was a difficult task, for they were as wary of humans as any wild game birds. After three winters of persistent effort Gaddy earned the trust of the geese, and they came within a few feet of him to pick up grain he scattered on the shore.

As the winters passed these

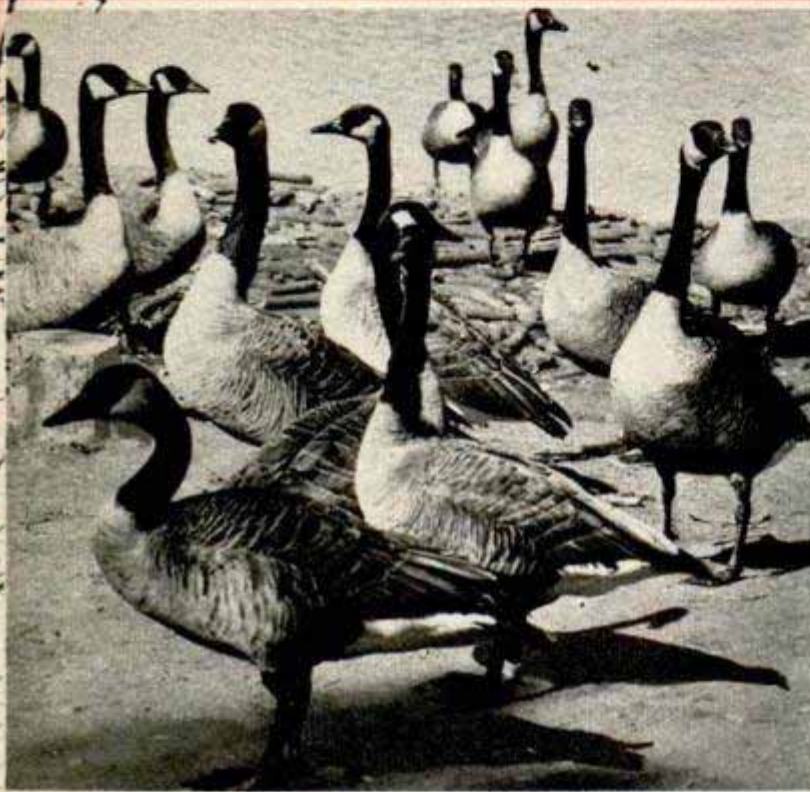

Friendly yet untamed, the geese permit humans to approach within a few feet of them—as long as they are at Gaddy's pond. Below, scores of people crowd the game refuge when the geese swoop in

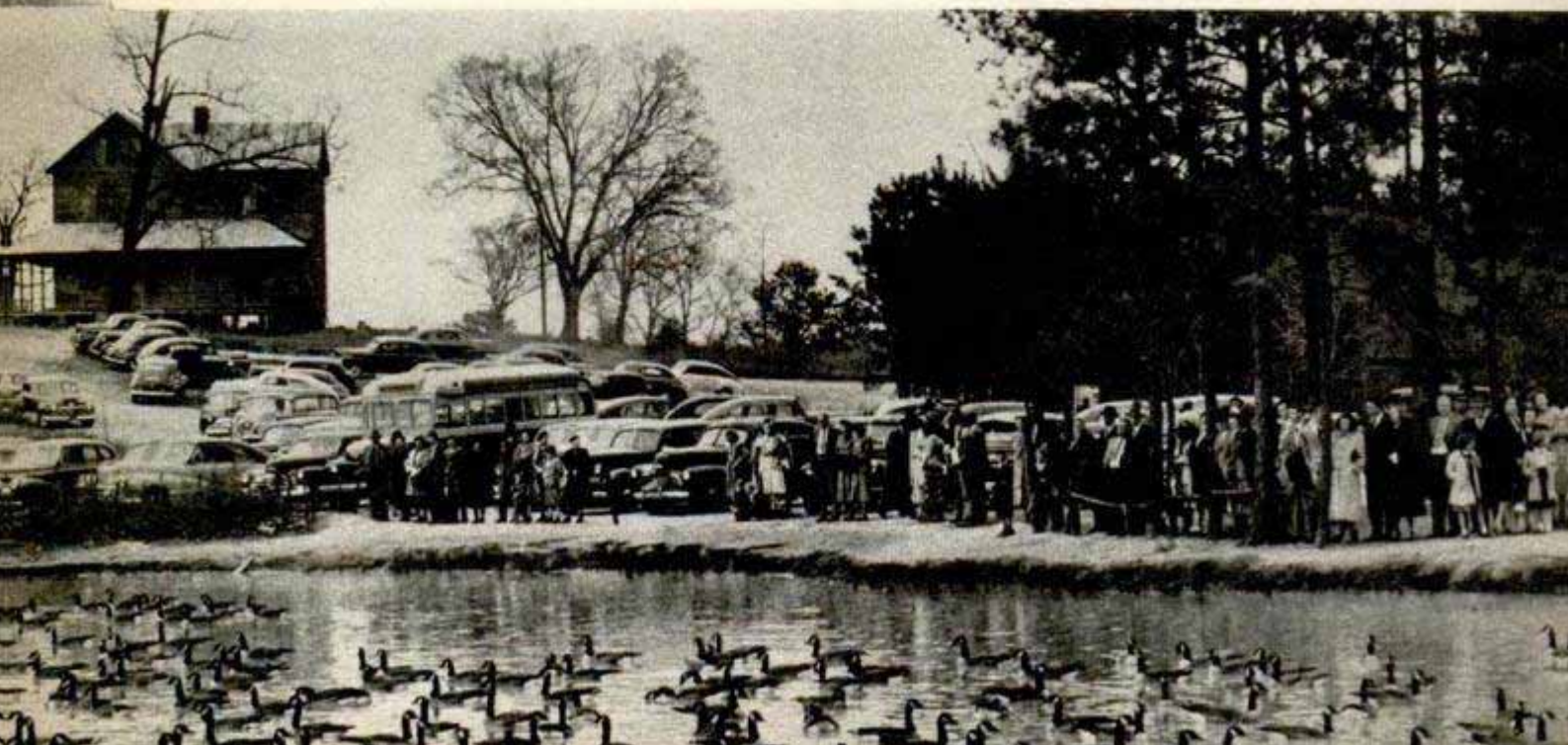



Flock of Canadian geese takes off from pond. Appreciating the hospitality, many will return next winter

birds attracted larger flocks until 6000 of them—a high mark in the winter-resort population—arrived for a six-month stay a few years ago. Last winter more than 5000 birds sought out Gaddy's protection.

The unique feature of the refuge is the way the wild geese completely trust human beings. Visitors line the shore of the little pond to watch as the birds congregate within reach. Both Gaddy and his wife visit the pond daily throughout the winter

to maintain their friendship with the birds. They even recognize individual geese who return winter after winter.

In recognition of the unique conservation role played by the Gaddy refuge, North Carolina has declared the area within  $\frac{1}{2}$  mile of the pond closed to all hunting.

Formerly an ardent hunter, Gaddy now is just as enthusiastic a conservationist. Since the geese first accepted his hospitality, he has regarded them as friends.

Close friend of thousands of wild geese is Lockhart Gaddy. You'll find no roast goose on his dining table



## Dodge Auto Engine Starts Jet Planes

Air Force technicians at Selfridge Field near Detroit helped solve the tactical problem of getting jet fighters into the air quickly by devising a special auxiliary power unit made up of a Dodge automobile engine, fluid-drive coupling and generators. The new unit has cut the starting time to a matter of several seconds. Jet power plants require a powerful kick to get them started.



## Cross-Country Tour On Plastic Skates

Roller skates made of Lucite are not only one half as heavy as steel skates, but also wear longer and are easier to repair. Except for the axles, wheel bearings, clamps and a few small parts, the skates are all plastic, even to the wheels. George "Dad" Brown, 66-year-old skating expert, skated from Los Angeles to New York City on a pair of Lucite skates he made. He used the trip to test the Lucite wheels and discovered that, while he wore out 18 sets of steel wheels in 1100 miles, he used only 3½ sets of Lucite wheels over an equivalent distance. From Chicago to New York, 980 miles which he covered in 9 days,



he used only Lucite wheels and was on his third set when he reached the coast. Brown custom-makes each pair of skates to match the skater's balance, but claims any handyman could easily make his own.



## Motorcycle Taxicab

Taxicabs made from motorcycles recently were exhibited at a trade fair in Hanover, Germany. The little cab, which seats two plus the driver, travels more than 60 miles on a gallon of gas. The maximum speed is about 31 miles an hour. Cost of the cab is about \$700.

☐ There were only 20 fatal accidents on the scheduled airlines of the world during 1948, in contrast to 32 the year previous.

Special heel plate must be fitted to shoes worn with skates; repairs measuring by 1/2 and 1/4 down



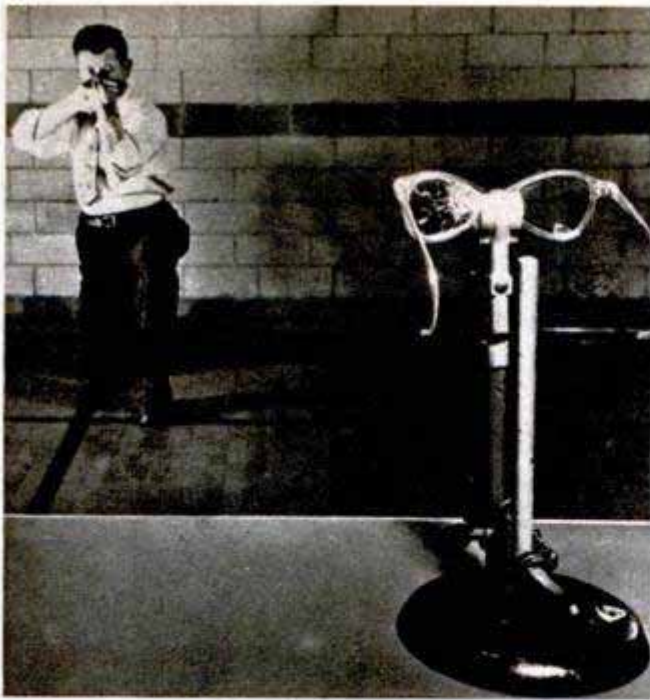

### Shatter-Resistant Glasses

Spectacles made of a glass that resists shattering and splintering protect children's eyes from accidents caused by BB guns, slingshots and other missiles. The new lenses are made of two pieces of polished glass joined by a sheet of tough plastic. The plastic's adhesive property helps prevent the glass from shattering under impact, although the lenses will crack. In one test, one of the new lenses was mounted in the left eye of a spectacle frame and a conventional glass inserted in the right eye. A marksman then fired a BB from a distance of 35 feet. The BB smashed the conventional lens but another shot failed to shatter the new glass.



### Range Finder for Movie Camera

Movie cameras can now be accurately focused with a detachable range finder. It is synchronized with the lens by lining up a red dot on the range finder with the infinity point on the lens housing. Operated like range finders on still cameras, the unit has a dial which is turned for pin-point focus until two images in the eyepiece superimpose.

### Truck Dumper

Unloading a trailer-truck filled with grain is a simple matter at a new elevator in St. Marys, Kans. A platform upends the truck and all the grain slides out. The truck is driven onto the 50-foot platform. The front end of the platform then swings  $33\frac{1}{2}$  feet up in the air, and 90 seconds later the trailer is empty.

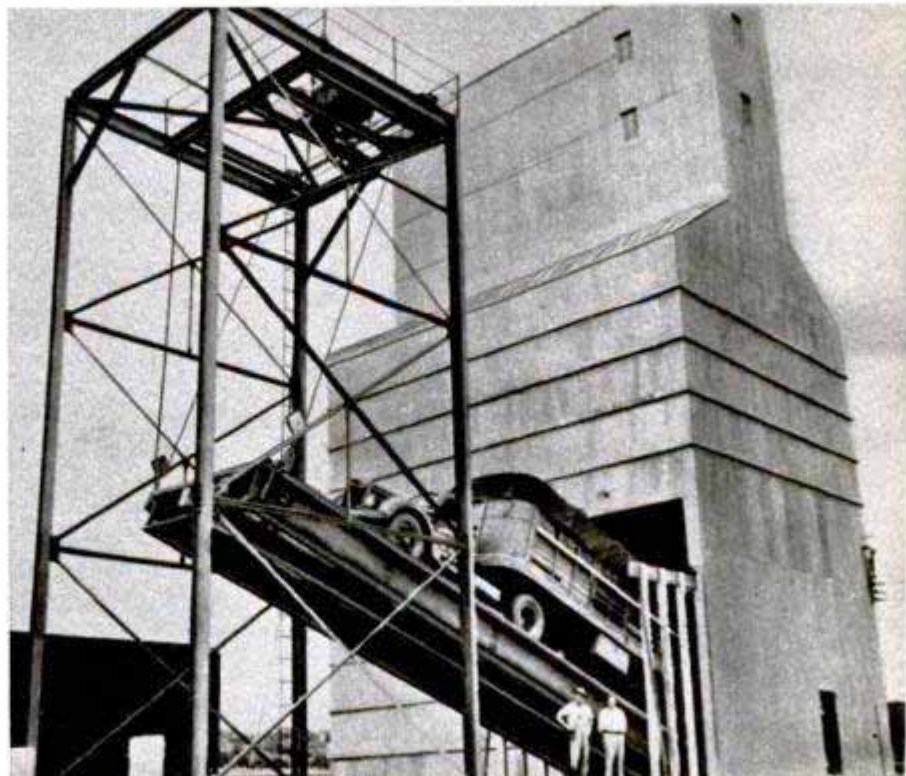

Counting the number of points on a male deer's antlers is not an accurate way to determine the exact age of the animal because when deer reach old age they often have only single points.

# BIG SECRET U.S.A.

By Thomas E. Stimson, Jr.

Stranger, prepare to tell the story of your life when you knock at the gates of Los Alamos, N. Mex. The home town of the atom bomb is wary of visitors. How it keeps its secrets is a secret

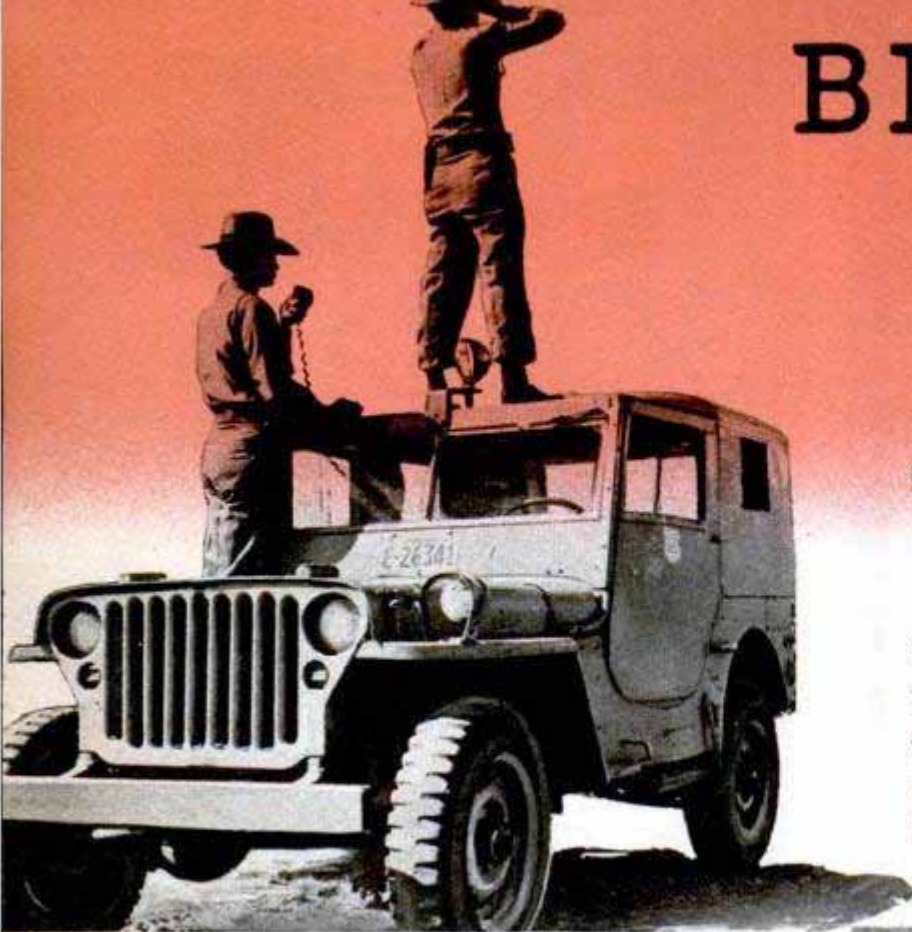

**H**ERE'S A MAP that shows you how to get to Los Alamos. Here's an aerial photo of what the place looks like. Here is all the money you need. And now, here are your assignments."

The speaker went into details. Half a dozen men, separately, were to make their way to America's secret town, the citadel in which the atom bombs are made. They were to use their own wits to get past the guards and collect every bit of information they could. Other men, friendly individuals with a knack for striking up conversations, were to mingle with the workers in the hope of gathering a few stray facts. Still others were to penetrate the laboratory area by hook or crook and devise sabotage methods.

"In short," the speaker concluded, "your job is to learn everything possible about what an atom bomb looks like, what's inside of it, how it's made and how the assembly plant could be destroyed. Get to it!"

Fortunately for the United States, the speaker and every man in his audience were trusted Americans. Each was skilled in espionage and each already had done valuable work for his country. This time their job was to test the defenses that surround the production of America's atomic weapons. If it were possible for them to penetrate the safeguards, it might be that unfriendly spies could do likewise.

Los Alamos, supersecret city, is located in the rugged mountains of northern New Mexico. Surrounded by a high fence, it is guarded by telltale instruments





Visitors pass through this gate, guarded by a watchtower. No one enters the city without permission

America's biggest secret is so secret that even the ways in which it is guarded are secret. The Atomic Energy Commission won't say whether the meeting outlined above was ever held. It won't enumerate the safeguards that surround the town or the supersafeguards that protect the laboratories.

All that it will state, in a general way, is

that the Los Alamos operations are conducted under "severe security regulations" and that the physical security system includes ingenious scientific detection and alarm devices.

If you lived in Los Alamos you'd be aware of the many miles of strong fencing, set in concrete and topped by barbed wire, around the whole community and its secret

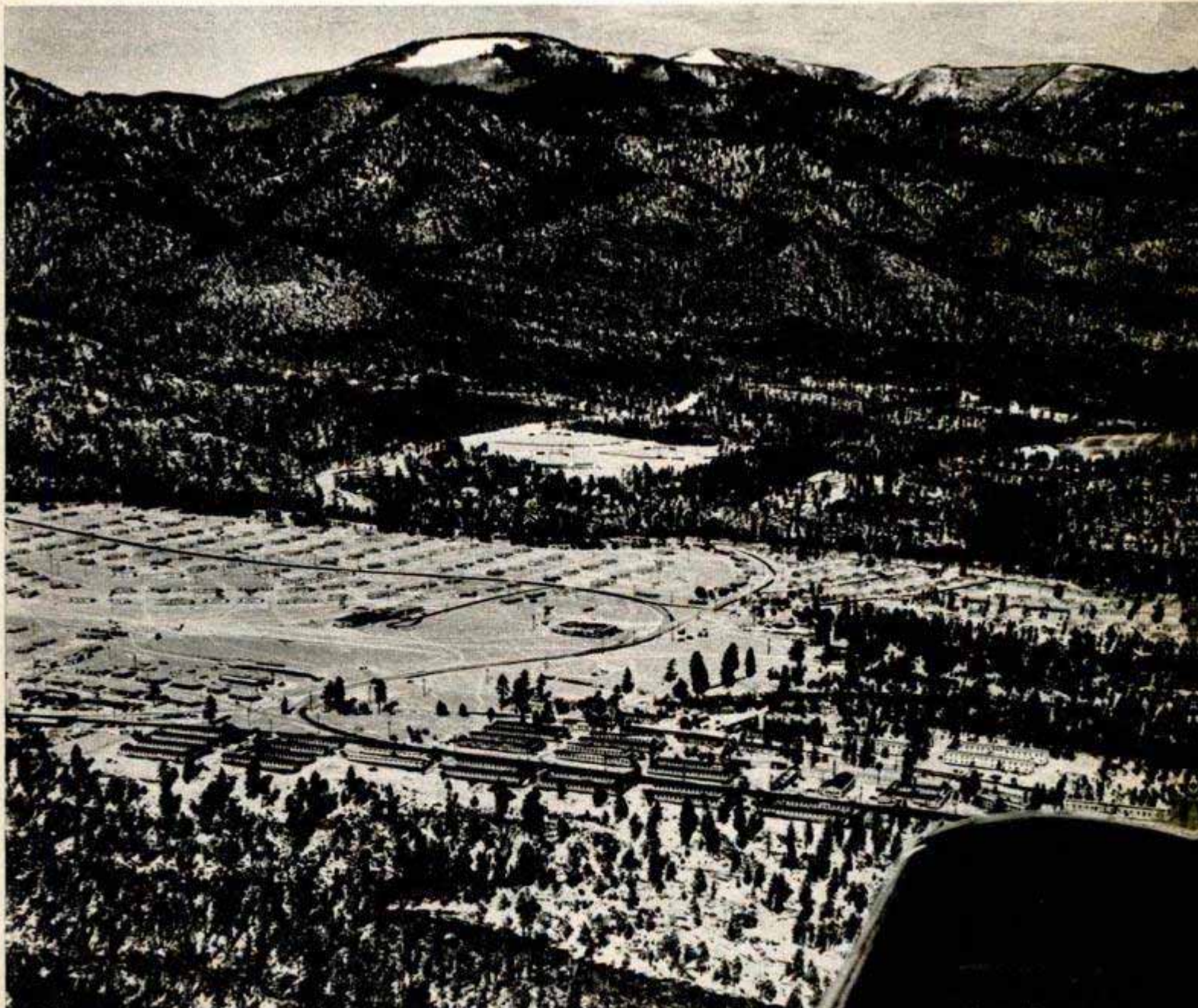

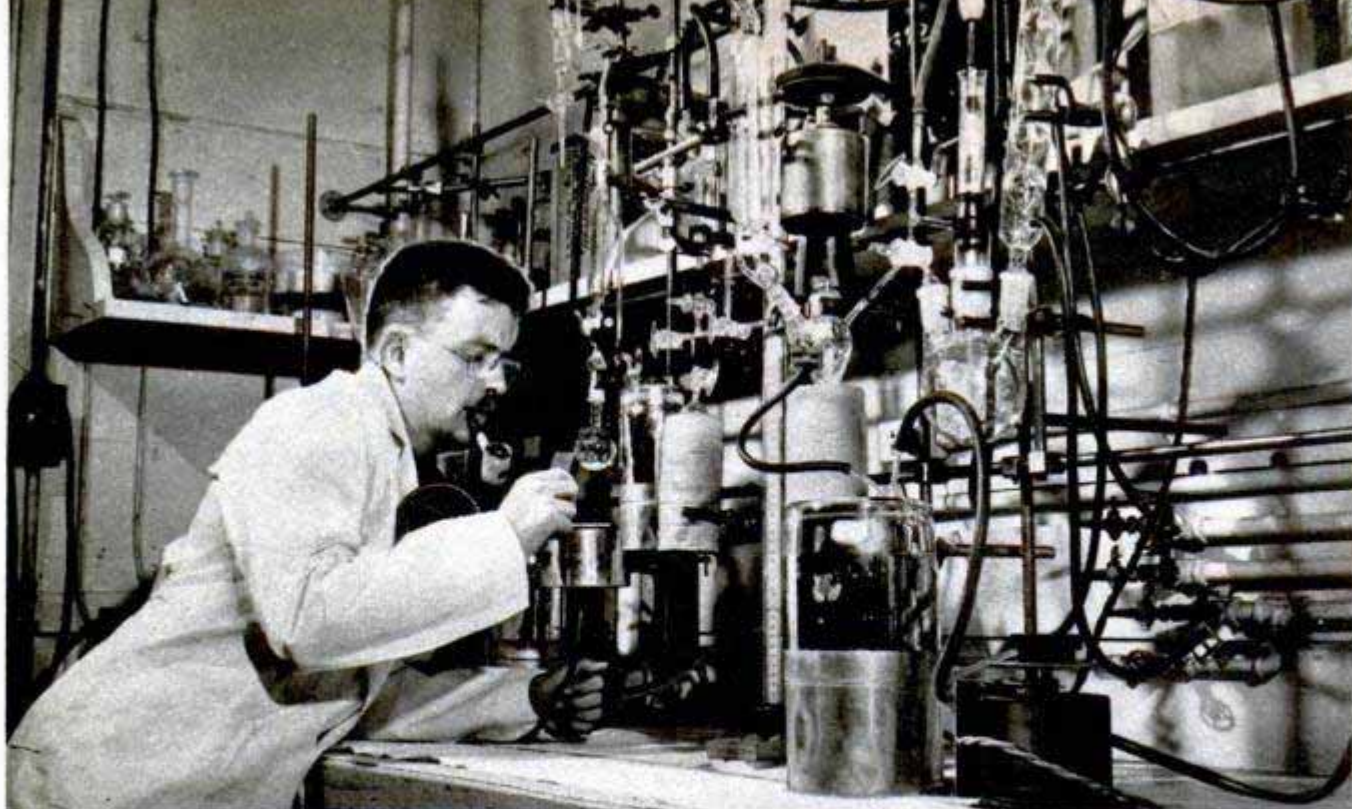

In one laboratory, radioactive carbon is mixed with a vitamin for use in studying reactions of human body

buildings. You'd be familiar with the trim AEC security police in their distinctive uniforms. These officers are so carefully selected that less than one applicant in a hundred passes the preliminary tests. Those who are accepted are trained under ex-Secret Service instructors in such subjects as police work, guard work, judo, fire fighting and terrain searches.

These human guards are assisted by never-sleeping automatic robots in the form of detection and alarm systems. Some of the robots are triggered by the heat radiated by a human body. Some are set off by the change in electrical resistance that occurs when a person walks into a forbidden area. It would be impossible for

Workers are protected by fences that prevent them from entering areas which are exposed to radiation



a spy to remain cold enough to avoid affecting the temperature circuits or to insulate himself against the electrical proximity detectors.

Other automatic alarms are actuated by the noises that a person unavoidably makes even while trying to move quietly, others employ infrared radiation, still others are hooked to photoelectric cells.

Los Alamos is located about 35 miles from Santa Fe in northern New Mexico, in a rugged mountain wilderness. The isolated site was chosen during the war both for safety and secrecy.

The city began as a temporary wartime camp, but now that atomic power seems to be here to stay the town is being developed into a permanent research center. Some 2700 people are employed in the laboratories and in the outlying installations, and the total population is close to 10,000.

You won't be admitted into the town unless you have business there or are sponsored by friends or relatives who live behind the fence. Curious sight-seers are turned back at the main gate. No one gets a job in Los Alamos, whether he is to work in one of the laboratories or in the community center, until after he is cleared by a rigorous investigation. Temporary construction workers are subjected to the same kind of scrutiny.

Nevertheless, Los Alamos has been made an "open" town as much as possible. Few restrictions are imposed on the people who must live and work there. They may come and go as they please, possess sporting firearms and cameras and lead generally normal lives. At 7500 feet altitude, on a

shoulder of the Rockies and not far from the Continental Divide, Los Alamos is in the middle of an unspoiled recreational area. Fishing, hunting, horseback riding, golf and tennis are popular sports.

Today Los Alamos has its own telephone exchange, its own newspaper, "wired" broadcasting station, library, hospitals, churches and schools. Apartment buildings are under construction and hundreds of homes are being built.

To make certain that the town and its laboratories remain self-sufficient under any foreseeable circumstance, Carroll L. Tyler, local manager for the AEC, has found additional sources of water for the community, laid in huge supplies of fuel oil and installed a stand-by propane gas-storage plant to supplement the normal supply of natural gas.

For protection in case of a possible emergency the AEC has borrowed weapons and armored vehicles from the Army. Alerts and tactical maneuvers are conducted in which the Army, Air Force and AEC protective forces operate jointly. The area has been declared a "danger" region over which aircraft may not operate without special permission.

In keeping with its position as a research center, Los Alamos contains what has been called the best physics laboratory of its type in the world. The laboratory has a cyclotron, a betatron, a Cockcroft-Walton accelerator and a 2½-million-volt electrostatic accelerator. A 12-million-volt electrostatic accelerator is under construction and other new huge research devices are being built.

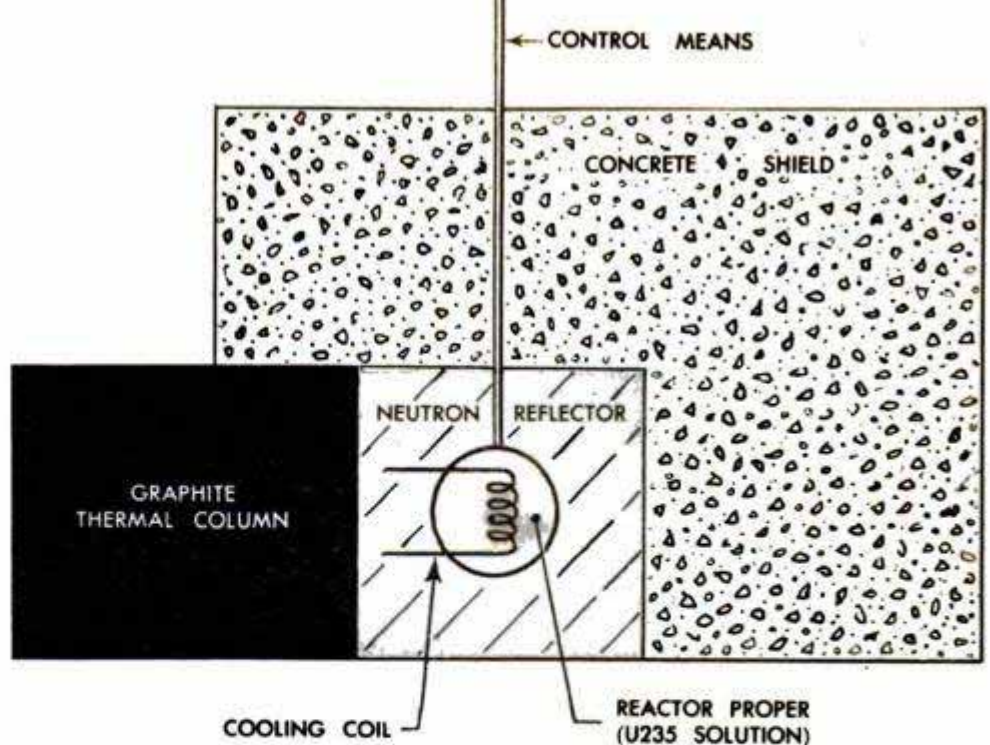

Here's a cross section of a "slow" atomic reactor of the so-called "water boiler" type. Inside the spherical container is an enriched U-235 salt dissolved in water. It is this material that is the source of the power. The reactor is employed chiefly to produce neutrons for experiments



AEC police examine an incoming truck. Nothing comes into the laboratory area or leaves it without permission. Some safeguards are automatic, touched off by heat of human body or by noise. Below, at the airport adjoining town is this combined control tower, weather and fire station



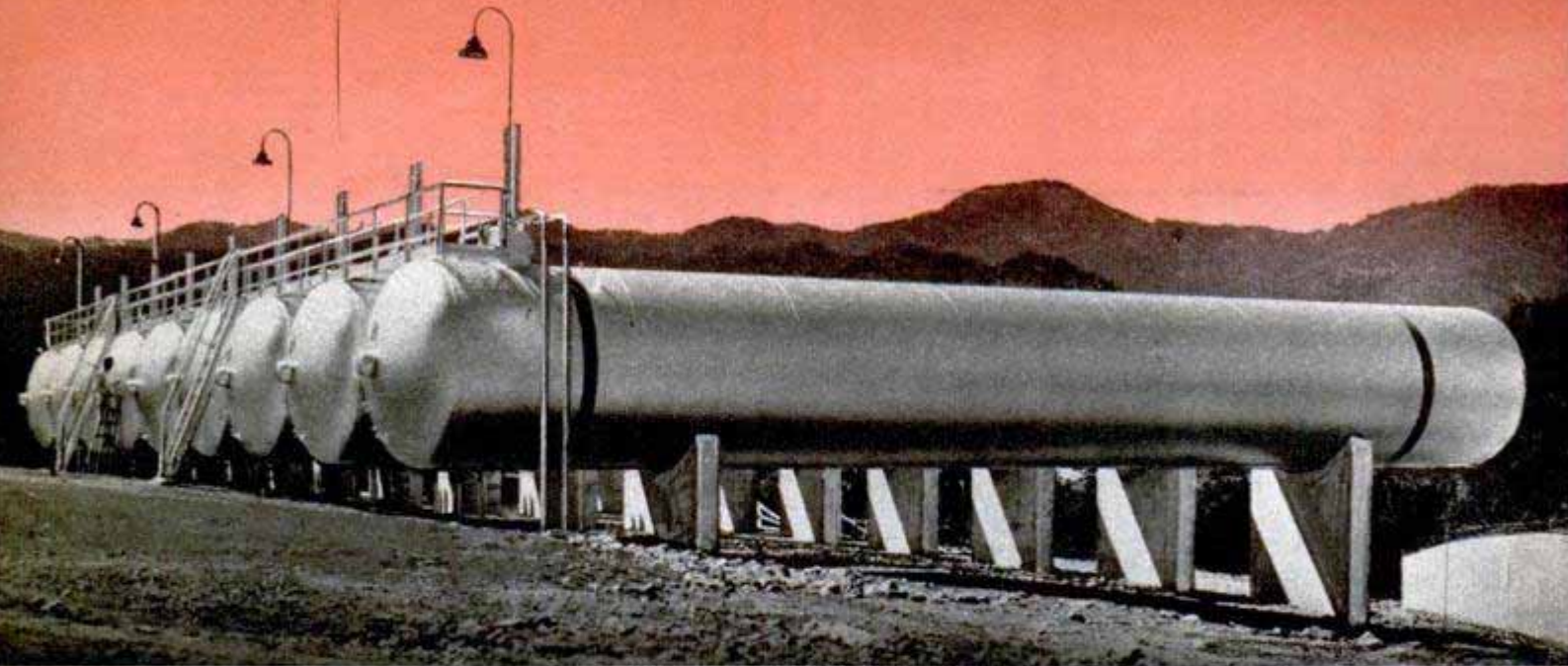

Los Alamos is self-sufficient in nearly all respects. Butane from these tanks could be used if anything happened to the natural-gas pipe line. The town also has extra water resources and a huge supply of fuel oil



Radioactivity is tested by placing material in lead safe with Geiger tube. Below, animal skeleton is checked for radioactivity



In the laboratory is a "slow" radioactive pile or reactor of the so-called water boiler type that uses enriched U-235 for the mass production of neutrons. One tool announced by Dr. Norris E. Bradbury, director of the laboratory, is a "fast" chain-reaction pile that makes use of man-made plutonium as the power source. Operated at partial power for several years, the reactor is serving as a guide in the designing of future atomic-power plants.

Inventing new atomic weapons is one job at the laboratory; engineering the weapons for greater ease of production and for greater serviceability are kindred projects. Also under way are numerous investigations for peacetime uses of atomic power. Many of these projects are "farmed out" to universities and other institutions in different parts of the United States; in these cases Los Alamos acts as a coordinating and advisory laboratory.

Among the investigations that are under way is the use of radioactive isotopes in seeking how to get more plant growth from certain fertilizers. The tracer isotopes, too, are being used to get new facts on animal growth and on how plant diseases and pests develop. Now that numerous "tagged" atoms are available, precise information is being sought on a wide list of subjects ranging from the vitality of the teeth and the causes of cancer to better understandings of photosynthesis.

petroleum refining and metallurgical processes that have defied analysis.

One of the exciting possibilities being studied at Los Alamos in conjunction with other AEC laboratories is that of "breeding" new supplies of radioactive materials and thus augmenting our natural and manufactured supplies.

The thought is that U-233 or plutonium, both capable of chain reaction, can be created as by-products during the operation of an industrial atomic power plant. A blanket of U-238 or thorium, each comparatively plentiful, would be put around the pile to absorb excess neutrons. The neutron action would be to transform the inert blanket material into radioactive substances that in turn could be used for powering other piles.

Recently, Los Alamos enlarged its health-physics laboratory, which is concerned first of all with the prevention of radiation sickness among those who work with radioactive materials. This is partly a matter of adequate design in shielding the reactors and other radioactive sources and is carried out to such an extent that the technicians who perform the final assembly operations on atomic bombs do all of their work by remote control, using mechanical hands and fingers. Seated in another room or even in another building, they view their work by wired television.

So little is known yet about radiation sickness that the health-physics laboratory is doing a great deal of basic research as well as practical work. New instruments for detecting and measuring radiation are evaluated, new tolerances have been set up, and new methods of treatment for those who have received over-exposures are being worked upon.

The guarding of our atomic secrets is one of the biggest security jobs that was ever attempted. There are miles of secret pho-

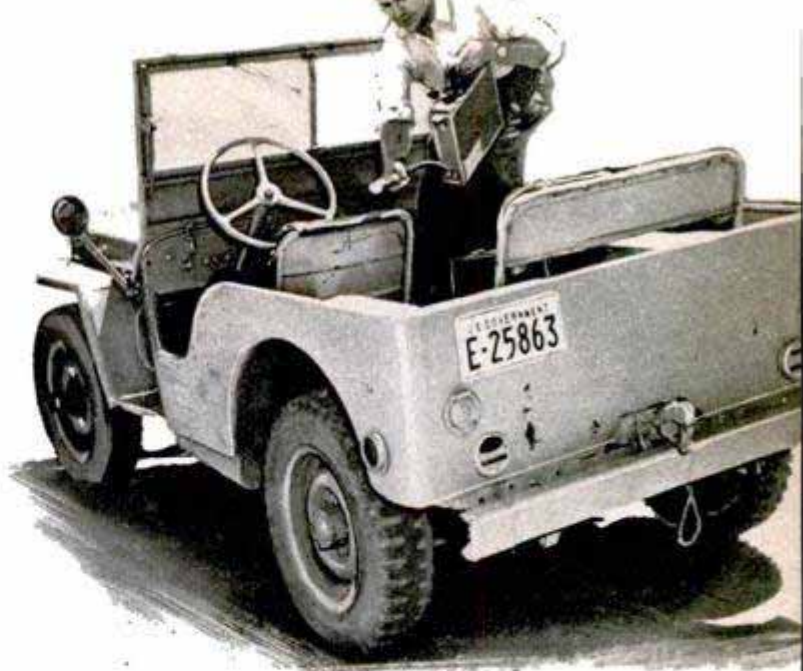

Equipment as well as humans can become contaminated. Here a technician checks a Jeep used in lab

tographic film. Secret construction blueprints would fill trains of freight cars. Hundreds of thousands of documents on secret experiments have been typed or mimeographed. Ten thousand more classified documents are originated every month and about that number must move from one installation to others each month. Even the messages that move between plants and laboratories are mostly in code. One of the biggest security tasks is the safeguarding in transit of several-thousand-mile shipments of atomic materials and the manufactured components of weapons.

Los Alamos is only one location that must be guarded and in all there are 1270 separate plants, laboratories, offices, storage areas and test facilities that must be defended against espionage and sabotage. These are located in 41 different states, in Canada and in the far Pacific. Some of the locations are well known and the very existence of others is secret.

Attractive new homes are built for workers, who find themselves in the center of a vast recreational area

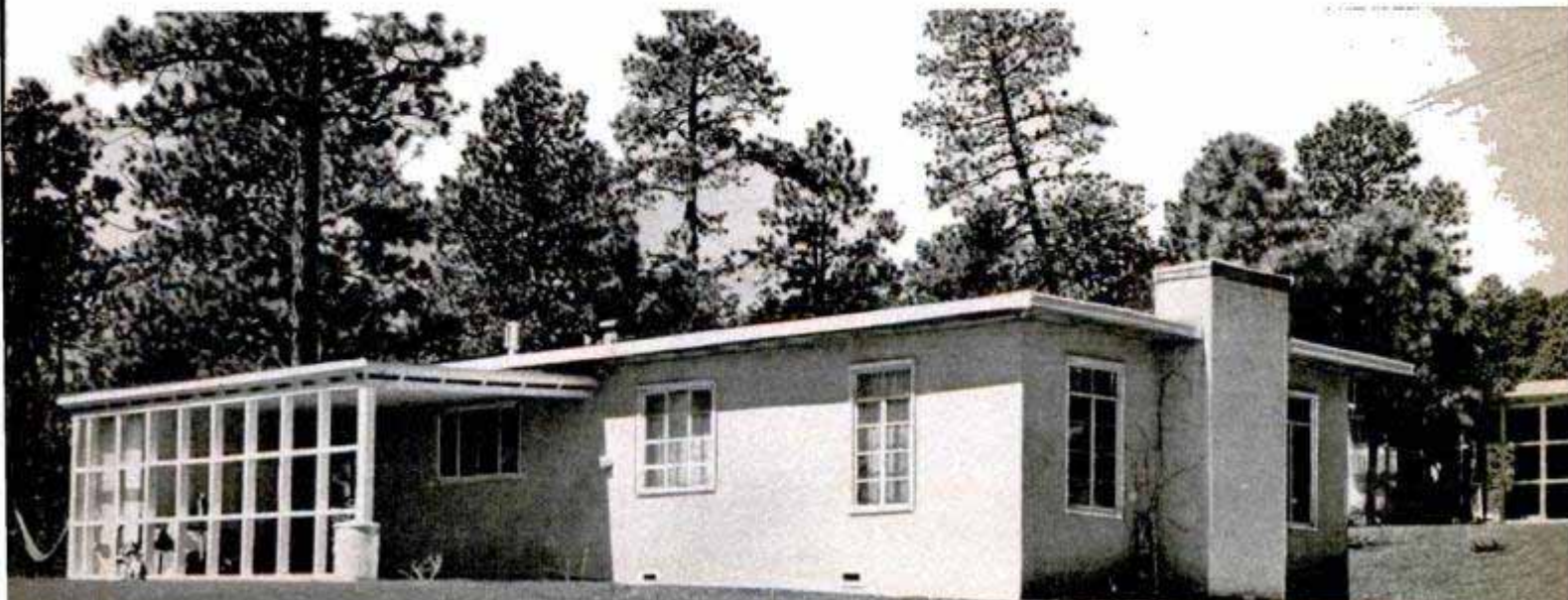



## Dual Wheels and Single Tires Add Stability to Tractor

When a tractor used by the city of Ishpeming, Mich., developed a tendency to tilt as its scoop was raised to full height, the city engineer decided that dual rear wheels might solve the problem. Extra tires were not purchased at the time, but the dual wheels and spacers were installed as soon

as they arrived. The single tire was mounted on the outer wheel. The operator discovered that the additional tires were unnecessary as the added width of the rear tread gave the necessary stability to stop the tilt and, to his surprise, the tractor steered more easily than before.

## Adjustable Clothes Rack for Automobile Mounts on Window Molding



Strong enough to support as many as 12 garments, an adjustable rod that mounts on the window molding of any car keeps clothes wrinklefree on motor trips. Existing screw holes can be used to mount the rack or, if the molding has no screws, it is installed by boring two small holes about 12 inches apart. The bar is adjustable in length to match holes in the molding.

## Adapter Unit Gives Bike Two-Speed Transmission

Bicycle riders can convert their bikes for two-speed operation with an adapter unit that fits any New Departure coaster brake. Shifting is accomplished by a finger lever mounted on the frame. The unit uses direct drive in low gear, and in high gear the gear ratio is increased by planetary gears similar in principle to those in automatic car transmissions.



## Horn-Shaped Trap Snares Plant Bugs

Government scientists, seeking a way to stop the spread of a potato disease in the state of Washington, have produced a new insect trap for catching aphids, the carriers of the disease. By studying the life history of the green peach aphid, entomologists hope to learn how to combat the disease. E. W. Davis of the U. S. Bureau of Entomology and Plant Quarantine designed the trap, which is several times more effective than previous models. Shaped like a curved horn, the free-swinging trap has a vane attached to its base to keep it headed into the wind. A roller-skate wheel is used as a bearing at the base of the trap. The wind-borne insects enter the large front opening



and make their way up the narrowing passage into a cloth bag on the top where they are trapped

## Multiple Drill Fits Saw Table

Twin horizontal holes can be drilled quickly in wood with an attachment that fits any circular-saw table. The machine saves time in joining window screens and screen-door frames. The head of the drill has two screws which hold the bits in line with each other, and another screw adjusts the height of the bits. Holes can be varied, center to center, from 1¼ inches to 3½ inches, and the attachment also can be used for vertical drilling.

## Car "Road Tested" On Dynamometer

Mechanics can test the pulling power of an automobile engine without leaving the garage by means of a dynamometer that simulates any desired road condition from level highway to a steep mountain grade. The car is driven on a pair of rollers and, as the rear wheels turn the rollers at varying speeds, the horsepower rating of the engine is shown on a gauge. By pressing buttons on a hand control, the mechanic varies the load on the rollers, reproducing a variety of road conditions. Long used by automobile



manufacturers to test new cars, the dynamometer has been modified to make it available to the automobile repair shop.

# Ageless "canvas" for

**A** UNIQUE art canvas that, according to exhaustive chemical and physical tests, should last for at least 500 years has been invented by Louis Francis, Miami artist. Made of ordinary copper screening treated with a mixture of graphite and a rubber-based oil, the canvas possesses all the painting qualities of regular linen canvas plus permanent flexibility, durability and an ageless resistance to the elements.

The canvas on which the artist paints his masterpiece has always been his worst enemy. Not only does the linen actually rot away from his pigments in the short span of about 20 to 30 years, but the added hazards of insects, mildew, expansion and contraction all mean that, if his work is to be preserved for posterity, it must be constantly restored and retouched. Because of this, the works of the old masters hanging in galleries throughout the world have been redone so many times that one sees more of the work of restorers than of the original artist. Many mediums have been tried in an effort to overcome this, but lacking flexibility and texture, they have never replaced linen as the artist's choice. However, Francis' new copper canvas should go a long way toward filling a need that has been felt by artists since the time of Michelangelo.

In addition to being impervious to dampness, age and insects, the copper canvas has other advantages which, even taken by themselves, should win it many friends among serious workers. Most important to the artist will be the new feeling he will acquire toward color. As the canvas is non-absorbent, there is no drinking up of the oils by the backing. Colors dreamed up on the artist's palette go on his canvas and remain that way — true, clear and bright. There is no fussing and "piddling" to bring out the delicate tones and shades that may become lost when applied to linen. Also, his canvases will be almost damageproof. They can be removed from the stretchers, rolled, pulled, restretched, hammered on and even walked on. They come through uninjured after abuse that would completely ruin linen.

The secret of Francis' canvas lies in an oil which is mixed with powdered graphite and applied to the copper screening. The same oil may soon become valuable in the manufacture of paints, coatings and water-

proofing materials because of its valuable properties. The oil makes it possible to use the ageless though greasy graphite as a filler. It is the only oil that will dry up the graphite, and it does this so well that one thin coat of zinc white and linseed oil will not pick it up, though it remains flexible.

The canvas is no new and untried product. Francis has been using and testing it over a period of 30 years, and he made it available to the public only upon the insistence of his many artist friends to whom he had given canvases. Canvases which he prepared 20 and 30 years ago are still perfect and so flexible they can be rolled around a lead pencil without cracking. A chemist of Coral Gables, Fla., who has been conducting all the laboratory tests for Francis, states that the canvases should last at least 500 years without showing signs of age or deterioration.

Francis hopes soon to have production kinks ironed out so his canvases can be made available through regular artists' supply houses. However, the oil can be obtained from him now and, as the preparation of the canvas is a simple matter, any artist can easily make his own. Standard  $\frac{1}{16}$ -mesh copper screening is used, with a mixture of 95 percent powdered graphite to 5 percent of the oil by volume. The



# artists

By  
B. E. Peerless

An artist himself, Francis puts the finishing touches on one of his own canvases. According to tests, this painting will last for at least 500 years

If a canvas is damaged by a sharp instrument, it is easily repaired. On opposite page, torn section is cut away and a new piece of canvas cut to the same size. Below, a larger square of canvas serves as a batten on the reverse side of the patch. Below, right, old canvas is restored by applying it to new canvas with graphite

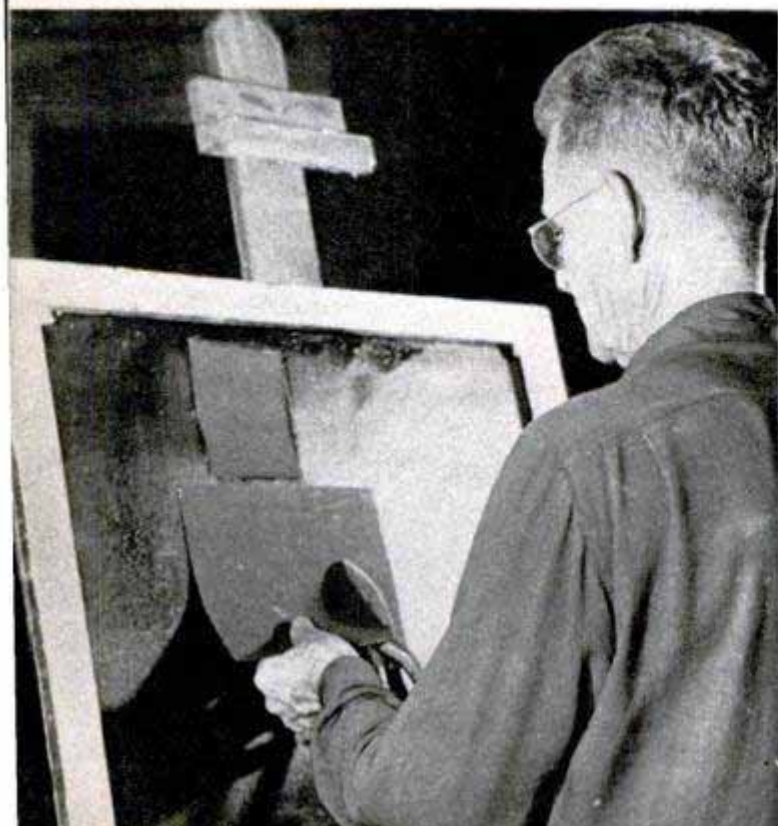



Copper screening is fed through a trough under a roller. Graphite-and-oil mixture fills the trough. Construction details of the trough are shown below



Screening is pulled through by a hoist, which prevents it from touching the edge of the trough, breaking surface tension. Detail below shows the hoist

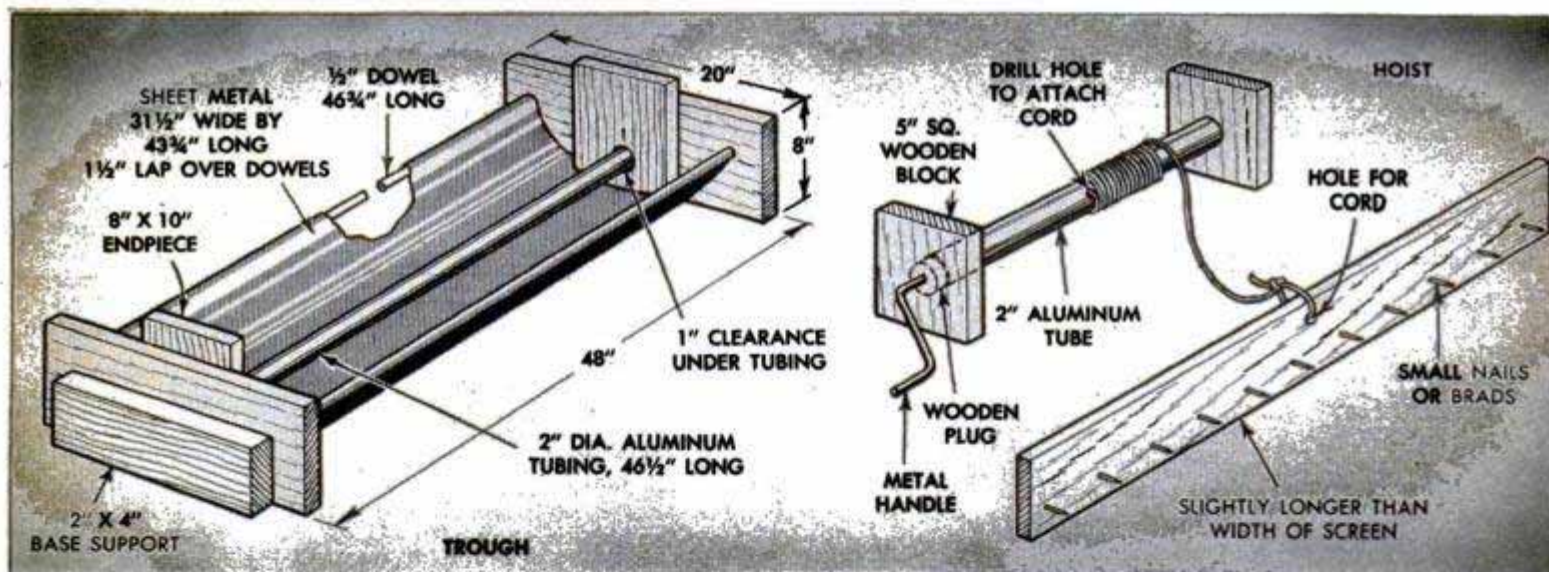

pictures and drawings on these pages show the equipment Francis uses and the manner in which he prepares personal canvases in his studio. Other methods of applying the mixture can be used, but they should permit an even application and prevent the treated screen from coming into contact with any other surface until it is dry. Contact of any sort will break the surface tension that keeps the mesh filled while it is still wet. Runners may appear in the surface of the filler as the canvas dries, but these are not permanent. By the time the canvas is completely dry, they will have leveled off to a nice even coating with a linenlike texture. A note of caution, however—wear old clothes while working

with the graphite mixture. It won't wash out, though it can be removed from the hands or hard surfaces with kerosene while it is still fresh.

Texture can be varied to suit individual preference by either using a coarser or finer-mesh screening (no adjustment in the proportion of graphite to oil is necessary) or by the manner in which the zinc-white coating is applied—rough or smooth.

While Francis' canvas will preserve the work of contemporary artists, its permanency can also be applied to works of the past. In this capacity, it will greatly lessen the work and care of those responsible for the preservation of valuable paintings. Old rotted canvases can be backed up by the



After the canvas is dry, Francis cuts it with tin snips and stretches it in the same manner as linen canvas. A zinc-white coating finishes the preparation



Francis doesn't anticipate that his canvases will be treated this way, but they are so tough and flexible they can absorb such punishment without any damage

permanent canvas by either of two methods. The first and best method is to apply the old canvas to a freshly treated screen that is still wet. As soon as it is dry, it is ready to be restretched and the restoring job completed. The second method is to apply the old canvas to an already dried and stretched copper canvas with either restorer's glue or the graphite mixture as a bonding agent. For this method, a thinner mixture of graphite and oil is used in preparing the screening—80 percent powdered graphite to 20 percent oil by volume. Such a backing will preserve the works of the old masters many years after the original paintings were made.

Small canvas shows the steps toward a finished painting on one of the screens. The graphite, which fills the screen, shows in the upper-right corner. The white coating of zinc comes next, then the artist applies his oils





### Back-Up Guard Stops Car

Automatically setting the brakes when it touches a person or object, a back-up guard prevents accidents that result because a driver can't see directly behind him while backing up. The guard, a slender bar that looks like a curtain rod, drops down over the rear bumper when the driver shifts into reverse. If the bar strikes something, it sends an impulse to a solenoid which locks the brakes. The brakes remain set until the gearshift is moved.



### Ring Locks Sanding Disk in Place

Abrasive disks snap on and off a new sanding head with a twist of a lock ring that clamps them securely in three places. The lock-ring pressure is adjustable for various types of abrasive, ranging from the very finest to the coarsest. The disks are slit in three places, around the edge so that portions of them protrude through slots in the sanding head. The lock ring holds the disk by pressure of its three spring-steel feet on these protrusions.

### Electric Abrasive Finisher Weighs Only Three Pounds



Small enough to be held in the hand, an electric rotary finisher is designed for abrasive finishing of small parts. The abrasive disk is spun at 4500 revolutions a minute by the  $\frac{1}{15}$ -horsepower motor. Weighing only three pounds, the machine is used for cleaning welds, removing paint and carbon, cleaning metal before brazing or soldering and deburring machine parts.

### Biological Warfare Kills Insects

Biological warfare is being waged against the alfalfa caterpillar in California with the virus of a wilt disease that apparently affects no other insect and is harmless to man and animals. Sprayed on fields where the caterpillars are feeding, the virus produces a sweepingly fatal epidemic. In one test plot, the number of active caterpillars was reduced from 96 to 4, while in an unsprayed plot the caterpillar population increased to 154 in 11 days.

## "Car-Bus" Carries Kids On Simulated Ride

Several months ago L. Volner of Los Angeles, Calif., was watching his grandson try to climb into the cab of a small toy train without success. So Volner, who works for the Los Angeles Transit Lines, went to work in his shop, and now his grandson has a "Car-Bus" which he "drives" to give the neighborhood youngsters a simulated ride through the streets of the city. Volner calls it a Car-Bus because it is a cross between a streetcar and a bus. The driver sits in front of a controller like those used on old-style streetcars. On his right is a fare box which accepts slugs. Beneath the floor is a gong, operated by a pin under the driver's foot. A cord above the rear seat permits passengers to ring a bell over the driver's head, indicating their desire to stop. Many of the parts that

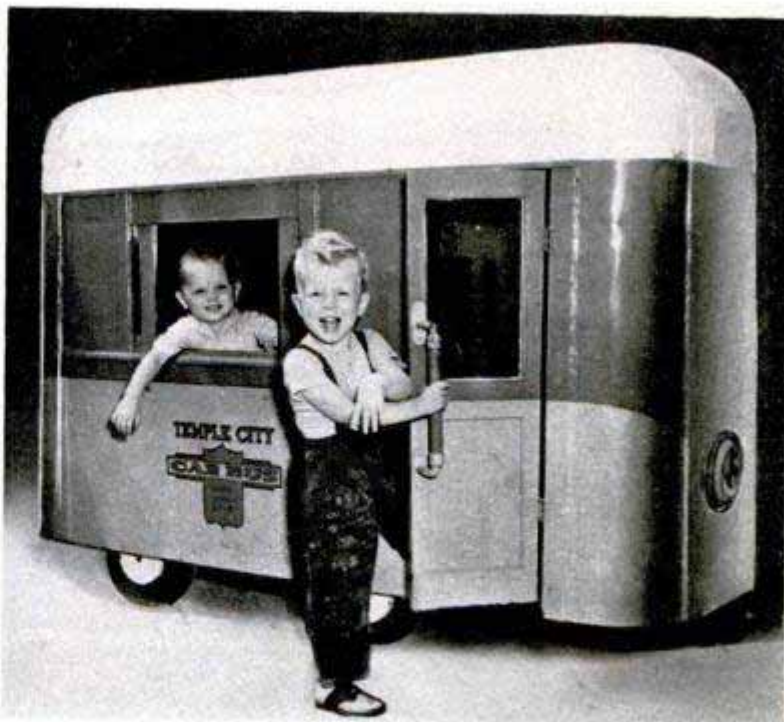

were used in the unique toy came from old streetcars scrapped by the Los Angeles Transit Lines.

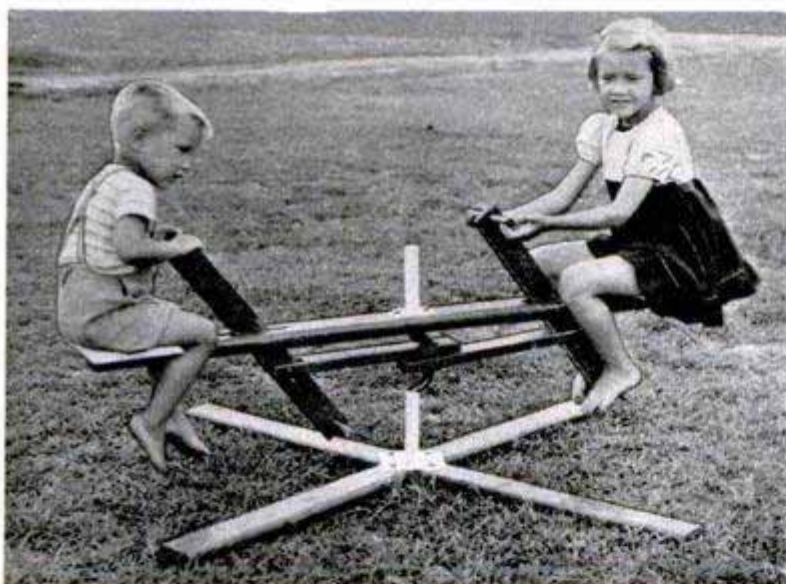

## Yard Merry-Go-Round Powered by Riders

Small fry furnish the power themselves for a small lawn merry-go-round which operates on a crankshaft. Two children sit opposite each other and alternately push and pull on their hand and foot supports. This forces the riding beam in a circle.

☐ There are more than 10 billion phosphor particles with a total weight of only 1½ grams inside a two-foot fluorescent-lamp tube, according to calculations of Westinghouse engineers.

## Single-Seater Automobile Has One-Horsepower Engine

So small that the authorities don't require it to be licensed, a miniature automobile being manufactured in Germany is only a little more than seven feet long. Its one-horsepower engine drives it over the road at a speed of 27 miles an hour. Strictly a one-seater, the car uses motorcycle wheels and costs about \$270.

☐ Horses have been found to be faster than dogs at distances of ½ mile to about 2½ miles, but at greater distances the dog's endurance usually makes him the winner.

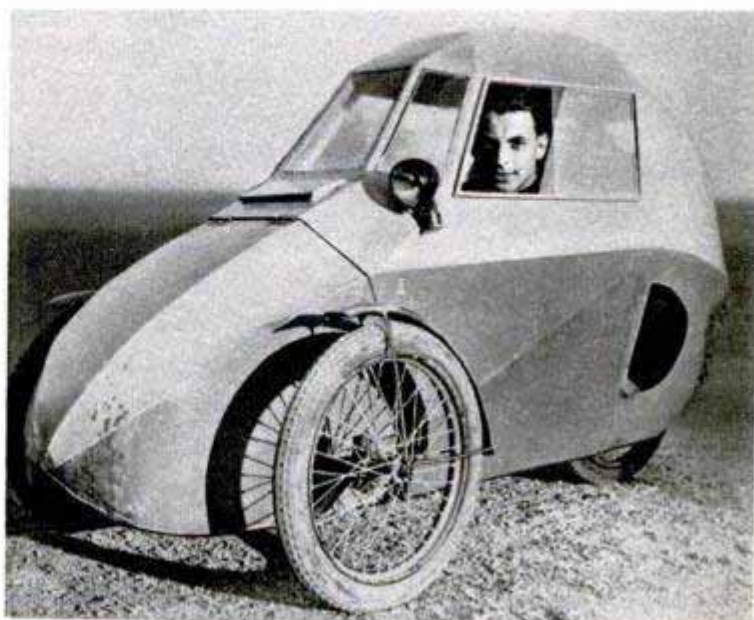



BISHOP

KNIGHT

QUEEN

KING

## ***Sculptor of Chessmen***



**M**EDIEVAL knights, priests and page boys battle to the death when the chess pieces of Al Kritzner are placed on the board for play. Kritzner, a boat-yard operator of Port Washington, Long Island, who was bedridden for eight months, developed a unique hobby—carving chessmen patterned after men of the Middle Ages. In a Kritzner set, which even includes a court jester and a butcher, no two pieces are alike. Kritzner roughs out the men with a saw, then uses a knife and electric carver to finish the pieces. Each piece is given a coat of lacquer that takes a high polish. Then, lined up on the board, they present a panorama of medieval times.

← After the intricate carving is completed, Kritzner finishes each piece with a high-gloss lacquer. Below, the hobbyist first roughs out the piece with a saw, then finishes with this electric carving tool







PAWN



PAWN



PAWN



PAWN

Lined up for play, the Kritzner chessmen present a unique spectacle. Even the pawns are all different

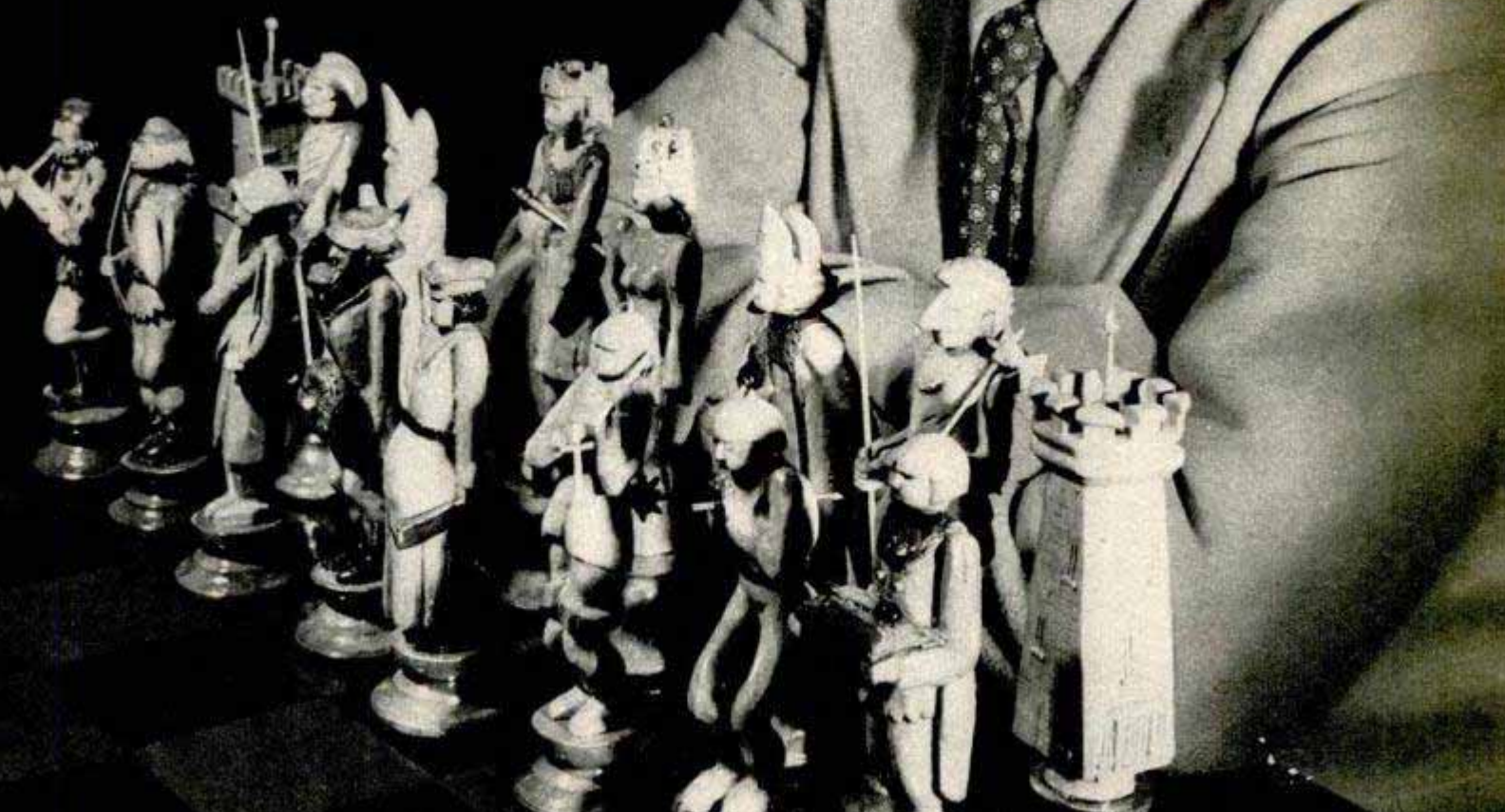

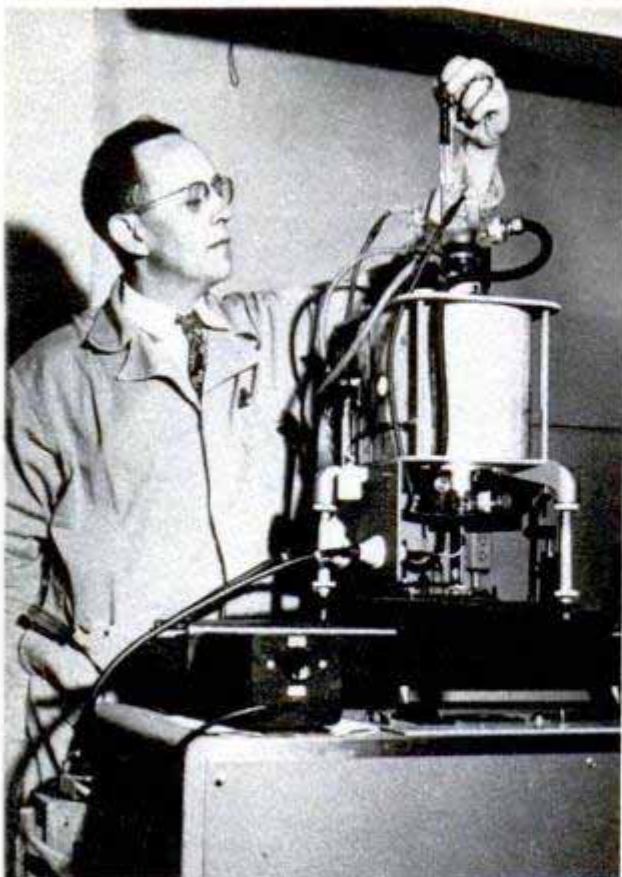

## Liquids "Fingerprinted"

COMPLEX liquid mixtures are "fingerprinted" and their ingredients quickly identified and measured by a new-type spectrometer. It makes a photographic record of the spectral lines of a solution or draws a graph of the liquid's characteristics on a chart. In a few minutes, the machine analyzes mixtures such as wood and grain alcohols dissolved in water, revealing what compounds are present and their quantity. Complex structures, as well as colorless solutions of most organic and some inorganic compounds, are similarly identified. It was previously known that many compounds give off a weak light that can be used to identify them when the compound is illuminated by a beam of mercury light. The difficulty was in creating a mercury light source powerful enough to scatter a useful amount of light through the sample. The new instrument does this by placing the sample in a special test tube, with an optical window in its bottom. The tube is then placed between two mercury arc lamps, operated at up to 30 amperes of direct current.

Above, dropping test-tube sample of liquid between two high-intensity mercury arc lamps, shielded in the picture. Below, the complete spectrometer unit for "fingerprinting" complex liquid mixtures

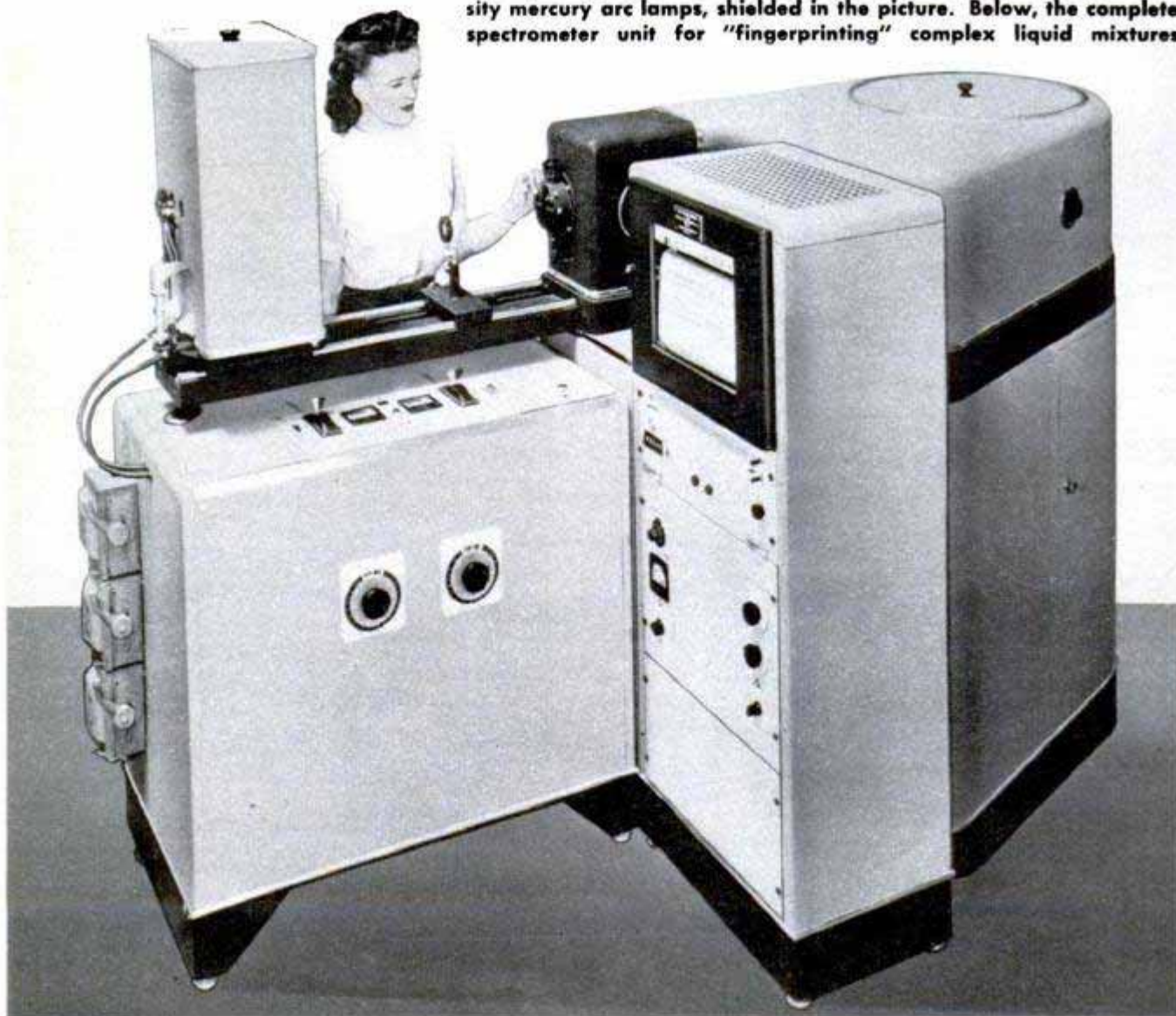



### Cattle Car for Toy Train Loads and Unloads Itself

Cattle move in and out of a toy cattle car as if under their own power when a remote-control button is pressed. A corral, set up alongside the track, serves as a loading dock and has three chutes to accommodate several carloads of cattle. An electric vibrator causes the cattle to move forward when the button is pressed.

### Pocket Fan

Not much larger than a cigarette lighter, an electric pocket fan provides a personal breeze on a warm day. The little fan was invented by a Polish engineer in England. The propeller blades are driven by a microscopic motor. Power is supplied by a standard  $4\frac{1}{2}$ -volt flat dry cell. The fan weighs only eight ounces.

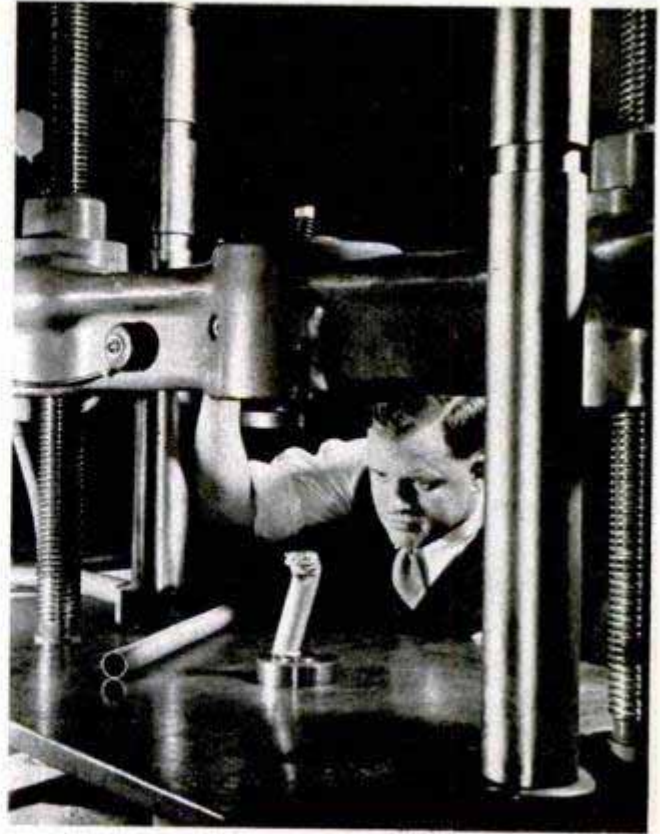

### Plastic Coating on Steel Tubing Resists Chipping and Corrosion

Outdoor structures made of a lightweight steel tubing are protected against corrosion by a plastic coating that is undamaged by rough handling. This coating clings so tightly to the metal that the tubing can be twisted into many shapes without chipping or flaking the finish. A compression test, in which the tubing was severely distorted, failed to damage the protective coating.

### Telephone-Wire Guards Of Lightweight Plastic

Spiral guards of tough, lightweight Tenite are used by the Bell System to protect telephone drop wires where contact with trees is unavoidable. Made in the form of spirally slit tubes, the plastic guards are installed either by threading the wire through them, or winding them about the wire. S-shaped aluminum clips lock the guards in place.



Producing cones in its third growing season, from one to three years in advance of natural seedlings, a fertile hybrid pine may soon fill the nation's need for vigorous, fast-growing timber.



# ***Comes the Flying Assessor***

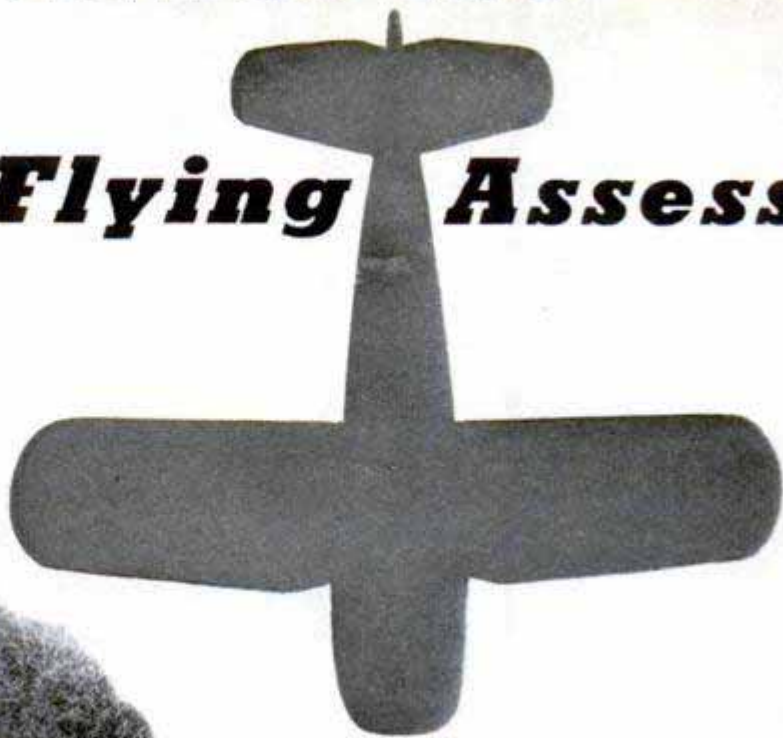

Above, field-checking an aerial photo. Below, a typical photo used by assessors. Key to the numbers: 1—Half-grown Douglas fir. 2—Mature timber. 3—New growth. 4—Farm. 5—Fertile bottom land. 6—Cut-over timber

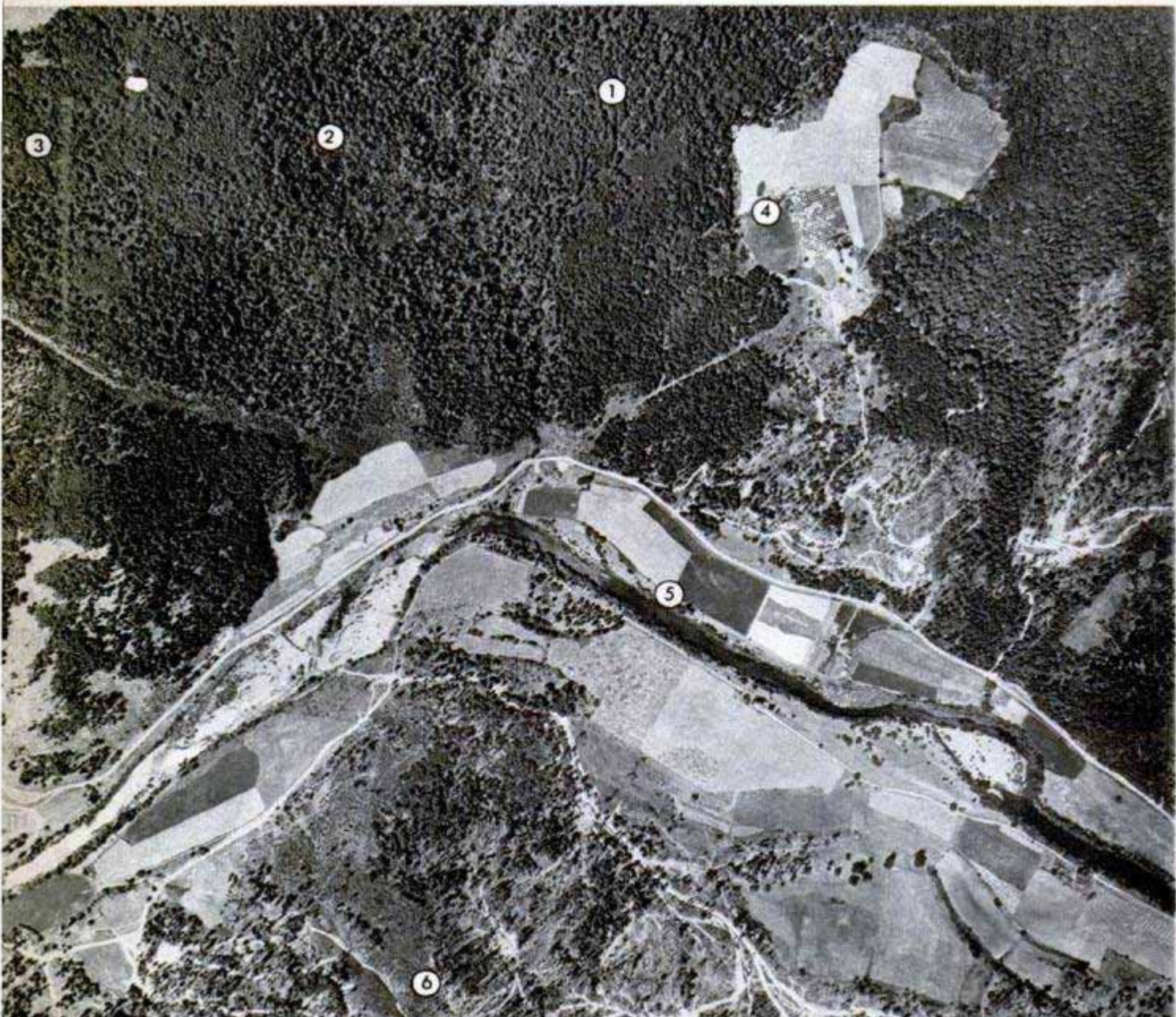

There's no place to hide down there when Oregon's assessors ride the sky, their aerial cameras gathering pictorial data in black and white for the tax commissioner

By

**Wallace S. Wharton**

**Member, Oregon State  
Tax Commission**



This photo of farm land has been divided into 40-acre squares and classified

**A**T A COST of less than a nickel an acre, Oregon tax assessors are reappraising the state's 61 million acres with the help of flying cameramen. Aerial photographs provide an accurate and up-to-date inventory of forest and farm lands, an inventory that disgruntled taxpayers can examine if they feel assessments are unfair. There's no way to argue down the camera's eye: the facts are there in black and white—buildings, improvements, tilled land, forests, wasteland and water areas.

Oregon's counties are big—so big that state officials estimate it would take about 52 years to reappraise the land by conventional ground inspection. The 36 counties range in size from 424 to 10,132 square miles. Ten counties spread over areas in excess of 3000 square miles each and only 9 of the 36 are under 1000 square miles in area. Each of 17 counties in the state has

more land area than the state of Delaware.

During the depression days of the '30s, county budgets were cut and appraisals neglected. In several counties, basic appraisals remained unchanged for 20 years. The state's population zoomed between 1940 and 1948, increasing 41 percent to bring about a marked change in land usage. The terrific demand for lumber during and after the war resulted in feverish cutting activity in the forests. The whole face of the state changed and the appraisals were hopelessly outdated. State tax authorities decided a complete reappraisal was necessary. The problem of reappraising the whole state quickly and accurately enough to prevent unfair assessments had to be solved.

Studying military techniques of aerial photography, the tax experts decided the only way to do the job was by air. All

**Range land like this in southeastern Oregon is quickly and accurately appraised by the aerial-photo method**



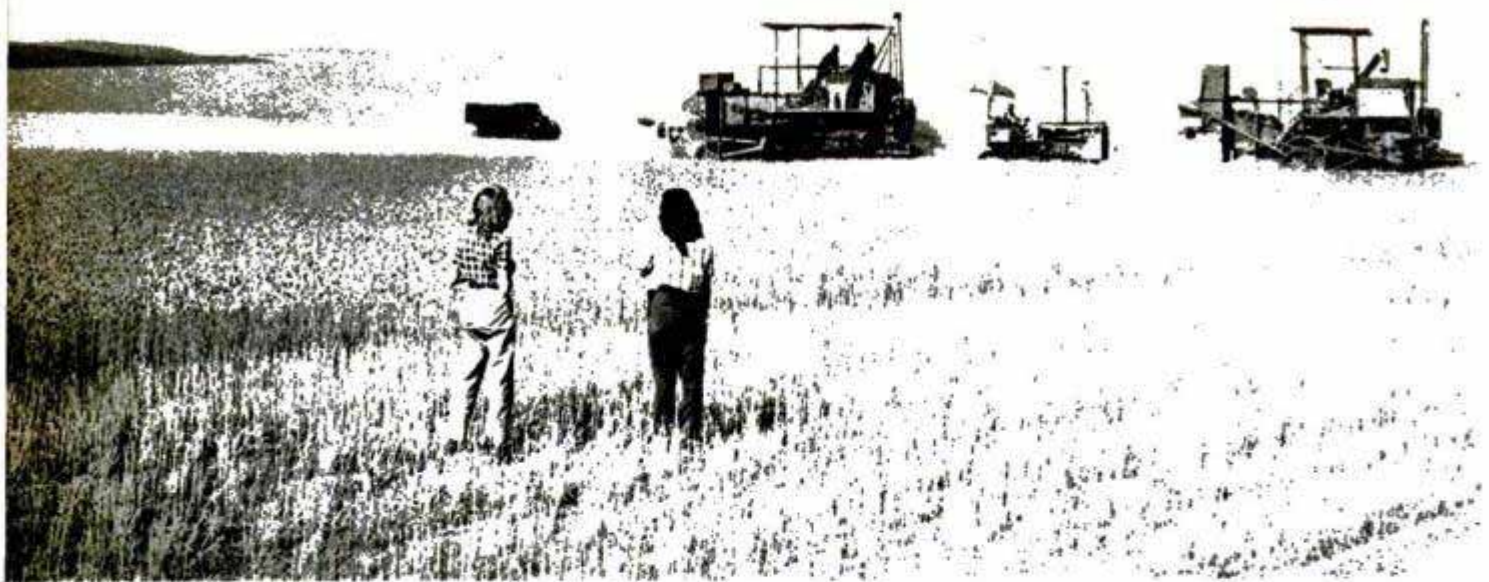

available aerial photographs were indexed and studied for possible use. Many federal agencies had already taken aerial surveys of the state's forests, rivers and shore line. To fill in the gaps, new pictures were ordered from private companies.

In one southern county with an area of 1625 square miles, a three-year program was set up, covering all rural lands, both farm and forest, at a total cost of picture-taking and appraisal of only \$43,859. It was estimated that, with the traditional method of survey, the program would have cost at least \$150,000.

Vertical shots are used exclusively. As in military mosaic work, only the center of the negative is used, the edges being discarded because of distortion that is always present in such photographs. Forest lands are assessed directly from contact prints with a scale of 1:10,000 or 1:15,000. Farm-land assessment requires enlargements of the negatives to provide a scale of 1:4800 or 1:8000. These larger pictures provide a valuable photo map of the terrain. Tell-tale variations in shading reveal good land and poor land. Many farmers have studied the pictures and discovered new information about their own farms, facts that will mean better

(Continued to page 252)

To scout around a ranch this size, the assessor would need seven-league boots—or a plane. This rancher grows wheat

Below, this lily-bulb farm on the shore of the Pacific is an example of intensified cultivation on high-priced land

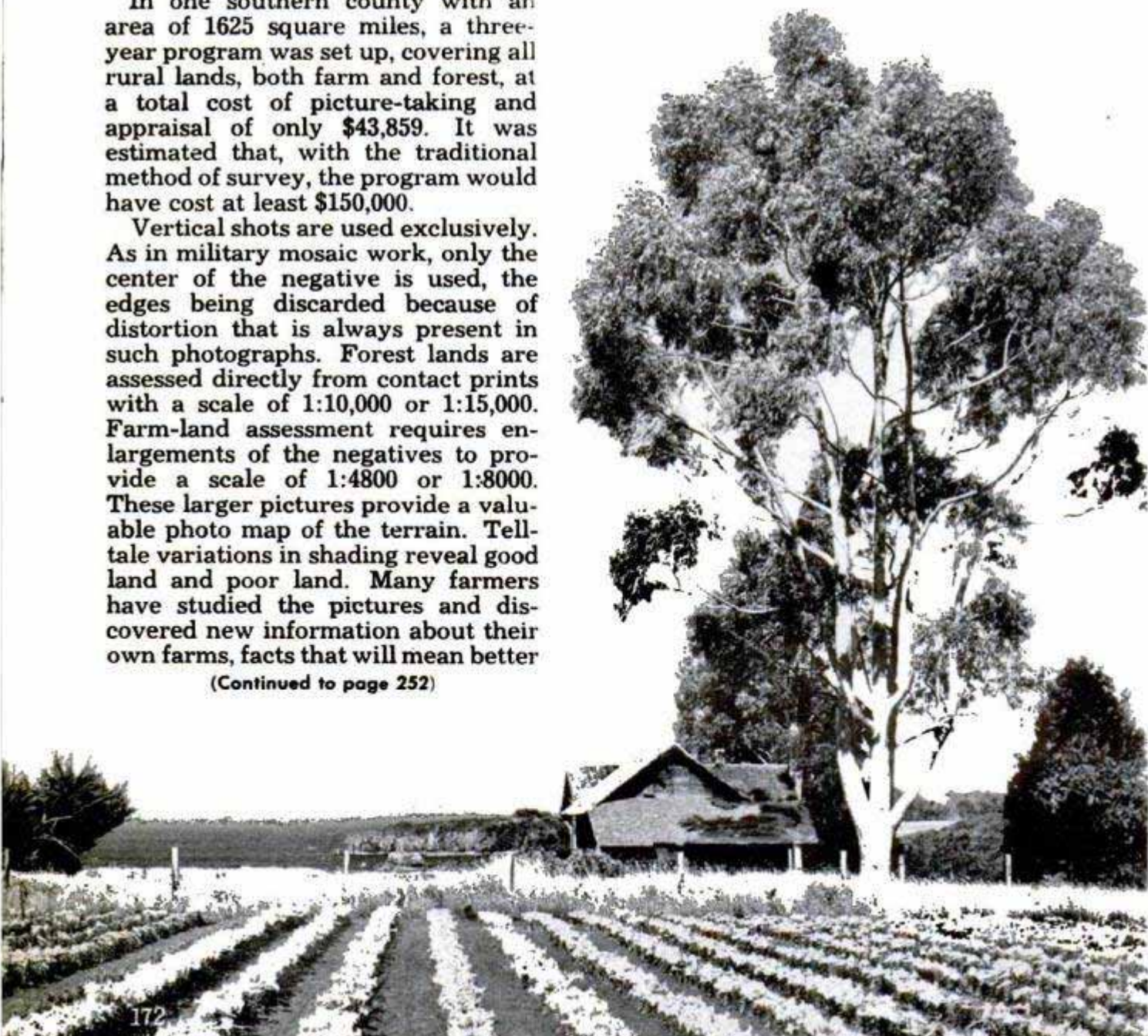

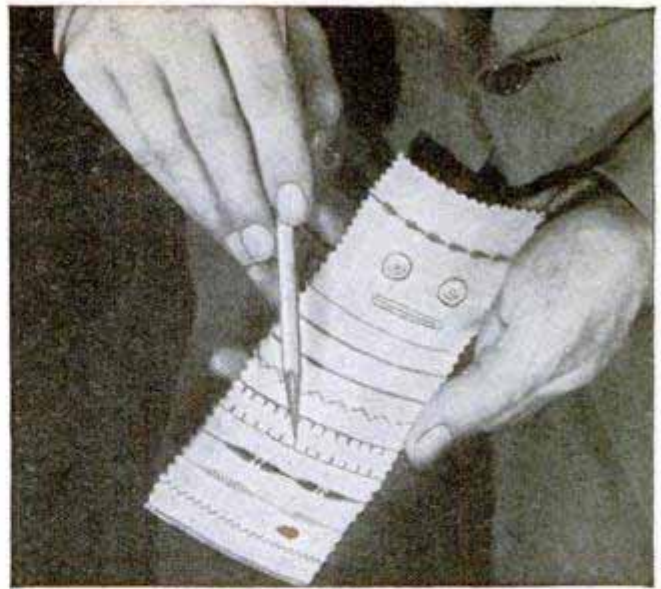
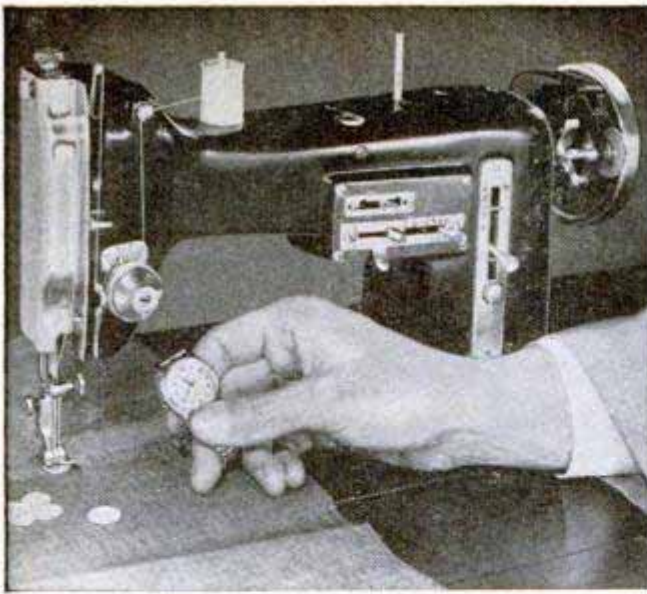

Above, machine can sew on a two or four-hole button in four seconds. Above, right, on this piece of cloth are some examples of the different stitches the machine makes. Right, milady can embroider her dresses

### Sewing Machine Sews on Buttons

Because its needle can be adjusted to zigzag, an Italian sewing machine makes buttonholes and does applique and monogram work. It also sews on buttons, entering first one hole and then the other. Powerful enough to sew through four thicknesses of shoe leather, the machine sews forward and reverse, over basting pins and does over-edging, such as the stitch used on carpets. Another setting permits the seamstress to make fancy embroidery. Three levers control the needle, eliminating the need for attachments. The sewing machine is distributed nationally in this country.



### Counterfeit-Money Detector

Counterfeit bills are detected quickly by an instrument resembling a telephone dial. Made of Beetle plastic, the dial has numerical designations opposite the finger holes. The user merely dials the numbers that appear on the suspected currency. An alphabetical series then appears on the dial. If the bill in question does not bear the same letters, it is counterfeit.

### Frozen Eggs in the Shell

Fresh eggs stay fresh longer when they are frozen in the shells. A new process, invented in Louisiana, makes it possible to freeze the egg without breaking the shell. The trick of the process is the evaporation of a small amount of the water inside the shell prior to freezing. The water is removed through the porous shell by dehydration, leaving space within the egg for the expansion that accompanies freezing.



## Glass-Fiber Dinghy

Weighing only 30 pounds, a six-foot sailing dinghy molded with four layers of glass fiber is being made by a California boatbuilder on an experimental basis. The hull, which is only  $\frac{1}{8}$  inch thick, is translucent and will not crack. It requires no paint or other maintenance. An elongated skeg runs the length of the bottom to serve as a keel.

## "Noiseless Sound" Opens Garage Door

Without getting out of your car you can open garage doors with sound you cannot hear. No wiring, switches or electric eyes between the car and the garage are required. In addition, lights inside or outside the garage are turned on. To operate this ultrasonic door opener, a push button on the car's dashboard is pressed. The button is connected with the vacuum system, which blows a whistle so high in pitch it is inaudible. A microphone mounted on the garage door picks up the sound, which is relayed electronically to a mechanism that opens and closes the door.

## Progress of Oil in Pipe Line Marked by Radioactive Tracer

When a radioactive barium isotope is introduced into a sample of oil, its progress through miles of pipe line can be followed accurately with a Geiger counter. Held alongside the pipe, the counter sends out

a signal when the radioactive oil passes. It is expected that this method will prove valuable since location of a particular sample aids the efficient movement of various crudes at the refinery.

## Mower DeLuxe Even Has Radio

Mowing his one-acre lawn is no back-breaking chore for Joe Reynolds of Clinton, N. C. He does it in comfort with a power mower that he has equipped with an electric fan, umbrella, radio and cigarette lighter. All these accessories are mounted on the sulky-type trailer on which he rides as he mows.



☞ Milkmen deliver 60 million quarts of fresh milk daily in the U. S.





Above, the German inventor photographs the subject with a pair of cameras. Right, a grid, projected on the model's face, provides guide lines on the photographs. Below, by looking through a stereoscope, he models a clay portrait



## Mechanical Sculpturing

Sculpturing in clay requires no artistic talent with a mechanical system developed by a German engineer, who turns out clay likenesses at about \$27 each. Stereoscopic photographs, taken simultaneously with two cameras, guide the sculptor as he works the clay. A screen, projected on the face of the model as the photographs are made, divides the pictures into grids, used for guiding the pointers. By looking at the two photographs through a stereoscope, the inventor, Curt Bayerlen, gets a three-dimensional view of the model and by tracing the grid lines with the pointers, he reproduces the features in plastic clay.

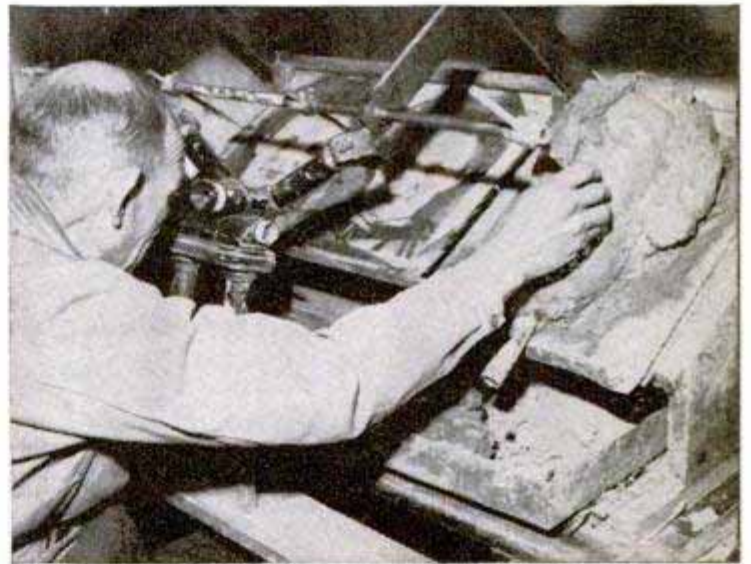

## Army Cargo Launch Is Assembled From Three Sections

Designed so that it can be knocked down into three sections for air transportation, an army cargo launch has an upswept bow for easy beaching. The three sections are quickly assembled with eight bolts. The stern section, which has a 60-horsepower

engine, can be used separately to move rafts and barges if desired. Especially designed for use in shallow water, the boat draws 24 inches with a 5000-pound load and travels up to 10 miles an hour. All aluminum, it weighs about 3200 pounds.



# TWO-MAN GOLD STRIKE

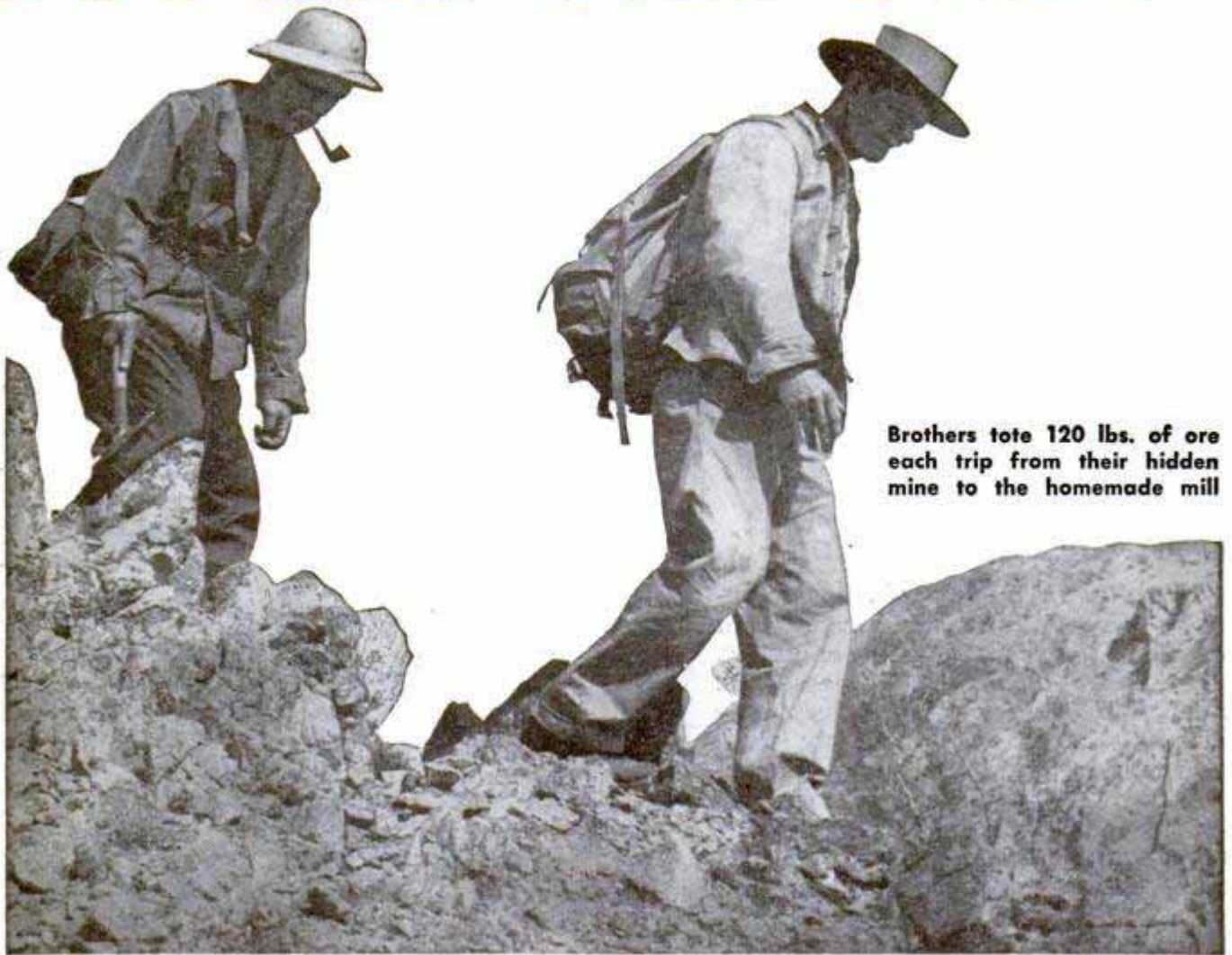

Brothers tote 120 lbs. of ore each trip from their hidden mine to the homemade mill

Below, Art installs distributor from their old car on the motor of milling machinery they improvised

By Gene Segerblom



ON A LONELY BEND of the Colorado River, Ed and Art Schroeder have pieced together a Rube Goldberg contraption to grind raw ore into pay dirt.

In fact, their whole layout is one of the most unusual in mining annals. Where the ore—rich in gold—comes from, they keep a secret. But they do admit, and offer a gold-filled vial as evidence, that they have found a vein streaked with high-grade ore. It's not rich or plentiful enough, however, to go into large-scale mining. So, brothers Ed and Art hit on the idea of digging the ore out by hand, packing it over the rugged terrain to their camp on the river bank and milling it in a hand-made mill.

The mill is a conglomeration of machines salvaged from ghost mining towns in southern Nevada and northern Arizona. One two-cycle motor runs the three machines for the milling process. Each time they run the mill they have to add parts—spark plugs, distributor, coil and battery—stripped off their Model-A Ford.

After they get the ingenious machine

assembled and chugging, the raw ore is thrown into the "chipmunk," which breaks the large lumps into marble-size pieces. These lumps are put into a hopper and ground into pieces small enough to go through an 80-mesh screen. Finally, it is fed into a ball machine that beats it into powder from which pure gold is panned.

The pure gold is amalgamated with mercury and marketed in Salt Lake City, Denver and Los Angeles.

The Schroeders are reluctant about giving the exact location of the mine as it has not been patented. Under government regulations—the property lies inside the National Park Service's Lake Mead Recreational Area—a permit to mine is not nec-

essary unless a permanent structure is erected at the site of the mine. And under Arizona mining laws, a mine claim is not surveyed for taxation unless patented, which means receiving ownership to the land where the claim is staked.

Of course, they can't buy the land as it belongs to Uncle Sam. Their mine, therefore, belongs to them only as long as they keep working it.

They do admit that their claim is several miles from camp, back from the river in the rugged, desolate mountains. The only path is the one their boots have worn by making the trip twice daily. It is rough going—hauling out the chunks of ore on their backs in Army-surplus packs.

**Mountaintop view shows Schroeders' camp on the Colorado, consisting of a tent, workshop and mill for gold ore**

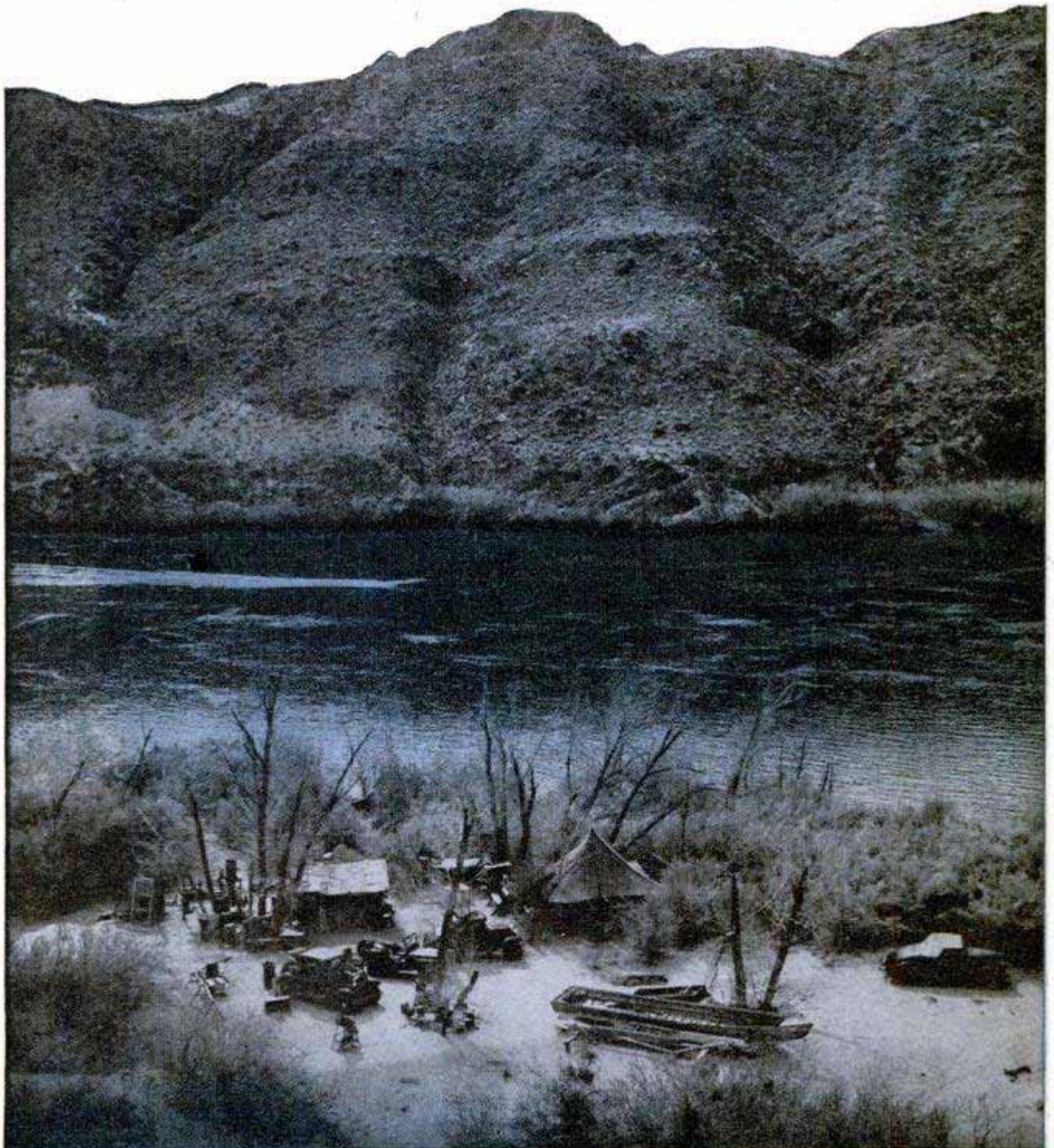

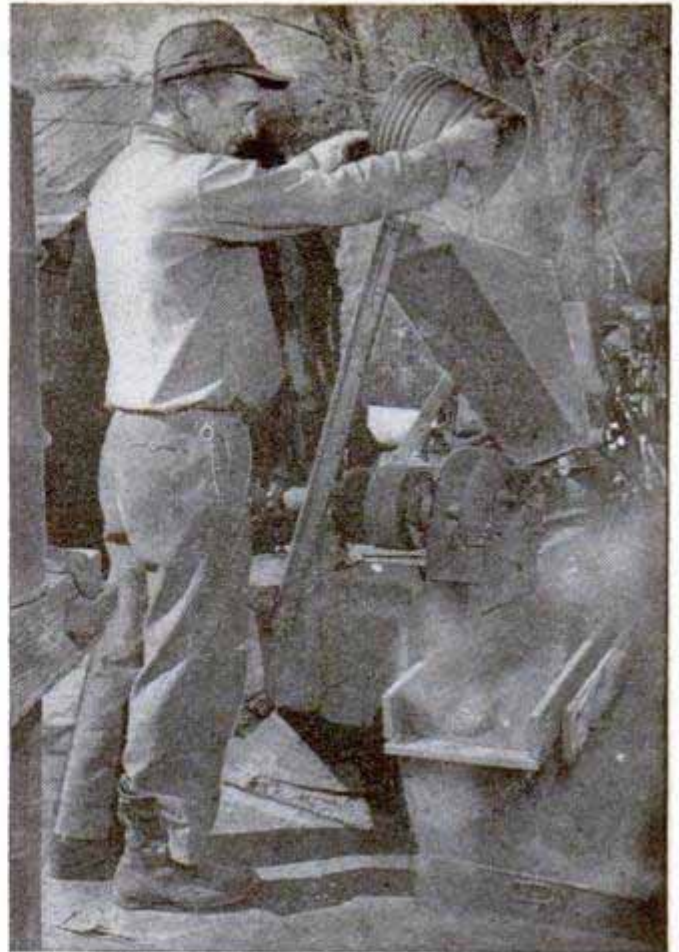
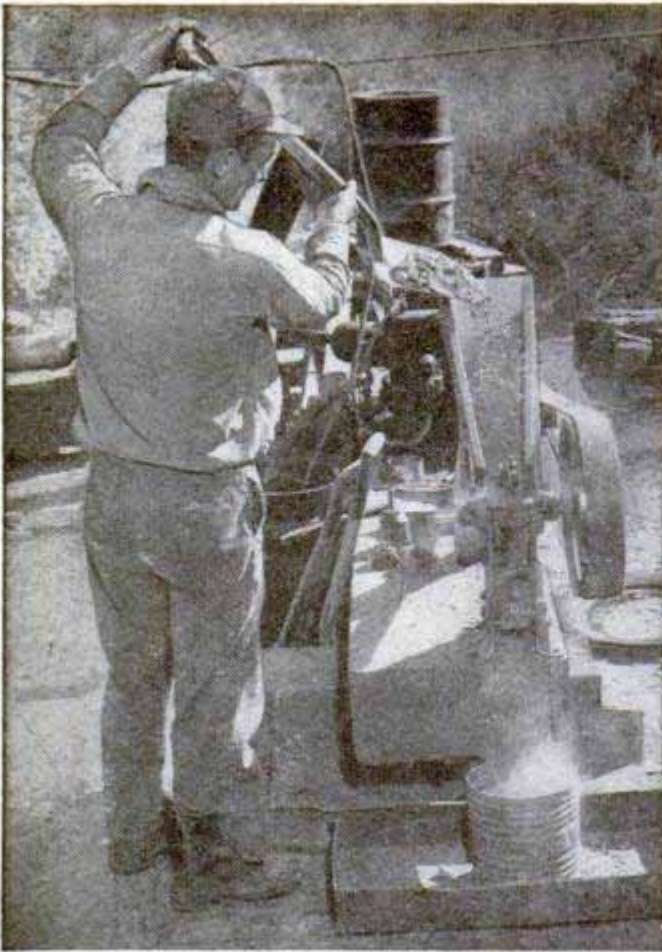

Here is the machinery the Schroeders have built from parts salvaged from mining camps in Arizona and Nevada. Above, the "chipmunk" breaks large chunks of raw ore into marble-size lumps. Above, right, Art pours the lumps into the crusher which mills them into small pieces. Below, ball machine beats ore into a fine powder. Art holds the pan which collects the richest ore

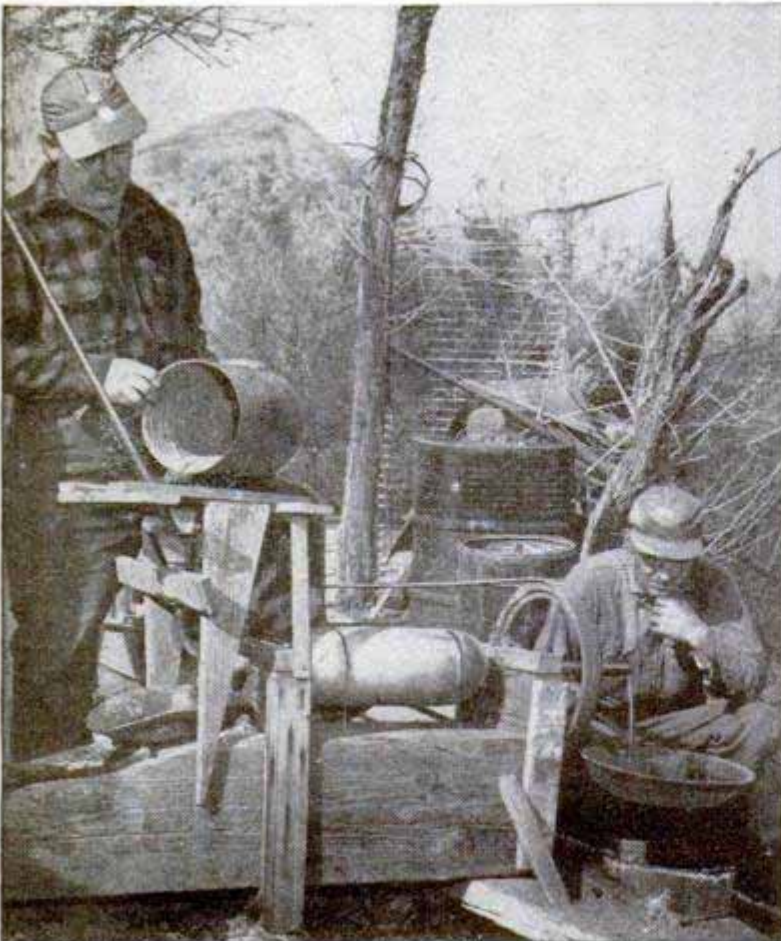

Ed and Art agree that the hodgepodge mill could handle eight tons of ore a day, if they could pack out that much from the mine. They each carry 60 pounds of ore a trip as it is.

Besides the mill, the camp consists of a dirt-floored tent which serves as "home," a wooden tool house and a desert cooler. They have a boat tied up on the river to use for catching some of the plentiful trout.

When they need to make a trip to town—the closest one is Boulder City, Nev., some 20 miles away—they stop operations and put the parts back in their automobile.

Before discovering this fissure vein about a year ago, the Schroeders spent 11 years searching for some of the gold dirt. They prospected along both sides of the Colorado River from Hoover Dam to Needles, Calif.

The only worry the busy Schroeders have now is the lake which is filling up behind Davis Dam below them. The waters of the lake will inundate their camp, but will the lake reach their mine claim? If it does, they will probably turn to panning for gold instead of digging.

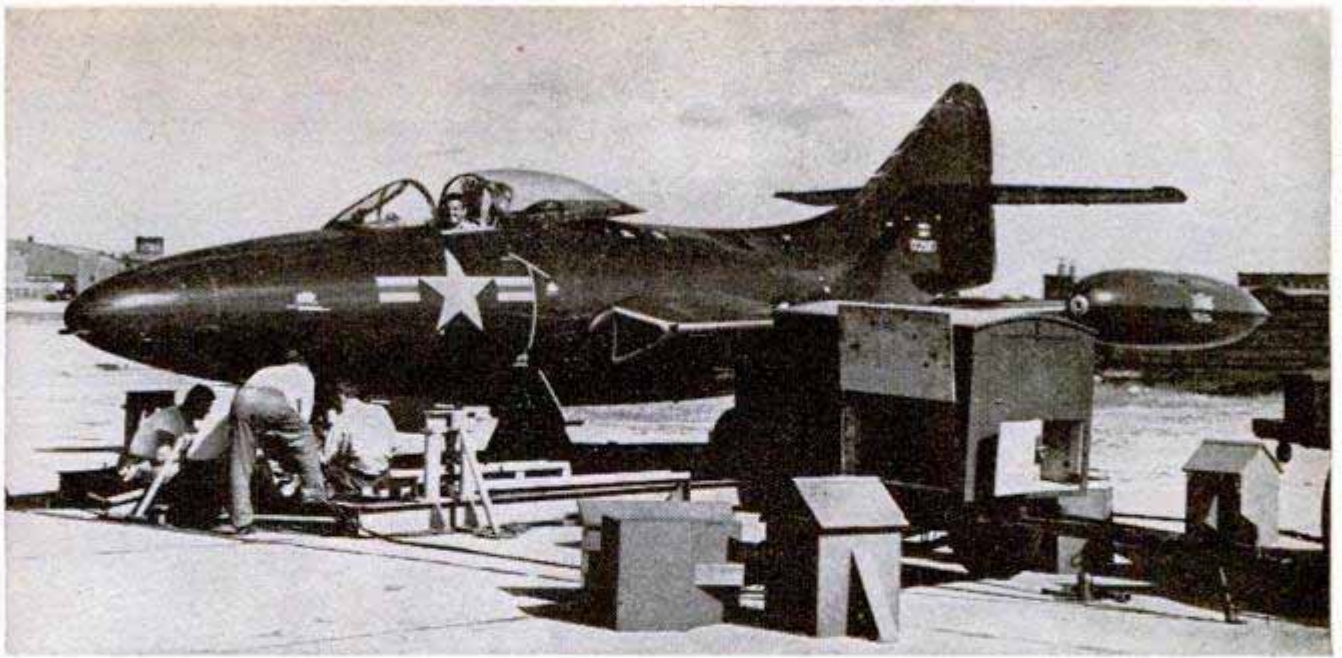

## Jet Fighter "Flies" Without Leaving Ground

Grumman Panthers "fly" without going anywhere, in a newly developed test-stand procedure. The Navy jet fighter is mounted on a suspension platform and operated

as if in free flight. Its full thrust is gauged by a Hagan meter, which measures the thrust by the compressed-air pressure required to hold the craft motionless.

## Stapling Hammer Has a Whiplike Driving Action

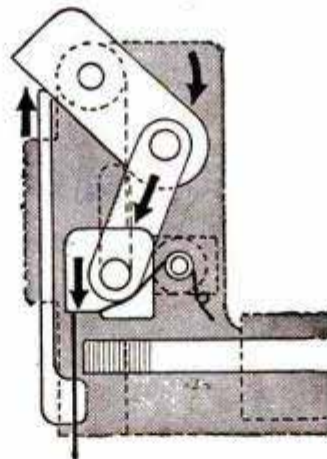
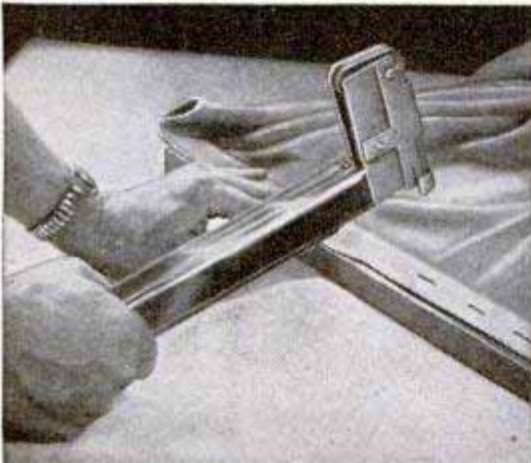

Heavy wire staples are driven into hardwood, sheet aluminum and hard-board by a stapling hammer that has a whiplike action. By a linkage inside the hammer head, the power of the blow is multiplied to force the staple into hard materials. Another feature is a transparent handle cover, enabling the operator to see the staple supply.

## Amphibian Cycle Makes Sea Voyage

Crossing the Gulf of Bothnia from Finland to Sweden was just a "bicycle" trip to a pair of Finnish boys who made the 28-mile voyage in a homemade amphibian cycle. Only 1,120,000 cycle-steps were required. When they reach shore, the boys lower the wheels of the craft and it becomes a land vehicle.

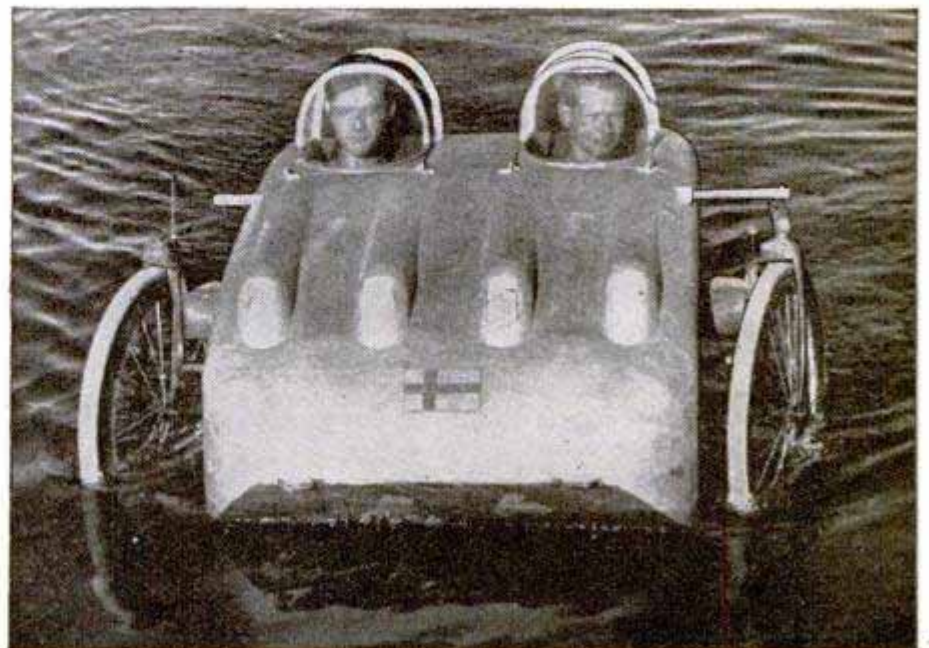

Modern skyscraper elevators travel about 14 miles an hour.



Trailer, mounted on sled runners, holds 20 skiers and their equipment. Below, the ski-steered tractor climbs hills and crosses side slopes which have a grade of up to 30 percent. Another model has four driving pontoons



### Skiers Ride in Trailer Behind Snow Tractor

Skiers are carried up steep mountain slopes inside a runner-mounted trailer pulled by a snow tractor. The lightweight trailer holds 20 persons. The tractor slides along the surface, yet has tank tracks. The open-link track moves around a light pon-

toon. It digs into the snow to move the vehicle, yet the snow sifts up through the links to support the pontoon. Several models are available, some with two powered pontoons in the rear and runners in front, and others with four powered pontoons.

### Radioactive Materials Show How Food Moves Up Tree

Radioactive isotopes are being used by the Department of Agriculture in experiments to discover how plant food moves through a tree. Holes are drilled in the tree trunk and chemical salts plus a radioactive phosphorus solution are inserted. Samples of the leaves, stem, wood, bark and roots then are taken from the tree. The experiments show that the radioactive substance

moves rapidly immediately after it is injected, and the movement is largely upward and outward. More of the substance is found in the upper part of the tree than the lower part. Experiments on pecan trees showed traces of the substance in the nuts.

☐ Diesel railroad locomotives are now being manufactured at the rate of 1800 a year.



## The *Craftsman*

★ Stunning, isn't it? But even more so when you see this modern living-room furniture in full color on page 190. It's our third article in a series on home-built furniture for every room in the house. Easy to build and upholster, it's a project we are especially proud to present. Beginning a two-part story, Part I details the cabinetwork. ★ The timely series on home upkeep continues with an article on floor finishing and repair, page 204. ★ Shop story of the month, page 226, deals with internal and external lathe grinding

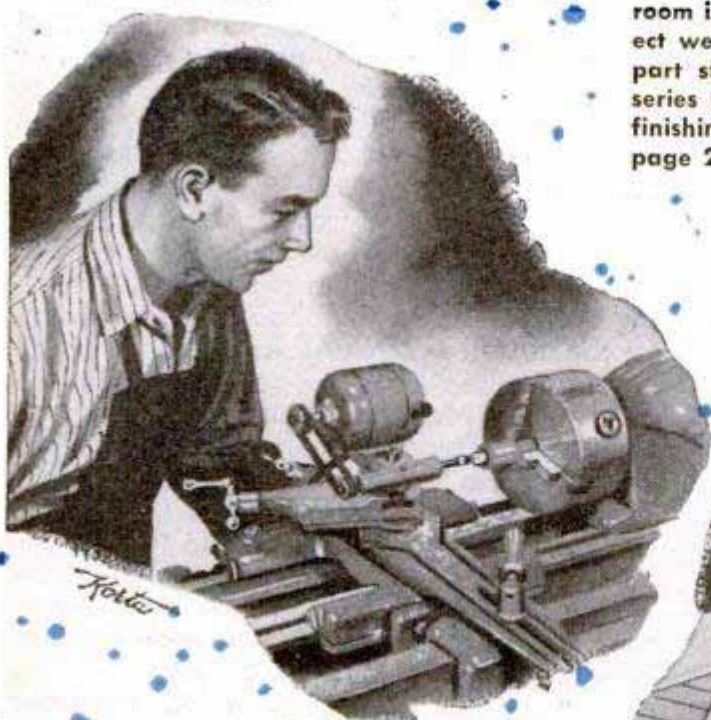

# TABLE-TOP LIGHTHOUSE

FLASHES  
ON AND OFF

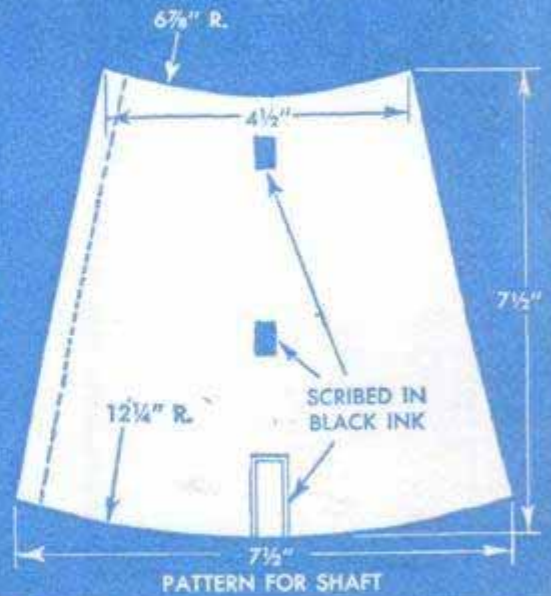

By  
*Douglas Rolfe*

**T**HIS TINY lighthouse with its friendly, flashing light appeals to children because of its realism and also to grownups with a liking for authentic miniatures. The light is operated by a power pack consisting of a condenser and hearing-aid batteries of specifications given in the wiring diagram. No flasher unit is used. Due to condenser build-up and release of current, the lamp alternately reaches full brilliance and fades in a continuous, uniform cycle. Nearly all parts of the lighthouse, base and the keeper's house, which houses the power pack, are made from heavy cardboard. Artist's 3-ply illustration board is just right. Make the column for the lighthouse first, following the pattern detailed on the opposite page. Overlapping edges of the piece are scarved so that they will join smoothly without a raised edge. Use model-airplane cement in joining all the cardboard parts. Glue in the disk which supports the double-contact lamp socket

(taken from an auto taillight assembly) and then assemble the circular gallery, or catwalk, as indicated, using paper clips to form the railing. The jar cover is cemented into an opening cut in the disk. Assemble the conical top and the spire and cement securely to the bottom of the glass bottle, or jar, which serves as a light globe. Cut the battery house from cardboard, following the pattern on the opposite page. Bend on the dotted lines and cement at the joint. Note that the roof is loose so it can be lifted off intact. Make the base according to pattern and glue cardboard to the underside to form recesses for the lighthouse shaft and the battery house. Install the battery pack and then complete the wiring. The conical lighthouse roof, band on the lighthouse shaft and the battery-house roof are red. Windows and doors are simulated by lines drawn with black ink. Other parts are left white. Apply a heavy coating of cement to the base, sprinkle sand over the cement and place several carefully selected pebbles to simulate rocks. Brush off loose sand after the cement sets.



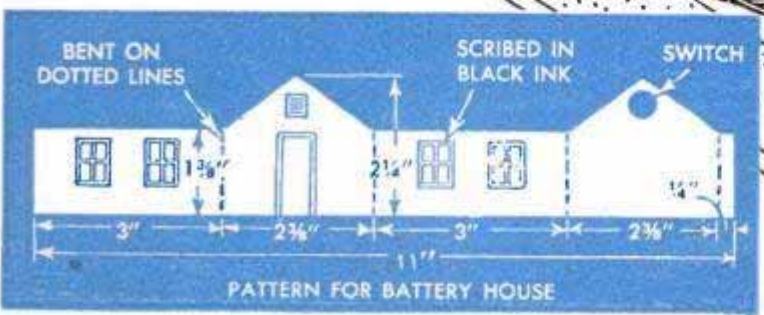
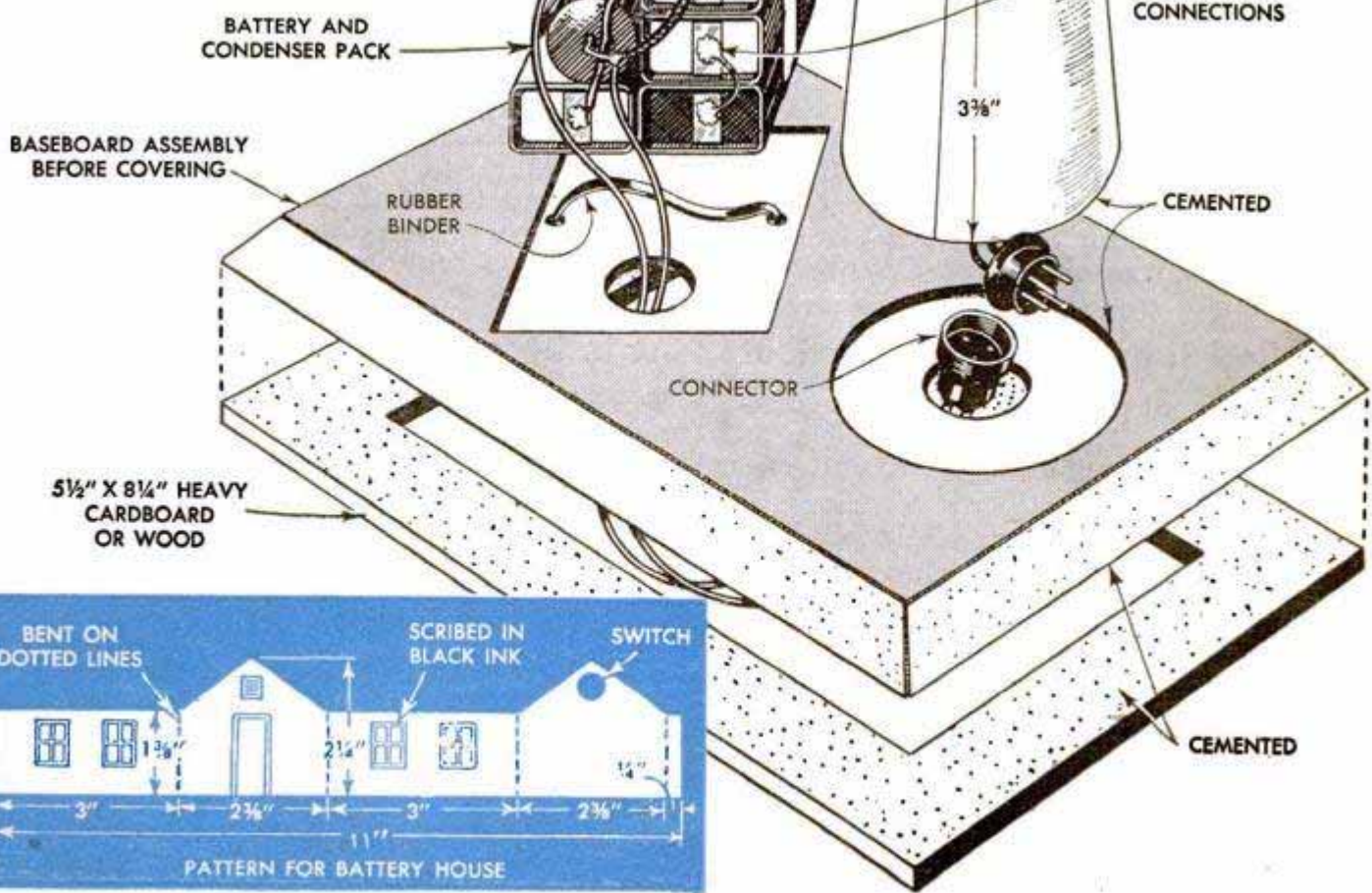
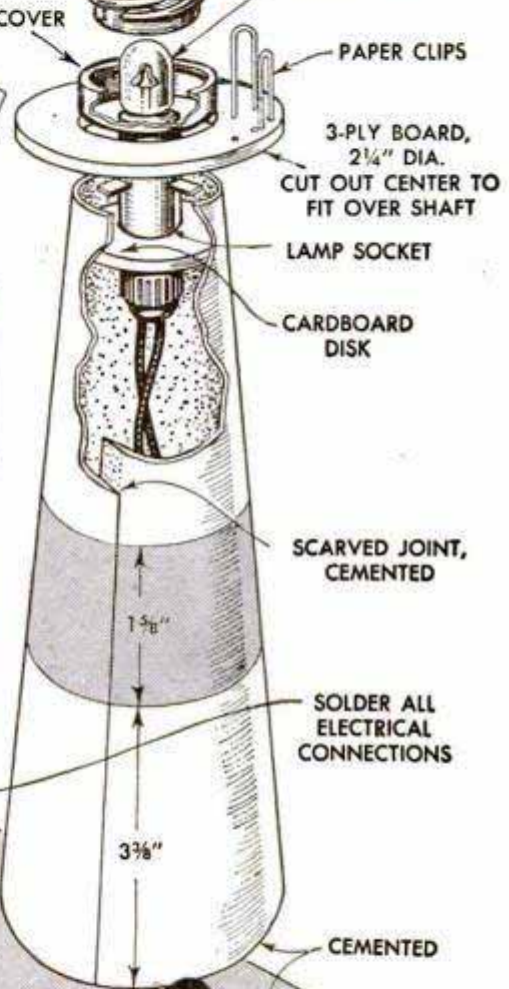
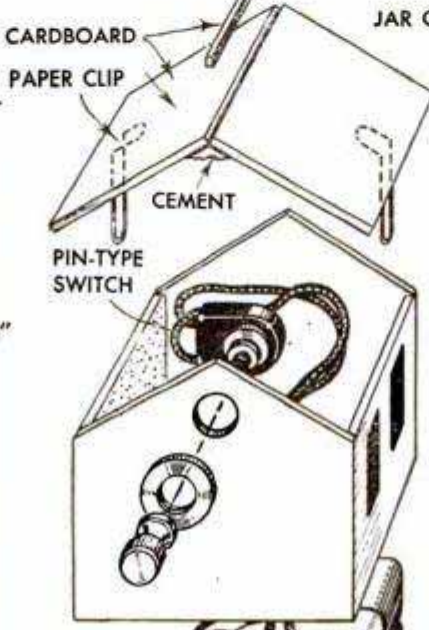
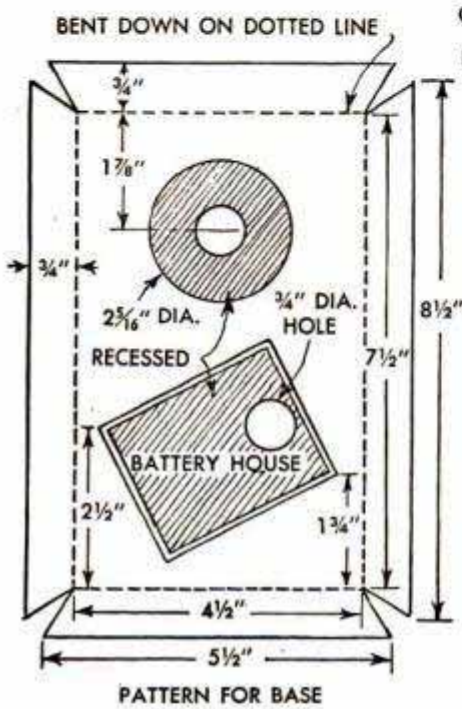
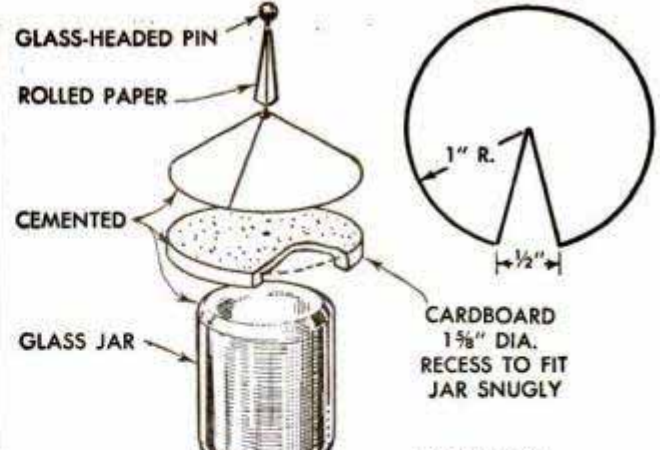
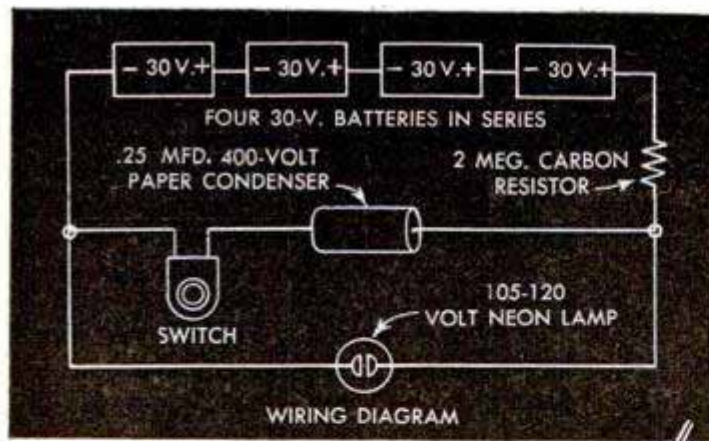

## Jewelry Box Turned From Dark Hardwood Is Ornamented With Tooled Gold Rose

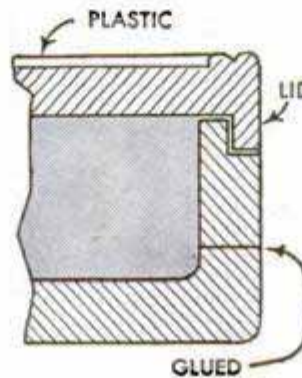
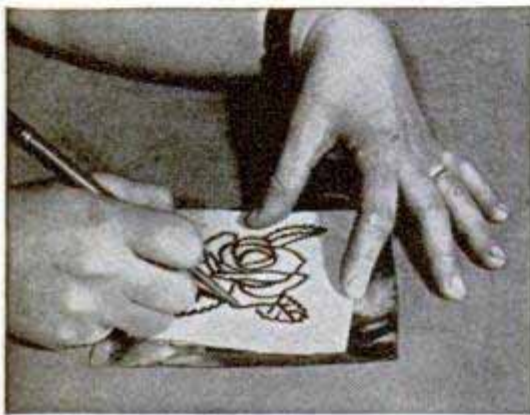
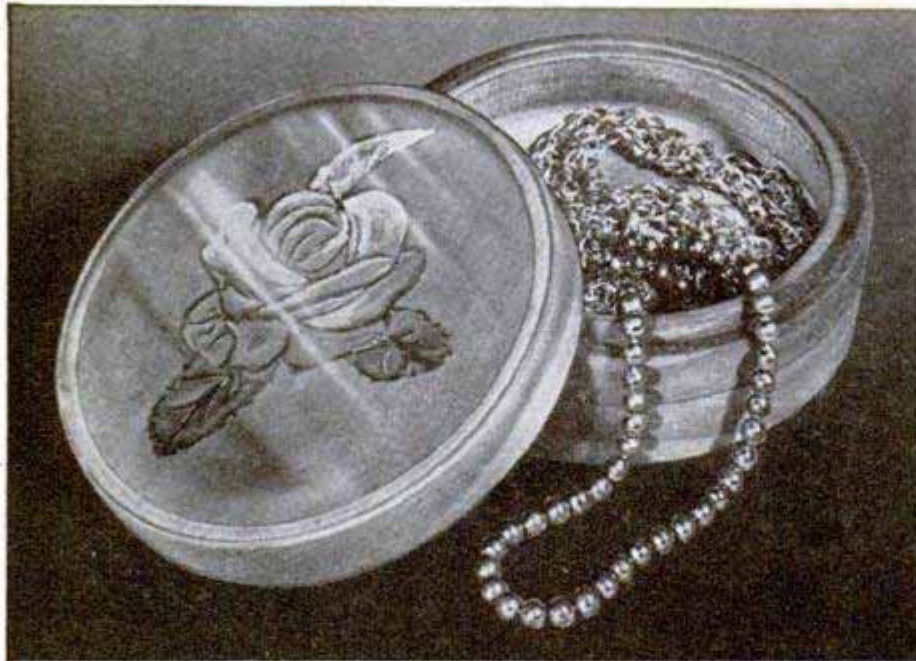

Turned from a dark-colored hardwood this attractive jewelry box is decorated with a tooled gold rose set under an in-laid top of transparent plastic. The box is essentially a hardwood ring sandwiched between two disks. The ring is glued to the bottom disk which is recessed in the lathe and a rabbet is turned around the edge of the ring to fit the extended lip of the lid. The lid is turned from the other disk and recessed as shown in the detail. By using a paper pattern and the rounded end of a penholder or watercolor brush, the rose is tooled from gold foil or metallic wrapping paper. The recess in the lid is varnished to darken it and, after the varnish dries, the rose is glued in place. Then a sheet-plastic disk is set in the recess and cemented around the edges with transparent plastic cement. Wooden parts of the box are given a hard wax finish. — Elma Waltner, Hurley, S. D.

## Simple Formula for Waterproofing Outdoor Blankets and Woolen Clothing

To be fully prepared for all kinds of weather when camping out on fall hunting or fishing trips, waterproof your blankets, woolen shirts, trousers and sweaters with a formula consisting of anhydrous lanolin, 4 oz., and white gasoline, 1 qt. Dissolve the

lanolin in the gasoline, making enough of the solution to submerge the clothing and soak the fabric for five minutes. Without wringing out the cloth, hang it in an airy place to dry. When the gasoline evaporates, the wool will be waterproofed.

## Truss Rod Supports Floor to Eliminate Post in Basement Recreation Room

If a basement post makes the space useless for a recreation room, the post can be removed and the floor braced with two lengths of pipe and a truss rod. Two lengths of 2-in. pipe are placed parallel from wall to wall across the joists. Notches are made in the sills to take the ends of the pipe. Then a  $\frac{3}{4}$ -in. truss rod, placed parallel to the joists at the center of the room, is inserted through holes drilled in the boxing. Steel plates and nuts over each end of the rod are used to draw it tight from the outside of the house. If the room is more than 16 ft. long, it is advisable to use two truss rods to provide sufficient support.

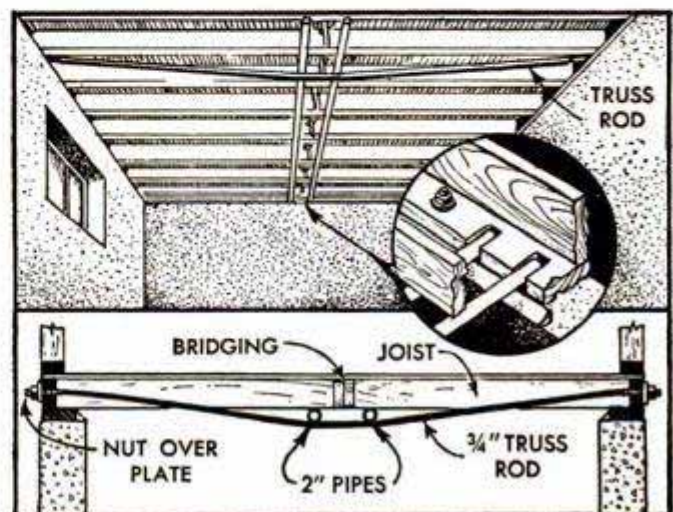

Not only can you slow down a toboggan or bring it to a complete stop in a hurry with this novel pair of hand brakes, but, by braking one side or the other, you can steer either right or left. The brakes are attached to the front batten of the toboggan with two angles made from flat iron. Holes are drilled in the horizontal legs of the angles to permit fastening them to the batten with screws, and the upright arms are drilled to take a 1/2-in. iron rod several inches longer than the width of the toboggan. A small hole is drilled through the rod near each end. Cotter pins inserted in these holes secure the braking levers to the rod. The two levers are made identically, each consisting of a 1-in. length of 1/2-in. pipe which serves as a bearing. To this an 8-in. length of rod is welded to provide a handle. Then a second rod, approximately 6 in. long, is welded to the pipe at an angle of about 120 deg. to the handle. This rod does the actual braking.

## Hand Brakes Mounted on Sides of Toboggan Permit Both Speed and Directional Control

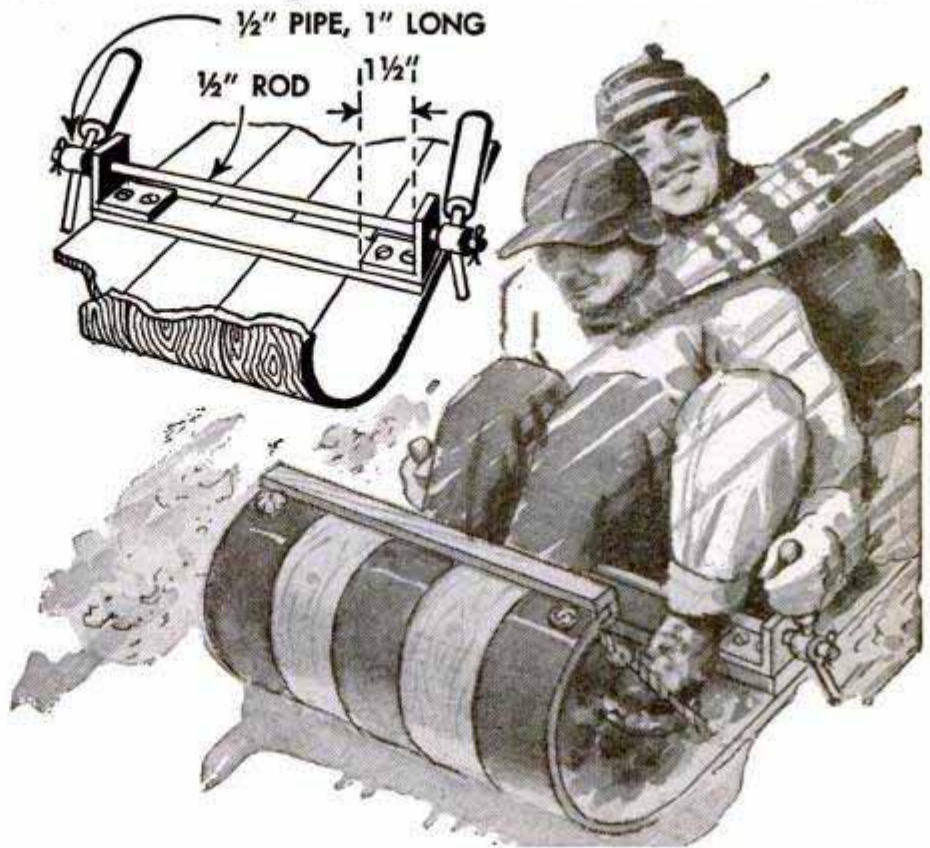

Wooden or rubber grips are fitted to the handles and the unit is assembled so that pulling back on the handle causes the braking rod to dig into the snow.

W. B. Shumilak, Islington, Ont., Can.

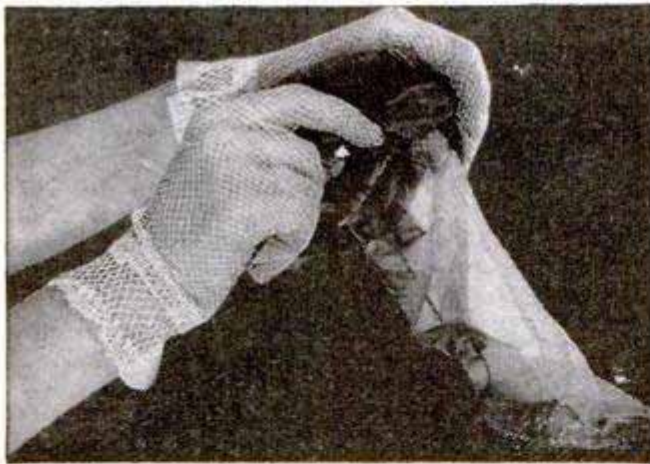

## String Gloves Protect Nylons

When putting on a pair of sheer nylon hose, wear a pair of summer string gloves to keep the fingernails or any slight roughness on the fingers from snagging the material. Although ordinary fabric gloves will do as well, the string gloves are easier to slip on and remove, and afford similar protection to the stockings.

☐ To warm the baby's bottle while driving, make a simple basket frame out of wire to hold the bottle in front of the car heater.

## Hole Stops Crack in Car Window

Noticing that a small crack in his car-door window grew larger day by day, one man halted the progress of the crack by drilling a 1/8-in. hole at its end. He used an ordinary twist drill lubricated with turpentine and, as only one layer of the glass was cracked, he stopped drilling when the plastic center of the pane was reached. Then he filled the hole with colorless nail polish to keep out moisture. Should both layers of glass be cracked, a hole can be drilled from each side, stopping the drill at the plastic center and filling both of the holes with colorless nail polish. — John Gaughan, Niagara Falls, N. Y.



☐ An oil spot on a rug can be removed if a clean blotter is laid directly over the spot and pressed with a moderate hot iron. This procedure is repeated until all the oil has been absorbed from the rug.

# Solving -



**OPENING MACHINE-MADE BUTTONHOLES** is done quickly and accurately with a razor blade and a wooden clothespin. Place the slotted portion of the clothespin directly under the buttonhole and cut the threads with the blade. In this way, the cloth or work surface under the buttonhole will not be damaged

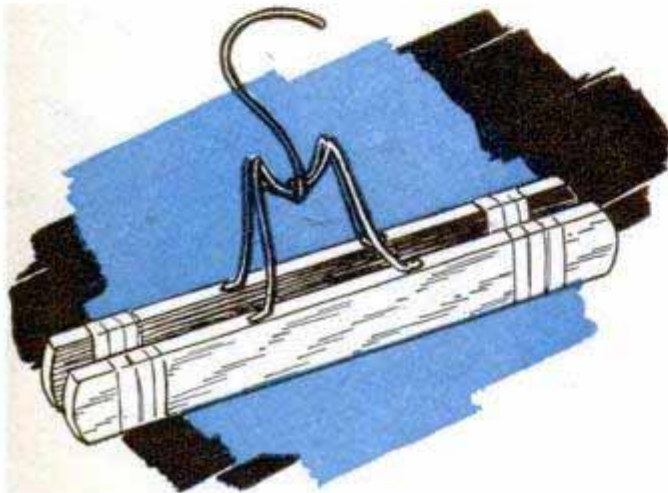

**LOOSE TROUSER HANGERS** that no longer have sufficient tension will clamp tightly if the ends are wrapped with strips of cloth. Cut four strips about 1 in. wide and wrap one of the strips around each end of the hanger. Then sew or pin the end of each strip to the wrapping to keep it from unwinding

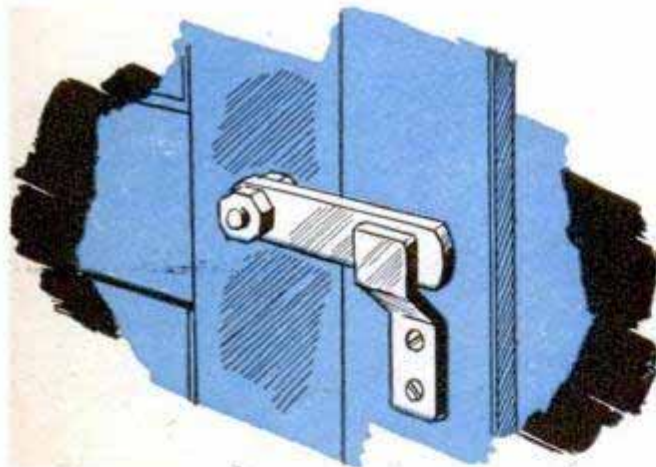

**SAFETY LATCH FOR BATHROOM DOOR** is opened from outside in an emergency with a screwdriver. Bracket and bar are made from flat iron. The bar pivots on a small machine screw and is fastened to the screw with double nuts so that turning the screw from the outside will lift the bar out of the bracket

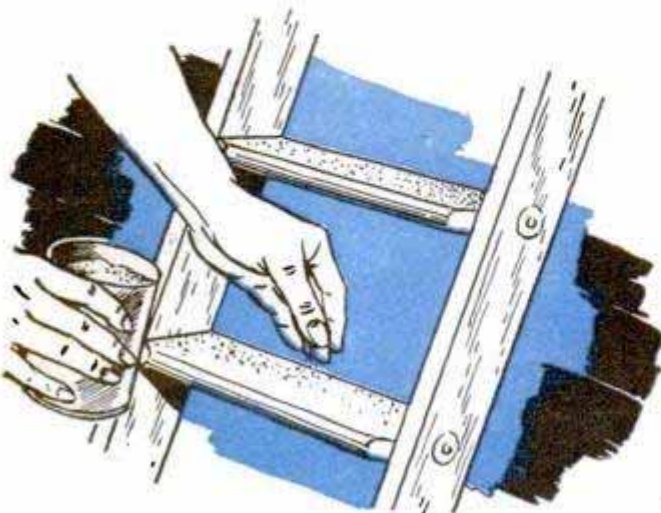

**NONSLIP LADDER STEPS** reduce the possibility of injury when using a stepladder to work around the home. The steps are made slip-proof simply by sprinkling coarse sand or sawdust over them after applying a fresh coat of paint or varnish. The sand or sawdust must be applied while the paint is still tacky

**THE TOP OF A PINEAPPLE** provides an attractive plant for the kitchen or sunporch. Cut the top from the fruit in the usual way and suspend the bottom portion of the foliage in a jar of water until roots begin to sprout. Transplanted in a flowerpot or decorative plant holder, plant will continue to grow



# - HOME PROBLEMS



**WINDOW MASK FOR PAINTING SASH** is had by using a short length of metal Venetian-blind slat to protect the glass. The slat is flexible and its curved cross section allows the edge to be held tightly against the window pane, thus preventing the paint from seeping under the edge of the mask and smearing the glass

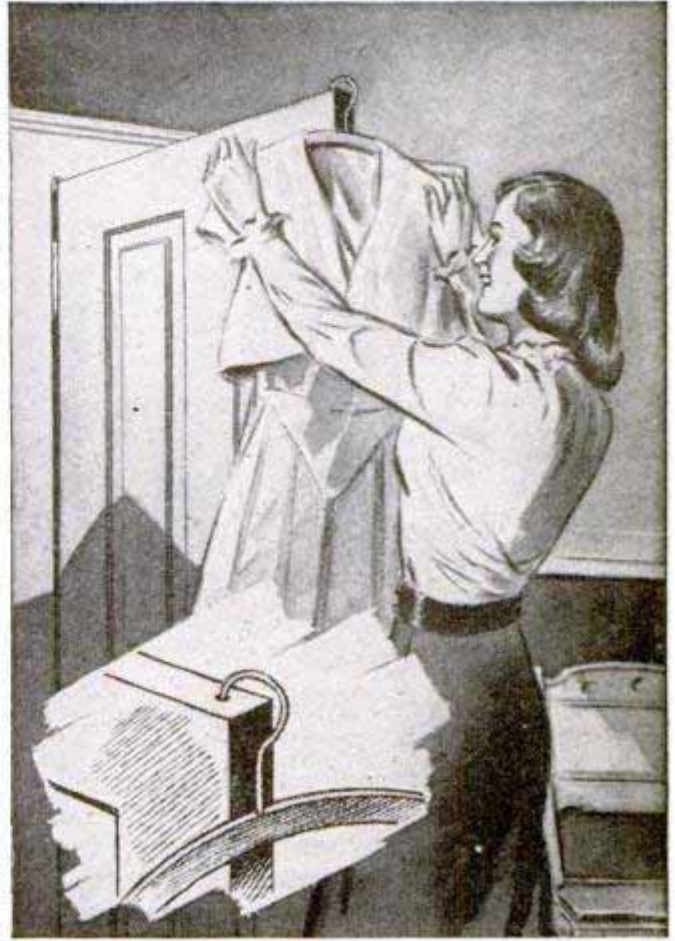

**WIRE COAT HANGERS SUSPENDED** from a door while pressing garments won't slip off if a hole for the hanger hook is drilled in the top of the door. Make the hole larger than the diameter of the hanger wire so that it is easy to locate. The hole is out of sight and does not mar the appearance of the door

**TO KEEP GREASE FROM SPLATTERING** from a frying pan when you are unable to find a pot cover of the right size, place an ordinary colander over the top of the pan. Inverted as shown in the drawing, the colander provides an effective cover that will prevent staining the range and protect your hands from burns

**IF A CLOTHES STICK IS NOT AVAILABLE** when dyeing garments, use spring-type clothespins as a substitute. The clamping action of the clothespins permits you to grasp the garment tightly without staining the fingers. Also, the garment is not likely to slip from pins and splash into the dye, staining your clothing

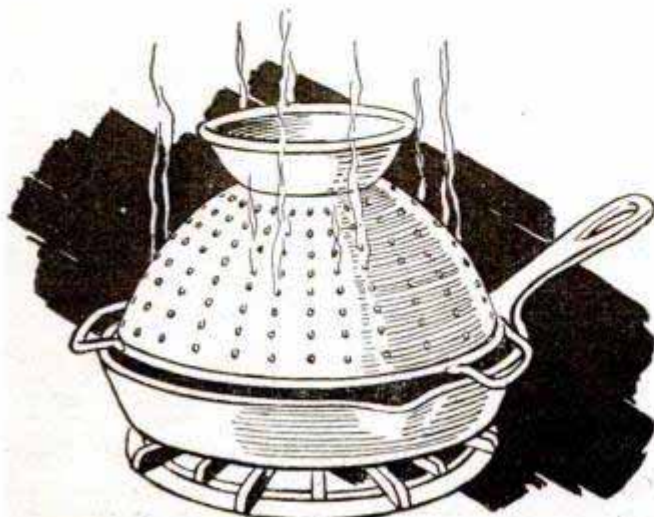

### Tire Traction on Slippery Pavement Gained With Asphalt Shingle



A few asphalt roof shingles, carried in the trunk of your car, will come in handy if the wheels spin when starting on hard-packed snow or icy pavements. A couple of the shingles placed under the rear wheels will provide the necessary traction to get rolling.—H. Leeper, Canton, Ohio.

### Switch Flashes Car Stop Light Without Applying Brakes

With a flasher unit and toggle switch wired into the circuit, a stop light can be used as a flashing warning light without applying the brakes. It is excellent for signaling an intention to slow down or stop

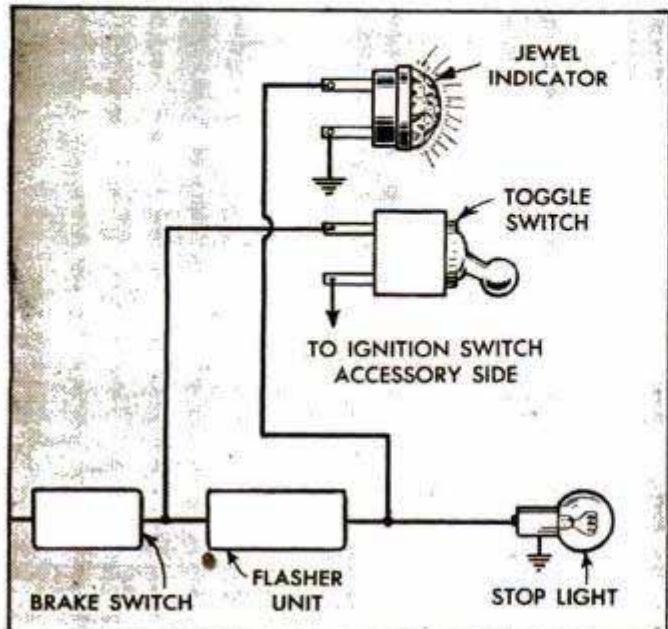

in heavy traffic or on slippery pavement and also is handy to caution approaching motorists if the car must be parked on the shoulder for repairs. The circuit is wired as shown and a radio-type jewel on the dashboard indicates when the light is on.

Richard Todd, Moundsville, W. Va.

### Beam Recharges Luminous Ring Painted Around Flashlight Lens

When marking a flashlight with luminous paint so that it can be found in the dark, apply the paint around the edge of the lens instead of on the barrel. The paint will then glow brightly over longer periods of time, as it is recharged whenever the light is used.



Gordon Wilson, Myrtle Sta., Ont., Can.

### Clock Spring Set Under Trap Pan Stops Tripping by Small Animals

One fur trapper, whose traps for large animals were frequently sprung by birds, squirrels and wood mice that were attracted by the bait, decided to put a stop to this loss of valuable pelts. First, he cut several 2 1/2-in. lengths from an old alarm-clock spring. Then, when setting a trap where small animals might trip it, he bent a length of spring to a U-shape and slipped the spring under the trap pan after setting the trap. Although the spring is stiff enough to prevent small animals from tripping the pan, a heavier animal will easily spring the trap.—R. A. Jenkins, St. Louis, Mo.

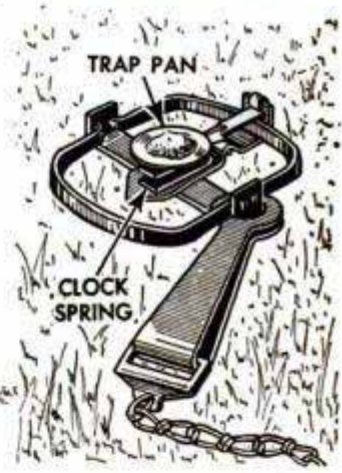

### Removing Paint From Fabric

Paint can be removed from fabric by softening it with turpentine and wiping with hot soapy water. Then fuller's earth, mixed with water to a pasty consistency, is applied over the spot. When dry, the fuller's earth is brushed off the fabric.

Store linen tablecloths by rolling them on a mailing tube. This will prevent wear at the creases which results from folding.



## TWIN PIN-UP LAMPS *in Plastic*

By John P. Arnold

**F**ORMED from acrylic plastic, such as Lucite or Plexiglas, these graceful pin-up lamps add a striking effect when mounted at each side of a vanity mirror. Each lamp consists of three parts, a bracket and two scrolls, which are bent by heating in the kitchen oven at 250 to 300 deg. F. and then placed in wooden jigs to set. Profile patterns for the parts are traced on plywood and jigsawed slightly oversize to permit easy removal of the plastic. The bracket requires a strip  $\frac{3}{16} \times 1\frac{1}{2} \times 18\frac{3}{4}$  in., while each scroll takes a piece  $\frac{1}{8} \times \frac{1}{2} \times 12\frac{1}{2}$  in. Three decorative grooves are made on the

back of the bracket strip, section AA, the center groove providing a channel for the lamp cord. The grooving is given a frosted finish by sanding with wet-or-dry paper.

In assembling, note that each scroll is grooved to fit over the edge of the bracket to which it is cemented and clamped lightly until dry. A  $\frac{1}{8}$ -in. pipe nipple and nut fasten a socket to the bracket. If the socket is the candle type pictured above, a square piece of plastic is used to form a base for the cardboard tube. The lamps are hung by placing the looped ends of the scrolls over small nails driven into the wall.

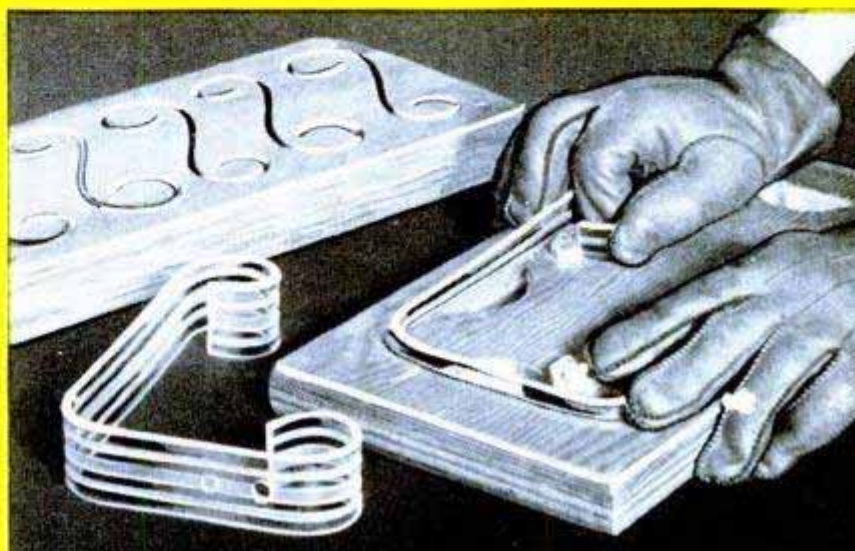
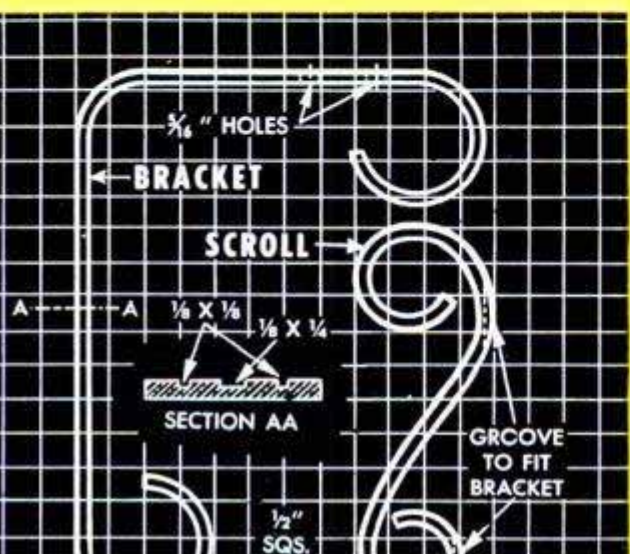





*This can be yours!*  
build it yourself .....





*Styled exclusively for Popular Mechanics by John Bergen, furniture designer*

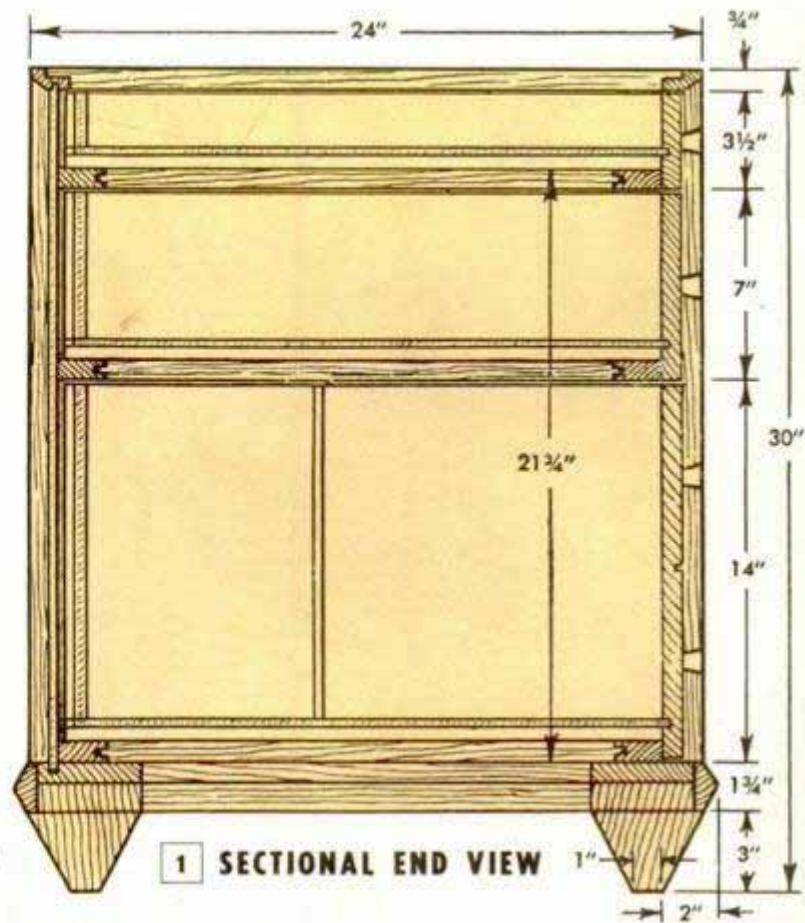

# Living-Room FURNITURE

Story by Wayne C. Leckey

## Part I

MODERN as tomorrow, here's a smartly styled ensemble that will transform your living room into a room of distinction. It's exclusive, colorful and, to top it off, this furniture is easy to build. Designed expressly with the home craftsman in mind, all the pieces of the group can be duplicated with just a jointer and a saw. Combining plywood with solid stock further simplifies construction, and the use of separate upholstered units enables the inexperienced worker to do a first-class job of upholstering the sectional units and easy chair.

The complete group pictured in full color on the preceding pages includes a sectional sofa, easy chair, hostess chair, step table, commode, cocktail table, corner table, desk, table lamp and floor lamp. The desk chair shown was an extra piece and is not included in the group. However, a dining chair of the style presented in our dining-room furniture series, September and October 1949 issues, will

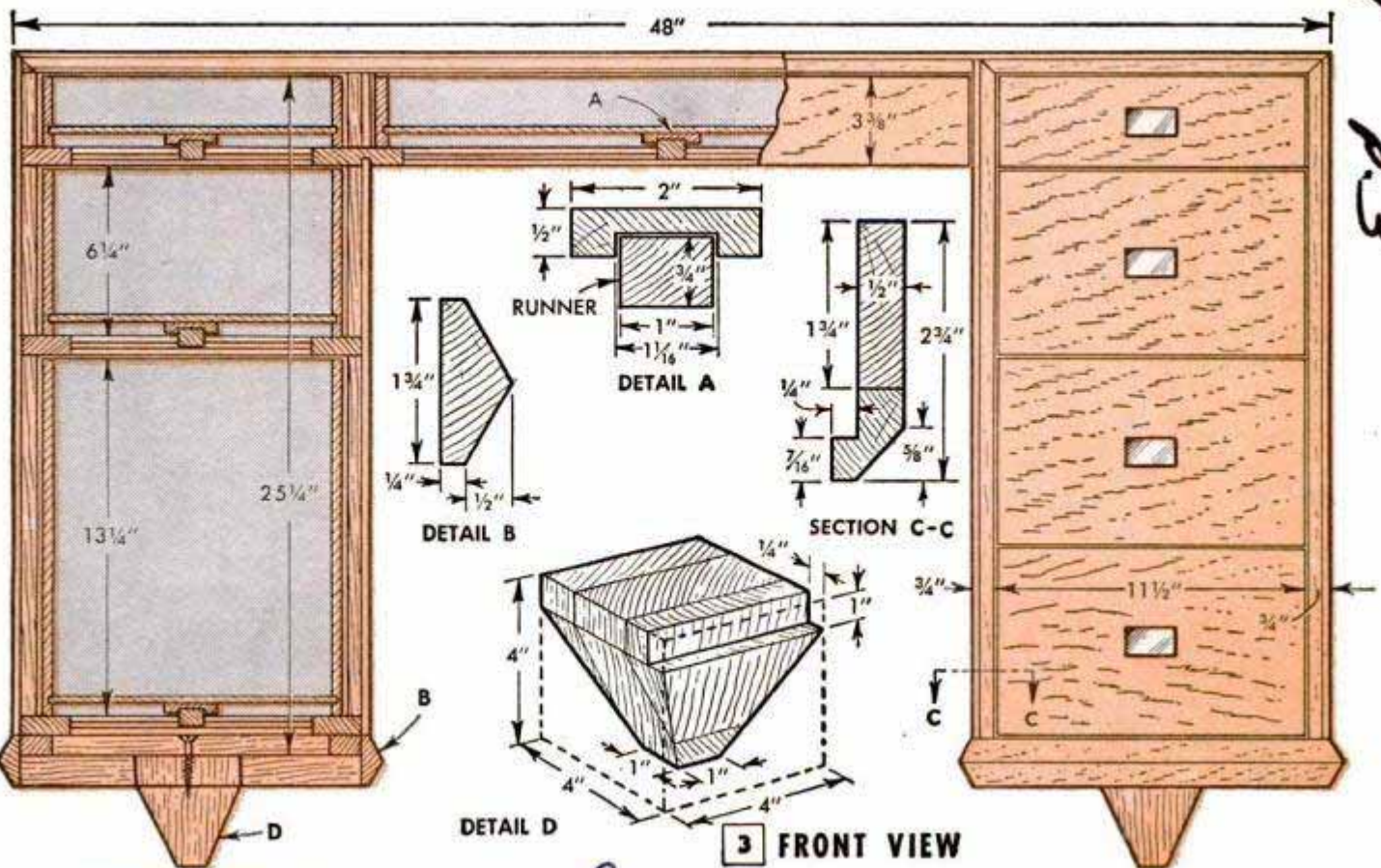
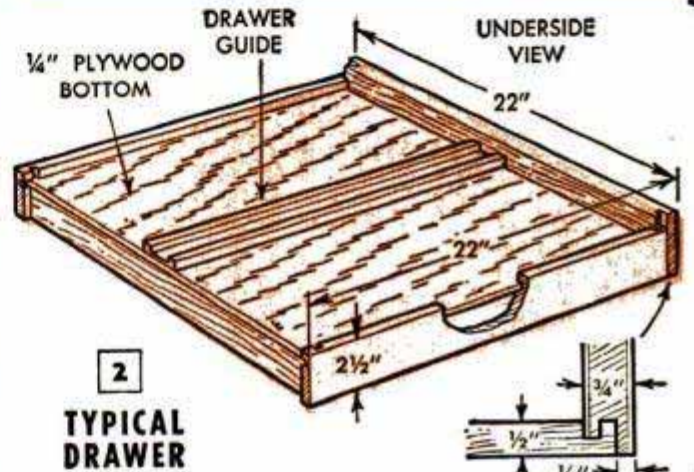
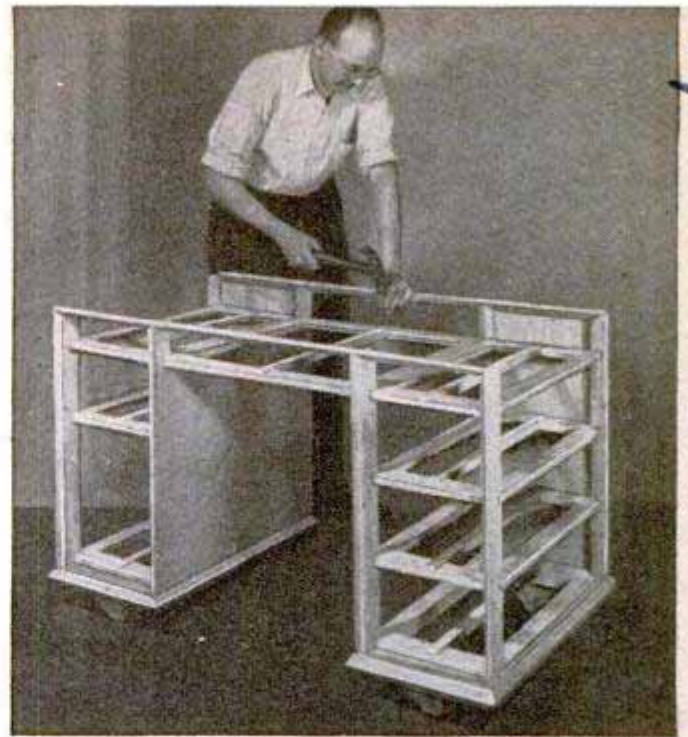

Step - Furniture you Can Build p. 3

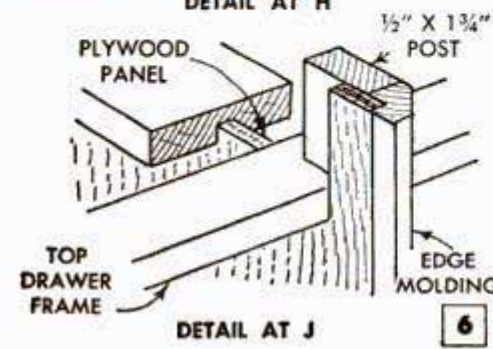
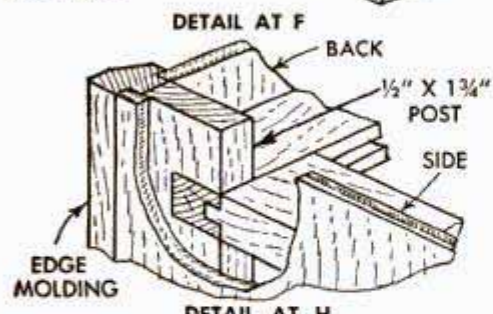
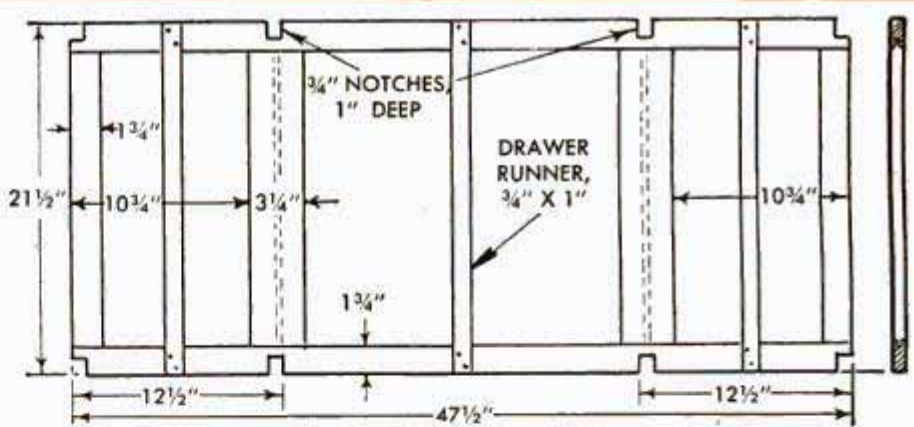
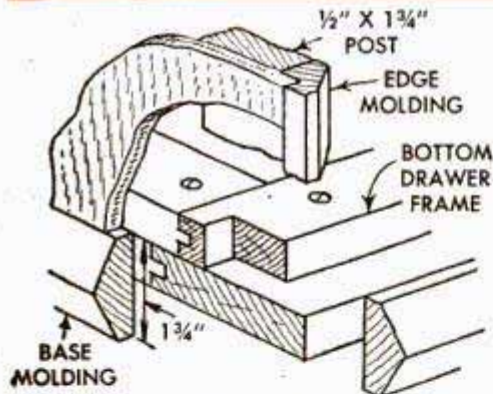
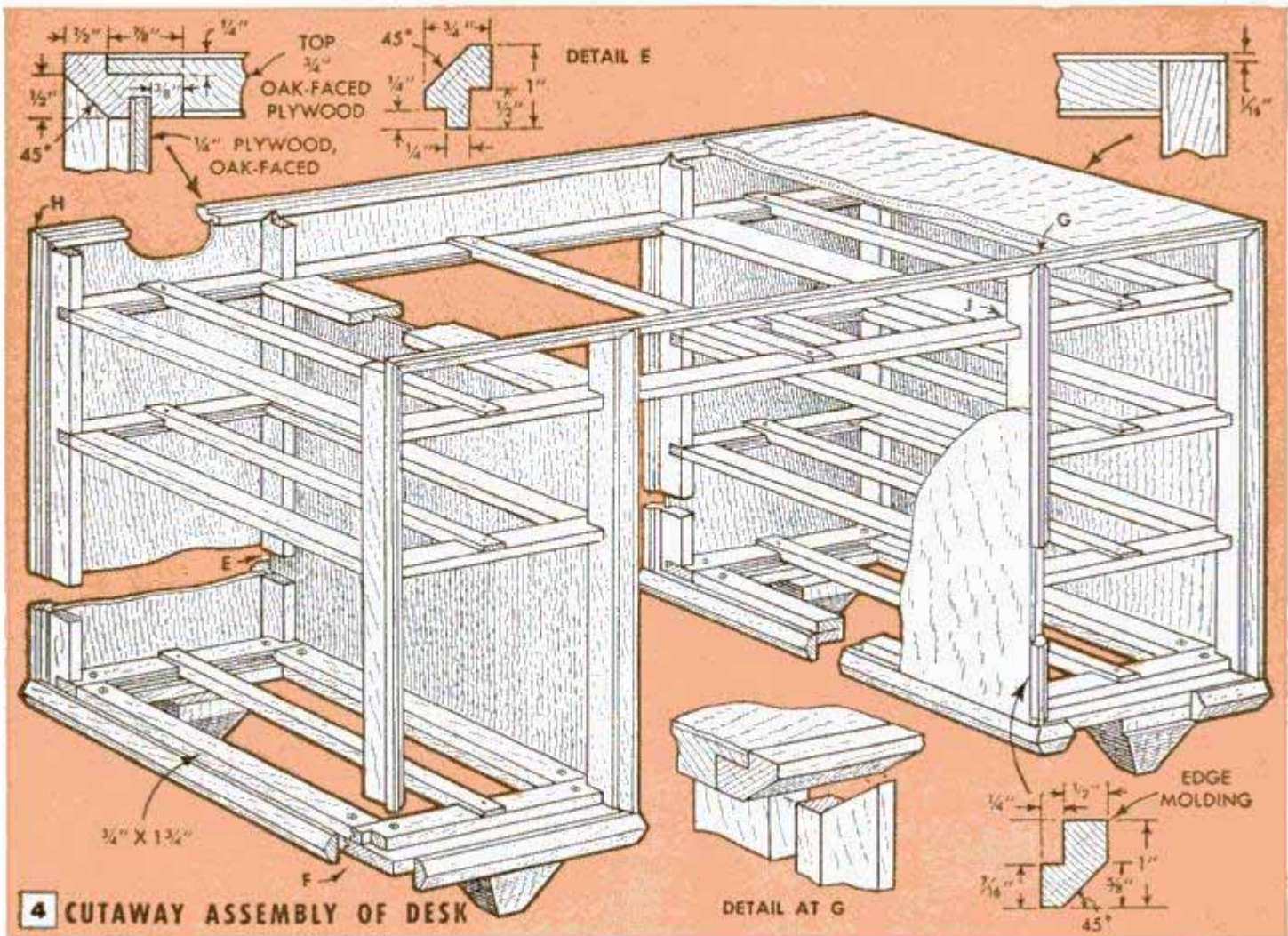

5 UPPER DRAWER-FRAME ASSEMBLY

provide a suitable matching chair for the desk. Part I in this issue covers construction of the cabinet pieces, while Part II will take up construction of the upholstered pieces and the two lamps.

The kneehole desk, which may be considered optional, is the most detailed piece of the group and, therefore, requires the most explanation. Figs. 1 and 3 show sectional views, while the cutaway view in Fig. 4 gives a general idea of the assembly. The original furniture was made of oak-faced plywood and solid stock and finished in limed oak, but birch, maple or other hardwood can be used. The upper drawer frame of the desk is made first, Fig. 5, and although the drawer runners are shown in place, these can be added later. The dotted lines represent 1/4-in. grooves which are made on the underside. As no part of this frame is exposed, it can be made of

inexpensive wood. The built-up bases at the bottom of each drawer unit are made exactly alike, consisting of a drawer frame, screwed to a bottom frame. The two frames must fit flush at the sides. The front member of the bottom frame should be about 4 in. wide and cut from finished stock. Note in Fig. 6, detail F, that the drawer frame is notched at the corners for  $\frac{1}{2}$ -in. posts which also are notched. Next, the posts are joined to the upper and lower frames, and then the intermediate drawer frames are installed. This produces the skeleton structure of the desk.

Now, a molding is applied around the base of each drawer unit, as in Fig. 3, detail B. This is mitered at the corners, and is glued and screwed to the bottom frame to bring it flush with the top. When this is done, the four tapered legs can be fitted. Fig. 3, detail D, shows how they are built-up and rabbeted across the front edge to come flush with the face of the base molding. Glue and a long, flat-headed screw are used to attach each leg. Next, a rabbeted molding is applied to the edge of the front posts. This is detailed in section C-C, Fig. 3, and is edge-glued to the posts. A similar molding cut according to detail E, Fig. 4, is edge-glued to the back posts. Note that the molding strips on the inner posts, at both front and back, are notched at the upper ends in

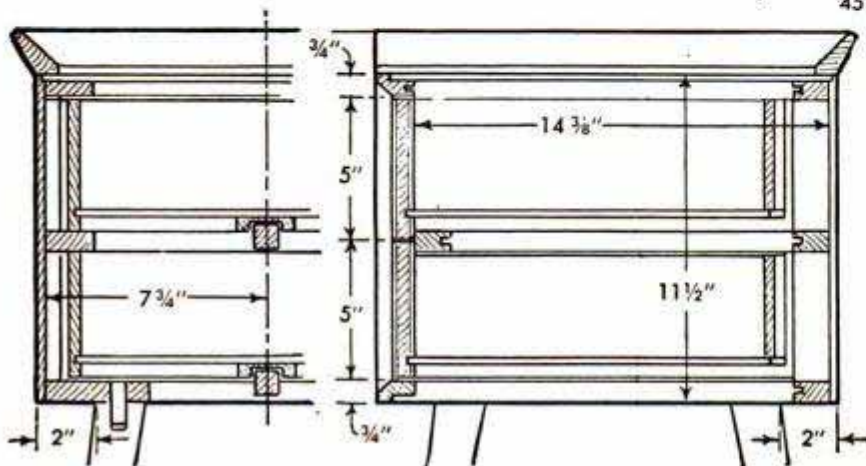
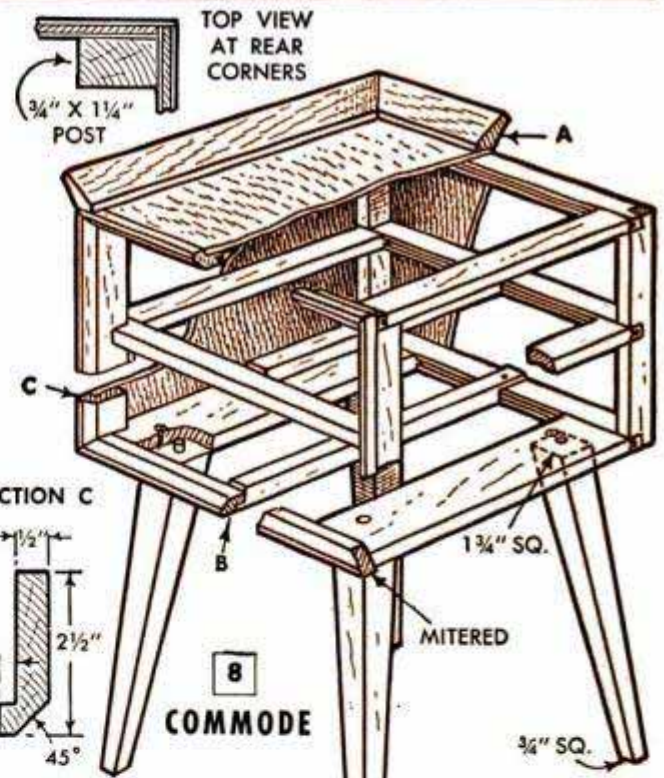
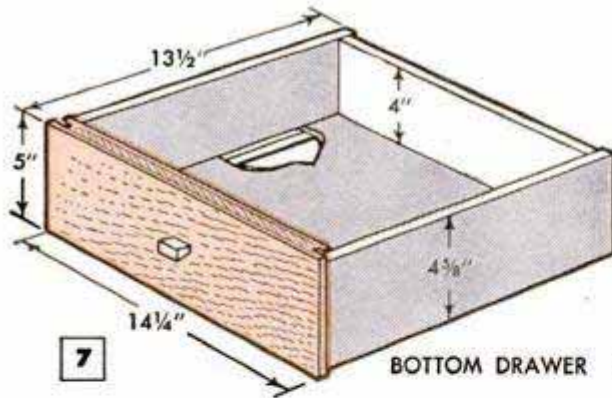
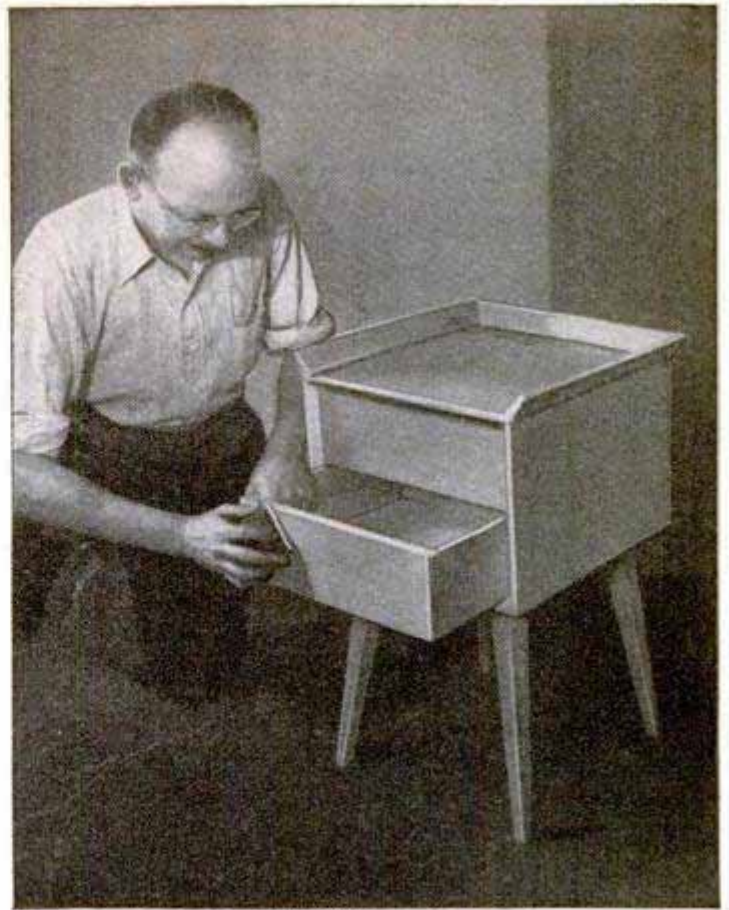

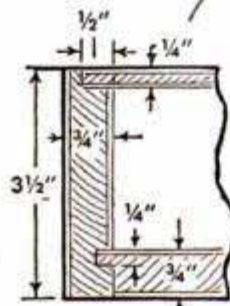
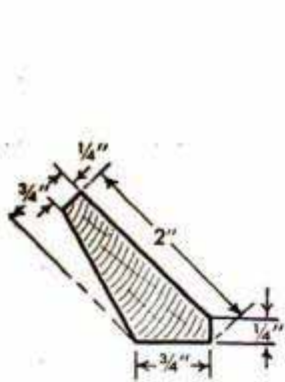
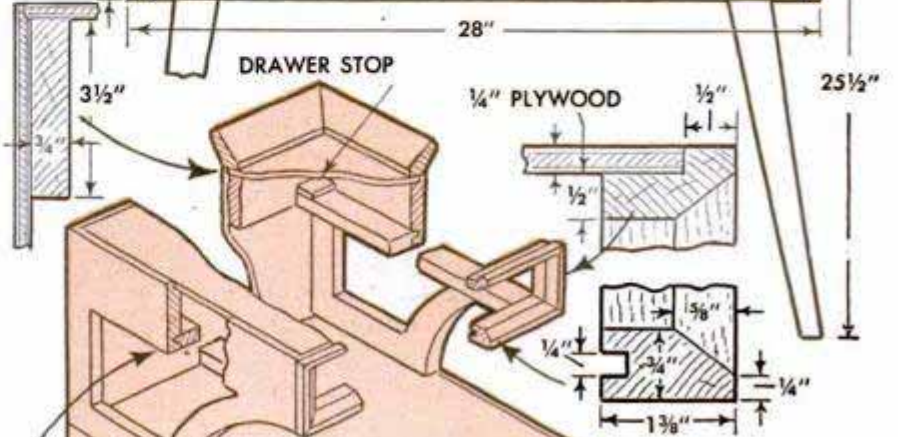
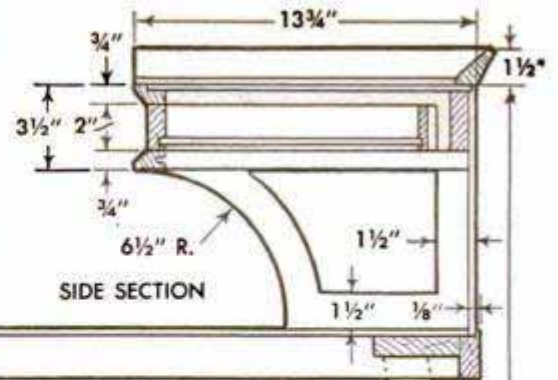
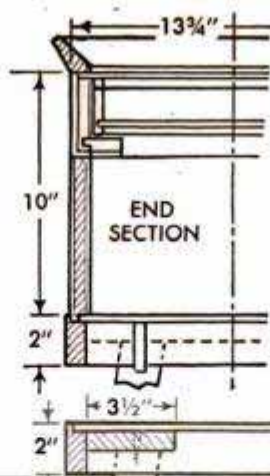
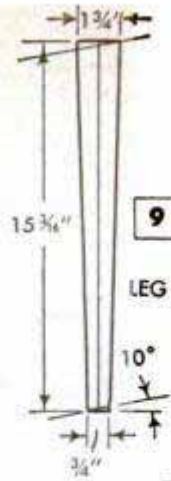
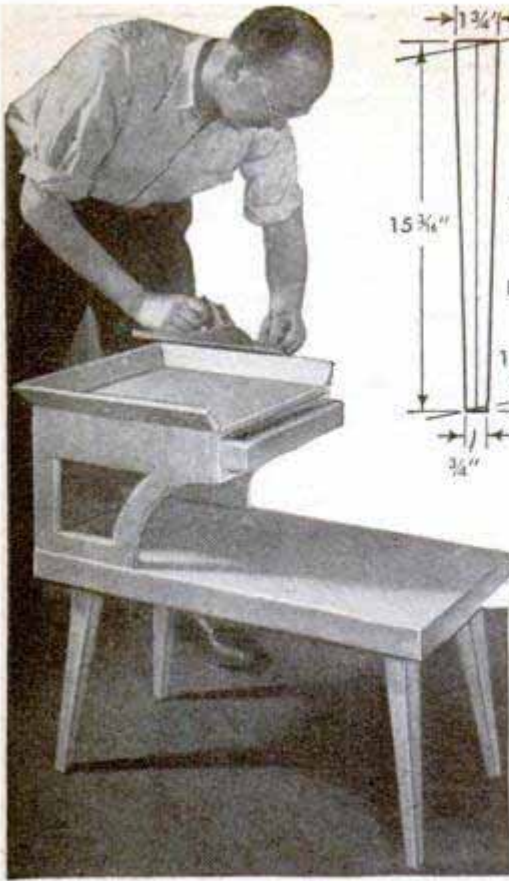

11  
STEP TABLE

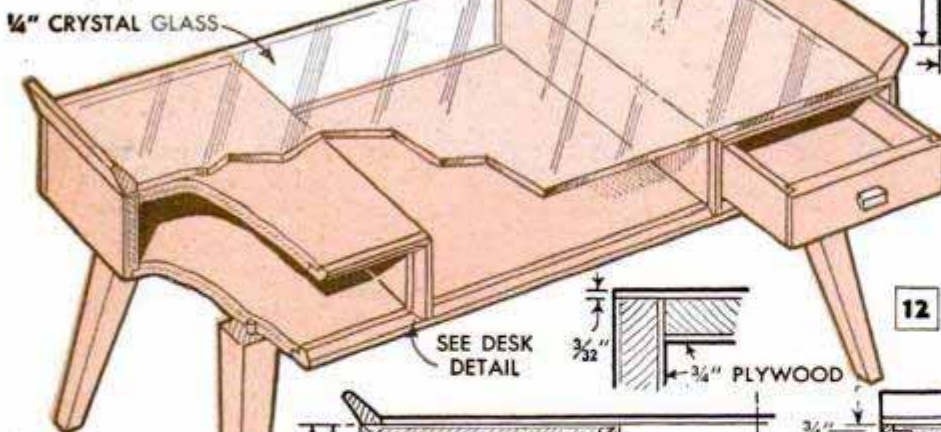
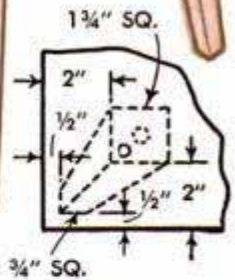
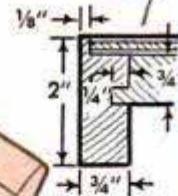

12 COCKTAIL TABLE  
(SEE DETAIL A)

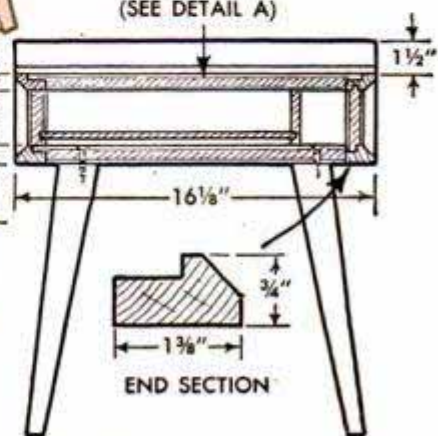
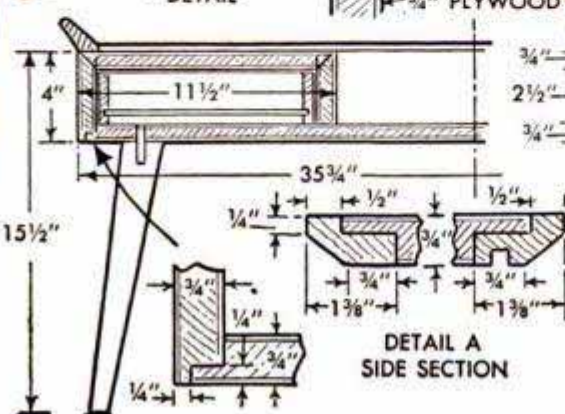
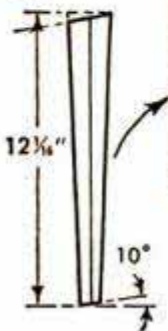

DETAIL A  
SIDE SECTION

END SECTION

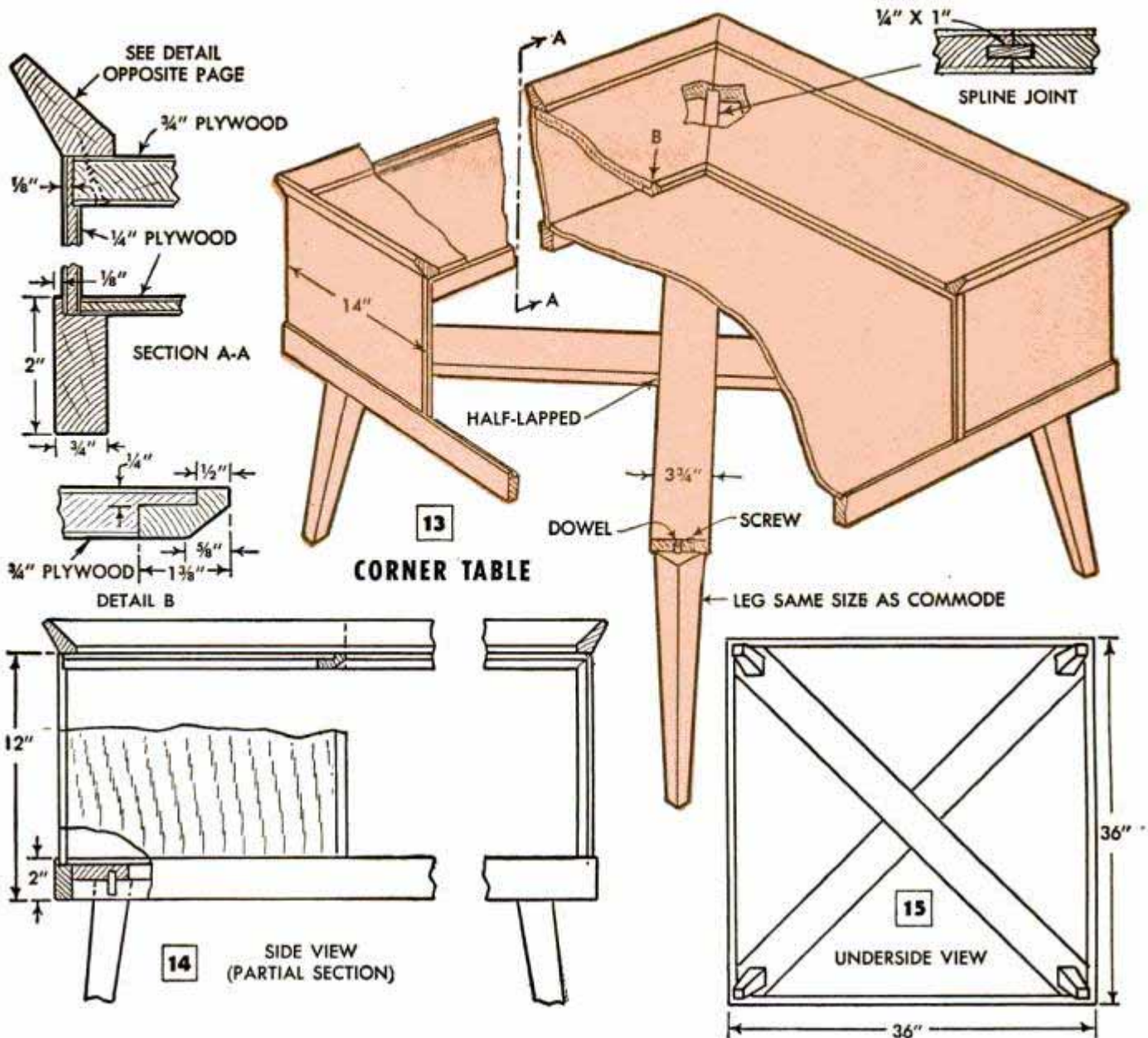

the manner shown in detail G, Fig. 4. The  $\frac{1}{4}$ -in. plywood panels on the inside of the kneehole are fitted next. These are cut to fit the rabbeted edge molding and the grooves in the underside of the upper drawer frame. You'll notice in Fig. 6, detail J, that the plywood is cut L-shaped at the top to continue it to the top of the front posts. In gluing and clamping in place, the panels are pushed up into the grooves so that the lower edge rests flush on the edge of the base molding. The panels covering the outside of the drawer units are installed similarly, except that they run to a point about  $\frac{1}{16}$  in. down from the mitered end of the edge molding. This permits the desk top to overlap the end plywood and conceal the plies in a rabbeted joint. Plywood panels which enclose the rear ends of the drawer units are slid into grooves in the edge molding, and then strips of rabbeted molding are run across the top of the desk at the front and back. Note that the rear strip differs slightly from the front one. This leaves the job of fitting the top and the drawers. The top, which is  $\frac{3}{4}$  in. thick,

is rabbeted all around, leaving about the thickness of one ply at the ends and  $\frac{1}{4}$  in. along the sides.

Fig. 2 details typical drawer construction. The one shown and dimensioned is the shallow center one, but all others are made essentially the same. Eight drawers are required, the bottom left-hand one being a deep single drawer which is grooved across the face to represent two smaller drawers. Guides for the drawers are  $\frac{1}{2}$ -in. strips grooved for the runners as detailed in Fig. 3, A.

The commode, detailed in Figs. 7 and 8, is built-up around a rough framework which has a mitered molding edge-glued around the front. The tapered legs are doweled and screwed 2 in. in each way from the corners. The framework is covered with  $\frac{1}{4}$ -in. plywood which is rabbeted, as shown, to conceal the plies at the rear corners and around the top. The top is finished off on three sides with a slanting molding and, finally, two drawers are made and installed on runners in the same way as those in the desk.



The step table, detailed in Figs. 9 to 11 inclusive, is made by grooving and rabbeting solid stock and then assembling it on edge to form a mitered frame. The grooves house tenons on two crosspieces to which the legs are fastened and the rabbet around the top edge receives a 1/4-in. plywood panel. The latter is glued flush with the top of the frame. The scrollsawed sides, which are cut from solid stock, are rabbeted along the top and bottom edges and grooved to take the drawer frame. An edging glued around the front frames a shallow drawer. After the top of the table

is covered, edging is added on three sides to match the commode.

The cocktail table, detailed in Fig. 12, features a glass top, a center pocket for magazines and two small drawers. Except for the legs and molding, the table is made of 3/4-in. plywood. The bottom board is rabbeted all around the edges, the rabbets at the ends being a reverse of those along the sides. The outer sides of the drawer compartments are likewise rabbeted and are glued and nailed from the bottom. Then the endpieces for the backs of the compartments are tenoned and rabbeted to take a rabbeted edge molding which frames both front and back. Conventional construction is used in making the drawers, and each end of the table is fitted with a slanting molding to match the other pieces.

The corner table for the sectional sofa is detailed in Figs. 13, 14 and 15. The top is made of 3/4-in. plywood while sides and bottom of the table are 1/4-in. plywood. Construction is apparent from the drawings. The base is similar to that of the step table, and the legs are the same size as those on the commode. The mitered joint in the top is fitted with a spline and an edge molding, detail B, Fig. 13, is used to conceal the laminations. Here again, a slanting molding is added to finish off the top.

(To be continued)

## Shadowgraph Utilizes Sheet of Glass to Produce Interesting Designs

Consisting of a sheet of plate glass clamped between two wooden uprights, this easily made shadowgraph will cast a variety of shadows for tracing unique de-

signs. The uprights are grooved at an angle to receive the edges of the glass and are drilled near the lower end for attaching to the drawing board with bolts and wing nuts. The bolts can be inserted through cleats screwed to the underside of the board. The shape of circles, designs and lettering is changed merely by tilting the supports backward or forward to vary the angle of the glass to an overhead light.

Bryan H. Neill, Waco, Tex.

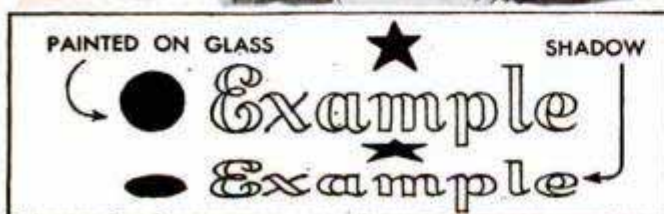
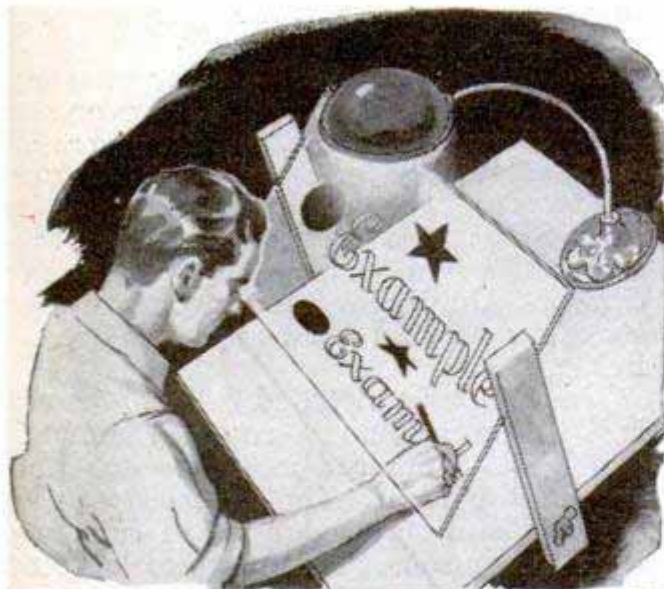

## Wall Rack for Hacksaw Blades

Two wooden cleats, nailed to a wall in an easy-to-reach spot, form a convenient rack for hacksaw blades. The cleats are mounted parallel with each other and spaced apart a little less than the length of the blades. By bending them slightly, the blades are wedged between the cleats and are simply pulled from the rack when needed.

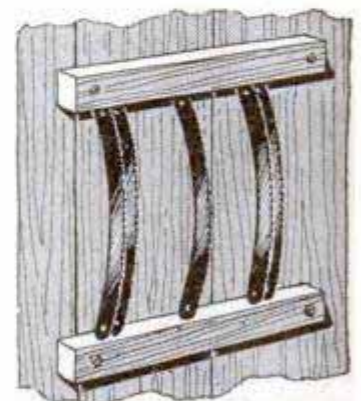



# Miniature PLANT STANDS

Old-time furniture salesmen, or "drummers," as they were called, carried sample cases of furniture miniatures which were scale models of the full-size pieces, complete in every detail even to the kind of wood and the type of finish used. Here's a new and novel application in which similar miniatures are put to practical use as a decorative feature of indoor plantings. Both plant stands accommodate small standard-size flower pots. You can do most of the work on the jigsaw. Use high-grade woods—full-size tables of the type shown usually were made of mahogany or maple—and, after cutting the pieces to size, Figs. 1 and 2, join the parts with waterproof glue and small brads. Lengths of stiff wire are used to represent the lyre strings as shown in Fig. 3. Sand the parts thoroughly and finish in the natural color of the wood with the application of sealer, filler and then varnish.—Charles and Bertram Brownold, Cedarhurst, New York

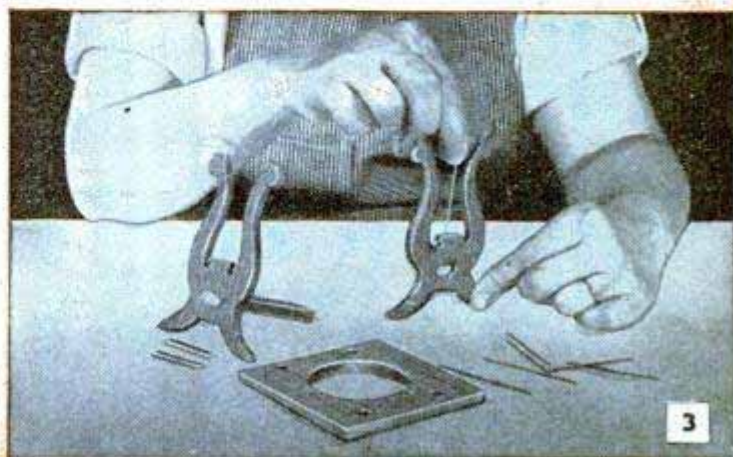
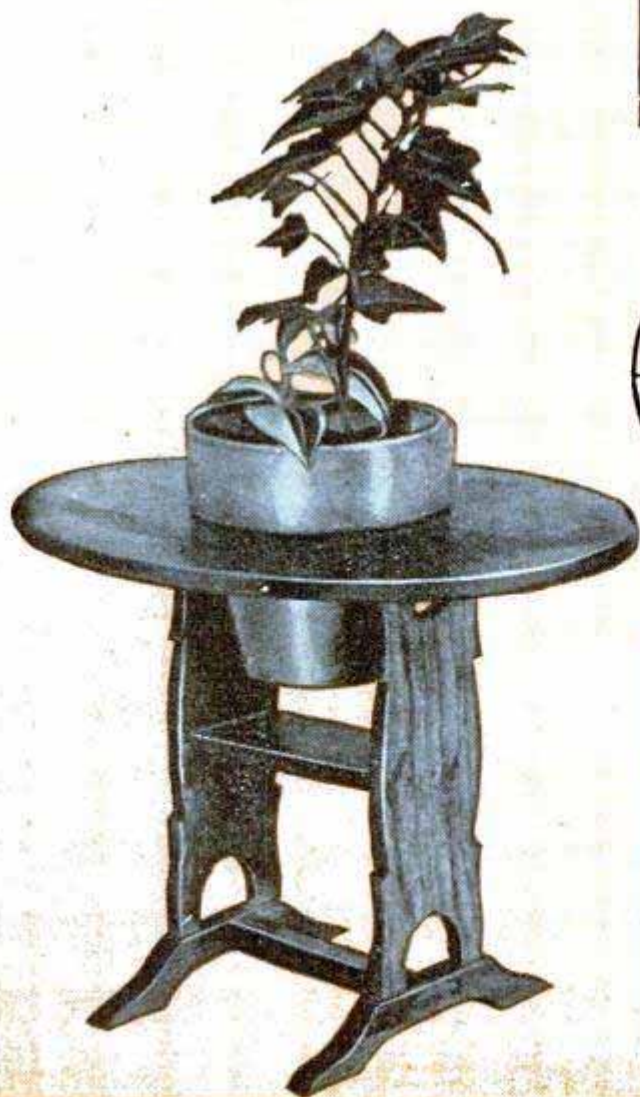
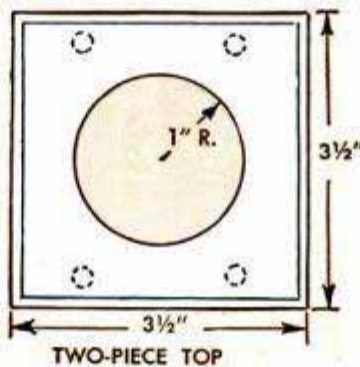
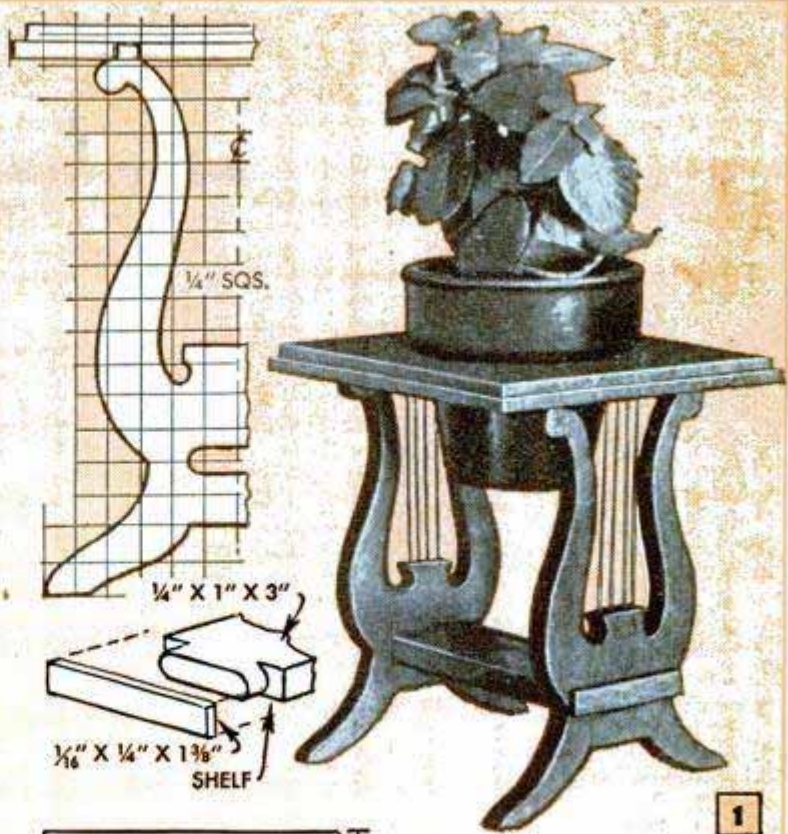

# PORTABLE FILING CABINET

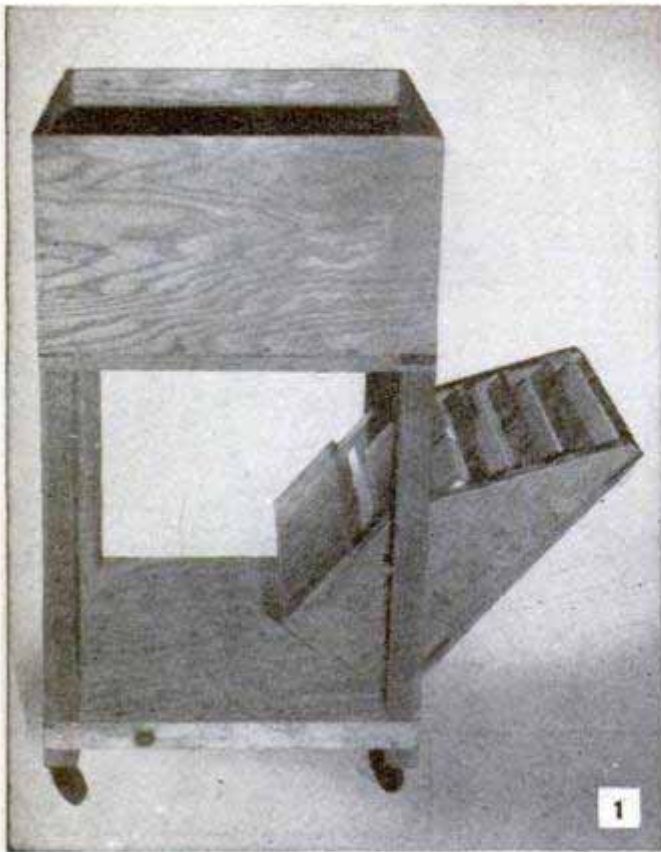

This handy rolling file, with its novel swing-out compartment, is a must for the home office or darkroom where filing space is necessarily kept at a minimum

By Louis Hochman

**M**ADE almost entirely from plywood, the top compartment of this portable file accommodates standard letter-size file folders while the swing-out compartment provides ample space for an assortment of stationery. The base, Fig. 2, supports the filing units and consists of four legs assembled with stretchers and cross members at the bottom. Note that the ends of the stretchers are housed in grooves cut in the legs. The cross members are butt-joined, doweled and glued to the legs. Next, a rectangular frame is lap-joined at the corners and attached to the top ends of the legs with screws, or nails, and glue. Then a plywood shelf is neatly notched around the legs and joined to the stretchers and cross members with screws as in Figs. 1 and 2. Install four rubber-tired casters of the plate type, which may be attached to the legs with screws. The upper file compartment is built with screwed-and-glued butt joints as in Figs. 2 and 3. The sides and ends are of  $\frac{3}{8}$ -in. plywood and the bottom is of  $\frac{3}{4}$ -in. solid stock. After the

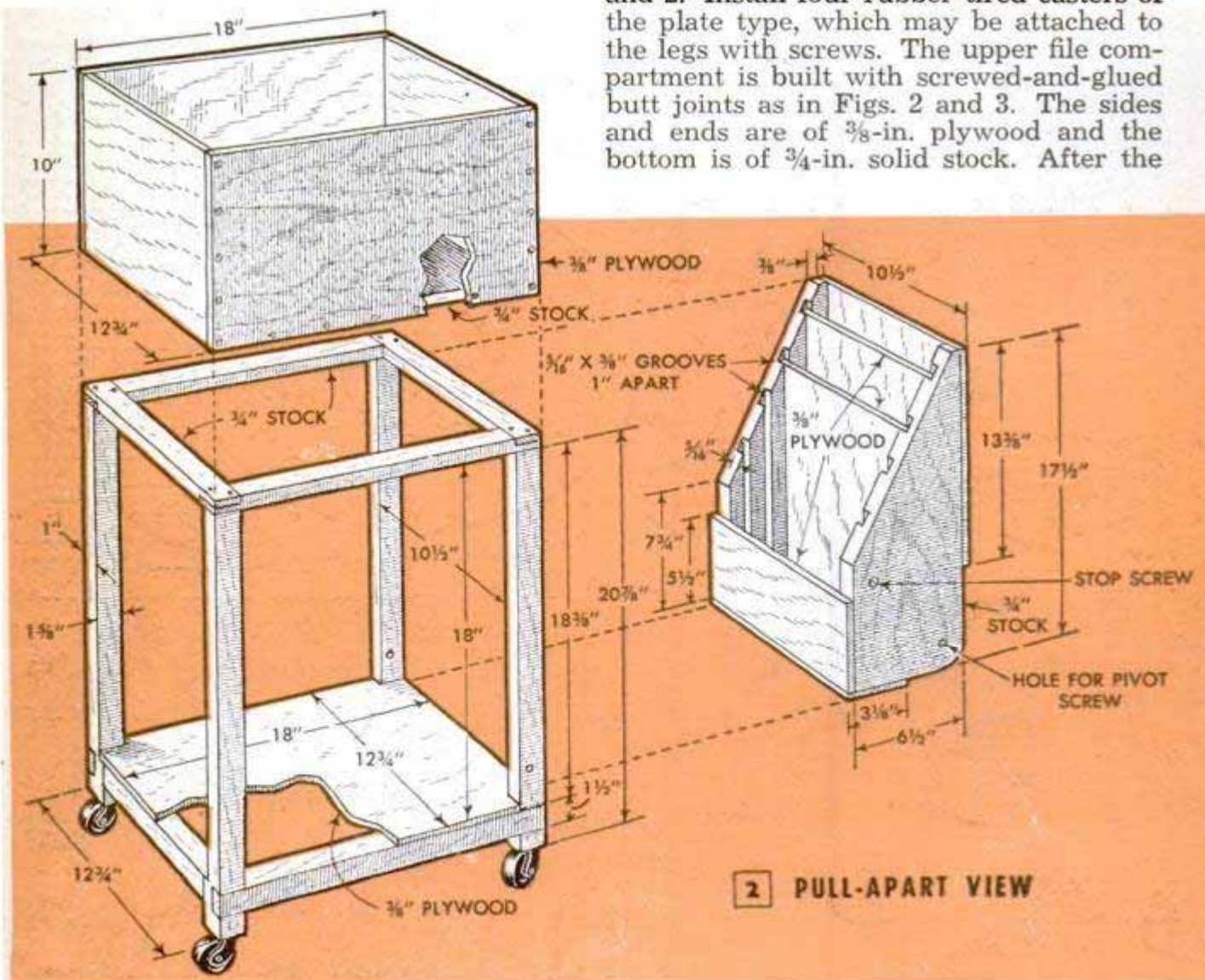

2 PULL-APART VIEW

box has been assembled, sand it thoroughly. It can be finished either in the natural color of the wood or enameled in color to match other furnishings. As shown in the cutaway view, Fig. 3, the swing-out unit is fitted with stepped compartments which are all of a uniform depth. The dividers are of  $\frac{3}{8}$ -in. plywood and are fitted in grooves cut in the sides. Solid stock is used for the sidepieces but all other parts are of plywood. Note in Fig. 2 that a radius is cut on the lower front corner of the sidepieces so that the unit can swing outward without striking the shelf. When installing the unit, the pivot screws are driven into the legs from the inside as in Fig. 3. Use round-headed screws and be careful not to drill the pilot holes clear through the legs. Leave the screws slack so that the unit will pivot easily. After installing, determine the balancing point of the unit, and then drive a stop screw into one side as in Fig. 2. This will hold the unit in the open position as in Fig. 1. Note in Fig. 3 that the total height of the completed file is  $31\frac{5}{8}$  in., not including the casters. If you wish the top of the file to be exactly desk height, Fig. 4, allowance must be made in the length of the legs and the height of the swing-out unit.

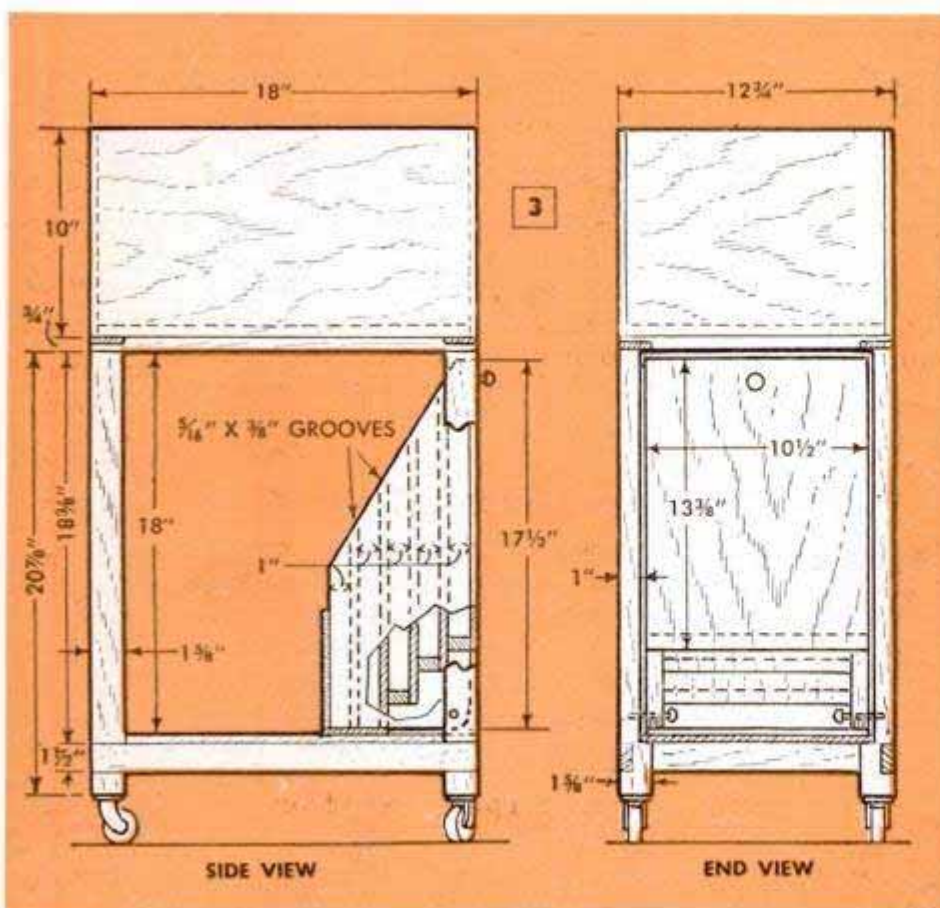

# Black-Walnut Book Ends in Ultramodern Design



Combining graceful design with the natural beauty of swirl-grained black walnut, these modern book ends are a one-evening project that you will be proud to display in the living room. Using 1-in. walnut, cut out both bases at the same time according to the squared pattern and chisel a recess in the underside of each one for a 3½ x 5-in. metal support plate. Then cut out the uprights, fit them in the bases and trim the backs flush. Carefully sand all the exposed surfaces and fill the wood with a matching filler. After allowing to dry overnight, sand the pieces lightly with fine sandpaper. Apply several coats of high-grade varnish, sanding lightly between the first two coats and rubbing between the following coats with rottenstone or polishing rouge. After finishing, assemble the parts and glue felt over the bottoms to prevent marring furniture.—Monroe A. Maller, North Hollywood, Calif.

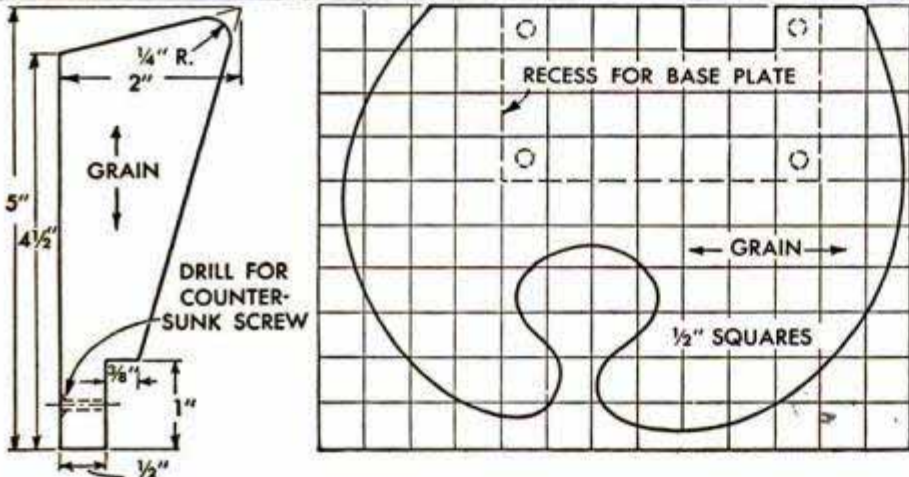

## Tags Tied to Heating-System Valves Give Emergency Information

In case a leak develops or some other emergency occurs in a hot-water heating system, it may save considerable expense if any member of the household is able to manipulate the valves to correct or minimize

the trouble. Instead of trusting to memory, attach tags, which give clear and complete information, to the various controls. Arrows can be used to indicate the direction of turn to open or close the valves, and the functions of the controls can be described sufficiently in a few words.

### Old Dress Serves as Pattern

If your favorite dress is becoming worn, why not use it as a pattern to make a new one just like it. Rip all the seams of the old dress and wash the pieces. Starch them so they are quite stiff and press them. Then use each piece as a pattern.

Pat Fey, New York City.

☞ To prevent eyeglasses from clouding with moisture, rub soap on each side of the lense and polish well. The glasses will stay clear for the day with this treatment.

Home Repairs

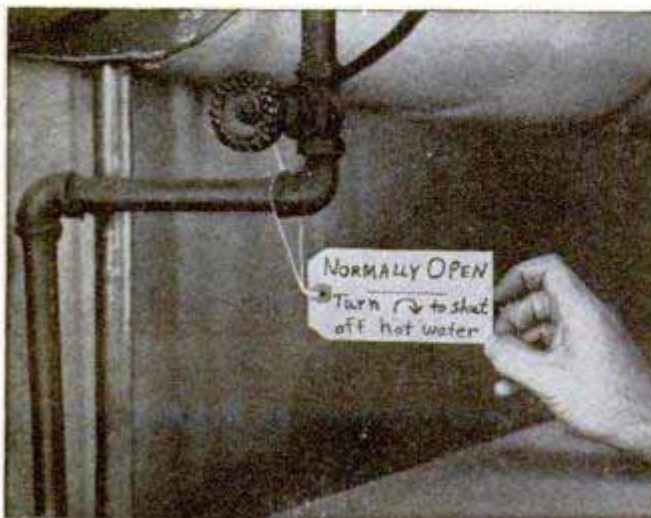

## Warming Varnish Aids Spreading



Varnish can be applied more evenly and with considerably less effort if it is kept warm while being used. When varnishing the floor or woodwork of an unheated room, the varnish may be kept warm by standing the can in a shallow pan filled with hot water.—R. F. Donovan, Jersey City, N. J.

## Length of Twine Removes Cork From Inside of Bottle



When a cork has been pushed inside a bottle, it can be removed easily with the aid of a length of twine. Double the twine to form a loop and, grasping the free ends with the fingers, insert the loop into the bottle. The twine should reach the bottom of the bottle. Shake the bottle lightly until the cork falls between the two strands of twine. Then, pull the twine slowly from the bottle, forcing the cork out through the neck.

## Taping Cord to Vacuum Cleaner Prevents Loose Connections

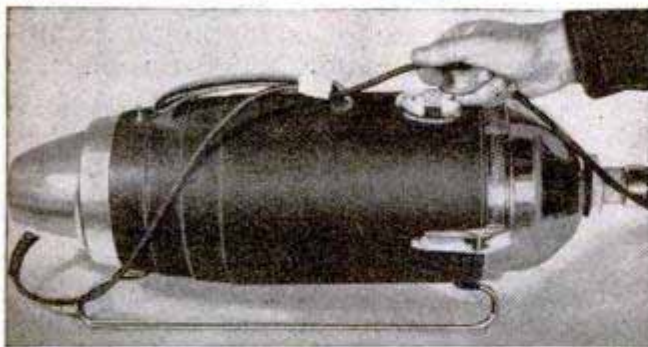

As a result of pulling a tank-type vacuum cleaner across the floor by means of the extension cord, the wire connections occasionally come loose inside the cleaner. To take the strain off the terminals, and keep the connections intact, allow a little slack in the cord and tape it to the vacuum-cleaner handle, using several wrappings of friction or adhesive tape.

☐ If lemons are put in the oven and heated, more juice can be obtained from them.

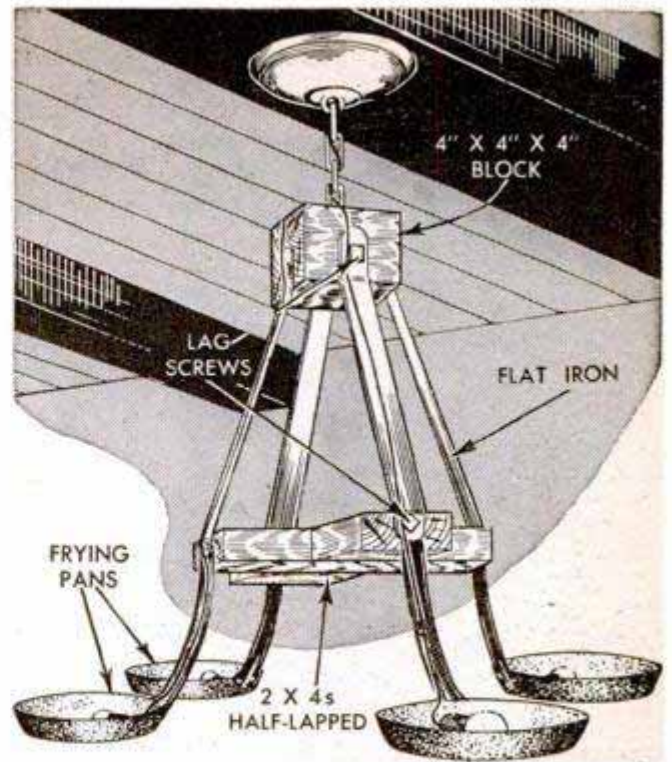

## Frying Pans Form Lighting Fixture For High Cabin Ceiling U. F. '51

Utilizing frying pans to provide indirect light, this novel fixture is just the thing for a high-ceiling cabin or hunting lodge. The fixture consists of two lengths of 2 x 4 lapped together to form a cross which is attached to a 4 x 4 x 4-in. block with four lengths of flat iron. The flat iron is attached to the top block and the ends of the cross with lag screws. The frying-pan handles are bent upward and are sandwiched between the ends of the cross and the flat iron, the lag screws passing through the holes in the handles. The unit is suspended from the ceiling with an ordinary drop chain, and sockets and bulbs, wired individually, are laid in the frying pans.

Eugene L. Heinrich, Peoria, Ill.

## Phonograph Needle Held in Pencil Provides Plastic Scriber

Worn phonograph needles are excellent for scribing plastic and celluloid. At first, I used them in the end of a dowel to provide a convenient handle, but then I found that the needles could be inserted in an old mechanical pencil. This made it easy to replace the needles when dull and the clip on the pencil permitted carrying the tool in a pocket.

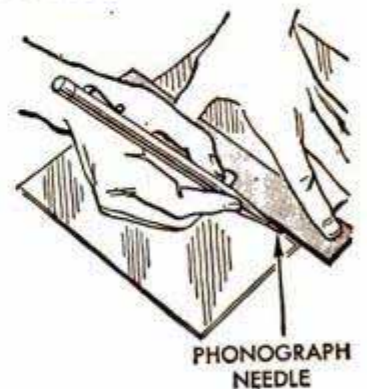

Victor H. Lamoy, Upper Jay, N. Y.

# FLOOR CARE

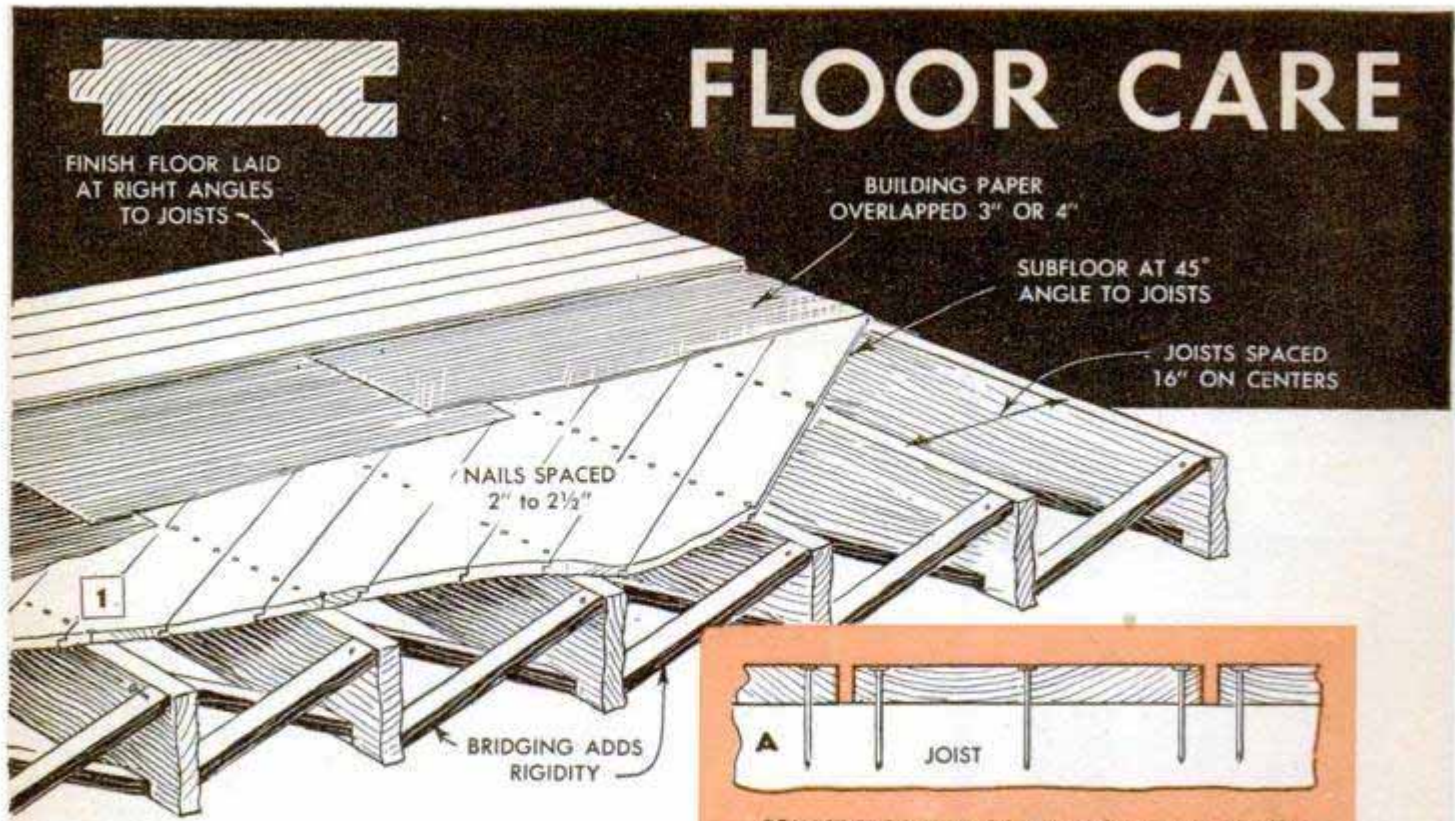

**AS FLOORS** are subjected to more wear and all-around harder usage than any other structural part of the home, they should receive proportionally more care. Fig. 1 shows the common construction of a wooden floor. In the best type of work, the subfloor is laid diagonally and the finish floor at right angles to the joists, with a layer of building paper between the subfloor and the top floor. In new construction, plywood also is extensively used for subflooring. It is important that the subfloor be nailed securely to the joists and that the wood be thoroughly dry. Square-edged subfloors, spaced  $\frac{1}{8}$  to  $\frac{1}{4}$  in., are used frequently in humid climates and where buildings are unheated. In laying this type of subfloor, 8 or 10d nails are driven straight as in Fig. 2 A. Tongue-and-groove subflooring, as well as finish flooring, is nailed with 8d flooring nails driven through the tongue at a 45-deg. angle, and spaced from 8 to 12 in. apart as in Fig. 2 B. Rabbeted subflooring, or shiplap, is nailed straight with 10d flat-headed nails spaced 2 to 2½ in. apart.

**Squeaking floors:** Shrinkage of wood often causes flooring to loosen slightly so that the boards rub on the nails and against each other, causing the floor to squeak when walked on. If the trouble is in the first floor, thin wedges driven between the top of the joists and the subfloor, as in Fig. 3, usually will stop the squeaks in that particular area. Where the tendency to squeak extends over a wide surface, strips of hardwood forced tightly against the underside of the subfloor and fastened with nails or

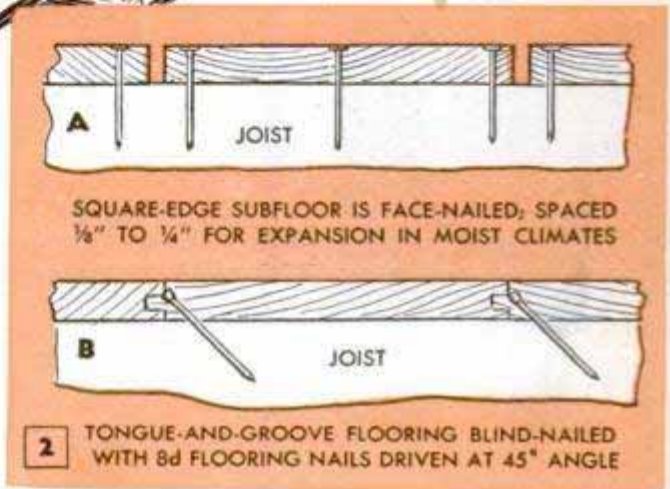

screws will help, Fig. 4. A squeaky second floor over a ceiling is a different problem. The simplest remedy is to drive flooring nails through both the finish floor and the subfloor into the joists. Fig. 5, details A, B and C, shows how to locate concealed joists. Slide a hardwood block along the floor at right angles to the joists, tapping it continuously with a hammer. When the block is directly over a joist the tapping gives off a solid sound, but anywhere between joists a hollow sound results. Determine the exact position of a joist by drilling a small hole close to the joist as in detail B. Bend a wire feeler as in detail C and insert this through the hole, turning it until the bent end contacts the joist under the floor. Mark the angle of the handle on the floor to locate the side of the joist. It is then easy to cross-nail the floor to the joist as in detail D. Avoid hammer marks on the floor by driving the nails only part way in, and sinking the heads below the surface with a nailset. After locating one joist in the manner described, measure 16 in. from its center to locate the next one. As a common joist spacing is 16 in. center-to-center, it is easy to drive the nails accurately by measuring 16 in. each way from the center of the joist first located. Nail holes in the

# and REPAIR

By E. R. Haan

What to do about floors that creak, sag or vibrate. Essentials on refinishing, re-surfacing, cleaning and waxing floors

floor are closed with filler stained to match.

**Squeaky stair treads:** On open stairs, it is possible to silence the squeaks by simply driving the wedges tight. These wedges will be found inserted between the treads and stringers on the underside of the stair. However, if the stair well is plastered under the stair it will be necessary to drive nails or screws through the offending treads into the risers or stringers as in Fig. 6. Counterbore the screw holes and after driving the screws, plug the holes with readymade screw-hole plugs of a matching wood—or better, with boat plugs which are cut at right angles to the grain. Sand the plugs flush, stain and refinish.

**Raising sagged floors:** Undue settling of floors at the center of the house often is due to rotting of wooden girder posts. In some cases uneven floors are caused by sagging of the girder between posts. To replace a post, first set up temporary supports on each side of the girder joint as in Fig. 7, with the lower ends of the supports resting on jackscrews. Make sure that the supporting posts are perpendicular, and raise the jackscrews until the weight is fully supported. Spike a 4 x 6-in. bridge block to the underside of the girder across the girder joint as in Fig. 8 and place a steel jack post as indicated, with its lower end bearing squarely on the concrete footing and its upper end centered against the underside of the bridge block. Now, being sure that the supporting jack post is perpendicular, tighten the jack at the top end to take the weight. The steel post is left in place permanently. Where additional supporting posts are required to straighten a sagging girder, it will be necessary to break up a portion of the concrete floor and pour a substantial footing for each post as in Fig. 9. After placing the jack post under a sagging girder, turn the jack up so that it takes the weight, and then raise the girder  $\frac{1}{8}$  in. at intervals over a period of time. In this way, loosening of framing nails and excessive cracking of plaster will be avoided.

**Vibrating floors:** Floors that vibrate when walked upon result from inadequate support, such as the use of joists which are too small in cross-sectional area, too long a

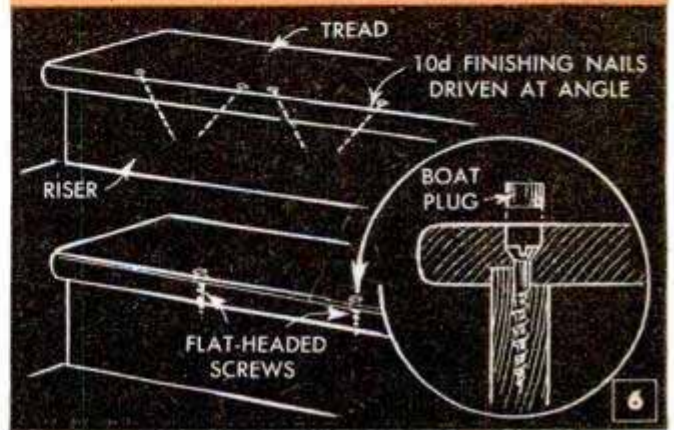
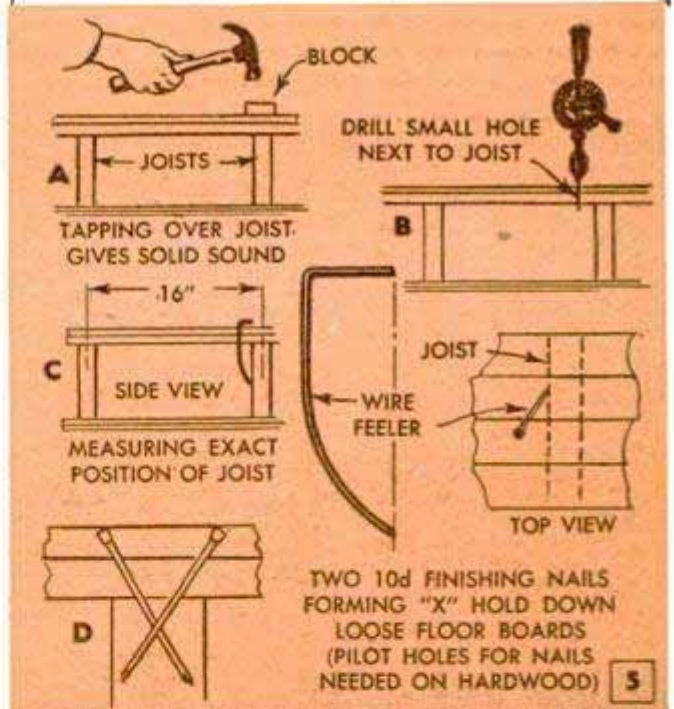
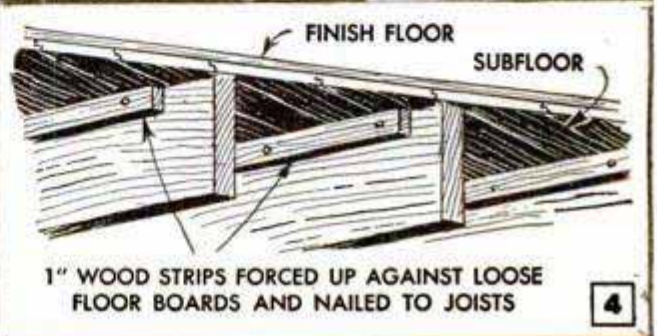

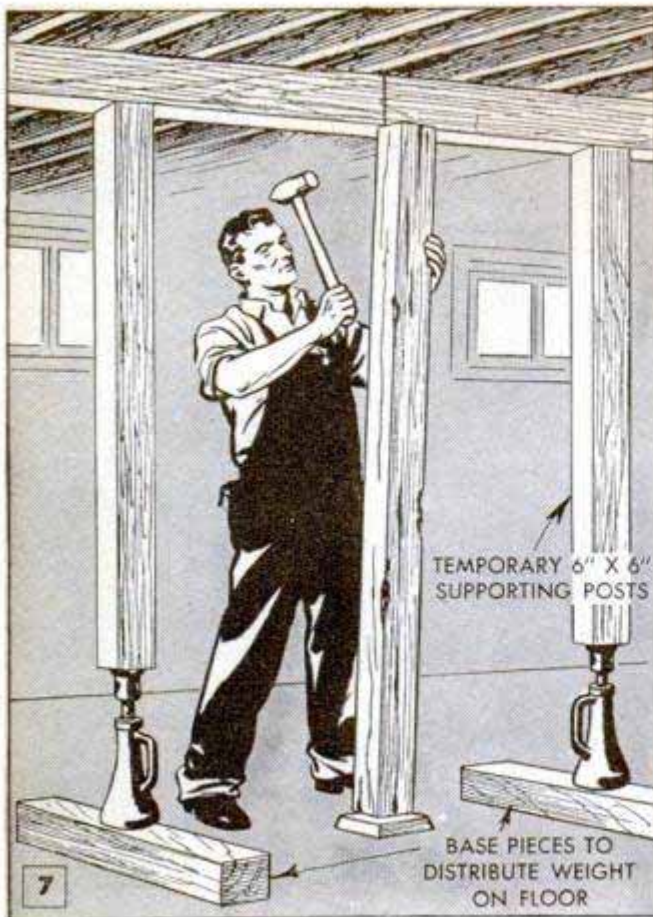

Above, to correct sagging of first floor, one or more temporary supports are placed under girder with the lower ends bearing on jackscrews. Below, the old post is then removed and replaced with a new-type steel post having a built-in jack for raising the girder



span between supporting girders, and insufficient or improperly located bridging between the joists, Fig. 1. There are several simple remedies that can be applied where the floor is open on the underside. Doubling the joists by nailing or bolting an additional member to each of those already installed often is practical and effective. Jacking up the floor from underneath and installing additional lines of bridging is nearly always a sure remedy. When vibration occurs in the second floor, the ceiling of the first floor may have to be opened to install bridging or extra joists.

**Gap at shoe mold:** Settling and shrinkage of wood often cause unsightly gaps between the baseboard and the shoe mold. Details A and B of Fig. 11 show what happens when the shoe mold is nailed either to the baseboard or to the finish floor. To make it easy to close these openings when they occur, the nails holding the shoe mold should be driven diagonally between the baseboard and the finish floor and into the subfloor as in detail C. This latter method of nailing can be used only if there is space equal to the width of the baseboard between the floor and wall. Otherwise, the only way to eliminate the gap is to re nail or replace the shoe mold periodically, Fig. 10.

**Refinishing wooden floors:** When hardwood floors are in good condition and the finish is not excessively marred or worn down to the bare wood in spots, refinishing without resurfacing, Fig. 12, is entirely practical. The floor should be thoroughly cleaned before refinishing, and all wax must be removed with turpentine. On ordinary work there is a choice of two types of floor finishes: (1) Floor sealers which penetrate into the wood, and (2) Floor varnish, shellac and paint, the latter three forming a coating on the surface. Floors treated with a sealer do not show scratches or streaks as readily as do varnished or shellacked floors. However, the sealers used alone are not as durable. The finish must be cleaned and renewed more frequently. Cleaning can be done with a me-

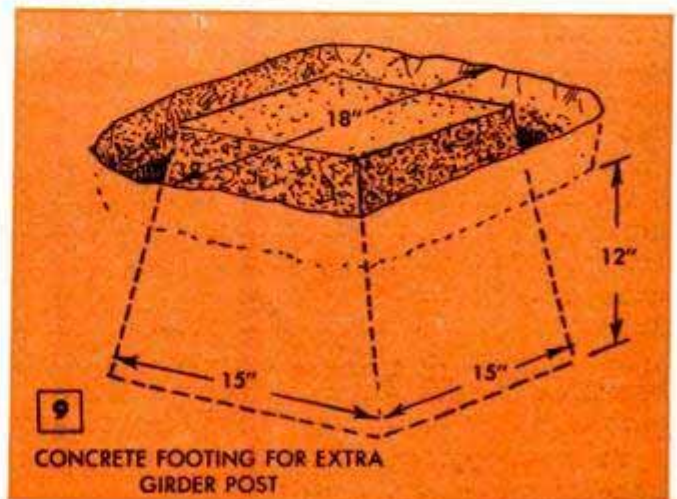



dium solution of trisodium phosphate. After washing the floor, there may be some discoloration and, if so, the wood can be bleached to a uniform color with a mild solution of oxalic-acid crystals (poison) and water. This is applied to the floor with a cloth swab and then rinsed off with clear water. Usually a single application is sufficient. Water in the solution will raise the grain of the wood, so, the floor should be sanded lightly before a finish is applied. (*Caution:* When sanding a floor on which a bleach has been used, wear a dust respirator.) Floor sealer must be laid on quickly, either with a wool applicator or with a wide-bristle brush, first working across and then with the grain. Allow the sealer to set for a few minutes and then wipe off the excess. When the sealer is dry, smooth the floor with No. 2 steel wool. When finishing a floor, start at the corner farthest from the door and cover the floor in strips 4 to 6 boards wide, ending up at the door opening. Clean up the dust as you go with a painters' tack rag and leave the window sash open at the top and bottom and the door slightly ajar until the finish is dry. White shellac is quite extensively used as a wax base on hardwood floors because it dries so quickly that the floor can be back in service within a day's time.

**Resurfacing wooden floors:** When a floor is uneven and its surface has become badly worn, resurfacing with a sanding machine, Fig. 13, will be necessary. These machines can be rented from most hardware and paint stores. Removal of varnish or paint will require the use of a No. 4 open-coat abrasive. After the finish is removed down to bare wood, use a No. 2 abrasive for reducing the deep scratches made by the coarse abrasive. Do not stop the machine while the sanding drum is in contact with the floor, but rather allow the machine to pull itself across the floor. After high spots and the old finish have been removed with the two coarser grades of abrasives, finish a hardwood floor with No. 1/2 or No. 0 abrasive. Most floor sanders will not run closer than 2 or 3 in. from the baseboard. This strip is finished with an electric edger, using the same abrasive grits as with the sander. Avoid getting the floor soiled or marked during or after sanding. If the resurfaced floor is to be stained, apply the stain first and then the filler, and after the latter is thoroughly dry, apply the finish. Use two applications of sealer and three coats of varnish on resurfaced floors. Allow 36 to 48 hrs. for drying between coats. Any type of floor wax can be used over floor sealer or varnish but do not apply a water-emulsion (self-polishing) wax over shellac.

**Painting concrete floors:** There are two general types of concrete floor paints, the

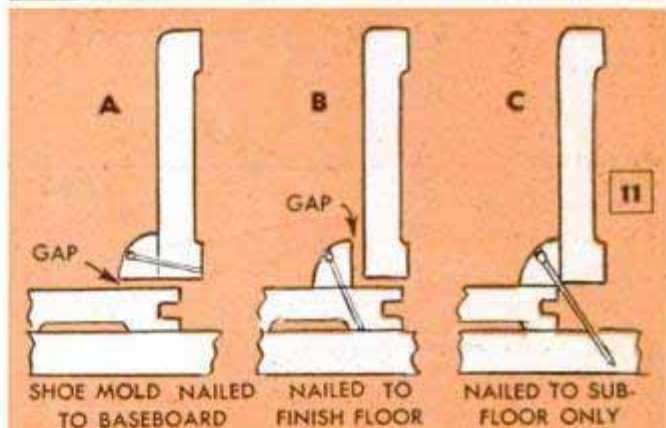

Shoe molds commonly are nailed to the baseboard or to the finish floor. Undue settling and shrinkage of wood in the framing often causes a gap to show under the shoe as at A, or, when nailed to the floor, as at B. To avoid these faults, the shoe mold should be nailed as in detail C. Then, when settling causes a gap to show in either position, it can be closed by simply driving the nails down as shown





13

ROLL ROOFING  
COATED WITH  
SPAR VARNISH

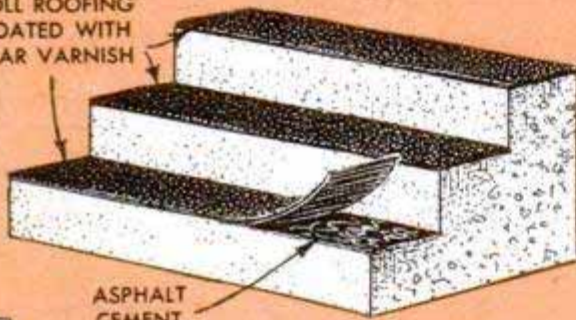

14

SMOOTH CEMENT STEPS MADE SLIP-PROOF



15

varnish-base enamel type and the rubber-base type. Use the former on concrete floors that are above grade and uniformly dry. The rubber-base concrete paints are suitable only for use on concrete floors below grade which are protected from direct sunlight. Rubber-base paints can be applied only to unpainted concrete floors, and should not be applied over any other type of paint. There also are combination concrete sealers and stains. These do not have the color brilliance of the others but do have an advantage in that worn spots can be finished to match other areas of the floor without producing a spotty appearance. In any case, new concrete should age for a year before being painted. Before painting, apply a neutralizer consisting of zinc-sulphate crystals, 3 lbs., dissolved in water, 1 gal. Concrete floors that have been troweled smooth should be etched to assure good adhesion of paint. An etching solution is made by slowly adding muriatic acid, 1 pint, to water, 1 gal., while stirring constantly. (*Caution:* Do not allow the acid or solution to touch the clothing or skin as it can cause severe burns. Avoid inhaling the fumes.) Apply the solution with a cloth swab, and allow to stand for 10 to 20 minutes. Then wash off with a soda solution to remove the acid and also to neutralize any remaining on the surface. Finally, flush off the floor with a quantity of clear water. To minimize dusting of unpainted concrete floors apply a hardener made by dissolving magnesium fluosilicate crystals, 2 lbs., in water, 1 gal. Allow the first application to dry 24 hrs. and then follow with a second application. This treatment may be followed by painting. Smoothly troweled concrete steps which are slippery when wet can be made slip-proof by etching as described, or by covering the treads with pieces of roll roofing laid on asphalt cement as in Fig. 14. The surface of the roofing is given three coats of spar varnish or enamel to bind the slate surfacing. Oil or grease spots on driveways and concrete floors can be removed by scrubbing with a solution of trisodium phosphate, 4 oz., and water, 1 gal. After scrubbing, sprinkle hydrated lime over the stained area and allow it to remain for several hours before sweeping it up. This will remove the oil, and generally most, if not all, of the stain.

**Floor coverings:** A common trouble with new floor coverings is lack of complete adhesion. When single tiles or blocks loosen, it will be necessary to remove the block entirely and replace it over new adhesive. To cement asphalt tile, use asphalt emulsion and spread it very thinly, as excess cement oozing up between the tiles may cause discoloration. The cement is allowed to set until tacky (unless instructions

direct otherwise) and then the tile is laid carefully in place. Asphalt tile can be cemented directly to smooth concrete floors above grade. On wooden floors, asphalt tile must be laid on an asphalt-impregnated felt cemented to the floor with lignin paste. Edges of the felt are butted, not lapped. Wooden flooring blocks can be easily cemented directly to concrete or wood with a hot asphalt cement specially made for the purpose. Lignin paste is used to cement cork and linoleum floor coverings. If the floor covering must be cleaned frequently by mopping or flushing with water, it is best to use resin cement and asphalt-impregnated felt as a base. For bonding rubber tile, lignin paste, rubber cement or latex cement may be used.

**Cleaning and waxing floors:** Varnished or shellacked floors which are not waxed should be cleaned with an oiled mop. Floors coated with a sealer can be washed with a slightly soapy water, rinsed with a wet cloth and then wiped dry. Clean waxed floors with a soft floor brush. Do not use an oiled mop as oil softens the wax. To remove embedded grime, rub lightly with a soft cloth wrung out in warm, soapy water. Clean painted concrete floors with plain water. Linoleum floors that are not waxed or lacquered are washed with a mild solution of trisodium phosphate, care being taken that water does not seep under the edges to loosen the adhesive bond. Rubber-tile floors should not be cleaned with hot water. Use a solution of household ammonia in cold water. Most common stains on rubber floor coverings can be removed by rubbing the stained area with No. 00 steel wool. Cork flooring is ordinarily cleaned with a floor brush or a dry mop. If it is very dirty and soiled, use warm, soapy water applied with a cloth or sponge. Rinse and dry the floor immediately. Cleaners and polishes containing oils should not be used on asphalt tile. The common floor waxes are of two kinds: (1) The paste and liquid waxes having volatile organic solvents, and (2) the water-emulsion waxes which are known as nonrubbing or self-polishing. The former require polishing either by hand or with an electric polisher, Fig. 15. Apply wax in thin coatings, each coat being wiped on at right angles to the previous one.

### Increasing Efficiency of Spray Gun Powered With Vacuum Cleaner

When using a tank-type vacuum cleaner to power a spray gun, remove the dust bag and cap from the intake end of the cleaner. This increases the pressure and the volume of air passing through the spray gun.

Mak Mulcahy, Las Cruces, N. Mex.

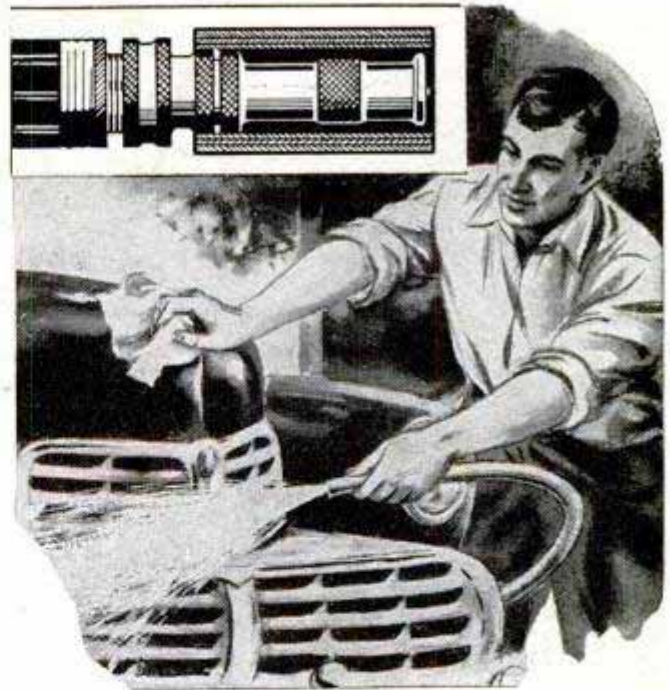

### Guard Over Garden-Hose Nozzle Prevents Marring Car Finish

To be sure that the finish of your car is not scratched when washing it with a garden hose, slip a short length of hose over the nozzle, allowing it to project about  $\frac{1}{4}$  in. beyond the end. This will not interfere with normal adjustment of the spray and will keep the end of the nozzle from rubbing against the paint when spraying in close quarters.

John Kretschmar, Monsey, N. Y.

### Fan Placed on Electric Range Dries Hair Quickly

Setting a fan on an electric range so it blows across the burners provides an efficient hair drier. Turn the burners to "high" and sit as shown in the illustration. Thus, the hot air from the burners will be blown through your hair to dry it quickly. Do not use this method on any range that has an open flame, as the flame may be blown out or possibly ignite your clothing or hair.

Wayne C. Stauffer, Eugene, Ore.



# Your Iceboat "Scoot"

The unique arrangement of the sail and rigging plan of Scoot will be apparent as soon as you begin construction of the parts. This special rigging is the secret of the extraordinary sailing qualities that make Scoot a top-flight performer

By Doug Rolfe

## Part II

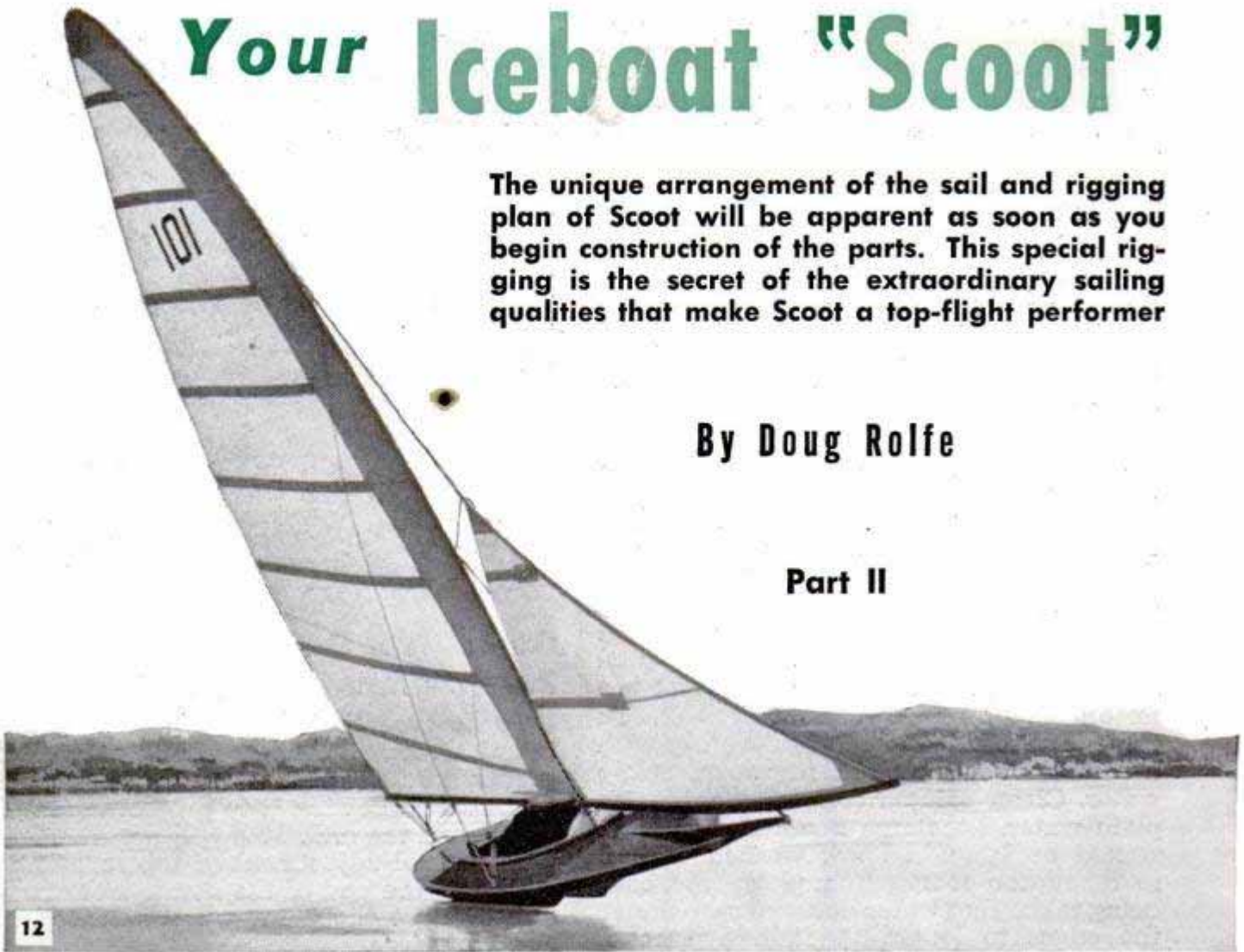

**I**N THE photo above you see "Scoot" in action, heeled over to starboard with the flat, streamlined hull bearing on only one runner and the sail rig trimmed for full drive on the long reach of the port tack. Note the trim, hard set of the sail rig, the smooth, tight curve of the hook mast and the pivoted jib boom carried on a specially designed horn, or bowsprit. This special rigging of the jib sail, which is used as a rudder, gives Scoot that quality of instantaneous rudder response so essential in a racing iceboat.

With the hull completed as described in Part I, the first step in fitting rigging is laying out and bandsawing the horn, Fig. 13.

The horn should be very carefully fitted to the curve of the deck, and then tapered and chamfered. The  $\frac{5}{8}$ -in. bolt which holds the horn in place, and at the same time makes it readily detachable, passes entirely through the breast hook. The aft end of the horn is held in a U-shaped clip, Fig. 16, which is screwed to the deck. The smooth round-bottom notch for the jib-boom ring fitting, Fig. 16, is formed by sawing down the sides, and smoothing with a wood rasp and fine sandpaper. A standard tiller-rope guide for the mainsail sheet, Fig. 22, a 7-in. traveler and cleats for the main and jib-sail sheets are the only other permanent deck fittings.

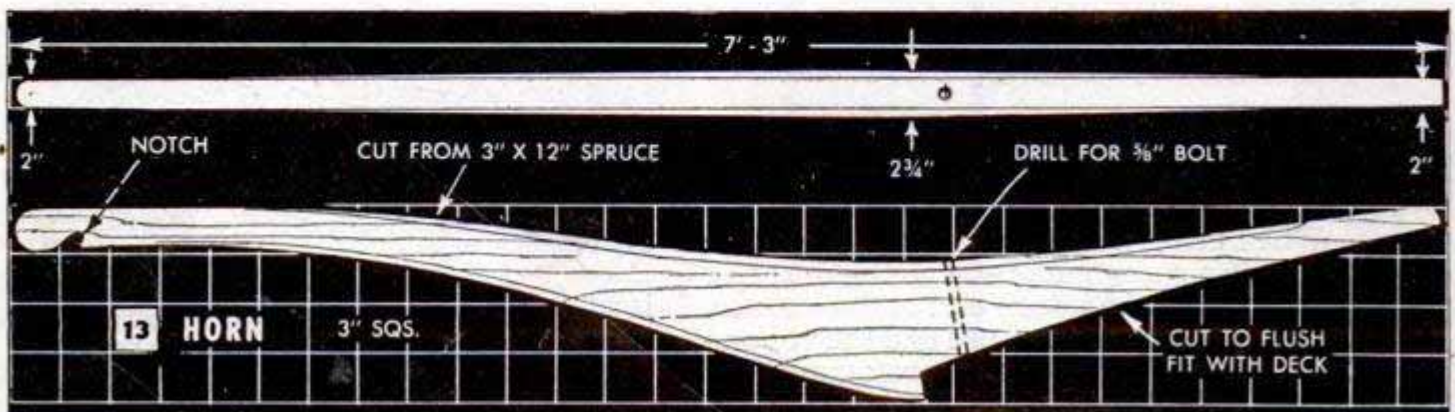

**14** **DETAIL OF MAST HOOK**

TAPER TO KNIFE EDGE ON AFT SURFACE

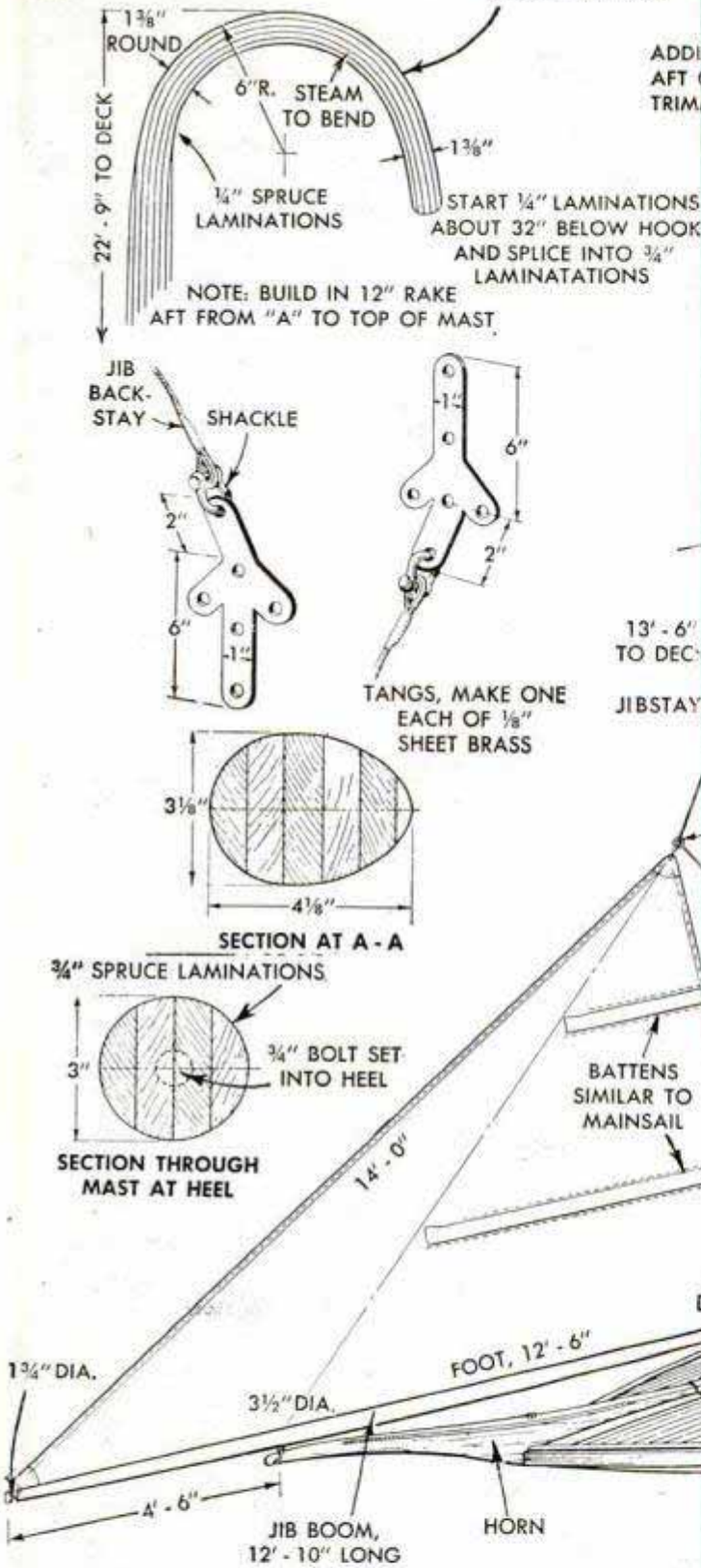

**15** **SAIL PLAN AND RIGGING DETAILS**

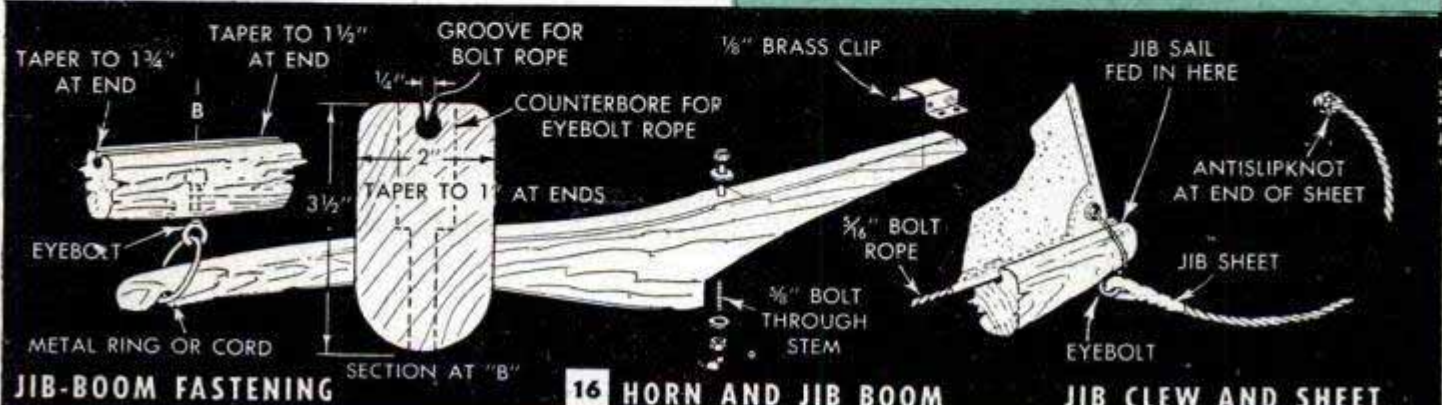
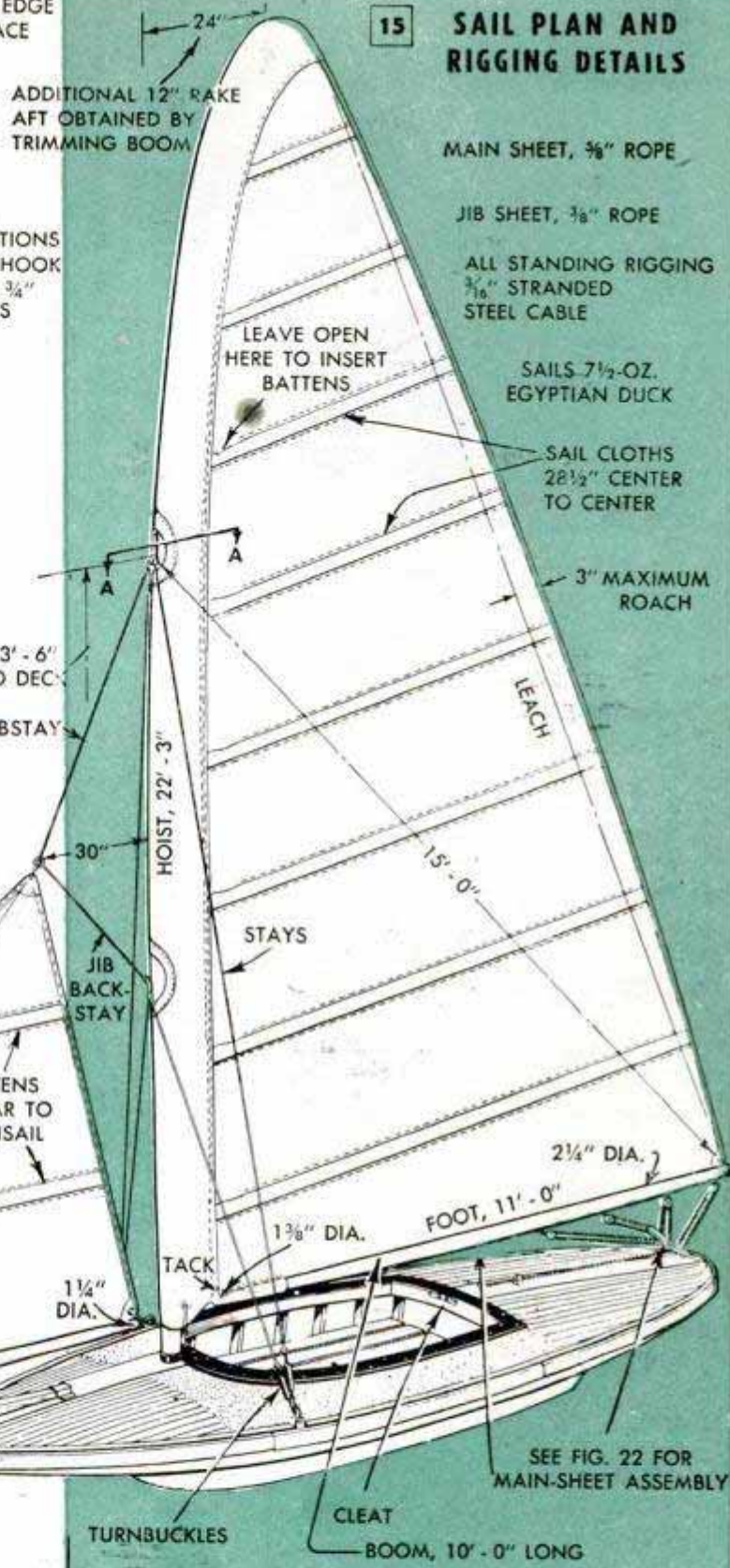

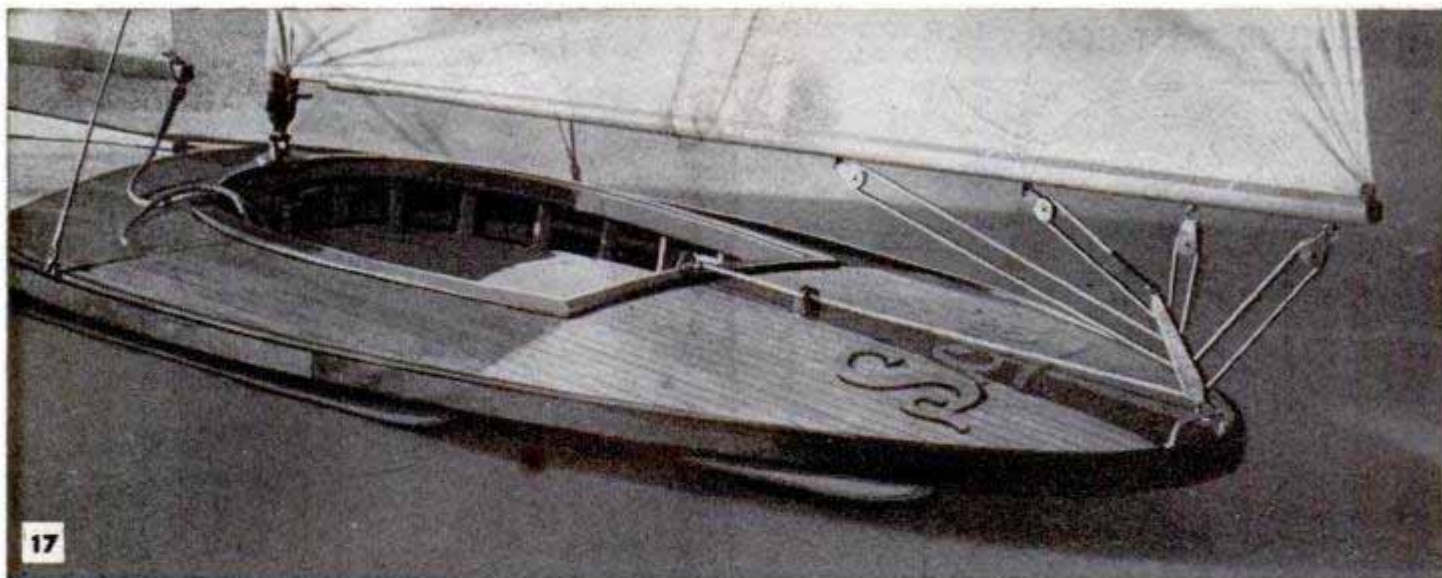

When fully rigged, Scoot looks like this. Note the roomy, shallow cockpit and the novel boom tackle for trimming the mainsail to suit wind conditions. Foot of the mainsail is attached to boom with bolt rope

The mainmast, Fig. 14, is built up to the required size by laminating selected spruce in a rectangular cross section, using both  $\frac{1}{4}$  and  $\frac{3}{4}$ -in. stock. By constructing a bending jig on a level floor of sufficient length, the mast can be built up in one operation. Stock for the hook section must be steamed before bending. Rip the  $\frac{3}{4}$ -in. stock for the lower section to  $3\frac{1}{4}$  in. in width and glue and clamp it into the improvised jig with C-clamps. Use waterproof glue. The ends of the outside members project about 32 in. (See note on the upper detail in Fig. 14.) As the  $\frac{1}{4}$ -in. laminations are built up in the jig, make sure that all joining flat surfaces are coated

liberally with waterproof glue and that the C-clamps are equally spaced and tightened to a uniform tension. Allow the glued-up mast to dry 24 hours before removing the clamps. Now, note from Fig. 14 that the mast is round at the heel, but that it changes gradually to a pear shape at section A-A, Figs. 14 and 15, and then back to a round section at the forward turn of the hook bend. From this point the section again changes to an elongated oval with a knife edge on the after turn of the bend, Fig. 14. Shaping of the mast is done by hand with a spokeshave. It is then sanded smooth and finished with at least two coats of spar varnish.

In the original rig, both the jib and the mainsail booms were of one piece cut from solid stock and grooved along the length for the bolt rope, Figs. 16 and 21. The mainsail boom is

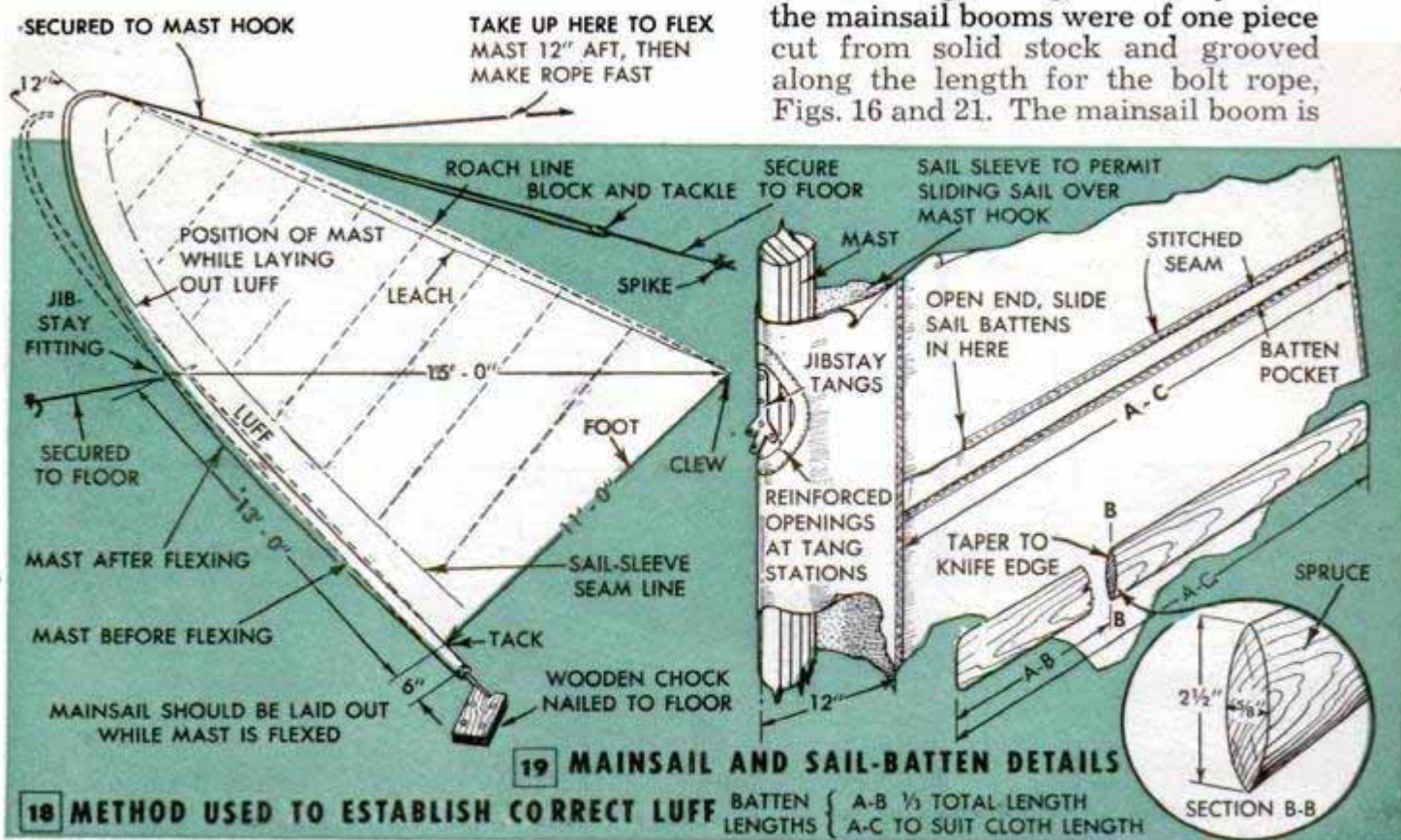

circular in section, but the jib boom tapers each way from the ring fastening and the section is rectangular with rounded corners, Fig. 16. However, it is easier to form the special undercut grooves if the booms are each made in two pieces and glued together after forming a round-bottom groove, or flute, in each piece. When the pieces are glued together, this will result in a single deep groove with a circular undercut as in the sectional view, Fig. 16. Finish the booms by sanding smooth and coating with spar varnish. Making the main and jib sails is a job for a professional sailmaker unless, of course, the builder has had experience in this work. Note from Fig.

21 that the mainsail boom is carried in a pocket sewed onto the foot of the mainsail. There is no gooseneck as in conventional rigging. Also, the builder will have to work closely with the sailmaker in establishing the luff of the mainsail, Fig. 18. The mast must be flexed with a tackle block in the manner shown, and it must be held in this position while laying out the luff of the mainsail. The luff, or leading edge, is in the form of a pocket, or boot, large enough to slip over the mast, Figs. 15, 18 and 19. No sail track is used, the luff being held taut by a short lashing made fast to a downhaul cleat, Figs. 17 and 21. Neither can the mainsail be raised or lowered once it is fully rigged. Instead, Scoot is simply tipped on her side as in Fig. 20 when mooring. Note in Figs. 12, 15 and 19 that both the jib and mainsail are fitted with special batten pockets, double-stitched at the edges. The pockets have open ends, Fig. 19,

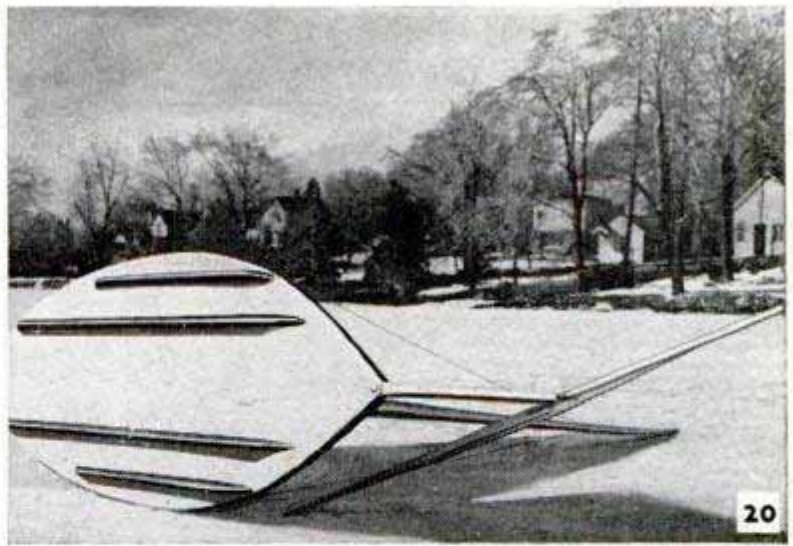

The mainsail cannot be raised or lowered once it is fully rigged. When not in use for short periods, Scoot is tipped on its side

so that the battens may be inserted and removed easily. The battens are of selected spruce, worked down to an elongated oval section with sharp edges. In addition, each batten is tapered slightly both ways from section B-B, Fig. 19, to a blunt edge at the ends. The multiple-sheave sheet yoke, Fig. 22, is another special part and must be made up according to the detail. It is essential that all sheaves turn freely. The yoke is attached to the traveler by means of a ring bolt as shown. One end of the sheet is passed through the drilled ends of the yoke straps and is seized to the standing part. Then the free end of the sheet is passed through four eye blocks attached to the boom on the spacings indicated and successively through the four sheaves to make the novel dual-purchase tackle shown in Fig. 22. Tie an antislipknot in the end of the sheet. Then, check for free running of the rope through the blocks.

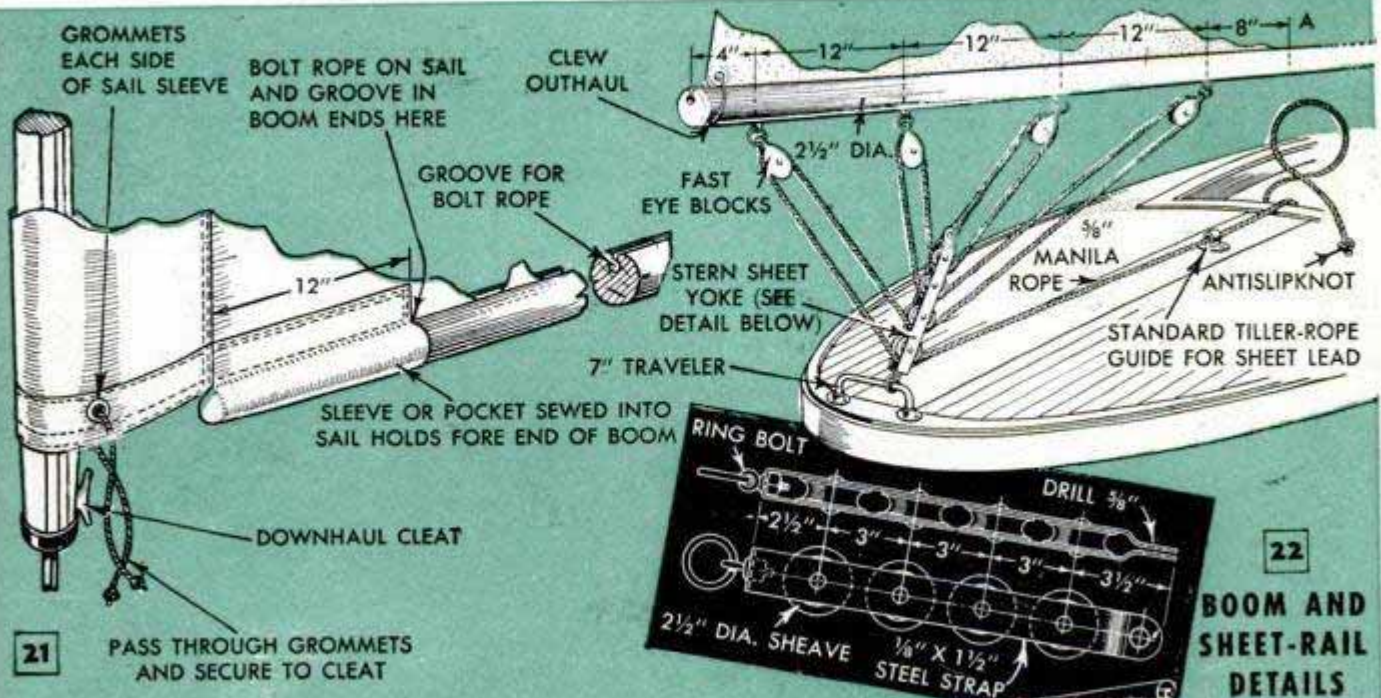

## Sidewalk Snowplow of Sheet Metal Mounted on Lawn Mower



Shoveling snow from the sidewalks around his home is no longer a back-breaking job for one homeowner who uses his lawn mower to push a lightweight snowplow. The latter is cut and bent from a piece of sheet metal and it is made wide enough to extend beyond both wheels of the mower. The plow is attached at the center with a flat-iron brace bolted to the mower handle and, at the sides, with additional braces notched to fit over the mower crossbar. The braces can be either bolted or riveted to the sheet metal. A strip of flat iron, bent at the center and riveted across the bottom edge of the sheet metal, adds rigidity to the plow. Note that the cutting reel and roller are temporarily removed from the mower and, on certain types, the bedplate also can be removed.

Paul J. Pirmann, Webster Groves, Mo.

## Improved Modelmaker's Clamp

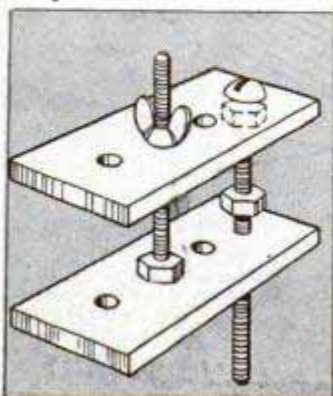

If you need an extra modelmaker's clamp, two steel mending plates and a couple of stove bolts can be used to improvise an inexpensive and satisfactory substitute. As shown in the drawing, the end

bolt, which is used for over-all adjustment, is tightened securely to the top plate and has an adjusting nut to keep the two plates separated. The second bolt is slipped through either of the three remaining sets of holes and the nut is tightened to the lower plate. A wing nut turned on this bolt draws the plates together to clamp the work.—John Behall, Richmond Hill, N.Y.

## Cork Sheathes Blade Point

Before carrying a paring knife or scissors in an apron pocket, press a small cork over the end of the blade to sheathe the sharp tip. This not only will keep the point from cutting through the fabric but will reduce the possibility of injury.

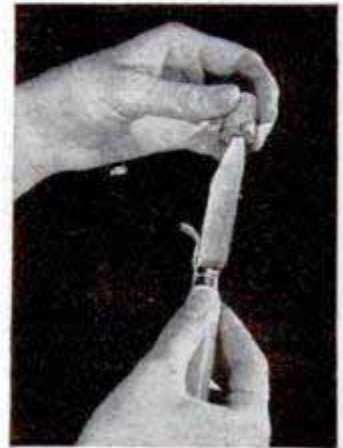

## Gluing Model Airplanes Simplified

When gluing wing and fuselage framing of model airplanes directly on a pattern, lay a sheet of wax paper over the pattern before setting the members in position. The wax paper will prevent the parts from sticking to the pattern.

Thomas Fuscaldo, Paterson, N. J.

## Glass Container for Toothbrush

A toothbrush can be safely carried in an overnight bag or make-up kit if it is inserted in a glass tube of the type in which toothbrushes ordinarily are sold. A small cork pressed into the open end of the oval-shaped tube keeps the brush from slipping out, yet allows air to enter.

Helen Lemberger, Chicago.





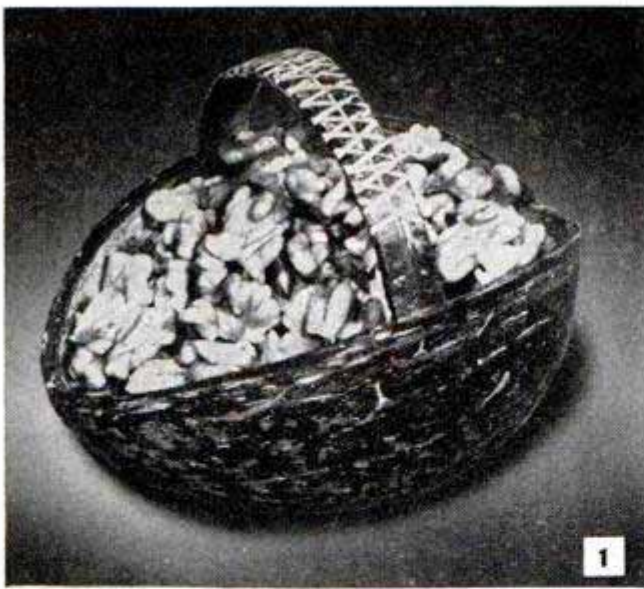

# COCONUT-SHELL BASKETS

*By Elma Waltner*

**U**SEFUL, attractive baskets are easily made from coconut shells, either by utilizing the shell alone or by combining parts of it with plastic handles or other ornamentation in color. Figs. 1 and 4 show a basket made from the whole shell, two sections of one side being cut away, leaving an integral handle. The cutting must be done with a fine-toothed saw blade so that the individual teeth do not bridge the rim of the shell and leave a rough surface. An ordinary hacksaw is just the thing for all straight cuts which must be made through both sides of the shell simultaneously. The rough, fibrous coating of the shell is removed with a wood rasp and the hard surface is smoothed with sandpaper. The ridge pattern can be preserved in low relief by sanding only the tops of the ridges, or a rather unusual finish can be had by first sanding to smooth the ridges and then working the surface with a wire scratch wheel. This treatment brings out the ridge pattern in bolder relief. Another shell basket, Figs. 2, 3 and 4, features a removable cover, a handle of colored plastic and a separate base, or collar, into which the basket fits snugly. It is made from portions of two shells and two pieces of colored plastic. Select two coconuts for uniformity of shell contour for this job. After cutting and smoothing the edges so that the parts fit together neatly, drill holes in the cover for the plastic ring, Fig. 4, and drill and slot the collar to take the ends of the twisted plastic handle. Heat the plastic to 250 deg. for bending and attach it to the shell with quick-setting cement. Finish the baskets with shellac, then wax and polish to a high gloss.

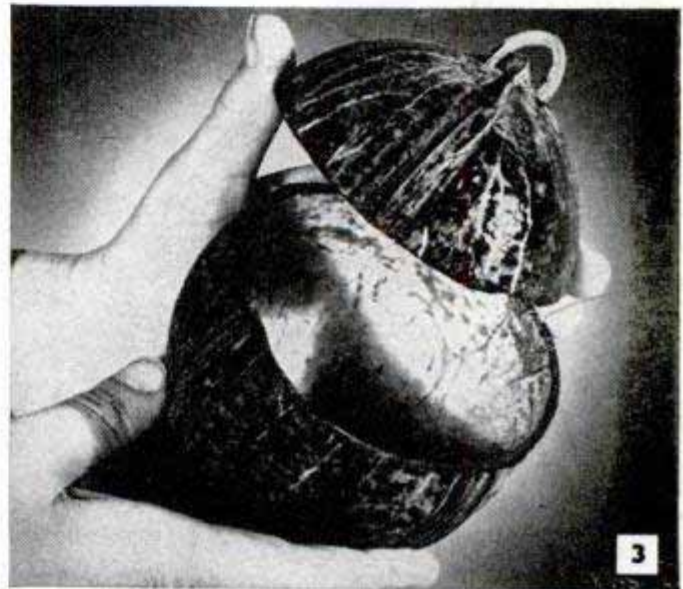

# Dual-Purpose

By Alexander Maxwell



IN IMPROVISED darkrooms where temperatures are likely to vary just enough to produce a sluggish developer at the critical moment, this simple three-stage hot plate will stabilize the solution at 70 deg. F. even when the temperature in the room drops to 50 deg. Just set the developer tray on the unit, place a thermometer in the solution and turn on one, two or three of the switches as required. The heating unit also is valuable in the propagation of temperature-sensitive tropical plants which cannot be exposed to temperature changes during winter months in the colder climates. Potted specimens, which also must be protected from drafts, are placed on the hot plate and covered with glass bottles or jugs from which the bottoms have been removed. The hot plate can be turned on and left in operation for months if necessary without harming the plants or the unit.

The heat source is three incandescent tubes which are supported inside a light-tight box fitted with a metal top. A con-

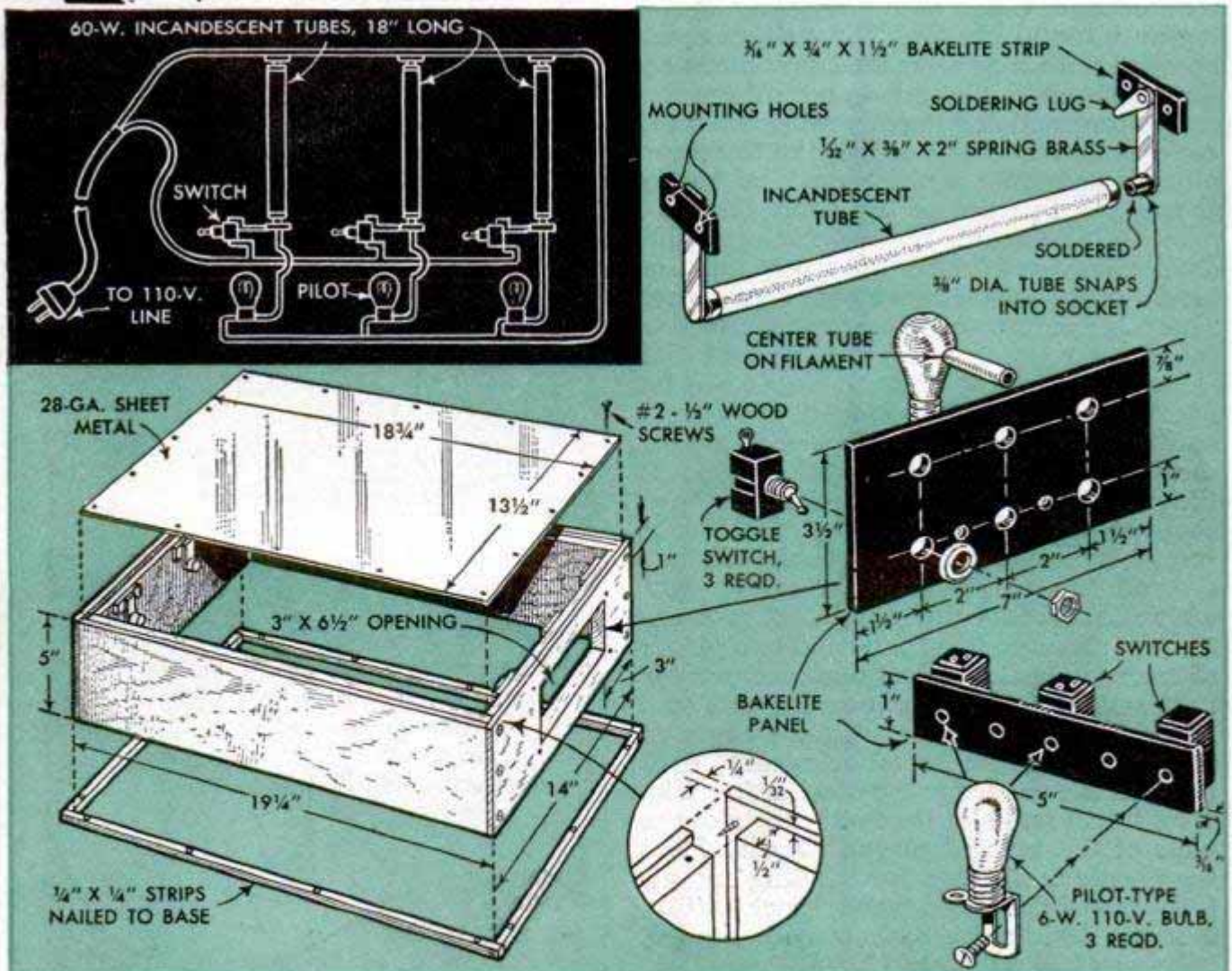

# Hot Plate

control panel having three toggle switches permits individual control of the incandescent tubes. First, construct a bottomless box of the over-all dimensions indicated in the detail below on the opposite page. Rabbet the top edges of the side and end pieces before assembling the parts with waterproof glue and screws. Use an ordinary drawing board for a base. Place the box on the base and mark lines around the outside to aid in locating the  $\frac{1}{4} \times \frac{1}{4}$ -in. strips which form the light trap at the bottom. Next, mount the tubes in the box, spacing them equally across the width. Cut a  $3 \times 6\frac{1}{2}$ -in. opening in one end of the box and fit the control panel. Then drill the panel for the switches and also the metal tubes centering on the pilot lamps. If desired, the holes for the tubes can be counterbored to take small plastic bezels in red. With this arrangement of the pilot lamps, it is easy to tell at a glance either in the darkroom or elsewhere how many of the incandescent tubes are switched on. Wire the unit as indicated in the wiring diagram on the opposite page. Now, coat the rabbeted top edges of the box with a gun-grade calking compound and screw the metal top, or plate, in place. Make sure that the metal is flat, without bulges at any point to form a light leak. Check for leaks by turning all three incandescent tubes on in a darkened room. Drive rubber-headed tacks into the base at the four corners to



form feet. Paint all the exposed parts with two coats of flat black, applying with a spray gun, if possible, to give a smooth, uniform job. Although not necessary, it is possible to add in some small measure to the heating efficiency by painting the inner surfaces of the sides, ends and bottom of the box with two light coats of aluminum paint applied with a spray gun. This should be done before the electrical fittings are installed and before the top is screwed on.

## Filing Cabinet Utilizes Cigar Boxes for Holding Classified Negatives

In order to file several hundred negatives sorted into a dozen general classifications, one photographer made a simple

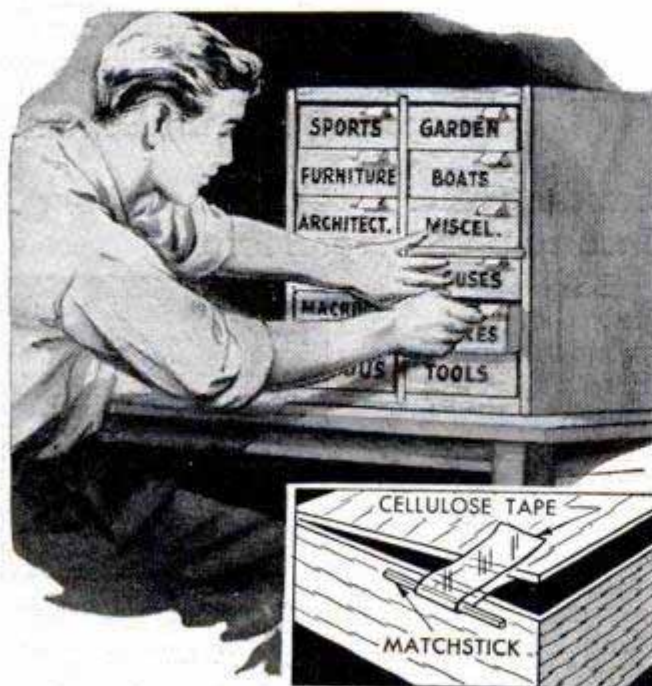

wooden filing cabinet, using ordinary cigar boxes as drawers. Although the original cabinet was divided into four sections, each holding three cigar boxes, it can be made to any size or shape required. The top, bottom and shelf are of  $\frac{3}{4}$ -in. solid stock and the sides and center partition are  $\frac{1}{4}$ -in. plywood. The cigar boxes, which will hold negatives up to  $5 \times 7$  in., are fitted with tabs to facilitate pulling them individually from their position in the cabinet.

## Shadowless Table-Top Shots

When you wish to make shadowless shots of small objects try this stunt. Place the objects on a white window shade. Then, with the lens stopped all the way down, use a photoflood lamp and make several exposures of one-second duration, changing the position of the lamp each time. Thus, by illuminating the background from different angles, converging shadows are nullified, resulting in a print completely void of shadows.

## Drop Outlets on Flash-Gun Extensions Prevent Pulling Cords in Front of Lens

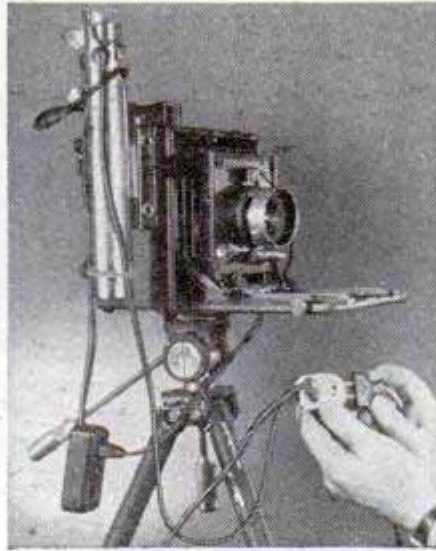
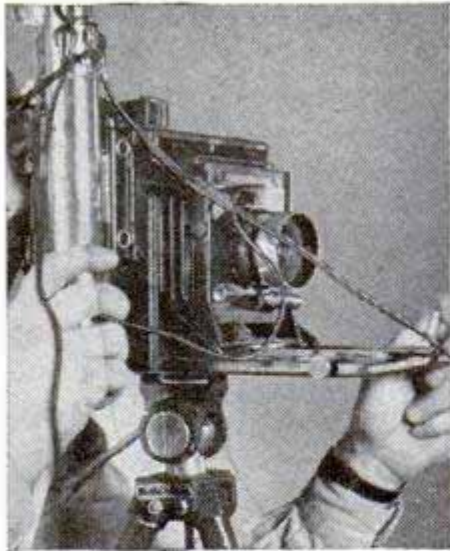

One photographer uses a couple of 2 or 3-way female plugs suspended from drop cords on the flash gun. This eliminates the possibility of side-light extension cords being pulled across the front of the lens as in the left-hand photo. The right-hand photo illustrates how this method lowers the extension below the camera. One to three extension cords can be used from each flash-gun receptacle, and the drop cords are taped to the lower part of the gun.

Frank P. Fritz, Chicago.

## Proper Diaphragm Opening Indicated By Handy Table Taped to Camera

On bellows-type cameras equipped with optical range finders, this handy table will instantly tell you the correct opening at which the diaphragm should be set for various ranges. The table must be used in conjunction with a constant flash-bulb size and shutter speed. Mark a short strip of waterproof adhesive tape to duplicate the spacings on the camera distance scale. Then, knowing the size of the bulbs you will use and determining the preferred shutter speed, calculate the diaphragm opening for the various ranges. Type these settings on the tape opposite the corre-

sponding marks and attach the tape to the camera bed in the same position as the distance scale but on the other side of the lens. Place a small piece of tape on the movable slide to serve as an index mark to indicate clearly the diaphragm opening on the table.

Kenneth Murray, Colon, Mich.

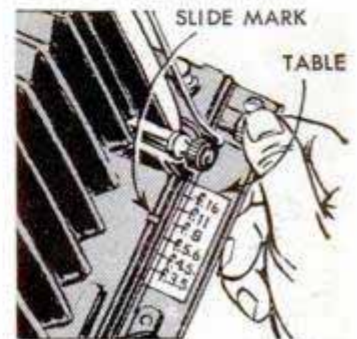

## Photo Outlined With Luminous Paint Brightens Youngster's Sleeping Room

A cutout photo of a pet or favorite toy outlined in luminous paint adds a cheerful note to a child's sleeping room after it has been darkened for the night. Using a 5 x 7 or 8 x 10 enlargement of the desired photo, carefully cut out the subject, such as the dog shown in the illustration. Then paste the cutout on a background of heavy colored paper. With a watercolor brush, apply yellow phosphorescent paint to the paper

around the edges of the cutout, stirring the paint often to be sure it flows evenly. Before painting the eyes, nose and other lines which run over the print itself, scrape off the emulsion with a sharp knife or razor blade. The picture can be framed in a regular mat-type photomount.

Betty Scheyer, Los Angeles, Calif.



## Sanding New Wooden Photo Tongs Insures Undamaged Prints

Before using a pair of wooden print tongs for the first time, it is a worth-while precaution to sand the inside edges smooth. In this way, you can insure against splinters or rough spots on the surfaces of the tongs marring the emulsion on the paper.

Virginia Hanson, Santa Monica, Calif.



# Lamp Dries Ferrotyped Prints Without Curling

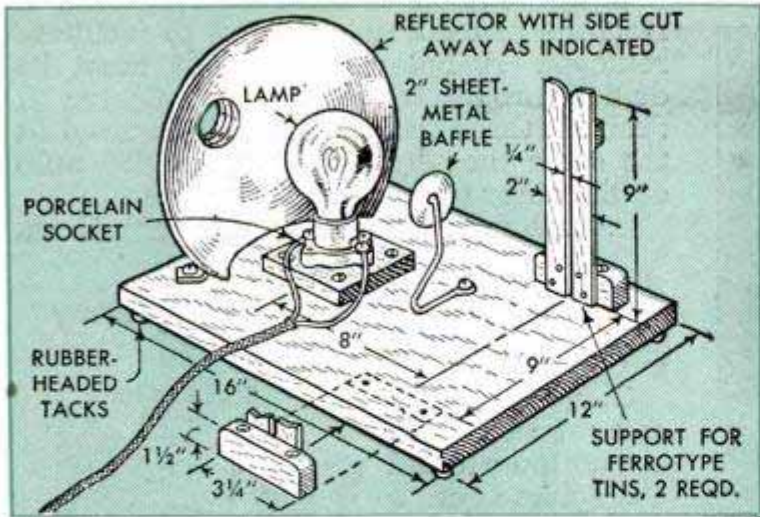

This print drier is designed especially for those whose photo hobby does not permit the expenditures necessary for professional drying equipment. The unit detailed is extremely simple to construct. The parts are arranged to utilize the heat from a special infrared lamp of 250-watt capacity to dry ferrotyped prints at a slow, uniform rate which prevents curling or cracking. The reflector is made by altering a 10 or 12-in. metal reflector of the type used for photoflood lighting. It is mounted at one end of the plywood base by means of small metal angles which are cut from light sheet metal and soldered to the back of the reflector. The angles are attached to the base with screws. Next, a porcelain socket is centered directly in front of the reflector. The metal baffle is supported by a wire holder screwed to the base. The center of the baffle should be at the same level as the lamp filament and about 4 in. in front of it. Ferrotyping tins

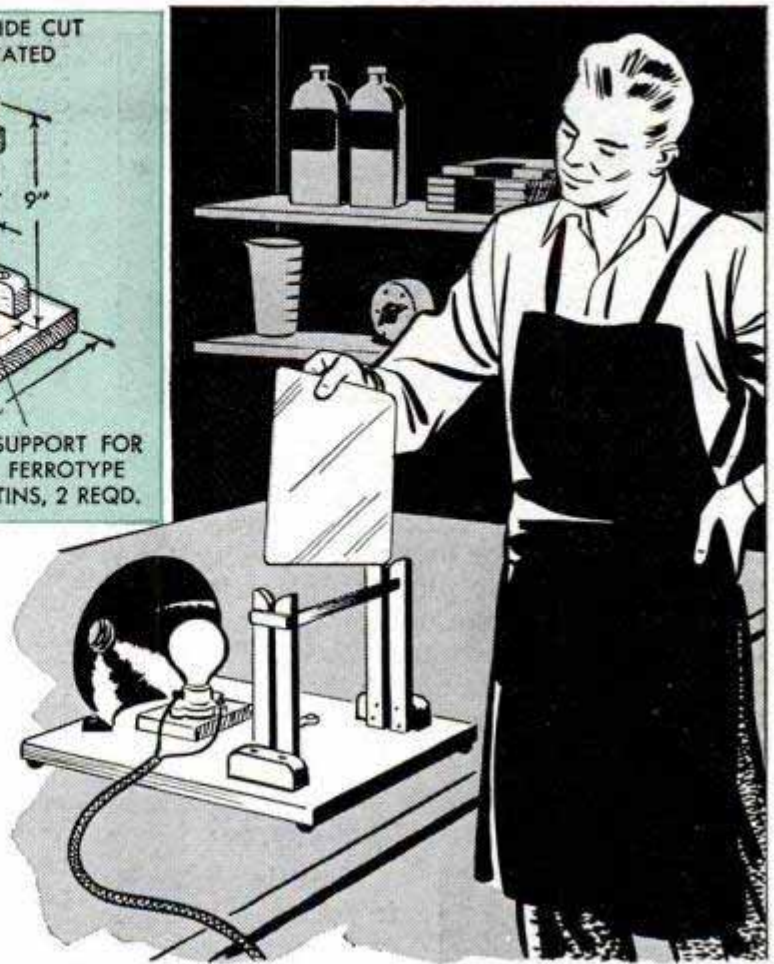

are supported in a vertical position in two special holders or guides, attached to the plywood base with screws in the manner indicated. Note that the distance from the lamp to the ferrotyping tin is given as 8 in. This is the minimum distance which is used for fast drying but for all-around work the distance may be increased to 9 in. At this latter distance, the drying time for the prints is approximately 25 minutes.

E. Peter Smith, Los Angeles, Calif.

## Paper Cut-Film Separators Hold Chemicals for Weighing on Balance

The black paper separators found in a package of cut film are a handy item to keep around the darkroom for weighing

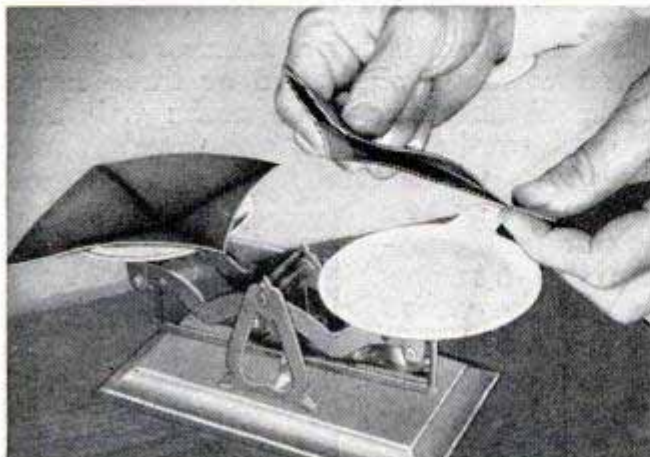

powdered chemicals on a balance. As these sheets of paper are identical in weight, using one of them to hold the chemical on one scale of the balance and another under the weight on the opposite scale will give accurate results. The sheets are creased diagonally between opposite corners to facilitate pouring the powder without spilling.

## Viewer Aids Color-Slide Projection

To make the showing of color transparencies to his friends more interesting, one photographer glances at each slide in a viewer before inserting it in the projector. In this way, he knows exactly which scene is going to be shown next. The dim light from the viewer is not distracting.

## Heating Pad Under Developer Tray Controls Solution Temperature

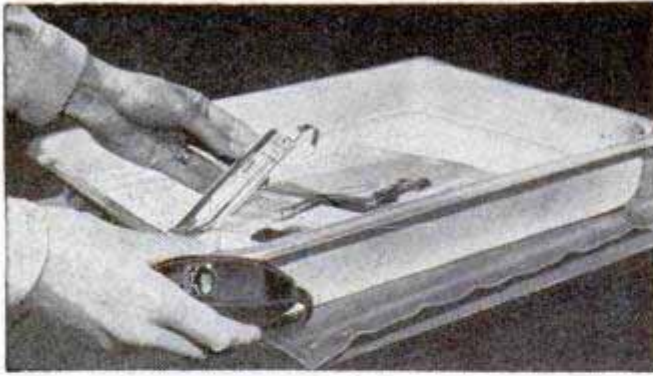

Because of the loss of heat through evaporation, it frequently is difficult to keep the developer solution within the temperature range necessary for best print quality. One way to do this is to place an electric heating pad, having a manual temperature control, under the developer tray. Then, by checking with a thermometer and adjusting the pad, the temperature of the solution can easily be kept within proper range.

## Salt Softens Contrasty Picture



If it is difficult to get a good range of tones from a contrasty negative even when using a soft grade of paper and diluted developer, add an ounce or more of table salt to the developer solution to soften the tone of the print. Because of the many variables, the exact amount of salt for best results must be determined by experimentation.

## Flash Bulbs Fired Simultaneously By Contact-Ignition Method



When an extra amount of light is necessary, it can be obtained by firing two flash bulbs simultaneously in the same reflector. This is done by placing a second bulb in contact with the one being fired. To mount the second bulb in the reflector, solder a threaded receptacle from an

old lamp socket to a length of stiff wire. Then bend a loop in the other end of the wire and bolt it to the reflector, using a machine screw and wing nut to facilitate removal. A hole for the bolt must be drilled through the side of the reflector. If desired, three flash bulbs can be fired at the same time by mounting a third bulb on the other side of the center one.

Arthur Trauffer, Council Bluffs, Iowa.

## Correcting Off-Color Transparency For Improved Projection

Covering an off-color transparency with colored Cellophane or a piece of color filter will considerably improve its quality when projected. If the transparency appears overly blue, use a yellow filter; if it is too yellow, use a blue filter, and so on.

When in doubt, the necessary correction can be determined by viewing the transparency through filters of various colors.

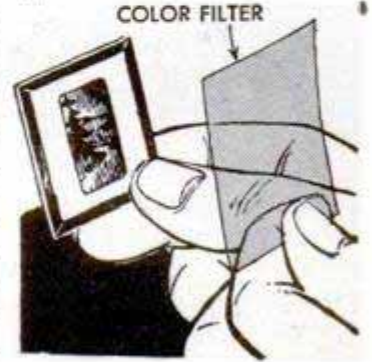

## Tape Stuck to Glass Funnel Permits Steady Flow

Liquid will flow more steadily from a glass funnel into a bottle if a strip of adhesive tape is fastened to the funnel as shown. The tape prevents air-lock by holding one side of the funnel slightly above the neck of the bottle.

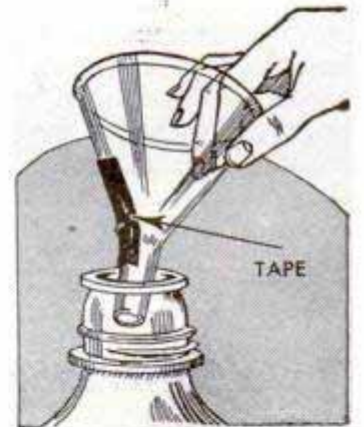

## Corks Floating in Washing Tray Keep Prints From Sticking

To keep prints from sticking together when washing, place two or three large corks in the tray. The corks will bob around in the current and break apart the prints which tend to stick, thus producing better washing and eliminating stains frequently caused by prints adhering to each other. — Harper Lyon, Topeka, Kans.

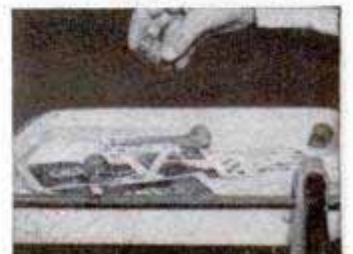



# SHOP NOTES

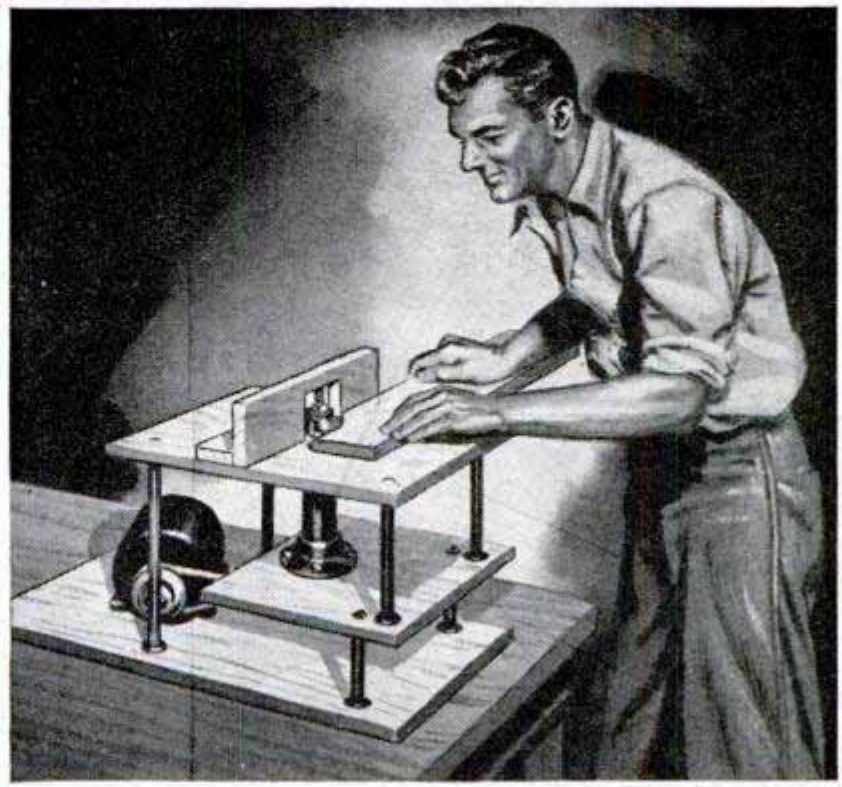
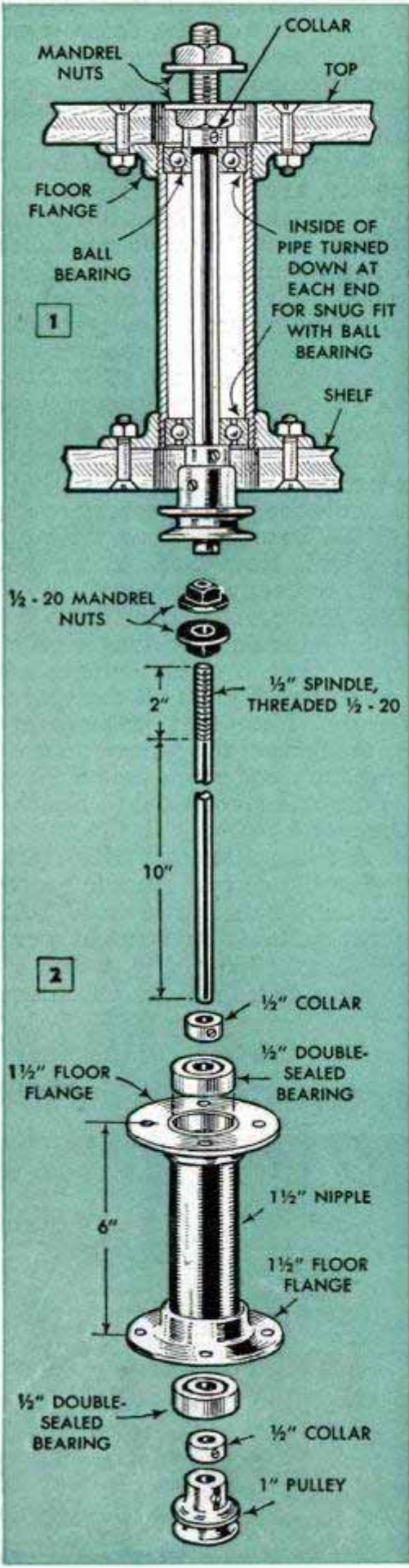

## WOOD SHAPER from pipe and plywood

By Evan Wright

HOME CRAFTSMEN and small woodworking shops having only occasional use for a shaper will find this unit practical and inexpensive to build. It handles any standard three-lip shaper cutter having a 1/2-in. hole and also safety cutterheads with removable knives. The spindle is mounted on sealed ball bearings which permit it to be driven at the high speeds necessary to produce smooth work. A 1/4-hp. motor supplies ample power for average work. The motor is mounted in the horizontal position and drives the spindle with a half-crossed round belt. By simply shifting the belt, the rotation of the spindle can be reversed, a requirement on some types of shaper work where separate cuts must be made on the top and bottom edges of the work. The spindle is made from a 12-in. length of 1/2-in. steel shafting. Cut a 1/2-in. No. 20 thread on one end for a distance of 2 in. It is best to cut this thread in a lathe if possible, as it is important that the thread be cut true with the axis of the spindle. The spindle housing, Figs. 1 and 2, is made from a 1 1/2-in. pipe nipple 6 in. long, and two 1 1/2-in. pipe floor flanges. Note in Fig. 1 that the pipe nipple is bored at both ends to house the ball bearings. This must be done in a lathe. To assemble the spindle unit, press the bearings in place

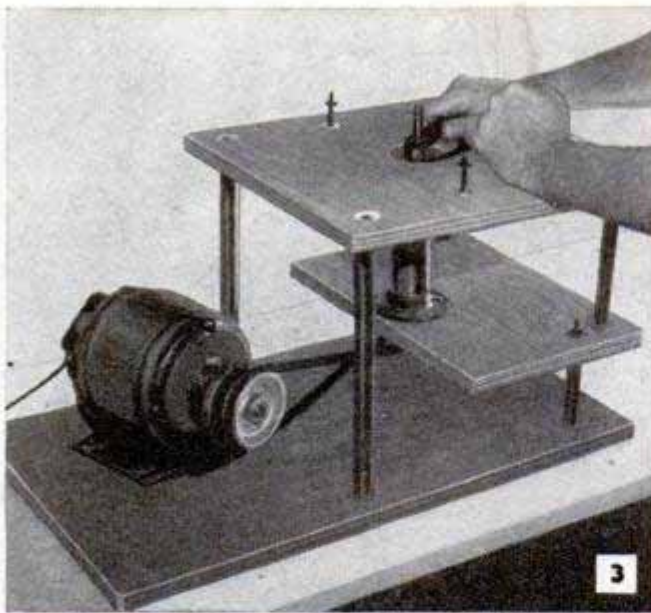

3

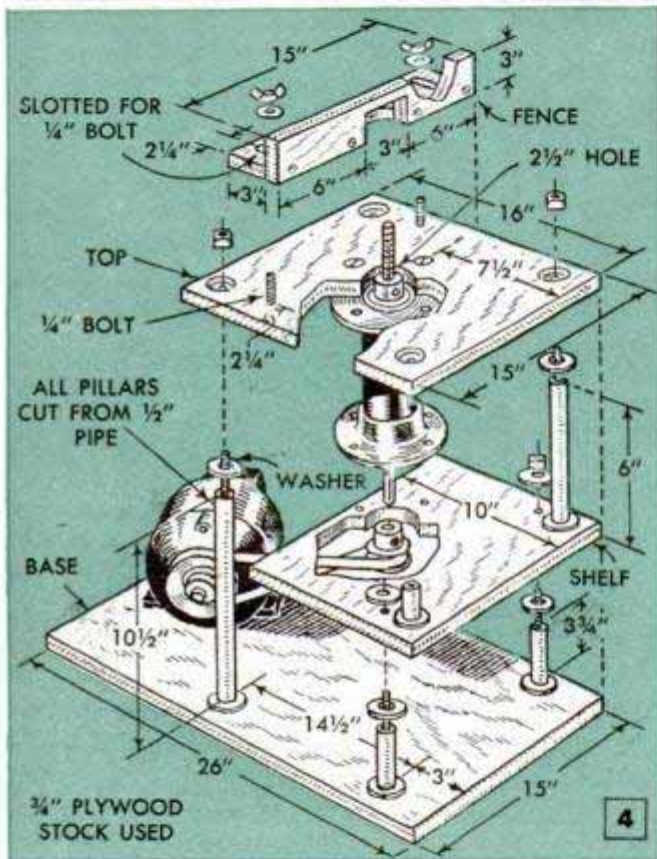

4

and then tighten a  $\frac{1}{2}$ -in. collar on the shaft just below the lower end of the thread. Pass the shaft through the bearings and tighten a second collar on the unthreaded end. This collar must fit snugly against the inner race of the bearing, Fig. 1. Then screw a floor flange on each end of the pipe housing but do not draw these up tightly. Now, note the manner of assembling the three-part frame which provides a table, a shelf support for the spindle assembly and a base for the motor, Figs. 3 and 4. The pipe pillars, or posts, which also serve as spacers, are cut from  $\frac{1}{2}$ -in. pipe to the lengths given. The base, shelf and top are cut from  $\frac{3}{4}$ -in. plywood and holes are drilled and counterbored in the positions indicated. Bolt the shelf to the base first, passing the bolts through holes drilled in the base, through the pipe spacers and through the holes drilled in the shelf. Support the shelf in the level position and set the spindle assembly in place. Then locate the table over the spindle and assemble all spacers between the top and the shelf. Finally, assemble the long spacers between the top and the base and draw the nuts down finger-tight. Now check to see that the spindle fits correctly between the shelf and the table. If necessary, adjust it to the proper length by turning the flanges off or on the nipple. Then bolt the spindle assembly in place and tighten all the spacer bolts uniformly. Note that washers are placed over the ends of the spacers to prevent crushing the wood when the bolts are tightened. Locate the motor on the base by lining up the motor pulley with the axis of the spindle. A 3-in. pulley on a 3450-r.p.m. motor will give the correct spindle speed. Use either a round belt or a  $\frac{3}{8}$ -in. V-belt. A simple fence suitable for straight work can be made as detailed in Fig. 4, and an adjustable shaper fence may be purchased if desired.

## Water Level Maintained in Range Trough By Float-Controlled Valve

To solve the problem of maintaining a constant supply of fresh water for his range flock without the bother of opening and closing hydrants at regular intervals, one poultryman replaced the faucets on several hydrants with float-controlled valves. To make suitable watering troughs that would require a minimum of attention, he cut old hot-water tanks in half lengthwise and placed one end of each trough under the float valves as pictured. When the water is turned on at the source, the troughs fill and thereafter the float valve permits the supply in each trough to be continually replenished without further attention.

A. M. Wettach, Mt. Pleasant, Iowa.

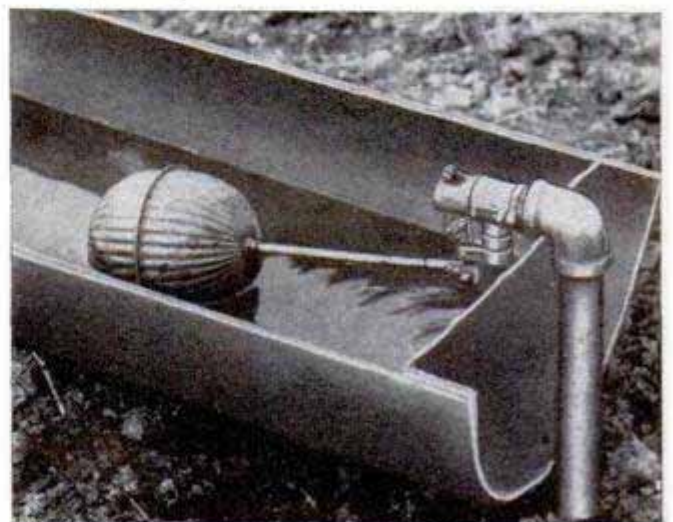



# Automatic Straightedge Utilizes Odds and Ends

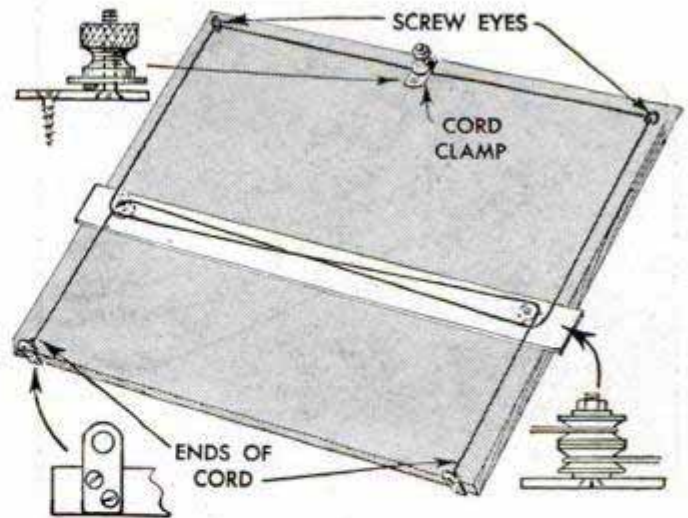
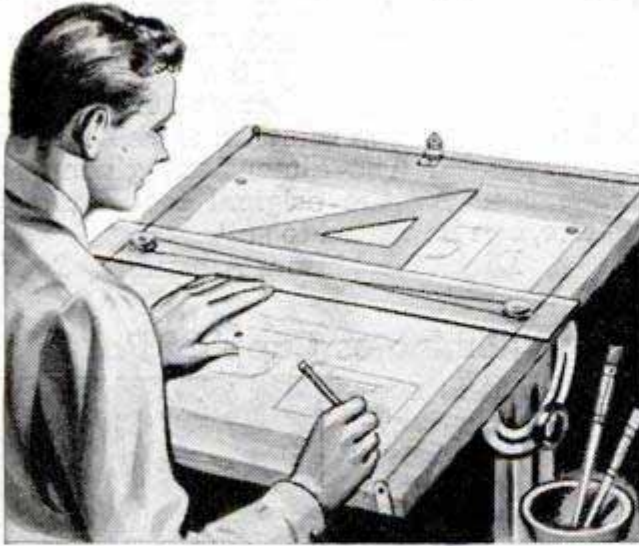

Operating on the same principle as the more costly professional type, this automatic draftsman's straightedge can be made quickly from scraps found around the home. A pulley-and-cord arrangement keeps the straightedge parallel with the position in which it has been set regardless of where it is moved along the height of the board. Double-groove pulleys attached near each end of the straightedge are made from flanges cut from the ends of thread spools. These are slipped over a flat-headed bolt and held together with a nut and washer. The bolt is first inserted through a countersunk hole in the straightedge and a washer is placed over the bolt to form a bearing surface for the pulley. Two screw eyes are turned into the surface of the drawing board at the upper corners, a metal anchor plate is fastened to each of the lower corners and a cord clamp is mounted at the top of the board. The clamp consists of a small piece of sheet metal, a knurled nut, a bolt and a washer which are assembled as shown in the upper left-hand detail. The countersunk bolt head is sol-

dered to the sheet metal to keep it from turning. After the straightedge has been adjusted to the correct position, the knurled nut is tightened, clamping the cord between the washer and the base. Begin threading the unit by tying the cord to the anchor in the lower left-hand corner of the board. Bring the cord up and over the bottom groove of the left-hand pulley and then along the straightedge to the bottom groove of the right-hand pulley. The cord is brought below the right-hand pulley and up through the screw eye in the upper right-hand corner. Then, pass the cord under the clamp, through the screw eye in the left-hand corner and down around the upper groove of the left-hand pulley. Again, bring it along the straightedge, crossing over the first pass and around the upper groove of the right-hand pulley to the anchor in the lower right-hand corner of the board. Finally, pull the cord taut and tie it to the anchor. Braided steel cable can be used in place of cord to eliminate the possibility of stretching.

Wm. E. Danneman, Chicago.

## Skids Under Platform of Large Self-Feeder Permit Easy Transport

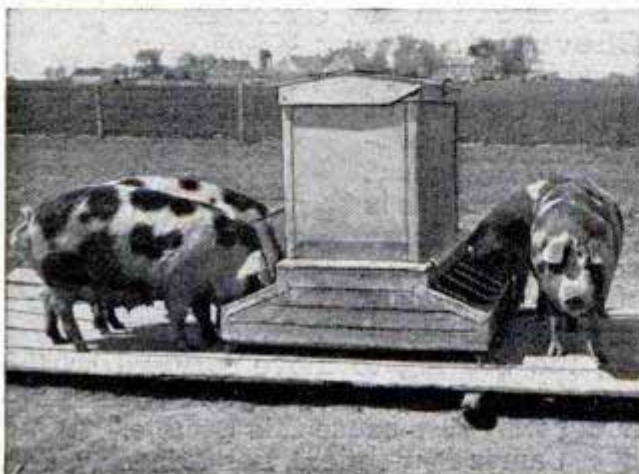

It is a growing practice among hog raisers to place large self-feeders on wooden platforms mounted on skids so the whole unit can be moved to a new location with a tractor. This promotes cleanliness, minimizes feed waste and lessens the chance of disease. The platform can be constructed of 1 x 4-in. stock laid over 2 x 4 or 2 x 6-in. skids spaced 18 to 24 in. apart. Some builders use 2 x 4s for the platform and also 2 x 4s spaced 18 in. apart for the skids. The platform should be about 4 to 6 in. wider than the feeder and 8 to 12 ft. long, depending on the size of the feeder. All edges are rounded to prevent injury.

## Tractor Exhaust Heats Blowtorch



If you happen to be working where a truck or tractor is available, you can pre-heat a blowtorch in a hurry by idling the engine and holding the nozzle of the torch over the exhaust. In about 30 seconds, the hot exhaust will heat the torch sufficiently for quick ignition, eliminating the bother of burning gasoline in the preheating pan.

P. R. Wilson, Brooklin, Ont., Can.

## Novel Spring-Brass Tweezers Retrieve Small Parts

A useful item for the shop or garage, these long-handled tweezers permit retrieving small parts that have fallen into hard-to-reach places. The tweezers are

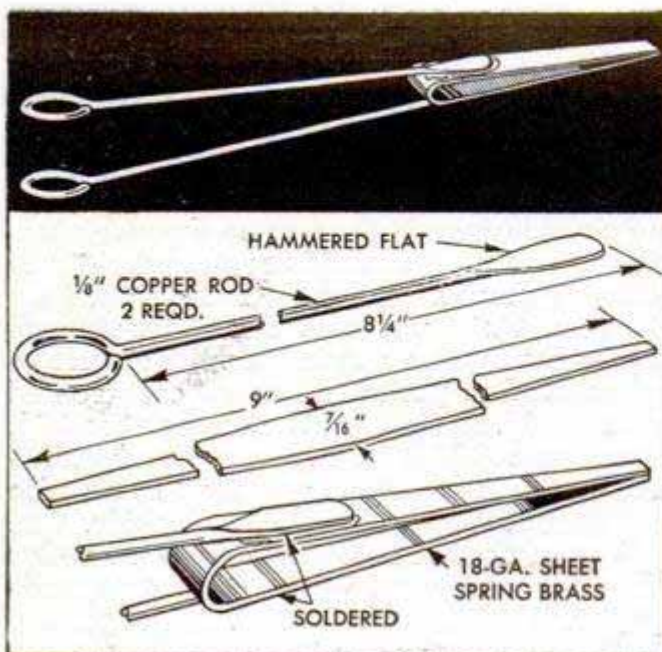

made by tapering and bending a length of 18-ga. spring brass, back on itself to form two tapered legs, or jaws, of equal length. Pieces of  $\frac{1}{8}$ -in. copper rod are used for the handles. After one end of the rod is formed into a loop and the other end hammered flat, the flat end is soldered to the side of the tweezers. The dimensions given are those used for the original tool, and, of course, can be varied to suit.

Dick Hutchinson, Alhambra, Calif.

## Cover Eliminates Capping Paints

When it is necessary to use several jars of show-card colors on a job, time can be saved by leaving the jars uncapped and protecting the paint by placing the jars under a large glass or metal cover. A bell-type butter-dish cover or one from a cake tray or bun warmer will do nicely.—G. E. Hendrickson, Argyle, Wis.



## Yoke "Weans" Self-Sucking Cow

Bandsawed from hardwood, this improvised yoke offers a sure way to cure a cow of the undesirable habit of self-sucking. The front of the yoke is attached to a halter and the back, which is slotted, is held with a belly-band. Although the yoke restricts sideways movement of the animal's head, it does not interfere with normal feeding.

Peter Krueger, Altona, Man., Can.

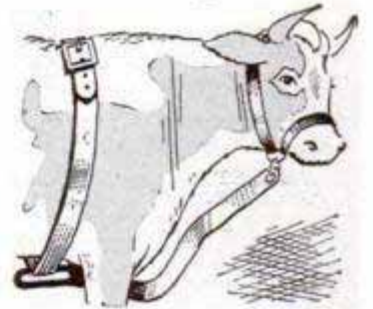

## Correcting Trouble in Shifting Gears By Tightening Bearing Retainer

Sometimes Chevrolets are brought into our garage because of difficulty in shifting into high gear. We find that this is often due to loose screws on the clutch-gear bearing retainer, allowing the bearing to move forward so the gears do not mesh properly. A cracked retainer may also cause this trouble.

James Crutchfield, Long Beach, Calif.

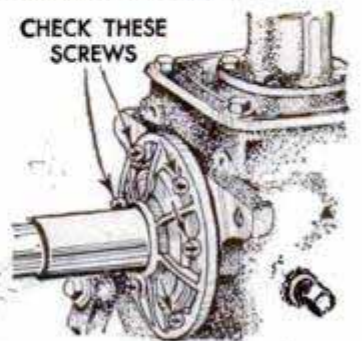

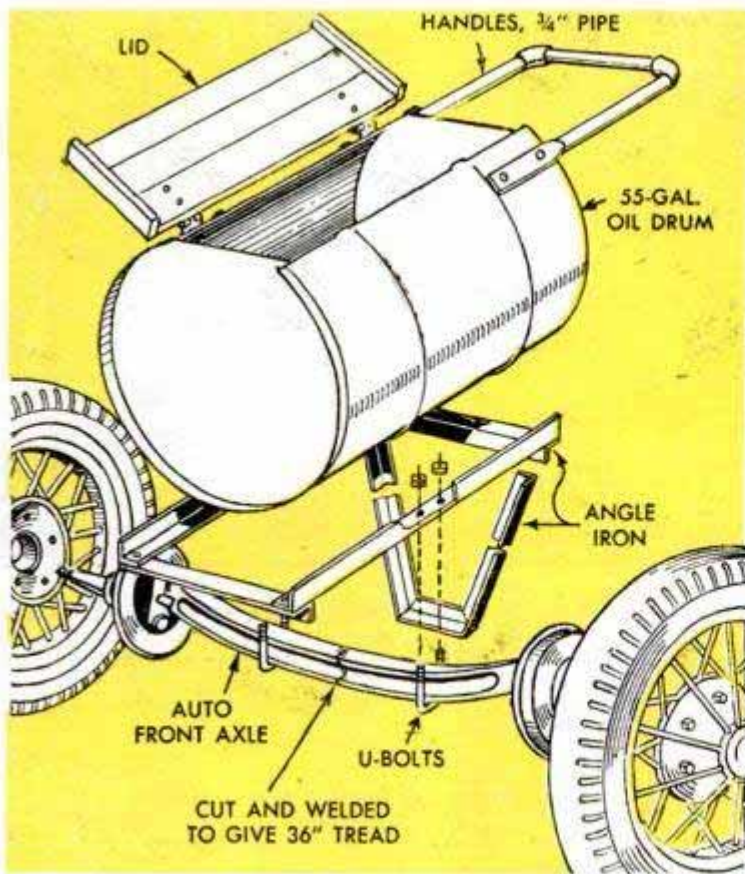

## Narrow-Tread Feed Cart Saves Time in Dairy Barns

Made from an oil drum, a few odds and ends of pipe and angle iron and a Model-A Ford front axle with wheels and tires, this feed cart is now saving one dairy farmer time and labor and preventing waste of dry feeds. To permit the cart to pass through the narrow passageway in front of dairy-barn stanchions, the Ford axle is cut and a section removed to give a tread width of 36 in. when the two parts are welded. With this tread width the cart also can be used in the narrow aisles between

farrowing pens and in large poultry houses for transporting either wet mashes or dry feeds. Build a cradle from angle iron to support the drum and attach it to the axle with U-bolts. Weld an angle-iron foot, or support, to the front end of the cradle frame as in the detail. Then cut one side from the oil drum and also cut a section from each end to form a rectangular opening. The hinged wooden lid is optional. Assemble a handle from pipe as detailed.

O. A. Fitzgerald, Moscow, Idaho.



## Inexpensive Forge for Farm Shop Utilizes Old Vacuum Cleaner

Needing a small forge for my farm shop, I made one inexpensively by utilizing an oil drum as a coke pit and an old vacuum cleaner as a bellows. A large opening was cut in one side of the drum and three channel-iron legs are welded to the bottom. Flat-iron cross braces welded between the legs formed a platform for the vacuum cleaner. I used a length of attachment hose to pipe the air from the cleaner to the coke pit.—J. D. Comstock, Pueblo, Colo.

☛ New coats of white paint on buildings in hog lots often look prematurely shabby because of the hogs soiling the lower boards by rubbing against them. The soiled boards won't be noticeable if the lower portion of the building is painted gray or black.

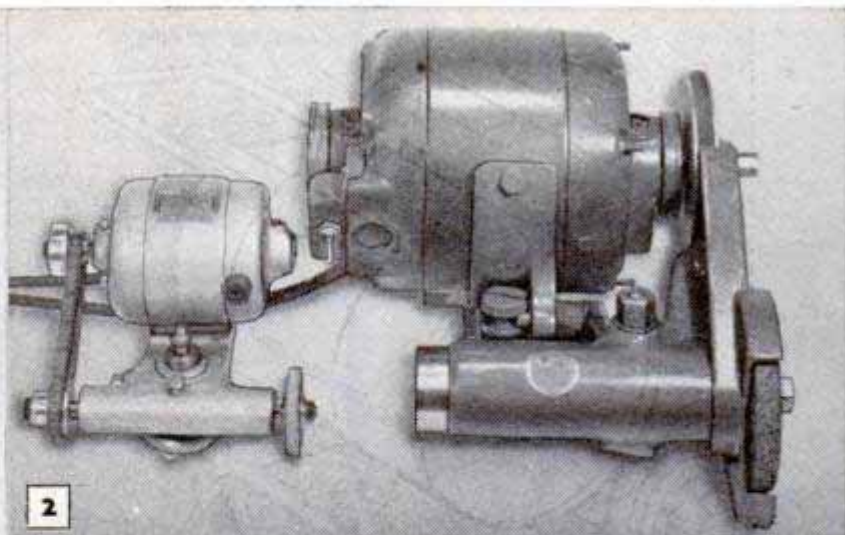

TYPICAL LARGE AND SMALL GRINDERS USED FOR LATHE WORK

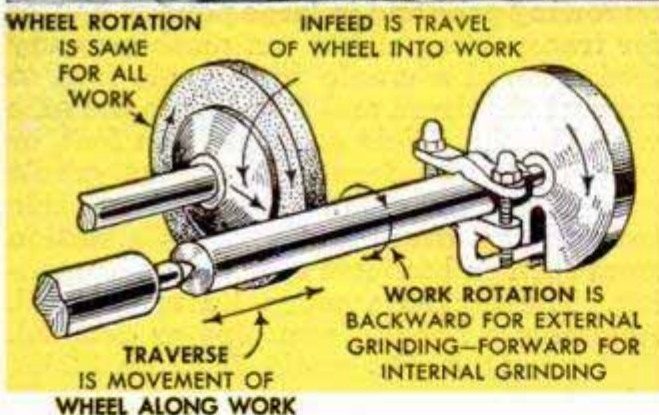
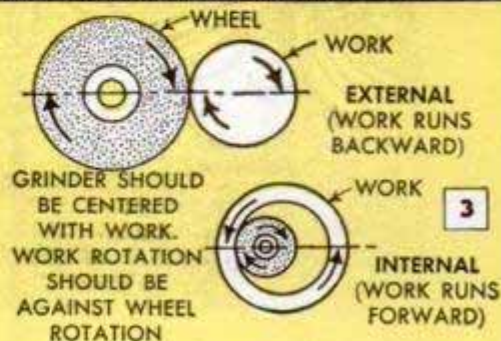

# TOOL-POST GRINDING

By Sam Brown

WHEN SMALL cylindrical work must be finished to true concentricity and very close size limits, lathe operators in small shops usually dispense with other methods and use a tool-post grinder for both inside and outside work. Although the grinder is slow when compared with cutting-tool operation, it is capable of producing a degree of accuracy and quality of finish unequalled by any other common lathe accessory. In small shops the largest grinder regularly used is powered by a ¼-hp. motor and swings a 4-in. grinding wheel. The smallest practical size for external grinding swings a 2-in. wheel. Typical grinders in these sizes are shown in Fig. 2. Some tool-post grinders are furnished with interchangeable spindles so that they can be set up for both internal and external grinding operations.

**Operation of tool-post grinder:** The important pointers in tool-post grinding are outlined in Fig. 4. Note that the maximum cut per single pass of the wheel is only .001 in. and about one fourth of this depth is permissible on finishing cuts. The grinding spindle must be set up "on center" in

- 4**
- WORK SPEED** ABOUT 100 S.F.M.\* FOR ALL TYPES OF WORK—HOWEVER, CAN BE FASTER FOR FINISHING CUTS OR FOR SOFT METALS
- WHEEL SPEED** 5000-6000 S.F.M. (THIS FEATURE IS FIXED BY THE GRINDER MANUFACTURER WHO RECOMMENDS A WHEEL DIAMETER TO GIVE CORRECT S.F.M. SPEED)
- INFEEED** .001" PER PASS FOR ROUGH GRINDING .00025" (¼ OF ONE THOUSANDTH) FOR FINISHING, OR IF WORK IS SLENDER
- TRAVERSE** .003" TO ½ THE WIDTH OF THE WHEEL PER REVOLUTION OF WORK. A GOOD AVERAGE SPEED IS .005"
- GRINDING ALLOWANCE** .006" TO .010" ON DIAMETER FOR MACHINED WORK. .015" TO .030" FOR WORK THAT IS TO BE HARDENED.
- WHEEL SELECTION** 46-GRIT ALUMINUM OXIDE BEST WHEEL FOR GENERAL WORK IT SHOULD BE A MEDIUM-SOFT GRADE. 60-GRIT WHEEL IS USEFUL FOR FINE FINISHING

\*S.F.M.—SURFACE FEET PER MINUTE

relation to the work. Nearly all small and large tool-post grinders have an adjustment for centering the spindle. Note the setups for internal and external grinding in Figs. 1 and 8. In internal-grinding operations the wheel and the work rotate in opposite directions as in the lower detail in Fig. 3. However, in external grinding the wheel and the work rotate in the same direction as in the upper detail in Fig. 3. In the latter case, the lathe is reversed.

**Wheel dressing:** The first requirement when working to close limits with a tool-post grinder is proper dressing of the wheel. Careful operators always dress the wheel before every job as it is not possible to do accurate work with a wheel that is even slightly out of round. Only a diamond dresser gives the precision cut needed for this job. Fig. 5 shows the setup and Figs. 6 and 7 detail the methods of setting the dresser on center. The dressing is done by traversing the wheel across the diamond with no more than .001-in. infeed. If a smooth wheel is required for a finishing operation, the speed of the traverse is slow, never more than .005 in. A fast traverse opens the wheel for rough grinding as in the upper detail, Fig. 5.

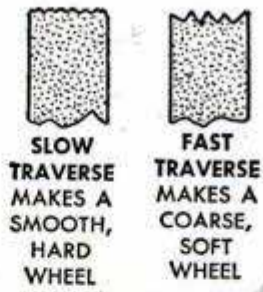

5



DRESSING IS ESSENTIAL FOR GOOD GRINDING. RATE OF TRAVERSE CONTROLS WHEEL HARDNESS

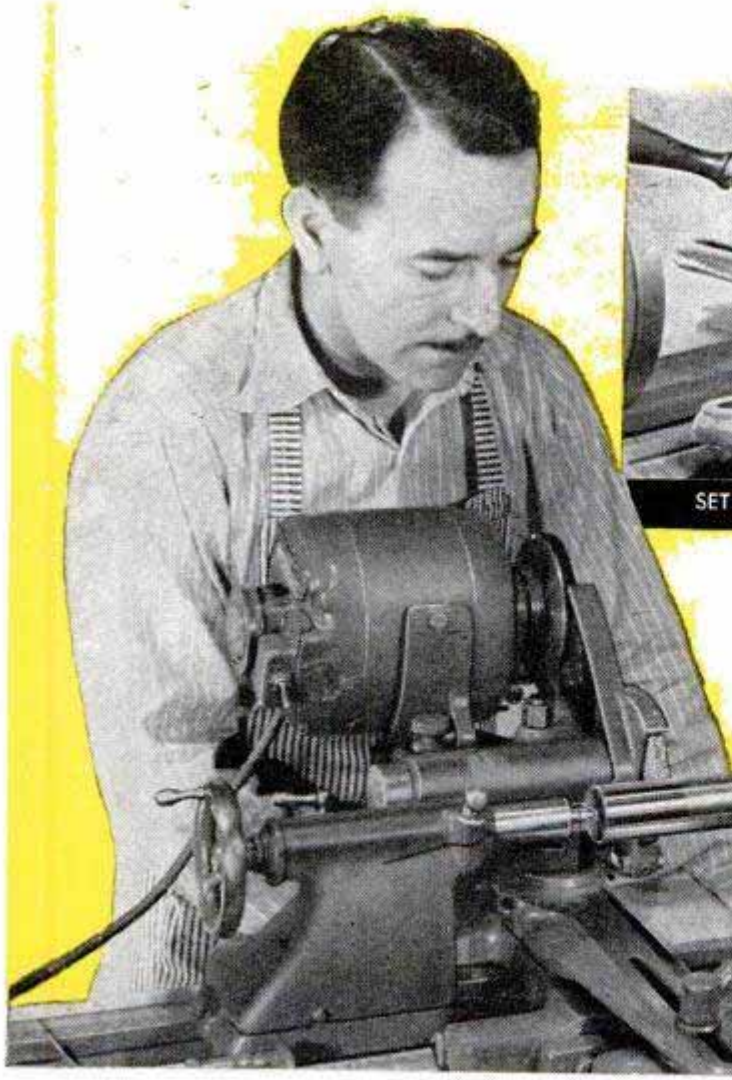

7 SET THE DRESSER "ON CENTER"

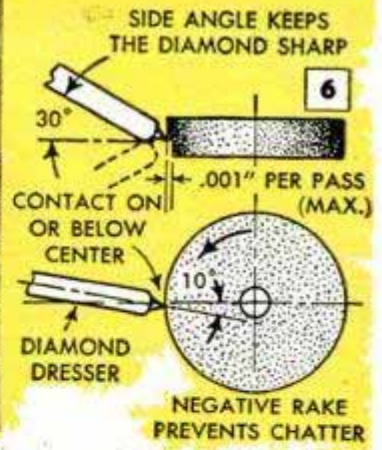

4-IN.-DIA. 46-GRIT WHEEL DOES A GOOD JOB OF EXTERNAL GRINDING WITH INFEEED OF .001" AND .005" TRAVERSE

8

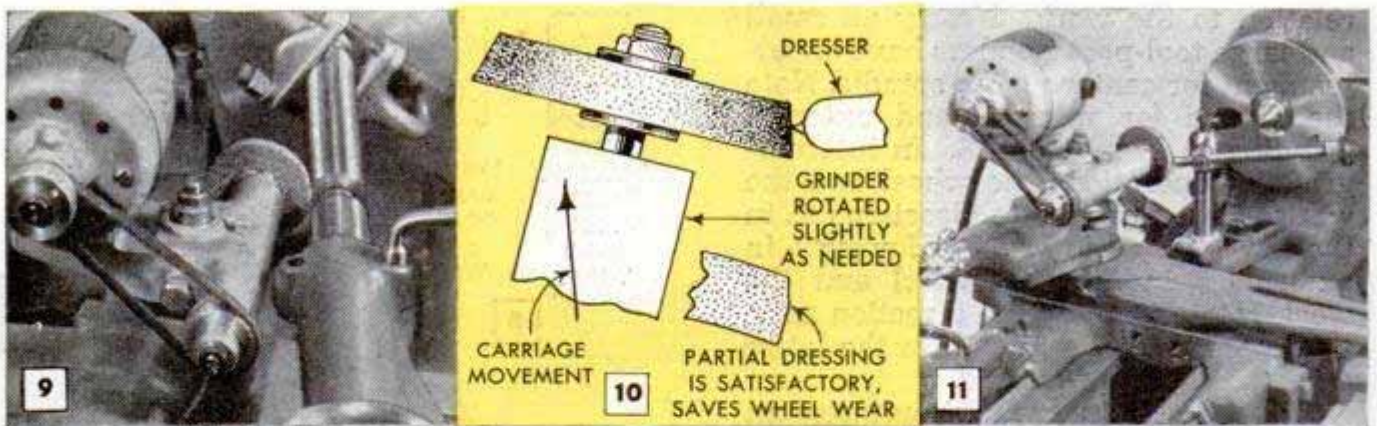

## GRINDING A CYLINDER

THIS JOB IS BEST DONE WITH 4-IN.-DIA. WHEEL, AS SHOWN IN FIG. 8 ON PRECEDING PAGE. IF SMALL GRINDER IS USED, IT MUST BE ANGLED SLIGHTLY TO CLEAR TAILSTOCK, FIG. 9. THE ABRASIVE WHEEL IS THEN DRESSED, AS IN FIGS. 10 AND 11, TO MAKE IT PARALLEL WITH WORK. TAKE LIGHT CUTS AND DO NOT RUN ABRASIVE WHEEL OFF ENDS OF WORKPIECE

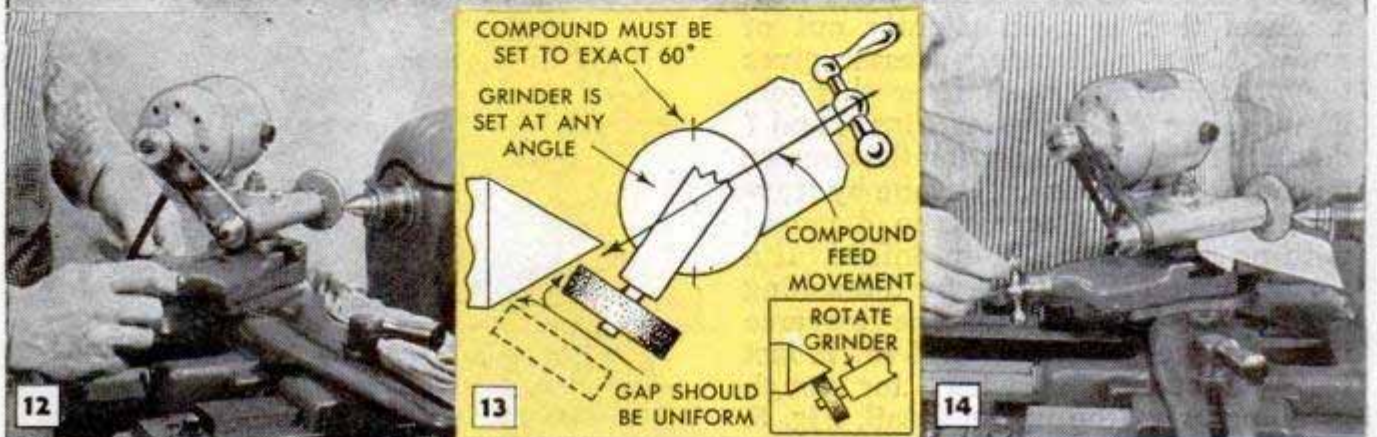

## GRINDING 60° CENTER

COMPOUND MUST BE SET AT EXACTLY 60 DEG. BECAUSE THIS SETTING DETERMINES GRINDING ANGLE ON WORK. A TEST SETUP SHOULD BE MADE, FIGS. 13 AND 14. THE WHEEL SHOULD REMAIN SAME DISTANCE FROM WORK SURFACE WHEN TRAVERSED WITH COMPOUND. AFTER COMPOUND SETTING IS MADE, GRINDER IS ROTATED TO BRING WHEEL PARALLEL WITH WORK

**Grinding a cylinder:** External grinding of a cylinder—a common operation—is pictured in Fig. 8. The work is machined .006 in. oversize. Then it is reduced to exact diameter by successive passes of the grinding wheel, the final pass being made with no infeed and a slow traverse. In making the successive passes, it is important to keep the wheel on the work. It should not run off more than one fourth of its width at the tailstock end. The finish obtained with the 46-grit wheel commonly used for this work is sufficiently uniform for ordinary purposes. If a mirror polish is required, this can be produced by hand polishing with an 80-grit aluminum-oxide tape. If a small grinder is used for finishing a cylinder, it may be necessary to angle the grinder unit to clear the tailstock, Fig. 9. In this case, the wheel must be dressed with the grinder in this position so that the face of the wheel will be parallel with the work, Figs. 10 and 11. The small grinder will do satisfactory work if light feed and slow traverse are used.

**Grinding a 60-deg. center:** This common operation is pictured and detailed in Figs. 12, 13 and 14. Here the traverse is made

with the compound rest, which must be set at exactly 60 deg. with the axis of the lathe in order to produce the required angle on the center. The traverse is hand-fed toward the headstock spindle as in Fig. 12. This brings the grinding pressure against the center and holds it firmly in position in the tapered spindle sleeve. The return movement of the wheel is made with no added infeed.

**Tool grinding:** Grinding of small milling cutters and other rotary cutting tools is easily done with the tool-post grinder within the required accuracy limits. Milling-machine cutters usually can be ground on their own arbors by simply placing the arbor and cutter between lathe centers. Indexing of toothed cutters is done by means of a tooth rest, which is positioned directly below the tooth being ground as in Figs. 15, 16 and 17. In the actual grinding procedure, the lathe is not in operation, but serves only as a support for the work and a means of traversing the grinder accurately. In some cases, of course, it is necessary to true up the cutter concentrically before grinding each individual tooth to the correct clearance angles. This opera-

CLEARANCE ANGLE (5° TO 12°)

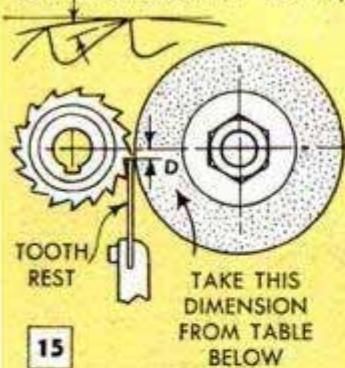

15

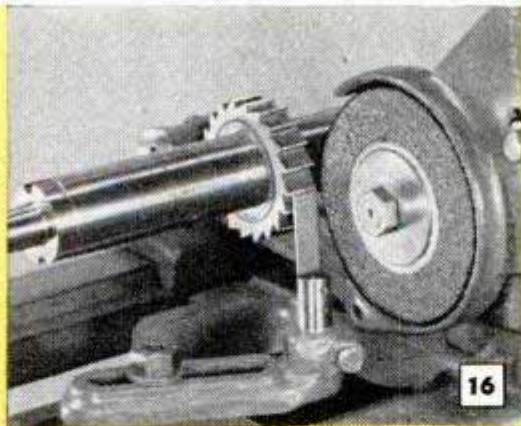

16

### TOOTH-REST SETTING

WHEEL DIA.	DISTANCE "D"			
	FOR 5°	FOR 7°	FOR 10°	FOR 12°
1"	.044	.061	.087	.104
1½"	.065	.091	.130	.156
2"	.087	.122	.174	.208
2½"	.109	.153	.218	.260
3"	.130	.182	.260	.312
3½"	.153	.214	.305	.364
4"	.174	.244	.348	.416



17

GRINDING OF MILLING CUTTERS, REAMERS, ETC., IS EASY TO DO ON A LATHE FITTED WITH TOOL-POST GRINDER

tion is handled in the lathe in much the same fashion as grinding a cylinder. The table, Fig. 15, gives the below-center distances for various wheel diameters when grinding the clearance angle on milling cutters. See dimension "D" in the detail, Fig. 15. After the tooth rest has been properly set, Fig. 16, the grinder is traversed once and then returned across the tooth without added infeed. The traverse is fast, but the return is slow to give a smooth finish. On cutters having teeth requiring a greater rake angle, it is common practice to locate the tooth rest to engage a tooth above the one being ground, Fig. 18. In some cases, the rest must be set two teeth above the one being ground, as in the detail in Fig. 18. Note also that a small wheel must be used to avoid striking the tooth immediately above the tooth in contact with the wheel.

**Surface grinding:** A common example of this type of work is that of surfacing the lathe faceplate, as in Fig. 19. Other work can be surface-ground by mounting it on the faceplate or in a chuck and using the same setup. A cup-type grinding wheel is commonly used for this work. The wheel is dressed with a cross-slide traverse as in Fig. 20. It will be noted that this trues the

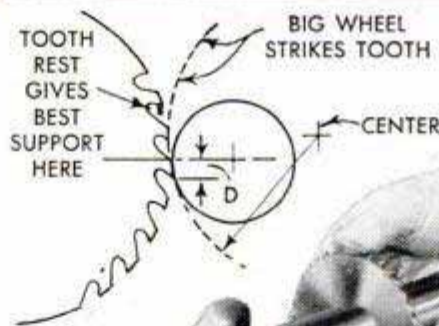

18

SMALL WHEEL IS SOMETIMES NEEDED FOR TOOTH CLEARANCE

wheel exactly parallel with the work surface, Fig. 21. This position of the wheel is practical for the rough-grind, using a coarse-grit, soft wheel. For the finish-grind, use a fine-grit wheel, dressed square, but angle the grinder unit about 1 deg. so that only the edge of the wheel is in contact, Fig. 22. Good surface grinding also can be done with a straight wheel. It is necessary to angle the grinder unit so that the spindle will clear the work, Figs. 23 and 24. After the angle setting has been determined and the grinder set, the wheel is dressed on the corner to form a flat about 1/16 in. wide, Fig. 24. Note in Fig. 23 that

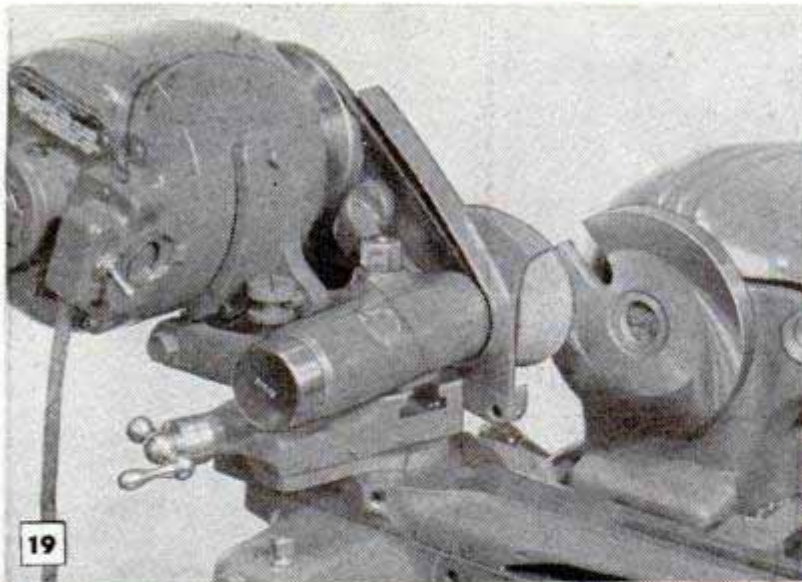

19 SURFACE GRINDING CAN BE DONE WITH CUP WHEEL, ABOVE, OR STRAIGHT WHEEL DRESSED TO CLEAR SPINDLE, BELOW

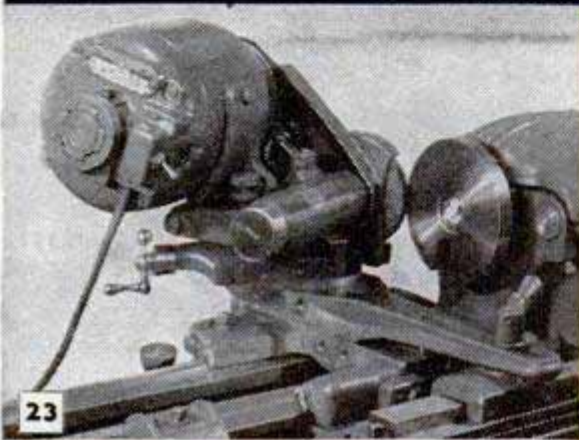
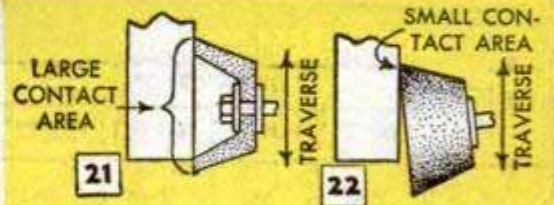
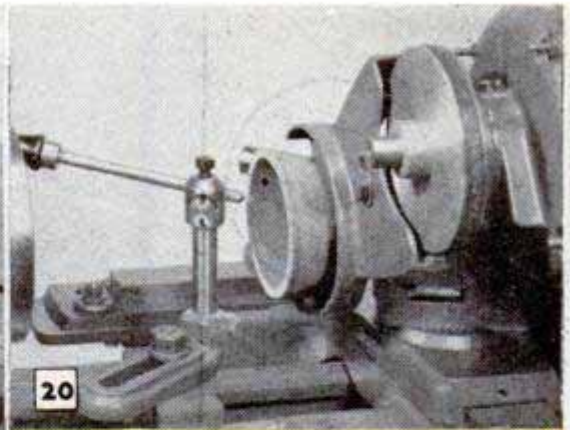

25 GRINDING-WHEEL SELECTION

WORK	ABRASIVE	GRIT		GRADE	"NORTON"	"CARBO-RUNDUM"
		Rough	Finish			
SOFT STEEL*	ALUMINUM OXIDE	46	60	MEDIUM	46-MB	401-J-30
CAST IRON	SILICON CARBIDE	36	60	SOFT	3736-J5	36-K-G
BRASS	SILICON CARBIDE	36	60	SOFT	3736-K5	36-N-G
ALUMINUM	SILICON CARBIDE	30	40	SOFT	3730-K5	30-N-EC
TOOL GRIND'G	SPEC. A.O. (WHITE)	—	50	SOFT	3850-K	A50-M-100
AUTO VALVES	ALUMINUM OXIDE	60	80	MEDIUM	50-MB	60-J-30
PLASTIC (Ph.)	SILICON CARBIDE	46	60	SOFT	3746-J5	46-O

\* ALL PURPOSE WHEEL

26 ONE-WHEEL SYSTEM (\*46-GRIT ALUMINUM OXIDE)

MATERIAL, OPERATION OR FAULT	WHEEL DRESSING	WORK SPEED	INFEED	TRAVERSE
AVERAGE WORK SOFT STEEL	SMOOTH	100 S.F.M.	.001"	.005"
FOR FAST CUTTING	COARSE	INCREASE	.0015"	.015"
FOR SMOOTH FINISH	VERY SMOOTH	LESS	.00025"	.003"
IF WHEEL GLAZES	COARSE	INCREASE	MAX.	INCREASE
CAST IRON	COARSE	INCREASE	MAX.	LESS
SOFT METALS	COARSE	200 S.F.M.	LESS	—
SMALL-DIA. WORK	SMOOTH	LESS	LESS	LESS

the infeed is set with the compound and that the traverse is made with the cross slide. The lathe carriage must be locked.

**Wheel selection:** A 46-grit aluminum-oxide wheel of medium grade ("grade" is resistance of the abrasive grains against tearing loose from the bonding material) is the best all-purpose wheel. By careful dressing and operating techniques, it can be made to cut as fast as a 40-grit wheel or as fine as a 60-grit one and can be made to run hard or soft as needed. The table, Fig. 26, shows the variations possible with the all-purpose wheel. The table, Fig. 25, lists special wheels for various materials.

**Internal grinding:** Internal grinding on light work, Fig. 1, usually is done with small-diameter mounted wheels running at high speeds to maintain the required 5000 f.p.m. surface speed. Very light infeeds and a slow traverse are required. Allowances for internal grinding should be somewhat less than the .006 in. allowed for external grinding and a softer wheel must be used.

**Protect the lathe:** Most of the abrasive dust from the grinding operation can be trapped in a pan filled with oil, Fig. 8. An oil-soaked cloth placed below the work also will protect the lathe where it is not possible to locate the pan directly under the wheel. In any case, the lathe should always be thoroughly cleaned up after every grinding job.



## Horseshoe Magnet Used as Anchor Simplifies Marking Metal Price Tags

Stapled to a board or worktable top, a small horseshoe magnet conveniently holds metal-bound price tags for marking. This leaves one hand free to handle the price list and thus permits marking the tags rapidly by eliminating waste motion.

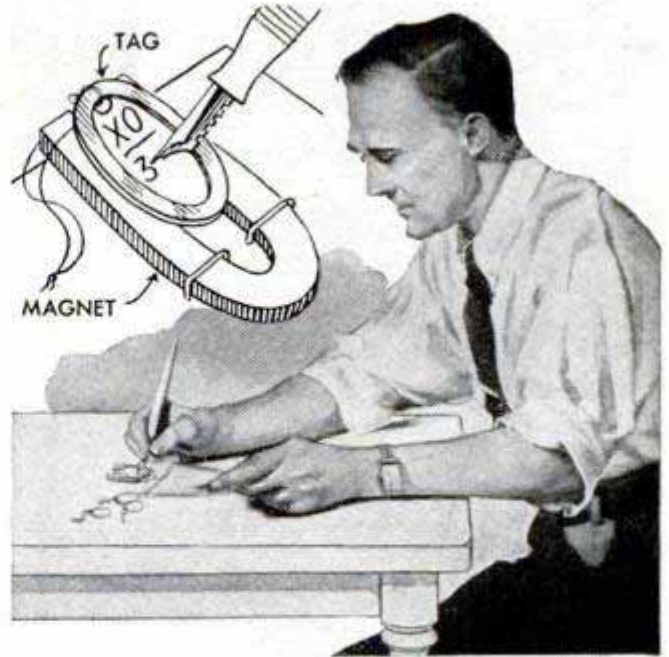

## Paper Clips Fastened to Dashboard Hold Delivery Sheets and Maps

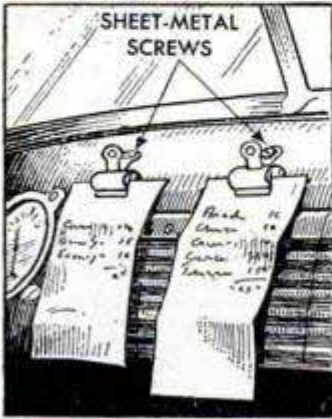

To permit checking delivery sheets and road maps at a glance, one truck driver mounted a couple of paper clips in a handy location on the dashboard of his truck. The clips, which are attached with sheet-metal screws, hold a sizable number of

orders plus a road map folded to show the particular territory which he is covering.

A. W. Ranniger, Carroll, Iowa.

## Self-Tilting Kerosene Drum Rests on Auto Springs

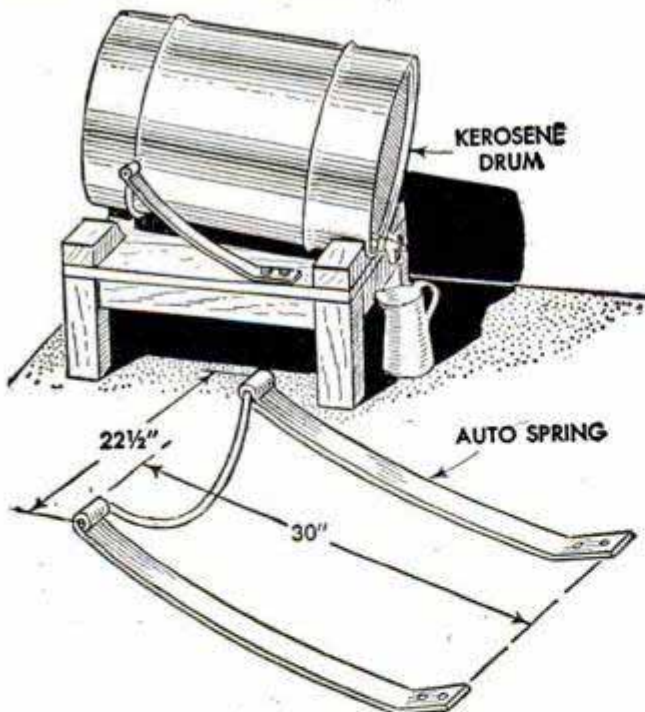

As a kerosene, gasoline or oil drum is gradually emptied, this self-tilting rack slowly tips it forward without stirring up the sediment in the bottom. Two old auto springs and a saddle formed from a length of rod provide the tilting mechanism. After the springs are heated and bent as shown, they are drilled and bolted to a wooden rack.—W. P. Houser, Organ, N. Mex.

## Removing Broken Bolts or Studs

If a set of screw extractors is not available, removing a broken bolt or stud from a blind hole can be done with a socket-head wrench. Drill a hole in the top of the bolt slightly smaller than the diagonal width of the wrench. File the tip of the wrench to a taper and hammer the tapered wrench end into the hole. Sharp edges of the wrench will broach the hole and prevent slipping while the wrench handle is used as a lever to loosen the bolt.—Henry Hanscom, Elmhurst, Ill.

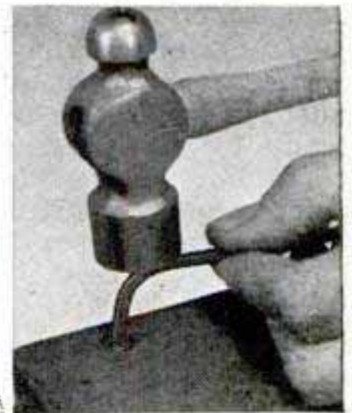

## Typing Gummed Labels in Quantity

When typing a number of small gummed labels, the job can be speeded by sticking as many as 25 or 30 of the labels to a sheet of paper and inserting the paper in the typewriter. Stick the label to the sheet by moistening a very small portion of the upper left-hand corner of the label. In this way, the latter will not be torn when it is pulled from the sheet of paper.—Mary Louise Stevenson, Davison, Mich.



# ARC WELDING for beginners

A. E. Youngquist

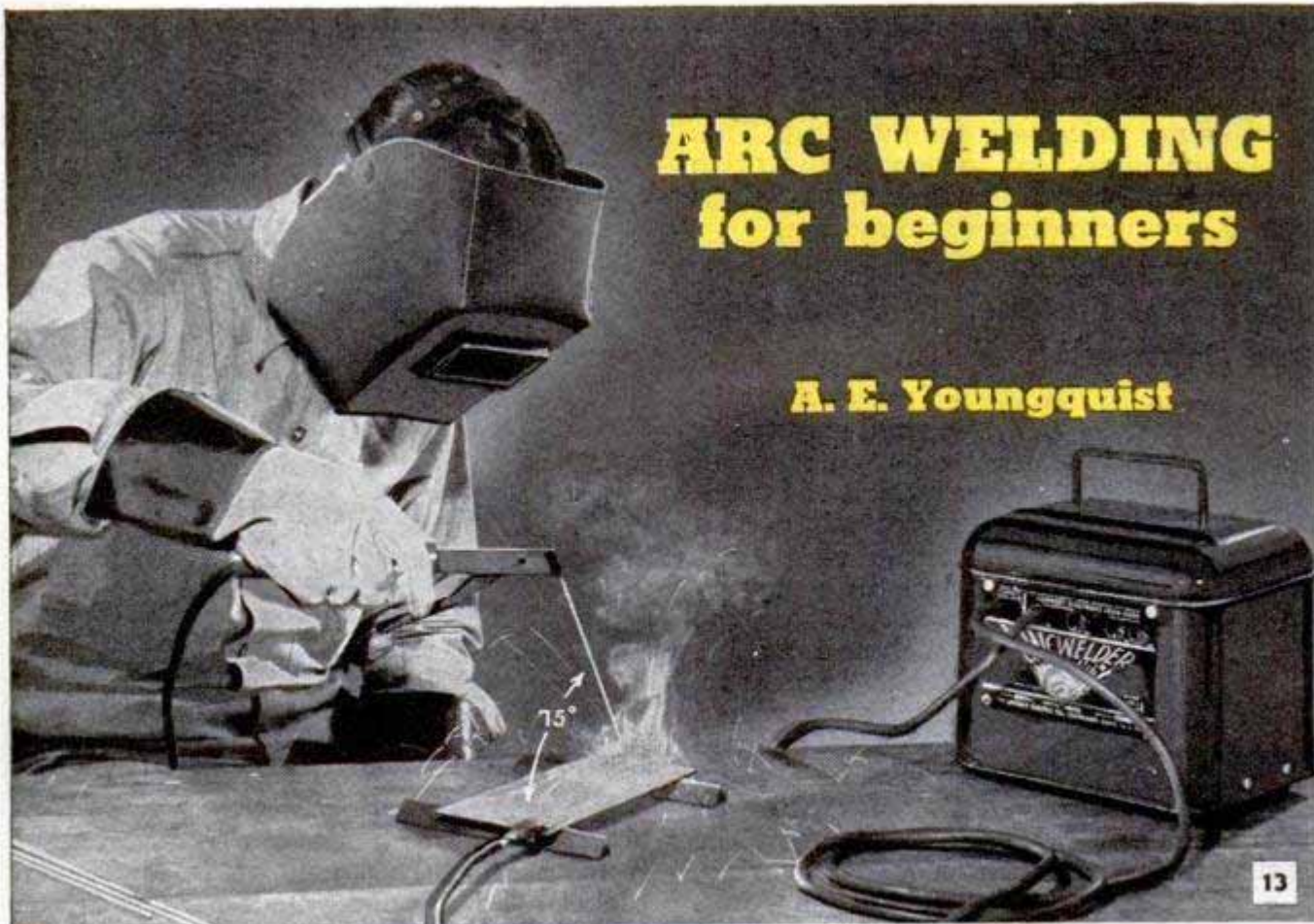

## PART II

**A**FTER purchasing the type and size of welding machine best suited to your particular needs, using the data given in Part I of this article as a guide, you will be ready to start teaching yourself how to weld. For best results, the welder should be connected to a separate circuit as close as possible to the current entrance switch box. The corner of the farm workshop or basement where welding is to be done should be kept clear of inflammable material and should have a concrete, cinder or crushed-stone floor. A workbench having a steel plate for a top and slightly lower than desk height will be needed, because a comfortable sitting position is important when learning to weld. A strained or awkward body position will result in fatigue and lack of control. All practice welding should be done on low-carbon-steel scrap such as angle iron and sheet metal. High-carbon and alloy steel, cast iron or non-ferrous metals should not be used by the beginner until he has mastered the technique of mild-steel welding.

Practice starting or "striking" an arc first. If your welding machine is the small 60-amp. size, use a  $\frac{1}{16}$ -in. electrode and practice on a piece of 16-ga. sheet metal. If your welder is a 180-amp. size, use a  $\frac{1}{8}$ -in. electrode and a piece of 10-ga. sheet metal. First, fasten the ground cable of the welding machine to the steel top of the

welding bench. The entire bench top will then be grounded and any work or practice pieces placed on the bench top will also be grounded. If a steel-topped bench is not used, the ground cable must be fastened directly to the metal being welded. Regulate the amperage control on the welding machine to produce the correct amount of current for the size and type of electrode to be used. This information is supplied with each box of electrodes purchased. After regulating the amperage control to the proper setting, place the uncoated portion of the electrode between the jaws of the electrode holder so that the rod is clamped firmly at a 90-deg. angle to the jaws. Then turn on the power switch on the welder and lower the helmet to protect your face and eyes from hot sparks and arc-ray burns.

The welding arc is started by momentarily bringing the tip of the electrode in contact with the work and then raising the electrode slightly to form a gap of approximately  $\frac{1}{8}$  in. between the tip of the rod and the work. The beginner may encounter some difficulty when starting or striking an arc the first few times due to the tendency of the electrode tip to stick or freeze to the work. To avoid this, gently scratch the tip of the electrode across the surface of the work as if striking a match. The arc will start with a sudden burst of light and sparks. This is startling at first, but do not pull the electrode away suddenly as this

will extinguish the arc. Instead, raise the electrode slowly, as in Fig. 14, until the tip is  $\frac{1}{8}$  to  $\frac{3}{16}$  in. away from the work. Then slightly lower the electrode until the arc gap is approximately the diameter of the rod. Practice this until you can maintain the arc for a few seconds' duration. After some experience, the correct arc length can be controlled by looking at the puddle of molten metal and listening to the regular crackling sound given off by the arc. To stop the arc, simply move the electrode away from the work. If the electrode sticks to the work, immediately bend it from side to side, Fig. 15, and quickly jerk it away from the work with the holder. If this action does not free the rod, release it from the jaws of the holder. If you find that it is impossible to hold or maintain the arc, increase the welding current slightly. Also, check the ground connection for proper contact with the work piece.

After becoming proficient in starting and maintaining an arc, try running a weld bead, which is a continuous deposit of weld metal. To lay a bead, two movements indicated by lines A and B, Fig. 16, are used. First, strike an arc and then slowly and uniformly move the electrode to the right in a straight line while maintaining the correct arc length by steadily feeding the electrode down towards the work while the electrode tip melts away. Tilt the electrode toward the direction of travel as shown in Fig. 13. This will enable you to keep your eye on the molten crater and control the rate of travel by observing the width of the weld. The tilt of the electrode also tends to force the molten metal away from the direction of travel and keeps the flux or slag flowing over the deposited weld metal. After laying a weld bead 5 or 6 in. long, allow it to cool slightly, and then remove the slag coating with the chipping hammer and wire brush. Carefully inspect the surface of the weld bead and compare it with those shown in Fig. 18, A to E inclusive. Teaching yourself to weld is simply a process of trial and error. If, for example, the bead appears as in Fig. 18E, the rod speed or rate of travel was too fast. Try laying another bead at a slower speed. If, after cleaning this bead, it appears as shown in Fig. 18B, you will know the rod speed was normal but the current setting on the welding machine was too high. So, reduce the welding current and lay another bead. In other words, eliminate only one condition or variable at a time. Changing more than one variable at a time only results in confusion for the beginner. It is also a good idea for the beginner to deliberately lay a bead with too low or too high a current or too fast or slow a speed. In this way, he will learn to recognize an

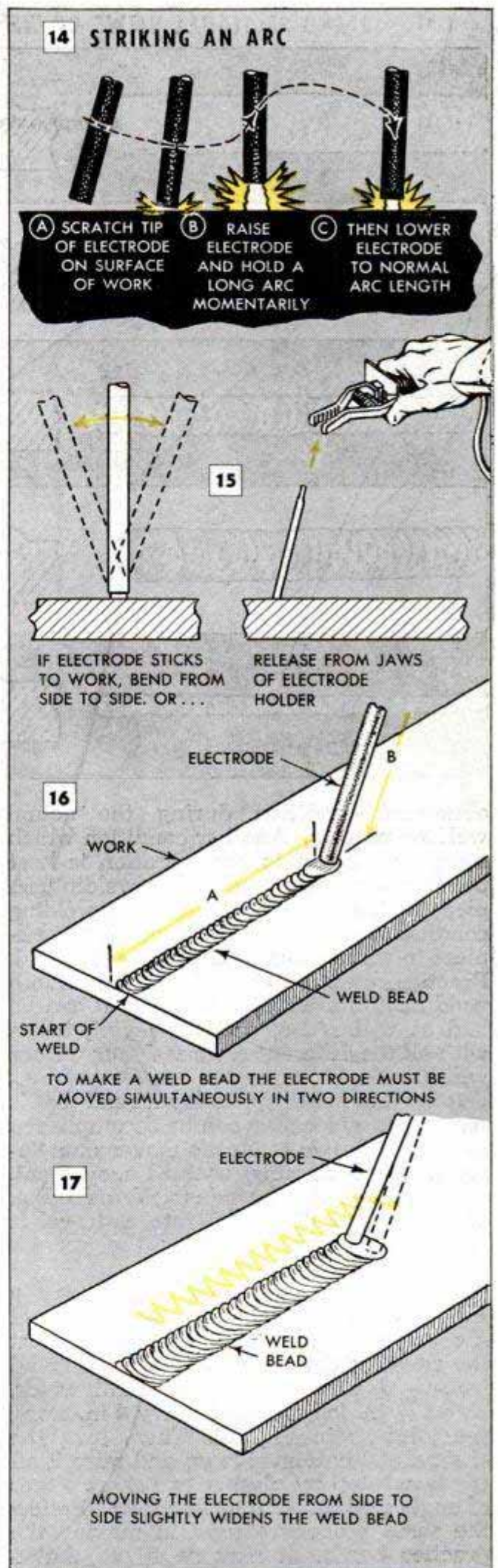



(A)



WELDING CURRENT AND ROD SPEED NORMAL. WIDTH OF WELD AND RIPPLES ON SURFACE ARE UNIFORM. PENETRATION IS FAIRLY DEEP AND WELL DEFINED. ARC HAS A SPATTERING HISS PLUS AN IRREGULAR CRACKLING SOUND



(B)

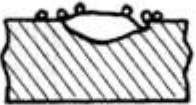

HIGH CURRENT, ROD SPEED NORMAL. WELD BROAD AND THIN WITH ROUGH SURFACE. CONSIDERABLE SPATTER AND UNDERCUT ALONG EDGES. CRATER IS LONG AND DEEP. ARC HAS A RATHER REGULAR EXPLOSIVE SOUND



(C)

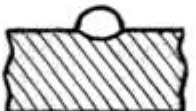

LOW CURRENT, ROD SPEED NORMAL. WELD NARROW AND VERY HIGH. ROD BURNS SLOWLY. PENETRATION OR FUSION NOT VERY DEEP OR WELL DEFINED. ARC HAS FEW CRACKLING SOUNDS WITH IRREGULAR SPATTERING



(D)



CURRENT NORMAL, ROD SPEED TOO SLOW. WELD IS EXCESSIVELY WIDE WITH OVERLAP ALONG EDGES. BASE METAL AND WELD BECOME HEATED OVER A CONSIDERABLE AREA WHICH OFTEN RESULTS IN CRATER BURNING THROUGH



(E)

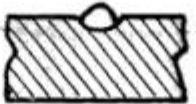

CURRENT NORMAL, ROD SPEED TOO FAST. WELD IS NARROW WITH VERY ROUGH SURFACE. EDGES OF BEAD UNDERCUT. SIZE OF BEAD DEPENDS ON RATIO OF ROD SPEED AND AMOUNT OF CURRENT USED. NORMAL ARC SOUND

abnormal condition during the actual welding process. Another condition which must be taken into consideration is heat put into the workpiece due to welding. A piece of hot metal will alter the welding conditions. To avoid this, quench the workpiece in water after each weld bead is laid. Practice running flat beads until a smooth weld of uniform width and height can be laid at will. Also, practice laying beads with all the different rod sizes your welder will handle.

It is often necessary to lay a bead that is somewhat wider than can be accomplished by using the two electrode movements described. To do this, a third movement, weaving the rod from side to side as in Fig. 17, is incorporated. The rate of travel is reduced to compensate for the greater width of the weld.

After becoming proficient at laying a weld bead, practice joining two pieces of sheet metal with a butt weld. First, butt the edges of the sheet metal together and tack-weld with a series of small welds, about 1/4 in. long, spaced every 4 in. along the joint as in Fig. 20. Then, turn the sheet metal bottom side up and raise it off the bench top by placing two short pieces of angle iron under it as indicated. Follow the same procedure used in making the practice beads. It may be found that a

slightly lower current setting is necessary to prevent the molten crater from burning through in some places. If the sheet metal is fairly thin, a single pass or weld on one side will give 100 percent penetration. To test for complete penetration, turn the work over and inspect the other side. A good weld should have a small uniform bead here. If the two edges of the metal at the joint can still be seen, a larger electrode with an increase in welding current should be used. However, if this is beyond the limits of the welding machine on hand, a gap may be left between the edges of the workpieces or the edges can be beveled and a number of welds laid in as shown in Fig. 22. The size of the welding machine will determine when a bevel is necessary. For example, with a 60-amp. machine, thinner material will have to be beveled than with a 180-amp. machine. Fig. 21 shows the procedure to follow when a weld of 100 percent penetration from one side on heavy material is needed.

Although welding can be done in all positions, the beginner should thoroughly familiarize himself with making various joints in the flat position before attempting position welding. Flat welding includes all types of joints in which the weld can be laid in horizontally. Fig. 19 shows five types of joints that the beginner can very

## 19 TYPES OF WELDED JOINTS

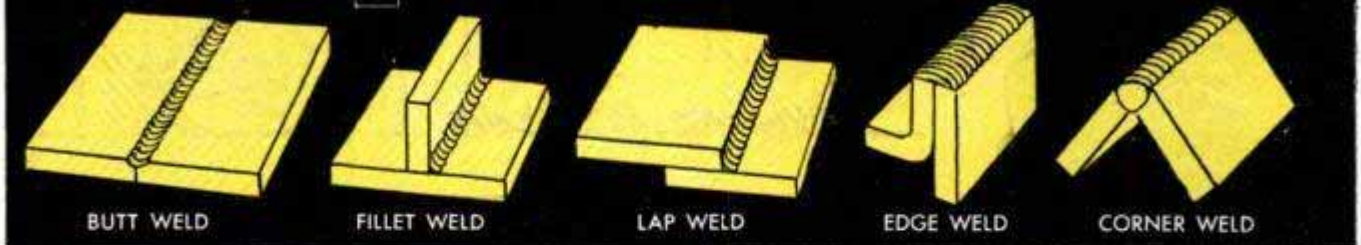

easily weld together in the flat position.

When welding light sheet metal, the most important requirement is good fitup. The two pieces of metal being joined should be held or clamped tightly together and then tack-welded. Also, lap welds, Fig. 19, rather than butt welds should be used wherever possible because proper fitup is much more readily obtained with a lap joint and the chance of burn-through is minimized.

Corner welds on various thicknesses of material are shown in Fig. 23. If the material is light sheet metal, the corner welds are made by running a fast, single-pass bead along the outside of the corner as indicated in the left-hand drawing of Fig. 23. On heavier metal, two or three passes or beads may be necessary and, when possible, a smaller bead welded along the inside of the corner, as shown in the right-hand drawings of Fig. 23, will greatly strengthen the joint. The corner weld, shown in the lower right-hand illustration in Fig. 23, can also be used on lighter metal by leaving a gap between the pieces instead of beveling as indicated.

When the edge of one piece of metal is joined to the side of another so the two pieces are at right angles to each other, a fillet weld is required as shown in Fig. 19. The size of a fillet weld is determined by the leg length of the largest isosceles right triangle which can be inscribed within its cross-sectional area, as indicated by the dotted lines in Fig. 26. The strength of a fillet weld is determined by the throat dimension multiplied by the length of the weld. The length of a fillet weld should always be at least four times its size. For example, a  $\frac{3}{16}$ -in. fillet weld should be not less than  $\frac{3}{4}$  in. in length, unless the weld is simply to hold a number of pieces together during assembly. For a weld with strength equal to that of the material being welded, the size of the fillet weld should be equal to the thickness of the material. For maximum strength, both sides of the joint should be welded.

There are two methods of making fillet welds, positioned and horizontal as shown in Fig. 26. The easiest method for the beginner is positioned fillet welding. To do this, the pieces to be welded must first be fastened together at right angles to one

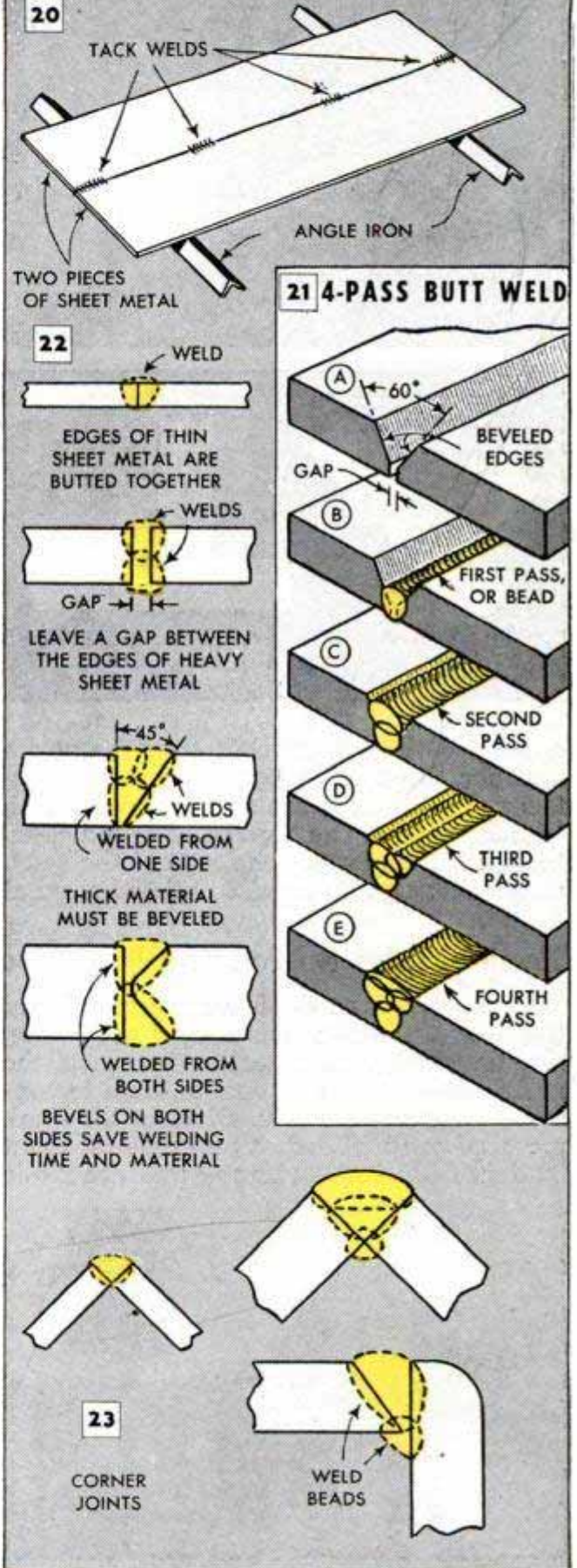

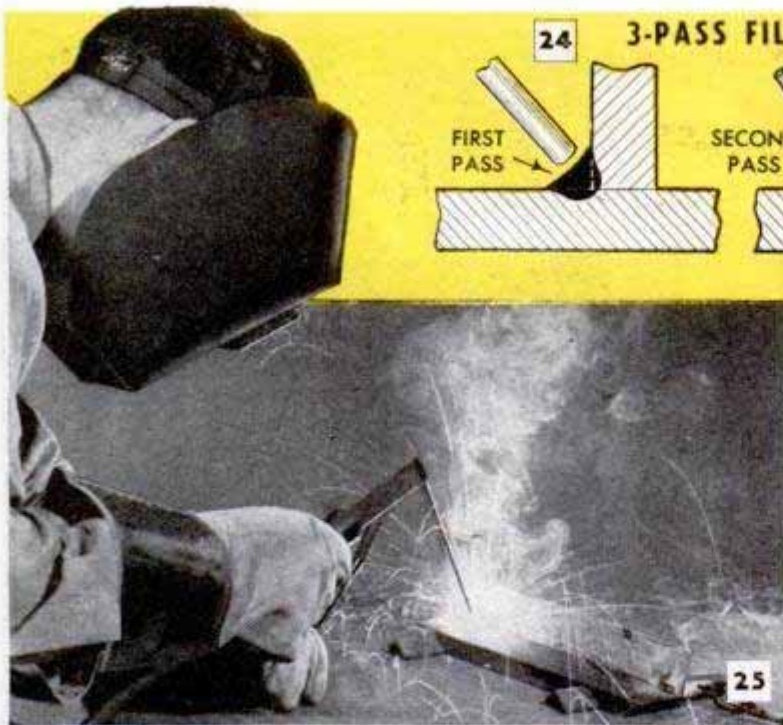

an even pace along the seam without any side-to-side movement. The surface contour of a good fillet weld should be nearly flat and have a slight concavity along the sides where the weld joins the metal pieces. Horizontal fillet welding is used when one member of the joint must remain in the vertical position as in Fig. 26. This method is especially useful for making small single-pass welds or when it is impractical to tilt the work. For practice, weld two pieces of sheet metal together at right angles to one another as before. Hold the electrode at a slight angle as for flat welding and at about 45 to 60 deg. from the horizontal, as shown in Fig. 25. Move the electrode at a steady, uniform rate of speed and point the rod at the corner of the joint. Use the highest welding current you can handle to assure penetration of the weld into the corner of the joint. Also hold a shorter arc than used when making positioned fillet welds. When fillet welds too large to be made with a single weld are required, several beads, one on top of the other, are built up until the desired size is obtained as shown in Fig. 24. Be sure to remove the slag that covers each bead before laying another bead.

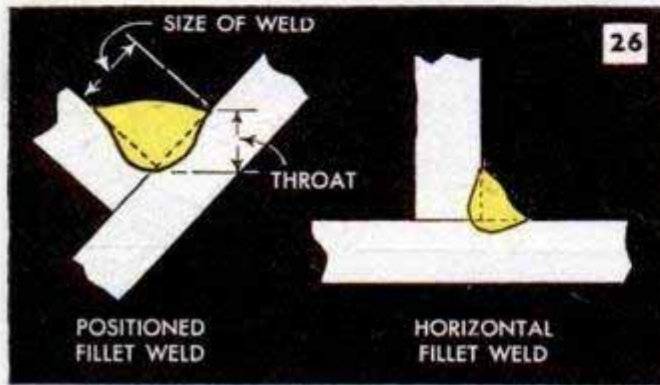

another with tack welds. Both of the pieces are then tilted and propped up so the surfaces of the pieces are at approximately a 45-deg. angle to the horizontal as indicated in Fig. 26. The electrode is held the same as for making a butt weld and is moved at

Photos courtesy The Lincoln Electric Co.

## Sloping Sides on Feeding Bunks Permit Cattle to Reach Feed More Easily

Experienced cattle feeders have found that feeding bunks constructed with wide, sloping sides permit cattle to reach the grain more easily and enable them to consume it with less waste. Sides of the bunk pictured are inclined at an angle of about 30 deg. from the horizontal and are made



from two 2 x 12-in. planks, each 16 ft. long. The bottom is made from two 2 x 10-in. planks of the same length. The meeting edges of the side and bottom planks are beveled to make a smooth-fitting joint and the tops of the 4 x 4-in. legs are sawed to the same angle as that of the sides. Horizontal 2 x 6-in. stretchers space the legs and support the bottom. Angle bracing of 2 x 4-in. stock reinforces both the sides and the legs. Lengthwise braces extending from the lower stretchers to a point near the center of the bottom are spiked or bolted in place to prevent endwise movement. Two or more bunks can be placed end to end.

☐ Before painting a new eaves trough, wash it with a cloth soaked in benzine. This leaves a clean surface to which the paint adheres satisfactorily.

# RADIO *Television* ELECTRONICS

## Special-Purpose TV Antennas

**E**FFICIENT TV-antenna systems are important. Inferior TV sets operating on well-designed and properly installed antenna systems will outperform better receivers that are using poor antennas in the same locality. Of course, if you are near transmitting stations or in an area where the TV signals are strong, almost any type of TV antenna will work, at least on some of the stations. However, in practically every locality where television stations are on the air, the antenna problem must be given careful attention if maximum results are to be expected.

Special-purpose TV antenna systems are now making good picture reception possible in fringe areas, and in remote locations ordinarily beyond the expected range of TV transmitters. In these remote locations, height above ground becomes an important factor; also two or more bays, (or sections) of antenna units are usually stacked together for added gain to overcome losses due to distance. The height problem is easily solved by the use of specially designed, self-supporting aluminum-alloy towers now available from several manufacturers. A tower of this type with a two-bay Amphenol TV stacked array antenna is shown in photo A; this installation gave excellent results on Chicago TV stations over a distance of 60 miles. The height of the antenna array from the ground was 75 feet. A close-up of the two-bay array, with provision made for rotating it in any direction, is illustrated in photo C.

Where there is only one TV transmitting

(Continued to page 244)

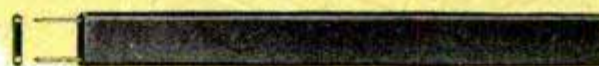
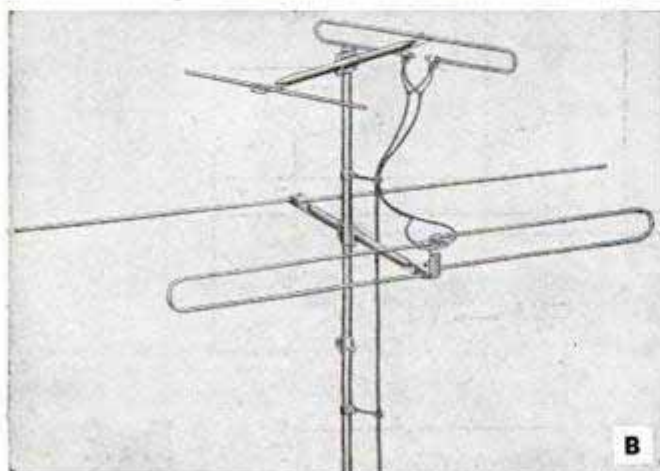

FIG. 1



FIG. 2



B

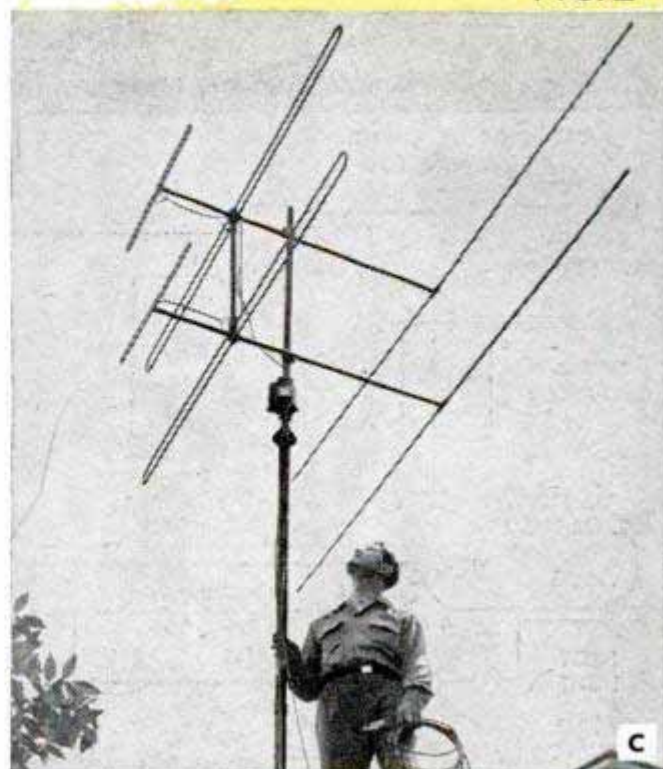

C

# INDOOR A.C.-D.C. AMPLIFIER

By L. M. Dezettel

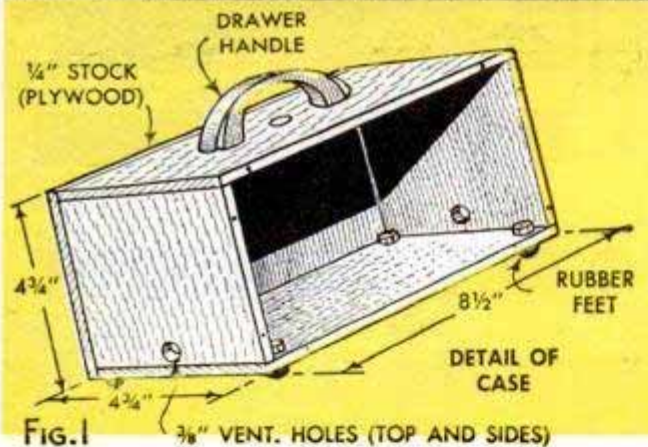
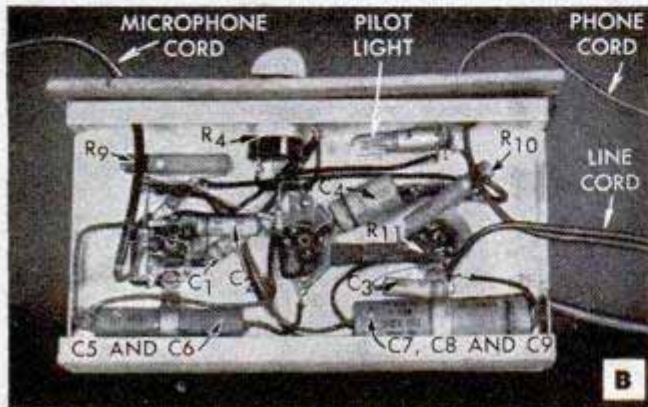
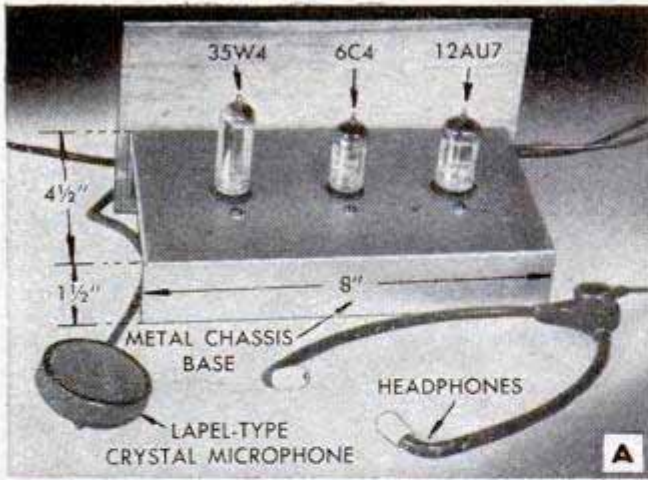

WHERE a hearing aid is intended for indoor use only, it may be designed to operate directly from the ordinary 110-volt house-lighting outlets, thus saving the cost of batteries. The one illustrated and described consists of a simple a.c.-d.c.-type amplifier that is easy to build from parts that are available from all radio supply houses. Designed for high gain, which is necessary when a crystal microphone is employed, this 3-tube amplifier is unusually sensitive and highly efficient. Three miniature-type tubes are used to keep the size at a minimum; however, a slightly oversize chassis was used so that the parts are well spread out to simplify wiring.

A type 12AU7 tube, which is a twin-triode amplifier, is used in this circuit with the two triodes in cascade. This, plus the 6C4 tube, which is the output amplifier, provides three stages of amplification. The rectifier is a type 35W4. The crystal microphone used is of the lapel type which is small, light in weight and has much better frequency response and quality characteristics than the cheaper carbon types. The output of the amplifier may be used to drive any type of high-impedance magnetic headphones of 2000 ohms or higher, or crystal headphones. During laboratory tests and for demonstration purposes a pair of Telex under-chin headphones were used as illustrated in photo C. This type of

### RESISTORS

- R1 = 1-megohm, 1/2-watt carbon
- R2 = 820-ohm, 1/2-watt carbon
- R3 = 47,000-ohm, 1/2-watt carbon
- R4 = 50,000-ohm, audio-taper, volume control with switch
- R5 = 47,000-ohm, 1/2-watt carbon
- R6 = 47,000-ohm, 1/2-watt carbon
- R7 = 47,000-ohm, 1/2-watt carbon
- R8 = 1500-ohm, 1/2-watt carbon
- R9 = 10,000-ohm, 2-watt carbon
- R10 = 10,000-ohm, 2-watt carbon
- R11 = 400-ohm, 10-watt (W.W.)

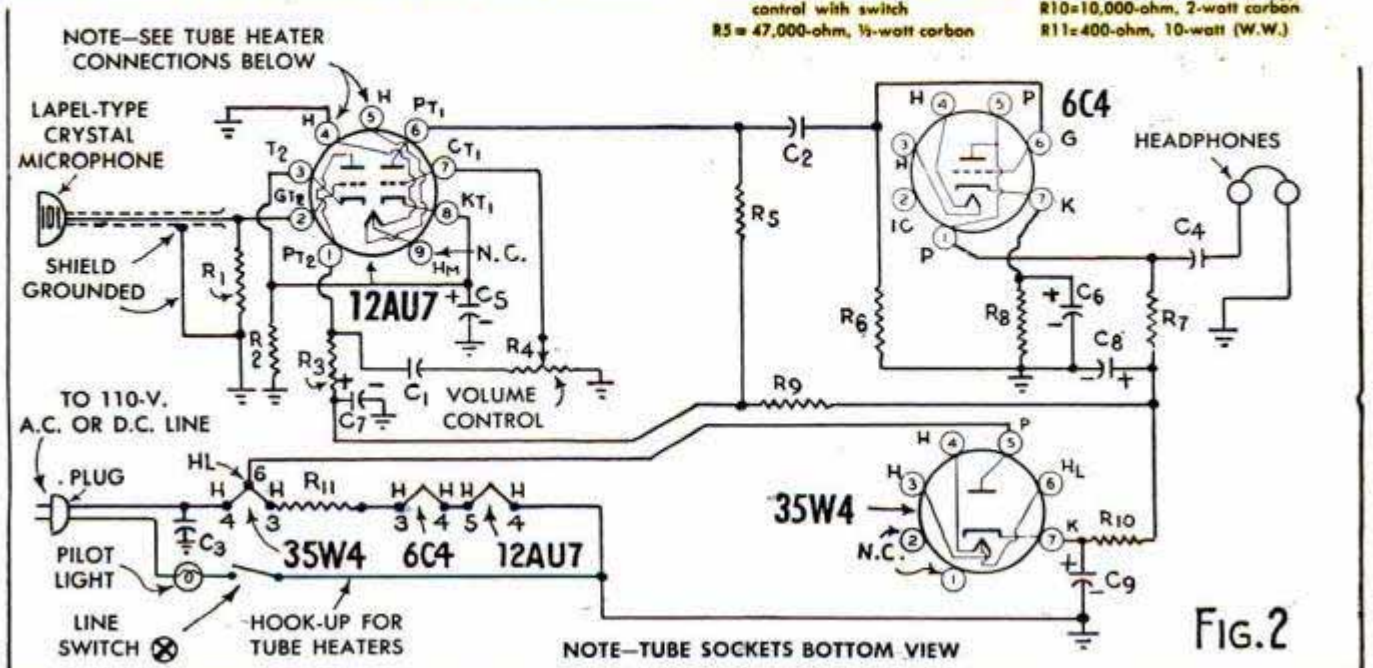



# FOR HARD-OF-HEARING PERSONS

popular with the ladies as it does with their hair. The chassis base is 5 in. long and 1 1/2 in. high. If a switch will be employed, the dimensions of the panel shown in photo E, Fig. 1; also the base is very simple and may be made from a sheet metal bent to shape between blocks of wood clamped in a vise. The holes for the miniature tube sockets are 5/8 in. in diameter. Before construction, study the schematic circuit diagram, Fig. 2, and the various photos carefully, and be sure that you have all the parts specified. The exact layout of the various parts on the chassis base is not critical. However, the approximate positions are clearly shown in the underside photo B and the pictorial wiring diagram, Fig. 3. Although not entirely necessary, the paper-type tubular condensers used were of the new midget variety. These are slightly more expensive, but they permit more compact construction and are easier to work with. In locating the position of

(Continued to page 242)

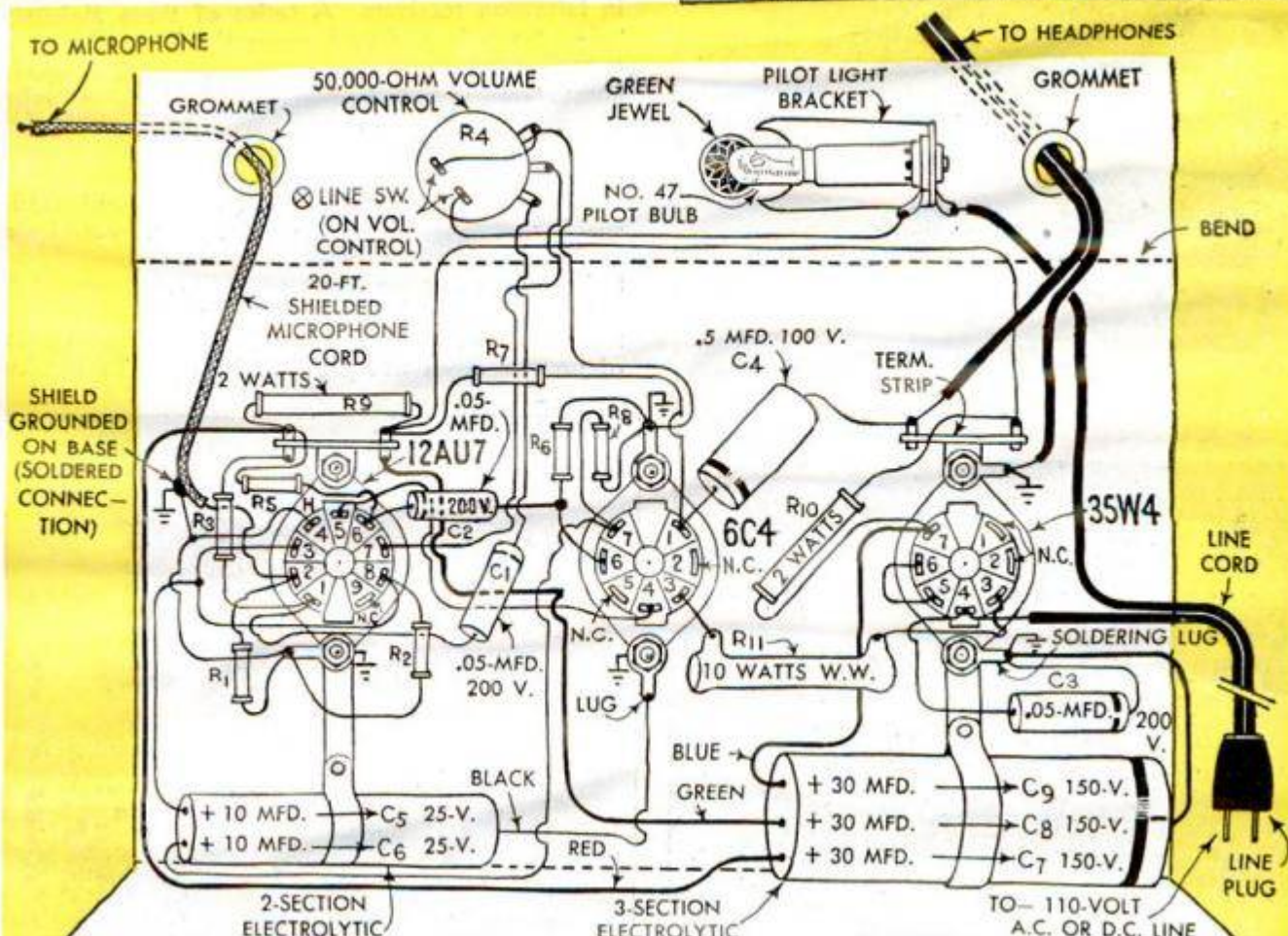
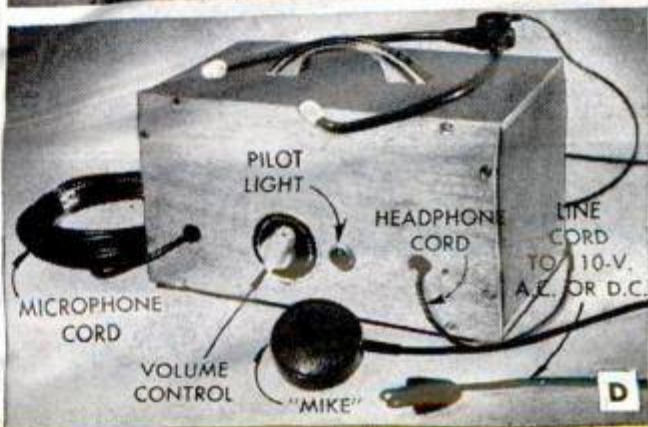

## RADIO AND ELECTRONICS TODAY



A

**A**—Three-speed automatic record player enables music lovers to enjoy the best of both worlds offered today. Two basic models are available for replacing existing changers or for new installations. One model employs a replaceable tandem-type cartridge designed to provide proper tracking of records at extremely low needle pressure required when playing the 78-r.p.m. groove records. This results in exceptionally long life for the 78-r.p.m. records. The proper needle tip is easily chosen by merely moving the tandem tip needle-selector lever to "Std" or "Micro." Another model features a special pickup arm with a pair of removable plug-in heads. These heads were designed especially for the G. E. type of variable reluctance cartridge and are color-coded for the particular type of record being played. A brass weight is provided with one of the heads to give the necessary additional needle pressure for proper tracking when playing the 78-r.p.m. records



B

**B**—Wake-up-to-music clock-radio features both "alarm" and "sleep" controls. The wake-up control on this 5-tube superheterodyne receiver permits the clock to be set at any time desired, or, it may be set to turn on any favorite radio program you wish. The sleep control allows you to preset the time that the radio will automatically turn off within a 60-minute range, if you wish to drop off to sleep

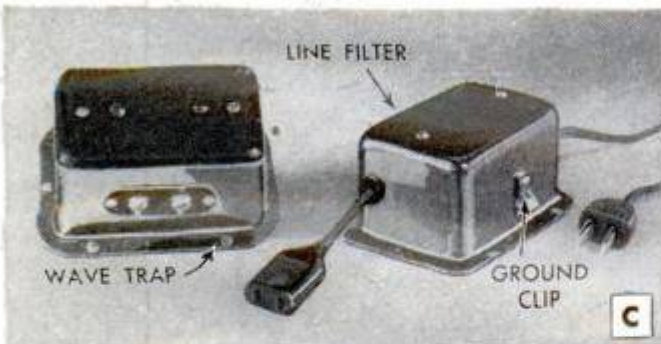

C

**C**—Wave trap and power-line filter combination eliminates many forms of troublesome interference in television receivers. A series of these Meissner wave traps is designed expressly for use in the reduction of unwanted signals of certain types encountered in both frequency modulation and television reception, and have proven highly successful



**D**—Table lamp includes a four-tube superheterodyne with a rectifier tube, built-in antenna and loud-speaker all housed in one compact plastic lamp base

**E**—Television in your home on a "pay as you see" basis is now available on a meter plan similar to the popular retail budget refrigerator purchase plan of prewar days; 25c provides 1 hr. of TV service



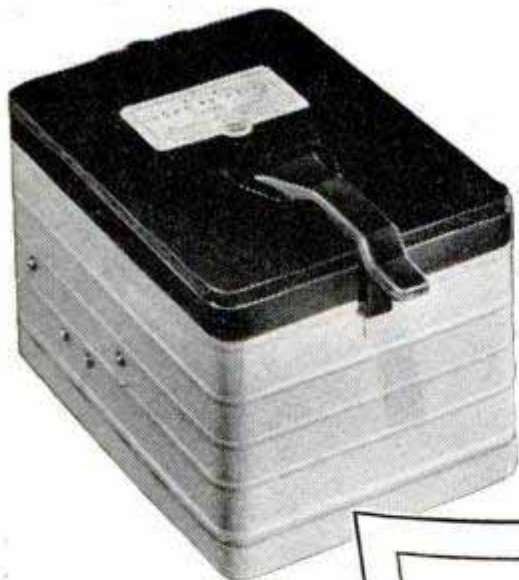

**Kodak Home Printer**—One-piece top automatically works light. Accepts negatives up to 4 x 5½ inches. Strip-prints 35mm. and larger roll-film negatives. Price, \$12.50.

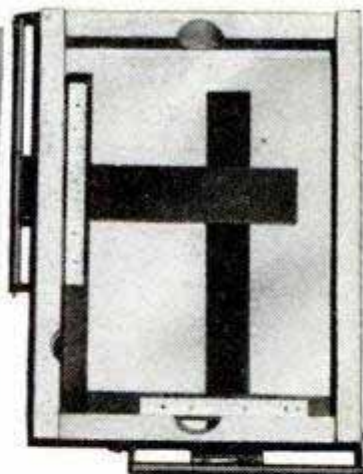

**Kodak Auto-Mask Printing Frame**—Clip holds negative firmly. Graduated scales on two sides also serve as paper guides. Price, \$3.25.

# PRINTING AIDS

## for your darkroom

Prints for your albums . . .  
extra prints for your friends  
. . . Kodak equipment makes  
home printing easy. Inspect  
these contact-printing aids  
at your Kodak dealer's.

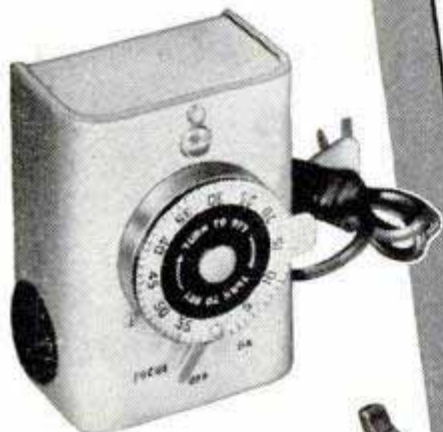

**Kodak Electric Time Control**—Plugs into printer or enlarger. 1 to 57 seconds. Repeat timing requires only original setting and turn of dial for each printing. Price, \$13.50.



**Kodak Timer with Tilting Base**—Has both minute and split-second hands. Switch permits stopping timer and then restarting it without resetting hands. Easy reading in dim light. Price, \$7.50.



**Kodak All-Metal Printer**—For negatives up to 4 x 5 inches and paper through 5 x 7 inches. Illuminated masking scales; center masking; guide for lining up paper; 35mm. guides for strip-printing; negative-locking device. Price, \$22.50.



**Kodak Printing Frame**—Offers a simple way to print. Three sizes available: 3¼ x 5½, 4 x 5, 5 x 7 inches. Supplied with a glass front—you use ordinary house lamp for light source. Price, from \$1.25.

Prices include Federal Tax where applicable

**Kodak**  
TRADE-MARK

EASTMAN KODAK COMPANY, ROCHESTER 4, N. Y.

# Indoor A.C.-D.C. Amplifier For Hard-of-Hearing Persons

(Continued from page 239)

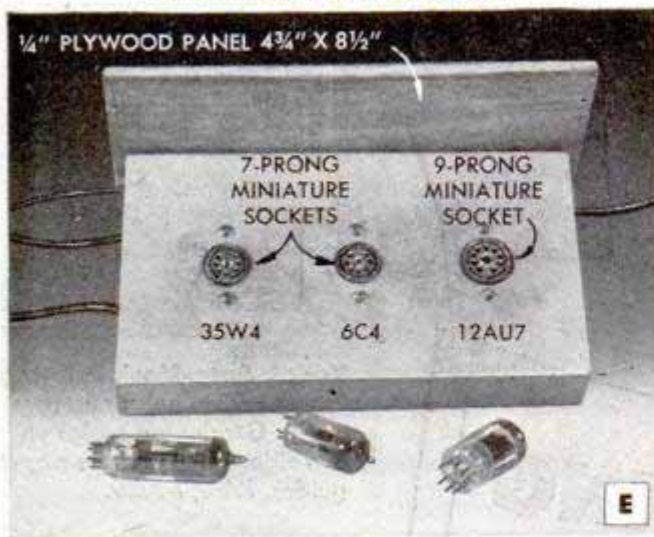

the tube sockets on the chassis base, arrange them as shown in the pictorial wiring diagram, Fig. 3, so that all circuit leads will be as short as possible.

In order to keep hum at a minimum, the chassis is part of the a.c. circuit and must not be exposed. This is why plugs and jacks were not used in this amplifier, and it is also the reason that the microphone and headphone cords were run into the ampli-

fier proper and permanently wired. The case must be of 1/4-in. plywood or similar insulating material, as specified in the detailed construction diagram, Fig. 1. As a result of this type of construction and the use of adequate filter capacity, hum is inaudible. In use, it is only necessary to plug the line cord into any convenient 110 to 120-volt a.c. or d.c. outlet and put on the headphones. The microphone is on a long cord so that it may be handed to other persons for conversation, or placed near a radio receiver. With a flexible pickup of this type, the deaf person can always take part in general conversations. The closer the microphone is to the speaking voices or music source, the less extraneous noises it will pick up. There will be considerable strain on the microphone cord due to its length. Therefore, when connecting it in the circuit, strip the woven-wire shield back far enough so that you can solder the shield directly to the ground lug, which is placed under the 12AU7 socket-mounting screw. This will take the strain off of the small insulated conductor which goes to terminal 2 on the tube socket. Care should also be taken in soldering the headphone-cord terminals permanently in the circuit. In ordinary types of headphones, the black

(Continued to page 244)

*Don't just paint it — let's use it!*



Remember Weldwood Glue when you need dependable wood-to-wood bonds. Quick and easy to mix with cold water... tremendously strong... stain-free... rot-proof... and *permanent*. At paint, hardware, variety stores and lumber yards. 15¢, 35¢, 65¢, 95¢ and larger sizes.

**WELDWOOD** PLASTIC RESIN GLUE  
United States Plywood Corporation, New York 18, N. Y.

## ALSO HANDY FOR WOOD HOBBYISTS!



### Firzite

—to give you smooth finishes on fir plywood and other soft woods.

A pre-finishing material that seals the wood pores... tames the wild grain... virtually eliminates checking and grain raising. An excellent base for stain, paint or enamel. White or clear. White Firzite provides an easy, low-cost way to achieve "blond," "bleached" or "wiped" finishes.



### Satinlac

—to preserve the beauty of all woods.

An inexpensive coating for the proper finishing of Weldwood Hardwood Plywood and similar woods. Clear. No brush marks. Brings out all the natural beauty of wood. Does not yellow or darken with age.

FIRZITE and SATINLAC are available from paint, hardware and lumber dealers. Write for leaflet No. 4 on finishing plywood.

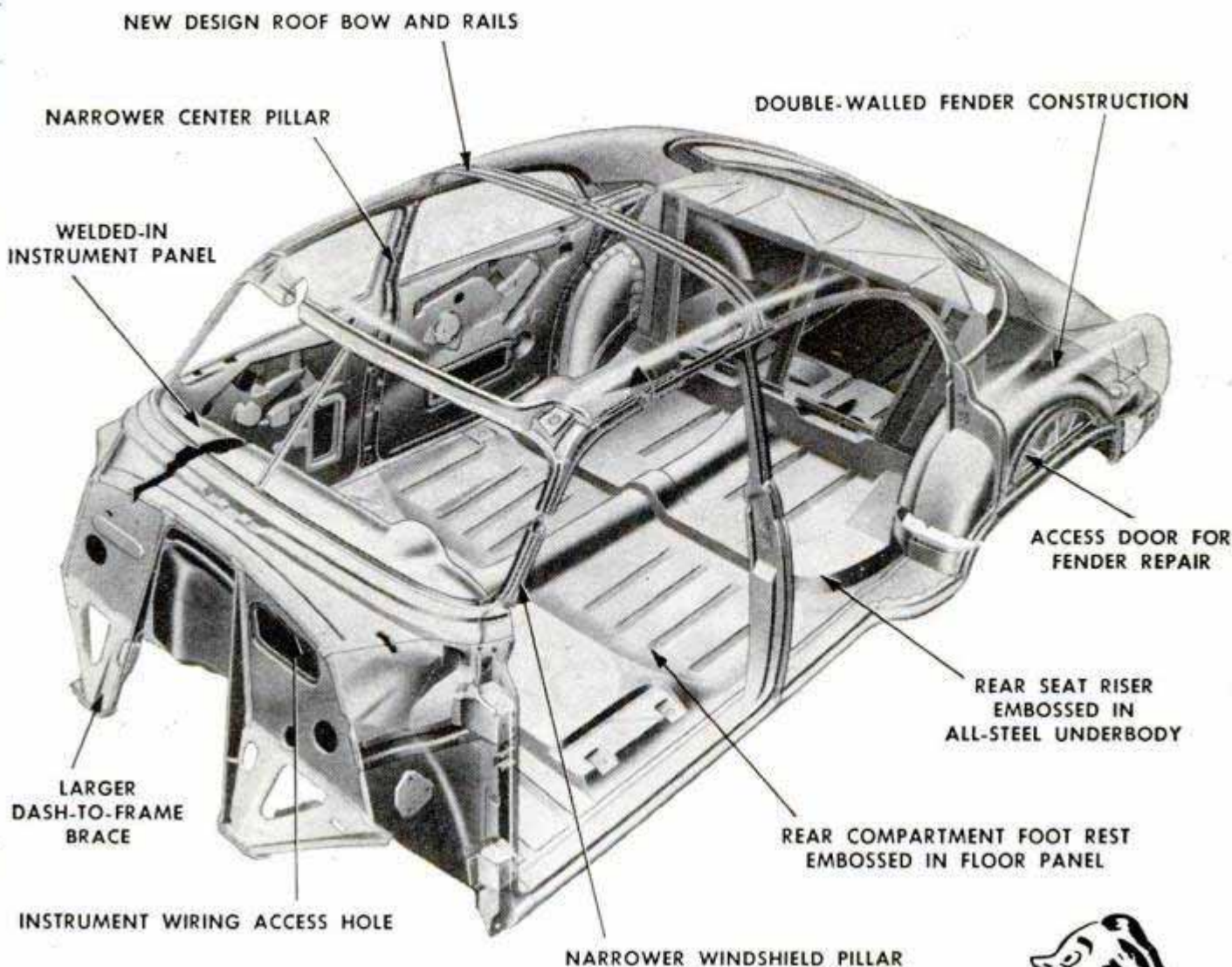

*Take a look beneath the Paint*

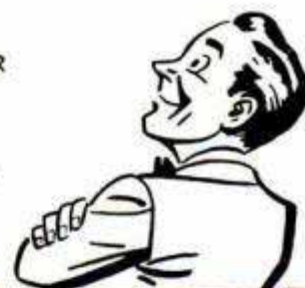

## **Chevrolet's Body by Fisher is a Masterpiece of Design and Engineering**

Yes, look beneath the paint—and you'll find that beauty is not merely skin deep in the Fisher Unisteel body of your Chevrolet. In fact, its greatest beauty lies in the qualities built into it—its strength, its safety, its durability. Its paint, its upholstery, its trim . . . these are important to

beauty, too—but the great extra value of the Chevrolet body lies in its design and construction. That's why Body by Fisher means Better by Far. And that's only one of the superior features that make Chevrolet—in engine, chassis, and body, in quality and value—"the most beautiful buy of all." See your Chevrolet dealer, now.

CHEVROLET MOTOR DIVISION  
General Motors Corporation  
DETROIT 2, MICHIGAN



lead goes to the ground side. The Telex under-the-chin-type headphones are provided with a miniature plug-in cord attachment so that the cord can be easily removed from the headset.

If you do not wish to build the portable plywood case for the instrument, you can house it in a small table-model wooden radio cabinet of suitable size. Blank cabinets of this type are to be found in all radio parts house catalogs. Do not house it in a metal cabinet. An inexpensive indoor hearing aid of this description serves many useful purposes in supplementing battery-operated devices for the hard of hearing, especially for use in the home, for shut-ins and for bench workers in stationary locations where ordinary line voltage is available. It has been estimated that approximately one out of every ten persons in the United States has a hearing defect, ranging from a slight impairment to almost total deafness.

Detailed student material list R-383 is available from Popular Mechanics Radio and Electronics department upon receipt of ordinary letter postage.

### Special-Purpose TV Antennas

(Continued from page 237)

station in a locality, the antenna problem is not serious. Trouble begins when other TV stations go on the air in different locations in the area and operate on widely separated frequency channels. This situation calls for specially designed antenna systems with high and low-frequency sections that can be separately oriented. In other words, in some locations the TV antenna must look in two directions at once in order to receive the maximum signal in both the high and low TV band. The Piggyback type of antenna illustrated in photo B is designed for this purpose. It consists of a high-band folded dipole with reflector in one plane, and a low-band folded dipole with reflector underneath. Although built for locations receiving signals from two directions, this type of antenna may also be used in localities where the TV stations are in the same direction. It is designed to receive on all 12 TV channels, using only one common transmission line, of either the standard flat 300-ohm twin-lead shown in Fig. 1, or the improved Amphenol tubular 300-ohm twin-lead illustrated in Fig. 2. This tubular-type twin-lead is claimed to reduce wind resistance and losses due to dirt and moisture, an important consideration in long runs, or in locations of low signal strength. The fact that it retains its efficiency in wet weather makes it ideal for critical installations.



Multiple Moderns #191



Modern Cabinet #193

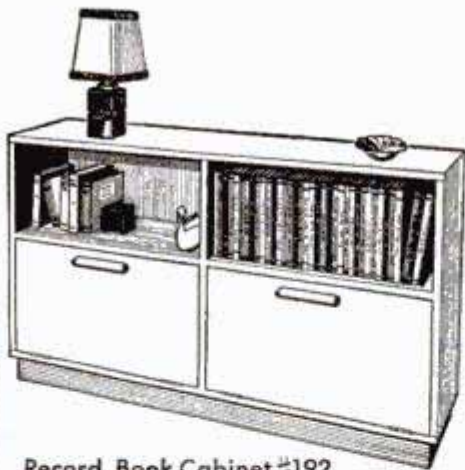

Record, Book Cabinet #192

## BUILD MODERN FURNITURE AT 1/2 STORE COST OR LESS!

The Easi-Bild\* Pattern Method takes the mystery out of making modern, professional looking furniture. Tells what materials to buy... when and where to use each... specifies the right Casco Glue.

Complete assembly illustrations and step-by-step directions make it fun to build your own lovely, practical "modern group."

\*Copr. 1949, Easi-Bild Pattern Co.

### How to choose a glue:

Follow these directions and you'll solve all your gluing problems:



For boats, outdoor furniture, sports equipment—joints that must withstand outdoor exposure—**CASCOHEN** (Resorcin Resin Glue). The first completely durable glue available to homecraftsmen.



For furniture, toys, heavy-duty home repairs—use **CASCAMITE** (Urea Resin Glue) where you want a light-colored or mold-proof glue line. Use **CASCO** (Casein Glue) for loose-fitting joints, general heavy-duty jobs. Both easily mixed in cold water.



Send coupon for furniture patterns to:

Casco Pattern Dept. PM-119  
P. O. Box 215, Pleasantville, N. Y.

Enclosed is .....¢ for patterns checked below.

- ( ) Record, Book Cabinet, Pattern No. 192—25¢  
( ) Multiple Moderns, Pattern No. 191—25¢  
( ) Modern Cabinet, Pattern No. 193—25¢

Name \_\_\_\_\_

Address \_\_\_\_\_

City \_\_\_\_\_ Zone \_\_\_\_\_ State \_\_\_\_\_

**THE BORDEN CO. • CHEMICAL DIVISION**  
Makers of Casco Glues

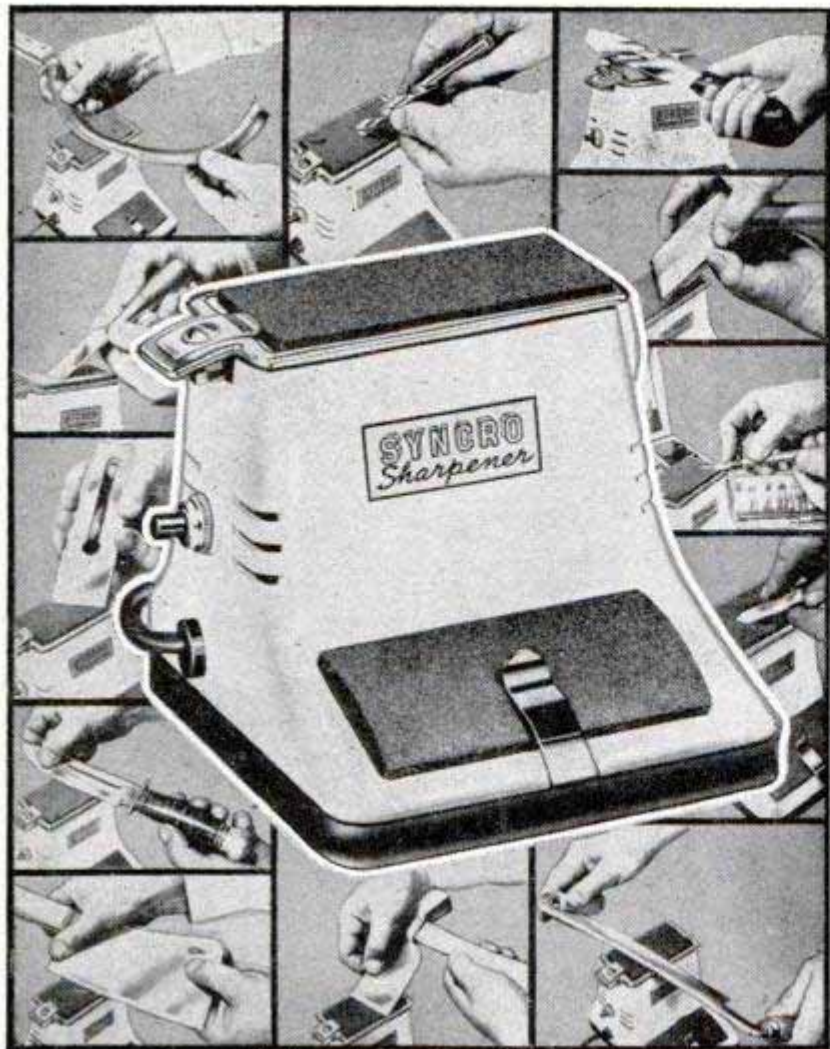

Hones all these sharp — hundreds more!

## SAFE ELECTRIC JIG SAW "FAMILY" PROJECT TOOL!

Here's a "Gift" tool that's safe for even small children yet powerful enough to be the most versatile tool in adult workshops! Thousands used by schools, craftsmen, hospitals, institutions, etc. Portable. No belts, gears or wheels. Operates on 60 cycle, 110-120 volt AC. Arm adjusts to permit cutting any length  $\frac{1}{2}$ " wood,  $\frac{1}{4}$ " plywood, thin metal and plastic. Not a "lumber cutter" but for delicate, fine craftsmanship. Perfect for family projects or making money. Made and GUARANTEED by the largest company of its kind. Built-in Motor. Complete ..... **\$17.50**

## NEW and BETTER Electric SANDER-POLISHER-MASSAGER The Perfect Gift!

You'll love this handy, beautiful, light-weight SYNCRO Electric SANDER-POLISHER! Also gives gentle body massage! 14,400 exclusive "Double Arc" strokes a minute makes sanding or polishing a pleasure instead of a chore! Just guide it. For light sanding, finishing, refinishing, redecorating. Perfect for polishing shoes, furniture, autos, etc. Give or get SYNCRO. 60 cycle, 110-120 Volt AC. Comes with 9 sheets Aluminum Oxide sandpaper, felt and virgin lambswool pads, 8 ft. cord, plug, only..... **\$14.50**



# NEW ELECTRICAL GIFT IDEAS for KITCHEN and WORKSHOP!

## NEW and ONLY ALL-PURPOSE Electrical HONE SHARPENER

The Gift any woman or man will really appreciate! This beautiful new SYNCRO sharpens *not just knives* but hundreds of other articles safely, quickly—by HONING the edge. "Honing" helps preserve edges. 14,400 gentle, rapid HONING strokes a minute! NOTHING ELSE like SYNCRO! No belts, gears or wheels. 60 cycle, 110-120 volt AC. Insist on genuine SYNCRO—the only electric ALL-PURPOSE HONE Sharpener! Comes with 3 Honing Stones, cord, plug, switch, only ..... **\$10.50**



YOU CAN DO IT BETTER WITH

# SYNGRO

QUALITY PRODUCTS

## HOW TO GET YOUR SYNCRO:

Because SYNCRO HONE SHARPENERS and SANDER-POLISHERS are so new, dealers may not yet have their stock. If dealer hasn't, order your SYNCRO Sharpener, Sander-Polisher-Massager and Saw direct. Send full amount, we'll ship prepaid! Remember—don't be satisfied with anything but a genuine SYNCRO!

**SYNGRO CORP., DEPT. H-119, ROCHESTER, MICHIGAN**  
World's Largest Makers of Safe Electric Jig Saws

## Army Hams to the Rescue

(Continued from page 101)

basis in a disaster or not, member hams are always ready to help people who are in trouble.

During "Operation Snowbound," when the prairie states were under a dozen feet of snow, several MARS boys were out pitching in an unofficial capacity.

WØHSO, which is M/Sgt. John McKinney, a National Guardsman in Grand Island, Neb., operated an Army mobile station for four weeks. He scouted and reported important roads blocked with snow, so rescue equipment could be sent to clear them. He found snowbound farm families and radioed for relief.

During this same disaster, the Pentagon stations were monitoring the frequencies, as were most of the members on the network—just to keep alert. AIR radioed WØIDR, 63-year-old rancher named Dominick Rolli, who was running a Jeep around the snowbanks, "fishing out Army boys from the drifts." Since power lines were down, Rolli used a put-put gasoline generator for his BC610 transmitter to keep rescue parties and the MARS net informed of his activities.

MARS members are always cooperating with other hams to do favors for people.

W2RGP is a building engineer with a ham shack on the 16th floor of a New York apartment house.

He uses his facilities to let Americans in the American-held zone of Germany talk to relatives in the States from ham stations over there. Recently, he put through a "telephone patch" for a man in South America, so he could talk with a brother in New York to whom he hadn't spoken for 40 years.

Even K4USA and K4AF get in on the act with this sort of thing. K4USA picked up one William Braud, broadcasting from W30ZA aboard the S. S. Joshua Tree in the Red Sea, 40 miles off Suez, not long ago. Braud said he had a wife and child in Baltimore whom he hadn't seen in months. So, while he waited, Master Sergeant Allyn, with an assist by a Baltimore ham, linked him into the telephone lines and Mr. and Mrs. Braud had a long, friendly chat.

On rare occasions, a sour note creeps into MARS, though it has never happened with a network member. Last spring, K4AF picked up a desperate QRR from a ham in Puerto Rico. Hurriedly, in broken English, the man stammered that a tidal wave had hit the island, washed away 200 homes, killed vast numbers of people and created a national emergency.

(Continued to page 252)

# NORWAY

## 2-WAY PROTECTION

**RADIATOR**

**GAS TANK**

**Extra Strength** gives the most protection at the lowest cost.  
**No disagreeable odors.**  
**Long Lasting!** Safe, sure protection with only an occasional check-up.  
**Prevents Corrosion** of all cooling system metals!

**Absorbs water** in gasoline.  
**Prevents stalls** from frozen fuel lines!  
**Stops motor spit** and sputter.  
**Relieves hard starting** due to moisture in fuel system.

NORWAY® DRY-EX®

PRODUCTS OF COMMERCIAL SOLVENTS CORPORATION



# SHOPMASTER will redeem this coupon for \$2.50 in Shopmaster "Build-it-Yourself" Plans

GOOD FOR  
**\$2.50**

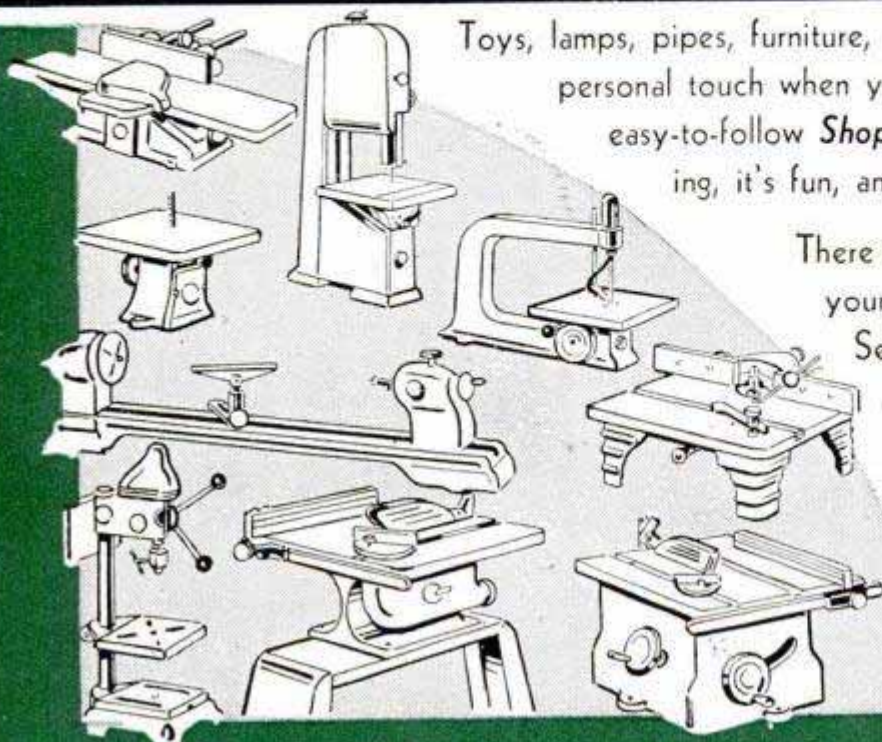

Toys, lamps, pipes, furniture, etc., will have that personal touch when you create them with easy-to-follow *Shopmaster* Plans. It's relaxing, it's fun, and it's profitable.

There is a famous *Shopmaster* Tool for your use, priced for your pocketbook. See your dealer, or write *Shopmaster, Inc.* for your copy of the new 28-page full-color illustrated catalog showing a complete line of tools and accessories.

With the purchase of a *Shopmaster* Tool, your *Shopmaster* dealer or the factory will redeem this coupon for \$2.50 worth of *Shopmaster* plans of your choice. Take this coupon to your dealer and purchase a tool today. If your dealer does not have the plans, he may sign the coupon with the registration number of your tool and mail it to the factory. Your plans will be sent to you immediately.

- |                             |                         |                             |
|-----------------------------|-------------------------|-----------------------------|
| <b>50c Plans</b>            | 52 Roller Toy           | 64 Kiddie Car               |
| 65 Smoking Pipes            | 53 Child's Wagon        | 67 Picket Fences            |
| 66 Modern Table Lamp        | 54 Coaster Set and Rack | 71 Picnic Table             |
| 68 Five-in-One Coffee Table | 55 Toy Duck             | 72 Silver Chest             |
| 69 Lawn Chairs              | 56 Broom Holder         | 73 Baby's Crib              |
| 70 Modern Coffee Table      | 57 Novelty Tie Rack     | 74 Child's Table and Chairs |
| <b>25c Plans</b>            | 58 Bouncing Dog Toy     | 75 Child's Play Pen         |
| 51 Nut Bowl and Mallet      | 59 Pull Toy Train       | 76 Three-in-One Decoy       |
|                             | 60 Gun Rack             |                             |
|                             | 62 Bird House           |                             |
|                             | 63 Rolling Hobby Horse  |                             |



**SHOPMASTER, INC.**  
1214 SOUTH THIRD ST.  
MINNEAPOLIS 15, MINNESOTA

*(Dealer Note: Shopmaster will replace all plans, free of charge, to your plan rack, on redemption of this coupon.)*

## CERTIFICATE

This certificate entitles you to \$2.50 worth of **Shopmaster** Plans with the purchase of any **Shopmaster** Tool. Circle the plan numbers desired. Your **Shopmaster** Dealer or **Shopmaster, Inc.**, will redeem this coupon. One to a customer. Coupon void after Dec. 31, 1949.

Tool Purchased \_\_\_\_\_ Registration Card No. \_\_\_\_\_  
 Dealer \_\_\_\_\_ Buyer \_\_\_\_\_  
 Address \_\_\_\_\_ Address \_\_\_\_\_  
 Signature \_\_\_\_\_ City and State \_\_\_\_\_

Redemption made by Dealer \_\_\_\_\_ Plans to be mailed direct to customer \_\_\_\_\_

51 52 53 54 55 56 57 58 59 60 61 62 63 64 65 66 67 68 69 70 71 72 73 74 75 76

This coupon is void if prohibited, licensed, or taxed in your state or locality.

**TWO FIFTY**

# PLUMB NEWS



A different name for  
your old friends...  
**PROTO TOOLS**  
—formerly  
**PLOMB TOOLS**



In your work, you deserve the best. And that means you deserve PROTO tools —formerly Plomb tools. They've been the favorites of professionals for 42 years because of their superior designs and extra long life. Buy them today from your dealer.

Write for catalog to

**PLOMB TOOL COMPANY**

2255 L Santa Fe Ave., Los Angeles 54, Calif.

4984



## Clinic



## for Homemakers

As a service to our readers in solving the hundreds of problems pertaining to a home—inside or out—the editors of *Popular Mechanics* invite you to present your problems to The Clinic Editor for help and advice. Address your questions to The Clinic Editor, *Popular Mechanics Magazine*, 200 East Ontario Street, Chicago 11, Ill.

### Hot-Water Heater

**Q**—I have an electric water heater and for reasons of economy I would like to install a heating coil in my boiler and connect it to the tank for part-time service. Is this considered advisable and, if so, what is the best way to go about it?

S.W., Trenton, N.J.



**A**—While we could not recommend this as a regularly approved procedure, the change-over can, of course, be made quite easily. Our suggestion as to the method of making the change would necessarily have to be governed by the local rulings of your power company regarding special rates applying to power consumption, and also any other rulings that might be in effect concerning such a change-over. Probably the simplest method of making the change would be to install a tee on the pipe at the cold-water inlet of the tank and hook the lower coil connection into the line at this point. Install a second tee in a similar manner at the hot-water outlet of the tank and connect the delivery end of the coil to this tee. It's a good idea also to install a shut-off valve in each line from the boiler so that the coil heater can be disconnected during the summer months when the furnace is not in use. With a hookup like this, the heating coil takes water directly from the cold-water line and delivers it to the hot-water line. When the faucet is open, hot water runs directly from the heating coil to the faucet and, when the faucet is closed, water circulates through the heating coil and into the tank, thus building up a reserve of hot water in the tank.

### Cold Chimney

**Q**—My outside two-flue chimney is about 25 ft. high and located on the north side of the house. In extremely cold weather, the draft is very sluggish both in the boiler and fireplace, so much so that it is difficult to hold a slow fire in the boiler. If I force the fire with all drafts open, it seems to burn freely but, when the draft closes with the thermostat satisfied, it dies out quickly and does not respond readily when the draft opens again. I burn a high grade of soft coal. What could be wrong?—B.G., Rochester, N.Y.

**A**—There always are several possible causes to consider when the boiler or furnace performs as you describe. These are: flue too small, flue coated or partially blocked with soot accumulations, an

(Continued to page 250)

# AMERICAN FLYER

Developed  
at the  
GILBERT  
Hall of Science

## More REALISM For Your MONEY

A PACEMAKER IN VALUE \$29.95

Complete with transformer  
Denver and west, \$31.45



No. 4904T Pacific 3-Car Freight Train—22 pieces—40½" long. Remote control. Powered by famous Gilbert Electric Motor. Superpower worm drive. Real smoke and "choo-choo" sounds. 3 realistic cars. Automatic coupling. Electric uncoupling. Track makes 140" oval.

### Only Trains With Real Smoke and "Choo-Choo" Sounds Synchronized With Train Speed

American Flyer—and only American Flyer—brings you both of these realistic features. The smoke is puffed out under pressure. The faster your train goes, the more smoke it puffs. In addition, the realistic "choo-choo" sounds change tone and tempo with every change in train speed.

### REALISTIC EQUIPMENT

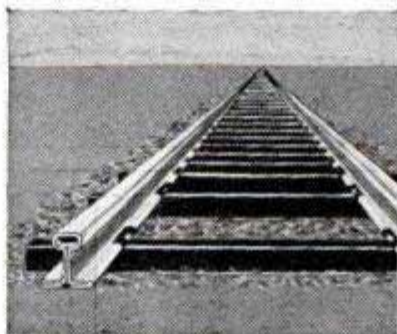

#### Real 2-Rail "T" Track

American Flyer track looks like the track of a real railroad. Notice there's no old-fashioned third rail in the middle.



#### TALKING R. R. Station

Produces true-to-life sounds of busy station. Stops train by remote control—starts it automatically. \$16.95. Denver and west, \$17.80.



## FREE GIANT Train Book

40 big pages. Over 100 color pictures. Shows all 16 American Flyer Trains and spectacular equipment. Mail coupon today.



The A. C. Gilbert Co.  
Gilbert Hall of Science  
105 Erector Square, New Haven, Conn.  
RUSH GIANT TRAIN BOOK—FREE

Name.....

Street.....

City..... State.....

THIS OFFER GOOD ONLY IN U. S. A.

# HOLIDAY

every day!

Enjoy that real Holiday feeling every day with HOLIDAY—the aromatic High Grade pipe mixture —at a popular price. Only 15 cents!

Also in vacuum pounds

TO MAKE NEW FRIENDS—FOR HOLIDAY

Here's a Sensational PIPE OFFER!

Cool-smoking aluminum pipe with genuine imported briar bowl!

Only **50¢ plus** inside paper wrapper from 12 tins of Holiday Pipe Tobacco.

Offer limited to U. S. A.  
Expires January 31, 1950  
Send to Holiday, Dept. PM-2, Richmond, Virginia

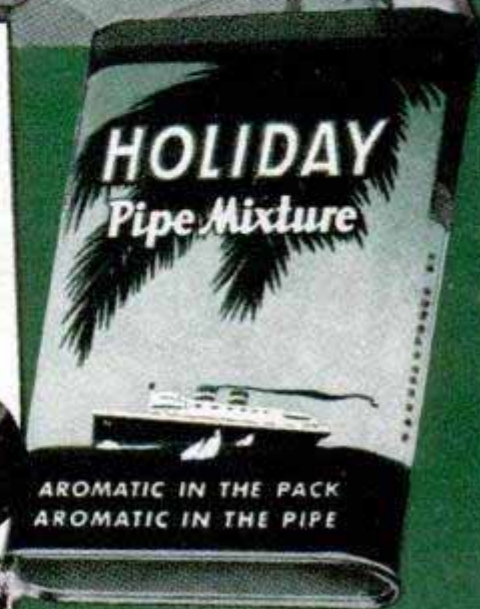

## AN ADVENTURE IN GOOD SMOKING

opening into the flue somewhere above the smoke-pipe opening and obstructions to air circulation, such as an overhanging tree branch, above or near the top of the chimney. However, your description would seem to indicate that your trouble very likely is due to a cold flue. When the fire is forced with open draft, hot gases warm the air in the flue, causing it to rise and thereby creating a draft. On the other hand, when the draft is closed and the check opened on a cold day, heat is largely confined to the boiler and, because of the northern exposure, air in the flue cools quickly to the point where there is very little upward movement. This condition could account for the sluggish performance you experience on cold days. One remedy that has been successful in a number of instances is that of replacing the regular check damper with one of the automatic, or atmospheric, type. This damper, operating without the check damper, can be manually adjusted to maintain a somewhat higher flue temperature. Of course, the arrangement is not economical from the standpoint of fuel but by adjusting the damper manually to compensate for atmospheric changes it is possible to control the fire satisfactorily. In your case, this suggestion might be worth a trial.

### Hanging Wallpaper

Q—I wish to hang wallpaper over gypsum wallboard in two small rooms. Only the walls are to be papered, not the ceilings. The wallboard has not been painted and the joints have been finished as directed by the manufacturer. How should I prepare this surface for hanging wallpaper?

D.L., Pasadena, Calif.

A—Application of a glue size generally is considered sufficient, but some paper hangers first ap-



ply a varnish size. This should be given plenty of time to dry thoroughly. Then the wall is coated with a glue size made according to the instructions on the package. This double sizing usually seals the surface completely and prevents absorption of the water in the paste used in hanging the paper. Check the joints before sizing the wall. If the joints are rough or raised at any point these irregularities should be removed by sanding as otherwise they will show through the paper.

### Cleaning Brass

Q—Some time ago I purchased at an auction a pair of brass candlesticks and brass andirons. The candlesticks, or candelabra, are badly tarnished. How can I clean and polish both the candlesticks and andirons to get that smooth, bright finish one sees on brasswork?  
W.D., St. Paul, Minn.

A—Assuming that both the candlesticks and the andirons are solid brass and are not plated or colored, first clean the parts with a solvent or with ammonia suds. This cleaning must be very thorough to remove all accumulations of dust, oil or grime. Do the work outdoors to avoid any risk of fire or the hazard of an accumulation of fumes in a closed room. Next, make a saturated solution of vinegar and common salt and rub the parts with a soft cloth wet in the solution. Intricate parts which cannot be reached with the cloth may be rubbed with a stiff-bristle brush. Wash off the acid-salt solution with quantities of clear water. Then polish with a fine abrasive such as tripoli, rottenstone or jeweler's rouge. A buffing wheel driven by a motor and flexible shaft and charged with any of the abrasives listed will speed up the job. Areas that cannot be reached with the wheel can be polished with a soft-bristle brush.



# AMAZING NEW LOW-PRICED ELECTRIC SPRAYER

*makes painting* **EASY!**

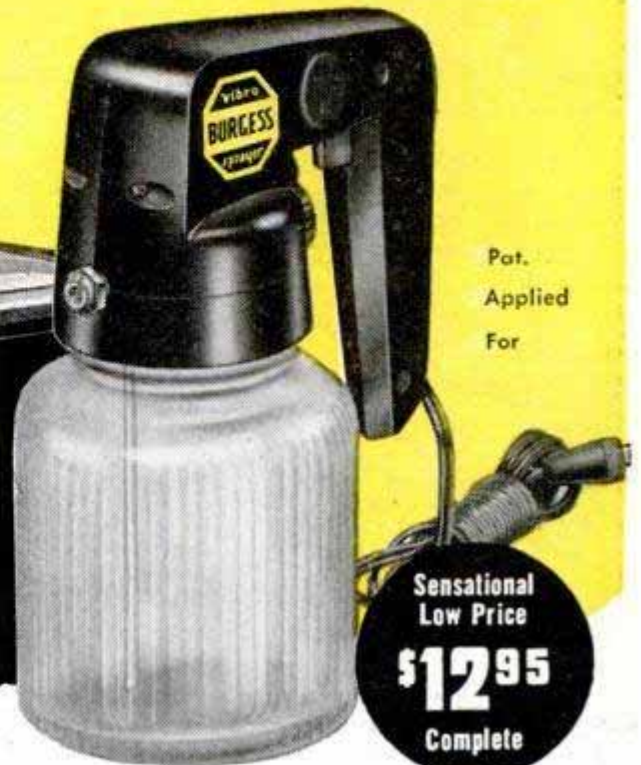

Pat.  
Applied  
For

*the original*  
**BURGESS**  
**vibro-sprayer**

NO MOTOR...NO COMPRESSOR...  
NO "EXTRAS" TO BUY

Sensational  
Low Price

**\$12.95**

Complete

*Just Plug In and Spray!*

Easy, economical paint spraying is now as convenient as your nearest electrical outlet. Just plug the sensational Burgess Vibro-Sprayer into any 110 volt A.C. socket, press the trigger and spray. You get a beautiful, smooth finish on tables, chairs, bookcases, toys, fences, screens, floors...almost anything around the home or shop... in minutes instead of hours. Refinishes car bodies and fenders, too. And Vibro-Sprayer handles enamel, lacquer, varnish, shellac...plus light oils, insecticides. Weighs only 2½ lbs. Comes complete with 25 oz. Mason-type jar and 8 ft. cord. Fully guaranteed.

Write for **FREE Literature**

*Unique* **BURGESS**  
**vibro-tool**  
adds **POWER**  
to hand skills!



This revolutionary marking tool delivers 7200 vertical strokes per minute to write like a pencil on hardest steel, mark tools, decorate glass, engrave plastics, tool leather, chisel wood or linoleum blocks, emboss metal foil, cut balsa wood, cork and cardboard. Specially designed kits for general use, leather tooling, and simple marking and engraving. All-purpose Master Craft Kit with 9 attachments shown, only...**\$9.95**  
Leather Craft Kit plus 9 attachments...  
.....**\$9.95**  
Marking Kit including Vibro-Tool and hard tantalum carbide point....**\$7.50**  
3 different kits...each packed in sturdy, attractive storage case

**BURGESS BATTERY COMPANY, Handicraft Division**  
156 RAND ROAD, LAKE ZURICH, ILLINOIS

Please send me full information on:  Vibro-Sprayer,  
 Master Craft Kit,  Leather Craft Kit,  Vibro-Tool and Point.

My Name \_\_\_\_\_

Street Address \_\_\_\_\_

City \_\_\_\_\_

Zone \_\_\_\_\_

State \_\_\_\_\_



**BURGESS BATTERY COMPANY** HANDICRAFT DIVISION  
LAKE ZURICH, ILLINOIS



# NEW TOOLS

by Starrett

"World's Greatest Toolmakers"



**"SATIN CHROME" MICROMETERS.** Pioneered only by Starrett. Non-reflecting finish cuts glare, resists rust and stains. Starrett precision craftsmanship plus 12 big features at no extra cost. Furnished in handsome Sycamore case.



**POCKET DIAL GAGE.** Vest pocket size, measures sheet metal, wire, plastics, paper, leather, etc. Reads in thousandths, 0-1", range  $\frac{3}{8}$ " "Rev" counter, chrome plated case, stainless steel parts, non-breakable crystal.



**TOOLMAKER'S HAMMER.** With Built-In Lens. An ideal hammer for light precision work — spotting in layouts, model making, jewelry, etc. Built-in magnifier saves fumbling for hammer or glass. Offset head permits working in close quarters.



**POCKET SLIDE CALIPER.** 6" capacity — graduated 32nds on stock, 64ths and 32nds on slide. Reads inside or outside measurements. Serrated thumb piece and knurled locking screw located for easy one-hand use. Also available in 3" and 5" capacities.



Get Your **FREE** Copy  
**STARRETT NEW TOOLS BOOKLET**  
 Describes, illustrates and prices these and many more important new tools. Write for your copy. Address Department AP.

THE L. S. STARRETT CO. • ATHOL, MASS., U. S. A.

TRADE MARK  
**Starrett**  
 REG. U. S. PAT. OFF.

Since 1880... Standard of Precision

Mechanics' Hand Measuring Tools and Precision Instruments • Dial Indicators • Steel Tapes • Hacksaws and Band Saws • Precision Ground Flat Stock  
 Buy Through Your Distributor

Sgt. James Williams, operator for K4AF, quickly notified the Red Cross and made his report. Hours later, the Red Cross announced that the report was false. "Probably just some bored ham trying to stir a little excitement," says Williams.

All told, MARS hams are pretty much the same as hams anywhere. The walls of K4USA and K4AF are papered with QSL cards from all over the world. QSLs are postcards, giving call letters and information, which hams send to each other after they have made contact. Many MARS stations have QSL cards, even from Russian hams. Every network member has one ambition—to get his "WAAFB" and "WAAP" certificates—which mean "Worked All Air Force Bases" and "Worked All Army Posts."

Meanwhile, the network is building fast. Eventually, the chiefs hope to supply key stations with facsimile and teleprinter equipment. With these, messages will be sent 10 times faster. The teleprinter transmits its impulses through an oscillator, the impulses are picked up on the other end and transcribed into print by the receiving machine at a rate of 60 words a minute. The signal transmitted over the air by the teleprinter sounds like a big diesel engine in the distance—a long, deep, wavering note with rapid, muffled breaks.

Until these speed demons do the work, MARS hams will continue to develop "sweet fists," and practice traffic handling for the day when a big emergency calls them out.

## Comes the Flying Assessor

(Continued from page 172)

land usage and bigger crops. They rarely object to assessments because they can compare the photographs with those of farms in their neighborhood and check relative assessments.

The first step in preparing the pictures for tax use is to mark off the area by sections, which are broken down to the usual 40-acre squares. Section corners are accurately located on the photo map by general survey data and known landmarks. The photograph is marked to show township, range and section. From the ownership records, property lines are laid out on an acetate overlay so they can be changed if necessary. Such data as soil type, slope, water resources including irrigation facilities, are entered right on the picture. This task is a gigantic one as there are 93 distinct soil types in western Oregon alone. Values range from 50 cents an acre in the

(Continued to page 254)

# SHOTGUN VALUES



## FIRST IN THE FIELD



Savage Models 755-775

Stevens Model 620

Stevens Model 820

Stevens Model 124

Stevens Model 530

Stevens Model 107

Stevens Model 59

Stevens Model 258

Looks . . . Performance . . . Dependability at *lowest cost* make Savage-built shotguns *the "first in the field" VALUES*. Look over this wide range of models. Take your pick from sleekly streamlined auto-loaders (standard and lightweight models) . . . fast-handling

"pump" guns . . . well balanced bolt action repeaters and dependable "singles" and "doubles". Then, choose the *kind* of gun for *your* kind of shooting at the price you want to pay. See these Values at your Dealer's—Write for Free Catalog.

Savage Arms Corporation • Firearms Division • Chicopee Falls, Mass.



**"First in the Field" in VALUE**

**Savage Streamlined Automatics**—Models 755 (standard for long range shooting with heavy loads); 775 (lightweight for upland game and skeet). 12 and 16 ga.—3-5 shot. New, streamlined design. No changes in tested, service-proven functional design, but trigger and hammer mechanisms have been improved.

**Stevens Model 620**—Slide Action Repeating Shotgun. 12, 16, 20 gauge. 5-shot with one in magazine, making 6-shot repeater. Fast handling, smooth operating, dependable. Checkered walnut pistol grip; checkered slide handle.

**Stevens Model 820**—Slide Action Repeating Shotgun. 12 gauge only. The newest Savage "first in the field" value. Sensationally low priced. Natural pointing, smooth operating. Stock and slide handle of Tenite.

**Stevens Model 124**—Repeating Shotgun. 12 gauge only. Features a compactly efficient, simple to operate cross bolt action—a Savage pioneered design. A new value in the repeating shotgun field. Tenite stock and fore-end.

**Stevens Model 530**—Double Barrel Shotgun. 12, 16, 20 and .410 gauges. Hammerless . . . coil springs . . . forged steel barrels. Checkered walnut stock and forearm, full pistol grip. Well balanced, natural pointing, dependable. (MODEL 311 DOUBLE—same as above but with stock and forearm of Tenite).

**Stevens Model 107**—Single Barrel Shotgun. 12, 16, 20 and .410 gauges. Hammer style . . . automatic ejector . . . take-down . . . case hardened frame. Walnut stock and forearm. (MODEL 94 SINGLE—same as above but with stock and forearm of Tenite).

**Stevens Model 59**—Bolt Action, Tubular Magazine, 6-shot Repeater. .410 gauge. 2½ or 3 inch shells. One piece walnut finish stock with black tipped forearm. Lightweight, well balanced, attractively priced.

**Stevens Model 258**—Bolt Action, Clip Magazine 3-shot Repeater—20 gauge. 2 shells in clip, one in chamber. Walnut finish stock with black tipped forearm. Takedown. A fast handling, low priced model in a popular gauge.

# Small motors that do **BIG JOBS BETTER**



There's a Hoover Electric Motor for every power job in workshop, farm or garage.

Every one is built by the makers of the famous Hoover Cleaner to deliver years of economical, dependable operation, even under the toughest conditions and continuous duty.

**Look at the features of the Hoover line:**

- Capacitor-start, split-phase and poly-phase types
- Ratings from  $\frac{1}{4}$  to  $1\frac{1}{2}$  H.P., some with double-end shafts
- Single or dual voltage, 1725 or 3450 R.P.M.
- Ball or sleeve bearings
- Rigid or resilient mounts that meet NEMA specifications
- Service and parts available from authorized agencies and dealers

Just

**13<sup>95</sup>**

for this  
versatile  
Hoover Motor



This is the new Hoover  $\frac{1}{4}$ -H.P., 1725-R.P.M., split-phase motor. Ideal for easy-to-start, quick-to-accelerate applications, such as fans, blowers and light machine tools, etc. Rotation can be reversed. Fully ventilated. 115 volt, 60 cycle, AC only. See it at your dealer's today!

## **HOOVER MOTORS**

Made in capacities of  $\frac{1}{4}$  to  $1\frac{1}{2}$  H.P.  
Product of Kingston-Conley Division  
**THE HOOVER COMPANY, North Canton, Ohio**

ranges of the east to \$2000 an acre in the Lake Labish onion-growing area.

Aerial photographs show at a glance any changes in tillable land. When a farmer clears some land and turns it into farm land, the assessor spots the change on his photograph. In one county, the assessor added more than 15,000 tillable acres to his assessment roll after studying the photographs. To detect such changes by ground inspection would require days of driving over rough terrain.

Although it cuts time and expense, aerial photography doesn't entirely eliminate the assessor's ground work. He still has to plod through woodlands and farm lands to check uncertain spots. Field inspection of timber is necessary to classify the quality of the growth. But the airborne camera has reduced field work by at least 70 percent and, at the same time, increased the accuracy of the assessments. Without it, the statewide reappraisal operation would be virtually impossible.

## **Logging "Cowboys" Ride The Sea Dozer**

(Continued from page 93)

down under the log. Then, he gives the engine full throttle in forward gear. The stern sinks, the bow rises and the end of the log is pulled upward.

Not all logs are light enough to float. The occasional heavy log contains excessive moisture and its density is greater than water. When a crib is broken up, there may be 15 or 20 logs that immediately sink to the bottom of the anchorage. These are recovered by Bob Forrest, deep-sea diver, who tours the bottom after each crib is broken up. He notes the positions of the sunken logs so that he can grapple for them from the surface, or he attaches wires to their ends so that they may be hauled up at once. Working in 40 to 60 feet of water, Forrest sometimes finds a giant octopus on one of the sunken logs. An octopus with a 10 or 15-foot spread between tentacle tips can be a nuisance even if it isn't actually dangerous and Forrest carries a small bag of blue vitriol crystals tied to his suit to ward them off. Dissolving slowly in the water, the chemical is repulsive to the devilfish and it usually moves away at once.

Puget Sound lumbermen, just like ranchers, have to contend with rustlers although the wholesale stealing of rafts and cribs has just about been wiped out. Occasionally, log thieves still raid an unguarded cove where logs are stored, round up as many logs as their boat can conveniently

(Continued to page 256)



# "Mr. Big"

## of Hand Guns

the

H&R

"922"

.22 CALIBER, DOUBLE  
ACTION REVOLVER

Only \$24.75.

**BIG** new features . . . **BIG** new performance!

*NEW* coil spring action. Gives match target trigger pull. Returns hammer to half cock automatically, preventing accidental discharge. *NEW* positive cylinder stop assures uninterrupted firing sequence. *NEW* cylinder release for easier, faster reloading. *NEW* front sight.

See . . . handle . . . sight the new improved "922" at your gun dealer's. It's a lot of revolver for little money.

*FREE* New catalog on all H & R sporting arms. Write for it.

**HARRINGTON & RICHARDSON ARMS CO., 446 Park Ave., Worcester 2, Mass.**

### SPECIFICATIONS

Solid frame; 9 shot; shoots long rifle, long, or short regular or high speed ammunition, both single and double action; 6", 4", or 2½" barrels; checkered Tenite stock.

### MODEL 923

Same as model "922" except all metal parts are of chrome finish. \$26.78

**FINE TOOLS  
NEED  
FINE OIL!**



• Lubricates



• Prevents Rust

• Cleans • Polishes

SOLD EVERYWHERE

**3-IN-ONE Oil**

**KING MIDGET**  
HOME ASSEMBLED MIDGET AUTO



**WORLD'S LOWEST PRICED AUTOMOBILE!**

80-90 MI. PER GAL.—45-50 MI. PER HR.

Drive this car for as low as 50c per week. Precision built parts direct from factory with beautiful all steel body. Get all the facts on this amazing small auto — send 25c for detailed circular with large picture, 4 view drawings and price of all parts, or send \$1 (refunded first order) for this plus actual assembly book with 42 photos, drawings; blueprints of snow and ice conversions, etc.

MIDGET MOTORS MFG. CO., ATHENS 1, OHIO

**SEND FOR FULL INFORMATION TODAY!**

King Midget is the ideal small car for errands, sports use, to and from work, short business or pleasure trips, delivery service or second-car utility for the whole family. Comfortable — room for husky six footer.



Fill cracks in floors—

Sands to a  
 swell finish,  
 stops annoy-  
 ing squeaks!



Fill nail and screw holes—

Replaces rotted  
 wood . . . dries  
 tight and hard!  
 Easy to apply!

Repair broken furniture—

Makes loose  
 joints firm,  
 steady!



Also useful in repairing broken balusters,  
 loose tiles . . . filling knot holes, gouges!  
 Handles like putty . . . hardens into wood!



IN CANS  
 OR TUBES



WON'T CHIP OR CRACK

handle, and tow them to another anchorage.

One way to discourage rustling is to brand every log just as if it were a cow, and that's the rule these days. Each company has its own brand, registered with the state. Instead of a hot iron, the lumberjack uses a heavy hammer with the brand embossed on its head. He marks the butt of each log with several blows. Some logs carry three or four brands by the time they get to the mill, each representing a successive change of ownership.

There are literally hundreds of protected anchorages and coves along the shores of Puget Sound in which logs can be stored, and there is constant traffic between the anchorages. Rafts are towed up and down and across the Sound as the logs are moved from the forests to the mills, to new owners or to storage areas. The traffic is so great that it forms the principal occupation for 75 tugboats that are operated by nearly 1000 crew members.

Some of the tows are for distances of only 45 or 50 miles, some rafts that are brought down the Inside Passage from Canada travel 600 miles before they reach their destinations. In round figures, about 2½ billion board feet of timber per year are rafted through the Sound for processing into plywood, other forms of lumber and into paper products.

With all this activity, some logs are bound to escape. Some float away from the booms in which they are corralled, some get loose from the rafts themselves. During heavy weather, there is always a chance that a raft may break up and if this happens, the storm then scatters the logs over square miles of water.

Rounding up these strays is the task of the log patrols, the private "beachcombing" outfits that are licensed to operate in assigned territories.

A big heavy log, low in the water, is a menace to navigation but fortunately the action of the tides usually beaches it in a few days. On the beach, it is no longer a danger to shipping but it remains a valuable piece of property. That's where the beachcombers come in.

Each salvage outfit makes frequent patrols along its stretch of coast, hunting for logs that have recently come ashore and noting their locations. Special searches are made after each big storm. Often, the patrol is made from small seaplanes because these craft are ideal for maneuvering in and out of the numerous small coves.

Periodically, the beachcombers tow a barge along the beaches and haul the stray logs out to it and lift them on board. Each

(Continued to page 258)

# BOYS! This coupon may send you to college!

It gets you started on a model car that can win a \$4,000 University Scholarship—a cash award—a tool chest — or all-expense convention trip! It's your first step in the 1950 Fisher Body Craftsman's Guild Competition — 734 awards — \$65,000!

SEND COUPON NOW FOR



**FREE**

Guild membership!  
Craftsman's button and card!  
Plans on building model!

If you were between 12 and 20 years of age on Sept. 1, 1949, this may be the biggest thing in your life.

For in the 1950 Fisher Body Craftsman's Guild Competition, you've a chance to win one of 8 University Scholarships, worth up to \$4,000. Also—expense-paid trips, generous cash awards, tool chests—altogether 734 awards worth \$65,000.

**No Entry Fees! No Special Tools!** Send in the coupon for your FREE membership in the Guild, FREE Craftsman's button, FREE instructions. Then, using balsa or any suitable material and the simplest tools, you simply make a solid scale model of your idea of a modern car.

**So Get Started Now!** It's not work—it's fun! Fill in and mail that coupon. It may make a college man of you!

### LOOK AT THESE AWARDS

8 University Scholarships—worth from \$1,000 to \$4,000 each. All-expense trips to the Guild Convention. Cash awards—up to \$150 each. Model Builders' Tool Chests.

**A Grand Total of 734, Worth \$65,000**

*Identical awards for Juniors and Seniors*

(If the son of a General Motors employe wins, a duplicate award is given.)

### LOOK AT THE EASY RULES

You're eligible if you were at least 12 but not yet 20 years old on Sept. 1, 1949. You compete against boys in your own age group—there is a Junior Division (12 to 15 years inclusive) and a Senior Division (16 to 19 years inclusive). You build a solid model of a car. No special tools needed.

**FISHER BODY CRAFTSMAN'S GUILD, Dept. J**  
General Motors Building, Detroit 2, Michigan

*Please enroll me in the Fisher Body Craftsman's Guild Competition for 1950. Also—send the Craftsman's button and membership card plus complete instructions for building a model. All this will be sent FREE and without obligation to me.*

Name \_\_\_\_\_

Address \_\_\_\_\_

City and Zone \_\_\_\_\_ State \_\_\_\_\_

I was born on the \_\_\_\_\_ day of \_\_\_\_\_, 19 \_\_\_\_\_

Parent or guardian \_\_\_\_\_

Name of my school \_\_\_\_\_

Town \_\_\_\_\_ State \_\_\_\_\_



Dealer Inquiries Invited

## SET THE PACE WITH THE

- Cruises at 45 MPH—with faster pickup than car
- 39" high, 71" long overall, wt., 190 lbs.
- 8 HP motorcycle engine
- 50 miles to the gallon
- Automatic clutch
- Internal expanding brakes—handle-grip throttle controls

**POWELL MANUFACTURING COMPANY**  
DEPT. PM1149 • COMPTON, CALIF.

*Powell*

**P-81!**

ONLY \$247<sup>34</sup>  
AT COMPTON, CALIF.  
EXCISE TAX INC.

Write for FREE folder and name of nearest dealer

## WRITE FOR YOUR FREE COPY OF THE NEW KRW HYDRAULIC PRESS BOOK

Describes all manner of Production and Shop Work on KRW Hydraulic and Bench Type Presses. Illustrates the new KRW Hand-operated, Electric-operated and Air-operated Hydraulic Presses. 25 to 100-ton capacities.

Write for your copy today.

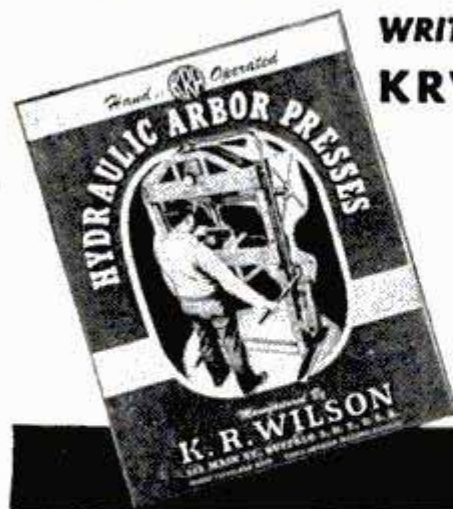

**K. R. WILSON, DEPT. 17, 215 MAIN ST., BUFFALO 3, N. Y.**

## M-SCOPE TREASURE-MINERAL LOCATORS

WRITE FOR FREE, ILLUSTRATED 16-PAGE BOOKLET

M-SCOPE TREASURE-MINERAL LOCATORS. Low priced, unsurpassed efficiency, lightweight models. Factory guaranteed. Immediate shipment. Credit plan available. Write for free 16-page booklet.

GEIGER COUNTERS for finding Uranium ores. Several models, Simple operation. Low priced. Immediate shipment. Interesting free literature.



URANIUM



GOLD

**FISHER RESEARCH LAB., INC., PALO ALTO, CALIF.**

log, of course, carries the brand of its owner and the owner has the right to recover his property on paying a standard log-salvage fee. Logs that are unclaimed by their owners become the property of the patrol concerns.

Cutting down America's forests used to be an extravagant, wasteful business but now the logging industries believe that by careful management and conservation the forests can be cropped time after time, far into the future. Recovering logs that have sunk in the water and rounding up stray logs from the beaches are only two of many conservation measures that are part of the program.

## Rail Car's Three Heating Systems Maintain Even Temperatures

Three independent heating systems are combined into one installation in a new method of maintaining comfortable temperatures in railroad cars. Each wall of the car has its own hot-water radiator and thermostat, thus keeping an even temperature throughout the car when the sun is warming one side and a cold wind chilling the other. The third heating system is an overhead warm-air circulator. In addition, thermostats outside the windows anticipate inside temperature changes and regulate the heating systems accordingly.

# The Ideal Christmas Gift DREMEL *Electric* MOTO-TOOL

The "Pocket Size Machine Shop"

Grinds, Routs, Drills, Carves, Engraves, Cleans, Polishes, Finishes

APPROX. 27,000 R.P.M.



MOTO-TOOL KIT NO. 2 With 23 Accessories (High-Speed Steel Cutters, Grinding Wheels, Polishing Accessories) \$23.50



MOTO-TOOL NO. 2 with one emery wheel point \$16.50



Great for Hobbyists

Saves Time and Labor

### 10 REASONS WHY MOTO-TOOL IS A BETTER BUY

Here's what you get in a Dremel No. 2 Moto-Tool: Oil-less, sealed bearings • Patented automatic chuck lock pin • Oversize armature shaft, hardened, ground, polished • Shockproof, bakelite housing • Dust filtered air cooling system • Dynamically balanced armature (for vibrationless operation) • Exclusive hanger hook • Sturdy 110-120 Volt AC-DC motor • Weight only 13 oz. • Cutters in Kit No. 2 are made of high speed steel (not common high carbon steel) for longer life, faster cutting.

### Portable DRILL PRESS

Add all-around versatility to your Moto-Tool with this 12" high drill press. Just the thing for creating costume jewelry, model making, carving, routing, drilling, etc. Utilizes No. 2 Moto-Tool, which can be raised, lowered or swung in any direction. Weighs 3½ lbs.

Only \$9.95 (Less Moto-Tool)



Moto-Tools, Kits and Accessories should not be confused with "bargain offers." We invite you to compare Dremel Products feature for feature with other similar equipment. If you are not fully convinced ours are far superior in quality, design and performance, we don't want you to buy.

**WIDELY USED IN INDUSTRY** —Moto-Tool is a precision-built electric tool, backed by over 13 years of industrial use in such plants as: GENERAL ELECTRIC • FORD • REMINGTON ARMS • NASH-KELVINATOR • WESTINGHOUSE • DOUGLAS AIRCRAFT, etc.

### PRE-WAR PRICES STILL PREVAIL

MOTO-TOOL KIT NO. 2 with 23 accessories including high-speed steel cutters and Model 2 Moto-Tool in natural finish hardwood case..... \$23.50

MOTO-TOOL NO. 2 with one emery wheel point..... \$16.50

**WHERE TO BUY** —Buy Moto-Tool from your dealer. If he cannot supply you, send check or M. O. for items desired and we will ship postpaid. Or, send only \$2 now and pay postman balance plus postage on delivery. **MONEY-BACK** if not delighted after 5 days' trial. Catalog of Dremel Tools **FREE**.

DREMEL MFG. CO., Dept. T119-L, Racine, Wis.

### BIG VALUE!



MODEL NO. 1

MOTO-TOOL KIT Only \$17.50

Moto-Tool Kit No. 1 contains the lighter Model No. 1 Moto-Tool and 34 practical accessories (steel cutters, grinding wheels, etc.) in an attractive, lacquer-finish wood case. It's the biggest bargain \$17.50 in the field..... MOTO-TOOL NO. 1 with one emery wheel point... \$9.85

A Gift the Whole Family Can Use

# THREE TOOLS IN ONE



Patented

Only \$14.85

POSTPAID



## DREMEL *Electric* SANDER

Popular Labor Saver for the HOME and SHOP



MAKES PLAY OF WAX POLISHING



SOOTHES TIRED MUSCLES BY MASSAGE

## FUN FOR BOYS FROM 8 TO 80 DREMEL *Electric* COPING SAW

CUTS SCROLLS LIKE MAGIC—SANDS AS IT SAWS



BLADE FACES 4 WAYS

SAFE!  
AS A  
HANDSAW

JUST  
GUIDE IT!

Only \$5.85  
with 3 saw blades

For men who harbor a hobby or do their own repair work . . . for boys who like to make things . . . no other tool will give as much pleasure and satisfaction in the home or workshop for the small amount of money invested as a Dremel Electric Coping Saw. It works in any direction . . . delivers 7,200 strokes per minute . . . so easily, there is no effort . . . so smoothly, work needs no sanding. Makes child's play of tricky scroll designs . . . saws through 3/4" medium hard wood at a foot-a-minute speed. Touch-of-the-trigger, foolproof action. Saw has only two moving parts . . . never needs oiling. Operates on AC current. Thousands and thousands of satisfied users.

**WHERE TO BUY IT**—Buy Dremel Electric Coping Saw from your dealer. If he cannot supply you, use the coupon to order direct from factory. We ship postpaid if you send check or money order in full. Or, send \$2 now and pay postman balance plus postage, on delivery. Money back if not delighted after 5 days' trial.

DREMEL MFG. CO. • Dept. S119-L • Racine, Wis.

FREE PROJECT PLANS

Plan for making six useful decorative projects packed with each Dremel Electric Coping Saw.

The popular Dremel Electric Sander is more than a sander . . . it's also a polisher and massager. This miracle machine is so easy to handle, a child can use it. It delivers 14,400 strokes per minute. (1) As a sander, it gets into tight corners, takes the effort out of sanding walls, woodwork, furniture, workshop projects, etc. Its straightline (non-rotary) action will not burn or scratch surfaces. (2) As a polisher, it does a professional job on waxed surfaces of cars, furniture, refrigerator cabinets, etc. (3) As a massager, it's ideal for tired or sore muscles of the back, legs or arms. Users testify it is more effective than machines made expressly for this purpose.

### LOOK AT THESE DREMEL FEATURES

Dremel Electric Sander does all the work . . . you merely guide it. It weighs only 2 1/2 lbs.; it's foolproof (has only two moving parts . . . never needs oiling). Quick-change clamps firmly hold abrasives and pads. Dremel Sander is sturdily built to give long, trouble-free service. Operates on 110-120 Volt, 60 Cycle, AC. Thousands and thousands of satisfied users prove its outstanding value.

**WHERE TO BUY IT** — Dremel Electric Sander comes complete with 6 sheets assorted grade Garnet Paper for sanding, plus felt pad and sheepskin for polishing. Buy it from your dealer. If he cannot supply you, use coupon below to order direct from factory. We ship postpaid if you send check or money order in full. Or, send \$2 now and pay postman balance plus postage, on delivery. Money back if not delighted after 5 days' trial.

**If Your Dealer Cannot Supply You  
USE THIS HANDY COUPON ORDER FORM**

DREMEL MFG. CO., • Dept. S119-L • Racine, Wisconsin

- Enclosed find \$\_\_\_\_\_ (Check or M. O.) in full payment for items checked below. Ship postpaid at once.
- Enclosed find \$2.00 in part payment for items checked below. I agree to pay postman balance plus postage, on delivery.
- Dremel Electric Sander \$14.85       Dremel Electric Coping Saw \$5.85
- Free catalog of Dremel Electric Tools.

Name \_\_\_\_\_  
Address \_\_\_\_\_  
City \_\_\_\_\_ Zone \_\_\_\_\_ State \_\_\_\_\_

# MOTORISTS WISE SIMONIZ

T.M. REG. U.S. PAT. OFF.

MAKES CARS STAY BEAUTIFUL

*Better than 10  
"Here-today...  
Gone-tomorrow"  
Polishings!*



**Simonizing saves you time and effort . . . because it lasts longer!**

Don't waste your time with 'temporary polishings'! Simonizing gives long lasting beauty...protects the finish and keeps colors from fading. Do as millions of motorists...Simoniz your car. It's easy to do yourself.

THE SIMONIZ COMPANY, CHICAGO 16, ILL.



Use Simoniz Kleener (liquid or paste) to clean finish. Then Simoniz for lasting beauty. Sold everywhere!

## Mexico City Is Sinking

(Continued from page 138)

basement demonstrated the soundness of his basic idea, Cuevas built the companion hull in the way he desired. It was built and sunk similar to the way a caisson is put down. A complete six-foot section of the circular hull, 66 feet in diameter, was built of concrete above ground, at the same time that six feet of dirt were excavated from underneath it. During the night, the circular ring sank into the ground. Next day, another six-foot course was poured and more material was excavated out from below. Day by day the work proceeded until the hull was complete except for the pouring of a waterproof floor at its bottom. Meanwhile, its interstructure had been loaded with ballast equal to the weight of the soil that had been removed. This ballast was in turn removed in pace with the construction of the building.

The first method of creating a foundation hull, Cuevas points out, permits a temporary unbalance in the soil. The caisson method is more satisfactory because the plumb of adjacent structures is not disturbed and the soil remains at rest.

In theory, the National Lottery Building will always remain vertical but in actual practice there is a chance that it may be tilted, if a large building is constructed nearby with pile underpinnings.

To correct any such list, Cuevas provided a water ballast tank with a capacity of 1200 cubic meters under the stage of the auditorium, and another tank of 4800 cubic meters capacity under each of the building's two wings. Provision for a fourth tank directly under the main entrance, under the tower, also was made. In addition to the water ballast, an amount of concrete-brick ballast is stored in the hulls, to be removed if and when additions to the building are made.

One of the first things that Cuevas discovered when he began his experiments with the subsoil of Mexico City is that the entire city, including open spaces such as parks and plazas, is sinking. By means of bench marks on nearby mountains he ascertained that the city had lost some 13 feet of altitude in the last 70 years in some places. Then, by means of an ingenious system of underground bench marks, he learned that the rate of sinking has been accelerated and that today some parts of the valley floor are dropping as much as a foot a year.

A number of years ago when the Republic erected its tall Independence Monument on the Paseo de la Reforma in Mexico

(Continued to page 262)

Ready Now!



The New

# LIONEL CATALOG

## 40 FULL PAGES IN COLOR WITH NEW 1949 SURPRISES

Get your Lionel catalog early. The supply is hardly enough to go around, even though we print over one million. It tells all about the new Lionel trains for 1949 — the new Diesel Switcher, and the Big Twin-Diesels. And it shows

some of the most realistic and exciting accessories. Big *Special Offer* will bring you the catalog and all the items listed below. Remember Lionel Train sets are priced as low as \$15.95. Mail coupon and 25¢ now.



*Special offer consists of:*

- 1) 40-page Full-color catalog
- 2) "Whistles & Bells" Sound Effects Record
- 3) R.R. Planning Book for "Pop"
- 4) 8 Miniature Billboards, featuring Ford, Heinz, Kellogg's, Baby Ruth, Wrigleys, Kleenex, and Nash Cars, etc. Realistic outdoor boards for your model railroad.

### MAIL COUPON FOR 1949 COLOR CATALOG

LIONEL TRAINS, P. O. Box 228  
Madison Square Station, New York 10, New York  
I enclose 25¢ for "Special Offer"—including 40-page full-color Lionel Train Catalog, Sound Effects Record, 8 Miniature Billboards, and Railroad Planning Book for "POP"

Name \_\_\_\_\_

Address \_\_\_\_\_

City \_\_\_\_\_ Zone \_\_\_\_\_ State \_\_\_\_\_

Send 25¢ for special Catalog offer!

# PLUMB TOOLS



## Do Better Jobs With Ease and Speed

Get a Plumb Hammer. You'll feel the difference immediately. The non-slip handle fits your hand comfortably, absorbs the shocks. Perfect balance lets you strike quick, hard blows with ease and little effort—makes light work of your heavy jobs.

Made of special analysis steel, Plumb hammers are tempered to withstand constant, heavy pounding. For pulling nails, even headless ones don't slip through the spring-tempered claws.

You'll discover quickly why more people choose Plumb than all others combined.

*The red handle with the black head — exclusively Plumb.*

**Quality Comes First**  
**PLUMB**  
**—is First in Quality**

# PLUMB

HAMMERS • HATCHETS • AXES • FILES

City, wooden piles were first driven down into the ground to serve as foundations for the monument. As it happened, the piles were driven home on the surface of a shallow basin with a solid-rock bottom. The result is that the monument has remained fixed in space while the city has subsided around it. The base of the monument, once at street level, is now some two feet above the pavement.

What is happening, apparently, is that Mexico City is drinking up its own foundations. The population of the metropolis has been growing rapidly and today some 2½ million people live in the capital. In need of more water than can be provided by the municipal water system, numerous industrial concerns and the city government have dug wells down into the artesian layers that lie at depths of several hundred feet. Today, these layers still provide water but the flow has diminished. The water must be pumped from the ground. Meanwhile, water slowly migrates out of the *jaboncillo* to replace the fluid in the gravel layers. Bereft of its water, the *jaboncillo* shrinks and subsidence occurs.

In 1936 Cuevas offered as a possibility the idea that if pumping of underground waters continued, the city eventually would sink to a level at which its sewage system would no longer drain away from the city. Two years later he predicted that some sewers would cease to flow efficiently within 10 or 11 years. This year, to the consternation of health authorities, his prediction came true during periods of flood.

The general settling of the basin floor presents a terribly urgent problem and, unless drastic remedies are applied, one of the largest cities in the world is threatened with extinction. Already it is apparent that new sewage lines of steeper gradient must be built if the city is to continue to exist. Eventually, unless water to supply all needs is brought in from the mountains and unless every well in town is shut down forever, the beautiful floating City of Mexico will become the sunken, dead City of Mexico. On the contrary, with a well-planned preventive program, the entire basin will continue to serve as a fine site for a big industrial city.

## Plastic-Coated Starter Rope For Outboard Motors

Coated with a vinyl plastic, a new starter rope for outboard motors is said to wear as much as 15 times longer than the usual cotton rope. The fibers are impregnated with the plastic, making the rope resistant to mildew, grease and moisture.



# a new high...



## ● A New High in spark plug reliability.

Owners of cars, trucks, tractors, or boats will find that new AC Spark Plugs set a new high in reliability . . . because of AC's patented CORALOX Insulator\*.

They withstand the punishment of heavy going or day-to-day driving better than plugs have ever done before.

They give you the benefits of easy starting and reliable performance in all seasons.

Get a set . . . and enjoy the new high in spark plug reliability.

AC SPARK PLUG DIVISION • GENERAL MOTORS CORPORATION



# SPARK PLUGS

BUY WHERE YOU SEE THIS SIGN



\* AC's patented processes make Coralox the finest insulator in spark plug history. Improved electrical insulation, no matter how high the temperature. Better heat conduction. Maximum resistance to heat shock. Less fouling. Harder, stronger, longer-lived.

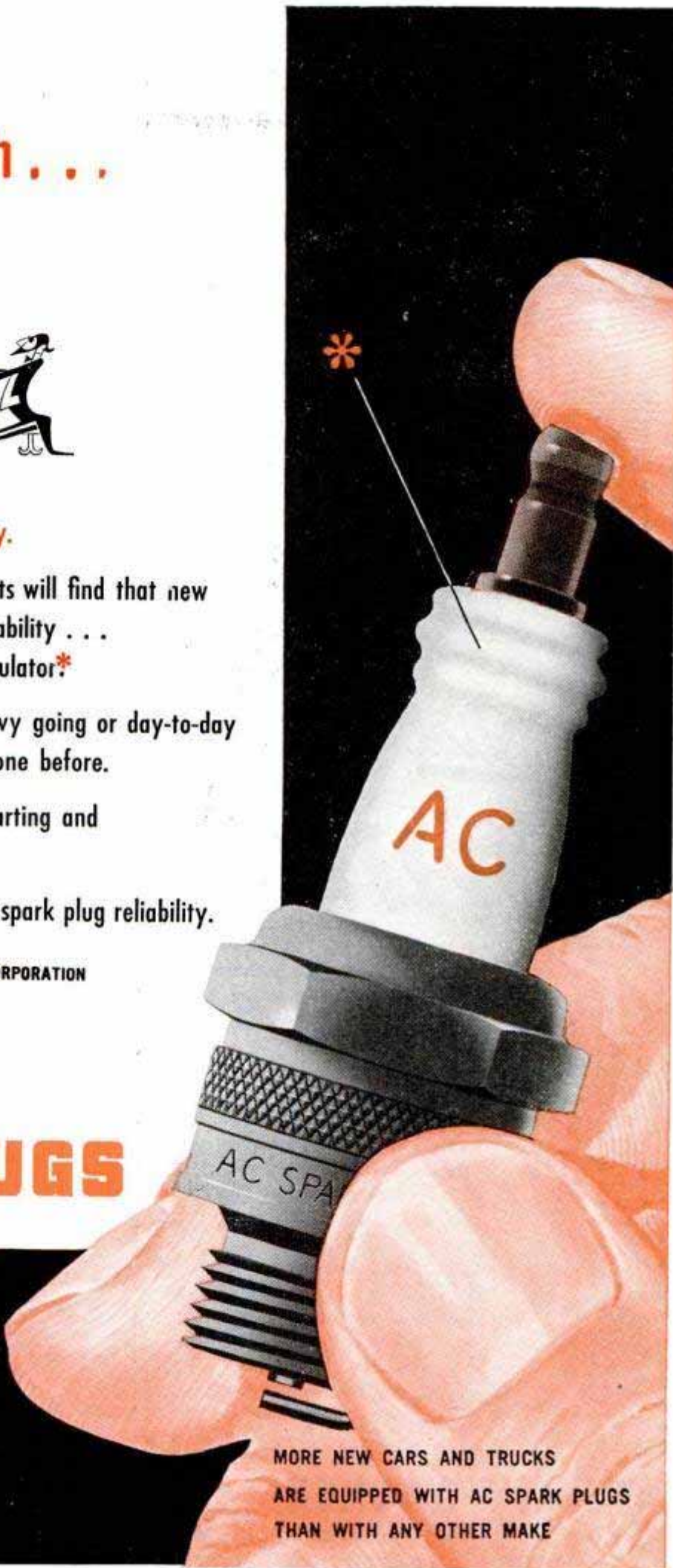

MORE NEW CARS AND TRUCKS  
ARE EQUIPPED WITH AC SPARK PLUGS  
THAN WITH ANY OTHER MAKE



*Just dial* ANY WIDTH CUT  
ON YOUR SAW



WITH

**Warren**

**DADO SAWING WASHERS**

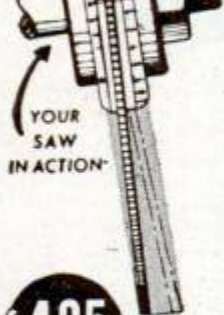

\$4.95  
SET

Cut clean, accurate, parallel grooves—12 widths, any angle. No chatter, burning, chewing—or sanding! No more blade vibration—no screws to fuss with—just four balanced washers. Simply dial desired width with Micro-matic adjustment. Can be left on blade for straight cuts. Available in 5 sizes— $\frac{1}{2}$ ",  $\frac{3}{4}$ ",  $\frac{5}{8}$ ", 1",  $1\frac{1}{8}$ ". A perfect gift for woodworkers. See your dealer or write—

**WARREN WASHERS CO.**

Dept. 31 • 70 Medbury • Detroit 2, Mich.

## Bail-Out Rehearsal

(Continued from page 123)

almost 2000 "bail outs" into wind-whipped nets from the cockpit of the stationary plane, while high-speed cameras above them recorded every mistake. Automatic timers clocked each jump.

Jumpers soon learned that the best method of exit was executed by grabbing the side of the cockpit, keeping the head low, and diving over the side perpendicular to the line of flight. The slip stream easily carried them back over the trailing edge of the wing.

Tests turned up a number of unsuspected facts. Of more than 50 bad bail-outs, most were caused by 'chutes and paraaft kits snagging on projections inside the cockpit. One pilot's foot caught in the rudder gear. Three others got nervous and pulled the rip cord before they were out. If they'd been in actual flight, the shrouds would surely have fouled the tail surfaces.

Each man made eight jumps. The slowest took nine seconds, and one man whipped out in three. Significantly, each man made his last jump an average of three seconds faster than his first. As a consequence, the "wind tunnel—jump plane" rig has been set up in several air stations throughout the country, where regular scientific jump-training programs have been started. Navy authorities are redesigning parachutes, rafts and radio-headset wire connections to eliminate snagging and catching parts.

There is still much to learn. Crippled planes can't be counted on to fly straight and level. In a spin, for instance, the rule is to go out on the inside of the spin. But there are many instances, like that of a Navy pilot who lost a wing in a mid-air collision. Centrifugal force of the spin was so great he could not turn his head to the left, much less pull himself over that side. He went on the outside, lost his goggles, a shoe and a leg when the wind and a stabilizer hit him.

The tests at Cherry Point, however, have set the pace for further experiments that will lead to scientific rules for bailing out of slow-speed aircraft, instead of relying on the word of pilots who were lucky enough to "get out alive" once or twice, but might not be able to maintain their record.

## Spray-On Paint Remover

Spraying on a fluid developed by the U. S. Air Force speedily removes aircraft camouflage enamels that resist ordinary removal techniques. All the paint can be stripped from a C-47 transport in half a day.

# **CRAFTSMAN** Tilting-Arbor Bench Saw REG. U.S. PAT. OFF. Sale-Priced for November only!

COMPLETE! This CRAFTSMAN saw is completely equipped... NOT a stripped model as are many saws on the market!



**Saw Table  
ONLY  
\$9.75**

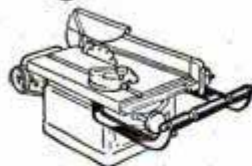

## **Bench Saw Table Extensions**

Available separately to give your CRAFTSMAN bench saw more table surface. **Side Table Extension** (upper view), 8½x20 in., of cast semi-steel, for either or both sides. One extension enlarges table working area to 25½x20 in. **New roller type Front or Rear Table Extension** (lower view), increases the capacity of the table without disturbing rip-fence set-up on the saw.

**See this sensational saw and accessories at your nearest Sears, Roebuck Retail Store TODAY! Sears Easy Terms make it much easier to own the tools you need NOW... pay as you use them!**

## **CRAFTSMAN "80" Tilting-Arbor Bench Saw**

**NOW ONLY \$49<sup>88</sup>**  
Cash

without motor

(\$52.88 West of Rockies)

**\$87.25 with motor, table,  
motor-pulley, and V-belt**

(\$91.25 West of Rockies)

As low as \$5.00 Down  
on Sears Easy Terms

## **Feature for Feature, CRAFTSMAN gives you more for your money!**



**NEW! Exclusive!** Tilting, raising and lowering of blade all controlled by a **SINGLE** hand wheel at front of saw!



**NEW! Floating motor mount** fastens to bench for easier tilting. Controls belt tension; reduces saw vibration; lessens strain on saw!

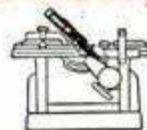

Work stays level! Blade and guard (not table and work) tilt any angle up to 45°, for much faster, easier, more accurate operation!

## **Look at these extra-value features for more accurate, better work!**

**Double-row, sealed precision ball bearings NEVER need further lubrication!**

**Rip fence locks on both ends with ONE handle; usable on either side of blade!**

**Special mechanism tilts saw arbor much faster without any loss of accuracy!**

A superb heavy duty CRAFTSMAN tilting-arbor saw... exceptionally accurate! Big, 20x17-in., smooth-ground table of cast semi-steel, with removable insert for dadoing or sanding. Depth of cut, up to 2½ in. Over-all length, 26-7/32 in.; width 17 in.; height 14¾ in.; Complete with automatic leveling guard, non-kickback pawls and splitter; accurate miter gauge; motor mount; 2½-in. machine pulley; and 8-in. combination blade (½-in. bore). (½-H.P., 3450 R.P.M. ball bearing capacitor motor for 110-120-volt, 60-cycle, A.C.; 2½-in. motor pulley and ½x40-in. V-belt recommended and sold separately, at extra cost.)

Saw may be purchased either with or without new, streamlined, sturdy table... specially designed for this CRAFTSMAN bench saw.

**CRAFTSMAN** Hand and Power Tools by **SEARS, ROEBUCK and CO.**  
REG. U.S. PAT. OFF.

Famous for fine quality... precision performance... low price!

# FREE

get it now—

## ALLIED'S NEW 1950 RADIO CATALOG!

196 PAGES OF  
BIG VALUES

EVERYTHING  
IN RADIO AT  
LOWEST PRICES



### Send for Radio's Leading Buying Guide

Save money on every radio need! Get the new 196-page 1950 ALLIED Catalog, preferred and used by everyone in radio. See the world's largest stocks of top-quality equipment, all at low, money-saving prices! Latest TV releases, home radios and radio-phonos, Amateur equipment, PA systems and High-Fidelity Sound, recorders, test instruments, builders' kits—plus thousands of parts, tubes, tools, books and diagrams. Have all the advantages of quick delivery, complete selections, big savings and expert personal help from the World's Largest Radio Supply House. Send today for your FREE copy of the 1950 ALLIED Radio Buying Guide!



TELEVISION AND  
HOME RADIOS



SERVICE SUPPLIES  
BUILDERS' SUPPLIES



AMATEUR GEAR



AMPLIFIERS, P.A.  
SYSTEMS, RECORDERS

## ALLIED RADIO

ALLIED RADIO CORP.  
833 W. Jackson Blvd., Dept. 5-LL-9  
Chicago 7, Illinois

Rush FREE 1950 ALLIED Catalog

Name .....

Address .....

City.....Zone.....State .....

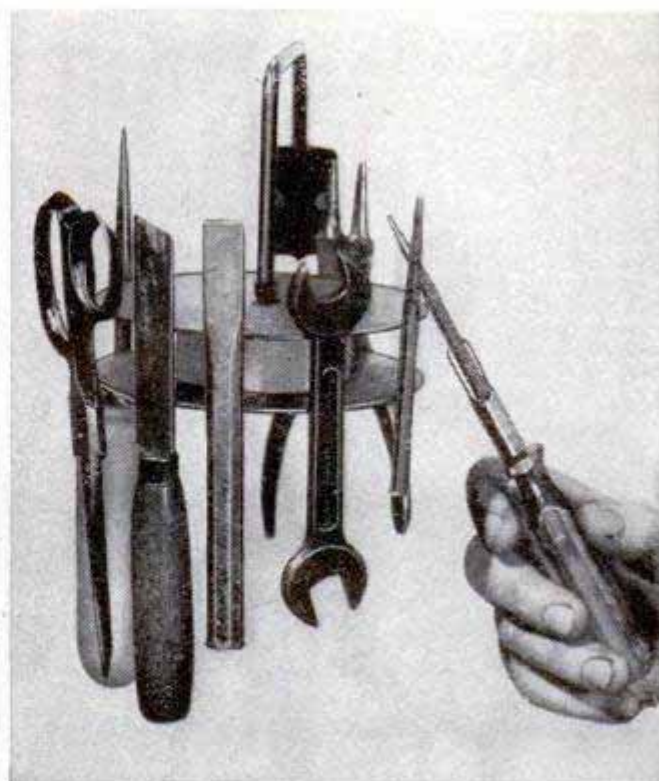

### Magnetic Tool Holder

Tools, knives and instruments can be quickly removed or replaced on a magnetic holder that accommodates all steel implements regardless of shape. It rotates on its bracket, making any tool readily accessible and providing a large holding capacity in a minimum of space. To replace a tool, you simply touch it to the holder.

### Stoves That Eat Their Own Smoke

(Continued from page 118)

the Lennox Furnace Company of Marshalltown, Iowa, has been actively pushing the development, and 700 of Fellows' furnaces were in use last winter. Homeowners report that more than 90 percent of the smoke is consumed, that fuel consumption is reduced by 25 percent or more, and that the cheaper grades of soft coal can be used.

In Professor Fellows' furnace, a sloping firebox floor provides gravity feed from the magazine area to the burning area, and the two areas are partially separated by a vertical baffle wall suspended from the firebox roof. Through a passage in this hanging baffle wall comes the secondary air feed, which mixes with the volatile gases given off by the coal, consuming them before they can be carried up the flue.

Because the furnace is equipped with automatic controls, and is built in a size which permits it to burn eight hours without attention, its cost is considerably higher than that of a conventional furnace, but Professor Fellows expects that it will be

(Continued to page 268)



## Piston rings need replacing, too...

OIL-PUMPING is a symptom of piston ring wear. And by the time you notice it, your rings will be pretty badly worn. They should be replaced immediately.

Hastings Rings are designed especially for replacement service. So ask

your motor serviceman for Hastings—the replacement ring that *stops* oil-pumping, *checks* cylinder wear and *restores* performance. It's the best money you can spend on your car.

HASTINGS MANUFACTURING COMPANY • HASTINGS, MICHIGAN  
Hastings Ltd., Toronto

# HASTINGS

## STEEL-VENT PISTON RINGS

"TOUGH . . . BUT OH SO GENTLE"

TOUGH on Oil-Pumping

GENTLE on Cylinder Walls

# Free...



## NEW POWER TOOL AND WELDING EQUIPMENT BOOK

Beautiful rotogravure 52-page book contains hundreds of illustrations, descriptions and specifications of Wards well-known Powr-Kraft line of tools for wood and metal, and motors. Also shows the nationally-known Logan Metal Lathes, Mall Electric Saws, Burke Milling Machines, Burgess Hand Tool Kits, deluxe quality Beaver Power Tools, etc. Book features the popular Shopsmith, a complete 5-tool-in-1 workshop. All tools may be purchased on convenient monthly payments at Wards Mail Order Houses, Catalog Order Offices or Retail stores.

Every power tool beginner, advanced hobbyist and production shop should have a copy of this money-saving catalog. Use coupon for your free copy now!

### Montgomery Ward

Chicago • Albany • Baltimore • Denver • Ft. Worth  
Kansas City • Oakland • Portland, Ore. • St. Paul  
Mail Coupon to Your Nearest Ward house—NOW.

MONTGOMERY WARD, Dept. 84PM-11  
Please send me free Power Tool and  
Welding Catalog.

Name \_\_\_\_\_  
(Print Plainly)

Street Address,  
Route, Box \_\_\_\_\_

Post Office \_\_\_\_\_ State \_\_\_\_\_

Phone \_\_\_\_\_

adopted by many homeowners who cannot afford the still more expensive automatic stoker. He has built the same idea into a smokeless stove, not yet in production.

Somewhat similar principles have been applied elsewhere in designing more efficient, slow-burning wood stoves and furnaces. Several types are in use in Europe, and D. E. Howes and F. G. Smith of the Bureau of Industrial Research, Norwich University, Northfield, Vt., have tested and modified foreign stoves to develop a new experimental wood furnace which has several advantages. It contains two fuel magazines, mounted side by side. One magazine burns continuously, the other intermittently, according to the demand for heat. When the temperature demand is satisfied, the drafts on the "spare" side are automatically closed and combustion dies down. Gaseous products of distillation pass through a hot zone and are thoroughly consumed. Firing is done at 8 to 12-hour intervals, and the inventors have been able, as a stunt, to maintain combustion for five days without adding fuel. Because of thorough combustion, there is no gumming of furnace or flue with creosote. It has been estimated that 90 percent of rural residents burn wood, and more efficient heaters are long overdue.

The Northeastern Wood Utilization Council has conducted considerable research on wood burners and aided in the development of the Woodomat warm-air furnace. This furnace has been built by the Pantex Manufacturing Corp., Pawtucket, R. I. It is designed to heat an eight-room house and can be connected with ordinary warm-air flues, or used as a space-heater or pipeless furnace. The fuel magazine needs to be filled only twice a day.

Research in domestic heating is continuing in these institutions and many more, and we may safely predict that in a few years the monster in the cellar will be man's servant, not his master.

## Fog Machine Aids Science

Scientists at the University of California have developed a fog machine that will produce any kind of fog they want for their experiments which may soon result in better fog lights and beacons. The scientists were unable to rely upon the elusive natural fog, so they built a machine that provides fogs of any type and density at the turn of a switch. The machine is a double-walled tank with windows for observation and photography. Warm or cold air is circulated through the jacket and fog results when cold or warm, moist air is pumped into the inner tank.

# NEW WAR SURPLUS BARGAINS

## MODEL 252 ARC WELDER 250 AMPS.

FOR ANY WELDING JOB, LIGHT OR HEAVY

Designed for Many Years of Trouble-Free Service! Handles Anything From Light Gauge Sheet Metal to 1/2" Plate.

This precision-engineered direct current ELECTRIC ARC WELDER is offered at but a fraction of its original value. It can be mounted permanently or easily transported for portable use. Does the job instantly, where and when you need it.



(ITEM No. 65)

The War Surplus generators for these Arc Welders were built by General Electric, Westinghouse, and Delco-Remy at a cost of over \$300.00. They are light in weight; have oversized lifetime grease-sealed ball bearings; air-cooled commutator; dial type rheostat for easy pin-point control; high-low range switch; reactor coil for even arc; handles 1/15" and 1/16" rods.

Runs welder at 2500 R.P.M. from drive pulley or power take-off of tractor, 7 1/2 H.P. electric motor or a 10 H.P. gas engine. Use one or two V-belts, or flat belt (on pulley). Continuous welding rating—200 amps; intermittent rating—250 amps. 0-40 volts.

**NOW AT A FRACTION OF ITS VALUE. Price includes double V or flat belt, pulley and instruction book. \$99.50**

Remember, Satisfaction is Guaranteed. ACCESSORY KIT including welding helmet, electrode holder, two 10 ft. cables with clamp, and 5 lbs. of assorted welding rods. F.O.B. Chicago (ITEM #66) \$10.50

## HANNA AIR CYLINDER

**Brand New** Used for heavy duty industrial applications on shop air lines or with low pressure systems. With 100 lbs. of air pressure, will deliver 1900 lbs. pressure at the ram shaft. All steel construction. Adjustable cushions at both ends of cylinder. Shaft dia. 1 1/2". Foot mounting with clevis on ram shaft. 26 1/2" double-acting stroke; 5" bore, 40 1/2" overall length closed. 7" overall width. 89 1/2 lbs. net wt. **\$39.50**



F.O.B. Chicago

## G-I STAINLESS TANK

Use these tanks on compressors, for tie inflators, pulsation chambers, floats, buoys, hydraulic reservoirs, fluid and milk containers, fuel containers, etc. Tough, light, shatterproof. 450 lbs. P.S.I. Aviator's Breathing Oxygen bottles, type G-1. 2100 cu. in. (approx. 9 gallons) int. vol. 24"x12". 1/4" threaded openings at ea. end. Wt. 19 lbs. (ITEM #63) **\$4.95**



## BRAND NEW GEAR TYPE

### INSECTICIDE PUMP

All Manganese Bronze for spraying D.D.T., 2,4-D, Sulphur Compounds, Etc. Pressures up to 200 lbs. and 14 gallons per minute—at 1200 RPM. Will not rust, pit, foul or freeze up. Use rubber hose inlet, pipe or tubing outlet. Equipped with intake flange for easy use. Wt. 24 lbs. Dimen. 8" x 7" x 10". Standard 1" manganese bronze shaft with keyway. U.S. Gov't. Acquisition cost \$62.00. **NOW ONLY \$15.00**



## LOGAN HEAVY DUTY OIL Hydraulic Control Valve

**BRAND NEW** control valve with built-in adjustable relief valve, will operate one double-acting hydraulic cylinder or two cylinders as one or a reversible hydraulic motor. Valve handle latches in neutral position. Made of rugged cast aluminum alloy. Open center unloads the pump in neutral position. Throttling control allows operator to regulate the speed of movement of the hydraulic cylinder or motor. Has removable mounting brackets with 4 bolt holes, 3/8" pipe thread connections. Overall dimen.: 12 1/2" H x 8 1/2" D x 8" W. Ship. Wt. 17 lbs. Gov't. Acquisition Cost over \$100.00. **\$21.95**



(ITEM #37) An Excellent Buy for F.O.B. Chicago

## Brand New GENERAL ELECTRIC 8" Sealed Beam

### SPOTLIGHTS

300 Watts, 110 Volts, A.C.-D.C.

Has countless uses for • Homes • Garages • Workshops • Driveways • Outdoor advertising • Displays • Beach lighting • Private air ports • Photography. Wherever you need flood-lighting! Bought by the U. S. Army for signal use. This is the greatest surplus bargain ever offered. Lens, reflector and electrode vacuum sealed in one dustproof, air tight unit. 300 Watts, 110 Volts. Weighs only 2 1/2 lbs. List price \$10.50. **\$2.75**

**A TREMENDOUS VALUE for . . . . . EA.**

(ITEM #8) 12 or more \$2.50 ea. postpaid



## A. C. LIGHT PLANT GENERATOR

Ideal for: Home Lighting, Hunting Lodges, Stand-by Electricity, Running all A.C. Electrical Appliances, including Fans, Motors, Electric Razors, Refrigerators, Incubators, etc. **110 VOLTS—60 CYCLE A. C.** 750 watts at 1800 R.P.M. using 1 1/2 H.P. gas engine. 1000 watts at 2400 R.P.M. using 2 1/2 H.P. gas engine. **Supplied with V-Belt Pulley Drive—0-150 Voltmeter with Regulator.** Protection for emergencies to operate oil burner, stoker, freezer, water pump and lights. These units, built to exacting Signal Corps specifications, are the answer to your lighting needs. Shipping weight 60 lbs. **\$59.50**



F.O.B. Chicago AN OUTSTANDING VALUE

## HYDRAULICS

### AIR OR OIL

Use hydraulics on arbor presses, hydraulic presses, hay lifts, manure loaders, lift trucks—push or pull, tilt or turn, press or squeeze, open or close, lift or lower—and other hydraulic and industrial applications. Use with either air or oil . . . of finest workmanship.

**ITEM #33—Double action, 1 1/2" bore, 5" stroke, will lift 1760 lbs. in one second with Logan Pump. Wt. 3 lbs. A \$35.00 value. **\$8.95****

**ITEM #32—Double action, 1 1/2" bore, 9" stroke, will lift 1760 lbs. in one second with Logan Pump. Wt. 4 lbs. A \$45.00 value. **\$10.95****

**ITEM #16—Use these cylinders on farm trucks, bulldozers, hay lifts, manure loaders, etc. Double action, 1 1/2" bore, 27" stroke. (Will lift 1760 lbs. in 2 seconds with Logan Pump). Wt. 8 lbs. A \$55.00 hydraulic cylinder value. **\$12.95****

**ITEM #15—Double action, 3" bore, 8 1/2" stroke. All steel hydraulic cylinder, will lift up to 12,000 lbs. in 3 seconds with Logan Pump. Complete with fittings. Wt. 12 lbs. A \$78.00 value. **\$19.50****

**ITEM #17—Double action, 2 3/4" bore, 8" stroke. (Will lift 4400 lbs. in one second with Logan Pump). Will withstand 1500 P.S.I. against wall. Wt. 7 lbs. A \$65.00 value. **\$14.50****

**ITEM #6—Double action, 3" bore, 23" stroke, hydraulic cylinder will lift 7070 lbs. in 3 1/2 seconds using Logan Hydraulic Pump. Especially suited for farm and construction machinery. Clevis mounting for easy use. Wt. 22 lbs. \$145.00 value. F.O.B. Chicago **\$27.50****

**HI-PRESSURE FITTINGS for cylinders and valves at 35c ea. for 3/4" pipe and 50c ea. for 1/2" pipe**



## Hydraulic CONTROL VALVE

**ITEM #24—Four way control valve for use with double action hydraulic cylinder, may be used with 1500 P.S.I. hydraulic system to open and close hydraulic cylinders. Brand new. Ship. wt. 4 lbs. A \$38.00 value. **\$7.95****

**ITEM #26—Four-way control valve for use with two hydraulic double action cylinders. Each cylinder may be operated independently of the other or in conjunction with the other. Oil may be locked in any of the cylinders to hold the piston at any required position. Brand new. Ship. wt. 6 lbs. \$60.00 value. . . . . **\$10.95****

**ITEM #28—A two cylinder double action valve with a unique arrangement, allowing the operator to raise both cylinders simultaneously, to lower them simultaneously or to raise one and lower the other at any predetermined rate and speed. Brand New. Ship. wt. 8 lbs. **\$14.95****

A \$75.00 value. . . . . **\$14.95**



## CENTRIFUGAL BELT PUMP DRIVEN

Ready for use on any Liquid Pumping Need. USE it for DRAINING BASEMENTS • HOME WATER SYSTEMS • IRRIGATION • STOCK WATERING • FIRE PROTECTION DRAINING PONDS, TANKS, etc. **MOVE LARGE VOLUME QUICKLY**

When operated at 1750 RPM, will pump 42 gallons per minute on a 23 foot head; at 3600 RPM on 52 foot head will pump 58 gallons per minute. May be run with electric motor, gas engine or power take-off on tractor.

**COMPLETE ENGINEERING REPORTS AND OPERATING INSTRUCTIONS FREE WITH PUMP** Pump has cast aluminum housing—accurately machined bronze impeller vanes. Complete with mounting bracket and 3 1/2" V belt pulley. Shaft rotates on sealed ball bearings with grease gun fitting. Has 1 1/2" threaded intake flange, two 1/2" outlets. Use one or both, as necessary. Made for Packard Motor Car Co. for use in Rolls-Royce Merlin Aircraft engines.

**GREATEST PUMP VALUE IN YEARS** Shipping weight 23 lbs. You can't beat this value at anywhere near this price. Satisfaction guaranteed.

**INDUSTRIAL PUMPING.** Com. (ITEM # 64) plate with Pulley and Mounting Bracket—Ready for Use. **\$29.75**

Original Cost Approx. \$147.00. F.O.B. Chicago



## LOGAN 4-Way Foot Operated AIR VALVE

**MODEL 6520**

**BRAND NEW.** For double acting pneumatic devices. Fine for operating air vices, presses, air machinery of many types. Heavy cast construction. Threaded for 1 1/2" pipe. Dimensions of valve body: 8 1/2" L x 5 3/4" W x 7 1/2" H. Net Wt. 28 lbs. Gov't. acquisition cost \$42.00. **\$15.00**

**AN OUTSTANDING BUY AT. . . . . F.O.B. Chicago (ITEM #59)**



## LOGAN HEAVY DUTY OIL HYDRAULIC PUMP

**BRAND NEW . . .** for operating hydraulic cylinders and hydraulic motors on tractors, bulldozers, construction machinery, lift trucks, industrial applications, etc. Delivers 8 GPM at 1200 RPM at 1000 P.S.I. using 5 H.P. Has 3/4" pipe thread inlet, 3/4" pipe thread outlet, 3/4" shaft with flat and keyway for direct or pulley drive. Has flange with 4 bolt holes for convenient mounting. Ship. wt. 22 lbs. Overall dimen.: 7" L x 5 1/2" H x 5 1/2" W. A \$105.00 value. **\$22.50**

FOR ONLY . . . . . (ITEM #29) F.O.B. Chicago



## ROPER LUBE PUMP

**MODEL C-75 — BRAND NEW**

This reversible pump is especially designed for delivering at least 50 gallons per minute of lubricating oil, Diesel fuel, molasses, tar, pitch, lacquer, and similar fluids at 80 P.S.I. pressure at 400 R.P.M.; 1 3/4" keyed shaft. Select any two of the four flanges for inlet and outlet. **\$377.00**



**FREE:** Write for free copy of our 40 page catalog including Hydraulic Manual featuring diagrams, photographs and instructions. Catalog lists excellent war surplus values: pumps, valves, hydraulics, lights, motors, etc.

**ORDER DIRECT FROM AD** Send payment or purchase order today **SATISFACTION GUARANTEED**

## CUNO OIL FILTER

**BRAND NEW**

The perfect permanent element oil filter to keep your motor oil or hydraulic fluid clean at all times. Protect your pump or engine with this unit. Just turn the handle and the element is clean. Standard 3/8" inlet and outlet ports to accommodate 12 gallons per minute. (ITEM #20) Shipping weight 10 lbs. **\$10.00**





## OWN YOUR BUSINESS

### Start in Spare Time with a FOLEY SAW FILER

Here is a steady repeat CASH business you can start at home in your basement or garage, while you are working at your regular job. No experience is necessary to turn out perfect cutting saws—"the first saw I sharpened came out 100%. I think the Foley Saw Filer is a marvel of perfection," writes Clarence E. Parsons. Every saw you sharpen will bring you new customers. You will find you can make up to \$2 or \$3 an hour—\$20 to \$30 a week in your spare time as a starter.

With a Foley Saw Filer you can file all hand saws, also band and cross-cut circular saws. It is easy to operate—simple adjustments—no eye-strain. Patented jointing principle evens up all irregular teeth and makes an old saw cut just like new.

#### This Free Book Shows How to Start

"INDEPENDENCE AFTER 40!" shows you how to get plenty of saws to file without canvassing, and how you can develop into a general repair shop that will be your own business. This is a helpful, practical book that tells just what to do—send for your free copy today.



#### Send For FREE BOOK

FOLEY MFG. CO., 1116-9 Foley Bldg.  
Minneapolis 18, Minn.

Send me free book "INDEPENDENCE AFTER 40!"

Name \_\_\_\_\_

Address \_\_\_\_\_



### Automatic Laundry For Small Parts

Small parts are thoroughly washed and dried in an automatic laundry that spins them in three solutions and finally air-dries them in a chamber in the base of the machine. The parts to be cleaned are placed in a wire basket which is snapped on the motor shaft. A push button starts the 12-minute cleaning cycle. Automatically, the parts are agitated in one wash solution and two rinse solutions and then spun dry.

### Radioactivity Locates Brain Tumors

Three surgeons now are using radioactive phosphorus, produced in atomic-energy laboratories, as an aid in locating brain tumors during delicate operations. The three Boston doctors report that in 14 cases they were able to locate the tumors at the time of operation by use of the radioactive isotope. The phosphorus is injected into the patient and eventually becomes concentrated in the brain tumor. The surgeon then uses a miniature model of a Geiger counter as a probe to locate the tumor. The exact location of the tumor is shown by an increase in the counting rate of the instrument during surgery.

☞ Only about 60 percent of the oil in any pool can be brought to the surface by methods used at present.



IF PLANS FOR THE WINTER  
TURN OUT LIKE THIS...IT'S  
TIME FOR A REFITTING...

*and*

IF YOUR CAR FEELS LIKE THIS...  
IT'S TIME FOR MARFAK  
CHASSIS LUBRICATION

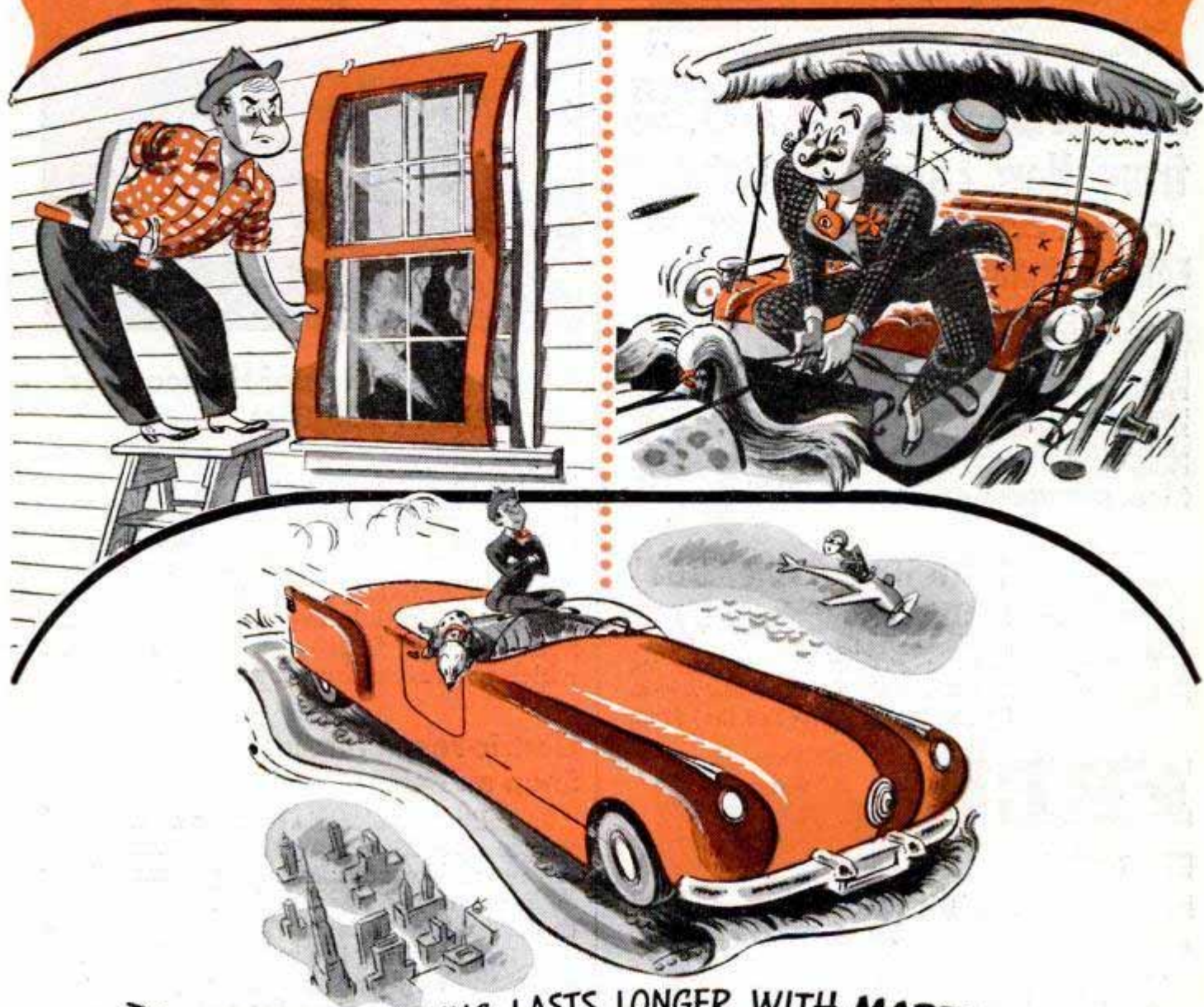

THAT CUSHIONY FEELING LASTS LONGER WITH MARFAK!

Tough, long-lasting *Marfak* is made to take road punishment for 1,000 miles and *more*. Chassis bearings and friction points are protected *all the way* because *Marfak* resists squeeze-out, wash-out and shock. You know *Marfak* "sticks around" because you feel it—in that "cushiony" driving ease you enjoy from one lube job to the next. Ask for *Marfak* lubrication today at your Texaco Dealer, *the best friend your car ever had*.



**THE TEXAS COMPANY**

**TEXACO DEALERS IN ALL 48 STATES**

*Texaco Products are also distributed in Canada and in Latin America*

# Lafayette

RADIO ELECTRO NEWS

★ 29th YEAR SERVING AND SAVING YOU MONEY

NEW YORK: 100 Sixth Avenue and 542 E. Fordham Road  
 CHICAGO: 901 W. Jackson Blvd. BOSTON: 110 Federal St.  
 NEWARK: 24 Central Avenue ATLANTA: 265 Peachtree St.

## SIZZLING VALUES from New Lafayette Catalog (return Coupon for yours NOW) FAMOUS-MAKE ELECTRIC HAND DRILL

Save \$3 on this well-known electric hand drill. Ideal "general purpose" tool for home and shop use. Takes bits up to 1/4". Self-tightening chuck. Precision 1400 rpm motor. On-off toggle switch. Pistol-grip handle. Strong die-cast zinc housing with aluminum finish. 110 volts, 60 cycles, A. C.



List Price: \$11.95  
 LAFAYETTE'S PRICE: **\$8.95**

No. 17N15796P (weight: 4 lbs.)

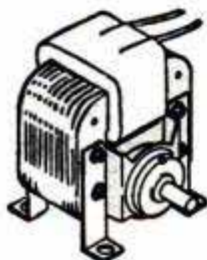

### 1/20 HP MOTOR "BUY"

LAFAYETTE'S PRICE: Only... **\$3.89**  
 You'll find many uses for this little giant 1/20 hp motor. 2900 rpm. 110 volts, AC, 50 or 60 cycles, 3 1/2 x 2 3/4 x 3 1/2 high. Shaft is 1/4 dia., 3/4 long.

No. 99N7079P (wgt.: 5 lbs.) \$3.89

## FREE

GET THIS BIG  
 NEW 1950 EDITION

- Bumper Crop of Values in Lafayette's **BARGAIN CATALOG** Of Everything New in Radio-Electronics!



JUST  
 OUT

Save up to 40% on everything you buy from this new 1950 Lafayette Radio Catalog, hot off press! Special Bargain Section included in 164 pages sizzling with newest famous-make electronic equipment! TV sets, chassis, viewing tubes, antennas, high fidelity, equipment, ham gear, 3-speed record changers, tools, parts, appliances, etc. For FREE bargain-hunter's handbook, mail coupon now!



### Illuminated Initials of Homeowner Show Up at 200 Feet

Rust and weather-resistant signs showing house numbers are made of a glass-beaded surface which glows in the glare of headlights or a flashlight. The signs can be seen plainly for 200 feet when a beam of light is directed at them. The numbers, or the owner's initials, are mounted in an aluminum holder fastened to two steel posts which are driven into the lawn.

### Electric-Fence Insulators Snap on Posts

Installing an electric fence is a quick and simple operation when clip-on insulators are used. For standard tee posts, no tools or adapters are needed. You merely snap the insulator in place. Adapters are available for attaching the insulators to wooden posts and angle posts. The clips hold the wire far enough from the post to allow it to be used with a woven-wire fence without shorting.

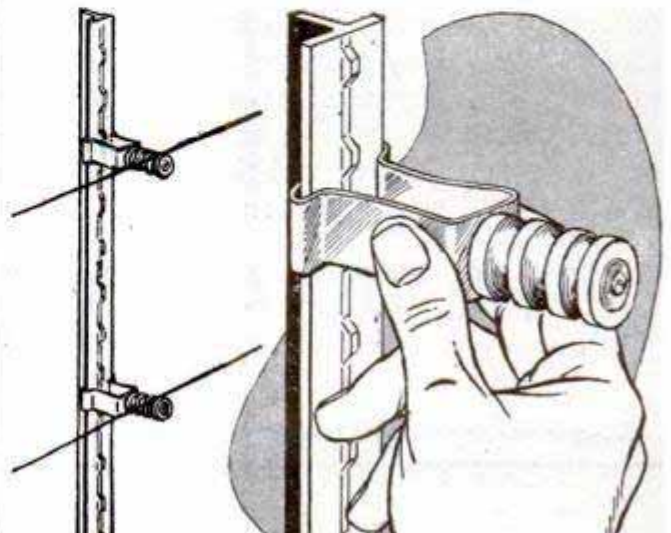

LAFAYETTE RADIO, Dept. LK-9  
 901 W. Jackson Blvd., Chicago 7  
 100 Sixth Avenue, New York 13

**MAIL COUPON NOW**

Check here for FREE Catalog. (Please don't check if you have already gotten yours.)

Please fill my order for items checked above for which I enclose \$..... in postal note, money order or check. I'm including shipping charges based on weight and zone.

NAME.....

ADDRESS.....

CITY..... ZONE..... STATE.....

*Hailed as the Greatest of all time!*

the NEW **1950**

**HARLEY-DAVIDSON**

**HYDRA-GLIDE**

**YEARS AHEAD!** More Power • Greater Acceleration • Road-hugging Stability • Feather Touch Steering • Positive Braking • Amazing Comfort.



Everywhere you go, experienced motorcyclists say this is the finest Harley-Davidson of them all! They acclaim its surging new power, its rocket-like acceleration, its easy steering, positive braking, ground-gripper stability and its amazing float-along comfort that lets you ride all day without tiring! You'll enjoy the outdoors as never before, as you take in thrilling race meets, hillclimbs, gypsy tours and sightseeing trips. And you'll agree, there's no sport like motorcycling, no fun like owning a Harley-Davidson! One ride will convince you. Small down payment and easy terms . . . and "you're in!" See your dealer without delay. Mail the coupon now.

**HARLEY-DAVIDSON MOTOR CO., Dept. P, Milwaukee, 1, Wis.**

Send *free* copy of ENTHUSIAST Magazine filled with motorcycle action pictures and stories; also literature on new 1950 models.

Name.....

Address.....

City..... State.....

**DEALERS:** Valuable franchises available for the full line of Big Twins and Lightweight. Write today!

# RISLONE with your oil makes winter starts quick and easy

—gets rid of gum and sludge for guaranteed smoother power within 10 miles



Your car runs better in any weather with Rislone in your oil to work its "motor magic."

In Winter — it keeps the oil free-flowing for quick, easy starting. It keeps grease from thickening, too. So put a little in your transmission and differential. That protects gears, makes shifting easy in spite of cold weather.

In any weather — Rislone frees sticking valves, restores lost compression, gives you smooth power in all gears, at all speeds.

Rislone is an oil-alloy that keeps modern motor-oils doing their best. It absorbs gum and sludge as you drive, to keep your car at peak performance all the time.

Prove it to yourself. Add a quart of Rislone to your oil today. If you can't feel a smooth-driving difference in 10 miles — you get a full refund. Available at car dealers, better garages, and service stations everywhere. The Shaler Co., Waupun, Wis.



whenever you change your oil

Add a quart of **SHALER**

# Rislone

(2 quarts for larger cars). As you add oil, make every fourth quart RISLONE.

**UTICA TOOLS**  
For More Tool Mileage



TOOL No. 41  
Electricians'  
Diagonal Pliers  
4", 5", 6"

SEE  
YOUR  
DEALER

UTICA DROP FORGE & TOOL CORP.  
UTICA 4, NEW YORK

# BACK ACHE?

## SORE MUSCLES?



When muscles are stiff and sore from unusual exercise or strain, use HEET®, the liniment that's strong yet does not burn the skin. Wonderful relief from muscular soreness comes as comforting HEET quickly starts to penetrate. Just brush it on with the applicator. HEET starts at once to ease muscular pain and keeps on working for hours, warms and soothes the painful area.

## Sand Casting — Forging — Heat Treating — Case Hardening BRONZE FOUNDRY



In your own workshop allows you to design and build your own GASOLINE ENGINES, STEAM ENGINES, STATUARY, ART OBJECTS, SPECIAL TOOLS, NEW INVENTIONS, ETC. You can also make forgings and case harden steel. Your shop is not complete without a FOUNDRYETTE. Three sizes are available capable of making bronze castings of 1½, 3 and 6 pounds weight, aluminum, copper, brass, etc., \$22.50, \$29.50, \$42.00 f.o.b. Kansas City. Domestic gas supply and 110 volt AC or DC energy required for operation. Write for circular.

**KANSAS CITY SPECIALTIES CO.**  
Box 6022, Dept. P-10 Kansas City, Mo.



## HEAT THAT COLD ROOM

Don't shiver in a cold room. You can install this booster fan in warm air furnace pipe yourself, and get forced circulation. Patented cooling feature prevents motor failure common to unventilated fans. Fits pipe sizes from 8" to 12", runs on house current. If your furnace dealer cannot supply you, write for free circular or send check to McLARTY SYSTEMS, Dickman & 26th St., Battle Creek, Mich.

**\$10.95**  
Delivered U.S.A.



## ENJOY MAKING YOUR OWN TOOLS

Machine your own lathe attachments from semi-finished castings of proven design. Faceplates, Carriage Stops, Boring Bar Holders, Tailstock Drill Pads, etc. All can be completed on your own lathe. Complete drawings and details. Save over 50%. Write for information. Give size, make and model of lathe.

**THE VESTA ENGINEERING CO.**  
5226 N. Hollywood Ave. Milwaukee 11, Wis.

SAY YOU SAW IT IN POPULAR MECHANICS

## Ball-Bearing SPEED WHEELS



### JUVENILE WHEELS

(No bearing, solid tires)

5".....45c 6".....65c  
7".....75c

(Semi-pneumatic tire, ball bearing)

8x1.25 .....1.85 10x1.25 .....2.20  
8x1.75 .....1.95 10x1.75 .....2.30  
8x2 .....2.20 12x1.75 .....3.45

### INDUSTRIAL WHEELS FOR HEAVY LOADS

5x1.75 Bolted ..3.65 10x2.75 HC.. 5.70  
6x2 Welded ..3.45 10x2.75 Pno. 7.60  
8x2 Bolted ..4.35 12x2.00 .. 6.90  
8x1 .....5.25 12x3.00 .. 10.60  
8x2.00 .....5.20 4.00x8-2 .. 14.70  
8x2.50 .....5.40 4.00x8-4 .. 15.85  
10x2.00 .....6.10 16x4.00 .....15.15

DEALERS, JOBBERS,  
AND MANUFACTURERS!  
OUR NEW PRICES WILL  
INTEREST YOU.

WRITE US NOW FOR COMPLETE  
NEW CATALOG

Send check with order. No C.O.D.

**JIM BROWN TOY COMPANY**  
1097 Home Ave.  
Akron 10, Ohio

# What's Your choice?...

of these sturdy, dependable  
**Low-Cost**  
*Marlin .22's*

TUBULAR MAGAZINE  
 18-25 shots on one loading  
**\$28.90\***  
*\*Price slightly higher west of the Rockies.*

CLIP MAGAZINE  
 for rapid fire  
**\$24.15\***  
*\*Price slightly higher west of the Rockies.*

## MARLIN MODEL 81-DL

Shooting efficiency, with *least* fuss and bother! Magazine holds a load for a full day's hunting. Patented non-jamming feed. Shoots .22 short, long and long rifle cartridges—regular and high speed without adjustment. Quick-release trigger—self-cocking action—side ejection—Off and On safety—American walnut stock. Available with peep sight or open sights; sling strap swivels.



Unbeatable for pests and vermin...owls, rats, hawks and crows, the 81-DL carries up to 25 shots.



## MARLIN MODEL 80-DL

Whale of a value—this man-sized .22 repeater! Ready for instant action on vermin or small game. 8 rapid-fire shots to get 'em, no matter how fast they run. Quick-release trigger—self-cocking action—side ejection—Off and On safety—American walnut stock. Available with peep sight or open sights; sling strap swivels. More sport for your money with Marlin's 80-DL!



Marlin's 80-DL is a sure getter of woodchuck, raccoons, rabbits and other fur-bearing game.



**THE MARLIN FIREARMS CO. • NEW HAVEN, CONN.**



SEND TODAY for new illustrated catalog\* with complete specifications! Enclose 10¢ to cover postage and handling. Mail coupon to Marlin, Dept. 8, New Haven, Conn.

\*Sample pack of Marlin Blades included, with our compliments

Name .....

Address .....

.....



**with PRE-FORMED METAL CIRCLES**

Pre-cut, pre-formed circles of Aluminum and Copper — ready to transform quickly and easily into colorful trays, coasters and other items with the Metal Goods Dek-All Color Kit. No cutting or forming. IT'S EASY—JUST TRACE ON DESIGN... THEN PAINT WITH "DEK-ALL" COLOR SET. The brilliant colors are chip-resistant, will not wash off.



**WRITE TODAY**  
for literature  
and price list

**METAL GOODS CORPORATION**

Dept. P.M. 5239 Brown Ave. St. Louis 15, Mo.

**The JIFFY metal CABINET**

**YOUR ANSWER TO SMALL ITEMS STORAGE**  
at home, office, and shop  
(IDEAL GIFT, TOO)

So handy to keep nuts, bolts, screws, nails, parts, washers, stamps, hobbyists' needs, etc., at your fingertips.



THIS 32 DRAWER UNIT ONLY \$5.95 POSTPAID

Stop searching, get a 32 or 64 drawer Jiffy to keep those small items that usually get mislaid. Spot welded steel, gray enamel finish, metal drawer guides. Dividers included with aluminum drawers make possible three compartments per drawer. Looks good anywhere. Send check or money order, please—no C. O. D.'s. Prices below. Your money refunded if not satisfied. Dealers write for quantity discount.

SPECIFICATIONS	WITH ALUMINUM DRAWERS	WITH CARDBOARD DRAWERS
<b>32 Drawer Unit</b> 6" Deep 12 3/4" Wide 15 1/4" High	<b>Dividers and Index Cards included</b> One piece rustproof aluminum drawers for heavy service—good for work bench and industry use.	Suitable for most home uses. Heavy board kraft covered. Metal drawer pulls.
<b>64 Drawer Unit</b> 6" Deep 25 1/2" Wide 15 1/4" High	<b>32 drawer - \$8.95</b> <b>64 drawer - \$15.95</b>	<b>32 drawer \$5.95</b> <b>64 drawer \$9.95</b>
<b>Drawer Size</b> 1 1/4" Deep 2 3/4" Wide 6" Long	OHIO ORDERS ADD 3% SALES TAX Marproof Rubber Feet included with all cabinets! POSTAGE PAID	POSTAGE PAID

KAYTEE PRODUCTS, Dept. M, Box 588, Canton, O.

**Removing Paint is no problem now!**



Yes, it's easy to remove any type of finish the professional WONDER-PASTE way. There's no arm-tiring work with a torch; no messy sanding needed afterward. Simply apply WONDER-PASTE directly over the old finish with a paint brush... Allow time for complete penetration—then remove with a putty knife. The butter-soft sludge peels off easily, quickly, cleanly! Won't injure wood, metal, fabrics, or your hands. At paint and hardware stores everywhere.

Write for Leaflet  
**WONDER-PASTE**

Wilson-Imperial Company, 119 Chestnut Street, Newark 5, N. J.

**NEW QUICK-CLAMP 30" BRAKE**

Forms angles, flanges, seams. Bends 26 gage steel. Heavier copper and aluminum. Cam locking. Portable, can be clamped to edge of truck. All steel. Shipping wt. 42 lbs. Shipped \$24.50 express collect. 30" size...



**12" BRAKE.** Fits in vise to form difficult compound bends, up to 20 gage steel. \$12.50 PP.  
**CUTTER.** Cuts 18 gage steel any length and width, \$12.50 PP.  
**SHEET METAL PLIERS.** 2 1/2" wide, \$2.00; 5", \$3.00.  
**PLASTIC BAR BENDER,** 1/4x8 capacity, \$1.00.  
**IRON BENDER.** Forms hooks, braces, eyelets. Bends 1/4x2, \$10.00.  
Immediate delivery. Order direct, cash or C.O.D., or send for folder.  
**WISE BRAKE MFG. CO., P1116 So. 27th St., Omaha 5, Nebr.**



**\$2.95 EACH**

**NOW! FILE YOUR OWN SAWS**

Do expert saw filing at home. Precision filing easy without experience. Two simple adjustments. Keeps any hand saw extra sharp and true-cutting. Complete with file. Money back guarantee. Cash with order, prepaid. (COD postage extra.) Order today. \$2.95.

**SPEEDCOR PRODUCTS, PM-11**  
512 N.E. 73 Ave., Portland 16, Oregon



**BEACNLITE**  
Illuminated  
\$5.95



**STREAMLINE, \$3.95**  
At your dealer's. Write for illustrated literature.

**HULL MFG. CO., P. O. Box 246-D11, Warren, Ohio**

**BUILD FINE GRANDFATHER CLOCK NOW**  
The simple sensible Red-i-Kut way as thousands have—**SAVE HALF. SHOP TESTED PLANS "SPIRIT OF THE CENTURY"** Narrow waist 83" tall or stately "SPIRIT OF AMERICA" straight side model with pictures. **EASY-TO-FOLLOW PLANS** tell all—plus **BROCHURE** of heavy brass weight Westminster, tube chime, movements, dials, solid mahogany case kits. Send \$1.00 today—Both Plans \$1.50 NOW.  
**KUEMPEL CHIME CLOCK CO., 25 Kuempel Bldg., Minneapolis 16, Minn.**

SAY YOU SAW IT IN POPULAR MECHANICS

**Command Bigger Money!**  
**STUDY LAW**

STUDY AT HOME for BUSINESS SUCCESS and LARGER PERSONAL EARNINGS. 40 years expert instruction — over 114,000 students enrolled. LL.B. Degree awarded. All text material furnished. Easy payment plan. Send now for FREE BOOK — "Law and Executive Guidance." It explains the course — how you may enroll and the many ways you can profit from Law Study. Write TODAY to:

(GI Approved)  
**AMERICAN EXTENSION SCHOOL OF LAW**  
Dept. 20-PM, 646 N. Michigan Ave., Chicago 11, Ill.

Make it a  
"MAKE-IT-YOURSELF" XMAS

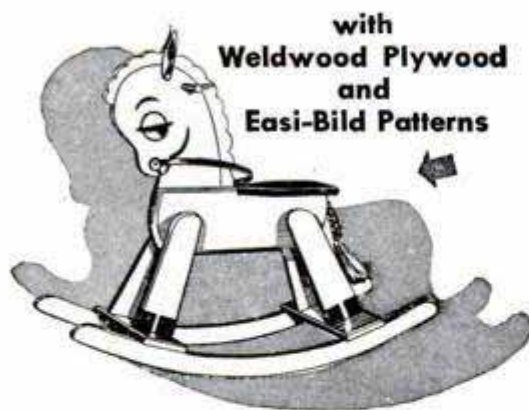

You save money on Christmas gifts when you make them yourself out of Weldwood plywood.

It's a cinch, too, with Easi-Bild\* Patterns. At your local lumber dealer you buy the Weldwood and other materials the patterns clearly specify. Then you cut each piece exactly as the pattern indicates, and assemble according to directions. No special tools or skill are needed.

Pattern for the Pony Ride Rocker, shown above, sells for 35¢. The Easi-Bild Pattern Book, illustrating 105 Build-It-Yourself projects, is only 20¢. Send for your copy now, and do your Xmas shopping right in your own shop!

\*T. M. Easi-Bild Pattern Co.

UNITED STATES  
PLYWOOD CORPORATION  
Dept. P 451, P. O. Box 215, Pleasantville, N. Y.

**NEW SAW EASY HANDLING BIG POWER**

New American Portable Electric Saw saves time, labor and money in production work. Not a hobby tool. One hand operation. Cuts any angle. 8" blade. Write... give occupation.

**AMERICAN**  
FLOOR SURFACING MACHINE COMPANY  
535 So. St. Clair St. Toledo 3, Ohio

**Build YOUR OWN LOG CABIN!**

**\$425 to \$5,000**

*Big Savings*

Shipped In Sections — Ready to Erect  
Build your log cabin yourself and save money! Braun Cabins (Patent No. 2320466) come to you prefabricated in sections, lettered and numbered—easy to erect. Beautiful Michigan White Cedar vertical half-logs. Weathertight joints. Interior—knotty cedar. Many designs to choose from, as low as \$425, F.O.B. Detroit—or we can adapt our material to your plan, FHA approved. Prompt shipment. Send 25c for 24-page Catalog, including overnight and guest cabins.

**BRAUN LUMBER CO.**  
CEDAR CABIN DIVISION  
1571 E. Davison Detroit 3, Mich.

Send 25c for Catalog

**BRAUN CEDAR CABINS**

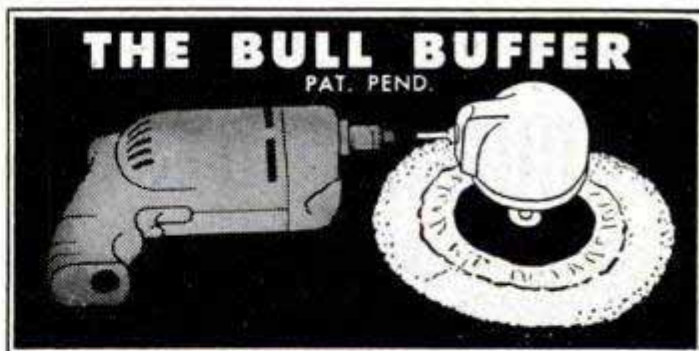

**\$9.95** Famous angle-head polisher-sander complete with sheepskin bonnet and 2 sanding discs. Fits the chuck of any 1/4 inch electric drill. A heavy-duty, rugged tool you'll use to make your car, floors, woodwork, furniture gleam like new! It's America's First Choice—more than 100,000 in daily use. Order today!

**Order These Accessories for Your Bull Buffer**  
(For use with Bull Buffer only)

- 5 3/4" finest quality bark tan sheepskin bonnet, ..... \$1.25
- 5" aluminum oxide production sanding discs (0000-00-0-1-2 1/2-3), \$ .10 each. #4 open grit, \$ .15 each.
- 1 1/2" Jacobs Hex key chuck. When attached to the Bull Buffer, gives you angle-head drilling attachment. Increases 1/4" drill to 1/2" capacity, provides power for heavy drilling in wood or steel. .... \$5.00
- 2 1/2" cup wire brush. Easily attached to Bull Buffer angle-head. Removes paint, rust, scale, etc. right now! ..... \$1.75

**NEW! JUST CHUCK IT IN YOUR DRILL— AND WATCH THE CHIPS FLY!**

Now you can mortise on-the-job, now you can rout on-the-spot with the new Bull Mortising Adapter! This amazing new adapter can be attached in either drill or drill press in a matter of seconds, and it gives you a powerful, portable tool that really makes the chips fly!

NOTE: Bull Mortising Adapter is designed specifically for use in any 1/4" electric drill or any drill press; it should not be used with 3/8" or 1/2" electric drills.

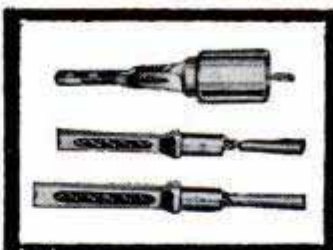

**BULL MORTISING KIT**  
Includes Bull Mortising Adapter and 1/4", 3/8", and 1/2" chisels with corresponding bits. Complete, guaranteed, **\$23.90** only.

**MORTISING ADAPTER ONLY**  
Fits only 1/4" electric drill or drill press; also fits any standard mortising bit and chisel. **\$6.95**



**NEW PORTABLE DRUM SANDER**  
Uses Standard Sandpaper Sheets!  
Now you can get to all those hard-to-reach places with the new Bull Drum Sander—a portable 2" drum sander that fits any electric drill (or drill press.) MOST ECONOMIC! drum sander on the market because you cut your own strips out of ordinary sandpaper sheets instead of buying costly sanding sleeves! No wedges or screws necessary; new patented feature lets you insert and remove sanding strips at the flick of a finger. Complete, with 6 sanding strips, **\$4.95.**



**NEW AUTOMATIC SCREW DRIVER!**  
Now you can get to all those "tight places" and drive screws in seconds where it used to take minutes by hand! The new Bull Driver fits any electric drill, drill press or flexible shaft. Automatically centers on screw groove; automatically disengages when screw is firmly home in wood or metal. Three models—take your choice and order today! Any model, **\$4.95.**  
When ordering, specify model in either standard or Phillips.  
MODEL A—Self-centering model for driving screws up to #14.  
MODEL B—Self-centering model for driving small machine screws.  
MODEL C—Without self-centering hood; long blade reaches those extra-deep countersunk jobs.

At All Leading Hardware and Department Stores or Order Direct  
For prepaid shipment, send cash, check or M.O. to  
**BERTRAM A. ENGINEERING COMPANY**  
3121 MAIN STREET Dealers Write Today KANSAS CITY, MO.

SAY YOU SAW IT IN POPULAR MECHANICS

# TERRIFIC CROSLLEY ENDURANCE TEST!



Here's proof of the amazing ruggedness of the new Crosley car! The Crosley Station Wagon (shown above during refreshment "refueling") completed on July 7, 1949, a continuous run of 50,025 miles—a distance of twice around the world—in 105 days and nights, averaging 45 miles per gallon of gasoline!

"This car was powered by the same Crosley CIBA (cast-iron block) engine which is now standard in all Crosley models," says H. A. McClellan, Crosley dealer, Jacksonville, Fla., who sponsored the test.

**CROSLLEY OWNERS**—The history-making CIBA (cast-iron block) is now available for 1946 and later models. Exchange your old engine for a factory-rebuilt engine with new cast iron block, and new engine guarantee—only \$89 (including Federal Tax), freight paid both ways! (Cost of removal and installation, about 5 hours labor time, extra.)

Order from your Crosley dealer today. For free literature on Crosley Cars and this offer, write Crosley Motors, Inc. 2530-HL Spring Grove Ave., Cincinnati 14, Ohio.

For a new thrill in motoring, drive the new Crosley Hotshot. See your dealer today for a free drive-it-yourself demonstration. The famous 2-passenger Hotshot is America's own sports car.

**CROSLLEY**



a FINE car

"You see them everywhere."

## DEMAND THE BEST

for easy to use convenience and accuracy...

GET THE

**Chief**  
STEEL TAPE  
RULE



★ A truly fine tool. You'll be money ahead when you buy the Chief. 6 ft., 8 ft., & 10 ft.

ASK YOUR HARDWARE DEALER

**CARLSON & SULLIVAN, INC.**

Monrovia, California

Mortite

KEEPS THE COLD OUT

SAVES FUEL AND MONEY

Cordlike and pliable, Mortite is the perfect weatherstripping. Goes on in a jiffy without tools or tacks. Keeps out wind, dust, dirt. Anyone can press it around windows, doors, transoms, baseboards. Weatherstrip a whole window for 29¢—costs even less if you use the larger package. Get Mortite at stores or write for circular. J. W. Mortell Co., 522 Burch St., Kankakee, Ill.



EVERY WORKSHOP SHOULD HAVE THIS NEW EAGLE PUMP OILER

\$1.00

Delivers one drop or a full stream—controlled by finger on lever. Dependable—guaranteed against leakage—saves time—saves oil. Comfortable grip. Easy to operate—easy to fill—clean to use. Just what you've needed for oiling motor-driven tools, home appliances and varied workshop uses. Also handy in the garage. Buy one today at your nearest Hardware Dealer, or if he does not have it, write Eagle Manufacturing Company, Wellsburg, West Virginia.



## REAL ESTATE BE A BROKER

**PAYS BIG! SEND FOR FREE, BIG, ILLUSTRATED CATALOG NOW!** No obligation. Graduates report making substantial incomes. Start and run your own business quickly. Men, women of all ages, learn easily. Course covers Sales, Property Management, Appraising, Loans, Mortgages, and related subjects. **STUDY AT HOME** or in our classrooms in big cities. Diploma awarded. G.I. approved. Nationally known.

**WEAVER SCHOOL OF REAL ESTATE (Est. 1936)**  
15 E. Pershing Road, Dept. PMB, Kansas City, Mo.

FREE BOOK TELLS HOW

## HANDY SEWING AWL



Patented lock-stitch awl, complete with 2 needles and reel of waxed thread at this special price! Satisfaction guaranteed, or money back. **HUNDREDS OF USES**—sewing and repairing leather goods, tents, belting, awnings, saddles, sporting goods and others. Complete instructions. Send currency, check or money order. Postpaid. \$1

**RADEN SALES COMPANY**

Dept. M, Box 5601, Dallas, Tex.



The Modern PLASTIC for lasting Home Repairs

PERMANENTLY mends cracks or holes in wood, tile, stone or plaster. Sticks and stays put—Does not chip, shrink or fall out. Easy to use. Economical. Mold it, chisel it, polish or paint it. If unobtainable from your lumber, paint or hardware dealer, the big 4-lb. can will be sent you postpaid (in U.S.) for only \$1. Full money-back guarantee, order now.

**DONALD DURHAM CO.**

Box 804-W, Des Moines, Iowa



# NOW 1950 MODEL of the famous... **HANDEE** TOOL OF 1001 USES

at new **LOW PRICE**

It's here—the biggest buy of all small power tools. First tool of this type and today's finest—the result of 18 years' scientific research and improvement—far ahead of all others and the choice of homecrafters and mechanics everywhere because of its dependable performance.

The housing, shaped to give perfect balance, fits your hand like a pencil and insures hours of pleasant, non-fatiguing operation.

Handee grinds, drills, polishes, cuts, engraves, routs, carves, sands, saws, etc. Works on metals, alloys, wood, leather, plastics, linoleum, glass, horn, bone, etc. This wonderful little tool is also your open sesame to the fascinating new craft—Internal Plastic Carving.

Handee with **51** accessories in handsome, heavy steel, piano-hinge case, now at the lowest price in all Handee history.

**NEW LOW PRICE**  
**\$24<sup>95</sup>**



## A WHOLE TOOLSHOP IN YOUR HAND

Start with a Handee and 6 accessories, if you like. In neat carton at only \$19.95. Then, add accessories as you need them. Widest assortment available, exclusively designed for Handee, give unlimited uses to your Handee

## 12 STAR FEATURES

- ☆ 7-bar radial armature
- ☆ Standard rotary field — not cheap horseshoe type
- ☆ Superior series-wound motor, AC or DC, 110 volts
- ☆ Triple grease-sealed ball bearings — mean longer life, smoother performance
- ☆ Duralumin housing with no obstructions—exclusive design for perfect balance
- ☆ Patented safety sleeve covers all moving parts
- ☆ Patented rotary switch
- ☆ Underwriters' Laboratories and Canadian Standards approved
- ☆ 6" long, 1 3/8" diameter
- ☆ Lightweight—12 ounces
- ☆ Precision attachments for changing into router, shaper, molding cuts, carver
- ☆ Speed—a cool, quiet 25,000 r.p.m.

**IT'S 7 TO 3!**

**HANDEE HAS 7 BAR ARMATURE (OTHERS HAVE 3)**

**WHAT THIS MEANS**

- LONGER LIFE
- BETTER PERFORMANCE
- SMOOTHER ACTION
- COOLER MOTOR WHICH PREVENTS FREQUENT BURNOUTS AND COSTLY REPAIRS

**GIVES YOU THE SAME ADVANTAGES YOU WOULD GET FROM AN 8-CYLINDER CAR AS COMPARED TO ONE HAVING ONLY 4-CYLINDERS**

## THE GIFT OF A LIFETIME FOR MAN OR BOY

Gives him a smooth, controlled powerhouse at his fingertips to make things for pleasure or profit; costume jewelry, train and plane models, puppets, also enables him to tool leather, initial tumblers, internally carve plastics, etc. To have a Handee is to have a hobby. So, don't be satisfied with anything less than the best. The Handee is recognized as the "Cadillac" of small power tools.

At Stores or order direct postpaid on 10-days money-back guarantee

SEND FOR FREE 52-PAGE MANUAL

**CHICAGO WHEEL & MFG. CO.**  
EST. 1895

1101 W. MONROE ST., Dept. PM, CHICAGO 7, ILL.

**PLASTIC-CRAFT KIT** —Contains all materials you need to do plastic carving. Kit includes cutters, buffers, sanding discs, dyes, cement, a liberal supply of clear plastics and instructions..... **\$6.95**

- Send Handee Kit, \$24.95
- Send Handee \$19.95
- Send Plastic-Craft Kit \$6.95
- Send C.O.D.
- Send Manual

Name \_\_\_\_\_

Address \_\_\_\_\_

City \_\_\_\_\_

State \_\_\_\_\_

PM-11



Model No. 37-510

**\$8920**

As illustrated below, less motor and switch rod. About \$8.92 down!

Price subject to change without notice

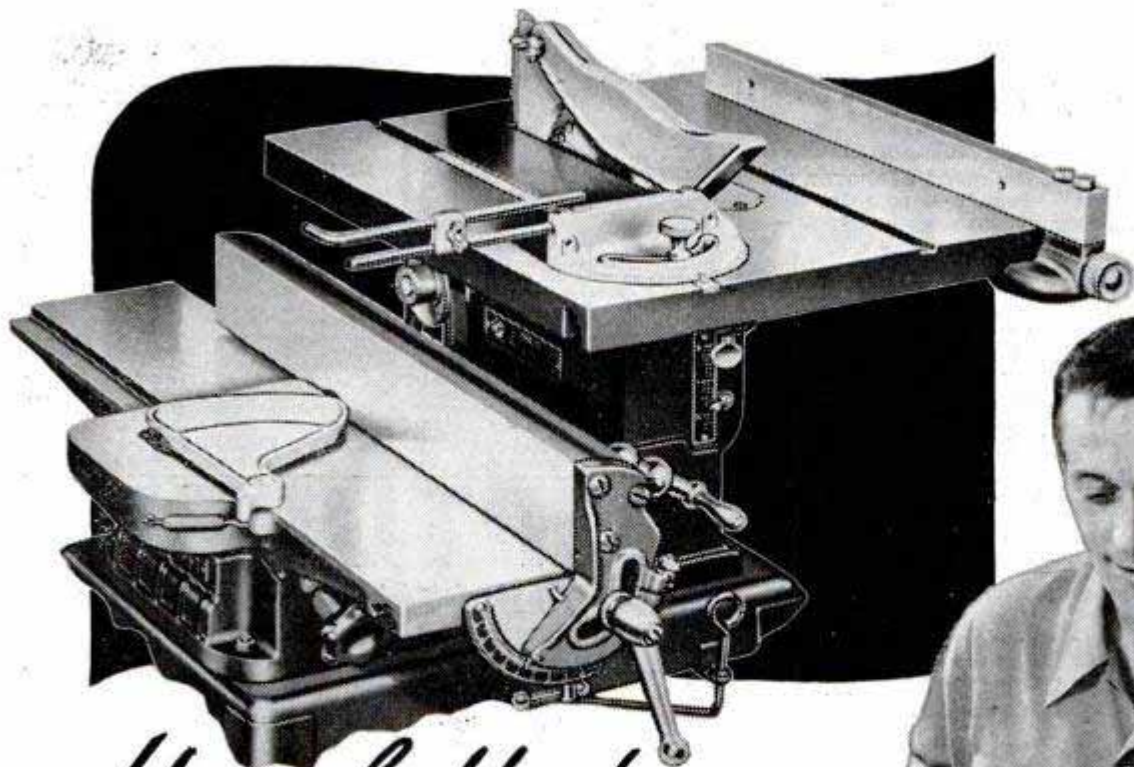

*Have hobby fun...*

cut cost of home repairs...with

## *New* Delta® Homecraft Saw-Jointer

**Low-cost combination unit does most home-shop jobs**

Two of the most versatile Delta Homecraft Power Tools, mounted on a single steel stand, driven by one motor — and offered at a money-saving price.

This new combination takes floor space of only 25 1/4" x 28 1/4". Husky 8" tilting-table circular saw cuts stock up to 2 1/4" thick on large 15" x 18" table. Jointer planes wood 4" wide and cuts rabbets 1/4" deep. Fence tilts 45° to right or left.

You can use this Delta Homecraft Saw-Jointer on many jobs around the house. Use it to make mouldings, picture frames, and railings. Fix broken drawers or make new ones, make those shelves you've wanted, make toys and gifts, and do countless other jobs.

See this new Delta Homecraft Saw-Jointer today at your nearest dealer. If you don't know who he is, send us coupon below for his name and address — and your free copy of shop-planning book.

**DELTA HOMEWORK**  
MILWAUKEE

**FREE "How to Start Your Home Workshop"**

**BOOK** Page after page of ideas, tips, and pictures to help you in planning and getting started. Send coupon at right for your copy.



**TEAR OUT COUPON AND MAIL TODAY!**

Power Tool Division  
ROCKWELL MANUFACTURING COMPANY  
680M E. Vienna Ave., Milwaukee 1, Wis.

Send me free book, "How to Start Your Home Workshop," and also list of Delta Homecraft dealers.

Name.....

Address.....

City.....(.....) State.....

HM-72

# HUNDREDS OF ITEMS AND IDEAS FOR THE WOODWORKER

A board or carload—Top grade kiln dried Mahogany—Walnut—Wh. Hd. Maple—Cherry—Poplar—Aromatic Red Cedar—Red, White and English Brown Oak—Sapeli—Andiroba—Balsa Wood.

## HARD TO FIND LUMBER

**BIG NEW NO. 16  
CATALOG FOR  
WOODWORKERS.  
144 PAGES  
OF HARD-TO-FIND  
SUPPLY ITEMS.**

The finest catalog we ever published. Full of unequalled bargains and useful information.

### Greatest Selection of Fine Domestic and Imported Woods

Catalog shows in natural color 32 rare and fancy woods, 43 matched veneer designs, multi-colored bandings, inlays, overlays, 275 scroll patterns to choose from, labor-saving machinery and a section for beginner's instruction.

#### OVER 100 NEW ITEMS

My stocks are gigantic—bigger than ever before. Really FAST SERVICE on your orders. My new catalog includes a "gold mine" of hard-to-find hardware items. Whatever Wood Craftsmen need—I HAVE IT.



**MAIL COUPON TODAY for  
GIANT NEW CATALOG #16**

**Only 15c** Refunded on first order.

Harold F. Hunt, President  
CRAFTSMAN WOOD SERVICE CO.  
2729 S. Mary St., Dept. A-11, Chicago 8, Ill.

I enclose 15c, to be refunded on my first order. Please send me your big new Catalog No. 16.

NAME \_\_\_\_\_  
ADDRESS \_\_\_\_\_  
TOWN \_\_\_\_\_ ZONE \_\_\_\_\_ STATE \_\_\_\_\_

## Keep Brushes like New

**BEFORE**

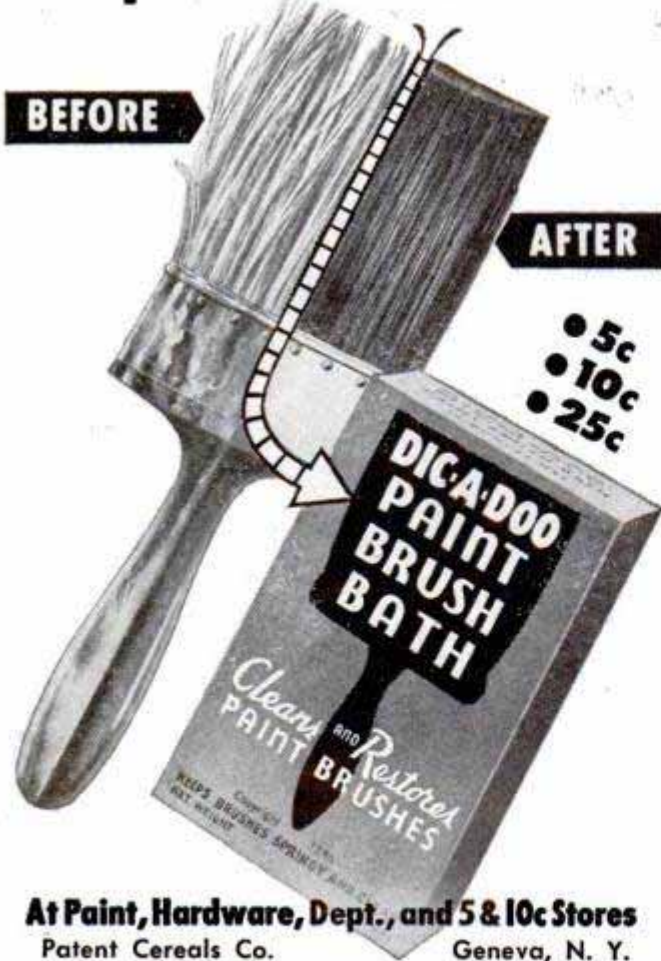

**AFTER**

• 5c  
• 10c  
• 25c

At Paint, Hardware, Dept., and 5 & 10c Stores  
Patent Cereals Co. Geneva, N. Y.

## SPEED & POWER HANDBOOK



**BUILD FAST STOCK CARS!  
COVERS FORDS to CADILLACS**

Build California Roadsters! Hollywood Sport Cars! 150 MPH Rods!  
Breathtaking Methods — Authentic — Direct from California!

### SAVE MANY DOLLARS

Build your own Dual Manifolds! Superchargers! Hot Cams! Water Injectors! Hi-Compression Heads! Mileage Devices! Get up to ten more miles per gallon! Get racing speed, lightning acceleration, dynamic power increases from any make passenger automobile! Get construction drawings! Tuning techniques! Speed tricks! Economy secrets! Ingenious formulas! Including "Racing Frames"—"Reciprocating Masses"—"Jet Engines"—"Braking Characteristics"—"Dynamometers"—Dual Pipes, Gears, Fuels, Manifolds, Porting, Relieving, Lowering! Balancing. Including complete Racing Equipment Catalogues!

Includes "CALIFORNIA AUTOMOBILE CUSTOMIZING" — Glossy photographs! Diagrams! Newest Ideas! Conversions! Re-Styling all makes! Streamlining! Chopping! Channeling! Customizing!  
50 CHAPTER LIBRARY EDITION—complete—\$1.98 Postpaid.

### NEWHOUSE AUTOMOTIVE INDUSTRIES

5805-84 EAST BEVERLY BLVD. LOS ANGELES 22, CALIF.

# RUPTURED?

## Get Relief This Proven Way

Why try to worry along with trusses that gouge your flesh—press heavily on hips and spine—enlarge opening—fall to hold rupture? You need the Cluthe. No leg-straps or cutting belts. Automatic adjustable pad holds at real opening—follows every body movement with instant increased support in case of strain. Cannot slip whether at work or play. Light. Waterproof. Can be worn in bath. Send for amazing FREE book, "Advice To Ruptured," and details of liberal truthful 60-day trial offer. Also endorsements from grateful users in your neighborhood. Write:

CLUTHE SONS, Dept. 31, Bloomfield, New Jersey

## 100,000 WASHER REPAIR PARTS

Start Your Own Washing Machine Repair Business

RETAIL CUSTOMERS MAIL IN OLD PARTS  
OR MODEL NO. OR SERIAL NO.

Tremendous field, excellent profits! Get our large complete wholesale catalogue showing thousands of repair parts illustrations: wringer rolls, V-belts, motors, gears, etc. Price \$2.00 per copy postpaid in U.S. Send check or money order today—price of catalogue refunded on first \$20.00 order. Established 20 years

WESTERN APPLIANCE CO., Inc.  
5650 GRAND RIVER AVE., DETROIT 8, MICH.



## MARCOT KEY MACHINE

Immediate Delivery



MARCOT No. 8 KEY MACHINE, mounted on Cabinet, less motor, \$ 95.00  
Auto Code Book and Depth Keys. 12.50  
100 Dz. Popular Key Blanks. 60.00  
Set — Key File, Follow-Through Rods, Lock Picks, Bit Key Gauge, Thimble, Pins, Springs. 10.50  
"Locksmith Trade Books". 6.75  
How to Open Locks without Keys or Picks; Secret of Locksmithing; How to Make Keys by the Impression Method; Master Key Systems.  
TOTAL COST .....\$184.75

A. J. MARCOTTE CO., 1200 N. Kedzie Ave., Dept. PM, Chicago 51, Ill.

## REAL DIESEL ENGINE

**\$2.95**

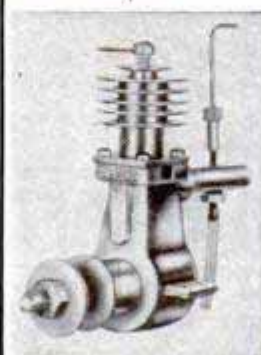

WE'RE CRAZY, they tell us, giving away a real diesel engine, complete with cylinder and piston, carburetor, crankshaft and connecting rod. All parts completely machined, ready for easy assembly. ONLY \$2.95. How do we do it? We're selling thousands of DEEZILS. So production's up; costs tumble down. DEEZIL is a precision engine. Actually runs at 7500 RPM. Produces 1/7 HP. Ideal for planes, boats, midget cars. Send \$2.95 plus 25c postage today.

### GOTHAM HOBBY CORP.

107 East 126th Street New York 35, N. Y. Dept. "P"

# New SpeedDrill

$\frac{3}{8}$ " Capacity  
 $\frac{1}{2}$ " Power  
 $\frac{1}{4}$ " Price



No. 79  
 $\frac{3}{8}$ " SpeedDrill  
**\$19.95**  
 with the Geared Jacobs  
 Chuck \$24.95



**GIVE**  
**SpeedWay**  
 ELECTRIC TOOLS and  
 TOOL KITS this

# SpeedWay

No. 89-J  
 $\frac{1}{2}$ " Drill  
**\$34.95**

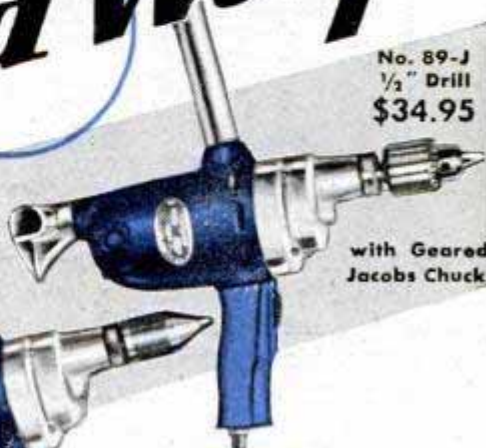

with Geared  
 Jacobs Chuck

No. 89  
 $\frac{1}{2}$ " Drill  
**\$29.95**



No. 209  
 Drill Stand  
**\$12.95**



Literally hundreds of thousands  
 of SpeedWay tools and kits are  
 in use. They have become more  
 than workmans' tools, they are  
 modern "home appliances."

## CHRISTMAS

No gift more welcome, more useful  
 or longer lasting for the  
 homeowner, mechanic, handy  
 man or craftsman—for the individual  
 or the whole family.

Each SpeedWay Tool does innumerable  
 useful things. All make tedious tasks fun.  
 Encourage creative abilities, foster enterprise,  
 provide useful avocations.

*Dad* needs SpeedWay Tools for repairing,  
 sharpening, sanding and building.

*Mother* will use a SpeedWay to clean  
 and polish the easy way.

*Sister* is apt to go in for art crafts,  
 wood carving or making novelty jewelry.

*Brother* will become a craftsman,  
 a model builder or a refinisher.

No. 69K  
 Drill Kit  
**\$18.95**



Combo Kit  
**\$29.50**



No. 117  
 Bench  
 Grinder  
**\$14.95**



No. 128 ( $\frac{1}{4}$  h.p.)  
 Bench Grinder  
**\$29.95**



No. 229  
 Drill Stand  
**\$5.25**



No. 129  
 Hand Grinder  
**\$8.25**



No. 69  
 $\frac{1}{4}$ " Drill  
**\$11.80**



G. A. Kit  
**\$13.95**



All Blue Line Tools are  
 guaranteed for 1 year by SpeedWay—  
 for over 40 years a famous name for quality tools.

**SPEEDWAY MFG. CO.**  
 1866 South 52nd Ave. CICERO 50, ILLINOIS

No. 700  
 SpeedSaw  
**\$59.95**



in steel case  
**\$59.95**

SpeedWay Blue Line Tools are  
 carried in stock by all leading  
 hardware, electrical and department  
 stores. Your local dealer will  
 gladly show them and help you  
 select for self or friends.

# Man's Gift of the Year! "FORTY-NINER"

Complete set of X-acto Hobby Knives  
and Tools in portable wooden chest **\$25**

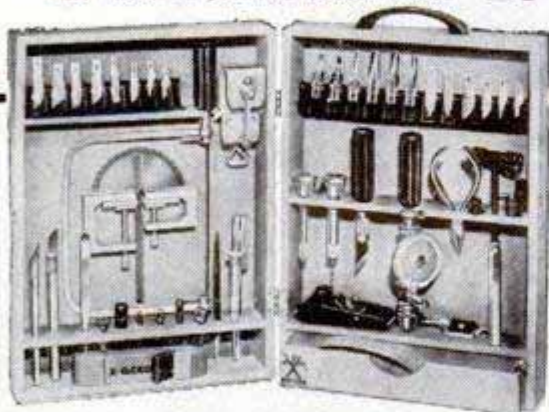

Every knife, tool and blade in the famous X-acto line. Precision made, easy to handle, joy of amateur and expert hobbycrafters in every field. X-acto knives and tools sell singly and in sets, 50¢ to \$50 at hobby, gift, hardware and department stores. (Prices slightly higher in Canada.)

## X-acto

X-acto Crescent Prod. Co., Inc., 440—4th Ave., N.Y. 16  
In Canada: Handicraft Tools, Ltd., Hermant Bldg., Toronto

### BOYS! Have fun with CHEMCRAFT!



## FREE-

This exciting new book



Send today for new, FREE Chemcraft Chemistry book—"The Wonders of Chemistry". Shows how to amaze friends and family with chemical magic. Describes many fascinating home experiments like making perfume, windshield cleaner, soap, etc. Loads of fun, thrills, excitement and adventure await boys who start now to obtain knowledge of Chemistry. Act now! Send for FREE Chemcraft Chemistry book—TODAY!

# CHEMCRAFT

REG U S PAT OFF  
Now—with Safe Atomic Energy

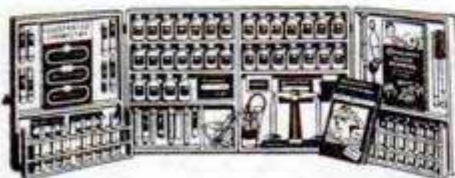

Sold in the best stores all over the country. Address below for your FREE copy of "THE WONDERS OF CHEMISTRY."

THE PORTER CHEMICAL COMPANY  
62 Prospect Avenue • Hagerstown, Md.



## DRIVERS!—SEE IN EVERY DIRECTION!

### NEW WYD VUE (WIDE VIEW) REAR VIEW MIRROR

One glance shows BOTH sides as well as rear! Safer driving and easier parking. No more blind spots!

Consists of a series of 5 optically true, non-glare mirrors, mounted in rubber at scientifically correct angles, on a frame of 22 gauge steel. 160 degrees of vision. 70 square inches of mirror surface. Harmonizes with all car interiors. WYD VUE fits any car. **\$7.95 POSTPAID. NO C.O.D.'s**

Agents! Dealers! Write for attractive profit plan.

O'NEILL'S Dept. M-1149, State Bank Bldg., Milwaukee 3, Wis.

RETAIL PRICE **\$125.00**  
**FACTORY TO YOU! \$59.95**  
**5 BIG POWER TOOLS in 1**



**SUPERSHOP** is the PRECISION-BUILT power tool WORKSHOP. Big capacity tilting table saw, vertical and horizontal drill press, 30" lathe, sander, grinder. Lifetime-lubricated BALL BEARINGS. Running parts precision-ground. Bearing seats precision-bored. Compare with finest production tools. Buy direct from factory—save \$65.00. Write for FREE catalog, full details, trial plan.

**SUPERSHOP POWER TOOLS INC.**  
105 YATES AVE., BELOIT, WIS.

## Build YOUR OWN BOAT



Build a better boat than you can buy for the money! Save 35-55%. Exclusive laminated rib construction. Prefabricated, mortised for easy assembly. All popular types from handy car-top models to mahogany-decked runabouts, priced from \$39.50 to \$199.50, for boats retailing up to \$400. Send 10 cents for literature.

**\$39.50**  
and up

## OZARKA

6119 BORDEN STREET  
WOODSTOCK, ILL.

## FURNACES FOR HOME AND SHOP



COAL—LP—GAS—OIL. Fittings, pipes and registers. Water heaters, Ranges and floor furnaces. BLOWERS with motors. Get the parts you need and modernize your own heating system. Wholesale & Retail. Lowest prices.

FREE BOOKLET

**PEERLESS SALES & SUPPLY**  
4318 Sheridan Lincoln 6, Nebr.

## Chronograph Wrist Watch

LOWEST  
MARKET  
PRICE  
**\$7.25**



Sweep Second Hand; Precision Workmanship; Rugged Shock-resistant case; Radium hands and numerals; Leather strap. It measures distance, speed of cars, planes, horses and other moving objects. It's a time keeper, stop watch, telemeter, tachometer. ONE YEAR WRITTEN GUARANTEE and full operating instructions enclosed with each watch. SEND NO MONEY. Mail your order today. Pay postman \$7.25 plus 10% Federal tax. Total \$8.00 plus postage. Or send cash (money order or check) with your order and save postage charge.

**MARDO SALES CO., Dept. 1703**  
480 LEXINGTON AVE. NEW YORK 17, N. Y.

SERRATED JAWS FOR POSITIVE GRIP

SWIVEL JAW



Only Locking Plier with All These Features

A plier, wrench, clamp; 1000's of uses in garage and home. Heavy pressed steel body, rugged tool steel, replaceable jaws.. 7" size, \$1.75; 10", \$2.25 (10% higher, Denver & West). At dealers everywhere.

SEYMOUR SMITH & SON, Inc.,  
900M Main St., Oakville, Conn.  
Quality Tools Since 1850

SEYMOUR SMITH  
**Snap-Lock**  
PLIER-WRENCH

ALL-NICKEL FINISH

CAPACITY INDICATOR

INSTANT LOCK RELEASE

**Little Lantern - Lots of Light**

● Keep this handy little BUDDY LIGHT in glove compartment, tool chest, or drawer. It's compact, sturdy, good looking! Switch *glows* in dark. Buy at hardware, sport, elec. stores. Uses 2 standard 1 1/4-in. batteries.



\$1.75

**Delta BUDDY ELECTRIC LANTERN**

**Genuine Snap-on Tools**

Available Only Through Snap-on's Direct-To-User Tool Service

WRITE FOR INFORMATION  
SNAP-ON TOOLS CORP. • Kenosha, Wisconsin

**Need a Chimney?**

SAFER Underwriters accepted, any fuel. Meets FHA requirements. **ECONOMICAL** save 50% over brick. **ENTIRE CHIMNEY SHIPPED COMPLETE** (convenient 2 ft. sections: base, housing, roof flashing, chimney cap). Nothing else to buy. **PERMANENT** . . . a lifetime chimney. **MORE DRAFT** . . . less soot, better heat.

Van-Packer Corp., Rm. 1749, 102 W. Adams St., Chicago 3

You Yourself Can install it . . .

The VAN-PACKER Packaged Chimney

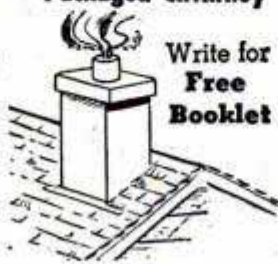

Write for Free Booklet

**"Build Your Own"**  
remote control, trailer type  
**arc welder**

Go to **BIG PAY** jobs like this man and thousands of others are doing.



**"Pay out of profits" TERMS - SMALL down payment**  
with balance spread over months makes it easy to get started now.

SAVE \$150 to \$300 . . . or more!

It's easy with a good used auto engine, chassis and one of these new HOBART arc welding generators.

**THOUSANDS HAVE DONE IT.** There's nothing new or untried about this idea. It's sound and practical. Any man, with average mechanical ability, can do it easily in spare time.

**HOBART HELPS YOU** get started with ideas, suggestions, illustrations. You can build as simple or elaborate an outfit as you want.

**FASTER WELDING EITHER A.C. OR D.C.** Exclusive HOBART features make welding easy for the unexperienced and beginners. Easier to strike and hold arc. Liberally rated for overloads. Built for any shop or field need to help you handle more business.

**HOBART WELDING SCHOOL** gives you low cost training. Learn by doing in short time. Latest methods, newest equipment. Check coupon for details.

HOBART BROTHERS CO., Box M-119, Troy, Ohio

**HOBART**

"one of the worlds' largest builders of arc welders"



A.C. Generator . . . welds, for lights, tools.



A.C. Transformer Welder speeds up shop work.

Free! "Build Your Own" Booklet

HOBART BROTHERS CO., Box M-119, Troy, Ohio

Please send details on HOBART "Build-Your Own" Welders and other information checked:  
 D.C. Generator to "Build-Your-Own"  
 A.C. Gen., Welder to "Build-Your-Own"

- "Build-Your-Own" Booklet
- A. C. Transformer Type Shop Welder
- Hobart Welding Trade School

Name \_\_\_\_\_

Street \_\_\_\_\_

City \_\_\_\_\_ State \_\_\_\_\_

# BUILD YOUR OWN TILTING ARBOR SAW!

Exclusive GIL-BILT Build-It-Yourself Features

- No machining—build easily with hand tools only
- No blueprint reading—step-by-step pictorial plans, full scale patterns, actual photographs
- Sturdy wood, aluminum, and steel construction
- Capacity and performance of commercial saws selling for \$60 and up

SAVE \$50 OR MORE

## GIL-BILT 10-INCH TILTING ARBOR SAW



- 27x28 in. table, 13 1/2 in. capacity in front of blade
- 10 in. blade cuts 3 1/4 in. deep, tilts full 45 degrees
- Floor model 34" high, table always stays level
- New Departure ball bearing arbor, 3/4" precision shaft turned down for 5/8" bore blades, alum. housing, shipped ready to run
- Jackscrew and 4 1/2 in. dia. handwheel lowers and raises blade
- Cast aluminum miter gauge and self-aligning rip fence guide

GIL-BILT Metal Parts Kit includes Plans, ball bearing arbor, miter gauge and bar, rip fence guide, dado insert, lock knobs, jack screw mechanism and handwheel, and all other metal parts (less blade).....\$20.95  
Same Kit with 10" Combination Blade \$24.90  
Same Kit with 8" Combination Blade \$23.90

## GIL-BILT 8-INCH TILTING TABLE SAW

- 21x27 in. table tilts full 45 degrees, 13 in. capacity in front of blade
- 8 in. blade cuts from 0 to 2 1/2 inches
- New Departure ball bearing arbor, 5/8" precision shaft turned down for 1 1/2" bore blades, alum. housing, ready to run
- Cast aluminum miter gauge and self-aligning rip fence guide (same as above)



GIL-BILT Metal Parts Kit includes Plans, Ball Bearing Arbor, Miter Gauge and Bar, Rip Fence Guide, Machined Lock Knobs, Tilt Support Segments and All Other Metal Parts (less blade).....\$15.95  
Same Kit with 8" Combination Blade.....\$18.90

## GIL-BILT 12-INCH BAND SAW

- Cuts to center of 24 inch circle
- Handles stock up to 6 inch thick
- 18x18 inch table tilts 45 degrees
- Lower wheel and drive pulley runs on sealed New Departure Ball Bearings; Upper wheel runs on two 5/8" bore Oilite Bronze bearings.
- Upper and lower blade guides. Each has ball thrust bearing, self-lub bronze jaws
- Rubber tired wheels. Choice of cast aluminum or make-your-own wood wheels on metal hubs.
- Uses standard 78 inch blades up to 3/8 inch wide.
- Fully enclosed mechanism for utmost safety.

GIL-BILT Metal Parts Kit includes Plans, rubber tires, 1 1/4 inch blade, hubs for wood wheels, ball bearing spindle, tilt mechanism, guides, table tilt segments, and all other metal parts.....\$16.95  
Same Kit with two machined ready-to-install 12" cast aluminum wheels.....\$20.95

NO DEALERS—ONE LOW FACTORY PRICE! Return in 10 days for full refund if not satisfied. Prices include postage within 800 miles. Over 600 miles add 5%. Send cash, check, or money order for parts kit, or send \$1.00 for Step-by-Step Plans and order kit later less cost of Plans. Plans sent postpaid anywhere in the world.

### GILLIOM POWER TOOLS

P. O. Box 1-PM, Lambert Field, St. Louis 21, Missouri

COMPLETE PLANS only \$1.00 EACH

# Local Colorcretors Can Earn High Incomes

COLORCRETE is today's biggest business opportunity in the building field. High returns from a low investment. Easy, fascinating work. Large waiting market because Colorcrete is applied over all kinds of old and new masonry surfaces — exterior and interior.

Beautifies and Protects All Types of Buildings



Pneumatic pressure sprays plastic-like Colorcrete to give enduring beauty and water-resistant values. Range of 30 gleaming colors; many textures. Easy to wash. Smartly modern. Write or wire today for Opportunity Portfolio, which gives complete story.

COLORCRETE INDUSTRIES, INC.  
570 Ottawa Ave., Holland, Mich.

# HOLD-E-ZEE

The Original AUTOMATIC GRIP SCREWDRIVERS



Hold, start and set up screws in unhandy places. Gripper instantly released by SPRING ACTION, sliding up out of way when not in use. Highest quality throughout.

New Models FOR RECESSED HEAD SCREWS

UPSON BROS., INC., ROCHESTER 4, N. Y.

At Leading Dealers Everywhere

## WORLD'S FINEST MODEL AIRCRAFT

# CLEVELAND

"EXACTLY LIKE REAL THING" Great show value. World favorites since '19. Wide range free lance, commercial, military planes, old and new, 1/4" scale, 20" span and over, sizes 8" through 10 ft. gliders, 35c to \$14.50.

Balsa frames. All fly for rubber, CO<sub>2</sub> or gas motors. Kits less liquids, flying groups. Add 75c post-post. Products 30 yrs. designing. Aerial copied. Get the real thing. Send for catalog, 2, 3c stamps or 5c.

A-LIGHTNING, 26" T-KH, D2 B-Ryan NAVION, 25 1/2" M-KH, \$1.75. C-AERONCA, IT-KH, \$1.00 & E-PANTHER & ESCOUPE, also 30" each \$1.00

SEND FOR NEW CATALOG

5c

CLEVELAND MODEL & SUPPLY CO.  
4515L21 LORAIN AVE., CLEVELAND 2, OHIO

## SPECIAL OFFER!

LOCK-STITCH SEWING AWL

\$1. Postpaid

Famous, patented lock-stitch sewing awl complete with needles, waxed thread and direction folder. Hundred uses — sewing, repairing leather goods, canvas, belting, harness, saddles, gun cases, awnings, golf bags. Extra needles and thread available. Satisfaction guaranteed or money back. Send currency, check or money order. Yates Mfg. Co., 611-H Main St., Lake Geneva, Wisconsin

## WHAT! NO LIGHTS!

Katolight Plants furnish the same kind of A.C. current as the High-lines. Sizes 500 Watt to 300 Kilowatt. Also manufacturers of Rotary Converters, Frequency Changers, D.C. Motors 1/4, 1/3, and 1/2 H.P., A.C. Motors, single phase in 2, 3, and 5 H.P., high frequency Generators.

KATO ENGINEERING COMPANY  
1402 FIRST AVENUE  
MANKATO, MINNESOTA



EST. 1914

BUY DIAMONDS at WHOLESALE PRICES

Save UP TO 50%

Learn how to benefit from Loan Foreclosures and Estate Liquidations. All Diamonds reset in new mountings. Your bank is our reference.

WRITE FOR FREE CATALOG

CITIZENS Diamond Brokers  
Dept. C • 195 Mitchell St. • Atlanta, Ga.



# Make your own TUBULAR STEEL CHAIR FOR AS LITTLE AS \$17.3 COMPLETE!

Make metal chairs, tables, chaise lounge, child's bed, wheelbarrow, many other useful articles for family and friends. Earn money spare time! Use tubular steel, aluminum, iron pipe. Make smooth bends quickly, easily, with HANDY Tube Bender. No other tools needed. Not a toy! HANDY Tube Benders used daily by thousands of plumbers. A guaranteed precision tool! Many uses around the home.

**FREE!** With Model B4-16 HANDY Tube Bender (for 1" O.D. tubing) we include simple instructions for making tubular chair, table, many other home furnishings. Send check or M.O. for only \$17.70 — we pay postage. Get your HANDY Tube Bender NOW — in time to make desirable Christmas gifts. Save money!

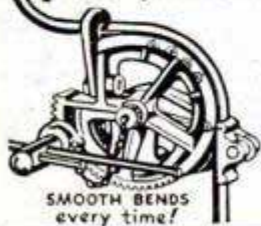

**HOLSCLAW BROS., Inc.**  
407 Willow Road  
EVANSVILLE 11, INDIANA

## BRASS NAME PLATES OR KEY TAGS

YOUR NAME  
STREET AND NUMBER  
CITY AND STATE  
PHONE NUMBER  
40c each—3 for \$1.00

Half actual size  
QUANTITY PRICE — SAME STAMPING  
8 for \$2. - 15 for \$3. - 25 for \$4. - 50 for \$6.  
LARGER QUANTITIES ON REQUEST  
TAGCO, BOX 38X, WINGDALE, N. Y. STAMPING EQUIPMENT

## CRESCENT TOOLS

*Give Wings to Work*

ASK YOUR  
HARDWARE  
DEALER



**\$2.00**  
Postpaid

Writes on glass, metals, plastics. Hex. Aluminum 6". Money back guarantee. Agent inquiries invited.

**CLIPPER DIAMOND TOOL CO., INC.** 21-B W. 46 ST., N. Y. 19

## AMES UNIVERSAL DIAL INDICATOR SETS

### New Surplus

Dial indicator — face 2 1/4", graduated in 1/1000ths. Dial reading-0-50-0; spindle travel — 1/4"; can be used on stationary or revolving parts on lathes, milling machines, drill presses, etc., and for automotive work. Comes complete with dial gage, hole attachment, bar with upright, clamp sliding swivel, dial holding rod and 3 contact points — with case shown.

Reg. Sold  
**\$23.00**

NOW  
**\$15.00**

**VETERAN TOOL AND SUPPLY CO.**  
88 BAXTER STREET NEW YORK 13, N. Y.

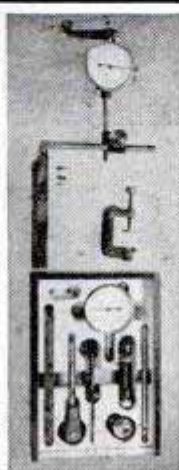

# Pint Sized Power Miracle



**Complete Super Power  
Tool Kit—Only**

**\$18.55**

Contains power unit with cord, 5 abrasive points and cutting burrs, full operating instructions—all in one case.

## New Duro Super Power Unit—the tool you'll use in a 1000 ways!

This is the kind of lightweight, perfectly balanced hand power tool that hobbyists and home craftsmen dream about! A compact fistful of super power, it runs cool and smooth at 20,000 RPM, develops 42 watts output. With it, you can do clean, professional-looking sanding, polishing, grinding, engraving, carving... and scores of other operations.

- Start with this low cost tool kit and build a complete home workshop! One Duro Super Power Unit is used on all of these home workshop tools! You may buy them singly—or in a group.
- Grinder & Shaper Only \$8.80
- Drill Press Only \$11.95
- Router Only \$8.15
- Lathe—Only \$10.15

**Ball Bearing Flexible Shaft Doubles the Fun**  
New Duro flexible shaft fits over nose-piece of power unit, makes free-hand carving, engraving lots more fun. Flexible shaft, complete with hanger, only.....\$15.55

**Write for Free Illustrated Circular** giving full details about the Duro Super-Power Unit and the low cost workshop units. Circular also shows almost a score of pictures and details about operations that you can do with these amazing power tools.

**DURO METAL PRODUCTS CO.**  
2669 N. Kildare Ave., Chicago 39, Ill.

Gentlemen: Send me free circular giving full details on the Duro Super-Power Unit and the low cost workshop units.

Name.....  
Address.....



**SO SMOOTH  
SO USEFUL!**

**POWER  
KING  
18" JIG SAW**

Furniture, toys, ornaments, jewelry, household equipment, scrolls, inlays, marquetry, fret work . . . the list is almost endless of the many ways you can use this Power King 18" jig saw in your shop. It cuts light metals and plastics, and wood up to 2" thick — all with a smoothness usually found only in more expensive equipment.

The Power King gives you exceptional working capacity and conditions for its price. The precision-ground grey iron table is 12" x 12". There are 18 inches from overarm to blade. Table tilts to 45°. Spring-steel hold-down and blade support directly above work makes accurate cutting easy. Strong air blower for sawdust. Splash oil lubrication. Built by Atlas

**— and only \$4275\***



**POWER  
KING  
11 3/4"  
DRILL PRESS**

The outstanding value among low cost drill presses today is this Power King No. 611. Jacobs chuck takes drills to 1/2". Makes fast, easy work of drilling metal, wood and plastics. And low cost accessories are available to help you get "professional" results on mortise and tenon joints, routing, shaping, sanding, carving, inlaying. With six-splined spindle, balanced pulleys, Oilite bronze bearings and ball bearing for end thrust, this PK 11 3/4" drill will give you good, long service. Built by Atlas

**— and only \$4275\***

There are 8 different tools in the Power King line, recognized in stores by their distinctive green color. Send postcard for complete FREE catalog.

**ATLAS PRESS COMPANY**  
1135 N. Pitcher St., Kalamazoo, Mich.



**MATCHED PRECISION TOOLS FOR  
WOODWORKING AND METALWORKING**

**"WOVEN-Gards"**

**BETTER  
Hand Protection  
at Amazing Low Cost**

"Woven-Gards" are hand protectors, mitts, pads and sleeves made out of a wholly new safety material to provide flexibility, comfort, resistance to abrasion and cutting far beyond that of anything used before. They are extremely oil-absorbent for excellent handling of oily, slippery sheets and slabs. The porous weave makes them the best "hot" handlers ever offered. Thousands of enthusiastic users say they have never seen values like "Woven-Gards," best protection at lowest cost. Send now for descriptive folder and prices.

**INDUSTRIAL GLOVES CO.**  
1405 Garfield St., Danville, Ill.  
(In Canada: Safety Supply Co., Toronto)

**INDUSTRIAL  
Safety Apparel**



**Automatic CENTER PUNCH**

**PRECISION MARKING — CENTERING — STAKING**

THE ONE-HAND PUNCH for accuracy, speed, facility otherwise unattainable. Adjustable 6 to 35 lbs. Micrometer calibrated for extremely fine work (jewelry, dies, etc.). Tool steel point. Nickel plated.

**C-15R PUNCH (as described above) \$2.75**

MASTER KIT contains No. C-15R punch with seven attachments for:—Precision centering all size hinges . . . Marking hard steel, glass . . . Chisel tooling all metals . . . Setting pins, brads . . . Light riveting . . . Hammer effects on soft metals. **MAKES IDEAL GIFT.** Free booklet.

**MASTER KIT complete with wood case . . . \$8.30**

At your dealer or Direct. All prices postpaid except COD. Moneyback guarantee.

**VINCO PRODUCTS, Asbury Park, N. J.**

**NEW GOVT. SURPLUS HOIST and WINCH**

Originally made to be used on B-29s for lifting bombs. Mounted on welded steel base, can be attached to truck body or any solid base. Ideal for lifting or moving loads onto trailers, trucks or tractors or for machine shops, garages or warehouses. Capacity 2,000 lbs. Equipped with ratchet for holding load and 18 ft. 3/16" steel cable. Shipping weight 50 lbs. FOB, Kansas City, Mo.

**\$29.95**

Send check or M.O. for immediate delivery. No COD's

**AMERICAN AUTO PARTS CO., INC.**  
1830 LOCUST DEPT. PM9 KANSAS CITY, MO.

**Only \$498**



**OTTAWA  
Mule Team Tractor**

Finest low-cost tractor. Costs too little to do without. Engines burn gasoline or kerosene. Starter and lights available. Other larger Models to choose from. Over 4,000 in world-wide use. Time-proved and tested. At low cost they easily mow, plow, disc, harrow, plant, cultivate, etc. Sold only direct to user. Write for FREE details.

**OTTAWA MFG. CO., 2-927 Garden St., Ottawa, Kansas**

**Build your own SMITH Compressor**

Operates spray guns, rock drills, tampers, paving breakers, sandblasting . . . Uses only 1 gallon of gas an hour!



Save Money—build your own Smith Air Compressor! Famous the world over! Capacity 60 cu. ft.; pressure up to 100 lbs. per sq. inch. Just order the Smith Compressor Head and Accessories with complete instructions for assembling. All you need is a Ford Motor and shop facilities. Head equipped with high speed compressor valves; automatic unloading and idling.

Write for complete information!

**GORDON SMITH & COMPANY, Inc.**  
410 College Street • Bowling Green, Ky.

# Precision Metalworking In Your Shop For Only \$113<sup>50</sup>\*

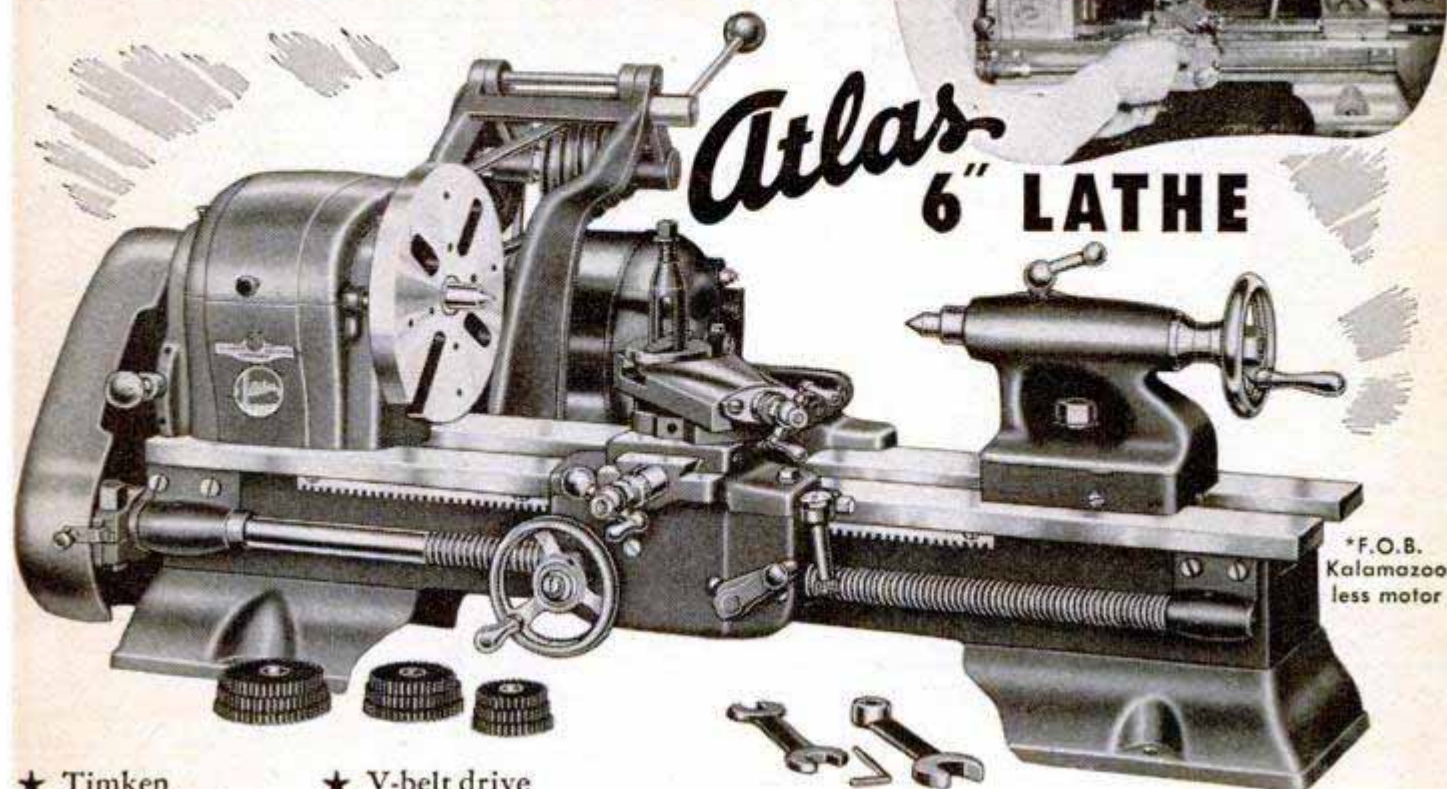
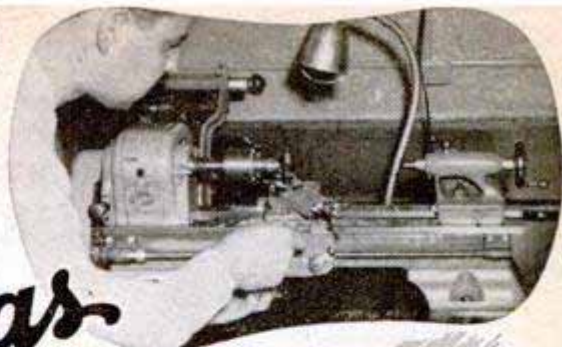

## Atlas 6" LATHE

\*F.O.B. Kalamazoo, less motor

- ★ Timken Bearings
- ★ 18" between centers
- ★ Precision Ground Bed Ways
- ★ Reversible automatic longitudinal feed
- ★ V-belt drive
- ★ 16 Speeds
- ★ Cuts 8 to 96 threads per inch
- ★ Back gears

*This is America's greatest lathe value—unequaled anywhere!* It gives you a back-geared screw-cutting precision lathe for your home shop, commercial shop, or garage at its lowest cost. More than that, with its wide speed range of 54 to 3225 RPM—plus Timken bearings to assure smooth running and long service—it gives you complete versatility in turning woods and plastics as well as metals! Now cost need not keep you from adding lathe metalworking to your shop, and most dealers can help you arrange low-cost monthly payments. Get all the facts about this unequalled lathe value. Send the coupon, or postcard, today.

### FREE CATALOG—Write Today!

- Please send Atlas 6" lathe catalog.
- Literature about Atlas woodworking tools.

Name \_\_\_\_\_  
Address \_\_\_\_\_  
City, State \_\_\_\_\_

**ATLAS PRESS COMPANY**  
1143 N. PITCHER ST., KALAMAZOO, MICH.



**MATCHED PRECISION TOOLS FOR  
WOODWORKING AND METALWORKING**

## You'll always value these **BIG Atlas** woodworking tools



8"-10"  
TILT/ARBOR SAW

**BIG** in capacities—for any size job you want to undertake—**BIG** in value—with many unique performance and construction features—and built to industrial quality standards, these are the tools for commercial quality workmanship in your home shop. Use coupon for latest literature.



10"  
Floor  
Saw



24" Jig Saw



6" JOINTER



12" Wood Lathe



Belt and Disc  
Sander



Wood  
Shaper



## THE TOOL SHARPENER you've always WANTED

THE REVOLUTIONARY NEW BOICE-CRANE

FRICION-MATIC WET TOOL GRINDER

for lathe tools, plane bits, scrapers, knives, sickles, scythes, carving tools, hatchets, axes, draw knives and household cutlery. Simplified self-adjusting friction roll drive. Peripheral speed remains constant as wheel wears. No water thrown on operator. Operator takes a comfortable standing position and works on top of the wheel for extra convenience and faster grinding. Larger tool rest (2½" x 5") perfect for long, slim knives, wide tools, tilts for grinding angles from zero to 30°. 8" dia. 1½" sandstone. Order today.

### BOICE-CRANE COMPANY 943 Central Avenue Toledo 6, Ohio

- Please send literature on Friction-Matic Wet Tool Grinder.  
 Please ship Friction-Matic Wet Tool Grinder. Enclosed is  check  money order.

Name \_\_\_\_\_  
 Street \_\_\_\_\_  
 City & State \_\_\_\_\_

THICKNESS PLANERS \* SPINDLE SHAPERS \* SAW JOINTERS  
 \* LATHES \* TILTING-ARBOR SAWS \* BELT SANDERS \*  
 SPINDLE SANDERS \* BAND SAWS \* JIG SAWS \* DRILL PRESSES

## Can You Run a Local Dunbrik-Dunstone Plant?

More local plants are needed. You can be one of a national chain. Simple, compact equipment. Moderate investment. 100%—150% mark-up on basic costs. Broad protection and liberal co-operation.

Outstanding Manufacturing Opportunity for Right Man



Tie in with today's demand for smart, colorful, low-cost masonry for homes and other buildings. Dunbrik-Dunstone has beauty, strength, modernity. Easily America's finest masonry, with tremendous appeal to building owners. Yet costs less than lumber because locally manufactured from local materials by local labor for local consumption.

**W. E. Dunn Mfg. Co.**  
 600 W. 24th Street  
 Holland, Mich.



Write for descriptive book "Blueprints for Profit."

**DUNBRIK-DUNSTONE**

**ALL NEW FOR 1950**

- \* PACKAGED BOAT KITS
- \* MOLDED BOATS
- \* PATTERNS · PLANS

### PACKAGED BOATS — EASY TO BUILD

7 NEW TREDRONIC RACERS. 17 sensationally new models, skiffs, outboards, runabouts, racing boats. 8' to 16', all new designs, increased performance, simplified assembly. World's best boat buy. Send 25c for 1950 literature. Literature & booklet "Plywood Boats" \$1.00.

### INDUSTRIAL MOLDED HULLS

Made by Industrial Shipping Co., Ltd., Halifax, Canada. Save time, save money, build your boat this sensationally new way from one piece, seamless hulls or complete kits (8-18 ft.). Send 25c for literature.

### NEW PLANS & PATTERNS FOR 1950

Over 100 modern designs by famous naval architects. Racing classes, cruisers, inboard, outboard, sail. 6 to 35 ft. Construction plans, full size patterns. Send 35c for catalog or \$1.00 for catalog and helpful booklet on Boat Building.

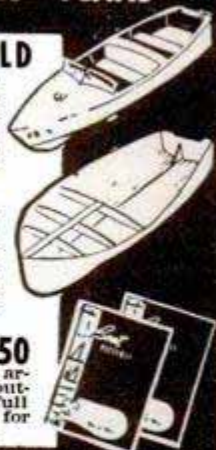

MARINE MART, 1700 NIAGARA ST., DEPT. 24, BUFFALO, N. Y.

## Build your own JET ENGINE!



SEND NO MONEY

Order these plans today

1. JET PROPELLED BICYCLE. Assemble your own. Photo and instructions \$1.00.
2. HOW TO MAKE EXPERIMENTAL JET ENGINES. Seven sheets drawings with information and instructions \$2.95.
3. BOTH OF ABOVE in one order \$3.75. SEND NO MONEY. Order both at once \$3.75 C.O.D. in USA plus c.o.d. postage. Send check or Money Order and we pay postage. Get other information too. Rush Order.

J. HOUSTON MAUPIN, Dept. 55, Tipp City, Ohio

## BRUSH PLATING OUTFITS

- for re-plating articles in the home and shop. No tanks necessary. Free particulars.

GUNMETAL CO., AVE. M, DECATUR, ILLINOIS

**make your own Gems 29.50**  
F.O.B.

All necessary lapidary equipment is furnished, including a super-charged diamond blade for sawing, and all wheels for grinding, shaping and polishing; also complete instructions. The complete equipment as shown, less motor and belt, for only \$29.50. L.o.b., Burlington, Wisconsin. Write today for information and literature.

**B&I MANUFACTURING CO.**  
Dept. S Burlington, Wis.

## FIBRE ARMS AND LEGS!

Light, correctly fitted, strong and comfortable. Natural appearance. Braces for all deformities. Scientific design. Fair Terms.

**BUCHSTEIN-MEDCALF** 223 S. 6th St., Minneapolis, Minn.

SAY YOU SAW IT IN POPULAR MECHANICS

## MAKE \$1000 A MONTH IN YOUR SPARE TIME

**HOW TO MAKE LUMBER FREE BOOK**

**ONE-MAN SAWMILL GIVES YOU EXTRA CASH IN "OFF-SEASON"**

TAKE your BELSAW Portable Sawmill right to the trees—turn out valuable lumber for local yards, all kinds of building material—do "custom sawing" for neighbors. Thousands of satisfied owners. One writes; "I make \$1000.00 a month, and do it easy!" No crew needed. Power with old auto engine or tractor.

Fast mechanical feed, positive top dogs, steel construction, safety features. Beginners get excellent results at once. BELSAWS last a lifetime. Low factory-to-you price. . . pay only \$62.50 down. Build a big-profit business. Send postcard for valuable FREE BOOK, "How To Make Lumber."



**BELSAW MACHINERY CO**  
 811W Field Bldg., 315 Westport Rd., Kansas City 2, Mo.

**MONEY BACK**  
if not delighted  
IN 10 DAYS

**AMERICA'S BEST WATCH VALUES**  
WHOLESALE PRICES • DIRECT TO USER

ORDER WITH CONFIDENCE  
**1 YEAR WRITTEN  
GUARANTEE**

men's fully guaranteed  
**15 JEWEL WRIST WATCH**  
ORIGINALLY \$30 to \$55

Luminous dial sweep second hand. Water repellent shock protected anti-magnetic. Imported Swiss precision movement and case. Worth triple this low price. Only \$12.95 plus \$1.30 tax. Don't delay Order now

**\$12.95**



14-KT. LADIES  
**17 JEWEL FILLED GOLD WATCH**  
YELLOW  
ORIGINALLY \$39.75

A thrilling precision watch with beautiful cord band. Built for life-time service. Shock protected construction. Lowest price ever. Only \$13.95 plus \$1.40 tax. Don't delay. Order now

OUR PRICE  
Now Only  
**\$13.95**



**17 JEWEL 2 Push CHRONOGRAPH**  
BUTTON  
ORIGINALLY \$71.50

Thousands sold at \$71.50. 2-push button combination wrist watch, stopwatch, telemeter, tachometer. Incablock shock resistant feature. Sweep second hand. Anti-magnetic. Radium dial. Stainless steel back. Unbreakable crystal. Only \$21.95 plus \$2.20 tax. Order now.

POST-WAR SURPLUS  
Now Only  
**\$21.95**



**Sturdy WRIST WATCH**

- Sweep Second Hand
- LUMINOUS DIALS
- WATER-PROOF PLASTIC BAND

Sturdy guaranteed men's watch. Built to keep accurate time. Many formerly sold at double this price and more. Yours now at only \$4.95 plus 50c tax. Order now for self and gifts.

OUR PRICE  
Now Only  
**\$4.95**



**17 JEWEL SELF WINDING**  
ORIGINALLY \$71.95

Post-War Surplus — Now Only  
One of World's finest. Needs no winding. Winds self as you move. Water and shock resistant. Anti-magnetic. Ace value at former \$71.50 price. Now only \$24.95, plus \$2.50 tax. Order now.

**\$24.95**



**17 JEWEL SHOCK PROOF WATERPROOF**

INCABLOCK—Shock Protected  
ORIGINALLY \$59.00  
OUR PRICE NOW ONLY

Handsome accurate. Has sweep second hand. Non-magnetic. Kept accurate time after 72-hour test under water. Amazing value at \$16.95 plus \$1.70 tax. Order now.

**\$16.95**



**FREE!**

Handsome expansion band included free if you send full payment plus tax with your order

ORDER DIRECT FROM THIS AD, FOR SELF AND FOR THRILLING GIFTS. Lowest prices ever, for these guaranteed watches! Order now on famous 1-year written guarantee. Send only \$1 down payment with order. Pay balance to postman on arrival plus postage. Or we pay postage if you enclose full payment plus tax with your order. Airmail Xmas delivery guaranteed!

MARYLAND DISTRIBUTORS, Dept. 120 501 E. Baltimore St., Baltimore 2, Md.



**FREE!**  
**SAMPLE**

That **GLOWS IN THE DARK!**

**AN EASY WAY TO MAKE BIG MONEY**

Be the first to sell sensational luminous house numbers, light switch plates, wall protectors, cord pulls, novelties, etc. Also luminous pictures, statues, decals, and a host of religious, nursery and other objects THAT GLOW IN THE DARK. Sell on sight. Get into this new and growing industry. ENORMOUS DEMAND... NO COMPETITION... BIG PROFITS. Represent a large manufacturer, established over 35 years. Write AT ONCE for liberal MONEY-MAKING offer and free sample to show you how they GLOW IN THE DARK. Madison Mills, 303 Fourth Ave., Dept. C-4, New York 10, N.Y.



**FREE parts catalog**

Build Better Trailers  
with Safety-Engineered

- ★ Torq-less Axles
- ★ Bull Dog Hitches
- ★ Parking Jacks

... Send for your copy TODAY!



**HAMMER BLOW TOOL CO.**

Dept. 135, Wausau, Wisconsin



IT'S easy to build an extra bedroom, workroom or playroom in your attic. You can do it quickly, at low cost with GOLD BOND Gypsum Wallboard. The handy panels are fireproof, moisture resistant, and easy to nail in place. Decorate with GOLD BOND Sunflex, the low-cost wall paint that dries in 1 hour. Get both at your local GOLD BOND Lumber and Building Material Dealer today.

SEND FOR FREE BOOKLET TODAY!

NATIONAL GYPSUM CO.  
Dept. E-8, Buffalo 2, New York



Gentlemen: Send free copy of new Booklet, "Modernizing Magic" showing remodeling ideas and methods:

Name.....

Street.....

City..... State.....

(Please print name and address)

WE FURNISH ALL MACHINED METAL PARTS, EVERY SCREW,  
NUT, BOLT, WASHER, AND COMPLETE PLANS FOR THIS...

## BIG 10" POWER SAW



**\$9.95**  
LESS GUARD  
AND WOOD

POST PAID  
ANYWHERE  
IN U.S.A.

FULL \$9.95  
REFUND IF  
NOT SATISFIED  
WITHIN 10 DAYS

ASSEMBLE IT YOURSELF WITH  
SIMPLE HOUSEHOLD TOOLS!

TABLE 24" x 20" • TILTS TO 45°  
CUTS 0" TO 3/4" DEEP • TAKES 10" BLADE

COMPLETE PLANS (WITHOUT PARTS) 10c

MARCUS • POLLAK DEPT. 44  
ROYERSFORD, PA.

## BRIMMS PLASTI-LINER

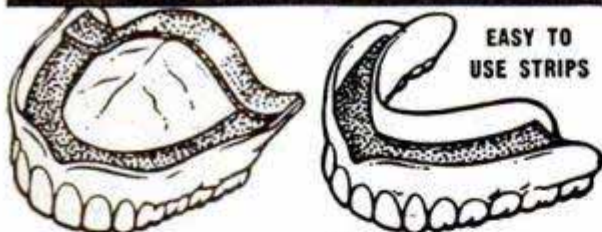

EASY TO  
USE STRIPS

One application  
MAKES FALSE TEETH FIT  
for the life of your plates

If your plates are loose and slip or hurt... if they rock and cause sore gums... you need *Brimms Plasti-Liner*. *Brimms Plasti-Liner* gives instant relief, perfect fit and lasting comfort. Lets you eat anything... talk freely without embarrassment. Ends forever the mess and bother of temporary "stickums" that last a few hours or days.

**EASY TO USE... REFITS FALSE TEETH PERMANENTLY**

Lay soft *Plasti-Liner* strip on upper or lower plate. Bite and it molds perfectly. Tasteless, odorless, harmless to you and your plates. *It hardens to your plate for lasting fit and comfort.* Even on old rubber plates, *Plasti-Liner* gives good results six months to a year or longer. Removable as per directions. *Guaranteed satisfaction or your money back.*

**SEND NO MONEY** Order a \$2.25 package to reline both upper and lower plates. Or a \$1.25 package to reline one plate. Pay your postman when he delivers. Or send money now and save C. O. D. charges. Generous sample of special plate cleaner included free.

PLASTI-LINER COMPANY, 1740 Bailey Avenue  
Buffalo 11, N. Y., Dept. 43-L

## GRIP "Hard-to-reach" NUTS THIS EASY WAY

Here's a real time and temper saving wrench that solves the problem of getting at those "hard-to-reach" nuts on radios, electric appliances, automobile bodies, other sheet metal products.

If you've ever fumbled a nut in the tight spots (and who hasn't?), here's your answer. No more unnecessary disassembly of confining parts in working areas either! This wrench slips on your finger and lets you get right at those nuts and bolts with your finger tip. Strong. Sturdy. Flanges adjust for snug fit on any size finger.

For a set of 4 wrenches that fit the 4 most popular hex nut sizes. — 1/4", 5/16", 11/32", 3/8" across the face.

Ask your hardware dealer. If he can't supply you, order direct. Send 39¢ plus 1¢ for postage—coin, check or money order. No. C.O.D.'s, please.



**TOUCH'N'GRIP**

FINGER TOOLS

F. E. REDFIELD

31 Colonial Pkwy, Dumont, N.J.

## New MILLING ATTACHMENT



SIZES for 8" to 16" METAL LATHES

Build it yourself from our sets of semi-machined castings and save \$8. Can be finished on your lathe alone. Complete drawings and instructions furnished with castings.

Mill keyways, slots, splines, dovetails, flutes for reamers, special cutters. Produce gears, ratchets, racks; bore, face, etc., with this precision attachment.

**FREE** Illustrated folder and price list of castings, milling cutters, etc. Write today. Mention your lathe.

HURON MACHINE AND TOOL CO.  
YALE 4, MICHIGAN

## AGENTS 300% Profit SIGN LETTERS

For Store Fronts and Office Windows. Anyone can put them on. Free Samples. Liberal Offer to General Agents.

METALLIC LETTER CO., 430 N. Clark, Chicago 10

## DRAINS CELLARS, WASH TRAYS CIRCULATES OIL



Pumps 1800 GPH 300 gal.  
30' high, use 1/8 to 1/2 HP **\$6.50**  
motor. Will not clog.

Postpaid if cash with order.  
(Add 50c for west of the Mississippi.)

Thousands in use since 1936

LABAWCO PUMPS, BELLE MEAD 7, N. J.

## LIQUID MARBLE COMPOSITION FLOORS FLEXIBLE MOLDS

Mold, Brush, Trowel, Spray It! Mold Novelties, Statuary, Art Goods in Flexible Plastic Molds; 5c material makes \$1 seller. Make Marbleized floors, Tile Walls. Colorful, glossy, amazing! Easily learned; start in garage or basement. Particulars free. MARBLEIZING SERVICE, Dept. 10-F, Edwardsville, Ill.

SAY YOU SAW IT IN POPULAR MECHANICS

## SAVE UP TO 25% ON QUALITY BALL-BEARING WHEELS!

Bilt-Rite wheels roll smoothly and easily, are semi-pneumatic, ball-bearing, painted red; guaranteed top quality—and you save up to 25%! Compare Bilt-Rite's quality and price—then get your order in today! Dealer inquiries invited.

BILT-RITE BARGAINS on BALL-BEARING WHEELS			
(For 1/2-inch Axles)			
6 x 1.00.....	\$1.30	10 x 1.25.....	\$1.95
8 x 1.25.....	1.65	10 x 1.75.....	2.15
8 x 1.75.....	1.80	10 x 2.00.....	2.45
6 x 1.50.....\$1.50			
(For 5/8-inch axle)			
6 x 2.00.....	\$3.95	8 x 2.50.....	\$4.45
10 x 2.75.....Only \$4.65!			



Bilt-Rite Guarantee

No better wheels are made regardless of price; 10 day return privilege.

If size you need isn't listed, write for Folio A  
ORDER TODAY—Send cash, check, or M.O.—Pay postage on arrival.

**BILT-RITE WHEEL COMPANY**  
520 EAST MISSOURI AVE. KANSAS CITY 6, MISSOURI

# CARTWRIGHT'S

Patented

## TRU-CUT TIN SNIPS

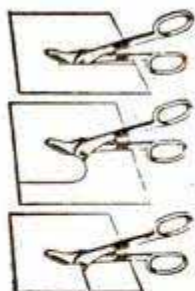

Prompt Delivery



**\$4.95** Postpaid on  
ea. cash orders

### CHECK THESE 10 TRU-CUT FEATURES

1—Cuts perfect circle, right or left. 2—Cuts square points, either right or left. 3—Hands always above metal. 4—Fits the hand, well balanced, light weight. 5—Forward Stop prevents pinched fingers. 6—Guaranteed against mechanical defects. 7—Special "Cup Tension Washer" retains tight fit. 8—Faster, truer, easier cutting. 9—Stays sharp longer. 10—Will cut up to 18 gauge sheet metal.

Send cash, check or money order.  
\$1.00 deposit on C.O.D.'s.  
Satisfaction guaranteed.

IF DEALER CAN'T  
SUPPLY, ORDER  
DIRECT FROM US

**J. CARTWRIGHT & SON**  
MALAGA, Dept. P.M., CALIF.

## WALKIE TALKIES

### A COMPLETE 2 WAY COMMUNICATIONS SYSTEM

Don't let this unbelievable low price fool you! A genuine two way Sound Powered System operating on an Electro-Sonic principle used extensively by the U. S. Armed forces. Amazing clarity and high volume level makes it effective for all types of work. Two complete units included.

Nothing to build — Nothing to buy  
Guaranteed to work — Indoors, Outdoors  
It's a natural for TV Antenna orientation  
C.O.D.'s, send \$1.00 deposit, pay **\$2.95** post  
postman balance plus postage. **\$2.95** paid  
**NORTH EAST SALES CO., Dept. PM-2**  
314 Market St. Newark, N.J.



## BUILD YOUR OWN POWER LAWN MOWER

### WHY PAY MORE FOR FACTORY BUILT MOWERS?

WRITE FOR FREE Building Instructions The Rite-Way Mower Attachment Ball Bearing



SAVE MONEY SAVE TIME

Now anyone can save time and effort mowing field or lawn by building their own whirl type power mower. Build according to your own ideas and needs at small cost. Cut close to fences, walks, buildings, etc. Build in short time with parts and instructions we furnish. Requires no special tools.



IT'S FUN TO BUILD

WRITE TODAY FOR FREE INFORMATION  
T & H MFG. CO., Inc., Dept. MPA-11  
811 E. 31, Kan. City 3, Mo.

SAY YOU SAW IT IN POPULAR MECHANICS

## An Outstanding METAL HAND PUNCH with unusual performance

Needed by every Mechanic in every Shop . . . . .

### No. 5 Jr. HAND PUNCH

CAPACITY—1/4" THRU 16 Ga. Mild Steel. 3/32" — 1/8" — 5/32" — 3/16" — 7/32" — 1/4" — 9/32" — Punches and Dies Furnished.



THROAT DEPTH 2 inches

Weights 2 3/4 lbs.

only **\$8.75**

ORDER YOURS TODAY!

Write for FREE Catalog on other tools.

**WHITNEY METAL TOOL CO., Dept. P-11. Rockford, Ill.**

Postpaid in U.S.A.

# 3 COMPLETE SETS OF WOODWORKING PLANS

plus a full size jar of Rogers famous "Gorilla Grip" glue for only 10c. These plans will tell you how to build bookcases, end tables, sewing chests, etc. They're easy to follow!

Furniture will last a lifetime with Rogers. It has a ton of strength in every drop. Don't miss this great offer. Send your 10c Now to Rogers Insinglass and Glue Company, Gloucester, Mass.

The Glue With the Grip of a Gorilla!

**ROGERS**

the best LIQUID FISH GLUE  
GLOUCESTER, MASS.



# "INVISIBLE ELECTRONIC EAR" HIDES DEAFNESS

Transmits Even Whispers With Startling Clarity!

•Now—a new way to hear *without any button in the ear*—without dangling wires—without clumsy battery packs! A way that has rendered old-style hearing-aids obsolete almost overnight.

Today Beltone's "Invisible Electronic Ear" is enabling thousands to hear *clearly* again—even faintest whispers. Actually enables you to *hide* your deafness while bringing amazing new *intensity* and *clarity* of sound.

Find out about this new electronic "miracle" today. Mail the FREE book coupon now.

**Beltone**  
FOREMOST ONE-UNIT HEARING AID



### SEND FOR VALUABLE FREE BOOK

Beltone Hearing Aid Co., Dept. PMM-11  
1450 W. 19th St., Chicago 8, Illinois

Please send me (in plain wrapper) your new FREE Book on DEAFNESS and the "Invisible Electronic Ear."

Name.....

Address.....

Town..... State.....



Get the  
**BEST**  
out of  
*Your GUN!*

Equip with Marble's Precision Sights... clean with Marble's Nitro-Solvent Oil and Marble's Jointed or one-piece Rifle Rods.



Flexible Rear \$5.50

**MARBLE'S** OUTING EQUIPMENT

Sheard Front \$1.75

Standard Front \$1.25

Jointed Rifle Rod, \$1.50

Nitro-Solvent Oil

Ask your Dealer or write for Catalog.  
**Marble Arms & Mfg. Co.** Gladstone, Mich., U.S.A. (218) 578 Delta Ave.

PISTON TYPE COMPRESSOR



**EASY PROFIT IN PAINT SPRAYING**

Paints walls, ceilings, screens, furniture and machinery faster, better. All complete as shown less motor. Carry anywhere. Fully guaranteed. Could be used with 1/4 H.P. motor or less. Price \$35.00 less motor F.O.B. Chicago. \$5.00 deposit balance C.O.D. or see your dealer. With motor \$55.00.

**IDEAL AUTOMATIC PUMP CO., Dept. P.M. 8**  
801 W. Washington Blvd. Chicago 7, Ill.

SAY YOU SAW IT IN POPULAR MECHANICS

**AMERICA'S MOST-WANTED SMALL TRACTOR!**



SEE THE POWERFUL 5-H.P. GRAVELY—

the world's finest, yet most moderately priced Garden Tractor. Complete line of exclusively designed power tools for every Garden, Lawn and Field job.

ONE TRACTOR DOES 17 JOBS!

**GRAVELY TRACTOR**

FIELD-TESTED FOR 27 YEARS

MAIL NOW! FOR NEW FREE BOOKLET!

GRAVELY MOTOR PLOW & CULTIVATOR CO  
BOX 1163 DUNBAR, W. VA.

NAME \_\_\_\_\_  
ADDRESS \_\_\_\_\_  
TOWN \_\_\_\_\_ STATE \_\_\_\_\_

SOLVING YOUR LAWN & GARDEN PROBLEMS

**300 PIECE ELECTRIC GRINDER OUTFIT**

**THE MASTER KIT**

fits all hand grinders for CUTTING, SHAPING, GRINDING, POLISHING Wood, Metal or Plastic  
**\$50 VALUE**

**\$9.75**  
Post Paid in U.S.A.



- 1 High Speed Steel Rotary File
- 3 Grinding Wheels 1 to 3" in diameter
- 12 Mounted Stones 1/8, 3/32, 1/4" Shanks
- 9 Rotary Cutters 1/8 and 3/32 Shanks
- 30 Miniature Rotary Cutters 3/32 Shank
- 10 Cut off Discs and Grinding Wheels
- 1 Drum Sander 1/4" Shank
- 15 Abrasive Bands for Drum Sander
- 15 Lea. & Felt Polishing Wheels—1/2" to 1" dia.
- 15 Felt Polishing Cylinders with Mandrel
- 25 Abrasive Sanding Discs 1 1/2 to 2" dia.
- 3 Rubber Wheels 7/8" diameter
- 2 Speed Drills 3/32 Shank
- 2 Mandrels 1/8 and 3/32" Shanks
- 3 Bristle Brushes
- 1 Rotary Wire Wheel Brush
- 1 Circular Saw on Mandrel 1/8" Shank
- 2 Rubber Cylinders with 3/32" Mandrels
- 150 other items—all new and valuable



**2 CIRCULAR SAWS**

ON 2 MANDRELS—ALL AT ONE AMAZING LOW PRICE... **\$1.50**  
1" diameter saws on 1/8" Mandrels. For cutting wood, plastic, or soft metals. Order at once! Send Check or Money Order for this big bargain. Post Paid in U.S.A.

**SCHUPACK SUPPLY CO., 7331 Cottage Grove, Dept. M10, Chicago 19, Ill.**  
Write for Free Illustrated Bargain Catalog

**BUILD YOUR POWER TOOLS**

WITH OUR GUARANTEED INDUSTRIAL **POLY BALL BEARING ARBORS**



New Departure Self Lubricating Bearings

10,000 R.P.M.



(No extra charge for left hand threads)

C4—1 1/2" Pictured

- B33—\$5.45 PP. C4—1 1/2 x 12 1/2 spindle, housing 2x8... \$7.95 PP.
- 5/8 x 4 1/2 Spindle C5—5/8 x 12 1/2 spindle, housing 2x8... \$8.45 PP.
- B15 Plain Spindle C6—3/4 x 12 1/2 spindle, housing 2 1/4 x 8... \$9.45 PP.
- \$3.95 PP. D8—1 x 17 1/2 spindle, housing 2 5/8 x 11... \$18.75 PP.

SHAPER ARBORS—Free literature on request.  
EXCLUSIVE EXPORT DISTRIBUTORS: Ovimplex Inc., 149 Broadway, New York 6, U.S.A. Some Exclusive Foreign Agencies Still Open-Contact Ovimplex Inc. Directly

**POLY PRODUCTS, 2032-A E. Walnut, Pasadena 8, Calif.**



**GERSTNER Tool Chests**

are outstanding in every way. Preferred by good Machinists and Toolmakers. Free catalog.

**GERSTNER TOOL CHESTS**

449 Columbia St. Dayton 7, Ohio

**SAVE MORE THAN 1/2 PRICE**

10 ft. PRE-BILT ROW BOAT **\$59.50**  
(Reinforced for Outboard Use) for only



STRONG ONE-PIECE BOTTOM, ALL PARTS PERFECTLY CUT FOR EASY ASSEMBLY WITH SIMPLE TOOLS IN A SINGLE DAY.

Also 12 and 14 ft. deluxe, decked V-Bottom Models

**Write BAY STATE BOAT CO.**

**30 Main St., Cambridge, Mass.**

for name of nearest dealer.



# WE'RE TALKIN' TURKEY ON THESE WAR SURPLUS & OTHER PRICES

## WOOD BUTCHERS & HOBBYISTS



**STEEL TABLE SAWS** 10" high, 1 1/2" thick table 13 1/2" x 27". With 7" combination blade, 6" grinding wheel, double end ball bearing arbor 1/2" shaft & steady rest for grinding. Makes 2 1/2" cut. Will take a 10" blade. All holes drilled, saw is ready to assemble. Stock #556. Your price... **\$9.95**

**TABLE SAW** Steel table top 3/4" thick with solid hardwood veneer center, 19 1/2" x 22" x 10" high. 7" Comb. blade, 6" grinding wheel, double end ball bearing 1/2" shaft arbor & steady rest for grinding are included. All holes drilled, ready to assemble. Will take 10" blade. Stock #555. **\$11.95**

**BUILD YOUR OWN SAW.** Saw table top only with legs, hardware, grooved for 10" blade. 22" x 35" **\$6.95**

**DOUBLE END BALL BEARING ARBOR** 1/2" shaft 11 1/2" long. Bearings alone worth \$10.00. Stock #305. ONLY **\$4.95**

**TILT TOP BENCH SAW** with 7" blade, 18" x 13" table, 2 1/2" cut, ball bearing. Wt. 48 lbs. Stock #574 Your Price **\$31.95**

**DRILL PRESS** 1/2" chuck, ball bearing. Drills to a 12" circle, 4 step pulley. Wt. **\$31.95**

**JOINTER PLANER** 4" Ball bearing 3/8" deep cut x 4" wide. Wt. 45 lbs. **\$31.95**

**BELT SANDER** 4", 11" table, 4" x 34" belt, oilite bearings. Wt. 22 lbs. Stock #577. Your Price **\$14.95**

**JIG SAW** cuts 2", 15" deep throat, 9" x 9" tilting table. Wt. 46 lbs. Stock #578. Your **\$31.95**

**WOOD LATHE** 12" x 31", ball bearing, head stock spindle, removable standards, steady rest, 4 step pulley. Wt. 40 lbs. Stock #579 **\$31.95**

**BAND SAW** 12" circular table 45 degree tilt, 3 1/2" cut, 52 1/2" length blade. Overall 15 1/2" x 22". Wt. 52 lbs. Stock #568 **\$21.95**

**DRILL PRESS VISE** opens to 7 1/4", 4 1/2" wide x 2 1/2" deep, 7" handle, 2 3/8" sq. thread. Wt. 8 lbs. Stock #570 **\$6.95**

**ANVIL BENCH VISE** 3 1/2" jaw, 4 1/2" opening, 1" thread, 1/2" bar. Semi steel, semi swivel. Wt. 15 lbs. Stock #580. Your price... **\$5.95**

**1/2" ELECTRIC DRILL** Mfg. & advertised at nationally known concern, it's the buy of the year and includes all the features you look for. Has motor power Jacobs 33" geared chuck, key gears, and all features of drills priced as high as \$18.00. SEPCOS Universal motor AC-DC, 115 V. HD switch. Ball, roller, oilite bearing. Helical cut gears. Aluminum alloy frame. Stock #565. Your price **\$29.95**

**SAME AS ABOVE WITH DRILL PRESS STAND.** Stock #566 **\$41.95**

**DRILL PRESS STAND ONLY.** Stock #567. Your price... **\$14.00**

**HEAVY DUTY ELECTRIC CABLE**

**3 WIRE #10 super cable.** Stock #351. 65' **\$13.00**  
with lugs. Value \$26.00. Our price...  
**3 wire #10 government submarine type.** Use underground, underwater, overhead. Cost U.S. 90c ft. Stock #542

**YOUR PRICE**  
100 ft. .... \$24.00  
250 ft. .... \$55.00  
500 ft. .... \$100.00  
2 conductor rubber cable #4-stranded-75 ft. length with connectors. Stock #543. List price \$177.00 **\$80.00**

**YOUR PRICE**  
50 ft. .... \$30.00  
100 ft. .... \$55.00  
250 ft. .... \$125.00  
500 ft. .... \$225.00  
1000 ft. .... \$400.00  
225 ft. lengths 3 wire #10 rubber cable, two male connectors. Value \$109.50. Stock #554. **\$35.00**

**WESTINGHOUSE**  
3 phase motors. All models 1/2 HP to 1 1/2 HP. 220 volts. Motors totally enclosed-ball bearing. Stock #541. 40% off list prices.

**ALL BRONZE GEAR PUMP**  
All bronze corrosion resistant gear pump. Lifts water 25'. Delivers 1020 gal. per hr. at 1200 RPM. Develops 110 lbs. pressure or 250' head. Self locking packing nuts, drain cock, reversible head. Will pump brine, salt water, oil, vinegar, gasoline, etc. Dimensions: 10" L x 7" H x 5 1/2" W. Base holes 1 3/8" x 3/8". Shaft 1 1/8". 1" x 1" inlet & outlet. Wt. 24 lbs. Mfg. by Sherwood Brass Works. All pumps belt driven. All bronze gear pump with 8" V pulley. PUMP ONLY. **\$24.00**

Same pump as above with motors (electric). Stock #549.  
1/2 HP .... \$67.00  
1 HP .... \$81.00  
3/4 HP .... \$74.00

Same pump with Briggs & Stratton gas engine. Stock #550.  
2 1/2 HP ... \$83.00  
3 1/2 HP ... \$103.00  
6 HP .... \$123.00

**CENTRIFUGAL PUMP** with 2" intake, 1 1/2" discharge with 6" variable speed **\$35.00**

## PAYSWELL SPRAY-PAK

Complete spray kit. Gun has built in compressor & motor weighs less than 5 lbs. Use with any sprayable liquid. Kit includes 23 items plus carrying case and instruction manual. Farmers spray animals, auto repairmen spray autos, use for stenciling, etc. Develops 50 lbs. pressure, 2.2 cu. ft. of air per min. disp. Self lubricated bearings. GUARANTEED Complete kit. **\$49.00**

**AIR COMPRESSORS**  
All ratings from 1/2 HP to 10 HP—new and rebuilt. Write for free details.

**Stainless Steel FLAT TOPS**  
Stainless steel one side, 1/2" veneer center, overall 3/4" thick. Ideal for sheives, back bar work board, work table, etc. Stock #411  
22 x 19 1/2 ..... \$1.95  
22 x 21 1/2 ..... \$1.95  
22 x 34 ..... \$3.45

**CLUTCH**  
For Motor-scooters, Motorbikes, Lawn Mowers, etc. Mercury centrifugal clutch for use with any small gas engine. 1/2" belt pulley, 5/8" & 3/4" bore. Stock #400 **\$9.95**  
Brand new only... **\$8.00**

**HEAVY DUTY FARM WAGON**  
5 to 7 ton capc.  
Heavy duty wheel 5-7 ton trailer, 27" high. Rack size is adjustable 12 to 20 ft. Built of heavy 6" I beam channel iron and a 3" dia. seamless tube. Double bronze king pins, heavy-duty hitch, double high speed Timken bearings. Width of track is 6'. This trailer will not whip & has been tested at speeds up to 50 MPH. Use it for chopper wagon, boat trailer, machine mover, logging, construction work. Trailer comes with 4 wheels and spare tire. All tires are airplane type and are GUARANTEED. Value is approx. \$500. Stock #558. Your price is only... **\$149.50**

**HALF TON WAGON**  
Half ton wagon with plate aluminum body 24" x 42", 3/8" steel axle. Stock #332. Write for details.

**4 Wheel ARMY BOMB TRAILER**  
Costs less than price of tires. Can be used for compressors, const. work, light plants, foundries, machinery, etc. Wt. 375. Goodrich & Firestone 6x9 tires, 21" high. Trailer is 6' 5" long, axle size 1 3/4". One ball bearing race, 3" center channel, 38" wide. Pay load 1 ton, will take 2 ton, 36" tongue, Zerk fittings. Tires list at \$28.00 each. Stock #559. Our price for complete trailer is... **\$90.00**

**NEW ELECTRIC MOTORS**  
LESS THAN 1/2 PRICE  
Single phase, heavy duty capacitor type, 60 cycle, Standard Nema frames, splashproof. ALL NEW in original cartons. ALL GUARANTEED.

**Special! HEAT BOOSTER**  
Fits any 8", 9", or 10" furnace pipe. 1500 RPM motor with 6' cord, mounting frame, 7" blade. Motor can be oiled from outside. Easy to install. Silent operation. Warm those rooms with long runs. Stock #583 Regular \$9.95. Your price **\$4.95**

**Special! HEAT BOOSTER**  
Fits any 8", 9", or 10" furnace pipe. 1500 RPM motor with 6' cord, mounting frame, 7" blade. Motor can be oiled from outside. Easy to install. Silent operation. Warm those rooms with long runs. Stock #583 Regular \$9.95. Your price **\$4.95**

**Special! HEAT BOOSTER**  
Fits any 8", 9", or 10" furnace pipe. 1500 RPM motor with 6' cord, mounting frame, 7" blade. Motor can be oiled from outside. Easy to install. Silent operation. Warm those rooms with long runs. Stock #583 Regular \$9.95. Your price **\$4.95**

**Special! HEAT BOOSTER**  
Fits any 8", 9", or 10" furnace pipe. 1500 RPM motor with 6' cord, mounting frame, 7" blade. Motor can be oiled from outside. Easy to install. Silent operation. Warm those rooms with long runs. Stock #583 Regular \$9.95. Your price **\$4.95**

**Special! HEAT BOOSTER**  
Fits any 8", 9", or 10" furnace pipe. 1500 RPM motor with 6' cord, mounting frame, 7" blade. Motor can be oiled from outside. Easy to install. Silent operation. Warm those rooms with long runs. Stock #583 Regular \$9.95. Your price **\$4.95**

**Special! HEAT BOOSTER**  
Fits any 8", 9", or 10" furnace pipe. 1500 RPM motor with 6' cord, mounting frame, 7" blade. Motor can be oiled from outside. Easy to install. Silent operation. Warm those rooms with long runs. Stock #583 Regular \$9.95. Your price **\$4.95**

**Special! HEAT BOOSTER**  
Fits any 8", 9", or 10" furnace pipe. 1500 RPM motor with 6' cord, mounting frame, 7" blade. Motor can be oiled from outside. Easy to install. Silent operation. Warm those rooms with long runs. Stock #583 Regular \$9.95. Your price **\$4.95**

**Special! HEAT BOOSTER**  
Fits any 8", 9", or 10" furnace pipe. 1500 RPM motor with 6' cord, mounting frame, 7" blade. Motor can be oiled from outside. Easy to install. Silent operation. Warm those rooms with long runs. Stock #583 Regular \$9.95. Your price **\$4.95**

**Special! HEAT BOOSTER**  
Fits any 8", 9", or 10" furnace pipe. 1500 RPM motor with 6' cord, mounting frame, 7" blade. Motor can be oiled from outside. Easy to install. Silent operation. Warm those rooms with long runs. Stock #583 Regular \$9.95. Your price **\$4.95**

**Special! HEAT BOOSTER**  
Fits any 8", 9", or 10" furnace pipe. 1500 RPM motor with 6' cord, mounting frame, 7" blade. Motor can be oiled from outside. Easy to install. Silent operation. Warm those rooms with long runs. Stock #583 Regular \$9.95. Your price **\$4.95**

**Special! HEAT BOOSTER**  
Fits any 8", 9", or 10" furnace pipe. 1500 RPM motor with 6' cord, mounting frame, 7" blade. Motor can be oiled from outside. Easy to install. Silent operation. Warm those rooms with long runs. Stock #583 Regular \$9.95. Your price **\$4.95**

**Special! HEAT BOOSTER**  
Fits any 8", 9", or 10" furnace pipe. 1500 RPM motor with 6' cord, mounting frame, 7" blade. Motor can be oiled from outside. Easy to install. Silent operation. Warm those rooms with long runs. Stock #583 Regular \$9.95. Your price **\$4.95**

**Special! HEAT BOOSTER**  
Fits any 8", 9", or 10" furnace pipe. 1500 RPM motor with 6' cord, mounting frame, 7" blade. Motor can be oiled from outside. Easy to install. Silent operation. Warm those rooms with long runs. Stock #583 Regular \$9.95. Your price **\$4.95**

**Special! HEAT BOOSTER**  
Fits any 8", 9", or 10" furnace pipe. 1500 RPM motor with 6' cord, mounting frame, 7" blade. Motor can be oiled from outside. Easy to install. Silent operation. Warm those rooms with long runs. Stock #583 Regular \$9.95. Your price **\$4.95**

**Special! HEAT BOOSTER**  
Fits any 8", 9", or 10" furnace pipe. 1500 RPM motor with 6' cord, mounting frame, 7" blade. Motor can be oiled from outside. Easy to install. Silent operation. Warm those rooms with long runs. Stock #583 Regular \$9.95. Your price **\$4.95**

**Special! HEAT BOOSTER**  
Fits any 8", 9", or 10" furnace pipe. 1500 RPM motor with 6' cord, mounting frame, 7" blade. Motor can be oiled from outside. Easy to install. Silent operation. Warm those rooms with long runs. Stock #583 Regular \$9.95. Your price **\$4.95**

**Special! HEAT BOOSTER**  
Fits any 8", 9", or 10" furnace pipe. 1500 RPM motor with 6' cord, mounting frame, 7" blade. Motor can be oiled from outside. Easy to install. Silent operation. Warm those rooms with long runs. Stock #583 Regular \$9.95. Your price **\$4.95**

**Special! HEAT BOOSTER**  
Fits any 8", 9", or 10" furnace pipe. 1500 RPM motor with 6' cord, mounting frame, 7" blade. Motor can be oiled from outside. Easy to install. Silent operation. Warm those rooms with long runs. Stock #583 Regular \$9.95. Your price **\$4.95**

**Special! HEAT BOOSTER**  
Fits any 8", 9", or 10" furnace pipe. 1500 RPM motor with 6' cord, mounting frame, 7" blade. Motor can be oiled from outside. Easy to install. Silent operation. Warm those rooms with long runs. Stock #583 Regular \$9.95. Your price **\$4.95**

## A TERRIFIC BUY!

### GAS ENGINES

Briggs & Stratton Model	HP	Shaft	Original List	Your Price
AP	1 1/2 to 2 1/2	Tapered	\$102	\$49.00
AP	1 3/4 to 2 1/2	3/4"	\$102	\$49.00
BP	2 1/2 to 3 1/2	1"	\$115	\$66.00
ZZP	5 to 7	1"	\$141	\$69.50

Buy TODAY—These BARGAINS just can't last.

### AC ARMY LIGHT PLANTS

300 WATT, 110-220 volt AC, 60 cycle light plant powered by 1 HP gas engine, direct drive. Mounted base weight 40#. Stock #409 **\$89.50**

500 WATT, 110 volt AC, 60 cycle. Onan direct connected. Stock #414 **\$139.50**

750 WATT, AC 110 volt, 60 cycle, direct drive, air-cooled, Briggs & Stratton model AP, Eacor generator, radio filter, self excitor, volt meter & regulator, rope start, 110 lbs. 20" long, 17" wide, 18 1/2" deep. Stock #573. Your price **\$149.50**

New 1000 WATT, 110 volt, 60 cycle AC plant with Briggs & Stratton directly coupled to a Leland generator. Stock #351 **\$189.50**

New 1500 WATT, 110 & 220 volt, 60 cycle, AC plant with Briggs & Stratton directly coupled to a Master generator. Stock #352 **\$209.50**

2500 WATT, 110 volt AC, 60 cycle with Briggs & Stratton Model Z and Land generator. Stock #317 **\$265.50**

Used but like new... **\$295.00** Add \$10.00 for tools and spare parts.

5000 WATT, 110 volt AC, 60 cycle with automatic remote control. Powered by 4 cyl. Jeep gas engine. Used but like new. Stock #318 **\$545.00**

7500 WATT, 110 volt AC, 60 cycle powered by a VE 4 Waukesha 4 cyl. gas engine. Continental or Hollinsworth generator. Remote control starting. Complete with switchboard. Stock #347 **\$625.00**

Add \$65.00 for transformer to make this plant 3 phase 220 volt.

10,000 WATT, 110-220 volt AC, 60 cycle. Remote control. Powered by a Jeep 4 cyl. gas engine. Used but like new. **\$800.00**

Stock #319. New job original crate only **\$1100.00**

25,000 WATT, 220 volt AC, 3 phase. Spare parts. New packed for export. Stock #415 **\$2150.00**

### Special! AC ARMY GENERATORS

300 WATT, 12 volt DC, 2000 RPM. Heavy duty with current cut out relay. High and low switch. 30 amp. meter. Can be bought less shaft and base to be used directly mounted to a Briggs & Stratton 1 HP engine. Tapered shaft engine required. Stock #323. NEW only **\$7.00**

Complete with shaft, base and bearing. Stock #324 **\$15.95**

300 WATT, 110-220 volt AC, generator. Mfg. by Electric Specialties Co. Weighs 20 lbs. Stock #416. **\$29.50**

750 WATT, 110 volt, 60 cycle, Eacor, ball bearing, with volt meter & rheostat, radio filter, self excitor. Generator fastens for direct drive to model AP & BP Briggs & Stratton tapered shaft. Price \$69.50. With AP engine assemble yourself, add **\$56.00**

1500 WATT, 110-220 volt, 60 cycle, 1800 RPM, Master ball bearing to fasten on ZZP Briggs & Stratton engine, **\$109.50**

2500 TO 3000 WATT, Leland generator 110 volt, 60 cycle. Self excitor, radio filter, junction box for plug in. **\$145.00**

Stock #525. New **\$145.00**

3000 WATT, Delco, 110 volt DC. Plug in, ball bearing 2800 RPM. List price \$343.00. Used but like new. **\$99.50**

Stock #321 **\$99.50**

50 KW or 62 1/2 KVD Cummins diesel generator. 240 volt, 3 phase, 60 cycle, AC. 1200 RPM, 150 amps. Rating 50%, continuous excitor; 110 volts Cummins diesel engine, water cooled exhaust, complete with operating panel starting. All automatic controls plus 3 point suspension. Rubber mount. Full set of diesel major operating parts. Was used as standby. 200 approx. running hrs. Appx. 6400 lbs. GUARANTEED. Like new. Price \$7400.00. Stock #572. **\$4400.00**

Save \$3000.00. Your price **\$4400.00**

**HERE'S  
YOUR  
YEAR  
'ROUND  
WORK  
SAVER!**

**Bready**

**GARDEN TRACTOR**  
SEE THE NEW **ECONOMY-  
PRICED MODELS!**

Use BREADY with these all-purpose implements:

- Complete line gardening implements
- Lawn Mower
- Cutter-Bar
- Snow Plow
- 2 Wheel Cart
- Air Compressor with attachments



NOW! Famous BREADY quality and dependability at a new low cost! See BREADY at your dealer's. WRITE TODAY for free folder.

**THE BREADY TRACTOR & IMPLEMENT CO.**  
BOX 230 • SOLON, OHIO

*"I'll take the WHITE one every time!"*



WYTEFACE Steel Tapes, with their jet black markings on a white background, are easier to read in any light. They are rust-resisting, hard to kink and easy to clean.

Protected by U. S. Patent 2,089,209

**WYTEFACE**  
TRADE MARK

**STEEL TAPES**  
**KEUFFEL & ESSER CO.**

**ELECTRIC SIREN**



6 volt. Complete with push button... **\$10.95**

**Fender Skirts for All Cars**



Give year, make & model of car when ordering. All Metal. Prime finish. Rubber beading prevents rattle. Easy to install. **\$12.95 PAIR..**

1935-48 FORD V8 & 1939-48 MERCURY

**DUAL MUFFLERS**

Increases power. Reduces back pressure. Saves gas. MD20N-208—Complete Set..... **\$14.95**

**DUALS FOR 1949 FORDS, Set ..... \$19.95**

**GUTTED MUFFLERS**

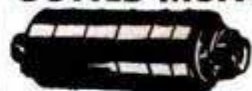

**FOR ALL CARS**

Gives that Motorboat Tone. Universal type to fit all cars, ea.... **\$4.95**

We Can Supply **NEW CONVERTIBLE TOPS & REBUILT MOTORS** for all Cars. Write for Prices.

Send 25% Cash With All Orders, Balance C.O.D.

**JUST OUT!** Get the largest Auto Accessory & Parts Catalog in the world. Over fifteen thousand items, including Hollywood Accessories, Hi-Speed Equipment, Rebuilt Engines, all parts & accessories for all cars & trucks. We have that Hard-to-Get-Part! Completely illustrated, Jam packed with bargains. Send 25c.

**J. C. WHITNEY & CO.**

1917 ARCHER AVE.

CHICAGO 16, ILL.

**BURIED TREASURE. MINERALS**  
**AMAZING NEW GOLDAK LOCATORS**

**SENSATIONAL NEW MODEL!**

ONLY 11 pounds weight! One hand operation! Money-Back Guarantee of Superiority. Write for full details.

**THE GOLDAK CO.**

1542 WEST GLENOAKS BLVD.  
GLENDALE 1, CALIFORNIA

World's largest maker of fine locators.



**Hobbyist Catalog**



64 pages

**WE PAY POSTAGE!**

SHIP MODELS... TRAINS... PLANES  
Cars... Art Supplies... Tools...  
Projects... Games.  
U.S.A. and Canada Orders Only.

10¢

write **Brown-Craft**

1232 ETOWAH, DEPT. PM-4, Royal Oak, Mich.

**ACCURATE 18 INCH WOOD LEVEL**



Also 12 inch Model—50¢ postpaid

NEVER OFFERED BEFORE AT THIS LOW PRICE! Full size. Carefully machined. Walnut stain or natural blond finish. Two securely set vials—1 level and 1 plumb, brass protecting plate and hand grip. Sent postpaid anywhere in U. S. on receipt of cash or money order.

FOR ONLY

**\$1.00**  
Post Paid

Mfg. **JOHNSON PRODUCTS CO.**  
by 1670 N. Jackson, Milwaukee 2, Wis.

**BURR HAND SAW FILER**

Makes More PROFITS

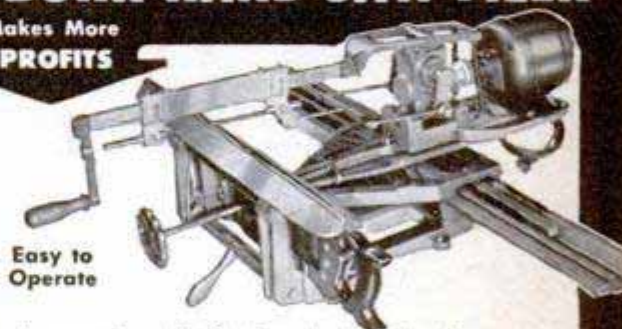

Easy to Operate

Fast, accurate, will file from both sides. Operator controls file arm. No saw carrier or adjusting screws to fuss with. A money-maker in any shop.

**BURR MFG. CO.**

8933 VENICE BOULEVARD  
LOS ANGELES 34, CALIF.

WRITE TODAY!

**CAR OWNERS — Protect Emergency Brakes with — EKLIND EMERGENCY BRAKE SIGNAL-LITE**



AN IDEAL XMAS GIFT FOR EVERY CAR OWNER

INSTALLS ON INSTRUMENT BOARD

- \* Save damaging wear from dragging emergency brake!
- \* Red light warns driver brake is on, when ignition is on.
- \* Red cap removes for handy map reading lite!
- \* Can be installed in a few minutes time!



\$2.00 Postpaid

Fits All Cars Including '49-'50 Models. Complete instructions with each lite. If Dealer cannot supply you send \$2 Direct (No C. O. D.'s). Dealers and Jobbers write for details.

**EKLIND TOOL & MFG. CO.**  
2627 North Western Ave. • Chicago 47, Ill.

**CHAMPION V-GLOW PLUGS**

for model engines only

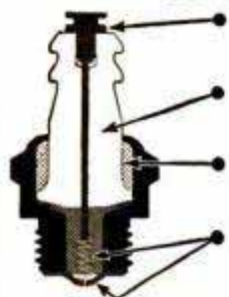

**CHAMPION TERMINAL**—assures better center electrode seal and provides sturdier electrical connection.

**CHAMPION-CERAMIC INSULATORS**—proved dependable in millions of Champion Spark Plugs.

**CHAMPION SILLMENT SEAL**—prevents excessive compression leakage between insulator and shell.

**CHAMPION "THERM-O-FLEX" CONSTRUCTION**—longer element life, more dependable performance.

Follow recommendations of plug types and fuels approved by engine manufacturer.

**CHAMPION SPARK PLUG COMPANY, TOLEDO 1, O.**

**Make Garden Masonry for Spare-Time Profits**

Millions of homes can use these Ornamental products — urns, vases, flower boxes, bird baths, lawn seats, flagstones, etc. Easily made of sand and cement. Permanently glazed in a range of smart colors. Distinctive — attractive — quick selling.

**Eye-Appeal Makes for Cash-and-Carry Sales**

Selling prices allow 200% to 300% mark-up on basic costs. Only a small investment needed for supply of molds. Easily set up in shed or garage. Write immediately for catalogue OM and price list.

**COLORCRETE INDUSTRIES, INC.**  
710 Ottawa Ave., Holland, Mich.



**HOW TO GIVE QUICK REST TO TIRED EYES**

1. Put two drops of soothing Murine in each eye. In seconds, your tired eyes feel fresh, rested, wide-awake.



2. Murine's 7 ingredients cleanse your eyes quickly, yet as gently as a tear. Murine helps your eyes feel fine.

**MURINE**  
FOR YOUR EYES



**AMAZING RESULTS**  
WITH THIS LOW PRICED, OILLESS

*Paint Sprayer*



only \$26.95

LESS MOTOR \$29.65 WEST COAST

An Ideal Xmas Gift

Get professional results, outside and inside, 3 to 10 times faster than brush method. New, full sized, streamlined Sprayit "Series 270" applies paint, varnish, enamel, lacquer, etc. Also pumps tires. Uses standard 1/4 H. P. motor. Delivers oil-free air in ample capacity from long-life diaphragm compressor.

Self-lubricating. No pistons or rings! No oil pumping! Easy to carry and use. Factory guaranteed. Complete with 15-foot hose, 1-quart container, *internal mix* spray gun with round, fan, and angle nozzles. A big value by the pioneers in portable paint spraying equipment. See Sprayit "Series 270" at paint, hardware or auto supply stores. *Accept no substitute!*

Write Dept. 1102 for FREE Book on Spray Painting



**ELECTRIC SPRAYIT CO.**  
SHEBOYGAN, WIS.



### Gear-Train Motor

Ball bearing, low inertia reversible type. Can be used to operate small displays, models, etc. Operates from 12 volt AC with use of condenser. Normally operates 110 volt 400 cycle. Motor 588 RPM; Low speed gear 14 RPM. Extra large gear for 7/8 RPM \$1.00 extra. Order #PM-4119 complete motor, gear-train, condenser, & instructions—Postpaid..... **\$2.00**

**TRANSFORMER** for above—110 volt input; output 12 volt. #PM-5119—Postpaid..... **\$2.00**

### 6 VOLT AC or DC MOTOR

Ideal for auto heaters, defrosters, fans, models, etc. Used by Gov't. in aircraft. Shaft size: 3/4"x7/8"  
Order #PM-6119—Postpaid.... **\$2.00**



### CAR SHAVER MOTOR

Use your electric shaver in your car! Dynamotor will supply 110 volt 10 watt current from 6 volt DC—will operate most types of AC-DC shavers. Used by Gov't. to supply voltage for radio equipment. #PM-2119—Postpaid **\$3.00**

**20 Watt MOTOR GENERATOR** — Permanent magnet field. Will supply 24 volts 1.8 amps and 480 volts .04 amps DC at approx. 3500 RPM. Shaft size: 3/8"x1". Motor size: 3"x4"x7 1/2". Can also be used as a motor on 12-24 VDC input. Order #PM-7119—Postpaid.... **\$3.00**

**P1 GENERATOR** —Aircraft type, supplies 24 volt DC 200 amps. Ideal for building your own welder. Shipping wt. approx. 65 lbs. Order #PM-8119—  
Brand NEW **\$30.00** USED **\$22.50** F.O.B., Lima



**HEATER UNIT** —Gasoline or oil forced air heater used to pre-heat tank engines. Easily adapted to other uses. Operates from 24 VDC source. Has electric igniter, thermostat control, forced air blower, auto-pulse electric fuel pump. Removed from unused Gov't. vehicles. Cost Gov't. many times this low price. Shipping wt. approx. 65 lbs.  
#PM-9119 **\$19.95** F.O.B., Lima

SEND FULL REMITTANCE ON S2 AND S3 ITEMS  
OTHER ITEMS 25% DEPOSIT AND BALANCE C.O.D.

### FAIR RADIO SALES

132 SOUTH MAIN ST. LIMA, OHIO



**5** big-capacity power tools in  
**1** rugged, precision-built unit

Write for free, 20-page, profusely illustrated book. SHOPSMITH, Dept. 109-B, 12819 Colt Rd., Cleveland 8, O.

# STOP CHANGING MOTOR OIL!



End this needless waste and expense forever with

## RECLAIMO Today's Most Advanced Oil RE-REFINING Filter

Continuously cleans and RE-REFINES motor oil as you drive (by utilizing motor heat)—keeps oil in high grade lubricating quality at all times! Proves conclusively that "Oil Does Not Wear Out Mechanically" as stated by U. S. Bureau of Standards. (Bulletin 86).

### "RECLAIMO"

- REMOVES SOLIDS (by filtration)
- REMOVES WATER (by distillation)
- PREVENTS Excess Fuel Dilution
- PREVENTS Acid and Sludge Formation

MAINTAINS Stable Viscosity ELIMINATES All Oil Changes  
CAR • TRUCK • TRACTOR OWNERS!

FREE 32-PAGE BOOK "OIL FACTS" (with bonafide \$1000.00 offer on page 30), gives you the complete "Reclamo" story and details of our extraordinary 90-DAY NO-RISK TRIAL OFFER! Write for your copy TODAY!

**NEW ADDED FEATURE!**  
Gas - Moisture Vapor Injector  
Increases Mileage with Smoother Performance



### RECLAIMO MFG. CO.

5083 ELSTON AVE., Dept. 14, CHICAGO 30, ILL.

ORDER NOW — SAVE 20%

## U-MAK-IT BOAT KITS EASY TO BUILD

- 5 ROWBOATS 8 TO 14 FT.
- 6 OUTBOARDS 12 TO 16 FT.
- 3 INBOARDS 16 TO 23 FT. & CABIN CRUISER



SEND 25c (coin) ORDER YOUR CATALOGS TODAY  
**U-MAK-IT PRODUCTS** 703P-WHITTIER ST. New York 59, N. Y.

## ELECTRIC SHEAR SHARPENER

Over 65,000 Sold—It Must Be Good!



Genuine Carborundum wheel ideal for shop or home use. Send remittance with order and shipment will be made at once, prepaid to your door, complete with electrical goods catalogue.

Motor driven  
**\$9.75**  
complete with vise

**WILLIAM MARVY COMPANY**  
477 St. Peter Street St. Paul 2, Minn.



Ask Your Hardware Store for  
**FULLER'S**  
Unbreakable Amber Handle  
**SCREW DRIVERS**

America's most popular line of moderately-priced screw drivers! Wide range of sizes.  
**FULLER TOOL COMPANY, Inc.**  
911 Faile St. New York 59  
World's largest makers of Amber-Handle Tools

## BARGAIN!

### HIGH SPEED ROTARY FILES

Set of 5 Assorted.....	\$ 2.00
" " 10 " .....	3.75
" " 20 " .....	7.25
" " 30 " .....	10.00

1/4" shank



WE BUY SURPLUS TOOLS

**SID TOOL CO., 183 Grand St., N. Y., N. Y.**

## GEIGER COUNTERS TREASURE DETECTORS

Sensational new low cost detectors. Light weight, portable, highly sensitive. Low operating cost. None finer REGARDLESS OF COST.



Write TODAY for FREE literature.

**The DETECTRON Company**  
5637 Cahuenga Rd., North Hollywood, Calif.

## Save! MANUFACTURER'S SURPLUS



OVER \$3.00 WORTH OF USEFUL SCREWS, BOLTS, WASH-ERS, RIVETS, NUTS, ETC. **\$1.00** only

POST PAID ANYWHERE IN U.S.A.

10 lbs.....\$3.25 25 lbs.....\$7.50

Send Cash, Check or Money Order.

A really practical assortment for every workshop, hobbyist, or maintenance service men. Satisfaction fully guaranteed. Order today from

**ILLINOIS SCREW & NUT COMPANY, Dept. A**  
3435 Fullerton Chicago 47, Illinois

## THE Eager Beaver

A man-size ball-bearing bench saw **\$10.95**



for only.....

### IMMEDIATE DELIVERY

LOOK AT THESE FEATURES:

1. All metal construction
2. Smooth-rolling ball bearings
3. Light and portable
4. Adjustable rip fence
5. Indexed mitre gauge
6. 1 1/2" arbor pulley
7. Full two inch cut
8. Designed for safety
9. Table size 12 1/2"x13 1/2"
10. 6 in. combination blade

If your dealer cannot supply you send check or money order with dealers name. We'll ship prepaid. Price does not include motor. No C.O.D.'s please. Send for Free Folder.

**SIERRA TOOL CO., INC., 1618-B NORTH VERMONT AVE. LOS ANGELES 27, CALIFORNIA**

# WORLD'S LOWEST PRICED ADDING MACHINE

VEST POCKET SIZE  
**IDEAL XMAS GIFT!**

FREE TRIAL  
**ONLY \$2.95**  
TOTAL COST  
SEND NO MONEY

**FREE!!**  
Each Baby Calculator in Beautiful, rich-looking Leatherette case—at no extra cost.



Fits vest pocket or purse. Guaranteed accurate. Operated as easily, and as reliable, as machines costing many times as much. Not a toy. Precision made, very durable—guaranteed for life against defects in construction. You positively can't buy a calculator of equal quality for as little money. **ACCEPTED AS THE FINEST LOW PRICED CALCULATOR FOR OVER 35 YEARS!** Operates with a flick of your finger. Adds, subtracts, multiplies, divides—counts up to one billion. Pays for itself over and over in mistakes avoided, and time saved.

**MAKES IDEAL GIFT**  
Sold on a positive money back guarantee. Send only \$2.95. Calculator sent postpaid, or send name and address and pay postman \$2.95 plus postage. **MONEY BACK IN 10 DAYS IF NOT DELIGHTED!** (If outside U. S., send \$3.50.)

**AGENTS WANTED**  
**CALCULATOR MACHINE CO., (Mfrs.)**  
Dept. 220, P. O. Box 248, Glenview, Illinois

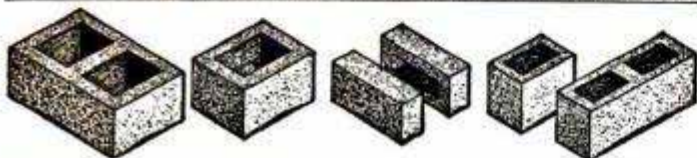

## Make Concrete Blocks and Bricks

New superior method makes square, true, easy-to-lay units which will pass any building code. Small investment, high production, big profits. One \$30.00 machine will make four 5"x8"x12" blocks per minute—1000 per day. Pays for itself in a few days. Sell blocks or save 2/3 building cost by making and laying your own.

POST CARD BRINGS FREE FOLDER

**Economy Manufacturing Company**  
Dept. P Stone Mountain, Georgia

## "IDEAL" PRECISION RANGE FINDER

Get professional, sharp, clear pictures from your movie or still camera with the beautiful precision built "IDEAL Range-Finder." Easy to use—guarantees perfect focusing. Works the same as \$15.00 models. Highest quality system.

Three year guarantee with each instrument. At your dealer or send \$3.00 (post paid) to:

**FEDERAL INSTRUMENT CORP.**  
14-02 Broadway, Dept. 23, L.I.C. 6, N. Y.



**ONLY \$2.95**  
Incl. Tax

## STEEL LEGS FOR WORKBENCH



Heavy Electric Welded Construction **\$4.50**

Drilled, ready for 3-2x10" planks and 16" shelf. Flanged Feet may be bolted to Floor!

**PICNIC TABLE LEGS**  
Heavy Steel, Electric-Welded Non-Tip Construction. **\$7.95**  
Drilled for top and bench

**East Moline Metal Products COMPANY**  
Box 35 East Moline, Ill.

Send Check or Money Order  
Freight, COD

# Handy Power Drill Big Help in Homes!



Drills Metal,  
Wood,  
Plastics



Fits in  
Vertical  
Stand



Drives  
Sanding Discs



Drives 3"  
Grinding Wheel

**HOME-UTILITY**  
**1/4" Electric**  
**DRILL**  
**\$18.95**

## Saves Hours on Many Jobs!

This versatile Home-Utility 1/4" Drill gives you hundreds of ways to speed up building and repairing things around your house! You'll be amazed at its many uses—installing household hardware and fixtures; polishing silver ware; waxing furniture; sharpening cutlery; sanding down furniture; knocking off old paint and rust; and many other jobs!

Made by the world's biggest builder of portable electric tools, **BLACK & DECKER!** Its well-built universal motor operates on AC or DC, with a handy trigger switch. Compact, well-balanced, lightweight, shaped to fit the hand.

See it, try it, at your hardware, electrical or implement dealer. Write today for your free copy of our brand-new "How-To-Do-It" booklet. Gives many helpful hints on saving time and money in home-and-farm building and repair jobs! Write to: **THE BLACK & DECKER MFG. Co., Dept. H11M, Towson 4, Md.**

Products of The **BLACK & DECKER Mfg., Co.**

## ELECTRIC HOME-UTILITY TOOLS



6" Saws



1/2" Drills



Sander-Polishers



1/4" Drill Kits

SAY YOU SAW IT IN POPULAR MECHANICS

## Genuine HANDI-SCOPE



**IDEAL FOR** The Sensational All-Purpose Microscope  
Machinists With Sharp **PUSH-BUTTON** Focusing

**Hobbyists**  
**Photographers**  
**Engineers**  
**Students**  
**Naturalists**

Use the amazing HANDI-SCOPE in your work at home, office, shop or school. Easy push-button focusing gives fine-detail examination of screw threads, finishes, insects, plants, minerals, etc. Fits easily into pocket, requires no special illumination.

Not just a magnifying tube, but a real fine-focusing microscope with precision 20-power compound optical system. Price, postpaid—\$4.95, check or M. O. Money-back guarantee.



DESK C-118, 1009 BEECH AVE., PITTSBURGH 12, PA.



"SAVE IT AND  
FIX IT"

# MENDS

DISHES, FURNITURE, LUGGAGE

It's transparent, water-proof, flexible and durable. Get a tube today.



# DUOCO CEMENT

REG. U. S. PAT. OFF.

## PARTS FOR MILITARY TRUCKS

4 or 6 Wheel Drive at a SAVINGS—  
1/4 ton to 20 ton.

Parts List Available on Most Military  
Trucks and Jeep Models



### JEEP TOPS and CURTAINS

(Weatherizing Kit), complete top with back curtain and side curtains with zip-in-doors. 5 windows. Waterproof O. D. color, shipping weight 40 lbs. **\$49.50**  
Wonderful value. F.O.B. K.C.

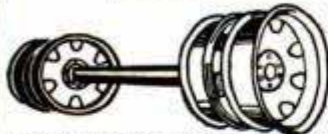

### TRAILER AXLE

Heavy duty trailer axle suitable for many types of trailer construction. Also excellent for building of heavy farm trailers and wagons. It is a 12,000 lb. capacity square type straight trailer axle complete with Timken roller bearings, hubs, and 6 hole 750 x 20 Budd Wheels. Without brakes. Axle is 2 inches square and 69 inches between wheel mounting flanges. Std. width. AN EXCELLENT BUY.

With Single Wheels. \$59.50 With Dual Wheels. \$69.50

### Save \$30.00 On JEEP Spare Parts KIT

Originally packed for Amphibious Jeeps. Also adaptable for all military and some civilian jeeps. Contain-  
ing 29 major items. Offered at our low price of. **\$8.95**

**WINCH CABLE, 1/2", 250 ft. \$30.00**

Hundreds of Other Truck & Jeep Parts and Supplies  
All prices quoted good 30 days FOB, Kansas City, 25%  
Deposit Required on All Orders.

**American AUTO PARTS CO.**  
1830 LOCUST — DEPT. PM  
KANSAS CITY, MISSOURI.



## Every Electric Drill A PORTABLE SAW

JUST TRY IT! YOU WON'T USE  
A HAND SAW ANYMORE

No. 444 "ARCO-SAW" with  
"Hycarbon" Blade fits any  
1/4" electric drill.

PAT.  
PEND.

**\$9.95**

ORDER YOURS TODAY

AT YOUR DEALER  
or send Money Order or  
Check for \$9.95 (complete  
with 4" "Hycarbon" blade.)

All parts Guaranteed.  
Precision Gear Box,  
Lightweight Alumi-  
num Casting. Exclu-  
sive safety yoke makes one  
unit out of drill and "AR-  
CO-SAW".  
Depth of Cut: 1 1/8". Cuts  
2x4 by turning over.  
Dealers—write for name of  
nearest wholesaler.

**ARROW METAL PRODUCTS CO.**

DEPT. A, 140 WEST BROADWAY, N. Y. 13, N. Y.

## AIR TANK and ACCESSORIES

Air receiver, stainless  
steel, 12 1/2"x24", 400  
lb. test. Ideal for carry-  
ing on trucks, autos and  
wherever compressed air  
is needed. Equipped  
with 500 lb. air gauge,  
tire chuck, 3 ft. high-  
test air hose, air infla-  
tion valve with core for  
retaining pressure in  
tank, and fittings.

Complete outfit **\$6.95**  
Shipping wt. 20 lbs.  
Tank only . . . **\$4.95**

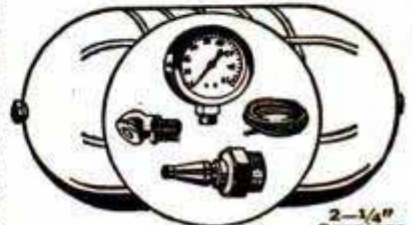

2-1/4" Openings

Prices F.O.B. Chicago. Sold on money back guarantee.

Send check or money order today. CATALOG FREE.

**WELLWORTH TRADING CO.**

1831 S. STATE STREET, DEPT. D-11, CHICAGO 16, ILL.

## Print Your Own

Cards, stationery, circulars, tags, labels, photo and movie titles, advertising, etc. Save money. **Print for Others, Good Profit; easy rules sent.** Raised Printing like Engraving, too. Sold direct from factory only. Write for free catalog of outfits and all details. **KELSEY PRESSES, M-37, Meriden, Conn.**

## EXPORT PAYS BIG

World Trade firm offers men and women plan for big pay positions or unlimited-profit businesses of their own in Export-Import Mail order World-wide without capital, from home, or travel abroad. Write today for Free Book. State if veteran. Airmail reaches us over night. **The Mellinger Co 1422-KC Westwood, Los Angeles 24, Calif**

## ARC WELDING FOR PROFIT OR PLEASURE

**60 LBS. OF READY MADE PARTS** Only \$24.95

### BUILD YOUR OWN HEAVY DUTY WELDER

SAVE Buy Only NECESSARY PARTS

All parts Ready-Made and easy to assemble. You can do all around welding on steel, cast iron and other metals after only a few hours practice. Illustrated instruction manual included. Sold on 30-Day Money-Back Guarantee!

**FREE:** Write today for fully illustrated Pamphlet P-11

**ATOMIC ARC WELDER CO.**  
1037 So. 19th St. OMAHA, NEBR.

Glves 100% penetration. Welds are stronger than original metal. Operates on 110 or 220 AC.

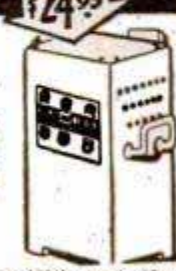

# Here's the Handgrinder you've always wanted... for HOBBYWORK...HOME USE...PROFITS

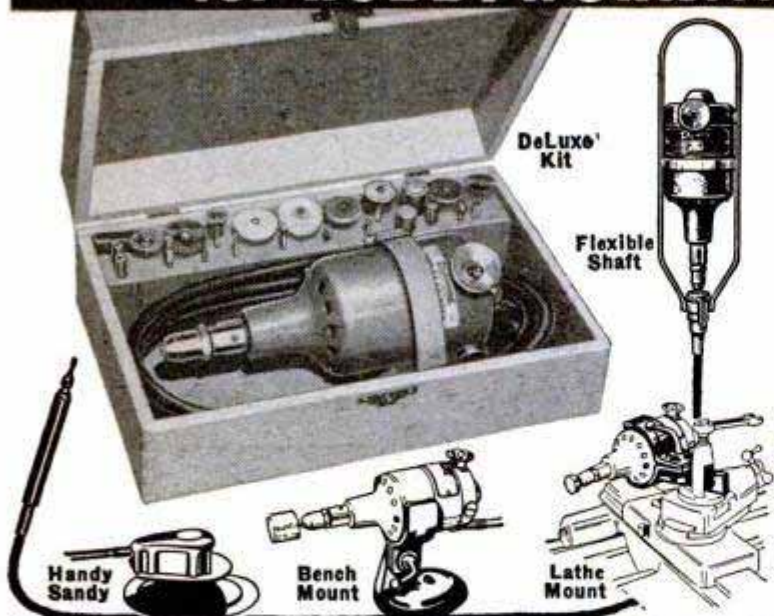

## More power, capacity, versatility than any other handgrinder

With the Dumore Duplex you get an all-around tool for your workshop... not just a one-purpose tool. 1/14 h.p. gives you extra power for heavy jobs... extra chuck capacity lets you handle all standard 1/4", 1/8", 3/32" shank tools... 8 low cost attachments (extra) quickly convert to flex-shaft, bench or lathe use, permit budget purchase of this 1-kit tool shop.

**DRILLS**      **BUFFS**      **CHAMFERS**      **CARVES**  
**GRINDS**      **POLISHES**      **SANDS**      **ROUTS**  
**SAWS**      **BURRS**      **SHARPENS**      **ETC.**

Perfect for your shop, for odd-jobs, as a gift, the Duplex is the best buy in handgrinders. See it today at your hardware dealer, or send in coupon below.

### The DUMORE COMPANY

Dept. L-51 Racine, Wisconsin

- Please send complete information on Duplex Grinder.
- Send me DeLuxe Duplex Kit with 51 accessories (as illustrated); \$27.50 enclosed.
- Send me Standard Duplex Kit (9 accessories); \$19.75 enclosed. (All shipping charges C.O.D.)

NAME.....

ADDRESS.....

CITY..... ZONE.... STATE.....

DD-1

CUT COUPON AND MAIL TODAY

## HERE IS EXTRA POWER

Brand New Factory Guaranteed 3 H. P.  
4 CYCLE GASOLINE ENGINE, PRECISION BALL  
BEARING FOR BOTH THRUST & RADIAL LOAD

IN COMPARISON TESTS this engine is efficient, quiet, vibration free, economical to run, and has excellent torque.

BEAUTIFULLY ENGINEERED  
CAREFULLY INSPECTED

DEALERS' Inquiries invited:— We took the Mfr's. entire model change close-out in order to offer this marvelous value. You know how fast this engine will be sold out at this price—so act at once.

Some of the MANY USES  
for this TERRIFIC ENGINE

Saws	Mowers
Pumps	Garden
Sprayers	Tractors
Compressors	Hoists
Generators	Conveyors
Scooters	Boats

LESS THAN 1/2 PRICE  
WHILE THEY LAST

REG. PRICE  
\$84.50

Now \$39.95

While they last  
F.O.B. Buffalo

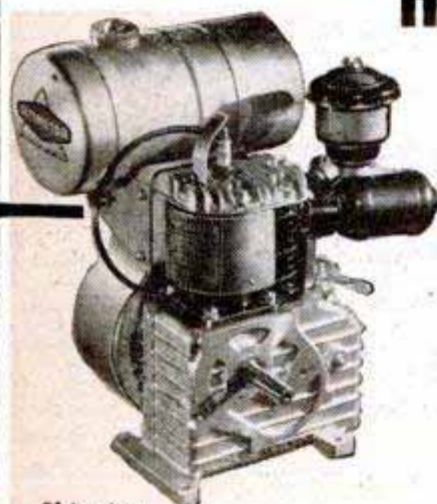

Shipping  
Weight  
48 lbs.

If You Can Use Power, Don't Miss This Big Bargain Opportunity

You may enclose only \$10.00 with your order for each engine, balance C.O.D. We suggest you enclose full amount and save C.O.D. fee. Add postage to cover 48 lb. Parcel Post shipment.

DIRECT SYSTEM CORP.

62 GILL

BUFFALO 13, N. Y.

## A SURE CURE for Cold Weather Starting... the new SHUR-HETE Motor Water Heater

Install a Shur-Hete unit on your engine—plug it into a 110 volt A.C. outlet and your car will start easily and quickly, even on the coldest mornings. Why? Because the water around the sealed electric element is heated, causing automatic circulation which keeps the entire engine block warm; therefore the oil in the crankcase and around the cylinder walls is always free-flowing.

Easy to install—Any garage mechanic can install a Shur-Hete in a short time. 1/4" connections into head block and into drain plug opening are all that are necessary. Fittings included—nothing else to buy,

Dealerships Open!

JOHANSON MOTOR HEATER CO.  
817 W. Webster St. Chicago 14, Ill.

## Save Time and Money with Shur-Hete!

Eliminate run-down batteries... towing charges... needless engine wear... and wasted gas.

Uses only 1/3 to 1/2c electric power per hour.

Safe to use with any standard anti-freeze.

Will not overheat engine or burn out.

### GUARANTEED!

Shur-Hete Outfits for  
AUTOS, TRUCKS,  
TRACTORS  
only \$13.95

Important: Give make and year of auto, truck or tractor. Shipped parcel post prepaid if remittance is enclosed; otherwise COD with postage added.



for All Autos, Trucks, Tractors  
Pat'd and Pat. Pend.



## For Loose Caster Guides

Remove the guide, fill the hole with a putty-like mixture of Smooth-On No. 1 Iron Cement and drive the guide back in. It will stay in place, because Smooth-On, in hardening, expands slightly and takes hold tight. Use Smooth-On for tightening other loose parts and also for stopping leaks in boilers, furnaces, piping, radiators, etc. Buy Smooth-On No. 1 in 1 3/4-oz., 7 oz., 1 lb. or larger sizes at your hardware store. If they haven't it, write us.

## FREE Repair Handbook

Shows how to save time and money, making many household repairs. 40 pages. 170 pictures. Clear directions. Send today. SO-313

SMOOTH-ON MFG. CO., Dept. 69  
570 Communipaw Ave., Jersey City 4, N.J.

Do it with  
**SMOOTH-ON**  
THE IRON CEMENT OF 1000 USES



# 2 DRILLS IN 1

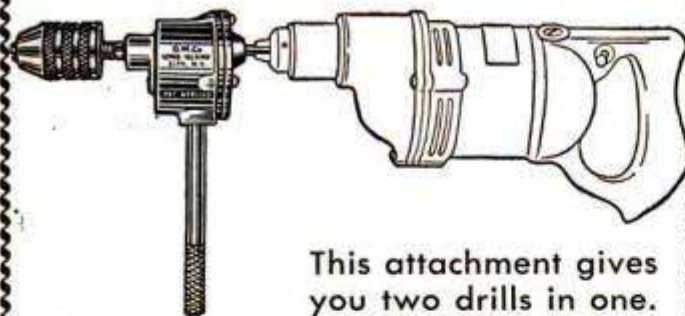

This attachment gives you two drills in one.

It converts any 1/4 inch electric drill to 1/2 inch capacity. Reduction gears reduce the drill speed 5 to 1, the average speed of a 1/2 inch drill, and thereby increases the power. Absolutely indispensable for all shop work and home craftsmen. Satisfaction guaranteed. Order yours now.....

**\$11.95**  
post paid

Send check or Money Order with order. Jobbers write for special information.

**G. M. CO. MANUFACTURING, INC.**  
1308 43rd Ave.  
Long Island City 1, New York

## GEARED TOOLS FOR THIS ATOMIC AGE

.. Are Saving USERS \$s — Energy Making **BIG MONEY** for AGENTS ..

.. Eifel-Line Super-Tools with the Amazing 4X, EXPANDO-Jaw



The NEW '4X' Jaw

Above Composite Cut shows 2 Positions, The Exclusive Parallel EXPANSION-Grip has countless new uses.

- A 3-Jaw, 7" Plierenck KIT and
- 8 1/2" KITS with 3 to 8 Jaws, etc.: Universal, Pipe, Wire; for a Million Sizes 0"-1 3/4", and
- GIANT Univ., '4X' and Pipe Jaws (Range 1" to 3")
- Tub'g Ctr., Grip-Clamp, etc. . . 1-Oz. to 1-TON grips! . . Do Thousands of Jobs, Quicker, Better and Easier.
- 8 1/2" Items FIT EIFEL-GEARED Plierencks . . '33 and later. Sold SINGLY or in ANY Combination.



GET the Most Amazing Gripping-tool Facts Ever

MAIL this COUPON TODAY ..

.. on a Postcard will do ..  
Print your Address . . . Get FREE  
1) The 115-Picture MANUAL—M,  
2) The 120-Picture CATALOG—C,  
With OFFER as marked —  
PART-TIME AGENT  USER   
FULL-TIME DISTRIBUTOR

**AMERICAN PLIERENCK CORP'N**  
4611 N. RAVENSWOOD AVE.,  
CHICAGO 40, ILL., DEPT. PM 9Y



3) Also FREE (in U.S.A.) this 3", 8-Edge, End-and-Angle Screwdriver, etc. . . often more Valuable, Useful than a Pocketknife!



## Colonial CORNER CABINET

Here is an original, authentic, Colonial Corner Cabinet. If purchased this cabinet would cost \$125.00 or MORE yet YOU can build it of the best materials with ordinary hand tools for a fraction of that cost. The easy to read plans show every detail and include complete instructions for the construction of this sturdy cabinet.

Cabinet is 7' 4" high x 39 1/2" wide with five shelves. This cabinet is a beautiful piece of furniture fit for ANY home.

Complete plans & instructions sent Post Paid **\$1.00** for only

**RESSCRAFT DESIGNS**  
5166 N. SHORELAND AVE.  
MILWAUKEE 11, WISC.

## BUILD YOUR OWN FAST FREEZER

PLANS \$1

It's easy to build this household appliance with LeJay Plans. Made from new or used parts. Save up to 75%. No expert knowledge needed. Plans show 5 sizes and are easy to follow. All details clearly explained. Enjoy making one of these freezers. Mail \$1 for set of plans and catalog. LEJAY MFG. CO., 447 LeJay Bldg., Minneapolis 8, Minnesota.



## ONAN Portable ELECTRIC PLANTS

FOR CABINS, TRAILERS, CONTRACTORS, BOATS

Light weight, compact, air-cooled engine-driven. Furnish regular city-type A.C. electricity for lights, appliances, radios, etc. Can be carried by hand. Fit trunk of car. Plug-in receptacles on plant. Larger models for farms, homes, businesses beyond highlines. Catalog shows over hundred models. 350 to 55,000 watts.



Gasoline or Diesel Powered

WRITE FOR CATALOG

**D. W. ONAN & SONS INC.**  
5827 Royalston Ave., Minneapolis 5, Minn.





Your weight does the work  
with a **"YANKEE"**  
QUICK-RETURN SPIRAL  
SCREW DRIVER

● Save your wrist: drive and draw screws faster. Just push on a "Yankee" 130A Spiral Driver. Your weight and the spiral turns the screw without blisters or fatigue. Quick-return spring in handle holds blade in slot and returns the handle after every stroke.

★  
Write for the  
"YANKEE"  
Tool Book  
... FREE ...  
"YANKEE" TOOLS  
NOW PART OF  
**STANLEY**  
THE TOOL BOX  
OF THE WORLD

**NORTH BROS.  
MFG. CO.**  
Philadelphia 33, Pa.

**FREES YOUR HANDS FOR ACTION!**  
TINY LINEMASTER  
**COMPACT**  
FOOT SWITCH  
ideal for power tools  
Weight: 6½ oz. • \$3.75



No home workshop should do without it—finest electric treadle switch ever developed! Built to exacting specifications of hard-headed industrial purchasing agents. Rugged and inexpensive. Sensitive, fool-proof actuating mechanism. Adaptable for operation by foot, finger, knee, elbow. Heavy gauge steel. Non-skid safety base.

Order your "COMPACT" Switch TODAY, \$3.75 postpaid Money back if not satisfied. **SIMONDS MACHINE CO., INC.**  
160 President Ave., Southbridge, Mass.

**EARN BIG MONEY**  
AND BE YOUR OWN BOSS  
*Sharpening Lawn Mowers*

Build a Business of Your Own With  
**A UNIVERSAL GRINDER**

In your own garage or basement, and earn \$25.00 a day or more. Mr. Hardy writes, "I am doing a fine business with the UNIVERSAL GRINDER. One customer sends another. I spent 40c for a newspaper ad and have done nearly \$500.00 worth of business." Mr. Helmeck of Canada writes, "We sharpened 750 mowers last year and are 1056 on this year's run. The Universal surely makes customers." Mr. Barton of California says, "The mower business, with the Universal Grinder, has been a gold mine these last two years."



Only on the UNIVERSAL GRINDER can the inside face and edge of the stationary blade, as well as the reel blades, be ground to proper clearance ALL IN ONE SET-UP without removing any blade from the mower.

WRITE FOR FREE FOLDER TODAY!  
**ROGERS MFG. CO., Dept. M-119, Lindsey, Ohio**

**New! TINY POCKET RADIO**  
LISTEN TO YOUR FAVORITE PROGRAM  
ANYWHERE ANY TIME PRIVATELY  
**PRIVAT-EAR**  
LEAVES YOUR HANDS COMPLETELY FREE



New 4-tube efficiency radio fits in pocket or purse. Small as penny postal card. 50 mile daytime range.

Now you can hear your favorite program with privat-ear phone, at your work bench — wherever you are, wherever you go, whatever you're doing, without disturbing others. You and you alone are the listener. See writeup page 237 in October issue of Popular Mechanics.  
★ Clear true tone. Ideal for home, cars, motorcycles, sports events, convalescents. Attractively packaged.

★ **Makes Ideal Christmas Gift**  
Complete replacement guarantee.

Weighs less than 6 ozs. Size 2¼" x 5¼" x ¾" thick. Be the first in your city to own a PRIVAT-EAR.  
\$19.95 POSTPAID INCLUDING BATTERY  
Send Check or Money Order To **RELOR INDUSTRIES INC.** 112 W. 18th St. Kansas City, Mo.



Be handier!  
End hand work!  
Get **SKIL**  
**Home Shop Tools!**

**6" SKIL Home Shop Saw** Here's a low-priced saw with big-saw features. Fully adjustable for depth and bevel. Powerful, protected 6 in. blade zips through wood, metal, plastics. Easy to handle. Built to last.



**1/4" SKIL Home Shop Drill**  
**1/4" SKIL Home Shop Drill Kit**



Steel case holds accessories for drilling, buffing, grinding, wire brushing. Includes horizontal drill stand, 13 drill bits, polishing compound, 3 in. grinding wheel, 3 in. buffing wheel, 4 in. wire brush and 1/4 in. SKIL Home Shop Drill. A fist-full of drilling power! You'll speed countless jobs in home repairs, remodeling and hobby work with this streamlined, easy-handling, fast-working drill. Best quality chuck. Capacity up to 1/4 in. in steel, 1/2 in. in hard wood.

**SKIL home shop Tools**  
See them at your dealer's today

Made only by SKILSAW, INC., 5033 Elston Avenue, Chicago 30, Illinois

# NEW! JIG SAW FOR LAD AND DAD!

## atkins NATIONAL

3 IN 1 ELECTRIC MOTOR DRIVEN



### JIG SAW... SANDER... FILING MACHINE

- 10 DAY FREE TRIAL
- Money Back If Not Satisfied!

**\$12.** POST PAID

Complete with 3 Blades, 3 Project Patterns and 2 Pieces of Wood

- Absolutely SAFE for Youngsters!
- Made of Light Weight Cast Aluminum!

This Jig Saw has everything any hobby-minded "boy"—whether 6 or 60—could possibly want! Its A.C. 110 Volt electric motor (3000 revolutions per minute) has plenty of power for sawing—sanding—filing.

**6 IN 1 UTILITY SET**

4 Screw Drivers & Hammer Combination \$1

So handy for any job in the home in the hobby shop. GUARANTEED RUSTPROOF! Post Paid

Versatile! Table tilts and rotates to cut at any angle—sanding table tilts through 46°—saw, which cuts to center of 16" circle, may be rotated to any position to cut longer lengths. Converts for filing by removing saw blade and arm and inserting 1/4" diameter standard files.

**USE HANDY ORDER COUPON**

**A. L. ATKINS & CO.** Dept. PM119  
4364 Elston Ave., Chicago, Ill.

Enclosed find \$12.00. (Check or money order in full.) Ship 3 in 1 Jig Saw-Sander-Filing Machine at once POST PAID.

Enclosed find \$2.00 as part payment. I will pay postman balance plus postage upon C. O. D. delivery.

Enclosed find \$1.00. (Check or money order in full.) Ship 6-in-1 Utility Set at once POST PAID.

NAME.....

ADDRESS.....

CITY..... STATE.....

## Say You Saw It in Popular Mechanics

# HAVE FUN! SAVE MONEY

### CHAIR KIT \$9.95 ONLY

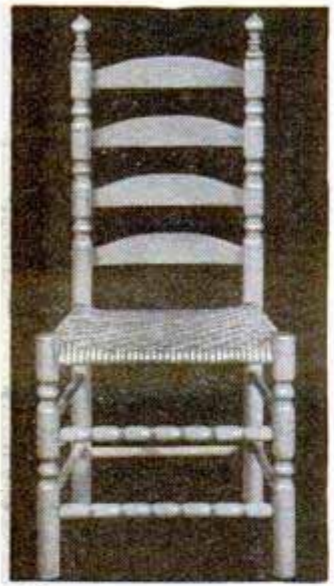

Assemble this Colonial beauty yourself. Authentic ladder-back replica. Finish to blend with your décor. Use at dining table, desk, or anywhere in house. It's fun—it's easy to put together. No tools needed other than an ordinary hammer.

Legs and rungs beautifully turned from selected hardwoods by New England craftsmen. Kit includes reed for easily woven seat and complete instructions.

A lovely, built-for-a-lifetime chair you can cherish—or give—with pride. 43 1/2" high; 17" deep; 19" wide. Send check or money order (\$9.95 ppd.) or write for literature on this Cohasset Colonial chair.

**HAGERTY OF COHASSET**  
31 BORDER STREET • COHASSET, MASSACHUSETTS

## HYDRAULIC Power Transmission

WITH Infinitely VARIABLE SPEEDS, Clutch and INSTANT REVERSE—OUTPUT TORQUE ADJUSTMENT UP TO 180 inch POUNDS

This positive displacement Hydraulic Torque Converter is the ideal fluid drive with thousands of uses... Output Speeds Infinite .0 to 550 R.P.M. . . . in either direction . . . Change Speeds WHILE RUNNING . . . Control and Transmit your power this SMOOTH Oil-Way . . . Will handle 1/4 H.P. to 1 1/2 H.P. Motor. Industrial or Home & Farm Use . . . Cost Government \$300. High Quality Precision Workmanship. Buy this unit to get the most for your money. Case measures 7 1/2" long 7" high 6 1/2" wide. Input & Output Shafts 5/8" dia. Beautiful Red Crackle Finish Case.



Shipping Wght. 25 pounds **Only \$54.50** PREPAID  
2 quarts oil included FREE

If C.O.D. is requested a 10% deposit must accompany order and we ship F.O.B. Chicago.

1 1/2"-8 thread Lathe Chuck Adapter, \$3 extra

DIRZIUS MACHINE SHOP "P" 1423-25 So. 52nd Ave., Cicero 50, Ill.

## SUPERETTE DUAL VACUUM AUTO HORNS

ONLY \$8.95 POSTPAID

Compares with \$25 to \$100 Air Horns

The voice of authority and commanding warning for safer highway driving. One BLAST and those "Road Hogs" really move over. Installed under the hood or on the front fender. Beautiful lacquer finish. Operates from intake manifold. No tank needed. Only \$8.95 complete with cylinder head bracket, steering column lever, hose, fittings etc.—Send check or money order today. We pay postage. \$1.00 deposit required on all C. O. D. orders.

THE PROTECTUOD CO.  
Dept. 401, 4033 Windsor Road, Youngstown 7, Ohio

## MICROSCOPES SUPPLIES-ACCESSORIES

SCIENTIFIC INSTRUMENTS

BEI SPENCER NEW & USED LEITZ ZEISS MEDICAL INDUSTRIAL AMATEUR

BOUGHT-SOLD EXCHANGED-REPAIRED

Send for FREE LIST

NATIONAL SCIENTIFIC INSTRUMENT CO. 119 CHAMBERS ST. NY 7

## RESIZE YOUR OWN PISTONS!

A bargain for mechanics

Sealed Power Piston Resizer equals work of machines costing hundreds of dollars. Simple to operate. Results permanent. Thousands now in use. Uses swaging action inside piston skirt, compressing action outside. Resizes steel, cast iron, aluminum pistons. Wood vice included. Satisfaction guaranteed. Send \$8.50, check or M. O. to Sealed Power Corporation, Muskegon 61, Mich.

\$8.50

## MAKE IT MOVE!

Only \$4.50 for dependable light duty electric motor, mounting rings and bracket, line cord, coupled light socket . . . and crank! Just plug in; light lit when motor on! Plus easy-to-follow illustrated instructions how to use crank to convert rotary motion to back-and-forth action. Hundreds of uses. 32 RPM only at low \$4.50 price. 28 other speeds 1/4 to 80 RPM sturdy M-K SG-15 motors \$9.25 each. With crank and plug \$9.95. State speed desired. Free delivery if prepaid.

GALE DOROTHEA MECHANISMS, 85 Jackson Heights, L.I., New York

## POWER MOWERS

Only \$69.65

Originally \$99.50

Powerful—Streamlined

Complete with Maytag, Power Products or Briggs-Stratton Engine—18" rotary tool-steel, fully guarded blades—cast aluminum body. Cuts grass and weeds, wet or dry—does all trimming—chops grass into fine mulch, eliminating raking. Send check with order, or specify C.O.D. Send for literature.

SALES REPRESENTATIVES WANTED

**HARTMAN Corp.**  
1100 SOUTH KIRKWOOD ROAD • ST. LOUIS COUNTY 22, MO.

**14 ALL PURPOSE PRECISION WHEEL KITS—  
TWO WHEELS, AXLES, AXLE SUPPORTS,  
SPACERS AND HARDWARE  
ASSEMBLED**

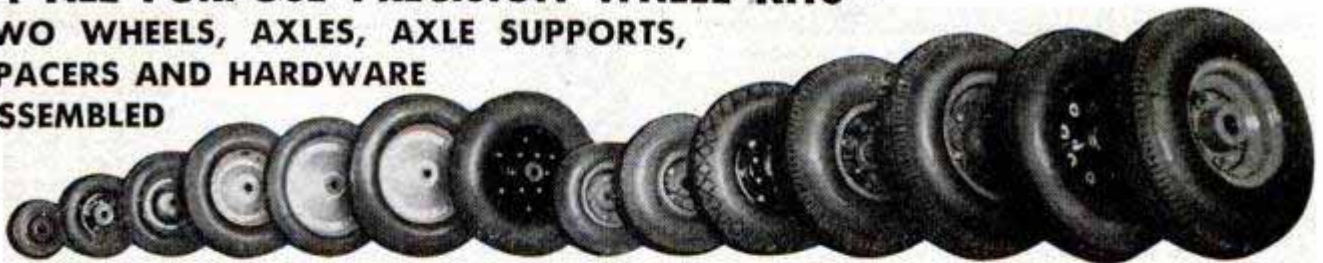

KIT	WHEELS	TIRES	BEARINGS	AXLE	LOAD 2 WHEELS	PRICE PER KIT
A	4 1/2" x 2"	Cushion	Oilite	5/8 x 30	900	\$ 7.10
B	6 x 2	Cushion	Ball	5/8 x 30	600	8.45
C	8 x 2	Cushion	Ball	1/2 x 20	200	6.10
D	10 x 2.75	Cushion	Ball	5/8 x 30	500	12.20
E	10 x 1.75	Cushion	Ball	1/2 x 20	250	7.10
F	12 x 2.50	Cushion	Ball	5/8 x 30	450	12.20
G	12 x 3	Cushion	Ball	5/8 x 30	680	18.20
H	8 x 3.00	Pneumatic	Ball	5/8 x 30	500	17.70
I	10 x 3.50	Pneumatic	Ball	5/8 x 30	500	19.70
J	12 x 4.00	Pneumatic	Ball	3/4 x 30	700	26.90
K	14 x 4.50	Pneumatic	Ball	3/4 x 36	700	26.60
L	5.00 x 8-16	Pneumatic	Ball	3/4 x 36	750	27.10
M	4.00 x 8-16	Pneumatic	Timken	1 x 40	1400	38.00
N	5.50 x 8-18	Pneumatic	Timken	1 1/4 x 54	1500	56.55

Kits M and N have 4 ply high speed tires and high speed Timken grease sealed taper roller bearings. Extra charge of 50 cents if you want a longer or shorter axle. Send 10 cents for circulars of other wheels, axles and small automobiles with and without gasoline engines. Buy direct from the leading manufacturer of precision wheels and save from 4.00 to 16.00 per kit. Prices FOB. DOY. 25% with COD's.

**OSBORN WHEEL CO.**  
115 South Main St.,  
Dept. P-11, Doylestown, Penna.

**Sensational Bargains: LOWEST PRICES! All Items Guaranteed As Represented**

**WORKSHOP MOTOR BARGAIN COUNTER**

1/2 H.P. \$19.75

General Electric, Leland, Delco, Westinghouse, Sunbeam, Brown, Brockmeyer and others. Repulsion induction and capacitor induction type motors, alternating current, 60 cycle single phase. Like New, Fully Guaranteed, some shop worn, many brand new, every one a whale of a bargain.



No.	H.P.	Volts	RPM	PRICE
12	1/4	110	1725	\$11.75
13	1/2	110	1725	\$14.75
14	1/2	110	1725	\$19.75
15	1/2	110	3450	\$19.75
16	3/4	110/220	1725	\$32.50
17	1	110/220	1725	\$42.50

Order by number. We have large stock of standard & special motors, all sizes. Write for prices. Write for our BARGAIN FAN & MOTOR Circular and SAVE MONEY. **C. MARSHALL SALES, 3546 W. Fullerton Ave., Dept. P-11, CHICAGO 47, ILL.**

**THE VAPORITE Automatic HUMIDIFIER for Warm Air Furnaces . . .**

**BARGAIN GASOLINE ENGINES**

Jacobsen 2 cycle 3/4-1 H. P. Ball Bearing. Less Gas Tank. Shop-worn but never used. FOB. ca. \$22.50

**THERMOSTATICALLY** controlled water supply puts more moisture in the air. Gives healthier air. Easily installed in bonnet of air furnace. Complete with Thermostat Water Control Valve, Tubing and parts for complete installation. **POSTPAID ONLY \$7.50** Prepare Now For Winter



**BALL BEARING MANDREL**  
High speed precision bearings for sawing, grinding, buffing, polishing, etc. 12"x5/8" shaft, threaded 1/2"x20 L.H. with flanges and nut, complete with 2 inch pulley. #100 Mandrel Only \$4.95 FOB Chicago



**QUALITY**  
**Dynasaw**  
Satisfaction  
Guaranteed or Money Back

- Cuts curves like a band saw
- cuts metal like a hack saw • cuts scrolls like a jig saw • cuts straight or angular like a bench saw • cuts to center of 48" circle • cuts 1/4" steel—brass—aluminum • 10" x 10" precision ground grey iron table tilts to 45°



Write for free catalogue on DYNASAW and other MP tools.

**\$18.95**  
F. O. B.  
ROYERSFORD, PA.

**\* MARCUS-POLLAK, DEPT. 1, ROYERSFORD, PA.**

**Now—SEE if safe to pass  
before pulling out of traffic lane!**

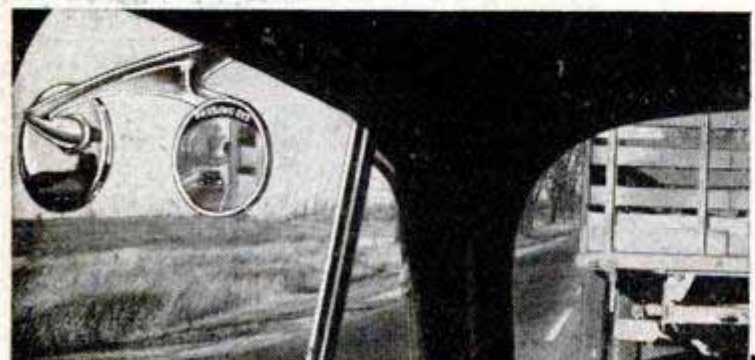

• New "Passing Eye" mirror looks around car or truck ahead—shows clear view of approaching traffic! Avoids dangerous pulling out. Heavily chromed, streamlined beauty. Easy to install. No drilling. Ideal gift—or for yourself. If dealer can't supply, order below.

**PASSING EYE, INC.**  
6329 — 31st Ave., Kenosha, Wisc.  
Enclosed — check  money order  of \$5.95 for Passing Eye.

Name .....

Address .....

City ..... State .....

# WAR EQUIPMENT MAIL SALE!

WE PAY ALL FREIGHT AND MAIL CHARGES.



★ **Power Plants.** 110-V. 60-C. 3,000-W. Remote switch electric self-starter. Easily made full automatic. Army's finest plants. Full instructions. Ideal for farmers, sportsmen, contractors. New condition. Fully guaranteed.  
Cost Gov't. \$756.....Sale Price—\$345.00



★ **Industrial Engines.** New 1-cyl. Briggs 3.5 heavy duty, air cooled. Excellent for boats, garden tractors, weed sprayers, elevators, pumps, scooters, saws, etc. Complete instructions.  
Cost Gov't. \$130.00.....Sale Price—\$75.50  
★ Same engine with Utility Clutch..... 86.50



★ **Winch—3,000 Lb.** 12" x 14". 9" high. New steel and bronze drive gears 80-to-1 power ratio. Useful for farmers, truckers, merchants, factories, etc. Used by leading truck lines for loading. Excellent for any hoist boat docks, wagon unloaders, etc. Drive with old car 6-volt starting motor, power take-off, fan pulley, etc. Easily mounted on tractors, trucks, docks, jeeps, etc. Pays for itself.  
Cost Gov't. over \$75.  
Sale Price.....\$24.95

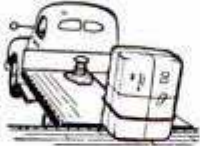

★ **Welding Generators.** 275-400 Amp. Brand new. Genuine G.E. units. Ready to operate. Complete with pulley, heat control rheostat, etc. Build and repair your own machinery. Do professional work for pay. Drive with tractor, old auto engine, or electric motor. Hundreds uses. Complete with instructions on "How To Weld."  
Cost Gov't. over \$275.....Sale Price, \$ 89.90  
★ Same unit with helmet, rods, holder, cables, etc.....\$104.50



★ **Pressure Air Unit and Sprayer.** Portable wheeled Briggs-N 1 1/2 hp. engine driven unit. Bendix 2-cylinder compressor. Gauge, regulator, valves, hose—complete. Excellent for painting, weed or insect spraying, tire pumping, cleaning and greasing equipment, etc. Hundreds uses—our most popular item. Guar.  
Cost Gov't. \$259.....Sale Price—\$99.50

### MANY OTHER BARGAINS SALE



- A. Utility Clutch, up to 6.5 h.p. \$13.95
- B. Magneto Rural Telephones 12.40
- C. Burglar Alarm System 6.99
- Fire Alarm System 9.90
- D. 2000-watt 110-volt Elements .99
- E. City Wall or Desk Phones 4.99
- Rotary Gear Pumps 3.95
- Briggs 1.5 h.p. Engine 49.50
- Multi-Speed 110-V, 60-C Motor 8.75

Also dozens electronic, hydraulic, mechanical bargains. Send Card for Free Catalog. We Pay All Freight and Mail Charges.

FREE CATALOG

## BURDEN SALES COMPANY

801 "O" ST. LINCOLN, NEBR.



**AMAZING INVENTION**  
**SOLDER-MATIC** AUTOMATIC SOLDERING IRON  
AUTOMATICALLY FEEDS SOLDER TO THE TIP OF THE IRON  
LEAVES ONE HAND FREE TO HOLD WORK  
HOLDS OVER 6 FEET OF SOLDER 1/8" TO 3/16" DIA.  
FEED ATTACHMENT REMOVABLE IN A MATTER OF SECONDS, FOR USE ON OTHER IRONS FROM 75 TO 250 WATT-SIZES  
Slight pressure on trigger brings solder to the tip of the iron in the exact quantity needed. Speeds production in workshop or factory. Comes complete with instructions. Underwriter Approved 85 watt precision electric iron and six feet of solder. Fully guaranteed—money back in five days if not satisfied.  
C. O. D. add postage—prepaid, we pay postage.  
**ACT TODAY**  
THE STERN CORPORATION  
219 A2 Investment Bldg.  
Pittsburgh 22, Pa.  
**ONLY \$5.95 COMPLETE**



### The Ideal Xmas Gift for Automobile, Tractor, Trailer or Truck Driver

Pumps up tires, anywhere, anytime. The car engine does the work... unscrew a spark plug, replace it with the ENGINAIR, attach hose to tire, and, idle the engine till pressure gauge indicates proper inflation (2 to 5 minutes)... then stop engine and replace the spark plug. No waiting for service. No slow leak or soft spare worries. Over a million in use. Used by 6 armies. Develops up to 105 lb. pressure. Guaranteed for 2 years and to pump only pure air.

## ENGINAIR SPARK PLUG TIRE PUMP \$5.00

with pressure gauge and 16 ft. air hose. If your dealer can't supply the up to 105 lb. capacity ENGINAIR, order direct. State make and model of your car.

G. H. MEISER & CO. (Est. 1906)  
313 E. Marquette Road, Chicago 37

A TOOL... NOT A BRUSH

**\$1.00 POST PAID**

## NOW! PAINT STRIPING MADE EASY!

## PAINTERS' STRIPING TOOL

Easy to use as a pencil! Draws parallel lines, straights, curves, circles with paint, enamel, lacquer, etc. Do your own striping on autos, furniture, toys, bikes, model planes, signs, linoleum... make wall board look like tile. Painters & craftsmen, order today! Type "M" Master Painters' Striping Tool complete with tip for 1/16" stripe, \$1.00. Other tools complete with following tips: 1/64", 1/32", 3/64", 5/64", 3/32", 1/8"; \$1.50 each. Extra tips 75c ea. Entire kit with tool and 7 tips—\$5.00. (C.O.D.'s postage collect.) Dealers write!

**WENDELL MFG. CO.**  
4234-B Lincoln Ave., Chicago 18, Illinois

**ELIMINATE 1000 NEEDLESS STEPS!** Money-back guarantee

**SAHARA** Will Remove Without Water Paint, Tar, Grease, Grime, Pipe Compound, Printer's Ink, Linoleum Paste, Pitch, etc.

SEND 2x FOR TWO 50¢ TUBES POSTPAID

AVAILABLE IN TUBES, ONE POUND CONTAINERS, AND PALE. AGENTS WANTED

Sahara Waterless Soap Co. — Grand Rapids, 2 Mich.

## MAGNETS OF ALL TYPES—10c UP

AMAZINGLY POWERFUL!!

4-oz. Alnico Magnet, lifts 10 lbs. \$1.10. Our Leader, 15 oz. Magnet, lifts 40 lbs. \$2.50. New alloy—will not weaken! Useful for lifting valuables from tanks, jakes, or flvers easily! 7 small magnets \$1.10 with list of many shop and home uses. Satisfaction guaranteed.

R. EYRICH, 2566 N. 49TH ST., MILWAUKEE 10, WIS.

## Practical Economical Winter Travel

Call Air SnowCars acclaimed by users everywhere. Attain high speed and travel rough steep country. Plans \$10.00. Complete machines from \$1550.00 up. Two, three and four place jobs with engines from 65 to 125 h.p.

**CALLAIR, Afton, Wyoming**

## METALS FOR HOME WORKSHOPS

Aluminum, Brass, Copper, Monel, Steel and Cast Iron. In Bars, Angles, Channels, Sheets and Tubes. Sold in Small Quantities. Write for Free Price List.

**CASHMETALS CO.**  
2720 CALIFORNIA AVE. PITTSBURGH 12, PA.

## SAVE \$55.00 ON THE PRICE OF THIS VERSATILE HEAVY DUTY TOOL!

**3/4 H. P. AC-DC motor 4200 R. P. M.**

**ONLY \$42.50** Direct from mfg.

Get this bargain now! Limited offer from surplus stock. No "catch." Brand new A-1 Spinner. Send check or M.O. today. (No C.O.D.) Money refunded within 10 days if not satisfied. CALIFORNIANS ADD 3% STATE SALES TAX

**HOLT MFG. CO.,** 272 BADGER AVE., NEWARK 8, N. J. 651 20th STREET, OAKLAND 12, CALIF.

# NOW! Sensational Cheap Oil Burner!

FOR COAL AND WOOD STOVES—FURNACES

**HEAT YOUR HOME COOK YOUR MEALS**  
with **CHEAP FURNACE OIL**

NO MORE SHOVELING COAL OR ASHES—No Chopping Kindling—No Slow Fires to Build—An oil burner entirely different—easy to install—easy to operate. Sets in the fire or ash box of your coal or wood range, cook stove, heating stove, laundry stove—larger size for furnaces, boilers. Makes one of the quickest, hottest fires known. Use No. 1 Furnace Oil, Distillate, Diesel, Range, Heater Oil and Kerosene. Simply turn a valve, light the Fuelizer Starter—a great heat for cold winter, moderate heat or just a simmering heat for slow cooking or chilly fall and spring weather.



**BIG PROFITS QUICK!**  
Distributors Salesmen Agents  
"Sold 10 first day," says D. E. PRICE  
"Started selling yesterday, sold six," says J. KLAPPERT  
"Sold 30—all satisfied," says Rev. R. O. BAZER  
Reap BIG CASH PROFITS Write today for details.

**TRIAL OFFER QUICK-HEAT** Oil Burner carries famous Iron Clad Lifetime Guarantee. So confident are we of the unusual satisfaction given by the QUIK-HEAT that we make \$1.00 BONUS OFFER FOR TESTING and let you try it in your own stove or furnace for one month. Get yours for introducing—big profits QUICK. Be first. Write today for details. DO IT NOW.

**NORTHWEST MFG. CO.**

Dept. 701-N

Mitchell, So. Dak.

## BUILD DUTCH WINDMILLS

Lighthouses, Lawn Figures, Lawn Chairs, Trellises, Etc., Beautify Your Garden

Model B-30 Windmill 24" high. Wings operate farmer at backsaw. Blueprint...50c  
Model B-10 Windmill hexagon style, 40" high overall. A beautiful model. Blueprint...75c  
Model H-10 Lighthouse, 40" high. Blueprint...75c  
Comfortable, Sturdy Cape Cod Lawn Chair. Blueprint...50c  
12 Artistic Trellises. Blueprint all 12 only...50c  
Special All Blueprints mentioned above for only \$2.50.



"Over 35,000 Satisfied Customers"  
Send 10c for Illustrated Catalog.

**CRAFTSMAN'S MODEL CO.**  
DELAFIELD, WIS.

Dept. P10

**LATHE CUTTER BIT GRINDING GAUGE**  
For checking clearance and rake angles.  
**50c** postpaid  
**SOUTH BEND LATHE WORKS**  
455H E. MADISON ST., SOUTH BEND 22, IND.

**Handy Flexible SHAFT**  
Converts any motor, drill press, electric drill, electric fan (10 inch or larger) into a handy rotary tool

Attach ROTA-SHAFT in a jiffy. Use for grinding, polishing, sharpening, cleaning, engraving, making tools, carving on metal, plastic, wood, glass. Convenient handpiece for easy handling... with 1/8 inch Adjustable Chuck. 40-inch overall length. Complete with buff and sanding disc ready to use in a drill press chuck. Order today!

**ONLY \$2.95**

**SEND NO MONEY!** Mail your order. Pay postman only \$2.95 plus postage on delivery. Try 10 days—if not delighted, return for money-back. For use on motor, add 35c for Special Coupling and state shaft diameter.

**STRADER PRODUCTS CO.**  
DEPT. L-101  
259 Strader Ave. Cincinnati 26, Ohio

**OLD FAN MOTOR**  
**VACUUM CLEANER MOTOR**

## 23 PIECE SOCKET SET



\$20 VALUE

PRICE \$9.50

Our purchase of over 200,000 wrenches as unused U. S. Airforce surplus makes this low price possible. All tools are NEW, all sockets are plated. They are well-known popular standard makes such as Plomb, Snap-On, etc.

Set consists of 23 pieces. 1/2" and 3/4" drive. Same quality as above set. Shipping weight 10 pounds. This is what you get.

1-1/4" Socket	1-13/16" Socket	1-4" Extension
1-5/16" Socket	1-7/8" Socket	1-18" Extension
1-3/8" Socket	1-15/16" Socket	1-T-Handle
1-1/2" Socket	1-1" Socket	1-1/2" Flex Handle
1-9/16" Socket	1-1-1/16" Socket	1-3/8" Speed Handle
1-5/8" Socket	1-11/8" Socket	1-1/2" Speed Handle
1-11/16" Socket	2-Bar Handles	
1-3/4" Socket	1-2" Extension	

## ARMY SURPLUS SPECIALS

Super 100 piece socket tool set	Value \$85.00	Our Price \$43.25
Sherrill Army Tank Compass	Value 25.00	Our Price 5.95 POST PD.
New Rubber suits with boots & gloves	Value 50.00	Our Price 10.00 POST PD.
Dark Room ventilators 4 1/2" thick, steel	Value 25.00	Our Price Set of 2-7.50 Each - 4.00
Twin beds—hardwood 2 beds, 2 springs, 2 new mattresses, 2 feather pillows	Value 50.00	Our Price 19.50
Mattresses, new 23 lb.—size 30" x 74"	Value 9.50	Our Price 5.25
Blankets, new, 64" x 84", grey or O. D.	Value 7.50	Our Price 3.95
Oxfords, black & brown, Military type	Value 7.95	Our Price 4.95
Jackets, all sizes, waterproof, sheep-skin lined, warm in coldest weather	Value 29.00	Our Price 17.50
8,000 candlepower, carbide flood lights	Value 51.00	Our Price 9.50
Rifle covers, waterproof, size 10" x 56"	Value 2.00	Our Price 4 for \$1.00
Hunting knife & sheath—chrome	Value 4.50	Our Price 1.95
5 gal. jeep gas can, with flexible spout	Value 3.95	Our Price 1.95
Rigid screw extractor set, No. 10 a mechanics friend	Value 12.00	Our Price 5.95
1" drive, Snap-on, socket set with ratchet, 13 pieces, plated	Value 75.00	Our Price 37.50
3/8" drive reversible ratchet—plated	Value 3.50	Our Price 1.95
1/2" drive reversible ratchet, Plomb—plated	Value 6.50	Our Price 2.95
Fraziers Solution—12 bottles	Value 5.00	Our Price 1.00



## New Aircraft Emergency Landing Light—

water activated—new complete with battery and 12 light bulbs—produces light equivalent to 12-4 cell flashlights—needed by motorists, truckers, campers, fishermen—excellent light for any emergency. Cost to govt. \$16.50 each, our price ONLY \$3.95 shipped postpaid, 2400 complete units available.

Send for catalog on home utility power hand tools, electric drills, portable electric saws, etc. The best medium priced electric tools for less. We pay all postage on power hand tools.

All orders are filled the day they arrive. Pay by check or money order. 25% dep. on C.O.D.'s. Prices are F.O.B. Fresno, except for rubber suits and compasses on which we pay postage. All items listed are new, except for bunk beds and jeep cans.

DEPT. 311

**ARMY SURPLUS SALES OF FRESNO**  
1820 TULARE ST., FRESNO, CALIF.

# VENETIAN BLIND KITS

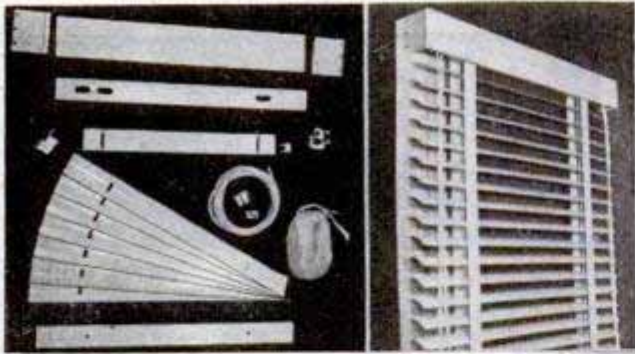

**SAVE AS MUCH AS 50%**

Assemble your own custom-made Venetian Blinds. Complete Flexolite Venetian Blind Kit takes only a few minutes of your time . . . so simple even a child can assemble it.

**NO "EXTRAS" TO BUY!** You get beautifully finished aluminum slats, all holes drilled—including screw holes, all hardware, screws, tapes and cord, headpiece, tilt, bottom rail, etc. Pre-painted in our factory. You need only a hammer and screwdriver. Built for a lifetime of service!

Available only by mail from the largest manufacturer of Venetian Blind Kits. Send for complete information today!

**FLEXOLITE MFG. AND SUPPLY CO.**  
366 Wilson Ave. Brooklyn 21, N. Y.

**RUSH COUPON NOW!**

**FLEXOLITE MANUFACTURING AND SUPPLY COMPANY**  
366 Wilson Avenue, Brooklyn 21, N. Y.  
Please send complete information and prices on Flexolite Venetian Blind Kits.

Name \_\_\_\_\_  
Address \_\_\_\_\_  
City \_\_\_\_\_ Zone \_\_\_\_\_ State \_\_\_\_\_ PM-11

# Buy the Best... WISS!



for all sheet metal cutting

## WISS Metal Master Compound Action Snips

#M-3. Easily cuts 18 gauge sheet metal. Cuts curves and circles as well as straight. Ideal for the home workshop. \$4.25. Rubber grips recommended, 60¢ extra.

## WISS Straight Cut Snips

#9. Crucible steel inlaid blades. The basic snips for straight metal cutting. Gun metal handles. Overall length 12½". \$4.25.

## WISS Combination Snips

#V-13. Solid steel, gray japanned handles. Cuts curves and irregular shapes with ease. Handy pocket size, 7" long. Accurately tempered jaws and strong bolts. \$1.75.



Prices slightly higher Denver and West



Quality for more than a Century

**J. WISS & SONS CO. • NEWARK 7, N. J.**

# WAR SURPLUS BARGAINS

**\$500,000.00 INVENTORY for QUICK LIQUIDATION**

Surplus items—hundreds of them for home, shop, factory, farm and outdoor use. New items, used items, reconditioned items—all at tremendous savings—all priced for quick sale.

**Page After Page of Values**

This big catalog shows page after page of amazing money saving values. Write for your copy today. Send 10c to cover postage, mailing, etc. Write today!

SEND TODAY FOR YOUR COPY **10c**

STARK'S

Dept. PM11 509 So. STATE STREET CHICAGO 5, ILLINOIS

## ACE TOOLS

No. 8-A SET

Be permanently toolled-up for every operation on your Metal Cutting Lathe.

No. 8-A Ace Tool Set for 9" and 10" Swing Lathes—fits shank size 3/4" x 3/4". Includes Turning, Boring, Knurling and Threading Tools with high speed cutters, blades and wrenches. 8 complete tools in fitted steel case—nothing else to buy. See your local dealer or order direct.

**ARMSTRONG BROS. TOOL CO.**  
5268 W. Armstrong Ave., Chicago 30, Ill. **\$24.25**

## INCREASE SAW SHARPENING PROFITS!

Sharpens Saws 5"—30"

**REYNOLDS CIRCULAR SAW GRINDER**

Produces top quality results in fraction of time usually necessary for resharpening, jointing, gumming and tooth forming. Any hook or pitch of tooth and depth of cut is quickly adjusted. Both hands are free to control position of saw while grinding. Write now for free circular!

**PROVIDENCE SAW & KNIFE COMPANY**  
Ship & Eddy Sts. Providence 3, R. I.

## Reduce RADIO NOISES

**SIMPLY PLUG** Radio or Appliance cord into Noise Eliminator & plug into wall socket. Enjoy reception FREE from many distracting noises. Send No Money, pay postman \$1 en. (2 for \$1.75) plus postage or send cash & we'll mail postpaid. Try 5 days, money back if not delighted. **HAND SALES, 688 Lee Street, Dept. A-1, Des Plaines, Ill.**

**NEW CLEAR-TONE LINE-NOISE ELIMINATOR**

## NEWEST OTTAWA LOG SAW

**SELF-PROPELLED — MOVES ANYWHERE on OWN POWER**

World's fastest Log Saw. Powerful 6 H-P air-cooled motor. Attachments for sawing down trees, buzzing limbs, post hole digging and pulley for belt jobs. Big demand for wood, pulp, posts. Make big money sawing wood this easy way. Low factory-to-user prices. Nothing like it. **FREE details.**

**OTTAWA MFG. CO., 7-927 Pine St., Ottawa, Kansas**

## HYDRAULIC BRAKE CONVERSION KITS

**FORDS — Models A-B & thru '38.**

Install Hydraulic Brake system now—Be SAFE. Complete kit includes everything needed—Cylinders, backer plates, lines, brackets, hoses, easy to follow instruction. Easy to install in 8 hours. Satisfactory operation guaranteed. Order Direct! Complete kits only **\$75.00**, Los Angeles. \$25 deposit on C.O.D. Return old backer plates for \$10.00 refund.

Send for HISTORY of HOT ROD & MIDGET RACING with 32 page illustrated Equipment Catalog . . . 25c

**ANSEN AUTOMOTIVE ENGINEERING CORP.**  
3801 W. Jefferson PM-11 Los Angeles 16, Calif.

Hot Rods and Race Cars

**DUAL MANIFOLDS, HEADS and CAMS** for all makes & models

**HOLLYWOOD CHROME TRIM LOWERING SHACKLES**

Set of 4 (Fords) \$1.50 State 4" or 6" year



Easy and Cheap to Operate

SAVE TIME, WORK, MONEY!

# SHAW "DU-ALL"

and "PEPPY PAL" TRACTORS

## PLOW

These rugged walking or riding tractors ideal for farm, truck garden, orchard, poultry farm. They operate on a few cents an hour. A child can handle them.

### DO DOZENS OF JOBS

The Shaw Du-All or Peppy-Pal does many jobs quickly and easily. Plows, cultivates, harrows, disks, bulldozes, sprays, hauls, grinds, and saws wood.

### BUILT FOR RUGGED WORK

Sturdy, extra-strength construction means low upkeep, long life. Full year's guarantee.

### LOW FACTORY PRICES

Buy direct or through your dealer! Almost anyone who owns a garden can afford a Shaw Du-All or Peppy Pal. Mass production holds prices down—quality up.

### RIDING TRACTORS

4 models, from 5 to 12½ H.P., 58 in. wheel-base, 36 in. wide, 24 in. plant clearance. Hand or electric starter. Improved steering device, brakes enclosed in differential housing. Heavier frame and bearings. Standard hitch for trailers and wagons. Plow, harrow, cultivator, cutter bar, snow plow, bulldozer available.

**FREE:** Illustrated folders giving complete details and price lists—write today!

4511 Front St., Galesburg, Kan.  
668-G North 4th St., Columbus, O.



## CULTIVATE



## MOW



## RIDE

**SHAW MFG. CO.**

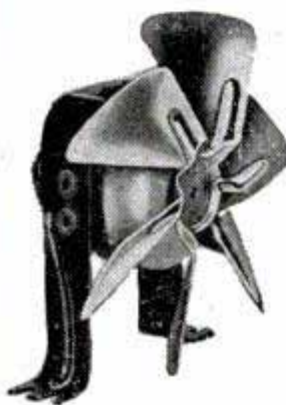

## DELCO FAN MOTORS BOOSTER FANS FOR HEATING or COOLING

Get immediate heating or cooling with this easy to install booster fan that really moves the air. Heavy duty Delco Motor, sturdy and quiet, assures excellent performance and long life. Has a 7¼" D.—6 blade fan. Operates on 110 V. 50-60 Cycle A.C. current at a speed of 1500 R.P.M. Has horseshoe steel base with triple rubber mounts. A real buy. Money back guarantee. Shipping weight 6 lbs. **\$4.75** No. 9989, only.....

Send check or money order plus postage

DEALERS WRITE for FREE CATALOG

**G & E EQUIPMENT SUPPLY COMPANY**  
1390 WEST FULTON STREET CHICAGO 7, ILLINOIS



Genuine **HIDE GLUE** is best for all **WOOD WORK**

**NO ODOR  
NO MIXING  
NO HEATING  
NO CHILLED JOINTS**  
at most hardware stores

15c extra-large TUBE

Used by furniture mfgs., craftsmen, schools. If dealer cannot supply, send 20c (postage and wrapping) to THE FRANKLIN GLUE CO., Columbus 15, O.

# THE BIGGEST SURPLUS BARGAINS IN YEARS

**ELECTRIC MOTOR ½ H. P. 27 V.D.C. R. P. M. 4000 No. 750.** For Intermittent or Continuous Duty ¾" SHAFT. VARIABLE SPEED MOTOR CAN BE ADAPTED, TO 110V.A.C. or R.E.A. line by simple arranging armature brush leads. UNUSED. Instructions **\$5.50** incl.....

**ELECTRIC MOTOR ½ H.P. 24 Volt D.C. R.P.M. 2500** Amp. 22 #HCA24. Gov't. cost \$75.00. BRAND NEW. .... **\$3.50**

**ELECTRIC MOTOR ¼ H.P. 28 Volt D.C. R.P.M. 4000 #2832** with simple instructions to convert to 28-32 Volt A.C. Gov't. cost \$82.84. Brand New..... **\$3.50**

**ECLIPSE MOTOR & GEAR UNIT.** Brand new. This is a 24 V. D.C. motor with built in planetary and bevel gear reduction. Has 1- horizontal and 1- vertical take off shaft. Overall gear ratio to motor is 40-1 can be adapted for 2-1 or 20-1 ratio. Unit can be operated from 32 D.C. Farm light plant. Ideal as OVERHEAD GARAGE DOOR OPERATOR. DRIVE FOR SMALL HOIST WELL PUMP JACK. LAWN MOWER DRIVE, DRIVE FOR POST DRILL, **\$12.50** etc. Wt. 23 lbs. Gov't. cost \$221.00. Only..... (Instructions incl.)

**WEAVERS HYDRAULIC HAND PUMP—** BRAND NEW. For hydraulic Jacks, presses, hoist, etc. For operating hydraulic cylinders, to pump oil or hydraulic fluid under pressure. Has built in check valve, and is capable of delivering 1000 lbs. pressure. Wt. 10½ **\$8.50** lbs. A \$50.00 value. Instructions incl.....

**VICKERS CONSTANT DISPLACEMENT HIGH PRESSURE PUMP.** Use it for any type liquid pumping job 375 gal. per hr. at 3750 R.P.M. 1000 pounds pressure per sq. in. Can be used as hydraulic motor O. Acq. \$100.00. **\$8.95** post-Brand new directions incl. Wt. 7 lbs..... paid

**HYDRAULIC CHECK & RELIEF VALVE** **\$2.50** Post-paid

**VICKERS UNLOADING VALVE.** Brand New—By passes full amount output of the pump while the cylinder is not in operation. Takes starting load off of electric **\$4.95** post-driving the pump. Price..... paid

**BRAND NEW HYDRAULIC CONTROL VALVE.** This is a TWO CYLINDER DOUBLE ACTION VALVE with unique arrangement allowing the operator to raise both cylinders simultaneously, to lower them simultaneously or to raise one and lower the other at any predetermined **\$8.95** Post-rate and speed. A \$75.00 value... paid

**ADEL PRECISION VALVE BRAND NEW.** This is for a double end cylinder control or for two single cylinders that are to work in opposition to each other. When pressure is applied on one line, it will open opposite check valve so that pressure in that line can be relieved. **\$5.50** Post-No. 10335. Now only..... paid

**BRAND NEW HYDRAULIC CONTROL VALVES.** Four way control for use with two hydraulic double action cylinders. Each cylinder may be operated, independently of the other or in conjunction with the other. Oil may be locked in any of the cylinders to hold the piston at any required position. Brand New **\$80.00** the **\$8.95** value. Only..... postpaid

**THOMPSON BOOSTER PUMP.** Use them for Homes, Farms, Ranch, and Shop. Motor driven centrifugal pump will empty 50 gal. drum of water in approx. 20 min. Runs on 24V. D.C. A.C. **\$7.50** New.....

**LUBE PUMP.** BRAND NEW. Precision Gear Impeller Pump. Pumps liquids up to 3 gal. per minute. Pressure up to 200 lbs. per sq. in. St'd ½" Threaded and keyed shaft. Instruc- **\$3.95** plus postage tions incl. Wt. 4 lbs. Price.....

**D.C. GENERATOR.** Brand new. For farm—Home—Ranch. Delivers 430 Volts D.C. at 3450 R.P.M. Ball bearing supported. Fan cooled armature. Self lubricating bearing. Drive it off farm tractor gas engine, etc. #211220-A, Wt. 21-lbs. **\$7.50** Now only.....

**SENSATIONAL FASCINATING MYSTERIOUS SELSYN.** Two or more connected together can be adapted for 110 V. A.C. For weather vanes rotating directional antennas or controlling distance operations. Diagram and instructions incl. Wt. **\$3.50** 3½ lbs. Price..... (plus postage)

**VALUABLE GEARS BARGAINS SPEED REDUCER** 10-1 or 5-1 ratio, 90 degree angle. Shaft Driven ½" spline Shaft with 3 mounting holes 5/16". Gears held in forged and machined aluminum housing with two needle bearings, one bronze bearing, and three high speed shielded bearings. Sealed self lubricating chamber. **\$3.50** Price.....

**NEW PURULATOR GASOLINE FILTER.** Aircraft type. Today's advanced gasoline Re-refining filter for all cars, Trucks, Tractors and all Motor Boats. Cleans and refines gasoline as you drive. Removes solids, water and prevents sludge formation. Install at home in a few minutes. STOP GASOLINE WASTE AND EXPENSE. Instructions incl. Permanent, needs no re- **\$4.95** placements. Ea. ....

**NEW CUNO OIL FILTER,** aircraft type. Filters oil without cartridge replacements. For Autos, Trucks, etc. Install at home in a few minutes. STOP CHANGING MOTOR **\$4.95** OIL. Instructions incl. Ea.....

Send check or Money order. No c.o.d.'s. Prices f.o.b. K.C. except when marked postpaid.

**GENERAL SALVAGE COMPANY**  
Dept. 17, 2922 E. 27th St. Kansas City, Mo.

SAY YOU SAW IT IN POPULAR MECHANICS

# GIGANTIC XMAS SAVINGS

## PNEUMATIC DRILL

Aro. #PDX22, w/ 1/4" Jacobs Chuck, Used, Guaranteed **\$12.95**



## New BLACK & DECKER DRILL

Home Utility 1/4" Portable. 110 Volt, AC-DC Jacobs Chuck.



trigger switch, sturdy..... **\$18.95**

1/2" Portable, same features..... **\$35.95**

## NEW "SPEEDY" SPRAYERS

W. R. Browne. Delivers 2 cu. ft. free air per minute at 30 to 40 lbs. pressure—ample for every material. Operated by any 1/4 hp 1750 RPM. Motor with 1/2" shaft.



Without motor.... **\$29.95**

## JOHN OSTER HEAVY DUTY FRACTIONAL H. P.



1/40 hp Induction type motor. 110 V-AC Reversible. 1725 RPM. ideal for home workshop and hobbyists or fan duty.

List price \$11.00. **\$4.95**

OUR PRICE.....

Torq-Master Electric Motors 110 V-AC Highest Quality.

## NEW MOTOR SPECIALS

1/4 hp Split Phase... \$12.28	1/2 hp Capacitor... \$26.30
1/4 hp Capacitor... \$14.30	1/2 hp Capacitor BB \$28.78
1/3 hp Capacitor... \$22.35	3/4 hp Capacitor BB \$38.85

PRICES FOB, KANSAS CITY, MO. NO COD'S

Send 10c for New 64 page Jam-packed Catalog.

## ATLAS EQUIPMENT CO.

229 S. W. BLVD. KANSAS CITY, MO.

## CAR OWNERS!

You can now increase car engine life

**73% to 98%**

with the new

## FILCOOLATOR

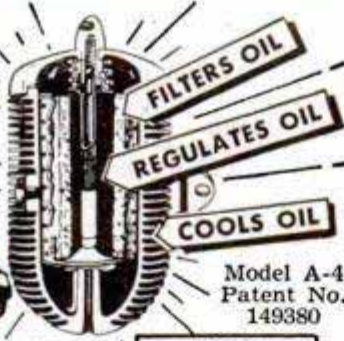

All aircraft and racing cars use oil coolers. Now give your car this extra protection with the new FILCOOLATOR. Get longer car life, longer filter life, less oil consumption. Stop oil thinning and breakdown, sludge, resins, acids, tars, carbons. Prevent burning out of bearings, scouring of cylinder walls and other engine damage. FILCOOLATOR maintains operating engine temperatures at optimum level at all speeds in both hot and cold climates.

**WINTER OIL NEEDS COOLING, TOO!** Patented valve controls oil flow for cold weather engine warm-up. FILCOOLATOR actually pays for itself in oil savings alone! **MONEY BACK GUARANTEE!**

**ONLY \$12.45**  
complete with installation kit for ANY MAKE, model or year car.

Easily Installed in 20 minutes

**MAIL THIS COUPON TODAY**

**FILCOOLATOR MFG. CO.** Dept. M-10  
10408 Regent St., Los Angeles 34, Calif.  
Send check or money order; or we will mail C.O.D. (you pay postage upon receipt).  
 Model A-4 Oil Heat Exchanger and Filter complete, ready to install @ \$12.45 (Calif. buyers add 3% for sales tax).

Car make \_\_\_\_\_ Year \_\_\_\_\_ Model \_\_\_\_\_  
Name \_\_\_\_\_  
Address \_\_\_\_\_ City \_\_\_\_\_ State \_\_\_\_\_  
My dealer's name and address is \_\_\_\_\_



## Combination Sharpener and Saw

An adjustable table model that will serve either as a saw sharpener and gummer or as a cut-off saw. Adjustable for any degree bevel on saws up to 20" or for inserted point teeth. Ideal for Dado cutters and Skill Saws. Sturdy 1/4 h.p. motor, weight 60 lbs. (Emery wheel or saw not included.)

**\$64.00**

F.O.B. PORTLAND

## P. T. HOBBS Machinery

8375 N. Interstate Ave.

Portland 3, Oregon

Pioneers

Leaders

AIR RIFLES

**BENJAMIN**

AIR PISTOLS

WITH SAFETY LOCK

SEND FOR FREE FOLDER OF LATEST MODELS TODAY

If you want a REAL GUN for PRACTICAL USE inside or outdoors, get a SAFE—CLEAN—ECONOMICAL—BENJAMIN with Adjustable Power and Amazing Accuracy. Use BENJAMIN H-C PELLETS for BEST RESULTS in all rifled models. WRITE AT ONCE.

BENJAMIN AIR RIFLE CO., 812 MARION ST., ST. LOUIS 4, MO.

## \$\$ EXTRA PROFITS! \$\$

## Flocks & Sandblasts



Dual Purpose Spray Gun! Uses only 25 lbs. Air Pressure

• Thousands of uses in Home, Shop, Industry: Makes Auto Interiors Clean & New, Lines drawers, Marproofs lamp bases, Refinishes any object. All in colorful Flock. Etch & Frost windows, glassware, etc. Removes Paint & Rust from Autos, Tools. Guaranteed! Send \$19.75 or write for free information. Flocking supplies!

BLASTO SPRAY GUN MFG. Dept. M-11, 7007 Haas Avenue, Los Angeles 47, Calif.

Only \$19.75 Complete

## MAKE! FOLD-A-WAY CHANNEL STEEL LEGS

Shipped complete, ready to fasten to your top in a minute. Rubber tipped. Used on the job, in homes, workshops, ping pong tables, trailers, camps, boats, churches, lodges, banquet halls.

Send for free circular.



\$4.98 Pr. 24" Legs  
\$5.98 Pr. 30" Legs  
Postpaid in U.S.A.

THE DIAMOND MFG. COMPANY

Dept. PM

1100 ALBANY AVENUE SCHENECTADY 7, N. Y.

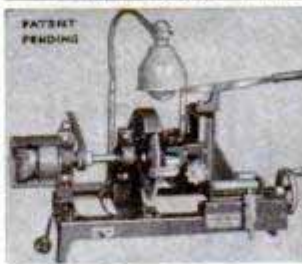

## Start a NEW BUSINESS!

or Add to your present Repair Business

## SHARPEN DULL PIPE WRENCHES

PIPE TAPS & DIES "GUM" CIRCULAR SAWS

Write for Information

J. C. MOORE INDUSTRIES  
BOX M 276 FREDONIA, PA.

## Say You Saw It in POPULAR MECHANICS

ITS EASY — ITS FUN — ITS PROFITABLE!

## MYSTERIOUS DEVICE WELDS ANYONE CAN OPERATE



**ONLY \$9.95**  
**FOUR-WAY WELDER**  
BRAZES SOLDERS & CUTS

This newly invented FOUR-WAY PORTABLE ELECTRIC WELDER will do brazing, soldering, welding and cutting on brass, bronze, iron, steel, cast iron and other metals. It's easy to use, WORKS INSTANTLY on any properly wired 110 VOLT A.C. OR D.C. LINE. Does a thousand and one professional type repair jobs. SAVES TIME AND MONEY on auto, home appliance, farm and shop repairs. Ideal for maintenance men, farmers, repair shops, engineers, tinsmiths, home and auto owners, bicycle and fix-it shops. 10 DAY TRIAL OFFER. COMES COMPLETE WITH ALL SUPPLIES READY TO OPERATE including instructions. FULLY GUARANTEED. Order today for 10 DAY TRIAL or write for FREE particulars.

FOUR-WAY WELDER CO. Dept. PMF-119  
2326 S. Michigan Ave., Chicago 16, Ill.



**Look - ONLY \$39.95**  
for This 5-in-1 Machine

**BUY NOW CHRISTMAS SALE**

## GREAT FUN—Make and Save Money

Fun for entire family at few cents per hour — *real gift for dad!* With an EMRICK you can work in wood, metals or plastics. Make furniture items of all kinds for yourself or for sale — turn out adorable presents — save many dollars annually doing home repairs.

An EMRICK includes big capacity, heavy-duty Lathe, Drill Press, Saw Arbor, Grinder, Sander — all in ONE power machine, using ONE motor. Only \$39.95 cash, or on Easy Payments. Christmas delivery assured. 10-Day Free Trial. **MONEY-BACK GUARANTEE.** Thousands of satisfied customers — our 51st year.

Write for FREE Catalog, describing Big Pre-Christmas Sale. EMRICK, INC., 1871 Clinton, Kalamazoo, Mich.

## 30 Early American Designs

New designs . . . Early American pieces adapted to modern living . . . a packet of 25c in 2 series, A and B. 15 plans. Each packet contains 15 sheets, 8½ x 11", with photos and working drawings. Easy to make practical gifts . . . cricket, napkin holder, candle stand, etc. Each packet 25c postpaid. Send for both packets, Stanley Tools, 1119 Elm St., New Britain, Conn.



**STANLEY**  
Reg. U.S. Pat. Off.

THE TOOL BOX OF THE WORLD

**DUST-O-VAC FOR ALL MACHINES**  
\$19.95

For Home Workshops & Industry. DUST-O-VAC collects & bags wood & plastic chips, wood & metal dust, wood shavings. Free Bag. Attaches to circular saw, planer, band saw, grinder, belt or disc sander, shaper, drill press with shaper or sander attachment, spindle shaper, wood lathe, jig saw. 110 A.C., D.C. Send for mounting instr. for all machines.

Free Ship. east of Miss. West of Miss., add \$1. Check, M.O.

**HEAVY CAST ALUMINUM BLOWER — ONLY \$9.75**  
110V, AC 50-60 cycles, cont. duty motor, deliver app. 100 C.F.M. For workshop, lab, kitchen, cellar, etc. Install yourself. Send for circular. UNIVERSAL YONKERS CORP., 137 Alexander St., (M11), Yonkers 2, N. Y.

**Send for NEW FREE BOOK!**

**"BENEFITS OF SEAMAN ROTARY TILLAGE"**

**FREE!** Packed with pictures, facts and figures from 18 years coast-to-coast experience in rotary tillage...Shows how SEAMAN Rotary Tillage will make bigger profits, *save money, time and labor* on your farm regardless of soil, or rocky fields...How it produces coarse, fine or medium tilth...uniform seed germination, harder crops, greater yields...Why best for pasture renovation, weed eradication...How it halts soil erosion, builds up land.

**SEAMAN MOTORS, INC.**  
364 No. 25th St., Milwaukee 3, Wisconsin

Send for "Benefits of Rotary Tillage" today.

**WAR SURPLUS AND OTHER BARGAINS**

**PNEUMATIC RIVETER & CHIPPING HAMMER**

Mfd. by Ingersoll-Rand, Chicago Pneumatic and Thor. Pistol grip. Ideal for fender, brake lining, concrete breaking work. Like new. Six rivet sets and bucking bar included, making a complete combination. Weight 9 lbs. . . . . Each **\$6.95**

**HAND MITRE** "It pays its way in just one day!"

**IT'S SENSATIONAL!**

New HAND MITRE saves the carpenter - picture framer - cabinet maker and craftsman hundreds of hours . . . a "flick" of the hand and a few seconds for a precision mitre every time.

The HAND MITRE will cut any desired angle. Its rugged construction will handle hard and soft wood mouldings, plastic trim, base shoe, dowels, laminated materials, rubber extrusions, leather, linoleums and asphalt tile. Made of heavy gauge stainless steel, electro polish finish. Will endure years of hard usage.

Eliminate bulky mitring equipment - save valuable hours and labor. . . . . **\$3.95** postpaid.

**TRANSFORMERS**

Stalle Engineering Co. Transformer. Primary Input, 115 Volts, 60 Cycles. Flexible color-coated leads. Output, 6-12-24 Volts. Will work aircraft gadgets, heater relays, signal systems, radio test filaments, home chimes, etc., off house current. A good item for the home gadgeteer. Weight 7 lbs. New. Each **\$7.95**

Stalle Engineering Co. Transformer. Output 12-24-32 V. Otherwise same as above. Weight 15 pounds. . . . . **\$14.95**

**FANCY BRIAR PIPES**

We have been awarded 100,000 fancy briar pipes by Quartermaster Corps. Assorted shapes and sizes. All popular makes. Buy now for Christmas Gifts. Set of 7. **\$3.50**

**MICROMETERS**

Chrome plated, precision engineered and carefully tool to give long life. All new.

0-1" capacity . . . each **\$2.25**  
1-2" capacity . . . each **3.50**  
2-3" capacity . . . each **3.50**  
3-4" capacity . . . each **6.50**

**EXPANSION REAMERS**

Spiral Flute. Mfd. by Alvard Polk Tool Co. All New, original pack. 1/4"-3/8"-7/16" Recommended expansion limit, .006" Original value \$12. Set of 3 . . . . . **\$4.95**

**HIGH SPEED DRILL BITS**

ALL NEW! Fractional and numbered. Original value \$15. 30 assorted sizes and lengths. . . . . **\$3.50**

**MICROSWITCH**

Type Z - 2"x1"x1/2". Used open or closed. For automatic contacting - light, sound, model train systems, chimes, etc. New 5 for **\$2.** Aluminum Spring Actuator to fit above Microswitch . . . 5 for **\$2.**

Send check, money order or cash. 25% Deposit required on C. O. D. orders. All prices F. O. B. Culver City, Calif.

**SEND 25c FOR ILLUSTRATED CATALOG**

**AIRBORNE SALES CO., INC.** DEPT. PM 11-9 CULVER CITY, CALIF.

# FURNITURE MAKING and CABINET WORK

By B. W. PELTON  
Complete Step-by-Step Directions for making Every Type of Furniture — Including Built-in Conveniences and Home-remodeling Jobs

Here, in a great new handbook is everything you want to know about furniture making: cabinet work, repair jobs, and remodeling projects. Accurate drawings and practical instructions show you all the tricks of the trade and the real professional methods of repairing, refinishing and reupholstering worn or broken pieces. And there are complete directions for every type of home-remodeling project. Every job is explained in careful detail by a master craftsman who gives you authentic instructions on exactly how to carry out each step in the work—from obtaining the materials to the final finishing operations: staining, varnishing, waxing, etc.

**MAIL THIS COUPON**

**D. VAN NOSTRAND COMPANY, INC.** Examine This **FREE!**  
250 Fourth Avenue, New York 3, N. Y. Great New Book

Please send me a copy of "Furniture Making and Cabinet Work." Within 10 days I will either return the book, or send you \$2.95, plus postage, as a down payment, and \$2.00 a month for two months until the total price of \$6.95, plus postage, is paid. (If you send entire amount of \$6.95 with this coupon, we will pay postage. Same return privilege and refund guarantee if not completely satisfied.)

**SEND NO MONEY**

NAME \_\_\_\_\_  
ADDRESS \_\_\_\_\_  
CITY \_\_\_\_\_ ZONE \_\_\_\_\_ STATE \_\_\_\_\_  
Pop. Mechanics—11-49

# COLD CARS START instantly



## with a STEWART-WARNER Electric Fuel Pump

Save yourself the trouble and expense of a car that won't start instantly, stalls in traffic or dies at every stop. Stewart-Warner's *Electric Fuel Pump* feeds a steady flow of fuel to your carburetor the second you turn on the ignition!

Save your battery with quick starts in any weather! Cut vapor lock and fuel pump failures, too. Hundreds of thousands already in use.

Easily installed — Replace your old mechanical pump with this dependable *Electric Fuel Pump*. Supplied complete with fittings for your particular car. Install it yourself or see your local Ignition and Carburetor Shop or Service Garage.



Free Illustrated Booklet sent on request. Write to—  
**STEWART-WARNER CORPORATION**  
1803 Diversey Parkway • Chicago 14, Illinois

## THAT ACCURATE TOUCH...

### with the FINEST IN STEEL TAPES

It's easy to be right the first time — it's easy to get "that accurate touch" . . . if your measuring instrument is the Master Streamline. This fine tool simplifies and speeds measuring and cuts down time-wasting errors. Its outstanding features are Streamline's guarantee of better measuring . . . graduations on both sides of blade . . . new lever brake to hold reading . . . direct reading inside measure . . . extra long tip holds blade steady . . . and many others found only in the Master Streamline. See your local hardware dealer or use the coupon.

# MASTER

REG. U.S. PAT. OFF.

WOOD AND STEEL TAPE RULES

Master Rule Mfg. Co., Inc. PM-11  
201 Main Street, White Plains, N. Y.

I enclose \$2.25 for the 6 ft. Streamline  
\$2.50 for the 8 ft. Streamline  
Engrave my name (75c extra). Please print clearly.

NAME.....  
ADDRESS.....  
CITY..... STATE.....

Binoculars for X'mas! Order Now. Quantity Discounts.

**SAVE UP TO 50% BINOCULARS**  
DIRECT From IMPORTER

*Use 10 Days At Our Risk!*  
IF YOU CAN FIND ANY BETTER AT ANY PRICE... ALL YOUR MONEY WILL BE GLADLY REFUNDED.

GERMAN ENGINEERED, BRAND NEW, DELUXE LEATHER CASE INCLUDED. Each instrument precision built to rigid military specifications. Buy direct at lowest unbreakable price! Free Catalog. Many other models. Largest stock in the West. ORDER TODAY! Send check or Money Order! \$2.00 deposit on C.O.D.'s. Add 20% Tax. Postage included.

**FREE BOOK "How To Select Binoculars"**

Bushnell Importers, Dept. M11, 43 E. Green, Pasadena 1, Calif.

**NEW EASYSHARP**

ROTARY KNIFE SHARPENER  
IDEAL GIFT

An indispensable tool for homes, workshop, kitchens, taverns, etc. Silicon Carbide Stone grinds, hones and sharpens knives in a few easy strokes. 4 vacuum cups fasten to any surface. Red enamel finish, nickel plated grinder. We pay postage. Dealers write. Send check or **\$1.00** money order for . . .

**COOKE & CO.**  
174 W. WASHINGTON - CHICAGO 2

Build it — Fix it with **AMBROID**

The Universal Liquid Waterproof Cement  
"It Stays Stuck"

At your dealers—or send 25c for generous 2 oz. tube. Postpaid.

**AMBROID CO., 303 Franklin Street, Boston 10, Mass.**

**POWER HACKSAW \$47.25**

LESS MOTOR  
F. O. B. Benton Harbor

• Rugged cast iron construction. Wt. 56 lbs. bronze bearings. Draw cut. Auto. return lift. Auto. shut-off. Vise swivels 45°. Cap. 4" x 4".

Send for full details and name of nearest dealer.

Dept. PM-119  
**EXCEL MACHINE TOOLS BENTON HARBOR, MICHIGAN**

**Guaranteed Rebuilt Transmissions**

PLYMOUTH-DODGE 35-39 FORD  
Exch. Price **\$22.95**

Also transmissions for all other cars. Write for our low prices on other parts you need.

All Parts F.O.B. Chicago, Ill.

**WORLD AUTO PARTS CO., Dept. B**  
2200 N. Ashland Ave., Chicago 14, Ill.

**Guaranteed Rebuilt GENERATORS**

Chevrolet—Plymouth—Ford 35-39  
Exch. Price **\$5.95**

We can furnish you with any part you need from our large stocks. Our prices are the lowest possible. Write us your needs today.

**END GENERATOR REGULATOR BATTERY TROUBLE!!**

With the greatest advancement in auto-ignition since the self-starter

**THE AMAZING NEW WATTAGE REGULATOR**

DRIVE WITH OR WITHOUT YOUR BATTERY  
100,000 MILE MONEY-BACK GUARANTEE

For all popular cars, only \$8.00 C.O.D. plus postage. State make and model of car—Write for free catalog today.

**SCIENTIFIC ELECTRIC CO.**  
P.O. Box 2162P1, Sta. N, Cleveland 8, Ohio

**CARBURETOR TOO RICH MAKES MOTORIST TOO POOR**

Car owners who are wasting money and not getting proper gas mileage due to over-rich mixtures will be pleased to learn how to save gasoline by VACU-MATING over-rich mixtures. VACU-MATIC fits all cars, trucks and tractors. It is automatic and operates on the supercharge principle. Easily installed in a few minutes.

**SALESMEN WANTED! Big Profits!**  
Send name, address on penny postcard for free particulars and how to get yours for introducing.

**VACU-MATIC CO., 7617-1542 W. State St., WAUWATOSA, WIS.**

**NOW! USE YOUR ELECTRIC DRILL for**  
**POLISHING!**  
**GRINDING!**  
**SANDING!**  
**Work on curved**  
**or flat**  
**surfaces**

You can use it to fix bodies, fenders; wax; polish cars, floors, linoleum; re-finish furniture, wood, metal surfaces; smooth, reduce welds, etc.

**FITS ANY 1/4 IN. CHUCK or DRILL, FLEXIBLE SHAFT, MOTOR, etc.**

Designed and engineered for high speed sanding, polishing, finishing, etc. Full 6 1/2 inch rubber face plate bends into curved surface. New clamp arrangement mounts sanding discs instantly—no cementing. Draw-string lamb's wool bonnet slips on for high speed polishing, finishing, etc. Outfit includes 6 1/2" flexible rubber disc with 1/4" metal shank, fibre backed sanding disc and heavy lamb's wool polisher. Equals \$75.00 outfits in performance. You'll find hundreds of time saving uses for it. Fully guaranteed. Shp. wgt. 2 lbs. F.O.B. Chicago. Shipment in U.S.A. only.

6 1/2 in. heavy duty type. Each \$4.95  
 5 in. size for light hand drills. Each \$2.49

At your favorite hardware store or direct.

**PREHLER PROVED PRODUCTS**

Division Norbert Prehler & Co.

1623-25 Milwaukee Ave. Dept. PM11 Chicago 47, Illinois

**SAVE MONEY on TRAILER BUILDERS' SUPPLIES! BUILD, REPAIR or MODERNIZE!** We are the largest and most complete trailer supply house in the States. Get our New Large 1949 Catalog 10c; blue prints and building instructions 25c.

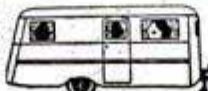

National Trailer Equipment Co., 1007 N. Water St., Milwaukee 2, Wisc.

**CUT METAL on your Woodworking Band Saw**

with the **ERWOOD**  
**PLANI-DRIVE Converter**

- Cut metal or wood with easy push-pull knob control.
- Fits 3/4" shaft . . . is supplied with 1/2" and 5/8" bushings.
- Easy to install . . . remove pulley and put on converter.
- Priced so that you cannot afford to be without it. . . **\$29.75**

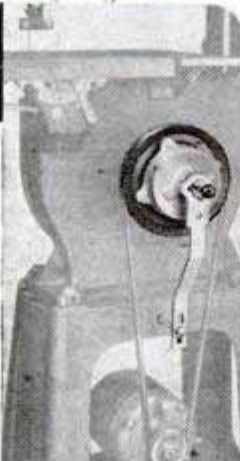

209 WOODSTOCK STREET

THE **Erwood** COMPANY, CRYSTAL LAKE, ILLINOIS

**REDUCED FOR QUICK SALE**

**Portable "GAS" ENGINES**

**A \$62.50 VALUE FOR ONLY \$37.50**



What a value! Brand new portable gasoline engines—ready to go. Use them to build your own power mower, air compressor, power bicycle, garden tractor, cultivator, boat, snow plow, etc. Of modern aircraft 4 cycle design, with aluminum alloy heat treated cylinder integral with crankcase. Easy starting even in cold weather. Drilled for mounting to any flat surface. Each motor is complete with magneto, carburetor, filter, governor and 2 1/2 quart gas tank with strainer. Fitted with 3/8 inch shaft. (Pulley not furnished.)

1 1/2 H.P. Size Reg. \$65.00 Value **\$37.50** NOW ONLY  
 1 3/4 H. P. Size Reg. \$75.00 Value **\$44.50** NOW ONLY

**SPECIAL WHEEL DEAL—BALL BEARING TYPE**

Brand new wheels with semi-pneumatic tires. Use them on trucks, wheelbarrows, for dollies, etc. 20% discount on 4 or more. Measure 8 inches by 1.75. With bronze Oilite Bearings, Ea. **\$1.95** With Ball Bearings, Ea. **\$2.95**

**HYDRAULIC PRESSURE GAUGE**

Brand new surplus; 0-2000 p.s.i.; Black plastic case with luminous numerals. Measures 3/4 in. in diameter, AAF type. AN5771-4. Ea. only **\$1.95**

**SCREW JACK** A high power screw jack with approx. 40 to 1 ratio worm gear drive. Built by Lear. Use them for leveling and adjusting, for raising obstinate windows, doors, etc. Has hundreds of uses around shop and home. Open length 19 inches, closed 9 inches. New surplus! Each only **\$2.95**



**COMPLETE GENERATOR SET.** Includes Aviation type generator (Type L3, 28 Volt, 25 Amp, rotation CW, 2500 RPM) measures 12 x 5 inches, weighs 24 lbs. Outfit also includes famous Carbon Pile type voltage regulator (AN3080-1) with mounting base for same. Holds voltage within given operating range of varied generator speeds. Complete set, generator, regulator and base (all like new) now offered at approx. 10% of AAF acquisition cost. Complete set only \$24.50. Generator only (shp. wgt. approx. 35 lbs.) only **\$19.95**

**PORTABLE FOOD WARMER KIT**

Used by AAF for warming liquids, food, etc. Operates on 110 V. AC or 28 V. DC. Keeps foods hot for hours. Case measures 11 x 17 x 17 in. Equipment includes 8 x 4 1/2 in. stainless steel cups with lids, 4 stainless food trays or plates with lids, 6 each knives, forks, spoons, 1 water container, plugs, etc. Use at home, on boats, planes, etc. to warm canned goods, etc. and to keep them warm. May be packed with dry ice to keep things cold. Use also on hunting and fishing trips, picnics, etc. Shp. wgt. approx. 33 lbs. Complete, only **\$14.95**

Send check or money order. All F.O.B. Houston. Can ship mail, express or freight, transportation charges collect. Order today while these bargains are available.

**AERO PARTS SUPPLY, Dept. PM11**

MUNICIPAL AIRPORT

HOUSTON 17, TEXAS

**SAY YOU SAW IT IN POPULAR MECHANICS**

**Industrial Transformer Type DYNAMIC Super Charged ARC WELDER**

**OVER 50,000 SATISFIED USERS!**

**IDEAL FOR AUTO HOME APPLIANCE AND FARM IMPLEMENT REPAIRS** WORKS ON IRON, STEEL and other metals. Does work you'd expect from a larger costlier machine. Portable, easily carried. OPERATES from any properly wired **110 Volt Line**. Also available for 220 volt current at slight additional cost.

**IT WELDS • BRAZES • SOLDERS • CUTS!**

**EASY TO OPERATE TRANSFORMER TYPE WELDER.** If inexperienced you can learn to do professional work by following the **SIMPLIFIED WELDING and OPERATING INSTRUCTIONS FURNISHED**—comes complete ready to operate with helmet, rods, cable, instructions. **SAVE TIME and MONEY**—Do your own welding. Just a few repair jobs will pay for this machine. A practical and profitable machine tool for any workshop. Make money doing repair work for others. Write today for full particulars.

**ONLY \$28.50 COMPLETE**



**DYNAMIC WELDER CO., Dept. TD-119, 15 E. 23rd St., Chicago 16, Ill.**

**SPECIAL GIFT OFFER! ARC TORCH WORTH \$6.80 YOURS at NO EXTRA COST!**

**TWIN CARBON TORCH** (illustrated) for use with **DYNAMIC** is unsurpassed for brazing, soldering, pre-heating and cutting iron, steel, brass, bronze and other metals. With it you greatly increase profitable uses of your welder. Does work of oxy-acetylene torch. Comes complete with instructions, carbons and cables. For **LIMITED TIME ONLY** we are giving a



**—Mail Coupon FOR FREE FACTS—**

**10-DAY TRIAL OFFER**

**DYNAMIC WELDER CO., Dept. TD-119, 15 E. 23rd St., Chicago 16, Ill.** Send me **FREE** details of your **ELECTRIC Arc Torch Gift Offer** and Dynamic Welder 10-Day **TRIAL OFFER.**

NAME \_\_\_\_\_  
 ADDRESS \_\_\_\_\_  
 CITY \_\_\_\_\_ ZONE \_\_\_\_\_ STATE \_\_\_\_\_

## 1/2" Electric Drill Special \$35.50 GUARANTEED VALUE **\$27.99**

Complete with Jacob's Key Chuck. This Drill is made by a Nationally Known Manufacturer. Satisfaction Guaranteed.



**HI-SPEED DRILL and WOOD BIT SET with TOOL BOX**  
5" x 7" x 11" 22 ga. Steel  
ONLY **\$9.90** COMPLETE  
Shipped Prepaid in U.S.A.

Set No. M-12  
**M-12 includes:**  
7 HI-SPEED TWIST DRILLS  
Sizes 1/16" to 1/4"  
Drill rack provides holes for 8 intermediate 32nd sizes.  
For Iron, Steel, Wood, Plastic, etc.  
5 WOOD BITS WITH 1/4" SHANK  
Sizes 1/4" to 1/2"  
For Use in Wood Only. Designed especially for use in 1/4" capacity portable electric drills.  
**ALL-METAL TOOL BOX**  
Compartment designed to hold all popular priced 1/4" electric drills.

**Also M-18 Set** Same as Above **\$11.90**  
Drill Box, includes 1/16" to 1/4" by 64ths. Hi-Speed Drills.

**CENTURY'S NEW WOOD BITS**  
The only drills expressly made to drill holes up to 1/2" Dia. in wood with 1/4" electric drills.  
Shipped Prepaid in U.S.A. **set \$3.95**

**SET W-5**  
Contains 5 Wood Bits with 1/4" round shank, sizes 1/4", 5/16", 3/8", 7/16", and 1/2", packed in cardboard box.

**5 Pc. WOOD BIT SET for 1/2" ELECTRIC DRILL** Only **\$8.45**  
Includes 1/2" - 3/8" - 3/4" - 7/8" - 1" Carbon Drills — 1/2" Round Shank SET

We are Authorized Distributors of the Complete Line of BLACK & DECKER Home Utility Drills — Sander-Polisher and Accessories. Send for Complete Black & Decker Home Utility Tools Catalog.

C.O.D. Orders Accepted only with 25% Deposit. All Shipments Prepaid if Money Accompanies Order.

MAIL ORDERS TO:

**CARL-SONS and COMPANY**

DIVISION OF CARL-SONS BEST HARDWARE  
1627-29 N. DAMEN AVE. CHICAGO 47, ILL.

The Ideal Gift for the Home Owner

**NO** COMPRESSOR  
HOSE • MOTOR  
WIRES • PUMP

## BECKER Self-Contained SPRAY GUN

Take it Anywhere for

- Painting
- Rust-Proofing
- Varnishing
- Starching
- Humidifying
- Moth-Proofing
- Insecticiding
- Fire-Proofing

Here is the first completely self-contained and fully portable spray gun . . . needs no wire or hose, no compressor or motor. Take the Becker gun anywhere to do dozens of spray jobs . . . in the house, workshop, garage or garden. Spraying pressure is provided by an inexpensive, easily replaced CO2 cartridge. One cartridge will spray up to 21 ounces of liquid (depending on viscosity). The Becker Spray Gun comes complete with 3 cartridges. Send only \$18.50 and we ship postpaid. Or, send only \$2 now and pay postman balance plus postage. **MONEY BACK** if not delighted after 5 days' trial. (Extra CO2 cartridges, 10 for \$1, postpaid.)

SULLIVAN-BECKER CO. • Dept. 119-L • Kenosha, Wis.



Only **\$18.50**

## D.C. ARC WELDER

OVER \$300 VALUE AT LESS THAN 1/3

200 Amperes Continuous Duty. Up to 250 amps. intermittent duty. Easily mounted on your tractor. Welding range from 0-up by dial type control. 1-yr. guarantee with money back 10-day trial period. Write for FREE literature. OR send \$35 for PLAN "Build Your Welder from Aircraft Generator" literature included.



LEJAY MFG., 847 LeJay Bldg., Minneapolis 8, Minn.

## SET and JOINT CIRCULAR SAWS

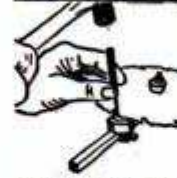

Joint and set circular saws in a jiffy. New tool combines both jointer and set in one precision instrument. Simple—accurate—anyone can get blades round and true. For blades 6 to 12 inches in diameter. Complete with file and hard steel anvil. Money-back guarantee. Both tools just \$4.95. Send for free illustrated folder.



SURE-SHARP MFG. CO., Dept. M-119, P. O. Box 24, Santa Ana, Calif.

**\$14.00 UNIVERSAL PRECISION CHUCK ONLY** **\$2.95**

2 inches with hardened steel jaws, perfectly balanced for trueness, made by nationally known chuck manufacturers. Every craftsman, machine shop, should own one at this unusually low price. Send check or money order to HAR-MUR • 2349 W. Devon Ave. • Chicago 45, Ill.

## GROBET BURS CRAFTSMEN JEWELERS DIESINKERS

Special Tungsten Steel unequalled for hardness, cutting, speed, and durability. Fine cuts for steel; coarse cuts for soft metals, wood, etc. Many different sets in wood and bakelite containers. Write today for FREE CATALOGUE.

G. HOTINE, 461 6th Avenue, Brooklyn 15, N. Y.

## \$4.95 REAL ENGINE VALUE

A miniature gas engine that really operates.



Thousands of Buzz "B" gasoline engines have been sold at twice the price. Now is your chance to buy a real 1/6 H.P. gas engine for only \$4.95. Turns up over 8,000 r.p.m. For Boats, planes, midget cars, etc. Guaranteed and ready to run. Includes Champion spark plug and tank. Send only \$4.00, engine shipped collect for balance, same day.

WRITE FOR FREE CATALOG OR SEND 10c FOR NEW MAMMOTH ILLUSTRATED CATALOG OF THOUSANDS OF HOBBY ITEMS.

America's Hobby Center, Inc., Dept. B-119, 156 West 22nd St., N. Y. 11

## Free Booklet on FLEX-O-SHAFT

Illustrating this all-purpose power machine with hand-piece that handles as easily as a pen. Motor with switch, foot-operated rheostat, and 66 accessories at special low price. Write

F. W. STEWART MFG. CORP.

Dept. A 4311 Ravenswood Ave. Chicago 13, Ill.

## "ZERO-ZIP" 7.50

Replace your oil drain plug with our Thermal Heater and forget about cold weather starting—leave in year around if desired. Keeps oil warm for instant starting in zero weather. For 110 V. A.C.—fits most cars. Specify make & model. Complete kit includes 15 ft. ext. cord, plugs, etc.

PRODUCT ENGINEERING COMPANY, Box No. 1781, Tulsa, Okla.

Say You Saw It in POPULAR MECHANICS

## LAWN ORNAMENT-NOVELTY PATTERNS

28 Lawn Ornament Patterns, 25c. Other patterns: 15-20" high; Dutch Girl, Dutch Boy, Pirate, Bull Terrier, Mexican Girl, Mexican Boy, Dwarf, Penguin, Flower Girl, 10c each. 25 Novelty Patterns, 30c. All 62 Full Size Patterns, \$1.00 Postpaid. Strother Pattern Service, Dept. BH-8, Box 128, Belington, W. Va.

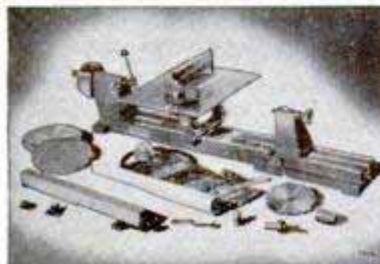

**NOW** You can GET THIS AMAZING Complete **WOODSHOP** • IN ONE RUGGED UNIT •



HERE is the Popular MULTI-MAC Complete Woodshop. Easy to operate for home or part-time business. Saves money on home repairs. Equals performance of outfits costing much more. Write today for Free Catalog.

MICHAEL MANUFACTURING CO., 718 So. Marquette St., Dept. P-11, RACINE, WISC. ORDER YOURS TODAY

All in One { 30 inch Lathe  
8 inch Saw  
Drill Press  
Disk Sander  
Grinder  
Horizontal Drill

IDEAL XMAS GIFT

(less motor) ONLY **\$79.50**

fob. Racine

YOU can find over 100 PRACTICAL USES and have LOTS OF FUN with

# 5 in 1 Miracle Projector

## Electric Enlarger and Copy Maker

### Magnify & Project

Stamps, coins, puzzles, clippings, maps, science specimens, plans, etc. Examine magnified details. Project on paper and sketch copies, large or small. Easier reading for weak eyes.



**Magnifying Reader for Small Detail & Print**

### Learn to Draw & Sketch Signs, Cartoons, Pictures Easily

#### Posters, Lettering, Comics, Objects

Project sketches, pictures, objects, etc. on drawing paper. Sketch over with pen, pencil, colors, etc. Easy to make any kind of cartoons, drawings, signs, etc. either large or small. Make cartoons from pictures. Easy to do; no skill, no practice.



Large or Small

#### Copy Any Picture or Object

Project a n d focus it large or small. Make enlargements o f plans or drawings. You'll be surprised h o w m a n y practical and entertaining uses y o u can make. Advertis- ing posters, cartoon sketches of friends, etc., etc.

### Natural Moving Pictures

#### Projecting Microscope Gives Live Show

Put ants, insects, flies & other bugs or animat- ed objects under glass & let them walk around. See them in a ctio n greatly enlarged a n d magnified MOVING on screen. Amazing, real- life scientific motion pictures. Like having a projecting microscope.



### Make Photo Enlargements and Copies Without Negatives!

#### Use Any Photo or Picture

Direct positive photo enlargements and prints without nega- tive using Eastman direct positive paper. Use any black & white or color picture, colored trans- parency, etc. Easy to do; excellent results. No complicated d a r k room equipment. Makes correct copy (same as original), large or small. Also useful for mak- ing copies of important papers, plans, documents, stamps, sketches, maps, etc., etc. EASY, FUN, USE- FUL, PROFITABLE.



### Picture Enlarger and Projector

#### Project 3-Dimension Pictures

Put on your own show by projecting snap- shots, pictures, post cards, photos, comics, clippings, etc. on wall or screen. Fine for school, clubs, talks, home shows, telling about your trip, salesmen, etc. Full color, correct projection, entirely readable & correct. Special device enables you to project real 3-dimension or stereoscopic pictures. Startling, life-like.



### Make Money Machine Pays for Itself

Many ways to make money. Make photo enlargements, photo copies, give shows, make sketches and drawings and advertising signs, etc. Easy to do—the machine does the work.

### Amazingly Useful Invention

Home Fun—Schools—Salesmen— Clubs—Artists—Teachers—Shops— Sign Makers—Doctors— Classroom—Scientists— Students—Money Maker—Photo- raphers—Experi- ments—Lab workers— Printers— Painters— Etc., etc.

HIGH FIDELITY, TRUE VIEW, FULL COLOR!



**\$3.98** Complete Cash Price

JOHNSON SMITH & CO. Dep. 157, Detroit 7, Mich.

Projects & en- larges in full natu- ral color; projects reading matter cor- rectly, readable. Clip- pings, pictures or sketches, color transparencies as well as small objects in brilliant natural colors, brightly lighted up by electric light inside projector.

#### Different Show Every Night; No Films

**to Buy; No More Expense; Sports, Girl Beauties, Comics, Etc.** **SPORTS, MOVIE or COMIC PICTURES** from papers & magazines. Enlarge action pictures, Project snapshots of your girl, family trip. Project and read comic strips to kids. Large pictures projected in full color!

**Educational, Scientific; Real Life Action!** Live ants, flies, bugs and small animals can be projected on screen; watch them in real life action, fighting, eating, playing. Great for amateur scientist experimenter and camera fan.

**Make Signs, Sketches, Posters, Cartoons, Lettering, Etc. Quick! Easy! In Black & White or Full Color; From Clippings or Copy; Large or Small** Make sketch or cartoon of friends, posters and signs for clubs, stores, dances. Easy to make, large or small. Project picture or rough sketch right on blank drawing paper. Using pen, pencil or colors, sketch OVER PROJECTED PICTURE. Project photos and make funny, life-like cartoons or sketches. Amazing & practical. Be a good artist, even though you never did it before! Lettering and signs easy to do.

**Magnifies Stamps, Specimens, Objects for Close Examination; Reader for Weak Eyes ABOUT 50 AREAS.** Make photo enlargements direct from objects! Enlarges small type, maps, etc., projecting it for easy reading.

**Photo Enlarger; Makes Photo Prints, Photo Copies, Etc.—No Negatives** Uses Eastman direct positive paper. Correct true-image photos, large or small, from any photo; or even from color prints & color transparencies. Photo enlargements, copies, etc. done cheaply, quickly, easily. 8x10-in. enlargement costs 12c; sell up to \$1.00. **NO NEGATIVES.** Made by projecting picture on direct positive printing paper. Duplicate copies of blueprints, diagrams, papers; large or small.

**3-Dimension Stereoscopic Pictures** By special process you can project 3-dimensional pic- tures and see in startling, life-like realism, 50 real you expect to reach out and touch them! Project beautiful girl pictures, travel scenes, etc.

**No Skill—No Experience—Fun All Year Round** Low-priced instrument that quickly pays for itself. No experience and no skill to operate. Just plug into any 110-volt AC-DC standard home socket. Years of entertainment and practical uses for every member of the family. Lasts indefinitely; nothing to wear out, so only cost is low price of **MIRACLE PROJECTOR.** Schools, shops, offices, artists, etc., all find many uses for it.

**Project on Table, Wall or Ceiling—No Screen Necessary** Project almost anywhere necessary—any blank wall or white paper will do. Wonderful for classroom, clubs and salesmen. Complete except for lamp bulb; use any household 60 to 100 watt lamp bulb. Steel construction, handsomely enameled in brilliant colors. Easy carrying: 7 1/2-in. high, 10-in. long. Optically ground and polished lenses; slide focusing, so you can PROJECT FROM VARIOUS DISTANCES to make picture large or small. Takes pictures up to 3 1/2x4-inches. With illustrated instruction booklet, views, price list for additional supplies, etc. (3 for \$10.50).

**COMPLETE, POSTPAID, CASH PRICE ONLY. \$3.98**

**What Users Say:** Artist & Signmaker: "Valuable aid; enables anyone to do all kinds of art work without training." Photographer: "Many uses; money maker and money saver." Teacher & Lecturer: "Makes talks ten times more interesting; Teaches faster, more fun." Collector: "Magnifies & illuminates specimens for easy study."

**Johnson Smith & Co., Dept. 157, Detroit 7, Mich.**

(Since 1914 America's Leading Novelty House; Big 500 page Catalog of 7,000 Novelties 10c)

Rush... Projectors at \$3.98 each, postpaid; 3 for \$10.50.

Enclosed is \$.....

Name.....

Address.....

(Sorry, No C.O.D.'s at This Cash Price)

Rush This Coupon Today!

# BARRON Drill Press TOOLS

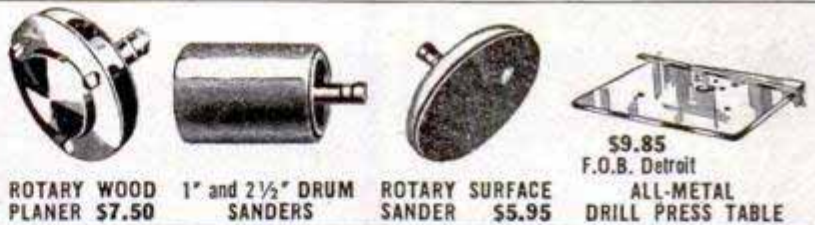

ROTARY WOOD PLANER \$7.50    1" and 2 1/2" DRUM SANDERS    ROTARY SURFACE SANDER \$5.95    \$9.85 F.O.B. Detroit ALL-METAL DRILL PRESS TABLE

ALL-METAL SHAPER FENCE \$8.25 F.O.B. Detroit



ROUTER & MORTISING BITS \$9.50 per set of six

SHAPER CUTTERS \$9.00 including 3 sets Blades



## 15 ESSENTIAL WORKSHOP OPERATIONS . . .

You can convert any standard make drill press into your most versatile, useful, low cost workshop tool. Barron Precision Tools now enable you to perform 15 indispensable shop operations—surface-plane woods and plastics—rabbet—tenon—panel—bead—groove—bevel—mortise—route—cut dovetail—sand surfaces and contours—shape—cut moldings—grind and buff. Over 200,000 Barron Tool users. Every tool sold on full 10 day money back guarantee.

See Your Dealer . . . Or Write Direct

BARRON TOOL COMPANY, INC.  
569 Architects Bldg., Detroit 1, Mich.

FREE Workshop Guide & Catalog

# The Chief WORK BENCH

Built to Last a Lifetime!

With Bottom Shelf and 18" Sq. Drawer. 2"x6", Solid Plank, Grooved and Dovetailed Top and 1"x8" Back Rail, Shellacked to a Smooth, Satiny Finish.

MOHAWK LUMBER CO. Dept. 33  
14525 W. Chicago Blvd. Detroit 27, Mich.  
Enclosed  Check  Money Order for \$.....  
Ship  CHIEF WORK BENCHES at Quantity  
\$16.95 each, F.O.B. Detroit, Mich.  
 Send C.O.D., \$5 Deposit Enclosed.

• 6 Ft. Long • 34" High • 26" Deep. Shipped Knock-down, with Bolts, Nuts and Screws and ABC Chart for Quick, Simple Assembly.

Prompt Delivery  
**MOHAWK LUMBER CO.**  
14525 W. Chicago Boulevard  
DETROIT 27, MICHIGAN

A CHRISTMAS PRESENT HE'D APPRECIATE



\$16.95 F.O.B. DETROIT

Send Check or Money Order, or Will Ship C. O. D. (\$5 Deposit)

NAME.....  
ADDRESS.....  
CITY..... STATE.....

# 1/4" POWERHOUSE ALL-PURPOSE ELECTRIC TOOL KIT



110  
120  
VOLTS  
A.C.  
D.C.

G. E. BENNETT STORES  
723 Granby St. (Dept. M) Norfolk 10, Va.

Give Yourself or Your Son This Wonderful Gift for Xmas!

COMPLETE 17.95 VALUE 23.95

UNDERWRITERS' APPROVED  
FACTORY GUARANTEED  
Powerhouse Drill Only 13.95

POWERHOUSE outperforms most drills selling for \$20.00 and more! 17 to 1 steel gear ratio maintains power without danger of overloading. Contains EVERYTHING for home or workshop . . . 5" lamb's wool polishing bonnet; rubber back-up disc; 4 sheets sand paper; paint mixer; 3 HIGH SPEED twist drills, 1/16", 3/32", 1/4"; mandrel assembly; Powerhouse Drill. Backed in natural-grain wooden box. Perfect for mixing paint, for sanding, waxing, polishing furniture, woodwork and cars. Drills holes up to 1/4" in steel . . . 1/2" in wood.

SEND CHECK or MONEY ORDER. NO C.O.D.'S PLEASE. MONEY REFUNDED IF NOT SATISFIED IN 10 DAYS.

DEALER INQUIRIES INVITED



# MAKE ANY CUT WITH THESE NEW WOODSHAPERS for YOUR CIRCLE SAW or DRILL PRESS!



MODEL #60—Originally designed for heavy industrial use, now priced for home workshop. Can be attached directly in chuck of your drill press. Exclusive pilot bearing (see illustration) eliminates side thrust, chatter and vibration—assures smooth cutting action. Blades can't come out—set screws hold them securely. Complete, with YOUR CHOICE OF ANY 6 PAIR DOUBLE-GROUND BLADES SHOWN BELOW, only \$12.95.

MODEL #50—Same as Model #60 but without exclusive pilot bearing. Designed for intermittent shaping; over 100 different shapes can be cut. Complete, with ANY 6 BLADES OF YOUR CHOICE SHOWN BELOW, only \$8.95. All Aladdin tools are guaranteed. Postage prepaid with all cash orders. C. O. D. plus postage. GET YOUR ORDER IN TODAY.



For Your Circle Saw  
Complete WITH ANY 6 PAIR OF READY-GROUND BLADES SHOWN BELOW, only \$14.95.

MODEL SA-10—Heavy-duty, industrial-type shaper of solid steel, now priced in home workshop range. Absolutely safe—blades locked in position with screws all the way through. In ordering, state diameter of shaft.

## ALADDIN WOODSHAPING BLADES

Specify by number the blades you want. Additional blades \$1.50 each, \$3.00 per set.

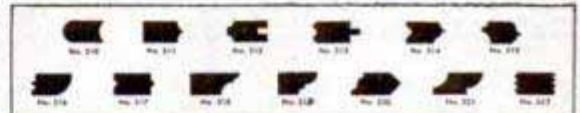

ALADDIN A. MFG. CO., INC.

3121 Main Street Kansas City, Missouri  
Dealers Write Today

# "Wellworth" Sensational Offer! Reg. \$60.50 WESTINGHOUSE AIR COMPRESSOR

## 2-CYLINDER PISTON TYPE

Operates with 1/2 H.P. Motor or equivalent gas engine.

Complete outfit consisting of compressor, pressure tank, air gauge, air chuck, 20-ft. hose, pop valve, copper tubing with 4 brass flared fittings for connecting compressor to tank, 4-way cross and 3 nipples. Complete outfit of 7 items..... **ONLY COMPRESSOR SEPARATELY..... \$21.50**

**\$29.95**  
SHIPPING WT. 40 LBS.

Model T-1  
Brand  
New!

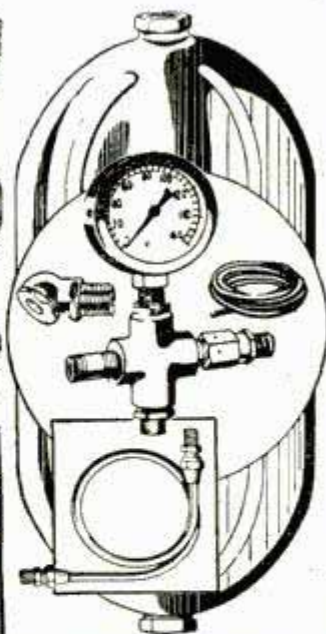
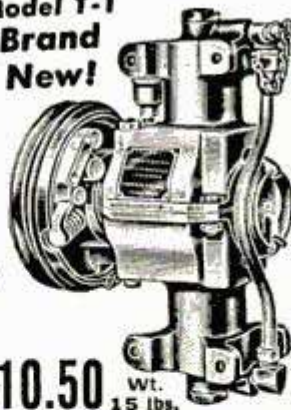

Equipment less compressor.... **\$10.50** Wt. 15 lbs.

### THE COMPRESSOR

Piston Type, 2-cylinder, 2 inch bore, 1 1/2" Stroke Ball Bearing. 3.27 C.F.M. at 600 R.P.M. Capacity up to 6.54 C.F.M. Suggested operating pressure 75 P.S.I. DIMENSIONS: 9" wide, 11 1/8" high, 6 3/8" deep. Wt. 26 lbs.

### TANK and ACCESSORIES

6" x 24" stainless steel tank suitable for 150 lb. pressure. Two 1/4" openings. Air gauge, pop valve, air chuck, 20 ft. hose, Copper tubing and fittings as shown. Wt. 15 lbs.

**THE BEST BUYS OF THE YEAR  
ARE ON THIS PAGE**

## PORTABLE SPRAY OUTFIT

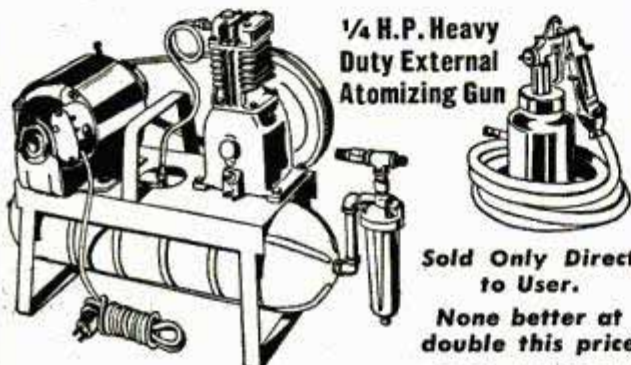

1/4 H.P. Heavy  
Duty External  
Atomizing Gun

Sold Only Direct  
to User.

None better at  
double this price

Paint Sprayer mounted on 6 x 24 inch tank, 1/4 H.P. 110 V. 60 cy. Heavy duty motor with overload relay, 19 ft. cord and plug, V Belt drive. Piston type Compressor with 2 Compression rings, 1 oil ring, 2 inch Bore, 1 1/2 inch stroke, displacement 2.86 C.F.M. at 60 lbs. pressure, Safety Valve. Gun external atomizing. Flat and round spray, quart cup; maintains 30 to 35 lbs. working pressure. Oil and water extractor, 1 air gauge, 20 ft. heavy duty 2-braid air hose with leak proof fittings, complete with carrying handle. Net weight 54 lbs., ship. wt. 60 lbs.....

**\$57.50**

**OUTFIT LESS MOTOR. Wt. 30 lbs.....\$47.50**  
**COMPRESSOR ONLY. Wt. 14 lbs..... 17.50**  
**SPRAY GUN AND 20 FT. HOSE. Wt. 7 lbs... 12.95**

## 140 CFM "WELLWORTH" BLOWER



Single-inlet blower that gives top performance on heating, ventilating, exhausting, cooling, drying and similar applications. 5 1/8 x 4" mounting flange with 2 1/2" square discharge. 3 1/2" dia. blower wheel powered by direct-connected 1/15 H.P., 110V., 60C., A.C. motor with conduit box and 20' leads. 7 1/2" wide less flange by 7 1/4" H. x 6 3/4" D. Suited for hundreds of new and replacement uses. Shpg. wt. 6 lbs.....

**\$16.50**

## PNEUMATIC AIR TOOLS

USED, GUARANTEED LIKE NEW.



**CHICAGO PNEUMATIC RIVETER & CHIPPING HAMMER**

CP4X Pistol grip handle. Takes up to 3/16" rivet. Weight 6 lbs. List price \$73.00.

**SPECIAL PRICE..... \$14.50**

Same as above, brand new..... **\$22.50**

Size CP3. Takes 5/32" Rivet... **\$10.95**

Chicago Pneumatic Lever Type  
**AIR DRILL**

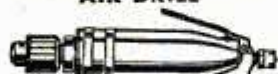

With 1/4" Jacob Chuck. Wt. 2 lbs. List price \$55.00. Only..... **\$17.50**



**Ingersoll Rand  
AIR DRILL**

With 1/4" Jacob Chuck. Wt. 2 lbs. List price \$53.00. Only..... **\$17.50**

## AUTOMATIC COMPRESSOR UNIT

**BEST BUY OF THE YEAR!  
A PRACTICAL XMAS GIFT**

1/2 H.P. heavy duty capacitor motor, AC 110/220 volt, 60 cycle, 2x1 3/4 inch piston type compressor, splash feed lubrication, 12x24 inch tank, automatic pressure switch, CFM 2.8 at 100 lb. pressure, or 150 lbs. pressure for intermittent duty. Check valve, safety valve, air regulator with gauge and filter, 20 ft. air hose with air chuck for inflating tires. V belt drive. Mounted on 2 wheels, ball bearing, with 2"x10" pneumatic tires. Portable, with handle. Shipping wt. 90 lbs.

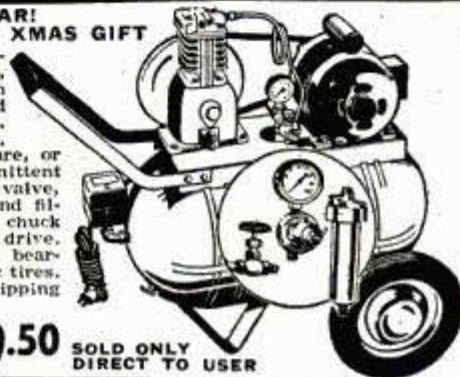

**SPECIAL PRICE..... \$89.50**

**SOLD ONLY DIRECT TO USER**

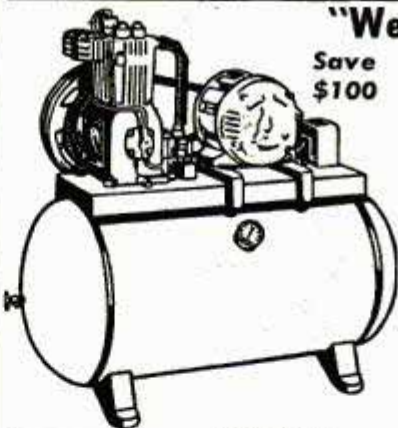

Save  
**\$100**

## "Wellworth" TWO-STAGE COMPRESSOR UNIT

Tank mounted unit 20x48 inches, 60 gal., A.S.M.E. 400 lbs. test. Compressor: Timken Bearing, size 3 1/2x2 1/2 with unloader for continuous pressure service; 10 c.f.m. at 200 lbs. pressure. Unloader set at 150 to 165 lbs. Compressor idles when 165 lbs. is reached, starts pumping again when pressure is down to 150 lbs. Wisconsin air cooled gasoline engine. 3 1/2 H.P. at 1800 r.p.m. 4.1 H.P. at 2400 r.p.m. 2 V belt drive, safety valve, drain cock, probe valve, pressure gauge, 20 ft. heavy duty air hose, tire chuck.

Model AK: Same unit furnished with 2 H.P. 220/440 V. 3 phase 60 cycle a.c. motor, with automatic pressure switch - same price. Unit complete as shown. All Brand New Equipment. Regular \$400.00 value..... **\$298.00**

**SOLD ONLY DIRECT TO USER**



**AUTOMATIC PRESSURE SWITCH with UNLOADER**

Double pole, with 2 way release valve. Set at 125 to 150 lbs. pressure. Wt. 4 lbs. Only..... **\$10.25**

Same without unloader..... **\$7.50** Switch-20 to 40 lb. adjustable unloader..... **\$5.50** to 80 lbs. For air or water..... **\$5.50**

## "Wellworth" 1/4" REDUCING VALVE & GAUGE



Oil resistant, pressure 0-to-200 lb. Reduced pressure 0-to-75 lb.; 3 outlets 1/4". **\$5.75** Wt. 2 lbs..

## 6 FT. STOW FLEXIBLE SHAFT



Heavy Duty, 3/8" Core. Best piano wire. Ball bearing handle and arbor, rubber covered housing; for 1/2" motor shaft; for 1/2" bore wheels. Operates on 1/4 H.P. Motor at 1725 or 3450 R.P.M. \$29.00 Value, **\$14.50**. Wt. 8 lbs.

Prices f.o.b. Chicago. Immediate delivery. All items sold on money back guarantee. Send check or money order today. Catalog FREE.

# WELLWORTH TRADING CO.

1831 S. STATE ST. DEPT. D-11 CHICAGO 16, ILL.

**GADGETEERS! HERE ARE THOSE TERRIFIC MIX VALUES**



**GADGET MIX** Especially prepared for the HOBBYIST. Rivets, Spacers, Bolts, Screws, Gears, Etc. A Gold Mine. #106. 5 lbs. . . . . \$1.19



**BEARING MIX** #170A A PALLEY SPECIAL!! Approx. 20 Needle, Ball & Roller Bearings, New & Used - Sizes 1/2" to 4". Some of these cost Gov't \$10 apiece. Never such a value! \$1.59 5 lbs. . . ONLY



**HINGE MIX** #170H. 12 pairs of strap & butt hinges. Sizes 1" x 1" to 1 1/2" x 4" in length to 8" strap. A \$3.00 VALUE for ONLY . . . . . \$1.09



**ABRASIVE AND GRINDING WHEEL MIX** 50 Pieces including honing stone, pencil rolls, wheels, Abrasive sheets, etc. A sharp value. #170AG 99c



**SPRING MIX** #206 Torsion, Compression & Tension Springs, asstd. sizes. A treasure trove for emergencies. 2 lbs. for ONLY . . . 89c

**COMBO-MIX** Comb. of all above in one pkg. Special deal. CB-2 \$5.59



**SWITCH MIX** #SM-1 12 assorted types of Aircraft Switches, including double & single throws, double & single poles & multiples. Voltage ratings from 5 to 20 amps, 125 Volts A.C., 35 amps, 24 Volts D.C. 1001 Uses . . . \$2.95



**FILE MIX** Ten Assorted Files of 6", 8", 10", 12", includes 3 Vixens, half rounds, bastards, mills, etc. in seconds and used but in good condition. 1 Vixen alone worth our price for entire mix. #F-1 99c

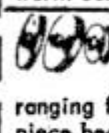

**PULLEY MIX** #PM-1 You'll want this one around. 10 micarta and metal pulleys ranging from 1" to 5" with ball and one piece bearings. These are aircraft pulleys, the best made, with 100's of uses. A WONDERFUL BUY @ . . . . . \$2.95

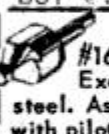

**COUNTERSINK MIX** #168 - Countersink Assortment. Excellent condition. High speed steel. Assortment of ten 100° and 110° with pilot sizes ranging from 3/32" to 3/16". . . #CM-1 \$2.69



**15" MONKEY WRENCH** Adjustable 4" Jaw opening Drop forge Auto type. Cad. Plated .89c Black 79c

**PALLEY SUPPLY COMPANY**  
6321 SAN FERNANDO RD.

DEPT. P.M. 11 GLENDALE 1, CALIF

# SAVE UP TO 85% IN WAR SURPLUS



**WHEELS** For Wagons, Dollys, Handtrucks, Wheelbarrows, etc. 10" dia., with 7/16" center hole. (can be drilled out to take 5/8" axle) Wheel is 1/8" steel with 10 x 1.75 heavy duty, semi-pneumatic cushioned rubber tire. . . . . EA. \$1.75

**PNEUMATIC AND AIR TOOLS** 10,000 in various popular makes, sizes, types, Cleco, Aro, Ingersoll Rand, Chicago, Pneumatic, Buckeye, etc.

**RIVET GUNS** Pistol & Gooseneck Type



101 Uses, Chipping, Riveting, Hammering. Breaking cement. Auto body work. Chicago Pneumatic, Cleco, Ingersoll-Rand Makes, E3, E2, 3X, 2X, 0Y. \$55 VALUE \$8.95 #180 Gooseneck \$80 Value \$15.95 #186 Squeezer PNEUMATIC ALLIGATOR SQUEEZER

## PALLEY NOVEMBER BARGAINS



**HYDRAULIC JACKS** Heavy duty steel For Truck or Auto Jack is Complete with Handle. 5 Ton. . . J-1 \$9.50 Hyd. Jack - Same as above - 3 Ton. . . 7.95



**TWO HEAT SOLDERING IRON** Has Two Operating Heats!! Just push the button & select 150 Watt or 300 Watt Heat. Complete with tip & bench holder. Ideal for light or heavy work. Operates on 110 V. AC. . . . . \$3.95



**OXYGEN & ACETYLENE REGULATORS**  
**OXYGEN REGULATOR** - - Bottle Press. Gauge - 0-3000 PSI. Regulating Press. Gauge - 0-400 PSI  
**ACETYLENE REGULATOR** - Bottle Press. Gauge - 0-500 PSI. Regulating Pressure Gauge - 0-50 PSI.  
AIRCO & Other Popular Makes to fit ALL Standard Bottles - - ALL NEW!! A Real Buy at . . . . . \$12.95 or Both for . . . . . \$25.00



**No. 100 WINCH HOIST** Thousands of Satisfied Users!! Capacity 2500 lbs. with 24 to 1 ratio. Controlled Bronze Worm Gear. Has 19 ft. of 1/4" alloy steel cable with hook and two-speed handle. Ideal for Boats, Factories, Shops, Garages, Tow Trucks, etc. A Real Holiday Special. . \$15.99



**NEW PRESSURE TANKS** Stainless steel - Shatterproof. Rustless. 10,000 available in 6 different sizes. 1001 Uses.

G-1... 1 1/2" x 24 inches - 2100 Cu. In. capacity 29 Cu. Ft. . . . . \$4.75  
D-2... 6 1/2" x 24 in. 500 Cu. In. capacity 7 Cu. Ft. Corrosion resistant steel. . . . . 2.49  
D-2... Stainless Steel . . . . . 3.49  
F-2... 6 x 45 in. 1000 Cu. In. capacity 14 Cu. Ft. . . . . 3.95  
A-4... 5 x 8 in. - 104 Cu. In. capacity . . . . . 1.35  
Ideal for painting, cooking, spraying, ocean buoys, underwater fishing, or diving.

### PIANO HINGE

Overall Width Length Price Ea.  
1 1/4" (5/8" side) 72" alum. \$1.00  
1 1/2" (3/4" side) 53" cad. steel \$0.75

SASH BRUSH - Handy for cleaning parts in home & Mach. shop. 27c

### REAMER MIX

168 - Reamer Assortment: Special Taper line finish Reamers - High Speed Steel. Slightly used but in excellent condition. Ten assorted sizes ranging from .168 x .165 and .244 x .215 to .425 x .385 and .432 x .403. One alone worth our selling price of ten. For set of ten Reamers. . . . . \$4.49

THE LARGEST FIRM OF ITS TYPE IN THE WORLD

**AIR DRILLS OR MOTOR SPECIAL** ARO PISTOL \$15.00 with 1/4" Jacobs Chuck

**THOR #210R Model 4526 2300 RPM REVERSIBLE AIR DRILL** Excellent for Tapping. \$19.95

**\$12.50 PNEUMATIC ANGLE DRILL** each With Terry Adapter Send for Catalog and List of Other Sizes, Types of Pneumatic Tools.

### NAVY Sealed Beam LAMP

US Navy Portable Pistol Grip, Sealed Beam, Search, Spot or Emergency Lite. 12 volt. Light weight. Ideal for Auto, Boat, Trailer, Farm, etc. Cost Gov't \$35. OUR PRICE \$2.95 Set of 3 extra filters, Red, Grn, Amber . 99c

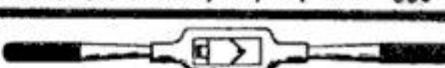

**ADJUSTABLE TAP WRENCHES** Jaws are made of tool steel, hardened & tempered. Won't break or get out of line.  
#7 Threadwell Cap. 1/4" to 1 1/8" Length 19" @ . . . . . \$2.49  
#8 Vermont Cap. 3/4" to 1 5/8" Length 40" @ . . . . . \$3.49  
#24 Greenfield Cap. 1 3/4" to 4" Length 72" @ . . . . . \$6.49

### AIRCRAFT CABLE

Alloyed steel, rust resistant. 3/16" ea. 18 ft. long, with turnbuckle ends. 99c ea. Preformed 7 x 19 strand - on reels In any length . . . . .  
1/16" . . . . . 3¢ ft. 1/4" . . . . . 8¢ ft.  
3/32" . . . . . 4¢ ft. 9/32" . . . . . 9¢ ft.  
1/8" . . . . . 4 1/2¢ ft. 3/8" . . . . . 12¢ ft.  
5/32" . . . . . 5¢ ft. 1/2" . . . . . 15¢ ft.  
3/16" . . . . . 6¢ ft. 1/4" Bronze 10¢ ft.

### OXFORD BRG & TOOL SCRAPERS

Complete set of 6 Tools packed in Grained Wood Case. Contains 1 ea. 8", 10", 12", 14" half round scraper. 1-6" Three square Scraper. 1-12" Double end Scraper. Made of Finest Tool Steel. Forged, Tempered, and Hollow Ground. An Unheard of Price! \$2.49



**New Hydraulic Cylinders, Valves, Pumps, Fittings, Hose and Tanks**  
**51 SIZES AND TYPES. WORLD'S LARGEST SUPPLY.** 1001 Labor Saving Adaptations for Pulling, Pushing, Lifting Operations. Finest Precision workmanship and materials. Liquid and/or Air Operation.  
 20,000 Available. Write for Catalog. Priced to sell at 15% Gov't Cost.

**Hydraulic PUMPS**  
**MP-5-HYDRAULIC MOTOR OR PUMP.** Logan Gerotor type. For operating hyd. systems on tractors, trucks, industrial machinery, etc. Delivers 8 GPM. at 1200 RPM. at 1000 PSI with 5 HP. Can also be used as Hydraulic Fluid Motor. Has 3/8" std. pipe parts. 1/2" splined shaft for pulley or direct attachment. 5 1/2" dia. x 7" long. Used but guaranteed condition. . . NOW ONLY. . . **\$17.50**

**P-1 PESCOTYPE**-Positive displacement gear type. Capacity: 1 gal. per minute, at 1500 RPM at 1500 PSI. Operating speed: 3700 RPM intermittent max. 4500 RPM. Rotation: either direction with slight adjustments. **\$9.49**

**ROME C FUEL PUMP**  
 800 GPH at 30 PSI, can also be used as hydraulic for 4 GPM at 400 PSI or for Vacuum drawing 15" mercury at 1500 RPM. **\$6.29**

**VALUABLE GEAR BARGAINS!**  
 #110 8 to 1 ratio, spindle drive \$2.98  
 #110 6 to 1 with screw shaft \$4.98  
 #111 85 to 1 (can be used for radio, antennae, etc.) . . #112 . . \$3.95  
 #G-11 - 10-1 gear ratio . . . . . \$3.95

**D. C. GENERATORS**  
 Suitable for adaption to home welding units, portable and rural lighting, power plant on boats, etc

TYPE	AMPS	VOLTS	
New T1	25	12	<b>\$13.95</b>
Used but Guaranteed Condition			
G1	140	27	<b>\$17.95</b>
P1	200	27 1/2	<b>\$22.50</b>
R1	300	30	<b>\$29.75</b>
E5A	50	12	<b>\$17.95</b>

**D. C. METERS**  
**AMMETERS** 0 - 120 **VOLTMETERS**  
 -30 - 0 - 30+ 0 - 240 0-30 **\$3.95**  
 -60 - 0 - 60+ 0 - 300 **\$3.95 ea.**  
 -60 - 0 - 60+ 0 - 350 **\$3.95 ea.**

All 2" face except 0-300 which is 3" face.  
**COMBINATION VOLT-METER - AMMETER**  
 30V - 30 AMP **\$4.95**  
 30V - 60 AMP  
**SHUNTS** - Required for use with D.C. Ammeters 30-60-120-240-300-350.  
**SOLD ONLY WITH METERS. . . \$1.00**

*Palley* **POWER PARADE**

**NEW BRIGGS & STRATTON MOD. "A"**

**GAS ENGINE** That nationally known "workhorse" of single cylinder engines! 2.10 HP-4 cycle, air cooled. Economical & Easy to Operate. Drives small pumps, boats & farm equipment. Brand New - Still in Original Crates. . . . . **BS-A ONLY. . . \$62.95**

**CONTINENTAL** The famous 4 cycle, aircooled-"L" head gas engine, 1 1/2 to 2 HP. Cheap power for Farm, Factory, Shop---ONLY **\$47.95**

**Ellinwood "44"** A Real Buy!! 4.4 to 5 HP with optional power take-off from crankshaft, 1-1 speed from camshaft 2-1 reduction. Lightweight & of finest component parts-Bendix, Timken, Air Maze, etc.  
 A Terrific Gas Engine Value . . . **\$69.95**

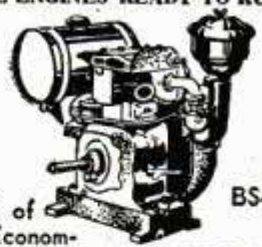

BS-A

**POWER UNIT PU-1**  
 Complete Model GKB 12-24-100 consists of sgl. cyl., 4 cycle, air cooled Briggs-Stratton Gas Engine directly connected to 2800 watt generator. Engine is 6 HP governed between 2500-3200 RPM. Generator rated 28.5 V - 100 A. Unit mounted 4 rubber shock mts., channel iron base & wheels. Use as Lighting or Power Plant The Buy Of The Century **\$109.89** Good Cond.

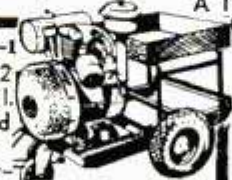

**BENDIX HYDRAULIC HAND PUMP**

Provides a quick immediate source of tremendous power for almost any heavy work. Double action stroke. Delivers .30 cu. in. per cycle at 3000 PSI. Max. press. 5000 PSI. Built-in Reservoir cap. 2 1/4 qts. 3/8" pipe outlets. Has Pressure Release Valve. 7 1/2" dia. by 23 3/16" overall ht. Weight 15.2 lbs. A **\$15.95** \$40.00 Value for...NEW Used - In Good Condition... **11.95**



**New Electric Motors**

#500 new 1/2 HP - 27 Volt DC 24 Volt AC.. This motor can be readily adapted to deliver up to 1/2 HP on 110 Volts AC by the simple method of rearranging armature brush-leads. Free diagram with each order. A Sensational Value . . . . . **\$5.95**  
 #500A Converted to 110 Volts-AC. Equipped with plug and 3 1/2 ft. Heavy Duty Cord . . . . . **\$8.49 ea.**  
 #501 - 1/6 HP - 24 Volt DC. Motor. Series wound. NEW- **\$3.95 ea.**  
 #502- 2 HP- 24 V DC used **\$8.95**



**GYRO COMPASS**

Precision made for Positive Direction. 360° swing calibrated in 1/10° (6 min). Built in bank indicator, lum. dial. 4 1/2" sq. with 3" dia. face. Vacuum operated. Ideal for autos, planes, boats. Can be used in autos and boats by attaching one tube to intake manifold. Complete with reset and caging knob. . . . ONLY **\$449**



**Black & Decker ELECT. DRILL** Drills all

materials, polishes, buffs, sands & grinds, Strong, light die-cast Aluminum housing, fast operating Jacobs hex-key type chuck, instant release trigger switch, hard wearing gears, pinions & bearings, Operates on 110 Volt AC or DC 7-5/8" long-wt. 3 1/4 lbs **\$18.95**



**Vickers Hydraulic Transmission**

Self contained, 2 H.P. constant torque at all speeds with variable volume reversible, piston pump (controlled by outside lever) supplying piston hydraulic motor. Automatic pressure, dash pot for smooth control. Power output R.P.M. - 0 to 1/3 input R.P.M. in both directions. Input R.P.M. 1800 continuous 4000 intermittent. Dash pot can be removed for greater R.P.M. Ideal for Lathes, Duplicator Setup on Mills, Conveyors, Small Cars, Drives, Gearing, etc. **\$19.50** COST GOV'T APP. \$400.00.



**FIRE EXTINGUISHER**

Kiddie Lux C-2 Type. Built to Gov't Spec. Shatter-proof, heavy case. Fully re-charged, with Horn.  
 4 lb. 18" x 5" - Wheel Control with horn... 4-TB Type. **\$14.25** A \$25.00 Value. #601-B  
 7 1/2 lb.-\$35 Value. #602A **\$19.75**  
 10 lb.- A \$65.00 Value - # 603 **\$25.75**  
 15 lb. - New. Break Disc Type. - A \$75.00 Value. #605-A **29.75**  
 15 lb. Wheel Control Type. #605-B **32.95**  
 15 lb. New. Squeeze Grip Type.- \$85.00 Value. - #605-C **\$39.95**



**GEAR BOXES** VTG-1 - 90°,

bevel gear 1 1/2 to 1 reduction, size 7" x 6". A Lifetime Value. . . . . **\$3.95**  
 VTG-2 - Inline spur gear 16 to 1 reduction, thru 4 gears. Final take-off 4 1/2" dia, 26 tooth. 3/4" Alum. spur gear. . **\$6.49**  
 Both above gear boxes have lever control for engaging & disengaging positive clutch. Dust proof housing. Prelubricated bearings. Both can be adapted to Vickers Transmission.



**92 PG. 1949 CATALOG**

10,000 Bargains in War Surplus Tools, Machinery, Raw Materials, Clothing, etc. 92 Pages, Illustrated with valuable information tables, charts & data. Send 25¢ to cover handling and postags.

Order from this Ad. All sales final. All Prices F.O.B. Los Angeles. Pay by M.O. or Check P.O.'s. Acptd. from D & B firms. 1/2 deposit with C.O.D.'s.

# NEW!

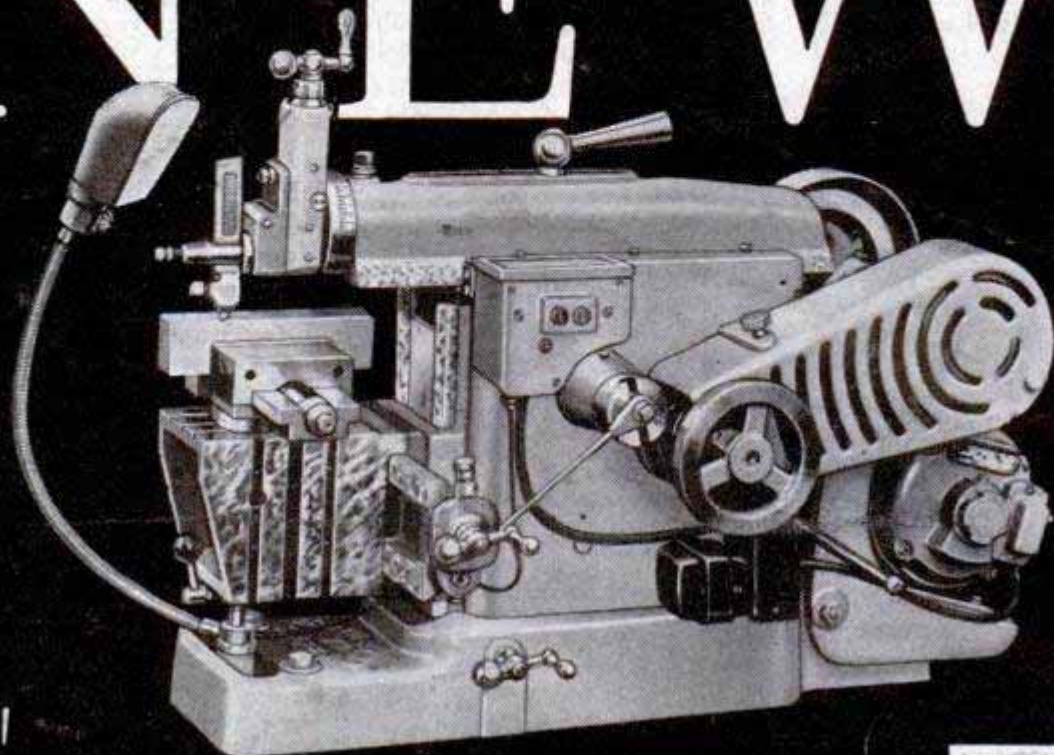

## 7" PRECISION SHAPER by SOUTH BEND

### *Fast... Accurate*

This new 7" Bench Shaper is a highly accurate, fast and rugged tool. It is easy to operate and is readily adaptable to a wide variety of small work. This production tool is ideal for any type of shop requiring close-tolerance machining, dependable service, and economical operation. *Write for literature.*



### **SOUTH BEND LATHE WORKS**

Building Better Tools Since 1906 • 455 E. Madison St., South Bend 22, Indiana

#### SPECIFICATIONS

**RAM**—0 to 7" stroke, 42 to 195 per minute in 4 steps. 3 to 114 feet per minute cutting speed.

**TOOL HEAD**—3" vertical feed, 180° rotation.

**TABLE**—Size 5-7/16" x 5" x 6". Travel—9-1/2" horizontal, 5" vertical. 1/2" to 5-1/2" ram clearance. Six power cross-feeds—.002" to .012".

**WISE**—Jaw width 4", depth 1", max. opening 4".

#### PRICES

7" Precision Bench Shaper . . . . . \$425

(Above shaper price includes light fixture, vise, drive unit, motor pulley, V-belt and switches. Stand for shaper, and motor are extra.)

Steel Stand . . . . . \$125

Motor—1/3 h. p., 115 volt, 1 phase, 60 cycle, A. C. . . . . \$31.30

*Prices f. o. b. factory • Time Payment Terms can be arranged.*



Steel stand for shaper—3 drawers and built-in chip pan.

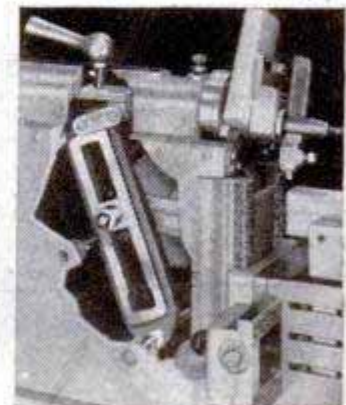

Rocker and crank assembly with graduated eccentric adjustment for ram stroke.

Printed by Popular Mechanics Company, Chicago, Ill., U. S. A.

What's **NEW**  
in Batteries?

# AUTO-LITE **Sta-ful** BATTERY...needs water only 3 times a year\*

A revolutionary new development, the Auto-Lite "Sta-ful" Battery, protects you against a major cause of battery failure . . . damage to plates due to liquid loss. This new "Sta-ful" Battery design permits a liquid reservoir with 3 times the capacity of ordinary batteries . . . keeps plates fully covered and active months longer in normal car use.

In addition, "Sta-ful" has Fibre-glass mats to hold the power-producing material in the plates for longer battery life. To get more for your battery dollars, replace with an Auto-Lite "Sta-ful". Money cannot buy a better battery.

AUTO-LITE BATTERY CORPORATION  
Toledo 1 Ohio

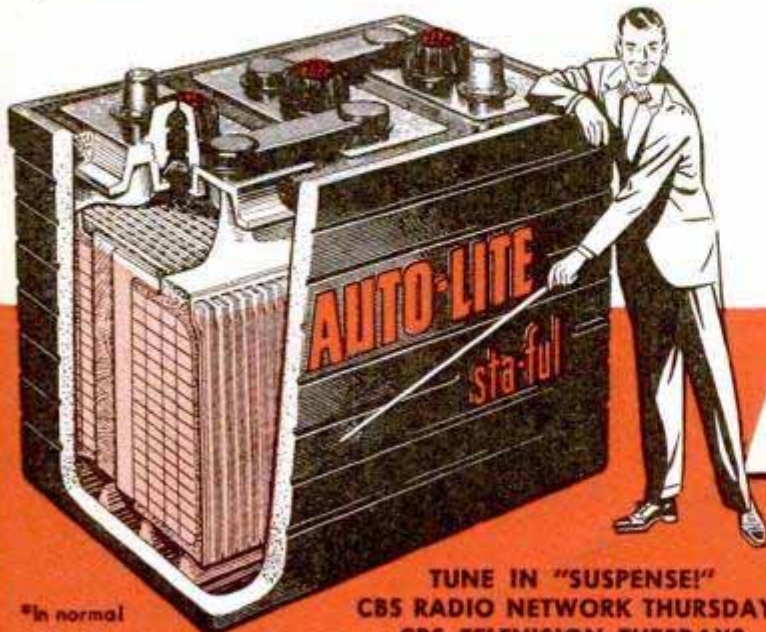

Because of a unique construction, the new Auto-Lite "Sta-ful" Battery holds more than 3 times the liquid reserve of ordinary batteries.

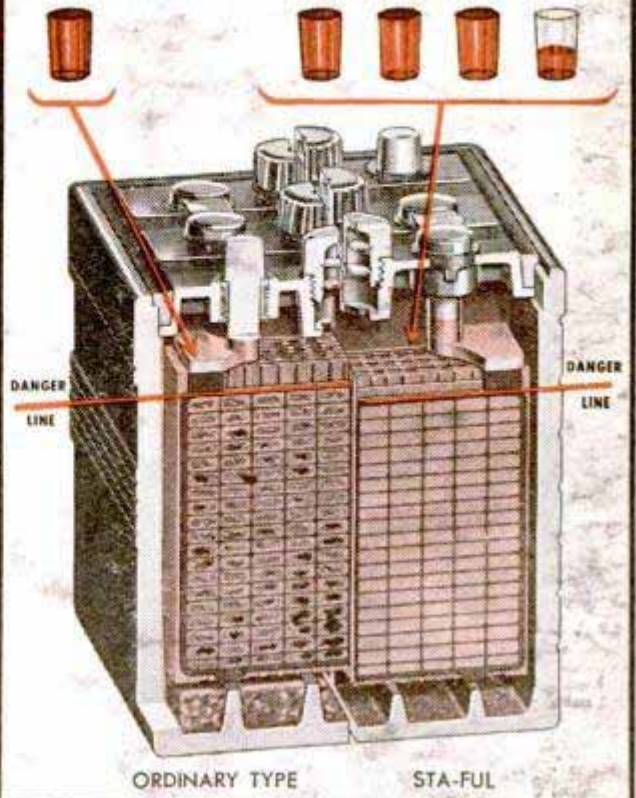

Note how the protective Fibre-glass mat retains the power-producing material in the positive plate while ordinary battery plates shed the active material until it fills the sediment well.

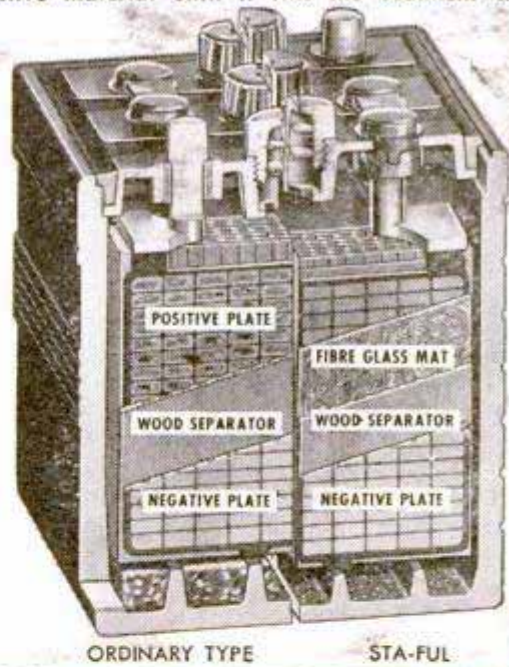

# AUTO-LITE **Sta-ful** BATTERIES

\*In normal car use

TUNE IN "SUSPENSE!"  
CBS RADIO NETWORK THURSDAYS  
CBS TELEVISION TUESDAYS

# When safety's a must, it's "PRESTONE" ANTI-FREEZE



**YOU'RE SAFE  
IN EMERGENCIES**

You know your car won't freeze  
up when you need it most!

**YOU'RE SAFE  
FROM WORRY**

One shot lasts all winter; put 'Prestone'  
anti-freeze in your car... and forget about it!

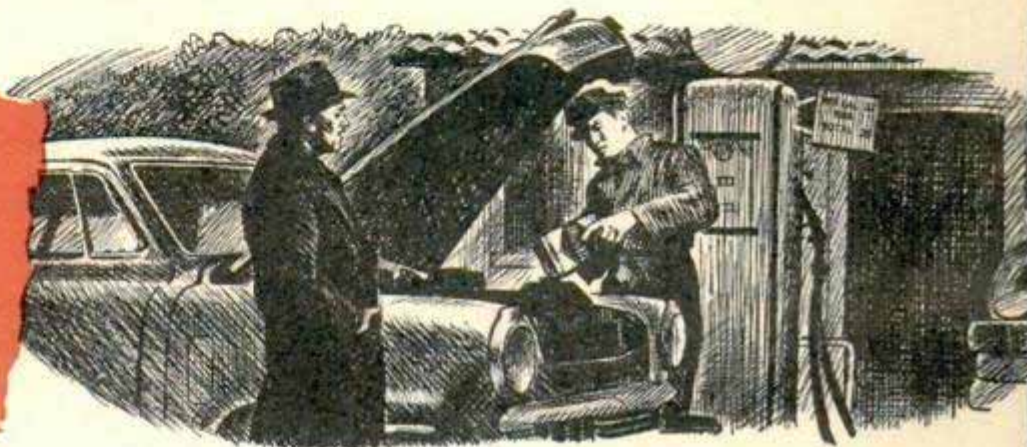

**YOU'RE SAFE  
FROM BOIL AWAY**

You're safe no matter how warm  
it gets between cold spells!

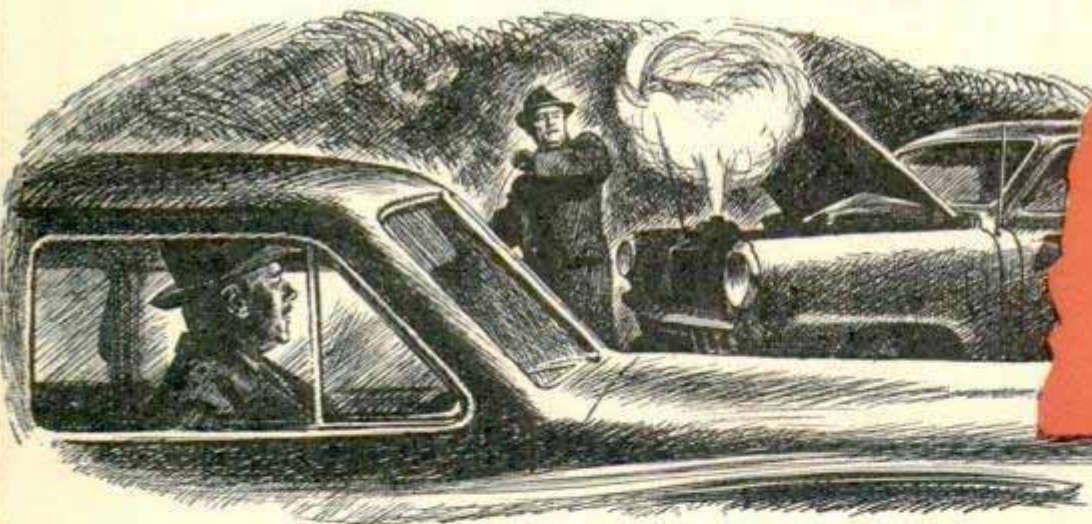

## One shot lasts all winter!

Give your car the same, safe, all-winter protection that fire chiefs, ambulance drivers, police chiefs give theirs. Insist on "Prestone" anti-freeze.

## There's nothing else like it!

"Prestone" anti-freeze, America's Number One Brand, is made to an exclusive formula. Year after year, more motorists depend on "Prestone" brand anti-freeze for safe, sure, all-winter protection.



**NO RUST • NO FOAM  
NO FREEZE • NO FAILURE**

**\$3.50  
PER GAL.**

### GUARANTEED!

Ask your dealer to show you the guarantee. It's your assurance of all-winter safety.

The registered trade-marks "Prestone" and "Eveready" distinguish products of  
**NATIONAL CARBON COMPANY, INC.**  
30 East 42nd St., New York 17, N. Y.

Unit of Union Carbide and Carbon Corporation